

AD-A110 692

COASTAL ENGINEERING RESEARCH CENTER FORT BELVOIR VA  
FLOATING BREAKWATERS: STATE-OF-THE-ART LITERATURE REVIEW. (U)

F/G 13/2

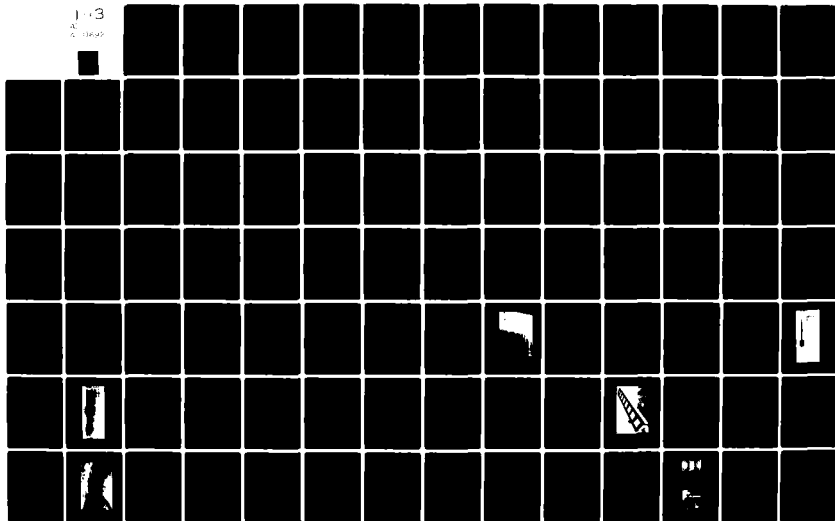
OCT 81 L Z HALES

CERC-TR-81-1

UNCLASSIFIED

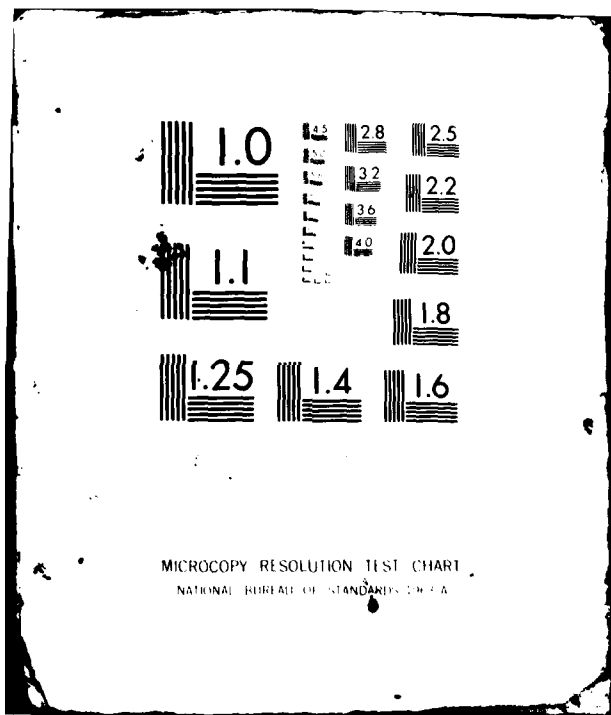
NL

1-3  
A  
2-1980



984

P-



MICROCOPY RESOLUTION TEST CHART  
NATIONAL BUREAU OF STANDARDS-1963-A

**LEVEL**

(4)

TR 81-1

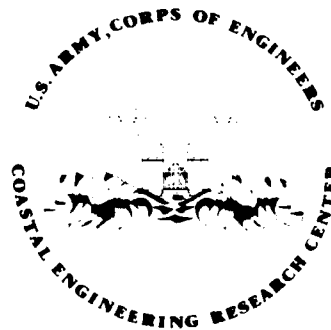
# Floating Breakwaters: State-of-the-Art Literature Review

by  
Lyndell Z. Hales

(U. S. Army Engineer Waterways Experiment Station)  
P. O. Box 631, Vicksburg, Miss. 39180

TECHNICAL REPORT NO. 81-1

OCTOBER 1981



DTIC  
SELECTED  
FEB 10 1982  
S H

Approved for public release;  
distribution unlimited.

U.S. ARMY, CORPS OF ENGINEERS  
COASTAL ENGINEERING  
RESEARCH CENTER

Kingman Building  
Fort Belvoir, Va. 22060

AD A110692

DTIC FILE COPY

82

Reprint or republication of any of this material shall give appropriate credit to the U.S. Army Coastal Engineering Research Center.

Limited free distribution within the United States of single copies of this publication has been made by this Center. Additional copies are available from:

*National Technical Information Service  
ARMY: Operations Division  
3325 Port Royal Road  
Springfield, Virginia 22101*

Contents of this report are not to be used for advertising, publication, or promotional purposes. Citation of trade names does not constitute an official endorsement or approval of the use of such commercial products.

The findings in this report are not to be construed as an official Department of the Army position unless so designated by other authorized documents.

UNCLASSIFIED

SECURITY CLASSIFICATION OF THIS PAGE (When Data Entered)

REPORT DOCUMENTATION PAGE		READ INSTRUCTIONS BEFORE COMPLETING FORM						
1. REPORT NUMBER TR 81-1	2. GOVT ACCESSION NO. AD-A110692	3. RECIPIENT'S CATALOG NUMBER						
4. TITLE (and Subtitle)  FLOATING BREAKWATERS: STATE-OF-THE-ART LITERATURE REVIEW		5. TYPE OF REPORT & PERIOD COVERED  Technical Report						
		6. PERFORMING ORG. REPORT NUMBER						
7. AUTHOR(s)  Lyndell Z. Hales		8. CONTRACT OR GRANT NUMBER(s)						
9. PERFORMING ORGANIZATION NAME AND ADDRESS Department of the Army Waterways Experiment Station, Hydraulics Laboratory Vicksburg, Mississippi 39180		10. PROGRAM ELEMENT, PROJECT, TASK AREA & WORK UNIT NUMBERS  F31679						
11. CONTROLLING OFFICE NAME AND ADDRESS Department of the Army Coastal Engineering Research Center (CERRE-CS) Kingman Building, Fort Belvoir, Virginia 22060		12. REPORT DATE September 1981						
		13. NUMBER OF PAGES 279						
14. MONITORING AGENCY NAME & ADDRESS (if different from Controlling Office)		15. SECURITY CLASS. (of this report)  UNCLASSIFIED						
		15a. DECLASSIFICATION/DOWNGRADING SCHEDULE						
16. DISTRIBUTION STATEMENT (of this Report)  Approved for public release; distribution unlimited.								
17. DISTRIBUTION STATEMENT (of the abstract entered in Block 20, if different from Report)								
18. SUPPLEMENTARY NOTES								
19. KEY WORDS (Continue on reverse side if necessary and identify by block number)								
<table border="0"> <tr> <td>Floating breakwaters</td> <td>Structure performance</td> </tr> <tr> <td>Literature review</td> <td>Wave transmission</td> </tr> <tr> <td>Mooring loads</td> <td></td> </tr> </table>			Floating breakwaters	Structure performance	Literature review	Wave transmission	Mooring loads	
Floating breakwaters	Structure performance							
Literature review	Wave transmission							
Mooring loads								
20. ABSTRACT (Continue on reverse side if necessary and identify by block number)								
<p>A multitude of conceptual models of floating breakwaters have been proposed without extensive or complete evaluation of most of these concepts. The technical literature regarding floating breakwater applicability and design procedures is fragmentary and sometimes confusing. Clear, concise guidance does not always exist for those responsible for planning and developing wave protection measures which utilize floating breakwaters. This study reviewed</p> <p style="text-align: right;">(continued)</p>								

UNCLASSIFIED

SECURITY CLASSIFICATION OF THIS PAGE(When Data Entered)

and evaluated the existing technical literature (theoretical, field, and laboratory) on floating breakwater concepts.

While floating breakwaters provide a lesser assurable degree of protection than a permanently fixed breakwater, they are in general less expensive and can be moved from one location to another. The cost of a floating system is only slightly dependent on water depth and foundation conditions. Adequate wave reduction or energy attenuation can be attained by a floating breakwater only if the incident wave is of a relatively low height. A reasonable magnitude appears to be an incident wave height not exceeding 4 feet, with a corresponding wave period not exceeding 4 seconds. Floating breakwaters can attenuate waves with these incident characteristics to a magnitude tolerable in a small-craft mooring area (wave heights up to 1.5 feet). Open-ocean applications of a distinctly different concept can be formulated to withstand substantial increases in the incident wave characteristics.

A group of prismatic structures contains the simplest forms of floating breakwaters. This group offers the best possibilities for multiple use as walkways, storage, boat moorings, and fishing piers. In addition to mass, the radius of gyration and the depth of submergence appear to significantly influence the attenuation characteristics. As the ratio of breakwater width-to-wavelength increases to values greater than 0.5, the wave attenuation features of the structure not only improve markedly, but the net result of the forces on the mooring and anchoring system becomes substantially less. This occurs because the wave dynamics are exerting forces on a part of the structure in a direction opposite to those forces on other parts of the breakwater.

Accession For	
NTIS GRA&I	<input checked="" type="checkbox"/>
DTIC TAB	<input type="checkbox"/>
Unannounced	<input type="checkbox"/>
Justification	
By _____	
Distribution/	
Availability Codes	
Dist _____	
A	



## PREFACE

This report is published to provide coastal engineers an evaluation of the existing technical literature (theoretical, field, and laboratory) on floating breakwater concepts. The work was carried out by the Hydraulics Laboratory of the U.S. Army Engineer Waterways Experiment Station (WES) under the coastal structures research program (Design of Floating Breakwaters work unit) of the U.S. Army Coastal Engineering Research Center (CERC). The Design of Floating Breakwaters work unit was created because of the strong interest of field personnel in research on floating breakwaters. The Directorate of Research and Development (DRD) of the Office, Chief of Engineers (OCE) requested that guidance on this research be made available to the field offices as soon as possible. Improvements in the state-of-the-art of floating breakwaters are continual, thus some parts of this report may have become outdated prior to final publication.

✓ The report was prepared by Dr. Lyndell Z. Hales, Research Hydraulic Engineer, Hydraulics Laboratory, under the general supervision of H.B. Simmons, Chief, Hydraulics Laboratory, WES.

Dr. R.M. Sorensen, Chief, Coastal Processes and Structures Branch, CERC, was the technical monitor during the preparation of the report.

Comments on this publication are invited.

Approved for publication in accordance with Public Law 166, 79th Congress, approved 31 July 1945, as supplemented by Public Law 172, 88th Congress, approved 7 November 1963.



TED E. BISHOP  
Colonel, Corps of Engineers  
Commander and Director

CONTENTS

	Page
CONVERSION FACTORS, U.S. CUSTOMARY TO METRIC (SI).....	15
SYMBOLS AND DEFINITIONS.....	16
<b>I INTRODUCTION.....</b>	<b>23</b>
1. Background.....	23
2. Floating Breakwater Applicability.....	24
3. Basic Floating Breakwater Groups.....	25
4. General Operational Aspects.....	28
5. The Study Objective.....	31
<b>II THEORETICAL ANALYSIS OF FLOATING BREAKWATER PERFORMANCE.....</b>	<b>31</b>
1. Fixed Rigid Structures.....	31
2. Dynamics of Elastically Moored Floating Breakwaters.....	33
3. Theoretical Model Developments.....	37
4. Applicability of Regular Wave Coefficients to Irregular Wave Climates.....	50
<b>III PONTOON FLOATING BREAKWATERS.....</b>	<b>51</b>
1. Single Pontoon.....	51
2. Double Pontoons.....	62
3. Catamaran-Type (Twin Pontoons).....	62
4. Alaska-Type Floating Breakwater.....	73
5. Hybrid Pontoon Structures.....	81
6. Construction Materials and Techniques.....	88
<b>IV SLOPING-FLOAT (INCLINED PONTOON) BREAKWATER.....</b>	<b>94</b>
1. Users and Applicability.....	95
2. Analytical Investigation.....	96
3. Experimental Investigation.....	98
4. Application to Random Open-Ocean Waves.....	110
5. Performance Summary.....	114
<b>V SCRAP-TIRE FLOATING BREAKWATERS.....</b>	<b>117</b>
1. Wave-Maze Scrap-Tire Floating Breakwater Concept.....	118
2. Goodyear Tire and Rubber Company Concept.....	124
3. Wave-Guard Scrap-Tire Floating Breakwater Concept.....	137
4. Simple Mat-Type Scrap-Tire Floating Breakwater.....	139
5. Theoretical Considerations.....	140
6. Construction Aspects.....	143
7. Estimated Scrap-Tire Floating Breakwater Cost.....	147
<b>VI A-FRAME ARRANGEMENT FLOATING BREAKWATERS.....</b>	<b>149</b>
1. Twin-Log Floating Breakwater.....	150
2. Twin-Cylinder Floating Breakwater.....	153
3. A-Frame Floating Breakwater.....	156
<b>VII TETHERED-FLOAT BREAKWATER.....</b>	<b>166</b>
1. Operational Theory.....	166
2. Performance Estimation.....	167
3. Potential Open-Ocean Applications.....	172
4. Tether Termination Assembly.....	180
5. Economic Feasibility Studies.....	182
<b>VIII POROUS-WALLED FLOATING BREAKWATERS.....</b>	<b>184</b>
1. Perforated Portable Floating Breakwater Units.....	184
2. Open-Tube Floating Breakwater System.....	189
<b>IX PNEUMATIC AND HYDRAULIC BREAKWATERS.....</b>	<b>196</b>
1. Pneumatic Breakwater System.....	198
2. Hydraulic Breakwater System.....	208
<b>X FLEXIBLE-MEMBRANE FLOATING BREAKWATERS.....</b>	<b>219</b>
1. Membrane Layers.....	219
2. Floating Fluid-Filled Bags.....	231
<b>XI TURBULENCE-GENERATOR FLOATING BREAKWATERS.....</b>	<b>239</b>
1. Seabreaker Floating Breakwater.....	239
2. Harris Floating Breakwater.....	241
3. Parabolic Beaches.....	245
4. Wave Tripper Floating Breakwater.....	248



CONTENTS--Continued

	Page
XII ENERGY PEAK DISPERSION FLOATING BREAKWATERS.....	248
1. Offset Floating Breakwater Configuration.....	249
2. Bowley Wave Barrier.....	253
XIII RESERVOIR APPLICATION FLOATING BREAKWATERS.....	257
1. Slope-Floating Beach with Pontoons.....	258
2. Twin-Pontoon Floating Breakwater.....	260
3. Twin Water Chamber and Pontoon Floating Breakwater.....	261
4. Fixed-Dissipator Floating Breakwater.....	262
XIV SUMMARY AND CONCLUSIONS.....	265
1. General Considerations.....	265
2. Basic Groupings of Floating Breakwaters.....	266
3. Construction Materials and Structure Features.....	267
4. Anchor Systems.....	268
5. Comparative Cost Estimates.....	269
LITERATURE CITED.....	270

TABLES

1 Three-dimensional tests of plan 1 for two sets of conditions at $d = 25$ feet.....	58
2 Properties of single- and double-pontoon floating breakwaters.....	64
3 Mooring line forces of two-dimensional model, Wave-Maze scrap-tire floating breakwater.....	124
4 Twin-log floating breakwater tests No. 1.....	150
5 Twin-log floating breakwater tests No. 2.....	153
6 Two-dimensional experimental investigation of properties of A-frame floating breakwater.....	161
7 Pneumatic breakwater tests of potential scale effects at a 50-percent wave height attenuation.....	203
8 Comparative data for various floating breakwaters.....	269

FIGURES

1 Idealized fixed structure of finite width, height, and draft.....	32
2 Theoretical coefficient of transmission, $C_t$ , past a fixed rigid structure.....	32
3 Comparison of theories and experimental data for wave transmission past a fixed, rigid, vertical thin plate.....	34
4 Effect of depth of submergence of thin, rigid, fixed vertical plate on transmission coefficient and power transmission theory.....	34
5 Definitive sketch, single degree of freedom, mechanical vibration system.....	35
6 Amplification factor and phase shift for single degree of freedom, forced harmonic oscillation system with various linear damping.....	37
7 Measured and predicted natural periods of free oscillation of small boat under various mooring arrangements.....	38
8 Conceptual model of surface gravity waves approaching a floating structure of arbitrary cross section.....	39
9 Linear system describing floating breakwater performance.....	40
10 Comparison of linear theoretical model and experimental data for a proposed floating breakwater.....	41

CONTENTS

FIGURES--Continued

	Page
11 Floating vertical thin plate permitting development of simple analytical expression of floating breakwater response.....	42
12 Effect of mass parameter on coefficient of transmission for floating breakwater.....	42
13 Effect of mooring stiffness parameter on coefficient of transmission for floating breakwater.....	43
14 Effect of depth of mooring on coefficient of transmission for floating breakwater.....	44
15 Effect of depth of mooring on mooring force for floating breakwater.....	44
16 Definitive sketch of moored floating object.....	45
17 Comparison of theory versus experiment, determination of effect of relative structure width, $W/L$ , on transmission coefficient, $C_t$ , for circular cylinder.....	48
18 Comparison of theory versus experiment, determination of effect of relative structure width, $W/L$ , on transmission coefficient, $C_t$ , for rectangular cylinder.....	48
19 Calculated transmission coefficients for floating structure with various mooring conditions.....	49
20 Single-pontoon floating breakwater.....	52
21 Effect of relative submergence, $d_2/d_1$ , and relative water depth, $L/d$ , on coefficient of transmission, $C_t$ , of single-pontoon floating breakwater.....	53
22 Physical model test facility for wave attenuation effectiveness of single-pontoon floating breakwater proposed for Olympia Harbor, Washington.....	54
23 Details of plans 1 and 2 for single-pontoon floating breakwater evaluated in two-dimensional wave flume for potential application at Olympia Harbor, Washington.....	55
24 Effect of relative breakwater width, $W/L$ , on coefficient of transmission, $C_t$ , for single-pontoon floating breakwater evaluated in two-dimensional wave flume for potential application at Olympia Harbor, Washington.....	56
25 Three-dimensional physical model configuration of single-pontoon floating breakwater for potential application at Olympia Harbor, Washington.....	57
26 Summary of three-dimensional experimental study of single-pontoon floating breakwater investigation, East Bay Marina, Olympia Harbor Washington.....	59
27 The proposed single-pontoon floating breakwater configuration for Seabrook Lock Complex, Lake Pontchartrain, Louisiana.....	60
28 Wave protection by a double section of a single-pontoon floating breakwater configuration, Seabrook Lock Complex, Lake Pontchartrain, Louisiana.....	61
29 Double-pontoon floating breakwater.....	62
30 Effect of relative submergence, $d_2/d_1$ , and relative water depth, $L/d$ , on transmission coefficient, $C_t$ , of double-pontoon floating breakwater.....	63
31 Effect of natural period increase of oscillation on transmission coefficient, $C_t$ , of double-pontoon floating breakwater.....	63
32 Two-dimensional model arrangement of catamaran-type floating breakwater, Oak Harbor, Washington.....	65

CONTENTS

FIGURES--Continued

	Page
33 Two-dimensional model tests of a chain mooring system, catamaran-type floating breakwater, Oak Harbor, Washington.....	66
34 Wave transmission tests of the chain mooring system, catamaran-type floating breakwater, Oak Harbor, Washington.....	67
35 Two-dimensional model tests of pile mooring system, catamaran-type floating breakwater, Oak Harbor, Washington.....	68
36 Wave transmission tests of the pile mooring system, catamaran-type floating breakwater, Oak Harbor, Washington.....	69
37 Two-dimensional experimental tests of chain anchor forces on seaside of catamaran-type floating breakwater.....	71
38 Two-dimensional experimental tests of pile anchor forces on seaside of catamaran-type floating breakwater.....	72
39 Alaska-type floating breakwater developed by State of Alaska, Department of Public Works....	73
40 Incident wave spectra, $S(\eta_i)$ , transmitted wave spectra, $S(\eta_t)$ , and coefficient of transmission, $C_t$ , from prototype field investigation of Alaska-type floating breakwater at Tenakee Springs, Alaska.....	75
41 Module of Alaska-type floating breakwater used in two-dimensional experimental study at a length of 120 feet, width of 21 feet, depth of 6 feet prototype dimensions.....	77
42 Details of Alaska-type floating breakwater used in two-dimensional experimental study, Olympia Harbor, Washington.....	78
43 Two-dimensional experimental study of Alaska-type floating breakwater mooring chain arrangement, Olympia Harbor, Washington.....	79
44 Coefficient of transmission, $C_t$ , versus relative breakwater width, $W/L$ , results from two-dimensional experimental investigation of Alaska-type floating breakwater, Olympia Harbor, Washington.....	80
45 Friday Harbor, Washington.....	82
46 Cross section of floating breakwater at Friday Harbor, Washington.....	83
47 Average transmission coefficients, Friday Harbor, Washington.....	84
48 Canadian caisson floating breakwater tested in three-dimensional wave basin.....	85
49 Effect of relative breakwater width, $W/L$ , on wave height attenuation, Canadian caisson floating breakwater.....	86
50 Anchor forces developed by Canadian caisson floating breakwater.....	87
51 Thompson floating breakwater adaptation of floating wharf or dock for marina application....	89
52 Connecting unit used to attach modules of Alaska-type floating breakwater.....	92
53 Connection redesign for concrete pontoon units.....	92
54 Tentative connection design of a rubber unit which serves as a bumper in compression and a restraining unit in tension.....	93
55 Geometry of barge under consideration as sloping-float breakwater.....	97
56 Sloping-float breakwater two-dimensional experimental tests.....	99
57 Two-dimensional experimental investigation of effect of incident wave height, $H_i$ , on coefficient of transmission, $C_t$ , for sloping-float breakwater with no bottom clearance at a 25-foot water depth.....	100

CONTENTS

FIGURES--Continued

	Page
58 Two-dimensional experimental investigation of effect of incident wave height, $H_1$ , on mooring force, $F$ , for sloping-float breakwater with no bottom clearance at a 25-foot water depth.....	101
59 Two-dimensional experimental investigation of effect of mooring location on coefficient of transmission, $C_t$ , for sloping-float breakwater with no bottom clearance at a 25-foot water depth.....	103
60 Two-dimensional experimental investigation of effect of mooring location on mooring force, $F$ , for sloping-float breakwater with no bottom clearance at a 25-foot water depth.....	104
61 Two-dimensional experimental investigation of effect of bow angle extension on coefficient of transmission, $C_t$ , for sloping-float breakwater with no bottom clearance at a 25-foot water depth.....	105
62 Two-dimensional experimental investigation of effect of bow angle extension on mooring force, $F$ , for sloping-float breakwater with no bottom clearance at a 25-foot water depth.....	107
63 Sloping-float breakwater two-dimensional experimental tests with wave crest at breakwater, wave period at 7.2 seconds, wave height at 10 feet, and bottom clearance at a 25-foot water depth.....	108
64 Two-dimensional experimental investigation of effect of incident wave height, $H_1$ , on coefficient of transmission, $C_t$ , for sloping-float breakwater with bottom clearance at a 25-foot water depth.....	109
65 Two-dimensional experimental investigation of effect of incident wave height, $H_1$ , on mooring force, $F$ , for sloping-float breakwater with bottom clearance at a 25-foot water depth.....	111
66 Two-dimensional experimental investigation of incident and transmitted Pierson-Moskowitz wave spectrum for 7-second peak, sloping-float breakwater with bottom clearance at a 25-foot water depth.....	112
67 Wave height and force spectrum for sloping-float breakwater subjected to 7-second Pierson-Moskowitz spectrum.....	113
68 Length of sloping-float breakwater required to reduce wave heights of Pierson-Moskowitz spectrum to sea-state 3 at a 30-foot water depth.....	115
69 Length of sloping-float breakwater required to reduce wave heights of Pierson-Moskowitz spectrum to sea-state 3 at a 45-foot water depth.....	115
70 Conceptual layout of sloping-float breakwater composed of 90-foot-long pontoons of sufficient dimension to provide minimal protection at a 30-foot water depth.....	116
71 Wave-Maze scrap-tire floating breakwater model structure.....	119
72 Definitive sketch of the two-dimensional model Wave-Maze scrap-tire floating breakwater, one-quarter scale.....	120
73 Effect of wave steepness, $H_1/L$ , and relative breakwater width, $W/L$ , on coefficient of transmission, $C_t$ , for the two-dimensional model of Wave-Maze scrap-tire floating breakwater at one-quarter scale.....	121
74 Effect of relative submergence, $y/d$ , and relative breakwater width, $W/L$ , on coefficient of transmission, $C_t$ , for the two-dimensional model of Wave-Maze scrap-tire floating breakwater at one-quarter scale.....	122
75 Definitive sketch of mooring line force determination for the two-dimensional model of Wave-Maze scrap-tire floating breakwater at one-quarter scale.....	123
76 Ratio of mooring line force, $f_c$ , to force due to total reflection of a vertical wall, $f_{tmax}$ , for the two-dimensional model of Wave-Maze scrap-tire floating breakwater at one-quarter scale.....	123

CONTENTS

FIGURES--Continued

	Page
77 Effect of relative wavelength, $L/W$ , and wave steepness, $H/L$ , on force parameter, $F/\gamma W^2$ , for two-dimensional model of Wave-Maze scrap-tire floating breakwater.....	125
78 Assembly of modules in a section of the Goodyear Tire and Rubber Company scrap-tire floating breakwater.....	125
79 Prototype installation of the Goodyear Tire and Rubber Company scrap-tire floating breakwater.....	127
80 Experimental arrangement of the Goodyear Tire and Rubber Company scrap-tire floating breakwater concept for prototype-scale transmission and mooring tests conducted in CERC's large wave tank.....	128
81 Design curve for determining width, $W$ , of the Goodyear Tire and Rubber Company scrap-tire floating breakwater concept for various wavelengths, $L$ , and allowable transmission coefficients, $C_t$ .....	129
82 Experimental arrangement for two-dimensional model-scale testing of the Goodyear Tire and Rubber Company scrap-tire floating breakwater concept for wave attenuation and mooring force data.....	130
83 Definitive sketch of pertinent variables in two-dimensional model-scale tests.....	131
84 Effect of relative breakwater width, $L/W$ , on transmission coefficient, $C_t$ , in two-dimensional model-scale test results.....	131
85 Comparison of prototype-scale and model-scale transmission coefficients, $C_t$ , as a function of relative breakwater width, $L/W$ .....	133
86 Design curve for predicting peak forces per meter of breakwater for a given incident wave height.....	134
87 Design curve for predicting average forces per meter of breakwater for a given incident wave height.....	134
88 Effect of relative wavelength, $L/W$ , and wave steepness, $H/L$ , on force parameter, $F/\gamma W^2$ , for two-dimensional prototype-scale model of Goodyear Tire and Rubber Company scrap-tire floating breakwater concept.....	135
89 Effect of relative wavelength, $L/W$ , on mooring line force parameter, $F/\gamma W^2$ , for two-dimensional model-scale Goodyear Tire and Rubber Company scrap-tire floating breakwater concept.....	136
90 Comparison of prototype- and model-scale force parameter, $F/\gamma W^2$ , as a function of relative breakwater width, $L/W$ .....	137
91 Model-scale Wave-Guard scrap-tire floating breakwater.....	136
92 Comparison of wave transmission coefficient, $C_t$ , for Wave-Guard and Goodyear Tire and Rubber Company concept of scrap-tire floating breakwaters, for various ratios of wavelength-to-breakwater width, $L/W$ .....	138
93 Comparison of force parameter, $F/\gamma W^2$ , for Wave-Guard and Goodyear Tire and Rubber Company concept of scrap-tire floating breakwaters, for various ratios of wavelength-to-breakwater width, $L/W$ .....	139
94 Relationship between instantaneous peak mooring force, $F_n$ , and radiation stress, $S_{xx}^*$ .....	142
95 Use of heavy steel chain to assemble units of Goodyear scrap-tire floating breakwater concept.....	143
96 Scrap-tire floating breakwater units constructed with heavy steel chain as connecting material.....	144
97 Use of conveyor belting strips for assembly of units in Goodyear scrap-tire floating breakwater concept.....	144

CONTENTS

FIGURES--Continued

	Page
98 Schematic of Wave-Guard scrap-tire floating breakwater mooring system.....	146
99 Goodyear scrap-tire floating breakwater concept in operation at Dunkirk Harbor, New York...	148
100 Wave-Maze scrap-tire floating breakwater concept protecting the east marina and northern section of Pier 39, San Francisco, California.....	149
101 Two-dimensional model investigation of twin-log floating breakwater at Juneau, Alaska, Small Boat Basin No. 2.....	152
102 Two-dimensional experimental investigation of twin-cylinder floating breakwater.....	154
103 Twin-cylinder floating breakwater stability and natural periods of oscillation.....	155
104 Effect of cylinder submergence, $a_1/a_2$ , and relative water depth $L/d$ , on transmission coefficient, $C_t$ , for twin-cylinder floating breakwater.....	155
105 Effect of relative water depth, $L/d$ , and initial wave steepness, $H_1/L$ , on transmission coefficient, $C_t$ , for twin-cylinder floating breakwater.....	156
106 A-frame floating breakwater evaluated experimentally in both a three-dimensional and two-dimensional wave basin.....	157
107 Total wave amplification downstream of A-frame, pontoon-type floating breakwater.....	158
108 Effect of initial wave steepness, $H_1/L$ , and relative breakwater width, $L/L_1$ , on transmission coefficient, $C_t$ , for A-frame floating breakwater.....	160
109 Effect of relative breakwater width, $L_1/d$ , and relative water depth, $L/d$ , on transmission coefficient, $C_t$ , for A-frame floating breakwater.....	161
110 Effect of relative breakwater width, $L/L_1$ , and relative depth of vertical curtain, $h_1/d$ , on coefficient of transmission, $C_t$ , for A-frame floating breakwater.....	163
111 Effect of relative breakwater width, $L/L_1$ , and relative cylinder submergence, $L_2/L_1$ , on transmission coefficient, $C_t$ , for four-cylinder A-frame floating breakwater.....	163
112 Effect of relative breakwater width, $L/L_1$ , on average and peak mooring force parameter, $F_{h_1}/\gamma H_1^2 L$ , for two-cylinder A-frame floating breakwater.....	164
113 Effect of relative breakwater width, $L/L_1$ , on average and peak mooring force parameter, $F_{h_1}/\gamma H_1^2 L$ , for four-cylinder A-frame floating breakwater.....	165
114 Definitive sketch of a tethered-float breakwater.....	167
115 Performance estimation of tethered-float breakwater at a theoretical 75-percent wave height reduction.....	170
116 Performance estimation of tethered-float breakwater at a theoretical 50-percent wave height reduction.....	171
117 Performance estimation of tethered-float breakwater at a theoretical 25-percent wave height reduction.....	171
118 Comparison of normalized wave spectra for JONSWAP spectra, Pierson-Moskowitz spectra, and modified spectra representative of that observed in nature.....	173

CONTENTS

FIGURES--Continued

	Page
119 Predicted performance of tethered-float breakwater with low density, 5-foot-diameter spherical floats which provide 50-percent wave height reduction of the modified Pierson-Moskowitz spectrum.....	173
120 Estimated number of rows of 5-foot-diameter spheres of tethered-float breakwater required to reduce wave heights of Pierson-Moskowitz spectrum to sea-state 3.....	175
121 Prototype tests of tethered-float breakwater, using 12-inch-diameter spherical floats designed for 2- to 4-second wave periods with heights up to 5 feet.....	176
122 Concept of floating concrete articulated-frame ballast tethered-float breakwater.....	178
123 Shallow-water, bottom-resting, steel frame ballast tethered-float breakwater concept using scrap tires.....	179
124 Porous-walled breakwater model under test conditions.....	185
125 Definitive sketch of porous-walled breakwater.....	185
126 Effect of breakwater width, $b$ , and dimensionless wave frequency, $\sigma^2h/g$ , on coefficient of reflection, $C_r$ , for the porous-walled floating breakwater.....	188
127 Effect of incident wave steepness, $H_i/L$ , and dimensionless wave frequency, $\sigma^2h/g$ , on coefficient of reflection, $C_r$ , for the porous-walled floating breakwater.....	188
128 Effect of bottom removal, incident wave steepness, $H_i/L$ , and dimensionless wave frequency, $\sigma^2h/g$ , on coefficient of reflection, $C_r$ , for the porous-walled floating breakwater.....	189
129 Comparison of seaward mooring line forces for porous-walled versus solid-walled floating breakwater.....	190
130 Experimental arrangement for evaluating effectiveness of open-tube floating breakwater concept.....	192
131 Effect of relative breakwater width, $L_T/L_i$ , and number of tubes on reflection coefficient, $C_r$ , for open-tube floating breakwater.....	193
132 Effect of incident wave steepness, $H_i/L_i$ , and relative breakwater width, $L_T/L_i$ , on reflection coefficient, $C_r$ , for open-tube floating breakwater.....	193
133 Effect of relative breakwater width, $L_T/L_i$ , and number of tubes on transmission coefficient, $C_t$ , for open-tube floating breakwater.....	195
134 Effect of incident wave steepness, $H_i/L_i$ , and relative breakwater width, $L_T/L_i$ , on transmission coefficient, $C_t$ , for open-tube floating breakwater.....	195
135 Effect of incident wave steepness, $H_i/L_i$ , and relative breakwater width, $L_T/L_i$ , on power loss, $P_D$ , for open-tube floating breakwater.....	196
136 Conceptual model of operation, pneumatic and hydraulic breakwater systems.....	197
137 Qualitative description of current patterns produced by pneumatic breakwater.....	199
138 Two sizes of small-scale laboratory flumes used to investigate pneumatic breakwater effectiveness.....	200
139 Effect of unit air discharge, $q$ , and relative depth of submergence, $y/d$ , on maximum surface current velocity, $U$ .....	201

CONTENTS

FIGURES--Continued

	Page
140 Effect of relative water depth, $L/d$ , and comparison of dimensionless horsepower requirements, $\phi$ , for pneumatic breakwater at a 50-percent wave height attenuation.....	202
141 Effect of unit air discharge, $q$ , and incident wave steepness, $H_1/L_1$ , on effectiveness of pneumatic breakwater.....	203
142 Effect of unit air discharge, $q$ , and orifice diameter on effectiveness of pneumatic breakwater.....	204
143 Effect of unit air discharge, $q$ , and multiple manifold systems on effectiveness of pneumatic breakwater.....	204
144 Effect of unit air discharge, $q$ , and manifold spacing on effectiveness of pneumatic breakwater.....	205
145 Effect of applied horsepower per foot and wavelength, $L$ , on effectiveness of pneumatic breakwater at a 40-foot water depth.....	206
146 Effect of supply pipeline diameter, length of supply pipeline, and supply pipeline velocity on total horsepower requirements of pneumatic breakwater.....	206
147 Pneumatic breakwater laboratory investigation of effect of wave frequency and applied power on cumulative spectral density at a 2-foot water depth.....	207
148 Current profiles of large-scale pneumatic breakwater system tests.....	209
149 Air discharge versus wave height attenuation in large-scale pneumatic breakwater system tests.....	210
150 Experimental facility used to evaluate hydraulic breakwater effectiveness.....	211
151 Effect of relative wavelength, $L/d$ , and nozzle jet diameter on horsepower requirements, $\phi$ , of hydraulic breakwater.....	212
152 Effect of incident wave steepness, $H_1/L_1$ , and relative wavelength, $L/d$ , on horsepower requirements, $\phi$ , of hydraulic breakwater.....	213
153 Effect of dimensionless jet area on discharge and horsepower requirements of hydraulic breakwater.....	213
154 Efficiency, $\epsilon$ , of hydraulic breakwater as a function of incident wave steepness, $H_1/L_1$ , and relative wavelength, $L/d$ .....	215
155 Effect of applied horsepower per foot, and wavelength, $L$ , on effectiveness of hydraulic breakwater at a 40-foot water depth.....	216
156 Effect of supply pipeline diameter, length of supply pipeline, and supply pipeline velocity on total horsepower requirements of hydraulic breakwater.....	216
157 Two-dimensional test on effect of relative jet power, $P_T$ , and incident wave steepness, $H_1/L_1$ , on attenuation of deepwater waves for a hydraulic breakwater.....	217
158 Two-dimensional tests on effect of relative depth of submergence, $y_0/L$ , and relative jet power, $P_T$ , on attenuation of deepwater waves for a hydraulic breakwater.....	218
159 Effect of incident wave steepness, $H_1/L_1$ , on efficiency, $\epsilon$ , for various degrees of attenuation, two dimensional deepwater wave test, hydraulic breakwater.....	218
160 Conceptual model of horizontal and vertical Wave Trap floating membrane breakwater.....	220
161 Valve sheet details of Wave Trap of flexible-membrane floating breakwater concept.....	221



CONTENTS

FIGURES--Continued

	Page
162 Effect of relative breakwater width, $L/W$ , and incident wave steepness, $H_i/L_i$ , on wave height attenuation for the Wave Trap membrane-type floating breakwater concept.....	222
163 Mooring line force versus wave steepness for Wave Trap membrane-type floating breakwater concept.....	223
164 Physical characteristics of Wave Blanket concept of membrane-type floating breakwater.....	224
165 Schematic diagram of Wave Blanket concept in test facility for attenuation and mooring load studies.....	224
166 Effect of relative breakwater width, $L/W$ , and various thicknesses and widths of blanket on wave height attenuation by Wave Blanket concept of membrane-type floating breakwater...	225
167 Mooring line force versus wave steepness for Wave Blanket concept of membrane-type floating breakwater .....	226
168 Effect of relative water depth, $L/d$ , and incident wave steepness, $H/L$ , on transmission coefficients, $C_t$ , for a woven fabric of plastic fibers.....	227
169 Effect of relative water depth, $L/d$ , and incident wave steepness $H/L$ , on transmission coefficients, $C_t$ , for thin impervious sheets of plastic or polyethylene.....	228
170 Effect of relative water depth, $L/d$ , and incident wave steepness, $H/L$ , on transmission coefficients, $C_t$ , for sponge blankets of various thicknesses.....	299
171 Effect of relative water depth, $L/d$ , and incident wave steepness, $H/L$ , on transmission coefficients, $C_t$ , for a corrugated blanket of woven plastic fabric.....	230
172 Experimental facilities for investigating flexible water-filled bags used as floating breakwaters.....	232
173 Effect of relative breakwater width, $L/W$ , and bag length on wave height attenuation of water-filled, bag-type floating breakwater.....	233
174 Effect of relative water depth, $L/d$ , and incident wave steepness, $H/L$ , on transmission coefficients, $C_t$ , of water-filled, cylindrical bag floating breakwater.....	234
175 Effect of relative water depth, $L/d$ , and incident wave steepness, $H/L$ , on transmission coefficients, $C_t$ , of water-filled bag floating breakwater.....	235
176 Mooring line force versus wave steepness for water-filled, cylindrical bag floating breakwater.....	236
177 Three-dimensional laboratory tests of the effect of relative breakwater width, $L/W$ , and mattress mooring angle on transmission coefficients, $C_t$ , for water-filled, mattress-type floating breakwater.....	237
178 Effect of relative water depth, $L/d$ , and incident wave steepness, $H/L$ , on transmission coefficients, $C_t$ , for water-filled bag floating breakwater.....	239
179 Seabreaker floating breakwater.....	240
180 Prototype Seabreaker floating breakwater.....	241
181 Scale model of Harris floating breakwater.....	242
182 Mooring arrangement of the Harris floating breakwater field test.....	243
183 Incident and transmitted wave spectrum of Harris floating breakwater.....	243
184 Performance characteristics of Harris floating breakwater.....	244
185 Effects of windspeed and tidal current on Harris floating breakwater.....	245

CONTENTS

FIGURES--Continued

	Page
186 Parabolic beach floating breakwater concept.....	246
187 Effects of relative water depth, $L/d$ , and porosity on transmission coefficients, $C_t$ , of hinged and freely floating parabolic beaches.....	247
188 Design concept for Wave Tripper floating breakwater.....	248
189 Offset floating breakwater configuration, showing pressure distribution on reflecting surfaces.....	249
190 Effect of relative penetration, $h/a$ , on ratio of force on offset breakwater, $F_{\text{offset}}$ to force on vertical rigid wall, $F_{\text{rigid wall}}$ , for offset floating breakwater configuration.....	250
191 Effect of relative penetration, $h/a$ , angle of incidence, $\theta$ , anchor location, offset width, $D_o$ , and relative wavelength, $L/2D_o$ , on transmission coefficients, $C_t$ , for offset floating breakwater configuration.....	251
192 Effect of ratio of wavelength to offset distance, $L/D_o$ , and depth of penetration, $h$ , on coefficient of transmission, $C_t$ , for offset floating breakwater configuration.....	252
193 Bowley wave barrier concept of floating breakwater.....	253
194 Wave pattern generated by Bowley wave barrier concept of floating breakwater.....	254
195 Experimental facility for evaluating the Bowley wave barrier concept of floating breakwater.....	255
196 Effect of number of modules, and relative water depth, $L/d$ , on transmission coefficient, $C_t$ , for Bowley wave barrier concept of floating breakwater.....	255
197 Effect of relative water depth, $L/d$ , and pitching mode period on transmission coefficient, $C_t$ , for Bowley wave barrier concept of floating breakwater.....	256
198 Effect of model buoy size, and relative water depth, $L/d$ , on transmission coefficient, $C_t$ , for Bowley wave barrier concept of floating breakwater.....	256
199 Effect of Bowley wave barrier concept of floating breakwater on Pierson-Moskowitz spectrum.....	257
200 Slope-floating beach with pontoons for reservoir applications.....	258
201 Effect of incident wave steepness, $H_i/L$ , and relative breakwater width, $L/W$ , on transmission coefficient, $C_t$ , for slope floating beach with pontoons.....	259
202 Twin-pontoon floating breakwater for reservoir applications.....	260
203 Effect of incident wave height, $H_i$ , and relative breakwater width, $L/W$ , on transmission coefficient, $C_t$ , for twin-pontoon floating breakwater.....	261
204 Twin water chamber and pontoon floating breakwater for reservoir applications.....	262
205 Effect of relative breakwater width, $L/W$ , on transmission coefficient, $C_t$ , for twin water chamber and pontoon floating breakwater.....	263
206 Fixed-dissipator floating breakwater for reservoir applications.....	264
207 Effect of relative breakwater width, $L/W$ , on transmission coefficient, $C_t$ , for fixed dissipator floating breakwater.....	264

CONVERSION FACTORS, U.S. CUSTOMARY TO METRIC (SI) UNITS OF MEASUREMENT

U.S. customary units of measurement used in this report can be converted to metric (SI) units as follows:

Multiply	by	To obtain
inches	25.4	millimeters
	2.54	centimeters
square inches	6.452	square centimeters
cubic inches	16.39	cubic centimeters
feet	30.48	centimeters
	0.3048	meters
square feet	0.0929	square meters
cubic feet	0.0283	cubic meters
yards	0.9144	meters
square yards	0.836	square meters
cubic yards	0.7646	cubic meters
miles	1.6093	kilometers
square miles	259.0	hectares
knots	1.852	kilometers per hour
acres	0.4047	hectares
foot-pounds	1.3558	newton meters
millibars	$1.0197 \times 10^{-3}$	kilograms per square centimeter
ounces	28.35	grams
pounds	453.6	grams
	0.4536	kilograms
ton, long	1.0160	metric tons
ton, short	0.9072	metric tons
degrees (angle)	0.01745	radians
Fahrenheit degrees	5/9	Celsius degrees or Kelvins <sup>1</sup>

<sup>1</sup>To obtain Celsius (C) temperature readings from Fahrenheit (F) readings, use formula:  $C = (5/9) (F - 32)$ .

To obtain Kelvin (K) readings, use formula:  $K = (5/9) (F - 32) + 273.15$ .

## SYMBOLS AND DEFINITIONS

A	Dynamic pressure head amplitude (feet) ●frontal projected area of tethered float (square feet)
a	abrasion constant (dimensionless) ●wave amplitude (feet)
$a_j$	jet area (dimensionless)
$a_1$	distance of first cylinder above waterline (feet) ●motion of breakwater in sway (feet)
$a_2$	distance of second cylinder above waterline (feet) ●motion of breakwater in heave (feet)
$a_3$	motion of breakwater in roll (degrees)
B	structure width (feet)
$\bar{B}$	center of buoyancy
b	anchoring depth ●depth of mooring point
C	mooring line constant (dimensionless)
$C_d$	drag coefficient (dimensionless)
$C_g(f)$	frequency group velocity (feet per second)
$C_t$	coefficient of transmission (dimensionless)
$C_t(f)$	coefficient of transmission, irregular waves (dimensionless)
$(C_t)_{1/3}$	coefficient of transmission of significant wave height (dimensionless)
c	damping function (pounds per second per foot) ●depth of the center of gravity
$c_c$	critical damping function (pounds per second per foot)
$c_u$	undrained cohesive strength of soil (pounds per square foot)
D	depth of submergence ●linearized damping coefficient for perforated breakwater (dimensionless) ●pile diameter (feet) ●structure draft (feet)
$D_o$	structure offset distance for offset breakwater (feet)
$D_t$	diameter of scrap tire (feet)

SYMBOLS AND DEFINITIONS--Continued

d	chain or joint pin diameter (feet) ●water depth (feet)
$d_{mi}$	mass point of floating body (dimensionless)
$d_1$	submergence of orifice (feet) ●water depth (feet) ●width of double pontoon floating system (feet)
$d_2$	depth of submergence (feet)
ETC(f)	energy transmission coefficient in frequency domain (dimensionless)
e	distance load is applied to pile above bottom (feet)
F	anchor force per foot of structure (pounds per foot) ●applied force (pounds) ●mooring line force (pounds)
$F_D(f)$	drag force in frequency domain (pounds)
$F_d$	damping force (pounds)
$F_i$	line force spectrum (pounds)
$F_{max}$	maximum probable force (pounds)
$F_n$	maximum instantaneous mooring force (pounds)
$F_o$	periodic forcing function (pounds)
$F_s$	factor of safety (dimensionless)
$F_t$	lateral mooring line peakload (pounds)
$F(t)$	excitation as a function of time
$F_x(i)$	ith mooring line effect on sway (pounds)
$F_z(i)$	ith mooring line effect on heave (pounds)
$F_1, F_2$	force in mooring line (pounds)
$F(\omega_1)$	incident force spectrum (pounds per second squared)
f	incident wave frequency (one per second)
$f_c$	force in breakwater mooring line (pounds)
$f_p$	peak energy frequency (one per second)
$f_{t_{max}}$	force due to total reflection from vertical wall (pounds)
$\bar{G}$	structure center of gravity (dimensionless)
GM	height of metacenter (feet)

SYMBOLS AND DEFINITIONS--Continued

$g$	gravitational constant (32.174 feet per second squared)
$H$	arbitrary wave height (feet)
$H_I, H_i$	incident wave height (feet)
$(H_i)_{1/3}$	incident significant wave height (feet)
$H_{max}$	maximum wave height (feet)
$H_S$	significant wave height (feet)
$H_T, H_t$	transmitted wave height (feet)
$h$	penetration of offset breakwater below waterline (feet) ●porous breakwater height (feet) ●structure height (feet)
$h_1$	penetration of A-frame (feet)
$h_3$	freeboard of A-frame (feet)
$I, I_c$	moment of inertia (feet <sup>4</sup> )
$I_1$	modified Bessel function (dimensionless)
$\bar{K}$	dimensionless spring constant
$K_p$	Rankine's coefficient of passive earth pressure (dimensionless)
$K_S$	restoring force per foot of immersion (pounds per foot)
$K_1$	modified Bessel function (dimensionless)
$K_2$	radius of gyration (feet)
$k$	restoring stiffness coefficient (pounds per inch) ●spring constant (pounds per foot) ●wave number, $2\pi/L$ (one per foot)
$k_1$	moment arm of mass point (feet)
$L$	incident wavelength ●wavelength (feet)
$L_i$	incident wavelength (feet)
$L_{mo}$	double pontoon structure width (feet)
$L_o$	deepwater wavelength (feet)
$L_{po}$	single pontoon structure width (feet)
$L_T$	average tube length (feet)

SYMBOLS AND DEFINITIONS--Continued

$L_W$	wavelength (feet)
$L_1$	distance of A-frame cylinder from centerline (feet)
$L_2$	vertical distance between cylinders of four-cylinder A-frame (feet)
$l$	distance of pile penetration into bottom (feet) ●structure width (feet)
$l_b$	sloping float breakwater ballasted length (feet)
$ln$	base of Napierian logarithm system (dimensionless)
$M$	structure mass (pounds per second squared per foot) ●total mooring line load (pounds)
$M_t$	total mass of floating body (pounds per second squared per foot)
$M_\theta(i)$	$i$ th mooring line effect on roll (degrees)
$m$	effective porosity of porous breakwater (dimensionless) ●structure mass (pounds per second squared per foot)
$N$	number of repetitions (dimensionless) ●number of waves (dimensionless)
$\bar{N}$	unit direction normal to surface (dimensionless)
$N_t$	number of waves (dimensionless)
$N\Delta_f$	Nyquist frequency (one per second)
$P$	load or surface pressure (pounds) ●structure porosity (dimensionless)
$P_D$	dissipated wave power (foot-pounds per second)
$P_D(f)$	float drag power in frequency domain (foot-pounds per second)
$P_i$	incident wave power (foot-pounds per second)
$P_j$	power of hydraulic jet (foot-pounds per second)
$P_r$	relative jet power (dimensionless)
$P_s$	hydrostatic effect on sway (pounds)
$P_t$	transmitted wave power (foot-pounds per second)
$P_x$	hydrodynamic effect on sway (pounds)
$P_z$	hydrodynamic effect on heave (pounds)

SYMBOLS AND DEFINITIONS--Continued

$p(x)$	probability density function (dimensionless)
$q$	air discharge (cubic feet per second)
$r$	radius of gyration (feet)
$S$	unit surface element (square feet)
$SG_s$	specific gravity of sand (dimensionless)
$S_i(f)$	incident wave spectrum (square feet per second)
$S_p$	spectrum of relative drag power (foot-pounds per second)
$S_r$	spectrum of relative velocities (feet per second)
$S_t(f)$	transmission wave spectrum (square feet per second)
$S_u$	spectrum of horizontal water particle velocities (feet per second)
$S_w(f)$	spectrum of wave power (foot-pounds per second)
$S_{xx}$	radiation stress due to waves in direction of wave travel (pounds per square foot)
$S_{xx}^*$	net radiation stress (pounds per square foot)
$S_\eta$	spectrum of surface elevations (feet)
$S(\omega)$	ocean wave spectrum (square feet per second)
$S(\omega_i)$	incident wave spectrum (square feet per second)
$s$	tethered float spacing along wave crest (feet) ●unit length of anchor line (feet)
$T$	tension in mooring line (pounds) ●wave period (seconds)
$T_d$	hydrodynamic effect on roll (pounds)
$T_h$	natural period of heaving (seconds)
$T_k(t)$	arbitrary mooring line tension (pounds)
$T_n$	natural period of oscillation (seconds)
$T_{pk}$	peak period of spectrum (seconds)
$T_r$	natural period of rolling (seconds)



SYMBOLS AND DEFINITIONS--Continued

$T_s$	hydrostatic effect on heave (pounds)
$T_1(t), T_2(t)$	mooring line tension (pounds)
$t$	time ●wave blanket thickness (feet)
$U$	maximum current velocity (feet per second) ●wind velocity (feet per second)
$U_r(f)$	relative velocity between tethered float and fluid particle (feet per second)
$V$	immersed volume (cubic feet)
$W$	anchor block weight (pounds) ●structure width (feet)
$W_t$	design anchor weight (pounds)
$W_l$	weight of floating breakwater (pounds)
$w$	weight of unit length of sloping float (pounds)
$w_b$	weight of internal ballast in unit length of sloping float (pounds)
$X$	amplitude of oscillation (feet)
$x$	horizontal dimension in direction of wave propagation (feet)
$y$	distance from water surface to arbitrary point (feet) ●horizontal dimension perpendicular to wave propagation (feet)
$y_0$	depth of submergence (feet)
$z$	vertical distance perpendicular to wave propagation (feet)
$\alpha$	angle of sloping float breakwater (degrees) ●water surface elevation in front of porous breakwater (feet) ●wave spectrum constant (dimensionless)
$\beta$	angle of incidence (degrees) ●wave spectrum constant (dimensionless)
$\gamma$	unit weight of fluid (pounds per cubic foot)
$\gamma_c$	unit weight of concrete in air (pounds per cubic foot)
$\gamma_s$	unit weight of soil (pounds per cubic foot)

SYMBOLS AND DEFINITIONS--Continued

$\gamma_w$	unit weight of water (pounds per cubic foot)
$\Delta f_i$	increment of line force spectrum (pounds)
$\Delta s$	change in anchor line per unit length (feet)
$\delta$	effective pore diameter in porous breakwater (feet)
$\epsilon$	efficiency (dimensionless)
$\zeta$	damping factor (dimensionless)
$\eta$	water surface elevation in front of porous breakwater (feet)
$\eta_F(x,t)$	wave transmission by fixed body (feet)
$\eta_{G1}(x,t)$	generated wave (feet)
$\eta_I(x,t)$	incident wave amplitude (feet)
$\eta_R(x,t)$	reflected wave amplitude (feet)
$\eta_T(x,t)$	transmitted wave amplitude (feet)
$\eta_X(x,t)$	incident wave amplitude (feet)
$\theta$	angle of rotational vibration (degrees) ●wave phase angle (degrees)
$\lambda$	reservoir breakwater width (feet) ●wavelength (feet)
$\mu$	coefficient of soil static friction (dimensionless)
$\pi$	3.14159
$\rho$	mass density (pounds second squared per foot <sup>4</sup> )
$\sigma$	statistical variance of force (pounds) ●wave frequency (one per second)
$\sigma(x)$	equivalent alternating stress (pounds per square foot)
$\phi$	dimensionless horsepower ratio
$\phi$	internal friction of sand (dimensionless)
$\Omega$	dimensionless discharge ratio
$\omega$	circular wave frequency (radian per second) ●natural frequency of structure (one per second)
$\omega_n$	natural frequency of structure (one per second) ●frequency of free oscillation (one per second)
$\omega_p$	peak frequency of wave spectrum (one per second)

# FLOATING BREAKWATERS: STATE-OF-THE-ART LITERATURE REVIEW

by  
*Lyndell Z. Hales*

## I. INTRODUCTION

### 1. Background.

The basic purpose of any breakwater is to protect a part of shoreline, a structure, a harbor, or moored vessels from excessive incident wave energy. Breakwaters may be broadly classified as either fixed structures (rubble-mound, precast units, sheet-steel modules, etc.), transportable structures (sunk-in-place barges, caisson units, etc.), tethered structures (buoyant floats), or free-floating structures (pontoons, flexible membranes, porous-walled units, scrap-tire modules, etc.). Most breakwaters, fixed or floating, are passive systems; i.e., no energy is produced by the device to achieve wave attenuation. The incident wave energy is either reflected, dissipated, transmitted, or subjected to a combination of these mechanisms. Conversion of wave energy into oscillatory motion through which power is generated is the concept by which power can be extracted from ocean waves. This is essentially another specific type of floating breakwater.

From an historical standpoint, the application of a floating structure for the attenuation of surface gravity waves was first considered by Joly (1905). Only minimal efforts were expended on the concept until the necessity for ensuring the offloading of men and materials during the Normandy invasion of World War II, at which time two different types of wave barriers were developed by Great Britain. One of these developments was a portable barge-type unit which was floated into position and sunk at a specific location by filling with seawater. This "phoenix" structure (204 feet long by 62 feet wide by 60 feet high) effectively intercepted the preponderance of wave energy to which it was subjected. The second type of wave barrier was a true floating breakwater which had a cruciform cross section (200 feet long by 25 feet wide by 25 feet deep). This "Bombardon" was designed to withstand a wave 10 feet high and 150 feet long, and was successful during the invasion. However, the structure collapsed during an unexpected storm when the seas grew to 15 feet in height with lengths of 300 feet, thus generating stresses more than eight times those for which the structure had been designed.

Interest in the open-ocean application of floating breakwaters then declined until 1957, when the U.S. Navy Civil Engineering Laboratory (NCEL) began a concerted exploration of the existing state of knowledge of transportable or floating units which could be adapted to protect small, moored craft and work platforms used in cargo transfer operations. Attention was also directed to military uses under rather severe criteria of incident wave heights up to 10 feet and wave periods up to 7 seconds. The U.S. Army Corps of Engineers (COE) has a potential requirement for a floating breakwater system to provide partial protection to dredges and work boats involved with the construction of coastal engineering features in the nearshore zone and on exposed coastlines with similar wave climates (in addition to more sheltered bay and estuary locations with somewhat less severe wave climates). Coordinated research efforts in this area of mutual interests are currently in progress.

With the continually increasing ownership of pleasure craft, available mooring spaces have been depleted in many locations. Escalating construction costs and environmental constraints require alternative considerations to the traditional fixed rubble-mound structure for harbor development. Many needed facilities, particularly in Alaska, are so small and serve so few vessels that large expenditures of funds cannot be justified. Additionally, at many of these locations, site parameters such as deep water or poor bottom conditions necessitate a floating structure. Research engineers and scientists recognized the potential for floating breakwaters in certain areas, and research interest has accelerated in recent years. This has also served to stimulate theoretical analyses of floating structures subjected to dynamic environments, as well as the more basic and fundamental physical hydraulic model approach to the evaluation of various conceptual models. Computerized mathematical models developed recently have produced quantitative theoretical results that compare quite closely with results of experimental model investigations and prototype monitoring efforts.

## 2. Floating Breakwater Applicability.

Permanently fixed breakwaters (rubble-mound or precast units) provide a higher assurable degree of protection than floating breakwaters; however, they are very expensive to construct. In water depths greater than about 10 feet, a fixed breakwater may not be competitive costwise with a floating breakwater (depending on the incident wave period). Floating breakwaters provide less protection, but they are less expensive and are movable from one location to another as required. It may be relatively easy to fabricate a floating breakwater at a site where a rigid bottom-resting gravity structure would be completely infeasible (water depth greater than about 30 to 40 feet, or unstable foundation conditions).

Several major points exist in the consideration of a floating breakwater. The cost of a floating system is only slightly dependent on water depth and foundation conditions. While the construction cost of a fixed rubble-mound breakwater increases exponentially with depth, a floating breakwater requires essentially the same structural features regardless of the water depth (except for mooring arrangements). The interference of a floating breakwater with shore processes, biological exchange, and with circulation and flushing currents essential for the maintenance of water quality is minimal (again depending on the incident wave period). The planform layout can be changed to accommodate changes in either seasonal or long-term growth patterns. Floating breakwaters appear to have greater multiple-use potential than fixed structures (they can be used as boat docks or boat mooring locations, and also serve as walkways).

Floating breakwaters, however, have some disadvantages which must be weighed in their evaluation. The design of a floating breakwater system must be carefully matched to the site conditions, with due regard to the longer waves which may arrive from infrequent storms. The floating breakwater can fail to meet its design objectives by transmitting a larger wave than can be tolerated without necessarily suffering structural damage. Uncertainties in the magnitude and types of applied loading on the system, and lack of maintenance cost information, dictate conservative design practices which naturally increase the initial project cost. A major disadvantage is that floating breakwaters move in response to wave action and thus are more prone to structural-fatigue problems.

### 3. Basic Floating Breakwater Groups.

Jones (1971) and Richey and Nece (1974) recognized at least 60 different floating breakwater configurations. Geometric and functional similarities among these various configurations, however, allow for logical classification into basic groups based on fundamental features.

a. Pontoon Floating Breakwaters. This group of prismatic structures (single pontoon, double pontoon, or other variations) contains the simplest forms of floating breakwaters, and has been dealt with extensively by experimentalists and theorists. The prismatic form offers the best possibilities for multiple use such as walkways, storage, boat moorings, and fishing piers. Catamarans also logically fit into this group. Several factors in addition to mass contribute to the performance of pontoon-type breakwaters. The radius of gyration, antirolling devices, and the depth of submergence influence wave attenuation characteristics. Furthermore, as the ratio of breakwater width-to-wavelength increases, the pontoons tend to deform, absorbing wave energy in the bending process. The design of the double-pontoon system attempts to combine relatively large mass and large radius of gyration, and pontoons of this configuration are capable of functioning as floating piers where cargo may be unloaded. In this case, the stability and performance of the structure under various loading conditions would be a prime consideration in design.

b. Sloping-Float (Inclined Pontoon) Breakwaters. The sloping-float breakwater concept is a wave barrier that consists of a row of moored, flat slabs or panels whose mass distribution is such that in still water each panel has one end resting on the bottom and the other end protruding above the water surface. Preliminary tests and experience indicate that waves in the lee of the structure will exist largely because of the induced motion of the float, which is resisted by inertia, gravity, and the moorings. The U.S. Navy is currently interested in a hollow, steel barge adaptation (a pontoon barge or causeway section) which appears to have acceptable dimensions and mass. The U.S. Army Engineer Waterways Experiment Station (WES) is conducting an experimental investigation into the possibility of utilizing the sloping-float breakwater to provide a temporary protection to dredges and work boats in the nearshore open-ocean region.

c. Scrap-Tire Floating Breakwaters. Used automobile and truck tires are accumulating at an enormous rate, and the seemingly physical indestructibility of these abandoned tires has historically posed a problem of pollution-free methods of disposal. The rubber industry is constantly seeking new and innovative methods for utilizing these wornout tires. Coastal engineers have long been interested in resilient energy absorption mats for shore protection, and the use of scrap tires as floating breakwaters has been investigated intermittently for the past 20 years. Stitt and Noble (1963) developed and patented a geometric assembly configuration known as the "Wave-Maze," and the Goodyear Tire and Rubber Company has investigated extensively the use of modular elements formed by securing together bundles of tightly interlocked scrap tires. Harms (1979a) experimentally investigated a concept known as the "Wave-Guard" (now referred to as the "Pipe-Tire" structure) which utilized massive logs (telephone poles or steel pipes) as structural components with the scrap tires threaded onto the poles. These three basic designs have received the greatest attention from an experimental investigation standpoint.

d. A-Frame Arrangement Floating Breakwaters. Because of the availability of timber in many parts of the United States and Canada, log structures have been utilized to provide protection for harbors and boat anchorages. The Canadian Department of Public Works has developed and evaluated a circular cylinder floating breakwater which incorporates a vertical wall for supplemental attenuation purposes. Of particular interest in this development has been the determination of the method and extent to which the requirement of large mass may be usefully replaced by a large moment of inertia. It appears the effectiveness range of this concept (the A-frame) can be significantly increased by enlarging its radius of gyration, which involves only a slight increase in the mass of the structure.

e. Tethered-Float Breakwaters. This unique breakwater concept consists of a large number of buoyant floats with a characteristic dimension about equal to the wave height. The floats are independently tethered at or below the water surface. Initially, the concept was developed for a water depth many times the float diameter; later a bottom-resting concept was developed for shallow water. The floats move because of the periodic fluctuation of the pressure gradient, and the dominant attenuation mechanism is drag resulting from the buoy motion. The tethered floats respond periodically with a definite phase relationship to the periodic driving force. Because of their dynamic response, it is possible to cause the buoys to pendulate out of phase with the wave orbital motions. This buoy motion transforms wave energy into turbulence.

f. Porous-Walled Floating Breakwaters. A solid vertical or sloping-face floating breakwater causes nonbreaking waves which strike it to be partially reflected. To be an effective reflector (good attenuator), a floating breakwater should remain relatively motionless. Such a breakwater requires great structural strength, and large forces are imposed on the mooring system. Any part of the wave energy dissipated by the floating breakwater system is no longer available to be either transmitted or reflected; hence, forces in the mooring system are accordingly reduced. From the standpoint of maximum wave energy dissipation internally and a resulting minimum reflection from the structure, the perforated (porous-walled) breakwater and open-tube wave attenuation systems have been investigated experimentally.

g. Pneumatic and Hydraulic Breakwaters. The most effective natural mechanism of wave energy dissipation is the phenomenon of wave breaking. Active wave attenuation systems are those devices which inject kinetic energy into the wave so that total or partial breaking of the wave train occurs. The resulting attenuation depends on the degree of breaking accomplished by the active breakwater. The underlying basis of operation for the air-release breakwater concept (pneumatic system) is the development of a vertical current of water which rises to the surface and spreads horizontally. In the water-jet release system (hydraulic breakwater), high velocity water is released in a horizontal layer near the surface. In either case, entrainment of the surrounding water results from momentum exchange, and partial or total wave breaking results. Compressors necessary for the generation of the low-pressure air may be situated on harbor docks, floating platforms, or ships. The hydraulic breakwater systems must be positioned at or slightly below the water surface; hence, the proper and effective flotation device is critical for successful attenuation by the hydraulic breakwater system.

h. Flexible-Membrane Floating Breakwaters. Several varieties of surface floating membranes have been investigated, and among these concepts the blanket layer types appear preferable to bag types for operational and logistic reasons. For short waves, deep draft is not needed by a floating breakwater; for long waves, deep draft may be desirable but it is difficult to contend with the resulting large mooring forces. Hence, an optimization is required which balances wave attenuation aspects and mooring loads, and the breakwater usually floats with a draft much less than the depth of the water. Soft floating systems have certain operational advantages over a rigid structure; damage, and possible loss through collisions in rough water, should not be a problem for flexible floating breakwaters. The mooring arrangement, hence, is less critical. While strength of the material may be a limiting factor, a properly designed flexible breakwater is not subject to the resonances which increase the peak mooring loads of rigid breakwater systems. Because of the collapsible nature of a flexible breakwater, a transport vessel could carry more linear feet of this type than any other. The major disadvantage of all thin surface membrane types is that a rather great width relative to the wavelength is required to obtain satisfactory wave attenuation.

i. Turbulence-Generator Floating Breakwaters. A floating breakwater concept consisting of relatively thin, horizontal barriers has been developed which causes dissipation of wave energy without creating major stresses in the structure and moorings. The dissipative mechanism for this design arises as the wave breaks over the upper surface of the system with great turbulence. Major eddy formation develops as the fluid moves between the breakwater members with supplementary loss of energy. The advantages of this design include shallow draft, relatively lightweight, and modest mooring loads even in fairly strong currents. Each unit is a long, rigid pontoon of specialized design which enables a string of units to be joined together.

j. Peak Energy Dispersion Floating Breakwaters. The opportunity often exists for a floating breakwater to alter the peak energy density occurring at narrow frequency bands to a broader spectrum of frequencies with much lower energy intensity. A method of wave interference to accomplish this desired objective has been developed. An offset breakwater configuration of vertical reflecting surfaces oriented normal to the direction of wave propagation and displaced from each other by one-half wavelength reduces the anchoring forces required to hold the floating breakwater in place, as the net pressure distributions on the various sections are out of phase by  $180^\circ$ . A slightly different version utilizes an array of wave-excited modules which act as sources of elliptical wave fronts radiating outward and interfering with the incident wave field. The radiated waves have characteristics which trigger instabilities in the incoming wave field and result in premature breaking.

k. Reservoir Application Floating Breakwaters. The development of multiple-purpose reservoir marinas requires breakwaters that can function over a wide range of water levels, as the water surface elevation of a flood control reservoir may fluctuate 50 feet or more. An adequately designed breakwater must be able to follow the water surface without undue stress in the moorings, and must have the capability to function at all elevations. Raichlen (1968) found that some smaller boats have larger natural periods of response than some larger boats. This is because the larger boats may have stiffer mooring lines in comparison to their weight than do the smaller boats. Extrapolated, this emphasizes that the moorings are extremely important to the problem of designing a floating breakwater to reservoir requirements.

#### 4. General Operational Aspects.

Certain fundamental operational aspects exist which are common to all types of floating breakwaters. These include the determination of the incident wave conditions for performance considerations, and the type of anchoring system to be developed for a particular location. The basic methods by which a floating breakwater reduces wave energy to produce a sheltered region include: (a) reflection, (b) dissipation, (c) interference, and (d) conversion of the energy into nonoscillatory motion. For effective reflection, the breakwater should remain relatively motionless and penetrate to a depth sufficient to prohibit appreciable wave energy from passing underneath. The structure could extend to the bottom and obstruct most of the water column, but it usually floats with a draft much less than the water depth. For short waves in the upper part of the water, deep draft is not needed; for long waves, deep draft may be desirable but again it is difficult to contend with the large mooring loads which may result. Optimization is often required between the wave attenuation aspects and mooring loading. Because of this turbulent dissipation of energy, forces in the mooring system are accordingly reduced.

a. Performance Considerations. The generally accepted criterion for evaluating a breakwater's performance is the transmission coefficient,  $C_t$ . This parameter is usually defined as the ratio of the transmitted wave height,  $H_t$ , to the incident wave height,  $H_i$

$$C_t = \frac{H_t}{H_i} \quad (1)$$

This definition is satisfactory as long as the waves are regular; however, in wave climates consisting of short-crested irregular waves, the definition may need to reflect the amount of energy transmission instead of wave height transmission. Accordingly, a transmission coefficient is frequently formulated as the ratio of the transmitted wave height squared,  $H_t^2$ , to the incident wave height squared,  $H_i^2$

$$C_t = \frac{H_t^2}{H_i^2} \quad (2)$$

As with all breakwaters, the design of a floating breakwater is always site-specific. Waves favorably attenuated by a floating breakwater usually do not exceed 4 feet in height, and periods usually do not exceed 4 seconds. Hence, for these relatively short-period waves, refraction and diffraction probably do not enter into the determination of the wave climate. If necessary, however, these effects can readily be incorporated into the design considerations. The wavelength,  $L$ , is uniquely related to wave period for the water depth in which the wave is propagating as

$$L = \left( \frac{gT^2}{2\pi} \right) \tanh \left( \frac{2\pi d}{L} \right) \quad (3)$$



Where

$g$  = gravitational constant

$T$  = wave period

$\pi$  = 3.14

$d$  = local water depth

Given the wave climate, it is pertinent to remember that the average waves are not the ones which contribute to the destruction of the breakwater. The peak waves or the rare, extreme occurrences are the parameters the structure must be designed to withstand. Once the incoming wave climate has been ascertained, the acceptable wave heights which can be tolerated in the sheltered area must be determined. When the acceptable transmitted wave has been determined, the transmission coefficient is fixed.

b. Anchoring Systems. As discussed by Giles and Eckert (1979), the type of system selected for anchoring a floating breakwater depends on the peak mooring forces estimated for the structure, the bottom conditions at the site, and the methods available for installing the anchor. The two most commonly used methods for anchoring any type of floating breakwater are the deadweight anchor and the pile anchor. Embedment anchors and screw anchors have had limited use, primarily because they have fairly short lengths and are difficult to install in firm marine soils.

The deadweight anchor is usually a concrete block cast at the site. The design anchor weight,  $W_t$ , is determined by the forces available to cause movement and the degree of resistance produced by the static friction of the bottom conditions (mud, sand, or rock bottom). Based on a static analysis, the relationship between these variables is

$$W_t = \frac{F_t F_s}{\left[ \mu - \left( \frac{\mu \gamma_w}{\gamma_c} \right) \right]} \quad (4)$$

where

$F_t$  = lateral mooring line peakload

$F_s$  = factor of safety

$\mu$  = coefficient of soil static friction

$\gamma_w$  = unit weight of water

$\gamma_c$  = unit weight of concrete in air

Anchor piles are designed by finding the ultimate lateral resistance of the pile-soil system and increasing the lateral mooring load,  $F_t$ , by a factor of safety,  $F_s$ , to determine the design lateral load on the pile. The ultimate lateral resistance of the anchor pile is reached when either the passive strength of the surrounding soil is exceeded or when the yielding

moment of the pile section is reached. The short-rigid pile case will normally suffice for anchor piles for floating breakwaters. The short-rigid pile is assumed not to bend when laterally loaded but will rotate about a point approximately one-third to one-quarter its length above the pile tip. Anchor piles are designed for the soil's ultimate lateral resistance rather than deflection of the pile head; hence, the design is predicated on sufficiently large deflection to develop the full passive resistance. This is defined as three times the Rankine passive earth pressure from the soil surface to the center of rotation. The expression for the ultimate lateral resistance of a short pile in a cohesionless soil is

$$F_t F_s = \frac{(\gamma_s D \ell^3 K_p)}{(2e + 2\ell)} \quad (5)$$

and

$$K_p = \frac{(1 + \sin \phi)}{(1 - \sin \phi)} \quad (6)$$

where

- D = pile diameter
- $\gamma_s$  = unit weight of soil
- $K_p$  = Rankine's coefficient of passive earth pressure
- e = distance load is applied above the bottom
- $\ell$  = distance pile penetrates into the bottom
- $\phi$  = internal friction of sand

Equation (5) may be solved by iteration unless the dimension e is zero. In that case, the lever arm of the load vanishes and the load is applied directly at the firm bottom. Equation (5) can then be solved directly for the required pile distance as

$$\ell = \left[ \frac{(2F_t F_s)}{(\gamma_s D K_p)} \right]^{0.5} \quad (7)$$

When the foundation soil conditions at the breakwater site are cohesive, Broms' (1964) method can be used to determine the ultimate lateral resistance of a rigid-pile anchor under lateral load. The distance the pile penetrates into the bottom is

$$\ell = 1.5D + f + q \quad (8)$$

where

$$f = \frac{(F_t F_s)}{(9c_u D)} \quad (9)$$

and

$$q = \frac{[F_t F_s (e + 1.5D + 0.5f)^{0.5}]}{(2.25D)} \quad (10)$$

Here  $c_u$  is the undrained cohesive strength of the soil. The pile spacing, as well as the deadweight anchor locations, should be close enough to overcome the peak lateral forces exerted by the floating breakwater on the mooring lines.

#### 5. The Study Objective.

Since the early 1900's, interest in the applications of floating breakwaters has occurred intermittently and to various degrees, and as a result a multitude of conceptual models have been proposed without extensive or complete evaluation of most of these concepts. Hence, the technical literature regarding floating breakwater applicability and design procedures is fragmentary and sometimes confusing. Clear, concise guidance does not always exist for those charged with the responsibility of planning and developing wave protection measures. The 1970's experienced a resurgence of interest in floating breakwaters, and the dearth of design information dictates that a conservative approach be followed when designing both the structure and the anchoring system (which can be significant costwise). Forces on anchors and in structure members should be investigated, in conjunction with the transmission characteristics of prototype structures to optimize floating breakwater cost and effectiveness.

This study reviewed and evaluated the technical literature (theoretical, field, and laboratory) on existing floating breakwater concepts. This state-of-the-art evaluation which furnishes a summary of available guidance will also be used in planning further research on floating breakwaters, and will supplement prototype monitoring programs.

## II. THEORETICAL ANALYSIS OF FLOATING BREAKWATER PERFORMANCE

### 1. Fixed Rigid Structures.

The wave attenuation characteristics of floating breakwaters were first investigated from an analytical standpoint by approximations which consisted of idealized forms of wave barriers. A rigid structure of finite width,  $W$ , height,  $h$ , and draft,  $D$ , fixed near the surface of a water body at depth,  $d$  (Fig. 1), was analyzed by Macagno (1953). He assumed that water did not overtop the barrier--as if the dimension  $(h - D)$  were very large. An expression for the coefficient of transmission,  $C_t$ , defined as the ratio of the wave height in the lee of the structure,  $H_t$ , to the incident wave height,  $H_i$ , was developed as

$$C_t = \frac{1}{\sqrt{1 + \left[ \frac{\pi W \sinh(2\pi d/L_i)}{L_i \cosh[2\pi(d - D)/L_i]} \right]^2}} \quad (11)$$

where  $L_i$  is the incident wavelength. This expression was displayed by Jones (1974) for the special case of  $d = 60$  feet (Fig. 2), using dimensional quantities rather than the dimensionless parameters to convey the impression of sizes involved at prototype scale. Two depths of submergence ( $D = 0$  foot and  $D = 5$  feet) were evaluated to ascertain the decrease in the magnitude of the transmission coefficient with increasing submergence. Jones (1974) indicated that great errors are not introduced by ignoring small degrees of submergence.

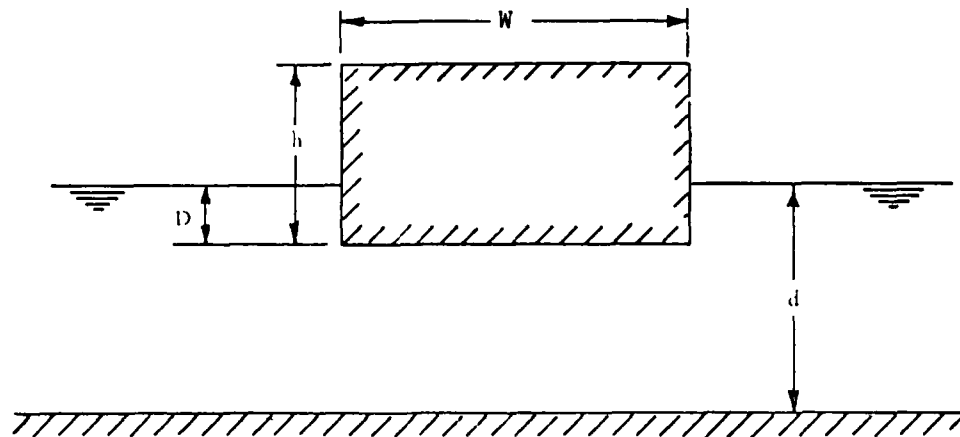


Figure 1. Idealized fixed structure of finite width, height, and draft (after Jones, 1974).

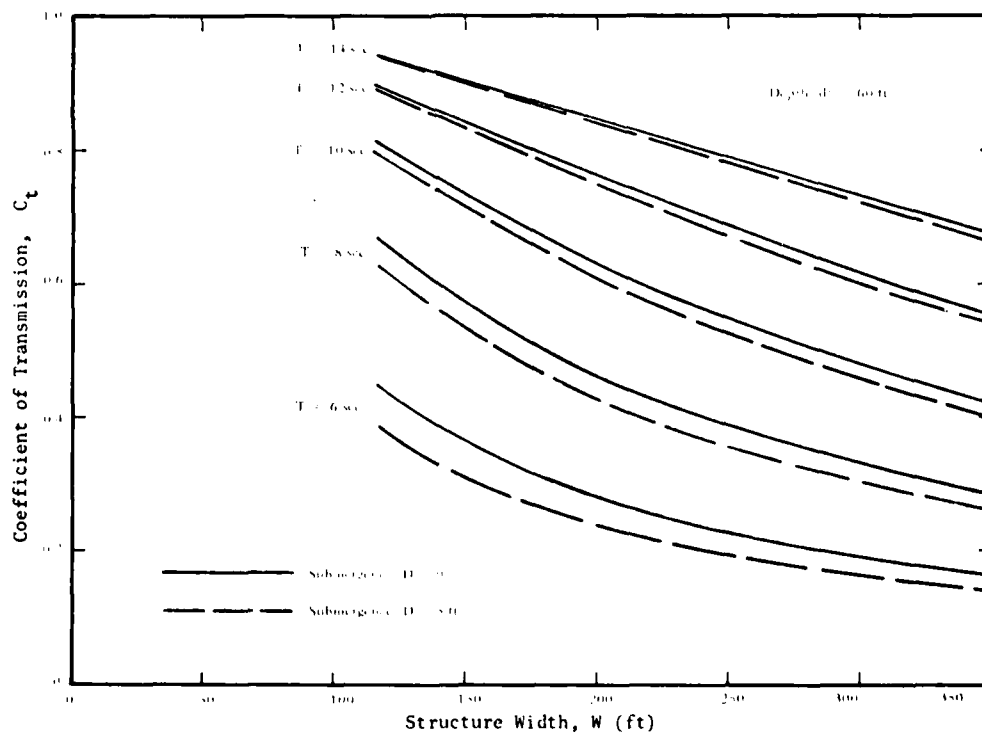


Figure 2. Theoretical coefficient of transmission,  $C_t$ , past a fixed rigid structure, with two depths of submergence,  $D$ , based on development by Macagno (1953) (after Jones, 1974).

By taking the finite width of such a fixed rigid structure to an infinitely small limit, Ursell (1947) developed a theory for the partial transmission and partial reflection of waves in deep water with the barrier extending from the water surface to some depth,  $D$ , such that

$$C_t = \frac{K_1(2\pi D/L_i)}{\sqrt{\pi^2 I_1^2(2\pi D/L_i) + K_1^2(2\pi D/L_i)^2}} \quad (12)$$

where  $I_1(2\pi D/L_i)$  and  $K_1(2\pi D/L_i)$  are modified Bessel functions. Experimental studies evaluated the goodness of fit of this theory; these data are shown in Figure 3. Wiegel (1959a) investigated this conceptual model with a consideration of the wave power transmission (the time rate of energy propagation), and he determined that the ratio of the transmitted wave power,  $P_t$ , to the incident wave power,  $P_i$ , is

$$\frac{P_t}{P_i} = \frac{\frac{4\pi(D+d)/L_i}{\sinh 4\pi d/L_i} + \frac{\sinh 4\pi(D+d)/L_i}{\sinh 4\pi/L_i}}{1 + \frac{4\pi d/L_i}{\sinh 4\pi d/L_i}} \quad (13)$$

The transmission coefficient,  $C_t$ , is the square root of  $P_t/P_i$ . Experiments performed by Wiegel (1959a) (Fig. 4) demonstrated that this theory might be useful for first approximations but that improvements in the theory were needed. A consistent trend of decreasing transmission coefficient with increasing wave steepness was evident from these laboratory measurements (all other things remaining constant). The power transmission theory predicts the transmission coefficient more closely for the deepwater wave ( $d/L = 0.68$ ) than for the other conditions tested (Wiegel, 1960). While these early attempts to describe the physical process are simple in theory, they offer initial first approximations and provide a foundation on which more elaborate numerical techniques can be used.

## 2. Dynamics of Elastically Moored Floating Breakwaters.

The response behavior of a single degree of freedom, linearly damped, vibrating spring-mass system is analogous to the response of a floating structure to waves (Harleman and Shapiro, 1958; Dean and Harleman, 1966; Sorensen, 1978). When a linear system of one degree of freedom is excited, its response will depend on the type of excitation and the damping which is present. The equation of motion of the system (Fig. 5), developed from Newton's second law of motion, will generally be of the form

$$m \frac{\partial^2 x}{\partial t^2} + F_d + kx = F(t) \quad (14)$$

where

- $m$  = mass of the structure
- $k$  = restoring stiffness coefficient
- $x$  = direction of motion
- $F(t)$  = excitation as a function of time
- $F_d$  = damping force

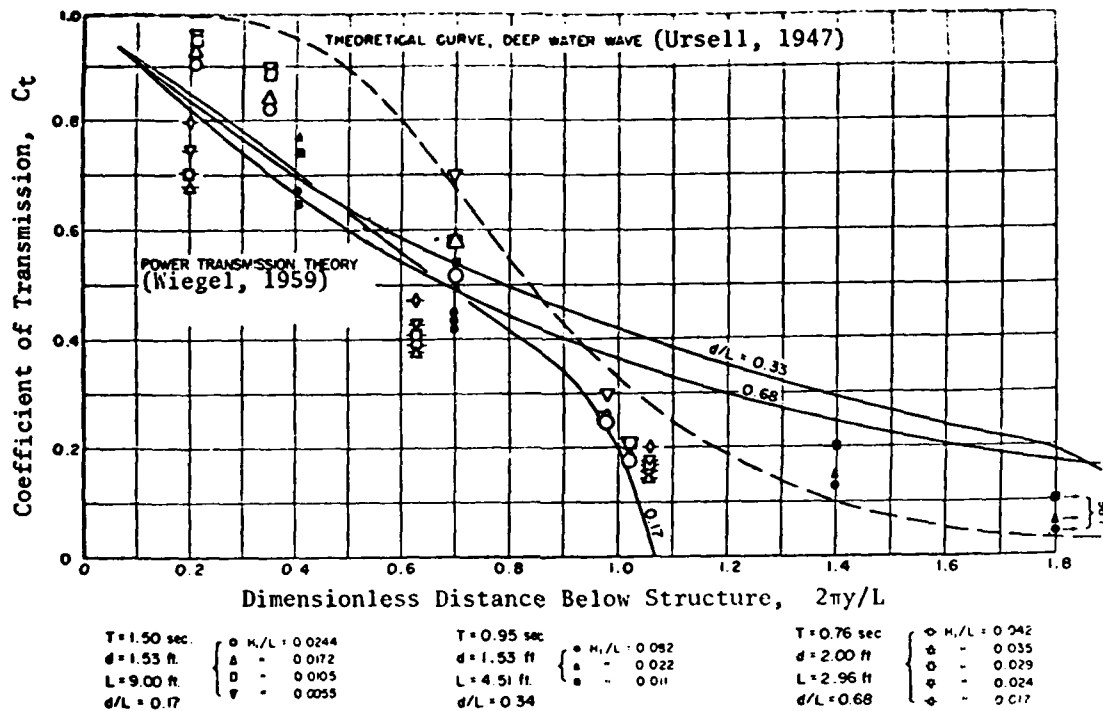


Figure 3. Comparison of theories and experimental data for wave transmission past a fixed, rigid, vertical thin plate (after Wiegel, 1959a).

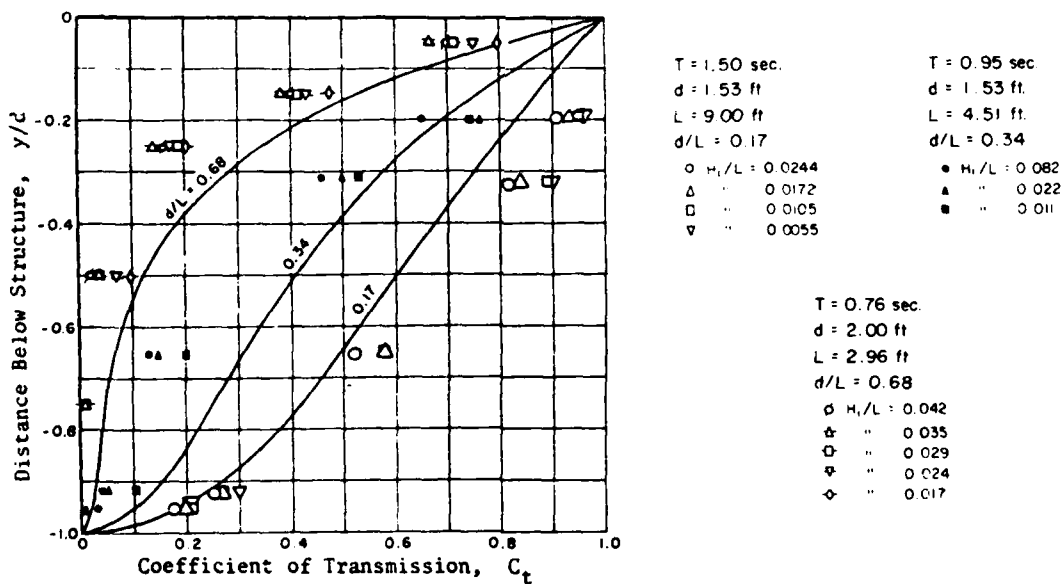


Figure 4. Effect of depth of submergence of thin, rigid, fixed vertical plate on transmission coefficient and power transmission theory (after Wiegel, 1959a).

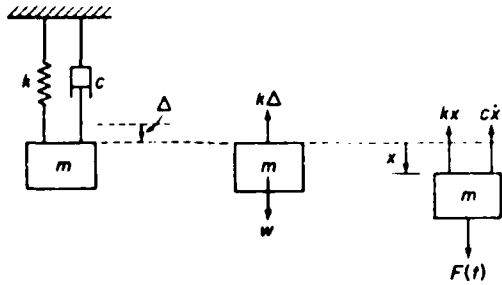


Figure 5. Definitive sketch, single degree of freedom, mechanical vibration system.

Ideal damping models produce results which satisfactorily predict the response when the damping force is formulated as being proportional to the velocity.

$$F_d = c \frac{\partial x}{\partial t} \quad (15)$$

where  $c$  is a constant of proportionality. Equation (14) thus becomes

$$m \frac{\partial^2 x}{\partial t^2} + c \frac{\partial x}{\partial t} + kx = F(t) \quad (16)$$

If  $F(t) = 0$ , the homogeneous differential equation results whose solution corresponds physically to that of damped free vibration. However, when the system is subjected to excitation by a harmonic force (e.g.,  $F_0 \sin \omega t$ ), the system becomes one of forced vibration with linear damping.

$$m \frac{\partial^2 x}{\partial t^2} + c \frac{\partial x}{\partial t} + kx = F_0 \sin \omega t \quad (17)$$

where  $F_0$  is the magnitude of the periodic forcing function, and  $\omega$  is the frequency of its application.

The solution of equation (17) consists of two parts--the complimentary solution, which is the solution of the homogeneous equation corresponding to the case of damped free vibration, and the particular solution of interest representing forced linearly damped vibration. The particular solution is a steady-state oscillation of the same frequency  $\omega$  as that of the excitation, and can be assumed to be of the form

$$x = X \sin(\omega t - \theta) \quad (18)$$

where  $X$  is the amplitude of oscillation, and  $\theta$  the phase of the displacement with respect to the exciting force. The amplitude and phase of equation (18) can be found by substitution into the differential equation (17). In harmonic motion the phases of the velocity and acceleration are ahead of the displacement by  $90^\circ$  and  $180^\circ$ , respectively; hence, it can be easily determined that (Thomson, 1972)

$$X = \frac{F_0}{\sqrt{(k - m\omega^2)^2 + (c\omega)^2}} \quad (19)$$

and

$$\theta = \tan^{-1} \frac{c\omega}{k - m\omega^2} \quad (20)$$

Expressing equations (19) and (20) in dimensionless form enables a concise graphical presentation. Defining the following quantities

$$\omega_n = \sqrt{\frac{k}{m}} = \text{natural frequency of undamped oscillation}$$

$$c_c = 2m\omega_n = \text{critical damping}$$

$$\zeta = \frac{c}{c_c} = \text{damping factor}$$

and

$$\frac{c\omega}{k} = \frac{c}{c_c} \frac{c_c\omega}{k} = 2\zeta \frac{\omega}{\omega_n}$$

the dimensionless expression for the amplitude becomes

$$\frac{Xk}{F_0} = \frac{1}{\sqrt{\left[1 - \left(\frac{\omega}{\omega_n}\right)^2\right]^2 + \left[2\zeta \left(\frac{\omega}{\omega_n}\right)\right]^2}} \quad (21)$$

and the dimensionless phase angle is

$$\tan \theta = \frac{2\zeta \left(\frac{\omega}{\omega_n}\right)}{1 - \left(\frac{\omega}{\omega_n}\right)^2} \quad (22)$$

Equations (21) and (22), shown in Figure 6, indicate that the amplification factor,  $Xk/F_0$ , and phase shift,  $\theta$ , are functions only of the frequency ratio,  $\omega/\omega_n$ , and damping factor,  $c/c_c$ . The damping factor,  $c/c_c$ , has a large influence on the amplitude and phase angle in the frequency region near resonance ( $\omega/\omega_n = 1$ ). For small frequency ratio ( $\omega/\omega_n < 0.2$ ), the response of the system is essentially equal to the excitation force. However, waves with periods at or near the resonance period of the structure (floating breakwater) will generate an increase in the amplification factor (the exact amount depending on the excitation period and degree of hydrodynamic damping). Hence, the movement of a floating breakwater can be several times greater than the incident wave amplitude. If the incident wave period is close to, but less than, the resonant period of the structure, there will be a phase lag between the wave and the structure motion that can approach 180°. This will create a phase lag between the incident and regenerated wave motions which increases the complexity of both the reflected and transmitted wave characteristics.



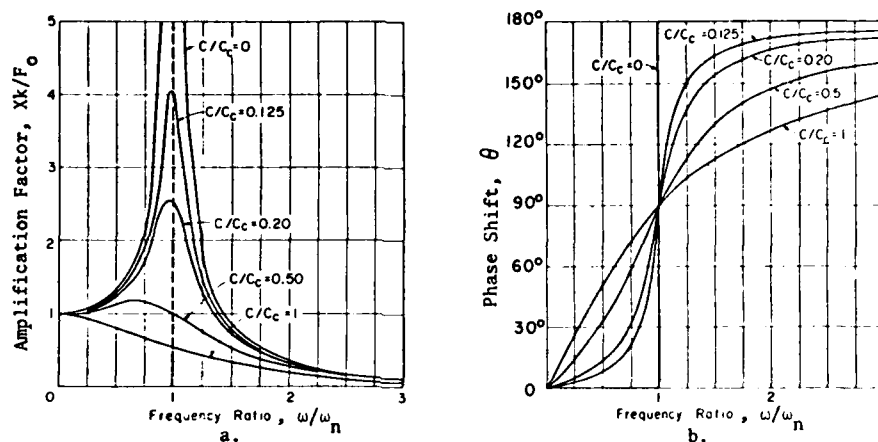


Figure 6. Amplification factor and phase shift for single degree of freedom, forced harmonic oscillation system with various linear damping (after Harleman and Shapiro, 1958).

The term *rigidly restrained* indicates that a structure under consideration is moored in such a way that the natural frequency of the structure-mooring system is high with respect to the forcing frequency (the frequency ratio,  $\omega/\omega_n$ , is small). The problems associated with mooring a floating breakwater on a water surface that fluctuates greatly with season is analogous to the difficulties involved with mooring a small boat on a body of water which experiences a large tidal range. Raichlen (1968) provided insight into the boat mooring problem when he analyzed the surging motion of several classes of small boats (20 to 40 feet long) subjected to uniform periodic standing waves with crests normal to the longitudinal axis of the moored boats, with two bowlines and two stern lines. The free oscillation surge periods for three mooring line conditions (0, 4, and 8 inches slack) for different initial displacements were measured and compared quite well with theory (Fig. 7). All other things being equal, the forcing function is directly proportional to the wave amplitude, and it is evident that either a boat or floating breakwater moored with slack lines at one tide stage may have taut lines at another; hence, its response will vary with stage. Raichlen (1968) determined that some smaller boats have larger natural periods of response than larger boats because the larger boats have stiffer mooring lines compared with their weight.

### 3. Theoretical Model Developments.

a. Model by Adee, Martin, Richey, and Christensen. The fundamental equations of motion have been utilized by Adee (1974, 1975a, 1975b, 1976a, 1976b), Adee and Martin (1974), and Adee, Richey, and Christensen (1976) to theoretically predict the complex performance of a floating breakwater. The results of these investigations are such that, in order to perform the calculated estimations, the user need only know the incident wave frequencies, the contour of the breakwater cross section, and the physical properties of the breakwater (mass, moment of inertia, and restoring-force coefficients). The prediction model was developed from two-dimensional, linearized solutions of the hydrodynamical equations formulated in terms of a boundary value problem for the velocity potential. This theoretical model for predicting the dynamic behavior characteristics of a floating breakwater estimates (a) total transmitted and reflected waves and their components, (b) wave forces on the

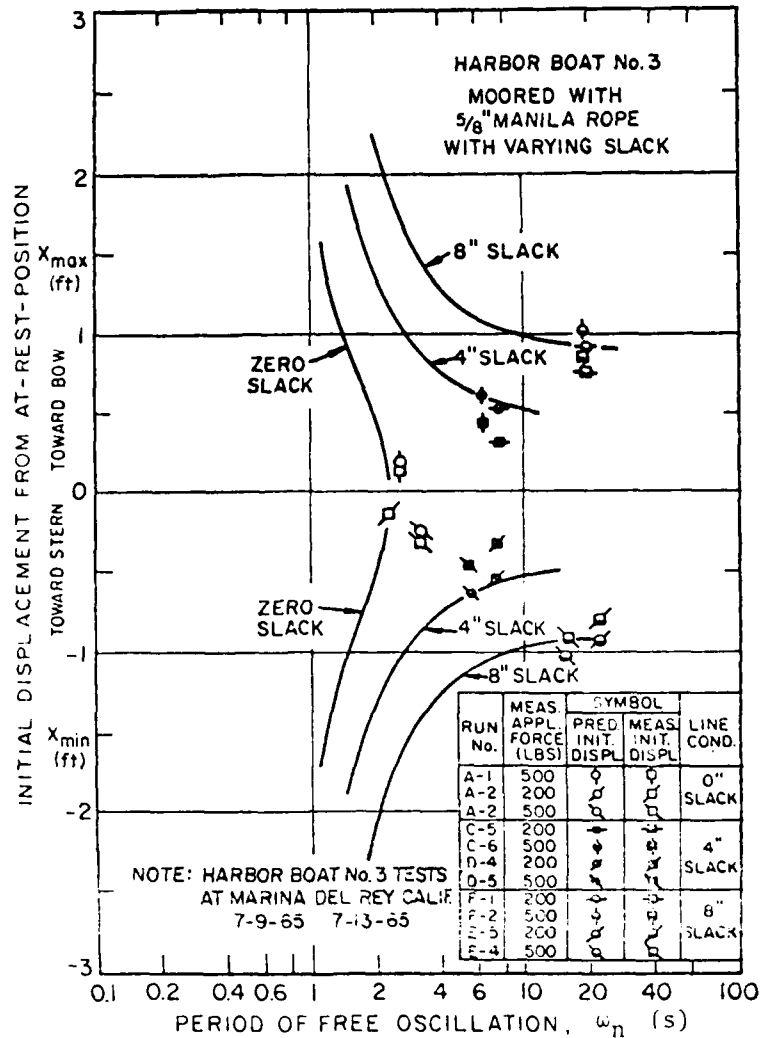


Figure 7. Measured and predicted natural periods of free oscillation of small boat under various mooring arrangements (after Raichlen, 1968).

breakwater, (c) motions of the breakwater, and (d) forces on the mooring lines. The two-dimensional model was developed for the breakwater that is assumed to be very long in one direction with the long-crested waves approaching so that their crests are parallel to the long axis of the breakwater. Under wind-wave conditions, this situation is rarely achieved; however, studies of boat waves near floating breakwaters (Stramandi, 1975) indicate that such waves often approach parallel to the long axis of the breakwater. As a design tool, this two-dimensional theoretical model by Adey, Richey, and Christensen (1976) will conservatively estimate wave transmission coefficients and mooring forces. Solutions of the hydrodynamic equations formulated in terms of the boundary value problem are difficult because of the nonlinearity of the free-surface boundary condition; however, an approximate solution may be obtained if this condition is linearized. This restriction theoretically limits the applicability to cases of small incident wave amplitude and small motion response of the breakwater.

The concept involved in theoretically predicting the performance of a two-dimensional floating breakwater has been schematized by Adee, Richey, and Christensen (1976) (Fig. 8). The incident wave approaches perpendicularly to the long axis of the structure; part of the energy contained in the incident wave is reflected, a part is lost through dissipation, and some of the wave energy is transmitted beneath the breakwater. A part of the wave energy is utilized in exciting motion of the breakwater, which is restrained by the mooring system. The oscillations of the structure, in turn, generate waves which travel away from the breakwater in both directions. The total transmitted wave, hence, is the sum of the component of the incident wave which passed beneath the structure and the leeward component generated by the breakwater motion. The linear system representing this floating breakwater analysis is shown in Figure 9. As long as the problem is linear, the computation of the performance of the breakwater may be separated into three parts: (a) formulation of the equations of motion, (b) solution for the waves diffracted by a rigidly restrained breakwater, and (c) summation of the components to obtain total transmitted wave. This provides the information of most interest to designers--the total transmitted wave, motions of the structure, and forces on the breakwater and in the mooring lines.

The linear model formulation by Adee, Richey, and Christensen (1976) is presented in the form of computer programs which calculate the hydrodynamic coefficients, breakwater motions, and the wave field. These computer programs determine the fixed-body parts of the transmitted and reflected waves by computing the forces, moments, and waves which result when a rigidly fixed body is struck by a sinusoidal incident wave of frequency,  $\omega$ . Motions are found by computing the steady-state solution of the three components of the equations of motion. The hydrodynamic coefficients and the waves generated by the body motions are found by computing the forces, moments, and waves which result when the body is forced to oscillate in still water in pure sway, pure heave, or pure roll.

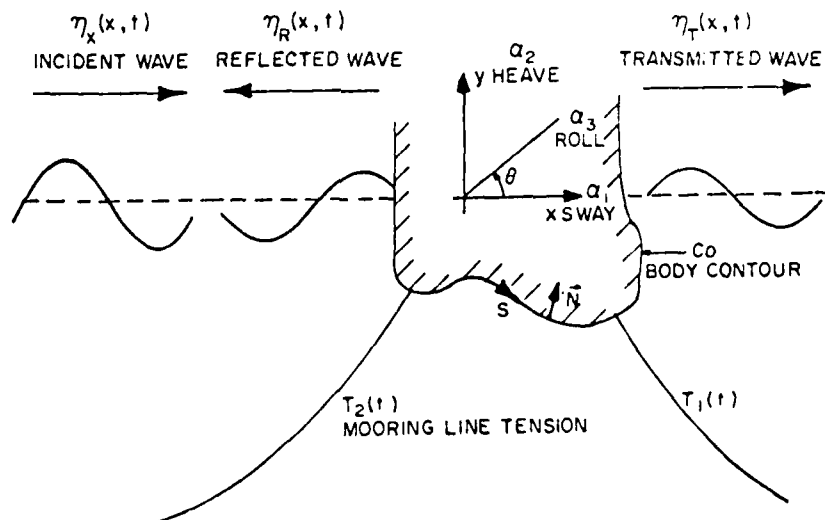


Figure 8. Conceptual model of surface gravity waves approaching a floating structure of arbitrary cross section (after Adee, Richey, and Christensen, 1976).

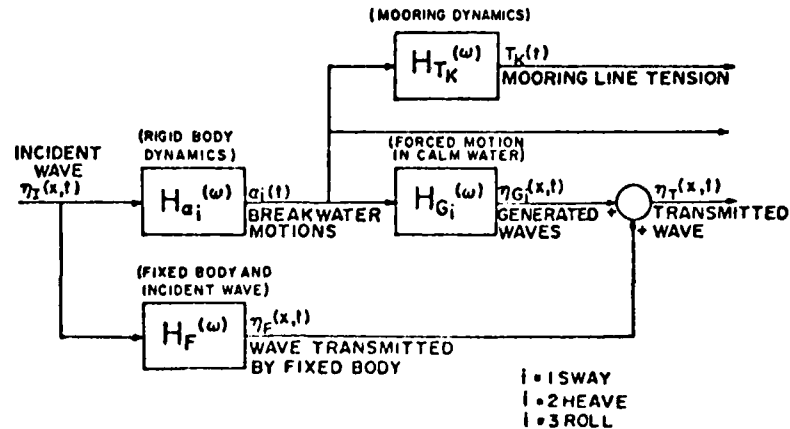


Figure 9. Linear system describing floating breakwater performance (after Adee, Richey, and Christensen, 1976).

The effectiveness of the theoretical linear model by Adee, Richey, and Christensen (1976) in evaluating the performance of floating breakwaters was determined by comparing the theoretical predictions with the physical model experiments of Davidson (1971) who carried out model tests of a proposed breakwater at Oak Harbor, Washington. The comparison between the theoretically predicted and experimentally measured transmission coefficient is shown in Figure 10. The results compare reasonably well (Adee, Richey, and Christensen, 1976), except for the predicted dip in transmission just above a  $W/L$  value of 0.20, where  $W$  is the structure width normal to the direction of wave propagation, and  $L$  is the wavelength. There is also some difference at the higher  $W/L$  ratios. The theory predicts that the transmitted wave which would result when the body is rigidly fixed is almost 100 percent for a  $W/L$  value less than 0.10, but drops rapidly at higher  $W/L$  ratios to the point where the transmitted wave is of little consequence above 0.15. Waves generated by the breakwater motions play an increasing role in  $W/L$  ratios above 0.15. Heave motion is the major contributor to the transmitted wave in the very narrow band of  $W/L$  between 0.15 and 0.18, with a predicted heave resonance at a  $W/L$  value of approximately 0.18. The dip in the curve occurs because the waves generated by heave and sway motions are almost  $180^\circ$  out of phase and, hence, cancel each other. At  $W/L$  ratios above 0.25, sway motion assumes an increasingly dominant role. According to Adee, Richey, and Christensen (1976), roll motions are small throughout and generate only very small waves.

b. Model by Stiassnie. Although a large volume of published work dealing with floating breakwaters exists, there does not appear to be an analytical expression that describes the influence of various breakwater characteristics (such as mass, draft, mooring stiffness, etc.) on performance (displacement and anchor forces) and on the transmission coefficient. Stiassnie (1980) developed a simple mathematical model, based on the solution of the two-dimensional problem of a vertical floating plate and on rigid body dynamics, to investigate the influence of these different characteristics on the breakwater performance. The results include information on the transmission coefficient, the plate displacement, and anchoring forces as functions of the plate geometry and incident wave parameters. This floating breakwater model has the advantage of having a closed mathematical solution, which permits focusing on the influence of each parameter separately.

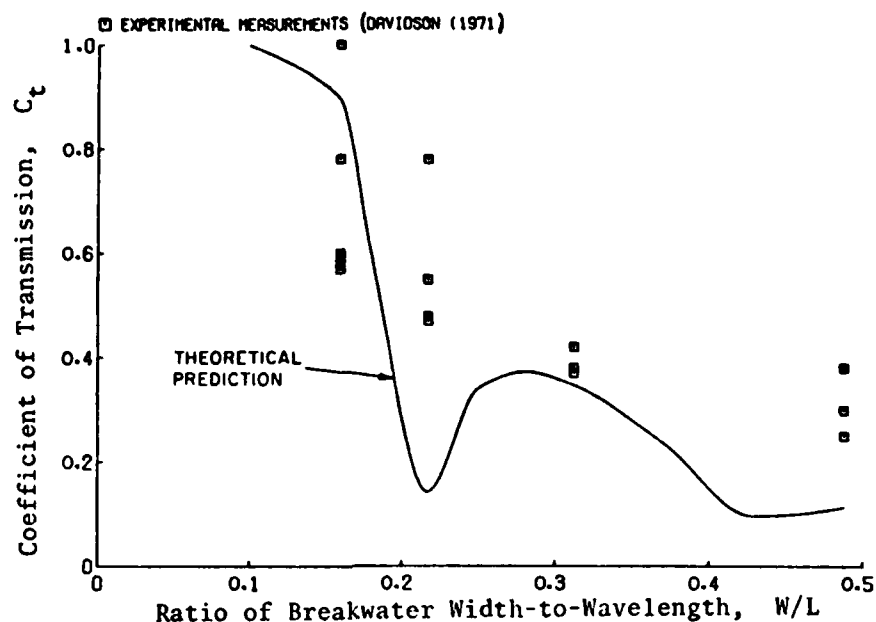


Figure 10. Comparison of linear theoretical model by Adee, Richey, and Christensen, and experimental data by Davidson (1971) for a proposed floating breakwater (after Adee, Richey, and Christensen, 1976).

To analytically simplify the problem, a breakwater with a simple form was considered, and some assumptions common in naval hydrodynamics were adopted. The breakwater model (Fig. 11) consisted of a vertical thin plate with the upper part above the water surface and lower part extending to a depth,  $D$ , beneath the surface. The breakwater mass per unit width is  $m$ , and the plate may float freely or be anchored at depth,  $b$ , to cables which are represented by linear springs having a spring constant,  $k$ , per unit width. The problem is two-dimensional and the water depth is assumed infinite. Monochromatic waves with frequency,  $\omega$ , approach from the left with crests parallel to the breakwater. Part of the wave energy is reflected by the plate and part is transmitted beneath it. The waves set the breakwater into periodic motion which, in turn, generates outgoing waves both upstream and downstream. Using the assumption of irrotational flow and considering linear waves, there exists a velocity potential,  $\phi$ , satisfying the Laplace equation and the free-surface boundary condition. The boundary conditions on the plate are the plate velocities. The resulting hydrodynamical equations are solved analytically by Stiassnie (1980), using complex variable techniques. The results are presented in three groups that define the performance of the floating breakwater.

(1) Influence of the Mass Parameter. The effect of the mass of the structure on performance was determined by setting  $k = 0$ , varying the parameter,  $W/L$ , and calculating the coefficient of transmission as a function of relative structure draft,  $D/L$ .  $W$  is the width of the breakwater. The results are presented in Figure 12 which shows the coefficient of transmission as a function of  $D/L$  for selected values of  $W/L$ ; also shown is the curve representing a fixed plate. For the case  $W/L = 0.01$ , the transmission coefficient is almost the same as that for a weightless breakwater of zero width.

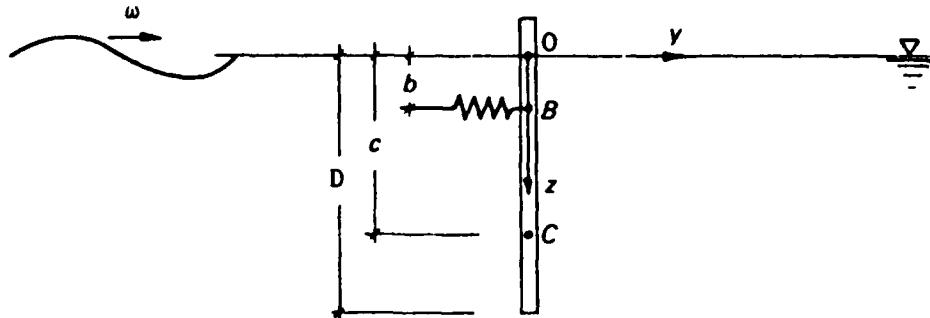


Figure 11. Floating vertical thin plate permitting development of simple analytical expression of floating breakwater response (after Stiassnie, 1980).

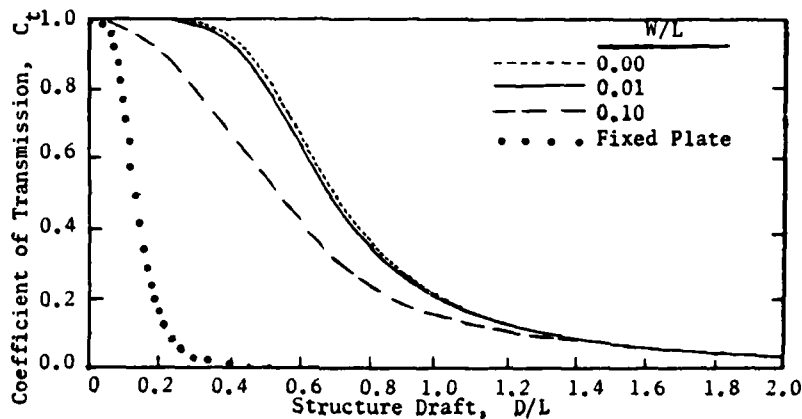


Figure 12. Effect of mass parameter on coefficient of transmission for floating breakwater,  $k = 0$  (after Stiassnie, 1980).

The case  $W/L = 0.10$  (which seems to be a reasonable upper limit for what may be called a "thin" plate) has a trend similar to the curve for  $W/L = 0.00$  but with smaller numerical values. In Stiassnie's example, the required draft necessary to obtain  $C_t = 0.50$  is equal to  $D/L = 0.70$ ,  $0.57$ , and  $0.13$  for the cases of  $W/L = 0.00$ ,  $0.10$ , and the fixed plate, respectively. Hence, very large masses would be required to approximate the fixed plate. At  $D/L = 0.70$ , an increase in the breakwater width by a factor of 10 will reduce the amount of wave transmission by approximately 15 percent. Thus, Stiassnie (1980) concluded, when considering a floating breakwater with a small mass, the minimal mass required for structural integrity should be used. However, the effect of the spring restoring force has been omitted from this comparison by setting  $k = 0$ . This probably isolates the effect of the mass parameter on the results, but the results may not be directly applicable to floating breakwater design.

(2) Influence of the Mooring Stiffness Parameter. The effects of the spring stiffness were investigated by setting the plate width equal to zero ( $W = 0$ ). Three different spring coefficients were considered: (a)  $k/\rho g L = 0.01$ , a weak spring; (b)  $k/\rho g L = 1.00$ , a medium spring; and (c)  $k/\rho g L = 100$ , a strong spring. The transmission coefficient under these conditions is presented in Figure 13. The transmission coefficient for the weak spring is

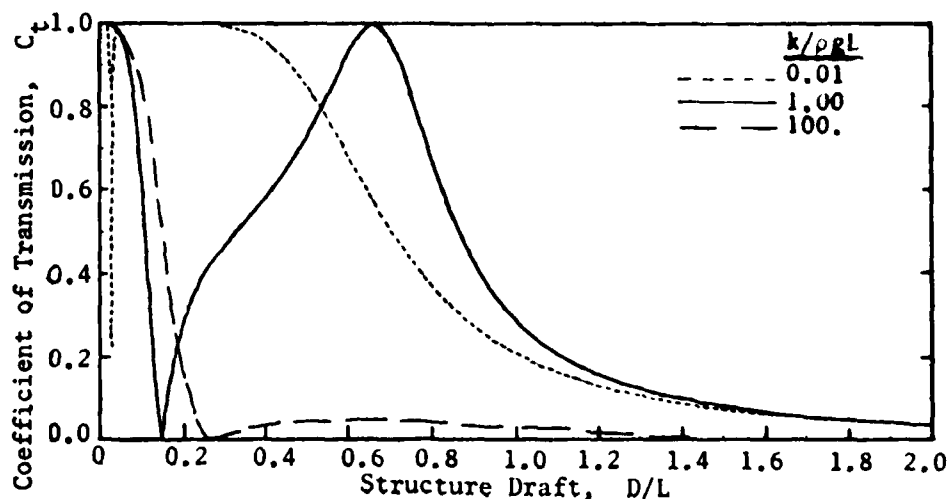


Figure 13. Effect of mooring stiffness parameter on coefficient of transmission for floating breakwater,  $W = 0$  (after Stiassnie, 1980).

similar to that of the free breakwater, except in the region of  $D/L = 0.03$  where a sharp decrease in  $C_t$  is noted, and occurs as a result of resonance. The behavior of the breakwater with a strong spring was generally similar to that of a fixed plate. For the case of the medium spring coefficient, the transmission is smaller than that for a fixed plate for  $D/L < 0.19$ . For larger values, the transmission coefficient increases and reaches  $C_t = 1.00$  at  $D/L = 0.67$ . According to Stiassnie (1980), the performance of the breakwater with medium mooring is generally worse than for the condition with no mooring. The varying results produced by the interaction of the mooring stiffness and resonance phenomenon are difficult to anticipate without detailed analysis.

(3) Influence of the Depth of Mooring Parameter. Stiassnie (1980) determined the effect of the depth of the mooring point on the breakwater performance by setting  $W = 0$  and  $k/\rho gL = 1$ , and determined the transmission coefficients and mooring force for three different points of attachment: (a) mooring at the water surface,  $b/D = 0$ ; (b) mooring at the midpoint of the breakwater,  $b/D = 0.5$ ; and (c) mooring at the lower edge of the breakwater,  $b/D = 1.0$ . The effect of the mooring location on the coefficient of transmission is presented in Figure 14; the effect on mooring force is shown in Figure 15. According to Stiassnie (1980), the differences between the various mooring depths are generally insignificant regarding both the transmission coefficients and mooring forces. However, it was determined that mooring at the lower edge of the plate allowed larger displacements (significantly larger in the region where  $C_t = 0$ ) than the other two alternatives, as anticipated. Despite the fact that Stiassnie's analytical treatment applies to that configuration of floating breakwater which is probably the simplest possible, 10 different input parameters are still required (i.e., wavelength and amplitude of the incident wave,  $L_1$  and  $H_1/2$ , respectively; water density,  $\rho$ ; acceleration of gravity,  $g$ ; draft of breakwater,  $D$ ; depth of the center of gravity,  $c$ ; mass per unit width,  $m$ ; moment of inertia,  $I_c$ ; spring constant,  $k$ ; and depth of mooring point,  $b$ ).

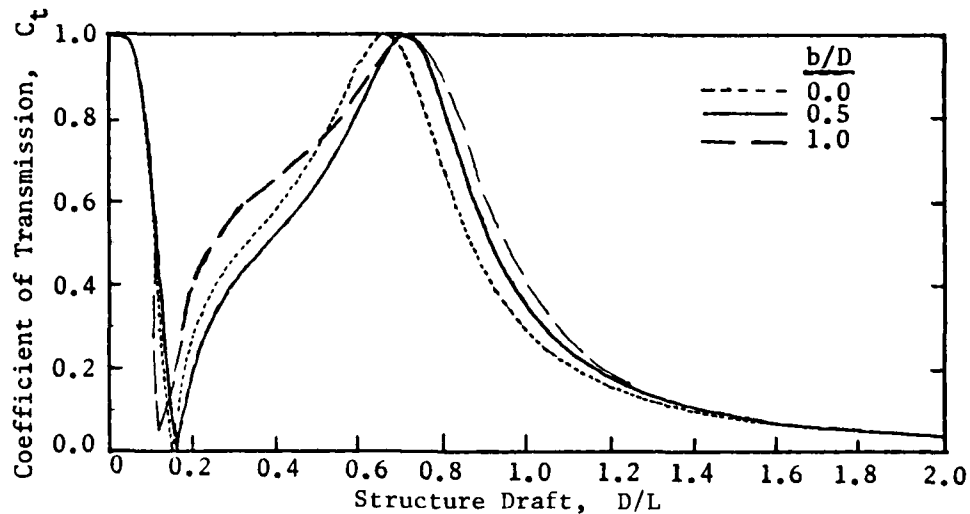


Figure 14. Effect of depth of mooring on coefficient of transmission for floating breakwater,  $W = 0$ ,  $k/\rho gL = 1$  (after Stiassnie, 1980).

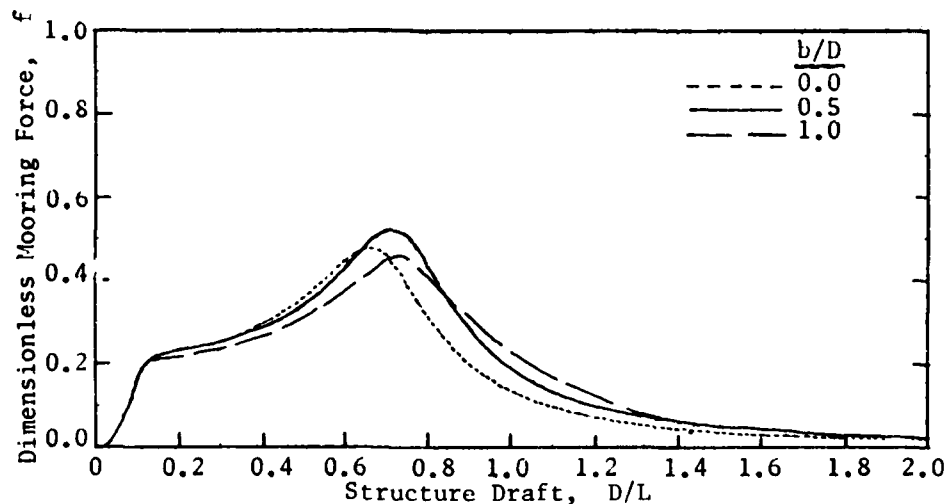


Figure 15. Effect of depth of mooring on mooring force for floating breakwater,  $W = 0$ ,  $k/\rho gL = 1$  (after Stiassnie, 1980).

c. Model by Yamamoto, Yoshida, and Ijima. The two-dimensional problem of wave transformation past, and motions of, moored floating objects has been solved numerically by Yamamoto and Yoshida (1979), Yamamoto, Yoshida, and Ijima (1980), and Yamamoto (1981). They solved this boundary value problem by direct use of Green's identity formula for a potential function. The cross-sectional shape of the floating object, the bottom configuration, and the mooring arrangements may all be arbitrary. For a given incident wave, the three modes of body motion, the wave system, and mooring forces are all solved at the same time. A laboratory experiment was conducted to verify the theory. Generally, good agreement between the theory and experiments was obtained as long as the viscous damping due to flow separation was small. This numerical study indicates that a conventional slack mooring worsens wave attenuation by a floating breakwater; a properly arranged elastic mooring can considerably improve attenuation characteristics.



The definitive sketch of the problem is given in Figure 16, where an arbitrarily shaped floating object is moored with elastic lines. The spring constants, the initial tension, and the number of attachment points of the mooring lines are also arbitrary. The center of gravity,  $\bar{G}$ , and the center of buoyancy,  $\bar{B}$ , are shown at hydrostatic conditions. Because of the incident wave, the object is assumed to undergo a small amplitude oscillation resulting in an alteration of the center of buoyancy and the metacentric height. The fluid motion is assumed to be inviscid and irrotational, so there is a velocity potential which satisfies the Laplace equation. The floating object reflects and transmits the incident wave and creates a local standing-wave system near the object, usually called scattered waves. The potential function for the scattered waves was expanded into an infinite series of scattered wave terms which decays exponentially with distance from the object. If imaginary boundaries are taken sufficiently away from the object to eliminate the effects of the local standing wave, it can be assumed that only the incident and reflected waves exist in the region (0), and that only the transmitted waves exist in the region (0') (see Fig. 16). The potential functions for these regions are straightforward. The potential function for region (I) (Fig. 16) was determined from Green's identity formula and the equations of motion for the floating structure.

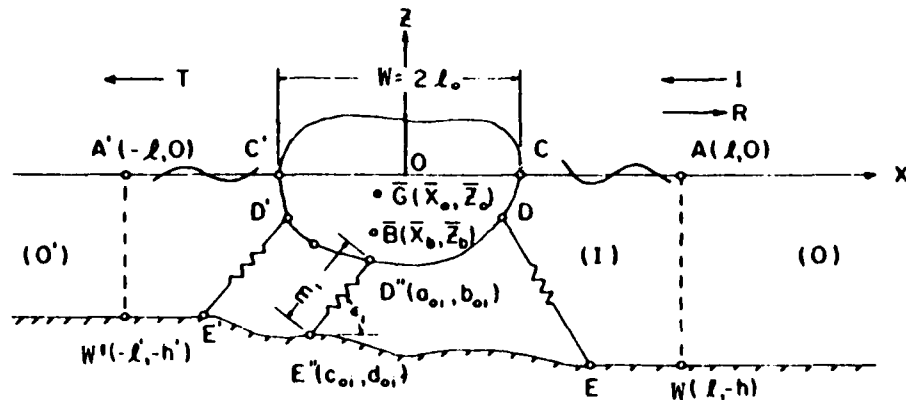


Figure 16. Definitive sketch of a floating object (after Yamamoto, Yoshida, and Ijima, 1980).

Yamamoto, Yoshida, and Ijima (1980) considered only the two-dimensional problem; the values of forces, moments, volumes, and spring constants have the dimensions per unit length of the floating body. At a given instant, the location of the center of gravity,  $\bar{G}$ , and the rotation,  $\theta$ , of the body are given by

$$x_0 - \bar{x}_0 = X e^{i\omega t} \quad (23)$$

$$z_0 - \bar{z}_0 = Z e^{i\omega t} \quad (24)$$

$$\theta = \Theta e^{i\omega t} \quad (25)$$

where  $\omega$  is the incident wave frequency, and  $X$ ,  $Z$ , and  $\Theta$  are the complex amplitudes of the three modes of motion to be determined. From Newton's second law of motion, the equations of the floating body for sway, heave, and roll modes are given as

$$M \frac{d^2 x_0}{dt^2} = P_x + \sum_{i=1}^n F_x(i) \quad (26)$$

$$M \frac{d^2 z_0}{dt^2} = P_z + P_s + \sum_{i=1}^n F_z(i) \quad (27)$$

$$I \frac{d^2 \theta}{dt^2} = T_d + T_s + \sum_{i=1}^n M_\theta(i) \quad (28)$$

where  $M$  is the mass, and  $I$  is the moment of inertia of the floating body. In equations (26), (27), and (28),  $(P_x, P_z, T_d)$ ,  $(P_s, T_s)$ , and  $(F_x(i), F_z(i), M_\theta(i))$  are the hydrodynamic effects, the hydrostatic effects, and the effects of the  $i$ th mooring line on the sway, heave, and roll modes, respectively. The mass,  $M$ , of the floating body and the moment,  $I$ , about the center of gravity may be expressed in terms of the fluid density,  $\rho$ , and a characteristic length,  $h_0$ , as

$$M = \rho v_1 h_0^2 \quad (29)$$

$$I = \rho v_2 h_0^2 \quad (30)$$

By assuming that the center of gravity of the body is on the vertical line through the center of the waterline,  $CC'$ , in equilibrium condition and by denoting the length of the waterline on the structure by  $2l_0$ , the second moment of the floating plane about the center,  $I_y$ , and the immersed volume of the body,  $V$ , are given by

$$I_y = \frac{2}{3} l_0^3 \quad (31)$$

$$V = v_3 h_0^2 \quad (32)$$

In equations (29), (30), and (32),  $v_1$ ,  $v_2$ , and  $v_3$  are constants, depending on the shape and the density distribution of the floating body, and the initial tension of the mooring lines.

The hydrodynamic forces and moment about the center of gravity are given by taking pressure and moment integrals on the immersed surface.

$$P_x = \int_S^p \cos(v, x) ds \quad (33)$$

$$P_z = \int_S^p \cos(v, z) ds \quad (34)$$

$$T_d = \int_S^p [-(x - \bar{x}_0) \cos(v, z) + (z - z_0) \cos(v, x)] ds \quad (35)$$

The restoring vertical force and moment due to the hydrostatic pressure are given as

$$P_s = -2\rho g l_o Z e^{i\omega t} \quad (36)$$

$$T_s = -\rho g V \left[ \left( \frac{(21^3)_o}{(3V)} \right) - (\bar{z}_o - \bar{z}_b) \right] \theta e^{i\omega t} \quad (37)$$

The linearized forces and moment about the center of gravity due to the *i*th mooring line are given by ignoring the inertia of the mooring line and the viscous forces on the line. The total mooring forces and moment on the body are given as the summation of the effects from all mooring lines as

$$\sum_{i=1}^n F_x(i) = (-k_{xx}X - k_{xz}Z + k_{x\theta}\theta) e^{i\omega t} \quad (38)$$

$$\sum_{i=1}^n F_z(i) = (-k_{zx}X - k_{zz}Z + k_{z\theta}\theta) e^{i\omega t} \quad (39)$$

$$\sum_{i=1}^n M_\theta(i) = (k_{\theta x}X + k_{\theta z}Z - k_{\theta\theta}\theta) e^{i\omega t} \quad (40)$$

where  $k_{xx}$ ,  $k_{xz}$ , etc. are linear spring constants obtained by considering elemental statical mechanics among the displacement of the mooring line cylinder, the elongation, and the change of angle of the mooring line. Substitution of equations (23), (24), (25), and (29) to (40) into equations (26), (27), and (28) yields a system of linear equations with respect to the same number of unknown quantities. This system of equations may be solved simultaneously for all the unknowns by numerical techniques.

Although only simple cases are demonstrated, researchers indicate that the numerical method is particularly useful for investigating the response of, and the wave transformation by floating objects having asymmetrical cross-sectional shapes, even in a water region with irregular bottom boundary configurations. In addition, a great advantage of this method is that the more general, yet rather complicated, problems such as multiple floating objects can be easily analyzed with only a little modification of the flow and boundary conditions.

To verify this numerical technique, Yamamoto, Yoshida, and Ijima (1980) performed large two-dimensional model tests at flume dimensions of 12 feet wide, 15 feet deep, and 342 feet long. The experimental results are compared with the numerically calculated results for the transmission coefficient,  $C_t$ , for a circular cylinder (Fig. 17) and a rectangular cylinder (Fig. 18). Excellent agreement between the theory and experiments for the circular cylinder was found for all the transmission coefficients and body motions. The agreements for the rectangular cylinder were also excellent except at resonant frequencies of the floating body. Theoretically, the cross-spring moored rectangular cylinder transmitted no waves associated with the resonance in heave motion at  $W/L = 0.21$ . At the resonant frequency, the measured wave transmission dropped to 0.40 only, not zero. The reason for this was that the viscous damping due to the flow separation at the sharp corners appeared to dampen the heaving motion of the rectangular cylinder. These comparisons indicate that the theory represents the real flow problem as long as the flow separation is small at the resonant frequencies of the body motion.

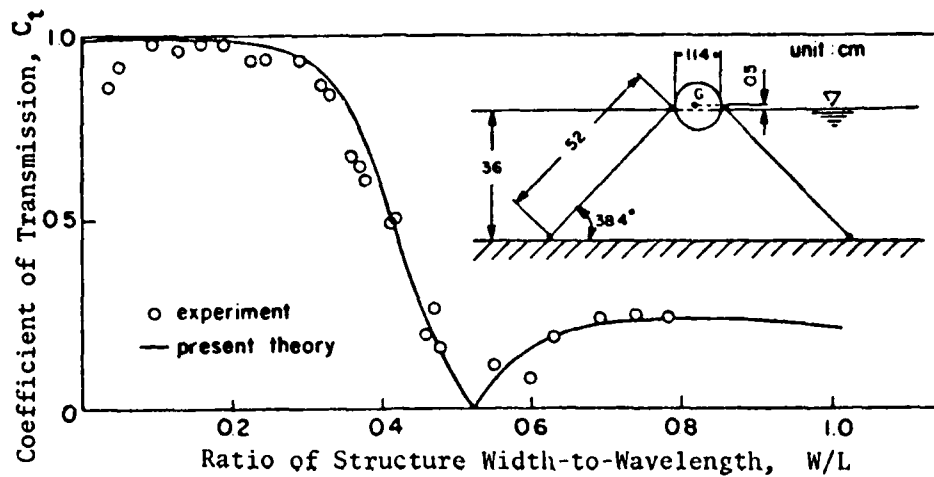


Figure 17. Comparison of theory versus experiment, determination of effect of relative structure width,  $W/L$ , on transmission coefficient,  $C_t$ , for circular cylinder (after Yamamoto, Yoshida, and Ijima, 1980).

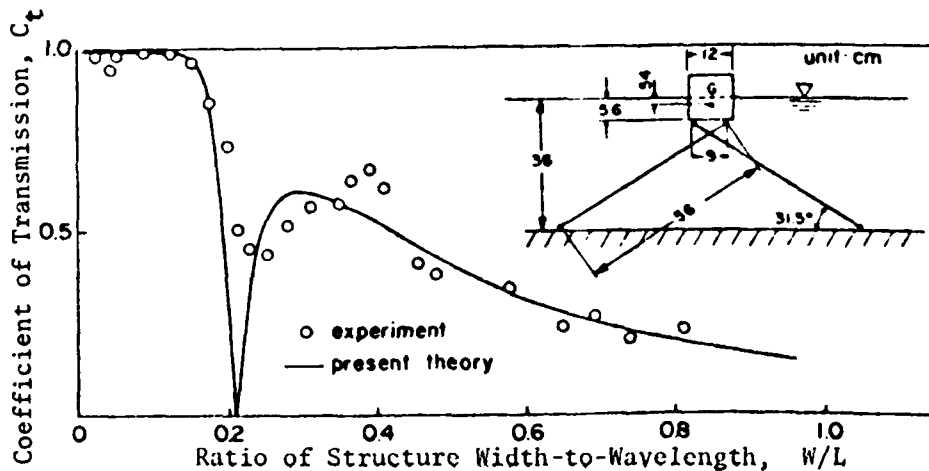


Figure 18. Comparison of theory versus experiment, determination of effect of relative structure width,  $W/L$ , on transmission coefficient,  $C_t$ , for rectangular cylinder (after Yamamoto, Yoshida, and Ijima, 1980).

As an example application of this numerical technique, a series of computations was performed to investigate how the mooring system affects the wave attenuation of a specific floating breakwater structure (Fig. 19). The figure shows the cross-sectional shape of two semicircles connected with parallel sides and the various mooring configurations, where  $k$  is the spring constant of the mooring system. Each body was filled with material of uniform mass density so that the center of gravity was always at the center of the cross section. The drafts were always kept at one-half of the heights of the structures for the free-floating condition. The calculated results of the transmission coefficient are presented in Figure 19. Owing to the small mass and

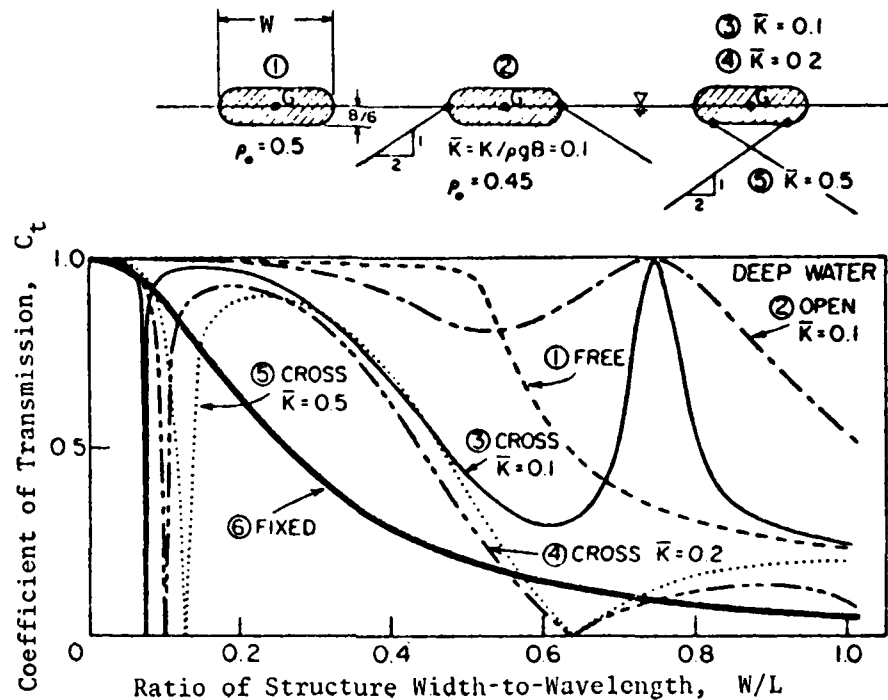


Figure 19. Calculated transmission coefficients for floating structure with various mooring conditions (after Yamamoto, Yoshida, and Ijima, 1980).

draft of the structure, the free-floating condition provides a rather poor wave attenuation (it was effective only to waves smaller than  $1.6 W/L$ ).

The open spring mooring with the dimensionless spring constant,  $\bar{K} = 0.1$ , worsened the results due to the undesirable rolling motion generated by the waves. The conventional slack moorings are usually approximated by open spring moorings with relatively weak spring constants. Hence, the effect of a slack mooring system (e.g., large tidal range) appears to be a worsening of the wave attenuation of a floating breakwater. The cross-spring moorings with  $\bar{K} = 0.20$  or higher significantly improved the wave attenuation. The small wave transmission created by this mooring condition for  $W/L$  values between 0.4 and 0.9 is associated with small body motions.

For this floating body, a cross-spring mooring provides a no-transmission condition at low wave frequencies or long wavelength approximately  $W/L = 0.10$ . These results suggest that in order to effectively use a shallow-drafted floating structure as a breakwater, a cross-spring mooring with proper spring constants can be optimized. If the condition is  $W/L = 0.10$ , the cross-spring mooring would appear to be extremely effective for narrow-banded waves such as ship waves adjacent to floating breakwaters, the problem investigated by Stramandi (1974). Although numerical techniques are continually improved to be adaptable to various structure and boundary conditions, the physical hydraulic model remains a powerful tool to supplement and verify such computational procedures.

#### 4. Applicability of Regular Wave Coefficients to Irregular Wave Climates.

Prototype wave conditions are, for the most part, strongly irregular. Many design coefficients, however, have been developed in laboratory experiments under regular monochromatic wave conditions. Hence, analysis of prototype situations based on regular waves generated in wave tank tests may be inadequate unless appropriate modifications are applied to the irregular spectrum. The transmission coefficient,  $C_t$ , for regular waves can be used to calculate the corresponding coefficients in irregular waves, according to Araki (1978). If the frequency of the incident wave is  $f$ , the transmission coefficient of the regular wave field is  $C_t(f)$ . The frequency spectrum of the transmitted wave,  $S_t(f)$ , is related to the frequency spectrum of the incident wave,  $S_i(f)$ , by

$$S_t(f) = [C_t(f)]^2 \times S_i(f) \quad (41)$$

When the probability density function of the wave heights follows a Rayleigh distribution, the significant wave height of the incident wave,  $(H_i)_{1/3}$ , is

$$(H_i)_{1/3} = 4.0 \sqrt{\int_0^{\infty} S_i(f) df} \quad (42)$$

Hence, the significant wave height of the transmitted wave,  $(H_t)_{1/3}$ , is

$$(H_t)_{1/3} = 4.0 \sqrt{\int_0^{\infty} [C_t(f)]^2 S_i(f) df} \quad (43)$$

The ratio of the significant transmitted wave height,  $(H_t)_{1/3}$ , to the significant incident wave height,  $(H_i)_{1/3}$ , is the significant transmission coefficient,  $(C_t)_{1/3}$

$$(C_t)_{1/3} = \sqrt{\frac{\int_0^{\infty} [C_t(f)]^2 S_i(f) df}{\int_0^{\infty} S_i(f) df}} \quad (44)$$

This description of an ocean wave climate provides for the application of experimental results from periodic wave tests to irregular wave conditions. An objective in the design of mooring systems is to obtain a force spectrum from which the various descriptors of the force (such as maximum probable force) can be evaluated. A pertinent assumption is that if the wave heights are distributed as a Rayleigh function, the mooring forces will be similarly distributed. This assumption allows a researcher to obtain the maximum probable force which can be used to indicate the probable degree of safety of a mooring. When a force spectrum has been obtained from the wave spectrum in the manner of Raichlen (1978), the maximum probable force can be expressed as

$$F_{\max} = 2\sigma \left\{ [2\ln(N)]^{1/2} + \left( \frac{0.5772}{[(2\ln(N))^{1/2}]} \right) \right\} \quad (45)$$

where  $\sigma^2$  is the variance of the force (area under the spectrum curve), and  $N$  is the expected number of waves in a specific storm system.

### III. PONTOON FLOATING BREAKWATERS

To be effective as a breakwater, the motions of a floating structure must be of small amplitude so that the structure does not generate waves into the protected region. Although at resonance the generated waves can be out of phase with the transmitted waves (resulting in lower coefficients of transmission), the structure must respond to a spectrum of incident wave conditions. Hence, the design of a floating structure for resonance characteristics only would not be satisfactory. Designers seek to achieve small wave transmission by incorporating a large mass to resist the exciting forces, and a natural period of oscillation which is long with respect to the period of the waves (Wiegel, 1964). To obtain a long natural period, it is generally necessary to combine large mass with small internal elastic response of the entire system. A floating breakwater should also extend deep enough into the water so that little of the wave kinetic energy can be transmitted beneath the structure. To make the internal elasticity small and the mass large at the same time, the bulk of the breakwater should be below the water surface at all times. A moored structure has an additional elastic restraining force due to the mooring lines, and the mass to be considered is the virtual mass (which includes the added mass term). The simplest forms of floating breakwaters include pontoon structures, although various modifications in geometry have been investigated in an effort to optimize the mass (and ultimately the cost) of potentially viable alternative systems.

#### 1. Single Pontoon.

The rectangular, prismatic (single) pontoon floating breakwater has been considered by several investigators (Carr, 1950; Hay, 1966; Ofuya, 1968; Carver, 1979; Bottin and Turner, 1980) either as a possible system or as a reference for comparison with other potential systems. Patrick (1951), as part of his investigations of a special form of pontoon (the inclined pontoon system), evaluated the efficiency of rectangular blocks in a model study. Blocks of various lengths parallel to the incident wave crest were tested in three different depths of water, at a constant wave steepness and relative water depth, to determine the relationship between the relative breakwater width and the coefficient of transmission. Patrick's analysis showed the existence of transmitted secondary waves in many cases, and showed that transmitted wave heights varied with distance away from the structure. The period of the major transmitted wave was the same as the incident wave, but a secondary wave was superposed. Because the draft-to-depth ratio was found to be a significant variable, studies were conducted with an irregular bottom on the structure which effectively made the draft much deeper. The investigations showed that the irregular bottom was not quite as effective as the prismatic structure; however, the mass was relatively less in the irregular version.

The floating single pontoon investigated experimentally by Ofuya (1968) was a massive structure of rectangular cross section (Fig. 20). This design

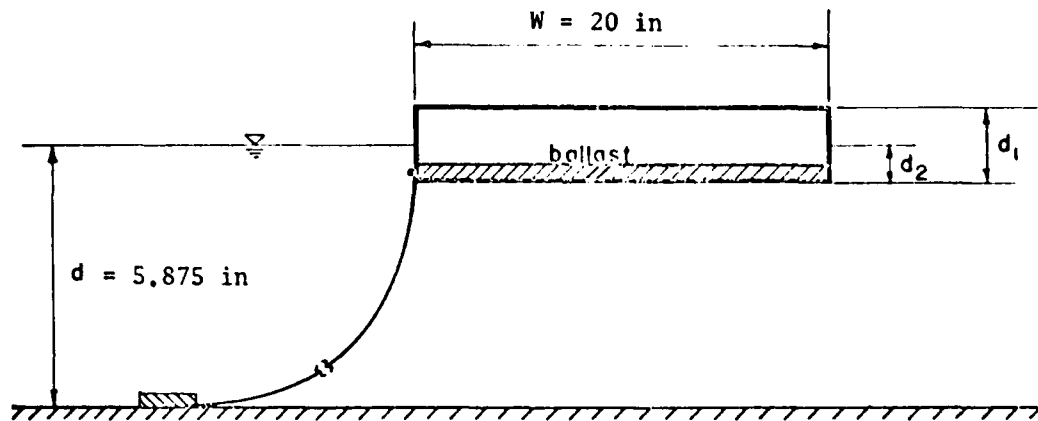


Figure 20. Single-pontoon floating breakwater (after Ofuya, 1968).

concept was based primarily on an attempt to provide a floating breakwater whose wave damping property is derived mainly from the criterion of large mass, which determines the depth of submergence. The radius of gyration remains nearly constant with depth of submergence, but the metacentric height (and hence stability) varies considerably with depth of submergence. It is intuitively logical to believe that the performance characteristics of the single-pontoon floating breakwater will depend not only on the initial wave steepness,  $H_i/L$ , and relative breakwater width,  $W/L$ , but also on the ratio of natural period of oscillation of the structure,  $T_n$ , to incident wave period,  $T$ . The natural period of heaving motion depends on the mass and elasticity. An increase in mass causes a proportional increase in draft, and the elasticity of the system remains nearly constant; hence, an increase in mass produces an increase in the natural period of oscillation.

Ofuya (1968) determined that for a 100-percent increase of mass (all other parameters remaining constant), the natural periods of heave and roll increase by 40 and 33 percent, respectively. However, he found that the metacentric height, which determines the stability of the floating body, decreased by about 45 percent. This decrease of metacentric height with increase of mass imposes a limitation on the extent to which the natural period of oscillation of a single pontoon may be increased.

a. Two-Dimensional Wave Attenuation Tests. Ofuya (1968) conducted experimental studies of a two-dimensional nature to determine the attenuation effectiveness of the single-pontoon floating breakwater. The results are shown in Figure 21 as transmission coefficient,  $C_t$ , versus relative water depth,  $L/d$ , for three different depths of submergence. The structure was found to be effective in damping waves over a wide range of values of  $L/d$ ; the difference in effectiveness between the pontoons of different submergence is small in the lower range of values of  $L/d$  but tends to increase for large values of  $L/d$ . A nonuniformity in the data display occurred because of harmonic components in the response characteristics of the breakwater.

Carver (1979) conducted two-dimensional (and three-dimensional) wave attenuation tests for the proposed floating breakwater at East Bay Marina, Olympia Harbor, Washington. This harbor is located in the extreme southern



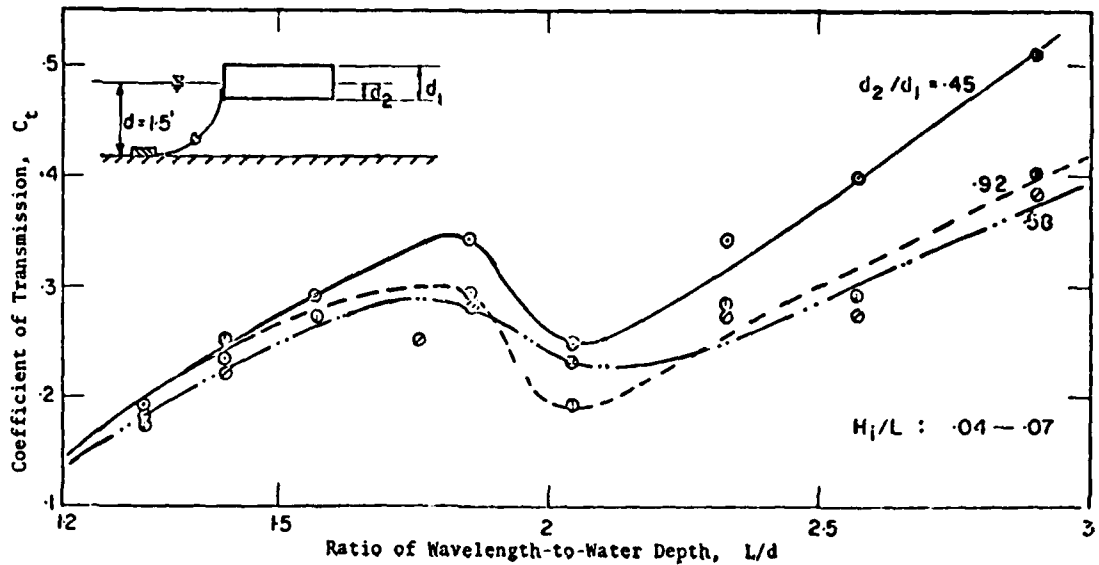


Figure 21. Effect of relative submergence,  $d_2/d_1$ , and relative water depth,  $L/d$ , on coefficient of transmission,  $C_t$ , of single-pontoon floating breakwater (after Ofuya, 1968).

reach of the semiprotected Puget Sound about 60 miles southwest of Seattle. The floating breakwater is to protect a small-boat marina which is being developed in the eastern part of the harbor. The proposed marina is exposed to short-period wind waves from the northwest clockwise to the north. The significant waves from the exposed directions range up to 2.8 seconds in period and 2.0 feet in height. Although model tests performed by Kamel and Davidson (1968), Davidson (1971), and Nece and Richey (1972) provided data on the wave attenuation capability of floating structures composed of tires, spheres, or a rectangular float, these data were not directly applicable to the East Bay Marina design because of certain site-specific conditions. Carver's (1979) study objective became twofold when it was believed that the wave attenuation could not be analytically predicted with sufficient accuracy at the time. A hydraulic model investigation appeared to offer the best means of accurately and reliably comparing the performance of potential floating breakwater plans. Initially, the wave attenuating properties of four floating breakwater cross sections were to be determined by two-dimensional flume tests for a selected range of wave conditions. Secondly, based on the two-dimensional test results and relative costs of the structures, the best plan was selected for three-dimensional testing. The three-dimensional tests investigated the combined effects of angular wave attack, structure alignment, wave transmission, and wave diffraction around the exposed end of the breakwater.

Tests were conducted at an undistorted linear scale of 1:10, model to prototype. All the model test sections were designed and constructed so that centers of gravity and buoyancy, draft, mass moments of inertia, and water-plane moments of inertia properly simulated those of the prototype structures under consideration. Although the prototype structures consisted of basic units of polystyrene foam covered with a concrete shell and added ballast that were posttensioned together, the model breakwaters were necessarily

constructed of marine plywood, galvanized sheet steel, and Styrofoam to allow better reproduction of the floating and dynamic characteristics of the breakwaters. Model design calculations included all the major materials used in the prototype modules, i.e., concrete, polystyrene, and posttensioned steel, but did not include the anchor-chain hardware connections and the bumper material between the modules because their proposed weight would be negligible in the overall considerations. The model structures floated within 0.10 foot prototype of the proposed structure.

All plans were tested with 72-foot-long anchor chains. The prototype chain, weighing 14.2 pounds per linear foot, was reproduced in the model by U.S. No. 1 double-link chain which had an approximate weight of 0.14 pound per linear foot, thus providing proper undistorted Froudian scaling. Tests were conducted in a flat-bottomed wave basin about 56 feet wide and 90 feet long (Fig. 22). A semiportable wall was used to create flume widths of 10 and 12.4 feet for two-dimensional tests and 35.5 feet for three-dimensional tests. Fibrous wave absorber was placed in the ends of the flume to dissipate wave energy that might otherwise be reflected from the model walls. Waves were generated by a 35.5-foot-long horizontal-displacement wave generator.

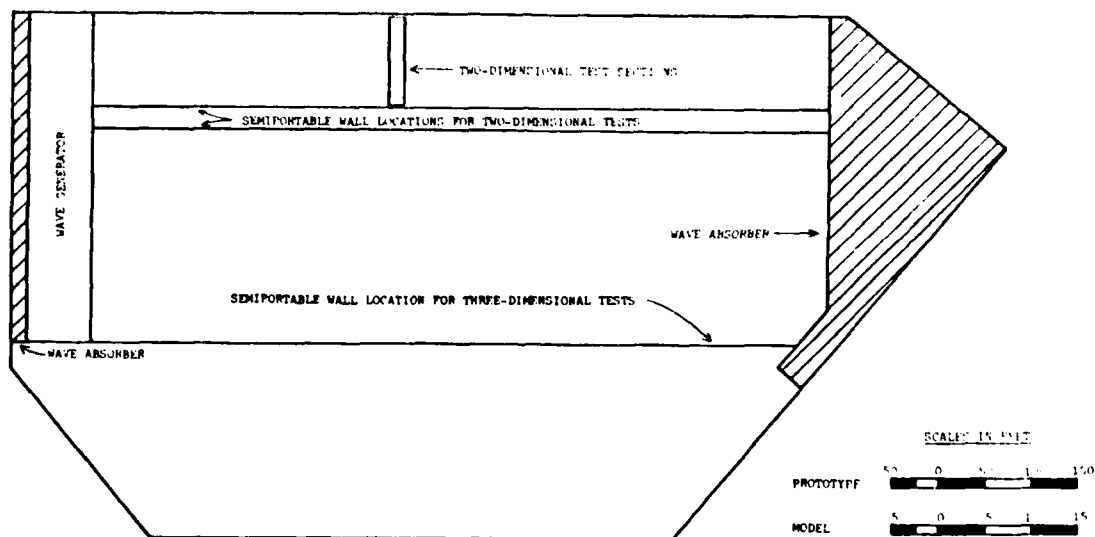


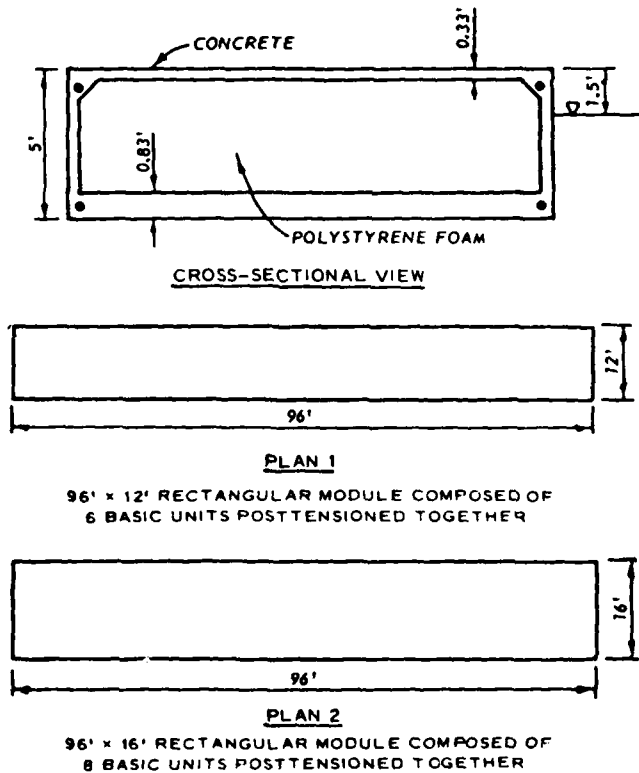
Figure 22. Physical model test facility for wave attenuation effectiveness of single-pontoon floating breakwater proposed for Olympia Harbor, Washington (after Carver, 1979).

Carver (1979) evaluated three single-pontoon floats. Specific details of the various plans were as follows:

(a) Plan 1 was a 12- by 96-foot rectangular float with a draft of 3.5 feet. The prototype structure weighed 258,000 pounds and had a unit weight of 44.8 pounds per cubic foot. Plan 1 was modeled with a uniform cross-sectional structure, 1.2 feet wide by 9.6 feet long, weighing 252 pounds with a unit weight of 43.7 pounds per cubic foot.

(b) Plan 1A was identical to Plan 1 except a 3.5-foot-high vertical-barrier plate was added to the bottom of the structure's seaward face.

(c) Plan 2 was a 16- by 96-foot rectangular float with a draft of 3.5 feet. The prototype structure weighed 344,000 pounds and had a unit weight of 44.8 pounds per cubic foot. The plan 2 model breakwater also had a uniform cross section, 1.6 feet wide by 9.6 feet long, weighed 335 pounds, and had a unit weight of 43.7 pounds per cubic foot. The details of plans 1 and 2 are shown in Figure 23.

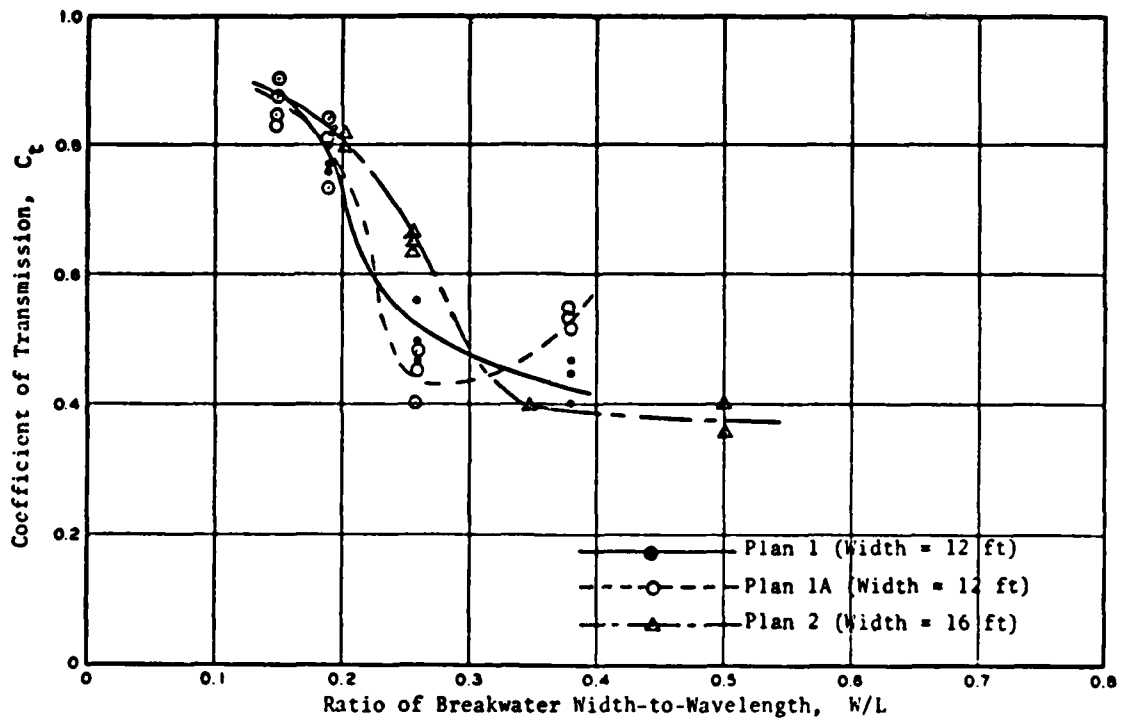


**WEIGHTS AND UNIT WEIGHTS**

CONFIGURATION	WEIGHT, lb	UNIT WEIGHT, lb/ft <sup>3</sup>
PLAN 1	259,000	44.8
PLAN 2	344,000	44.8

Figure 23. Details of plans 1 and 2 for single-pontoon floating breakwater evaluated in two-dimensional wave flume for potential application at Olympia Harbor, Washington (after Carver, 1979).

All the plans investigated utilized crossed anchor chains; i.e., beach-side anchor points on the breakwater were connected to seaside anchor points on the floor, and seaside anchor points on the breakwater were connected to beach-side anchor points on the floor. Wave attenuation tests were conducted in 25 feet of water (representative of high tide conditions in Olympia Harbor) with prototype wave periods of 2.5, 3.0, 3.5, 4.0, and 4.5 seconds. Test waves ranged in height from 1.5 to 3.5 feet incident, and transmitted waves were measured one wavelength behind the structure. The two-dimensional transmission coefficients,  $C_t$ , for plans 1, 1A, and 2 are presented in Figure 24.



**COEFFICIENT OF TRANSMISSION ( $C_t$ )  
VERSUS RELATIVE WIDTH ( $W/L$ )  
TWO-DIMENSIONAL TESTS**

NOTE: NUMBERS BESIDE DATA POINTS  
INDICATE THAT THE NUMBER  
OF DATA POINTS EXCEEDS ONE.

Figure 24. Effect of relative breakwater width,  $W/L$ , on coefficient of transmission,  $C_t$ , for single-pontoon floating breakwater evaluated in two-dimensional wave flume for potential application at Olympia Harbor, Washington (after Carver, 1979).

Carver (1979) observed that the plans 1 and 1A test results afforded some interesting comparisons. Based solely on the physical dimensions of the structure, it is probably reasonable to assume that for the range of wave conditions tested, plan 1A exhibited a slight increase in performance relative to plan 1. Actually, plan 1A exhibited slightly higher transmitted values for the 2.5-second wave period, slightly lower values for the 3.0-second wave period, and almost the same values for the 3.5-second wave period. The dynamic response of plan 1A was significantly different from Plan 1. A decrease in roll and an increase in heave was observed for all wave conditions; consequently, the mechanism of wave transmission was fundamentally different, thus accounting for the variations in transmitted wave heights. Based on these observations (Carver, 1979), the decrease seems to result from wave components generated by heave and sway motions being almost  $180^\circ$  out of phase and tending to cancel each other. Since plans 1 and 2 were both single-pontoon floats with widths of 12 and 16 feet, respectively, plan 2 was expected to generally yield somewhat lower transmitted wave heights than plan 1. There was, indeed, a consistent trend of plan 2 exhibiting an increase in performance relative to plan 1 for  $W/L$  values greater than about 0.3; however, this improved performance was not discernible at smaller values of  $W/L$ .

b. Three-Dimensional Wave Attenuation Tests. Based on the two-dimensional test results and relative costs of the plans investigated by Carver (1979), it was determined that plan 1, with proper alignment of the structures, could provide adequate and economical protection. Therefore, it was decided to initially test four configurations of plan 1 in the 25-foot depth, and based on the test results, to select two configurations for testing in a 10-foot depth. The 10-foot depth represents low tide conditions at Olympia Harbor. To investigate the combined effects of transmission and diffraction, three modules of plan 1 were used. Tests were conducted with the anchor chains crossed and the breakwater sections arranged in the following configurations: 60° linear, 75° linear, concave, and convex. The layout of the three-dimensional 60° configuration is shown in Figure 25.

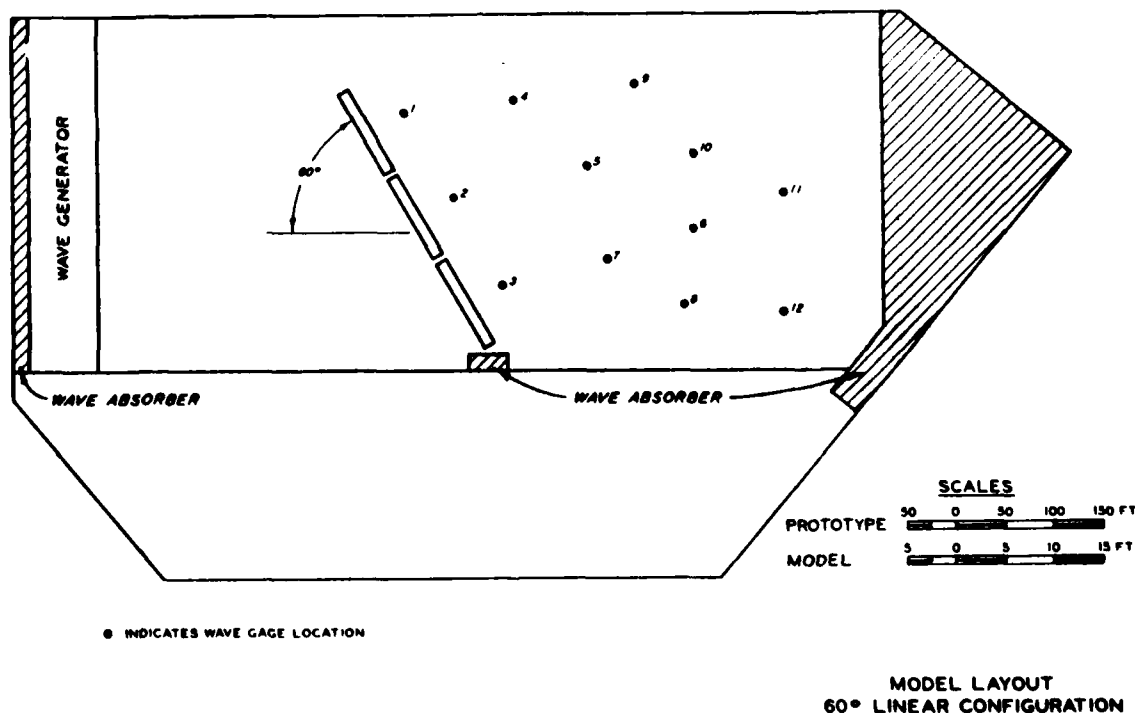


Figure 25. Three-dimensional physical model configuration of single-pontoon floating breakwater for potential application at Olympia Harbor, Washington (after Carver, 1979).

For all configurations, transmitted wave heights were measured directly behind the breakwaters (gages 1, 2, and 3), in the vicinity of the proposed marina (gages 11 and 12), and at selected intermediate locations (gages 4 to 10). Transmitted wave heights and coefficients of transmission for the 25-foot depths are presented in Table 1 for two representative sets of conditions. It is apparent from these data that no specific configuration yields consistently lower transmitted heights for all test conditions at all gage locations. The model study showed that no adverse motions of the structures were observed for the range of configurations and test conditions. Also, no violent motions of roll, pitch, heave, or sway were observed. The model did not simulate any type of bumper system between individual sections; however,

Table 1. Three-dimensional tests of plan 1 for two sets of conditions at d = 25 feet (Carver, 1979).

Gage No.	Configuration							
	60° linear		75° linear		Concave		Convex	
	H <sub>t</sub> (ft)	C <sub>t</sub>	H <sub>t</sub> (ft)	C <sub>t</sub>	H <sub>t</sub> (ft)	C <sub>t</sub>	H <sub>t</sub> (ft)	C <sub>t</sub>
T = 2.5 s, H <sub>1</sub> = 1.5 ft								
1	1.1	0.73	0.5	0.33	1.1	0.73	0.5	0.33
2	0.5	0.33	0.4	0.27	0.6	0.40	0.9	0.60
3	0.4	0.27	0.2	0.13	0.3	0.20	0.4	0.27
4	0.9	0.60	0.8	0.53	0.8	0.53	0.3	0.20
5	0.4	0.27	0.4	0.27	0.3	0.20	0.9	0.60
6	0.5	0.33	0.5	0.33	0.3	0.20	0.4	0.27
7	0.3	0.20	0.6	0.40	0.5	0.33	0.6	0.40
8	0.3	0.20	0.2	0.13	0.3	0.20	0.4	0.27
9	0.8	0.53	1.4	0.93	0.9	0.60	1.0	0.67
10	0.6	0.40	0.4	0.27	0.5	0.33	0.8	0.53
11	0.7	0.47	0.5	0.33	0.7	0.47	0.4	0.27
12	0.6	0.40	0.3	0.20	0.3	0.20	0.5	0.33
T = 3.5 s, H <sub>1</sub> = 2.5 ft								
1	1.7	0.68	1.8	0.72	1.9	0.76	2.0	0.80
2	1.7	0.68	1.9	0.76	2.3	0.92	2.2	0.88
3	1.8	0.72	1.2	0.48	2.3	0.92	1.7	0.68
4	2.0	0.80	1.9	0.76	2.1	0.84	2.5	1.00
5	2.1	0.84	1.4	0.56	1.7	0.68	1.7	0.68
6	1.9	0.76	1.7	0.68	2.0	0.80	2.2	0.88
7	2.0	0.80	1.5	0.60	2.2	0.88	2.0	0.80
8	2.1	0.84	1.3	0.52	1.9	0.76	1.8	0.72
9	2.4	0.96	2.7	1.08	2.3	0.92	2.1	0.84
10	1.8	0.72	1.5	0.60	2.0	0.80	2.2	0.88
11	1.9	0.76	1.7	0.68	1.8	0.72	1.9	0.76
12	1.8	0.72	1.5	0.60	2.1	0.84	1.8	0.72

even though the sections occasionally bumped each other, they were never observed to violently collide. Relative to the 25-foot depth, the 10-foot depth generally resulted in slightly lower transmitted wave heights, and the 75° linear configuration appeared to provide slightly better protection. A summary of the various data is presented in Figure 26.

Separate and distinct three-dimensional model tests have been performed at the U.S. Army Engineer Waterways Experiment Station (WES) to evaluate a proposed single-pontoon floating breakwater system on Lake Pontchartrain, Louisiana. The Seabrook Lock complex will be constructed on the south shore of the lake at its junction with the Inner Harbor Navigation Canal. The installation of a breakwater lakeward of the lock is proposed to provide wave protection to the lock entrance. U.S. Army Engineer District, New Orleans, requested that a hydraulic model investigation be conducted to (a) determine wave conditions at the lock entrance with no breakwater protection, (b) determine the degree of protection afforded by the various proposed breakwater

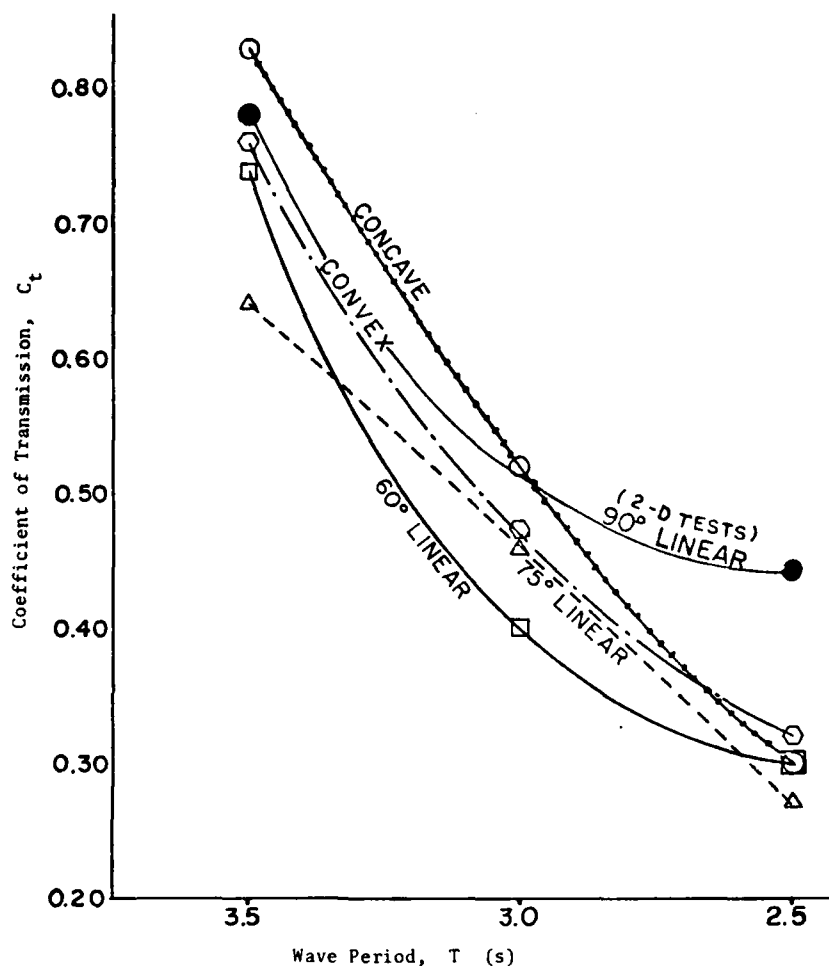


Figure 26. Summary of three-dimensional experimental study of single-pontoon floating breakwater investigation, East Bay Marina, Olympia Harbor, Washington (averages of gages 2, 3, 6, 7, 8, 11, and 12) (after U.S. Army Engineer District, Seattle, 1979).

plans, (c) develop additional plans as necessary for the alleviation of undesirable wave conditions, and (d) determine if modifications of the proposed breakwaters could be designed to reduce construction costs significantly and still provide wave protection.

For this study, it was specified that for an improvement plan to be acceptable, maximum wave heights in the Seabrook Lock entrance should not exceed 2.0 feet. However, it was desired, if possible, that maximum wave heights in the lock entrance not exceed 1.0 foot. To achieve the established wave height criterion at the lock entrance with floating structures (providing 50 percent attenuation for waves approaching from a direction perpendicular to the structure), Bottin and Turner (1980) determined that a total breakwater length of 5,088 feet is required, consisting of two outer and three inner breakwaters (Fig. 27). The typical wave pattern for a 3-second, 4.0-foot wave is shown in Figure 28.

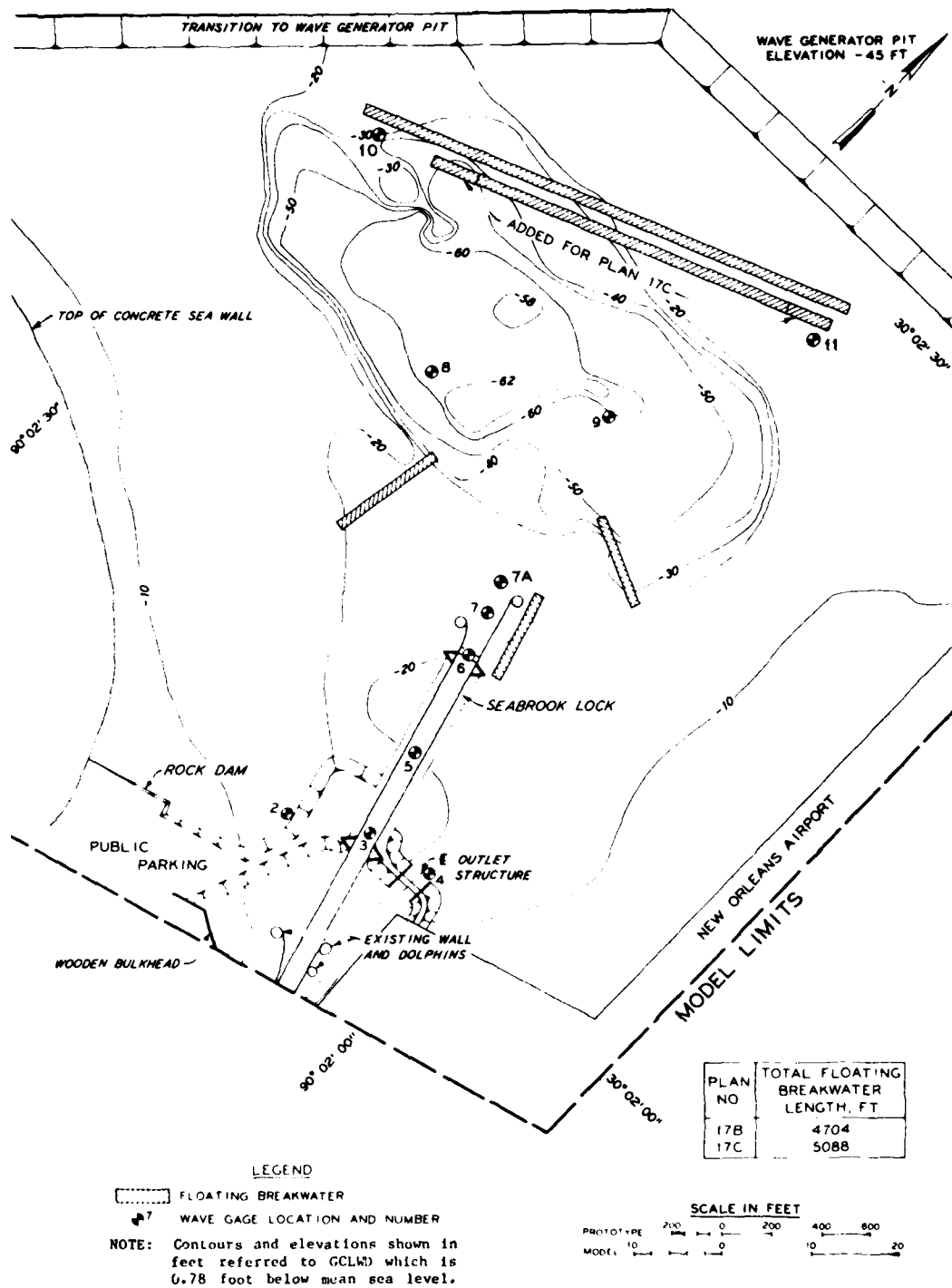


Figure 27. The proposed single-pontoon floating breakwater configuration for Seabrook Lock Complex, Lake Pontchartrain, Louisiana (after Bottin and Turner, 1980).





Figure 28. Wave protection by a double section of a single-pontoon floating breakwater configuration, Seabrook Lock Complex, Lake Pontchartrain, Louisiana, at  $T = 3$  seconds,  $H_i = 4$  feet (after Bottin and Turner, 1980).

## 2. Double Pontoons.

The double-pontoon floating breakwater (Fig. 29) consists of two massive units of rectangular cross sections which are rigidly connected at intervals only. The essentially open interior allows turbulent energy dissipation between the separate single-pontoon sections. The design concept is based on an attempt to dampen waves by primarily wave reflection from a massive structure with a large radius of gyration which experiences only small displacements, the turbulence mechanism playing a secondary role.

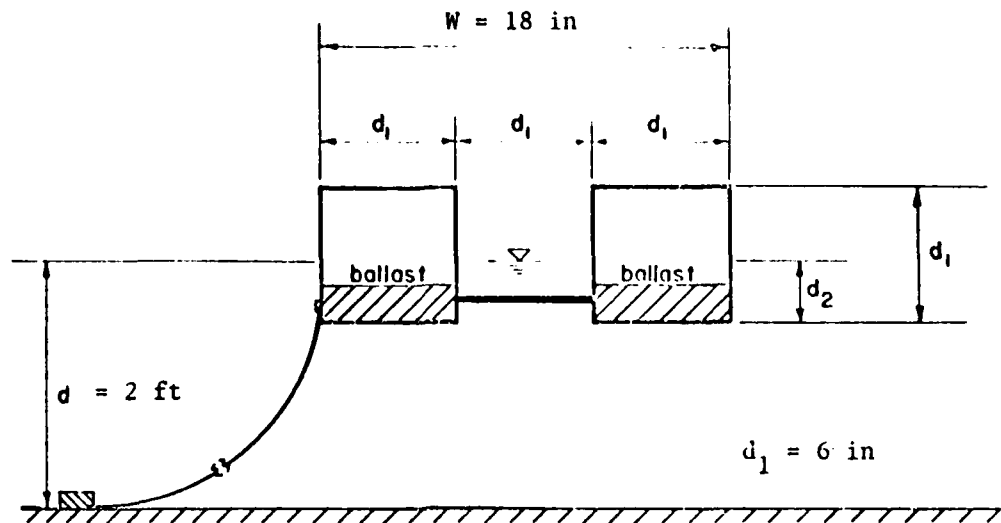


Figure 29. Double-pontoon floating breakwater (after Ofuya, 1968).

Ofuya (1968) conducted experimental studies to determine the effectiveness of the double-pontoon concept of floating breakwater on wave attenuation; these data are shown in Figure 30. The coefficient of transmission,  $C_t$ , is also shown versus the ratio of structure period of oscillation,  $T_n$ , to wave period,  $T$  (Fig. 31). These data show that the effectiveness of the breakwater in wave damping increases with increase of mass (which involves slight reductions in the values of radii of gyration). The similarity between the results of the single pontoon and the double pontoon is evident by comparing Figures 21 and 30. The comparison indicates the single pontoon is significantly better, from the wave transmission standpoint, for values of  $L/d$  greater than approximately 1.7; however, the significance becomes less apparent at lower values of  $L/d$ . The geometric properties of both the single and the double pontoons are presented in Table 2 for comparison.

## 3. Catamaran-Type (Twin Pontoons).

When the development of a small-boat basin at Oak Harbor, Washington, was proposed, attention was directed toward the establishment of effective breakwater designs in this region where maximum tide elevation is +14.5 feet mean lower low water (MLLW). The harbor, which is primarily a pleasure boat and small fishing boat haven, is located on the mainland side of Whidbey Island in Puget Sound, and is therefore not directly exposed to large ocean waves. The maximum waves from the exposed directions range up to 3.5 seconds in period

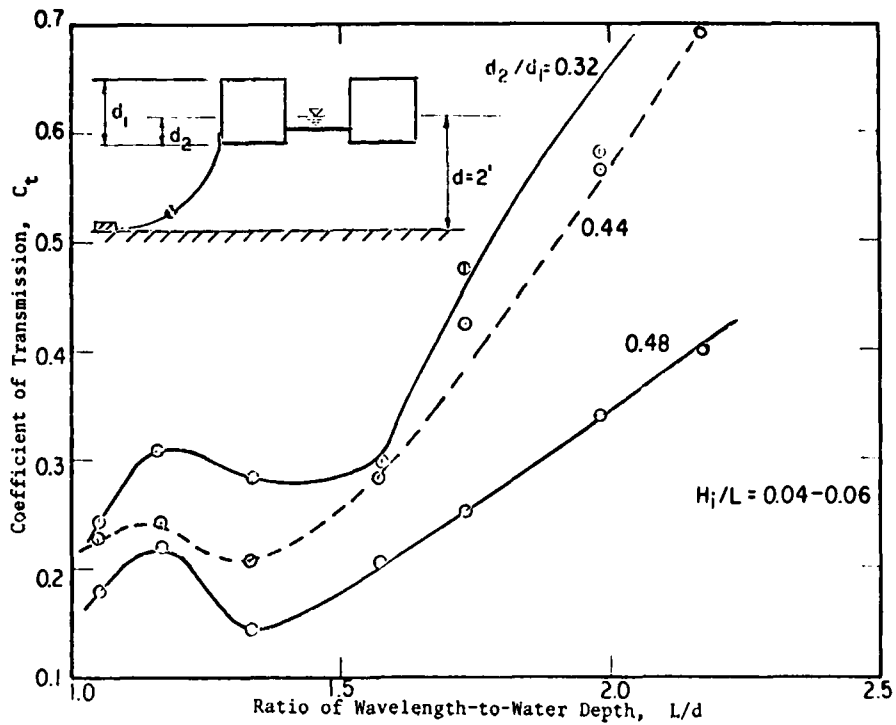


Figure 30. Effect of relative submergence,  $d_2/d_1$ , and relative water depth,  $L/d$ , on transmission coefficient,  $C_t$ , of double-pontoon floating breakwater (after Ofuya, 1968).

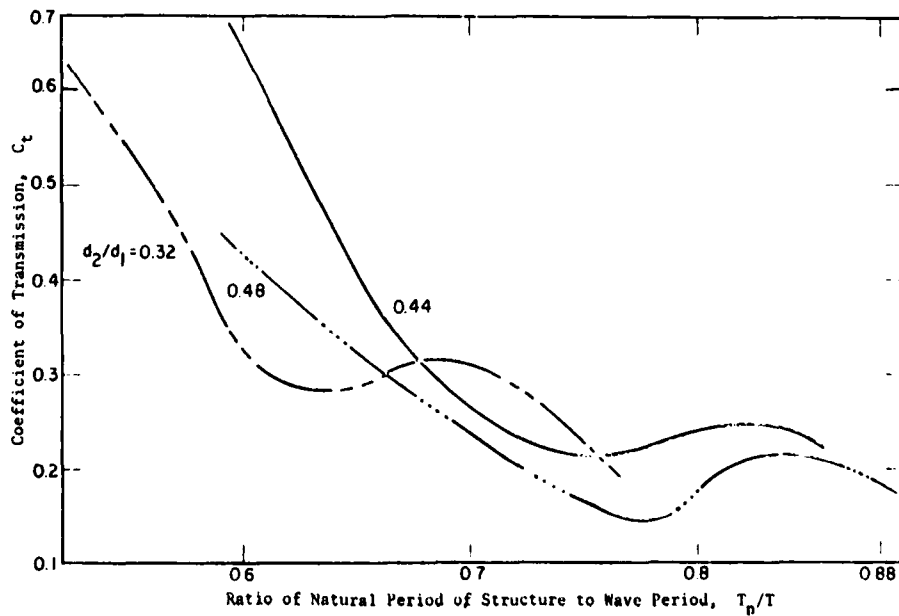


Figure 31. Effect of natural period increase of oscillation on transmission coefficient,  $C_t$ , of double-pontoon floating breakwater (after Ofuya, 1968).

Table 2. Properties of single- and double-pontoon floating breakwaters (after Ofuya, 1968).

$d_2/d_1$	Wt. (lb)	Radius of gyration (ft)	Metacentric height (ft)	Natural period		$T_h/T_r$
				Heaving (s)	Rolling (s)	
Single pontoon						
0.45	45	0.475	1.023	0.52	0.52	1.00
0.58	58	0.470	0.814	0.59	0.58	1.02
0.92	92	0.468	0.556	0.74	0.70	1.07
Double pontoon						
0.32	20	0.539	1.600	0.44	0.47	0.94
0.44	27	0.530	1.182	0.52	0.54	0.96
0.48	29	0.528	1.073	0.54	0.57	0.96

and 2.0 feet in height. It was desired that wave heights within the proposed basin not exceed 0.5 foot. Soil studies of the east and south sides of the proposed basin showed an unsuitable foundation for the construction of rubble-mound or composite-type breakwaters. Therefore, because of the poor foundation conditions and relatively large range of tides, a 2,509-foot-long floating catamaran-type breakwater was proposed.

The potential structure consisted of rectangular wooden modules, each approximately 42.5 feet long, 10 feet wide, and 7.2 feet deep, fastened together to obtain the required breakwater length. Each module had a wooden framework covered with wood decking on the top and sides, concrete beams for ballast, and polystyrene for flotation. The proposed mooring system consisted of either chain mooring lines fastened to concrete anchors both seaward and shoreward of the breakwater, or piles placed between the breakwater modules. Davidson (1971) conducted two-dimensional model tests to obtain wave attenuation characteristics and mooring forces for the proposed structure (Fig. 32). Tests were conducted on a 1:10 scale model specifically to determine (a) the effectiveness of the proposed structure in reducing the existing wave heights, (b) the mooring forces for both the chain- and the pile-type mooring systems, (c) whether or not the proposed breakwater and mooring system would oscillate in resonance with the existing wave conditions, and (d) the natural period of oscillation of the proposed breakwater while unrestrained in still water.

One module of the proposed Oak Harbor, Washington, floating breakwater was reproduced, using a linear scale of 1:10. In the model, the chain mooring system consisted of two anchor chains on each side (both the sea and harbor) of the breakwater module. Each chain was fastened to strain-gage measuring devices on the bottom of the test flume to measure the forces in the mooring lines. The pile mooring system consisted of a pile on each end of each module. Each of these piles was fitted with a strain gage at the bottom of the flume that was calibrated to measure the seaside and harborside forces in the direction parallel to that of wave travel.

a. Transmission Tests with Chain Mooring System. Tests were conducted at the 10- and 29.5-foot water depths for the selected wave conditions. The flotation depth of the modules at the 29.5-foot water depth was 5.0 feet; each of the four anchors had an initial tension force of about 2,200 pounds (about 100

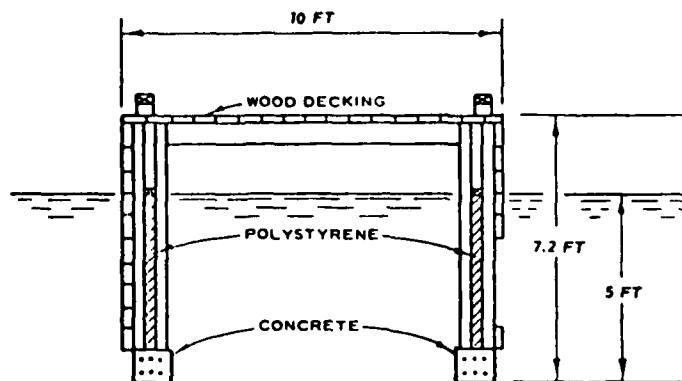


Figure 32. Two-dimensional model arrangement of catamaran-type (twin pontoons) floating breakwater, Oak Harbor, Washington (after Davidson, 1971).

pounds per foot of structure width perpendicular to the direction of wave travel). When the water level was lowered to the 10-foot depth, most of the anchor chains lay on the flume bottom; thus the initial tension on the anchors was reduced to zero and the draft of the floating module was decreased to approximately 3.8 feet. Figure 33 shows the chain mooring system at the 29.5-foot water depth.

Transmitted wave heights at the two depths were measured at a distance of one and one-half wavelengths from the structure (Fig. 34). These data indicate that the transmitted wave height varies more with wave period than with change in water depth. For an allowable transmitted wave height of 0.5 foot, proposed modules, using a chain mooring system, would not be adequate for incident waves greater than approximately 2.0 feet in height and approximately 2.5 seconds in period. During wave attack, the module oscillated about its longitudinal centerline and at the same time rocked with the waves. Over-topping of the module began with lesser wave heights at the 29.5-foot depth because the initial tension in the chain restraints limited the upward motion of the module at this depth more than at the 10-foot depth. During the transmission tests, the module was not observed to be in resonance with any of the wave periods tested. Also, an analysis of the wave data did not indicate that the breakwater module would create larger transmitted wave heights due to resonance.

b. Transmission Tests with Pile Mooring System. Davidson (1971) also performed tests at the 10- and 29.5-foot water depths to determine the effectiveness of the proposed catamaran-type breakwater with a pile mooring system (Fig. 35). The flotation depth at both water depths was 5.0 feet. The results of the transmission tests with a pile mooring system are shown in Figure 36. These data indicate that, with the exception of the 3.0-second wave period, the transmitted wave height again varied more with wave period than with change in water depth. The 3.0-second wave period at both depths caused the breakwater module to rock in such a fashion that larger transmitted wave heights were produced than had been anticipated, resulting from resonant action of the system. For a maximum incident wave height of 2.0 feet and an allowable transmitted wave height of 0.5 foot, a breakwater constructed of the catamaran-type modules would be inadequate for wave periods greater than 2.5 seconds.

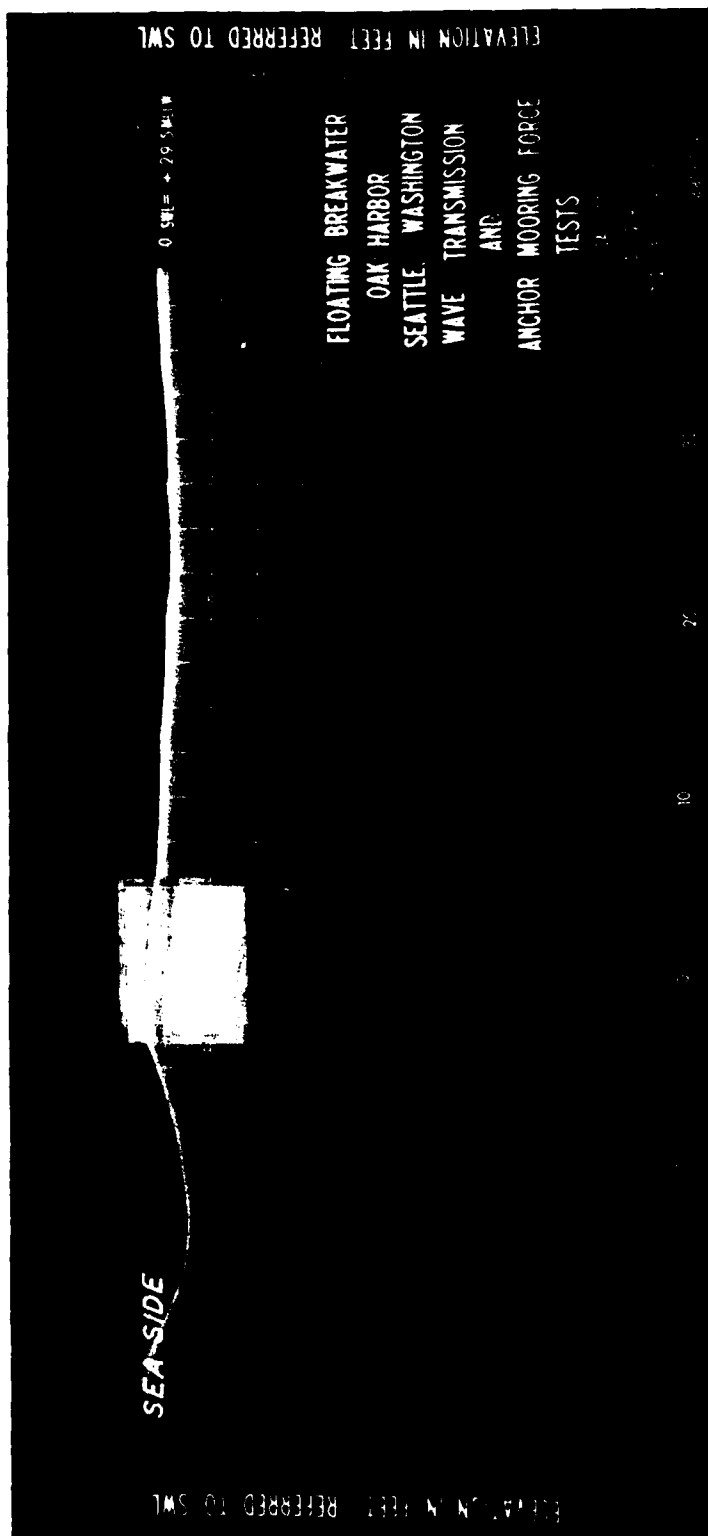
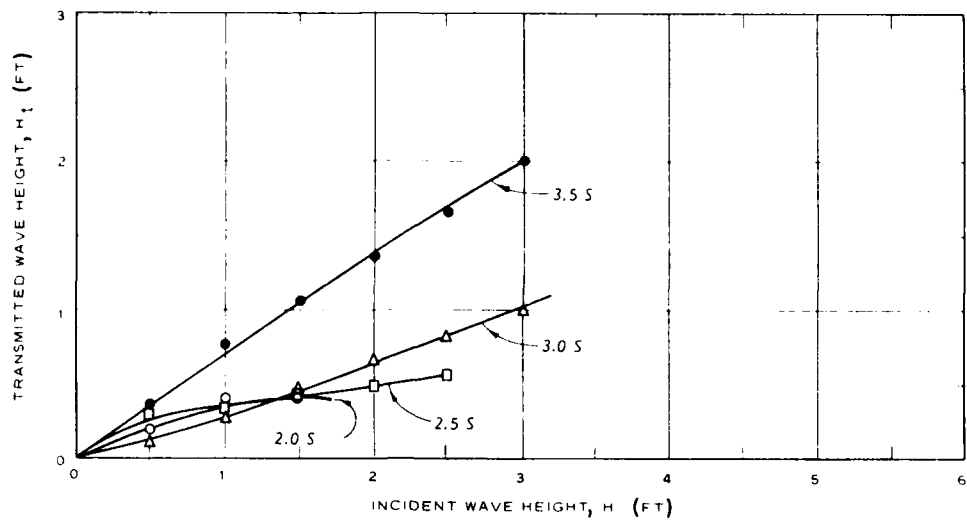
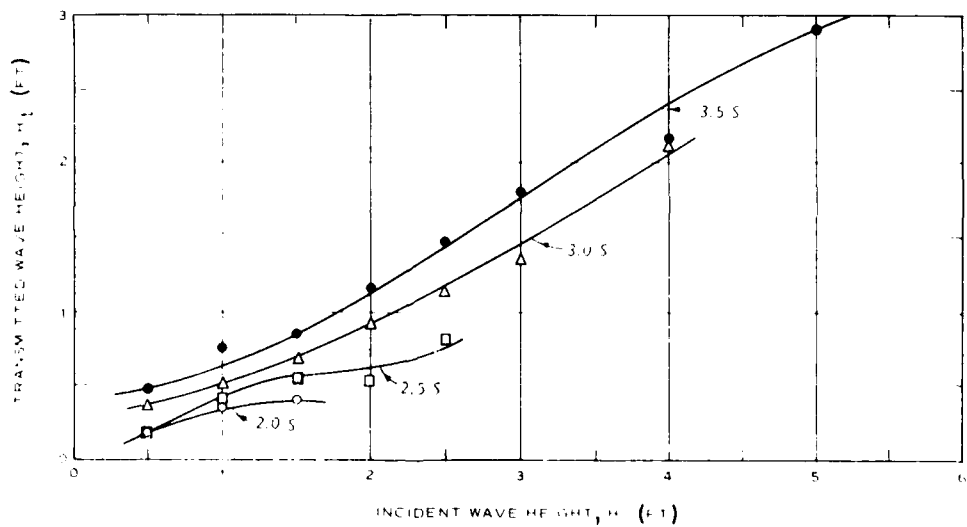


Figure 33. Two-dimensional model tests of a chain mooring system, catamaran-type (twin pontoons) floating breakwater, Oak Harbor, Washington (ends of the breakwater module were sealed for stability), at a wave period of 2.0 seconds, a wave height of 1.5 feet, and a water depth of 29.5 feet prototype (after Davidson, 1971).



d = 10 FT



d = 29.5 FT

LEGEND

SYMBOL	T SEC
○	2.0
□	2.5
△	3.0
●	3.5

Figure 34. Wave transmission tests of the chain mooring system, catamaran-type floating breakwater, Oak Harbor, Washington (after Davidson, 1971).

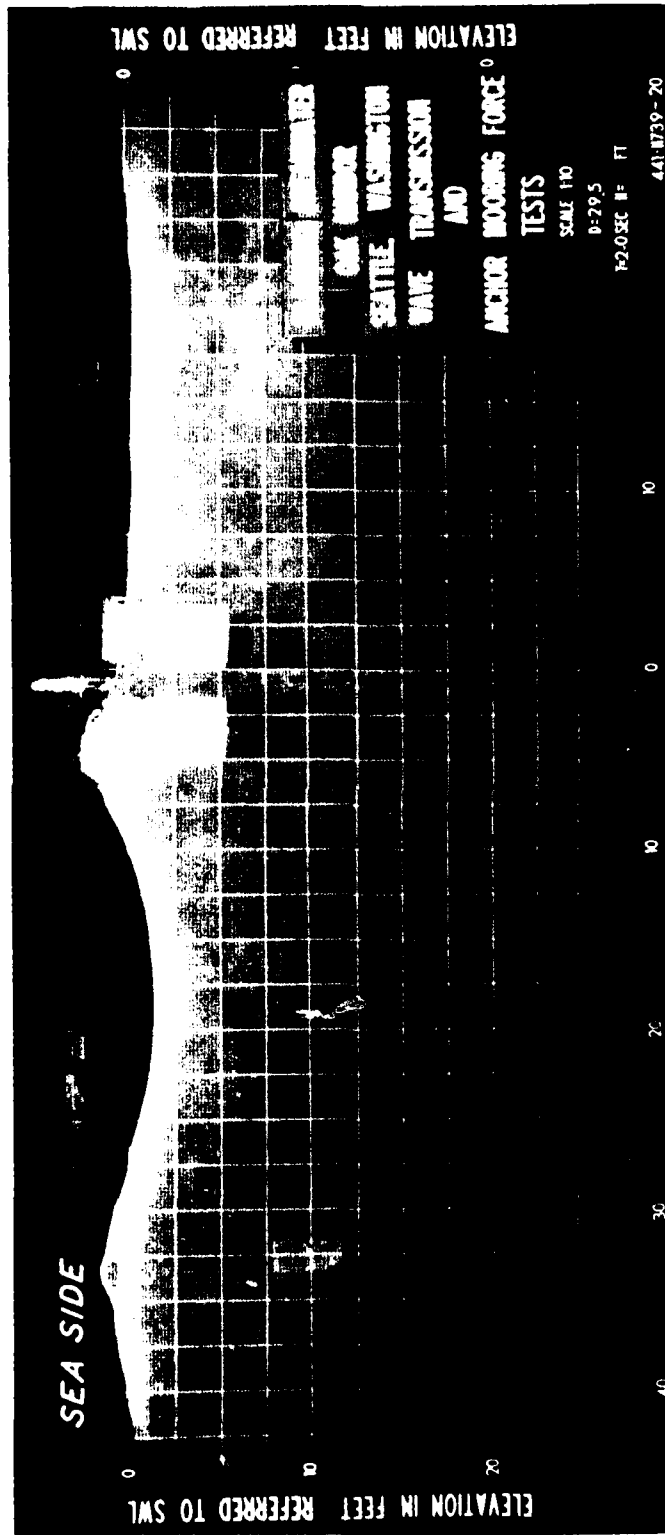
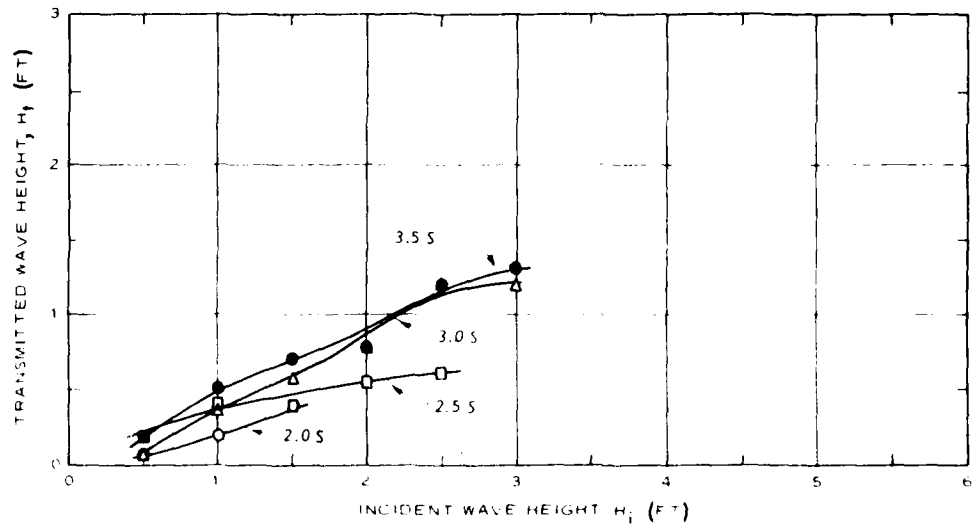
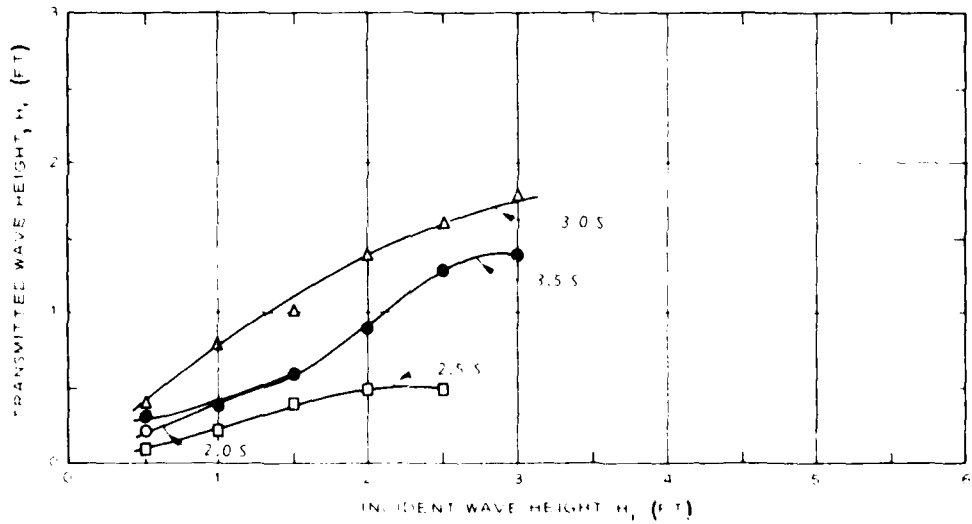


Figure 35. Two-dimensional model tests of pile mooring system, catamaran-type (twin pontoons) floating breakwater, Oak Harbor, Washington (ends of the breakwater module have been sealed for stability), at a wave period of 2.0 seconds, wave height of 1.5 feet, and water depth of 29.5 feet prototype (after Davidson, 1971).





d = 10 FT



d = 29.5 FT

LEGEND

SYMBOL	T SEC
○	2.0
□	2.5
△	3.0
●	3.5

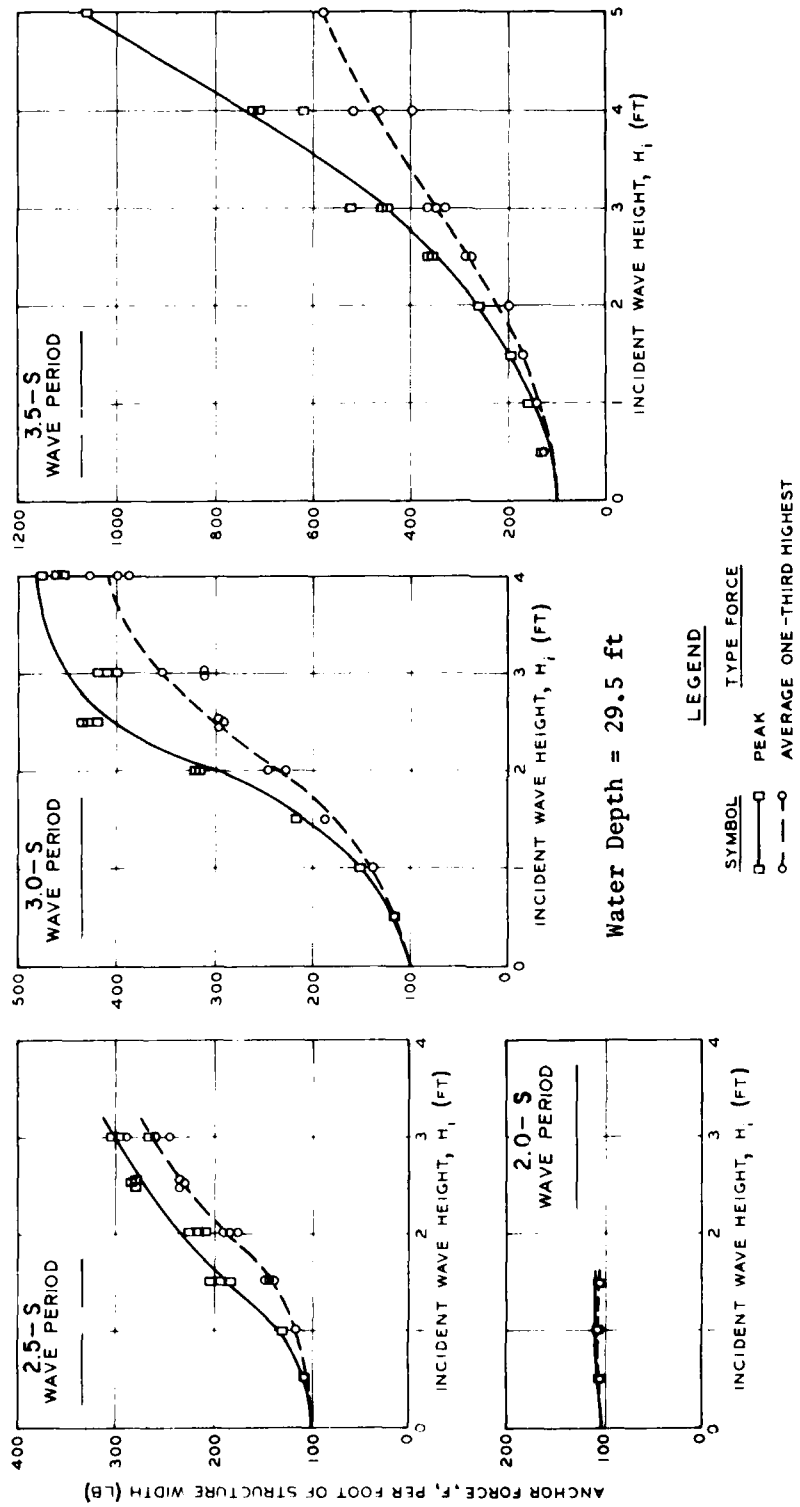
Figure 36. Wave transmission tests of the pile mooring system, catamaran-type floating breakwater, Oak Harbor, Washington (after Davidson, 1971).

c. Anchor Force Tests with Chain Mooring System. Davidson (1971) performed tests at both water depths to determine the forces in the anchor chains for each wave condition tested. Strain gages were mounted in such a way as to measure the vertical and horizontal components of the force in each anchor chain. The force components recorded at each anchor were then analyzed and combined into the resulting force for that chain. For each chain, the peak anchor force was taken as the sum of the initial force placed in the anchor chain and the highest peak force that occurred for a given test condition. The average anchor force was taken as the sum of the initial anchor chain force and the average of the highest one-third of the peak anchor forces measured during a test. The chain anchor force data are shown in Figure 37 as plots of the anchor force per foot of structure width versus incident wave height.

The chain anchor force test results show that, although there is some scatter of the data points, definite trends are established from which the peak or average of the one-third highest force can be selected. The anchor force test results at both depths show, with the exception of the 2.0-second wave period and a 29.5-foot depth, that the maximum peak anchor force is greater on the seaside anchors than on the harborside anchors. Considering the range of incident wave conditions at Oak Harbor, the maximum peak anchor force on the seaside was found to be about 300 pounds per linear foot of structure; the maximum peak anchor force on the harborside was about 220 pounds per linear foot of structure.

d. Anchor Force Tests with Pile Mooring System. During the transmission tests on the pile mooring system, the forces exerted on the restraining piles in the direction of wave travel were measured for each wave condition, using strain gages mounted flush with the floor on each of the piles. Thus, it was assumed that, on the average, the forces applied by the module to the piles during testing would be in the plane of the stillwater level. At the time of testing, the exact type of prototype pile to be used and its energy absorption characteristics had not been determined. Hence, it was assumed that with known forces on a pile with no deflection and absorption, it would be possible to determine with sufficient accuracy the forces on selected prototype piles with given deflection and absorption characteristics.

The pile mooring force test results are presented in Figure 38 as plots of the force on a pile per foot of structure width versus incident wave height. In each of the pile force plots, the solid line represents the maximum summation of forces per foot of structure width that simultaneously occurred on the model piles. The dashlines represent the limits of the range of forces that expected to occur on a pile due to the relative positions of the breakwater module and the pile. There is sufficient trend in the data to approximate the extreme forces exerted on a pile by the breakwater module under the given wave conditions. The maximum force on the seaside of the pile was found to be about 4,200 pounds per linear foot of structure width (2.5-second curve); the maximum force on the harborside of the pile was about 4,600 pounds per linear foot of structure width. Before the pile mooring data from these tests are used for prototype design, the type of model mooring system used to obtain the pile force data should be noted and the resulting data adjusted in accordance with the deflection and absorption characteristics of the selected prototype piles.



NOTE: TOTAL INITIAL FORCE ON THE SEA-SIDE ANCHORS WAS 100 LB PER FOOT OF STRUCTURE WIDTH

Figure 37. Two-dimensional experimental tests of chain anchor forces on seaside of catamaran-type (twin pontoons) floating breakwater (after Davidson, 1971).

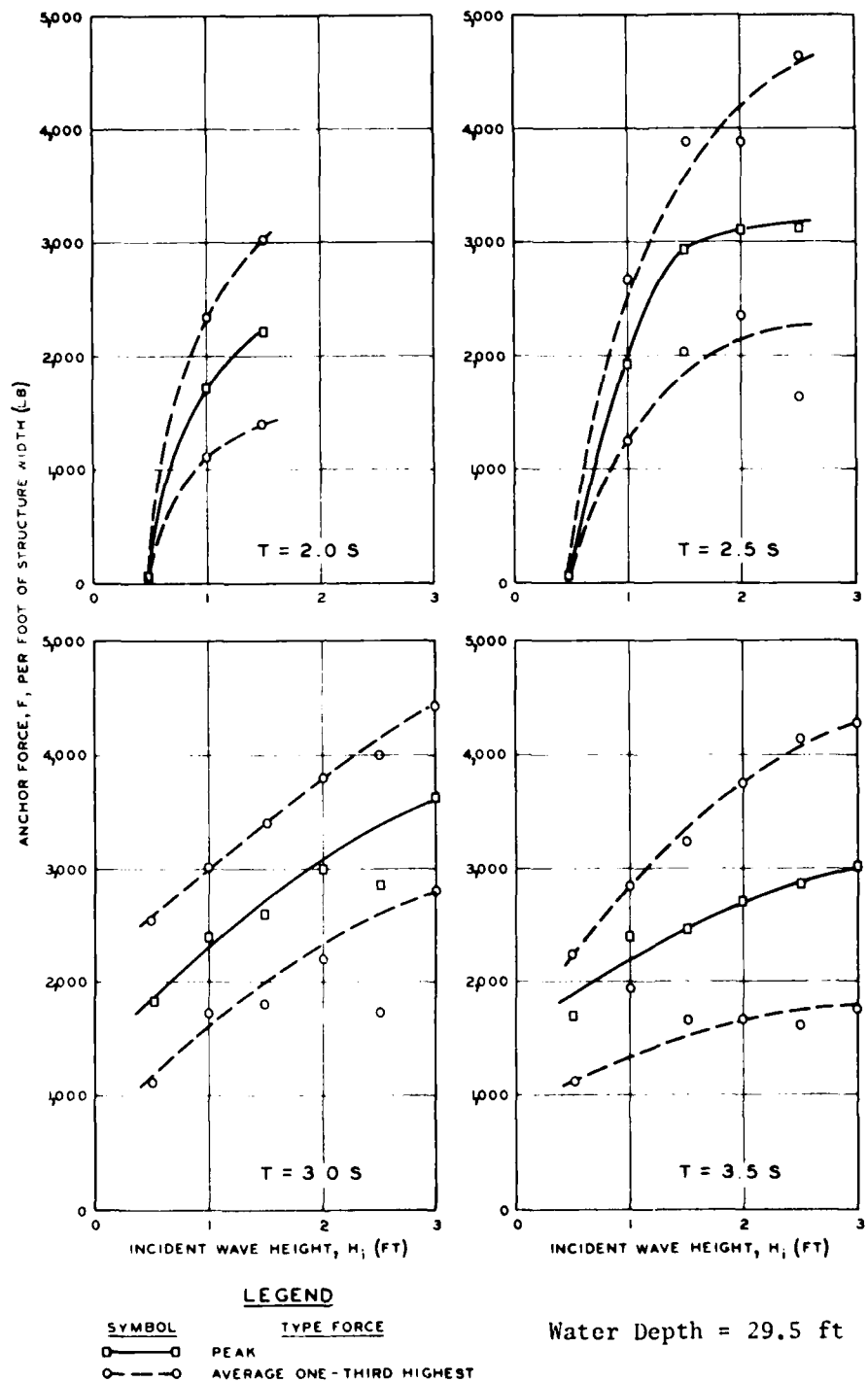


Figure 38. Two-dimensional experimental tests of pile anchor forces on seaside of catamaran-type (twin pontoons) floating break-water (after Davidson, 1971).

#### 4. Alaska-Type Floating Breakwater.

The Department of Public Works, State of Alaska, has constructed and maintains more than 100 moorage or boat service facilities. Many are quite small and cannot justify large expenditures of funds. Others have poor bottom conditions or deep water, which dictates the possibility of a floating breakwater application. The department developed a breakwater unit which consists of twin pontoons connected with cross pontoon sections. This floating breakwater has been installed at a few sites since the early 1970's. The modular construction was developed for ease of transportation to remote sites, and for ease of assembly at the site. The breakwater at Tenakee Springs was completed in November 1972, and the one at Sitka was completed in November 1973. Both these locations are in the island region of southeastern Alaska. Before this time, the sites had been protected by floating log booms which were in danger of breaking apart. Hence, because of the urgency of the situation, the State of Alaska decided to forego the time and funds required for a full-scale site investigation and invested in a massive configuration which would be studied for prototype performance characteristics. The same basic configuration (Fig. 39) was utilized at both locations.

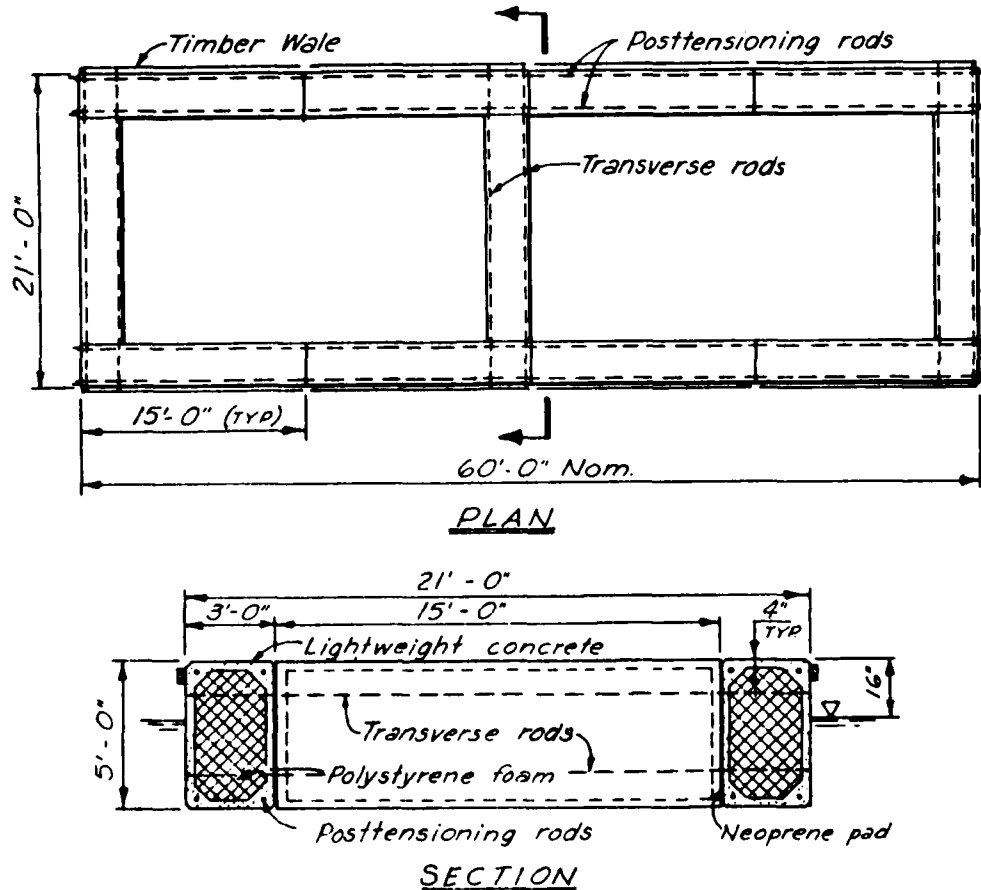


Figure 39. Alaska-type floating breakwater developed by State of Alaska, Department of Public Works, for installation at Tenakee Springs and Sitka, Alaska (after Miller, 1974b).

a. Tenakee Springs, Alaska, Installation. The Alaska-type floating breakwater at Tenakee Springs has 3- by 5- by 15-foot reinforced precast concrete pontoons with a minimum 4-inch wall thickness and an interior of solid polystyrene foam. Design strength of the concrete is more than 5,000 pounds per square inch, and the unit weight is between 90 and 100 pounds per square foot. Four 15-foot units were assembled on barges into 60-foot-long modules and posttensioned with four 60-foot-long, 1.75-inch-diameter galvanized bars of 160 kips per square inch tensile-strength steel. The joints between the 15-foot precast segments were fabricated with an epoxy mortar to ensure even bearing. On the site, two 60-foot-long modules were connected together on a grid at low tide with three 15-foot-long units crosswise and posttensioned with four 21-foot-long, 1-inch-diameter, high-stress bars through each of the cross units. A 70-durometer Neoprene bearing pad was used between the abutting concrete surfaces, and the result was a 5-foot-deep by 21-foot-wide by 60-foot-long rigid frame of prestressed concrete. The 21- by 60-foot modules were then coupled with chain links and rubber compression bumpers to form an Alaska-type floating breakwater 308 feet long. The breakwater was anchored at each 60-foot junction with two 26-ton concrete anchors and 270 feet of chain (diameter 1-3/8 inches) to the seawardside and one 26-ton anchor on 180 feet of chain on the harborside (Miller, 1974b).

There are two main directions for waves incident to the harbor at Tenakee Springs--one from the southeast with a fetch of approximately 3.5 miles, and the other from the southwest (out of Crab Bay) with a fetch of about 5 miles, although the effective fetch length is uncertain due to the extension of the bay. No wind records of the site exist, but local residents have reported winds in the 60- to 70-mile-per-hour range. The harbor is shielded partially by landforms for waves which move up Tenakee Arm and strike the breakwater at an appreciable angle. The tidal range is about 20 feet, and the water depth is about 30 feet at low tide.

Prototype field measurements of the performance characteristics of the Alaska-type floating breakwater at Tenakee Springs, Alaska, were made during the 1973-74 winter period by Christensen and Richey (1974, 1976). They evaluated the Alaska-type floating breakwater, under different wave exposures, and obtained basic data for the verification and development of a theoretical predictive model for breakwater performance. Wave characteristics were recorded at three locations. Two spar buoys, instrumented to measure wave amplitudes, were placed outboard of the breakwater and positioned so that one measured the incident wave field and the other measured the incident plus reflected wave field. A third gage (stationary) was positioned behind the breakwater to measure the transmitted wave height. Anchor cable forces were measured using bonded strain gage-type load cells that were placed in the anchor chains beneath the water surface. These cells calibrated to an accuracy of 0.75 percent of the rated total load-cell capacity, over a temperature range of 10° Celcius (design load 12,500 pounds).

The transmitted wave spectra showed very distinct peaks at 5.5, 11, and about 100 seconds with an appreciable amount of energy spread over the lower end of the spectra from the 100- to the 11-second peak. This energy could be from many sources. A preliminary investigation of the across-channel oscillation, which could easily be excited by the extreme tides and inlet geometry, showed a natural period of this mode of about 2 minutes. Also, oscillations within the harbor, between the breakwater and the shore, give a natural period

of the first mode of oscillation of about 10 seconds. The low-frequency part of the load-cell output was exactly  $180^\circ$  out of phase, indicating that sway and possibly roll are the primary motions involved in this frequency range. The maximum force variation measured due to local storm conditions was less than 700 pounds; the variation due to tides alone was more than 1,000 pounds. Regretfully, this record of incident waves had a significant wave height of about 1 foot. Data from much larger storms are required before definitive statements can be made about the anchor forces, especially for design purposes. A sample record of the incident and transmitted wave spectra, along with the corresponding transmission coefficients at Tenakee Springs, Alaska (Christensen and Richey, 1974), is shown in Figure 40.

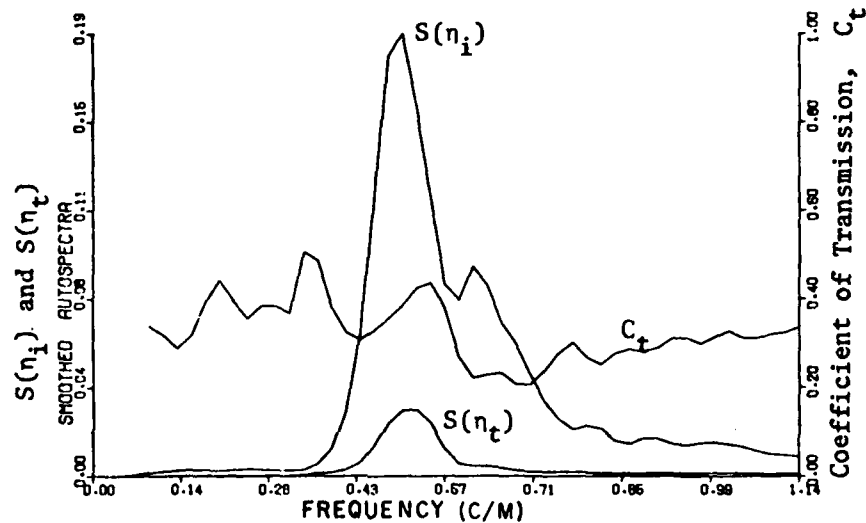


Figure 40. Incident wave spectra,  $S(\eta_i)$ , transmitted wave spectra,  $S(\eta_t)$ , and coefficient of transmission,  $C_t$ , from prototype field investigation of Alaska-type floating breakwater at Tenakee Springs, Alaska (after Christensen and Richey, 1974).

b. Sitka, Alaska, Installation. The Alaska-type floating breakwater installation at Sitka, Alaska, was completed in autumn 1973. This site is exposed to a tidal range of 17 feet, and the bottom elevation under the breakwater is about 35 feet below low tide elevation. The total length of the breakwater was 960 feet. The design of the Sitka structure was basically the same as that for Tenakee Springs, but with improvements in design and construction details learned from the previous installation. The fabrication was simplified by using a single cage of rebars, and cast-in-place bearing plates and connection assemblies. Posttensioning the concrete in the transverse direction was eliminated to facilitate assembly while the breakwater is floating. Two 1-inch transverse rods of 83 kips per square inch tensile-strength steel were used instead of the four 160 kips per square inch rods for each transverse unit used at Tenakee Springs. The rods were tensioned to 36,000 pounds each with equipment from atop the floating units. The connections at the junctions for Sitka incorporated 1-foot-square by 3-1/2-foot-long rubber compression bumpers and an added lower chain-link connection. The chain and timber bumpers were sized to provide a slight compression of the rubber.

The Sitka anchors consisted of a combination of piles and concrete blocks. Jetting was accomplished with high-capacity equipment at the planned anchor location before contracting. Up to 18 feet of penetration was attained in some locations. Steel piles were much more economical to install than concrete blocks, and when penetration was deemed insufficient to develop the required lateral resistance, a concrete block was installed adjacent to the pile. The anchor line at Sitka was used, regalvanized stud link chain (1-1/4 and 1-3/8 inches) proof-tested up to 130,000 pounds. The chain was connected to the pile or concrete block prior to placement. The only underwater work was the installation of one bolt for the lower chain connection and the attachment of the anchor chain shackle (Miller, 1974b).

c. Olympia Harbor, Washington, Experimental Investigation. The Alaska-type floating breakwater was investigated experimentally by Carver (1979) for potential application at East Bay Marina, Olympia Harbor, Washington. The structure, which was tested in the two-dimensional wave flume, had prototype dimensions of 21 feet wide by 120 feet long (Fig. 41). The 381,226-pound prototype structure was reproduced with a 372-pound model structure. Detailed geometry of the prototype structure is presented in Figure 42. Tests were conducted with two different mooring arrangements--anchor chains crossed and uncrossed (Fig. 43). Wave attenuation tests were conducted in 25 feet of water, with wave periods of 2.5, 3.0, 3.5, 4.0, and 4.5 seconds. Test waves ranged in height from 1.5 to 3.5 feet. Transmitted wave heights were measured one wavelength behind the structure.

The experimental study results indicated that both anchoring arrangements gave almost identical values for the 2.5- and 3.0-second wave periods; however, the crossed arrangement yielded slightly lower transmitted wave heights for the 3.5- and 4.0-second wave periods, and the differences observed in the model should be representative of the prototype behavior. It appeared that the anchoring arrangement had a wave period-dependent effect on the amount of roll experienced by the structure and, hence, a wave period-dependent effect on transmitted wave heights. Observations of the Alaska-type floating breakwater under test conditions showed that for a 3-second wave period, an incident wave height of 1.5 feet produced a high degree of roll. However, as the incident wave height was increased to 2.0 and 2.5 feet, progressively larger amounts of water washed over the structure and dampened its rotation. The net result was that the transmitted wave heights observed for all three incident wave heights were nearly the same. The coefficients of transmission,  $C_t$ , versus the relative breakwater width,  $W/L$ , resulting from these two-dimensional tests of the Alaska-type floating breakwater are presented in Figure 44.

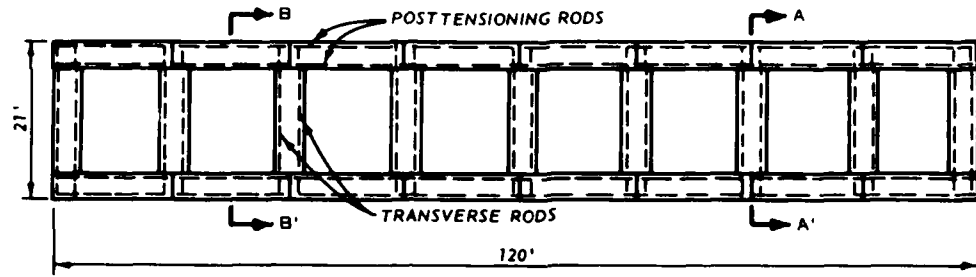
d. Potential Prototype Installations.

(1) Bar Point Harbor, Ketchikan, Alaska. This site lies on the northeast shore of Tongass Narrows, a fjord oriented between bordering mountains which guide the approach of strong winds up or down the channel. In the absence of site wave records, wave conditions were predicted from fetch-speed relationships. Short-term speeds of at least 50 miles per hour can be expected, and with a fetch of 1 nautical mile, a significant wave height of 3.2 feet and period of 3.5 seconds can be expected. The magnitude of prototype anchor forces is a parameter which should be the subject of further study. In the usual laboratory scale investigation, a relatively short

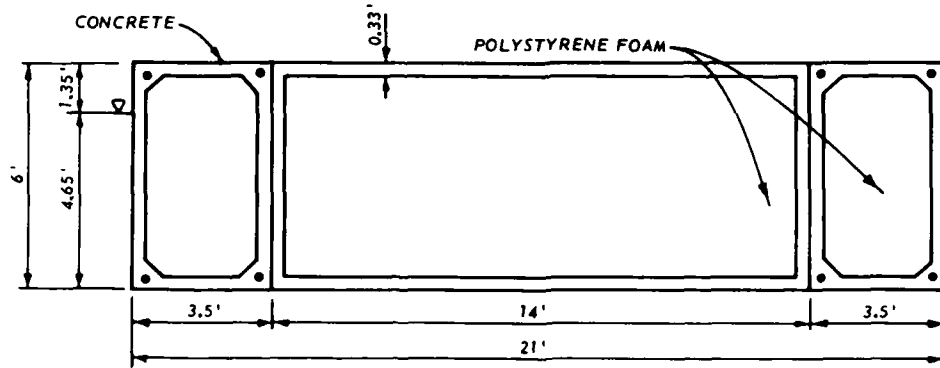




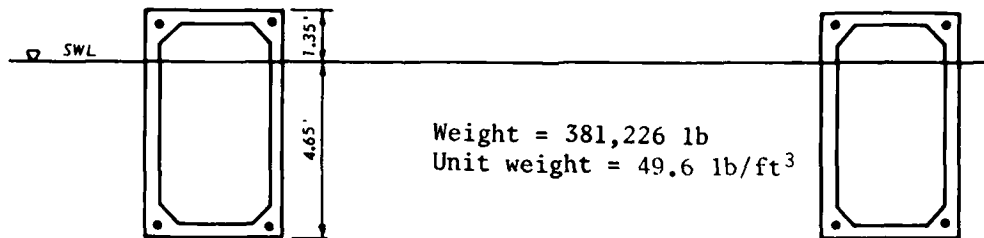
Figure 41. Module of Alaska-type floating breakwater used in two-dimensional experimental study at a length of 120 feet, width of 21 feet, depth of 6 feet prototype dimensions; each model unit length was 14 feet (after Carver, 1979).



PLAN VIEW

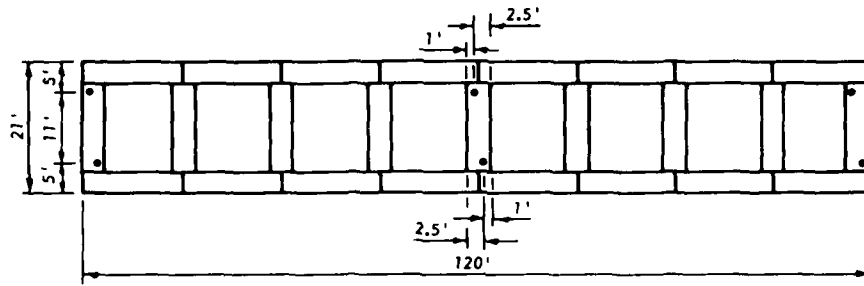


SECTION A-A'



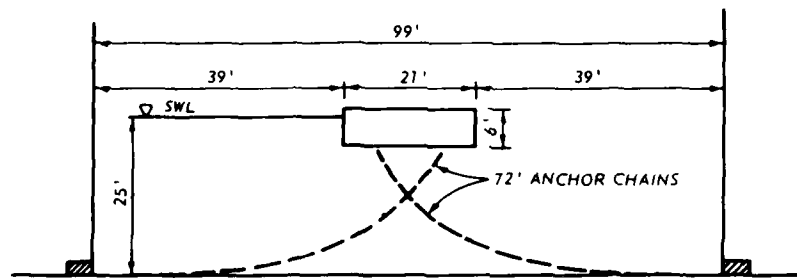
SECTION B-B'

Figure 42. Details of Alaska-type floating breakwater used in two-dimensional experimental study, Olympia Harbor, Washington (after Carver, 1979).



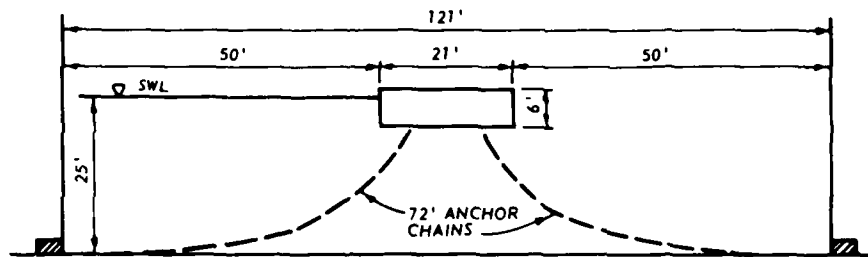
PLAN VIEW

● INDICATES ANCHOR POINT ON BOTTOM OF MODULE



END VIEW

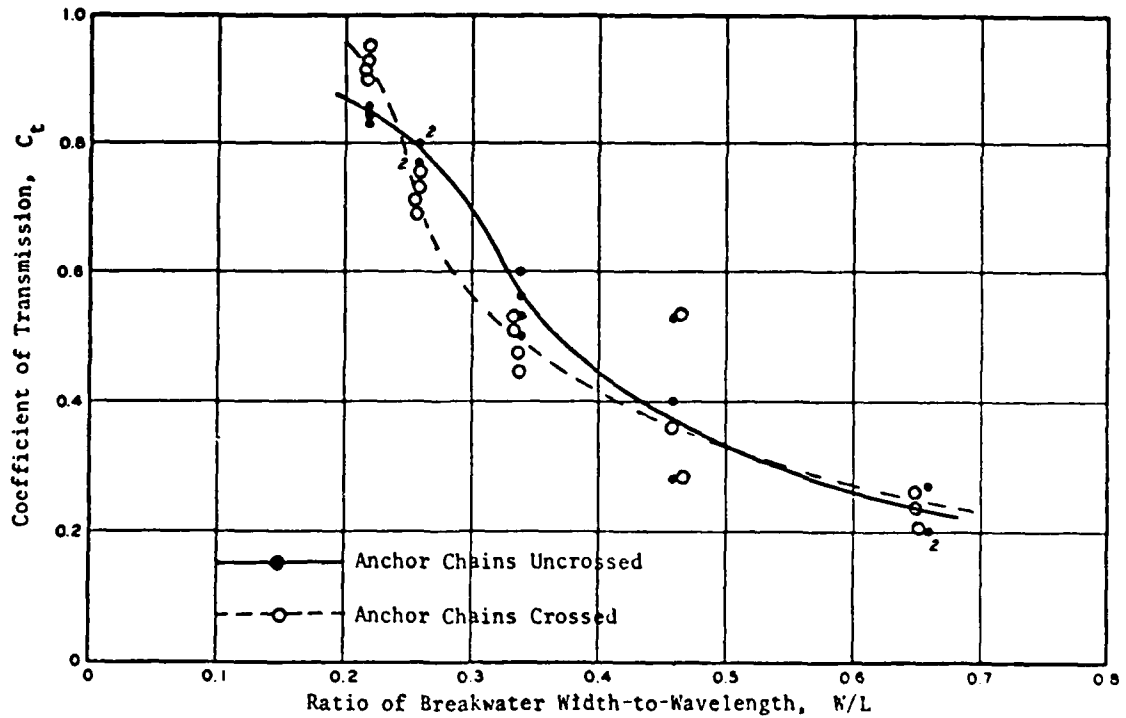
Anchor Chains Crossed



END VIEW

Anchor Chains Uncrossed

Figure 43. Two-dimensional experimental study of Alaska-type floating breakwater mooring chain arrangement, Olympia Harbor, Washington (after Carver, 1979).



NOTE: NUMBERS BESIDE DATA POINTS INDICATE THAT THE NUMBER OF DATA POINTS EXCEEDS ONE

COEFFICIENT OF TRANSMISSION ( $C_t$ )  
VERSUS RELATIVE WIDTH ( $W/L$ )  
TWO-DIMENSIONAL TESTS  
PLAN 3 (W=21 FEET)

Figure 44. Coefficient of transmission,  $C_t$ , versus relative breakwater width,  $W/L$ , results from two-dimensional experimental investigation of Alaska-type floating breakwater, Olympia Harbor, Washington (after Carver, 1979).

section of a model breakwater is subjected to monotonic waves and the force parameters are measured. Anchor forces scaled up from such tests are apt to be unrealistically large (Richey and Adey, 1975) because: (a) the elasticity and restraint conditions are not precisely simulated, (b) the model is usually short with respect to the crest lengths of the incident wave, and therefore receives the wave over its full length, and (c) the regular, monotonic waves can force the breakwater to translate to the end of its tether, taking up all slack in the anchor system, at which time high forces develop. In the natural random wind-wave environment, the probability of a series of waves striking the full length of a floating breakwater is very low. Anchor forces measured at Tenakee Springs, Alaska, indicated the large forces to be 7,146 pounds for a 60-foot module, or about 6 percent of the weight of the structure.

Richey and Adey (1975) combined the studies of Sorensen (1967) on ship waves and Stramandi (1974) on breakwater response of ship waves to assess the ship wave problem in the Bar Point Harbor site. When vessels travel at speeds less than 8 knots, wave heights exceeding 1 foot would be exceptional; the waves would strike the breakwater at an appreciable angle, so the transmission coefficient of 0.3 or less would be appropriate. Therefore, the transmitted

wave will be less than the specified upper limit of 1 foot. Under reasonable operating conditions, vessel wake is likely to be noticeable within the marina, but should not cause any problems (Richey and Adee, 1975).

(2) Auke Nu Cove, Alaska. Stormer (1979) prepared a detailed in-depth design of an Alaska-type floating structure to protect Auke Nu Cove, Alaska. The design wave for Auke Nu Cove was determined to be 3 feet high with a 2.7-second period. As general guidance, the beam width of a floating breakwater should be at least 0.5 times the incident wavelength to provide adequate attenuation. This also permits parts of the wave to exert forces on the structure in opposite directions, which tends to reduce the net force on anchoring systems. Based entirely on the design wavelength, the width of the proposed floating breakwater should be at least 10 feet. The criterion for harbor design under consideration specifies the transmitted wave should not exceed 1 foot in height. With a coefficient of transmission of 0.33 from laboratory tests of similar structures, the design width was approximated to be about 20 feet. The same type of analysis of prototype data from the Tenakee Springs site provides a breakwater width of about 20 feet. Based on these similar situations, it appeared reasonable to Stormer to design a structure 21 feet wide, assuming all other dimensions are similar. Construction cost for the Alaska-type structures is estimated to be about \$425 per linear foot of breakwater (1979 dollars), including shipment and installation.

#### 5. Hybrid Pontoon Structures.

a. Friday Harbor, Washington, Installation. The floating breakwater at Friday Harbor, Washington (Fig. 45), was installed in late 1972; 904 feet of the structure was placed in an L-shaped configuration. Some features of this breakwater identify with various other configurations, but the breakwater is unique of all currently existing structures. The operational experience has been documented by Adee (1975b, 1977). This breakwater has a continuous structure with a wooden deck across the beam and is supported by heavy wooden stringers which run the length of the breakwater. Buoyancy is provided by 356 polyolefin, irregular-shaped pontoons (10 by 5 by 5 feet), arranged four-across the 25-foot beam, which leaves a gap in the middle and gives the structure a catamaran appearance (Fig. 46).

Occasional severe winter storms with winds from the northeast are the most troublesome at Friday Harbor. The site is well protected from very long waves, but the short-period winter waves strike almost directly on the beam of the long leg of the structure. The performance of the breakwater in protecting the moorage has been satisfactory, although boat wakes have caused some concern. The Washington State Ferry, which stops at Friday Harbor, creates waves which seem to pass through the breakwater, but this is of a short-term nature.

The mooring lines of this breakwater are made up of a section of chain (7/8 inch) which extends about 45 feet below the breakwater. Beyond this point, a three-strand, double-braided nylon line is used. At the bottom, another length of the same size chain is connected to a piling. Mooring lines are spaced at 50-foot intervals. The major problem encountered at Friday Harbor has been with the plastic pontoons. During a severe storm shortly after the structure was built in 1972, 34 of the 356 pontoons were destroyed. More pontoons have failed since that time, with failure occurring just below

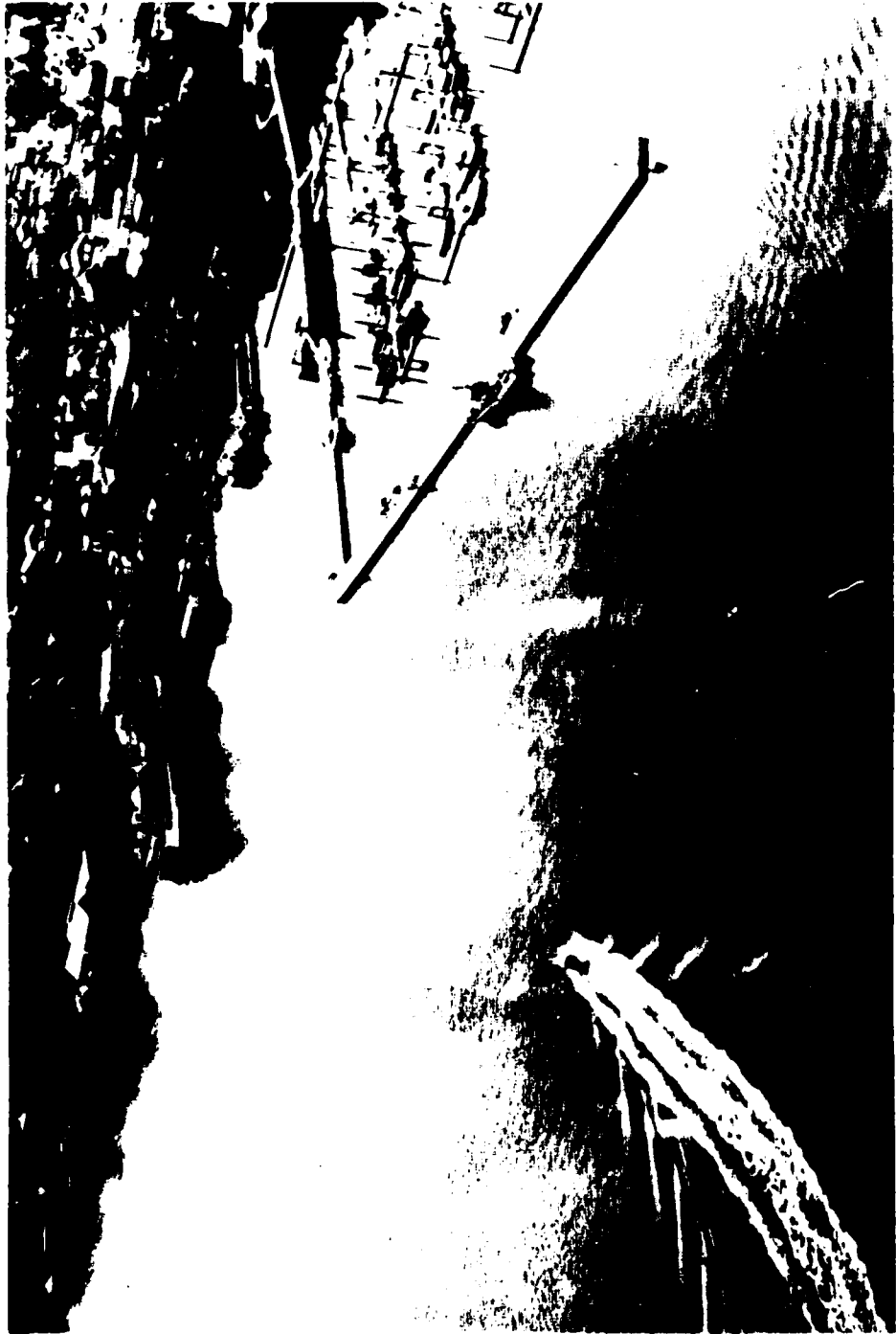


Figure 45. Friday Harbor, Washington (after Adee, Richey, and Christensen, 1976).

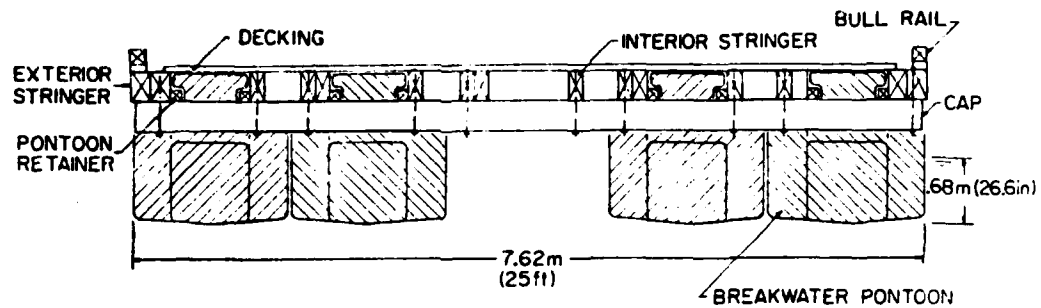


Figure 46. Cross section of floating breakwater at Friday Harbor, Washington (after Adee, © 1975b).

the point where the pontoons are attached to the structure. This failure appears to be a result of fatigue from the cyclic wave loading. The current method of protecting the breakwater is to moor unused barges to the seaward-side of the breakwater during the winter months when severe storms are likely. The construction cost of the Friday Harbor, Washington, breakwater (1972 dollars) was about \$320 per linear foot.

The Friday Harbor breakwater was instrumented by Adee, Richey, and Christensen (1976) to obtain performance information from a field assessment program. Four types of time-dependent data which are basic to describing the response of the breakwater were collected: (a) wind velocity and duration, (b) wave heights or water surface time histories at key locations, (c) anchor cable forces, and (d) directional acceleration and angular motions of the breakwater. Two spar buoys instrumented to measure wave heights were located seaward of the breakwater and positioned so that one measured the incident wave field, and the other measured the incident plus reflected wave field. Two other stationary gages were located behind the structure to measure the transmitted wave height. This was essentially the same instrumentation and arrangement which had been previously used to monitor the performance of the floating breakwater at Tenakee Springs, Alaska.

A total of 95 records were obtained at the Friday Harbor breakwater between December 1974 and May 1975. There was no known equipment failures or breakdowns except for one of the load cells going off scale at low tide. The average overall response, or transmission curves, for the events within each wind direction window and for all the recorded data, are given in Figure 47. These data were obtained by averaging the square root of the ratio of the transmitted to the incident wave spectras for the records indicated for each curve. Hence, they all have the same frequency resolution of 0.10195 hertz.

All the anchor cable data showed a very dominant amount of energy at lower frequencies. The exact location of these peaks varied for different records, but in all records the peak of the force spectra was contained in the frequency band of approximately 0.015 to 0.050 hertz. In most cases, however, a relatively dominant peak appeared in the 56- to 63-second range. The anchor forces measured were all quite low, with the largest range being only 628 pounds. The cables were spaced at 50-foot intervals along the structure. An extreme storm event did not occur during the sampling season nor during two winter sampling periods on the Alaska-type breakwaters at Friday Harbor, Washington; however, the anchor forces were about an order of magnitude less

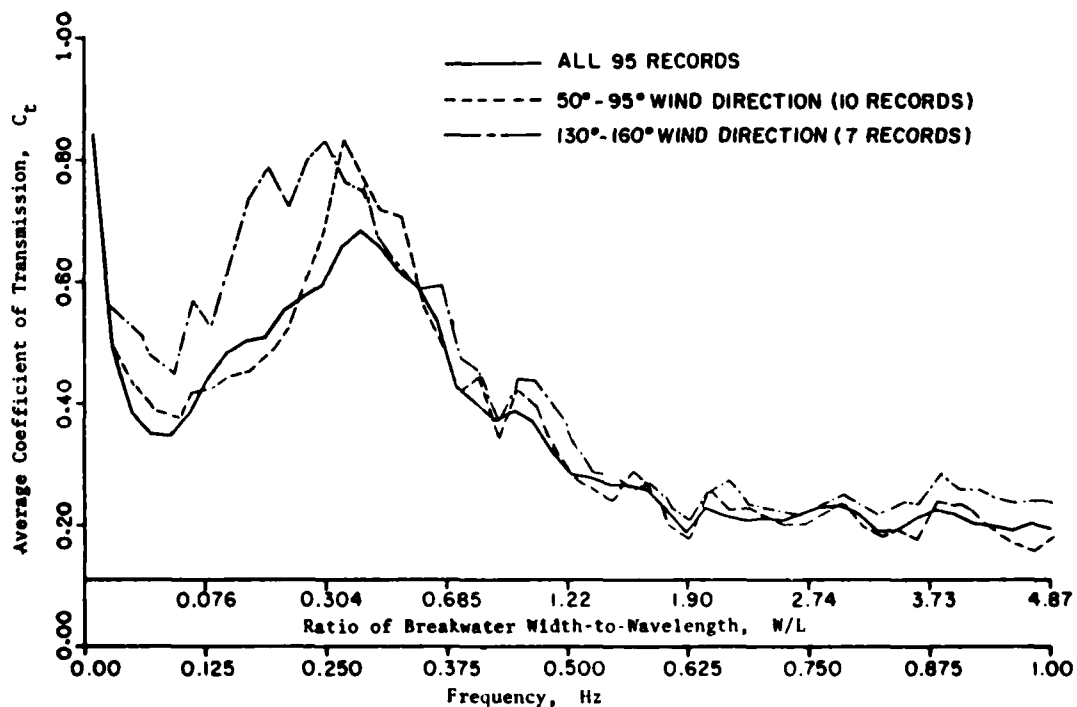


Figure 47. Average transmission coefficients, Friday Harbor, Washington (after Adee, Richey, and Christensen, 1976).

than had been anticipated (Adee, Richey, and Christensen, 1976). The natural frequencies of each of the motions were outside the range of significant incident wave energy, and no dominant features were observed in the motion spectra during this field monitoring program.

b. Canadian Caisson. A floating breakwater denoted as the Canadian caisson type presents a design concept which differs materially from that of most existing or proposed breakwaters. Its dual-intended purpose is not only to protect a harbor from excess wave action, but also to provide a platform of sufficient stability for use as a floating wharf. Experimental studies have been conducted (Western Canada Hydraulic Laboratories Ltd., 1966b) to evaluate the wave damping effectiveness and to measure the anchor chain forces of the Canadian caisson-type breakwater under wave conditions typical of coastal waters.

The models of the Canadian caisson floating breakwater were constructed to a scale of 1:24. The basic unit of construction was a rectangular pontoon (open on the bottom), representing a prototype structure 50 feet long by 24 feet wide by 8.5 feet deep, divided into 16 compartments, each about 5 by 12 feet. All walls were of 6-inch-thick reinforced concrete construction. Two additional units (18 and 36 feet wide) were also tested. The geometry of the 24-foot-wide section is shown in Figure 48. The breakwater anchors used by Western Canada Hydraulic Laboratories (1966b) in these studies consisted of lead blocks of sufficient weight to prevent sliding under the most severe wave conditions. The anchor chain length used for these tests was approximately 2.5 times the depth of water (about 40 feet prototype), and the chain weighed the equivalent of 14 pounds per foot of prototype length.



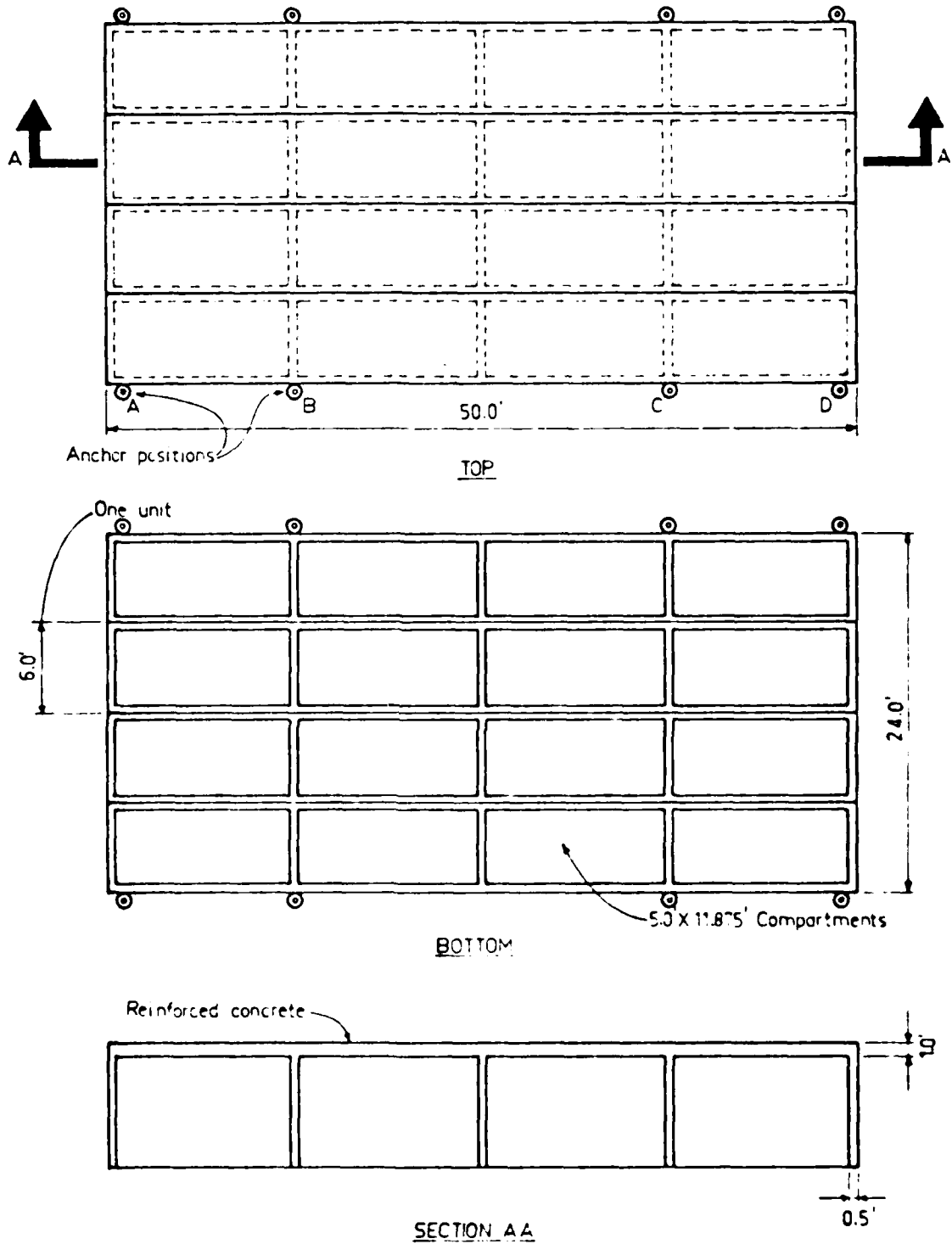


Figure 48. Canadian caisson floating breakwater tested in three-dimensional wave basin (after Western Canada Hydraulic Laboratories Ltd., 1966b).

Each breakwater model was evaluated in a three-dimensional wave basin by anchoring with eight chains. A wave sensor was mounted on a movable rail to obtain wave measurements over a system of coordinates on the lee side of the breakwater. The measuring points covered a 50-foot area on each side of the breakwater centerline and extended leeward a distance of 80 feet. After a complete cycle of wave height recordings for each breakwater had been obtained, the model was removed and the incident wave height at the same measuring points (in the breakwater absence) was recorded.

Instrumentation for measuring anchor stresses consisted of duralumin rings in which strain gages were mounted to form one-half of an electronic bridge. The duralumin rings were calibrated, then placed in position, forming the terminal links at the breakwater end of the anchor chain, and adjusted to read zero when completely load-free. The incident wave was then imposed on the model, and each anchor force was recorded.

The three Canadian caisson-type breakwater models tested reached their maximum wave damping effectiveness of 55 to 60 percent with a wavelength of 50 feet. The width of the breakwater had no marked effect on the wave damping effectiveness with wavelengths of 50 feet or less. These data indicated that the breakwater effectiveness deteriorates rapidly for small ratios of breakwater width-to-wavelength (Fig. 49). Due to the low freeboard of the structures, the decks were constantly awash when wavelengths of more than 15 feet with heights greater than about 2 feet struck the breakwaters. Generally, the anchor forces were smaller for the wider breakwaters; hence, this substantiated the previous conclusion that a part of the wave should be made to react against other parts of the wave to produce a smaller net force on the anchor system. This phenomenon occurs when the breakwater is at least half as wide as the wavelength. The anchor forces measured during these three-dimensional wave basin tests of the Canadian caisson floating breakwater are presented in Figure 50.

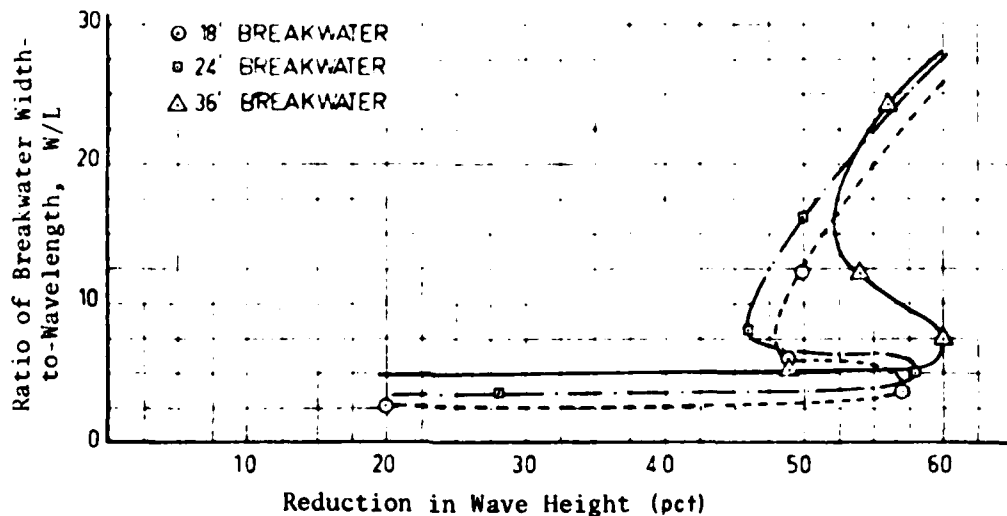


Figure 49. Effect of relative breakwater width,  $W/L$ , on wave height attenuation, Canadian caisson floating breakwater (after Western Canada Hydraulic Laboratories, 1966b).

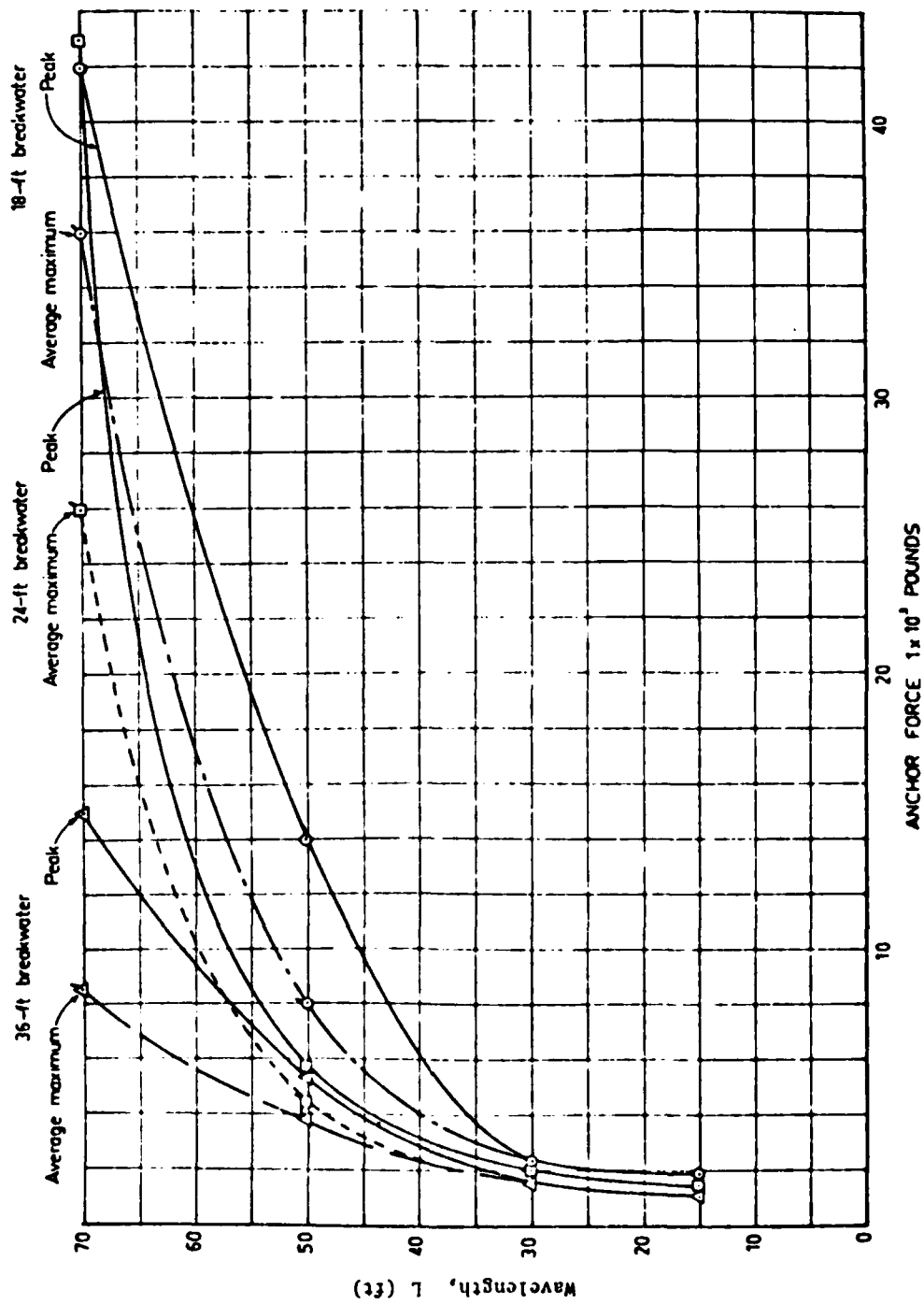


Figure 50. Anchor forces developed by Canadian caisson floating breakwater (after Western Canada Hydraulic Laboratories, 1966b).

c. Floating Docks as Breakwaters. While the Canadian caisson floating breakwater was evaluated from the standpoint of serving as a wharf or floating dock, U.S. manufacturers of floating docks for marinas have recently been investigating the effectiveness of docks as floating breakwaters. The Thompson Flotation Company has had many years of experience in building strong, durable floating structures for use in open-sea conditions, as well as small-boat marinas that are subjected to rough water environments (T. Thompson, personal communication, 1980). Drawing upon this previous experience, the company has developed a floating breakwater (either permanent or temporary) installation which is easily transported. The Thompson Floating Breakwater (Fig. 51) has excellent strength-to-weight characteristics; however, no actual experimental studies or field testing has taken place to quantify the degree of attenuation the system will provide.

#### 6. Construction Materials and Techniques.

In the design of a floating breakwater, selecting the appropriate materials is as important as determining the performance characteristics and loading requirements (Stormer, 1979). The density of a material is frequently a critical factor, since structure weight is often a major design consideration. Fracture toughness is a measure of a material's ability to absorb energy through plastic deformation before fracturing. Loads or deformations which will not cause a fracture in a single application can result in fracture when applied repeatedly. Fatigue failure is a complex mechanism involving the initiation of small cracks, usually from the surface, that spread under repeated loading.

Structural materials exposed to seawater must have an adequate resistance to corrosion and to stress corrosion cracking, the fracture of a material by stress and certain environmental factors. Other material properties to be considered include ease of fabrication, weldability, durability, maintenance, general availability, and finally, cost. With several possible modes of failure existing in a floating breakwater, the properties and cost of structural materials should be thoroughly studied before the final choice is made for any specific application.

Wood and concrete are often suggested for use in underwater work because of their relatively low cost and availability. Concrete has good compressive strength, resistance to corrosion, and formability; however, a disadvantage is its limited tensile strength. The density of concrete is affected by the type of aggregate used. Sand and gravels or crushed stone produce concrete weighing about 150 pounds per cubic foot. Portland cement, magnetite, ilmenite, limonite, and steel shavings yield densities up to about 300 pounds per cubic foot. Protection against chemical attack (sulfates in seawater solution) and leaching of lime from the concrete by the seawater can be provided through the use of high-quality, high-strength concrete. Limiting the tricalcium aluminate content of the cement will increase resistance to chemical attack in the ocean environment.

A floating breakwater has to endure the worst possible environmental situations (corrosion, abrasion, and freeze-thaw conditions). The structure is partially submerged with parts alternately exposed and submerged. Construction materials for pontoon-type floating breakwaters must be resistant to ordinary solvents, particularly gasoline and petroleum. These structures are inevitably used as docking platforms, whether designed for this purpose or not. Ice, particularly floating and moving ice floes, can cause extreme



damage. On the Great Lakes, floating breakwaters are designed for removal during ice-cover periods to prevent destruction.

The materials and construction techniques appropriate for the pontoon-type floating breakwaters have been discussed by Miller (1974a, 1974b), Adee (1975b), Araki (1978), and Stormer (1979). These investigators generally concluded that concrete provides the mass and durability necessary for these breakwaters.

a. Concrete. Richey and Adee's (1975) conclusion that the displaced volume of water is far more important than breakwater shape has another ramification regarding the materials used for the construction of the breakwater; i.e., lightweight concrete should not be used. Maintaining the mixing and placing standards is easier with regular concrete which has a long history of successful performance in saltwater. Durability and impermeability, the objectives for concrete used in a floating breakwater, are properties gained with the proper constituents and good workmanship. Chemical attack on concrete is hastened by sulfates and chlorides in seawater and by carbon dioxide in the air. Salt cells from these chemicals promote galvanic action and corrosion of steel.

Density and impermeability can be gained with a low water-to-cement ratio, a high cement content, proper compaction and curing (Miller, 1974a). Freezing and spalling resistance is gained from sound, proven aggregates and a dense mix of at least seven sacks of cement per cubic yard, generally, with a minimum design strength of 5,000 pounds per square inch. The concrete should be properly cured to the appropriate strength before being placed in the water, to provide adequate resistance to spalling.

Prestressed concrete should be used in a floating breakwater because of its strength and its resistance to the intrusion of water and chemicals. Prestressed concrete units also easily join together to form a module for installation. Stressed steel is susceptible to fatigue and corrosion from saltwater, so it should be sealed or otherwise protected. All accessories embedded in the concrete pontoon should be noncorrosive materials which will not promote galvanic action; galvanized steel and stainless steel have been used successfully. Records of the use of concrete, which has been used extensively in marina floats, indicate time-dependent deterioration patterns and suggest at least a 20-year lifespan.

b. Steel. The cyclic loading nature of a floating breakwater requires close scrutiny of the factors necessary to prevent fatigue and brittle fracture (Miller, 1974a). The ambient temperature of the structure may not be significant since it is unlikely that the temperature of a floating breakwater, even in the most northern latitudes, will drop below  $-2^{\circ}$  Celcius. Design stresses less than 20 percent of the yield stress will probably protect against crack propagation; this level is recommended for the critical areas of connections, anchor attachments, and other components.

One of the most important considerations for the use of steel in the marine environment is its limited lifespan because of corrosion. Steel should preferably be hot-dip galvanized after all fabrication and welding. Alternatively, there are many proprietary coatings on the market, the best of which appears to be a coal-tar epoxy amine type applied over a zinc-rich primer on a sandblasted surface. All stainless steels exhibit some susceptibility to seawater corrosion. Attaching stainless steel to uncoated and unalloyed structure steel may provide cathodic protection.

c. Flotation Materials. Floating breakwaters should be fail-safe if specific compartments are filled with polystyrene or other foam flotation materials. Certain compartments should be left open for weighting of the structure to allow even flotation characteristics (Stormer, 1979); this would be much simpler than adding flotation to a breakwater which was otherwise overweighted. The method of providing flotation should allow for punctures and leakage by including a redundancy in the form of bulkheads or simply the interconnection of all components. The flotation material must be resistant to, or protected from, impact and deterioration. Polystyrene foam is both gasoline- and solvent-resistant, and should be specified for all uses in floating breakwaters.

d. Timber Components. Timber is both abundant and versatile in framing, but the connection between members is always the weakness in the system. Two timber members should be connected with long dapped joints, heavy bolts, and large washers. All hardware should be hot-dip galvanized, and the timber structure should be as continuous as possible (eliminating all unnecessary joints). The mass, depth, and width of a floating breakwater should be as great as economically allowable. The mass of a proposed pontoon-type structure consists of concrete supported by timber-framed floats. The timber, hence, provides both a sound structure and a means of supporting the required flotation.

All timber used in a floating structure should be pressure-treated in accordance with industrial standards. Any cuts or holes required after the treatment should have similar solutions applied hot and forced to soak into the wood. Miller (1974a) considers creosote the most effective substance for use in the Pacific Northwest; however, copper-chrome-arsenate has been found more resistant to borer attack elsewhere. The use of creosote in sunbathing areas has been objectionable; thus, chemonite or pentachlorophenol treatment is recommended for decking, with creosote used on those parts below the waterline.

e. Module Connections. All hardware and mechanical connections necessary to join modules of a floating breakwater should be carefully sized to exceed the strength of the anchor lines in retaining the structure. The connections (shackles, clevises, swivels, bolts, pins, etc.) usually experience the greatest wear and motion and should have secondary methods of loss prevention such as cotter pins or double nuts. Custom-designed and fabricated connecting devices have been found to be the best and most economical, but compatible materials can be used to lessen galvanic action. Under load conditions equivalent to those of actual breakwaters, Araki (1978) performed tests on chains, pin joints, and boss holes in seawater tanks to determine the amount of abrasion anticipated after a finite number of loadings.

Different schemes at different locations have been used in efforts to develop the most appropriate connector of large concrete pontoon-type units. Figure 52 shows the connection used at Sitka, Alaska. In this system, chains at the top and at the bottom pull the modules together and compress the square rubber bumpers slightly. The rubber bumpers are bolted to one module but not to the other; hence, any tension in the chains is not transmitted to the rubber bumpers. Wooden blocks were also placed between the concrete modules and the bumpers. This system is believed to be an improvement over the system previously used at Tenakee Springs, Alaska (Adee, 1975b).

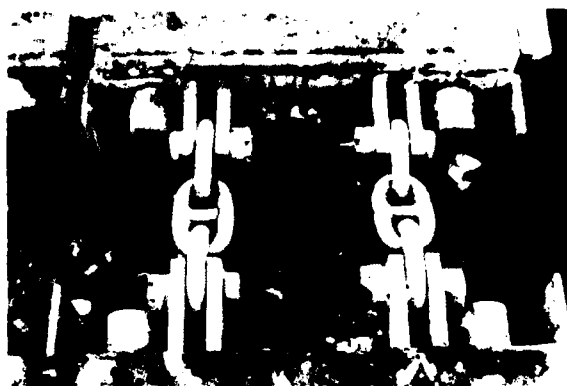


Figure 52. Connecting unit (chain restraints and rubber bumpers) used to attach modules of Alaska-type floating breakwater (after Adeo, © 1975b).

Private developers installed a floating concrete pontoon-type breakwater to protect a marina at Embarcadero, Yaquina Bay, near Newport, Oregon. The wave climate at this site is quite limited with a maximum fetch of about 1 mile. The water depth beneath the breakwater at low tide is about 20 feet, and a chain (diameter, 1-1/2 inches) connected to piles driven into the bottom is used to secure the structure. The breakwater has had one problem which occurred at the connections between the modules. The original installation used eyebolts on each module, connected with a chain, and rubber tires as bumpers between the modules. The failure of several eyebolts necessitated a redesign of the connection. To correct this situation, holes were drilled and steel reinforcing plates were installed in the concrete shell; neoprene-covered wire rope was then installed through the holes (Fig. 53). The redesign appears to have successfully corrected the connection problem.

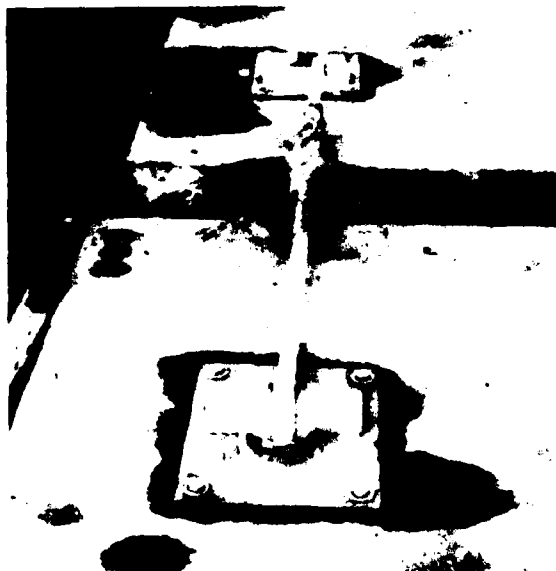


Figure 53. Connection redesign (consisting of wire rope through reinforcing steel plates) for concrete pontoon units (after Adeo, © 1975b).



The connection detail tentatively proposed for the East Bay Marina, Olympia Harbor, Washington, consists of the square rubber bumper similar to that used at Sitka, Alaska, except the rubber unit serves as both a bumper and a tension restraint. The unit is designed so that steel plates bolted to the concrete modules penetrate the hole in the center of the rubber unit on each side and restrain the modules from moving apart. During compression, the rubber bumper absorbs forces and energy (Fig. 54).

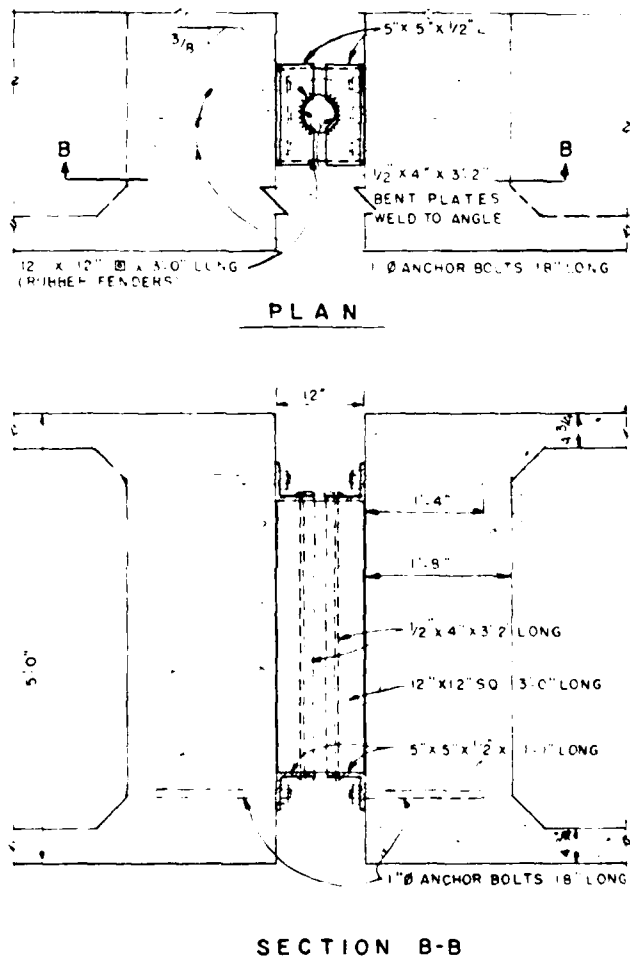


Figure 54. Tentative connection design of a rubber unit which serves as a bumper in compression and a restraining unit in tension (after U.S. Army Engineer District, Seattle, 1979).

f. Anchoring Systems.

(1) Anchors. The type of anchoring system designed for a particular location depends to a large extent on the type of bottom material at that specific site. Conventional ship-type anchors are available in used condition in the 6,000- to 8,000-pound range, but their holding power under actual site conditions has not been field tested. Pile anchors are quite effective if penetration is sufficient to develop adequate shear and bending strength of

the pile. Concrete mass anchors have the advantage of being relatively inexpensive with a practical burial in soft-bottom material. Many bottom locations have at least a few feet of soft or otherwise favorable material for anchor placement. A concrete mass anchor is only capable of developing a resistance to movement of about one-half its submerged weight if the ground is firm enough to resist settling. Both concrete mass anchors and pile anchors for floating breakwaters are discussed in Giles and Eckert (1979).

(2) Anchor lines. Acceptable materials for a floating breakwater anchoring system are synthetic fibers, chain, or wire rope. Design comparisons should consider cost, size, working strength, and elasticity. Wire rope is economical but with low longevity; it does not stretch or absorb shock as readily as other materials. Wire rope is available in many varieties and yields the highest strength per cost, but requires replacement frequently (Stormer, 1979).

Chain is available in many grades and types of materials. For anchoring purposes, Miller (1974a) recommends stud link primarily because of ease of handling. Chain derives its energy absorption capabilities from the components of weight and the resultant catenary effect which effectively functions as a spring. Connection is easily provided at any point on its length. Anchor chains which are not galvanized should be designed oversized to allow for corrosion. This oversizing is beneficial because the weight gained yields a deeper catenary curve and more absorption capability because of the spring effect. Mooring chains and joints always experience repeated loading, causing a decrease in strength from fatigue and a loss in chain diameter through abrasion and corrosion. Araki (1978) conducted preliminary investigations to determine cumulative fatigue damage.

Nylon, dacron, or polypropylene synthetic lines each have unique characteristics to be considered, but nylon is more practical because of its energy absorption nature (the fundamental purpose of the floating breakwater system). The size of nylon lines is important because the elongation and resultant lateral movement of the floating breakwater must be kept within reasonable limits. The recommended factor of safety for synthetic lines is 4 to 5. Miller (1974a) noted that pertinent to the design of a floating breakwater is the availability of sufficient reserve strength for the rare storm which would greatly exceed the normal working loads. Prototype observations indicate that it would be a rare condition if the entire length of a floating breakwater were loaded uniformly at a particular time. It is more probable that only a small percentage of the total number of anchor lines will be fully loaded at any time.

#### IV. SLOPING-FLOAT (INCLINED PONTOON) BREAKWATER

The sloping-float breakwater, proposed by Patrick (1951), consists of a row of moored, flat slabs or panels which lean into the incident waves, and whose mass distribution is such that, in still water, each panel has one end resting on the bottom and the other protruding above the water surface. Incoming surface gravity waves encounter the structure which occupies the entire water column. Some energy may pass over the barrier (if the freeboard is not high enough to prevent overtopping), some will usually pass under it, and in an assembly of floats, some energy will pass through the gaps between the floats. Waves in the lee of the structure exist largely because of the induced motion of the float, which is resisted by inertia, gravity, and the moorings. A proposed modification of the original concept (Patrick, 1951) is the addition of legs to create a gap between the lower edge of the float

AD-A110 692

COASTAL ENGINEERING RESEARCH CENTER FORT BELVOIR VA  
FLOATING BREAKWATERS: STATE-OF-THE-ART LITERATURE REVIEW. (U)  
OCT 81 L Z HALES  
CERC-TR-81-1

F/G 13/2

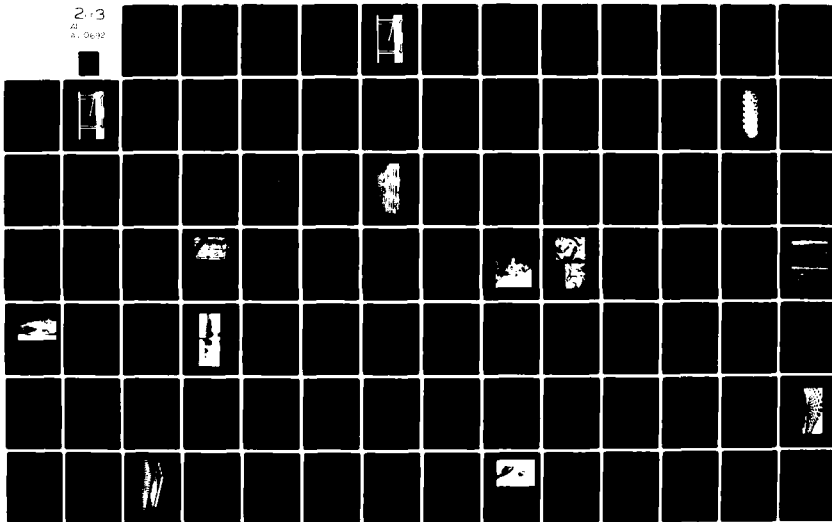
UNCLASSIFIED

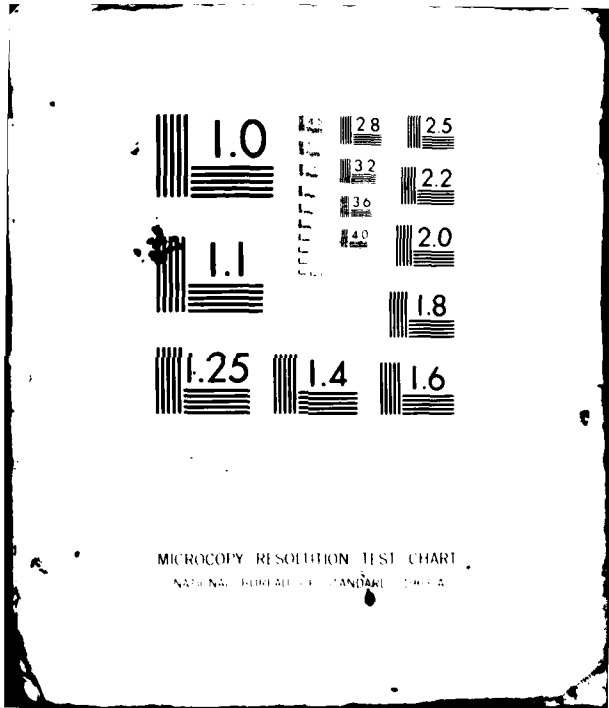
NL

2 of 3

AL

2 Oct 82





MICROCOPY RESOLUTION TEST CHART  
NATIONAL BUREAU OF STANDARDS-1963-A

the sea floor. This alteration would increase the depth range in which a float of a given length can be used.

1. Users and Applicability.

a. U.S. Army Corps of Engineers. The COE has a potential requirement for a floating breakwater system to protect dredges and work boats involved in coastal engineering construction in the nearshore zone of exposed coastlines. The wave climate in these regions far exceeds the wave climate which floating breakwaters are generally intended to attenuate (4-foot-high waves with up to 4-second periods, the wave climate of semiprotected bays and lakes). An increase in effective working time can be accomplished by increasing the wave window for dredges and barges by reducing the energy of waves substantially larger than commonly encountered in sheltered regions.

b. U.S. Navy. The Navy has a requirement for a ship-transportable breakwater to be used in conjunction with the Container Offloading and Transfer System (COTS) being developed by the Naval Facilities Engineering Command (Jones, 1978). In this concept, a container ship moored in exposed locations offshore could have cargo expeditiously offloaded and transferred ashore. These operations occur in water depths ranging from 20 to 60 feet or more. Sloping-float breakwaters are being considered for protecting small, moored craft and work platforms where waves with periods as small as 2 or 3 seconds can be troublesome. The U.S. Navy is currently interested in a hollow, steel barge adaptation (a pontoon barge or causeway section) which appears to have acceptable dimensions and mass. These barges can be ballasted by flooding compartments with seawater to provide the appropriate mass distribution. This system requires mass that would not have to be transported to the desired site, as the ballast water may account for more than three-fourths of the total mass. The installation procedure currently under investigation is to assemble floating (unballasted) modules on the surface and then, by venting, flood the shoreward end of each float until the lower end rests on the bottom and the upper end settles to the desired freeboard level.

Preliminary experimental wave transmission data indicate that floats 90 feet long reduce the significant height of local wind-generated waves by more than 50 percent when the dominant wave period is less than about 7 seconds and the water depth is less than about 30 feet. Thus, pontoons, barges, or causeway sections may be considered for such ocean applications. Jones (1980) estimated that an assembly of 30 such pontoon structures (each 90 feet long by 21 feet wide by 5 feet deep) could be carried on the hatch covers of a LASH barge. This assembly would form a sloping-float breakwater with a sea-to-shore dimension slightly less than 90 feet and an axial length of about 700 feet, which is considered sufficient to shelter a localized area for naval operations. In water depths greater than 30 feet, floats would have to be longer than 90 feet to maintain the same performance; e.g., in a 45-foot water depth the float should be about 110 feet long. The Naval Civil Engineering Laboratory is continuing research in this area with interest centered on wave transmission and mooring forces for arbitrary float properties, water depths, wave characteristics, and mooring system properties. The operational characteristics of sloping-float breakwaters through full-scale open-ocean experiments are being investigated.

## 2. Analytical Investigation.

A dimensional analysis of the pertinent variables involved indicates that the transmission coefficient,  $C_t = H_t/H_i$ , is functionally related to at least five other dimensionless parameters, all of which are totally independent from each other.

$$C_t = f\left(\frac{\ell}{L}, \frac{\ell}{d}, \frac{H_i}{L}, \frac{\ell_b}{\ell}, \frac{w_b}{w}\right) \quad (46)$$

where

- $C_t$  = wave transmission coefficient
- $H_t$  = height of transmitted wave
- $H_i$  = height of incident wave
- $\ell$  = effective width of structure
- $\ell_b$  = ballasted length of sloping float
- $L$  = incident wavelength
- $d$  = water depth
- $w$  = weight of unit length of sloping float
- $w_b$  = weight of internal ballast in a unit length of sloping float

The coefficient of transmission,  $C_t$ , depends on the wavelength and the water depth relative to the length of the float, the wave steepness, and two parameters which govern the distribution of mass of the ballasted float (effectively, the moment of inertia and the location of the center of gravity). Both mathematical modeling and physical experimentation were undertaken to determine the functional relationship between these independent variables.

Raichlen and Lee (1978) studied initially the dynamics of a sloping-float breakwater to determine the forces in the mooring lines and the motion of the semisubmerged pontoons under wave action. Mooring forces can be predicted by evaluating the pressure distribution around the breakwater as a function of time, the forcing function which causes the breakwater motion. The geometry of an individual barge element initially considered is shown in Figure 55. For the theoretical investigation, waves are considered to be approaching normal to the barge and the mathematical model is two-dimensional. The possible motions of the barge when referenced to this orientation are surge, heave, and pitch. Raichlen and Lee's (1978) objective was to predict the tension in the mooring line as a function of time due to incident waves and determine the motion of the barge center of gravity. The approach to the problem is to develop the equations of barge motion, written in terms of the unknown pressure distribution on the body defined in terms of the time derivative of the velocity potential, a function of the incident wave height, period, water depth, and inclination angle of the barge. The problem is complicated by the interrelationships of motions and waves, and is similar to the problem of defining the motions of a moored ship.

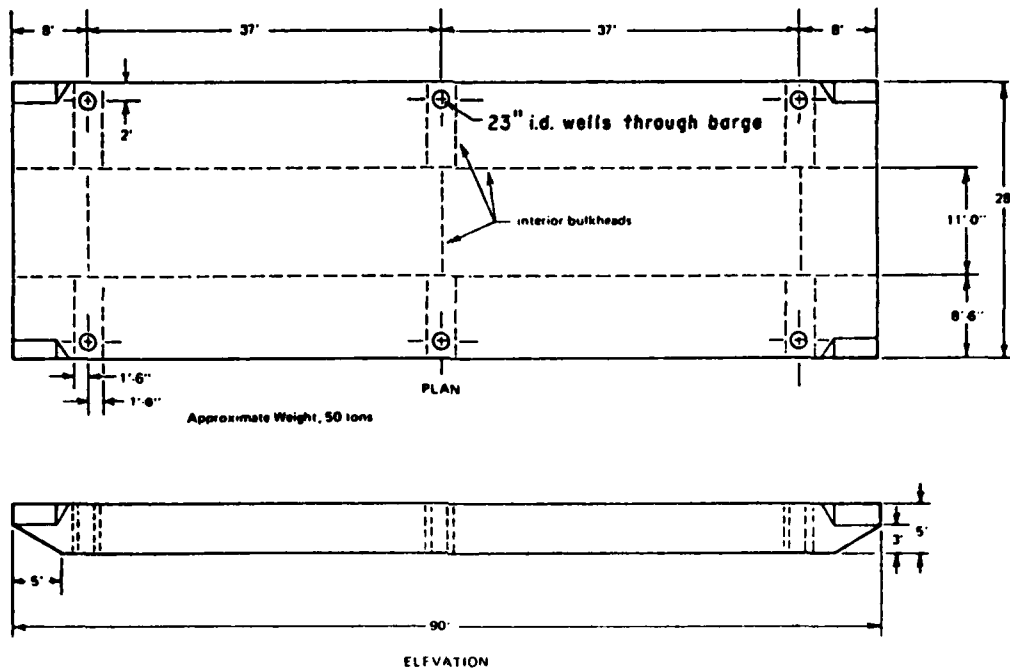


Figure 55. Geometry of barge under consideration as sloping-float breakwater for protection of dredges, sand bypassing, or cargo loading (after Raichlen and Lee, 1978).

The equations of motion of the moored barge may be deduced after approximating the change in the buoyancy and the elastic restraint associated with the mooring line. The restraining force due to buoyancy depends primarily on the unit weight for resistance to small motions; for an elastic mooring, the developed force is of the form

$$T = C \left( \frac{\Delta s}{s} \right)^m \quad (47)$$

where  $\Delta s/s$  is the strain, and  $C$  and  $m$  are constants unique to the type of mooring line. To define the tension in the mooring line, the strain,  $\Delta s/s$ , which is related to the tension at breaking, must be determined. Hence, the tension,  $T$ , can be determined from the characteristics of the mooring lines.

When the restoring forces have been defined in terms of the motion of the barge, the equations of motion can be expressed in terms of surge ( $x$ -direction), heave ( $y$ -direction), and pitch ( $\psi$ -direction). Raichlen and Lee (1978) noted that because of the analogous nature of the resulting expressions, only the  $x$ -component should be considered. This is a balance of the mass of the barge times the acceleration equated to the summation of six force terms acting on the body: (a) effect of the weight of the body; (b) effect of and change in buoyancy (a form of interaction among motions in the three directions--surge, heave, and pitch); (c) stress in the mooring line; (d) normal force acting on the bottom; (e) friction forces acting on the bottom; and (f) the forcing function (the integrated pressure force acting in

the x-direction). The last term is obtained from the time derivative of the velocity potential and, hence, the equation of motion is fully defined in terms of the incident wave amplitude. To verify the equations of motion of the sloping float breakwater, and to provide the Naval Civil Engineering Laboratory with useful information for a full-scale prototype test program of this structure, Raichlen (1978) tested a statically and dynamically accurate scale model of the sloping-float and mooring system so that both the mooring forces and the transmission characteristics of such an inclined pontoon could be estimated with confidence.

### 3. Experimental Investigation.

Particular objectives of Raichlen's (1978) experimental program were to investigate the effect on the mooring forces and transmission characteristics of the location of the mooring point on the barge, of a gap under the end of the barge which rests on the sea floor, and of structures placed atop the inclined pontoons to minimize wave overtopping. All experiments were conducted using periodic incident waves with a 25-foot prototype depth. Since actual incoming wave energy has a spectral distribution, the regular wave experiments were also analyzed with respect to irregular wave application. The wave tank used in the study was about 120 feet long, 3 feet wide, and 3 feet deep. All data were obtained without reflection influences.

a. Structure Resting on Bottom (No Bottom Clearance). The first series of experiments conducted by Raichlen (1978) dealt with a mooring configuration where the mooring point on the barge was located 29.5 feet from the seaward end of the barge. The center of gravity of the flooded barge at a depth of 72.5 feet was located 52.65 feet from the seaward end; thus, the mooring point was located 23.15 feet above the center of gravity of the flooded barge. The bottom of the barge was positioned on the bottom of the flume. Experiments were conducted for 3 different prototype wave heights (3, 6, and 10 feet); for each wave height, the barge was exposed to about 15 different wave periods at a 25-foot depth. The periods varied from 5.2 to 18.7 seconds, the full range of the important wave periods expected in an irregular sea at the site of potential field experiments. For each wave period, curves of prototype mooring force versus wave height and transmission coefficient versus wave height were determined. The experimental configuration is shown in Figure 56; experimental results are presented in Figures 57 and 58.

(1) Effect of Wave Height on Transmission Coefficient. For dimensionless depths,  $kd$  (where  $k = 2\pi/L$ ) greater than approximately 0.6, there is a significant increase in the transmission coefficient with increasing wave height. Part of this nonlinear effect is due to waves overtopping the seaward edge of the structure. For example, for a 7-second wave period, the transmission coefficient varies from approximately 0.15 for a 2-foot-high wave to nearly 0.55 for a 10-foot-high wave (Fig. 57). There is transmission both over and under the structure as the barge is able to move off the bottom during testing. In addition, one of the major factors influencing transmission is the motion of the barge itself, which acts as a wave generator. For large incident waves, the generation process is probably not linear.

(2) Effect of Wave Height on Mooring Forces. The variation of the mooring line force with  $kd$  is shown in Figure 58 for constant wave heights varying from 2 to 10 feet. The angle of inclination of the barge with the





Figure 56. Sloping-float breakwater two-dimensional experimental tests with wave crest at breakwater, wave period at 7.2 seconds, wave height at 6 feet, and no bottom clearance at a 25-foot water depth (after Raichlen, 1978).

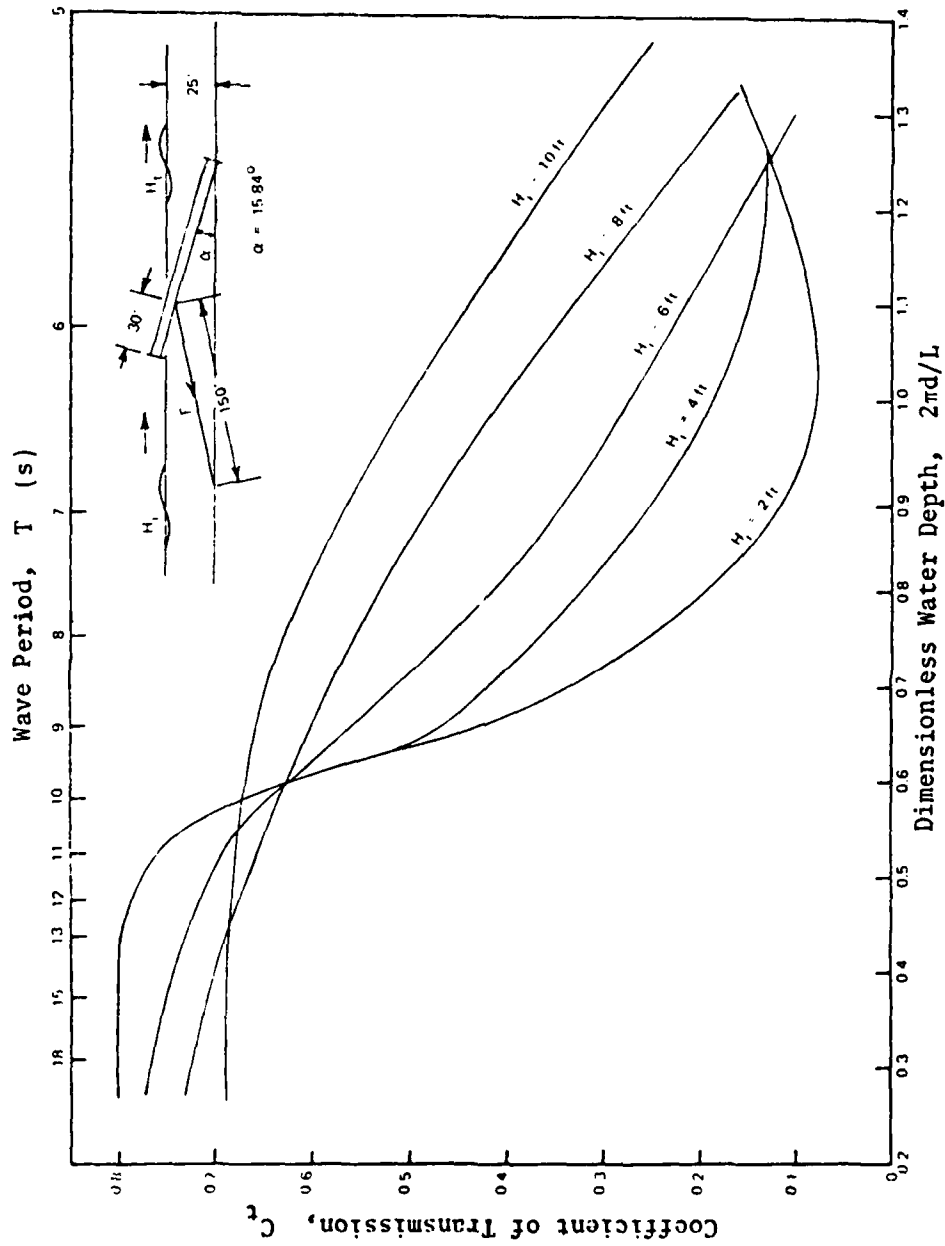


Figure 57. Two-dimensional experimental investigation of effect of incident wave height,  $H_i$ , on coefficient of transmission,  $C_t$ , for sloping-float breakwater with no bottom clearance at a 25-foot water depth (after Raichlen, 1978).

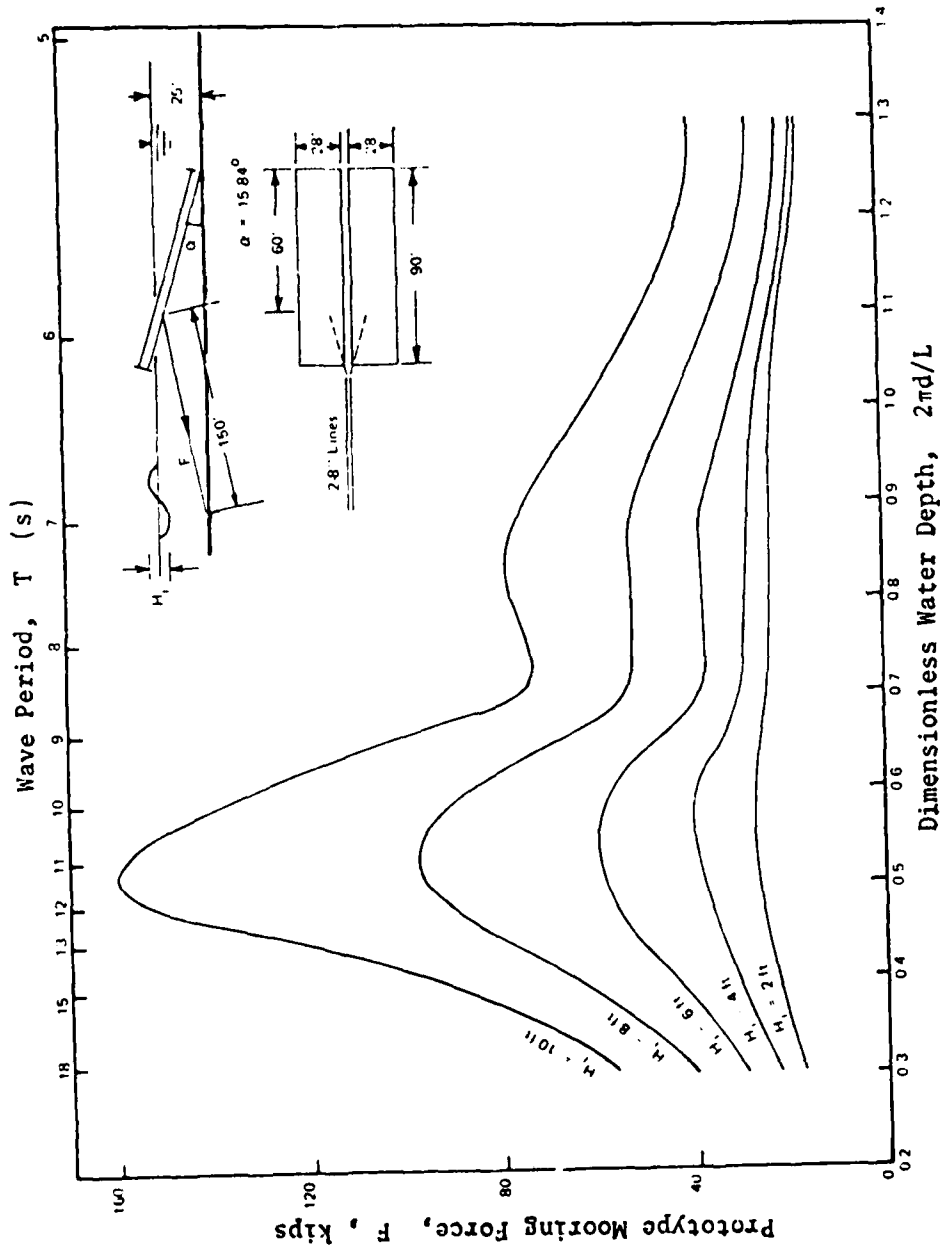


Figure 58. Two-dimensional experimental investigation of effect of incident wave height,  $H_i$ , on mooring force,  $F$ , for sloping-float breakwater with no bottom clearance at a 25-foot water depth (after Raichlen, 1978).

bottom was  $15.84^\circ$ . The most reliable information on these data is for a value of  $kd$  greater than approximately 0.45; i.e., for wave period somewhat less than about 13 seconds. The dominant feature of these data is the extreme mooring line forces experienced in the region of 12-second waves ( $kd = 0.5$ ) with the forces dropping significantly for shorter wave periods. The maximum mooring force for the 10-foot wave is about 160,000 pounds, which is approaching the breaking strength for this particular line. For small wave heights from 2 to 6 feet, the mooring force appears roughly linear with wave height, although for larger waves the nonlinearity becomes quite apparent.

(3) Effect of Mooring Location on Transmission Coefficient. The variation of the transmission coefficient is presented as a function of  $kd$  for three mooring arrangements (Fig. 59). There appears to be some fundamental difference in the transmission coefficient for cases A and C, shown in the figure, compared to case B for the region of  $kd$  between 0.7 and 1.0. In the region of interest to both Navy and Corps operations (wave periods about 7 seconds or values of  $kd$  about 0.9), the transmission coefficient varies from approximately 0.35 to 0.45, depending on the mooring system. Raichlen (1978) did not entirely expect such differences; he recommended that, since the curve of case B was obtained by interpolation and cases A and C were actual data, more confidence could be placed on the data points than on the interpolated curve.

(4) Effect of Mooring Location on Mooring Forces. The effects of variation of the mooring position on the mooring forces, as a function of  $kd$ , are presented in Figure 60. Except for experimental scatter, there appears to be little such effect for values of  $kd$  greater than approximately 0.5. There is a large deviation of the data of cases A and C from those of case B for values less than 0.5; it is probable that the curve for case B may be in error for this region. In general, the mooring force is largest for long waves and decreases with an increase in the depth-to-wavelength ratio. This is reasonable considering the variation in the velocity distribution under a wave with increasing  $kd$ . For small  $kd$  values, the pressures will be positive along one side of the barge; for large values of  $kd$ , the pressure would reverse sign along one side of the barge, perhaps leading to a smaller total force and moment.

(5) Effect of Bow Angle on Transmission Coefficient. From preliminary experiments, it was concluded that a part of the wave transmission past the barge was due to overtopping of the structure by some waves. To increase the freeboard and minimize the effect of overtopping, Raichlen (1978) added a perpendicular wall extension to the seaward face of the inclined pontoon. He termed this vertical distance the "bow angle," although in reality there is no angle associated with this distance. For the two cases, the height of the extension was 2.5 feet in one set and 5.0 feet in another set, both conducted with 6-foot-high waves; the corresponding attenuation results are presented in Figure 61, as well as for the case of zero bow angle. Also, for the case of no bow angle, two mooring line restraints (a nonlinear spring and an inextensible mooring line) were evaluated. Generally, it appeared that the transmission was largest for the condition of greatest restraint. For the case with the dynamic restraint, the transmission was the smallest when the bow angle was the largest. However, the effect of the bow angle was smaller than expected. In the region near a value of  $kd = 0.9$ , the bow angle reduces the transmission from approximately 0.47 to 0.35. Significant transmission must

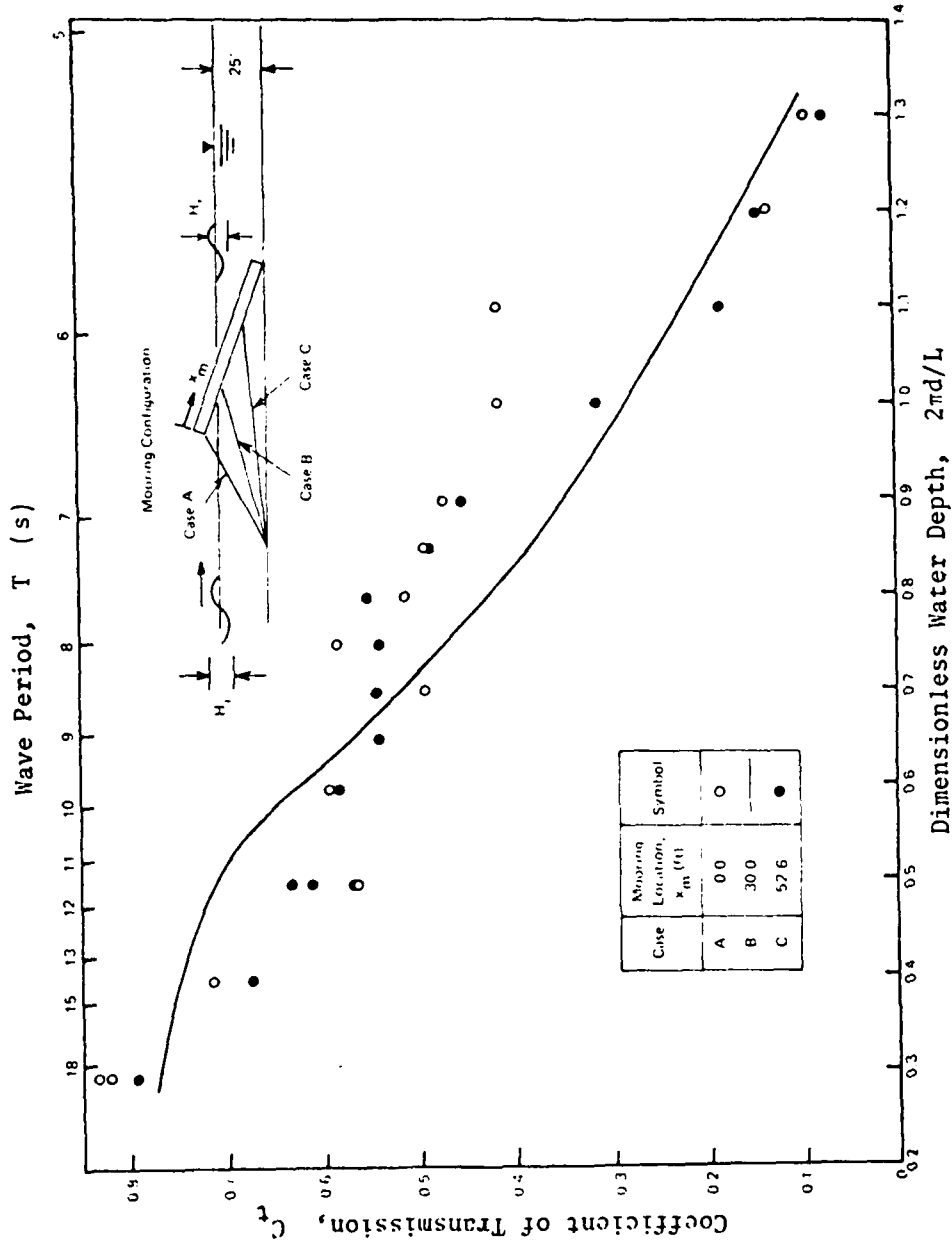


Figure 59. Two-dimensional experimental investigation of effect of mooring location on coefficient of transmission,  $C_t$ , for sloping-float breakwater with no bottom clearance at a 25-foot water depth (after Raichlen, 1978).

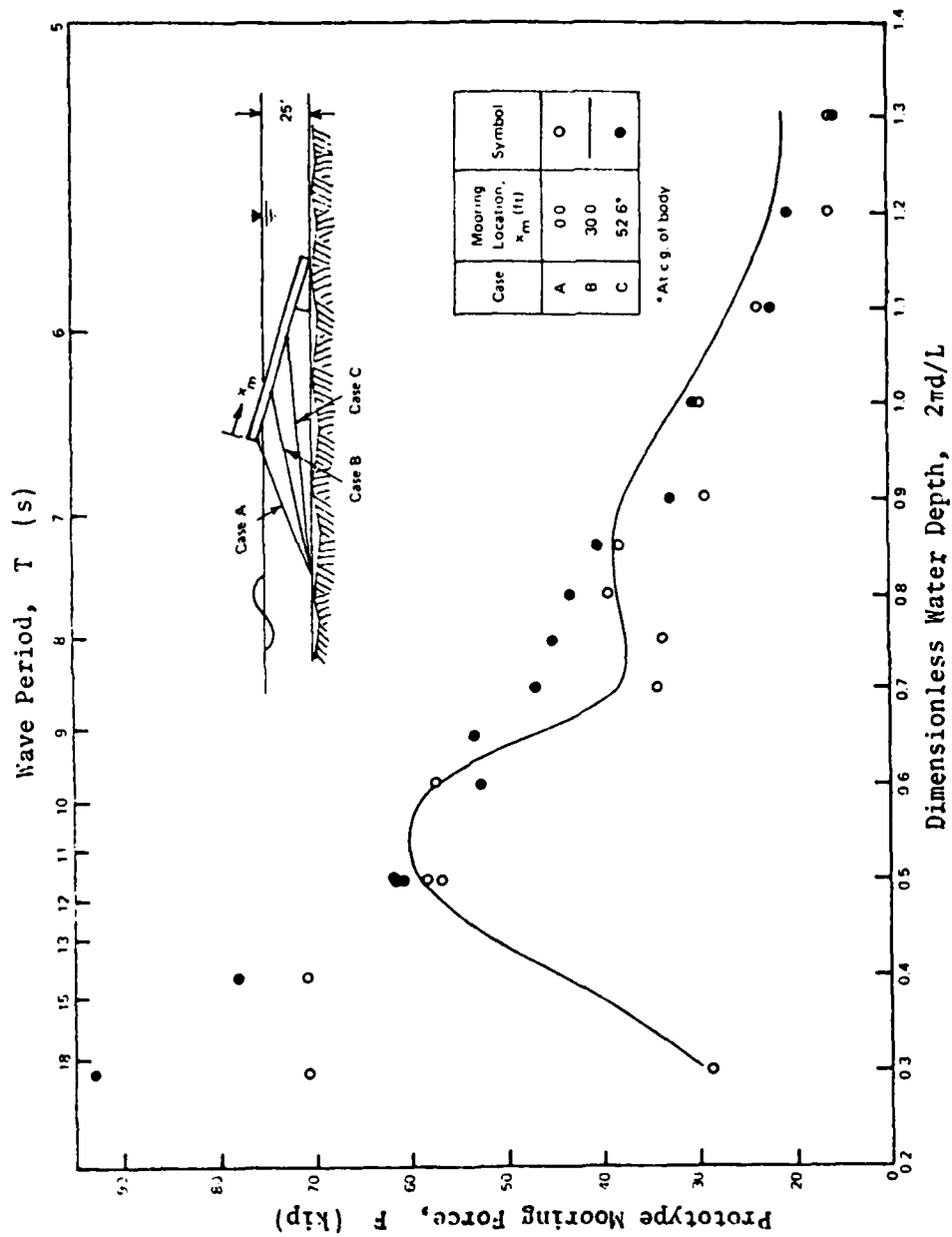


Figure 60. Two-dimensional experimental investigation of effect of mooring location on mooring force,  $F$ , for sloping-float breakwater with no bottom clearance at a 25-foot water depth (after Raichlen, 1978).

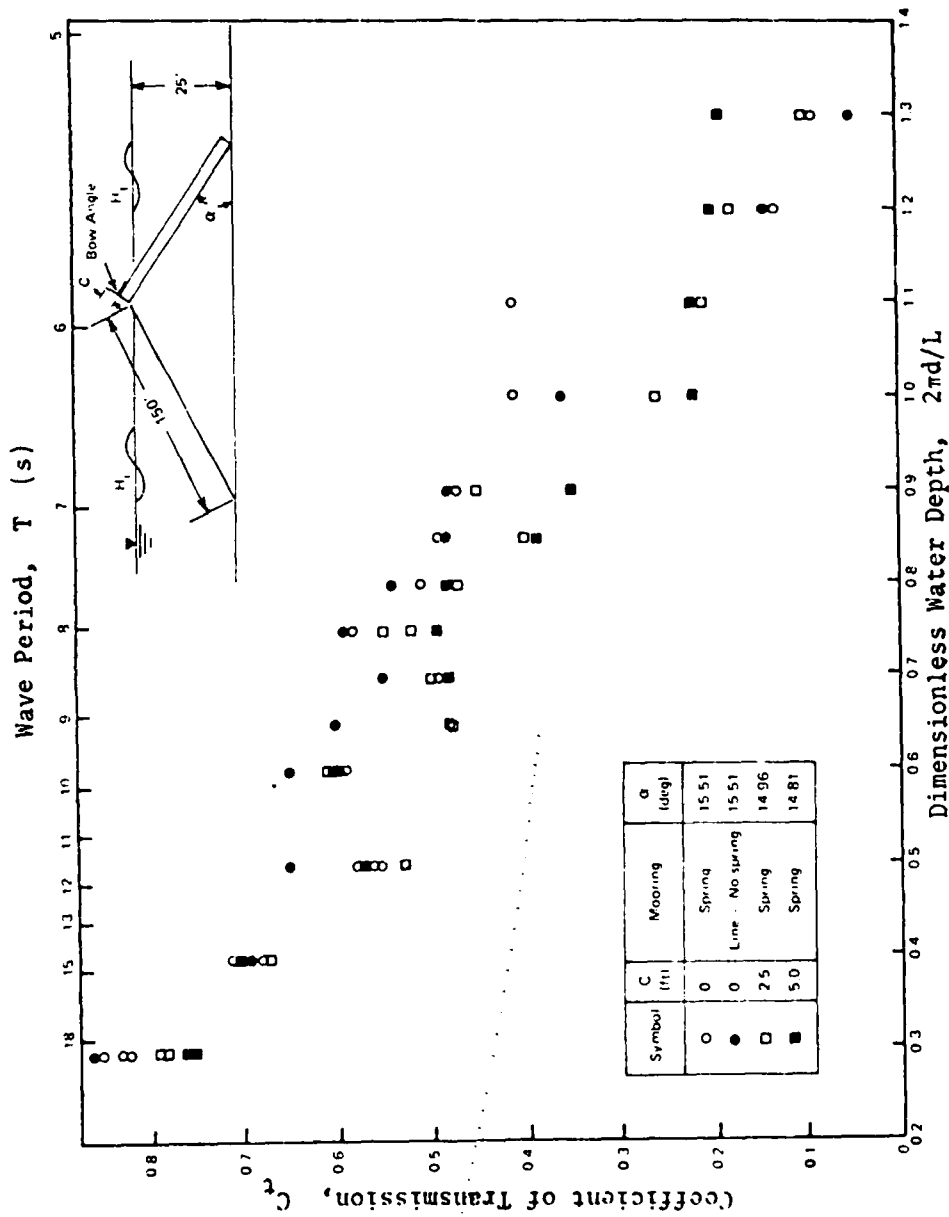


Figure 61. Two-dimensional experimental investigation of effect of bow angle (freeboard) extension on coefficient of transmission,  $C_t$ , for sloping-float breakwater with no bottom clearance at a 25-foot water depth (after Raichlen, 1978).

occur because of the movement of the inclined barge acting essentially as a wave generator. Also, transmission occurs through the gap which periodically opens under the bottom edge of the barge. The transmission coefficient with and without the spring mooring system (and without the bow angle) is approximately the same. This suggested to Raichlen (1978) that the dynamics of the barge mooring system are important with respect to forces but apparently not very important in connection with the wave transmission.

(6) Effect of Bow Angle on Mooring Forces. There appeared to be a slight increase in the mooring force due to the installation of the bow angle; however, the difference was too small to differentiate from experimental scatter. The mooring force tended to decrease from the larger values for the long waves to relatively small values for the shorter (deeper water) waves (Fig. 62). Figure 62 also displays the variation with  $kd$  of the forces which would be associated with the mooring line if the line were infinitely stiff. For very long waves, this force appears to be the same as the force associated with the spring line. Hence, the dynamics on the mooring line for these long waves are little affected where the ratio of depth-to-wavelength is of the order of 0.048. However, in the region of  $kd$  at approximately 0.75, the mooring line force without the spring is nearly three times that with the spring. The spring system allows the barge to attain an orientation that is conducive to minimal hydrodynamic force. For the inextensible spring, the body moves but cannot orient itself to significantly reduce the mooring force. Raichlen's (1978) experiments tend to demonstrate that the more flexible the spring system, the smaller the mooring force, presumably because the barge is allowed to move proportionally more and assume an orientation which minimizes the restraining forces. However, the disadvantage of the softer spring is the increased motion of the barge which tends to generate larger waves on the lee side, compared to the stiffer mooring.

b. Structure Resting on Supports (Bottom Clearance). Raichlen (1978) conducted two-dimensional experimental studies with a spacer mounted to the end of the barge resting on the bottom where a bottom gap of 4.75 feet prototype existed (Fig. 63). Since the length of the mooring line remained unchanged, the angle of inclination of the barge with the bottom was decreased to approximately  $12.2^\circ$ .

(1) Transmission Coefficient. A greater transmission for the same wave height was anticipated when the structure was supported above the bottom of the wave flume (see Fig. 64). A comparison with Figure 57 (the corresponding figure when the structure was not elevated above the bottom) reveals that indeed there is a distinct difference in transmission although not to the degree anticipated. A certain amount of disturbance occurred during the transmission process, particularly at the seaward edge of the barge. Bubbles were observed just after the wave trough had passed, as the wave became detached from the seaward edge. The end of the barge near the bottom moved almost 5 feet (one gap height) off the bottom. If a gap at the bottom is to be maintained in the prototype, the forces involved when the barge drops back to the seabed should be determined. The downward movement of the seaward end of the barge during the overtopping process was probably due to the water mass associated with extreme wave tests, and was not as readily apparent for smaller waves. Although tested for transmission, the larger waves are probably not realistic in terms of either the design or the operation of the mooring system for the sloping-float breakwater.



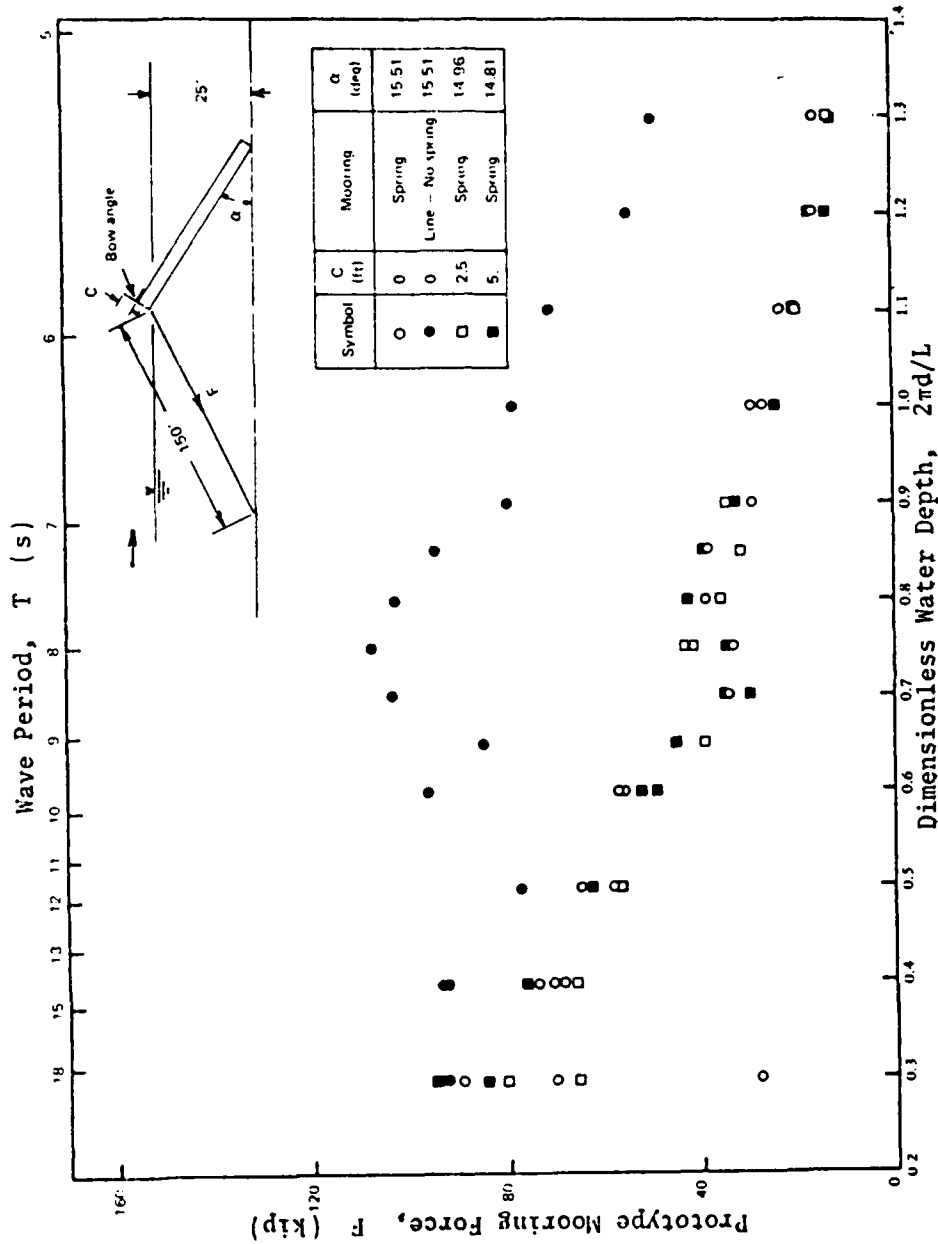


Figure 62. Two-dimensional experimental investigation of effect of bow angle (freeboard) extension on mooring force, F, for sloping-float breakwater with no bottom clearance at a 25-foot water depth (after Raichlen, 1978).



Figure 63. Sloping-breakwater two-dimensional experimental tests with wave crest at breakwater, wave period at 7.2 seconds, wave height at 10 feet, and bottom clearance at a 25-foot water depth (after Raichlen, 1978).

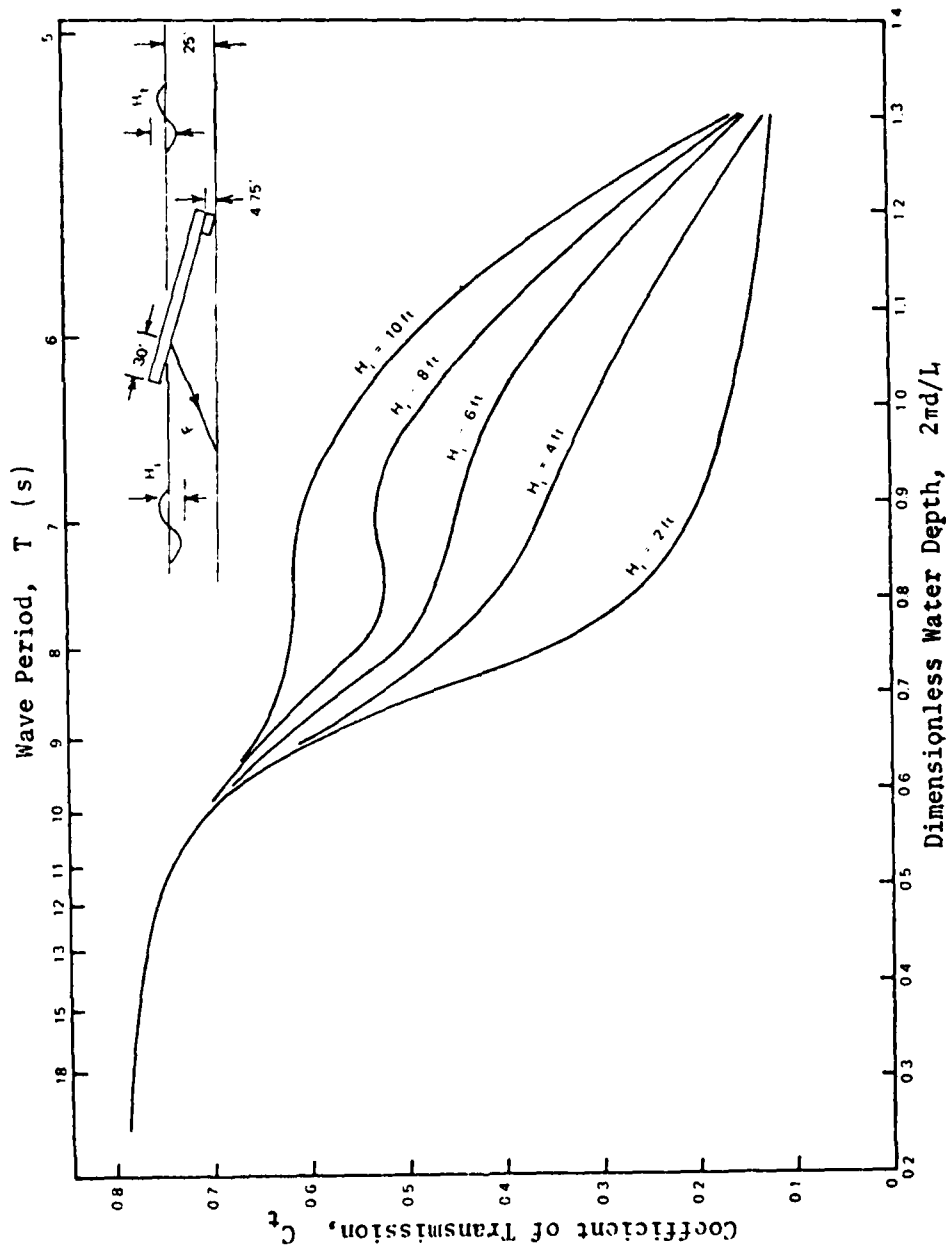


Figure 64. Two-dimensional experimental investigation of effect of incident wave height,  $H_i$ , on coefficient of transmission,  $C_t$ , for sloping-float breakwater with bottom clearance at a 25-foot water depth (after Raichlen, 1978).

(2) Mooring Forces. The variation of the mooring force with the relative depth,  $kd$ , is presented in Figure 65 for waves of constant height and the condition of a bottom-supported barge. A comparison of Figure 65 and Figure 58 (no bottom clearance) indicates significant differences in the shape of the curves; for the case with a gap, the maximum mooring force is shifted to smaller wave periods. For wave heights up to 8 feet, the mooring force increases compared to the case of no bottom clearance. For a 10-foot wave height, the maximum mooring force decreases from about 160,000 pounds at no gap to about 130,000 pounds with the gap. For the shorter waves and the larger wave heights, there is no significant difference between the mooring forces for the case with or without a gap. This is probably due to the fact that the velocities near the bottom are smaller for the shorter waves than they are for the longer waves, represented by values of  $kd$  less than approximately 0.6.

#### 4. Application to Random Open-Ocean Waves.

Raichlen's (1978) experimental study dealt with the forces in the mooring system and the transmission characteristics of the partially flooded barge exposed to periodic waves. The results for an irregular wave climate on the ocean surface can be interpreted, using a wave spectra model. A commonly used spectrum in oceanographic work is the Pierson-Moskowitz spectrum

$$S(\omega) = \frac{\alpha g^2}{\omega^5 \exp[-\beta(g/U\omega)^4]} \quad (48)$$

where

$g$  = gravitational acceleration

$\omega$  = wave circular frequency

$U$  = wind velocity at standard height of 19.5 meters above sea level

$\beta$  = 0.74, commonly used value

$\alpha$  = 0.0081, commonly used value

The peak frequency of the spectrum described by equation (48) is

$$\omega_p = \left(\frac{4\beta}{5}\right)^{1/4} \left(\frac{g}{U}\right) \quad (49)$$

from which the windspeed can be obtained corresponding to that peak frequency. It can be easily shown that the wave spectrum,  $S(\omega)$ , can be converted to a line spectrum of wave height as

$$H_i = 2 [2 S(\omega_i) (2\pi \Delta f_i)]^{1/2} \quad (50)$$

where  $\Delta f_i$  is the frequency bandwidth corresponding to the spectral estimate  $S(\omega_i)$  centered at  $\omega_i$ . If a mooring force,  $F_i$ , is defined which corresponds to the wave height,  $H_i$ , from mooring force curves such as Figure 65,

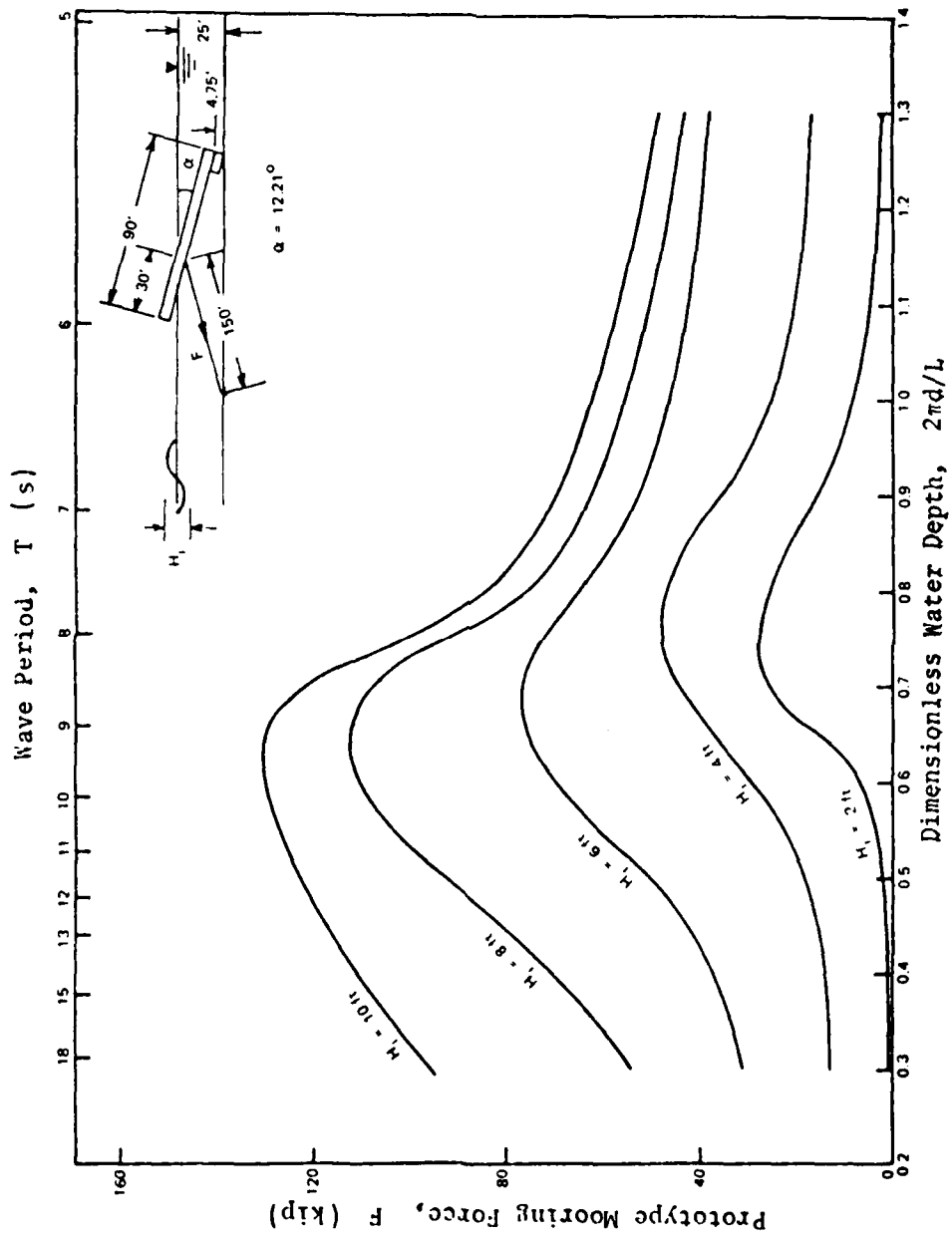


Figure 65. Two-dimensional experimental investigation of effect of incident wave height,  $H_1$ , on mooring force,  $F$ , for sloping-float breakwater with bottom clearance at a 25-foot water depth (after Raichlen, 1978).

a transfer function can be deduced, analogous to the wave height line spectrum, to develop a line force spectrum

$$F_i = 2 [2 F(\omega_i) (2\pi \Delta f_i)]^{1/2} \quad (51)$$

From equation (51), a continuous force spectrum,  $F(\omega_i)$ , can be established for determining the maximum probable force.

The size of barges under consideration for use as a sloping-float breakwater by either the Navy or the COE is expected to yield beneficial effectiveness for wave periods up to 7 seconds. The Pierson-Moskowitz open-ocean wave spectrum with peak at 7 seconds is shown in Figure 66 as the incident wave climate. Equation (49) can be utilized to yield the wind velocity required to generate this spectrum. The transformation shown in equation (50) is used to obtain the incident wave height spectrum, presented in Figure 67(a). These heights represent periodic waves of the indicated frequency which, when superposed on each other, yield the irregular wave field approximating the continuous spectrum of Figure 66. For each wave height in Figure 67(a), a transmission coefficient,  $C_t(\omega_i)$ , can be obtained from the experimental data corresponding to the appropriate configuration. The product of these coefficients and the incident wave height,  $(C_t(\omega_i) \times H_i)$ , produces the transmitted wave height spectrum, also shown in Figure 67(a). The continuous frequency spectrum of the transmitted wave height can be obtained by applying equation (48); this spectrum is shown in Figure 66. The mooring forces pertaining to the individual wave periods are obtained in an analogous manner, and are shown in Figure 67(b), with the continuous force spectrum shown in Figure 67(c).

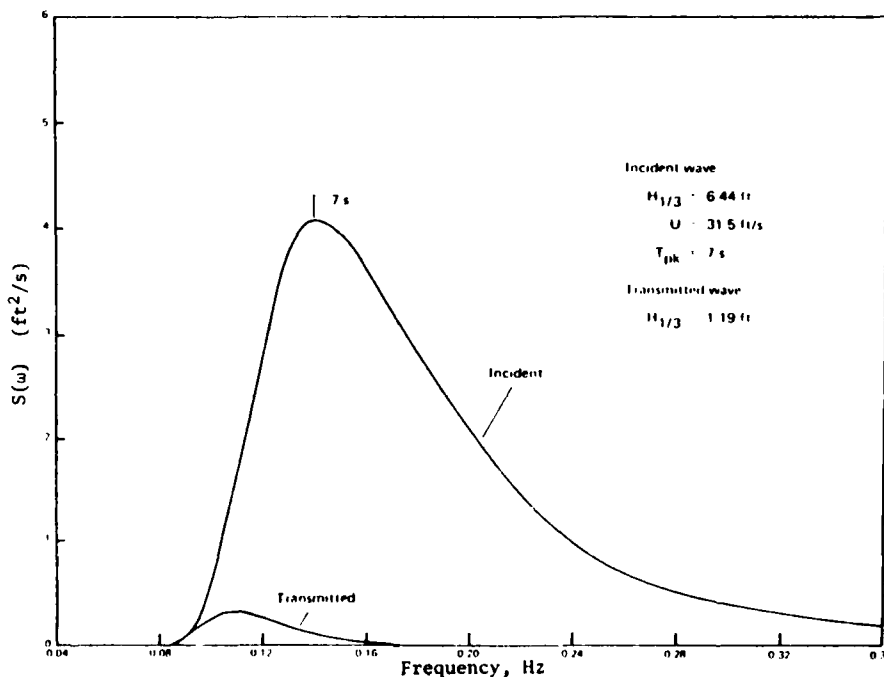


Figure 66. Two-dimensional experimental investigation of incident and transmitted Pierson-Moskowitz wave spectrum for 7-second peak, sloping-float breakwater with bottom clearance at a 25-foot water depth (after Raichlen, 1978).

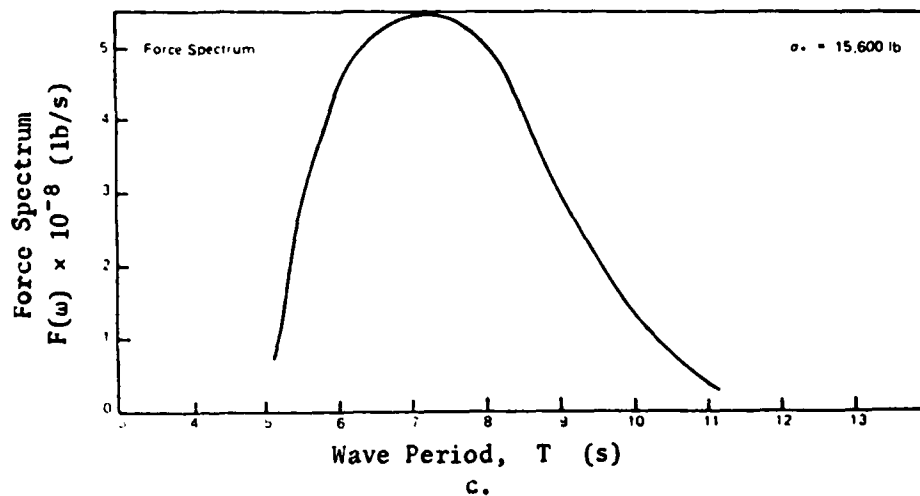
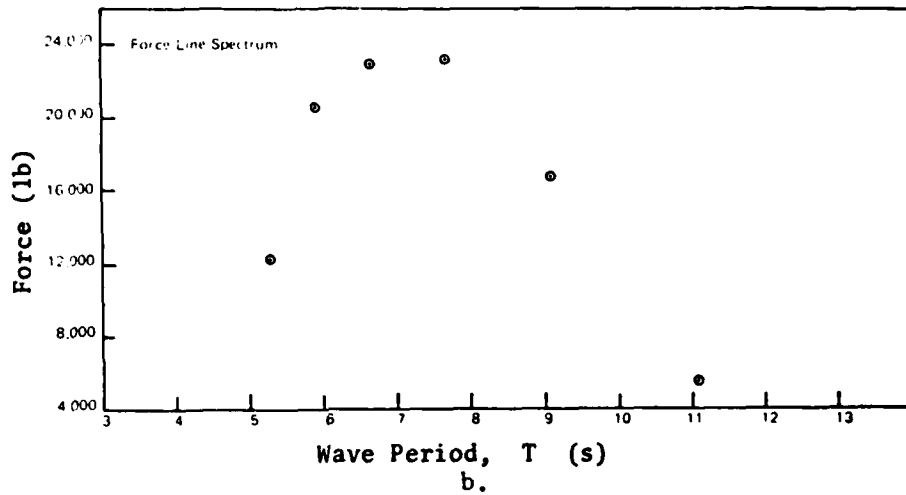
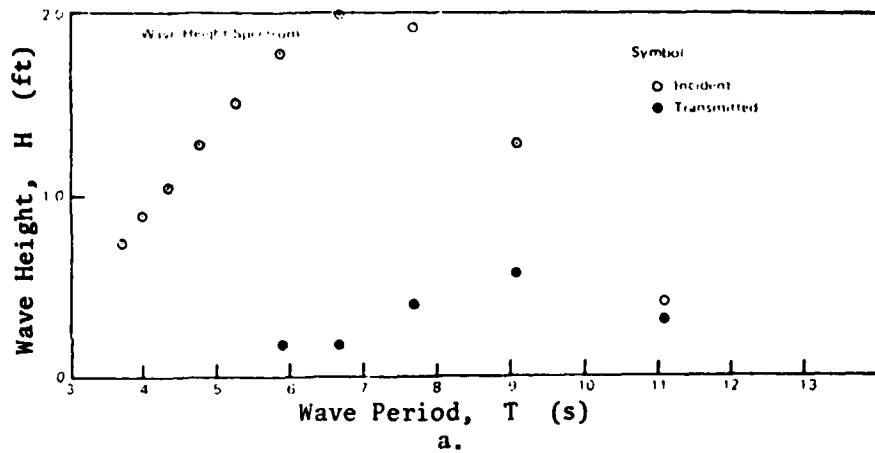


Figure 67. Wave height and force spectrum for sloping-float breakwater subjected to 7-second Pierson-Moskowitz spectrum (after Raichlen, 1978).

WES is presently conducting two-dimensional wave flume experiments on the sloping-float breakwater concept. These wave tests on dynamically modeled barges are being performed with the use of a spectral wave generator capable of producing any desired frequency-energy spectrum. U.S. Army Engineer District, Wilmington, is considering the sloping-float breakwater (along with other floating breakwater concepts) for protection of dredging operations and sand bypassing at Oregon Inlet, North Carolina. Current COE floating breakwaters are effective in wave attenuation for periods up to about 4 seconds in semiprotected bays and estuaries; however, the open-ocean application such as Oregon Inlet construction requires substantial wave attenuation for wave periods up to 7 seconds. This requirement has initiated joint investigative action between NCEL and COE.

#### 5. Performance Summary.

Jones (1978) adapted the performance of the sloping-float breakwater for solid (no clearance) breakwaters in a regular wave climate to predict breakwater performance in fully developed, local wind-generated seas represented by the Pierson-Moskowitz spectrum. Figures 68 and 69 show the float length required to reduce wave heights to levels associated with sea-state 3 (small waves, crests beginning to break, foam of glassy appearance, occasional white foam crests) for water depths of 30 and 45 feet, respectively, developed by a reanalysis of Patrick's (1951) original laboratory experimental data. For a spectrum peaked at 7 seconds and a water depth of 30 feet, Figure 68 indicates that the significant wave height is reduced to 4 feet if the floats are 76 feet long, or to 3 feet if the floats are 98 feet long. The mass and shipping requirements of the transportable sloping-float breakwater are highly dependent on the float length, which must be selected on the basis of water depth. A system constructed from a standard module design, such as the 28- by 90- by 5-foot pontoon, should be the minimal engineering development.

a. Installation. Jones, Lee, and Raichlen (1979) considered a proposed layout for an assembly of sloping-float breakwaters, and Jones (1980) advanced the layout of Figure 70. It was envisioned that the floating modules would be connected, temporarily held in position by tugs, and then attached to preset moorings. The containers would be ballasted by flooding with seawater through valves in manifold headers which could be opened in quick succession. The rate of flooding would be controlled by the module size selected for the ports and by valves in the air system. After flooding, the moorings would require readjustment. Experiments and experience indicate that floats as short as the 90-foot pontoon produce a useful degree of wave height reduction for dominant wave periods up to 7 seconds; therefore, manageable-size floats have open-ocean application. Experimental evidence indicates that sloping floats are most effective if the angle of inclination is less than about 20°. Thus, a 90-foot float would be most effective in water depths less than about 30 feet.

An important area of investigation is the mooring system. Raichlen (1978) obtained mooring force data on a dynamically scaled model of a typical pontoon moored in regular waves. The mooring simulated the resistance of one double-braided polyester rope, 8-inch circumference per each 28-foot-wide pontoon. The maximum mooring line tension was found to be excessive for some of the larger wave heights when the wave period was greater than 7 seconds. However,



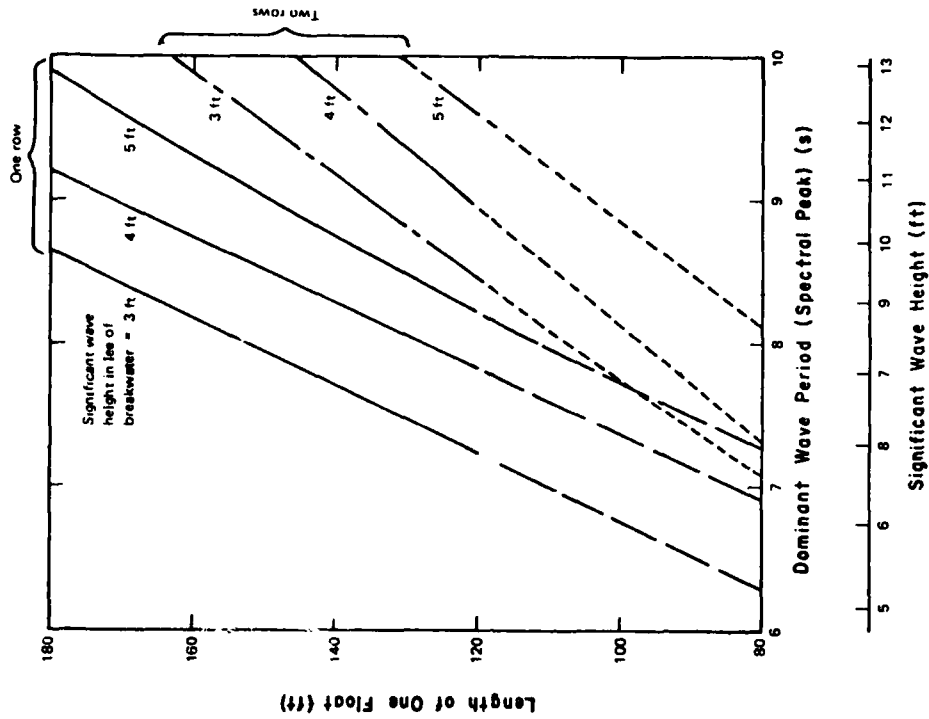


Figure 68. Length of sloping-float breakwater required to reduce wave heights of Pierson-Moskowitz spectrum to sea-state 3 at a 30-foot water depth (after Jones, 1978).

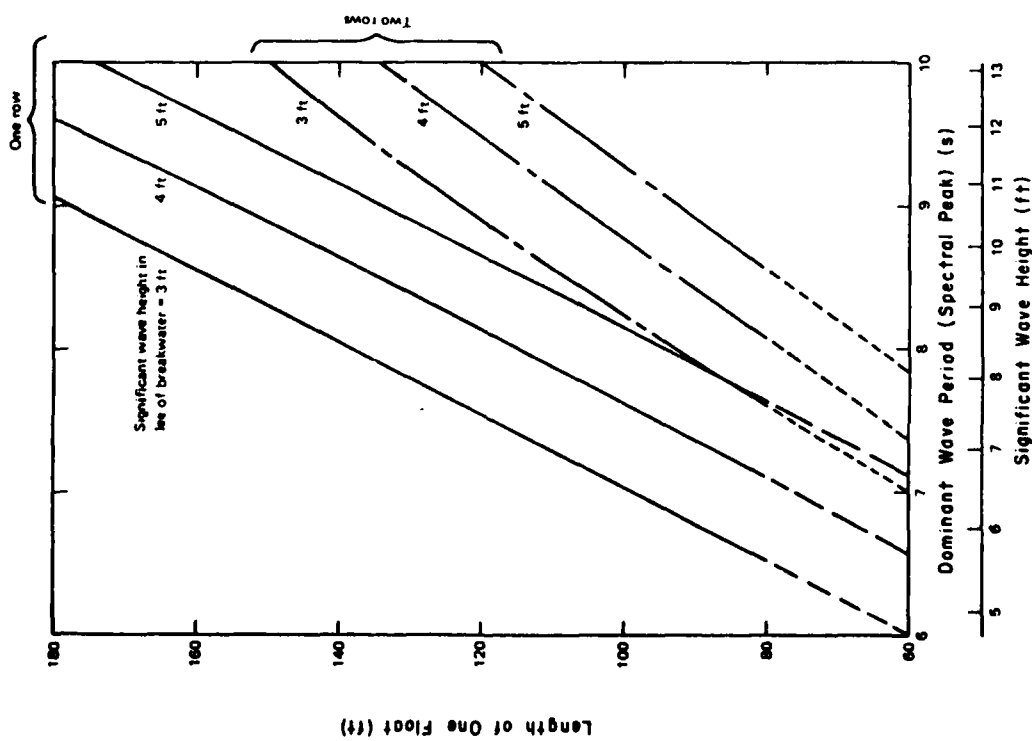


Figure 69. Length of sloping-float breakwater required to reduce wave heights of Pierson-Moskowitz spectrum to sea-state 3 at a 45-foot water depth (after Jones, 1978).

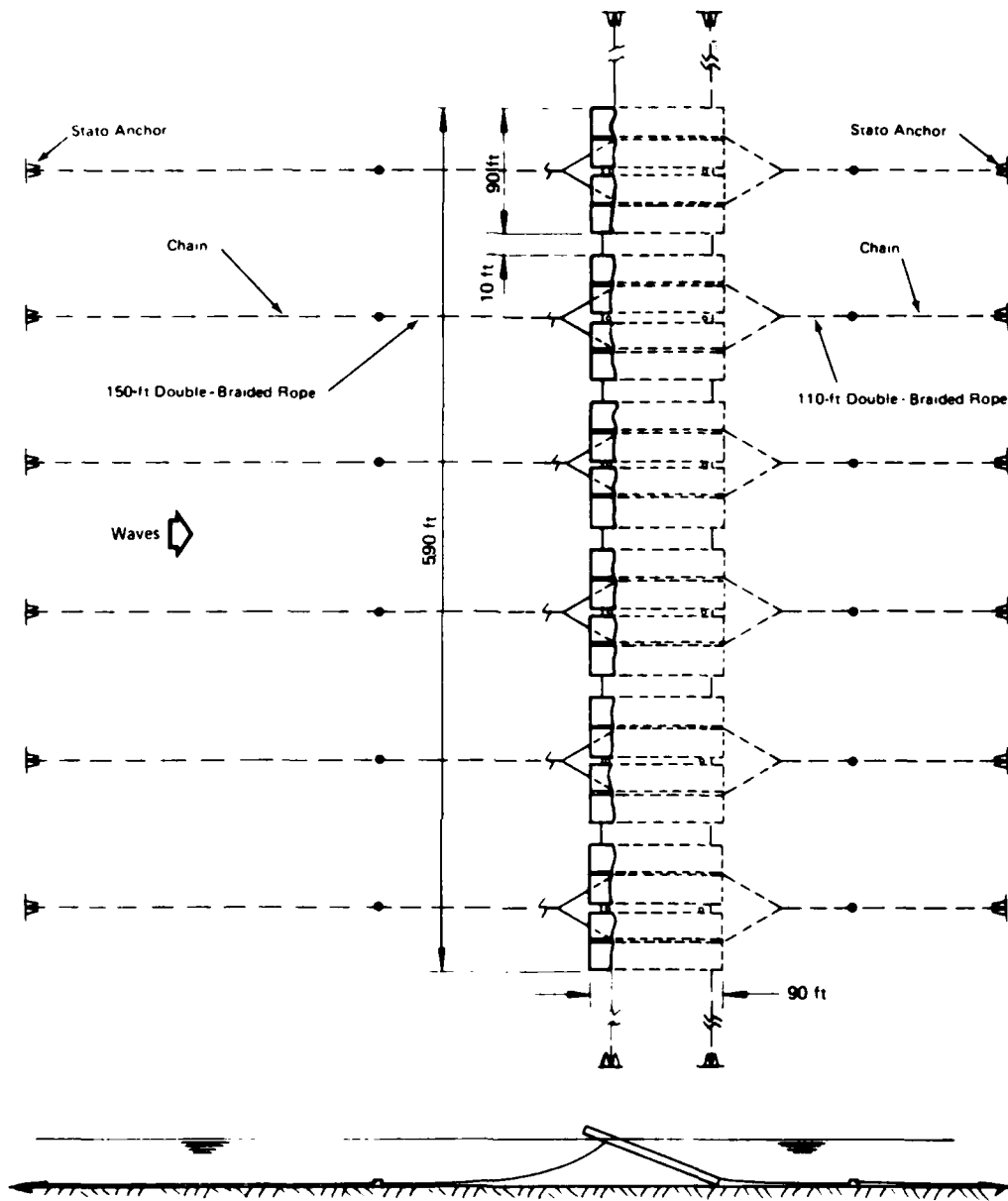


Figure 70. Conceptual layout of sloping-float breakwater composed of 90-foot-long pontoons of sufficient dimension to provide minimal protection at a 30-foot water depth (after Jones, 1980).

a more compliant material to reduce the peak tensions, such as double-braided nylon, can be used.

b. Cost Estimate. For prototype field test planning purposes, Jones (1980) provided cost estimates for installing a 90-foot-long pontoon barge for a proposed sloping-float breakwater. The estimates reflect system definition now available, including conventional drag-embedment anchors, and chain and synthetic-fiber rope moorings. The uninstalled cost estimate of \$6,000 per front foot includes about 10 percent for moorings at a 30-foot water depth, with the estimate based on the assumption that the average spacing between floats would be approximately 3.5 feet. This spacing is determined by the selected design of the moorings and connectors. The cost estimate allowed for minor structural additions to the pontoon sections for mooring line attachment points, for piping for ballasting and deballasting the individual pontoons, and for interconnections between adjacent modules.

Jones' (1980) cost estimate for the uninstalled sloping-float breakwater contrasts significantly with estimates for present COE floating breakwaters. The conventional type of floating breakwater usually adapted to semiprotected regions cost about \$1,500 to \$2,000 per linear foot, but they are only effective wave attenuators for wave periods up to about 4 seconds. The NCEL concept, and the requirements for the COE open-ocean operations, are considered significantly effective for periods up to 7 seconds. This degree of protection increases effective working time enough to make the estimate attractive for selected situations and environments. The estimated cost for 600 feet of sloping-float breakwater (considered minimal for open-ocean operations) is approximately \$3.6 million. The maximum probable forces to which this structure will be exposed far exceed the forces induced by the 7-second design wave conditions. The system simply cannot withstand these forces; hence, a sloping-float breakwater installation must not be left unattended for long periods of time, as is the case for semiprotected bays or harbors.

## V. SCRAP-TIRE FLOATING BREAKWATERS

Used automobile and truck tires are accumulating at an estimated rate of about 200 million yearly, with only about 10 percent recycled. This indicates that about 2 million tons of material is added each year to an already immense stockpile of existing scrap tires, conservatively estimated (Kowalski and Ross, 1975) to exceed 2 billion in the United States alone. The seemingly physical indestructibility of these abandoned tires has historically posed a vexing problem in seeking pollution-free methods of disposal. Concerned with the magnitude of this problem, the rubber industry and their research scientists are constantly seeking new and innovative methods for utilizing these wornout tires after they have served their initial purpose.

Coastal engineers have long been interested in resilient energy absorption mats for shore protection and harbor problem solutions, and scrap tires have been used occasionally for revetment stabilization; however, it is not known precisely who was the first to utilize scrap tires in a floating configuration to dissipate wave energy before it reaches shore. Systematic investigations of the use of scrap tires as floating breakwaters have been limited to the past 20 years. Stitt and Noble (1963) developed and patented the "Wave-Maze,"

a geometric assembly configuration, and subsequently conducted performance and evaluation tests. The Goodyear Tire and Rubber Company has investigated extensively the use of modular building-block elements formed by securing together bundles of tightly interlocked scrap tires with high-strength rope or cable, but the company has not patented nor commercially used scrap tires in this form (Candle, 1974). The information from this research has been made available for public use. Kowalski (1974) tested a simple mat-type floating breakwater of scrap automobile tires, constructed in various layers of mats fastened together. Harms (1979a) experimentally investigated a concept known as the "Wave-Guard" (now the "Pipe-Tire" structure) which differed from both the Wave-Maze and the Goodyear concept. Structural components of massive logs (telephone poles, concrete beams, etc.) were utilized with the scrap tires being threaded onto the poles, which were in turn connected with conveyor belting. While an almost limitless variety of assembly configurations appears possible, these basic designs constitute those which have received the greatest attention from an experimental investigation standpoint.

#### 1. Wave-Maze Scrap-Tire Floating Breakwater Concept.

Stitt and Noble's (1963) patented Wave-Maze scrap-tire floating breakwater was subsequently investigated for performance effectiveness by Kamel and Davidson (1968) and Noble (1969, 1976). The basic component of the breakwater is used truck tires, some of which are filled with flotation material such as polystyrene or polyurethane. The construction consists of both a top horizontal layer and a bottom horizontal layer of truck tires bolted to a center element of vertical tires arranged in a triangular pattern (Fig. 71). Each line of tires in plan view is approximately 4.5 feet wide. According to Noble (1976), the breakwater should be constructed so that the total width of breakwater is at least one-half of the length of wave to be attenuated. If wave heights are greater than about 4 feet, additional tiers of tires should be added so that the depth of the Wave-Maze exceeds the wave height to be attenuated. Truck tires were recommended instead of automobile tires because the extra sidewall plies in the casing help reinforce the connections. At least two layers of reinforcement material (sections of tire casings or conveyor belting) should be added inside the tires at each bolted joint. Hot-dip galvanized bolts and washers should be used for all connections in saltwater environments.

a. Wave Attenuation Effectiveness. The Wave-Maze physical model tested at WES by Kamel and Davidson (1968) was constructed of 6-inch-diameter tires assembled in the same fashion as in the prototype with one exception--the method of fastening the tires together. In the prototype, the tires were fastened together by bolts; however, because of the size of tires in the physical model, wire connections were used instead of bolts. The precise effects of this connection method are unknown, but it is believed to allow relatively consistent comparable flexing of the assembly.

The flotation system in the prototype was reproduced in the model, using commercial Styrofoam that was cut and placed inside the model tires. Floating height of the test structure varied according to the flotation material used in either all the tires or the desired number of tires. The assembly of tires remained the same throughout the tests; therefore, the porosity of the model Wave-Maze was the same for all the test structures--about 80 percent. The definitive sketch for the two-dimensional model is shown in Figure 72.

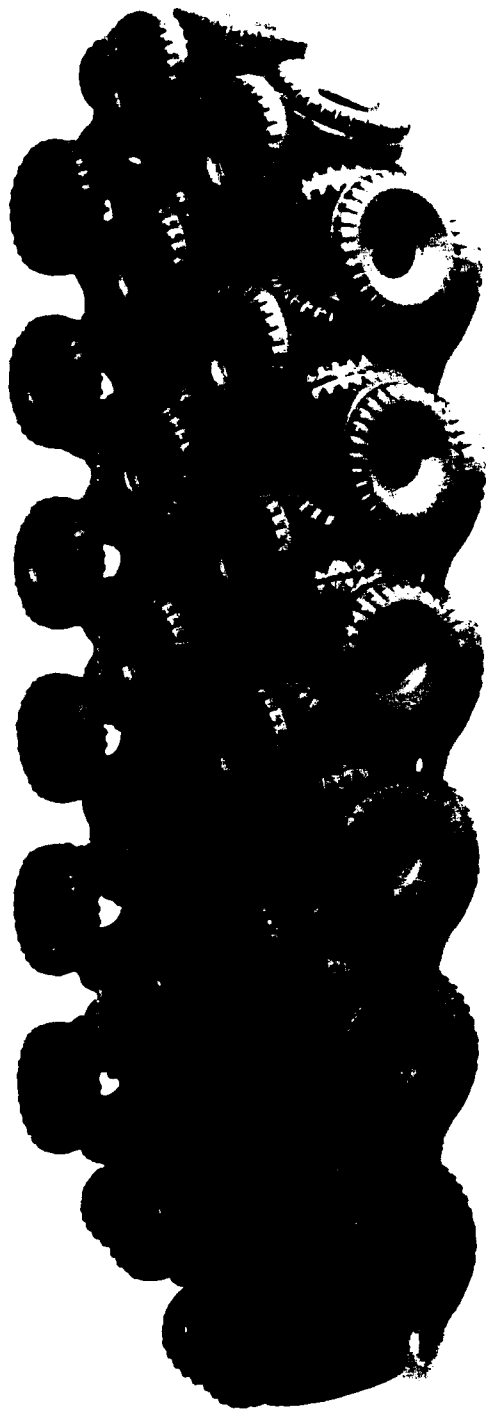


Figure 71. Wave-Maze scrap-tire floating breakwater model structure (after Kamel and Davidson, 1968).

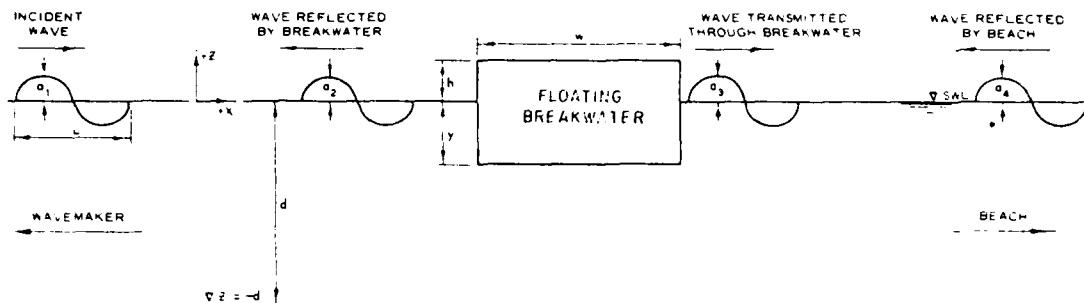
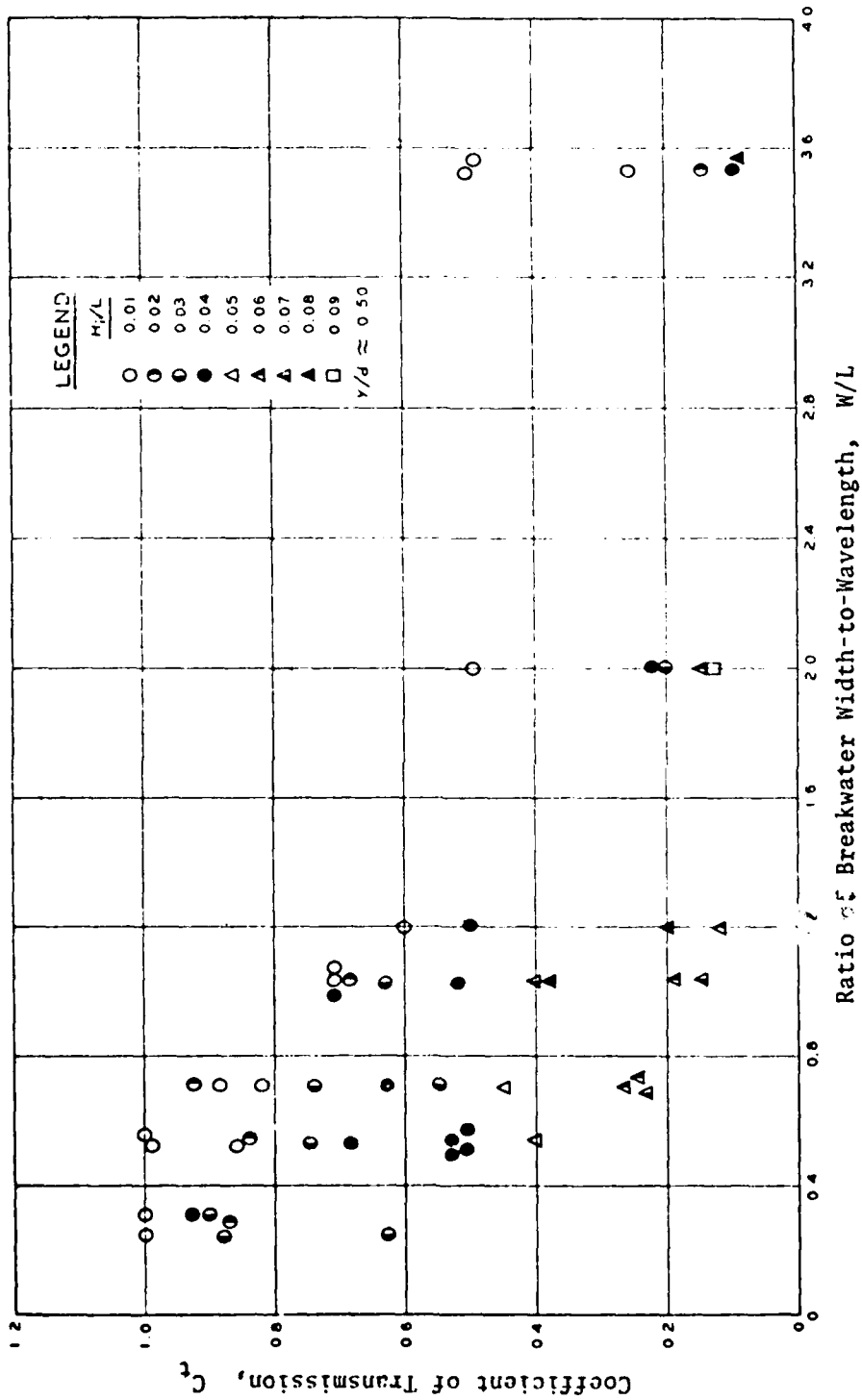


Figure 72. Definitive sketch of the two-dimensional model Wave-Maze scrap-tire floating breakwater, one-quarter scale (after Kamel and Davidson, 1968).

To be effective, the depth of a floating breakwater must be deep enough that little wave energy can be transmitted beneath it. The breakwater must also have the mass and damping characteristics necessary to prevent it from moving extensively so that it will not generate large-amplitude waves. To fulfill the latter requirement, the floating breakwater must have large natural periods to compare with the wave periods to which it will be subjected. Analysis of the test data indicated that the relative height to which the breakwater extends above still water does not seem to affect the wave reflection coefficient,  $C_r$ , or the wave transmission coefficient,  $C_t$ . This was due to the high flexibility of the breakwater which moved extensively as if it were a part of the water surface. At the same time, a large increase in the relative penetration into the fluid,  $y/d$ , resulted in only a small decrease in the coefficient of wave transmission. These data are presented in Figure 73, which shows the effect of initial wave steepness,  $H_1/L$ , on the coefficient of transmission,  $C_t$ , and in Figure 74, which displays the effect of relative submergence,  $y/d$ , on the transmission coefficient,  $C_t$ .

b. Mooring Line Forces. Kamel and Davidson (1968) found that a convenient way of studying the mooring line forces on the Wave-Maze model floating breakwater was to determine the ratio of the maximum horizontal forces exerted on the structure,  $f_c$ , to the maximum force that would exist in the case of total reflection from a vertical wall,  $f_{t_{max}}$ . The approximate order of magnitude of the maximum horizontal force exerted on the structure was determined by attaching a force meter to the mooring lines (Fig. 75). The variation in the ratio of the maximum force in the breakwater mooring lines to the maximum total horizontal force exerted on a vertical reflecting wall,  $f_c/f_{t_{max}}$ , with the relative breakwater width,  $W/L$ , is shown in Figure 76; the model data are tabulated in Table 3. It was discerned that the forces on the breakwater mooring lines,  $f_c$ , are relatively small compared to the force due to total reflection of a vertical wall,  $f_{t_{max}}$ . For the one-quarter scale model scrap-tire Wave-Maze floating breakwater, the ratio of  $f_c/f_{t_{max}}$  did not exceed 0.29 and 0.22 for the seaward and shoreward mooring lines, respectively. It was projected that since forces in the seaward mooring lines of prototype structures are considerable, these types of floating breakwaters will be subject to large drift if slack in the mooring lines is large.



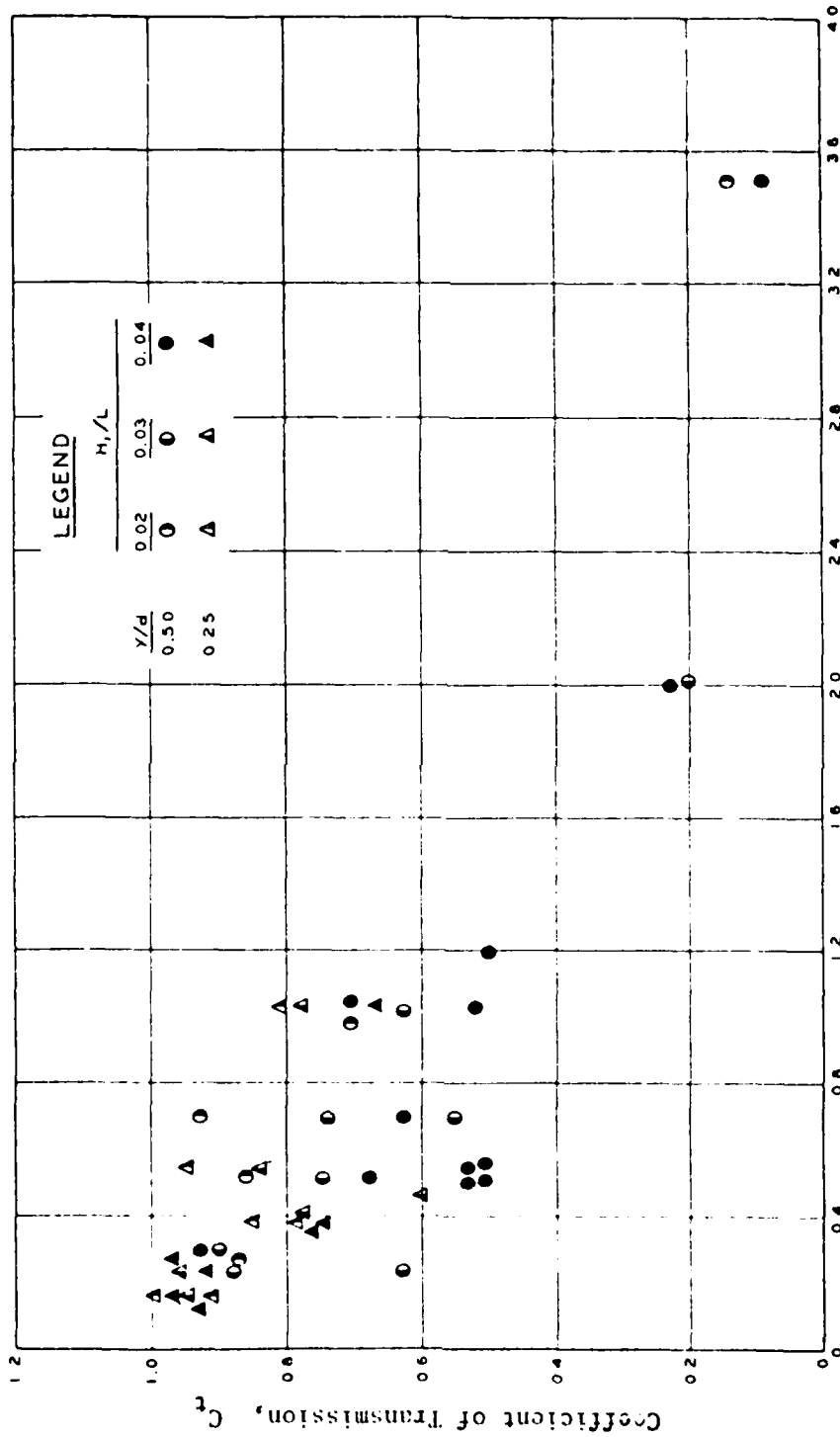


Figure 74. Effect of relative submergence,  $y/d$ , and relative breakwater width,  $W/L$ , on coefficient of transmission,  $C_t$ , for the two-dimensional model of Wave-Maze scrap-tire floating breakwater at one-quarter scale (after Kamel and Davidson, 1968).



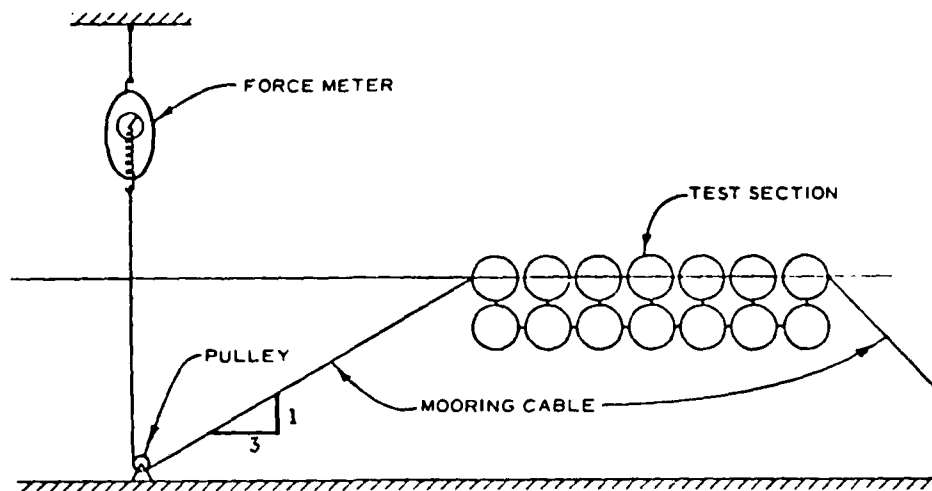


Figure 75. Definitive sketch of mooring line force determination for the two-dimensional model of Wave-Maze scrap-tire floating breakwater at one-quarter scale (after Kamel and Davidson, 1968).

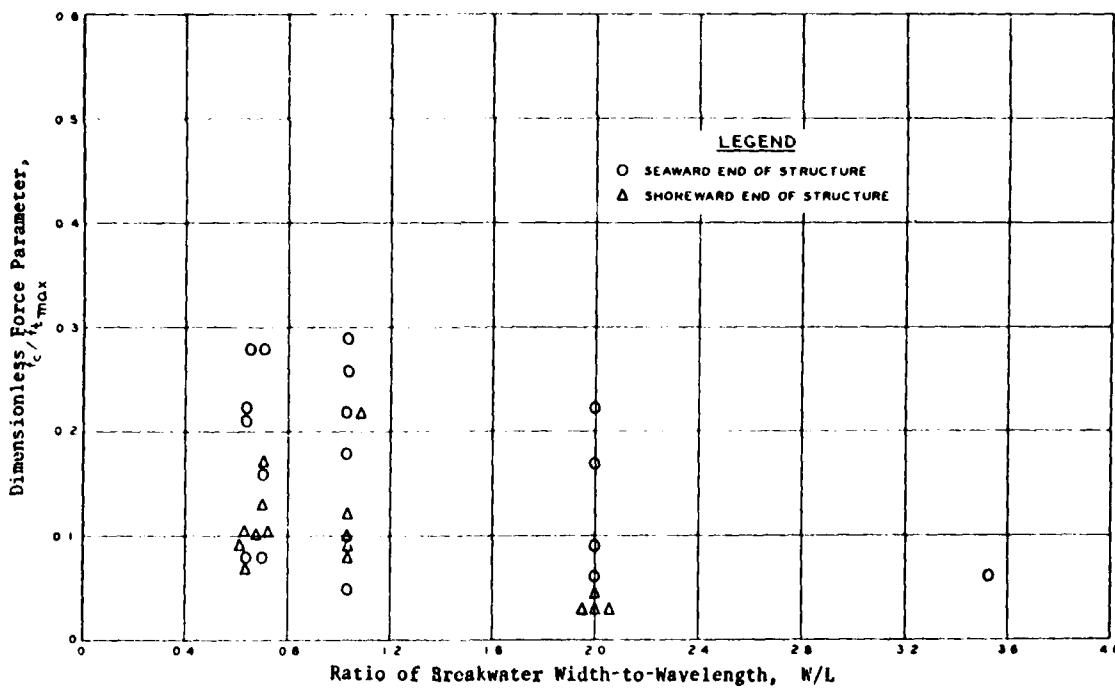


Figure 76. Ratio of mooring line force,  $f_c$ , to force due to total reflection of a vertical wall,  $f_{t,max}$ , for the two-dimensional model of Wave-Maze scrap-tire floating breakwater at one-quarter scale (after Kamel and Davidson, 1968).

Table 3. Mooring line forces of two-dimensional model, Wave-Maze scrap-tire floating breakwater (after Kamel and Davidson, 1968).<sup>1</sup>

Test No.	d (ft)	y (ft)	h (ft)	w (ft)	T (s)	$H_1 = 2a_1$ (ft)	$F_1$ (lb)	$F_2$ (lb)
1	2.0	0.98	0.32	10.15	0.75	0.03	----	----
2						0.09	----	----
3						0.14	----	----
4						0.20	----	----
5						0.26	0.5	----
6					1.0	0.05	----	----
7						0.15	0.5	0.3
8						0.25	1.4	0.4
9						0.35	3.5	0.6
10						0.46	6.0	1.2
11					1.5	0.10	0.5	2.2
12						0.30	5.5	3.7
13						0.49	11.0	5.2
14						0.69	20.0	6.7
15						0.89	24.0	7.7
16					2.0	0.15	1.5	3.2
17						0.44	9.0	7.2
18						0.73	24.0	9.2
19						0.78	26.0	10.2
20					2.5	0.19	2.0	2.0
21						0.56	15.6	7.8
22						0.87	19.5	8.5

<sup>1</sup>Definitive sketch of pertinent variables shown in Figure 72.

Harms and Bender (1978) and Harms (1979a, 1979b) demonstrated that a force parameter,  $F/\gamma W^2$ , is functionally related to the relative wavelength,  $W/L$ , and wave steepness,  $H/L$ . They reanalyzed the experimental data of Kamel and Davidson (1968), and determined the relationship between these parameters to be that shown in Figure 77. Harms and Bender (1978) assumed that geometric scaling and scaling of elastic and inertia properties of the tires and binding materials had been accomplished in the original experiments.

## 2. Goodyear Tire and Rubber Company Concept.

The Goodyear scrap-tire floating breakwater concept uses a modular building-block design with the breakwater section constructed of units of relatively few tires secured together to form a small, easily assembled, portable building unit which serves as the basic element for constructing the large structure. The simple construction procedure is accomplished by securing 18 individual tires together to form a 7- by 6.5- by 2.5-foot tightly interlocked bundle of scrap tires (Candle and Fischer, 1976). The basic method of constructing the tire modules is to stack the tires flat, but vertically, in a 3-2-3-2-3-2-3 combination (Fig. 78), constantly interweaving the tying material. The increasing weight of the tire stack and the physical compression of the tires during assembly will compress the tires enough to

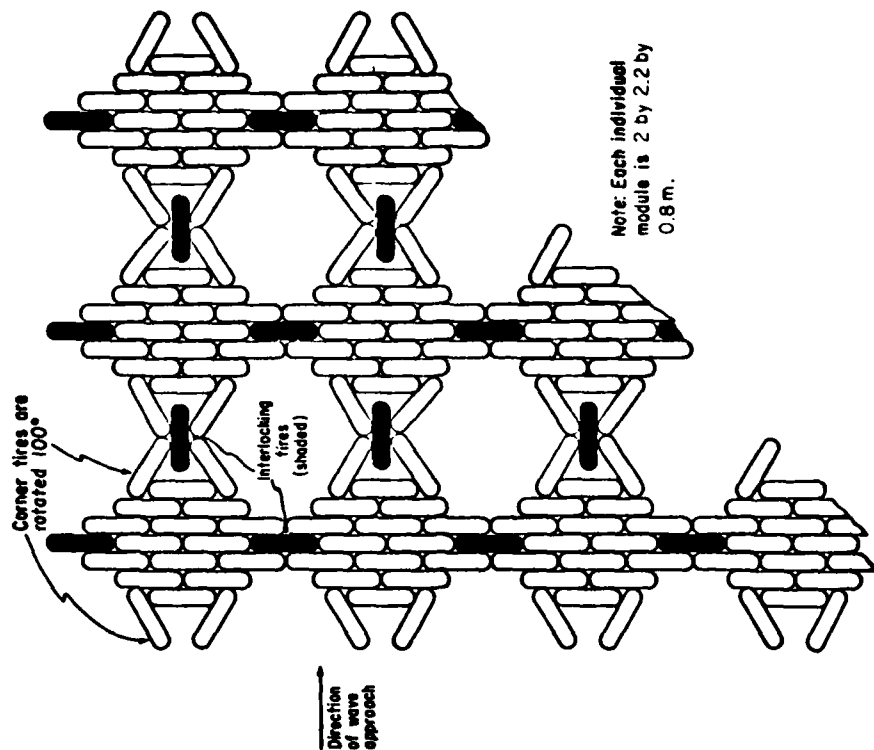


Figure 78. Assembly of modules in a section of the Goodyear Tire and Rubber Company scrap-tire floating breakwater (after Giles and Sorensen, 1978).

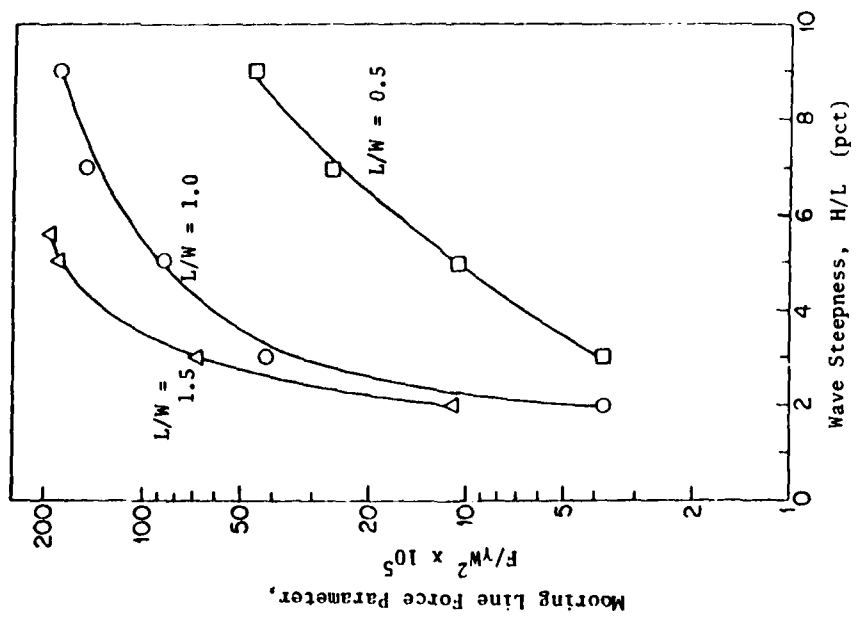


Figure 77. Effect of relative wavelength, L/W, and wave steepness, H/L, on force parameter,  $F/\gamma W^2$ , for two-dimensional model of Wave-Maze scrap-tire floating breakwater (after Harms and Bender, 1978).

allow easy fastening of the tying material, forming a tightly secured bundle. After construction, the modules are easily transportable for assembly at the project location. A prototype installation is shown in Figure 79.

A prototype scrap-tire floating breakwater assembled according to the Goodyear Tire and Rubber Company concept has high-strength characteristics (as high as 56,000-pound breaking strength on a 6.5-foot-spaced longitudinal and transverse grid), and can absorb great amounts of energy by yielding and deforming when overloaded. Candle and Fisher (1976) reported elongation of more than 30 percent in both directions. The type of interlocking hardware to be used in the construction, which depends on the desired strength and expected service life of the installation, represents about 35 to 50 percent of the total cost of the breakwater; labor and the mooring system represent the remaining cost. Any temptation to economize on tying materials should be avoided as the interlocking material can be the weak link in the entire system.

Of the interlocking materials investigated by Goodyear Tire and Rubber Company as of 1976, specially manufactured, unwelded open-link chain (1/2-inch diameter) proved to be best-suited for the construction of scrap-tire floating breakwaters. The open-link chain has adequate strength, is easily handled, and has a long life expectancy in seawater. It is also easily interconnected with the use of simple handtools. The use of dissimilar metals should always be avoided in a marine environment.

a. Prototype-Scale Wave Attenuation Effectiveness. Prototype-scale mooring load and transmission tests for the Goodyear Tire and Rubber Company floating tire breakwater concept were performed at the U.S. Army Coastal Engineering Research Center (CERC) (Giles and Sorensen, 1978, 1979; Giles and Eckert, 1979). The tests were conducted in CERC's large wave tank which is 6.1 meters (20 feet) deep, 4.6 meters (15 feet) wide, and 194 meters (635 feet) long. Waves of constant period and height were produced by a piston-type generator.

Two floating tire breakwaters (one containing 8 Goodyear modules, the other 12 modules) were tested. The breakwaters included modules constructed with 14- and 15-inch automobile tires, two modules wide across the tank and four or six modules along the tank (the width of the breakwater in the direction of wave advance). A schematic diagram of the wave tank setup is shown in Figure 80. Incident and transmitted wave heights were measured with fore-and-aft wave gages, and seaward mooring forces were measured with a load cell. Anchor locations were adjusted to produce mooring line slopes compatible with field conditions.

Each breakwater section was tested using wave conditions commonly found on a sheltered body of water such as a reservoir or bay. A total of 165 combinations of wave period, wave height, structure width, and water depth were tested. Wave periods ranged from 2.64 to 8.25 seconds. Wave heights varied from 20 to 140 centimeters (0.6 to 4.5 feet) at water depths of 2 and 4 meters (6.5 and 13 feet). Each combination of wave height, wave period, water depth, and structure width was tested for 5 minutes, which allowed sufficient time to determine the pertinent forces and wave heights.

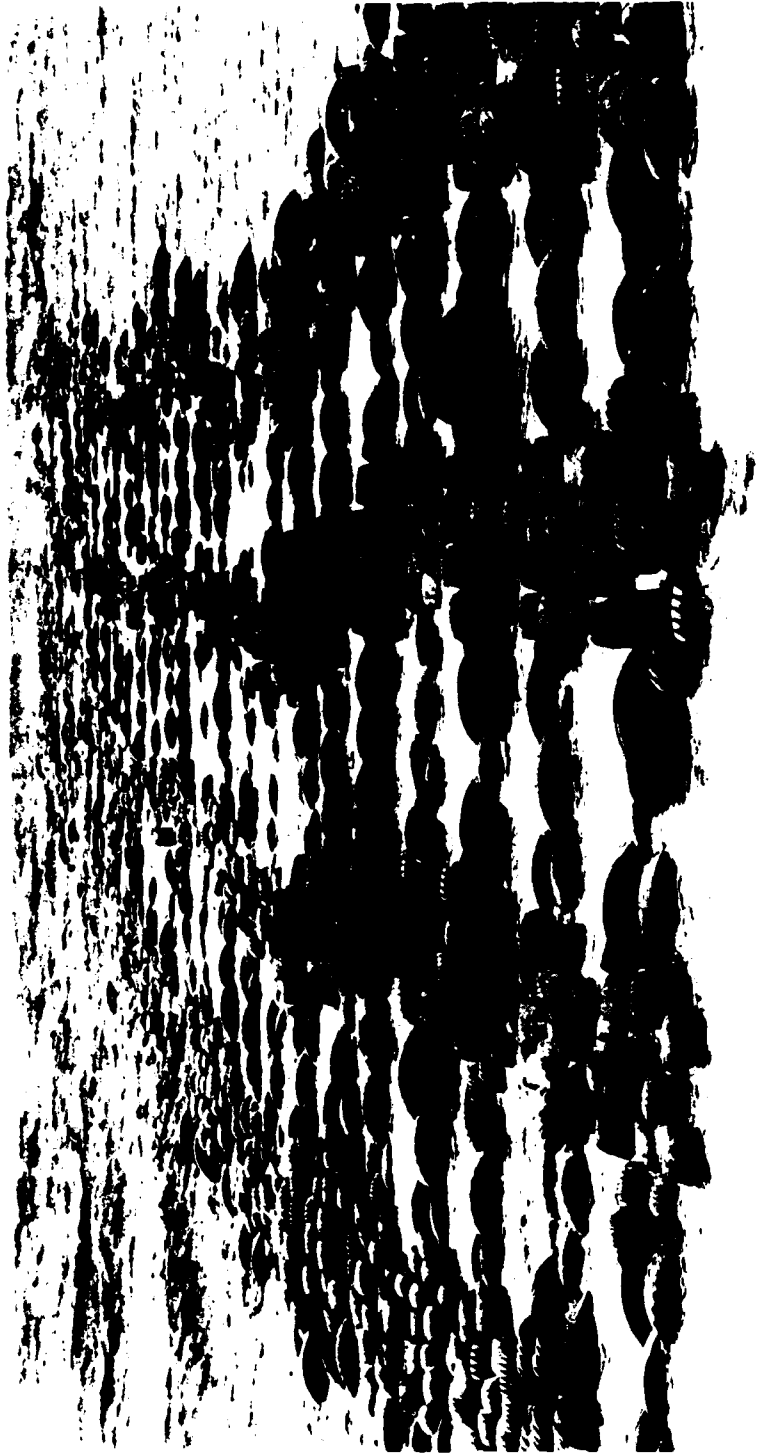


Figure 79. Prototype installation of the Goodyear Tire and Rubber Company scrap-tire floating breakwater.

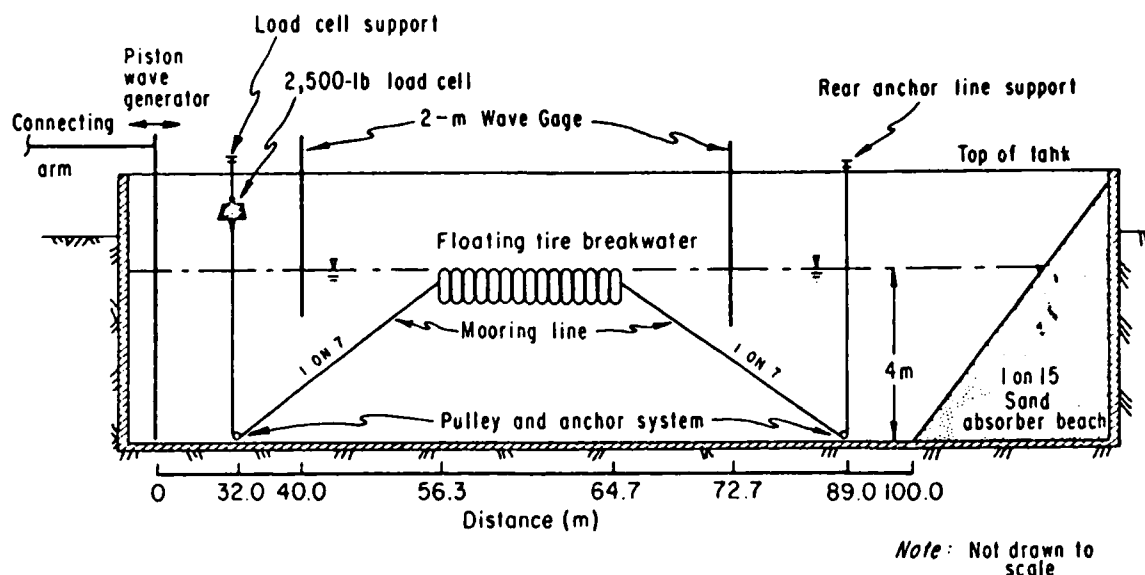


Figure 80. Experimental arrangement of the Goodyear Tire and Rubber Company scrap-tire floating breakwater concept for prototype-scale transmission and mooring tests conducted in CERC's large wave tank (after Giles and Sorensen, 1978).

The transmission coefficient,  $C_t$ , versus the breakwater width-to-wavelength ratio,  $W/L$ , is shown in Figure 81. This effectively constitutes a design curve as all data are shown on this particular figure with the range of incident wave heights indicated by the legend symbols. (Designers should not extrapolate beyond  $W/L = 1.40$ , or apply these data to breakwaters with a width of more than 12 modules.) Generally, the data show that as  $W/L$  increases, the transmission coefficient,  $C_t$ , decreases. Also, for the same value of  $W/L$ , as the incident wave height increases, the transmission coefficient decreases slightly. There is considerable scatter in the data for  $W/L$  values less than 0.40 because the incident wave height was usually small and was only 2 to 4 centimeters (0.05 to 0.13 foot) greater than the transmitted height. Thus, a small change in the measured transmitted height caused a large change in the value calculated for the transmission coefficient,  $C_t$ . A comparison of the data at 2- and 4-meter water depths shows that for the conditions tested the water depth does not appear to influence the transmission coefficient. This observation is contrary to the expectation that as more of the water depth is taken up by the breakwater section, the wave attenuation should increase.

b. Model-Scale Wave Attenuation Effectiveness. Harms and Bender (1978) and Harms (1979a, 1979b) conducted scale-model tests of the Goodyear Tire and Rubber Company scrap-tire floating breakwater concept. Waves were produced by a hydraulically driven piston-type wave generator or by use of the wave tank as a wind tunnel at windspeeds up to 64 kilometers (40 miles) per hour. Wave heights were measured with capacitance wave probes, and mooring forces were obtained from strain-gage cantilever-force transducers. The experimental

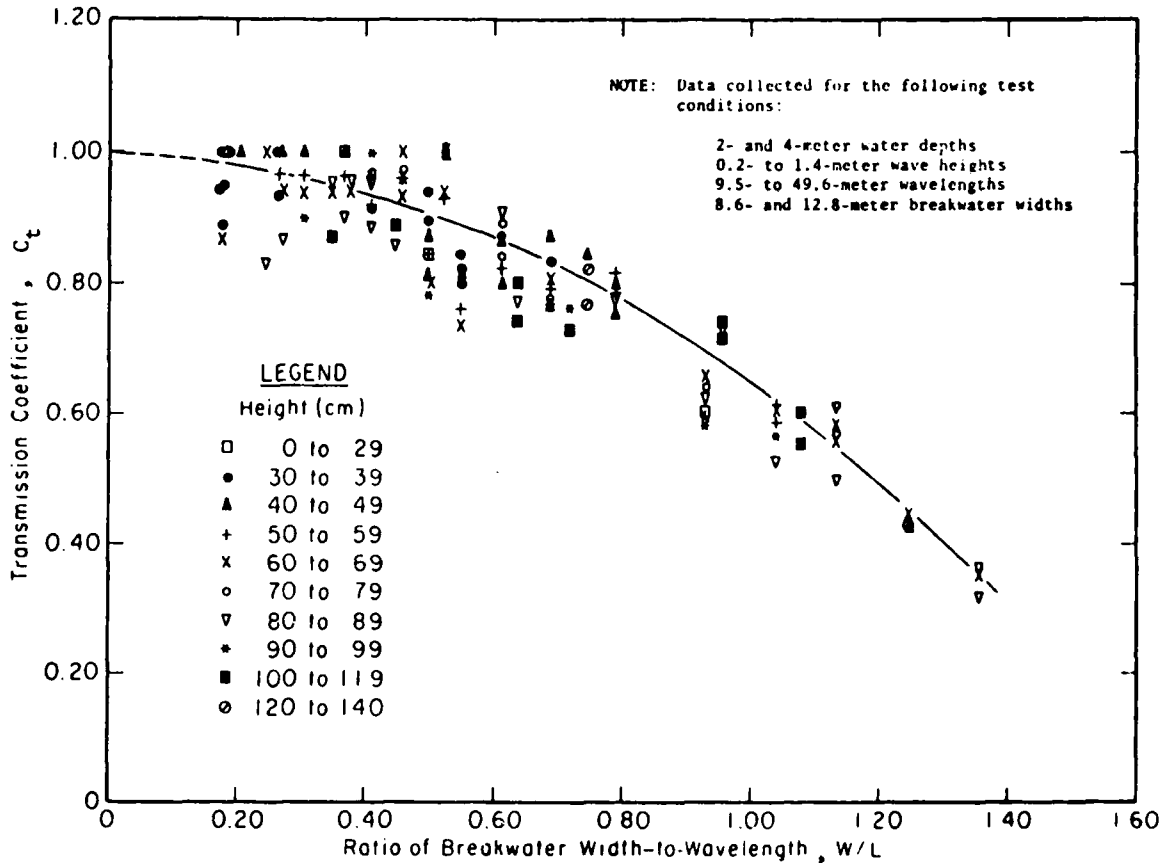
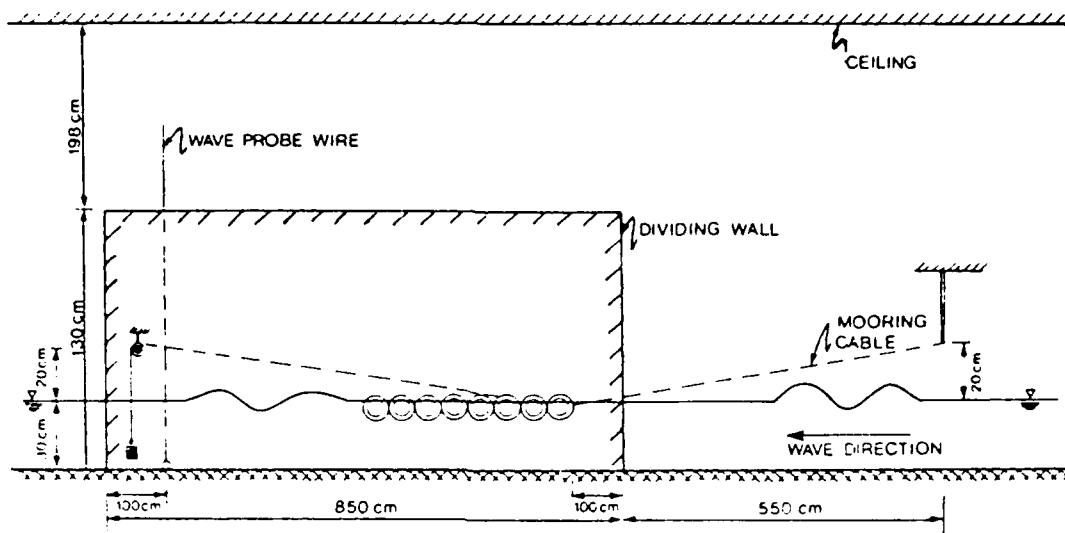


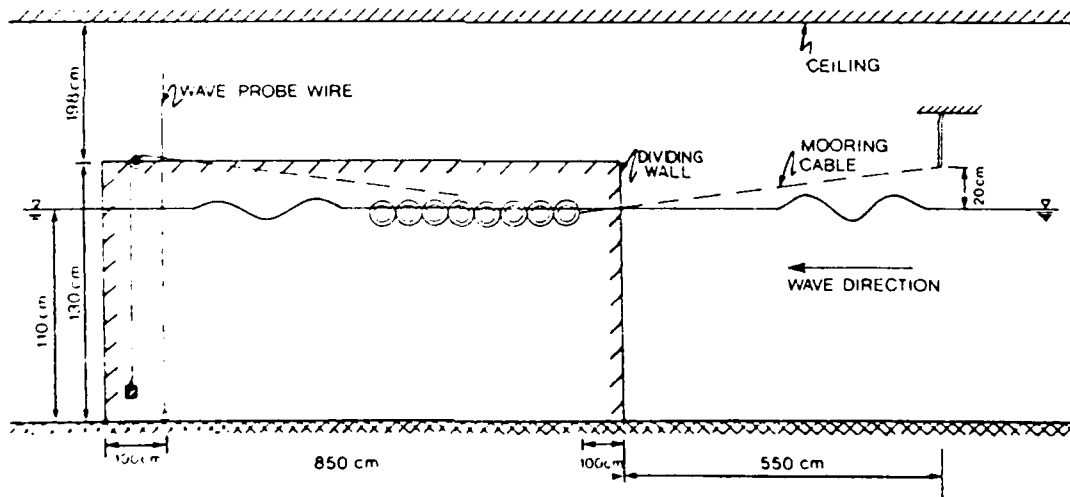
Figure 81. Design curve for determining width,  $W$ , of the Goodyear Tire and Rubber Company scrap-tire floating breakwater concept for various wavelengths,  $L$ , and allowable transmission coefficients,  $C_t$  (after Giles and Sorensen, 1978).

arrangement for these scale-model tests is shown in Figure 82; the definitive sketch in Figure 83 describes the pertinent variables investigated in that study.

The use of regular waves had been intended for all these laboratory tests, but it was impossible to generate regular waves less than 1.3 meters (4 feet) long at the test section location. Since shorter waves with periods of 1 second or less were required to adequately define the wave attenuation performance of the model breakwater and irregular waves had to be used at the test section, it was necessary to combine the irregular wave (narrow-spectra) data with that from other tests with regular waves. The equivalent monochromatic wave height and wavelength needed for this purpose were defined as the average wave height and peak-energy wavelength, respectively, obtained from time-series analysis of the water surface elevation. The number with each data symbol represents the wave steepness in percent, and the letters  $r$ ,  $m$ , and  $w$  designate regular waves, machine-generated wave spectra, and wind-generated waves, respectively. The letter  $x$  indicates that the value of the transmission coefficient,  $C_t$ , was obtained directly from the analog trace and not from time-series analysis. The relationship between the transmission coefficient,  $C_t$ , and the relative breakwater width,  $L/W$ , is presented in Figure 84 for these model-scale data of Harms and Bender (1978).



a. Shallow-water test arrangement.



b. Deepwater test arrangement.

Figure 82. Experimental arrangement for two-dimensional model-scale testing of the Goodyear Tire and Rubber Company scrap-tire floating breakwater concept for wave attenuation and mooring force data (after Harms and Bender, 1978).



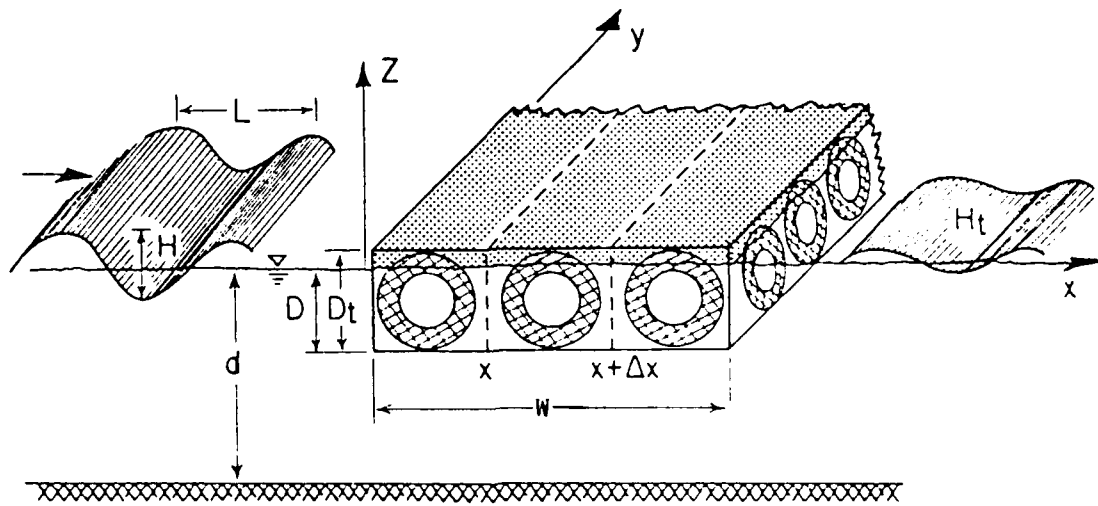


Figure 83. Definitive sketch of pertinent variables in two-dimensional model-scale tests of Goodyear Tire and Rubber Company scrap-tire floating breakwater concept (after Harms and Bender, 1978).

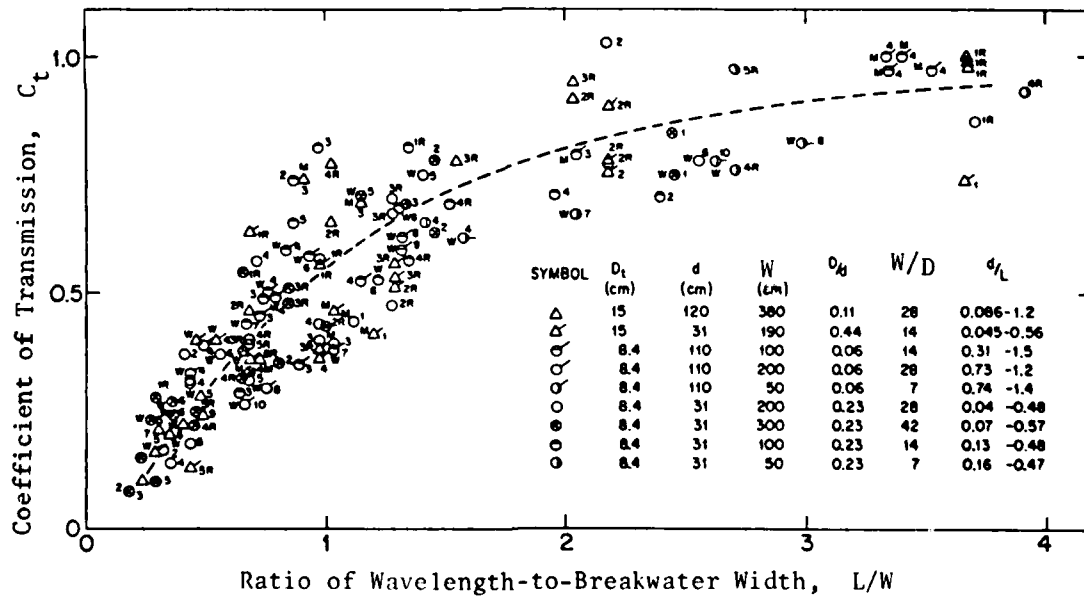


Figure 84. Effect of relative breakwater width,  $L/W$ , on transmission coefficient,  $C_t$ , in two-dimensional model-scale test results of the Goodyear Tire and Rubber Company scrap-tire floating breakwater concept (after Harms and Bender, 1978).

c. Comparison of Prototype- and Model-Scale Wave Attenuation Effectiveness. The model-scale tests of Harms and Bender (1978), using a wave steepness of 4 percent, were compared to the full-scale prototype-size waves of Giles and Sorensen (1978) where only regular waves had been studied (Harms, 1979b). Harms' comparison (Fig. 85) indicates that it is principally the influence of wave steepness that causes the data points to lie above or below the transmission curve of the Harms and Bender (1978) investigation. The inverse relationship between  $C_t$  and  $H/L$  is apparent since waves of low steepness are associated with relatively large values of  $C_t$  (above the solid curve), and waves of large steepness are associated with relatively low values of  $C_t$ . The floating tire breakwater acts as a wave energy filter that discriminates according to both relative breakwater width,  $L/W$ , and wave steepness,  $H/L$  (Harms, 1979b). The effectiveness of the structure increases with  $H/L$  and decreases with  $L/W$ , all other things remaining constant. Near breaking, the breakwater simply acts as a mechanism which induces wave breaking and, therefore, large-scale turbulent dissipation of energy. Harms (1979b) suggests that the data which incorporate large variations of  $H/L$  not be indiscriminately combined to generate single best-fit curves.

d. Prototype-Scale Mooring Line Forces. During Giles and Sorensen's (1978) testing of the prototype-scale floating tire breakwater at CERC, two measures of the mooring force (peakload and average load) were obtained, each per meter length of breakwater. In comparing the peak force to the average force for each of the conditions, they noted that the peak force is the same or only slightly higher for 8 modules in 4 meters of water and 12 modules in 2 meters of water. However, when comparing the 12-module structure in 4 meters of water, the peak force is about 20 percent higher than the average force. This indicates that for the same wavelength and wave height, additional modules slightly increase the peak force. The peak forces shown in Figure 86 represent the maximum force measured during the test, and usually occurred when the motionless breakwater was first subjected to wave motion. The relative velocity between the water motion and the breakwater was largest at that time. Average force values are shown in Figure 87.

In all cases tested, Giles and Sorensen (1978) found the larger the wave height and  $W/L$  ratio, the higher the peak and average forces, as shown in Figures 86 and 87. However, no strong steepness or period effect was discerned in the data for either the peak or average force. Plotting all the peak force data together and all the average force data together permitted a conservative prediction curve to be drawn through the upper boundary of the data. Since the peak force represented the situation when the breakwater was initially at rest and then subjected to monochromatic waves, the maximum force that would be calculated using the peakload curve would probably be somewhat larger than the peakload that would occur in a train of irregular waves. Therefore, a conservative force prediction for the Goodyear Tire and Rubber Company scrap-tire floating breakwater concept would be to obtain the mooring force load based on the peakload curve in Figure 86.

Harms (1979a) reanalyzed the CERC data, using the force parameter,  $F/\gamma W^2$ , and relative breakwater width,  $L/W$ , and determined that the effect of varying the wave steepness,  $H/L$ , could be ascertained; these results are presented in Figure 88.

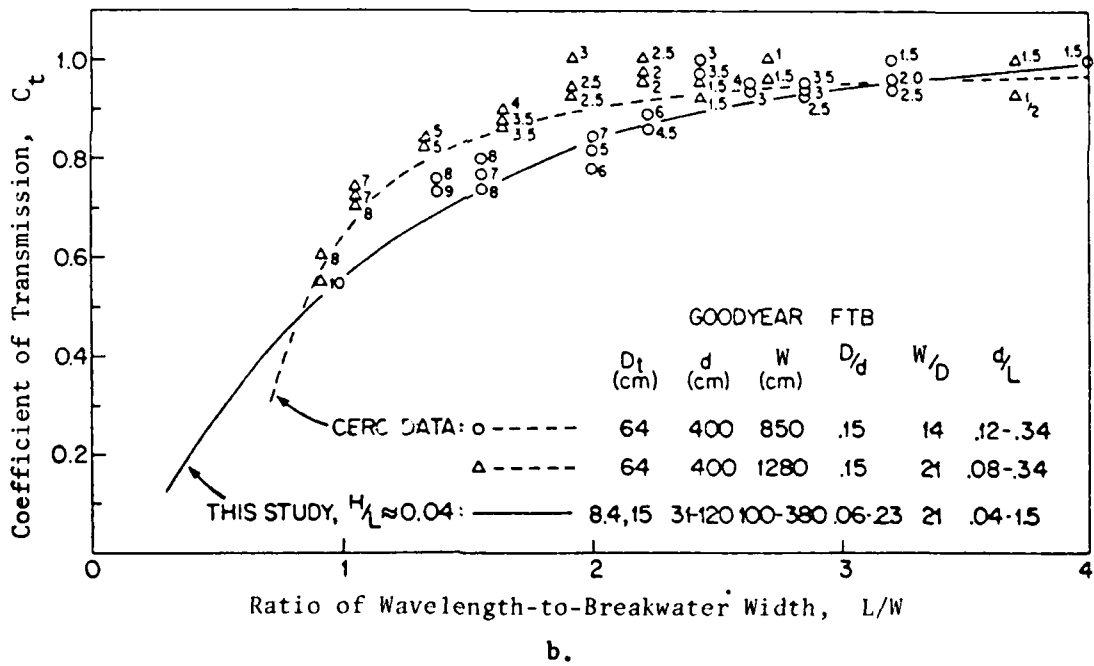
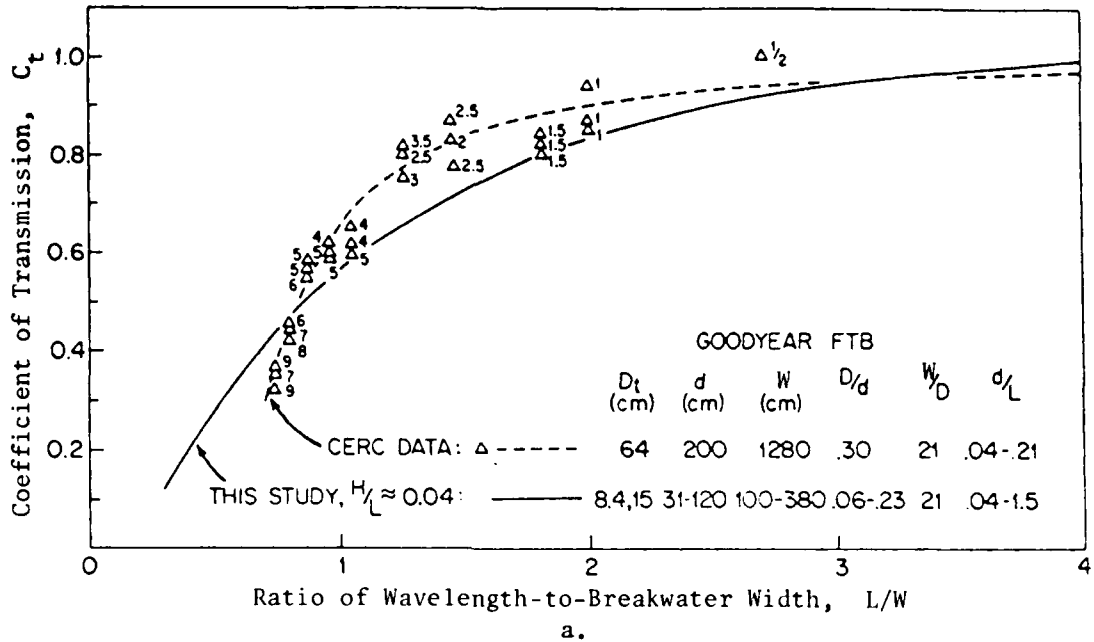


Figure 85. Comparison of prototype-scale and model-scale transmission coefficients,  $C_t$ , as a function of relative breakwater width,  $L/W$ , for the Goodyear Tire and Rubber Company scrap-tire floating breakwater (after Harms and Bender, 1978).

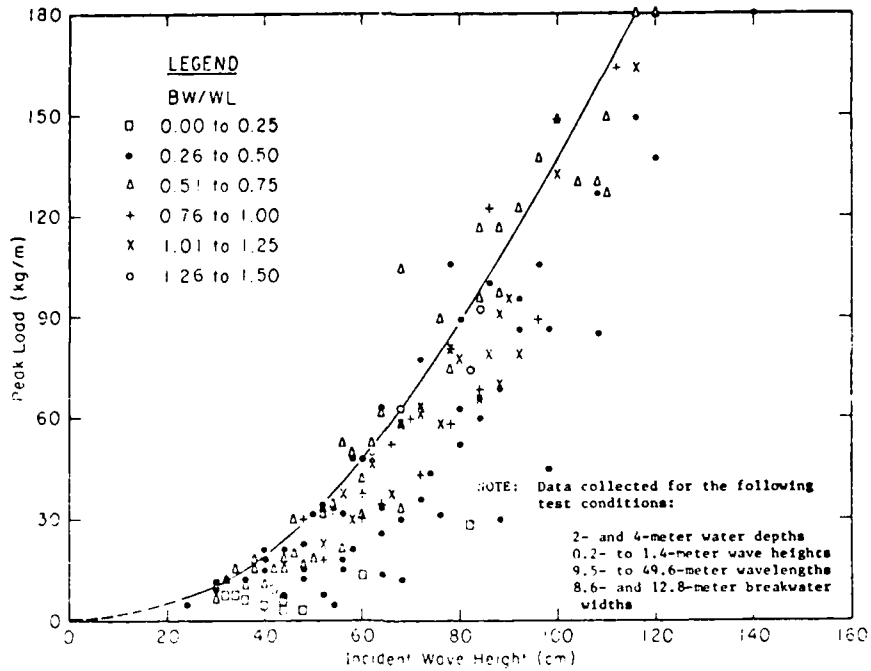


Figure 86. Design curve for predicting peak forces per meter of breakwater (Goodyear Tire and Rubber Company scrap-tire floating breakwater concept) for a given incident wave height (after Giles and Sorensen, 1978).

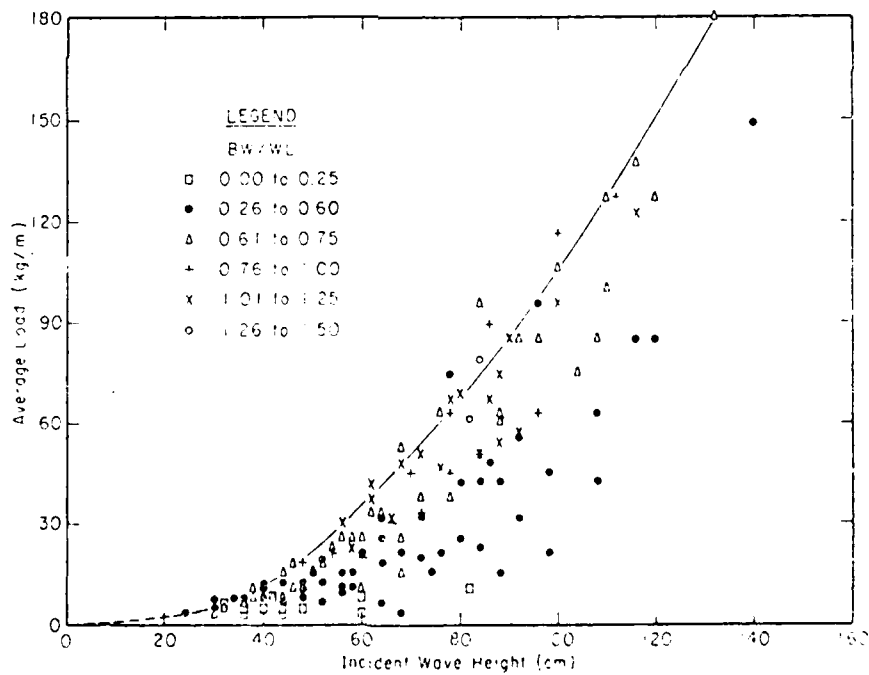


Figure 87. Design curve for predicting average forces per meter of breakwater (Goodyear Tire and Rubber Company scrap-tire floating breakwater concept) for a given incident wave height (after Giles and Sorensen, 1978).

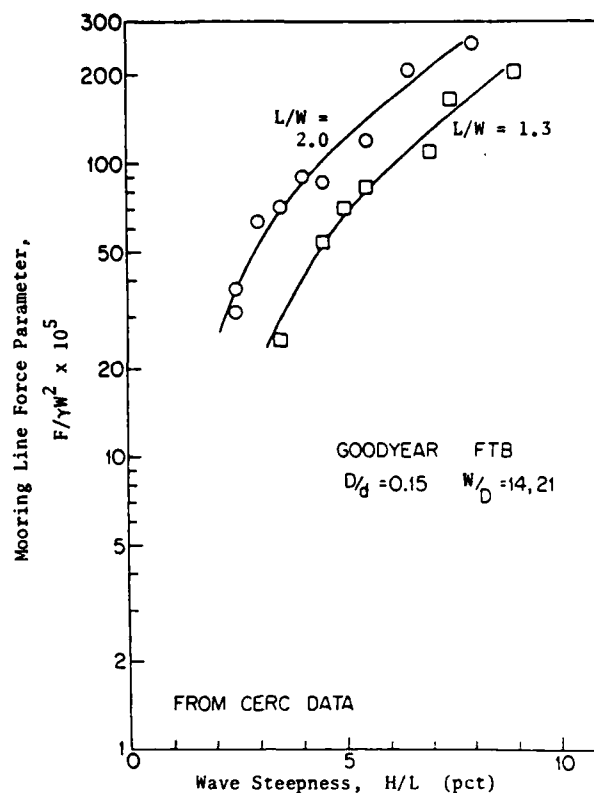
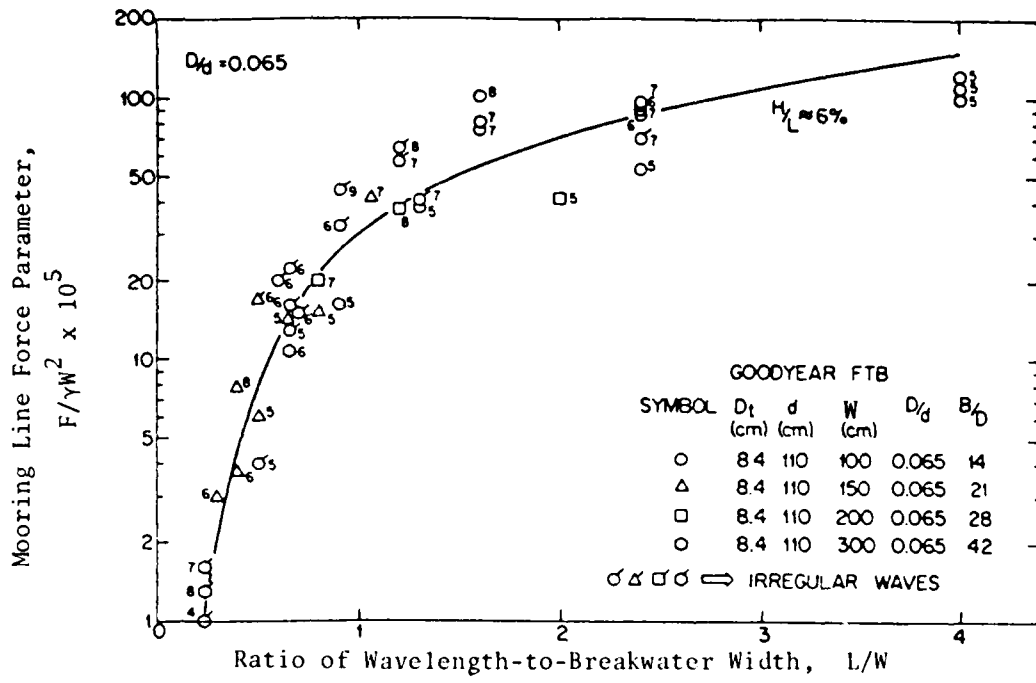


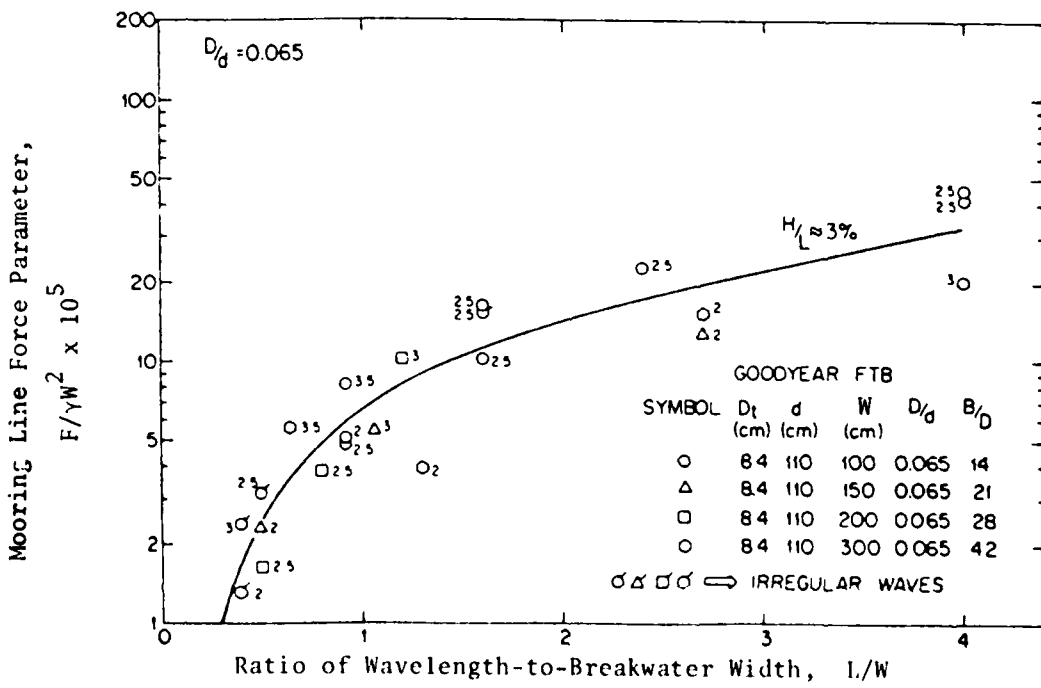
Figure 88. Effect of relative wavelength,  $L/W$ , and wave steepness,  $H/L$ , on force parameter,  $F/\gamma W^2$ , for two-dimensional prototype-scale model of Goodyear Tire and Rubber Company scrap-tire floating breakwater concept (after Harms, 1979a).

e. Model-Scale Mooring Line Forces. The force parameter,  $F/\gamma W^2$ , has some advantageous properties (it is a monotonically increasing function of both  $L/W$  and  $H/L$ ). This behavior is shown in Figure 89, where the curves were generated by fixing the relative depth parameter,  $D/d$ , and the wave steepness,  $H/L$ . The resulting design force curves are applicable for wave steepness of 3 and 6 percent for the Goodyear Tire and Rubber Company breakwater concept, according to Harms and Bender (1978).

f. Comparison of Prototype- and Model-Scale Mooring Line Forces. Harms (1979a) compared the prototype-scale data by Giles and Sorensen (1978) to the model-scale data of the same breakwater configuration by Harms and Bender (1978). The data, plotted as the force parameter,  $F/\gamma W^2$ , versus the relative breakwater width,  $L/W$ , showed good agreement in Figure 90, surprisingly so in view of the differences in elasticity of the mooring systems used in the two studies. This circumstance was attributed to the great flexibility of the breakwater system; i.e., when attached to such a highly flexible structure as a tire breakwater, even the most rigid mooring system cannot generate the peak shock-load mooring forces associated with rigid structures. The influence of wave steepness,  $H/L$ , is also apparent (Harms, 1979a), as doubling of the wave steepness (from 4 to 8 percent at  $L/W = 0.8$ ) causes a force parameter increase of about 400 percent.



a.



b.

Figure 89. Effect of relative wavelength,  $L/W$ , on mooring line force parameter,  $F/\gamma W^2$ , for two-dimensional model-scale Goodyear Tire and Rubber Company scrap-tire floating breakwater concept (after Harms and Bender, 1978).

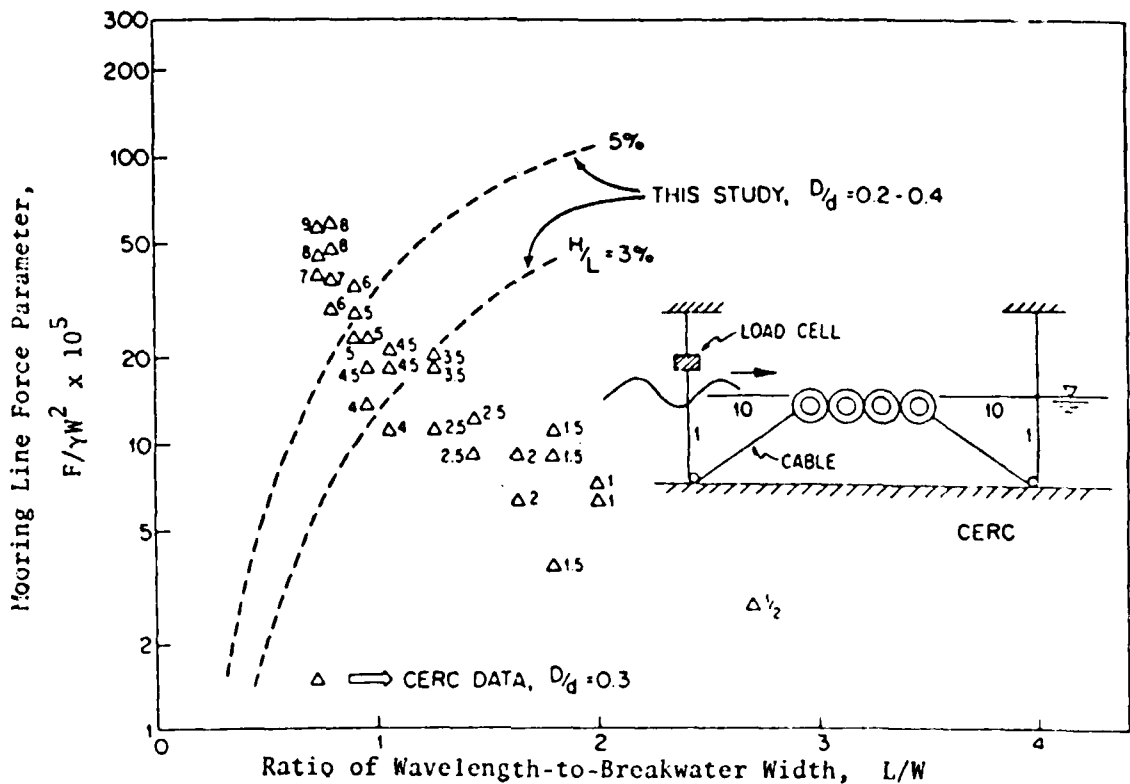


Figure 90. Comparison of prototype- and model-scale force parameter,  $F/\gamma W^2$ , as a function of relative breakwater width,  $L/W$ , Goodyear Tire and Rubber Company scrap-tire floating breakwater (after Harms, 1979a).

### 3. Wave-Guard Scrap-Tire Floating Breakwater Concept.

Harms and Bender (1978) developed and tested a scrap-tire floating breakwater which differs principally from other scrap-tire concepts in terms of tire arrangement (spatial tire density) and rigidity. This concept, called the "Wave-Guard" (also referred to as the "Pipe-Tire" structure), was experimentally tested at model scale. The structural component of the Wave-Guard is constructed with massive logs (telephone poles, steel beams, reinforced concrete beams, etc.). Strips of conveyor belting are used to connect one beam to another, and to thread the scrap tires. The tire strings are closely spaced (Fig. 91) so that the spatial density (number of tires per unit volume of breakwater) is relatively high, which results in a tightly packed structure. A significantly smaller structure in planform area is required to attain the same wave attenuation performance.

a. Wave Attenuation Effectiveness. Harms and Bender (1978) compared the performance of the Wave-Guard and the Goodyear Tire and Rubber Company concept for the same wave characteristics. Wave transmission design curves were generated, and it was determined that the Wave-Guard offers a significantly greater degree of wave attenuation than the Goodyear concept. This was attributed to the greater rigidity of the Wave-Guard, and to the fact that it is much less porous than the Goodyear structure. The results of the comparison are presented in Figure 92.

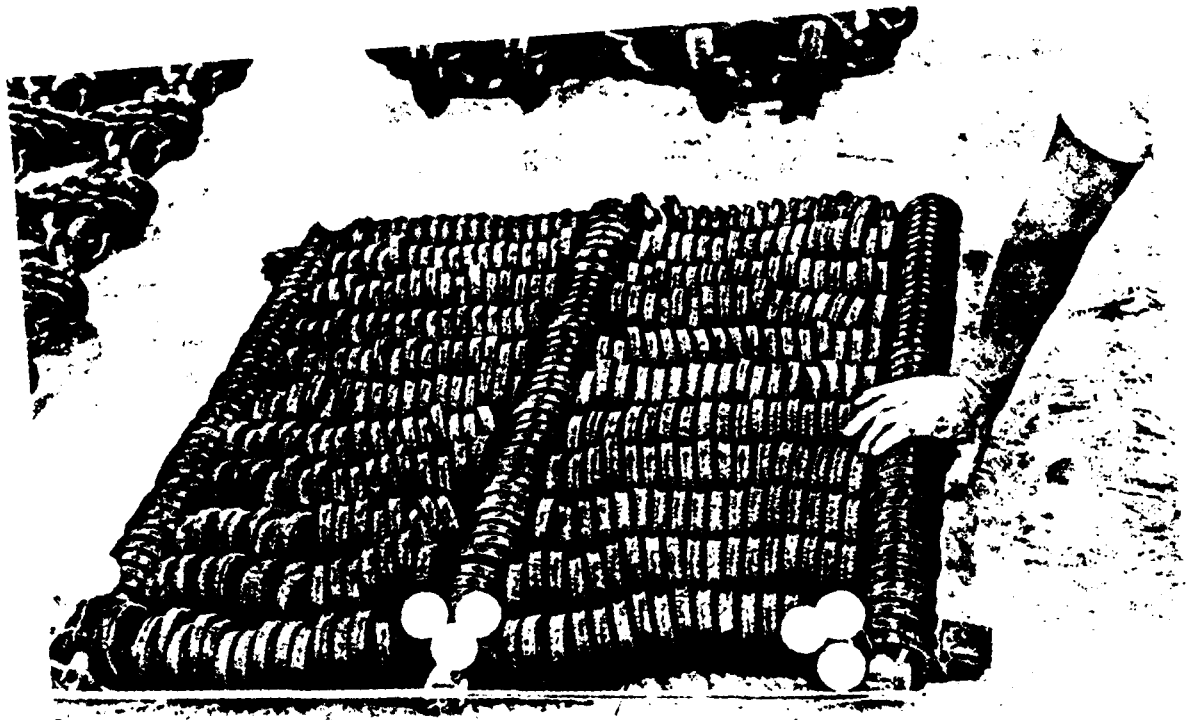


Figure 91. Model-scale Wave-Guard scrap-tire floating breakwater (after Harms and Bender, 1978).

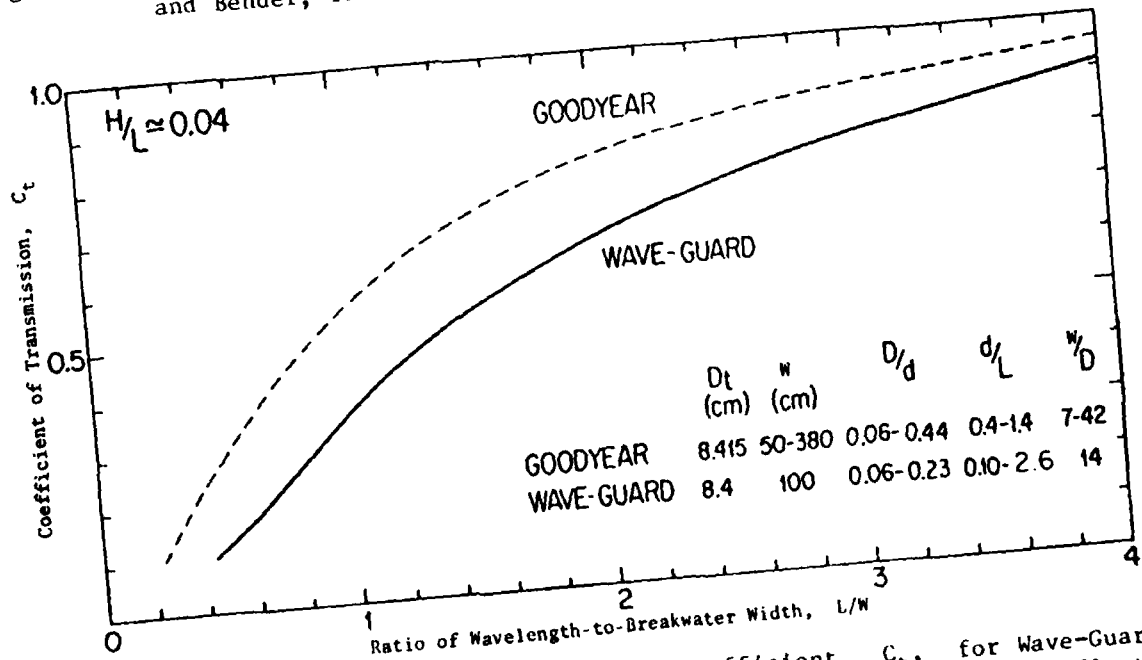


Figure 92. Comparison of wave transmission coefficient,  $C_t$ , for Wave-Guard and Goodyear Tire and Rubber Company concept of scrap-tire floating breakwaters, for various ratios of wavelength-to-breakwater width,  $L/W$  (after Harms and Bender, 1978).



b. Mooring Line Forces. In the Wave-Guard tests, a mooring line with a three-tire mooring damper was installed. This allowed the mooring connection at the breakwater end to be made directly to the massive beams, as opposed to the more flexible but weaker tire connections, without incurring excessively high peak mooring loads. Harms and Bender (1978) recommended that such mooring dampers should also be installed in prototype structures. Since full-scale tires are stiffer than the one-eighth scale-model tires tested, it was recommended that at least five tires be used in the full-scale mooring damper. Structural failures of scrap-tire floating breakwaters often occur because of stress concentrations near the mooring connection.

Design curves of the mooring force parameter,  $F/\gamma W^2$ , were developed for the Wave-Guard and compared to the corresponding curves of the Goodyear Tire and Rubber Company concept. Because of the greater wave attenuation capacity of the Wave-Guard, a larger amount of wave energy is dissipated by this structure; hence, the forces existing in the moorings are accordingly increased. These force parameter comparisons are presented in Figure 93.

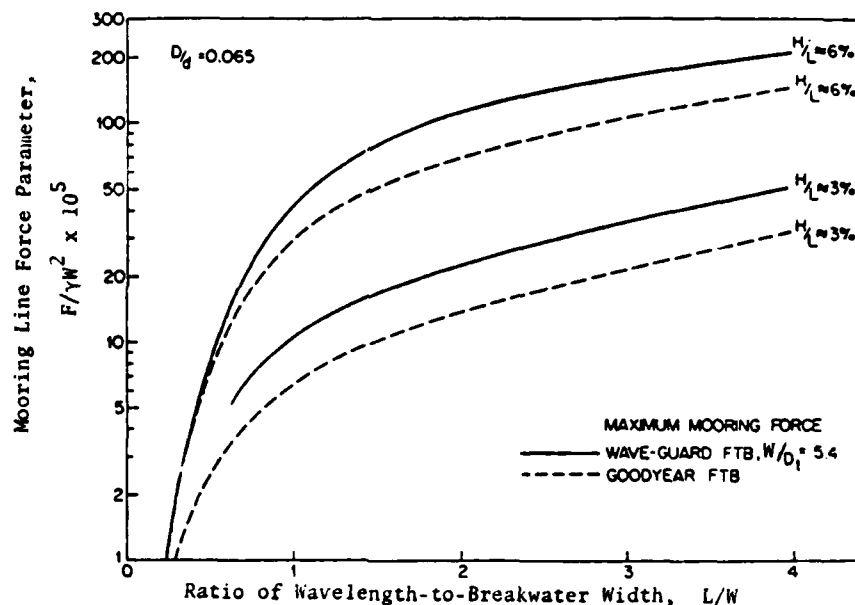


Figure 93. Comparison of force parameter,  $F/\gamma W^2$ , for Wave-Guard and Goodyear Tire and Rubber Company concept of scrap-tire floating breakwaters, for various ratios of wavelength-to-breakwater width,  $L/W$  (after Harms and Bender, 1978).

#### 4. Simple Mat-Type Scrap-Tire Floating Breakwater.

Kowalski (1974) conducted tests on a simple mat-type floating breakwater constructed of scrap automobile tires to prove the effectiveness of the breakwater for wave suppression, and to determine the construction problems and durability of such a simple structure. The tests indicated that even a three-tire-deep mat has a wave suppression efficiency of about 70 percent in waves with a significant height of 2.5 feet when the spectral peak exists with a

period of about 2 seconds. Problems were encountered with the strapping material which proved inadequate when subjected to continuous twisting action; better protection was needed for the foam which provided buoyancy for the tire structure.

Based on Kowalski's (1974) experience, recommendations are made for a more effective breakwater configuration to be constructed by considering the actions of the different parts of the structure. The leading edge could be made into a sloping beach so that incoming waves will break by running up the incline. By arranging the foamed tires so that the resultant buoyancy is negative along the first few rows of tires, the leading edge will stay submerged, providing runup. The breakwater should dissipate as much of the wave energy as possible by internal friction and interference with the structure. This is accomplished by adjusting the flexibility of the strapping and by the arrangement of the tires. The trailing edge of the structure should be so designed as not to create new waves due to its motion. The breakwater should end with a thin, scalloped edge to prevent continuous, long-crested waves. Finally, the orbital motion of the wave can be suppressed by vertical tire rows suspended beneath the breakwater.

## 5. Theoretical Considerations.

a. Estimate of Transmission Coefficient. Harms (1979b) analyzed a simple model for estimating the transmission coefficient,  $C_t$ , of a scrap-tire floating breakwater by considering the power required to propel a tire of negligible mass at velocity,  $U(t)$ , unidirectionally through a viscous fluid at rest. The product of the drag force on the tire and the velocity of motion is equivalent to the time rate of change of the kinetic energy of the surrounding fluid. It was assumed that this basic relationship is still applicable when the tire is fixed in place and  $U(t)$  represents the instantaneous velocity of an external current, even when this flow is not only unsteady but also periodically reverses. In view of the complexity of the flow field within the structure, which cannot be accounted for even by the most sophisticated wave theories, it was deemed sufficient to use linear wave theory and deepwater conditions for a first approximation. The drag-related dissipation was considered to vary only in proportion to  $H^2(x)$ , so that the total rate of energy dissipation anywhere along the breakwater was proportional to the local wave energy density,  $\gamma H^2(x)/8$ . The energy flux balance, integrated across the beam of the breakwater, yielded

$$C_t = \frac{H_t}{H_i} = \exp \left\{ \frac{[-20\pi C_d(H_i/L)]}{3P(L/W)} \right\} \quad (52)$$

where  $C_d$  and  $P$  are the dimensionless drag coefficient and structure porosity, respectively.

For each structure tested, Harms (1979b) determined the appropriate value of  $C_d$  from equation (52) after measuring the transmitted wave height. The value of  $C_d$  did not change significantly from one structure concept to another; hence, the transmission performance was deduced to be governed primarily by the porosity parameter,  $P$ , for the same value of  $H_i/L$  and  $L/W$ . In the principal region of interest (where the breakwater provides significant wave protection, typically  $L/W < 2$ ), the theoretical values were found to

differ from those measured by less than 10 percent. In view of this, Harms (1979b) concluded that equation (52) describes the wave transmission characteristics of these structures adequately, at least until more comprehensive models become available. The value of  $C_d$  was found to be fairly constant at around 0.6; however, it must be realized that  $C_d$  incorporates, among other things, the integrated effect of nontire structural components and binding materials. Hence, for other types of floating tire breakwaters,  $C_d$  may differ from 0.6. For the Goodyear concept, Harms and Bender (1978) found the porosity to be approximately 0.87. The porosity of the Wave-Guard approaches 0.53, which partially accounts for the better wave attenuation capacity of the Wave-Guard concept.

b. Mooring Force Estimate Based on Radiation Stress. Galvin and Giles (1978) developed a method of predicting mooring forces for scrap-tire floating breakwaters, based on the radiation stress concept of Longuet-Higgins and Stewart (1964). Wave forces in a floating tire breakwater differ from the more studied cases of wave forces on fixed cylinders and in a ship mooring line. The forces on a fixed cylinder alternate with time; those in a ship single mooring line vary from slack to taut in a rather irregular manner, being essentially zero for a significant fraction of the wave period, and then rising abruptly to a peak; the floating tire breakwater is wide enough that parts of the structure tend to move in one direction while parts are being stressed in the opposite direction. The result is that the mooring lines are subjected to continual forces which alternate in magnitude but always remain positive (the force in the oceanside mooring is opposite to the wave travel direction throughout the wave cycle). The fact that the force in the cable on the oceanside remains positive and greatly exceeds the force in the mooring line on the landside is assumed to be due to the wave-induced radiation stress. Although radiation stress is normally small relative to wave-induced drag and inertia forces on fixed cylinders, drag and inertia forces on a floating tire breakwater tend to cancel out internally since the breakwater usually extends more than one-quarter of a wavelength (the distance between maximum of drag and inertia forces). (This is not precise at the mooring line point of attachment, but is approximately correct at a finite distance from the mooring point.)

The radiation stress,  $S_{xx}$ , is the excess flux of momentum, due to the presence of waves, in the direction of wave travel. It is obtained by integrating the flux of momentum, from bottom to surface, then taking the mean value with respect to time, and finally subtracting the hydrostatic pressure.  $S_{xx}^*$  is defined as the net radiation stress due to incident and transmitted waves only (the case of zero reflection)

$$S_{xx}^* = \frac{\gamma}{8H_1^2(1 - C_t^2)n} \quad (53)$$

where

$$n = \frac{1}{2} + \left[ \frac{(kd)}{(\sinh 2kd)} \right] \quad (54)$$

and  $k$  is the wave number,  $d$  the stillwater depth, and  $\gamma$  the unit weight of fluid. If  $F_n$  is defined as the maximum instantaneous mooring force, then a balance of forces on the breakwater indicates that

$$F_n \leq \frac{\gamma}{2H_1^2(1 - C_T^2) n} \quad (55)$$

Since equation (55) is an inequality, verification requires that the data plot below the line be given by

$$F_n = 4S_{xx}^* \quad (56)$$

When Giles and Sorensen's (1978) data are plotted in Figure 94, they do indeed fall below the inequality line, with only limited exceptions associated with probable resonance near  $W/L = 0.5$ .

Galvin and Giles (1978) concluded that measured values of mooring force are consistent with the radiation stress inequality. For the case of force measured in 2 meters of water, the data are remarkably linear and approximately equal to  $S_{xx}^*$ . Force records for high waves on the floating tire breakwater are consistent with the hypothesis that radiation stress exerts the principal force experienced by the mooring line on the oceanside of the breakwater. Resonance should be expected whenever  $W/L$  is approximately 0.5, but under most practical conditions, the resonant conditions do not produce the maximum probable force in the mooring line.

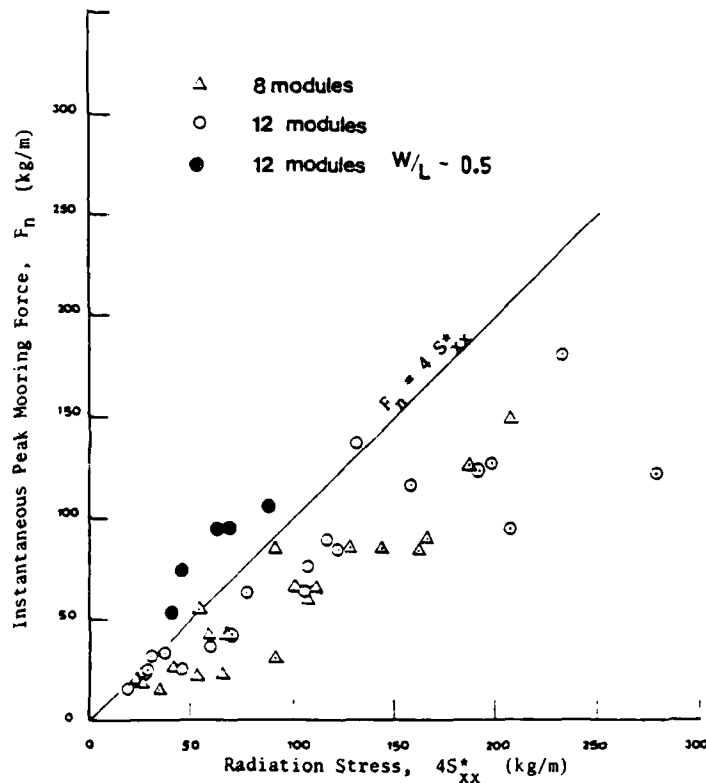


Figure 94. Relationship between instantaneous peak mooring force,  $F_n$ , and radiation stress,  $S_{xx}^*$ , for the Goodyear Tire and Rubber Company scrap-tire floating breakwater concept (after Galvin and Giles, 1978).

## 6. Construction Aspects.

Guidance for the assembly of unit modules to fabricate the Goodyear scrap-tire floating breakwater concept has been provided by Candle (1974), Kowalski and Ross (1975), Candle and Fisher (1976), Shaw and Ross (1977), and DeYoung (1978). Additional guidance on the construction of the Wave-Guard concept has been provided by Harms (1979a). Basically, the component parts and connectors are similar, except for the rigid member poles or piling of the Wave-Guard.

a. Tire Assembly. The design of the Wave-Maze and Wave-Guard is such that assembly will probably be required onsite. The Goodyear concept, based on easily assembled unit modules in which relatively few tires are secured together to form a portable building block for larger structures, can be transported from the assembly site to the breakwater location. Connecting materials for assembling the tires of the Goodyear concept include heavy steel chain (Figs. 95 and 96) or conveyor belting materials (Fig. 97). The Wave-Maze is constructed with tire sidewalls bolted together, using pieces of conveyor belting as reinforcement washers; hence, the heavier truck tires are recommended in this concept.



Figure 95. Use of heavy steel chain to assemble units of Goodyear scrap-tire floating breakwater concept (1976 photo by Goodyear Tire and Rubber Company).



Figure 97. Use of conveyor belting strips for assembly of units in Goodyear scrap-tire floating breakwater concept (1976 photo by Goodyear Tire and Rubber Company).



Figure 96. Scrap-tire floating breakwater units constructed with heavy steel chain as connecting material (1976 photo by Goodyear Tire and Rubber Company).

Davis (1977) and Shaw and Ross (1977) conducted in-situ saltwater tests to evaluate the reliability of 12 different potential materials for connectors. The binding material recommended above all those tested is conveyor belt edging material (a scrap product resulting from the trimming of new conveyor belts). This material demonstrated ultimate tensile strength on the order of 9,500 pounds per square inch, and is available from several manufacturers. Minimum recommended belt dimensions are 2 inches wide by 0.375 inch thick, with three or more nylon plies. This material can be easily cut with a band or hacksaw, and holes can be punched singly or with a multiple punch. Conveyor belting is virtually inert in the marine environment. Shaw and Ross (1977) recommended the use of nylon bolts, nuts, and washers as a means of fastening the belting together. Heavy steel chain is recommended as a secondary choice. Materials definitely not recommended for assembly of the units include nylon lines (poor abrasion resistance, knot-loosening, and ultraviolet degradation) and metallic-wire rope (inherent corrosive problems, metal fatigue, and cutting action of the rope on the tire body).

Shaw and Ross (1977) found that in addition to being inert in seawater, conveyor belting has excellent abrasion resistance to chafing against tire casings, and it showed no signs of delamination. The belting allowed loading to be distributed throughout the entire system and was essentially unaffected by ice conditions. The belting material is readily unfastened for addition of tires or for other repairs.

b. Foaming for Buoyancy. Air trapped in the tire crowns provides sufficient buoyancy to keep a floating tire breakwater afloat for a while. However, to ensure that the structure remains in a position to provide protection for up to the estimated 10-year life, supplemental flotation should be added in every tire. Candle (1974) described a technique for onsite foaming of scrap tires that can be easily handled by one or two people. This technique uses simple, flat plate molds to hold expanding urethane foam inside the tire. The foam is a two-component pourable mixture of a 1:1 ratio by weight which can be easily mixed by an electric drill-type mixer. The liquid foam can then be poured into the tires where it expands and cures in about 15 minutes. It may be necessary to vent the top half of the tire if trapped air voids occur under the sidewall areas. This is easily accomplished by drilling holes through the upper part of the tire to allow air to escape as the foam rises. Other types of flotation materials, such as milded polyethylene floats or 1/2-gallon plastic bottles inserted into the tires, have also been used. Completely uniform flotation will facilitate interconnecting the units in water, and the independent flotation of each unit allows the interconnecting hardware to be used with maximum efficiency.

c. Mooring Systems. The type of line or chain used to moor a floating tire breakwater is important from the standpoint that it must be strong enough and resilient enough to withstand peak forces and fatigue failures. Local experience in mooring large ships has been used as a guide, and past studies have indicated that the vertical load on the anchor should be minimized. The mooring line should have a minimum length of approximately eight times the maximum expected water depth and the anchor should be positioned seven times the maximum water depth from the breakwater (Giles and Eckert, 1979). During storm conditions, local seas have to lift the mooring line off the bottom before forces are applied directly to drag the anchor; hence, many builders have used chain (either galvanized steel or wrought iron) rather than other

materials in the mooring system. Wire cable has occasionally been used, but cable is subject to both axial fatigue and corrosion weakening. Chain moorings should be attached to the breakwater in a manner that distributes the load between two or more modules. This can be accomplished by attaching a short bridle to the outer tires of the module, and then attaching the mooring chain to the bridle.

Because of its unique construction aspects, the recommended mooring line of the Wave-Guard (Harms, 1979a) consists of a tire mooring damper located at the breakwater end of the mooring line, plus an anchor chain near the bottom (Fig. 98). The use of open-link low-carbon chain (1/2-inch diameter) appears to be most economical. This chain has an average tensil strength of 2,200 pounds and is heavy enough to withstand years of abrasion. The tire mooring damper should consist of at least five tires in series. The mooring line should be fastened to the poles or piling through 2 tires about 10 tires from the end.

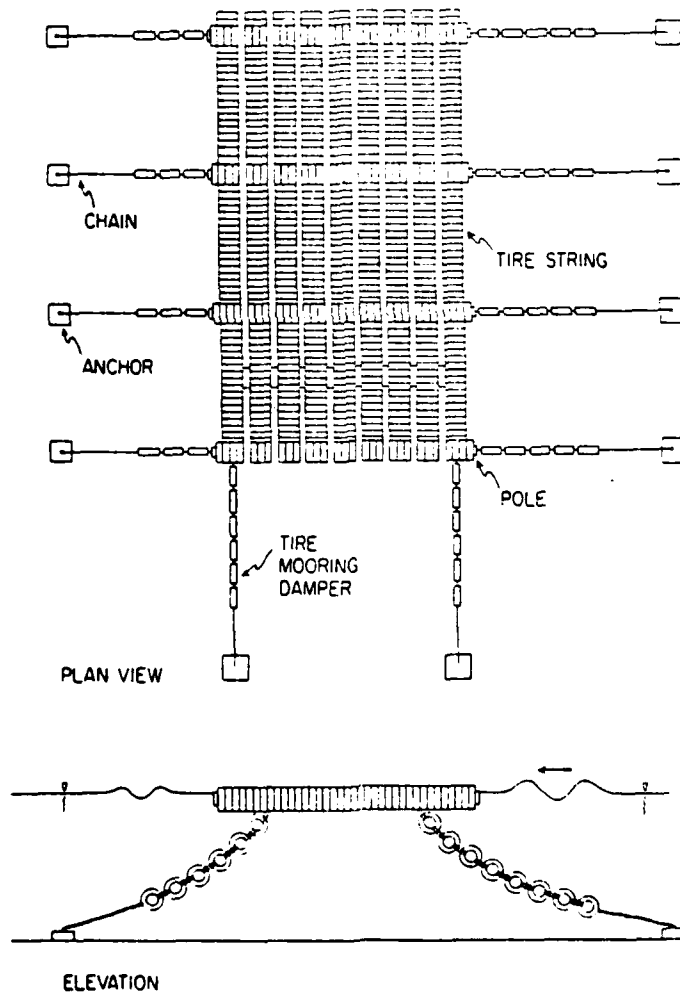


Figure 98. Schematic of Wave-Guard scrap-tire floating breakwater mooring system (after Harms, 1979a).



## 7. Estimated Scrap-Tire Floating Breakwater Cost.

The total cost of a scrap-tire floating breakwater will depend to a large degree on the labor cost of accumulating and assembling the tires onsite, and on the types of binding and flotation materials used. With an estimated existing stockpile of more than 2 billion scrap tires in the United States, large quantities are available free-of-charge at most metropolitan regions. However, labor involved with transporting the tires to the project location can become significant. Giles and Sorensen (1978) estimated that flotation and tieline typically account for one-third of the breakwater cost, with labor and the anchoring system accounting for the remaining cost. Candle and Fischer (1976) estimated the cost of a 26-foot-wide breakwater to be about \$27 per linear foot, and of a 105-foot-wide breakwater to be about \$98 per linear foot (based on the Goodyear concept). The City of Dunkirk, New York, constructed a 28-foot-wide section in 1976 at a cost of \$17 per linear foot (Fig. 99); at about the same time, the Dock and Coal Marina at Plattsburg, New York, was constructed with scrap-tire units 28 feet wide at a cost of about \$28 per linear foot (DeYoung, 1978). For the Goodyear concept in 1976, the estimated cost of a scrap-tire floating breakwater was about \$1 per square foot of breakwater area.

Because the Wave-Maze is considerably more dense than the Goodyear concept, Noble (1976) estimated a one-tier assembly to cost about \$4 per square foot of surface area. A royalty for the use of this patent adds about 10 percent to the construction cost. Historically, the Goodyear Tire and Rubber Company scrap-tire floating breakwater concept has been used primarily on the Great Lakes and the Atlantic coastal areas, while the Wave-Maze has been constructed on Pacific waters suitable for its installation. An example of the Wave-Maze in operation is the siting in San Francisco Bay where two sections of the structure protect the expanded Pier 39 marinas and berthing complex (Fig. 100). A fixed-timber breakwater approximately 1,190 feet long was erected on the west side of the pier, and the two sections of a scrap-tire floating breakwater with a combined length of 1,815 feet, are permanently anchored with a combination concrete-block and steel anchoring system.

Since the Wave-Guard concept of scrap-tire floating breakwater has been laboratory tested only, a direct comparison of prototype cost with other concepts is not possible. However, to obtain an indication of variations in the construction costs of the three dominant concepts, Harms (1979a) performed calculations based on "equal wave protection," since the wave attenuation performance of the three types of breakwaters are quite different, even for the same beam width. The cost of each structure was evaluated only after having been "sized" to provide the same degree of wave protection. The cost of the mooring system was not included because it is inherently site-dependent, and probably does not vary greatly in cost from one type of breakwater to another. Harms (1979a) determined that the Wave-Guard construction costs are slightly less than the Goodyear Tire and Rubber Company concept, but at the same time it is significantly smaller for the same degree of protection. Although the Wave-Maze scrap-tire floating breakwater concept was found to be far more costly than either the Goodyear concept or the Wave-Guard, it perhaps has a longer useful life and greater extreme event survival capability.



a.



b.

Figure 99. Goodyear scrap-tire floating breakwater concept in operation at Dunkirk Harbor, New York (1976 photo by Goodyear Tire and Rubber Company).



Figure 100. Wave-Maze scrap-tire floating breakwater concept protecting the east marina and northern section of Pier 39, San Francisco, California.

#### VI. A-FRAME ARRANGEMENT FLOATING BREAKWATERS

Because of the availability of timber in both the United States and Canada, individual logs or log rafts have been used to provide protection for harbors and boat anchorages. The deeply indented coastlines of British Columbia and Alaska have many harbors (large and small) which are well protected by natural topography from the action of storm-generated waves. However, numerous coastal settlements and potential harbors exist which are exposed to some degree to waves, and which would benefit greatly from the installation of an effective and economical type of breakwater. WES has investigated the applicability of specific arrangements of floating log breakwaters for Alaskan areas, and the Canadian Department of Public Works has developed and evaluated a floating circular-cylinder design concept which also incorporates a vertical wall for supplemental attenuation purposes. Of interest in this development has been the determination of the method and extent to which the requirement of large mass may be usefully replaced by large moment of inertia of mass. It appears that the Canadian concept (the A-frame) effectiveness range can be significantly increased by a large increase of its radius of gyration, involving only a slight increase of mass.

### 1. Twin-Log Floating Breakwater.

Jackson (1964) conducted experimental studies on 1:6 scale models of twin-log floating breakwaters to determine the feasibility of this structure to protect Small-Boat Basin No. 2, Juneau, Alaska, from wave action. Specifically, it was desired to determine the most economical floating log breakwater that would reduce a 2-foot-high wave to approximately 0.5 foot in the mooring area. The basin site is exposed to waves from the southeast through the northwest direction, with maximum wave height due to storms from these critical directions about 2 feet. Water depths at the breakwater site range from about 2 to 25 feet; the maximum tide is 21 feet. Because of the large water depths, the large range of tides, and poor foundation conditions prevent the construction of a rubble-mound breakwater, and since logs of considerable diameter and reasonable cost were available at the project site, a twin-log floating breakwater was proposed. The structure would consist of two logs floating parallel, spaced about 1.5-log diameters on centers, connected by a timber superstructure, and restrained in a horizontal plane by vertical piles but allowed to float with the rise and fall of the tide.

Tests were conducted on 1:6-scale section models of the twin-log floating breakwater in a concrete flume 119 feet long, 5 feet wide, and 4 feet deep. The various floating log breakwater designs were installed in one end of the wave flume and subjected to waves generated by a plunger-type wave generator located at the other end of the flume. The effectiveness of the breakwaters was determined by measuring the heights of the incident and transmitted waves. The incident waves were measured at the breakwater site before the structure was installed; the transmitted waves were measured at a distance of about two wavelengths toward the harbor of the breakwater.

Jackson (1964) conducted a series of tests to determine the effect of angle of wave attack, water depth, and wave period on wave attenuation. The model structure simulated a twin-log floating breakwater constructed of 4-foot-diameter logs spaced on 5.7-foot centers. Based on the specific weight of prototype logs, the flotation depth of the model structure was 3.45 feet. Wave attenuation tests were conducted using (a) 45° and 90° angles of wave attack; (b) water depths of 10 and 20 feet, referred to stillwater level; and (c) 2.0-second waves of 2.0-foot height, and 2.5-second waves of 2.5- and 2.6-foot height. Test results are given in Table 4.

Table 4. Twin-log floating breakwater tests No. 1 (after Jackson, 1964).

Wave period (s)	d/L		H <sub>i</sub> (ft)		H <sub>t</sub> (ft)		H <sub>t</sub> /H <sub>i</sub>	
	β, 45°	β, 90°	β, 45°	β, 90°	β, 45°	β, 90°	β, 45°	β, 90°
d = 10 ft; y/d = 0.35								
2.0	0.40	0.49	2.0	2.0	0.4	0.4	0.20	0.20
2.5	0.32	0.32	2.5	2.5	1.2	0.8	0.48	0.32
d = 20 ft; y/d = 0.17								
2.0	0.98	0.98	2.0	2.0	0.4	0.4	0.20	0.20
2.5	0.63	0.63	2.6	2.6	1.3	0.6	0.50	0.23

Table 4 shows that the transmission coefficient,  $H_t/H_i$ , varied primarily with wave period and angle of wave attack. When the angle of wave attack was  $45^\circ$ , an increase in the wave period from 2.0 to 2.5 seconds resulted in a maximum increase of 150 percent in the value of  $H_t/H_i$ . When the angle of wave attack was  $90^\circ$ , an increase in wave period from 2.0 to 2.5 seconds caused a maximum increase of 60 percent in the value of  $H_t/H_i$ . Assuming that 0.5-foot-high waves are the maximum size that can be tolerated on the harborside of the structure, a twin-log floating breakwater constructed of 4-foot-diameter logs spaced on 5.7-foot centers would not be satisfactory for attenuation of waves with heights greater than 2.0 feet and periods greater than 2.0 seconds. Figure 101 shows waves attacking the model breakwater. The most severe movement of the breakwater structure occurred when the angle of wave attack was  $90^\circ$  and the wave period 2.5 seconds. The structure rolled and oscillated about its longitudinal centerline, and resisted violent pounding by the fixed pile mooring system.

Jackson (1964) conducted another series of tests to determine the effect of log diameter, log spacing, water depth, and wave period on wave attenuation, repeating the previously used angles of attack and water depths, and adding (a) center-to-center log spacings of 4.0, 5.7, and 8.2 feet; and (b) 1.7-second waves 0.9 foot high, 2.0-second waves 2.0 feet high, and 2.5-second waves 2.5 and 2.6 feet high. The test results are given in Table 5.

Table 5 indicates that the ratio  $H_t/H_i$  varied primarily with wave period. Varying the center-to-center spacing between logs from 4.0 to 8.2 feet did not improve the wave attenuation characteristics of the structure. On the basis of the criterion that waves in the mooring area should not be greater than 0.5 foot high, a twin-log floating breakwater constructed of 3-foot-diameter logs would not be satisfactory for this degree of attenuation of 2.0-second waves greater than approximately 1.5 feet high. Decreasing the diameter of the logs from 4 to 3 feet resulted in a maximum increase of 75 percent in the value of the ratio  $H_t/H_i$  for the 2.0-second waves, and a maximum increase of 33 percent for the 2.5-second waves.

Based on the experimental results, it was concluded that for incident waves not greater than 2.0 feet in height and 2.0 seconds in period (wave attenuation criterion:  $H_t \leq 0.5$  foot), a twin-log floating breakwater constructed of either 4- or 3-foot-diameter logs with vertical barrier plates attached, extending to a 4-foot depth below stillwater level, would provide sufficient protection for Small-Boat Basin No. 2 at Juneau, Alaska. Logs spaced 5.5 to 6.0 feet apart would be satisfactory. Increasing the center-to-center log spacing from 4.0 to 8.2 feet had a negligible effect on the wave attenuation characteristics of the structure tested. Wave attenuation characteristics of twin-log floating breakwaters vary primarily with flotation depth and wave period. An increase in the flotation depth results in a decrease in the value of  $H_t/H_i$ ; an increase in the wave period results in an increase in  $H_t/H_i$ . Varying the angle of attack from  $45^\circ$  to  $90^\circ$  resulted in a slight and somewhat erratic variation in the wave attenuation characteristics; however, the test data indicate that such a structure would be slightly more effective when the angle of wave attack is  $90^\circ$  than when it is  $45^\circ$ . For the conditions tested, the most economical and effective breakwater configuration was that which utilized 3-foot-diameter logs with vertical barrier plates attached to the channel-side face of the channel-side log. The addition of barrier plates to the harborside face of the harborside log, in conjunction



Figure 101. Two-dimensional model investigation of twin-log floating breakwater at Juneau, Alaska, Small Boat Basin No. 2--wave period = 2.5 seconds, wave height = 2.5 feet, log diameter = 4 feet, log spacing = 5.7 feet, water depth = 10 feet, and angle of attack =  $90^\circ$  (after Jackson, 1964).

Table 5. Twin-log floating breakwater tests No. 2  
(after Jackson, 1964).

Center-to-center log spacing (ft)	$\beta = 45^\circ$				
	Wave period (s)	d/L	$H_1$ (ft)	$H_t$ (ft)	$H_t/H_1$
$d = 10 \text{ ft}; y/d = 0.24$					
4.0	2.0	0.49	2.0	0.6	0.30
5.7	1.7	0.69	0.9	0.2	0.22
5.7	2.0	0.49	2.0	0.7	0.35
5.7	2.5	0.32	2.5	1.6	0.64
8.2	2.0	0.49	2.0	0.6	0.30
$d = 20 \text{ ft}; y/d = 0.12$					
4.0	2.0	0.98	2.0	0.7	0.35
5.7	1.7	1.35	0.9	0.2	0.22
5.7	2.0	0.98	2.0	0.7	0.35
5.7	2.5	0.63	2.6	1.6	0.62
8.2	1.7	1.35	0.9	0.2	0.22
8.2	2.0	0.98	2.0	0.7	0.35
8.2	2.5	0.63	2.6	1.6	0.62

with the plates on the channel-side log, did not appreciably improve the wave attenuation characteristics of the structure. However, the addition of the barrier plates to the 3-foot-diameter logs increased the forces on the restraining piles. For the conditions tested, the flotation depth and wave period were more critical than water depth. This occurred because increasing the water depth from 10 to 20 feet for the wave periods tested did not increase the wavelengths under investigation.

## 2. Twin-Cylinder Floating Breakwater.

A variation of the twin-log floating breakwater uses the concept of hollow cylinders filled or partially filled with water for mass variability effects. The twin-cylinder floating breakwater (Fig. 102) consists essentially of two circular cylinders rigidly connected at intervals by structural supports. This design, based on a concept of LaSalle Hydraulic Laboratories, Canada, has been investigated experimentally in the laboratory by Ofuya (1968). The depths of submergence of the cylinders and the stability of the structure depend on the amount of fluid in the cylinders. This design attempts to attenuate wave energy mainly through forced instability of the incident waves and to produce wave breaking and turbulence in the gap between the cylinders. The optimum depth of submergence,  $a_1/a_2$ , was determined by Ofuya (1968).

The wave damping performance of the twin-cylinder breakwater is discussed in terms of its transmission coefficient,  $C_t$ , as functions of the incident wave steepness,  $H_1/L$ , and relative water depth,  $L/d$ . The stability and natural period of oscillation of the twin-cylinder float in still water were determined experimentally. The breakwater remained stable over a wide range of values of  $a_1/a_2$  when the lower cylinder was filled with water and the upper cylinder was empty. Its natural periods of rolling were found to depend

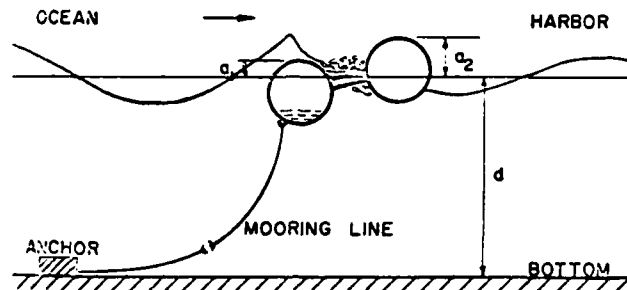
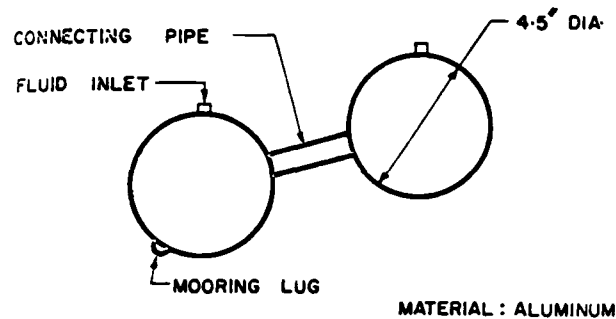


Figure 102. Two-dimensional experimental investigation of twin-cylinder floating breakwater (after Ofuya, 1968).

on the ratio  $a_1/a_2$  also. These periods increased with decreasing values of  $a_1/a_2$  (as indicated in Fig. 103) which was consistent with a decrease of  $a_1/a_2$  causing an increase in the radius of gyration of the structure and a decrease in its metacentric height. When both cylinders were filled with water, the range of stability of the breakwater decreased considerably. Near the limit of stability, a slight lateral displacement of the filling fluid caused the structure to float with both cylinders vertically oriented, and the performance of the breakwater was severely impaired. For optimum wave attenuation with one cylinder filled, the submergence position had a value of  $a_1/a_2 = 0.4$  and appeared to be independent of the incident wavelength (Fig. 104).

Ofuya (1968) found that wave damping by the twin-cylinder floating breakwater depended on several factors, such as wave reflection, interference effects, and particularly at small values of  $L/d$ , turbulent action in the gap between the cylinders. All these factors contributed to the existence of a floating position for optimum wave damping. For large values of  $L/d$ , the structure would not be effective as a breakwater since long waves pass through with little damping, as indicated in Figure 105. However, for  $L/d < 1.3$ , the twin-cylinder floating breakwater has a transmission coefficient,  $C_t$ , less than 0.5. As shown in Figure 105, an almost linear relationship exists between  $C_t$  and  $L/d$  for wave steepness in the range 0.045 to 0.065. This relationship does not, perhaps, indicate the complex nonlinear interaction processes occurring between the structure and the waves. For small values of  $L/d$ , wave breaking in the gap between the two cylinders appeared to be the dominant mechanism influencing wave damping. The heaving, swaying, and rolling motions decreased considerably in the range of  $L/d$ , when the structure was effective in wave attenuation.



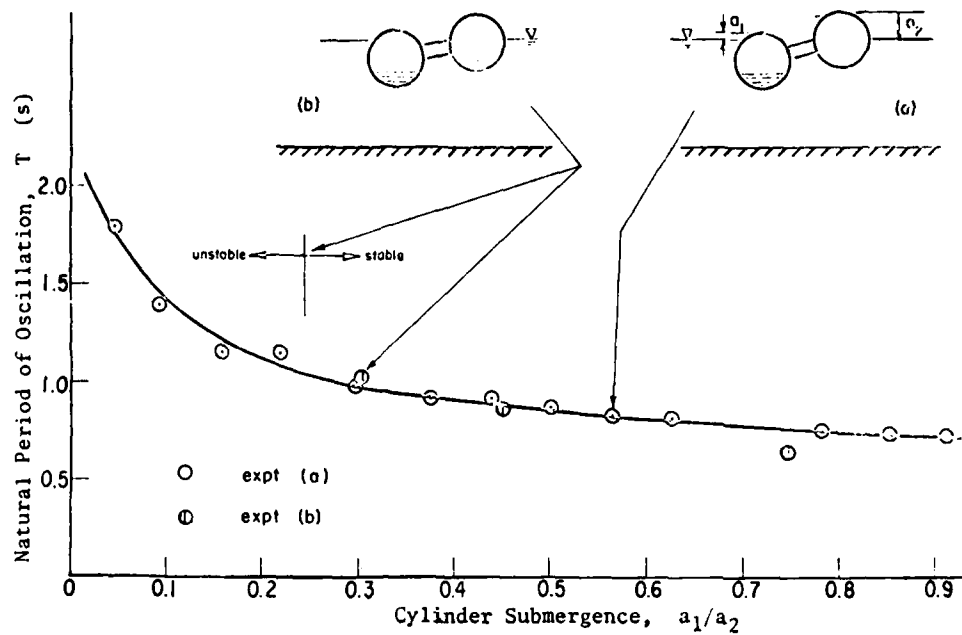


Figure 103. Twin-cylinder floating breakwater stability and natural periods of oscillation (after Ofuya, 1968).

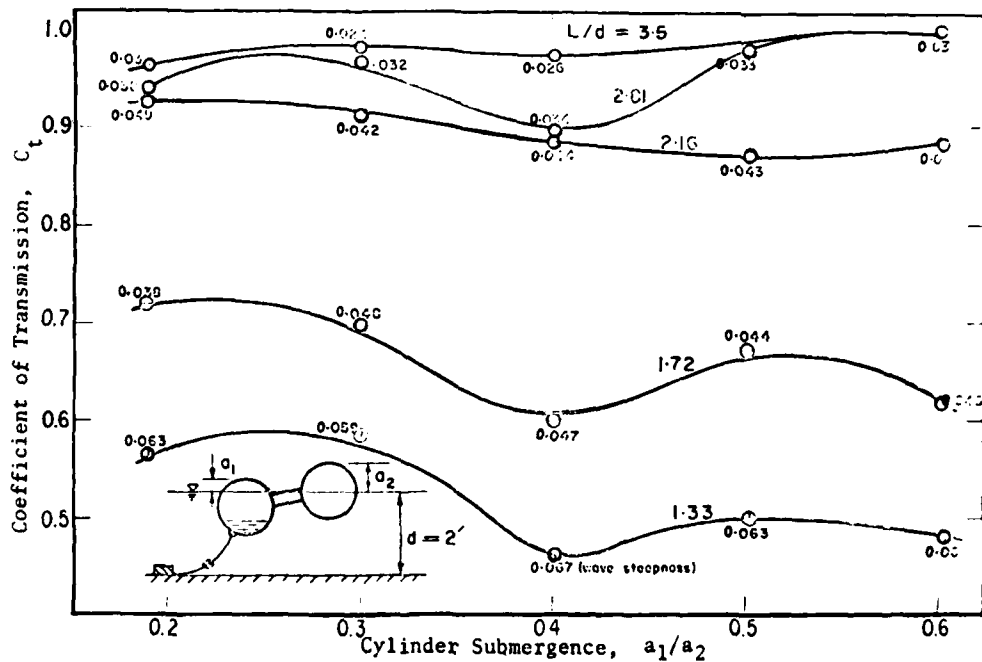


Figure 104. Effect of cylinder submergence,  $a_1/a_2$ , and relative water depth,  $L/d$ , on transmission coefficient,  $C_t$ , for twin-cylinder floating breakwater (after Ofuya, 1968).

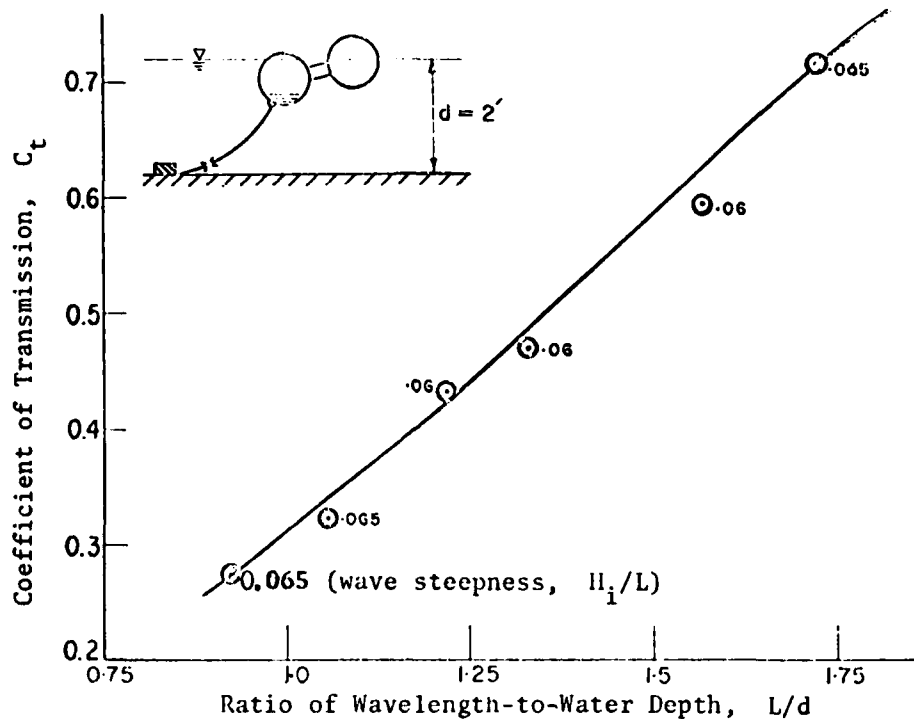


Figure 105. Effect of relative water depth,  $L/d$ , and initial wave steepness,  $H_i/L$ , on transmission coefficient,  $C_t$ , for twin-cylinder floating breakwater (after Ofuya, 1968).

In a practical application of the twin-cylinder floating breakwater, the most economical filling fluid would be water. Ofuya (1968) found that the oscillation characteristics of the structure, and hence its wave damping performance, was influenced by properties such as density and viscosity of the filling fluid. With filling fluid of a higher viscosity than water, the amplitude of oscillation was reduced considerably; with both cylinders filled, the stable range of the structure was increased. Both factors tend to increase the range of effectiveness of the twin-cylinder floating breakwater. At a model-to-prototype scale of 1:16, each cylinder corresponds to a prototype dimension of 6 feet in diameter. For an arbitrarily defined limit of wave transmission,  $C_t = 0.5$ , the twin-cylinder floating breakwater would be effective as a breakwater for deepwater waves of lengths up to about 40 feet. In its submerged position, the twin-cylinder breakwater appears to be an esthetic structure (Ofuya, 1968). Application of the structure to protect locations exposed to deepwater waves would depend, therefore, on economic considerations. Neither field tests nor prototype-scale investigations have been conducted of this concept.

### 3. A-Frame Floating Breakwater.

A floating breakwater of the A-frame, pontoon-type (designed by the Department of Public Works, Canada) has been in field service at Lund, British Columbia, Canada, for several years, and has performed efficiently under all wave conditions encountered at this site. Both Western Canada Hydraulic Laboratories (1966a) and Ofuya (1968) conducted a series of tests to evaluate

the wave damping characteristics and to relate its efficiency to a range of wavelengths typical of coastal waters. Revised designs have been proposed.

a. Western Canada Hydraulic Laboratories Investigations. Three models of the A-frame floating breakwater (Fig. 106) were constructed at Western Canada Hydraulic Laboratories to a scale of 1:23.4, representing prototype dimensions of 15, 25, and 35 feet wide by 60 feet long. The framework of the breakwaters, which consisted of angles and channels of standard pattern, was duplicated to the proper scale by forming thin metal plates. Anchor chains of copper were used, representing a prototype chain weight of 11 pounds per foot of length. The vertical timber wall was represented by 0.5-inch painted plywood to prevent water absorption. Anchorage was provided by lead blocks of sufficient weight to prevent dragging (sliding) under the most severe wave conditions. The anchor chain length used in the model was approximately 2.5 times the water depth, which was 40 feet prototype dimension.

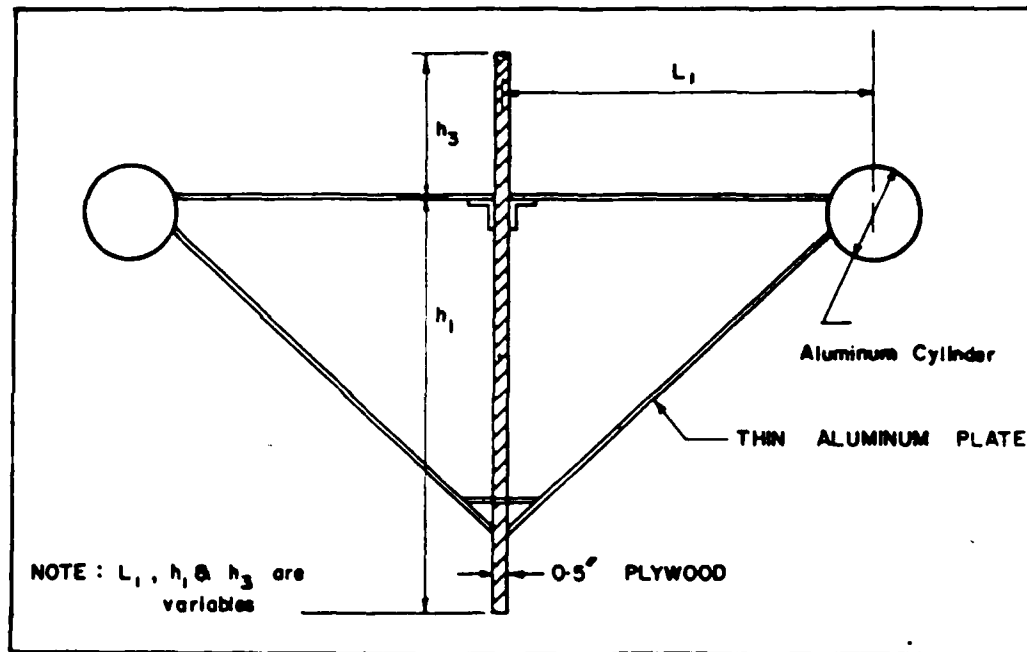


Figure 106. A-frame floating breakwater evaluated experimentally in both a three-dimensional and two-dimensional wave basin.

Rolling action of the breakwaters differed noticeably under various wave conditions. When subjected to long waves, the roll was fairly symmetrical about the longitudinal axis, coupled with the normal rise and fall. As wavelengths decreased, the leeward pontoon tended to be displaced less than the windward. This was most noticeable in the three-dimensional tests when wavelengths were about equal to the breakwater width. The leeward pontoon at times rotated on its axis, acting as a pivot which moved the windward pontoon through an arc of 2 to 3 feet. A strong reflected wave was noted with each breakwater, indicating an effective interference with the imposed wave. The



The A-frame floating breakwater was found to be an effective means of damping wave action, provided the breakwater width,  $2L_1$ , is not less than about 75 percent of the length of the maximum design wave. The efficiency of the A-frame increases rapidly as the ratio of breakwater width-to-wavelength increases until the ratio reaches approximately 0.75. The efficiency then decreases gradually until the ratio is approximately 1.75, and again gradually increases with further increases in the ratio  $W/L$ . The efficiency is very low when the breakwater width is less than 25 percent of the wavelength, increases rapidly as the breakwater width-to-wavelength increases from 25 to 60 percent, and reaches a maximum when the width is about 75 percent of the wavelength.

This breakwater has three distinct types of motion as the breakwater width-to-wavelength ratio changes. With small ratios, the motion is mainly a rocking motion with the breakwater pontoons moving with the wave. With intermediate ratios, the windward pontoon moves up and down with the wave while the leeward pontoon rotates back and forth as if it were hinged on its longitudinal axis. This is the most efficient action and occurs when the wavelength is approximately equal to the breakwater width. With larger ratios, both pontoons move up and down, as well as rotate about the center wall.

The diffraction pattern of the waves (shown in Fig. 107 as total wave height amplification) as they pass the breakwater is similar for all wavelengths and breakwater widths. The greatest reduction in height is immediately downstream from the central part of the breakwater; the reduction becomes less toward the ends of the breakwater, and as the waves move farther downstream. Generally, there is a slight buildup of the waves off the ends of the breakwater and downstream, as well as in the reflected wave area upstream. A buildup also occurs some distance downstream from the breakwater center. Waves at this location (several breakwater widths downstream) are, in some cases, equal to the approaching incident wave; reflected waves upstream are about 150 percent of the incident wave.

b. Queen's University Hydraulic Laboratories Investigations. The A-frame floating breakwater, evaluated in two-dimensional wave tests by Ofuya (1968) and Brebner and Ofuya (1968), consists essentially of a central thin, vertical rigid wooden curtain with two symmetrically located circular aluminum cylinders connected to the vertical board at intervals by thin rods. The depth of the vertical board below the water surface can vary; the height of the curtain above the water surface must be sufficient to prevent wave breaking above the curtain. Variations of the cylinder spacing indicate changes in the radius of gyration of the structure about a lateral axis through its center of gravity. The use of four-cylinder pontoons is a variation of the basic unit. Two different locations of the mooring line attachment were investigated. The line attached to the bottom of the vertical curtain is considered the most effective. The line attachment to a cylinder was abandoned because the system produced irregular and jerky breakwater motions.

The effect of wave steepness,  $H_1/L$ , on transmission coefficient,  $C_t$ , is shown in Figure 108. These data show the general trend of steep waves experiencing greater attenuation than waves of lower steepness. However, there appears to be deviations from this general trend for certain values of  $L/L_1$ , where  $L_1$  is the distance from the vertical curtain to the pontoon. Experiments on wave transmission past fixed, thin vertical barriers extending into

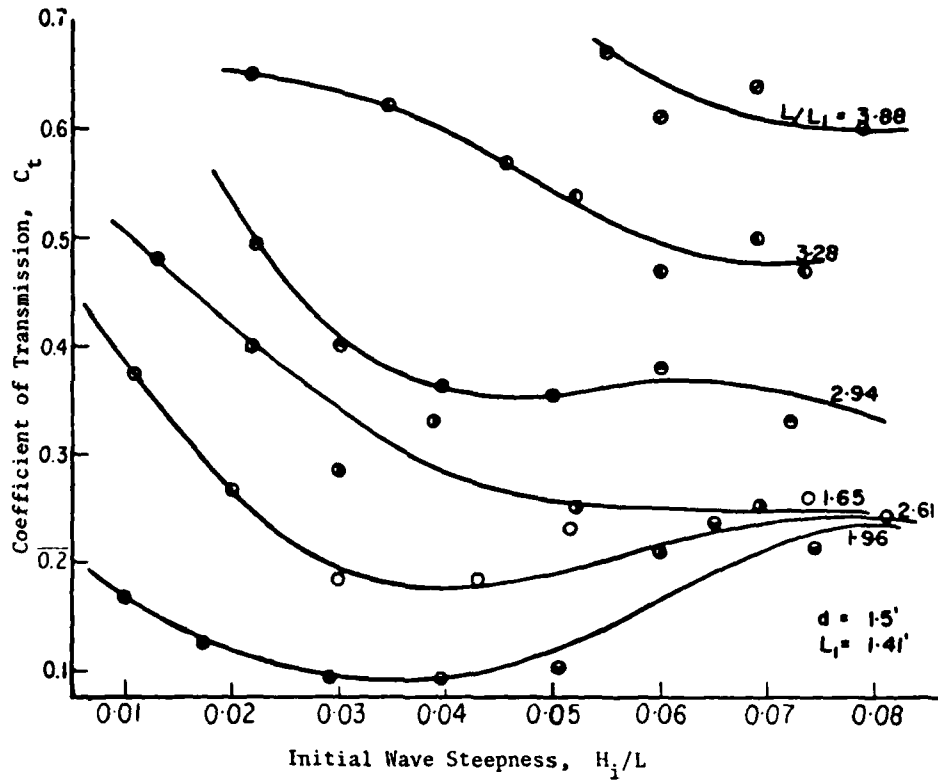


Figure 108. Effect of initial wave steepness,  $H_i/L$ , and relative breakwater width,  $L/L_1$ , on transmission coefficient,  $C_t$ , for A-frame floating breakwater (after Ofuya, 1968).

water also show that steep waves experience greater attenuation than low waves. This is partly attributed to the increase in water particle velocity with increase in wave steepness, and the resulting increase in loss of energy due to separation of fluid at the bottom of the barrier. The increase of  $C_t$  with increasing steepness for certain values of  $L/L_1$  may be due to wave generation by the oscillating breakwater.

The effect of relative water depth,  $L/d$ , on the transmission coefficient,  $C_t$ , is shown in Figure 109, for various values of  $L_1/d$ , which is effectively a radius of gyration parameter. The water depths used in the experiments were 1.5 and 2.5 feet. The ratio  $L_1/d$ , held constant for each of the curves in this figure, specifies the spacing of the cylinders. The wave steepness,  $H_i/L$ , varied from 0.06 to 0.07. The properties of the A-frames used in Ofuya (1968) are presented in Table 6. One of the most important features shown in Figure 109 is that the effectiveness of the A-frame floating breakwater can be increased by increasing the cylinder spacing. This process indicates an increase of the mass radii of gyration of the breakwater about a lateral axis through its center of gravity. For example, at a value of  $C_t = 0.5$ , the effectiveness (length of wave which can be attenuated by 50 percent) of the A-frame in wave damping can be increased by a factor of about 1.7 for a threefold increase of its radius of gyration. Highly significant is the fact that masses of the breakwaters under consideration differed by only 7 percent.

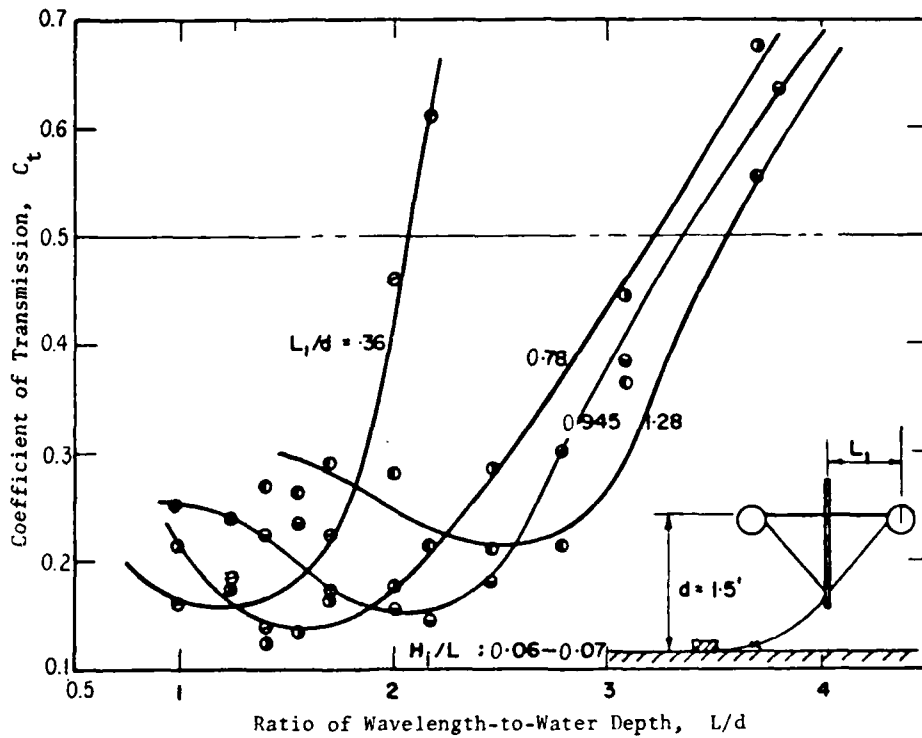


Figure 109. Effect of relative breakwater width,  $L_1/d$ , and relative water depth,  $L/d$ , on transmission coefficient,  $C_t$ , for A-frame floating breakwater (after Ofuya, 1968).

Table 6. Two-dimensional experimental investigation of properties of A-frame floating breakwater (after Ofuya, 1968).

Half-cylinder spacing $L_1$ (ft)	Weight of breakwater $W_1$ (lb)	Radius of gyration $K_2$ (ft)	Metacentric height GM (ft)	Angle of heel	Natural period of rolling motion $T_r$ (s)
1.17	16.4	1.01	2.92	2.5°	0.655
			1.87	5.0°	0.82
1.92	17.08	1.58	7.65	1.5°	0.63
			5.06	3.0°	0.778
1.41	16.64	1.19			
0.54	15.9	0.53			
$h_1 = 1.17$ ft					

Theories of water wave transmission past fixed barriers indicate that the transmitted wave heights depend on the depth of barrier below the water surface. In Ofuya's (1968) tests to determine the influence of the depths of vertical curtain on wave damping of the A-frame, the masses of two breakwaters and their mass radii of gyration were held constant. This was achieved by maintaining equal lengths of vertical curtain but having different depths of submergence below stillwater level. It was assumed that the slight difference in the location of the center of mass of the two breakwaters had only minimal effects on their motions. Figure 110 shows the effect of this relative penetration depth,  $h_1/d$ , on transmission coefficient,  $C_t$ . The transmission coefficient for an  $h_1/d$  value of 0.47 exceeds that for  $h_1/d$  of 0.23 by only about 10 percent, in relatively deep water. However, in an intermediate depth, the difference becomes more than 15 percent. In shallow water, the influence of depth of vertical curtain on  $C_t$  is expected to be significant since kinetic energy concentration is approximately distributed uniformly throughout the water depth. In deep water, the A-frame breakwater with an  $h_1/d$  value of 0.25 can achieve transmission coefficients of 0.4 or less, depending on the cylinder spacing.

Brebner and Ofuya (1968) investigated two variations of the four-cylinder A-frame floating breakwater, using either a chain connection between the cylinders or a welded connection. Figure 111 shows the wave attenuation characteristics of the two variations. Wave damping by the chain-connected cylinders decreased with decreasing values of  $L_2/L_1$ , which may be partly attributed to the fact that a decrease in values of  $L_2/L_1$  causes both cylinders to become more located in regions of large kinetic energy concentration. The experiments indicated that, since both cylinders move independently, the waves generated by the lower cylinders augment those produced by the basic A-frame unit (although this effect is not intuitive. At certain values of  $L_2/L_1$ , the structure moved in the seaward direction and, hence, the mooring cable remained slack. The seaward movement, which made the mooring forces a minor measurement, can be partly attributed to the inertial effects of the lower cylinder. A greater effectiveness of the four-cylinder A-frame can be achieved by welding the cylinders. Unlike the chain-connected system, this system experienced no seaward movement.

The horizontal force components of the mooring force parameter,  $Fh_1/\gamma H_1^2 L$ , are presented in Figure 112 as a function of the relative width of the breakwater,  $L/L_1$ , for the two-cylinder A-frame floating breakwater evaluated by Ofuya (1968). The data for the four-cylinder A-frame are shown in Figure 113 for cylinder spacings of  $L_1 = 0.54$  foot and  $L_1 = 1.41$  feet, respectively. In Figure 112, both peak and average forces for the two-cylinder A-frame are shown with the average forces defined here as the average over 70 cycles of loading. It was evident from the frequency distribution of the resulting



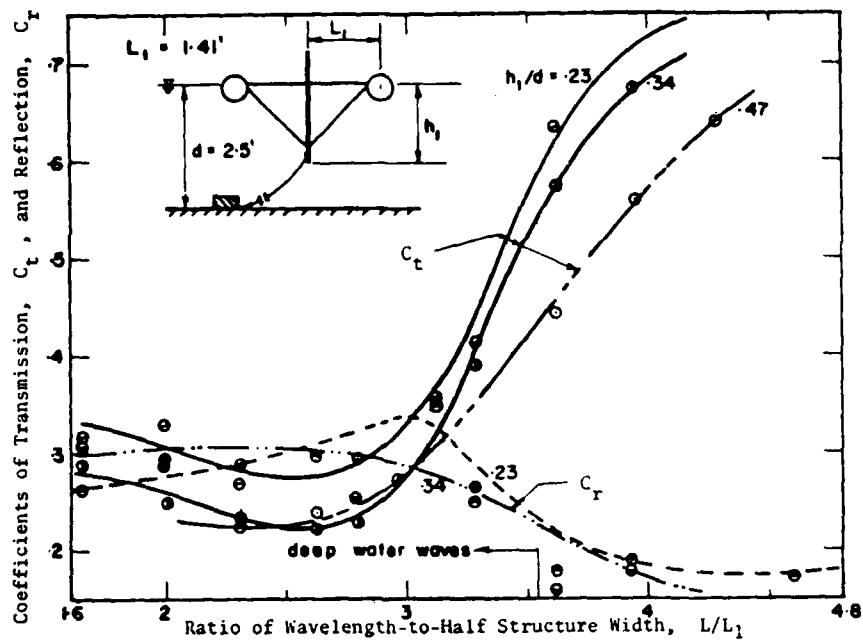


Figure 110. Effect of relative breakwater width,  $L/L_1$ , and relative depth of vertical curtain,  $h_1/d$ , on coefficient of transmission,  $C_t$ , for A-frame floating breakwater (after Ofuya, 1968).

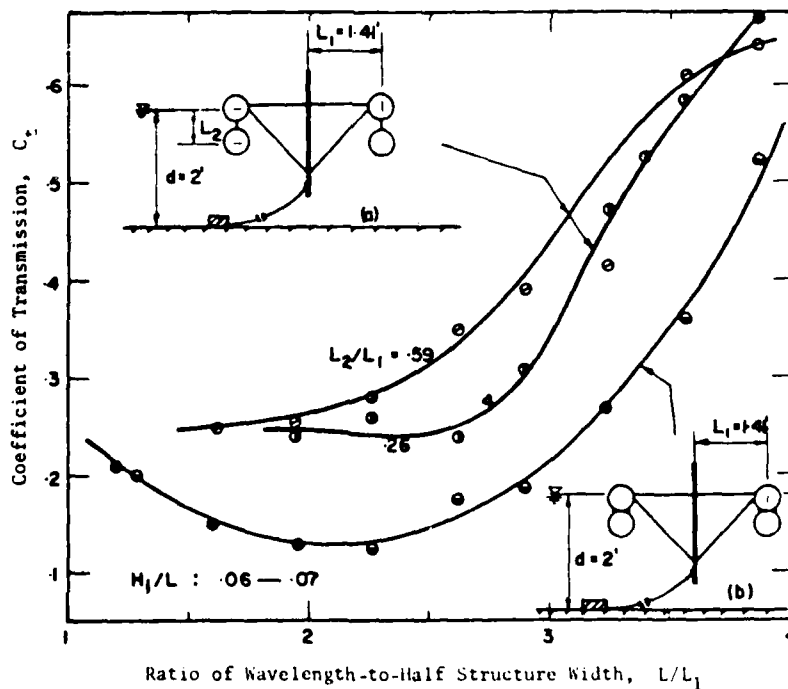


Figure 111. Effect of relative breakwater width,  $L/L_1$ , and relative cylinder submergence,  $L_2/L_1$ , on transmission coefficient,  $C_t$ , for four-cylinder A-frame floating breakwater (after Ofuya, 1968).

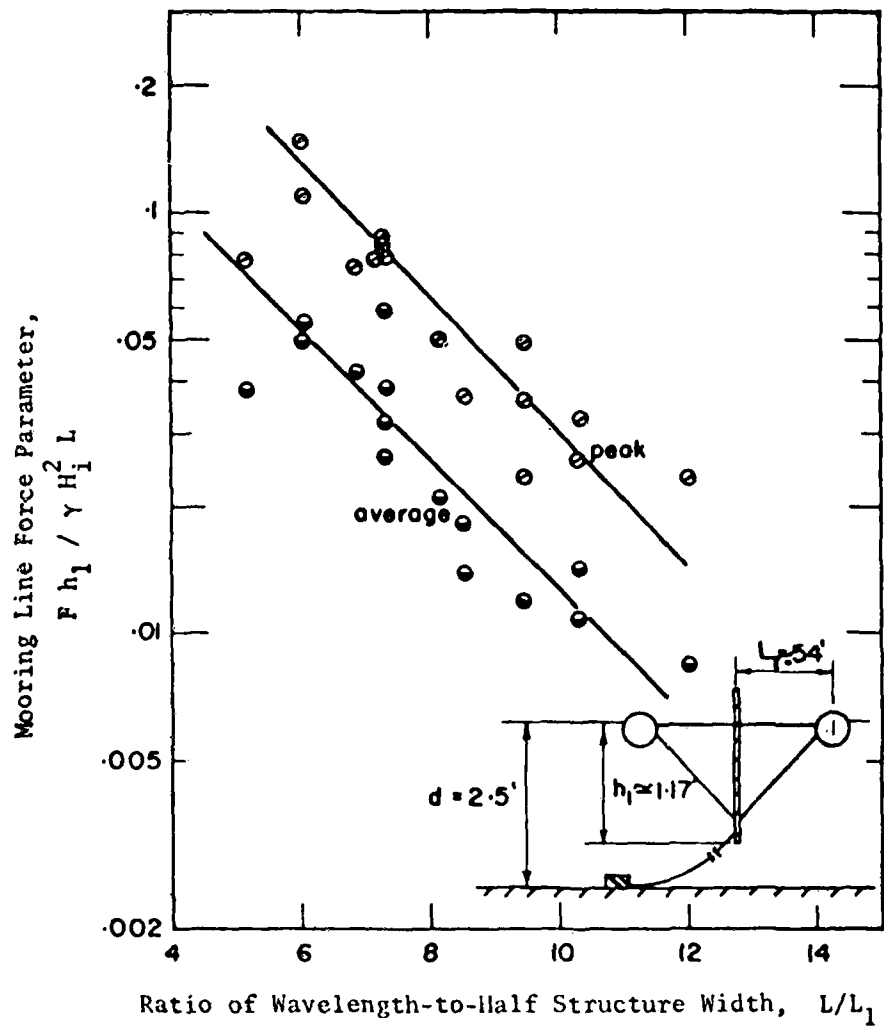


Figure 112. Effect of relative breakwater width,  $L/L_1$ , on average and peak mooring force parameter,  $Fh_1/\gamma H_1^2 L$ , for two-cylinder A-frame floating breakwater (after Ofuya, 1968).

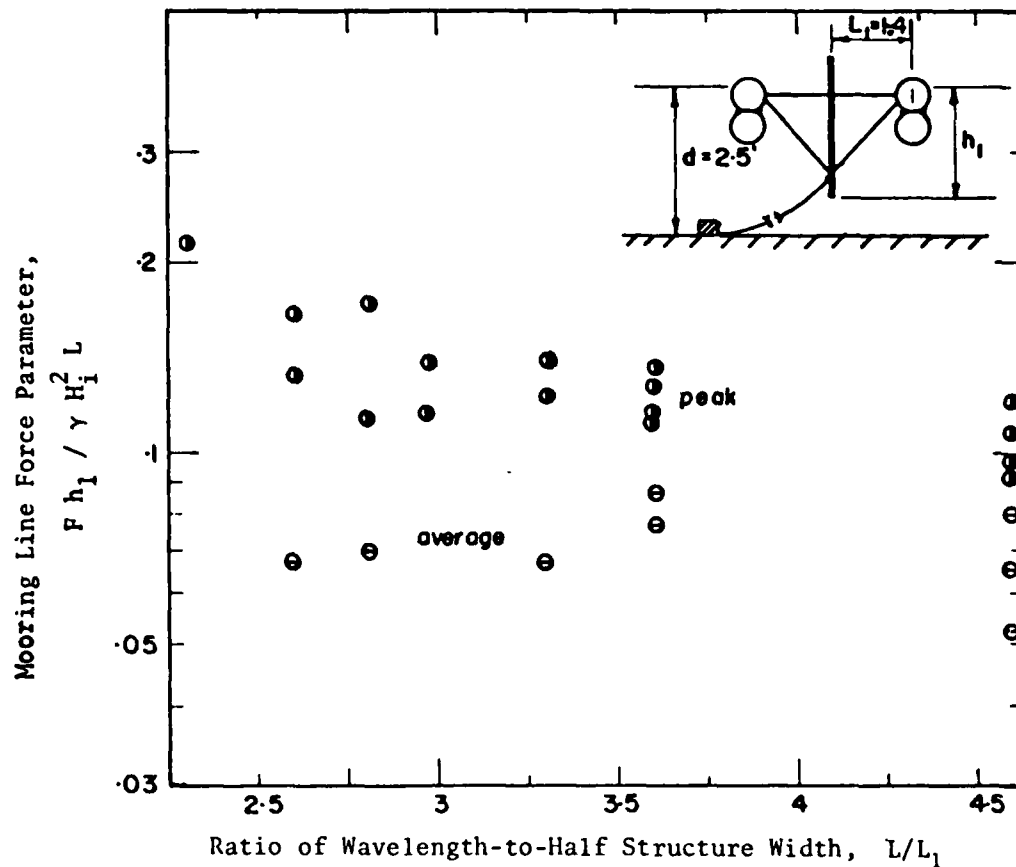


Figure 113. Effect of relative breakwater width,  $L/L_1$ , on average and peak mooring force parameter,  $Fh_1/\gamma H_1^2 L$ , for four-cylinder A-frame floating breakwater (after Ofuya, 1968).

forces on the structures that the magnitude of the forces induced in the mooring lines varied randomly with time. From a design standpoint, the peak forces are of most interest; however, the average forces regarding hysteresis of the mooring ropes, due to repeated loading, are also important. A strong trend exists in the relationship between the mooring force parameter,  $Fh_1/\gamma H_1^2 L$ , and the relative breakwater width,  $L/L_1$ , although the scatter is partly due to several factors (wave steepness, relative water depth, and response characteristics of the moored breakwater to excitation).

The A-frame floating breakwater investigations conducted by Western Canada Hydraulic Laboratories Ltd. (1966a) and Ofuya (1968) indicate that an effective floating breakwater system can be developed which has the large moment of inertia of mass as the dominant factor, rather than the mass itself. Wave heights are reduced by the combined processes of wave reflection, dissipation, and wave interference. The reflection and transmission coefficients are influenced by incident wave steepness, and for the deepwater waves, the effect of the vertical curtain depth on the transmission coefficient,  $C_t$ , is small, provided  $h_1/d$  is approximately 0.25. The scatter in the display of the horizontal force parameter,  $Fh_1/\gamma H_1^2 L$ , versus the relative breakwater width,  $L/L_1$ , is due to the effect of wave steepness.

## VII. TETHERED-FLOAT BREAKWATER

The tethered-float breakwater is constructed of a large number of very buoyant floats, each with a characteristic dimension about equal to the wave height. The floats are independently tethered at or below the water surface. Initially, the concept was developed for a water depth many times the float diameter; later, a bottom-resting concept was developed for shallow water. The floats move as a result of the wave pressure gradient, and the dominant attenuation mechanism is drag resulting from the buoy motion. Seymour and Isaacs (1974) developed a theoretical model which predicts the attenuation by a particular array configuration of a given incident wave spectrum. This model was verified in a two-dimensional laboratory flume, and its essential features were confirmed in semiprotected bay field tests. Performance predictions have been advanced for a wide range of design conditions. The system can be constructed in any water depth greater than specified limiting minimum depths. Potential applications include harbor and marina protection, beach erosion control, and offshore terminal offloading facilities.

The tethered-float breakwater design was conceived by Professor John D. Isaacs of Scripps Institution of Oceanography, San Diego, California, in 1970 (Jones, 1978). Subsequently, a research project to evaluate the effectiveness of this concept was initiated in 1972 by the California Department of Navigation and Ocean Development (DNOD) and the California Sea Grant College Program of the National Oceanic and Atmospheric Administration. Engineering development was undertaken with a joint project of the State of California and the Naval Facilities Engineering Command, and continued under a consortium of Federal and State agencies, including the COE and the Maritime Administration. Moffatt and Nichol Engineers, Ogden Beeman, and International Maritime Associates (1977) (a private engineering cooperative effort) conducted a feasibility study to evaluate the commercial market for a tethered-float breakwater system, and NCEL performed conceptual design studies (Jones, 1978).

### 1. Operational Theory.

Many floating breakwaters rely on reflection or turbulence generation to disrupt the wave orbits and attenuate wave energy. The energy dissipated by friction (drag) is normally a small component of the total wave energy, since the relative velocities between the breakwater and the fluid particles are low. However, the drag power is proportional to the cube of these relative velocities. Hence, if a substantial increase in relative velocity can be achieved, the energy dissipation due to drag can become the most important mode. This constitutes the fundamental mechanism that the tethered-float breakwater serves as a wave energy dissipator.

The tethered-float breakwater system is composed of a large number of independently operating floats, each of which is quite small in comparison to a wavelength. In the original design, the floats were spherical (other shapes have since been investigated) with high buoyancy, and were tethered with their crown just above the water surface with at least one-diameter clear space between floats in all directions. The width of the array, or the number of rows of floats past which the wave field must advance, is determined by the desired level of wave energy attenuation. A schematic diagram of the tethered-float breakwater is shown in Figure 114.

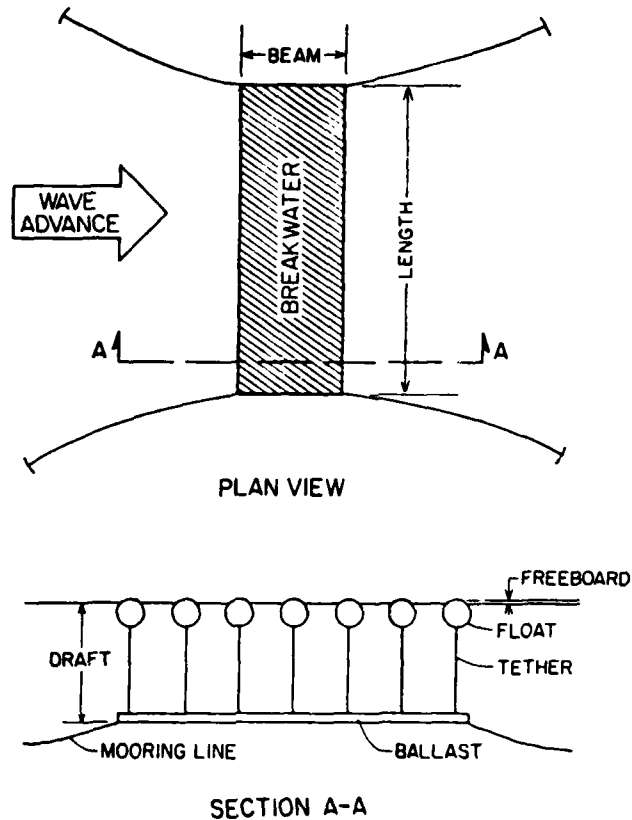


Figure 114. Definitive sketch of a tethered-float breakwater.

The natural frequency of oscillation of the tethered float is inversely proportional to the square root of the tether length, as in the case of a pendulum. The tethered float responds to the periodic wave-driving force with a definite phase relationship. The responses are typical of damped oscillators (Fig. 6), with the float motion amplitude peaking near the natural frequency, and with the phase lag angle increasing with increasing wave frequency. In effect, the floats can have a natural frequency approximately equal to the incident wave frequency. Near resonance, the float motion is greatly amplified and out of phase with the fluid particle motion. If there are wave components with frequencies near the natural frequency of the floats, the relative velocity will be quite high because the floats are moving a greater distance than the local water particles, and because they lag the water motion substantially in their phases. Because of their dynamic response, it is possible to cause the buoys to pendulate in the incoming wave field out of phase with the wave orbital motions. The effect of this wave-excited buoy motion is to transform wave energy into water turbulence and then into heat into the wake of the buoy.

## 2. Performance Estimation.

Because preliminary laboratory measurements of the tethered-float breakwater suggested that scattering and reflection are minor contributors to the reduction of wave energy, the analytical model for predicting the performance

of the system (Seymour and Isaacs, 1974; Seymour and Hanes, 1979) considers only drag dissipation. Fluid drag, proportional to the square of the velocity, is nonlinear even in steady flows. Since the driving force (wave-field pressure gradient) is always a random broad-spectrum process, the response of a linear oscillator will also be random and broad spectrum; hence, the drag itself is a wide-band random variable. It is therefore difficult to predict the drag in a deterministic sense from some measured parameter such as the water-surface elevation time-history. With random processes, it is more convenient to work with the frequency domain and deal with the statistics of fluid drag.

Following the usual form for quadratic damping, Seymour and Hanes (1979) defined the drag force in frequency space for a single float as

$$F_D(f) = \frac{1}{2} \rho A C_d [U_r(f)]^2 \quad (57)$$

where

- $F_D(f)$  = drag force in frequency space
- $\rho$  = fluid density
- $A$  = frontal projected area of a float
- $C_d$  = empirically determined drag coefficient
- $U_r(f)$  = relative velocity between float and fluid particle

It follows that the drag power of the float,  $P_D(f)$ , is

$$P_D(f) = U_r(f) F_D(f) \quad (58)$$

By taking temporal average values

$$\overline{[U_r(f)]^3} = S_r^{3/2} \quad (59)$$

where the overbar indicates an average value with respect to time, and  $S_r$  is the spectrum of relative velocities. The drag power for a single float then becomes

$$P_{D_{total}} = \frac{1}{2} \rho A C_d \sum_{n=0}^N [S_r(n\Delta_f)]^{3/2} \quad (60)$$

where  $N\Delta_f$  is the Nyquist frequency.

Seymour (1974) showed that the spectrum of relative velocities for a single float,  $S_r$ , can be estimated by

$$S_r = S_u \gamma(f) \quad (61)$$

where

$$\gamma(f) = 1 + |H|^2 - 2|H| \cos \theta \quad (62)$$

in which  $|H|$  and  $\theta$  are defined as the complex transfer function of float position relative to water-particle horizontal motion, and  $S_u$  is the energy spectrum of horizontal water-particle velocity which can be readily obtained from the spectrum of surface elevation by linear theory.

$$S_u = S_\eta \beta(f) \quad (63)$$

and

$$\beta(f) = \frac{\cosh^2 k(d - d_s) \omega^2}{\sinh^2 kd} \quad (64)$$

where

$S_\eta$  = surface elevation spectrum

$k$  = wave number

$\omega$  = radian frequency

$d$  = water depth

$d_s$  = depth of float below stillwater level

An expression is developed for the spectrum of average drag power of a single float in terms of the wave spectrum as

$$S_p = S_\eta \gamma \beta \quad (65)$$

Seymour and Hanes (1979) determined that the power consumed in the drag of the float occurs at the expense of the spectrum of incident wave power, which can be expressed per unit of float spacing along the wave crest as

$$S_w(f) = S_\eta(f) \alpha(f) \quad (66)$$

where  $S_w(f)$  is the spectrum of wave power, and  $S_\eta(f)$  is the spectrum of surface elevation. Here

$$\alpha(f) = \frac{1}{2} \rho g C_g(f) s \quad (67)$$

in which  $C_g(f)$  is the wave group velocity, and  $s$  is the float spacing along a wave crest. Seymour and Hanes (1979) analyzed an energy transmission coefficient, ETC, which is the traditional parameter for describing breakwater performance. It can be specified in terms of three coefficients:

$$ETC(f) = \frac{(S_w - S_p)}{S_w} = \frac{1 - [\gamma \beta(f)]}{\alpha} \quad (68)$$

Thus, in principle, the performance of a tethered-float breakwater can be estimated only if the incident wave field characteristics, breakwater geometry, and appropriate values of drag and mass coefficients are known.

To illustrate the performance characteristics, Seymour and Isaacs (1974) generalized the described process by specifying an arbitrary spectrum, the Pierson-Moskowitz model (Pierson and Moskowitz, 1963). The equations governing this spectrum are such that the spectrum can be uniquely specified by the frequency at which the peak energy,  $f_p$ , is found. From this, the deepwater wavelength,  $L_p$ , is calculated as

$$L_p = \frac{g}{2\pi(f_p)^2} \quad (69)$$

The wavelength at which the peak energy is found can be used to develop two dimensionless ratios which define the breakwater:  $d_f/L_p$ , the ratio of float diameter-to-peak wavelength and  $d/L_p$ , the ratio of water depth-to-peak wavelength. A digital computer search of  $d_f/L_p$  and  $d/L_p$  space will determine the required number of rows of floats to achieve a desired level of wave height reduction. For an assumed float density of 4 percent, with the anchor assumed to be on the bottom, and for a float just below the surface, Seymour and Isaacs (1974) present example performance estimations which determine the number of rows of floats to provide 75-, 50-, and 25-percent wave height reduction (Figs. 115, 116, and 117, respectively).

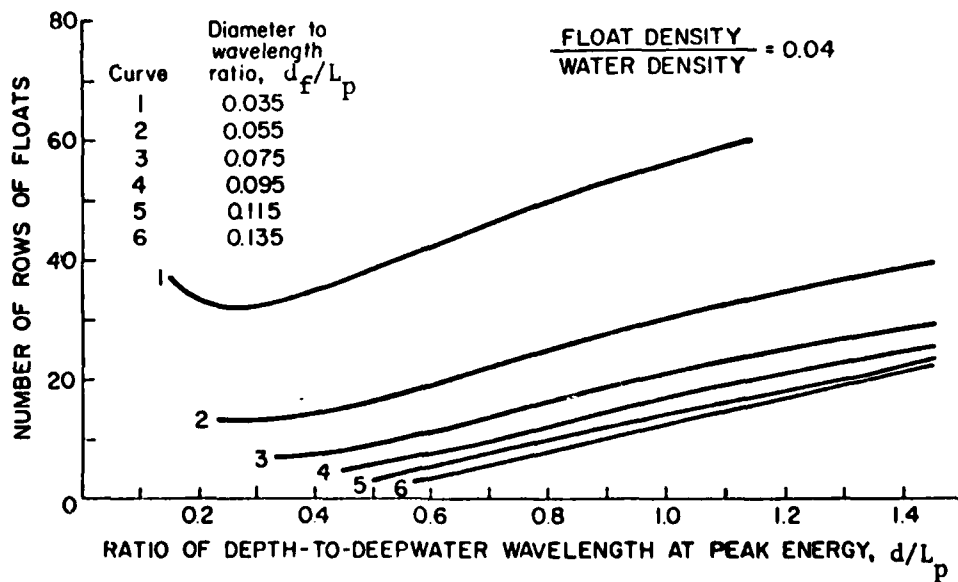


Figure 115. Performance estimation of tethered-float breakwater at a theoretical 75-percent wave height reduction (after Seymour and Isaacs, 1974).



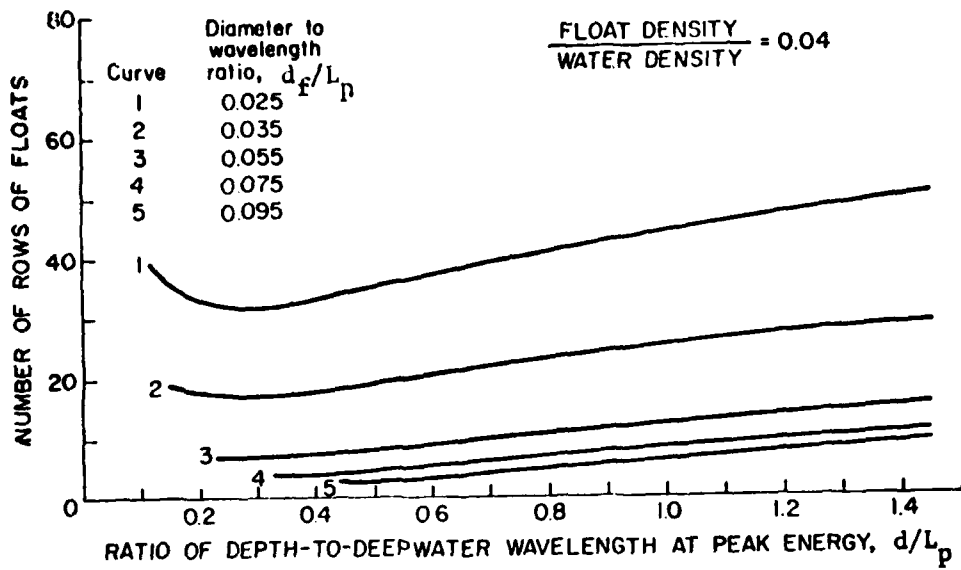


Figure 116. Performance estimation of tethered-float breakwater at a theoretical 50-percent wave height reduction (after Seymour and Isaacs, 1974).

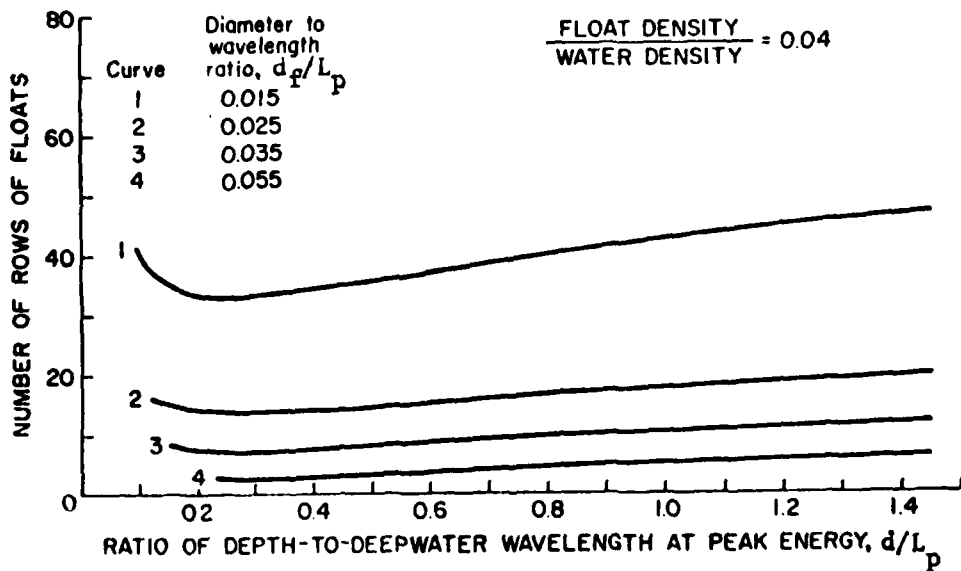


Figure 117. Performance estimation of tethered-float breakwater at a theoretical 25-percent wave height reduction (after Seymour and Isaacs, 1974).

Although the tethered-float breakwater is a tuned oscillator, its performance was found to be remarkably insensitive to tether length. For example, a spectrum with energy peaked at a period of 8 seconds produces  $L_p = 330$  feet and  $d_f/L_p = 0.035$ , or a float diameter of 11.5 feet. For a 90-foot water depth, it was determined that the number of rows (and the cost of the breakwater, to a first approximation) varied by only 15 percent over depths which varied from 50 to 180 feet. Performance improves with increasing diameter, but at a decreasing rate. This is the result of the decay of the pressure gradient force as the center of the float is lowered farther below the water surface with increasing diameter. In the Pierson-Moskowitz spectrum model, the significant wave height,  $H_s$ , can be shown as

$$H_s = 0.026 L_p \quad (70)$$

so that reasonable diameters for the breakwater floats will be of the same order as the significant wave height, and reasonable water depths will be 5 to 20 times  $H_s$  (Seymour and Isaacs, 1974). However, the optimum depth performance can be achieved at all greater depths by using the floating anchor concept. Other application and performance estimations have been discussed by Essoglou, Seymour, and Berkley (1975) and Seymour (1975, 1976a, 1976b, 1977).

### 3. Potential Open-Ocean Applications.

Jones (1978) referred to a 7-second breakwater as one which produces 50-percent reduction of the significant wave height in a storm sea represented by the Pierson-Moskowitz wave spectrum with a 7-second peak period. Since the significant wave height for this spectrum is 6.4 feet, the significant wave height in the lee of the breakwater would be 3.2 feet (within the sea-state 3 range). It is characteristic of partial wave barriers that the reduction of wave height is somewhat less than 50 percent if the incident wave spectrum is more sharply peaked than the Pierson-Moskowitz spectrum. It is also characteristic that the degree of wave height reduction decreases as the dominant period of the incident wave increases. Under fetch-limited conditions, spectra that are more peaked than the Pierson-Moskowitz spectrum are observed. The Joint North Sea Wave Project (JONSWAP) spectra were derived from measurements taken on the open ocean in the North Sea. An example of the JONSWAP spectra is compared to the Pierson-Moskowitz spectra in Figure 118. The modified spectrum in this figure is an artificial case devised to represent, by means of a spectrum which is readily expressible mathematically, certain bimodal sea-plus-swell spectra which are often observed in nature. Jones (1978) applied the performance estimation procedure of Seymour (1976a) for a float diameter of 5 feet and the Pierson-Moskowitz spectrum. Moffatt and Nichol Engineers, Ogden Beeman, and International Maritime Associates (1977), utilizing a newer mathematical model, indicate that the number of rows of floats predicted by Seymour (1976a) should be increased by about 45 percent. Jones (1978) incorporates this adjustment into Figure 119.

The number of rows of floats required for a given degree of reduction in wave height is a fairly strong function of the size of the floats (Jones, 1978). When the size of the floats is some reasonable value, the system is most efficient when the length of the tethers is equal to a specific fraction of the dominant wavelength. For deepwater floating systems, the optimum arrangement consists of spherical lightweight floats positioned with tops submerged one-fourth diameter, and spaced horizontally two diameters apart.

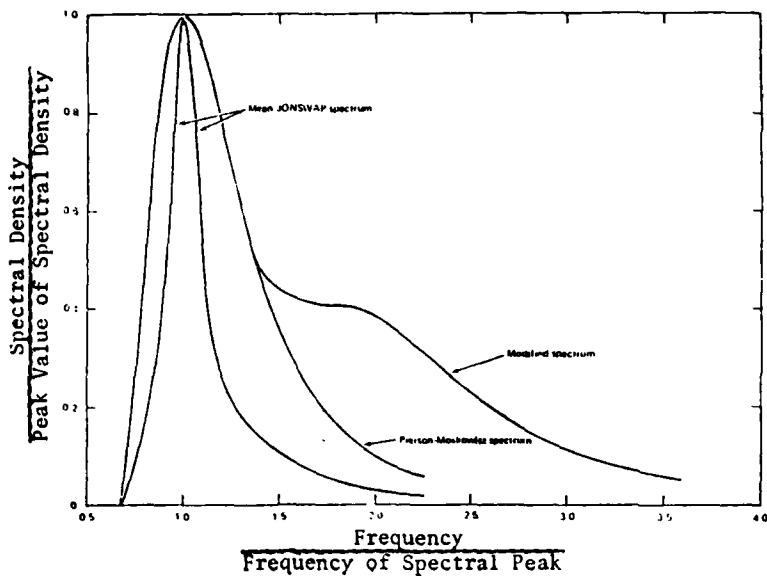


Figure 118. Comparison of normalized wave spectra for JONSWAP spectra, Pierson-Moskowitz spectra, and modified spectra representative of that observed in nature (after Jones, 1978).

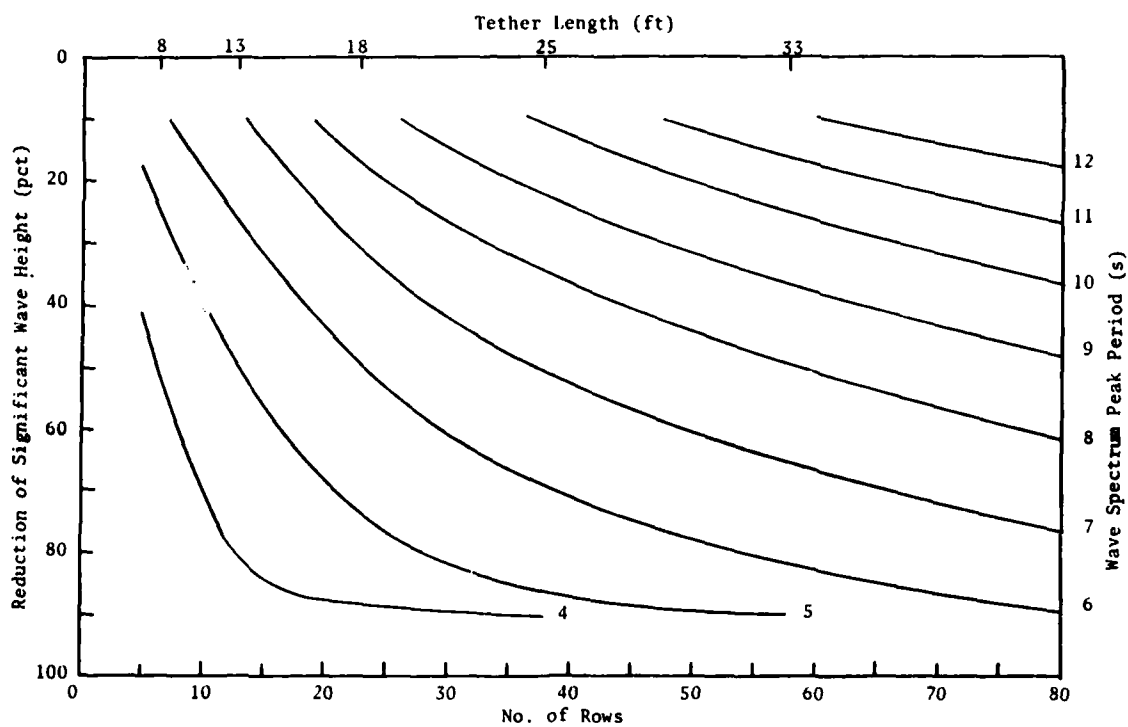


Figure 119. Predicted performance of tethered-float breakwater with low density, 5-foot-diameter spherical floats which provide 50-percent wave height reduction of the modified Pierson-Moskowitz spectrum (after Jones, 1978).

The optimum tether length for these conditions is about one-tenth of the dominant wavelength. However, it would be practical on occasion to use tethers that are somewhat longer than optimum in order to have a bottom-resting system instead of a floating system, thus eliminating moorings. Conversion of any floating system to a bottom-resting system would require additional ballasting mass. The reduction of effectiveness due to tethers that are too long is small if the increase in length is small. However, with the floats fixed at about the water surface elevation at low tide, some effectiveness during high tide is lost due to excessive submergence of the floats. In shallow water, where a bottom-resting system with tethers shorter than the deepwater optimum may be necessary, performance may be partially or fully restored by use of cylindrical floats, increased density of the floats, or closer spacing of the floats in the direction normal to the direction of wave propagation.

The data in Figure 120 (Jones, 1978) summarize the performance of optimum floating systems in fully developed, local wind-generated seas, as represented by the Pierson-Moskowitz spectrum. This figure shows the number of rows required to reduce wave heights to levels associated with sea-state 3, and pertains to 5-foot-diameter spheres, each of which weighs less than 400 pounds (relative density less than 10 percent). These data also pertain to an approximate tether length of 30 feet ( $\pm 20$  percent). Variation within this range has little effect on performance for spectral peak periods between 6 and 9 seconds. However, as the tether length varies farther from this range, additional rows of floats would be required to maintain a 7-second breakwater capability.

A 150-foot length of marina-scale tethered-float breakwater was installed in San Diego Bay in 1976 to obtain verification data from a field experiment. The breakwater was subjected to ship and boat wakes generated in the main entrance channel to San Diego Bay, and to limited-fetch wind waves from the south. The breakwater was protected from wind-generated ocean waves because it was located on the lee side of Point Loma. Significant south wind activity was observed at the field site only twice in the 8-month span of the experiment. In both instances the wind rose from calm to a maximum of about 22 knots within a 2-hour period, with the direction essentially constant from the south. A total of 26 experiments were recorded during the duration of these two storms. These spectra were quite broad, bearing little resemblance to the sharply peaked spectra characteristics of waves generated on the open ocean (Seymour and Hanes, 1979). The wave attenuation aspects of the tethered-float breakwater were satisfactorily demonstrated in this limited-fetch application (Fig. 121). Three particular designs of open-ocean tethered-float breakwaters with significant differences in float and ballast properties (two floating systems and a bottom-resting system) were described by Jones (1978).

a. Concrete Barge-Type (Floating) Ballast Tethered-Float Breakwater. NCEL undertook a conceptual-design study in 1975 to develop a ship-transportable ballast module, and several concepts were investigated for a 5-foot-diameter spherical float system mounted on a ballast structure of reinforced concrete. The type of construction envisioned was similar to that developed for a concrete landing craft during World War II, although the structural integrity of landing craft may not be required for the breakwater ballast. Each module was designed to carry a four by seven array of floats, with both columns and rows of floats spaced 10 feet apart. Five rows of modules contain 35 rows of floats, almost the number required for a 7-second breakwater. Sets of 15

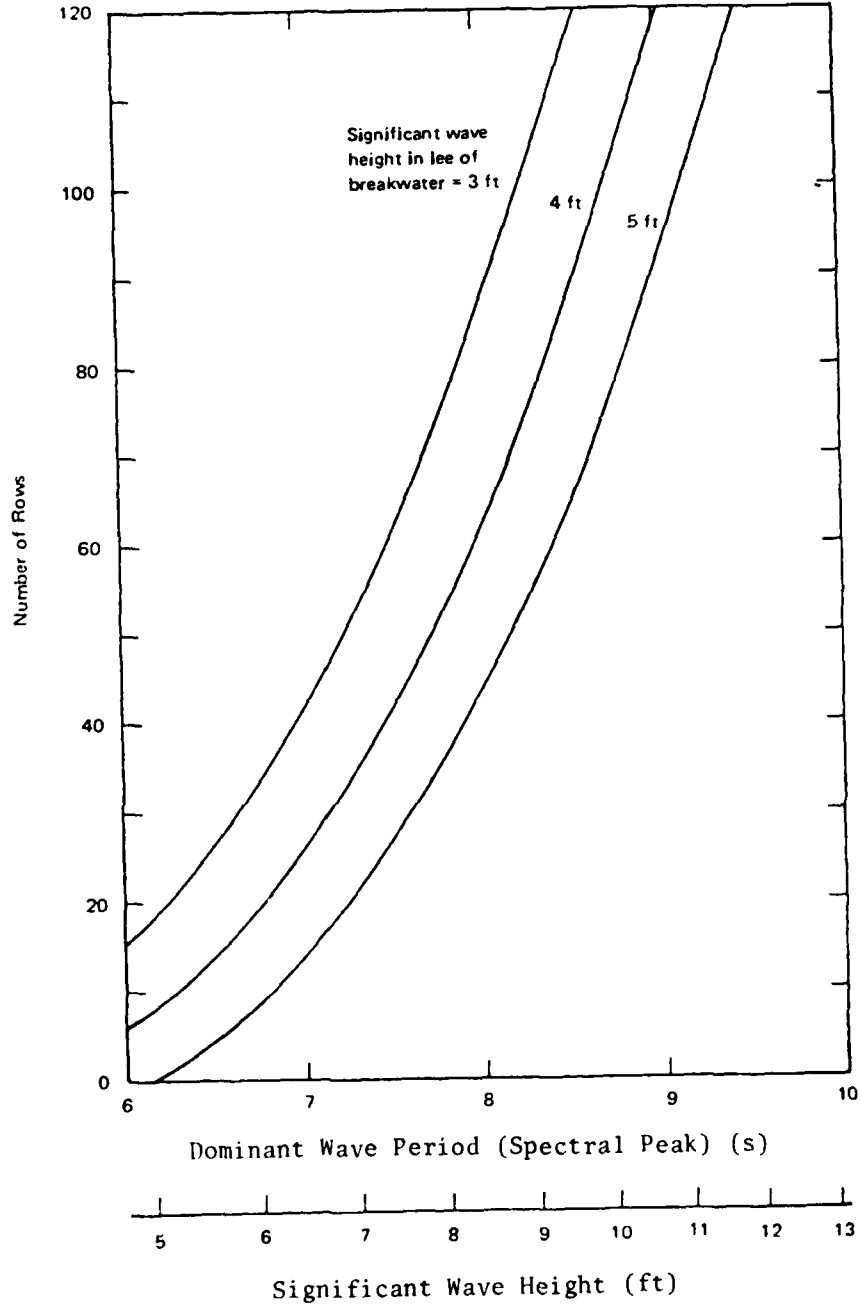


Figure 120. Estimated number of rows of 5-foot-diameter spheres of tethered-float breakwater required to reduce wave heights of Pierson-Moskowitz spectrum to sea-state 3 (after Jones, 1978).

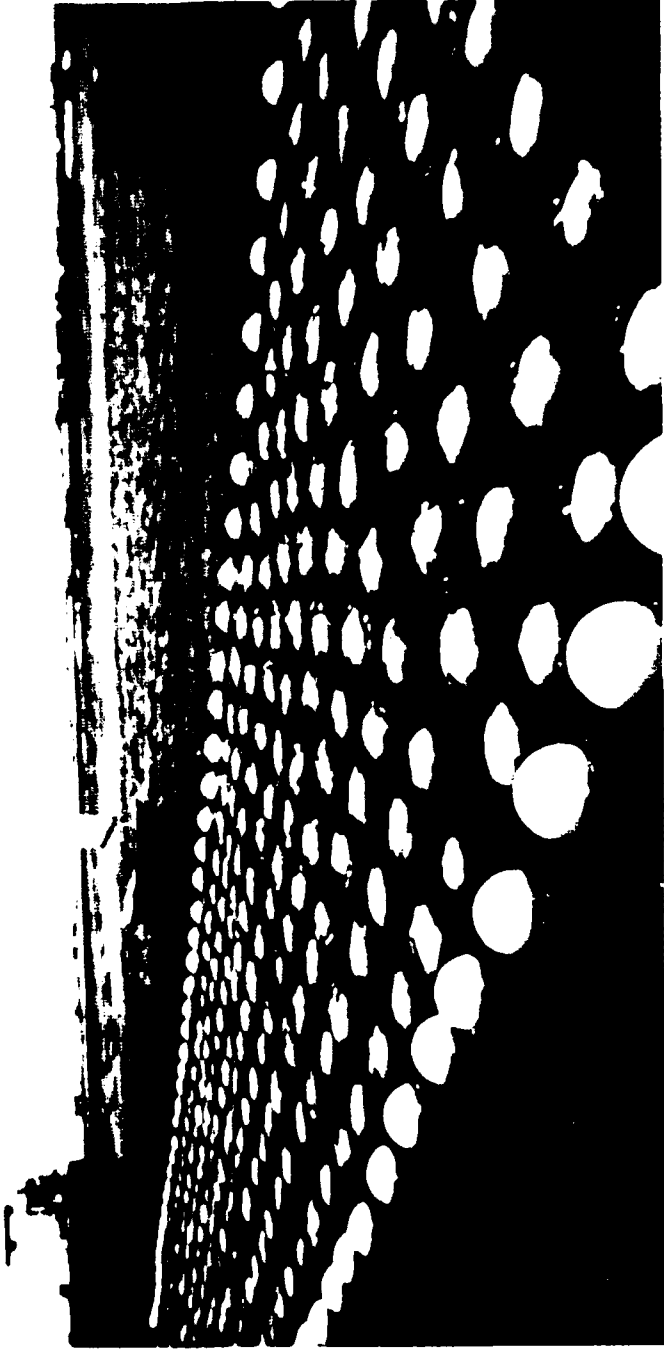


Figure 121. Prototype tests of tethered-float breakwater, using 12-inch-diameter spherical floats designed for 2- to 4-second wave periods with heights up to 5 feet, San Diego Bay, California (1975 photo by Scripps Institution of Oceanography).

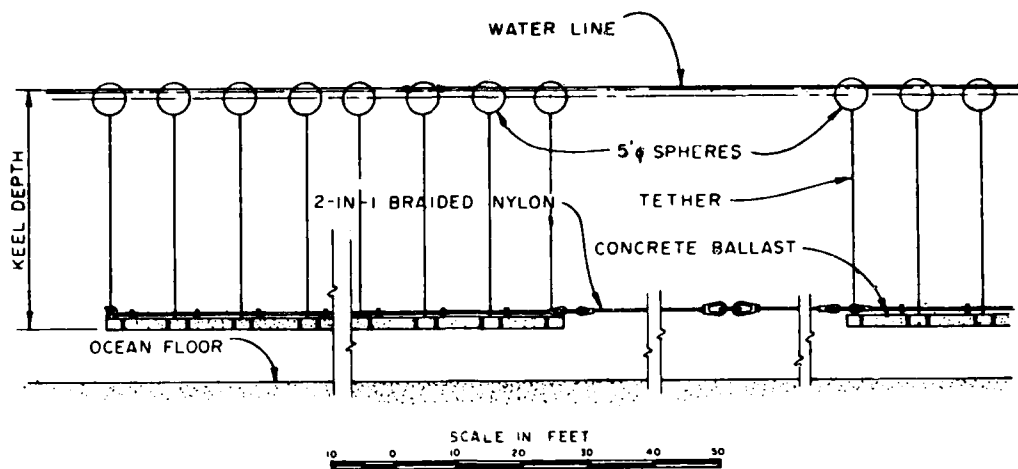
modules, lashed together, form a moored element. Alternate moored elements are displaced seaward in a staggered (checkerboard) layout to facilitate mooring. Each array of nine elements has an axial length of about 1,070 feet, and an effective length of about 640 feet.

In this concept the module is a barge which can be towed short distances, carrying its complement of floats to the point of installation. It can also be transported by various means over the ocean. Upon delivery to the site, the floating modules can be immediately unloaded from the transport ship or barge and temporarily stored at moorings or on the sea floor. Another feature is a provision to refloat the module by introducing low-pressure air into chambers in the structural members. The goals of versatility with respect to transportation, installation, and retrieval time were approached through use of the largest size preassembled units, which make handling less difficult for naval operations.

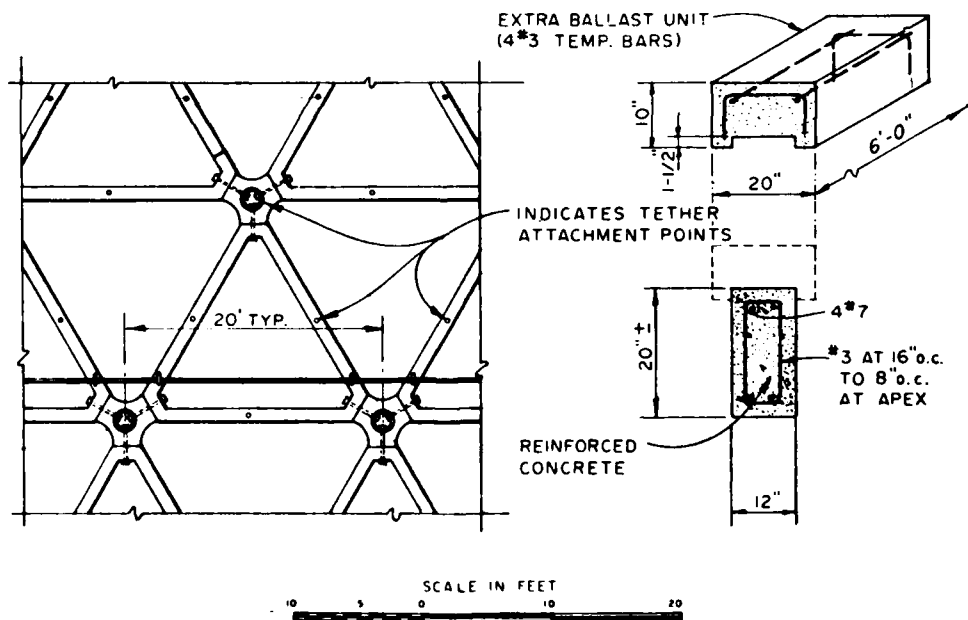
b. Concrete Articulated-Frame (Floating) Ballast Tethered-Float Breakwater. The Tethered Float Breakwater Ocean Experiment project in 1976 selected an articulated ballast concept from several design proposals from private industry. A contract was awarded for the design of an articulated framework of relatively small, triangular modules of reinforced concrete, joined together with flexible connectors at their apexes (Fig. 122). The modules are designed as equilateral triangles 20 feet on each side. The cross section of the legs of the triangle is about 12 inches wide and 20 inches deep. Float attachment points are located on the connectors and at the mid-points of the sides. The triangular modules are designed to be assembled into an articulated frame normally 100 feet wide; the length depends on the number of rows of floats. The breakwater is composed of several of these large assemblies.

The width of a typical moored element containing 37 rows of floats would be 312 feet. A staggered array of 19 moored elements would be a breakwater with an overall axial length of 1,900 feet, which provides a 7-second breakwater with about 1,500 feet of effective length. The major features of this concept include flexibility, obtained through numerous articulations, which permits greater amplitudes in vertical motion of the ballast, eliminating concern about extreme dynamic loads in the tethers. A consequence of the flexible ballast concept is that components are small (the heaviest are the 6.5-ton triangles and the 0.5-ton trimming weights). Buoyancy is provided only in the floats. Once assembled and placed in sufficiently deep water, a moored element would be towed with the ballast submerged.

c. Steel-Frame (Bottom-Resting) Ballast Tethered-Float Breakwater. In 1977 the Tethered Float Breakwater Ocean Experiment project developed a bottom-resting system for about a 25-foot depth for installation at an ocean site near San Diego, California. Preliminary performance analysis indicated that cylindrical floats of relatively high density would be the most efficient. The Naval Ocean Systems Center, San Diego, California, designed a float made from scrap automobile tires with a ballast module compatible with the float properties (Fig. 123). Two modules were installed in 1978. The float is a stack of five or six used automobile tires filled with polyurethane foam, with the top and bottom of the foam core capped with concrete. A steel hook for connecting the tethers is embedded in the concrete. The float is essentially a cylinder about 2 feet in diameter and 4 feet high, and weighs about 475 pounds with a relative density of 0.56.



a.



b.

Figure 122. Concept of floating concrete articulated-frame ballast tethered float breakwater (after Moffatt and Nichol Engineers, Ogden Beeman, and International Maritime Associates, 1977).



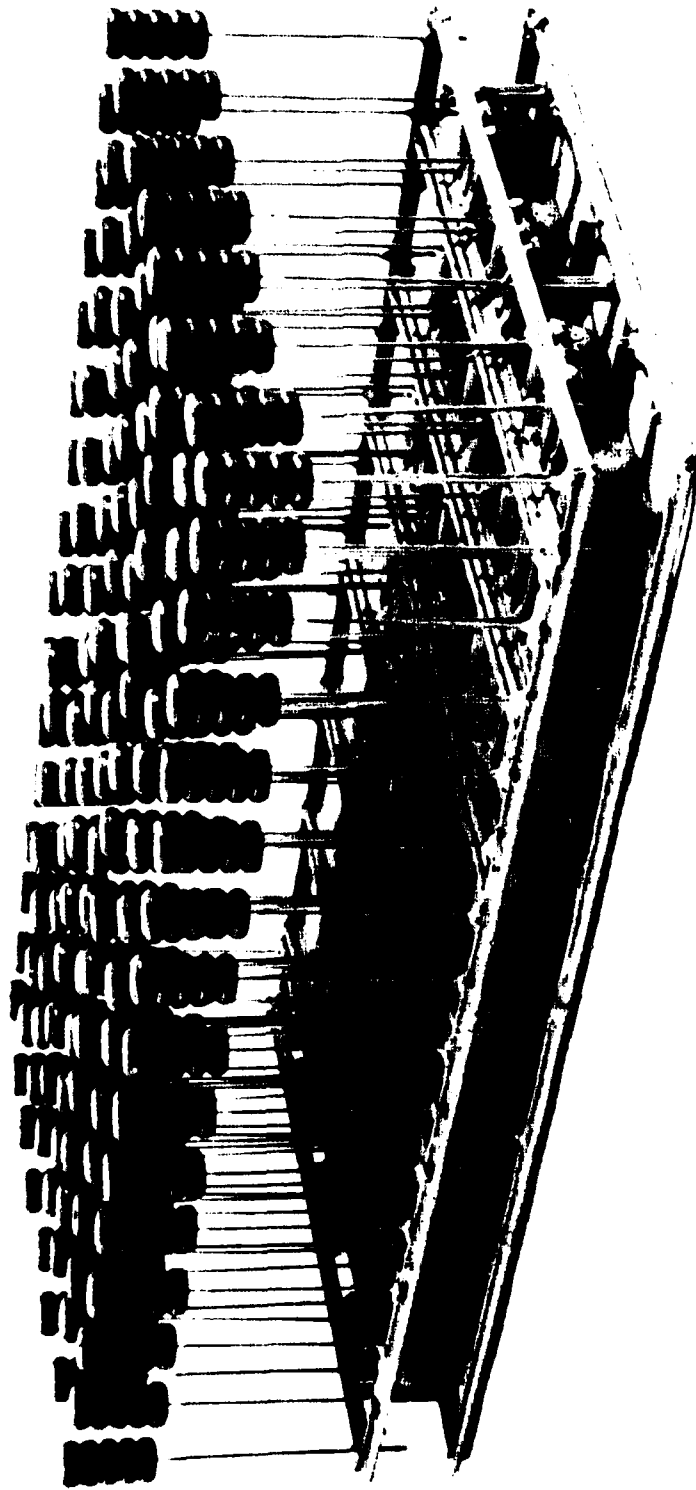


Figure 123. Shallow-water, bottom-resting steel frame ballast tethered-float breakwater concept using scrap tires, developed by Naval Ocean Systems Center.

The ballast module is a rectangular, welded-steel framework made from scrap railroad rails about 60 feet long, 30 feet wide, and 4 feet high. Each module, which weighs about 115,000 pounds, has four cylindrical tanks and 128 scrap-tire floats mounted within the framework. Important features of the ballast design are the economical use of scrap metal and the retrieval use of buoyancy tanks. When the tanks are empty, the ballast module is suspended by the 128 floats. When the tanks are fully flooded, the ballast module rests on the bottom with a foundation reaction on one module of about 50,000 pounds. Empty tanks provide a net upward force of about 50,000 pounds to raise the ballast off the bottom. This module can be towed with ballast submerged, or floated by add-on buoyancy, and can be stored on the sea floor.

#### 4. Tether Termination Assembly.

The function of the tether is to maintain the floats at a fixed distance above the ballast, allowing them to oscillate freely in all planes about an axis formed by a line through the base of the tether and perpendicular to the ballast. The tether length is set according to the chosen float; the two should form a pendulum with a natural frequency equal to that of the most significant waves which the tethered-float breakwater is designed to attenuate. Tether tensile strength is determined by the buoyancy of the float and appropriate safety factors. The material must be able to withstand long-term ocean use and corrosion, biological fouling, and shock loads.

There are essentially two scales of tethered-float breakwaters: the marina scale and the open-ocean scale. The primary difference between the two scales is the size and buoyancy of the floats to be used. Marina tethered-float breakwaters are designed to use floats of about 1-foot diameter; the open-ocean scale uses floats up to 5-foot diameter. The marina floats provide about 27 pounds of buoyancy each, and the 5-foot-diameter ocean float provides up to 4,000 pounds of buoyancy each, depending on construction. Suitable tether termination assemblies have been developed and used on marina tethered-float breakwaters; however, because of manufacturing difficulties, these smaller assemblies cannot be scaled for the larger systems.

a. Design Considerations. The Naval Undersea Center, San Diego, California, developed a tether termination assembly suitable for open-ocean installation on a tethered-float breakwater. Flexure life was judged to be the most critical consideration in the initial design. Float movement through the water causes the tether to flex randomly in all planes about the tether axis. Best estimates indicate that, over a 5-year period, the tether will flex  $\pm 11^\circ$  about the tether axis for 18 million cycles and  $\pm 17^\circ$  for an additional 1 million cycles. No severe shock loading on the tether is anticipated after installation, since the ballast is designed so that even under storm conditions the floats will not surface enough to significantly reduce the tensile load on the tethers. However, experience indicates that shock loading may occur during assembly and installation; hence, it is essential to use risers which are nontorquing.

Uniformity of stretch and creep in a tethered-float breakwater is also an important design consideration. If stretch and creep are not uniform throughout the array of tethers, some of the floats will eventually surface to the point where their tethers become slack. Thus, it is necessary to select a riser which has no significant stretch or creep, or one which can be controlled by proper design and manufacture. Designs must also include environmental considerations such as biological fouling or corrosion, which will

impede the natural action of the tether. Temperature extremes could damage tethers if inadequate materials are used. For ease of handling, the riser should be flexible enough to be coiled within a diameter equal to that of the associated float. To ensure only minimal influence on float performance, the tether termination assembly should be kept to about 10 percent of the dry weight of the float (Johnson, 1977).

b. Prototype Designs. The Naval Undersea Center investigated three different prototype tether termination assemblies, each using a 5-foot-diameter float with 3,000 pounds of buoyancy.

(1) Ball and Socket Termination Assembly. In this tether termination assembly concept, the ball was cast phenolic resin, and the socket was ultra-high molecular-weight polyethylene. The materials were chosen for compatibility, noncorrosive characteristics, availability, toughness, and excellent abrasion resistance. The phenolic balls are available commercially in a range of sizes. The high density polyethylene with extreme abrasion resistance is available for forming or machining the sockets. The riser material (tether) is Sampson very low stretch, single-braid polyester rope (7/8-inch diameter), which is relatively new commercially.

(2) Booted Assembly for Wire Rope Riser. This concept uses steel torque-balanced Amgal polyethylene-jacketed wire rope (1/2-inch diameter). The riser is swaged into an open socket which supports all tensile loads. Length of the swage is eight rope diameters, a figure proven over the years to be optimal for swaged sockets. The slip-on boot is designed to control flexure, so that under 4,000 pounds of tension the riser will have no curvature with less than a 12-inch radius. A seal is provided by the boot to prevent seawater from entering under the riser jacket. No part of the tensile loading is supported by the boot.

(3) Booted Assembly for Synthetic Rope Riser. Lane Instrument Company, San Diego, California, specifically designed a tether termination assembly of the booted type for use with synthetic rope. The Sampson very low stretch, single-braid polyester rope was used as the riser because of its nonhocking property. It is easy to handle, can be spliced quickly, and has a high modulus of elasticity (less than 3 percent elongation at design load). The riser (7/8-inch diameter) terminates inside the boot, using an eye splice through an eyebolt, which in turn is threaded into the bottom plate of the assembly. The threads are then locked with a setscrew placed along the margin of the eyebolt and bottom plate threads, and the region is sealed with epoxy to prevent corrosion. The boot design for this assembly was the same as was used in the wire rope assembly; the boot was molded in place instead of being slipped on.

In February 1976, twelve of these tether configurations, using eight 1,200-pound-buoyancy and four 800-pound-buoyancy floats, were installed at a test site off Imperial Beach, California. There were no failures after a year in the ocean environment. These tests provided a good understanding of the long-term effects of corrosion, fouling, tensile loading, tensile cycling, elongation, and other similar forces. Little is known, however, which can help predict the flexure life of a specific tether termination assembly for a given set of operating requirements. Both laboratory and ocean testing are currently underway, and the results are expected to permit more efficient designs of tether termination assemblies.

## 5. Economic Feasibility Studies.

Economic evaluations of potential tethered-float breakwater installations have been prepared for site-specific locations by both private consulting firms and by the U.S. Navy. In general, it was found that such feasibility varied widely with the wave exposure and bottom depth characteristics at the various sites. The tethered-float breakwater shows potential use where conventional structural breakwaters cannot be built because of extreme water depth, where protection is needed only for a short period of time, and where the protected area must shift with a transient maritime operation. For shallow-water short-fetch sites, the feasibility of the tethered-float breakwater looks very promising. For shallow-water, long-fetch sites, current research on bottom-resting ballast frames and higher specific gravity floats may produce systems which will serve specific needs better than present alternatives. For deepwater, long-fetch sites, the tethered-float breakwater system appears feasible only for naval or military operations (Moffatt and Nichol Engineers, Ogden Beeman, and International Maritime Associates, 1977).

a. NCEL Evaluation. Two of the three designs of the open-ocean tethered float breakwater considered by Jones (1978) were evaluated to estimate their feasibility from the cost-effectiveness standpoint.

(1) Concrete Barge-Type (Floating) Ballast Tethered-Float Breakwater. For estimating cost, the float was assumed to be a 400-pound 5-foot-diameter float costing about \$450 each in some quantity. One tether with special termination was expected to cost \$175. The concrete ballast module for these floats weighs about 5,600 pounds and costs between \$300 and \$500 per cubic yard (1978 dollars). The transportation system and work boats required to assemble the structure are not included in the comparative cost estimates. The cost of materials for a 7-second breakwater, with moorings designed for less than a 100-foot depth, was estimated to be \$9,600,000 for a breakwater with 15 moored elements.

(2) Concrete Articulated-Frame (Floating) Ballast Tethered-Float Breakwater. Data for floats and tethers were as assumed in the concrete barge-type estimate, with the ballast cost estimated to be \$160 per float. The flexible intermodule connectors were a development item and were assumed to cost \$1,500 each. Lines and fittings for connecting moored elements will add 5 to 10 percent to the other costs; moorings will add 5 to 10 percent, depending on the water depth and the length of the breakwater. The cost of materials for a 7-second breakwater with moorings designed for less than a 100-foot depth was estimated to be \$7,600,000 for a breakwater with 15 moored elements.

(3) Steel-Frame (Bottom-Resting) Ballast Tethered-Float Breakwater. This design consists of 128 cylindrical floats approximately 2 feet in diameter and 4 feet high, assembled from automobile tires and attached to a steel-frame ballast module, 30 by 60 feet. Proposals to supply floats for an ocean experiment ranged between \$50 and \$500 per float, with an average cost of \$125 for each float, tether, and termination assembly. The ballast system added an additional estimated \$225 per float. A cost comparison of the bottom-resting structure with the two floating structures was not made by Jones (1978) because such a comparison would be meaningful only if the breakwaters produced the same degree of wave attenuation. For the two floating structures, the number of rows of floats is known from existing performance prediction techniques for low-density, spherical floats in deep water. For the bottom-resting system using high-density, pseudo-cylindrical floats in shallow water, no performance prediction technique has been advanced.

b. Moffatt and Nichol Engineers, Ogden Beeman, and International Maritime Associates (1977) Evaluation. This study examined the commercial feasibility of the tethered-float breakwater for use by U.S. merchant ship Lighter Aboard Ship Handling (LASH) operations and for offshore construction operations. Specific applications of the tethered-float breakwater system were investigated to derive the cost and possible benefits for each application. The findings relating to system components, methods of deployment, and costs are also documented for potential users of the tethered-float breakwater system.

(1) Kenitra, Morocco, LASH Operation. The estimated cost of a tethered-float breakwater system suitable for protection of LASH barge-loading operations at this site off the Atlantic coast of Morocco was \$15,600,000, which is about \$3,695,000 per annual amortization. Since the use of the system would result in a savings of only \$80,000 per year in comparison to present LASH operations, the tethered-float breakwater to protect LASH and other lighterage operations at the 1977 state-of-the-art could not be justified.

(2) Lae, New Guinea, LASH Operation. The estimated cost of a tethered-float breakwater system for the protection of LASH barge-loading operations at this site was \$10,500,000, which is about \$2,519,000 annually with potential benefits of only \$90,000 per year. The annual cost was considered too large to justify the use of a tethered-float breakwater.

(3) Grays Harbor, Washington, Pipeline Dredging Operations. The estimated cost of a tethered-float breakwater system designed for protection of pipeline dredging operations at this site on the Pacific coast was \$398,000. Distributing hardware costs over three dredging projects within a 10-year period, the total cost of the system installation and use in one project is estimated to be \$231,000. The savings due to use of the system in the proposed 3,000,000-cubic yard channel dredging project was estimated at \$488,000, producing a net benefit of \$257,000, an attractive return for this particular project.

(4) Ketchikan, Alaska, Small-Craft Harbor. The estimated cost of a tethered-float breakwater system to protect a marina basin at this location was \$1,010,000. This cost reasonably approximates that of a concrete pontoon-type floating breakwater already in use in Alaskan waters. Safety considerations and the possibility of a better performance could make the tethered-float breakwater a preferable alternative.

(5) Vandenberg Air Force Base, California, Over-the-Beach Operations. The cost of a tethered-float breakwater designed to protect a landing area at this base would approximate \$9,300,000. Insufficient data were available to evaluate the monetary benefits from this application of the tethered-float breakwater system.

c. Economic Conclusions. Moffatt and Nichol Engineers, Ogden Beeman, and International Maritime Associates (1977) concluded that the tethered-float breakwater system shows potential use for a number of possible applications under short-fetch wave exposure conditions. The use of the bottom-resting ballast concept for shallow-water, long-fetch conditions to reduce wave heights in small-craft harbor entrance channels by positioning a system just seaward of the entrance appears to be another feasible application. The practicality of using medium-sized floats (about 3-foot diameter) should be

investigated. The cost of the currently designed system for use under long-fetch, deepwater conditions is too great for practical applications at many sites. Dissemination of the advances in the state-of-the-art of tethered-float breakwater design and possible practical applications may stimulate interest by potential users. Agerton, Savage, and Stotz (1976) independently developed and field-tested a dynamic floating breakwater of the tethered concept, using funds from several government agencies. The system is not patented and is available to commercial developers without license.

#### VIII. POROUS-WALLED FLOATING BREAKWATERS

Reflection is one of the mechanisms by which a floating breakwater reduces incident wave energy. To be an effective reflector to particle movement, a breakwater should remain relatively motionless. Such a breakwater requires great structural strength under wave exposure conditions, as large forces are imposed on the mooring system. Any part of the incident wave energy which can be dissipated by turbulence is no longer available to be either reflected or transmitted. Hence, forces in the mooring system are accordingly reduced. Perforated breakwaters have been specifically designed for such a mission. A variation of this concept which is constructed of a horizontal array of open tubes has also been evaluated.

##### 1. Perforated Portable Floating Breakwater Units.

O'Brien, Kuchenreuther, and Jones (1961) considered a framework through which proposed concepts of floating breakwaters could also serve as piers or docks for offloading purposes. Marks (1966), Marks and Jarlan (1968), and Terrett, Osorio, and Lean (1968) conducted experimental studies on the perforated breakwater developed by Jarlan (1960, 1965) to compare the behavior of the perforated breakwater with the caisson type from the standpoint of wave-dam effectiveness and forces on mooring lines. Such a system is potentially applicable not only for military applications, but also for many civil works areas; for example, to dissipate energy at floating bridges on large bodies of water. Garrison (1968) showed analytically that a rigid plate of zero draft fixed at the stillwater surface in deep water (a floating bridge analogy) has a reflection coefficient,  $C_r$ , of 90 percent for wavelength-to-structure width of 2.4:1. If internal energy dissipation at the structure could be increased, then a reduction in loading on the structure and its mooring system, along with a decreased amount of reflected wave energy, would result.

From the standpoint of maximum wave energy dissipation internally and a resulting minimum reflection from the structure, Richey and Sollitt (1969a, 1969b, 1970) experimentally investigated Jarlan's (1960) concept of the perforated portable floating breakwater unit (Fig. 124). The dynamic processes resulting from the incidence of waves on this structure can be interpreted by considering the pressure differential across the porous wall (Fig. 125). As the waves impinge on the front wall, part of the energy is reflected and the remainder passes through the perforations. For  $\eta > \alpha$ , the potential energy in the wave is converted to kinetic energy, in the form of a jet, which then tends to be partially dissipated by viscosity in the channel and by turbulence in the chamber. Kinetic energy is lost as the flow expands and diffuses in the chamber; fluid influx causes the water surface,  $\alpha$ , to rise. Then, as  $\alpha$  becomes greater than  $\eta$ , the flow reverses and the chamber empties. The water flowing back out of the holes then encounters the next



Figure 124. Porous-walled breakwater model under test conditions (after Jarlan, 1960).

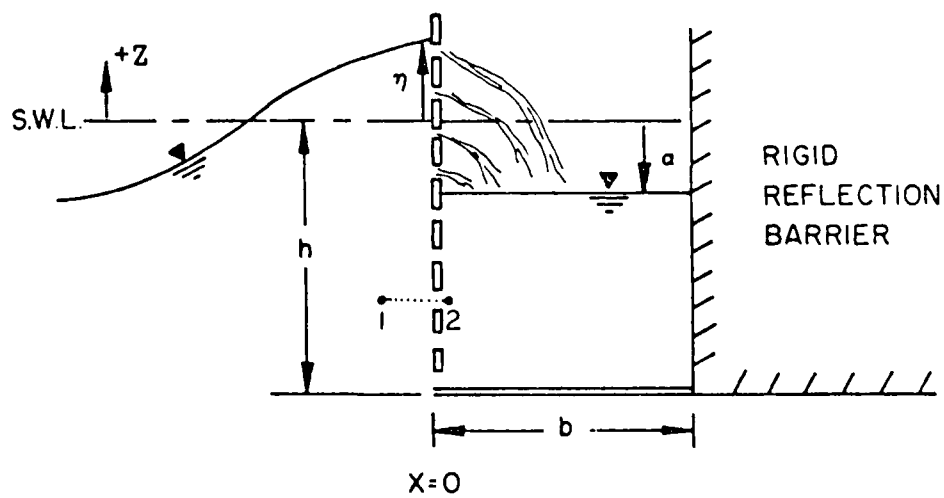


Figure 125. Definitive sketch of porous-walled breakwater (after Richey and Sollitt, 1969a).

oncoming wave, and partial energy destruction is accomplished even before that wave reaches the breakwater. If the walls were not perforated, total reflection would occur on the face of the wall and the resultant high impact forces would be transmitted to the mooring cables. Part of the forces would be directed to oscillating the breakwater, thus inducing waves on the protected side of the structure. In a perforated breakwater, that part of the incident wave energy which is dissipated internally in the form of heat and eddies is not available for such activity.

a. Reflection Coefficients. Richey and Sollitt's (1969a, 1969b) linearized differential equation describing the motion of the fluid in the breakwater chamber is

$$\alpha + \frac{(b^2 D) \partial \alpha}{(2m^2 h^2 g) \partial t} + \frac{1 \partial^2 \alpha}{\omega^2 \partial t^2} = A \sin \sigma t \quad (71)$$

where

- A = depth-averaged dynamic pressure head amplitude
- $\alpha$  = water surface elevation in breakwater chamber
- b = breakwater chamber width
- D = linearized damping coefficient
- m = effective breakwater porosity
- h = breakwater depth
- g = acceleration due to gravity
- $\omega$  = natural frequency of the breakwater system
- $\sigma$  = wave frequency

Equation (71) has the form of a forced, damped oscillator which occurs frequently in mechanical systems. Any system which behaves according to this expression can be considered a resonator because  $\alpha$  attains an absolute maximum value at one particular wave frequency,  $\sigma$ , referred to as the resonant frequency.  $\alpha$  decreases continuously for frequencies greater than or less than the resonant frequency. Richey and Sollitt (1969a, 1969b) developed an analytical expression for the reflection coefficient,  $C_r$ , which must be solved by iterative techniques. Nevertheless, the form of the expression indicates that the system is frequency selective and behaves as a resonator; i.e., the reflection coefficient,  $C_r$ , tends to unity as  $\sigma$  approaches either zero or infinity, and  $C_r$  attains a minimum value at some intermediate value of  $\sigma$ , the resonant frequency. Since the expression cannot be solved explicitly for  $C_r$ , the reflection coefficient cannot be maximized to yield the resonant frequency. However, iterative solutions show that resonance occurs when the frequency of the incident wave approaches the natural frequency of the breakwater system. By reasoning from the pertinent dimensions and variables involved, it can be concluded that the reflection coefficient,  $C_r$ , is functionally related to the breakwater geometry by



$$C_r = \frac{H_r}{H_i} = f \left( m, \frac{H_i}{L}, \frac{b}{h}, \frac{\delta}{h}, \frac{\sigma^2}{\omega^2} \right) \quad (72)$$

where  $H_r$  is the reflected wave height, and  $\delta$  the effective pore length. For any particular breakwater configuration,  $m$ ,  $b/h$ , and  $\delta/h$  are constant. Then, the reflection coefficient,  $C_r$ , can be displayed as a function of the square of the ratio of wave frequency,  $\sigma$ , to the natural frequency of the system,  $\omega$ , for constant values of incident wave steepness,  $H_i/L$ . Hence, the reflection is a function of the breakwater geometry, the wave steepness, and the dimensionless wave frequency.  $\sigma^2/\omega^2$  can be redefined as  $\sigma^2 h/g$  by considering the linear deepwater wave theory equivalent

$$\sigma^2 = kg = \frac{2\pi g}{L} \quad (73)$$

Richey and Sollitt (1969a, 1969b) conducted a laboratory investigation to study a number of breakwater geometries as potential solutions for floating bridge problems or other applications desiring wave energy dissipation. It was evident that the optimum breakwater design is one which attains a minimum reflection coefficient at the peak energy frequency and maintains small values of  $C_r$  over the frequency range of the incident wave spectrum. This will yield a minimum energy level in the reflected wave spectrum. The natural frequency of the breakwater can be adjusted to cause  $C_r$  to resonate at any desired frequency by changing the width of the breakwater,  $b$ . With this in mind, Richey and Sollitt suggested that the other breakwater parameters be fixed according to combined engineering and economic considerations, which allows the breakwater width to be chosen to attain the desired resonant frequency. For the porous-walled breakwaters investigated, the most effective absolute porosities appeared to be in the range of 0.2 to 0.3. The pore diameters should remain less than one-half the average design wave height with the pore length about 1.3 times the pore diameter. The breakwater depth,  $h$ , should be at least one-eighth wavelength at the resonant frequency. For the breakwater in Figure 125, the effect of varying breakwater width (other parameters remaining constant) on the reflection coefficient,  $C_r$ , is shown in Figure 126. Figure 127 shows the effect of varying initial wave steepness on the reflection coefficient with a constant width breakwater for the same breakwater configuration. Figure 128 presents the effects of various wave steepnesses when the breakwater is altered slightly by omitting the bottom (a free vertical exchange between the sea and the chamber).

In a sample application of the design procedures, the principles were applied to an assumed site just north of the Lake Washington Floating Bridge, State of Washington, using only waves generated from northerly winds. A windspeed of 15 miles per hour is considered common in this region, so for design purposes, the associated waves are characterized as having significant heights of 1.0 foot and periods of 2.0 seconds. For maximum energy dissipation within the breakwater, the minimum reflection coefficient should be near the frequency of the maximum wave energy. This value depends on several variables, but generally lies near  $\sigma^2/\omega^2 = 1.2$ . A representative value of the breakwater chamber width,  $b$ , was found to be about 6 feet. Although the theory was developed for deepwater wave properties, its extension to include intermediate and shallow-water waves should be straightforward by using the pressure response functions appropriate for the wave climate at the particular site of interest.

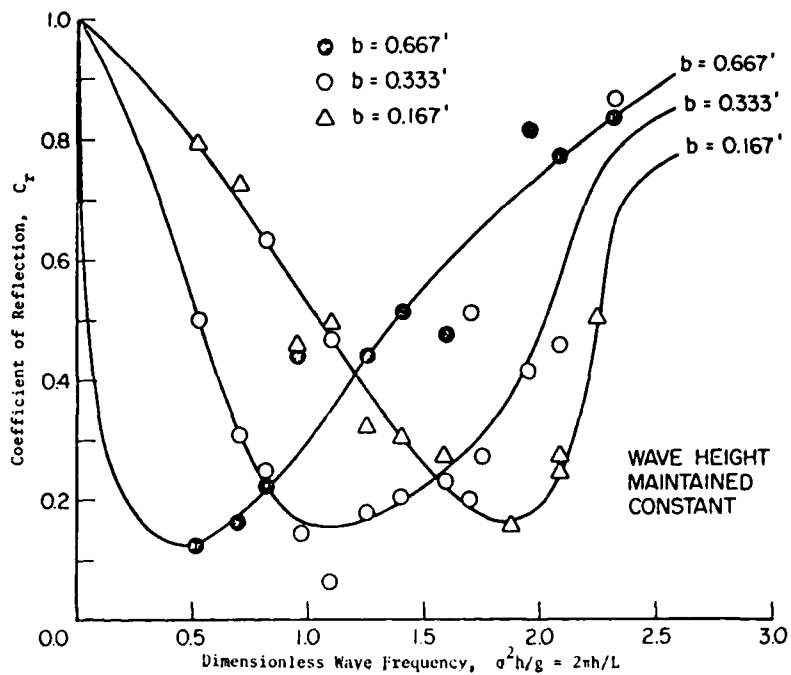


Figure 126. Effect of breakwater width,  $b$ , and dimensionless wave frequency,  $\sigma^2 h/g$ , on coefficient of reflection,  $C_r$ , for the porous-walled floating breakwater (after Richey and Sollitt, 1969a).

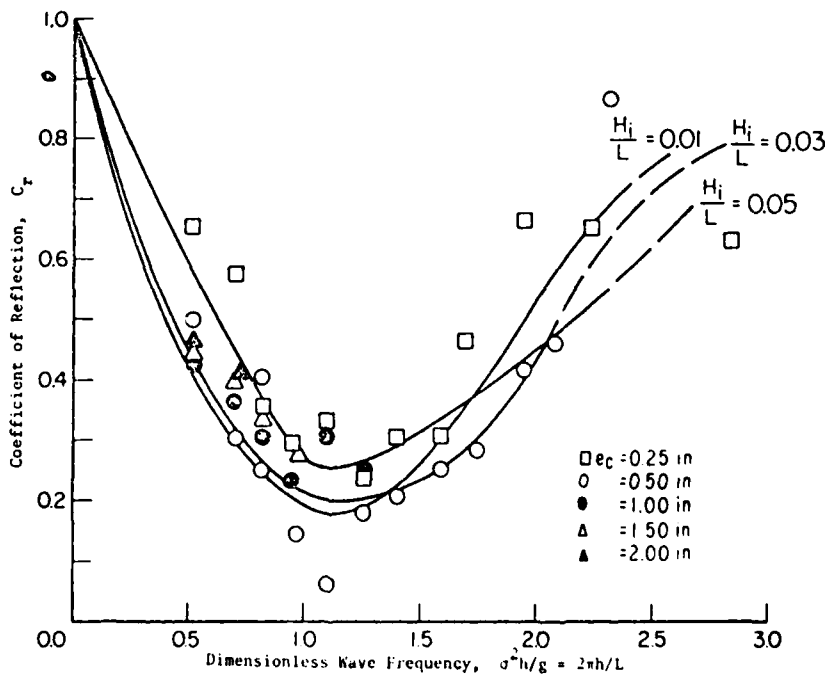


Figure 127. Effect of incident wave steepness,  $H_i/L$ , and dimensionless wave frequency,  $\sigma^2 h/g$ , on coefficient of reflection,  $C_r$ , for the porous-walled floating breakwater (after Richey and Sollitt, 1969a); various symbols denote different wave generator eccentricities,  $e_c$ .

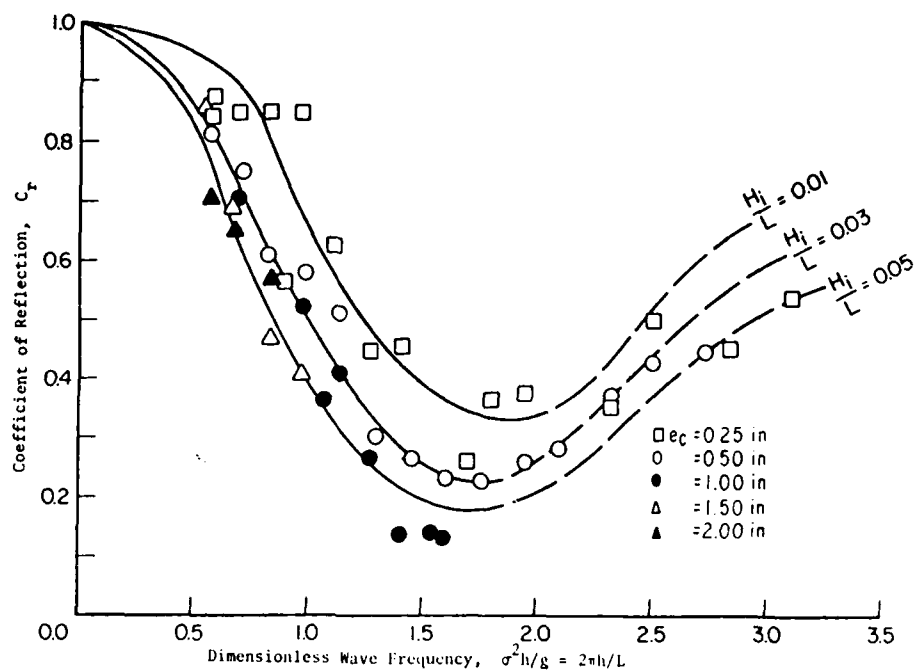


Figure 128. Effect of bottom removal, incident wave steepness,  $H_i/L$ , and dimensionless wave frequency,  $\sigma^2 h/g$ , on coefficient of reflection,  $C_r$ , for the porous-walled floating breakwater (after Richey and Sollitt, 1969a); various symbols denote different wave generator eccentricities,  $e_c$ .

b. Mooring Line Force Investigation. Marks (1966) conducted mooring line force studies of the porous floating breakwater in Figure 125, and the results were compared to those forces existing in mooring lines attached to a nonporous structure of similar dimensions. The perforated breakwater experienced less force in all mooring lines; at the design wave, the mooring lines in the perforated breakwater experienced less force by about a factor of 2. Wave reduction in the lee of the structure varied from approximately 0.2 to 0.8. However, the motion of the breakwaters as measured by horizontal and vertical accelerations in these two-dimensional tests showed no clear superiority, and this was reflected in wave reduction behind the breakwaters. It was evident that the mooring arrangement influences the rolling motion and, hence, the waves generated by the breakwater. An optimum mooring arrangement must be devised whereby motion is minimized without sacrifice of minimum mooring line force. A comparison of the seaward mooring line force for the perforated and the caisson-type floating breakwaters is shown in Figure 129.

## 2. Open-Tube Floating Breakwater System.

The search for breakwaters that are less expensive than the full-depth penetrating rubble-mound variety has led to many proposals for instituting interactions with waves, primarily in the upper layers of the water column where most of the wave energy is concentrated. The requirements for such a breakwater, which extends over only part of the depth, include: (a) maximum wave attenuation, (b) maximum energy dissipation with minimum reflection,

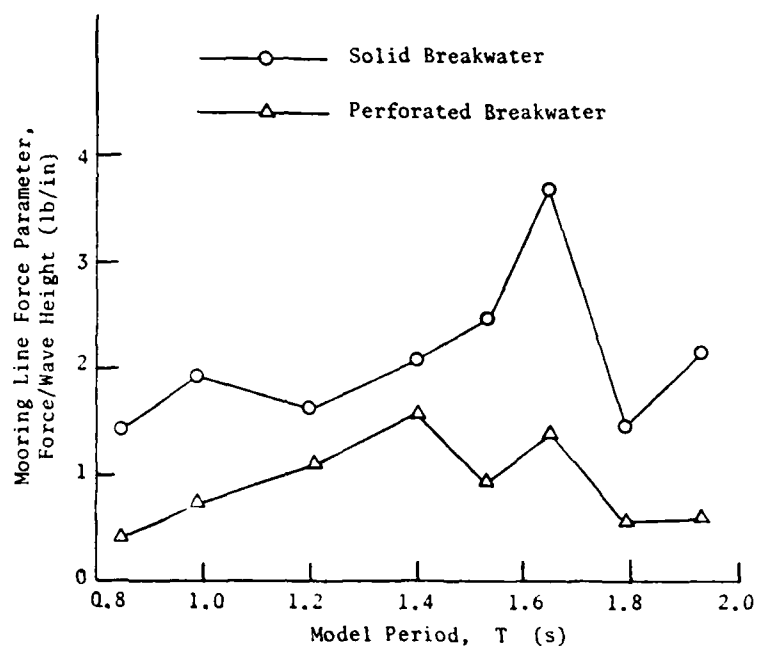


Figure 129. Comparison of seaward mooring line forces for porous-walled versus solid-walled floating breakwater (after Marks, 1966).

(c) minimum mooring forces, (d) mobility, and (e) ease of construction (including availability of construction materials). In early 1960, A.T Ippen of the Massachusetts Institute of Technology, Cambridge, Massachusetts, proposed a variation of the porous-walled structure which would satisfy a number of these requirements. He initiated a systematic study to analyze the dynamic properties of this floating breakwater, which consisted of an array of open tubes alined in the direction of wave propagation but extending over only the upper part of the water depth, with a random distribution of tube lengths. Barnett (1962) performed the initial experimental testing, with subsequent investigations by Ippen and Bourodimos (1964), Bourodimos and Ippen (1968), and Chatham (1971).

The basic idea for the type of tubular floating breakwater proposed in this conceptual model was to extend the reflecting and energy dissipating action over a wider span of the wavelength and, if possible, randomize or scatter the periodic motion associated with regular waves, thereby dissipating the energy into turbulence. Such action can be accomplished by an array of tubes of random lengths arranged in several rows to various depths below the sea surface and alined parallel to the direction of wave propagation. If the oncoming wave crest is over one end of an open tube and the wave trough is over the other end in such an array, a pressure differential exists over the tube length. This pressure differential induces a flow in the tube which is out of phase with the normal wave-induced velocities. Changes with time in this pressure gradient are periodic and are transmitted over the tube length with the speed of an elastic wave. Hence, periodically reversing flows are generated through the tube which leave the tube ends as jets, the kinetic energy of which must be dissipated into turbulence at either end.

AD-A110 692

COASTAL ENGINEERING RESEARCH CENTER FORT BELVOIR VA  
FLOATING BREAKWATERS: STATE-OF-THE-ART LITERATURE REVIEW. (U)  
OCT 81 L Z HALES  
CERC-TR-81-1

F/6 13/2

UNCLASSIFIED

NL

3-3

At

210990

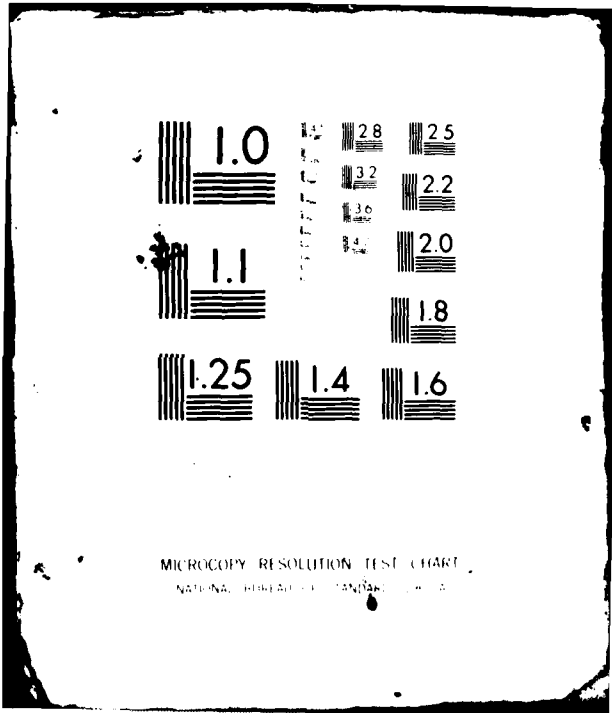
END

DATE

FILED

3 82

DTIC



MICROCOPY RESOLUTION TEST CHART  
NATIONAL BUREAU OF STANDARDS-1963-A

With longitudinal displacement of the ends of adjacent tubes relative to each other, the flow in the tube is induced with various phase shifts, thus distributing the flows and pressure forces on the tubes with respect to time. Any reflecting forces are randomized, as well as the kinetic energies of the jets leaving the tubes. In addition, the presence of the tubes affects that part of the wave energy passing between the tubes. The effect of such a tube array is a scattering of a train of waves incident on the system. This array of tubes should perform in this fashion for all wavelengths; it is most efficient, however, when the maximum pressure gradient exists between the ends of the tubes. A highly efficient breakwater system can thus be theoretically maintained for a range of wavelengths by using tubes of different lengths in a single floating breakwater configuration.

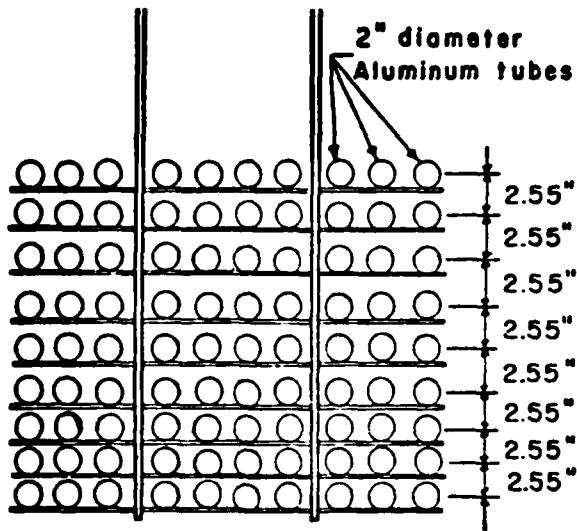
Ippen and Bourodimos (1964) conducted an experimental study to determine reflection and transmission coefficients, and power losses through the application of a floating breakwater system composed of random length tubes. The reflection coefficient,  $C_r$ , was determined by obtaining the envelope of the wave amplitudes on the oceanside of the breakwater. The reflection coefficient is defined as the difference between the maximum and the minimum amplitudes of the wave envelope, divided by the sum of the maximum and the minimum amplitudes of the wave envelope. Correspondingly, the transmission coefficient,  $C_t$ , is the ratio of the same amplitude quantities on the lee side of the breakwater.

In analyzing the effects of the tube system on the waves, the power (lost or dissipated) per wave cycle can be considered as the average time rate of change of energy within an element of fluid through which the wave passes. The power dissipated by the breakwater can be computed by using an expression equating the power incident on the breakwater, the power transmitted through the breakwater, and the power reflected from the breakwater. Defining  $P_D$  as the fraction of incident wave power dissipated, it can be shown that

$$P_D = 1 - C_r^2 - C_t^2 \quad (74)$$

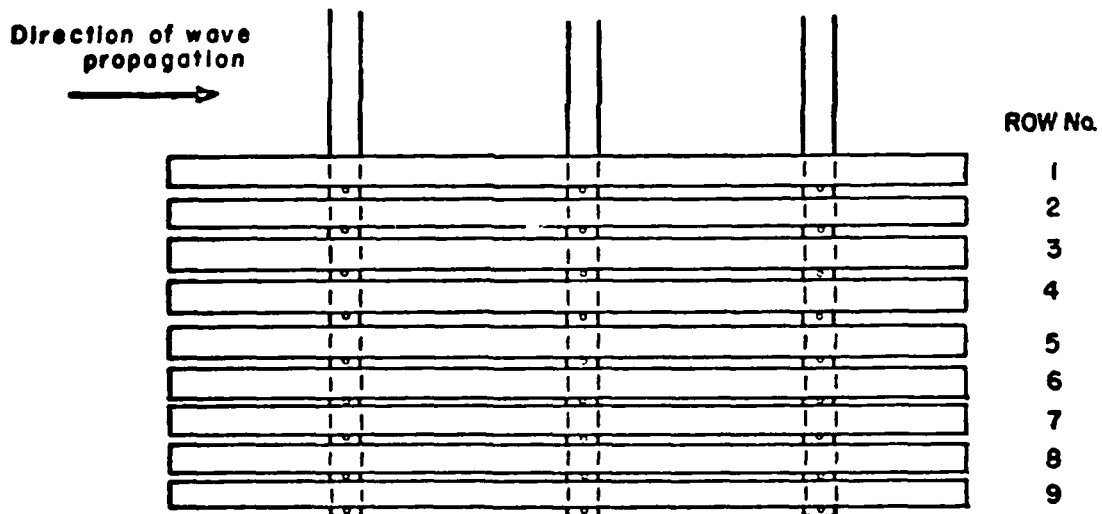
As for other types of breakwaters, the theoretical aspects of the floating tube system pertaining to effects of partial reflection and transmission of wave energy, and to the balance of power transmission, apply as derived. However, the amount of dissipation is subject to complex influences which cannot be specified by analytical expressions. Hence, the experimental investigation was conducted on a model scale, but the results can be extrapolated to prototype behavior on the basis of the usual similarity principles.

a. Reflection and Transmission Coefficients. The experimental arrangement of the open-tube floating breakwater concept (Fig. 130) was installed in a two-dimensional wave flume and subjected to a range of wave characteristics. The dissipative action of the breakwater is due to the combination of dissipation of the kinetic energy of the flow induced in the tubes, boundary resistance of the flow generated in and around the tubes, and general interference with the normal transient velocity field of the waves in both the vertical and horizontal directions. The results of the study are presented graphically in Figures 131 and 132. While the data exhibit apparent scattering, tests under the same test conditions were highly repeatable, indicating consistent accuracy in measurements. Much of the apparent scatter can therefore be attributed to inherent changes in performance of the various models with



**END VIEW**

a.



Vertical spacing of rows 2.55" center to center of tubes  
**SIDE VIEW**

b.

Figure 130. Experimental arrangement for evaluating effectiveness of open-tube floating breakwater concept (after Ippen and Bourodimos, 1964).



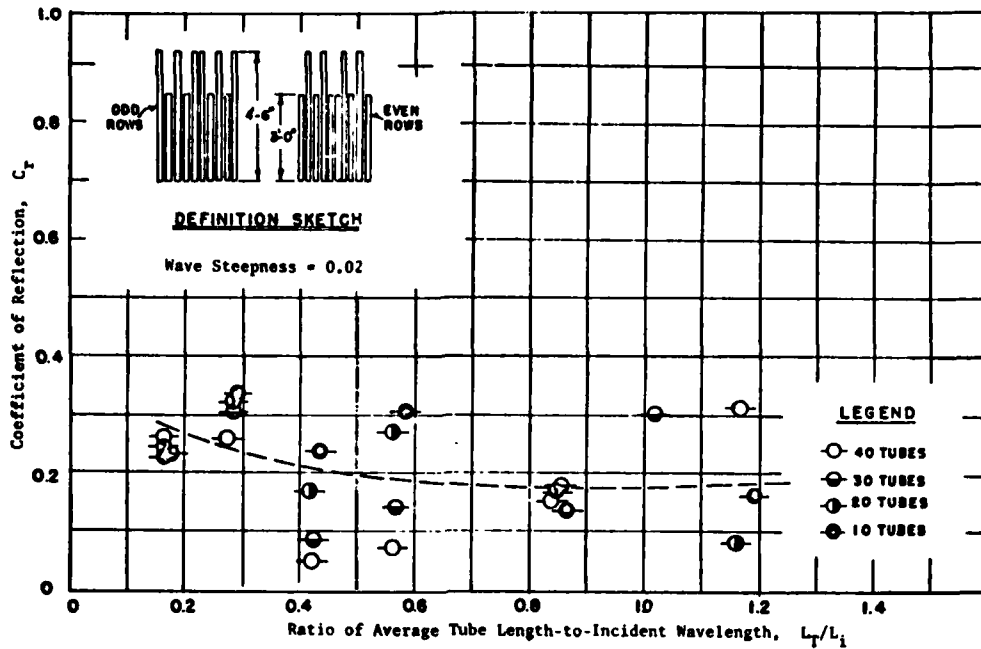


Figure 131. Effect of relative breakwater width,  $L_T/L_i$ , and number of tubes on reflection coefficient,  $C_r$ , for open-tube floating breakwater (after Ippen and Bourodimos, 1964).

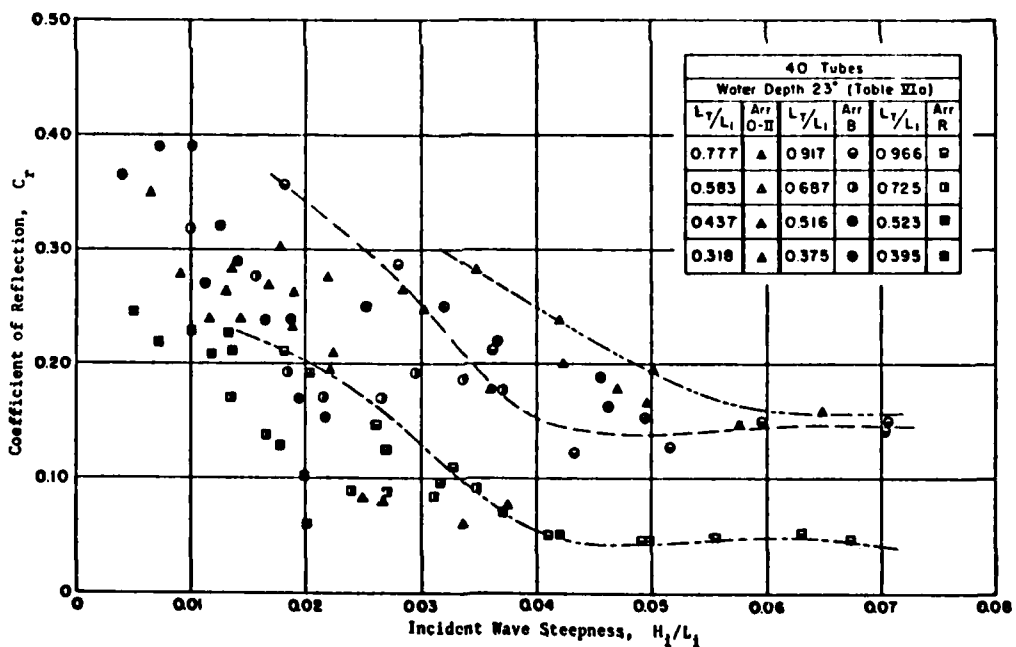


Figure 132. Effect of incident wave steepness,  $H_i/L_i$ , and relative breakwater width,  $L_T/L_i$ , on reflection coefficient,  $C_r$ , for open-tube floating breakwater (after Ippen and Bourodimos, 1964).

changing wave conditions. This conclusion is supported by the consideration that wave reflection and dissipation are associated with various complex flow processes, and that the number of parameters chosen to correlate the data is inadequate to account for all these physical factors.

The effect of relative open-tube breakwater width,  $L_T/L_i$ , on reflection coefficient,  $C_r$ , is shown in Figure 131 for an arrangement with various numbers of open tubes. Here  $L_T$  is the average tube length, defined as the total length of tubes in the system divided by the number of tubes, and  $L_i$  is the incident wavelength. Generally, all values are contained between a maximum of  $C_r = 0.35$  and a minimum of  $C_r = 0.10$ , allowing for experimental scatter. This indicates that the number of tubes is not too critical, since for the short and intermediate waves the wave energy is concentrated in the upper parts of the water column. Hence, the reflection coefficient is reduced by a relatively small number of tubes to a value corresponding to that of beaches of relatively small slope. When the effect of wave steepness,  $H_i/L_i$ , is isolated (Fig. 132), it is apparent that the reflection coefficient,  $C_r$ , decreases sharply with increasing values of wave steepness (for low values of wave steepness), and approaches a minimum value for higher wave steepness at all relative breakwater widths,  $L_T/L_i$ . For all types of arrays, the reflection coefficient was found to decrease at constant wave steepness as relative breakwater width decreased.

Transmission coefficients,  $C_t$ , versus relative breakwater widths,  $L_T/L_i$ , are presented in Figure 133 for a constant value of wave steepness,  $H_i/L_i = 0.02$ . Generally, the transmission coefficients decrease materially with increasing values of  $L_T/L_i$  (with decreasing wavelength). Hence, the effectiveness of the open-tube concept as an energy dissipator increases as the wavelength decreases (conversely, as the breakwater width increases). When the steepness is incorporated as a parameter, the transmission coefficient was found to decrease with increasing wave steepness for all tube arrays (Fig. 134). It was also found that the transmission coefficients approached a constant value for large wave steepness,  $H_i/L_i$ .

b. Variation of Power Loss with Wave Steepness. Power losses, computed by equation (74) for the experimental tests of Ippen and Bourodimos (1964), are presented in Figure 135 as a function of incident wave steepness,  $H_i/L_i$ , and relative breakwater width,  $L_T/L_i$ . Power losses,  $P_D$ , increased with the number of rows in the array, but the change above three rows was not very significant. Hence, additional rows do not seem justified for the range of wave conditions tested. Power losses decrease sharply with a decrease in the relative breakwater width,  $L_T/L_i$ . For low wave steepness and longer wavelengths, there is little variation in the relatively small power loss for the different arrangement of open-tube system. However, the power losses were distinctly higher for the random-type structure as wavelengths became shorter and wave steepness increased, indicating the favorable aspects of the irregularity of tube arrangements.

Ippen and Bourodimos (1964) made several general conclusions as a result of this experimental investigation into the effectiveness of an open-tube system application for floating breakwater utilization. Depending on the particular type array, reflection coefficients,  $C_r$ , ranged from a minimum of 0.05 to a maximum of 0.53. Transmission coefficients,  $C_t$ , showed corresponding values from 0.40 to 0.96. Energy dissipation was accomplished

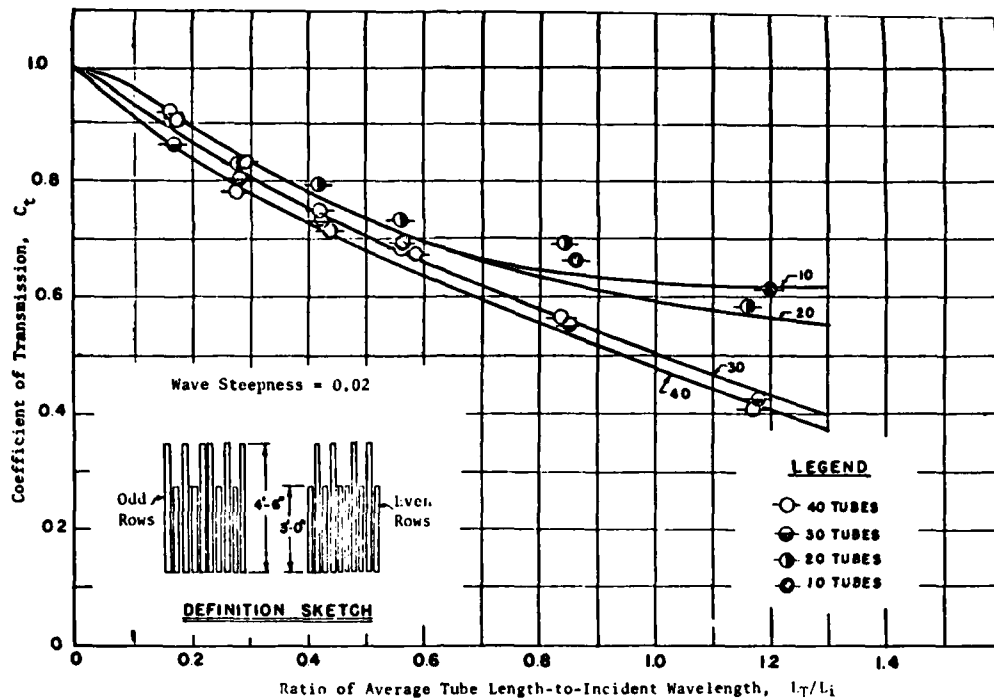


Figure 133. Effect of relative breakwater width,  $L_T/L_1$ , and number of tubes on transmission coefficient,  $C_t$ , for open-tube floating breakwater (after Ippen and Bourodimos, 1964).

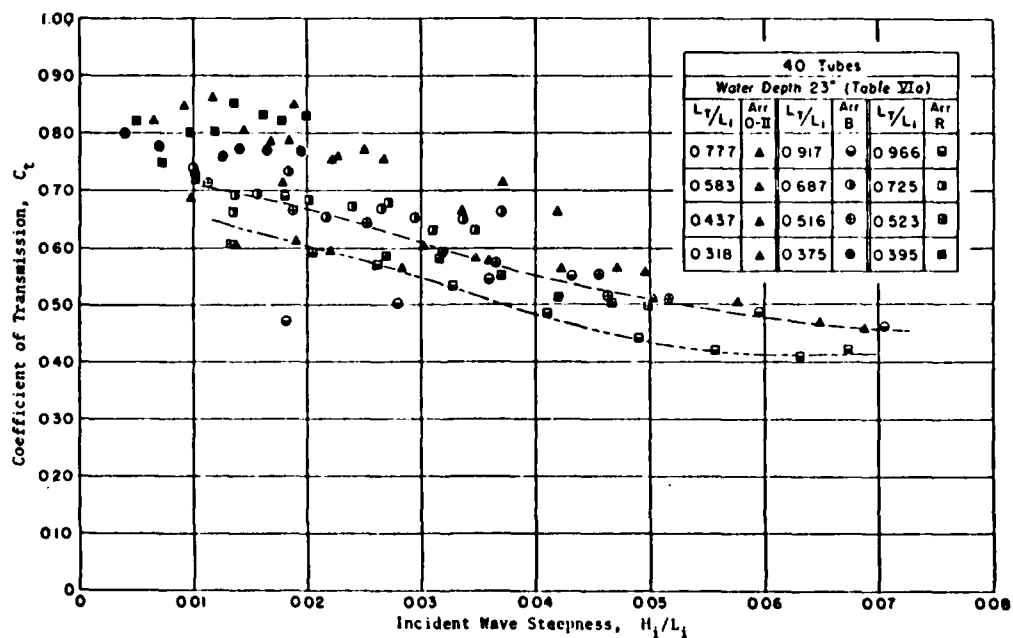


Figure 134. Effect of incident wave steepness,  $H_1/L_1$ , and relative breakwater width,  $L_T/L_1$ , on transmission coefficient,  $C_t$ , for open-tube floating breakwater (after Ippen and Bourodimos, 1964).

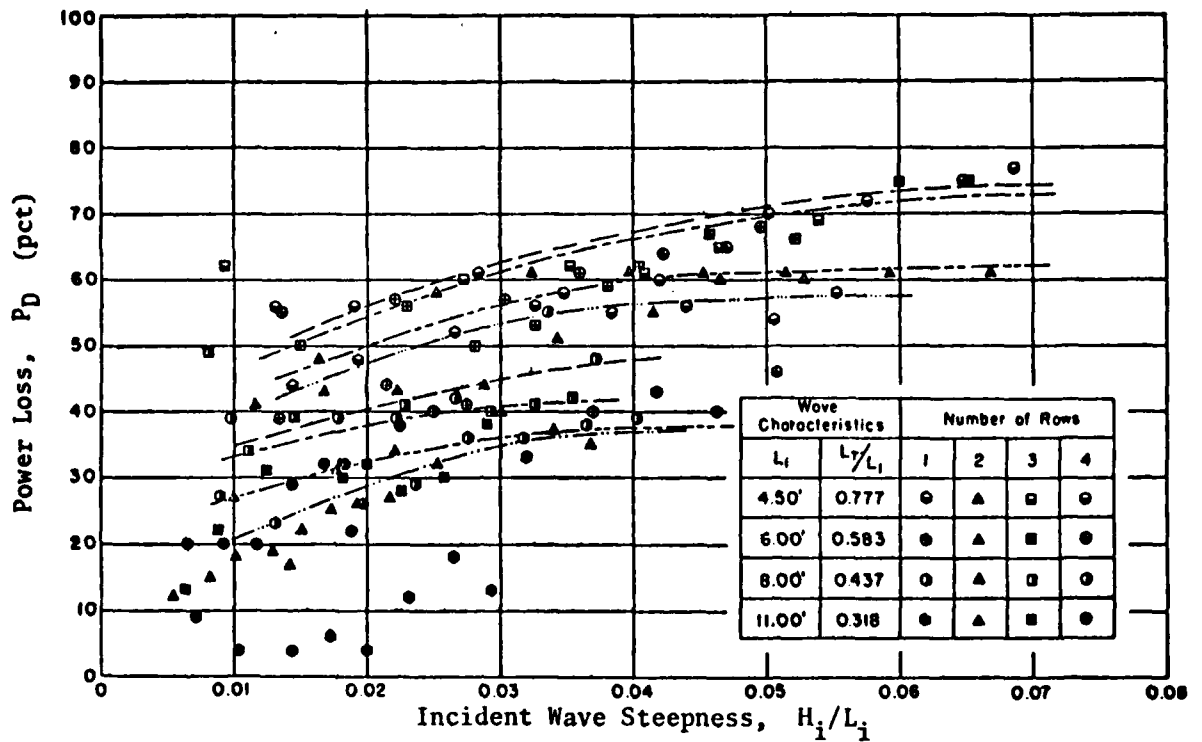


Figure 135. Effect of incident wave steepness,  $H_1/L_1$ , and relative breakwater width,  $L_T/L_1$ , on power loss,  $P_D$ , for open-tube floating breakwater (after Ippen and Bourdinos, 1964).

primarily through interference with the wave-induced velocity pattern and through turbulence generated by motion around and through the tube arrays. Energy dissipation rates for some arrays reached 80 percent. No wave breaking occurs with this type breakwater, which is in contrast to conventional structures. The forces on the breakwater (determined from limited tests) were generally only a small percentage (2 to 5 percent) of the total forces exerted on a vertical wall with complete wave reflection. The forces were essentially the same in both directions, which indicates negligible drift by wave action for floating breakwaters of this type and similar mooring. The results were achieved with arrays extending over only a limited part of the depth, from 20 to 35 percent; however, the length of the tubes had to be about one-half to one wavelength. Wave steepness,  $H_1/L_1$ , significantly affected the results, with increasing wave steepness causing a decrease in reflection coefficients,  $C_r$ , and transmission coefficients,  $C_t$ , and an increase in power losses,  $P_D$ , for a given array and wavelength.

#### IX. PNEUMATIC AND HYDRAULIC BREAKWATERS

Most floating breakwaters can be classified in general as passive systems; i.e., the devices provide no energy to attenuate waves. The incident wave energy is either reflected or dissipated by the system. The most effective natural mechanism of wave energy dissipation is the phenomenon of wave breaking. Active wave attenuation systems produce and inject kinetic energy

for the occurrence of total or partial breaking of the wave train, with the resulting attenuation depending on the degree of breaking accomplished by the system. The active breakwaters evaluated to date involve the release of low-pressure air at a preselected water depth, or the ejection of high-velocity water jets near the water surface. The underlying basis of the air-release concept (pneumatic breakwater) is the development of a vertical current of water which rises to the surface and spreads horizontally in both the upstream and downstream directions from the breakwater. In the water-jet release system (hydraulic breakwater), high-velocity water is released in a horizontal layer near the surface of the water. In either case, entrainment of the surrounding water results from momentum exchange, and partial or total wave breaking results. A definitive sketch outlining the operation of each system is shown in Figure 136.

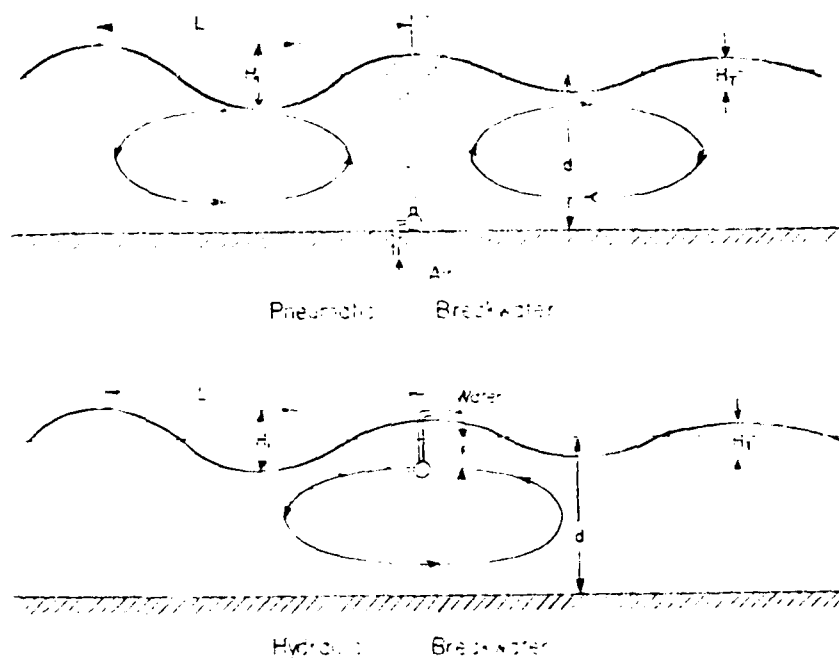


Figure 136. Conceptual model of operation, pneumatic and hydraulic breakwater systems.

Parts of the pneumatic breakwater system require placement on the sea floor or harbor bottom to allow for the rise of air bubbles to entrain surrounding fluid particles. The compressors necessary for generating low-pressure air may be situated on harbor docks, floating platforms, or ships. The hydraulic breakwater systems must be positioned at or slightly below the water surface; hence, the proper and effective flotation device is critical for successful attenuation by the hydraulic breakwater. From these considerations, the hydraulic breakwater more nearly satisfies the criterion of a floating breakwater than does the pneumatic breakwater. However, because of the mobility of both systems, they are considered closely related. Both concepts should be evaluated further.

## 1. Pneumatic Breakwater System.

The initial concept of the pneumatic breakwater was patented in 1907 (Brasher, 1915). Attenuation in this concept is the release of compressed air through a submerged perforated pipe. Several prototype installations of this system have been described as successful. A few model studies were conducted before 1950, but the results were incomplete and in some cases contradictory. These early tests indicated excessively large power requirements which were probably true for the shallow-water waves under investigation at the time. In addition to attenuating waves near the seacoast, there is a sufficient requirement for reducing deepwater wave heights to warrant thorough investigations under deepwater conditions. For example, the offshore transfer of cargo from conventional ships to amphibians in military discharge operations is severely curtailed when wave heights exceed about 2 feet. If areas of relatively calm water can be produced immediately around ships at anchor, the capability of moving supplies ashore will increase substantially.

a. Theoretical Analysis. At the request of the British Admiralty, Taylor (1943) conducted an analysis of the pneumatic breakwater, and his development became one of the most significant advances in this area of research. The investigation was formulated around the superposition of a uniform current of velocity,  $U$ , and thickness,  $h$ , on the velocity potential of a deepwater wave. It was assumed that air bubbles had little effect on the attenuation, and that the vertical-induced current caused by the rising bubbles diffusing both upstream and downstream at the surface was solely responsible for the attenuation of the incident waves. Taylor's analysis was aimed at determining the current velocity necessary to attenuate waves of a given length, and he found that for a given current, it was kinematically impossible to transmit waves shorter than a given length.

Taylor (1955) modified the theory by using a triangular velocity distribution, which is more in accord with actual prototype distributions (Fig. 137). To relate the velocity and thickness of the current to the air discharge and the submergence of the perforated pipe, Taylor used the analogous solution for the convective currents above a horizontal line source of heat. The maximum velocity of the current,  $U$ , was found to be related to the air discharge,  $q$ , as

$$q = 0.00454 U^3 \quad (75)$$

As the current reaches the surface, it spreads horizontally with maximum velocity occurring at the water surface. It was determined that the depth of air release plays only a minor role in the maximum velocity at the surface; however, for maximum efficiency, the perforated pipe should be placed at the bottom so that the rising bubbles will approach terminal velocity as nearly as possible. The surface velocity will remain nearly the same for equal discharges, but the effective current depth changes in proportion to the air-release depth. Hence, for attenuating longer waves where a deeper current is necessary, an increase in submergence is required. However, this entails larger power requirements because the power necessary to release a given amount of air is directly proportional to the depth of release.

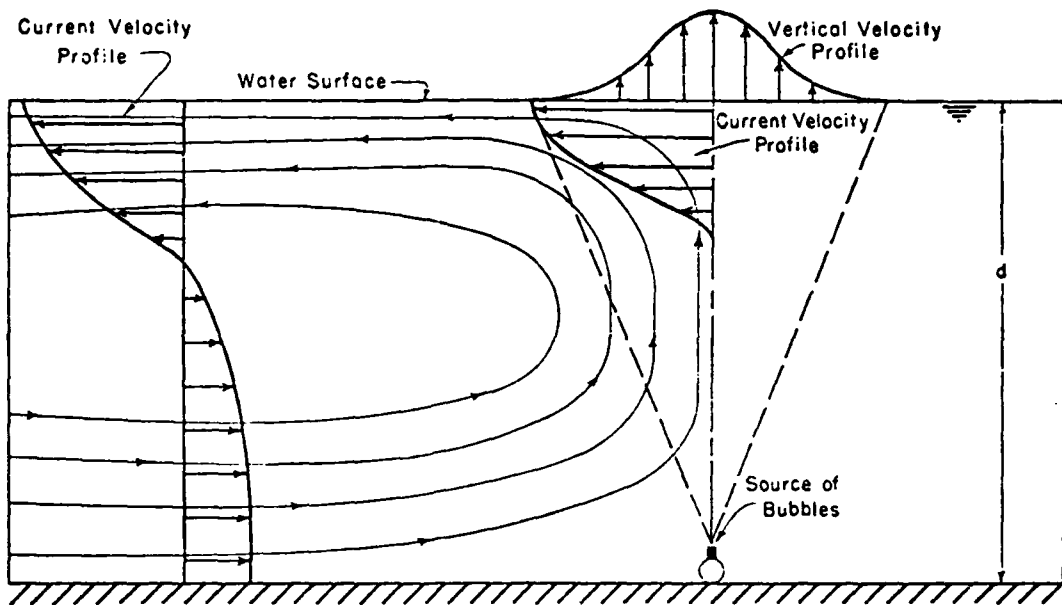


Figure 137. Qualitative description of current patterns produced by pneumatic breakwater (after Straub, Bowers, and Tarapore, 1959).

From equation (75), an increase of air discharge by a factor of 8 is necessary to double the maximum surface current. As the air discharge increases at a given water depth, a condition is eventually reached where further increases in discharge result in little change in attenuation. With increasing submergence comes larger power requirements to overcome hydrostatic pressure. Hence, an optimum depth for air release for a given wavelength and water depth exists, but in practical applications the air-release mechanism would probably be placed on the sea floor.

Kurihara (1958) conducted theoretical and experimental studies of pneumatic breakwaters which qualitatively verify the Taylor (1955) theory. The experimental laboratory work included three full-scale tests of prototype conditions. It was found that the full-scale tests required much less power than would be expected from a Froude extrapolation of the model data. The power requirement was also much below that predicted by Taylor. Kurihara reinterpreted the mechanism of attenuation to include the induced surface current as the main attenuation factor, and developed a concept of turbulent eddy viscosity which was defined as the product of current velocity and depth. The surface current served as a catalytic agent affecting the turbulent diffusion process. Kurihara also noted that the velocity of the induced current in the model tests was proportional to the cube root of the discharge; however, it deviated significantly from this relationship in actual field tests at small discharge rates. A parameter was introduced which functionally related the air discharge and the depth of the release pipe. A limiting value of this bubble efficiency parameter was determined below which the velocity was no longer proportional to the cube root of the discharge. This tended to explain the deviation of the model studies from prototype field tests, and also confirmed the presence of scale effects because of the inability to scale the model bubble growth in the laboratory.

b Small-Scale Experimental Studies. Several extensive, although relatively small-scale, experimental studies have been conducted on the mechanism and efficiency of wave attenuation by pneumatic breakwaters (Wetzel, 1955; Straub, Bowers, and Tarapore, 1959; Colonell, Carver, and Lacouture, 1974). The studies of Wetzel (1955) and Straub, Bowers, and Tarapore (1959) were performed in two wave channels which were geometrically similar but of two different sizes (Fig. 138). The smaller of the two channels was 2 feet wide, 1 foot deep, and 50 feet long; the larger was 9 feet wide, 4.5 feet deep, and 253 feet long. The test procedures consisted essentially of measuring the incident and transmitted wave heights, and correlating these measurements with the amount of air discharge during the specific test. Figure 139 shows the variation in velocity at three points in each channel, as a function of air discharge, and Taylor's (1955) theoretical development. If the point of velocity measurement is other than at a maximum, then the constant 0.00454 would not apply. It was found in these laboratory studies that the maximum velocity measured one water depth distance from the breakwater was in good agreement with the Taylor theory.

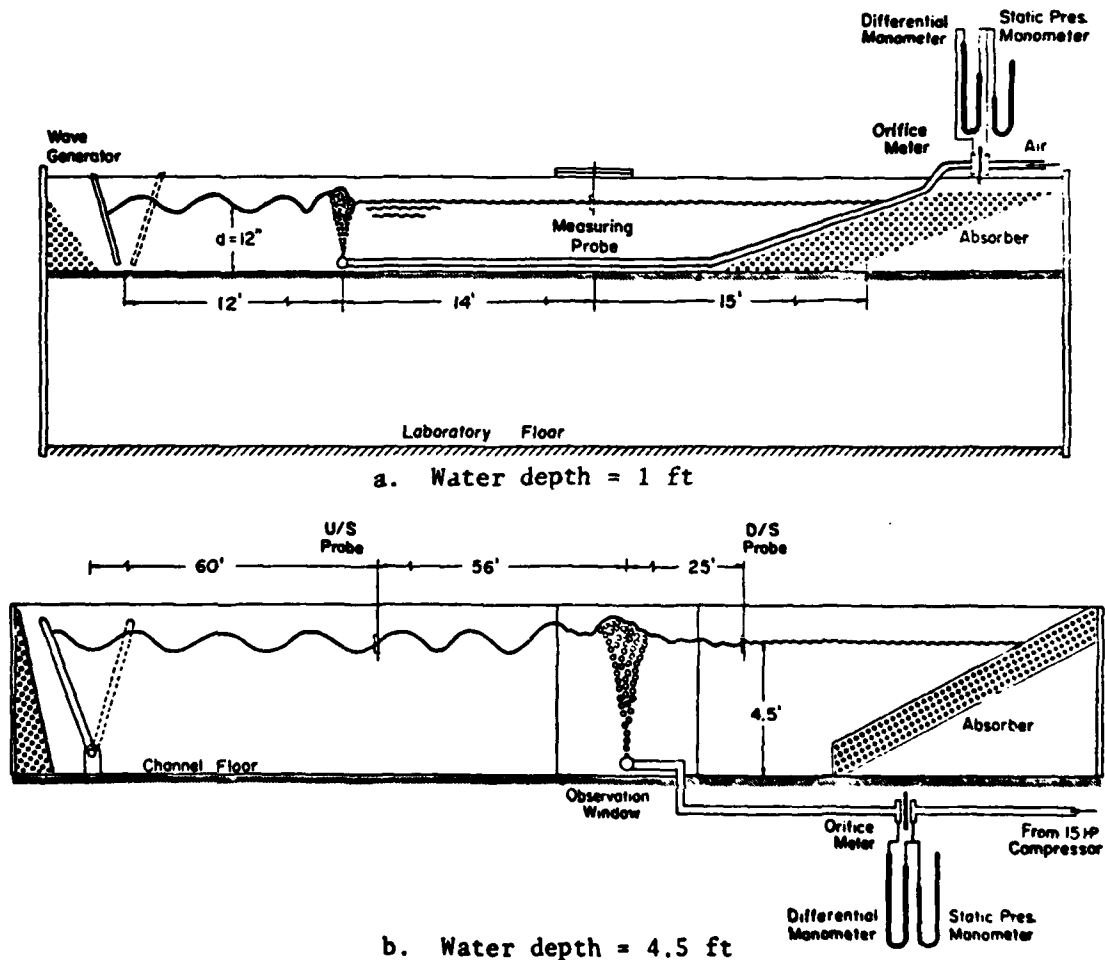


Figure 138. Two sizes of small-scale laboratory flumes used to investigate pneumatic breakwater effectiveness (after Straub, Bowers, and Tarapore, 1959).



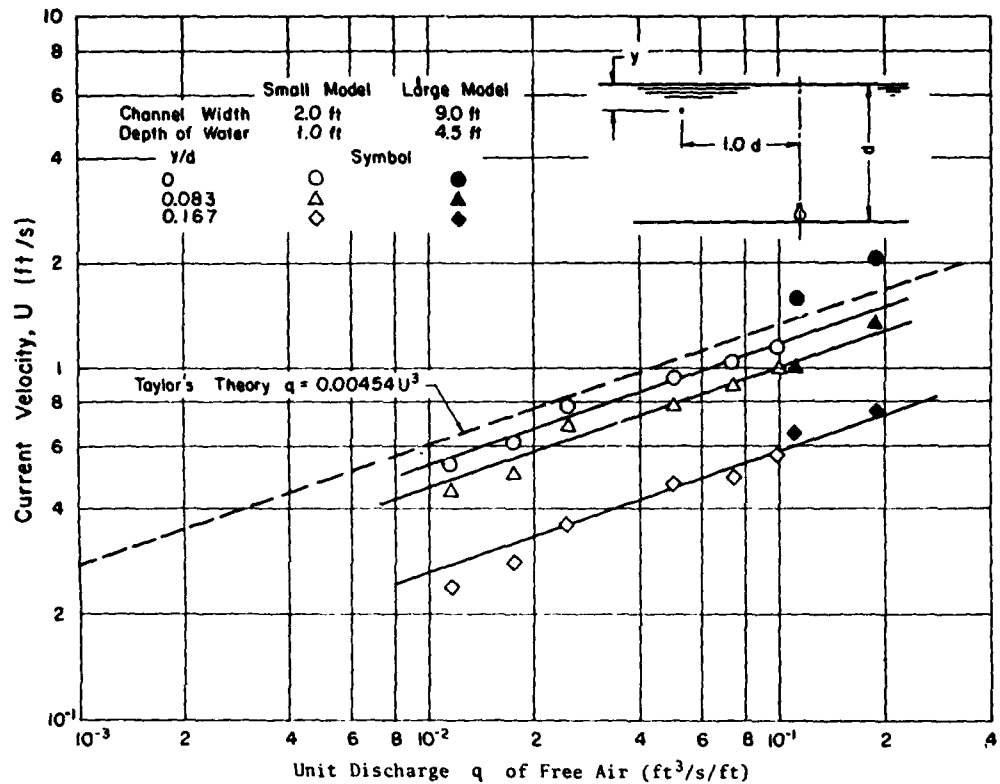


Figure 139. Effect of unit air discharge,  $q$ , and relative depth of submergence,  $y/d$ , on maximum surface current velocity,  $U$  (after Straub, Bowers, and Tarapore, 1959).

Straub, Bowers, and Tarapore (1959) determined that the power required for discharging air through the pneumatic breakwater could be conveniently expressed by the dimensionless parameter

$$\phi = \frac{(\text{hp/ft})}{(\rho g^{3/2} L^{5/2})} \quad (76)$$

The horsepower per foot was computed at the orifices from the expression:

$$\text{hp/ft} = \frac{(q\gamma d_1)}{550} \quad (77)$$

where

- $q$  = unit air discharge at orifice
- $\gamma$  = specific weight of water
- $d_1$  = submergence of orifices
- $\rho$  = density of water
- $g$  = acceleration of gravity
- $L$  = wavelength

For a 50-percent wave height attenuation, results of Straub, Bowers, and Tarapore (1959) and other investigators are compared in Figure 140. The horsepower ratio for the data of the other investigators was about 50 percent less than that of Straub, Bowers, and Tarapore, and may be due in part to different methods of measuring the attenuated wave.

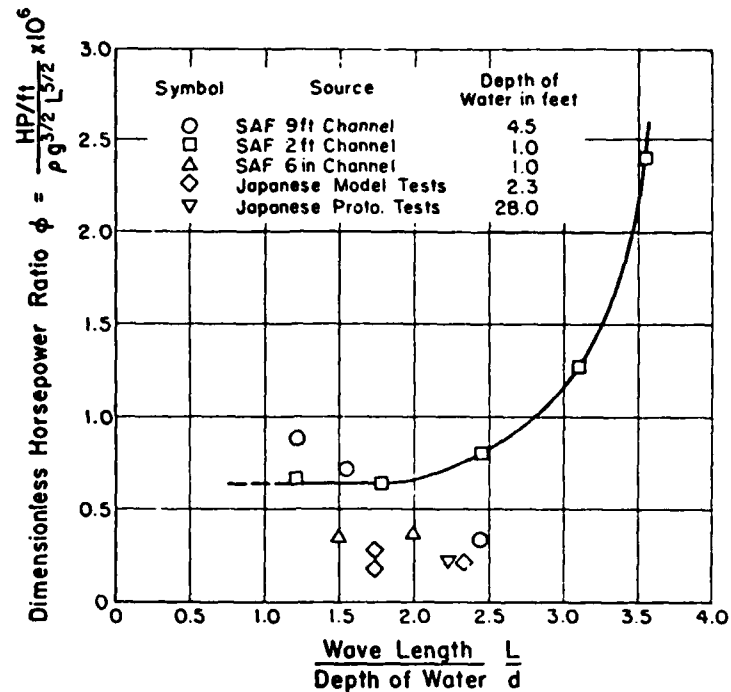


Figure 140. Effect of relative water depth,  $L/d$ , and comparison of dimensionless horsepower requirements,  $\phi$ , for pneumatic breakwater at a 50-percent wave height attenuation (after Straub, Bowers, and Tarapore, 1959).

If scale effects were not present (i.e., the Froude law relating the model to the prototype was completely valid), the value of  $\phi$  would remain unchanged for a given value of  $L/d$ . Kurihara (1958) reported that his prototype tests required much less power than that predicted from the model tests. A factor which may affect data comparisons of various sources is the location of the measuring element with respect to the breakwater. If the wave sensor is less than twice the depth from the breakwater, the attenuation will be higher; for a given attenuation, the power requirement will be lower. Table 7 shows the  $\phi$  values for 50-percent attenuation for Kurihara's (1958) model and prototype tests, and comparative values from Straub, Bowers, and Tarapore's (1959) laboratory tests.

(1) Effect of Wave Steepness. The steepness in the laboratory experiments varied from 0.02 to 0.08. It was found that the air requirement for a given attenuation was essentially independent of the wave steepness (Fig. 141). The power requirements for hydraulic breakwaters to achieve the same degree of wave attenuation increase with wave steepness by as much as a factor of about 3; wave steepness increases from approximately 0.02 to 0.08. This indicates that the pneumatic breakwater is more efficient for waves of higher steepness than the hydraulic breakwater.

Table 7. Pneumatic breakwater tests of potential scale effects at a 50-percent wave height attenuation.

Water depth (ft)	L/d	φ (model-prototype tests) <sup>1</sup>	φ (laboratory tests) <sup>2</sup>
0.7	2.32	0.206	0.76
0.7	1.73	0.175	0.64
0.8	1.75	0.282	0.64
16.1	1.45	0.067	0.64
15.6	1.51	0.053	0.64
9.5	1.53	0.097	0.64
10.0	2.20	0.215	0.70

<sup>1</sup>Kurihara (1958).

<sup>2</sup>Straub, Bowers, and Tarapore (1959)

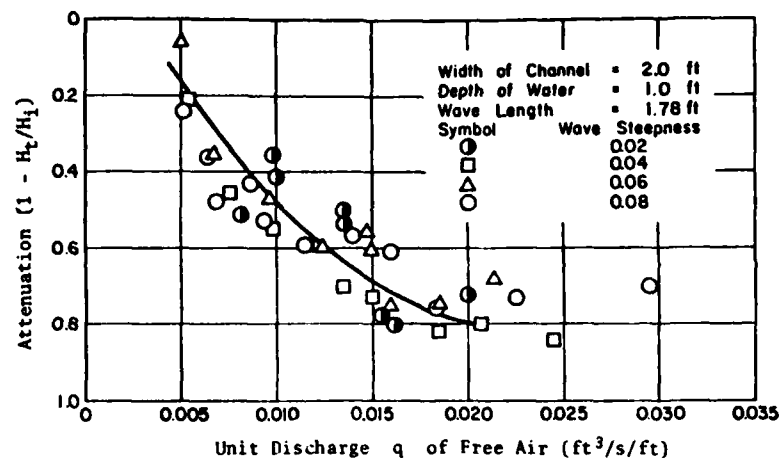


Figure 141. Effect of unit air discharge,  $q$ , and incident wave steepness,  $H_1/L_1$ , on effectiveness of pneumatic breakwater (after Straub, Bowers, and Tarapore, 1959).

(2) Effect of Orifice Area. Straub, Bowers, and Tarapore (1959) tested this effect in the larger channel with orifices of 1/8-, 3/16-, and 1/4-inch diameters and with  $L/d$  values of 1.22, 1.78, and 2.44, respectively. These data are shown in Figure 142 which indicates no pronounced change in the air requirements for the different orifice sizes.

(3) Effect of Multiple Manifolds. Straub, Bowers, and Tarapore (1959) originally hypothesized that a multiple manifold (parallel manifolds spaced a finite distance apart for simultaneous air release) system would be advantageous for attenuation of longer waves. This would provide a deeper (thicker) surface current which would enable the breakwater to intercept the orbital motion over a greater part of the wavelength. It was also believed if the manifolds were sufficiently far apart, they would each attenuate the wave and thus provide extremely high attenuations. Up to four manifolds at

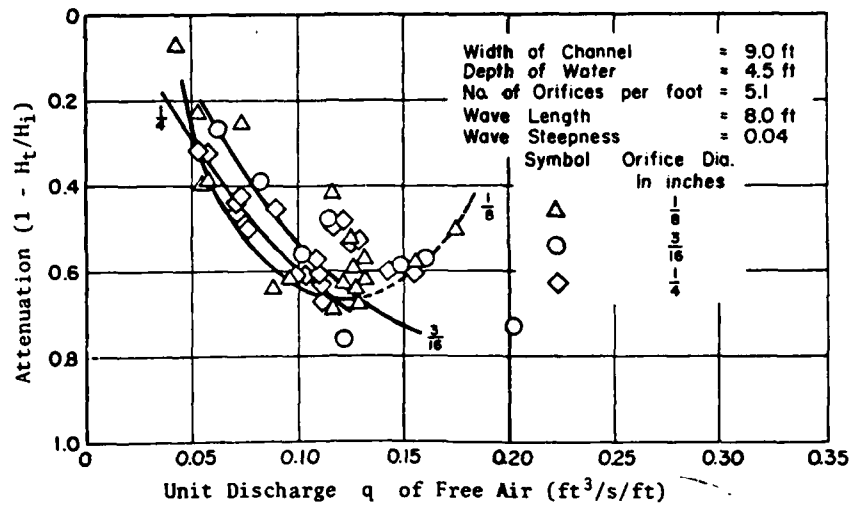


Figure 142. Effect of unit air discharge,  $q$ , and orifice diameter on effectiveness of pneumatic breakwater (after Straub, Bowers, and Tarapore, 1959).

spacings of 1-foot centers were tested in the larger channel, but there appeared to be no advantage to using multiple manifolds. Actually, for lower discharges, the airflow was not uniform and resulted in poor efficiency (Fig. 143). The spacing was varied for a two-manifold arrangement in the smaller wave channel in an attempt to isolate the desired spacing of two release points. Again, the performance appeared to be no better than for the one-manifold system (Fig. 144).

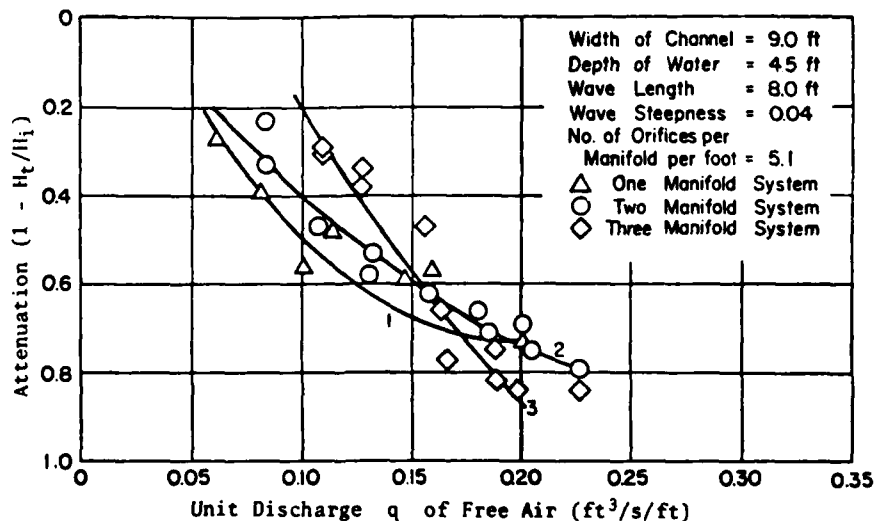


Figure 143. Effect of unit air discharge,  $q$ , and multiple manifold systems on effectiveness of pneumatic breakwater (after Straub, Bowers, and Tarapore, 1959).

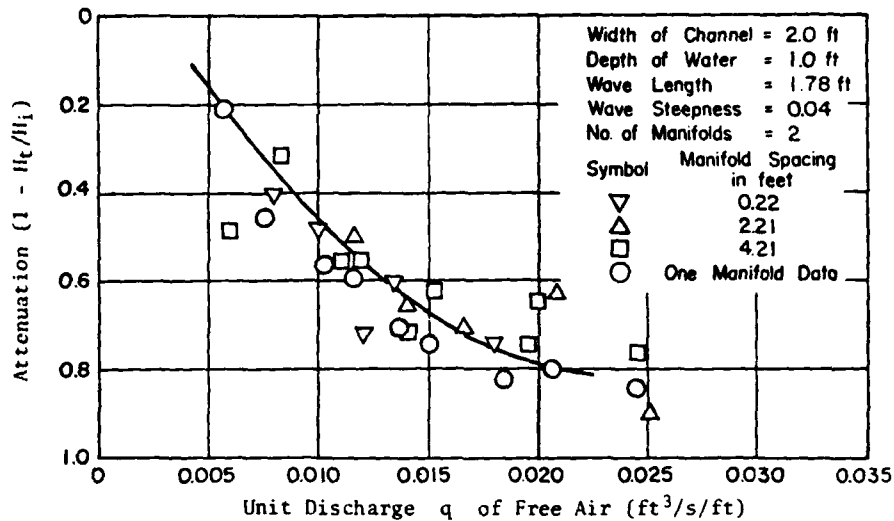


Figure 144. Effect of unit air discharge,  $q$ , and manifold spacing on effectiveness of pneumatic breakwater (after Straub, Bowers, and Tarapore, 1959).

(4) Power Requirement. The horsepower required for a potential prototype installation was computed, based on the results of the small-scale laboratory experiments of Straub, Bowers, and Tarapore (1959). Since it was previously determined that attenuation was effectively independent of wave height, the steepness was not a pertinent parameter for the pneumatic breakwater. For an installation depth of 40 feet and for various wavelengths (periods), the attenuation as a function of applied horsepower per foot of breakwater is shown in Figure 145. Because of the possible scale effects involved with extrapolating small-scale data with parameters that cannot be properly scaled in the model, additional larger scale laboratory tests were performed with prototype-size wave heights. Field installations were required to input power of sufficient magnitude to overcome any supply pipeline losses, as well as provide a release rate of air for the desired attenuation. Accordingly, for an applied 100 horsepower per foot, the total power requirement including losses for various supply-line diameters was determined (Straub, Bowers, and Tarapore, 1959). The total applied power depends on the length of both the breakwater and the supply lines. The data in Figure 146 assumes that the supply line is 250 feet long with a total coefficient of 1.00 for losses of valves and bends. From this direct extrapolation of small-scale experimental data to prototype scale, the total horsepower requirement appears excessive, except for very limited specific applications. Carr (1950) previously concluded that, for typical ocean waves with 10-second periods or greater in nearshore waters, the pneumatic breakwater system did not appear to be a viable alternative. However, for the attenuation of deepwater waves of finite areal extent, the pneumatic system may be worthy of evaluation.

Colonell, Carver, and Lacouture (1974) conducted an experimental study of pneumatic breakwaters to examine the efficiency of the system in a wind-generated wave environment, although the verification of Kurihara's (1958) eddy viscosity theory was beyond the scope of the investigation. As the breakwater power input was increased, greater degrees of randomness of the

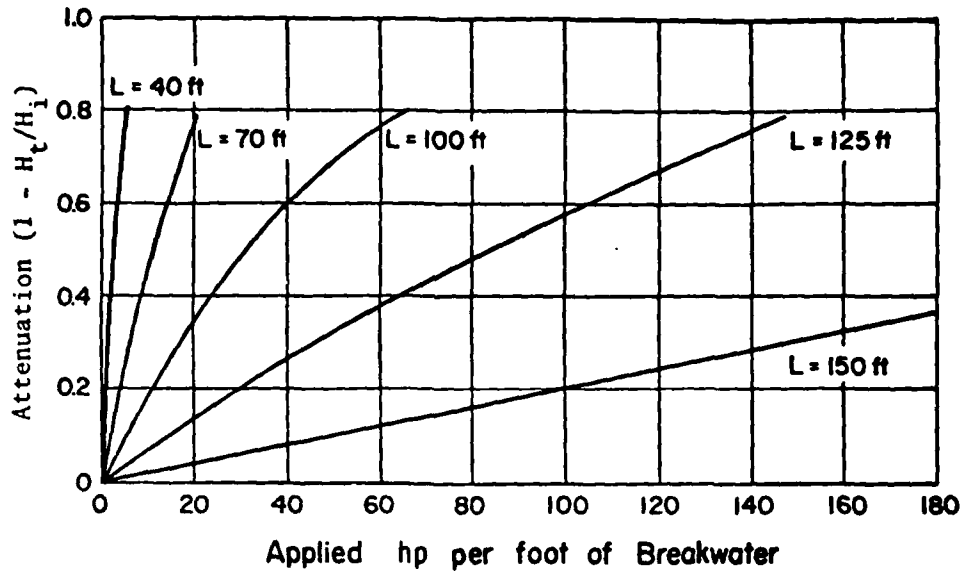


Figure 145. Effect of applied horsepower per foot and wavelength,  $L$ , on effectiveness of pneumatic breakwater at a 40-foot water depth (after Straub, Bowers, and Tarapore, 1959).

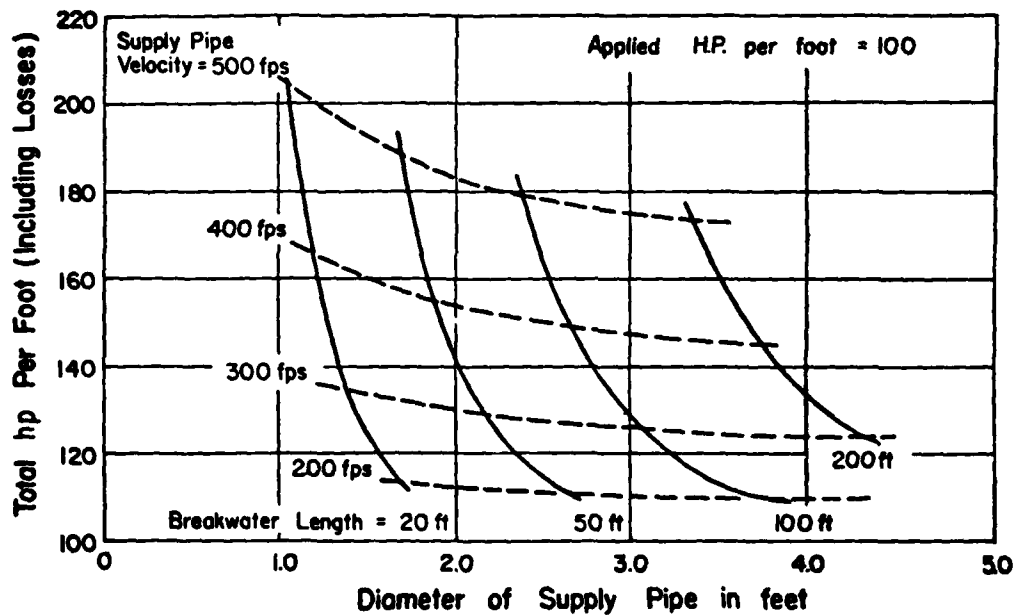


Figure 146. Effect of supply pipeline diameter, length of supply pipeline, and supply pipeline velocity on total horsepower requirements of pneumatic breakwater, extrapolated from small-scale laboratory data (after Straub, Bowers, and Tarapore, 1959).

water surface disturbances downstream were induced, and the effectiveness of the breakwater as a function of frequency could be ascertained. The breakwater tended to operate as a low-band pass filter for the various components of the spectrum. Figure 147 shows that the breakwater was ineffective below a frequency of about 1.8 hertz, but was extremely effective for higher frequency components. This observation was consistent with Taylor's (1955) conclusions, and similar behavior may be expected on larger scale tests and prototype installations.

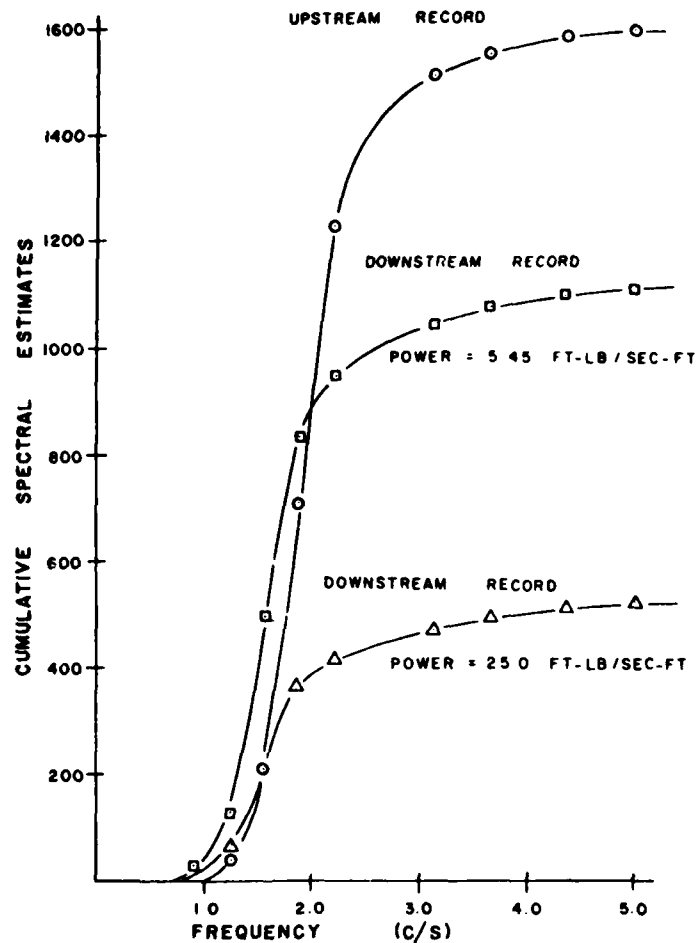


Figure 147. Pneumatic breakwater laboratory investigation of effect of wave frequency and applied power on cumulative spectral density at a 2-foot water depth (after Colonell, Carver, and Lacouture, 1974).

c. Large-Scale Experimental Studies. The need for a mobile breakwater system that allows unrestricted passage over it and does not require the costly construction points directly toward the adoption of pneumatic wave attenuation systems. Although previous research indicated that the volume of air required to produce any reasonable degree of wave height attenuation prohibits the use of this system, recent research has indicated that good

results could be obtained, with refinements in the system, for smaller volumes of air. Sherk (1960) considered that new evidence showed such good possibilities that the concept should not be ignored, and was worth testing to verify or negate the claims. A full-scale experimental tank test program was executed in as near-actual field conditions as possible.

Sherk's experimental study was conducted in CERC's wave tank, 635 feet long, 20 feet deep, and 15 feet wide. A reciprocating wave generator was located at one end of the flume and a submerged rock wave absorber was located at the other end. The normal operating water depth in the tank was 16 feet, and various wave heights, lengths, and periods were generated. The most important, and accurate, measurement needed to regulate and evaluate the effectiveness of a pneumatic breakwater system is the volume of air discharged. Commercial flowmeters were used for this critical airflow measurement. The wave periods tested ranged from 2.61 to 16.01 seconds, sufficiently covering the range of wave periods most often found in the open ocean. A cone anemometer-type rotary meter was used for the water velocity measurements.

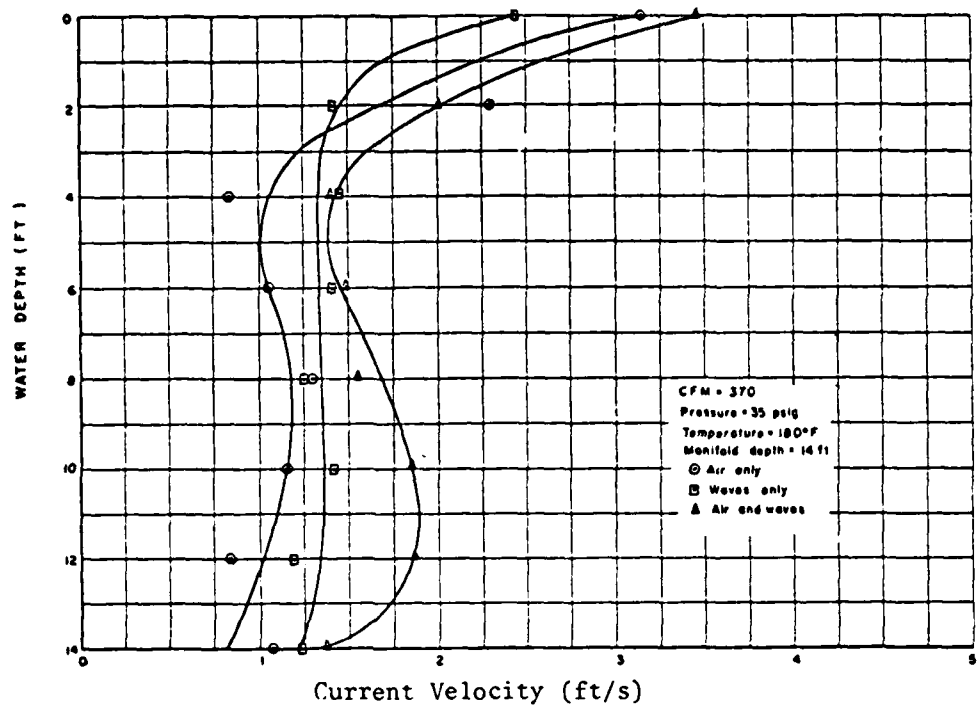
The experimental results recorded during the pneumatic wave attenuation tests provided both a quantitative and a qualitative nature, and showed close agreement with past theory. Much of the analysis is qualitative, and such factors as prototype concepts, construction cost, and ease of operation should be subjectively evaluated. The fact that these tests were large-scale tank tests ensures that the results more closely approach the magnitudes required for a prototype installation than the data from small-scale laboratory tests. Typical examples of the current profiles are presented in Figure 148 for distances of 3 and 16 feet from the pneumatic breakwater. The velocities remained fairly constant for about 36 feet from the system. The attenuation produced by various air discharges is shown in Figure 149 for periods of 3.75 and 5.3 seconds. Figure 149(b) indicates a multiple manifold system may be more effective than a single manifold under prototype conditions. This conclusion could not be ascertained from the results of the previous smaller scale tests, which indicates the necessity for large-scale (near-prototype) investigations when phenomena cannot be extrapolated directly from laboratory tests.

As a result of these large-scale pneumatic breakwater tests, Sherk (1960) concluded that the use of this system in limited problem areas appears to be feasible, although the air requirement would still be high. However, since the need is for large volumes of relatively low-pressure air, it should be within the capability of gas turbine compressors. Pneumatic wave attenuation installations are easily traversed by ship or offloading craft. The large-scale tank tests indicated that approximately one-sixth less air horsepower than was predicted from previous small-scale tests is needed to produce a like attenuation. Open-ocean applications may require even less air than the full-scale tank tests because reflections in the model are not possible under prototype conditions; however, this is not conclusive.

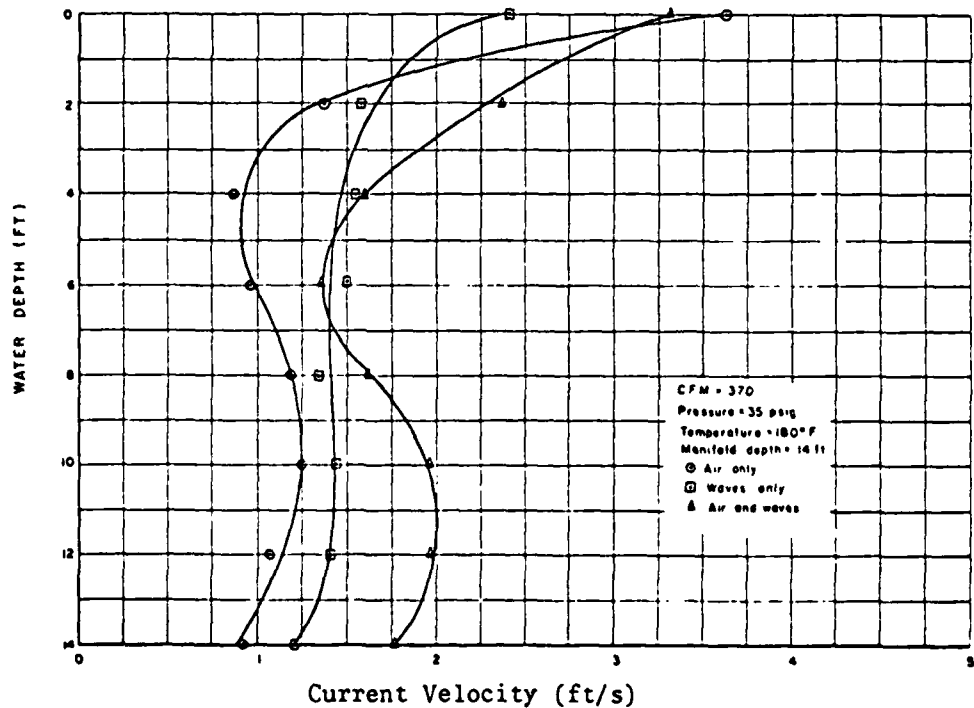
## 2. Hydraulic Breakwater System.

A hydraulic breakwater is formed by discharging water under pressure through a manifold in a direction opposed to a train of surface gravity waves. The water jets diffuse, a horizontal current is formed, and a high degree of turbulence and mixing occurs. When waves propagate into a current,



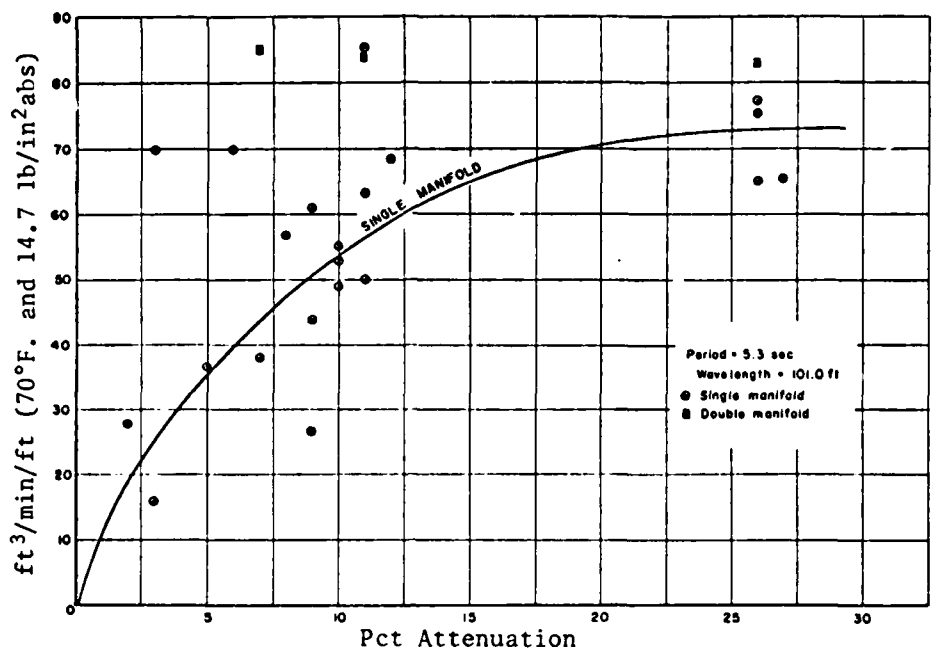


a. Distance = 3 ft from pneumatic breakwater

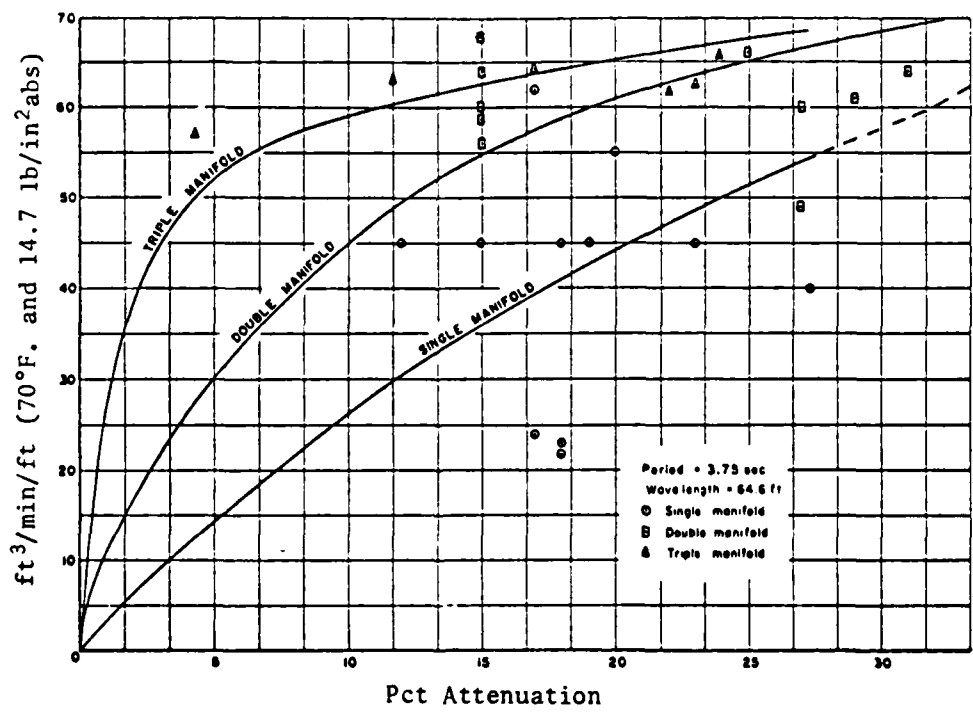


b. Distance = 16 ft from pneumatic breakwater

Figure 148. Current profiles of large-scale pneumatic breakwater system tests (after Sherk, 1960).



a. Wave Period = 5.3 s



b. Wave Period = 3.75 s

Figure 149. Air discharge versus wave height attenuation in large-scale pneumatic breakwater system tests (after Sherk, 1960).

a part of the energy is dissipated by partial or complete breaking. Historically, hydraulic breakwaters were preceded by pneumatic breakwaters. It was a simple advancement to the initial creation of the surface current by the injection of high-velocity water near the surface in a horizontal layer. This development occurred when it was noted that the pneumatic breakwater produces two horizontal currents, one opposing and the other following the incident wave. Nearly half the energy input of the pneumatic breakwater is wasted in generating the unnecessary current. This would not be true for a hydraulic breakwater.

Herbich, Ziegler, and Bowers (1956), Straub, Herbich, and Bowers (1958), and Williams (1960) investigated the characteristics of two-dimensional hydraulic breakwaters for intermediate depth waves (where  $2 < L/d < 20$ ) because it appeared that this type of breakwater would be useful mainly in attenuating waves near the coast. Rao (1968) and Nece, Richey, and Rao (1968) believed that the hydraulic breakwater would have important applications in deepwater waves; e.g., preventing deepwater waves from reaching structures such as floating bridges or offshore drilling operations. The hydraulic breakwater should be most effective for deepwater waves because most of the kinetic energy of the waves is concentrated in the upper layers of the water column.

a. Intermediate Water Waves. The primary objectives of the two-dimensional hydraulic breakwater studies by Herbich, Ziegler, and Bowers (1956) and Straub, Herbich, and Bowers (1958) were to obtain information concerning the effect of various parameters on wave attenuation, discharge, and horsepower requirements. Major parts of the studies were conducted in the larger wave flume (4.5 feet deep) with the use of only one manifold (Fig. 150). The experimental data indicated that the power requirements of the hydraulic breakwater primarily depend on wavelength, water depth, wave steepness, and submergence, spacing, and size of nozzles. The dimensionless horsepower ratio,  $\Phi$ , was again expressed as equation (76), but a dimensionless discharge ratio,  $\Omega$ , was also found to be convenient for data display purposes.

$$\Omega = \frac{q}{[L(gd)^{1/2}]} \quad (78)$$

where  $q$  is the discharge per linear foot of breakwater.

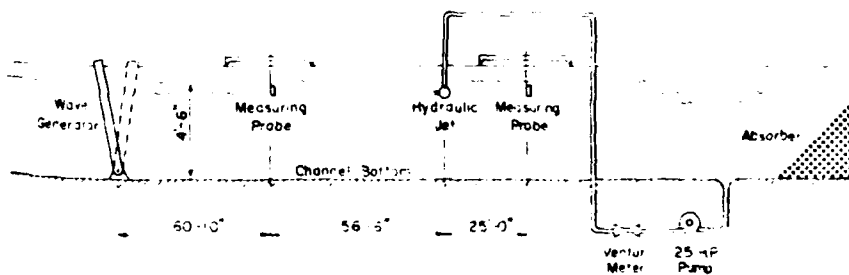


Figure 150. Experimental facility used to evaluate hydraulic breakwater effectiveness (after Herbich, Ziegler, and Bowers, 1956).

(1) Effect of Relative Wavelength. Experimental data were obtained for values of relative wavelength,  $L/d$ , up to 5.60. It appeared that the dimensionless horsepower ratio,  $\phi$ , remained fairly constant for values of  $L/d$  up to about 2.00, and then increased rapidly for larger values of  $L/d$ . Figure 151 illustrates typical data for a 100-percent attenuation; the power requirements for a single manifold increased by a factor of 7 as the  $L/d$  value increased from 2.00 to 5.00.

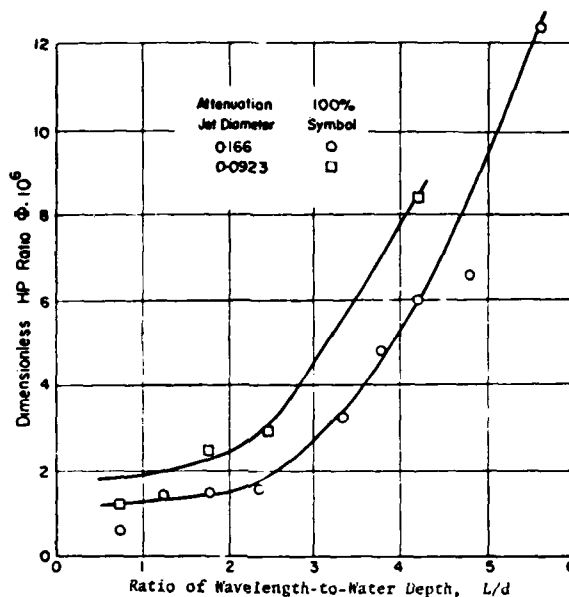


Figure 151. Effect of relative wavelength,  $L/d$ , and nozzle jet diameter on horsepower requirements,  $\phi$ , of hydraulic breakwater (after Herbich, Ziegler, and Bowers, 1956).

(2) Effect of Wave Steepness. Wave steepness was found to have an important effect on power requirements, unlike the performance of the pneumatic breakwater. Figure 152, which presents typical data for three  $L/d$  ratios, displays the effect of wave steepness,  $H_i/L_i$ , on the dimensionless horsepower ratio,  $\phi$ . Considering the curve of  $L/d = 3.33$ , an increase in wave steepness from 0.02 to 0.08 (a factor of 4) increased the required horsepower ratio by a factor of about 3. The true efficiency,  $\epsilon$  (ratio of attenuated wave energy-to-jet energy), however, was considerably higher for the steep waves than it was for the lower waves.

(3) Effect of Jet Area. Herbich, Ziegler, and Bowers (1956) found one of the most important parameters affecting both the dimensionless discharge,  $\Omega$ , and horsepower ratio,  $\phi$ , to be the jet nozzle cross-sectional area per linear foot of breakwater. This jet area is dependent on the jet spacing and the jet size, both of which were varied over considerable ranges during the test program. A dimensionless jet area was defined as the ratio of the area of the jets to the cross-sectional area of the wave channel; the ratio was correlated with the dimensionless discharge and horsepower ratios (Fig. 153). These data indicate that the discharge and power requirements are strongly dependent on the jet area. The power requirements decrease as the

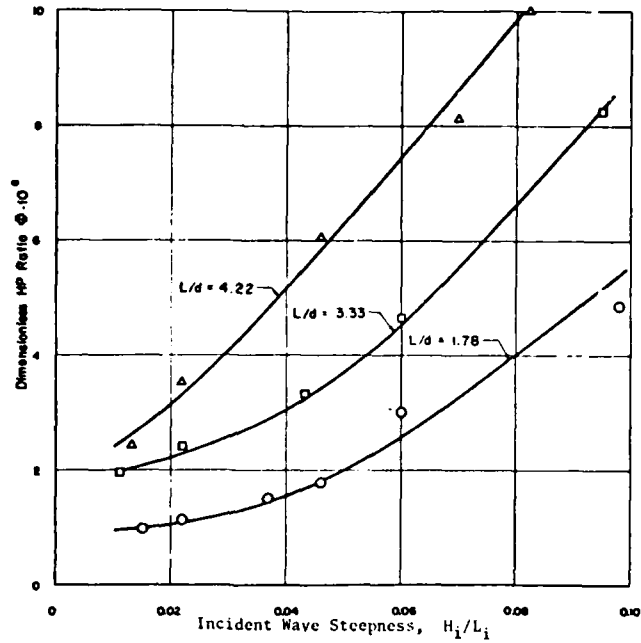


Figure 152. Effect of incident wave steepness,  $H_i/L_i$ , and relative wavelength,  $L/d$ , on horsepower requirements,  $\Phi$ , of hydraulic breakwater (after Herbich, Ziegler, and Bowers, 1956).

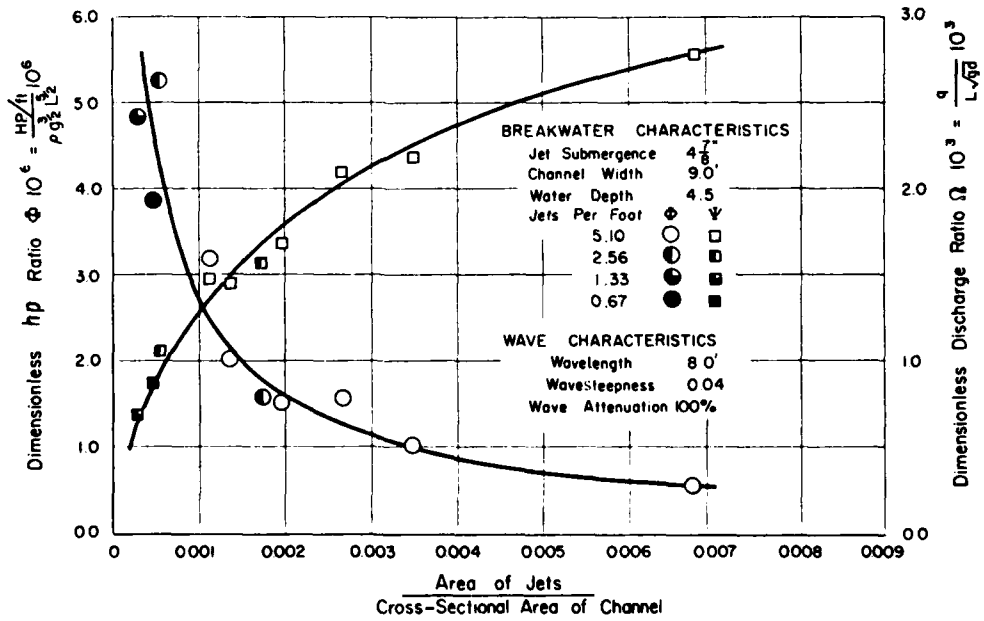


Figure 153. Effect of dimensionless jet area on discharge and horsepower requirements of hydraulic breakwater (after Herbich, Ziegler, and Bowers, 1956).

jet area is increased, and the turbulent losses in the jet decrease as the jet velocity decreases. The overall result of this combination is better efficiency,  $e$ . However, as the jet area is increased, the required discharge is accordingly increased; hence, the use of larger manifolds and supply pipes may be necessitated.

(4) Efficiency. More power was found to be required to attenuate relatively steep waves than for the flatter waves; however, the efficiency of the system,  $e$ , was found to be higher for the steeper waves. Defining the efficiency,  $e$ , as

$$e = \frac{(P_i - P_t)}{P_j} \quad (79)$$

where  $P_i$  is the power of incident wave train,  $P_t$  the power of transmitted wave system, and  $P_j$  the power of hydraulic jets. The experimental data are illustrated in Figure 154. For a one-manifold system, the efficiency,  $e$ , varied with incident wave steepness,  $H_i/L_i$ , attenuation, and relative wavelength,  $L/d$ , with the maximum efficiency about 12 percent. The attenuation and total power requirements are presented in Figures 155 and 156.

b. Deepwater Waves. Rao (1968) and Nece, Richey, and Rao (1968) conducted two-dimensional studies of the effectiveness of hydraulic breakwaters in attenuating deepwater waves. The studies covered mostly a range of  $L/d < 1$ , since few detailed results were available in this range. The incident wave steepness,  $H_i/L_i$ , varied from 0.01 to 0.11, which is the range of typical representative deepwater conditions. The manifold was designed so that the average efflux velocity would be the same for all jets, and the current velocity was measured in the absence of waves.

A major concern of this investigation was the effect of relative jet power,  $P_r$ , on attenuation of deepwater waves of various steepness, and on efficiency. The relative jet power is defined as

$$P_r = \frac{P_j}{P_i} \quad (80)$$

where  $P_j$  is the energy flux across the cross section of the jets (power available from the jets) per unit width of tank, calculated at the plane of orifice outlet, and  $P_i$  the rate at which energy is transmitted by the incident waves across the tank cross section per unit width of wave tank. The effect of the relative jet power is shown in Figure 157 for  $L/d = 0.53$ ; the data extend over the complete range of attenuation. The attenuation increases with increasing  $P_r$ , and the curves tend to flatten in the range of higher attenuation. In other words, the amount of extra jet power required to increase the attenuation from 80 to 100 percent, for example, is higher than that needed to increase the attenuation from 20 to 40 percent. For the finite observed attenuation at  $P_t = 0$ , an explanation is that the breakwater, when it is not functioning, can be considered a fixed, submerged circular cylinder. As the steepness increases, the relative jet power required to achieve a given attenuation decreases. The breakwater is more efficient in damping steeper waves, and this trend conforms with the fact that as steepness increases, the crests tend to become less stable. Spilling rollers, although not completely breaking, are formed, and energy is lost.

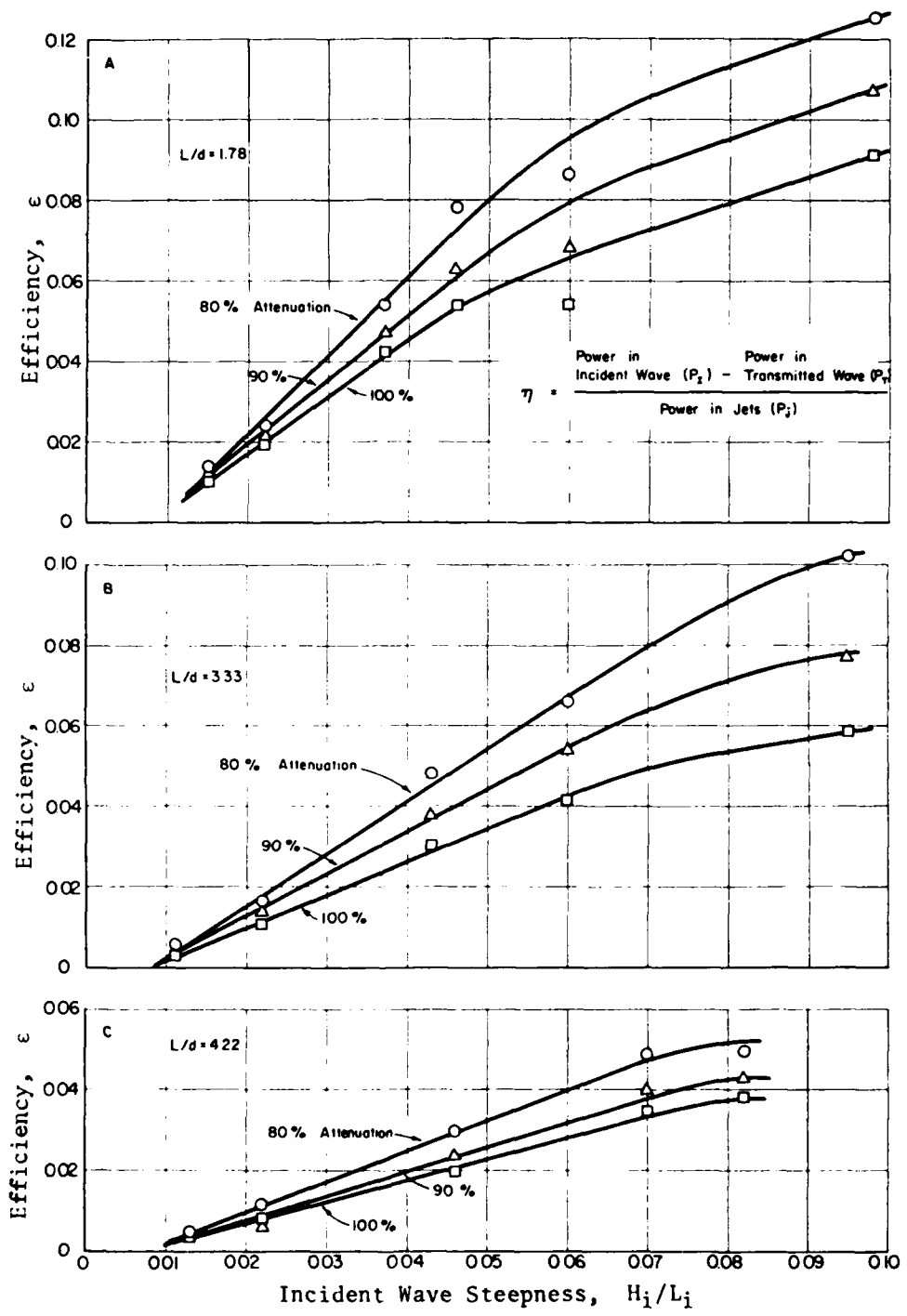


Figure 154. Efficiency,  $\epsilon$ , of hydraulic breakwater as a function of incident wave steepness,  $H_i/L_i$ , and relative wavelength,  $L/d$  at water depth = 1 foot, jets per foot = 23, jet diameter = 0.166 inch, jet submergence = 1.08 inches (after Herbich, Ziegler, and Bowers, 1956).

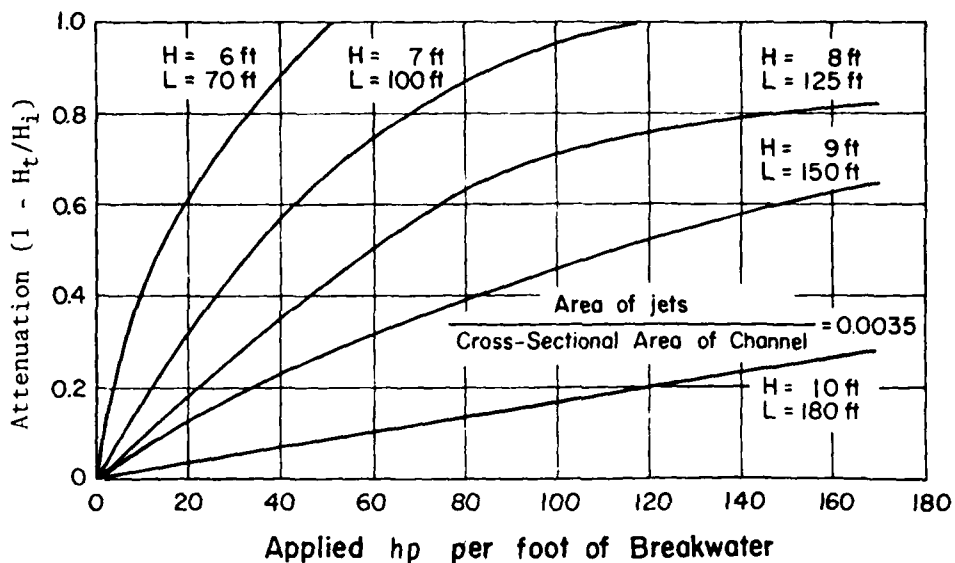


Figure 155. Effect of applied horsepower per foot, and wavelength,  $L$ , on effectiveness of hydraulic breakwater (various wave heights,  $H$ ) at a 40-foot water depth (after Herbich, Ziegler, and Bowers, 1956).

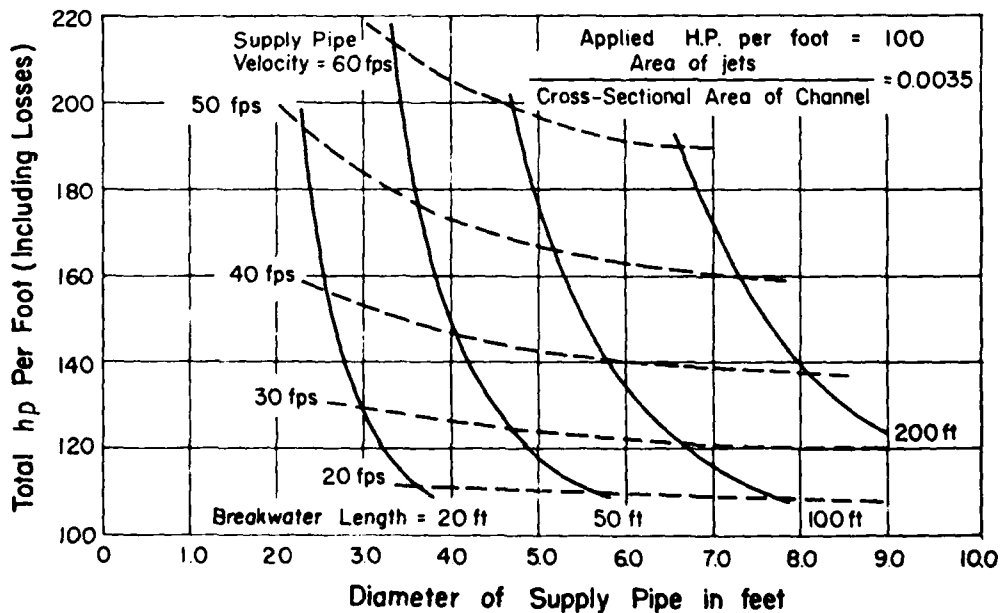


Figure 156. Effect of supply pipeline diameter, length of supply pipeline, and supply pipeline velocity on total horsepower requirements of hydraulic breakwater, extrapolated from small-scale laboratory data (after Herbich, Ziegler, and Bowers, 1956).



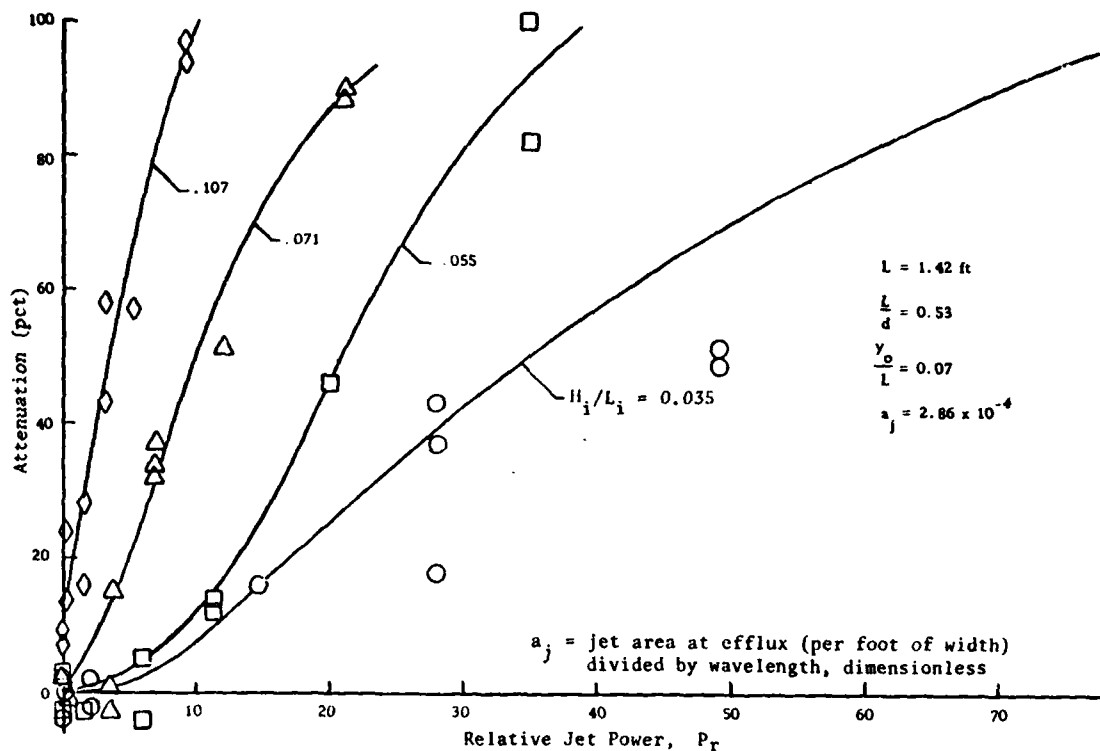


Figure 157. Two-dimensional test on effect of relative jet power,  $P_r$ , and incident wave steepness,  $H_i/L_i$ , on attenuation of deepwater waves for a hydraulic breakwater (after Rao, 1968).

Rao's (1968) observations in studying the effect of relative depth of submergence,  $y_o/L$ , are shown in Figure 158. These data show that generally, as the relative depth of submergence is increased, the attenuation decreases. The local peculiarity observed in the trend of  $P_r = 2.52$  was investigated. The experimental results on the effect of manifold submergence on the current for the same discharge indicated that as the depth of submergence,  $y_o$ , is decreased, there is a range of  $y_o$  in which the momentum of the current at a given section downstream may decrease with  $y_o$ . Since the interaction of the incident deepwater wave and the current is strongly dependent on the free-surface conditions, this could result in a decrease in the attenuation. The experimental data were limited, and it was not possible to define all conditions under which such an event would occur.

The efficiency,  $e$ , of the entire hydraulic breakwater system was considered. Equation (79) defines the efficiency of the attenuation; Rao's (1968) experimental data are shown in Figure 159. Two basic trends are evident: (a) efficiency increases with wave steepness,  $H_i/L_i$ , and (b) efficiency decreases as attenuation increases. The data indicate that the efficiency of the hydraulic breakwater in attenuating deepwater waves does not exceed about 12 percent for most of the experimental data in the range of attenuation considered. This has serious implications because it raises the question of economic feasibility in applying the hydraulic breakwater to prototype conditions.

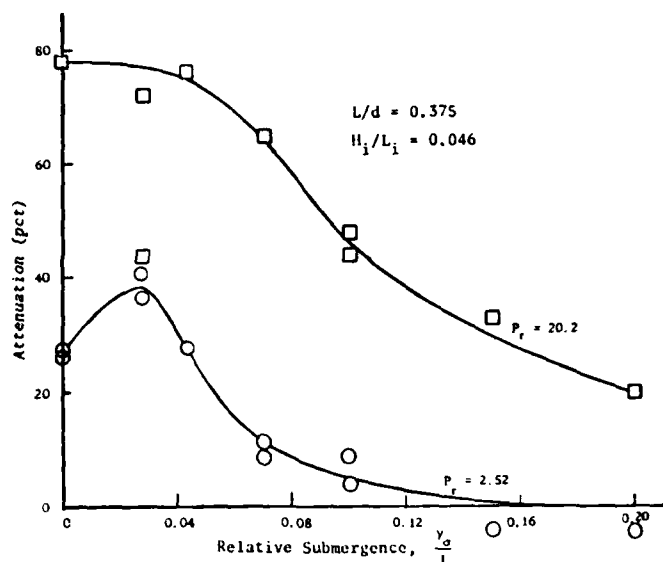


Figure 158. Two-dimensional tests on effect of relative depth of submergence,  $y_0/L$ , and relative jet power,  $P_r$ , on attenuation of deepwater waves for a hydraulic breakwater (after Rao, 1968).

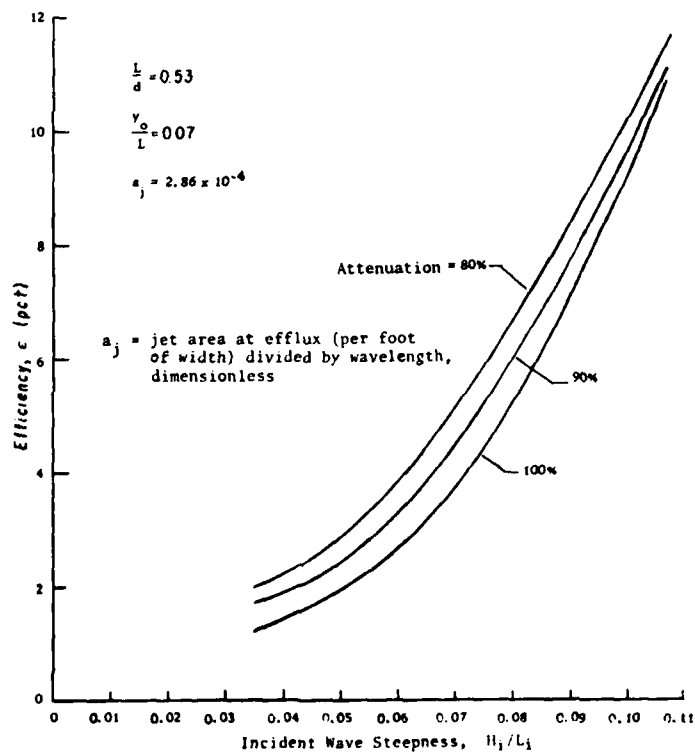


Figure 159. Effect of incident wave steepness,  $H_1/L_1$ , on efficiency,  $e$ , for various degrees of attenuation, two-dimensional deepwater wave test, hydraulic breakwater (after Rao, 1968).

## X. FLEXIBLE-MEMBRANE FLOATING BREAKWATERS

For short waves in the upper layers of the water column, a deep-draft floating breakwater is not needed; however, for long waves, deep draft may be desirable but difficult because of such large mooring forces. Hence, an optimization is required between wave attenuation aspects and mooring loads. Soft floating systems have certain operational and logistic advantages over rigid structures. Damage and possible loss from collisions in rough water should not be a problem for flexible floating breakwaters; therefore, the mooring arrangement is less critical. Although the strength of the material in a flexible barrier may be a limiting factor, a properly designed flexible breakwater will probably not be subject to the resonances which increase the peak mooring loads in rigid breakwater systems. Because of the collapsible nature of a flexible breakwater, from the military standpoint, a transport vessel could carry more linear feet of this breakwater than other types. Several varieties of surface floating membranes have been investigated, as well as component structures constructed of fluid-filled bags from such flexible-membrane materials.

Among the concepts tested as flexible wave barriers, the blanket layer types are preferred to bag types for operational and logistic reasons. Puncturing problems and the equipment needed for filling bags complicate the construction of a bag system. The major disadvantage of all blanket layer types is that great widths relative to the wavelength are required to obtain satisfactory wave attenuation. For ocean waves, this implies great absolute lengths, since wave height reduction depends largely on the viscosity of the water, and this property is relatively ineffective in the absence of great turbulence.

A significant number of laboratory experiments have been conducted with various types of floating membrane and fluid-filled bags. Although the studies are valuable in visually studying breakwater action and comparing data, the studies may not provide definitive data for assessing the potential of flexible floating breakwaters. The data cannot be scaled directly for prototype predictions because the role of the properties of the materials was not explicitly defined (Jones, 1974).

### 1. Membrane Layers.

The wave damping properties of several floating plastic materials were investigated by Keulegan and Kulin (1958), and plastic mats were experimentally studied by Schwartz and Watts (1959), and Watts (1960), as a result of the 1958 tests. Specific tests of certain patented designs of floating membrane layers were conducted by Frederiksen and Wetzel (1959), and by Ripken (1960a).

a. Wave Trap. The U.S. Rubber Company developed the Wave Trap, a proprietary design of a wave absorber, in the late 1950's. Ripken (1960a) conducted experimental studies of the Wave Trap which was then investigated analytically by U.S. Rubber Company (1961) and Miller (1961a, 1961b, 1961c). The system consists of a large, thin, rather impermeable floating sheet fitted with numerous attachment cords supporting a large, thin valve sheet (horizontally weighted to trap short-period waves, vertically weighted to trap long-period waves) (Fig. 160). The valve sheets are shown in

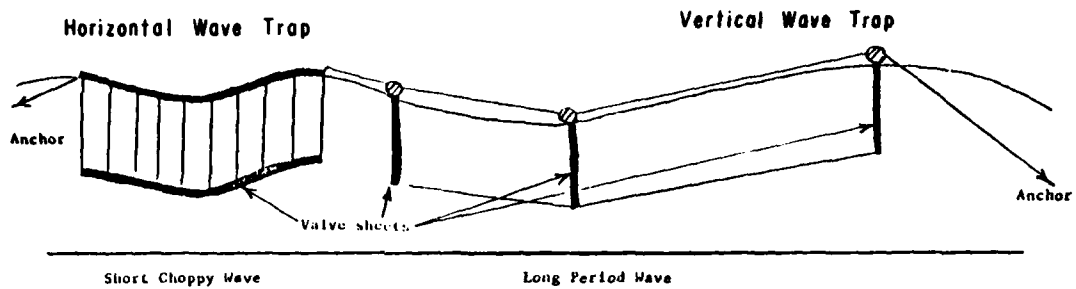


Figure 160. Conceptual model of horizontal and vertical Wave Trap floating membrane breakwater developed by U.S. Rubber Company.

Figure 161. Preliminary research by the U.S. Rubber Company indicated that the most successful membrane-type wave damping system consisted of a flexible floating blanket, which rides on the top of the sea surface, attached by numerous flexible cords to a second weighted blanket suspended beneath the sea surface. The bottom sheet is valved for maximum resistance when rising and minimum resistance when falling. In this arrangement, the rising and falling of the wave tends to accelerate the large mass of water contained between the two sheets, which effectively reduces the wave amplitude. The efficiency of the system was good in the preliminary tests on waves of high steepness because of the large vertical accelerations (vertical forces). Low steepness required a long trap (in width) to achieve a substantial reduction in wave height. U.S. Rubber Company has conducted research on variations of the basic conceptual arrangement.

In a prototype situation, the Wave Trap assembly would be anchored in the ocean in relatively shallow water but beyond the breaker formation point. Waves moving in from deeper water will pass through the first baffle sheet. Because one of the remaining valve sheets will generally be positioned at least one-half a wavelength away, the forces of the wave against the shoreward baffle will be balanced by opposing forces acting against the seaward baffle sheet. This effect tends to exert an accelerating effect on the mass of water in the wave train without putting a large strain on the anchor lines (U.S. Rubber Company, 1961).

(1) Wave Attenuation Effectiveness. For Ripken's (1960a) experimental investigation, the float sheet of the Wave Trap was composed of four 18-inch-wide strips lashed together to form one large, impermeable sheet. The valve sheet was a coated, synthetic fabric with the edge stiffened and transversely weighted with metal rods. Closely spaced holes (diameter, 1-5/8 inches), fitted with 2-3/4- by 3-inch coated fabric flaps to serve as check valves, were arranged in a staggered pattern (Fig. 161) with about one-half inch of fabric between holes. The valve flaps readily opened and closed for upward and downward flow, respectively. The assembly was tested in 20-foot lengths (breakwater width) and was exposed to various wavelengths and wave steepnesses, with a 1:10 mooring line slope and a 4.5-foot water depth.



a.



b.

Figure 161. Valve sheet details of Wave Trap flexible-membrane floating breakwater concept (1961 photo by U.S. Rubber Company).

Figure 162 showed excellent wave height attenuation for small values of the ratio of wavelength-to-trap length. The attenuation coefficients then diminished with increasing values of the ratio; reflection was not a major factor. The Wave Trap showed a slight decrease in performance with increased wave steepness. Limited duration tests indicated the system design appeared to be restricted to wave heights of about 1 foot. Larger values produced evidence of structural damage due to the dynamic wave forces. Direct scaling to prototype dimensions for ocean-type installations would involve wave heights 5 to 10 times those of the laboratory tests; hence, the internal forces and stresses would range from about 100 to 1,000 times as great as those in the model. It appears impractical to design a Wave Trap to sustain such prototype forces. Ripken (1960a) recommended that the sheet spacing be retained at a distance that would provide a differential vertical orbiting distance of about 1 foot.

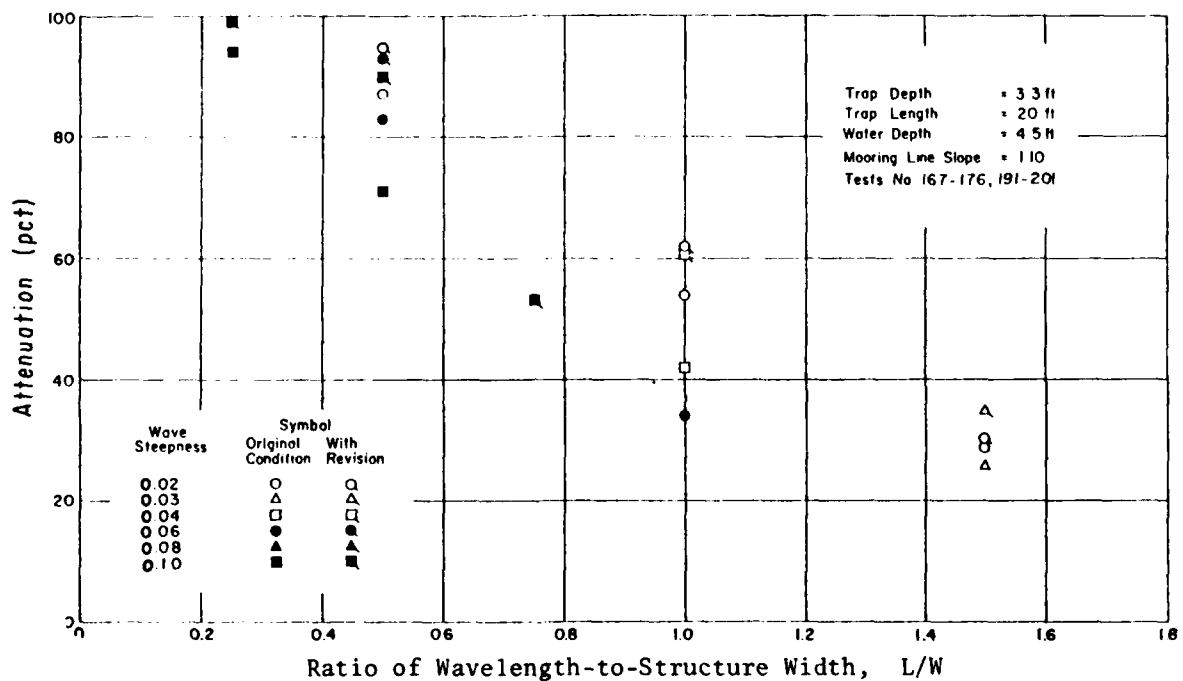


Figure 162. Effect of relative breakwater width,  $L/W$ , and incident wave steepness,  $H_1/L_1$ , on wave height attenuation for the Wave Trap membrane-type floating breakwater concept by U.S. Rubber Company (after Ripken, 1960a).

(2) Mooring Force Evaluation. Ripken (1960a) conducted tests with the Wave Trap structure moored by a single cable running at a selected slope angle between the mooring tube lashed to the front of each absorber and a mooring line anchor on the channel floor. The mooring forces were evaluated with a dynamometer which measured the tension in the mooring cable at the bottom anchorage. The mooring line force data obtained from these rather limited tests are shown in Figure 163; the data were obtained under two-dimensional conditions and should be used conservatively. In low steepness waves, the Wave Trap tends to move forward into the oncoming wave train. This situation requires either stern mooring lines or revision of the check valves to provide a better balance of valve-induced horizontal forces.

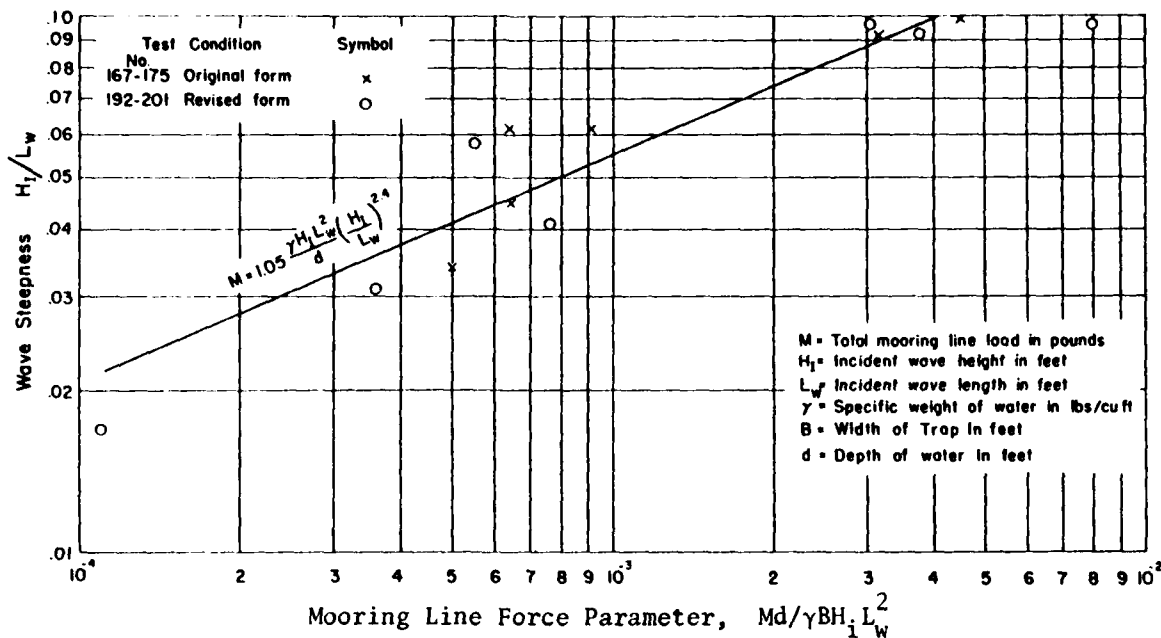
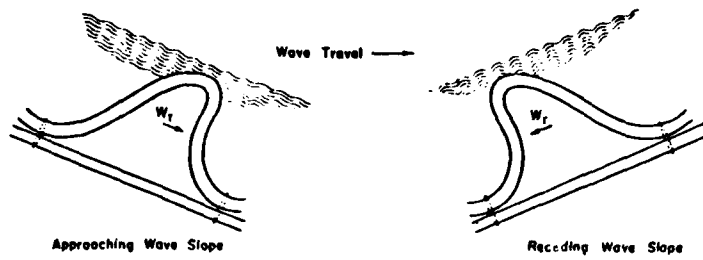


Figure 163. Mooring line force versus wave steepness for Wave Trap membrane-type floating breakwater concept by U.S. Rubber Company (after Ripken, 1960a).

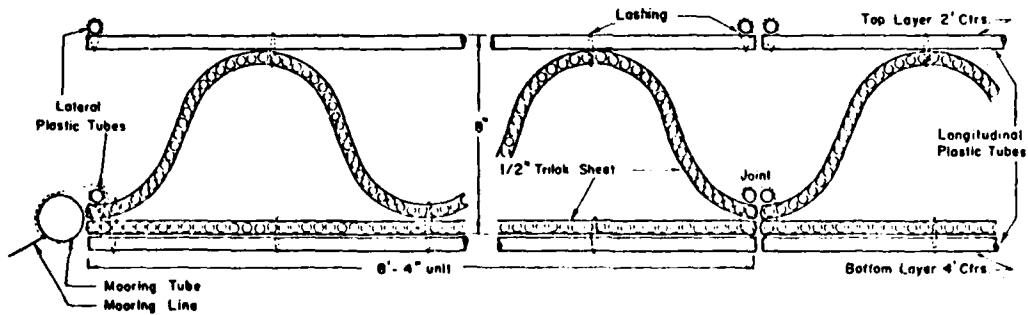
b. Wave Blanket. Ripken (1960a) investigated the effectiveness of the Wave Blanket, a proprietary design of a wave absorber also developed by U.S. Rubber Company. The design consists of a moored blanket of permeable material designed to float just below the surface of the waves. The concept of the design assumes that the orbit and translation velocity of the wave will force a flow through the permeable structure of the blanket; the flow resistance of the dense permeable structure should induce enough energy loss to dissipate parts of the wave energy.

The blanket units in Ripken's (1960a) tests were assembled from sheets of three-dimensional fabric woven from stiff plastic fibers varying from 0.014 to 0.020 inch in diameter. The fabric used in the two-dimensional wave tests was designated 4-ply "Trilok," about 1/2 inch thick; the total thickness of the various units tested ranged from 8 to 24 inches. The nature of the fabric, which is slightly buoyant in freshwater, is shown in Figure 164. The blanket assembly consisted of two sheets of Trilok fabric. The upper sheet had a corrugated or sine waveform, and the lower sheet lay flat. The two sheets were lashed together with plastic cording to form the unit blankets, which were then attached to form various test assemblies up to 50 feet wide.

Ripken's (1960a) initial tests demonstrated that where waves had a length greater than the blanket width, the blanket was subjected to substantial alternate tension and compression across the width. In tests using multiple layers of the basic blanket unit, the individual layers were securely lashed at close intervals around the outside edges of the blanket units and at spaced intervals in the interior. Mooring stiffeners were provided across the front of the top and bottom layers of the stacked units. Tests were conducted with the one-, two-, and three-layer blankets at a total thickness of 8, 16, and 24 inches, respectively. Figure 165 is a schematic diagram of the Wave Blanket



a. Distortion of Wave Blanket under wave action



b. Structure of Wave Blanket

Figure 164. Physical characteristics of Wave Blanket concept of membrane-type floating breakwater by U.S. Rubber Company (after Ripken, 1960a).

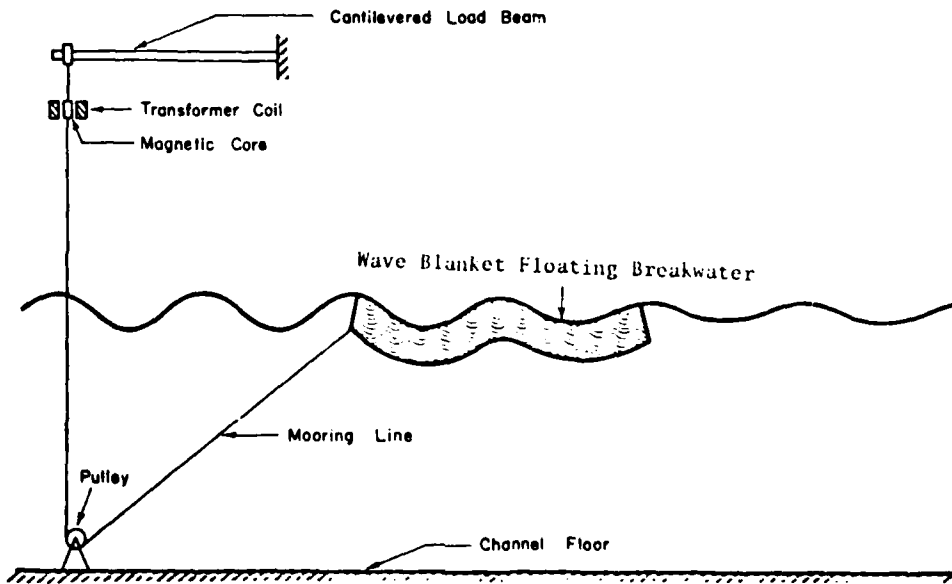


Figure 165. Schematic diagram of Wave Blanket concept in test facility for attenuation and mooring load studies (after Ripken, 1960a).



installation in the experimental facility for attenuation and mooring load determinations.

An important requirement of hydraulic model testing is the establishment of the modeling laws regarding basic forces which dominate the physical processes. For model tests of many hydraulic designs, previous experience has defined the dominant force system and the related model laws of similitude. However, there is no precedent for the Wave Blanket which clearly establishes the force mechanism. An analysis of the force system, which dominates the fluid dynamics of the blanket action, indicates that both viscous and gravity forces may be involved extensively. It was originally hypothesized that viscous action in the permeable blanket structure controlled the attenuation effects, but the extent to which gravity effects are felt is obscure. Because of the variety of factors which interact in the Wave Blanket system and the inability to scale the physical properties of the system, it is difficult to summarize the performance.

(1) Wave Attenuation Effectiveness. Since various thicknesses (layers) of the Wave Blanket were tested, Ripken (1960a) treated the test data as broad, inclusive bands representing significant differences in thickness. Figure 166 indicates that the degree of attenuation increased as the ratio of wavelength-to-blanket width decreased, and as the ratio of blanket thickness-to-water depth increased. For a thin blanket, the width should be several times the wavelength, and the thickness should be about 15 percent or more of the water depth. A blanket construction with decreasing thickness from front to rear has approximately the same attenuation characteristics as a blanket with the same width and volume and a uniform thickness. A blanket fabrication, using a dense sponge, gave essentially the same type of attenuation as the blanket of permeable Trilok. The conclusion was that internal flow resistance within the Trilok material accounts for only a minor part of the total energy dissipation. Attenuation did not appear to be critically dependent on the structure of the blanket, provided the system interfered with orbiting of the contained fluid.

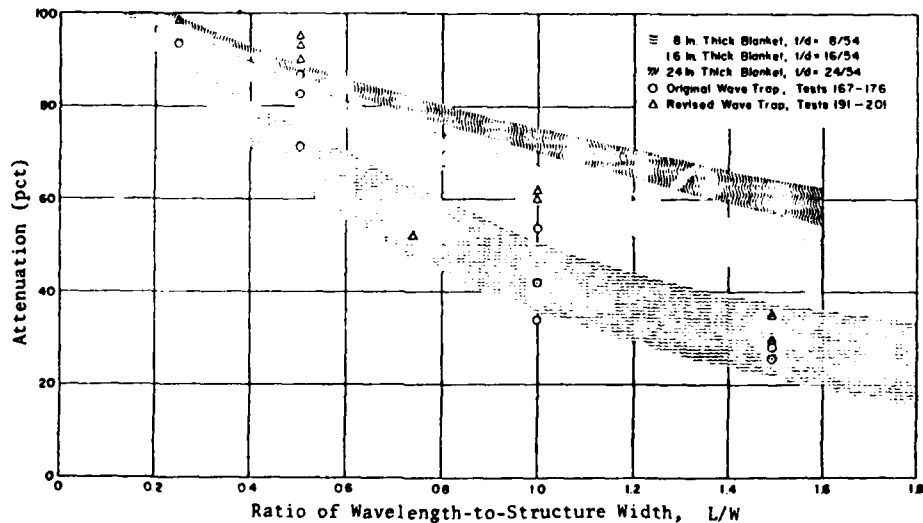


Figure 166. Effect of relative breakwater width,  $L/W$ , and various thicknesses and widths of blanket on wave height attenuation by Wave Blanket concept of membrane-type floating breakwater of U.S. Rubber Company (after Ripken, 1960a).

(2) Mooring Force Evaluation. Based on Ripken's (1960a) experimental studies, the magnitude of the mooring force may be determined from Figure 167 or from the equations in the figure. These data can probably be applied to scaled versions of blankets proportioned similar to those of the test unit, provided the three-dimensional end effects are considered. Blankets with a short width relative to the wavelength involve mooring forces that continually oscillate from zero to a maximum, which is somewhat irregular for successive waves. Blankets with a long width relative to the wavelength involve mooring forces that continually oscillate from some nonzero value to a maximum. The pattern of force variation is quite uniform for successive waves. The mooring forces in Figure 167 were derived from tests with a relatively inelastic mooring system. Other mooring systems which involve greater elastic or damping action may be expected to reduce these peak mooring force requirements. The mooring force for a given blanket and wave condition did not change materially for variations of 1:4 to 1:10 in the mooring line slope.

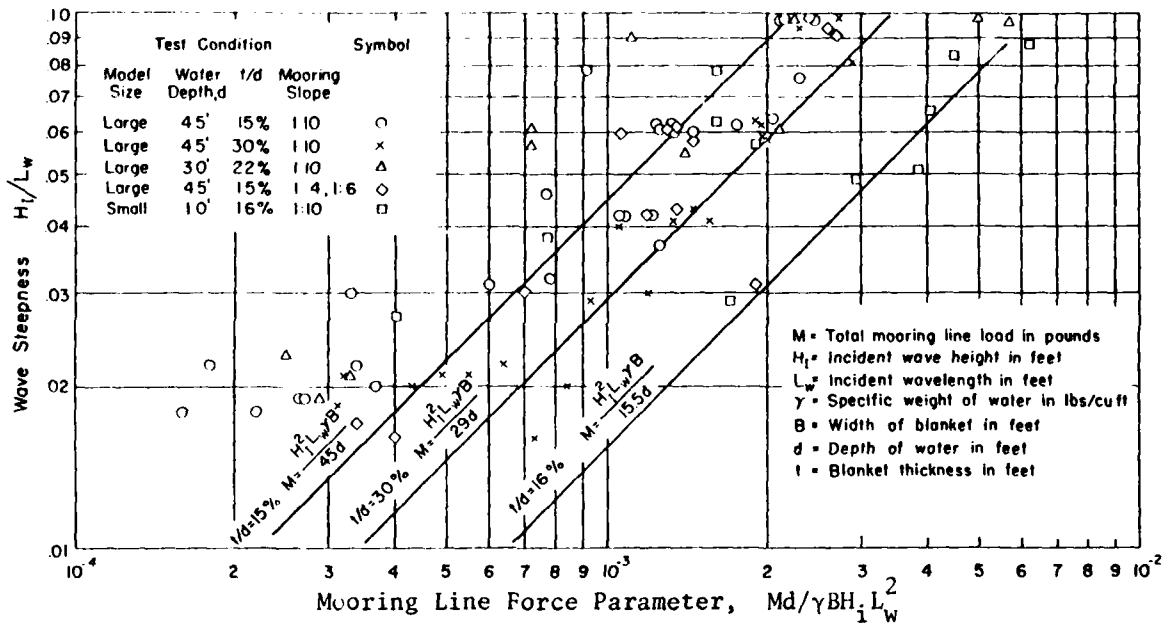


Figure 167. Mooring line force versus wave steepness for Wave Blanket concept of membrane-type floating breakwater by U.S. Rubber Company (after Ripken, 1960a).

c. Thin Surface Barriers. Frederiksen and Wetzel (1959), Schwartz and Watts (1959), Watts (1960), Ripken (1960a, 1960b), and Ofuya and Reynolds (1967) have experimentally studied several other types of thin membranes (plastic sheets, polyethylene films, and rubber material). A comparison of the materials was somewhat hampered by the lack of uniformity in data presentation. To provide a common format, Jones (1974) reanalyzed the data of these researchers and presented transmission coefficients,  $C_t$ , as a function of relative water depth,  $L/d$ , for the parameter of wave steepness,  $H/L$ . Figures 168 to 171 provide Jones' reanalysis of four different materials.

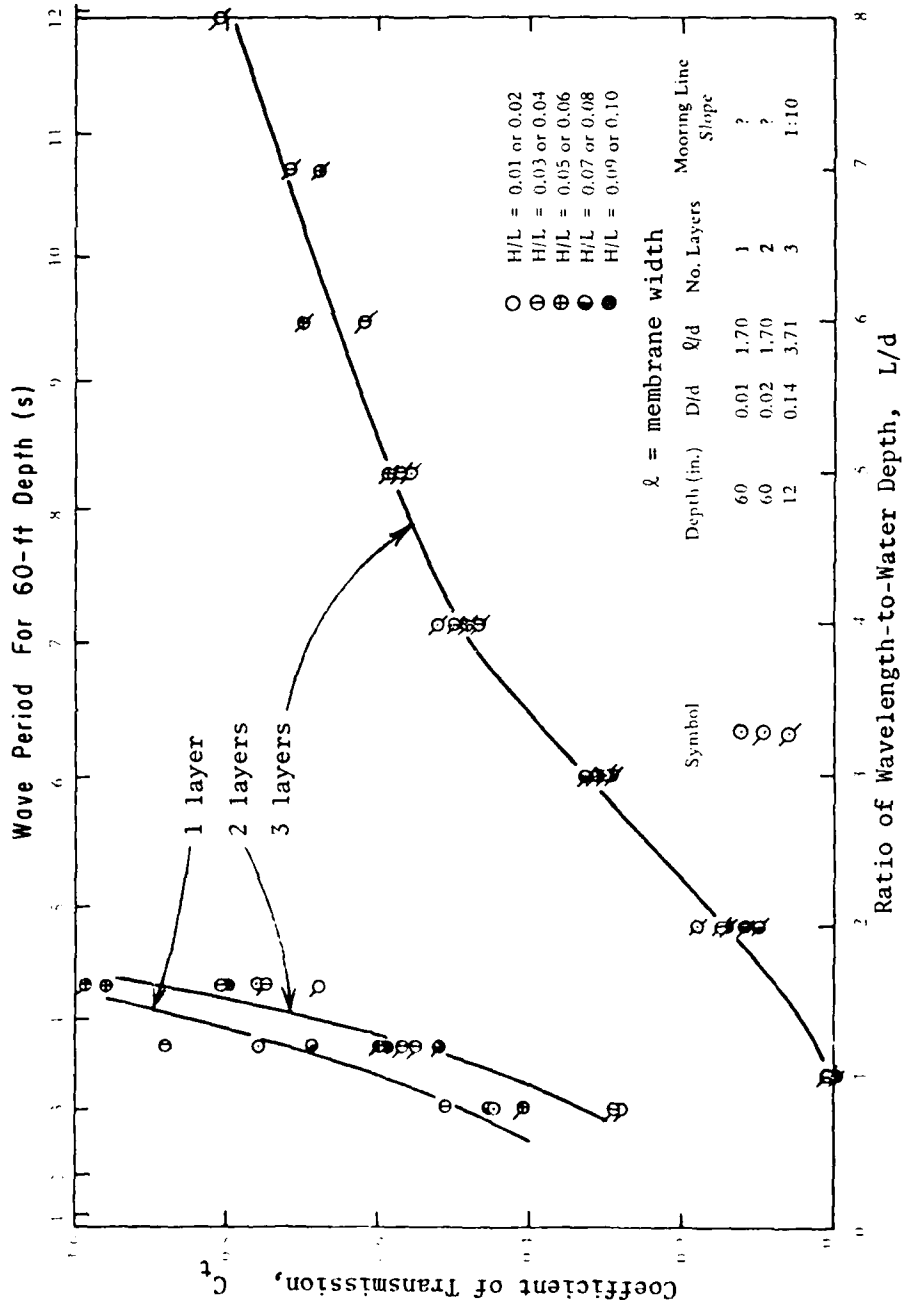


Figure 168. Effect of relative water depth,  $L/d$ , and incident wave steepness,  $H/L$ , on transmission coefficients,  $C_t$ , for a woven fabric of plastic fibers (after Jones, 1974).

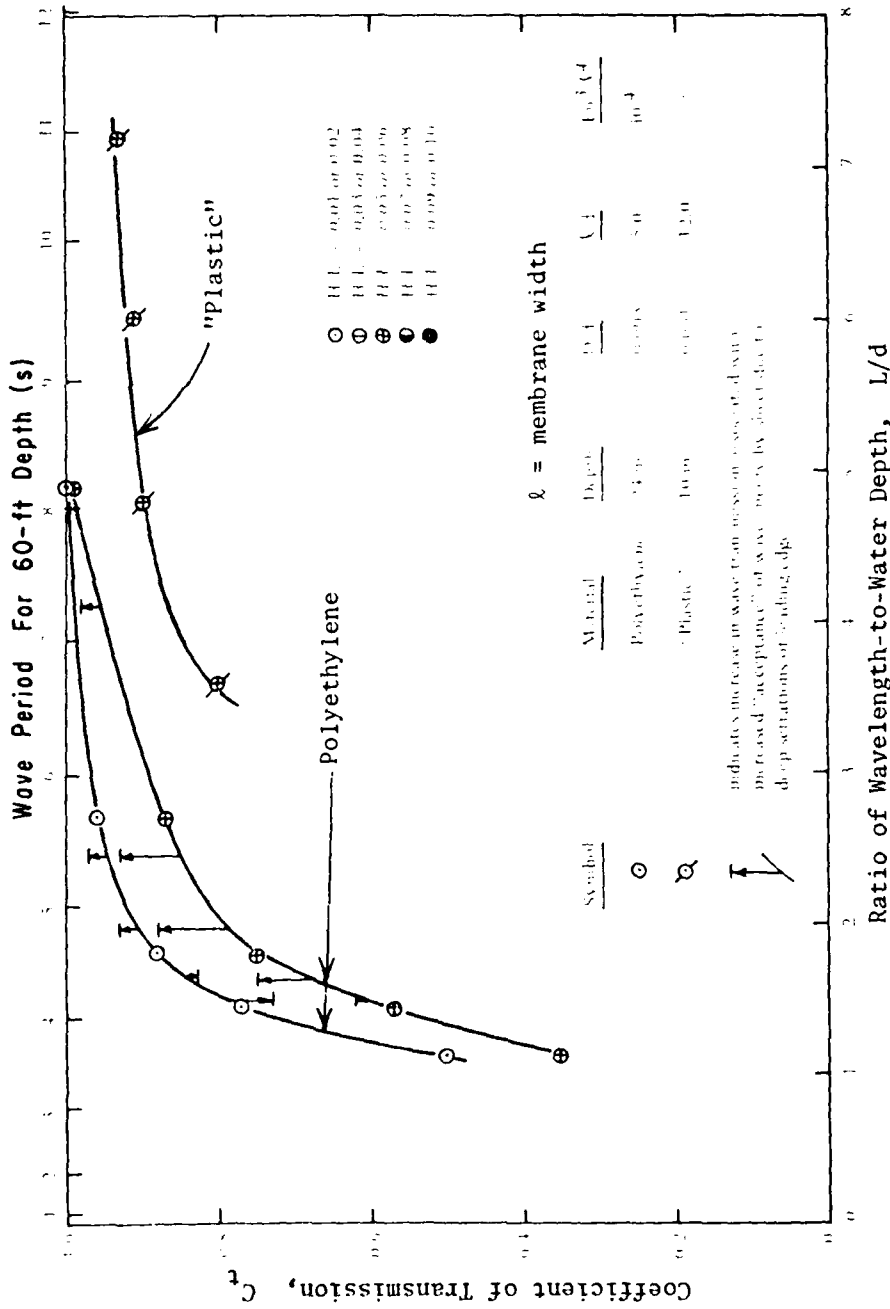


Figure 169. Effect of relative water depth,  $L/d$ , and incident wave steepness,  $H/L$ , on transmission coefficients,  $C_t$ , for thin impervious sheets of plastic or polyethylene (after Jones, 1974).

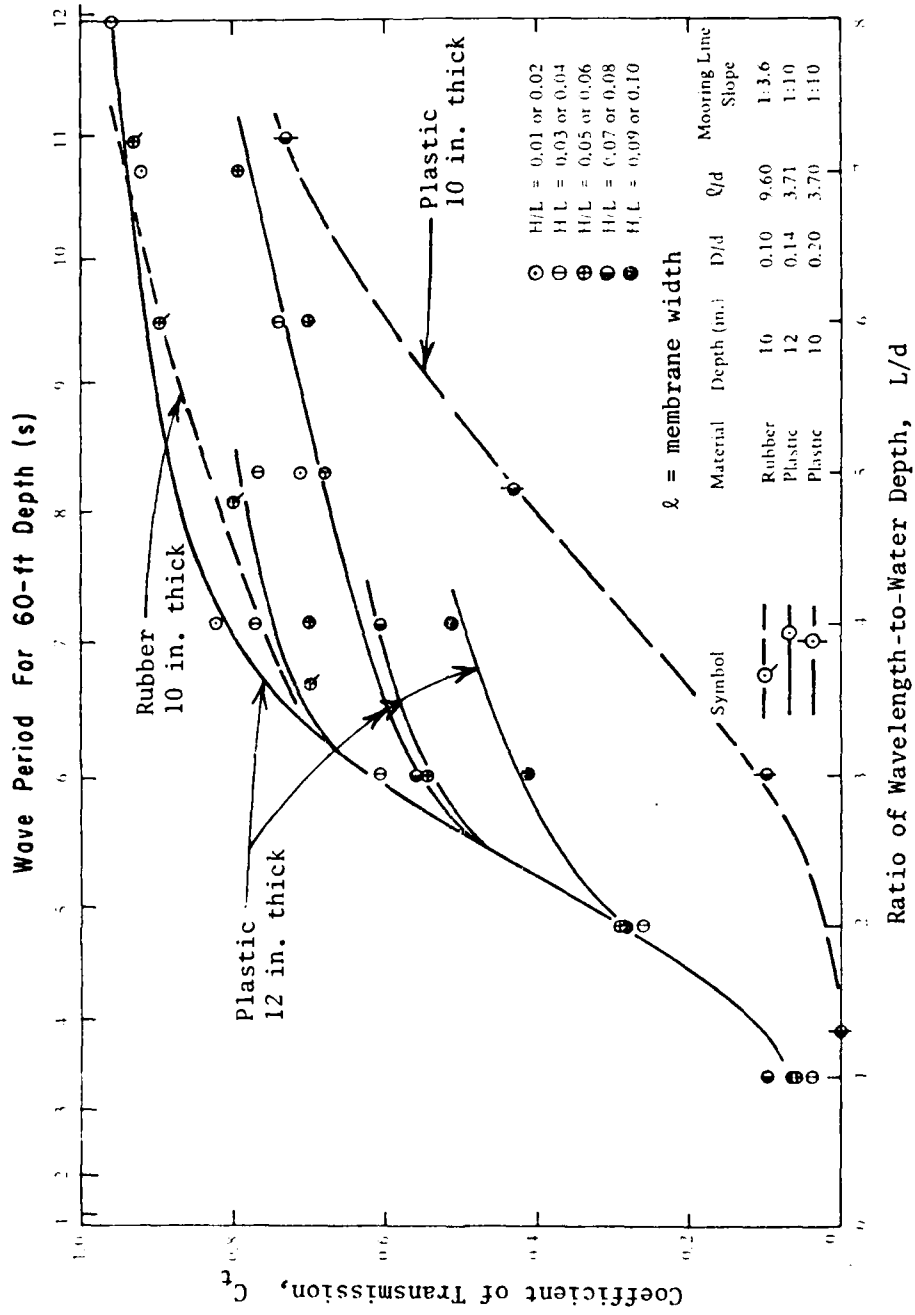


Figure 170. Effect of relative water depth,  $L/d$ , and incident wave steepness,  $H/L$ , on transmission coefficients,  $C_t$ , for sponge blankets of various thicknesses (after Jones, 1974).

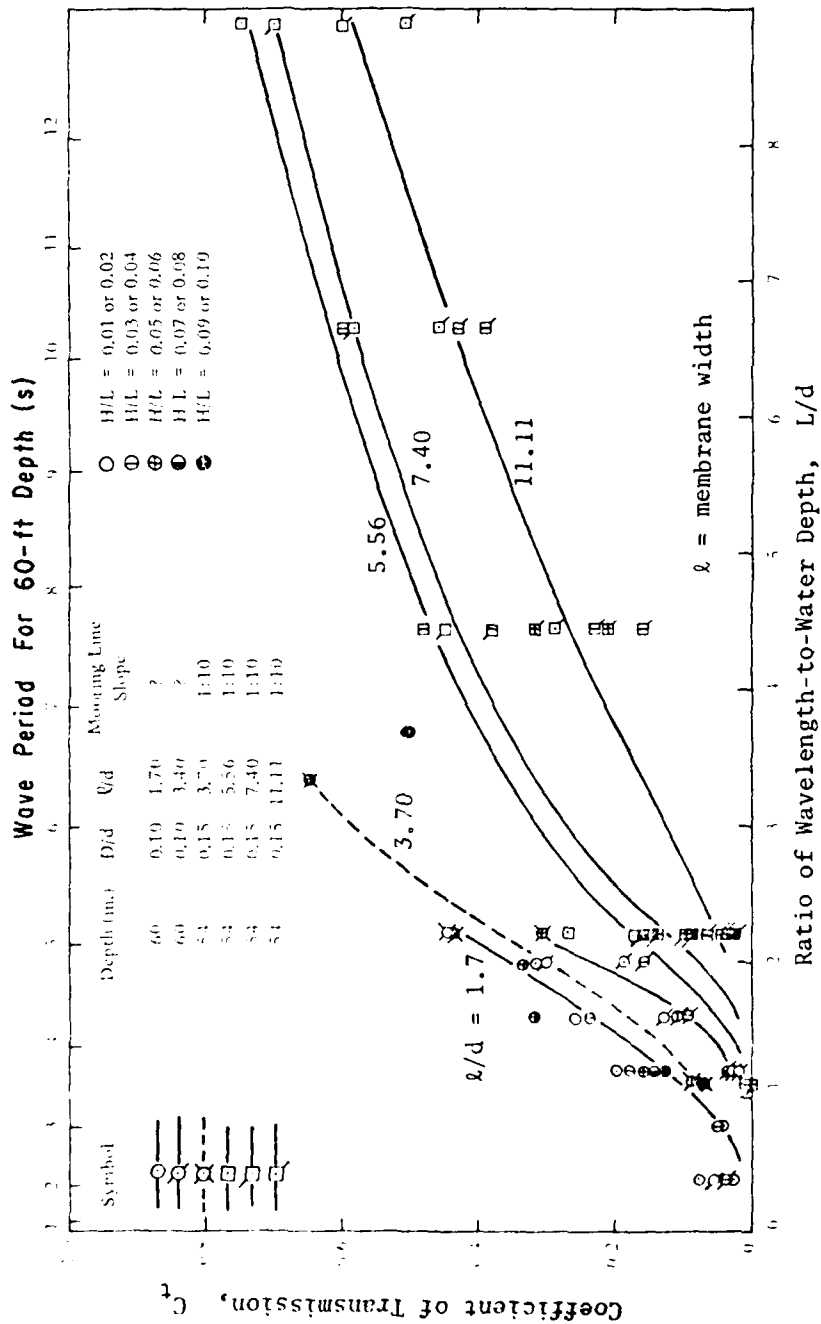


Figure 171. Effect of relative water depth,  $L/d$ , and incident wave steepness,  $H/L$ , on transmission coefficients,  $C_t$ , for a corrugated blanket of woven plastic fabric (after Jones, 1974).

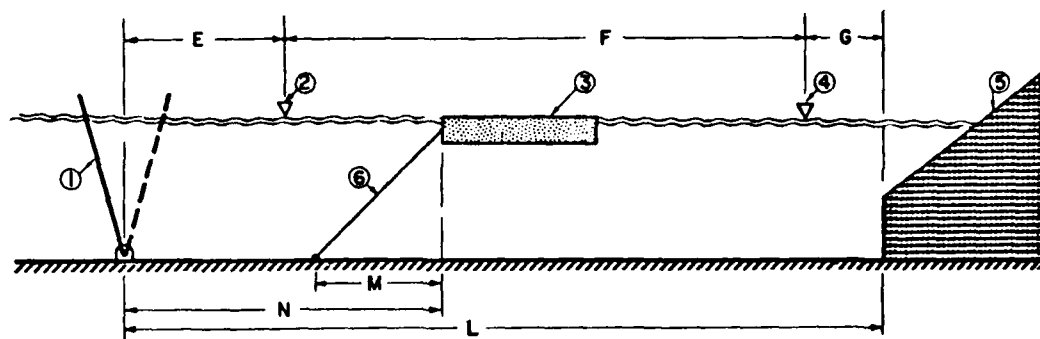
In the evaluation of floating breakwater concepts for prototype installation, Jones (1974) pointed out that an important consideration is the upper limit of the range of wavelengths over which a given level of effectiveness is achieved. The performance of a given structure may be compared to the given performance requirement. However, this criterion does not address the relative merit of two types of wave barriers; the one with second-best performance can be made to yield the best performance merely through an increase in size (e.g., draft or width). Numerous other factors, which are not apparent in Figures 168 to 171, must enter into an evaluation of breakwaters for physical applications.

## 2. Floating Fluid-Filled Bags.

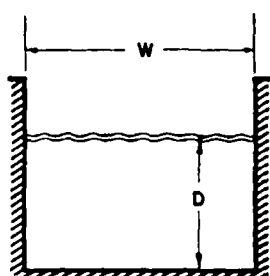
Frederiksen and Wetzel (1959) studied a variety of mobile floating breakwater configurations fabricated from flexible membranes. They recommended that additional studies be made of a fluid-filled flexible bag. Ripken (1960b) and Frederiksen (1971) reported on two-dimensional laboratory investigations of the configuration. The University of California, Berkeley, on contract by the U.S. Navy, performed three-dimensional experimental studies and conducted field tests of a surface floating fluid-filled bag configuration known as a "hovering" breakwater; the studies were discussed by Wiegel (1959b), Wiegel, Shen, and Wright (1960), Shen (1961), and Wiegel, Shen, and Cumming (1962).

A typical installation consists of a blanket composed of several individual fluid-filled bags joined together, with the length and thickness of each bag depending on the wave characteristics to be encountered and the attenuation desired. The horizontal position of such a floating breakwater must be stabilized for effective use. Stabilization requires the application of substantial forces and design considerations of load handling both within and upon the breakwater structure, and an external mooring system that must be comprehensive. Since this concept was a new innovation, there were no established procedures to be followed during the two- and three-dimensional investigations.

a. Two-Dimensional Experimental Studies. Ripken (1960b) and Frederiksen (1971) performed laboratory studies in flumes which varied in width from 6 inches to 9 feet. The significant dimensions used in these tests are shown in Figure 172. Wave conditions during the tests were varied over the maximum practical range permitted by the generator. In the larger channel, the wavelength varied from 5 to 40 feet, and the wave height varied from 0.1 to 1.5 feet. The values of wave steepness varied from 0.02 to 0.10, which is representative of the range found in prototype situations. Preliminary tests indicated that effective wave attenuation could be achieved, and that increasing the viscosity of the bag fluid substantially increased the attenuation. It was presumed that the bag motion initiated a wave or relative motion of the fluid within the bag and that a high fluid viscosity damped this internal movement in a continuous action, which, in turn, dissipated the energy of the exciting external water wave. Because of the economic implications associated with prototype use of a viscous fluid, attention was directed toward the bulk dimensions of water-filled bags.



Channel Elevation



Channel Section

Features	Dimensions							
	W	L	D	M/D	N	E	F	G
① Wave generator								
② Seaward wave meter	6"	24'	10"	1:10	14'	8'	12'	4'
③ Test breakwater								
④ Shoreward wave meter	24"	38'	12"	1:10	21'	14'	14'	10'
⑤ Permanent absorber								
⑥ Mooring line								
	9'	210'	45"	1:10	120'	95'	90'	25'

Figure 172. Experimental facilities for investigating flexible water-filled bags used as floating breakwaters (after Ripken, 1960b).

(1) Wave Attenuation Effectiveness. A water-filled cylindrical bag floating breakwater, moored with axes perpendicular to the wave crest and floating just below the water surface, is capable of attenuating surface gravity waves. The findings (Fig. 173) indicate that attenuation performance is very dependent on the length of the wave relative to the length of the bag, and to a lesser extent dependent on the relative depth of the bag and the relative amount of water in the bag. Good wave attenuation (height reduction more than 80 percent) can be achieved if the length of the incident design wave can be restricted to about 60 to 70 percent of the bag length. Wave attenuation characteristics improve as the depth or diameter of the bag increases (Ripken, 1960b), but this influence is small relative to the influence of the bag length. In view of the increasing structural problem with increasing bag diameter, it was recommended that a bag diameter equal to about 20 percent of the water depth be used with shallow-water installations, and a diameter of about 75 percent of the design wave height be used for deepwater conditions.

For small values of the ratio of wavelength-to-bag width,  $L/W$  (0.5 or less), wave steepness had little effect on the resulting attenuation of wave height. For medium values of this ratio (approximately 1.0), steepness had an appreciable influence (about 20 percent) on attenuation, with the higher steepness experiencing the greatest attenuation. The attenuation action of the water-filled bag on gravity waves appeared to be due to out-of-phase



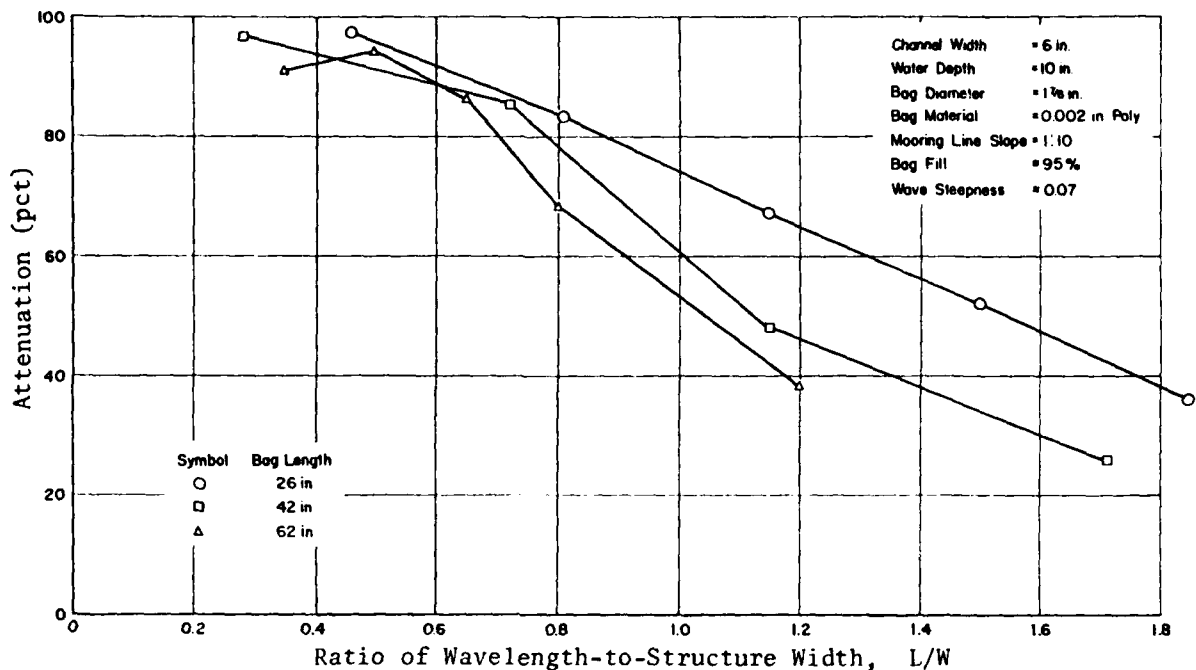


Figure 173. Effect of relative breakwater width,  $L/W$ , and bag length on wave height attenuation of water-filled, bag-type floating breakwater (after Ripken, 1960b).

damping caused by the pressure constraint provided by the bag walls in interfering with the orbiting characteristics of the bag content. Preliminary tests indicated that the scale effects would probably not exceed 10 percent if these data were extrapolated to prototype conditions. Jones (1974) also reanalyzed the data of Ripken (1960b) and Frederiksen (1971) for comparison purposes, since different configurations of bag types and wave characteristics had been used (see Figs. 174 and 175).

(2) Mooring Force Evaluation. The peak force required to stabilize the actively oscillating, floating fluid-filled bag breakwater was inherently related to the mass characteristics of the structure, the motion characteristics of the structure in a given wave climate, and the degree of constraint imposed by the mooring system. Since the mass and motion characteristics of the structure and waves were presumably simulated in the model studies, determining the representative model forces would depend on selecting a mooring system having suitable constraint. Preliminary small-scale tests indicated that the peak mooring force increased by about 30 percent when the line was changed from moderate elasticity to low elasticity. Ripken (1960b) conducted subsequent tests with moorings of low elasticity, thus obtaining relatively large or conservative peak mooring forces. For tests in the 6- and 24-inch channels, the mooring line consisted of a solid strand of stainless steel music wire (0.01-inch diameter). For tests in the 9-foot channel, the line was a 1/16-inch stainless steel aircraft cable of 7 by 7 stranding. The mooring force data (Fig. 176) were determined with a mooring line slope of 1:10. Pilot tests with slopes varying from 1:4 to 1:10 indicated that line slope variations in this range had little influence on the peak force values.

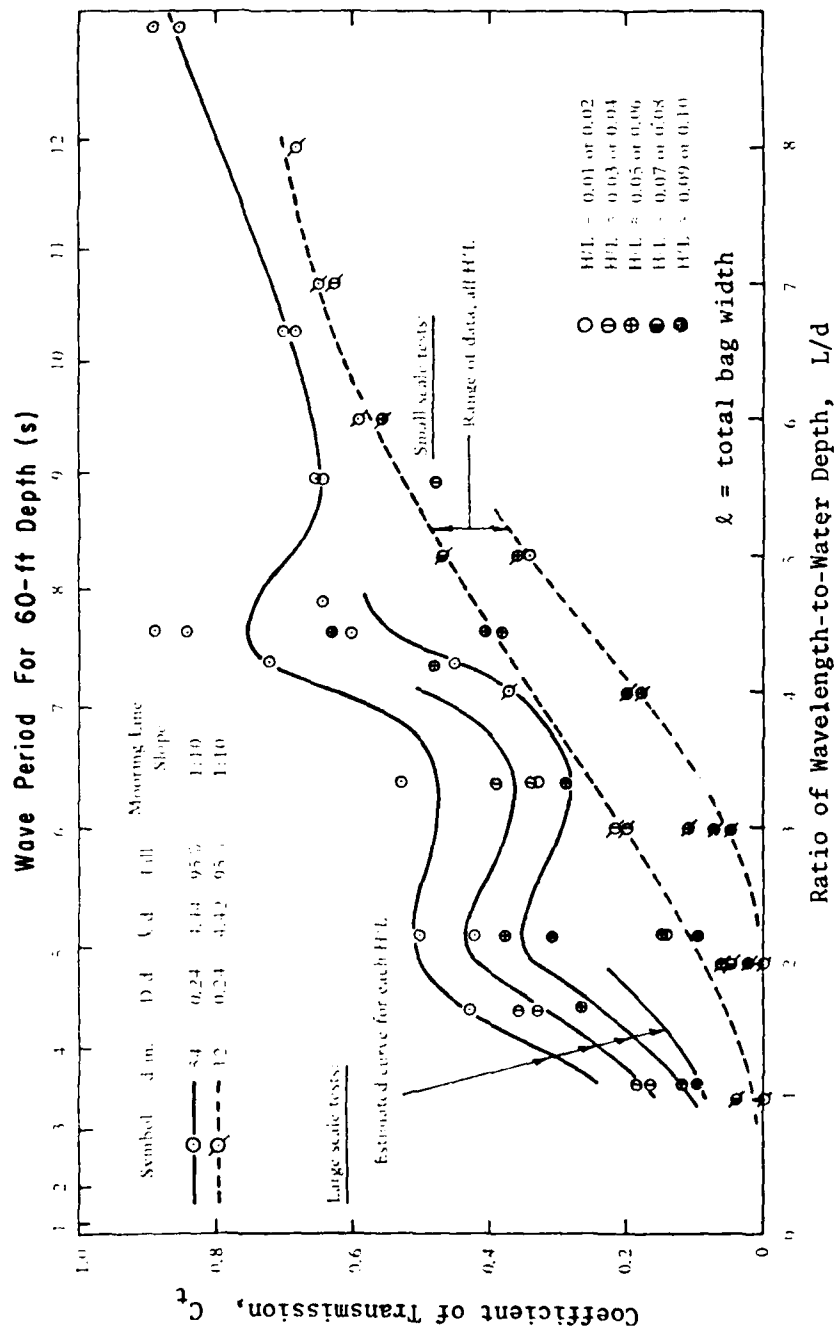


Figure 174. Effect of relative water depth,  $L/d$ , and incident wave steepness,  $H/L$ , on transmission coefficients,  $C_t$ , of water-filled, cylindrical bag floating breakwater (after Jones, 1974).

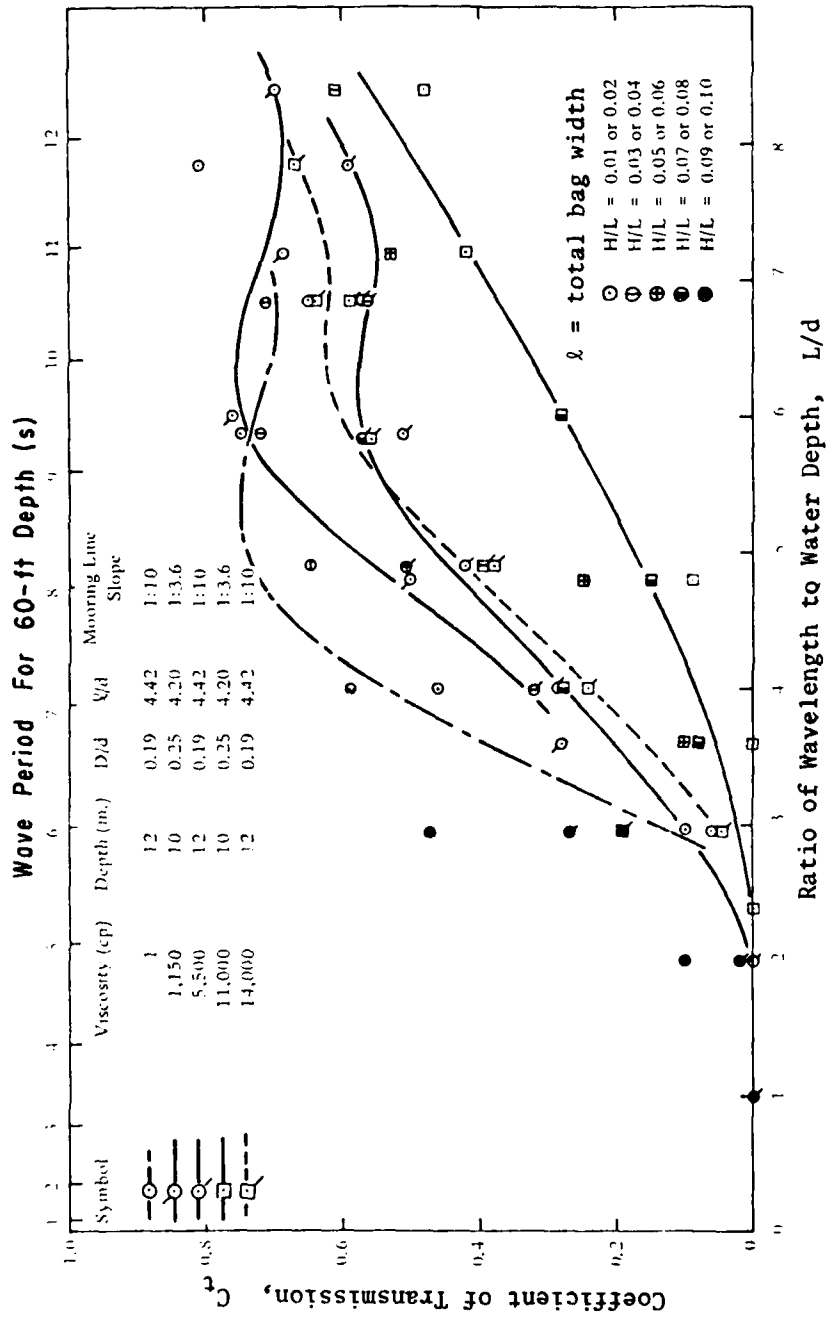


Figure 175. Effect of relative water depth,  $L/d$ , and incident wave steepness,  $H/L$ , on transmission coefficients,  $C_t$ , of flat water-filled bag floating breakwater (after Jones, 1974).

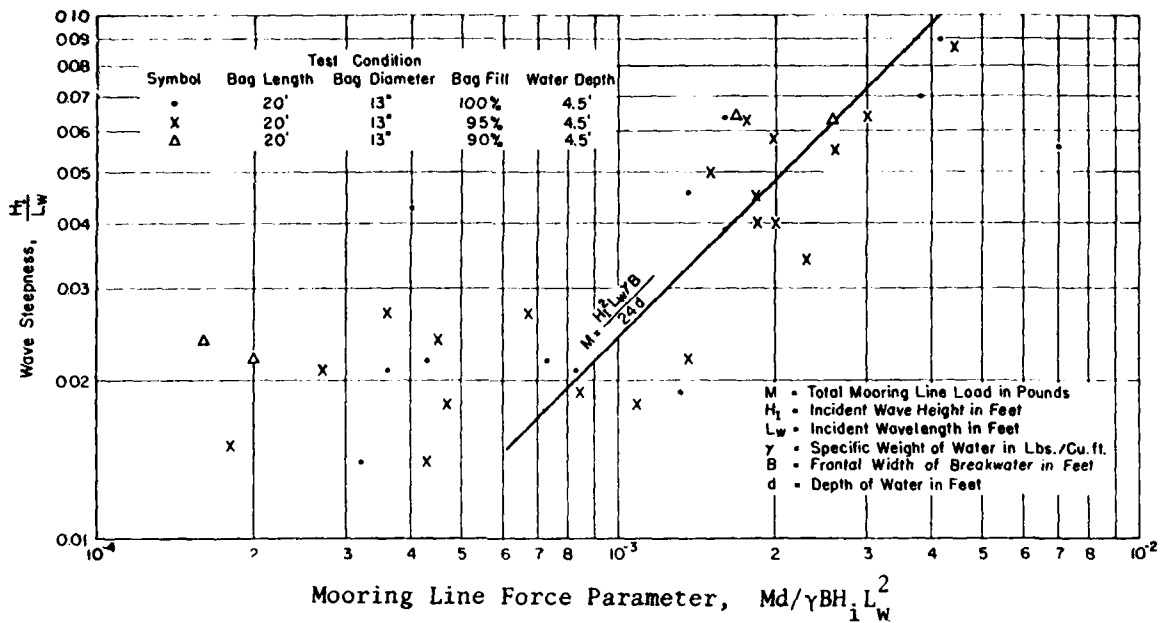


Figure 176. Mooring line force versus wave steepness for water-filled, cylindrical bag floating breakwater (after Ripken, 1960b).

b. Three-Dimensional Experimental and Field Studies. Wiegel (1959b), Wiegel, Shen, and Wright (1960), Shen (1961), and Wiegel, Shen, and Cumming (1962) conducted laboratory studies in a three-dimensional wave basin to investigate attenuation and mooring characteristics of specially constructed mattresses, 10 feet by 10 feet by 4 inches, to be used as a portable floating breakwater. The advantage of such a structure is that it could be transported to the site as a collapsed form in a roll, then unrolled, lashed to other sections, moored, and filled with seawater. The wave basin used in the study was 64 feet wide (a sufficient width to remove any boundary effects from the vicinity of the prototype-size bags). Uniform periodic waves were generated, and the heights were measured both in front of and behind the mattresses. The mattresses were fabricated with a material of specific gravity slightly greater than 1, so plastic tubes were attached to the mattresses and filled with air. The proportions of the volumes of the air-filled tubes and water-filled mattresses were such that the system hovered in the water with its top surface barely at the stillwater level.

Three different water depths (8, 16, and 24 inches) were used in the wave basin, and either one, two, or three layers of mattresses were used with each water depth. Because of the dynamic characteristics of the fluid in the mattresses, a single mattress in 8 inches of water was found to be only a little more effective than the same bag in deeper water. Since the ratio of water depth-to-wavelength,  $d/L$ , is greater for a triple bag in 24 inches of water than for a single bag in 8 inches of water; however, the single bag is relatively more efficient than the triple bag. One phenomenon was evident in all the tests: a multiple peak trough relationship existed between the ratio of transmitted wave height-to-incident wave height,  $H_t/H_1$ , and the relative breakwater width,  $L/W$  (Fig. 177). Laboratory observations indicated that

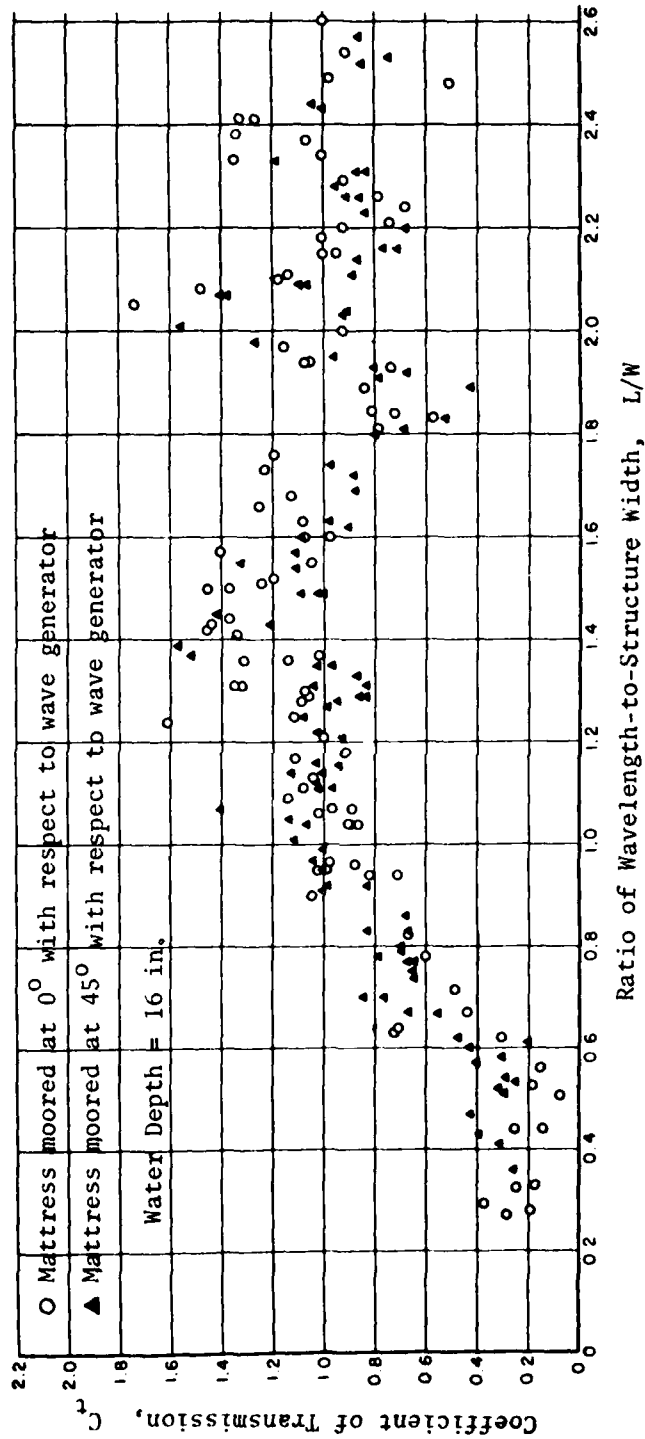


Figure 177. Three-dimensional laboratory tests of the effect of relative breakwater width,  $L/W$ , and mattress mooring angle on transmission coefficients,  $C_t$ , for water-filled, mattress-type floating breakwater (after Wiegel, 1959b).

when the wave attenuation was high, the transmitted wave had multiple crests, implying that the mattresses filled with water are a highly nonlinear mechanism. When the breakwater was only partially effective, the waves transmitted past the breakwater were only partially deformed. The effect of wave diffraction in the mattress floating breakwater was significant (phenomena which were precluded in the two-dimensional tests). The three-dimensional laboratory tests indicated the water-filled floating mattress should have a width of about twice the wavelength to be an effective wave attenuator. In the effective range, the ratio of transmitted wave height-to-incident wave height was approximately equal to the ratio of wavelength-to-breakwater length. The mattress breakwater hovering in the top one-third of the water was nearly as effective as the breakwater extending to the bottom of the basin.

Breakwater devices should be tested in the irregular waves of an ocean environment. Water-filled mattresses were placed in a test installation in San Francisco Bay where the waves are both wind- and ship-generated waves, although somewhat smaller than the waves of the open Pacific Ocean, and were tested by the same investigators. The field test site, located directly across the bay from the bay entrance, was usually relatively calm in the mornings; onshore winds in the afternoons generated waves with 1- to 2-second periods and 0.5- to 1.5-foot heights.

Diffraction was found to be as important in these field tests as had been determined in the three-dimensional laboratory experiments. However, the two-dimensional wave spectra characteristics of wind-generated waves appeared to be more significant. Wind-generated waves have components that are radiated with a considerable spread of directions, and have a two-dimensional energy spectra. It was obvious that wave components were arriving at an angle in the lee of the breakwater. The wave height sensor in the lee of the breakwater was placed near enough to the structure to minimize these effects. Multi-crested records were due to oscillations of the mattresses, not to either diffraction or angular components of the two-dimensional wave spectra.

Wind-wave tests on San Francisco Bay showed that if the significant wavelength was used in data reduction and analysis, the coefficient of transmission,  $H_t/H_i$ , was only about one-half the value obtained in the laboratory for the same relative breakwater width,  $L/W$ . This was attributed to the relative instability of the wind waves compared with the laboratory waves, making the water-filled floating mattress breakwater more effective in wind waves than in swell. Computations based on the component wave period associated with the maximum energy density did not correlate well with the laboratory results. There was no linear coherence between the incident waves and the transmitted waves, indicating the breakwater acts as a nonlinear process. To provide an observational format consistent with other data displays, Jones (1974) reanalyzed Wiegel, Shen, and Wright's (1960) data, and displayed the transmission coefficients,  $C_t$ , as a function of relative water depth,  $L/d$ . The asymptotic leveling of the curve with increasing  $L/d$  suggests a better performance than most other barriers for very long waves ( $L/d < 8$ ). However, both the length and the submergence of the bags were relatively large. Jones' (1974) reanalyzed data are presented in Figure 178.

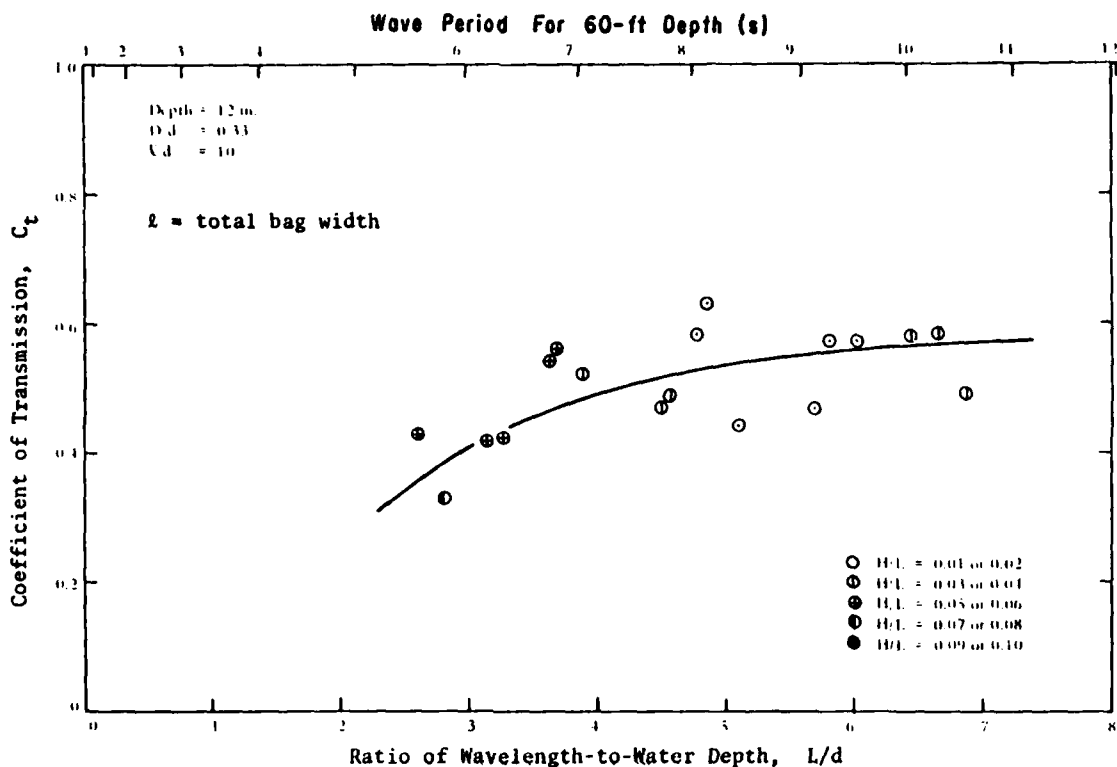


Figure 178. Effect of relative water depth,  $L/d$ , and incident wave steepness,  $H/L$ , on transmission coefficients,  $C_t$ , for flat, water-filled bag floating breakwater (after Jones, 1974).

## XI. TURBULENCE-GENERATOR FLOATING BREAKWATERS

A floating breakwater concept of relatively thin, horizontal barriers, developed and tested in both laboratory and field conditions, causes dissipation of wave energy without creating major stresses in the structure and moorings. The dissipative mechanism for this design arises as the greater part of the wave breaks over the upper surface of the system with great turbulence and energy loss taking place as the fluid interacts with the structure members. Major eddy formations exist as the fluid moves between and around the breakwater elements with supplementary loss of energy, and the inertia of the breakwater itself opposes the orbital motion reflecting a small part of the wave energy. The advantages of this design include shallow draft, relatively lightweight, and modest mooring loads, even in fairly strong currents.

### 1. Seabreaker Floating Breakwater.

Hasler (1974) developed the floating breakwater concept known as the "Seabreaker," which uses a long, stiff, horizontal surface for wave attenuation. This design evolved during flume tests in England in 1963. Further tank tests and model experiments in simulated prototype waves led to the construction in 1971 of a long, rigid pontoon of specialized design (Fig. 179), 131 feet long, full size, with a universal joint at either end for joining a string of units.

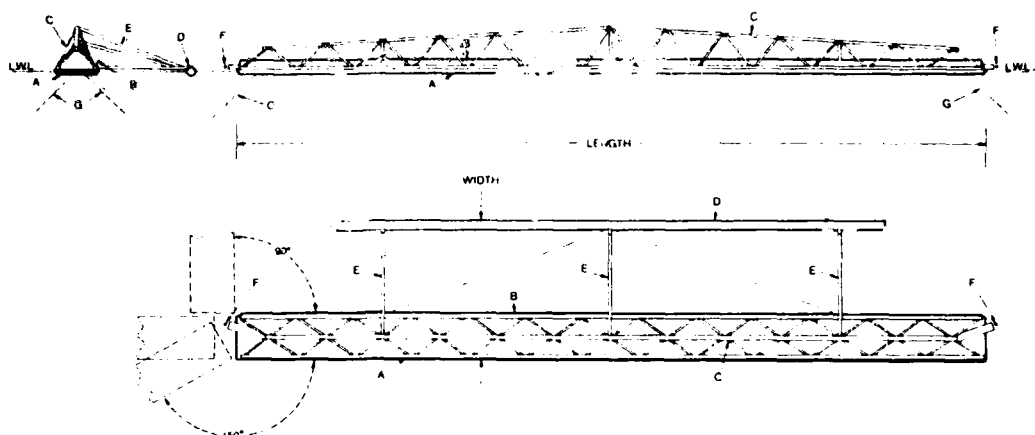


Figure 179. Seabreaker floating breakwater (after Hasler, 1974).

Before 1963, the surfaces of most floating breakwater designs were essentially vertical for reflection purposes. As a result of Hasler's (1974) preliminary tests, a floating breakwater operating on the principal of a single horizontal plate to be held ideally at the level of the wave troughs and as motionless as possible, was developed. The general arrangement of the Seabreaker contains a main float, A, which provides a flat plate effect (Fig. 179). This unit has a length-to-width ratio of about 17:1, with only about 20- to 25-percent reserve buoyancy. When prevented from heaving bodily, its horizontal surfaces interfere with the vertical component of the orbital motion of the water particles within the wave. The back wall, B, reduces overtopping by wave crests and, in heavy seas, traps a considerable amount of water on the deck. This causes the float to trim lower in the water, and pours continuously off the seaward edge, creating a local surface current which opposes the motion of the waves. Both these effects appeared to Hasler (1974) to improve attenuation. The girder, C, of tubular steel, limits the flexing of float, A, both in longitudinal bending and in torsion. It was intended that the Seabreaker ride as high in the water as possible; hence, it was designed to be as light as economically feasible. The outrigger float, D, carried on three cantilever arms, E, was added supplementally to reduce rolling and prevent risk of capsizing. It also contributes to the wave attenuation by blocking short-period waves created when the crests of large waves overtop the back wall and plunge between the main float and the outrigger.

a. Model Investigations. A small model 20 feet long was tested in a three-dimensional wave basin, using uniform wave trains of varying periods and heights, and moored at angles between  $0^\circ$  and  $40^\circ$  with the wave crests; reflection, transmission, and mooring forces were determined. A second larger model 36 feet long was constructed and moored in a harbor with a fetch of about 1 mile, and tested in natural wind-driven waves. The incident and transmitted waves were recorded by motion-picture camera, and simultaneous strain-gage readings were obtained of the loads on the main girder. Mooring loads were not measured, but were apparently modest; the model remained on station unattended for months without either dragging anchor or breaking a mooring line. The entire mooring arrangement consisted of two polyester ropes (1/4-inch diameter) with a breaking load limit of 1,200 pounds when new.



b. Field Studies. In 1971, a full-size Seabreaker unit 131 feet long was constructed and then towed off an open beach into the English Channel by a 65-foot fishing vessel with a 160-horsepower engine. Towing 110 miles was not difficult at an average speed of more than 4 knots. The unit was moored in Stokes Bay, with a fetch of 3.5 miles in tidal streams up to about 2 knots. The prototype section of Seabreaker remained on station (Fig. 180) for 2 years before being towed to another location for further tests. Although neither attenuation nor mooring data were available, Hasler (1974) contends that the Seabreaker attained up to 60-percent wave height reduction at the design wave in both wind-driven waves and steep swell.

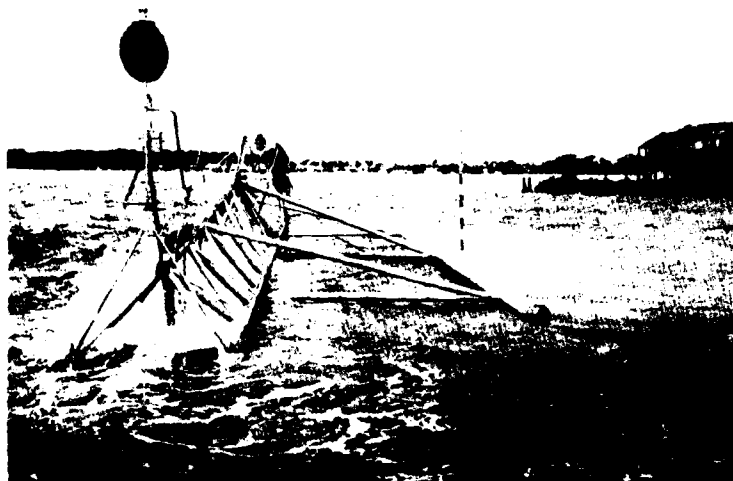


Figure 180. Prototype Seabreaker floating breakwater positioned in Stokes Bay, England (after Hasler, 1974).

## 2. Harris Floating Breakwater.

In the late 1960's, the Harris floating breakwater configuration was developed to accentuate hydrodynamic instabilities in the waveform that result in turbulent breaking and energy dissipation (Harris and Webber, 1968; Harris and Thomas, 1974). The structure, which also presents a thin, horizontal barrier to the wave motion, consists of a floating slab with a width comparable to the length of the wave to be attenuated. Various arrangements of slots and mass damping have improved performance. The Harris breakwater acts primarily by inhibiting the vertical component of orbital motion, with a secondary action of energy dissipation by wave breaking and eddy formation. There is also a slight degree of reflection (Shaw, 1973).

Harris and Thomas (1974) tested a 1:10 scale model of the Harris floating breakwater designed for the Port of Le Havre, England, in Stokes Bay. The prototype was required to be effective in seas up to 10 meters (33 feet) in height; hence, the test site required seas up to 1 meter (3 feet) in height, with otherwise relatively calm conditions. Prevailing winds in the Stokes Bay region are from the southwest with a fetch distance of about 3.5 miles. In winds up to 25 knots, wave heights of 1 meter can be expected. Disadvantages at the test site included relatively strong tidal currents with only brief

periods of slack water, occasional large swells from the southeast, and occasional heavy wash from shipping operations. Testing was conducted at slack water to minimize undesirable effects.

The design at Stokes Bay consisted of equally spaced crossmembers connecting the front and back booms (leading and trailing edge) (Fig. 181). This produced a rectangular floating plate on the surface with slots of open water between the crossmembers. These slots generate turbulence which helps dissipate a large part of the wave energy. The model was composed essentially of five units, each 9.6 by 10 meters (31 by 33 feet), joined by two 10- by 10-inch steel sections along the entire length of the front and back booms; the overall dimensions were 48 by 10 meters (157 by 33 feet). This form of construction greatly reduced launching problems because the breakwater was constructed in sections and assembled together while afloat. The marine plywood model was 0.3 meter (1 foot) in overall depth and floated with about 0.045 meter (0.15 foot) freeboard, this value being controlled by buoyancy compartments throughout the complete structure. In the mooring arrangement (Fig. 182), nylon lines, each attached to 50 feet of 3/4-inch chain with a plow anchor on the end, were fastened to each corner of the breakwater. Nylon was used to eliminate shock loads on the breakwater from movement in the seaway.

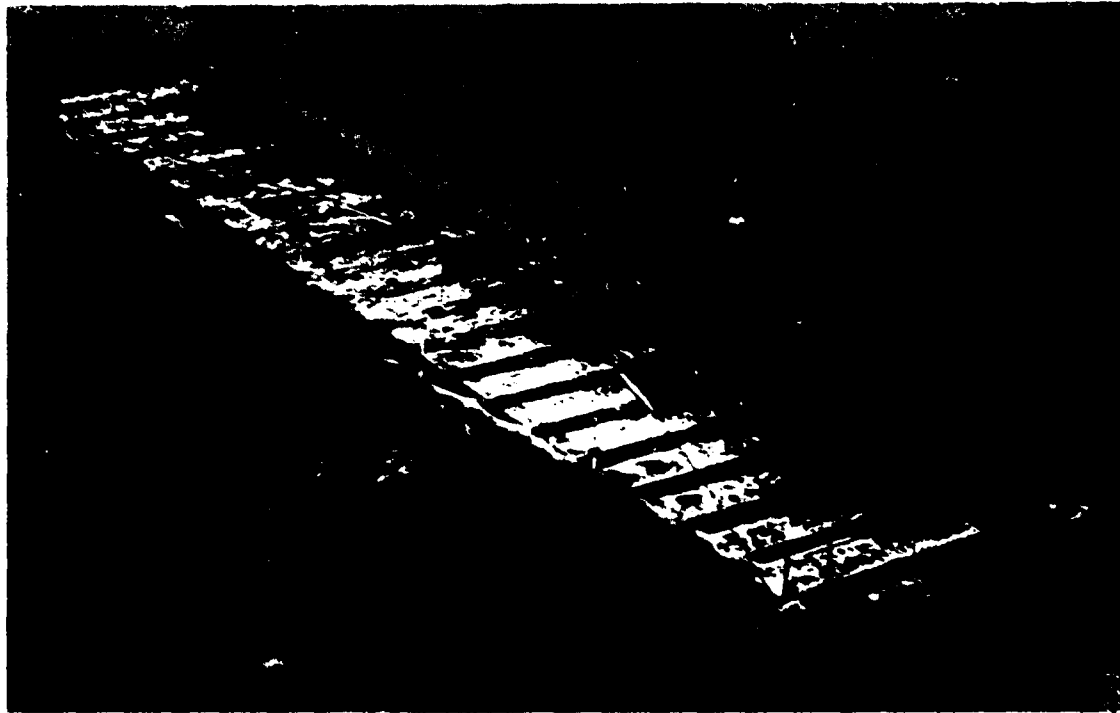


Figure 181. Scale model of Harris floating breakwater at Stokes Bay, England (after Harris and Thomas, 1974).

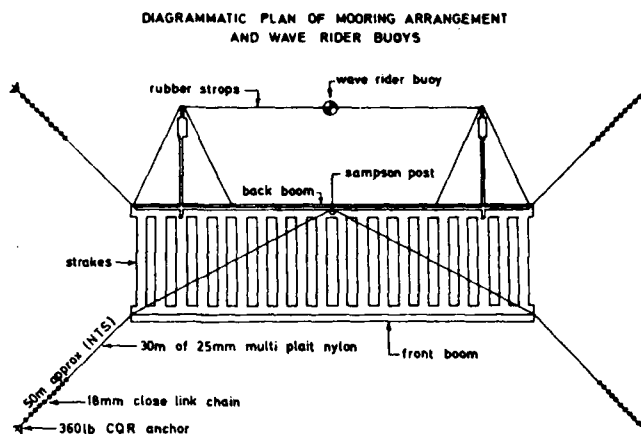


Figure 182. Mooring arrangement of the Harris floating breakwater field test at Stokes Bay, England (after Harris and Thomas, 1974).

The Harris floating breakwater performance was measured by percentage energy reduction, with wave data collected in digital form on magnetic tape, to determine the wave energy spectrum. Figure 183 shows a typical wave energy spectrum for one test run from both the windward and leeward sides of the structure. The attenuation factors developed for waves of 1.5 to 3.0 seconds are shown in Figure 184. For the data obtained, most of the results occurred between the curve, for a free plate, and the theoretical wave tank curve, for a rigidly fixed plate, indicating that only short sections, which are stabilized by adjacent sections in a long breakwater are attacked by waves at a given time.

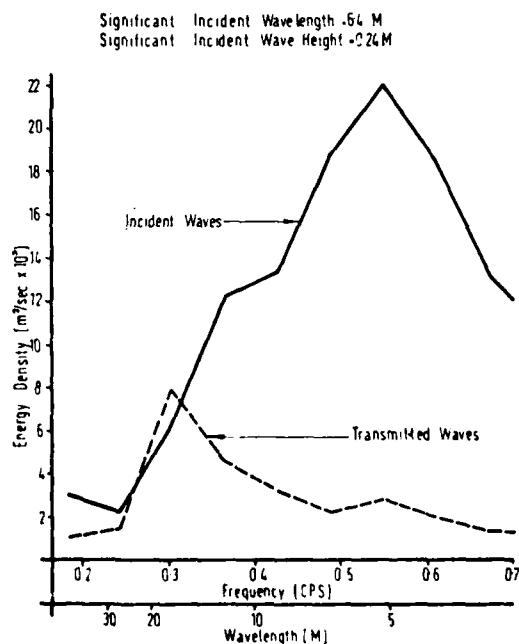


Figure 183. Incident and transmitted wave spectrum of Harris floating breakwater at Stokes Bay, England (after Harris and Thomas, 1974).

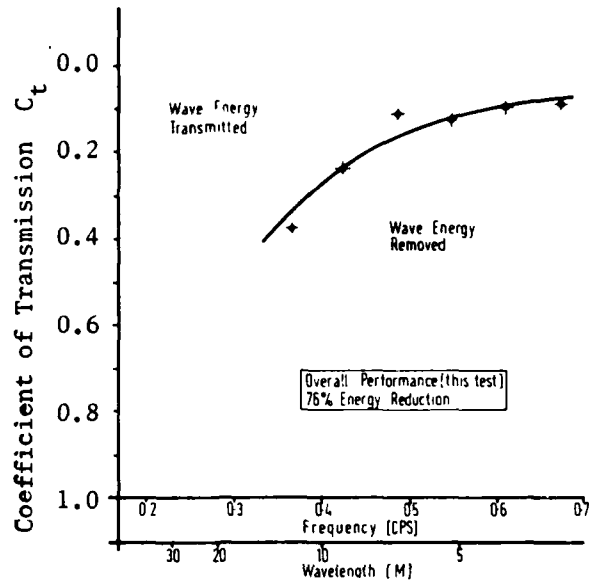
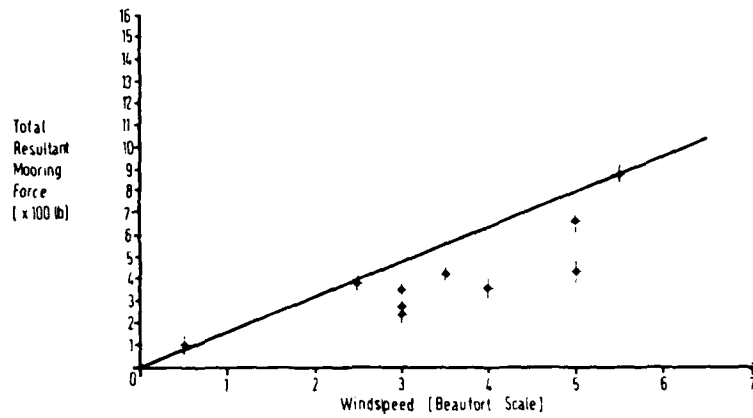


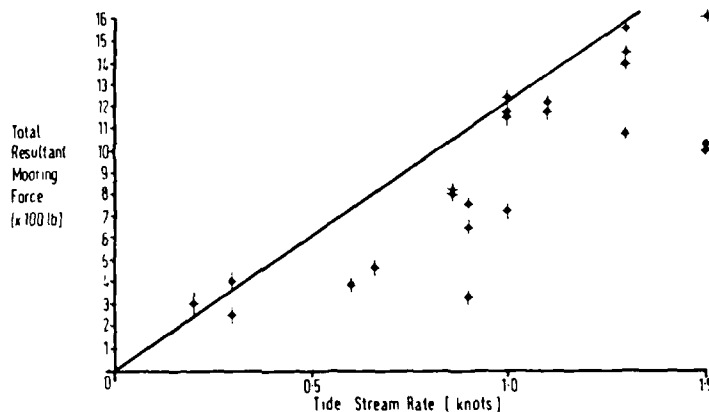
Figure 184. Performance characteristics of Harris floating breakwater, developed from incident and transmitted wave spectra at Stokes Bay, England (after Harris and Thomas, 1974).

The mooring forces in the lines attached to the breakwater were measured, using a lever and spring balance, to determine the horizontal and vertical angle of each mooring line, relative to the breakwater. This permitted the resultant mooring force on the breakwater to be calculated vectorially. Wind strengths were estimated, using the Beaufort scale, by an experienced observer and verified from local weather stations. The tidal current velocity was measured to within 0.05 knot by current meters. The mooring forces determined for wind effects and tidal current effects are presented in Figure 185 (a and b). Part of the scatter may be attributed to the effect of the breakwater orientation, and a part may be due to a lack of correlation between wind and waves. A wind of a given strength could be accompanied by a wide range of sea conditions for adjacent sources. The data on the effect of tidal currents on the mooring forces varied by about 30 percent on either side of the mean value, and was mainly attributed to breakwater orientation in the direction of the tidal stream.

The essential purpose of the Stokes Bay experiment was to expose the floating structure to the free interplay of the many variables on the open ocean (Harris and Thomas, 1974). Performance was found to be most sensitive to the area of solid slab per foot of breakwater length, but less sensitive to overall width; i.e., for a given area, performance was improved if that area can be formed over a larger width. The area per foot of length, chosen as the principle parameter, is also closely related to cost of structure. The performance of a long breakwater was substantially better than that of a short one, due to longitudinal stiffness; the performance approached that of a rigidly fixed breakwater. Mooring forces were relatively low, about 2 percent of the deadweight of the structure.



a. Effect of windspeed on mooring force



b. Effect of tidal current on mooring force

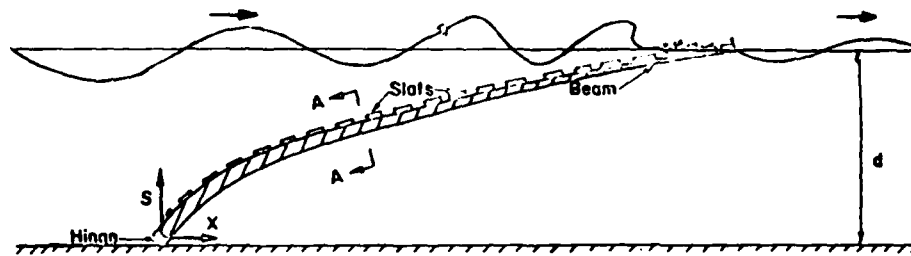
Figure 185. Effects of windspeed and tidal current on Harris floating breakwater at Stokes Bay (after Harris and Thomas, 1974).

### 3. Parabolic Beaches.

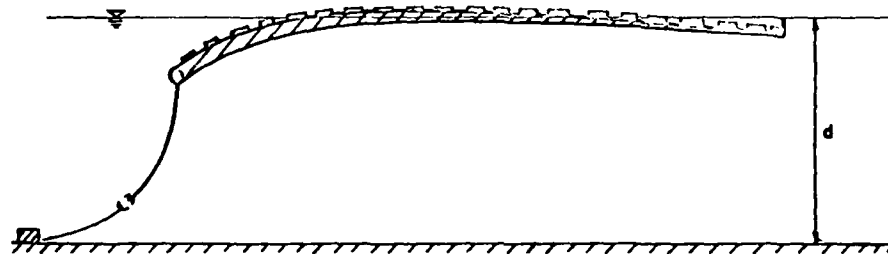
The floating, parabolic beach breakwaters (hinged or free floating) are essentially special floating sloping barriers. They differ, however, from the sloping-float breakwater in that the design attempts to cause wave damping by forced instability and breaking of the incident waves, producing a counter current by the motion of the breakwater, and by absorption of energy through the deflection of the structure. Ofuya (1968) evaluated parabolic beaches with structures made of wooden beams of the form:

$$y^2 = \frac{4x}{3d} \quad (81)$$

where  $y$  is the vertical distance from sea bottom,  $x$  the horizontal distance from hinged or anchored end, and  $d$  the water depth at the site. Schematics of the structures with wooden slats of equal sizes placed over the beams are shown in Figure 186. Restraint was provided by pivotal points at the bottom of the experimental wave channel for the hinged beach, and the



a. Hinged parabolic beach



b. Freely floating parabolic beach

Figure 186. Parabolic beach floating breakwater concept (after Ofuya, 1968).

freely floating beach was moored by an anchor line. The performance of the beaches was evaluated by their porosities, defined as the number of slat gaps on the beach surface to the number of slats required to cover the entire surface; e.g., a fully covered beach has zero porosity. The porosity varied exponentially from the harbor to the seaward end.

Ofuya (1968) conducted the experimental investigation in a wave channel (two-dimensional), rectangular in the cross section (100 feet long by 2 feet wide by 4 feet deep). The porosity effect of the hinged beach on wave attenuation properties was determined for beach porosities ranging from 0 to 60 percent. The breakwater was progressively more effective in wave damping with decrease in porosity (except below 10 percent). Wave attenuation resulted from several complex processes which occur both within the beach structure and in the vicinity. Incident waves propagating toward the slope were forced to steepen, become unstable, and sometimes break completely. The oscillation of the hinged parabolic beach produced reverse currents through the rectangular slat openings. Water jets produced an additional source of energy dissipation. The slightly sloping surface of the slats and the reverse currents, which were produced, induced partial reflection of the incident waves.

Ofuya (1968) tested the parabolic beach as a freely floating structure primarily for energy dissipation, with wave energy reflection as secondary. The floating parabolic beach differs from the floating pontoon, floating plastic membrane, or floating water-filled plastic bag, due to the following features: (a) the slightly sloping leading edge induces steepening of the incident wave; (b) the porous internal structure dissipates wave energy by turbulence and wave breaking; and (c) a sufficient length can be attained for energy absorption to partially occur through repeated bending of the structure.

The effects of relative water depth,  $L/d$ , on the attenuation characteristics of a 25-percent porous freely floating parabolic beach and of 20- and 30-percent hinged parabolic beaches are shown in Figure 187. The moored freely floating structure is evidently more effective in wave damping than the hinged beach, particularly for the deeper water conditions. Ofuya (1968) partially attributed the better performance of the floating beach to interaction of the complete structure with waves in the region of large kinetic wave energy concentration. The lower sections of the hinged beach, located in a region of low kinetic wave energy, serve mainly as structural support. Furthermore, oscillations of water between the slats and the partial breaking of waves due to forced instability of waves progressing past the structure cause large energy dissipation within the freely floating structure.

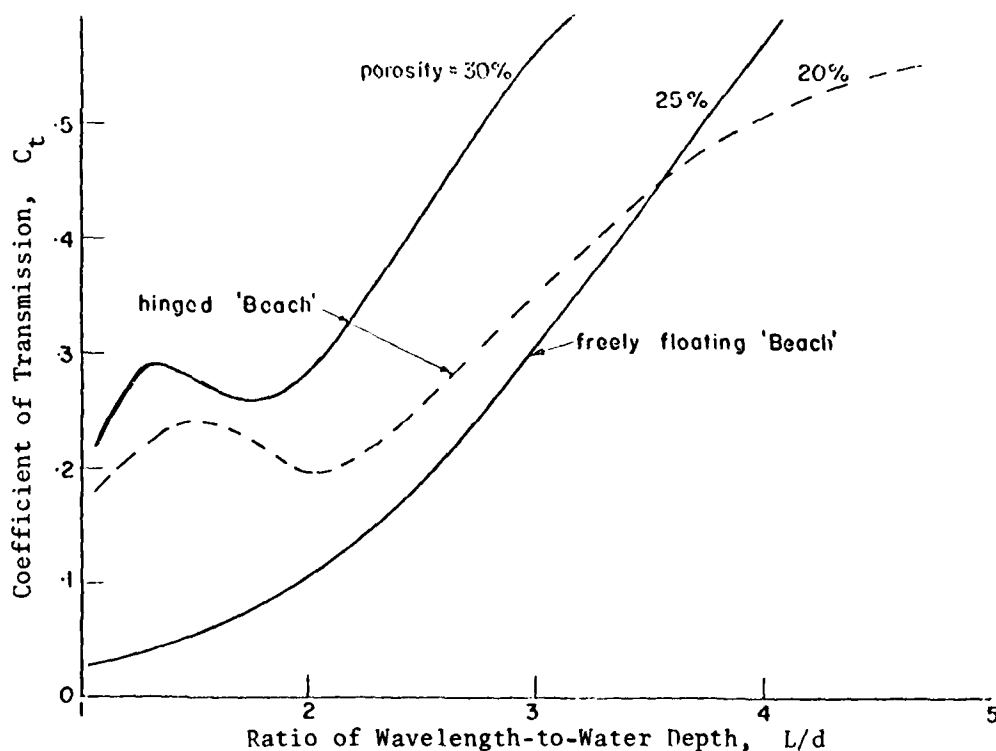


Figure 187. Effects of relative water depth,  $L/d$ , and porosity on transmission coefficients,  $C_t$ , of hinged and freely floating parabolic beaches (after Ofuya, 1968).

If geometrical similarity is maintained between model and prototype, the modulus of elasticity of the prototype parabolic beach material should be several times greater than that of the model beach. Hence, a material other than wood (which was used in the model) will be required for the construction of prototype parabolic beaches. Ofuya (1968) found the floating breakwater to be more effective, in general, than the hinged beach for wave damping. Furthermore, the method of mooring by an anchored mooring line appeared more practical than providing a pivotal hinge on the ocean floor.

#### 4. Wave Tripper Floating Breakwater.

Potter (J. Potter, WES, personal communication, 1975) designed and patented a floating breakwater concept which utilizes the turbulent dissipative mechanism by inducing instabilities and breaking surface gravity waves (Fig. 188). The structure can be constructed to various widths, lengths, and heights, depending on the wave climate. No actual evaluation testing or prototype installations have been performed to date.

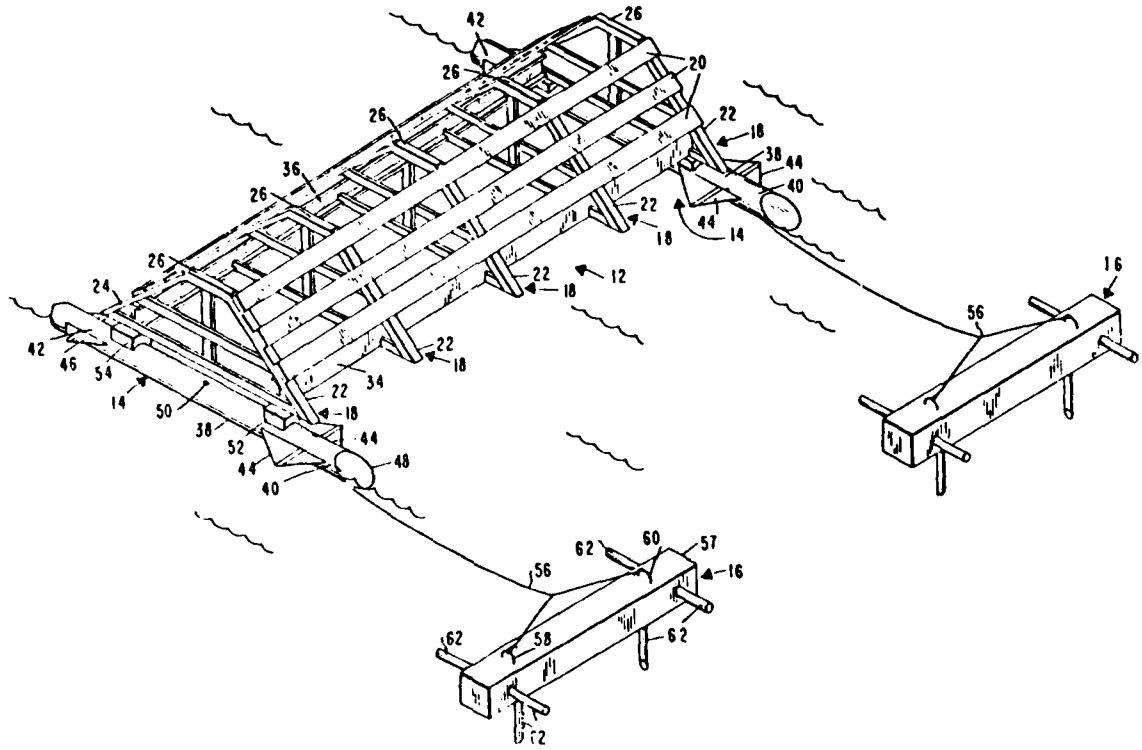


Figure 188. Design concept for Wave Tripper floating breakwater (numbers identify structure components).

#### XII. ENERGY PEAK DISPERSION FLOATING BREAKWATERS

The method of wave train interference has been developed to reduce the peak energy density of waves in which the energy is concentrated in narrow frequency bands, using two distinctly different mechanisms. An offset breakwater configuration incorporates vertical reflecting surfaces (static system) oriented normal to the direction of wave propagation and displaced from each other by one-half wavelength. This design reduces the anchoring forces required to hold the floating breakwater in place, as the net pressure distributions on the various sections of the structure are in opposite directions. The reflected waves are accordingly  $90^\circ$  or  $180^\circ$  out of phase with the incident waves. The wave barrier concept consists of an array of wave-excited modules acting as sources of elliptical wave fronts (dynamic system) which radiate outward and interfere with the incident wave field. The radiated waves should be high enough to trigger instabilities in the incoming waves, resulting in premature breaking and dissipation of the energy peak in the region of interference.



### 1. Offset Floating Breakwater Configuration.

A fixed, rigid wall normal to the direction of wave travel will reflect the incoming wave train and produce standing waves in front of the wall (the amount of the reflection depends on the penetration of the wall beneath the water surface). Large forces are required to hold a floating structure in a fixed position, and it is not possible to anchor such a structure to prevent all movement (resulting in wave regeneration). An offset breakwater configuration has been developed and patented (Sethness and Moore, 1973; Dailey, Moore, and Sethness, 1974; Sethness, Moore, and Sabathier, 1974; Sethness, Moore, and Dailey, 1975) (Fig. 189), which reduces the external forces required to restrict the motion of the structure by making half of the wave work against the other half. When the crest of one wave is pushing against one set of offset surfaces, the trough of the wave is at the other set of surfaces, producing an opposing force. The ratio of the force on the offset configuration,  $F_{\text{offset}}$ , to that on a vertical rigid wall,  $F_{\text{rigid wall}}$ , is presented in Figure 190. Here,  $a$  is the wave amplitude, and  $h$  the penetration of the structure below the stillwater level.

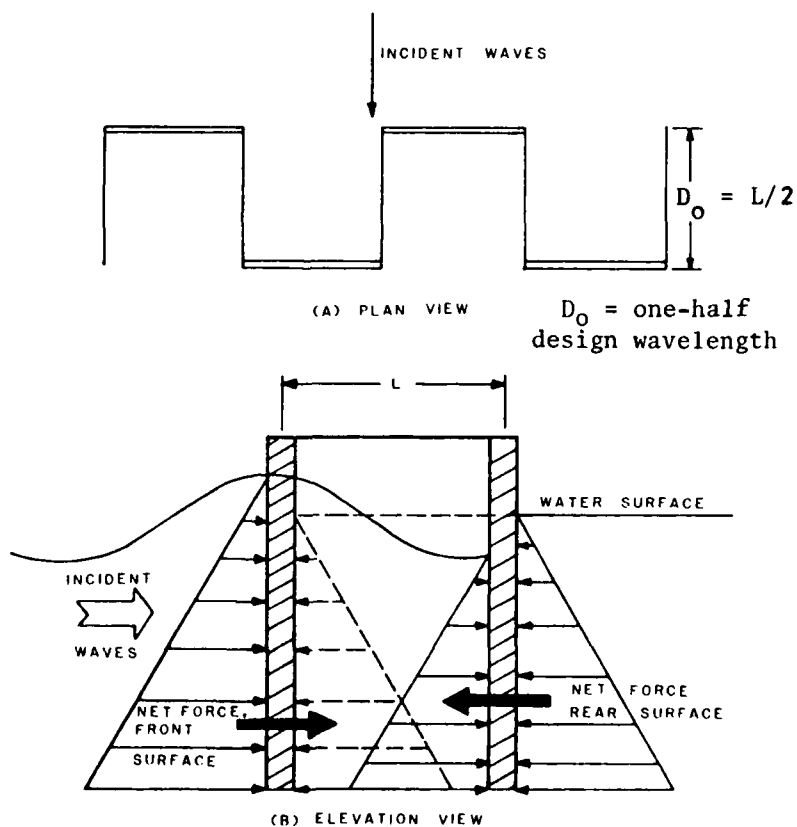


Figure 189. Offset floating breakwater configuration, showing pressure distribution on reflecting surfaces (after Sethness and Moore, 1973).

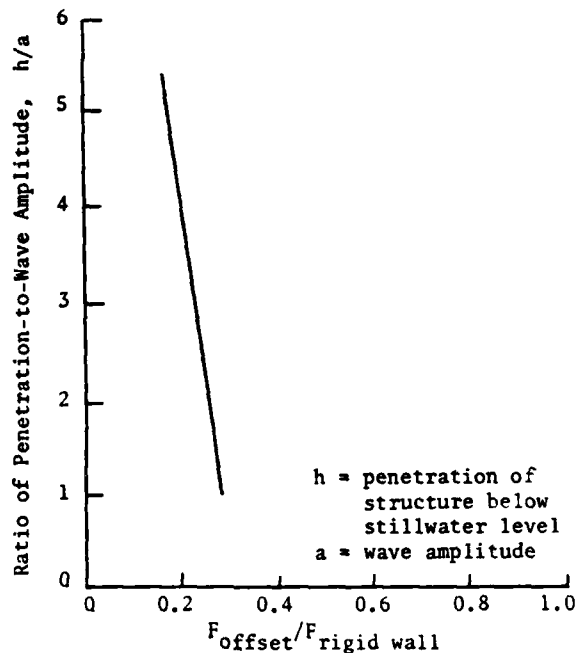
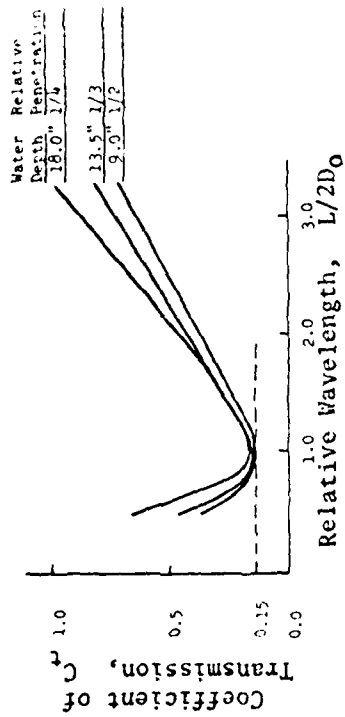


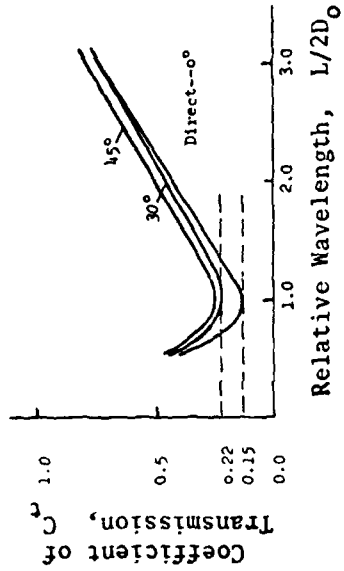
Figure 190. Effect of relative penetration,  $h/a$ , on ratio of force on offset breakwater,  $F_{\text{offset}}$ , to force on vertical rigid wall,  $F_{\text{rigid wall}}$ , for offset floating breakwater configuration (after Sethness and Moore, 1973).

A two-dimensional experimental investigation of a breakwater constructed of 20-gage aluminum sheeting and styrofoam was conducted in a wave basin 25 feet long, 6 feet wide, and 2 feet deep. The structure was a series of L-shaped pieces connected so that the offset between the forward and rear faces, and the span between the side faces, could be adjusted. An offset distance of 6 inches was used as the primary setting for the 6-inch-high model. In still water, 4.5 inches of the model was submerged with 1.5 inches above the water surface. The rectangular units were joined to extend the model to 70 inches long, the width of the wave basin. Steel weights anchored the model and were attached to allow the breakwater to pivot freely.

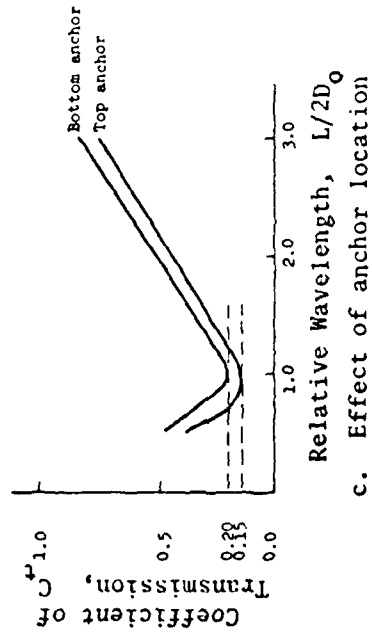
Sethness and Moore (1973) conducted tests with the offset breakwater penetrating one-half, one-third, and one-fourth of the water depth. Transmission coefficient data for the tests are presented in Figure 191(a); the transmission coefficient,  $C_t$ , approaches the same value when the relative wavelength,  $L/2D_o$ , approaches the optimum value of 1.00. Here  $L$  is the design wavelength and  $D_o$  is the breakwater offset distance. The angle of incidence was investigated by placing the axis of the model at angles of  $30^\circ$  and  $45^\circ$  to the incident wave fronts. These data are shown in Figure 191(b), where the deviation from direct wave incidence is apparent. For all wavelengths, an increase in transmission coefficient occurred as a result of indirect incidence, with the greatest increase occurring at the optimum wavelength. The best location for attaching mooring cables was determined to be the top part of the structure (Fig. 191,c). A final evaluation determined the



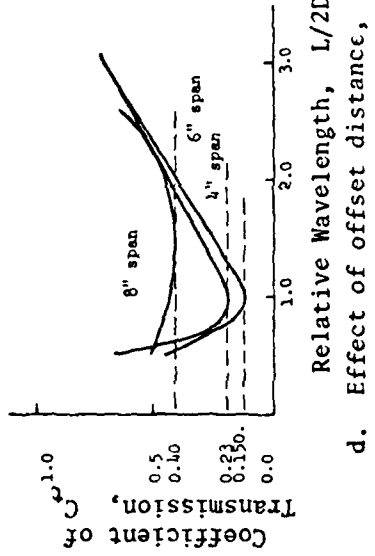
a. Effect of penetration,  $h/a$



b. Effect of angle of incidence,  $\theta$



c. Effect of anchor location



d. Effect of offset distance,  $D_0$

Figure 191. Effect of relative penetration,  $h/a$ , angle of incidence,  $\theta$ , anchor location, offset width,  $D_0$ , and relative wavelength,  $L/2D_0$ , on transmission coefficient,  $C_t$ , for offset floating breakwater configuration (after Sethness and Moore, 1973).

optimum width of the offset sections. Figure 191(d) shows that, as the section width was decreased from a value of one-half wavelength, the coefficient of transmission,  $C_t$ , increased from a distinct optimum value to the point of no actual offset width.

Figure 192 shows the offset breakwater performance in wind-generated waves in terms of the ratio of wavelength-to-offset distance between the reflecting surfaces. Theory indicates that the resultant forces and moments acting on the vertical reflecting surfaces of the offset breakwater are much less than for a vertical, fixed wall. Theoretically, the reduction in force will be a maximum if the offset walls are a distance apart equal to one-half the incident wavelength. Figure 192 shows that a maximum average attenuation occurred at a wavelength 1.7 to 1.8 times the offset distance. Sethness and Moore (1973) considered this in relatively good agreement with the simple theory used in the development. Considering the complexities of prototype situations, the agreement indicated that model data subjected to even simple analysis can be considered quite useful. The test results generate a well-defined family of curves which would allow for reasonable accuracy in the design of an offset floating breakwater. When the dominant design wave has been determined, Sethness and Moore's (1973) theory can be applied to determine the geometry of the acceptable offset breakwater.

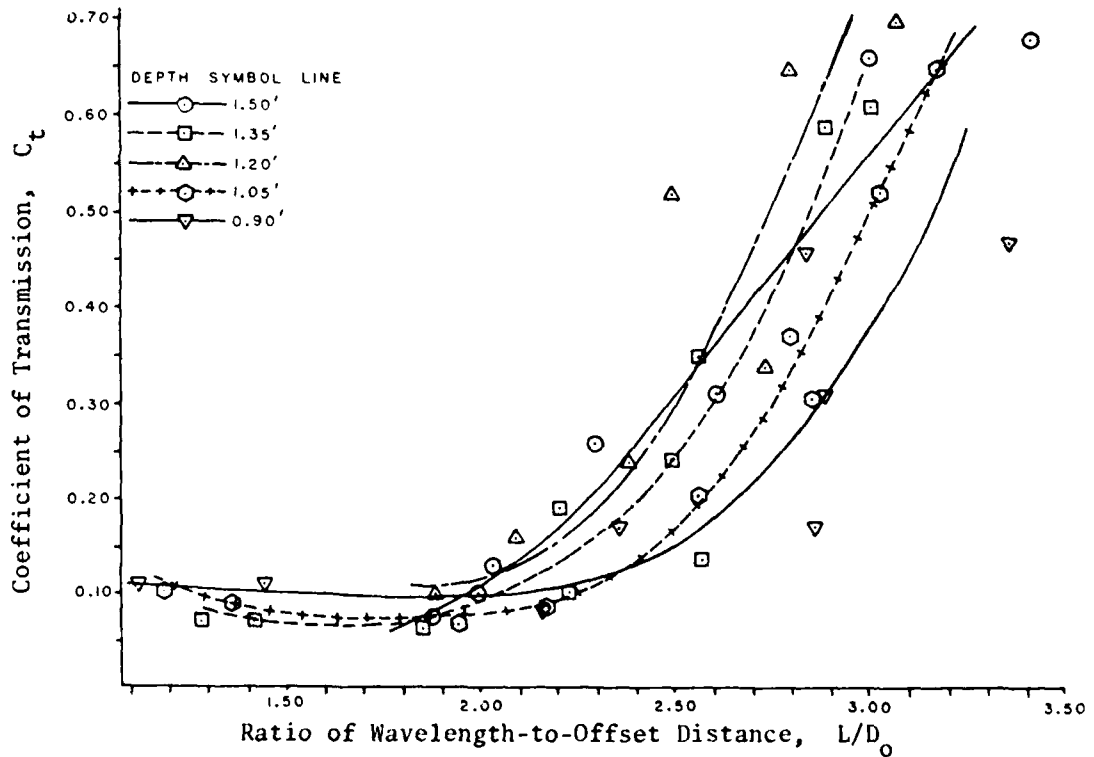


Figure 192. Effect of ratio of wavelength to offset distance,  $L/D_0$ , and depth of penetration,  $h$ , on coefficient of transmission,  $C_t$ , for offset floating breakwater configuration (after Sethness and Moore, 1973).

## 2. Bowley Wave Barrier.

The wave barrier concept developed by Bowley (1974) consists of modular units which can be deployed in various arrays to form a system capable of attenuating waves. This active concept (dynamic system) is based on the principle that a desired wave field can be developed from incident waves superposed on radiated point sources of mass or momentum. The multiple-point sources are emitters of circular or elliptical wave fronts which interact with the incoming wave train to produce a resultant wave field substantially attenuated from the incident conditions. The linear character of the wave equation allows these systems to be modeled mathematically in an exacting manner. This system involves an array of wave-excited modules which acts as a source of a series of elliptical wave fronts (Fig. 193), where the wave is generated by the pitching motion of the module. Figure 194 is a schematic of the wave pattern generated by the Bowley wave barrier. This wave pattern is elliptical in shape because the motion about the pitch axis causes the module collar to activate larger amounts of water in proportion to the distance from the axis. The envelope of the emanating elliptical wave fronts is roughly linear traveling seaward and shoreward, but the waves are high enough to trigger instabilities in the incident waves which result in partial or complete breaking.

Bowley (1974) used a large amount of documented experience in the area of large sea buoys, mooring lines, durability of materials, etc., to develop a dynamic system capable of attenuating wave trains with a minimum of energy dissipation within the system itself. Flexibility for performance tuning of the system was obtained by several techniques. Various module anchoring patterns can be used, and the length of the system can be altered simply by the addition of module rows. The counterweight size and position can be varied to change the pitching period, and the size of collar and air can diameter is adjustable, as well as the collar position at the stillwater level. The module is simple enough for construction by unskilled labor with inexpensive materials; the system array can be installed by a barge-tug system which eliminates the need for any special machinery. Hence, the parameters of the system will fit a variety of installation criteria.

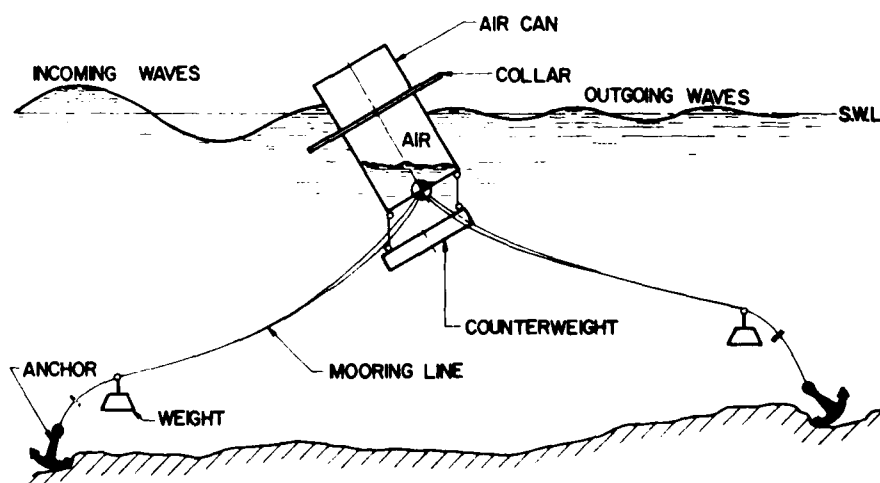


Figure 193. Bowley wave barrier concept of floating breakwater (after Bowley, 1974).

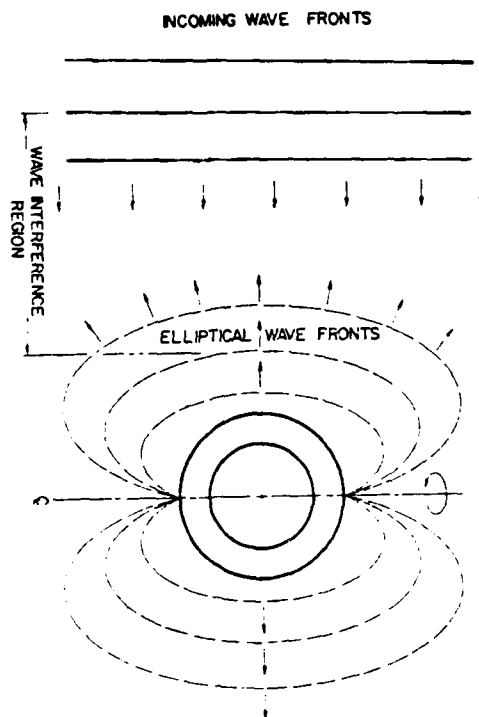


Figure 194. Wave pattern generated by Bowley wave barrier concept of floating breakwater (after Bowley, 1974).

Bowley (1974) investigated each of the flexibility criteria using three primary module types and more than 500 combinations of wave heights, wavelengths, and random seas (Pierson-Moskowitz spectrum model). The experimental study was conducted in towing tank facilities (Fig. 195). Much of the data obtained in the study were directed toward the evolution of the system for some degree of optimization under technical and economic constraints. Much of the previously reported data are for periodic wave input. However, the power spectral density versus frequency display is probably better because it approximates the conditions that the system will be subjected to in the open-ocean environment. Bowley (1974) used both types of wave climates in the experimental investigation of the wave barrier system acting as an "air spring." Bowley's extensive theoretical analysis of the motion of a single module provides little useful information on the performance of the modules because of the extremely complicated interactive, nonlinear process. It does, however, help to understand the relative significance of the primary design variables for a single module.

Figure 196 provides an indication of row effectiveness for the larger scale modules. In this test, four rows in the full array were anchored across the tank in a sequence of three buoys in the first row, two in the second, three in the third, and two in the fourth. The removal of the last two rows did not affect the function of the system until larger wave inputs were applied. The system is such that the buoy size can be changed with the row position away from the upwave direction (because each successive row must function in a different wave climate); however, standard sizes would probably be more economical to fabricate.

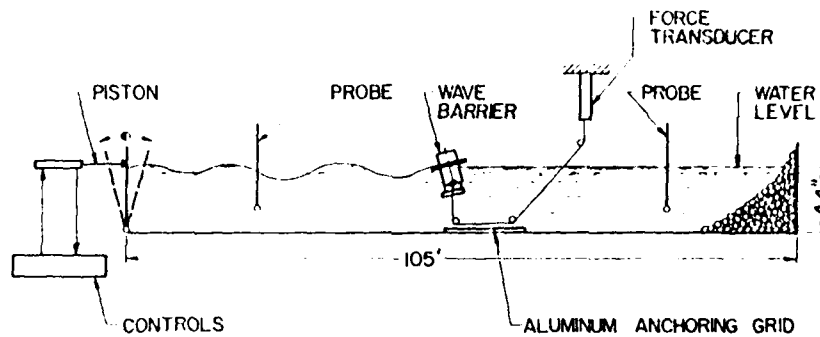


Figure 195. Experimental facility for evaluating the Bowley wave barrier concept of floating breakwater (after Bowley, 1974).

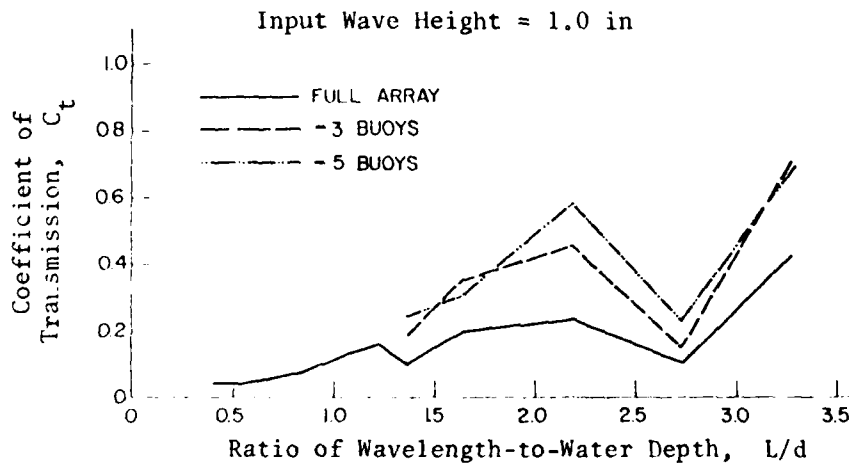


Figure 196. Effect of number of modules, and relative water depth,  $L/d$ , on transmission coefficient,  $C_t$ , for Bowley wave barrier concept of floating breakwater (after Bowley, 1974).

The degree of sensitivity for the module, and ultimately the system, to changes in the pitching mode period is shown in Figure 197. This effect is accomplished by simply changing the length of the lines supporting the counterweights. Increasing the length of these lines increases the period of the module, allowing it to pitch significantly out of phase with the input waves. A wide variation in the degree of this effect can be attained; Figure 197 is the result of two particular counterweight locations with respect to the center of buoyancy. The module acts as a pendulum, pitching about an axis, and is thus amenable to simple pendulum adjustments. The scale effects of a larger module were investigated, but were not readily apparent, as evidenced in Figure 198. The results of a random sea input of the Pierson-Moskowitz type are shown in Figure 199. A comparison of the input energy density versus the transmitted energy density reveals that the wave barrier is quite capable of spreading a sharp-peaked energy spectrum over a large frequency band.

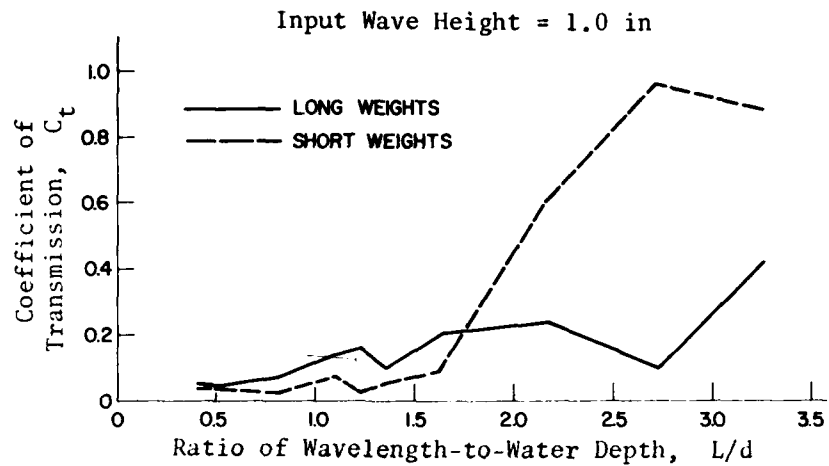


Figure 197. Effect of relative water depth,  $L/d$ , and pitching mode period (weight line length) on transmission coefficient,  $C_t$ , for Bowley wave barrier concept of floating breakwater (after Bowley, 1974).

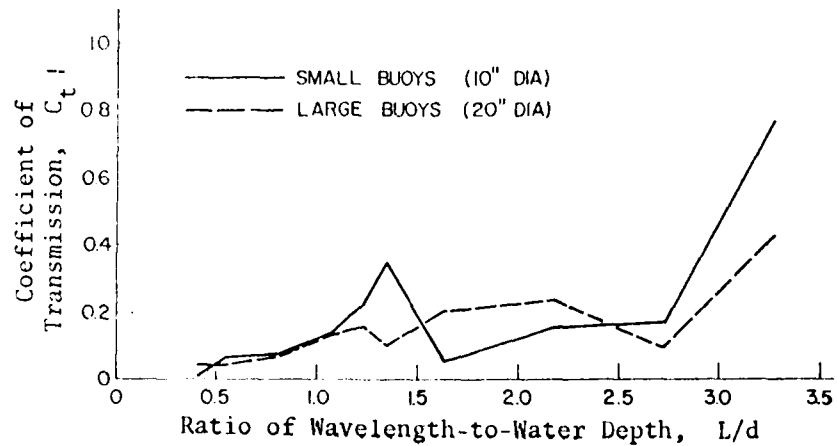


Figure 198. Effect of model buoy size and relative water depth,  $L/d$ , on transmission coefficient,  $C_t$ , for Bowley wave barrier concept of floating breakwater (after Bowley, 1974).



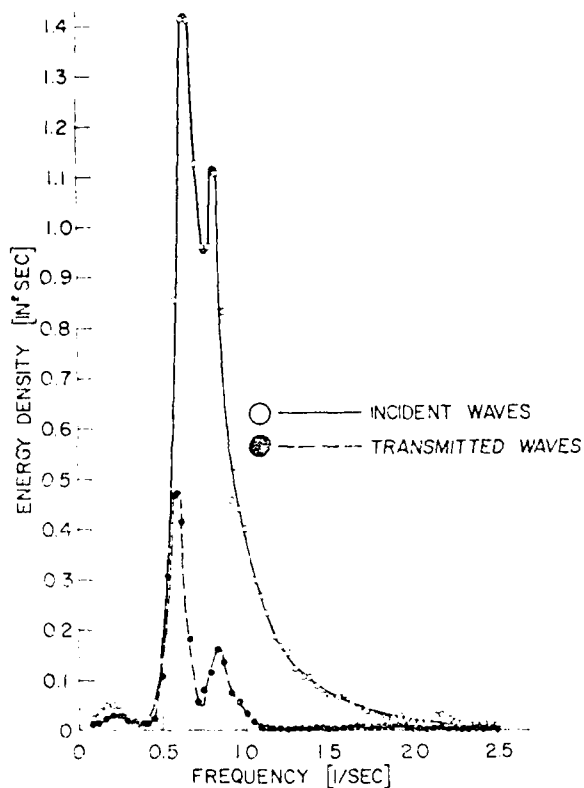


Figure 199. Effect of Bowley wave barrier concept of floating breakwater on Pierson-Moskowitz spectrum (after Bowley, 1974).

### XIII. RESERVOIR APPLICATION FLOATING BREAKWATERS

Reservoir marinas often require breakwaters that can function over a large range of water levels. The water surface elevation of a flood control reservoir may fluctuate 50 feet or more because of necessary drawdown during the summer and autumn seasons. An adequately designed breakwater must be capable of following the water surface elevation, without undue stress in the moorings, and function at all elevations. Typical design criteria include waves up to 60 feet long, periods up to 4 seconds, and heights up to 5 feet; however, the Task Committee on Small-Craft Harbors (1969) recommended that wave heights not exceed 1 foot in the mooring areas. Hay and Skoda (1967), Chen (1969), and Chen and Wiegel (1969, 1970) addressed the problem of developing floating breakwater designs especially for reservoir applications. The problems arising from the necessity of mooring floating structures were approached from the concept of increasing the effective mass or moment of inertia with entrained water, and Chen and Wiegel (1969) conducted experimental investigations. Several hybrid types of moored floating structures which combine two or more previously investigated concepts were formulated. These structures are reasonably small compared with the longest design wavelength, and are capable of reducing the highest design incident wave height to less than 1 foot in the lee of the breakwater.

### 1. Slope-Floating Beach with Pontoons.

The basic concept of this design by Chen and Wiegel (1969) was the dissipation of wave energy by waves breaking on a sloping beach. They constructed and tested a physical model (Fig. 200) consisting of a sloping beach 25 feet long (prototype dimensions), with the seaward end attached to a rectangular air chamber (pontoon) 2.5 by 2.5 feet to provide buoyancy. The lee side of the sloping beach was connected to a 14-foot-high vertical wall by steel frames; about 11 feet of the vertical wall was submerged. A lee-side floating pontoon 4 by 5.5 feet was connected to the vertical wall by a steel frame. The total width,  $W$ , of the structure was 43.5 feet prototype dimension. Experiments were conducted in a two-dimensional wave flume 106 feet long by 1 foot wide by 3 feet deep, with a 1:12 scale ratio, model-to-prototype.

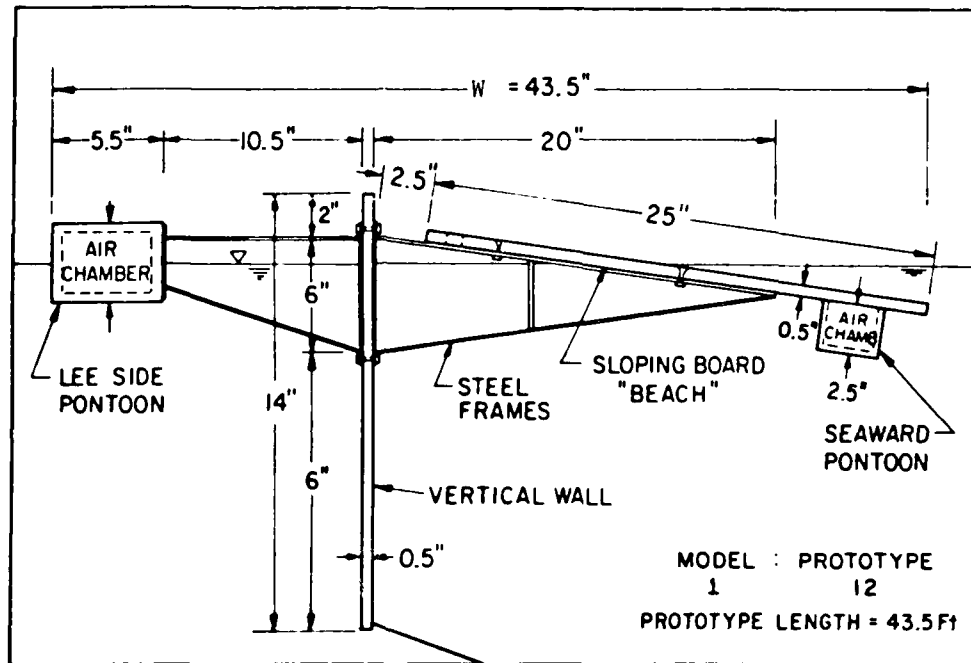


Figure 200. Slope-floating beach with pontoons for reservoir applications (after Chen and Wiegel, 1969).

Chen and Wiegel (1969) observed that small-amplitude waves broke completely on the sloping beach. The limited length of the slope prevented large-amplitude waves from breaking completely on the beach. For waves about as long as the breakwater width, a substantial amount of wave energy was dissipated in the breaking process. The top of the beach was designed to have a cavity of 2.5 feet between the beach and the vertical wall; hence, when large-amplitude waves partially broke on the beach, parts of the wave mass overtopped the beach and dropped beside the vertical wall. Considerable air entrainment and mixing occurred in this process. The periodic impact of the wave runup created a pressure fluctuation under the beach, which in turn caused a heaving motion of the water surface. A further observation was made of the slope-floating beach with pontoons drifting freely in the waves. Chen and Wiegel (1969) believed that the slow drift rate indicated a minimal mooring problem.

The wave transmission coefficients,  $C_t$ , versus the ratio of wavelength,  $L$ , to breakwater width,  $W$ , are presented in Figure 201. In wavelengths ranging from 30 to 55 feet, the steep waves (steepness of 0.055 to 0.075) had a higher transmission coefficient than did the waves of relatively small steepness (steepness of 0.022 to 0.030). The two curves coincided at a wavelength of about 60 feet; in wavelengths ranging from 65 to 90 feet, the relationship was opposite of that for the smaller wavelengths. This phenomenon is explained by the steep waves breaking partially on the beach and partially spilling over the top of the beach, causing dynamic pressure fluctuations and considerable mixing of the water to a depth of about 15 feet. This action, consequently, interfered with the orbital motion of the incident waves. Conversely, relatively small-amplitude waves broke completely on the beach. For a large-amplitude wave, part of the energy dissipation occurred in breaking and part occurred in the mixing process; for a relatively flat wave, all the energy dissipation was accomplished in the breaking process. In addition, the longer waves transmitted wave energy under the structure. The longer waves also caused a horizontal motion of the floating breakwater, and the vertical wall acted as a wave generator on the lee side.

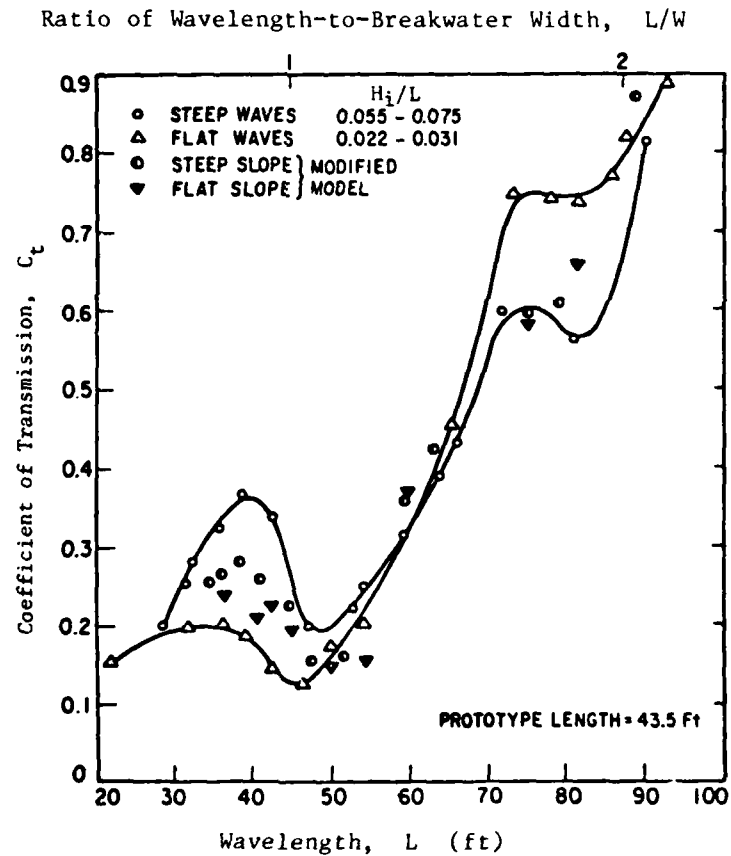


Figure 201. Effect of incident wave steepness,  $H_i/L$ , and relative breakwater width,  $L/W$ , on transmission coefficient,  $C_t$ , for slope-floating beach with pontoons (after Chen and Wiegel, 1969).

## 2. Twin-Pontoon Floating Breakwater.

Chen and Wiegel (1969) formulated a variation of the slope-floating beach with pontoons which consisted of two pontoons separated by a perforated bottom with a cross section of 7 feet by 9.5 feet prototype dimension (Fig. 202). The width of the structure was 18.5 feet, with an additional 5 feet of sloping beach extending seaward above the water surface, for a total width of 23.5 feet. A vertical barrier 9.5 feet high was attached below the lee side of the perforated section. The pontoon on the lee side had a rectangular cross section of 7 by 4.5 feet; the pontoon on the seaward side had unequal vertical sides of 7 and 6 feet, with a sloping top extending about 5 feet outward. The draft of the twin-pontoon floating breakwater was 4.5 feet, with a model-to-prototype scale ratio of 1:12.

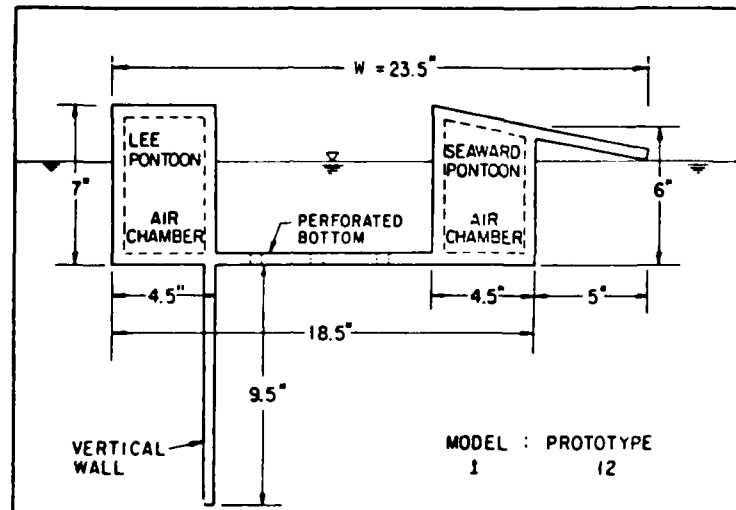


Figure 202. Twin-pontoon floating breakwater for reservoir applications (after Chen and Wiegel, 1969).

The results of the wave transmission tests from the investigation of the twin-pontoon floating breakwater are presented in Figure 203. For wavelengths less than 60 feet ( $L/W < 2.7$ ), the transmission coefficient,  $C_t$ , was less than 0.20. Considering the expected range of wavelengths in a reservoir, this was believed to be a satisfactory attenuation. For wavelengths between 65 and 80 feet, the transmission coefficient varied between 0.30 and 0.50; wavelengths more than about 90 feet produced transmission coefficients in the range of 0.60 to 0.65.

Observations during the testing program indicated that more than half of the energy of the incident wave was reflected by the breakwater as a wave train with an apparent higher frequency than the frequency of the incident waves. This breaking of the oncoming waves into a series of shorter reflecting waves appeared to result in smaller forces acting on the mooring system. Because of the vertical barrier and the overall geometric arrangements, this floating breakwater had a rather large moment of inertia with respect to rolling motion. The center perforated bottom had been designed to work as a damping device, similar to the antirolling tanks on ships. Parts of the wave energy were therefore dissipated by overtopping of the slope and by eddy formation in the center section.

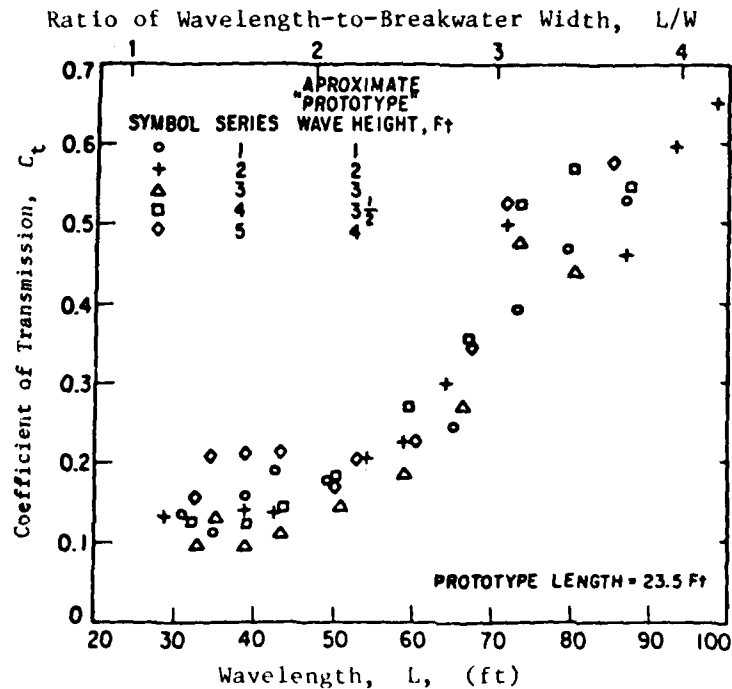


Figure 203. Effect of incident wave height,  $H_i$ , and relative breakwater width,  $L/W$ , on transmission coefficient,  $C_t$ , for twin-pontoon floating breakwater (after Chen and Wiegel, 1969).

Tension in the mooring line generally consisted of two components: one component caused by the rolling motion of the breakwater, the other caused by the wave breaking directly on the structure. The breakwater was designed, however, so that the maximum component of the two forces did not act on the mooring lines simultaneously. The rolling axis of the system is above the mooring point; when incident waves strike the breakwater, the rolling motion of the body tends to release the tension in the mooring line. When incident wave troughs reach the breakwater, the tension in the mooring line is caused by the rolling motion. Because of the reflections from the breakwater when wavelengths were 40, 60, or 80 feet, reflected waves tended to increase what otherwise would have been designated as the incident wave height. When the wavelength was equal to 50, 70, or 90 feet, the reflected wave tended to decrease the incident wave height (Chen and Wiegel, 1969).

### 3. Twin Water Chamber and Pontoon Floating Breakwater.

Chen and Wiegel (1969) developed a variation of the twin-pontoon system designed to take advantage of a fixed, perforated wall by decreasing the striking force of the wave by decreasing the reflection area. Wave energy was partially dissipated by the flow through the perforated wall, as previously suggested by Jarlan (1960, 1965), Marks (1966), Marks and Jarlan (1969), and Terrett, Osorio, and Lean (1969). The design (Fig. 204) has double perforated walls which form two 8.5-foot-high water chambers, each with 5.5 feet immersed. The distance from the front perforated wall to the second perforated wall is 4 feet; the distance from the second perforated wall to the back

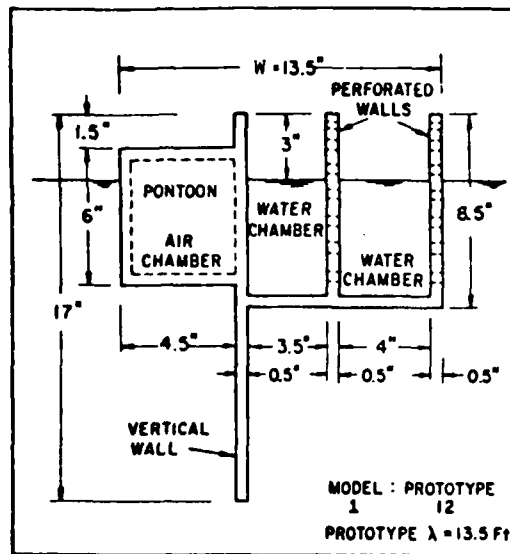


Figure 204. Twin water chamber and pontoon floating breakwater for reservoir applications (after Chen and Wiegel, 1969).

of the structure is 3.5 feet. The vertical back wall extends 8.5 feet downward to provide a large moment of inertia of added mass. The air chamber (pontoon) has a cross section of 5 by 6 feet, and can serve as a walkway along the breakwater. The width of the breakwater is 13.5 feet prototype dimension.

The wave transmission coefficient,  $C_t$ , as a function of relative breakwater width,  $L/W$ , is shown in Figure 205. For wavelengths up to about 40 feet, the results appear to be reasonably satisfactory. Beyond 40 feet, the curve of transmission coefficient versus wavelength steepens rapidly. The energy dissipation that was expected to occur with this arrangement apparently did not develop. Only a small percentage of the wave energy was dissipated by flow through the perforated walls. The remainder of the energy was either reflected or transmitted into the lee side either through the motion of the structure, which acted as a wave generator, or by wave energy passing under the breakwater.

#### 4. Fixed-Dissipator Floating Breakwater.

Chen and Wiegel (1969) evaluated a type of floating breakwater conceived by the California Department of Harbors and Watercraft. The system consisted of a platform 32 feet wide which was ballasted enough to be immersed with the bottom 6 feet below the water surface. A series of gates were suspended upward by their own buoyancy which prevented the platform from sinking. The gates, which had a cross section of 6 by 4 feet, were connected to the platform by a 1-foot-wide rubber sheet which acted as a hinge. The gates were designed so that alternate rows of gates would move in opposite directions at any specific time. The restrained motion of the gates was expected to interrupt the orbital motion of the waves, resulting in energy dissipation. The experimental results were unsatisfactory because the joint between the gates and the platform was not a simple hinge, and because of the flexibility

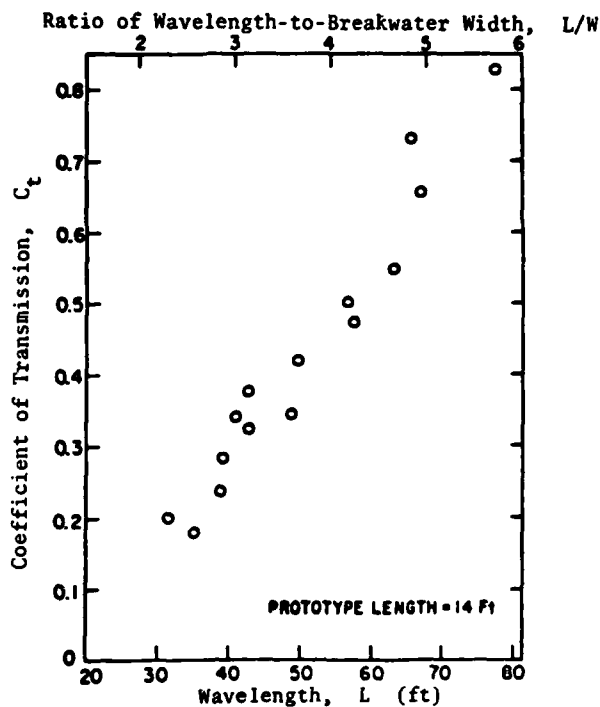


Figure 205. Effect of relative breakwater width,  $L/W$ , on transmission coefficient,  $C_t$ , for twin water chamber and pontoon floating breakwater (after Chen and Wiegel, 1969).

of the rubber sheet. Hence, the motion of the gates was not confined to a simple rolling motion; there was also a parallel displacement. In addition, the simple flat platform provided a smaller moment of inertia than would be the case of a structure equipped with a vertical barrier.

The breakwater was modified by installing a fixed energy dissipator similar to those used below large reservoir spillways. Since most of the energy transmitted by deepwater waves occurs near the water surface, the horizontal platform was redesigned to be submerged 1.75 feet below the water surface to disrupt the orbital motion of the wave. Two vertical walls extending 11 feet below the platform were attached to the platform (Fig. 206). The vertical walls and the platform provided a large moment of inertia, because of added mass, and prevented the transmission of wave energy under the platform to a depth of 13 feet. The structure was 32 feet wide. Vertical sections, mounted on the topside of the horizontal submerged platform, consisted of six rows of 2- by 2-foot stilling blocks. Each block was set in alternating patterns at an angle of  $30^\circ$  to the direction of wave propagation. Energy dissipation occurred as the waves passed through the maze of blocks and formed eddies and a high degree of turbulence.

Waves were observed colliding on the platform with great impact, apparently caused by the combination of the motion of the platform and the wave action; collision occurred at wavelengths of about 50, 70, and 90 feet (related to the period of the waves and natural frequency of the structure).

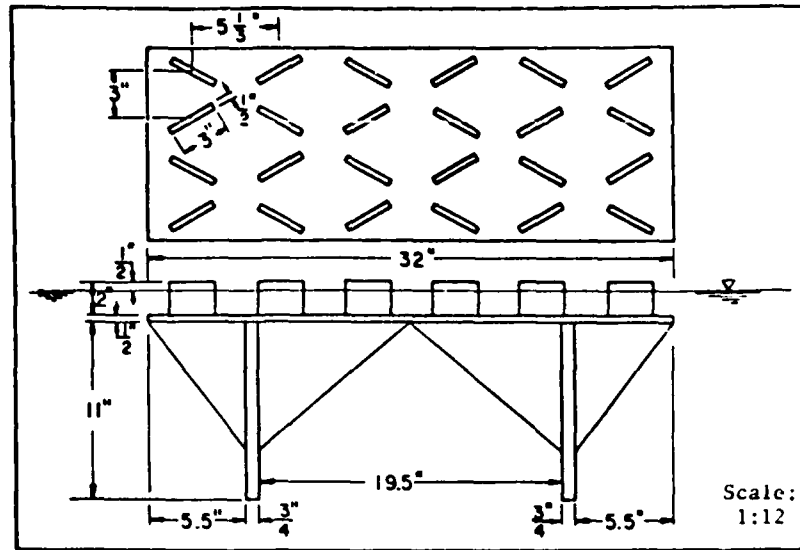


Figure 206. Fixed-dissipator floating breakwater for reservoir applications (after Chen and Wiegel, 1969).

The impact of the collision resulted in the dissipation of a part of the wave energy. The effect of relative breakwater width,  $L/W$ , on wave energy transmission is shown in Figure 207. The transmission coefficient was less than 0.40 when the wavelength was less than 55 feet (the maximum design wavelength to be expected in reservoirs is 65 feet). When the wavelength was increased to 95 feet, the resulting transmission coefficients ranged from 0.45 to 0.65.

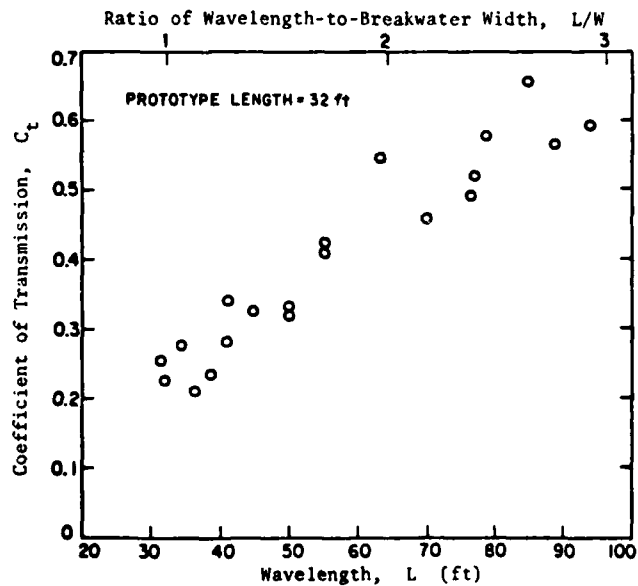


Figure 207. Effect of relative breakwater width,  $L/W$ , on transmission coefficient,  $C_t$ , for fixed dissipator floating breakwater (after Chen and Wiegel, 1969).



As a result of these two-dimensional experimental studies, Chen and Wiegel (1969) deduced that the slope-floating beach with pontoons, the twin-pontoon breakwater, and the fixed-dissipator breakwater were the most effective of those concepts tested. Scale effects, mooring forces, and mooring line elasticity were not evaluated in these investigations.

#### XIV. SUMMARY AND CONCLUSIONS

##### 1. General Considerations.

A need exists in coastal and semishielded bay regions for a means of protecting certain operations and shoreline features from the effects of excess wave energy. Permanently fixed breakwaters provide the highest degree of protection and can be exceedingly expensive to construct under certain conditions. Floating breakwaters, however, provide a lesser degree of protection, but they are generally less expensive and movable from one location to another or replaceable if circumstances such as floe ice dictate. Floating breakwaters should be evaluated as a viable alternative when the cost of a fixed structure exceeds the economic return to be gained at that location.

The construction cost of a fixed rubble-mound breakwater increases exponentially with water depth, while a floating breakwater requires essentially the same structural features regardless of the depth. The cost of a floating system is only slightly dependent on water depth and foundation conditions. The interference of a floating breakwater with shore processes, biological exchange, or circulation in bays and estuaries is minimal. Floating breakwaters also have a great multiple use (if pontoon-type structures) of serving as boat docks, moorings, or walkways.

There are certain disadvantages with floating breakwaters to be weighed in an evaluation. The design of a floating system must be carefully matched to the site conditions, with due regard to the longer waves which may arrive from infrequent storms. The floating breakwater can fail to meet its design objectives by transmitting a larger wave than can be tolerated without experiencing structural damage. Since this is a mobile system, cumulative fatigue stresses may eventually lead to system collapse. Uncertainties in the magnitudes of applied loads and lack of maintenance cost information dictate conservative design practices which increase initial project cost.

Adequate wave reduction or energy attenuation can be attained by a floating breakwater only if the incident wave is of a relatively low height. A reasonable magnitude appears to be an incident wave height not exceeding 4 feet, with a corresponding wave period not exceeding 4 seconds. Floating breakwaters can attenuate waves with these incident characteristics to a magnitude tolerable in a small-craft mooring area (wave heights up to 1.5 feet). The location of a floating breakwater should not be subjected to design waves exceeding the 4-foot-high, 4-second condition, except for open-ocean applications of a distinctly different concept formulated to withstand substantial increases in the incident wave characteristics. The structure and mooring system should be designed to withstand maximum probable forces from the maximum storm wave which occurs very infrequently.

## 2. Basic Groupings of Floating Breakwaters.

The group of prismatic structures (single-pontoon, double-pontoon, catamaran, Alaska-type, or variations thereof) contains the simplest forms of floating breakwaters. This prismatic form offers the best possibilities for multiple use as walkways, storage, boat moorings, and fishing piers. For the pontoon-type breakwaters, several factors in addition to mass seem to contribute to their performance. The radius of gyration and the depth of submergence appear to significantly influence the attenuation characteristics. Furthermore, as the ratio of breakwater width-to-wavelength increases to values greater than 0.5, the wave attenuation features of the structure not only improve markedly, but the net result of the forces on the mooring and anchoring system becomes substantially less. This occurs because the wave dynamics are exerting forces on a part of the structure in a direction opposite to those forces on other parts of the breakwater. The design of the catamaran and double-pontoon systems attempts to combine relatively large mass and large radii of gyration, thereby increasing the stability and performance of the structure.

The sloping-float breakwater concept is a wave barrier that consists of a row of moored, flat slabs or panels whose mass distribution is such that, in still water, each panel has one end resting on the bottom and the other end protruding above the water surface. The U.S. Army Corps of Engineers has a potential requirement for such a mobile breakwater system to provide partial protection to dredges and work boats involved with the construction of coastal engineering features in the nearshore zone of exposed open-ocean coastlines. The wave climate in these regions can easily approach heights up to 8 feet with periods up to 7 seconds. An increase in effective working time can be accomplished by widening the wave window used by dredges and barges, which reduces the wave energy in the sheltered region. Initial data on wave transmission indicate that sloping floats 90 feet long reduce the significant height of local wind-generated waves by more than 50 percent when the dominant wave period is less than about 7 seconds and the water depth is less than about 30 feet.

Coastal engineers have long been interested in resilient, energy-absorption systems for shore protection, and the use of scrap tires for floating breakwaters or other purposes have been investigated intermittently for the past 20 years. Three basic designs constitute those which have received the greatest attention from an experimental standpoint. A geometric assembly configuration known as the "Wave-Maze" has been patented, and the Goodyear Tire and Rubber Company has investigated extensively the use of modular building-block elements formed by securing together bundles of tightly interlocked scrap tires. Another concept known as the "Wave-Guard" uses massive beams or poles onto which the scrap tires are threaded.

Because of the availability of timber in many parts of the United States and Canada, log structures have been used to protect harbors and boat anchorages. The Canadian Department of Public Works developed and evaluated a floating breakwater concept of circular cylinder design (the A-frame) which incorporates a vertical wall for supplemental attenuation purposes. It appears the effectiveness range of this concept can be significantly increased by a large increase of its radius of gyration involving only a slight increase in the mass of the structure.

The tethered-float breakwater is a unique concept constructed of numerous buoyant floats with a characteristic dimension about equal to the wave height. The floats are independently tethered at or below the water surface in a water depth many times the float diameter. They are driven in opposition to the waves by the pressure gradient, and the dominant attenuation mechanism is drag resulting from the buoy motion. Because of their dynamic response, there is a possibility that the buoys will pendulate in the incoming wave field out of phase with the orbital motions. This out-of-phase motion transforms wave energy into turbulence and ultimately into heat.

The five concepts (pontoons, sloping float, scrap tire, cylinders, and tethered float) discussed appear to be the dominant floating breakwater types which merit serious evaluation and investigation where conditions are suitable. Other floating structures have been developed as wave attenuators, but for the most part appear to be complex arrangements with various degrees of complicated construction features. These five concepts have shown much promise for wide application but are in need of additional laboratory and field evaluation from a three-dimensional standpoint of wave transmission and mooring loads. The response of floating breakwaters to certain critical, irregular wave conditions and to oblique waves requires further investigation. Evidence indicates that long-crested waves do not strike an entire section of floating breakwater simultaneously (except for unusual occurrences such as boat wave generation); hence, the usual two-dimensional wave tank investigations probably provide highly conservative mooring data.

Theoretical work by Richey and Adey (1975) tends to indicate that the water volume (mass) displaced by a given breakwater section is more important for performance than the shape of the cross section. This conclusion has ramifications regarding materials to be used in the breakwater construction; e.g., no advantage is gained by using lightweight concrete. Mixing and placing standards are easier to maintain with standard concrete which has a long history of successful performance in both saltwater and freshwater. Sutko and Haden (1974) believe that a square cross section gives slightly better wave reduction than a triangular, circular, or trapezoidal section. The ballast should be concentrated low in the profile, and performance seems to be best when submergence is about two-thirds of the structure height. Stormer (1979) feels the designs should be kept as simple, durable, and maintenance-free as possible to avoid highly complex structures that are difficult and expensive to design, construct, and maintain. The weak links in a floating breakwater are quality control during construction of the breakwater units and the connections used to attach various modules of the system.

### 3. Construction Materials and Structure Features.

The reinforced concrete pontoon-type structures with a foam core for flotation currently appear to be the most widely accepted floating breakwaters meeting the standard wave climate. The use of scrap tires for construction material may be an exception; however, Steiner (no date) states that extensive experience with European floating breakwaters indicates the concrete floating pontoon breakwater should always be given prominent consideration.

Two important parameters for floating breakwater design include (a) the ratio of structure width-to-wavelength, and (b) the ratio of water depth-to-wavelength. A typical design of concrete pontoon floating structure uses a

width that is 30 to 40 percent of the design wavelength. Unfortunately, this ratio leads to very wide units for long wavelengths, and it has been hypothesized that deeper sections may be more appropriate for the deepwater locations such as in the Pacific Northwest. Adee (1977) concluded that the overall section profile (width and depth) of the Alaska-type and the single-pontoon structures has essentially the same degree of effectiveness. Some researchers feel the single-pontoon structure is more economical than the Alaska-type because of construction and forming aspects, even though it may require slightly more material.

The "averaging" effect of wave forces on breakwaters has been found to exist where the continuous sections are four to five times as long as the wavelength. The result of this phenomenon is that anchor cable stresses are much less than ordinary two-dimensional wave flume investigations indicate. Where deepwater conditions exist, a continuous breakwater with a relatively deep section (perhaps 12 to 15 feet square) will probably be highly effective. Polystyrene foam as an interior void filler is probably desirable for sections up to 5 feet wide by 6 feet deep. Larger cavities would be best designed as a hollow interior. For larger box units, concrete construction recommendations are to precast the sidewalls and top deck, and use a cast-in-place bottom; good construction in a prestressed structure will result in a leak-free unit.

The connection unit between modules requires much continued research and field experience evaluation. The rubber-type connectors appear to be successful (even though they are quite costly); however, more experience under severe loading conditions is required to ascertain their longevity under repeated cyclic stresses.

#### 4. Anchor Systems.

The magnitude of anchor forces under field prototype conditions is a parameter which should be determined by direct measurement methods. As noted by Richey and Adee (1975), anchor forces scaled from two-dimensional laboratory experiments are unrealistically large because (a) the elasticity and restraint conditions of the anchor system are not simulated and are inordinately stiff in the model; (b) the model is short, with respect to the crest length of the incident wave, and receives the wave force over its entire length; and (c) monochromatic laboratory waves force the breakwater to translate to the end of the tether (taking up all slack in the anchor system) to develop large forces. In a wind-generated random wave environment, the probability is very low that a series of waves would strike the full length of a floating breakwater (except possibly for boat-generated waves).

Field data are becoming available on anchor forces of floating breakwaters (e.g., Tenakee Springs, Alaska; Sitka, Alaska; Friday Harbor, Washington), and it is becoming apparent that the breakwater must move appreciably and stretch the anchor system before large forces will develop. The actual displacement of a floating breakwater in a real wind-wave exposure appears to be small, due in part to the fact that the waves do not approach the structure with crests simultaneously along the breakwater. The largest anchor force measured at Tenakee Springs, Alaska, from September 1973 to August 1974, was 7,146 pounds for a 60-foot module, about 6 percent of the weight of the structure (Richey and Adee, 1975). Similar experience with an A-frame structure at Lund, British Columbia, Canada, in 1964 (Harris, 1974) indicated mooring forces were relatively low, at less than 2 percent of the deadweight of the structure.

Richey and Adee (1975) emphasize that the sway periods (movement in the direction of wave propagation) of the structure should be long compared to the periods of the incident waves at the site. The longer the structure relative to the crest length of the incident waves, the lower will be the force in the anchor lines. However, the anchor system is a very important component of the floating breakwater installation; hence, the conservative attitude in existence should continue until more substantiating field experience is acquired.

#### 5. Comparative Cost Estimates.

Comparative cost estimates for approximating construction cost of various types of floating breakwaters, developed by Adee (1975b) and Jones (1980), are presented in Table 8. A cost comparison is strictly meaningful only if the structures produce the same degree of wave attenuation. The structures presented in Table 8 are of various designs which produce a coefficient of transmission,  $C_T$ , peculiar to that specific design. Accordingly, any cost per foot comparison of the structures of Table 8 should be used with the understanding that the effectiveness of the compared structures may not be precisely identical.

Table 8. Comparative data for various floating breakwaters.

Breakwater	Maximum width (ft)	Weight (lb/ft)	$C_T$ (approx.)	Cost/ft (yr)	Construction material
A-frame <sup>1</sup>	28.17	-----	0.4	\$230 (1965)	Steel frame, wood planking
Alaska-type <sup>1</sup>	21.	2,006	0.4	\$425 (1972)	Lightweight concrete, foam core
Friday Harbor <sup>1</sup>	25.	1,965	0.25	\$320 (1972)	Plastic flotation, wooden deck
Holmes Harbor <sup>1</sup>	29.	-----	-----	\$197 (1973)	Foam-filled aluminum drainpipe
Embarcadero <sup>1</sup>	14.	-----	0.3	\$275 (1973)	Regular concrete, foam core
Port Orchard <sup>1</sup>	12.	1,535	0.3	\$175 (1974)	Rectangular section, lightweight concrete, foam core
Scrap tires <sup>1</sup>	30.	-----	0.4	\$100 (est)	Scrap tires in bundles
Tethered float <sup>1</sup>	-----	-----	0.35	\$175 (est)	Plastic floating spheres
Sloping float <sup>2</sup>	90.	-----	0.5	\$6,000 (1980) (est)	Barge pontoon

<sup>1</sup>Cost estimate developed by Adee (1975b).

<sup>2</sup>Cost estimate developed by Jones (1980).

#### LITERATURE CITED

- ADEE, B.H., "Analysis of Floating Breakwater Mooring Forces," *Ocean Engineering Mechanics*, Vol. 1, 1974, pp. 77-92.
- ADEE, B.H., "Analysis of Floating Breakwater Performance," *Proceedings of the Symposium on Modeling Techniques*, American Society of Civil Engineers, Vol. 2, 1975a, pp. 1585-1602.
- ADEE, B.H., "Floating Breakwaters - An Idea Whose Time Has Returned," *Proceedings of the 11th Annual Meeting of the Marine Technology Society*, 1975b, pp. 707-715.
- ADEE, B.H., "A Review of Developments and Problems in Using Floating Breakwaters," *Proceedings of the Offshore Technology Conference*, Vol. 2, 1976a, pp. 225-230.
- ADEE, B.H., "Floating Breakwater Performance," *Proceedings of the 15th Conference on Coastal Engineering*, American Society of Civil Engineers, Vol. III, 1976b, pp. 2777-2791.
- ADEE, B.H., "Operational Experience with Floating Breakwaters," *Marine Technology*, Vol. 14, No. 4, Oct. 1977, pp. 379-386.
- ADEE, B.H., and MARTIN, W., "Theoretical Analysis of Floating Breakwater Performance," *Proceedings of the Floating Breakwater Conference*, University of Rhode Island, Kingston, R.I., 1974, pp. 21-40.
- ADEE, B.H., RICHEY, E.P., and CHRISTENSEN, D.R., "Floating Breakwater Field Assessment Program, Friday Harbor, Washington," TP 76-17, U.S. Army, Corps of Engineers, Coastal Engineering Research Center, Fort Belvoir, Va., Oct. 1976.
- AGERTON, D.J., SAVAGE, G.H., and STOTZ, K.C., "Design, Analysis, and Field Test of a Dynamic Floating Breakwater," *Proceedings of the 15th Conference on Coastal Engineering*, American Society of Civil Engineers, 1976, pp. 2792-2809.
- ARAKI, T., "Development of the IHI Floating Breakwater," *IHI Engineering Review*, Vol. II, No. 3, July 1978, pp. 45-53.
- BARNETT, A.W., "Characteristics of an Open-Tube Wave Attenuation System," M.S. Thesis, Massachusetts Institute of Technology, Cambridge, Mass., 1962.
- BOTTIN, R.R., Jr., and TURNER, K.A., "Seabrook Lock Complex, Lake Pontchartrain, La., Design for Wave Protection at Lock Entrance," Technical Report HL-80-7, U.S. Army Engineer Waterways Experiment Station, Vicksburg, Miss., May 1980.
- BOURODIMOS, E.L., and IPPEN, A.T., "Characteristics of an Open-Tube Wave Attenuation System," *Journal of the Waterways and Harbors Division*, Vol. 94, No. WW4, Nov. 1968, pp. 465-487.
- BOWLEY, W.W., "A Wave Barrier Concept," *Proceedings of the Floating Breakwater Conference*, University of Rhode Island, Kingston, R.I., 1974, pp. 91-112.

- BRASHER, P., "The Brasher Air Breakwater," *Compressed Air Magazine*, Vol. 20, 1915.
- BREBNER, A., and OFUYA, A.O., "Floating Breakwaters," *Proceedings of the 11th Conference on Coastal Engineering*, American Society of Civil Engineers, Vol. 2, 1968, pp. 1055-1094.
- BROMS, B.R., "Lateral Resistance of Piles in Cohesive Soils," *Journal of Soil Mechanics and Foundation Division*, Vol. 90, No. SM2, Mar. 1964, pp. 27-63.
- CANDLE, R.D., "Goodyear Scrap Tire Floating Breakwater Concepts," *Proceedings of the Floating Breakwaters Conference*, University of Rhode Island, Kingston, R.I., 1974, pp. 193-212.
- CANDLE, R.D., and FISCHER W.J., "Scrap Tire Shore Protection Structure," unnumbered report, The Goodyear Tire and Rubber Co., Akron, Ohio, 1976.
- CARR, J.H., "Mobile Breakwater Studies," Report No. N-64-2, California Institute of Technology, Pasadena, Calif., Dec. 1950.
- CARVER, R.D., "Floating Breakwater Wave-Attenuation Tests for East Bay Marina, Olympia Harbor, Washington," Technical Report HL-79-13, U.S. Army Engineer Waterways Experiment Station, Vicksburg, Miss., Apr. 1979.
- CHATHAM, C.E., Jr., "Random-Length Pipe Mobile Breakwater for Expedient Military Cargo Docking and Unloading Facility," Miscellaneous Paper H-71-8, U.S. Army Engineer Waterways Experiment Station, Vicksburg, Miss., June 1971.
- CHEN, K., "Preliminary Study of Mobile Breakwaters for Use in Lake and Reservoir Small Craft Harbors," Technical Report HEL 20-1, University of California, Berkeley, Calif., Jan. 1969.
- CHEN, K., and WIEGEL, R.L., "Hydraulic Study of Five Floating Breakwaters for Use in Reservoirs," Technical Report HEL 20-2, University of California, Berkeley, Calif., Sept. 1969.
- CHEN, K., and WIEGEL, R.L., "Floating Breakwaters for Reservoir Marinas," *Proceedings of the 12th Conference on Coastal Engineering*, American Society of Civil Engineers, Vol. III, 1970, pp. 1647-1666.
- CHRISTENSEN, D.R., and RICHEY, E.P., "Prototype Performance Characteristics of a Floating Breakwater," *Proceedings of the Floating Breakwater Conference*, University of Rhode Island, Kingston, R.I., 1974, pp. 159-180.
- CHRISTENSEN, D.R., and RICHEY, E.P., "Prototype Performance Characteristics of Two Floating Breakwaters," *Proceedings of the Offshore Technology Conference*, Vol. 2, 1976, pp. 237-252.
- COLONELL, J.M., CARVER, C.E., Jr., and LACOUTURE, J.M., "Attenuation of Wind-Generated Deep Water Waves by Pneumatic and Hydraulic Breakwaters," *Proceedings of the Floating Breakwater Conference*, University of Rhode Island, Kingston, R.I., 1974, pp. 131-158.
- DAILY, J.E., MOORE, W.L., and SETHNESS, E.D., "Applications of an Offset Floating Breakwater Configuration," *Proceedings of the Offshore Technology Conference*, Vol. 2, 1974, pp. 933-942.

- DAVIDSON, D.D., "Wave Transmission and Mooring Force Tests of Floating Breakwater, Oak Harbor, Washington," Technical Report H-71-3, U.S. Army Engineer Waterways Experiment Station, Vicksburg, Miss., Apr. 1971.
- DAVIS, A.P., Jr., "Evaluation of Tying Materials for Floating Tire Breakwaters," Marine Technical Report No. 54, University of Rhode Island, Kingston, R.I., Apr. 1977.
- DEAN, R.G., and HARLEMAN, D.R., "Interaction of Structures and Waves," *Estuary and Coastline Hydrodynamics*, A.T. Ippen, ed., Ch. 8., McGraw-Hill Book Co., New York, 1966, pp. 341-403.
- DeYOUNG, B., "Enhancing Wave Protection with Floating Tire Breakwaters," Information Bulletin 139, Cornell University, Ithaca, N.Y., Oct. 1978.
- ESSOGLU, M.E., SEYMOUR, R.J., and BERKLEY, J.B., "TFB: A Transportable Open Ocean Breakwater," *Proceedings of the 11th Annual Meeting of the Marine Technology Society*, 1975, pp. 723-725.
- FREDERIKSEN, H.D., "Wave Attenuation by Fluid Filled Bags," *Journal of the Waterways, Harbors, and Coastal Engineering Division*, Vol. 97, No. WW1, Feb. 1971, pp. 73-90.
- FREDERIKSEN, H.D., and WETZEL, J.M., "An Exploratory Investigation of Mobile Breakwaters," Project Report No. 60, St. Anthony Falls Hydraulic Laboratory, University of Minnesota, Minneapolis, Minn., June 1959.
- GALVIN, C., and GILES, M., "Radiation Stress Prediction of Mooring Force for Floating Tire Breakwaters," unnumbered report, U.S. Army, Corps of Engineers, Coastal Engineering Research Center, Fort Belvoir, Va., Sept. 1978.
- GARRISON, C.J., "Interaction of an Infinite, Shallow Draft Cylinder Oscillating at the Free Surface with a Train of Regular Waves," unpublished Ph.D. Dissertation, University of Washington, Seattle, Wash., 1968.
- GILES, M.L., and ECKERT, J.W., "Determination of Mooring Load and Transmitted Wave Height for a Floating Tire Breakwater," CETA 79-4, U.S. Army, Corps of Engineers, Coastal Engineering Research Center, Fort Belvoir, Va., Sept. 1979.
- GILES, M.L., and SORENSEN, R.M., "Prototype Scale Mooring Load and Transmission Tests for a Floating Tire Breakwater," TP 78-3, U.S. Army, Corps of Engineers, Coastal Engineering Research Center, Fort Belvoir, Va., Apr. 1978.
- GILES, M.L., and SORENSEN, R.M., "Determination of Mooring Loads and Wave Transmission for a Floating Tire Breakwater," *Proceedings of the Coastal Structures '79 Conference*, American Society of Civil Engineers, Vol. II, 1979, pp. 1069-1086.
- HARLEMAN, D.R., and SHAPIRO, W.C., "Investigations on the Dynamics of Moored Structures in Waves," Technical Report No. 28, Massachusetts Institute of Technology, Cambridge, Mass., July 1958.



- HARMS, V.W., "Data and Procedures for the Design of Floating Tire Breakwaters," Water Resources and Environmental Engineering Research Report No. 79-1, State University of New York, Buffalo, N.Y., Jan. 1979a.
- HARMS, V.W., "Design Criteria for Floating Tire Breakwaters," *Journal of the Waterway, Port, Coastal, and Ocean Division*, Vol. 105, No. WW2, May 1979b, pp. 149-170.
- HARMS, V.W., and BENDER, T.J., "Preliminary Report on the Application of Floating-Tire-Breakwater Design Data," Water Resources and Environmental Engineering Research Report No. 78-1, State University of New York, Buffalo, N.Y., Apr. 1978.
- HARRIS, A.J., and THOMAS, J.M., "The Harris Floating Breakwater," *Proceedings of the Floating Breakwaters Conference*, University of Rhode Island, Kingston, R.I., 1974, pp. 213-232.
- HARRIS, A.J., and WEBBER, N.B., "A Floating Breakwater," *Proceedings of the 11th Conference on Coastal Engineering*, American Society of Civil Engineers, Vol. 2, 1968, pp. 1049-1054.
- HASLER, H.G., "The 'Seabreaker' Floating Breakwater," *Proceedings of the Floating Breakwaters Conference*, University of Rhode Island, Kingston, R.I., 1974, pp. 181-192.
- HAY, D., "Considerations for the Design of a Floating Breakwater," unnumbered report, Department of Public Works of Canada, Vancouver, British Columbia, Canada, Sept. 1966.
- HAY, D., and SKODA, J., "Model Study of a Floating Breakwater," unnumbered report, Department of Public Works of Canada, Vancouver, British Columbia, Canada, June 1967.
- HERBICH, J.B., ZIEGLER, J., and BOWERS, C.E., "Experimental Studies of Hydraulic Breakwaters," Project Report No. 51, St. Anthony Falls Hydraulic Laboratory, University of Minnesota, Minneapolis, Minn., June 1956.
- IPPEN, A.T., and BOURODIMOS, E.L., "Breakwater Characteristics of Open-Tube Systems," Report No. 73, Hydrodynamics Laboratory, Massachusetts Institute of Technology, Cambridge, Mass., 1964.
- JACKSON, R.A., "Twin-Log Floating Breakwater, Small Boat Basin No. 2, Juneau, Alaska," Miscellaneous Paper No. 2-648, U.S. Army Engineer Waterways Experiment Station, Vicksburg, Miss., May 1964.
- JARLAN, G.E., "Note on the Possible Use of a Perforated, Vertical-Wall Breakwater," unnumbered report, Canadian National Research Council, Ottawa, Canada, Aug. 1960.
- JARLAN, G.E., "The Application of Acoustic Theory to the Reflective Properties of Coastal Engineering Structures," Quarterly Bulletin No. 1965(1), National Research Council of Canada, Ottawa, Canada, 1965.
- JOHNSON, N.F., "Design of Tether Termination Assembly for Tethered Float Breakwater, Preliminary Report," Report No. NUC TP 558, U.S. Naval Undersea Center, San Diego, Calif., Jan. 1977.

- JOLY, J., "On Floating Breakwaters," *Scientific Proceedings of the Royal Dublin Society*, Vol. 10, 1905, pp. 378-383.
- JONES, D.B., "Transportable Breakwaters--A Survey of Concepts," Technical Report R-727, U.S. Navy Civil Engineering Laboratory, Port Hueneme, Calif., May 1971.
- JONES, D.B., "Flexible Breakwaters," Technical Note N-1351, U.S. Navy Civil Engineering Laboratory, Port Hueneme, Calif., Sept. 1974.
- JONES, D.B., "An Assessment of Transportable Breakwaters with Reference to the Container Off-Loading and Transfer System (COTS)," Technical Note No. N-1529, U.S. Navy Civil Engineering Laboratory, Port Hueneme, Calif., Sept. 1978.
- JONES, D.B., "Sloping Float Breakwater: Interim Data Summary," Technical Note No. N-1568, U.S. Navy Civil Engineering Laboratory, Port Hueneme, Calif., Jan. 1980.
- JONES, D.B., LEE, J.J., and RAICHLIN, F., "A Transportable Breakwater for Nearshore Applications," *Proceedings of Civil Engineering in the Oceans IV*, American Society of Civil Engineers, Vol. 1, 1979, pp. 433-457.
- KAMEL, A.M., and DAVIDSON D.D., "Hydraulic Characteristics of Mobile Breakwaters Composed of Tires or Spheres," Technical Report H-68-2, U.S. Army Engineer Waterways Experiment Station, Vicksburg, Miss., June 1968.
- KEULEGAN, G.H., and KULIN, G., "Preliminary Tests of Wave Absorbers," Report No. 6.3/154506, National Bureau of Standards, Washington, D.C., Oct. 1958.
- KOWALSKI, T., "Scrap Tire Floating Breakwaters," *Proceedings of the Floating Breakwater Conference*, University of Rhode Island, Kingston, R.I., 1974, pp. 233-246.
- KOWALSKI, T., and ROSS, N., "How to Build a Floating Scrap Tire Breakwater," Marine Bulletin No. 21, University of Rhode Island, Kingston, R.I., 1975.
- KURIHARA, M., "Pneumatic Breakwater III: Field Test at Ha-Jima. A Translation by K. Horikawa," Research Report No. 104, University of California, Berkeley, Calif., 1958.
- LONGUET-HIGGINS, M.S., and STEWART, R.W., "Radiation Stresses in Water Waves; A Physical Discussion with Applications," *Deep-Sea Research*, Vol. II, 1964, pp. 529-562.
- MACAGNO, E.O., "Fluid Mechanics-Experimental Study of the Effects of the Passage of a Wave Beneath an Obstacle," *Proceedings of the Academic des Sciences*, Paris, France, Feb. 1953.
- MARKS, W., "A Perforated Mobile Breakwater for Fixed and Floating Application," *Proceedings of the 10th Conference on Coastal Engineering*, American Society of Civil Engineers, Vol. 2, 1966, pp. 1079-1129.

- MARKS, W., and JARLAN, G.E., "Experimental Studies on a Fixed Perforated Breakwater," *Proceedings of the 11th Conference on Coastal Engineering*, American Society of Civil Engineers, Vol. II, 1968, pp. 1121-1140.
- MILLER, D.S., "Materials and Construction Techniques for Floating Breakwaters," *Proceedings of the Floating Breakwaters Conference*, University of Rhode Island, Kingston, R.I., 1974a, pp. 247-262.
- MILLER, D.S., "Practical Applications of Floating Breakwaters for Small Craft Harbors," *Proceedings of the Floating Breakwater Conference*, University of Rhode Island, Kingston, R.I., 1974b, pp. 263-278.
- MILLER, H.F., "A Mathematical Model of the Wave Trap and the Wave Blanket," unnumbered report, U.S. Rubber Company, Wayne, N.J., Feb. 1961a.
- MILLER, H.F., "A Mathematical Model of the Long Period Wave Trap," unnumbered report, U.S. Rubber Company, Wayne, N.J., Oct. 1961b.
- MILLER, H.F., "Long Period Wave Trap, Design Charts and Model Test," unnumbered report, U.S. Rubber Company, Wayne, N.J., Oct. 1961c.
- MOFFATT AND NICHOL ENGINEERS, OGDEN BEEMAN, AND INTERNATIONAL MARITIME ASSOCIATES, "Feasibility Study to Evaluate the Commercial Market for a Tethered Float Breakwater System," unnumbered report, Long Beach, Calif., Mar. 1977.
- NECE, R.E., and RICHEY, E.P., "Wave Transmission Tests of Floating Breakwater for Oak Harbor, Washington," Technical Report No. 32, University of Washington, Seattle, Wash., 1972.
- NECE, R.E., RICHEY, E.P., and RAO, V.S., "Dissipation of Deep Water Waves by Hydraulic Breakwaters," *Proceedings of the 11th Conference on Coastal Engineering*, American Society of Civil Engineers, Vol. II, 1968, pp. 1032-1048.
- NOBLE, H.M., "Wave-Maze, Floating Breakwater," *Proceedings of Civil Engineering in the Oceans II*, American Society of Civil Engineers, 1969, pp. 929-942.
- NOBLE, H.M., "Use of Wave-Maze Flexible Floating Breakwater to Protect Offshore Structures and Landings," *Proceedings of the Offshore Technology Conference*, Vol. 2, 1976, pp. 215-224.
- O'BRIEN, J.T., KUCHENREUTHER, D.I., and JONES, R.E., "Mobile Piers and Breakwaters--An Exploratory Study of Existing Concepts," Technical Report 12, U.S. Navy Civil Engineering Laboratory, Port Hueneme, Calif., Apr. 1961.
- OFUYA, A.O., "On Floating Breakwaters," Research Report No. CE-60, Queen's University, Kingston, Ontario, Canada, Nov. 1968.
- OFUYA, A.O., and REYNOLDS, A.J., "Laboratory Simulation of Waves in an Ice Floe," *Journal of Geophysical Research*, Vol. 72, No. 14, July 1967, pp. 3567-3583.
- PATRICK, D.A., "Model Study of Amphibious Breakwaters," Issue 332, Series 3, University of California, Berkeley, Calif., Oct. 1951.

- PIERSON, W.J., and MOSKOWITZ, L., "Proposed Spectral Form for Fully Developed Wind Seas Based on the Similarity Theory of S.A. Kitaigowskii," Technical Report No. USNOO, New York University, New York, 1963.
- RAICHLIN, F., "Motions of Small Boats Moored in Standing Waves," Report No. KH-R-17, California Institute of Technology, Pasadena, Calif., Aug. 1968.
- RAICHLIN, F., "Experiments on an Inclined Pontoon Breakwater in Water Waves," Report No. N62583/78 M R668, U.S. Navy Civil Engineering Laboratory, Port Hueneme, Calif., Nov. 1978.
- RAICHLIN, F., and LEE, J.J., "The Behavior of an Inclined Pontoon Breakwater in Water Waves," Report No. N62583/78 M R552, U.S. Navy Civil Engineering Laboratory, Port Hueneme, Calif., May 1978.
- RAO, V.S., "Experimental Studies on Hydraulic Breakwaters," M.S. Thesis, University of Washington, Seattle, Wash., 1968.
- RICHEY, E.P., and ADEE, B.H., "Review of Proposed Floating Breakwater for Bar Point Harbor, Ketchikan, Alaska," Technical Report No. 43, University of Washington, Seattle, Wash., 1975.
- RICHEY, E.P., and NECE, R.E., "Floating Breakwaters: State-of-the-Art," *Proceedings of the Floating Breakwaters Conference*, University of Rhode Island, Kingston, R.I., 1974, pp. 1-20.
- RICHEY, E.P., and SOLLITT, C.K., "Attenuation of Deep Water Waves by a Porous Walled Breakwater," Technical Report No. 25, University of Washington, Seattle, Wash., Jan. 1969a.
- RICHEY, E.P., and SOLLITT, C.K., "Wave Attenuation by a Porous Walled Breakwater," *Proceedings of Civil Engineering in the Oceans II*, American Society of Civil Engineers, 1969b, pp. 903-928.
- RICHEY, E.P., and SOLLITT, C.K., "Wave Attenuation by Porous Walled Breakwaters," *Journal of the Waterways, Harbors, and Coastal Engineering Division*, Vol. 96, No. WW3, Aug. 1970, pp. 643-663.
- RIPKEN, J.F., "Evaluation Studies of the United States Rubber Company Wave Blanket and Wave Trap," Project Report No. 62, St. Anthony Falls Hydraulic Laboratory, University of Minnesota, Minneapolis, Minn., Aug. 1960a.
- RIPKEN, J.F., "An Experimental Study of Flexible Floating Breakwaters," Technical Paper No. 31, Series B, St. Anthony Falls Hydraulic Laboratory, University of Minnesota, Minneapolis, Minn., Oct. 1960b.
- SCHWARTZ, F.M., and WATTS, M.J., "A Study of Wave-Damping Properties of Several Geometric Configurations of Plastic Material," Report No. 1313, U.S. Navy David Taylor Model Basin, Washington, D.C., Mar. 1959.
- SETHNESS, E.D., Jr., and MOORE, W.L., "The Performance of an Offset Breakwater Configuration in Wind-Generated Waves," Technical Report HYD-18-7301, University of Texas, Austin, Tex., Feb. 1973.

- SETHNESS, E.D., Jr., MOORE, W.L., and DAILEY, J.E., "Offset Surface Breakwater," *Proceedings of Civil Engineering in the Oceans III*, American Society of Civil Engineers, Vol. II, 1975, pp. 677-688.
- SETHNESS, E.D., Jr., MOORE, W.L., and SABATHIER, E., "The Performance of an Offset Breakwater Configuration in Wind-Generated Waves," *Proceedings of the Floating Breakwater Conference*, University of Rhode Island, Kingston, R.I., 1974, pp. 73-90.
- SEYMOUR, R.J., "Resistance of Spheres on Oscillatory Flows," Ph.D. Thesis, University of California, San Diego, Calif., 1974.
- SEYMOUR, R.J., "Wave Induced Loads on Multi-Element Structures," *Proceedings of the Symposium on Modeling Techniques*, American Society of Civil Engineers, Vol. 2, 1975, pp. 1552-1567.
- SEYMOUR, R.J., "Performance of Tethered Float Breakwaters in Deep Ocean Waves," IMR Reference 76-4, Sea Grant Publication, No. 46, Scripps Institution of Oceanography, La Jolla, Calif., Jan. 1976a.
- SEYMOUR, R.J., "Tethered Float Breakwater: A Temporary Wave Protection Measure for Open Ocean Construction," *Proceedings of the Offshore Technology Conference*, Vol. 2, May 1976b, pp. 253-264.
- SEYMOUR, R.J., "The Application of Tethered Float Breakwater to the Protection of Nearshore Dredging," unnumbered report, Scripps Institution of Oceanography, La Jolla, Calif., July 1977.
- SEYMOUR, R.J., and HANES, D.M., "Performance Analysis of Tethered Float Breakwater," *Journal of the Waterway, Port, Coastal, and Ocean Division*, Vol. 105, No. WW3, Aug. 1979, pp. 265-280.
- SEYMOUR, R.J., and ISAACS, J.D., "Tethered Float Breakwaters," *Proceedings of the Floating Breakwaters Conference*, University of Rhode Island, Kingston, R.I., 1974, pp. 55-72.
- SHAW, G., and ROSS, N., "How to Build a Floating Tire Breakwater," Informational Bulletin No. 1, University of Maine and University of New Hampshire Cooperative Institutional Sea Grant Program, University of Maine, Orono, Maine, University of New Hampshire, Durham, N.H., Sept. 1977.
- SHAW, P., "Test on Scale Model Floating Breakwater," *The Dock and Harbour Authority*, London, England, Vol. 54, No. 636, Oct. 1973, pp. 200-203.
- SHEN, H.W., "Floating Breakwater Survey, Summer and Fall, 1960," Technical Report Issue 4, Series 140, University of California, Berkeley, Calif., June 1961.
- SHERK, S.N., "Offshore Discharge, Pneumatic Wave Attenuation Full-Scale Tank Tests," Technical Report TREC 60-26, U.S. Army Transportation Research Command, Fort Eustis, Va., Dec. 1960.
- SORENSEN, R.M., "Investigation of Ship-Generated Waves," *Journal of the Waterways, Harbors, and Coastal Engineering Division*, Vol. 93, No. WW1, Feb. 1967, pp. 85-99.
- SORENSEN, R.M., *Basic Coastal Engineering*, John Wiley & Sons, Inc., New York, 1978.

- STEINAR, O., "Design and Construction of Seawalls and Breakwaters, Part 10, Floating Breakwaters, Examples of and Experience with Norwegian Structural Types," unnumbered report, Norwegian Civil Engineers Association, Norway Technical College, undated.
- STIASSNIE, M., "A Simple Mathematical Model of a Floating Breakwater," *Applied Ocean Research*, Vol. 2, No. 3, July 1980, pp. 107-111.
- STITT, R.L., and NOBLE, H.M., "Introducing Wave-Maze Floating Breakwater," unnumbered report, Temple City, Calif., 1963.
- STORMER, C.D., "Floating Breakwater, Auke Nu Cove, Alaska," unnumbered report, U.S. Army Engineer District, Alaska, Anchorage, Alaska, 1979.
- STRAMANDI, N., "Transmission Response of Floating Breakwaters to Ship Waves," M.S. Thesis, University of Washington, Seattle, Wash., 1975.
- STRAUB, L.G., BOWERS, C.E., and TARAPORE, Z.S., "Experimental Studies of Pneumatic and Hydraulic Breakwaters," Technical Paper 25, Series B, St. Anthony Falls Hydraulic Laboratory, University of Minnesota, Minneapolis, Minn., Aug. 1959.
- STRAUB, L.G., HERBICH, J.B., and BOWERS, C.E., "An Experimental Study of Hydraulic Breakwaters," *Proceedings of the Sixth Conference on Coastal Engineering*, American Society of Civil Engineers, 1958, pp. 715-728.
- SUTKO, A.A., and HADEN, E.L., "The Effect of Surge, Heave, and Pitch on the Performance of a Floating Breakwater," *Proceedings of the Floating Breakwaters Conference*, University of Rhode Island, Kingston, R.I., 1974, pp. 41-54.
- TASK COMMITTEE ON SMALL-CRAFT HARBORS, "Report No. 50 on Engineering Practice," American Society of Civil Engineers, New York, 1969.
- TAYLOR, G.I., "Note on Possibility of Stopping Sea Waves by Means of a Curtain of Bubbles," Admiralty Scientific Research Department Report No. ATR-Misc-1259, London, England, 1943.
- TAYLOR, G.I., "The Action of a Surface Current Used as a Breakwater," *Proceedings of the Royal Society of London*, London, England, Series A, Vol. 231, 1955, pp. 466-478.
- TERRETT, F.L., OSORIO, J.D., and LEAN, G.H., "Model Studies of a Perforated Breakwater," *Proceedings of the 11th Conference on Coastal Engineering*, American Society of Civil Engineers, Vol. II, 1968, pp. 1104-1120.
- THOMSON, W.T., *Theory of Vibrations with Applications*, Prentice-Hall, Inc., Englewood Cliffs, N.J., 1972.
- URSELL, F., "The Effect of a Fixed Vertical Barrier on Surface Waves in Deep Water," *Proceedings of the Cambridge Philosophical Society*, Vol. 43, Part 3, July 1947, pp. 374-382.
- U.S. ARMY ENGINEER DISTRICT, SEATTLE, "East Bay Marina, Olympia Harbor Washington, Detailed Project Report," Seattle, Wash., 1979.
- U.S. RUBBER COMPANY, "Proposal for Damping Sea Waves," Wayne, N.J., June 1961.

- WATTS, M.J., "A Further Study of Wave-Damping Properties of Several Geometric Configurations of Plastic Material," Report No. 1349, U.S. Navy David Taylor Model Basin, Washington, D.C., Feb. 1960.
- WESTERN CANADA HYDRAULIC LABORATORIES LTD., "Report on Hydraulic Model Studies of Wave Damping Characteristics of "A" Frame Pontoon-Type Floating Breakwater," unnumbered report, Port Coquitlam, British Columbia, Canada, Nov., 1966a.
- WESTERN CANADA HYDRAULIC LABORATORIES LTD., "Report on Hydraulic Model Studies of Wave Damping Characteristics and Anchor Forces for Caisson-Type Floating Breakwater," unnumbered report, Port Coquitlam, British Columbia, Canada, Dec. 1966b.
- WETZEL, J.M., "Experimental Studies of Pneumatic and Hydraulic Breakwaters," Report No. 46, St. Anthony Falls Hydraulic Laboratory, University of Minnesota, Minneapolis, Minn., May 1955.
- WIEGEL, R.L., "Rigid Vertical Thin Barrier," Technical Report, Issue 1, Series 140, University of California, Berkeley, Calif., June 1959a.
- WIEGEL, R.L., "Floating Breakwater Survey to 15 August 1959," Technical Report, Issue 2, Series 140, University of California, Berkeley, Calif., Aug. 1959b.
- WIEGEL, R.L., "Transmission of Waves Past a Rigid Vertical Thin Barrier," *Journal of the Waterways, Harbors, and Coastal Engineering Division*, Vol. 86, No. WW1, Part 1, Mar. 1960, pp. 1-12.
- WIEGEL, R.L., *Oceanographical Engineering*, Prentice-Hall, Inc., Englewood Cliffs, N.J., 1964.
- WIEGEL, R.L., SHEN, H.W., and CUMMING, J.D., "Hovering Breakwater," *Journal of the Waterways, Harbors, and Coastal Engineering Division*, Vol. 88, No. WW2, May, 1962, pp. 23-50.
- WIEGEL, R.L., SHEN, H.W., and WRIGHT, O.C., "Floating Breakwater Survey, 15 August 1959 to 30 June 1960," Technical Report, Issue 3, Series 140, University of California, Berkeley, Calif., June 1960.
- WILLIAMS, J.A., "Verification of the Froude Modeling Law for Hydraulic Breakwaters," Technical Report No. 104-11, University of California, Berkeley, Calif., Aug. 1960.
- YAMAMOTO, T., "Moored Floating Breakwater Response to Regular and Irregular Waves," *Applied Ocean Research*, Vol. 3, No. 1, Jan. 1981, pp. 27-36.
- YAMAMOTO, T., and YOSHIDA, A., "Large Wave Tank Tests on Taut-Moored Breakwaters," *Proceedings of Coastal Structures '79*, American Society of Civil Engineers, Vol. II, 1979, pp. 1087-1105.
- YAMAMOTO, T., YOSHIDA, A., and IJIMA, T., "Dynamics of Elastically Moored Floating Objects," *Applied Ocean Research*, Vol. 2, No. 2, Apr. 1980, pp. 85-92.

<p>Hales, Lyndell Z. (Lyndell Zelton)</p> <p>Floating breakwaters : state-of-the-art literature review / by Lyndell Z. Hales.--Fort Belvoir, Va. : U.S. Army Coastal Engineering Research Center ; Springfield, Va. : available from NTIS, 1981. [279] p. : ill. ; 27 cm.--(Technical report / U.S. Army Coastal Engineering Research Center ; no. 81-1) Cover title. "October 1981." "Literature cited": p. 270.</p> <p>This report provides an evaluation of the existing technical literature (theoretical, field, and laboratory) on floating breakwater concepts.</p> <p>1. Floating breakwaters. 2. Wave propagation. I. Title. II. Series: Technical report (Coastal Engineering Research Center (U.S.)) ; no. 81-1.</p> <p>TC203 .U58ltr no. 81-1 627</p>	<p>Hales, Lyndell Z. (Lyndell Zelton)</p> <p>Floating breakwaters : state-of-the-art literature review / by Lyndell Z. Hales.--Fort Belvoir, Va. : U.S. Army Coastal Engineering Research Center ; Springfield, Va. : available from NTIS, 1981. [279] p. : ill. ; 27 cm.--(Technical report / U.S. Army Coastal Engineering Research Center ; no. 81-1) Cover title. "October 1981." "Literature cited": p. 270.</p> <p>This report provides an evaluation of the existing technical literature (theoretical, field, and laboratory) on floating breakwater concepts.</p> <p>1. Floating breakwaters. 2. Wave propagation. I. Title. II. Series: Technical report (Coastal Engineering Research Center (U.S.)) ; no. 81-1.</p> <p>TC203 .U58ltr no. 81-1 627</p>
<p>Hales, Lyndell Z. (Lyndell Zelton)</p> <p>Floating breakwaters : state-of-the-art literature review / by Lyndell Z. Hales.--Fort Belvoir, Va. : U.S. Army Coastal Engineering Research Center ; Springfield, Va. : available from NTIS, 1981. [279] p. : ill. ; 27 cm.--(Technical report / U.S. Army Coastal Engineering Research Center ; no. 81-1) Cover title. "October 1981." "Literature cited": p. 270.</p> <p>This report provides an evaluation of the existing technical literature (theoretical, field, and laboratory) on floating breakwater concepts.</p> <p>1. Floating breakwaters. 2. Wave propagation. I. Title. II. Series: Technical report (Coastal Engineering Research Center (U.S.)) ; no. 81-1.</p> <p>TC203 .U58ltr no. 81-1 627</p>	<p>Hales, Lyndell Z. (Lyndell Zelton)</p> <p>Floating breakwaters : state-of-the-art literature review / by Lyndell Z. Hales.--Fort Belvoir, Va. : U.S. Army Coastal Engineering Research Center ; Springfield, Va. : available from NTIS, 1981. [279] p. : ill. ; 27 cm.--(Technical report / U.S. Army Coastal Engineering Research Center ; no. 81-1) Cover title. "October 1981." "Literature cited": p. 270.</p> <p>This report provides an evaluation of the existing technical literature (theoretical, field, and laboratory) on floating breakwater concepts.</p> <p>1. Floating breakwaters. 2. Wave propagation. I. Title. II. Series: Technical report (Coastal Engineering Research Center (U.S.)) ; no. 81-1.</p> <p>TC203 .U58ltr no. 81-1 627</p>



**DAT  
FILM**