

LEVEL

USAAVRADCOM-TR-81-D-15

12



AD A105512

**HELICOPTER LANDING GEAR DESIGN AND TEST
CRITERIA INVESTIGATION**

David Crist, L. H. Symes
BELL HELICOPTER TEXTRON
P.O. Box 482
Fort Worth, Texas 76101

August 1981

Final Report

**DTIC
ELECTE.
OCT 8 1981
S A**

Approved for public release;
distribution unlimited.

Prepared for
**APPLIED TECHNOLOGY LABORATORY
U. S. ARMY RESEARCH AND TECHNOLOGY LABORATORIES (AVRADCOM)
Fort Eustis, Va. 23604**

BIG FILE COPY

81 10 8 002

APPLIED TECHNOLOGY LABORATORY POSITION STATEMENT

This report presents the results of an investigation to summarize the landing gear criteria for helicopters. The investigation was conducted in two phases. The first phase constitutes a summary of a literature survey and the second phase consists of a design study of various landing gear configurations. Landing gears designed to the proposed new criteria are considered to be cost-effective since the savings in damage will exceed the procurement cost differential for the gear.

William T. Alexander and Charles E. Stuhlman of the Aeronautical Technology Division, Structures Technical Area, served as project engineers for this effort.

DISCLAIMERS

The findings in this report are not to be construed as an official Department of the Army position unless so designated by other authorized documents.

When Government drawings, specifications, or other data are used for any purpose other than in connection with a definitely related Government procurement operation, the United States Government thereby incurs no responsibility nor any obligation whatsoever; and the fact that the Government may have formulated, furnished, or in any way supplied the said drawings, specifications, or other data is not to be regarded by implication or otherwise as in any manner licensing the holder or any other person or corporation, or conveying any rights or permission, to manufacture, use, or sell any patented invention that may in any way be related thereto.

Trade names cited in this report do not constitute an official endorsement or approval of the use of such commercial hardware or software.

DISPOSITION INSTRUCTIONS

Destroy this report when no longer needed. Do not return it to the originator.

UNCLASSIFIED

SECURITY CLASSIFICATION OF THIS PAGE (When Data Entered)

REPORT DOCUMENTATION PAGE		READ INSTRUCTIONS BEFORE COMPLETING FORM
1. REPORT NUMBER USAAVRADCOM TR-81-D-15	2. GOVT ACCESSION NO. AD-A 105512	3. RECIPIENT'S CATALOG NUMBER
4. TITLE (and Subtitle) HELICOPTER LANDING GEAR DESIGN AND TEST CRITERIA INVESTIGATION	5. TYPE OF REPORT & PERIOD COVERED FINAL REPORT	
7. AUTHOR(s) DAVID CRIST L. H. SYMES	6. PERFORMING ORG. REPORT NUMBER 699-099-026	
9. PERFORMING ORGANIZATION NAME AND ADDRESS BELL HELICOPTER TEXTRON P. O. BOX 482 FORT WORTH, TEXAS 76101	8. CONTRACT OR GRANT NUMBER(s) DAAK51-79-C-0011	
11. CONTROLLING OFFICE NAME AND ADDRESS Applied Technology Laboratory, US Army Research and Technology Laboratories (AVRADCOM) Fort Eustis, Virginia 23604	10. PROGRAM ELEMENT, PROJECT, TASK AREA & UNIT NUMBERS 612209 1L162209AH76 00 258 EK	
14. MONITORING AGENCY NAME & ADDRESS (if different from Controlling Office)	12. REPORT DATE August 1981	
	13. NUMBER OF PAGES 190	
	15. SECURITY CLASS. (of this Report) UNCLASSIFIED	
16. DISTRIBUTION STATEMENT (of this Report) Approved for public release; distribution unlimited.		
17. DISTRIBUTION STATEMENT (of the abstract entered in Block 20, if different from Report)		
18. SUPPLEMENTARY NOTES		
19. KEY WORDS (Continue on reverse side if necessary and identify by block number) HELICOPTER LANDING GEAR CRASHWORTHINESS LANDING GEAR CRITERIA		
20. ABSTRACT (Continue on reverse side if necessary and identify by block number) This program was an investigation of the criteria relating to helicopter landing gears. A computerized literature search was conducted and a bibliography is included in this report. Existing criteria were reviewed and conflicts were identified. An analysis of survivable Army helicopter accidents was performed. The results were used to formulate a tentative criterion. A		

DD FORM 1473 1 JAN 73 EDITION OF 1 NOV 65 IS OBSOLETE

UNCLASSIFIED

SECURITY CLASSIFICATION OF THIS PAGE (When Data Entered)

C-4200

-CD

UNCLASSIFIED

SECURITY CLASSIFICATION OF THIS PAGE(When Data Entered)

20. (Continued)

design study was conducted to evaluate the practicality of the tentative criteria. This investigation compared wheel and skid-type landing gears designed to the tentative criteria and to MIL-S-8698. A crashworthiness analysis of the tentative criteria tailwheel tricycle gear was performed. Weights and landing loads were calculated. A cost comparison was made between tailwheel tricycle gears designed to the two criteria. The gear designed to the new criteria was cost-effective. The results of the investigation were used to modify the tentative criteria and recommendations were made for a new helicopter landing gear military specification and for changes to the existing criteria.

Accession For	
NTIS GRA&I	<input checked="" type="checkbox"/>
DTIC TAB	<input type="checkbox"/>
Unannounced	<input type="checkbox"/>
Justification	
By	
Distribution/	
Availability Codes	
Avail and/or	
Special	

I
B

UNCLASSIFIED

SECURITY CLASSIFICATION OF THIS PAGE(When Data Entered)

SUMMARY

This report presents the results of a USARTL-sponsored program to investigate and recommend helicopter landing gear criteria.

The investigation was conducted in two phases. The initial phase included a search and review of landing gear literature, existing criteria, and design, test, and analysis practices. Army helicopter accident data were analyzed to identify the operational need for landing and crash impact conditions. The existing criteria are based on the MIL-S-8698 requirement for limit landing at 8.0 ft/sec sink speed and reserve energy landings at 9.8 ft/sec. These requirements have been modified by other criteria for the UTTAS and AAH. These latest requirements were incorporated into a draft MIL-L-XXXX(AV) in the contract Statement of Work. This draft was in Phase I to produce a tentative criterion. Principal differences include limit drops at 10 ft/sec, a flightworthy airframe at 20 ft/sec, and a survivable crash at 42 ft/sec vertical sink speeds. This phase determined the requirements for the landing gear, but did not evaluate the practicality of meeting these requirements.

In the second phase, the practicality of meeting the tentative criteria was investigated by conducting a design study of various landing gear configurations for a generic 8000-pound light scout/observation helicopter. Nosewheel and tailwheel tricycle, and a quadricycle wheel-type and an oleo skid landing gear were designed to meet the tentative criteria. A tricycle tailwheel gear designed to MIL-S-8698 and a production AH-1S yielding crosstube skid gear were used for comparison. Weights were calculated for all the designs. Costs were estimated for the two tailwheel gears and a cost-effectiveness and weight comparison was made to evaluate the advantages and disadvantages of the more stringent requirements. The results were used to make final recommendations for a new landing gear military specification and for changes to the related criteria.

Landing gears designed to the proposed new criteria appear to be cost-effective since the savings in damage will exceed the procurement cost differential for the gear. There are also benefits from reduced injuries. The new criteria will result in a heavier landing gear with a differential landing gear weight of about two percent of the helicopter design gross weight. The landing gear weight increase would require growth of the helicopter if the mission requirements are held constant. This growth would cause a 4 to 5 percent increase in helicopter design gross weight.

PREFACE

This report was prepared by Bell Helicopter Textron (BHT), Fort Worth, Texas, 76101, under U.S. Army Contract DAAK51-79-C-0011, "Helicopter Landing Gear Design and Test Criteria Investigation." The contract was administered under the technical direction of Mr. William T. Alexander of the Applied Technology Laboratory, U.S. Army Research and Technology Laboratories (AVRADCOM), Fort Eustis, Virginia.

Technical tasks in this program were conducted under the direction of Mr. David Crist, BHT Research Project Engineer. Principal investigators were Messrs. L. H. Symes for the Landing Gear Criteria Review and Landing Loads Analysis, Victor Berry and Jim Cronkhite for Crashworthiness Analysis, C. W. Raney for Accident Data Analysis, and Tom Waak for Computing support.

The investigators would like to express their appreciation of Mr. William T. Alexander's assistance and support in the performance of this investigation. We also appreciate the assistance of Messrs. Leo Hoecherl of Ozone Industries, Inc., for Recurring Cost Estimation; A. Q. Hales of Goodyear Aerospace Corporation for providing tire, wheel, and brake data; and George Singley III of ATL for Crashworthiness and related matters.

TABLE OF CONTENTS

	<u>Page</u>
SUMMARY.....	3
PREFACE.....	4
LIST OF ILLUSTRATIONS.....	9
LIST OF TABLES.....	12
INTRODUCTION.....	14
LITERATURE SURVEY.....	15
SURVEY METHODOLOGY.....	15
SYNOPSIS OF PERTINENT DOCUMENTS.....	18
CRITERIA REVIEW.....	20
MIL-L-8552.....	20
MIL-B-8584.....	20
MIL-T-5041.....	20
MIL-W-5013.....	21
MIL-A-008866A.....	21
MIL-I-5014.....	21
DESIGN AND TEST PARAMETERS.....	22
GROUND HANDLING OBSTRUCTION, AND TAXIING CONDITIONS.....	22
Mooring.....	22
Transport.....	22
Two-point and Three-point Braked Roll.....	23
NORMAL, RESERVE ENERGY, AND CRASH IMPACT LANDING CONDITIONS.....	23
Normal (Limit) and Reserve Energy Land- ing Conditions.....	23
Crash Impact Landing Conditions.....	24
LANDING TERRAIN AND SURFACE.....	25
TRANSPORTABILITY (KNEELING FEATURES).....	25
ENERGY ABSORPTION MECHANISMS.....	25
ROTOR LIFT FACTOR.....	28
HELICOPTER/LANDING GEAR CONFIGURATION.....	30

TABLE OF CONTENTS (Continued)

	<u>Page</u>
ENERGY ABSORBER STROKING DISTANCE AND LOAD	
FACTOR ALLOWABLE.....	30
RETRACTABLE VERSUS NONRETRACTABLE LANDING GEAR.....	33
LANDING GEAR ATTITUDE, EFFECTIVE MASS, ROTOR	
LIFT FACTOR, IMPACT SURFACE, AND IMPACT	
VELOCITY FOR LANDING GEAR DROP TESTING.....	33
STATIC ASSEMBLY TESTING.....	36
WIRE STRIKE.....	36
DESIGN AND TESTING PRACTICES.....	37
DESIGN PRACTICES.....	37
Rollover Angle.....	37
Tire and Wheel Growth.....	37
TESTING PRACTICES.....	37
Wheel Gear.....	37
Skid Gear.....	39
Current Test Programs.....	39
STATIC AND DYNAMIC ANALYTICAL METHODS.....	40
STATIC METHODS.....	40
DYNAMIC METHODS.....	40
Normal Landing Conditions.....	40
Crash Landing Conditions.....	40
ACCIDENT DATA ANALYSIS.....	42
DESCRIPTION OF DATA.....	42
WHEEL GEAR VS SKID GEAR.....	42
DATA ANALYSIS.....	42
Type of Terrain at Crash Site.....	43
Vertical Velocity or Sink Rate.....	43
Airspeed at Impact.....	43
Flight Path Angle.....	43
Impact Angle.....	49
Aircraft Attitude at Impact.....	49
Critical Impact Factors.....	49
Landing Gear Sensitive Accidents.....	49

TABLE OF CONTENTS (Continued)

	<u>Page</u>
DESIGN STUDY APPROACH.....	59
HELICOPTER CHARACTERISTICS.....	59
LANDING GEAR CONFIGURATION.....	61
DESIGN METHODOLOGY.....	61
Basic Landing Gear Layout.....	61
Landing Gear Sizing Computer Program.....	64
Jig Drop Computer Program.....	65
Helicopter Drop Computer Program.....	66
Landing Gear Evaluation.....	66
Crashworthiness Analysis.....	67
MODEL DESCRIPTION FOR 20-FT/SEC STUDY.....	67
MODEL DESCRIPTION FOR 42-FT/SEC STUDY.....	68
DESIGN STUDY CONFIGURATIONS.....	70
New Criteria Wheel Gear.....	70
Old Criteria Wheel Gear.....	71
New Criteria Skid Gear.....	71
Old Criteria Skid Gear.....	71
DESIGN STUDY RESULTS SUMMARY.....	72
NEW CRITERIA TAILWHEEL TRICYCLE.....	72
Slope Landings.....	72
Limit Landings.....	72
Reserve Energy.....	74
High Sink Speed Landings.....	74
Crashworthiness Study.....	86
NEW CRITERIA NOSEWHEEL TRICYCLE.....	102
NEW CRITERIA QUADRICYCLE.....	105
NEW CRITERIA SKID GEAR.....	105
OLD CRITERIA TAILWHEEL TRICYCLE.....	105
OLD CRITERIA SKID GEAR.....	105
EVALUATION OF DESIGN STUDY CONFIGURATIONS.....	106
OPERATIONAL EFFECTIVENESS.....	106
WEIGHTS.....	106
COSTS.....	114
COST EFFECTIVENESS.....	115
ADVANTAGES AND DISADVANTAGES.....	116
APPLICABILITY TO OTHER HELICOPTERS.....	116

TABLE OF CONTENTS (Concluded)

	<u>Page</u>
CONCLUSIONS.....	118
RECOMMENDATIONS.....	118
REFERENCES.....	119
BIBLIOGRAPHY.....	120
APPENDIX A - DESIGN STUDY CONFIGURATIONS.....	125
APPENDIX B - CRITERIA RECOMMENDATIONS.....	141
MIL-L-XXXX(AV).....	141
PROPOSED MILITARY SPECIFICATION LANDING GEAR, HELICOPTER.....	142
AMCP 706-201.....	165
AMCP 706-202.....	170
AMCP 706-203.....	171
MIL-STD-1290.....	174
USARTL-TR-79-22C.....	176

LIST OF ILLUSTRATIONS

<u>Figure</u>		<u>Page</u>
1	Literature survey methodology.....	16
2	Subjects formed from keyword combinations.....	17
3	BHT tube cutting energy absorbers used on nose gear.....	27
4	Crush testing of composite cylinders.....	29
5	Stroking distance vs ground load factor.....	32
6	Injuries vs sink rate.....	57
7	Typical wheel-type main landing gear.....	60
8	Typical new criterion air-oil shock absorber.....	62
9	Simplified KRASH model of wheeled landing gear..	69
10	Slope landing gear loads.....	73
11	Limit drop with forward speed 0-degree pitch....	75
12	Limit drop with forward speed 10-degree pitch noseup.....	76
13	Limit drop with forward speed 10-degree pitch nosedown.....	77
14	Baseline - 20 ft/sec, level.....	79
15	Baseline - 20 ft/sec, +10° pitch, 0° roll.....	80
16	Baseline - 20 ft/sec, -10° pitch, 0° roll.....	81
17	Baseline - 20 ft/sec, 0° pitch, +10° roll.....	82
18	Baseline - 20 ft/sec, +10° pitch, +10° roll.....	83
19	Baseline - 20 ft/sec, -10° pitch, +10° roll.....	84
20	Inertia spike load simulation.....	85
21	Shock strut load-deflection data for 20 ft/sec vertical impact velocity with level attitude....	87

LIST OF ILLUSTRATIONS (Continued)

<u>Figure</u>		<u>Page</u>
22	Shock strut load-deflection data for 20-ft/sec vertical impact velocity with 10 degrees nose-up pitch attitude.....	88
23	CG vertical velocity time history for 20-ft/sec vertical impact velocity with level attitude....	90
24	CG vertical acceleration time history for 20-ft/sec vertical impact velocity with level attitude.....	91
25	Right and left main gear tire load time history for 20-ft/sec vertical impact velocity with level attitude.....	92
26	Tail gear tire load time history for 20-ft/sec vertical impact velocity with level attitude....	93
27	CG vertical velocity time history for 20-ft/sec vertical impact velocity with 10 degrees nose up pitch attitude.....	94
28	CG vertical acceleration time history for 20-ft/sec vertical impact velocity with 10 degrees noseup pitch attitude.....	95
29	Main gear tire load time history for 20-ft/sec vertical impact velocity with 10 degrees nose up attitude.....	96
30	Tail gear tire load time history for 20-ft/sec vertical impact velocity with 10 degrees nose up pitch attitude.....	97
31	Maximum energy attenuator stroke required to decelerate aircraft from 42 to 30-ft/sec for various pitch impact attitudes.....	99
32	Maximum stress ratio in main gear trailing arm during deceleration of aircraft from 42 to 30-ft/sec for various pitch impact attitudes.....	100
33	Maximum stress ratio in tail gear trailing arm during deceleration of aircraft from 42 to 30-ft/sec for various pitch impact attitudes.....	101

2
B

LIST OF ILLUSTRATIONS (Concluded)

<u>Figure</u>		<u>Page</u>
34	Maximum energy attenuator stroke required to decelerate aircraft from 42 to 30-ft/sec for various roll impact attitudes.....	103
35	Maximum stress ratio in main gear trailing arm during deceleration of aircraft from 42 to 30-ft/sec for various roll impact attitudes.....	104
A-1	New criterion tailwheel tricycle.....	129
A-2	New criterion nosewheel tricycle.....	131
A-3	New criterion quadricycle wheels.....	133
A-4	Old criterion tailwheel tricycle.....	135
A-5	New criterion skid gear.....	137
A-6	Old criterion skid gear.....	139
B-1	Crash impact conditions.....	177

LIST OF TABLES

<u>Table</u>		<u>Page</u>
1	LANDING GEAR COMPARISON.....	31
2	LIMIT AND RESERVE ENERGY SINK SPEEDS.....	35
3	SINK SPEED - DROP HEIGHT RELATIONSHIP.....	38
4	TYPES OF TERRAIN ENCOUNTERED.....	44
5	SPECIFIC TERRAIN CONDITIONS ENCOUNTERED.....	45
6	DISTRIBUTION OF SINK RATE.....	46
7	DISTRIBUTION OF AIRSPEED AT IMPACT.....	47
8	DISTRIBUTION OF FLIGHT PATH ANGLE AND DIRECTION.	48
9	DISTRIBUTION OF IMPACT ANGLE.....	50
10	DISTRIBUTION OF PITCH ANGLE AND DIRECTION AT IMPACT.....	51
11	DISTRIBUTION OF ROLL ANGLE AND DIRECTION AT IMPACT.....	52
12	DISTRIBUTION OF YAW ANGLE AND DIRECTION AT IMPACT.....	53
13	VERTICAL VELOCITY VS IMPACT ANGLE.....	54
14	VERTICAL VELOCITY VS ROLL ATTITUDE.....	55
15	MAJOR INJURIES IN LANDING GEAR SENSITIVE ACCI- DENTS.....	57
16	HELICOPTER PRINCIPAL CHARACTERISTICS.....	59
17	WEIGHTS BREAKDOWN - NEW CRITERION TAILWHEEL TRICYCLE (30° TURNOVER).....	107
18	WEIGHTS BREAKDOWN - NEW CRITERION TAILWHEEL TRICYCLE (25° TURNOVER).....	108
19	WEIGHTS BREAKDOWN - NEW CRITERION NOSEWHEEL TRICYCLE.....	109

LIST OF TABLES (Concluded)

<u>Table</u>		<u>Page</u>
20	WEIGHTS BREAKDOWN - NEW CRITERION QUADRICYCLE...	110
21	WEIGHTS BREAKDOWN - NEW CRITERION SKID GEAR.....	111
22	WEIGHTS BREAKDOWN - OLD CRITERION TAILWHEEL TRICYCLE.....	112
23	UNINSTALLED WEIGHTS SUMMARY.....	113
24	LANDING GEAR COST COMPARISON.....	115

INTRODUCTION

Army helicopter landing gear requirements have changed dramatically during recent years. The UTTAS and AAH programs included landing gear requirements that are far more demanding than those in MIL-S-8698. These requirements have not been completely integrated into the published criteria. A preliminary helicopter landing military specification was prepared by ATL to include these new requirements. The objectives of this investigation were to determine the state of the art in landing gear, to define the operational needs, to assess the practicality of meeting these needs, and to make recommendations for helicopter landing gear criteria.

The initial phase of the contract consisted of a review of existing literature, criteria, design, analysis, and test practices and an analysis of Army helicopter accidents. These data were used to prepare a tentative criterion based on the operational needs. The second phase was a design study to determine the practicality of designing landing gears to meet the tentative criteria.

This was done by designing wheel and skid landing gears to both the old (MIL-S-8698) criteria and the tentative criteria and comparing the costs, weights, and benefits of gears meeting the two criteria. These results were evaluated and final recommendations were made for a new military specification and changes to related criteria.

LITERATURE SURVEY

The Technology Investigation Task included a survey of available literature. This survey included USAAMRDL Technical Reports 77-27, 72-61, and 71-22 and USAAVS Technical Reports 76-2 and 77-2. In addition, a computerized literature search was conducted. The more promising documents identified, which were not already available at BHT, were ordered for review. The references identified in this search are listed in the bibliography of this report.

Most of the information obtained in the literature survey is discussed under the relevant subject in the following sections of this report, but three reports not discussed elsewhere are covered at the end of this section.

SURVEY METHODOLOGY

A computerized literature search was conducted using the following data bases:

- The National Technical Information Service (NTIS)
- The Defense Technical Information Center (DTIC)
- The Engineering Index (Compendex)

The NTIS and DTIC files access engineering reports, standards, and books. The DTIC file also includes classified military documents that are not available through NTIS.

The Engineering Index contains publications of engineering societies such as proceedings of conferences, journals, and magazines. The available in-house information was also surveyed and catalogued. The survey procedure is illustrated in Figure 1.

The interactive computer search was done using the key word combinations as shown in Figure 2.

Interactive computer scan of
data bases

Review of personal files,
reports, journals, papers

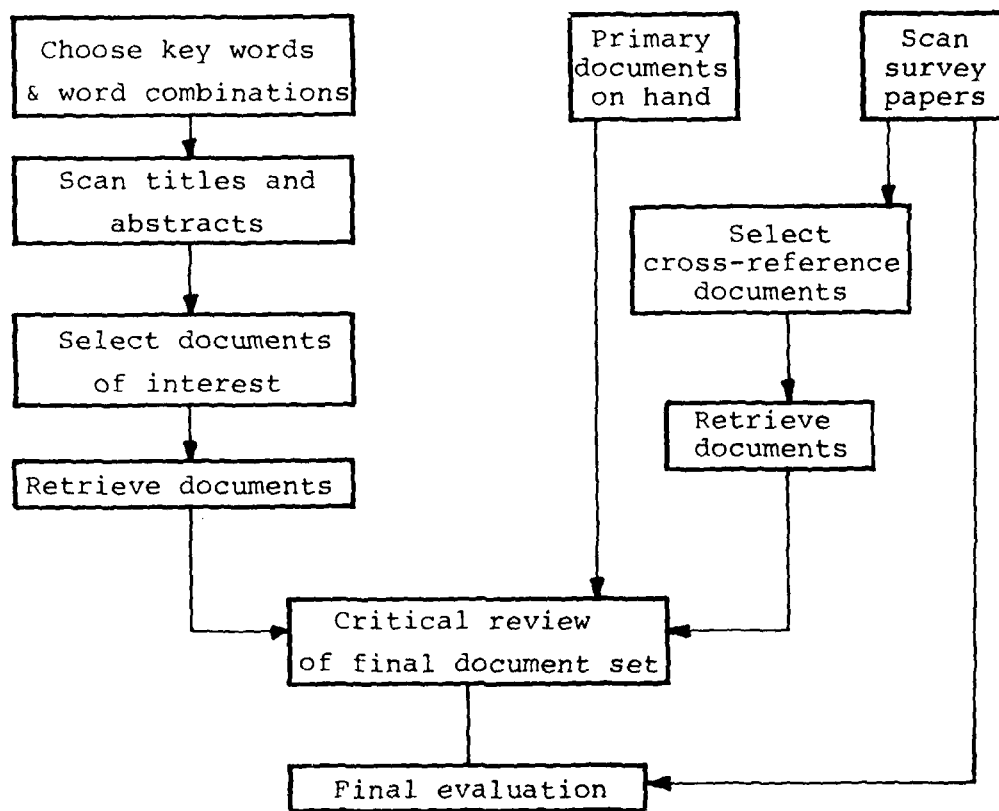

Figure 1. Literature survey methodology.

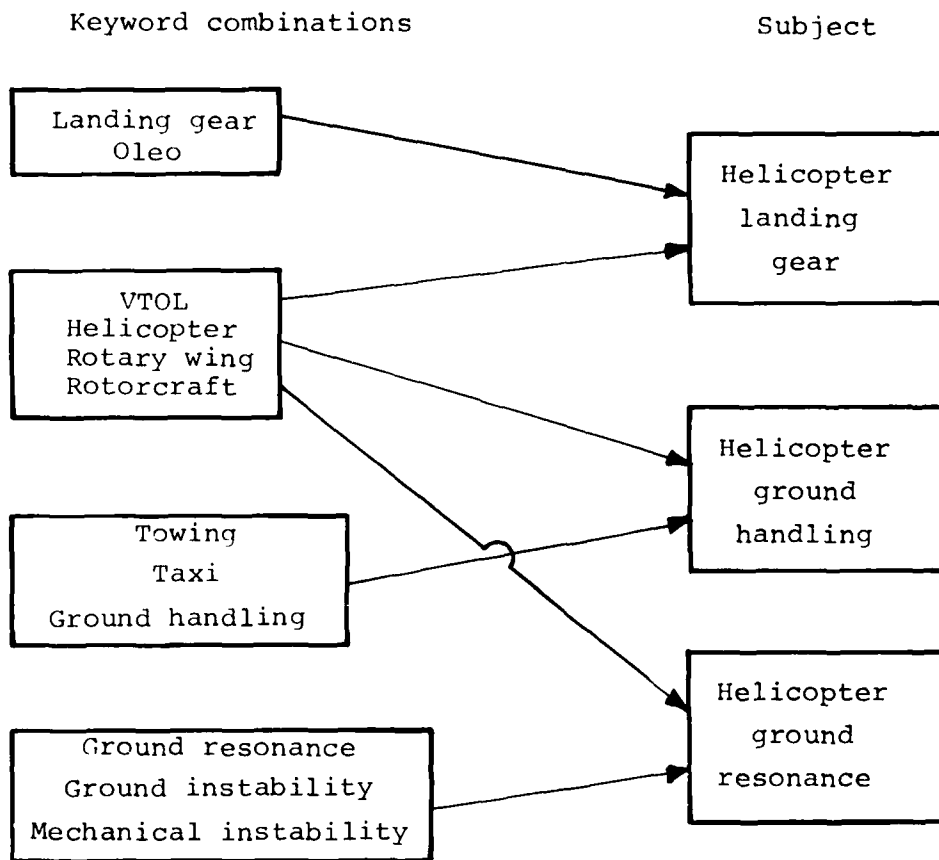

Figure 2. Subjects formed from keyword combinations.

Using this keyword format, a set of abstracts was obtained as shown below:

<u>Library</u>	<u>No. of Abstracts</u>
NTIS	468
DTIC	27
Eng. Index	32

The abstracts were reviewed to eliminate common sources and nonpertinent papers resulting in 48 potentially useful papers. From this group, five references were available in-house, and eighteen references were ordered. These 48 papers are listed in the bibliography of this report.

SYNOPSIS OF PERTINENT DOCUMENTS

Most of the reports that were reviewed are discussed under the relevant subject in the following section. The three reports discussed below were not covered under another subject.

USAAMRDL TR 72-61 Crashworthy Landing Gear Study¹

The purpose of the above study was twofold: (1) to develop rotary wing landing gear concepts and criteria, which, when applied, would lessen the magnitude of crash forces transferred to occupiable areas of helicopters involved in severe yet survivable accidents; and (2) to use the concepts to design, fabricate, and test an experimental prototype skid landing gear system up to 25 fps impact velocity. The design concept was based on a UH-1 helicopter with skid-type landing gear. An "additional" skid energy attenuation system based on a linkage arrangement in series with commercially available energy absorbers was designed and fabricated. The failure of the energy absorbers and test structure to perform as predicted negated the results of the first test and eliminated further testing.

¹Phillips, Norman S., Carr, Richard W., and Scranton, Richard S., CRASHWORTHY LANDING GEAR STUDY, Beta Industries, Inc., USAAMRDL TR 72-61, Eustis Directorate, U.S. Army Air Mobility Research and Development Laboratory, Fort Eustis, Virginia, April 1973, AD 765489.

USAAAVS TR 76-2, Economic Benefits of Utility Aircraft
Crashworthiness²

and

USAAAVS TR 77-2, The Economic Benefits of Crashworthiness
and Flight Safety Design Features in Attack Helicopters³

The above reports contain the results of analysis of the economic benefits of providing crashworthiness and other safety-related design improvements within future Army utility and attack helicopters.

Baseline data for the utility aircraft were obtained from 138 major accidents of the UH-1H from January 1972 through December 1975. Baseline data for the attack aircraft were from 141 major accidents of the AH-1G from January 1971 through December 1976.

Accident rates per 100,000 aircraft flight hours are 4.86 for the UH-1H and 20.58 for the AH-1G.

Projected accident rates and life-cycle costs for several other potential BHT candidate aircraft and for the UH-60 and AH-64 are included in the reports.

²Hicks, James E., ECONOMIC BENEFITS OF UTILITY AIRCRAFT CRASH-WORTHINESS, Directorate for Technical Research and Applications, U.S. Army Agency for Aviation Safety, Fort Rucker, Alabama, U.S. Army Training and Doctrine Command (TRADOC), USAAAVS TR 76-2, July 1976.

³Anonymous, THE ECONOMIC BENEFITS OF CRASHWORTHINESS AND FLIGHT SAFETY DESIGN FEATURES IN ATTACK HELICOPTERS, Directorate for Technical Research and Applications, U.S. Army Agency for Aviation Safety, Fort Rucker, Alabama, USAAAVS TR 77-2, June 1977.

CRITERIA REVIEW

Existing criteria pertaining to landing gear design and testing were reviewed to determine relevance to the Army helicopter landing gear requirement and to identify any conflicting requirements. Existing criteria reviewed included: MIL-STD-1290, AMCP 706-201, AMCP 706-202, AMCP 706-203, ANC-2, MIL-S-8698, AR-56, FAR 27, FAR 29, MIL-A-8862, MIL-L-8552, MIL-T-6053, MIL-A-8421F, MIL-T-5041, MIL-W-5013, MIL-A-008866A, and MIL-I-5014. Most of the results of the criteria review are grouped by subject and are presented in the Design and Test Parameters Section, and in the Design and Testing Practices Section. Individual criteria that are not discussed in another section are covered below.

MIL-L-8552

This specification covers the requirements for shock absorber landing gears of the air-oil type.

The maximum allowable bearing stress of the piston and cylinder bearings is 6000 psi based upon limit load and a uniform distribution. The computed shock absorber efficiency, determined from data obtained during a drop test, will not be less than 75 percent for a variable orifice and 60 percent for a constant orifice. The maximum load factor resulting from the drop tests will not be greater than that specified or selected for determination of the maximum landing load.

MIL-B-8584

This specification covers the brake system design requirements for aircraft equipped with wheel-type landing gear.

Required strength in the brake pedal and associated linkage is 300 pounds applied at the tip of the pedal with no yielding.

MIL-T-5041

This specification covers the requirements for aircraft pneumatic tube-type and tubeless tires.

The load rating of airplane tires, when used for helicopter applications, will be obtained by multiplying the airplane tire and dynamic load ratings by a factor of 1.67 for outside tire diameters of 26 inches and under, and by a factor of 1.50 for diameters over 26 inches. The tire inflation pressure at helicopter rated load will be approximately 1.50 times the airplane tire-rated inflation with a maximum allowable inflation of 1.80 times the airplane-rated inflation pressure, or

45 percent of the specified airplane tire burst pressure, whichever is less.

MIL-W-5013

This specification covers main and auxiliary wheels for use with pneumatic tires, brakes, and wheel-brake assemblies for all types of military aircraft.

Brake capacity requirements are 20 dynamometer stops at a deceleration rate of 6 ft/sec/sec from a landing speed of 35 knots. Peak braking torque during any braking condition within the speed and pressure range of the aircraft will not exceed the product of 0.8 times the maximum vertical load at maximum design gross weight times the static rolling radius of the tire. Rated load capacity of each wheel will be equal to or greater than the maximum load that the wheel will be subjected to at maximum towing or taxiing static design gross weight of the aircraft.

MIL-A-008866A

This specification contains the fatigue and damage tolerance requirements applicable to procurement of airplanes; helicopter fatigue requirements are not included.

MIL-I-5014

This specification covers pneumatic tire inner tubes for use in main, nose, tail and beaching wheel casings of aircraft. MIL-I-5014 supersedes MIL-T-5014.

DESIGN AND TEST PARAMETERS

This section covers existing and proposed criteria affecting design and testing of helicopter landing gear. Where there are conflicts between the different specifications, each requirement is listed but no conclusions are given. The Design Study Approach section of this report covers the criteria that will be used for the Task II Design Study.

GROUND HANDLING, OBSTRUCTION, AND TAXIING CONDITIONS

Ground load conditions for helicopters are summarized in AMCP 706-201. The conditions are essentially the same as those contained in ANC-2 and MIL-A-8862 for fixed-wing aircraft. Specific conditions are as follows:

- GROUND HANDLING

- Towing
- Jacking
- Mooring
- Transport

- TAXIING

- Two-point braked roll
- Three-point braked roll
- Unsymmetrical braking
- Reverse braking
- Turning
- Pivoting
- Taxiing
- Special tail-gear condition
- Tail gear obstruction condition (MIL-A-8862 only)

Differences in individual ground load conditions between ANC-2, MIL-A-8862, and AMCP 706-201 are noted below:

Mooring. ANC-2 and MIL-A-8862 required 65-knot horizontal wind and AMCP 706-201 required 70-knot horizontal wind.

Transport. ANC-2 and MIL-A-8862 do not contain transport requirements. AMCP 706-201 requires a limit vertical load factor of 2.67 for air transport, but MIL-A-8421 requires a limit vertical load factor of 4.5 for air transport.

Two-point and three-point braked roll. ANC-2 and MIL-A-8862 require a vertical load factor of 1.2 at landing weight and 1.0 at maximum weight. AMCP 706-201 requires a vertical load factor of 1.2 at all weights.

NORMAL, RESERVE ENERGY, AND CRASH IMPACT LANDING CONDITIONS

Normal (Limit) and Reserve Energy Landing Conditions

Limit landing conditions for helicopters are summarized in AMCP 706-201, pages 4 through 18. The symmetric landing conditions for wheel-type (tricycle nose and tail wheel) gear are essentially the same as those contained in MIL-S-8698 and ANC-2. The symmetric landing conditions for quadricycle gear and skid gear are new because MIL-S-8698 and ANC-2 do not contain criteria for these types of gears for helicopters.

Differences in landing conditions and parameters between MIL-S-8698, AMCP 706-201, and MIL-L-XXXX (if applicable) are noted below:

Obstruction Landing Conditions. MIL-S-8698 requires a horizontal load equal to 70 percent maximum vertical for the auxiliary gear (nose or tail) and 50 percent for the main gear, and AMCP 706-201 requires 50 percent for each gear.

Limit Sinking Velocity. MIL-S-8698 requires 8 fps at minimum flying weight and basic structural design gross weight. AMCP 706-201 increases the sink speed to 10 fps.

Basic Structural Design Gross Weight. MIL-S-8698 requires only mission fuel, and AMCP 706-201 requires full internal fuel to be included in the basic structural design gross weight (BSDGW).

Horizontal Speeds. MIL-S-8698 specifies the touchdown speed to be the maximum forward speed corresponding to an autorotative landing with a sinking speed of 8 fps at basic design gross weight (BDGW) and 6 fps at design alternate gross weight (DAGW) during the flare out following the approach.

AMCP 706-201 specifies all values between zero and 120 percent of the speed corresponding to minimum power required for level flight at the landing gross weight.

MIL-L-XXXX specifies all speeds from zero up to 50 knots at limit sink speed on level ground and from zero up to 40 knots at reserve energy sink speed on level ground.

Reserve Energy Landing Conditions. Two levels of reserve energy are required by AMCP 706-201. The lower level is 1.5 times design limit sinking velocity that is common to MIL-S-8698, AMCP 706-201, and MIL-L-XXXX. The upper limit is new for AMCP 706-201 and is defined as two times design limit sinking velocity where minor field repairable damage to the airframe is permitted provided the landing gear does not collapse or fail.

The last sentence of paragraph 4-5.2.3 of AMCP 706-201 states, "This combination of velocities (vertical and forward) should be considered throughout the attitude range from 15-degree nose-down to the maximum nose-up attitude during a maximum horizontal decelerative maneuver." Although this attitude range is not mandatory, it is the same as that specified in AR-56, and it exceeds the limit attitude range specified in AMCP 706-201 for the symmetric and asymmetric landing condition.

Slope Landing. AMCP 706-201 requires a 15-degree slope in the most adverse direction together with a sinking velocity of 8 ft/sec, and MIL-L-XXXX requires slopes up to 12 degrees and sideways on a 15-degree slope together with a sink speed that need not exceed 6 ft/sec.

CRASH IMPACT LANDING CONDITIONS

The crashworthy requirements of MIL-STD-1290 represent the modern Army criteria for current helicopters such as UTTAS and AAH. The new criteria include higher sink speeds, pitch-roll attitudes, and crash force attenuation requirements as noted in the following paragraphs:

Crashworthiness - Landing Gear. The landing gear will be of the load-limiting type, and be capable of decelerating the aircraft at basic structural design gross weight from a vertical impact velocity of 20 ft/sec onto a level, rigid surface without allowing the fuselage to contact the ground. Plastic deformation of the landing gear and mounting system is acceptable in meeting this requirement; however, the remainder of the aircraft structure, except rotor blades, will be flight-worthy after the impact. The aircraft will be capable of meeting this requirement in accidents including a simultaneous fuselage angular alignment of ± 10 degrees roll and pitch.

(It should be noted that paragraph 4-5.3.2.6 of AMCP 706-201 is essentially a repeat of the 20 ft/sec upper level of reserve energy and does not include all of the requirements of MIL-STD-1290 for crashworthiness of the landing gear.)

Crashworthiness - Aircraft. The contractor will analytically demonstrate the capability of the aircraft at basic structural design gross weight to withstand vertical impacts of 42 ft/sec without: (1) a reduction of the cockpit and passenger/troop compartments of more than 15 percent, and/or (2) causing the occupants to experience injurious accelerative loading. For this analysis, the aircraft orientation will be any attitude within ± 15 degrees pitch and ± 30 degrees roll.

(The above aircraft crashworthiness requirements of MIL-STD-1290 are the same as those defined earlier by the crash survival design guide, USAAMRDL TR 71-22.)⁴

LANDING TERRAIN AND SURFACE

AMCP 706-201 lists adverse terrain or obstructions as one of ten most prominent factors causing asymmetric landings in normal operations. However, no definition of adverse terrain or obstruction is given other than in MIL-A-008862A, which specifies runway roughness and bare soil fields for braking and taxi conditions.

AR-56 specifies rough field conditions for takeoffs and landings including a 4-inch step bump during takeoff and during landing impact at all critical times during the compression stroking of the landing gear for all initial landing impact conditions.

TRANSPORTABILITY (KNEELING FEATURES)

Kneeling features were required for transportability of the UH-60 and AH-64 helicopters. Report USAAMRDL 77-27⁵ for the YAH-64 advanced technology landing gear describes a dual purpose main gear shock strut that has an oil load limiter above the normal air-oil unit and it serves as an actuator during kneeling and a 5g load limiter during crash conditions.

⁴Anon., CRASH SURVIVAL DESIGN GUIDE, Dynamic Science, a Div. of Marshall Industries, USAAMRDL TR 71-22, Eustis Directorate, U. S. Army Air Mobility Research and Development Laboratory, Fort Eustis, Virginia, October 1971, AD 733358.

⁵Goodall, Ralph E., ADVANCED TECHNOLOGY HELICOPTER LANDING GEAR, Hughes Helicopter Div. of Summa Corp., USAAMRDL TR 77-27, Applied Technology Laboratory, U.S. Army Research and Technology Laboratories, Fort Eustis, Virginia, October 1977, AD A048891.

ENERGY ABSORPTION MECHANISMS

Reference 4 describes a number of "one-shot" load-limiting energy absorbers. The types of devices include the following:

- Honeycomb compression
- Tube flare
- Inversion tube
- Rod thru tube
- S-shaped bar
- Standard cable
- Metal tube
- Strap/rod
- Tension pulley
- Bar thru die
- Wire through platten
- Rolling torus

The honeycomb compression-type load limiter has been used by Sikorsky in their Models S-58, S-61 and S-62 landing gear above the normal oleo shock strut to provide additional energy absorption capability in severe accidents.

Reference 5 evaluated several of the above types of "one-shot" load limiters and concluded that several of the energy-absorbing devices are promising candidates for landing gear use, but experience data regarding their capabilities are limited except for the honeycomb compression type. The advanced technology landing gear study considered the honeycomb load limiter and the baseline oil load limiter. It was concluded that the oil load limiter was the most cost-effective.

BHT designed and tested a tube cutter energy-absorbing device that was located around the upper portion of the cantilever shock strut. This gear, a typical load deflection curve of the tube cutter device, and pictures of some tube cutter specimens are shown in Figure 3. The tube cutter operated in series with the shock strut that incorporated a blow-off plate to open auxiliary orifices and reduce the 42 ft/sec crash velocity to 31 ft/sec at fuselage contact with a constant 8g deceleration. In order to provide adequate performance at lower crash velocities, a spring-loaded variable orifice could be used instead of the blow-off plate. BHT has recently designed, built, and tested a spring-loaded variable orifice device.



TEST SPECIMENS



CUTTING DIE

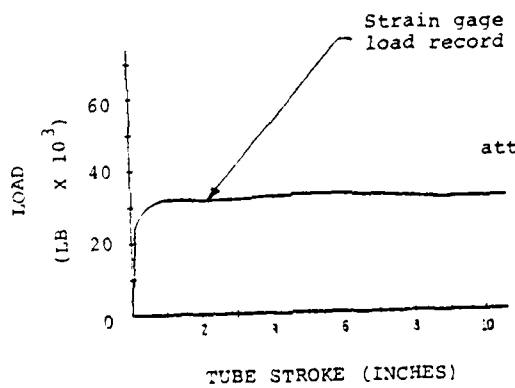

TUBE CUTTING DROP TEST RESULTS

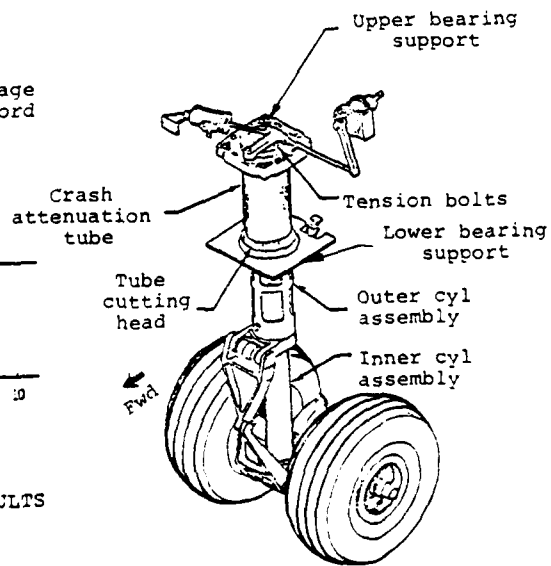

Figure 3. BHT tube cutting energy absorbers used on nose gear.

The use of composite materials for energy absorption looks promising. Recent tests at BHT showed that composite cylinders, when progressively crushed, exhibited high-energy absorption for their weight. An index of this characteristic of energy absorbers is the Specific Energy Absorption or SEA, which is the area under the load-deflection curve (energy in ft-lb) divided by the weight of the device to give SEA in ft-lb/lb. Figure 4 shows typical load deflection curves obtained with three composite materials: graphite, Kevlar, and fiberglass. Preliminary tests have already yielded SEA values of 40,000 ft-lb/lb with graphite cylinders. For comparison, metal honeycomb has SEA values of approximately 5000-12000 ft-lb/lb, and the highest metal energy absorbing devices, frangible tubes for example, have SEA values of approximately 30000 ft-lb/lb. It is anticipated that other fiber orientations for the graphite cylinders could increase the preliminary test SEA value of 40,000 ft-lb/lb by a factor of 2.

ROTOR LIFT FACTOR

The rotor lift factor varies with different procuring agencies/specifications as noted below:

Agency/Spec.	Limit	Reserve Energy	Crash
Civil/FAR 27, FAR 29	2/3	1.0	-
Navy/AR56	1.0 (Design)	-	-
Army/MIL-S-8698	2/3	2/3	2/3
Army/AMPC706-201	2/3	2/3	2/3
Army/MIL-L-XXXX	2/3	2/3	2/3

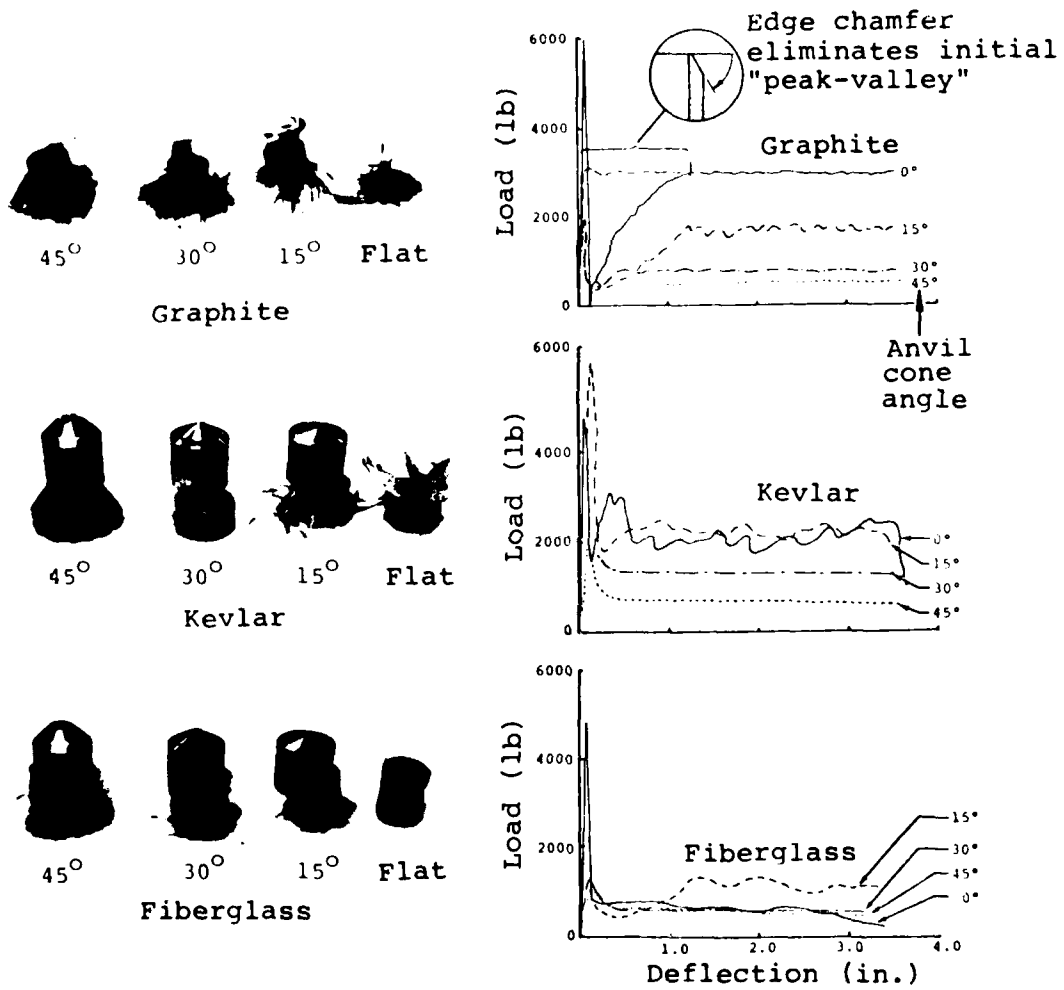

Figure 4. Crush testing of composite cylinders.

It should be noted that MIL-STD-1290 and Reference 4 do not specifically address rotor lift but infer that a rotor lift of 1.0 can be assumed for crash conditions. The Hughes Report, Reference 5, criterion uses a rotor lift of 1.0 for the crash conditions. The effect of using a rotor lift of 2/3 is to increase the kinetic energy by the potential energy of W/3 times the vertical stroking distance of the tire plus the shock strut.

HELICOPTER/LANDING GEAR CONFIGURATIONS

Helicopter landing gear configurations include skid gears and quadricycle gears. Table 1, taken from Reference 5, summarizes landing gear configurations of 21 helicopters. Skid gears have been used for low gross weight helicopters for many years. As the gross weight increases, tricycle tailwheel or nosewheel types have been used. The quadricycle type has been used at the high gross weights.

Quadricycle gears have also been used at low gross weights. Some of BHT's early models such as Models 47, 47A, 47B, 47D, 48, 49 and 61 used quadricycle gears.

ENERGY ABSORBER STROKING DISTANCE AND LOAD FACTOR ALLOWABLE

Figure 5 shows the relationship between energy absorber stroking distance and landing gear ground load factor for impact velocities of 10, 20, and 30 ft/sec with .75 and .875 shock absorber efficiency, 2/3 rotor lift, and neglecting tires.

Reference 5 reports that the main gear shock strut for the YAH-64 is designed for a 3g limit ground load factor at 10 ft/sec limit velocity with a vertical stroking distance of 10 inches. MIL-STD-1290 requirements of 20 ft/sec are exceeded under a 5g ground load factor with 31 ft/sec impact velocity at fuselage contact and a vertical stroking distance of 39 inches. For the 42 ft/sec crash condition, the oil load limiter maintains the ground load factor at 5g with the same vertical stroking distance of 39 inches. Both crash conditions assume a rotor lift factor of 1g.

The limit ground load factor consistent with a limit flight load factor at the center of gravity of 3.5 and 0.67 rotor lift is equal to $3.5 - 0.67 = 2.83g$.

TABLE 1. LANDING GEAR COMPARISON

Helicopter	Manufacturer	Helicopter Gross Weight, lb	Tricycle		Skid	Quad- ricycle
			Nose- wheel	Tail- wheel		
300C	Hughes	2,050			X	
F28A	Enstrom	2,150			X	
OH-6A	Hughes	2,400			X	
500D	Hughes	3,000			X	
OH-58A	Bell	3,000			X	
206L	Bell	3,900			X	
105C	Boeing Vertol	5,070			X	
UH-1H	Bell	9,500			X	
AH-1T	Bell	14,000			X	
HH-52A	Sikorsky	7,900		X		
SH-2D	Kaman	12,800		X		
YAH-64	Hughes	13,200		X		
YUH-60A	Sikorsky	15,850		X		
SH-3D	Sikorsky	20,500		X		
YAH-63	Bell	15,000*	X			
YUH-61A	Boeing Vertol	15,000*	X			
CH-3E	Sikorsky	22,050	X			
CH-46E	Boeing Vertol	23,300	X			
RH-53	Sikorsky	41,126	X			
CH-54A	Sikorsky	42,000	X			
CH-47A	Boeing Vertol	46,000				X

* Approximate

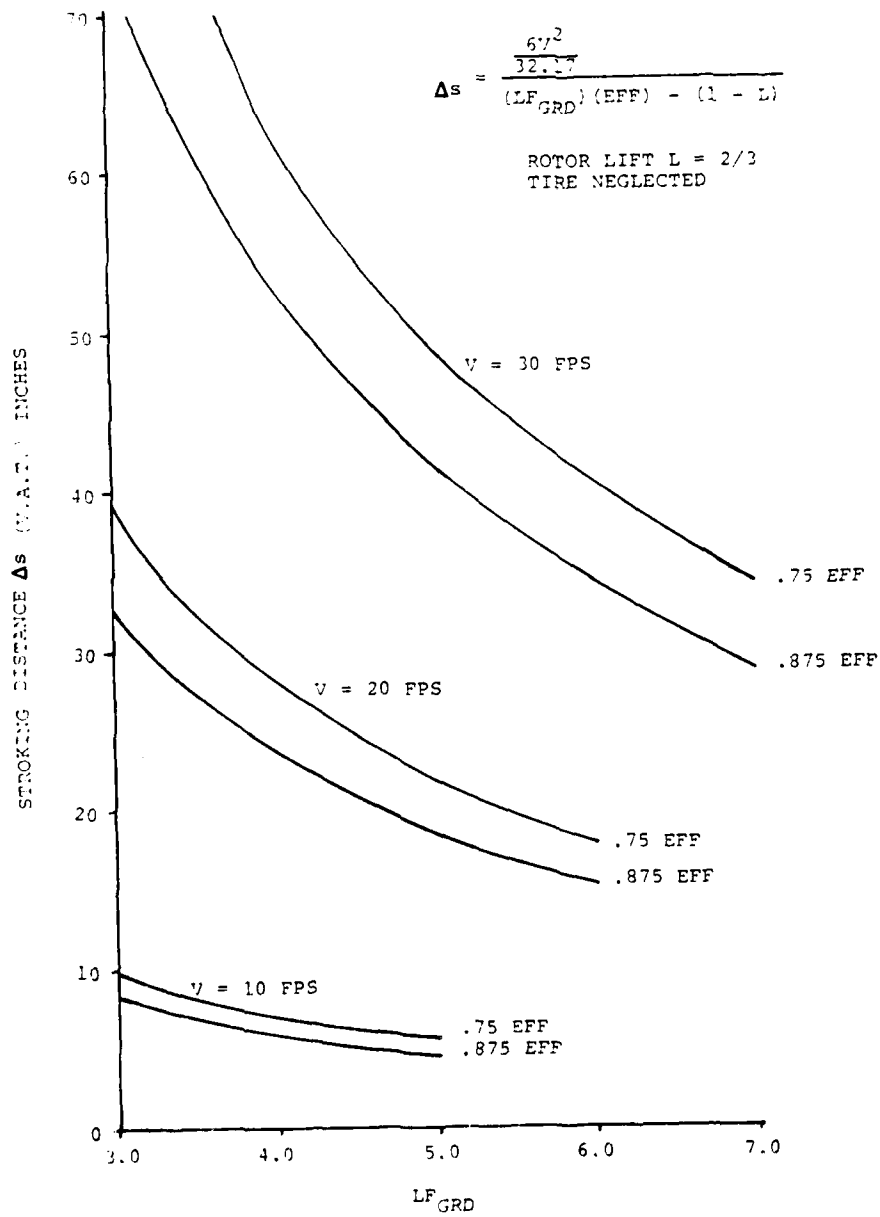

Figure 5. Stroking distance vs ground load factor.

RETRACTABLE VERSUS NONRETRACTABLE LANDING GEAR

The only helicopters designed to meet the MIL-STD-1290 crashworthiness requirements are the UH-60 and the AH-64. Both helicopters have nonretractable landing gears because of the additional energy-absorbing capability provided by the design of the shock strut and gear configuration. It is extremely doubtful that alternate designs for equivalent energy absorption and equal weight could be developed for crash landings with a retractable gear in the up position.

Reference 5 states that the YAH-64 main landing gear can absorb 57 percent of the total impact energy for the design 42 ft/sec vertical velocity impact in a three-point landing attitude. (Calculations are not shown.)

LANDING GEAR ATTITUDE, EFFECTIVE MASS, ROTOR LIFT FACTOR, IMPACT SURFACE, AND IMPACT VELOCITY FOR LANDING GEAR DROP TESTING

AMCP 706-203 contains a brief section (9-2.3) covering landing gear drop testing. Reference is made to MIL-T-6053B for jig drop testing of individual gears (main, nose, tail) and to MIL-T-8679 for drop testing of the complete helicopter or landing gear test assemblies that include representative actual helicopter mass and inertial characteristics.

The major differences between a jig drop test of an individual landing gear assembly and a drop of a complete helicopter are the weight the gear must react and the pitch and roll attitude. In a jig drop test, the weight on the gear and the attitude of the gear remain constant throughout the drop. In a complete helicopter drop test, the helicopter will pitch, roll, and redistribute loads between the individual landing gears.

Over the years, a large number of successful aircraft have been designed and built with landing gears that have been tested only by individual gear jig drop tests. The addition of crashworthiness requirements involving roll/pitch considerations and significantly higher sink speeds will require a reassessment of past practices and procedures. It is anticipated that the analytical studies to be conducted in Phase II will provide important information for design of future Army helicopter landing gears.

Landing gear drop testing of individual wheel-type gears is performed in order to demonstrate that the limit and reserve energy load factors selected for design are not exceeded during the drop tests.

The tests include a representative range of helicopter weights, attitudes, vertical impact velocities, and, for wheel-type landing gear, sufficient wheel spin-up to simulate critical horizontal velocities. The impact surface is steel or other suitable material that will provide a friction coefficient of .55 or higher.

Rotor lift is $2/3W$ for all weights and may be introduced into the drop test by appropriate energy-absorbing devices such as lift cylinders or by the use of an effective mass. The effective mass method of simulating rotor lift in the drop test provides that the energy-absorption requirements imposed on the landing gear by a dead weight test fixture are the same as would be imposed if the aircraft were dropped at the required weight, attitude, and height with a specified value of rotor lift being applied simultaneously at touchdown.

Skid gear drop tests are performed on complete skid gear assemblies mounted on a test fixture that simulates actual mass moments of inertia. Limit and reserve energy drop tests are conducted for the following three conditions:

- Level landing vertical reactions
- Level landing with drag load (drag = .5 vertical)
- Level landing with side load (side = .25 vertical)

Table 2 compares limit and reserve energy sink speeds for different procuring agencies/specifications:

5
B

TABLE 2. LIMIT AND RESERVE ENERGY SINK SPEEDS

Agency/Spec	Gross Weight	Sink Speed (ft/sec)	
		Limit	Reserve Energy
Army/MIL-S-8698	BSGW	8.0	9.8
	ADGW	6.0	7.35
Army/AMCP 706-201	BSDGW	10.0	12.25
	ADGW	6.0	7.35
Civil/FAR 27	MAX WT	8.35	10.23
Civil/FAR 29	MAX WT	6.55	8.02
Navy/AR-56	BDGW(VTOL)	12	-
	ADGW(VTOL)	8	-

NOTE: AR-56 sink speeds are design and include variations in sink speeds with roll angles:

2° roll @ 12 fps to 9° roll @ 3 fps
 2° roll @ 8 fps to 7° roll @ 3 fps

STATIC ASSEMBLY TESTING

AMCP 706-203 contains a section (9-2.2) covering static assembly testing. Reference is made to MIL-T-8679 for developing the structural test program of a complete airframe.

The major structural areas (fuselage, wing, horizontal tail, vertical tail, tailboom, landing gears, control system, engine mounts, transmission mounts, and rotor mounts) must all be tested to the critical bending and/or torsional and/or shear condition. Tests are to be carried to limit, ultimate, and failing loads. Critical test loads for a specific helicopter can be determined from a review of the helicopter load report and stress report.

WIRE STRIKE

BHT, under contract with the Applied Technology Laboratory, has been investigating helicopter obstacle strikes. The objective of the effort was to define viable concepts and design criteria that will reduce the frequency and severity of Army helicopter mishaps attributable to in-flight obstacle strikes. Army mishap information was used to verify the need for obstacle strike protection, and then to determine what protection is actually needed. An integral part of the effort involved determination of where on the aircraft an obstacle struck. For example, for the period 1971 through November 1977, there were at least 28 U.S Army helicopter mishaps where the landing gear was struck, some of which resulted in major accidents. It was determined that it could be feasible to incorporate simple protection techniques into the landing gear to reduce their share of the risk. For example, a sloped fairing from the forward end of the skid tubes to the bottom of the fuselage would prevent wire engagement. For wheel gear, a retractable landing gear would reduce wire strikes. Consideration of the obstacle strike, particularly wire/rope/cable strike, for both in-flight and low-level or ground operation would be most effective in the initial design concept phase.

The landing gear basic type has a major effect on the need for auxiliary wire strike protection. A trailing arm configuration is inherently less susceptible to hanging up during a wire strike than a cantilever-mounted landing gear. A wire striking a trailing arm will tend to slide aft and down the arm, hit the tire and slide free of the landing gear. A cantilever-mounted landing gear presents a vertical column that is much more likely to hang up on a wire. The cantilever gear can be expected to require some type of auxiliary device, external to the basic gear, for wire strike protection.

DESIGN AND TESTING PRACTICES

DESIGN PRACTICES

The customary design and testing practice (before crashworthiness requirements) has been to select a landing load factor that did not exceed any flight load factor at the cg, and calculate landing loads based upon that landing load factor. During the drop test program, a metering pin configuration would be developed so that the drop test loads did not exceed the previously calculated landing loads.

AMCP 706-202 (Section 12-2) states that it is normal practice to design the energy-absorbing capability of the landing gear so that the landing and ground-handling loads are critical only for the landing gear attachment and support points. Should the specified landing or ground-handling loads exceed the flight loads, it is usually appropriate to revise the landing gear energy-absorbing system to reduce the load factor at the cg, and/or the local loads. (Crashworthiness requirements are not specifically noted.)

Reference 3 states that the crashworthiness requirements of MIL-STD-1290 increased the weight empty of the YAH-64 helicopter by 382 pounds or 3.7 percent.

Rollover Angle

AMCP 706-201 increases the minimum rollover angle from 27 degrees to 30 degrees for all new Army helicopters.

Tire and Wheel Growth

AMCP 706-202 requires an allowance for growth in gross weight (25 percent minimum) to be made when wheel and tire sizes are selected and clearances are established. To provide for such weight growth, the addition of plies to increase the load rating of a tire otherwise suitable for the design and/or dynamic load is acceptable.

TESTING PRACTICES

Wheel Gear

The principal testing of wheel landing gear in the past has been the jig drop test. This involves a single gear mounted on a carriage in a tracked drop test tower. The carriage is loaded with a weight to simulate the individual landing gear's portion of the aircraft weight, and the gear is dropped from a height sufficient to give the proper sink speed at ground

contact. Usually a reduced drop weight is used so that the potential energy change of the drop weight compensates for rotor lift. Sometimes the full drop weight is used and lift cylinders or other mechanisms are used to simulate rotor lift. It is usually possible to change the gear mounting angle in the drop test rig to simulate different pitch attitudes, but not roll. This angle change is constant during the drop. A series of tests would be run at different sink speeds and weights to cover the different design conditions. Normally there would not be any drop tests of the landing gear installed on the helicopter.

This basic approach has proven adequate in the past when low to moderate sink speeds and low aircraft pitch and roll angles were required. Since the required drop height increases as the square of the sink speed, the new crash conditions require much greater drop heights than previously needed. Representative drop heights are shown in Table 3. The increased drop heights mean that many of the drop test rigs in existence will not be able to handle the higher sink speeds, but some manufacturers have the capability of testing at 42 ft/sec.

TABLE 3. SINK SPEED - DROP HEIGHT RELATIONSHIP

Sink Speed (ft/sec)	Drop Height (feet)
6	0.6
8	1.0
9.8	1.5
10	1.6
12.25	2.3
20	6.2
42	27.4

Another significant factor is damage to the test landing gear. In the past, a single landing gear assembly could often be used for the entire drop test program. The new 20 and 42 ft/sec drop conditions will result in damage to the landing gear that would render it unusable for further testing. The high cost of a new landing gear assembly for each test will severely limit the number of test points. There are also many more required conditions.

An additional consideration is the redistribution of load between the individual landing gears in a pitched-rolled landing. This redistribution cannot be accurately represented in a jig drop test. Accurate simulation of pitched-rolled landings will require drop testing of either a complete helicopter or a test structure simulating the helicopter.

The high cost of testing for the 20 and 42 ft/sec conditions indicates an approach where all conditions will be checked analytically and a limited number of tests will be conducted to verify the analysis.

Skid Gear

Skid landing gears have generally been tested by dropping a skid gear mounted on a frame weighted to simulate the helicopter.

Current Test Programs

There are three current helicopter development programs with significant landing gear test programs. These are the UTTAS (YH-60) and AAH (YAH-64) for the Army, and LAMPS (SH-60), a UTTAS derivative, for the Navy. The UTTAS and AAH are designed to essentially meet the requirements of MIL-L-XXXX(AV). LAMPS will be tested to the requirements of AR-56, but some of the AR-56 requirements have been relaxed.

The UTTAS and AAH landing gears will be tested in the same manner. Both will use jig drops of the individual gears for normal and crash landing conditions. The crash landing condition jig drops will be at a vertical sink speed equivalent to the maximum capability of the landing gear alone. This is 35 ft/sec for the UTTAS and 31 ft/sec for the AAH. The UTTAS main gear was drop tested in July 1979 at 35 ft/sec. The gear did fail in the test (wheel split, upper cylinder split). The AAH landing gear has not been tested at 31 ft/sec. The gear functioned properly, but the loads exceeded the capability of the backup structure. Landing gear and/or structure changes were being evaluated at print time (May, 1981).

LAMPS is a derivative of UTTAS, but there has been extensive redesign of the landing gear, including moving the tailwheel forward and eliminating the secondary (upper) cylinder in the main landing gear shock strut. The test program will start with a conventional jig drop test program for the individual gear assemblies. This will be followed by complete helicopter drops using a lift cylinder to simulate rotor lift. These tests will be followed by flight test 'Hard Landings' and beartrap compatibility testing. The test program will be completed with shipboard landings for moving deck effects. There will be extensive instrumentation on all helicopter testing.

STATIC AND DYNAMIC ANALYTICAL METHODS

STATIC METHODS

Static loads on the complete airframe are usually analyzed by using a finite element method. BHT uses NASTRAN for static load reports. Individual landing gear components are analyzed using conventional stress analysis techniques. Loads are obtained from dynamic analyses, drop tests, or particular specification conditions (such as obstruction loads).

DYNAMIC METHODS

Normal Landing Conditions

There are no general-use dynamic analysis programs for analyzing landing gear. Most companies have proprietary programs to provide the necessary loads and motions for the required conditions. AR-56 requires dynamic analyses for all landing conditions except for the obstruction cases, but no new landing has been designed to the AR-56 requirements. It is currently practical to analyze the dynamics of the various landing conditions with either digital or analog computer models.

BHT currently has both digital and hybrid (analog) computer programs for analyzing landing gear, but the trend is toward more extensive use of digital methods. There are two types of digital programs in use for analysis of landing gear drop cases. The first type models an individual landing gear assembly for simulation of jig drop conditions. The gear may be rotated in pitch, but the gear attitude remains fixed throughout the drop. This program is used in the same manner as a jig drop test program would be used to develop the load-stroke curve of the individual landing gear assembly. The second type of digital program simulates a helicopter landing. This program combines the individual landing gear models with a helicopter model to allow pitch-rolled landing conditions with redistribution of landing loads between the individual gears.

Crash Landing Conditions

There are several computer programs such as "CRASH", "DYCAST", and "KRASH" that can be used for analyzing crash impact conditions. Of these, the "KRASH" analysis is the most useful program for modeling crash behavior of landing gear.

The "CRASH" program is a two-dimensional analysis using rigid masses and nonlinear springs to represent the aircraft. This

program cannot be used to analyze the three-dimensional crash impact behavior of landing gear.

The "DYCAST" program is a detailed nonlinear finite element computer code that can be used to model aircraft structures. Due to modeling complexity, this program is not well suited to crash analysis of landing gear designs using load attenuators and shock struts.

The "KRASH" program utilizes nonlinear spring and beam elements arranged in an arbitrary three-dimensional framework to simulate the fuselage and landing gear. The nonlinear characteristics needed to describe the structural elements are derived from test data or other analyses. A recent update of the "KRASH" program includes a shock strut element that allows the user to model this type of landing gear accurately. The "KRASH" analysis has been evaluated extensively in Army, FAA, and NASA programs, and BHT and other industry members have gained experience in using it.

ACCIDENT DATA ANALYSIS

DESCRIPTION OF DATA

The accident data reviewed for this program was limited to all survivable and partially survivable U. S. Army helicopter accidents during the time 1974 through 1978 and was supplied to BHT by the U. S. Army Safety Center via computer tape. During this period, the Army reported 373 survivable and partially survivable helicopter accidents. The data base contains the most recent accident data available and should be representative of Army helicopter operations for the near future. Nonsurvivable accidents were not included in the data base because it is doubtful that any significant landing gear information could be extracted from the records of accidents of that severity nor is it practical to design landing gear to meet high impact force requirements that are prevalent in these accidents.

WHEEL GEAR VS SKID GEAR

One purpose of this study was to compare the crash characteristics of different types of landing gear, such as wheel gear vs skids. This was not possible due to the limited amount of accident data available for helicopters equipped with wheel gears. The majority of the Army inventory of helicopters are equipped with skids (e.g., Models UH-1, AH-1, OH-58A, OH-6A, and TH-55A); relatively few are equipped with wheels (e.g., Models CH-47 and CH-54). For the period 1974 through 1978, helicopters equipped with wheel gears were involved in only eight survivable or partially survivable accidents compared to 365 for skid gear models. Furthermore, six of these eight accidents were not applicable to this study because the landing gear was not involved in the accident. In these six accidents, damage to the helicopter occurred while the aircraft was on the ground performing runup or shutdown procedures (four occurrences), or the damage occurred in-flight and the aircraft was able to make a normal landing (two occurrences). Of the remaining two accidents, the accident report of one was not available for review and the other aircraft was completely destroyed by fire after impact so the performance of the landing gear could not be evaluated. Therefore, no accident data comparison of skid vs wheel landing gear was done.

DATA ANALYSIS

The first approach used in analyzing the accident data was to find the distribution of the various impact factors, such as

airspeed, sink rate, flight path angle, impact angle, and aircraft attitude (pitch, roll and yaw), and the type of terrain of the impact area. All impact factors were not reported for each accident so the sample size varies for each factor. The type of terrain was reported for all of the accidents, while the impact factors were reported for approximately 60 percent of the accidents. Only survivable and partially survivable accidents were analyzed. The distributions for these factors and types of terrain are contained in Tables 4 through 14 and a definition and brief summary of each follows below.

Type of Terrain at Crash Site

The computer record for each accident allowed the recording of up to five types of terrain per accident, but the usual number reported was three. There were 1130 reports of terrain type reported for the 373 accidents. The distributions of these types of terrain are listed in Table 4. From this table it is evident that generally the flight crew is successful in selecting a hospitable landing area, i.e., sod, open terrain, and level. Table 5 lists the actual types of terrain that were reported most frequently and covers over 70 percent of the accidents. Again, it is evident that in most cases the landing area selected was either sod or a prepared surface, open terrain, and level.

Vertical Velocity or Sink Rate

The sink rate is one of the most critical factors to consider in the design of a landing gear. There were 235 accidents that reported a sink rate; their distribution is shown in Table 6.

Airspeed at Impact

The distribution of the aircraft airspeed at impact is shown in Table 7. The airspeed was less than 15 knots in 77 percent of all accidents that reported airspeed; therefore, most aircraft hit with relatively low forward airspeed.

Flight Path Angle

The aircraft attitude at impact is not necessarily related to the direction of aircraft motion (i.e., flight path). The flight path angle is defined as the angle between the aircraft flight path and the horizon at the moment of impact. The distribution of the flight path angle is shown in Table 8. In almost all accidents (97 percent), the flight path angle direction was reported to be down.

TABLE 4. TYPES OF TERRAIN ENCOUNTERED

Type of Terrain	No. Times Reported*	Percent of Total Accidents	Percent of Total Types Reported
Sod	242	64.9	21.4
Open Terrain	201	53.9	17.8
Level	172	46.1	15.2
Slope	115	30.8	10.2
Prepared Surface	91	24.4	8.1
Trees	71	19.0	6.3
Rolling	71	19.0	6.3
Rocks	45	12.1	4.0
Mountains	32	8.6	2.8
Other	22	5.9	1.9
Desert	18	4.8	1.6
Boggy	16	4.3	1.4
Snow	16	4.3	1.4
Water	11	2.9	1.0
Ice	4	1.1	0.4
Building	3	0.8	0.3
Total	1130		100.0

*The computer record for each accident allows the recording of up to five types of terrain. Therefore, the total for type of terrain will exceed the number of accidents.

TABLE 5. SPECIFIC TERRAIN CONDITIONS ENCOUNTERED

Terrain	No. of Reports	Percent of Accidents
Sod, open terrain, level	73	19.6
Prepared surface, open terrain	32	8.6
Prepared surface	24	6.4
Sod, slope, open terrain	14	3.8
Sod, trees, slope	12	3.2
Sod, open terrain, rolling	11	2.9
Sod, trees, level	10	2.7
Sod, slope, open terrain, rolling	10	2.7
Prepared surface, sod, open terrain, level	7	1.9
Prepared surface, level	7	1.9
Sod, slope	6	1.6
Water	6	1.6
Sod, slope, rolling	6	1.6
Sod, trees, rolling	5	1.3
Sod, level	5	1.3
Sod, trees, slope, rolling	4	1.1
Sod, trees, rocks, slope, mountains	4	1.1
Sod, open terrain	4	1.1
Trees, rocks, mountains	4	1.1
Trees, rocks, slope, mountains	3	0.8
Prepared, sod	3	0.8
Sod, open terrain, level, other	3	0.8
Prepared, slope	3	0.8
Sod, boggy, open terrain, level	3	0.8
Sod, rocks, slope, mountains	3	0.8
Sod, open terrain, level, desert	3	0.8
Subtotal	265	71.1
All other terrain conditions	108	28.9
Total	373	100.0

TABLE 6. DISTRIBUTION OF SINK RATE

Feet Per Second	No. of Reports	Percent of Total Reported
0-5	119	51.3
5-10	38	16.4
10-15	24	10.3
15-20	20	8.6
20-25	8	3.4
25-30	10	4.3
30-40	8	3.4
40-50	1	0.4
50-60	3	1.3
60+	1	0.4
Total	232	100.0

TABLE 7. DISTRIBUTION OF AIRSPEED AT IMPACT

Knots	No. of Reports	Percent of Total Reported
1-15	186	77.2
15-30	32	13.3
30-45	6	2.5
45-60	7	2.9
60-75	4	1.7
75-90	1	0.4
90-120	4	1.7
120-150	1	0.4
150-180	0	0
180-210	0	0
210+	0	0
Total Reports	241	100.0

TABLE 8. DISTRIBUTION OF FLIGHT PATH ANGLE AND DIRECTION

Angle (deg)	Direction		Total Reported	Percent of Total Reported
	Up (no.)	Down (no.)		
0-5	4	56	60	26.0
5-10	0	22	22	9.5
10-15	0	12	12	5.2
10-20	0	22	22	9.5
20-25	1	6	7	3.0
25-30	1	12	13	5.6
30-35	0	3	3	1.3
35-40	0	2	2	0.9
40-45	0	15	15	6.5
45-60	0	12	12	5.2
60-75	1	11	12	5.2
75-90	0	51	51	22.1
Total	7 (3%)	224 (97%)	231	100.0

Impact Angle

The impact angle is measured from the terrain to the flight path in the vertical plane through the flight path. The impact angle is critical to ensure that the landing gear contacts the ground prior to the fuselage. Unfortunately, the impact angle was reported for only 63 of the accidents (e.g., 17 percent). Consequently, the impact angle, when not reported, was considered to be the same as the flight path angle if the type of terrain was reported to be level or a prepared surface and not sloping. This method increased the number of accidents to 158, which was 42 percent of the accidents. Table 9 indicates that in over 60 percent of the accidents, the aircraft impacted with a very low impact angle of 0 to 15 degrees or with a nearly vertical impact angle of 75 to 90 degrees.

Aircraft Attitude at Impact

The aircraft attitudes at impact, (e.g., pitch, roll and yaw angles) are represented in Tables 10, 11, and 12. The pitch and roll angles are the most critical during landing. The pitch angle was 15 degrees or less for 73 percent of the accidents, and the roll angle was 30 degrees or less for 83 percent of the accidents. Furthermore, 62 percent of the accidents reported either a pitch angle of 10 degrees or less and/or a roll angle of 10 degrees or less.

Critical Impact Factors

The distributions presented earlier give an overall view of the aircraft attitudes and impact conditions that were present for survivable and partially survivable accidents. However, specific combinations of these factors, e.g., (1) sink rate and impact angle, and (2) sink rate and roll angle are considered to be more critical to landing gear design than others. The results of these combinations are listed in Tables 13 and 14. These results were inconclusive, suggesting that a further detailed analysis was needed. Landing gear sensitive accidents were analyzed further; the results are discussed below.

Landing Gear Sensitive Accidents

It is difficult to determine from accident data the benefits of using a landing gear of increased energy attenuation capabilities. However, a conservative approach would be to determine the injuries and cost of aircraft damage for those accidents with impact attitudes applicable to the use of a landing gear and with sink speeds of 10 ft/sec and above. Present landing gear can prevent major fuselage contact for sink speeds of 5 to 10 ft/sec if the aircraft attitude is

TABLE 9. DISTRIBUTION OF IMPACT ANGLE*

Angle (deg)	No. of Occurrences	Percent of Reports
0-5	43	27.2
5-10	11	7.0
10-15	9	5.7
15-20	14	8.9
20-25	4	2.5
25-30	13	8.2
30-35	3	1.9
35-40	1	0.6
40-45	12	7.6
45-60	7	4.4
60-75	7	4.4
75-90	35	22.2
Total	158	100.0

*Impact angle considered to be the flight path angle in those cases where impact angle was not reported and the terrain was level.

TABLE 10. DISTRIBUTION OF PITCH ANGLE AND DIRECTION AT IMPACT

Angle (deg)	Direction			Total	Percent of Total
	Up	Down	Level		
0-5	48	30	30	108	45.4
5-10	30	14		44	18.5
10-15	19	3		22	9.2
15-20	17	6		23	9.7
20-25	7	2		9	3.8
25-30	4	5		9	3.8
30-45	7	6		13	5.5
45-60	4	2		6	2.5
60-75	1	2		3	1.3
75-90	0	0		0	0.0
90-120	0	1		1	0.4
120-150	0	0		0	0.0
150-180	0	0		0	0.0
Total	137 (57.6%)	71 (29.8%)	30 (12.6%)	238	100.0

TABLE 11. DISTRIBUTION OF ROLL ANGLE AND DIRECTION AT IMPACT

Angle (deg)	Direction			Total	Percent of Total
	Right	Left	Level		
0-5	39	39	53	131	55.5
5-10	9	11		21	8.9
10-15	9	5		14	5.9
15-20	4	5		9	3.8
20-25	1	4		5	2.1
25-30	9	7		16	6.8
30-45	7	4		11	4.7
45-60	4	3		7	3.0
60-75	1	2		3	1.3
75-90	4	4		8	3.4
90-120	4	2		6	2.5
120-150	1	1		2	0.8
150-180	2	1		3	1.3
Total	94 (39.8%)	88 (37.3%)	53 (22.5%)	236	100.0

*Includes one direction not reported.

TABLE 12. DISTRIBUTION OF YAW ANGLE AND DIRECTION AT IMPACT

Angle (deg)	Direction			Total	Percent of Total
	Right	Left	None		
0-5	24	31	79	134	62.0
5-10	10	10		20	9.3
10-15	4	7		11	5.1
15-20	2	4		6	2.8
20-25	1	0		1	0.5
25-30	2	8		10	4.6
30-45	5	6		11	5.1
45-60	0	1		1	0.5
60-75	1	0		1	0.5
75-90	5	3		8	3.7
90-120	2	2		4	1.9
120-150	0	2		2	0.9
150-180	6	1		7	3.2
Total	62 (28.7%)	75 (34.7%)	79 (36.6%)	216	100.0

TABLE 13. VERTICAL VELOCITY VS IMPACT ANGLE*

Impact Angle (deg)	Vertical Velocity (ft/sec)										Total
	0-5	5-10	10-15	15-20	20-25	25-30	30-40	40-50	50-60	60+	
0-5	37	4	2	0	0	0	0	0	0	0	43
5-10	9	1	0	0	1	0	0	0	0	0	11
10-15	4	2	0	2	0	0	1	0	0	0	9
15-20	10	1	0	1	1	1	0	0	0	0	14
20-25	3	0	1	0	0	0	0	0	0	0	4
25-30	5	0	4	2	0	2	0	0	0	0	13
30-35	0	2	0	0	0	0	0	0	1	0	3
35-40	0	0	0	1	0	0	0	0	0	0	1
40-45	3	5	2	1	1	0	0	0	0	0	12
45-60	3	0	1	0	0	1	0	0	0	0	5
60-75	0	1	0	1	0	2	2	0	0	1	7
75-90	12	8	9	2	2	0	2	1	1	0	37
Total	86	24	19	10	5	6	5	1	2	1	159

*Flight path angle was considered to be the impact angle in those cases where the impact angle was not listed and the terrain was level or prepared surface and not sloping.

TABLE 14. VERTICAL VELOCITY VS ROLL ATTITUDE

Roll Angle (deg)	Vertical Velocity (ft/sec)										Total
	0-5	5-10	10-15	15-20	20-25	25-30	30-40	40-50	50-60	60+	
0-5	64	20	14	13	5	8	3	0	0	0	127
5-10	9	5	1	1	0	0	2	0	0	0	18
10-15	9	1	0	1	0	0	1	1	0	0	13
15-20	4	1	0	1	1	1	0	0	0	0	8
20-25	1	1	1	1	0	0	0	0	1	0	5
25-30	8	3	0	0	0	1	1	0	0	0	13
30-45	7	3	1	0	0	0	0	0	0	0	11
45-60	5	0	0	0	1	0	0	0	1	0	7
60-75	0	0	1	0	0	0	1	0	0	1	3
75-90	5	1	1	1	0	0	0	0	0	0	8
90-120	2	2	0	0	0	0	0	0	0	0	4
120-150	1	1	0	0	0	0	1	0	0	0	3
150-18	2	0	0	0	0	0	1	0	1	0	4
Total	117	38	19	18	7	10	10	1	3	1	224

basically level. Therefore, all the survivable accidents with sink speeds greater than 10 ft/sec, pitch-and-roll angles of less than 15 degrees, and where the terrain of the crash site allowed the landing gear to function were reviewed in detail. A group of 37 accidents met these constraints. This group includes some tree and wire strikes but does not include accidents occurring in heavily wooded areas that prevent the landing gear from functioning. The areas of greatest concern in these accidents were the damage to the aircraft as a result of the landing gear collapsing and occupant injuries. A detailed analysis of the final Army accident report was reviewed at Ft. Rucker for each of these accidents. A summary of the findings of the analysis, with respect to occupant injuries and aircraft damage caused by landing gear collapsing, is included below.

Injuries

Many factors dissipate vertical impact energy in addition to the landing gear, which include earth gouging, deformation of airframe structure, seat deformation, and human tolerance. Most major injuries occur at sink speeds of 20 ft/sec and higher, as shown in Table 15. For example, less than 10 percent of the occupants received major injuries for sink speeds less than 20 ft/sec, even though current landing gears are designed for only 5 to 10 ft/sec. The percentage of major injuries increases sharply above 20 ft/sec, as shown in Figure 6. It is expected that the level of protection now provided with the present landing gear in the 5- to 20-ft/sec range will be extended to higher ranges with the introduction of 20 ft/sec energy attenuating landing gear. From this figure, it appears that the potential for the 20-ft/sec landing gear should nearly eliminate the major injuries along the 10-ft/sec level. The upper limit of protection from a 20-ft/sec landing gear cannot be determined, but intuitively we believe it would be in the neighborhood of 25 ft/sec. There are other factors, such as those mentioned earlier, in addition to the landing gear that should make this possible.

There were no fatalities in these survivable and partially survivable accidents. All the occupants injured in these accidents suffered back injuries. In addition, some occupants received other injuries such as concussions, fractured ribs, and lacerations. The back injuries, which consisted of 23 fractured vertebrae and 3 back strains, were due to deceleration forces.

TABLE 15. MAJOR INJURIES IN LANDING GEAR SENSITIVE ACCIDENTS

Sink Rate (ft/sec)	Number of Accidents	Number of Major Injuries	Total on Board	Percent of Occupants Injured
10-15	15	4	41	9.8
15-20	11	3	34	8.8
20-25	4	6	13	46.2
25-30	2	3	5	60.0
30+	5	10	10	100.0
Total	58	26	153	17.0

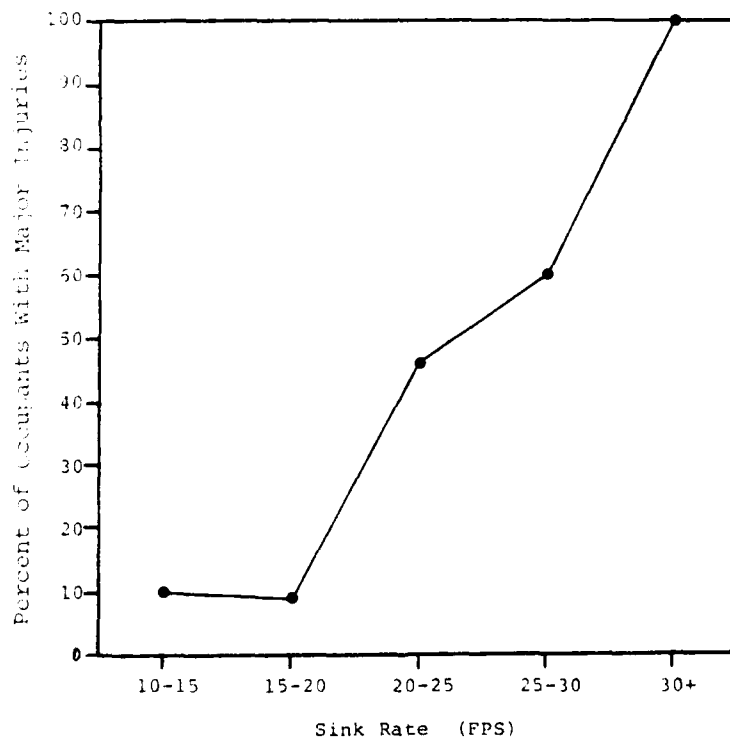

Figure 6. Injuries vs sink rate.

Damage

For the time period 1974 through 1978, all survivable and partially survivable helicopter accidents were evaluated to determine the amount of damage that energy attenuating landing gear could have prevented. This analysis indicates that the cost savings provided by 20 ft/sec energy-attenuating landing gear during this time could have been approximately 10 million dollars in equipment. These values were estimated using the following procedure and assumptions.

Present landing gears are basically good for a 5- to 10-ft/sec impact, if the aircraft impacts flat. Less capability is available with uneven landing gear contact (e.g., aircraft attitude with pitch or roll). Therefore, the accidents in the 0- to 5-ft/sec sink speeds were not included in determining the cost benefits of a 20-ft/sec landing gear. It was assumed that the 20-ft/sec landing gear would have prevented all damage to the helicopter in those accidents where the sink rate was reported to have been 5 to 20 ft/sec, the pitch and/or roll angles were not greater than 15 degrees, and the terrain of the impact site would have allowed the landing gear to function.

The damage cost could not be determined directly because the sink rate was not reported for all accidents. However, 45 accidents met the above constraints during this time period, which was 19.4 percent of the accidents reporting sink rate. The total cost of the damage incurred in these accidents was \$5,854,171 for an average of \$130,093 per accident. Sink rates were not reported for 141 accidents, but if we assume that the same ratio and average cost apply to these accidents as above, then 27 more accidents (19.4 percent x 141) and \$3,512,511 (27 x \$130,093) would be added to the totals. This results in a potential cost savings of \$9,366,682 for 72 accidents. During this period, Army helicopters accumulated approximately 6.5 million flight hours. Thus, the potential cost savings provided by the 20-ft/sec gear would have been about \$1.44 per flight hour.

It should be noted that these costs are related to replacement costs at the time of the accident and would be considerably higher now due to inflation. Further, the cost is an average for the Army fleet studied, which ranged from \$35,590 to \$618,055 for the total loss of a Model TH-55 to a Model UH-1, respectively. Therefore, more cost savings will be realized for a more expensive helicopter like the UH-60 and AH-64 models than is indicated by this average cost number.

DESIGN STUDY APPROACH

One of the major tasks of the contract was to investigate the feasibility and practicality of the proposed landing gear criteria. This was done by conducting a design study to compare wheel and skid helicopter landing gears designed to the previous criteria (MIL-S-8698) with those designed to the proposed new criteria. A generic helicopter was used for this study to minimize the effects of the airframe in determining the gear configuration.

HELICOPTER CHARACTERISTICS

The contract specified that the design study be performed for a light scout/observation helicopter with a basic structural design gross weight (BSDGW) less than 10,000 pounds. A generic narrow body helicopter with a BSDGW of 8,000 pounds was selected. An AH-1S was used for reference to aid in establishing the overall size and shape of the helicopter and for pitch and roll inertias and center-of-gravity position and travel. The assumption was made that the internal structure was not a constraint on the location of the landing gear. External contour was used as a reference for locating gear attach points, but it was assumed that internal structure could be provided as required to mount the landing gear. The principal helicopter characteristics for the design study are listed in Table 16.

TABLE 16. HELICOPTER PRINCIPAL CHARACTERISTICS

Type	Scout/Observation
Configuration	Narrow Body
BSDGW	8000 lb
Inertias at BSDGW	
Pitch	14000 slug-ft ²
Roll	2500 slug-ft ²
Yaw	12000 slug-ft ²
Center-of-Gravity Travel	
Fore & Aft	±6 in.
Vertical	±5 in.
Lateral	±3 in.

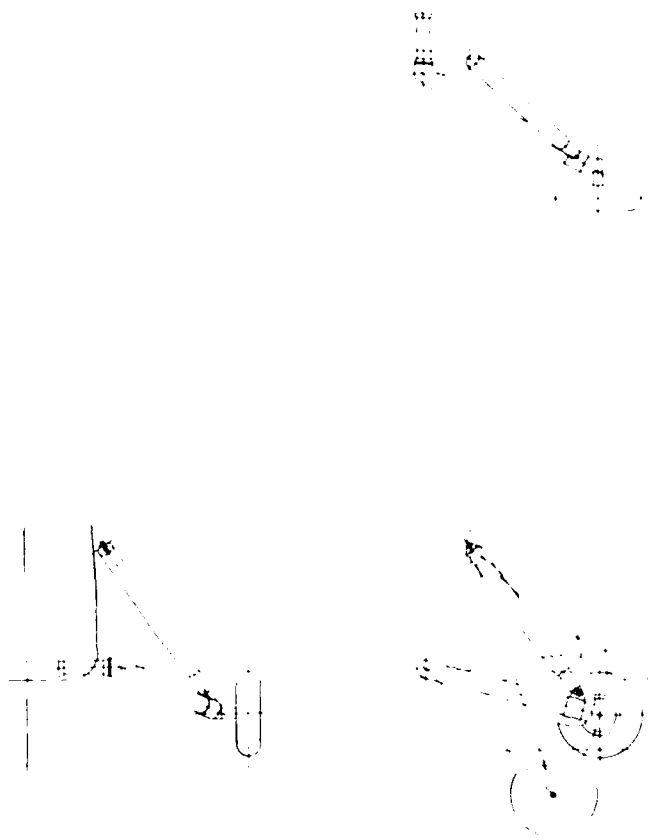

Figure 7. Typical wheel-type main landing gear.

LANDING GEAR CONFIGURATION

A trailing arm basic design with an air-oil shock absorber was used for all the gears except for the old criterion skid gear where a production AH-1S yielding crosstube skid gear was used for comparison. All the trailing arms used a side axle configuration. The trailing arm was mounted on the fuselage by a lateral arm cantilevered from the trailing arm with both pivot bearings inboard of the trailing arm centerline. The main gear trailing arms were designed with oleo attach lugs on the top and bottom so the arm could be used on either side of the helicopter. A typical main gear is shown in Figure 7.

The air-oil shock absorber basic design is a fairly conventional "inverted" oleo. "Inverted" refers to the air being located below the oil inside the piston (inner cylinder) with a free-floating separator piston between the air and the oil. Both ends of the oleo have a single lug with a monoball bearing for attachment to the airframe or the trailing arm. A conventional, multistep, linear taper metering pin was used for all designs. The new criterion gears incorporated an energy absorber in series with the oleo. This energy-absorbing device (EAD) was not detail designed, but space and weight allowances were made. A crush tube or tube cutter energy-absorbing device was used. The EAD was located just below the oleo upper attach lug between the lug and what would be the top of a normal oleo. A typical new criterion air-oil shock absorber is shown in Figure 8.

DESIGN METHODOLOGY

A standardized landing gear design methodology was developed for use in this design study. The objective of this standardization was to minimize the differences in results caused by variations in assumptions, method of analysis, changes in design features, etc., that are common from one design to the next. The principal means of achieving this desired consistency was the use of a family of computer programs for sizing and landing load analyses of the various configurations. In addition, several ground rules were established in the layout and design of the gear. As an example, the trailing arm angle from the horizontal was set at 45 degrees with the gear fully extended. Some deviations from the established ground rules were needed for some configurations. These are discussed in the description of the individual gear configuration.

Basic Landing Gear Layout

A layout of the complete landing gear and selected critical airframe components is the starting point for design of the

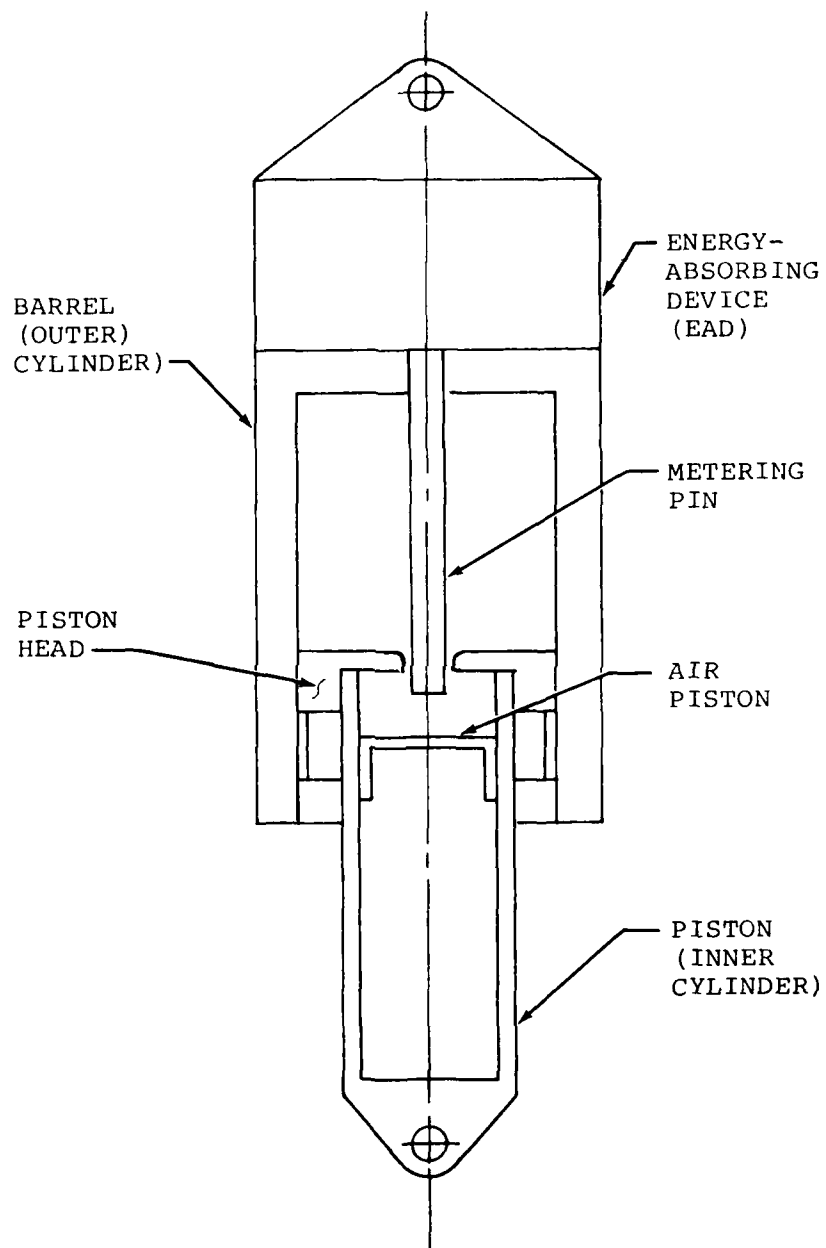

Figure 8. Typical new criterion air-oil shock absorber.

landing gear. For this discussion, a wheel-type tailwheel tricycle landing gear will be described. Some variations were required for other gear types.

The process starts with the layout of the basic helicopter external contour including any potential clearance critical items such as chin turrets and antennas. For this study, the internal structure was not considered; in a design for a real helicopter, the locations of major structural items would be laid out. The static ground line at BSDGW would be established based on clearance and airframe attitude relative to the ground. Lines establishing the minimum forward, and aft if needed, turnover angles are drawn in. As a starting point, the forward gear axle would be located at the minimum forward turnover line. The aft gear would be located at the pitch center of percussion. The pitch center of percussion can be calculated by

$$R = I_{cg} / (M \cdot r) + r$$

where

I_{cg} = inertia about center of gravity

M = helicopter mass

r = radius from gear to center of gravity

R = radius from gear to other gear

With the aft gear located, wheel static reactions can be calculated. Also, the main gear butt line can be determined based on lateral turnover angle. Tires are selected based on the load rating and the towing requirements on soft ground. Tire pressures are based on static deflection, CBR considerations, and bottoming on high sink speed and crash landings. The static vertical axle position is calculated from the static load and the published load-deflection curves for the tire. Up to this point, the total required vertical axle travel (VAT) has not been a factor in the design. The required VAT is calculated using the basic energy method described in Appendix B of this report. The upper end of the travel is defined by the loaded tire radius and fuselage-to-ground clearance for the high sink speed landing. This establishes the gear fully extended/static/fully compressed relationship. For a trailing arm gear, the arm pivot waterline is set, and the arm effective radius is determined by the extended arm angle. For this study, an extended arm angle of 45 degrees was used. The static axle position, the arm pivot waterline, and the arm effective radius are used to find the arm pivot

station. On an actual helicopter, there would be some modification in this procedure due to the need to locate the arm pivot near the major structure. In a new helicopter, the desired gear attach points would be a major factor in locating the structure. The lateral location of the trailing arm centerline is set by tire, wheel, and brake clearance at the lower end and by the pivot bearing location at the upper end. An arm diameter must be assumed based on experience.

The air-oil shock absorber location depends on the desired mechanical advantage of the gear. In general, the closer to the arm pivot the arm-oleo attach point is located, the higher the mechanical advantage. There are a number of factors affecting the selection of a mechanical advantage. It is usually easier to incorporate ground resonance damping in a low mechanical advantage gear. This may be needed with soft-inplane main rotors. A low mechanical advantage gear will have a smaller diameter, longer stroke oleo. This may be an advantage or a disadvantage, depending on the location of potential upper oleo attach points. The upper attach point is selected based on estimated oleo length, location of structure, and judgement and experience of the designer. Oleo extended length is estimated by using twice the piston stroke plus allowances for overlap, end fittings, and crash energy absorber length.

In the initial design process, a number of assumptions are made that must be checked later. Depending on the accuracy of these assumptions, several iterations may be required.

The output of the layout process is a definition of the basic geometry of the complete landing gear installation and static gear reactions.

Landing Gear Sizing Computer Program

When the basic gear configuration has been defined, it is necessary to size the major components of the individual gears. The two major areas of this sizing are structural checks for anticipated loads and the air spring and hydraulic design of the oleo. For this study, a BHT-developed interactive computer program was used for both sizing tasks. The program is organized such that it will perform a section of calculations, print the results, and ask the designer for approval to proceed to the next section of the program. If the results are satisfactory, the user only needs to hit the "enter" key to proceed. If the results are unacceptable, the user may modify the input data and go back to an earlier point in the program. This uses the judgement of the designer in

the sizing process while the computer handles the calculations. The program is run for one main gear and the auxiliary gear (tailwheel).

The first section of the program gets the basic individual gear geometry in helicopter coordinates. This consists of attach points, radii, and axle travels. The program calculates piston and crash energy absorbing device (EAD) strokes, arm angles, and a table of stroke and mechanical advantage versus vertical axle travel. When the gear kinematics are satisfactory, static reaction, load factor, rotor lift, and maximum oleo pressure are entered and used to calculate the oleo diameters. The raw numbers are processed through a routine to convert the diameters to standard O-ring sizes. After the diameters are approved, the rest of the shock strut is sized, including selection of air volumes and pressures to match the air curve to the desired static position.

Principal characteristics of a number of wheels, tires, and brakes are stored in the program, or data may be entered directly for other sizes. Data defining the trailing arm centerline and pivot bearings are entered and a design load spectrum is selected. Several spectrums are stored representing normal, high sink speed and crash landings, and obstruction loads. The pivot arm, trailing arm, and axle are checked for each loading condition with five vertical axle travels for each condition. Section shears, moments, and stresses are calculated, and if the stress exceeds the material allowables, the section is changed by increasing the O.D. or decreasing the I.D. as appropriate. At the end of each load spectrum, a summary is printed showing the section size and the critical loading condition that sized the section. The critical condition from the previous load spectrum is used as a starting point if more than one spectrum is run. At this point, weights are calculated and a weight summary is printed. Since the program has trailing arm I.D. as an input item and varies O.D., some arm optimization may be done by varying the arm I.D. and rerunning the load spectrum. When an acceptable gear configuration has been reached, an output data set is filled with the gear data required for the individual gear jig drop computer program. The user may also request a printed copy of the run and design dimensions sufficient to lay out the shock absorber, trailing arm, and axle.

Jig Drop Computer Program

The output from the sizing program is used as input for an interactive computer program simulating a jig drop test of an individual landing gear assembly. This program is used in the

same manner as a conventional jig drop development test program. Drop conditions are entered, and the computer program produces a time history and a table of maximum values for tire and oleo load, piston stroke and velocity, sink speed, load factor, and vertical axle travel. The first drop will be made with a metering pin recommended by the sizing program. The user then modifies the pin based on the drop results until a satisfactory load-stroke curve is achieved. An output dataset is prepared with the configuration data from the final jig drop run.

Helicopter Drop Computer Program

The sizing and jig drop programs are run for both a main gear and the auxiliary gear. The output datasets for both gears from the jig drop program are used as input for a helicopter input preparation computer program. This program creates opposite-hand gear data and obtains helicopter characteristics, such as cg location and pitch and roll inertias, to build up a definition of the complete landing gear and helicopter configuration. Helicopter drop conditions are added to this basic data, and any other configuration changes desired from one case to the next are specified. This is written on an output dataset that is used as input for the helicopter drop computer program.

The helicopter drop program is a batch run digital computer program. It has a rigid body fuselage with four wheel-type air-oil landing gears and a spring tailskid. One gear may be disabled to model tricycle gears. A rotor model is available, but a vertical lift vector was used for this study. The helicopter may be dropped, pitched, and rolled on either level or sloped ground. Program output includes a summary of maximum values, a digital time history, and plotted time histories. The summary includes maximums for helicopter pitch and roll accelerations, cg load factor, individual gear tire and oleo loads, piston strokes, and vertical axle travels. The time required for the maximum value to occur is also listed. The digital time history lists current values for helicopter and gear loads and motion. Attach point loads are available as an option. Normally, output is printed every .01 second. Plotted time histories are available for helicopter angular accelerations, tire loads, and strut loads. These are a great help in visualizing the landing performance of the helicopter.

Landing Gear Evaluation

After the helicopter drop cases have been run, the configuration can be evaluated against the original design requirements and assumptions. If a gear is bottoming the piston or tire,

the vertical axle travel (VAT) may need to be increased. If all the stroke is not used on the most critical condition, the VAT available can be reduced. The loads must be checked against the assumptions used in the sizing program. It may be necessary to go back to the jig drop or sizing programs or even to the basic layout, modify the gear, and continue through the same design process until an acceptable gear is obtained.

Crashworthiness Analysis

A crashworthiness analysis was performed on the new criterion wheel-type tailwheel tricycle design. This analysis used the KRASH computer program, which was developed originally for the Army by Whittlin and Gamon of the Lockheed California Company. Later, the FAA funded work to improve the code and enhance the capabilities of the program. This study utilized the latest version of KRASH.

KRASH is a hybrid finite element structural crash simulation having both geometric and material nonlinearity capability. However, it is not mathematically complete in that the user must supply some of the load-deflection characteristics for the structure. In general, the math model is an arbitrarily arranged three-dimensional network of mass points and massless node points connected by beam elements. Crushing springs are used to introduce the crash impact loads into the structure. The user selected the desired impact initial conditions for the model that include transitional velocity, angular velocity, and attitude. KRASH computes mass point response and beam element internal load time histories for the duration of the crash impact. More information about the KRASH computer program can be found in Reference 6.

In-house BHT landing gear analyses provided the substantiating data for the high sink speed landing conditions. The KRASH computer program was used to correlate with these data for selectively chosen impact conditions of a typical wheeled landing gear configuration.

MODEL DESCRIPTION FOR 20-FT/SEC STUDY

For the KRASH analysis math model, the fuselage was idealized as rigid and was represented as a point mass located at the

⁶Wittlin, G., et al., GENERAL AVIATION AIRPLANE STRUCTURAL CRASHWORTHINESS USER'S MANUAL, Volumes I, II, and III, Lockheed-California Company, FAA-RD-77-189, Federal Aviation Administration, Washington, D.C., February 1978.

aircraft cg with the appropriate inertia parameters. The reasons for making this simplifying assumption were:

- to provide a math model comparable to that used in the BHT landing gear analyses for correlation
- to reduce computer run time requirements for improved job turnaround.

The trailing arms for the main gears and the tail gears were modelled with linear beam elements having section properties derived from an in-house BHT landing gear sizing analysis. At the attachment to the rigid body fuselage, each trailing arm was pinned in the aircraft pitch degree of freedom. The inertia properties of the trailing arms were distributed to the appropriate mass points.

The wheels were represented as point masses rigidly attached to the trailing arms. At each of these mass points a vertical crushing spring was used to represent the nonlinear load-deflection characteristics of the tire and hub. Upon ground contact, the springs introduce the crash impact loads into the landing gear structural elements.

For each of the gears, the shock strut or eleo was modelled as a single nonlinear beam element having axial stiffness only. The KRASH computer program features a shock strut beam element with a constant metering pin diameter. Although the element is velocity-dependent, it cannot represent the characteristics of the variable metering pin shock strut used in the landing gear configuration under study. As a result, an in-house BHT landing gear analysis was used to calculate the velocity-dependent shock strut characteristics including the nonlinear load-deflection data for input to KRASH. The shock struts were attached between the rigid body fuselage and the flexible trailing arms.

The complete KRASH math model is illustrated in Figure 9 with the mass points, node points, and beam elements labelled.

MODEL DESCRIPTION FOR 42-FT/SEC STUDY

The major difference between the 20-ft/sec and 42-ft/sec math models was in the treatment of the energy-absorbing device. The landing gear configuration uses a shock strut in series with a mechanical load limiter to attenuate the crash impact forces to the airframe. Previously, only the shock strut load-deflection characteristics were represented with the mechanical load limiter acting as a structural member. For the 42-ft/sec impact condition, the mechanical load limiter is designed to provide significant energy absorption capability in conjunction with the shock strut.

Mass point ●
 Massless node point ○
 Beam element —
 Rigid element

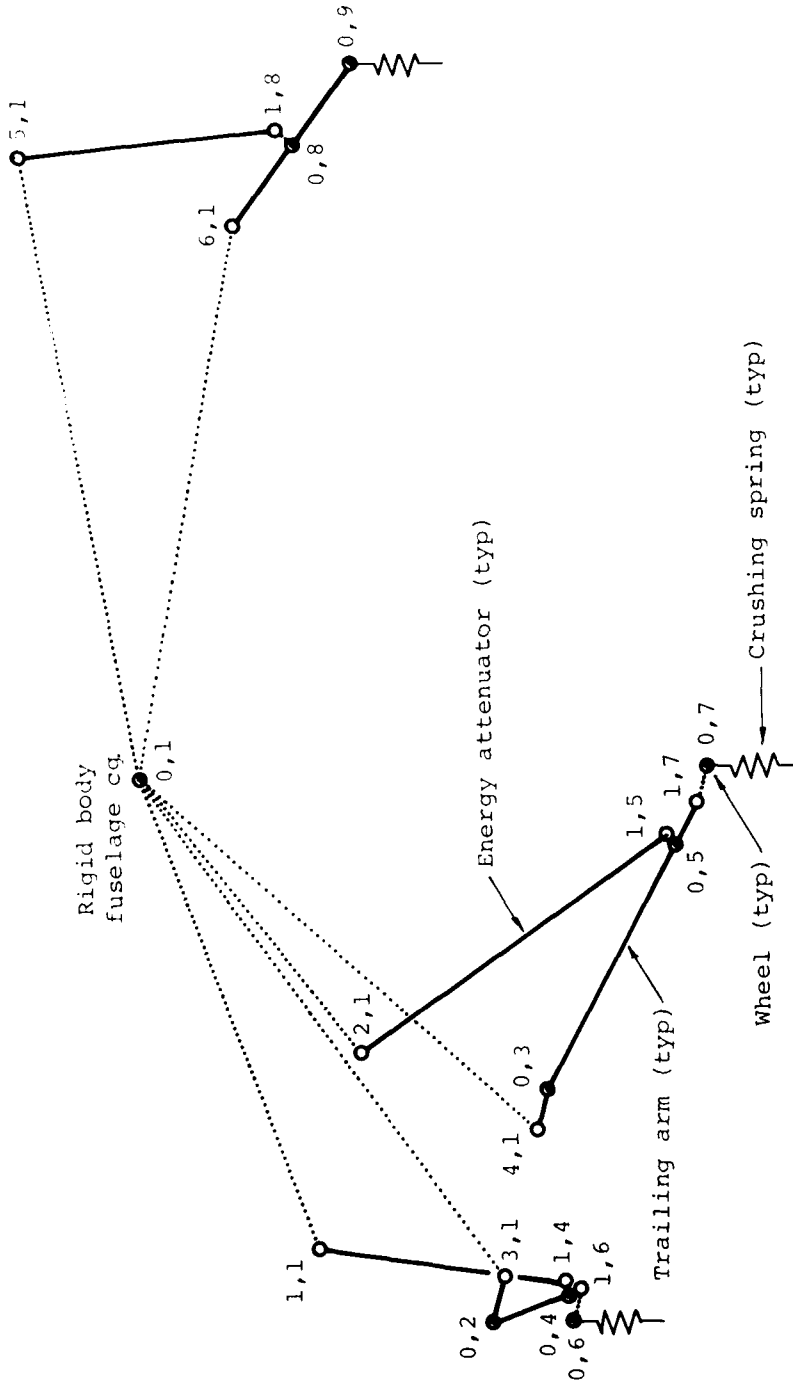

Figure 9. Simplified KRASH model of wheeled landing gear.

For the KRASH analysis, the two components were combined and represented as a single beam element. The effective nonlinear load-deflection parameters for the element were derived from the known landing gear geometry and desired aircraft cg load factor. Specifically, the product of the basic design gross weight and cg load factor is reacted at the three ground contact points for the fully extended landing gear. Using static balance equations, the reaction load is calculated at each tire location. The energy attenuator load-deflection characteristic is then computed by multiplying the constant tire load by the mechanical advantage as the trailing arm travels through its prescribed motion. For the 42-ft/sec KRASH analysis, the basic load-deflection parameters did not vary dependent on aircraft impact attitude.

The idealization of the airframe as a rigid body was judged to be an adequate representation for the 42-ft/sec KRASH analysis because the study centered on determining landing gear design criteria. As such, the analysis was concerned with the landing gear structure crash impact dynamics prior to fuselage contact with the ground. An additional benefit of using the simplified math model was the reduction in computer run time usage which allowed more rapid job turnaround for parameter sweeps.

In general, a comprehensive KRASH analysis to evaluate aircraft structure crashworthiness for the 95th potentially survivable accident demands a more rigorous treatment for the airframe representation. Detailed modelling is required to accurately determine factors such as occupied volume reduction, large mass item retention strength, and occupant acceleration environment.

DESIGN STUDY CONFIGURATIONS

Wheel and skid gears were designed to both the proposed new landing gear criteria and to the old (MIL-S-8698) criteria. The majority of the study effort was spent on the new criteria wheel gears, since this type is of greatest interest for future Army helicopters. The old criteria designs were used as a basis for comparison of cost, weight, and benefits versus the new criteria designs. Drawings and a more detailed description of the main study configurations are presented in Appendix A.

New Criteria Wheel Gear

Several new criteria wheel landing gears were designed and analyzed. The most extensively studied configuration was a tailwheel tricycle design with a 30-degree turnover angle. This design was checked for all required landing conditions including slope landings, limit landings with and without

forward speed, high sink speed (20 ft/sec) landings, and crash (42 ft/sec) landings. This configuration was used to develop the study procedure and served as a baseline for comparison with the other designs. A tailwheel tricycle with a 25-degree turnover angle was designed to evaluate the effect of varying turnover angle. A nosewheel tricycle was designed with a 25-degree turnover angle, but in this case, 25 degrees was all that could reasonably be achieved while meeting air transportability requirements. A quadricycle wheel gear with a 30-degree turnover angle and roughly equal loading on the four gears was also designed.

Old Criteria Wheel Gear

A tricycle tailwheel gear was designed to the old, or MIL-S-8698, landing gear criteria. The basic gear was designed to be as similar as practical to the new criteria tailwheel gear. The wheel locations on the helicopter were essentially the same, except the old criteria gear has a 27-degree turnover angle. There was a problem in locating the upper oleo attach point on the old criteria gear. The short oleo stroke and the outboard location of the trailing arm at the lower oleo attach point made it impractical to attach the top of the oleo to the side of the fuselage. A decision was made to use a basically vertical oleo. This would require building support structure out to the oleo attach point. If the study had been done on a wide body helicopter, this problem would not have existed.

New Criteria Skid Gear

This gear is essentially the quadricycle wheel gear with the wheels removed and a skid tube added between the axles on each side. The vertical axle travel was increased to compensate for the loss of the tire deflection.

Old Criteria Skid Gear

An AH-1S skid gear with yielding crosstubes was used for comparison with the new criteria skid gear. This gear is representative of the majority of landing gears in the current Army inventory.

DESIGN STUDY RESULTS SUMMARY

The new criteria tailwheel tricycle gear was used as the baseline for this study to develop the basic individual designs and to establish the study procedure for all gears. All the drop conditions were run for the baseline gear. Only the critical conditions for the baseline were run for the other gear configurations. Only the baseline gear was analyzed for the crash conditions.

NEW CRITERIA TAILWHEEL TRICYCLE

There were two tailwheel tricycle gears designed to the new criteria. The first had a 30-degree turnover angle. This gear was used as a baseline. The second gear had a 25-degree turnover angle and was only analyzed enough to determine the effects of reducing turnover angle. The following discussion is for the 30-degree configuration except as specified otherwise.

Slope Landings

The baseline helicopter was analyzed for a 6-ft/sec landing on a 12-degree slope. The helicopter was in a level attitude at initial contact; i.e., the bottoms of the tires were in a horizontal plane. The helicopter was oriented from noseup slope (azimuth = 0 degrees) to nosedown slope in 30-degree increments. The helicopter was rotated to the right so the high ground was on the pilot's right. It was assumed that the slope was localized so rotor-to-ground clearance was not a problem. The landing conditions analyzed an approximate situation wherein the helicopter was level and the pilot was unaware that the ground was sloped locally. A 90-degree azimuth orientation on a 15-degree slope was also run.

The tire loads developed for the different cases are shown in Figure 10. The second main gear to hit always produced the highest loads. None of these conditions produced high enough loads to enter into sizing any part of the design study gear.

Limit Landings

The limit landing condition was retained mainly to develop loads for the obstruction loading conditions. Limit loads are not anticipated to be significant in the design of the gear, although obstruction loads may design some areas. A second reason for retaining the limit condition is the forward speed requirement. A very extensive check of limit conditions was

10
F

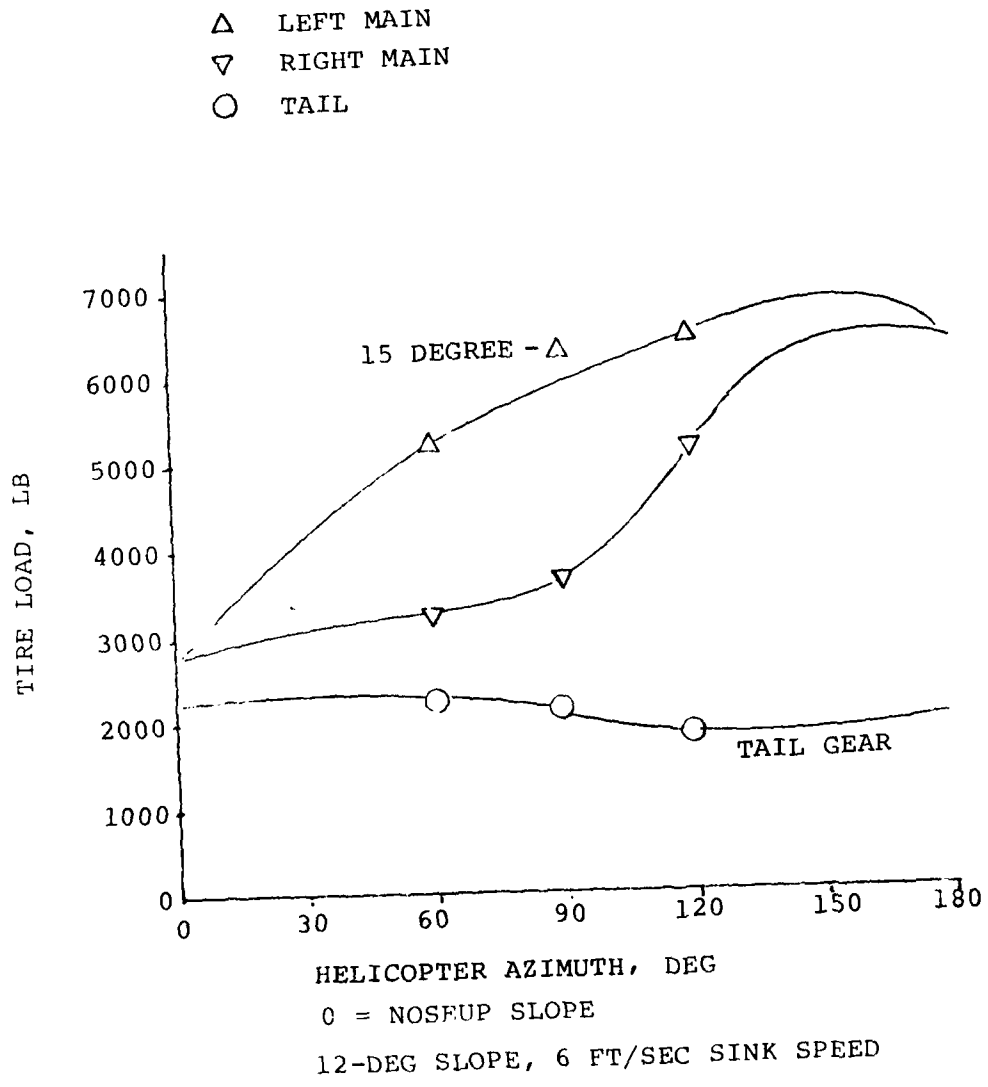

Figure 10. Slope landing gear loads.

run. This included a number of cases outside of the recommended criteria. Figure 11 shows tire load and vertical axle travel for a 10-ft/sec level limit drop with forward speed varied from 0 to 100 knots in 20-knot increments. The tire loads with forward speed are all lower than the zero speed case. A drag load on a trailing arm gear applies a moment which acts to compress the oleo. This unloads the tire and reduces the tire load. A second effect is redistribution of the load from the aft to the forward gear. This is caused by the nosedown moment due to the tire drag acting below the helicopter cg. This causes the main gear stroke to go up and the tail gear stroke to go down. The total energy absorbed in the gear increases slightly with forward speed to compensate for the energy due to tire spinup. These loads are not critical for design for the study gear. In a cantilever landing gear design, the tire drag load produces bending in the piston and causes bearing friction that resists gear stroking. This increases tire loads. There can also be problems caused by gear spring back when the tire drag drops off. These problems could be critical design conditions in a cantilever gear with the long stroke needed to meet the new criteria.

Figures 12 and 13 are 10-ft/sec drops with 10 degrees pitch noseup and nosedown respectively.

Reserve Energy

A series of drop conditions were analyzed at the existing criteria reserve energy sink speed of 12.25 ft/sec. The tentative criteria established in Task I recommended dropping the reserve energy requirement. These runs were made to confirm that recommendation.

Pitch attitudes of zero, 10 degrees noseup, and 10 degrees nosedown were analyzed. Forward velocities of zero to 100 knots in 20-knot increments were run for each pitch attitude. The results were very similar to the limit drop cases, except for the slightly higher loads and longer strokes required for the higher sink speed. None of the loads or strokes were critical to designing the gear. This condition is not necessary, since the high sink speed landings at 20 ft/sec are more severe than the reserve energy requirement.

High Sink Speed Landings

In effect, the high sink speed landing becomes the "limit" design condition. However, this condition was not specified as "limit" because obstruction loads based on a 20-ft/sec drop would be excessive. A basic spectrum of drop conditions was

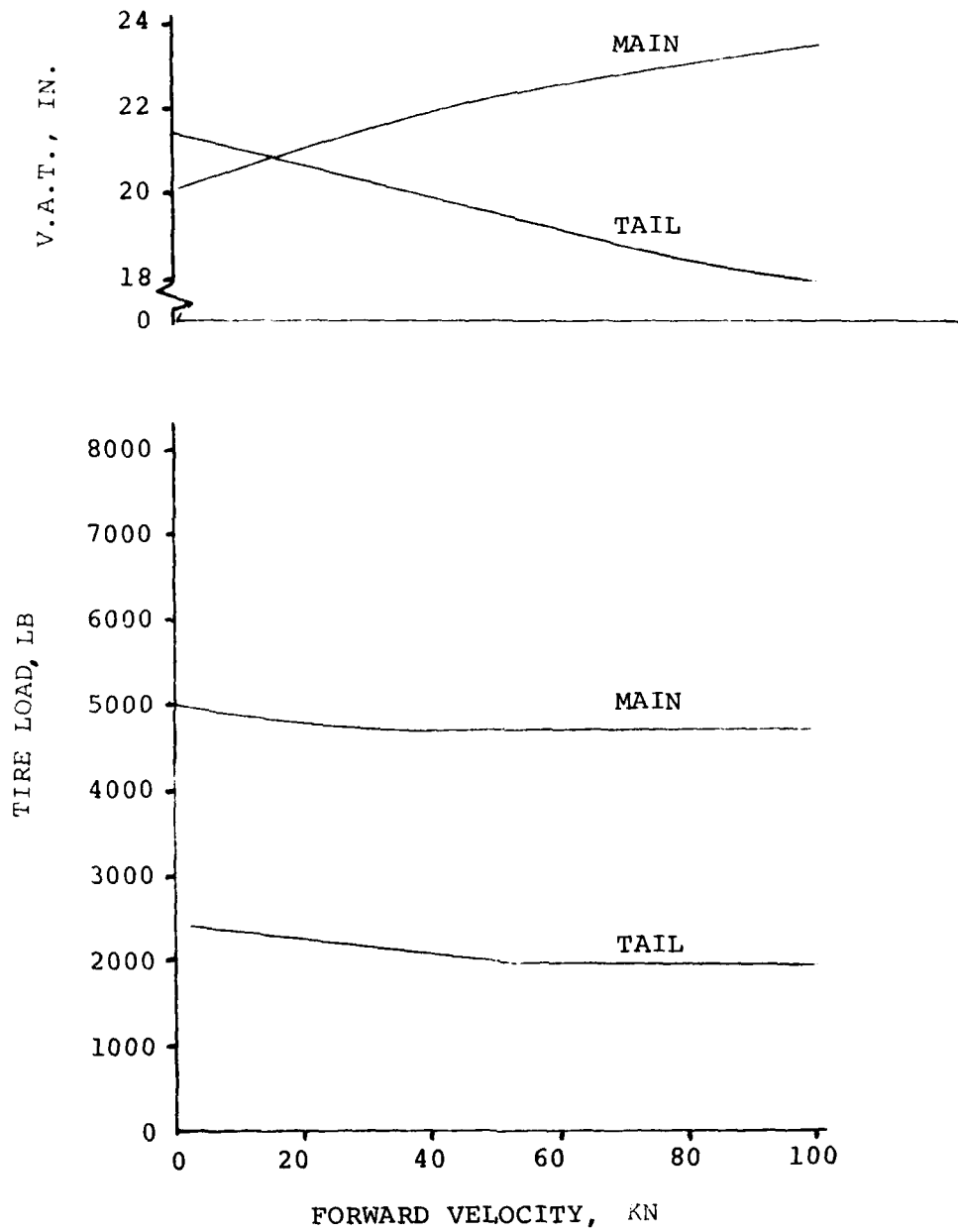

Figure 11. Limit drop with forward speed 0-degree pitch.

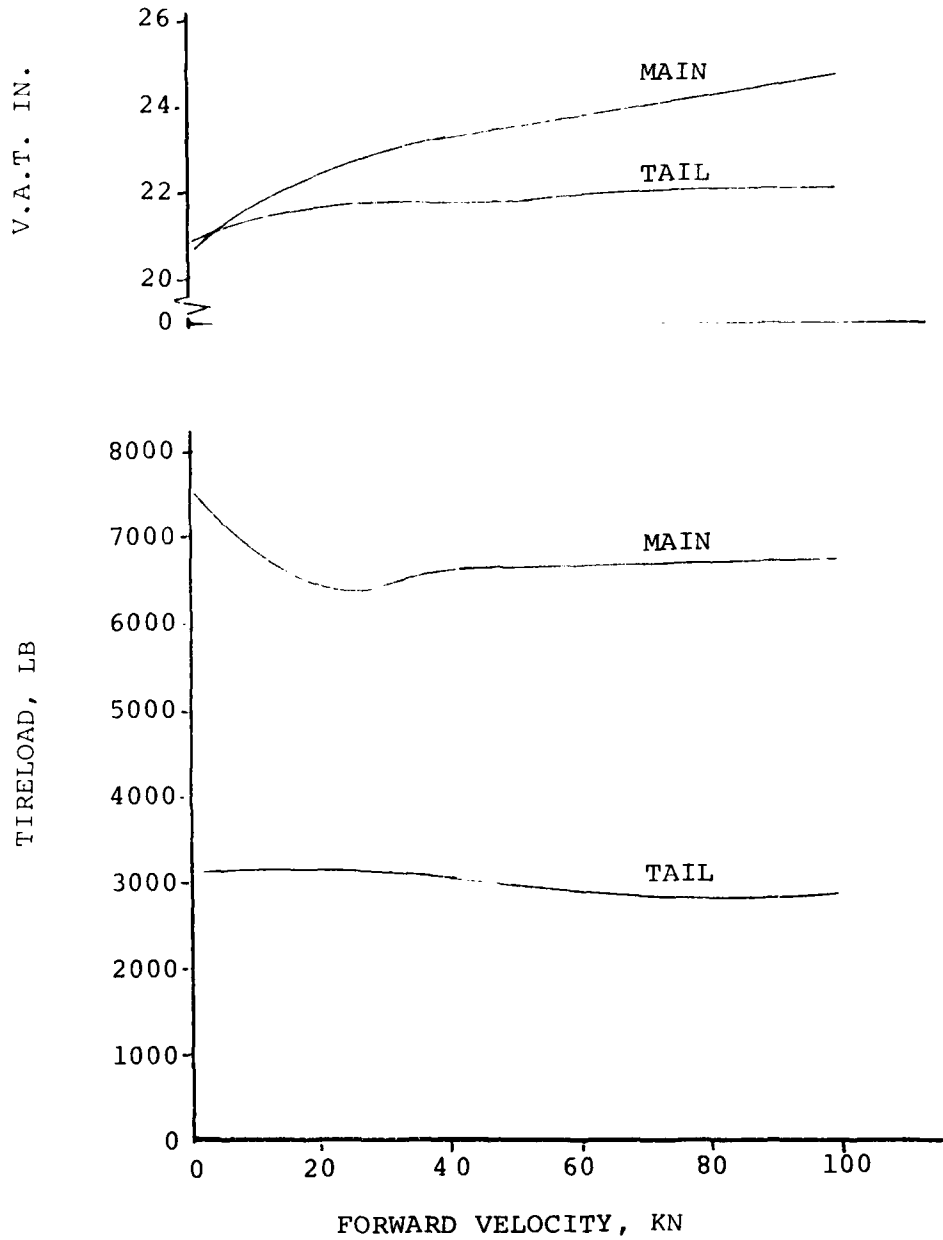

Figure 12. Limit drop with forward speed 10-degree pitch nose up.

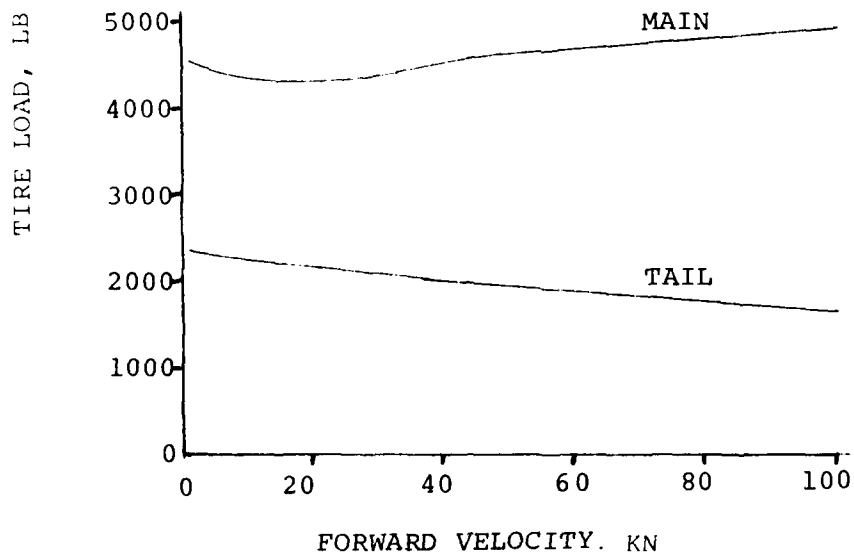
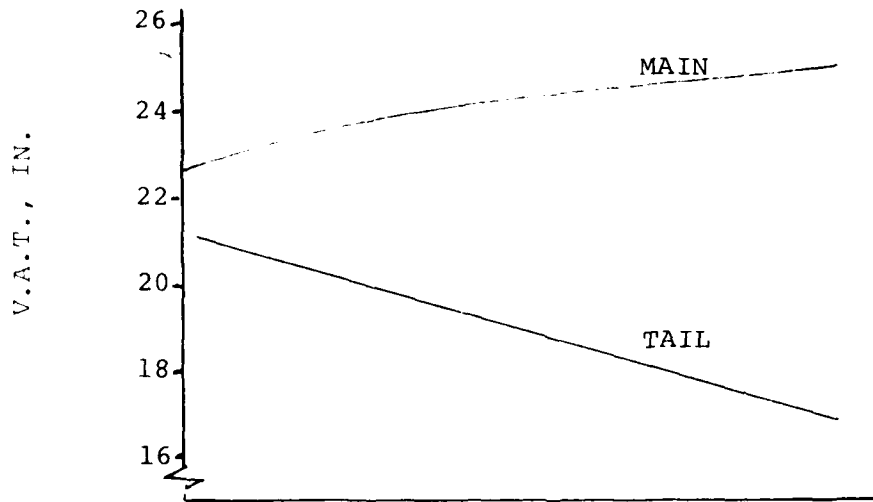

Figure 13. Limit drop with forward speed
10-degree pitch nose down.

developed for the 20-ft/sec sink speed. This consisted of six drop attitudes as listed below:

<u>Case</u>	<u>Attitude</u>
1	Level
2	+10° Pitch, 0° Roll
3	-10° Pitch, 0° Roll
4	0° Pitch, +10° Roll
5	+10° Pitch, +10° Roll
6	-10° Pitch, +10° Roll

Noseup and roll right are positive.

The six cases of this basic spectrum were run for the baseline tricycle gear at 20 ft/sec with the helicopter cg at the mid-point and at the forward and aft limits of the cg range. Figures 14 through 19 are computer generated time histories of tire load for the basic drop spectrum for the mid-cg conditions.

These plots are time histories and are essential to show the relationship between the loads in the different gears, but they can be misleading to someone accustomed to cross plots of load versus vertical axle travel. At the beginning of the stroke, the piston closure velocity is relatively high, i.e., there is a large change in vertical axle travel (VAT) per unit time. This means a time history will be compressed along the time axis compared to a plot against VAT. Near the end of the stroke, when piston closure velocity is low, the time history will be expanded relative to a load versus VAT crossplot. This makes it difficult to estimate efficiency from a time history.

The tire load curves show a load "spike" at the beginning of the drop. Classically, there have been two load peaks in an air-oil load-stroke curve: an oil-damping load near the start of the stroke, and an air compression peak at the end of the stroke. During the design study, a third load component was discovered which was not significant in gears designed to the old criteria. This is an "inertia spike" load. If we were to take a trailing arm and tire, as shown in Figure 20, but without a shock absorber attached, we can demonstrate this inertia spike load. If we drop the arm and tire, the tire will develop a load as it is compressed. This will develop an acceleration on the arm, and the arm will start to rotate away from the tire load. As long as the vertical velocity of the axle due to arm rotation is less than the sink speed of the arm pivot, the tire will continue to compress and the tire load will increase. When the axle vertical velocity due to

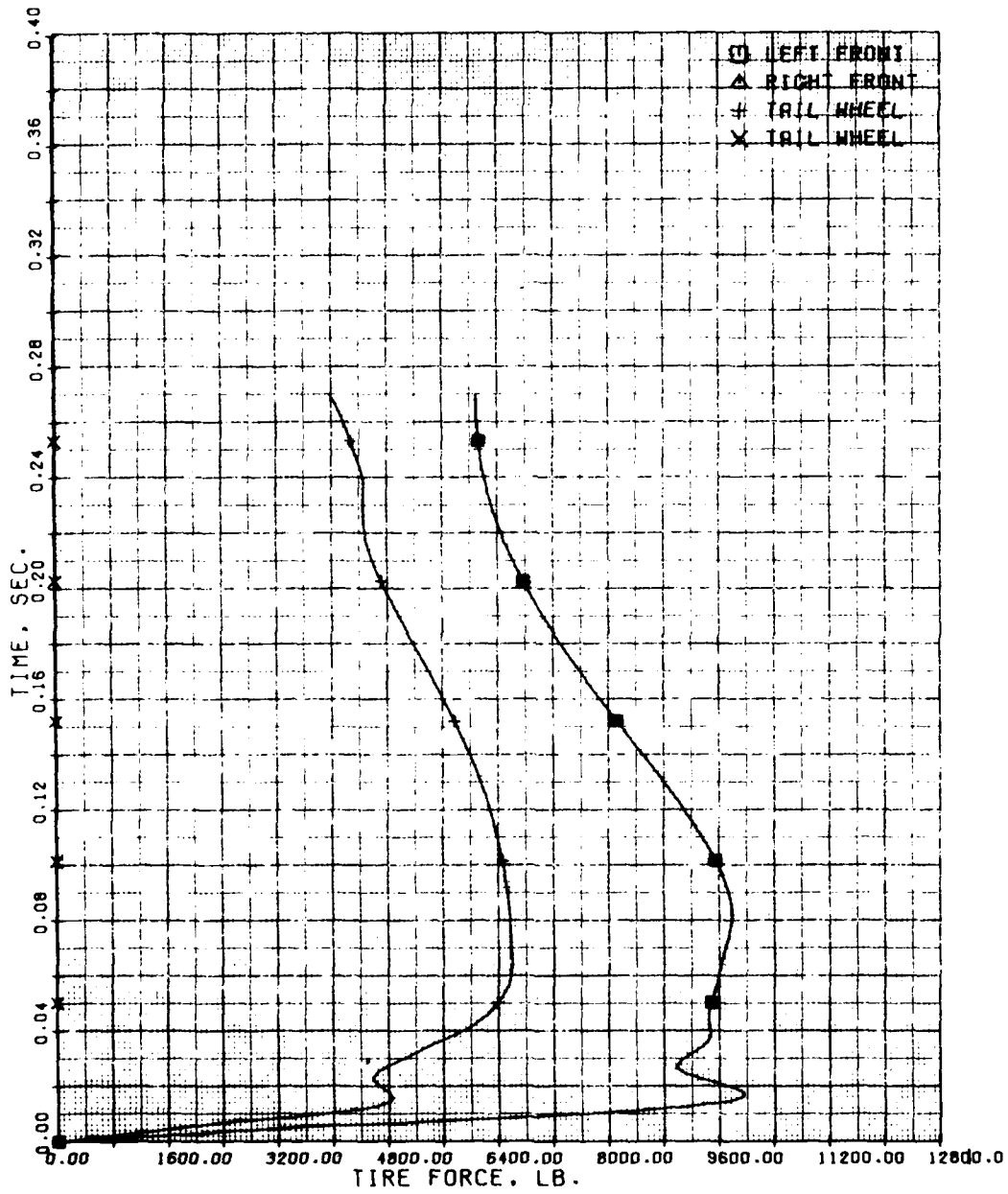

Figure 14. Baseline - 20 ft/sec, level.

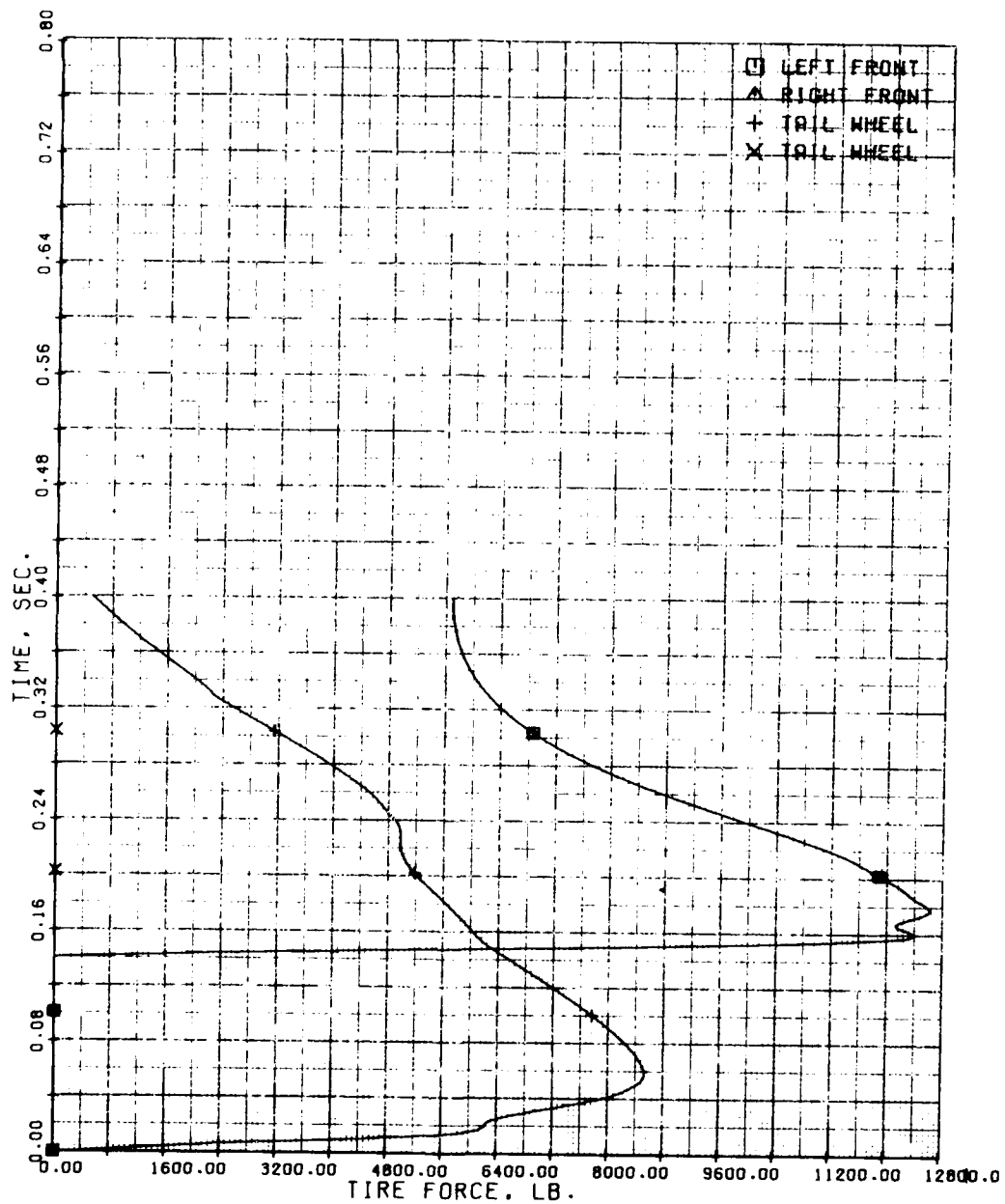

Figure 15. Baseline - 20 ft/sec, +10° pitch, 0° roll.

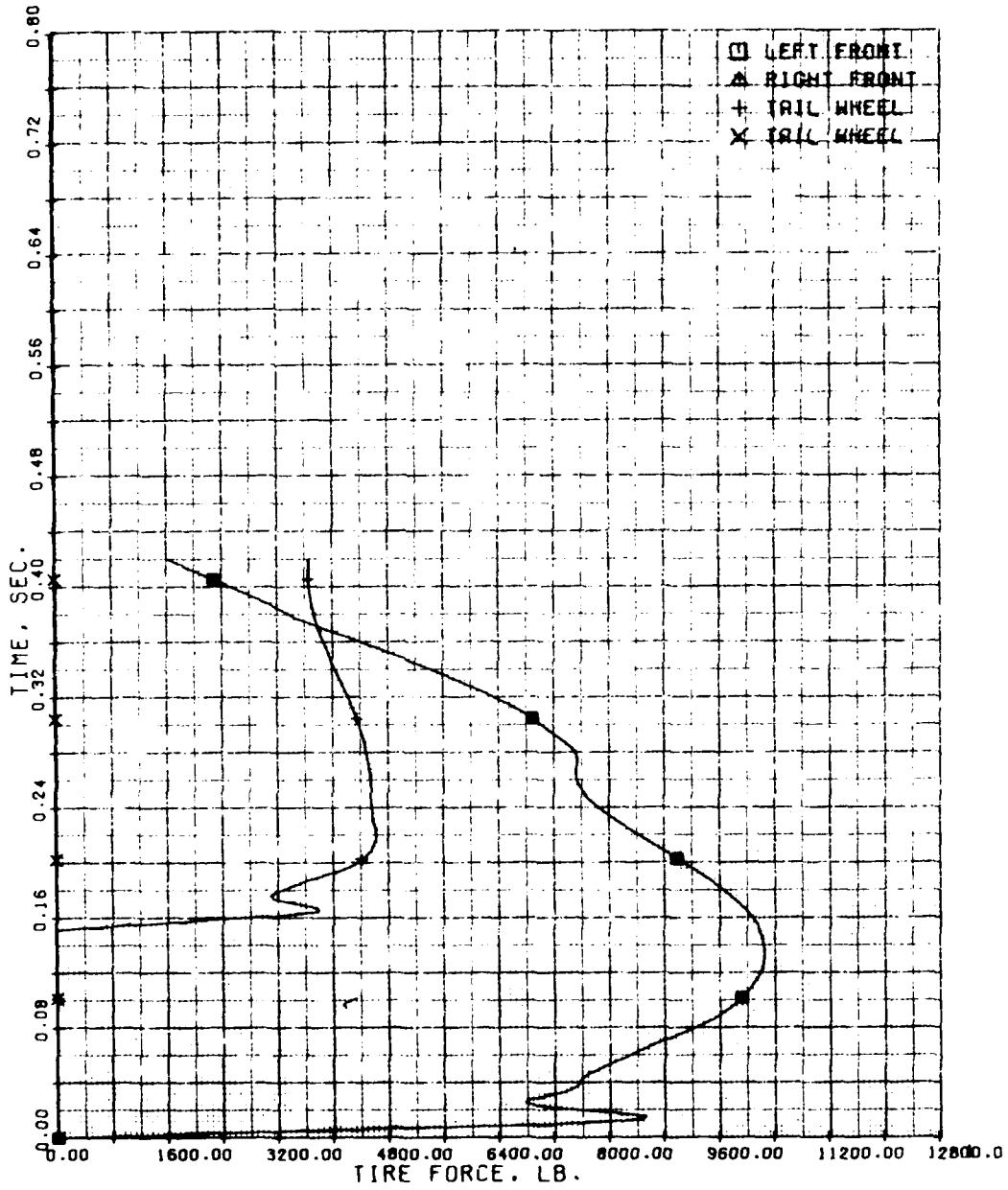

Figure 16. Baseline - 20 ft/sec, -10° pitch, 0° roll.

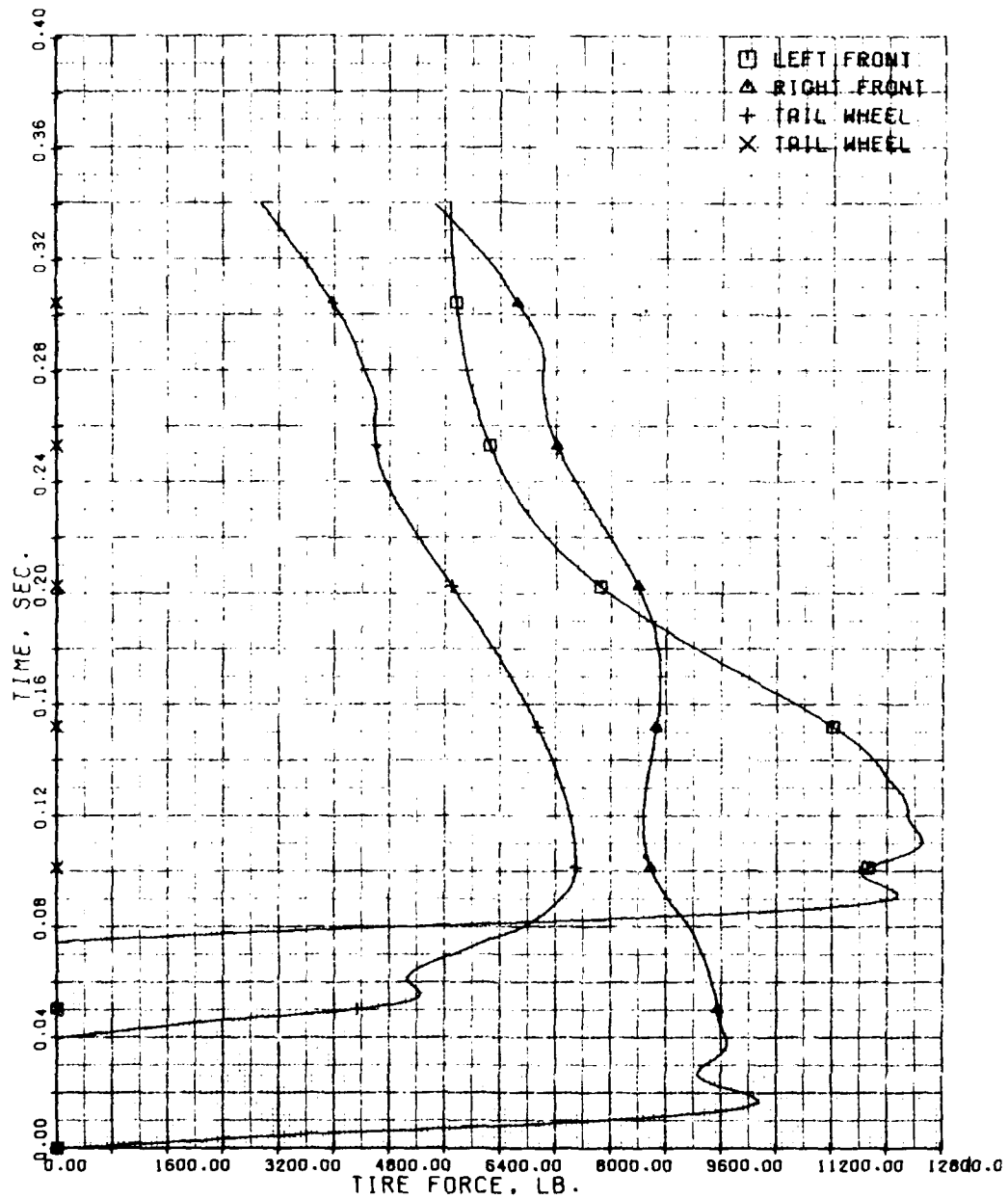

Figure 17. Baseline - 20 ft/sec, 0° pitch, +10° roll.

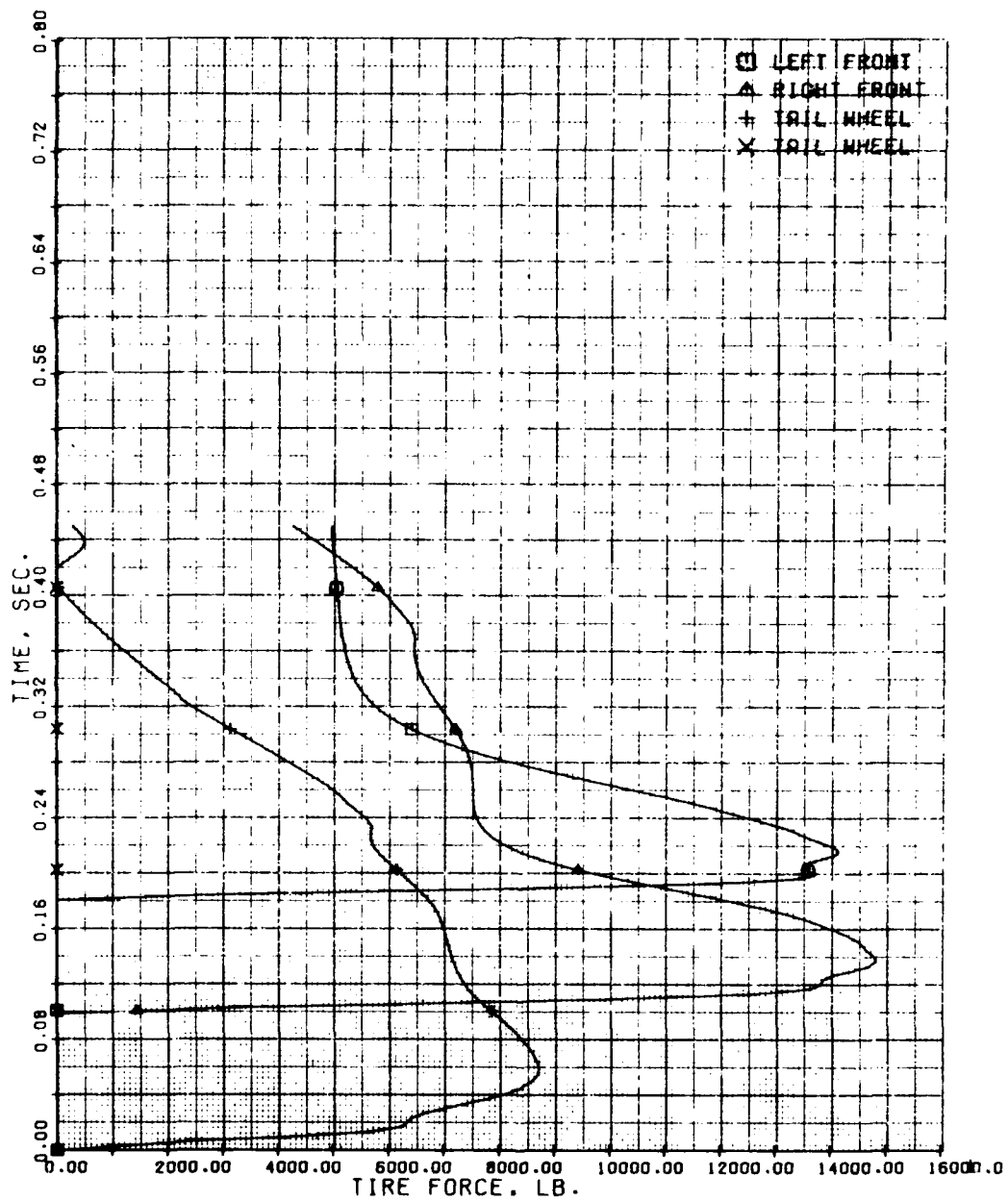

Figure 18. Baseline - 20 ft/sec, +10° pitch, +10° roll.

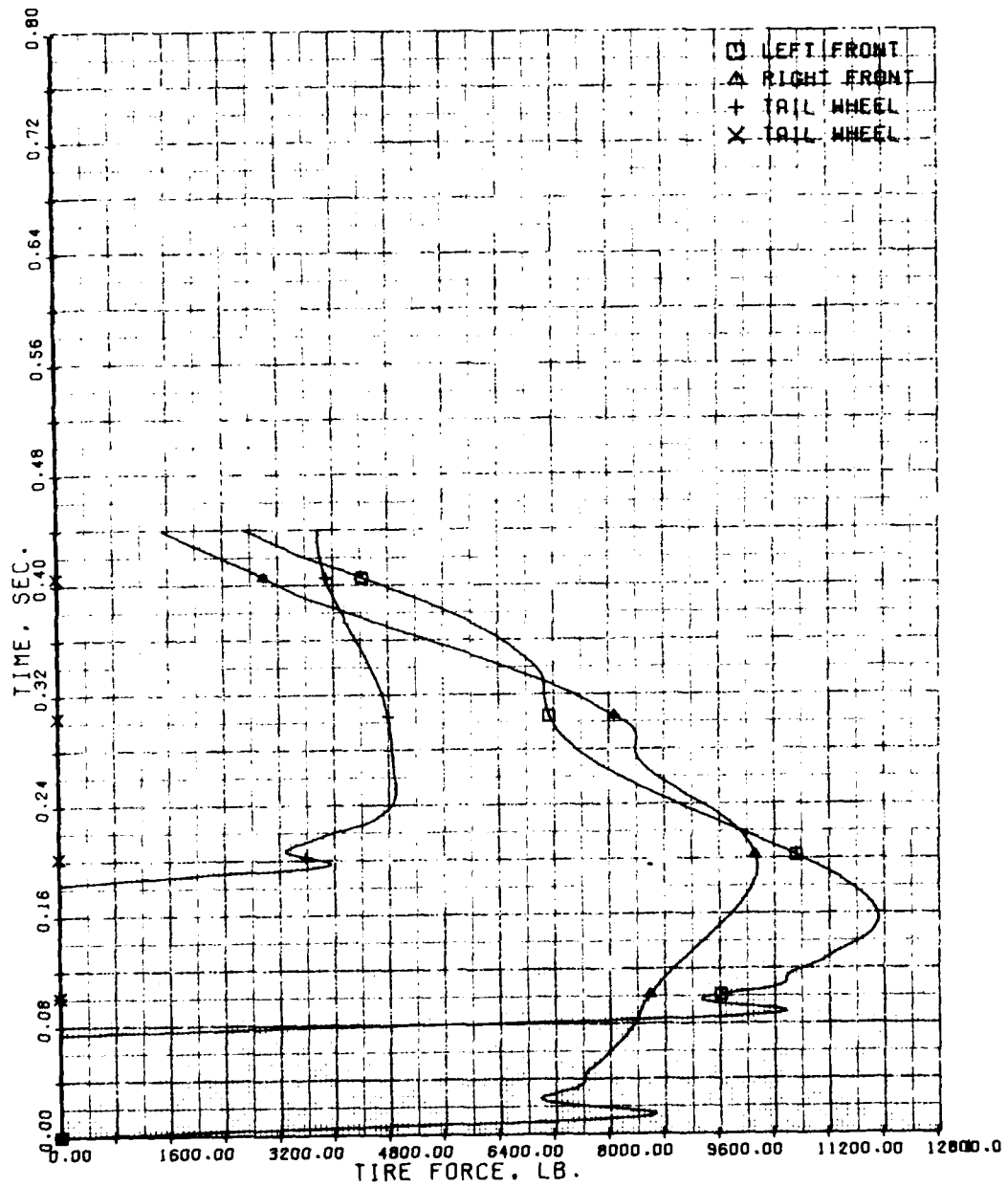

Figure 19. Baseline - 20 ft/sec, -10° pitch, $+10^{\circ}$ roll.

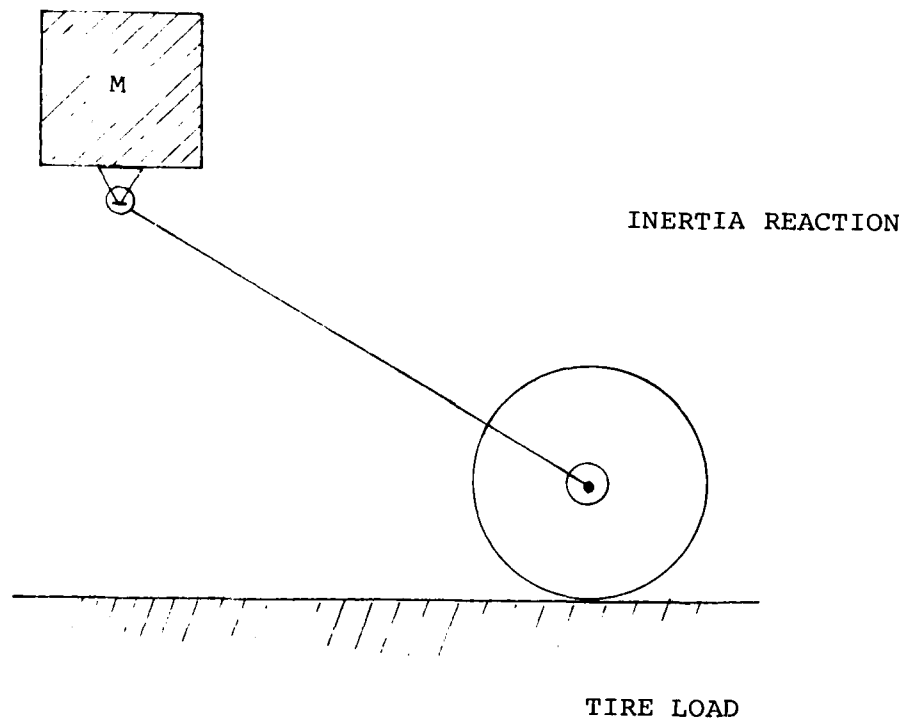

Figure 20. Inertia spike load simulation.

arm rotation matches and then exceeds the arm pivot sink speed, the arm will continue to accelerate due to the tire load, but now the tire will be extending and the tire load will drop off. The loads developed are a function of the tire spring rate and the trailing arm inertia. The tire spring rates and tire, wheel, brake, and axle weights are roughly comparable between the new and old criteria, the inertia spike for a given drop sink speed will be proportional to the square of the trailing arm radius (arm inertia equals mass times distance squared). The old criteria tailwheel gear used a 16-inch radius arm, while the new criteria gear used a 47-inch arm for a ratio of squares of 8.63 to 1. The inertia spike load is hidden in the old criteria drop curves, but it is quite noticeable in the new criteria curves. This is also partially due to the lower sink speeds for the old criteria. The inertia spike for the new criteria baseline gear at 20 ft/sec occurs about 20 milliseconds after initial tire contact. As the inertia load starts to drop off, the oleo load often cannot increase rapidly enough to prevent a dip in the load stroke curve. A similar, but smaller, effect would be present in a cantilever gear due to the higher unsprung weight of a long stroke gear to meet the new criteria.

Crashworthiness Study

20-ft/sec Conditions

The primary purpose for the KRASH analysis at the 20 ft/sec vertical velocity wash impact condition was to provide correlation with the calculated data from the BHT in-house landing gear analysis described above. Using the simplified KRASH math model shown in Figure 9, the landing gear structure response was calculated for level and 10-degree noseup pitch impact attitudes. For these cases friction was not represented in the simulation.

As explained earlier, the shock strut nonlinear load-deflection data input to the KRASH math model was obtained from BHT in-house landing gear analyses. Since the data is velocity dependent, each impact condition analyzed with KRASH requires a different set of load-deflection parameters for the shock strut beam element. The shock strut load-deflection characteristics for the level and 10-degree noseup pitch impact attitudes are plotted in Figures 21 and 22, respectively.

For both impact conditions, the calculated results from KRASH and the BHT in-house landing gear analysis agree favorably. As shown in Figure 21, the maximum strokes in the main and tail gear shock struts for the level impact agree. Likewise, Figure 22 shows agreement for the 10-degree noseup pitch impact condition. The time histories of cg vertical velocity, cg vertical acceleration, and landing gear vertical tire load

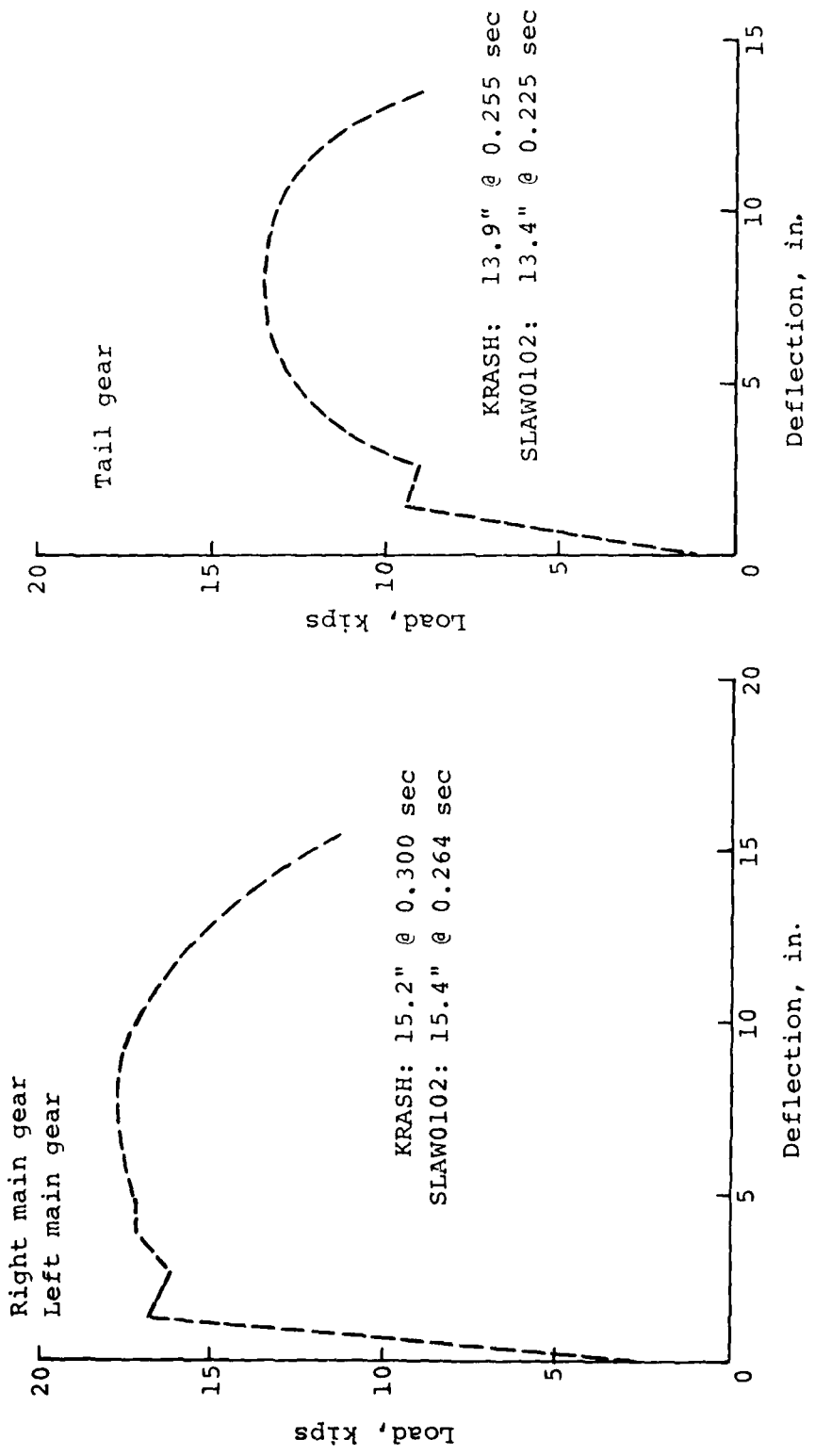

Figure 21. Shock strut load-deflection data for 20 ft/sec vertical impact velocity with level attitude.

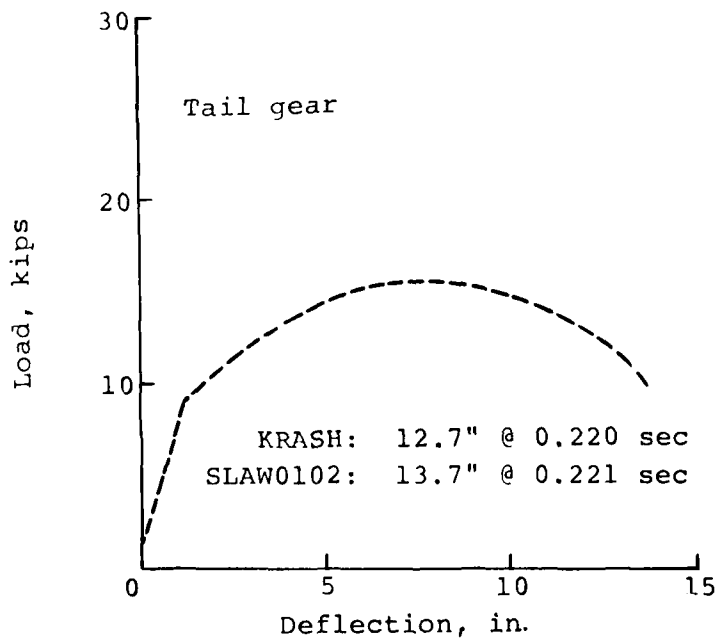
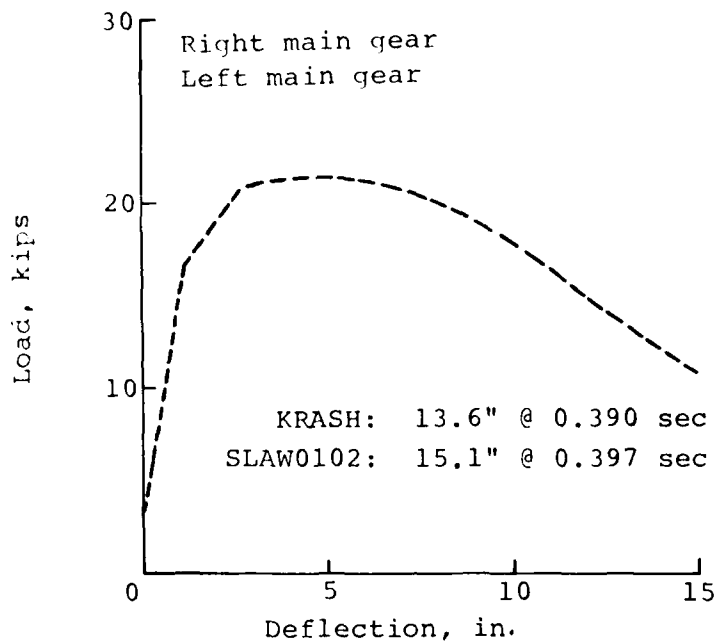

Figure 22. Shock strut load-deflection data for 20 ft/sec vertical impact velocity with 10 degrees nose-up pitch attitude.

calculated by each analytical method are compared in Figures 23 through 26 for the level impact, and in Figures 27 through 30 for the 10-degree noseup pitch impact. In general, the KRASH results contain oscillations which are not present in the landing gear program results. This appears to be due to the modeling technique used in the KRASH analysis. A possible problem area is the use of an input data load-deflection curve to represent the shock absorber. If an oscillation develops in the landing gear program, the shock absorber closure velocity varies and the load will change accordingly to help damp the oscillation. With a position dependent load-deflection curve, the load will not vary with closure velocity, so there will be much less damping in the system. If these oscillations in the KRASH results are smoothed out to approximate the mean values, there is good correlation between the two programs.

42-ft/sec Conditions

For the 42-ft/sec vertical velocity crash impact condition, the KRASH analysis examined (separately) the effects of pitch and roll altitude variation on the landing gear strength requirements to prevent structural failure. Using the math model described earlier, the duration of the KRASH analytical simulation time was selected to allow reduction of the aircraft vertical velocity from 42 ft/sec to 30 ft/sec. Only the energy attenuating capability of the wheeled landing gear was utilized.

The KRASH analysis calculated the internal loads for the various landing gear structural components at several nonzero aircraft impact attitudes. To establish a common base for comparison, the landing gear structural loads for the level impact crash condition were selected as the datum to determine load amplification factors resulting from increases in pitch and roll impact attitudes. Comparisons of the individual shear force and bending moment components in the landing gear structural elements from the KRASH analysis proved unwieldy for determining strength requirement trends. A more quantitative measure was found by using the stress ratio output from KRASH for each structural element. The stress ratio is defined as the ratio of the actual stress to the yield stress. Of the two options available in KRASH, maximum shear stress theory and theory of constant energy of distortion, the latter was chosen for use in this study. With this method the calculated stress ratio is as follows.

$$\frac{\sigma_{\text{actual}}}{\sigma_{\text{yield}}} = \frac{1}{\sqrt{2}} \sqrt{\frac{(\sigma_1 - \sigma_2)^2 + (\sigma_2 - \sigma_3)^2 + (\sigma_3 - \sigma_1)^2}{\sigma_y}}$$

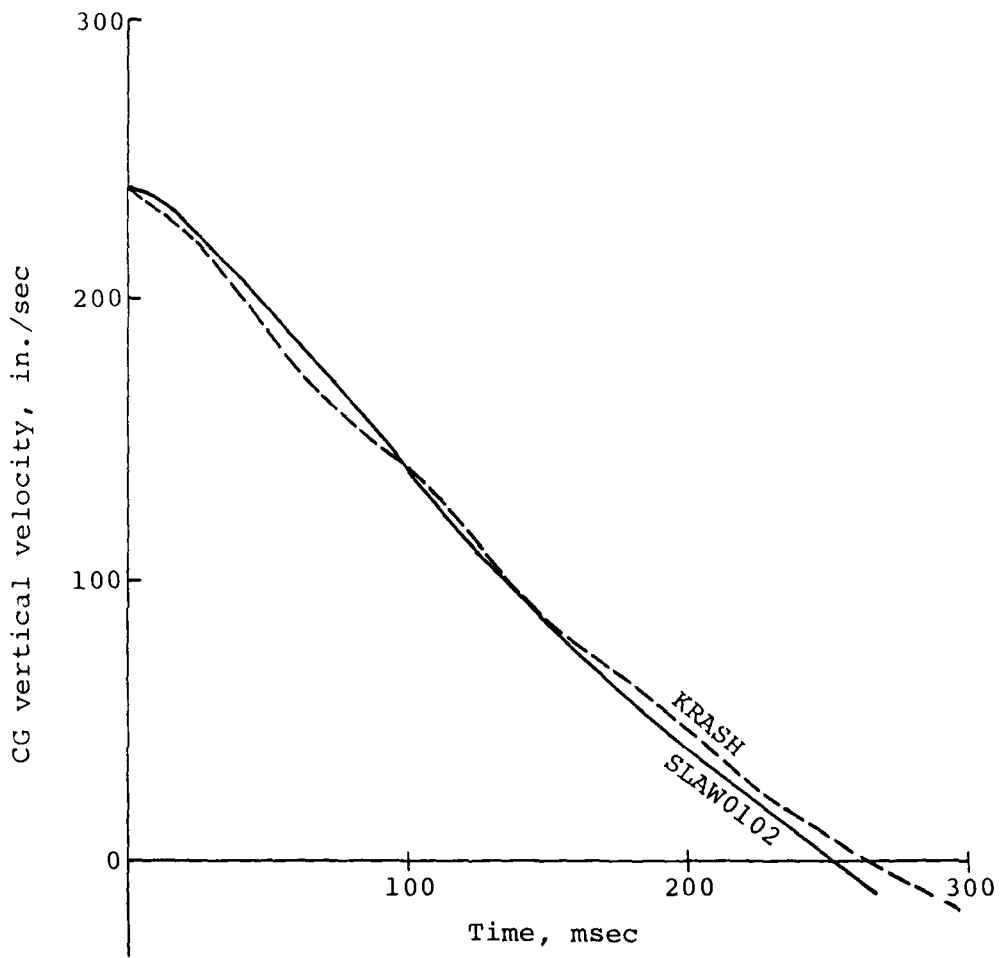

12
B

Figure 23. CG vertical velocity time history for 20 ft/sec vertical impact velocity with level attitude.

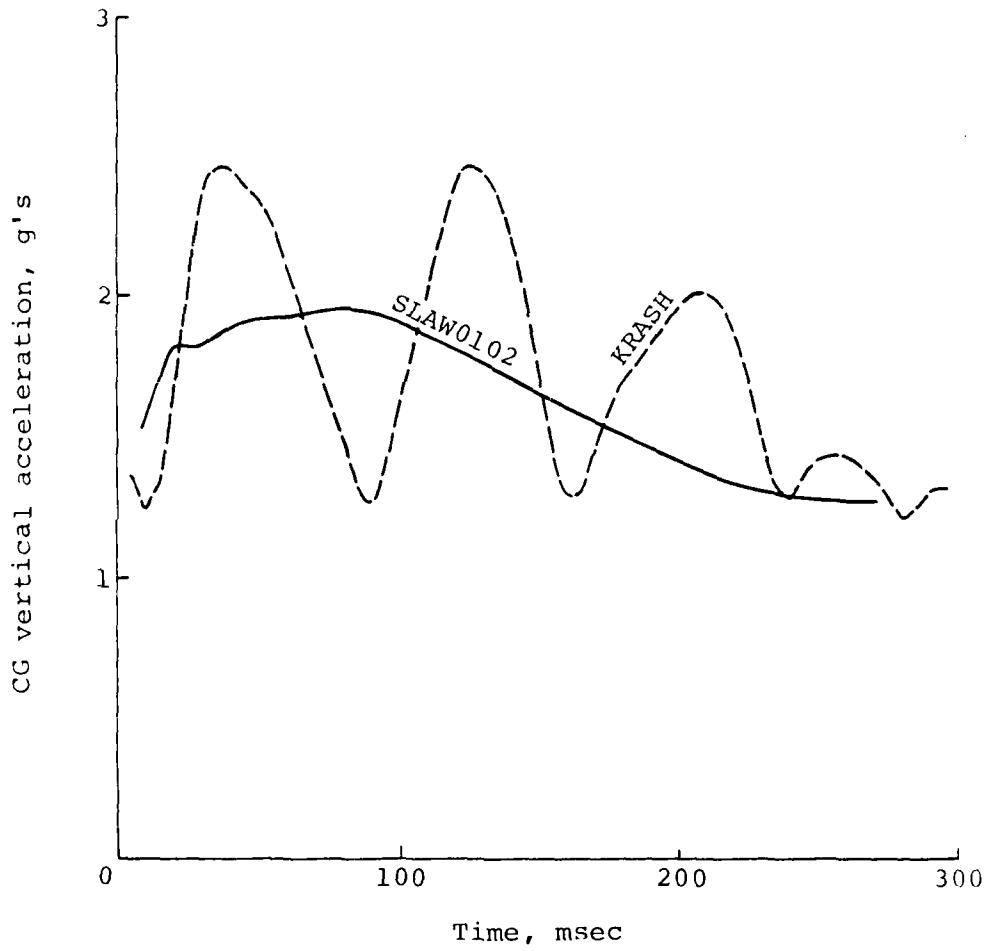

Figure 24. CG vertical acceleration time history for 20 ft/sec vertical impact velocity with level attitude.

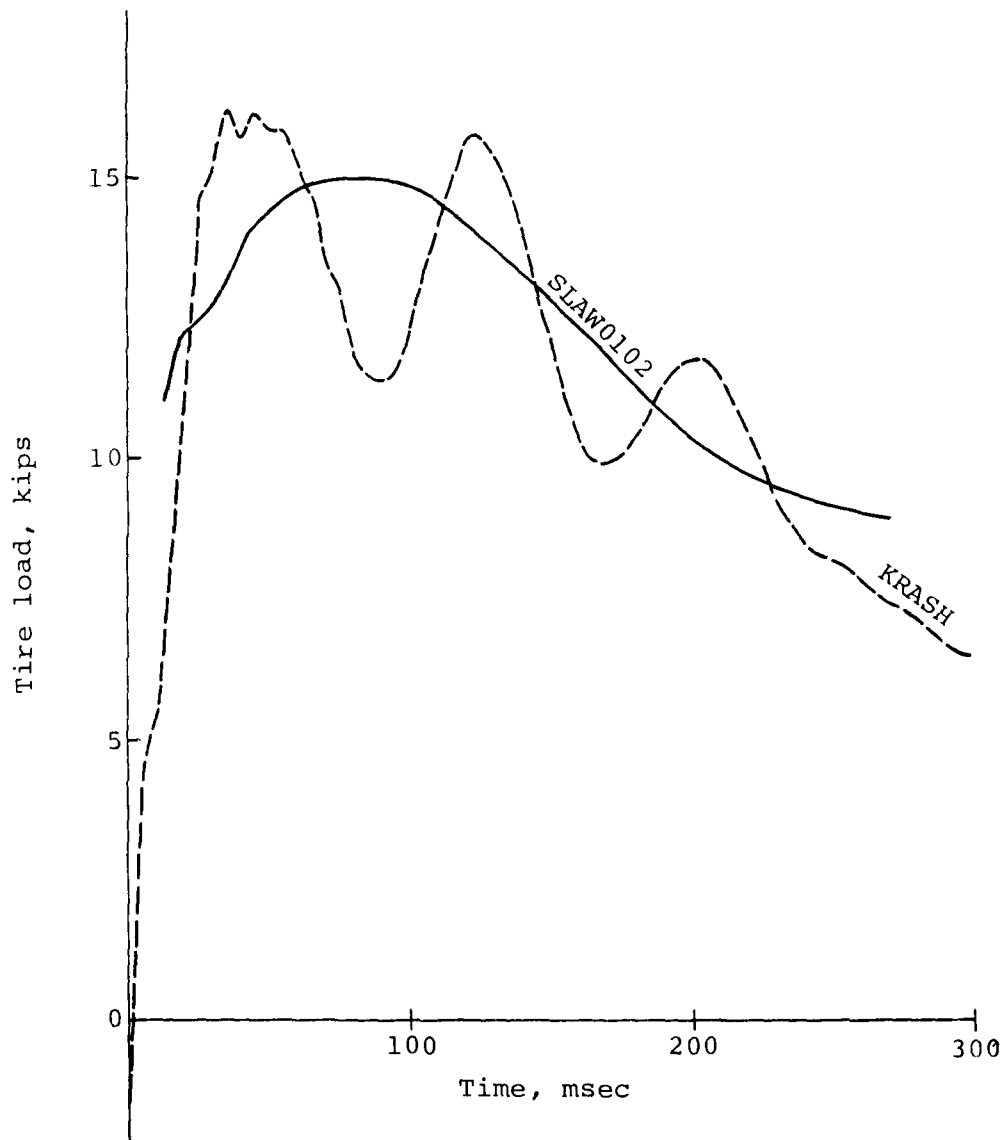

Figure 25. Right and left main gear tire load time history for 20 ft/sec vertical impact velocity with level attitude.

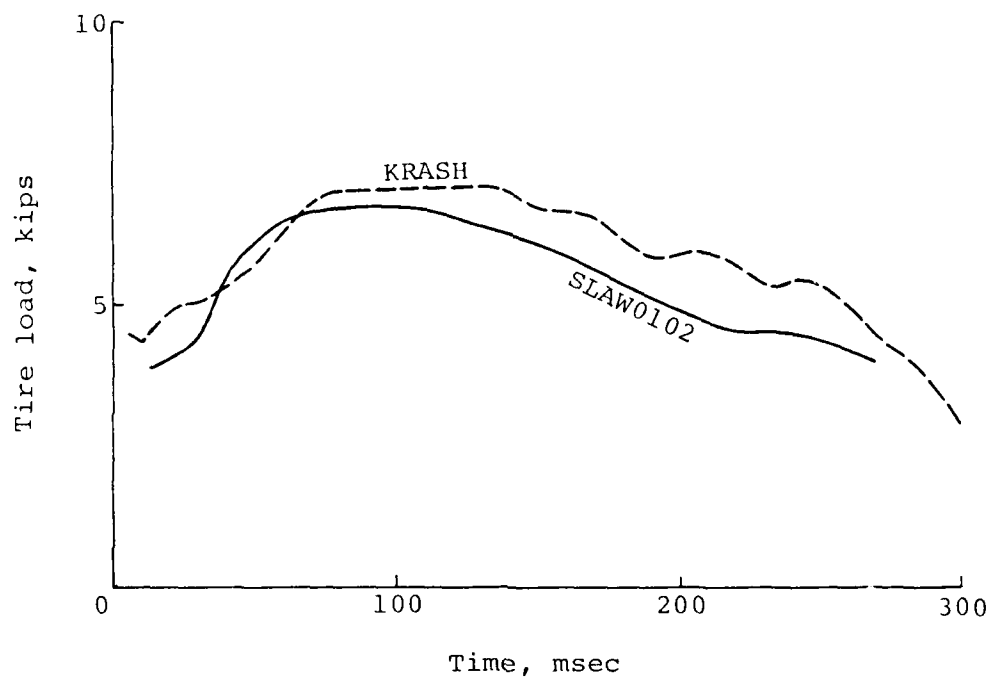

Figure 26. Tail gear tire load time history for 20 ft/sec vertical impact velocity with level attitude.

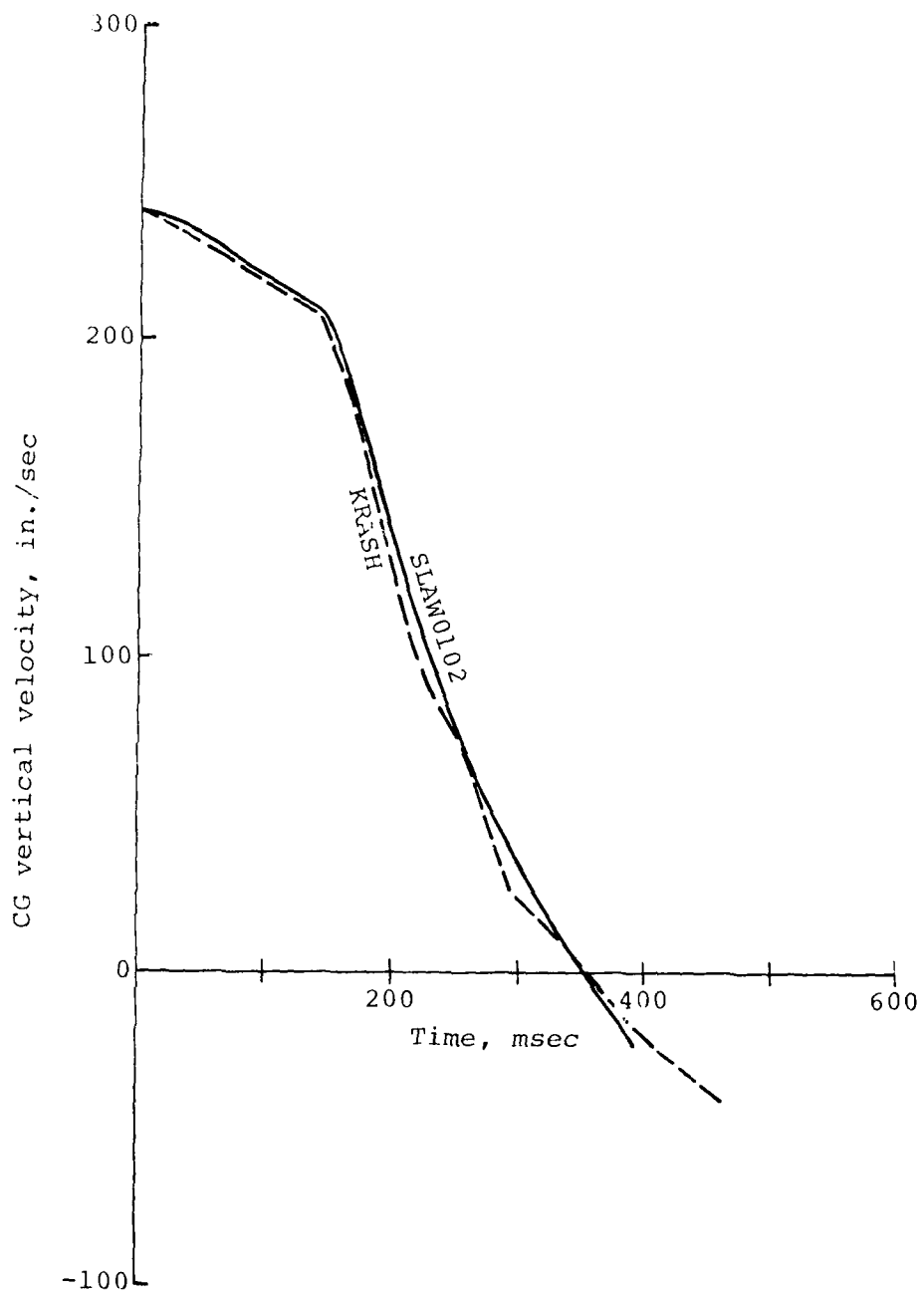

Figure 27. CG vertical velocity time history for 20 ft/sec vertical impact velocity with 10 degrees noseup pitch attitude.

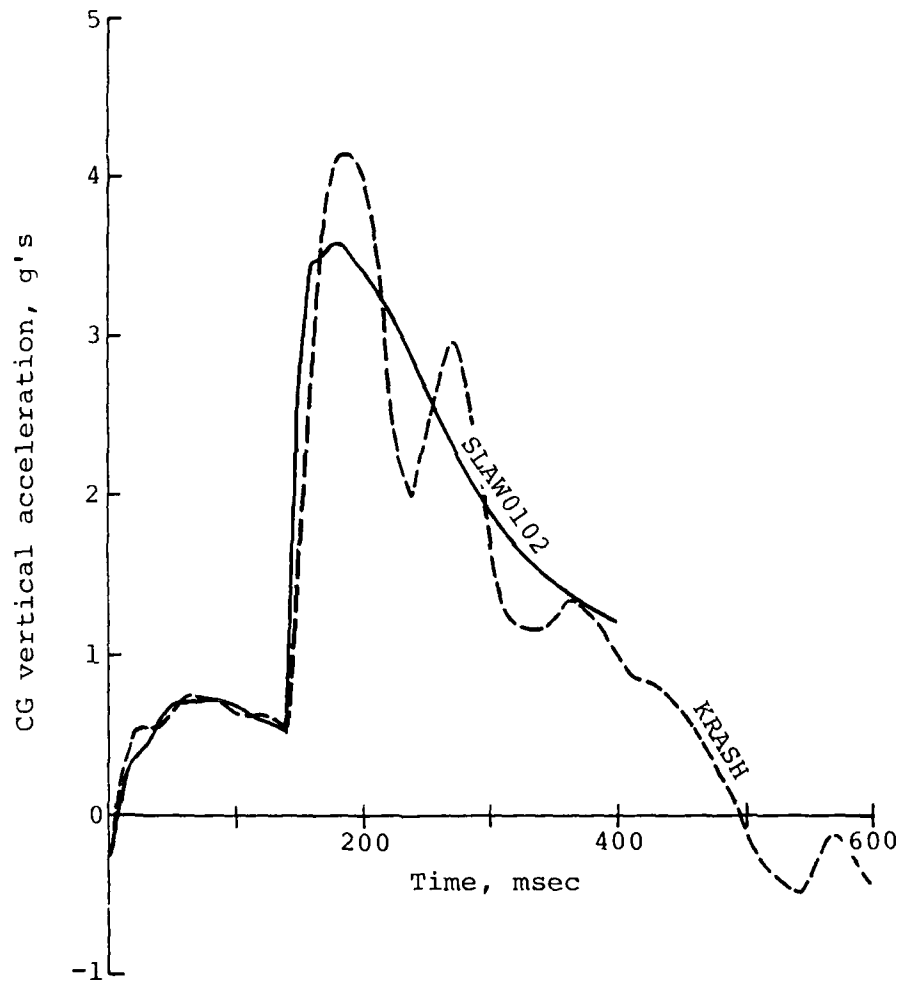

Figure 28. CG vertical acceleration time history for 20 ft/sec vertical impact velocity with 10 degrees noseup pitch attitude.

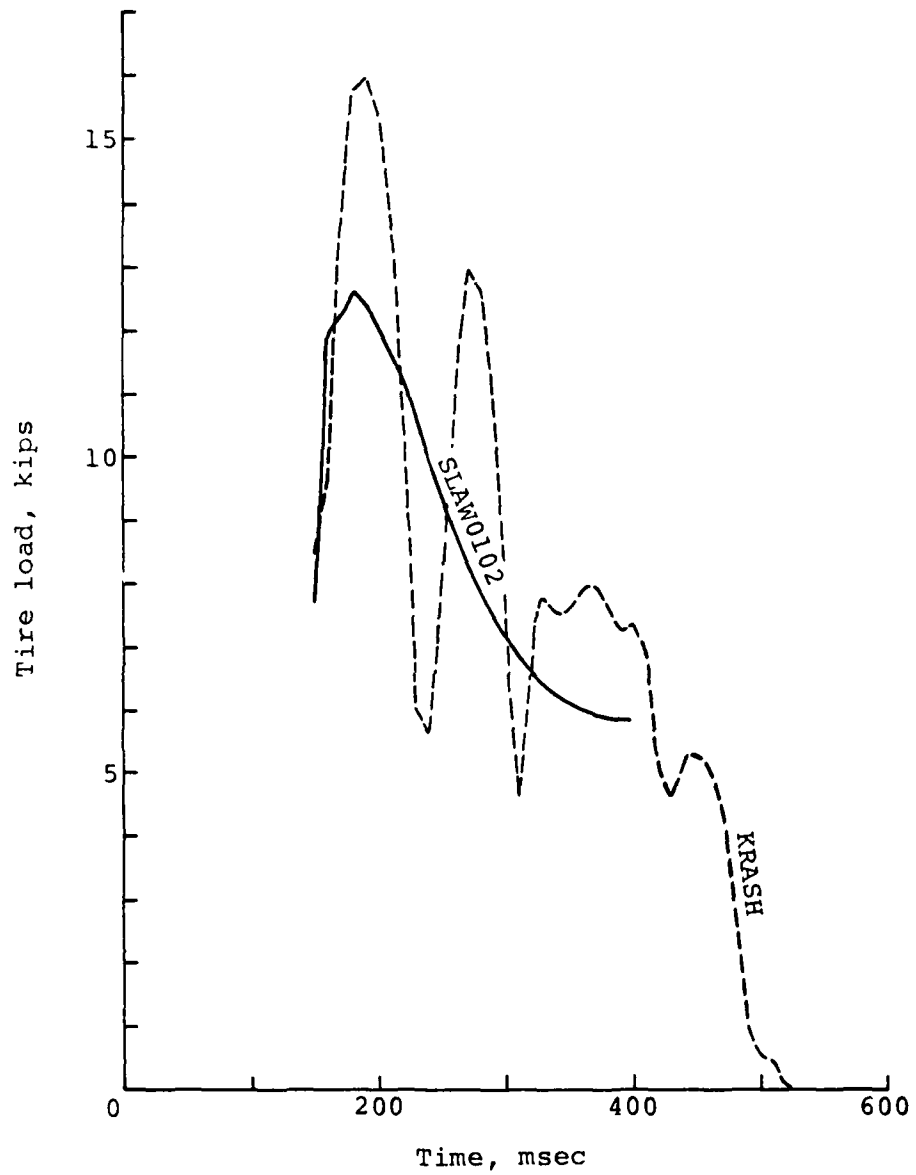

Figure 29. Main gear tire load time history for 20 ft/sec vertical impact velocity with 10 degrees nose-up attitude.

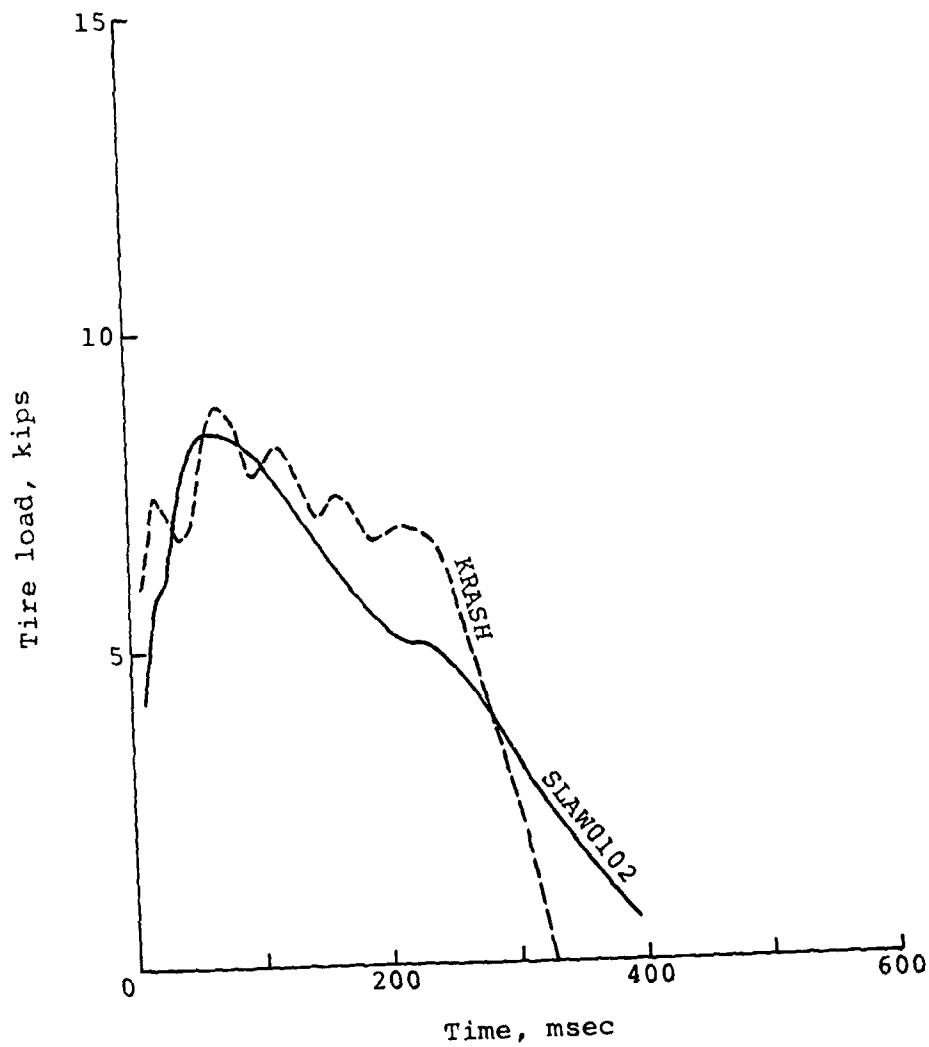

Figure 30. Tail gear tire load time history for 20 ft/sec vertical impact velocity with 10 degrees nose-up pitch attitude.

where

σ_1 , σ_2 , and σ_3 are the principal stresses, σ_y is the yield stress

When the stress ratio for a beam element exceeds 1.00, elastic failure is indicated.

Various aircraft impact pitch attitudes (ranging from 10 degrees nosedown to 30 degrees noseup) were simulated with the KRASH analysis. Friction effects were not included. The stress ratio time histories for the landing gear trailing arm structural elements before fuselage impact were calculated. The maximum energy attenuator stroke to slow the aircraft from 42 ft/sec to 30 ft/sec was also calculated for each gear.

Figure 31 presents the maximum energy attenuator stroke for the main and tail gears plotted as a function of aircraft impact pitch attitude. The maximum stroke occurs just before fuselage structure impact. The results do not reflect the effect of landing gear structure failure prior to reaching maximum stroke. The results show that the tail gear stroke requirement increases significantly as the aircraft impact pitch attitude increases noseup. The main gear stroke requirement increases for the nosedown pitch impact attitudes.

The KRASH results for the stress ratios in the landing gear trailing arms were examined to find the critical elements for strength requirements. In Figures 32 and 33, the maximum stress ratios in the main and tail gear trailing arms are plotted versus aircraft impact pitch attitude. For both, the strength requirements grow as the pitch attitude is increased.

As defined in MIL-STD-1290, the 95th potentially survivable accident includes aircraft impact pitch attitudes to 15 degrees noseup. To utilize the full energy absorption ability of the landing gear in the aircraft crashworthiness system, the landing gear design strength must be sufficient to prevent structural failure. For a 15-degree noseup pitch, the KRASH results indicate that the trailing arm strength requirement is approximately 19 times greater than that for the level impact condition. In addition, the tail gear energy attenuator stroke is increased by a factor of 1.75.

To examine the effect of aircraft roll impact attitudes on the landing gear design criteria, the simplified KRASH model was analyzed for roll impact attitudes from level to 30 degrees. To introduce side loads on the landing gear trailing arms, a coefficient of friction of 0.6 was used in the tire crushing

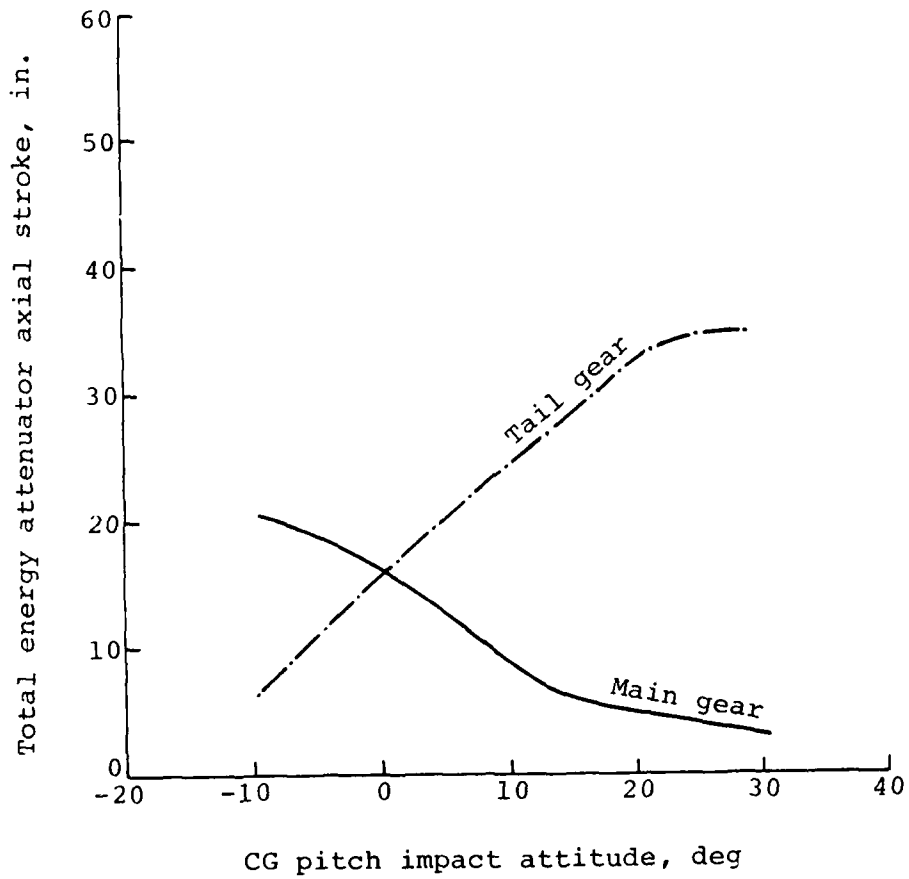

Figure 31. Maximum energy attenuator stroke required to decelerate aircraft from 42 ft/sec to 30 ft/sec for various pitch impact attitudes.

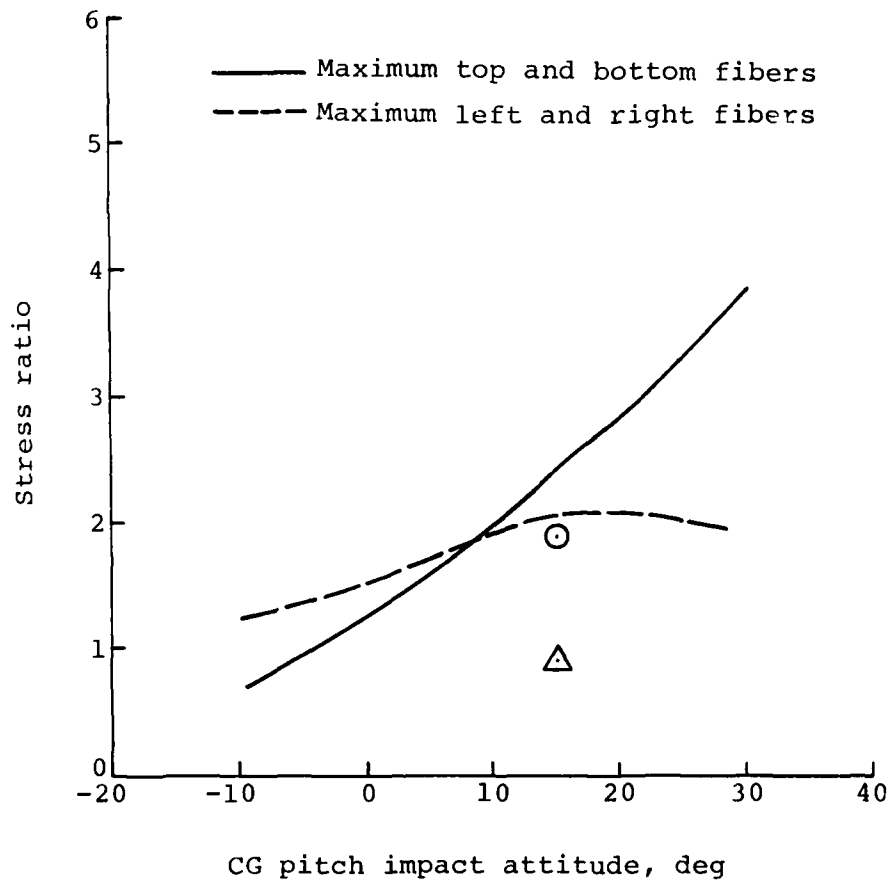

Figure 32. Maximum stress ratio in main gear trailing arm during deceleration of aircraft from 42 ft/sec to 30 ft/sec for various pitch impact attitudes.

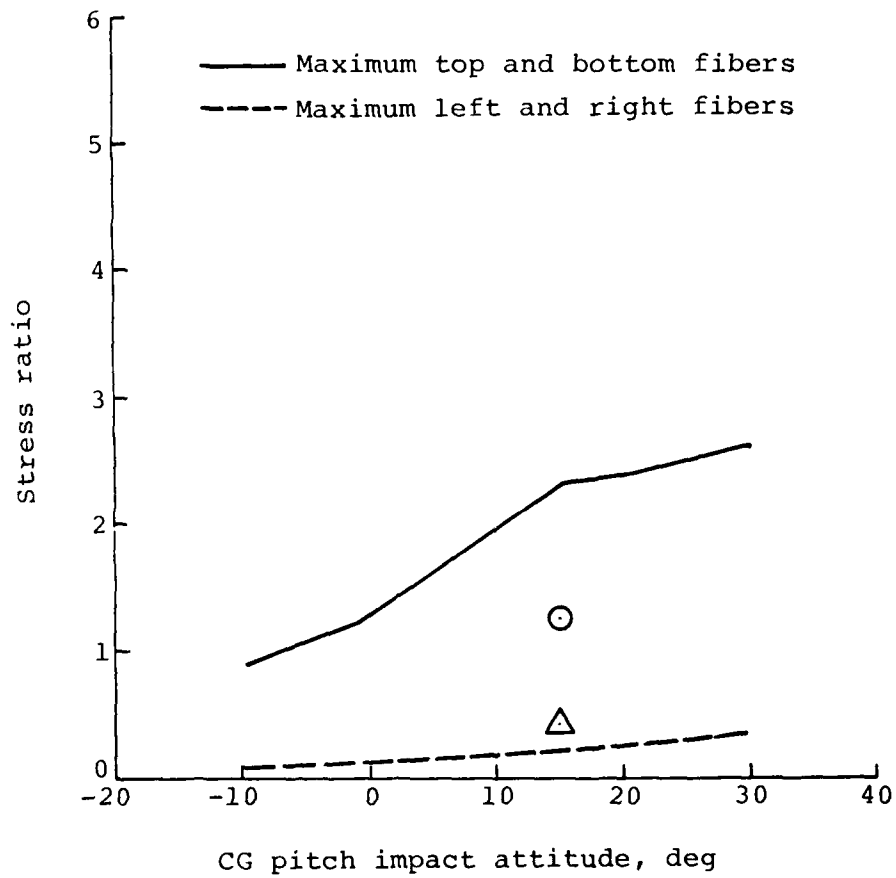

Figure 33. Maximum stress ratio in tail gear trailing arm during deceleration of aircraft from 42 ft/sec to 30 ft/sec for various pitch impact attitudes.

springs. As in the aircraft pitch impact attitude study, the KRASH analysis simulation time was selected such that the aircraft was decelerated from 42 fps to 30 fps with the landing gear only.

Figure 34 shows the maximum energy attenuator stroke for the main and tail gears versus aircraft roll impact attitude. The KRASH analysis indicates that only the right main gear stroke requirement increases as the roll attitude is increased. The tail gear stroke is essentially constant for any roll attitude, and the left main gear stroke decreases significantly as the landing gear decelerates the aircraft, the right main gear contributes more energy attenuation as the roll impact attitude is increased.

Correspondingly, the maximum stress ratios in the right main gear trailing arm exceed those in the left main and tail gears. As Figure 35 illustrates, the stress ratios increase with aircraft roll impact altitude.

The roll impact attitude requirement for aircraft crashworthiness design per MIL-STD-1290 is 30 degrees. To prevent trailing arm structural failure in the right main gear, the strength requirement predicted by KRASH analysis is a factor of 3.61 greater at 30 degrees roll than at zero or level impact. In addition, the stroke requirement increases by a factor of 2.06.

NEW CRITERIA NOSEWHEEL TRICYCLE

As discussed in Appendix A, configuration restraints limited this design to 72 percent of the pitch center of percussion for the wheel base and to a 25-degree turnover angle. This produced less desirable landing dynamic characteristics than those of the baseline design. The shorter moment arms do not develop the pitching moment needed to rotate the helicopter to relieve the load on the first gear to hit the ground. For the pure pitch conditions, the first gear (or gears) to hit absorbs a higher percentage of the drop energy than it does on a level landing. This is shown by the higher loads and longer strokes developed by this gear. The second gear to hit develops lower loads and shorter strokes than it does on a level landing.

If the gears are located closer together than the center of percussion location, the first gear to hit will develop the highest loads. If the gears are located farther apart than the center of percussion location, the second gear to hit will develop the highest load.

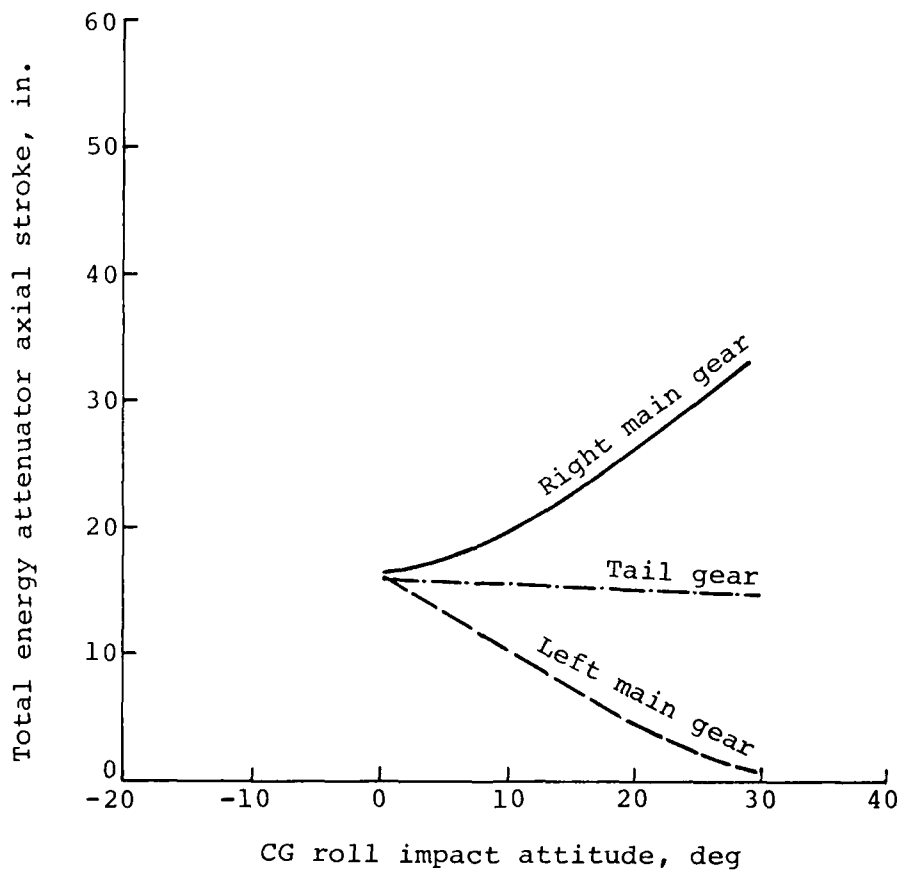

Figure 34. Maximum energy attenuator stroke required to decelerate aircraft from 42 ft/sec to 30 ft/sec for various roll impact attitudes.

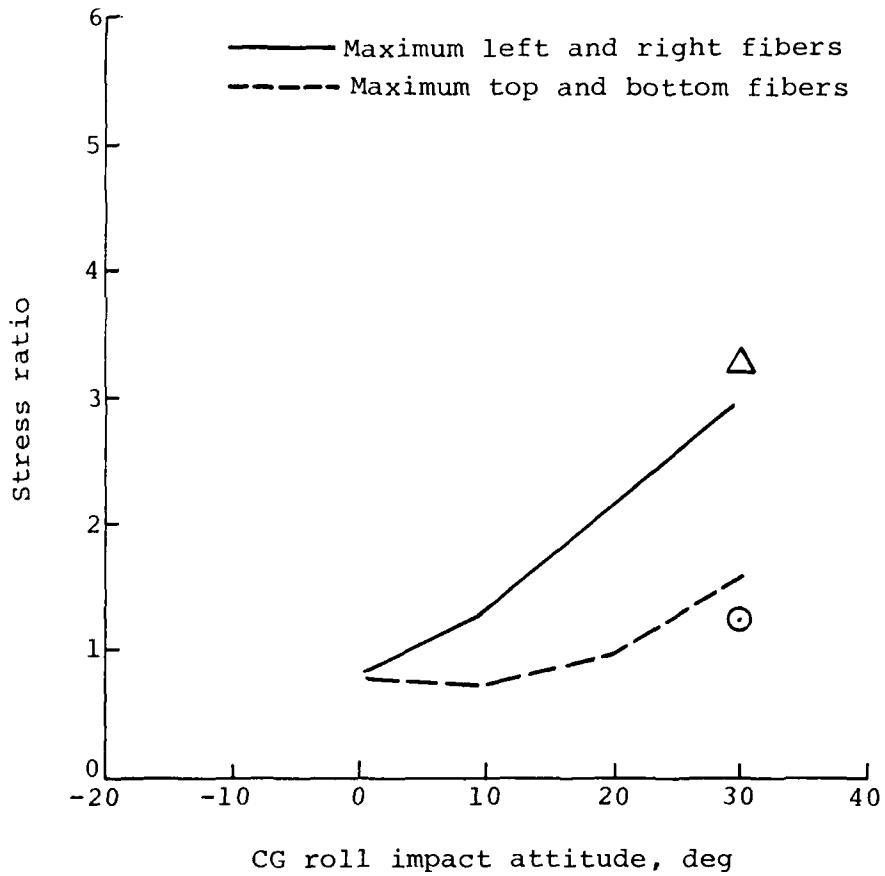

Figure 35. Maximum stress ratio in main gear trailing arm during deceleration of aircraft from 42 ft/sec to 30 ft/sec for various roll impact attitudes.

NEW CRITERIA QUADRICYCLE

This gear had good landing dynamic characteristics, particularly in roll. There was a tire bottoming problem on one condition, but the required vertical axle travels and the cg load factors developed were more consistent for the six cases checked than the other gears. With more optimization, the quadricycle should produce excellent landing dynamics.

NEW CRITERIA SKID GEAR

This is basically the quadricycle gear with more vertical axle travel, the wheels removed, and skid tubes mounted below the axles. The landing dynamic characteristics of this gear were generally poor, and this seems to be a fundamental problem. The skid tube is very stiff compared to a tire. This produces a relatively severe "inertia spike" at initial gear contact. Since the gears on one side are interconnected, in a pitched landing the first gear to hit will pull (or push) the other gear, causing both gears to stroke at approximately the same rate. This effectively doubles the stiffness of the first gear which causes high loads and high pitching velocities. When the second gear hits, it hits at a higher impact velocity and the gear has already been partially stroked, often half or more of the available stroke. This results in high loads and high angular accelerations and velocities, and requires long strokes.

OLD CRITERIA TAILWHEEL TRICYCLE

This gear was dropped at 8.0 and 9.8 ft/sec with level and ± 10 degrees of pitch attitudes. Forward speeds of zero to 100 knots were run for each case. The loads were generally well behaved, although the main gear loads in the noseup landings were higher relative to the level landing than the baseline gear. The main gear loads also increased with forward speed up to 60 knots and then fell off. This is due to load redistribution to the forward gear caused by tire drag and because the load peaked in the middle of the drop instead of near the front. This means the load relief in the trailing arm due to tire spinup did not affect the load peak.

OLD CRITERIA SKID GEAR

Since this is a production AH-1S skid gear, no load checks were required.

EVALUATION OF DESIGN STUDY CONFIGURATIONS

The design study configurations were evaluated for operational effectiveness, weights, costs, and the advantages and disadvantages of landing gears designed to the new criteria. Both quantitative and qualitative evaluations were made. There was also a brief qualitative assessment of the applicability of the design study results.

The primary intent of this evaluation was a comparison of the previous criteria designs with the proposed new criteria designs. This effort was concentrated on the new and old criteria tailwheel tricycle designs.

OPERATIONAL EFFECTIVENESS

All of the design study configurations are considered to meet the design criteria. While there were some shortcomings in some of the designs, they can be corrected with additional design refinement without significant effects on cost or weight. For example, on two gear designs one tire bottomed, causing a load spike. The tire pressure could be increased enough to prevent bottoming, thereby eliminating the load spike. In both cases, there was adequate reserve oleo stroke, so reduced tire deflection would not be a problem.

WEIGHTS

Tables 17 through 22 contain the weights predictions from the Landing Gear Sizing Program discussed earlier in this report. The new criteria skid gear weight is a computer prediction for the trailing arms and shock absorbers and a manual estimate on the skids. Table 23 is a summary of all the gears. The old criteria skid gear weight is the actual weight of an AH-1S skid gear assembly.

These weights are generally representative for other gear designs of the same general configuration. Small differences between configurations are not significant because slight configuration changes could result in a tire and wheel size change for the new load distribution. Since tires and wheels come in discrete sizes, a change in load distribution can cause step changes in total gear weight as the individual gears are repositioned fore and aft.

Most of the weight difference between the 30- and 25-degree turnover angle tailwheel gears is due to relocation of the individual gears. The reduced forward turnover angle moved

TABLE 17. WEIGHTS BREAKDOWN - NEW CRITERION
TAILWHEEL TRICYCLE (30° TURNOVER)

	APPROXIMATE WEIGHTS (LB)		
	MAIN	TAIL	
LANDING GEAR ASSY		124.64	80.50
SHOCK ASSY	39.86		27.50
ENERGY ABSORBER	10.00		8.00
BARREL	6.58		4.66
PISTON	10.25		6.63
OIL	6.61		3.60
BEARINGS	0.32		0.20
PISTON HEAD	1.93		1.48
LOWER BEARING	0.58		0.48
RING	0.81		0.45
AIR PISTON	1.24		0.65
METERING PIN	1.54		1.26
TRAILING ARM ASSY	45.98		36.29
ARM	26.18		22.03
PIVOT ARM	9.40		6.60
ARM LUGS	0.80		0.77
AXLE FITTING	8.40		5.0?
TOW FITTING	1.20		1.20
ARM PIVOT BEARINGS	0.70		0.57
AXLE	4.90		2.84
BRAKE ASSY	6.40		0.00
BRAKE DISC	2.50		0.00
BRAKE CALIPER	3.90		0.00
WHEEL WEIGHT	12.80		? .80
TIRE WEIGHT	14.00		7.50
TOTAL UNINSTALLED		329.78	

TABLE 18. WEIGHTS BREAKDOWN - NEW CRITERION
TAILWHEEL TRICYCLE (25° TURNOVER)

	APPROXIMATE WEIGHTS (LB)	
	MAIN	TAIL
LANDING GEAR ASSY		
SHOCK ASSY	45.44	23.31
ENERGY ABSORBER	10.00	8.00
BARREL	8.07	3.68
PISTON	12.20	5.41
OIL	8.11	2.60
BEARINGS	0.48	0.12
PISTON HEAD	2.04	1.15
LOWER BEARING	0.60	0.39
RING	0.89	0.24
AIR PISTON	1.28	0.47
METERING PIN	1.76	1.26
TRAILING ARM ASSY	36.78	24.56
ARM	20.20	13.95
PIVOT ARM	6.68	4.44
ARM LUGS	1.43	0.52
AXLE FITTING	7.28	4.45
TOW FITTING	1.20	1.20
ARM PIVOT BEARINGS	0.59	0.49
AXLE	3.72	2.24
BRAKE ASSY	6.40	0.00
BRAKE DISC	2.50	0.00
BRAKE CALIPER	3.90	0.00
WHEEL WEIGHT	12.80	5.00
TIRE WEIGHT	14.00	4.80
TOTAL UNINSTALLED	299.86	

TABLE 19. WEIGHTS BREAKDOWN - NEW CRITERION
NOSEWHEEL TRICYCLE

	APPROXIMATE WEIGHTS (LB)		
	NOSE	MAIN	
LANDING GEAR ASSY		103.20	127.47
SHOCK ASSY	34.60		240.31
ENERGY ABSORBER	10.00		
BARREL	5.98		
PISTON	8.86		
OIL	4.95		
BEARINGS	0.20	(2 MS14103)	(2 MS14103)
PISTON HEAD	1.31		
LOWER BEARING	0.44		
RING	0.34		
AIR PISTON	0.65		
METERING PIN	1.96		
TRAILING ARM ASSY		36.53	49.04
ARM	20.54		
PIVOT ARM	8.01		
ARM LUGS	1.22		
AXLE FITTING	5.57		
TOW FITTING	1.20		
ARM PIVOT BEARINGS		0.61	0.70
AXLE		4.59	4.23
BRAKE ASSY		0.00	6.40
BRAKE DISC	0.00		
BRAKE CALIPER	0.00		
WHEEL WEIGHT		12.80	12.80
TIRE WEIGHT		14.00	14.00
TOTAL UNINSTALLED		358.14	

TABLE 20. WEIGHTS BREAKDOWN - NEW CRITERION
QUADRICYCLE

	APPROXIMATE WEIGHTS *(LB)	
	FORWARD AND AFT	
LANDING GEAR ASSY		113.27
SHOCK ASSY	36.74	
ENERGY ABSORBER	10.00	
BARREL	6.09	
PISTON	9.93	
OIL	5.29	
BEARINGS	0.16	(2 MS14103)
PISTON HEAD	1.40	
LOWER BEARING	0.46	
RING	0.40	
AIR PISTON	1.10	
METERING PIN	1.92	
TRAILING ARM ASSY	38.37	
ARM	21.61	
PIVOT ARM	7.51	
ARM LUGS	0.86	
AXLE FITTING	1.20	
TOW FITTING	1.20	
ARM PIVOT BEARINGS		0.63
AXLE		4.34
BRAKE ASSY		6.40
BRAKE DISC	2.50	
BRAKE CALIPER	3.90	
WHEEL WEIGHT		12.80
TIRE WEIGHT		14.00
TOTAL UNINSTALLED		440.28

* Forward and aft gears are identical except forward gear does not have a brake.

TABLE 21. WEIGHTS BREAKDOWN - NEW CRITERION
SKID GEAR

	APPROXIMATE WEIGHTS* (LB)	
	FORWARD AND AFT	
LANDING GEAR ASSY		83.79
SHOCK ASSY	34.07	
ENERGY ABSORBER	8.00	
BARREL	5.81	
PISTON	9.73	
OIL	4.98	
BEARINGS	0.16	
PISTON HEAD	1.39	
LOWER BEARING	0.46	
RING	0.39	
AIR PISTON	1.34	
METERING PIN	1.81	
TRAILING ARM ASSY	33.64	
ARM	19.91	
PIVOT ARM	5.54	
ARM LUGS	1.05	
AXLE FITTING	5.94	
TOW FITTING	1.20	
ARM PIVOT BEARINGS	0.55	
AXLE	2.91	
BRAKE ASSY	0.00	
BRAKE DISC	0.00	
BRAKE CALIPER	0.00	
WHEEL WEIGHT	12.80	
TIRE WEIGHT	0.00	
SKID ASSY	41.50	
TOTAL UNINSTALLED		418.88

* Forward and aft gears are identical except forward gear does not have a brake.

TABLE 22. WEIGHTS BREAKDOWN - OLD CRITERION
TAILWHEEL TRICYCLE

	APPROXIMATE WEIGHTS (LB)		
	MAIN	TAIL	
LANDING GEAR ASSY		73.76	33.15
SHOCK ASSY	12.08		8.42
ENERGY ABSORBER	0.00		0.00
BARREL	3.13		2.08
PISTON	3.17		2.75
OIL	1.62		1.11
BEARINGS	0.27		0.12
PISTON HEAD	1.84		1.08
LOWER BEARING	0.56		0.37
RING	0.73		0.19
AIR PISTON	0.31		0.29
METERING PIN	0.44		0.43
TRAILING ARM ASSY	23.36		9.29
ARM	8.53		2.02
PIVOT ARM	7.49		3.03
ARM LUGS	0.42		0.34
AXLE FITTING	5.73		2.71
TOW FITTING	1.20		1.20
ARM PIVOT BEARINGS		0.61	0.42
AXLE		4.51	1.72
BRAKE ASSY		6.40	0.00
BRAKE DISC	2.50		0.00
BRAKE CALIPER	3.90		0.00
WHEEL WEIGHT		12.80	5.80
TIRE WEIGHT		14.00	7.50
TOTAL UNINSTALLED		180.67	

TABLE 23. UNINSTALLED WEIGHTS SUMMARY

CONFIGURATION	FORWARD (EACH)	AFT (EACH)	TOTAL	% BSDGW
NEW CRITERIA				
TAILWHEEL (30°)	125	80	330	4.13
TAILWHEEL (25°)	120	60	300	3.75
NOSEWHEEL	103	127	358	4.48
QUADRICYCLE	107	113	440	5.50
SKID	84	84	419	5.24
OLD CRITERIA				
TAILWHEEL	74	33	181	2.26
SKID	-	-	119	1.49

the main gears aft. Maintaining the center of percussion relationship moved the tail wheel aft resulting in much lower loads on the tail gear. Normally, the main gear weight would go up due to the higher static reaction, but the reduced lateral turnover angle moved the gears inboard which reduced the forward gear weight. The net effect was a 10-percent gear weight reduction for a 5 degree turnover angle reduction. Part of this reduction was due to better landing loads with the 25-degree gear.

A nosewheel trailing arm gear designed to the new criteria will probably always be heavier than an equivalent tailwheel gear. The long trailing arm moves the wheel aft from the nose so the nose gear is much closer to the helicopter cg than a tailwheel. This also forces the main wheels outboard, for a given turnover angle, causing increased main gear weight.

The quadricycle gear has several advantages, but it is somewhat heavier than a tricycle. The weight savings from lower loads is not sufficient to compensate for the fourth gear. Three larger gears will almost always be lighter than four smaller gears, although sometimes installation advantages may give a lighter quadricycle design.

The new criteria skid gear is essentially the quadricycle wheel gear with skids replacing the wheels. The skids are lighter than wheels, tires, and brakes.

These results indicate that a landing gear designed to the new criteria will weigh about 4 to 4.5 percent of BSDGW. The old criteria gear designs should weigh about 2 to 2.5 percent of BSDGW, or a net landing gear weight increase of 2 percent of BSDGW. If the helicopter gross weight is held, this weight difference would come out of payload. If payload and mission performance are held, the helicopter weight will increase 2 to 2.5 times the added weight, or helicopter gross weight would increase 4 to 5 percent for a 2-percent BSDGW landing gear weight increase.

COSTS

A cost comparison was made between the new criteria 30-degree turnover angle tailwheel tricycle and the old criteria tailwheel tricycle landing gears. The comparison was based on cost of acquisition including recurring and nonrecurring costs. Ozone Industries Inc. assisted by estimating the recurring costs of the two gear assemblies. Wheel, tire, and brake costs were not included, since the same parts are used on both gears.

The cost comparison ground rules were as follows:

- Constant FY 1980 dollars
- Continuing production at a rate of 7 to 15 aircraft sets per month.
- 1000 helicopters production run
- Nonrecurring cost includes design, tooling, development, and qualification testing.
- 6000-hour average helicopter service life

The cost comparison based on these ground rules is shown in Table 24.

TABLE 24. LANDING GEAR COST COMPARISON

	COST	
	OLD CRITERIA	NEW CRITERIA
NONRECURRING	950	1,800
RECURRING		
LANDING GEAR	12,900	18,100
FORGINGS	200	500
TOTAL	14,050	20,400
COST/FLIGHT HOUR	2.34	3.40
DIFFERENCE		1.06

All costs are per aircraft set.

COST EFFECTIVENESS

The Accident Data Analysis section showed that a 20-ft/sec sink speed "No Damage" landing gear would produce savings of \$1.44 per flight hour. This estimate was based on repair costs during the 1974-78 time period. The helicopters in the data base also were much lower in cost than those currently entering Army inventory. If the costs were adjusted upward to reflect current repair costs and the higher cost of current production helicopters, the damage savings can be expected to be in the \$2.50 to \$3.00 per-flight-hour range.

Acquisition cost differential for the new criteria landing gear for the design study helicopter was shown to be \$1.06 per flight hour. There will also be additional costs associated with the new landing gear. If the same payload is maintained, the helicopter with the new criteria gear will be heavier with higher acquisition and operating costs. The new gear, assuming nonretractable gear, will have higher drag. This will cause increased fuel flow and higher operating costs. The actual cost of the new gear is probably closer to \$2.00 per flight hour.

Either the calculated costs or the estimated higher adjusted costs show the new criteria landing gear to be cost effective.

ADVANTAGES AND DISADVANTAGES

There are a number of advantages and disadvantages to a landing gear designed to the proposed new criteria as compared to the previous criteria. As shown above, the gear is cost effective because it has greater savings in reduced damage than in its cost. Another major benefit that was not costed, is reduced injuries. The Accident Data Analysis section discusses the potential injury reduction for the new gear. An additional advantage is increased operational availability. The new gear would convert some crashes into hard landings with no damage. This means that some helicopters that would have otherwise been out of service for repairs would now be in service.

The main disadvantage of the new criteria is increased weight, both of the gear and the gross weight of the helicopters. This will result in a larger helicopter for a given mission. The gear will also have increased drag which causes higher fuel flows. This may not be as important for some missions as others. A typical mission for a scout/observation helicopter (such as the design study aircraft) involves a large percentage of low-speed flight where drag is less important. The greater ground clearance requirements may hurt access for maintenance. This problem will vary greatly from helicopter to helicopter.

APPLICABILITY TO OTHER HELICOPTERS

This design study was conducted for an 8000-pound helicopter. As gross weight increases or decreases, different parts of the landing gear will scale up or down with different factors. Some items will be essentially unchanged with gross weight. These include cg load factor, vertical axle travel, and tire pressure. Piston diameter, assuming the same gear geometry, varies as the square root of gross weight. The height of the helicopter cg above ground will increase relatively slowly

with gross weight. Therefore, the landing gear spread required for turnover angle will also increase slowly. These effects mean that some designs, practical for heavy helicopters, are impractical for light helicopters.

As an example, assume:

- Cantilever gear
- Equal load distribution
- Tricycle configuration
- 2500 PSI @ 2.83 ground load factor
- 30 inch stroke

This would produce the following calculated piston sizes. These sizes have also been rounded up to the next standard seal size and the length/diameter ratio calculated.

GROSS WEIGHT (LB)	PISTON CALC (IN.)	DIAMETER STD (IN.)	L/D (RATIO)
1,000	.69	.75	40
3,000	1.20	1.25	24
5,000	1.55	1.625	18.5
8,000	1.96	2.00	15
10,000	2.19	2.25	13.3
15,000	2.69	2.75	10.9
20,000	3.10	3.25	9.2
30,000	3.80	4.00	7.5
40,000	4.39	4.50	6.7
60,000	5.37	5.50	5.5
80,000	6.20	6.25	4.8
100,000	6.94	7.00	4.3

These dimensions are based on hydraulic considerations only. Obviously, a 30-inch stroke, .75-inch-diameter cantilevered piston would be unworkable, but a 4- to 4.50-inch piston seems quite reasonable. If a cantilever-mounted gear was used on a light helicopter, the piston diameter would have to be increased for structural reasons. This would substantially increase the gear weight.

A similar condition exists for a trailing arm gear. For a particular design concept, the effective trailing arm radius will stay roughly constant with gross weight. For lightly loaded gears, the trailing arm may well be sized by minimum wall thickness or manufacturing considerations instead of by stress.

In general, it is anticipated that it will be more difficult to design a gear for the proposed new criteria for light helicopters than for heavier helicopters.

CONCLUSIONS

Based on the results of this effort, it is concluded that:

1. The current published Army helicopter landing gear criteria appear to be justified. The proposed criteria changes listed in Appendix B are considered to be refinements, as opposed to a fundamental change in requirements.
2. It is cost-effective to design to the high sink speed landing requirement.
3. Either the high sink speed condition or the 95th percentile survivable crash condition may be the major sizing factor in the design of the gear.
4. Reduction of the requirements for simultaneous application of the maximum pitch and roll attitudes can significantly reduce the landing gear weight with minimal loss in operational effectiveness.
5. The current reserve energy requirement should be eliminated, since it is less severe than the high sink speed landing requirement.
6. The limit drop condition should be retained as a reference point for obstruction loads.
7. There are significant shortcomings in the general use (public domain) computer programs for analysis of landing gear, both for normal landings and crash conditions.
8. The cost and weight impact of the proposed criteria will be proportionally greater for smaller helicopters than for larger helicopters.

RECOMMENDATIONS

It is recommended that the changes in criteria presented in Appendix B be adopted for future Army helicopters.

REFERENCES

- ¹Phillips, Norman S., Carr, Richard W., and Scranton, Richard S., CRASHWORTHY LANDING GEAR STUDY, Beta Industries, Inc., USAAMRDL TR 72-61, Eustis Directorate, U.S. Army Air Mobility Research and Development Laboratory, Fort Eustis, Virginia, April 1973, AD 765489.
- ²Hicks, James E., ECONOMIC BENEFITS OF UTILITY AIRCRAFT CRASH-WORTHINESS, Directorate for Technical Research and Applications, U.S. Army Agency for Aviation Safety, Fort Rucker, Alabama, U.S. Army Training and Doctrine Command (TRADOC), USAAAVS TR 76-2, July 1976.
- ³Anon., THE ECONOMIC BENEFITS OF CRASHWORTHINESS AND FLIGHT SAFETY DESIGN FEATURES IN ATTACK HELICOPTERS, Directorate for Technical Research and Applications, U.S. Army Agency for Aviation Safety, Fort Rucker, Alabama, USAAAVS TR 77-2, June 1977.
- ⁴Anon., CRASH SURVIVAL DESIGN GUIDE, Dynamic Science, a Div. of Marshall Industries, USAAMRDL TR 71-22, Eustis Directorate, U. S. Army Air Mobility Research and Development Laboratory, Fort Eustis, Virginia, October 1971, AD 733358.
- ⁵Goodall, Ralph E., ADVANCED TECHNOLOGY HELICOPTER LANDING GEAR, Hughes Helicopter Div. of Summa Corp., USAAMRDL TR 77-27, Applied Technology Laboratory, U.S. Army Research and Technology Laboratories, Fort Eustis, Virginia, October 1977, AD A048891.
- ⁶Wittlin, G., et al., GENERAL AVIATION AIRPLANE STRUCTURAL CRASHWORTHINESS USER'S MANUAL, Volumes I, II, and III, Lockheed-California Company, FAA-RD-77-189, Federal Aviation Administration, Washington, D.C., February 1978.

BIBLIOGRAPHY

- Anon., BAND-PASS SHOCK ABSORBER STUDIES, Bendix Products Aerospace Div., Bendix Corp., South Bend, Indiana, Report No. SH-64-1, April 1964, AD-603 749.
- Anon., EXPLORATORY APPLICATION OF FILAMENT WOUND REINFORCED PLASTICS FOR AIRCRAFT LANDING GEAR, Bendix Corp., South Bend, Indiana, Bendix Products Aerospace Div., AFML Technical Report 66-309, December 1966, AD-806 336/4ST.
- Anon., FILAMENT COMPOSITE MATERIAL LANDING GEAR PROGRAM VOL. I, Bendix Corp., South Bend, Indiana, Energy Controls Div., AFFDL Technical Report 72-78, August 1972, AD-756 922.
- Anon., FILAMENT COMPOSITE MATERIAL LANDING GEAR PROGRAM VOL. II, Bendix Corp., South Bend, Indiana, Energy Controls Div., AFFDL Technical Report 72-78, August 1972, AD-756 923.
- Anon., GRAPHITE COMPOSITE AIRCRAFT LANDING GEAR WHEEL, Hercules Inc., Magna Utah Bacchus Works, AFFDL Technical Report 76-38, May 1976, AD-A036 207/9ST.
- Attri, N. S., and Domandl, H., IMPACT OF TIRE DYNAMIC PROPERTIES ON AIRPLANE LANDING GEAR SHIMMY, Boeing Co., Reuton, Washington, Commercial Airplane Div., Report No. D6-58384-20TN, October 1970, AD-749 296.
- Bieber, Myron J., and Fricker, Walter W., GRAPHITE COMPOSITE LANDING GEAR COMPONENT - UPPER DRAG BRACE HARDWARE FOR F-15 AIRCRAFT, Cleveland Pneumatic Co., Ohio, AFFDL Technical Report 77-88, 1 September 1977, AD-A052 764/8ST.
- Brady, Jack C., and Fewel, Kenneth J., ACCELERATION SENSITIVE SHOCK ABSORBER VALVE, Report No. PAT-APPL-159319, Department of the Navy, Washington, D.C., 2 July 1971, AD-164 111/7.
- Carden, H. D., and McCarty, J. L., EXPERIMENTAL STUDY OF VERTICAL IMPACTS OF AN LM-TYPE LANDING GEAR ASSEMBLY UNDER SIMULATION LUNAR GRAVITY, NASA Technical Report TN-D-4711, NASA Langley Research Center, Langley Station, Virginia, August 1968, N68-30505.
- Creech, Dale E., AIRCRAFT BRAKE ENERGY ANALYSIS PROCEDURES, ASD Technical Report 68-56, Aeronautical Systems Div., Wright-Patterson AFB, Ohio, October 1968, AD-68J 775.

Done, G. T. S., SIMPLIFIED APPROACH TO HELICOPTER GROUND RESONANCE, The Aeronautical Journal, Vol. 78, No. 671, May 1974, pp. 204-208.

Donham, R. E., Cardinale, S. V., and Sachs, I. B., GROUND AND AIR RESONANCE CHARACTERISTICS OF SOFT IN-PLANE RIGID ROTOR SYSTEM, Journal of the American Helicopter Society, Vol. 14, No. 4, October 1969, pp. 33-41.

Doyal, F. H., Younghusband, K. T., McCutchen, H., Ankeny, R. A., and Weisinger, M. D., BORON/ALUMINUM LANDING GEAR FOR NAVY AIRCRAFT, General Dynamics, San Diego, California, Convair Div., Report No. CASD-NADC-76-003, September 1978, AD-A060 043/7ST.

Eddins, Timothy O., SPACECRAFT SOFT LANDING SYSTEM, NASA Patent No. 3, 181, 821, 4 May 1965.

Fasanella, E. L., McGehee, J. R., and Pappas, M. S., EXPERIMENTAL AND ANALYTICAL DETERMINATION OF CHARACTERISTICS AFFECTING LIGHT AIRCRAFT LANDING-GEAR DYNAMICS, NASA Technical Report TM-X-3561, L-11472; NASA Langley Research Center, Langley Station, Virginia, November 1977, N78-11052-5ST.

Fisher, B. D., Sleeper, R. K., and Stubbs, S. M., SUMMARY OF NASA LANDING GEAR RESEARCH, Nasa Technical Report TM-78679, NASA Langley Research Center, Langley Station, Va., March 1978, N78-26048/6ST.

Fricker, Walter W., DEVELOPMENT OF AIRCRAFT SHOCK ABSORBERS USING FRICTION AS THE ENERGY DISSIPATOR, Cleveland Pneumatic Tool Co., AFFDL Technical Report 65-96, October 1965, AD-476 615/OST.

Gamon, Max, and Mahone, Tom, ACTIVE SHIMMY CONTROL SYSTEM, Lockheed-California Co., Burbank, AFFDL Technical Report 75-136, December 1975, AD-A022 146/5ST.

Goodall, Ralph E., ADVANCED TECHNOLOGY HELICOPTER LANDING GEAR, Hughes Helicopters, Culver City, California, USAAMRDL Technical Report 77-27, October 1977, AD-A0418 891/6ST.

Gupta, Bharat P., HELICOPTER OBSTACLE STRIKE TOLERANCE CONCEPTS ANALYSIS, Bell Helicopter Textron, USARTL TR 78-46, Applied Technology Laboratory, U.S. Army Research and Technology Laboratories (AVRADCOM), Fort Eustis, Virginia, April 1979, ADA069877.

Gurganious, Joseph T., UH-1 GROUND HANDLING WHEEL ADAPTER BARS FOR OH-58 HELICOPTERS, PROTOTYPE DESIGN FABRICATION, AND USER TEST, LWL Technical Report 74-27, Army Land Warfare Lab, Aberdeen Proving Ground, Md., March 1974, AD-778 199/0.

Guridon, E. I., HYDRAULIC TWO-CHAMBERED DAMPER WITH A PNEUMATIC SPRING, Foreign Technology Div., Wright-Patterson AFB, Ohio, FTD-HT-23-756-74, 29 November 1973, AD-771 611/1.

Hahn, Edward E., DESIGN CRITERIA FOR GROUND-INDUCED DYNAMIC LOADS, ITT Research Inst., Chicago, Illinois, November 1963, AD-600 923.

Hodges, Dewey H., AEROMECHANICAL STABILITY ANALYSIS FOR BEARINGLESS ROTOR HELICOPTERS, presented at the 34th Annual National Forum of the American Helicopter Society, Washington, D.C., May 1978.

Hopping, Russell, L., Forlifer, William R.; and Gaston, Robert, P., Jr., LANDING GEAR, Report No. PAT-APPL-410 331, NASA, 3 January 1967.

Karnopp, D. C., and Trikha, A. K., COMPARATIVE STUDY OF OPTIMIZATION TECHNIQUES FOR SHOCK AND VIBRATION ISOLATION, Massachusetts Institute of Technology, Cambridge Dept. of Mechanical Engineering, January 1968, AD-666 928.

Kisielowski, E., Korsak, K., and Kubicki, P., ROUGH TERRAIN GROUND HANDLING SYSTEM FOR HELICOPTERS, Dynasciences Corp., Blue Bell, Pennsylvania, April 1974, AD-778 758/3.

Kraft, David C., ANALYTICAL LANDING GEAR - SOILS INTERACTION - PHASE I, Dayton University, Ohio Research Institute, AFFDL Technical Report 68-88, August 1968, AD-840 087/1ST.

16
B

Kraft, David C., Luming, Henry, and Hoppenjans, J. Richard, AIRCRAFT LANDING GEAR - SOILS INTERACTION AND FLOTATION CRITERIA, PHASE II, Dayton University, Ohio Research Inst., AFFDL Technical Report 69-76, November 1969, AD-864 013/8ST.

Labrecque, Jean P., OIL LEVEL INDICATOR FOR USE WITH DAMPING FLUID METERING PINS, Report No. PAT-APPL-840 189, Department of the Navy, Washington, D. C., October 1977, AD-D005 261/3ST.

Logan, A. H., ANALYTICAL INVESTIGATION OF AN IMPROVED HELICOPTER LANDING GEAR CONCEPT, Hughes Helicopters, Culver City, California, Report No. HH-76-37; August 1976, AD-A029 372/0ST.

Lytwyn, R. T., Miao, W. and Woitsch, W., AIRBORNE AND GROUND RESONANCE OF HINGELESS ROTORS, Journal of the American Helicopter Society, Vol. 16, No. 2, April 1971, pp. 2-9.

McDermott, John M., and Vega, Ed, THE EFFECTS OF LATEST MILITARY CRITERIA ON THE STRUCTURAL WEIGHT OF THE HUGHES ADVANCED ATTACK HELICOPTER - YAH-64, Journal of the American Helicopter Society, Volume 23, Number 4, October, 1978.

McGehee, J. R., and Carden, H. D., A MATHEMATICAL MODEL OF AN ACTIVE CONTROL LANDING GEAR FOR LOAD CONTROL DURING IMPACT AND ROLL-OUT, NASA Technical Report TN-D-8080, L-10440, NASA Langley Research Center, Langley Station, Virginia, February 1976, N76-17090/1ST.

McGehee, John R., Hathaway, Melvin E., and Zavada, Edmond J., FRANGIBLE TUBE ENERGY DISSIPATION, NASA Patent No. 3,143,321, 4 August 1964.

McGehee, J. R., and Stubbs, S. M., EXPERIMENTAL VALIDATION OF A LANDING - DYNAMICS COMPUTER PROGRAM FOR LEGGED SPACECRAFT LANDERS, NASA Technical Report TN-D-7301, L-8726; NASA Langley Research Center, Langley Station, Virginia, December 1973, N74-12535/2.

Melik-Zade, N. A., THE OPERATION OF A TWO-CHAMBER PNEUDRAULIC SHOCK ABSORBER, Report No., FTD-MT-24-964-72, Foreign Technology Div., Wright-Patterson AFB, Ohio, 4 January 1973, AD-754 609.

Mitchell, Bruce, DESIGN NOTES FOR THE DYNASORB ENERGY ABSORBER, Lockheed-California Co., Burbank Report No., LR-17201, 18 December 1963, AD-A008 386/5ST.

Phillips, Norman S., Carr, Richard W., and Scranton, Richard S., A STATISTICAL INVESTIGATION INTO THE DEVELOPMENT OF ENERGY ABSORBER DESIGN CRITERIA, Beta Industries, Inc., Dayton, Ohio, Report No. BII-217-5, 30 December 1971, AD-749 333.

Phillips, Norman, S., Carr, Richard W., and Scranton, Richard S., CRASHWORTHY LANDING GEAR STUDY, Beta Industries, Inc., Dayton, Ohio, Report No. BII-214-6, April 1973, AD-765 489/0.

Rich, M. J., Ridgley, G. F., and Lowry, D. W., APPLICATION OF COMPOSITES TO HELICOPTER AIRFRAME AND LANDING GEAR STRUCTURES, United Aircraft Corp., Stratford, Connecticut, Sikorsky Aircraft Div., NASA Technical Report CR-12333, September 1973, N73-31957/6.

Rogers, W. F., APOLLO EXPERIENCE REPORT LUNAR MODULE LANDING GEAR SUBSYSTEM, NASA Technical Report TN-D-6850, MSC-S-316, NASA Manned Spacecraft Center, Houston, Texas, June 1972, N72-25903.

Skorupa, John Anthony, SYSTEM SIMULATION IN AIRCRAFT LANDING GEAR AND TIRE DEVELOPMENT, Air Force Inst. of Tech., Wright-Patterson AFB, Ohio School of Engineering, Report No. GAE/MC/76D-7, December 1976, AD-A034 942/3ST.

Speeling, F. B., THE SURVEY OR SHOCK ABSORBER, Jet Propulsion Lab, California Institute of Technology, Pasadena, California, 1 October 1968, N69-11821.

Stubbs, S. M., EXPERIMENTAL INVESTIGATION OF THE LANDING DYNAMICS OF THREE-LEGGED SPACECRAFT MODELS, NASA Technical Report TN-D-7664, L-9499, NASA Langley Research Center, Langley Station, Virginia, September 1974, N74-32427/8SL.

Tremblay, David Bruce, LANDING GEAR SYSTEM ANALYSIS, ASD Technical Report 69-113, Aeronautical Systems Div., Wright-Patterson AFB, Ohio, March 1970, AD-712 661.

Turnbow, J. W., Robertson, S. H., Carroll, D. F., and McWilliam, R. D., FULL-SCALE DYNAMIC CRASH TEST OF A SMALL OBSERVATION TYPE HELICOPTER, Aviation Safety Engineering and Research, Phoenix, Arizona, USAAVLABS Technical Report 66-32, May 1966, AD-483 730/8ST.

Wilson, V. E., NEW CONCEPTS IN COMPOSITE MATERIAL LANDING GEAR FOR MILITARY AIRCRAFT, Vol. I, Rockwell International, Los Angeles, California, Los Angeles Aircraft Division, AFFDL Technical Report 78-2, February 1978, AD-A058 529/9ST.

Wilson, V. E., NEW CONCEPTS IN COMPOSITE MATERIAL LANDING GEAR FOR MILITARY AIRCRAFT, VOL. II, Rockwell International, Los Angeles, California, Los Angeles Aircraft Div., AFFDL Technical Report 78-2, February 1978, AD-A058 672/7ST.

Yurenka, Steven, INVESTIGATION OF ADVANCED FILAMENT WOUND AIRCRAFT LANDING GEAR STRUCTURES, McDonnell Douglas Corp., Long Beach, California, Douglas Aircraft Div., Report No. DAC-33940, January 1970, AD-871 275 4ST.

APPENDIX A - DESIGN STUDY CONFIGURATIONS

This appendix presents the major design study landing gear configurations. There is a short description of the features of each configuration, a table of the principal characteristics of the gear, and a drawing of the landing gear installed on the helicopter.

NEW CRITERIA - TAILWHEEL TRICYCLE (Figure A-1)

This configuration was the baseline design and several variations were studied. The configuration shown in Figure A-1 has a 30-degree turnover angle. The gears are located on the pitch center of percussion with the midpoint of the individual gear's fore and aft travel used in the calculations. The principal characteristics of the gear are:

	<u>Forward</u>	<u>Aft</u>
Static Load Per Wheel	3065	1870
Load Distribution	76.6%	23.4%
Vertical Axle Travel	32	28
Piston Stroke	17.900	14.338
Average Mechanical Advantage	1.79	1.95
Tire Size	6.50-10	6.00-6

The tail gear mechanical advantage is higher than the main gear due to the need to shorten the oleo length to avoid an interference with the tail rotor driveshaft. The tail gear is shown as a fixed side axle. This is the only configuration that the current gear sizing computer program will accept. In actual practice, the tail gear would use a fork mounted on a swivel. This would seem to indicate a weight increase over the study configuration, but in practice, this weight difference is very small. Another design effort at BHT during this study used the same gear sizing program on a tailwheel gear, but manually sized out a new arm with a swivel fork. Moving the arm inline with the wheel reduced the torque on the trailing arm, which allowed the arm section to be decreased enough to compensate for the weight of the swivel. Since all the wheel gears used the same sizing program, the comparison between gears should be valid.

The most significant variation from the baseline tricycle tailwheel was a tricycle tailwheel with a 25-degree turnover angle. This gear is very similar to the baseline except the main gear is moved aft and inboard for the reduced turnover angle. The tailwheel was moved aft to maintain the center of percussion location. This gear was not drawn since it is so similar to the baseline gear. The principal characteristics of this gear are:

similar to the baseline gear. The principal characteristics of this gear are:

	<u>Forward</u>	<u>Aft</u>
Static Load Per Wheel	3526	948
Load Distribution, %	88.2	11.8
Vertical Axle Travel,	32	28
Piston Stroke,	20.667	14.363
Average Mechanical Advantage,	1.55	1.95 Tire
Tire Size,	6.50-10	5.00-5

NEW CRITERIA - NOSEWHEEL TRICYCLE (Figure A-2)

This gear illustrates a fundamental problem with a long stroke trailing arm gear on a nosewheel design. In this case, the nose gear attach point was located as far forward as practical, but the long trailing arm positioned the wheel 3-1/2 feet behind the pivot. This gives a large angle between the centerline of the helicopter and the turnover line between the nose and main gears. This means the main gear must move outboard relatively rapidly as the gear is moved aft. This quickly leads to air transportability width problems and to increased gear weight. In this case, it was impractical to achieve more than a 25-degree turnover angle. In addition, the gear spread fore and aft was only 72 percent of the pitch center of percussion distance. The principal characteristics of the gear are:

	<u>Forward</u>	<u>Aft</u>
Static Load Per Wheel	2462	2769
Load Distribution	30.8%	69.2%
Vertical Axle Travel	32	32
Piston Stroke	25.084	19.385
Average Mechanical Advantage	1.39	1.65
Tire Size	6.50-10	6.50-10

NEW CRITERIA - QUADRICYCLE WHEELS (Figure A-3)

The quadricycle gear was designed with the mid-points of the fore and aft axle travels equally spaced about the helicopter cg. This gives a slightly higher static load on the forward gear than on the aft gear. The gears are on the pitch center of percussion. A major advantage of a quadricycle gear is the capability of achieving a 30-degree lateral turnover angle while maintaining a relatively narrow width. This facilitates air transport and usually locates the gear closer to the roll center of percussion than is possible with a tricycle gear. The roll center of percussion for the study helicopter corresponds to a wheel location at B.L. 38. The quadricycle gear wheels are at B.L. 41.5. The other study configurations have wheel locations ranging from B.L. 46.2 to B.L. 57.0. The forward and aft turnover angles are quite high. The principal characteristics of the gear are:

	<u>Forward</u>	<u>Aft</u>
Static Load Per Wheel	2111	1889
Load Distribution	52.8%	47.2%
Vertical Axle Travel	32	32
Piston Stroke	22.602	22.602
Average Mechanical Advantage	1.42	1.42
Tire Size	6.50-10	6.50-10

OLD CRITERIA - TAILWHEEL TRICYCLE (Figure A-4)

This gear was used as a baseline for comparisons between the old and new landing gear criterias. For this reason, the basic arrangement and the wheel positions were the same as the new criteria tricycle. The turnover angle was reduced to 27 degrees in accordance with previous practice. One significant difference is the main gear oleo position. The short stroke oleo would not reach the side of the fuselage without the addition of a long extension. The design shown would require addition of structure extending out to the oleo attach point. The principal characteristics of the gear are:

	<u>Forward</u>	<u>Aft</u>
Static Load Per Wheel	3143	1714
Load Distribution	78.6%	21.4%
Vertical Axle Travel	8	8
Piston Stroke	4.139	6.427
Average Mechanical Advantage	1.93	1.24
Tire Size	6.50-10	6.00-6

NEW CRITERIA - SKID GEAR (Figure A-5)

This is essentially the new quadricycle gear with the wheels removed and a skid tube attached between the axles on each side. The vertical axle travel was increased to compensate for the loss of the tire deflection. This required a longer trailing arm to maintain the same extended arm angle as the other gears. The pitch center of percussion based on axle position was maintained. The principal characteristics of the gear are:

	<u>Forward</u>	<u>Aft</u>
Static Load Per Axle	2000	2000
Load Distribution	50%	50%
Vertical Axle Travel	34	34
Piston Stroke	21.5	21.5
Average Mechanical Advantage	1.58	1.58

OLD CRITERIA - SKID GEAR (Figure A-6)

This is the existing production AH-1S skid gear. Since the AH-1S is the reference helicopter for the design study, the production skid gear was used to represent the old criteria skid gear. This gear is typical of the AH-1, UH-1, and OH-58 gears. Since these models form the majority of the current Army inventory, this gear is a good representation of past skid landing gear practice.

17
F

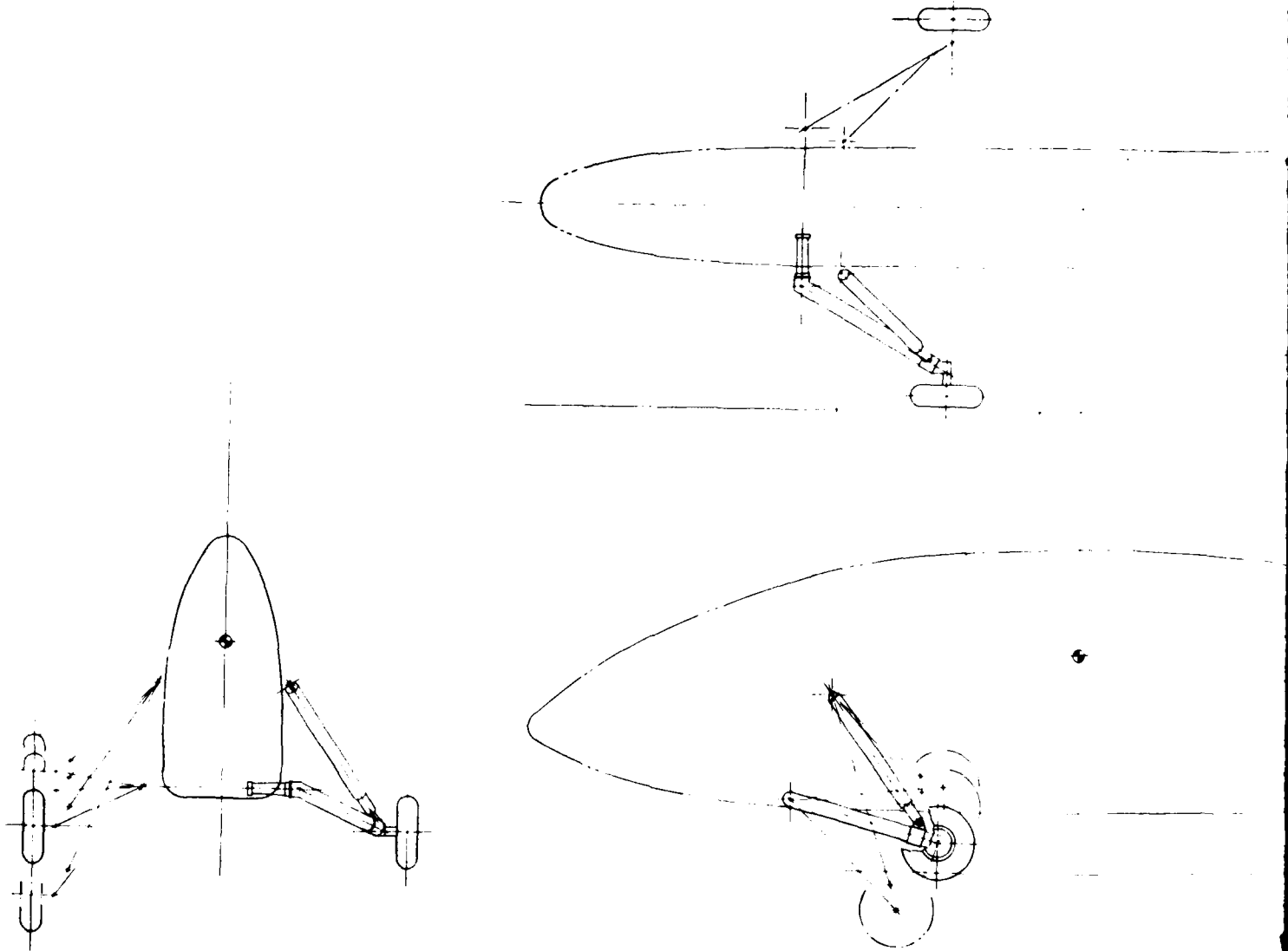
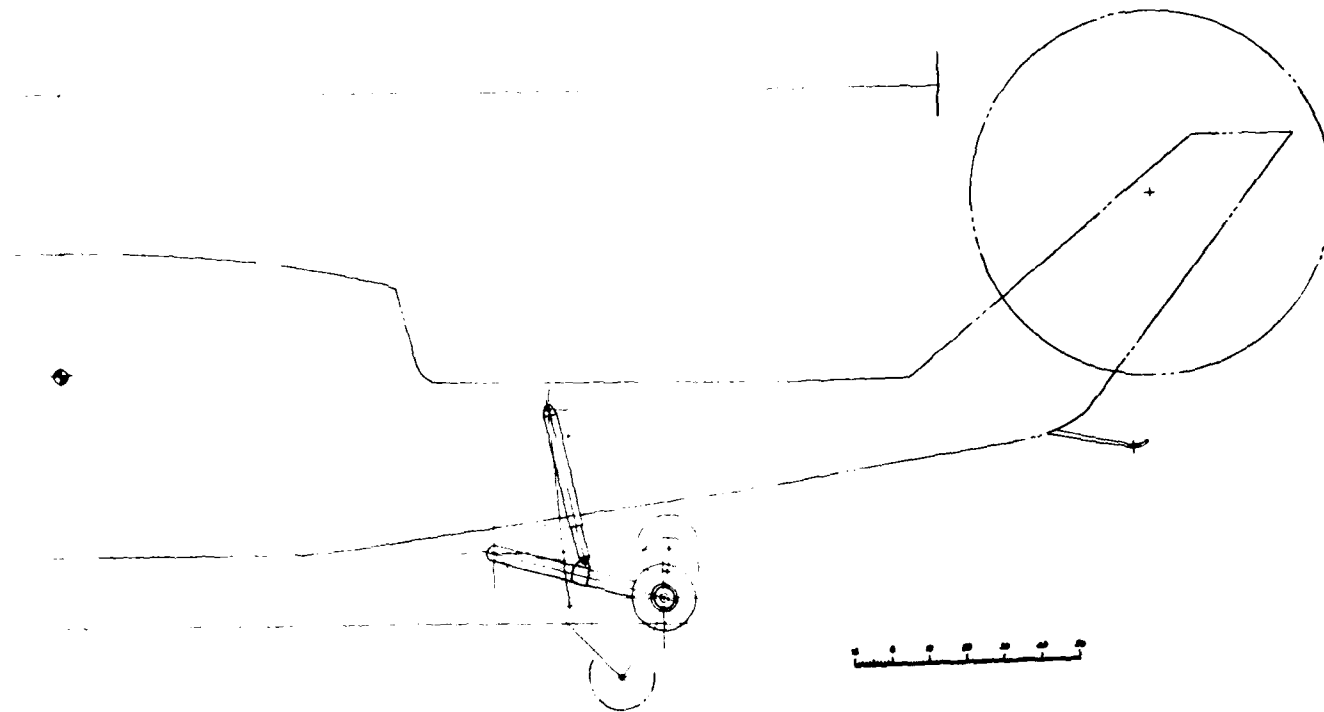
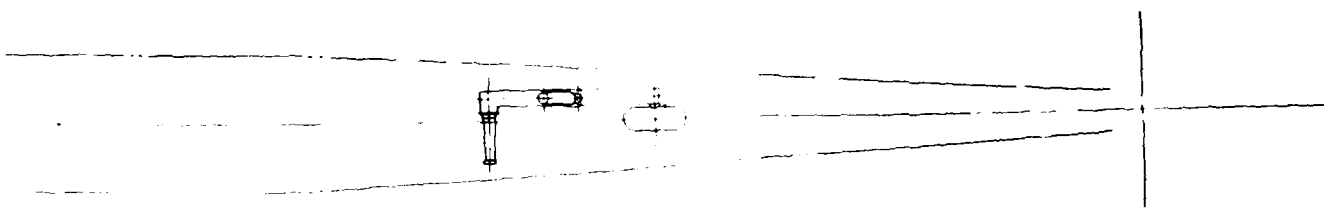
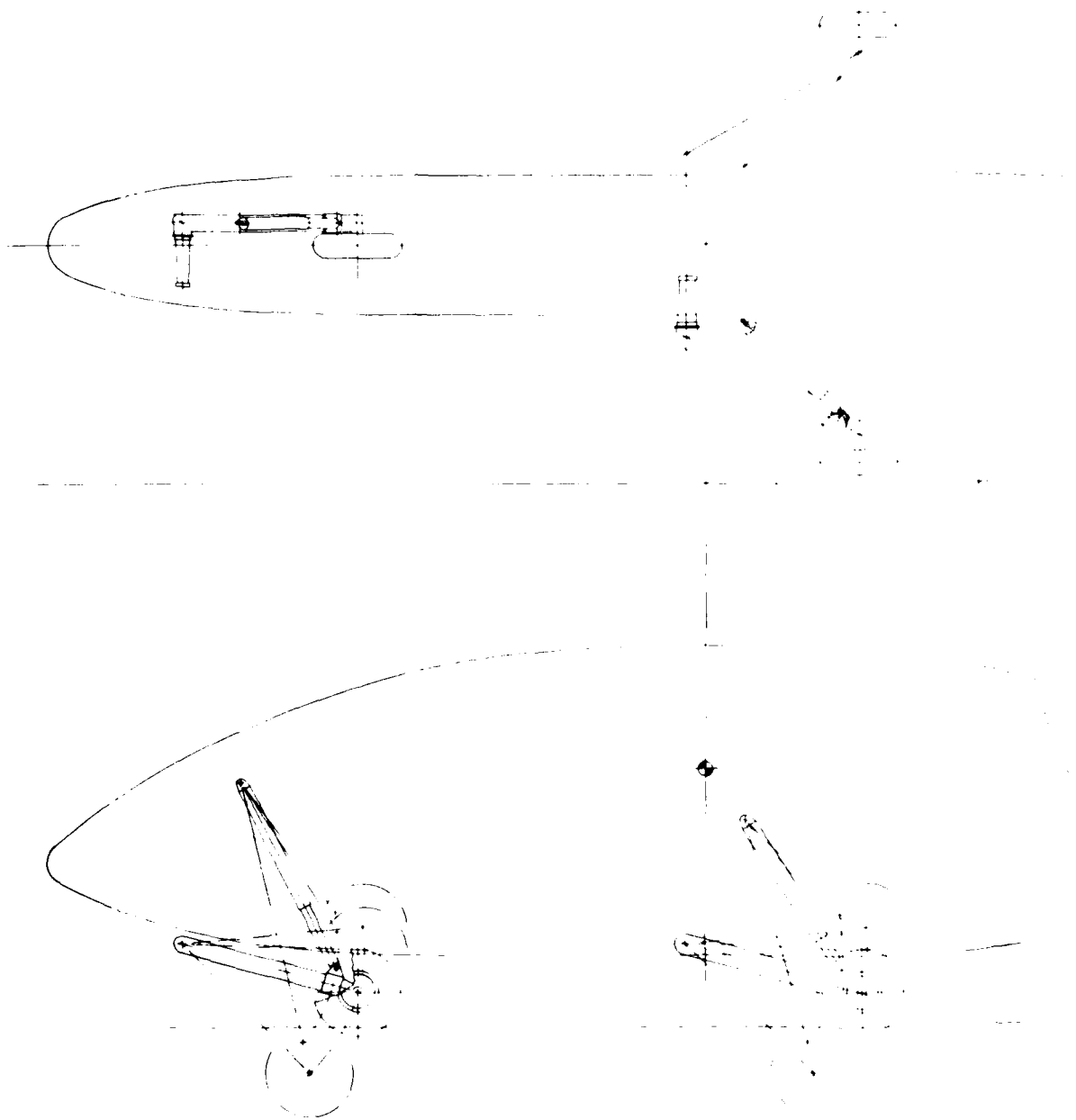

Figure A-1. New criterion tailwheel tricycle.



2



18
F

Figure A-2. New criterion nosewheel tricycle.

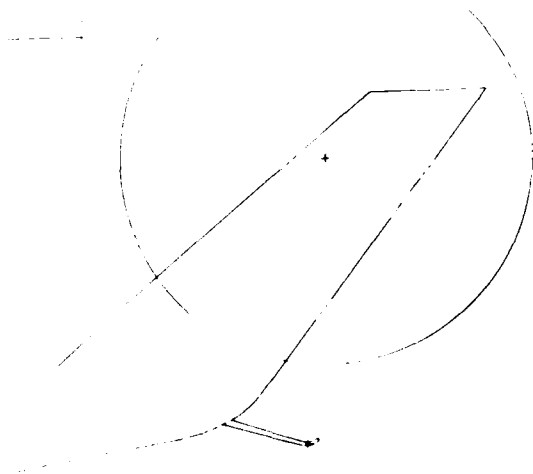
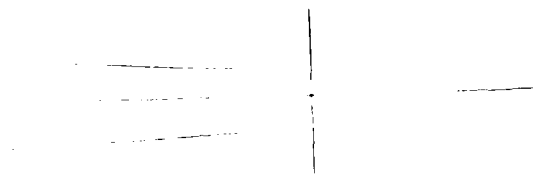

2



Figure A-3. New criterion quadricycle wheels.



6 40 30

Figure A-4. Old criterion tailwheel tricycle.

1021



1021

2

cle.



Figure A-5. New criterion skid gear.

100
100
100

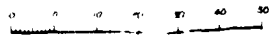
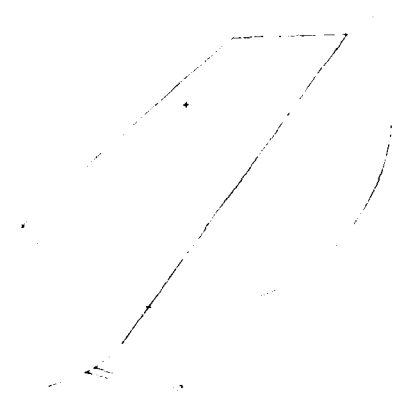

2

22
F

Figure A-6. Old criterion skid gear.

139

PRECEDING PAGE BLANK-NOT FILMED

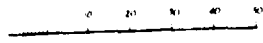
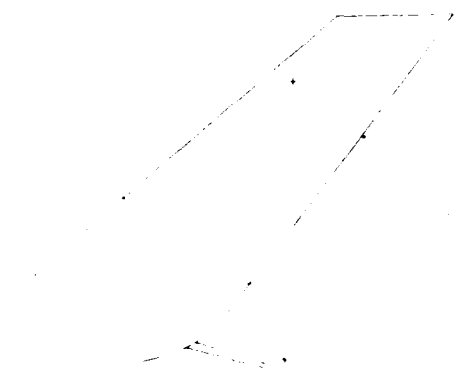

2

APPENDIX B - CRITERIA RECOMMENDATIONS

This Appendix contains the recommendations and a proposed military specification for Army Helicopter Landing Gear. Changes to related specifications and reports are included as required for consistency with the proposed MIL-SPEC.

MIL-L-XXXX(AV)

This is a proposed military specification for Army Helicopter Landing Gears. It is based on the conclusions from the design study and evaluation for both the operational needs and the practicality of meeting these needs.

The format used for MIL-L-XXXX(AV) consists of the draft specification on one page with the rationale for major items on the opposing page adjacent to the MIL-SPEC paragraph. Rationale is not given for those items that are accepted standard practice or those that are considered to be self explanatory.

23
F

PRECEDING PAGE BLANK-NOT FILMED

PROPOSED

MILITARY SPECIFICATION

LANDING GEAR, HELICOPTER

1. SCOPE

1.1 Purpose. This specification establishes the design and testing requirements for Army helicopter landing gear.

2. APPLICABLE DOCUMENTS

2.1 Documents list. The following specifications (publications of the issue in effect on the date of invitation for bids) form a part of this specification to the extent specified herein:

SPECIFICATIONS

Military

MIL-W-5013	"Wheel and Brake Assemblies, Aircraft"
MIL-I-5014	"Inner Tube, Pneumatic Tire, Aircraft"
MIL-T-5041	"Tires, Pneumatic Aircraft"
MIL-A-8421	"Air Transportability Requirements, General Specification for"
MIL-I-8500	"Interchangeability and Replaceability of Components Parts for Aerospace Vehicles"
MIL-L-8552	"Landing Gear, Aircraft Shock Absorber (Air-Oil Type)"
MIL-B-8584	"Brake Systems, Wheel, Aircraft Design of"
MIL-S-8698	"Structural Design Requirements, Helicopters"

MIL-A-008860 "Airplane Strength and Rigidity, General Specification for"
MIL-A-008862 "Airplane Strength and Rigidity, Landing and Ground Handling Loads"
MIL-A-008866 "Airplane Strength and Rigidity Requirements, Repeated Loads and Fatigue"
MIL-C-21180 "Aluminum Alloy Castings, High Strength"

FAA

FAR 27 Airworthiness Standards:
Normal Category Rotorcraft
FAR 29 Airworthiness Standards:
Transport Category Rotorcraft

PUBLICATIONS

Army

AMCP 706-201 Engineering Design Handbook,
Helicopter Engineering, Part
I - Preliminary Design
AMCP 706-202 Engineering Design Handbook,
Helicopter Engineering, Part
II - Detail Design
AMCP 706-203 Engineering Design Handbook,
Helicopter Engineering, Part
III - Qualification Assurance

STANDARDS

Military

MIL-STD-1290 "Light Fixed and Rotary-Wing
Aircraft Crashworthiness"

Army

ADS-13 Air Vehicle Materials, Processes and Parts

PROPOSED SPECIFICATION

3. REQUIREMENTS

3.1 Specification sheets. The individual item requirements shall be as specified herein and in accordance with the applicable specification sheets. In the event of any conflict between requirements of this specification and the specification sheet, the latter shall govern.

3.2 Configuration requirements.

3.2.1 Basic requirements.

3.2.1.1 Wheel travel. The geometry of the gear shall be such that wheel travel during strut compression and extension shall be essentially vertical, i.e., wheel travel shall be in a plane parallel to a vertical plane through the center of the helicopter.

3.2.1.2 Entanglement. The landing gear system shall be designed to minimize entanglement with brush, landing mats, wires and other obstructions.

3.2.1.3 Retraction. The landing gear may be fixed or retractable.

3.2.1.4 Ground resonance. The helicopter shall not be subject to ground resonance conditions that could cause damage to the helicopter. The landing gear installation shall be designed to incorporate those dynamic characteristics required to satisfy the helicopter ground resonance requirements. The landing gear contribution will vary according to the overall helicopter design.

3.2.3 Operational requirements.

3.2.3.1 Turnover angle. Turnover requirements shall be met with the helicopter landing gear correctly serviced and with the individual gears stroked to static position corresponding to BSDGW. The helicopter center of gravity shall be at the position, within the normal flight limits, or normal ground handling conditions, which would produce the worst turnover condition. The minimum lateral turnover angle shall be 30 degrees. The minimum turnover angle shall be 25 degrees forward and 20 degrees aft, provided that the helicopter design is such that the helicopter may rotate to contact the airframe (or a skid or bumper) but will not fall over or impact the ground in a manner that would cause damage requiring repair if the helicopter is placed on a 30-degree nose or tail down slope. If this no-damage criterion is not met, the forward or aft turnover angle shall be 30 degrees.

MIL-A-008860

"Airplane Strength and Rigidity, General Specification for"

MIL-A-008862

"Airplane Strength and Rigidity, Landing and Ground Handling Loads"

MIL-A-008866

"Airplane Strength and Rigidity Requirements, Repeated Loads and Fatigue"

MIL-C-21180

"Aluminum Alloy Castings, High Strength"

FAA

FAR 27

Airworthiness Standards:
Normal Category Rotorcraft

FAR 29

Airworthiness Standards:
Transport Category Rotorcraft

PUBLICATIONS

Army

AMCP 706-201

Engineering Design Handbook,
Helicopter Engineering, Part
I - Preliminary Design

AMCP 706-202

Engineering Design Handbook,
Helicopter Engineering, Part
II - Detail Design

AMCP 706-203

Engineering Design Handbook,
Helicopter Engineering, Part
III - Qualification Assurance

STANDARDS

Military

MIL-STD-1290

"Light Fixed and Rotary-Wing
Aircraft Crashworthiness"

Army

ADS-13

Air Vehicle Materials, Processes and Parts

PROPOSED SPECIFICATION

3. REQUIREMENTS

3.1 Specification sheets. The individual item requirements shall be as specified herein and in accordance with the applicable specification sheets. In the event of any conflict between requirements of this specification and the specification sheet, the latter shall govern.

3.2 Configuration requirements.

3.2.1 Basic requirements.

3.2.1.1 Wheel travel. The geometry of the gear shall be such that wheel travel during strut compression and extension shall be essentially vertical, i.e., wheel travel shall be in a plane parallel to a vertical plane through the center of the helicopter.

3.2.1.2 Entanglement. The landing gear system shall be designed to minimize entanglement with brush, landing mats, wires and other obstructions.

3.2.1.3 Retraction. The landing gear may be fixed or retractable.

3.2.1.4 Ground resonance. The helicopter shall not be subject to ground resonance conditions that could cause damage to the helicopter. The landing gear installation shall be designed to incorporate those dynamic characteristics required to satisfy the helicopter ground resonance requirements. The landing gear contribution will vary according to the overall helicopter design.

3.2.3 Operational requirements.

3.2.3.1 Turnover angle. Turnover requirements shall be met with the helicopter landing gear correctly serviced and with the individual gears stroked to static position corresponding to BSDGW. The helicopter center of gravity shall be at the position, within the normal flight limits, or normal ground handling conditions, which would produce the worst turnover condition. The minimum lateral turnover angle shall be 30 degrees. The minimum turnover angle shall be 25 degrees forward and 20 degrees aft, provided that the helicopter design is such that the helicopter may rotate to contact the airframe (or a skid or bumper) but will not fall over or impact the ground in a manner that would cause damage requiring repair if the helicopter is placed on a 30-degree nose or tail down slope. If this no-damage criterion is not met, the forward or aft turnover angle shall be 30 degrees.

RATIONALE

3.1 Specification sheets. The detail specification for a specific helicopter should take precedence over the general specification.

3.2.1.1 Wheel travel. Essentially vertical wheel travel is required to prevent tire scrubbing on a landing without forward speed.

3.2.1.4 Ground resonance. The landing gear is only one of several components that affect ground resonance. Different rotor types require different damping characteristics and the manufacturer may elect to obtain the required damping in various manners. The only general requirement is that the landing gear develop the damping required for the specific application.

3.2.3.1 Turnover angle. The basic requirement is for operation of slopes up to 15 degrees. The turnover angle should provide a margin for towing, taxiing, and braking. A high turnover angle requires a wide gear, which is undesirable for air transport; will usually have poorer landing dynamics (gear spread greater than center of percussion); and will be heavier as gear width increases. In addition, increased forward or aft turnover angle will increase the gear width required to maintain lateral turnover angle for a tricycle configuration. In general, if the helicopter exceeds the lateral turnover angle, it will fall completely over on its side with probable significant damage. If the helicopter exceeds the turnover angle forward or aft, it will usually only rotate a few degrees until the nose or the tail skid hits the ground. If the nose contact point is structure, or a bumper, there would not normally be any damage. Therefore, it is recommended that the lateral turnover requirement be maintained at 30 degrees and the forward and aft angles be reduced. The forward angle is larger than the aft angle because of the higher likelihood of hard braking with forward speed than with aft speed, which would be expected to be very low.

PROPOSED SPECIFICATION

3.2.2.2 Ground handling. Wheel landing gears and skid landing gears, with ground handling wheels installed, shall be designed to allow the helicopter to be towed across ground with a California Bearing Ratio of 2.5 under the following conditions.

- a. Weight empty plus full fuel plus 200 pounds.
- b. Maximum drawbar pull shall be 4000 pounds, with a desired capability of towing with a maximum drawbar pull of 2000 pounds.

3.2.2.3 Air transport. The landing gear installation shall be compatible with movement via current USAF transport aircraft in accordance with MIL-A-8421, except the air drop cargo provisions of MIL-A-8421 do not apply. The landing gear shall be designed such that the helicopter may be transported in the smallest aircraft (as described above) that is compatible with the overall size of the helicopter. If kneeling, landing gear removal, or other reconfiguration of the landing gear or the helicopter is required for air transport, the landing gear shall be designed to meet these requirements with minimum practical time and effort. The landing gear shall incorporate a kneeling or lowering system if required to facilitate loading aboard transport aircraft.

3.3 Landing conditions.

3.3.1 Rotor lift. Rotor lift shall be two-thirds of landing weight for all landing conditions.

3.3.2 Limit landings.

3.3.2.1 Limit conditions. The limit landing condition shall be a vertical sink speed of 10 ft/sec with the helicopter at the basic structural design gross weight (BSDGW). All limit landings shall be on level ground with the helicopter in a level attitude (all gears touch simultaneously). The vertical sink speed shall be combined with a forward velocity of zero to the greater of:

- a. 50 knots
- b. 120 percent of the speed for minimum power with the helicopter in level flight at BSDGW at 4000 feet altitude on a 95°F day.

RATIONALE

3.2.2.2 Ground handling. 2000-pound and 4000-pound drawbar pulls correspond to 1/4-ton and 3/4-ton trucks on CBR 2.5 ground. It is desirable to be able to tow with either vehicle, but it would not be reasonable to require the smaller drawbar pull requirement for a large transport helicopter, while it would also be unreasonable to need the larger drawbar pull for a light scout.

3.3.1 Rotor lift. Two-thirds rotor lift has been widely used and is generally accepted. Some criteria use 1g rotor lift for the higher sink speeds, but two-thirds seems to be a reasonable figure and is the value currently used by the Army.

3.3.2 Limit landings. The limit drop condition primarily serves as a basis for obstruction loads and the forward speed conditions. The design study indicates that it is improbable that the limit drop condition will size the gear. This condition should be retained since it represents the upper limit of "normal" landings. No pitch or roll conditions are included, because the high sink speed and survivable crash conditions give adequate coverage for other-than-level landings.

There are three probable reasons for high forward speed on touchdown. One is a deliberate run-on landing. Fifty knots is adequate to cover intentional landings with forward speed. The second condition is a poor autorotation landing. A good flare is required to lower the autorotation sink speed to the 10 ft/sec range for the limit drop condition. With a good flare, the forward velocity should be reduced to at least one-half the minimum power required speed. The third reason would be a landing following loss of directional control. In this case the pilot must maintain enough forward speed for the vertical tail aerodynamic forces to keep the fuselage from spinning due to main rotor torque. Normal procedure would be an approach slightly above minimum power speed. Minimum power speed of 120 percent is a reasonable value and would almost certainly set the forward speed requirement.

PROPOSED SPECIFICATON

3.3.2.2 Yielding. No yielding of any part of the landing gear or any other part of the helicopter shall be permitted for the limit drop conditions.

3.3.3 Slope landing conditions. The helicopter shall be capable of landing, takeoff, taxiing, towing, and parking on slopes of zero to 12 degrees, at any orientation to the helicopter, with no abnormal characteristics that would endanger the helicopter or cause damage requiring repair to any part of the helicopter. The above requirements must also be met for a landing on a 15-degree slope with the helicopter oriented parallel to the maximum slope. The helicopter shall be in a level attitude relative to a zero-sloped surface and shall have zero horizontal speed relative to the ground at initial landing gear contact. Vertical sink speed shall be 6 ft/sec for all slope landing conditions. A differential kneeling landing system shall not be used to meet the above-listed slope conditions.

3.3.4 High sink speed landing.

3.3.4.1 Damage criteria. The helicopter shall be capable of landing with a vertical sink speed as described below without causing damage requiring repair for continued safe operation, except for the landing gear assembly or main rotor blades and the main rotor blade droop restraint mechanism. Plastic deformation or other damage requiring component replacement is permissible for the landing gear installation, main rotor blades, and the main rotor blade droop restraint mechanism. Damage to the landing gear and mounting system shall be limited to that which is within the repair capability of Aviation Unit Maintenance (AVUM).

3.3.4.2 Landing attitude. The landing shall be onto a level, rigid surface with the helicopter at basic structural design gross weight. The helicopter shall be at any attitude of pitch and roll from zero to 10 degrees from level. The sum of the absolute values of the pitch and roll angles shall not exceed 15 degrees. The horizontal velocity at contact shall be zero.

3.3.4.3 Vertical sink speed. The landing gear shall be designed to meet the above requirements for the greater of the following vertical sink speeds:

- a. 20 ft/sec, or

RATIONALE

3.3.3 Slope landing conditions. This section is based on landing vertically on a sloped surface. An example would be landing at night on a basically level surface with local slope area that was not apparent to the pilot until touchdown.

3.3.4.1 High sink speed landing. The high sink speed landing requirement is designed to minimize damage to the helicopter at sink speeds above limit landings. This basically requires holding the landing load factor to a level that will not yield the structure. This load factor will usually be higher than flight limit because the yield/ultimate stress ratio of most materials is greater than the 1.5 times limit used for design. Also, the helicopter shear and moment distribution for a landing is different from a distribution in flight because of the support points. Although a landing condition may produce a higher load factor at the helicopter cg, it still will not be as critical as the flight condition. The landing gear and rotor components are not likely to require replacement after a landing that meets this requirement, since the requirement of no failure under crash loads will normally require more strength than needed to prevent yield in a high sink speed landing. This condition, in effect, becomes a limit landing, except obstruction loads are not applied to the loads obtained. The AVUM repair requirement is used to define acceptable damage, even though repairs would probably be made at a higher level maintenance facility.

3.3.4.2 Landing attitude. This reduces the requirement for combined pitch and roll. Since the maximum pitch or roll limits are relatively low-probability occurrences, the likelihood of having the maximum of both simultaneously is very low. The loads for various combinations of pitch and roll are discussed in the Design Study section.

PROPOSED SPECIFICATION

- b. The highest sink speed that may be obtained by utilizing the maximum practical amount of vertical axle travel required for the survivable crash conditions described below. The travel shall be the maximum amount of the crash travel usable without fuselage contact. The landing gear shall be designed to meet the damage criteria described above at the higher of these two sink speeds.

3.3.5 Survivable crash.

3.3.5.1 Impact conditions. The helicopter shall meet the MIL-STD-1290 requirements for a survivable crash with 42-ft/sec sink speed. The contribution of the landing gear in meeting this requirement will vary according to the basic design of the helicopter, in particular the amounts of fuselage crushing and seat energy absorption available. Therefore, it is not possible to set specific requirements for the landing gear contribution for this landing condition. The landing gear shall develop the dynamic characteristics specified by the helicopter prime contractor in a survivable crash such that the helicopter meets the requirements of MIL-STD-1290.

3.3.5.2 Failure characteristics. The landing gear installation shall be designed and located in a manner that will minimize the probability that a part of the gear or gear support structure will be driven into an occupiable space of the helicopter, or into an area containing a flammable fluid tank or line, in any accident falling within the 95th percentile survivable accident envelope as defined by MIL-STD-1290. Failure of the landing gear shall not result in failure of any personnel seat/restraint system or seat/restraint system tie-down. Failure of the landing gear shall not result in blockage of a door or other escape route, or prevent the opening of any door or escape route.

3.4 Design Characteristics.

3.4.1 General.

3.4.1.1 Operation requirements. The landing gear shall be capable of ground taxiing, towing, ground handling, takeoff and landing roll, and landings including autorotative landings at design landing conditions in accordance with paragraph 3.3.

3.4.1.2 Wheel replacement. Landing gear design shall permit rapid replacement of all wheels.

RATIONALE

3.3.4.3 Vertical sink speed. A 20-ft/sec vertical sink speed was used for the tentative new criteria configurations in the design study. This sink speed was shown to be cost effective. The required vertical axle travel may be set by either the high sink speed landing or by the survivable crash, depending on the particular helicopter design and the design approach used by the manufacturer. If the vertical axle travel required for the crash condition is greater than required for the high sink speed landing, the additional travel should be utilized to increase the maximum sink speed allowable for the high sink speed landing while still meeting the same damage criteria. This would probably be done by changes in the metering pin or load limiters, depending on the approach used.

3.3.5.1 Impact conditions. The survivable crash condition is designed to eliminate injuries at impact conditions up to and including the 95th percentile survivable crash as defined in MIL-STD-1290. Since this is a helicopter design requirement, and not just landing gear, it is not possible to define the landing gear requirements as an independent item. We have recommended new attitude limits for MIL-STD-1290. These are defined on Page 177.

3.3.5.2 Failure characteristics. This essentially says that the gear shall not cause damage to other systems that could be hazardous to the occupants.

3.4 Design Characteristics. Most requirements in this section are accepted practice. Only those items that are significantly different from past Army requirements or those that are not fairly obvious are discussed.

PROPOSED SPECIFICATION

3.4.1.3 Bearing protection. Wheel bearings shall be protected from entry of dirt, sand, or other foreign materials.

3.4.1.4 Fork clearance. The minimum fork clearance for tires shall be at the entrance point of the tire and shall not be less at any point passed later by the tire when the tire is rotated in normal direction for forward travel of the helicopter.

3.4.1.5 Wheel retention. Wheels shall be retained on the axis in case of wheel bearing failure. This may be accomplished by inherent design characteristics, such as a double fork, or by additional means, such as a mechanical retainer outboard of the wheel which would be sufficient to hold the wheel on the axle following a wheel bearing failure.

3.4.1.6 Wheel failure mode. Wheels shall be designed and constructed in a manner to avoid sudden failure in a crash condition where the tire is bottomed on the wheel. This capability shall be met up to the maximum load obtained under the landing conditions of Paragraph 3.3.5 of this specification. This requirement may be met by designing the wheel for no failure under the maximum wheel load, or by using design features or materials which fail in a progressive manner.

3.4.2 Main landing gear.

3.4.2.1 Commonality. Where practical, main landing gears shall be interchangeable left and right as a complete unit. When the main landing gears are not interchangeable as a complete unit, there shall be the maximum practical common use of detail parts and assemblies such that a gear assembly may be reconfigured into the opposite hand part with minimum effort.

3.4.2.2 Wheels and brakes. Main wheels and brakes shall be in accordance with MIL-W-5013 (Method I analysis) and MIL-A-008866. The brake system shall be capable of a single stop with the helicopter on level ground at BSDGW and a forward velocity for the greater of:

- a. 50 knots, or
- b. One-half the speed for minimum power with the helicopter in level flight at BSDGW at 4000 feet altitude on a 95°F day.

3.4.2.3 Brake control subsystem. Brake control subsystems shall be provided for the pilot and copilot and shall be in accordance with MIL-B-8584. A fail-safe brake subsystem,

RATIONALE

3.4.1.5 Wheel retention. This is derived from a Navy SD-24K requirement. It would prevent loss of the wheel if a wheel bearing fails. This should minimize damage to the gear and helicopter.

3.4.1.6 Wheel failure mode. Sudden failure of a wheel can cause load spikes in the gear installation, which can cause failures that would not occur due to the basic loads on the gear. An example is a recent landing gear drop test where the wheel halves came apart with the resulting load spike causing rupture of the oleo. If the wheel was designed to fail in a progressive manner, any load spikes caused by wheel failure should be small enough to avoid failure of the basic gear assembly.

25
F

3.4.2.1 Commonality. It is often impractical to design main landing gears that will interchange from side to side as a complete unit, but is usually practical to build the gear such that the same basic assemblies can be reconnected to form an opposite-hand assembly. As an example, the main gears for the design study configurations are designed with double lugs (top and bottom) on the trailing arm for attaching the oleo. This allows the same trailing arm to be flipped over to build up an opposite-hand installation.

3.4.2.2 Wheels and brakes. The Method I analysis method in MIL-W-5013 seems adequate for helicopter usage; Method II is much more involved and does not appear to offer any significant advantage. The forward speed rationale is the same as that discussed for limit drops (Specification paragraph 3.3.2.1) except the need for braking following a no-directional-control landing does not seem to be justified.

PROPOSED SPECIFICATION

complete with parking locks, shall be utilized for parking and directional control. Equal positive action of the brake subsystem shall be provided when the aircraft is moving forward or aft with the same effort on the brake control. The brake subsystem shall be capable of securing the aircraft on a 12-degree slope at maximum alternate gross weight (assume no tire slip relative to the ground). Complete brake control shall be possible while the aircraft is being towed without requiring the operation of the main engine(s) or auxiliary power unit (APU) (if applicable).

3.4.3 Auxiliary landing gear. The auxiliary landing gear shall incorporate 360-degree free-swiveling with self-centering when the gear is fully extended in flight. The gear shall include a pilot-controlled swivel lock to lock the gear in the centered position. It shall be possible to engage the swivel lock control with the gear in any position, such that the swivel lock will engage when the gear aligns in the centered position. It shall not be possible to lock the gear in any position except centered.

3.4.4 Nose or tail bumper. Nose and/or tail bumper wheels or skids shall be provided as necessary. Skids shall have a simple hardened replaceable shoe to absorb the wear and damage of impact.

3.4.5 Tires and tubes. Pneumatic tires and tubes shall be in accordance with MIL-T-5014 and MIL-I-5014. Either tube-type or tubeless tires may be used.

3.4.6 Shock absorbers. Shock absorber struts shall be in accordance with MIL-L-8552. Shock absorber struts shall be readily replaceable as a complete unit and shall be interchangeable left and right without change of major parts.

3.4.7 Retraction, extension and locking. Devices used for retraction, extension, locking, and position indication of landing gears shall be positive.

3.4.7.1 Airspeed requirements. Retraction and extension requirements shall be met at airspeeds of zero to minimum power speed with the helicopter in level flight at BSDGW at sea level standard day conditions.

3.4.7.2 Lock devices. The location of the landing gear ground lock devices shall be identified by fluorescent red identification stencils or nameplates. Design of the ground lock devices shall be such that they cannot be erroneously installed.

RATIONALE

3.4.4 Nose or tail bumper. The addition of a nose bumper is related to the forward turnover angle requirement in Specification paragraph 3.2.3.1.

3.4.7.1 Airspeed requirements. There is no need for a high speed flight gear retraction or extension requirement.

PROPOSED SPECIFICATION

3.4.7.3 Emergency extension. Operation of an emergency extension subsystem shall not preclude subsequent operation of the normal retraction of extension subsystems.

3.4.7.4 Strut compression. When a strut compression mechanism is used, means shall be provided to preclude jamming of the gear in the wheel well in case of failure of the compressing mechanism.

3.4.7.5 Retraction. The landing gear shall be capable of being retracted in not more than 10 seconds. A safety lock shall be provided in the landing gear retraction control system to prevent inadvertent retraction when the aircraft is on the ground.

3.4.7.6 Extension. The landing gear shall be capable of being extended in not more than 10 seconds. An emergency extension subsystem shall be provided in case of malfunction of the normal extension subsystem. The emergency extension subsystem shall be capable of extending the landing gear in not more than 30 seconds. It shall not be necessary for the pilot/copilot to physically hold the emergency extension control in the actuated position.

3.4.7.7 Locking. Switches used to indicate an up-lock or a down-lock position of the gear shall be activated directly by the locking device.

3.4.7.8 Doors and fairings. The leading edges of the wheel well doors shall be rigidly held in the closed position to avoid partial opening under air and/or inertial loads. Fairings on the landing gear shall be readily removable and shall prevent the accumulation of foreign matter as far as practical. The door opening subsystem shall be such that the doors, when designed to close with the landing gear fully extended, can be opened from the ground, with the aircraft weight on its wheels without utilizing the normal or emergency extension subsystems. Doors and fairings located in the vicinity of the wheels and tires shall be designed such that damage to the doors or fairings, such as might be caused by impact with brush or other obstacles on landing, will not interfere with the tires or wheels to prevent completion of a satisfactory landing.

3.4.8 Ground clearance. The level ground clearance for antitorque (tail) rotor (exclusive of tail bumper wheel or skid structure), fairings, control surfaces, antennas, fuselage, and external stores shall not be less than 16 inches (or as defined by the helicopter type specification) with the aircraft at rest at BSDGW with the landing gear properly

RATIONALE

3.4.8 Ground clearance. These attitude requirements for clearance are essentially the same as previous requirements, but the worst combination must be determined by the manufacturer instead of listing the various combinations in the specification.

PROPOSED SPECIFICATION

serviced and at normal static deflection, and not less than six inches clearance with the worst combination of:

- a. One to all tires and struts flat with the remaining gears in normal static position, or
- b. The aft fuselage or tailskid touching the ground with aft landing gears at normal static position (not required for tail wheel tricycle configurations).

3.5 General strength requirements.

3.5.1 MIL-S-8698 requirements. Unless otherwise specified, strength and rigidity requirements shall be provided in accordance with MIL-S-8698.

3.5.2 MIL-A-008862 requirements. The following paragraphs of MIL-A-008862 shall apply for ground loads:

- 3.3 (except 3.3.7),
- 3.4,
- 3.5 (except 3.5.3),
- 3.6.

3.5.3 Obstruction loads. For obstruction loading conditions, the horizontal load for each gear shall be equal to 50 percent of the maximum vertical load developed during a level limit drop.

3.5.4 Casting factor. An analytical casting factor of 1.25 shall be applied for the design of all castings which will not be static tested to failure, or which are not procured to MIL-C-21180. There shall be no yield of castings at design limit load.

3.6 Fatigue.

3.6.1 Failure definition. A fatigue failure shall be defined as a crack which renders the component inoperable, unable to support design limit loads without failure, or which leads to a potentially catastrophic failure mode.

3.6.2 Life requirements. The landing gear shall be designed such as to not have a fatigue failure or to require maintenance beyond that which is within the capability of Aviation Unit Maintenance, when the landing gear is loaded with the equivalent of 10,000 level landings with the helicopter at BSDGW, no horizontal velocity, and the vertical sink speed distributed as listed below.

RATIONALE

3.5.3 Obstruction loads. Obstruction loads are the primary reason for retaining the limit drop condition. Our design study indicates that obstruction loads could size parts of the gear, while limit loads would not otherwise be expected to be significant in sizing the gear.

3.6.2 Life requirements. This load spectrum is approximately the same sink speed distribution as MIL-A-008866, but adjusted for a 10-ft/sec limit drop. A load spectrum and number of load applications (landings) are required to define fatigue life.

PROPOSED SPECIFICATION

<u>Percent of Landings</u>	<u>Vertical Sink Speed - Ft/Sec</u>
0.1	10
1.9	8
18.0	6
60.0	4
20.0	2

3.7 Damage tolerance. The primary structure as defined in MIL-A-008860 shall incorporate materials, stress levels, and structural configurations that will minimize the probability of loss of the aircraft due to damage of a single structural element or due to propagation of undetected flaws, cracks, or other damage. Slow crack growth, crack arrestment, alternate load paths and systems, and other available design principles shall be used to achieve this capability.

3.8 Construction.

3.8.1 Materials, processes, and parts. Materials, processes, and parts shall be in accordance with ADS-13.

3.8.2 Workmanship. Workmanship shall be in accordance with high-grade aircraft practice and quality to ensure safety, proper operation, and service life. Workmanship shall be subject to the inspection and approval of the cognizant inspection activity.

3.8.3 Interchangeability and replaceability. Parts, sub-assemblies, assemblies, units, and sets of the landing gear system shall be interchangeable or replaceable as defined in MIL-I-8500.

4. QUALITY ASSURANCE PROVISIONS

4.1 General requirements. Quality assurance provisions shall be as specified in Chapter 9 of AMCP 706-203. Drop testing of wheel and skid landing gears shall be in accordance with paragraph 3.3 of AMCP 706-203 and shall include demonstration of compliance with the drop condition requirements of paragraph 3.3 of this specification.

4.2 Test requirements.

4.2.1 Required tests. The landing gear shall be tested to verify that the gear installation performs satisfactorily when dropped at the most critical conditions specified in paragraph 3.3 of this specification. At least one test each of a limit drop with and without forward speed, a slope landing, a high

RATIONALE

26
F

4.2.1 Required tests. This section requires at least one test of the most critical condition for each of the major types of landings. The method of determining the critical condition is not specified, although it will almost certainly be through analysis because testing to determine critical conditions would be prohibitively expensive. The required tests would be for verification of the design. Jig drops of individual gear assemblies will probably be needed in development, but these tests are not required.

PROPOSED SPECIFICATION

sink speed drop, and a survivable crash drop condition must be performed. The survivable crash condition drop test shall be at a vertical sink speed of 42 ft/sec.

4.2.2 Test methodology. These drop conditions may be performed by flight testing of a helicopter, or by drop testing a complete helicopter or a complete landing gear installation which is installed on a test jig with accurate simulation of the helicopter mass, inertia, and stiffness properties. Drop tests may be performed at the actual helicopter gross weight with simulation of rotor lift, or at a reduced drop weight to provide equivalent drop energy if no rotor lift simulation is used.

4.2.3 Correlation requirements. If analytical methods were used to select the critical conditions for testing, the flight test or drop test results shall be compared to the analysis used to determine the critical cases selected for testing. If reasonable correlation between test and analysis is not obtained, additional test or analysis shall be performed until acceptable correlation is obtained.

5. PREPARATION FOR DELIVERY

5.1 Applicability. Section 5 is not applicable to this specification.

26
B

6. NOTES

6.1 Intended use. This specification is to be used for the design and qualification of helicopter landing gear.

6.2 Definitions. The definitions of AMCP 706-201, 706-202, and 706-203 shall apply except as listed below.

6.2.1 Ground plane. A plane at the surface of the ground. The ground plane may be level or sloped.

6.2.2 Turnover angle. Turnover angle is the angle from a line through the helicopter center of gravity perpendicular to the ground plane to a line connecting the center of gravity and the ground contact points of tires (or skids). The turnover angle is measured in a plane perpendicular to the ground plane (horizontal) and perpendicular to the line between the contact points of the two gears. For skid gears, the ground contact points are the most forward or aft points on the skid which are in contact with the ground plane.

RATIONALE

4.2.2 Test methodology. Jig drop tests of individual gear assemblies have been used in the past to qualify new gears. These tests cannot represent the redistribution of loads between the gears during a pitched-rolled landing. It is essential that the entire landing gear installation be dropped as a unit and that the drop test simulate the helicopter characteristics. An actual helicopter drop is most desirable, but a test fixture could be built to simulate the helicopter.

Since the survivable crash test (42 ft/sec) will destroy a helicopter, this drop will most likely be performed on the static test article or ground test vehicle after completion of the structural test program.

4.2.3 Correlation requirements. Since analytical methods will most likely be used to determine the critical conditions to be tested, the validity of the analysis must be established by correlation with the test results. If the correlation is poor, the selection of the critical conditions would be suspect. This would require resolution before final acceptance of the gear.

PROPOSED SPECIFICATION

6.2.3 Lateral turnover angle. The turnover angle along the line between the ground contact points of one main gear and the nose or tail gear for tricycle gears, or the ground contact points on one side of the helicopter for quadricycle or skid gears.

6.2.4 Forward or aft turnover angle. The turnover angle perpendicular to the line between the ground contact points of two gears opposite of each other across the centerline of the helicopter.

AMCP 706-201

Section 4-5 of AMCP 706-201 contains an extensive discussion of landing conditions. This section covers many of the factors which enter into developing landing gear requirements. While this discussion covers many valid considerations, it is of little value to the designer since the various criteria have established specific requirements for the design of the gear. The changes proposed below are those required to avoid conflict with MIL-L-XXXX.

Paragraph 4-5.1.1.1, Page 4-18

EXISTING TEXT

Due to the inadequacy of these criteria to account for the severe usage of Army helicopters under combat conditions, the design sink speed shall be a minimum of 10 fps in lieu of 8 fps for all new designs.

PROPOSED TEXT

Due to the inadequacy of these criteria to account for the severe usage of Army helicopters under combat conditions, the design limit sink speed shall be 10 fps in lieu of 8 fps for all new designs.

Paragraph 4-5.1.1.2, Pages 4-18 through 4-20

Delete the existing paragraph and Figures 4-16 through 4-19.

PROPOSED TEXT

Limit landings, as defined in MIL-L-XXXX, shall be performed on level ground with the helicopter in a level attitude (all gears contact simultaneously). Landings shall be with or without forward speed. This condition is primarily to establish loads for obstruction loading conditions.

Paragraph 4-5.1.2, Page 4-23

Delete the final paragraph in its entirety.

Paragraph 4-5.1.2.1, Pages 4-23 through 4-26

Delete the entire paragraph including Figures 4-21 through 4-24.

PROPOSED TEXT

MIL-L-XXXX does not require asymmetric landings at limit sink speed. Asymmetric landings are included in the high sink speed landing requirements listed in paragraph 4-5.2.

Paragraph 4-5.2, Pages 4-26 through 4-28

EXISTING TEXT

4-5.2 Reserve Energy Requirements.

4-5.2.1 Reserve Energy Descent Velocities. The reserve energy requirements for helicopter landing impacts are important to both the safety and the continued operational availability of the vehicles under the anticipated military operating environment (Reference 11).

PROPOSED TEXT

4-5.2 High Sink Speed Requirements.

4-5.2.1 High Sink Speed Landings. The requirements for helicopter landings at higher sink speeds than limit are important to both the safety and the continued operational availability of the vehicles under the anticipated military operating environment (Reference 11).

NOTE: Change Reference 11 from USAAMRDL TR 71-22 to USARTL TR-79-22.

EXISTING TEXT

Thus, the criteria for the design reserve energy descent velocities at ground contact for Army helicopters are as follows:

1. $\sqrt{1.5 X}$ (design limit sinking velocity) = 12.24 ft/sec. Under this severity of impact, minor, quickly repairable or replaceable damage to the landing gear components only is to be permitted. No damage to the airframe that would prevent continued safe vehicle operation is permitted.
2. 2.0 X (design limit sinking velocity) = 20 ft/sec. Under this severity of impact, major landing gear damage is permissible, provided that complete collapse or sudden catastrophic failure

does not result and that only minor, field repairable damage to the airframe is likely to be incurred.

PROPOSED TEXT

The requirements for Army helicopter high sink speed landings are defined in MIL-L-XXXX as follows:

1. Minimum sink speed shall be 20 fps.
2. Attitudes shall be all attitudes within an envelope of ± 10 degrees pitch and/or roll except the sum of the absolute values of pitch and roll need not exceed 15.
3. The helicopter shall be flightworthy except for the landing gear, main rotor blades, and blade droop restraint system.
4. Damage shall be limited to that which is within the repair capability of aviation absorbers; provisions must be made to compensate for the rapid increase in load as sink speed increases. This may be done by designing the orifice for the higher impact conditions, adding an internal pressure actuated auxiliary orifice or by adding an energy absorber in series with the shock absorber to reduce the effective piston stroking velocity. These techniques are discussed in USAVRADCOM TR-81-D-15, May 1981.

4-5.2.2 Reserve Energy Design Considerations.

EXISTING TEXT

4-5.2.2 Reserve Energy Design Considerations. As stated in Paragraph 4-5.2.1 and Reference 19, it is essential that means be provided in helicopter landing gear design to absorb additional impact energy while limiting the magnitude of the loads imposed upon the vehicle. Characteristics that help in achieving maximum reserve energy capability include the effective dissipation of the initial impact energy so as to minimize bounce and the severity of secondary impact, and effective load compensation for "hydraulic lock" (Reference 20) of air-oil shock struts or for the elastic "spring" effect of under-damped landing gear designs. A yielding "structural fuse" (e.g., honeycomb-filled cylinder in landing gear

system with yield load above normal landing gear limit load) has been found to be most effective in limiting vehicle damage for the unusually high descent velocities occasionally encountered in service.

PROPOSED TEXT

4-5.2.2 High Sink Speed Landings Design Considerations. As discussed above and in Reference 19, it is essential that means be provided in helicopter landing gear design to absorb additional impact energy while limiting the magnitude of loads imposed upon the vehicle. Desired characteristics include absorption of the initial impact energy to minimize rebound and secondary impacts for air-oil shock.

EXISTING TEXT

Formerly it was thought that reserve energy impact capability was dependent largely upon reserve strength (which adds cost and weight penalties), but now it has been proven that relatively low landing load factors are acceptable, and even desirable, provided adequate provision is made in the landing gear design for energy dissipation and load compensation. This is true particularly of vehicles that are to be operated routinely for pilot training or in the battle zone environment. As shown in Reference 17, little or no weight and/or cost penalty need result from the provision of relatively severe reserve energy capability in a landing gear design, provided proper optimization of the desired characteristics is included during the preliminary design stage of a vehicle. For example, substantial experience now is available on helicopters with landing gears having reserve energy descent velocity capabilities on the order of 15 fps, even though the design limit ground load factor was on the order of 2.0 to 2.5. These landing gears also are among the lightest in the industry, exploding the myth of an excessive weight penalty for an adequate reserve energy capability.

While structural yielding can be utilized efficiently in achieving adequate reserve energy capability at little or no overall weight penalty, there no doubt are alternative concepts that would be effective for achieving the specified objectives.

PROPOSED TEXT

Some additional sink speed capability above limit sink speed may be added for very little cost or weight. This may be done by adding some type of load limiter which will allow the gear to utilize the maximum stroke available without exceeding the allowable landing load factor. Some extra capability is available by utilizing a higher load factor, since for most aircraft materials yield is above the design limit load. As the sink speed is increased, a point is reached where additional vertical axle travel must be added to hold the load factor to a level that will preserve a flightworthy helicopter. Above this point, there is a significant increase in gear weight as sink speed is increased.

Paragraph 4-5.2.3

EXISTING TEXT

Because the reserve energy descent velocities specified inherently take into account abnormally severe impact conditions,

PROPOSED TEXT

Because the high sink speeds specified inherently take into account abnormally severe impact conditions,

EXISTING TEXT

Reference 11 indicates that the forward velocity at impact generally is no greater than that for best approach speed-power-off, i.e., best glide angle. Therefore, for design purposes the reserve energy descent velocity shall be combined with a horizontal velocity equal to 120% of the speed for minimum power required. This combination of velocities should be considered throughout the attitude range from 15-degrees nose-down to the maximum nose-up attitude attained during a maximum horizontal deceleration maneuver.

PROPOSED TEXT

The limit drop condition provides for moderate sink speeds with forward speeds up to 120 percent of minimum power speed. This should provide adequate forward speed capability, even at the higher sink speeds, since most landings including survivable crashes are at low forward speeds.

Paragraph 13-1.1.8

EXISTING TEXT

Army helicopters normally have a requirement for landings on slopes up to 15 degrees in any direction. Compliance with this requirement often is demonstrated by landing on a slope while holding partial thrust of approximately 1/3 the weight of the helicopter on the main rotor. Because an operational requirement exists for 15 degrees, a minimum turnover angle of 30 degrees has been established. This constitutes a configuration restraint in regard to the distance between the landing gears and the relative vertical position of the CG.

PROPOSED TEXT

Army helicopters normally have a requirement for landings on slopes up to 12 degrees in any direction and 15 degrees to the side. In addition, the helicopter may taxi or be towed on sloped ground. If the helicopter tips over laterally, it will usually fall completely over, often with major damage. If the helicopter tips over forward or aft, it will generally only rotate a small amount until nose or tail contact occurs, often with no damage. MIL-L-XXXX specifies that the minimum turnover angle shall be 30 degrees. If a forward or aft tipover will not cause damage, turnover angle may be reduced to 25 degrees forward and 20 degrees aft.

27
B

AMCP 706-202

Paragraph 12-1.1

EXISTING TEXT

Because of the requirement for Army helicopters to operate on or from surfaces with as much as 15 degrees slope the turnover angle in any direction should be at least 30 degrees (Paragraph 13-1.1.8, AMCP 706-201). Other than turnover angles, there are no specific requirements for or limitations on the location of the individual gear fore and aft of the CG.

PROPOSED TEXT

Because of the requirement for Army helicopters to operate on or from surfaces with as much as 15 degrees slope, the turnover angle should be 30 degrees. If a tipover forward or aft would not cause damage to the helicopter,

the turnover angle may be reduced to 25 degrees forward and 20 degrees aft (Paragraph 13-1.1.8, AMCP 706-201). Other than turnover angles, there are no specific requirements for or limitations on the location of the individual gear locations. However, the gears should be located to minimize the landing load increase for pitched-rolled landings.

Figure 12-1

In the side view:

EXISTING TEXT

Not less than 30°

PROPOSED TEXT

Not less than 30° except see Note 6

NOTE 6 - May be reduced to 25° forward and 20° aft if the requirements of MIL-L-XXXX are met.

Figure 12-2

EXISTING TEXT

Not less than 30°

PROPOSED TEXT

Not less than 30° except see Note 4

NOTE 4 - May be reduced to 25° forward and 20° aft if the requirements of MIL-L-XXXX are met.

AMCP 706-203

Paragraph 9-2.2.1, Page 9-3, Item 6.

EXISTING TEXT

6. NOSE LANDING GEAR AND CARRY-THROUGH STRUCTURE.

PROPOSED TEXT

6. AUXILIARY LANDING GEAR AND CARRY-THROUGH STRUCTURE.

Paragraph 9-2.3, Page 9-5.

EXISTING TEXT

9.2.3 Landing Gear Drop Tests. The normal landing load factor and the reserve energy-absorption capacity of the landing gear shall be demonstrated by conducting drop tests on the landing gear. These tests shall be conducted to determine the dynamic load characteristics over a representative range of helicopter weights, angles of attack, and sinking speeds, as applicable to the landing gear type, and shall include, for wheel-type landing gear, sufficient wheel spin-up to simulate critical wheel contact velocities. In addition ...

PROPOSED TEXT

The normal and high sink speed capabilities of the landing gear shall be demonstrated by conducting drop tests on the landing gear installation. These tests shall be conducted to determine the dynamic load characteristics for the conditions specified in MIL-LXXXX. The landing gear performance in a survivable crash shall be evaluated as a part of the crash testing of the helicopter. In addition ...

Paragraph 9.2.3.1.1, Page 9-6

EXISTING TEXT

9.2.3.1.1 Wheel Gear. In accordance with pars. 3.3.2 through 3.3.3.2 of MIL-T-8679, the drop conditions shall be expanded, as required, to insure that a representative range of drop weights, contact velocities, and attitudes have been covered adequately for the gear being tested.

PROPOSED TEXT

ADD:

... the gear being tested. As a minimum, the drop conditions shall include the required conditions of MIL-L-XXXX.

Paragraph 9-2.3.1.2, Page 9-7.

EXISTING TEXT

9.2.3.1.2 Skid Gear. The skid gear drop tests shall be performed at the basic design gross weight and design

alternate gross weight at their critical cg locations for the following three conditions:

1. Condition I. Level landing with vertical reaction.
2. Condition II. Level landing with longitudinally inclined reaction. The vertical ground loads shall be combined with a rearward acting drag force equal to one-half the total vertical ground reaction.
3. Condition III. Level landing with laterally inclined reaction. The vertical ground loads shall be combined with a laterally acting drag force equal to one-fourth of the total vertical ground reaction.

Limit and reserve energy drop tests shall be conducted for each of the conditions described. In addition, the yield sinking speed shall be determined, utilizing Condition I, by dropping a skid gear assembly in increments of sinking velocity until a permanent set of 0.2 percent is obtained.

PROPOSED TEXT

Skid landing gear installations shall be tested to verify compliance with the requirements of MIL-L-XXXX. If yielding members are used for energy absorption, the yield sink speed for level landings shall be determined by dropping a skid gear assembly in increments of sink speed until a permanent set of 0.2 percent is obtained.

EXISTING TEXT

The requirements of Condition II (illustrated in Figure 9-1), which specifies a forward reaction equal to one-half of the vertical reaction at ground contact, can be satisfied by providing inclined guide rails to guide the test assembly during the drops.

The requirements of Condition III (illustrated in Figure 9-1), which specifies a lateral drop reaction equal to one-fourth of the vertical reaction, can be satisfied by constructing a sloped platform to provide the lateral reaction. The platform should be high enough to provide an angle of 14 deg (tangent of 14 deg = 0.25) from the horizontal for a line drawn between the points of ground contact of each skid rail. The platform should be long enough to provide support for the entire length of the skid rail.

PROPOSED TEXT

Drag and lateral loads may be developed during the drop tests by using inclined guide rails or drop platforms with different heights for the two skids. Figure 9-1 shows test setups for a drag reaction of one-half the vertical reaction and a lateral reaction of one-quarter of the vertical.

Figure 9-1

EXISTING TEXT

Drop Condition II

PROPOSED TEXT

Drag Reaction = .5 of vertical

EXISTING TEXT

Drop Condition III

PROPOSED TEXT

Lateral reaction = .25 of vertical

MIL-STD-1290

Paragraph 2.1, Page 2

Add

MIL-L-XXXX

Landing Gear, Helicopter

Paragraph 2.2, Page 2

EXISTING TEXT

USAAMRDL TECHNICAL
Report 71-22

Crash Survival Design Guide

PROPOSED TEXT

USARTL-TR-79-22

Aircraft Crash Survival
Design Guide

EXISTING TEXT

5.1.6 Landing gear. Landing gear, including the skid-type shall provide maximum practical energy absorption capabilities to reduce the vertical velocity of the fuselage as much as possible under the crash conditions defined in 4.2. The landing gear shall be capable of decelerating the aircraft at normal gross weight from an impact velocity (ΔV_z) of 20 ft/sec onto a level, rigid surface without allowing the fuselage to contact the ground. Plastic deformation of the gear and mounting system is acceptable in meeting this requirement; however, the remainder of the aircraft structure except rotor blades shall be flightworthy after the impact. The aircraft shall be capable of meeting this requirement in accidents including a simultaneous fuselage angular alignment of ± 10 degrees roll and pitch. The landing gear shall be designed so that failure does not increase danger to occupants, either by penetrating the occupiable areas or by rupturing flammable fluid containers. If this cannot be accomplished by location, the gear shall be designed to breakaway under longitudinal impact conditions, with points of failure located so that damage to critical areas is minimized. Skid-type gear shall be designed to resist snagging or rough terrain and such obstacles as roots and debris.

PROPOSED TEXT

5.1.6 Landing gear. Landing gear, including the skid-type shall provide maximum practical energy absorption capabilities to reduce the vertical velocity of the fuselage as much as possible under the crash conditions defined in 4.2. The landing gear shall be capable of decelerating the aircraft at normal gross weight from an impact velocity (ΔV_z) of 20 ft/sec onto a level, rigid surface without allowing the fuselage to contact the ground. Plastic deformation of the gear and mounting system is acceptable in meeting this requirement; however, the remainder of the aircraft structure except rotor blades and blade droop restraint mechanisms shall be flightworthy after the impact. The aircraft shall be capable of meeting this requirement in landings with pitch and/or roll angles of zero to ± 10 degrees except the sum of the absolute values of the pitch and roll angles need not exceed 15. The landing gear shall be designed so that failure does not increase danger to occupants, either by penetrating the occupiable areas or

by rupturing flammable fluid containers. If this cannot be accomplished by location, the gear shall be designed to breakaway under longitudinal impact conditions, with points of failure located so that damage to critical areas is minimized. Skid type gear shall be designed to resist snagging on rough terrain and such obstacles as roots and debris.

Paragraph 5.1.2.1, Page 9

EXISTING TEXT

For this analysis, the aircraft orientation (attitude) upon impact shall be any attitude within +15° pitch and +30° roll.

PROPOSED TEXT

For this analysis, the aircraft orientation (attitude) upon impact shall be any attitude within the envelope shown in Figure B-1.

USARTL-TR-79-22C

Paragraph 5.3.1.8 Landing Gear

This section contains design requirements for landing gear. The existing report includes both crash-related and noncrash-related requirements. This report should be changed to include the crash requirements of MIL-L-XXXX and refer to MIL-L-XXXX for noncrash requirements.

PROPOSED TEXT

5.3.1.8 Landing Gear. The landing gear is a major contributor in achieving satisfactory crash performance. In emergency landing, the gear usually makes initial contact with the ground, absorbs a major part of the initial impact energy, and determines the helicopter attitude and velocity at fuselage ground contact. Landing requirements for both normal and crash landings are defined in MIL-L-XXXX. The crashworthiness related sections of MIL-L-XXXX are reproduced below.

3.3.4 High Sink Speed Landing.

3.3.4.1 Damage Criteria. The helicopter shall be capable of landing with a vertical sink speed as described below without causing damage requiring repair for continued safe operation, except for the

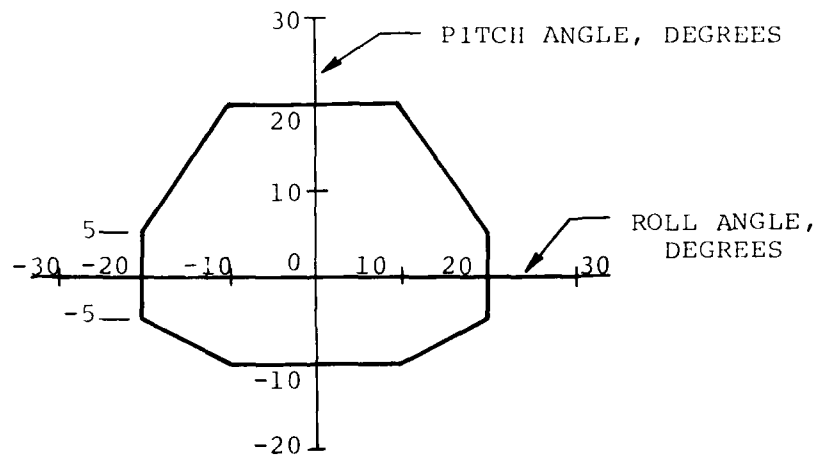
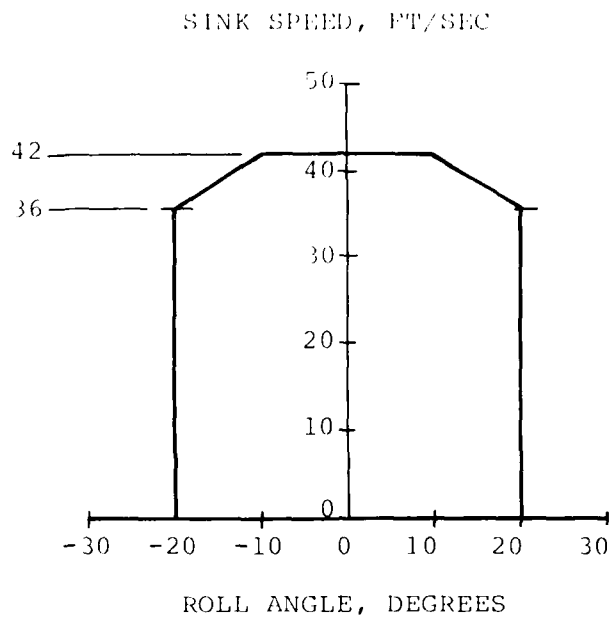

Figure B-1. Crash impact conditions.

landing gear assembly or main rotor blades and the main rotor blade droop restraint mechanism. Plastic deformation or other damage requiring component replacement is permissible for the landing gear installation, main rotor blades, and the main rotor blade droop restraint mechanism. Damage to the landing gear and mounting system shall be limited to that which is within the repair capability of Aviation Unit Maintenance (AVUM).

3.3.4.2 Landing Attitude. The landing shall be onto a level, rigid surface with the helicopter at basic structural design gross weight. The helicopter shall be at any attitude of pitch and roll from zero to 10 degrees from level. The sum of the absolute values of the pitch and roll angles shall not exceed 15 degrees. The horizontal velocity at contact shall be zero.

3.3.4.3 Vertical Sink Speed. The landing gear shall be designed to meet the above requirements for the greater of the following vertical sink speeds:

- a. 20 ft/sec, or
- b. The highest sink speed that may be obtained by utilizing the maximum practical amount of vertical axle travel required for the survivable crash conditions described below. The travel shall be the maximum amount of the crash travel usable without fuselage contact. The landing gear shall be designed to meet the damage criteria described above at the higher sink speed.

28
B

3.3.5 Survivable Crash.

3.3.5.1 Impact Conditions. The helicopter shall meet the MIL-STD-1290 requirements for a survivable crash with 42-ft/sec sink speed. The contribution of the landing gear in meeting this requirement will vary according to the basic design of the helicopter, in particular the amounts of fuselage crushing and seat energy absorption available. Therefore, it is not possible to set specific requirements for the landing gear contribution for this landing condition. The landing gear shall develop the dynamic characteristics specified by the helicopter prime contractor in a survivable crash such that the helicopter meets the requirements of MIL-STD-1290.

3.3.5.2 Failure Characteristics. The landing gear installation shall be designed and located in a manner that will minimize the probability that a part of the gear or gear support structure will be driven into an occupiable space of the helicopter, or into an area containing a flammable fluid tank or line, in any accident falling within the 95th percentile survivable accident envelope as defined by MIL-STD-1290. Failure of the landing gear shall not result in failure of any personnel seat/restraint system or seat/restraint system tiedown. Failure of the landing gear shall not result in blockage of a door or other escape route, or prevent the opening of any door or escape route.

Paragraph 5.4.2 Landing Gear Crash Testing

This section lists landing gear crash testing requirements. It should be changed to incorporate the proposed MIL-LXXXX requirements.

PROPOSED TEXT

5.4.2 Landing Gear Crash Testing. Landing gear crash testing should be incorporated in the overall crash testing of the aircraft. It is essential that the tests simulate the load redistribution between individual gears that occurs in pitched or rolled landings. For the high sink speed landings (20 ft/sec) where the fuselage remains intact, it is possible to drop test a test fixture with the entire landing gear installed on the fixture. This fixture would be built to represent the aircraft weight, center of gravity, and inertia characteristics with stiffness simulation a desired feature. A preferred method would be a drop of an actual aircraft. For the survivable crash conditions (42 ft/sec), the interaction of the landing gear, fuselage crushing, and seat stroking is extremely important. A realistic test can only be obtained by drop testing a complete aircraft. Individual jig drop tests of a single gear may be needed in development, but individual gear tests do not adequately verify the performance of the gear installed on the aircraft. Landing gear testing requirements for Army helicopters are defined in MIL-L-XXXX. Test procedures are covered in MIL-L-XXXX and AMCP 706-203. The test requirements of MIL-L-XXXX are reproduced below.

4. QUALITY ASSURANCE PROVISIONS

4.1 General Requirements. Quality assurance provisions shall be as specified in Chapter 9 of AMCP 706-203. Drop testing of wheel and skid landing gears shall be in accordance with paragraph 9-2.3 of AMCP 706-203 and shall include demonstration of compliance with the drop condition requirements of paragraph 3.3 of this specification.

4.2 Test Requirements.

4.2.1 Required Tests. The landing gear shall be tested to verify that the gear installation performs satisfactorily when dropped at the most critical conditions specified in paragraph 3.3 of this specification. At least one test each of a limit drop with and without forward speed, a slope landing, a high sink speed drop, and a survivable crash drop condition must be performed. The survivable crash condition drop test shall be at a vertical sink speed of 42 ft/sec.

4.2.2 Test Methodology. These drop conditions may be performed by flight testing a helicopter, or by drop testing a complete helicopter or a complete landing gear installation which is installed on a test jig with accurate simulation of the helicopter mass, inertia, and stiffness properties. Drop tests may be performed at the actual helicopter gross weight with simulation of rotor lift, or at a reduced drop weight to provide equivalent drop energy if no rotor lift simulation is used.

4.2.3 Correlation Requirements. If analytical methods were used to select the critical conditions for testing, the flight test or drop test results shall be compared to the analysis used to determine the critical cases selected for testing. If reasonable correlation between test and analysis is not obtained, additional test or analysis shall be performed until acceptable correlation is obtained.

Paragraph 6.5 Landing Gear

The proposed text is considered to be a more useful approach to establish the basic design of a landing gear.

PROPOSED TEXT

6.5 Landing Gear. The landing gear is a major contributor to the behavior of the aircraft in a crash. The landing gear will typically absorb 40 to 60 percent of the aircraft energy in a 42-ft/sec crash. A 50-percent reduction in energy would reduce the sink speed from 42 ft/sec at initial contact to 30 ft/sec at fuselage contact. In addition, the gear should reduce any pitch and roll at initial contact so the aircraft is nearer level at fuselage contact. After fuselage contact, the gear may be designed such that it continues to stroke, or may be designed to fail so it no longer absorbs energy. In either case, the gear must be designed so it will not intrude into occupied areas or flammable fluid areas, will not cause failure of occupant protection systems, or will not block an escape route.

There are two basic conditions that establish the overall landing gear configuration. These are the high sink speed landing (20 ft/sec) and the survivable crash (42 ft/sec). The high sink speed landing is a damagerelated design condition where the objective is a flightworthy aircraft (with some limited part replacement permitted). The survivable crash is an injury-related design condition where the objective is to prevent injury and aircraft damage is not a consideration. Both conditions have major impact on the design of the landing gear.

In the high sink speed landing, the landing gear must absorb all the drop energy without reaching a load that would cause damage requiring repair to major aircraft systems for continued flight. The permissible landing load factors can exceed the normal flight load factors for two reasons. First, structure is designed so it will not fail at 1.5 times design limit loads. This means that design limit load is two-thirds of ultimate, but typical aircraft materials have yield strengths above two-thirds of ultimate. This allows the load factor to exceed the design limit load factor without causing yielding of the structure. Second, the shear-moment distribution for landings is different from the flight conditions. This will often allow a landing cg load factor higher than the design flight cg load factor without exceeding the design flight loads. Typically, for a design flight cg load factor of 3.5, the landing cg load factor could reach 4 to 4.25.

With the load factor tentatively established, the required gear vertical stroking distance may be determined from the following relationship:

$$V^2/2g + (1-LR)(\Delta_T + \Delta_A) = Ng (\eta_T \Delta_T + \eta_A \Delta_A)$$

Kinetic Energy + Potential Energy = Gear Work Done

Where:

V = Vertical Sink Speed Ft/Sec
 g = Gravitational Constant
 LR = Lift Ratio (Lift/Weight)
 Δ_T = Tire (or Skid) = Deflection Ft
 Δ_A = Axle Vertical Travel Ft
 Ng = Ground Load Factor
 (cg Load Factor - Lift Ratio)
 η_T = Tire Efficiency
 η_A = Axle Load Efficiency

Solving for Vertical Axle Travel Yields:

$$\Delta_A = [(N_g \eta_T + LR - 1)\Delta_T - V^2/(2g)] / (1 - LR - N_g \eta_A)$$

As an example, substituting typical values for a helicopter with an air-oil oleo wheel landing gear gives

$$\Delta_A = [(3.33 \cdot .44 + 2/3 - 1) \cdot 33 - (20)^2 / (2 \cdot 32.3)] / (1 - 2/3 - 3.33 \cdot .85)$$

$$\Delta_A = 2.34 \text{ Ft. or } 28.08 \text{ in.}$$

This corresponds to a level landing using all of the available travel. It is necessary to add additional travel to allow for pitched-rolled landings. This additional travel is usually on the order of 10 percent.

In a survivable crash, the load factors may be increased to just below failure. Continuing the example above, we could expect to stroke the gear at a 5.25 to 5.5 cg load factor. Using this value and an available travel of 32 inches, we can solve for the aircraft velocity at fuselage contact by the following method:

Initial Kinetic Energy + Potential Energy Change - Landing Gear Work = Final Kinetic Energy

$$V_i^2/2g + (1-LR)(\Delta_T + \Delta_A) - N_g (\eta_T \Delta_T + \eta_A \Delta_A) = V_F^2/2g$$

Where

V_i = Initial Contact Velocity
 V_F = Final Contact Velocity

Solving for V_F yields

$$V_F = 2g[V_1^2/2g + (1-LR)(\Delta_T + \Delta_A) - N_g(n_T\Delta_T + n_A\Delta_A)]$$

Substituting Typical Values gives

$$V_F = 2(32.3)\{(42)^2/[2(32.3)] + (1-2/3)(.33+32/12) - (5.25-2/3)[.44(.33) + .85(32/12)]\}$$

$$V_F = 33.41 \text{ Ft/Sec.}$$

or the landing gear would absorb 40 percent of the initial drop energy. This energy could be absorbed without adding stroke or strengthening the gear or structure beyond the requirements of the high sink speed landing. There would need to be modifications to the energy absorbing mechanism to allow for the higher sink speed. If airframe crushing and seat stroking capability were adequate to absorb the remaining energy, there would be very little penalty involved in adapting a gear with 20-ft/sec capability for the 42-ft/sec condition. If additional energy capability is needed in the gear, the vertical travel or load factor can be increased, but at the cost of additional weight in the gear and local backup structure.

Paragraph 7.3.1 Wheel Landing Gear

PROPOSED TEXT

The methodology for designing a strut-wheel landing gear delineated below is that contained in Reference 27 with some modification.

The typical oleo strut-wheel landing gear is essentially an air-oil hydraulic cylinder as shown in Figure 73, which schematically represents one stage of the landing gear illustrated in Figure 32. The cylinder is pressurized with an air pressure that balances the static loads of the vehicle and the dynamic loads during taxi. The air trapped within the cylinder follows the laws governing compressibility of a gas in a closed container that are simply described by

$$P_1 V_1^n = P_2 V_2^n$$

where P = pressure of the gas (lb/in.²)
 V = specific volume (in.³/lb_m)

The subscripts 1 and 2 define the initial and final states of the gas, respectively, and the exponent n defines the nature of the process between states 1 and 2.

During taxi, the vehicle rides on an air cushion. Since the temperature of the air within the cylinder remains essentially constant during taxi, the process can be considered isothermal and n is approximately 1. *However, during impact conditions the small time available for heat transfer from the rapidly compressed air ensures a nearly adiabatic process, for which n = 1.4.*

The rapid air compression that occurs during a landing allows very little time for heat transfer, so the air compression exponent is closer to the adiabatic value of 1.4. The value of the exponent will vary depending on the rate of compression and the design of the oleo, especially whether the oil and air are in contact with each other or divided by a separator piston. Typical values in use in industry for the air compression exponent are 1.2 to 1.25. It is common practice to plot a static and dynamic air curve for the oleo.

The hydraulic portion of the cylinder functions to limit loads during impact conditions. The high stroking rate of the gear is limited by the pressure generated in the oil as it is forced through the orifice, rather than by air pressure. As the fluid is forced through the orifice, the pressure in the cylinder is defined in Bernoulli's principle for an ideal fluid. The hydraulic force becomes

$$F_h = \frac{\rho A_h^3 \dot{S}^2}{2(G_d A_n)^2}$$

Where ρ = density (lb_m/in.³)

A_h = hydraulic area of the piston (in.²)

\dot{S} = stroke velocity (in./sec)

G_d = orifice coefficient

A_n = orifice area (in.²)

This equation is an approximation of the oleo hydraulic force because it assumes an incompressible fluid and infinitely stiff inner and outer cylinders. In actual practice, there is significant oil compression. Typical values would be oil with a bulk modulus of 100,000 psi which would compress 2 percent at 2000 psi applied pressure. This compressibility effect is most noticeable at the beginning and end of the oleo stroke. At the beginning of the stroke, the pressure above the orifice rises very rapidly with a corresponding compression in the oil above the orifice. This reduces the oil flow through the orifice until the oil has been compressed. At the end of the oleo stroke, oil compression strongly affects the air load in the strut. For example, with a bulk modulus of 100,000 psi, a compressed pressure 2000 psi greater than initial pressure and an oil volume 10 times the air volume, the resulting 2 percent change in oil volume would produce a 20-percent change in air volume with a corresponding pressure change. Cylinder expansion under pressure produces similar, but smaller, effects.

29
F

The hydraulic force basic equation indicates the reason that oleo landing gears without crashworthy features often fail in a high sink speed landing. Since the hydraulic force is proportional to the square of the piston closure velocity, a landing at sink speeds very much above the design sink speed will cause high enough loads to fail the oleo or its attachment to the structure. There is a common misconception that the oleo "locks up" or becomes a "rigid link" without stroking under this condition. Examination of the basic equation shows that this cannot occur. A "locked up" or "rigid" oleo implies high loads and no motion, but the oleo must be stroking at well above the design closure velocity to develop high enough loads to fail the landing gear. This misconception is probably due to the fact that gear failure occurs before the oleo has stroked very far. This is because the oleo closure reaches its highest value very early in the stroke. If the sink speed is excessive, the load reaches the failure load and the gear fails without much stroking distance covered, but the oleo is stroking at a high velocity at failure.

In a satisfactory crashworthy landing gear installation, some method must be used to reduce the oleo hydraulic load to below failure levels until the gear has stroked the required amount. There are two fundamental methods of accomplishing this. The hydraulic force may be reduced by increasing the effective orifice area or by reducing the oleo closure velocity. Both methods could be used in a single gear assembly.

Increasing the effective orifice area is normally accomplished by adding an auxiliary orifice in the piston head. This allows additional oil flow from the upper to the lower chamber, thereby reducing the hydraulic force in the oleo. This auxiliary orifice is sized in the same manner as the main orifice so a desired hydraulic load is produced at the design crash oleo closure velocity. The auxiliary orifice may be a blowout type that will blow a plug out of the auxiliary orifice when a predetermined pressure differential across the orifice is reached. This is the equivalent of a plain orifice, since once the blowoff plug functions, the auxiliary orifice area remains constant for the rest of the stroke. This will produce a significant drop in hydraulic force as the closure velocity drops during the stroke. Another, usually better, method is a spring-loaded auxiliary orifice in the piston head. This consists of an orifice with a spring loaded plug that progressively opens once a predetermined differential pressure is exceeded. The advantage of this approach is the capability of the auxiliary orifice to open or close as the differential pressure increases or decreases. This holds a more constant hydraulic force than can be achieved with a constant orifice. Another approach is to place the auxiliary orifice between the upper chamber and the exterior of the oleo. The orifice must dump into some type of container to avoid dumping flammable oil into the atmosphere. This approach will give different oleo loads, since oil is being removed from the oleo and this will reduce the amount of air compression for a given piston displacement.

29
B

The second fundamental method for limiting the oleo load is to reduce the oleo closure velocity. This may be done by adding a device in series with the oleo to allow the oleo outer cylinder to stroke relative to the airframe. This allows the outer cylinder to move away from the piston to reduce the effective closure velocity. Typical devices are tube crushing or tube cutting units between the oleo and structure. This type of device strokes at a constant load independent of velocity so the airframe will see a constant "oleo" load. Devices of this type are commonly called load limiters or energy-absorbing devices (EAD). The stroking velocity of the EAD will be the difference in the closure velocity of the piston relative to the airframe and the oleo closure velocity required to develop an oleo load equal to the EAD load. For example, if the overall closure velocity is 42 ft/sec and the oleo will develop the desired load at 30 ft/sec,

the EAD would stroke at 12 ft/sec. As the overall closure velocity is reduced to 35 ft/sec during the crash, the EAD stroking velocity would drop to 5 ft/sec. In general, the oleo stroke will be four to five times the EAD stroke. It should be noted that a constant oleo/EAD load may not produce a constant net vertical load into the airframe. A trailing arm gear with a varying mechanical advantage will not produce a constant net vertical load for a constant oleo load.

This applies to a single-stage strut without any blow-off capability. If a blow-off valve is incorporated, as discussed in Section 6.5, by sizing the orifice, the strut can be designed to stroke at high velocity levels and high load values. The incorporation of a variable orifice offers even more control over the load-stroke relationship and allows more energy to be absorbed, as illustrated in Section 6.5. The landing gear cylinder also resists motion through bearing frictional forces that act upon the piston.

The cylinder is supported to resist lateral loads associated with both operational and crash conditions.

All of the landing gear systems reviewed have some of the design features mentioned. Many variations are possible. The orifice usually is combined with a metering pin to adjust the orifice area with stroke length. Orifice and relief valve combinations are used to introduce orifice variations as a function of the force. Some liquid springs have been used where the function of the air pressure is replaced by compression of a fluid. These are a few of the possible variations that produce desirable refinements of the response but do not alter the basic characteristics of the landing gear.

The approach to the design of the particular landing gear is discussed here to demonstrate the various steps leading to a finished piece of hardware. The major airframe manufacturer generates a set of criteria for the landing gear design subcontractor. These are the appropriate military specifications, preliminary weight estimates, moments of inertia, center-of-gravity locations, landing gear stroke requirements, and vehicle attitudes.

If the energy relation is used, the sink rate, gross weight, and strut efficiency are needed to calculate a load factor. This is calculated for forward and aft centers of gravity, as well as for selected attitudes such as level two-point, level three-point, and tail

down. The attitude is important because it modifies the stroke of the strut. It is assumed that the vehicle falls vertically, but the strut compresses along its axis. The output from the energy equation is the load factor.

There are several phases involved in the design of a landing gear installation. The initial phase is developing a design concept. This involves identifying the most significant requirements for the gear, obtaining the critical aircraft characteristics and roughing out the number and type of gears, their location on the aircraft, and the basic geometry of the individual gears. Key items in this process include determining the permissible load factors for normal, high sink speed, and crash landings. These can be used, with assumed efficiencies for the gear or any auxiliary energy absorbers, to calculate the required vertical axle travels. A method for this calculation is described in Section 6.5 of this report. The location of the gear is based on turnover angle and air transportability requirements, the need for the individual gears to be located near the pitch and roll centers of percussion, and the location of adequate structure for gear attach points. When the location has been established, static loads can be calculated and tire sizes can be selected. Tire size will often be decided by the need for a low pressure tire to allow towing on soft ground. At this point, the individual gear type and basic geometry can be established. This includes the definition of wheel travel, airframe attach points, oleo attach points, etc., as required to define the gear installation. Obviously, this process involves many conflicting requirements and often requires several iterations to reach an acceptable configuration. The conceptual design will be established by the aircraft prime contractor, although sometimes a landing gear company may assist in the configuration development.

The next step in the design process is developing a preliminary design. This may be done either by the airframe prime contractor or by a landing gear company. This process consists of sizing out the various elements of the gear and developing preliminary loads. It may be done either by manual or computer-aided design methods. There are no general-use landing gear design and analysis programs, but several companies have proprietary computer programs for design and analysis of landing gear. There will be some variation on the design process depending on the company and the analytical tools available to them, but essentially the same process will be followed with

the main difference being the level of analysis at a particular stage in the development of the gear. The development of a trailing arm air-oil helicopter wheel-type landing gear is described below as an example of a typical preliminary design effort.

The process would start with a check of the geometry from the conceptual design. This check would include calculating the gear mechanical advantage over the entire travel and calculating piston stroke corresponding to static, fully compressed, and crash wheel travels. The geometry would be modified until an acceptable mechanical advantage is obtained. Oleo diameters would be calculated based on static and fully compressed pressures and by standard seal sizes. Air and oil volumes and air pressure are calculated by using the piston stroke, desired pressure static and fully compressed, and allowances for bearing overlap, sufficient oil between the orifice and the air piston, spacers, etc. The oleo attach bearings and lugs are sized based on maximum oleo loads, and provisions will be made for an in-series energy absorbing device if required. The oleo length can now be calculated and compared to the geometric length available from the basic geometry of the gear. Usually there will be enough difference in the calculated oleo length and the geometric length available that either the oleo or the geometry must be adjusted.

Tires, wheels, and brakes are selected with static load, estimated maximum landing load, soft ground towing load and design braking speed the major sizing factors. The axle, trailing arm, and trailing-arm-to-airframe bearings are sized based on estimated applied loads for the various landings and ground handling conditions. Landing loads would typically include normal landings, obstruction loads, high sink speed landings, and crash conditions. These include side and drag loads due to pitch and roll attitudes. Typically, about 15 load conditions would be used with the tire load calculated from static load multiplied by estimated ground load factor and this increased by an additional factor to allow for the individual gear's load increase in a pitched, rolled landing. Loads would be developed for gear positions from fully extended to fully compressed with any crash overtravel included. This will usually be five or six positions including static. Then several sections on the axle, trailing arm and arm-to-fuselage attach hardware are checked for stress for each loading condition. This will usually be 10 to 12 sections checked. The critical section stresses will be checked against allowables and the

design modified until an acceptable design is obtained. Some design optimization may be done at this time.

With the design established, weights and inertias can be calculated. A first cut metering pin can also be estimated by assuming a constant deceleration during the gear stroke, solving for the oleo closure velocity at a travel corresponding to the desired metering pin break point, subtracting the air load from the desired oleo load to obtain the oil damping load required, and solving the hydraulic force equation for orifice area.

With the gear configuration defined, it is possible to develop the dynamic characteristics of the gear. The metering pin configuration can be checked and modified as required by using a computer program to simulate a jig drop of an individual landing gear. This is a simulation of a conventional jig drop where a single gear is mounted on a weighted carriage which is installed on a vertical track. The carriage is dropped from a sufficient height to reach the desired sink speed at impact. The computer program or a jig drop program are both used in the same manner. The gear is dropped at a given weight, sink speed, and attitude; the loads and travels are recorded; and the maximum values and efficiency are compared to the desired values. The metering pin is modified and the gear is redropped until satisfactory values are obtained.

The process described above is repeated for the main and auxiliary gear, and gear characteristics are combined with the helicopter characteristics to form a helicopter drop dataset. This dataset is used as input for the helicopter landing computer program. The helicopter model will be dropped at the different required drop conditions to produce time histories and maximum values for tire and oleo loads and deflections; helicopter pitch and roll accelerations; velocities and angles; and cg load factors. These values are compared to the assumed values used in sizing the gears. If the comparison is not satisfactory, it is necessary to iterate back through the sizing and drop process.

It is also necessary that the gear be checked for the crash conditions, but crash modeling requires modeling the fuselage and seat characteristics.