

HELICOPTER ICING REVIEW

17

AD A094175

LEVEL II

A. A. Peterson
L. U. Dadone

BOEING VERTOL COMPANY
A Division of the Boeing Company
P. O. Box 16858
Philadelphia, Pennsylvania 19142



DTIC
ELECT
JAN 20 1981
E

FINAL REPORT

SEPTEMBER 1980

Document is available to the U.S. public through
the National Technical Information Service,
Springfield, Virginia 22161.

Prepared for
U. S. DEPARTMENT OF TRANSPORTATION
FEDERAL AVIATION ADMINISTRATION
TECHNICAL CENTER
Atlantic City Airport, New Jersey

DDC FILE COPY

81 1 26 024

*

NOTICE

This document is disseminated under the sponsorship of the Department of Transportation in the interest of information exchange. The United States Government assumes no liability for the contents or use thereof.

The United States Government does not endorse products or manufacturers. Trade or manufacturer's names appear herein solely because they are considered essential to the object of this report.

<p>1. Report No. 18 19 FAA-CT-80-210</p>	<p>2. Government Accession No. AD-A094175</p>	<p>3. Recipient's Catalog No.</p>	
<p>4. Title and Subtitle 6 HELICOPTER ICING REVIEW.</p>		<p>5. Report Date 11 Sep 1980</p>	<p>6. Performing Organization Code</p>
<p>7. Author(s) 10 A. A. Peterson L. U. Dadone</p>		<p>8. Performing Organization Report No. 14 D210-11583-1</p>	<p>9. Performing Organization Name and Address Boeing Vertol Company A Division of The Boeing Company P.O. Box 16858 Philadelphia, Pennsylvania 19142</p>
<p>9. Performing Organization Name and Address Boeing Vertol Company A Division of The Boeing Company P.O. Box 16858 Philadelphia, Pennsylvania 19142</p>		<p>10. Work Unit No. (TRAIS)</p>	<p>11. Contract or Grant No. 15 DOT-FA78WA-4258</p>
<p>12. Sponsoring Agency Name and Address U.S. Department of Transportation Federal Aviation Administration Technical Center Atlantic City Airport, New Jersey 08405</p>		<p>13. Type of Report and Period Covered 9 Final Report. 30 Sep 78 - 31 Jul 80</p>	
<p>14. Sponsoring Agency Code</p>			
<p>15. Supplementary Notes</p>			
<p>12 249</p> <p>16. Abstract The development of techniques and criteria permitting the release of a helicopter into known (i.e., forecast) icing situations is actively being investigated by both military and civilian agencies through ongoing test programs and study efforts. As part of this overall effort, helicopter icing characteristics, available ice protection technology, and test techniques are discussed in this technical treatment. Recommendations are provided in the areas of icing certification procedures and icing research.</p> <p>One of the key issues addressed in this report is the test environment, i.e., the use of inflight evaluation in natural icing only, or, the use of a simulated icing environment to supplement and/or expand the certification envelope. Involved in this issue is the shape (and extent) of the rotor ice (natural vs simulated) as it affects the aerodynamics and dynamics of the rotor system, together with the shedding characteristics as it affects the behavior and safety of the complete vehicle.</p>			
<p>17. Key Words Helicopter Ice Protection Icing Certification Icing Environment Icing Research Rotor Icing</p>		<p>18. Distribution Statement Document is available to the U.S. public through the National Technical Information Service, Springfield, Virginia 22161</p>	
<p>19. Security Classif. (of this report) Unclassified</p>	<p>20. Security Classif. (of this page) Unclassified</p>	<p>21. No. of Pages</p>	<p>22. Price</p>

403682

METRIC CONVERSION FACTORS

Approximate Conversions to Metric Measures

Symbol	When You Know	Multiply by	To Find	Symbol
LENGTH				
in	inches	2.5	centimeters	cm
ft	feet	30	centimeters	cm
yd	yards	0.9	meters	m
mi	miles	1.6	kilometers	km
AREA				
sq ft	square inches	6.5	square centimeters	cm ²
sq ft	square feet	0.09	square meters	m ²
sq yd	square yards	0.8	square meters	m ²
sq mi	square miles	2.6	square kilometers	km ²
acres	acres	0.4	hectares	ha
MASS (weight)				
oz	ounces	28	grams	g
lb	pounds	0.45	kilograms	kg
	short tons (2000 lb)	0.9	tonnes	t
VOLUME				
tsp	teaspoons	5	milliliters	ml
Tbsp	tablespoons	15	milliliters	ml
fl oz	fluid ounces	30	milliliters	ml
c	cups	0.24	liters	l
pt	pints	0.47	liters	l
qt	quarts	0.96	liters	l
gal	gallons	3.8	liters	l
ft ³	cubic feet	0.03	cubic meters	m ³
yd ³	cubic yards	0.76	cubic meters	m ³
TEMPERATURE (exact)				
°F	Fahrenheit temperature	5/9 (after subtracting 32)	Celsius temperature	°C

*1 in. = 2.54 exactly. For other exact conversions, including area and volume, see NBS Monograph 168, Units of Weights and Measures, Price \$2.25, SD Catalog No. C-111-290.

Approximate Conversions from Metric Measures

Symbol	When You Know	Multiply by	To Find	Symbol
LENGTH				
mm	millimeters	0.04	inches	in
cm	centimeters	0.4	inches	in
m	meters	3.3	feet	ft
km	kilometers	1.1	yards	yd
		0.6	miles	mi
AREA				
cm ²	square centimeters	0.16	square inches	in ²
m ²	square meters	1.2	square yards	yd ²
km ²	square kilometers	0.4	square miles	mi ²
ha	hectares (10,000 m ²)	2.5	acres	acres
MASS (weight)				
g	grams	0.035	ounces	oz
kg	kilograms	2.2	pounds	lb
t	tonnes (1000 kg)	1.1	short tons	short tons
VOLUME				
ml	milliliters	0.03	fluid ounces	fl oz
l	liters	2.1	pints	pt
l	liters	1.06	quarts	qt
l	liters	0.26	gallons	gal
m ³	cubic meters	35	cubic feet	ft ³
m ³	cubic meters	1.3	cubic yards	yd ³
TEMPERATURE (exact)				
°C	Celsius temperature	9/5 (then add 32)	Fahrenheit temperature	°F

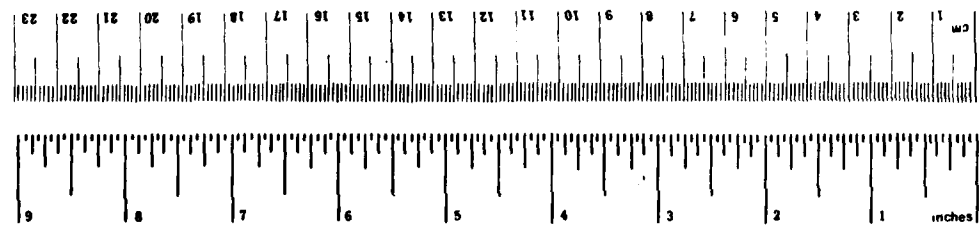
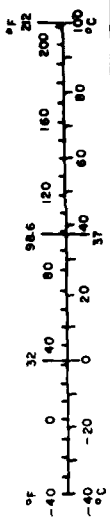

TABLE OF CONTENTS

<u>SECTION</u>		<u>PAGE</u>
1.0	INTRODUCTION, SUMMARY AND CONCLUSIONS	1
1.1	INTRODUCTION	1
1.2	SUMMARY	2
1.3	CONCLUSIONS	6
2.0	TECHNICAL DISCUSSION	7
2.1	HELICOPTER CHARACTERISTICS IN ICING ENVIRONMENT	8
2.1.1	Icing Experience	9
2.1.2	Helicopter Flow Field	18
2.1.3	Rotor Environment	23
2.1.4	Airfoil Ice Documentation	26
2.2	CERTIFICATION CONSIDERATIONS	31
2.2.1	Meteorological Review	32
2.2.2	Current Standards	41
2.2.3	Recommended Icing Certification Environment	55
2.2.4	Primary Certification Factors	58
2.2.5	Recommended Helicopter Icing Certification Test Procedure	68
2.3	ICE PROTECTION TECHNOLOGY	75
2.3.1	Types of Systems	76
2.3.2	Design Factors	109
2.4	AIRFOIL ICING ASSESSMENT	109
2.4.1	Typical Fixed Wing Data	109
2.4.2	Applicable Rotor Data	111
2.4.3	Evaluation of the Impact of Ice Accumulation	114
2.5	DESIGN APPROACH	117
2.5.1	Major Icing Consideration Areas	121
2.5.2	General Approach	122
2.5.3	Summary of Design Considerations	124
2.6	ICE PROTECTION CONCEPTS	125
2.6.1	Composite Rotor Deicing	128
2.6.2	Ice Protection Concept Categories	128

<u>SECTION</u>		<u>PAGE</u>
2.7	ICE MEASURING INSTRUMENTATION	135
2.7.1	Current Ice Detector Systems	137
2.7.2	Current Water Droplet Measurement	139
3.0	CONCLUSIONS	144
4.0	RECOMMENDATIONS	147
4.1	ICING CERTIFICATION ENVIRONMENT	147
4.2	ICING CERTIFICATION TEST PROCEDURE	147
4.3	ADVISORY CIRCULAR FOR HELICOPTER ICE PROTECTION	148
4.4	INTERIM ICING CLEARANCE CONSIDERATIONS	148
4.5	BASIC ICING RESEARCH	148
4.6	ANALYTICAL TOOL DEVELOPMENT	149
4.7	ICING ENVIRONMENT SIMULATION	150
5.0	REFERENCES	151
Appendix A -	Helicopter Icing Spray System (HISS) Improvement Program	A-1
Appendix B -	Draft Advisory Circular - Helicopter Ice Protection	B-1
Appendix C -	Airfoil Characteristics	C-1

LIST OF ILLUSTRATIONS

<u>FIGURE</u>	<u>TITLE</u>	<u>PAGE</u>
1-1	INTERACTION BETWEEN EACH ITEM WITHIN TECHNICAL DISCUSSION SECTION	3
1-2	ROTOR ICING FACTORS	5
2-1	POTENTIAL OPERATIONAL ICING ENVELOPE	12
2-2	AERODYNAMIC INTERACTIONS	19
2-3	GROUND VORTEX	20
2-4	ROTOR DOWNWASH CHARACTERISTICS	21
2-5	ROTOR ENVIRONMENT - HOVER	24
2-6	ROTOR ENVIRONMENT - FORWARD FLIGHT	25
2-7	KEY LIFT COEFFICIENT AND MACH NUMBER COMBINATIONS	27
2-8	ROTOR CONTOUR PLOT	28
2-9	ROTOR CONTOUR PLOT	29
2-10	ROTOR CONTOUR PLOT	30
2-11	FAR PART 25 ICING LEVEL DEFINITIONS	34
2-12	ICING INTENSITIES AND RATES OF ACCRETION DEVELOPED FROM MEASURED ICING DATA	36
2-13	PROPERTIES OF STRATIFORM CLOUDS	38
2-14	PROPERTIES OF CUMULIFORM CLOUDS	39
2-15	CUMULIFORM CLOUD DISTRIBUTION	40
2-16	CLOUD LIQUID WATER CONTENT LIMITS AT LOW ALTITUDES	42
2-17	ICING LEVEL DEFINITIONS PER TR-75-34A	45
2-18	ICING ENVELOPE COMPARISON	46
2-19	20 MICRON ICING ENVELOPE BELOW 10,000 FEET	47
2-20	COMPARISON OF SPECIFICATION ICING CRITERIA	48
2-21	DERIVATION OF FAR ICING STANDARDS	51

LIST OF ILLUSTRATIONS (Continued)

<u>FIGURE</u>	<u>TITLE</u>	<u>PAGE</u>
2-22	MILITARY SPECIFICATION PATH	54
2-23	TYPICAL FIXED-WING PROTECTION	94
2-24	TYPICAL FIXED-WING PROTECTION	95
2-25	APPLICABILITY OF FIXED-WING DATA BASE TO HELICOPTERS	96
2-26	TYPICAL COMPOSITE ROTOR BLADE CONSTRUCTION WITH ELECTRO-THERMAL DEICING BLANKET	97
2-27	ENGINE INLET BLEED AIR ANTI-ICING SYSTEM	98
2-28	ENGINE COMPRESSOR BLEED EXTRACTION PENALTIES	101
2-29	INDUCTION SYSTEM LOSSES UNDER ICING CONDITIONS	102
2-30	METAL D-SPAR ROTOR DEICE THERMAL ANALYSIS	105
2-31	COMPOSITE ROTOR DEICE THERMAL ANALYSIS	106
2-32	TYPICAL ROTOR BLADE DEICING SYSTEM CONTROL SCHEMATIC	107
2-33	EFFECTS OF ICE SHAPE	110
2-34	DRAG RISE DUE TO LEADING EDGE DISTURBANCE	112
2-35	EFFECT OF PITCHING MOMENT ON ROTOR LOADS	113
2-36	EFFECT OF SURFACE ROUGHNESS ON LOSS IN MAXIMUM LIFT CAPABILITY	115
2-37	AIRFOIL DRAG DUE TO ICE	116
2-38	EVOLUTION OF TWO ENGINE INLET SYSTEMS	126
2-39	ICE PROTECTION SYSTEM PARAMETERS	127
2-40	ROSEMOUNT ICE DETECTOR	138
2-41	LEIGH ICE DETECTOR	140
2-42	NORMALAIR-GARRETT ICE DETECTOR	141
2-43	UNITED CONTROLS ICE DETECTOR	142
2-44	JOHNSON-WILLIAMS LIQUID WATER CONTENT INDICATOR	142

LIST OF ILLUSTRATIONS (Continued)

<u>FIGURE</u>	<u>TITLE</u>	<u>PAGE</u>
2-45	LASER SPECTROMETERS	143

LIST OF TABLES

<u>TABLE</u>	<u>TITLE</u>	<u>PAGE</u>
2-1	METEOROLOGICAL FACTORS FOR CONSIDERATION IN THE DESIGN OF AIRCRAFT ICE PREVENTION EQUIPMENT	37
2-2	FREEZING RAIN AND LOW ALTITUDE ICING ENVIRONMENT.	43
2-3	ICING ENVIRONMENT REFERENCE	44
2-4	RECOMMENDED ICING ENVIRONMENT	56
2-5	TEST ICING CONDITIONS	61
2-6	TYPICAL RECIPROCATING ENGINE POWERED AIRCRAFT INSTALLATION.	77
2-7	TYPICAL TURBOPROP POWERED AIRCRAFT INSTALLATION	78
2-8	TYPICAL TURBOJET/TURBOFAN POWERED AIRCRAFT INSTALLATION.	79
2-9a	TYPICAL HELICOPTER ROTOR GEOMETRY	80
2-9b	TYPICAL HELICOPTER ICE PROTECTION	84
2-9c	TYPICAL HELICOPTER FLIGHT MANUAL ICING RESTRICTIONS	89
2-10	ROTOR ICING EVALUATION REQUIREMENTS	118
2-11	ACTIVE ICE PROTECTION CONCEPTS.	128
2-12	PASSIVE ICE PROTECTION CONCEPTS	132

LIST OF SYMBOLS

A	Rotor disc area	Ft ²
b	Number of blades	
c	Blade chord	Ft
C_l	Blade element lift coefficient, $\frac{\text{Lift}}{qc}$	
C_m	Blade element pitching moment coefficient about the quarter chord, $\frac{\text{Moment}}{qc^2}$	
C_d	Blade element profile drag coefficient, $\frac{\text{drag}}{qc}$	
C_p	Pressure coefficient, p/q	
C_P	Rotor power coefficient, $P/\rho\pi R^2 V_T^3$	
C_T/σ	Rotor thrust coefficient, $T/\sigma\rho AV_T^2$	
C_T'/σ	Rotor lift coefficient, $L/\sigma\rho AV_T^2$	
D	Rotor diameter	Ft
k	Reduced frequency parameter, $\frac{c\Omega}{2\bar{v}}$	
M	Mach Number	
P	Rotor power	HP
p	Static pressure	lb/in ²
q	Dynamic pressure, $\frac{1}{2}\rho V^2$	lb/ft ²
r	Blade radial station	Ft
R	Blade radius	Ft
Rn	Reynolds Number based on chord, $\frac{cv}{\nu}$	

V	Free stream velocity	Ft/sec
V_T	Rotor tip speed	Ft/sec
x	Blade element chordwise location measured from leading edge	in.
X	Rotor propulsive force	lbs
\bar{X}	Rotor propulsive force coefficient, $X/qd^2\sigma$	
y	Blade element surface location measured perpendicular to chord line	in.
μ	Advance ratio, V/V_T	
α	Blade element angle of attack	deg
α_s	Rotor shaft angle	deg
α_{TPP}	Rotor tip path plane angle $\alpha_s - \beta_{ic}$	deg
β	Blade flapping angle	deg
ρ	Density of air	slugs/ft ³
σ	Rotor solidity, $\frac{bc}{\pi R}$	
ν	Kinematic viscosity	ft ² /sec
ψ	Blade azimuth angle	deg
Ω	Rotor speed	rad/sec

1.0 INTRODUCTION, SUMMARY AND CONCLUSIONS

The development of techniques and criteria permitting the release of a helicopter into known (i.e., forecast) icing situations is actively being investigated by both military and civilian agencies through ongoing test programs and study efforts. As part of this overall effort, a study of helicopter icing characteristics, available ice protection technology, and test techniques has been accomplished under the Federal Aviation Administration (FAA) contract DOT-FA78WA-4258.

1.1 INTRODUCTION

The intent of this study is to provide a technical treatment of helicopter icing including certification recommendations and operational approval recommendations. Related documents, U.S. Army Air Mobility Research and Development Laboratory (a) (USAAMRDL) TR-73-38 and TR-75-34A (References 1 and 2) develop criteria for military helicopter ice protection systems. Earlier documents, FAA Technical Report ADS-4 (Reference 3) and Advisory Circular (AC) 20-73 (Reference 4) are directed primarily toward fixed-wing aircraft icing requirements with only brief discussions of helicopter icing problems.

Currently, Federal Aviation Regulations (FAR) (Reference 5) Parts 27 and 29 address primarily the rotorcraft induction system ice protection and refer to FAR Part 25 Appendix C for the icing envelope definitions. Neither Part 27 nor Part 29 define the method of compliance for rotorcraft ice protection. Part 29 addresses rotorcraft ice protection with a general statement "The Rotorcraft must be able to operate safely through the range of icing conditions for which certification is requested." Two key issues not addressed in the FAR (but being considered in proposed FAR changes) are:

- o The helicopter icing envelope
- o The method of compliance

A discussion of these issues, and the associated recommendations are presented herein.

- (a) NOW: Applied Technology Laboratory U.S. Army Research and Technology Laboratories (AVRADCOM)

The overall subject of the icing environment and of the helicopter characteristics within this environment is a technical field with many questions and phenomena requiring continuing research by Industry and Government. This study examines available research results and analytical approaches as a basis for the recommendations presented in the areas of basic icing research, simulation techniques and analytical tool development.

Figure 1-1 illustrates the interaction between the items within the technical discussion (Section 2.0) and shows the flow-path leading to the recommendations presented in Section 4.0 and the appendices of this report.

Appendix A contains an outline of the Helicopter Icing Spray System (HISS) Improvement Program effort accomplished during October 1979 in the National Aeronautics and Space Administration (NASA) Lewis Research Center (Cleveland, Ohio) Icing Research Tunnel. This Appendix is included as part of this report to illustrate one of the parallel joint U.S. Army and FAA efforts to improve Helicopter Inflight Icing Simulation.

Appendix B contains a draft of a recommended advisory circular for helicopter ice protection. This draft is modeled in similar format to the Advisory Circular (AC) 20-73 for aircraft ice protection. As noted earlier, AC 20-73 addresses primarily fixed-wing aircraft icing.

Appendix C contains a technical discussion of airfoil aerodynamic characteristics and the prediction methods used to determine the effects of ice on the airfoils. This appendix provides an expansion of the rotor environment (Section 2.1.3) and airfoil icing assessment (Section 2.4) portions of this report.

1.2 SUMMARY

Helicopter icing occurs primarily at ambient temperature below 0°C (some engine inlet configurations may ice at ambients slightly above 0°C) in weather systems containing liquid water (free moisture) clouds, snow, freezing rain/drizzle in independent or combined (mixed) zones. Snow and/or ice crystals may be found mixed within icing cloud formations thus introducing an icing condition not easily categorized by the standard meteorological definitions. Snow conditions may exist in several forms including mixtures within a cloud, falling below a cloud, and recirculating from the ground.

The most susceptible helicopter surfaces to icing within a cloud are the leading edge of the rotor, and small radius surfaces such as control surfaces/linkages, engine/engine inlets, stabilizers, antenna, pitot probes, secondary inlets/screens, and vent/drain lines. Icing due to freezing rain/drizzle may occur at and aft of leading edge surfaces due to the impingement and runback of the associated large water droplets. Snow and/or ice crystals can present major problems for engine inlet installations (particularly screened and/or submerged configurations). The rotor

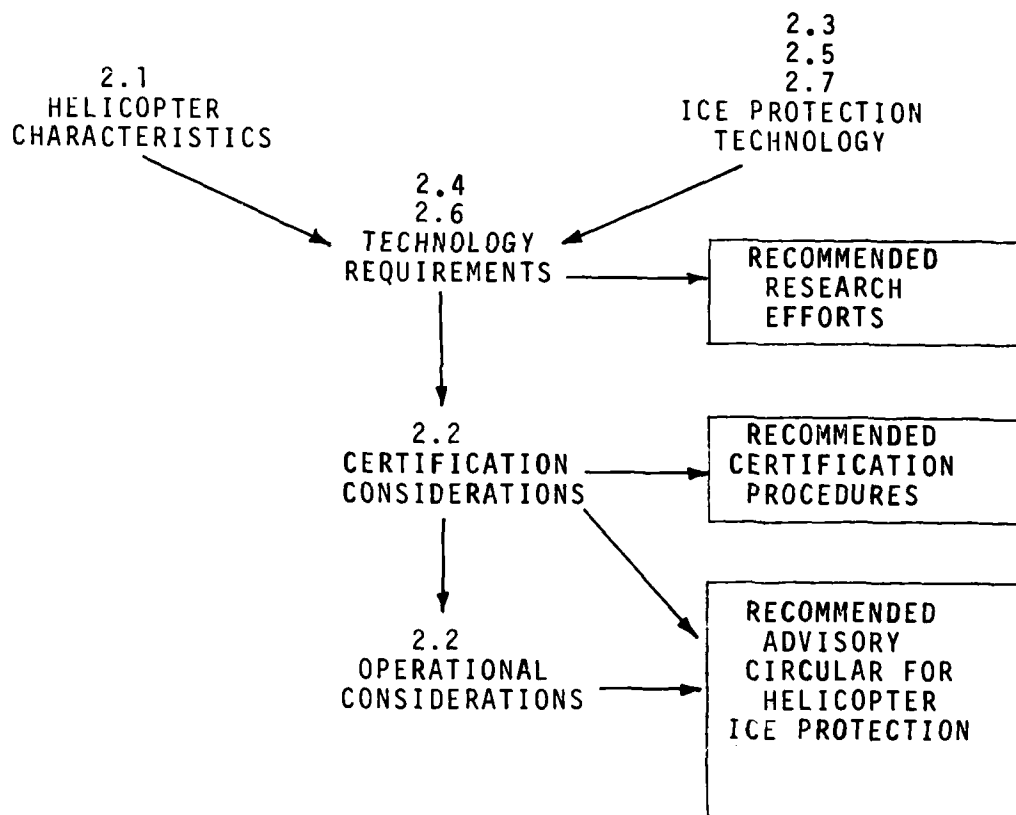

FIGURE 1-1 INTERACTION BETWEEN EACH ITEM
WITHIN THE TECHNICAL DISCUSSION
SECTION

system presents unique icing problems compared to fixed airfoils because of the rotation, angle of attack changes, high catch efficiency, impact of rotor dynamics on control loads, and ice shedding trajectories. Figure 1-2 illustrates the general rotor icing factors to be considered in the evaluation of the rotor system.

One of the key issues in an icing certification program, because of the rotor system, is the test environment, i.e., the use of in-flight evaluation in natural icing only, or, the use of a simulated icing environment to supplement and/or expand the certification envelope. This issue centers around both the shape (and extent) of the rotor ice (natural vs simulated) as it affects the aerodynamics and dynamics of the rotor system, together with the shedding characteristics as it affects the behavior and safety of the complete vehicle.

Existing icing test facilities (icing wind tunnels, hover and inflight spray rigs) have shortcomings in areas affecting the helicopter icing evaluation, in particular, evaluation of rotor icing and rotor ice protection systems. The major limitation of the complete helicopter (hover and in-flight) test facilities lies generally in the inability to immerse the entire helicopter in a uniform cloud (i.e. cloud with constant liquid water content cross-section). The control capability and repeatability of these facilities, however, makes use of them necessary because of the time consuming problem of locating natural icing (particularly the higher liquid water contents required in the intermittent maximum range) within the normal upper range of operating altitudes (10,000-15,000 feet) for most helicopters and difficulty in obtaining repeatable icing conditions.

The issue of the test environment becomes even more important if consideration is to be given to an interim icing clearance. Recognizing that the current FARs make no specific provisions for an interim icing clearance (i.e. a clearance limiting altitude, ambient temperature, icing intensity, VFR ceiling, or time in icing), a case may be made for a clearance based on the normal limited range usage of a helicopter as compared to fixed wing transport aircraft.

The interim icing clearance can be conceived in three basic parts each varying in present capability to forecast:

- o Altitude - (The altitude can be easily specified and if the helicopter is not in a controlled zone the pilot has the ability to alter altitude).
- o Temperature - (The temperature range can be forecast within a limited area and the normal limited helicopter range reduces the time factor in the forecast).
- o Liquid Water Content - (The most difficult parameter to forecast and the most difficult to obtain in the test environment required to explore helicopter capability at limits. However, in a specific geographic area the ability to forecast icing is improved due to continuing in-flight weather reporting, and knowledge of the frontal system patterns).

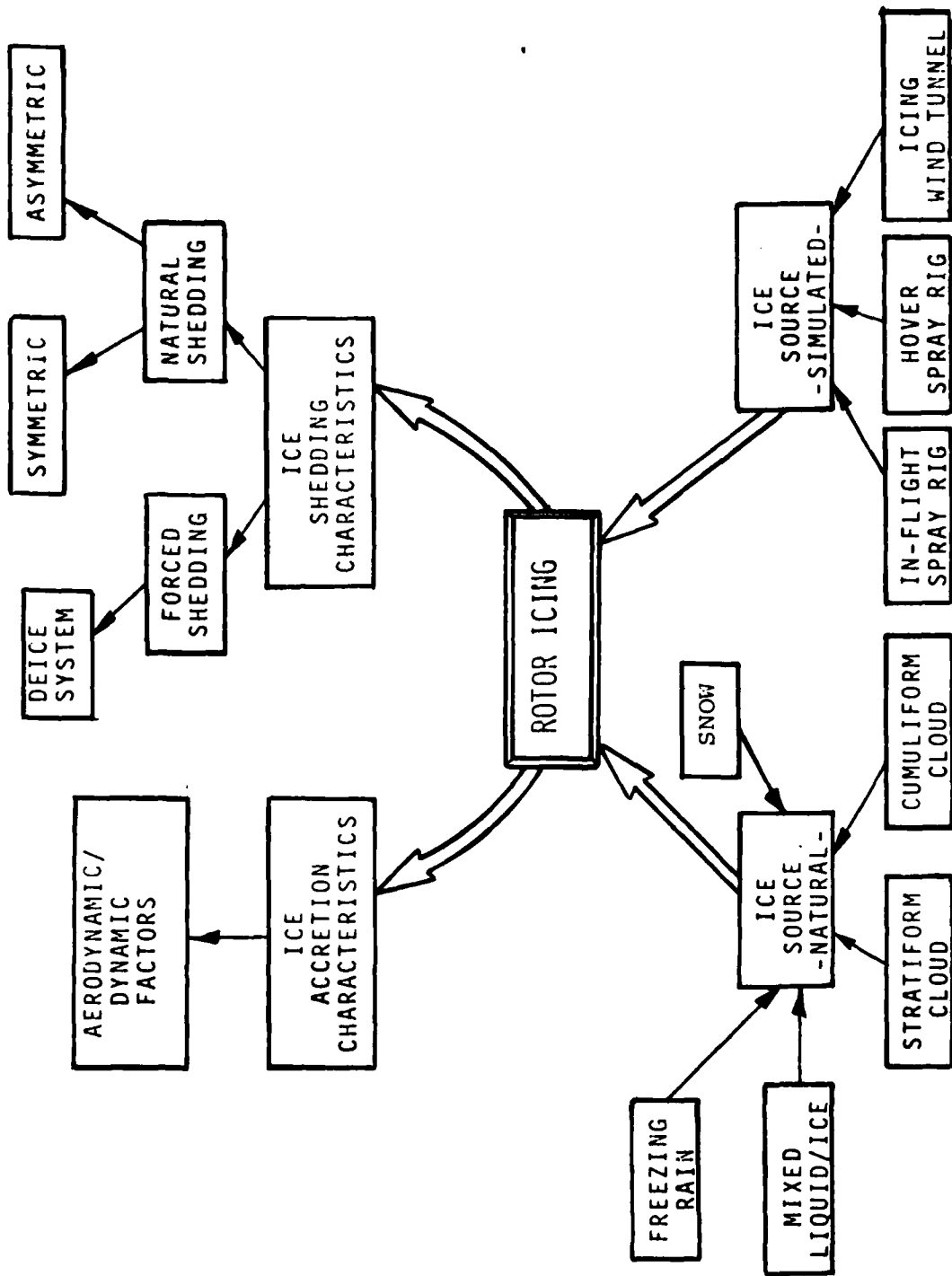

FIGURE 1-2. ROTOR ICING FACTORS

The British Civil Airworthiness requirements (BCAR) Paper 610 (Reference 6) (Proposal for inclusion into Section G - Rotorcraft) offers an approach to an interim helicopter icing certification... "In the event of insufficient demonstration being available at certification because of a lack of experimental facilities or the timely occurrence of natural icing conditions, the icing clearance of the rotorcraft will be limited so as to restrict its operation to those conditions for which it has been shown to be suitable..." This is not dissimilar to the current provisions of FAR 29.

Although current helicopter icing evaluations have indicated that, within a limited envelope, an interim clearance could be considered for a non-deiced (nonforced shedding) rotor system, satisfactory operation within the entire FAR icing envelope can only be accomplished with an ice-protected rotor. The only workable rotor ice protection system today, capable of providing protection over the full icing envelope, is electro-thermal deicing.

In summary, the major certification issues are:

- o Current interpretation of rotorcraft category FARs (Parts 27 and 29) icing certification requirements.
 - Definition of overall icing envelope.
 - Definition of critical test points.
 - Method of compliance.
- o Acceptable Test Environment
 - Natural icing only
 - Or combined natural and simulated icing environment.
- o Acceptable Test Data
 - Extent to which critical test points have been achieved
 - Acceptable instrumentation to verify icing test points
 - Acceptable instrumentation to verify helicopter performance
- o Allowable change (deterioration) in helicopter performance, handling, autorotation capability.

1.3 CONCLUSIONS

The major conclusions reached during the helicopter icing review are:

- o The rotor is the predominate system that differs between a helicopter and fixed-wing aircraft in terms of ice protection requirements and techniques.

- o Rotor icing presents a unique set of problems (aerodynamic and dynamic) that are not easily solvable through fixed-wing ice protection technology.
- o The helicopter icing environment and means to find or produce the environment is not clearly defined currently for certification applications. Section 2.2 presents a recommended approach to establishing a helicopter icing certification envelope and a recommended icing test procedure.
- o The definition of critical icing test points for certification, and the criteria for acceptance of the icing test data is not currently defined, however, recommendations are discussed in Section 2.2.
- o The definition of an acceptable test environment (i.e. natural icing only, or combined natural and simulated icing environment) is discussed in detail in Section 2.2. In general, there is a need to utilize the simulated icing environment to supplement and expand the icing results obtained in the natural environment.
- o To date, the electrothermal rotor deice system is the only rotor ice protection method capable of satisfactory operation under the full FAR icing envelope.
- o The existing icing test facilities (simulated icing environment) have many limitations (in terms of liquid water content range, droplet size, cloud size, airspeed range). However, maximum use of these facilities (and in particular upgraded versions of these facilities) is necessary to supplement and expand the natural icing test results.
- o Analytical tools currently exist for evaluating the aerodynamic and dynamic effects of rotor ice. Little use of these tools has been made to date because of the lack of correlating icing test data.

2.0 TECHNICAL DISCUSSION

The technical discussion of helicopter icing includes an evaluation of helicopter characteristics in an icing environment based on test experience and analytical studies, an examination of current and potential ice protection technology, and an identification and review of the major certification issues pertaining to the release of a helicopter into a forecast icing condition.

The ability of a helicopter to operate safely through an icing regime is dependent upon a number of factors involving the types and capabilities of on-board ice protection equipment, the helicopter sensitivity without specific equipment (or during equipment failure), the extent of icing experience (both the helicopter systems experience and the experience of the pilot), and the criteria for release of the helicopter into the icing condition.

The limit of ice accretion for satisfactory helicopter operation will vary with each component; for a windshield it will be when the reduction in clear area limits the pilot's field of view below the safe limit, for a rotor blade it may be increased drag or increased pitching moment causing high control system loads, a vibration increase due to asymmetric ice shedding that interferes with the pilot's function, or when self-shedding pieces of ice are large enough to cause damage to other rotor blades, engines, nearby aircraft when on the ground or could be injurious to persons on the ground. Ice on the rotor hub and fuselage may become critical in a flight transitioning from an icing condition into warm air where some of the ice may be shed and enter an engine inlet.

Helicopter size, type of rotor system, power available, and location of critical components may influence the icing release criteria for various helicopter types.

Consideration of the icing release criteria may also be influenced by the ability to forecast icing severity and the ice detection/ice rate prediction capability on board, giving the pilot the capability to determine the allowable safe operating time in icing based on measured icing severity levels.

In the overall evaluation of helicopter icing many factors and issues which are discussed in this report require resolution between the manufacturer, the user and the certifying agency prior to actual icing release.

2.1 HELICOPTER CHARACTERISTICS IN ICING ENVIRONMENT

The sensitivity of a helicopter to icing and the helicopter flight limitation when operating in ice is a function of one or more of the following:

- o Decreased pilot's vision (upon leaving Instrument Flight Rules (IFR) condition).
- o Increase in power required (thus decreasing the available power margin).
- o Decreased blade stall limits.
- o Increased blade pitching moments causing high control loads.
- o Increased vibration due to asymmetrical ice shedding.
- o Degraded autorotational capability.
- o Reduction of helicopter stability or control.
- o Reduction of performance (range/endurance/climb capability).

- o Damage due to shedding ice striking rotor blades, fuselage or entering engine inlet.
- o Flame out due to engine blockage or excessive ice or snow ingestion.
- o Pitot blockage/distortion causing loss of airspeed indication.
- o Degraded empennage effectiveness or vibration.
- o Weight of ice accumulation.

2.1.1 Icing Experience

The following paragraphs provide insight into some of the icing test experience used to determine a tolerance level for helicopter icing penetrations.

During the winters of 1964 and 1965, a CH-47A was flight tested in an icing cloud produced by a spray system installed in a C-130 aircraft operated by the USAF out of Wright-Patterson Air Force Base, Dayton, Ohio, (Reference 7). During the test runs accomplished in February 1965, the CH-47A made two flights of approximately 30 minutes duration with the ambient temperature between -12°C and -19°C . During the flights in the estimated 10 to 15 foot diameter icing cloud the helicopter accumulated (as noted after landing) up to 1/2 inch of ice on the forward rotor blades at 50% radius and 1/4 inch on the aft blades. No uniform self-shedding of the rotor ice could be observed at these ambients and no attempt was made to induce shedding by collective or cyclic pitch changes or by rpm changes. Disengagement from the icing cloud was accomplished when the helicopter vibration, probably caused by asymmetric shedding, became uncomfortable for the pilot. As a result of these icing tests, the test report recommended that the CH-47 be restricted to flight into light icing because of lack of blade deicing.

The Air Force definition of light icing was based on the original (1964) icing severity definitions of the Air Weather Service Manual (AWSM) 105-39 (Reference 8), i.e., one-half inch of ice on a thin probe in 40 miles of flight. No in-flight measurements of liquid water content or droplet diameter were made during these icing flights. However the USAF test engineer judged the ice accretion rate to be "in the heavy category of the new government icing specification which defines heavy icing as a accretion rate of one-half inch of ice in 10 miles of flight on a thin probe, reference AWSM 105-39 15 Sept '64, page 2."

Icing flight tests were conducted by the USAF Flight Test Center (Edwards Air Force Base, California) on a HH-53C helicopter in Alaska (Eielson AFB) during March-April 1971, (Reference 9). The icing conditions for the tests were both natural icing and icing formed by use of a C-130 equipped with a water spray system. The HH-53 was operated in the icing cloud (C-130 spray system) for periods up to 20 minutes in light icing and up to 18 minutes in moderate icing with rotor ice accumulations up to 1-1/8 inch. The icing severity was based on an estimated total ice accumulation

and on periodic indications from a Rosemount Ice Detector probe mounted in the heater air inlet. In addition, a number of short duration natural icing encounters were made. Helicopter flight roughness due to asymmetrical shedding of rotor ice was reduced or eliminated by increasing the rotor rpm from 95% to 105%. Rotor ice was also shed by dropping collective and then applying full up collective, however, altitude could not be maintained during the collective pitch change. Based on these tests, the test report recommended that "The HH-53C Helicopter should be cleared for flight in light and moderate icing and freezing rain conditions with or without EAPS installed, but such flight should be restricted to mission essential operations."

In both the CH-47 and HH-53 icing tests, the rotor ice build-up did not cause an unsatisfactory loss of flight capability, because each aircraft had sufficient power margin available. Rotor ice accretion and asymmetric shedding did cause "uncomfortable" vibration levels in each helicopter, however, both helicopters were able to continue operation without danger of structural vibration damage. Some skin damage due to ice shedding did occur during the HH-53 testing caused by impact of main rotor ice on the tail rotor and tail rotor ice on the main rotor.

The USAF C-130 used in both icing trials was equipped with a five concentric ring icing nozzle configuration (the outside ring being 48 inches in diameter) extending out the rear ramp. No reliable direct indication of liquid water content was used in either trial (the Rosemount detector was noted as "unreliable" as located in the HH-53C heater air inlet). The icing severity, therefore had to be judged by the flight test crew.

It is interesting to note actual flight manual cautions or warnings regarding icing encounters. The CH-47 B/C manual (Reference 10) states "Caution...areas where moderate to severe icing is known to exist or forecast to occur are to be avoided," and "Caution...extended flight in light icing conditions may result in lateral and vertical vibrations caused by asymmetric self-shedding of ice. When vibrations are encountered, the airspeed should be reduced and the aircraft should be flown out of the icing area."

The CH-53E manual (Reference 11) states "Warning...the helicopter is restricted from flying in moderate or heavy icing conditions. Flight in light icing conditions is limited to 30 minutes duration, due to the probability of damage from shedding ice."

In neither manual is a clear definition of light icing provided, also no reference to ambient temperature is made. The influence of ambient temperature on rotor icing has been evident in past and current icing trials. As the ambient temperature decreases, the ice adheres further outboard along the rotor span, thus creating an increasing potential for asymmetric shedding and/or ice shedding damage to other components. As stated in the HH-53C icing test report (Reference 9) "The tests...indicated that outside

air temperature is a more important factor than the degree of icing conditions or rate of accumulation. A temperature decrease below approximately -12 degrees C increases the possibility of minor tail rotor damage due to ice shed from the main rotor blades."

For at least the larger helicopters (CH-47/CH-53 size), there would appear to be an operational icing envelope without rotor ice protection which can be defined in terms of ambient temperature and liquid water content for continuous and time limited operation based on the accumulation of data from documented natural and simulated icing trials. One possible envelope is illustrated in Figure 2-1 utilizing the FAR Part 25 Appendix C continuous maximum 15 micron and 20 micron droplet diameters to reference the boundaries. Below -10 to -15°C and at liquid water contents to the right of the boundaries, the helicopters would be allowed only a time limited icing exposure. Icing trial results would be required to determine the specific boundaries for each helicopter type.

A great deal of the current U.S. helicopter icing experience has been in the National Research Council of Canada (NRC) Hover Spray Rig (HSR) or behind the U.S. Army HISS. A test UH-1H, equipped with electrothermal rotor deicing, electrically-heated windshield and stabilizer bar, and ice detectors (Rosemount and Leigh - see Section 2.7) has and is currently being operated in the simulated icing facilities (HSR and HISS) and in natural icing conditions. This UH-1H icing research effort is being directed by the U.S. Army Applied Technology Laboratory (formerly the U.S. Army Air Mobility R&D Laboratory) Fort Eustis, Virginia. The United Kingdom (U.K.) has, over the past ten years, been conducting HSR and natural icing trials utilizing primarily the Wessex Helicopter, with and without rotor deice provisions. In addition to testing of electrothermal rotor deicing systems and testing of unheated rotors, effort is being applied by the U.S. Army and the U.K. to the investigation of ice-phobic coatings for rotor ice protection. Recent icing trials of the CH-47 and UH-60 have taken advantage of available natural icing conditions to expand the experience levels beyond that of the simulated icing facilities. The following presents a summary of recent icing experience and illustrates some of the problems and achievements.

2.1.1.1 UH-1H Simulated Icing Tests (HISS) September-October 1973
(Reference 12)

- o Alcohol windshield anti-ice system installed.
- o No rotor deice system.
- o Asymmetrical rotor ice shedding caused severe vibration.
- o Deliberate control inputs to induce rotor ice shedding may cause asymmetrical shedding.
- o Rotor ice greater than 1/2 inch severely degrades safe autorotational capability.

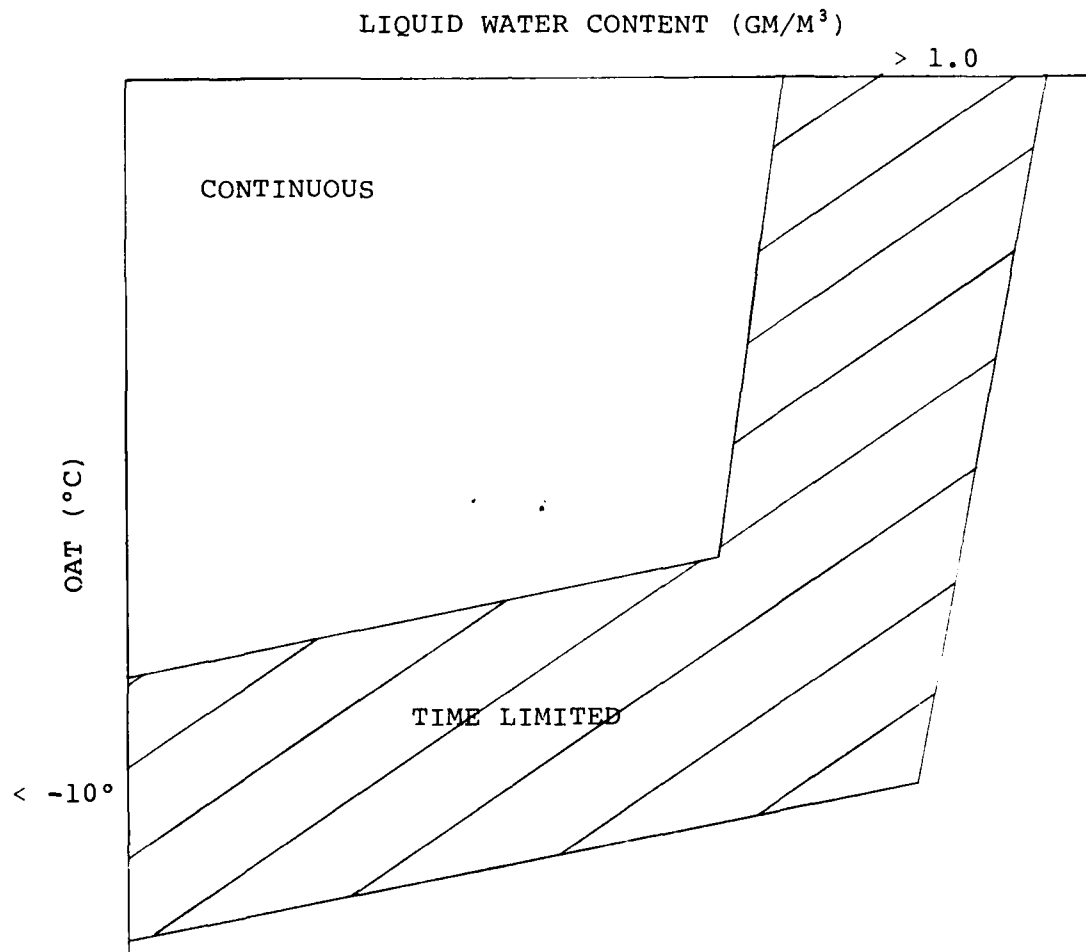

FIGURE 2-1. POTENTIAL OPERATIONAL ICING ENVELOPE

- o Conclusions from test:

Intentional flights into light icing would require:

- Windshield anti-ice.
- Sensitive OAT gage.
- Rotor ice not to exceed 1/2 inch (based on autorotational capability).
- No icing flights below -10°C.
- No flights into freezing rain.

2.1.1.2 UH-1H Operational Procedures During Icing Weather 1974
(Reference 13)

- o Remove side barrier filters from engine inlet.
- o Pitot heat and engine heat is mandatory.
- o Flight permitted into forecast intermittent trace or intermittent light icing only.
- o No flight permitted into forecast continuous light icing or greater (moderate or heavy).
- o Light icing forecast must be above approximately 5000 feet.

2.1.1.3 AH-1G Simulated Icing Tests (HISS) October-November 1973,
March-April 1974 (Reference 14)

- o No rotor deice system.
- o Standard engine anti-icing system.
- o Canopy rain removal system.
- o Rotor ice shedding characteristics similar to UH-1H.
- o Conclusions from test:
 - Severe vibrations from asymmetrical rotor ice shedding particularly below -10°C.
 - Autorotational rotor speed severely degraded with rotor ice.
 - Anti-icing sprays were not effective in preventing rotor ice.

2.1.1.4 CH-47C (Metal Rotors) Simulated Icing Tests (HISS) April 1974
(Reference 15)

- o No rotor deice system.
- o Standard engine/engine inlet anti-icing system.

- o No engine inlet screen installed.
- o Electrically heated windshields.
- o HISS cloud not deep enough to accomplish simultaneous icing of both rotor systems.
- o Conclusions from test:
 - Level flight power increases of 5 to 31% with rotor ice.
 - Symmetrical rotor ice shedding with light to heavy icing at -6°C and light icing at -9°C .
 - Asymmetrical rotor ice shedding with moderate icing at -9°C .
 - Engine FOD occurred with no inlet screens installed.

2.1.1.5 AH-1J Simulated Icing Tests (NRS Ottawa Hover Spray Rig) January-February 1974 (Reference 16)

- o No rotor deice system.
- o Engine inlet with particle separator (unheated)
- o Canopy rain removal system.
- o Conclusions from test:
 - Engine inlet system satisfactory for operation in icing conditions.
 - Rain removal system satisfactory for light icing conditions.
 - Severe vibrations from asymmetrical rotor ice shedding at temperatures from -4°C to -19°C .

2.1.1.6 BO-105 Simulated Icing Tests (NRC Ottawa Hover Spray Rig) and Natural Icing Tests (Ottawa Area) December 1973-April 1974 (Reference 17)

- o Rotor electrothermal deice (main and tail).
- o Engine inlet anti-icing with snow and ice deflector.
- o Electrically heated pilot's windshield.
- o Conclusions from tests:
 - No rotor deice required down to -5°C (within range of spray rig icing intensity).

- Rotor deice required for icing penetration below -5°C.

2.1.1.7 YUH-61A Simulated Icing Tests (HISS) October-November 1976
(Reference 18)

- o Rotor electrothermal deice (main and tail).
- o Engine inlet electrical and bleed air anti-icing.
- o Electrically heated windshields.
- o Conclusions from unheated rotor tests:
 - Level flight power increases of 22 to 28% during 6 to 18 minutes in icing cloud.
 - Some asymmetrical ice shedding occurred causing moderate vibration (-13.5°C and 0.25 GM/M³ during 18 minutes test run).
 - Autorotational rate increase of 35% and 6% decrease in rotor rpm (full down collective) after 18 minutes in icing cloud.
- o Conclusions from heated rotor tests:
 - Level flight power increased nominally from .5 to 17%.
 - Autorotational rate increase of 18% with no change in rotor rpm.

2.1.1.8 CH-47C (Fiberglass Rotors) Simulated Icing Tests (HISS) and
Natural Icing Tests (Minnesota) February 1979

- o Electrothermal rotor deice system.
- o Engine inlet anti-icing (bleed air).
- o Engine inlet all-weather screen.
- o Electrically heated windshields
- o Conclusions from unheated rotor tests:
 - Fiberglass blades showed minimum evidence of asymmetric shedding down to -12°C in natural icing and to -15°C behind the HISS.
 - No indication of power increase.
 - No apparent changes in handling qualities with rotor ice.
- o Conclusions from heated rotor tests:
 - Rotor deicing system functioned satisfactorily over the HISS test range to -16°C.

2.1.1.9 UH-1H Simulated Icing Tests (HISS) March 1975 (Reference 19)

- o Electrothermal rotor deicing system (main and tail).
- o Electrically heated pilot and copilot windshields.
- o Conclusions from test:
 - Windshield anti-ice satisfactory.
 - Engine power increases of 15 to 20% (level flight) during rotor icing sequences.
 - Main rotor deicing appeared capable of satisfactory operation throughout operational icing range.

2.1.1.10 UH-1H Simulated Icing Tests (NRC Ottawa Hover Spray Rig) January-March 1976 (Reference 20)

- o Electrothermal rotor deicing system (main and tail)
- o Electrically heated pilot and copilot windshields.
- o Conclusions from test:
 - Main and tail rotor deicing is effective over a wide range of icing conditions in hover and forward flight.
 - Blade heater electrical problems require further design improvements and improved fabrication techniques.

2.1.1.11 UH-1H Simulated Icing Tests (NRC Ottawa Hover Spray Rig) and Natural Icing Tests (Ottawa Area) February-March 1978 (Reference 21)

- o Electrothermal rotor deicing system (main and tail).
- o Electrically heated pilot and copilot windshields.
- o Conclusions from tests:
 - Main rotor deicing appears satisfactory.
 - Tail rotor deicing may not be necessary particularly with IR suppressor installed.
 - Deicing failure modes requires further investigation.
 - Natural icing exposure not increased from previous experience.

2.1.1.12 SA 330 "PUMA" Simulated Icing Tests (NRC Ottawa Hover Spray Rig) 1975-1977 and Natural Icing Tests (Denmark) 1977-1978 (Reference 22)

- o Electrothermal rotor deicing system (main and tail).
- o Electrically heated windshields.
- o Multi-purpose (all-weather) engine inlet system.
- o Conclusions from tests:
 - Rotor deicing system optimized during NRC icing trials (hover).
 - Rotor deicing system reoptimized for forward flight icing conditions.
 - Rotor deicing system reoptimized for icing conditions below -10°C.
 - Certificate of airworthiness for flight in icing conditions without any limitations granted by French authorities 25 April 1978.

If continuous icing operations are required beyond the unheated rotor uniform self-shedding boundaries, rotor ice protection is required. At today's level of technology, the electrothermal deicing system is the only rotor ice protection available.

A great deal of effort has been put into investigating rotor blade ice protection systems because of the concern for the increased power required, vibration, and potential engine/airframe damage due to rotor ice. The rotor deicing allows control of the ice thickness to be shed from the blades. The rotor deicing system of the electrothermal type available today, however, requires a bonded blade heater blanket, slip rings, electrical wiring, stepping control system and an ice detector with timing control system. The exposure to severe operational environment conditions such as rain and sand/dust may cause blade erosion with possible heater blanket damage unless care is taken in providing sufficient erosion protection.

Because of the costs and periodic maintenance requirements of the deicing system electronics, efforts are continuing to find a cheaper, less maintenance prone method of providing rotor ice protection to extend the helicopter capabilities beyond the current icing boundaries. As noted earlier, ice-phobic coating investigations are being conducted by the U.S. Army and the U.K. in an effort to provide an alternate to electrothermal deicing.

2.1.2 Helicopter Flow Field

Flow field studies have been initiated as part of an overall helicopter icing effects evaluation. The initial effort was directed towards examination of the flow field around the helicopter and localized flow fields about critical components. The generalized aerodynamic interaction between various helicopter components and between the helicopter and external objects (including other aircraft) is illustrated in Figure 2-2 for a typical single rotor configuration (Reference 23).

The predominant interactive effects shown in Figure 2-2 are representative of hover or close ground proximity operation. During this type of operation the rotor environment, i.e., tip vortex path, downwash velocity distribution, load distribution and lift coefficients, and the ground plane reaction determine the primary flow field environment (Figure 2-3 illustrates the ground plane reaction). In terms of icing effects, the problems of snow and slush impact/ingestion are the primary concerns particularly in the engine inlet, fuselage, and windshield areas. The snow cloud generated by the ground vortex also may present a severe visibility problem.

2.1.2.1 Rotor Downwash

A plot of downwash velocity approximately 15 feet below the rotor and average rotor wake angle is presented in Figure 2-4 for several gross weights, over a range of forward airspeeds.

The magnitude of the induced velocity varies as the reciprocal of the air density ratio in moderate and high speed flight, and in low speed flight it varies as the reciprocal of the square root of the air density ratio. Consequently, the downwash velocity increases with altitude for a given gross weight, ambient temperature, and forward speed.

Rotor downwash velocities in low and high speed flight have been estimated based on the analysis presented in NACA Technical Note TN-3690, Reference 24. Theoretically predicted generalized downwash data are presented in the Technical Note for several rotor wake skew angles (referenced to the rotor tip path plane). Induced velocity patterns (lines of constant values of induced velocity) in the flow field of the rotor are presented to permit determination of the downwash at a given point for a given set of flight conditions.

A comparison of analytical results derived with the aid of TN-3690 with test data obtained from the Langley full-scale tunnel is contained in NACA Technical Note 3691, Reference 25. The Langley test data indicates that the theoretical analysis used for predicting rotor downwash in forward flight provides reasonably good accuracy for an isolated rotor. Actual helicopter downwash values will differ somewhat (tend to be lower) because of fuselage interference.

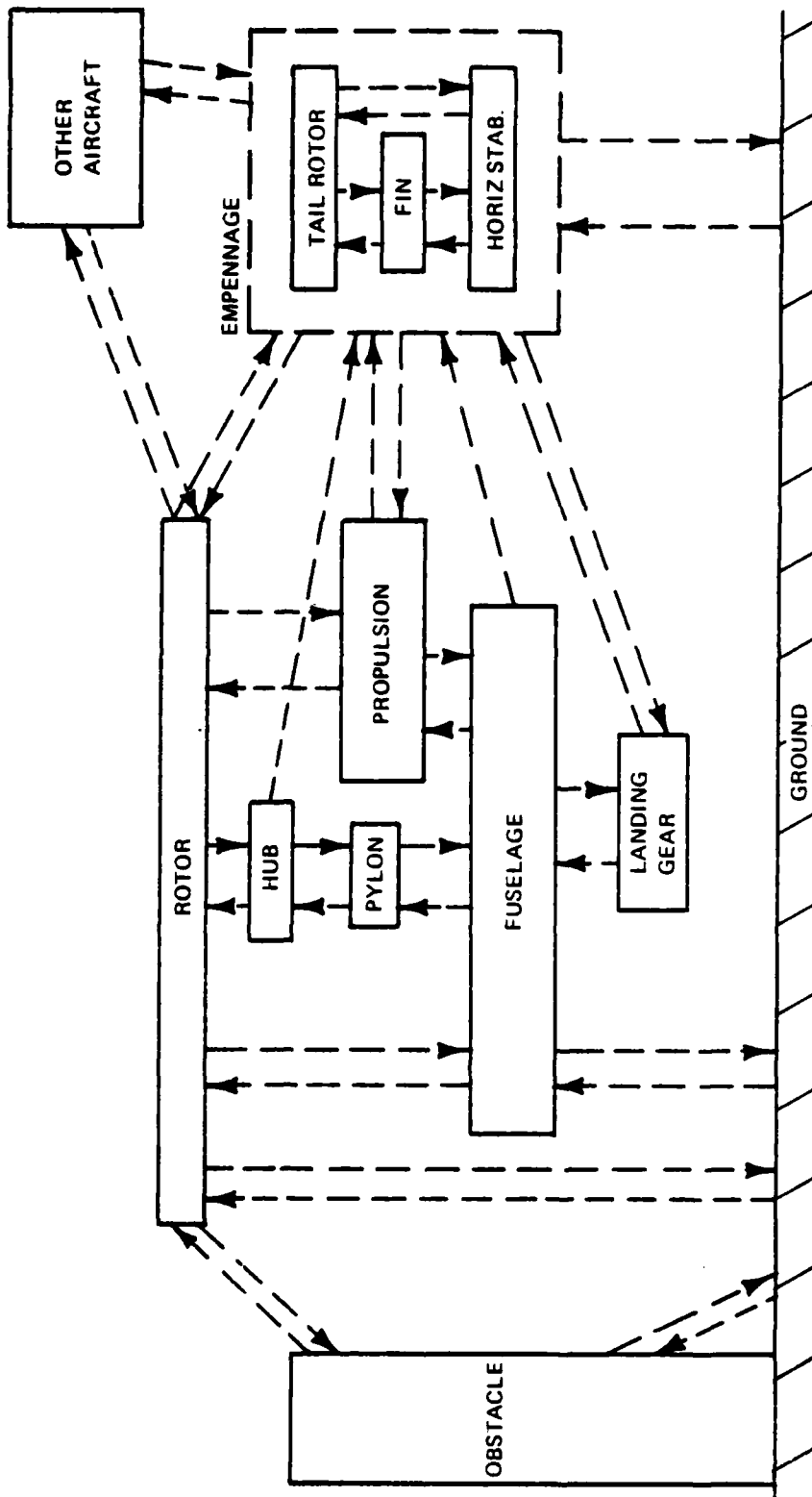

FIGURE 2-2. AERODYNAMIC INTERACTIONS

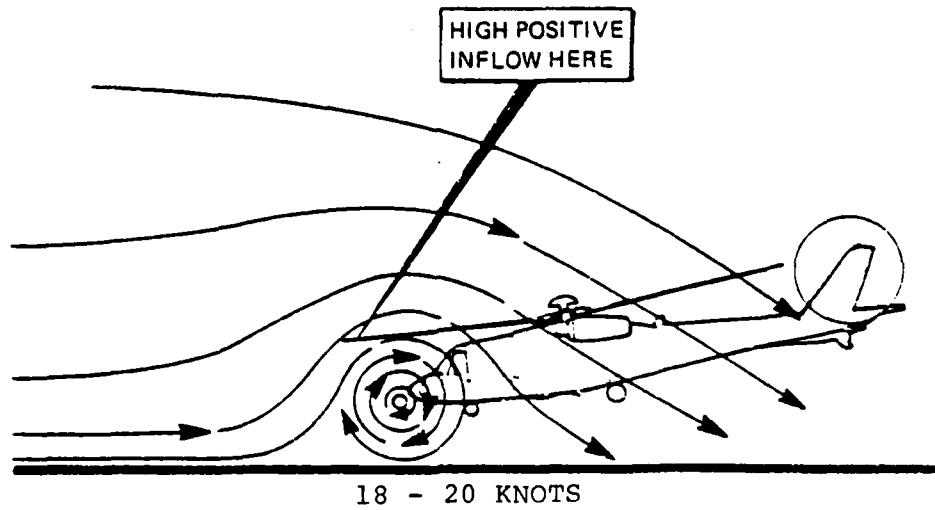
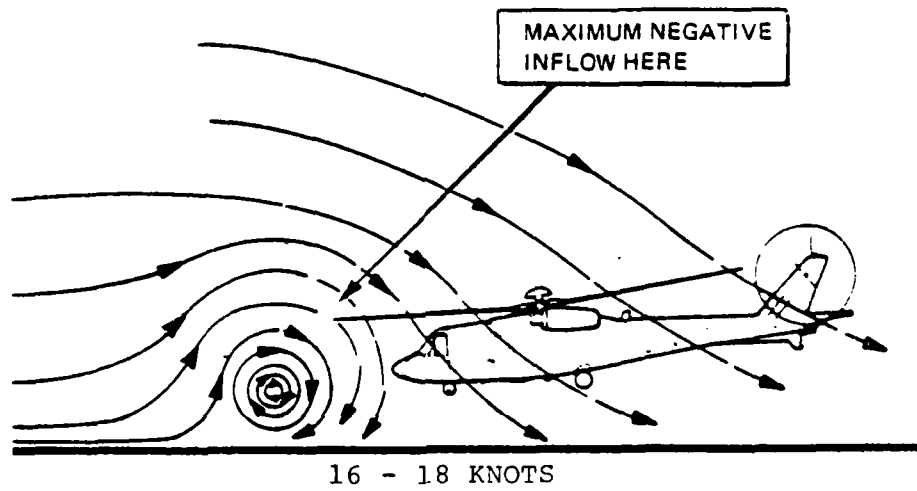
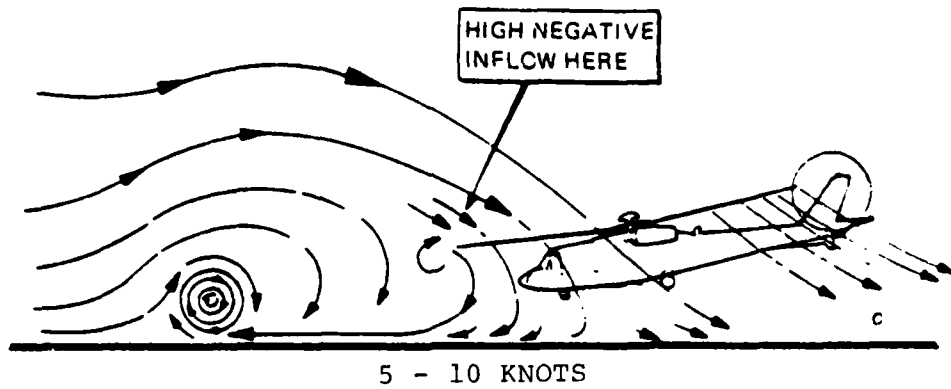

FIGURE 2-3. GROUND VORTEX.

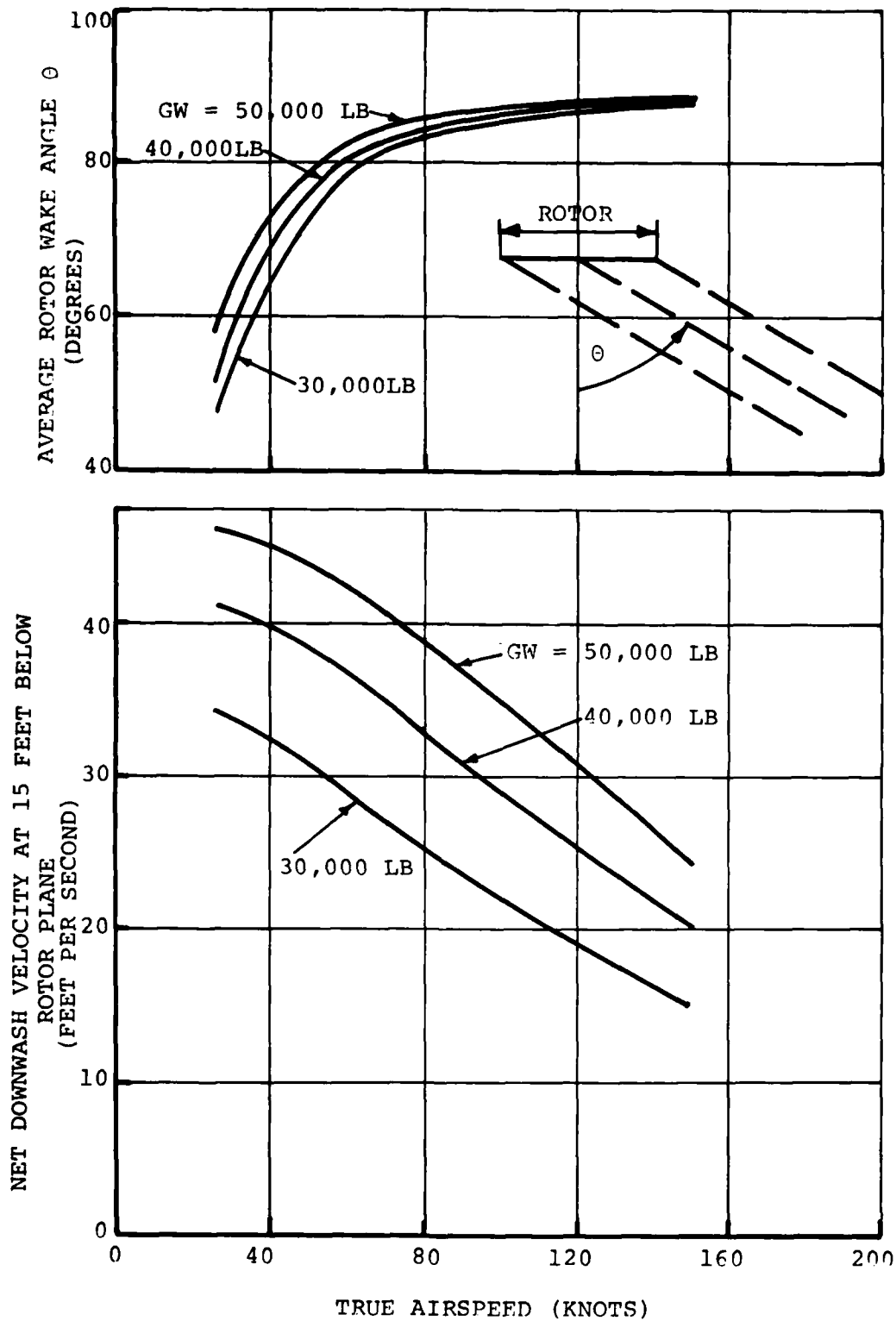

FIGURE 2-4. ROTOR DOWNWASH CHARACTERISTICS
21

Prediction or measurement of the downwash velocity angle and magnitude is particularly important when evaluating the results of simulated icing trials (i.e. HISS or HSR). The wash from the forward rotor (tandem), or main rotor (single) forces the icing cloud downward, thus the aft regions of the helicopter (aft rotor or tail rotor) may not experience the same water concentration as the forward regions.

2.1.2.2 Fuselage/Engine/Engine Inlet/Windshield

Data from wind tunnel tests (Reference 23) of a single rotor helicopter configuration has been used to evaluate the fuselage flow field during loose ground proximity operations. The general conclusions reached from wind tunnel testing appear applicable to all single-rotor helicopters regardless of rotor configuration. The ground vortex effects during snow operation primarily concern visibility and engine snow ingestion, particularly when operating at a rotor height-to-diameter less than 1.0. The wind tunnel program addressed a range of problems to be considered including potential engine surge from flow distortion. Ground vortex flow distortion coupled with an iced inlet screen or heavy snow ingestion, for example, could cause sudden loss of engine power during a low landing approach.

An associated phenomenon that surfaced during Army testing of the YUH-61A is entrainment of rocks and other surface debris by the high-velocity winds associated with the ground vortex flow. The case in point involved high-altitude, hot-day running takeoffs with marginal power above a broken surface runway. The testing had to be terminated because of high velocity paving fragments that hit the airframe. This is perhaps an extreme example but rock-strewn areas are common in nature and debris (including ice pieces) may be found on unprepared landing areas. The use of the new higher disc loading helicopters with higher, more concentrated rotor wake energy poses questions of serious aerodynamic interference between adjacent helicopters due to the ground vortex. The vortex forms in front of the helicopter as illustrated in Figure 2-3 at a distance depending on speed. The strength of the vortex at remote lateral distances has not been determined but flow visualization using smoke indicates significant energy transfer along the axis of the vortex. The potential upsets to helicopters flying into the ground vortices of the aircraft ahead may be large. Visibility limitations (snow) and debris (ice) entrainment with respect to parked aircraft are other potential hazards.

As pointed out in Reference 23 a requirement still exists for a complete flow description of the interaction of interest, which should include flow visualization in association with data measurements. It is emphasized that the dynamic aspects must be carefully considered. If there is one lesson from the wind tunnel tests, it is that all the helicopter aerodynamic interactions are extremely unsteady, showing time-variant components that rival the mean in magnitude. Typically, the steady and unsteady flow pattern will change rapidly with changes in the helicopter trim airspeed and often in a highly non-linear manner.

2.1.3 Rotor Environment

Figures 2-5 and 2-6 illustrate the key characteristics of the rotor environment in hover and in forward flight, respectively, and are used to point out the regions where rotor ice affects performance.

In hover, Figure 2-5, the local Mach number along a rotor blade increases linearly from 0.0 at the center of rotation to a maximum value at the tip. This maximum value is generally near $M = 0.6$. Most of the lift of the rotor is generated outboard of 60% of the blade radius, at local lift coefficient levels $0.4 < C_L < 0.65$ at the optimum efficiency design levels. Ice accreting inboard of 60% will have minimum effect on rotor hover performance, except for possible increases in profile drag (power).

The forward flight environment is more complex. In forward flight, the limit in operating conditions is typically dictated by either advancing blade compressibility effects or by retreating blade stall, although an overall increase in profile drag (such as due to adverse ice shapes) will cause a power penalty and reduce the operating range, even when critical blade and control load limits have not been exceeded.

Near the tip of the advancing blade the forward flight speed adds on to the blade rotational speed, with resulting tip Mach number levels beyond $M = 0.9$ for high speed helicopter operation. At local Mach numbers beyond $M = 0.7$, significant transonic flow phenomena take place over the airfoil sections typically used on rotor blades. While very small contour discrepancies (from a clean profile) and some surface roughness due to erosion will not cause an unacceptable degradation in the local flow at transonic speeds, the buildup of ice at the rotor leading edge (or along the chord near the leading edge) will probably cause a severe degradation in the local airfoil sectional characteristics (i.e. increased profile drag and increased pitching moment) and (depending upon the spanwise extent of the ice) may cause an overall adverse change in rotor performance.

Another critical area in which a deterioration in performance and/or loads may be experienced in the rotor plane azimuth is the outboard half of the retreating blade, since there the forward flight velocity is subtracted from the rotational speed, while the need to balance the lift generated by the advancing and retreating sides of the rotor disc results in high angle of attack operation on the retreating side. The combination of high angles of attack, local Mach numbers between $M = 0.3$ and $M = 0.5$ and unsteady aerodynamic effects causes potentially high dynamic stall loads. Operation in presence of significant ice accretion may cause stall resulting in both performance degradation and increased blade/control loads. The presence of ice on a rotor leading edge region, particularly when the ice surface is rough (characteristic of rime ice), is likely to induce premature flow separation at the high lift levels experienced on the retreating blade side (of the rotor disc), thus limiting considerably the thrust or speed range of the rotor (as defined by the limiting loads anticipated with the nominal blade section contour).

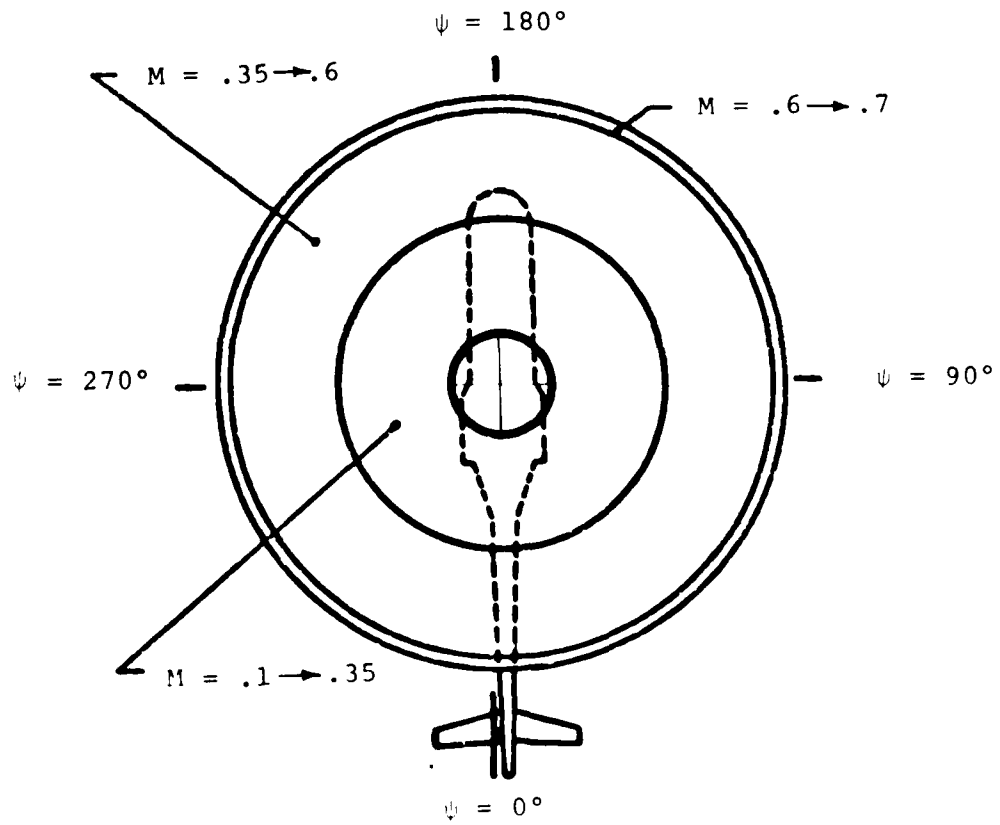

FIGURE 2-5. ROTOR ENVIRONMENT - HOVER

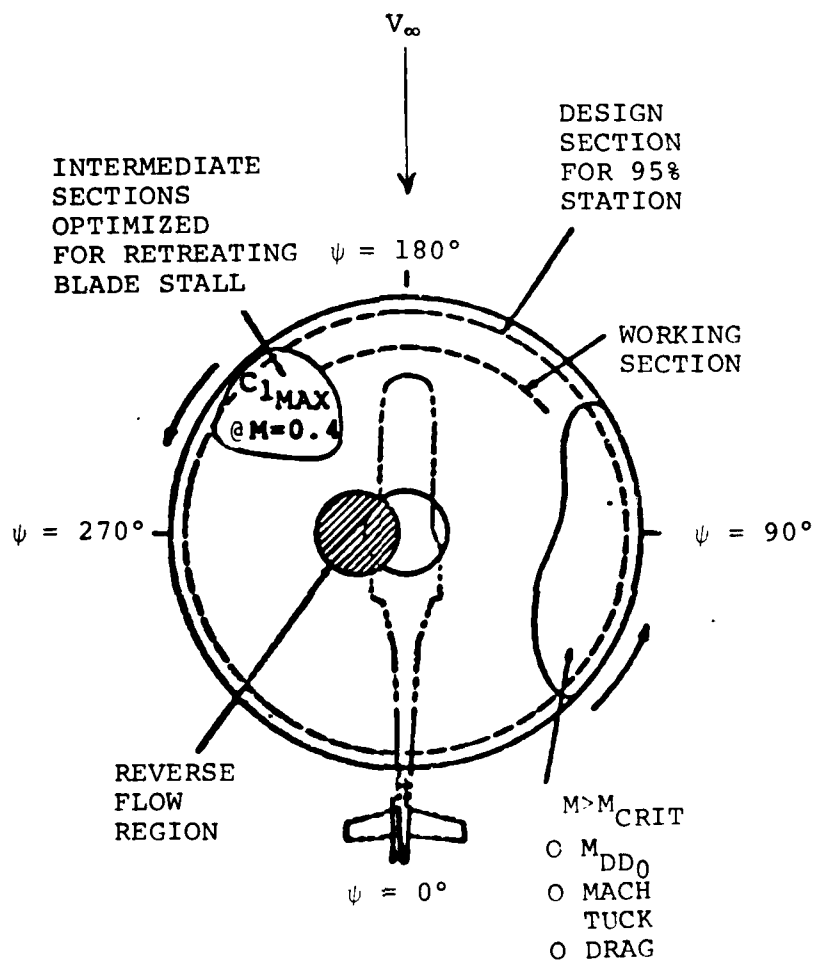

FIGURE 2.6. ROTOR ENVIRONMENT - FORWARD FLIGHT

The magnitude of the changes in lift, drag and pitching moment characteristics due to ice is a function of: a) the ice shape and thickness, b) the span extent of the ice, and c) the airfoil profile. Methods by which the effect of ice contour changes may be quantified is discussed in more depth in Appendix C.

The key lift coefficient and Mach number combinations influencing rotor operation are illustrated in Figure 2-7. A more detailed discussion of the rotor environment and of the sectional characteristics which limit rotor operation is presented in Reference 26, together with a detailed description of current computer codes and methods to calculate the sectional characteristics of "clean" airfoil contours (i.e. airfoils with no surface irregularities).

To illustrate actual rotor characteristics for specific helicopters the nominal load Mach number environments for the BO-105 and the CH-47C rotors are shown in Figures 2-8, 2-9, and 2-10. The Mach number boundaries include an approximation of 3-D tip relief effects, evaluated using the methods of Reference 27. In Figures 2-8, 2-9, and 2-10, the blades are assumed to rotate counterclockwise, and the direction of flight is from right to left. The 0° azimuth angle identifies the position of the downstream rotor blade. At the 90° azimuth position, the rotational and flight velocity components add up. These characteristics are used in the evaluation of rotor icing effects in Appendix C.

2.1.4 Airfoil Ice Documentation

There is evidence (documented in various icing trials reports - see References 12 thru 22) that ice accumulation on rotor blades can pose a hazard to helicopter operation; however, there is relatively little specific data detailing when, where, and how ice accumulates and sheds from helicopter rotor blades in flight. By necessity, most icing/deicing tests on helicopters are operational in scope, since they must verify the adequacy of any deicing equipment installed, and provide guidelines for safe deployment and are not designed (or planned) for documentation of the nature of rotor ice. Icing research programs, specifically the UH-1H helicopter (S/N 70-16318) under the direction of USAATL and the Wessex (Mk.5) under the direction of the Aeroplane and Armament Experimental Establishment (A&AEE) (Boscombe Down) have been and are utilizing photographic techniques to document the ice accretion and ice shedding characteristics of the rotor.

Because of the large centrifugal forces and the vibration characteristics of rotor operation, photographic coverage of rotor ice has been limited to hub mounted or fuselage mounted cameras on the test helicopter or use of chase plane photography. The "periscope" type hub camera system used on the Wessex (capable of photographing the upper surface - essentially full span - of all blades at the head being documented) combined with a lower (tail boom) camera (for a blade lower surface) appears to be one of the more effective ways of documenting rotor ice buildup and shedding in-flight. Determining the ice shape and thickness, however, is still a problem because of the viewing angle between the camera and the blade.

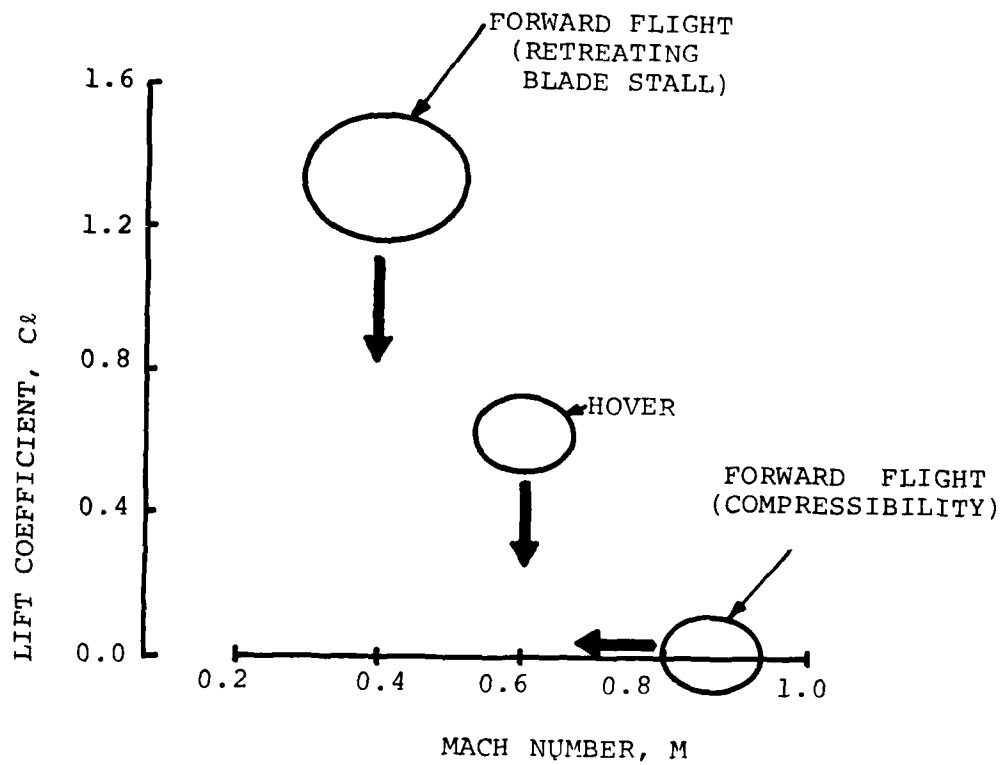

FIGURE 2-7. KEY LIFT COEFFICIENT AND MACH NUMBER COMBINATIONS

BO-105 / 110 KTS / 424 RPM / -10 C
 MAP OF LOCAL MACH NUMBER ENVIRONMENT

8/28/78

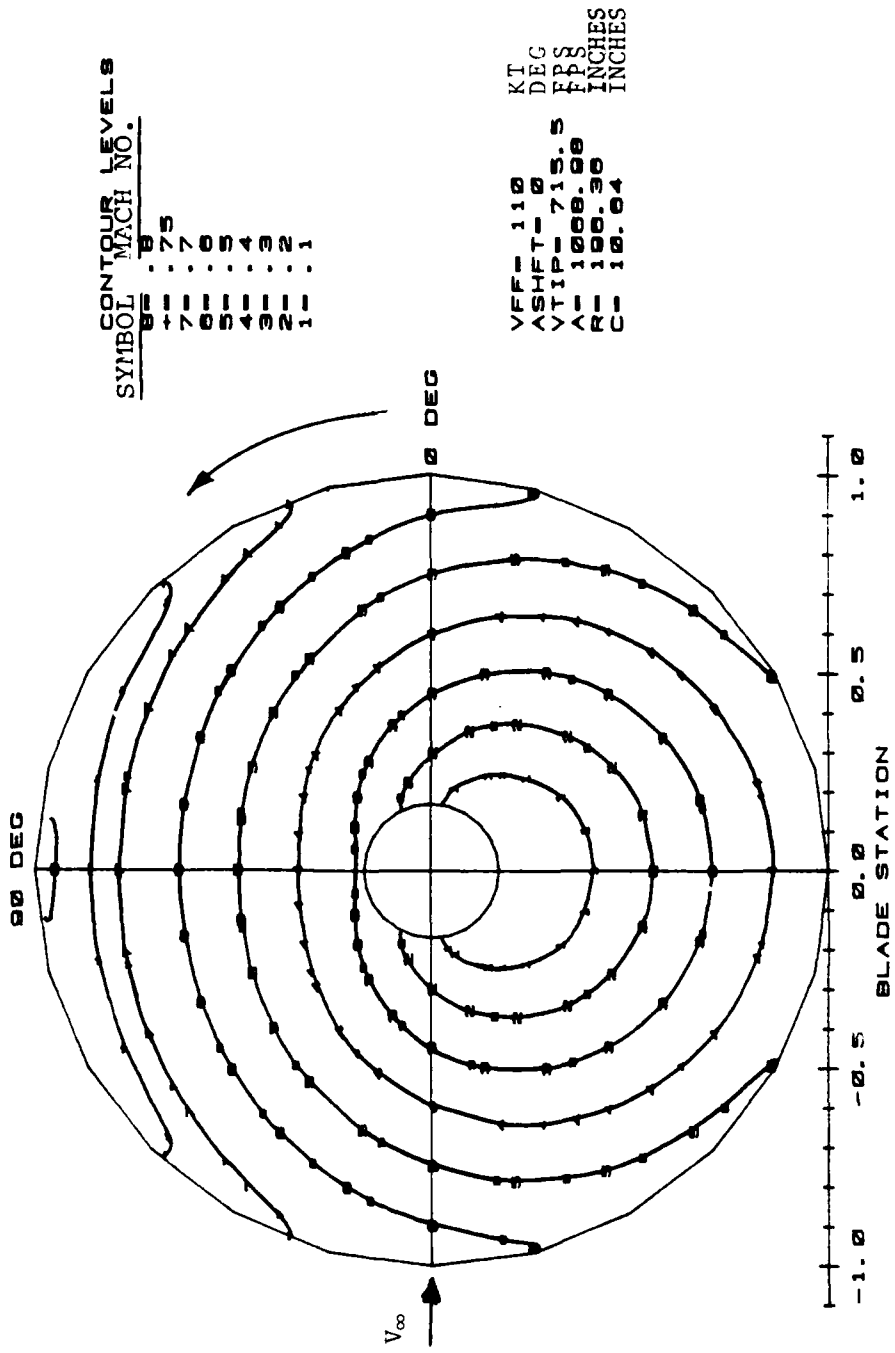

FIGURE 2-8. BO-105 ROTOR CONTOUR PLOT

CONTOUR PLOT
 CH-47C 90.0 KTS. 225 RPM -5.0 C
 MAP OF LOCAL MACH NUMBER ENVIRONMENT

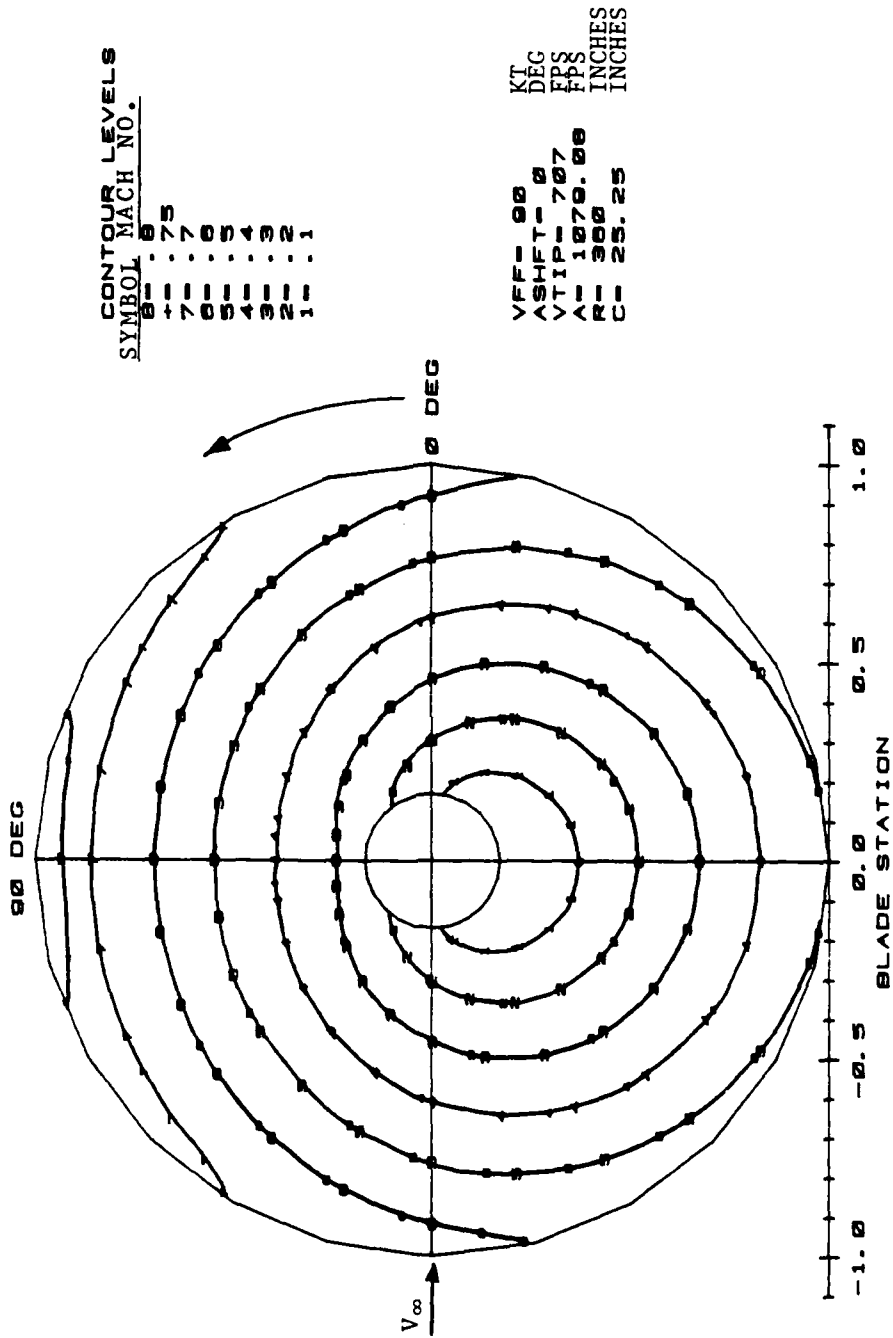
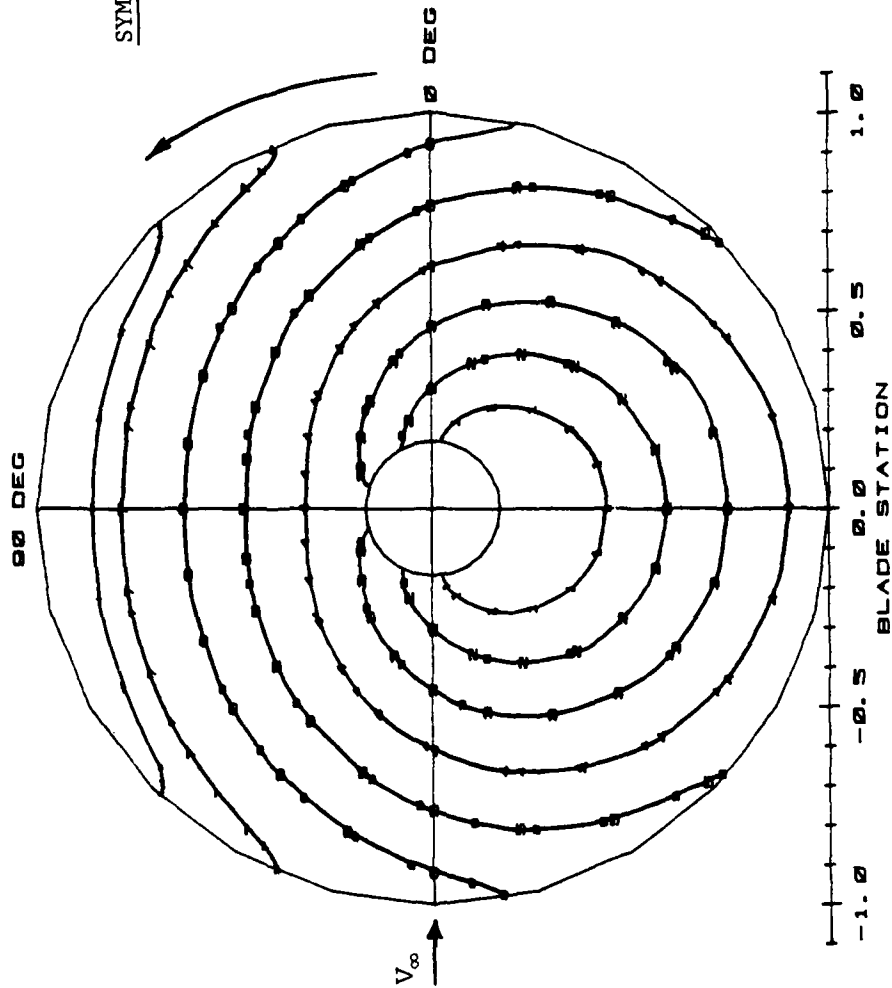

FIGURE 2-9. CH-47C ROTOR CONTOUR PLOT AT 90 KNOTS

CH-47C / 120.0 KTS. / 225 RPM / -5.0 C
 MAP OF LOCAL MACH NUMBER ENVIRONMENT

8/28/79

CONTOUR PLOT



SYMBOL	MACH NO.
8	8
+	7.5
7	7
6	6
5	5
4	4
3	3
2	2
1	1

VFF - 120 KT
 ASHFT - 0 DEG
 VTIP - 707 FPS
 A - 1070.00 INCHES
 R - 300 INCHES
 C - 25.25 INCHES

FIGURE 2-10. CH-47C ROTOR CONTOUR PLOT AT 120 KNOTS

Determination of the full span rotor ice shapes after helicopter shutdown can normally only be accomplished when using a hover spray rig for several reasons:

- o Minimum rotor angle-of-attack changes from hover to shutdown, as compared to landings from forward flight icing tests.
- o There is minimum change in ambient temperature (at constant altitude) during flight, whereas ground temperature may differ greatly from forward flight altitude temperature.
- o Time from hover cloud exit to shutdown is very short compared to shutdown time after completion of a forward flight test run.

The hover ice shapes, however, differ from those in forward flight because of the rotor angle of attack and Mach number differences. The exact nature of these differences is still under investigation by various icing research groups (NASA, U.K., etc.).

Most of the available test data about ice accumulation on airfoil shapes comes from fixed wing work. Such data is available as an experimental base to develop and validate performance prediction techniques, but as far as helicopter applications are concerned, fixed wing data suffer from two major drawbacks:

- o Most available airfoil icing test data (i.e. icing tunnel) is limited to low speed conditions ($M < 0.3$), while data of interest in helicopters would have to cover the range from $M = 0.3$ to at least $M = 0.8$.
- o Data acquired for fixed wing applications is for ice accretion at fixed incidence, a condition not at all representative of the helicopter flow environment.

2.2 CERTIFICATION CONSIDERATIONS

The various standards, advisory material and other documents pertaining to "all weather aircraft" present a picture of the need for a more representative definition of the meteorological requirements for ice protection design criteria and characteristics of helicopters during icing encounters. The existing meteorological requirements generally define the icing envelope in terms of the cloud liquid water content, water droplet size, and ambient temperature. Specific application to helicopters is only contained in a few documents (discussed in paragraph 2.2.2) and these generally address the hazards of helicopter icing flights without examination of the helicopter flight envelope. USAAMRDL Technical Reports 73-38 and 75-34A (References 1 and 2) represent the only comprehensive investigation of the meteorological conditions upon which to base a helicopter icing envelope.

Based on the review of the available meteorological data, helicopter operational envelopes and available data on helicopter performance under icing

conditions a recommended icing certification environment is developed (discussed in paragraph 2.2.2) and a recommended helicopter icing certification test plan is presented (paragraph 2.2.4). Two key certification issues are addressed in these paragraphs:

- o The required (critical) icing test conditions that must be obtained (demonstrated) during the certification test program.
- o The acceptable test environment icing source (i.e. natural icing only or combined natural and simulated icing).

2.2.1 Meteorological Review

2.2.1.1 Icing Types

The general categories of aircraft icing as defined in the Handbook of Meteorology (Reference 28) is as follows:

- o Clear ice - Transparent ice formed by the freezing of large water droplets. This is most likely to occur at ambient temperature near freezing (0°C) when the droplets which may not be supercooled are able to flow along the surface before freezing occurs. The ice formed during freezing rain is a good example.
- o Rime ice - Opaque ice formed in clouds by the rapid freezing of small supercooled water droplets. The freezing rate of the water droplet (which is influenced greatly by the amount of supercooling) affects the shape of the ice (i.e. double horn, rectangular, spear) forming on the surface; the slower freezing rates tend toward the double horn shape, while the faster rates tend to produce the spear shape, with the rectangular in between.
- o Hoarfrost - Ice crystals deposited on below freezing surfaces directly from water vapor.
- o Wet snow - Snow (ice crystals) existing at near freezing ambient temperatures. Wet snow tends to cling to exposed surfaces and may create a rime ice like formation (similar to the double horn shape). Wet snow is subject to packing and therefore presents a particular hazard to engine inlet systems with turning sections or plenum chambers.

As stated in Reference 28 icing conditions can exist in most cloud types with the proper temperature distribution (i.e. temperatures below 0°C). Rime ice is more common with little turbulence (stratiform type cloud formation), while clear ice predominates when turbulence and vertical velocities are present (cumuliform cloud formation). The intensity of icing increases with increased turbulence.

Both of the typical cloud types can produce a mixture of icing conditions depending upon the weather frontal conditions and the rate of moisture (cloud) lifting.

2.2.1.2 Icing Parameters (Supercooled Water Droplets)

The shape, consistency and ice accretion rate will vary with:

- o The cloud liquid water content.
- o The water droplet diameter.
- o The ambient temperature.
- o The velocity of the object sweeping the cloud.
- o The surface temperature of the object passing through the cloud. The surface temperature may be above ambient due to internal heating or ram temperature rise.
- o The geometry of object (i.e. catch efficiency) within the cloud.

The liquid water content is of prime importance in both the total water accumulation on a surface (i.e. total accretion) and the heat transfer from the surface affecting the energy load required to prevent the ice formation. The liquid water content of an icing cloud can be measured with a variety of instrumentation therefore, design analyses of ice protection systems can be checked using the test measurements.

The water droplet diameter is a major factor in both the water catch efficiency of a surface and the downstream extent of water impingement. The water droplet diameter in combination with the liquid water content of the icing cloud determine to a large extent the overall rate of water or ice accretion, and the overall energy load for thermal ice protection systems.

Temperature, both ambient and surface, in combination with the liquid water content, ice crystal and/or snow content and water droplet diameter, affects the overall shape and consistency of the ice formation on a surface (with a below freezing surface temperature) or affects the thermal load on an anti-icing system. In the case of a thermal deicing system, the temperature directly influences the time of heat application to accomplish ice shedding.

The velocity of the object sweeping the cloud affects the surface heat transfer rate and the total water catch. In the case of a helicopter rotor, the velocity is a major term in the centrifugal force field equation, which along with blade surface temperature greatly influence the ice shedding characteristics.

2.2.1.3 Meteorological Data

The fixed wing aircraft meteorological data contained in FAR Part 25 Appendix C (illustrated in part in Figure 2-11 for Continuous Maximum and Intermittent Maximum icing envelopes) is used as an extension of the originally derived icing criterion developed under the NACA work in Reference

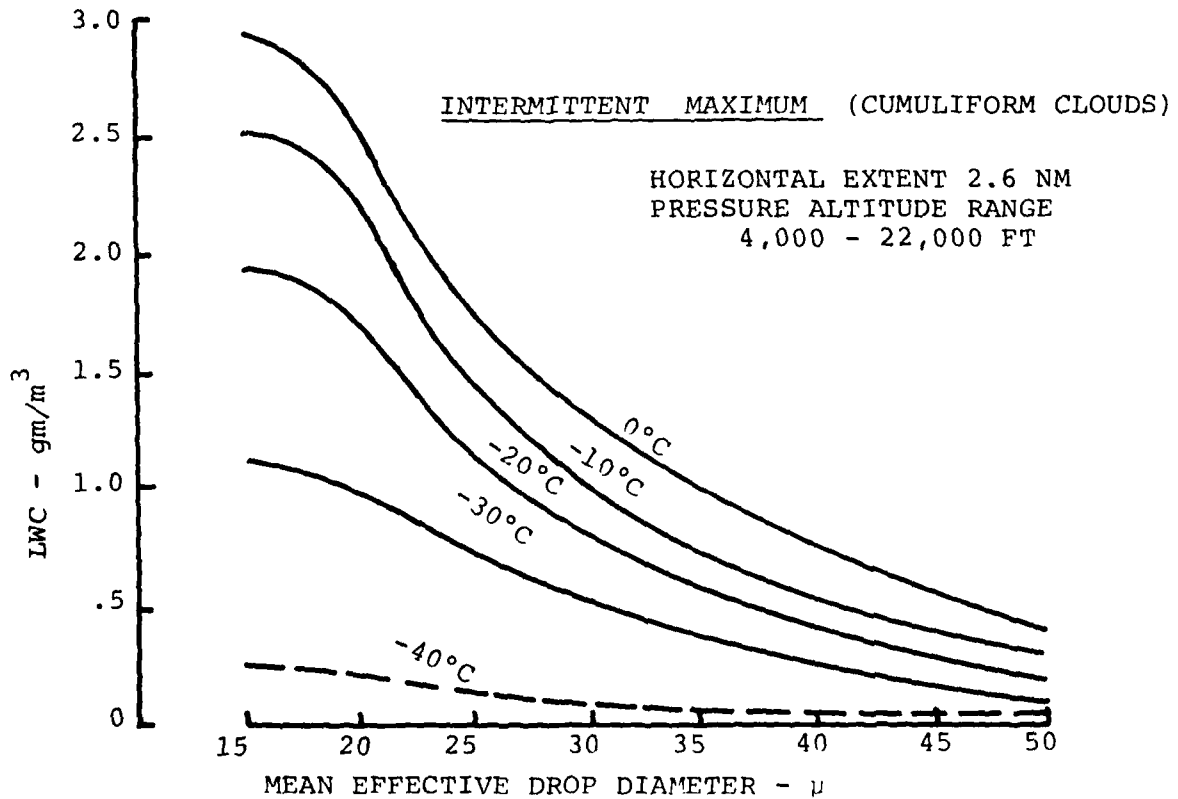
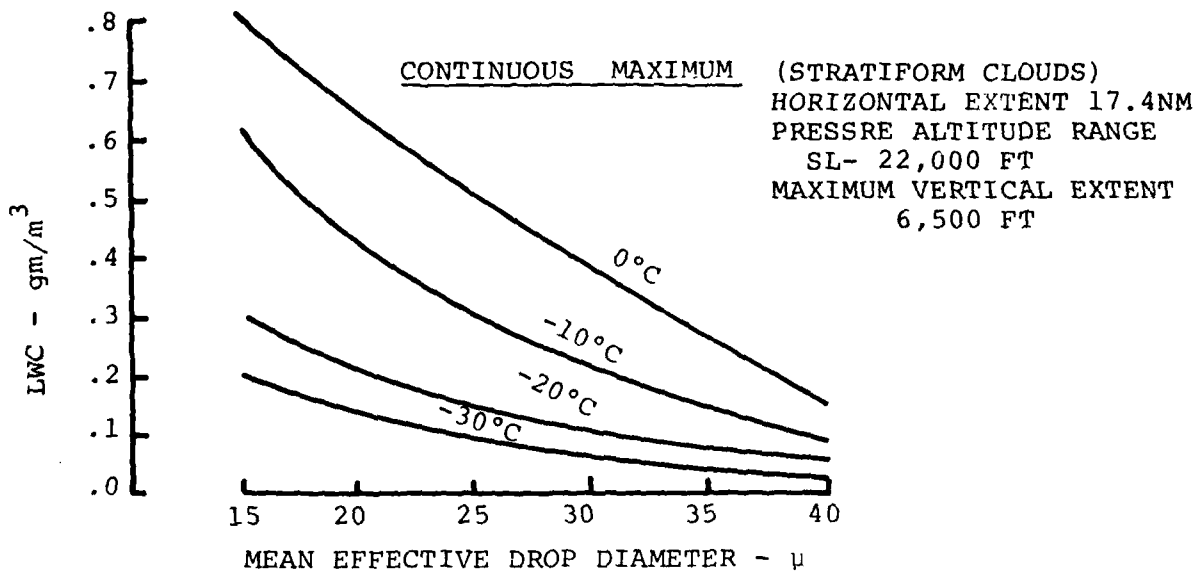

FIGURE 2-11. FAR PART 25 ICING LEVEL DEFINITIONS

29 (NACA TN 1393) and related efforts conducted during the 1940's and 1950's. Figure 2-12 illustrates the range of data collected during the early icing surveys (and its relationship to FAR Part 25 icing criteria, and to AWSM 105-39 Reference 8).

The NACA statistical data for various icing classes is tabulated in Table 2-1 (Table 1 of NACA TN 1855 Reference 30). The basis for the continuous maximum and intermittent maximum definitions contained in the criteria is the NACA stratiform and cumuliform cloud properties developed during the icing surveys. Figure 2-13 illustrates the properties of typical non-cyclonic stratus clouds (from Reference 31).

Stratiform clouds existing at temperatures below 0°C may contain light to moderate liquid water content (LWC-0.1 to 1.0 gm/m³), maximum probably cloud depth of 6500 feet above the cloud base, mass (volume) median droplet diameters of 10 to 30 microns, temperatures of 0°C to -30°C, cloud-base altitudes of 3,000 ft to 22,000 ft., and horizontal extents of 20 miles to 200 miles. The LWC in stratiform clouds tends to increase somewhat with increasing cloud height, however the overall trend is a reduction in LWC as air temperature decreases. It is observed that stratiform icing encounters in flight are most likely to occur at altitudes from 3,000 to 6,000 ft. Icing encounters above 22,000 ft. are rare, and the minimum icing temperature appears to be about -30°C.

Typical cumuliform clouds may vary from two to six miles in horizontal extent at altitudes from 4,000 to 24,000 ft., with moderate to heavy LWC of 0.2 to 2.5 gm/m³ or more, and mass (volume) median droplet diameters of 15 to 50 microns or larger with the higher LWC generally occurring at the smaller drop sizes. Figures 2-14 and 2-15, taken directly from ADS-4 (Reference 3), shows properties of two separate cumuliform clouds. Because of the increased turbulence associated with the cumuliform clouds the LWC distribution is generally not as uniform as the stratiform cloud. Cumuliform icing encounters tend to be of relatively short time duration because the cloud horizontal extent is short (2.6 nautical miles), but can be about two or three times as severe as stratiform icing because of high liquid water content. Cumuliform icing encounters are most likely to occur at altitudes from 8,000 to 12,000 ft. Icing encounters above 22,000 ft. are rare, and the minimum icing temperature appears to be about -30°C.

Although reports from aircraft that have encountered freezing rain are relatively common, detailed atmospheric data on freezing rain is not well documented for in-flight encounters. According to NACA TN 1855 (Reference 30), freezing rain is characterized by some large droplets (up to 1,000 microns), temperatures of 0°C to -4°C, altitudes from 0 to 5,000 ft., and liquid water content of about 0.15 gm/m³ (which corresponds to a rain fall rate of about 0.1 inch per hour). Horizontal extent may be as much as 100 miles. Supplementary freezing rain data (Reference 3) seem to suggest that these conditions represent realistic values for design purposes.

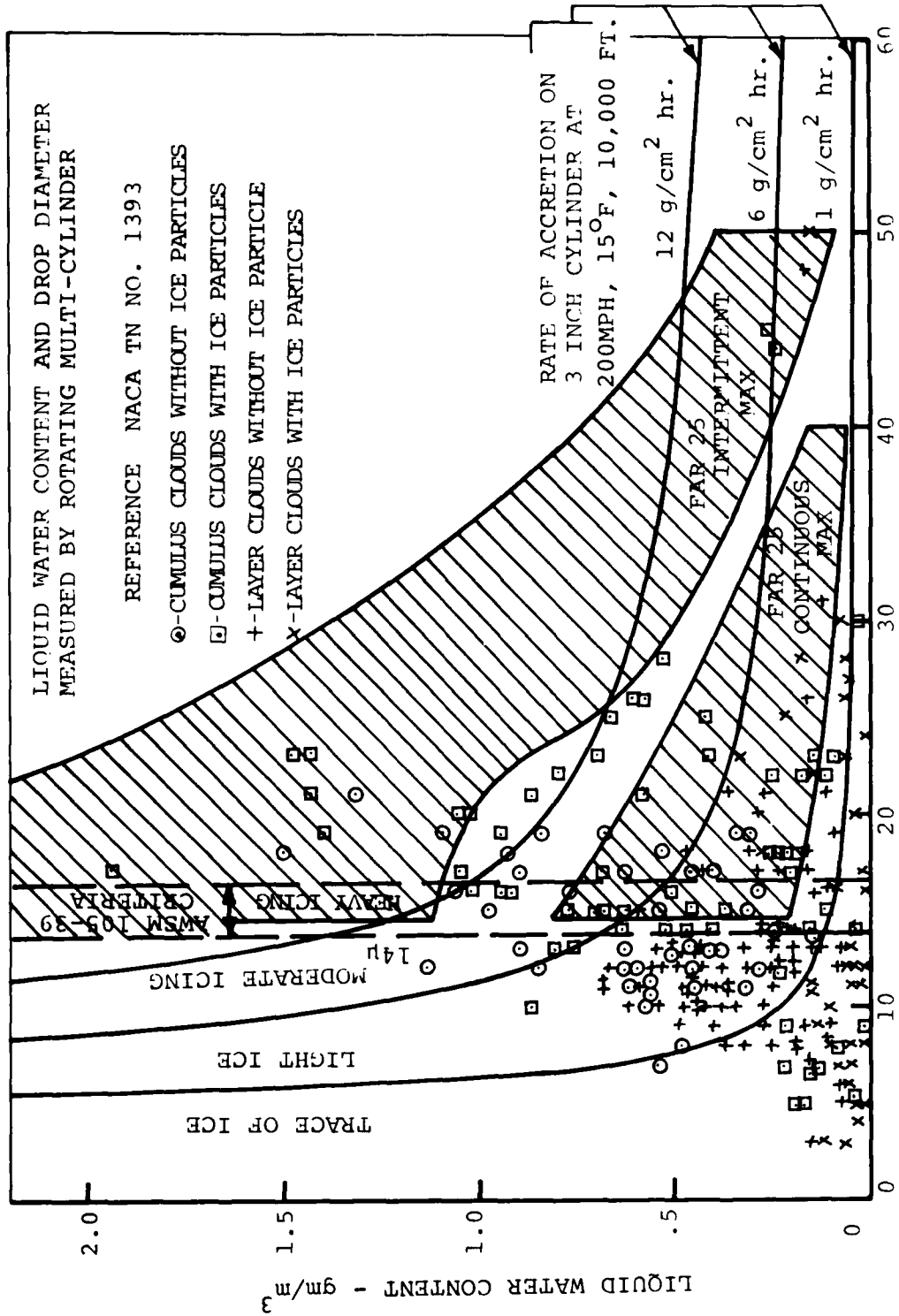

FIGURE 2-12. ICING INTENSITIES AND RATES OF ACCRETION DEVELOPED FROM MEASURED ICING DATA.

TABLE 2-1. METEOROLOGICAL FACTORS FOR CONSIDERATION
IN THE DESIGN OF AIRCRAFT ICE PREVENTION EQUIPMENT

Class	Item	Air Temp. (°F)	Liquid Water Content (g/m ³)	Drop Diameter (Microns)	Pressure Altitude (ft)	Remarks	
I-M Instantaneous Maximum	1	32	5.0	25	18,000 to 20,000	Horizontal extent: ½ mile. Duration at 180 mph: 20 seconds. Characteristic: Very high liquid water content. Applicable to: Any part of the airplane, such as guide vanes in inlet ducts, where a sudden large mass of supercooled water would be critical, even though of short duration. Example: Induction systems, particularly turbine-engine inlets.	
	2	14	4.0	25	22,000 to 25,000		
	3	-4	3.0	25	25,000 to 30,000		
	4	-22	2.0	20	20,000 to 30,000		
	5	-40	0.5	15	20,000 to 30,000		
I-N Instantaneous Normal	6	32	1.0	20	10,000 to 20,000		
	7	14	1.0	20	10,000 to 25,000		
	8	-4	0.6	18	12,000 to 30,000		
	9	-22	0.2	15	15,000 to 30,000		
	10	-40	<0.1	13	15,000 to 30,000		
II-M Intermittent Maximum	11	32	2.5	20	10,000 to 15,000	Horizontal extent: 3 miles Duration at 180 mph: 1 minute Characteristic: High liquid water content Applicable to: Any critical component of the airplane where ice conditions, even though slight and of short duration could not be tolerated. Example: Induction systems, windshields when continuous visibility is required.	
	12	14	2.2		10,000 to 20,000		
	13	-4	1.7		12,000 to 30,000		
	14	-22	1.0		15,000 to 30,000		
	15	-40	0.2		15,000 to 30,000		
	16	32	1.3	30	8,000 to 15,000		
	17	14	1.0		8,000 to 20,000		
	18	-4	0.8		10,000 to 30,000		
	19	-22	0.5		15,000 to 30,000		
	20	-40	0.1		15,000 to 30,000		
21	32	0.4	50	8,000 to 15,000			
22	14	0.3		8,000 to 20,000			
23	-	0.2		10,000 to 30,000			
24	-22	0.1		15,000 to 30,000			
25	-40	<0.1		15,000 to 30,000			
II-N Intermittent Normal	26	32	0.8	20	8,000 to 12,000		
	27	14	0.6	20	8,000 to 15,000		
	28	-4	0.4	18	12,000 to 20,000		
	29	-22	0.1	15	15,000 to 25,000		
	30	-40	<0.1	13	15,000 to 25,000		
III-M Continuous Maximum	31	32	0.8	15	3,000 to 20,000	Horizontal extent and duration: Continuous. Characteristic: Moderate to low liquid water content for an indefinite period of time. Applicable to: All components of the airplane: that is, every part of the airplane should be examined with the question in mind, "Will this part be affected seriously by accretions during continuous flight in icing conditions?" Example: Wings and tail surfaces.	
	32	14	0.6				0.5
	33	-4	0.3				0.3
	34	-22	0.2				0.2
	35	-40	0.05				0.1
	36	32	0.5	25			0.3
	37	14	0.3				0.15
	38	-4	0.15				0.10
	39	-22	0.10				0.03
	40	-40	0.03				0.15
41	32	0.15	40	0.10			
42	14	0.10		0.06			
43	-4	0.06		0.04			
44	-22	0.04		0.01			
45	-40	0.01					
III-N Continuous Normal	46	32	0.3	15			
	47	14	0.2				
	48	-4	0.1				
	49	-22	<0.1				
IV-M Freezing Rain	50	25 to 32	0.15	1000	0 to 5,000	Horizontal extent: 100 miles. Duration at 180 mph: 30 minutes. Characteristic: Very large drops at near-freezing temperatures and low values of liquid water content. Applicable to: Components of the airplane for which no protection would be supplied after considering classes I, II, and III. Example: Fuselage static pressure airspeed tests.	

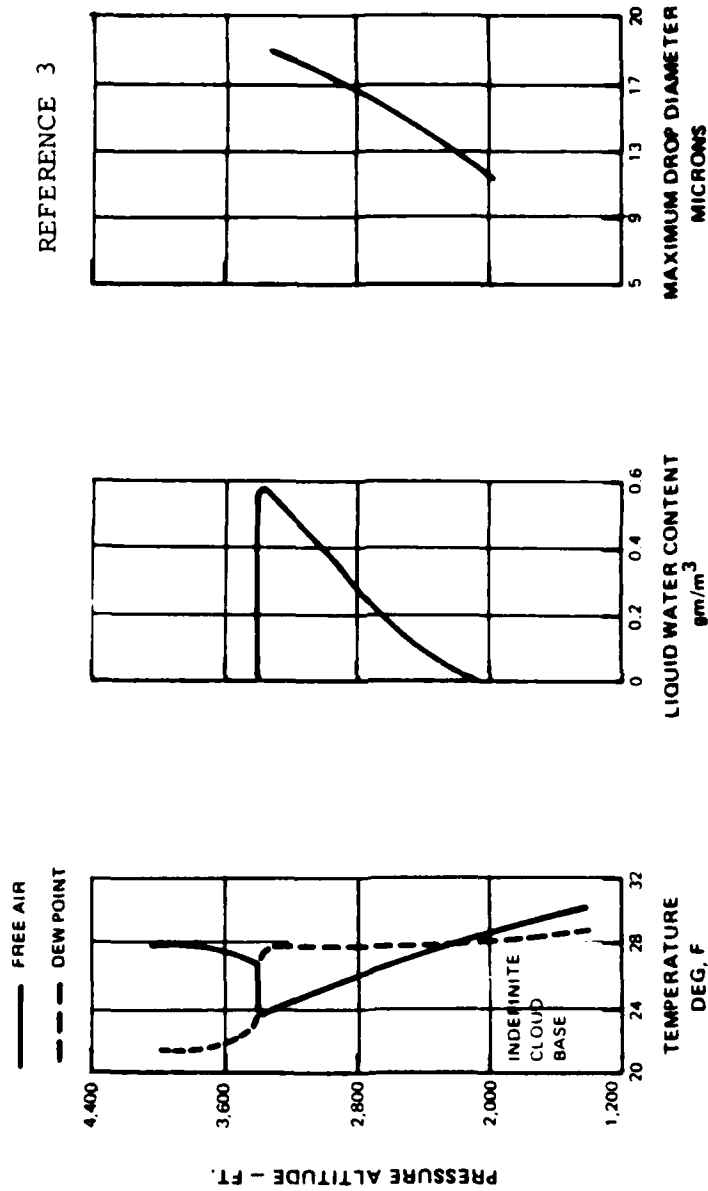
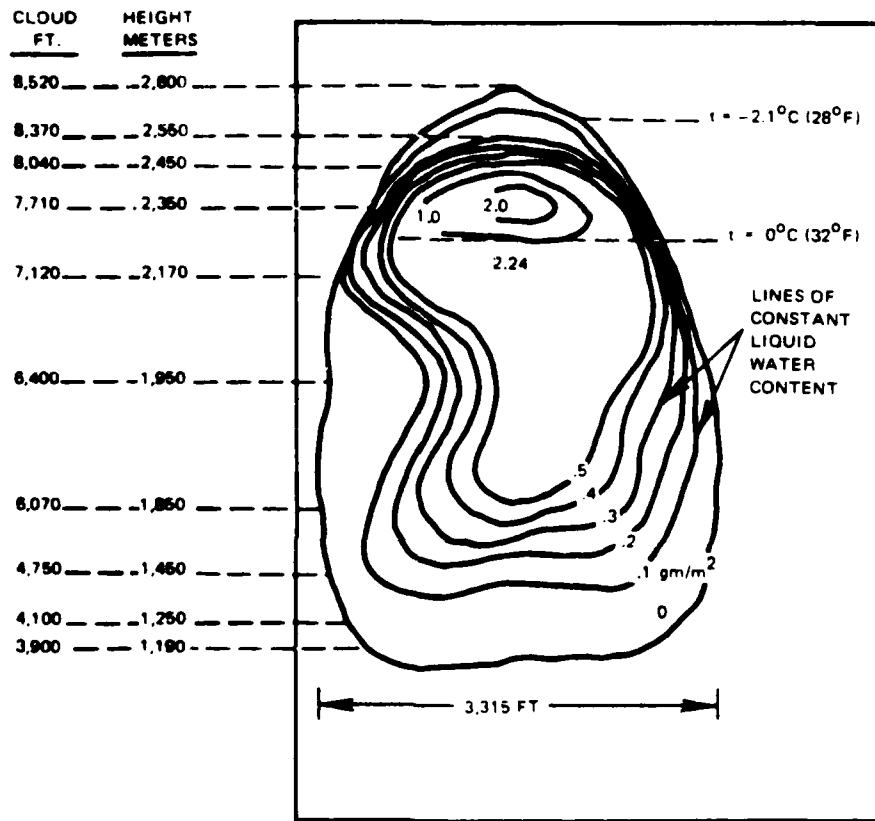

FIGURE 2-13. PROPERTIES OF STRATIFORM CLOUDS



DISTRIBUTION OF LIQUID WATER

REFERENCE 3

FIGURE 2-14. PROPERTIES OF CUMULIFORM CLOUDS

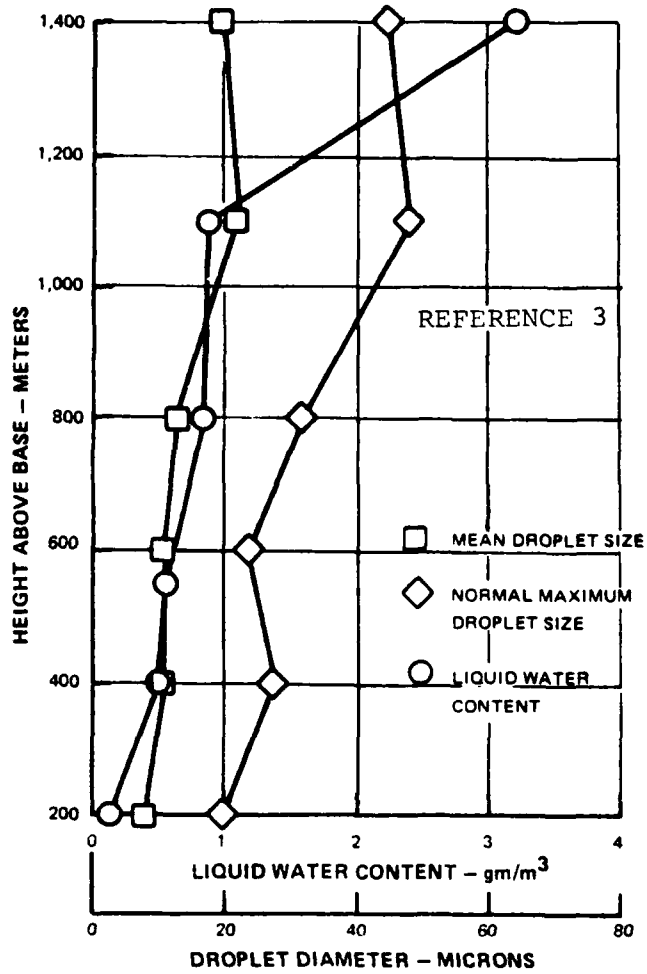

FIGURE 2-15. CUMULIFORM CLOUD DISTRIBUTION

Other low-altitude icing data is presented in Figure 2-16 taken directly from ADS-4. These data show that the liquid water content is reduced below stratiform-cloud values in low altitude icing environments. Table 2-2 summarizes many of the environmental definitions for freezing rain and low-altitude icing.

Freezing rain presents specific problems for airplanes and helicopters unique from those encountered in supercooled liquid water. The high sub-freezing ambient temperatures and the large water droplets (ranging to 1000 microns or more) present in the freezing rain environment may cause ice formations far aft on many surfaces because of the high catch efficiency of the large droplets and the slow freezing rate allowing a large amount of runback. The extent of icing, for example, on a helicopter rotor would be aft of the normal extent of a deicing system coverage. Because freezing rain tends to occur at the higher ambient temperatures (primarily -4 to 0°C with some potential to -10°C), the rotor self-shedding characteristics tend to reduce the amount and severity of freezing rain icing, other parts of the helicopter, however, may encounter major problems, i.e. windshields, engine inlets, inlet screens, vents, drain lines, etc. Inlet screens may present a problem because of potential icing on the aft side of the screen (engine side) with the associated FOD if the ice dislodges.

The U.S. Army (References 1 and 2) and the British (as defined in the British Civil Airworthiness Requirements (BCAR) - Reference 6) icing investigations have led to recommendations for helicopter icing environmental definitions differing from the current FAR criteria. Table 2-3 illustrates the various definitions to be considered for helicopter ice protection design. Figure 2-17 (taken from Reference 2) shows the Army recommended icing criteria for helicopters. Figure 2-18 presents a composite plot of FAR, BCAR and Army icing envelopes for comparison. Because the primary helicopter envelope is between SL and 10,000 feet, the altitude vs liquid water content range (for a 20 μ MVD cloud droplet) is illustrated in Figure 2-19 for each icing definition.

2.2.2 Current Standards

Current icing standards (or recommended standards) exist in the form of specification documents (including Federal Aviation Regulations), advisory and guidance documents, and reference technical reports. A composite of a number of these icing standards is illustrated in Figure 2-20. The basis of the existing icing standards is primarily from NACA (NASA) icing analysis and test using fixed-wing aircraft configurations. FAR Part 25 (Reference 5) Appendix C which is applied to aircraft ice protection systems under Part 23 (23.1419) and to turbine engines under Part 25 (25.1093), Part 27 (27.1093) and Part 29 (29.1093) is derived from NACA documents written for the evaluation of aircraft ice protection equipment. There is no attempt in these NACA documents to apply the data to helicopter operations in icing. ADS-4 (Reference 3) contains a section entitled "Application to Helicopters" which describes briefly the hazards of helicopter icing flights, areas requiring ice protection, ice accretion effects on

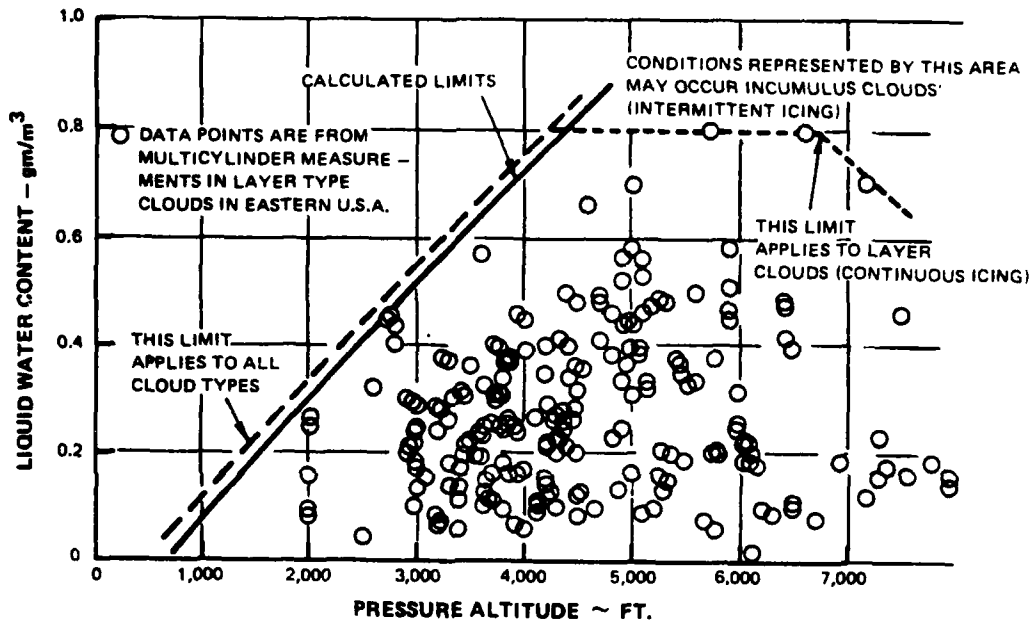

FIGURE 2-16. CLOUD LWC LIMITS AT LOW ALTITUDES.

TABLE 2-2. FREEZING RAIN AND LOW-ALTITUDE ICING ENVIRONMENT

Data Source	Icing Environment	Liquid Water Content gm/m ³	Ambient Temperature °C	Droplet Diameter Microns
NACA TN 1855	Freezing Rain 0 to 5000 ft.	0.15	0 to -4	1000
Unpublished NASA Data (Ref. 1-18 of ADS-4)	Low-Altitude layer clouds 0 to 5000 ft.	0.05 At Ground,	-	-
		0.80 At 5000 ft.		
Test Requirement: FAR Part 33	Ground Level Icing	0.6	-1.6	40
USAAMRDL TR 75-34A	Freezing Rain and Drizzle Low Altitude	0.32 (max)	0 to -10	400 to 1200
USAETL Report ETL-SR-73-1	Freezing Rain Ground Level	-	0 to -30	-
Test Requirement: Mil Spec MIL-E-5007D	Low Altitude Icing 0 to 5000 ft.	0.4	-5	30
British Test Require- ment:	Ground Level Icing	0.3	-2	20
British Civil Air- worthiness Require- ments: (Ref. 1-29 ADS-4)	Continuous Max- imum Icing	0.8	0	20
Military Design Requirements (RAF) AvP 970	Freezing Rain	0.3	0 to -10	1500
	Freezing Drizzle	0.3 to 0.0	0 to -15	200

TABLE 2-3. ICING ENVIRONMENT REFERENCE

Icing Environment Reference	Altitude
NACA TN 1393	
Icing Intensities Rates of Accretion	4000 to 19,000 ft
FAR PART 25	
Continuous Maximum	SL to 22,000 ft
Intermittent Maximum	4000 to 22,000 ft
BCAR SECTION C	
Continuous Maximum	SL to 22,000 ft
Intermittent Maximum	4000 to 22,000 ft
Ice Crystal	10,000 to 40,000 ft
BCAR SECTION D	
Continuous Icing	SL to 30,000 ft
Intermittent Icing	5000 to 40,000 ft
Ice Crystal	10,000 to 40,000 ft
Conditional approval for light or moderate icing requires use of icing rate meter.	
BCAR SECTION G (Ref. G4-7 Paper 610)	
Continuous	SL to 10,000 ft
Conditional approval for light or moderate icing requires use of icing rate meter.	
ATL RECOMMENDED ICING CRITERION	
Continuous Maximum	SL to 10,000 ft
Intermittent Maximum	

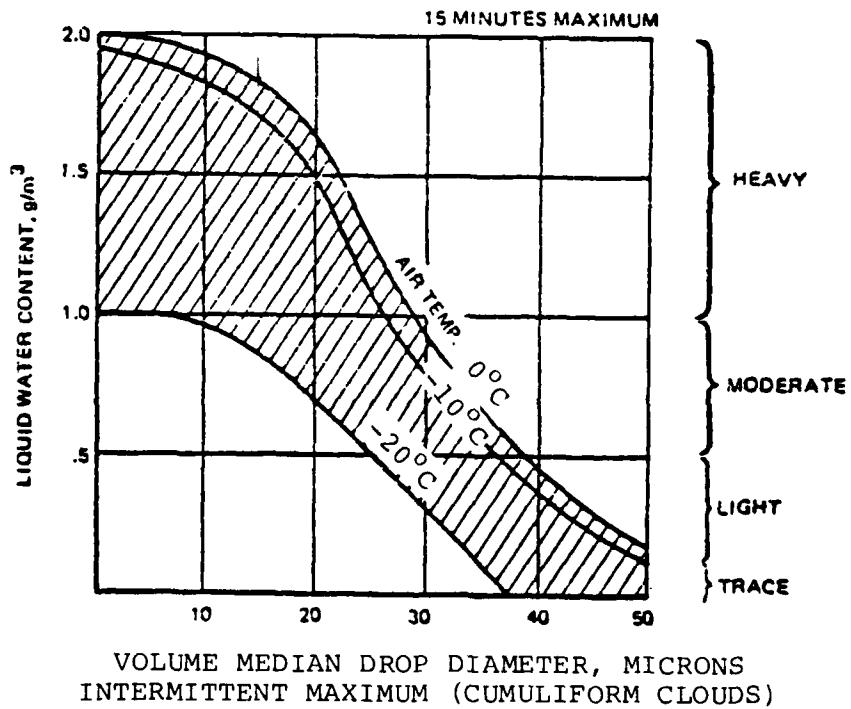
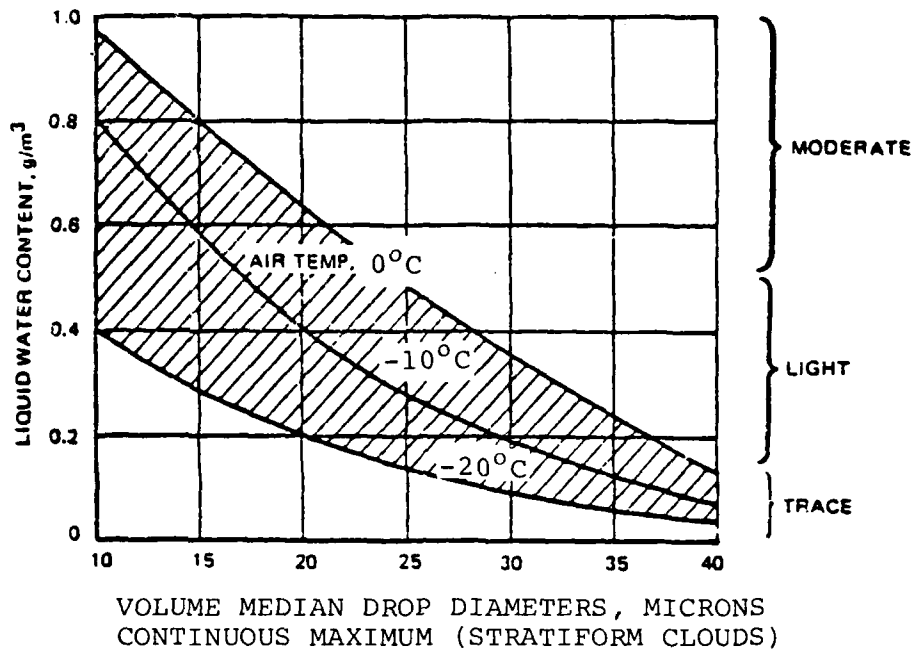

FIGURE 2-17. ICING LEVEL DEFINITIONS PER TR-75-34A.

- FAR PART 25
INTERMITTENT MAXIMUM (2.6 NM)
- FAR PART 25
CONTINUOUS MAXIMUM (17.4 NM)
- △ BCAR INTERMITTENT (2.5 NM CONTINUOUS
ALTERNATING WITH 2.5 NM INTERMITTENT)
- ▲ BCAR CONTINUOUS (UNLIMITED HORIZONTAL
DISTANCE)
- USAAMRDL TR-75-34A

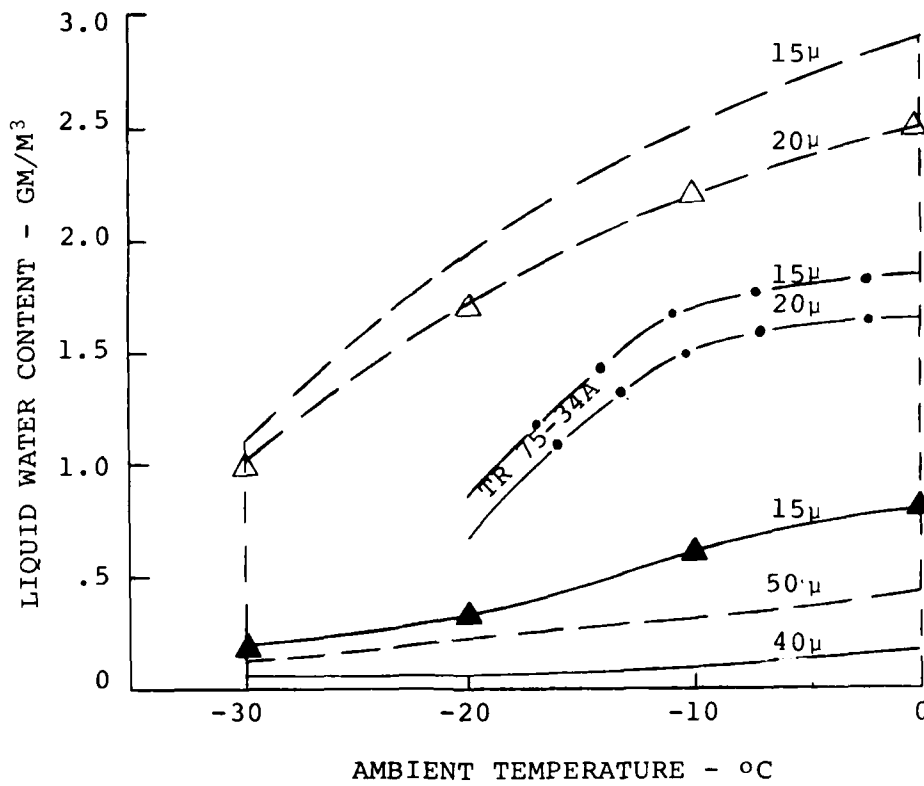

FIGURE 2-18. ICING ENVELOPE COMPARISON

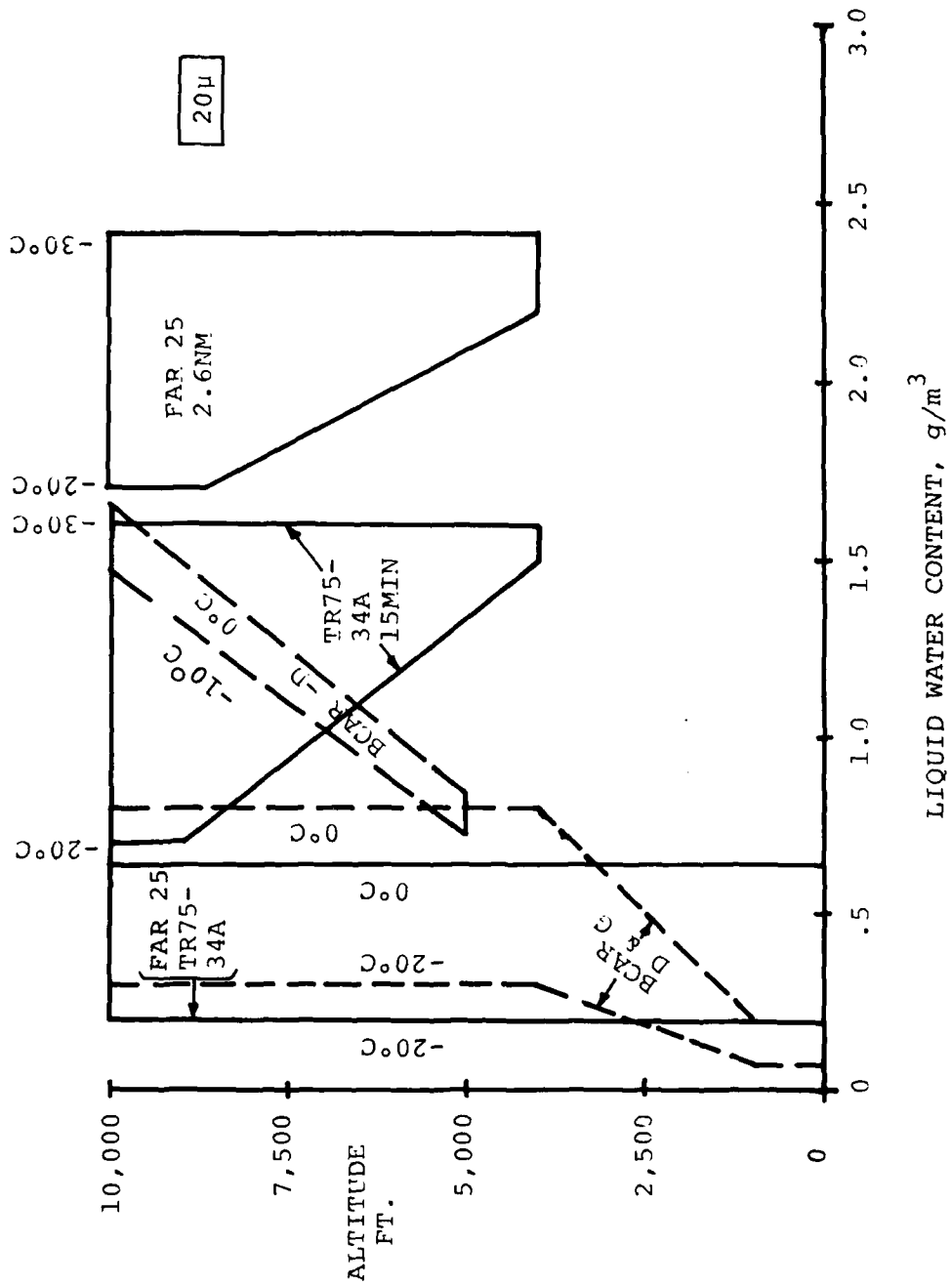

FIGURE 2-19. 20 MICRON ICING ENVELOPE BELOW 10,000 FEET

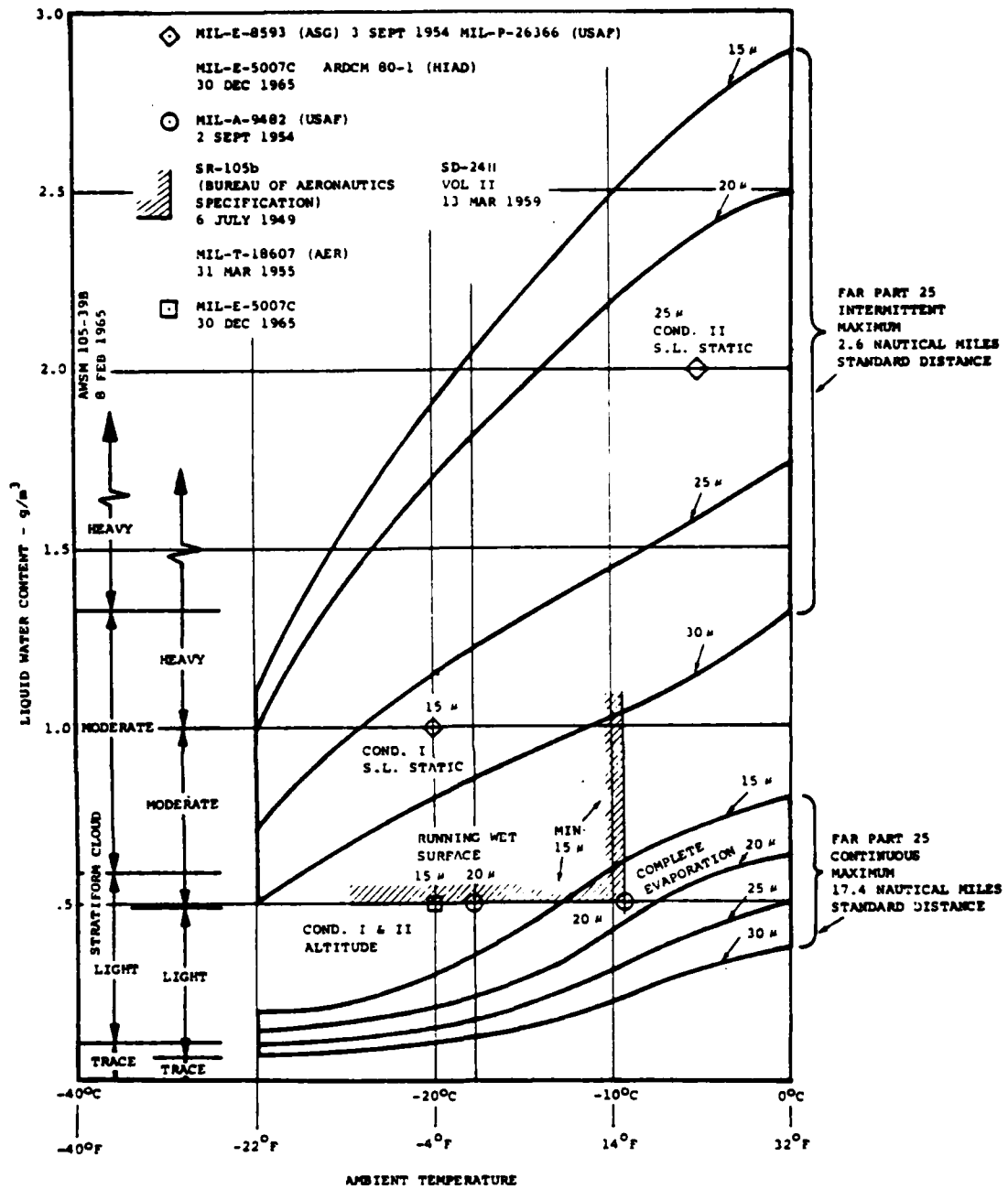

FIGURE 2-20. COMPARISON OF SPECIFICATION ICING CRITERIA

the helicopter rotor, and types of anti-icing/deicing systems applicable to helicopters based primarily upon early studies by the National Research Council of Canada.

Advisory Circular 20-73 (Reference 4) refers to helicopters under "Helicopter Operational Factors" and states that "current development of helicopter rotor system deicing or anti-icing means has not provided systems or hardware deemed acceptable by helicopter manufacturers". Because of this conclusion stated in AC 20-73, the Advisory Circular also notes that during icing tests of a helicopter comparative testing of the engine inlet and the rotor system may be used to establish equivalent safety (provided however that liquid water content, droplet size, and temperature are known).

USAAMRDL Technical Report 73-38 (Eustis Directorate), August 1973 (Reference 1), provides an extensive survey of the military helicopter icing environment. This report reviews the current icing severity criteria and the definition of degree of icing severity. The conclusion of this technical report refers back to the icing criteria defined in FAR Part 25 Appendix C and MIL-E-38453 as currently the most meaningful historical criteria available to define Army helicopter ice protection systems requirements. This conclusion is refined in USAAMRDL Technical Report 75-34A (Reference 2) by taking into account the normal lower operating altitude (below 10,000 feet) of helicopters. TR 75-34A recommends that the design meteorological conditions contained in MIL-E-38453 as modified (refer to Figure 12 of TR 75-34A) to a lower design temperature of -20°C be used to define the supercooled water droplet icing envelope.

Reference 32, reviews U.S., Canadian, British and Russian civilian aircraft icing specifications and analyzes this data in terms of the probability of exceedance of each icing criteria. The basic problem indicated by these surveys and analyses is that most data has been taken above 4,000 foot altitude. A limited amount of data (refer to the following sections for further discussion of available data) is available between sea level and 4,000 feet where a great deal of helicopter operation would be done. Current low altitude icing surveys should add considerably to the data base in this range.

2.2.2.1 Applicable Federal Aviation Regulations

Rotorcraft ice protection is defined under the following parts of the Federal Aviation Regulations:

FAR Part 27 which in summary includes:

- o Primary ice protection requirements defined for induction system (refer to Appendix C of Part 25)
- o Reference to snow ingestion by the turbine engines, both falling and blowing

- o Engine Idle for 30 minutes (ground operation) under specified icing condition

and Part 29 which is similar to Part 27 with the addition of "the rotorcraft must be able to operate safely through the range of icing conditions for which certification is requested." It is important to note that the method of compliance with the ice protection requirements for rotorcraft is not currently defined in either part. Proposed changes to Part 27 and Part 29 (Proposal 92 to modify 27.877 and Proposal 275 to modify 29.877) which will define the compliance procedures for certification with ice protection provisions are under review by the FAA. These proposed changes would require that "the rotorcraft must be able to safely operate in the continuous maximum and intermittent maximum icing conditions determined under Appendix C of Part 25 of this chapter within the rotorcraft flight envelope." In order to demonstrate compliance within the proposed icing envelope, the changes to 27.877 and 29.877 would require an analysis and physical evaluation of the ice protection systems and the following:

- o "...flight tests of the rotorcraft or its components in measured natural atmospheric icing conditions and by one or more of the following tests..."
- o "Laboratory dry air or simulated icing tests..."
- o "Flight dry air tests..."
- o "Flight tests of the rotorcraft or its components in measured simulated icing conditions."

As stated in the proposed change to 29.877 "it is therefore proposed to replace the existing 29.877 with essentially the same icing environment criteria that has been used for fixed-wing aircraft in FAR 25.1419, with minor changes." The minor changes would include the recognition of the "inherent altitude limitations of helicopters" (relative to the icing envelope defined in FAR Part 25 Appendix C), and "A requirement for a means of identifying the formation of ice on the critical parts of the rotorcraft."

The derivation of the icing envelope defined in FAR Part 25 Appendix C is illustrated in Figure 2-21. An examination of the reference sources indicates that the values (liquid water content, water droplet diameter, ambient temperature and altitude) are based (per Reference 35) on a "study of the available observational data and theoretical considerations where observations are lacking." Table 2-1 in Section 2.2.1 lists the meteorological categories resulting from the investigations noted in the referenced document. These meteorological categories formed the framework upon which the probability analysis effort noted in NACA TN 2738 (Reference 33) was undertaken and upon which the FAR Part 25 Appendix C draws its main support (i.e. the intermittent maximum and continuous maximum icing envelope calculated exceedance probability of 0.001). It is interesting to

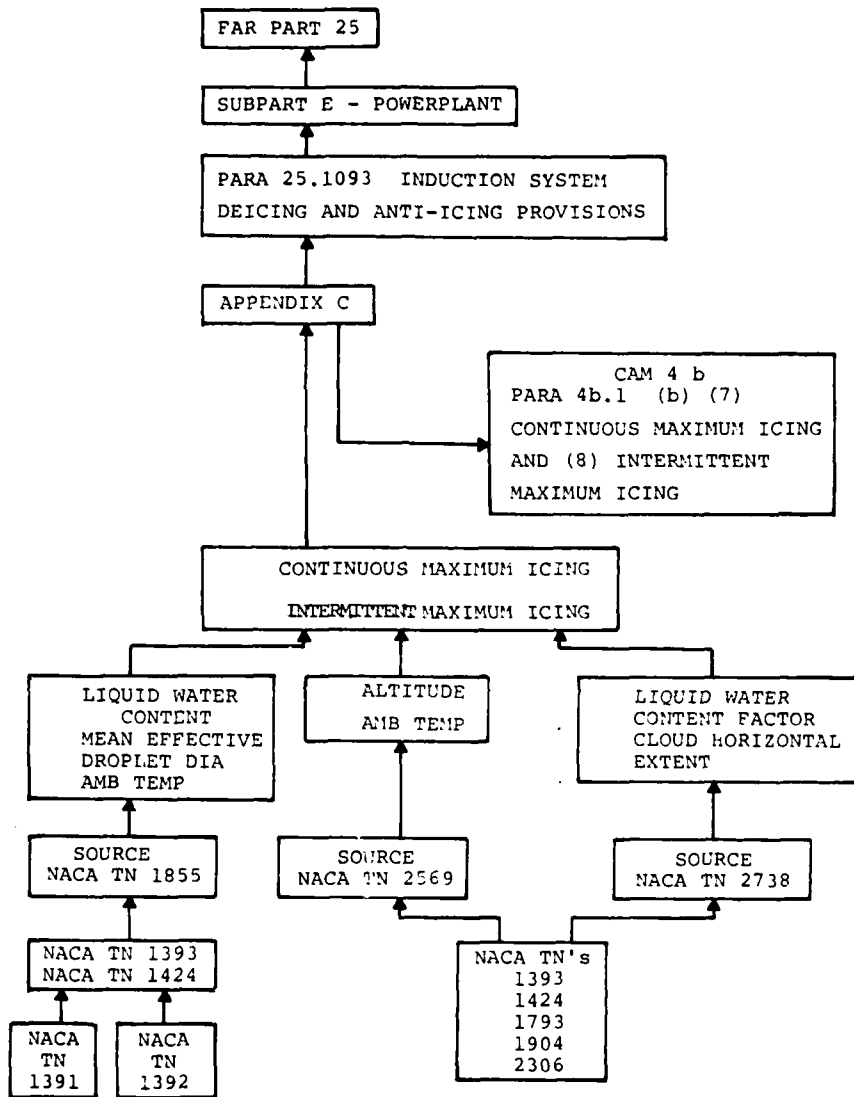

FIGURE 2-21. DERIVATION OF FAR ICING STANDARDS

note that (per Reference 33) "the majority of the data utilized in the probability analysis was taken at comparatively low altitude (13,000 feet) whereas the temperature range between -4°F and -40°F represents considerably higher altitudes (18,000 to 28,000 feet)."

The intent of these early icing investigations was to provide the fixed-wing aircraft ice protection system designer with a meteorological criteria primarily for thermal ice-prevention (anti-icing) equipment. Because the helicopter mode of operation and operating envelope is considerably different from that of most fixed-wing aircraft, it is suggested that a specific helicopter (rotorcraft) icing certification envelope (independent of FAR Part 25 Appendix C) be created based upon current helicopter icing research efforts. A recommended icing certification environment is outlined and discussed in paragraph 2.2.3 of this section.

2.2.2.2 U.S. Military Specifications

The military specifications having the most direct influence on helicopter ice protection systems design are categorized as follows:

Turboprop/Turboshaft Engines. MIL-E-8593A (Reference 34) presents the current icing meteorological requirements in terms of continuous maximum and intermittent maximum icing conditions (essentially the same as the icing conditions defined in FAR Part 25 Appendix C) and in addition, environmental icing test demonstration points at sea level are specified.

Transparent Areas. MIL-T-5842A (Reference 35) presents the windshield anti-icing heat requirements (as a function of cruise airspeed) and the defrosting/defogging requirements for all mission essential transparent areas. A draft (APR 1979) revision of this specification proposes to add an anti-icing design requirement using atmospheric icing conditions (continuous maximum and intermittent maximum) based upon FAR Part 25 Appendix C.

Environmental Control. MIL-E-38453A (Reference 36) incorporates continuous maximum and intermittent maximum icing condition charts similar to those of FAR Part 25 Appendix C.

Ice Detector. MIL-D-8181B (Reference 37) establishes the requirements for two types of ice detectors (i.e. a Type I detector designed to sense accumulating ice, and a Type II detector designed to sense impending ice) which includes the airstream temperature, liquid water content range and mean effective droplet diameters at which testing is to be accomplished. The range of design icing conditions specified fall somewhat within the FAR Part 25 Appendix C icing envelope, although the specific anti-icing test points lie outside the FAR envelope.

Rotorcraft Design. SD-24K (Reference 38) specifically addresses the rotorcraft ice protection requirements. Engine inlet anti-icing is to be designed for ice free operation (30 minute icing duration) while under the continuous maximum icing specified at a droplet size of 30 microns (i.e.

the FAR Part 25 Appendix C continuous maximum 15 micron droplet size icing condition is used at 30 microns). Also specified is the requirement for rotor blade anti-icing or deicing provisions, however no rotor icing environment is defined.

Figure 2-22 traces the turbine engine military specification path from the ANA bulletin 407 (Turbojet) which defined the continuous and intermittent icing conditions for turbine engine ingestion (similar to the FAR Part 25 icing conditions) to the present MIL-E-8593A specification for turboprop/turboshaft engines.

2.2.2.3 Other Standards

British Civil Airworthiness Requirements (BCAR) (Reference 39) addressing the icing environment and the ice protection requirements are included in Section C (Engines and Propellers), Section D (Aeroplanes) and Section G (Rotorcraft). The engine icing protection requirements use as a basis the regulations of FAR Part 25, Appendix C.

Under Section C, tests in precipitation and ice-forming conditions for single and multi-engined helicopters are specified to be accomplished in an alternating cycle of continuous and intermittent icing conditions.

The definitions of continuous and intermittent icing conditions for turbine engine testing are contained in Section D (Chapter D1-2) as Table 2 (Continuous) and Table 3 (Intermittent).

Helicopter icing clearance under Section G is currently defined in Paper No. 610 (pending approval for incorporation into Section G) for flight in precipitation and ice-forming conditions. A key element in the discussion presented in BCAR paper 610 is the reference to a limited icing clearance based on available icing test experience. As stated in the paper "in the event of insufficient demonstration being available at certification because of a lack of experimental facilities or the timely occurrence of natural icing conditions, the icing clearance of the rotorcraft will be limited so as to restrict its operation to those conditions for which it has been shown to be suitable." Ice Protection Systems and the required design atmospheric icing conditions are addressed in detail in AvP 970 (Reference 40) for the Royal Air Force.

2.2.2.4 Overall Standards Evaluation

The current standards (which are primarily directed towards fixed wing aircraft icing) rely greatly on the icing envelopes defined in FAR Part 25 Appendix C (continuous maximum and intermittent maximum). Several documents (i.e. TR 75-34A, SD-24K, BCAR Paper 610 and RAF AvP 970) specifically address the helicopter icing environment by recognizing the altitude limitation (unpressurized limit) and the associated minimum ambient temperature and maximum liquid water content ranges.

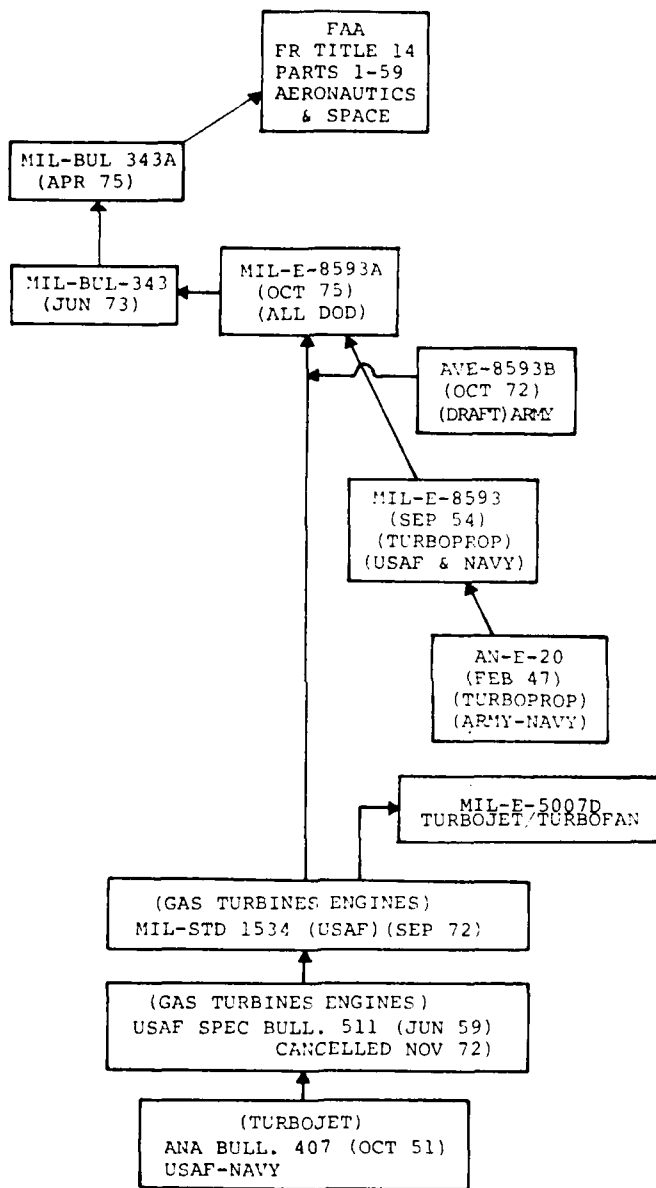

FIGURE 2-22. MILITARY SPECIFICATION PATH

The rationale for a departure from the current fixed wing icing envelope definition is contained within the NACA documents referenced in Appendix C to FAR Part 25. One of the intents of the referenced NACA Technical Notes (1855, 2569 and 2738) was to introduce a design criteria for thermal ice-prevention (anti-ice) systems by providing a rate, duration, and frequency of occurrence of various icing conditions. As noted in NACA TN 1855 (Reference 35) the "Tentative Listing" (reproduced as Table 2-1) "based on winter flights and confined, for the most part, to northern United States ..." requires additional flight research to establish the degree of representation to other areas.

Again in NACA TN 2569 (Reference 41) it is pointed out that "most of the research flights on which the data were obtained have been restricted to the Great Lakes and West Coast regions of the United States." While the continuous maximum liquid water contents presented in TN 1855 appear to match the .001 exceedance probability (per TN 2738) for layer clouds occurring across the United States, the intermittent maximum values only match the Pacific Coast cumulus (.001 exceedance probability) data taken above 10,000 feet.

It appears, therefore, that a low altitude (sea level to 10,000 foot) icing envelope is required for helicopter certification use as an integral modification to FAR Part 29. This incorporation of a specific helicopter icing envelope in Part 29 instead of the "Proposal 275" referral to Appendix C of Part 25 would allow independent control and development of icing criteria fitting the needs of current and future helicopters.

2.2.3 Recommended Icing Certification Environment

The recommended helicopter icing certification environment is separated into seven major groups (defined in Section 2.2.4.2) because of the unique operating characteristics and icing effects on systems within each group. The term "icing" as used to define the environment includes:

- o Supercooled liquid water
- o Snow (falling and blowing)
- o Mixed snow or ice crystal with supercooled liquid water
- o Freezing rain/drizzle
- o Freezing fog

Table 2-4 presents the icing environment in terms of the specific atmospheric and operational parameters associated with each icing condition. The applicability of each icing condition to specific helicopter systems or to the overall helicopter is identified in the table. It is pointed out that the icing conditions specified for the turbine engines in Tables 2-4 and 2-5 extend beyond (in terms of liquid water content and ambient

TABLE 2-4. RECOMMENDED ICING ENVIRONMENT

ICING CONDITION	AMB. TEMP °C	LIQUID WATER CONTENT GM/M ³			MEDIAN VOLUME DROPLET DIA. MICRONS			TIME IN ICING CONDITION	ALTITUDE RANGE FT.
		(a), (c)			(a), (c)				
Supercooled Liquid Water		(1)	(2)	(3)	(1)	(2)	(3)		
Continuous Maximum	0	0.8	0.5	0.15	15	25	40	30 min	0 - 10,000
	-10	0.6	0.3	0.10	15	25	40		
	-20	0.3	0.15	0.04	15	25	40		
	-30	0.2	0.1	0.04	15	25	40	30 min	above 10,000
Intermittent Maximum A (Engines & Inlets)	0	2.5	1.3		20	30		2 min	0 - 10,000
	-10	2.2	1.0		20	30			
	-20	1.7	0.8		20	30			
	-30	1.0	0.5		20	30		2 min	above 10,000
Intermittent Maximum B (Airframe)	0	1.65	0.95	0.2	20	30	50	15 min	0 - 10,000
	-10	1.50	0.80	0.14	20	30	50		
	-20	0.70	0.30	(b)	20	30	(b)		
Snow									
Falling	0	2.0			-			30 min	0 - 10,000
	-20	1.0			-				
Blowing (Recirculating)	0	1.5			-			5 min	Surface
	-20	1.5			-				
Mixed	0	LWC	ICE		-			15 min	0 - 10,000
	-10	0.45	1.2		-				
	-20	0.40	1.1		-				
Freezing Rain/Drizzle	0	0.3			200-2000			30 min	0 - 5,000
	-15	0.0			200-2000				
Freezing Fog	0	0.3			15			30 min	0 - 1,000
	-20	0.1			15				

(a) The supercooled liquid water content columns (1), (2) and (3) are matched with the corresponding columns of droplet diameter.

(b) Liquid water content = 0 at 37 microns (Reference 2).

(c) The liquid water contents and droplet diameters expressed in Table 2-4 represent the most probable conditions for airfoils (Reference 3). Other helicopter components should be assessed to determine the ice accretion characteristics.

temperature) those specified in Table 2-4 for other systems and the overall helicopter. The rationale is twofold: (1) Helicopter turbine engines are generally very sensitive to ice ingestion (and other foreign objects) unless specific foreign object protection is included as an integral part of the engine (for example, T-700) or as part of the airframe inlet installation. (2) The turbine engine, with or without the airframe inlet installation, can be tested under a range of icing conditions independent of the helicopter (i.e. in an icing tunnel or engine test cell) and therefore can be subjected to controlled icing where specific problems can be safely identified.

In addition to the icing conditions noted in Table 2-4, the turbine engine or engine/inlet combination must satisfactorily complete testing under FAR Part 33 which includes ice pieces and hail.

2.2.3.1 Discussion of Icing Environment

The recommended icing environment presented in Table 2-4 is based on a detailed review of the references discussed under 2.2.2. The source and justification for each icing condition listed is as follows:

Supercooled Liquid Water. Three conditions are defined under the supercooled liquid water category. The first condition, continuous maximum icing, is based on the Table I of NACA TN 1855 (reproduced as Table 2-1 of this report) and Figure 12A of TR-75-34A (reproduced as Figure 2-17 of this report). The primary helicopter altitude/temperature range is considered to be 0 to 10,000 feet and 0°C to -20°C. The additional range (10,000 to 20,000 feet and to -30°C) is for the turbine engine or engine/inlet ice protection systems only. The liquid water content range is chosen at the droplet diameters that appear to yield maximum airfoil water catch (per Reference 2). The 30 minute time in icing is chosen as being representative of a continuous icing penetration since, from a practical demonstration test standpoint, 30 minutes of icing should be sufficient for evaluation of ice protected surfaces. Unprotected surfaces must be more thoroughly evaluated. As a point of reference, the 17.4 nautical mile (horizontal extent) continuous maximum cloud defined under FAR Part 25 Appendix C calculates to be 10.4 minutes at 100 knots or 7.0 minutes at 150 knots.

Intermittent maximum icing is divided into two parts: Part A is defined for the turbine engine or engine/inlet system qualification (to comply with the intent of FAR Part 33, paragraph 33.68 "Induction System Icing") while Part B is defined for the overall helicopter based on the rationale of TR-75-34A Figure 12B (reproduced as Figure 2-17). Again, as discussed for the continuous maximum icing, the liquid water contents for two droplet sizes are chosen as best representing the maximum water catch range (and falling within the measured average droplet sizes of natural icing per Reference 41).

Snow. Falling and blowing (recirculating) snow concentrations are based on the values estimated for worldwide maximum snowfall (Reference 2

for falling snow) and for blowing snow (Reference 40). The 30 minute duration for falling snow encounter is representative of essentially a continuous exposure. Additional experience is required, however, to determine if the exposure time and concentrations are satisfactory. Blowing snow (primarily caused by rotor downwash) is (or should be) a very limited time condition. Pilot visibility, along with the potential engine/inlet icing is the major problem, and thus prolonged hover or snow flight close to snow packed ground is not a recommended procedure.

Mixed. Mixed snow or ice crystal with supercooled liquid water can create a hazard for thermal anti-icing systems (by requiring a heat load higher than available to maintain an ice-free surface) and potentially may pose an adverse icing situation for the rotors. The values of liquid water and ice concentrations chosen match the total concentration of the intermittent maximum Part B values under the supercooled liquid water condition of Table 2-4. The rationale for this approach is based on a review of AvP 970 (Reference 40).

Freezing Rain/Drizzle. Freezing rain and drizzle concentrations are combined into one set of values based on 4 mm/hr rainfall at 0°C (refer to Figures 3 and 4 of TR-75-34A and AvP 970) and 0 rainfall at -15°C. The resulting liquid water content ranges to a maximum of 0.3 gm/m³. While this value is higher than that calculated in TN-1855 (.15 gm/m³), it appears consistent with more recent studies.

Freezing Fog. Freezing fog is assumed to have the values defined in TN 1855 continuous normal (see Table 2-1 of this report). These values are somewhat lower than the freezing fog definition presented in Table 1 of AvP 970, however until further data is available the recommendations shown in Table 2-1 appear satisfactory. A more conservative approach as suggested in TR-75-34A is to assume the same water concentration as defined for continuous maximum icing.

2.2.4 Primary Certification Factors

The process of developing and conducting an icing certification program for a helicopter involves the definition, evaluation and application of many factors. The primary factors include the following:

- o Definition of the icing certification environment (overall helicopter icing environment).
- o Definition of the icing demonstration test conditions (critical icing conditions for the major systems and overall helicopter).
- o Definition of the acceptable icing test environment source (natural icing only or combined natural and simulated icing).
- o Definition (of the allowable effects) and evaluation of the effects of icing on the helicopter (i.e. performance, handling, autorotation).

- o Identification of icing operational limits determined during the demonstration program (i.e. limits of ice protection systems capabilities, limits of icing encounter related instrumentation available to the pilot and limits of helicopter performance, handling, and autorotation capabilities).

Discussion of these factors follows.

2.2.4.1 Icing Certification Environment

Section 2.2.3 presents a detailed discussion of the recommended icing certification environment.

2.2.4.2 Icing Demonstration Test Conditions

Table 2-4 outlines the recommended icing environment required for helicopter icing certification. Within this environmental envelope specific conditions (combinations of type of icing, ambient temperature, liquid water content, droplet diameter, time in icing) applicable to major systems (i.e. engine or engine/inlet) or the overall helicopter must be defined and used to demonstrate compliance with the intent of the icing environment. It is difficult to specify exact icing demonstration points as a requirement because of the major differences between helicopters (i.e. engine installations, rotor systems, etc.). In general though, test verification of the ice protection capabilities, ice tolerance, or proper functioning under icing conditions is required for the following (as applicable):

- o Induction System Ice Protection
 - Reciprocating Engines
 - Turbine Engines
 - Airframe Installed Engine Inlet
- o Induction System Foreign Object Protection
 - Inlet Screens
 - Foreign Particle Separators
 - Particle Deflectors
 - Plenum Chambers
- o Transparent Area Ice Protection
 - Primary Pilot Visibility
 - Secondary Visibility
 - Crew Visibility
- o Flight Instrument Ice Protection
 - Pitot Probes
 - Static Ports
 - Other Essential for IFR (Adverse Weather) or Navigation

- o Ice Rate/Intensity Indicators

- Probes
- Ice Detectors/Indicators

- o Rotor System

- Blades
- Controls
- Hubs
- Rotor Mast

- o Other Systems

- Vents
- Drains
- Antenna
- Radomes
- Control Surfaces
- Stabilizers

As a guideline, the required test icing conditions for each of the systems noted in this section are outlined in Table 2-5.

2.2.4.3 Icing Test Environment Source

The icing tests required for certification may involve both natural and artificial icing conditions. In the planning of the tests the following factors require consideration in determining the acceptable source of the icing:

- o Natural Icing Environment

- Selection of suitable operating base with high probability of ice encounters in proximity
- Location of icing for test (ability to forecast icing)
- Icing measurement equipment (ability to measure liquid water content and droplet diameter until adequate statistical relationships are developed)
- Relationship of icing encounter to specified certification criteria

- o Simulated Icing Environment

- Available test facilities (consider advantages/disadvantages of each facility)

TABLE 2-5. TEST ICING CONDITIONS

Major System Category	Applicable Icing Condition	Icing Type
Induction System	Supercooled Liquid Water	Continuous Maximum
		Intermittent Maximum A
	Snow	Falling & Blowing
	Mixed	Liquid + Ice
Foreign Object Protection System	Supercooled Liquid Water	Continuous Maximum
		Intermittent Maximum A and B
	Snow	Falling & Blowing
	Mixed	Liquid + Ice
	Freezing Rain/Drizzle	Liquid on Cold Surface
Transparent Areas	Supercooled Liquid Water	Continuous Maximum
		Intermittent Maximum B
	Snow	Falling & Blowing
	Mixed	Liquid + Ice
	Freezing Rain/Drizzle	Liquid on Cold Surface

TABLE 2-5. TEST ICING CONDITIONS (Continued)

Major System Category	Applicable Icing Condition	Icing Type
Flight Instruments	Supercooled Liquid Water	Continuous Maximum
		Intermittent Maximum B
	Snow	Falling & Blowing
	Mixed	Liquid + Ice
	Freezing Rain/Drizzle	Liquid On Cold Surface
Ice Rate/Intensity Indicators (current systems)	Supercooled Liquid Water	Continuous Maximum
		Intermittent Maximum A and B
	Snow	Falling & Blowing
	Mixed	Liquid + Ice
	Freezing Rain/Drizzle	Liquid on Cold Surface
Rotor System	Supercooled Liquid Water	Continuous Maximum
		Intermittent Maximum B
	Snow	Falling & Blowing
	Mixed	Liquid + Ice
	Freezing Rain/Drizzle	Liquid On Cold Surface

TABLE 2-5. TEST ICING CONDITIONS (Continued)

Major System Category	Applicable Icing Condition	Icing Type
Other Systems	Supercooled Liquid Water	Continuous Maximum
		Intermittent Maximum B
	Mixed	Liquid + Ice
	Freezing Rain/Drizzle	Liquid On Cold Surface

- Icing measurement equipment (ability to compare artificial to natural icing)
- Relationship of icing test environment to specified certification criteria

Natural Icing Environment - The best method for determining the performance handling and autorotational capability of a helicopter is to subject the helicopter and its protection systems to natural icing conditions and to demonstrate that the helicopter can be safely operated while exposed to the icing conditions defined by the certification requirements.

The major problems associated with testing in the natural icing environment are: (1) Locating an acceptable test site where sufficient natural icing conditions (in terms of temperature and liquid water content) are forecast to exist within the helicopter flight envelope, (2) having the proper instrumentation on board the test helicopter so that the actual natural icing conditions can be established and documented, and (3) having satisfactory chase aircraft (helicopter) contact so that external ice accretions can be documented in flight (as near the icing source as safely possible).

Natural icing overall (i.e. worldwide) frequency of occurrence is generally low (probably less than 10% per Reference 1) particularly at the lower ambient temperatures (below -10°C) within the normal helicopter altitude range (SL to 10,000 feet). Therefore test site selection is extremely important to minimize the icing certification program duration (which will probably extend over 2 to 3 icing seasons as a minimum). While, by using the proper test site, instrumentation, and documentation techniques, helicopter flights into natural icing conditions can (probably) yield sufficient data to permit an icing clearance, it would appear that a more efficient utilization of the test helicopter and the available weather (during the icing seasons) would be by supplementing the natural icing flights with simulated icing.

Simulated Icing Environment. Five general methods can be envisioned for generation of a simulated icing environment for an entire helicopter (including rotors):

- o Large icing wind tunnel (NASA Lewis Research Center, Cleveland, Ohio is proposing the rehabilitation into an icing tunnel of an existing altitude wind tunnel with 20 foot and 48 foot diameter test sections).
- o Environmental cold chamber (the existing Eglin Air Force Base, Florida climatic hanger is one example).
- o Cold region helicopter tie-down site (a natural icing site (i.e. Mount Washington, N.H.)).
- o Hover spray rig (i.e. NRC Ottawa spray rig).
- o In-flight spray system (i.e. U.S. Army HISS, USAF C-130).

Icing Wind Tunnel. Icing tunnel testing is the least expensive and most comprehensive method for determining the performance of an ice protection system under various ambient conditions. There are a number of icing tunnels in existence which have the capability to control LWC, droplet size, and temperature conditions quite accurately over their range of capabilities. The largest of these at present is the NASA Lewis Icing Tunnel (6 ft x 9 ft) test section in Cleveland, Ohio. Wind tunnel instrumentation is generally more extensive and accurate than flight test instrumentation. The disadvantages of ice tunnel tests are their inability generally to simulate altitude effects or the overall effects of ice accumulations on unprotected surfaces, and their inability to provide the combined operational and meteorological conditions that exist during an icing encounter on the full-scale helicopter.

One of the major disadvantages of current icing tunnels is the lack of capability to test a full scale rotating main rotor. Stationary, and oscillating airfoil sections have been evaluated (without centrifugal force field effects) and NASA (Lewis) is planning to evaluate a 5 foot diameter tail rotor, however, to date only limited success has been achieved in relating the icing tunnel data to the actual helicopter icing trial results. The NASA (Lewis) proposed large icing wind tunnel (altitude wind tunnel) may reduce many of the current tunnel disadvantages.

Environmental Cold Chamber. The cold chamber (hanger) can enclose an entire (tied down) helicopter with a controlled environment (ambient temperature, liquid water content). The general problem with the chamber is the recirculation of the icing cloud and snow/ice crystal formations circulating with the close proximity of the helicopter rotor system to the chamber floor (unless a high mounting platform is incorporated) and due to sidewall effects. The cold chamber instrumentation, like that of the wind tunnel can normally be more extensive than that used in flight testing because of the use of direct cable transmission of data from the tied-down helicopter to the control center.

Cold Region Helicopter Tie-Down Site. This type of helicopter tie-down facility utilizes the natural icing environment as the source. The difficulties in locating an accessible test site (transporting a helicopter to the top of Mount Washington is feasible - but difficult) with a sufficiently long icing season may make this approach unattractive. However, an additional look is probably warranted. The outdoor site reduces many of the cold chamber problems (recirculation, wall effects) and (if the prevailing wind is sufficient) may provide at least some forward flight simulation. If the normal natural icing conditions do not provide a large enough variation, an icing spray system could be introduced as a supplement. Again, as with the wind tunnel and cold chamber, instrumentation can be more extensive than in flight testing.

Hover Spray Rig. Ground level (hover) icing spray rig testing (i.e. NRC Ottawa spray rig) offers a closely controlled icing environment for development and check-out of ice protection equipment. The hover rig allows rapid access by ground personnel for examination of ice accretion

and ice shedding characteristics. Good water droplet size and liquid water content controls over the continuous maximum icing envelope can be maintained during the helicopter hover icing penetration. The major problem is the correlation of the rotor icing with that obtained in forward flight simulation and in natural icing.

In-Flight Spray System. Helicopter in-flight tanker (HISS) tests are being used by the U.S. Army to verify operation of various helicopters under simulated icing conditions. Ice protection systems and unprotected helicopter areas can be evaluated over a range of ambient temperatures and liquid water contents.

The HISS has encountered difficulties in simulating natural icing conditions because of lack of good water droplet size control. During this icing season (Jan - Mar 1980) new spray nozzles capable of producing 20 to 50 micron (median) droplets were incorporated with good success. Additional discussions of the HISS improvement program are contained in Appendix A and in Reference 55.

2.2.4.4 Effects of Icing

The determination of the most severe conditions for ice protection system design involves consideration of the operational helicopter. Operational regimes such as hover (IGE, OGE) transition and forward flight must be investigated at several altitudes. The cruise condition (level flight) tends to be severe because of the lift, drag, and pitching moments associated with the buildup of ice on rotors and the ice accretion on other exposed surfaces. Experience indicates that the helicopter attitude and rotor wash pattern can contribute to the formation of ice on critical areas. Continuing exposure to icing conditions may cause some helicopters to become incapable of sustaining flight. Because of excessive power requirements due to rotor icing, or due to excessive vibration caused by asymmetric ice shedding from the rotor.

Engine. The engine factors to be considered in determining the most severe icing conditions are directly related to helicopter operation because changes in speed and attitude and ice accretion are accompanied by changes in engine power requirements. These factors are especially critical if hot air anti-icing systems are used where the air source is the engine compressor bleed because of the power loss due to bleed extraction.

Ice accretion on engine inlets, inlet air screens, and inlet lips is considered critical because of the possibility of an appreciable quantity of ice being ingested into the engine causing serious damage to compressor blades (foreign object damage). Runback water can also refreeze on unprotected surfaces of the inlet and, if excessive, can reduce engine airflow or distort the flow pattern in such a manner as to excite compressor blades to critical frequencies, or break away and strike the compressor blades.

Rotor. The rotor operational factors involve the airfoil sensitivity to ice accretion (in terms of maximum lift capability, pitching moment and drag divergence), the spanwise extent of icing, the blade torsional stresses and the rotor control loads. These factors determine the operating limits of an unprotected (nondeiced) rotor system, and/or the need for a deice system.

Rotor icing can cause excessive power required demands (possibly exceeding the engine output capability), result in asymmetrical ice shedding (creating excessive vibration), and/or reduce the autorotational capability of the rotor (high drag over inboard portions of rotor).

Because of the high water catch efficiency of most rotor systems, rotor icing, particularly at the lower ambient temperatures, may be one of the major limiting factors in the helicopter's ability to operate in icing conditions without rotor deicing. The ability (in terms of cost, weight, power, space) to provide an adequate deicing system may limit the helicopter's capability under the more severe icing conditions (high liquid water content, and/or low ambient temperature).

Ice Shedding. When ice is shed from the rotor or fuselage during or after an ice encounter, it may create a hazard by entering engine inlet ducts or by striking and damaging other parts of the helicopter. The design should consider these hazards and appropriate steps should be taken to prevent unwanted buildup and release of large pieces of ice that could cause hazardous malfunctioning or substantial damage to the engine or fuselage. Maximum ice shedding usually occurs after an ice encounter when the helicopter is flown into outside air temperatures above freezing. Ice can be expected to be shed from the rotors, windshields, the fuselage nose, pitot masts, antennae, etc. Engine inlet ducts and other parts of the helicopter located in the path of released ice are susceptible to ice damage. Experience on the CH-46 and CH-47 indicates that the small turbine engines typically used on helicopters are more sensitive to compressor blade damage and adverse engine operation during ice ingestion than are larger turbine engines typically used on fixed-wing aircraft.

During the icing flight tests specific ice potential problem areas should be noted for observation and photographic documentation:

- o Ice Shedding Paths. Particular concern should be given to ice striking engine inlets, pylons, rotors, control rods, antenna, and other vulnerable helicopter components. A particular ice shedding hazard occurs during landing and rotor shutdown.
- o Ice Accretion on Critical Components. Icing of fuel vents, drain lines, droop stops, inlet screens, etc. should be noted for determination of degree of hazard.

In addition to the usual measurements and observations made during ice encounter tests, the following additional instrumentation and/or observations may be considered.

- o High speed (i.e. 200 to 400 frames per second) motion pictures to record the trajectory of ice released from the helicopter.
- o Recording system for turbine-engine-powered helicopter to record EGT, gas generator speed, engine torque and rotor rpm and torque for the purpose of detecting adverse effects on engine and rotor operation.
- o Visual examination of the helicopter for damage before and after ice encounters, especially in the area of the engine compressor, inlet, aft or tail rotor, and pylon/fins.

2.2.5 Recommended Helicopter Icing Certification Test Procedure

A helicopter icing certification test procedure must be based around the specific helicopter undergoing the certification icing trials because of unique characteristics of individual helicopter types in terms of general configuration (single-rotor, tandem-rotor, etc.), and specific systems (engine inlet location, rotor type, control systems, etc). There are, however, general requirements that must be addressed if the helicopter is to meet the certification criteria.

- o Ice protection systems design analyses (includes design concept, predicted function, failure probability, and consequences if failure occurs), and justification for no ice protection on specific systems.
- o Demonstration of ice protection systems capabilities prior to flight evaluation program. This may involve the use of an icing wind tunnel, and/or model techniques to verify the predicted functioning of the system prior to the helicopter icing trials program.
- o Detailed icing trials flight planning. It is recommended that this plan include the use of simulated icing facilities as well as natural icing flights. As will be discussed in more detail later in this section, use of both the NRC (Ottawa) hover rig and the U.S. Army HISS is highly recommended.
- o Flight instrumentation, recording, and data reduction design (includes detailed list of all instrumentation to be on-board test helicopter and a definition of the methods by which the data will be recorded and reduced).
- o Flight photographic equipment definition and photographic techniques (includes use of on-board fuselage mounted cameras, rotor hub mounted cameras (or other satisfactory camera position to document rotor ice), and cameras to be used on chase aircraft and at ground locations).
- o Execution of the icing trials (as defined in the flight plan). Because of the uncertain character of the weather for both simulated and natural icing, the icing trials will extend over several icing seasons (probably 2 to 3 as a minimum). This extended time, however,

does allow sufficient time for evaluation of each season's icing runs, thus allowing for modifications in the flight plan as necessary.

- o Final data reduction procedure for the icing trials. It is recommended that this procedure specify the technique by which the data is compared to the ice protection systems design to see if the design goals were met, and to determine if production configuration modifications are required.
- o Data submittal to the certifying agency (this will include substantiation for ice certification, estimate of expected deterioration in helicopter performance and handling under icing conditions, and expected flight manual inputs).

2.2.5.1 Ice Protection Systems Design Analysis

Design analyses are required for each major ice protection system to insure that (1) the design concept is viable based on past helicopter icing experience, (2) sufficient energy (or other means) is input to the system to meet the certification icing environmental conditions, and (3) failure of the system is not a critical flight safety problem. Additionally, if no ice protection is selected for specific helicopter areas, satisfactory justification must be provided based on past helicopter experience or on a proven analytical or test model. In general, the helicopter systems requiring some form of ice protection verification are as shown in Table 2-5 and listed as follows:

- o Induction System (Engines, Inlets).
- o Foreign Object Protection Systems (Inlet Screens, Separators, Deflectors, Plenum Chambers).
- o Transparent Areas (Windshields, etc.).
- o Flight Instruments (Pitot, Static, etc.).
- o Ice Rate/Intensity Indicators (Probes, Detectors, Indicators).
- o Rotor System (Blades, Controls, Hubs).
- o Other Systems (Vents, Drains, Antenna, Radomes, Control Surfaces, Stabilizers).

Table 2-5 lists the applicable icing condition and icing type that each major system must be protected against. The Ice Protection System Design Analysis must therefore account for each condition and type shown as part of the overall systems evaluation.

2.2.5.2 Ice Protection Systems Demonstration

Many of the systems noted in 2.2.5.1 can be evaluated in icing test cells or icing wind tunnels over at least the supercooled liquid water icing range of Table 2-5 (some test facilities may have capability to simulate mixed icing conditions, or a form of snow). The use of these test facilities permits system verification, adjustment or modification without the need to wait for the proper icing weather, and thus maximum use of available icing test weather can be made during the flight test phase of the Certification Program.

Satisfactory anti-icing tests of non-rotating thermal systems (engine inlets, transparent areas, pitot, static ports, and other systems) can be accomplished on full scale complete systems or full scale sections using an icing wind tunnel such as at NASA Lewis (6 x 9 foot test section) or at Arnold AFB. As noted above, these tests are necessary for verification of the system (and necessary for adjustments/modifications to the system) because specific critical icing conditions can be simulated and the results quickly analyzed to determine the adequacy of the thermal anti-icing. Testing in an icing wind tunnel can be accomplished at any time of the year (pending tunnel availability) and therefore scheduling can be adapted to meet icing flight test schedule (icing test weather availability).

Rotating component icing tests (i.e. rotor systems) are generally not feasible because of the limited size test section of current icing tunnels. Tail rotors (such as the OH-58 planned by NASA Lewis) can be tested, however, only short sections of main rotors or scaled rotors (if scaling of icing can be properly verified) can be fitted into current tunnels. Rotor deicing sequencing can be checked out to a limited extent (without the centrifugal force field) by using an oscillating airfoil set-up. Correlation of the oscillating airfoil to the full scale rotating system has only been accomplished on a limited basis in the U.K. so that this technique could only be used as a guide in the deicing system evaluation.

2.2.5.3 Icing Trials Flight Planning

The flight icing trials form the primary verification that the helicopter meets the icing certification requirements. These requirements include operation within the specified icing environment with no adverse change in power required, or handling qualities, or loss of autorotational capability. Additionally, the ice protection systems must demonstrate adequate performance and it must be shown that failure of any ice protection system will not cause a safety of flight problem.

The state-of-the-art in the understanding of helicopter icing and in particular, rotor icing is very limited. This is evident by the lack of a production helicopter cleared for unlimited icing penetration in the U.S., with only the French "PUMA" cleared in the free world. The major problem encountered in icing by most helicopters is the effect of ice on the rotor.

This effect may be in terms of increased power required, increased vibration levels, increased control loads, or decreased autorotational capability.

This limited understanding of rotor icing dictates that maximum utilization of testing methods be made to insure that the many icing variables are explored.

The icing flight planning, therefore, should include specific testing to examine rotor icing and the effectiveness of the rotor ice protection system (deicing system). In the early phases of the testing it is important to have the capability of making rapid adjustments to the rotor deicing cycles (electrothermal deicing is presumed to be the only system capable of meeting the full icing certification envelope) and corrections to the power input.

Testing in the hover spray rig (NRC, Ottawa) offers advantages in making required system evaluations because of the ability to perform controlled short duration icing runs, and immediately being able to document the system performance. While it is recognized that rotor icing in hover differs (because of angle of attack, mach number, and blade loading differences) from that in forward flight (clear documentation of these differences has not been accomplished), use of the hover results as demonstrated in testing described in Section 2.1 has proven to be a valuable first test. Use of the hover rig also offers an excellent way to check out flight instrumentation and most importantly, the onboard photographic systems.

In-flight icing tests behind an icing tanker (i.e. HISS) can use using the same instrumentation and photographic setup as in the hover testing (in-flight Chase Aircraft photographic coverage to be added). In planning the HISS flights, it is highly desirable to match certain specific icing test points achieved during the hover testing (i.e. same combination of liquid water content and ambient temperature within the limitation of both facilities) to be used to check the facilities correlation.

During testing in either facility it is important to be prepared to explore natural icing conditions as they become available in the test area (after satisfactory checkout of all systems).

The recommended test plan sequence therefore is:

- o Initial checkout and adjustment of all systems in the hover spray rig.
- o Forward flight testing behind the HISS.
- o Natural icing flights (may be interspersed with hover rig or HISS tests as appropriate).

2.2.5.4 Flight Instrumentation

While each helicopter type will have specific instrumentation requirements a general recommended list of instrumentation pertaining to the icing trials is presented as follows:

- o Engine torque, gas generator RPM, turbine inlet temperature
- o Airspeed, altitude, ambient temperature
- o Rotor RPM, rotor torque, pitch link load (one fixed, one rotating per rotor head)
- o 3 axis vibration (at critical locations)
- o Engine inlet pressure (if appropriate)
- o Icing rate, ice detector signal
- o Generator output voltage, current to deice system (signal per phase)
- o Deice heater power on/off vs. time
- o Camera(s) signal
- o Event marker
- o Water droplet size indication device (i.e. fixed cylinder, gelatin slide, spectrometer or other acceptable means)

The list above represents instrumentation that should be recorded continuously on board the test helicopter. Additionally, specific data as deemed critical for the test helicopter should be transmitted during flight (real time) to a ground station for immediate evaluation. Data reduction facilities should be available on site to permit rapid review at completion of a test run, (or at the latest by the end of a test day). This data list should apply to each type of icing test run. (i.e. hover rig, HISS, natural). The real time transmitted data may differ as the program progresses.

2.2.5.5 Flight Photography

Flight Photography is extremely important in documenting ice accretion on critical areas of the helicopter (rotors, hubs, engine inlets, etc.). Techniques for photographing non-rotating components and systems involve fixed-mounted (fuselage mounted) cameras (movie or still) or use of windows or ports to obtain in-flight icing photographs. The most difficult area to photograph is the rotor because of the rotation, distance from fuselage to rotor outboard sections, and viewing angle. Hub mounted cameras (aimed along the blade leading edge) have only had limited success. The U.K. has developed a hub mounted periscope prism camera system for the

Wessex, capable of photographing the upper surface of all main rotor blades simultaneously. This camera system coupled with a tail boom mounted camera can document the upper and lower surface ice accretion and ice shedding of a selected blade. The photographs taken with this system also contain event marks to tie into the flight instrumentation recordings. USAATL is developing a synchronized rotor camera system (fuselage mounted) for documentation of the leading edge and lower surface ice buildup and shedding as part of their continuing icing research efforts.

Chase plane and ground photography still play important parts in the overall icing documentation. Photographs (stills and movies) taken from the Chase Aircraft (and from the HISS ramp) provide good coverage of the overall icing patterns and can be used to determine the spanwise extent of rotor icing.

Ground photography can provide excellent coverage in the hover spray rig. During operation behind the HISS and in natural icing ground photography can be used effectively for coverage of nonrotating systems (engine inlets, screens, windshields, vent, trails) and for rotor areas around the hub. The rotor blade icing can only be partially documented because of the loss of much ice after leaving the icing cloud and during landing/shutdown.

2.2.5.6 Icing Trials

As described under paragraph 2.2.5.3 (flight planning) the recommended icing trials include the use of the NRC hover spray rig as well as the U.S. Army HISS to supplement and expand the natural icing flight data. Since the trials will probably take place over a 2 to 3 year span, sufficient time is available to evaluate the results from each season to see if system modifications, instrument changes or changes to the testing techniques are required.

The evaluation of the results of each icing trial season should also take into consideration the application of these results to an interim icing clearance based on the factors discussed in Section 1.2 (Summary) of this report.

An important approach during the icing trials is to check the helicopter, and particularly the rotor system to the extremes of the icing envelope (i.e., high liquid water content regions and low temperature regions). This approach, which should be accomplished early in the program, will help identify system deficiencies (if any) and allow time for correction.

This aspect of the icing trials lends itself to use of the hover spray rig because of the rapid turnaround time (in spray rig operation) from data point to data point and the ability to repeat specific points at short interval (without major changes in the ambient temperature). The ability to repeat data points is a key to evaluating the icing results because of the impact of other variables (solar heating effects, humidity, sublimation) which are still under study.

The time duration between HISS flights (probably a maximum of 3 flights per day) depends on the number of test helicopters awaiting icing flights, thus making repeat flights (same temperature and liquid water content) at a short interval very doubtful.

2.2.5.7 Final Data Reduction

The results of the icing trials should be reviewed in light of the following:

- o Available test data (based on flight instrumentation and photographic documentation).
- o Overall flight characteristics during icing encounters (both pilot inputs and instrumentation read out).
- o Ice protection systems functioning (evaluated on a run by run basis).
- o Instrumentation and essential equipment function (IFR and icing encounter priority).
- o Flight envelope definition during IFR and icing operation (developed from the available data).
- o Reliability (fail-safe features) for ice protection systems and instrumentation (duplex/redundant systems consideration) based on the results of the final data reduction.

2.2.5.8 Data Submittal

Data submittal to the certifying agency and the request for an icing certification (clearance for known or forecast icing penetration) must include the following:

- o The analyses of the ice protection systems, expected helicopter flight characteristics and system failure analyses.
- o The documented results of the icing trials (icing tunnel, hover rig, in-flight rig and natural).
- o The complete list of instrumentation used during the icing trials.
- o The recommended production flight instrumentation. Particular attention should be noted to the icing rate/indication instrumentation selected (i.e., justification for selection, function, activation of ice protection system(s)).
- o The specific flight manual limitations to be observed by the flight crew prior to and during actual icing penetration. These limitations should include:

- Gross Weight
 - Airspeed
 - Ambient Temperature
 - Altitude
 - Center of Gravity Location
 - Engine and Rotor Torque
 - Vibration
 - Control Loads (Fixed and Rotating Links if applicable)
 - Icing Rate (and/or liquid water content)
- o The ice protection equipment operation specified in terms of:
 - Normal Operation
 - Operation beyond Qualification
 - Failure Modes and Identification of Failure
 - o Instrument output data unique to icing identification, icing rate, and ice protection systems operation. The instrumentation data should enable the flight crew to:
 - Identify and quantify the icing condition.
 - Relate the icing condition to the helicopter clearance.
 - Identify proper ice protection equipment operation and/or malfunction.
 - Provide guidance as other helicopter limits are approached (i.e. torque limits, vibration limits, control load limits, etc.).

2.3 ICE PROTECTION TECHNOLOGY

State-of-the-art ice protection technology, is available (as noted in Reference 1) primarily for fixed-wing aircraft components, such as: engine inlet, engine, propeller, wing, windshield, control surfaces, essential flight instruments. These systems, grouped according to the principle of their operation (hot air, electrical liquid and mechanical-expandable boot systems) provide a general technology baseline for helicopters.

For instance turbine engine and engine inlet anti-icing systems on a fixed-wing aircraft are similar in basic concept to those on a helicopter. Boeing's 737 Commercial Transport and the Boeing CH-47 both use bleed air to anti-ice the engine inlets. However, the major difference in external flow fields between the fixed-wing and helicopter must be taken into account. Inlet screen and foreign particle separators required for most turbine-powered helicopter engine systems pose unique problems not found for fixed-wing systems. Current helicopter deicing systems utilize the basic approach developed for propellers of fixed-wing aircraft with however unique design solutions pertaining specifically to the helicopter rotor operation.

2.3.1 Types of Systems

Ice protection systems are broadly divided into two classes: anti-icing systems, which maintain the critical surface free of ice at all times, or deicing systems, which remove ice after it is formed, either periodically or possibly at the end of an encounter. Some systems may be used for either mode (anti-icing or deicing) of operation, such as thermal systems or chemical freezing point depressant systems. Thermal anti-icing can be of either the evaporative type, wherein the entire water catch is evaporated within a discrete area determined by the droplet impingement limits, or of the running-wet type, wherein the entire affected surface is maintained at a temperature above the freezing point.

Propulsion systems, windshields, and pitot static systems are normally protected with anti-icing systems since the presence of ice is generally not desirable. Aerodynamic surfaces, such as the wings, empennage, or propellers may be operated with some degree of ice, depending upon the penalty imposed upon the specific aircraft. An anti-icing, deicing or, no ice protection system may be selected after evaluation of the icing effects.

Tables 2-6, 2-7 and 2-8 (based in part on References 42 thru 45 illustrate ice protection methods utilized on fixed-wing transport type airplanes, for reciprocating engine, turboprop and turbojet/turbofan installations. Table 2-9 summarizes helicopter ice protection systems as defined in available flight manuals and associated documents. Also, contained in Table 2-9 is a listing of the rotor characteristics including the deicing parameters as available.

Figures 2-23 and 2-24 denote the surface locations of the ice protection systems on two typical turbine powered aircraft.

The inherent characteristics, advantages, and disadvantages of the various fixed-wing ice protection systems must be evaluated for a particular helicopter application. Figure 2-25 illustrates specific fixed-wing technology with helicopter applicability. The following paragraphs discuss some of the major aspects of the ice protection systems which affect or influence their selection for rotorcraft engine inlets, windshields, empennages, radomes, pitot tubes, and most important, main and tail rotor blades.

The primary thermal ice protection systems utilize either electrical or pneumatic (hot air) power sources to provide the necessary anti-icing or deicing heating operations at the protected surfaces. Basically, electrothermal systems utilize a heater blanket technique incorporated into the surface of the area being protected as shown in Figure 2-26 for a typical composite rotor blade. Hot air systems basically require the protected control surface to function as a double-skinned heat exchanger through which hot air would transmit heat to the surfaces requiring protection from ice formations. Figure 2-27 illustrates a hot air (engine compressor bleed air) engine inlet anti-icing system.

TABLE 2-6. TYPICAL RECIPROCATING ENGINE POWERED AIRCRAFT INSTALLATION

AIRCRAFT	ENGINE	ICE PROTECTION SYSTEMS				
		WING	EMPENNAGE	WINDSHIELD	ENGINE INLET	PROPELLER/ SPINNER
DC-3	P&W R202	Pneumatic Boot	Pneumatic Boot	Hot Air (Aux) Fluid	Fluid (Carb)	Fluid
Martin 202	202	Hot Air	Hot Air	Electro- Thermal	---	Electro- Thermal
C-82	P&W R2800	Hot Air	Hot Air	Hot Air	---	Fluid
Lockheed 749	P&W CA-15	Pneumatic Boot	Pneumatic Boot	Electro- Thermal	---	Fluid
DC-6	P&W R28000	Hot Air	Hot Air	Fluid	---	Fluid or Electro- Thermal
DC-7	P&W 4360	Hot Air	Hot Air	Hot Air	---	Electro- Thermal
B-377	P&W 4360	Hot Air	Hot Air	Electro- Thermal	---	Electro- Thermal
C-124C	P&W 4360	Hot Air	Hot Air	Hot Air or Electro- Thermal	---	Electro- Thermal
I1-14	ASH- 82T	Hot Air	Hot Air	Electro- Thermal	Hot Air (Carb)	---

--- System Not Known

TABLE 2-7. TYPICAL TURBOPROP POWERED AIRCRAFT INSTALLATION

AIRCRAFT	ENGINE	ICE PROTECTION SYSTEMS				
		WING	EMPENNAGE	WINDSHIELD	ENGINE INLET	PROPELLER/ SPINNER
Super Constellation	P&W T-34	Hot Air	Hot Air	Electro-Thermal	---	---
C-130	T56-A7	Hot Air	Hot Air	Electro-Thermal	Hot Air	Electro-Thermal
C-133	P&W T34R-3	Hot Air	Pneumatic Boot	Electro-Thermal	Electro-Thermal or Hot Air	Electro-Thermal
XC-142	CE T64-1	Pneumatic Boot	Pneumatic Boot	Electro-Thermal	Hot Air	Electro-Thermal
Electra	Allison 501-D13	Hot Air	Electro-Thermal or Hot Air	Electro-Thermal	Hot Air	Electro-Thermal
Martin	Allison T-38	Hot Air	Hot Air	Electro-Thermal	---	Electro-Thermal
Viscount 800 810	Dart RDA6	Hot Air	Electro-Thermal	Electro-Thermal	Electro-Thermal	Electro-Thermal
Britania	Proteus 755	Hot Air	Electro-Thermal	Electro-Thermal	Electro-Thermal	Electro-Thermal
Vanguard	RR Tyne	Hot Air	Hot Air	Electro-Thermal or Fluid	Electro-Thermal & Hot Air	Electro-Thermal

--- System Not Known

TABLE 2-8. TYPICAL TURBOJET/TURBOFAN POWERED AIRCRAFT INSTALLATION

AIRCRAFT	ENGINE	ICE PROTECTION SYSTEMS			
		WING	EMPENNAGE	WINDSHIELD	ENGINE INLET
Vickers	RR Convey	Hot Air	Hot Air	Electro-Thermal	Hot Air
DH DN 121	RR Spey RB 163	Hot Air	Hot Air	Electro-Thermal	Hot Air
BAK 111	RR Spey RB 163	Hot Air	Hot Air	Electro-Thermal	Hot Air
210 Caravelle	RR Evon 522	Hot Air	Hot Air	Fluid	Hot Air
C5A	GE TF 39	Hot Air	---	---	Hot Air
B707	P&W J-57 J73C10	Hot Air	Electro-Thermal	Electro-Thermal	Hot Air
B727	P&W JT8D	Hot Air	Optional Bleed Air	Electro-Thermal	Hot Air
DC-8	P&W J-75 JT3C, JT4A	Hot Air	Hot Air	Electro-Thermal	Hot Air
DH Comet	Evon 525	Hot Air	Hot Air	Electro-Thermal	Hot Air

--- System Not Known

TABLE 2-9a. TYPICAL HELICOPTER ROTOR GEOMETRY

H/C TYPE & NAME MIL (CIV)	MFG.	MAIN ROTOR						TAIL/AFT ROTOR			
		DIA. (FT.)	CH. (IN)	NO. OF BLADES (TANDEM)	AIRFOIL DESIG.	ROTOR RPM	BLADE CONSTR.	DIA. (FT.)	CH. (IN.)	NO. OF BLADES (TANDEM)	AIRFOIL DESIG.
CH-47A CHINOOK	BV	60	25.3	3 (TANDEM)	V0011 MOD	230	METAL	60	25.3	3 (TANDEM)	V0011 MOD
CH-47C (114) CHINOOK	BV	60	25.3	3 (TANDEM)	V23010- 1.58	225	COMPOSITE	60	25.3	3 (TANDEM)	V23010- 1.58
YCH-47D (145) CHINOOK	BV	60	32	3 (TANDEM)	VR-7 VR-8	225	COMPOSITE	60	32	3 (TANDEM)	VR-7 VR-8
CH-46D SEA KNIGHT	BV	51	16.6	3 (TANDEM)	V23010- 1.58	264	METAL	51	16.6	3 (TANDEM)	V23010- 1.58
CH-46A SEA KNIGHT	BV	50	16.6	3 (TANDEM)	V0011 MOD	264	METAL	50	16.6	3 (TANDEM)	V0011 MOD
CH-46E SEA KNIGHT	BV	50	16.6	3 (TANDEM)	VR-7 VR-8	264	COMPOSITE	50	16.6	3	VR-7 VR-8
YUH-61A UTTAS	BV	49	23.2	4	VR-7 VR-8 VR-9	286	COMPOSITE	11.3	8.8	4	VR-7 VR-8
OH-6A (500)	HUGHES	26.3	6.8	4	NACA 0012	470	COMPOSITE	4.3	4.8	2	NACA 0012
SH-2F (K888) SEASPRITE	KAMAN	44	21.6	4	NACA 23012	287	GLASS- FIBRE	8.2	9.3	4	--

TABLE 2-9a. TYPICAL HELICOPTER ROTOR GEOMETRY (continued)

H/C TYPE & NAME MIL (CIV)	MFG.	MAIN ROTOR					TAIL ROTOR				
		DIA. (FT)	CH. (IN)	NO. OF BLADES	AIRFOIL DESIG.	ROTOR RPM	BLADE CONSTR.	DIA. (FT)	CH. (IN)	NO. OF BLADES	AIRFOIL DESIG.
HH-2D (K860)	KAMAN	44	21.6	4	--	281	GLASS- FIBRE	8.2	9.3	4	--
SH-3D(S-6TD) SEA KING	SIK.	62	18.3	5	NACA 0012	203	METAL	10.6	7.3	5	NACA 0012
(S-6TN)	SIK.	62	18.3	5	NACA 0012	203	METAL	10.6	7.3	5	NACA 0012
CH-3E(S-6TR)	SIK.	62	18.3	5	NACA 0012	203	METAL	10.6	7.3	5	NACA 0012
CH-54A(S-64) TARHE	SIK.	72	26	6	NACA 0012	185	AL.	16.0	15.4	4	NACA 0012
(S-64E) SKYCRANE	SIK.	72	26	6	NACA 0012	185	AL.	16.0	15.4	4	NACA 0012
CH-53A(S-65) SEA STALLION	SIK.	72	26	6	NACA 0011 MOD	185	AL. ALLOY	16.0	15.4	4	NACA 0012
CH-53E(S-65) SUPER SEA STALLION	SIK.	79	26	7	NACA 0011 MOD		TITANIUM	20.0	15.4	4	NACA 0012
HH-53C(S-65)	SIK.	72.2	26	6	NACA 0011 MOD	185	AL. ALLOY	16	15.4	4	NACA 0012
UH-60A(S-70) BLACK HAWK	SIK.	53.7	--	4	SIC1095 R8	--	COMPOSITE	11.0	--	4	--

TABLE 2-9a. TYPICAL HELICOPTER ROTOR GEOMETRY (continued)

H/C TYPE & NAME MIL (CIV)	MFG.	MAIN ROTOR					TAIL ROTOR				
		DIA. (FT)	CH- (IN)	NO. OF BLADES	AIRFOIL DESIG.	ROTOR RPM	BLADE CONSTR.	DIA. (FT)	CH. (IN)	NO. OF BLADES	AIRFOIL DESIG.
OH-58A (206A) KIOWA	BELL	35.3	13	2	NACA 0012 MOD	354	AL.SPARS	5.2	5.3	2	NACA 0012
UH-1H IROQUOIS	BELL	48	21	2	NACA 0012	324	AL.SPARS	8.5	8.4	2	NACA 0012
AH-1G (209) -1S COBRA	BELL	44	27	2	9.3 SYM	324	(19)METAL (15)COMP.	8.5	8.5 11.5 (1S)	2	NACA 0012
AH-1J (209)	BELL	44	27	2	FX69H 098	324	METAL	8.5	8.4	2	NACA 0012
SEA KING	WESTLAND	62	18.3	5	--	203	METAL	10.3	7.3	5	NACA 0012
(WG-13) LYNX	WESTLAND	42	15.5	4	NPL 9615 & 9660	--	COMPOSITE	7.3	7.1	4	--
WESSEX(MK 1)	WESTLAND	56	16.5	4	NACA 0012	--	METAL	9.5	7.4	4	NACA 0012
WESSEX(MK 5)	WESTLAND	56	16.5	4	NACA 0012	--	METAL	9.5	7.4	4	NACA 0012
(BO-105)	MBB	32.2	10.6	4	NACA 23012 MOD	424	GLASS- FIBRE	6.2	7.1	2	NACA 0012
(A-109A)	AGUSTA	36.1	12	4	NACA 23012 NACA 13006	385	--	6.6	7	2	--
(SA-330J) PUMA	AERO	19.2	21	4	NACA 0015	265	COMPOSITE	9.9	--	5	NACA 0012

TABLE 2-9a. TYPICAL HELICOPTER ROTOR GEOMETRY (continued)

H/C TYPE & NAME MIL (CIV)	MFG.	MAIN ROTOR				TAIL ROTOR					
		DIA. (FT)	CH. (IN)	NO. OF BLADES	AIRFOIL DESIG.	ROTOR RPM	BLADE CONSTR.	DIA. (FT)	CH. (IN)	NO. OF BLADES	AIRFOIL DESIG.
(SA-332) SUPER PUMA	AERO	49.2	21	4	NACA 0015	--	COMPOSITE	9.9	--	5	--
Mi-4 HOUND	MIL	68.9	--	4	NACA 230XX	--	METAL	11.9	--	3	--
Mi-24	MIL	55.8	--	5	--	--	GLASS- FIBRE	12.8	--	3	--

-- INFORMATION NOT AVAILABLE

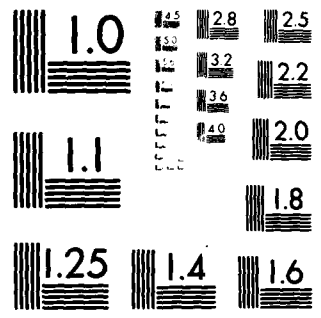

MICROCOPY RESOLUTION TEST CHART
NATIONAL BUREAU OF STANDARDS-1963-A

TABLE 2-9b. TYPICAL HELICOPTER ICE PROTECTION

H/C TYPE & NAME MIL (CIV)	ICE PROTECTION	ICING TESTS
CH-47A CHINOOK	<ul style="list-style-type: none"> <input type="checkbox"/> ENGINE INLET ANTI-ICING <input type="checkbox"/> PITOT AND YAW PORT HEATING <input type="checkbox"/> WINDSHIELD ANTI-ICING 	<ul style="list-style-type: none"> <input type="checkbox"/> TANKER (WRIGHT PATTERSON AFB (C-130)) <input type="checkbox"/> ICING TUNNEL (NASA LEWIS)
CH-47C CHINOOK	<ul style="list-style-type: none"> <input type="checkbox"/> ENGINE INLET ANTI-ICING <input type="checkbox"/> PITOT AND YAW PORT HEATING <input type="checkbox"/> WINDSHIELD ANTI-ICING <input type="checkbox"/> ELECTROTHERMAL SPANWISE ROTOR DEICING (TEST AIRCRAFT ONLY) 	<ul style="list-style-type: none"> <input type="checkbox"/> TANKER (HISS) <input type="checkbox"/> NATURAL (MINNESOTA, WASHINGTON)
YCH-47D CHINOOK	<ul style="list-style-type: none"> <input type="checkbox"/> ENGINE INLET ANTI-ICING <input type="checkbox"/> PITOT AND YAW PORT HEATING <input type="checkbox"/> WINDSHIELD ANTI-ICING <input type="checkbox"/> ELECTROTHERMAL SPANWISE ROTOR DEICING (TEST AIRCRAFT ONLY) 	<ul style="list-style-type: none"> <input type="checkbox"/> TANKER (HISS) <input type="checkbox"/> NATURAL (MINNESOTA)
CH-46D SEA KNIGHT	<ul style="list-style-type: none"> <input type="checkbox"/> ENGINE INLET ANTI-ICING <input type="checkbox"/> PITOT AND YAW PORT HEATING <input type="checkbox"/> WINDSHIELD ANTI-ICING <input type="checkbox"/> ELECTROTHERMAL SPANWISE ROTOR DEICING 	NONE
CH-46A SEA KNIGHT	<ul style="list-style-type: none"> <input type="checkbox"/> ENGINE INLET ANTI-ICING <input type="checkbox"/> PITOT AND YAW PORT HEATING <input type="checkbox"/> WINDSHIELD ANTI-ICING <input type="checkbox"/> ELECTROTHERMAL SPANWISE ROTOR DEICING 	<ul style="list-style-type: none"> <input type="checkbox"/> HOVER SPRAY RIG (NRC) <input type="checkbox"/> ICING TUNNEL (NASA LEWIS)
CH-46E SEA KNIGHT	<ul style="list-style-type: none"> <input type="checkbox"/> ENGINE INLET ANTI-ICING <input type="checkbox"/> PITOT AND YAW PORT HEATING <input type="checkbox"/> WINDSHIELD ANTI-ICING <input type="checkbox"/> ELECTROTHERMAL SPANWISE ROTOR DEICING 	NONE

TABLE 2-9b. TYPICAL HELICOPTER ICE PROTECTION (continued)

H/C TYPE & NAME MIL (CIV)	ICE PROTECTION	ICING TESTS
YUH-61A UTTAS	<input type="checkbox"/> ENGINE INLET ANTI-ICING <input type="checkbox"/> PITOT AND YAW PORT HEATING <input type="checkbox"/> WINDSHIELD ANTI-ICING <input type="checkbox"/> ELECTROTHERMAL SPANWISE DEICING - MAIN & TAIL	<input type="checkbox"/> TANKER (HISS)
OH-6A	<input type="checkbox"/> ENGINE INLET ANTI-ICING <input type="checkbox"/> VORTEX TYPE PARTICLE SEPARATORS <input type="checkbox"/> WINDSHIELD BLEED AIR ANTI-ICING	<input type="checkbox"/> ICING TUNNEL <input type="checkbox"/> HOVER SPRAY RIG (NRC) <input type="checkbox"/> NATURAL ICING
SH-2F (K888) SEASPRITE	<input type="checkbox"/> ENGINE INLET ANTI-ICING <input type="checkbox"/> PITOT HEAT <input type="checkbox"/> WINDSHIELD ANTI-ICE	INFORMATION NOT AVAILABLE
HH-2D (K860)	<input type="checkbox"/> ENGINE INLET ANTI-ICING <input type="checkbox"/> PITOT HEAT <input type="checkbox"/> WINDSHIELD ANTI-ICING <input type="checkbox"/> ROTOR DEICE	INFORMATION NOT AVAILABLE
SH-3D (S-61D) SEA KING	<input type="checkbox"/> ENGINE INLET ANTI-ICING <input type="checkbox"/> WINDSHIELD ANTI-ICING <input type="checkbox"/> ICE DETECTOR FORWARD OF THE ENGINE	<input type="checkbox"/> ICING TUNNEL <input type="checkbox"/> TANKER <input type="checkbox"/> NATURAL ICING <input type="checkbox"/> HOVER SPRAY RIG (NRC)
(S-61N)	<input type="checkbox"/> ENGINE INLET ANTI-ICING <input type="checkbox"/> PITOT HEAT <input type="checkbox"/> WINDSHIELD ANTI-ICING <input type="checkbox"/> ICE DETECTOR	<input type="checkbox"/> NATURAL ICING (UK)

TABLE 2-9b. TYPICAL HELICOPTER ICE PROTECTION (continued)

H/C TYPE & NAME MIL (CIV)	ICE PROTECTION	ICING TESTS
CH-3E (S-61R)	<ul style="list-style-type: none"> o ENGINE INLET ANTI-ICING o PITOT HEAT o SOME A/C EQUIPPED WITH CONTRAHESSIVE POLY-ETHELENE ANTI-ICING TAPE ON MAIN ROTOR BLADE 	<ul style="list-style-type: none"> o HOVER SPRAY RIG (NRC)
CH-54A (S-64) TARHE	<ul style="list-style-type: none"> o ENGINE ANTI-ICING - VORTEX TYPE PARTICLE SEPARATORS o PITOT HEAT 	<ul style="list-style-type: none"> o ICING TUNNEL
(S-64E) SKYCRANE	<ul style="list-style-type: none"> o ENGINE INLET ANTI-ICING 	<p>INFORMATION NOT AVAILABLE</p>
CH-53A (S-65) SEA STALLION	<ul style="list-style-type: none"> o SOME A/C ARE EQUIPPED WITH A BELLMOUTH. ENGINE AIR INLET ANTI-ICING VORTEX TYPE PARTICLE SEPARATORS. 	<ul style="list-style-type: none"> o HOVER SPRAY RIG (NRC) o ICING TUNNEL
CH-53E (S-65) SUPER SEA STALLION	<ul style="list-style-type: none"> o ENGINE INLET - ELECTRICAL ANTI-ICING o WINDSHIELD ANTI-ICING o PITOT HEAT 	<ul style="list-style-type: none"> o ICING TUNNEL
HH-53C (S-65)	<ul style="list-style-type: none"> o ENGINE INLET 	<ul style="list-style-type: none"> o TANKER o NATURAL
UH-60A (S-70) BLACK HAWK	<ul style="list-style-type: none"> o ENGINE AND ENGINE INLET ANTI-ICING o WINDSHIELD ANTI-ICING o PITOT HEAT 	<ul style="list-style-type: none"> o TANKER (HISS) o NATURAL (MINNESOTA)
OH-58A KIOWA	<ul style="list-style-type: none"> o PITOT HEAT 	<ul style="list-style-type: none"> o ICING TUNNEL o HOVER SPRAY RIG

TABLE 2-9b. TYPICAL HELICOPTER ICE PROTECTION (continued)

H/C TYPE & NAME MIL (CIV)	ICE PROTECTION	ICING TESTS
UH-1H IROQUOIS	<input type="checkbox"/> WINDSHIELD ELECTRICAL ANTI-ICE A/C 318 (TEST)	<input type="checkbox"/> TANKER <input type="checkbox"/> NATURAL <input type="checkbox"/> HOVER SPRAY RIG (NRC)
AH-1G (209) COBRA	<input type="checkbox"/> ELECTRICAL ENGINE INLET ANTI-ICING <input type="checkbox"/> PITOT HEAT	<input type="checkbox"/> TANKER (ALASKA) <input type="checkbox"/> NATURAL (WASHINGTON)
AH-1J SEA COBRA	<input type="checkbox"/> PITOT HEAT	<input type="checkbox"/> HOVER SPRAY RIG (NRC)
SEA KING	<input type="checkbox"/> ENGINE ICE DEFLECTOR	<input type="checkbox"/> NGTE (UK)
(WG-13) LYNX	<input type="checkbox"/> ENGINE INLET ANTI-ICING	<input type="checkbox"/> NGTE - ENGINE INTAKE TESTING (UK)
WESSEX (MK1)	NOT AVAILABLE	<input type="checkbox"/> HOVER SPRAY RIG (NRC)
WESSEX (MK5)	NOT AVAILABLE	<input type="checkbox"/> HOVER SPRAY RIG (NRC) <input type="checkbox"/> NATURAL (DENMARK)
BO-105	<input type="checkbox"/> ENGINE INLET ANTI-ICING <input type="checkbox"/> HEATED WINDSHIELD <input type="checkbox"/> PITOT HEAT <input type="checkbox"/> ICE DETECTORS (ALL NON STANDARD)	<input type="checkbox"/> ICING TUNNEL (VIENNA) <input type="checkbox"/> HOVER SPRAY RIG (NRC) <input type="checkbox"/> NATURAL ICING (CANADA, GERMANY)
(A-109A)	NOT AVAILABLE	<input type="checkbox"/> LOW TEMP. TESTING (ITALY)

TABLE 2-9b. TYPICAL HELICOPTER ICE PROTECTION (continued)

H/C TYPE & NAME MIL (CIV)	ICE PROTECTION	ICING TESTS
(SA-330J) PUMA	<ul style="list-style-type: none"> o CERTIFIED FOR FLIGHT IN ICING CONDITIONS, 1978 o HEATED PITOT HEADS o ENGINE INLET VORTEX SEPARATORS o HEATED WINDSHIELD o NO HEATING/WEATHER RADAR 	<ul style="list-style-type: none"> o HOVER SPRAY RIG (NRC) o NATURAL ICING (DENMARK, FRANCE)
(SA-332) SUPER PUMA	<ul style="list-style-type: none"> o "BASKET" INTAKE SHIELD (NO HEATING) o WINDSHIELD ANTI-ICING 	NONE
Mi-4 HOUND	<ul style="list-style-type: none"> o LIQUID LEADING EDGE ROTOR BLADE DEICING 	INFORMATION NOT AVAILABLE
Mi-24	<ul style="list-style-type: none"> o ELECTRICAL LEADING EDGE ROTOR BLADE DEICING 	INFORMATION NOT AVAILABLE

TABLE 2-9c. TYPICAL HELICOPTER FLIGHT MANUAL ICING RESTRICTIONS

H/C TYPE & NAME MIL (CIV)	FLIGHT MANUAL ICING RESTRICTIONS
CH-47 A/B/C CHN00K	<p>"Areas where moderate to severe icing is known to exist or forecast to occur are to be avoided." (TM 55-1520-227-10)</p> <p>"Extended flight in light icing conditions may result in lateral and vertical vibrations caused by asymmetric shelf-shedding of ice. When vibrations are encountered, the airspeed should be reduced and the helicopter should be flown out of the icing area." (TM55-1520-209-10, 1973)</p>
CH-47C CHN00K	<p>"Significant engine FOD can be sustained by the unprotected T55-L-11A engines as a result of shed ice particle ingestion. The CH-47C helicopter equipped with unprotected T55-L-11A engines should not be flown in known or forecast icing conditions." (U.S. Army "Artificial Icing Tests CH-47C Helicopter" August 1974)</p>
CH-46E SEA KNIGHT	<p>"Flight into known icing conditions is prohibited." (NAVAIR 01-250HDC-1, 1978)</p>
YUH-61A UTTAS	<p>"Flight in icing conditions is prohibited. The following are specified icing condition limits:</p> <ol style="list-style-type: none"> (1) If temperature is below 5°C (41°F), with visible moisture, select anti-ice protection. (2) Helicopter operation is permitted down to an ambient temperature of -2°C (28.5°F) with visible moisture. However, discontinue operation if ice accumulation on the fuselage is apparent. (3) If temperature is below -2°C (28.5°F), with visible moisture, discontinue operations." (DTM55-1520-XXX-10, 1976)
CH-147	<p>"Areas where moderate to severe icing is known to exist or forecast to occur are to be avoided." (C-12-147-C00/MB-001, 1978)</p>
OH-6A	<p>"Engine anti-icer should be used when flying in visible moisture at OAT 5°C or below."</p>

TABLE 2-9c. TYPICAL HELICOPTER FLIGHT MANUAL ICING RESTRICTIONS (continued)

H/C TYPE & NAME MIL (CIV)	FLIGHT MANUAL ICING RESTRICTIONS
SH-2D/2F SEASPRITE	<p>"This helicopter is restricted from flying in known icing conditions." "Ice formation on the lower hub assembly of the main rotor head may prevent droop stop engagement." "Ice formation on the rescue hoist arm and associated wires may separate in forward flight and be ingested by the engine." (NAVAIR 01-260HCD-1, 1976)</p>
HH-3F	<p>"To preclude the possibility of ice ingestion failure, the helicopter will not be flown in icing conditions or in visible moisture when temperature are at or below 50C (410F) without the foreign object deflector installed." (T.O. 1H-3(H)F-1, 1973)</p>
HH-2C/2D	<p>"Flight through known or forecast icing conditions is not recommended." (NAVAIR 01 260HCC-1, 1970)</p>
SH-3D (S-61D) SEA KING	<p>"This helicopter is restricted from flying in known icing conditions when visible moisture, except dry snow, is present." (NAVAIR 01-230HLC-1, 1969)</p>
(S-61N)	<p>"Not approved for operation in icing conditions." (FAA) "Limited approval for operation into forecast light icing conditions." (CAA):</p> <p style="text-align: center;"><u>Provisions</u></p> <ul style="list-style-type: none"> - Forecast light icing - Not colder than -50C at cruise altitude - 5000 feet maximum altitude - Freezing level not below 500 feet - 1000 pound reduction in takeoff weight - Change in torque of not more than 3 or 4 percent - Airspeed deterioration not greater than (V_R - 20 knots) - Required equipment: <ul style="list-style-type: none"> o Engine icing shields o Ice detector rod o HF aerial restraint o Illuminated OAT gauge o Windshield heating

TABLE 2-9c. TYPICAL HELICOPTER FLIGHT MANUAL ICING RESTRICTIONS (continued)

H/C TYPE & NAME MIL (CIV)	FLIGHT MANUAL ICING RESTRICTIONS
CH-3E (S-61R)	<p>"To preclude the possibility of engine failure due to ice ingestion, the foreign object deflector shield must be installed prior to flight in known or forecast icing conditions, or visible moisture at or below 50C (41°F). Without the foreign object deflector installed, minimize flight in icing conditions inadvertently encountered."</p> <p>"Do not attempt flight in freezing rain. Flight in icing conditions exceeding trace icing is not recommended unless contrahesive polyethelene anti-icing tape is installed on the main rotor blades. Flight in known light icing conditions is permitted if the tape is installed."</p> <p>"Minimize flight in icing conditions without anti-icing tape installed to avoid rotor blade damage." (T.O. 1H-3CC) C-1, 1978)</p>
CH-54A TAHRE	<p>"With EAPS installed, should icing conditions arise on aircraft with EAPS, open bypass doors and land as soon as possible."</p> <p>"Without EAPS installed should icing conditions arise ... with bellmouth P/N 6430-80140-041 installed, there are no icing limitations." (TM55-1520-217-10/1, 1969)</p>
CH-53 A/D SEA STALLION	<p>"Icing conditions should be avoided whenever possible."</p> <p>"The helicopter is restricted from flying in known moderate or heavy icing conditions." (NAVAIR 01-230HMA-1, 1977)</p>
CH-53E SUPER SEA STALLION	<p>"The helicopter is restricted from flying in moderate or heavy icing conditions. Flight in light icing conditions is limited to 30 minutes duration, due to the probability of damage from shedding ice." (NAVAIR 01-H53AAB-1, 1976)</p>

TABLE 2-9c. TYPICAL HELICOPTER FLIGHT MANUAL ICING RESTRICTIONS (continued)

H/C TYPE & NAME MIL (CIV)	FLIGHT MANUAL ICING RESTRICTIONS
HH-3A	"This helicopter is restricted from flying in known icing conditions when visible moisture except dry snow is present. When icing conditions except dry snow are inadvertently encountered, immediately turn on the engine/inlet and windshield anti-icing system. With dry snow present, use of anti-icing system may result in melting of the snow on the intake ducts and subsequent refreezing and ice accumulation at the engine front frame. Under such conditions, use of the inlet anti-icing system is not recommended." (NAVAIR 01-230HLF-1, 1972)
CH-21B	"Flight during known icing conditions is prohibited. There is no rotor anti-icing system installed on these helicopters... When unexpected and unavoidable icing conditions are encountered in flight, a landing should be made as soon as possible." (T.O. 1H-21(C) B-1, 1967)
UH-1N TWIN HUEY	"Intentional flight through known icing conditions with OAT colder than minus 5 degrees C is prohibited." "This helicopter is restricted from flight in icing conditions other than trace ice. Continuous flight in trace icing conditions is not recommended because the ice shedding from the inlet duct could cause engine damage." (T.O. 1H-1(U)N-1, 1974)
UH-1F/1P	"This helicopter is restricted from flight in other than trace icing conditions. Continuous flight in trace icing conditions is not recommended." (T.O. 1H-1(U)F-1, 1971)
AH-1G	"Continuous flight in light icing is not recommended." (TM55-1520-221-10, 1971)
UH-2A/2B	"Flight through known or forecast icing conditions is not recommended." (NAVAIR 01-260HCA-1, 1968)

TABLE 2-9c. TYPICAL HELICOPTER FLIGHT MANUAL ICING RESTRICTIONS (continued)

H/C TYPE & NAME MIL (CIV)	FLIGHT MANUAL ICING RESTRICTIONS
UH-1H	<p>"Helicopter should be restricted from operating in known or forecast icing conditions.</p> <p>"Intentional flight into known icing conditions is prohibited. Flight tests in controlled icing conditions have indicated that, if a 5 psi (or greater) torque pressure increase is required above cruise torque setting used prior to entering icing conditions, it may not be possible to maintain autorotational rotor speed within operational limits, should an engine failure occur."</p> <p>(U.S. Army Aviation Systems Test Activity Report "Natural Icing Tests UH-1H Helicopter" June 1974)</p>
SH-3A/G	<p>"This helicopter is restricted from flying in known icing conditions when visible moisture, except dry snow, is present. When icing conditions, except dry snow, are inadvertently encountered, immediately turn on the engine/inlet and windshield anti-icing systems. On helicopters modified by the installation of an ice deflector forward of the engine air inlets, flight operations may be conducted when icing conditions are forecast; however, known areas of icing shall be avoided." (1969)</p>
HH-3P	<p>"To preclude the possibility of ice ingestion failure, the helicopter will not be flown in known icing conditions or in visible moisture when the temperature is below 5°C without the foreign object deflector installed." (1972)</p>
BO-105A	<p>"Flight in icing conditions is prohibited." (1970)</p>

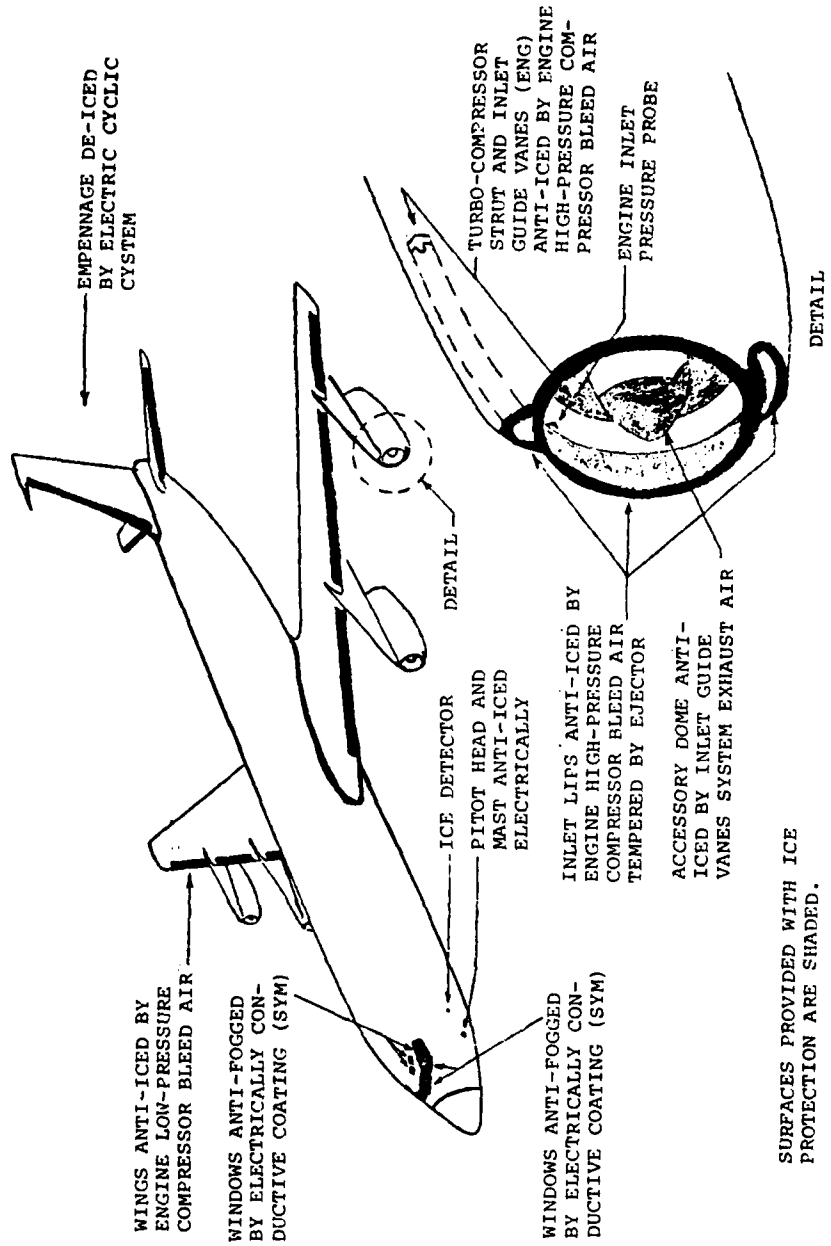

FIGURE 2-23. TYPICAL FIXED-WING ICE PROTECTION

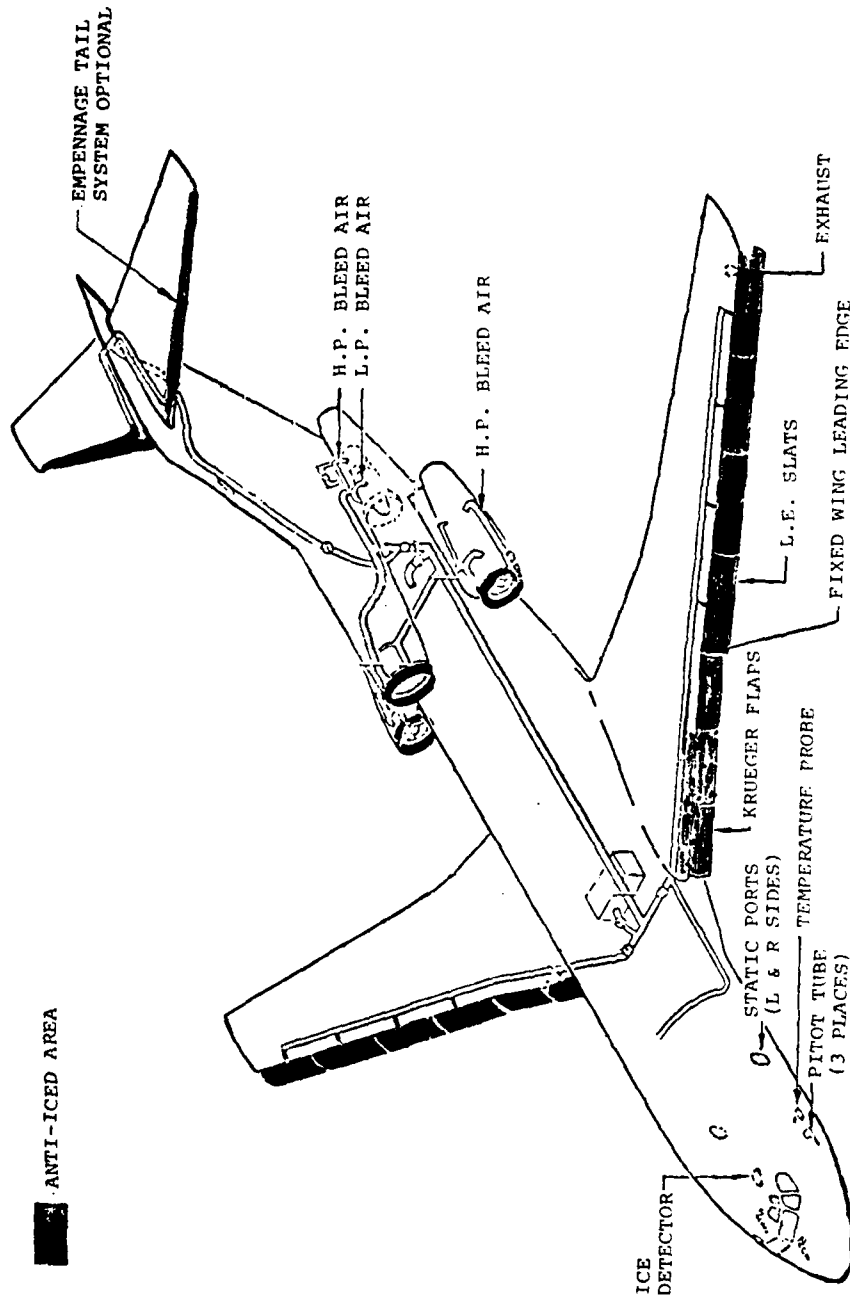

FIGURE 2-24. TYPICAL FIXED-WING ICE PROTECTION

● FIXED WING

● HELICOPTER

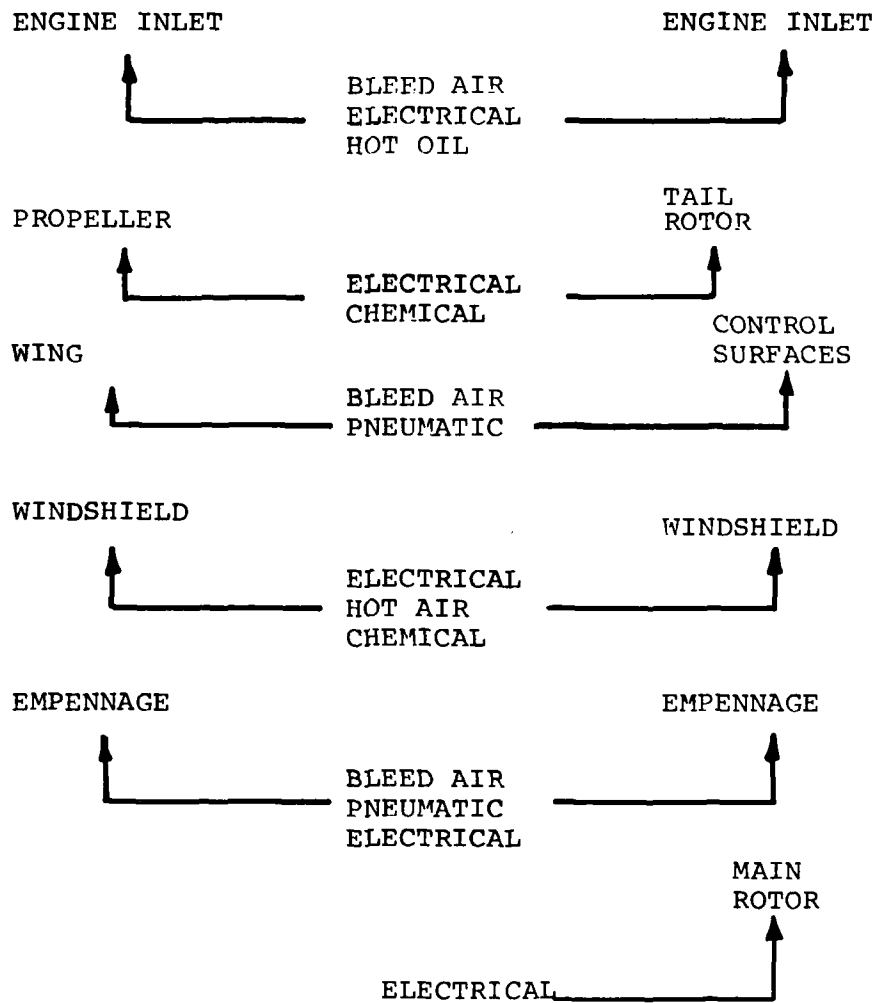

FIGURE 2-25. APPLICABILITY OF FIXED-WING DATA BASE TO HELICOPTERS

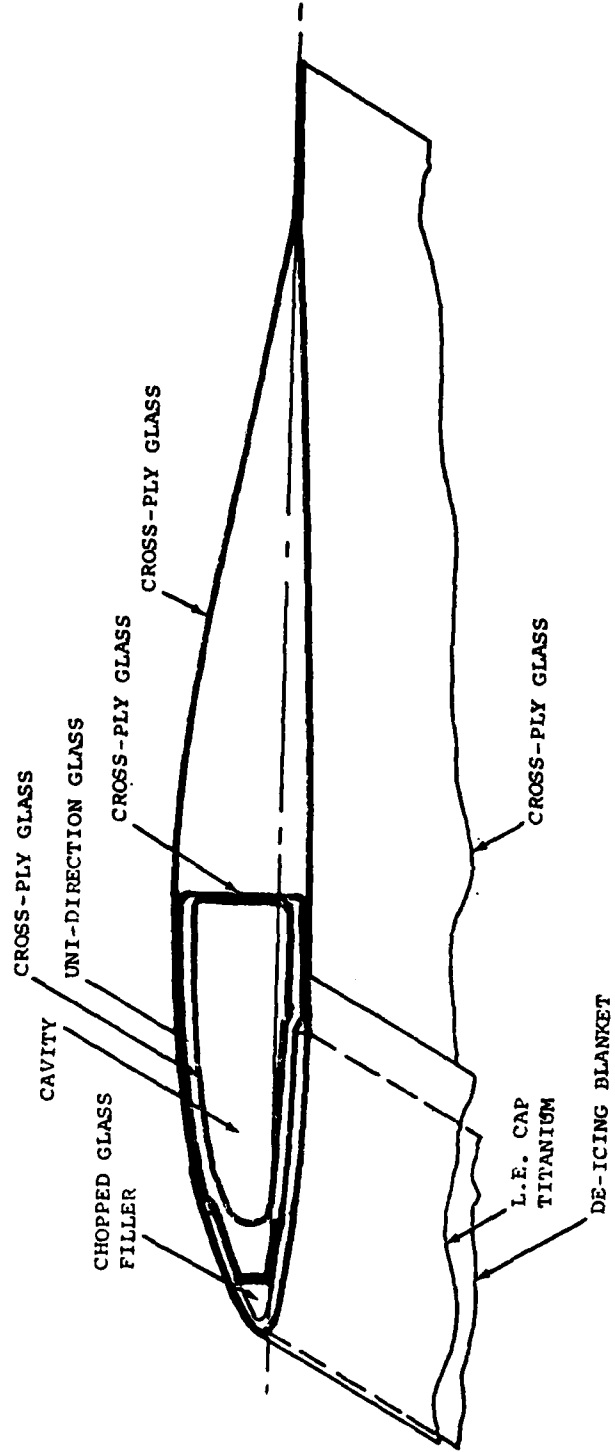

FIGURE 2-26. TYPICAL COMPOSITE ROTOR BLADE CONSTRUCTION WITH ELECTROTHERMAL DE-ICING BLANKET

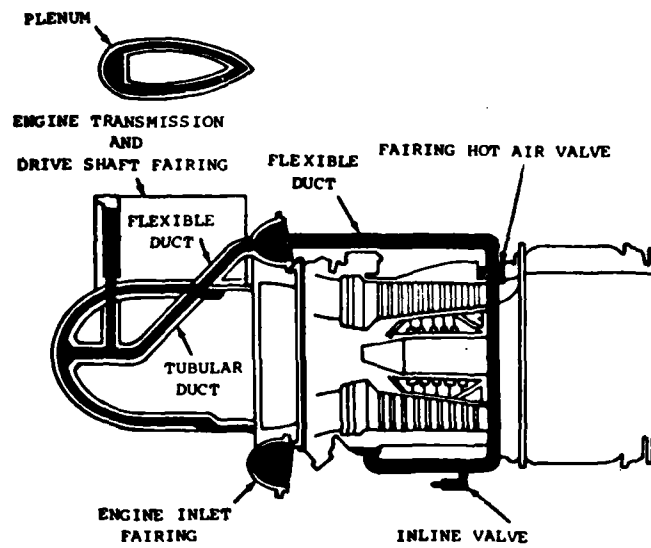

FIGURE 2-27. ENGINE INLET BLEED AIR ANTI-ICING SYSTEM

The electrothermal and hot air thermal ice protection systems (when installed) are the primary systems presently used on current rotorcraft; the hot air for engine and some engine inlet installations, and the electrothermal for windshield, engine inlet, empennage, pitot, and rotor installations. Electrothermal ice protection (anti-ice or deice) is most adaptable to complex shapes, transparent areas (conductive films), and to areas requiring close control of heat cycle times (i.e. rotors). Hot air (normally turbine engine compressor bleed) is most adaptable to systems near the source (i.e. engine front frames, inlet guide vanes, inlets) and those systems where air flow passages are easily fabricated, and precise control of heat distribution and cycle time are not critical.

Near term rotorcraft ice protection will likely be of the electrothermal (or hot air thermal for engine and certain engine inlet installations) type, however, work being conducted by ATL and RAE and planned by NASA in ice-phobics (pastes, waxes, flexible substrates) may lead to alternates, principally for rotor ice protection.

Ice protection research with rotorcraft application has been and is being conducted (in addition to ice-phobics noted above) in the areas of:

- o Electro-impulse deicing (USSR initial development - Bell Helicopter and Lockheed conducting in-house efforts).
- o Microwave deicing (initial investigations conducted under ATL contract. NASA conducting evaluation to determine further effort).
- o Pneumatic boot deicing (NASA has conducted stationary blade tests. Full scale rotating testing still pending).
- o Vibratory deicing (ATL reviewing data on testing conducted by Bell Helicopter).
- o Ice-phobic deicing (ATL evaluating results of 1980 icing trials in the NRC Ottawa hover spray rig).
- o Electrothermal deicing (current programs on U.S., U.K., and others to evaluate improved systems).

2.3.1.1 Thermal Systems

Basically the sources of heat for thermal anti-icing used in fixed-wing aircraft include electrical heaters and hot air from engine compressor bleed, combustion heaters or exhaust heat exchangers. Areas of an aircraft that may use thermal ice protection are noted in Tables 2-6, 2-7 and 2-8. Of these areas, the windshields, pitot probes, and engine inlets are anti-iced while other areas may be anti-iced or deiced, depending on the power available for ice protection and the effects of ice accretion on the aircraft.

Hot Air Systems - Fixed-Wing Aircraft. The hot air anti-icing systems illustrated in Figures 2-23 and 2-24 illustrate a typical ice protection system for wing leading edges with Krueger flaps and leading edge slats, engine inlet lip, engine nose dome, oil cooler lip empennage horizontal stabilizer, and other aircraft/engine components.

Hot air systems are used on most of the large jet transports because of the availability of hot bleed air from the engines, and the relative efficiency and reliability of these systems. Hot air is used to anti-ice or deice leading edge wing panels and high lift devices, empennage surfaces, engine inlet and air scoops, radomes, and some types of instruments.

Hot air for a typical present day wing ice protection system is obtained from low and/or high-pressure engine compressor bleed systems available from current twin spool turbine engines. Many hot air anti-icing systems utilize engine compressor bleed air for the source of heat and pressure. On some turboprop transport aircraft (i.e. CL-44), however, tailpipe (exhaust) heat exchangers are employed. These heat exchangers utilize ram air as the source of pressurized air, which after being heated in the heat exchanger, is then used as hot anti-icing air.

Hot Air Systems - Helicopter. Hot air (engine compressor bleed) systems are used on many helicopters for anti-icing engine front frames, struts, inlet guide vanes, particle separators and for airframe mounted inlet configurations (inlet bellmouths, gearbox fairings). The availability and close proximity of the engine bleed port(s) to the heated system make this form of anti-icing attractive. The disadvantage of using engine compressor bleed is primarily in the increased fuel flow required or loss of horsepower during bleed extraction. Figure 2-28 illustrates the horsepower loss and fuel flow increase trends for 1% bleed. The variation in the bleed effect on power represents individual engine parameter effects (i.e. bleed pressure ratio, engine limits, etc.). Hot air from compressor bleed or from an auxiliary system may be used for anti-icing other airframe surfaces (windshield, other transparent areas, empennage, auxiliary air intakes, etc.) and for defogging of windshields.

The simplicity and reliability of a hot air system is a primary factor for its continued use for helicopter applications. Even though electrical systems provide a more efficient means of heat transfer from a power utilization standpoint, as illustrated in Figure 2-29, hot gas air protection systems have tended to have endurance and more consistent operational qualities overcoming the power penalty effects. The system basically employs a double-skin heat exchanger principle with hot gas directed at a sufficient rate to maintain the required surface temperature in a passageway adjacent to the surface to be protected. The double-skin design generally is configured, for manufacturing simplicity, of two metal sheets with periodically positioned spacers to maintain required passageway dimensions and structural integrity of the assembly.

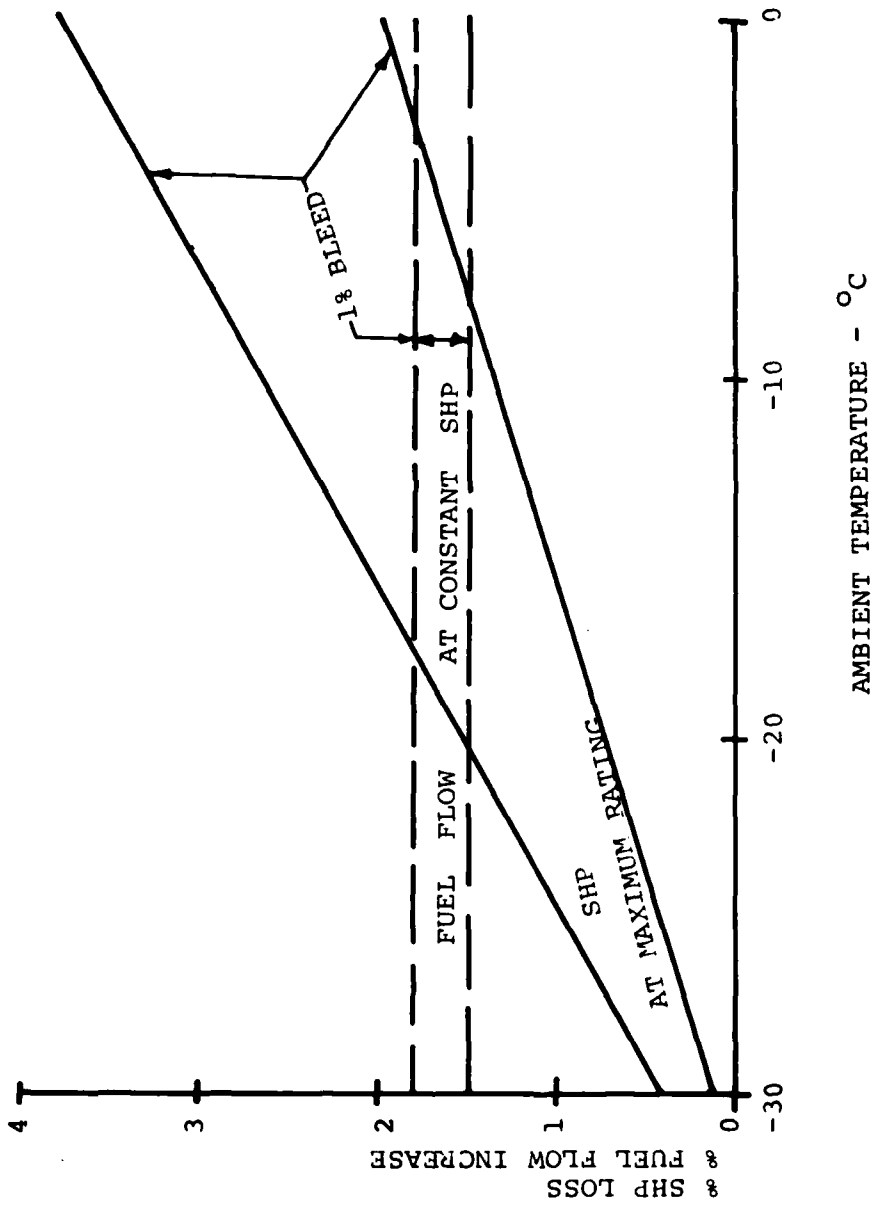

FIGURE 2-28. ENGINE COMPRESSOR BLEED EXTRACTION PENALTIES

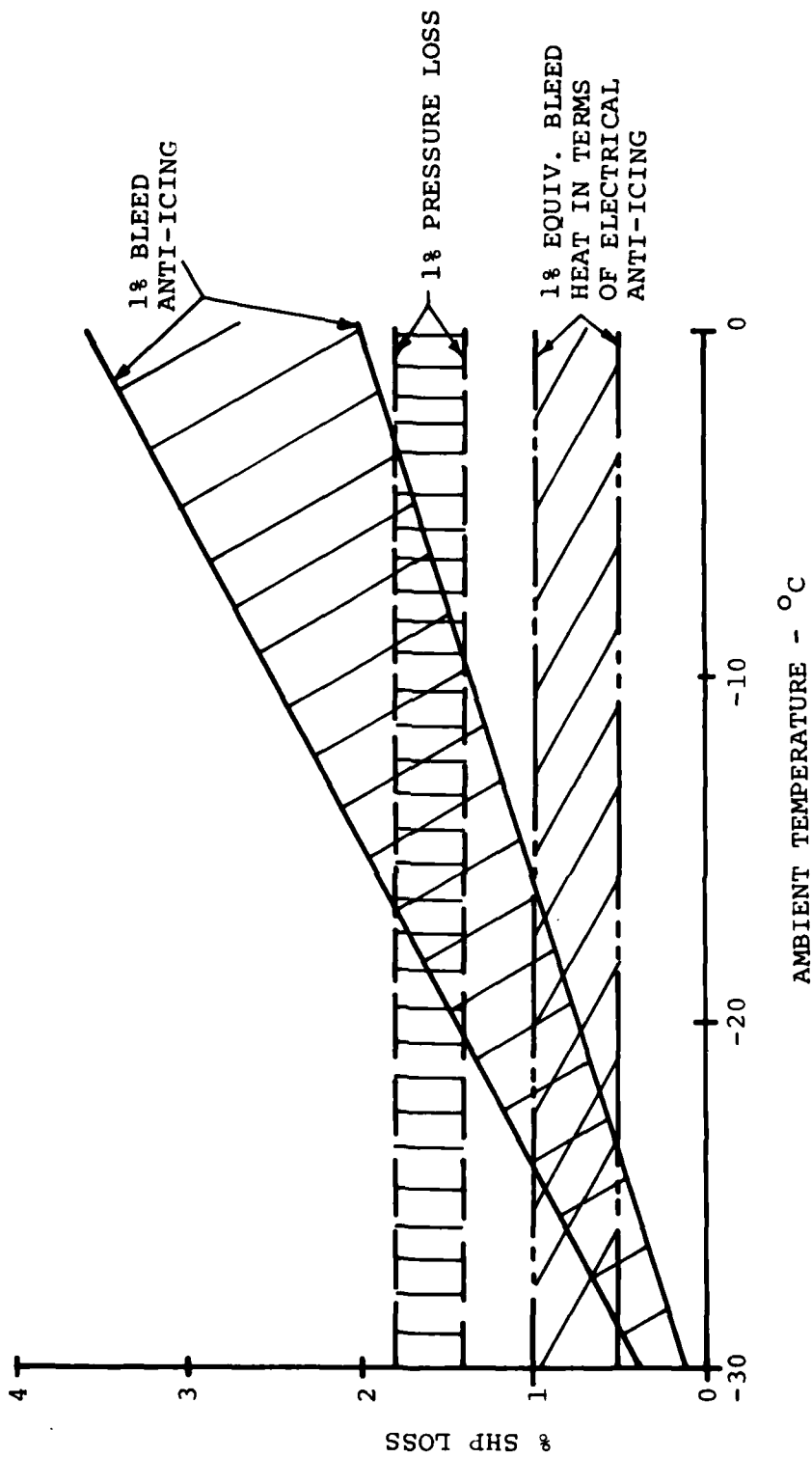

FIGURE 2-29. INDUCTION SYSTEM LOSSES UNDER ICING CONDITIONS

Various types of bleed air control systems are utilized depending upon application requirements. Either simple on-off valves or modulating control valves (more efficiently varying the hot gas flow into the heat exchanger) can provide the required heat to the surface.

Hot gas surface configurations are usually designed to use optimum velocities for heat transfer at a particular volumetric flow rate. As such, the design must consider the ice protection load requirements (icing rates) for the aircraft's altitude operational requirement. Due to density effects, the heat exchanger surface design will transfer less energy from the gas to the surface during this altitude operation.

Hot Oil Systems. Engine front frames and struts may be anti-iced through hot oil circulation in lieu of compressor bleed. This method also provides partial cooling of engine oil.

Hot oil is not normally used for airframe primary anti-icing, however in certain configurations (i.e. nose gearbox fairings) the hot oil may provide an assist to a hot air or electrically heated fairing.

Electrothermal Systems - Fixed-Wing Aircraft. The power requirements for completely anti-icing an airplane using an electrical powered heat source are prohibitive; therefore, the areas generally anti-iced electrically are the windshield, some air inlets and areas remote from any hot air source. For windshields, the basic systems of electrical heating used are thin, transparent, metallic oxide or metallic films deposited on the inner surface glass or plastic plys, or wire grids adjacent to the inner surface of the glass plastic. The thickness of the conducting medium can be varied to accommodate variation in heating requirements or to heat irregular shapes. Inlets and other areas to be given electrical anti-ice protection will have the heating element (foil, resistance wires, flame-sprayed metal, expanded metal, etc.) imbedded in a flexible pad bonded to the surface or imbedded in a plastic, fiberglass or metal part, which is the basic structure.

Electrothermal Systems - Helicopter. Electrothermal systems are incorporated in many helicopter anti-icing and deicing systems because of the adaptability of electrical heater elements into composite material structures (i.e engine inlets, rotors, empennage leading edges). The ability to control heat application and density readily lends the electrothermal deicing concept to the helicopter rotor system. Windshield anti-icing incorporating film resistance elements, and engine inlets incorporating embedded heaters are found in a number of current helicopters. Additional areas incorporating electrical anti-icing include pitot tube, static ports, radio masts, auxiliary inlets, radomes and stabilizers.

An example of early electrothermal utilization is illustrated by the CH-46 metal rotor blades which utilized an epoxy/glass heater blanket assembly which was contoured for the airfoil configuration and bonded to an alloy steel blade spar. A stainless steel erosion shield was similarly bonded

over a substantial portion of the exterior surface of the blanket to protect the blanket from rain and other foreign particle impingement damage. The heater elements for this assembly were imbedded within the epoxy resin fiberglass laminates.

Current rotor blades such as those used on the CH-46E, and YCH-47D for example are of composite material construction with embedded heater elements. The advantage of composite over metallic blades is the unique fracture dynamics of composites which offer greater reliability, survivability, and operational effectiveness by virtue of limiting crack propagation. Additionally, the heat transfer characteristics of the composite construction provide for a more efficient utilization of electrical power (unless specific care is taken when heater installations are made on metal rotors) as can be noted by comparing Figures 2-30 and 2-31 (CH-46 metal and composite deicing cycle) and is noted in Reference 46 (Thermal Aspects Of De-icer Design, J. R. Stallabrass). The key point in the comparison of deicing efficiency (i.e. heat transfer efficiency) is the thickness ratio (or thermal conductivity ratio) between the inner (heater-to-spar) and outer (heater-to-surface) insulation layers. In the case of the composite blade, the insulation thickness ratio is extremely large, while with the metal-spared blades the specific design and fabrication of the heater system over the spar determines how efficiently the heat reaches the leading edge surface. Stallabrass notes in Reference 46 that insulation thickness ratios of between 3 and 5 are recommended when the deicing system contains a metal substrate. It is interesting to note that the CH-46 metal D-spar rotor used in this analysis (Figure 2-30) has a thickness ratio of 1.53, while the research UH-1H (Eustis) deicing system has a thickness ratio of 4.5.

An advantageous feature of an electrothermal system for rotor deicing is that it can provide a graded heat dissipation with either spanwise or chordwise arrangements. The element spacing arrangement in the blanket structure or the resistance characteristics of the heater element can be varied as required.

Structural and fatigue loads on electrical conductors providing power to the heater element may determine type of material and heater arrangement. The limited fatigue strength of copper wire used in power supply leads is one reason why spanwise heater element arrangements have been utilized on a number of blade deicing systems. Additionally, the greater level of experience with spanwise elements generally forced a decision (because of blade manufacturing considerations) to continue with the spanwise arrangement. Blade design studies have indicated that more efficient utilization of power would result by chordwise arrangements which provide complete spanwise deicing, however, currently only a UH-1H has been provisioned in this manner for purposes of testing this concept.

Figure 2-32 illustrates a typical rotor deice system control arrangement.

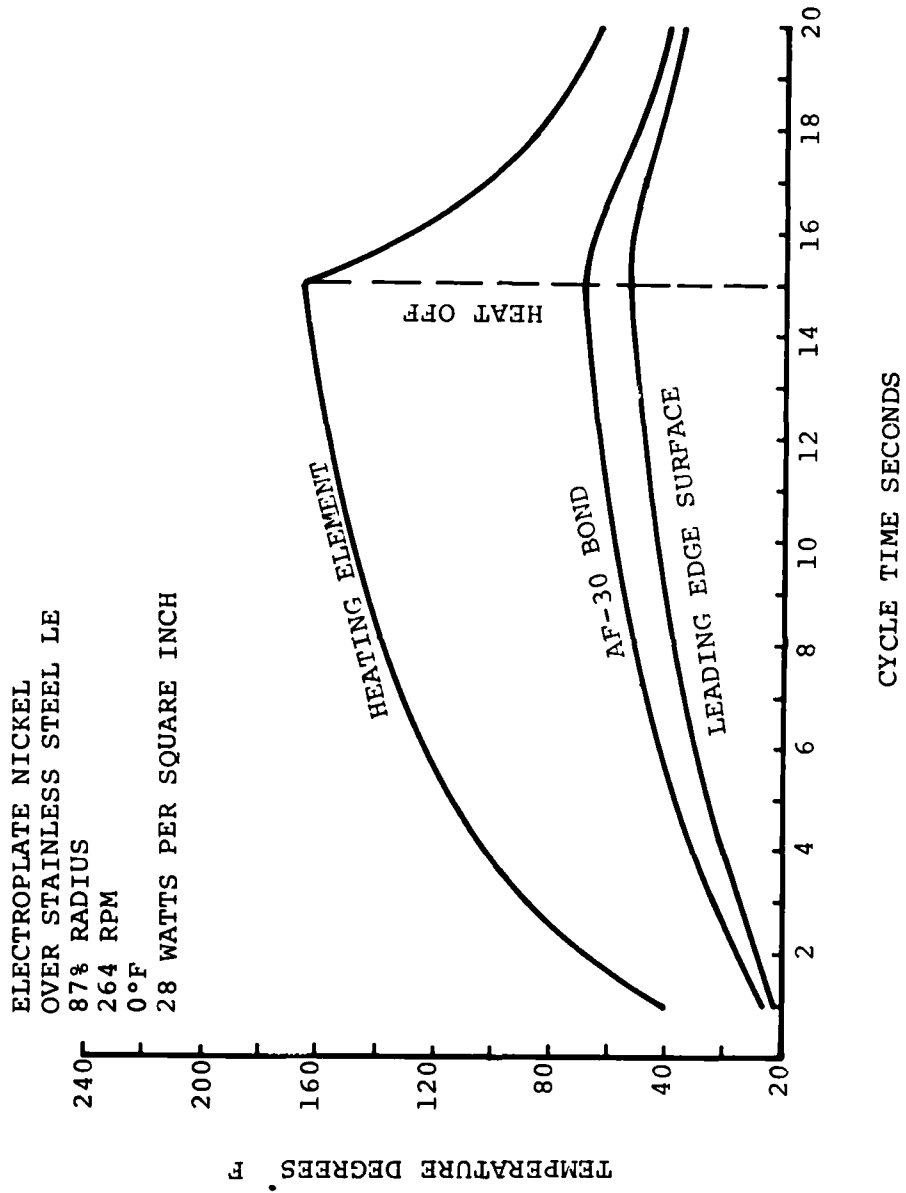

FIGURE 2-30. METAL D-SPAR ROTOR DEVICE THERMAL ANALYSIS

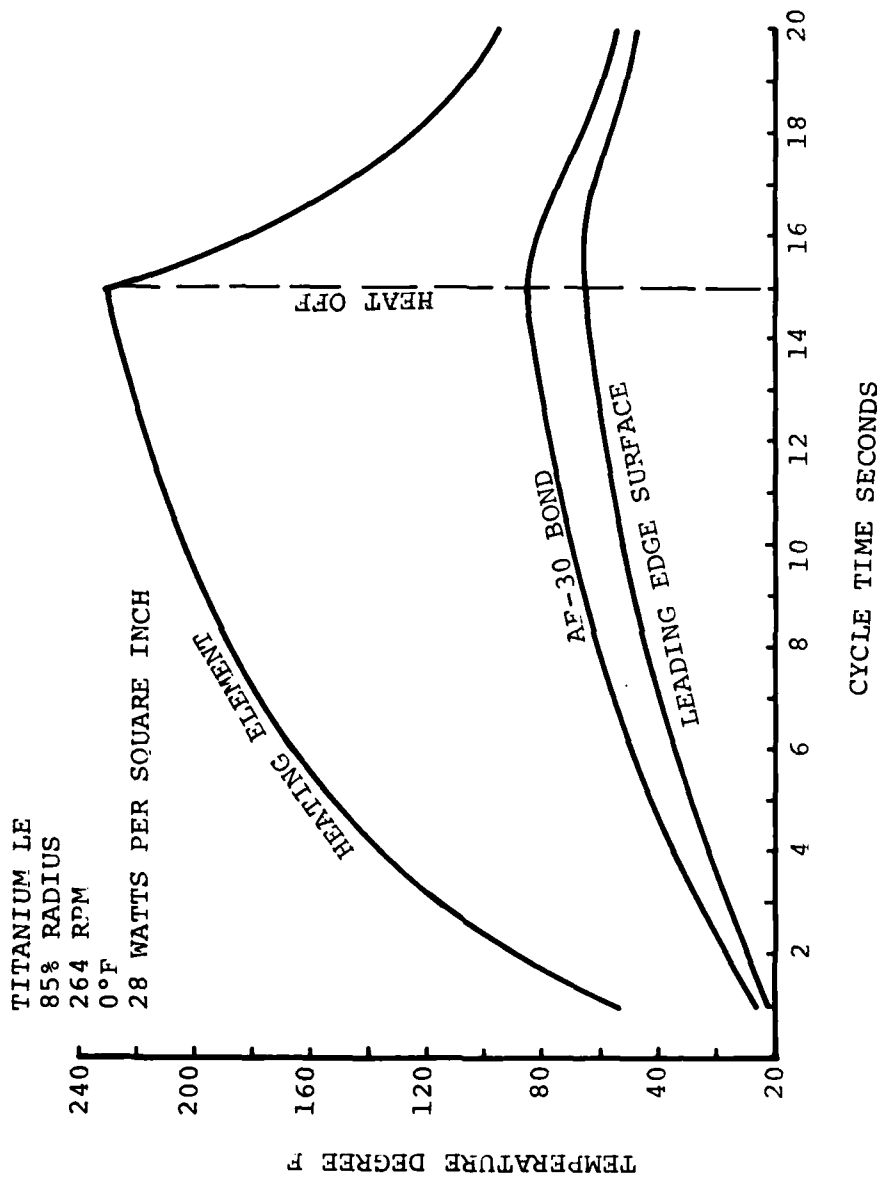

FIGURE 2-31. COMPOSITE ROTOR DEVICE THERMAL ANALYSIS

2.3.1.2 Chemical Systems

Freezing point depressant as noted in Reference 1, can be used (e.g. glycol, alcohol, etc.) in a thin film over the protected surface, thus lowering the freezing point and preventing the formation of ice. Although relatively simple in concept, it does have some drawbacks when applied to airfoil anti-icing, such as difficulty in obtaining an even flow distribution in the presence of a variable external pressure field. It is an expendable system which requires resupply; and the sensitivity of the fluid distribution holes to clogging, particularly in a dusty environment. Depending upon the width of the fluid expulsion band, the system performance may be sensitive to aircraft attitude (angle of attack). Also, chemical systems have, at best, marginal recovery capability as evidenced by icing tunnel tests (Reference 47). Chemical deicing/anti-icing systems have been tested on helicopter rotors with very limited success. A chemical system was designed and tested on a CH-47 rotor to determine system feasibility (Reference 48). The major problem encountered during whirl tower testing was the non-uniform span distribution of the fluid due to both changes in the external aerodynamic flow field coupled with various internal flow channel misalignment problems. The program was discontinued in the early 1960s. Other companies (Bell Helicopter, Lockheed) have investigated chemical systems for helicopter rotors but have found similar problems.

2.3.1.3 Mechanical Systems

Pneumatic deicing boot systems have been in use longer than any other concept for fixed wing applications. The boots, when inflated, break the bond between the ice and the surface, thus allowing aerodynamic forces to blow the ice away. This method is often used for light aircraft because of its simplicity and relatively low first cost. In turboshaft powered aircraft, a pneumatic deicing system can utilize a very small quantity of cooled engine bleed air continuously to provide ejector suction for maintaining the boots in a deflated position (minimizing drag), and intermittently to inflate the boots. The amount of bleed air extraction for deicer boots is small, and the fuel penalty due to engine bleed is negligible. Thus, in icing conditions the penalty of a pneumatically operated boot system is due solely to the drag resulting from ice buildup on leading edges before the ice is shed. In addition to the drag increase due to ice buildup before shedding, the boots may impose a permanent drag increase regardless of whether the flight is performed in clear air (non-icing weather).

Technologically, these systems have been extensively developed and improved whereby boot inflation operation develop little or no effect upon the airfoil lift. Power requirements to activate the mechanical boot deicer are minimal compared to a thermal system for the same area. Materials are constantly being improved to overcome the erosion effects due to foreign particle and water impingement.

The pneumatic boot deicer for rotor blade systems has not progressed much beyond the study phase because of anticipated detrimental aerodynamic effects upon blade performance and because of potential rapid boot material erosion. Erosion testing by B.F. Goodrich has indicated a material with apparent good anti-erosion properties. Some limited testing on a rotor blade pneumatic boot installation has been accomplished by NASA and B.F. Goodrich in the Lewis Research Center Icing Tunnel (non-rotating). Testing by NASA Ames is planned for a full-scale rotating rotor blade system to evaluate the pneumatic boot under centrifugal force and high mach number loading.

2.3.2 Design Factors

Ice protection systems are designed to provide protection when the helicopter is exposed to atmospheric icing conditions. Determination of the ice protection design conditions and the need for ice protection involves consideration of the following:

- o The meteorological conditions specified for the helicopter systems and flight envelope.
- o The operational conditions which are affected by the accumulation of ice on protected and unprotected surfaces.
- o The operational conditions affecting the engine and rotor based on the potential accumulation of ice and/or the availability of energy to operate the ice protection system.
- o The cost of the ice protection in terms of the initial installation and the maintainance of the system during the helicopter life.
- o The installed weight of the ice protection system and the resultant payload impact. The weight factor will differ between removable kit installations and permanent systems.
- o The system reliability in terms of fail-safe features, probability of failure, and the resultant problems occurring to the helicopter in the event of a failure.

2.4 AIRFOIL ICING ASSESSMENT

2.4.1 Typical Fixed Wing Data

Figure 2-33 from Reference 49 illustrates several ice shapes at the leading edge of a NACA 65A215 airfoil operating at $M = 0.25$, at a Reynolds number near 6×10^6 . Ice shapes I, Ia and II might be representative of the ice accretion possible on helicopter rotor blades. Configuration I represents a thin but rough layer of ice (hoar frost), Configuration Ia is the result of uneven ice accumulation at the leading edge, and Configuration II is the result of a uniform buildup of smooth ice. As shown in

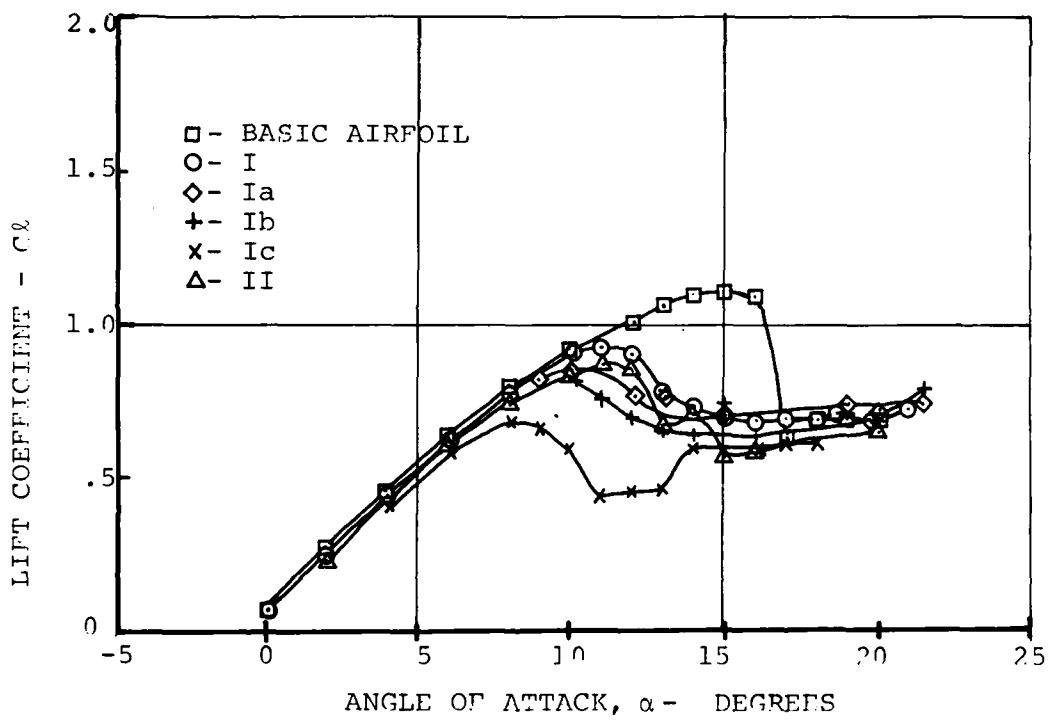
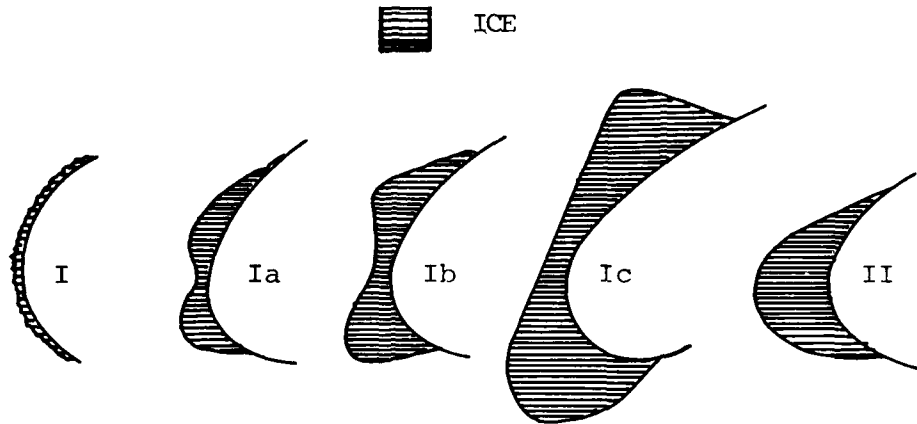

FIGURE 2-33. TYPICAL EFFECTS OF ICE SHAPE

Figure 2-33 all ice shapes cause a degradation in the maximum lift from $C_{l\max} = 1.1$ down to $0.8 < C_{l\max} < 0.9$, a 20% to 30% loss in maximum lift. Configuration 1C causes an even greater loss in lift capability, but such an ice shape is probably not relevant for rotor icing studies because the ice is the least likely to withstand the vibratory forces and bending of a helicopter rotor blade, and shedding would take place before ice could accumulate in any substantial amounts over critical outboard areas.

To be truly useful in helicopter rotor applications the data on ice effects must include a wider Mach number range than tested in Reference 14, but assuming that the lift data at $M = 0.3$ to 0.4 is not substantially different from the data at $M = 0.25$, a 20% loss in sectional maximum lift could be related to as much as a 20% loss in rotor lifting capability due to premature stall inception. The stall inception is interpreted here as due entirely to changes in airfoil characteristics; penalties due to changes in blade mass and balance would have to be assessed separately. The relationship between sectional and rotor lifting capabilities is discussed in Reference 50.

2.4.2 Applicable Rotor Data

Other sources of data on the effect of some classes of ice shapes are wind tunnel test data on the effect of a deicing blanket applied outside of the blade contour. Figure 2-34 for instance, illustrates the drag rise penalty due a .060 in. thick layer applied on the leading edge of an 18 in. chord symmetrical section used on the Vertol 107 helicopter. Although the level of the drag rise boundary shown in Figure 2-34 is somewhat optimistic (the test was conducted in a 3D rectangular model of aspect ratio 5), the data show that even a smooth leading edge contour change can cause a penalty at Mach number levels near drag divergence. In this case, the reduction in drag divergence Mach number (defined for $dC_d/dM = 0.1$) is about $\Delta M_{DD} = 0.02$. Since the rotational speed of a rotor cannot be reduced significantly to overcome this degradation in drag, the maximum flight speed capability of the 107 would be reduced by 13 knots.

Figure 2-35 shows the sensitivity of blade loads to sectional pitching moments. The loads shown were measured during unpublished rotor tests conducted at Boeing Vertol. The pitching moment changes were achieved by trailing edge modifications which produced little or no effect on the mass balance of the blades. Sectional pitching moment changes at least as large as those shown in Figure 2-35 could be easily achieved considering that the ice accumulation can increase the camber while shifting forward the aerodynamic center by about 3/4 of the chordwise extension in leading edge (i.e. ice extending 0.2 chord lengths beyond the original leading edge would shift the aerodynamic center by 0.015 chord lengths, without taking into account any flow separation).

Asymmetric ice shedding, blade pitch inertia changes, blade mass changes, etc. would also significantly contribute to blade vibratory loads, but this section will deal only with aerodynamic effects.

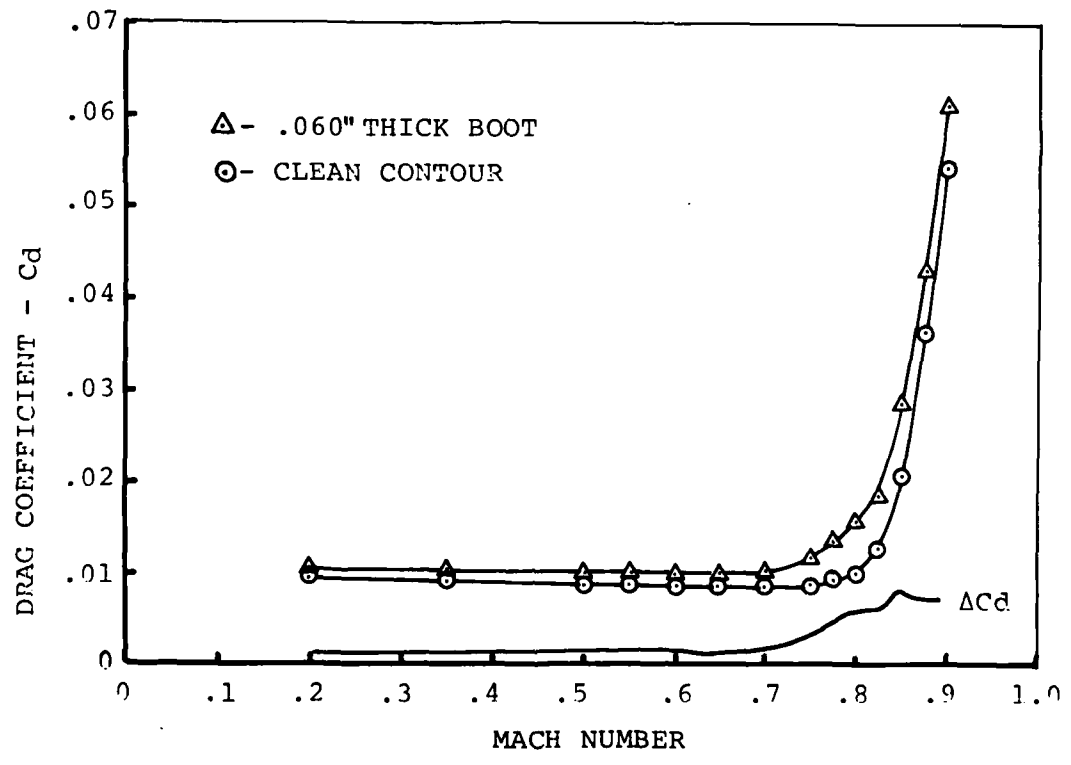
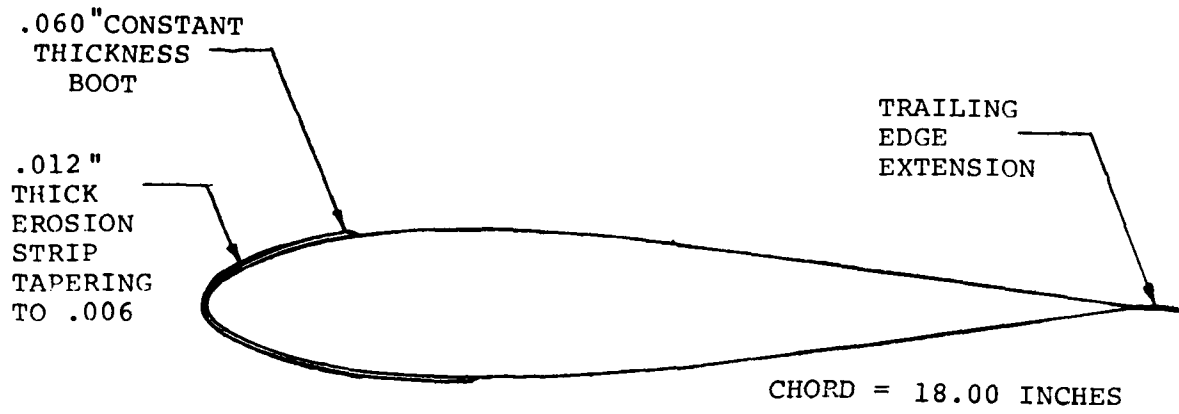

FIGURE 2-34. DRAG RISE DUE TO LEADING EDGE DISTURBANCE

6 FT. DIA. VR-7/8 ROTOR

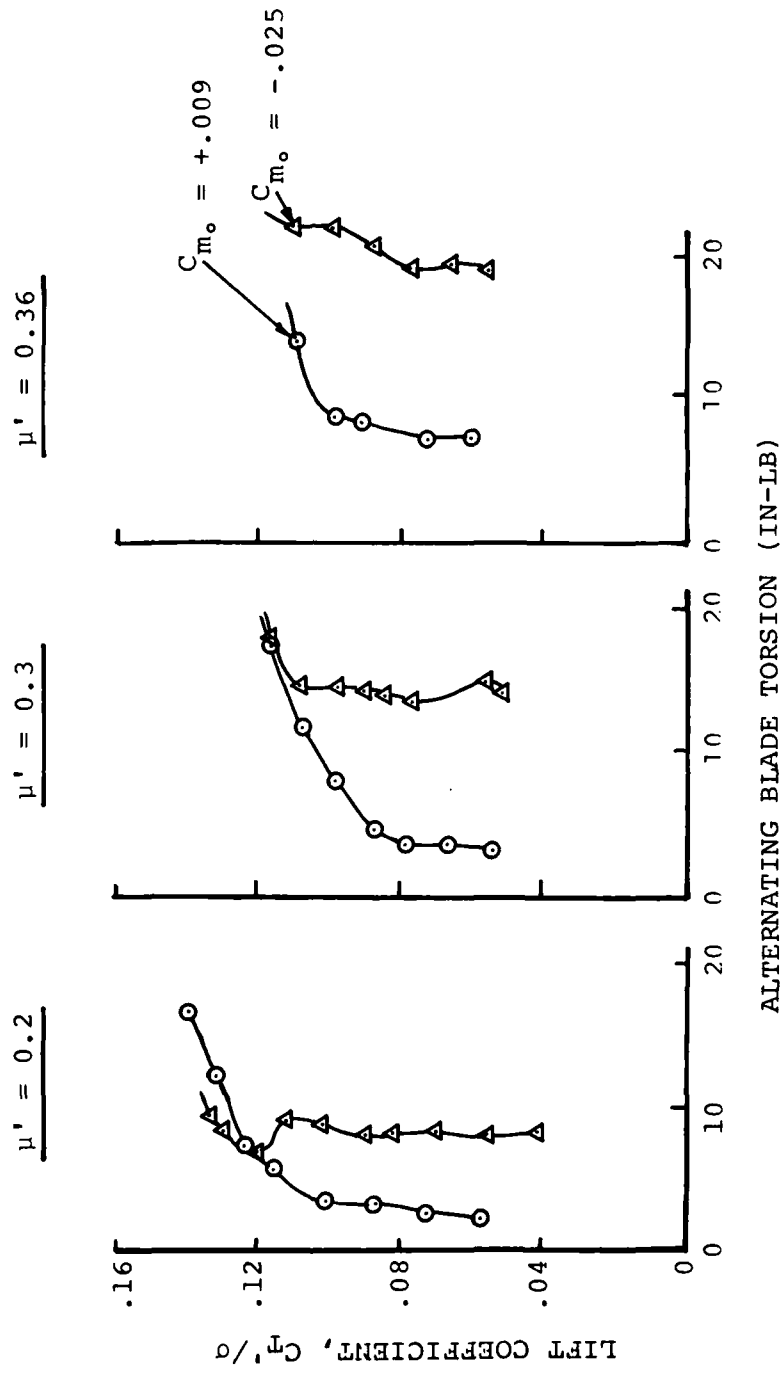

FIGURE 2-35. EFFECT OF PITCHING MOMENT ON ROTOR LOADS

Figure 2-36, reproduced from Reference 51, shows a method to evaluate the effect of surface roughness on the loss in sectional maximum lift capability. In the case of ice accumulation, the surface roughness could be assumed distributed at and near the leading edge (0 to .05c). A roughness to chord ratio of 0.0008 causes a loss in maximum lift between 15% and 20%, confirming qualitatively the measurements for Configuration I in Figure 2-33.

Figure 2-37, from Reference 49, shows the effect of roughness and ice accumulation on the profile drag. Data on the effect of surface roughness can be found in standard reference texts such as Hoerner (Reference 52).

While surface roughness causes premature thickening of the boundary layer, leading to subsequent premature boundary layer separation, the effect of the ice shape on drag is much harder to assess with any degree of accuracy because of the formation of both thick boundary layers and regions of separated flow. Based on the simplifying assumption that ice accumulation causes a constant drag coefficient increment along the entire span of a rotor blade, the incremental power penalty ΔC_p associated with a drag increment ΔC_d is

$$\Delta C_d = \frac{8\Delta C_p}{\sigma}$$

where σ is the torque weighted solidity of a rotor.

While it is difficult to assess the effect of ice accumulation on changes in sectional lift drag and pitching moment characteristics, the effect of known changes on rotor performance and loads can be approximated with the methods outlined above. Conversely, known changes in rotor power or load levels may be related to changes in sectional characteristics thus providing some indirect evidence of the nature of the ice accumulation.

2.4.3 Evaluation of the Impact of Ice Accumulation

The analytical assessment of the impact of ice accumulation on rotor performance and loads could be carried out by following the procedure outlined below. The procedure would utilize methods which are generally available at this time, although in some areas further theoretical development, and some experimental evidence are necessary. Preliminary results illustrating the use of airfoil design methods to predict the effect of ice accumulation are discussed in Appendix C.

The assessment of the impact of ice accumulation on rotor blades includes the following steps:

- o Definition of ice shapes and accumulation features on rotor blades over a given range of flight and weather conditions.
- o Evaluation of the impact of ice accumulation on the sectional aerodynamic and dynamic characteristics of rotor blades.

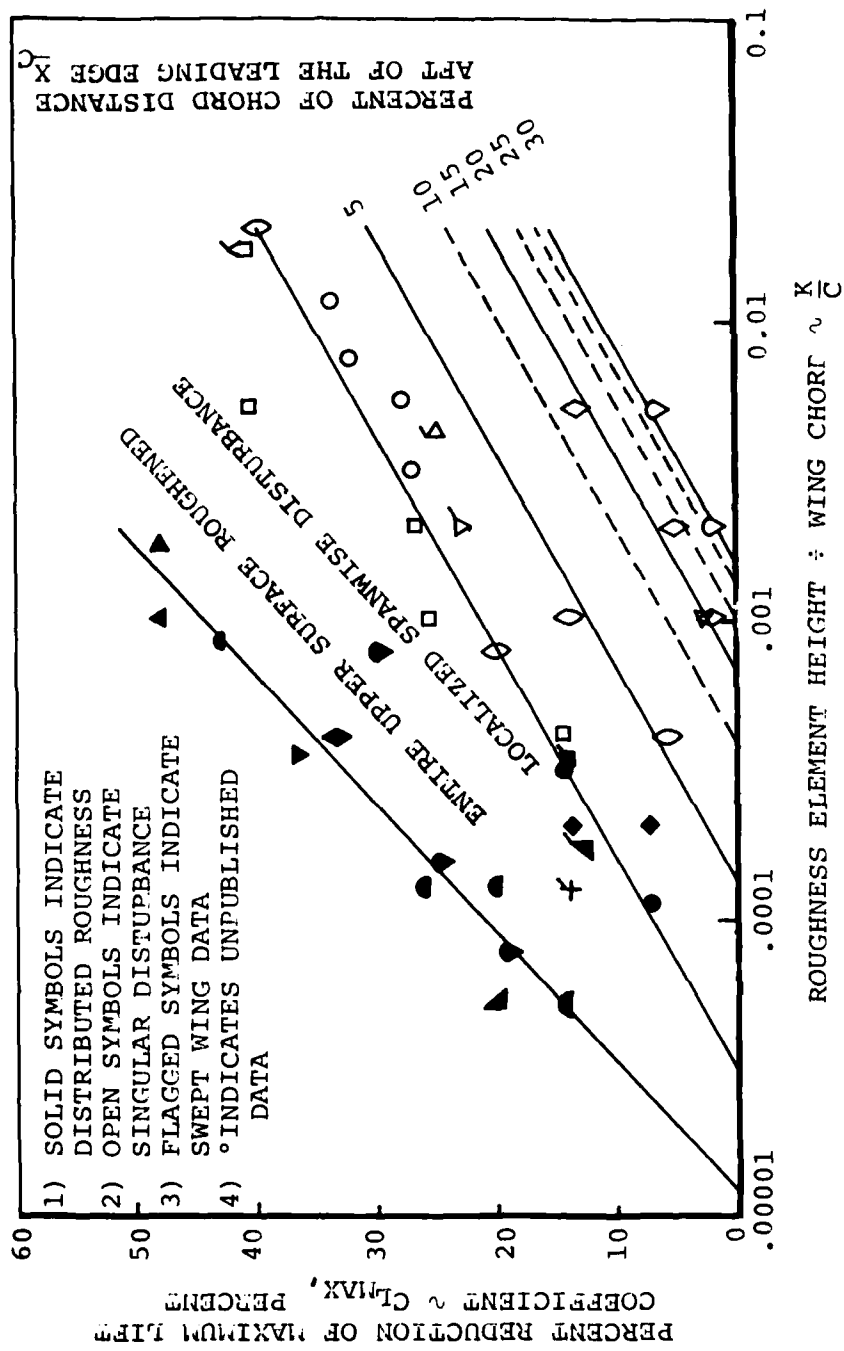
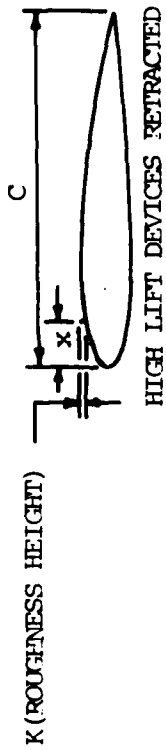

FIGURE 2-36. EFFECT OF SURFACE ROUGHNESS ON LOSS IN MAXIMUM LIFT CAPABILITY

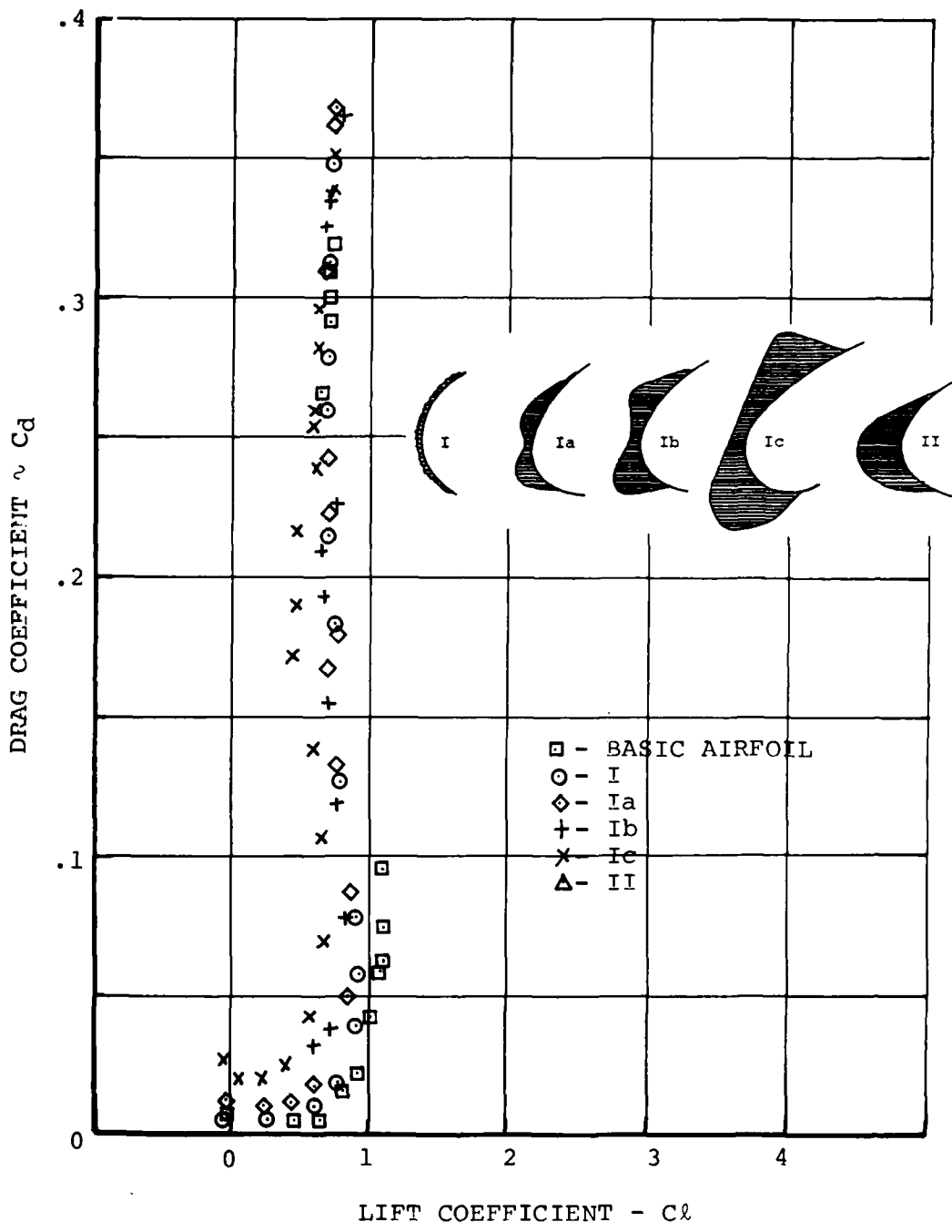

FIGURE 2-37. AIRFOIL DRAG DUE TO ICE

- o Determination of performance penalties.
- o Assessment of blade and control load penalties due to:
 - Uniform and steady ice buildup
 - Uneven buildup and/or natural shedding
- o Evaluation of problems related to the deployment of deicing systems.
- o Assessment of the impact of residual ice accumulation in presence of active deicing (e.g. runback ice).

Currently the most difficult task appears to be the determination of accurate ice shapes on occurring over rotor blades in flight. If ice accumulation could be monitored with some degree of accuracy, experimental and theoretical interjections could be then directed to quantify the aerodynamic and dynamic consequences of rotor blade icing, and a rigorous approach to deicing systems and flight safety could be then defined.

The analytical/experimental process to quantify rotor blade icing is summarized in Table 2-10.

2.5 DESIGN APPROACH

The overall objective of the design analysis is to verify that no combination of icing meteorological conditions as specified in the basic design criteria coupled with the helicopter operational envelope will result in an accumulation of ice on any surface which will cause an unsafe operating condition.

Different design approaches are needed for airframe, powerplant, and rotor ice protection systems. Fuselage surfaces are in general more tolerant of ice accretion than engine/engine inlet surfaces or rotors.

The design margins for each ice protection system are established by the simultaneous consideration of meteorological factors, helicopter engine operational factors, and other pertinent factors.

Design points chosen for analysis should be sufficiently defined in terms of meteorological and operational factors for the certification agency to determine how the severity of these factors was established.

The frequency and duration of icing encounters also determines the severity of the icing conditions and has a major impact on the ice protection capability; particularly on thermal systems. Continuous maximum conditions interspersed with intermittent maximum conditions occur in natural icing particularly at higher altitudes and therefore should be examined during the design analysis phase.

TABLE 2-10. ROTOR ICING EVALUATION REQUIREMENTS

TASK	CURRENTLY AVAILABLE METHODS	RESEARCH REQUIREMENTS
Definition of Ice Shapes and Accumulation Patterns	- Fixed wing tests	- Oscillatory tests for ice accumulation at constant Mach number over a range of mean angles of attack and pitch oscillation amplitudes
	- Fixed incidence 2-D impingement and accumulation calculation	
		- Validation of averaged ice accumulation shapes from fixed incidence calculations at constant Mach number
		- Extension of ice shape averaging to variable incidence and Mach number
Evaluation of the degradation in sectional characteristics due to ice accretion	- Subcritical potential flow/boundary layer interaction methods	- Modification of separated flow analysis methods to handle specifically ice accumulation problems
	- Viscous transonic flow analysis	
	- Preliminary 2-D separated flow analysis	- Improved methods to assess the impact of surface (ice) roughness
	- Two-dimensional wind tunnel tests with simulated ice shapes.	- Thick boundary layer methods
Preparation of sets of airfoil data reflecting the effect of ice accumulation	- At present airfoil tables of lift, drag and pitching moment characteristics are prepared by hand and input in rotor analysis computer program over a very limited number of spanwise stations (3 to 5 maximum)	- The preparation of airfoil tables would have to be automated to whatever degree is possible if a large number of ice shape variations is to be considered

TABLE 2-10. ROTOR ICING EVALUATION REQUIREMENTS (Continued)

TASK	CURRENTLY AVAILABLE METHODS	RESEARCH REQUIREMENTS
(Continued)		<ul style="list-style-type: none"> - Rotor performance and loads analysis computer programs will have to be altered to accept an air-foil table for each computation bay (up to 15 computation stations)
Evaluation of the effect of ice on local blade properties	<ul style="list-style-type: none"> - Changes in mass distribution due to ice accumulation can be easily evaluated 	<ul style="list-style-type: none"> - Changes in elastic properties (torsional and flapwise stiffness) as a function of ice will have to be determined
		<ul style="list-style-type: none"> - Blade analysis programs will have to be able to account properly for the extension of ice beyond the leading edge. The reference axis for the definition of pitching moment coefficients will have to be standardized
Assessment of rotor performance penalties	<ul style="list-style-type: none"> - Current rotor performance analysis computer programs are available by means of which rotor performance degradation due to degradation in sectional characteristics can be evaluated 	<ul style="list-style-type: none"> - Model/full scale tests with realistic ice shapes
	<ul style="list-style-type: none"> - Flight tests provide selected performance and leads data but little information on ice shapes 	<ul style="list-style-type: none"> - Flight tests with complete performance and leads instrumentation, and advanced ice monitoring techniques
	<ul style="list-style-type: none"> - Model rotor tests can be run with assumed ice shapes 	

TABLE 2-10. ROTOR ICING EVALUATION REQUIREMENTS (Continued)

TASK	CURRENTLY AVAILABLE METHODS	RESEARCH REQUIREMENTS
Evaluation of loads penalties	<ul style="list-style-type: none"> - Performance and loads analysis should not be separated, however computer programs are available in which the dynamics of the rotor is defined in more detail than the aerodynamics. Current dynamics programs are not equipped to handle specifically ice problems 	<ul style="list-style-type: none"> - Modify loads (dynamics) analysis codes to allow the investigation of both steady ice accumulation and uneven shedding

2.5.1 Major Icing Consideration Areas

In general, the major areas of concern for ice protection consideration on the helicopter can be summarized as follows:

2.5.1.1 Airframe Surfaces

Airframe surfaces include all nontransparent and nonrotating areas such as radio antenna, pylons, auxiliary inlets (heater, oil cooler, etc.), vents, drains, landing gear, fixed control links and rods, etc. In general, the effect of icing in these areas is very much dependent upon the specific configuration. The ice protection analysis of these airframe surface components should take into account (1) the probability of ice forming on the specific component under investigation, (2) the problem created to the specific component and related systems if ice forms, (3) the problem created if ice sheds from the specific component in question, and (4) the best method of providing satisfactory ice protection for the specific component (if so needed) and the associated effects on the related systems.

2.5.1.2 Transparent Surfaces

Windshields, side windows, bubble nose windows, and passenger windows are included in this category. In general, the primary area of concern is the pilot and copilot windshields because of forward visibility requirement after exiting an icing situation and the quantity of ice forming on forward facing surfaces. The other noted transparent areas, in particular the side facing windows, are generally not prone to any substantial icing. Although the windshield design is configuration dependent, the general approach is to anti-ice at least the critical forward visibility areas.

2.5.1.3 Rotating Components

Swashplates, rotating links, droop stops, upper controls, balance weights, etc. are included for ice protection evaluation. The major emphasis in the examination of these components are (1) ice accretion probability, (2) severity of damage to the component if ice accumulates to any significant amount (damage may be in terms of jamming or deflection of component or in terms of preventing the component from performing its designed function), (3) severity of damage if ice shedding from other areas strikes the component under investigation and, (4) need for and best ice protection means, if required.

2.5.1.4 Engine/Engine Inlet

Ice accumulation on the engine or engine inlet surfaces are generally not acceptable from both the standpoint of airflow blockage, and engine compressor damage. The small turbine engines used in current helicopters are particularly sensitive to ice because of the small compressor blade sizes and thin leading edges. Integral engine particle separators (such as is

on the T700) reduce the ice hazard to the compressor. In engine installations without integral separators, however, the airframe mounted inlet system must provide the majority of the ice protection by (1) preventing ice formation or (2) blocking ice from reaching the engine.

2.5.1.5 Rotor

Rotor icing is a unique area because of (1) the extreme configuration dependency of the effect of rotor ice on the dynamic and aerodynamic reaction forces throughout the helicopter, (2) the high collection efficiency of the airfoil coupled with the varying Mach number and angle of attack across the rotor span and azimuth, (3) the high velocity ice shedding trajectories, and (4) the rotor wash effects directing the icing cloud water droplets into specific flow paths dependent upon the helicopter flight condition. The determination of ice protection for a specific rotor system therefore requires a design analysis of not only the means to protect the rotor but the need for any protection system.

2.5.2 General Approach

A choice is required in the early design stages of the helicopter design to determine which areas require ice protection. Those surfaces and components of the helicopter directly exposed to stagnation flow conditions usually accumulate the largest quantity of ice.

Selection of the surfaces and components to be protected is made after a careful consideration of the most severe meteorological and operating conditions, the probable extent of ice accumulations on exposed surfaces, the effects of such accumulations on lift, drag, and controllability of the helicopter and the operation of systems. Consideration of takeoff, hover, transition, level flight, descent and landing performance should be provided under operating conditions specified. Some ice buildup may be tolerable on some surfaces if the helicopter has sufficient rotor power to offset the additional lift and drag forces and no unsatisfactory operating condition results. The extent of the icing protection needed for various air scoops is directly related to the need for such protection to maintain satisfactory operation of an essential system.

The choice between a deicing or an anti-icing system or no ice protection will be influenced by an assessment of such factors as effect of shedding ice onto other surfaces or engine inlets, the complexity of a cyclic system, and the availability of a sufficient quantity of heat. In general, the rotors will be deiced if required while the engine inlets and window-shields will be anti-iced. After due consideration of the foregoing design factors, the manufacturer can establish the airframe system design points in terms of LWC, droplet diameter, and temperature together with those factors necessary for the certification agency to determine by tests that all design objectives have been met.

In addition to the meteorological conditions under consideration, appropriate operational parameters including such factors as speed, altitude,

engine power setting, etc., should be varied over the helicopter operating envelope to determine the combination or combinations of meteorological and operating parameters which result in the most critical design point or points. Because of the large number of variables involved in these design considerations, more than one critical design point may exist for both intermittent maximum and continuous maximum meteorological conditions.

The design analysis should indicate that no hazardous quantity of ice will form on the surfaces under consideration when exposed to intermittent maximum and continuous maximum icing conditions consistent with the operational needs of the helicopter.

The engine icing system should be designed to cope with the most severe meteorological conditions occurring simultaneously with the most severe engine operational conditions. Critical design points for both Continuous Maximum and Intermittent Maximum conditions should be developed.

The principal differences in the design approach applicable to airframe and engine systems arise from the need for reliability of the engine during severe icing encounters to insure that a helicopter will have sufficient power to continue flight to an area of less severe meteorological conditions.

Although the engine manufacturer generally may have some idea of the eventual application of his engine, he cannot be sure that some future application will not be totally different from that planned. Therefore, the ice protection system should not be limited to a specific application or specific helicopter operational envelope.

In addition to the foregoing, the buildup of ice on unprotected surfaces of the helicopter and the helicopter operational conditions during an icing encounter place further emphasis on the necessity for reliable engine performance. Engine struts, gearbox fairings, and inlet guide vanes, if unprotected, may be subject to accumulating excessive ice deposits. When heated surfaces are employed for keeping these surfaces free of ice, the possibility of runback and refreezing should be considered. The first-stage compressor blading of axial flow engines should also be evaluated for possible ice accumulation, with the ice protection system operating. It is not considered essential to eliminate ice buildup at the engine face, but any ice buildup allowed on an operating engine should be kept to a minimum to prevent possible damage from ice ingestion.

Ice protection should be provided for all sensors essential for safe operation of the helicopter which are subject to ice impingement or to runback and refreeze. The functioning of essential static ports should not be adversely affected by ice accumulation, freezing of runback water from forward surfaces, or water and slush from rotor downwash during takeoff and landing. It is possible that slush ingestion and water, ingested at a lower altitude, might freeze when ascending to higher altitudes and lower temperatures. Some of the sensors that might be affected are pitot tubes, total pressure probes, and control surface indicators. These instruments

are generally anti-iced by electrical resistance heaters because of the small areas involved and the need to maintain ice-free operation in all icing conditions.

The forward surfaces of windshields should be protected to provide visibility during the most severe icing and freezing rain conditions.

Rotor operation would be considered unsafe if an accumulation of ice caused a serious increase in power required, loss of thrust and/or lift, caused a reduced autorotational condition to develop, caused damage to adjacent structure when detached by centrifugal force, caused vibrations which could result in control or structural failure, or caused any other erratic helicopter operation.

2.5.3 Summary of Design Considerations

- o Performance (Power Available vs Power Required)
 - Hover
 - Takeoff
 - Landing
 - Forward Flight
 - Autorotation
- o Stability and Control
 - Vibration Levels
 - Control Loads (Pitch Link Loads)
 - Torsional Blade Root Stress
 - Control Surface Movement
 - Autorotation
- o Ice Shedding
 - Main Rotor Shedding
 - Asymmetrical Shedding (Rotor Balance)
 - Fuselage Shedding
 - Impact Damage
 - Personnel Hazard
 - Rotor Shutdown
- o Ice Protection Systems
 - Rotors
 - Engine and Engine Inlets
 - Control Linkages
 - Windshield
 - Pitot-Static System
 - Vents

- o Rotary Wing Airfoil Design
 - Ice Accretion
 - Ice Sensitivity
 - Critical Sections (Airfoil Type and Span Critical Location)
 - Platform and Rotor Diameter
 - Rotor System (Rigid, Articulated, etc.)

2.6 ICE PROTECTION CONCEPTS

Ice protection design methodology used to develop a system concept and then a final configuration evolves about a number of considerations such as:

- o Meteorological Design Conditions
- o Icing Impingement Areas and Rate of Ice Collection
- o Potential Runback Areas
- o Heat Transfer
- o Source and Availability of Heat (i.e. bleed air, electrical, etc.)
- o Availability of Test Data (heat transfer, icing tunnel, flight test, etc.)

An example of an ice protection system development is illustrated in Figure 2-38 showing the evolution of two engine inlet anti-icing designs including an engine inlet foreign particle separator configuration with the associated anti-iced surfaces. These inlets were tested under icing conditions in the NASA Lewis Icing Tunnel and on helicopters in the NRC Ottawa Spray Rig. As can be noted in the figure, the type of anti-icing and the extent of heated coverage varied as a function of the amount of available test data (i.e. the test results identified specific areas requiring heat).

Figure 2-39 depicts some of the ice protection system parameter interrelationships and shows most parameters directly influencing takeoff gross weight (TOGW), range, and life cycle costs. As shown, system power and performance requirements directly affect takeoff gross weight and life cycle costs. The result is reflected not only in the fuel costs and weights due to shaft power and bleed air extraction, but also in establishing component weights and volumes. Therefore, it becomes extremely important to select the most efficient match of the power sources with the generation, distribution, and utilization systems.

In addition, short-duration, high-power requirements must be evaluated and techniques must be developed to meet these demands without oversizing the basic airframe systems.

Volume considerations are also extremely important. Associated increases in sizes of installation hardware such as fittings, brackets, and clamps for pneumatic ducting and electrical distribution systems increase weight and degrade the aircraft's performance.

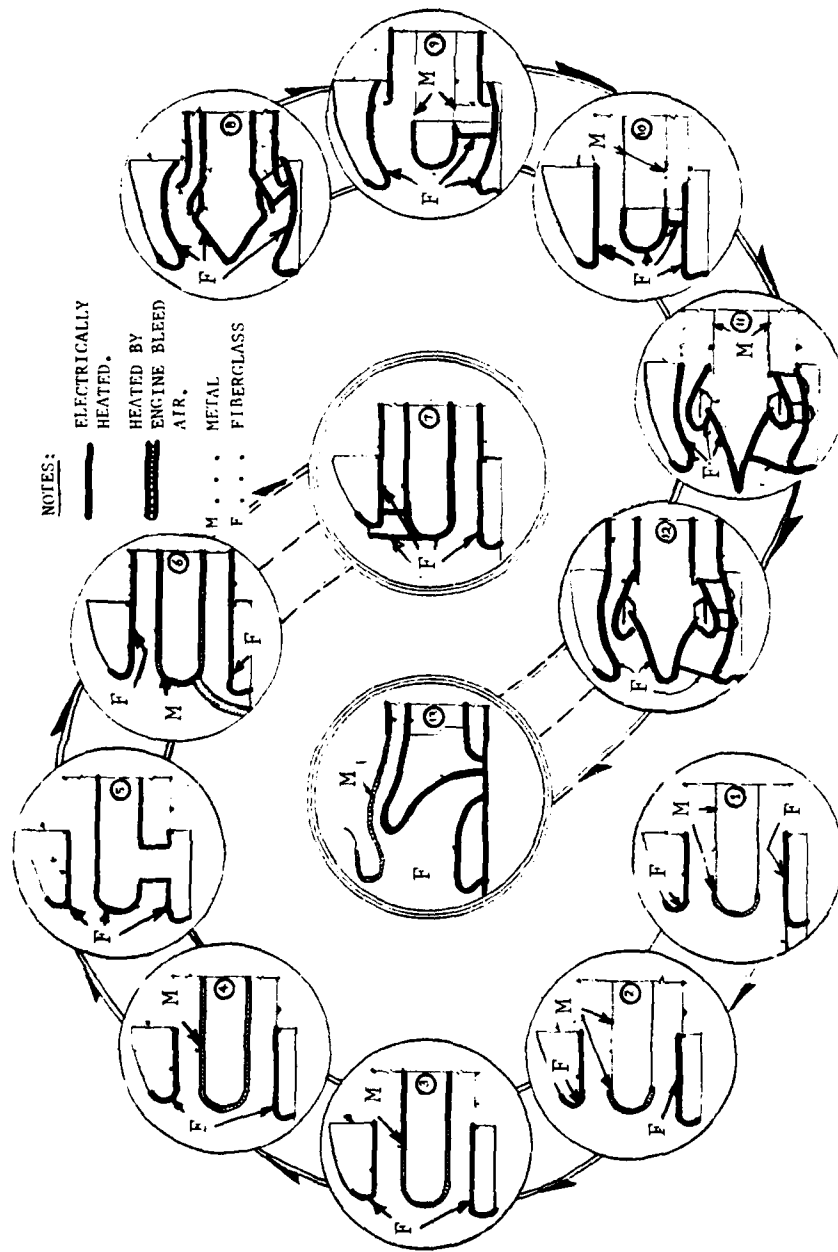

FIGURE 2-38. EVOLUTION OF TWO ENGINE INLET SYSTEMS

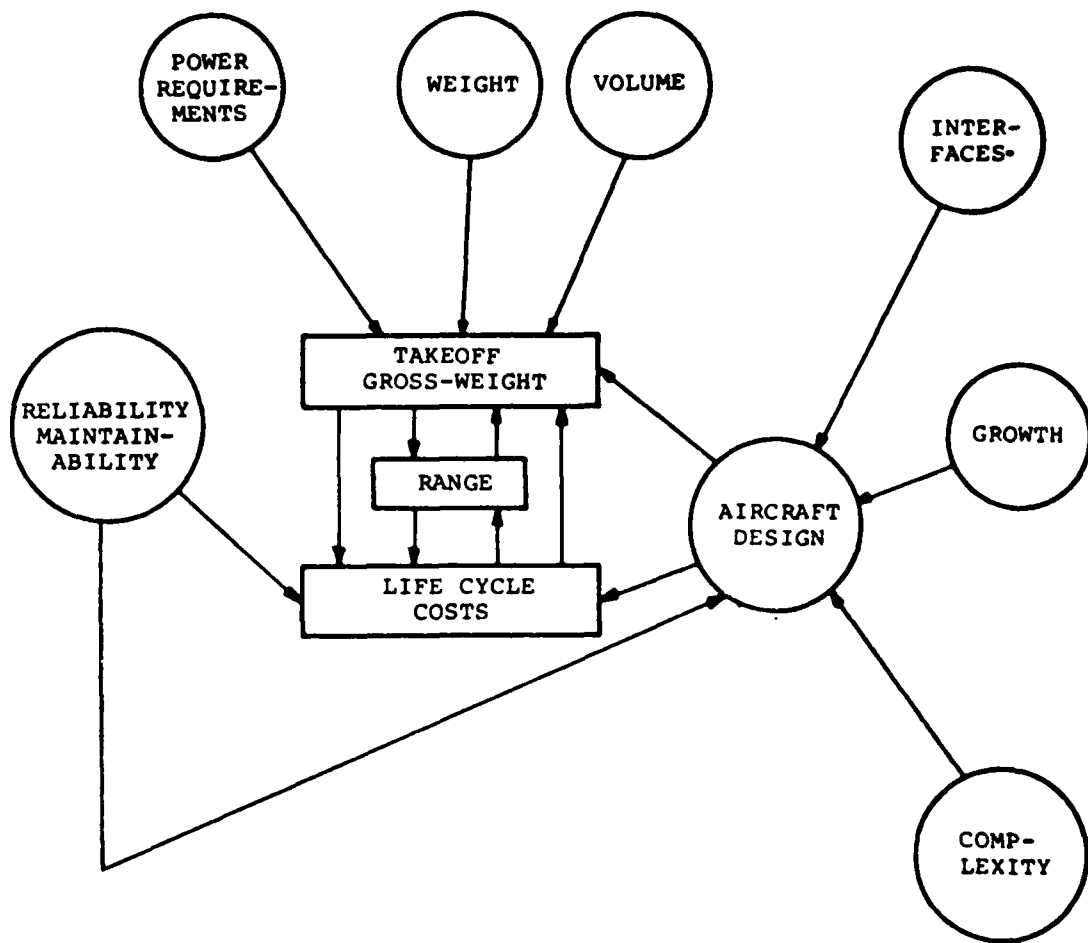

FIGURE 2-39. ICE PROTECTION SYSTEM PARAMETERS

Reliability goals and redundancy levels must be established in consonance with safety aspects to obtain an optimum system with assurance of mission success.

System complexity, growth considerations, and interfaces influence and direct aircraft design which, in turn, manifests itself in aircraft performance and ownership cost.

Summarizing, it is no single parameter, but rather the understanding of the interrelationship of all parameters and design considerations that leads to an optimized system.

2.6.1 Composite Rotor Deicing

Composite blades offer many advantages for deicing improvements. Strain levels are higher than the conventional metal blades such that some natural shedding action may occur, especially at nodal points; limited testing to date (YCH-47D) has indicated this trend, however, a full analysis has not been accomplished to date. Heater blanket thermal efficiency is improved by virtue of the reduced thermal losses to the interior blade as discussed in 2.3.1.1. Material selection of the nose clad is extremely significant since the thermal diffusivity and thickness of the material control the deicing cycle performance.

The deicer blanket for the rotor blade is located on the leading edge of the blade between the titanium or other metal and fiberglass surfaces. Analysis and tests have shown that transient temperatures developed at the heater blanket bond interfaces can be kept within acceptable limits (120-150°C) by proper design and fabrication techniques.

Increased flexure loads on the heater blankets must be considered to preclude premature fatigue failure. Insulation layers, wiring and the bond integrity must be designed to withstand the imposed stresses.

2.6.2 Ice Protection Concept Categories

Helicopter ice protection concepts generally fall into two major categories, i.e. active (system require activation or power source) and passive (no power source required). Within the category of active, the systems may be anti-iced or deiced by several mechanisms as illustrated in Table 2-11. Table 2-12 lists the passive anti-icing/deicing concepts in use or being currently investigated. The concepts under current investigation or consideration are discussed as follows:

2.6.2.1 Ice Phobic

Ice shedding coatings/ice phobic investigations are continuing for helicopter rotor application. The British investigated the use of a composited low-energy surface film and a flexible sponge rubber substrata applied to a rigid structural base. This type of material composition appeared to offer inherent ice shedding using the principle that the flexibility of

TABLE 2-11. ACTIVE ICE PROTECTION CONCEPTS

Concept	Mechanism	System	Advantages	Disadvantages
ACTIVE ANTI-ICING				
Thermal Evaporative	Evaporate Impinging Water as Rotor Leading Edge With Electrical Elements Bleed or Combustion Heated Air, Heated Oil or Ethylene Glycol	o Electro-Thermal	o No Run-Back o State of the Art	o High Electrical Power Required o High Mat'l Temp.
		o Hot Air	o No Run-Back o Bleed Source Available From Engine	o Engine Power Penalty o High Temperature o Large Rotational Seals
		o Hot Liquid	o No Run-Back o Liquid Reusable	o Large Rotational Seals o Leakage Potential
Running Wet	Maintain Surface Above Freezing	o Electro-Thermal	o Heaters Available o Low Blade Temp	o Run-Back Potential
		o Hot Air	o Bleed Source Available From Engine	o Rotational Seals
		o Hot Liquid	o Liquid Reusable	o Rotational Seals o Leakage Potential
Chemical	Freezing Point Depressant	o Anti-Ice Fluid	o Technology Available From Fixed-Wing A/C	o Distribution Difficult to Control o Rotational Seals

TABLE 2-11. ACTIVE ICE PROTECTION CONCEPTS (Continued)

Concept	Mechanism	System	Advantages	Disadvantages
ACTIVE DEICING				
Thermal	Leading Edge Surface Heater Periodically No Shed Ice Buildup	o Electro-Thermal	o Systems in Production o State of the Art Components	o High Electrical Required o Cost
		o Hot Gas	o Bleed Source Available From Engine	o Thermal Lag Rotational Seals
		o Hot Liquid	o Liquid Reusable	o Thermal Lag o Leakage
		o Microwave	o Low Power Demand o Potentially Lightweight o Compatible with Nonmetallic Blade	o Only in Model Stage - Requires Full-Scale Development
Chemical	Freezing Point Depressant	o Deice Fluid	o Technology Available	o Fluid Penetration Into & Distribution Into Ice Layer o Time Lag for Ice Shedding
Mechanical	Physically Break Ice Bond at Blade Leading Edge	o Pneu. Boot	o Minimum Cost o Minimum Power Demand o Technology Available	o Low Temperature Performance o Aerodynamic Performance

TABLE 2-11. ACTIVE ICE PROTECTION CONCEPTS (Continued)

Concept	Mechanism	System	Advantages	Disadvantages
ACTIVE DEICING (Continued)				
Mechanical (Continued)		o Electro- Impulse	o Probable Low Power Demand	o Developed for Fixed- Wing Aircraft o Requires Deformation of Rotor Leading Edge
		o Vibratory	o Potentially Low Cost & Minimum Power Demand	o Research Not Com- pleted

TABLE 2-12. PASSIVE ICE PROTECTION CONCEPTS

Concept	Mechanism	System	Advantages	Disadvantages
PASSIVE ANTI-ICING				
Ice Deflection	Deflect Ice Around Critical System	<ul style="list-style-type: none"> o Inlet Barrier 	<ul style="list-style-type: none"> o Low Development Cost o Ease of Installation o No or Minimum Heat Required 	<ul style="list-style-type: none"> o Pressure Loss (Loss of Ram) o External Frontal Drag
Ice	Stop Ice/Capture Ice	<ul style="list-style-type: none"> o Inlet Screen o Inlet External Separator 	<ul style="list-style-type: none"> o Good Pressure Recovery In Non-Icing Mode o Good Pressure Recovery o Can Be Anti-Iced Easily 	<ul style="list-style-type: none"> o High Pressure Loss When Iced o High Development Costs

TABLE 2-12. PASSIVE ICE PROTECTION CONCEPTS (Continued)

Concept	Mechanism	System	Advantages	Disadvantages
PASSIVE DEICING				
Ice Phobic	Low Ice Adhesion Bond to Blade Leading Edge Surface Material	<ul style="list-style-type: none"> o Polymer Coatings (Teflon Tape) 	<ul style="list-style-type: none"> o Minimum Cost o No Moving Components 	<ul style="list-style-type: none"> o Still Undergoing o Potential Fuselage Damage
Centrifugal Force	Fracture Ice Band by Changes In Centrifugal Field	<ul style="list-style-type: none"> o Rotor RPM Sweep o Rotor Collective Pitch Sweep 	<ul style="list-style-type: none"> o Minimum Cost and Weight Impact 	<ul style="list-style-type: none"> o Small Helicopters Not Tolerant of Large Ice Buildup o Danger of Fuelage Damage From Ice

the sponge rubber substratum ultimately concentrated developed shear stresses at the edges of, and at the interface of, the composite surface and ice to destroy the adhesive bond. Peeling or shedding should theoretically result because of the concentrated stresses applied to a very limited area of the interface at any one time.

Laboratory testing looked encouraging however wind tunnel and flight testing showed that ice would remain at the blade stagnation region.

As a follow-on to the original flexible substrata deicing investigations, the British have continued with studies of hybrid systems utilizing a narrow chord heating strip combined with either an ice phobic paste or a flexible substrate aft of the heater strap. Initial testing of the hybrid system with the paste applications has indicated that this approach is worthy of further investigations. The use of a flexible substrate combined with a leading edge heater is still in very preliminary status.

Continuing ice phobic coating investigations are being conducted by the U.S. Army (ATL) using a UH-1H as the primary test vehicle. Initial results of the tests have shown somewhat erratic measured shear force shedding characteristics during repeated cycles, particularly after erosion due to rain.

Limited flight testing of two materials on the UH-1H rotor during January-February 1978 showed encouraging results. Additional tests are planned during 1979-1980 icing season for further ice phobic material evaluation.

2.6.2.2 Electro Impulse

The electric impulse deicing system developed in the USSR mechanically sheds the accreted ice by deforming the skin structure under the ice. The initial deformation is accomplished in a very short period of time at discrete points in the structure. Deicing of the structure between these discrete points depends on the deformation wave being propagated on the surface from the point of initial deformation.

Initial reports indicate that the system tested on the Russian test aircraft (IL-18) used inductors of three to four inches in diameter and that surfaces developed impulse stresses of 4000 psi.

Patented adaptations of this system are also being promoted by the USSR which features a pressure pulse in a non-conductive, non-flammable hydraulic liquid generated by an electrical spark discharge, causing the periodic pulsation of a relatively large surface area structure subject to ice buildups.

For this type of system to be successful, it must be applied to structures where the ripple caused by the local deformations can be propagated a reasonable distance without appreciable attenuation. The further the structure can propagate the wave, the fewer will be the number of points at which initial deformations will be required.

Structures designed to transmit the mechanical ripples or waves must span a finite length of the basic structure without energy absorbing attachments. The structure material must also possess low damping characteristics.

Current practice in rotor blade design and construction places the primary structure close to the leading edge. The leading edge is bonded to the structural member throughout its length with a balance weight often located on the inside. With advanced composite blades, the metal leading edge is load-carrying member structurally bonded to the blade throughout its length. Therefore, these rotor blade design configurations could not readily incorporate the electric-impulse design technique without considerable revisions and modification. The operational principles and potential advantages of this mechanical deicing system warrant more detailed studies to investigate and establish feasible conceptual configurations which would be operationally and cost-effectively applicable for rotorcraft use. The studies could include engine inlet application configurations.

2.6.2.3 Microwave

The microwave rotor deicing concept has proceeded through analysis and laboratory testing but has not undergone full scale demonstrations. The principal of the microwave system is to transmit the microwave energy through a rotor leading edge wave guide. Ice on the leading edge surface extracts a portion of the energy from the passing wave sufficient to cause local shedding. The remaining energy continues along the wave guide, progressively heating the ice/surface interface with repeated local ice shedding along the rotor length. Much further development is required, however, to determine the actual adaptability to a helicopter.

2.6.2.4 Pneumatic Boot

Preliminary assessments by NASA are being accomplished for pneumatic boot rotor deicing. The major concerns are (1) the ability of boot material to withstand the rotor environment, and (2) the aerodynamic impact of boot inflation. A full scale rotor (UH-1H) with a pneumatic boot installation is planned (by NASA Ames) for evaluation in mid 1980.

2.6.2.5 Vibratory

Rotor induced vibration offers potential deicing capability as demonstrated in preliminary testing. Much additional work is required to provide a system that is not detrimental to rotor and airframe dynamic components. ATL (Eustis) is currently evaluating this concept.

2.7 ICE MEASURING INSTRUMENTATION

Ice detection on a helicopter presents a more complex problem than on a fixed-wing aircraft because of (1) the extreme variations between the rotor velocities (therefore ice accretion rates) and the fuselage velocities during forward flight, (2) the large flow field directional changes

between hover and forward flight, and (3) the sensitivity of the rotor to ice accretion (very rapid performance degradation of some helicopters as noted by Stallabrass (Reference 53) and Bradley (Reference 54)).

Results of current helicopter icing tests have indicated a need for both icing severity (in terms of liquid water content) and total ice accumulation (or rate of build-up) icing rate (in terms of liquid water content) and total ice accumulation to give the pilot a reference for icing encounters in specific helicopter types. The location of the ice detector requires knowledge of the helicopter flow field and correlation between the detector location and the critical ice accretion area for each specific helicopter type.

The velocity across the detector sensor should be constant over the range of operating airspeeds (including hover) if correlation with rotor icing is to be obtained. Additionally, the detector should be able to respond rapidly to high liquid encounters including encounters at ambient temperatures just below the freezing level.

In the rotor blade deicing system where the ice detector signal is required to be proportional to the ice accretion rate on the rotor blades, placing the ice detector on the rotor blade would be highly desirable from a detection standpoint. Due to the accretion characteristics at various temperatures and icing intensities, the detector would have to be located approximately midspan. This presents many design problems with regard to the blade structure, the deicing blanket design, the blade balance, the aerodynamic drag, the vibration, and high "g" environment. For these reasons, all ice detectors to date have been fuselage mounted and the proportionality is achieved by the interface between the ice detector and the signal that initiates deice cycles.

The selection of a fuselage location is still a problem because it should have almost constant airflow, regardless of aircraft speed, and must be exposed to impingement of the airstream. The best location on each aircraft design requires investigation to determine its influence on the interface design and operation parameters.

One of the design objectives of an optimum anti-ice/deice system for application to future helicopters is automatic operation. This would minimize the aircraft power requirements - and thus any effect on the aircraft range or endurance - and the burden played on the aircraft crew. Automatic operation would also achieve optimum effectiveness for the system, with operation occurring at the proper time, repeating when required and reverting to standby when not needed.

The extent of the interface relationship can vary greatly. The simplest relationship was developed for the CH-46 deicing system. This consisted of a counter initiating a deice cycle every three ice detector signals. Another development system has included factoring of proportionality by icing severity. Other parameters that can easily be used at OAT and airspeed. Provisions can be made for incorporating these parameters into the

test aircraft system if the analysis shows their need. The design of the ice detector can also be modified to change its physical package or sensitivity.

2.7.1 CURRENT ICE DETECTOR SYSTEMS

A large number of ice detectors have been developed during the past years (as noted by Stallabrass in Reference 53). A few of these detectors are still in production and have continuing development through current helicopter icing programs. Of primary interest for helicopter operations are concepts that indicate icing severity (liquid water content) and/or icing rate during forward flight and hover. This capability can be accomplished by an aspirator-type device (usually by using a small quantity of engine bleed air) or helicopter induced airflow (engine, oil coolers, etc.) to induce the icing cloud over the sensing surface.

Warning of icing can be accomplished by either a discrete yes/no signal as a minimum requirement, or by an icing rate display of severity levels, or both. The latter can be used as an input to a control system setting the power input and/or ON and OFF time for electro-thermal deicing, commensurate with the icing intensity and ambient temperature. A summary of existing ice detectors is presented in the following paragraphs.

2.7.1.1 Heated "Hot Rod" Probe

The "hot rod" detector probe is a thin rod or airfoil with manual deicing capability designed to give the pilot a visual indication of ice build-up. A variation of the "hot rod" is created by use of photoelectric light beam along the leading edge of an airfoil shaped rod. Ice, interrupting the light beam, is sensed by a photodetector which can then signal a controller triggering the heater circuit and activating a specific signal to the pilot. Reference 2 described the application of this system on a Sea King.

2.7.1.2 Non-Heated Probes

A single probe ice accretion indicator (Normalair Garrett Limited) and a two-bladed indicator "Harvey Smith" (a second blade set at an angle to the measuring blade) have been used on the Wessex during icing trials as reported by Bradley in Reference 54. As noted in the reference while the total ice thickness can be determined, it is difficult to derive the rate of ice growth and/or liquid water content with any degree of accuracy unless a record is made of specific timed (interval) ice thickness.

2.7.1.3 Rosemount

The Rosemount Ice Detector (shown in Figure 2-40) utilizes a change in axial vibration of the sensing element (initially at 40 KHz) to trigger an icing signal. Ice accumulating on the probe decreases the resonant frequency which is sensed and input to the icing rate meter as an analog voltage representing ice thickness. The meter has a visual readout calibrated for

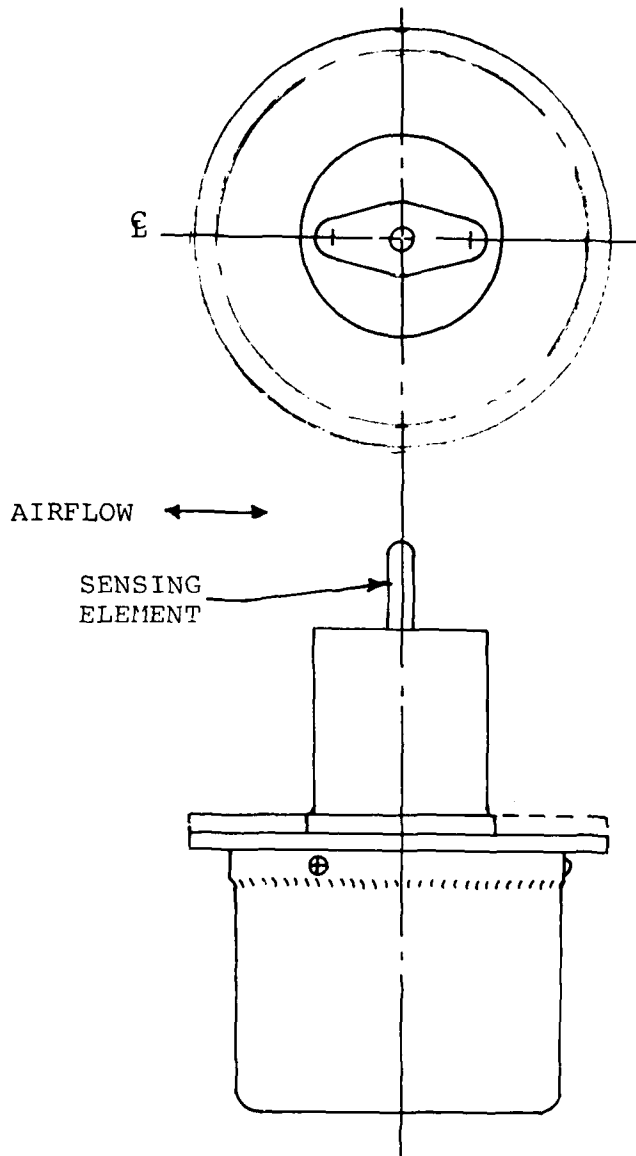

FIGURE 2-40. ROSEMONT ICE DETECTOR

trace, light, moderate and heavy icing rates which correlate to liquid water content. A built-in heater deices the sensing element at a predetermined mass.

2.7.1.4 Leigh

The Leigh Ice Detector unit (shown in Figure 2-41) sensing head draws in ambient air by an ejector, allowing ice to build up on the sensor probe (inside the head). The ice on the probe includes an infrared light beam, thus indicating an icing rate which is processed through an analog-to-digital converter into a liquid water content/severity meter output. At a predetermined ice thickness, a deicing heater is activated.

2.7.1.5 Normalair Garrett

The Normalair Garrett Detector (Figure 2-42) utilizes an inferential technique to compare the temperature change between a wet and dry sensor. The power differential required to maintain the same temperature on both sensors is related to the intercepted liquid water content. The electrical signal is processed into an output meter displaying liquid water content.

2.7.1.6 United Control

An ice detector (Figure 2-43) developed by United Controls was based on the attenuation by ice accretion on an airfoil section of a Beta particle beam passing along the airfoil leading edge between a Strontium 90 source and a Geiger-Muller tube. The Beta particle attenuation triggered output circuitry at a controller which passed a signal to an airframe mounted system (signal light, deice controller, etc.) and also deiced the airfoil in preparation for a new signal.

2.7.1.7 Johnson-Williams

The Johnson-Williams instrument (Figure 2-44) is primarily intended as a research unit for measuring liquid water content. Change of resistance of an electrically heated wire due to the cooling effect of impinging liquid drops is processed into a signal proportional to liquid water content.

2.7.2 Current Water Droplet Measurement

In addition to the ice detectors noted, Laser Spectrometers are currently being used on helicopters to measure both liquid water content and water droplet diameter. (See Figure 2-45).

Measurement of the droplet size distribution and concentration of the droplets in the 3-45 micron range can be counted by a Forward Scattering Spectrometer Probe (FSSP) or by an Axially Scattering Spectrometer Probe (ASSP). These instruments employ a light scattering technique. Photo detectors measure the intensity of light scattered out of a laser beam passed through a sample of the spray cloud, and the probe electronics and recording equipment convert this signal into a droplet count for each of

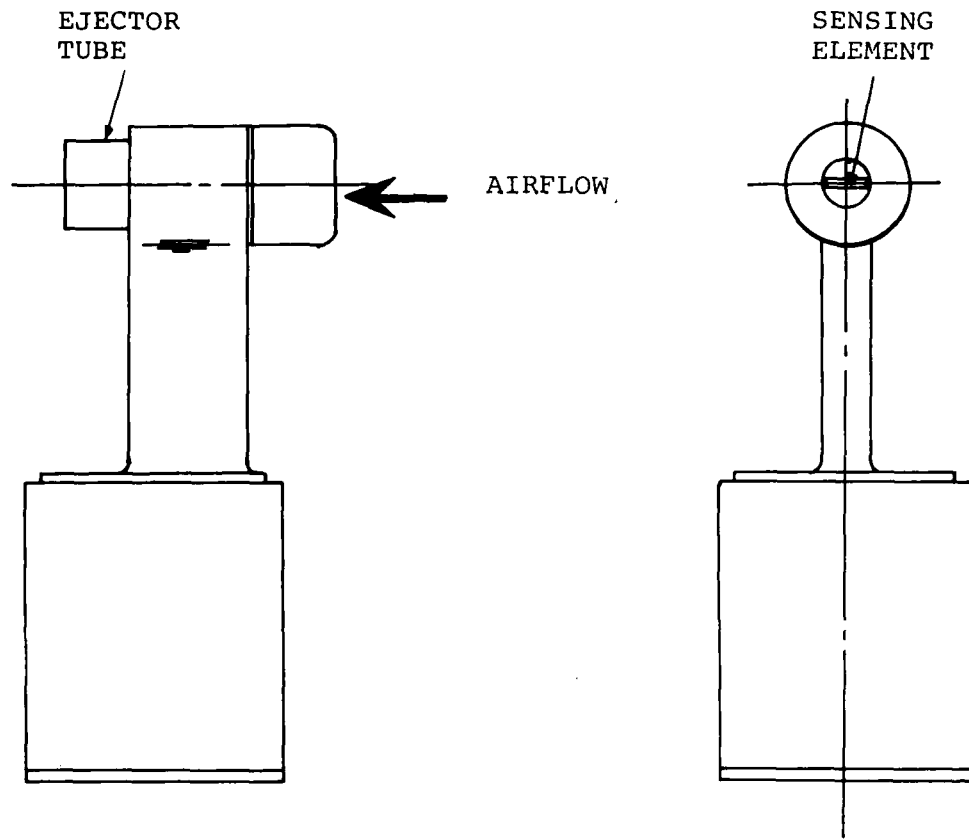

FIGURE 2-41. LEIGH ICE DETECTOR

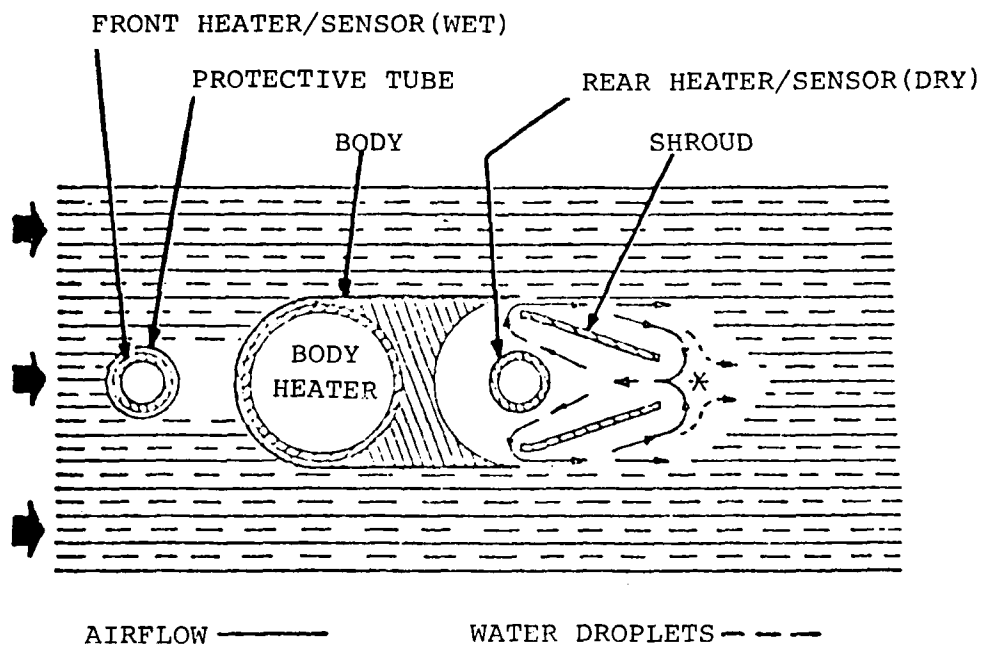

FIGURE 2-42. NORMALAIR - GARRETT ICE DETECTOR

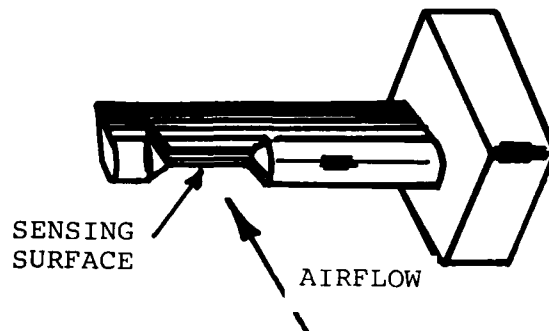

FIGURE 2-43. UNITED CONTROLS ICE DETECTOR

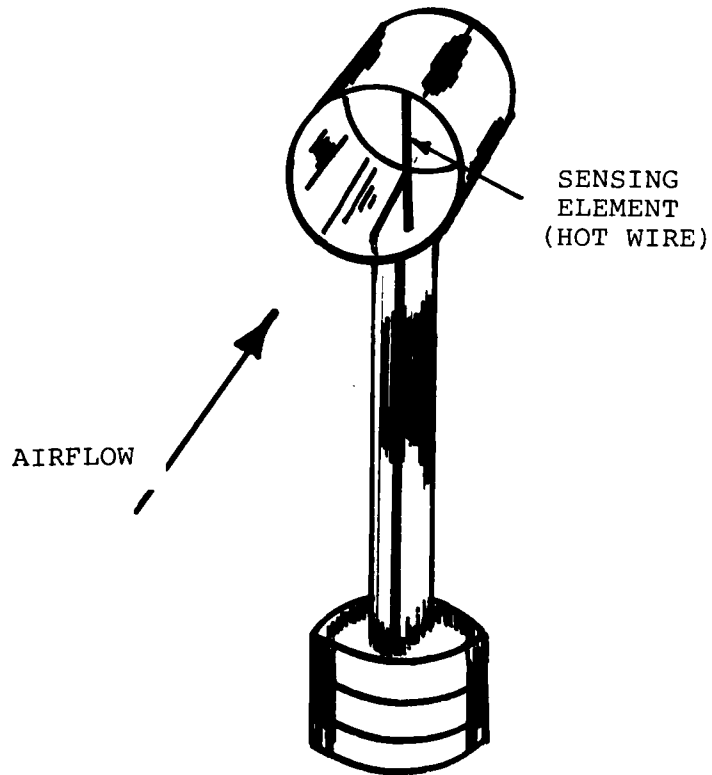

FIGURE 2-44. JOHNSON-WILLIAMS LIQUID WATER CONTENT INDICATOR

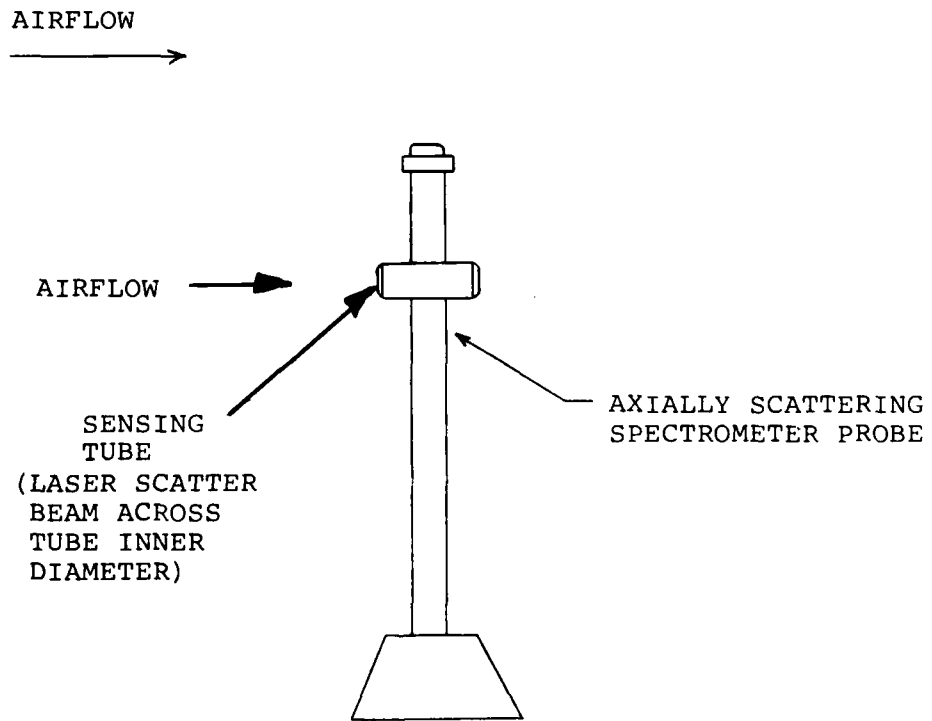
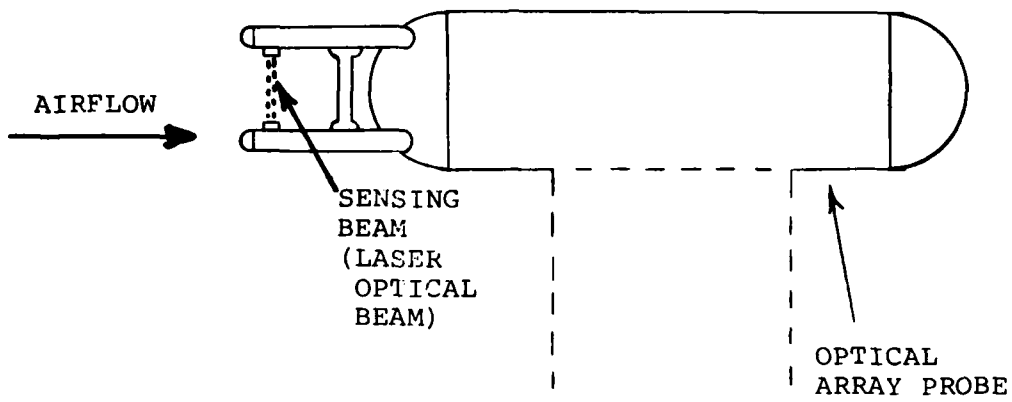

FIGURE 2-45. LASER SPECTROMETERS

15 size categories. The sample period is normally one second in duration. An external probe houses the laser, condensing and imaging optics, and photo detector modules. The signal conditioners, pulse height detector, and power supplies necessary for independent operation are all housed in a separate enclosure. The sensing element is built into an airfoil shaped boom 24 inches long and particles are sized within an isokinetic annulus of approximately 1.5 inches diameter. The system is capable of resolving particles as small as two microns in diameter at 250 knots airspeed.

Droplets in the 30-300 micron range can be measured by an Optical Array Probe (OAP). Particles passing through a laser beam cast shadows on a linear array of photo diodes and the size of the droplet is determined from the number of elements in the diode array which are shadowed.

A second Optical Array Probe which measures droplets in the range of 140-1200 microns can also be used. Physically, this probe is similar to the other OAP however, it is able to measure particles over different size ranges because of different optics. The two OAP probes also categorize the droplets into 15 size classes.

With these instruments, real time measurements of droplet size can be used to compute liquid water content if the full range of droplets are measured to obtain the total water mass.

2.7.2.1 Prior Systems For Droplet Measurement

Prior to the introduction of the laser spectrometers, a number of systems have been used (and in the case of the gelatin coated slide is still being used) to measure water droplet diameter in icing tunnels and in flight. These systems are as follows:

- o Rotating Multicylinders
- o Stationary Large-Diameter Cylinder
- o Laser Holography Photography
- o Doppler Radar
- o Oil Coated Slide
- o Gelatin Coated Slide

3.0 CONCLUSIONS

The Technical Discussion Section of this report addresses helicopter icing characteristics, ice protection technology (including concepts, instrumentation and design approaches) and icing certification considerations. Specifically the rationale is presented for the development of a helicopter (rotorcraft) icing certification procedure and environment unique to FAR Part '27 and 29 with provisions (based on individual helicopter type capabilities) for interim icing clearances where the available test data and proposed operations are sufficiently justified.

Advantage is taken of much past and current helicopter icing investigations in order to provide a substantial base from which stem the overall

conclusions of this study. The major effort evolves about the certification issues as follows:

- o The current interpretation of the rotorcraft category FARs (Parts 27 and 29) icing certification requirements. Specifically, a requirement exists for a definition of the overall icing envelope, the critical test points, and the methods to demonstrate compliance.
- o The method of achieving an acceptable icing test environment. This issue concerns the use of simulated (HISS, Hover Spray Rig, Icing Tunnel) icing environments to supplement and expand the testing obtained under natural icing conditions.
- o The acceptable test data taken during the icing trials. This issue centers about the definition of acceptable instrumentation to verify both the icing test points (icing environment) and the helicopter performance (power change, handling, vibration, autorotation), and the extent to which the critical icing test points are achieved during the icing trials.
- o The allowable change (deterioration) in helicopter performance during the icing encounters. The amount (and location) of ice protection equipment evolves to a large extent from the definition of this allowable performance change (system safety also influences ice protection requirements).

The major conclusions reached during the helicopter icing review are:

- o Rotor icing predominates the helicopter performance during icing encounters. The degree of performance change depends upon the specific rotor characteristics (i.e. such characteristics as airfoil profile, blade loading, Mach number, icing catch efficiency, blade flexibility) and the reaction between the rotor and the airframe (i.e. control loads, shaft loads, fuselage reaction).
- o Analytical tools currently exist having the capability to permit evaluation of the aerodynamic and dynamic effects of rotor ice. Very limited use of these tools has been made to date because of a minimum amount of correlating icing test data (icing tunnel, hover, or in-flight correlation). Current icing tunnels do not have the capability to generate exact correlating data because of (1) the inability to rotate full scale rotors and (2) the lack of scaling verification (scaled rotors). Hover and in-flight data (in particular ice accretion/ice shedding) is difficult to document.
- o The critical icing test environment is not clearly defined, particularly for the rotor system. Additionally, the ability to produce a satisfactory simulated rotor icing environment is only partially in hand.

- o Electrothermal rotor deicing is the only system (to date) capable of providing satisfactory rotor ice protection over the full FAR icing envelope.
- o Maximum use of simulated icing facilities is necessary to supplement and expand the natural icing test results. The current usable full helicopter icing test facilities are the U.S. Army HISS (and possibly the USAF C-130 or KC-135) and the NRC Hover Spray Rig. Current icing tunnels can be used to evaluate most non-rotating helicopter ice protection systems.

4.0 RECOMMENDATIONS

The recommendations presented herein have evolved from the study of Helicopter Ice Protection Technology and Test Techniques as discussed in the Technical Section of this report. Two recommendations (i.e. icing certification environment and helicopter Icing Certification Test procedure) are discussed in detail within Section 2.2 (Certification Considerations). Appendix B contains a proposed Draft Advisory Circular for helicopter ice protection modeled after the Aircraft Ice Protection Advisory Circular 20-73.

The recommendations are within the categories as follows:

- o Icing Certification Environment
- o Icing Certification Test Procedure
- o Advisory Circular for Helicopter Ice Protection
- o Interim Icing Clearance Considerations
- o Basic Icing Research
- o Analytical Tool Development
- o Icing Environment Simulation

4.1 ICING CERTIFICATION ENVIRONMENT

Table 2-4 (located in Section 2.2.3) presents the recommended icing environment in terms of specific atmospheric and operational parameters associated with each defined icing condition. Associated with icing environment listed in Table 2-4 is Table 2-5 which defines specific Icing Test Conditions for each major helicopter system as outlined in Section 2.2.4.2.

4.2 ICING CERTIFICATION TEST PROCEDURE

Section 2.2.5 presents a detailed discussion of the recommended Helicopter Icing Certification Test procedure. The discussion addresses the following recommended actions:

- o Ice Protection Systems Design Analyses
- o Ice Protection Systems Demonstration
- o Flight Instrumentation
- o Flight Photography
- o Icing Trials

- o Final Data Reduction
- o Data Submittal

4.3 ADVISORY CIRCULAR FOR HELICOPTER ICE PROTECTION

Appendix B contains a proposed Draft Advisory Circular for Helicopter Ice Protection modeled after the Aircraft Ice Protection Advisory Circular 20-73. The Appendix B Draft incorporates information specifically applicable to current helicopter icing, ice protection systems (including systems under investigation) and icing test methods.

4.4 INTERIM ICING CLEARANCE CONSIDERATIONS

The current FARs make no specific provisions for an interim icing clearance (i.e. a clearance limiting altitude, ambient temperature, icing intensity, VFR ceiling, or time in icing). Because of the normal limited range usage of a helicopter (compared to fixed-wing transport aircraft), a recommendation is made to consider a clearance based in three parts (each varying in present capability to forecast as follows:

- o Altitude - The pilot has direct control of altitude outside of controlled zones and local forecasting (over controlled routes) can be accomplished with high degree of reliability.
- o Temperature - The temperature range can be forecast within a limited geographic area.
- o Liquid Water Content - This is the most difficult parameter to forecast and therefore a satisfactory icing test environment is required to explore the helicopter capability at the high water content limits. However in a specific geographic area the ability to forecast icing is improved due to continuing in-flight weather reporting, and knowledge of the regional frontal system patterns.

4.5 BASIC ICING RESEARCH

4.5.1 Rotor Aerodynamics and Dynamics During Modeled Icing

Rotor aerodynamic and dynamic performance/loads investigations under modeled icing conditions are recommended for current and advanced rotor systems including rigid, articulated, semi-articulated configurations using scaled rotors in a wind tunnel. Blade root torsional stresses and rotor control loads need to be measured for specific ice mass (and ice shape) rotor span location (of ice formation) and span extent to determine the critical combinations for the various rotor systems. These tests can then be used to document the rotor ice sensitivity for a variety of airfoil shapes, rotor hub configurations and rotor flexibility as a primary step in the prediction of the effects of ice on rotor aerodynamics and dynamics.

4.5.2 Rotor Airfoil Ice Accretion/Aerodynamic Performance

Testing to determine rotor airfoil ice shape characteristics is recommended using an icing wind tunnel with an oscillating and stationary airfoil test setup. The oscillating airfoil operates at varying angles of attack at the appropriate rotating frequency to simulate the desired rotor system. This testing can be used to determine:

- o The rate and chordwise extent of ice accretion on the airfoil section during the variable angle of attack excursions, for each desired combination of liquid water content, droplet diameter, and ambient temperature.
- o The ice shapes and airfoil sectional performance parameters (i.e. C_L , C_D , C_M) measured to determine the correlation with airfoil theory. Since current airfoil theory deals primarily with clean sections, techniques are required to permit the proper analytical modeling of specific ice shapes. As a part of this effort, a determination of specific families of ice shapes detrimental to rotor performance can be investigated.

4.5.3 Scale Rotor Icing

The development of scale model analogy techniques is recommended for icing tunnel testing of rotors. The scaling techniques must address the ice accretion characteristics, deicing/anti-icing thermodynamic properties and geometry simulation of full scale rotor systems. Additionally, the centrifugal force/Mach number field, angle of attack changes and differential aerodynamic heating must be properly simulated on the scale model.

4.6 ANALYTICAL TOOL DEVELOPMENT

4.6.1 Airfoil Performance

The incorporation of ice shape contouring is recommended for current airfoil performance programs to enable the programs to predict change (due to ice) in:

- o Advancing Blade Drag Divergence Mach Number
- o Retreating Blade Stall
- o Blade Pitching Moment

4.6.2 Rotor Dynamic Reactions

The development and improvement of techniques to determine the rotor dynamic reaction to ice (and asymmetrical ice shedding) are recommended. Specific areas that should be addressed include:

- o Blade Root Torsional Stresses

- o Control Link (Rotating and Stationary) Stresses
- o Rotor Shaft Bending
- o Asymmetrical Ice Shedding Reactions Within the Rotor System and within the Airframe

4.7 ICING ENVIRONMENT SIMULATION

4.7.1 Improved Icing Wind Tunnel Capabilities

The development of rotating airfoil icing capabilities is recommended as a highly desirable icing wind tunnel improvement. This improvement along with improvements in the analytical prediction techniques would allow the full accomplishment of the basic icing research and provide the means from which future rotor ice protection may develop.

4.7.2 Improved In-Flight Icing Simulation

In-flight icing simulation (for example, the U.S. Army HISS) requires improvement in the following areas:

- o Increase in overall icing cloud dimensions to provide more complete helicopter immersion.
- o Capability to produce water droplets in the 15 to 25 micron range over a full range of liquid water contents (to at least 1.0 grams/meter³).
- o Airspeed range to 30 - 150 knots.

4.7.3 Development of Large Ground-Level (Hover) Icing Simulator

It is recommended that a ground-level icing simulator be developed with the following capabilities:

- o Complete (large) helicopter icing cloud immersion capability.
- o Liquid water content range to at least 2.0 grams/meter³ over a water droplet size range of 15 to 50 microns.
- o Capability for producing ice crystal, snow, freezing rain and mixed (ice and liquid water) conditions.

5.0 REFERENCES

1. WERNER, J.B.: Ice Protection Investigation for Advanced Rotary-Wing Aircraft. USAAMRDL Technical Report 73-38, August 1973.
2. WERNER, J.B.: The Development of an Advanced Anti-Icing/Deicing Capability for U.S. Army Helicopter, Volume I - Design Criteria and Technology Considerations. USAAMRDL-TR-75-34A, November 1975.
3. BOWDEN, D.T., GENSEMER, A.E., and SPEEN, C.A.: Engineering Summary of Airframe Icing Technical Data, FAA Technical Report ADS-4, 1964.
4. FAA Advisory Circular AC No. 20-73: Aircraft Ice Protection. 21 April 1971.
5. Department of Transportation, Federal Aviation Administration: Federal Aviation Regulations (FAR).
6. CIVIL AVIATION AUTHORITY: Flight in Precipitation and Ice-Forming Conditions; British Civil Airworthiness Requirements Paper No. 610, Section G, Rotorcraft, September, 1973.
7. WADC Report, Adverse Weather Tests of the CH-47A Helicopter, ASD-TR-65-11, October, 1965.
8. AIR WEATHER SERVICE MANUAL: Forecasters Guide on Aircraft Icing, AWSM 105-39, 7 January 1969.
9. AFFTC Report, Category II Icing Test of the HH-53C Helicopter, FTC-TR-71-26, June, 1971.
10. U.S. Army Flight Manual, CH-47 B/C, TM 55-1520-227-10, 1969.
11. U.S. Navy Flight Manual, CH-53E, NAVAIR 01-H53AAB-1, 1976.
12. Final Report, USAASTA, Project No. 73-04-4, Artificial Icing Tests, UH-1H Helicopter, Part I, January, 1974.
13. U.S. Army 14th Aviation Company, Germany, Procedure for UH-1H Without Rotor Deicing, 1974.
14. REID, J.W. (CW4): Artificial Icing Tests AH-IG, USAAEFA, Presented at Rotary Wing Icing Symposium at USAAEFA, June, 1974.
15. O'CONNOR, J.C. (CPT): Artificial Icing Tests CH-47C Helicopter, USAAEFA, Presented at Rotary Wing Icing Symposium at USAAEFA, June, 1974.
16. EARGLE, T.P. (LT): Results of AH-1J Icing Tests Conducted January-February 1974, U.S. Naval Air Test Center Program, Presented at Rotary Wing Icing Symposium at USAAEFA, June, 1974.

17. BENDER, D.: BO-105-S2 Icing and Deicing Tests Conducted During the Winter of 1973/74, MBB Technical Report D143-156/74, Translated by USAFSTC, March, 1976.
18. FINAL REPORT, USAAEFA, Artificial Icing Test Utility Tactical Transport Aircraft System (UTTAS), Boeing Vertol YJH-61A Helicopter, USAAEFA Project No. 76-09-2, January, 1977.
19. WERNER, J.B.: The Development of an Advanced Anti-Icing/Deicing Capability for U.S. Army Helicopters, Volume II - Ice Protection System Application to the UH-1H Helicopter, USAAMRDL-TR-75-34B, November, 1975.
20. COTTON, R.H.: Ottawa Spray Rig Tests of an Ice Protection System Applied to the UH-1H Helicopter, USAAMRDL-TR-76-32, November, 1976.
21. COTTON, R.H.: Icing Tests of a UH-1H Helicopter With an Electrothermal Ice Protection System Under Simulated and Natural Icing Conditions, USARTL-TR-78-48, April, 1979.
22. BOULET, J. and LECOURTRE, J.C.: Ice Protection Systems of the PUMA, Paper No. 51, Fourth European Rotorcraft and Powered Lift Aircraft Forum, Stresa, Italy, September, 1978.
23. SHERIDAN, P.F.: Interactional Aerodynamics of the Single-Rotor Helicopter Configuration, Volume I, Final Report, USARTL TR-78-23A, February, 1978.
24. HEYSON, H.H. and KATZOFF, S.: Normal Component of Induced Velocity in the Vicinity of a Lifting Rotor with a Non-Uniform Disk Loading, NACA TN 3690, 1956.
25. HEYSON, H.H.: Analysis and Comparison with Theory of Flow-Field Measurement Near a Lifting Rotor in the Langley Full Scale Tunnel, NACA TN 3691.
26. DADONE, L.U.: Design and Analytical Study of a Rotor Airfoil, NASA CR 2988, May, 1978.
27. LENARD, J. and BOEHLER, G.D.: Inclusion of Tip Relief in the Prediction of Compressibility Effects on Helicopter Performance. USAAMRDL, TR-73-71, 1973.
28. BERRY, F.A., BOLLAY, E., and BEERS, N.R.: Handbook of Meteorology, 1945.
29. LEWIS, Wm.: A Flight Investigation of the Meteorological Conditions Conducive to the Formation of Ice on Airplanes, NACA TN 1393, August, 1947.

30. JONES, A.R. and LEWIS, Wm.: Recommended Values of Meteorological Factors to be Considered in the Design of Aircraft Ice Prevention Equipment, NACA TN 1855, 1949.
31. LEWIS, Wm.: Icing Properties of Noncyclonic Winter Stratus Clouds, NACA TN 1391, 1947.
32. PETACH, A.: A Summary of Aircraft Icing Criteria, Third Annual Conference on Environmental Effects on Aircraft and Propulsion Systems, NATTS, Paper 63-ENV-12, September, 1963.
33. LEWIS, Wm., and BERGRUN, N.R.: A Probability Analysis of the Meteorological Factors Conducive to Aircraft Icing in the United States, NACA TN 2738, 1952.
34. Military Specification: Turboprop/Turboshaft Engines, MIL-E-8593A, October, 1975.
35. Military Specification: Transparent Areas, MIL-T-5842A, ADD.1, July, 1953.
36. Military Specification: Environmental Control, MIL-E-38453A, December, 1971.
37. Military Specification: Ice Detector, MIL-D-8181B, March, 1965.
38. Military Design Handbook: Rotorcraft, SD-24K, December, 1971.
39. British Civil Airworthiness Requirements: Section C - Engines and Propellers, Section D - Aeroplanes, and Section G - Rotorcraft.
40. Military Design Document: Design Requirements for Aircraft for the Royal Air Force, AvP 970, Volume 3, October, 1977.
41. HACKER, P.T. and DORSCH, R.G.: A Summary of Meteorological Conditions Associated with Aircraft Icing and a Proposed Method of Selecting Design Criteria for Ice-Protection Equipment, NACA TN 2569, 1951.
42. TRUNOV, O.K.: Icing of Aircraft and the Means of Preventing It; Foreign Technology Division, MT-65-490, August, 1967.
43. BOEING COMPANY: Ice and Frost Protection Data for Certification of 707 Series Airplanes, D6-1157, June, 1958.
44. BOEING COMPANY: Ice and Frost Protection Data for Certification of 727 Series Airplanes, D6-7506, November, 1963.
45. BOEING COMPANY: Ice and Frost Protection Data for Certification of 737 Series Airplanes, D6-17728, October, 1966.

46. STALLABRASS, J.R.: Thermal Aspects of Deicer Design, Presented at the International Helicopter Icing Conference, Ottawa, Canada, May, 1972.
47. HARDY, J.K.: Kinetic Temperature of Wet Surfaces. A Method of Calculating the Amount of Alcohol Required to Prevent Ice, and the Derivation of the Psychometric Equation, ARC R&M 2830 1953 (NACA ARR 5G13, 1945).
48. SKOPOWSKI, P. and PARANICH, A.: YHC-1B Rotor Blade Chemical Anti-Icing System Initial Whirl Test, Boeing Vertol Report 114-T-103, February, 1962.
49. INGLEMAN-SUNDBERG, M., TRUNDY, O.K., and IVANIKO, A.: Methods for Prediction of the Influence of Ice on Aircraft Flying Characteristics, Swedish-Soviet Working Group on Flight Safety, 6th Meeting, Report No. JR-1, 1977.
50. BENSON, R.G., DADONE, L.U., GORMONT, R.E., and KOHLER, G.R.: Influence of Airfoils on Stall Flutter Boundaries of Articulated Helicopter Rotors, 28th AHS Forum, Preprint 621, May 1972.
51. BRUMBY, R.E.: Wing Surface Roughness, Cause and Effect, McDonnell-Douglas.
52. HOERNER, S.F.: Fluid Dynamic Drag, Published by the Author 1965.
53. STALLABRASS, J.R.: Helicopter Ice Detection, Icing Severity and Liquid Water Content Measurements, AGARD Fluid Dynamics Panel Meeting, September, 1977, Reported in Advisory Report 127, November, 1978.
54. BRADLEY, J. and LAKE, H.B. (Sqn. Ldr.): The Problem of Certifying Helicopters for Flight in Icing Conditions, Aeronautical Journal of the Royal Aeronautical Society, October, 1976.
55. LYNCH, C.P. and PETERSON, A.A.: Helicopter Icing Spray System (HISS) Improvement Program - Final Report, Boeing Vertol Report D210-11570-1, January 1980.

APPENDIX A

HELICOPTER ICING SPRAY SYSTEM (HISS) IMPROVEMENT PROGRAM

(Reference Boeing Report D210-11570-1 January 1980)

A.1 DESCRIPTION

The Helicopter Icing Spray System (HISS), operated by the U.S. Army to evaluate helicopters under in-flight icing conditions, consists of a U.S. Army CH-47C equipped internally with an 1800 gallon water tank and an externally mounted spray boom (See Figure A-1). The spray boom is a four-inch diameter tube system with approximately 60 ft. span and provisions for mounting 172 nozzles. The boom is raised and lowered by hydraulic actuators (Figure A-2 illustrates the boom in the deployed and retracted positions). Water is supplied to the spray nozzles through a hydraulically driven water pump with the capacity to deliver up to 125 gallons per minute at 54 psig (pump discharge). Engine bleed air is also delivered to the spray nozzles at a pressure (measured at the boom) of 20-30 psig. The water is atomized at the throat of the air-water nozzles and a water cloud is generated behind the HISS. The aircraft to be tested is flown through the cloud (at below freezing temperatures) at a fixed standoff distance (approximately 150 feet). Spray system liquid water content and water droplet size distribution are controlled by adjusting water flow rate and air pressure within the HISS.

A.2 BACKGROUND

The current HISS configuration with 54 spray nozzles (All-American Engineering Company design illustrated in Figure A-3) has been found to produce water droplets much larger than the 15 to 50 micron range measured in natural icing clouds. Figure A-4 presents a sample of HISS cloud data measured with in-flight laser spectrometers during the January-March 1979 icing trials in Minnesota. As can be noted in Figure A-4, the median droplet diameters range from 50 to 450 microns. Additionally, the measured liquid water content varies considerably from the calculated value based on water flow rate.

Evidence of the HISS cloud problems were also noted during the 1979 icing trials when the ice quality and impingement patterns of HISS ice versus natural ice were compared on the CH-47 (which was undergoing Army icing evaluation). The heavy ice formations on the windshield and forward pylon region of the CH-47 after flights behind the HISS did not occur when the CH-47 was operated in the natural icing conditions in the Minnesota area.

A.3 PROGRAM

Under a joint sponsorship program with the U.S. Army and the FAA, Boeing Vertol Company was contracted to design and test an improved spray system so that necessary modifications could be incorporated into the HISS test period (January-March 1980) in Minnesota.

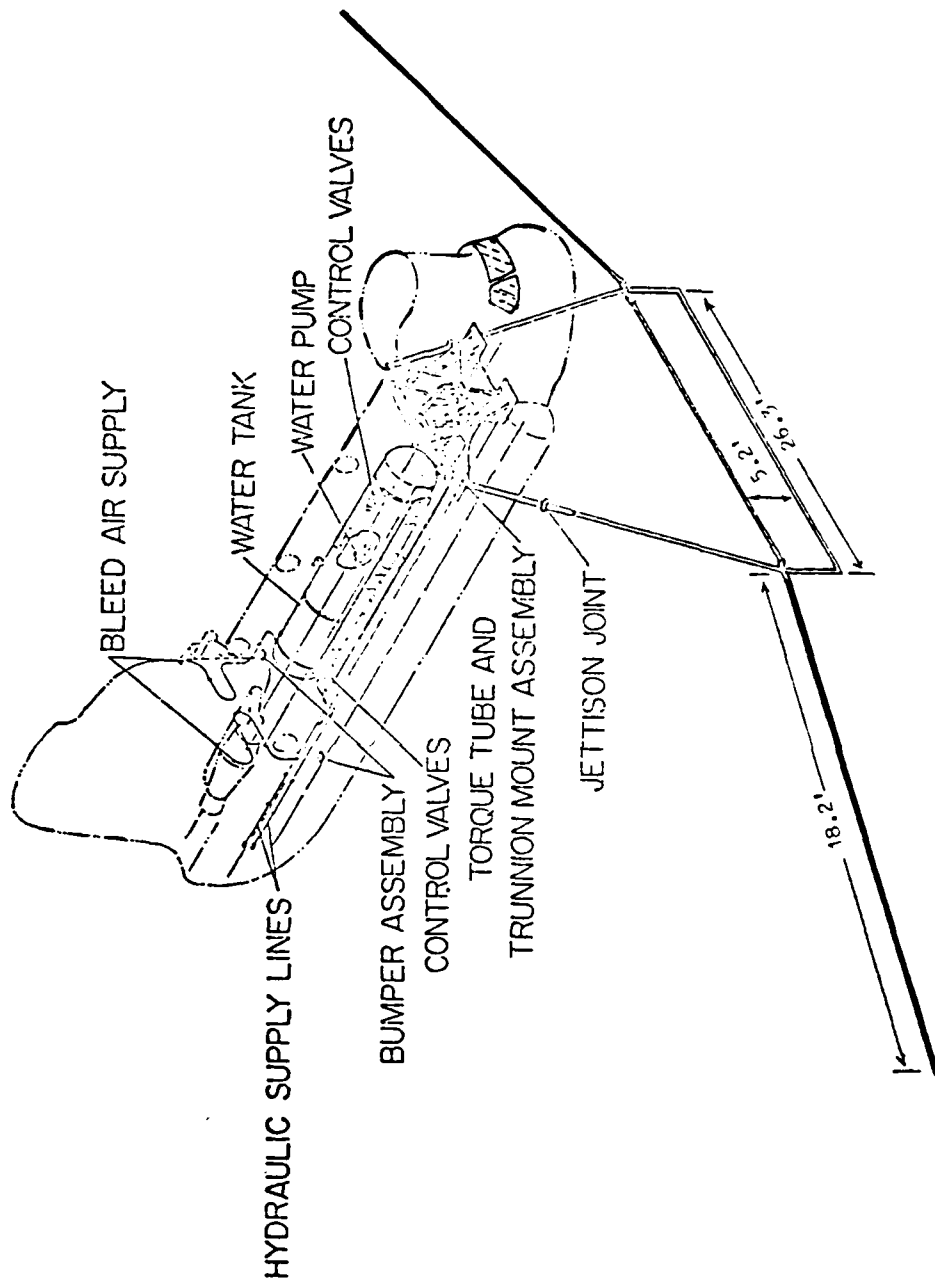

FIGURE A-1. HELICOPTER ICING SPRAY SYSTEM (HISS)

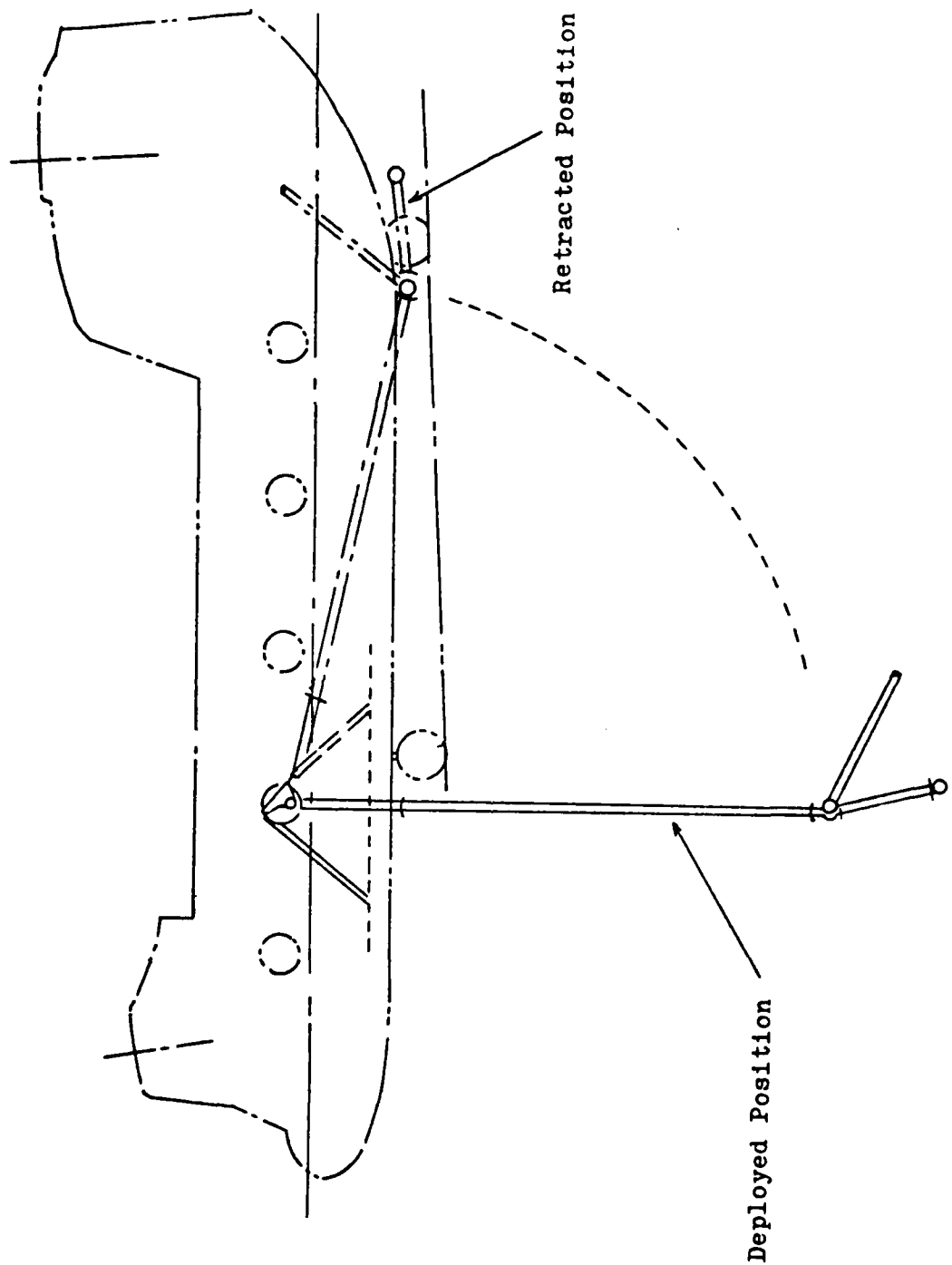

FIGURE A-2. HISS BOOM POSITIONS

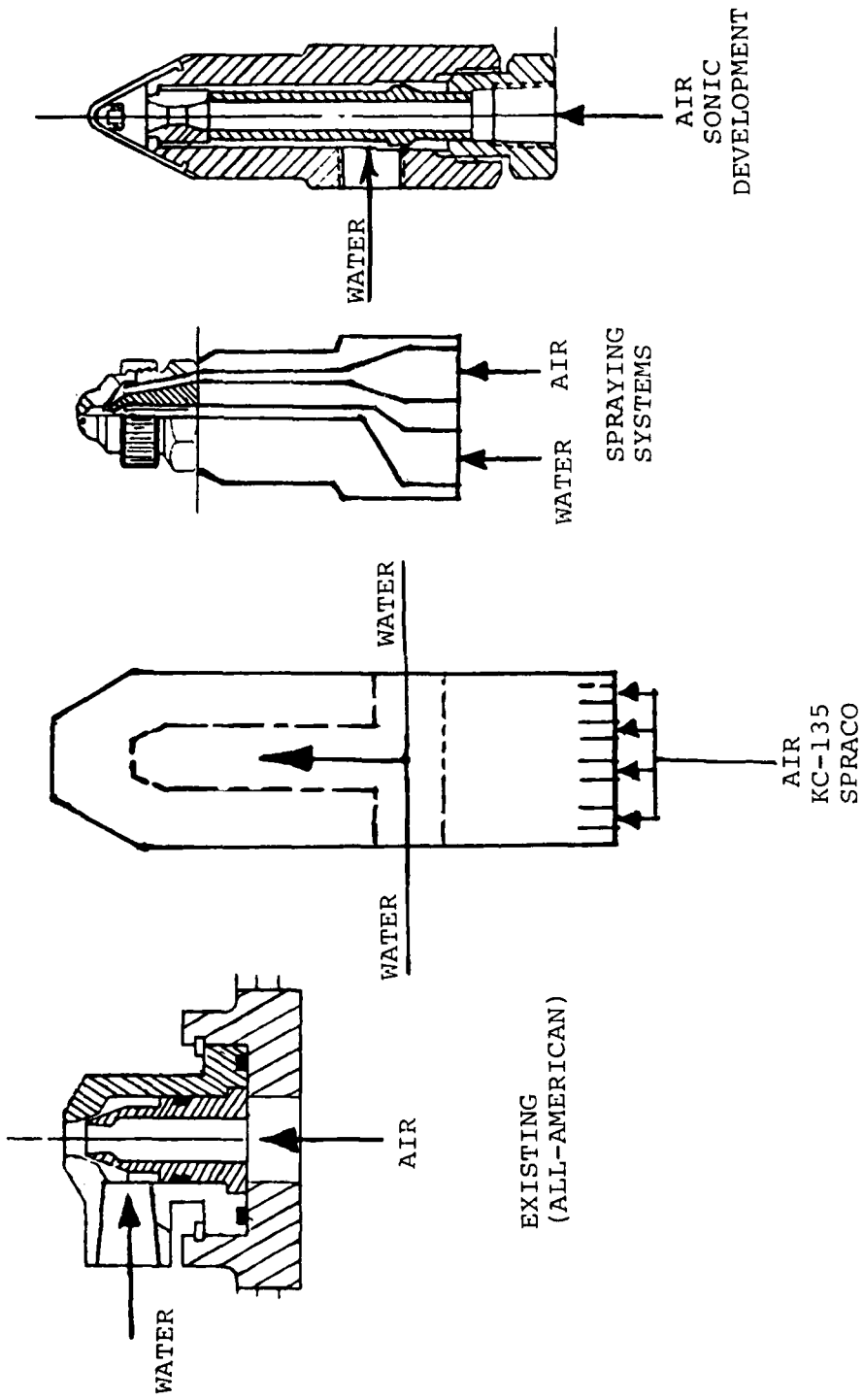

FIGURE A-3. HISS TEST NOZZLE CONFIGURATIONS

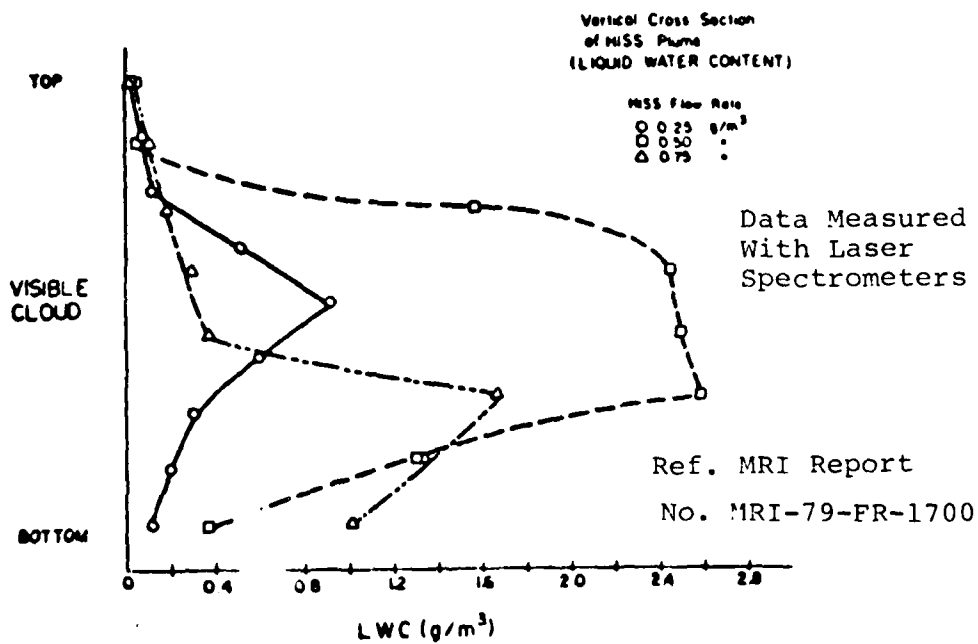
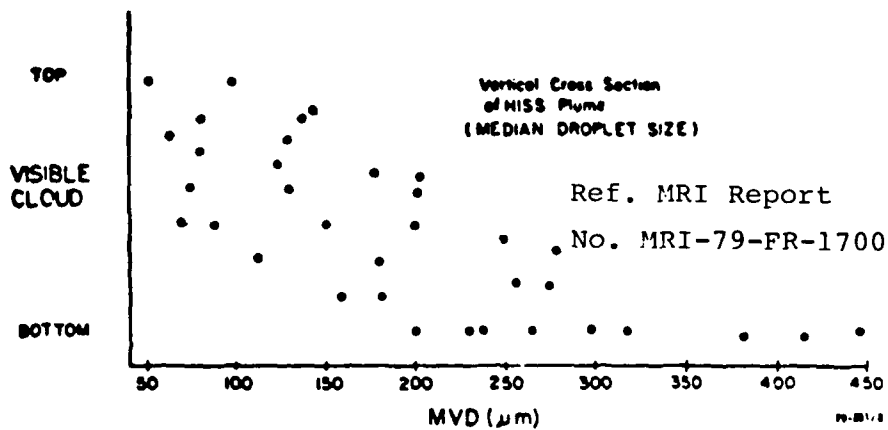

FIGURE A-4. TYPICAL HISS CLOUD DATA MEASURED IN-FLIGHT

A section of the HISS spray boom was mounted and tested in the Icing Research Tunnel at the NASA Lewis Research Center, Cleveland, Ohio during October 1979 (see Figure A-5) to determine necessary modifications to achieve:

- o Water droplet median volume diameters within the 15 to 40 micron range.
- o Minimum distribution variations (vertically and horizontally) of liquid water content.

A full scale nine-foot section of the HISS spray boom, with provisions for 13 nozzles, was mounted in the 6 x 9 foot test section of the Icing Research Tunnel (see Figure A-6). The boom was equipped with water and air supplies and devices for measuring pressures, temperatures, and flow rates.

Installed 21.5 feet downstream from the spray boom test rig was a platform with instrumentation for measuring spray characteristics (droplet size distribution, MVD, LWC), ice accretion rate, total temperature, and tunnel airspeed (see Figure A-5). A hydraulic cylinder provided for a horizontal traverse of the platform. A vertical traverse was possible in discrete steps by installing a combination of three spacers (two 12" spacers and one 7-1/2" spacer) under the platform. The tests were conducted over a range of airspeeds (60 to 120 knots) and tunnel temperatures (80°F (26°C) to -15°F (-26°C)) simulating the range of current HISS in-flight conditions as well as for improved pressure/flow capabilities.

The following is a list of nozzles that were tested (refer to Figure A-3 for representative nozzle cross sections):

- o All American (Baseline) Nozzle
- o Sprayco 2627A (Air Force) Nozzle (used in the C-130 and KC-135 icing tankers)
- o Spraying Systems 1/4 J Setup 29
- o Spraying Systems 1/4 J Setup 22
- o Spraying Systems 1/4 J Setup 42
- o Sonicore Nozzle 125H-A
- o Sprayco 3806375 Set N133

Configurations tested included single and multiple nozzle arrangements. Nozzles were oriented upward, downward, aft behind the boom, and aft above the boom with various extensions.

A.4 SUMMARY OF RESULTS

- o All American (Baseline)
 - Large MVD (200 to 300 microns)
 - LWC = 0.1 to 0.5 gm/m³ (for single nozzle)
 - Some evidence of "rooster tail" (spray separation)

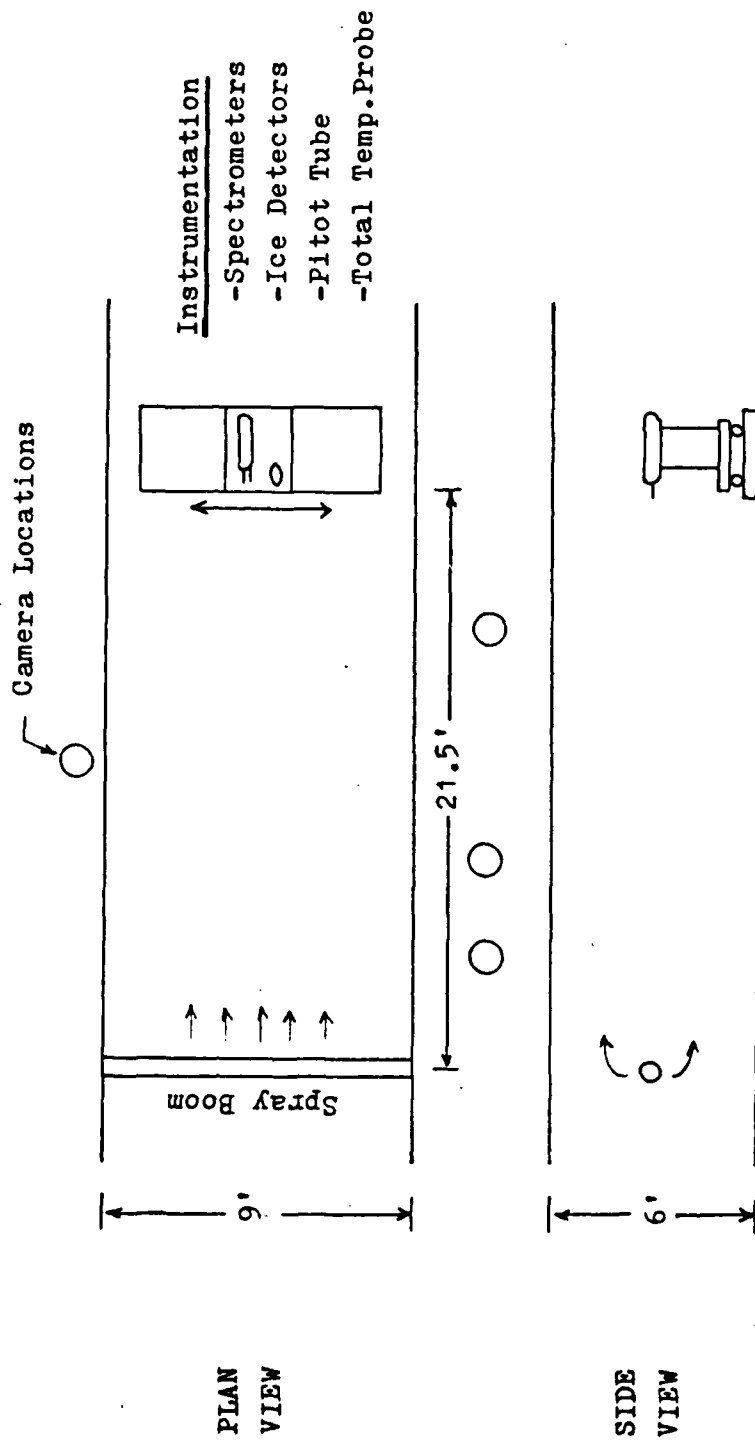

FIGURE A-5. TEST SET-UP IN NASA LEWIS ICING TUNNEL

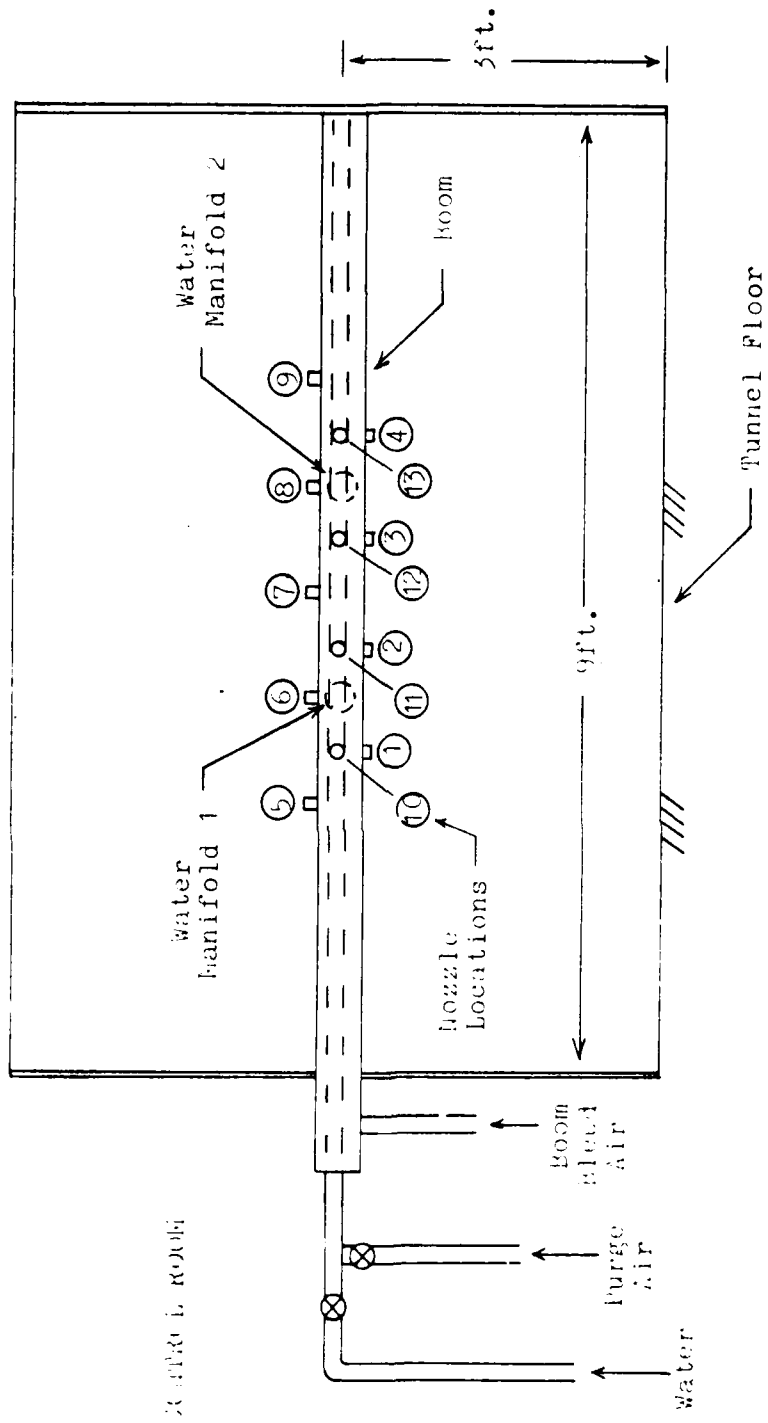

FIGURE A-6. HISS SPRAY BOOM ASSEMBLY

- o Sprayco 2627A (Air Force)
 - Very large MVD (300 to 500 microns)
 - LWC = 0.1 to 2.0 gm/m³ (for single nozzle)
- o Spraying Systems 1/4 J #29
 - MVD = 15 to 50 microns
 - LWC = 0.5 to 5.0 gm/m³ (nine nozzle arrangement)
 - Some nozzle icing problems at temperatures below freezing.
- o Spraying Systems 1/4 J #22
 - MVD = 20 to 50 microns
 - LWC = 0.25 to 1.0 gm/m³ (three nozzle arrangement)
 - Narrow spray pattern.
- o Spray Systems 1/4 J #42
 - MVD = 20 to 50 microns
 - LWC = 0.25 to 1.0 gm/m³ (two nozzle arrangement)
 - Very poor spray pattern: distinct "rooster tail"
- o Sonicore 125 HS
 - MVD = 15 to 50 microns
 - LWC = 0.25 to 5.0 gm/m³ (nine nozzle arrangement)
 - Good spray pattern. No icing problem.
 - Nozzles will be installed on the HISS.
- o Sprayco
 - Very large MVD (visually tested).
 - Narrow spray pattern.

A.5 SONICORE NOZZLE CHARACTERISTICS

The Sonicore 125 HS Nozzle (Figure A-7) has been selected for installation on the HISS for the January-March 1980 icing season in Minnesota. Figures A-8, A-9 and A-10 illustrate the Sonicore nozzle performance over a range of air pressures and water flow rates. The current HISS available bleed flow/pressure limitations does not permit the nozzle to operate at its full capability; however, as can be seen in Figure A-10, a median droplet diameter of 50 microns or less should be achievable.

A.6 COMPARISON OF WIND TUNNEL RESULTS WITH HISS DATA

Comparison between the wind tunnel Baseline nozzle data and data taken behind the HISS during the winter of '79 testing is shown in Figure A-11. For droplets larger than 30 microns, the two sets of data show very good agreement. For droplets smaller than 30 microns, the number concentration for the tunnel data is much higher than for the actual HISS, and this is reasonable in view of the difference in standoff distance (150 ft. for the HISS, 21.5 ft. in the tunnel). At 90 knots airspeed, the droplet evaporation time is 1.3 seconds for the HISS and this is sufficient time for most droplets below 30 microns to disappear (Reference Calspan Corporation Report No. CG-5391-M-1, December, 1973).

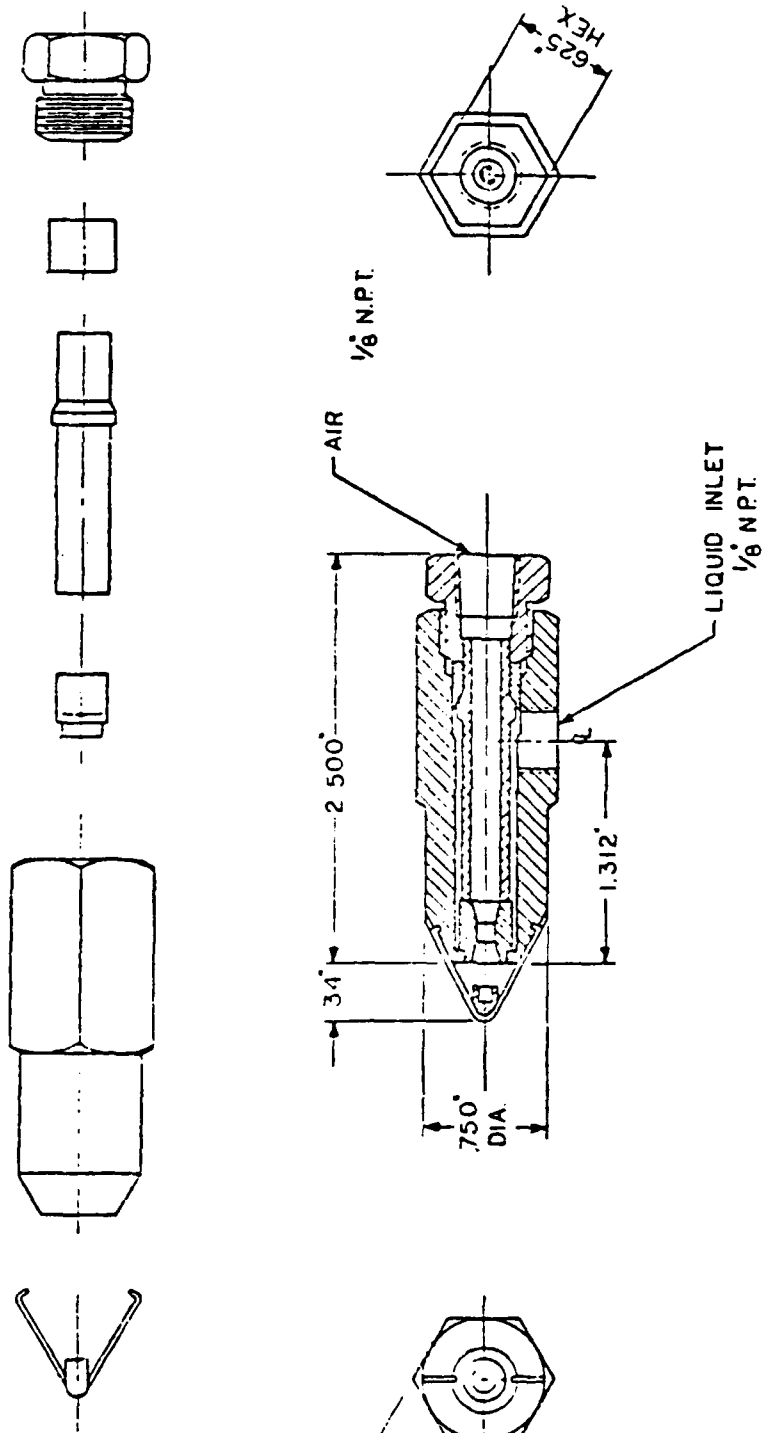

FIGURE A-7. SONICORE NOZZLE 125 DIAGRAM

9 Sonic Nozzles
 Ambient Calibration
 Airspeed = 90 kts.

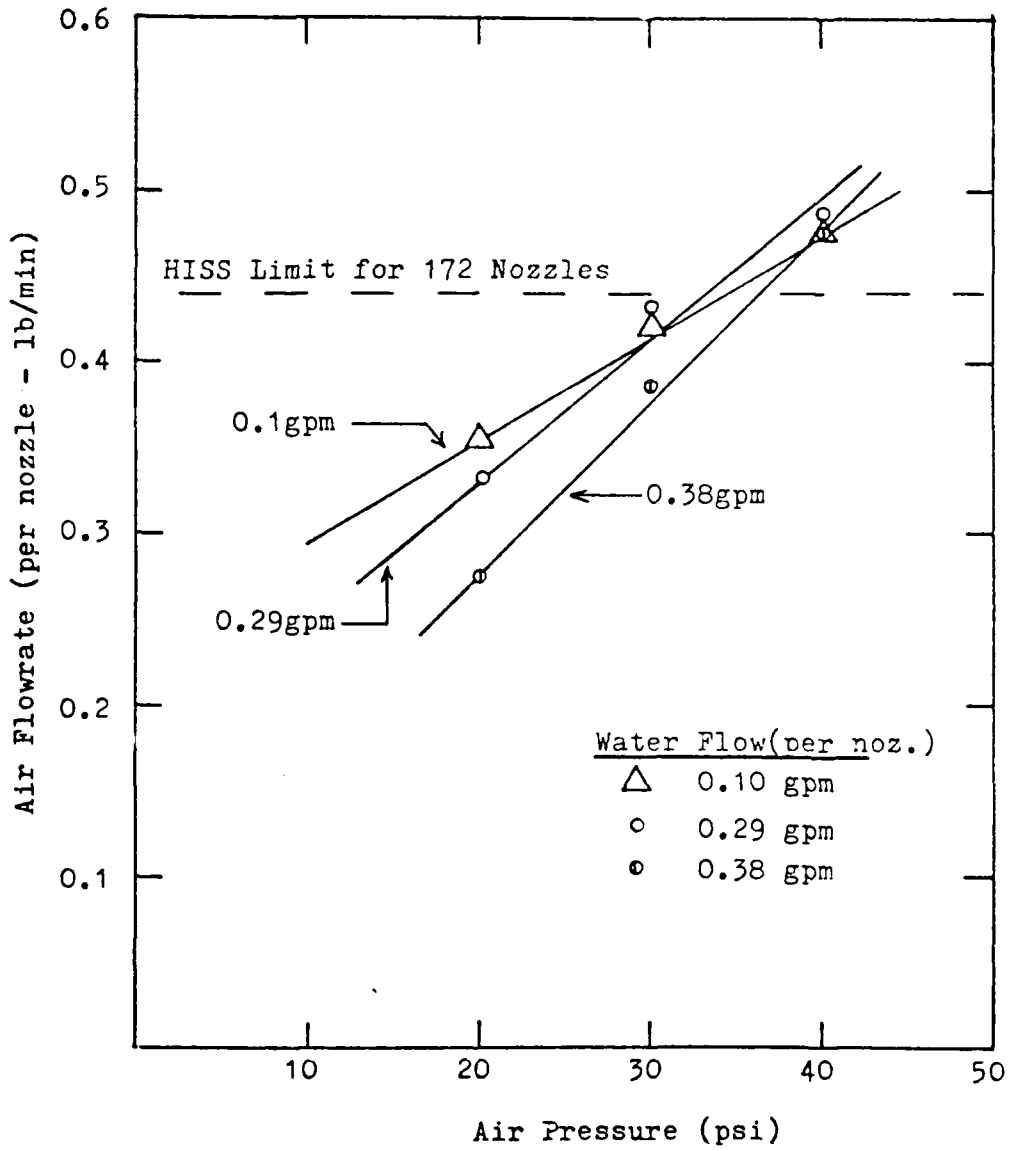

FIGURE A-8. NASA ICING TUNNEL RESULTS

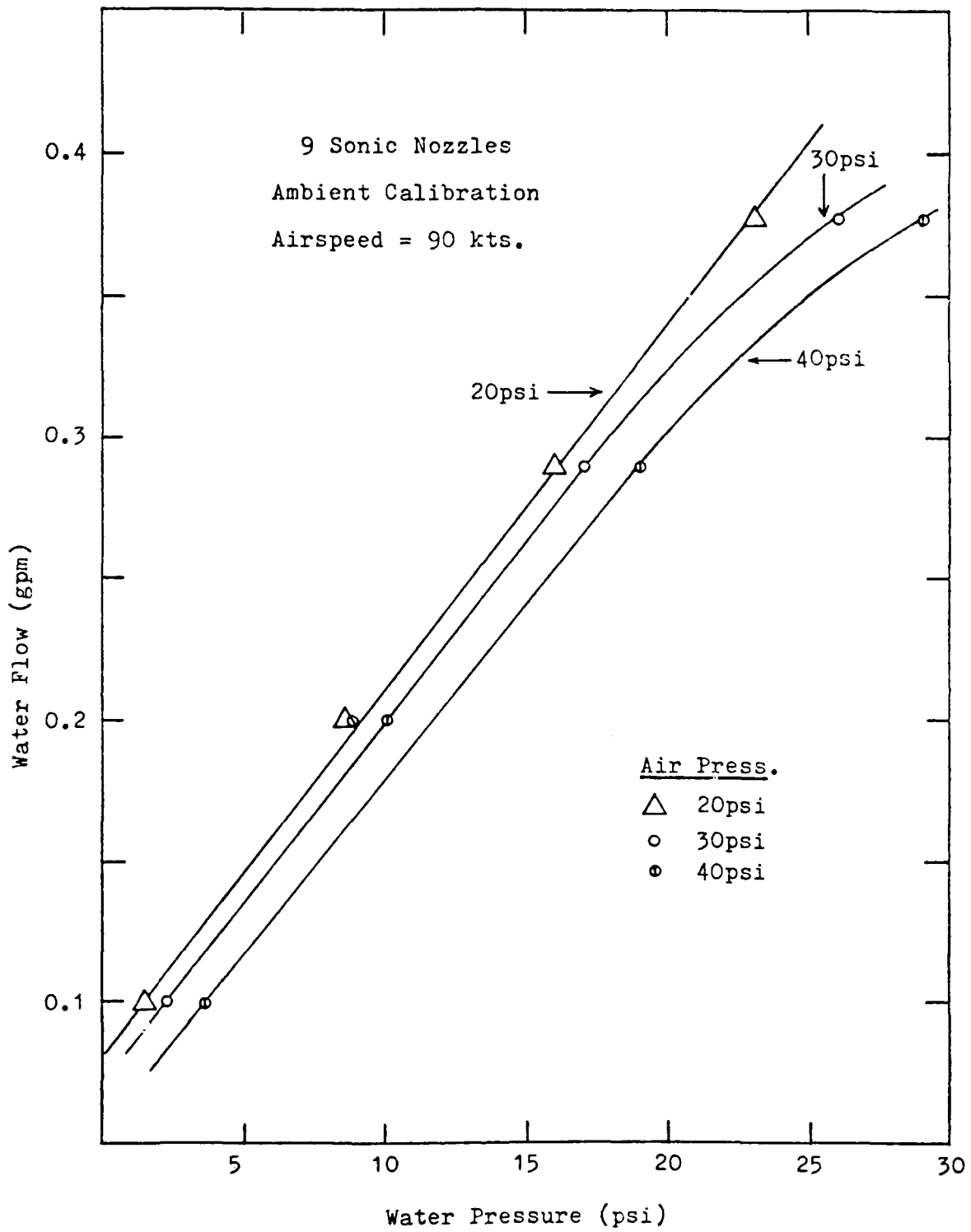

FIGURE A-9. NASA ICING TUNNEL RESULTS

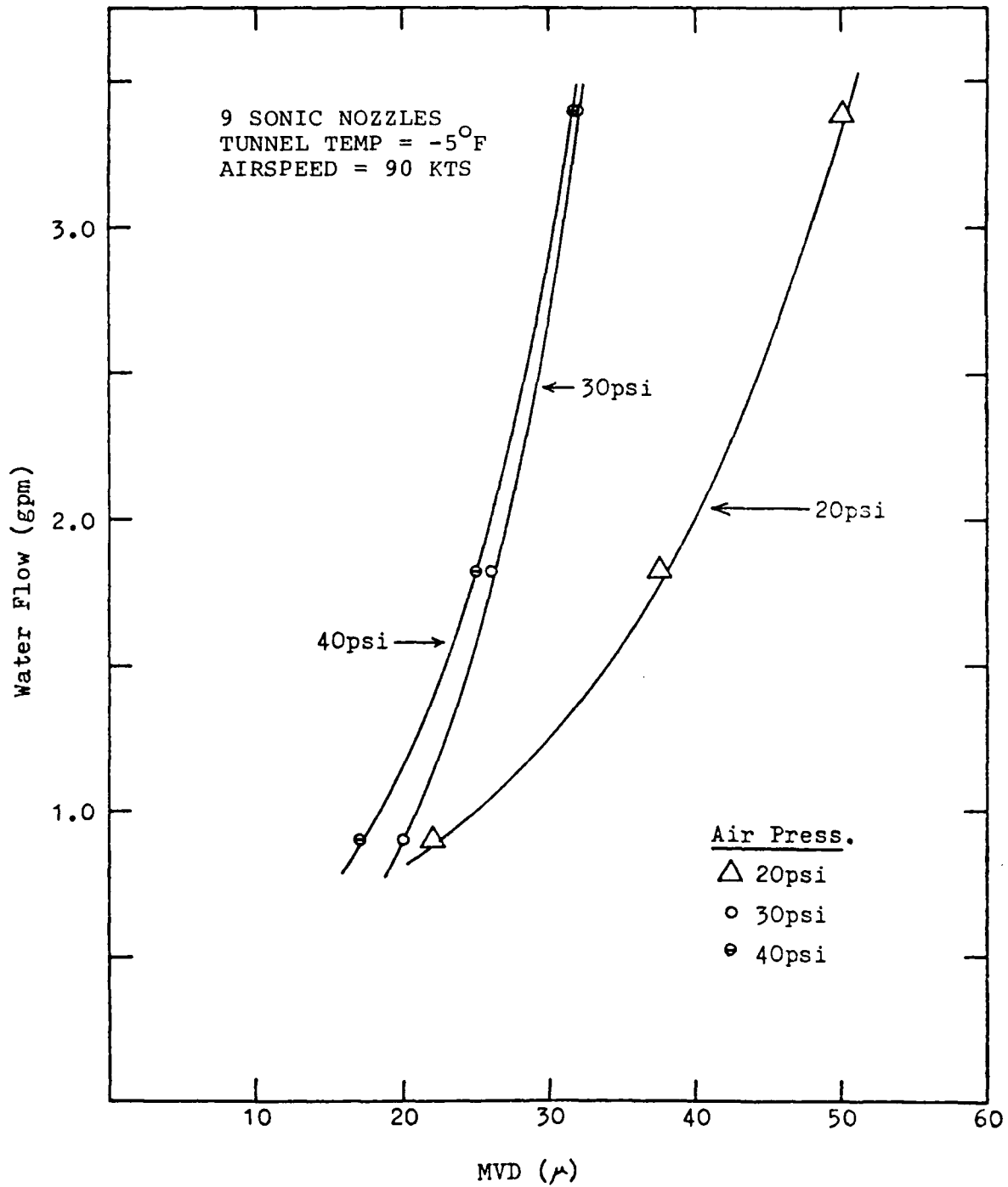

FIGURE A-10. NASA ICING TUNNEL RESULTS

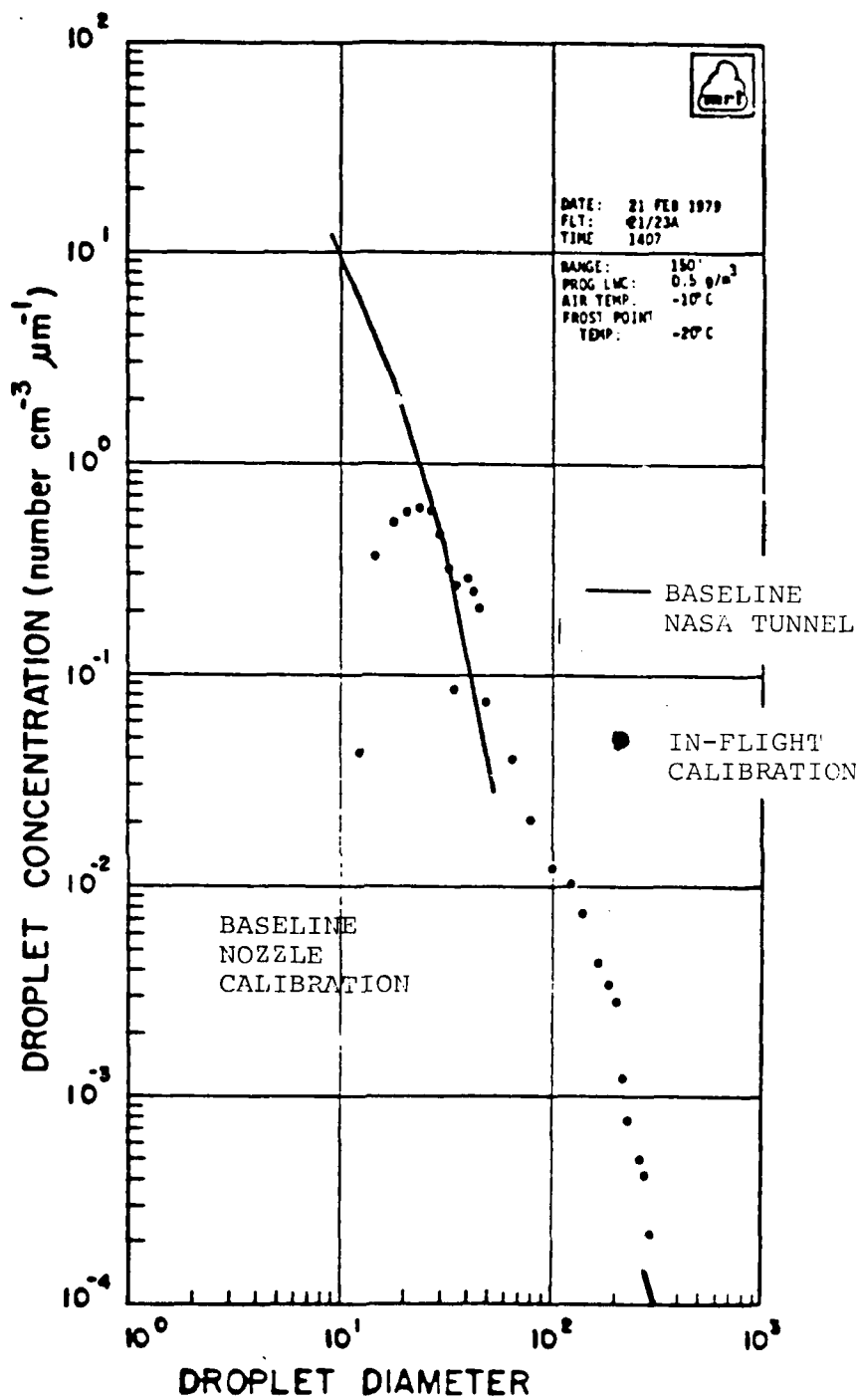

FIGURE A-11. COMPARISON OF HISS IN-FLIGHT MEASUREMENTS AND NASA TUNNEL CALIBRATION

A.7 CONCLUSIONS AND RECOMMENDATIONS (FROM REFERENCED TEST REPORT)

Two (2) nozzles were found that generate a spray cloud with MVD and LWC that are representative of natural icing conditions; the Sonicore 125 and the Spraying Systems 1/4 J Setup 29. The Sonicore nozzle, however, performed better under low temperature conditions (i.e. there was no problem of nozzle freezeup), and in general produced a spray with a more uniform cloud and better droplet size distribution (lower standard deviation from the mean diameter). Other conclusions reached include the following:

- o The Sonicore nozzle will operate within the current HISS pressure/flow limitations (20-30 psi air, 1.25 lb/min. total airflow).
- o Nozzles should be mounted upward and downward on the boom (the current HISS configuration) rather than aft.
- o The large drop in air temperature across the boom may point out the need for insulation.
- o If freezing problems are encountered in the 1979-80 winter HISS testing, consideration of heating the water in the 1800 gallon HISS supply tank should be made. Also, the tank should be insulated.
- o The engine bleed valve of the HISS should be examined to determine the modifications necessary to minimize bleed air pressure drop.

A.8 CONCLUSIONS BASED ON 1980 ICING TRIALS

The 1980 HISS icing cloud is a major step improvement over the previous clouds in terms of median droplet size (30-35 microns vs 300-400 in 1979) and in terms of liquid water content control (peak variation approximately 1.5 to 2 times average vs 1979 peak variations of 3 to 5 times average). Further improvements are recommended which include high pressure air source, additional boom sections to deepen and widen the cloud, and simplified water/air control system. Additionally, boom insulation (to maintain bleed temperatures), improved nozzle installation (to protect nozzle and decrease drag) and water heating (to eliminate nozzle icing problems) are recommended.

The overall impression of the HISS cloud as observed from the chase aircraft this year (1980) is:

- o The cloud appears much more uniform than the 1979 cloud (although of smaller cross sectional area).
- o The ice impingement areas (and limits of impingement) appear to closely match the natural icing areas. This is particularly noticeable when the 1979 HISS and natural icing on the CH-47C are compared to the 1980 icing on the YCH-47D.
- o The HISS ice texture this year appears to resemble the natural conditions. This is probably most noticeable on the inlet screens.

- o The HISS cloud width and depth require increases to provide better coverage of large helicopters. The CH-47 rotors are in and out of the cloud as can be concluded from a 60-foot diameter rotor operating in a 35-40 width cloud. The forward rotor of the CH-47 tends to drive the cloud downward and laterally, thus making simultaneous forward and aft rotor coverage extremely difficult. Even during attempted aft rotor immersion, the forward rotor drags the lower portion of the cloud downward, probably reducing the effective liquid water content reaching the aft rotor.

APPENDIX B

Draft Advisory Circular

Helicopter Ice Protection

B.1 INTRODUCTION

Advisory circular 20-73 (Reference B1) was prepared to provide information relating to the substantiation of ice protection systems on aircraft (i.e. fixed-wing). Reference to helicopter ice protection is contained in two paragraphs, i.e., paragraph 13 "Helicopter Operational Factors" and paragraph 34 "Helicopter Engine Inlet and Rotor." In essence these paragraphs address the powerplant (engine and engine inlet) installation requirement for ice protection during inadvertent icing encounters. As stated in paragraph 13 "current development of helicopter rotor system deicing or anti-icing means has not provided systems or hardware deemed acceptable by helicopter manufacturers. Therefore, all helicopters to date have been restricted against operating in icing conditions". The helicopter ice protection draft presented herein uses the basic format of the referenced advisory circular, but incorporates information specifically applicable to current helicopter icing, ice protection systems (including systems under investigation) and icing test methods.

B.2 TYPES OF ICE PROTECTION SYSTEMS

The primary types of systems developed for use in anti-icing or deicing exposed surfaces of helicopters are:

- o Hot air systems
- o Hot oil systems
- o Electrothermal systems
- o Liquid/chemical systems

B.2.1 Hot Air Systems

Hot air (engine compressor bleed) systems are used on many helicopters for anti-icing engine front frames, struts, inlet guide vanes, particle separators and for airframe mounted inlet configurations (inlet bellmouths, gearbox fairings). The availability and close proximity of the engine bleed port(s) to the heated system make this form of anti-icing attractive. The disadvantage of using engine compressor bleed is primarily in the increased fuel flow required or loss of horsepower during bleed extraction. Figure B-1 illustrates a typical horsepower loss trend for 1% bleed. The variation in the bleed effect on power represents individual engine parameter effects (i.e. bleed pressure ratio, reingestion of hot air, engine limits, etc.). Hot air from compressor bleed or from an auxiliary system may be used for anti-icing other airframe surfaces (windshield, other transparent areas, empennage, auxiliary air intakes, etc.) and for defogging of windshields.

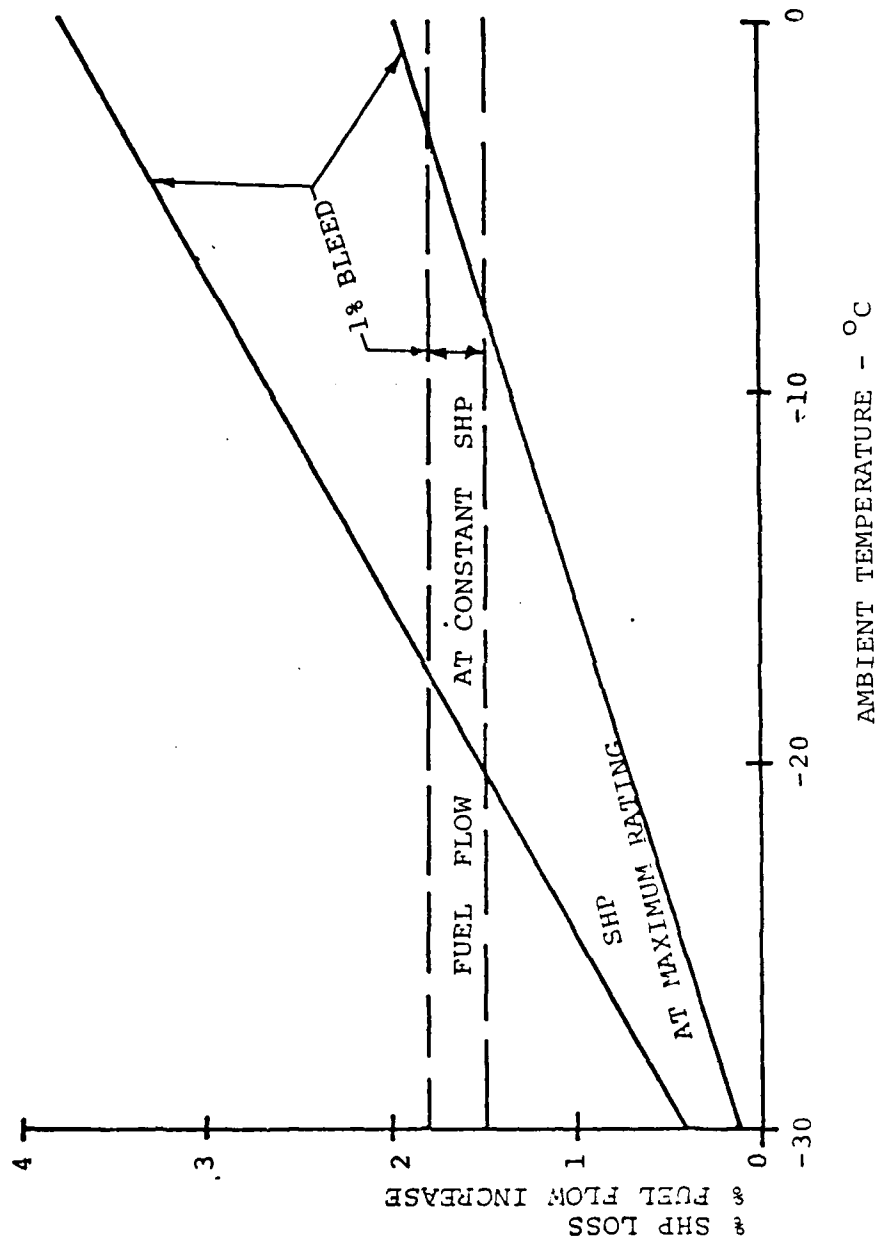

FIGURE B-1. ENGINE COMPRESSOR BLEED EXTRACTION PENALTIES

B.2.2 Hot Oil Systems

Engine front frames and struts may be anti-iced through hot oil circulation in lieu of compressor bleed. This method also provides cooling of engine oil and may partially replace a separate engine mounted heat exchanger. Hot oil is not normally used for airframe primary anti-icing, however, in certain configurations (i.e. nose gearbox fairings) the hot oil may provide an assist to a hot air or electrically heated fairing.

B.2.3 Electrothermal Systems

Electrothermal systems are incorporated in many helicopter anti-icing and deicing systems because of the adaptability of electrical heater elements into composite material structures (i.e. engine inlets, rotors, empennage leading edges). The ability to control heat application and density readily lends the electrothermal deicing concept to the helicopter rotor system. Windshield anti-icing incorporating film resistance elements, and engine inlets incorporating embedded heaters are found in a number of current helicopters. Additional areas incorporating electrical anti-icing include pitot tube, static ports, radio masts, auxiliary inlets, radomes and stabilizers.

B.2.4 Liquid/Chemical Systems

Liquid systems using glycol, alcohol, or mixtures of these and other chemicals have been devised for such applications as windshields and rotors. However, no operational system is currently being used. Several techniques have been devised for applying the liquid to the protected surfaces (i.e. bleed holes, porous material, etc.). Liquids may be used either to deice or anti-ice protected surfaces. However, the quantity of liquid which can be carried imposes a limitation as to time or available protection.

B.2.5 Systems Under Investigation/Consideration

B.2.5.1 Ice Phobic

Evaluation of ice phobic materials and coatings continues with some success for rotor deicing. The major problems appear to be erosion of the material (rain, sand, dust) and the limited icing severity/ambient temperature range capability. Recent testing of ice phobic coatings has been conducted on an UH-1H in the NRC (Ottawa) hover spray rig (January - March 1980) as reported in Reference B2. The results indicated that three coating materials have satisfactory ice shedding potential. Further testing is planned.

B.2.5.2 Pneumatic Boot

Preliminary assessments are being accomplished for pneumatic boot rotor deicing. The major concerns are (1) the ability of boot material to withstand the rotor environment and (2) the aerodynamic impact of boot

inflation. NASA has recently conducted stationary blade feasibility testing and is planning to conduct a full scale rotating test.

B.2.5.3 Microwave

Use of microwave as a rotor deicing heat source offers potential advantages of reduced weight, cost, and power over the present electrothermal deicing configurations as reported in Reference B3 (initial investigation effort). Much further development is required however to determine the actual adaptability to a helicopter.

B.2.5.4 Electro-impulse

The electro-impulse deicing concept (developed in the USSR) offers some advantages over the electrothermal system where a thin leading edge skin can be incorporated. Several helicopter manufacturers (in the U.S.) are conducting preliminary feasibility studies.

B.2.5.5 Vibratory

Rotor induced vibration offers potential deicing capability as demonstrated in preliminary testing reported in Reference B4. Much additional work is required to provide a system that is not detrimental to rotor and airframe dynamic components.

B.3 DESIGN FACTORS

Ice protection systems are designed to provide protection when the helicopter is exposed to atmospheric icing conditions. Determination of the ice protection design conditions and the need for ice protection involves consideration of the following:

- o The meteorological conditions specified for the helicopter systems and flight envelope.
- o The operational characteristics which are affected by the accumulation of ice on protected and unprotected surfaces.
- o The operational conditions affecting the engine and rotor based on the potential accumulation of ice and/or the availability of energy to operate the ice protection system.

B.3.1 Meteorological Data

The aircraft meteorological data in FAR 25 Appendix C (Reference B5) is referenced because the background derivation has a similar (Reference B5) data base as the atmospheric icing criterion recommended for helicopters. The icing cloud types (shown in Figure B-2) are the results of analyses performed by NACA of data collected from fixed-wing icing surveys primarily during the 1940's (see References B5, B6 and B7). Helicopter icing weather studies reported in References B8 and B9 recommend an updated atmospheric icing criterion for military helicopter ice protection design

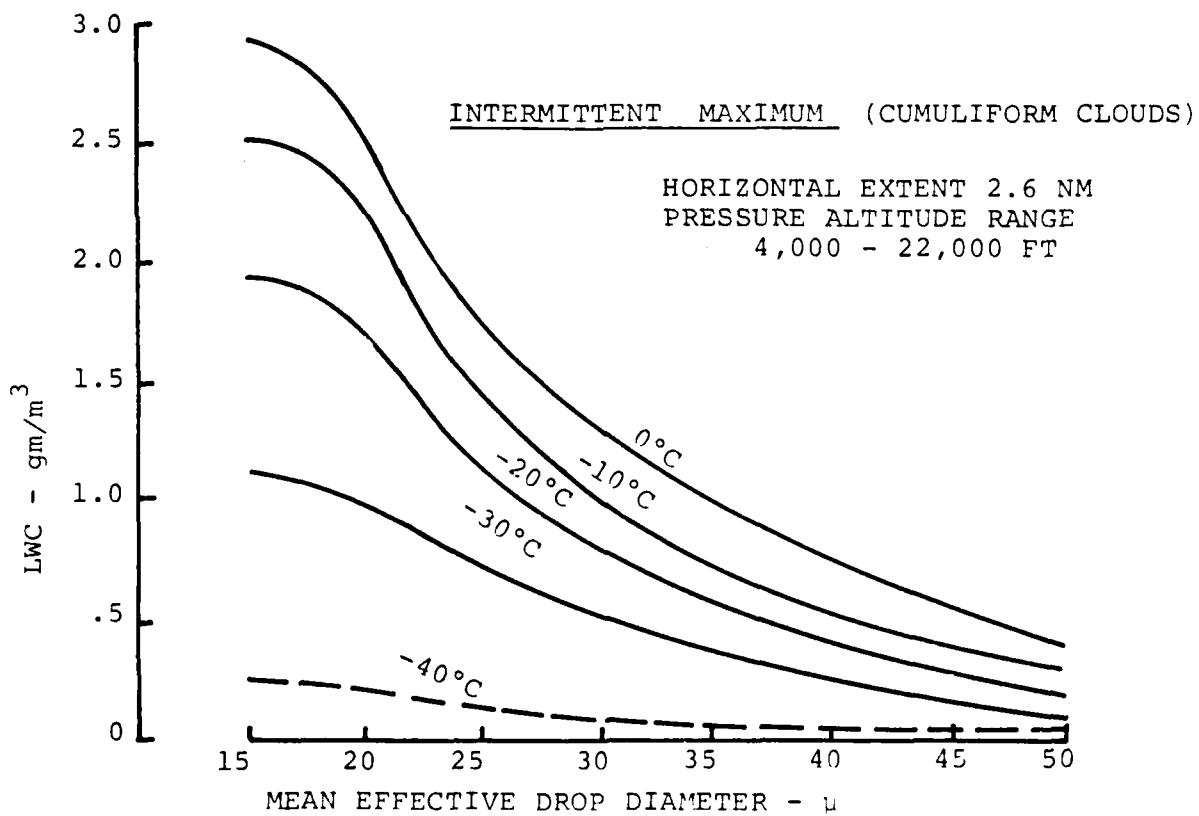
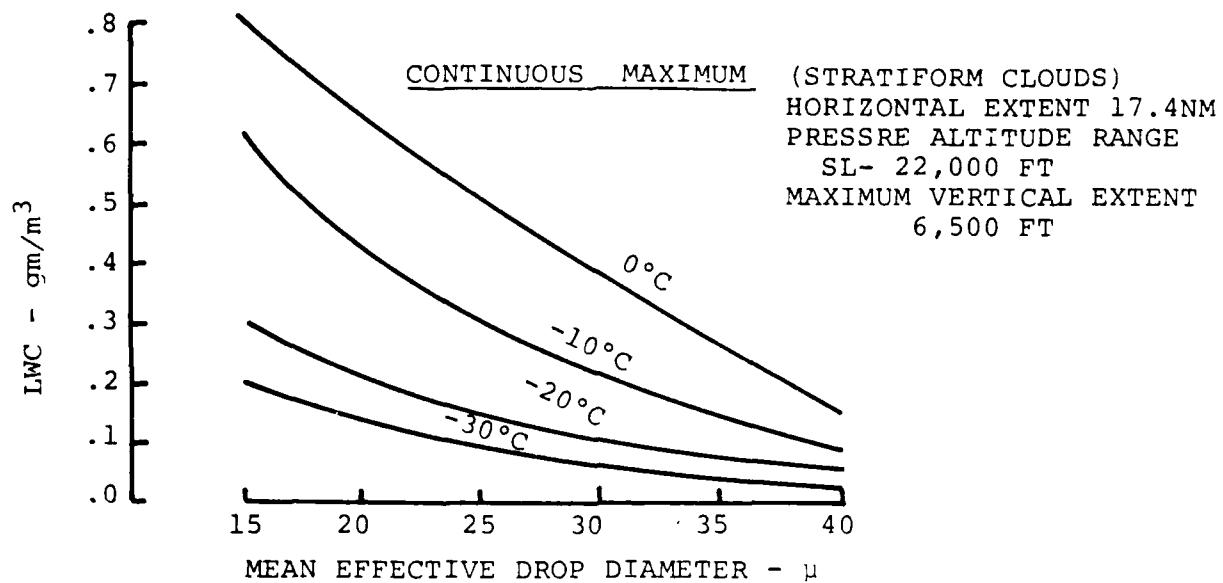

FIGURE B-2. FAR PART 25 ICING LEVEL DEFINITIONS

(see Figure B-3). Meteorological data are defined in terms of liquid water content (LWC), volume median droplet diameter (MED), and temperature (T), and each of these parameters is involved in the determination of the design points for ice protection systems.

B.3.1.1 Liquid Water Content

LWC (gm/m^3) is of prime interest to the designer because it influences the maximum quantity of ice that can accumulate. All of the liquid to which a surface is exposed, however, does not collect on the surface. Water collection is a function of flight speed, geometry, droplet size, and other ambient conditions in addition to LWC. Data covering conditions within a specific cloud type indicate that there is a definite relationship between LWC, temperature, pressure altitude, and droplet diameter. Statistical analysis of data covering many icing encounters, in contrast with that shown for conditions in a single cloud type, indicates that high LWCs are associated with high temperature and low droplet diameters and vice versa. This trend is shown in Figures B-2 and B-3.

B.3.1.2 Droplet Diameter

All the water contained in the swept volume of a cloud formation does not impinge on the exposed surfaces. Impingement rate is a function of droplet size as well as quantity, and catch efficiency of the body under investigation. The larger drops due to their increased inertia have the higher impingement rate. Drops occur in many sizes in nature. For convenience in cloud classification, Langmuir, et al, defined the distributions shown in Table B-1 as covering some of the range believed to be encountered in nature. These distributions formed the basis for the rotating multicylinder data analysis used during the evaluation of the early NACA icing data collection.

The size of droplets contained in a "Langmuir" distribution is expressed as the ratio of the average diameter "a" in each group to the volume median drop diameter "a₀". The volume (mass) median diameter (MED) divides a distribution so^o that the volume of water contained in drops of a larger diameter than the MED is equal to the volume of water contained in drops of a smaller diameter. An MED of 15 to 30 is generally used to determine the water catch rate and an MED of 40 to 50 microns used to determine the impingement limits. However, the complete range of droplet sizes should be considered to establish the most severe conditions.

B.3.1.3 Temperature

Temperature affects the severity of an icing encounter in many ways. Data indicate that the highest LWC concentrations occur at the higher temperatures as previously indicated. This trend can be seen in the curves. Temperature affects the impingement computations which involve viscosity, density, and the quantity of heat, Q, required to anti-ice or deice a surface. In this respect, an anti-icing system design is chosen such that the Q_A available exceeds the Q_R required for a chosen group of meteorological and operational conditions. In the deice system design, the heat

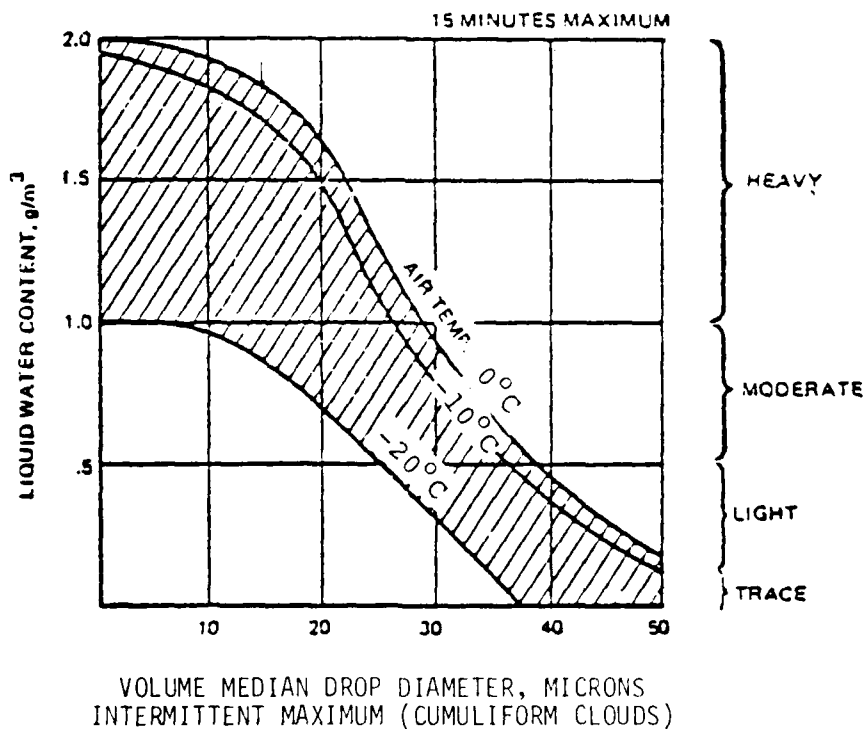
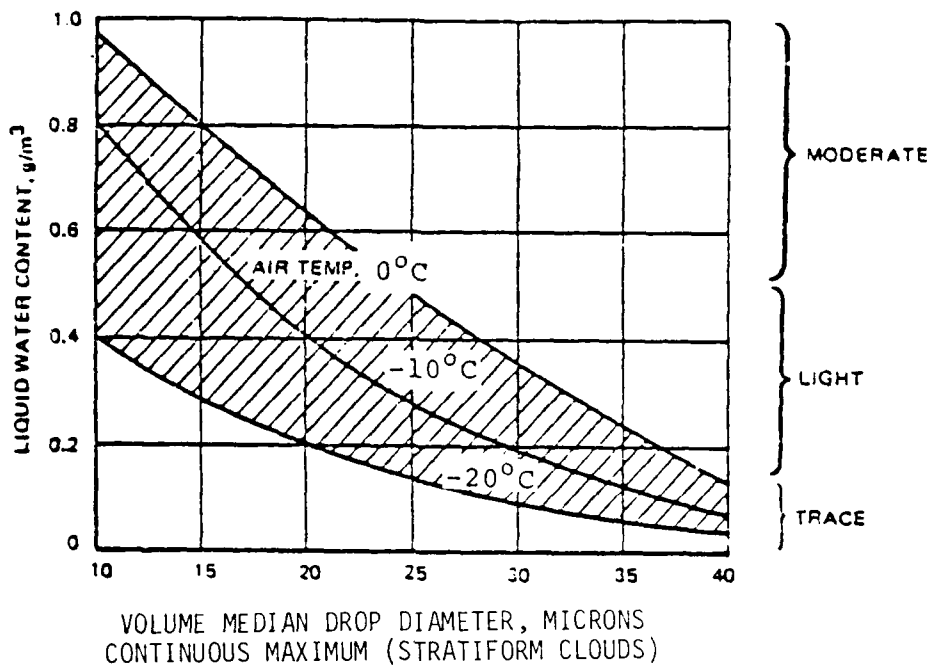

FIGURE B-3. ICING LEVEL DEFINITIONS PER TR-75-34A.

TABLE B-1. LANGMUIR CLOUD DROPLET CLASSIFICATION

Total LW in Each Size Group -- %	a/a ₀ Distributions				
	A	B	C	D	E
5%	1.00	0.56	0.42	0.31	0.23
10%	1.00	0.72	0.61	0.52	0.44
20%	1.00	0.84	0.77	0.71	0.65
30%	1.00	1.00	1.00	1.00	1.00
20%	1.00	1.17	1.26	1.37	1.48
10%	1.00	1.32	1.51	1.74	2.00
5%	1.00	1.49	1.81	2.22	2.71

input is selected as a function of the desired ice shedding cycle time (element-on-time in the case of an electrothermal deice system) versus ambient temperature schedule. Temperature also affects the ice shape, thus changing the aerodynamics of the impinging body.

B.3.2 Icing Types

The general categories of aircraft icing as defined in the handbook of meteorology (Reference B10) is as follows:

- o Clear Ice - Transparent ice formed by the freezing of large water droplets. This is most likely to occur at ambient temperature near freezing (0°C) when the droplets which may not be supercooled are able to flow along the surface before freezing occurs. The ice formed during freezing rain is a good example.
- o Rime Ice - Opaque ice formed in clouds by the rapid freezing of small supercooled water droplets. The freezing rate of the water droplet (which is influenced greatly by the amount of supercooling) affects the shape of the ice (i.e. double horn, rectangular, spear) forming on the surface; the slower freezing rates tend toward the double horn shape, while the faster rates tend to produce the spear shape, with the rectangular in between.
- o Hoarfrost - Ice crystals deposited on below freezing surfaces directly from water vapor.
- o Wet Snow - Snow (ice crystals) existing at near freezing ambient temperatures. Wet snow tends to cling to exposed surfaces and may create a rime ice like formation (similar to the double horn shape). Wet snow is subject to packing and therefore presents a particular hazard to engine inlet systems with turning sections or plenum chambers.

As stated in Reference B10 icing conditions can exist in most cloud types with the proper temperature distribution (i.e. temperatures below 0°C). Rime ice is more common with little turbulence (stratiform type cloud formation), while clear ice predominates when turbulence and vertical velocities are present (cumuliform cloud formation). The intensity of icing increases with increased turbulence.

B.3.3 USE OF METEOROLOGICAL DATA FOR DESIGN

LWC, droplet diameter, and temperature are used to determine the water catch rate, and extent of ice accumulation on a surface. The collection rate is given by the following equation:

$$W_M = 5.278 \times 10^{-4} \times V_o \times LWC \times H \times E_m$$

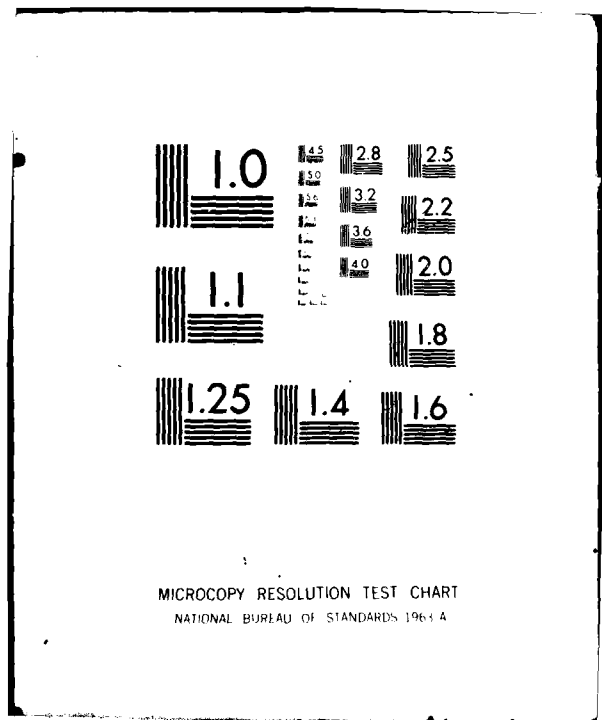

MICROCOPY RESOLUTION TEST CHART
NATIONAL BUREAU OF STANDARDS 1963-A

where:

W_M = Mass of water intercepted lb/min/ft of span

E_M = Collection efficiency

LWC = Liquid Water Content (gm/m³)

H = Projected height (inches)

V_o = Forward speed (knots)

The collection efficiency (E_M) is defined as the ratio of the mass of liquid water contained in the swept volume of the surface at a given angle of attack to the mass of water actually impinging on the surface. Collection efficiency (E_M) is a function of flight speed, droplet size, body geometry, ambient temperature and pressure.

The collection efficiency of a surface can be determined either by analysis or test. Potential flow/particle trajectory analysis methods can be used to calculate the theoretical amount of ice catch on various body shapes. Figure B-4 illustrates airfoil particle trajectories (and the associated collection efficiencies) for a typical helicopter airfoil section. An approximate collection efficiency can be established by calculating the inertia parameter (K_o) and matching the value with known shapes tested for ice accretion. For example K_o may be calculated by the method outlined in Reference B11 and illustrated as follows:

$$K_o = 1.87 \times 10^{-7} \times \frac{(V_o \times 1.15)^{0.6}}{\mu} \times \frac{(d^{1.6})}{\rho^{0.4} \times C}$$

where:

K_o = Inertia Parameter Dimensionless

V_o = Forward Speed Knots

μ = Viscosity of Air $\frac{\text{lb (mass)}}{\text{ft. sec.}}$

d = Droplet Diameter Microns

ρ = Air Density lb/ft³

C = Chord Length of Effective Surface Length Inches

The pressure distribution over a body may be determined experimentally by wind tunnel or flight tests to check the analytical results in predicting

WATER DROP CATCH % V = 650 FT/SEC
 DIA ~ μ % α = 0°

○	15	15.2
◇	30	34.3
□	300	92.5

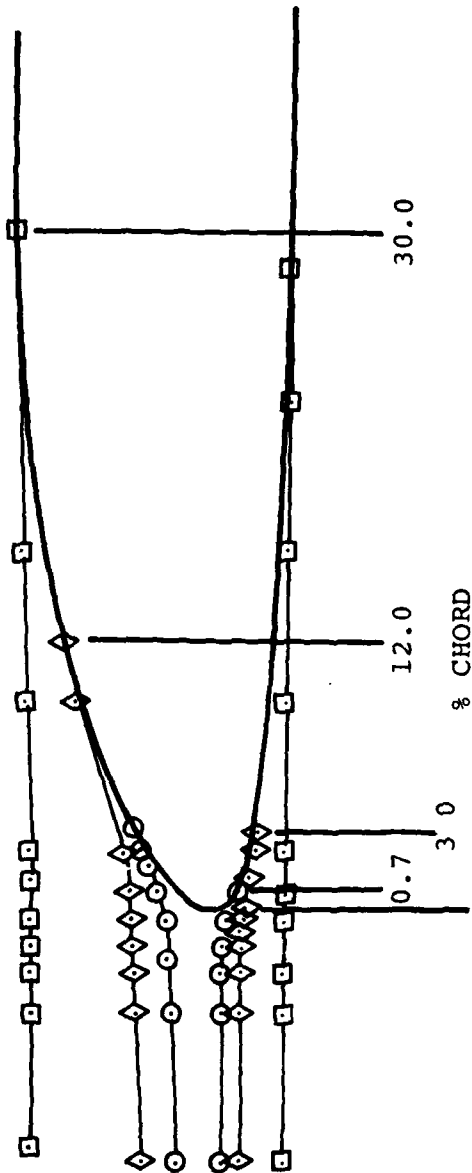

FIGURE B-4. AIRFOIL PARTICLE TRAJECTORIES
 - 0 DEGREE ANGLE OF ATTACK

ice impingement. In some cases, the impingement characteristics can be estimated by a "matching technique" by which a particular airfoil section is compared to a model of known impingement characteristics. Plots and table relating the various functional parameters used to determine collection efficiency are available. As an example of use of airfoil matching, Figure B-5 is provided to illustrate the inertia parameter change with droplet diameter and location on a typical rotor radius. Figure B-6 shows the match of known airfoil data to obtain collection efficiency. The collection efficiency for a 15 and 30 micron droplet (at a radius ratio of .91 ($V = 650$ ft/sec)) as determined by Figure B-6 (at $\alpha = 0^\circ$) shows a close comparison to the values noted in Figure B-4. "Matching techniques" should be used with caution on sections where the airfoil section is subjected to influences which did not exist when impingement characteristics were established on the reference model. Such influences would include but are not limited to engine air flow into an inlet duct, rotor wash on various surfaces, including downwash effects on aft mounted engine inlets, etc.

B.4 OPERATIONAL FACTORS

The determination of the most severe conditions for which an icing system is to be designed involves consideration of the helicopter operation. Operational regimes such as hover (IGE, OGE) take-off/landing and forward flight, are usually investigated. In some cases, the cruise condition (level flight) may be the most severe because of the total icing exposure time and associated lift change and drag rise of the rotor, or control problems associated with the buildup of ice. Some experience indicates that the helicopter attitude and rotor wash pattern can contribute to the formation of ice on certain critical areas. Continuing exposure to icing conditions may cause certain helicopters to become incapable of sustaining flight.

B.4.1 ENGINE OPERATIONAL FACTORS

The engine operational factors to be considered in determining the most severe conditions are directly related to helicopter operational procedures because changes in speed and attitude are usually accompanied by changes in engine power requirements. The prime factors to be evaluated are the quantity and temperature of air available from the engine and the airflow through the engine during the most critical operational mode. These factors are especially critical for evaluation of hot air anti-icing systems where the air source is the engine compressor bleed. The airflow through the engine is critical in terms of the flow field around the inlet lip and the engine inlet. The flow field must be known in order to determine the heat transfer relationships between the heated surfaces, the hot air used to heat the surfaces, and the quantity of water impinging on the surfaces.

Engine inlets, inlet air screens, and inlet lips are considered to be more critical with respect to accumulations of ice on surfaces exposed to engine airflow due to the possibility of an appreciable quantity of ice being ingested into the engine. Ice ingestion can cause serious damage to

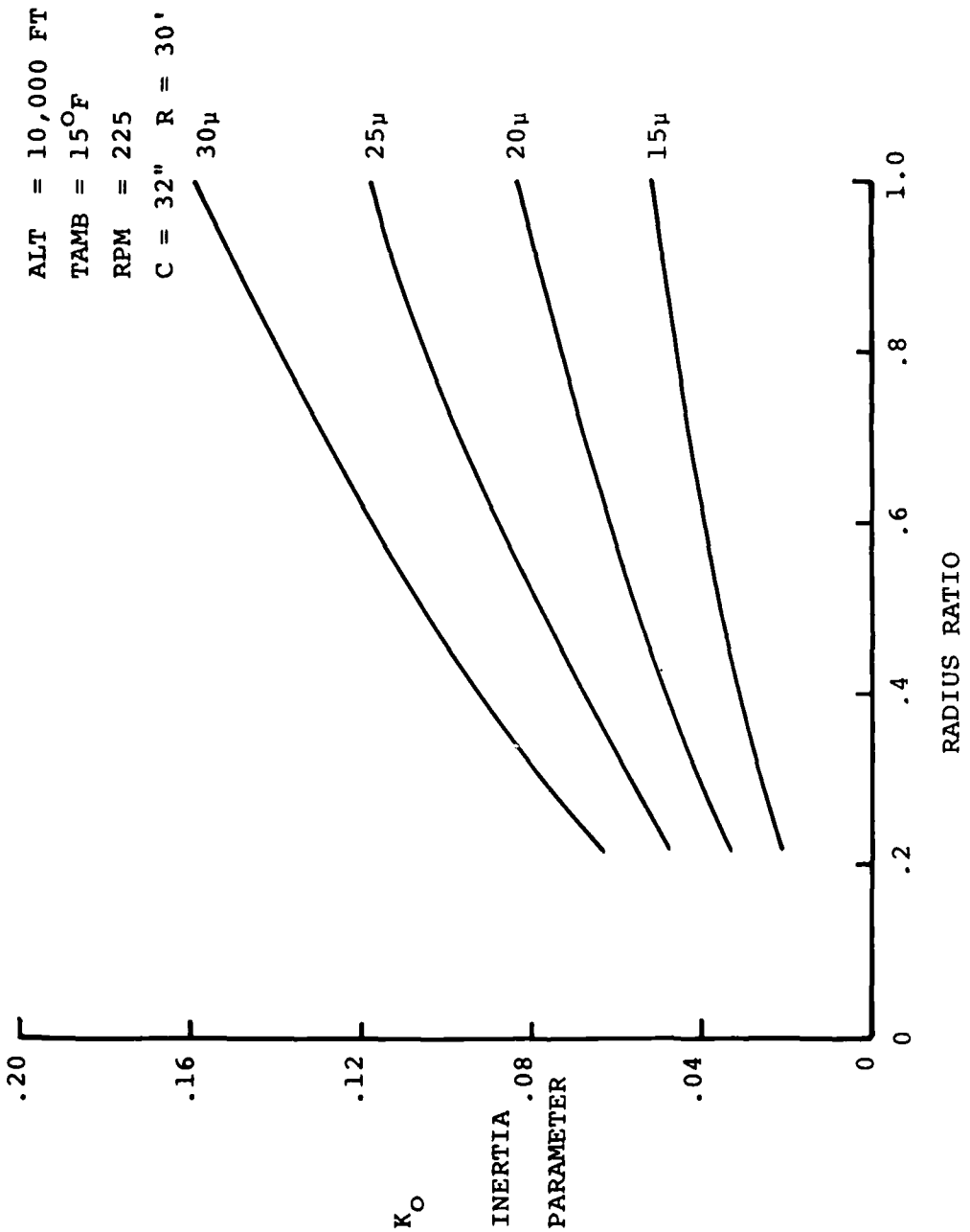

FIGURE B-5. MODIFIED INERTIA PARAMETER ACROSS ROTOR SPAN

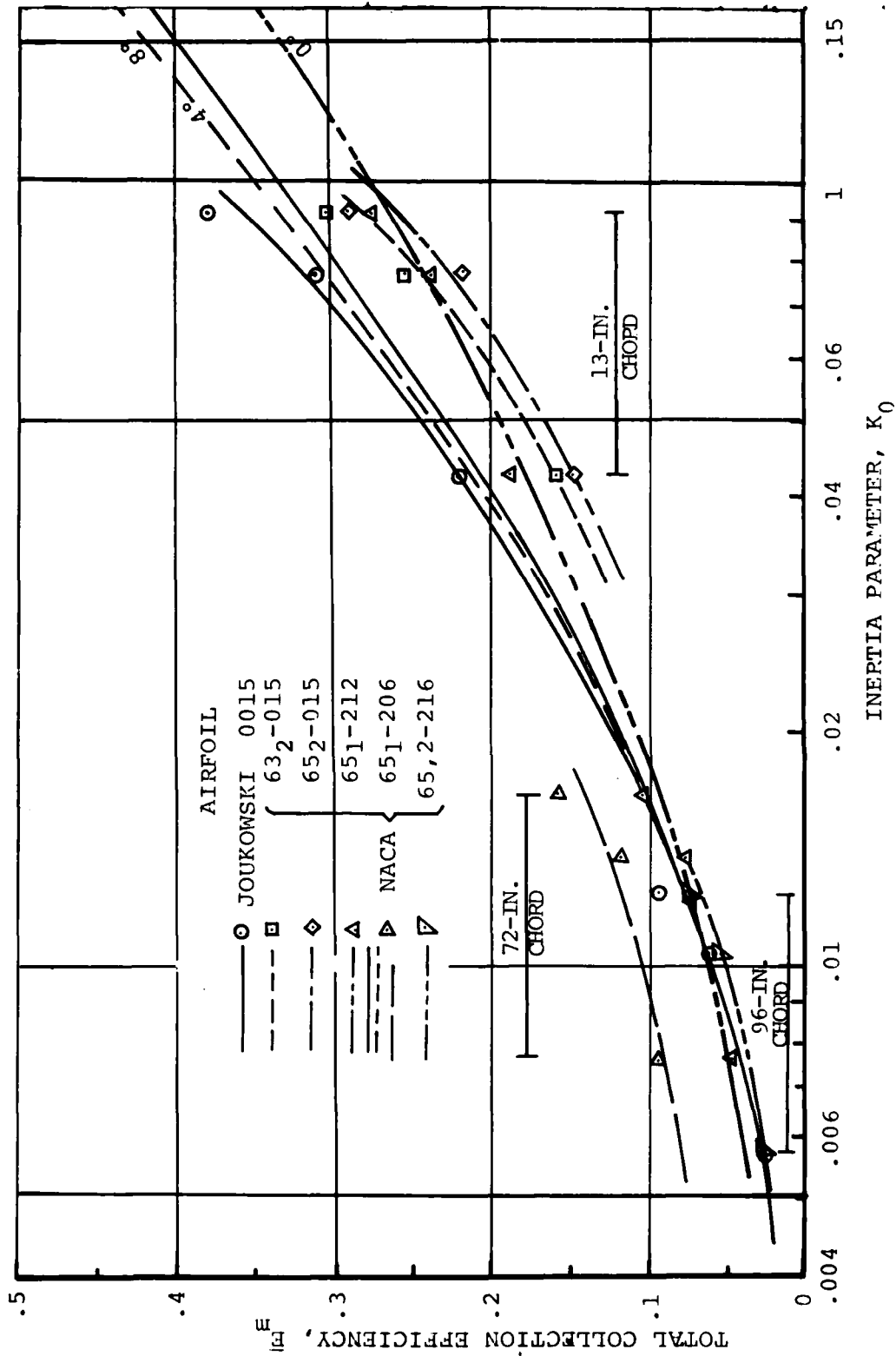

FIGURE B-6. AIRFOIL MATCHING USING KNOWN AIRFOIL COLLECTION DATA

compressor blades. Runback water can also refreeze on unprotected surfaces of the inlet and, if excessive, can reduce engine airflow or distort the flow pattern in such a manner as to excite compressor blades to critical frequencies.

In addition to the foregoing, the buildup of ice on unprotected surfaces and the general operational conditions prevalent during an icing encounter place further emphasis on the necessity for maintaining an acceptable level of power output.

B.4.2 ROTOR OPERATIONAL FACTORS

The rotor operational factors involve the airfoil sensitivity to ice accretion (in terms of maximum lift capability, pitching moment and drag divergence), the spanwise extent of icing, the blade torsional stresses and the rotor control loads. These are factors in determining the operating limits of an unprotected (nondeiced) rotor system, and/or the need for a deice system. A major factor in rotor icing evaluation is the potential pilot and passenger reactions to asymmetrical ice shedding and the ability of the pilot to safely control the helicopter if severe asymmetric shedding occurs.

An additional factor in determining the need for rotor deicing is the landing and rotor shutdown hazard of shed ice from the rotor.

B.5 OTHER FACTORS

B.5.1 ICE SHEDDING

When ice is shed during or after an ice encounter, it may create a hazard by entering engine inlet ducts or by striking and damaging other parts of the helicopter including rotor blades. The design should consider these hazards and appropriate steps should be taken to prevent unwanted buildup and release of large pieces of ice that could cause hazardous malfunctioning or substantial damage to the engine or fuselage. Maximum ice shedding usually occurs after an ice encounter when the helicopter is flown into outside air temperatures above freezing. Ice can be expected to be shed from the rotors, windshields, the fuselage nose, pitot masts, antennae, etc. Engine inlet ducts and other parts of the helicopter located in the path of released ice are susceptible to ice damage. Experience indicates that the small turbine engines typically used on helicopters are more sensitive to compressor blade damage and adverse engine operation during ice ingestion than are larger turbine engines typically used on fixed-wing aircraft.

B.5.2 ICE SHAPES

The critical shapes that can be expected to form on unprotected surfaces can be established by flight tests in natural or artificial ice conditions, if the critical temperature, LWC and drop size associated with these shapes can be measured and the ice shapes documented.

Ice shapes vary with liquid water content, drop size, and ambient temperature control, as well as with airfoil thickness, and angle of attack.

Extensive natural icing and icing tunnel experience has been documented for fixed-wing airfoils and other shapes. Correlation of laboratory ice shapes with ice shapes observed under natural conditions on specific fixed-wing airfoils has been accomplished. The need exists to test and document the ice formations on rotor airfoils under rotating and oscillating conditions.

B.5.3 UNPROTECTED SURFACES

Helicopters normally include surfaces on which ice will accumulate and for which no ice protection is provided. The helicopter will be able to operate safely under the specified icing conditions only if the effect of ice accumulation on these surfaces has been shown not to introduce a hazard.

To establish the helicopter's tolerance to the continuous accumulation of ice on unprotected surfaces, flight tests should explore stratiform icing clouds (continuous maximum Figure B-2) for a period of time representative of today's flight patterns. It is recommended that the tests include a continuous exposure for at least 30 minutes. If the handling characteristics are found to deteriorate below those specified for stability and control, the helicopter certification limitations should state the maximum time.

A precautionary note should be provided in the flight manual to warn the crew of the possibility that, during prolonged encounters, ice buildup on the unprotected surfaces, perhaps including rotors, may not be visible to the crew.

It is recommended that an ice detector be utilized to guide the pilot in determining the time in icing and the accumulation of ice on critical unprotected surfaces, in particular the rotors.

B.6 DESIGN ANALYSIS

The overall objective of the design analysis should be to analytically show that no combination of meteorological conditions in the icing envelopes coupled with any condition in the helicopter operational envelope will result in an accumulation of ice on any surface which will cause an unsafe operating condition.

Different design approaches are needed for airframe, powerplant, and rotor ice protection systems. Fuselage surfaces may be more tolerant to ice accretion than engine/engine inlet surfaces or rotors, and the design approach applied to an airframe system will differ from those applied to an engine or rotor system. The helicopter operational envelope can be defined but the engine and rotor operational envelopes should consider all possible applications and installations. A helicopter surface's tolerance

to ice accretions should be demonstrated before omitting possible applications and installations from the performance envelope. Airframe anti-icing systems may be designed for either complete evaporation or running wet operation under continuous maximum conditions. Engine inlets and associated airframe ducting should meet the same general meteorological design criteria as required for the engine.

Design margins for each system will be established by the simultaneous consideration of meteorological factors, helicopter engine operational factors, and any other pertinent factor which might be involved.

The most critical conditions applicable to the design of engine inlet and rotor systems should be developed from a consideration of the entire array of meteorological and operational conditions within the operational envelope of the engine. Design points should be sufficiently defined in terms of meteorological and operational factors for the agency to determine how the severity of these factors was established. The determination of the most critical conditions should be made with a specific design objective in mind.

The frequency and duration of icing encounters also determine the severity of the conditions for which a system should be designed. Continuous maximum conditions interspersed with intermittent maximum conditions occur in the U.S. and other areas of the world, and international usage dictates the need for a design to cover this situation.

B.6.1 AIRFRAME SURFACES, EMPENNAGE, CONTROL SURFACES, ETC.

A choice should be made in the early design stages of the icing system to determine which portion of these areas should be protected. Those surfaces of the helicopter directly exposed to stagnation flow conditions usually accumulate the largest quantity of ice. These include the radome, surface leading edges, radio masts, auxiliary air scoops, droop stop actuators, vent and drain lines.

Selection of the surfaces to be protected is made after a careful consideration of the most severe meteorological and operating conditions, the probable extent of ice accumulations on exposed surfaces, the effects of such accumulations on lift, drag, and controllability of the helicopter and the operation of systems. Consideration of takeoff, hover, transition, level flight, descent and landing performance should be provided under operating conditions specified. Some ice buildup may be tolerable on some surfaces if the helicopter has sufficient rotor power to offset the additional lift and drag forces and no unsatisfactory operating condition results.

The extent of the icing protection needed for various auxiliary air scoops is directly related to the need for such protection to maintain satisfactory operation of an essential system.

The choice between an ice detector (or ice shield) a deicing or an anti-icing system may be influenced by an assessment of such factors as effect

of accreting and/or shedding ice onto other surfaces or engine inlets, the complexity of an ice protection system, and the availability of a sufficient quantity of heat or electrical power (thermal anti-icing or de-icing). In general, the rotors will be deiced (electrically) while the engine inlets and windshields will be anti-iced (the inlets by bleed air and/or electrical heaters, or windshield electrically). After due consideration of the foregoing design factors, the manufacturer can establish the airframe system design points in terms of LWC, droplet diameter, and temperature together with those factors necessary for the Administration to determine by tests that all design objectives have been met.

In addition to the meteorological conditions under consideration, appropriate operational parameters including such factors as speed, altitude, engine power setting, etc., should be varied over the helicopter operating envelope to determine the combination or combinations of meteorological and operating parameters which result in the most critical design point or points. Because of the large number of variables involved in these design considerations, more than one critical design point may exist for both intermittent maximum and continuous maximum meteorological conditions.

The design analysis should indicate that no hazardous quantity of ice will form on the surfaces under consideration when exposed to intermittent maximum and continuous maximum icing conditions consistent with the operational needs of the helicopter.

B.6.2 ENGINE INLETS, WINDSHIELDS, AND INSTRUMENTS

The accumulation of ice on the engine inlet bellmouth cowl, bulletnose, and other areas of the helicopter which could affect engine operation is generally more critical from the standpoint of continued safe operation than ice accumulation on helicopter surfaces discussed in B.6.1. Design meteorological conditions remain the same, but operational conditions, particularly with respect to the surface flow conditions, may vary considerably. Long curved inlets are particularly susceptible to snow, slush, and ice crystal impingement on the curved surfaces.

The most probable engine operational mode associated with a particular helicopter operational mode is normally the basis for the design of airframe icing systems. However, due consideration should be given to the need for increased reliance on engine power output during severe icing conditions and to the possibility that the engine may be actually operated through a wide range of power settings during such an encounter.

Ice protection should be provided for all instruments essential for safe operation of the helicopter which are subject to ice impingement or to runback and refreeze. The functioning of essential static ports should not be adversely affected by ice accumulation, freezing of runback water from forward surfaces, or water and slush from rotor downwash during take-off and landing. It is possible that slush ingestion and water, ingested at a lower altitude, might freeze when the helicopter ascends to higher altitudes and lower temperatures. Some of the instruments that might be

affected are pitot tubes, total pressure probes, and control surface indicators. These instruments are generally protected by electrical resistance systems because of the small areas involved and the need to maintain ice-free operation in all icing conditions.

The forward surfaces of windshields should be protected to provide visibility during the most severe icing conditions. While these surfaces are generally protected by electrical resistance systems because of small areas involved, there is also the need to require duplication to maintain ice-free operation in all icing conditions.

The techniques for determining the most critical design points are similar to those previously discussed:

- o The design analysis should indicate that the engine inlet ice protection system will preclude the formation of any ice which could adversely affect continued safe engine operation or cause serious loss of power when exposed to the meteorological conditions as defined in combination with the helicopter operational needs and helicopter envelope.
- o Engine inlets are generally designed to be running wet. Service experience indicates that this approach has been satisfactory provided adequate precautions are taken to prevent hazards due to possible runback and refreeze.

B.6.3 ENGINE SYSTEMS

In defining the most severe conditions for the design of icing systems for the engine, and related components, the manufacturer should not only give consideration to the icing envelopes but to the entire environmental and operational envelopes.

The engine icing system should be designed to cope with the most severe meteorological conditions occurring simultaneously with the most severe engine operational conditions. Critical design points for both continuous maximum and intermittent maximum conditions should be developed. Procedures for determining water catch rate, impingement data, QA available, and QR required are similar to those previously discussed for aircraft systems. The flow field around engine surfaces should be based on the pressure and velocity relationships of the air flowing through the engine.

The principal differences in the design approach applicable to airframe and engine systems arise from the need for reliability of the engine during severe icing encounters to insure that a helicopter will have sufficient power to enable it to continue flight to an area of less severe meteorological conditions.

Although the engine manufacturer generally may have some idea of the eventual application of his engine, he cannot be sure that some future application will not be totally different from that planned. Therefore,

the ice protection system should not be limited to a specific application or specific helicopter operational envelope.

In addition to the foregoing, the buildup of ice on unprotected surfaces of the helicopter and the helicopter operational conditions during an icing encounter place further emphasis on the necessity for reliable engine performance. Engine struts, gearbox fairings, and inlet guide vanes, if unprotected, may be subject to accumulating excessive ice deposits. When heated surfaces are employed for keeping these surfaces free of ice, the possibility of runback and refreezing should be considered. The first-stage compressor blading of axial flow engines should also be evaluated for possible ice accumulation, with the ice protection system operating. It is not considered essential to eliminate ice buildup at the engine face, but any ice buildup allowed on an operating engine should be kept to a minimum to prevent possible damage from ice ingestion and to ensure reliable engine operation.

An accumulation of ice on any engine surface would be considered unsafe if it caused a serious loss of power or thrust, caused airflow disturbances which excited harmonic compressor blade frequencies, became large enough to cause serious engine damage when ingested, caused damage to adjacent structure or engine components when detached by centrifugal force from rotating surfaces, caused an unbalance of rotating components which produced vibrations greater than those for which the engine had been approved, caused damage due to reduced clearance between rotating and stationary components, or caused any other erratic engine operation.

B.6.4 ROTOR

Rotor operation would be considered unsafe if an accumulation of ice caused a serious loss of thrust and/or lift, caused a reduced autorotational condition to develop, caused damage to adjacent structure when detached by centrifugal force, caused vibrations which could result in control or structural failure, or caused any other erratic helicopter operation.

In hover, the local Mach number along a rotor blade increases linearly to a ~~maximum value~~ at the tip generally near 0.6. Most of the rotor lift is generated within the .35 to .6 Mach number range (outboard of approximately 60% radius). Therefore, the most significant ice accretions (in hover) are those occurring outboard of 60% radius. Ice accreting inboard of 60% will have minimum effect on rotor hover performance, except for probable increases in profile drag (with an associated power required increase).

In forward flight, the rotor limit in normal operating conditions is typically defined by either advancing blade compressibility (Mach numbers beyond 0.7) or retreating blade stall (high angles of attack and Mach numbers 0.3 to 0.5). Ice accretion (causing an overall increase in profile drag) may result in a reduction in the rotor forward flight capability by causing premature drag divergence with the resulting increased blade loads.

In both hover and forward flight, asymmetric shedding of the ice in the outboard regions may cause adverse alternating loads which are transmitted to the airframe, creating as a minimum pilot and passenger discomfort.

The most severe icing conditions for the rotor, therefore, are those conditions which create ice at the critical outboard regions of the rotor. These icing conditions generally occur at the lower ambients (below -5 to -10°C) or at very high liquid water contents (above 1.0 grams per meter³) at ambients above -10°C.

B.6.5 SUMMARY OF RECOMMENDED DESIGN PROCEDURES

As a summary of the procedures for developing a design analysis, an approach similar to the following may be utilized:

- o Choose a sufficient number of helicopter operational conditions to cover that portion of the operational envelope which lies within the icing meteorological envelope for which certification is to be requested. In general, idle power (on the ground), takeoff, hover, cruise, idle power descent and landing conditions will be examined to determine the critical design points. In particular, engine power setting determines the compressor bleed energy available for anti-icing. The specific engine under consideration must be examined to determine allowable bleed extraction and the power/fuel flow impact of bleed.
- o Develop appropriate engine/engine inlet, rotor, windshield, and other critical systems required operational conditions associated with flight envelope.
- o Determine the flow field around the system surfaces under consideration by use of appropriate procedures (i.e. potential flow analysis, test data, etc.) to establish the local velocity and pressures.
- o Select adequate sets of meteorological values in terms of liquid water content, median droplet diameter, maximum droplet diameter, and ambient temperature covering continuous and intermittent icing conditions over the applicable range of values.
- o Establish the water impingement rate on each surface under consideration by use of appropriate procedures (i.e. particle trajectory analysis, test data, contour matching, etc.) to establish the local and total water catch, limits of impingements, estimate ice accretion thickness and ice shape.
- o Determine surfaces requiring ice protection, type of protection (i.e. deflection, anti-icing or deicing), method of protection (shield, deflector, screen, heated surface) and available anti-icing/deicing sources (i.e. hot air, hot oil, electrical liquid/chemical, etc.).
- o Determine the overall heat required to satisfy the system demands in the case of thermal systems. For anti-icing systems, first determine

the surface heat (or flow) distribution from the leading edge (or stagnation point) to the impingement limit aft (for upper and lower surface contours as appropriate. Aft of the impingement limit, water runback must be considered in the heat (or flow) distribution. The choice of anti-icing system determines the method of calculating total heat (or flow) required. For example, if an electrically heated composite material is selected, the heat losses between the external (water impingement side) surface, the heater location, and the interior surface must be determined to establish the local heater power density and the total required input power. In the case of a hot air heated system, for example, when a double skinned flow passage is considered, a step-wise heat balance calculation technique is required to establish the external surface temperature distribution at various hot air flow/temperature/pressure inputs. Again as with the composite material (electrically heated) system, the interior heat losses must be taken into account.

- o The deicing system overall heat (the electrothermal deicing for the rotor is described) is determined by the shedding cycle time desired at a specific ambient temperature (and ice thickness), the size and number of heater elements to be activated at any given time, and the material in which the heater is embedded. The shedding cycle time is a function of the electrical power input (power density), the rotor flow field (including ice adhesion forces, centrifugal forces, aerodynamic heating, blade motion, etc.) and the physical arrangement of the heater elements (i.e. chordwise, spanwise, tapered power density, etc.)
- o The anti-icing/deicing system requirements are then compared to the available power/heat sources to determine overall system capability.
- o Once the basic ice protection systems have been established, and the design analysis procedures developed, a range of icing meteorological conditions, and helicopter operating conditions can be checked to insure satisfactory overall ice protection systems design over the range for which icing certification is to be requested.

B.7 TESTS

The considerations of meteorological and operational factors were discussed in B.3 and B.4 to indicate how the performance of an icing system can be predicted from an analysis of a combination of these factors. This section (B.7) outlines procedures for testing ice protection systems in terms of these factors.

Assuming that a system has been designed in accordance with the foregoing design approach that the design points can be justified as being the most severe, testing at the design points is all that would be required to show compliance with the regulations. Tests should be adequate to verify the manufacturer's analysis and selection of critical design points.

B.7.1 TEST METHODS

B.7.1.1 Natural Icing Flight Tests

One of the best methods for determining the performance of any ice protection system is to subject the helicopter and the protection system to natural icing conditions and to demonstrate that the helicopter can be safely operated while exposed to the icing conditions defined by the requirements. Natural icing tests are required prior to certification for operation in icing conditions.

Since natural icing conditions within the helicopter flight envelope are difficult to find, it is preferable to select the geographical area and seasonal period most likely to produce the desired conditions and to constantly check the local weather forecast for the desired altitude, cloud condition, and temperature. Efforts should be made to find an area where air traffic will permit climbs through stratiform clouds to seek out the higher LWC levels of the cloud.

The flight test helicopter should have instrumentation to determine liquid water content and droplet size or a means of determining ice accretion rate and the extent of impingement from which these parameters can be established. The instrumentation should permit evaluation of icing rates on all critical systems including the rotors. Current aspirated ice detectors (calibrated in icing tunnels) appear to offer an acceptable means to measure liquid water content. Drop size can be approximated from the extent of impingement on any shape with known impingement characteristics by use of droplet spectrometers or by other acceptable means.

State-of-the-art airborne icing measurement instrumentation, however, has shortcomings. A simple but imprecise indicator of the liquid water content and drop size values specified is the observation and photographing of ice buildup on small rod or airfoil and correlation (corrected for velocity) with similar buildup under measured conditions in icing tunnel. When the specified conditions have been obtained, the helicopter should be investigated for handling qualities to explore the effect of ice accretion on the unprotected surfaces, particularly the rotors if no deicing system is installed.

For a helicopter of new design and for aft-mounted engines, where ice shedding from the fuselage and rotor can cause engine damage or flameout, the flight test program should require determination of the effects of ice shedding, and verification of the engine protection system.

The value of the natural icing flight tests can vary with the following:

- o Correlation of test results with analysis predictions.
- o Ability to compare with previous designs.
- o Extent of icing tunnel tests as basic criteria.

- o Extent of successful correlation of flight skin temperature surveys in dry and wet air full-scale tests with similar shapes and temperatures investigated in the icing tunnel.
- o Correlation of natural icing test buildup on representative or known sections with icing tunnel shapes, considering correction for time and airspeed.
- o The existence of unprotected ice-catching protuberances, such as antennas, scoops, struts, fuel vents, controls, etc.

B.7.1.2 Dry Air Flight Tests

Dry air flight tests can be used to verify the design objectives of a thermal ice protection system. These tests may be conducted as a preliminary to natural icing tests to check the function and performance of system components and compatibility of systems. Calculated engine bleed air mass flows for anti-icing systems can be verified. Ice shape testing of the rotor has not progressed to a point where this procedure can be recommended. An analysis of heat requirements and availability at various operational conditions can be performed from data collected during dry air tests.

B.7.1.3 Helicopter Icing Spray System (HISS) Tests

Helicopter in-flight tanker (HISS) tests are being used by the U.S. Army to verify operation of various helicopters under simulated icing conditions. Ice protection systems and unprotected helicopter areas can be evaluated over a range of ambient temperatures and liquid water contents.

The current HISS is working toward simulating natural icing conditions by maintaining good water droplet size control. Programs are currently underway incorporating spray nozzles capable of producing 20 to 50 micron (median) droplets. Testing of the nozzles has been accomplished (January - March 1980) and the results show a major step improvement toward achieving simulation of natural icing.

B.7.1.4 Hover Spray Rig Tests

Ground level (hover) icing spray rig testing (i.e. NRC Ottawa spray rig) offers a closely controlled icing environment for development and check-out of ice protection equipment. The hover rig allows rapid access by ground personnel for examination of ice accretion and ice shedding characteristics. Good water droplet size and liquid water content controls over the continuous maximum icing envelope can be maintained during the helicopter icing penetration.

B.7.1.5 Icing Tunnel Tests

Icing tunnel tests are perhaps the least expensive method for determining the performance of an icing system under various conditions. There are several icing tunnels in existence which have the capability to control

LWC, droplet size, and temperature conditions quite accurately over their range of capabilities. The largest of these is the NASA Lewis Icing Tunnel (6 ft x 9 ft test section) in Cleveland, Ohio. The advantages of ice tunnel test facilities are their ability to control the meteorological conditions through a range of values, to simulate a variety of operational conditions, and to measure performance quite accurately. Instrumentation is generally more extensive and accurate than flight test instrumentation. The disadvantages of ice tunnel tests are their inability to simulate the effects of ice accumulations on unprotected surfaces, and their inability to provide the combined operational and meteorological conditions that exist during an icing encounter of the full-scale helicopter. Turbulence, sidewall effects, size, and scaling factors can be problems in ice tunnel tests. Most tunnels are very small and obtaining aerodynamic and thermodynamic similarity for models of large components can be difficult. This is particularly true of the rotor system, because of lack of proper rotating capability of current icing tunnels, and lack of verification of scaling the rotor to fit within current tunnels. Full-scale values may be determined from natural icing flight tests, dry air flight tests, hover spray rig tests, in-flight tanker tests, or any combination of these tests.

B.7.1.6 Combination of Methods

Flight tests in natural icing conditions under design point meteorological and operational conditions provide the most desirable method for showing compliance with the regulations. For substantiation, however, a combination of methods may be necessary. The most desirable combination of methods would usually comprise icing tunnel tests at the design points for those systems adaptable to the tunnel (for example, engine inlet), with dry air, hover rig, in-flight tanker and natural icing tests of the full-scale system under actual flying conditions. Data obtained by the flight tests can be used to verify the manufacturer's analysis and ice tunnel data. The flight tests should also assure that no severe operational or design deficiency exists.

B.7.2 ICE SHEDDING

The path of ice released from the helicopter fuselage or rotor varies with parameters such as ice shape and density, attitude and altitude, airspeed, rotor rpm, air flow, ambient temperature and rotor recovery temperature, ice release mechanism (i.e., anti-icing/deicing system operation), etc. Therefore, it may be difficult on some configurations to show that ice released will not enter into engine inlet ducts or strike and damage other parts of the aircraft. A desirable approach for resolving an apparent "ice shedding" problem is to install ice protection provisions in critical areas or insure that vulnerable components have adequate FOD protection.

If ice protection provisions are not installed in critical ice shedding areas, in particular, the rotors, pylons and upper windshield areas, then investigations should be conducted to show that ice which sheds off of the helicopter surfaces will not cause an unsafe condition. "Ice shedding" investigations should be made during and after ice encounters. Sufficient

encounters in all intended operation conditions should be made to minimize the hazard associated with the release of ice. In addition to the usual measurements and observations made during ice encounter tests, the following additional instrumentation and/or observations are suggested:

- o High speed (i.e., 200 to 400 frames per second) motion pictures to record the trajectory of ice released from the helicopter.
- o Photopanel for turbine-engine-powered helicopter to record EGT, gas generator speed, engine torque and rotor RPM and torque for the purpose of detecting adverse effects on engine and rotor operation.
- o Visual examination of the helicopter for damage before and after ice encounters, especially in the area of the engine compressor, inlet, aft or tail rotor, and pylon/fins.

B.7.3 TEST PROCEDURES FOR AIRFRAME SURFACES

B.7.3.1 Ice Tunnel Tests

For ice tunnel tests of these areas, design point values of LWC, Dd, and T should be established in the tunnel at the pressure, temperature, velocity, etc., defined by the design operational conditions. In an ice tunnel test of an evaporative system, all of the impinging water should evaporate. In an ice tunnel test of a non-evaporative or running wet system, the predicted amount of runback water should not be exceeded and any ice that forms on critical surfaces should be within the limits predicted in the design analysis and confirmed as acceptable by flight tests.

Liquid systems tested in an icing tunnel should preclude ice formation on the protected surfaces for the designed period of protection with flow of temperature depressant fluids within the design value.

B.7.3.2 In-Flight Tanker or Hover Spray Rig Tests

In-flight tanker (HISS) tests can be useful as a development tool and, with the droplet size improvements accomplished, offer a good correlation with natural icing conditions.

Hover spray rig tests of full-scale helicopters may be used in the substantiation of the critical design points, since the spray can be calibrated to produce the design LWC and droplet diameter. Tests are conducted under hover conditions representative of the design point conditions, however, correlation of this data must be made with forward flight icing tests.

B.7.3.3 Dry Air and Natural Ice Tests

Dry air and natural icing tests of full-scale helicopters should be conducted as closely as possible to design point conditions to reduce the uncertainty associated with extensive extrapolations. These tests should

demonstrate the effectiveness of the icing system under natural conditions. The tests should also provide the means by which the buildup of ice on running wet and unprotected surfaces can be evaluated with respect to the engine operational characteristics. It may be possible to simulate ice accumulations on full-scale helicopter rotors during dry air flight tests. However this approach on the rotor should be with extreme caution until the rotor dynamics are fully understood.

The natural icing tests should demonstrate that no hazardous accumulations of ice occur which could cause an unsafe condition to develop when icing is encountered. Sufficient testing in natural ice conditions should be accomplished to confirm assumptions made in the manufacturer's analysis and to establish that the extrapolations are accurate within acceptable limits.

B.7.4 TEST PROCEDURES FOR ENGINES

For complying with FAR Part 33.67, the icing conditions defined by charts in Appendix C of Part 25 (Reference B12) are given as the general icing conditions under which engine qualification should be accomplished. Appendix C charts cover such a wide range of conditions and combinations of the various icing parameters that numerous data test points would seem to be indicated. However, experience with turbine engines has indicated that the critical conditions can be covered adequately by engine icing tests covering only a few specific conditions coupled with acceptable analyses, dry air tests, rig tests, or experience with similar engines.

The U.S. military services, for many years, have been qualifying engines to two specific conditions for sea level testing. An update of these icing test conditions per MIL-E-8593A (Reference B13) denoted as Part 1 are:

- o Inlet total temperature = -20°C ; mean effective drop diameter = 20 microns; liquid water content = 1 gram/meter³.
- o Inlet total temperature = -5°C ; mean effective drop diameter = 20 microns; liquid water content = 2 grams/meter³.

Part 2 icing conditions (MIL-E-8593A) are.

- o Inlet total temperature = -5°C ; mean effective drop diameter = 30 microns; liquid water content = 0.4 grams/meter³.

The following guidelines are provided to assist in establishing acceptable testing programs and to promote uniform levels of compliance.

B.7.4.1 Acceptable Means of Compliance

The engine should be capable of operating acceptably under the meteorological conditions of Appendix C of FAR 25 over the engine operating envelope.

Experience has indicated that testing to the points set forth in the following table and schedule has been considered a successful means of showing compliance if used in conjunction with the critical conditions determined in the design analysis.

- o Operate the engine steadily under icing conditions noted under Part 1 for at least 10 minutes each at takeoff setting, 75 percent and 50 percent of maximum continuous power and at flight idle setting, then accelerate from flight idle to takeoff. If ice is still building up at the end of 10 minutes, continue running until the ice begins to shed or until the engine will no longer operate satisfactorily.
- o Operate steadily at ground idle setting for at least 60 minutes under the icing condition noted under Part 2 followed by acceleration to takeoff setting.

Engine operation in these icing conditions should be reliable, uninterrupted, without any significant adverse effects, and include the ability to continue in operation and accelerate. Some power reduction is acceptable at idle power settings but all other operation should be unaffected.

Special consideration and tests should be conducted to adequately substantiate:

- o Engines with inlet screens.
- o Engines with air passages which might accumulate snow or ice due to restrictions or contours.
- o Unprotected surfaces upon which ice may build up to significant degrees for longer exposures than specified above.

B.8 FINDING ICING CONDITIONS FOR TEST PURPOSES

Helicopter icing has been the subject of a great deal of discussion, but actual operational encounters with icing conditions have been rarely documented. Scheduled flight operation in icing conditions is not usual, while finding natural icing conditions for testing ice protection systems can be a problem during certification programs.

Ice accretion will occur on any object moving through a cloud when the temperature is below freezing. The rate of ice buildup will vary with:

- o The water density of the cloud, i.e., liquid water content.
- o The velocity of the object.
- o The size and shape of the object.
- o The temperature of the air and the temperature of the object.
- o The temperature of the water drops.

The shape and consistency of ice buildup will vary with:

- o Temperature of the object, the cloud, and the water drop.
- o The velocity of the object, as it (the ram temperature rise) affects the surface temperature.
- o Thickness ratio of the object and "sweep" with respect to the free stream.

Typical icing zones along frontal weather conditions are illustrated in Figures B-7 through B-10. The comments in each figure discuss the general icing severity that may exist on either side of the front.

B.8.1 FINDING ICE IN STRATIFORM CLOUDS

The following conclusions are based on practical experience and success in finding icing conditions in stratiform cloud conditions:

- o Flight over mountainous terrain should be avoided because of inconsistencies in the relationship between liquid water content and temperatures.
- o For given temperature, the shape of the ice accretion will vary with droplet size.
- o Conditions approaching rain, such as large drops splatterings on the windshields or intermittent sharp increase in catch, rate, should be avoided. These conditions indicate that there is a rain-producing cloud above the stratoform cloud and that intermittent conditions may be encountered.
- o It should be recognized that the variation in LWC with temperature (for a given drop size) is an expression of the predicted variation of cloud density with temperature. One should choose what is believed to be critical temperature for the type of protection system involved.
- o Icing conditions frequently occur in very moist air masses blowing inland from warmer seas, such as the Gulf of Mexico, the Japan current, and the Gulf Stream, or over the Great Lakes.
- o Random seeking of ice is time consuming and wasteful. Adequate planning will increase the chance of success.

B.8.2 FINDING ICE IN CUMULIFORM CLOUDS

- o The meteorological condition which yields reasonably consistent icing can be found in a mild or building (cold) frontal system.
- o Intense line squalls should be avoided, such as those prevalent in "tornado alley" in central U.S. and all "contour holes" in radar. These conditions contain extreme vertical air currents, which produce large variations in LWC, drop size, and temperature. The ice catch in severe line squalls will probably be very erratic and conditions change so rapidly that instrumentation is useless.

ICE & WATER CLOUD

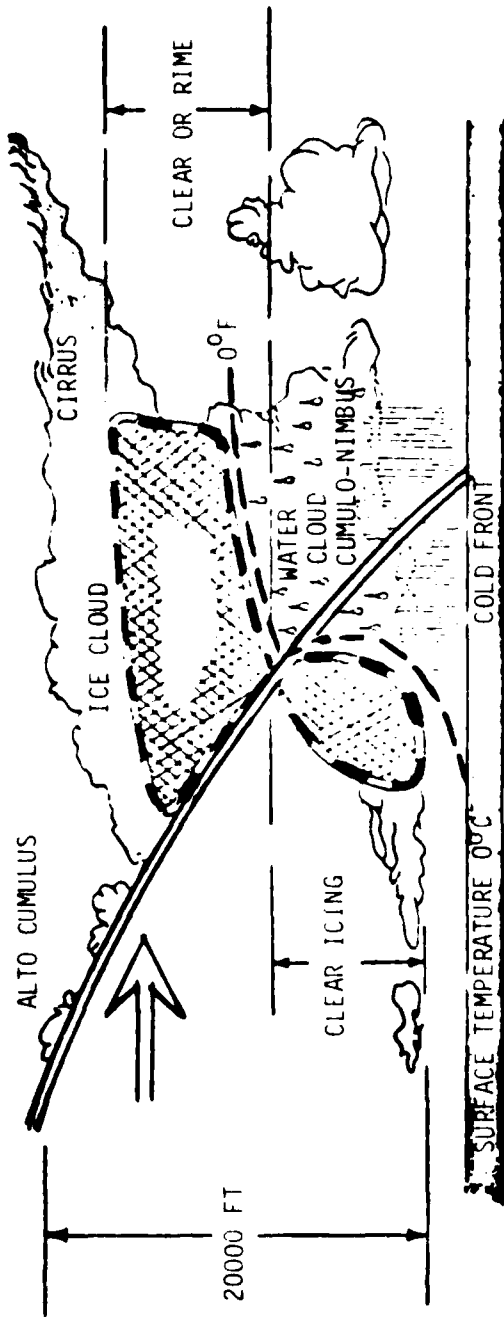

COMMENTS: ICING ASSOCIATED WITH COLD FRONTS IS USUALLY SPOTTY: ALSO ITS HORIZONTAL EXTENT IS LESS, AND THE AREAS OF ICING ARE LOCALIZED.

CLEAR ICING IS MORE PREVALENT THAN RIME ICING.

CLEAR ICING IS USUALLY LIMITED TO SUPERCOOLED CUMULIFORM CLOUDS WITHIN 100 MILES TO THE REAR OF THE COLD-FRONT SURFACE POSITION.

ICING IS OFTEN ENCOUNTERED IN THE EXTENSIVE LAYERS OF SUPERCOOLED STRATOCUMULUS CLOUDS WHICH FREQUENTLY EXIST BEYOND COLD FRONTS.

FIGURE B-7. ICING ZONES ALONG A COLD FRONT

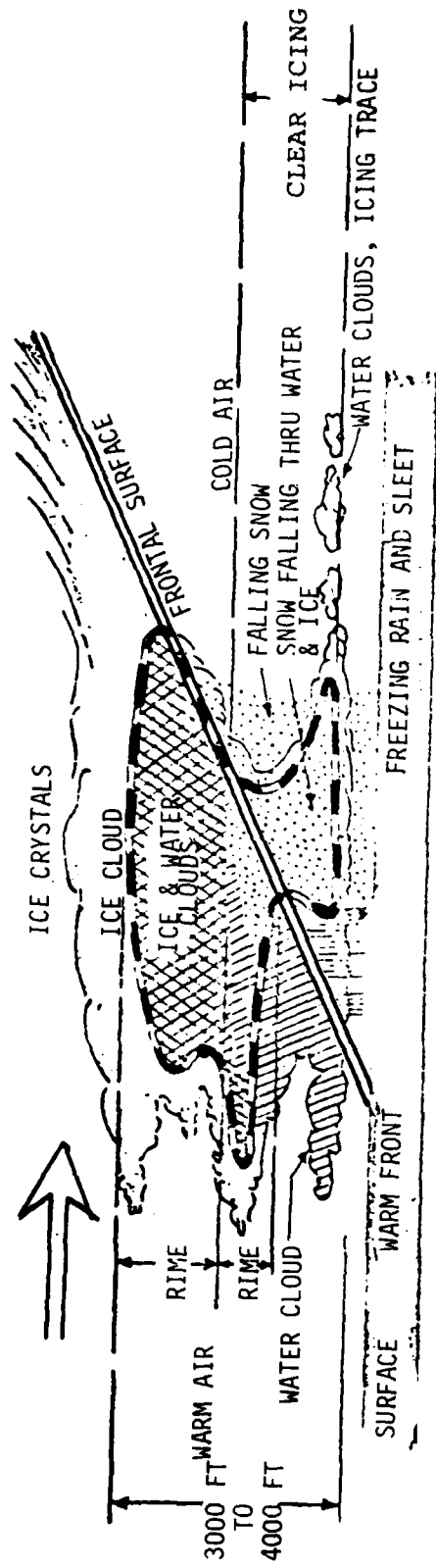

B-31

COMMENTS: CLEAR ICING USUALLY OCCURS WHERE FREEZING RAIN OR FREEZING DRIZZLE FALLS THROUGH THE COLD AIR BENEATH THE FRONT.

ICING USUALLY MIXED OR CLEAR MAY OCCUR WITHIN 100 TO 200 MILES AHEAD OF THE WARM-FRONT SURFACE POSITION. (PARTICULARLY FAST-MOVING FRONTS)

RIME ICE MAY OCCUR IN THE ALTOSTRATUS UP TO 300 MILES AHEAD OF THE WARM-FRONT SURFACE POSITION.

FIGURE B-8. ICING ZONES ALONG A WARM FRONT

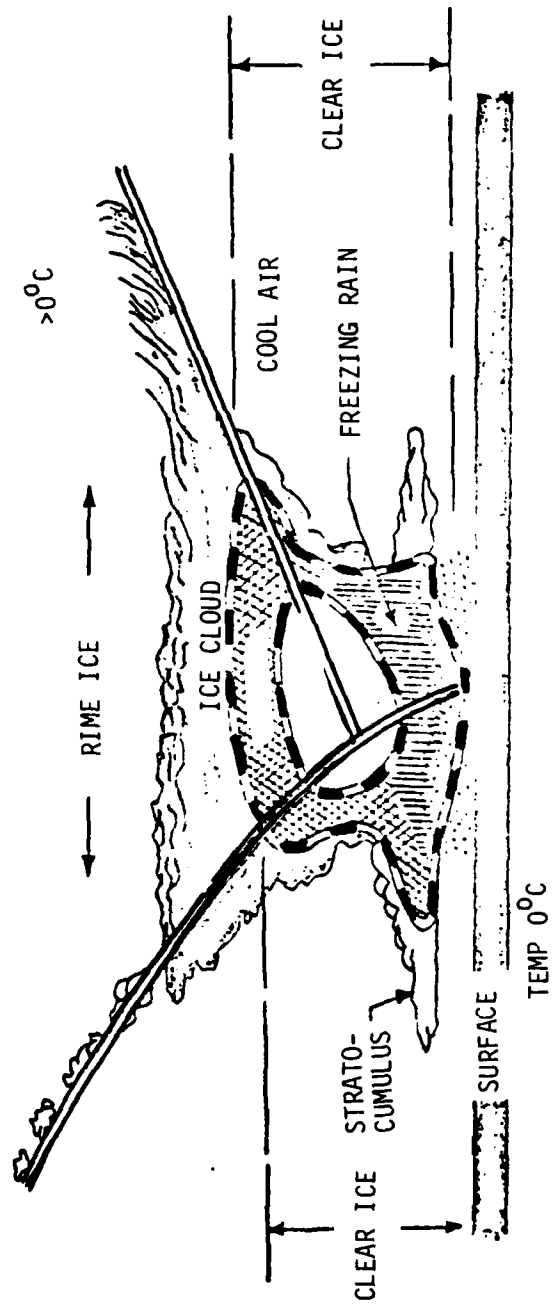

COMMENTS: ICING CONDITIONS ARE FREQUENTLY ASSOCIATED WITH DEEP, COLD, LOW-PRESSURE AREAS IN WHICH THE FRONTAL SYSTEMS ARE QUITE DIFFUSE.

FIGURE B-9. ICING ZONES ALONG AN OCCULDED FRONT

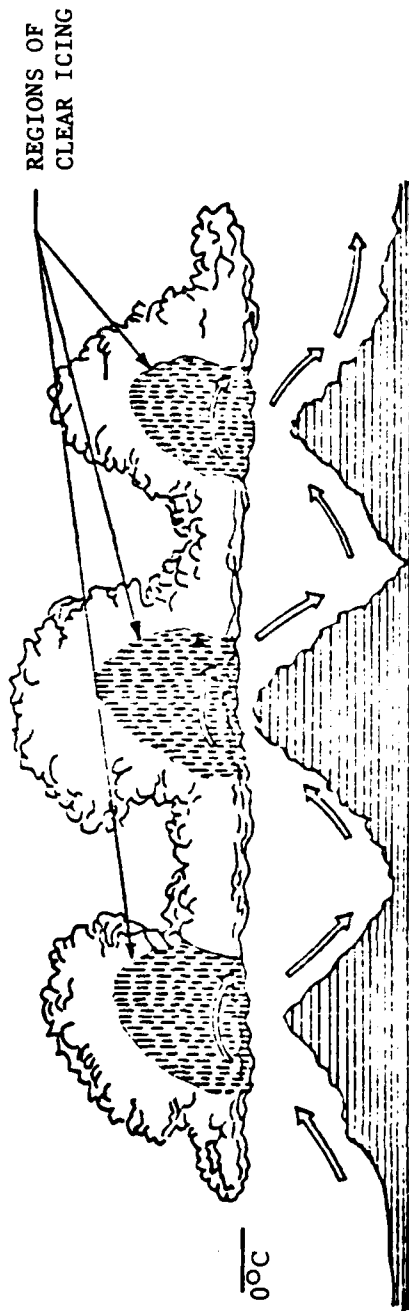

COMMENTS: HIGH OR STEEP TERRAIN, PARTICULARLY MOUNTAINS, CAUSES ICING TO BE MORE INTENSE THAN USUAL UNDER IDENTICAL CONDITIONS OVER LOW, FLAT TERRAIN.

ICING IS GREATER OVER THE RIDGES THAN OVER VALLEYS AND GREATER ON THE WINDWARD SIDE THAN ON THE LEEWARD SIDE.

ICING, USUALLY CLEAR, IS EXPERIENCED IN CONVECTIVE CLOUDS OVER MOUNTAINOUS TERRAIN.

FIGURE B-10. ICING OVER MOUNTAINS

- o It is best to avoid mountainous areas, because the mechanical lifting causes erratic vertical variations in temperature and only complicate finding the correct altitude (temperature).

B.9 SUMMARY OF RECOMMENDED PROCEDURES FOR TYPE CERTIFICATION

B.9.1 AIRFRAME MANUFACTURER

The airframe manufacturer should submit a design analysis which has as its prime objective the determination of the critical design points and prediction of performance of protective systems for those areas of the helicopter for which he has certification responsibility. The selection of these points should involve consideration of all the factors covered in this advisory circular. The manufacturer's test proposal should be submitted and agreement reached on procedures before testing is begun.

B.9.2 ENGINE MANUFACTURER

The engine manufacturer should submit a design analysis which has as its prime objective the establishment of sufficient critical design points to assure that the engine can function adequately in continuous maximum and intermittent maximum conditions. The selection of these points should involve consideration of all the factors covered in this advisory circular. The manufacturer's test proposal should be submitted and test procedures agreed upon before testing is begun. Testing should be conducted at sufficient points throughout the power or thrust range to demonstrate that no unsatisfactory engine operational feature exists under these conditions.

B.10 REFERENCES

- B1. FAA Advisory Circular 20-73: Aircraft Ice Protection, 21 April 1971.
- B2. KITCHENS, P.F.: Simulated Icing Tests of Rotor Blade Ice Phobic Coatings, 36th Annual Forum of the American Helicopter Society, Paper No. 80-53, May 1980.
- B3. MAGENHEIM, B.: Demonstration of the Microwave Ice Protection Concept, USAAMRDL-TR-77-34, May 1978.
- B4. Vibratory Ice Protection System, Investigation, USAAMRDL-TR-77-29, June 1978.
- B5. JONES, A.R. and LEWIS, W.M.: Recommended Values of Meteorological Factors to be Considered in the Design of Aircraft Ice Prevention Equipment, NACA TN 1855, 1949.
- B6. HACKER, P.T. and DORSCH, R.G.: A Summary of Meteorological Conditions Associated with Aircraft Icing and a Proposed Method of Selecting Design Criteria for Ice-Protection Equipment, NACA TN 2569, 1951.
- B7. LEWIS, W.M. and BERGRUN, N.R.: A Probability Analysis of the Meteorological Factors Conductive to Aircraft Icing in the United States, NACA TN 2738, 1952.
- B8. WERNER, J.B.: Ice Protection Investigation for Advanced Rotary-Wing Aircraft. USAAMRDL Technical Report 73-38, August 1973.
- B9. WERNER, J.B.: The Development of an Advanced Anti-Icing/De-Icing Capability for U.S. Army Helicopters, Volume I - Design Criteria and Technology Considerations. USAAMRDL-TR-75-34A, November 1975.
- B10. BERRY, F.A., BOLLAY, E., and BEERS, N.R.: Handbook of Meteorology, 1945.
- B11. BOWDEN, D.T., GENSEMER, A.E., and SPEEN, C.A.: Engineering Summary of Airframe Icing Technical Data, FAA Technical Report ADS-4, 1964.
- B12. Department of Transportation, Federal Aviation Administration: Federal Aviation Regulations (FAR).
- B13. Military Specification: Turboprop/Turboshaft Engines, MIL-E-8593A, October 1975.

APPENDIX C

PREDICTION OF AIRFOIL CHARACTERISTICS

C.1 REVIEW OF THEORETICAL METHODS OF ANALYSIS

As illustrated in Figure C-1, the performance and loads characteristics of a helicopter rotor in forward flight are dominated by the outboard 40% of the advancing and retreating blade. Specifically, the sectional characteristics which have the largest impact on rotor limits are:

- o The maximum lift coefficient at Mach numbers from 0.3 to 0.5 for the retreating blade.
- o The drag divergence and pitching moment break characteristics for the tip of the advancing blade.
- o The overall sectional pitching moment level, normally quantified by the low-speed zero-lift pitching moment coefficient.

In addition, the overall power level both in hover and forward flight can be related to the degradation in profile drag coefficient at a typical Mach number $M = 0.6$, at representative lift levels $0.4 < C_L < 0.65$.

These and other sectional characteristics of importance in helicopter airfoil design are discussed in detail in Reference C1. The methods of References C2 and C3 can be used to determine the impact of airfoil contour variations on the maximum lift coefficient, drag, drag divergence, pitching moments, etc., by following the procedures outlined in detail in Reference C1. The key characteristics of the flow for each design condition are summarized in Figure C-2, quoting from introductory material in Reference C1.

C.1.1 Maximum Lift Coefficient in Absence of Substantial Transonic Effects ($0.3 < M < 0.45$)

The maximum lift between $M = 0.3$ and $M = 0.5$ has been shown to be critical in delaying retreating blade stall. The flow phenomena which cause separation at high lift levels are a function of both free stream Mach number and airfoil shape. For the airfoils typically employed on helicopter rotors, the maximum lift at $M = 0.3$ and $M = 0.4$ is associated with only a small supersonic region at the leading edge, so that the use of potential flow/boundary layer interaction methods, such as Reference C2, is generally acceptable. At $M = 0.5$, the local flow can include larger supersonic regions and the analysis must be carried out with different techniques.

The use of potential-flow/boundary-layer interaction methods, e.g., Reference C2, requires careful correlation with test data. Most of the correlation necessary for the present work was carried out using data from Reference C4 for airfoils acquired in one wind tunnel facility. The best correlation for the maximum lift at $M = 0.4$ was obtained by assuming that

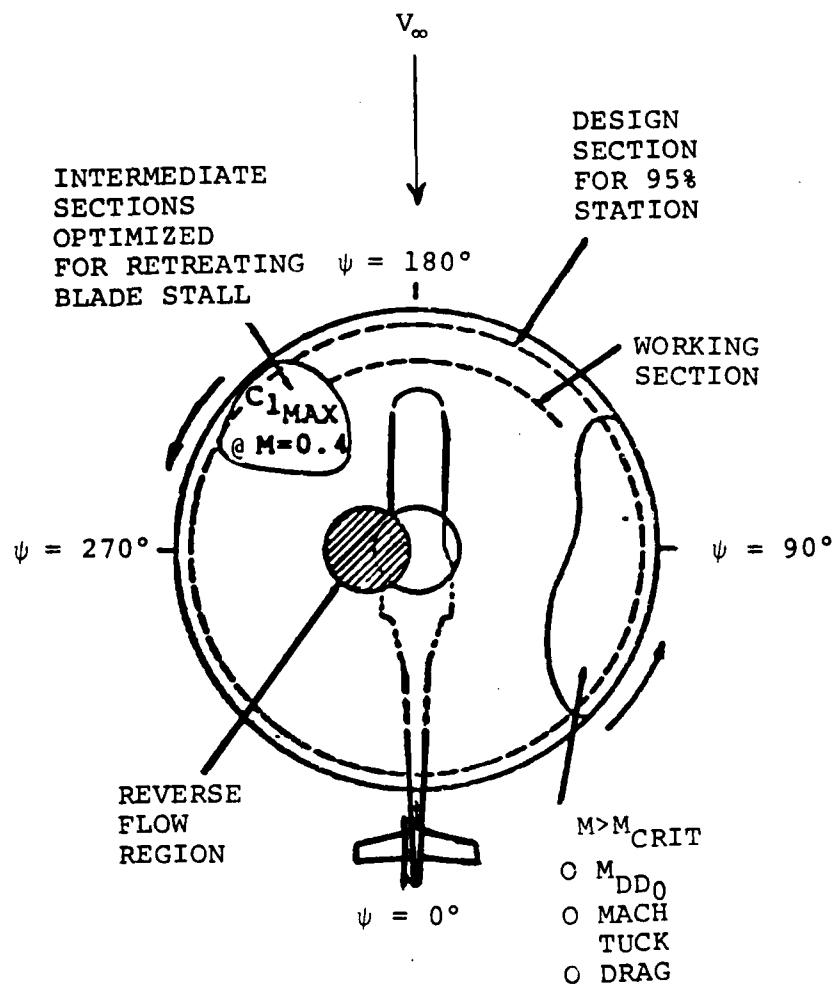

FIGURE C-1. ROTOR ENVIRONMENT - FORWARD FLIGHT

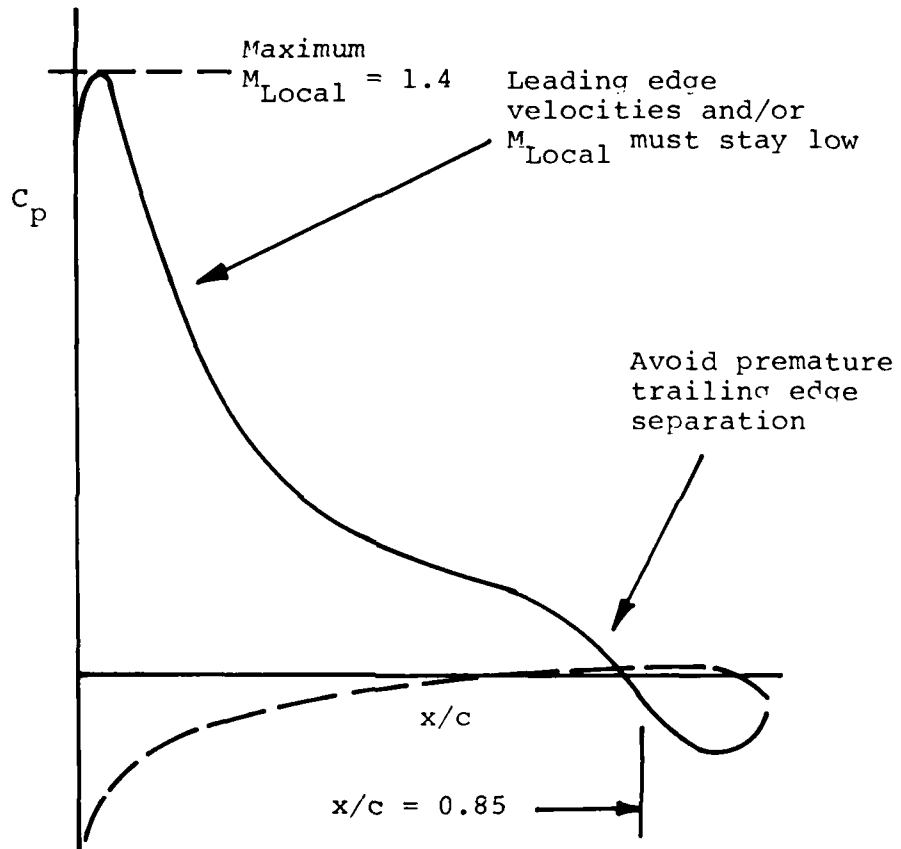

FIGURE C-2. AIRFOIL CORRELATION PARAMETERS

the flow over an airfoil cannot sustain additional lift when the local Mach number exceeds $M\ell = 1.4$ near the leading edge, or when the turbulent separation reaches the $x/c = 0.85$ chord location, as illustrated in Figure C2.

C.1.2 Maximum Lift Coefficient in Presence of Transonic Effects ($M > 0.45$)

High maximum lift capability at $M = 0.5$ is desirable for operating conditions which result in retreating blade stall at $M > 0.4$. Dr. Wortmann, Reference C5, pointed out that the chances for a high maximum lift capability at $M = 0.5$ can be improved by properly tailoring the upper surface between the leading edge and the 10% chord location. However, the supersonic region near the leading edge levels can be of a significant size. When this is the case, conventional subcritical flow analysis methods cannot be meaningfully extended to the flow conditions near maximum lift. Transonic flow methods are the necessary.

A transonic analysis allows the evaluation of the supersonic region near the leading edge. The resulting local velocities display a significant redistribution compared to the subcritical potential flow solution. When transonic flow effects are included, the maximum lift levels based on a "maximum" allowable local Mach Number (e.g., $M\ell = 1.4$) can be higher than those possible with subcritical flow solutions. A more meaningful correlation could be obtained by interpreting shock/boundary-layer interaction effects, but such correlation was not attempted within the scope of this report.

The viscous, transonic flow analysis, Reference C3, predicts quite successfully the maximum lift trend of airfoils benefitting of favorable transonic effects. The only question which remains unanswered is the magnitude of the maximum lift possible above the potential flow level. Such additional lift could not be determined with any degree of confidence because it is not clear at this time to what extent wall effects influences the high lift levels measured on airfoils, such as the VR-7, Reference C4.

C.1.3 Low Speed Pitching Moment Coefficient

It has been pointed out in a number of instances, e.g., Reference C6, that small, and in some cases, nose-up pitching moments are necessary to minimize rotor loads in forward flight. Although the theoretical zero-lift pitching moment is generally quoted from incompressible and inviscid flow solutions, a low Mach number value is more meaningful when viscous and compressible flow solutions are available. As shown in Figure C-3, low or nose-up pitching moments require:

- o Most of the lift from the front 50% of the chord.
- o Zero or down-load on the trailing edge of the airfoil.

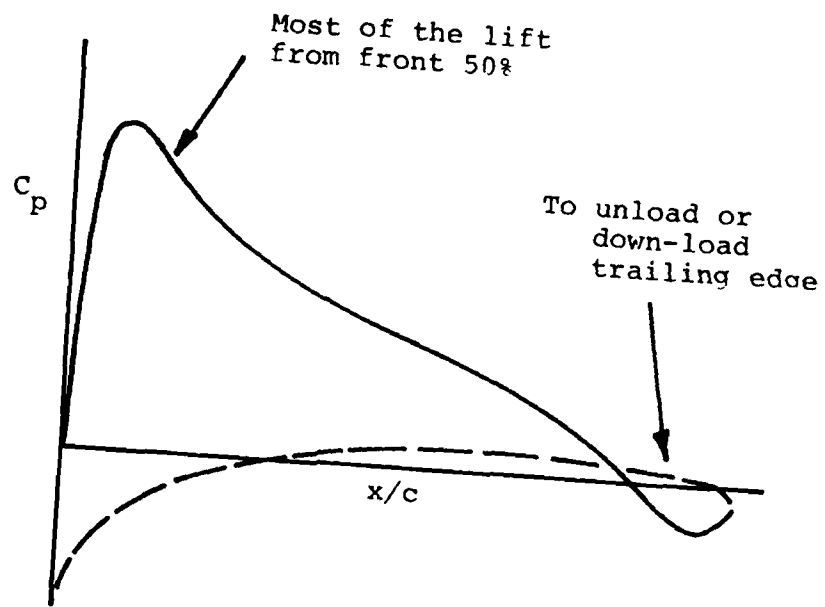

FIGURE C-3. Pitching Moment Requirements

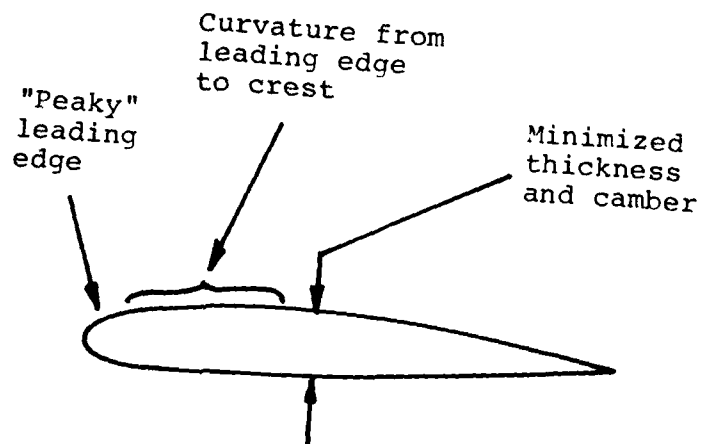

FIGURE C-4. Airfoil Geometric Characteristics

Since present analysis methods do not account for the effect of thick boundary layers or separated flow, theory generally overpredicts the effectiveness of the contour changes used to compensate pitching moments in the nose-up direction.

C.1.4 Drag Divergence and Pitching Moment Break Characteristics

The drag-divergence Mach number at zero lift is a measure of the usefulness of a section near the tip of a helicopter rotor blade in forward flight. While the drag-divergence Mach number is not the best parameter to quantify the drag penalty associated with strong compressibility effects, the method available to evaluate it (crest-line theory, Reference C7), is simple and reliable. Therefore, crest-line theory is the most efficient way of approaching airfoil design at the onset of supercritical flow conditions. Figure C-4 summarizes some of the geometric characteristics which have a dominant role in increasing M_{DD} .

The theoretical drag-divergence boundary as estimated from crest-line theory is always conservative with respect to wind tunnel test data. Although it is possible that in some cases the test data show some relief due to wall effects, the discrepancy between theory and test appears to be quite consistently $\Delta M_{DD} = 0.02$. The viscous transonic flow method of Reference C3 does not improve this correlation, and a $\Delta M_{DD} = 0.02$ discrepancy between theory and test is reported in the text.

Crest-line theory alone does not give any indication of the presence of drag creep at Mach numbers below M_{DD} , nor does it quantify the rate of growth in drag beyond M_{DD} . Other empirical methods are available to provide guidelines (Reference C1). In the case of drag creep, the information obtained from crestline theory at least establishes the optimum potential of an airfoil. More sophisticated methods of analysis and, ultimately, test verification are necessary to rigorously establish the drag divergence Mach number and the level of drag at drag divergence.

The growth in the sectional pitching moment coefficient cannot be estimated by means of crest-line theory; however, since the mechanism in pitching moment growth is the same as that for drag rise, as a first approximation it can be assumed that the pitching moment break boundary is not far from the drag divergence boundary. However, a review of the details of these compressibility effects shows that, at the onset, drag and pitching moments do not grow to unacceptable levels at the same time, as illustrated in Figure C-5, from Reference C8. Acceptable helicopter rotor configurations display a growth in power drag before the onset of severe loads (pitching moment).

A qualitative assessment of drag rise and pitching moment break can be obtained by use of the viscous transonic code of Reference C3, although great care must be exercised to correlate the predictions with 2-D airfoil test data. Certain complexities of the transonic flow cannot yet be successfully modeled, and the analysis will not predict correctly either the effect of severe shock/boundary layer interaction or the growth in separated flow regions.

LOADS AT 90% OF SPAN

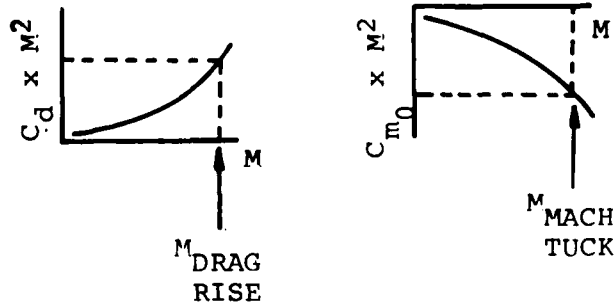
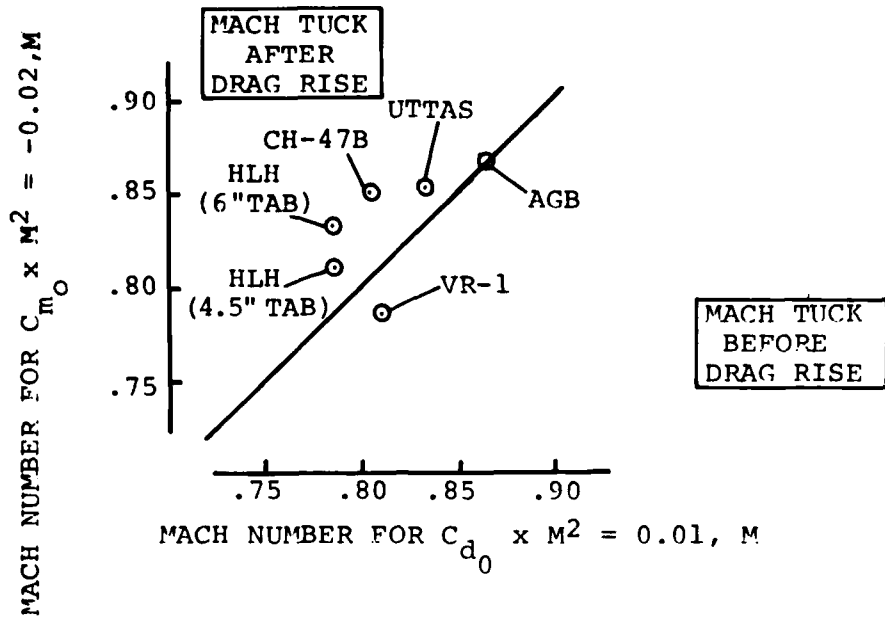

FIGURE C-5. Compressibility Effects on Drag and Pitching Moment Characteristics of Several Helicopter Rotor Sections.

C.1.5 Stall Characteristics

Helicopter rotor design guidelines are generally aimed at the reduction in load excursions associated with stall. A further consideration is that gradual stall in the quasi-steady regime has been correlated with positive aerodynamic damping for pitch oscillations through stall at the 1/rev and 2/rev frequencies, Reference C9. While the stall character cannot be predicted rigorously, potential-flow/boundary-layer interaction methods give a good indication of which type of stall is most likely to take place. Trailing-edge stall, characterized by the movement upstream of the turbulent separation point, is qualitatively predictable. Leading-edge stall is very likely when the local Mach number at the leading edge reaches $M = 1.4$. However, the prediction of the actual shape of the C_l , α and C_m , α curves at and beyond stall can be approximated only by comparison with known test data. A correctly optimized airfoil will display a combination of leading-edge and trailing-edge stall characteristics, with trailing-edge separation becoming dominant somewhat ahead of leading-edge separation.

C.2 APPLICATION OF CURRENT AIRFOIL PERFORMANCE PREDICTION METHODS TO ROTOR ICING PROBLEMS

C.2.1 Limitation of Methods

The potential flow/boundary layer interaction and viscous transonic flow codes currently available for airfoil analysis, References C2 and C3, have inherent limitations which must be understood before any attempt is made to extend their use to airfoil contours with ice.

The first limitation is in the potential flow model, even before any viscous corrections (boundary layer) are applied to the airfoil contour. In potential flow, the airfoil contours are simulated by series of straight line segments, and basically, the flow solution is obtained with the boundary condition that the external flow be tangent at the center of each of the elements of the polygon replacing the airfoil contour. Codes which allow arbitrary spacing in the definition of such polygon have the implicit requirement that the length of each straight element be not larger than some fraction of the local radius of curvature. By this requirement, a small surface wave or contour irregularity would require a large number of small straight segments to be modeled correctly in inviscid flow. However, most of the recent codes, including the codes of References C2 and C3, have been improved to eliminate the requirement that the input geometry be defined in a manner compatible with the potential flow solution. In the new codes, the arbitrary input geometry is reprocessed, curve-fitted, smoothed, under some circumstances, and a potential flow model is defined by criteria built into the analysis. While this treatment of input coordinates eliminates the need for experience on the part of the individual using the airfoil analysis code, the drawback is that certain types of contour variations are averaged out whether such a smoothing process is desirable or not.

This leads to a second limitation of the potential flow/boundary layer interaction codes. The flow field about an airfoil section is dictated by the "fluid airfoil" shape rather than the physical surface of a section. This "fluid airfoil" includes the boundary layer thickness and any regions of separated flow which might take place in the vicinity of the section. Currently, available methods of analysis do not include regions of separated flow such as might take place near the leading edge due to natural or induced leading edge stall, or near the trailing edge due to turbulent boundary layer separation. Methods accounting for flow separation, including reattachment, when possible, will be available during 1980.

A further limitation is due to the current state of boundary layer theory, and this problem is a separate issue from the problem of separated flow modeling. Research is being currently and actively pursued to correct these deficiencies in boundary layer analysis, but the methods available at this time do not include:

- o Thick boundary layer effects.
- o The effect of free-stream turbulence.
- o The effect of surface roughness.
- o Correct shock-boundary layer interaction modeling.

Improved airfoil codes will be available during 1980. These codes will be tested to determine their usefulness in predicting rotor blade icing effects. The probable outcome of such study will be the recommendation that some of the codes be modified specifically to handle ice contour problems.

C.3 PRELIMINARY TEST/THEORY CORRELATION

An initial investigation of airfoil characteristics under icing conditions was conducted using the early NACA 65-series airfoil sections. NACA Icing Tunnel data, Reference C10, correlates ice shape measurements, impingement rates, icing conditions and drag coefficients for the NACA 65A004 airfoil. The airfoil prediction program described in Reference C2 was used for an approximate check of the performance of the NACA 65A004 with and without ice, as illustrated in Figure C-6. Note that the predicted clean airfoil drag (2 degree angle of attack) is 12% less than that measured in the NACA (NASA) tunnel (probably due to tunnel turbulence effects).

The first trial correlation of the iced airfoil using a natural boundary layer transition (laminar-to-turbulent) showed a decrease in drag coefficient because the analytical ice contour could not be modeled with the proper roughness (one of the limitations of current boundary layer computing capability).

Application of NASA standard airfoil roughness and other ice-shape induced losses would be necessary to match the original test data. Several problems were apparent during this initial analytical correlation effort:

DRAG COEFFICIENT C_D NACA 65A004

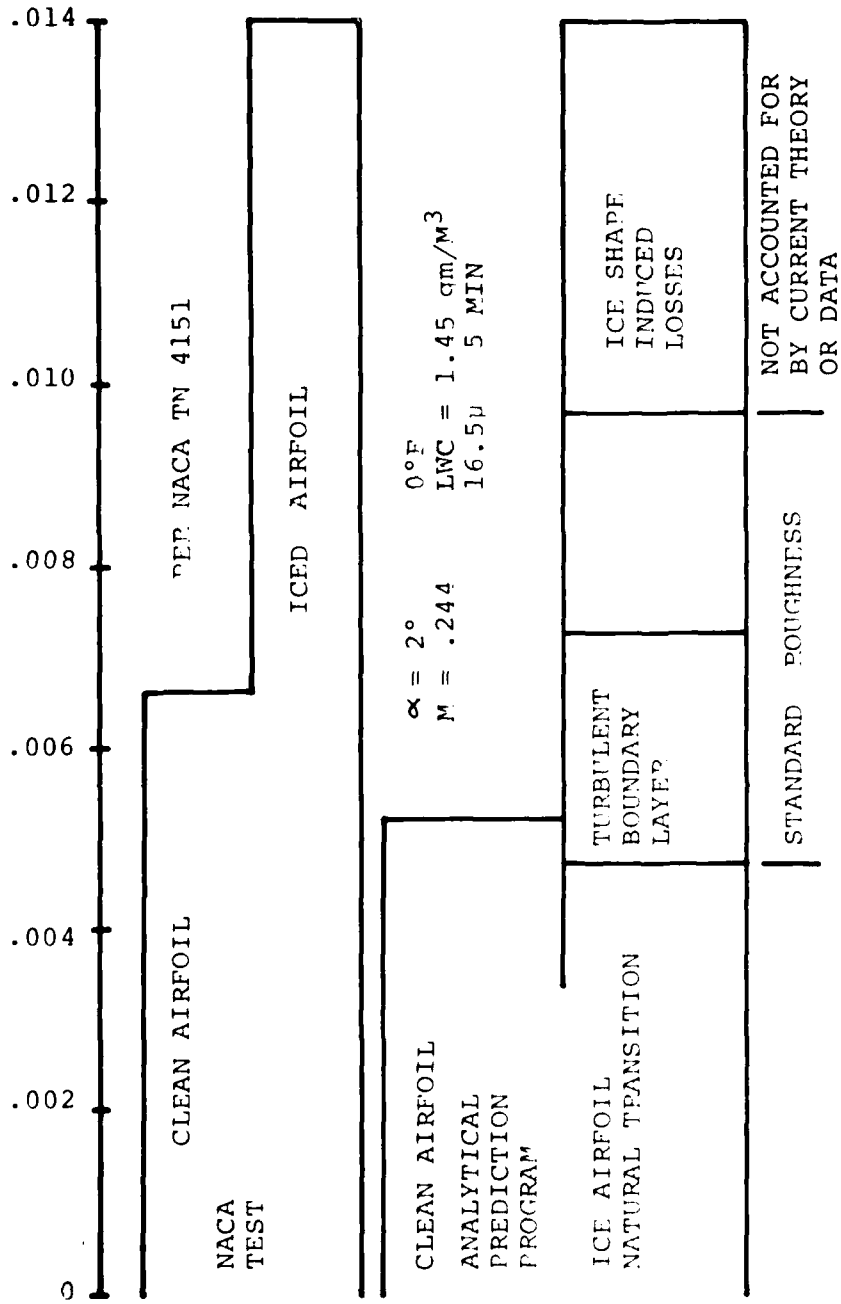

FIGURE C-6. EXAMPLE OF DRAG COEFFICIENT CORRELATION - TEST VS. THEORY

C.3.1 Thin Airfoil

A very thin airfoil (4% thickness) is not representative of helicopter rotor sections. Both the ice impingement limits and the stall characteristics differ considerably from the typical helicopter airfoils (8% to 12% thick). The data was used for an initial assessment because the report of Reference C10 is one of the best current sources of "quasi-steady" icing data.

C.3.2 Mach Number

The Mach number (.244) of the tunnel data is at the lower limit of helicopter airfoil high angle of attack prediction capability by means of standard potential flow/boundary layer interaction methods. The current method is not valid when a "laminar flow separation bubble" is present, as is always the case with thin airfoils.

C.3.3 Ice Shapes - Wind Tunnel

The ice shapes derived from the wind tunnel test of Reference C10 are obtained at fixed angle of attack, while the helicopter rotor angle of attack varies both spanwise and (during forward flight) azimuthally.

C.3.4 Ice Shapes - Potential Flow

Ice shape modeling with the current potential flow techniques as illustrated in Figure C-6 does not account for ice roughness. Additional effort is required to allow prediction of the boundary layer thickness and transition caused by the ice contour as well as separated flow regions. Applicable work is currently underway, but it will not be available in time to be included in the present report.

Test/theory correlation was also unsuccessfully attempted with several of the ice shapes reported in Reference C11 for the NACA 65A215 airfoil. Even though the NACA 65A215 is 15% thick, and, therefore, it does not display any of the thin (4%) airfoil characteristics of the NACA 65A004 (e.g., laminar separation and reattachment), current computer programs did not adequately predict the effect of ice accumulation. Furthermore, the data of Reference C11 was limited to $M < 0.3$, and, therefore, it did not provide the basis for correlation of losses in maximum lift at $M > 0.4$, changes in drag divergence boundaries, degradation in drag rise and pitching moment break beyond drag divergence as necessary to quantify rotor icing penalties.

Although the correlation with the NACA 65A215 data was not successful the attempt was valuable in pointing out the extent to which current airfoil analysis computer programs will have to be improved and expanded to allow the analysis of ice shapes. The detailed review of this subject is outside of the scope of the present report, but the areas in which additional test and theoretical efforts are required include the modeling of thick boundary layers, roughness effects, and potential flow/boundary layer interaction techniques.

C.4 EFFECT OF PREDICTED ICE CONTOURS

On the basis of ice accumulation taking place at a constant incidence and Mach number, representative of average conditions encountered in helicopter rotor flight, the effect of smooth ice accumulation was evaluated for the NACA 23012 and VR-7 airfoils. The airfoil performance evaluation codes employed were the potential flow/boundary layer interaction analysis of Reference C2, and the viscous transonic code of Reference C3.

Figure C-7 compares the leading edge contours of the NACA 23012 without and with ice. Figure C-8 compares test and theory at $M = 0.4$ for the clean NACA 23012 contour, and illustrates the limitations of airfoil analysis methods which do not include thickened boundary layers and separated flow models. In this case, the attainment of maximum lift was marked by leading edge separation, evidenced by the attainment of a local Mach number level of 1.4 at the leading edge, with upper surface turbulent separation $x/c = 0.85$ and 1.0, as discussed in section C.1.1.

The differences in pitching moment slope ($dC/d\alpha$) between test and theory may be due to wind tunnel wall effects. Figures C-9 and C-10 compare theoretical pressure distributions over the NACA 23012 at $M = 0.4$ without and with ice. In presence of ice, the upper surface pressures display a significantly higher suction level at the leading edge than on the clean airfoil. This higher suction (i.e. velocity) level is followed by significant fluctuations which have a destabilizing influence on the boundary layer.

Similarly, the VR-7 contour without and with ice accumulation is shown in Figure C-11. Lift and pitching moment data for the clean contour are compared to test in Figure C-12, and pressure distributions are shown in Figures C-13 and C-14.

Figure C-15 summarizes the effect of ice accumulation on the maximum lift coefficient of the NACA 23012 and VR-7 airfoils at Mach numbers from 0.4 to 0.60. The loss in $C_{l_{max}}$ at $M = 0.4$ appears to be the same for the two airfoils, although the losses are different at higher Mach numbers. By Boeing Vertol experience, the loss in maximum lift at $M = 0.4$ can be related to a degradation in stall flutter boundaries, as discussed earlier. Changes in $C_{l_{max}}$ at rotor Mach numbers above $M = 0.4$ do not cause as significant deterioration in rotor performance as the loss in lift at $M = 0.4$.

Figure C-16 compares the change in low-speed pitching moment coefficient due to leading edge ice accumulation. The most striking result is the change in pitching moment for the NACA 23012. As shown in Figure C-17, a change in sectional pitching moment of $\Delta C_m \cong -.02$ caused a significant increase in the level of blade loads on a model rotor employing the VR-7 and VR-8 airfoils. These results are qualitatively applicable to rotors employing any airfoil section. In the case of ice accumulation the effect of changes in pitching moment level would be further compounded by changes in moment distribution.

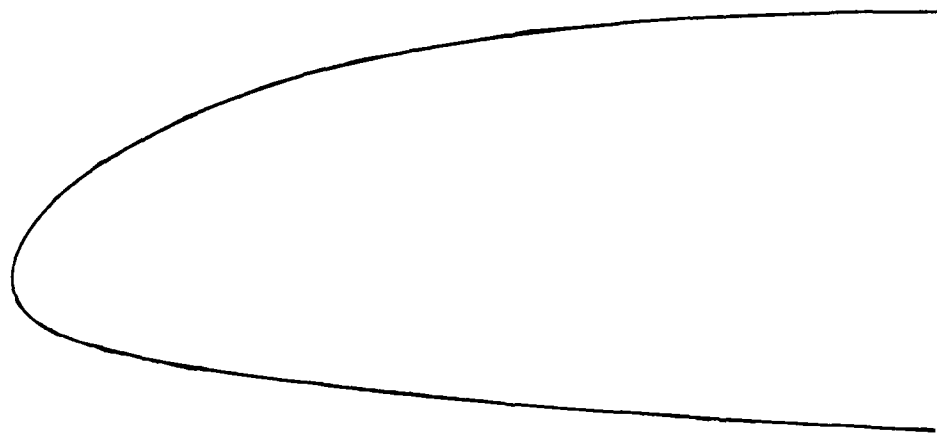

BASIC
CONTOUR

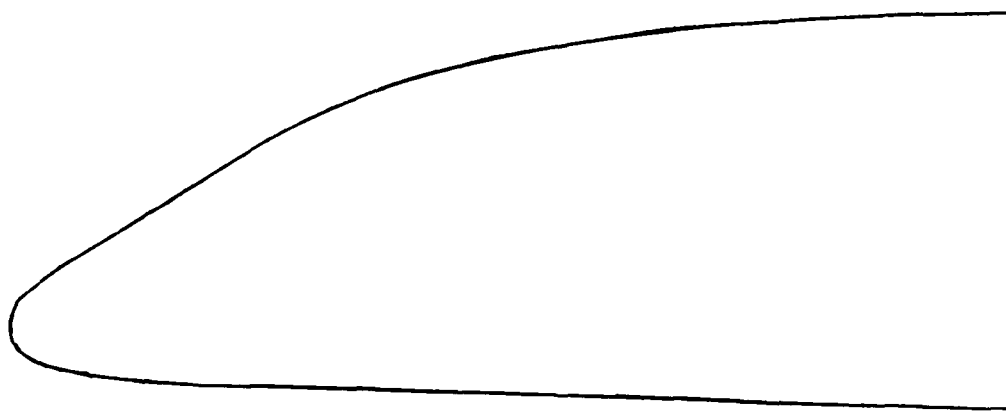

CONTOUR
WITH ICE

FIGURE C-7. AIRFOIL CONTOURS - NACA 23012

M = 0.4
Rn = 2.7x10⁶

NACA 23012

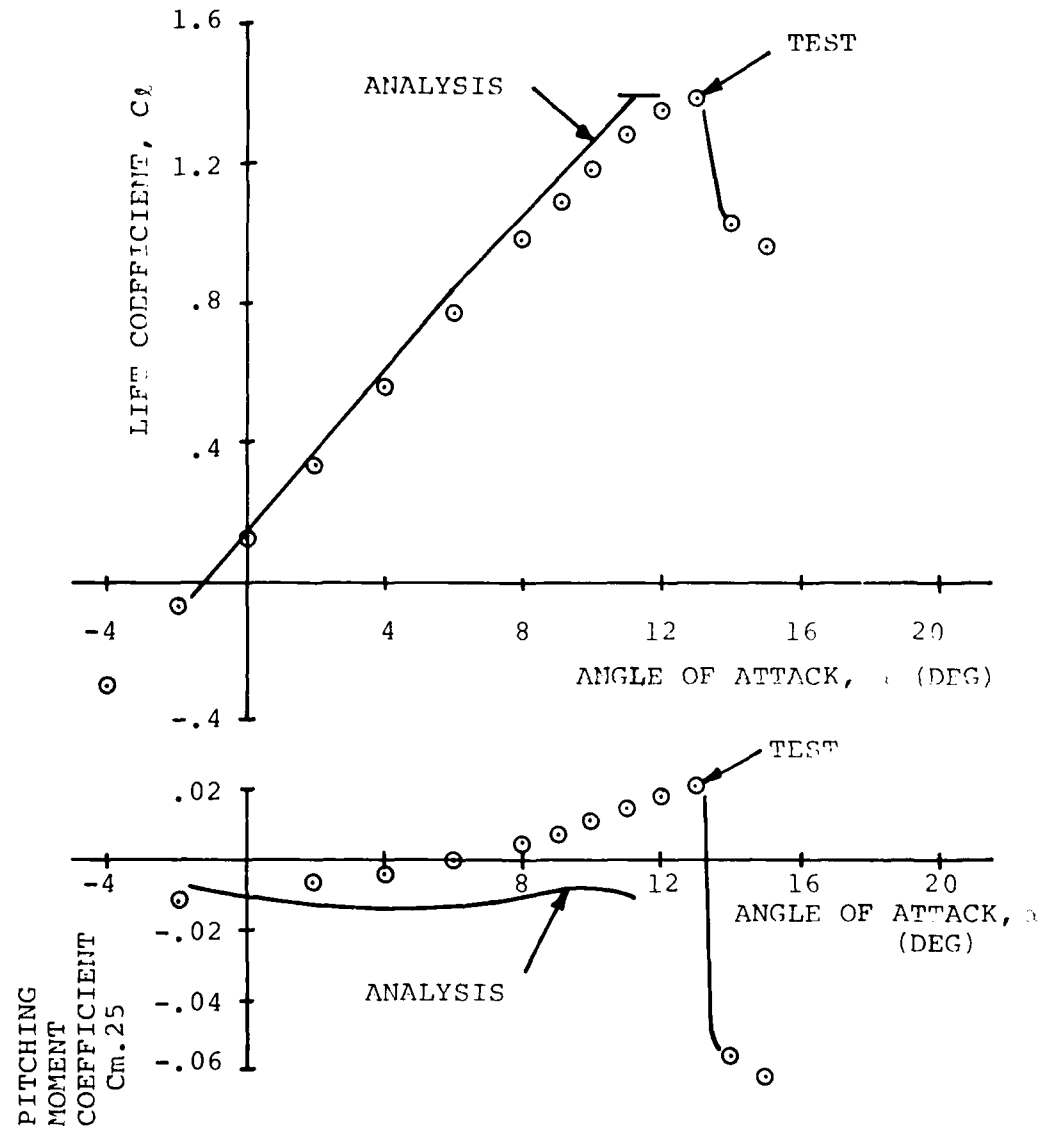

FIGURE C-8. TEST/THEORY CORRELATION OF LIFT AND MOMENT DATA FOR THE NACA 23012 AIRFOIL

0496 B0-105 ICE STUDY (BASELINE)

M = 0.400
RN = 2.700
XTRAN(UPPER) = 0.200
XTRAN(LOWER) = 0.200

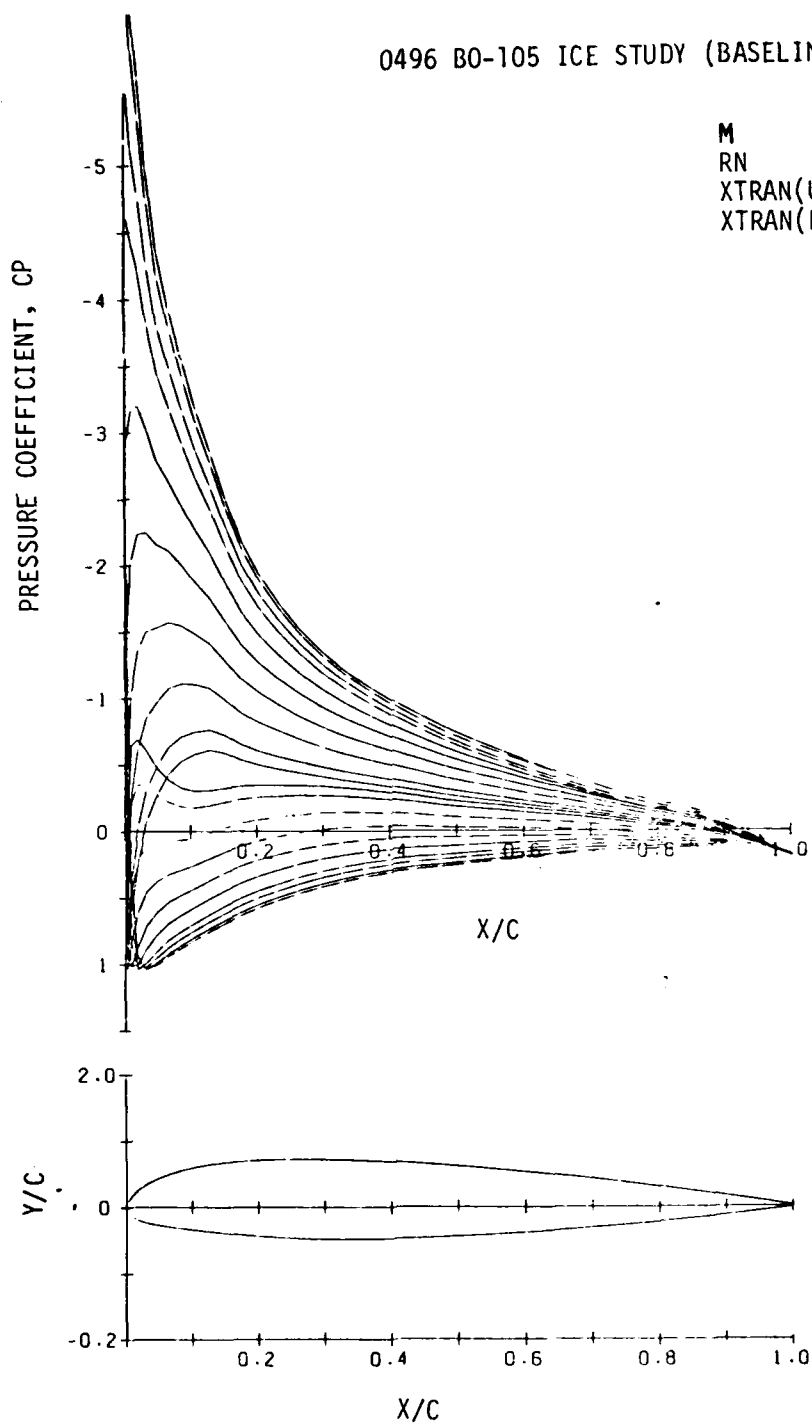

FIGURE C-9. BO-105 ROTOR ICE STUDY (BASELINE) - PRESSURE DISTRIBUTION

0499 BO-105 ICE STUDY (ICE CONTOUR)

M = 0.400
RN = 2.700
XTRAN(UPPER) = 0.188
XTRAN(LOWER) = 0.200

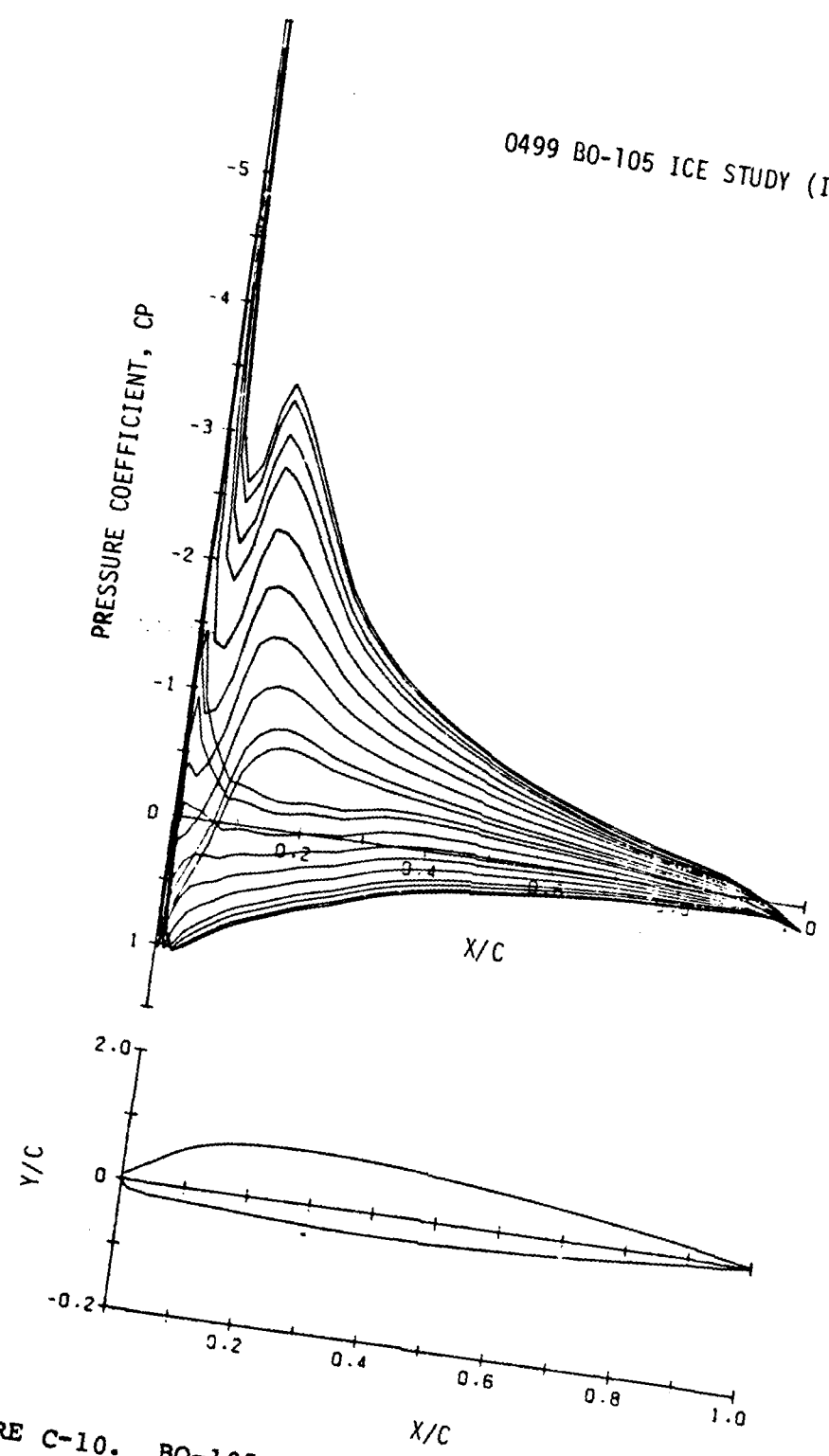
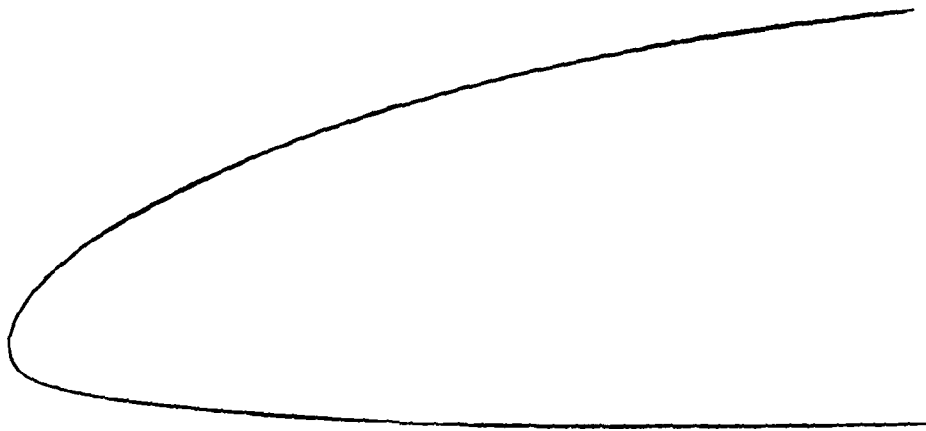
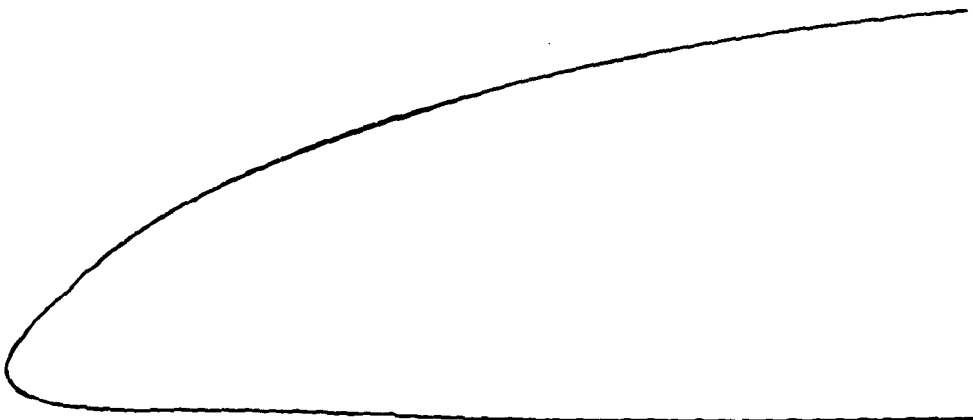

FIGURE C-10. BO-105 ROTOR ICE STUDY (ICE CONTOUR) - PRESSURE DISTRIBUTION



BASIC CONTOUR



CONTOUR
WITH ICE

FIGURE C-11. AIRFOIL CONTOURS - VR-7

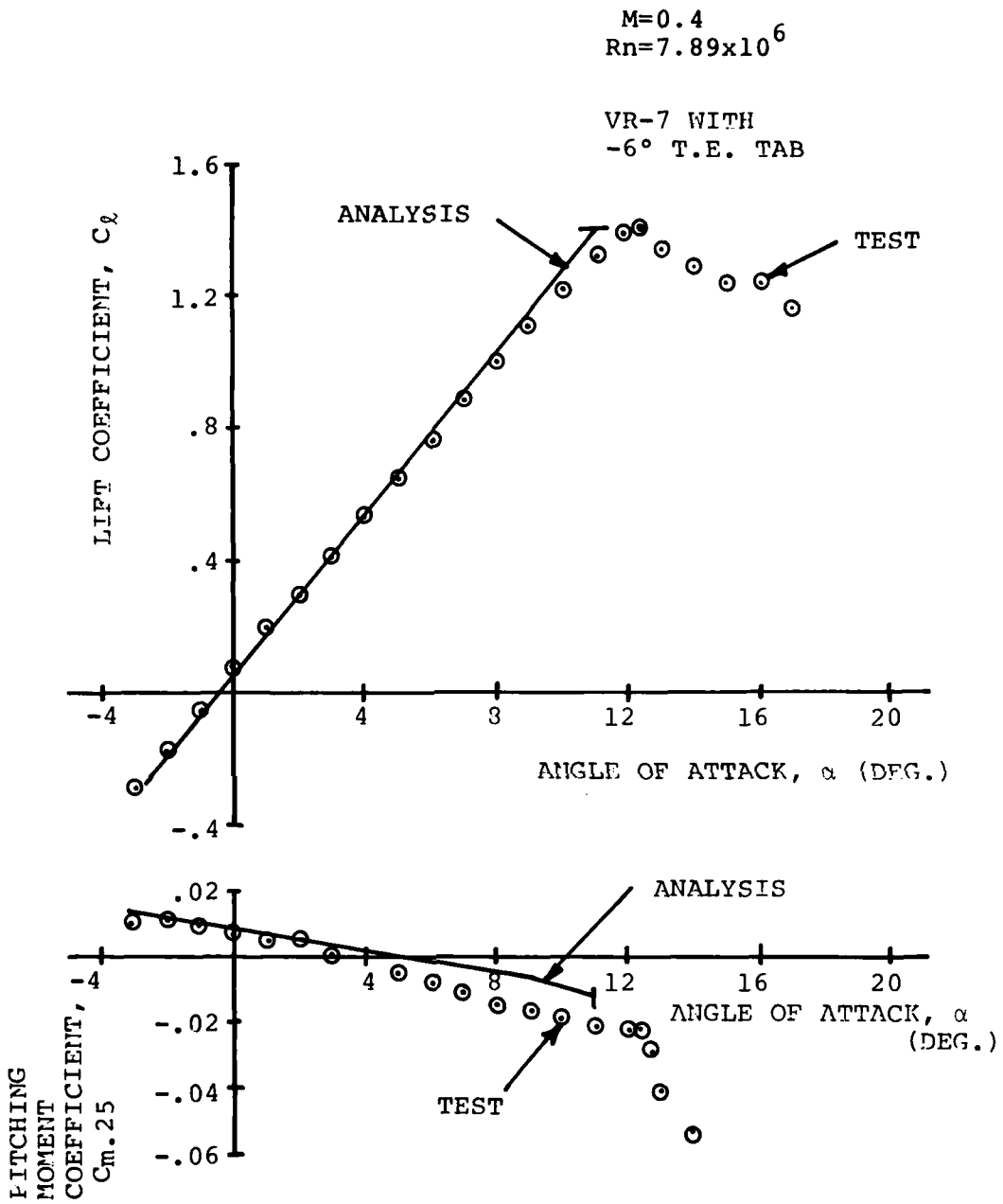

FIGURE C-12. TEST/THEORY CORRELATION OF LIFT AND MOMENT DATA FOR THE VR-7 AIRFOIL

0493 VR-7 ICE STUDY (BASELINE) -4.35 DEG. T.E. TAB

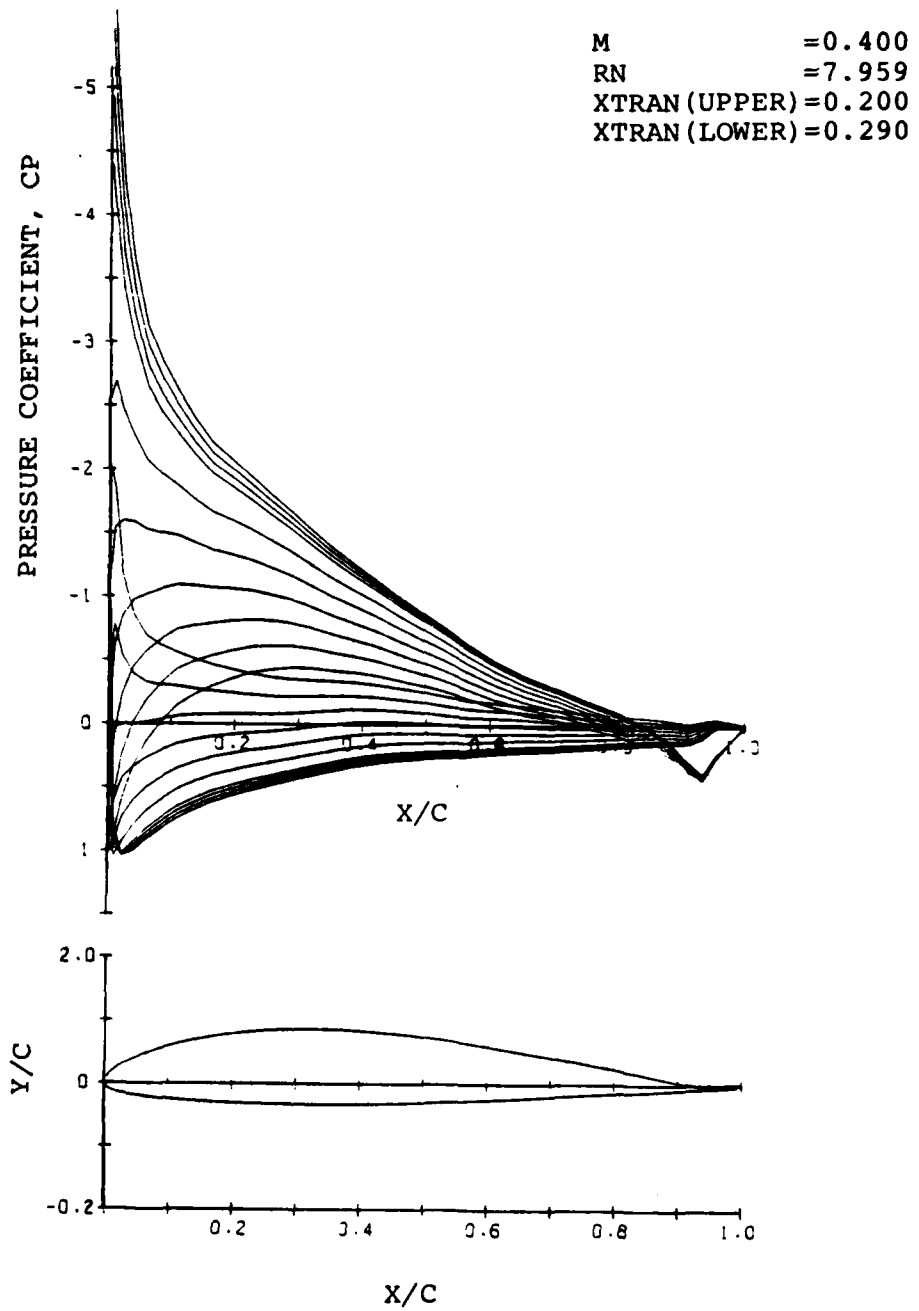

FIGURE C-13 VR-7 ROTOR ICE STUDY (BASELINE)
- PRESSURE DISTRIBUTION

0502 VR-7 ICE STUDY

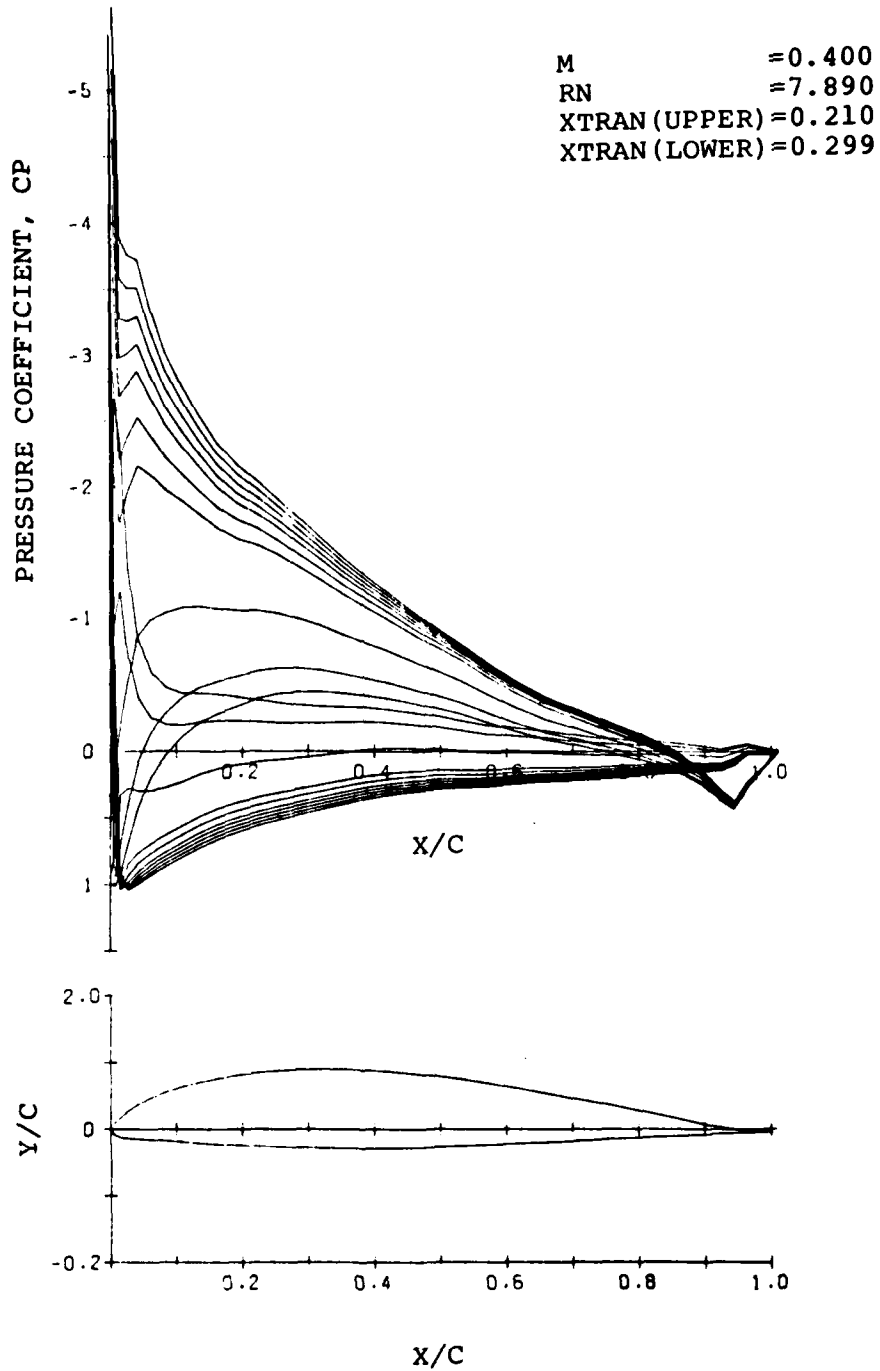

FIGURE C-14. VR-7 ROTOR ICE STUDY (ICE CONTOUR)
- PRESSURE DISTRIBUTION

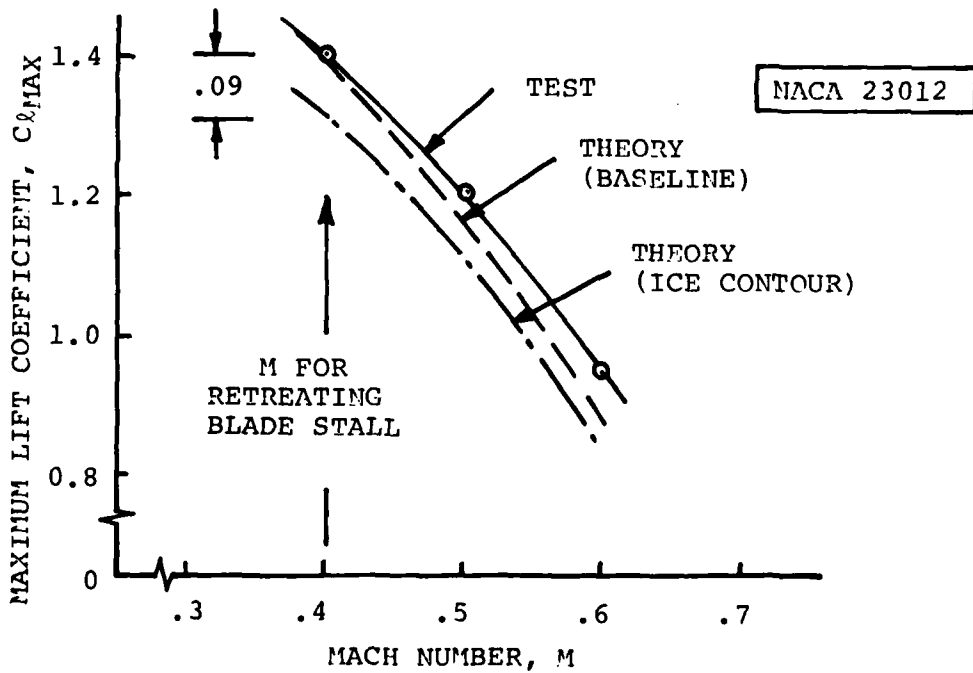
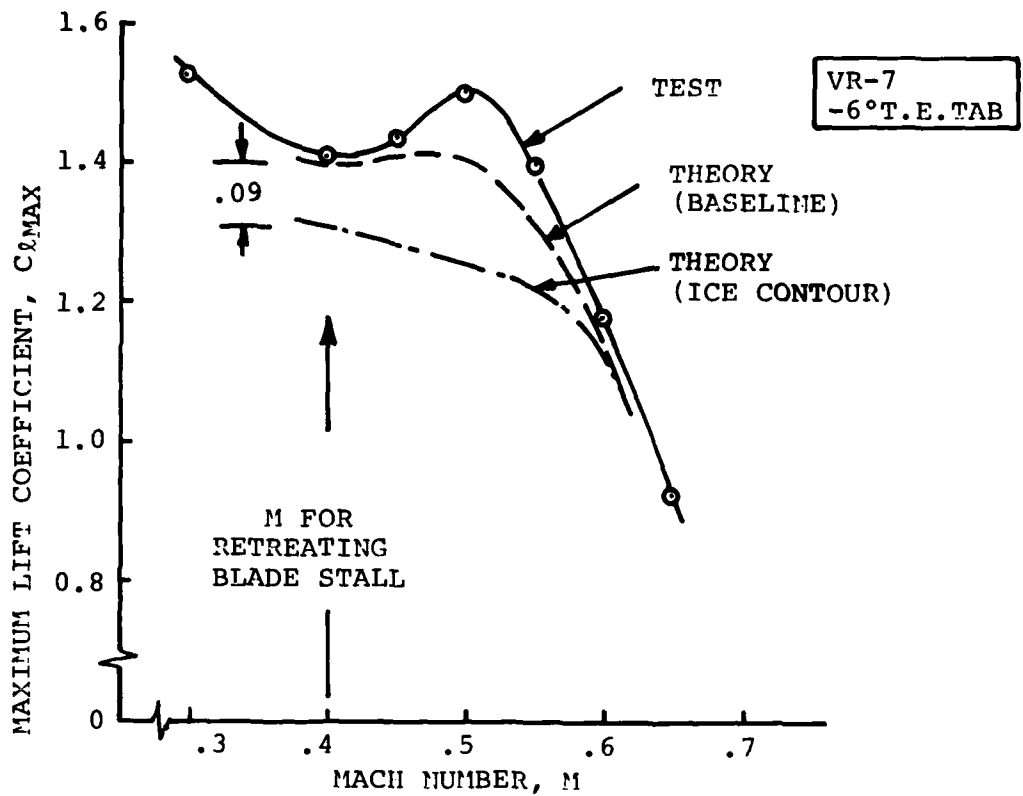

FIGURE C-15. MAXIMUM LIFT BOUNDARIES OF THE VR-7 AND NACA 23012 AIRFOILS

$M = 0.4$

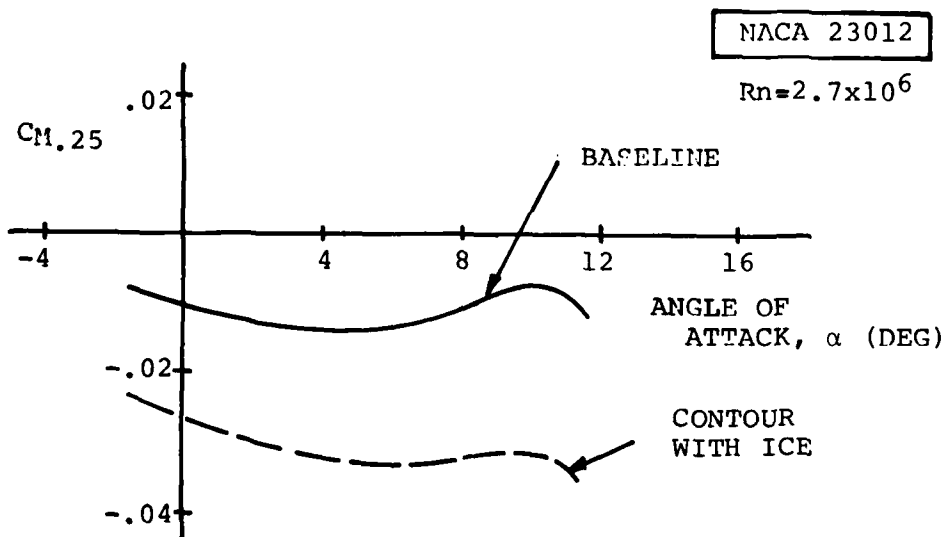
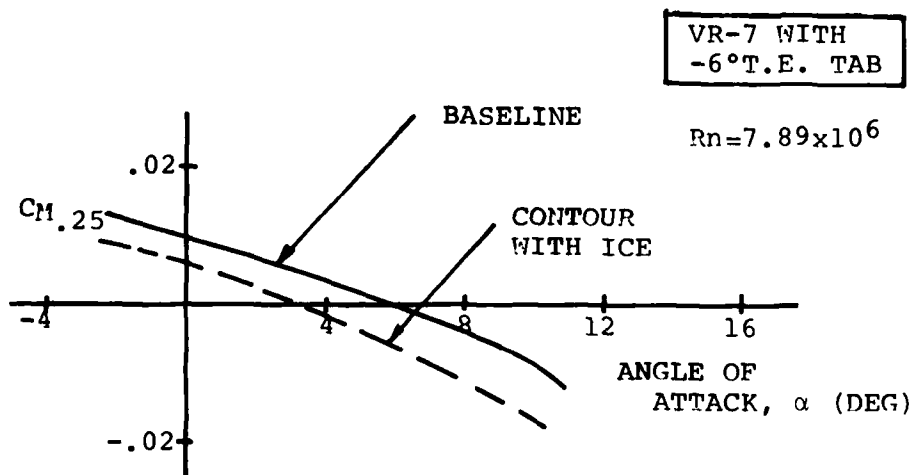

FIGURE C-16. EFFECT OF ICE ACCUMULATION ON THE LOW SPEED PITCHING MOMENTS OF VR-7 AND NACA 23012 AIRFOILS

6 FT. DIA. VR-7/8 ROTOR

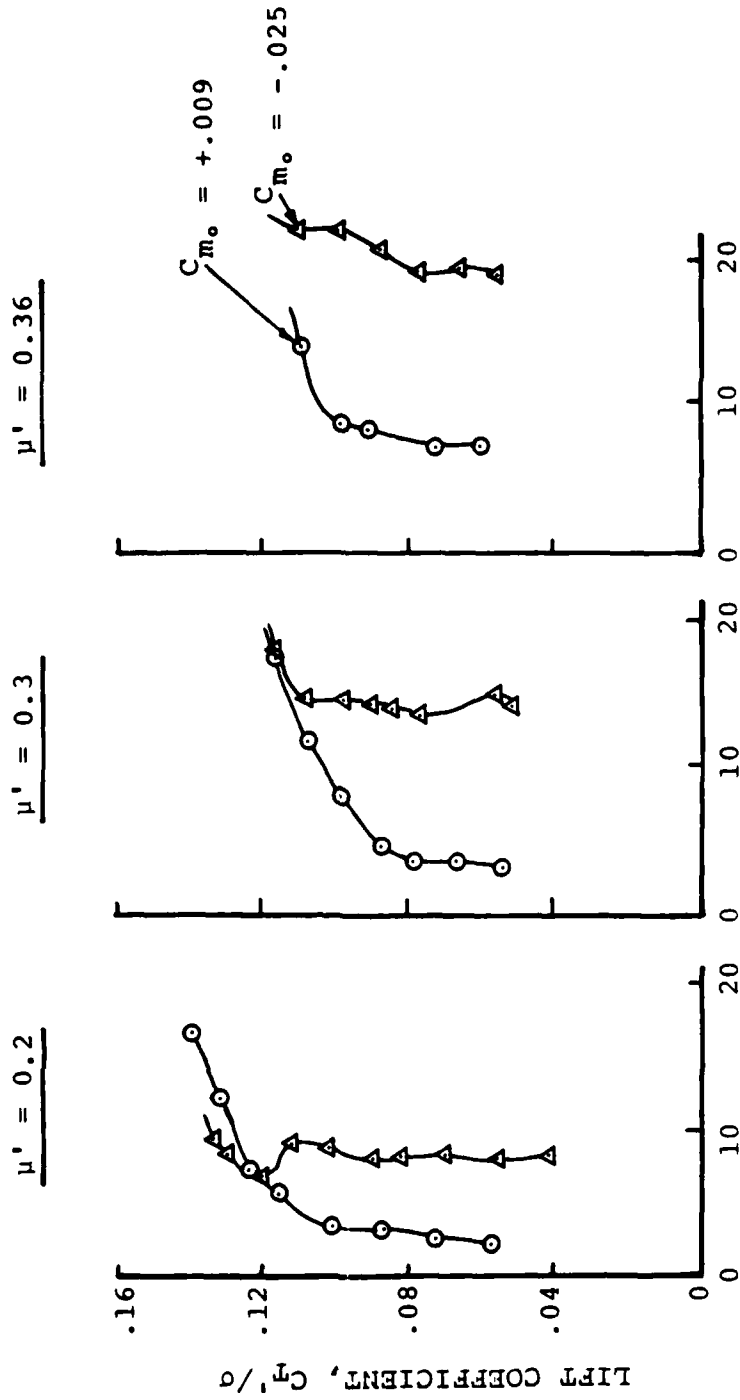

FIGURE C-17. EFFECT OF PITCHING MOMENT ON ROTOR LOADS

Figure C-18 compares the drag divergence boundaries of the VR-7 and NACA 23012 with and without ice. As was the case for the pitching moment, the VR-7 appears to be less sensitive to ice contour than the NACA 23012 in drag divergence degradation. This decreased sensitivity is due to the pressure distribution characteristic of the VR-7 compared to the NACA 23012. The NACA 23012 is a conventional "front loaded" airfoil, whereas the VR-7 has "rooftop" loading characteristics which make it less sensitive to those leading edge contour changes which dominate the onset of drag divergence. Drag rise on an airfoil will take place when the local supersonic flow and associated shock move from upstream of the "crest" (approximately the location of maximum thickness at very low lifts) to downstream. Upstream of the crest, the local pressures will exercise a strong chordwise component opposing the drag, while when the high pressure (suction) region moves downstream of the crest, a large pressure drag component will be generated.

Of course, a supersonic region so intense as to cause shock induced separation upstream of the crest would eliminate any advantage due to low crest velocities. Highly rough or uneven ice shapes might cause such shock-induced separation, but these effects cannot be quantified with current airfoil analysis methods and further analytical and experimental work will have to be carried out before reliable empirical methods are developed and validated. Figures C-19 through C-22 illustrate the effect of smooth ice shapes on the pressure distributions near drag divergence for the VR-7 and NACA 23012 sections.

Finally, Figure C-23 illustrates the components of profile drag not accounted for by current analysis. The NACA "standard roughness" from Reference C12 is added to the drag polars of the VR-7 and NACA 23012 to show the extent of the uncertainty in determining the drag level.

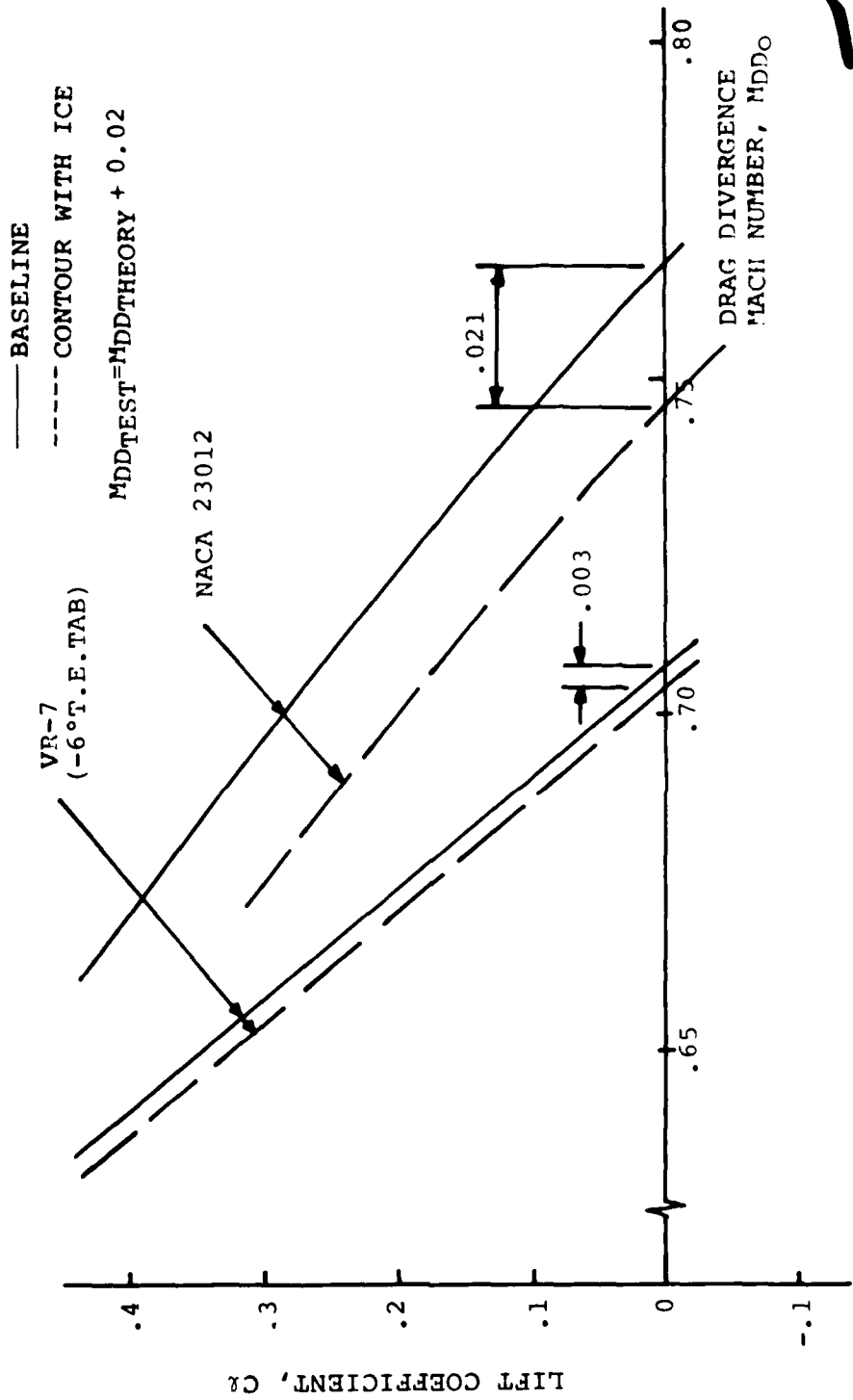

FIGURE C-18. EFFECT OF ICE ACCUMULATION ON THE DRAG DIVERGENCE BOUNDARIES OF THE VR-7 AND NACA 23012 AIRFOILS AS ESTIMATED BY CREST LINE THEORY

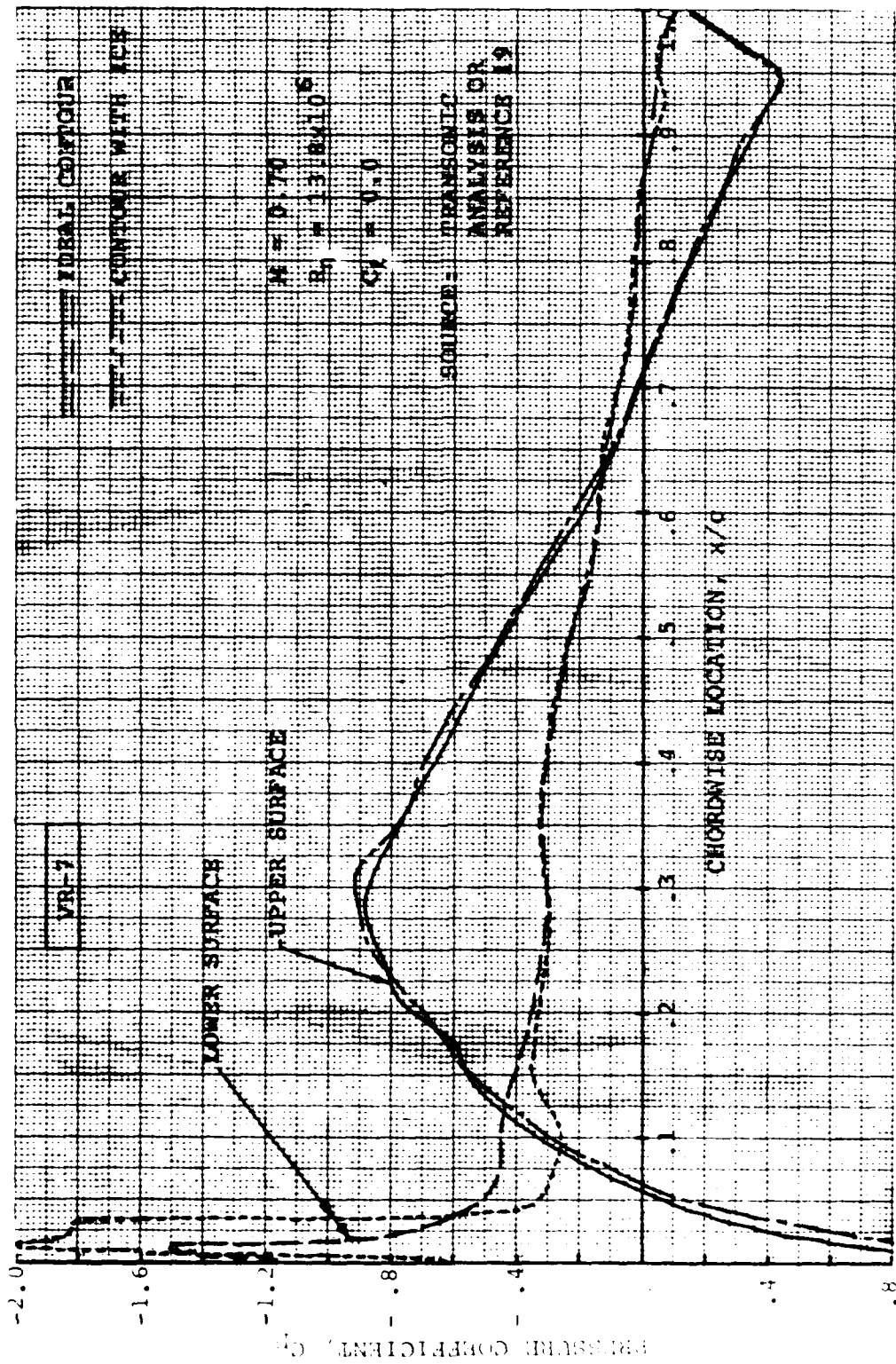

FIGURE C-19. EFFECT OF L.E. ICE ACCUMULATION ON A PRESSURE DISTRIBUTION OVER THE VR-7 AIRFOIL BELOW DRAG DIVERGENCE

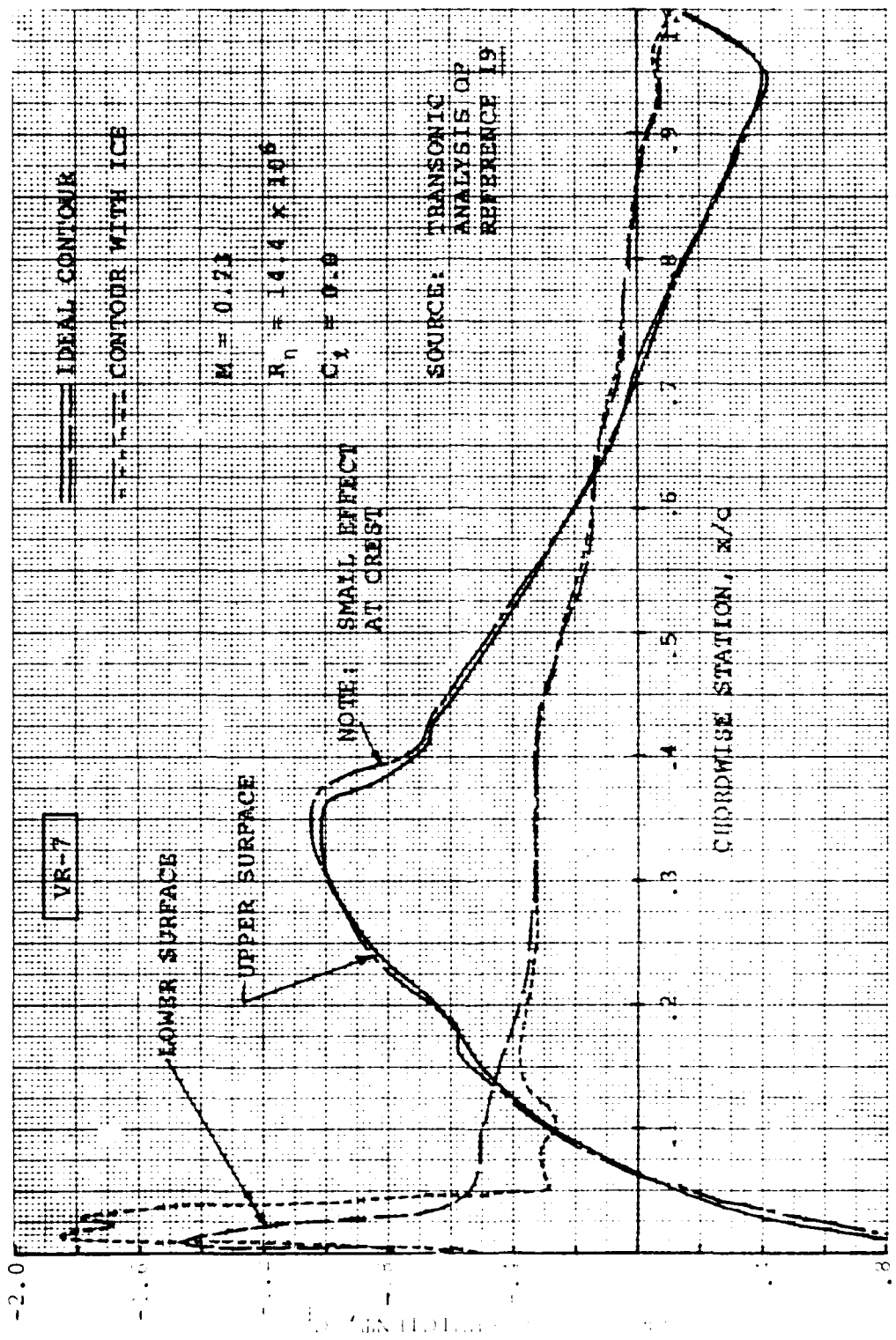

FIGURE C-20. EFFECT OF L.E. ICE ACCUMULATION ON A PRESSURE DISTRIBUTION OVER THE VR-7 AIRFOIL NEAR DRAG DIVERGENCE.

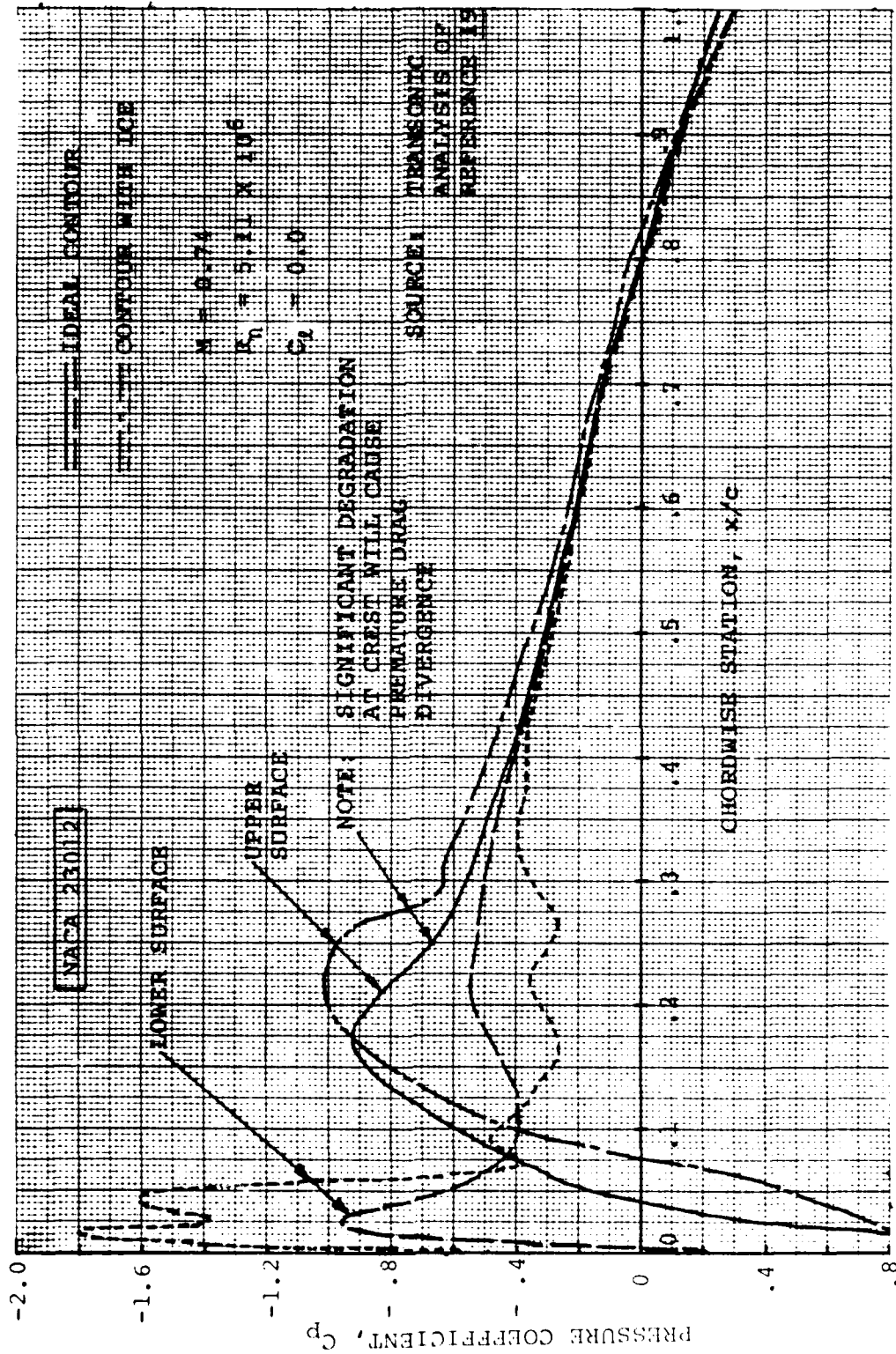

FIGURE C-21. EFFECT OF L.E. ICE ACCUMULATION ON A PRESSURE DISTRIBUTION OVER THE NACA 23012 AIRFOIL, BELOW DRAG DIVERGENCE

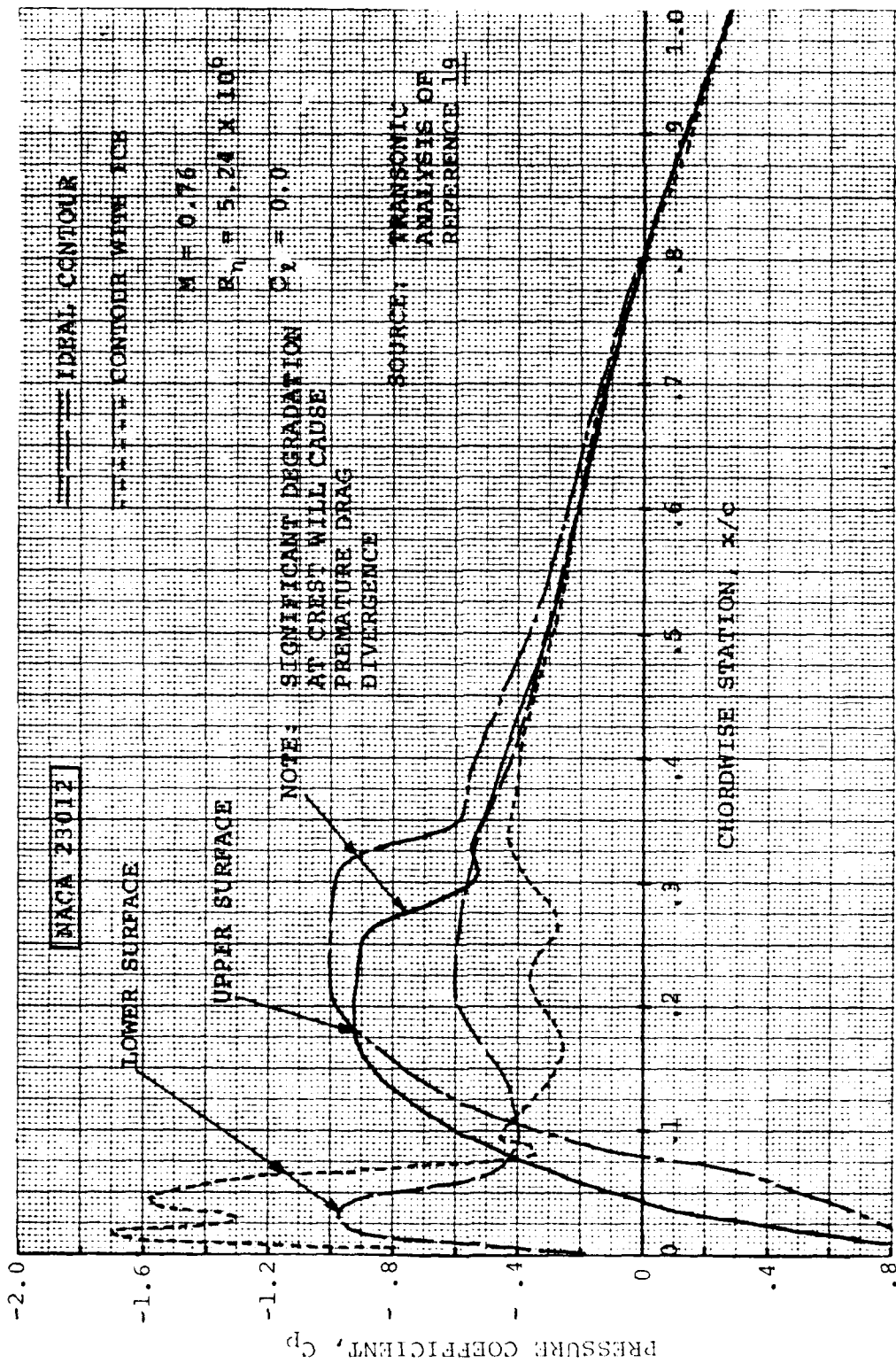

FIGURE C-22. EFFECT OF L.E. ICE ACCUMULATION ON A PRESSURE DISTRIBUTION OVER THE NACA 23012 AIRFOIL NEAR DRAG DIVERGENCE

NOTE: ANALYSIS CANNOT ACCOUNT FOR CHANGES IN BOUNDARY LAYER THICKNESS DUE TO ROUGHNESS

$M = 0.6$

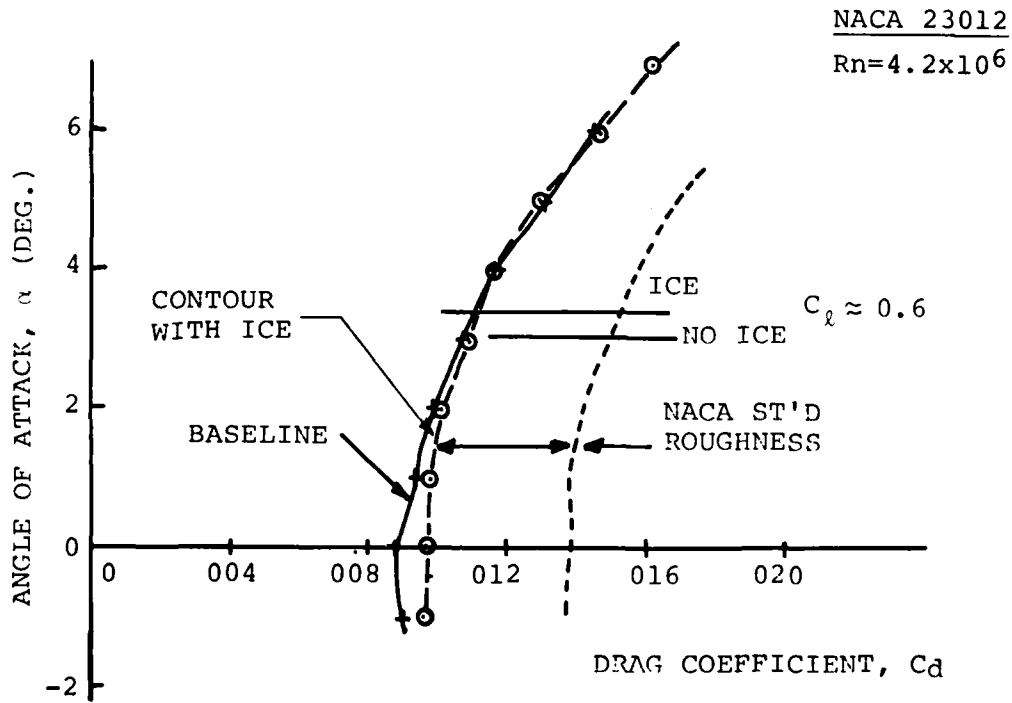
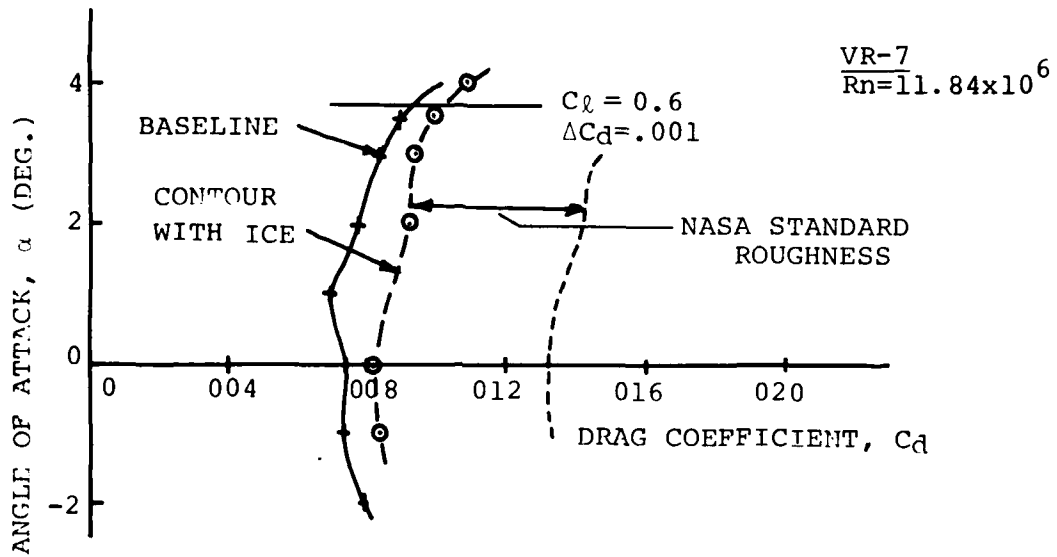

FIGURE C-23. EFFECT OF ICE ACCUMULATION ON THE CALCULATED DRAG COEFFICIENT

C.5 REFERENCES

- C1. DADONE, L.U.: Design and Analytical Study of a Rotor Airfoil, NASA CR 2988, May 1978.
- C2. STEVENS, W.A., GORADIA, S.H., and BRADEN, J.A.: Mathematical Model for Two-Dimensional Multi-Component Airfoils in Viscous Flow. NASA CR-1843, July 1971.
- C3. BAUER, F., GARABEDIAN, P., KORN, D., and JAMESON, A.: Supercritical Wing Sections II. Lecture Notes in Economics and Mathematical Systems, Volume 108, Springer-Verlog (New York, 1975).
- C4. DADONE, L.U.: U.S. Army Helicopter Design Datcom, Volume I - Airfoils. NASA CR-153247, 1976.
- C5. WORTMANN, F.X., and DREES, J.M.: Design of Airfoils for Rotors. Paper presented at CAL/AVLABS 1969 Symposium on Aerodynamica of Rotary Wing and VTOL Aircraft.
- C6. BENSON, R.G., DADONE, L.U., GORMONT, R.E., and KOHLER, G.R.: Influence of Airfoils on Stall Flutter Boundaries of Articulated Helicopter Rotors, 28th AHS Forum, Preprint 621, May 1972.
- C7. A Method for Estimating Drag-Rise Mach Number for Two-Dimensional Aerofoil Section. R. Ae. S. T.D. Memorandum 6407, 1964.
- C8. DADONE, L.U., FUKUSHIMA, T.S.: A Review of Design Objectives for Advanced Helicopter Rotor Airfoils. Presented at the AHS Symposium on Helicopter Aerodynamic Efficiency, Hartford, CT, March 1975.
- C9. DADONE, L.: Observations on the Dynamic Stall Characteristics of Advanced Helicopter Rotor Airfoils. ATAR Conference, NASA Conference Publication 2045, Volume 1, Part 2. 1979.
- C10. GRAY, V.H.: Correlations Among Ice Measurements, Impingement Rates Icing Conditions, and Drag Coefficients for Unswept NACA 65A004 Airfoil, NACA TN 4151, February 1958.
- C11. INGLEMAN-SUNDBERG, M., TRUNDY, O.K., and IVANIKO, A.: Methods for Prediction of the Influence of Ice on Aircraft Flying Characteristics, Swedish-Soviet Working Group on Flight Safety, 6th Meeting, Report No. JR-1, 1977.
- C12. ABBOTT, I.H., VonDOENHOFF, A.E.: Theory of Wing Section. Dover Publications, Inc., New York, New York 1958.

END

DATE
FILMED

2 8/1

DTIC