

AD-TR-80-63

FINAL REPORT

12 **LEVEL III**
B.S.

AD A092515

SCALE FACTOR AND NOISE PERFORMANCE TESTS
OF THE
BENDIX CORPORATION RATE GYRO ASSEMBLY (RGA)
CONDUCTED BY
CENTRAL INERTIAL GUIDANCE TEST FACILITY
6585TH TEST GROUP
HOLLOMAN AIR FORCE BASE, NEW MEXICO
AUGUST 1980

THIS DOCUMENT IS UNCLASSIFIED PRACTICABLE.
THE COPY FURNISHED TO DDC CONTAINED A
SIGNIFICANT NUMBER OF PAGES WHICH DO NOT
REPRODUCE LEGIBLY.

Approved for public release; distribution unlimited.

ARMAMENT DIVISION

AIR FORCE SYSTEMS COMMAND • UNITED STATES AIR FORCE



DDC FILE COPY

S DTIC ELECTE **D**
DEC 8 1980

B

80 10 27 085

THIS TECHNICAL REPORT HAS BEEN REVIEWED AND IS APPROVED:

Robert E. Deane

DISCLAIMER NOTICE

THIS DOCUMENT IS BEST QUALITY PRACTICABLE. THE COPY FURNISHED TO DTIC CONTAINED A SIGNIFICANT NUMBER OF PAGES WHICH DO NOT REPRODUCE LEGIBLY.

UNCLASSIFIED

SECURITY CLASSIFICATION OF THIS PAGE(When Data Entered)

Block 20 (Cont'd)

The purpose of the tests was to characterize the noise performance of each gyro in the RGA in the frequency range of 0.01 Hz to 20 Hz. Gyro noise performance was then compared with seismic activity and previous results from Bendix Corporation testing.

Eight-point tests were performed to obtain scale factors which were used to scale the Power Spectral Density (PSD) data. The PSD test series consisted of 1, 2.5, 5, 40, and 180 minute tests under various operating conditions (wheels on and off, low and high rate modes, and horizontal and vertical output axis orientations).

The data are presented as PSD plots in the frequency domain. These results show a negligible seismic contribution and are comparable with data obtained at the Bendix test facility.

UNCLASSIFIED

SECURITY CLASSIFICATION OF THIS PAGE(When Data Entered)

FOREWORD

This report documents the results of scale factor and noise performance tests of three Bendix Corporation Rate Integrating Gyroscopes which were part of a Rate Gyro Assembly (RGA) to be used on the Space Telescope Pointing and Control System. Two gyros were standard Bendix models, while the third used a low-viscosity flotation fluid. The tests were performed by the Central Inertial Guidance Test Facility (CIGTF), Holloman Air Force Base, New Mexico. The responsible development agency (RDA) was the National Aeronautics and Space Administration (NASA), Marshall Space Flight Center (MSFC), Huntsville, Alabama, which provided reimbursable funds under JON: 921END10. The tests were conducted during June 1980, and the results are presented as Power Spectral Density (PSD) plots across the frequency band of interest.

This report was prepared by Mr. Robert Kim, Test Engineer, and 1Lt John Hoffman, Test Director.

Approved for	
<input checked="" type="checkbox"/>	<input type="checkbox"/>
<input type="checkbox"/>	<input type="checkbox"/>
By	
Distribution/	
Availability Codes	
Avail and/or	
Dist	Special
A	23/

SUMMARY

Three Bendix Corporation gyroscopes in a Rate Gyro Assembly (RGA) were tested at the Central Inertial Guidance Test Facility (CIGTF), 6585th Test Group, Holloman Air Force Base, New Mexico, from 29 May through 19 June 1980, for the National Aeronautics and Space Administration (NASA), Marshall Space Flight Center (MSFC), Huntsville, Alabama.

The purpose of the tests was to characterize the noise performance of each gyro in the RGA in the frequency range of 0.01 Hz to 20 Hz. Gyro noise performance was then compared with seismic activity and previous results from Bendix Corporation testing.

Eight-point tests were performed to obtain scale factors which were used to scale the Power Spectral Density (PSD) data. The PSD test series consisted of 1, 2.5, 5, 40, and 180 minute tests under various operating conditions (wheels on and off, low and high rate modes, and horizontal and vertical output axis orientations).

The data are presented as PSD plots in the frequency domain. These results show a negligible seismic contribution and are comparable with data obtained at the Bendix test facility.

PRECEDING PAGE BLANK-NOT FILLED

TABLE OF CONTENTS

	<u>PAGE</u>
FOREWORD	1
SUMMARY	3
TABLE OF CONTENTS	5
LIST OF FIGURES	7
LIST OF TABLES	9
1. INTRODUCTION	11
1.1 Authority	11
1.2 Test Objectives	11
1.3 Test History	12
2. TEST ITEM DESCRIPTION	12
2.1 General Description	12
2.2 Operational Description	13
2.3 Functional Description	13
3. TEST EQUIPMENT	16
3.1 Testbeds and Fixtures	16
3.1.1 Precision Position Table	16
3.1.2 Isolated Test Pad	16
3.2 Test Support Equipment	17
3.3 Data Acquisition Equipment	17
3.4 Data Reduction Equipment	20
4. TEST AND ANALYSIS PROCEDURES	20
4.1 Eight-Position and Scale Factor Tests	20
4.1.1 Eight-Position and Scale Factor Test Procedures	21
4.1.2 Eight-Position and Scale Factor Test Analysis	24
4.2 Drift Tests	25
4.2.1 Drift Test Procedures	25
4.2.2 Drift Test Analysis	33
5. TEST RESULTS	37
5.1 Eight-Position and Scale Factor Test Results	37
5.2 Drift Test Results	39
6. CONCLUSIONS	48
APPENDIX A	A-1
Gyro PSD's and RMS Noise Calculations	
DISTRIBUTION LIST	

LIST OF FIGURES

<u>FIGURE</u>		<u>PAGE</u>
1	ST/RGA Block Diagram (One Channel)	15
2	Data Acquisition System (DAS) Block Diagram	18
3	PSD of a Vertical Seismometer on a Typical Day	43
4	PSD of a Vertical Seismometer on 12 Jun 80	44
5	LVG - Time Domain Data of Run #8-4	46
6	LVG - Time Domain Data of Run #8-5	47
A-1	Example of a Typical PSD Plot	A- 4
A-2	Example of a Typical RMS Rate Noise Table	A- 5

PRECEDING PAGE BLANK-NOT FILLED

LIST OF TABLES

<u>TABLE</u>		<u>PAGE</u>
1	List of CIGTF Equipment	19
2	Channel 1 Orientations	22
3	Channel 2 Orientations	23
4	Drift Test Conditions	27
5	Offsets and Averages for Each Test Condition	34
6	Logarithmic Averaging of 2048 PSD Points	36
7	Eight-Position and Scale Factor Test Results	38
8	Space Telescope Rate Gyro Assembly Specification	40

PRECEDING PAGE BLANK-NOT FILLED

1. INTRODUCTION

1.1 Authority

Laboratory tests of the Bendix Corporation Rate Gyro Assembly (RGA) were requested by the National Aeronautics and Space Administration (NASA), Marshall Space Flight Center (MSFC), Huntsville, Alabama, on 19 June 1979. The RGA is part of the Pointing and Control System for the Space Telescope (ST) project developed by NASA and Lockheed Missile and Space Company (LMSC).

In accordance with AFSC Supplement 1 to AFR 80-14, the Central Inertial Guidance Test Facility (CIGTF), 6585th Test Group, Holloman AFB, New Mexico, documented this test program in a Test Directive dated 13 Feb 80, and in a Statement of Capability dated 5 Mar 80. The project was assigned JON: 921END10, and testing began in May 80.

This report documents the results of testing three Bendix gyros in the RGA.

The gyro and its support equipment are UNCLASSIFIED to both physical and visual access. All test procedures, schedules and data are UNCLASSIFIED.

1.2 Test Objectives

The test objectives were as follows:

- a. To characterize the noise performance of the RGA in the frequency range of 0.01 Hz to 20 Hz.
- b. To compare the results with those from previous testing performed at the Bendix test facility.
- c. To compare the performance of the standard

Bendix gyroscopes with that of the low-viscosity gyroscope.

1.3 Test History

- 27 May 80 - Test Support Equipment arrived.
- 28 May 80 - Test Support Equipment set up and checked out. Rate Gyro Assembly arrived.
- 29 May 80 - Manufacturer's checkout tests began.
- 2 Jun 80 - Eight-position tests and scale factor tests began.
- 4 Jun 80 - Rate Gyro Assembly and Test Support Equipment moved to the Advanced Inertial Test Laboratory.
- 5 Jun 80 - Drift tests began.
- 19 Jun 80 - Test Support Equipment packed and shipped. Rate Gyro Assembly packed and hand carried to Bendix plant.

2. TEST ITEM DESCRIPTION

This section briefly provides an operational and functional description of the Rate Gyro Assembly. This information was obtained primarily from the Bendix ST/RGA System Description; MT-41, 023; 26 March 1979.

2.1 General Description

The RGA is a strapdown reference gyro package designed to meet the requirements of the pointing and control system which is part of the NASA/LMSC Space Telescope. It is composed of two separately packaged subassemblies designated as the Rate Sensor Unit (RSU) and the Electronics Control Unit (ECU). The RGA senses vehicle motion utilizing two size 64 Permanent Magnet Rate Integrating Gyros (64 PM RIG) to provide two channels of digital attitude and analog rate information. Each channel operates in a Pulse Rebalance Loop

(PRL) that uses digital electronics in a binary-forced-limit-cycle design approach. This technique provides digitizing of sensor output for computer interface.

In addition to the two gyros normally contained in an RGA, a third gyro with a lower viscosity fluid was also tested. This Low Viscosity Gyro (LVG) was mounted on the fixture in the same orientation as the Channel 2 gyro and was connected in place of the Channel 1 gyro at the rate sensor (R/S) connector. The lower viscosity fluid allowed the gyro to be servoed by a PRL with less gain. Lower electronic gain in the loop should cause less noise on the output, since any noise produced by the gyro would not be amplified as much as it would by a higher gain loop.

2.2 Operational Description

The Pointing and Control System accomplishes the stabilization and control of the ST spacecraft. The RGA forms an integral part of this system's sensor complement and will provide for short term attitude reference. Three RGA assemblies are present onboard the ST spacecraft; each containing two reference channels. Each channel is separate, except for the interface between reference clocks, of which either or both can operate at one time. Since the channels are separate, a failure in one will not result in a failure of the other.

2.3 Functional Description

The RSU consists of two 64 PM RIG Gyro Rate Sensors, each having pulse rebalance loop electronics integral within

the overall rate sensor dimensions. These electronics are located on the signal generator end of the gyro and take advantage of its controlled temperature to provide a stable environment. Each of the rate sensors is functionally interchangeable. A gyro electronics card is provided for each channel and serves as an interface driver and receiver between the ECU and the rate sensors.

The system operates in the following manner: precessional torques due to sensed rates generate an error signal at the output of the signal generator in the form of an amplitude modulated signal. This signal is then demodulated to a magnitude which is proportional to the gyro float displacement in the analog portion of the servo amplifier. In the digital section, the signal is added to a sawtooth waveform which is then used to generate a pulse width modulated signal. Based on this digital signal, the rebalance torque is generated, as well as the output rate signal.

A block diagram of the system is shown in Figure 1. The Gyro Electronics Card produces the signal generator excitation and provides power regulation for the RSU, and contains the necessary drivers and receivers to interface the rate sensor to the ECU.

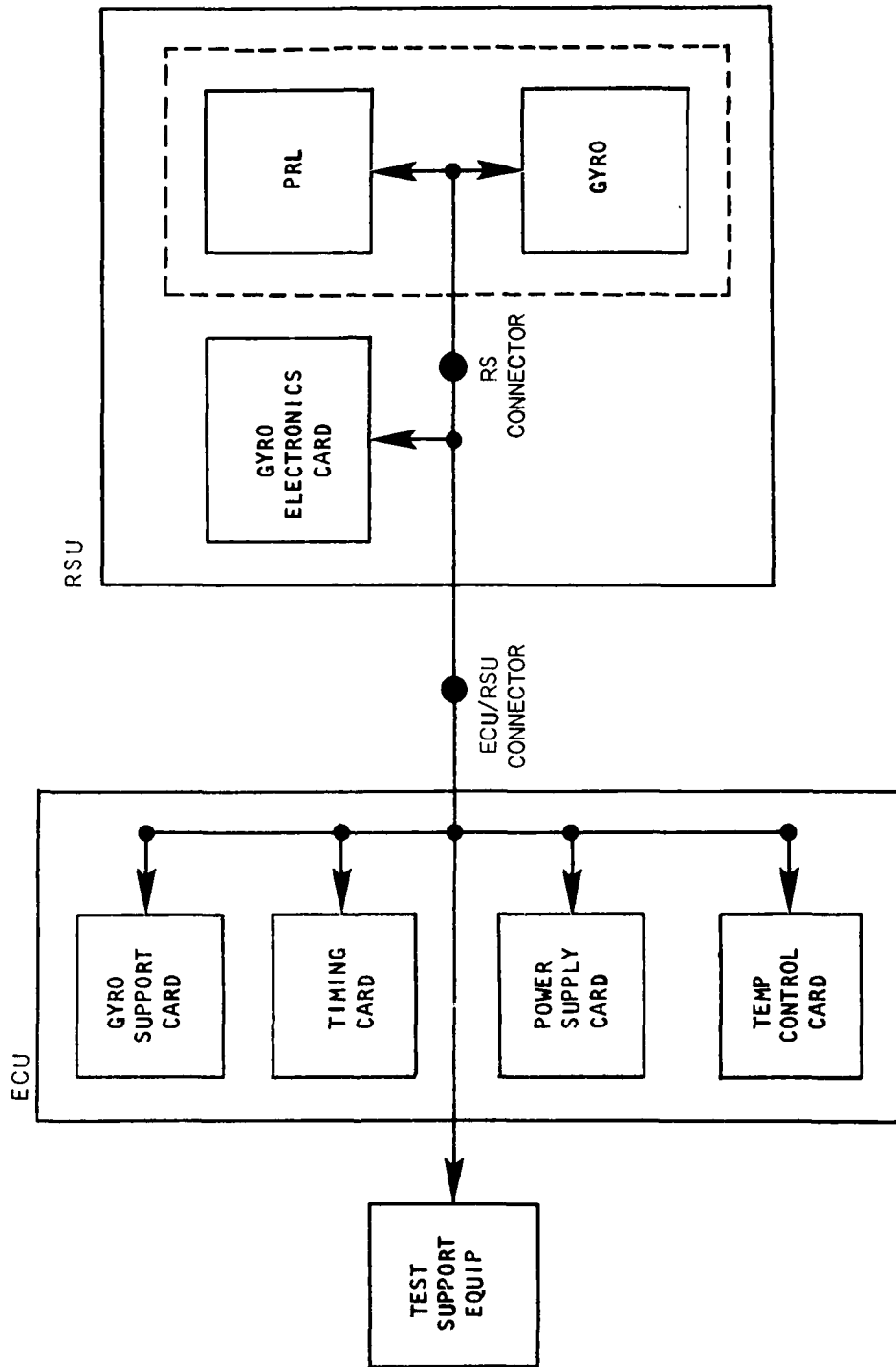

FIGURE 1. ST/RGA BLOCK DIAGRAM (ONE CHANNEL)

The ECU consists of two independent sets of control electronics containing the following cards for each channel (eight total): Gyro Support Card, Timing Card, Power Supply Card and Temperature Controller Card.

The Gyro Support Card drives the spin motor and suspension system and provides most of the telemetry functions and output signals. All timing signals are generated on the timing card which provides for cross-strapping (interface) with the Channel 2 clock. The Power Supply Card provides all DC power to the ECU and RSU. The Temperature Controller Card provides the stable operating temperature to the gyro and selects either the normal or backup temperature control sensor.

3. TEST EQUIPMENT

3.1 Testbeds and Fixtures

Mounting fixtures were supplied by Bendix to interface the RGA to the testbeds and provide the necessary orientations. RGA tests were performed using the testbeds described below.

3.1.1 Precision Position Table

A Goerz T-500 air bearing rate and positioning table located on an isolated pad in the CIGTF Gyroscope Laboratory, Bldg 1265, was used to conduct the eight-position and scale factor tests.

3.1.2 Isolated Test Pad

The drift tests were conducted on a mounting plate attached to an isolated test pad in Room 13 of the

CIGTF Advanced Inertial Test Laboratory, Bldg 1256. This pad was instrumented with tiltmeters, seismometers, and an ambient temperature monitor.

3.2 Test Support Equipment

Bendix supplied all necessary test support equipment and personnel to operate and control the RGA.

3.3 Data Acquisition Equipment

A block diagram of the data acquisition equipment for RGA testing is shown in Figure 2. It consisted of two parts, one supplied by Bendix, the other supplied by CIGTF. Table 1 lists the CIGTF equipment which was used.

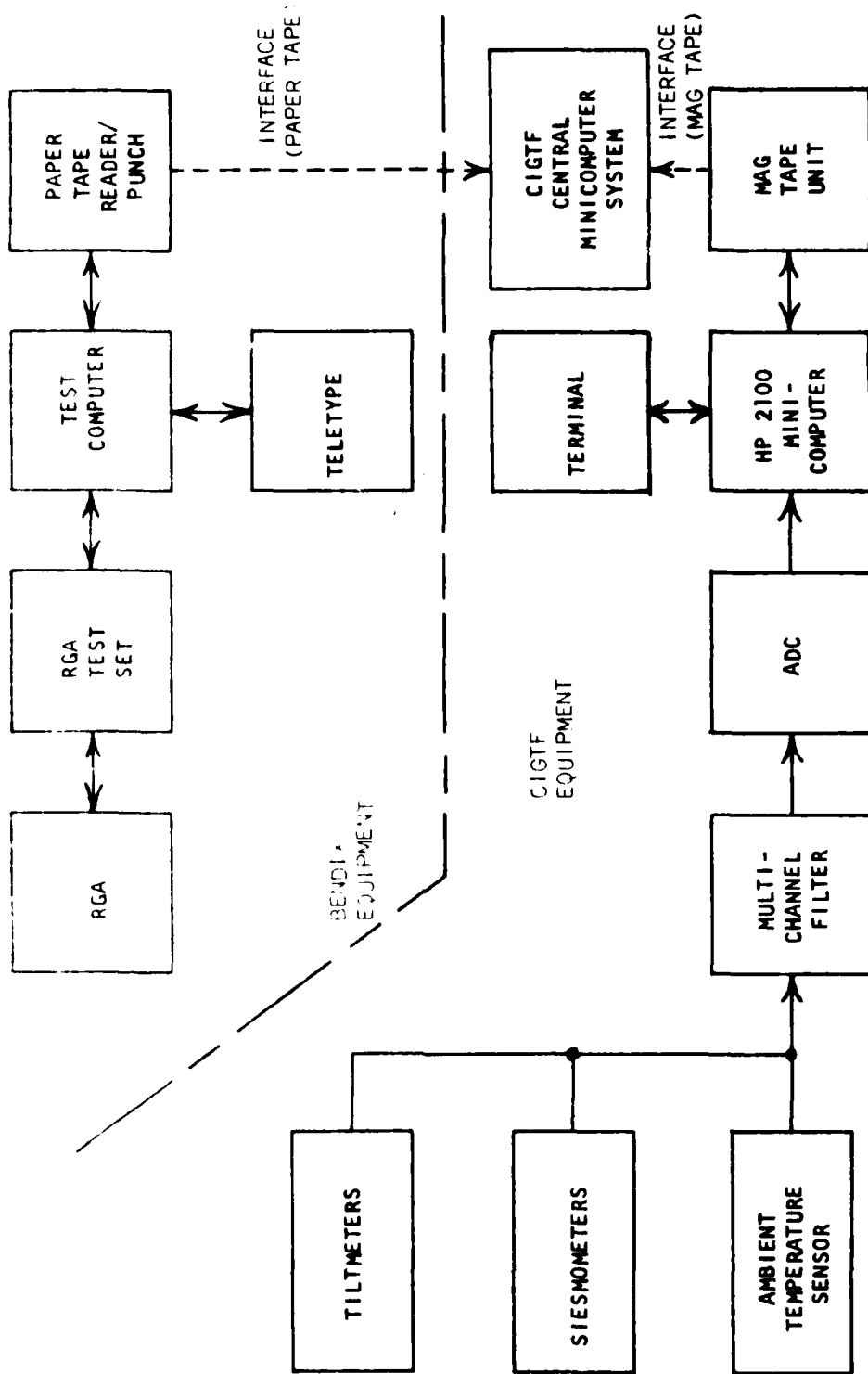

FIGURE 2. DATA ACQUISITION SYSTEM BLOCK DIAGRAM

TABLE 1. CIGTF EQUIPMENT

<u>Manufacturer</u>	<u>Model</u>	<u>Description</u>
Autonetics	A1-001A	2-Axis Tiltmeter
Electrotechnical Lab	EV22C	Portable Seismic Monitor (PRM) Sensors
USAF Sieler Laboratory		PSM Electronics
Rockland	816	Multichannel Low Pass filter
Analogic	AN5800	Analog-to-Digital Converter
Hewlett-Packard	2100	Minicomputer
Hewlett-Packard	7970E	Digital Tape Unit
Hewlett-Packard	2600A	Terminal
Harrel	CI207A	Temperature Indicator
Hewlett-Packard		CIGTF Central Minicomputer System

The gyro output data were acquired using a contractor-supplied Bendix 9000 minicomputer. Paper tape was used to transfer the gyro data to the CIGTF data reduction computer.

The CIGTF data acquisition system recorded the tiltmeter, seismometer, and temperature data on magnetic tape. The seismic, tilt, and temperature information was filtered with a multichannel programmable low-pass filter and digitized at the various accumulation frequencies, using a 15 bit analog-to-digital converter (ADC). The data were then written on magnetic tape and transferred to the data reduction computer.

3.4 Data Reduction Equipment

Data reduction was accomplished on the CIGTF central minicomputer system which uses a Hewlett-Packard 1000 Floating Point Processor. All data reduction software was developed at the CIGTF. These programs implement a Fast Fourier Transform and all computations are made in double precision (four 16-bit words per data point).

4. TEST AND ANALYSIS PROCEDURES

4.1 Eight-Position and Scale Factor Tests

An eight-position test was conducted to determine the low rate scale factor and g-sensitive drift coefficients for the RGA Channel 1 and Channel 2 gyros. A two-position test was used to obtain high rate scale factors for Channels 1 and 2 and also high and low rate scale factors for the LVG.

4.1.1 Eight-Position and Scale Factor Test Pro-

cedures

The RGA was mounted on a precision angle fixture which was adapted to the Goerz T-500 rate and position table. It was turned on in the low rate mode and allowed to stabilize overnight. With the table spin axis parallel to local vertical, the angle fixture placed the spin axis (SA) of Channel 1 down and the SA of Channel 2 up, so it was not possible to obtain the same orientations for both gyros.

Each axis was placed in the orientations shown in Tables 2 and 3, by rotating the table top and tilting about the horizontal axis. Data were acquired from the teletype printout of a 15-minute bias test after allowing time for the output axis (OA) slew transient to decay.

After the above tests were completed, the angle fixture was removed and the RGA and LVG were mounted directly on a flat bolt hole adaptor plate on the T-500 table with the OA's horizontal. Input Axis (IA) north and IA south orientations were then used to obtain high and low rate scale factors for the LVG. Data were taken at each position for 15 minutes, using the bias test program.

TABLE 2. CHANNEL 1 ORIENTATIONS

Channel 1 - Low Rate Mode - Eight-Position Test

<u>Position</u>	<u>Spin Axis</u>	<u>Input Axis</u>	<u>Output Axis</u>
1	Down	North	East
2	Down	East	South
3	Down	South	West
4	Down	West	North
5	North	East	Down
6	North	Down	West
7	North	West	Up
8	North	Up	East

Channel 1 - High Rate Mode - Scale Factor Test

<u>Position</u>	<u>Input Axis</u>
1	North
2	South

TABLE 3. CHANNEL 2 ORIENTATIONS

Channel 2 - Low Rate Mode - Eight-Position Test

<u>Position</u>	<u>Spin Axis</u>	<u>Input Axis</u>	<u>Output Axis</u>
1	Up	South	East
2	Up	West	South
3	Up	North	West
4	Up	East	North
5	North	East	Down
6	North	Down	West
7	North	West	Up
8	North	Up	East

Channel 2 - High Rate Mode - Scale Factor Test

<u>Position</u>	<u>Input Axis</u>
1	North
2	South

4.1.2 Eight-Position and Scale Factor Test Analysis

The performance equation which models the

gyro is as follows:

$$SN = D_F + D_I a_I + D_O a_O + D_S a_S + D_{II} a_I^2 + D_{SS} a_S^2 \\ + D_{IO} a_I a_O + D_{IS} a_I a_S + D_{OS} a_O a_S + \omega_I$$

where

N = Gyro torquer output (Pulses Per Second (PPS))

S = Gyro axis torquer scale factor (Deg/Hr/PPS)

D = Gyro drift coefficient

a_I = Acceleration, with respect to inertial space, of the gyro case along the input axis (g)

a_O = Acceleration, with respect to inertial space, of the gyro case along the output axis (g)

a_S = Acceleration, with respect to inertial space, of the gyro case along the spin axis (g)

ω_I = Angular velocity, with respect to inertial space, of the gyro case about the input axis (Deg/Hr)

δ = IA misalignment about a vertical axis

θ = IA misalignment about a horizontal axis

The equations for the gyro output at each of the

eight orientations for Channel 1 follow:

1. $SN_1 = D_F - D_S + \omega_H \cos \delta$
2. $SN_2 = D_F - D_S + \omega_H \sin \delta$
3. $SN_3 = D_F - D_S - \omega_H \cos \delta$
4. $SN_4 = D_F - D_S - \omega_H \sin \delta$
5. $SN_5 = D_F - D_O - \omega_V \sin \theta$
6. $SN_6 = D_F - D_I - \omega_V \cos \theta$
7. $SN_7 = D_F + D_O + \omega_V \sin \theta$
8. $SN_8 = D_F + D_I + \omega_V \cos \theta$

where

ω_H = The horizontal component of earth rate at the test site latitude = 12.595672 Deg/Hr

ω_V = The vertical component of earth rate at the test site latitude = 8.14556175 Deg/Hr

Equations 1-4 can be combined to give:

$$S = \frac{2\omega_H}{\sqrt{(N_1-N_3)^2 + (N_2-N_4)^2}}$$

$$\delta = \sin^{-1} \left[\frac{S (N_2-N_4)}{2\omega_H} \right] \text{ or } \delta = \tan^{-1} \left[\frac{N_2-N_4}{N_1-N_3} \right]$$

$$D_F - D_S (1-4) = S (N_1 + N_2 + N_3 + N_4)/4$$

Equations 5-8 yield the following:

$$D_F = S (N_5 + N_6 + N_7 + N_8)/4$$

$$D_I = S (N_8 - N_6)/2 - \omega_V$$

The Channel 2 eight-position test data were analyzed in a similar manner; however, the equations were different since the orientations were not the same.

The high rate scale factor for Channels 1 and 2, and the high and low rate scale factors for the low viscosity gyro were determined by dividing the known difference in earth rate by the change in gyro output from the IA north orientation to the IA south orientation.

4.2 Drift Tests

Drift tests were performed to characterize the RGA output noise in the frequency range from 0.01 Hz to 20 Hz in a quiescent environment. These tests were the primary

objective of the test program.

4.2.1 Drift Test Procedure

The drift tests were conducted on an isolated test pad in Room 13 of the Advanced Inertial Test Laboratory, Bldg 1256. The RGA was mounted, turned on, and allowed to stabilize. Gyro data were taken using the drift test program with various accumulation times and numbers of points. Table 4 shows the specific conditions of each test.

The drift tests were conducted with the wheels either enabled or off, with the gyro in the low or high rate mode, and in both the OA horizontal and OA vertical orientations. They were also run with the Channel 1 gyro off and with the LVG substituted in place of the Channel 1 gyro.

On the ninth day of testing (17 Jun), the two cables were swapped between the RSU and the ECU channels at the RSU/ECU connectors (shown in Figure 1). On the tenth day, the cables were swapped back and the rate sensors (R/S) were swapped by exchanging R/S connectors inside the RSU (as shown in Figure 1) between Channel 1 and Channel 2.

Run 9-9X on 17 June was conducted immediately after the Channel 2 heater was turned off to determine the effect of temperature instability on the noise level.

On 19 June, the OA vertical orientation was repeated for two tests to confirm a bandwidth problem discovered on 11 June.

TABLE 4. DRIFT TEST CONDITIONS

Date (1980)	Run #	Orientation	Chan- nel Recor- ded	Status	Time (Min)/ Accumula- tion (Sec)/ # of Points
5 Jun	1-1	OA-H IA-E/W	1	CH1=CH2= ON/LO/EN	5/.025/12000
5 Jun	1-2	OA-H IA-E/W	2	CH1=CH2= ON/LO/EN	5/.025/12000
5 Jun	1-3A	OA-H IA-E/W	1	CH1=CH2= ON/LO/EN	2.5/.025/6000
5 Jun	1-3B	OA-H IA-E/W	2	CH1=CH2= ON/LO/EN	2.5/.025/6000
5 Jun	1-4	OA-H IA-E/W	1	CH1=CH2= ON/LO/EN	1/.005/12000
5 Jun	1-5	OA-H IA-E/W	2	CH1=CH2= ON/LO/EN	1/.005/12000
5 Jun	1-6	OA-H IA-E/W	1	CH1=CH2= ON/LO/EN	40/.2/12000
5 Jun	1-7	OA-H IA-E/W	2	CH1=CH2= ON/LO/EN	40/.2/12000
5 Jun	1-8	OA-H IA-E/W	1	CH1=CH2= ON/LO/EN	180/1/10800
5 Jun	1-9	OA-H IA-E/W	2	CH1=CH2= ON/LO/EN	180/1/10800
6 Jun	2-1	OA-H IA-E/W	1	CH1=CH2= ON/HI/EN	5/.025/12000
6 Jun	2-2	OA-H IA-E/W	2	CH1=CH2= ON/HI/EN	5/.025/12000
6 Jun	2-3A	OA-H IA-E/W	1	CH1=CH2= ON/HI/EN	2.5/.025/6000
6 Jun	2-3B	OA-H IA-E/W	2	CH1=CH2= ON/HI/EN	2.5/.025/6000

TABLE 4 (CONTINUED)

Date (1980)	Run #	Orientation	Chan- nel Recor- ded	Status	Time (Min)/ Accumula- tion (Sec)/ # of Points
6 Jun	2-4	OA-H IA-E/W	1	CH1=CH2= ON/HI/EN	1/.005/12000
6 Jun	2-5	OA-H IA-E/W	2	CH1=CH2= ON/HI/EN	1/.005/12000
6 Jun	2-6	OA-H IA-E/W	1	CH1=CH2= ON/HI/EN	40/.2/12000
6 Jun	2-7	OA-H IA-E/W	2	CH1=CH2= ON/HI/EN	40/.2/12000
6 Jun	2-8A	OA-H IA-E/W	1	CH1=CH2= ON/HI/EN	180/2/5400
6 Jun	2-8B	OA-H IA-E/W	2	CH1=CH2= ON/HI/EN	180/2/5400
9 Jun	3-1	OA-H IA-E/W	1	CH1=CH2= ON/LO/OFF	5/.025/12000
9 Jun	3-2	OA-H IA-E/W	2	CH1=CH2= ON/LO/OFF	5/.025/12000
9 Jun	3-3A	OA-H IA-E/W	1	CH1=CH2= ON/LO/OFF	2.5/.025/6000
9 Jun	3-3B	OA-H IA-E/W	2	CH1=CH2= ON/LO/OFF	2.5/.025/6000
9 Jun	3-4	OA-H IA-E/W	1	CH1=CH2= ON/LO/OFF	1/.005/12000
9 Jun	3-5	OA-H IA-E/W	2	CH1=CH2= ON/LO/OFF	1/.005/12000
9 Jun	3-6	OA-H IA-E/W	1	CH1=CH2= ON/LO/OFF	40/.2/12000
9 Jun	3-7	OA-H IA-E/W	2	CH1=CH2= ON/LO/OFF	40/.2/12000

TABLE 4 (CONTINUED)

Date (1980)	Run #	Orientation	Chan- nel Recor- ded	Status	Time (Min)/ Accumula- tion (Sec)/ # of Points
9 Jun	3-8A	OA-H IA-E/W	1	CH1=CH2= ON/LO/OFF	180/2/5400
9 Jun	3-8B	OA-H IA-E/W	2	CH1=CH2= ON/LO/OFF	180/2/5400
10 Jun	4-1	OA-H IA-E/W	1	CH1=CH2= ON/HI/OFF	5/.25/12000
10 Jun	4-2	OA-H IA-E/W	2	CH1=CH2= ON/HI/OFF	5/.25/12000
10 Jun	4-3A	OA-H IA-E/W	1	CH1=CH2= ON/HI/OFF	2.5/.025/6000
10 Jun	4-3B	OA-H IA-E/W	2	CH1=CH2= ON/HI/OFF	2.5/.025/6000
10 Jun	4-4	OA-H IA-E/W	1	CH1=CH2= ON/HI/OFF	1/.005/12000
10 Jun	4-5	OA-H IA-E/W	2	CH1=CH2= ON/HI/OFF	1/.005/12000
10 Jun	4-6	OA-H IA-E/W	1	CH1=CH2= ON/HI/OFF	40/.2/12000
10 Jun	4-7	OA-H IA-E/W	2	CH1=CH2= ON/HI/OFF	40/.2/12000
10 Jun	4-8A	OA-H IA-E/W	1	CH1=CH2= ON/HI/OFF	180/2/5400
10 Jun	4-8B	OA-H IA-E/W	2	CH1=CH2= ON/HI/OFF	180/2/5400
11 Jun	5-1	OA-V CH1 IA N	1	CH1=CH2= ON/LO/EN	5/.025/12000
11 Jun	5-2	OA-V CH1 IA N	2	CH1=CH2= ON/LO/EN	5/.025/12000

TABLE 4 (CONTINUED)

Date (1980)	Run #	Orientation	Chan- nel Recor- ded	Status	Time (Min)/ Accumula- tion (Sec)/ # of Points
11 Jun 5-3A		OA-V CH1 IA N	1	CH1=CH2= ON/LO/EN	2.5/.025/6000
11 Jun 5-3B		OA-V CH1 IA N	2	CH1=CH2= ON/LO/EN	2.5/.025/6000
11 Jun 5-4		OA-V CH1 IA N	1	CH1=CH2= ON/LO/EN	1/.005/12000
11 Jun 5-5		OA-V CH1 IA N	2	CH1=CH2= ON/LO/EN	1/.005/12000
12 Jun 6-1		OA-V CH1 IA N	2	CH1 OFF/ CH2/ON/LO/EN	5/.025/12000
12 Jun 6-2		OA-V CH1 IA N	2	CH1 OFF/ CH2/ON/LO/EN	1/.005/12000
12 Jun 6-3		OA-V CH1 IA N	2	CH1 OFF/ CH2/ON/LO/EN	40/.2/12000
12 Jun 6-4		OA-V CH1 IA N	2	CH1 OFF/ CH2/ON/LO/EN	180/.2/5400
13 Jun 7-1		OA-H IA-W	LVG	LVG=CH2= ON/LO/EN	5/.025/12000
13 Jun 7-2		OA-H IA-W	2	LVG=CH2= ON/LO/EN	5/.025/12000
13 Jun 7-3		OA-H IA-W	LVG	LVG=CH2= ON/LO/EN	1/.005/12000
13 Jun 7-4		OA-H IA-W	LVG	LVG=CH2= ON/LO/EN	40/.2/12000
13 Jun 7-5		OA-H IA-W	LVG	LVG=CH2= ON/LO/EN	180/2/5400
16 Jun 8-1		OA-H IA-W	LVG	LVG=CH2= ON/LO/OFF	5/.025/12000

TABLE 4 (CONTINUED)

Date (1980)	Run #	Orientation	Chan- nel Recor- ded	Status	Time (Min)/ Accumula- tion (Sec)/ # of Points
16 Jun 8-2		OA-H IA-W	2	LVG=CH2= ON/LO/OFF	5/.025/12000
16 Jun 8-3		OA-H IA-W	LVG	LVG=CH2= ON/LO/OFF	1/.005/12000
16 Jun 8-4		OA-H IA-W	LVG	LVG=CH2= ON/LO/OFF	40/.2/12000
16 Jun 8-5		OA-H IA-W	LVG	LVG=CH2= ON/LO/OFF	180/2/5400
17 Jun 9-1		OA-H IA-E/W	CH1 RSU	CH1=CH2= ON/LO/EN	5/.025/12000
17 Jun 9-2		OA-H IA-E/W	CH2 RSU	CH1=CH2= ON/LO/EN	5/.025/12000
17 Jun 9-3A		OA-H IA-E/W	CH1 RSU	CH1=CH2= ON/LO/EN	2.5/.025/6000
17 Jun 9-3B		OA-H IA-E/W	CH2 RSU	CH1=CH2= ON/LO/EN	2.5/.025/6000
17 Jun 9-4		OA-H IA-E/W	CH1 RSU	CH1=CH2= ON/LO/EN	1/.005/12000
17 Jun 9-5		OA-H IA-E/W	CH2 RSU	CH1=CH2= ON/LO/EN	1/.005/12000
17 Jun 9-6		OA-H IA-E/W	CH1 RSU	CH1=CH2= ON/LO/EN	40/.2/12000
17 Jun 9-7		OA-H IA-E/W	CH2 RSU	CH1=CH2= ON/LO/EN	40/.2/12000
17 Jun 9-8		OA-H IA-E/W	CH2 RSU	CH1=CH2= ON/LO/EN	180/2/5400
17 Jun 9-9X		OA-H IA-E/W	CH2 RSU	CH1=CH2= ON/LO/EN	5/.025/12000

TABLE 4 (CONTINUED)

Date (1980)	Run #	Orientation	Chan- nel Recor- ded	Status	Time (Min)/ Accumula- tion (Sec)/ # of Points
18 Jun 10-1	OA-H	IA-E/W	CH1 R/S	CH1=CH2= ON/LO/EN	5/.025/12000
18 Jun 10-2	OA-H	IA-E/W	CH2 R/S	CH1=CH2= ON/LO/EN	5/.025/12000
18 Jun 10-3A	OA-H	IA-E/W	CH1 R/S	CH1=CH2= ON/LO/EN	2.5/.025/6000
18 Jun 10-3B	OA-H	IA-E/W	CH2 R/S	CH1=CH2= ON/LO/EN	2.5/.025/6000
18 Jun 10-4	OA-H	IA-E/W	CH1 R/S	CH1=CH2= ON/LO/EN	1/.005/12000
18 Jun 10-5	OA-H	IA-E/W	CH2 R/S	CH1=CH2= ON/LO/EN	1/.005/12000
18 Jun 10-6	OA-H	IA-E/W	CH1 R/S	CH1=CH2= ON/LO/EN	40/.2/12000
18 Jun 10-7	OA-H	IA-E/W	CH2 R/S	CH1=CH2= ON/LO/EN	40/.2/12000
19 Jun 11-1	OA-V	CH1 IA N	1	CH1=CH2= ON/LO/EN	5/.025/12000
19 Jun 11-2	OA-V	CH1 IA N	2	CH1=CH2= ON/LO/EN	5/.025/12000

The gyro output was recorded by the Bendix 9000 test computer and punched out on paper tape. The data were read from the paper tape and stored in the CIGTF central minicomputer system, where it was reformatted and reduced.

During each test, tiltmeter and seismometer data were recorded under the same conditions, and during the same time period as the gyro data. These data were low pass filtered (to prevent aliasing) and recorded on magnetic tape to be processed on the CIGTF central minicomputer in the same manner as the gyro data.

4.2.2 Drift Test Analysis

Each channel of data was scaled into appropriate units, and least squares fitted to a straight line. The bias and slope were removed from the data and the results were Fast Fourier Transformed and self-conjugate multiplied. These power spectrums were averaged as described below, and normalized to produce Power Spectral Density (PSD) plots or integrated and the square root was taken to produce root mean square (RMS) noise calculations.

Several blocks, each of 2048 points, were averaged (using a "sliding average" technique) to obtain power spectrums. Each block was delayed in the time domain by an offset of 128 points. Table 5 shows the various numbers of data points in a test, the associated number of averages that were used, and the amount of offset between averages.

TABLE 5. OFFSETS AND AVERAGES FOR EACH TEST CONDITION

# Pts	Accum Time (Sec)	Offset (# Pts)	Offset (Sec)	# Blocks Averaged	# Points Not Used
12000	0.005	128	0.64	78	96
12000	0.025	128	3.2	78	96
6000	0.025	128	3.2	31	112
12000	0.2	128	25.6	78	96
10800	1.0	128	128.0	69	48
5400	2.0	128	256.0	27	24

After normalizing the averaged power spectrums, the PSD data were averaged logarithmically to prevent the "bunching-up" effect on the plot. As shown in Table 6 (from Koenigsberg, W.E., "Spectral Analysis of Random Signals - Techniques and Interpretation", Charles Stark Draper Laboratory Report E-2771, June 1973), the first 32 points were plotted directly; the next 32 points were averaged 2 at a time, the next 64 points were averaged 4 at a time, and so on.

For the RMS noise calculations, power spectrum points were grouped to yield convenient frequency increments, integrated, and the square root taken. The RMS noise was also calculated and printed for the entire data block (2048 points).

TABLE 6. LOGARITHMIC AVERAGING OF 2048 PSD POINTS.

k defines the averaging interval	2^k no. of PSD points to be averaged	n harmonic number	no. of points in the averaging interval	m index of averaged points	no. of averaged points in the interval
0	1	1-32	32	1-32	32
1	2	33-64	32	33-48	16
2	4	65-128	64	49-64	16
3	8	129-256	128	65-80	16
4	16	257-512	256	81-96	16
5	32	513-1024	512	97-112	16
6	64	1025-2048	1024	113-128	16

5. TEST RESULTS

5.1 Eight-Position and Scale Factor Test Results

The results of the eight-position and scale factor tests are presented in Table 7.

TABLE 7. EIGHT-POSITION AND SCALE FACTOR TEST RESULTS

Parameter (Units)	Channel 1 Results	Channel 2 Results	LVG Results
DF (Deg/Hr)	-0.6053	1.2592	
DS (Deg/Hr/g)	-0.7274	1.1704	
DI (Deg/Hr/g)	0.2642	0.9788	
Low Rate Scale Factor (Arc Sec/Pulse)	0.0002485	0.0002494	0.0002354
High Rate Scale Factor (Arc Sec/Pulse)	0.01481	0.01525	0.01410

5.2 Drift Test Results

Appendix A contains the PSD plots and RMS noise calculations of the gyro data for each drift test. Table 8 contains the RMS noise specifications for the RGA.

Since the Pointing and Control system uses a sample time of 0.025 sec, the 0.025 sec accumulation tests were considered the most critical. The PSD's of the 0.025 sec accumulation time tests conducted at the CIGTF were very comparable to similar tests conducted previously at Bendix in Teterboro, NJ, indicating that there was little seismic contribution to the PSD level or RMS rate noise. Tests of other accumulation times had not been previously conducted and analyzed, so comparison was not possible.

The gyro output was not low-pass filtered since it would not be filtered during the mission; therefore, noise above the frequency range of interest was allowed to fold back due to aliasing, in some cases. Aliasing did not appear to be significant in the 20 Hz and 100 Hz maximum frequency tests (0.025 sec and 0.005 sec accumulation time tests), due to the inherent low-pass filtering of the RGA system frequency response. However, in the lower frequency (longer accumulation time) tests, this caused the PSD noise levels to appear higher than they actually were and to change with frequency range.

TABLE 8. SPACE TELESCOPE RATE GYRO ASSEMBLY SPECIFICATION

LMSC 4171761A

FREQ (Hz)	MAX RMS RATE NOISE (ARC SEC/SEC)
0.01-1.0	0.019
1.0 -2.0	0.047
2.0 -3.0	0.074
3.0 -4.0	0.101
4.0 -5.0	0.127
5.0-10.0	0.463
10.0-20.0	1.242
0.01 -5.0	0.185
0.01-20.0	1.337

An example of this is the Channel 2 data on 6 Jun, over various frequency ranges. In Run 2-2 (Page A-28, 20 Hz range), the PSD level at 1 Hz was about 0.001 (arc sec/sec)²/hz and the RMS noise from 0 to 1 Hz was 0.0167 arc sec/sec. In Run 2-5 (Page A-36, 100 Hz range), the PSD level was the same. This indicates that the aliasing of noise above 20 Hz was not significant at 1 Hz in Run 2-2. However, in Run 2-7 (Page A-40, 2.5 Hz range), the PSD level was 0.01 (arc sec/sec)²/Hz at 1 Hz and the RMS noise from 0 to 1 Hz was 0.1394 arc sec/sec. This large increase in measured noise over the 0 to 1 Hz range from Run 2-2 to Run 2-7 was not due to an actual increase in the noise level; but instead, it was due to noise above the frequency range of Run 2-7 (2.5 Hz) folding back or aliasing. Therefore, it is cautioned that the noise levels of the 40-minute and 3-hour tests contain noise that has been aliased.

Run 5-1 (Page A-86) and Run 11-1 (Page A-162), conducted on 11 and 19 Jun, respectively, had a lower PSD level and a reduced total RMS noise compared with other Channel 1 tests. Bendix representatives preliminarily attributed this to an intermittent gyro failure that caused a reduced bandwidth when the OA's were oriented vertical.

The Channel 2 1-minute tests with wheels enabled (Run 1-5 (Page A-16), Run 2-5 (Page A-36), Run 5-5 (Page A-96) and Run 6-2 (Page A-100)), show a spike at 80 Hz, which Bendix attributed to a 320 Hz spike that aliased. The spike followed the rate sensor when the electronics were swapped in

Run 9-5 (Page A-136) and Run 10-5 (Page A-156).

Since there was no apparent seismic contribution to the data, only two seismometer plots are presented. Figure 3 shows the seismic PSD level on a typical test day. This level was about the same for all seismometer orientations; horizontal (with axis east-west), horizontal (with axis north/south), and vertical. The tiltmeters showed very little activity during any test.

Figure 4 shows the seismic PSD level on 12 Jun 80, the only day that differed significantly from a typical day. Run 6-4 (Page A-104) appears to be the only test that shows significant seismically induced noise. The rise in low frequency noise may have been due to the higher seismic level on that day (12 Jun).

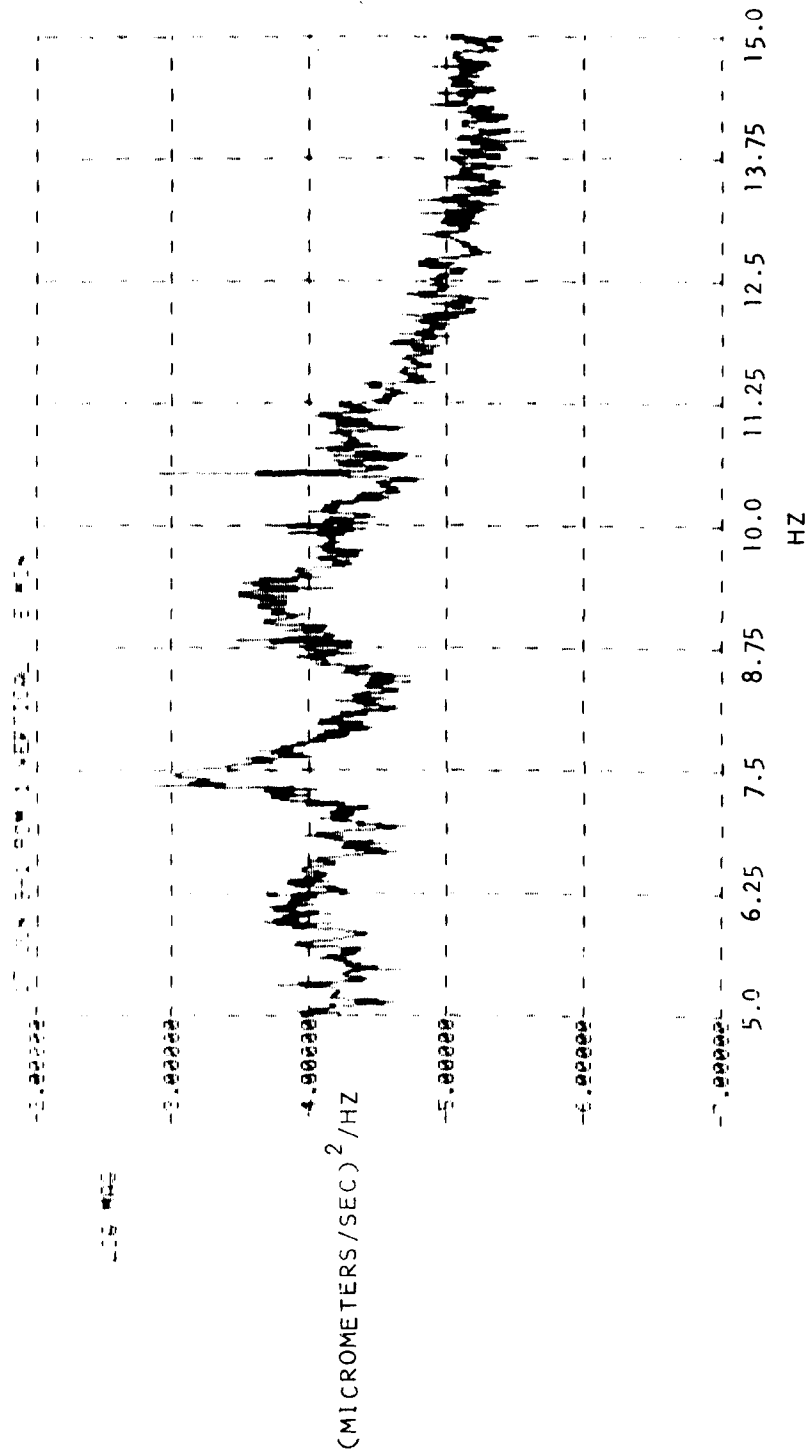

FIGURE 3. PSD OF A VERTICAL SEISMOMETER ON A TYPICAL DAY.

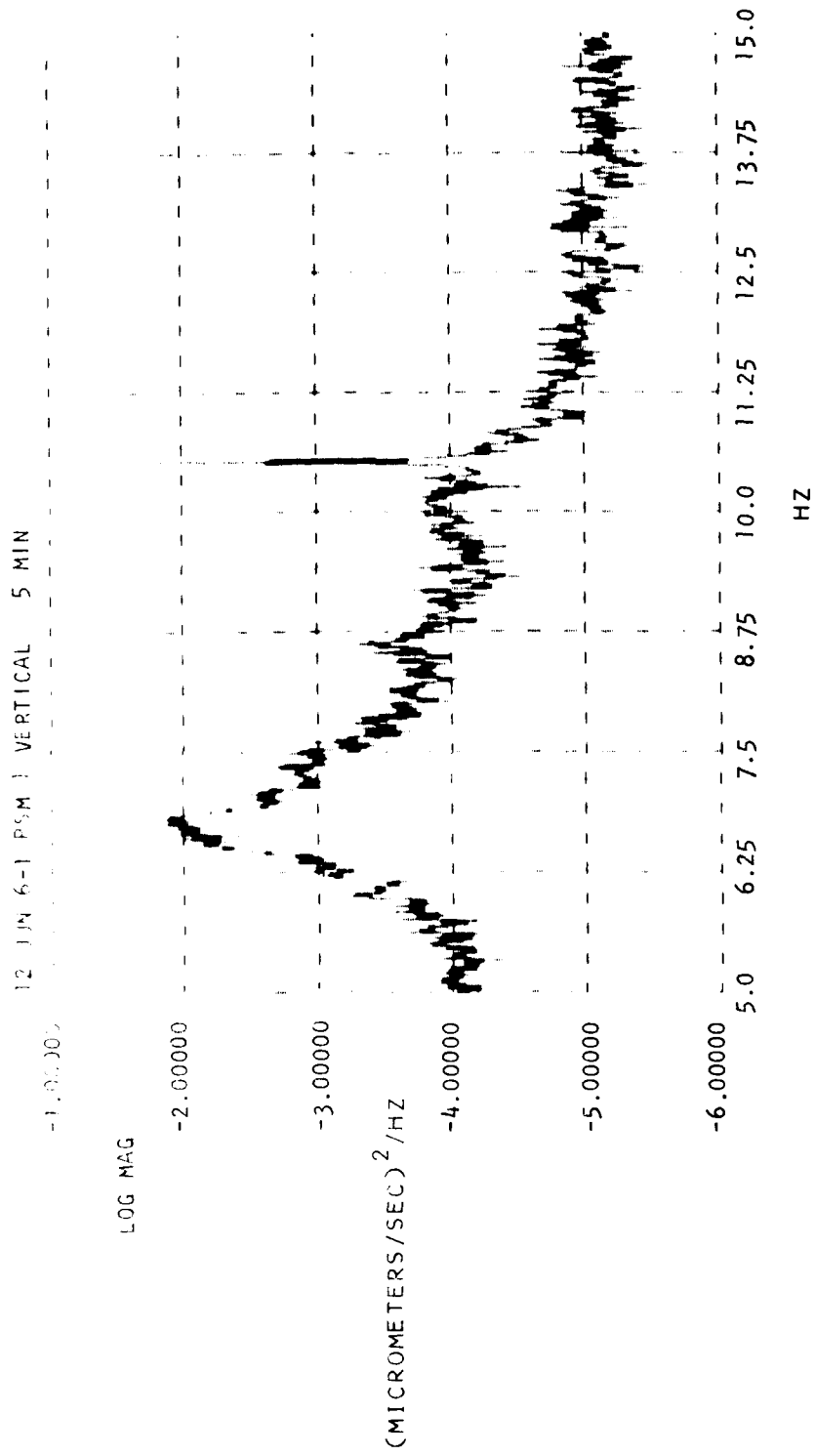

FIGURE 4. PSD OF A VERTICAL SIESMOMETER ON 12 JUN 80.

Two LVG tests, Run 8-4 (Page A-121) and Run 8-5 (Page A-123), displayed peculiarities in the time domain that affected the PSD's. These are shown in Figures 5 and 6. Figure 5 shows 2048 points of Run 8-4, starting with point 3073; Figure 6 shows the first 4096 points of Run 8-5. In both tests there were periods of approximately 200 seconds when the gyro output dropped, causing a large increase in the low frequency PSD level. These fluctuations did not correlate with any seismic or tilt fluctuations.

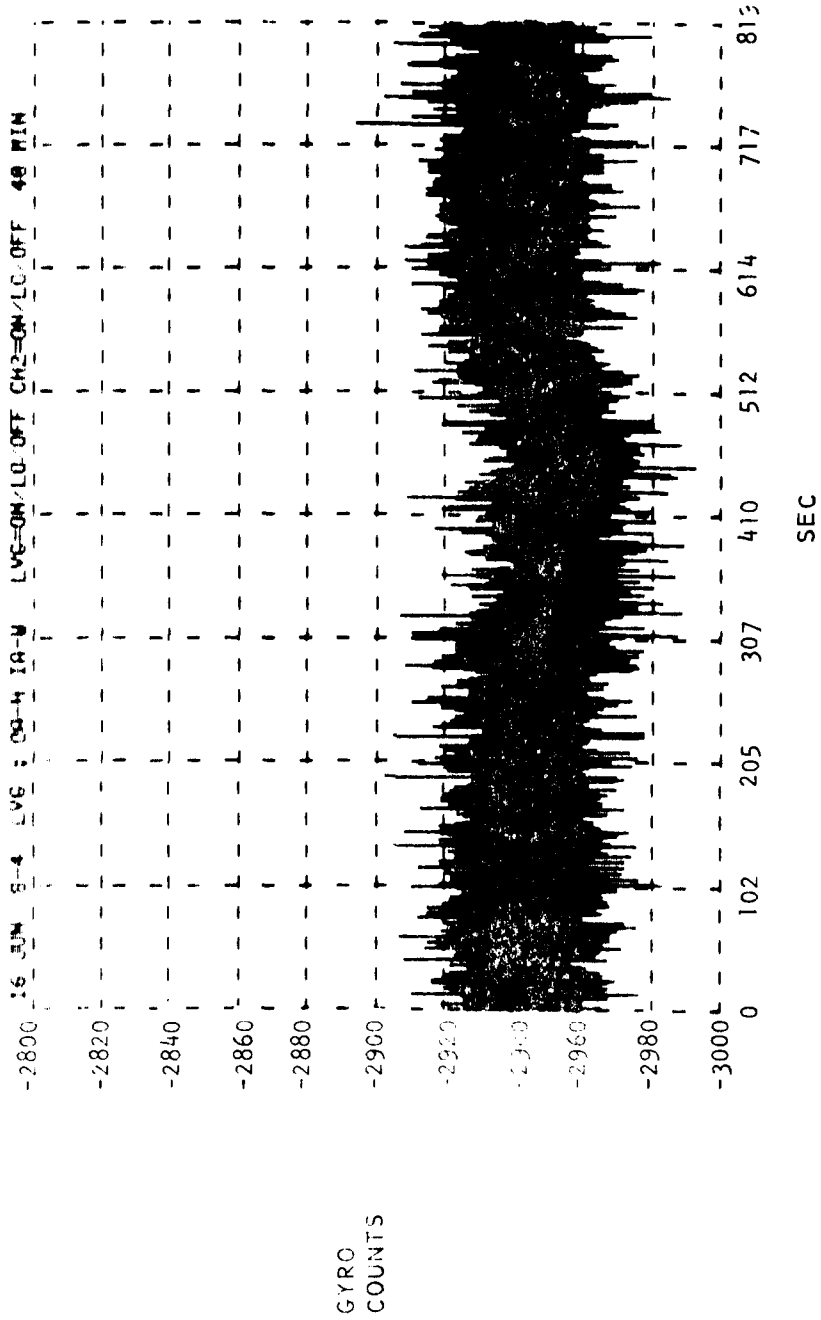

FIGURE 5. LGV-TIME DOMAIN DATA OF RUN #8-4.

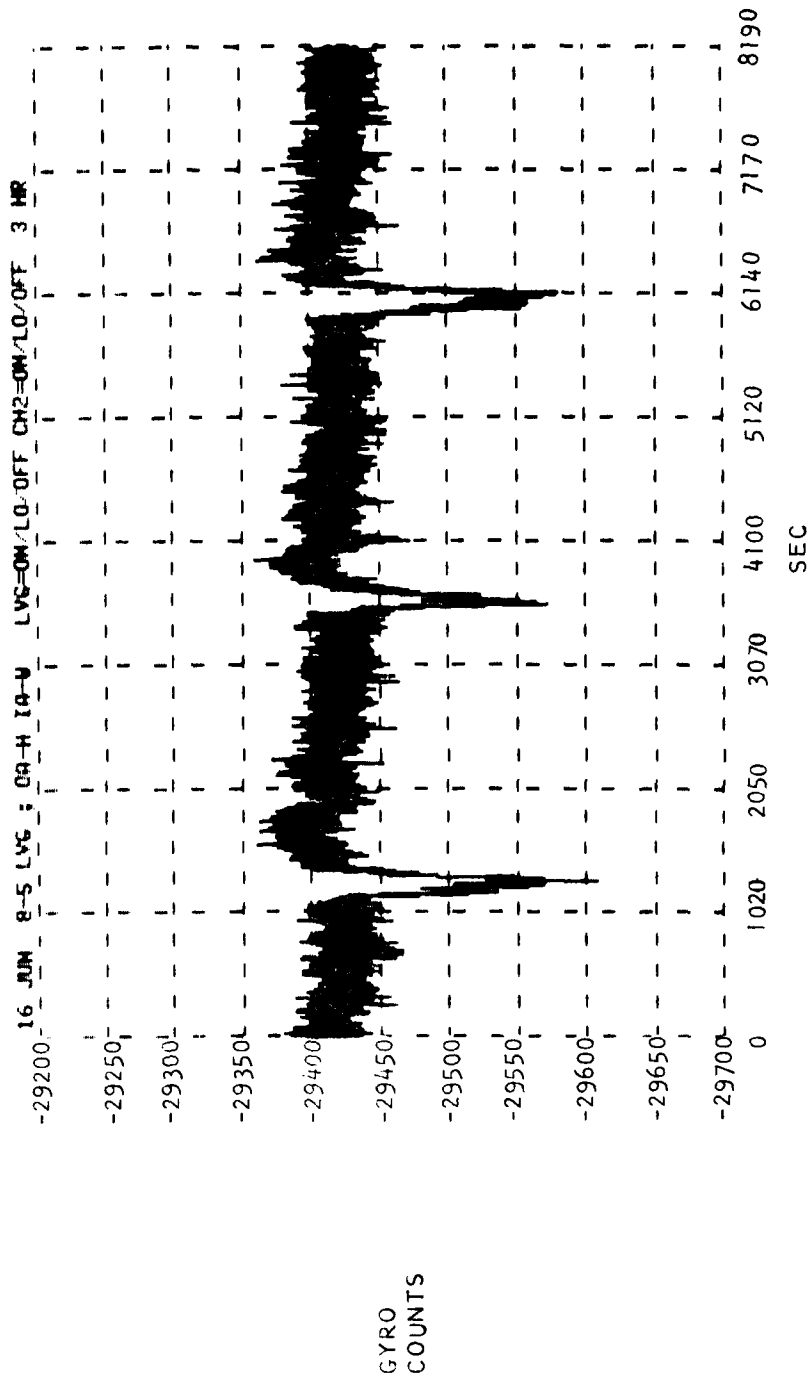

FIGURE 6. LVC-TIME DOMAIN DATA OF RUN #8-5.

6. CONCLUSIONS

Three Bendix PM 64 RIG gyros were tested from 2-19 Jun 80. Multi-position tests were used to determine g-sensitive drift coefficients for each gyro and scale factors for each gyro rate mode. Drift test data were used to calculate RMS rate noise and to compute PSD's over various operating conditions and frequency ranges of 100 Hz, 20 Hz, 2.5 Hz, and 0.25 Hz. The multi-position and drift tests yielded results that were similar to previous tests conducted at Bendix. The 2.5 Hz and 0.25 Hz data contain noise that was aliased, therefore the PSD level and RMS rate noise are higher than the actual noise levels of the system. There was no apparent seismic contribution to the drift data, except possibly to Run 6-4, which was conducted on a relatively seismically noisy day and had a rise in the low frequency noise.

Two LVG tests, Runs 8-4 and 8-5, displayed peculiarities in the time domain that affected the PSD's and did not correlate with seismic data.

APPENDIX A

This appendix contains the PSD plots and RMS noise calculations of the gyro data for each drift test.

Figure A-1 is an example of a typical PSD plot. The sections noted in Figure A-1 are described below.

1. Title: Date, Run No., Channel Recorded, Orientation, Status, Length of Test.

2. Ordinate scale (common logarithm of the PSD magnitude). The units for the ordinate are $(\text{arc sec/sec})^2/\text{Hz}$.

3. Abscissa scale (logarithm of the frequency). The units of the abscissa are Hz.

4. Plot parameters:

N = No. of points in the PSD data block

DT = Accumulation time

T = Total time of the PSD data block

DF = Frequency resolution

F = Maximum frequency of the PSD data block

5. The data have been averaged logarithmically as described in Section 4.2.2 of the main body of this report.

Figure A-2 is an example of a typical table of RMS noise calculation values. The sections noted in Figure A-2 are described below.

1. Title: Date, Run No., Channel Recorded, Orientation, Status, Length of Test, No. of complex points in the Power Spectrum Block, Frequency Resolution of the Block (DF), Maximum Frequency of the Block (F).

2. Column headings and units.

3. RMS rate noise values calculated over various intervals.

4. Total RMS rate noise calculated over the entire frequency range.

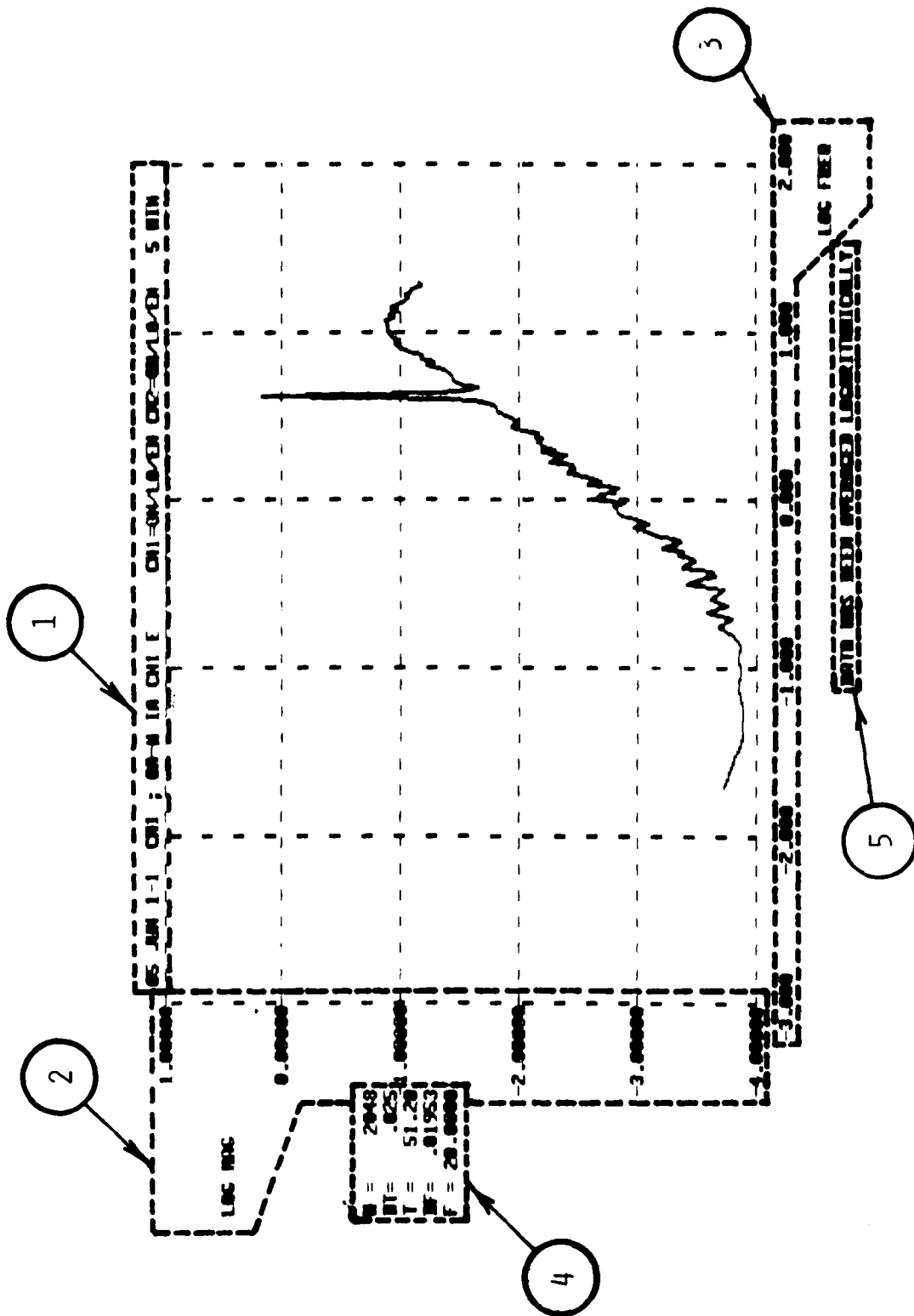

FIGURE A-1. EXAMPLE OF A TYPICAL PSD PLOT

20 111 1-1 CH1=ON/LO/EN CH2=ON/LO/EN 5 MIN
 W 0111112 P15 11 1111111 = 1124, DF, F ARE .195313F-w1 .2111111E+w2

1
2

		MAX F	RMS RATE NOISE
	HZ	HZ	ARC SEC/SEC
1	1.99	1.99	.0256
2	1.99	1.99	.0597
3	1.99	2.99	.0924
4	2.99	3.98	.1288
5	3.98	4.98	.5138
6	4.98	5.98	.1938
7	5.98	6.97	.2366
8	6.97	7.97	.2835
9	7.97	8.96	.3235
10	8.96	9.96	.3465
11	9.96	10.96	.3581
12	10.96	11.95	.3617
13	11.95	12.95	.3517
14	12.95	13.95	.3368
15	13.95	14.94	.3326
16	14.94	15.94	.3100
17	15.94	16.93	.3002
18	16.93	17.93	.2883
19	17.93	18.93	.2771
20	18.93	19.92	.2662

3

1	4.98	4.98	.5416
2	4.98	9.96	.6313
3	9.96	14.94	.7790
4	14.94	19.92	.6457

1	0.00	20.00	1.3117
---	------	-------	--------

4

FIGURE A-2. EXAMPLE OF A TYPICAL RMS RATE NOISE TABLE

05 JUN 1: CH1: 00-H IA CH: E CH1=ON/LO/EN CH2=ON/LO/EN 5 MIN

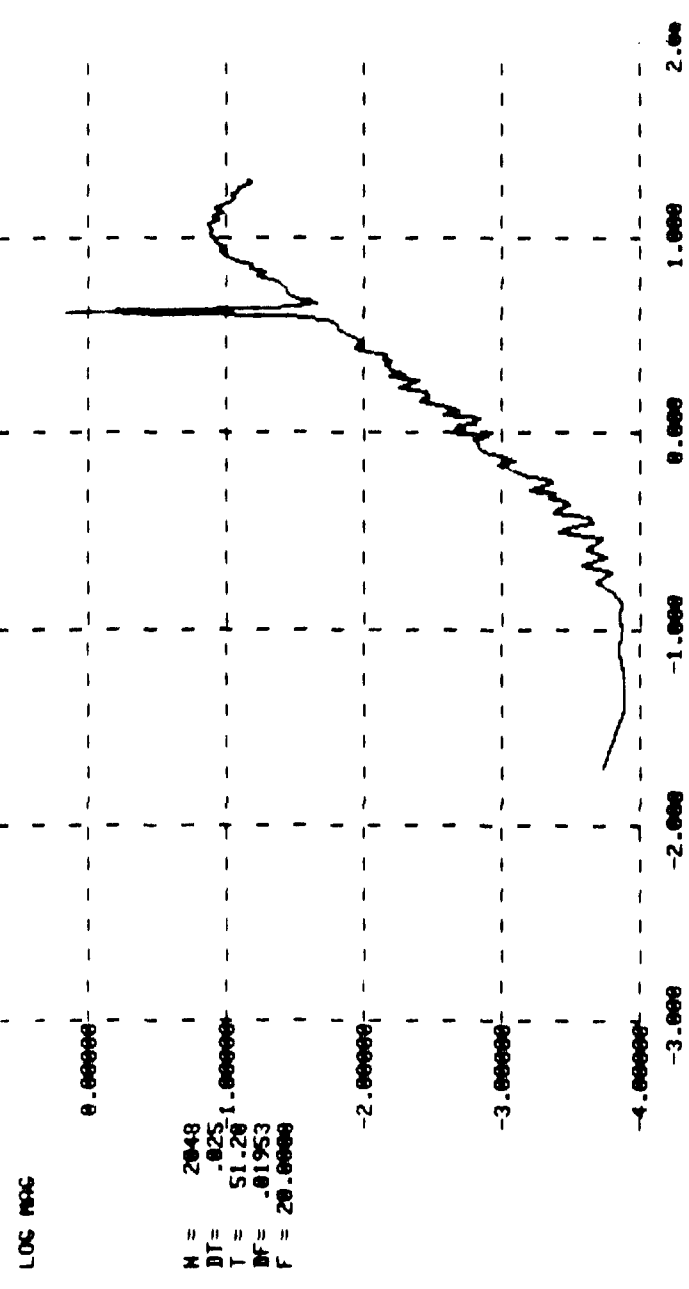

H = 2048
DT = .025
T = 51.20
BF = .01953
F = 20.0000

LOG F/E
DATA HAS BEEN AVERAGED LOGRITHMICALLY

05 JUN 1-1 LHI 3 UA=0 IA CH1 E CH1=ON/LOZEN CH2=ON/LOZEN 5 MIN
 # COMPLEX PIS IN BLOCK OF 1024. OF, F AMF .195313E+01 .200000E+02

INTERVAL #	MIN F HZ	MAX F HZ	RMS RATE NOISE ARC SEC/SEC
1	0.00	1.00	.0256
2	1.00	1.99	.0597
3	1.99	2.99	.0924
4	2.99	3.98	.1288
5	3.98	4.98	.5138
6	4.98	5.98	.1938
7	5.98	6.97	.2366
8	6.97	7.97	.2835
9	7.97	8.96	.3235
10	8.96	9.96	.3465
11	9.96	10.96	.3561
12	10.96	11.95	.3617
13	11.95	12.95	.3517
14	12.95	13.95	.3368
15	13.95	14.94	.3326
16	14.94	15.94	.3100
17	15.94	16.93	.3002
18	16.93	17.93	.2863
19	17.93	18.93	.2771
20	18.93	19.92	.2662
1	0.00	4.98	.5416
2	4.98	9.96	.6313
3	9.96	14.94	.7790
4	14.94	19.92	.6457
1	0.00	20.00	1.3117

05 JUN 1-2 CMZ : GR-H 18 CMZ U CM1=ON LO EN CM2=ON .0/EN 5 MI

LOG MAG

N = 2048
 DT = .825
 T = 51.28
 DF = .01953
 F = 20.0000

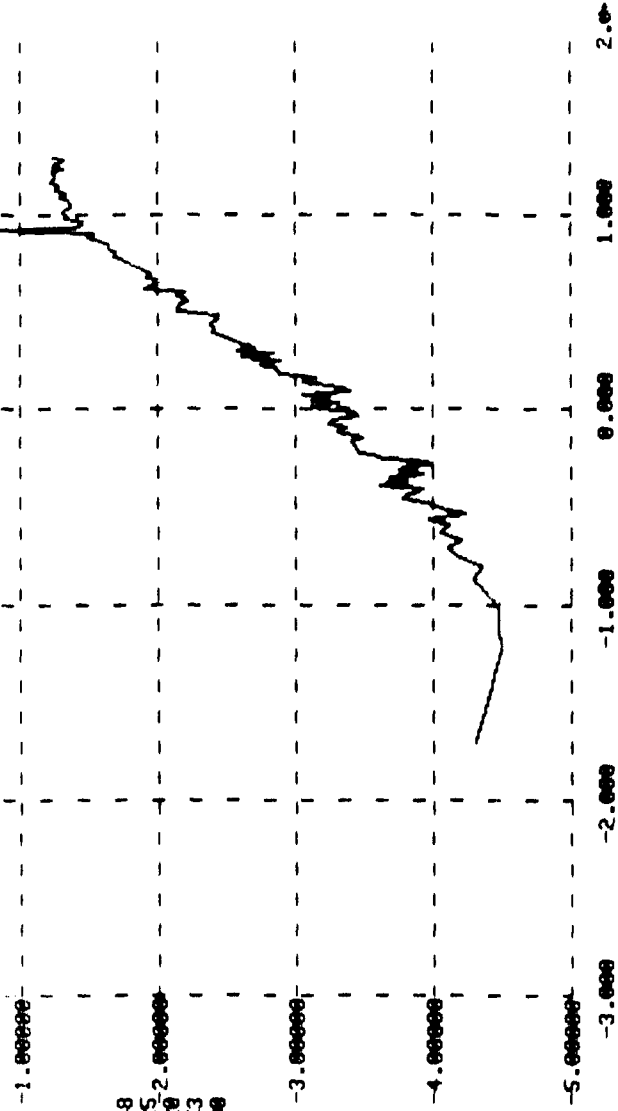

LOG F:
 DATA HAS BEEN AVERAGED LOGRITHMICALLY

20 JUN 1-2 CH2 : UA-H IA CH2 W CH1=ON/LO/EN CH2=ON/LO/EN 5 MIN
 * COMPLEX PIS IN BLU CA W= 1W24, OF, P ARE .195313E-01 .200000E+02

INTERVAL #	MIN F HZ	MAX F HZ	RMS RATE NOISE ARC SEC/SEC
1	0.00	1.00	.0154
2	1.00	1.99	.0354
3	1.99	2.99	.0587
4	2.99	3.98	.0807
5	3.98	4.98	.1043
6	4.98	5.98	.1253
7	5.98	6.97	.1455
8	6.97	7.97	.1667
9	7.97	8.96	.2699
10	8.96	9.96	.2036
11	9.96	10.96	.2188
12	10.96	11.95	.2136
13	11.95	12.95	.2222
14	12.95	13.95	.2271
15	13.95	14.94	.2475
16	14.94	15.94	.2326
17	15.94	16.93	.2445
18	16.93	17.93	.2297
19	17.93	18.93	.2298
20	18.93	19.92	.2337
1	4.98	4.98	.1494
2	4.98	9.96	.4231
3	9.96	14.94	.5056
4	14.94	19.92	.5235
1	0.00	20.00	.8584

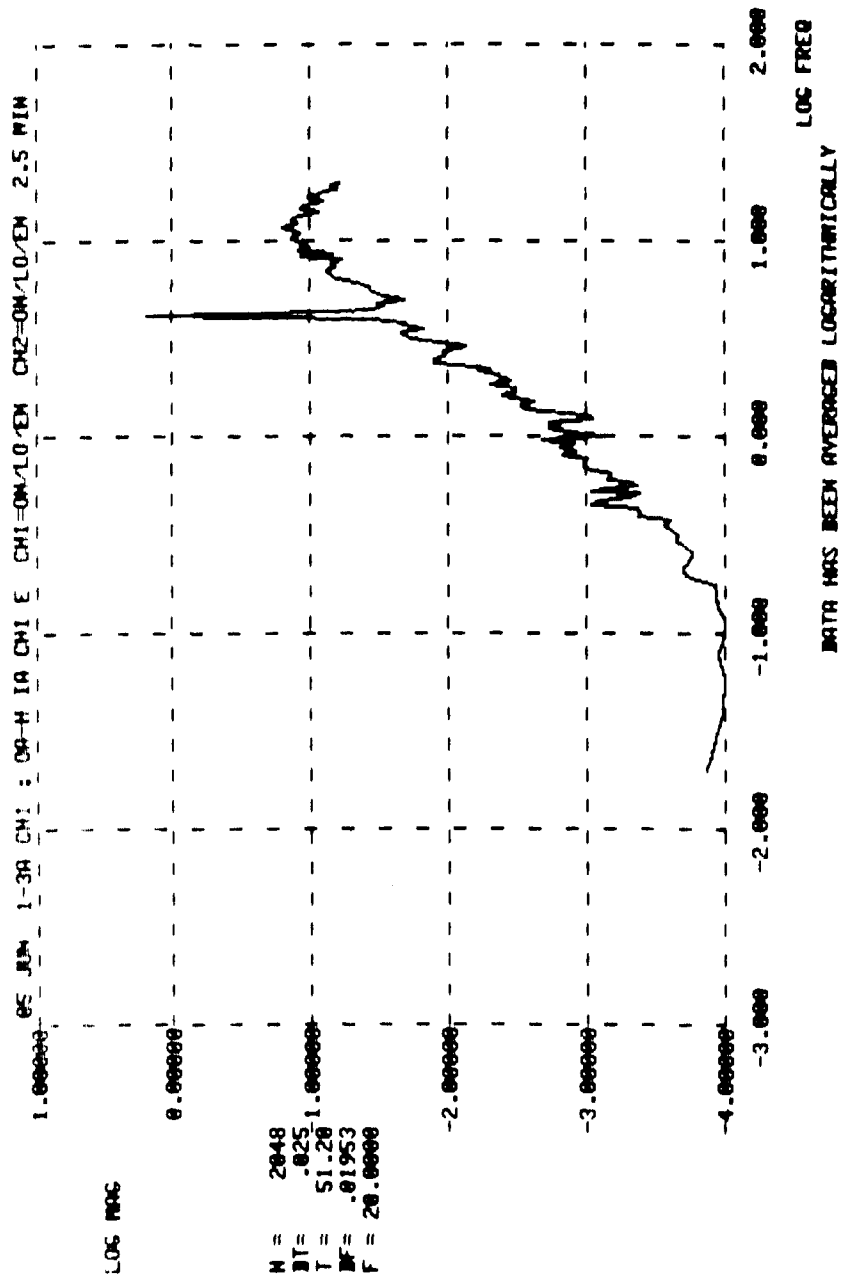

3 JUN 1-3A CH1 ; DA=M IA CH1 F CH1=ON/LO/EN CH2=ON/LO/EN 2,5 MIN
 * COMPLEX PTS IN BLOCK * = 1024, DF,F ARE .195313E-01 .200000E+02

INTERVAL #	MIN F HZ	MAX F HZ	RMS RATE NOISE ARC SEC/SEC
1	0.98	1.00	.0257
2	1.98	1.99	.0520
3	1.99	2.99	.0939
4	2.99	3.98	.1383
5	3.98	4.98	.5227
6	4.98	5.98	.1841
7	5.98	6.97	.2580
8	6.97	7.97	.2630
9	7.97	8.96	.3108
10	8.96	9.96	.3299
11	9.96	10.96	.3620
12	10.96	11.95	.3796
13	11.95	12.95	.3549
14	12.95	13.95	.3594
15	13.95	14.94	.3212
16	14.94	15.94	.3157
17	15.94	16.93	.3052
18	16.93	17.93	.2994
19	17.93	18.93	.2650
20	18.93	19.92	.2535
1	0.00	4.98	.0518
2	4.98	9.96	.6125
3	9.96	14.94	.7959
4	14.94	19.92	.6457
1	0.00	20.00	1.3163

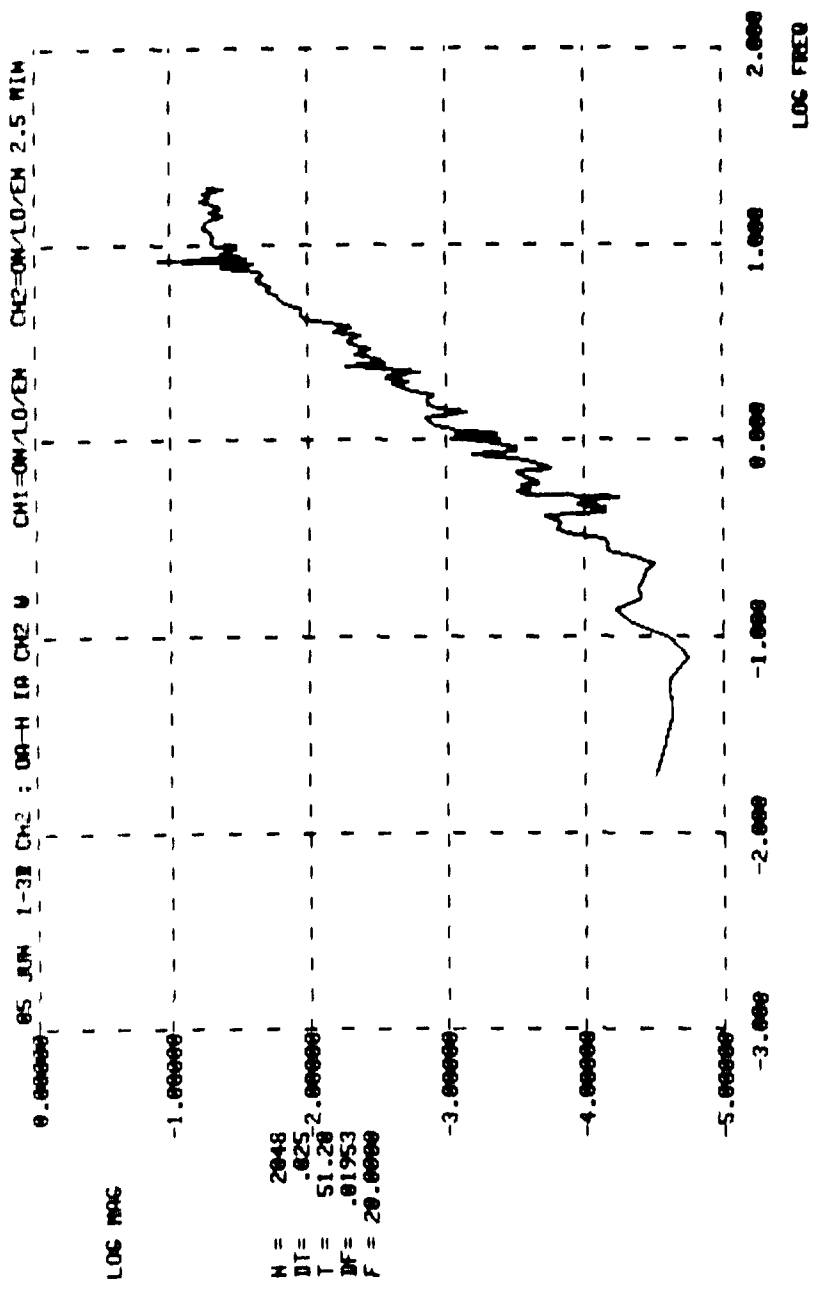

00 JUN 1-38 CH2 1 UA-N IA CH2 W CH1=UN/LO/EN CH2=ON/LO/EN 2.0 MIN
 * COMPLEX PTS IN BLOCK W= 1024, DF, F ARE .195313E-01 .200000E+02

INTERVAL #	MIN F HZ	MAX F HZ	RMS RATE NOISE ARC SEC/SEC
1	0.00	1.00	.0138
2	1.00	1.99	.0373
3	1.99	2.99	.0584
4	2.99	3.98	.0721
5	3.98	4.98	.1086
6	4.98	5.98	.1340
7	5.98	6.97	.1490
8	6.97	7.97	.1694
9	7.97	8.96	.2464
10	8.96	9.96	.2002
11	9.96	10.96	.2244
12	10.96	11.95	.2219
13	11.95	12.95	.2375
14	12.95	13.95	.2259
15	13.95	14.94	.2176
16	14.94	15.94	.2135
17	15.94	16.93	.2409
18	16.93	17.93	.2247
19	17.93	18.93	.2364
20	18.93	19.92	.2225
1	0.00	4.98	.1463
2	4.98	9.96	.4119
3	9.96	14.94	.5043
4	14.94	19.92	.5094
1	0.00	20.00	.8415

05 JUN 19 04:18 CH1E CH10M101EN CH20M101EN 1 MIP

LOG MAG

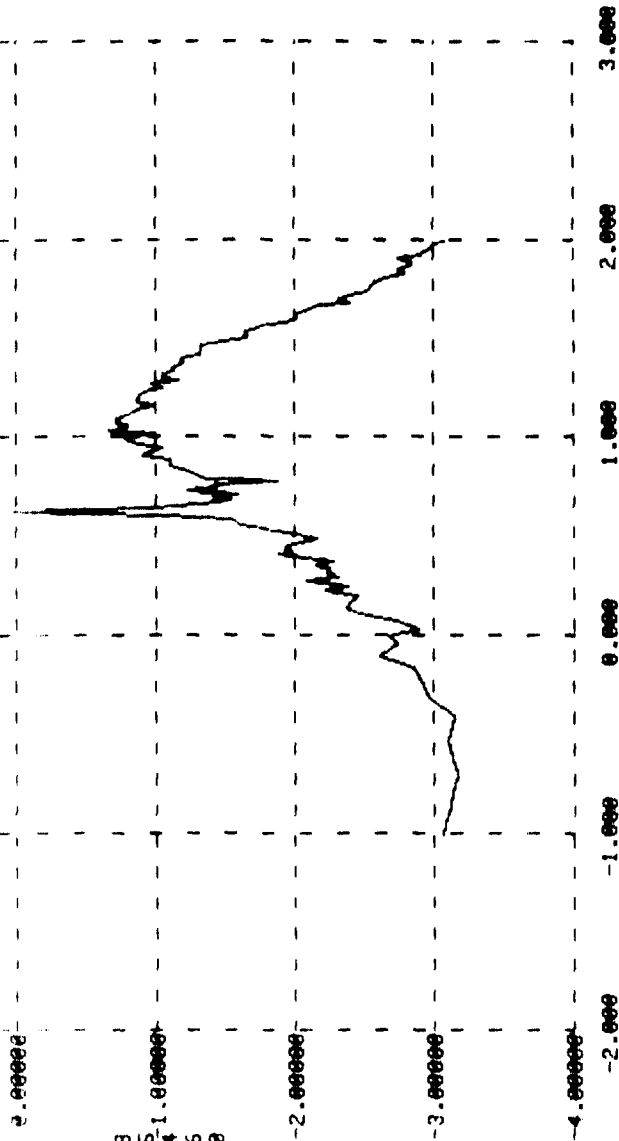

N = 2048
DT = .005
T = 10.24
DF = .09766
F = 100.00000

LOG FREQ

DATA HAS BEEN AVERAGED LOGARITHMICALLY

05 JUN 1-4 CH1 ; UA=M IA CH1 E CH1=ON/LO/EN CH2=ON/LO/EN 1 MIN
 # COMPLEX PTS IN BLOCK 0= 1424. OF, F ARE .976563E-01 .100000E+03

INTERVAL #	MIN F HZ	MAX F HZ	RMS RATE NOISE ARC SEC/SEC
1	0.00	9.96	.8552
2	9.96	19.92	1.1496
3	19.92	29.88	.7823
4	29.88	39.84	.4400
5	39.84	49.80	.2673
6	49.80	59.77	.1811
7	59.77	69.73	.1456
8	69.73	79.69	.1212
9	79.69	89.65	.1175
10	89.65	99.61	.1002
1	0.00	100.00	1.7386

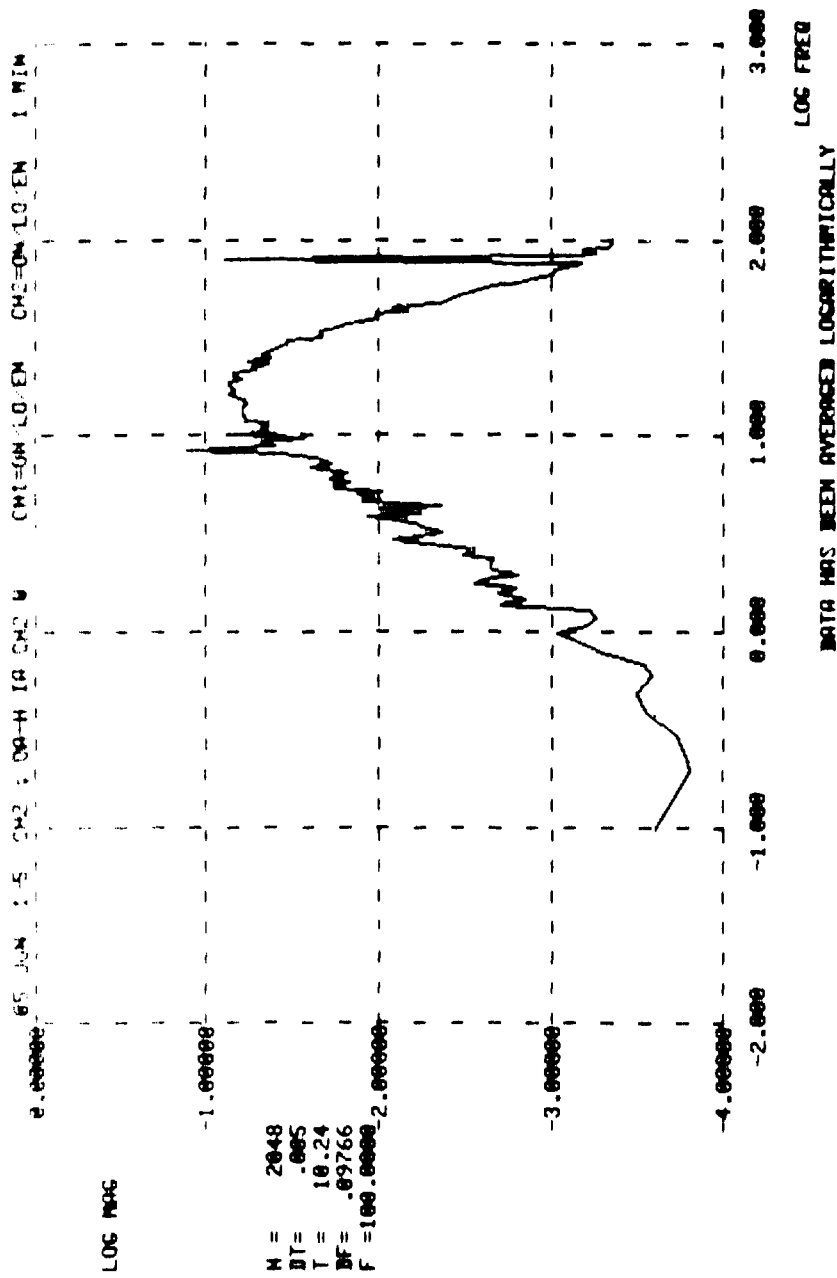

45 JUN 1-5 CH2 ; UA-M IA CM2 W CH1=ON/LO/EN CH2=ON/LO/EN 1 MIN
 * COMPLEX PTS IN BLOCK W= 1024. DF, F ARE .976563E-01 .100000E+03

INTERVAL #	MIN F HZ	MAX F HZ	RMS RATE NOISE ARC SEC/SEC
1	0.00	9.96	.4434
2	9.96	19.92	.7861
3	19.92	29.88	.8845
4	29.88	39.84	.4371
5	39.84	49.80	.2652
6	49.80	59.77	.1668
7	59.77	69.73	.1065
8	69.73	79.69	.0981
9	79.69	89.65	.5007
10	89.65	99.61	.0693
1	0.00	100.00	1.3599

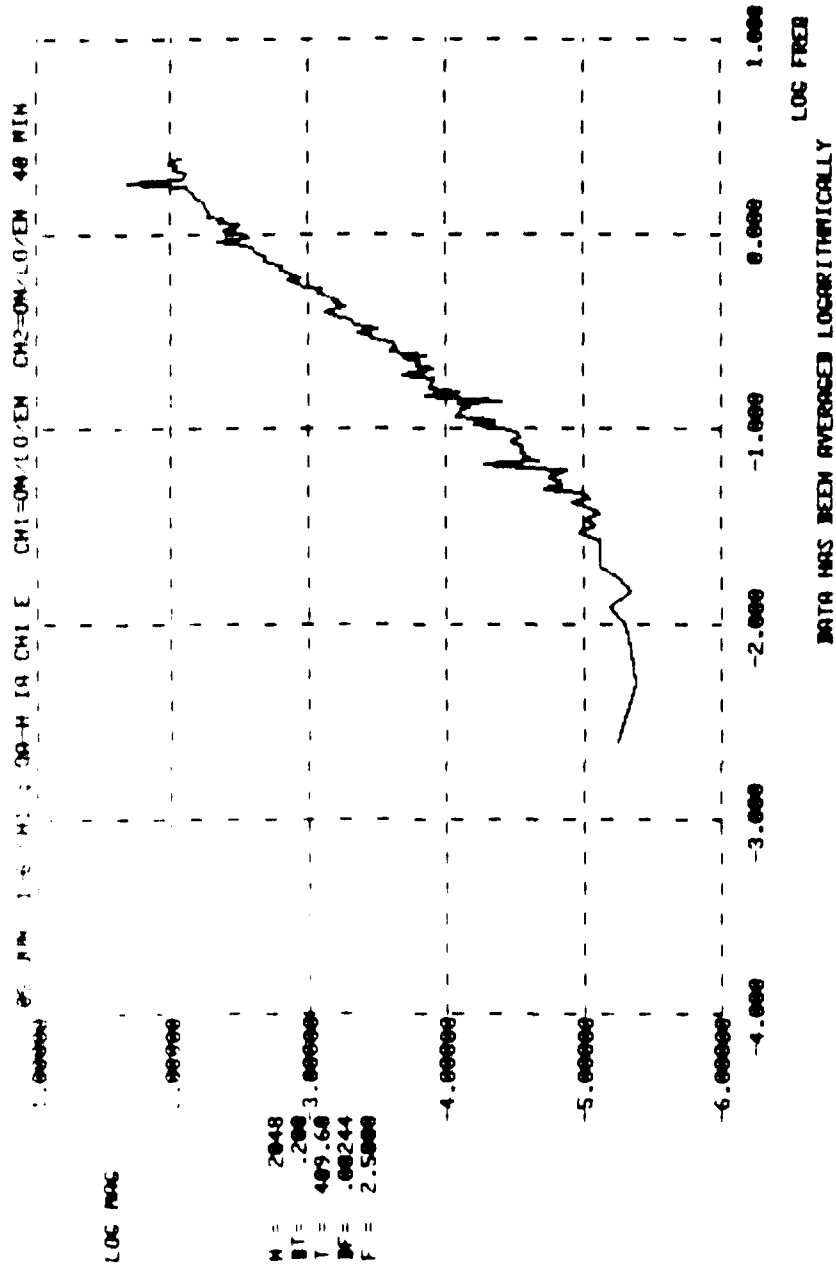

05 JUN 1-6 CH1 ; 0A-0 1A CH1 E CH1=ON/LOZEN CH2=ON/LOZEN 40 MIN
 * COMPLEX PTS IN BLOCK * 1M24. OF, F ARE .244141E-02 .250000E+01

INTERVAL #	MIN F HZ	MAX F HZ	RMS RATE NOISE ARC SEC/SEC
1	0.00	.10	.0013
2	.10	.20	.0033
3	.20	.30	.0048
4	.30	.40	.0071
5	.40	.50	.0081
6	.50	.60	.0107
7	.60	.70	.0124
8	.70	.80	.0149
9	.80	.90	.0173
10	.90	1.00	.0179
11	1.00	1.10	.0192
12	1.10	1.20	.0198
13	1.20	1.30	.0233
14	1.30	1.40	.0229
15	1.40	1.50	.0241
16	1.50	1.60	.0266
17	1.60	1.70	.0264
18	1.70	1.80	.0409
19	1.80	1.90	.0308
20	1.90	2.00	.0287
21	2.00	2.10	.0283
22	2.10	2.20	.0309
23	2.20	2.30	.0307
24	2.30	2.40	.0323
1	0.00	1.00	.0355
2	1.00	2.00	.0852
1	0.00	2.50	.1146

03 JUN 1-7 CH2 ; NA=1 IN CH2 a CH1=ON/LO/EN CH2=ON/LO/EN 40 MIN
 # COMPLEX PTS IN BLOCK = 1024. DP, F ARE .244141E-02 .250000E+01

INTERVAL #	MIN F HZ	MAX F HZ	RMS RATE NOISE ARC SEC/SEC
1	0.00	.10	.0019
2	.10	.20	.0047
3	.20	.30	.0079
4	.30	.40	.0111
5	.40	.50	.0135
6	.50	.60	.0164
7	.60	.70	.0205
8	.70	.80	.0226
9	.80	.90	.0272
10	.90	1.00	.0280
11	1.00	1.10	.0293
12	1.10	1.20	.0322
13	1.20	1.30	.0327
14	1.30	1.40	.0361
15	1.40	1.50	.0362
16	1.50	1.60	.0405
17	1.60	1.70	.0440
18	1.70	1.80	.0421
19	1.80	1.90	.0466
20	1.90	2.00	.0447
21	2.00	2.10	.0479
22	2.10	2.20	.0472
23	2.20	2.30	.0461
24	2.30	2.40	.0462
1	0.00	1.00	.1178
2	1.00	2.00	.1229
1	0.00	2.50	.2406

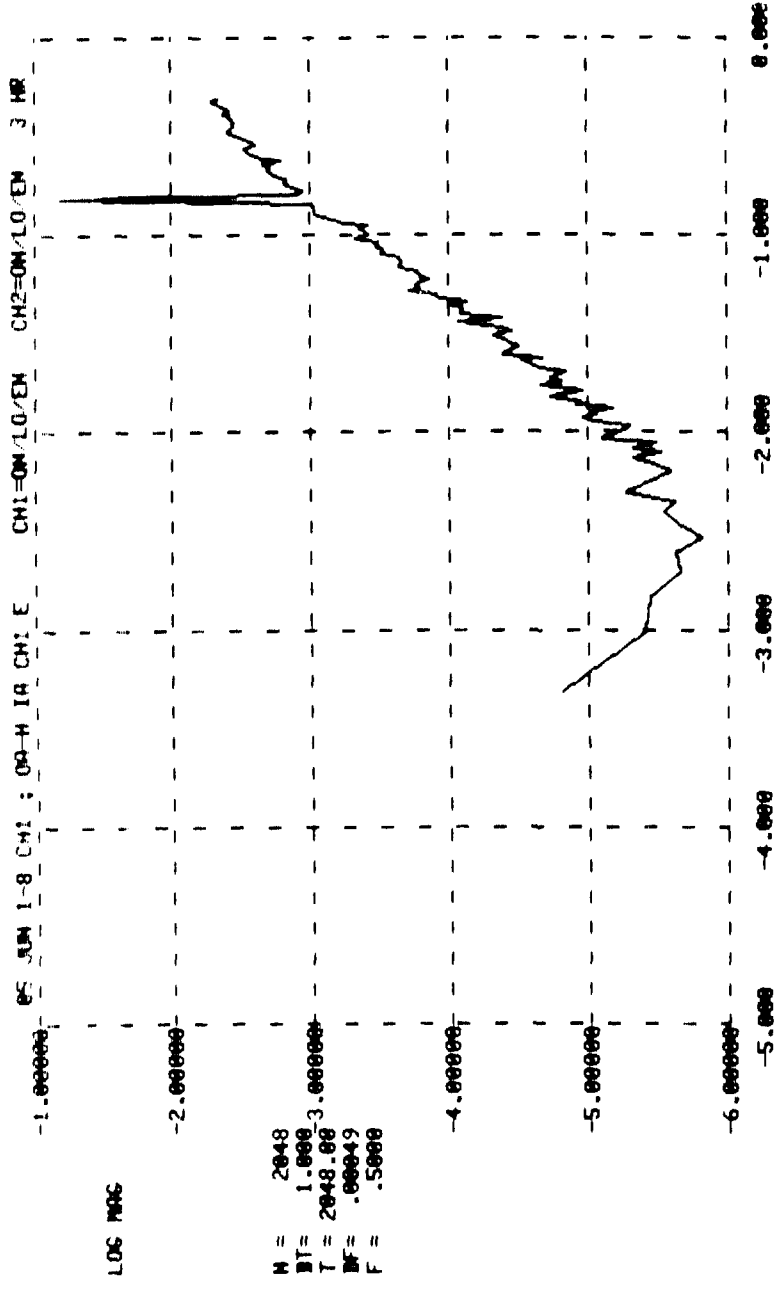

DATA HAS BEEN AVERAGED LOGARITHMICALLY

15 JUN 1-8 LHI / 0A-01 1A CH1 E CH1=ON/LO/EN CH2=ON/LO/EN 3 HR
 # COMPLEX PIS IN BLOCK # 1024, OF, F ARE .400201E-03 .500000E+00

INTERVAL #	MIN F Hz	MAX F Hz	RMS RATE NOISE ARC SEC/SEC
1	.00	.01	.0002
2	.01	.02	.0004
3	.02	.03	.0005
4	.03	.04	.0007
5	.04	.05	.0009
6	.05	.06	.0013
7	.06	.07	.0013
8	.07	.08	.0015
9	.08	.09	.0018
10	.09	.10	.0019
11	.10	.11	.0020
12	.11	.12	.0021
13	.12	.13	.0028
14	.13	.14	.0031
15	.14	.15	.0031
16	.15	.16	.0228
17	.16	.17	.0034
18	.17	.18	.0034
19	.18	.19	.0040
20	.19	.20	.0038
21	.20	.21	.0042
22	.21	.21	.0045
23	.21	.22	.0045
24	.22	.23	.0040
25	.23	.24	.0039
26	.24	.25	.0049
27	.25	.26	.0053
28	.26	.27	.0053
29	.27	.28	.0053
30	.28	.29	.0048
31	.29	.30	.0050
32	.30	.31	.0058
33	.31	.32	.0059
34	.32	.33	.0062
35	.33	.34	.0059
36	.34	.35	.0060
37	.35	.36	.0060
38	.36	.37	.0059
39	.37	.38	.0063
40	.38	.39	.0058
41	.39	.40	.0061
42	.40	.41	.0064
43	.41	.42	.0066
44	.42	.43	.0058
45	.43	.44	.0064
46	.44	.45	.0065
47	.45	.46	.0067
48	.46	.47	.0069
49	.47	.48	.0072
50	.48	.49	.0071
51	.49	.50	.0067
1	.00	.10	.0038
2	.10	.20	.0247
3	.20	.29	.0150
4	.29	.39	.0186
5	.39	.49	.0208
1	.00	.50	.0410

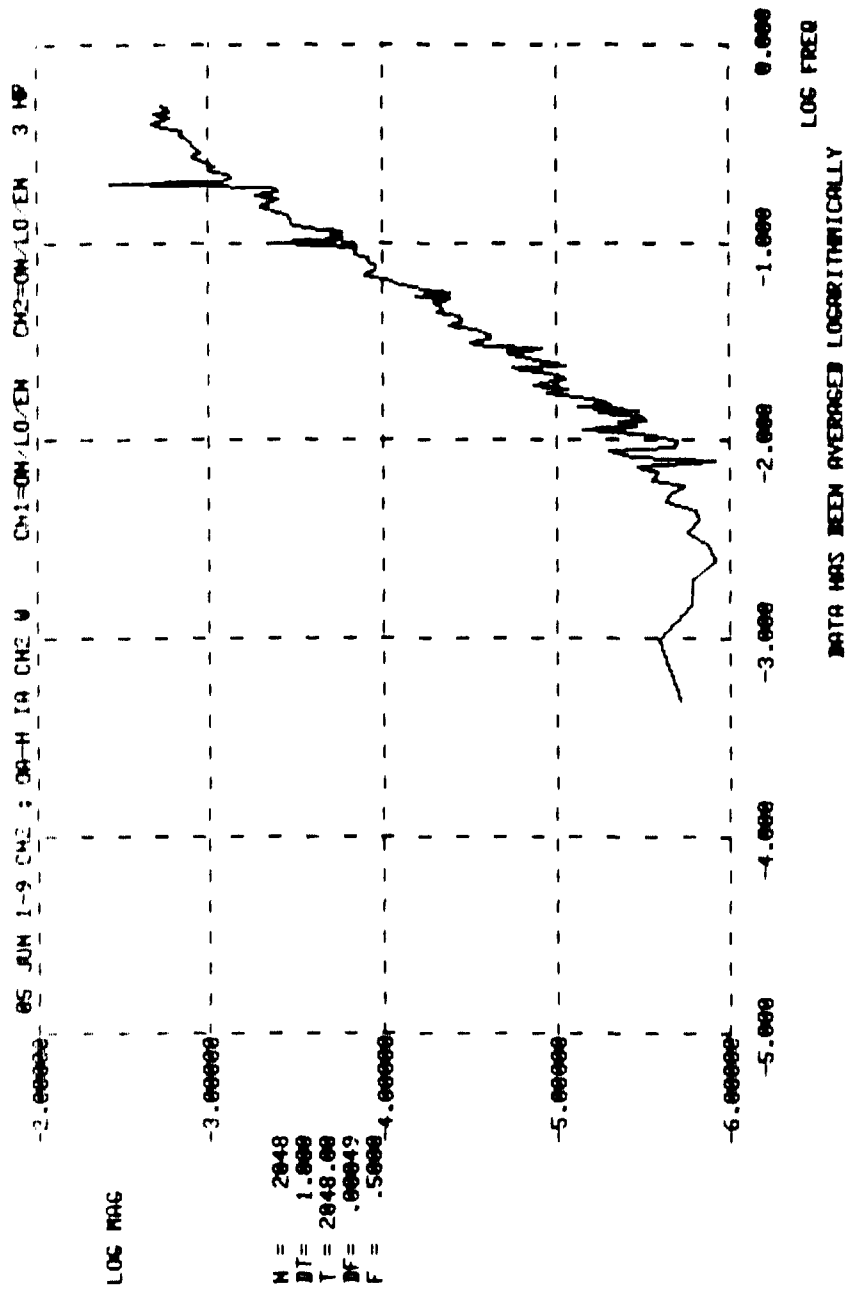

05 JUN 1-9 CH2 ; 04-11 1A CH2 4 CH1=ON/LO/EN CH2=UN/LO/EN 3 HR
 # COMPLEX PTS IN BLOCK IS 1024, OF, F ARE .488281E+03 .500000E+00

INTERVAL #	MIN F HZ	MAX F HZ	RMS RATE NOISE ARC SEC/SEC
1	.00	.01	.0001
2	.01	.02	.0003
3	.02	.03	.0004
4	.03	.04	.0005
5	.04	.05	.0006
6	.05	.06	.0007
7	.06	.07	.0010
8	.07	.08	.0010
9	.08	.09	.0011
10	.09	.10	.0012
11	.10	.11	.0016
12	.11	.12	.0013
13	.12	.13	.0017
14	.13	.14	.0019
15	.14	.15	.0019
16	.15	.16	.0022
17	.16	.17	.0021
18	.17	.18	.0021
19	.18	.19	.0020
20	.19	.20	.0020
21	.20	.21	.0020
22	.21	.22	.0027
23	.21	.23	.0029
24	.22	.23	.0031
25	.23	.24	.0031
26	.24	.25	.0032
27	.25	.26	.0036
28	.26	.27	.0033
29	.27	.28	.0033
30	.28	.29	.0035
31	.29	.30	.0033
32	.30	.31	.0036
33	.31	.32	.0035
34	.32	.33	.0035
35	.33	.34	.0036
36	.34	.35	.0039
37	.35	.36	.0037
38	.36	.37	.0039
39	.37	.38	.0044
40	.38	.39	.0044
41	.39	.40	.0050
42	.40	.41	.0043
43	.41	.42	.0042
44	.42	.43	.0040
45	.43	.44	.0044
46	.44	.45	.0043
47	.45	.46	.0039
48	.46	.47	.0041
49	.47	.48	.0040
50	.48	.49	.0041
51	.49	.50	.0025
1	.00	.10	.0060
2	.10	.20	.0109
3	.20	.29	.0118
4	.29	.39	.0134
5	.39	.49	.0224
1	.00	.50	.0224

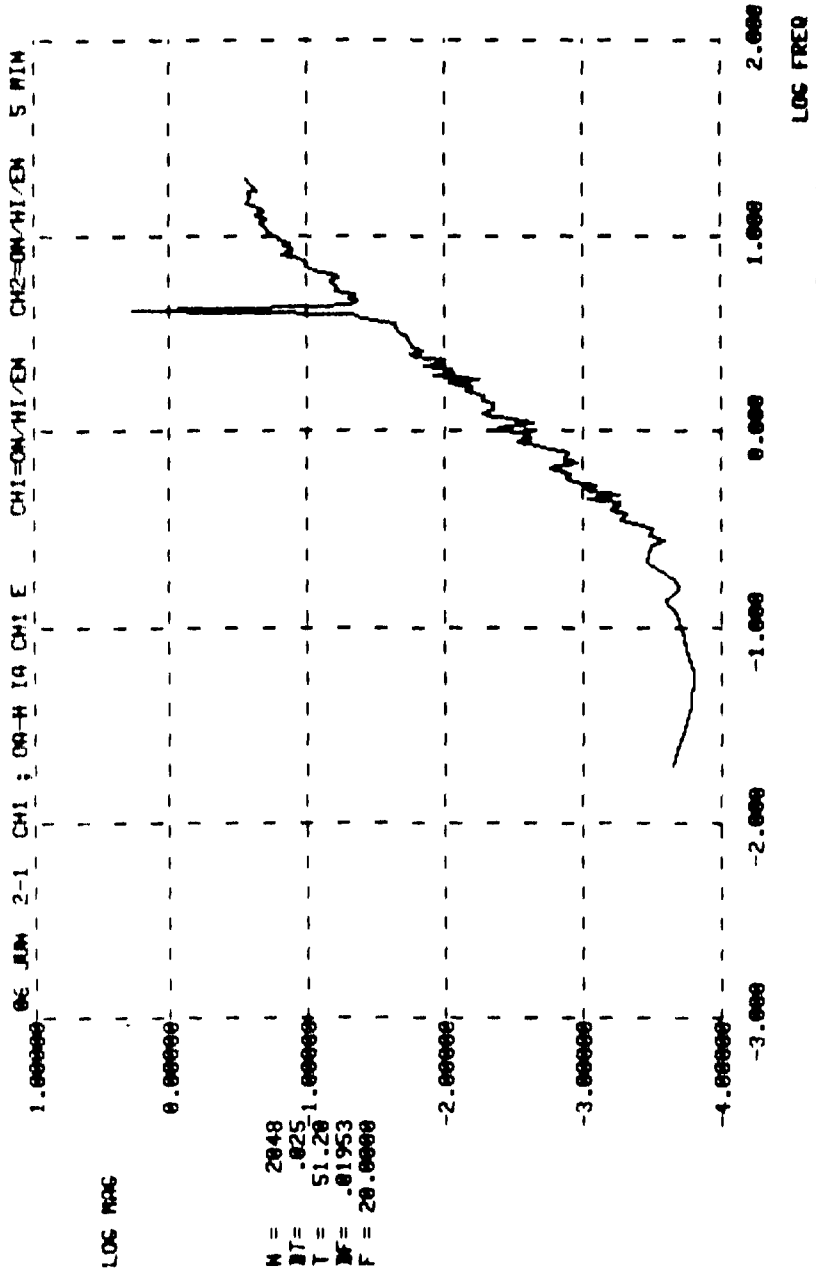

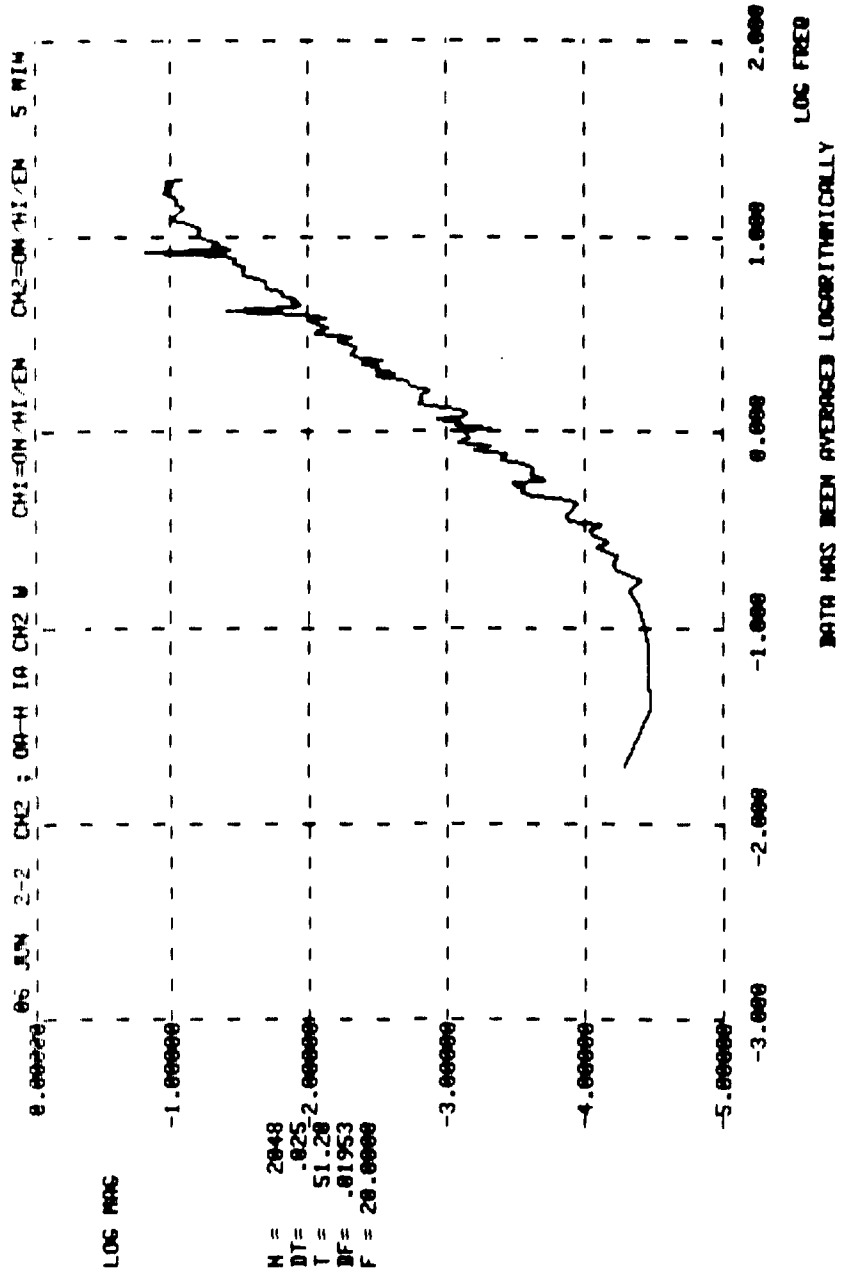

25 JUL 2-2 CH2 ; UA=M IA CH2 W CH1=ON/MI/EN CH2=ON/MI/EN 5 MIN
 # COMPLEX PTS IN BLOCK IS 1024. DF,F ARE .195315E-01 .200000E+02

INTERVAL #	MIN F HZ	MAX F HZ	RMS RATE NOISE ARC SEC/SEC
1	0.00	1.00	.0167
2	1.00	1.99	.0398
3	1.99	2.99	.0660
4	2.99	3.98	.0904
5	3.98	4.98	.1315
6	4.98	5.98	.1558
7	5.98	6.97	.1700
8	6.97	7.97	.1869
9	7.97	8.96	.2785
10	8.96	9.96	.2285
11	9.96	10.96	.2502
12	10.96	11.95	.2639
13	11.95	12.95	.3163
14	12.95	13.95	.3024
15	13.95	14.94	.2880
16	14.94	15.94	.3485
17	15.94	16.93	.3300
18	16.93	17.93	.3250
19	17.93	18.93	.3218
20	18.93	19.92	.3125
1	4.00	4.98	.1780
2	4.98	9.96	.4605
3	9.96	14.94	.6377
4	14.94	19.92	.7148
1	0.00	20.00	1.0007

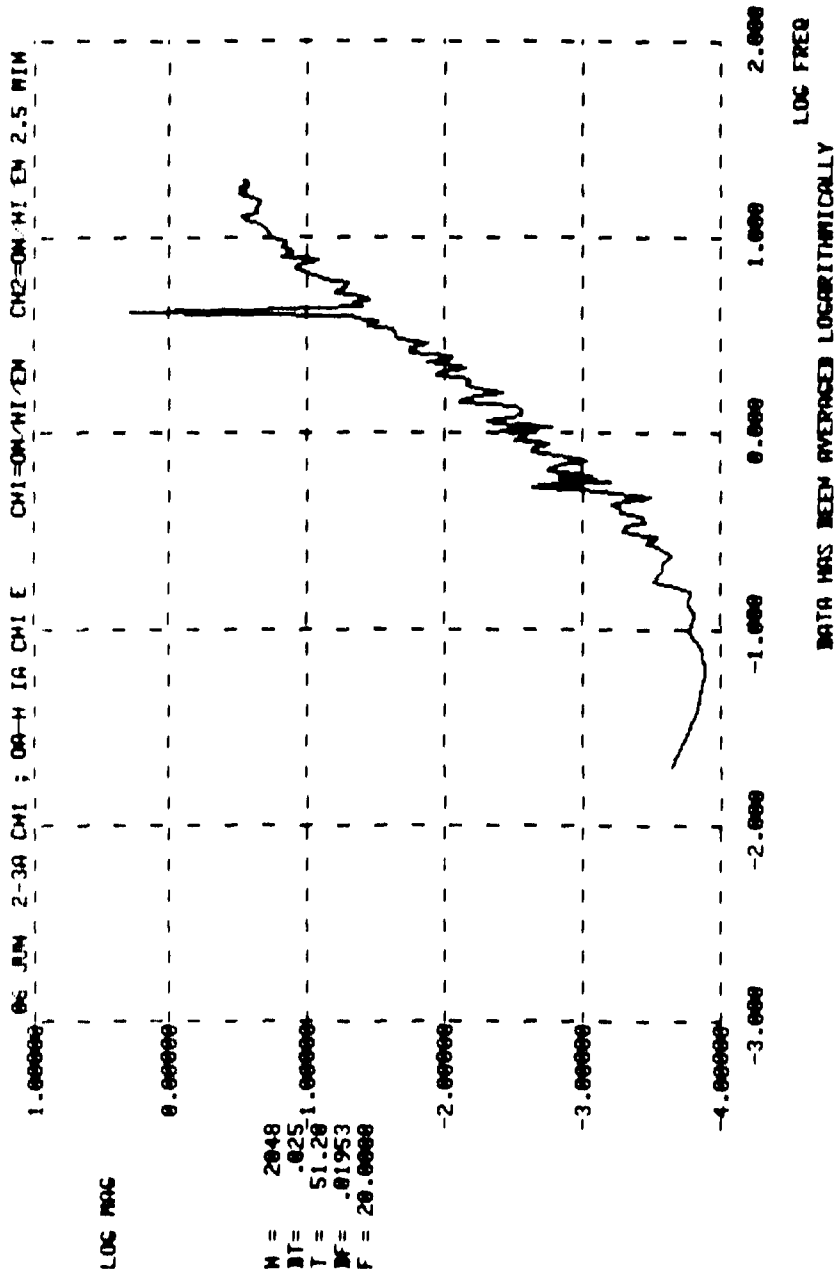

06 JUN 2-3A CH1 ; 0A-H 1A CH1 E CH1=ON/HI/EN CH2=ON/HI/EN 2.5 MIN
 # COMPLEX PIS IN BLOCK # 1024, DF, F ARE .195313E-01 .200000E+02

INTERVAL #	MIN F HZ	MAX F HZ	RMS RATE NOISE ARC SEC/SEC
1	0.00	1.00	.0330
2	1.00	1.99	.0730
3	1.99	2.99	.1152
4	2.99	3.98	.1754
5	3.98	4.98	.5954
6	4.98	5.96	.2366
7	5.98	6.97	.3166
8	6.97	7.97	.3194
9	7.97	8.96	.3786
10	8.96	9.96	.3899
11	9.96	10.96	.4464
12	10.96	11.95	.4750
13	11.95	12.95	.5278
14	12.95	13.95	.4941
15	13.95	14.94	.4824
16	14.94	15.94	.4792
17	15.94	16.93	.5400
18	16.93	17.93	.5379
19	17.93	18.93	.5259
20	18.93	19.92	.5358
1	0.00	4.98	.0363
2	4.98	9.96	.7441
3	9.96	14.94	1.0864
4	14.94	19.92	1.1722
1	0.00	20.00	1.8808

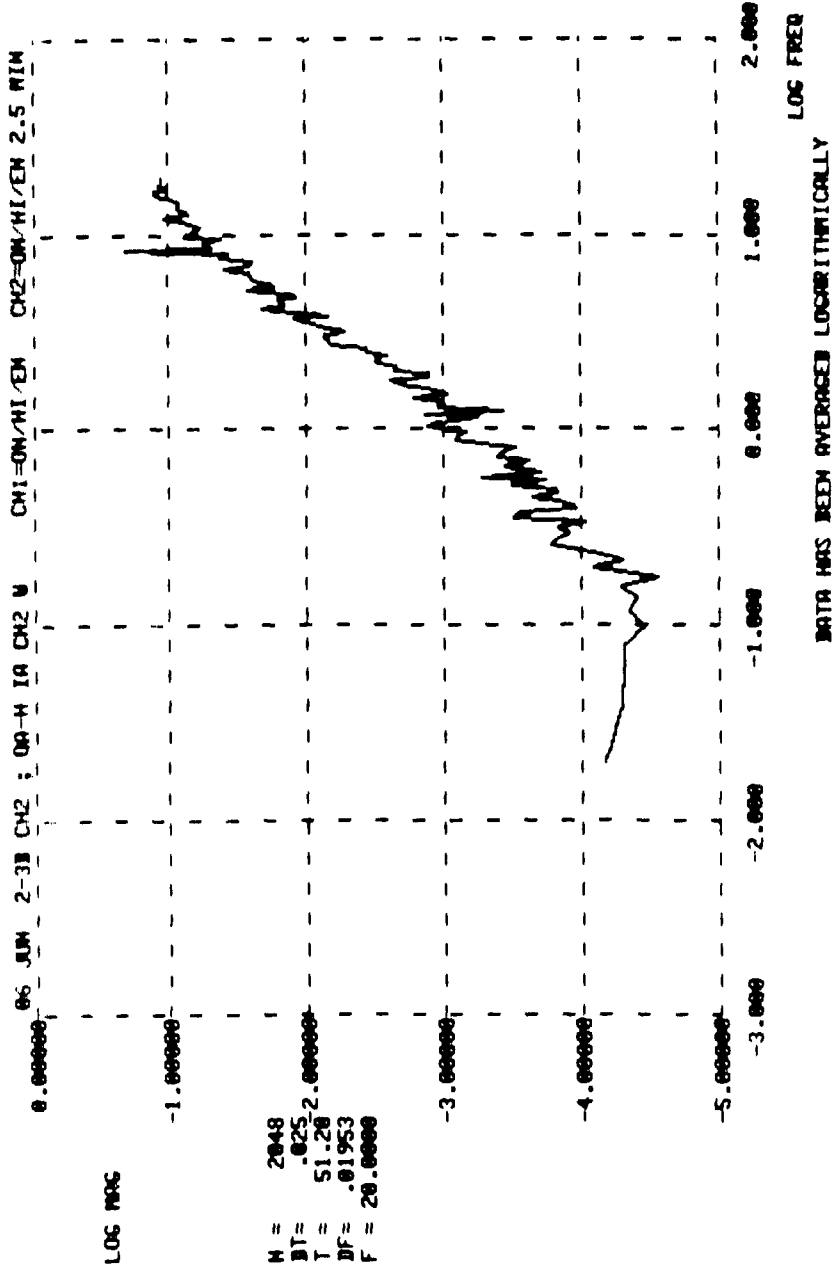

05 JUN 2-36 CH2 ; CA-M IN CH2 W CH1=ON/HI/EN CH2=ON/HI/EN 2.5 MIN
 * COMPLEX PTS IN BLOCK = 1024. DF, F ARE .195313E-01 .200000E+02

INTERVAL #	MIN F HZ	MAX F HZ	RMS RATE NOISE ARC SEC/SEC
1	0.00	1.00	.0169
2	1.00	1.99	.0373
3	1.99	2.99	.0662
4	2.99	3.98	.0931
5	3.98	4.98	.1237
6	4.98	5.98	.1491
7	5.98	6.97	.1726
8	6.97	7.97	.1845
9	7.97	8.96	.3170
10	8.96	9.96	.2377
11	9.96	10.96	.2541
12	10.96	11.95	.2724
13	11.95	12.95	.3055
14	12.95	13.95	.2879
15	13.95	14.94	.2940
16	14.94	15.94	.3201
17	15.94	16.93	.3491
18	16.93	17.93	.3326
19	17.93	18.93	.3444
20	18.93	19.92	.3297
1	0.00	4.98	.1733
2	4.98	9.96	.4930
3	9.96	14.94	.6336
4	14.94	19.92	.7498
1	0.00	20.00	1.1172

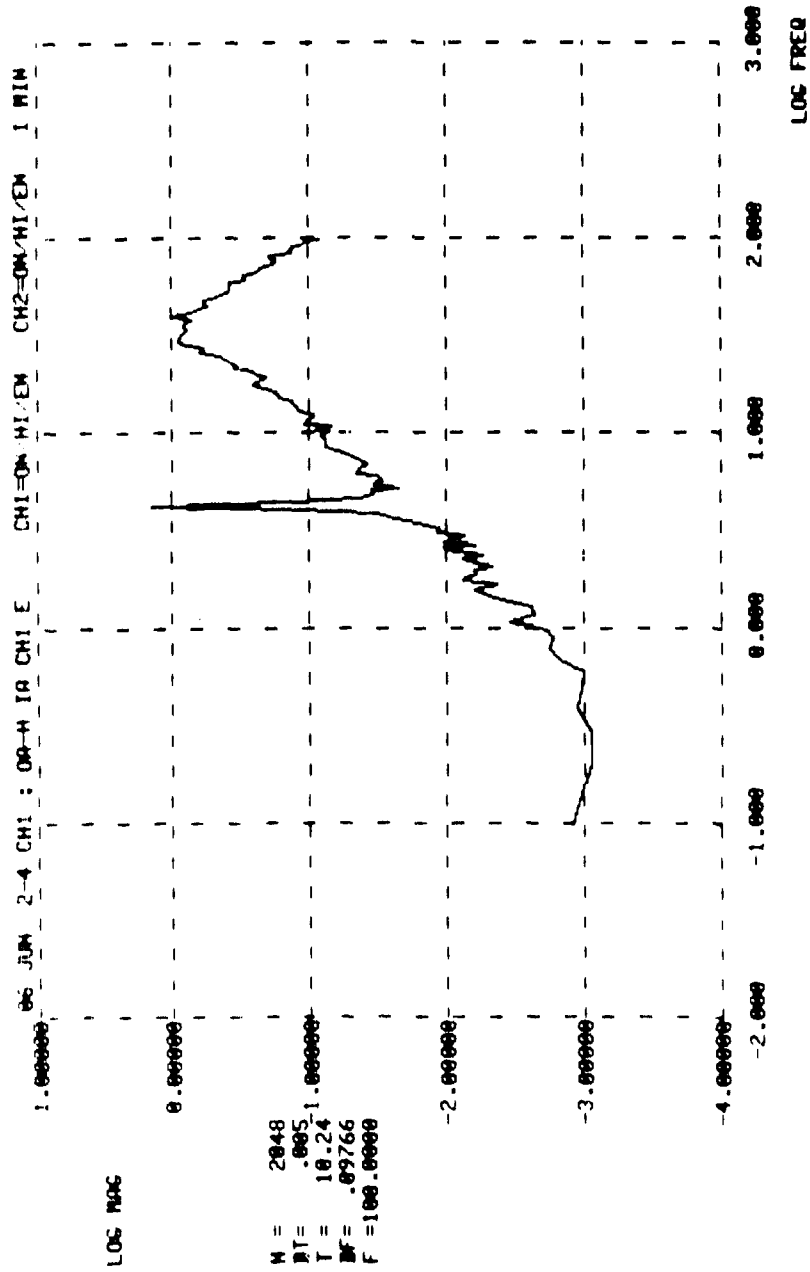

25 JUN 2-4 (M) ; 0A-M 1A (M) E CH1=ON/HI/EN CH2=ON/HI/EN 1 MIN
 # COMPLEX PTS IN BLOCK N= 1024. DF, F ARE .976563E-01 .100000E+03

INTERVAL #	MIN F HZ	MAX F HZ	RMS RATE NOISE ARC SEC/SEC
1	0.00	9.96	.8103
2	9.96	19.92	1.2675
3	19.92	29.88	2.2991
4	29.88	39.84	2.6710
5	39.84	49.80	2.5125
6	49.80	59.77	1.9600
7	59.77	69.73	1.6489
8	69.73	79.69	1.3707
9	79.69	89.65	1.2204
10	89.65	99.61	1.0202
1	0.00	100.00	5.7539

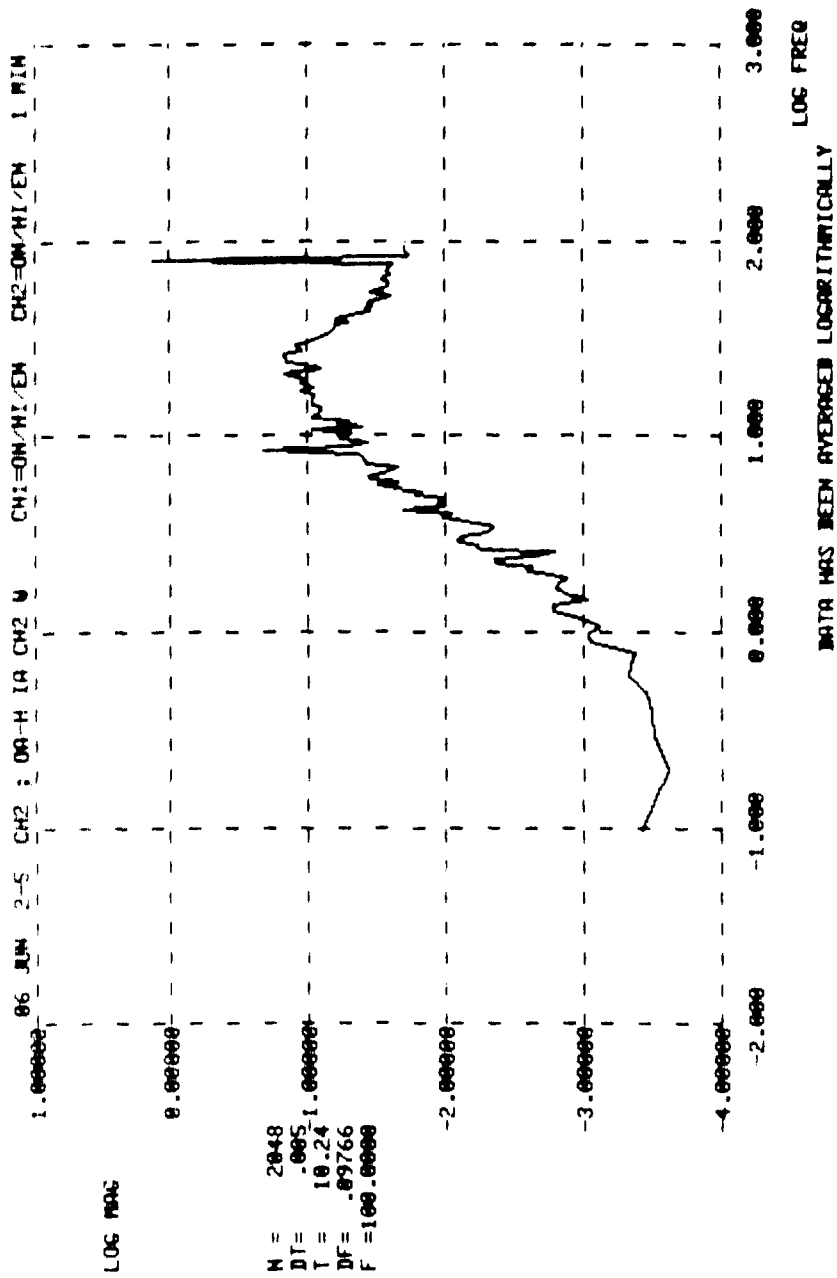

25 JUN 2-5 CH2 ; 04-H 1A CH2 * CH1=ON/HI/EN CH2=ON/HI/EN 1 MIN
 # COMPLEX PTS IN BLOCK N# 1024. DF,F ARE .976563E-01 .100000E+03

INTERVAL #	MIN F HZ	MAX F HZ	RMS RATE NOISE ARC SEC/SEC
1	0.00	9.96	.5268
2	9.96	19.92	.9362
3	19.92	29.88	1.1170
4	29.88	39.84	.8352
5	39.84	49.80	.6348
6	49.80	59.77	.5393
7	59.77	69.73	.5107
8	69.73	79.69	.5302
9	79.69	89.65	2.0575
10	89.65	99.61	.4451
1	0.00	100.00	2.9622

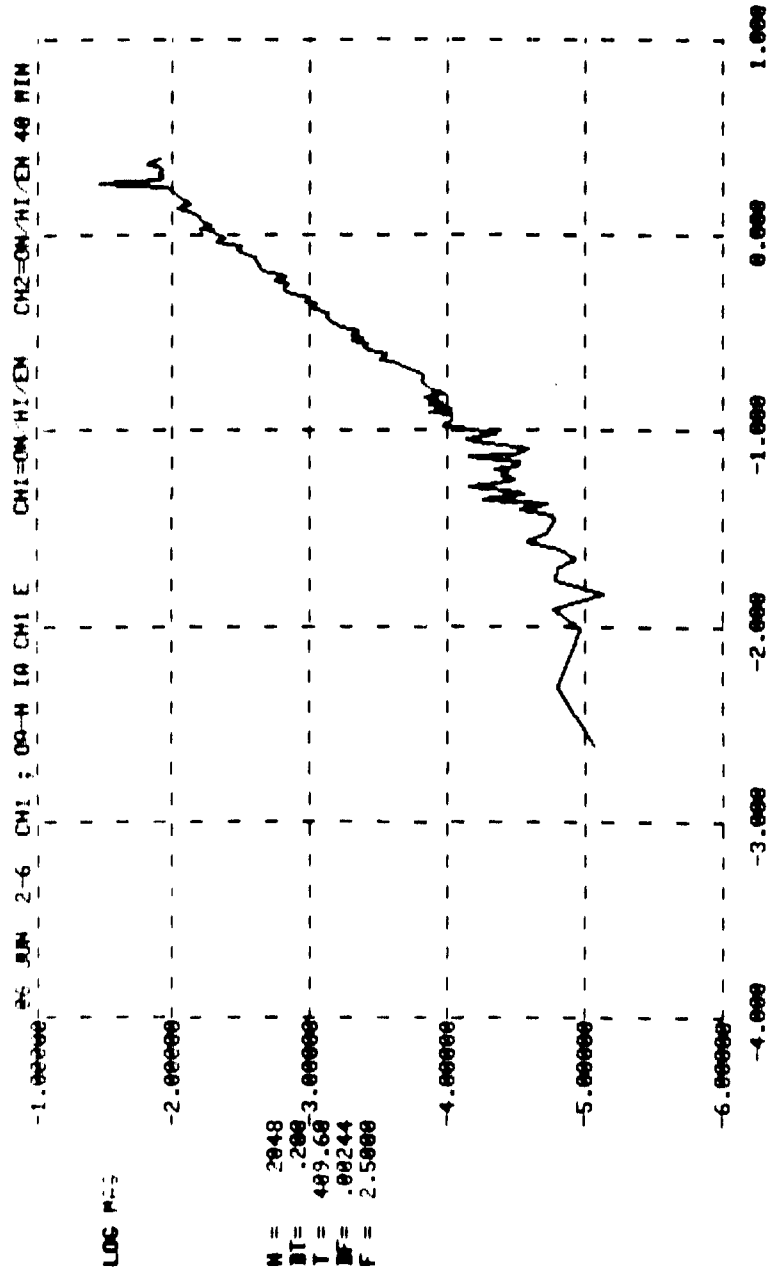

N = 2048
 RT = .200
 T = 409.60
 BF = .00244
 F = 2.5000

15 JUN 2-6 CH1 : 0A-H TA CH1 F CH1=ON/HI/EN CH2=ON/HI/EN 40 MIN
 # COMPLEX PTS IN BLOCK IS 1024. DF, F ARE .244141E-02 .250000E+01

INTERVAL #	MIN F HZ	MAX F HZ	RMS RATE NOISE ARC SEC/SEC
1	.000	.10	.0018
2	.10	.20	.0036
3	.20	.30	.0057
4	.30	.40	.0080
5	.40	.50	.0099
6	.50	.60	.0128
7	.60	.70	.0144
8	.70	.80	.0162
9	.80	.90	.0186
10	.90	1.00	.0212
11	1.00	1.10	.0237
12	1.10	1.20	.0245
13	1.20	1.30	.0245
14	1.30	1.40	.0279
15	1.40	1.50	.0300
16	1.50	1.60	.0303
17	1.60	1.70	.0313
18	1.70	1.80	.0331
19	1.80	1.90	.0354
20	1.90	2.00	.0358
21	2.00	2.10	.0346
22	2.10	2.20	.0356
23	2.20	2.30	.0373
24	2.30	2.40	.0374
1	0.000	1.000	.0405
2	1.000	2.000	.1034
1	0.000	2.500	.1373

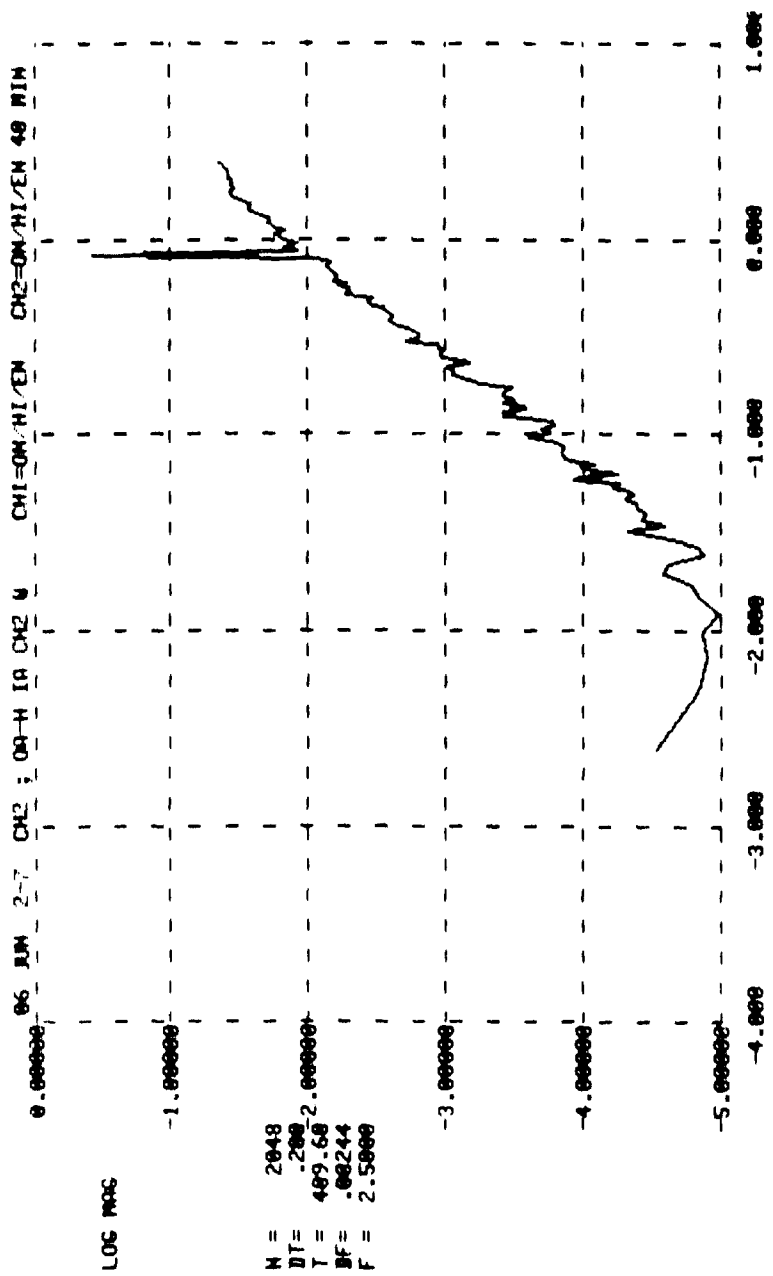

DATA HAS BEEN AVERAGED LOGARITHMICALLY

05 JUN 2-7 CH2 ; 0A-H IN CH2 4 CH1=ON/HI/EN CH2=ON/HI/EN 40 MIN
 # COMPLEX PIS IN BLOCK 0# 1024, OF, F ARE .244141E-02 .250000E+01

INTERVAL #	MIN F HZ	MAX F HZ	RMS RATE NOISE ARC SEC/SEC
1	0.00	.10	.0028
2	.10	.20	.0063
3	.20	.30	.0103
4	.30	.40	.0144
5	.40	.50	.0177
6	.50	.60	.0226
7	.60	.70	.0255
8	.70	.80	.0275
9	.80	.90	.1244
10	.90	1.00	.0369
11	1.00	1.10	.0406
12	1.10	1.20	.0414
13	1.20	1.30	.0438
14	1.30	1.40	.0462
15	1.40	1.50	.0526
16	1.50	1.60	.0515
17	1.60	1.70	.0565
18	1.70	1.80	.0620
19	1.80	1.90	.0585
20	1.90	2.00	.0604
21	2.00	2.10	.0605
22	2.10	2.20	.0635
23	2.20	2.30	.0628
24	2.30	2.40	.0626
1	0.00	1.00	.1394
2	1.00	2.00	.1648
1	0.00	2.50	.2578

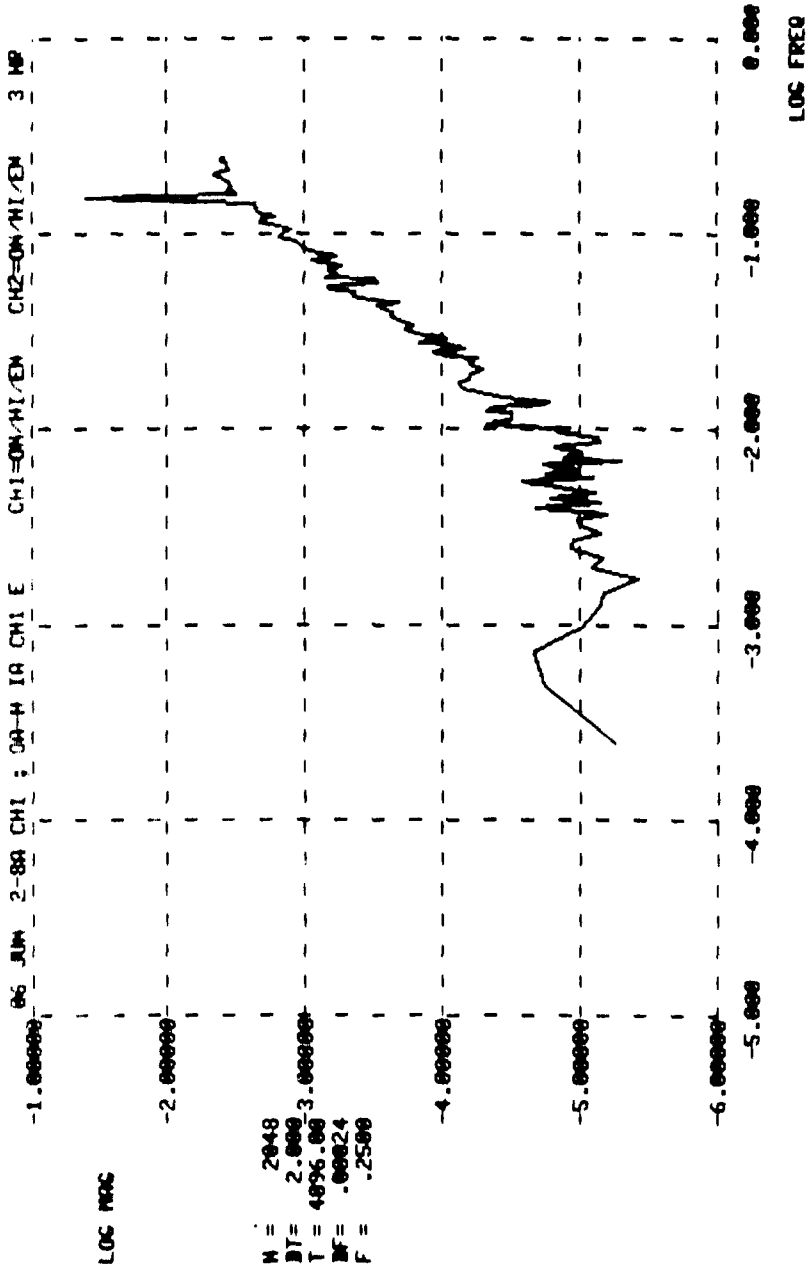

05 JUN 2-0A CH1 ; 0A-H 1A CH1 E CH1=ON/HI/EN CH2=ON/HI/EN 3 HK
 # COMPLEX PTS IN BLOCK = 1024, DF, F ARF .244141E-03 .250000E+00

INTERVAL #	MIN F HZ	MAX F HZ	RMS RATE NOISE ARC SEC/SEC
1	.00	.01	.0003
2	.01	.02	.0007
3	.02	.03	.0009
4	.03	.04	.0014
5	.04	.05	.0018
6	.05	.06	.0023
7	.06	.07	.0025
8	.07	.08	.0028
9	.08	.09	.0031
10	.09	.10	.0037
11	.10	.11	.0038
12	.11	.12	.0044
13	.12	.13	.0045
14	.13	.14	.0047
15	.14	.15	.0048
16	.15	.16	.0181
17	.16	.17	.0060
18	.17	.18	.0058
19	.18	.19	.0060
20	.19	.20	.0068
21	.20	.21	.0067
22	.21	.22	.0060
23	.22	.23	.0058
24	.23	.24	.0068
1	.00	.10	.0070
2	.10	.20	.0241
1	.00	.25	.0287

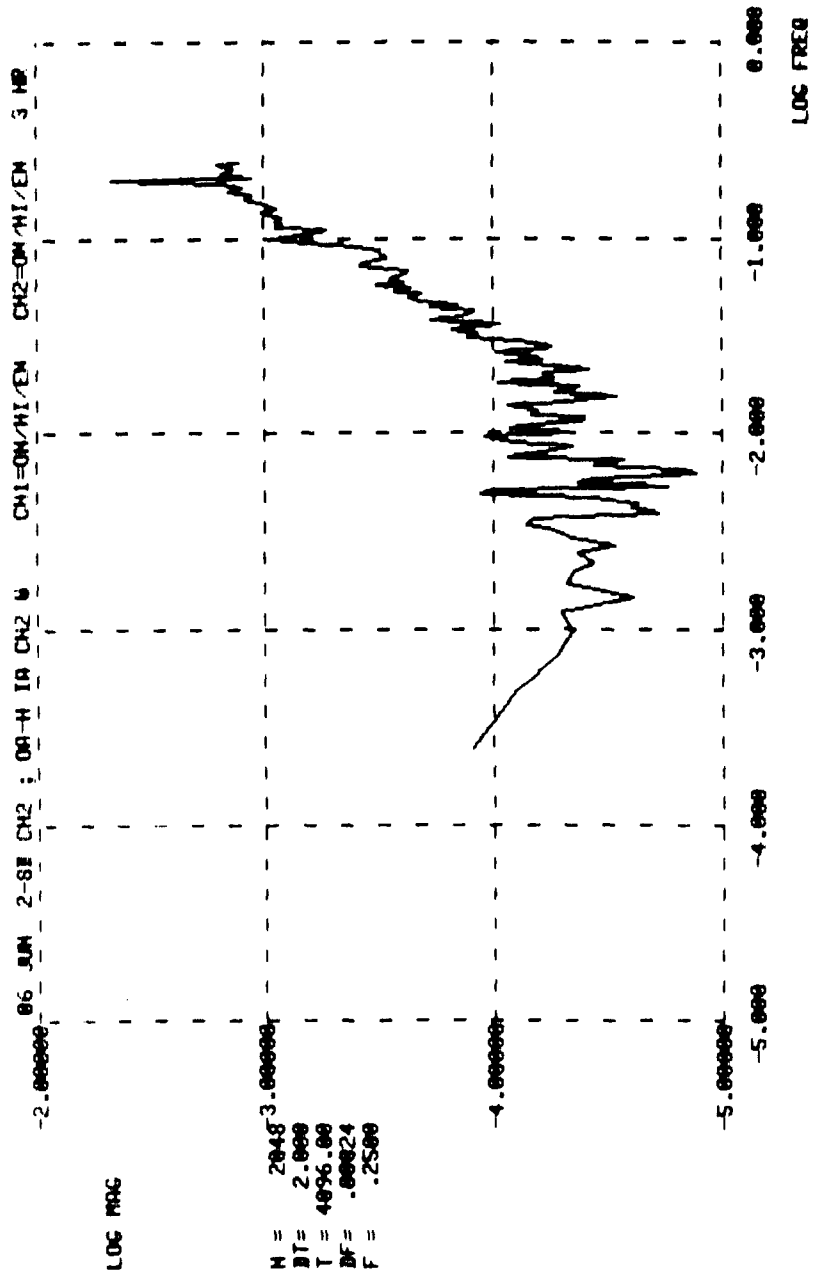

05 JUN 2-80 CH2 , DA-H IA CH2 * CH1=ON/HI/EN CH2=ON/HI/EN 3 HR
 * COMPLEX PTS IN BLOCK * 1024, DF, F ARE .244141E-03 .250000E+00

INTERVAL #	MIN F HZ	MAX F HZ	RMS RATE NOISE ARC SEC/SEC
1	.01	.01	.0007
2	.01	.02	.0008
3	.02	.03	.0008
4	.03	.04	.0012
5	.04	.05	.0013
6	.05	.06	.0016
7	.06	.07	.0016
8	.07	.08	.0019
9	.08	.09	.0018
10	.09	.10	.0023
11	.10	.11	.0027
12	.11	.12	.0028
13	.12	.13	.0029
14	.13	.14	.0032
15	.14	.15	.0029
16	.15	.16	.0034
17	.16	.17	.0034
18	.17	.18	.0037
19	.18	.19	.0037
20	.19	.20	.0046
21	.20	.21	.0055
22	.21	.22	.0039
23	.22	.23	.0036
24	.23	.24	.0039

1	.00	.10	.0047
2	.10	.20	.0106

1	.00	.25	.0149
---	-----	-----	-------

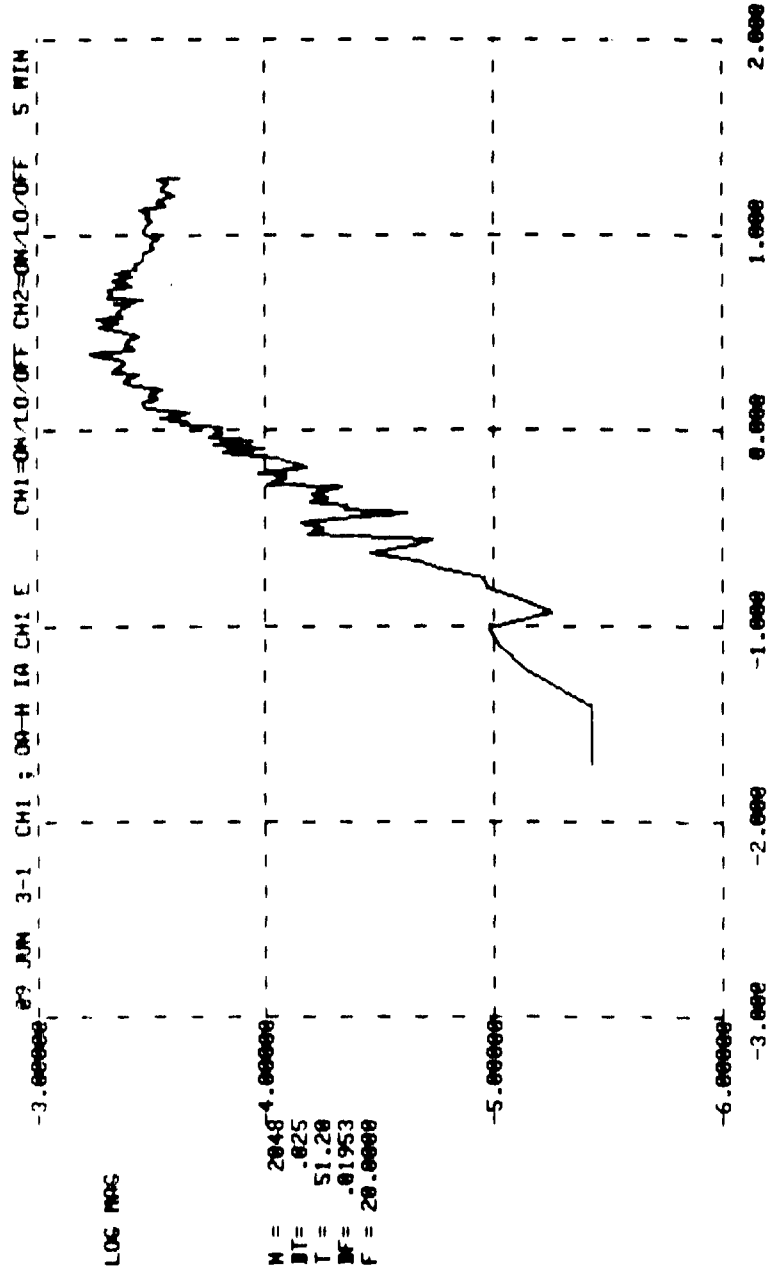

29 JUN 3-1 CH1 ; UA=N IA CH1 F CH1=ON/LO/OFF CH2=ON/LO/OFF 5 MIN
 * COMPLEX PIS IN BLOCK * 1024, DF, F ARF .195313E-01 .200000E+02

INTERVAL #	MIN F HZ	MAX F HZ	RMS RATE NOISE ARC SEC/SEC
1	0.98	1.98	.0064
2	1.98	1.99	.0176
3	1.99	2.99	.0208
4	2.99	3.98	.0211
5	3.98	4.98	.0207
6	4.98	5.98	.0210
7	5.98	6.97	.0201
8	6.97	7.97	.0182
9	7.97	8.96	.0176
10	8.96	9.96	.0173
11	9.96	10.96	.0166
12	10.96	11.95	.0174
13	11.95	12.95	.0178
14	12.95	13.95	.0182
15	13.95	14.94	.0167
16	14.94	15.94	.0163
17	15.94	16.93	.0161
18	16.93	17.93	.0165
19	17.93	18.93	.0164
20	18.93	19.92	.0159
1	4.98	4.98	.0411
2	4.98	9.96	.0422
3	9.96	14.94	.0396
4	14.94	19.92	.0363
1	0.98	20.98	.0799

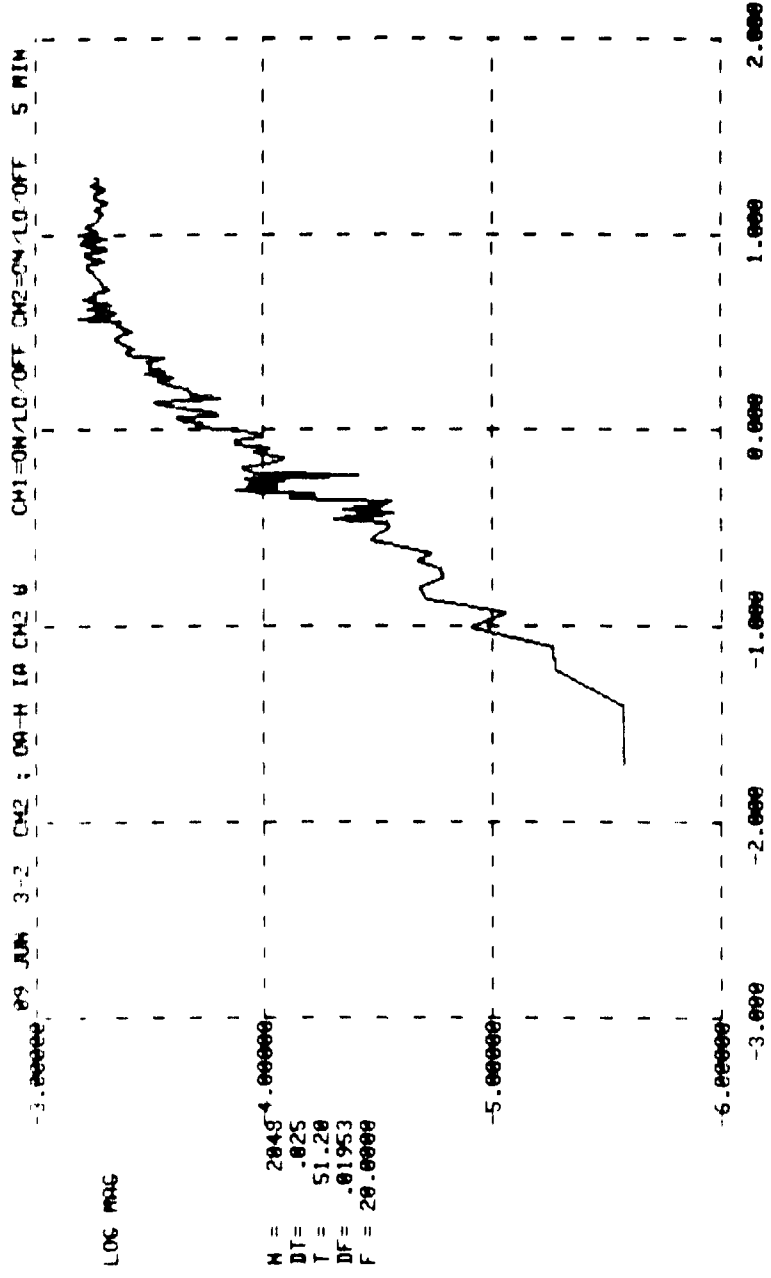

DATA HAS BEEN AVERAGED LOGRITHMICALLY

09 JUN 3-2 CH2 ; UA=M IA CH2 * CH1=ON/OFF CH2=ON/OFF 5 MIN
 * COMPLEX PTS IN BLOCK W# 1024. OF, F ARE .195313E+01 .200000E+02

INTERVAL #	MIN F HZ	MAX F HZ	RMS RATE NOISE ARC SEC/SEC
1	0.98	1.98	.0061
2	1.98	1.99	.0152
3	1.99	2.99	.0191
4	2.99	3.98	.0215
5	3.98	4.98	.0230
6	4.98	5.98	.0222
7	5.98	6.97	.0237
8	6.97	7.97	.0236
9	7.97	8.96	.0233
10	8.96	9.96	.0239
11	9.96	10.96	.0235
12	10.96	11.95	.0233
13	11.95	12.95	.0233
14	12.95	13.95	.0229
15	13.95	14.94	.0229
16	14.94	15.94	.0231
17	15.94	16.93	.0226
18	16.93	17.93	.0225
19	17.93	18.93	.0235
20	18.93	19.92	.0231
1	4.98	4.98	.0407
2	9.96	9.96	.0522
3	9.96	14.94	.0514
4	14.94	19.92	.0514
1	20.00	20.00	.0965

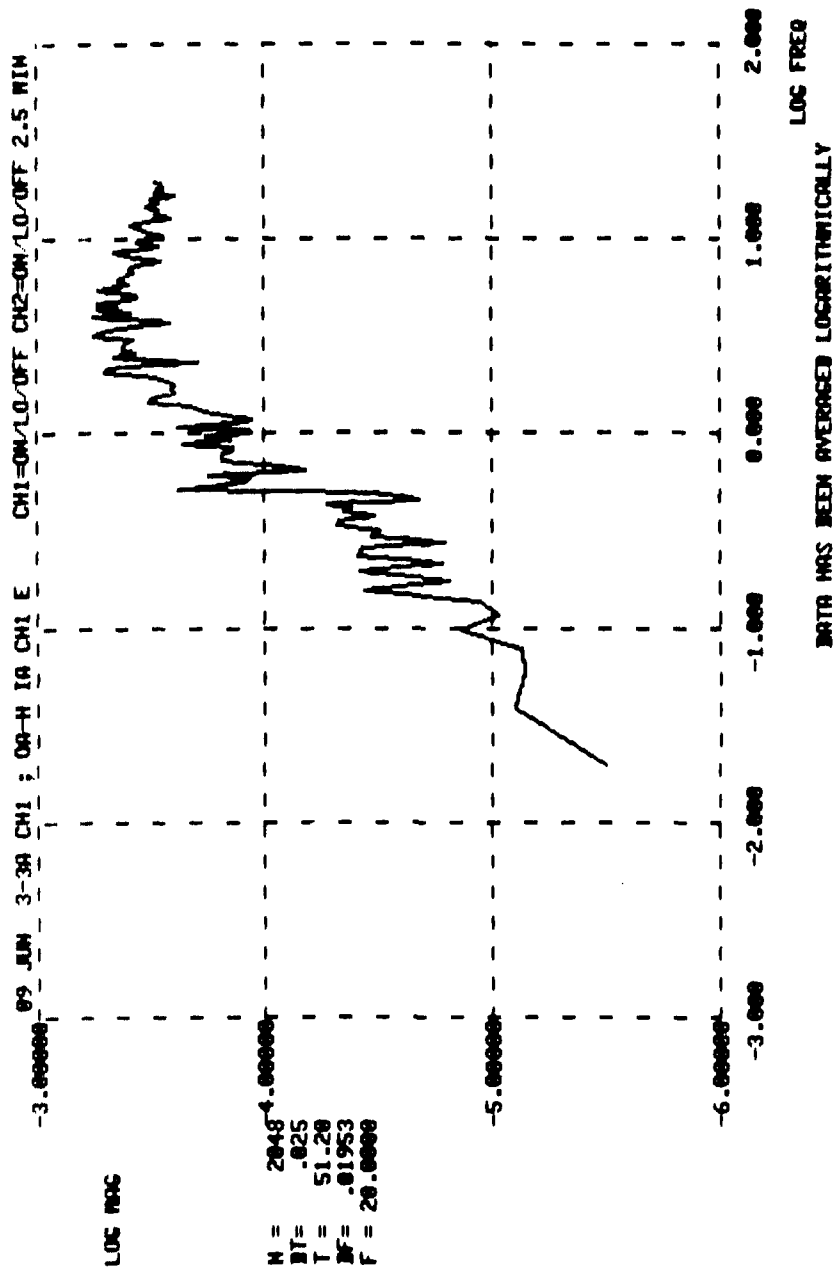

09 JUN 3-3A CH1 ; 0A-H 1A CH1 E CH1=ON/LO/OFF CH2=ON/LO/OFF 2.5 MIN
 * COMPLEX PTS IN BLOCK N= 1024, OF, F ARE ,195313E-01 ,200000E+02

INTERVAL #	MIN F HZ	MAX F HZ	RMS RATE NOISE ARC SEC/SEC
1	0.00	1.00	.0092
2	1.00	1.99	.0153
3	1.99	2.99	.0196
4	2.99	3.98	.0197
5	3.98	4.98	.0216
6	4.98	5.98	.0208
7	5.98	6.97	.0204
8	6.97	7.97	.0180
9	7.97	8.96	.0198
10	8.96	9.96	.0185
11	9.96	10.96	.0172
12	10.96	11.95	.0192
13	11.95	12.95	.0167
14	12.95	13.95	.0171
15	13.95	14.94	.0177
16	14.94	15.94	.0167
17	15.94	16.93	.0170
18	16.93	17.93	.0168
19	17.93	18.93	.0175
20	18.93	19.92	.0164
1	0.00	4.98	.0395
2	4.98	9.96	.0437
3	9.96	14.94	.0394
4	14.94	19.92	.0377
1	0.00	20.00	.0804

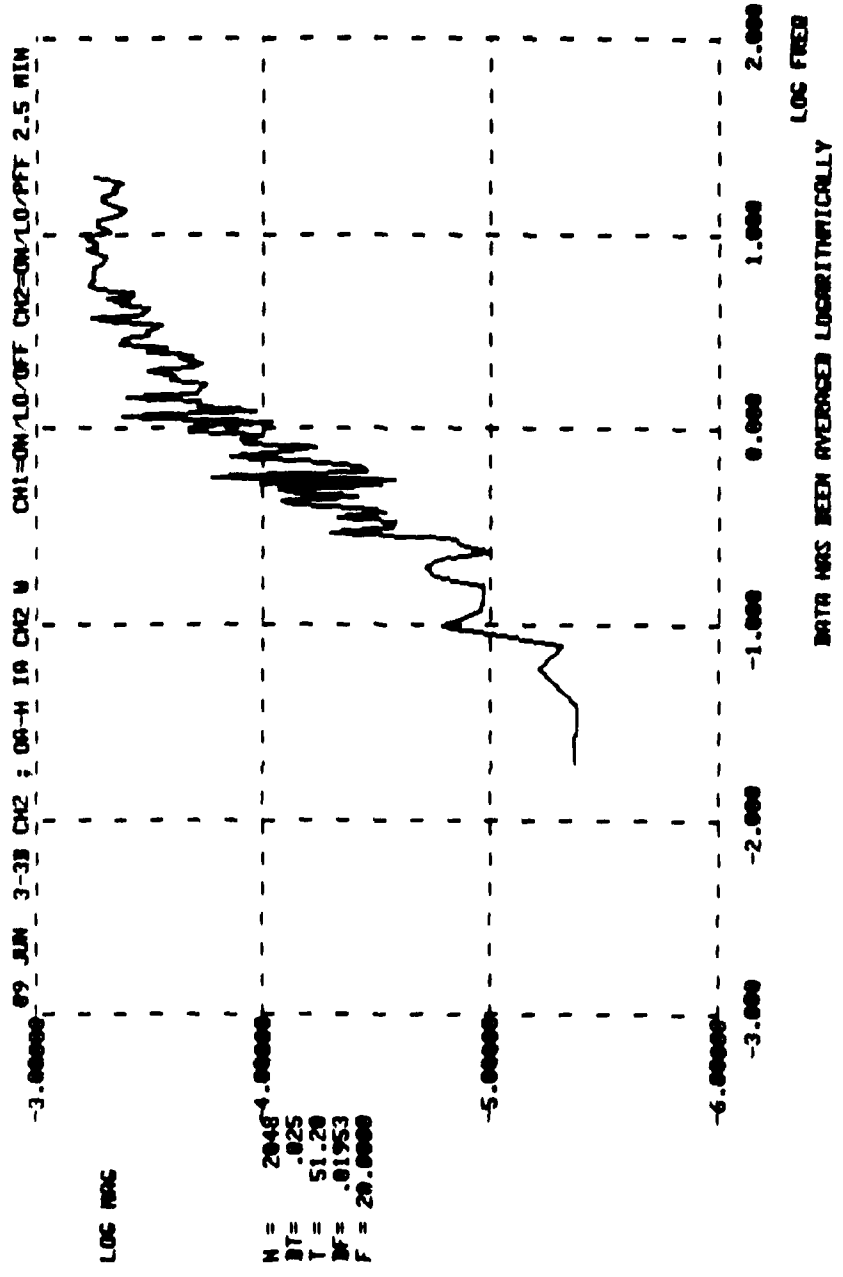

FETCH BLOCKX
 09 JUN 3-30 CH2 ; UA-H IA CH2 W CH1=ON/LO/OFF CH2=ON/LO/PPF 2.5 MIN
 # COMPLEX PTS IN BLOCK # 1024. OF, F ARE .195313E-01 .200000E+02

INTERVAL #	MIN F HZ	MAX F HZ	RMS RATE NOISE ARC SEC/SEC
1	0.00	1.00	.0078
2	1.00	1.99	.0152
3	1.99	2.99	.0173
4	2.99	3.98	.0193
5	3.98	4.98	.0198
6	4.98	5.98	.0234
7	5.98	6.97	.0234
8	6.97	7.97	.0227
9	7.97	8.96	.0235
10	8.96	9.96	.0238
11	9.96	10.96	.0217
12	10.96	11.95	.0236
13	11.95	12.95	.0208
14	12.95	13.95	.0203
15	13.95	14.94	.0216
16	14.94	15.94	.0228
17	15.94	16.93	.0208
18	16.93	17.93	.0207
19	17.93	18.93	.0216
20	18.93	19.92	.0221
1	0.00	4.98	.0368
2	4.98	9.96	.0523
3	9.96	14.94	.0483
4	14.94	19.92	.0483
1	0.00	20.00	.0939

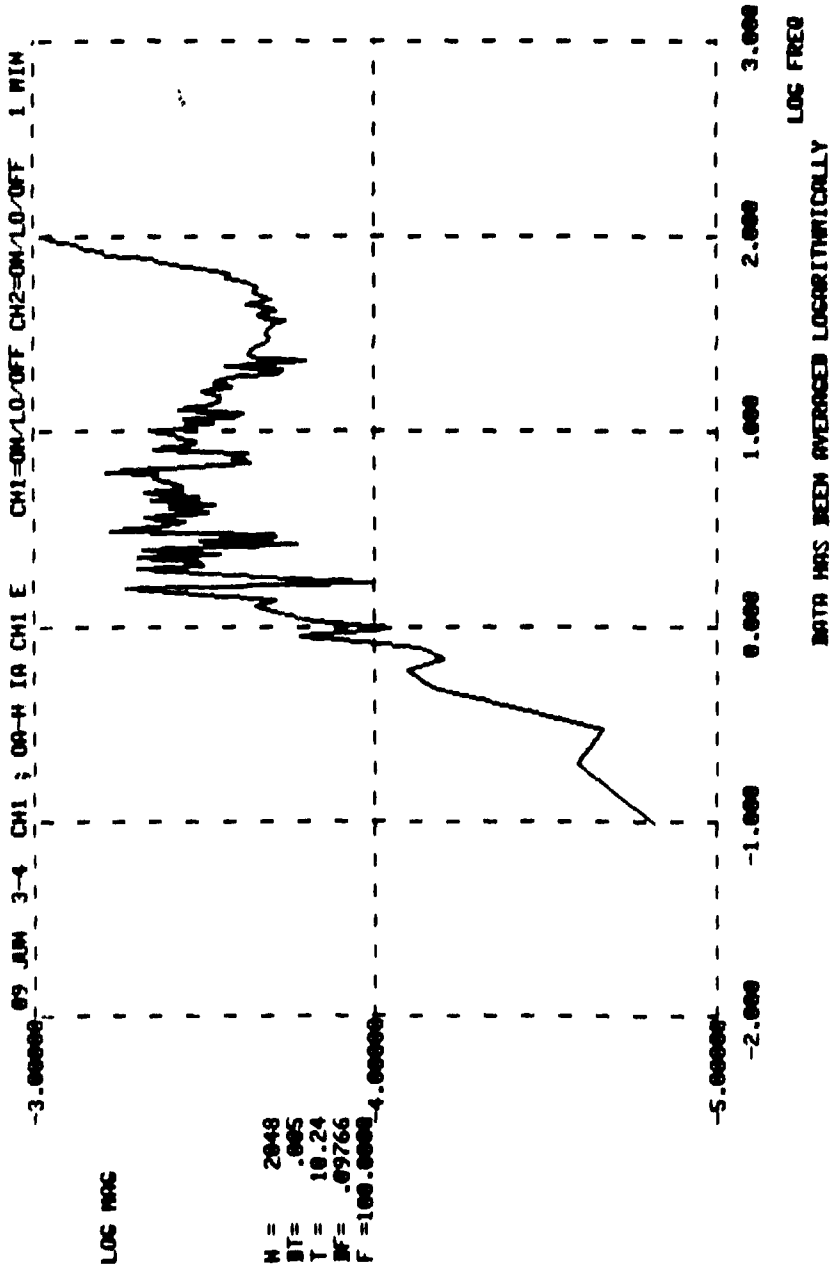

09 JUN 3-4 CH1 ; UA-H IA CH1 ; CH1=ON/LO/OFF CH2=ON/LO/OFF 1 MIN
 # COMPLEX PTS IN BLOCK = 1024. DF, F ARE .976563E-01 .100000E+03

INTERVAL #	MIN F M/	MAX F M/	RMS RATE NOISE ANG DEG/SEC
1	0.00	9.96	.0567
2	9.96	19.92	.0538
3	19.92	29.88	.0460
4	29.88	39.84	.0452
5	39.84	49.80	.0454
6	49.80	59.77	.0473
7	59.77	69.73	.0528
8	69.73	79.69	.0654
9	79.69	89.65	.0828
10	89.65	99.61	.0913

1	0.00	100.00	.1930
---	------	--------	-------

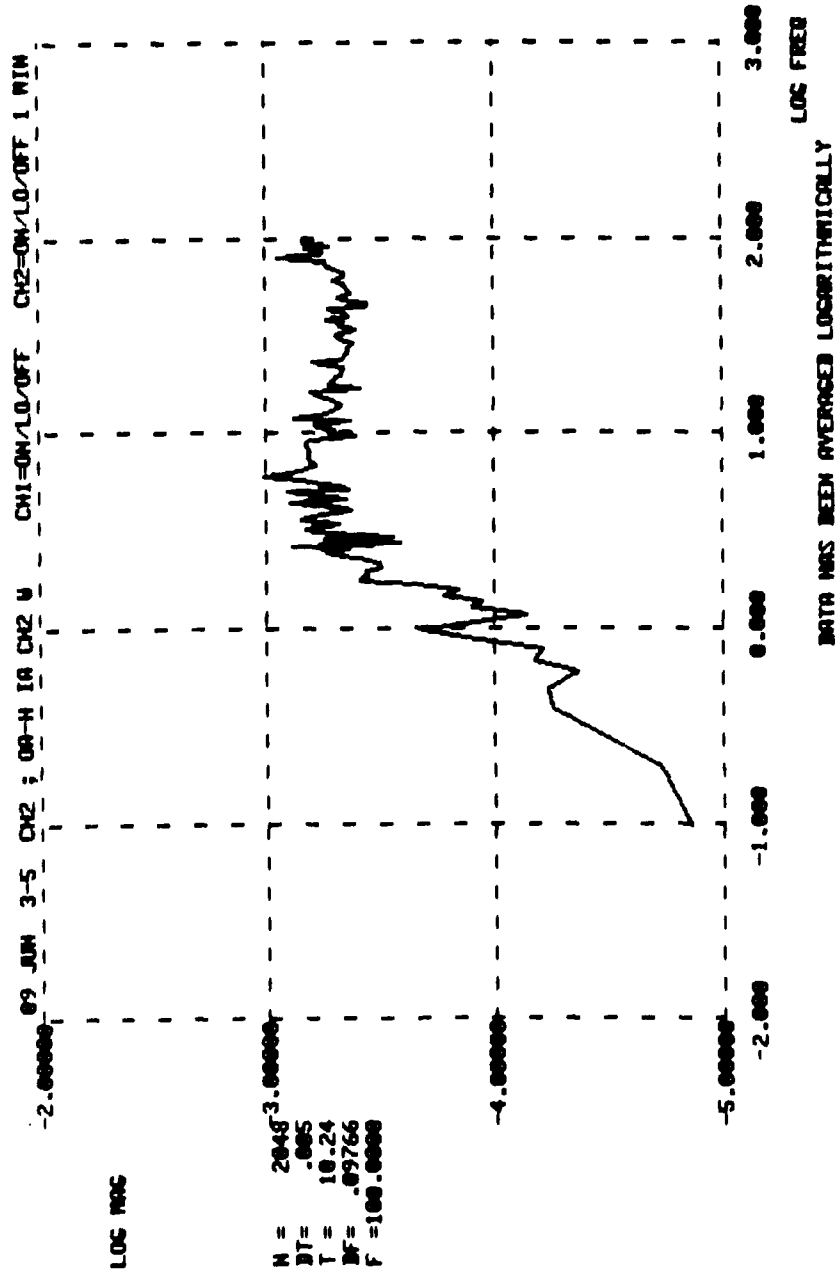

29 JUN 3-5 CH2 ; 0A-M 1A CH2 * CH1=ON/LO/OFF CH2=ON/LO/OFF 1 MIN
 * COMPLEX PTS IN BLOCK * 1024. DF, F ARE .976563E-01 .10000RE+03

INTERVAL #	MIN F HZ	MAX F HZ	RMS RATE NOISE ARC SEC/SEC
1	0.00	9.96	.0706
2	9.96	19.92	.0722
3	19.92	29.88	.0677
4	29.88	39.84	.0685
5	39.84	49.80	.0654
6	49.80	59.77	.0665
7	59.77	69.73	.0683
8	69.73	79.69	.0728
9	79.69	89.65	.0818
10	89.65	99.61	.0800
1	0.00	100.00	.2269

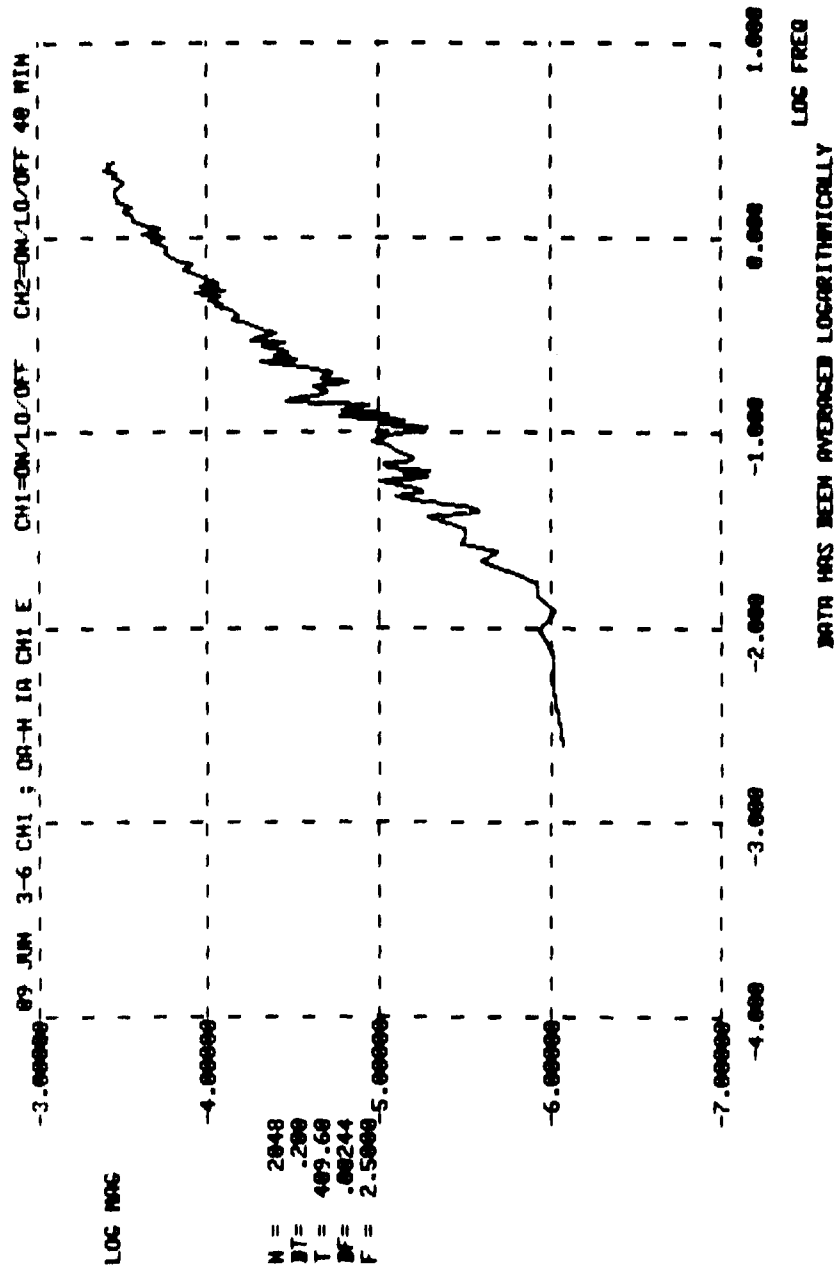

09 JUN 3-6 CH1 ; DA-N 1A CH1 E CH1=ON/LO/OFF CH2=ON/LO/OFF 40 MIN
 * COMPLEX PTS IN BLOCK IS 1024, OF, F ARE .244141E-02 .250000E+01

INTERVAL #	MIN F HZ	MAX F HZ	RMS RATE NOISE ARC SEC/SEC
1	0.00	.10	.0007
2	.10	.20	.0013
3	.20	.30	.0019
4	.30	.40	.0024
5	.40	.50	.0029
6	.50	.60	.0031
7	.60	.70	.0035
8	.70	.80	.0038
9	.80	.90	.0042
10	.90	1.00	.0044
11	1.00	1.10	.0047
12	1.10	1.20	.0047
13	1.20	1.30	.0053
14	1.30	1.40	.0055
15	1.40	1.50	.0053
16	1.50	1.60	.0057
17	1.60	1.70	.0059
18	1.70	1.80	.0060
19	1.80	1.90	.0057
20	1.90	2.00	.0057
21	2.00	2.10	.0060
22	2.10	2.20	.0059
23	2.20	2.30	.0064
24	2.30	2.40	.0061
1	0.00	1.00	.0096
2	1.00	2.00	.0173
1	0.00	2.50	.0240

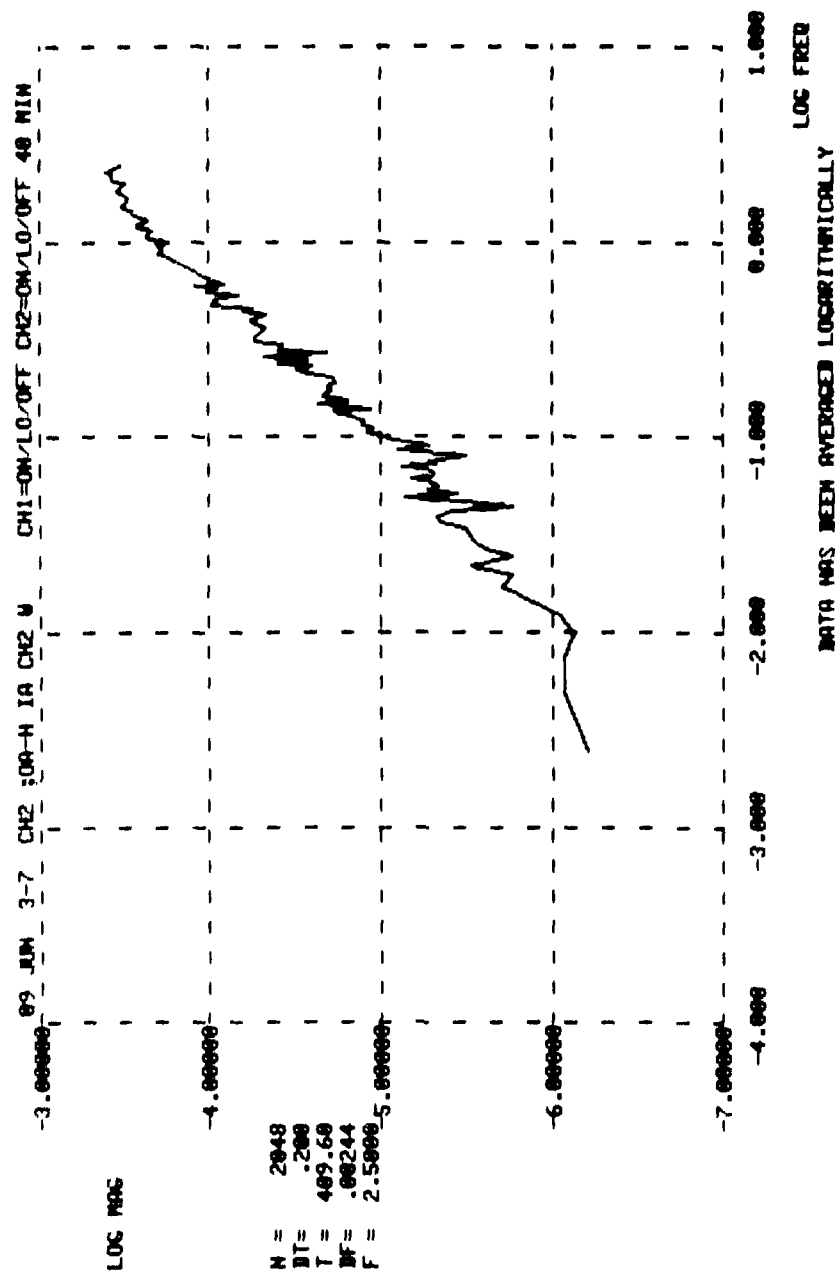

09 JUN 3-7 CH2 10A-n 1A CH2 n CH1=ON/LO/OFF CH2=ON/LO/OFF 40 MIN
 # COMPLEX PTS IN BLOCK n= 1024, OF, F ARE .244141E+02 .250000E+01

INTERVAL #	MIN F HZ	MAX F HZ	RMS RATE NOISE ARC SEC/SEC
1	0.00	.10	.0006
2	.10	.20	.0013
3	.20	.30	.0018
4	.30	.40	.0023
5	.40	.50	.0026
6	.50	.60	.0031
7	.60	.70	.0032
8	.70	.80	.0037
9	.80	.90	.0043
10	.90	1.00	.0043
11	1.00	1.10	.0047
12	1.10	1.20	.0049
13	1.20	1.30	.0050
14	1.30	1.40	.0051
15	1.40	1.50	.0053
16	1.50	1.60	.0056
17	1.60	1.70	.0055
18	1.70	1.80	.0057
19	1.80	1.90	.0059
20	1.90	2.00	.0058
21	2.00	2.10	.0058
22	2.10	2.20	.0061
23	2.20	2.30	.0064
24	2.30	2.40	.0061
1	0.00	1.00	.0094
2	1.00	2.00	.0170
1	0.00	2.50	.0236

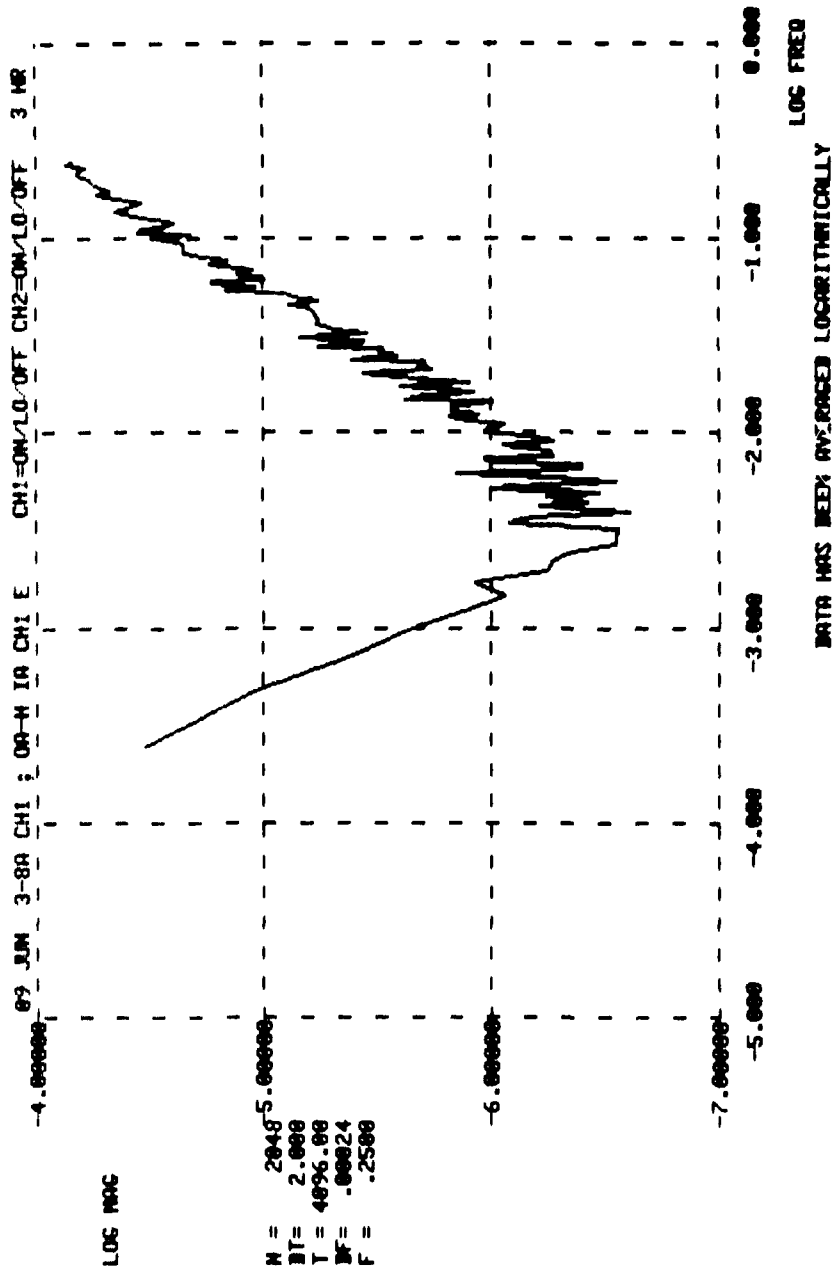

09 JUN 3-BA CH1 ; UA=M 1A CH1 E CH1=ON/LO/OFF CH2=ON/LO/OFF 3 HR
 # COMPLEX PTS IN BLOCK 0# 1024, UF,F ARE .244141E-03 .250000E+00

INTERVAL #	MIN F HZ	MAX F HZ	RMS RATE NOISE ARC SEC/SEC
1	0.00	.01	.0001
2	.01	.02	.0001
3	.02	.03	.0002
4	.03	.04	.0002
5	.04	.05	.0003
6	.05	.06	.0004
7	.06	.07	.0003
8	.07	.08	.0004
9	.08	.09	.0005
10	.09	.10	.0005
11	.10	.11	.0005
12	.11	.12	.0005
13	.12	.13	.0006
14	.13	.14	.0006
15	.14	.15	.0006
16	.15	.16	.0006
17	.16	.17	.0007
18	.17	.18	.0007
19	.18	.19	.0007
20	.19	.20	.0007
21	.20	.21	.0008
22	.21	.22	.0008
23	.22	.23	.0008
24	.23	.24	.0008
1	0.00	.10	.0010
2	.10	.20	.0020
1	0.00	.25	.0029

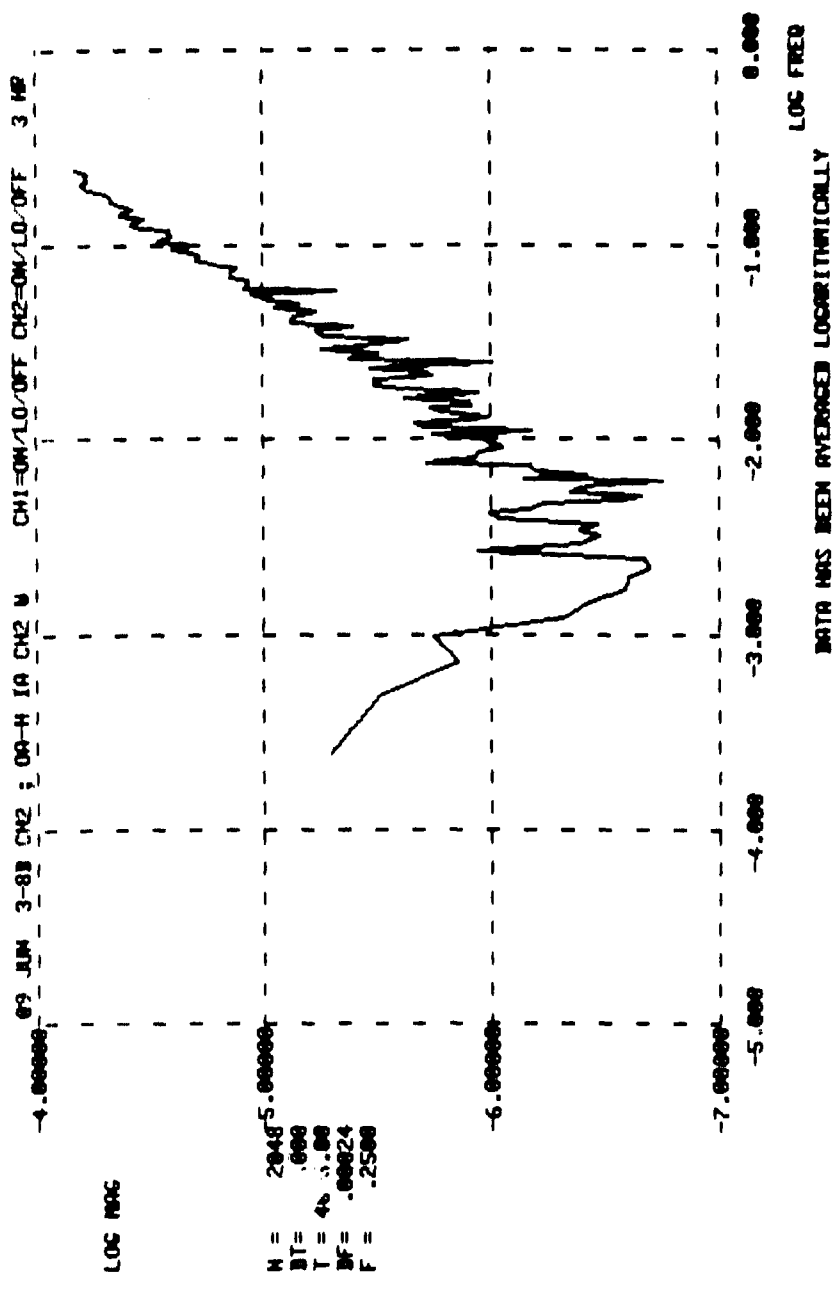

09 JUN 3-88 CH2 ; UA-H IA CH2 * CH1=ON/LO/OFF CH2=ON/LO/OFF 3 HR
 # COMPLEX PTS IN BLOCK # 1024. DF, F ARE .244141E-03 .250000E+00

INTERVAL #	MIN F HZ	MAX F HZ	RMS RATE NOISE ARC SEC/SEC
1	.00	.01	.0001
2	.01	.02	.0001
3	.02	.03	.0002
4	.03	.04	.0002
5	.04	.05	.0003
6	.05	.06	.0003
7	.06	.07	.0004
8	.07	.08	.0004
9	.08	.09	.0004
10	.09	.10	.0005
11	.10	.11	.0005
12	.11	.12	.0005
13	.12	.13	.0006
14	.13	.14	.0006
15	.14	.15	.0006
16	.15	.16	.0006
17	.16	.17	.0007
18	.17	.18	.0007
19	.18	.19	.0007
20	.19	.20	.0008
21	.20	.21	.0008
22	.21	.22	.0008
23	.22	.23	.0008
24	.23	.24	.0008
1	.00	.10	.0010
2	.10	.20	.0020
1	.00	.25	.0020

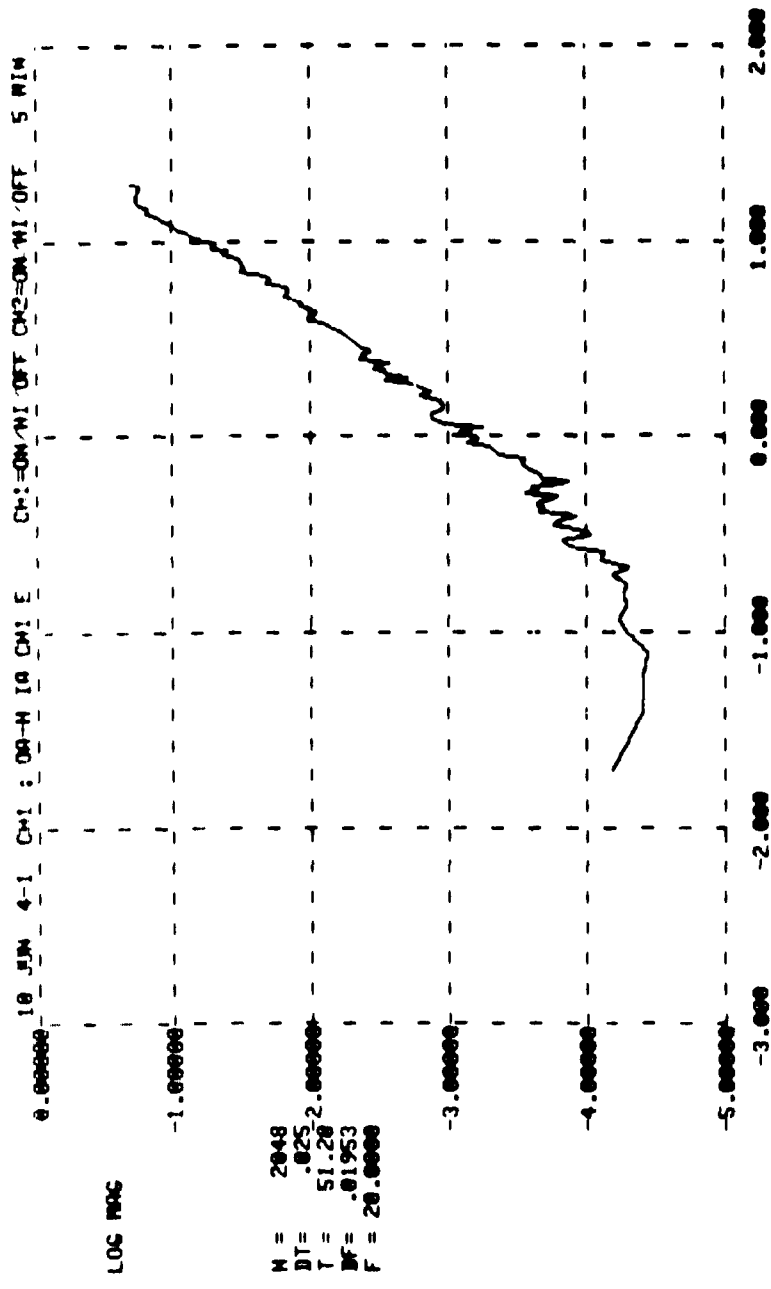

DATA HAS BEEN AVERAGED LOGRITHMICALLY

14 JUN 4-1 LMI : 04-04 TA LMI E CH1:0UN/HI/OFF CH2:0UN/HI/OFF 5 MIN
 * COMPLEX PIS IN BLOCK 0# 1024. DT, F ARE .195310E-01 .200000E+02

INTERVAL #	MIN F HZ	MAX F HZ	RMS RATE NOISE ARC SEC/SEC
1	0.98	1.00	.0156
2	1.07	1.99	.0376
3	1.99	2.99	.0604
4	2.99	3.98	.0830
5	3.98	4.98	.1033
6	4.98	5.98	.1241
7	5.98	6.97	.1489
8	6.97	7.97	.1759
9	7.97	8.96	.2006
10	8.96	9.96	.2237
11	9.96	10.96	.2506
12	10.96	11.95	.3016
13	11.95	12.95	.3265
14	12.95	13.95	.3618
15	13.95	14.94	.3936
16	14.94	15.94	.4286
17	15.94	16.93	.4334
18	16.93	17.93	.4197
19	17.93	18.93	.4264
20	18.93	19.92	.4337
1	4.98	4.98	.1513
2	9.96	9.96	.3985
3	14.94	14.94	.7411
4	19.92	19.92	.9579
1	20.00	20.00	1.2911

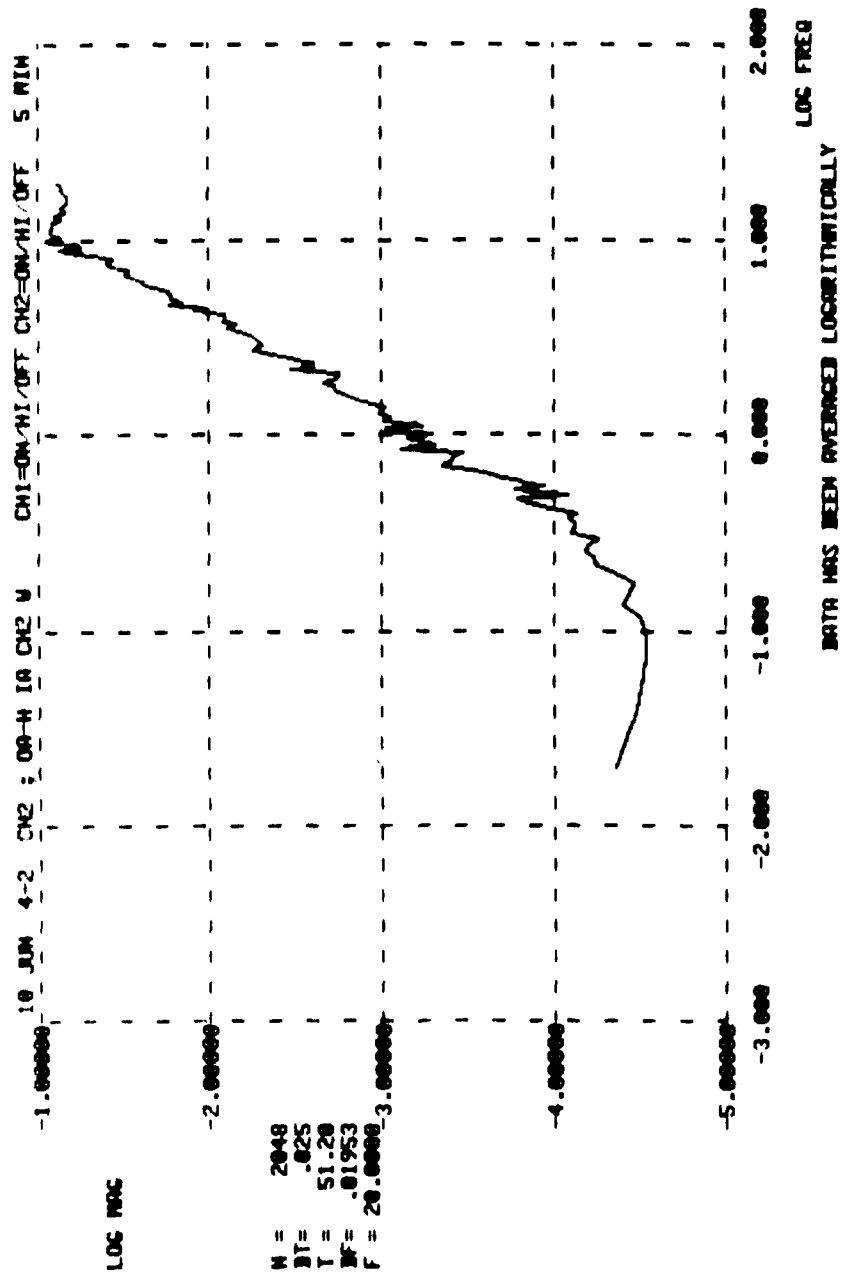

10 JUN 4-2 CH2 : UA=N 1A CH2 : CH1=ON/HI/OFF CH2=ON/HI/OFF 5 MIN
 # COMPLEX PIS IN BLOCK OF 1024. OF, F ARE .195313E-01 .200000E+02

INTERVAL #	MIN F HZ	MAX F HZ	RMS RATE NOISE ARC SEC/SEC
1	0.98	1.98	.0152
2	1.98	1.99	.0371
3	1.99	2.98	.0610
4	2.98	3.98	.0829
5	3.98	4.98	.1131
6	4.98	5.98	.1363
7	5.98	6.97	.1693
8	6.97	7.97	.1876
9	7.97	8.96	.2360
10	8.96	9.96	.2635
11	9.96	10.96	.2843
12	10.96	11.95	.2865
13	11.95	12.95	.2800
14	12.95	13.95	.2820
15	13.95	14.94	.2710
16	14.94	15.94	.2615
17	15.94	16.93	.2606
18	16.93	17.93	.2633
19	17.93	18.93	.2700
20	18.93	19.92	.2808
1	4.98	4.98	.1581
2	4.98	9.96	.4556
3	9.96	14.94	.6279
4	14.94	19.92	.5978
1	0.00	20.00	.9948

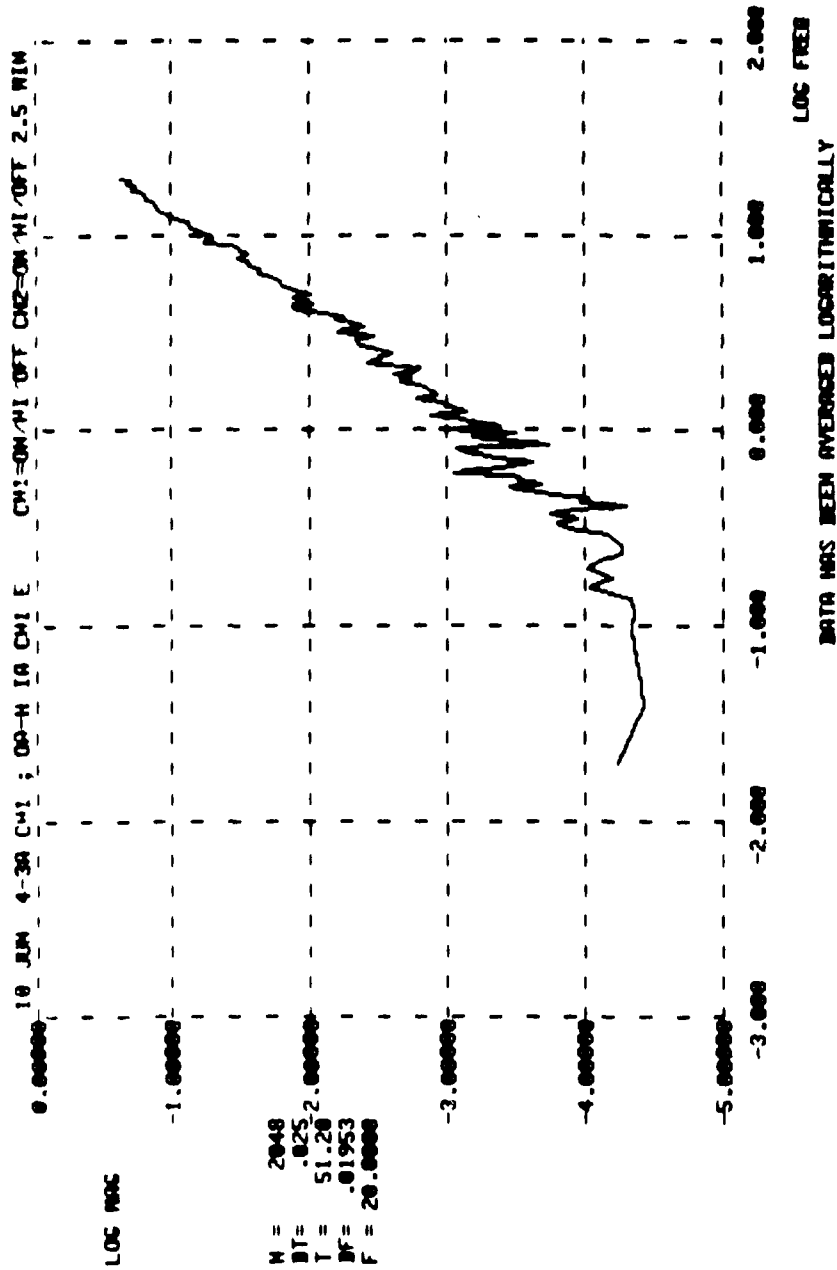

14 JUN 4-3A CH1 ; 0A-M 1A CH1 L CH1=ON/HI/OFF CH2=ON/HI/OFF 2.5 MIN
 M COMPLEX PTS IN BLOCKS = 1024. DF, F ARE .195313E-01 .200000E+02

INTERVAL #	MIN F HZ	MAX F HZ	RMS RATE NOISE ARC SEC/SEC
1	0.96	1.00	.0167
2	1.00	1.99	.0378
3	1.99	2.99	.0577
4	2.99	3.98	.0746
5	3.98	4.98	.1075
6	4.98	5.98	.1222
7	5.98	6.97	.1516
8	6.97	7.97	.1729
9	7.97	8.96	.1834
10	8.96	9.96	.2366
11	9.96	10.96	.2438
12	10.96	11.95	.2730
13	11.95	12.95	.3250
14	12.95	13.95	.3487
15	13.95	14.94	.3623
16	14.94	15.94	.3937
17	15.94	16.93	.4078
18	16.93	17.93	.4417
19	17.93	18.93	.4574
20	18.93	19.92	.4542
1	4.98	4.98	.1489
2	4.98	9.96	.3932
3	9.96	14.94	.7017
4	14.94	19.92	.9653
1	0.00	20.00	1.2757

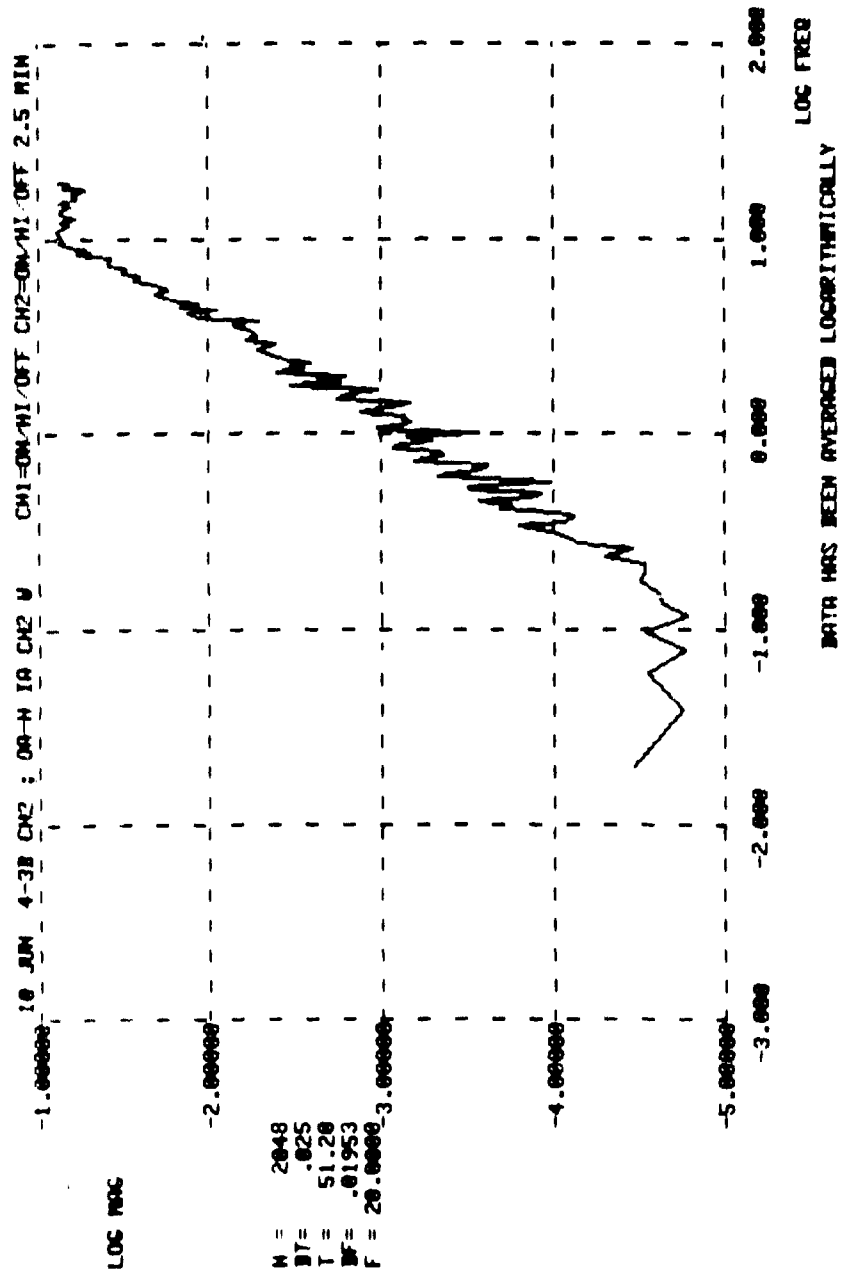

12 JUN 4-35 CH2 7 0A-M IA CH2 W CH1=ON/HI/OFF CH2=ON/HI/OFF 2.5 MIN
 # COMPLEX PTS IN BLOCK OF 1024. OF, F ARE .195313E-01 .200000E+02

INTERVAL #	MIN F HZ	MAX F HZ	RMS RATE NOISE ARC SEC/SEC
1	0.98	1.00	.0103
2	1.00	1.99	.0371
3	1.99	2.99	.0640
4	2.99	3.98	.0791
5	3.98	4.98	.1164
6	4.98	5.98	.1383
7	5.96	6.97	.1704
8	6.97	7.97	.1895
9	7.97	8.96	.2290
10	8.96	9.96	.2659
11	9.96	10.96	.2746
12	10.96	11.95	.2648
13	11.95	12.95	.2641
14	12.95	13.95	.2674
15	13.95	14.94	.2601
16	14.94	15.94	.2685
17	15.94	16.93	.2417
18	16.93	17.93	.2418
19	17.93	18.93	.2612
20	18.93	19.92	.2629
1	4.98	4.98	.1598
2	4.98	9.96	.4552
3	9.96	14.94	.5953
4	14.94	19.92	.5712
1	0.00	20.00	.9592

18 JUN 4-4 CH1 : 00-H IA CH1 E CH2 : ON HI / OFF CH2 : ON HI / OFF 1 MIN

LOG MAG

N = 2048
DT = .005
T = 10.24
DF = .09766
F = 100.0000 2.00000

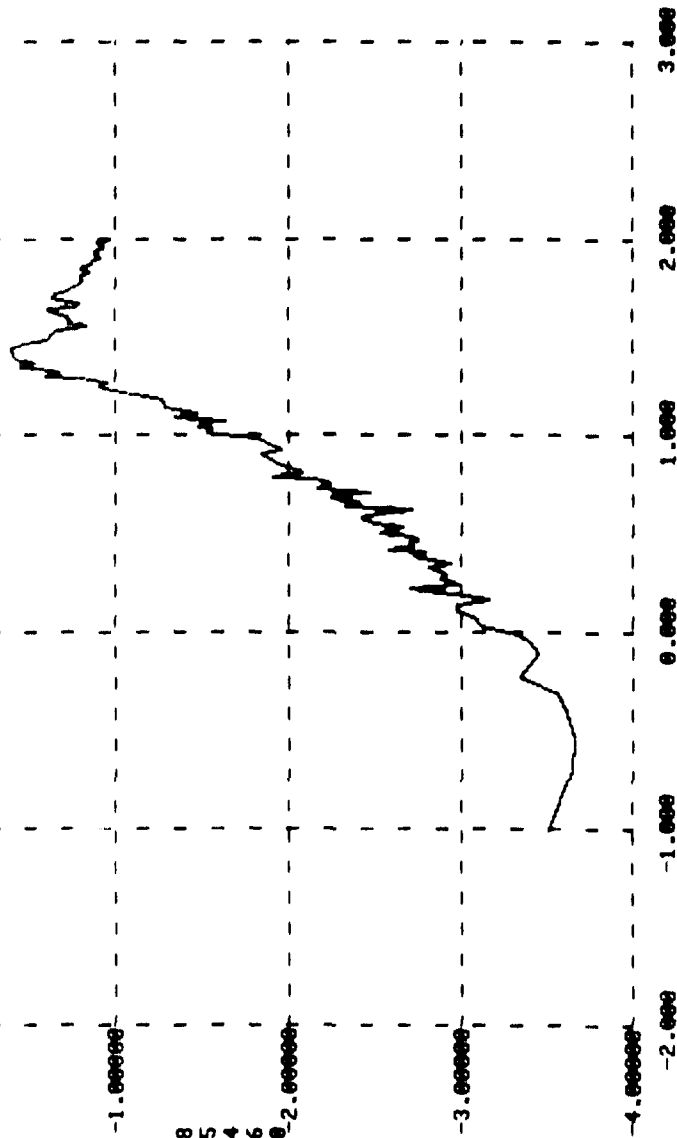

LOG FREQ
DATA HAS BEEN AVERAGED LOGARITHMICALLY

10 JUN 4-4 011 , 0A-11A 011 E CH1=UN/HI/OFF CH2=UN/HI/OFF 1 MIN
 # COMPLEX PTS IN BLOCK OF 1024. DF, F ARE .976563E-01 .100000E+03

INTERVAL #	MIN F HZ	MAX F HZ	RMS RATE NOISE ARC SEC/SEC
1	0.00	9.96	.2550
2	9.96	19.92	.8739
3	19.92	29.88	1.8546
4	29.88	39.84	1.4182
5	39.84	49.80	1.4348
6	49.80	59.77	1.3766
7	59.77	69.73	1.2340
8	69.73	79.69	1.1915
9	79.69	89.65	1.1343
10	89.65	99.61	1.0923
1	0.00	100.00	3.9617

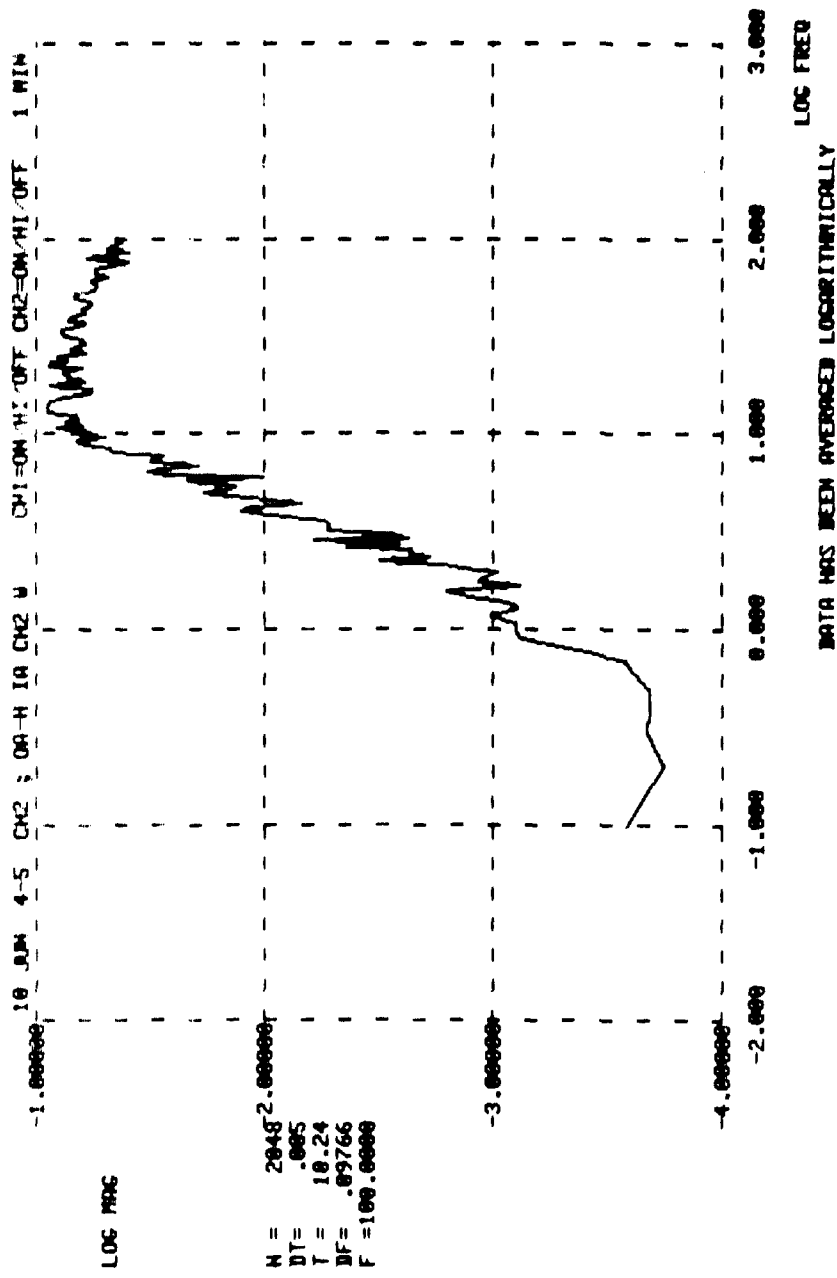

10 JUN 4-5 CH2 ; NA=N IA CH2 . CHI=ON/HI/OFF CH2=ON/HI/OFF 1 MIN
 # COMPLEX PIS IN BLOCK # 1024, DF, F ARE .976563E-01 .100000E+03

INTERVAL #	MIN F HZ	MAX F HZ	RMS RATE NOISE ARC SEC/SEC
1	0.00	9.96	.4539
2	9.96	19.92	.8608
3	19.92	29.88	.8411
4	29.88	39.84	.8274
5	39.84	49.80	.7865
6	49.80	59.77	.7650
7	59.77	69.73	.7253
8	69.73	79.69	.6766
9	79.69	89.65	.7068
10	89.65	99.61	.6669
1	0.00	100.00	2.3414

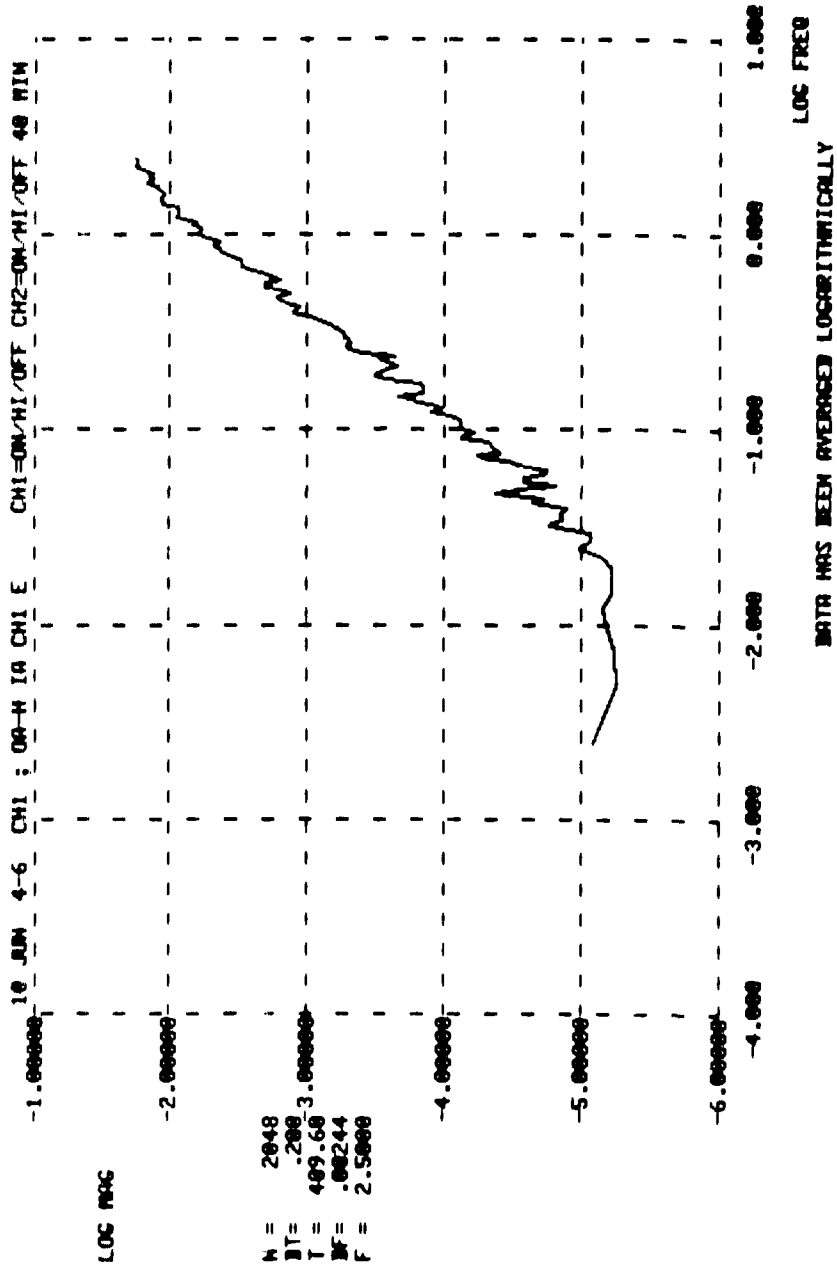

10 JUN 4-5 CHI ; 0A-M IA CHI E CHI=ON/HI/OFF CH2=ON/HI/OFF 40 MIN
 # COMPLEX PTS IN BLOCK = 1024. DF,F ARE .244141E-02 .250000E+01

INTERVAL #	MIN F HZ	MAX F HZ	RMS RATE NOISE ARC SEC/SEC
1	0.00	.10	.0017
2	.10	.20	.0041
3	.20	.30	.0063
4	.30	.40	.0089
5	.40	.50	.0120
6	.50	.60	.0134
7	.60	.70	.0159
8	.70	.80	.0186
9	.80	.90	.0215
10	.90	1.00	.0227
11	1.00	1.10	.0246
12	1.10	1.20	.0264
13	1.20	1.30	.0297
14	1.30	1.40	.0290
15	1.40	1.50	.0338
16	1.50	1.60	.0336
17	1.60	1.70	.0350
18	1.70	1.80	.0347
19	1.80	1.90	.0384
20	1.90	2.00	.0377
21	2.00	2.10	.0373
22	2.10	2.20	.0399
23	2.20	2.30	.0430
24	2.30	2.40	.0420
1	0.00	1.00	.0451
2	1.00	2.00	.1031
1	0.00	2.50	.1451

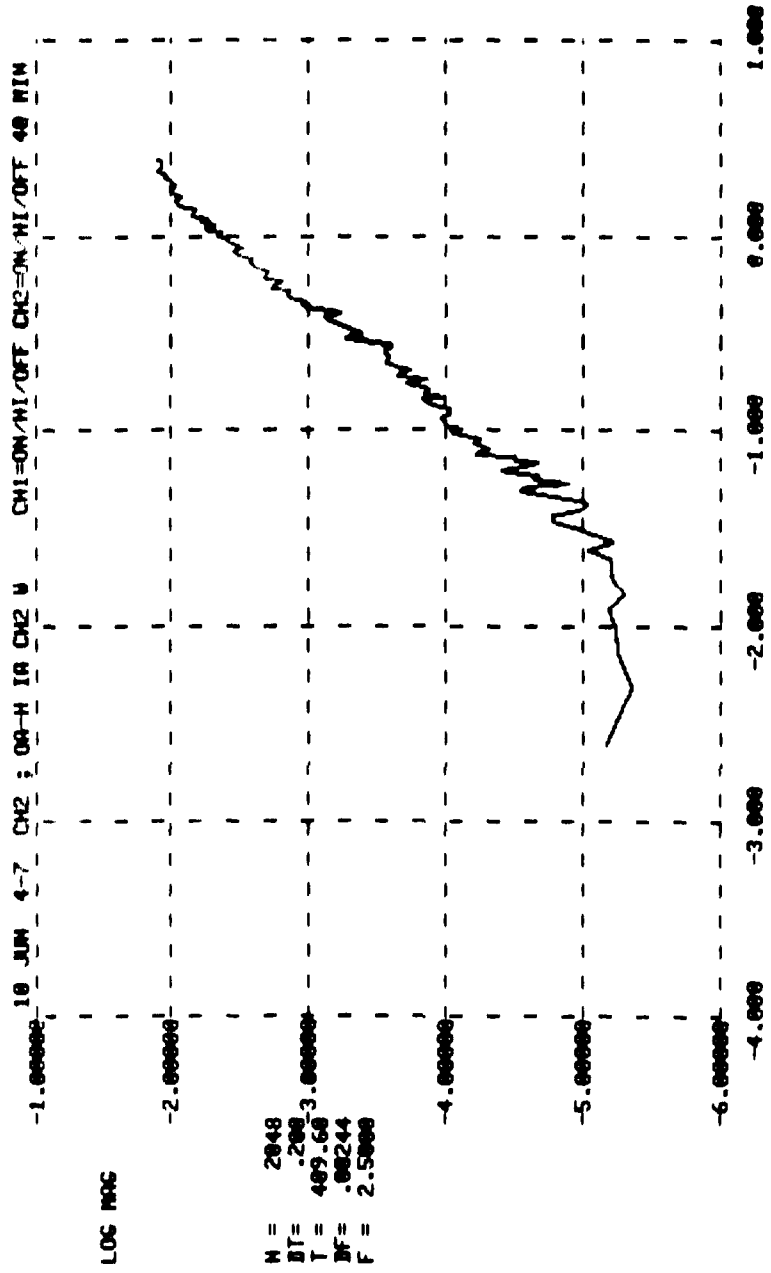

DATA HAS BEEN AVERAGED LOGRITHMICALLY

PATCH 3000X

10 JUN 4-7 CH2 ; JAPN IN CH2 4 CH1=ON/HI/OFF CH2=ON/HI/OFF 40 MIN
COMPLEX PIS IN BLOCK # 1024. DF, F ARE .244141E-02 .250000E+01

INTERVAL #	MIN F HZ	MAX F HZ	RMS RATE NOISE ARC SEC/SEC
1	.000	.10	.0017
2	.10	.20	.0038
3	.20	.30	.0055
4	.30	.40	.0078
5	.40	.50	.0106
6	.50	.60	.0133
7	.60	.70	.0148
8	.70	.80	.0168
9	.80	.90	.0180
10	.90	1.00	.0200
11	1.00	1.10	.0223
12	1.10	1.20	.0238
13	1.20	1.30	.0253
14	1.30	1.40	.0260
15	1.40	1.50	.0269
16	1.50	1.60	.0311
17	1.60	1.70	.0307
18	1.70	1.80	.0316
19	1.80	1.90	.0315
20	1.90	2.00	.0330
21	2.00	2.10	.0336
22	2.10	2.20	.0357
23	2.20	2.30	.0342
24	2.30	2.40	.0346
1	0.000	1.00	.0402
2	1.00	2.00	.0906
1	0.000	2.50	.1257

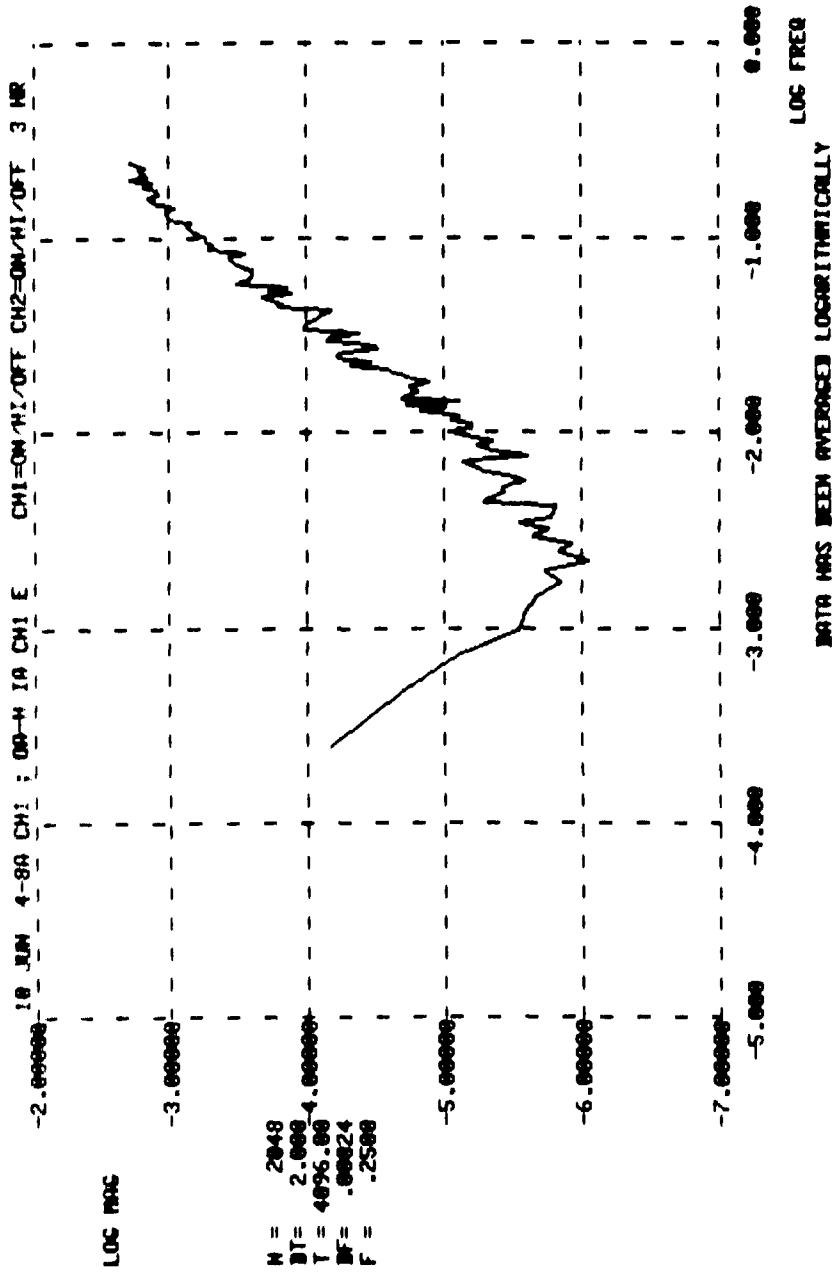

10 JUN 4-BA CH1 7 DA-M 1A CH1 E CH1=ON/HI/OFF CH2=ON/HI/OFF 3 HR
 # COMPLEX PTS IN BLOCK OF 1024. OF, F ARE .244141E-03 .250000E+00

INTERVAL #	MIN F HZ	MAX F HZ	RMS RATE NOISE ARC SEC/SEC
1	0.00	.01	.0002
2	.01	.02	.0004
3	.02	.03	.0007
4	.03	.04	.0009
5	.04	.05	.0012
6	.05	.06	.0015
7	.06	.07	.0016
8	.07	.08	.0018
9	.08	.09	.0020
10	.09	.10	.0023
11	.10	.11	.0025
12	.11	.12	.0027
13	.12	.13	.0031
14	.13	.14	.0033
15	.14	.15	.0031
16	.15	.16	.0037
17	.16	.17	.0037
18	.17	.18	.0035
19	.18	.19	.0039
20	.19	.20	.0038
21	.20	.21	.0042
22	.21	.22	.0040
23	.22	.23	.0040
24	.23	.24	.0041
1	0.00	.10	.0045
2	.10	.20	.0106
1	0.00	.25	.0148

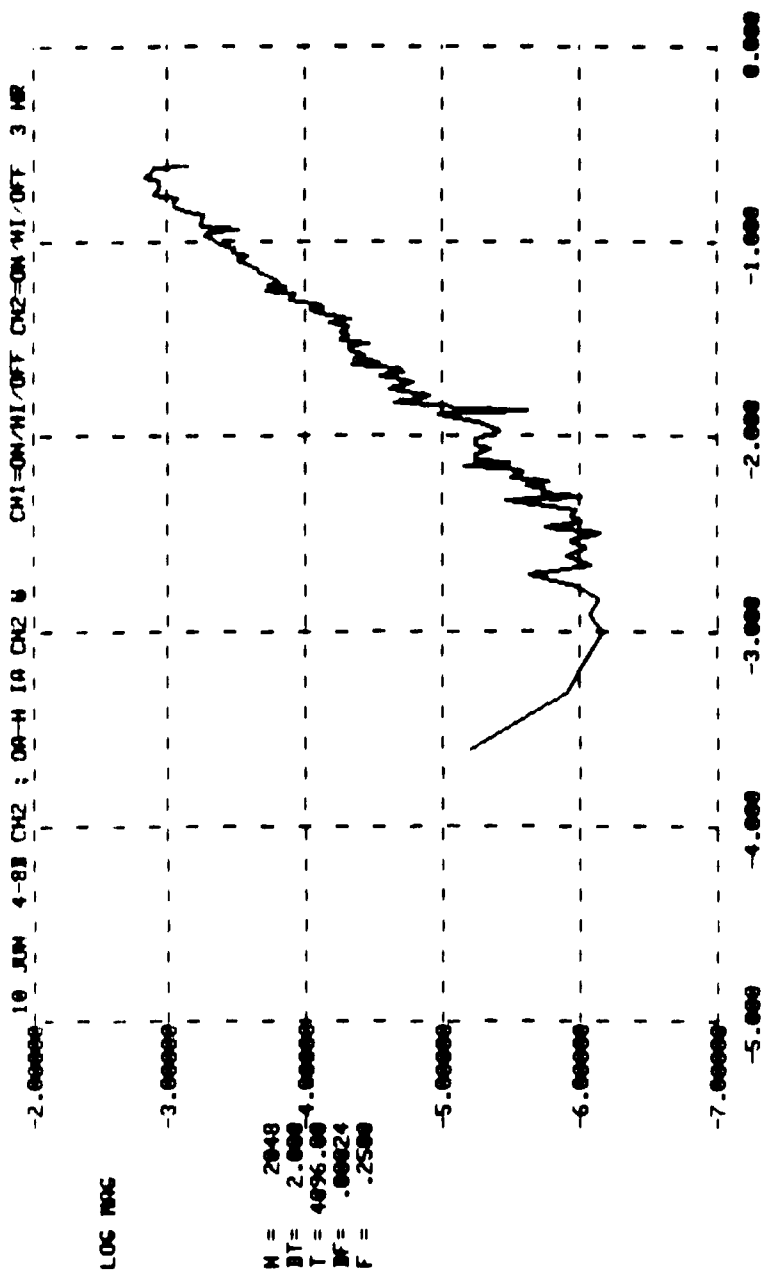

DATA HAS BEEN AVERAGED LOGORITHMICALLY

14 JUN 4-AM CH2 ; 04-AM IA CH2 W CH1=ON/HI/OFF CH2=ON/HI/OFF 3 HR
 # COMPLEX PTS IN BLOCK = 1024. DF, F ARE .244141E-03 .250000E+00

INTERVAL #	MIN F HZ	MAX F HZ	RMS RATE NOISE ARC SEC/SEC
1	.00	.01	.0002
2	.01	.02	.0004
3	.02	.03	.0006
4	.03	.04	.0007
5	.04	.05	.0009
6	.05	.06	.0012
7	.06	.07	.0014
8	.07	.08	.0017
9	.08	.09	.0017
10	.09	.10	.0020
11	.10	.11	.0022
12	.11	.12	.0021
13	.12	.13	.0025
14	.13	.14	.0024
15	.14	.15	.0028
16	.15	.16	.0027
17	.16	.17	.0031
18	.17	.18	.0034
19	.18	.19	.0034
20	.19	.20	.0035
21	.20	.21	.0034
22	.21	.22	.0038
23	.22	.23	.0038
24	.23	.24	.0037
1	.00	.10	.0039
2	.10	.20	.0090
1	.00	.25	.0125

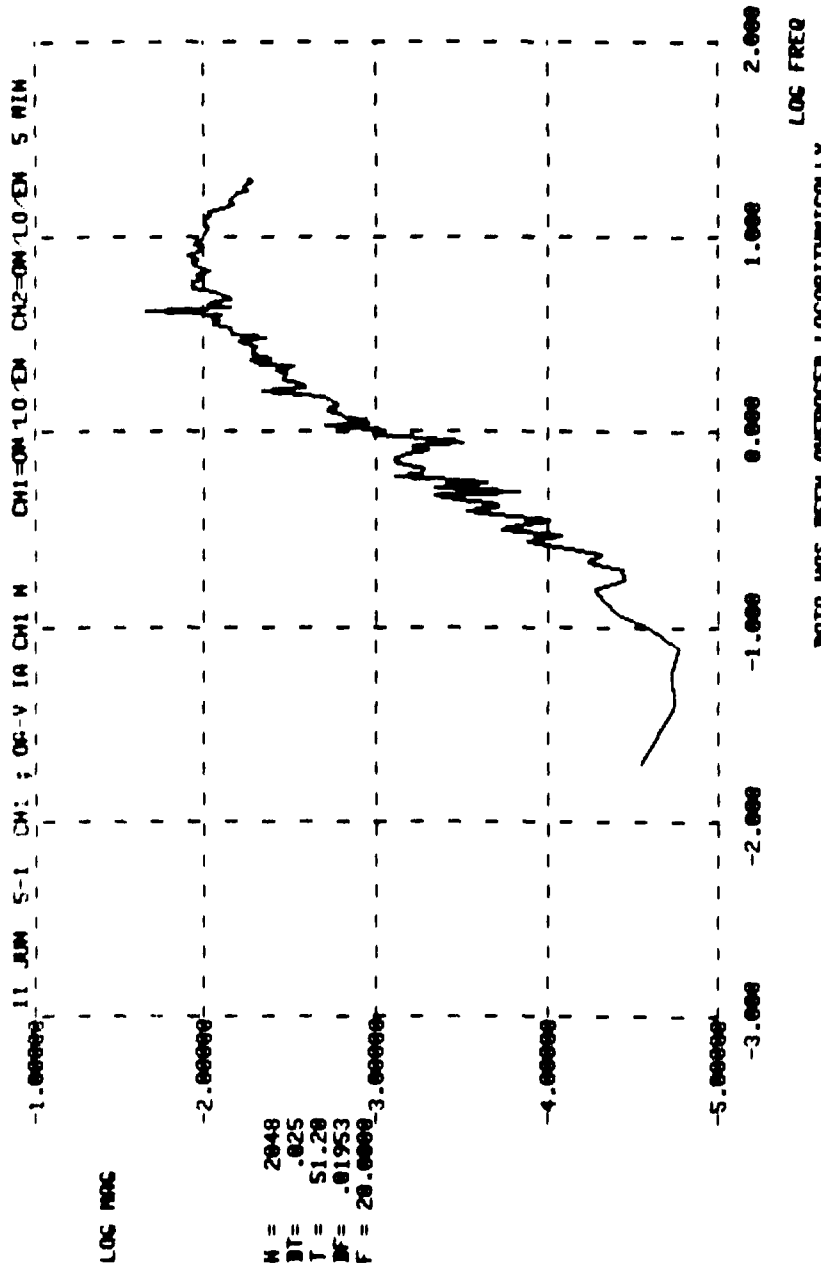

11 JUN 5-1 CH1 J JA-V LA CH1 N CH1=ON/LO/EN CH2=ON/LO/EN 5 MIN
 # COMPLEX PIS IN BLOCK # 1024, DF, F ARE .195313E-01 .200000E+02

INTERVAL #	MIN F HZ	MAX F HZ	RMS RATE NOISE ARC SEC/SLC
1	0.00	1.00	.0188
2	1.00	1.99	.0488
3	1.99	2.99	.0695
4	2.99	3.98	.0860
5	3.98	4.98	.1007
6	4.98	5.98	.1026
7	5.98	6.97	.1015
8	6.97	7.97	.1044
9	7.97	8.96	.1057
10	8.96	9.96	.1023
11	9.96	10.96	.0989
12	10.96	11.95	.0985
13	11.95	12.95	.0988
14	12.95	13.95	.0922
15	13.95	14.94	.0857
16	14.94	15.94	.0833
17	15.94	16.93	.0808
18	16.93	17.93	.0760
19	17.93	18.93	.0753
20	18.93	19.92	.0749
1	0.00	4.98	.1584
2	4.98	9.96	.2310
3	9.96	14.94	.2123
4	14.94	19.92	.1739
1	0.00	20.00	.3925

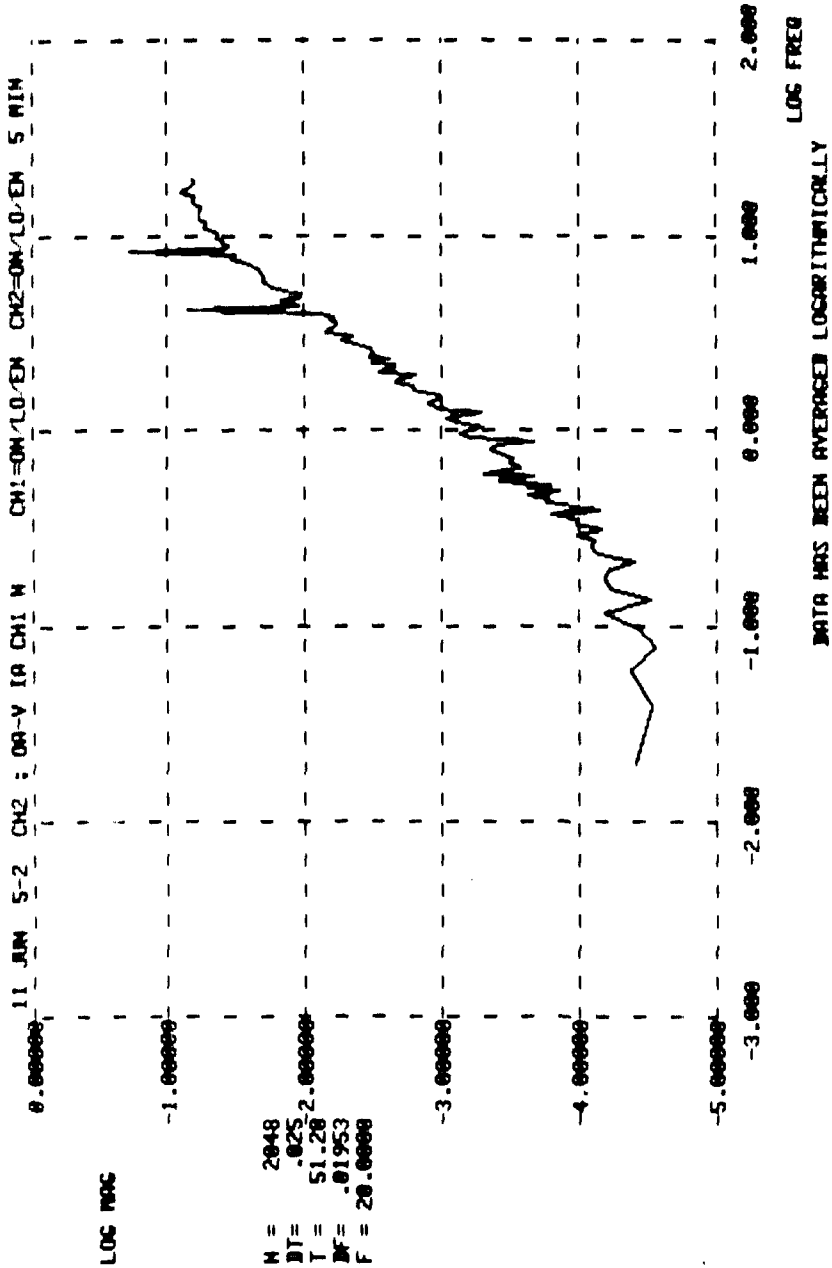

11 JUN 5-2 CH2 : UA-V IA CH1 N CH1=UN/LO/EN CH2=UN/LO/EN 5 MIN
 # COMPLEX PTS IN BLOCK N# 1024, DF, F ARE .195313E-01 .200000E+02

INTERVAL #	MIN F HZ	MAX F HZ	RMS RATE NOISE ARC SEC/SEC
1	0.00	1.00	.0154
2	1.00	1.99	.0374
3	1.99	2.99	.0588
4	2.99	3.98	.0790
5	3.98	4.98	.1462
6	4.98	5.98	.1311
7	5.98	6.97	.1474
8	6.97	7.97	.1685
9	7.97	8.96	.2917
10	8.96	9.96	.2021
11	9.96	10.96	.2152
12	10.96	11.95	.2307
13	11.95	12.95	.2441
14	12.95	13.95	.2435
15	13.95	14.94	.2456
16	14.94	15.94	.2567
17	15.94	16.93	.2717
18	16.93	17.93	.2689
19	17.93	18.93	.2589
20	18.93	19.92	.2558
1	0.00	4.98	.1808
2	4.98	9.96	.4396
3	9.96	14.94	.5279
4	14.94	19.92	.5869
1	0.00	20.00	.9252

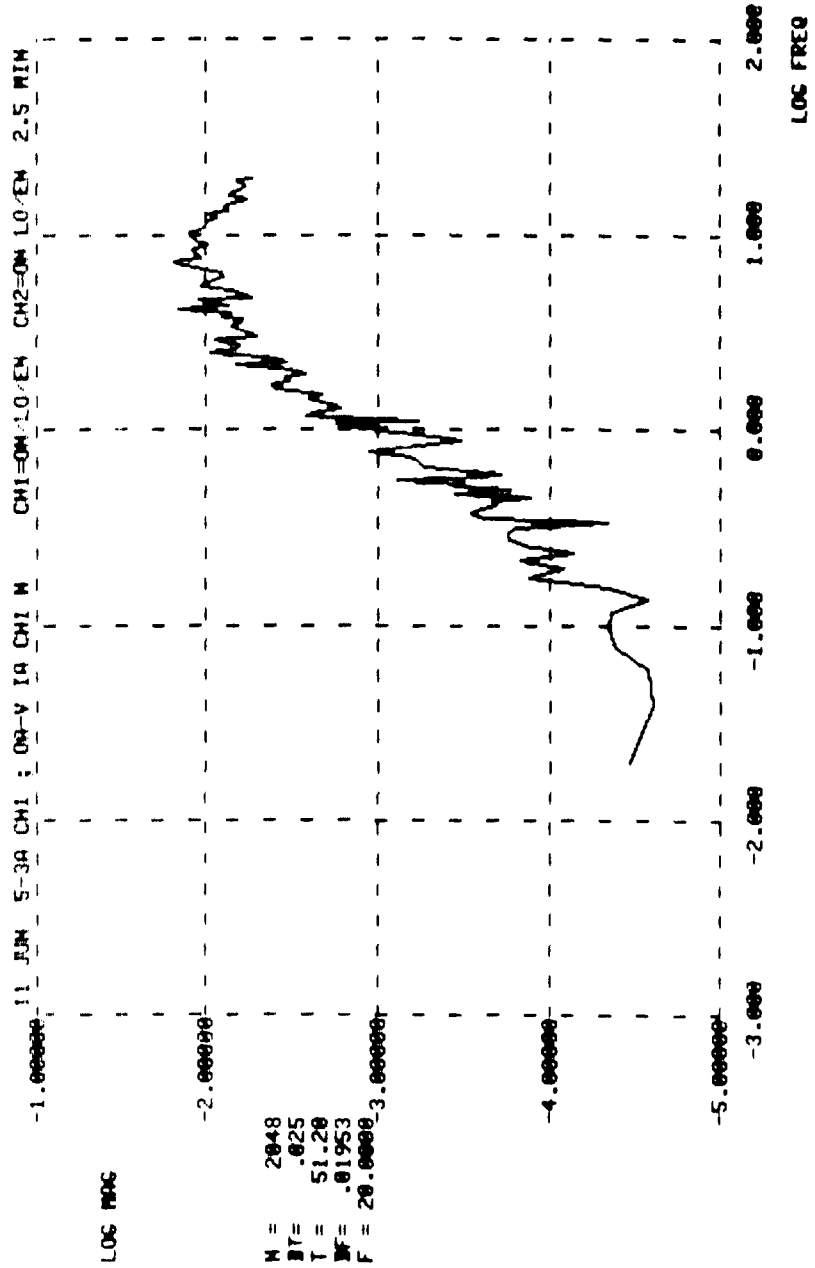

11 JUN 5-3A CH1 ; 0A-V 1A CH1 N CH1=ON/LO/EN CH2=ON/LO/EN 2.5 MIN
 # COMPLEX PTS IN BLOCK W= 1024. DF, F ARE .195313E-01 .200000E+02

INTERVAL #	MIN F HZ	MAX F HZ	RMS RATE NOISE ARC SEC/SEC
1	0.00	1.00	.0107
2	1.00	1.99	.0510
3	1.99	2.99	.0788
4	2.99	3.98	.0797
5	3.98	4.98	.0945
6	4.98	5.98	.0941
7	5.98	6.97	.0952
8	6.97	7.97	.1153
9	7.97	8.96	.1046
10	8.96	9.96	.1069
11	9.96	10.96	.1109
12	10.96	11.95	.0944
13	11.95	12.95	.0948
14	12.95	13.95	.0911
15	13.95	14.94	.0837
16	14.94	15.94	.0806
17	15.94	16.93	.0840
18	16.93	17.93	.0782
19	17.93	18.93	.0774
20	18.93	19.92	.0775
1	0.00	4.98	.1563
2	4.98	9.96	.2315
3	9.96	14.94	.2133
4	14.94	19.92	.1779
1	0.00	20.00	.3945

1 JUN 5-38 CH2 : DR-V IA CH1 N CH1=ON/10.EM CH2=ON/10.EM 2.5 MIN

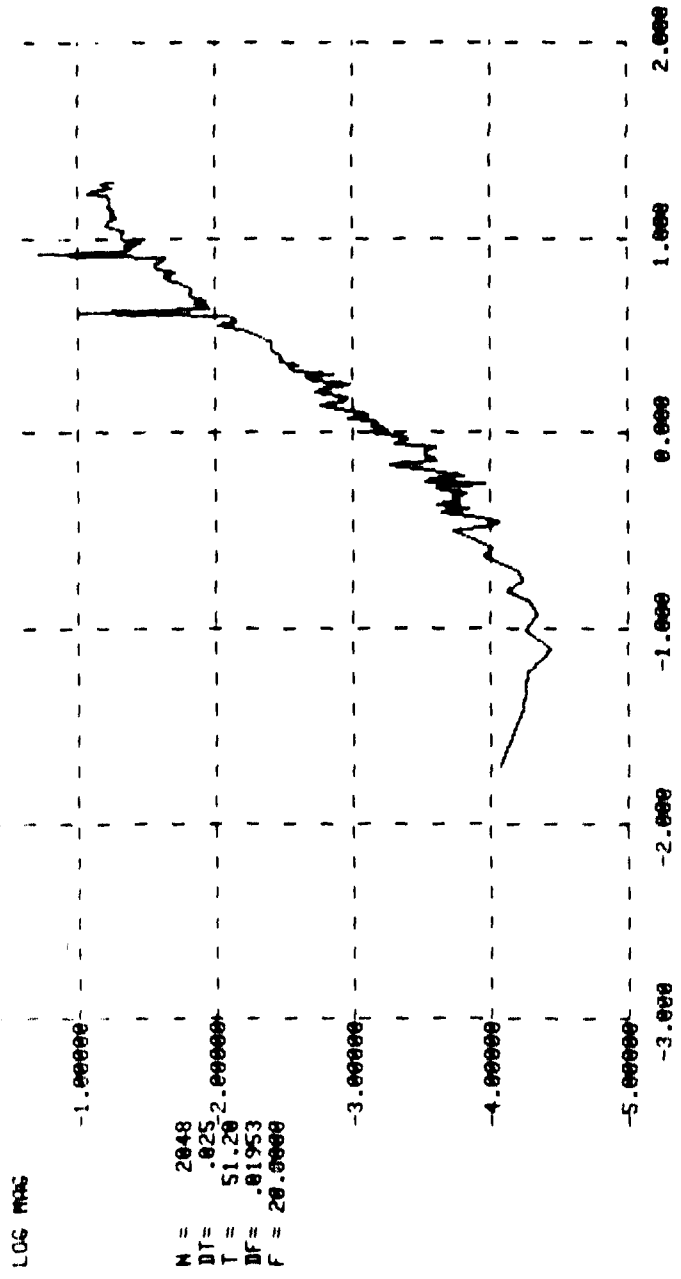

N = 2048
DT = .025
T = 51.20
DF = .01953
F = 20.0000

DATA HAS BEEN AVERAGED LOGARITHMICALLY

11 JUN 5-38 CH2 ; JA-V TA CH1 N CH1BUN/LOZEN CH2BUN/LOZEN 2.5 MIN
 R COMPLEX PIS IN BLOCK 18 1024, DE, F ARE .195313E+01 .200000E+02

INTERVAL #	MIN #	MAX #	RMS RATE NOISE AND MIN #
	1.00	1.00	.0149
1	1.00	1.99	.0366
2	1.99	2.98	.0583
3	2.98	3.97	.0815
4	3.97	4.96	.1614
5	4.96	5.95	.1269
6	5.95	6.94	.1567
7	6.94	7.93	.1591
8	7.93	8.92	.2986
9	8.92	9.91	.2096
10	9.91	10.90	.2100
11	10.90	11.89	.2433
12	11.89	12.88	.2397
13	12.88	13.87	.2457
14	13.87	14.86	.2403
15	14.86	15.85	.2391
16	15.85	16.84	.2472
17	16.84	17.83	.2829
18	17.83	18.82	.2454
19	18.82	19.81	.2362
20	19.81		
	4.98	4.98	.1940
1	4.98	4.98	.4441
2	4.98	14.94	.5261
3	4.98	19.92	.5615
4	4.98		
	20.00	20.00	.9151
1	20.00		

11 JUN 54 CHI : CR-V IR CHI M CHI=OM/LO/EN CH2=OM/LO/EN 1 MIN

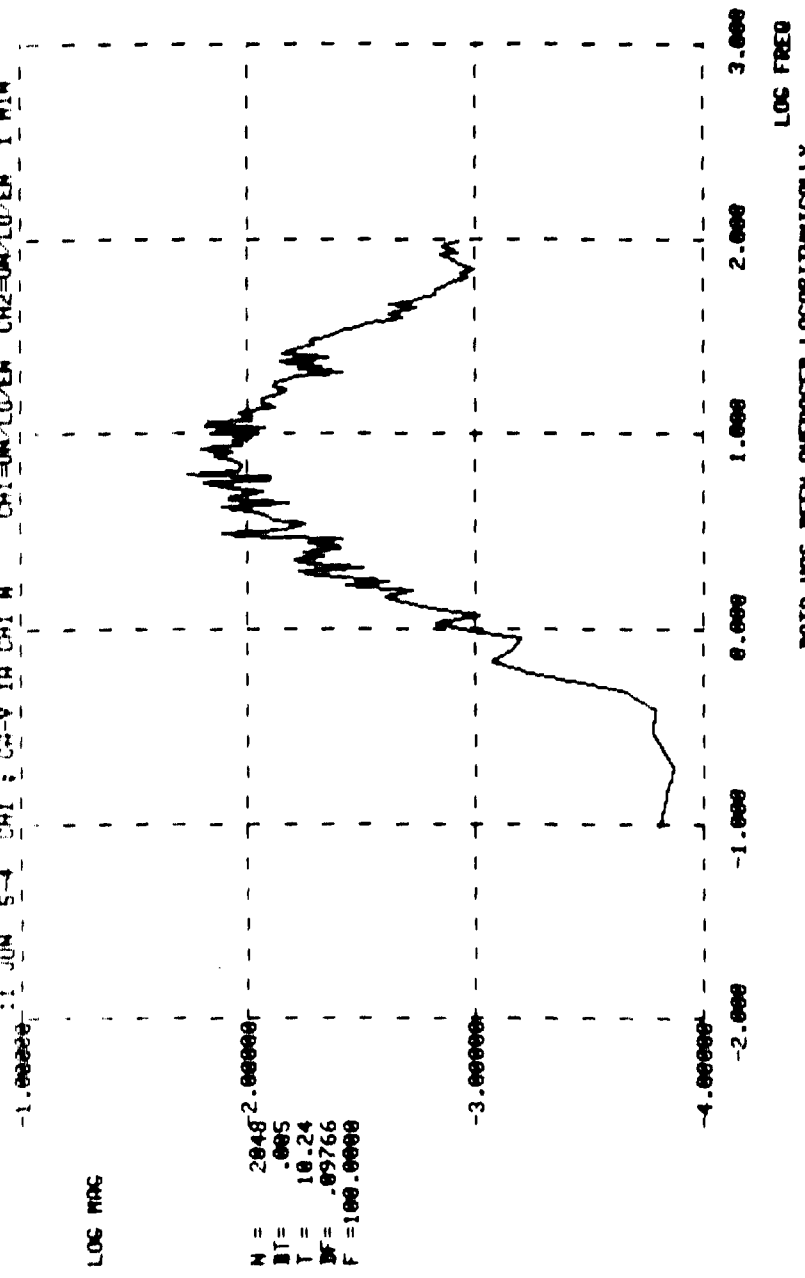

N = 2048
RT = .005
T = 10.24
SF = .05766
F = 100.0000

11 JUN 5-4 CH1 ; JA-V IA CH1 0 CH1=ON/LOZEN CH2=ON/LOZEN 1 MIN
 R COMPLEX PIS IN BLOCK V= 1024. DE,F ARE .975063E-01 .100000E+03

INTERVAL #	MIN F HZ	MAX F HZ	RMS RATE NOISE ARC SEC/SEC
1	0.00	9.96	.2902
2	9.96	19.92	.2979
3	19.92	29.88	.2393
4	29.88	39.84	.1879
5	39.84	49.80	.1434
6	49.80	59.77	.1192
7	59.77	69.73	.1071
8	69.73	79.69	.1068
9	79.69	89.65	.1148
10	89.65	99.61	.1128
1	0.00	100.00	.5912

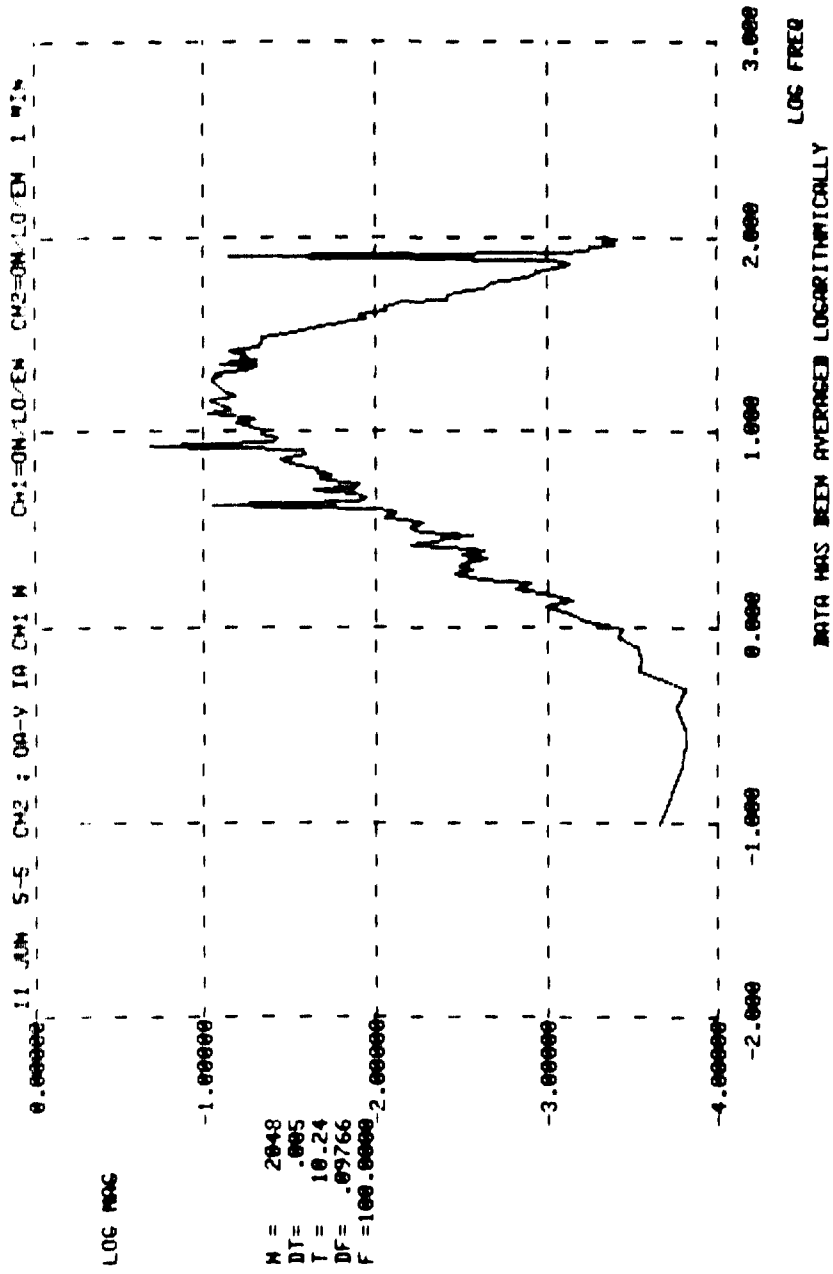

11 JUN 5-5 CH2 : DA-V IA CH1 N CH1=ON/LO/EN CH2=ON/LO/EN 1 MIN
 # COMPLEX PTS IN BLOCK = 1024. DF, F ARE .976563E-01 .100000E+03

INTERVAL #	MIN F HZ	MAX F HZ	RMS RATE NOISE ARC SEC/SEC
1	0.00	9.96	.5043
2	9.96	19.92	.8632
3	19.92	29.88	.7663
4	29.88	39.84	.4780
5	39.84	49.80	.2645
6	49.80	59.77	.1598
7	59.77	69.73	.1108
8	69.73	79.69	.0999
9	79.69	89.65	.4755
10	89.65	99.61	.0660
1	0.00	100.00	1.4709

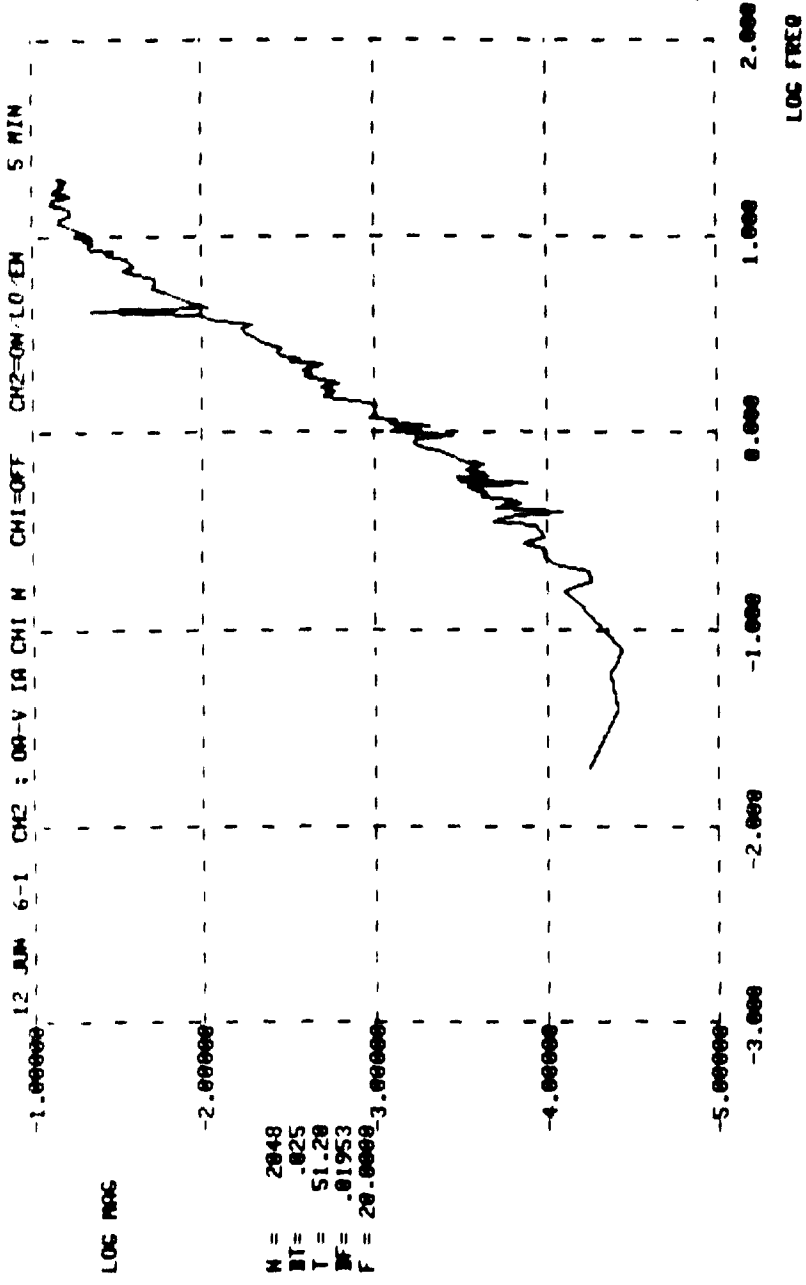

DATA HAS BEEN AVERAGED LOGRITHMICALLY

12 JUN 6-1 CH2 ; UA-V IA CH1 N CH1=OFF CH2=ON/LO/EN 5 MIN
 2.00000E+02 IN BLOCK # 1024. OFF ARE .195313E-01 .200000E+02

INTERVAL #	MIN F HZ	MAX F HZ	RMS RATE NOISE ARC SEC/SEC
1	0.00	1.00	.0156
2	1.00	1.99	.0385
3	1.99	2.99	.0574
4	2.99	3.98	.0812
5	3.98	4.98	.1302
6	4.98	5.98	.1336
7	5.98	6.97	.1564
8	6.97	7.97	.1657
9	7.97	8.96	.2011
10	8.96	9.96	.2119
11	9.96	10.96	.2229
12	10.96	11.95	.2556
13	11.95	12.95	.2597
14	12.95	13.95	.2401
15	13.95	14.94	.2719
16	14.94	15.94	.2643
17	15.94	16.93	.2691
18	16.93	17.93	.2634
19	17.93	18.93	.2554
20	18.93	19.92	.2596
1	0.00	4.98	.1690
2	4.98	9.96	.3938
3	9.96	14.94	.5604
4	14.94	19.92	.5868
1	0.00	20.00	.9210

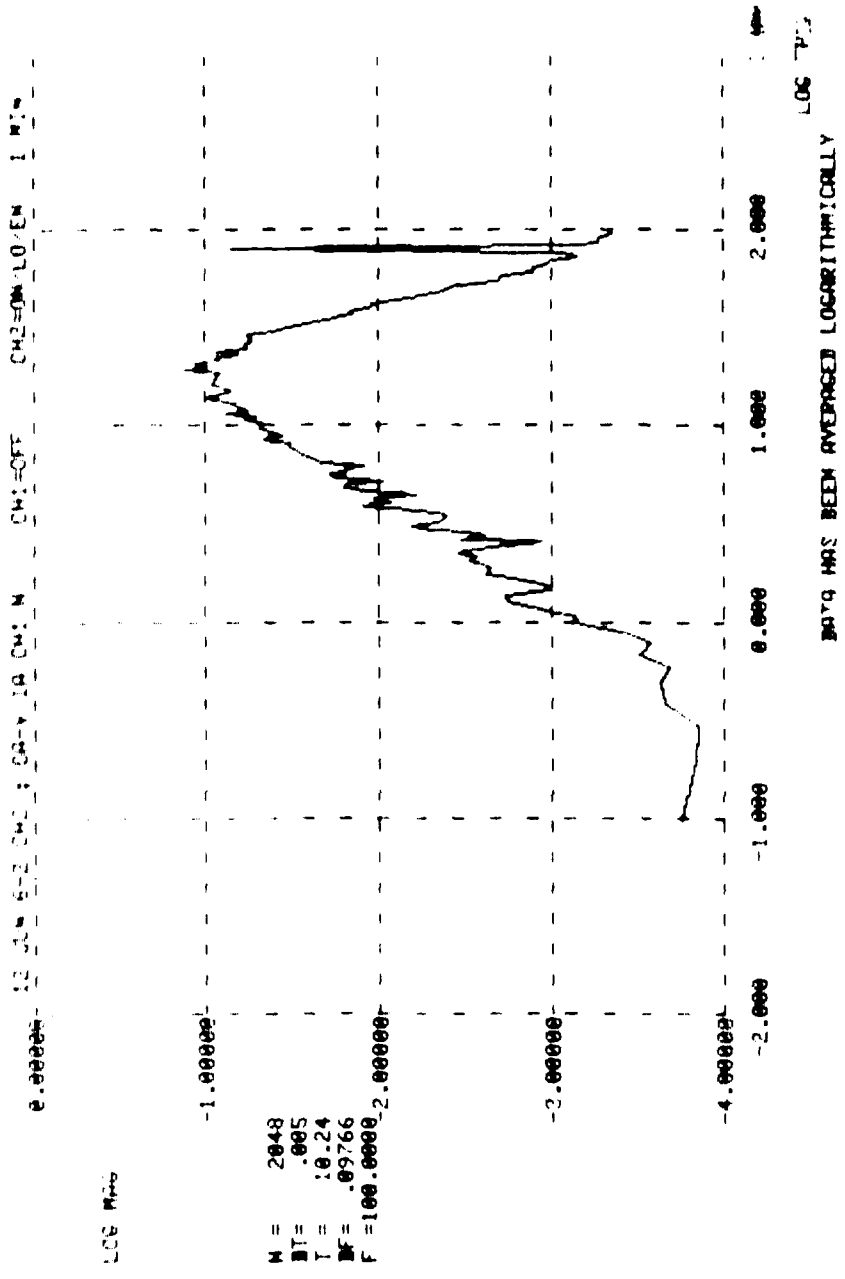

12 JUN 6-2 CH2 ; UA-V IA CH1 N CH1=OFF CH2=ON/LO/EN 1 MIN
 # COMPLEX PIS IN BLOCK # 1024, OF, F ARE .976563E-01 .100000E+03

INTERVAL #	MIN F HZ	MAX F HZ	RMS RATE NOISE ARC SEC/SEC
1	0.00	9.96	.4147
2	9.96	19.92	.8962
3	19.92	29.88	.8400
4	29.88	39.84	.4754
5	39.84	49.80	.2667
6	49.80	59.77	.1560
7	59.77	69.73	.1090
8	69.73	79.69	.0979
9	79.69	89.65	.4750
10	89.65	99.61	.0683
1	0.00	100.00	1.5014

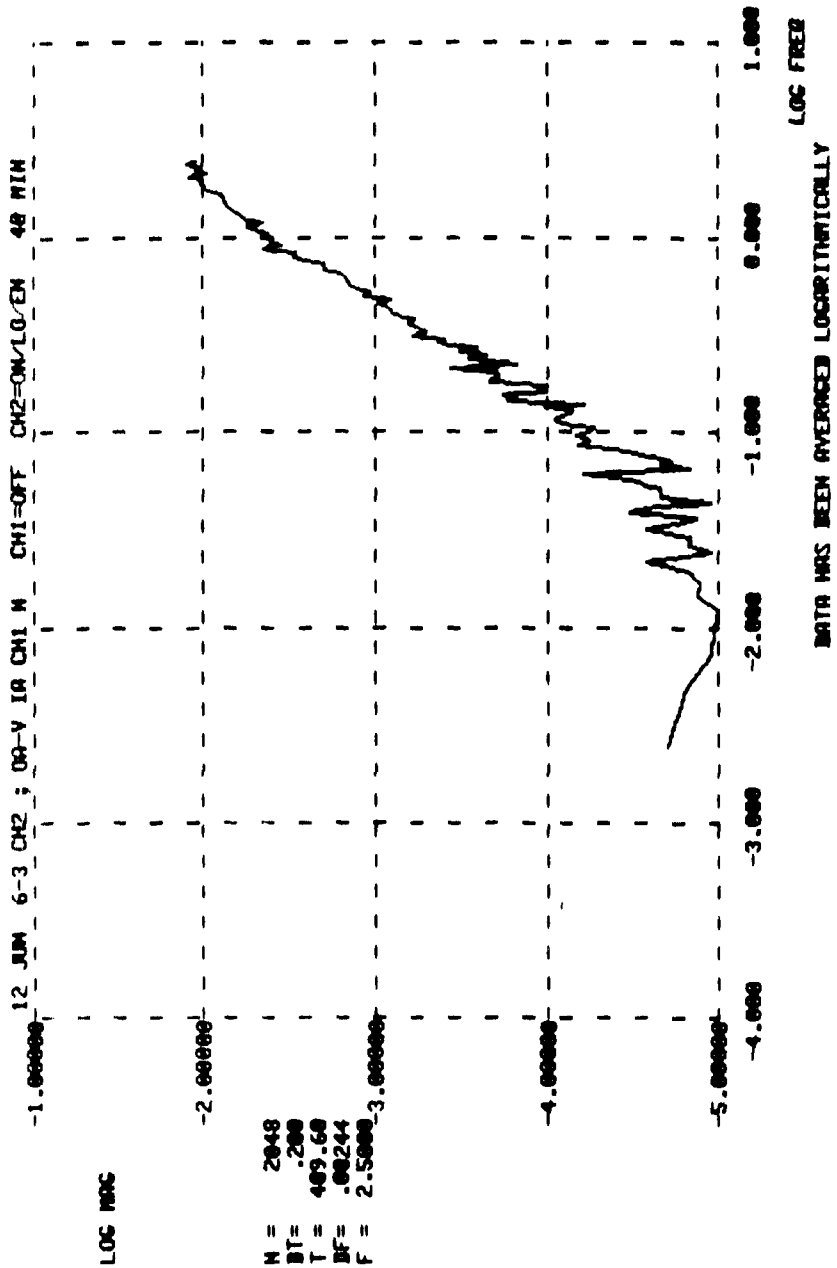

12 JUN 6-3 CH2 / DA-V IA CH1 N CH1=OFF CH2=ON/LO/EN 40 MIN
 * COMPLEX PTS IN BLOCK N= 1024, DF, F ARE .244141E-02 .250000E+01

INTERVAL #	MIN F HZ	MAX F HZ	RMS RATE NOISE ARC SEC/SEC
1	0.00	.10	.0017
2	.10	.20	.0035
3	.20	.30	.0054
4	.30	.40	.0076
5	.40	.50	.0096
6	.50	.60	.0112
7	.60	.70	.0131
8	.70	.80	.0154
9	.80	.90	.0187
10	.90	1.00	.0196
11	1.00	1.10	.0217
12	1.10	1.20	.0221
13	1.20	1.30	.0240
14	1.30	1.40	.0250
15	1.40	1.50	.0265
16	1.50	1.60	.0274
17	1.60	1.70	.0285
18	1.70	1.80	.0300
19	1.80	1.90	.0321
20	1.90	2.00	.0318
21	2.00	2.10	.0337
22	2.10	2.20	.0324
23	2.20	2.30	.0322
24	2.30	2.40	.0334

1	0.00	1.00	.0382
2	1.00	2.00	.0858

1	0.00	2.50	.1196
---	------	------	-------

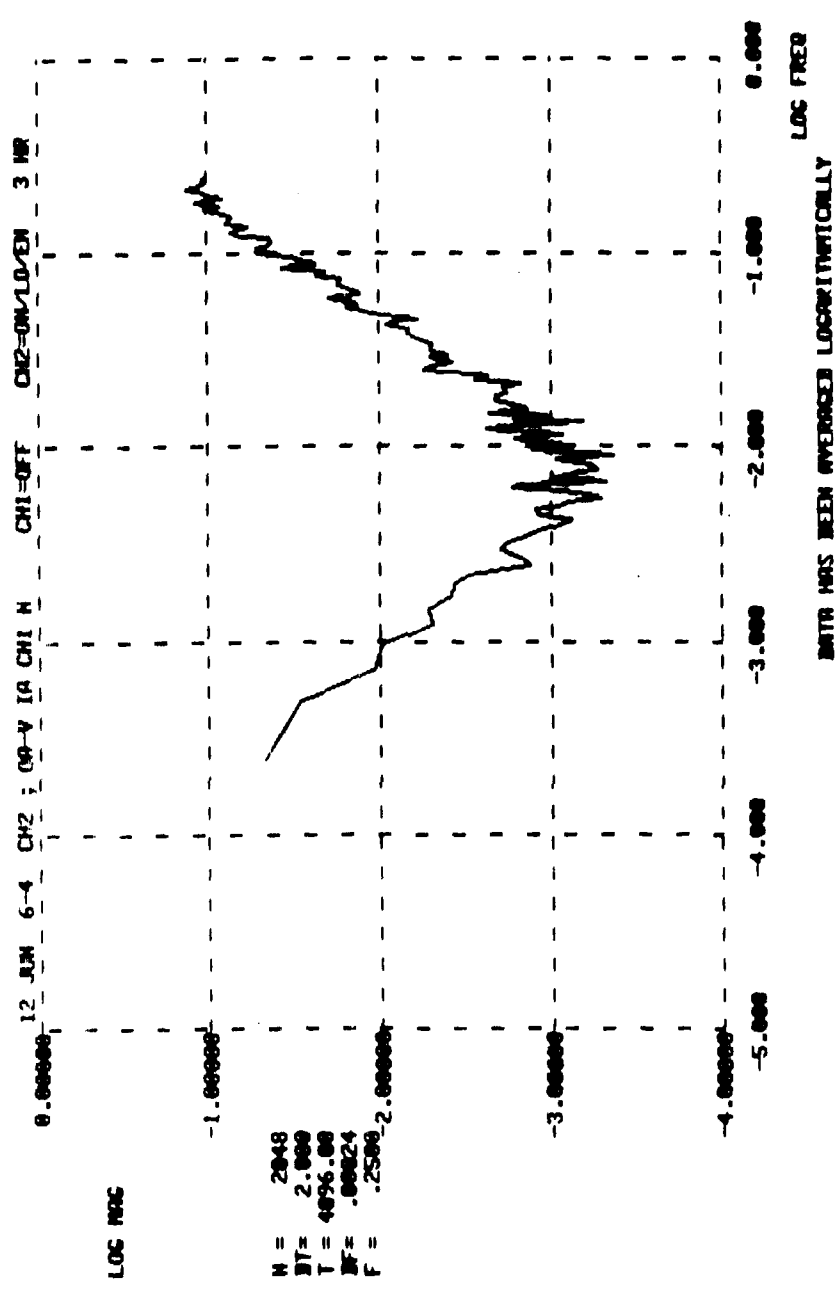

12 JUN 6-4 CH2 : 01-V TA CH1 W CH1=OFF CH2=ON/LO/EN 3 HR
 R COMPLEX P15 IN BLOCK # 1424, OF, F ANT .244141E-03 .250000E+00

INTERVAL #	MIN F HZ	MAX F HZ	RMS RATE NOISE ARC SEC/SEC
1	.00	.01	.0064
2	.01	.02	.0040
3	.02	.03	.0060
4	.03	.04	.0075
5	.04	.05	.0093
6	.05	.06	.0125
7	.06	.07	.0122
8	.07	.08	.0145
9	.08	.09	.0164
10	.09	.10	.0190
11	.10	.11	.0222
12	.11	.12	.0266
13	.12	.13	.0238
14	.13	.14	.0263
15	.14	.15	.0281
16	.15	.16	.0268
17	.16	.17	.0305
18	.17	.18	.0297
19	.18	.19	.0335
20	.19	.20	.0292
21	.20	.21	.0322
22	.21	.22	.0363
23	.22	.23	.0316
24	.23	.24	.0340
1	.00	.10	.0371
2	.10	.20	.0864
1	.00	.25	.1198

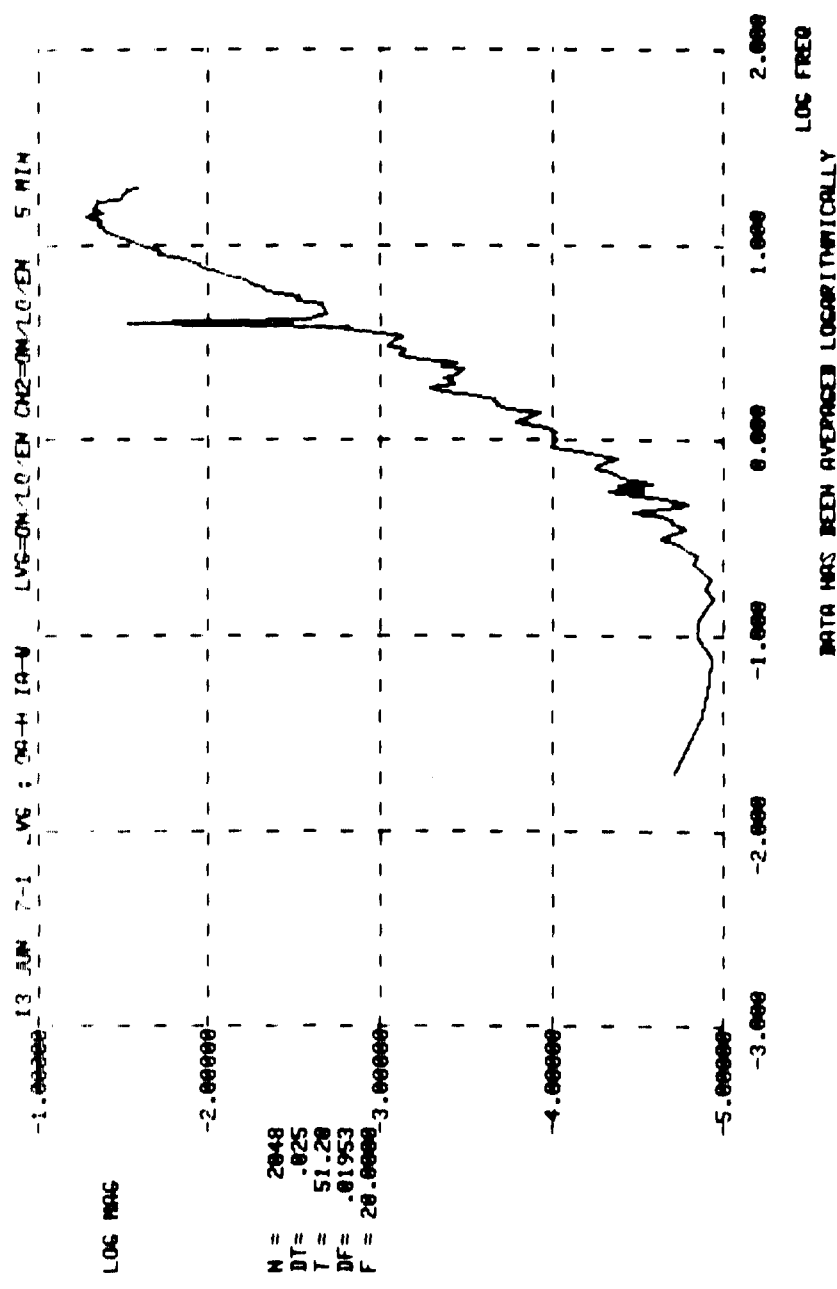

13 JUN 7-1 LVS 2 1A-H 1A-H (VGM/DN/LO/EN CH2/DN/LO/EN 5 MIN
 # COMPLEX PIS IN BLOCK IS 1024. OF, F ARE .195313E-01 .200000E+02

INTERVAL #	MIN F HZ	MAX F HZ	RMS RATE NOISE ARC SEC/SEC
1	0.00	1.00	.0000
2	1.00	1.99	.0153
3	1.99	2.99	.0232
4	2.99	3.98	.0357
5	3.98	4.98	.0804
6	4.98	5.98	.0600
7	5.98	6.97	.0752
8	6.97	7.97	.0972
9	7.97	8.96	.1191
10	8.96	9.96	.1429
11	9.96	10.96	.1678
12	10.96	11.95	.1938
13	11.95	12.95	.2056
14	12.95	13.95	.2106
15	13.95	14.94	.2143
16	14.94	15.94	.2119
17	15.94	16.93	.2144
18	16.93	17.93	.1770
19	17.93	18.93	.1798
20	18.93	19.92	.1626
1	4.98	4.98	.0925
2	4.98	9.96	.2309
3	4.96	14.94	.4453
4	14.94	19.92	.4254
1	0.00	20.00	.0656

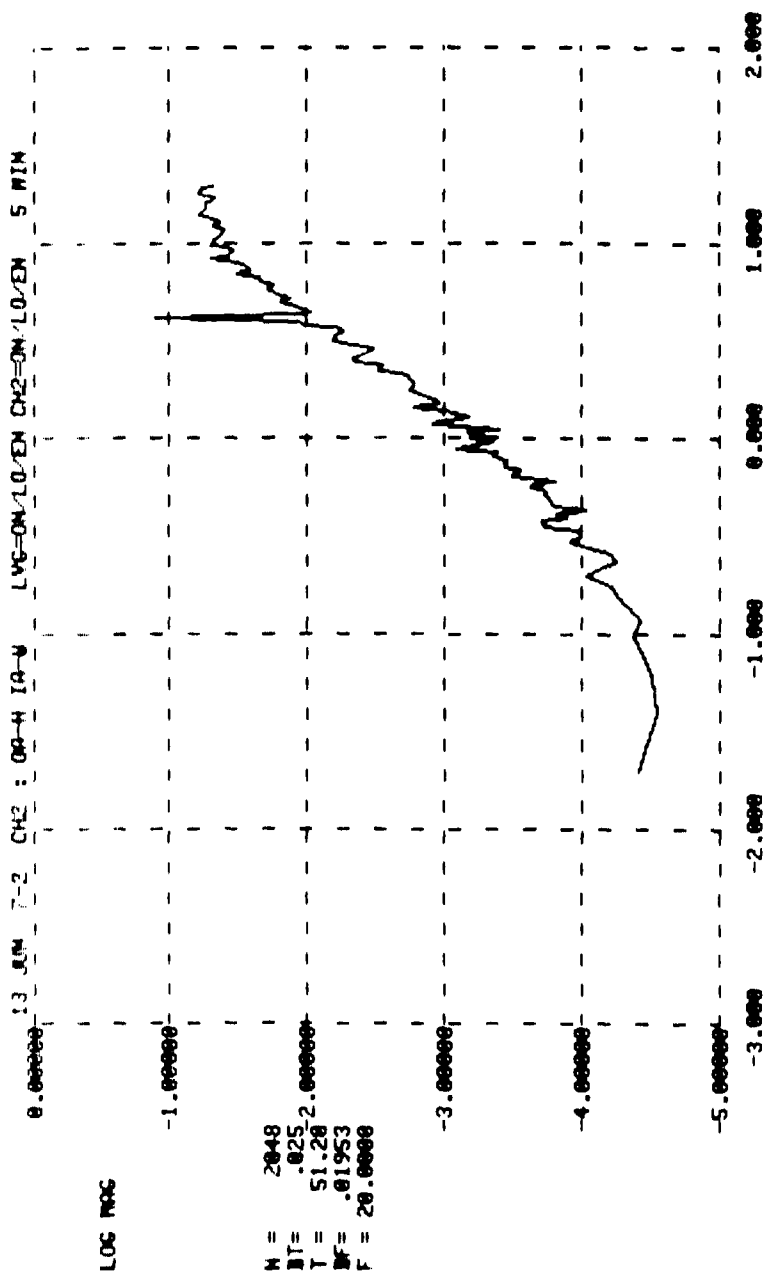

13 JUN 7-2 CH2 ; RA-H IA-R (VGE=ON/LO/EN CH2=UN/LO/EN 5 MIN
 # COMPLEX PIS IN BLOCK # 1024, DF, F ARE .195313E-01 ,200000E+02

INTERVAL #	MIN F HZ	MAX F HZ	RMS RATE NOISE ARC SEC/SEC
1	0.98	1.98	.0154
2	1.98	1.99	.0353
3	1.99	2.99	.0575
4	2.99	3.98	.0836
5	3.98	4.98	.1748
6	4.98	5.98	.1281
7	5.98	6.97	.1490
8	6.97	7.97	.1711
9	7.97	8.96	.2002
10	8.96	9.96	.2030
11	9.96	10.96	.2142
12	10.96	11.95	.2040
13	11.95	12.95	.2145
14	12.95	13.95	.2235
15	13.95	14.94	.2433
16	14.94	15.94	.2299
17	15.94	16.93	.2232
18	16.93	17.93	.2328
19	17.93	18.93	.2451
20	18.93	19.92	.2303
1	0.98	4.98	.2057
2	4.98	9.96	.3862
3	9.96	14.94	.4926
4	14.94	19.92	.5196
1	0.98	20.92	.6418

13 JUN 7-3 LVC : 0A-H 1A-M LVC=0M/1.0/EM CM2=0M/1.0/EM 1 MIN

LOC MAG

M = 2048
BT = .005
T = 10.24
BF = .09766
F = 100.0000-3.00000

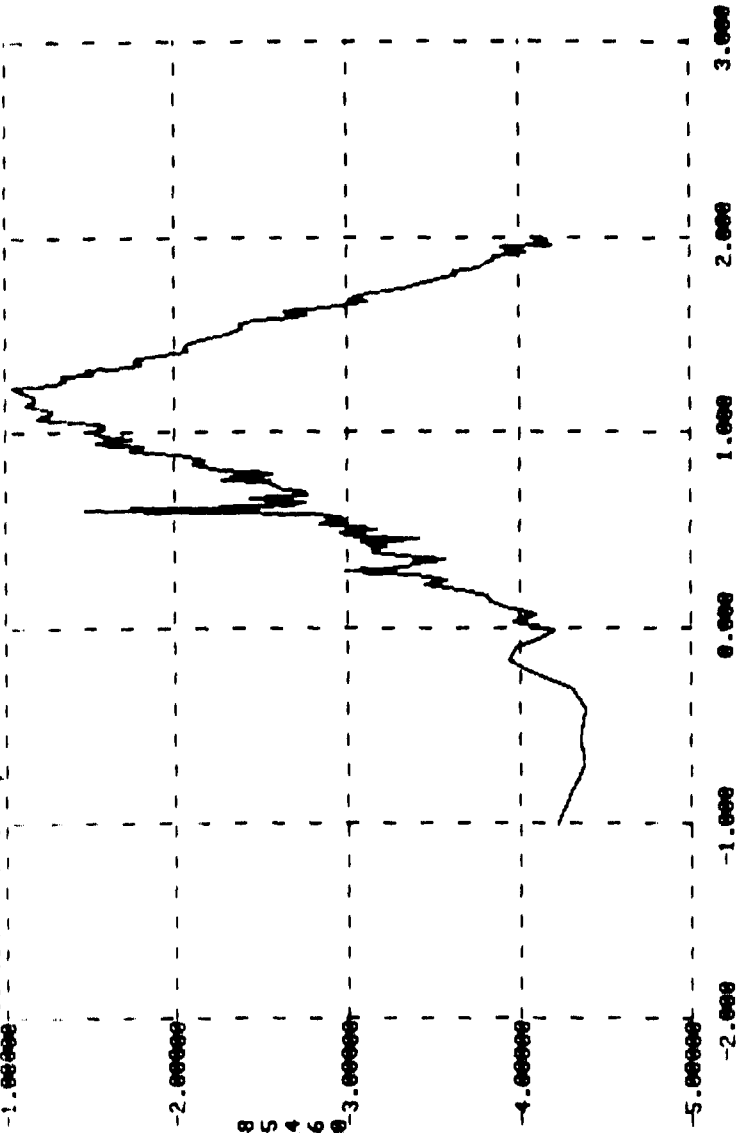

LOC FREQ

DATA HAS BEEN AVERAGED LOGRITHMICALLY

13 JUN 7-3 LVG ; UA-H IA-W LVG=DN/LO/EN CH2=UN/LO/EN 1 MIN
 * COMPLEX PIS IN BLOCK 0= 1024, DF,F ANE .976563E=01 .100000E+03

INTERVAL #	MIN F HZ	MAX F HZ	RMS RATE NOISE ARC SEC/SEC
1	0.00	9.96	.2701
2	9.96	19.92	.7518
3	19.92	29.88	.3752
4	29.88	39.84	.1985
5	39.84	49.80	.1129
6	49.80	59.77	.0767
7	59.77	69.73	.0494
8	69.73	79.69	.0388
9	79.69	89.65	.0341
10	89.65	99.61	.0274
1	0.00	100.00	.0176

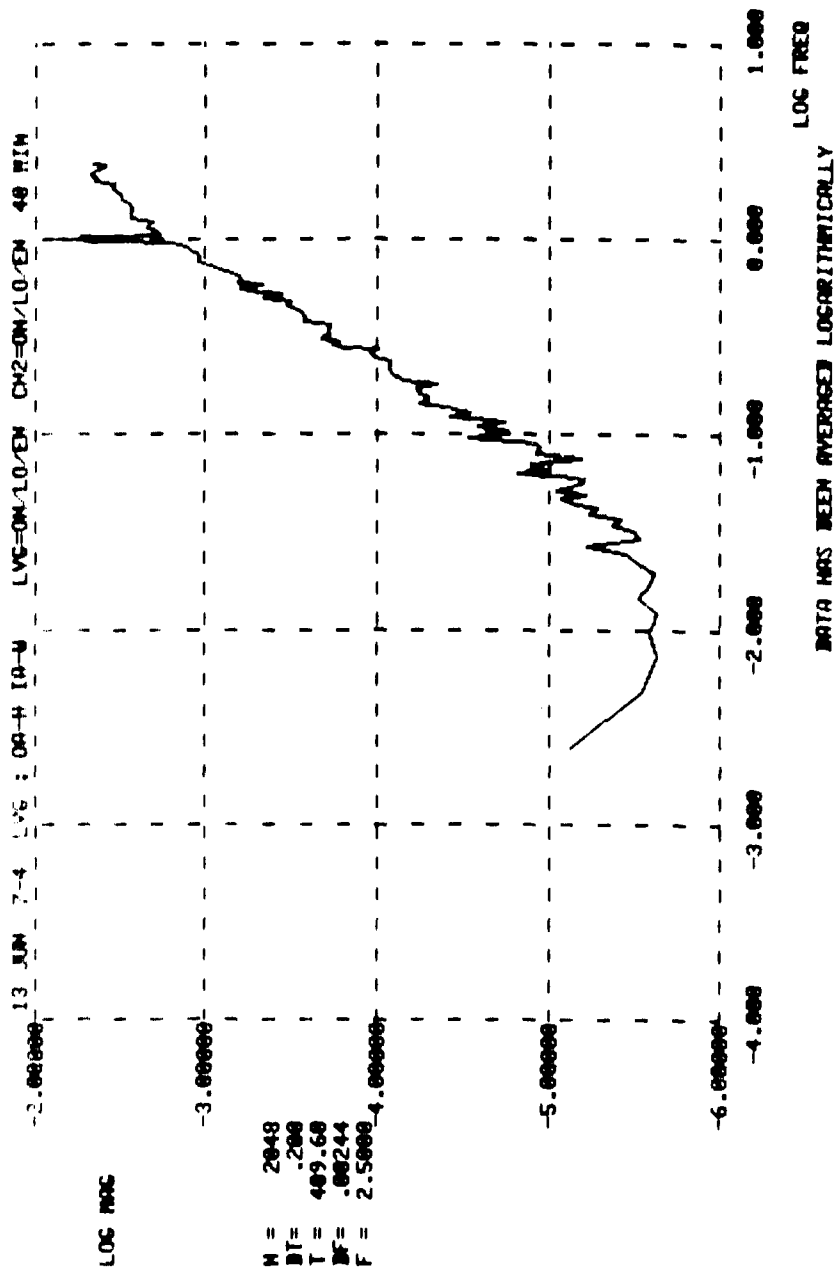

13 JUN 7-4 LYG ; JA-H JA-W 1VG=ON/LO/EN CH2=ON/LO/EN 40 MIN
 # COMPLEX PTS IN BLOCK = 1024, DF,F ARF .244141E-02 .250000E+01

INTERVAL #	MIN F HZ	MAX F HZ	RMS RATE NOISE ARC SEC/SEC
1	0.00	.10	.0009
2	.10	.20	.0022
3	.20	.30	.0033
4	.30	.40	.0047
5	.40	.50	.0057
6	.50	.60	.0071
7	.60	.70	.0084
8	.70	.80	.0101
9	.80	.90	.0108
10	.90	1.00	.0199
11	1.00	1.10	.0137
12	1.10	1.20	.0145
13	1.20	1.30	.0151
14	1.30	1.40	.0169
15	1.40	1.50	.0161
16	1.50	1.60	.0167
17	1.60	1.70	.0187
18	1.70	1.80	.0182
19	1.80	1.90	.0185
20	1.90	2.00	.0199
21	2.00	2.10	.0208
22	2.10	2.20	.0217
23	2.20	2.30	.0210
24	2.30	2.40	.0203
1	0.00	1.00	.0284
2	1.00	2.00	.0535
1	0.00	2.50	.0766

PETCH BLDXXX
 15 JUN 7-5 LVD 3 PA=H IA=W LVD=ON/LO/EN CH2=ON/LO/EN 3 HR
 # COMPLEX PTS IN BLOCK IS 1024. DF, F ARE .244141E-03 .250000E+00

INTERVAL #	MIN F HZ	MAX F HZ	RMS RATE NOISE ARC SEC/SEC
1	.00	.01	.0002
2	.01	.02	.0003
3	.02	.03	.0003
4	.03	.04	.0005
5	.04	.05	.0006
6	.05	.06	.0007
7	.06	.07	.0009
8	.07	.08	.0010
9	.08	.09	.0012
10	.09	.10	.0012
11	.10	.11	.0012
12	.11	.12	.0016
13	.12	.13	.0015
14	.13	.14	.0015
15	.14	.15	.0018
16	.15	.16	.0017
17	.16	.17	.0018
18	.17	.18	.0020
19	.18	.19	.0020
20	.19	.20	.0020
21	.20	.21	.0021
22	.21	.22	.0020
23	.22	.23	.0021
24	.23	.24	.0022
1	.10	.18	.0024
2	.13	.20	.0055
1	.00	.25	.0076

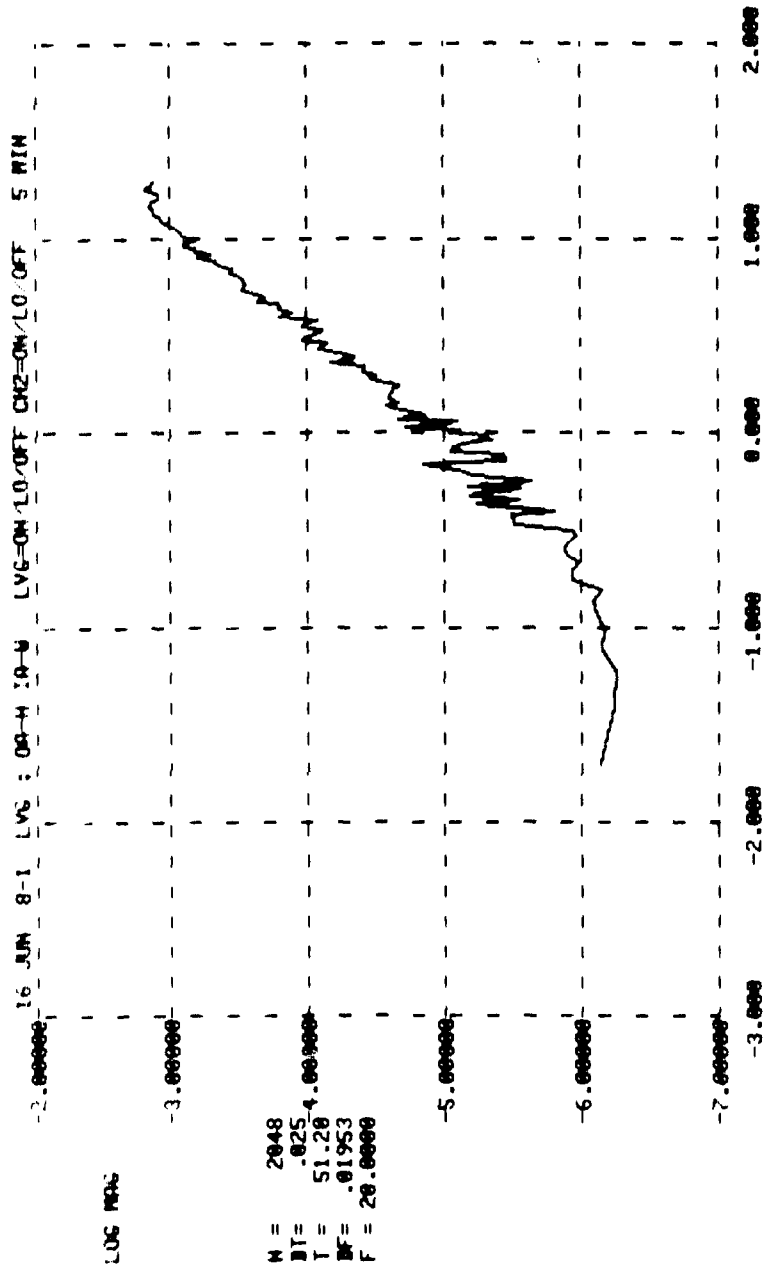

DATA HAS BEEN AVERAGED LOGARITHMICALLY

1955 JUN 8-1 LVG 7 0A-M 1A-W LVG=ON/LU/OFF LM2=ON/LU/OFF 5 MIN
 # COMPLEX PTS IN BLOCK IS 1024, DF,F ANT .195313E-01 .200000E+02

INTERVAL #	MIN F HZ	MAX F HZ	RMS RATE NOISE ARC SEC/SEC
1	0.00	1.00	.0020
2	1.00	1.99	.0048
3	1.99	2.99	.0077
4	2.99	3.98	.0100
5	3.98	4.98	.0131
6	4.98	5.98	.0167
7	5.98	6.97	.0181
8	6.97	7.97	.0216
9	7.97	8.96	.0242
10	8.96	9.96	.0278
11	9.96	10.96	.0288
12	10.96	11.95	.0310
13	11.95	12.95	.0338
14	12.95	13.95	.0365
15	13.95	14.94	.0377
16	14.94	15.94	.0354
17	15.94	16.93	.0357
18	16.93	17.93	.0382
19	17.93	18.93	.0380
20	18.93	19.92	.0374
1	0.00	4.98	.0169
2	4.98	9.96	.0493
3	9.96	14.94	.0754
4	14.94	19.92	.0826
1	0.00	20.00	.1241

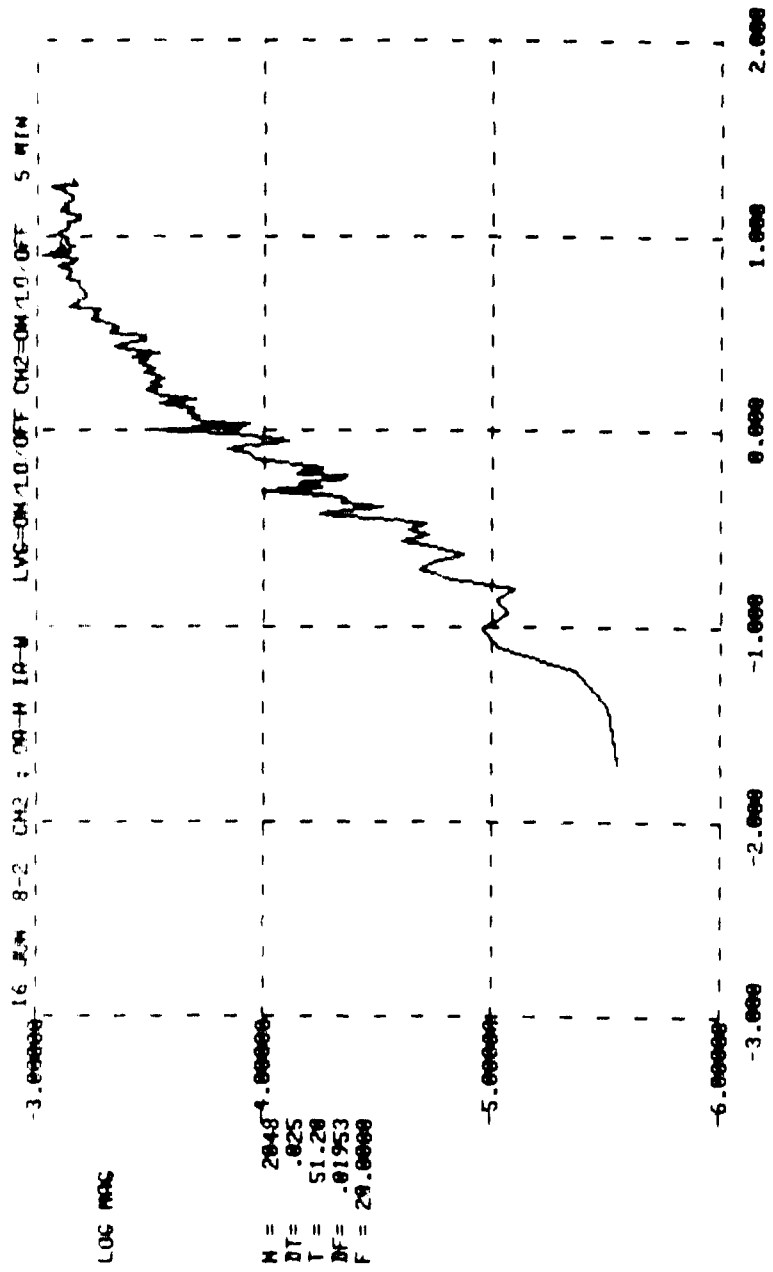

13 JUL 68-2 CH2 7 DATA IN=K 1 VGE=ON/LO/OFF CH2=ON/LO/OFF 5 MIN
 # COMPLEX PTS IN BLOCK = 1024, DF, F AKF .195313E+01 .200000E+02

INTERVAL #	MIN F HZ	MAX F HZ	RMS RATE NOISE ARC SEC/SEC
1	0.00	1.00	.0078
2	1.00	1.99	.0159
3	1.99	2.99	.0189
4	2.99	3.98	.0221
5	3.98	4.98	.0247
6	4.98	5.98	.0255
7	5.98	6.97	.0269
8	6.97	7.97	.0273
9	7.97	8.96	.0278
10	8.96	9.96	.0275
11	9.96	10.96	.0285
12	10.96	11.95	.0265
13	11.95	12.95	.0254
14	12.95	13.95	.0273
15	13.95	14.94	.0275
16	14.94	15.94	.0262
17	15.94	16.93	.0273
18	16.93	17.93	.0292
19	17.93	18.93	.0264
20	18.93	19.92	.0256
1	4.98	4.98	.0421
2	4.98	9.96	.0604
3	9.96	14.94	.0646
4	14.94	19.92	.0603
1	0.00	20.00	.1131

A-120

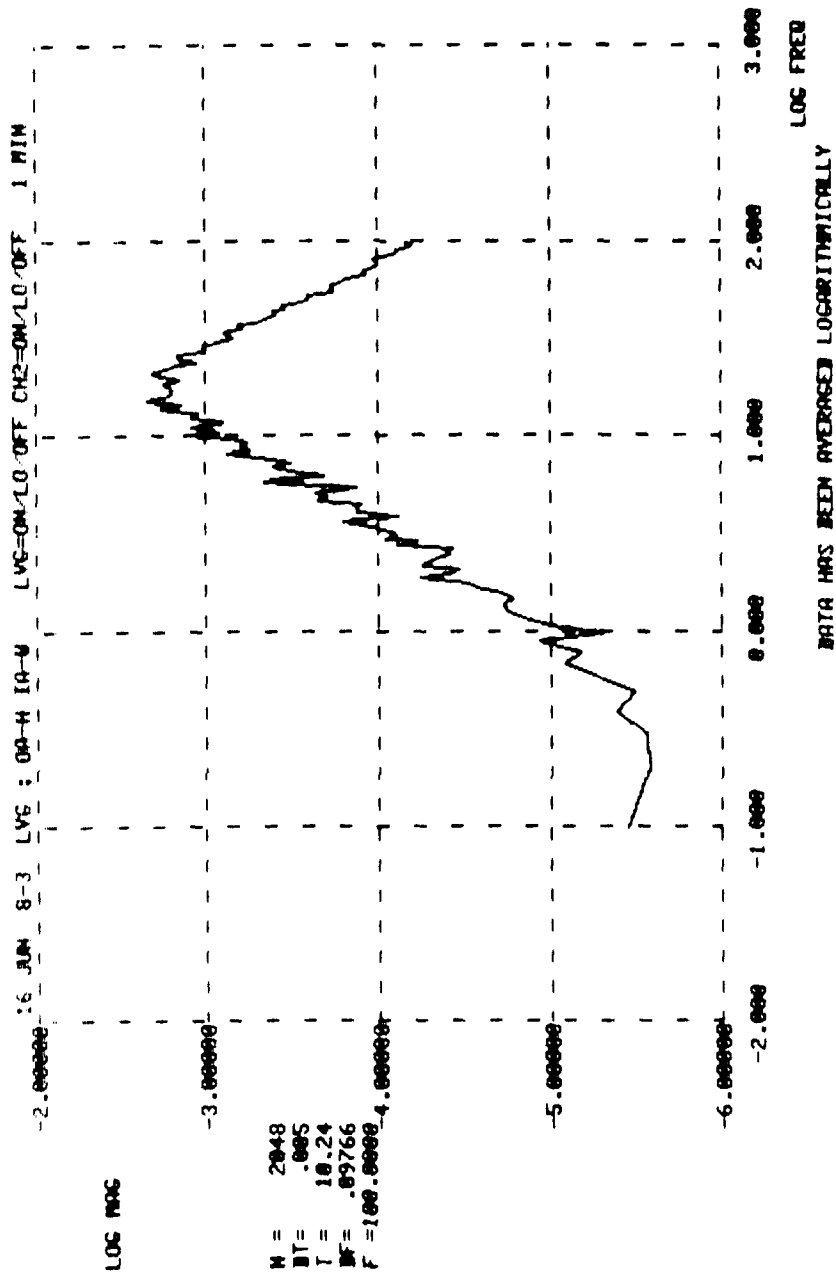

15 JUN 8-3 LVL ; UA-H TA-H LVL=ON/LO/OFF CH2=ON/LO/OFF 1 MIN
 # COMPLEX PTS IN BLOCK = 1024. DF, F ARE .976563E-01 .100000E+03

INTERVAL #	MIN F HZ	MAX F HZ	RMS RATE NOISE ARC SEC/SEC
1	0.00	9.96	.0531
2	9.96	19.92	.1202
3	19.92	29.88	.1179
4	29.88	39.84	.0817
5	39.84	49.80	.0588
6	49.80	59.77	.0456
7	59.77	69.73	.0376
8	69.73	79.69	.0322
9	79.69	89.65	.0299
10	89.65	99.61	.0261
1	0.00	100.00	.2178

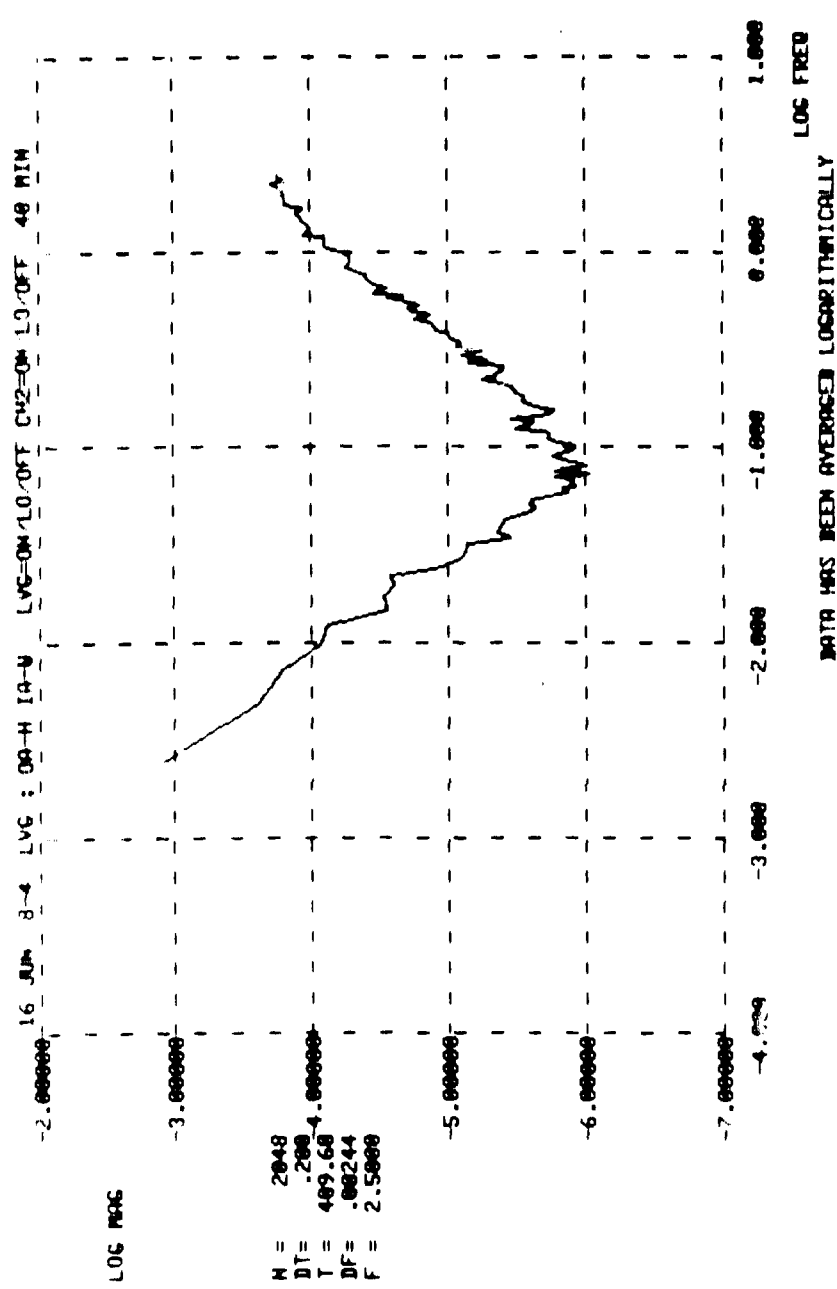

10 JUN M=4 LVB ; DA=M IA=W LVB=ON/LU/OFF CH2=ON/LU/OFF 40 MIN
 # COMPLEX PIS IN BLOCK = 1024, OF, F ARE .244141E-02 .250000E+01

INTERVAL #	MIN F HZ	MAX F HZ	RMS RATE NOISE ARC SEC/SEC
1	0.00	.10	.0022
2	.10	.20	.0005
3	.20	.30	.0007
4	.30	.40	.0009
5	.40	.50	.0012
6	.50	.60	.0014
7	.60	.70	.0018
8	.70	.80	.0020
9	.80	.90	.0024
10	.90	1.00	.0024
11	1.00	1.10	.0027
12	1.10	1.20	.0028
13	1.20	1.30	.0032
14	1.30	1.40	.0033
15	1.40	1.50	.0034
16	1.50	1.60	.0036
17	1.60	1.70	.0035
18	1.70	1.80	.0038
19	1.80	1.90	.0040
20	1.90	2.00	.0039
21	2.00	2.10	.0041
22	2.10	2.20	.0041
23	2.20	2.30	.0042
24	2.30	2.40	.0042

1	0.00	1.00	.0053
2	1.00	2.00	.0109

1	0.00	2.50	.0153
---	------	------	-------

16 JUN 8-5 LVS : 00-H IA-U LVS=ON/LO/OFF CH2=ON/LO/OFF 3 MR

LOG MAG

M = 2048
BT = 2.0000
T = 4056.00
BF = .00024
F = .2500 4.00000

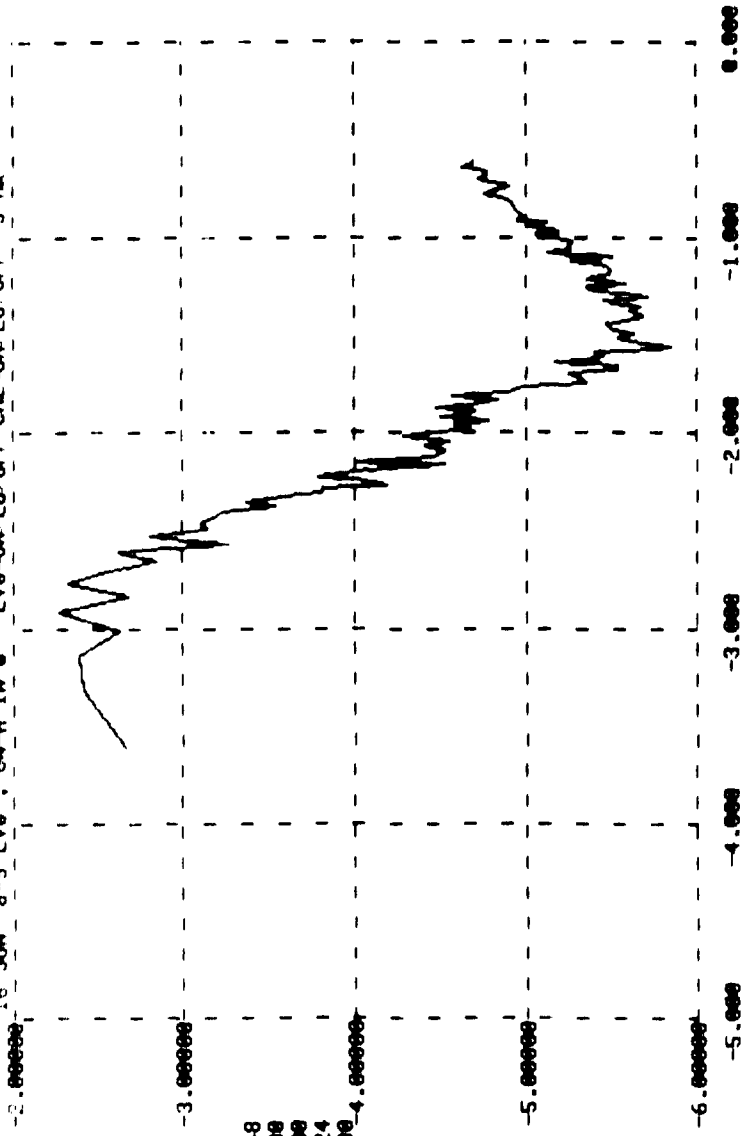

LOG FREQ
DATA HAS BEEN AVERAGED LOGARITHMICALLY

15 JUN 8-5 LVL 5 ; UA=M IA=W LVL ON/OFF CH2=ON/OFF 3 HR
 # COMPLEX PTS IN BLOCK N= 1024, OF, F AXI .244141E-03 .250000E+00

INTERVAL #	MIN F HZ	MAX F HZ	RMS RATE NOISE ARC SEC/SEC
1	.00	.01	.0001
2	.01	.02	.0004
3	.02	.03	.0002
4	.03	.04	.0002
5	.04	.05	.0002
6	.05	.06	.0002
7	.06	.07	.0002
8	.07	.08	.0002
9	.08	.09	.0002
10	.09	.10	.0002
11	.10	.11	.0003
12	.11	.12	.0003
13	.12	.13	.0003
14	.13	.14	.0003
15	.14	.15	.0003
16	.15	.16	.0004
17	.16	.17	.0004
18	.17	.18	.0004
19	.18	.19	.0004
20	.19	.20	.0004
21	.20	.21	.0004
22	.21	.22	.0004
23	.22	.23	.0005
24	.23	.24	.0004
1	.10	.10	.0002
2	.10	.20	.0011
1	.00	.25	.0005

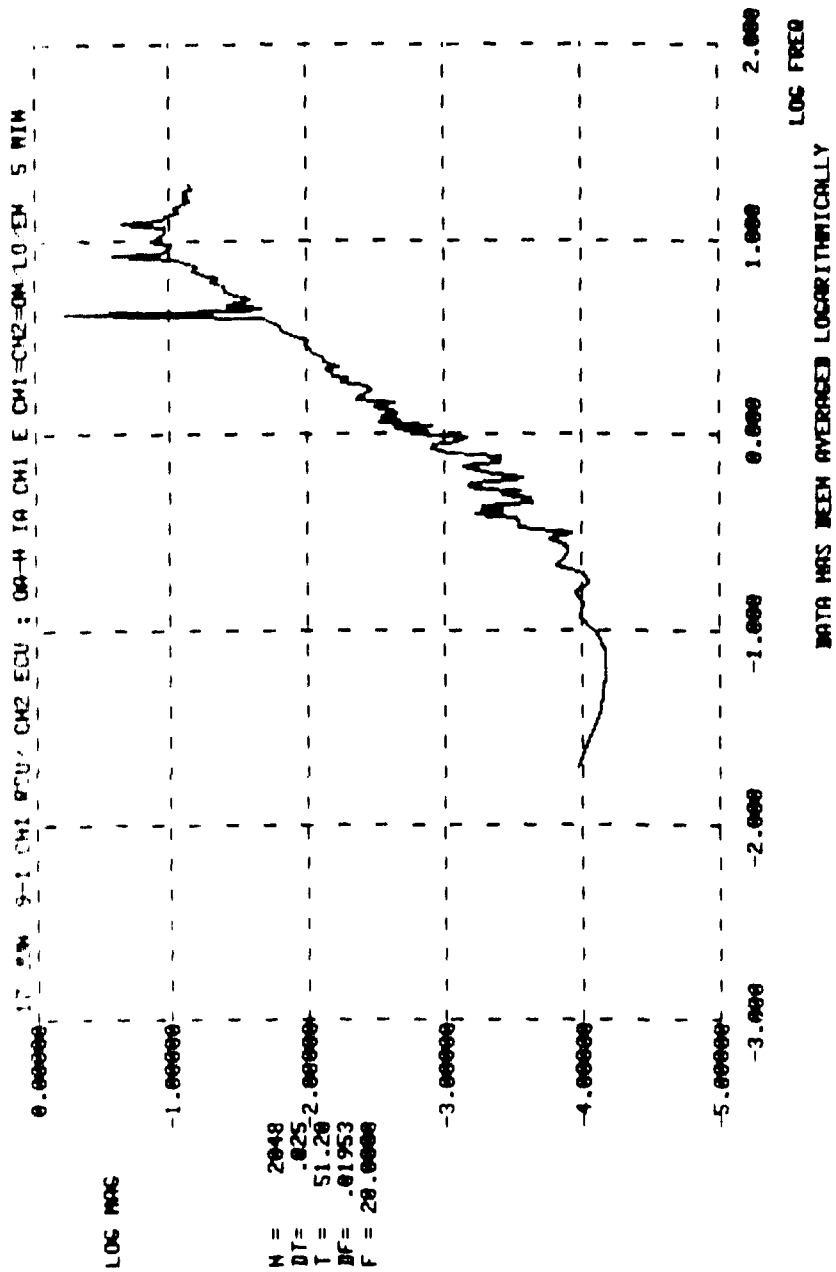

17 JUN 9-1 CH1 RSU/ CH2 ECU ; NA-M IA CH1 E CH1=CH2=UN/LO/EN 5 MIN
 # COMPLEX PTS IN BLOCK OF 1024, OF, F ARE .195313E+01 .200000E+02

INTERVAL #	MIN F HZ	MAX F HZ	RMS RATE NOISE ARC SEC/SEC
1	0.98	1.98	.0213
2	1.98	1.99	.0584
3	1.99	2.99	.0920
4	2.99	3.98	.1241
5	3.98	4.98	.3447
6	4.98	5.98	.1951
7	5.98	6.97	.2258
8	6.97	7.97	.2709
9	7.97	8.96	.3996
10	8.96	9.96	.3318
11	9.96	10.96	.3421
12	10.96	11.95	.3317
13	11.95	12.95	.4295
14	12.95	13.95	.3241
15	13.95	14.94	.3042
16	14.94	15.94	.2797
17	15.94	16.93	.2819
18	16.93	17.93	.2877
19	17.93	18.93	.2593
20	18.93	19.92	.2728
1	0.98	4.98	.3828
2	4.98	9.96	.6574
3	9.96	14.94	.7805
4	14.94	19.92	.6181
1	0.98	20.98	1.2553

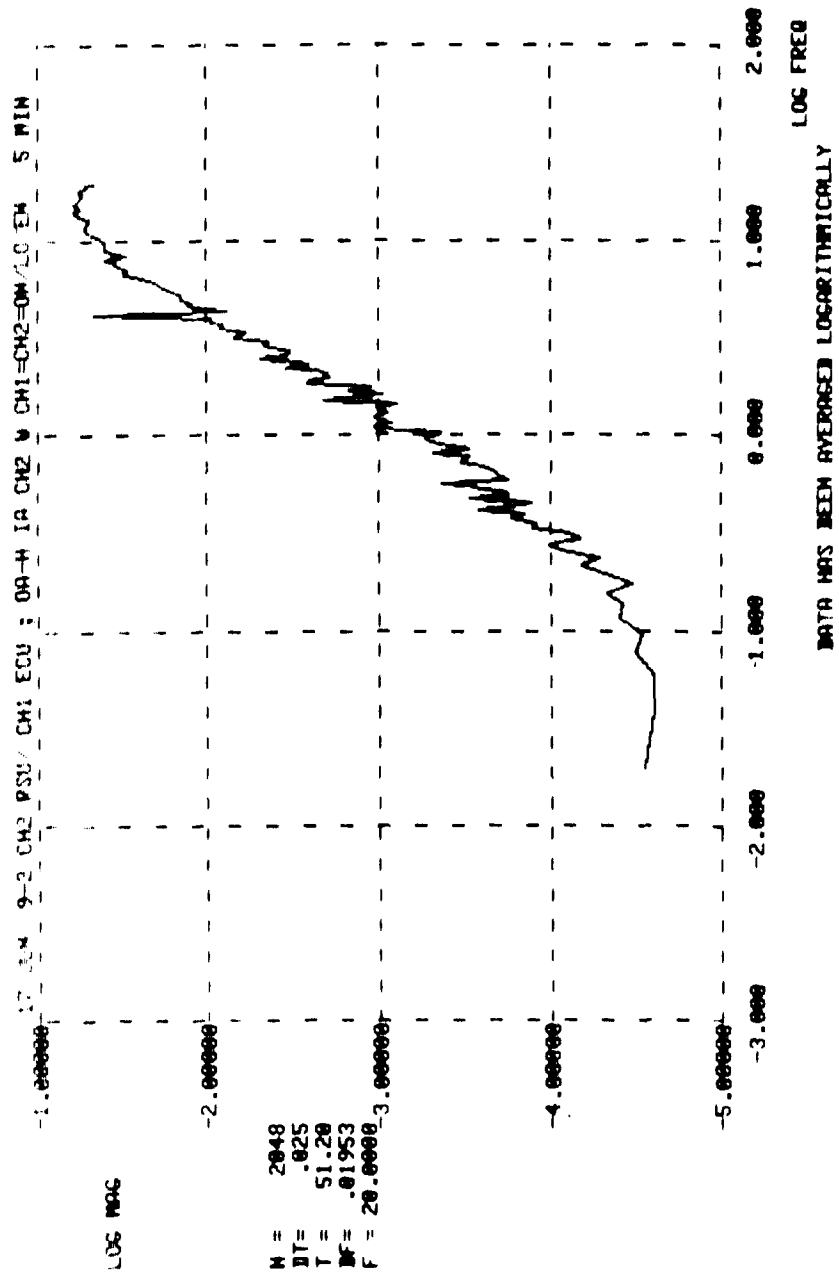

17 JUN 9-2 CH2 RS07 LMI ECU ; DA-H IA CH2 W CH1=CH2=UN/LO/EN 5 MIN
 W COMPLEX HIS IN BLOCK OF 1024, DF, F ARE .195313E-01 .200000E+02

INTERVAL #	MIN F H7	MAX F H7	RMS RATE NOISE ARC SEC/SEC
1	0.00	1.00	.0147
2	1.00	1.99	.0372
3	1.99	2.99	.0578
4	2.99	3.98	.0859
5	3.98	4.98	.1288
6	4.98	5.98	.1297
7	5.98	6.97	.1614
8	6.97	7.97	.1799
9	7.97	8.96	.1883
10	8.96	9.96	.1996
11	9.96	10.96	.2135
12	10.96	11.95	.2364
13	11.95	12.95	.2244
14	12.95	13.95	.2395
15	13.95	14.94	.2388
16	14.94	15.94	.2438
17	15.94	16.93	.2385
18	16.93	17.93	.2308
19	17.93	18.93	.2352
20	18.93	19.92	.2234
1	4.98	4.98	.1700
2	4.98	9.96	.3874
3	9.96	14.94	.5132
4	14.94	19.92	.5242
1	0.00	20.00	.8493

17 JUN 9 34 PM '66 CH2 EQJ : 00-H IA CH1 E CH1=CH2=ON 10/EM 2.5 MIN

LOG MAG

M = 2048
DT = .025
T = 51.26
DF = .01953
F = 20.0000

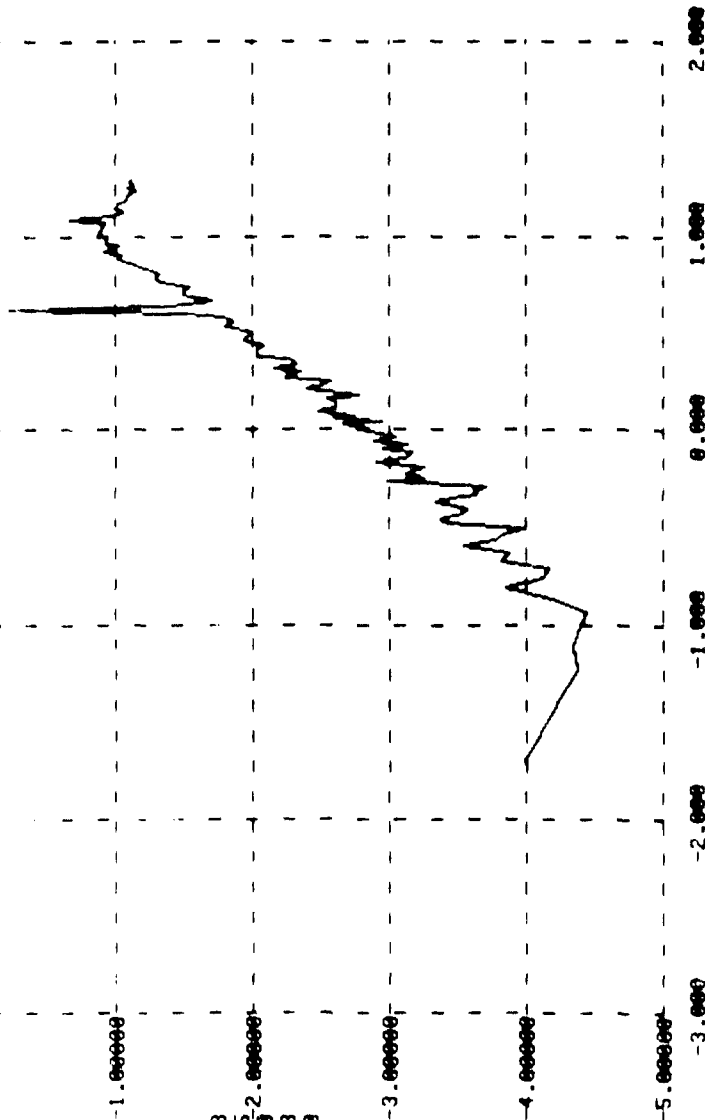

LOG FREQ

DATA HAS BEEN AVERAGED LOGRITHMICALLY

17 JUN 9-3A CH1 RS07 CH2 ECU F DA-H IA CH1 E CH1#CH2#ON/LOZEN P.5 MIN
 B COMPLEX PIS IN BLOCK N# 1024. OF, F ARE .195313E-01 .200000E+02

INTERVAL #	MIN F HZ	MAX F HZ	RMS RATE NOISE ARC SEC/SEC
------------	-------------	-------------	-------------------------------

1	0.00	1.00	.0232
2	1.00	1.99	.0554
3	1.99	2.97	.0910
4	2.99	3.98	.1217
5	3.98	4.98	.3550
6	4.98	5.98	.1936
7	5.98	6.97	.2337
8	6.97	7.97	.2899
9	7.97	8.96	.3262
10	8.96	9.96	.3399
11	9.96	10.96	.3631
12	10.96	11.95	.3480
13	11.95	12.95	.4183
14	12.95	13.95	.3023
15	13.95	14.94	.3142
16	14.94	15.94	.3002
17	15.94	16.93	.2790
18	16.93	17.93	.2787
19	17.93	18.93	.2711
20	18.93	19.92	.2840

1	0.00	4.98	.3900
2	4.98	9.96	.6310
3	9.96	14.94	.7862
4	14.94	19.92	.6323

1	0.00	20.00	1.2544
---	------	-------	--------

17 JUN 9-38 CM2 PSU CH1 ECU : 00-H 10 CM2 W CH1=CH2=0M 10:EM 2.5 MIN

LOG MAG

N = 2048
DT = .025
T = 51.20
BF = .01953
F = 20.0000 3.00000

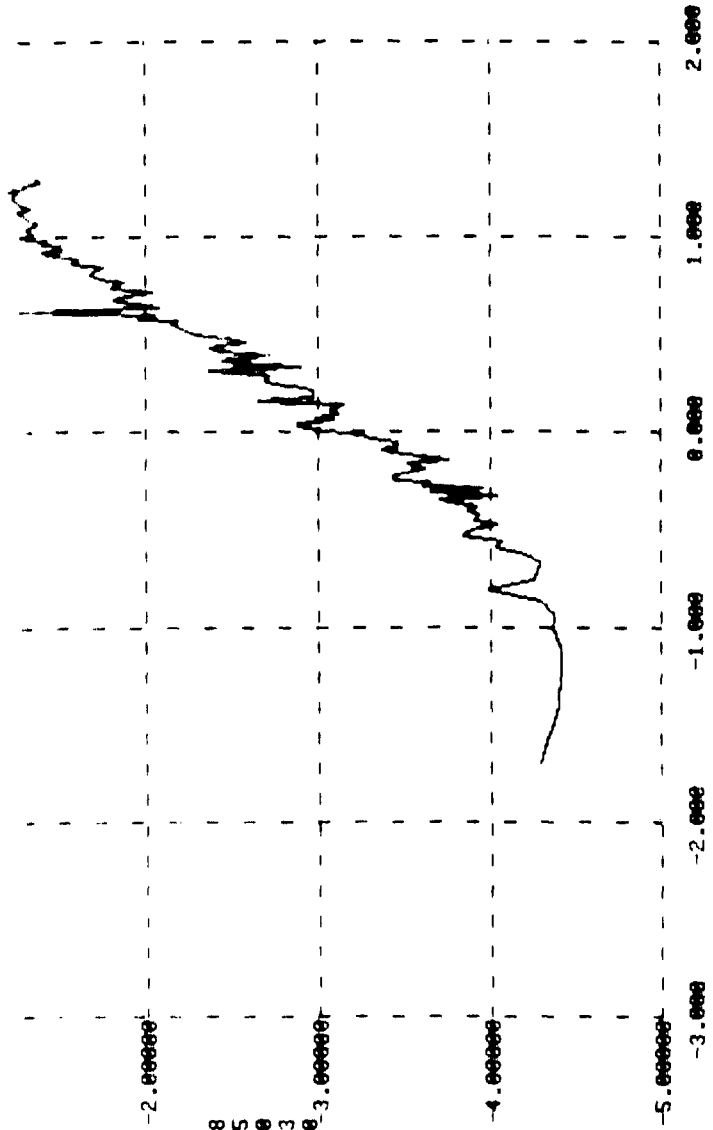

LOG FREQ
DATA HAS BEEN AVERAGED LOGARITHMICALLY

17 JUN 9-30 CH2 RSU/ CH1 ECU 7 PA-H IA CH2 W CH1=CH2=UN/LO/EN 2.5 MIN
 R COMPLEX PTS 1- BLOCK 4# 1424. DF, F ARE .195313E-01 .200000E+02

INTERVAL #	MIN F HZ	MAX F HZ	RMS RATE NOISE ARC SEC/SEC
1	0.00	1.00	.0146
2	1.00	1.99	.0367
3	1.99	2.99	.0557
4	2.99	3.98	.0822
5	3.98	4.98	.1364
6	4.98	5.98	.1176
7	5.98	6.97	.1416
8	6.97	7.97	.1577
9	7.97	8.96	.1846
10	8.96	9.96	.2056
11	9.95	10.96	.2167
12	10.96	11.95	.2185
13	11.95	12.95	.2239
14	12.95	13.95	.2312
15	13.95	14.94	.2342
16	14.94	15.94	.2343
17	15.94	16.93	.2547
18	16.93	17.93	.2463
19	17.93	18.93	.2202
20	18.93	19.92	.2064
1	0.00	4.98	.1733
2	4.98	9.96	.3676
3	9.96	14.94	.5031
4	14.94	19.92	.5211
1	0.00	20.00	.8335

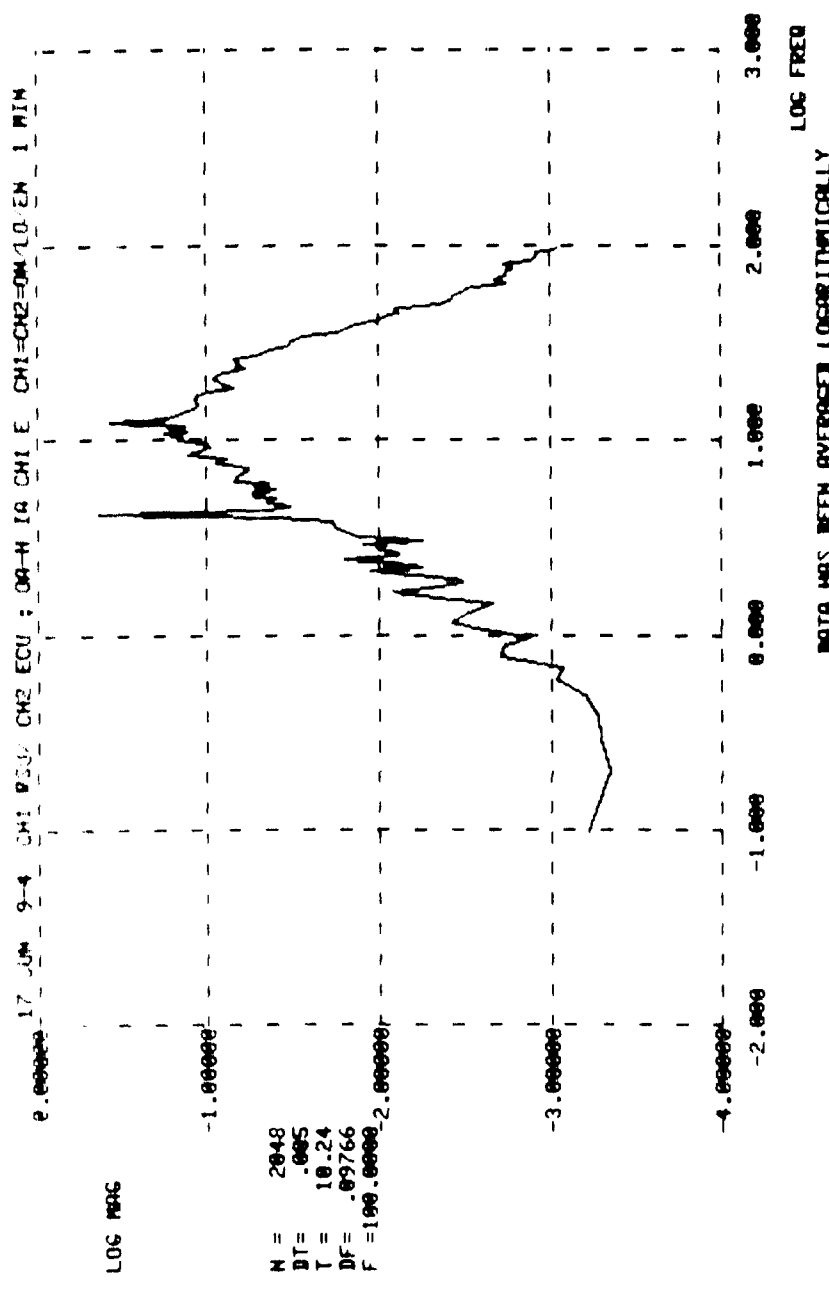

17 JUN 9-4 CH1 RSU/ CH2 ECU I PA-N IA CH1 F CH1=CH2=ON/LU/EN 1 MIN
 # COMPLEX PIS IN BLOCK # 1024. OF, F ARE .976563E-01 .100000E+03

INTERVAL #	MIN F HZ	MAX F HZ	RMS RATE NOISE ARC SEC/SEC
1	0.00	9.96	.7403
2	9.96	19.92	1.1404
3	19.92	29.88	.8001
4	29.88	39.84	.4724
5	39.84	49.80	.2784
6	49.80	59.77	.1872
7	59.77	69.73	.1474
8	69.73	79.69	.1292
9	79.69	89.65	.1179
10	89.65	99.61	.1017
1	0.00	100.00	1.6992

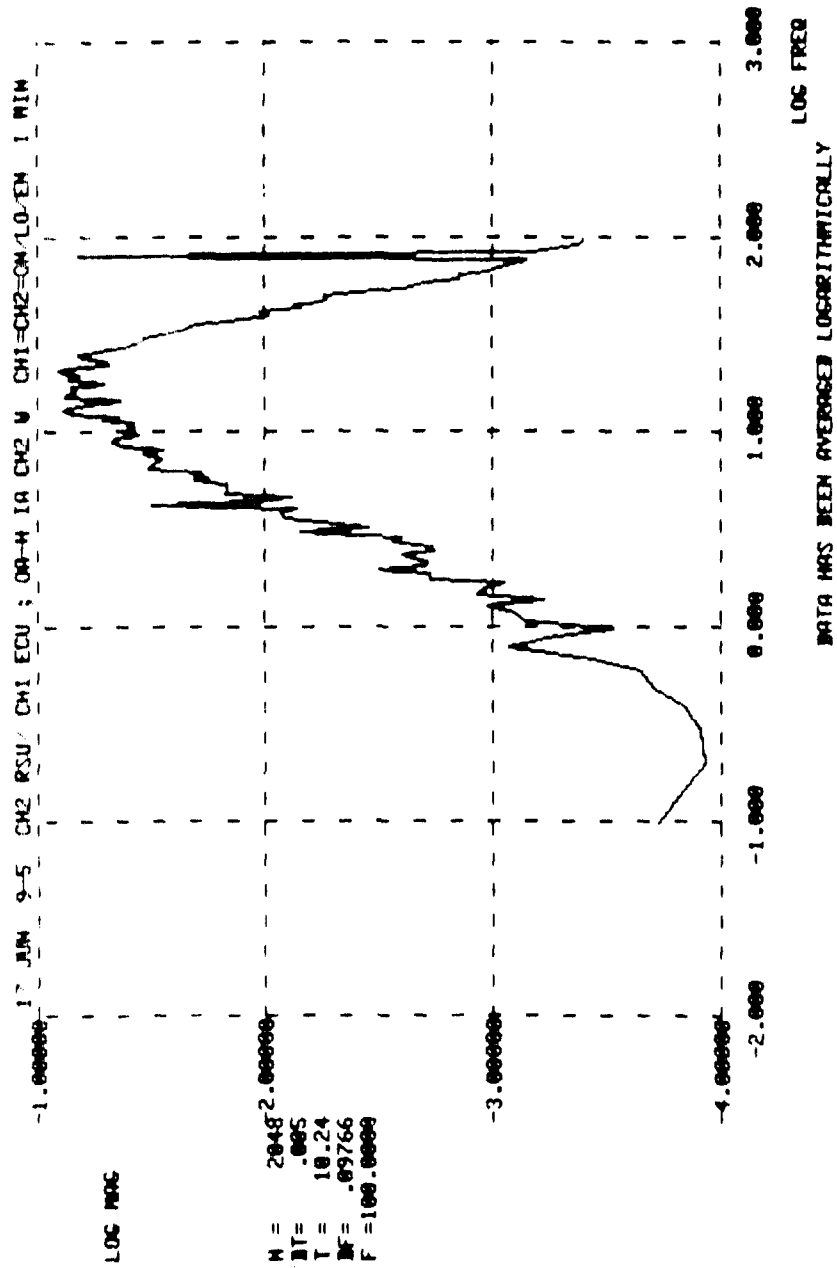

17 JUN 9-0 LMZ RSJZ CH1 ECT, GA-H IA CH2 W CH1=CH2=UN/LU/EN 1 MIN
 * COMPLEX PIS IN BLOCK * 1024, OF, F ARE .976563E-01 .100000E+03

INTERVAL #	MIN F HZ	MAX F HZ	RMS RATE NOISE ARC SEC/SEC
1	0.00	9.96	.4206
2	9.96	19.92	.7776
3	19.92	29.88	.7259
4	29.88	39.84	.4473
5	39.84	49.80	.2670
6	49.80	59.77	.1668
7	59.77	69.73	.1100
8	69.73	79.69	.0971
9	79.69	89.65	.4585
10	89.65	99.61	.0644
1	0.00	100.00	1.3579

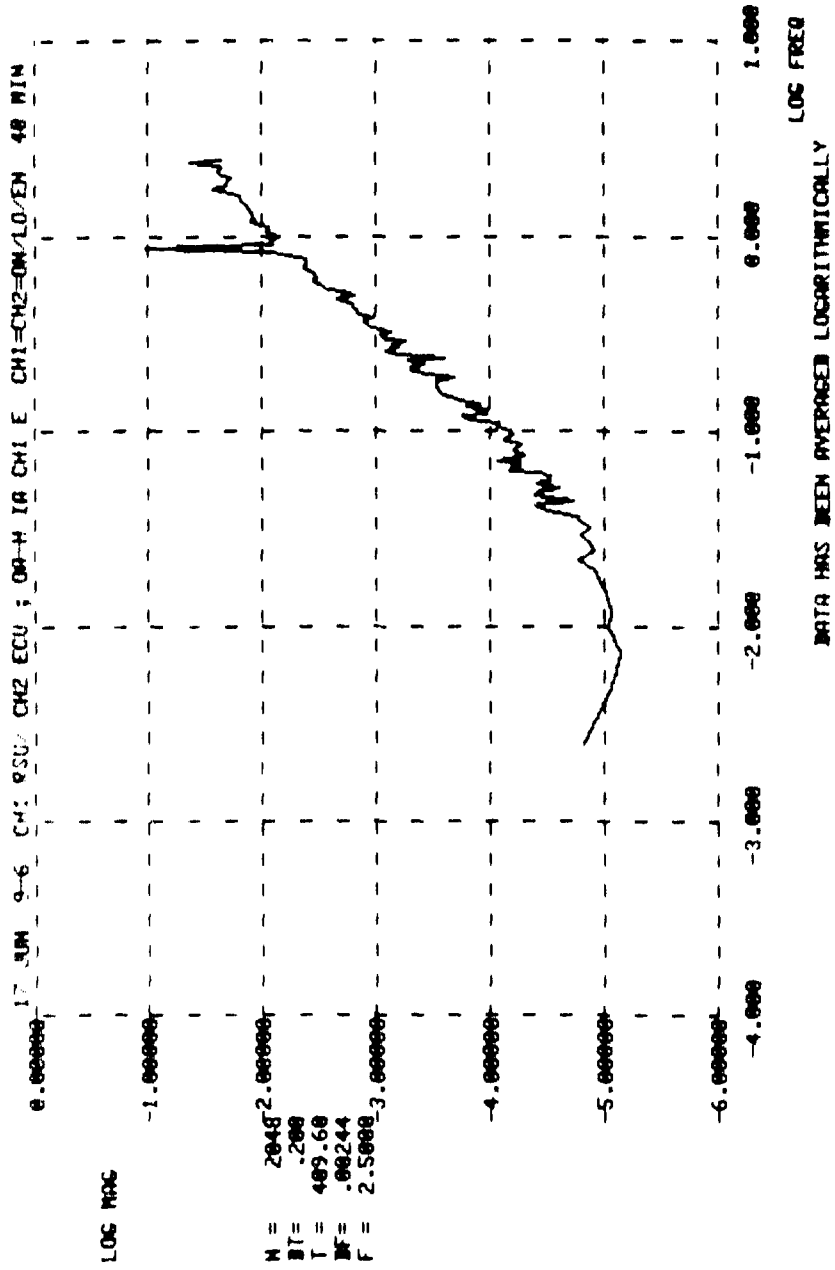

17 JUN 1966 LMI R307 CH2 FCU 7 0A-M 1A CH1 E CH1=CH2=UN/LD/EN 4M MIN
 # COMPLEX PIS IN BLOCK # 1024, DF, F ARE .244141E-02 .250000E+01

INTERVAL #	MIN F HZ	MAX F HZ	RMS RATE NOISE ARC SEC/SEC
1	.10	.10	.0019
2	.10	.20	.0045
3	.20	.30	.0076
4	.30	.40	.0100
5	.40	.50	.0132
6	.50	.60	.0166
7	.60	.70	.0193
8	.70	.80	.0210
9	.80	.90	.0270
10	.90	1.00	.0273
11	1.00	1.10	.0297
12	1.10	1.20	.0322
13	1.20	1.30	.0336
14	1.30	1.40	.0358
15	1.40	1.50	.0372
16	1.50	1.60	.0378
17	1.60	1.70	.0405
18	1.70	1.80	.0501
19	1.80	1.90	.0452
20	1.90	2.00	.0452
21	2.00	2.10	.0439
22	2.10	2.20	.0483
23	2.20	2.30	.0467
24	2.30	2.40	.0473

1	0.00	1.00	.0817
2	1.00	2.00	.1240

1	0.00	2.50	.1857
---	------	------	-------

A-140

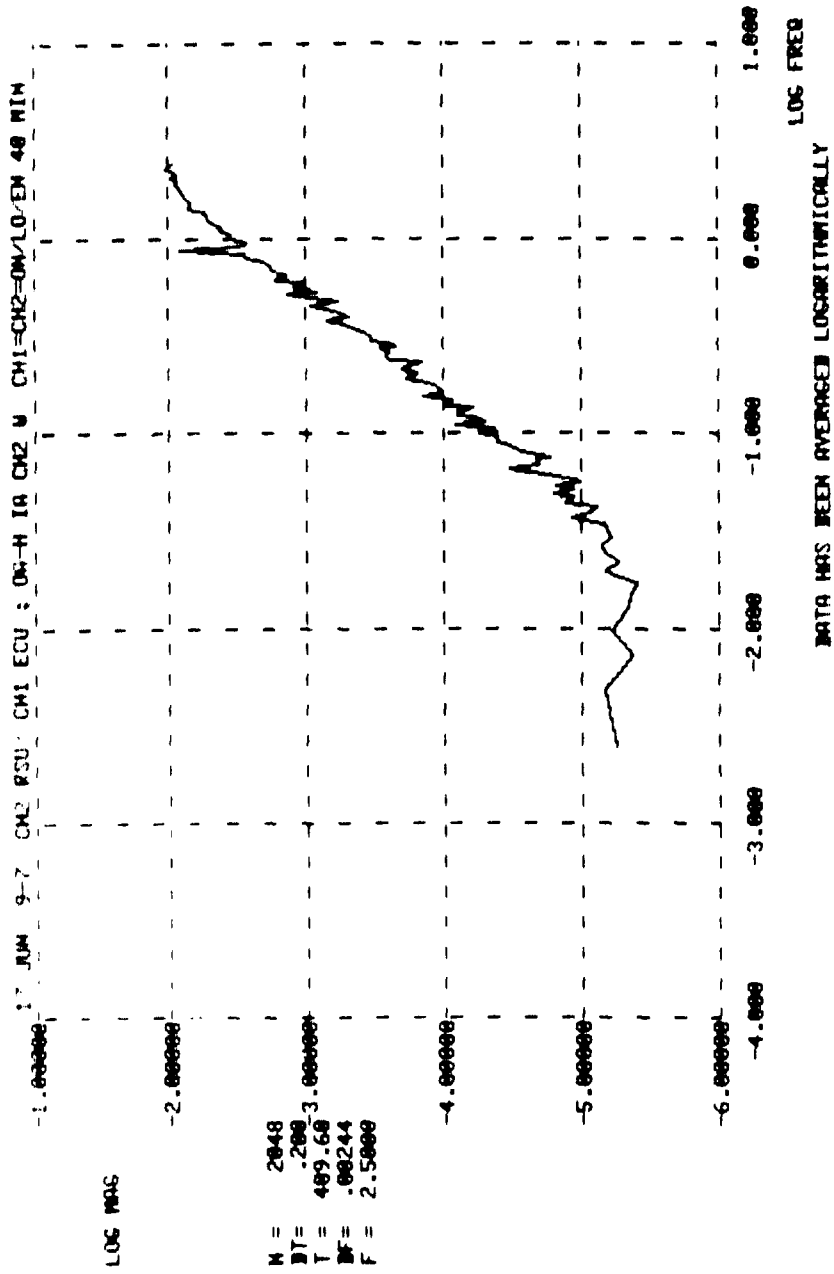

17 JUN 67 CH2 ASD/ CH1 ELO 7 1A-H 1A CH2 W CH1=CH2=ON/10/EN 40 MIN
 # COMPLEX PTS IN BLOCK # 1024, DF, F ANF .244141E-02 .250000E+01

INTERVAL #	MIN F HZ	MAX F HZ	RMS RATE NOISE ARC SEC/SEC
1	0.00	.10	.0013
2	.10	.20	.0033
3	.20	.30	.0048
4	.30	.40	.0071
5	.40	.50	.0086
6	.50	.60	.0105
7	.60	.70	.0124
8	.70	.80	.0145
9	.80	.90	.0225
10	.90	1.00	.0171
11	1.00	1.10	.0196
12	1.10	1.20	.0207
13	1.20	1.30	.0234
14	1.30	1.40	.0229
15	1.40	1.50	.0266
16	1.50	1.60	.0265
17	1.60	1.70	.0270
18	1.70	1.80	.0290
19	1.80	1.90	.0295
20	1.90	2.00	.0290
21	2.00	2.10	.0316
22	2.10	2.20	.0300
23	2.20	2.30	.0319
24	2.30	2.40	.0309
1	0.00	1.00	.0378
2	1.00	2.00	.0811
1	0.00	2.50	.1132

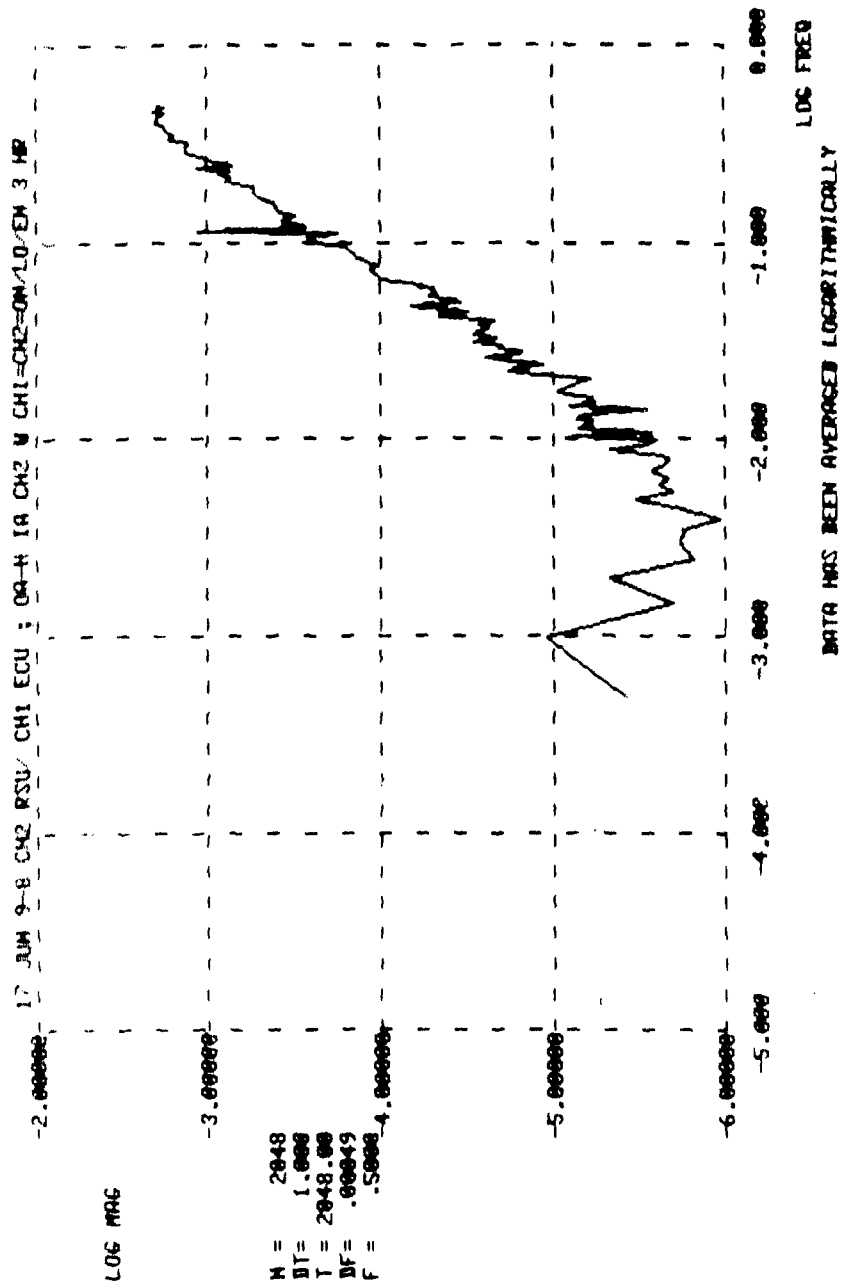

17 JUL 9-0 CH2 500Z CH1 FCU : UA-M 1A CH2 W CH1=CH2=UN/LD/EN 3 HK
 * COMPLEX PIS IN BLOCK # 1024. UT, F AKF .488281E-03 .500000E+00

INTERVAL #	MIN F	MAX F	RMS RATE NOISE ARC SEC/SEC
1	.02	.02	.0002
2	.00	.02	.0003
3	.01	.01	.0004
4	.02	.02	.0005
5	.03	.03	.0006
6	.04	.04	.0007
7	.05	.05	.0009
8	.06	.06	.0010
9	.07	.07	.0012
10	.08	.08	.0012
11	.09	.09	.0016
12	.10	.10	.0016
13	.11	.11	.0019
14	.12	.12	.0024
15	.13	.13	.0017
16	.14	.14	.0019
17	.15	.15	.0019
18	.16	.16	.0020
19	.17	.17	.0020
20	.18	.18	.0021
21	.19	.19	.0022
22	.20	.20	.0026
23	.21	.21	.0026
24	.21	.21	.0029
25	.22	.22	.0027
26	.23	.23	.0032
27	.24	.24	.0032
28	.25	.25	.0032
29	.26	.26	.0033
30	.27	.27	.0033
31	.28	.28	.0035
32	.29	.29	.0035
33	.30	.30	.0035
34	.31	.31	.0036
35	.32	.32	.0036
36	.33	.33	.0041
37	.34	.34	.0040
38	.35	.35	.0042
39	.36	.36	.0042
40	.37	.37	.0041
41	.38	.38	.0042
42	.39	.39	.0042
43	.40	.40	.0042
44	.41	.41	.0042
45	.42	.42	.0044
46	.43	.43	.0043
47	.44	.44	.0043
48	.45	.45	.0045
49	.46	.46	.0045
50	.47	.47	.0045
51	.48	.48	.0048
1	.49	.49	.0044
2	.50	.50	.0045
3	.10	.10	.0024
4	.20	.20	.0024
5	.29	.29	.0024
6	.39	.39	.0123
1	.49	.49	.0137
	.50	.50	.0224

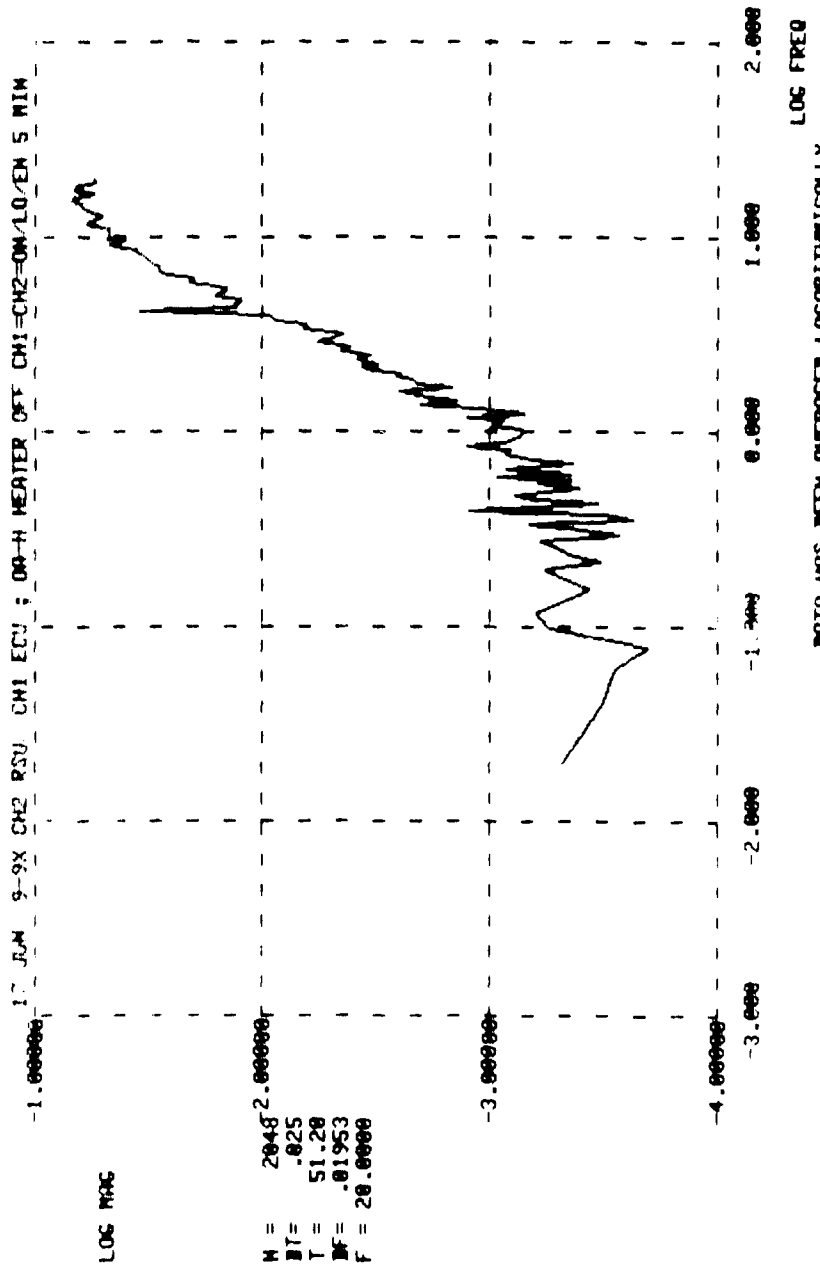

17 JUN 4-9A LMZ RSD/ LM1 EQU 2 PA-H HEATER OFF CH1=CH2=ON/LOZEN 5 MIN
 R COMPLEX PIS 17 BLOCK 2# 1024. DF, F AKF .195313E-01 .200000E+02

INTERVAL #	MIN F HZ	MAX F HZ	RMS RATE NOISE ARC SEC/SEC
1	0.98	1.98	.0245
2	1.98	1.99	.0404
3	1.99	2.99	.0635
4	2.99	3.98	.0826
5	3.98	4.98	.1267
6	4.98	5.98	.1278
7	5.98	6.97	.1582
8	6.97	7.97	.1739
9	7.97	8.96	.1953
10	8.96	9.96	.2164
11	9.96	10.96	.2167
12	10.96	11.95	.2284
13	11.95	12.95	.2269
14	12.95	13.95	.2347
15	13.95	14.94	.2478
16	14.94	15.94	.2632
17	15.94	16.93	.2371
18	16.93	17.93	.2613
19	17.93	18.93	.2493
20	18.93	19.92	.2317
1	4.98	4.98	.1707
2	4.98	9.96	.3924
3	9.96	14.94	.5185
4	14.94	19.92	.5564
1	19.92	20.92	.8734

AD-A092 515

ARMAMENT DIV (AFSC) EGLIN AFB FL
SCALE FACTOR AND NOISE PERFORMANCE TESTS OF THE BENDIX CORPORAT--ETC(U)
AUG 80 R KIM, J HOFFMAN

F/6 22/2

UNCLASSIFIED

AD-TR-80-63

SBIE-AD-E800 119

NL

3 of 3

AD-TR-80-63



END
DATE
FILMED
1 81
DTIC

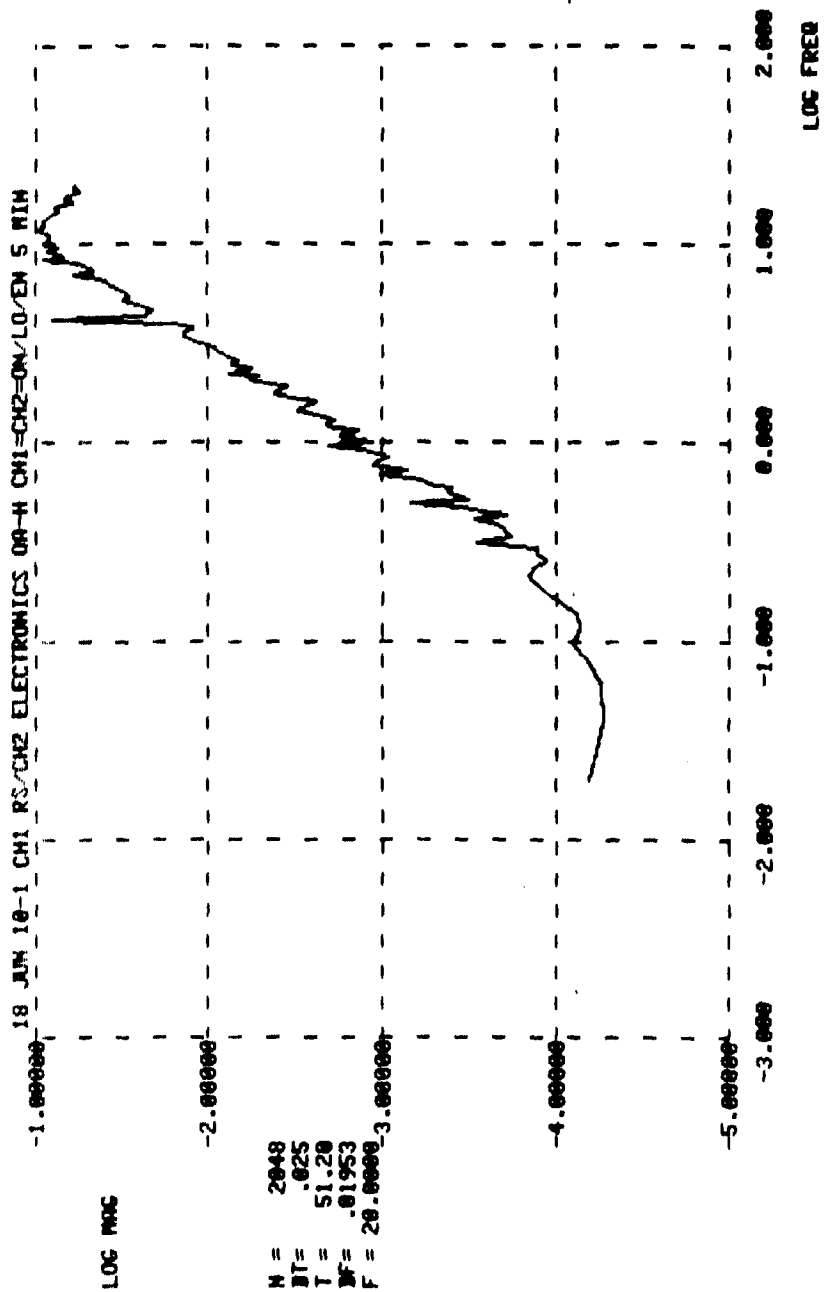

18 JUN 1964 OHI RS/CH2 ELECTRONICS DA-4 CH1=CH2=ON/LO/EN 5 MIN
 4 COMPLEX PLS IN BLOCK #8 124. DF, F ARE .195313E-01 .200000E+02

INTERVAL #	MIN F HZ	MAX F HZ	RMS RATE NOISE ARC SEC/SEC
1	0.99	1.99	.0231
2	1.99	1.99	.0519
3	1.99	2.99	.0835
4	2.99	3.98	.1119
5	3.98	4.98	.1772
6	4.98	5.98	.1737
7	5.98	6.97	.2430
8	6.97	7.97	.2264
9	7.97	8.96	.2763
10	8.96	9.96	.2890
11	9.96	10.96	.2963
12	10.96	11.95	.3031
13	11.95	12.95	.2973
14	12.95	13.95	.3068
15	13.95	14.94	.2863
16	14.94	15.94	.2661
17	15.94	16.93	.2668
18	16.93	17.93	.2521
19	17.93	18.93	.2386
20	18.93	19.92	.2464
1	4.98	4.98	.2326
2	4.98	9.96	.5325
3	9.96	14.94	.6585
4	14.94	19.92	.5675
1	0.00	20.00	1.0478

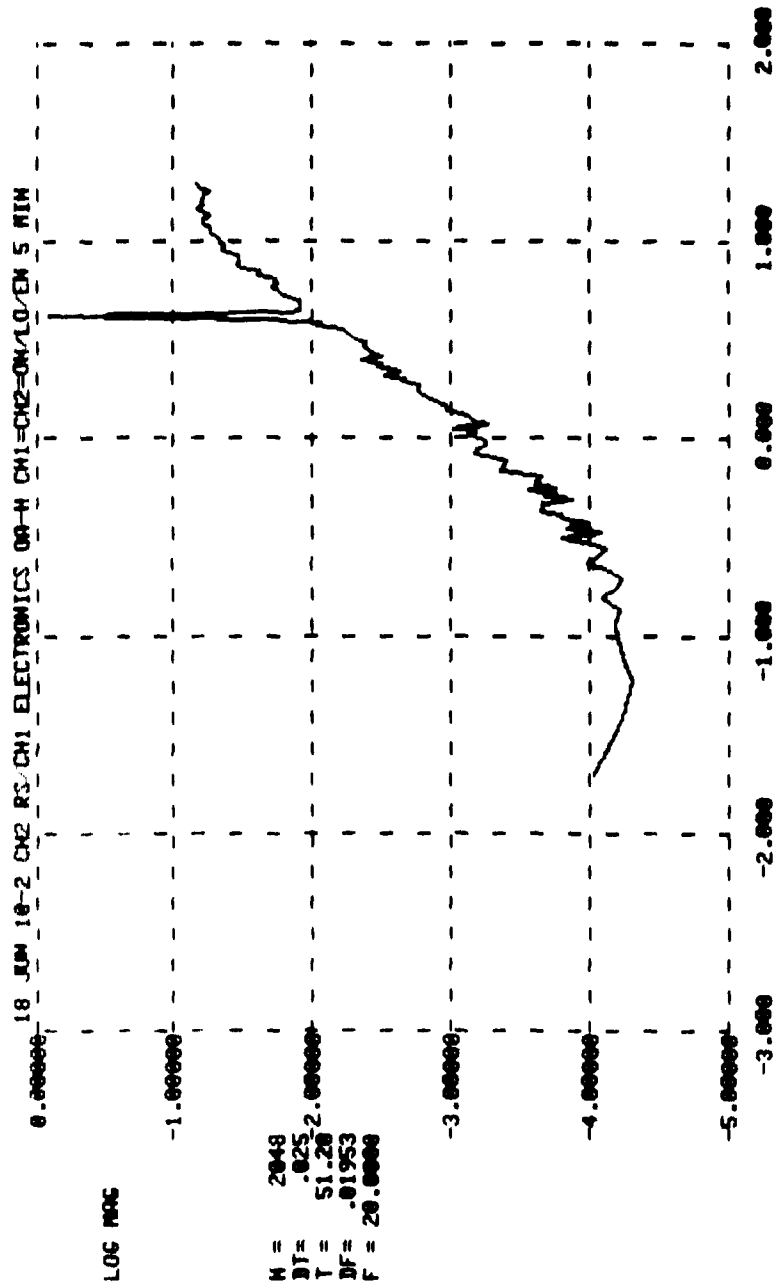

DATA HAS BEEN AVERAGED LOGARITHMICALLY

18 JUN 10-2 CH2 RS/LM1 ELECTRONICS (A-M CH1=CH2=ON/LO/EN 5 MIN
 * COMPLEX PIS IN BLOCK W# 1024, DF, F ARE .195313E-01 .200000E+02

INTERVAL #	MIN F HZ	MAX F HZ	RMS RATE NOISE ARC SEC/SEC
1	0.00	1.00	.0162
2	1.00	1.99	.0360
3	1.99	2.99	.0587
4	2.99	3.98	.0836
5	3.98	4.98	.1253
6	4.98	5.98	.1814
7	5.98	6.97	.2431
8	6.97	7.97	.3175
9	7.97	8.96	.4037
10	8.96	9.96	.5093
11	9.96	10.96	.6345
12	10.96	11.95	.7806
13	11.95	12.95	.9484
14	12.95	13.95	.11383
15	13.95	14.94	.1379
16	14.94	15.94	.16521
17	15.94	16.93	.1960
18	16.93	17.93	.2376
19	17.93	18.93	.2851
20	18.93	19.92	.339
1	0.00	4.98	.3909
2	4.98	9.96	.3881
3	9.96	14.94	.5354
4	14.94	19.92	.5613
1	0.00	20.00	.9542

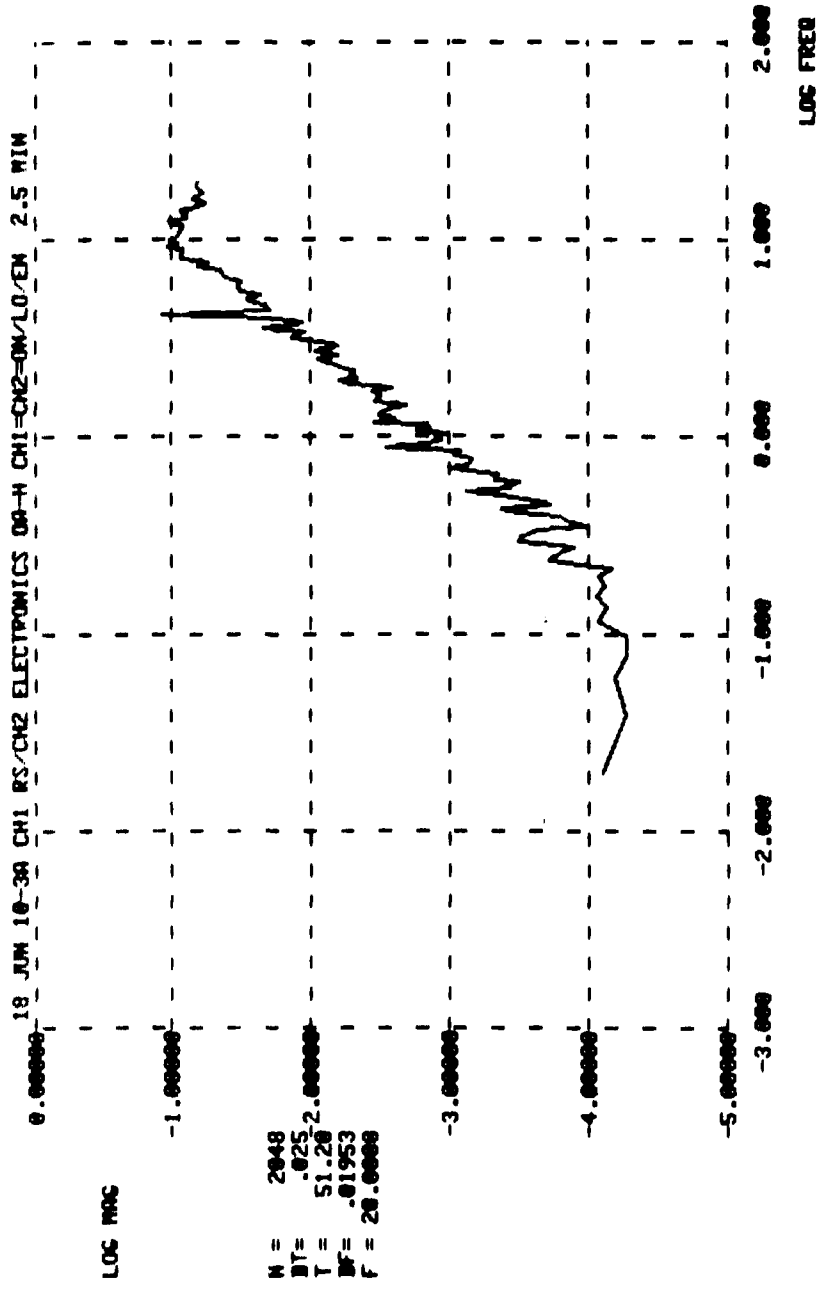

18 JUN 14-34 CH1 RS/CH2 ELECTRONICS DA-M CH1=CH2=UN/LO/EN 2.5 MIN
 * COMPLEX PIS IN BLOCK * 1424. DF, F ARE .195313E-01 .200000E+02

INTERVAL #	MIN F HZ	MAX F HZ	RMS RATE NOISE ARC SEC/SEC
1	0.00	1.00	.0233
2	1.00	1.99	.0567
3	1.99	2.99	.0837
4	2.99	3.98	.1177
5	3.98	4.98	.1949
6	4.98	5.98	.1724
7	5.98	6.97	.1996
8	6.97	7.97	.2444
9	7.97	8.96	.2961
10	8.96	9.96	.3161
11	9.96	10.96	.3122
12	10.96	11.95	.2861
13	11.95	12.95	.2988
14	12.95	13.95	.2866
15	13.95	14.94	.2658
16	14.94	15.94	.2494
17	15.94	16.93	.2594
18	16.93	17.93	.2484
19	17.93	18.93	.2508
20	18.93	19.92	.2554
1	0.00	4.98	.2502
2	4.98	9.96	.5629
3	9.96	14.94	.6491
4	14.94	19.92	.5651
1	0.00	20.00	1.0610

A-152

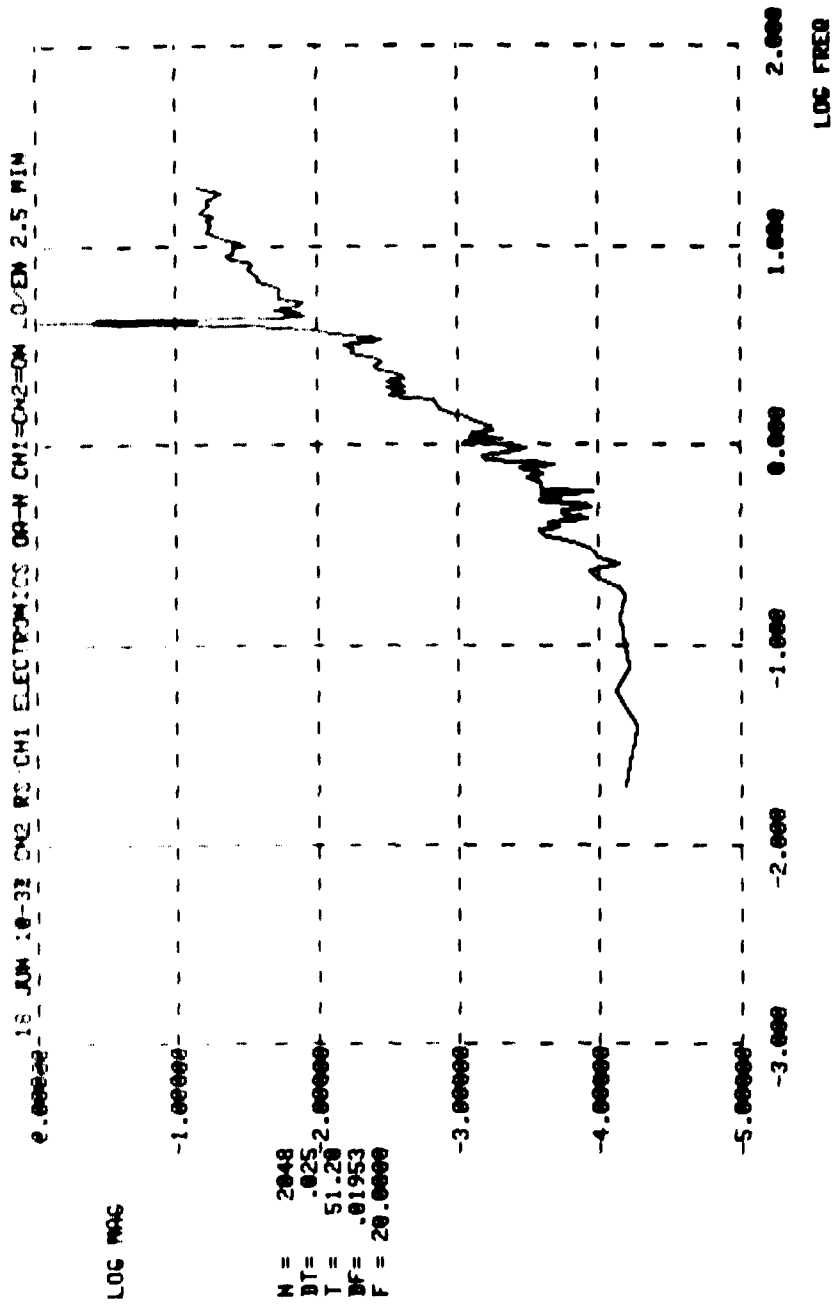

15 JUN 14-36 CH2 RS/CHI ELECTRONICS DA-M CH1=CH2=UN/LO/EN 2.5 MIN
 * COMPLEX PTS IN BLOCK # 1024, DF, F ARE .195313E-01 .200000E+02

INTERVAL #	MIN F HZ	MAX F HZ	RMS RATE NOISE ARC SEC/SEC
1	0.00	1.00	.0154
2	1.00	1.99	.0390
3	1.99	2.99	.0615
4	2.99	3.98	.0902
5	3.98	4.98	.4028
6	4.98	5.98	.1310
7	5.98	6.97	.1515
8	6.97	7.97	.1693
9	7.97	8.96	.1964
10	8.96	9.96	.1988
11	9.96	10.96	.1961
12	10.96	11.95	.2382
13	11.95	12.95	.2463
14	12.95	13.95	.2377
15	13.95	14.94	.2547
16	14.94	15.94	.2535
17	15.94	16.93	.2375
18	16.93	17.93	.2354
19	17.93	18.93	.2348
20	18.93	19.92	.2617
1	0.00	4.98	.4194
2	4.98	9.96	.3832
3	9.96	14.94	.5266
4	14.94	19.92	.5475
1	0.00	20.00	.9512

18 JUN 10-4 CH1 RS/CH2 ELECTRONICS OR-H CH1=CH2=ON/LO/EN 1 MIN

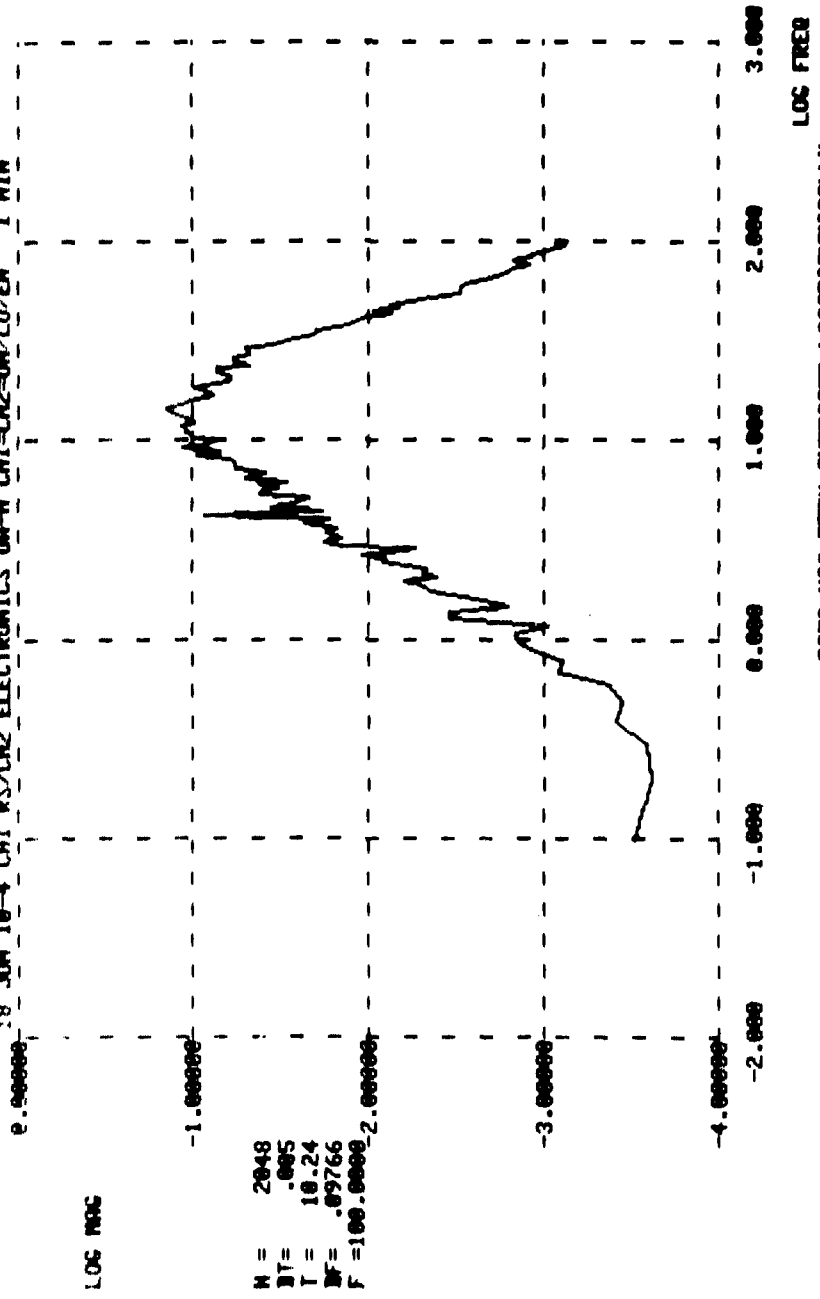

19 JUN 14-4 (M1 RS/CH2 ELECTRONICS UA-M CH1=CH2=ON/LO/EN 1 MIN
 # COMPLEX PIS IN BLOCK 03 1024, DF, F ARF .976063E-01 .100000E+03

INTERVAL #	MIN F HZ	MAX F HZ	RMS RATE NOISE ARC SEC/SEC
1	0.00	9.96	.6039
2	9.96	19.92	1.0072
3	19.92	29.88	.7615
4	29.88	39.84	.4551
5	39.84	49.80	.2828
6	49.80	59.77	.1859
7	59.77	69.73	.1466
8	69.73	79.69	.1186
9	79.69	89.65	.1083
10	89.65	99.61	.0917
1	0.00	100.00	1.5286

A-156

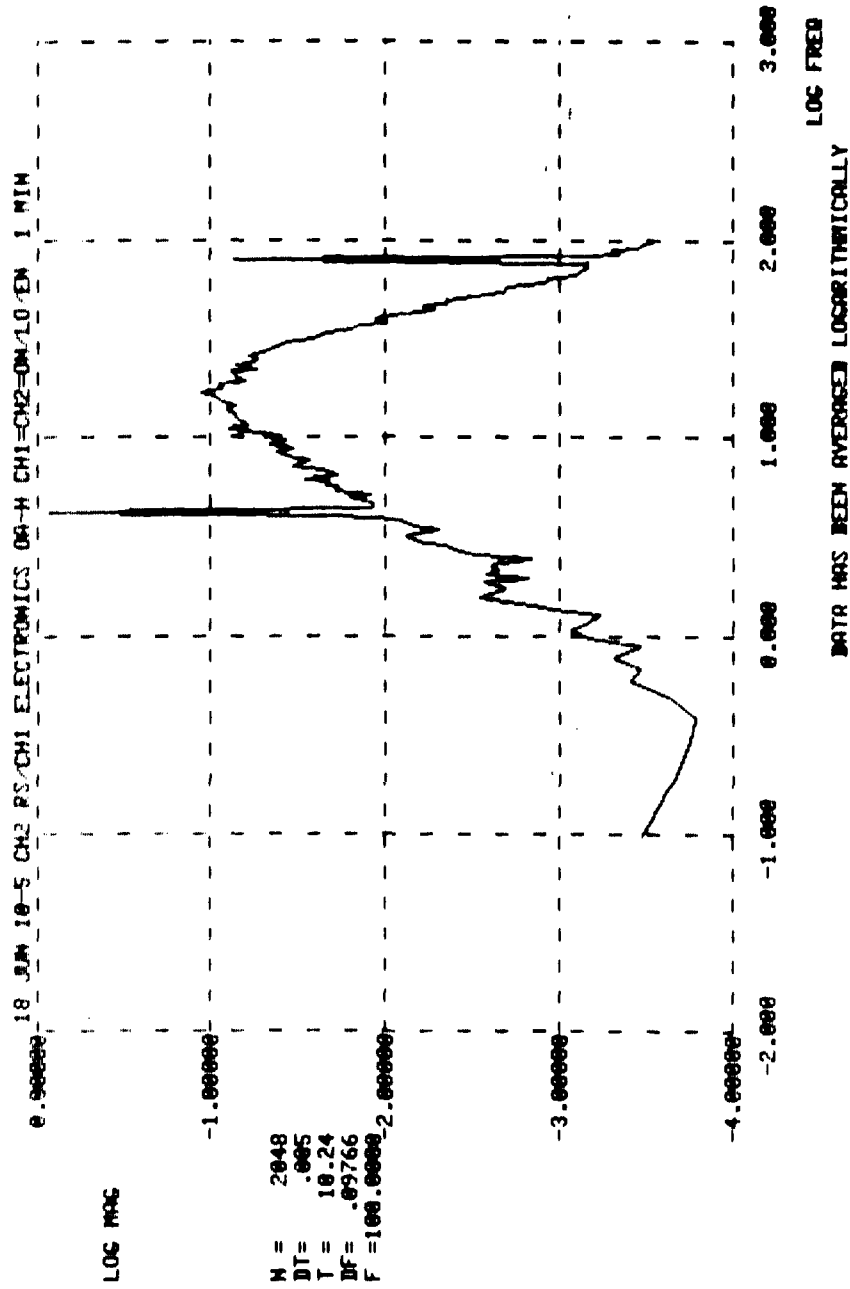

18 JUN 14-5 CH2 RS/LH1 ELECTRONICS UA-M CH1=CH2=ON/LO/EN 1 MIN
 * COMPLEX PIS IN BLOCK 0= 1024, DF, F ARE .976563E-01 .100000E+03

INTERVAL #	MIN F HZ	MAX F HZ	RMS RATE NOISE ARC SEC/SEC
1	0.00	9.96	.5857
2	9.96	19.92	.8814
3	19.92	29.88	.7595
4	29.88	39.84	.4389
5	39.84	49.80	.2545
6	49.80	59.77	.1547
7	59.77	69.73	.1015
8	69.73	79.69	.0910
9	79.69	89.65	.4834
10	89.65	99.61	.0590
1	0.00	100.00	1.4946

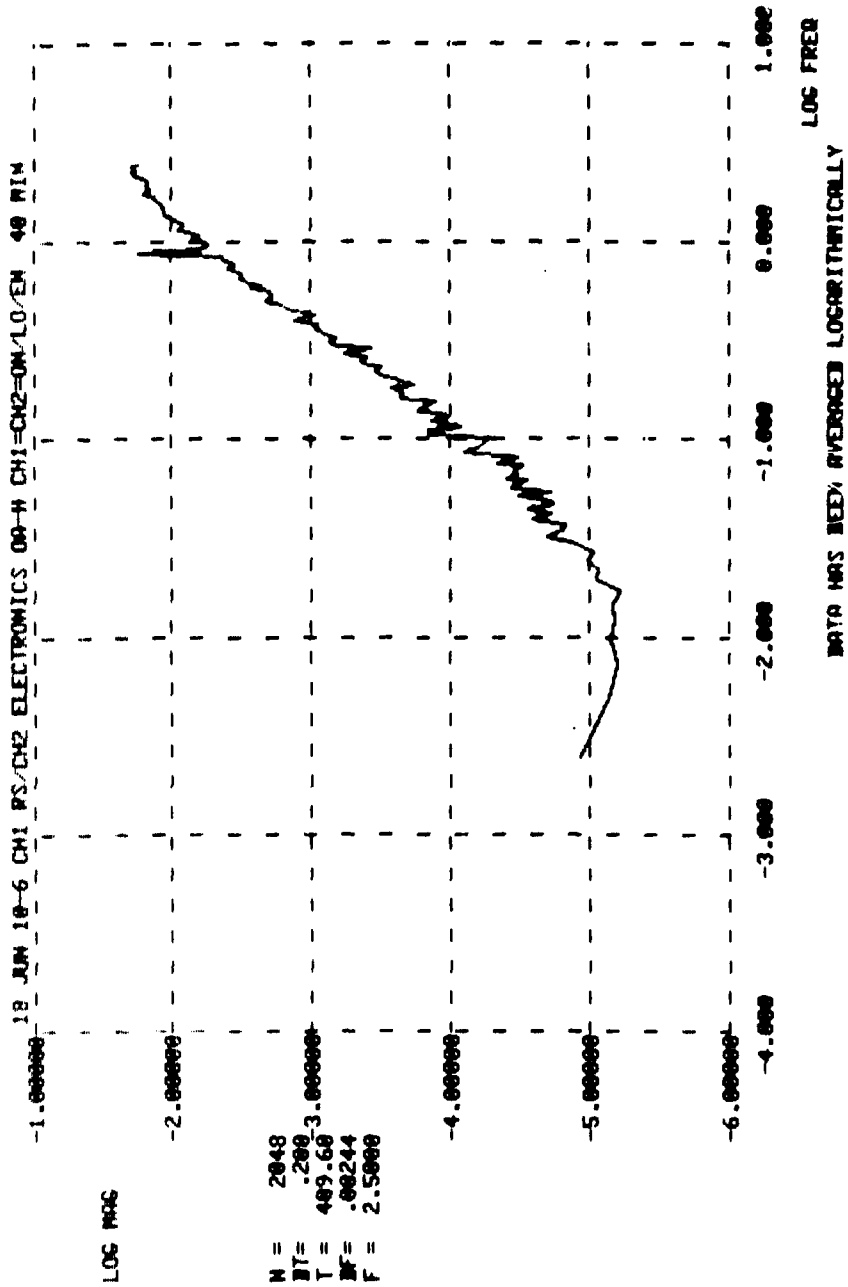

13 JUN 1966 CH1 RS/LH2 ELECTRONICS UA-M CH1=CH2=ON/LD/EN 40 MIN
 * COMPLEX PIS IN BLOCK # 1424, OF, F ARF .244141E-02 .250000E+01

INTERVAL #	MIN F HZ	MAX F HZ	RMS RATE NOISE ARC SEC/SEC
1	.00	.10	.0017
2	.10	.20	.0041
3	.20	.30	.0065
4	.30	.40	.0092
5	.40	.50	.0122
6	.50	.60	.0148
7	.60	.70	.0174
8	.70	.80	.0196
9	.80	.90	.0308
10	.90	1.00	.0244
11	1.00	1.10	.0259
12	1.10	1.20	.0292
13	1.20	1.30	.0299
14	1.30	1.40	.0338
15	1.40	1.50	.0339
16	1.50	1.60	.0361
17	1.60	1.70	.0350
18	1.70	1.80	.0395
19	1.80	1.90	.0369
20	1.90	2.00	.0395
21	2.00	2.10	.0387
22	2.10	2.20	.0436
23	2.20	2.30	.0434
24	2.30	2.40	.0425
1	0.00	1.00	.0524
2	1.00	2.00	.1089
1	0.00	2.50	.1533

A-160

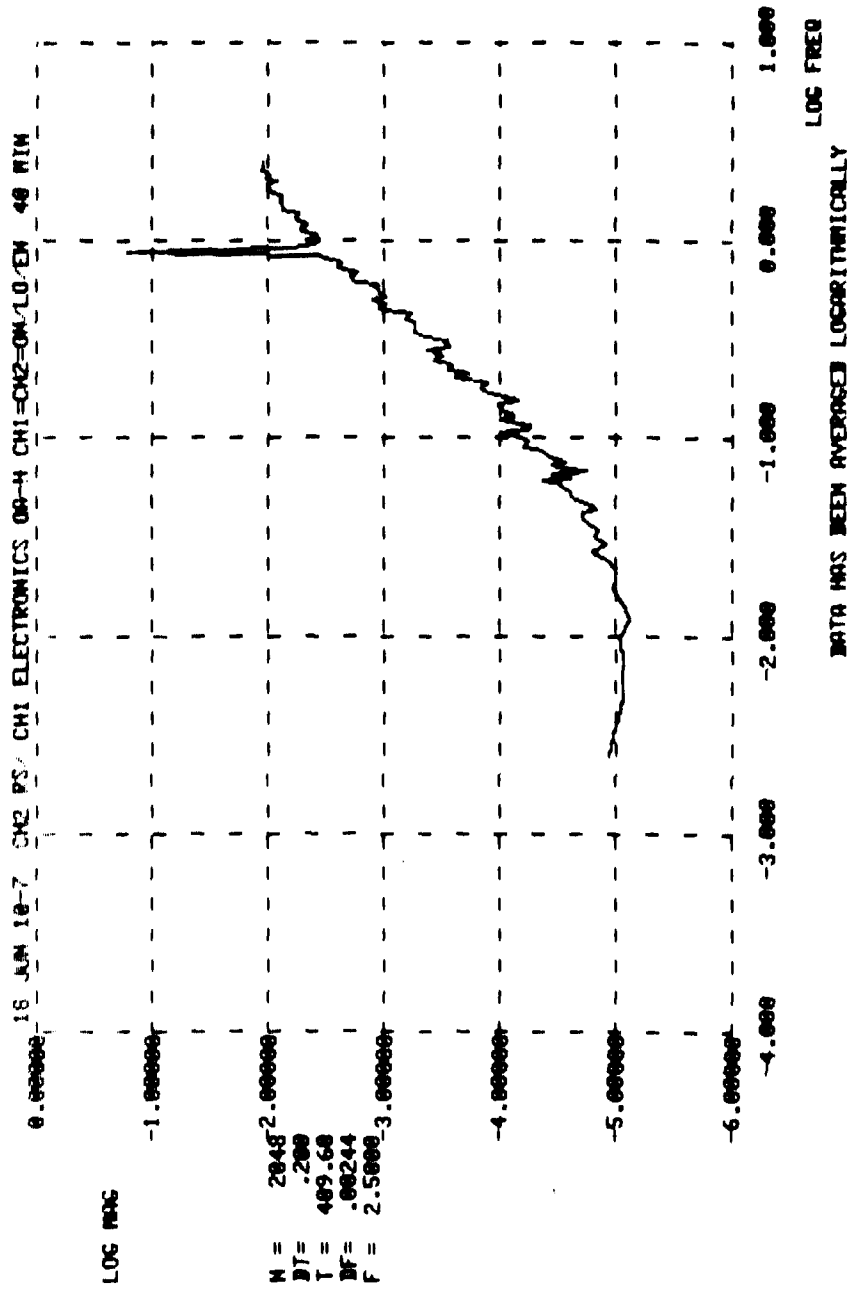

18 JUN 10-7 CH2 MS/ CH1 ELECTRONICS OA-M CH1=CH2=ON/LO/EN 40 MIN
 R COMPLEX MS IN BLOCK N= 1424, DF, F ARF .244141E-02 .250000E+01

INTERVAL #	MIN F HZ	MAX F HZ	RMS RATE NOISE ARC SEC/SEC
1	0.00	.10	.0016
2	.10	.20	.0033
3	.20	.30	.0055
4	.30	.40	.0070
5	.40	.50	.0096
6	.50	.60	.0105
7	.60	.70	.0131
8	.70	.80	.0159
9	.80	.90	.0011
10	.90	1.00	.0213
11	1.00	1.10	.0196
12	1.10	1.20	.0224
13	1.20	1.30	.0227
14	1.30	1.40	.0237
15	1.40	1.50	.0277
16	1.50	1.60	.0277
17	1.60	1.70	.0265
18	1.70	1.80	.0307
19	1.80	1.90	.0308
20	1.90	2.00	.0305
21	2.00	2.10	.0308
22	2.10	2.20	.0321
23	2.20	2.30	.0340
24	2.30	2.40	.0307
1	0.00	1.00	.0881
2	1.00	2.00	.0838
1	0.00	2.50	.1413

A-162

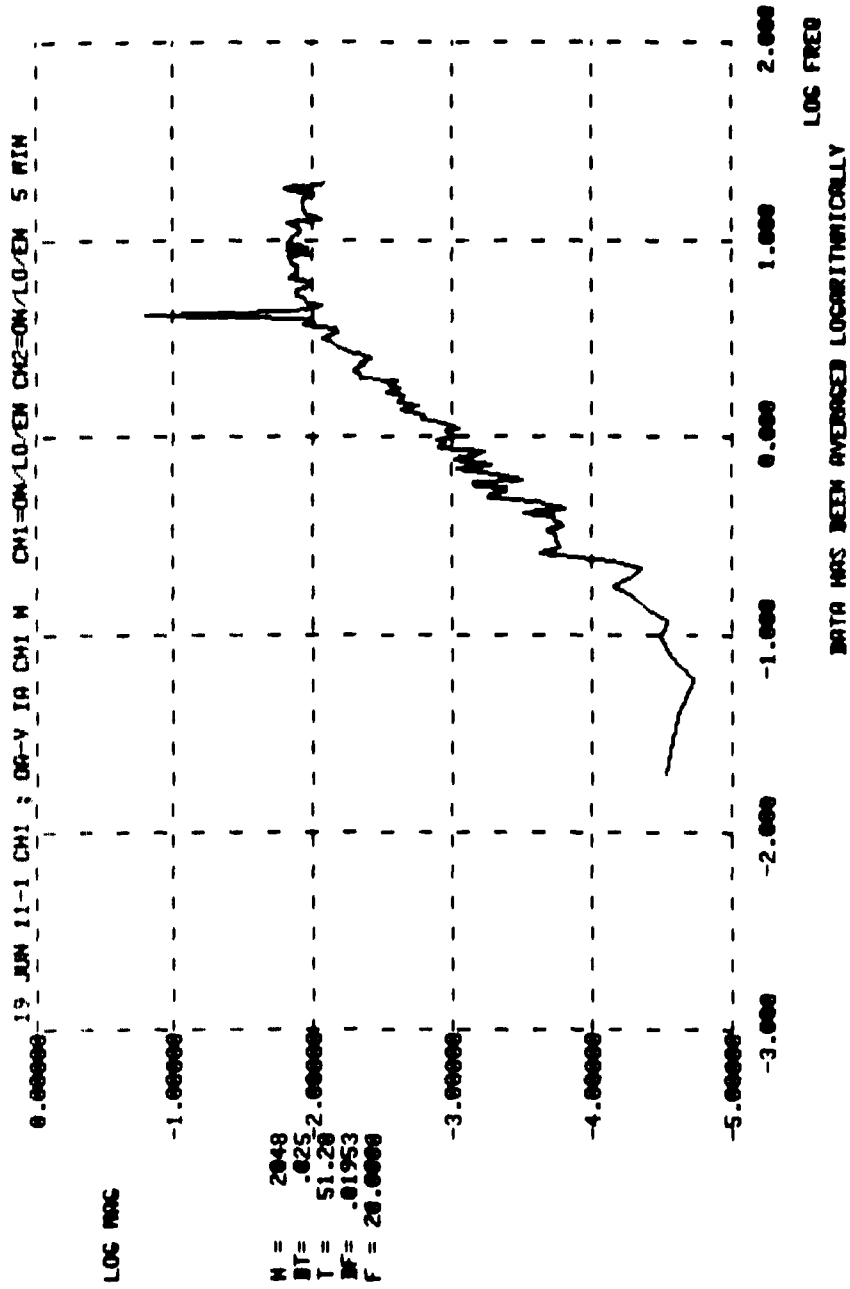

19 JUN 11-1 CH1 3 0A-V 1A CH1 N CH1=ON/LO/EN CH2=ON/LO/EN 5 MIN
 # COMPLEX PTS IN BLOCK 0# 1024, OF, F ARF .195313E-01 .200000E+02

INTERVAL #	MIN F HZ	MAX F HZ	RMS RATE NOISE ARC SEC/SEC
1	0.00	1.00	.0216
2	1.00	1.99	.0459
3	1.99	2.99	.0718
4	2.99	3.98	.0924
5	3.98	4.98	.1864
6	4.98	5.98	.1122
7	5.98	6.97	.1140
8	6.97	7.97	.1159
9	7.97	8.96	.1100
10	8.96	9.96	.1177
11	9.96	10.96	.1175
12	10.96	11.95	.1138
13	11.95	12.95	.1096
14	12.95	13.95	.1029
15	13.95	14.94	.1072
16	14.94	15.94	.1119
17	15.94	16.93	.1036
18	16.93	17.93	.1018
19	17.93	18.93	.1256
20	18.93	19.92	.0938
1	0.00	4.98	.2258
2	4.98	9.96	.2585
3	9.96	14.94	.2467
4	14.94	19.92	.2412
1	0.00	20.00	.4873

19 JUN 11-2 CH2 ; 00-Y 10 CH1 M CH1-ON/LO/EN CH2-ON/LO/EN 5 MIN

LOG MAC

N = 2048
BT = .025
T = 51.28
BF = .01953
F = 20.0000 3.00000

LOG FREQ

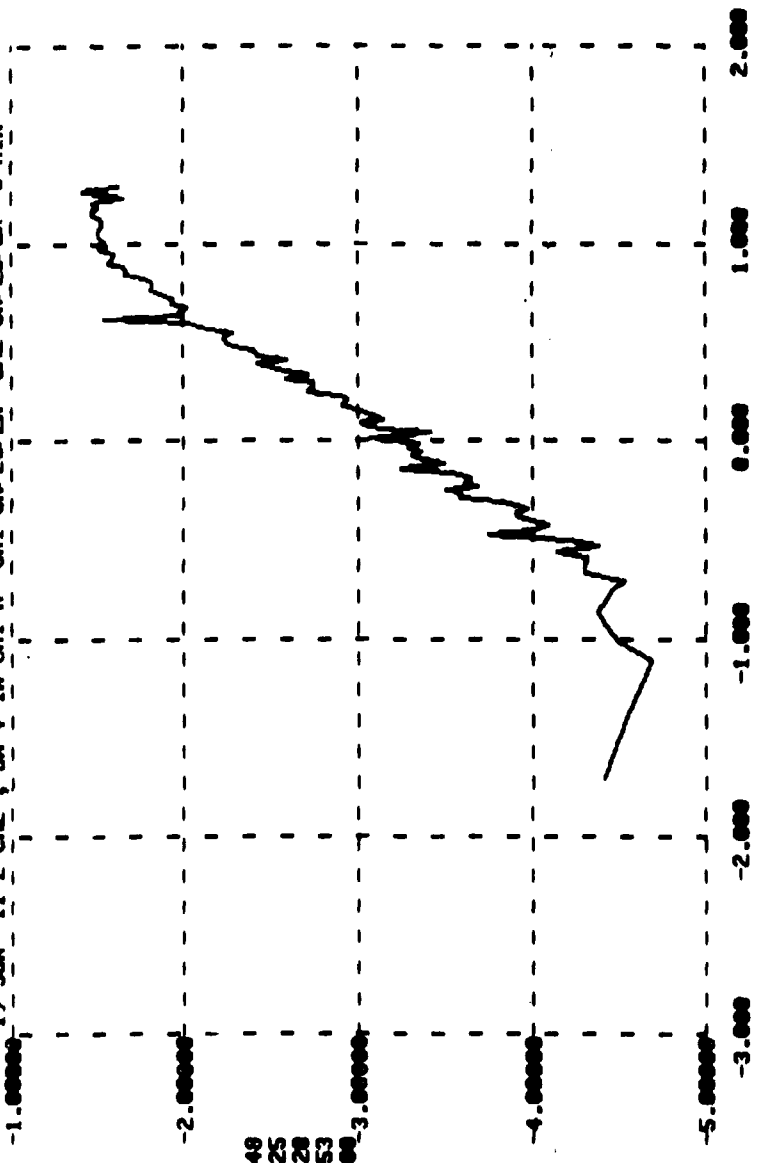

DATA HAS BEEN AVERAGED LOGRITHMICALLY

19 JUN 11-2 CH2 ; UA-V TA CH1 N CH1=ON/LO/EN CH2=ON/LO/EN 5 MIN
 N COMPLEX PIS IN BLOCK N= 1024, DF, F ARE .195313E-01 .200000E+02

INTERVAL #	MIN F HZ	MAX F HZ	RMS RATE NOISE ARC SEC/SEC
1	0.00	1.00	.0148
2	1.00	1.99	.0341
3	1.99	2.99	.0556
4	2.99	3.98	.0808
5	3.98	4.98	.1137
6	4.98	5.98	.1160
7	5.98	6.97	.1268
8	6.97	7.97	.1509
9	7.97	8.96	.1591
10	8.96	9.96	.1666
11	9.96	10.96	.1727
12	10.96	11.95	.1756
13	11.95	12.95	.1678
14	12.95	13.95	.1756
15	13.95	14.94	.1861
16	14.94	15.94	.1795
17	15.94	16.93	.1728
18	16.93	17.93	.1525
19	17.93	18.93	.1918
20	18.93	19.92	.1618
1	0.00	4.98	.1547
2	4.98	9.96	.3256
3	9.96	14.94	.3927
4	14.94	19.92	.3851
1	0.00	20.00	.6589

DISTRIBUTION LIST

	<u>Copies</u>
Defense Documentation Center Cameron Station Alexandria, VA 22314	12
AD/TETPR Eglin AFB, FL 32542	1
AD/DLOSL Eglin AFB, FL 32542	1
3201 Air Base Group (HO) Eglin AFB, FL 32542	1
AD/CS Eglin AFB, FL 32542	1
AU Maxwell AFB, AL 31142	1
NASA/Marshall Space Flight Center (Attn: Mr. Henning Krome) Code: TA01 Huntsville, AL 35812	10
Lockheed Missile and Space Co. (Attn: Mr. Gus Brady) Orgn. 62-34/Bldg 562/Fac. 5 P. O. Box 504 Sunnyvale, CA 94086	4
The Bendix Corporation Guidance Systems Division (Attn: Mr. Joseph Blondin) Dept 6401 Teterboro, NJ 07608	4
6585th Test Group Holloman AFB, NM 88330	
TSL	2
GDP	4
GDA	2
GDL	2