

12

REPORT NO. MT-050

SEPTEMBER 1978

**ELECTROCHEMICAL MACHINING
OF
GUN BARREL BORES
AND RIFLING**

LEVEL

AD A072437

**A PROJECT OF THE
MANUFACTURING TECHNOLOGY PROGRAM
NAVAL SEA SYSTEMS COMMAND**

**DDC
R
AUG 8 1979
C**

FINAL REPORT



**NAVAL ORDNANCE STATION
LOUISVILLE, KENTUCKY 40214**

**APPROVED FOR PUBLIC RELEASE
DISTRIBUTION UNLIMITED**

79 08 06 022

WUC FILE COPY

"The citation of trade names and names of manufacturers in this report is not to be construed as official government endorsement or approval of commercial products or services referenced herein."

ELECTROCHEMICAL MACHINING
OF
GUN BARREL BORES
AND RIFLING

A PROJECT OF THE
MANUFACTURING TECHNOLOGY PROGRAM
NAVAL SEA SYSTEMS COMMAND

FINAL REPORT

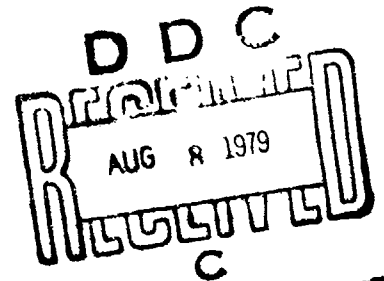

NAVAL ORDNANCE STATION
LOUISVILLE, KENTUCKY 40214

APPROVED FOR PUBLIC RELEASE
DISTRIBUTION UNLIMITED

ABSTRACT

In recent years, the trend in gun development programs has emphasized higher rates of fire, greater accuracy and increased projectile muzzle velocities, requiring higher propellant temperatures and chamber pressures. Current gun barrel steels cannot withstand these increased temperatures and pressures without a significant reduction in barrel life. Fabrication of gun barrels from high strength superalloy materials that would better withstand these increased temperatures and pressures present problems in machining rifling configurations by conventional methods such as broaching.

With major caliber gun barrel material and design technology almost at a standstill due to having reached the limit of economical and quality machining by conventional methods, it was envisioned that electrochemical machining (ECM) could be used to machine the bore and rifling configuration in high strength materials. ECM could also improve the surface finish in machining current gun barrel materials. It could also provide an economical means of producing experimental rifling configurations since a single experimental tooling head would be required in contrast to numerous expensive broaches required for conventional machining.

A special 10,000 ampere ECM machine and associated 1,000 gallon prototype electrolyte system was designed and built at Naval Ordnance Station, Louisville, Kentucky. This machine is unique in its extraordinary size and 22 1/2 foot stroke. Tool design and experimental machining were performed, with one quarter scale tooling for economy in establishing a basic tool design and machining parameters. With these parameters established, full size tooling was built and a full length 5"/54 caliber gun barrel was successfully bored and rifled. This represented the longest successful ECM cut ever made and demonstrates the capability for electrochemical machining major caliber gun barrels.

Accession For	
DTIC QUALI	
DDC TAB	
Unannounced	
Justification	
By _____	
Distribution/	
Availability Codes	
Dist	Avail and/or special
A	

FOREWORD

This is the final report of work completed under NAVSEASYSKOM's Work Requests WR-8-7184, WR-3-5565, WR-4-5887 and WR-6-4105, issued to investigate the feasibility of electrochemically boring and rifling major caliber gun barrels. The study was performed by the Manufacturing Technology Department, Naval Ordnance Station, Louisville, Kentucky. Funds were provided by the Materials and Mechanics Division of NAVSEASYSKOM (NAVSEA 0354) under the Navy's Manufacturing Technology Program.

The Navy acknowledges the assistance of Anocut, Inc., Elk Grove Village, Illinois, who provided machine components under PO-0-0020 and PO-9-0367.

This Manufacturing Technology Report has been reviewed and is approved.



THAD A. PEAKE, JR.

Director

Manufacturing Technology Department

Naval Ordnance Station

Louisville, Kentucky

TABLE OF CONTENTS

<u>SECTION</u>	<u>PAGE</u>
ABSTRACT	i
FOREWORD	iii
TABLE OF CONTENTS	v
LIST OF ILLUSTRATIONS	vii
1.0 INTRODUCTION	1
1.1 Advantages of the ECM Process	1
1.2 Selection of 5"/54 Gun Barrel for Initial ECM Machining	1
2.0 ECM MACHINE COMPONENTS AND SPECIFICATIONS	7
3.0 BARREL INSTALLATION AND MACHINE COMPONENTS	9
3.1 Positive Side of the DC Circuit	9
3.2 Anoguard and Microbar	9
3.3 Negative Side of the DC Circuit	9
3.4 Boring Bar	9
3.5 Tooling Head	10
4.0 ELECTROLYTE	17
4.1 Electrolyte Conductivity	17
4.2 Electrolyte Temperature	17
4.3 Electrolyte Ph	17
5.0 ELECTROLYTE SYSTEM	19
5.1 Auxiliary Electrolyte Tank	19
5.2 Electrolyte Circuit	19
5.3 Electrolyte Sludge Content	20
5.4 Diatomaceous Earth Filtering System	20
6.0 TOOL DEVELOPMENT	25
6.1 Lands and Grooves	25
6.2 Experimental Scaled Down Tooling	25
6.3 Linear Insulation of the Cathode	26
6.4 Electrolyte Concentration	27
7.0 FULL SIZE SEGMENTED TOOLING	35
8.0 ECM MACHINING THE 5"/54 GUN BARREL	47
8.1 Machining Speed	47
8.2 Restart Procedure	48
8.3 Quality of the ECM Bore and Rifling	49

<u>SECTION</u>		<u>PAGE</u>
9.0	SUMMARY AND CONCLUSIONS	53
10.0	RECOMMENDATIONS	55
	DISTRIBUTION LIST	57
	FORM DD 1473	59

LIST OF ILLUSTRATIONS

<u>FIGURE</u>	<u>TITLE</u>	<u>PAGE</u>
1	The ECM Process	3
2	The ECM Machine	4
3	Component Layout of ECM Machine	5
4	Digital Hydraulic Drive System	6
5	Gun Barrel Installed in Machine	11
6	Microbar	12
7	Mercury Slip Ring	13
8	Boring Bar (Cross Section)	14
9	Master Guidance Cylinder	15
10	Tooling Head	16
11	Electrolyte Tank	22
12	Water Chiller	23
13	Centrifuge	24
14	Tooling Head (25 Degree Cathode)	28
15	Scaled Down Tooling	29
16	Scaled Down Tooling Installation	30
17	Scaled Down Segmented Cathode (Exploded View)	31
18	Scaled Down Segmented Cathode	32
19	Test Data - Scaled Down Tooling	33
20	Full Size Segmented Tooling	36
21	5"/54 Gun Barrel Rifling Configuration	37
22	Machining Parameters and Bore-Groove Dimensions 5"/54 Mk 18 Mod 5 Electrochemically Machined Gun Barrel	38
23	ECM Rifling Configuration	50
24	ECM and Conventional Machined Surface (Comparison)	51

SECTION 1

INTRODUCTION

Electrochemical machining (ECM) has been used commercially for over 20 years. Its use was pioneered by the aircraft industry due to the development and introduction of much needed, difficult to machine by conventional means, superalloy materials. ECM is a highly sophisticated machining process in that electrical and chemical energy are the cutting edges of the tool. A more scientific definition is, "the controlled removal of metal by anodic dissolution in an electrolytic cell in which the workpiece is the anode and the tool is the cathode." An electrolyte (conducting medium) is pumped through the machining gap (.001" - .010") between the tool and the workpiece (Figure 1). Low voltage direct current (approximately 15 volts) is induced to create the electrolytic cell for dissolving material from the workpiece. Due to the proximity of the tool and workpiece, a nearly mirror image of the tool is machined in the workpiece. Material removal rate is independent of material hardness and is approximately 1 cubic inch per minute per 10,000 amperes of machining power used.

1.1 Advantages of the ECM Process

The advantages of ECM are: complex configurations can be machined in metals without regard to its hardness, virtually no tool wear, and the machined surface is metallurgically undisturbed. The surface is free of the typical microscopic layer of sharp peaks and valleys inherent in conventional machining. There is a complete blend of radii and fillets without burrs, sharp edges, or residual stress. These advantages make ECM particularly adaptive for boring and rifling gun barrels, especially when new and harder materials are used in gun barrel manufacturing in the future.

Electrochemical machining involves a number of variables such as feed rate, cathode surface area, current density, type of electrolyte, electrolyte temperature, pH and electrolyte concentration. This large number of process variables can be considered an advantage since it makes the process that much more versatile. However, once the desired machining parameters have been established for optimum results, these variable factors must be closely controlled for accuracy and repeatability.

ECM is a somewhat difficult yet proven process. It should be used only when no other process can produce the desired results. This is true even for the more simple product requirements. It can be said that the extraordinarily long stroke and time required for machining gun barrels is utilizing the ECM process to the fullest extent.

1.2 Selection of 5"/54 Gun Barrel for Initial ECM Machining

Since 5"/54 caliber gun barrels have a tensile strength of 180,000 psi and a hardness range up to Rockwell 40-C, it was decided to design and build a machine (Figures 2, 3, and 4) and tooling to bore and rifle this particular barrel. This would not only improve the state of the art in the manufacture of this barrel, but would prepare the way for use of more exotic materials and designs in the future. A hardness

of Rockwell 40-C is approaching the limit of which gun barrels can be rifled by conventional means. Indication of approaching this limit is reflected by the surface finish and blending of radii and fillets of rifling configuration currently produced. The quality of the rifling configuration affects the adherence of chromium plating (.005" per side) applied for extending the life of current gun barrels. The ECM process produces the ideal surface prior to chromium plating due to the smooth surface (free of tool marks) and the complete blend of radii and fillets. In fact, before plating a conventionally machined gun barrel, the DC current is reversed (reversed plating) for several minutes prior to applying plating. This process (reversing the current) is actually electrochemical machining and is performed in an attempt to improve plating adherence. However, this brief exposure to the ECM process does not produce a surface finish equal to that of absolute and total form ECM machining.

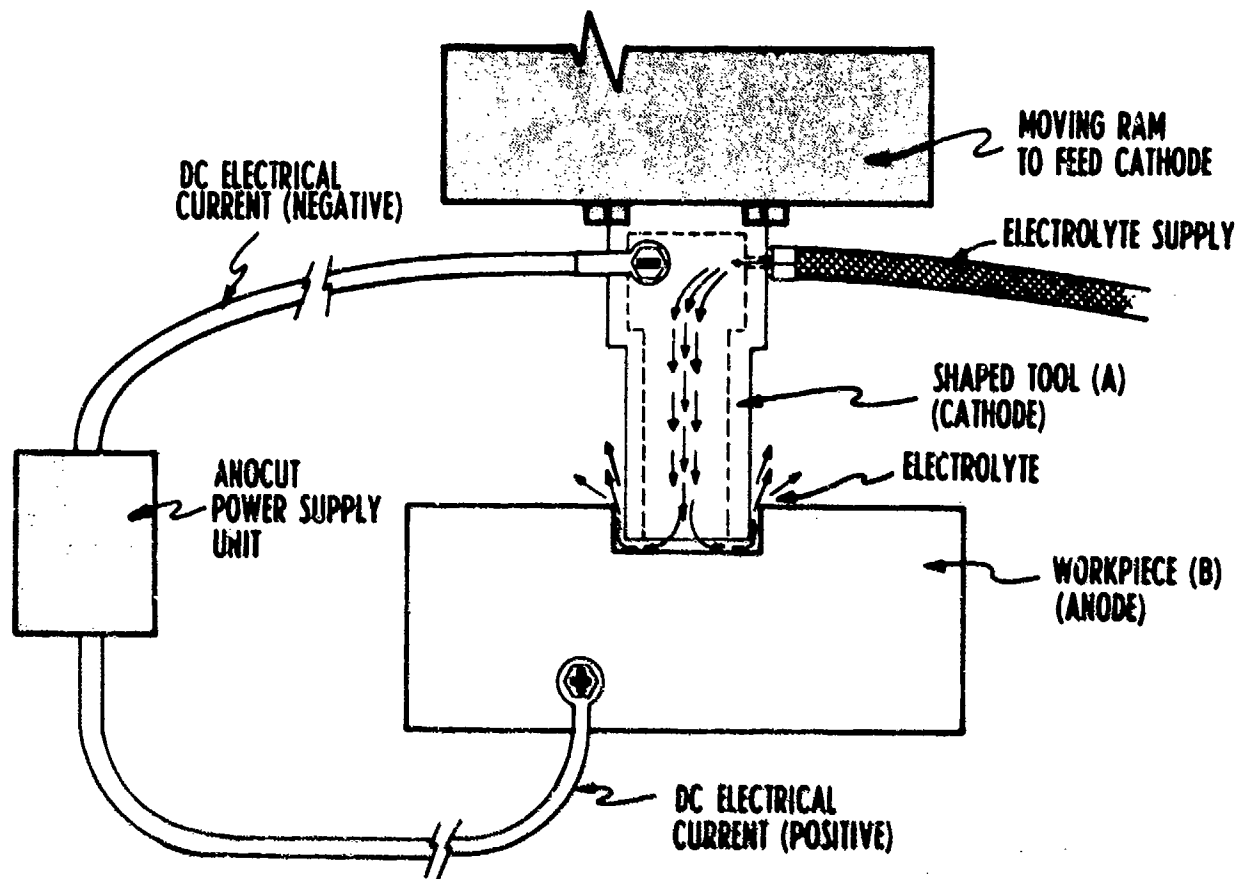

Electrochemical machining (ECM) utilizes electricity, chemistry and basic mechanical components usually arranged as depicted schematically in Figure 1. The cathode tool (A) is shaped to provide the form desired in the workpiece (B) with appropriate modification or compensation for overcut. Low voltage (5-20 V) D.C. current is supplied by power cables from the Anocut power unit; negative charge to the tool (A), positive charge to the workpiece (B). An electrolyte (electrically conductive solution) is pumped under high pressure between the tool and the work. A mechanically-driven ram feeds the tool at a constant rate, pre-set by the operator, into the workpiece to machine the desired shape or cavity.

Metal is removed from the workpiece in accordance with the precepts of Faraday's laws at a rate determined by the amperage flowing between the tool and the work. The amperage is, of course, limited by the capacity of the power supply unit. Rate of removal is determined by the area between the cathode tool and the workpiece and the rate at which the tool is fed. Although the exact removal rate for a particular metal is strictly dependent upon its electrochemical equivalent, all the common metals are removed at approximately the same rate. For estimating removal rates, it is safe to assume that 10,000 amperes will remove 1 cubic inch of metal per minute. Therefore, 20,000 amperes will remove 2 cubic inches per minute, 40,000 amperes, 4 cubic inches per minute, etc.

The tool never touches the workpiece; there is no friction, no damage from heat or sparking and no tool wear.

FIGURE 1

THE ECM PROCESS

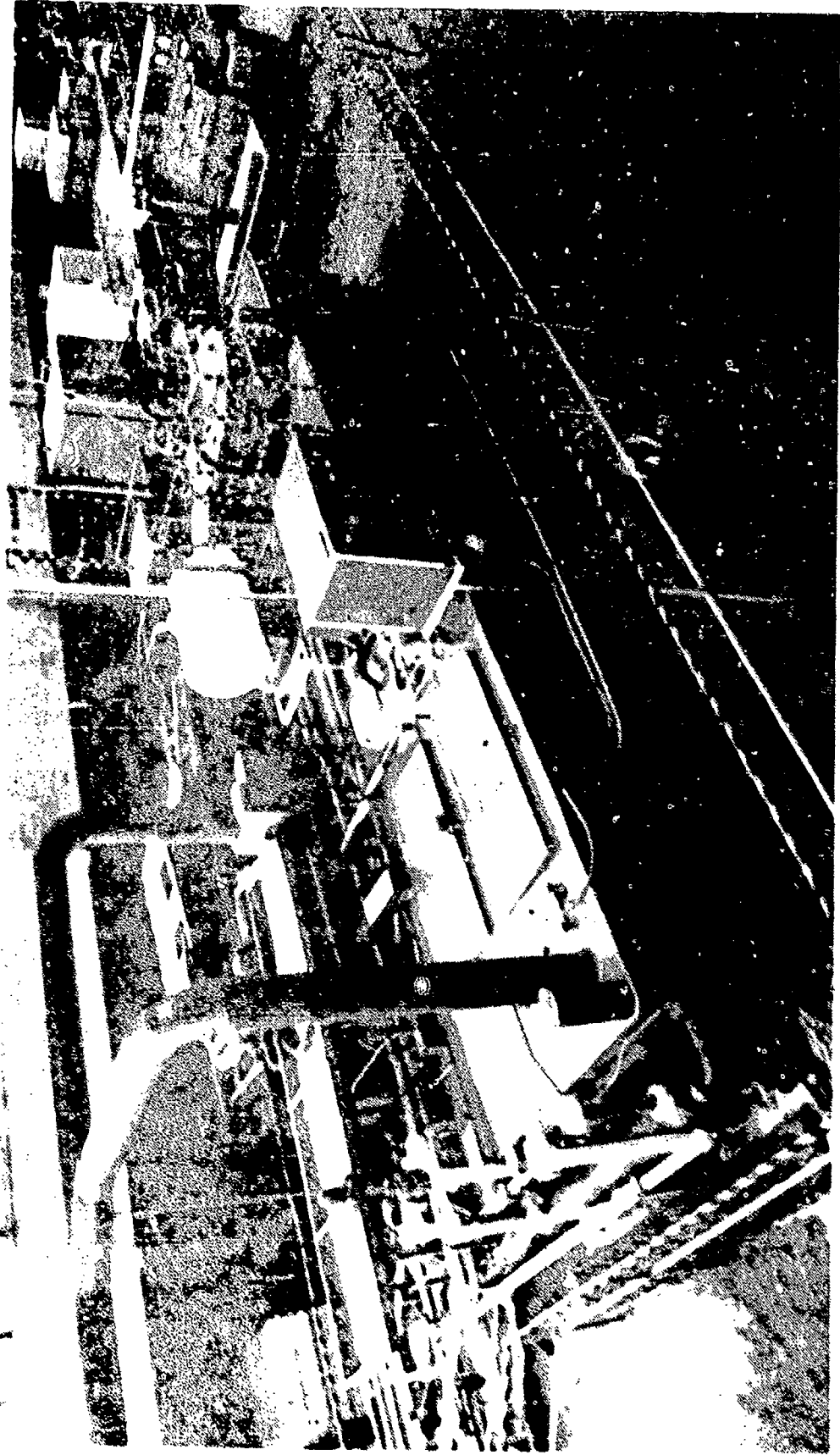

THE ECM MACHINE

FIGURE 2

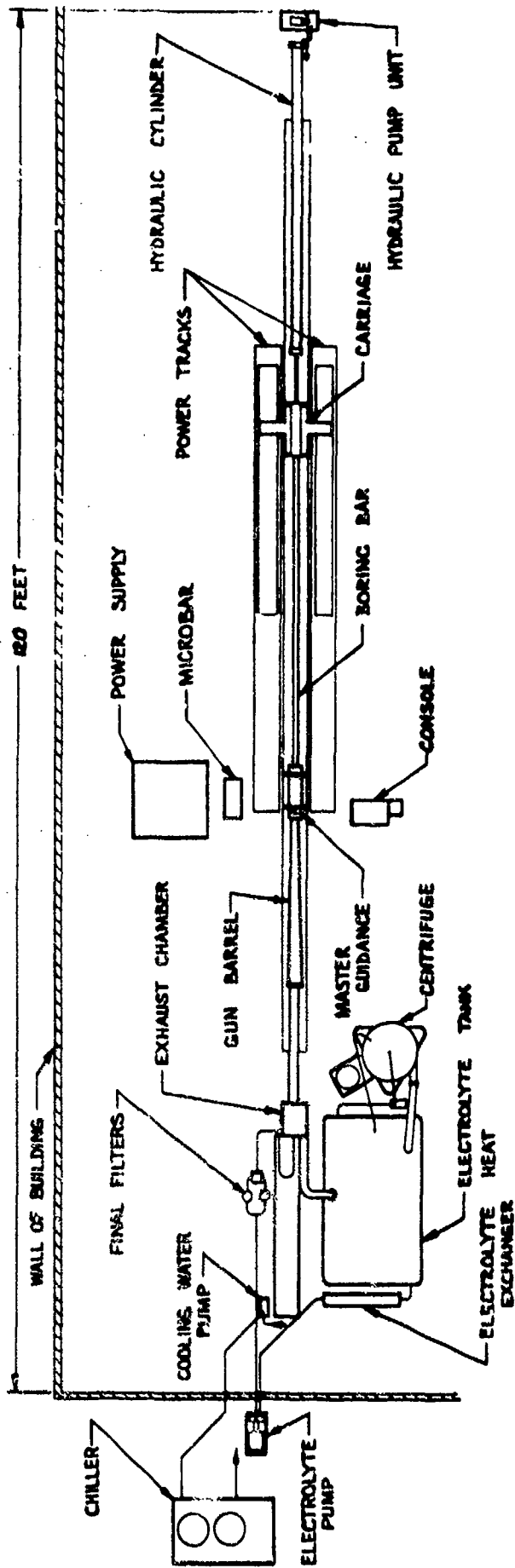
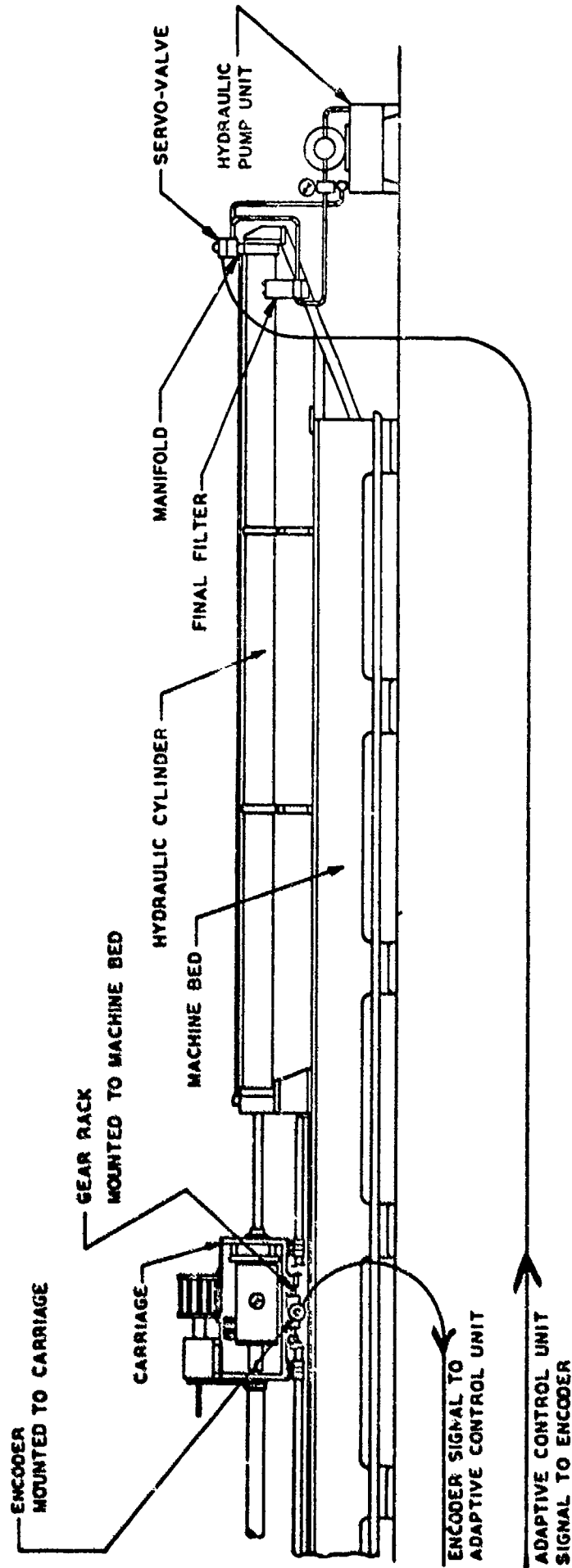

FIGURE 3 COMPONENT LAYOUT OF ECM MACHINE

FIGURE 3



6

FIGURE 4 DIGITAL HYDRAULIC DRIVE SYSTEM

FIGURE 4

SECTION 2

ECM MACHINE COMPONENTS & SPECIFICATIONS

Electrolyte Tank	Fiberglass construction 1000 gallon capacity
Electrolyte Pump	Centrifugal 200 GPM @ 225 psi
Final Filters	Two assemblies in parallel to permit cleaning during operation
Heat Exchanger	To control electrolyte entry temperature
Chiller	50 Ton capacity for cooling electrolyte, power supply, and cathode bar
Power Supply	10,000 amp/24 volt
Anoguard and Microbar	Spark detection for fast shutdown
Console	Standard cabinet with extra controls
Exhaust Chamber	To collect and exhaust hydrogen gas from barrel and electrolyte tank
Centrifuge	Sludge removal and electrolyte clarification
Hydraulic Cylinder	8 inch bore/3 inch piston rod 270 inch stroke
Servo Valve	12 gallons/minute
Hydraulic Pump Unit	60 gallons reservoir and gerotor pump
Encoder	10,000 pulses/revolution
Gear Rack	Precision 3 gear rack 10 TPI
Adaptive Control	Digital counter and rate controller

SECTION 3

BARREL INSTALLATION AND MACHINE COMPONENTS

The gun barrel is installed in the machine (Figure 5) with the breech extending into the exhaust chamber. The muzzle end is drawn up to the guidance cylinder head by small air cylinders. The barrel is supported in the middle by two steady-rest units. Since the barrel does not rotate but is moved laterally for installation, the rollers on the steady rest are turned 90 degrees from the norm for steady rest units. This permits a lateral movement for installation and moving the barrel out of machining position for occasional inspection during test machining. The barrel is accurately (within .001") located in the machine, moved into machining position by the air cylinders and secured by means of a yoke bolted to the guidance cylinder.

3.1 Positive Side of the DC Circuit

The positive side of the DC circuit power cables (approximately 15) are attached to the barrel (anode) with clamps. The cables lead from a 3" x 3" central copper bus bar mounted on, but insulated from, the machine. Power is supplied to the bus bar by water cooled hollow copper leads from the transformer through the anoguard and microbar.

3.2 Anoguard and Microbar

One of the plaguing difficulties with ECM is the undesired occurrence of sparking (electrical shorts) between the workpiece and tool. These sparks are referred to as spark-outs and can severely damage the workpiece and/or tool if machining is not stopped immediately. Spark-outs are caused by small foreign particles (metallic or nonmetallic) in the electrolyte, workpiece passivity, or the metallurgical integrity of the workpiece. Any of these will cause spark-outs or unstable machining conditions. To detect these unstable conditions and immediately stop machining, a highly sophisticated electronic unit called the microbar (Figure 6) is used. This unit can sense sparking in the machining gap and shut off the machine in a few millionths of a second.

3.3 Negative Side of the DC Circuit

The negative side of the DC circuit ultimately leads to the tool (cathode). The tool must rotate one turn in every 125 inches of linear distance to produce the desired rifling twist and still conduct high amperage current. This is accomplished by use of a mercury slip ring (Figure 7).

3.4 Boring Bar

The boring bar must perform two basic functions. One is to conduct current of 10,000 amperes to the tool with little temperature rise. The other is to initiate and maintain the desired rifling twist. The bar is constructed (Figure 8) of a 2-5/8" diameter copper bar, encased in steel tubing for rigidity and covered with fiberglass for insulation. It is cooled by water through inlaid 3/8 inch copper tubing (Item I, Figure 8). For producing the rifling twist,

three rifled guide blocks (Figure 8) matching and engaging the rifling twist of the guidance cylinder (Figure 9) are provided. As the bar advances, the guide blocks exit the guidance cylinder and simultaneously engage with the previously machined rifling in the gun barrel. This engagement with the machined rifling continues throughout the length of the barrel. Three plain guide blocks are also provided as bearing surfaces on the machined rifling.

3.5 Tooling Head

The tooling head (Figure 10) unit consists of a combination porting and guidance block. It receives high pressure (250 psi) electrolyte and distributes it evenly behind the cathode. It also guides the tooling through a previously conventionally machined pilot bore of 4.940 inch diameter in the gun barrel. Straightness, concentricity and run out of the finished rifling depends on the quality of the pilot bore. The electrolyte reverses direction and flow over the insulator and through the machining gap (.010) between the gun barrel and advancing tool. A teflon seal confines the electrolyte in the machining area and prevents its flowing into the finished rifled area. A drain hole is provided for any leakage past the seal. Air is injected behind the seal, through the drain hole and down the barrel toward the exhaust chamber. This is for expelling hydrogen gas generated in the ECM process. The tool (cathode) is made of copper tungsten, an alloy commonly used for ECM machining. The cathode contains the rifling profile and its design is very critical for the quality and configuration of rifling produced. A more detailed description of cathode design is given in Section 6, Tool Development.



GUN BARREL INSTALLED IN MACHINE

FIGURE 5

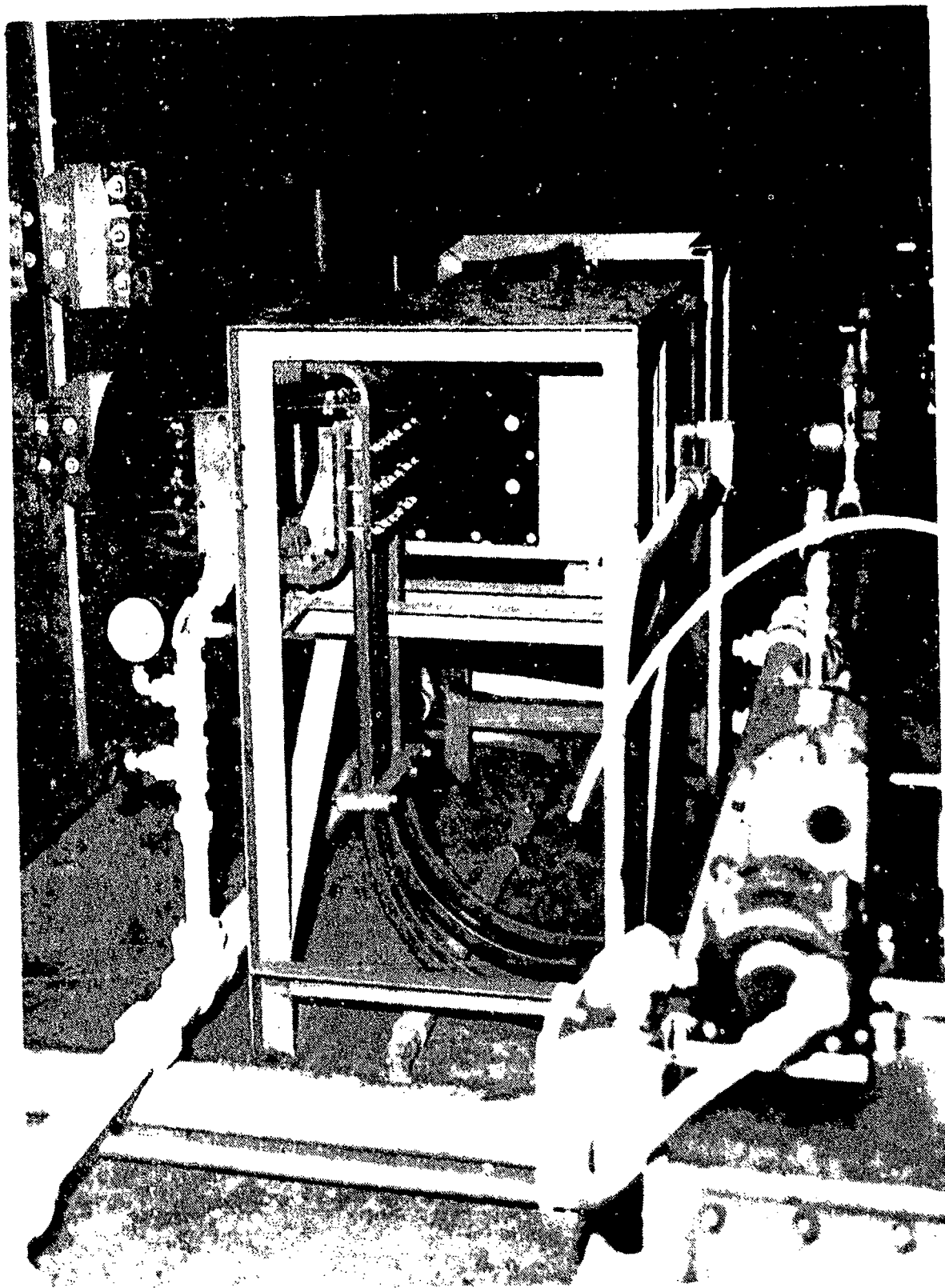

FIGURE 6

MICROBAR



MERCURY SLIP RING

FIGURE 7

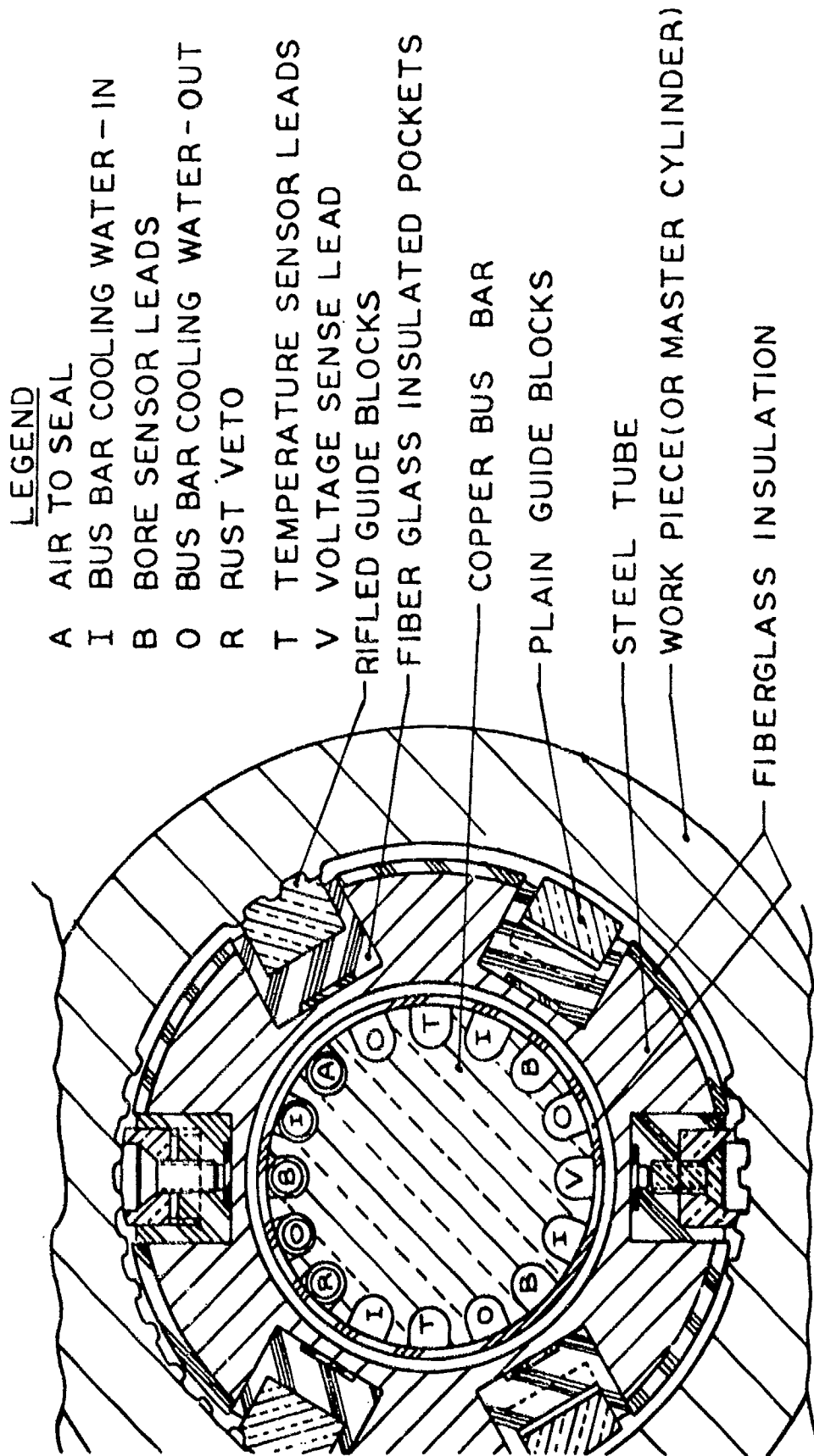
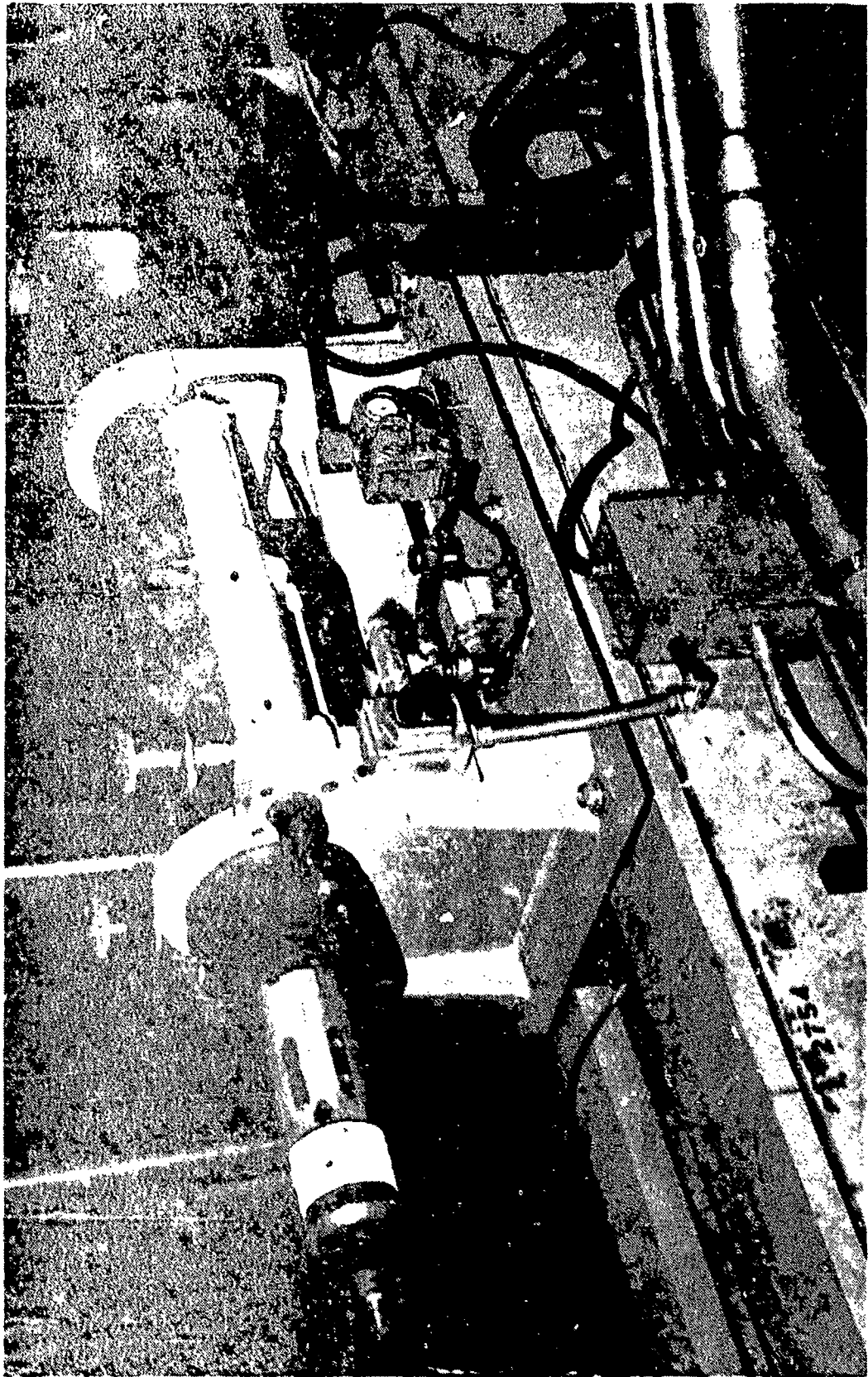
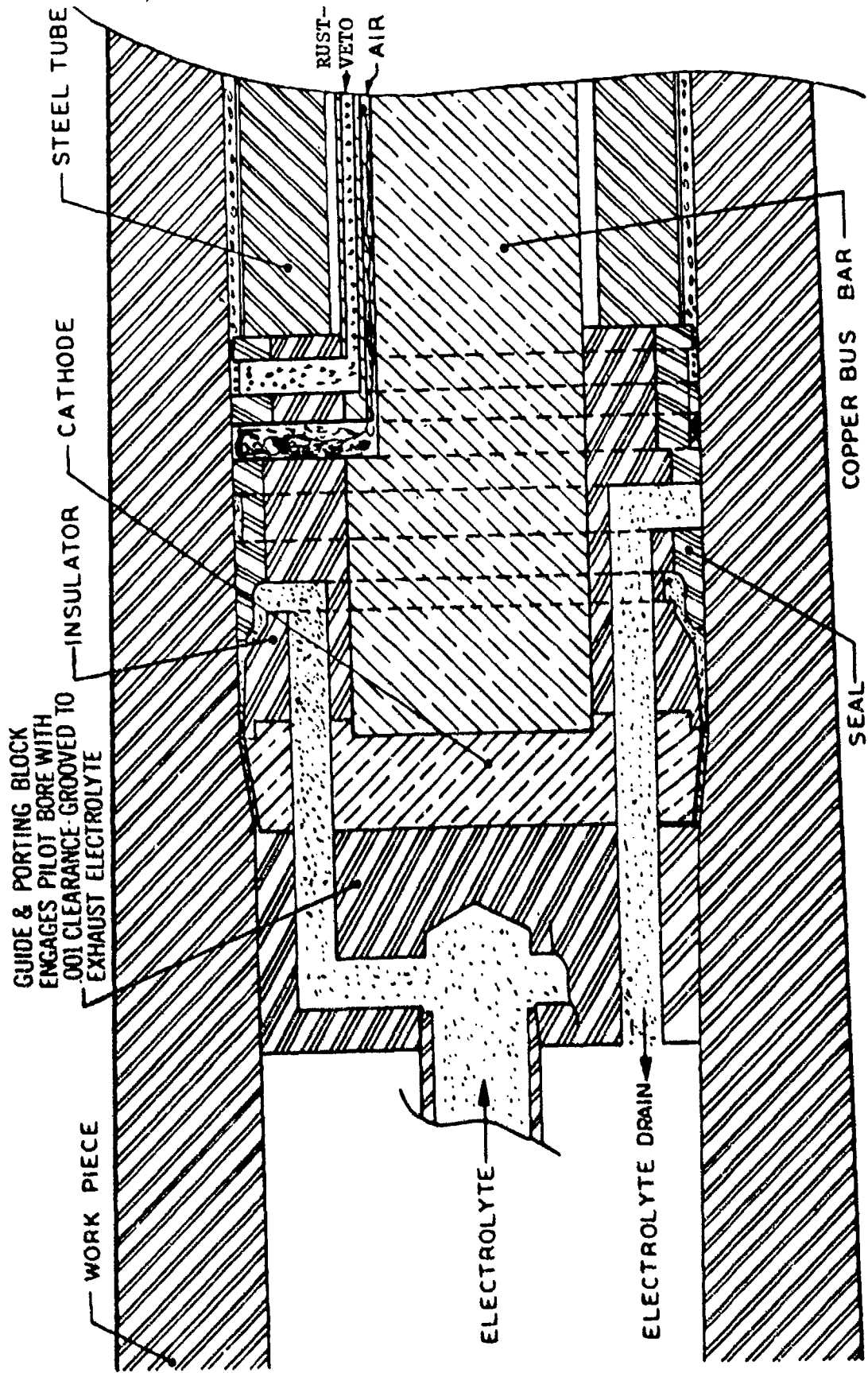

FIGURE 8 BORING BAR (CROSS SECTION)



MASTER GUIDANCE CYLINDER

FIGURE 9



TOOLING HEAD

FIGURE 10

SECTION 4

ELECTROLYTE

The electrolyte is the current conducting medium between the positive (workpiece) and negative (tool) sides of the high amperage DC electrical circuit. The electrolyte completes the circuit and the process of electrolysis occurs for controlled molecular chemical decomposition of the workpiece. There are two general types of electrolytes used in ECM. The most commonly used of these is a mixture of sodium chloride (NaCl) and water which has good "throwing" power (more active) but is highly corrosive. The other type is a mixture of sodium nitrate (NaNO_3) and water which is less active but also less corrosive to the finished machined surface when exposed for extended periods of time.

4.1 Electrolyte Conductivity

The recommended concentration of either sodium chloride or sodium nitrate electrolyte is approximately 2 lbs per gallon of water. The concentration is important as it affects the electrolyte conductivity and the surface finish produced (see Section 6.4). The addition of these chemicals decreases the resistivity of the solution and correspondingly increases the conductivity. Sodium chloride seems to be the most preferred type of electrolyte due to its cost and activeness. In the machining of some metals that tend to become passive during machining, it is necessary that sodium chloride be used due to it being more active than sodium nitrate.

4.2 Electrolyte Temperature

Another electrolyte variable equally important as the concentration is electrolyte temperature. As the temperature increases, the specific resistance decreases, thereby increasing the conductivity. Thus, with the electrolyte at a higher temperature, more current will flow and a higher rate of penetration and metal removal will be sustained with everything else being equal. However, it should be remembered that one of the functions of the electrolyte is to dissipate heat generated by the metal removal process. This fact places limitations on the upper range of electrolyte temperature; otherwise, it would be advantageous to use electrolytes at temperatures of $140^\circ - 150^\circ\text{F}$. By using electrolyte at a high temperature, the differential between this temperature and the boiling point (approximately 200°F) is decreased considerably and the capacity of the electrolyte to dissipate heat is reduced. If the electrolyte is unable to dissipate the heat generated in the machining gap (approximately 180°F) at a satisfactory rate, the machining gap temperature rises above the boiling point. Since the gas bubbles formed by boiling electrolyte in the gap cannot conduct current, a shorted circuit results and the machining process stops. Electrolyte temperatures between 95° and 120°F are low enough to eliminate boiling in the machining gap. However, once the desired machining temperature has been selected, it must be maintained within several degrees for close tolerance machining.

4.3 Electrolyte Ph

Another consideration in monitoring the composition and use of electrolyte is the Ph. While the Ph has some effect on the conductivity of the electrolyte, it is

not appreciable unless very strong acid or alkali solutions are used. However, there are serious drawbacks to using electrolytes that are either acid or alkaline. Acids have an etching effect on the workpiece that could result in a poor surface finish. Also, metal ions removed from the workpiece are more soluble in an acid solution and have a greater tendency to plate out on the tool. Alkalines tend to cause passivity in most metals, resulting in cessation of machining or causing non-uniform machining. Therefore, electrolytes should be kept as nearly neutral as possible.

Sodium nitrate electrolyte gradually becomes more alkaline with use and requires the addition of an acid for maintaining neutral Ph. A solution of boric acid (H_3BO_3) was used for this purpose in machining the 5"/54 gun barrel.

SECTION 5
ELECTROLYTE SYSTEM

The major components of the electrolyte system are the electrolyte tank, pump, heat exchanger, filters, flow meter, and clarification system (centrifuge). The function of the electrolyte system is to supply clean electrolyte to the machining gap at a constant temperature, pressure and volume. The size of electrolyte system required is dictated by the power utilized in machining, which in turn is dependent on the cathode area and current density. As a general rule in the ECM industry, the size of the electrolyte system should be approximately three gallons per ampere of power consumed in machining. The capacity of the electrolyte system for the ECM boring and rifling machine is 1000 gallons. Needless to say, this system is inadequate for a production type operation and, in fact, could be classified as a prototype electrolyte system. The power required for boring and rifling a 5 inch gun barrel is 7000 amperes. According to industry recommendations, this would require an electrolyte system of at least 21,000 gallons per continuous production type machining. This size system is required to insure that sludge and impurities will settle out and allow clean electrolyte to be pumped from the top of the settled pool. Although centrifuging is used for electrolyte clarification, it does not remove particles and impurities having the same density as that of the electrolyte.

5.1 Auxiliary Electrolyte Tank

An 800 gallon auxiliary electrolyte tank was added to the electrolyte system for machining the full length 5"/54 gun barrel. This increased the total electrolyte system capacity to 1800 gallons but was far below the recommended size of 21,000 gallons (3 gallons per ampere). The auxiliary tank was used as an integral part of the electrolyte system in preference to using it as a reservoir for replenishing electrolyte loss through centrifuging. This was accomplished by using circulating pumps and piping to connect the two tanks. It was hoped that enlarging the electrolyte system would reduce agitation and permit a more laminar flow of the electrolyte. This would have allowed the settling out of sludge and foreign particles in the electrolyte. However, the flow volume of circulating electrolyte (80 gallons per minute) was too great for a laminar flow and there was considerable electrolyte agitation in the tanks. In all probability the agitation and suspension of foreign particles was partly responsible for sparkouts encountered in machining.

5.2 Electrolyte Circuit

The electrolyte tank (Figure 11) is constructed of fiberglass with an internal partition. This partition actually forms two independent tanks. One side is called the clean side (800 gallons) and the other side the sludge side (400 gallons). Electrolyte is pumped and filtered from the clean side and through the heat exchanger for temperature control. Chilled water is supplied by the outside water chiller (Figure 12) and modulated through the heat exchanger to maintain the electrolyte at a predetermined temperature within two degrees. In addition to a set of filters at the tank outlet, the electrolyte passes through a final filter and on through a flow meter. The flow meter is a very necessary instrument as

it indicates the size of machining gap being maintained and the bore size being machined. In other words, it serves somewhat like an air gauge used for bore measuring.

From the flow meter the electrolyte enters a high pressure flexible hose leading to the porting block. This hose extends through the gun barrel from the breech end to the porting block and retracts as machining progresses. The electrolyte flows through the porting block (Figure 9), beyond the cathode and then reverses direction to flow forward through the machining gap. In the machining gap electrolysis occurs, electrolyte temperature increases to 140°F, and the sludge (a by-product) is washed away. The used electrolyte is exhausted down the barrel which is open to the atmosphere and discharged into the sludge side of the electrolyte tank. From the sludge side of the tank, the electrolyte is pumped through the centrifuge (Figure 13) for sludge removal. The relatively clean electrolyte is then discharged back into the clean side of the electrolyte tank. During the machining process, the electrolyte is flowing at the rate of 60 gallons per minute. This keeps the entire system in agitation and dependent upon centrifuging for cleanness. As stated before, the electrolyte system should be large enough to permit a laminar flow of electrolyte and cleaning by sedimentation.

5.3 Electrolyte Sludge Content

An interesting aspect of electrochemical machining is the amount of sludge produced in relation to the amount of metal machined from the workpiece. In boring and rifling a 5 inch gun barrel, approximately 250 cubic inches of metal is removed. This volume of metal, when changed into sludge by ECM machining, results in approximately 350 gallons of centrifuged sludge. This sludge is of a rather thick consistency although a large percentage of it is electrolyte solution. This high liquid content of centrifuged sludge makes it unacceptable as a landfill material in meeting environmental regulations and is difficult to dispose. The high liquid content also means a loss of electrolyte solution that could be saved by a more efficient clarification system.

5.4 Diatomaceous Earth Filtering System

In an effort to find a more efficient method of electrolyte clarification, tests were performed with a vacuum precoat diatomaceous earth filtering system. The tests showed this may be the ultimate system for electrolyte clarification. The system yields a sludge with minimum moisture content that is suitable for landfill disposal. The low moisture content is also a saving in electrolyte loss. This would be a large factor to consider when using sodium nitrate with current prices of approximately 35 cents per gallon. This filtering system should be used with an electrolyte system large enough to permit settling of the sludge. The settled sludge would periodically be pumped from the settling tank for filtering.

The filtering process involves a vacuum drum coated on the outside with diatomaceous earth as a filtering media. The sludge is vacuumed through the diatomaceous earth from the outside. The sludge particles that are one to four microns in size are collected on the outer layer of the filtering media. The outer layer immediately becomes clogged and loaded with the small dehydrated solid particles. To dispose of these particles and again expose a clean filtering surface,

the drum continually rotates past a fixed knife. The knife scrapes away the filtered particles plus several thousandths of an inch of filtering material, thereby exposing a new clean filtering surface. The drum rotation speed and knife penetration rate are variable which makes it a rather versatile system.

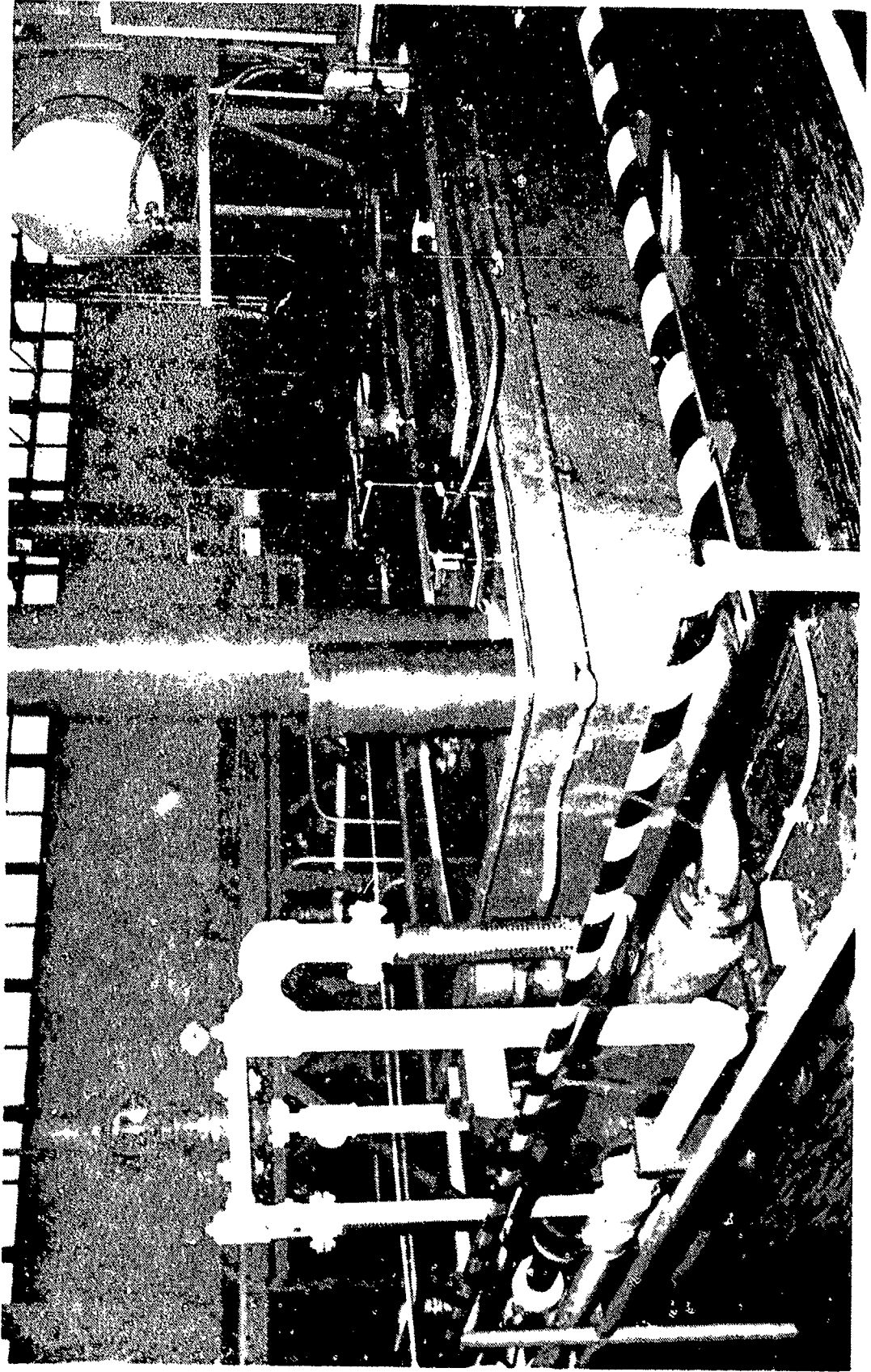

ELECTROLYTE TANK

FIGURE 11

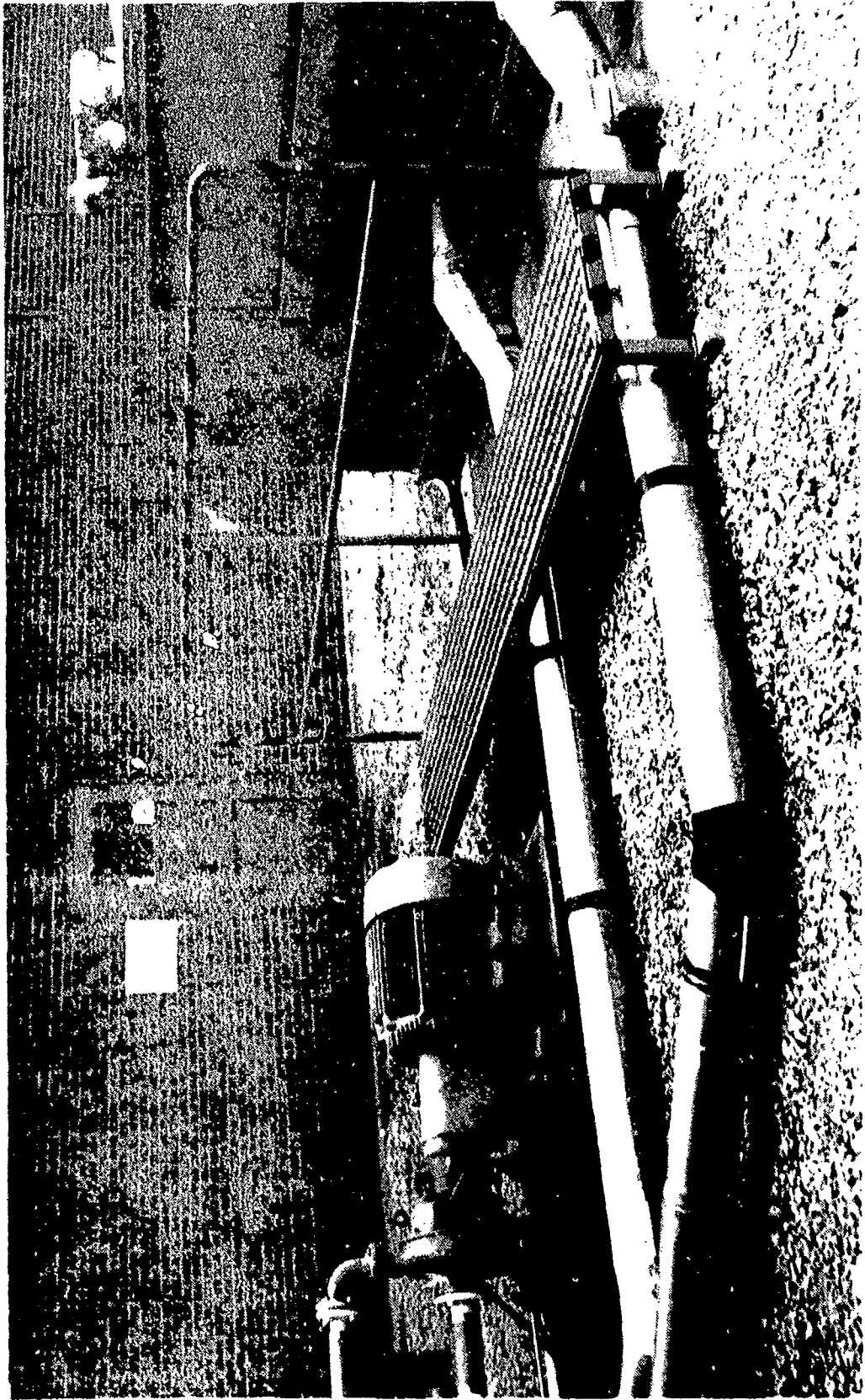

WATER CHILLER

FIGURE 12

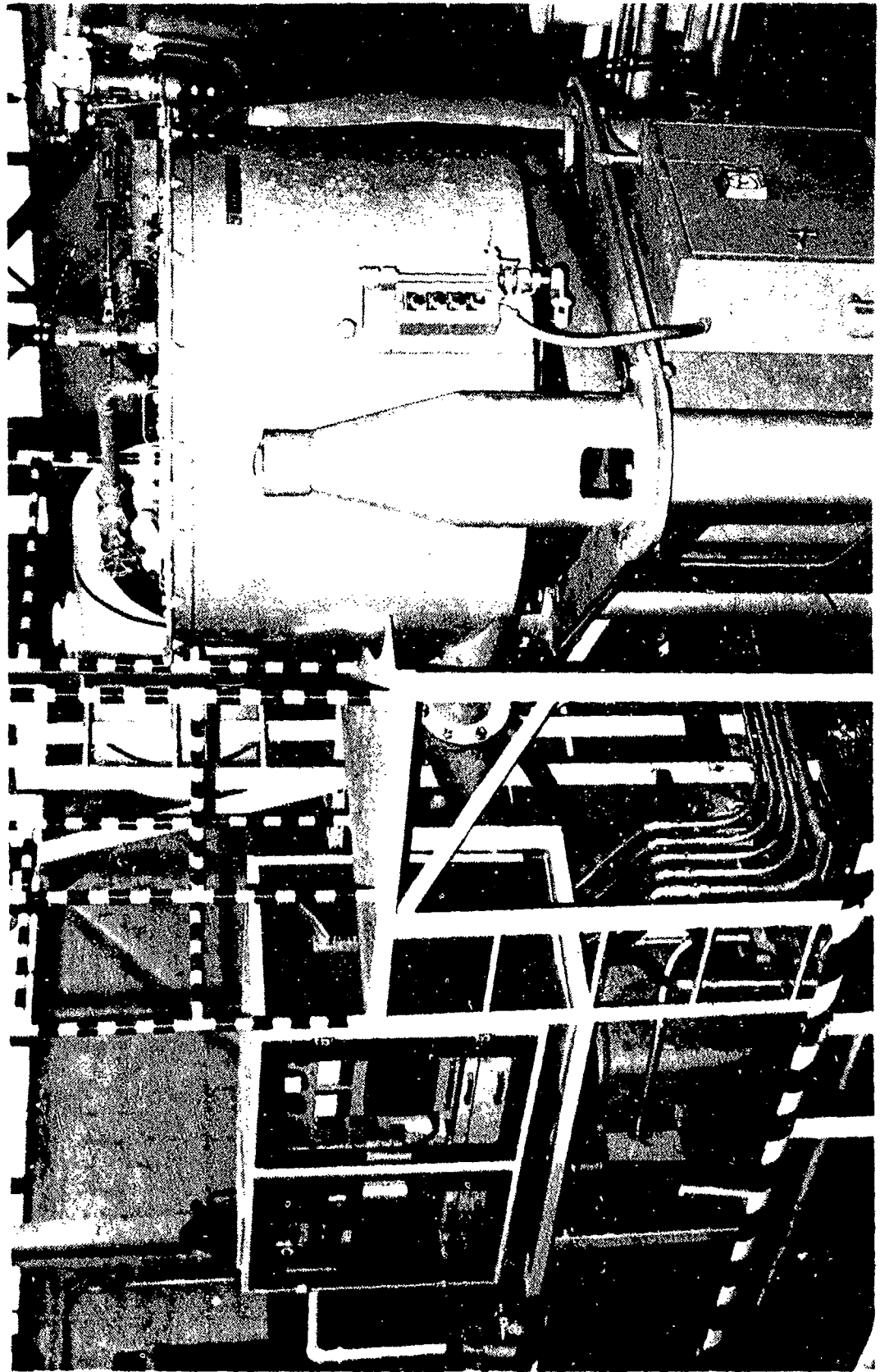

CENTRIFUGE

FIGURE 13

SECTION 6

TOOL DEVELOPMENT

The initial cathode tool design was a frustum with a 50 degree included angle containing the rifling and groove configuration (Figure 14). The 50 degree included angle resulted in engagement of the cathode with the barrel bore at an angle of 25 degrees on the side. It was intended this design would remove .200 of metal from a pilot bore of 4.800 plus the groove depth of .050 per side with the tool advancing at a rate of .275 inch/minute. It was discovered that the 4.800" diameter was not large enough for removing all forging slag from the pilot bore. The slag, contrary to feasibility reports, could not be ECM machined. Forging slag is dielectric and unaffected by the electrochemical machining process and its adherence to the barrel surface is too great for effective erosion by the electrolyte. As the underlying metal was removed by the advancing cathode, the existing slag became a protrusion in the machining gap that eventually came in contact with the cathode. This restricted the flow of electrolyte and machining became ineffective in the slag area, resulting in a sparkout. To insure the pilot bore would be free of forging slag and surface inclusions, the pilot bore was enlarged to 4.940" diameter. Another advantage in enlarging the pilot bore diameter was there would be less metal to remove by the ECM process. A cardinal rule in electrochemical machining is never ECM material or a configuration that can economically be machined by conventional means. Since the pilot bore is initiated on a conventional deep hole boring machine, it only required making an extra cut to enlarge the bore and remove all slag.

6.1 Lands and Grooves

With the pilot bore established at 4.940" diameter, a number of additional tests were performed, including machining a full length gun barrel. These tests produced inconclusive results and there was evidence of severe sparking in the machining gap. This was indicated by burned spots on the cathode lands (counterpart of the gun barrel grooves, Figure 14). Efforts to correct this condition by varying the feed rate, voltage, etc. seemed to have little or no effect. From these results it was evident more extensive testing was required. Due to the anticipated number of tests required for solving this problem, it was decided to use scaled down tooling for expedience and economy.

6.2 Experimental Scaled Down Tooling

One quarter scaled down tooling was constructed (Figure 15) and installed on the large ECM gun barrel bore and rifling machine (Figure 16). This tooling would permit performing a large number of tests, using small test pieces, in a minimum of time. Although the tooling was designed to one quarter size, the full scale groove depth of .050 inch was maintained. It was suspected the main problem existed in that area where the volume of metal being removed varied. The scaled down tooling was constructed using a one piece copper tungsten cathode that incorporated several modifications from the original design. One modification changed the included angle of the frustum shaped cathode from 50 degrees to 10 degrees. This allowed the cathode to engage the workpiece at

a 5 degree angle on a side. This differed from the original design of 25 degrees. The reasoning for this modification was that a larger effective cathode area would be utilized for consuming more current with optimum current density. Current density is the amount of current passed through a given area of effective cathode surface and is expressed in amperes per square inch. The optimum current density for machining steel is approximately 1100 amperes per square inch; thus, recalling Faraday's laws - the rate of metal removal is directly proportional to the total amount of current flowing through the machining gap (current density X sq/in effective cathode area = total current).

Approximately 30 machining tests were performed with the scaled down tooling mounted in the large ECM gun barrel rifling machine. These tests involved machining with different parameters by changing the speed, voltage, electrolyte temperature and even a complete change in the type of electrolyte (sodium nitrate to sodium chloride). This was done to determine the source of persistent and sporadic machining difficulties encountered throughout the gun barrel boring and rifling program. The results of these tests indicated there were areas of electrolyte starvation in the machining gap caused by a land/groove overcut variance in the ratio of two to one (.010 and .020 - .015 and .030). This variance was caused by two different volumes of metal (lands and grooves) being removed, yet each was being exposed to electrochemical machining for the same period of time. The larger overcut allowed most of the electrolyte to flow to the areas (gun barrel lands) of least resistance, thereby starving other areas (gun barrel grooves) which actually required more electrolyte due to the larger volume of metal to be removed. Technically, this is similar to having 45 (number of barrel lands) high velocity orifices adjacent to and interconnected with 45 low velocity orifices. High pressure (275 psi) electrolyte flowing through different size orifices resulted in cavitation and aspiration within the machining gap. Based on this theory, it was apparent that both the land and groove machining gap must produce the same overcut and have the same length. This would provide for the equal resistance of electrolyte flow in all areas of the total rifling configuration.

6.3 Linear Insulation of the Scaled Down Cathode

At first it seemed impossible to equalize the resistance to flow of the electrolyte in both the land and groove areas. A cathode designed with equal machining gap lengths for both the land and groove areas machined a larger overcut on the barrel land due to the smaller volume of metal being removed. If the barrel land machining gap was shortened in length for maintaining equal overcut, the differential in length would have in itself created unequal resistance to flow. In summary, and considering the machining gaps (lands and grooves) as adjoining and interconnected orifices, it was imperative they have identical thickness and length for uniform electrolyte flow.

To solve this problem, a subscale cathode for machining an equal overcut for both the land and groove areas was designed, built, and successfully tested. This involved a complicated cathode design but was considered an absolute necessity for maximum ECM machining efficiency. This design required a two piece segmented cathode (Figures 17 and 18) with one piece being of a nonconductive material. The linear dimension of the insulation controlled the machining time in the barrel land machining gap and its length was relative to the volume of

metal to be removed. The rifling helix angle of $7^{\circ}-9'-45''$ was omitted on the sub-scale cathode; however, all effective angular machining surfaces were 5° to the cathode axis. There was a uniform .010 inch overcut around the cathode as it entered the pilot bore. Machining in the barrel land gap was interrupted at the point of insulation. The .010 inch overcut initially established was maintained as the cathode advanced due to the insulated surface. This surface was parallel with the axis of the cathode and extended to a point of intersection with the conductive material. At this point total form machining of the rifling configuration was resumed with an equal amount of metal being removed from both the land and groove areas. In essence, machining was curtailed in the barrel land machining gap while machining was continuous in the barrel groove machining gap. At a calculated point, when the metal to be removed was equal in both machining gaps, total form machining was continued.

The results of the tests (Figure 19) conducted with the segmented-insulated-cathode were conclusive enough that the following basic guidelines can be established for maximum ECM efficiency of rifling configurations:

- A. All effective (conductive) cathode surfaces must engage the workpiece at the same angle.
- B. All machining gaps must be equal in length.
- C. When different volumes of metal to be removed are involved, linear insulation of the cathode in proportion to the differential in volumes is required for maintaining an equal machining gap thickness.

6.4 Electrolyte Concentration

While conducting tests with the scaled down tooling, another very important factor was ascertained. It was learned that the electrolyte concentration of 4 lbs of sodium nitrate (NaNO_3) to a gallon of water, used for all previous machining tests in the project, was incorrect. In retrospect, this had plagued the project since its beginning and its continued use only emphasized the need to investigate the many critical parameters involved in electrochemical machining. It was felt that the scaled down tooling was the ultimate in cathode design, yet the machined surface produced was imperfect. The surface had a ripple finish that seemed to originate in the frontal machining gap. The surface in the frontal machining gap had a burnt burnished appearance that somewhat resembled a weld fillet in color. It was decided that the electrolyte was too concentrated (too hot) and possibly so conductive as to permit arcing in the machining gap. Gradual reductions in the electrolyte concentration were made until it was established that approximately 2 lbs of sodium nitrate to a gallon of water was a more realistic concentration.

The use of the high electrolyte concentration in addition to inadequate tool design greatly compounded the problems encountered in the early stages of the project. This can be attributed to the infancy and complexity of the ECM process. Due to this, the results of tests prior to test #73 are erroneous and misleading, and are omitted from this report.

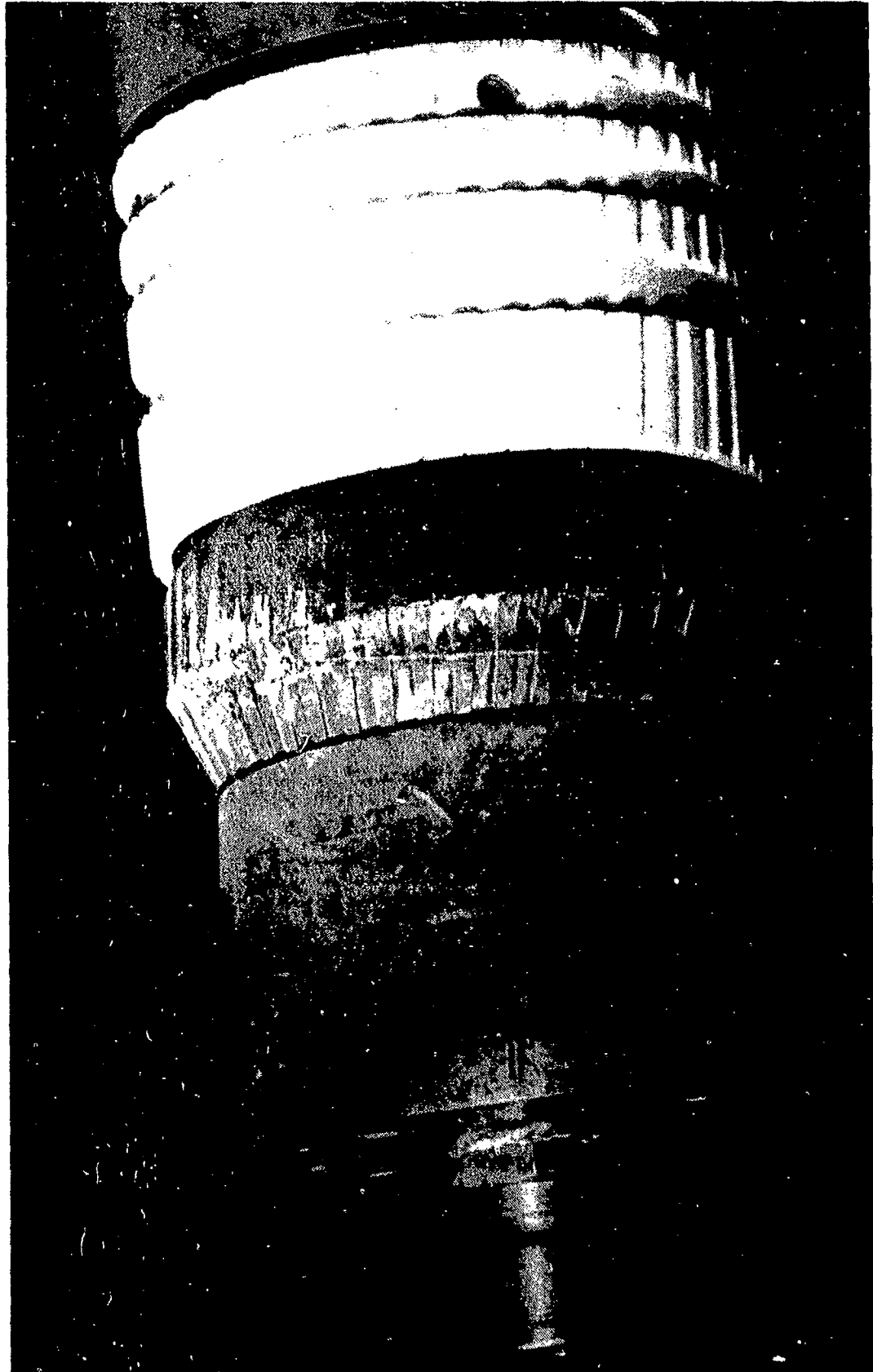

TOOLING HEAD (25 DEGREE CATHODE)

FIGURE 14

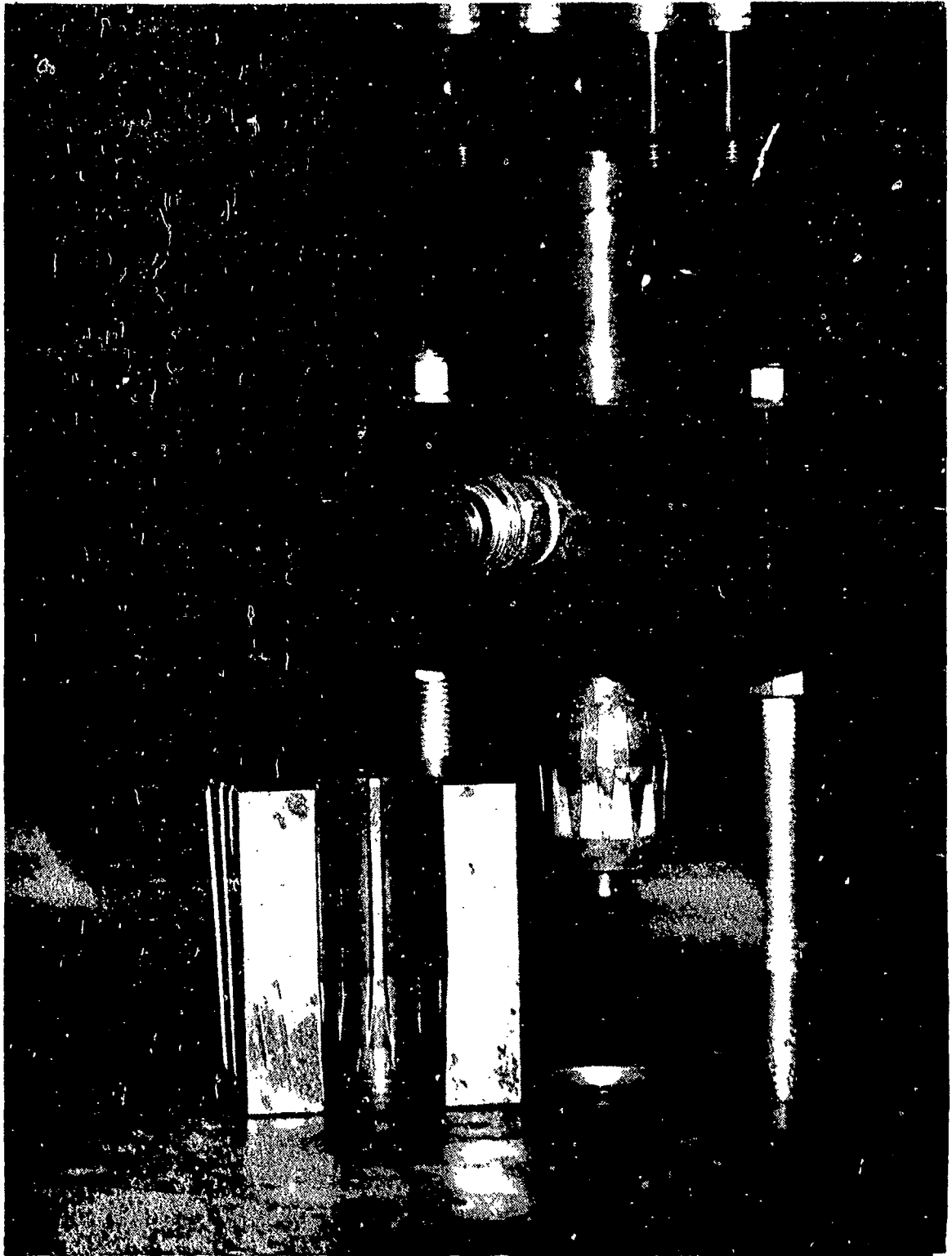
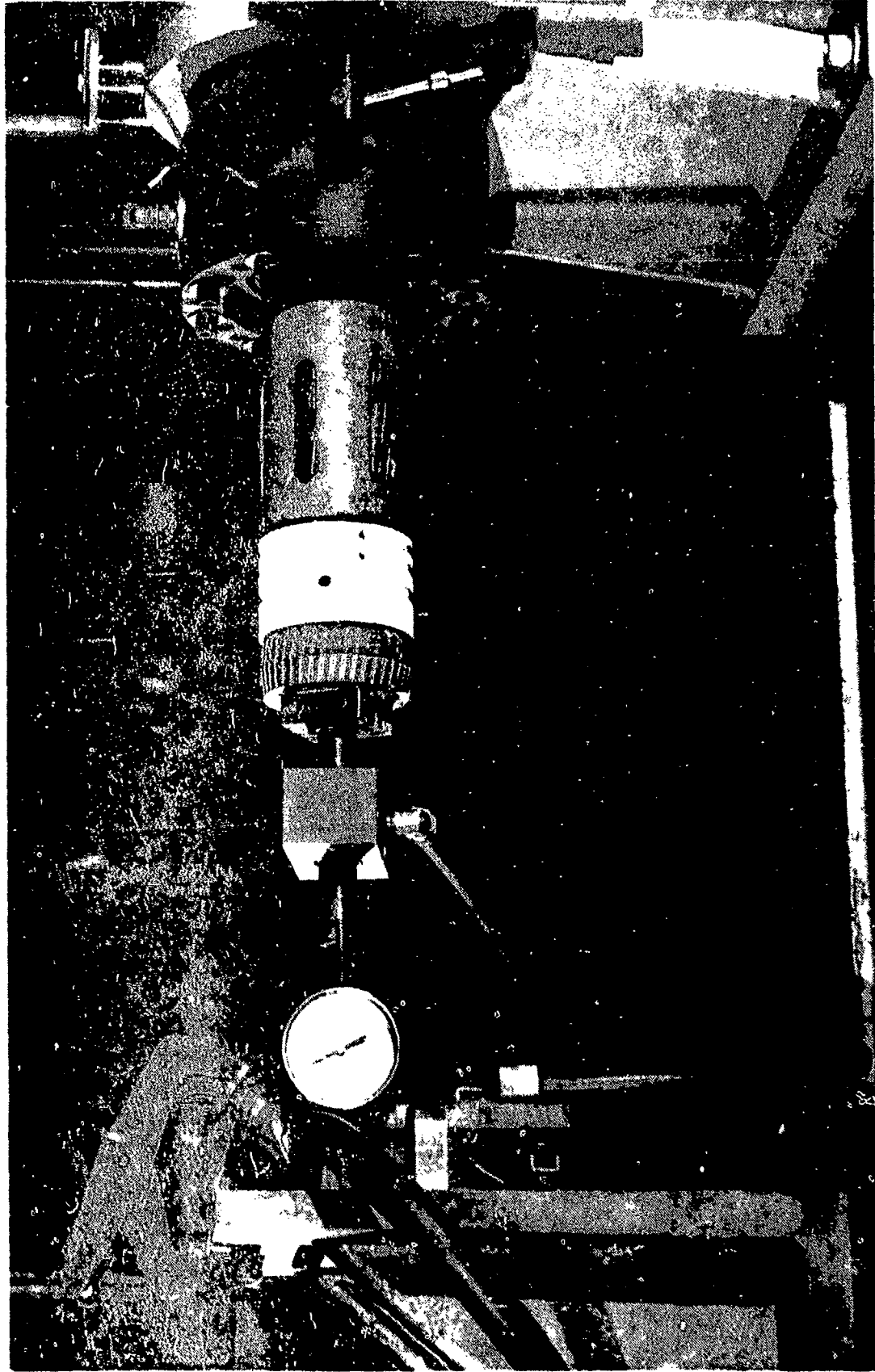

FIGURE 15

SCALED DOWN TOOLING



SCALED DOWN TOOLING INSTALLATION

FIGURE 16

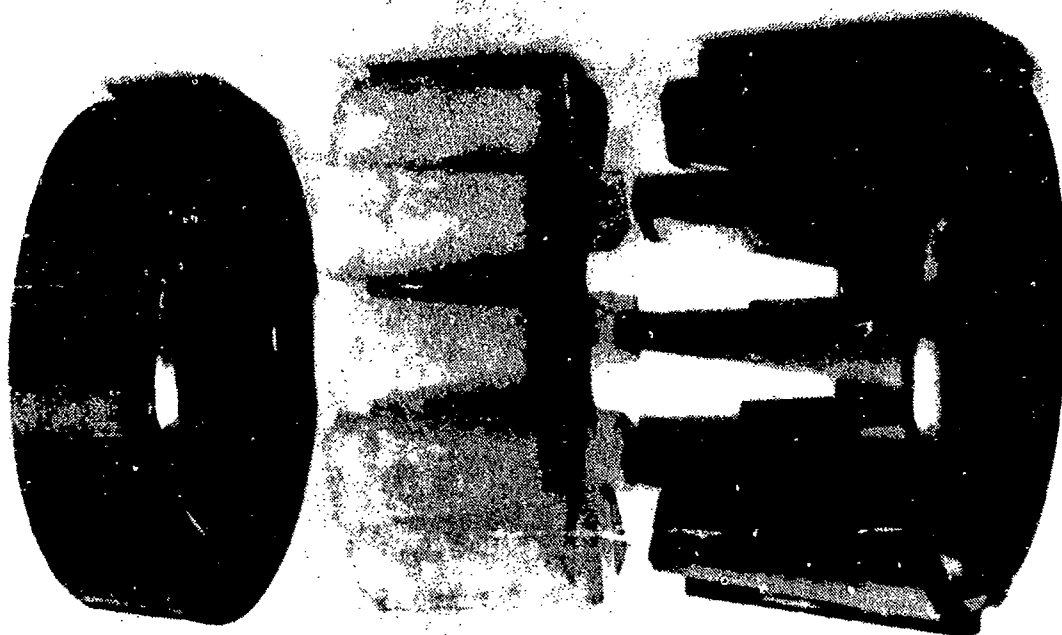

FIGURE 17

SCALED DOWN SEGMENTED CATHODE
(EXPLODED VIEW)

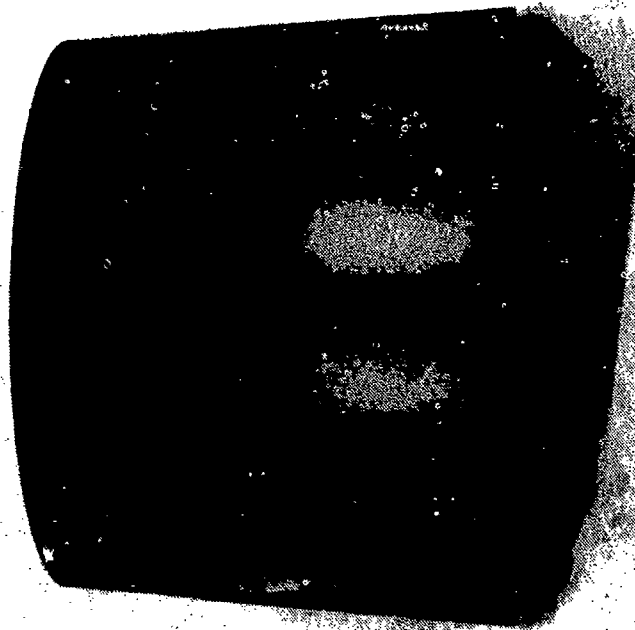

FIGURE 18

SCALED DOWN SEGMENTED CATHODE

TEST NO.	ELECTROLYTE	DENSITY	TEMP (°F)	PH	SPEED (IN/MIN)	VOLTS	AMPS	PRESSURE (PSI)	FLOW (GPM)	OVERCUT LAND GROOVE	FINISH LAND GROOVE
73	NaNO ₃	1.285 @ 95°F	110	7.6	1.000	15	2000	275	15	.010 .010	Poor Poor
74	NaNO ₃	1.285 @ 95°F	110	7.6	.500	9	1000	275	17	.010 .010	Fair Fair
75	NaNO ₃	1.143	110	7.6	1.000	15	2000	250	10	.008 .008	Excellent Excellent
76	NaNO ₃	1.143	110	7.7	1.000	18	2100	250	15	.0105 .0105	Excellent Excellent
77	NaNO ₃	1.143	110	7.7	1.000	18	2100	255	15	.0105 .0105	Excellent Excellent
78	NaNO ₃	1.145	110	7.7	.800	15	1900	250	12	.0095 .0095	Excellent Excellent
79	NaNO ₃	1.145	110	7.7	.800	15	1700	250	20	.0105 .0105	Excellent Excellent
80	NaNO ₃	1.145	110	7.7	1.000	18	2100	250	19	.0105 .0105	Excellent Excellent
81	NaNO ₃	1.154	110	7.5	1.000	15	2000	250	12	.0085 .0085	Excellent Excellent
82	NaNO ₃	1.154	110	7.5	1.000	18	2100	250	16	.011 .011	Excellent Excellent
83	NaNO ₃	1.154	110	7.5	.800	18	1700	250	20	.011 .011	Excellent Excellent

All tests were numbered consecutively throughout the ECM program.

FIGURE 19

TEST DATA - SCALED DOWN TOOLING

SECTION 7

FULL SIZE SEGMENTED TOOLING

The conclusive results obtained with the scaled down tooling warranted the construction of full size tooling (Figure 20). From these results, precise allowances for land/groove overcut were calculated to produce the required 5"/54 gun barrel rifling configuration (Figure 21). The accuracy of these calculations is evident by the machined land/groove dimensions (Figure 22). The circumferential effective machining surfaces of the cathode were designed 5 degrees to the cathode axis. To include the rifling helix twist, the center line of the cathode lands was located $7^{\circ}-9'-45''$ to the cathode axis. The angular sides of the cathode lands were located 5° to the cathode land center line. This resulted in all the effective machining surfaces of the cathode (circumferential and side cut) engaging the workpiece at 5 degrees to the helix angle required for producing the rifling twist. The insulated surfaces of the cathode were designed parallel to the cathode axis for maintaining the established side overcut of .010 inch. The insulating material was a continuous filament woven glass fabric impregnated with epoxy resin conforming to MIL-P-18177. Although this material has a relatively low coefficient of thermal expansion, it still must be taken into consideration when calculating the diameter of the insulated surfaces. Estimated machining gap temperature is 180°F . This requires calculating the expansion for a 100°F rise in operating temperature. The accuracy of the insulated surfaces cannot be over emphasized since it is in this area that the static machining gap thickness is maintained.

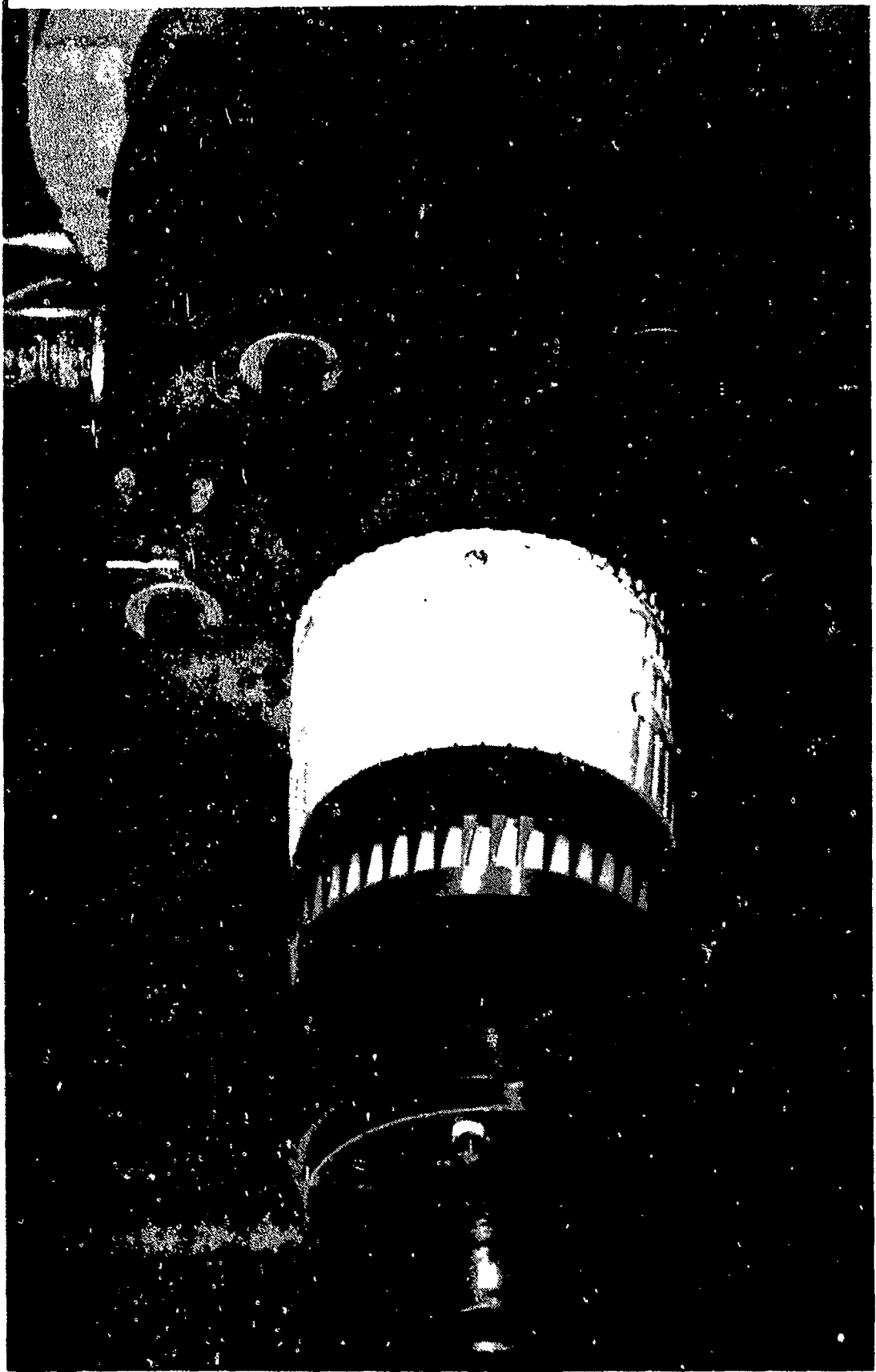

FULL SIZE SEGMENTED TOOLING

FIGURE 20

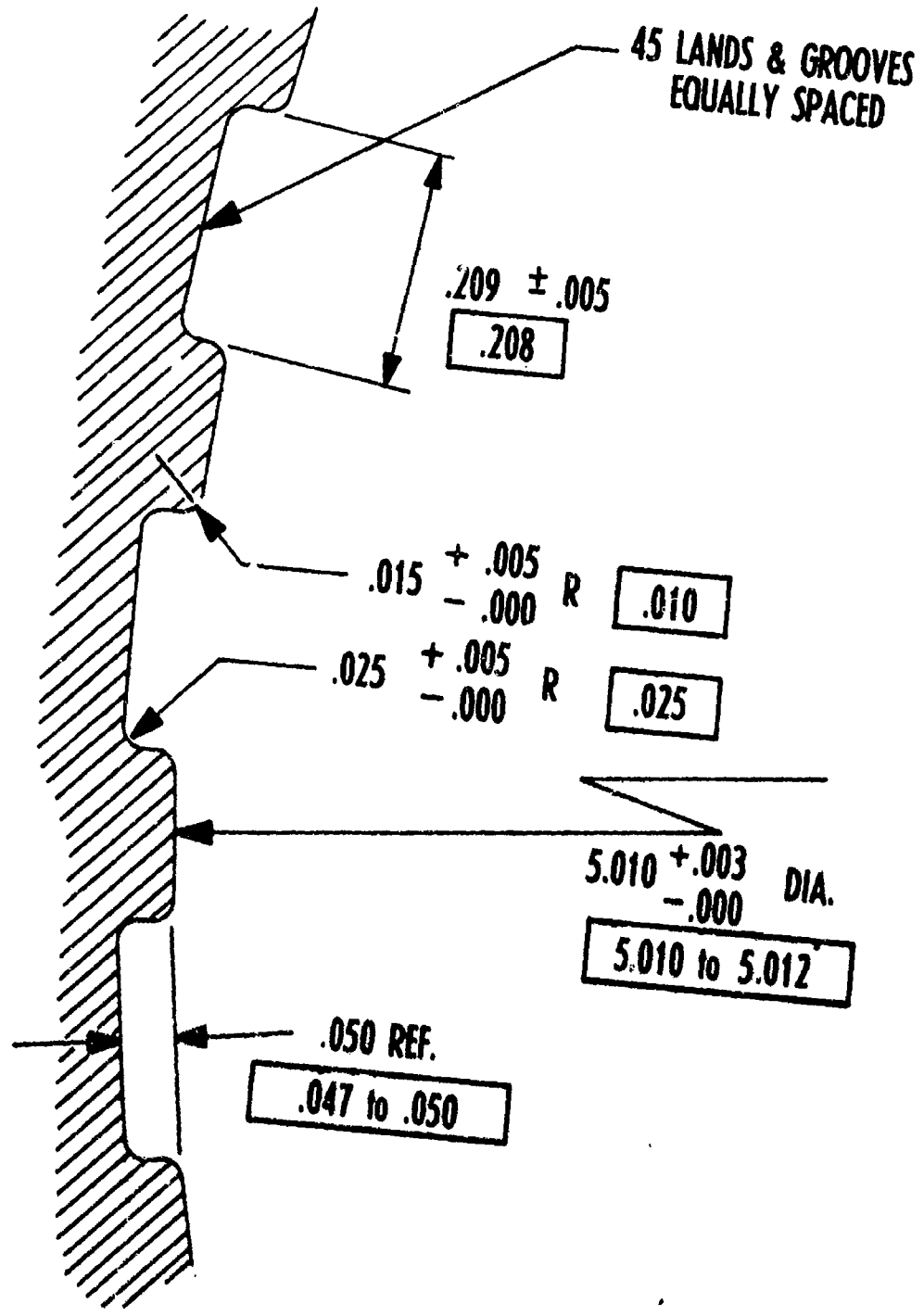

.XXX -DRAWING REQUIREMENTS
.XXX - TYPICAL DIMENSIONS ACHIEVED

FIGURE 21

5" / 54 GUN BARREL RIFLING CONFIGURATION

REMARKS

a. Constant Factors

Electrolyte Solution - Sodium Nitrate (NaNO₃)
 Electrolyte Concentration - 1.146 Specific Gravity @ 110°F (approx. 2 lbs/gal)
 Electrolyte Pressure - 250 psi
 Electrolyte Ph - 7.5

b. Ram speed was deliberately changed for experimental purposes in chamber area (246 inches from muzzle face)

c. Volts were manually adjusted for maintaining constant amperage

INCHES FROM MUZZLE FACE	ELECTROLYTE TEMP (°F)	RAM SPEED (IN/MIN)	VOLTS	AMPS	ELECTROLYTE FLOW GPM	DIMENSIONS	
						LAND INCHES	GROOVE INCHES
1	110	.750	15	6650	60	5.011	5.108
2	110	.750	15	6650	60	5.010	5.108
3	110.5	.750	15	6650	60	5.010	5.107
4	110	.750	15	6650	60	5.010	5.107
5	110.5	.750	15	6650	60	5.010	5.107
6	110.5	.750	15	6650	61	5.010	5.107
7	108	.750	15	6650	59	5.010	5.107
8	108	.750	15	6650	59	5.011	5.108
9	110	.750	15	6650	60	5.011	5.108
10	111	.750	15	6650	60	5.011	5.108
11	111	.750	15	6650	61	5.011	5.108
12	112	.750	15	6650	61	5.010	5.108
13	110	.750	15	6650	61	5.010	5.108

FIGURE 22

MACHINING PARAMETERS AND BORE-GROOVE MEASUREMENTS
 5"/54, MK 18, MOD 5 ELECTROCHEMICALLY MACHINED GUN BARREL

INCHES FROM MUZZLE FACE	ELECTROLYTE TEMP (°F)	RAM SPEED (IN/MIN)	VOLTS	AMPS	ELECTROLYTE FLOW GPM	DIMENSIONS	
						LAND INCHES	GROOVE INCHES
14	110	.750	15	6650	60	5.010	5.108
15	110	.750	15	6650	60	5.010	5.108
16	110.5	.750	15	6650	60	5.010	5.108
17	111	.750	15	6650	60	5.010	5.108
18	110	.750	15	6650	60	5.010	5.108
19	109.5	.750	15	6650	60	5.010	5.108
20	110	.750	15	6650	60	5.011	5.108
21	110	.750	14.9	6700	60	5.011	5.108
22	110	.750	14.9	6700	60	5.011	5.109
23	110.5	.750	14.9	6700	60	5.011	5.109
24	110.5	.750	14.9	6700	61	5.011	5.109
25	110.5	.750	14.9	6750	60	5.011	5.109
26	110.5	.750	14.9	6750	60	5.012	5.109
27	110.5	.750	14.9	6750	60	5.012	5.109
28	110	.750	14.9	6750	60	5.012	5.109
29	110	.750	14.9	6750	60	5.012	5.109
30	110	.750	14.9	6750	60	5.012	5.109
31	110.5	.750	14.9	6750	60	5.012	5.109
32	110.5	.750	14.9	6750	60	5.012	5.109
33	110	.750	14.9	6750	60	5.012	5.110
34	110	.750	14.9	6750	60	5.012	5.109
35	110.5	.750	14.9	6800	60	5.012	5.110
36	110.5	.750	14.9	6800	60	5.012	5.110
37	110.5	.750	14.9	6800	60	5.012	5.109
38	110.5	.750	14.9	6800	60	5.011	5.108
39	110.5	.750	14.9	6800	60	5.010	5.108
40	111.5	.750	14.9	6800	60	5.010	5.107
41	110.5	.750	14.9	6800	60	5.010	5.107
42	109.5	.750	14.9	6800	55.5	5.010	5.107
43	108.5	.750	14.9	6800	55.5	5.010	5.107
44	108	.750	14.9	6800	55.5	5.010	5.107
45	107.5	.750	14.9	6800	55.5	5.010	5.107

FIGURE 22 - Continued

INCHES FROM MUZZLE FACE	ELECTROLYTE TEMP (°F)	RAM SPEED (IN/MIN)	VOLTS	AMPS	ELECTROLYTE FLOW		DIMENSIONS	
					GPM	INCHES	LAND INCHES	GROOVE INCHES
46	108	.750	14.9	6800	55.5	5.010	5.107	
47	109	.750	14.9	6800	55.5	5.010	5.107	
48	110.5	.750	14.9	6775	55.5	5.010	5.107	
49	110.5	.750	14.9	6800	55.5	5.010	5.107	
50	110.5	.750	14.9	6800	55.5	5.010	5.107	
51	110.5	.750	14.9	6800	55.5	5.010	5.107	
52	110.5	.750	14.9	6800	55.5	5.010	5.107	
53	110.5	.750	14.9	6800	55.5	5.010	5.107	
54	110.5	.750	14.9	6800	55.5	5.010	5.107	
55	110.5	.750	14.9	6800	55.5	5.010	5.107	
56	110.5	.750	14.9	6800	55.5	5.010	5.107	
57	110.5	.750	14.9	6800	55.5	5.010	5.107	
58	110.5	.750	14.9	6800	55.5	5.010	5.107	
59	110.5	.750	14.9	6800	55.5	5.010	5.107	
60	110.5	.750	14.9	6800	55.5	5.010	5.107	
61	110.5	.750	14.9	6825	55.5	5.010	5.106	
62	109	.750	14.9	6725	55.5	5.009	5.106	
63	108	.750	14.9	6725	55	5.009	5.107	
64	112	.750	14.9	6800	55	5.009	5.107	
65	108.5	.750	14.9	6800	55.5	5.009	5.107	
66	110	.750	14.9	6800	55	5.010	5.107	
67	111	.750	14.9	6800	55	5.010	5.107	
68	111.5	.750	14.9	6800	55	5.010	5.107	
69	112	.750	14.9	6800	55	5.010	5.107	
70	110.5	.750	14.9	6800	55.5	5.010	5.107	
71	110.5	.750	14.9	6800	55.5	5.010	5.107	
72	110.5	.750	14.9	6800	55.5	5.010	5.107	
73	110	.750	14.9	6800	55.5	5.010	5.107	
74	110.5	.750	14.9	6800	55.5	5.010	5.107	
75	109.5	.750	14.9	6800	55.5	5.010	5.107	
76	110	.750	14.9	6800	55.5	5.010	5.107	
77	110	.750	14.9	6800	55.5	5.010	5.107	

FIGURE 22 - Continued

INCHES FROM MUZZLE FACE	ELECTROLYTE TEMP (°F)	RAM SPEED (IN/MIN)	VOLTS	AMPS	ELECTROLYTE FLOW GPM	DIMENSIONS	
						LAND INCHES	GROOVE INCHES
78	110.5	.750	14.9	6825	55.5	5.010	5.107
79	110.5	.750	14.9	6825	55.5	5.010	5.107
80	110.5	.750	14.9	6800	55.5	5.010	5.107
81	110	.750	14.9	6800	55.5	5.010	5.108
82	110.5	.750	14.9	6800	55.5	5.010	5.108
83	110.5	.750	14.9	6800	55.5	5.010	5.108
84	110.5	.750	14.9	6800	55.5	5.010	5.108
85	110.5	.750	14.9	6800	55.5	5.010	5.108
86	110.5	.750	14.9	6800	55.5	5.010	5.108
87	110	.750	14.7	6800	55.5	5.010	5.108
88	110	.750	14.75	6800	55.5	5.010	5.108
89	110	.750	14.75	6800	55.5	5.010	5.108
90	110.5	.750	14.75	6800	55.5	5.010	5.108
91	110	.750	14.75	6800	55.5	5.010	5.107
92	110	.750	14.75	6800	55.5	5.010	5.107
93	110	.750	14.75	6800	55.5	5.010	5.107
94	110	.750	14.75	6800	55.5	5.010	5.107
95	110	.750	14.75	6800	55.5	5.010	5.107
96	110	.750	14.75	6800	55.5	5.010	5.107
97	110	.750	14.75	6800	55.5	5.010	5.107
98	110	.750	14.75	6800	55.5	5.010	5.107
99	110	.750	14.75	6800	55.5	5.010	5.107
100	110.5	.750	14.75	6800	55.5	5.010	5.107
101	110.5	.750	14.75	6800	55.5	5.010	5.107
102	110.5	.750	14.75	6800	55.5	5.010	5.107
103	110.5	.750	14.75	6800	55.5	5.010	5.107
104	110.5	.750	14.75	6800	55.5	5.010	5.107
105	110.5	.750	14.75	6800	55.5	5.010	5.107
106	110.5	.750	14.75	6800	55.5	5.010	5.107
107	110.5	.750	14.75	6800	55.5	5.010	5.107
108	110.5	.750	14.75	6800	55.5	5.010	5.107
109	111	.750	14.70	6800	55.5	5.010	5.107
110	110.5	.750	14.70	6800	55.5	5.010	5.107

INCHES FROM MUZZLE FACE	ELECTROLYTE TEMP (°F)	RAM SPEED (IN/MIN)	VOLTS	AMPS	ELECTROLYTE FLOW GPM	DIMENSIONS	
						LAND INCHES	GROOVE INCHES
111	110.5	.750	14.70	6800	55.5	5.010	5.107
112	110.5	.750	14.70	6800	55.5	5.010	5.107
113	110.5	.750	14.70	6800	55.5	5.010	5.107
114	110.5	.750	14.70	6800	55.5	5.010	5.107
115	110.5	.750	14.70	6800	55.5	5.010	5.107
116	110	.750	14.70	6800	55.5	5.010	5.107
117	110	.750	14.70	6800	55.5	5.010	5.107
118	110	.750	14.70	6800	55.5	5.010	5.107
119	110	.750	14.70	6800	55	5.010	5.107
120	110	.750	14.70	6800	55	5.010	5.107
121	109.5	.750	14.70	6800	55	5.010	5.107
122	109.5	.750	14.70	6800	55	5.010	5.107
123	109.5	.750	14.70	6800	55	5.010	5.107
124	109.5	.750	14.70	6800	55	5.010	5.107
125	109.5	.750	14.70	6800	55	5.010	5.107
126	109	.750	14.70	6800	54	5.010	5.107
127	109	.750	14.70	6800	55	5.010	5.107
128	109	.750	14.70	6800	55	5.010	5.107
129	109.5	.750	14.70	6800	55	5.010	5.107
130	109.5	.750	14.70	6800	55	5.010	5.107
131	110	.750	14.70	6800	55	5.010	5.107
132	110	.750	14.70	6800	55	5.010	5.107
133	110	.750	14.70	6800	55	5.010	5.107
134	110	.750	14.70	6800	55	5.010	5.107
135	110.5	.750	14.70	6800	55	5.010	5.107
136	110.5	.750	14.70	6800	55	5.010	5.107
137	111	.750	14.70	6800	55	5.010	5.107
138	111	.750	14.70	6800	55	5.010	5.107
139	111.5	.750	14.70	6800	55	5.010	5.107
140	111.5	.750	14.70	6800	55	5.010	5.107
141	111	.750	14.70	6800	55	5.010	5.107
142	110.5	.750	14.70	6800	55	5.010	5.107
143	110.5	.750	14.70	6800	55	5.010	5.107

FIGURE 22 - Continued

INCHES FROM MUZZLE FACE	ELECTROLYTE TEMP (°F)	RAM SPEED (IN/MIN)	VOLTS	AMPS	ELECTROLYTE FLOW GPM	DIMENSIONS	
						LAND INCHES	GROOVE INCHES
144	110.5	.750	14.70	6800	55	5.010	5.107
145	110.5	.750	14.70	6800	55	5.010	5.107
146	110.5	.750	14.70	6800	55	5.010	5.107
147	110.5	.750	14.70	6800	55	5.010	5.107
148	110.5	.750	14.70	6800	55	5.010	5.107
149	110.5	.750	14.70	6800	55	5.010	5.107
150	110.5	.750	14.70	6800	55	5.010	5.107
151	110.5	.750	14.70	6800	55	5.010	5.107
152	110.5	.750	14.70	6800	55	5.010	5.107
153	110.5	.750	14.70	6800	55	5.010	5.107
154	110	.750	14.70	6800	55	5.010	5.107
155	108.5	.750	14.70	6800	55	5.010	5.107
156	109.5	.750	14.70	6800	55	5.010	5.107
157	109	.750	14.70	6800	55	5.010	5.107
158	109	.750	14.70	6800	55	5.010	5.107
159	109	.750	14.70	6800	55	5.010	5.107
160	109.5	.750	14.70	6800	55	5.010	5.107
161	109.5	.750	14.70	6800	55	5.010	5.107
162	109.5	.750	14.70	6800	55	5.010	5.107
163	110	.750	14.70	6800	55	5.010	5.107
164	110	.750	14.70	6800	55	5.010	5.107
165	110	.750	14.70	6800	55	5.010	5.107
166	110.5	.750	14.70	6800	55	5.010	5.107
167	110.5	.750	14.70	6800	55	5.010	5.107
168	110.5	.750	14.70	6800	55	5.010	5.107
169	110	.750	14.71	6800	55	5.010	5.107
170	110.5	.750	14.71	6800	55	5.010	5.107
171	110.5	.750	14.71	6800	55	5.010	5.107
172	110.5	.750	14.71	6800	55	5.010	5.107
173	110.5	.750	14.71	6800	55	5.010	5.107
174	110.5	.750	14.71	6800	55	5.010	5.107
175	110.5	.750	14.71	6800	55	5.010	5.107
176	110.5	.750	14.71	6800	55	5.010	5.107

INCHES FROM MUZZLE FACE	ELECTROLYTE TEMP (°F)	RAM SPEED (IN/MIN)	VOLTS	AMPS	ELECTROLYTE FLOW GPM	DIMENSIONS	
						LAND INCHES	GROOVE INCHES
177	110.5	.750	14.71	6800	55	5.010	5.107
178	110.5	.750	14.71	6800	55	5.010	5.108
179	110.5	.750	14.71	6800	55	5.010	5.108
180	110.5	.750	14.71	6800	55	5.010	5.108
181	110.5	.750	14.71	6800	55	5.010	5.108
182	110.5	.750	14.71	6800	55	5.010	5.108
183	111	.750	14.71	6800	55	5.010	5.108
184	111	.750	14.71	6800	55	5.010	5.108
185	110.5	.750	14.71	6800	55	5.010	5.108
186	110.5	.750	14.71	6800	55	5.010	5.108
187	110.5	.750	14.71	6800	55	5.010	5.108
188	110.5	.750	14.71	6800	55	5.010	5.108
189	110.5	.750	14.71	6800	55	5.010	5.108
190	110.5	.750	14.71	6800	55	5.010	5.108
191	110.5	.750	14.71	6800	55	5.010	5.108
192	110.5	.750	14.71	6800	55	5.010	5.108
193	110.5	.750	14.71	6800	55	5.010	5.108
194	110.5	.750	14.71	6800	55	5.010	5.108
195	110.5	.750	14.70	6800	55	5.010	5.108
196	110.5	.750	14.71	6800	54	5.010	5.107
197	110	.750	14.71	6800	54	5.010	5.107
198	110	.750	14.71	6800	54	5.010	5.107
199	109.5	.750	14.71	6800	54	5.010	5.107
200	109.5	.750	14.71	6800	54	5.010	5.107
201	109.5	.750	14.71	6800	54	5.010	5.107
202	109.5	.750	14.71	6800	54	5.010	5.107
203	110	.750	14.94	6800	54	5.011	5.108
204	110	.750	14.00	6750	54	5.011	5.108
205	110.5	.750	15.00	6700	55	5.011	5.108
206	111	.750	15.00	6750	55	5.011	5.108
207	110.5	.750	15.00	6750	55	5.011	5.108
208	110.5	.750	15.21	6800	55	5.011	5.109
209	111	.750	15.35	6800	56	5.012	5.109

FIGURE 22 - Continued

INCHES FROM MUZZLE FACE	ELECTROLYTE TEMP (°F)	RAM SPEED (IN/MIN)	VOLTS	AMPS	ELECTROLYTE FLOW GPM	DIMENSIONS	
						LAND INCHES	GROOVE INCHES
210	111	.750	15.39	6800	56	5.012	5.109
211	110	.750	15.39	6800	56	5.011	5.109
212	110	.750	15.39	6775	56	5.011	5.109
213	110.5	.750	15.39	6800	56	5.011	5.109
214	110.5	.750	15.39	6800	56	5.011	5.109
215	110	.750	15.39	6800	56	5.011	5.109
216	110	.750	15.39	6800	56	5.011	5.109
217	110.5	.750	15.39	6800	56	5.011	5.109
218	110.5	.750	15.39	6800	56	5.011	5.109
219	110.5	.750	15.39	6800	56	5.012	5.109
220	110.5	.750	15.39	6800	56	5.012	5.109
221	111	.750	15.39	6800	56	5.012	5.109
222	110	.750	15.39	6800	56	5.012	5.110
223	110	.750	15.39	6800	56	5.012	5.109
224	110	.750	15.39	6800	56	5.012	5.109
225	110	.750	15.39	6800	56	5.011	5.109
226	110	.750	15.39	6800	56	5.012	5.109
227	110.5	.750	15.39	6800	56	5.012	5.109
228	110.5	.750	15.39	6800	56	5.012	5.109
229	110.5	.750	15.39	6800	56	5.012	5.109
230	110.5	.750	15.39	6800	56	5.012	5.109
231	110.5	.750	15.39	6800	56	5.012	5.109
232	110.5	.750	15.39	6800	56	5.012	5.109
233	110.5	.750	15.39	6800	56	5.012	5.109
234	110.5	.750	15.39	6800	56	5.012	5.109
235	110.5	.750	15.39	6800	56	5.012	5.109
236	110.5	.750	15.39	6800	56	5.012	5.109
237	110.5	.750	15.39	6800	56	5.012	5.109
238	110.5	.750	15.39	6800	56	5.012	5.109
239	110.5	.750	15.39	6800	56	5.012	5.109
240	110.5	.750	15.39	6800	56	5.012	5.109
241	110.5	.750	15.39	6800	56	5.011	5.109

FIGURE 22 - Continued

INCHES FROM MUZZLE FACE	ELECTROLYTE TEMP (°F)	RAM SPEED (IN/MIN)	VOLTS	AMPS	ELECTROLYTE FLOW GPM	DIMENSIONS	
						LAND INCHES	GROOVE INCHES
242	109.5	.650	15.39	6200	65	5.015	5.112
243	109.5	.650	15.39	6200	65	5.016	5.112
244	109.5	.650	15.39	6200	65	5.016	5.112
245	111	.650	15.39	6200	65	5.016	5.113
246	111.5	.650	15.39	6200	65	5.016	5.113
247	111.5	.650	15.39	6200	65	5.016	5.113
248	111	.650	15.39	6200	65	5.016	5.113
249	111	.650	15.39	6200	65	5.016	5.112
250	110.5	.650	15.39	6200	65	5.016	5.112
251	110.5	.650	15.39	6200	65	5.016	5.112
252	110	.650	15.39	6200	65	5.016	5.112
253	110	.650	15.39	6200	65	5.016	5.112
254	110.5	.650	15.39	6200	65	5.016	5.113
255	110.5	.650	15.39	6200	65	5.016	5.114
256	110	.650	15.39	6200	65	5.015	5.113
257	109.5	.700	15.39	6500	60	5.015	5.111
258	109.5	.700	15.39	6500	60	5.015	5.111
259	109.5	.700	15.39	6500	60	5.014	5.111
260	108.5	.700	15.39	6500	60	5.014	5.111
261	108.5	.700	15.39	6500	60	5.014	5.111
262	108	.700	15.39	6500	60	5.015	5.111
263	109.5	.700	15.39	6500	60	5.015	5.112
264	109.5	.700	15.39	6500	60	5.015	5.112
265	109.5	.700	15.39	6600	60	5.015	5.112
266	109.5	.700	15.39	6600	60	5.016	5.112
267	108.5	.700	15.39	6550	60	5.014	5.110
268	110	.750	15.39	6800	56	5.014	5.110
269	110	.750	15.01	6800	56	5.013	5.110
270	109	.750	14.79	6800	54	5.013	5.109
271	109	.750	14.79	6800	54	5.013	5.109
272	109.5	.750	14.79	6800	54	5.013	5.109
273	109.5	.750	14.79	6800	54	5.013	5.109

FIGURE 22 - Concluded

SECTION 8

ECM MACHINING THE 5"/54 GUN BARREL

The boring and rifling of this gun barrel represents the longest, most successful electrochemical machined cut ever completed.

A previous attempt was made to machine a full length gun barrel but ended with uncontrollable dimensions and a severely damaged cathode. It was felt this attempt would be successful due to the following major modifications made and proven with scaled down tooling:

A. The pilot bore size was increased to insure the absence of any forging slag in the bore. It was discovered, contrary to initial feasibility investigations, that forging slag is nonconductive and consequently cannot be electrochemically machined.

B. A guide block was installed at the front of the cathode to help support and guide the tooling through the pilot bore.

C. The electrolyte concentration was drastically reduced as explained in Section 6.4.

D. The most significant modification was the development of a two piece segmented insulated cathode. This is explained in detail in Section 6.3 and so far as known the development of this tooling concept represents a first in ECM machining.

8.1 Machining Speed

A machining speed of 1.000 inch per minute was achieved with the scaled down tooling. Theoretically, greater machining speeds are possible with the two piece segmented insulated cathode, perhaps up to 2.000 inch per minute. The limiting factor for maximum machining speed is the effective cathode area and/or the available power supply. A machining speed of .750 inch per minute was selected for machining the full length gun barrel. This speed was selected to provide a safety factor in the amount of current required for the full size cathode and the maximum current available. Based on the 2000 amperes required for a machining speed of 1.000 inch per minute with the scaled down tooling (Figure 19), it was calculated that approximately 7000 amperes would be required for the full size 5 inch cathode at the reduced speed of .750 inch per minute.

Although the required machining current did not exceed the ECM power supply capacity, there were interruptions in machining. After machining to a depth of 84 inches, there was a complete power failure. This failure was due to inadequate or defective fuses in the electrical service to the ECM installation and not caused by exceeding the power supply capacity. Machining did not resume until the next day due to the time required to analyze the power failure and install new fuses. Machining continued to a depth of 202 inches when another power failure was encountered. This delayed machining until the following day. Although these power failures were foreign to the ECM process itself, it does emphasize the need for more direct and reliable electrical service to the ECM installation.

These interruptions caused undue exposure of the barrel to the electrolyte. Without these prolonged interruptions in machining, actual exposure time would have been approximately six hours. The increased exposure was surprisingly not detrimental to the gun barrel and is attributed to and further confirms the need of using sodium nitrate electrolyte.

8.2 Restart Procedure

Extended periods of interrupted machining caused by complete power failures are unusual and generally not anticipated. However, brief interruptions caused by sparkouts are not uncommon. In ECM machining there is always the inherent possibility of a sparkout (machine shutdown), particularly during extended periods of machining. A shutdown is activated by a sensing system (Anoguard and Microbar, Figure 6) that detects when machining is approaching an unstable condition. This condition can be caused by small foreign particles (metallic or nonmetallic) in the electrolyte, workpiece passivity, or metallurgical integrity of the workpiece.

Interrupted machining for any reason has always been undesirable and an area of concern in ECM machining. This concern is due to the difficulty in blending the restart cut with the previous cut (before shutdown) without leaving a step dimension in the bore. Applying current too soon will result in overlapping cuts and an enlarged dimension. Late application of machine current will result in a raised area or smaller dimension. The timing is critical considering the cathode is advancing at .750 inch per minute (.0125 inch per second) and current must be applied at a specific point within a .010 inch zone (machining gap at shutdown). Sparkouts were encountered in machining the 5"/54 gun barrel. With the successful restart procedure used, sparkouts are no longer an area of great concern. Sections in the bore where sparkouts did occur are visible with reflected light, as in any interrupted machine cut, but when measured are less than .0005 of an inch.

The restart procedure used was manually operated but could be automated for accuracy and consistency. When a sparkout occurred, the cathode was retracted .020 as indicated on the digital readout. At this point, the cathode was set in forward motion. When .010 of the retracted .020 was regained (as indicated on the rapidly changing digital readout), the machining current switch was activated. Activating this switch does not immediately produce peak current due to the electromechanical and electrochemical forces of the ECM process. Instead, there is a gradual buildup with peak current being reached at a point which coincides with the interrupted cut. The correct timing is in fractions of a second and dependent on an individual's reaction time between observing the readout and responding by applying machining current. Needless to say, the sensitivity of this procedure warrants that it be automated for a production type operation.

8.3 Quality of the ECM Bore and Rifling

Machining of the first ECM bored and rifled 5"/54 gun barrel is considered a definite success and major breakthrough in electrochemical machining. It represents technical efforts in sophisticated tooling, controlled concentricity, and perfection of an acceptable restart method. This was accomplished in spite of adverse conditions of a major power failure and an inadequate electrolyte system.

The inspection report of the barrel reads that "the general appearance of the bore and grooves is good, that they are smoother than that produced by conventional means." The bore and rifling dimensions are to size within the .003 inch allowable tolerance over the entire 23 foot length of barrel. This degree of accuracy extending 23 feet, involving 6 hours of machining time, is unparalleled. This is particularly true when the finished configuration is produced with a one chance-one pass operation with predetermined parameters. This requires that all factors and parameters be established and maintained for producing the dimensions and configuration desired. Figure 23 shows the detail bore and rifling produced by ECM in the full length 5"/54 gun barrel. The dark area in Figure 23 is a metal cast (mirror image) of the actual rifling configuration.

The surface finish, although different in appearance photographically (Figure 24) and difficult to measure with a stylus type profilometer, appears to be superior to a 16 RMS finish. It should be emphasized that an electrochemically machined surface is different than a conventionally machined surface. The surface does not contain the microscopic lay of sharp peaks and valleys as in conventional machining. There is a complete blend of radii and fillets with no tool definition marks or residual stress. The surface is free of hydrogen embrittlement since hydrogen is given off at the tool during machining, not at the workpiece, and the electrolyte Ph is neutral rather than acid. In summary, the smooth (edge and tool mark free) mechanically undisturbed ECM surface is ideal for maximum plating adherence. The degree of improvement in plating adherence will be verified in test firing the completed gun barrel. Plans are to test fire the barrel for immediate Fleet service.

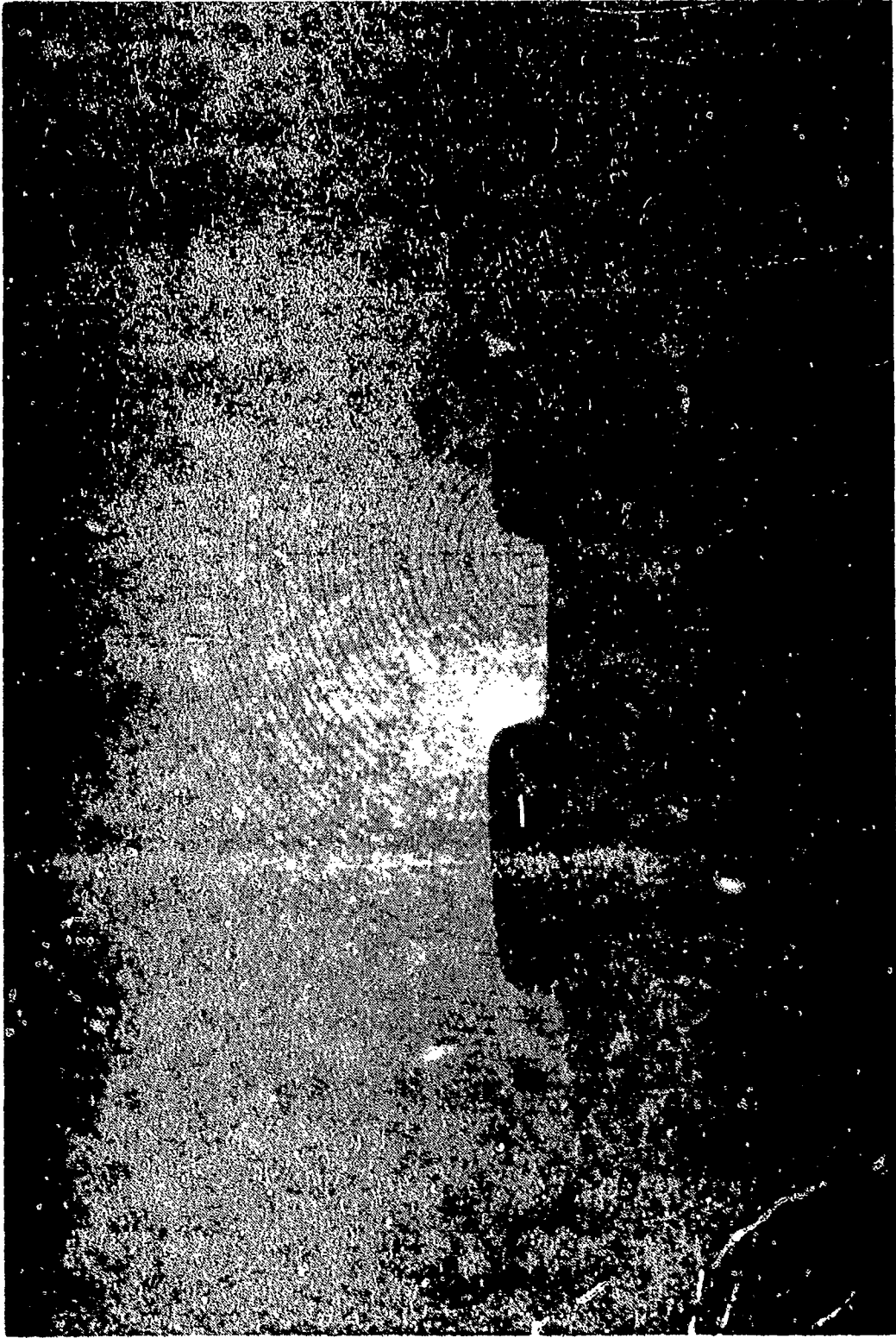

FIGURE 23

ECM RIFLING CONFIGURATION

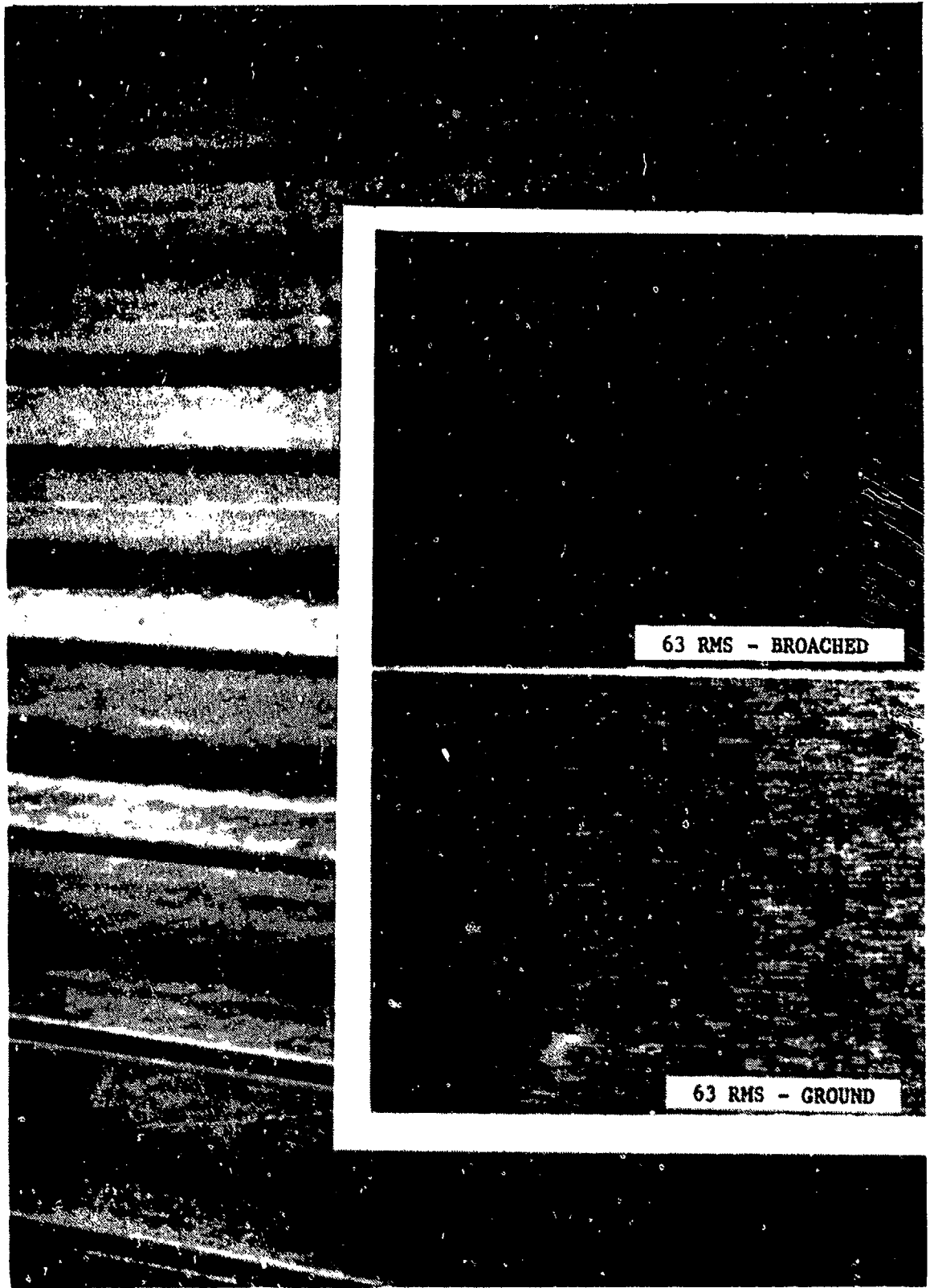

FIGURE 24

ECM AND CONVENTIONAL MACHINED
SURFACE (COMPARISON)

SECTION 9

SUMMARY AND CONCLUSIONS

Machining of the 5"/54 gun barrel represents the longest electrochemical machining operation ever completed. It was accomplished in view of doubtful opinions within the ECM industry due to the type of configuration, length of cut, and specified tolerances. It involved designing and building the actual machine of which there is no equal today for its extraordinary long stroke and dual movement ram (linear and rotary).

Development of the segmented (insulated) tooling to provide partial interrupted machining for equalizing the interconnected differential machining gaps was imperative for single tool-total form machining of rifling configurations. With the conclusive results obtained, the development and use of this tooling establishes a precedent in electrochemical machining. It demonstrates that hydrokinetics in the machining gap are equally as critical as the electrical and chemical aspects of the ECM process.

Any manufacturer engaging in electrochemical machining for the first time must anticipate going through a learning cycle. As stated early in this report, ECM is still very much of an art. Not enough experience has been obtained to establish the limits of the usefulness of the process. Almost every application must be studied on a part by part basis to determine whether or not ECM may be applicable. This lack of information obviously makes the process more expensive because of the timely trial and error process of coordinating the parameters into producing an efficient cut. This is particularly true in boring and rifling gun barrels. A more mammoth and complex project could not have been selected for initially acquiring ECM expertise. In addition to acquiring ECM expertise, significant developments were made in the process that will no doubt contribute in advancing the state of the art. These developments would include the successful 23 feet ECM cut, development of segmented tooling, and attaining a machining speed of .750 inch per minute in contrast to .250 inch per minute at the project's inception.

SECTION 10

RECOMMENDATIONS

The completed gun barrel should be extensively test fired to confirm the anticipated advantages of ECM boring and rifling gun barrels. Positive results of the firing tests would warrant machining additional 5 inch barrels with existing tooling to establish reliability and repeatability factors. Satisfactory establishment of these factors would then dictate the design and construction of a new and enlarged electrolyte system for production machining.

The increase in the use of ECM will certainly be influenced by the quantity of hard metals machined in future years. The trend in the use of hard metals is clear. This is evident by the continuing increase in the use of molybdenum, titanium, cobalt, and tungsten. Aside from machining the more exotic hard metals, ECM will find wider use in machining the common metals. This is due to the increased importance of the properties of the finished part and the ability to machine complex shapes. With this in view, it is necessary that the Navy maintain a capability in this versatile new process.

DISTRIBUTION LIST

Commander Naval Sea Systems Command Facilities and Equipment Division (SEA-07013) National Center Bldg. 3, Rm. 6E06 Department of the Navy Washington, D. C. 20362	2 copies
Commander Naval Air Systems Command Program and Resources Division Industrial Resources Branch (AIR-5018) Jefferson Plaza Bldg. 2, Rm. 794 Department of the Navy Washington, D. C. 20362	1 copy
Defense Documentation Center Cameron Station Alexandria, VA 22314	12 copies
Manufacturing Technology Division Air Force Materials Laboratory Wright-Patterson Air Force Base Ohio 45433	1 copy
U. S. Army Production Equipment Agency c/o Rock Island Arsenal Rock Island, IL 61201	1 copy
Officer in Charge Naval Material Industrial Resources Office Philadelphia Navy Base, Bldg. 77L Philadelphia, PA 19112 Attn: Mr. W. J. Welsh	2 copies
Commander Naval Sea Systems Command Library Branch (SEA-08G3) National Center Bldg. 3, Rm. 3S08 Department of the Navy Washington, D. C. 20362	2 copies
Commander Naval Sea Systems Command Manufacturing Technology Branch (SEA-05R2) Crystal Mall Bldg. 4, Rm. 109 Department of the Navy Washington, D. C. 20362	2 copies

SECURITY CLASSIFICATION OF THIS PAGE (When Data Entered)

REPORT DOCUMENTATION PAGE		READ INSTRUCTIONS BEFORE COMPLETING FORM
1. REPORT NUMBER MT-050	2. GOVT ACCESSION NO. DNS 00205	3. RECIPIENT'S CATALOG NUMBER
4. TITLE (and Subtitle) ELECTROCHEMICAL MACHINING OF GUN BARREL BORES AND RIFLING.		5. TYPE OF REPORT & PERIOD COVERED Final Report
7. AUTHOR(s) Lloyd E. Wessel		6. PERFORMING ORG. REPORT NUMBER
9. PERFORMING ORGANIZATION NAME AND ADDRESS Naval Ordnance Station (Code 85) Southside Drive Louisville, KY 40214		8. CONTRACT OR GRANT NUMBER(s) 12/63p.
11. CONTROLLING OFFICE NAME AND ADDRESS Naval Sea Systems Command (SEA-0354) Washington, DC 20362		10. PROGRAM ELEMENT, PROJECT, TASK AREA & WORK UNIT NUMBERS
14. MONITORING AGENCY NAME & ADDRESS (if different from Controlling Office)		12. REPORT DATE September 1978
		13. NUMBER OF PAGES 80
		15. SECURITY CLASS. (of this report) Unclassified
		15a. DECLASSIFICATION/DOWNGRADING SCHEDULE
16. DISTRIBUTION STATEMENT (of this Report) Approved for Public Release - Distribution Unlimited 14 NOSL-MT-050		
17. DISTRIBUTION STATEMENT (of the abstract entered in Block 20, if different from Report)		
18. SUPPLEMENTARY NOTES		
19. KEY WORDS (Continue on reverse side if necessary and identify by block number) Electrochemical Machining Gun Barrels		
20. ABSTRACT (Continue on reverse side if necessary and identify by block number) In recent years, the trend in gun development programs has emphasized higher rates of fire, greater accuracy and increased projectile muzzle velocities, requiring higher propellant temperatures and chamber pressures. Current gun barrel steels cannot withstand these increased temperatures and pressures without a significant reduction in barrel life. Fabrication of gun barrels from high strength superalloy materials that would better withstand these increased temperatures and pressures present problems in machining rifling configurations by conventional methods such as broaching. (Cont'd)		

DD FORM 1473
1 JAN 73EDITION OF 1 NOV 69 IS OBSOLETE
S/N 0102-LF-014-6601

53

UNCLASSIFIED

SECURITY CLASSIFICATION OF THIS PAGE (When Data Entered)

404 531

Liu

20. (Cont'd)

With major caliber gun barrel material and design technology almost at a standstill due to having reached the limit of economical and quality machining by conventional methods, it was envisioned that electrochemical machining (ECM) could be used to machine the bore and rifling configuration in high strength materials. ECM could also improve the surface finish in machining current gun barrel materials. It could also provide an economical means of producing experimental rifling configurations since a single experimental tooling head would be required in contrast to numerous expensive broaches required for conventional machining.

A special 10,000 ampere ECM machine and associated 1,000 gallon prototype electrolyte system was designed and built at Naval Ordnance Station, Louisville, Kentucky. This machine is unique in its extraordinary size and 22 1/2 foot stroke. Tool design and experimental machining were performed, with one quarter scale tooling for economy in establishing a basic tool design and machining parameters. With these parameters established, full size tooling was built and a full length 5"/54 caliber gun barrel was successfully bored and rifled. This represented the longest successful ECM cut ever made and demonstrates the capability for electrochemical machining major caliber gun barrels.