

AFFDL-TR-79-3036
Volume II

LEVEL III
A072386

②
SC

AD A 072387

IMPROVED METHODS FOR PREDICTING SPECTRUM LOADING EFFECTS - PHASE I REPORT

Volume II - Test Data

J. B. Chang
J. H. Stolpestad

Rockwell International Corporation
Los Angeles Division
P. O. Box 92098
Los Angeles, California 90009

DDC
RECEIVED
AUG 6 1979
ALBANY

~~March 1978~~

Phase I Technical Report
February 1978-January 1979

DDC FILE COPY

Approved for public release; distribution unlimited.

Prepared for

AIR FORCE FLIGHT DYNAMICS LABORATORY
Air Force Wright Aeronautical Laboratories
Air Force Systems Command
Wright-Patterson Air Force Base, Ohio 45433

79 08 2 065

NOTICE

When Government drawings, specifications or other data are used for any purpose other than in connection with a definitely related Government procurement operation, the United States Government thereby incurs no responsibility nor any obligation whatsoever; and the fact that the government may have formulated, furnished, or in any way supplied the said drawings, specifications, or other data, is not to be regarded by implication or otherwise as in any manner licensing the holder or any other person or corporation, or conveying any rights or permission to manufacture, use, or sell any patented invention that may in any way be related thereto.

This report has been reviewed by the Information Office (OI) and is releasable to the National Technical Information Service (NTIS). At NTIS, it will be available to the general public, including foreign nations.

This technical report has been reviewed and is approved for publication.

ROBERT M. ENGLE, JR.
Project Engineer

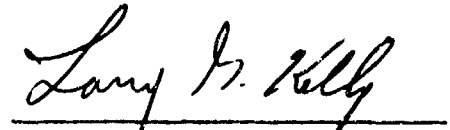
LARRY G. KELLY, Chief
Structural Integrity Branch

FOR THE COMMANDER

RALPH L. KUSTER, JR., Col, USAF
Chief, Structures & Dynamics Division

"If your address has changed, if you wish to be removed from our mailing list, or if the addressee is no longer employed by your organization please notify AFFDL/FBE, W-PAFB, OH 45433 to help us maintain a current mailing list."

Copies of this report should not be returned unless return is required by security considerations, contractual obligations, or notice on a specific document.

UNCLASSIFIED

SECURITY CLASSIFICATION OF THIS PAGE (When Data Entered)

(19) REPORT DOCUMENTATION PAGE		READ INSTRUCTIONS BEFORE COMPLETING FORM	
1. REPORT NUMBER AFFDL TR-79-3036 + VOL-2	2. GOVT ACCESSION NO.	3. REPORT NUMBER NA-78-491-3- VOL-2	4. RECIPIENT'S CATALOG NUMBER
5. TITLE (and Subtitle) Improved Methods for Predicting Spectrum Loading Effects - Phase I Report. Volume II, Test Data.		6. TYPE OF REPORT & PERIOD COVERED Interim Report 15 Feb 1979 15 Jan 1979	
7. AUTHOR(s) B. Chang & H. Stolpestad - Rockwell International <i>James J. Smith</i>		8. CONTRACT OR GRANT NUMBER(s) F33615-77-C-3121	
9. PERFORMING ORGANIZATION NAME AND ADDRESS Los Angeles Division Rockwell International International Airport, Los Angeles, CA 90009		10. PROGRAM ELEMENT, PROJECT, TASK AREA & WORK UNIT NUMBERS <i>(12) 330 p.</i>	
11. CONTROLLING OFFICE NAME AND ADDRESS Structural Integrity Branch (AFFDL/FBE) Air Force Flight Dynamics Laboratory Wright-Patterson Air Force Base, Ohio 45433		12. REPORT DATE 31 Jan 1979	
13. MONITORING AGENCY NAME & ADDRESS (if different from Controlling Office)		13. NUMBER OF PAGES 328	
		14. SECURITY CLASS. (of this report) Unclassified	
		15. DECLASSIFICATION DOWNGRADING SCHEDULE	
16. DISTRIBUTION STATEMENT (of this Report) Approved for public release; distribution unlimited			
17. DISTRIBUTION STATEMENT (of the abstract entered in Block 20, if different from Report)			
18. SUPPLEMENTARY NOTES			
19. KEY WORDS (Continue on reverse side if necessary and identify by block number) constant amplitude loading, fatigue crack growth, flight-by-flight loading, overload, underload, 2219-T851 aluminum, cycle-by-cycle spectrum			
20. ABSTRACT (Continue on reverse side if necessary and identify by block number) This report presents the interim status of a program which is aiming to upgrade the crack growth prediction technology required for the implementation of the damage-tolerance and durability control procedures throughout the life cycle of any weapon system. The controlling damage parameters in flight-by-flight loading for all classes of aircraft have been identified. Methodologies which characterize the flight spectra have been developed. Guidelines for development			

DD FORM 1473 1 JAN 73 EDITION OF 1 NOV 68 IS OBSOLETE

UNCLASSIFIED

420 665

SECURITY CLASSIFICATION OF THIS PAGE (When Data Entered)

79 08

2 065

UNCLASSIFIED

SECURITY CLASSIFICATION OF THIS PAGE(When Data Entered)

of three levels of crack growth analysis used for detail design, individual aircraft tracking, and preliminary design have been established. Crack growth data generated from the test program has been summarized. ↙

UNCLASSIFIED

SECURITY CLASSIFICATION OF THIS PAGE(When Data Entered)

FOREWORD

Volume II of this report presents the test results of phase I - identification of controlling damage parameters of a research program entitled "Improved Methods for Predicting Spectrum Loading Effects". This program is being administered by the Air Force Flight Dynamics Laboratory, Air Force Systems Command, Wright-Patterson Air Force Base, Ohio, under contract F33615-77-C-3121. Mr. Robert M. Engle (AFFDL/FBE) is the air Force project engineer.

The test data included in this volume were performed primarily by personnel from the Fatigue and Fracture Mechanics Group, Dynamics Technology, and Structures Systems, supervised by George E. Fitch, Jr., Supervisor, Joseph S. Rosenthal, Manager, and Dr. George P. Haviland, Director. The program manager and principal investigator is James B. Chang. The deputy program manager is John A. Stolpestad. Principal contributors to the test program include Ko-Wei Liu, Fatigue and Fracture Mechanics, Wally Ferentz, Structural Testing Laboratory, and Howard Ross, Manufacturing Engineering.

Accession For	
NTIS G.A.A.I	<input checked="" type="checkbox"/>
DDC TAB	<input type="checkbox"/>
Unannounced	<input type="checkbox"/>
Justification	<input type="checkbox"/>
By _____	
Distribution/	
Availability Codes	
Dist	Available/or. special
A	

SUMMARY

An experimental and analytical investigation is being performed under contract F33615-77-C-3121 with the objective of upgrading crack-growth prediction methodology as it is impacted by spectrum loading effects. This report deals with the phase I studies of this program. Three interrelated tasks have been performed in phase I. The first task included an evaluation of the state-of-the-art of currently used methods for analyzing fatigue crack-growth behavior under flight-by-flight loading. The second task dealt with the development of a general methodology for characterizing flight-by-flight loading such that the requirement of a cycle-by-cycle crack-growth analysis could be eliminated. The third task called for the definition of guidelines for the development of crack-growth analyses for preliminary design, for detail design, and for individual aircraft tracking.

To aid in formulation of methodology for the second task, an experimental testing program was conducted. This volume contains tabulations and plots of basic data collected during this experimental program. Data tabulations are presented for 106 tests ranging in complexity from simple baseline da/dN tests to sophisticated randomized cycle-by-cycle fighter and transport spectrum tests. In between these extremes were test groups that studied the influence of single and periodic overloads and underloads, multiple overloads and underloads, and simplified flight spectra. The text preceding the data provides a discussion of test purposes, specimen design and fabrication, testing procedures, and data presentation.

GENERAL

A portion of the phase I effort of the IMPSLE program called for an evaluation of the state-of-the-art of present methods for analyzing fatigue crack growth under flight-by-flight loading. The results and conclusions of this study are documented in Volume I of this report. Following the completion of this study, it was planned that a general methodology would be developed for characterizing flight-by-flight loading, eliminating the necessity for a cycle-by-cycle analysis while predicting equivalent crack growth behavior. To aid in the formulation of this methodology, an experimental program was planned to study the significant stress parameters which control the rate of damage on a flight-by-flight basis. The following paragraphs describe the approach taken in planning and carrying out this test program, and present tabulations and graphical presentations of the test data.

TEST DESCRIPTION

The methodology development test program consisted of a series of eight baseline tests to develop basic fatigue crack growth rate properties, plus

five groups of methodology development test specimens varying in complexity from simple constant-amplitude tests to complex random cycle-by-cycle spectrum tests.

The baseline tests (see Table 1) applied a common maximum stress of 20 ksi with variations in the R-factor ranging + 0.70 to -0.30. One special static test was conducted on a precracked specimen to verify the fracture toughness of the material. In this test, the calculated stress intensity factor at failure using the plane strain stress intensity formula, $K_I = \sigma \sqrt{\pi C} \times W_C$, was 49,000 psi $\sqrt{\text{inch}}$, an acceptable value for this material.

The methodology development tests consisted of the following five groups:

Group I - Constant-amplitude loads - 10 tests (Table 10)

Group II - Single or periodical overload/underload - 20 tests (Table 21)

Group III - Multiple overload/underload - 30 tests (Table 42)

Group IV - Simplified flight spectrum - 25 tests (Table 73)

Group V - Random cycle-by-cycle spectrum - 13 tests (Tables 99, 103, 107, 110, and 114)

Details of the loading conditions for each test are shown in the referenced tables. The selected magnitudes of the maximum stresses, the stress ratios, and the number of cycles for each test segment were predicated on design limit load levels for typical fighter and transport aircraft.

MATERIALS AND SPECIMENS

All tests were performed on plates from a single heat of 2219-T851 aluminum alloy, specification QQ-A-250/30. The plate material was purchased from Ti-Con Industries, Huntington Beach, California. A description of the material, including the chemical and physical properties, follows:

2219-T851 aluminum QQ-A-250/30,
1/4 x 48 x 144 inches

Mill source: Reynolds

Chemical properties									
Heat no.	Al	Mg	Mn	Zn	Ar	Si	Fe	Cu	Ni
743025D			0.20	0.02		0.05	0.10	5.8	
		0.02	.40	.10		.15	.25	6.8	
	Cr	Ti	Th	Ca	c	S	P	Others	
	0.10	0.20						Each 0.05 max Total	

Physical properties			
Heat no.	Yield strength	Tensile strength	% Elong.
743025D	46,000 min (psi)	62,000 min (psi)	8 min

The physical properties were verified by a tensile coupon test at Rockwell during which a load/strain curve was recorded. (See Figure 1.) Yield strength, ultimate strength, and elongation properties exceeded minimum requirements.

The test specimen blanks were machined from two full plates and a small portion of a third plate. Each blank was uniquely serialized to identify the plate from which it came and its location within that plate. (See Figure 2.) The blanks were then finish-machined to the configuration of Figure 3. All test section thicknesses were 0.250 inch, and the longitudinal grain was oriented parallel to the loading direction. The center notches were installed by EDM Laboratories, Garden Grove, California, employing the wire electrical discharge machining process. The center-notch configuration was selected in order to minimize the geometric considerations in the calculation of the stress intensity factor.

TESTING PROCEDURES

All tests were conducted in the Rockwell LAD Structures Test Laboratory, employing the 500 and 1,500 K MTS fatigue testing systems. An MTS load tower (Figure 4) consists of a rigid load frame and incorporates a dual bridge load cell and hydraulic actuator. Applied loads are controlled through a closed loop servo system and load programmer test system, with load cells and servo uses a digital PDP 8E computer for program control. All tests except the randomized cycle-by-cycle spectrum tests were controlled by the MTS system. The randomized tests were controlled by the Datum servo system 70, a computer-controlled fatigue test system selected for this application because of its capability to handle much longer waveforms than is possible with the integral MTS computer equipment. As used on the random spectrum tests, the Datum system acts as a waveform generator and provides a command signal output to the MTS servo controller. The MTS system returns a load cell feedback signal to the Datum system which was used for "desired versus actual load" error checking. The only other interfaces between the two systems are discrete signals providing test control, including hold, run, and ramp on servo controller error detection. A schematic of the interrelationship of the MTS and Datum 70 systems is shown in Figure 5. Loads were transmitted from the test machine head to the specimens through hydraulically actuated friction grips.

In most cases, the EDM crack starter slot in the specimen was precracked to produce an initial crack length, $2a$, of 0.30 inch approximately. Precracking was performed under constant-amplitude cycling at an R-factor of zero and with maximum cyclic stresses of 8 or 10 ksi, but in no case exceeding the maximum stress applied in the subsequent test. All tests were run in ambient laboratory air at room temperature. The cyclic rate for constant amplitude testing was approximately 6 Hz, and for spectrum testing between 4 and 6 Hz, depending on such factors as load level, load range, and the presence of compression loads. Crack growth was measured by visual optics reading from precision scales attached to each side of the specimen adjacent to the EDM slot. Measurements were made and recorded after approximately each 0.05-inch increment of growth. The long edges of the specimens were restrained against lateral motion when subjected to compression loads.

DATA TABULATIONS AND PLOTS

The raw data tabulations were initially made in laboratory log books. For the dual purposes of data reduction and of presentation in this report, the data were coded into program PLOTDATE, resulting in a computer printout of the data for each test together with a graphical figure of crack length versus applied cycles. Data tabulations and plots in this report are copies of the computer output. Figure 6 shows a typical data tabulation together with explanatory remarks concerning the K-max and delta K columns, the numbers in which are inappropriate for all except the constant amplitude baseline tests. The remaining columns are correct and pertinent to all other tests.

The data tabulations are organized by test groups as follows:

Group	Type load	Test Description Table	Test Data	
			Tables	Figures
Baseline	Constant amplitude (for da/dN)	1	2-9	7-14
I	Constant amplitude	10	11-20	15-24
II	Single or periodical overload/underload	21	22-41	25-44
III	Multiple overload/underload	42	43-72	45-74
IV	Simplified flight spectrum	73	74-98	75-99
V	Random fighter spectrum, air-to-air mission	99	100-112	100-102
V	Random fighter spectrum, air-to-ground mission	103	104-106	103-105
V	Random fighter spectrum, instr & nav mission	107	108-109	106-107
V	Random fighter spectrum, composite mission	110	111-113	108-110
V	Random transport spectrum, composite mission	114	115-116	111-112

LOG PAGE 12176-16 TEMP RT F° MACHINE 120K RIEHLE

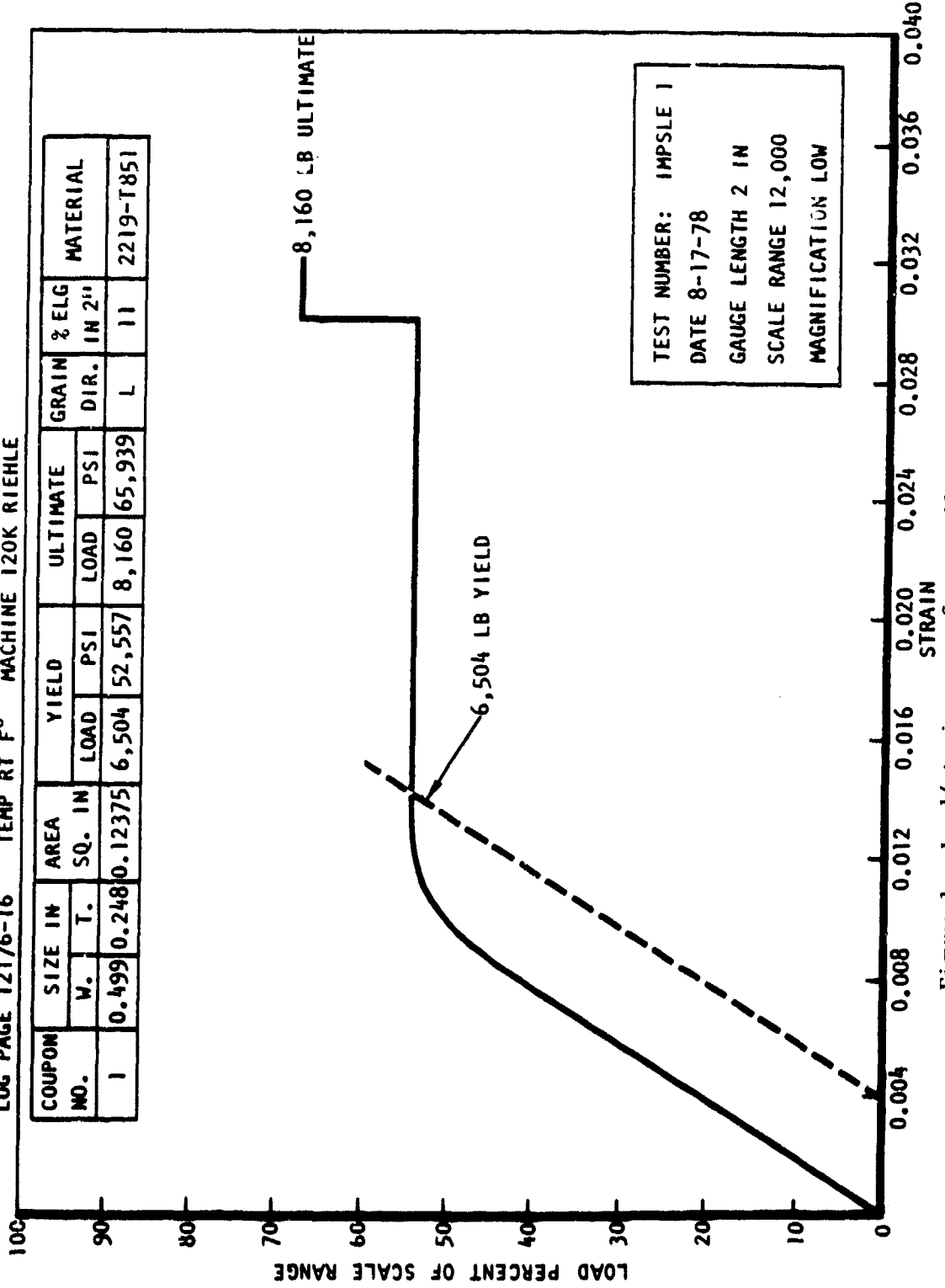

TEST NUMBER: IMPSLE 1
 DATE 8-17-78
 GAUGE LENGTH 2 IN
 SCALE RANGE 12,000
 MAGNIFICATION LOW

Figure 1. Load/strain curve for tensile coupon test.

MATERIAL: 2219-T851 AL ALLOY PLATE, QQ-A-250/30

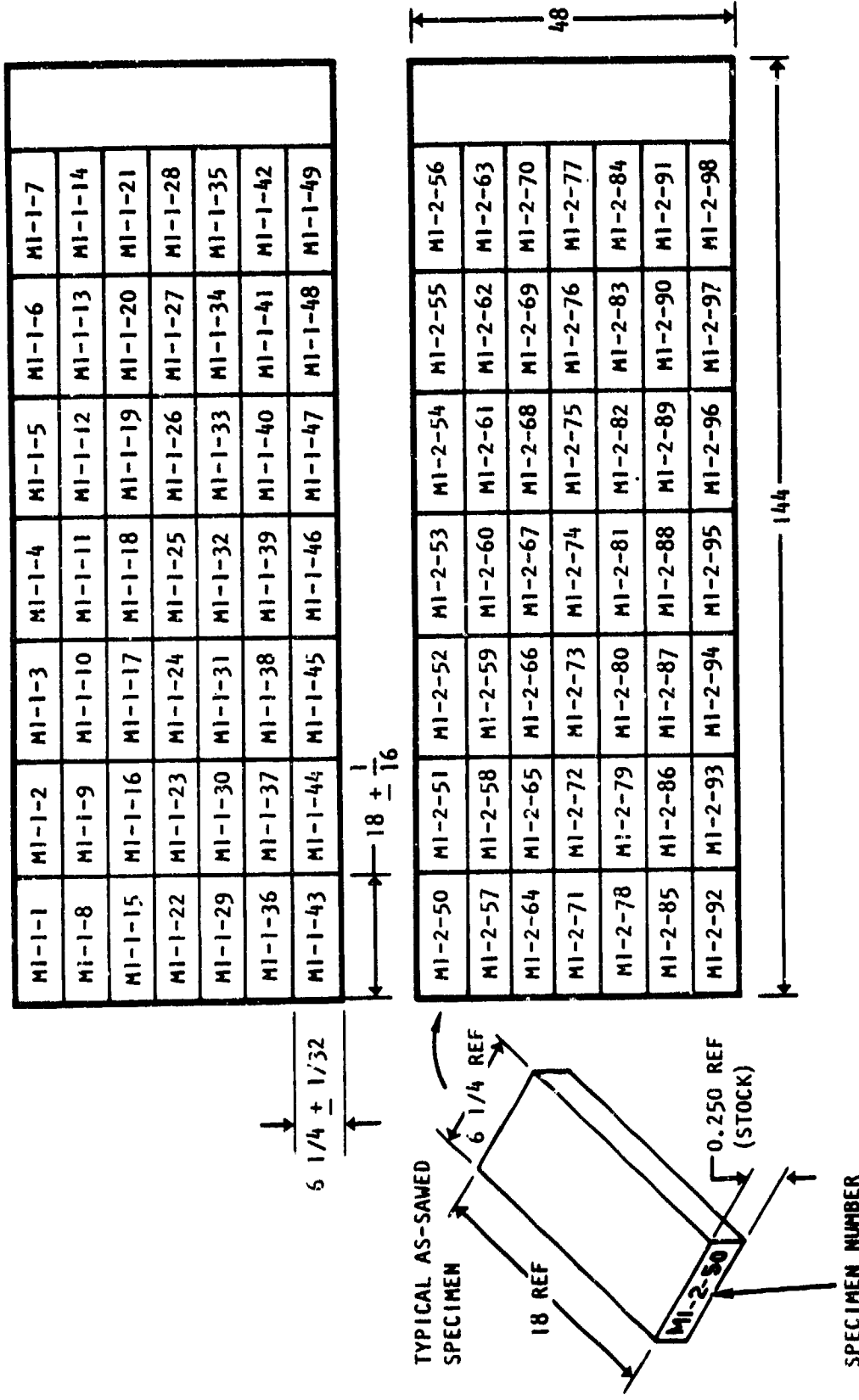

Figure 2. Test specimen location and identification system.

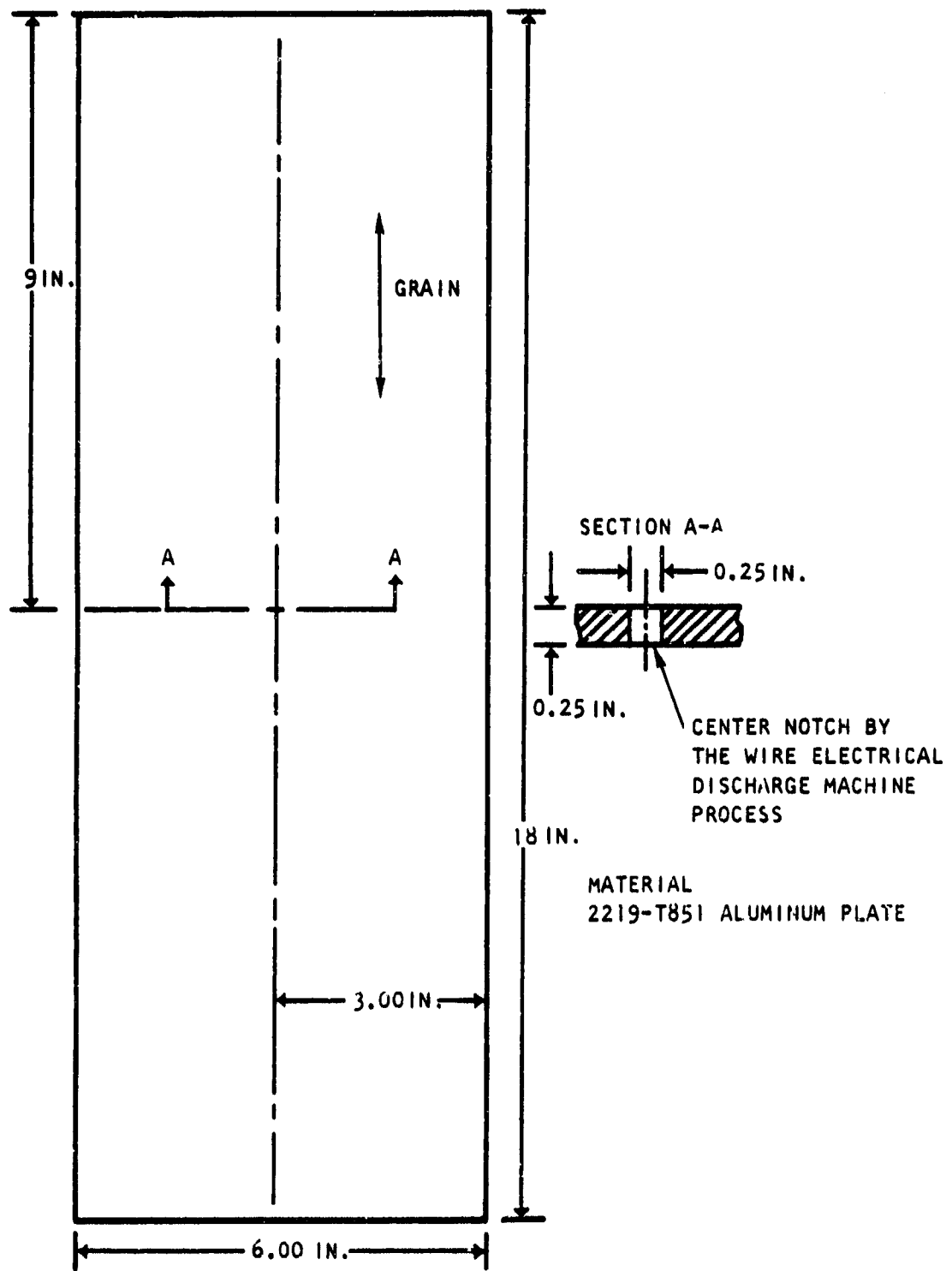

Figure 3. Test specimen configuration.

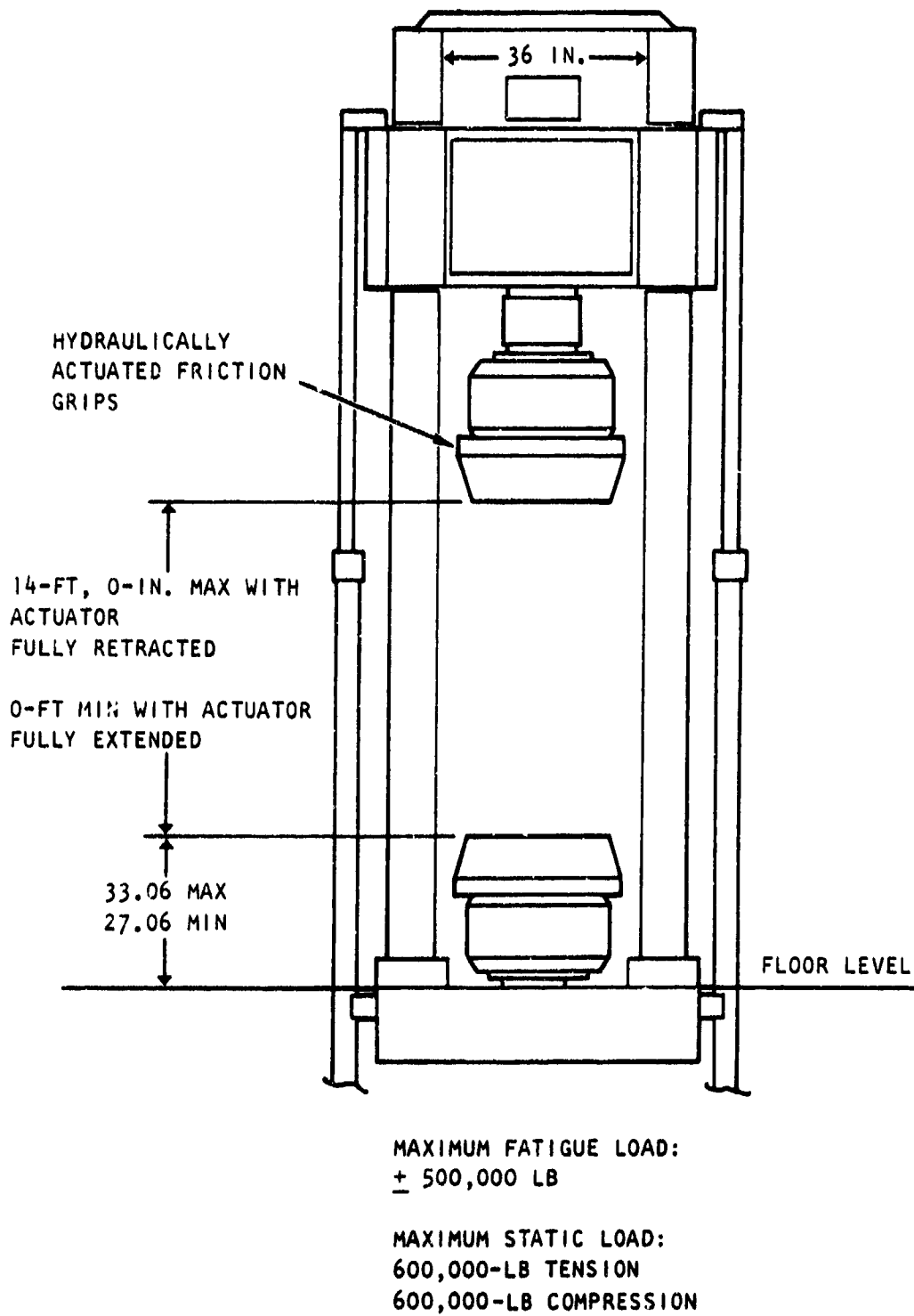

Figure 4. 500-KIP materials test system.

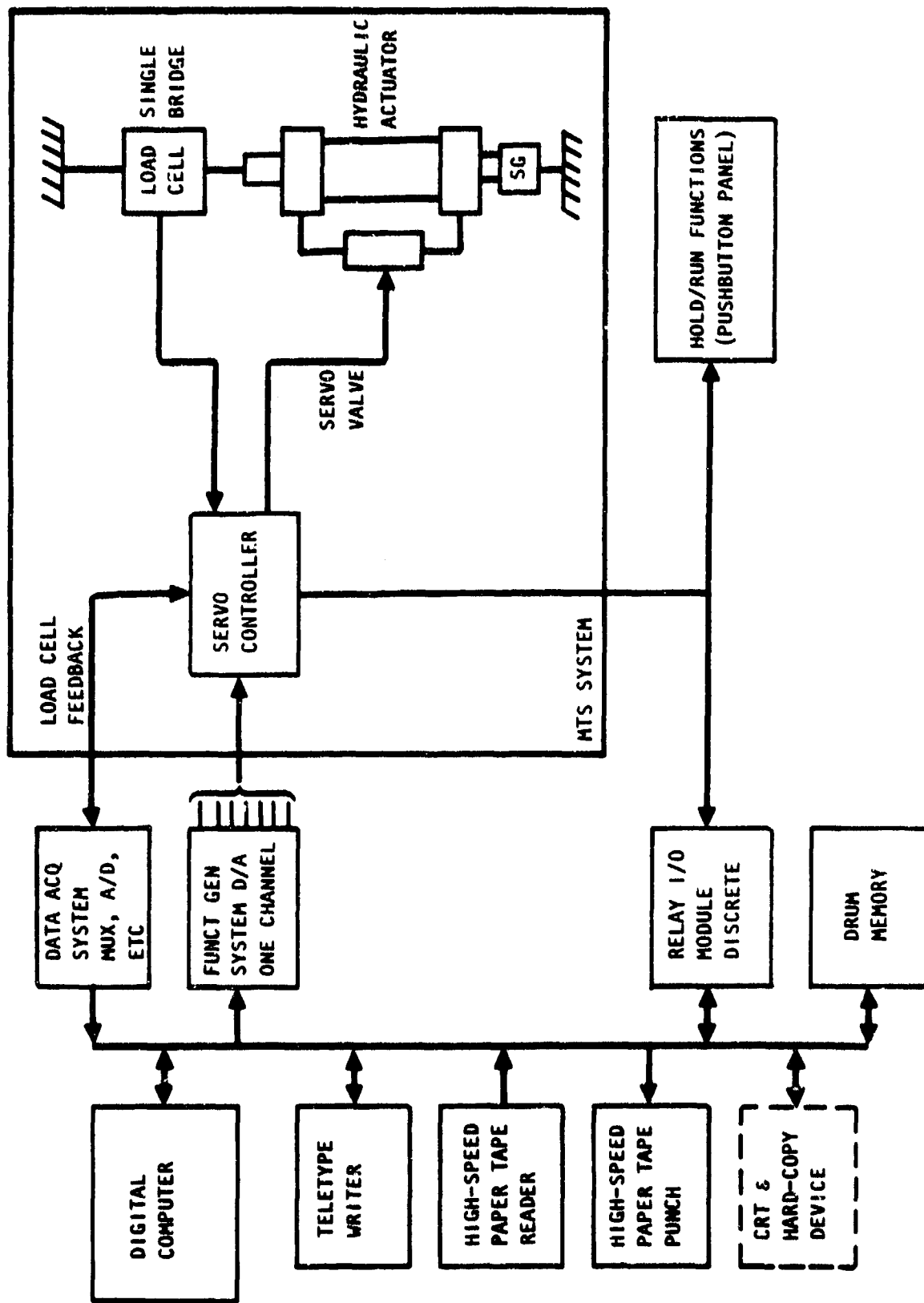

Figure 5. Schematic of MTS system/Datum system 70.

SPECIMEN NO.: M1-2-P0 BASELINE, 10 KSI STRESS

TEST SPECIMEN R = 0.150 IN. W = 6.000 IN. AN = 0.0 IN.
 PMIN = 0.15KIPS PMAX = 15.00KIPS R = 0.010 TEST FREQ = 6.000HZ.

ENVIRONMENT CONDITION: ROOM AMBIENT

NO.	CYCLES	F (MEASURED)	A (REGRESSION)	MULT. CORR. COEFF	K-MAX	DELTA K	DA/DM
1	0.	0.317	0.317	1.000000	7.07	7.00	1.250E-07
2	5000.	0.312	0.324	0.997810	7.14	7.07	4.167E-07
3	10000.	0.311	0.337	0.996029	7.29	7.22	1.406E-06
4	15000.	0.315	0.354	0.995174	7.47	7.40	1.705E-06
5	20000.	0.315	0.373	0.998334	7.68	7.60	2.027E-06
6	25000.	0.344	0.394	0.997320	7.89	7.81	2.339E-06
7	30000.	0.415	0.417	0.998860	8.12	8.04	2.696E-06
8	35000.	0.445	0.445	0.999693	8.39	8.31	3.134E-06
9	40000.	0.480	0.460	0.999689	8.71	8.63	3.625E-06
10	45000.	0.520	0.520	0.999969	9.07	8.98	4.098E-06
11	50000.	0.563	0.562	0.999954	9.45	9.35	4.527E-06
12	55000.	0.610	0.610	0.999919	9.85	9.75	4.971E-06
13	60000.	0.660	0.661	0.999950	10.26	10.16	5.449E-06
14	65000.	0.717	0.716	0.999952	10.71	10.60	6.002E-06
15	65000.	0.755	0.755	0.999956	10.99	10.88	6.493E-06

Laboratory measurements

M neglect these columns for all but baseline tests

Figure 6. Typical data tabulation.

TABLE 1. BASELINE TESTS FOR FATIGUE CRACK GROWTH RATE DATA

Test No.	Specimen No.	Stress (ksi)		R-Factor	Remarks
		Max	Min		
B-1-1	MI-1-47	20	0.2	+0.01	Conventional EDM
B-1-2	MI-1-14	20	4	+0.20	Conventional EDM
B-2	MI-2-64	20	6	+0.30	Conventional EDM
B-3	MI-1-26	20	14	+0.70	Conventional EDM
B-4	MI-2-90	20	-6	-0.30	Conventional EDM
B-5	MI-1-8	20	-2	-0.10	Conventional EDM
B-6-1	MI-2-88	20	0.2	+0.01	Slot by wire EDM method
B-6-2	MI-1-31	20	0.2	+0.01	Conventional EDM
Special	MI-2-89	10	0.1	+0.01	da/dN growth to 2c = 0.75, then static load to failure

NOTE:

1. All tests in ambient laboratory air.
2. Maximum cyclic rate 360 cpm.
3. Lateral restraints used in compression load tests.

TABLE 2. DATA TABULATION FOR TEST B-1-1

SPECIMEN NO.: B-1-1 BASELINE: 20 KSI STRESS

CCI SPECIMEN B= 0.250 IN. M= 6.000 IN. AN= 0.0 IN.

PNIN= 0.3 KIPS PNA= 30.0 KIPS R= 0.010 TEST FREQ= 6.00 HZ.

ENVIRONMENT CONDITION: ROOM AMBIENT

NO.	CYCLES	A (MEASURED)	A (REGRESSION)	MULT. CORR. COEFF	K-MAX	DELTA K	DA/DM
1	0.	0.525	0.526	0.995528	18.26	18.04	2.605E-05
2	1000.	0.660	0.590	0.997529	19.37	19.18	3.881E-05
3	2000.	0.670	0.661	0.998349	20.04	20.63	5.252E-05
4	2700.	0.765	0.761	0.998515	22.08	21.86	6.103E-05
5	3300.	0.840	0.838	0.996716	23.22	22.98	7.040E-05
6	3901.	0.923	0.929	0.997935	24.51	24.26	8.222E-05
7	4502.	1.020	1.028	0.998660	25.86	25.60	9.629E-05
8	5106.	1.145	1.151	0.998482	27.50	27.22	1.200E-04
9	5600.	1.225	1.223	0.999855	28.42	28.14	1.379E-04
10	5706.	1.345	1.309	0.999509	29.51	29.22	1.586E-04
11	6000.	1.410	1.463	0.998617	30.69	30.39	1.857E-04
12	6306.	1.515	1.515	0.998900	32.00	31.76	2.227E-04
13	6656.	1.675	1.676	0.997954	34.06	33.72	2.901E-04
14	6956.	1.860	1.833	0.988259	35.97	35.61	4.141E-04
15	7256.	2.080	2.059	0.992501	39.24	38.85	5.646E-04
16	7556.	2.345	2.463	0.955978	43.89	43.45	7.826E-04
17	7856.	3.015	3.012	0.998516	51.69	51.17	1.146E-03

PLOT RATE CRACK GROWTH ANALYSIS
B-1-1 BASELINE, 20 KSI STRESS R = .01

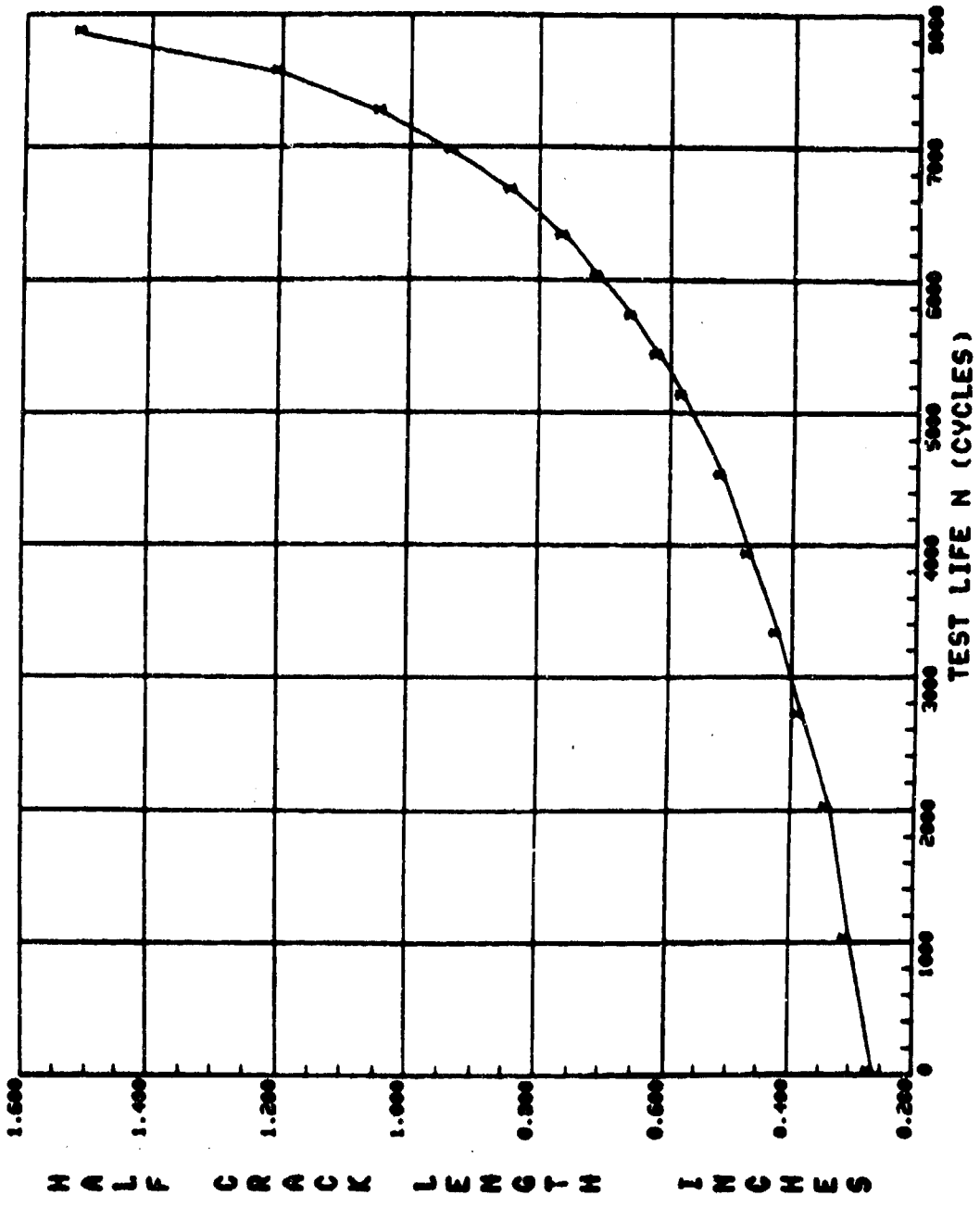

Figure 7. Crack growth curve for test B-1-1.

TABLE 3. DATA TABULATION FOR TEST B-1-2

SPECIMEN NO.: B-1-2 BASELINE, STRESS = +4 TO +20 KSI

CCY SPECIMEN W= 0.750 IN. M= 6.000 IN. AN= 0.0 IN.

PRIN= 6.0 KIPS PMAX= 30.0 KIPS R= 0.200 TEST FREQ= 6.00 HZ.

ENVIRONMENT CONDITION: ROOM AMBIENT

NO.	CYCLES	A (MEASURED)	A (REGRESSION)	MULT. CORR. C (EFF)	K-MAX	DELTA K	DA/DN
1	0.	0.360	0.360	0.999981	15.07	12.06	2.174E-05
2	1300.	0.420	0.412	0.999609	16.26	13.01	2.666E-05
3	2600.	0.490	0.488	0.999728	17.59	14.07	2.938E-05
4	3900.	0.560	0.564	0.999376	18.92	15.14	3.426E-05
5	4700.	0.630	0.628	0.998053	19.99	15.99	4.142E-05
6	5500.	0.690	0.694	0.997522	21.06	16.84	5.038E-05
7	6200.	0.760	0.766	0.993615	22.16	17.73	5.944E-05
8	6800.	0.840	0.840	0.998660	23.25	18.00	6.954E-05
9	7300.	0.920	0.915	0.997076	24.31	19.45	8.126E-05
10	7700.	0.980	0.982	0.997782	25.24	20.19	9.423E-05
11	8100.	1.050	1.057	0.998197	26.26	21.01	1.111E-04
12	8450.	1.135	1.135	0.999794	27.29	21.83	1.324E-04
13	8750.	1.220	1.220	0.999840	28.39	22.71	1.521E-04
14	9060.	1.300	1.302	0.999756	29.43	23.54	1.805E-04
15	9200.	1.375	1.370	0.999596	30.29	24.23	1.813E-04
16	9400.	1.445	1.444	0.999172	31.21	24.97	1.994E-04
17	9600.	1.520	1.515	0.995401	32.21	25.77	2.194E-04
18	9900.	1.615	1.614	0.999665	33.30	26.04	2.513E-04
19	9950.	1.645	1.642	0.999494	34.25	27.40	2.846E-04
20	10100.	1.775	1.781	0.9999501	35.33	28.27	3.224E-04
21	10250.	1.840	1.861	0.999757	36.55	29.24	3.697E-04
22	10350.	1.960	1.957	0.999877	37.40	29.99	4.069E-04
23	10450.	2.040	2.043	0.999644	38.54	30.83	4.550E-04
24	10550.	2.125	2.136	0.999667	39.70	31.76	4.977E-04
25	10600.	2.165	2.186	0.999913	40.33	32.26	5.251E-04
26	10650.	2.245	2.241	0.999243	41.03	32.82	6.161E-04
27	10700.	2.295	2.305	0.999356	41.89	33.47	6.554E-04
28	10750.	2.375	2.374	0.9997951	42.73	34.19	7.161E-04

TABLE 3. DATA TABULATION FOR TEST B-1-2 (CONCL)

SPECIMEN NO.: B-1-2 BASELINE STRESS = +4 TO +20 KSI
 CCT SPECIMEN W = 6.250 IN. W = 6.000 IN. AN = 0.0 IN.
 PHIN = 6.0 KIPS PMAX = 30.0 KIPS R = 6.200 TEST FREQ = 6.00 HZ.
 ENVIRONMENT CONDITION: ROOM AMBIENT

NO.	CYCLES	A (MEASURED)	A (REGRESSION)	MULT. CORR. COEFF	K-MAX	DELTA K	DA/DN
29	10800.	2.440	2.448	0.993052	43.69	34.96	7.696E-04
30	10850.	2.570	2.528	0.998284	44.76	35.81	8.411E-04
31	10900.	2.610	2.609	0.996598	45.85	36.68	9.288E-04
32	10950.	2.705	2.700	0.998984	47.10	37.63	1.022E-03
33	11000.	2.810	2.814	0.998716	48.73	38.99	1.309E-03
34	11050.	2.945	2.947	0.995831	50.70	40.56	1.694E-03
35	11100.	3.120	3.129	0.999060	53.54	42.83	2.909E-03
36	11125.	3.225	3.267	0.979333	55.82	44.86	3.850E-03
37	11150.	3.395	3.463	0.989225	59.32	47.46	5.370E-03
38	11175.	3.780	3.778	0.997778	65.70	52.56	8.623E-03

PLOTRATE CRACK GROWTH ANALYSIS
B-1-2 BASELINE, STRESS = +4 TO +20 KSI

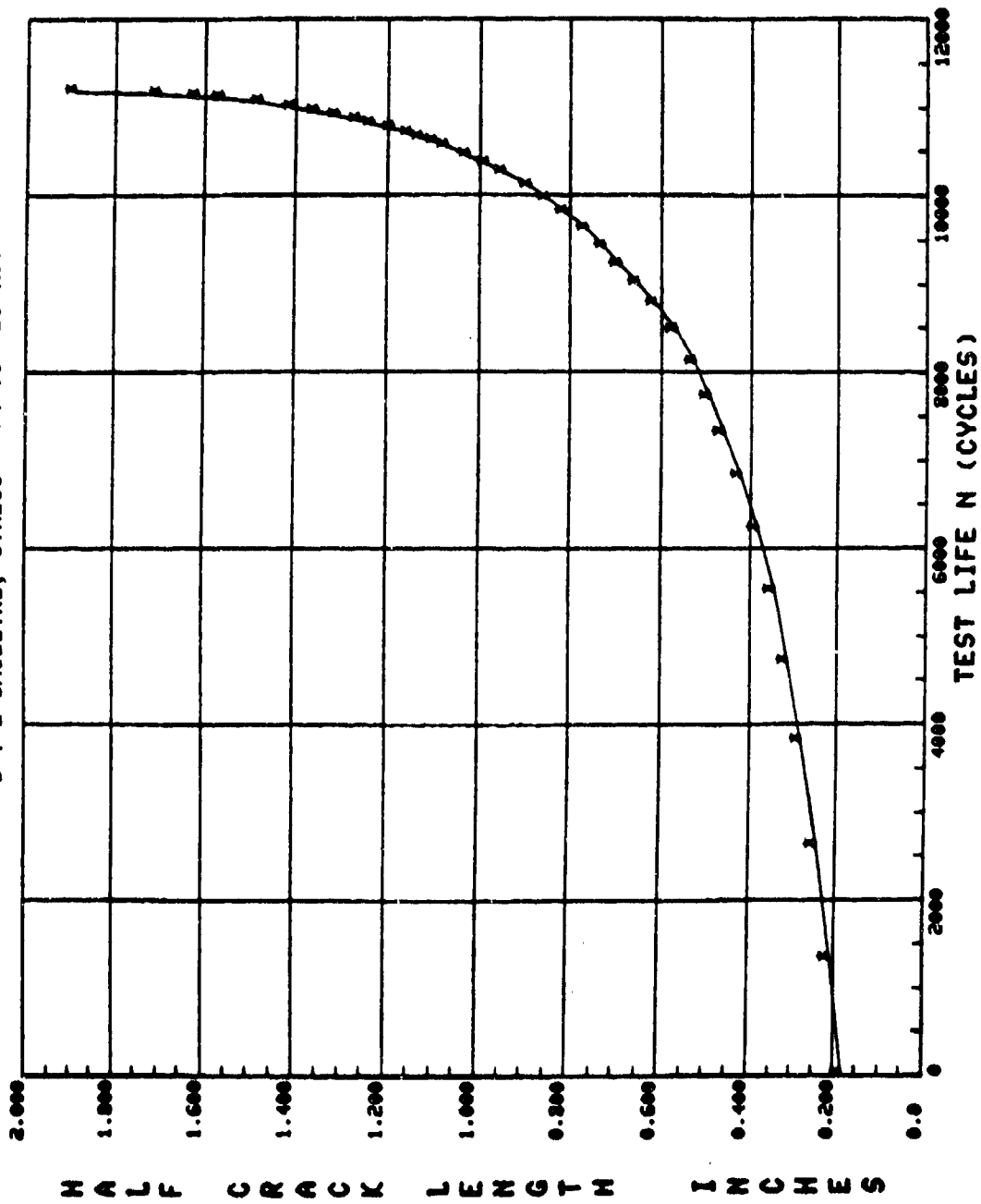

Figure 8. Crack growth curve for test B-1-2.

TABLE 4. DATA TABULATION FOR TEST B-2

SPECIMEN NO.: D-2 STRESS = +6 TO +20 KSI

CCI SPECIMEN B= 0.150 IN. W= 6.000 IN. AN= 0.0 IN.

PMIN: %C KIPS IMAX= 30.0 KIPS K= 0.30 TEST FREQ= 6.00MHZ.

ENVIRONMENT CONDITION: ROOM AMBIENT

NO.	CYCLES	A(MEASURED)	A(REGRESSION)	MULT. CORR. COEFF	K-MAX	DELTA K	DA/DM
1	D.	0.320	0.320	0.99898	14.20	9.94	7.726E-06
2	479E.	0.420	0.419	0.99913	16.26	11.38	1.312E-05
3	6500.	0.465	0.467	0.999904	17.19	12.03	1.499E-05
4	7400.	0.495	0.494	0.999166	17.69	12.38	1.659E-05
5	9400.	0.565	0.562	0.999192	18.90	13.23	1.903E-05
6	10900.	0.620	0.624	0.999404	19.93	13.95	2.326E-05
7	12400.	0.658	0.698	0.999262	21.11	14.76	2.790E-05
8	13700.	0.772	0.774	0.999629	22.27	15.59	3.265E-05
9	14600.	0.873	0.836	0.999703	23.19	16.23	3.592E-05
10	15400.	0.896	0.895	0.999243	24.03	16.82	4.026E-05
11	16100.	0.955	0.953	0.998870	24.84	17.39	4.509E-05
12	16700.	1.001	1.006	0.997031	25.57	17.90	5.252E-05
13	17300.	1.076	1.073	0.998605	26.43	18.50	5.906E-05
14	17900.	1.140	1.146	0.996167	27.43	19.20	6.639E-05
15	18500.	1.243	1.232	0.997195	28.54	19.96	7.752E-05
16	19000.	1.316	1.313	0.996696	29.57	20.70	8.553E-05
17	19400.	1.370	1.384	0.995225	30.46	21.32	9.351E-05
18	19700.	1.450	1.440	0.997316	31.15	21.81	1.109E-04
19	19800.	1.480	1.463	0.995368	31.44	22.01	1.089E-04
20	19900.	1.485	1.487	0.997246	31.74	22.22	1.143E-04
21	20100.	1.535	1.528	0.997185	32.24	22.57	1.145E-04
22	20300.	1.575	1.578	0.998051	32.85	23.00	1.204E-04
23	20500.	1.625	1.630	0.996750	33.50	23.45	1.366E-04
24	20700.	1.695	1.666	0.998161	34.17	23.92	1.570E-04
25	20900.	1.750	1.754	0.997484	35.00	24.50	1.745E-04
26	21100.	1.820	1.827	0.996286	35.90	25.13	1.815E-04
27	21250.	1.895	1.882	0.994339	36.57	25.60	2.024E-04
28	21350.	1.925	1.924	0.992436	37.08	25.96	2.255E-04

TABLE 4. DATA TABULATION FOR TEST B-2 (CONCL)

SPECIMEN NO.: B-2		STRESS = +6 TO +20 KSI					
CCT SPECIMEN		B= 0.250 IN.	M= 6.006 IN.	A= 0.0 IN.			
PHIN=	9.0KIPS	PMA=	30.0KIPS	R= 0.30	TEST FREQ= 6.00HZ.		
ENVIRONMENT CONDITION: ROOM AMBIENT							
NO.	CYCLES	A(MEASURD)	A(REGRESSION)	MULT. CORR. COEFF	K-MAX	DELTA K	DA/DM
29	21450.	1.953	1.970	0.991164	37.64	26.35	2.343E-04
30	21550.	2.020	2.018	0.984652	38.24	26.77	2.289E-04
31	21650.	2.080	2.070	0.990643	38.89	27.22	2.302E-04
32	21750.	2.110	2.116	0.982527	39.45	27.62	2.350E-04
33	21850.	2.150	2.154	0.989361	39.92	27.95	2.304E-04
34	21950.	2.190	2.197	0.990651	40.47	28.33	2.407E-04
35	22050.	2.255	2.254	0.990263	41.19	28.83	2.591E-04
36	22150.	2.375	2.321	0.995251	42.05	29.43	3.420E-04
37	22250.	2.395	2.396	0.999692	43.01	30.11	3.714E-04
38	22350.	2.470	2.465	0.994211	43.92	30.75	4.286E-04
39	22450.	2.555	2.549	0.996233	45.04	31.53	5.096E-04
40	22550.	2.635	2.655	0.998456	46.49	32.54	6.125E-04
41	22650.	2.795	2.779	0.997349	48.23	33.76	7.812E-04
42	22750.	2.955	2.949	0.997665	50.72	35.50	9.797E-04
43	22850.	3.135	3.166	0.997513	54.13	37.89	1.207E-03
44	22950.	3.435	3.434	0.998825	58.77	41.14	1.595E-03

PLOT RATE CRACK GROWTH ANALYSIS
B-2
STRESS = +6 TO +20 KSI

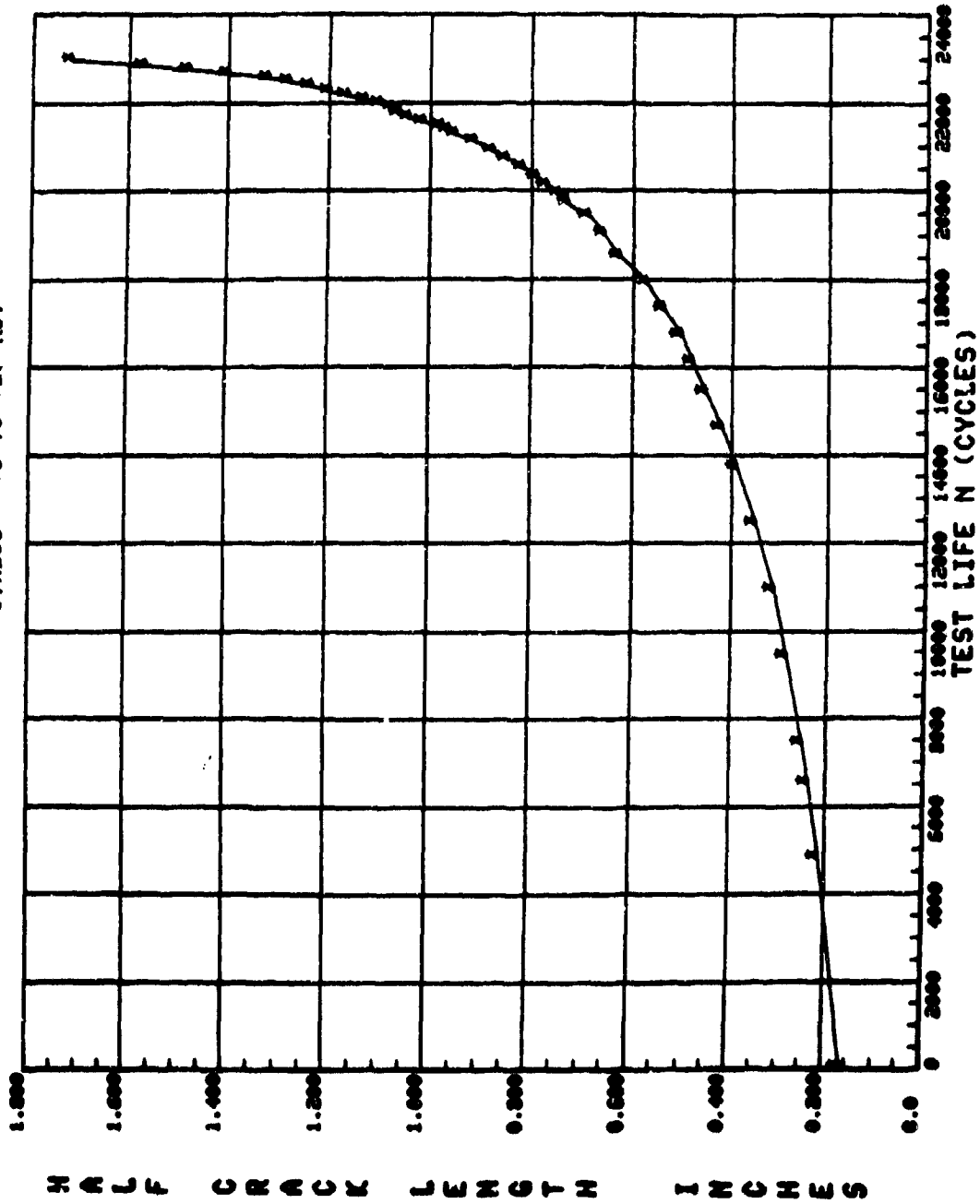

Figure 9. Crack growth curve for test B-2.

TABLE 5. DATA TABULATION FOR TEST B-3

SPECIMEN NO.: B-3		STRESS +14 TO +20 KSI		CCT SPECIMEN		b = 1.250 IN.		W = 6.000 IN.		AN = 0.0 IN.	
PMIN = 21.0KIPS		PMAX = 30.0KIPS		K = 0.70		TEST FREQ = 6.00HZ.					
ENVIRONMENT CONDITIONS: ROOM AMBIENT											
NO.	CYCLES	A (MEASURED)	A (REGRESSION)	MULT. CORR. COEFF	K-MAX	DELTA K	DA/DN				
1	0.	0.310	0.310	0.999592	13.98	4.19	1.345E-06				
2	11700.	0.340	0.340	0.999662	14.65	4.39	1.215E-06				
3	30000.	0.380	0.377	0.992145	15.44	4.63	1.052E-06				
4	50000.	0.415	0.419	0.982096	16.27	4.88	1.320E-06				
5	55000.	0.420	0.431	0.957805	16.50	4.95	1.550E-06				
6	60000.	0.445	0.444	0.991061	16.77	5.03	1.566E-06				
7	70000.	0.485	0.476	0.996260	17.35	5.21	1.646E-06				
8	87000.	0.530	0.531	0.996253	18.35	5.50	1.606E-06				
9	105000.	0.595	0.596	0.998095	19.47	5.84	2.119E-06				
10	120000.	0.660	0.661	0.999315	20.53	6.16	2.598E-06				
11	132000.	0.725	0.726	0.996404	21.55	6.47	3.261E-06				
12	143000.	0.795	0.800	0.997135	22.67	6.60	4.017E-06				
13	153000.	0.875	0.866	0.997653	23.91	7.17	5.075E-06				
14	158700.	0.950	0.949	0.998425	24.79	7.44	6.341E-06				

PLOTRATE CRACK GROWTH ANALYSIS
B-3
STRESS = +14 TO +20 KSI

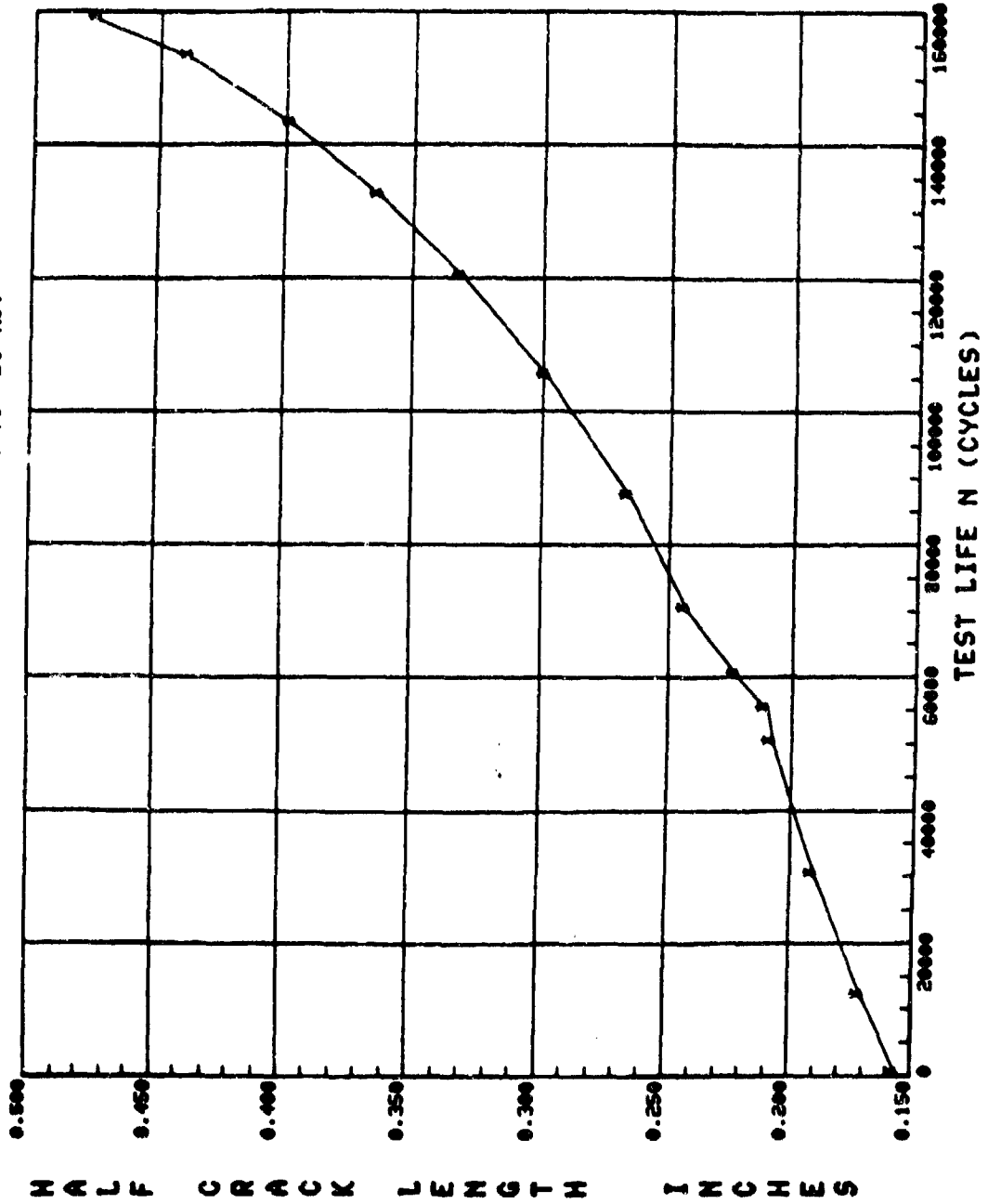

Figure 10. Crack growth curve for test B-3.

TABLE 6. DATA TABULATION FOR TEST B-4

SPECIMEN NO.: B-4		STRESS -6 +20 KSI		R= 0.250 IN.		V= 6.000 IN.		AN= 0.0 IN.		TEST FREQ= 6.00HZ.	
CCJ SPECIMEN		PMIN= -9.0KIPS		PMAX= 30.0KIPS		R=-0.30		R=-0.30		TEST FREQ= 6.00HZ.	
ENVIRONMENT CONDITIONS: ROOM AMBIENT											
NO.	CYCLES	A (MEASURED)	A (REGRESSION)	MULT. CORR. COEFF	K-MAX	DELTA K	DA/DM				
1	0	0.325	0.324	0.997473	14.30	16.59	1.694E-05				
2	832	0.353	0.354	0.996965	14.94	19.42	1.965E-05				
3	2000	0.415	0.405	0.997094	16.00	20.60	2.704E-05				
4	3006	0.466	0.470	0.996534	17.25	22.42	3.432E-05				
5	4000	0.545	0.546	0.996793	18.61	24.20	4.191E-05				
6	4700	0.620	0.607	0.996567	19.65	25.54	4.926E-05				
7	5200	0.650	0.660	0.994199	20.51	26.66	5.747E-05				
8	5700	0.710	0.716	0.995468	21.38	27.80	6.374E-05				
9	6200	0.780	0.779	0.997401	22.55	29.06	7.567E-05				
10	6600	0.855	0.846	0.996236	23.34	30.34	8.615E-05				
11	6900	0.850	0.899	0.997632	24.69	31.32	9.644E-05				
12	7200	0.960	0.957	0.996455	24.90	32.37	1.126E-04				
13	7470	1.015	1.017	0.998371	25.72	33.44	1.263E-04				
14	7730	1.065	1.069	0.996610	26.62	34.64	1.473E-04				
15	7970	1.170	1.162	0.999022	27.63	35.92	1.661E-04				
16	8170	1.225	1.232	0.998465	28.54	37.10	1.870E-04				
17	8370	1.310	1.309	0.998836	29.51	38.37	2.118E-04				
18	8540	1.380	1.381	0.999702	30.42	39.54	2.375E-04				
19	8700	1.460	1.462	0.999477	31.44	40.85	2.712E-04				
20	8850	1.545	1.545	0.999913	32.45	42.16	3.044E-04				
21	8980	1.625	1.622	0.999166	33.46	43.50	3.407E-04				
22	9080	1.750	1.698	0.999815	34.32	44.61	3.751E-04				
23	9170	1.765	1.767	0.999651	35.16	45.71	4.074E-04				
24	9240	1.825	1.825	0.998199	35.66	46.62	4.594E-04				
25	9310	1.890	1.890	0.998374	36.66	47.66	4.965E-04				
26	9370	1.945	1.952	0.998329	37.43	48.66	5.360E-04				
27	9430	2.030	2.019	0.998167	38.25	49.72	5.847E-04				
28	9480	2.075	2.079	0.996003	38.99	50.69	6.314E-04				

TABLE 6. DATA TABULATION FOR TEST B-4 (CONCL)

SPECIMEN NO.: B-4 STRESS -6 TO +20 KSI

CC1 SPECIMEN B= 0.250 IN. W= 6.000 IN. AN= 0.0 IN.

PMIN= -9.0KIPS PMAX= 30.0KIPS R=-0.30 TEST FREQ= 6.00HZ,

ENVIRONMENT CONDITION: ROOM AMBIENT

NU.	CYCLES	A (MEASURED)	A (REGRESSION)	MULT. CORR. COEFF	K-MAX	DELTA K	D/DM
29	9530.	2.140	2.144	0.997312	39.80	51.74	7.007E-04
30	9570.	2.200	2.197	0.999762	40.47	52.61	7.479E-04
31	9610.	2.260	2.264	0.999461	41.31	53.71	8.391E-04
32	9650.	2.325	2.334	0.999398	42.21	54.87	9.144E-04
33	9680.	2.395	2.390	0.999405	42.94	55.82	9.712E-04
34	9710.	2.445	2.449	0.998436	43.71	56.83	1.067E-03
35	9740.	2.515	2.511	0.998434	44.53	57.89	1.196E-03
36	9770.	2.560	2.586	0.998758	45.54	59.20	1.329E-03
37	9800.	2.670	2.671	0.998843	46.71	60.73	1.517E-03
38	9825.	2.760	2.749	0.998284	47.80	62.14	1.729E-03
39	9850.	2.830	2.839	0.997525	49.09	63.82	2.024E-03
40	9870.	2.915	2.919	0.998350	50.27	65.39	2.325E-03
41	9890.	3.015	3.012	0.997922	51.69	67.19	2.889E-03
42	9910.	3.130	3.137	0.994764	53.67	69.77	3.919E-03
43	9920.	3.200	3.212	0.995675	54.90	71.37	4.941E-03
44	9930.	3.305	3.310	0.999147	56.57	73.54	5.985E-03
45	9940.	3.435	3.436	0.999976	58.82	76.46	7.416E-03
46	9950.	3.600	3.600	0.999969	61.96	80.54	8.921E-03

PLOT RATE CRACK GROWTH ANALYSIS
B-4 STRESS = -6 TO +20 KSI

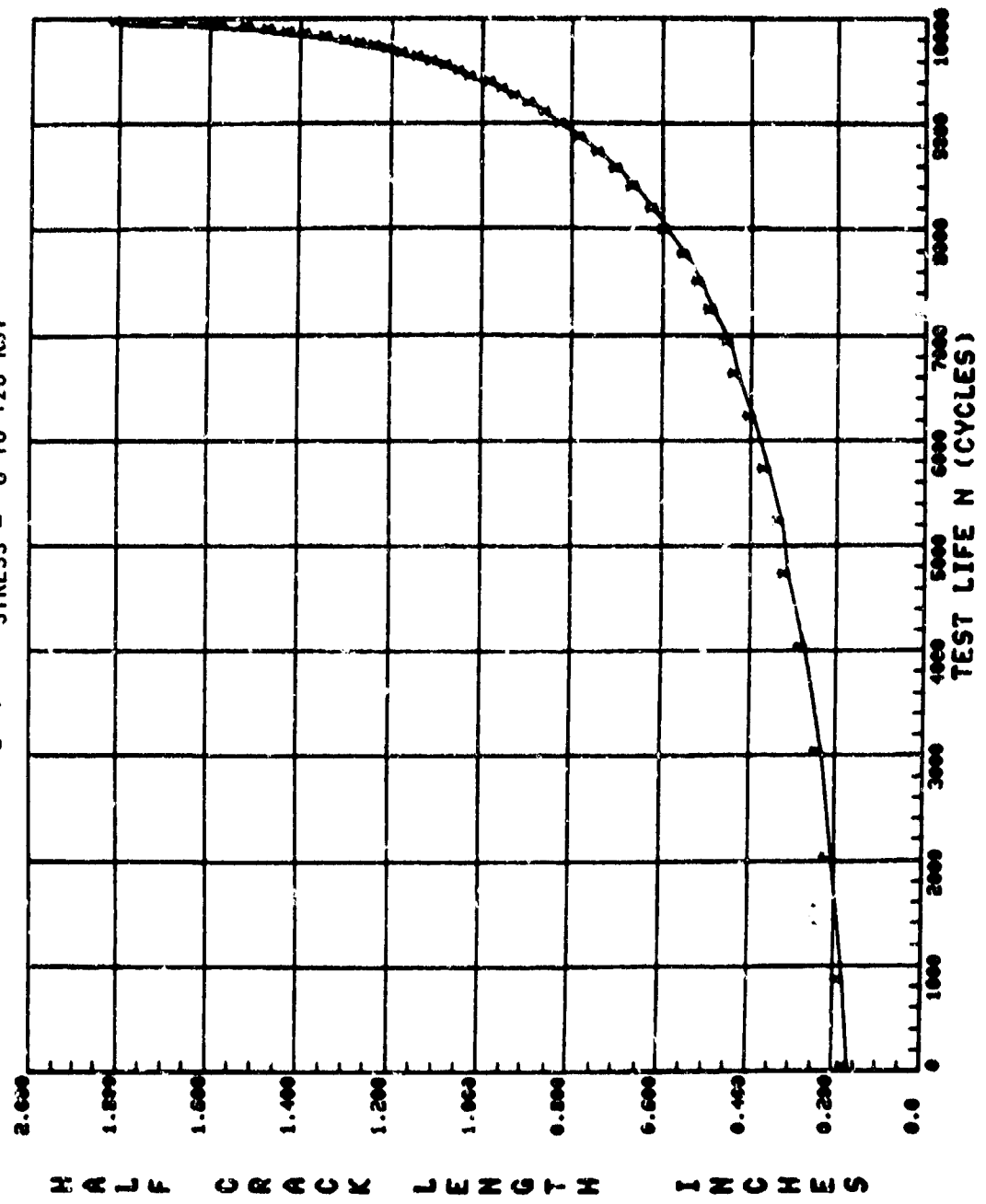

Figure 11. Crack growth curve for test B-4.

TABLE 7. DATA TABULATION FOR TEST B-5

SPECIMEN NO.: B-5 BASELINE STRESS = -2 TO 20 KSI

CCT SPECIMEN B= 0.150 IN. W= 6.000 IN. AN= 0.0 IN.

PMIN= -3.0KIPS PMAX= 30.0KIPS R=-0.10 TEST FREQ= 6.00KHZ.

ENVIRONMENT CONDITION: ROOM AMBIENT

NO.	CYCLLS	A(MEASURED)	A(REGRESSION)	MULT. CORR. COEFF	K-MAX	DELTA E	DA/DM
1	0.	0.303	0.303	0.997602	13.81	15.19	8.596E-04
2	2700.	0.385	0.380	0.998558	15.49	17.04	1.970E-05
3	4200.	0.440	0.447	0.998669	16.82	18.50	2.632E-05
4	5400.	0.510	0.517	0.998426	18.16	19.91	3.246E-05
5	6400.	0.580	0.584	0.999107	19.26	21.19	3.925E-05
6	7100.	0.640	0.642	0.998891	20.22	22.24	5.448E-05
7	7800.	0.705	0.705	0.999165	21.22	23.34	5.298E-05
8	8400.	0.770	0.772	0.999040	22.25	24.47	6.028E-05
9	8700.	0.805	0.808	0.997117	22.78	25.06	7.011E-05
10	9000.	0.855	0.851	0.997588	23.40	25.74	7.704E-05
11	9300.	0.890	0.898	0.997732	24.07	26.46	8.690E-05
12	9600.	0.920	0.953	0.997966	24.85	27.33	9.710E-05
13	9900.	1.010	1.014	0.997786	25.68	28.25	1.056E-04
14	10200.	1.085	1.081	0.994902	26.58	29.24	1.249E-04
15	10400.	1.130	1.129	0.996807	27.21	29.93	1.405E-04
16	10600.	1.175	1.158	0.996594	27.97	30.77	1.589E-04
17	10800.	1.260	1.252	0.998429	28.80	31.66	1.761E-04
18	10902.	1.295	1.292	0.995766	29.30	32.22	1.781E-04
19	11000.	1.330	1.330	0.997423	29.79	32.77	1.900E-04
20	11100.	1.365	1.363	0.997622	30.20	33.22	2.020E-04
21	11200.	1.400	1.408	0.996536	30.76	33.63	2.120E-04
22	11300.	1.450	1.452	0.997946	31.30	34.43	2.279E-04
23	11400.	1.510	1.497	0.998382	31.86	35.05	2.454E-04
24	11600.	1.595	1.598	0.998033	33.09	36.40	2.844E-04
25	11800.	1.715	1.715	0.998865	34.53	37.98	3.444E-04
26	11950.	1.870	1.821	0.998260	35.82	39.40	4.124E-04
27	12100.	1.955	1.957	0.998720	37.48	41.23	5.188E-04
28	12256.	2.110	2.115	0.996907	39.43	43.36	6.728E-04

TABLE 7. DATA TABULATION FOR TEST B-5 (CONCL)

SPECIMEN NO.: B-5 BASELINE STRESS = -2 TO 20 KSI

GCT SPECIMEN B= 0.250 IN. W= 6.000 IN. AN= 0.0 IN.

PMIN= -3.0KIPS PMAX= 30.0KIPS R=-0.10 TEST FREQ= .600HZ.

ENVIRONMENT CONDITIONS: ROOM AMBIENT

NO.	CYCLES	A (MEASURED)	A (REGRESSION)	MULT. CORR. COEFF	K-MAX	DELTA K	DATE
29	12356.	2.245	2.243	0.991703	41.05	45.15	9-031E-04
30	12456.	2.465	2.416	0.984603	43.27	47.60	1-203E-03
31	12556.	2.640	2.674	0.991253	46.75	51.43	1-080E-03
32	12656.	3.015	3.005	0.994741	52.84	58.12	2-069E-03
33	12706.	3.590	3.384	0.996767	57.86	63.65	3-547E-03

**PLOT RATE CRACK GROWTH ANALYSIS
B-5 BASELINE STRESS - 2 TO 20 KSI**

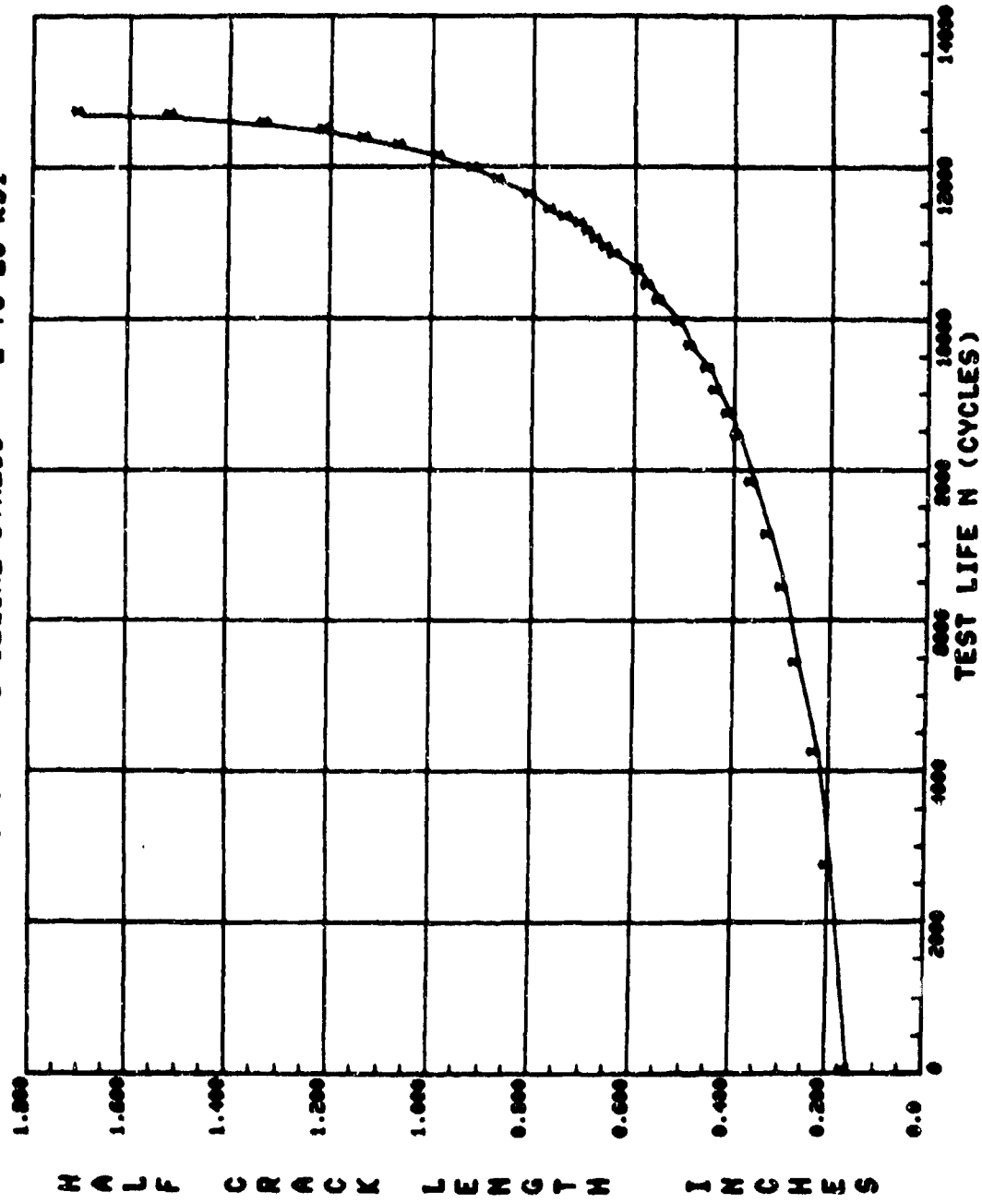

Figure 12. Crack growth curve for test B-5.

TABLE 8. DATA TABULATION FOR TEST B-6-1

SPECIMEN NO.: B-6-1 BASELINE, 20 KSI STRESS

CC1 SPECIMEN B= 0.250 IN. W= 6.000 IN. AM= 0.0 IN.

PMIN= 0.3KIPS PHAX= 30.0KIPS R= 0.01 TEST FREQ= 3.00HZ.

ENVIRONMENT CONDITION: ROOM AMBIENT

NO.	CYCLES	A (MEASURED)	A (REGRESSION)	MULT. CORR. COEFF	K-MAX	DELTA K	DA/DM
1	0.	0.305	0.305	0.99719	13.87	13.73	2.746E-05
2	600.	0.335	0.331	0.994395	14.45	14.31	2.025E-05
3	1200.	0.355	0.354	0.995726	14.94	14.80	1.817E-05
4	1800.	0.370	0.375	0.996185	15.38	15.22	1.637E-05
5	2400.	0.395	0.391	0.993533	15.71	15.55	1.607E-05
6	3000.	0.410	0.406	0.979309	16.02	15.86	1.979E-05
7	3600.	0.425	0.430	0.969233	16.50	16.33	2.426E-05
8	4200.	0.45	0.462	0.951599	17.10	16.93	2.827E-05
9	4800.	0.510	0.503	0.991654	17.85	17.69	3.229E-05
10	5400.	0.550	0.547	0.997509	18.64	18.45	3.557E-05
11	6000.	0.590	0.591	0.997705	19.38	19.19	3.705E-05
12	6600.	0.630	0.631	0.999243	20.05	19.85	3.864E-05
13	7200.	0.680	0.678	0.997720	20.79	20.58	4.482E-05
14	7800.	0.730	0.733	0.998402	21.65	21.44	5.315E-05
15	8400.	0.795	0.801	0.998109	22.67	22.45	6.134E-05
16	8700.	0.845	0.839	0.998054	23.22	22.99	6.713E-05
17	9000.	0.885	0.881	0.996250	23.83	23.59	7.674E-05
18	9300.	0.920	0.929	0.995754	24.50	24.26	8.144E-05
19	9600.	0.975	0.978	0.997125	25.18	24.93	8.805E-05
20	9900.	1.045	1.033	0.997334	25.93	25.67	9.970E-05
21	10200.	1.040	1.046	0.997690	26.76	26.51	1.122E-04
22	10500.	1.160	1.164	0.998277	27.67	27.39	1.244E-04
23	10800.	1.245	1.240	0.999366	28.64	28.35	1.441E-04
24	11100.	1.330	1.334	0.999330	29.94	29.54	1.677E-04
25	11200.	1.365	1.368	0.994216	30.26	29.96	1.761E-04
26	11300.	1.405	1.403	0.999154	30.69	30.39	1.838E-04
27	11400.	1.445	1.442	0.999047	31.16	30.67	1.973E-04
28	11500.	1.480	1.482	0.994078	31.68	31.36	2.036E-04

TABLE 8. DATA TABULATION FOR B-6-1 (CONCL)

SPECIMEN NO.: B-6-1 BASELINE, 20 KSI STRESS

CCI SPECIMEN R= 0.250 IN. W= 6.000 IN. AN= 0.0 IN.

PMIN= 0.3KIPS PMAX= 30.0KIPS R= 0.01 TEST FREQ= 3.00HZ. f

ENVIRONMENT CONDITION: ROOM AMBIENT

NO.	CYCLES	A(MEASURED)	A(REGRESSION)	MULT. CORR. COEFF	K-MAX	DELTA K	DA/DN
29	11600.	1.520	1.523	0.995222	32.16	31.86	2.009E-04
30	11700.	1.570	1.565	0.996811	32.69	32.36	2.231E-04
31	11800.	1.610	1.611	0.998954	33.26	32.92	2.402E-04
32	11900.	1.655	1.640	0.999322	33.86	33.52	2.536E-04
33	12000.	1.715	1.711	0.999326	34.48	34.13	2.714E-04
34	12100.	1.770	1.768	0.999503	35.16	34.82	2.955E-04
35	12200.	1.825	1.830	0.999457	35.93	35.57	3.125E-04
36	12300.	1.895	1.893	0.999520	36.70	36.33	3.321E-04
37	12400.	1.965	1.960	0.999040	37.52	37.14	3.681E-04
38	12500.	2.036	2.036	0.999232	38.46	38.07	4.009E-04
39	12600.	2.115	2.116	0.999389	39.45	39.05	4.462E-04
40	12700.	2.215	2.206	0.999066	40.59	40.18	5.214E-04
41	12800.	2.310	2.316	0.999037	41.99	41.57	6.137E-04
42	12900.	2.440	2.444	0.999448	43.65	43.21	7.283E-04
43	13000.	2.600	2.599	0.999314	45.72	45.26	9.144E-04
44	13050.	2.690	2.692	0.997334	46.99	46.53	1.094E-03
45	13100.	2.790	2.798	0.996463	48.51	48.02	1.345E-03
46	13150.	2.925	2.895	0.974989	49.92	49.42	2.004E-03
47	13200.	3.100	3.105	0.985410	53.14	52.63	2.901E-03
48	13250.	3.330	3.423	0.991047	58.57	57.99	4.275E-03
49	13300.	3.940	3.936	0.995574	69.35	68.66	6.670E-03

**PLOTRATE CRACK GROWTH ANALYSIS
B-6-1 BASELINE, 20 KSI STRESS**

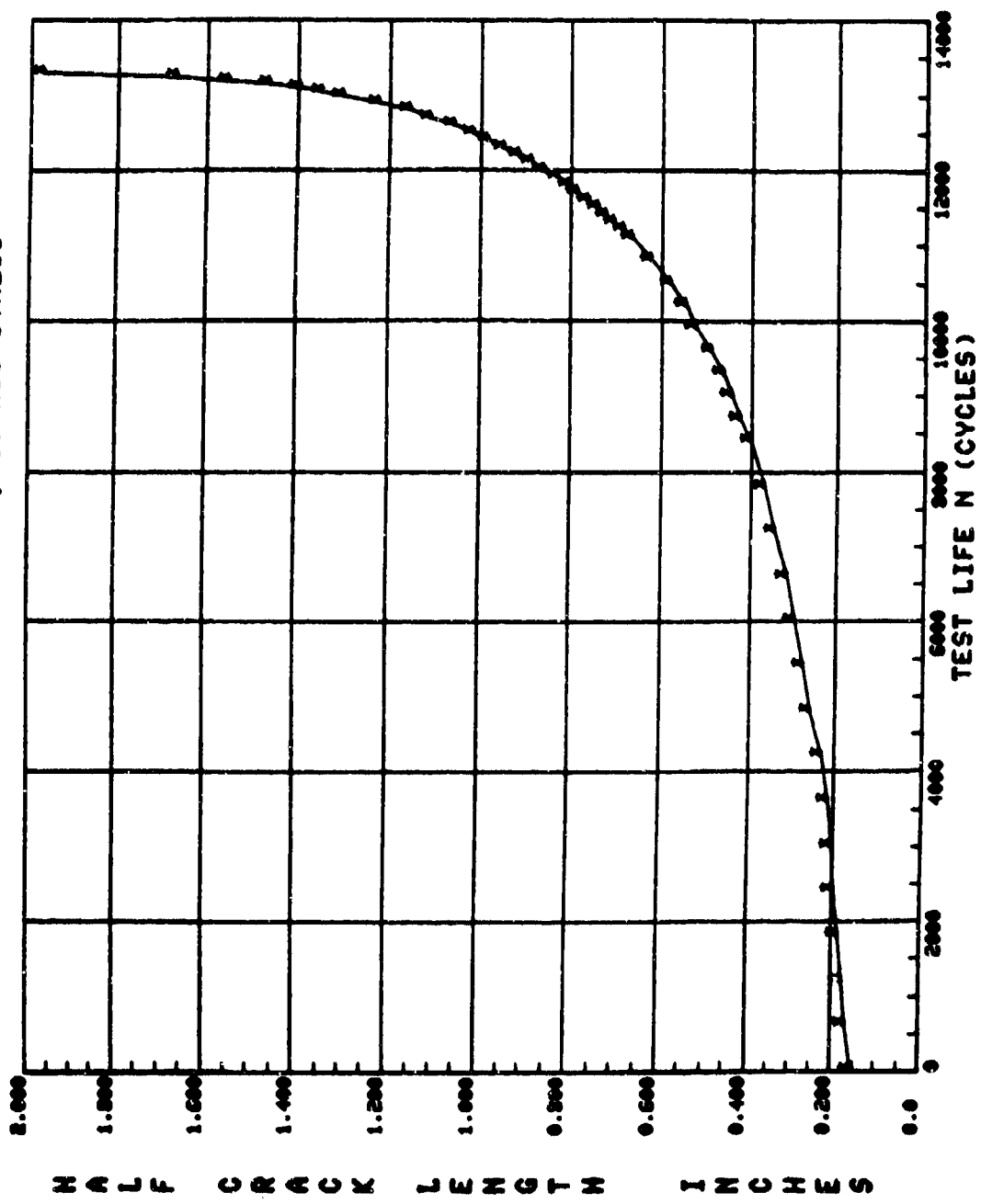

Figure 13. Crack growth curve for test B-6-1.

TABLE 9. DATA TABULATION FOR TEST B-6-2

SPECIMEN NO.: B-6-2 BASELINE: 20 KSI STRESS

SCT SPECIMEN B= 0.250 IN. W= 6.000 IN. AN= 0.0 IM.

PHIN= 0.3 KIPS PMAX= 30.0 KIPS R= 0.01 TEST FREQ= 6.00HZ.

ENVIRONMENT CONDITION: ROOM AMBIENT

NO.	CYCLES	A (MEASURED)	A (REGRESSION)	MULT. CORR. COEFF	K-MAX	DELTA K	DA/DN
1	0.	0.315	0.315	0.999996	14.09	13.95	1.322E-05
2	1200.	0.350	0.345	0.997148	14.76	14.61	1.527E-05
3	2850.	0.410	0.409	0.998022	16.08	15.92	2.308E-05
4	3800.	0.450	0.457	0.998263	17.01	16.84	2.813E-05
5	4600.	0.510	0.504	0.997000	17.87	17.69	3.474E-05
6	5300.	0.550	0.555	0.995774	18.77	18.58	3.855E-05
7	5900.	0.600	0.605	0.996069	19.61	19.41	4.304E-05
8	6400.	0.660	0.648	0.996507	20.31	20.11	4.704E-05
9	6900.	0.690	0.699	0.996865	21.12	20.91	5.093E-05
10	7400.	0.750	0.751	0.996584	21.92	21.70	5.439E-05
11	7900.	0.810	0.804	0.996651	22.72	22.49	6.376E-05
12	8200.	0.840	0.845	0.996698	23.31	23.08	7.068E-05
13	8500.	0.880	0.886	0.998172	23.90	23.66	7.968E-05
14	8800.	0.940	0.933	0.995229	24.57	24.32	9.167E-05
15	9100.	0.990	0.995	0.998674	25.41	25.16	1.038E-04
16	9400.	1.060	1.061	0.998746	26.31	26.05	1.145E-04
17	9700.	1.140	1.133	0.996105	27.25	26.98	1.348E-04
18	9900.	1.160	1.189	0.994884	28.00	27.72	1.513E-04
19	10000.	1.210	1.216	0.991552	28.37	28.08	1.527E-04
20	10100.	1.260	1.249	0.985752	28.76	28.48	1.522E-04
21	10200.	1.290	1.263	0.993696	29.19	28.90	1.732E-04
22	10300.	1.310	1.317	0.984885	29.62	29.32	1.768E-04
23	10400.	1.340	1.349	0.992984	30.02	29.72	1.839E-04
24	10500.	1.400	1.389	0.992549	30.52	30.22	2.000E-04
25	10600.	1.430	1.434	0.996342	31.08	30.77	2.174E-04
26	10700.	1.480	1.476	0.995842	31.62	31.30	2.321E-04
27	10800.	1.520	1.523	0.997411	32.18	31.86	2.321E-04
28	10900.	1.570	1.571	0.997828	32.77	32.45	2.536E-04

TABLE 9. DATA TABULATION FOR TEST B-6-2 (CONCL)

SPECIMEN NO.: B-6-2		BASELINE, 20 KSI STRESS		W = 6.000 IN.		AN = 0.0 IN.	
TEST SPECIMEN		L = 0.250 IN.		P MAX = 30.0 KIPS		R = 0.01	
P MIN = 0.3 KIPS		CYCLES		A (MEASURED)		A (REGRESSION)	
ENVIRONMENT CONDITION: ROOM AMBIENT		MULT. CORR. COEFF		K-MAX		DELTA K	
NO.	CYCLES	A (MEASURED)	A (REGRESSION)	MULT. CORR. COEFF	K-MAX	DELTA K	DA/DM
29	11000.	1.630	1.623	0.997849	33.41	33.08	2.625E-04
30	11100.	1.670	1.677	0.997411	34.06	33.72	2.857E-04
31	11200.	1.740	1.730	0.995129	34.72	34.37	3.268E-04
32	11300.	1.790	1.799	0.993986	35.56	35.20	3.536E-04
33	11400.	1.870	1.875	0.994862	36.48	36.12	4.050E-04
34	11500.	1.980	1.960	0.994856	37.53	37.15	4.393E-04
35	11580.	2.020	2.035	0.993374	38.45	38.07	4.984E-04
36	11660.	2.120	2.116	0.992165	39.46	39.06	5.254E-04
37	11740.	2.190	2.198	0.993056	40.49	40.08	6.051E-04
38	11790.	2.280	2.265	0.993673	41.33	40.92	6.607E-04
39	11836.	2.310	2.324	0.993808	42.08	41.66	7.201E-04
40	11884.	2.400	2.384	0.992463	43.04	42.61	8.030E-04
41	11910.	2.440	2.435	0.996196	43.52	43.09	8.956E-04
42	11940.	2.490	2.495	0.998033	44.32	43.88	1.004E-03
43	11970.	2.550	2.556	0.997835	45.13	44.66	1.045E-03
44	12000.	2.630	2.620	0.997198	46.00	45.54	1.177E-03
45	12035.	2.710	2.706	0.997495	47.20	46.73	1.339E-03
46	12060.	2.760	2.769	0.994954	48.08	47.60	1.563E-03
47	12090.	2.870	2.863	0.998477	49.44	48.94	1.865E-03
48	12120.	2.970	2.962	0.999077	51.23	50.71	2.273E-03
49	12150.	3.140	3.133	0.998959	53.60	53.06	2.729E-03
50	12180.	3.310	3.311	0.998783	56.58	56.01	3.311E-03

PLOTRATE CRACK GROWTH ANALYSIS
B-6-2 BASELINE, 20 KSI STRESS

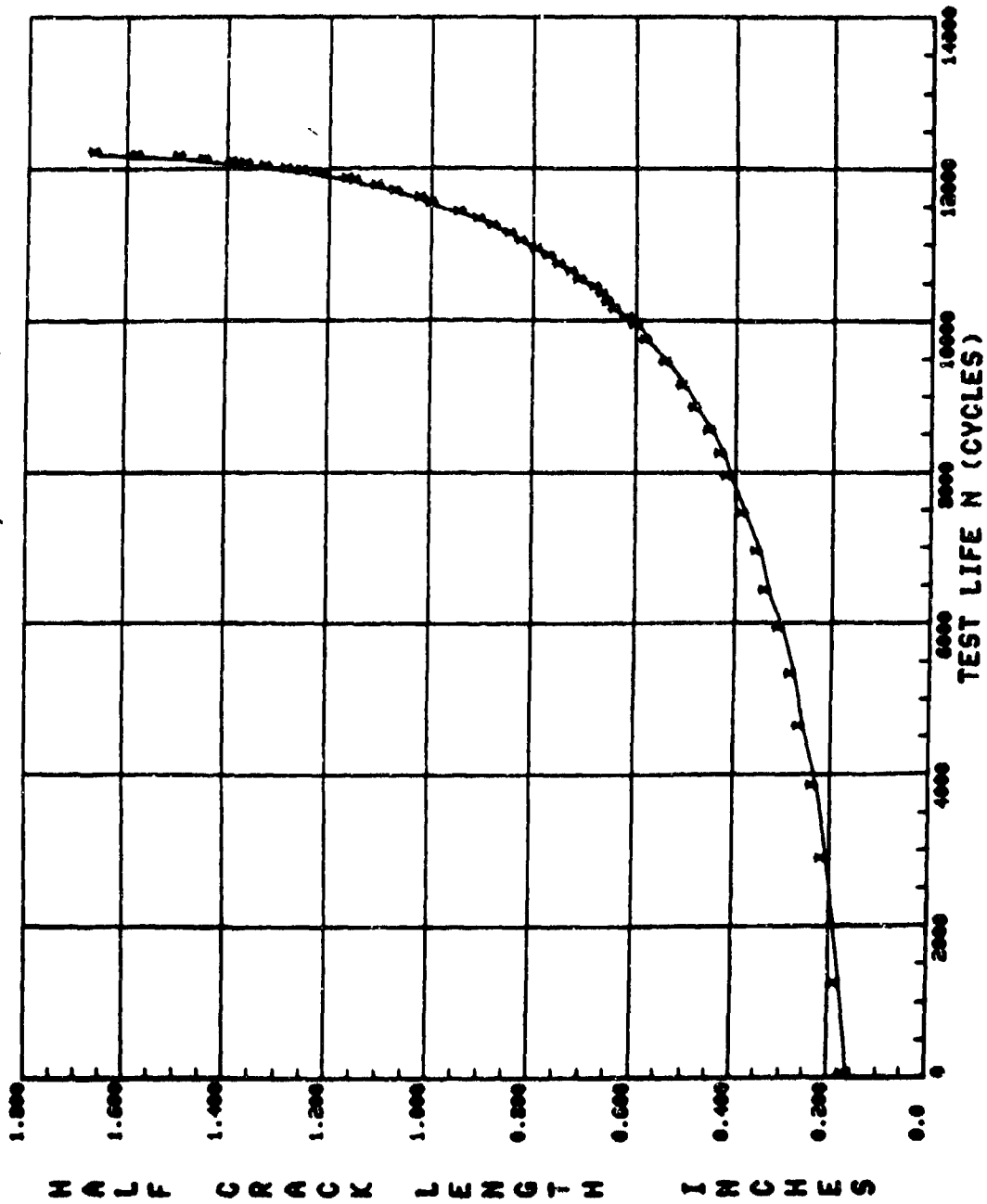

Figure 14. Crack growth curve for test B-6-2.

TABLE 10. METHODOLOGY DEVELOPMENT TESTING PROGRAM GROUP I -
CONSTANT-AMPLITUDE LOAD



Test No.	Applied Base Load		Over-load / Under-load		N_I Cycle	N_{II} Cycle	Comments
	Loading Profile	σ_{Max} Ksi	σ_{Min} Ksi	σ_{Max} Ksi			
M-1		8	0				da/dn at low ΔK range, $R = 0$
M-2		8	2.4				da/dn at low ΔK range, $R = 0.3$
M-3		8	-8				da/dn at $R = -1$
M-4		8	-2.4				da/dn of negative stress ratio at low ΔK range
M-5		40	0				da/dn at high ΔK range, $R = 0$
M-6		40	12				da/dn at high ΔK range, $R = 0.3$
M-7		40	28				da/dn at high ΔK range, $R = 0.7$
M-8		40	-4				da/dn of negative stress ratio at high ΔK range
M-9		8	-0.8				da/dn of negative stress ratio at low ΔK range, $R = -0.1$
M-10		20	-6				da/dn of negative stress ratio at high ΔK range, $R = -0.5$

TABLE II. DATA TABULATION FOR TEST M-1

SPECIMEN NO.: M-1 CENTER CRACKED PANEL. STRESS = 8KSI. R = 0
 CCT SPECIMEN R = 0.250 IN. W = 6.000 IN. ΔL = 0.0 IN.
 PMIN = 0.0 KIPS PMAX = 12.00KIPS P = 0.0 TEST FREQ = 6.000HZ.
 ENVIRONMENT CONDITION: ROOM AMBIENT

NO.	CYCLES	A (MEASURED)	A (PREDICTED)	MULT. CORR. COEFF	←-MAX	DELTA K	DA/DN
1	0.	0.280	0.280	0.995571	5.31	5.31	1.456E-07
2	75000.	0.345	0.344	0.995652	5.89	5.89	6.260E-07
3	105000.	0.380	0.386	0.995188	6.25	6.25	8.147E-07
4	120000.	0.420	0.412	0.995980	6.46	6.46	9.339E-07
5	140000.	0.445	0.450	0.995300	6.75	6.75	1.145E-06
6	155000.	0.485	0.485	0.996613	7.01	7.01	1.339E-06
7	170000.	0.525	0.526	0.999092	7.31	7.31	1.511E-06
8	187000.	0.565	0.584	0.996658	7.71	7.71	1.817E-06
9	206000.	0.660	0.657	0.999294	8.19	8.19	2.155E-06
10	223000.	0.720	0.726	0.998019	8.68	8.68	2.620E-06
11	233000.	0.785	0.788	0.998027	9.00	9.00	3.012E-06
12	241000.	0.825	0.837	0.999796	9.28	9.28	3.398E-06
13	248000.	0.850	0.846	0.999688	9.56	9.56	3.775E-06
14	255000.	0.940	0.942	0.999463	9.88	9.88	4.066E-06
15	262000.	1.000	1.000	0.998001	10.20	10.20	4.558E-06
16	268000.	1.060	1.055	0.998767	10.49	10.49	5.077E-06
17	274000.	1.110	1.118	0.998638	10.83	10.83	5.794E-06
18	280000.	1.155	1.190	0.998998	11.20	11.20	5.534E-06
19	286000.	1.270	1.273	0.999077	11.62	11.62	7.432E-06
20	291000.	1.355	1.353	0.999252	12.03	12.03	7.854E-06
21	294000.	1.400	1.400	0.999144	12.27	12.27	8.168E-06
22	297000.	1.455	1.452	0.999334	12.52	12.52	8.582E-06
23	300000.	1.500	1.502	0.999497	12.77	12.77	8.959E-06
24	303000.	1.555	1.556	0.999402	13.03	13.03	9.702E-06
25	306000.	1.615	1.615	0.999750	13.32	13.32	1.039E-05
26	309000.	1.680	1.680	0.999741	13.64	13.64	1.140E-05
27	312000.	1.755	1.751	0.999582	13.99	13.99	1.265E-05
28	315000.	1.825	1.830	0.999518	14.37	14.37	1.369E-05

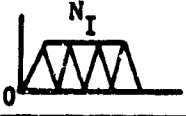
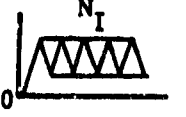
TABLE 11. DATA TABULATION FOR TABLE M-1 (CONCL)

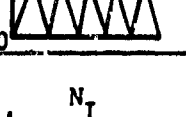
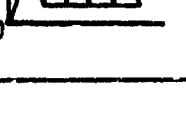
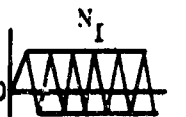
SPECIMEN NO.: M-1 CENTER CRACKED PANEL, STRESS = 8KSI, R = 0

CCT SPECIMEN R = 0.250 IN. W = 6.000 IN. AK = 0.0 IN.

PMIN = 0.0 KIPS P MAX = 12.0 KIPS R = 0.0 TEST FREQ = 6.000 HZ.

ENVIRONMENT CONDITION: ROOM AMBIENT

NO.	CYCLES	A (MEASLED)	A (REGRESSION)	"HIL" CORR. COEFF	K-MAX	DELTA K	DA/DN
29	318000.	1.915	1.915	0.999486	14.79	14.79	1.503E-05
30	321000.	2.015	2.011	0.998789	15.26	15.26	1.589E-05
31	324000.	2.105	2.113	0.999308	15.76	15.76	1.673E-05
32	327000.	2.225	2.211	0.997773	16.26	16.26	1.601E-05
33	330000.	2.315	2.317	0.998149	16.80	16.80	1.974E-05
34	333000.	2.425	2.475	0.998353	17.41	17.41	2.247E-05
35	336000.	2.580	2.573	0.999790	18.14	18.14	2.565E-05
36	339000.	2.725	2.737	0.999653	19.05	19.05	3.033E-05
37	342000.	2.925	2.970	0.996976	20.12	20.12	3.729E-05
38	345000.	3.145	3.144	0.994730	21.51	21.51	4.778E-05
39	348000.	3.415	3.459	0.996911	23.62	23.62	6.219E-05
40	351000.	3.820	3.971	0.997998	27.03	27.03	8.493E-05
41	352406.	4.125	4.172	0.995077	29.67	29.67	1.060E-04

M-1
 PLOTRATE CRACK GROWTH ANALYSIS
 CENTER CRACKED PANEL, STRESS = 8KSI, R = 0

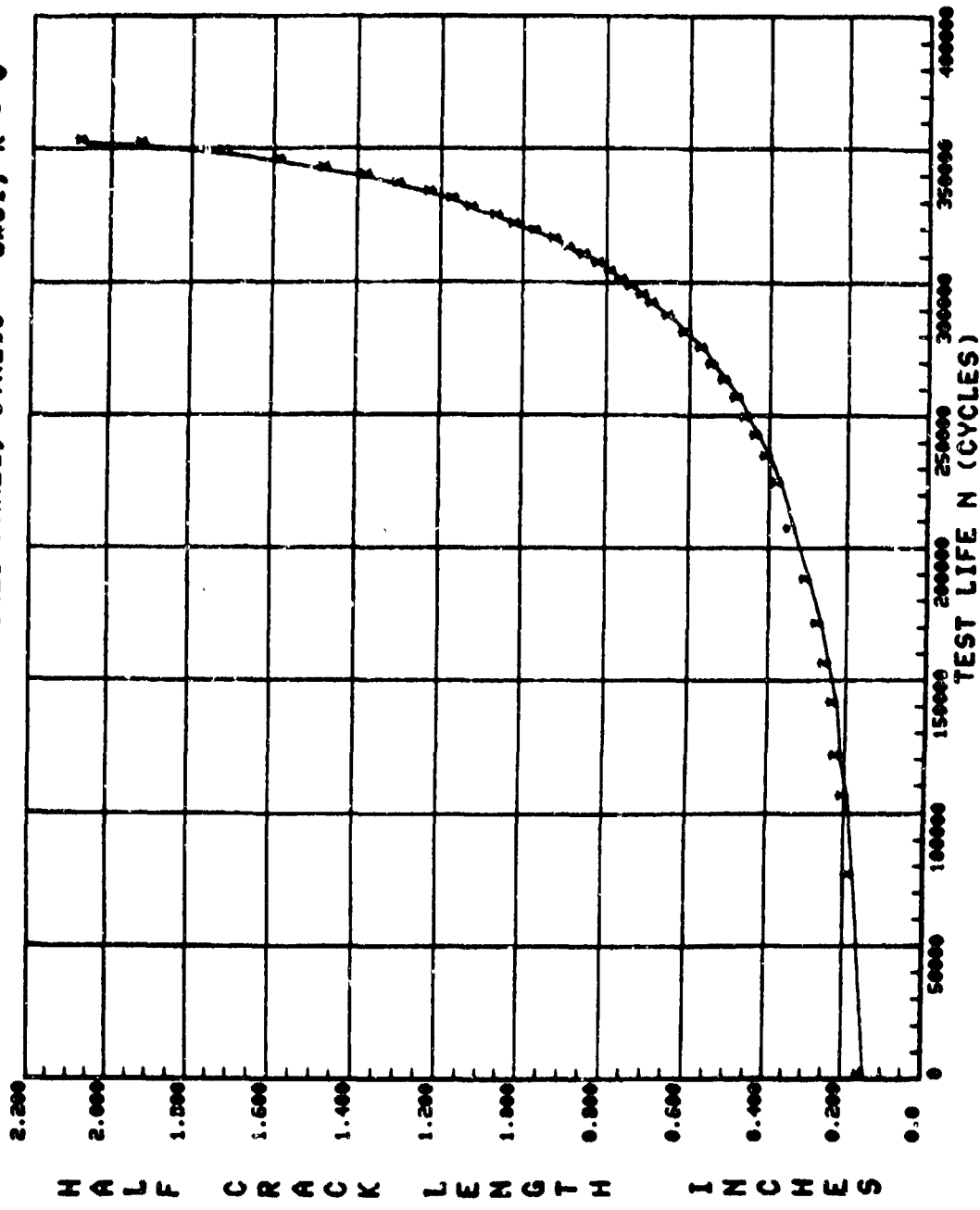

Figure 15. Crack growth curve for test M-1.

TABLE 12. DATA TABULATION FOR TEST M-2

SPECIMEN NO.: M-2 CENTER CRACK PAN-L STRESS = 2.4 TO 8.0 KSI

CCT SPECIMEN A = 0.250 IN. W = 6.000 IN. AN = 0.0 IN.

PMIN = 3.6 KIPS PMAX = 12.0 KIPS R = 0.30 TEST FREQ = 6.00 /MT.

ENVIRONMENT CONDITION: ROOM AMBIENT

NO.	CYCLES	A (MEASUREMENT)	A (REGRESSION)	UNIT	COEFF	K-MAX	DELTA K	DA/DM
1	0.	0.305	0.305		0.999484	5.55	3.88	3.551E-07
2	45000.	0.340	0.336		0.998739	5.32	4.07	3.669E-07
3	94000.	0.375	0.374		0.998435	5.14	4.30	4.427E-07
4	145000.	0.420	0.423		0.998877	6.54	4.58	5.252E-07
5	195000.	0.480	0.479		0.999243	6.97	4.88	6.269E-07
6	237000.	0.540	0.535		0.998766	7.37	5.16	7.090E-07
7	245000.	0.545	0.546		0.998164	7.44	5.21	6.557E-07

M-2
PLOT RATE CRACK GROWTH ANALYSIS
CENTER CRACK PANEL, STRESS = 2.4 TO -8KSI

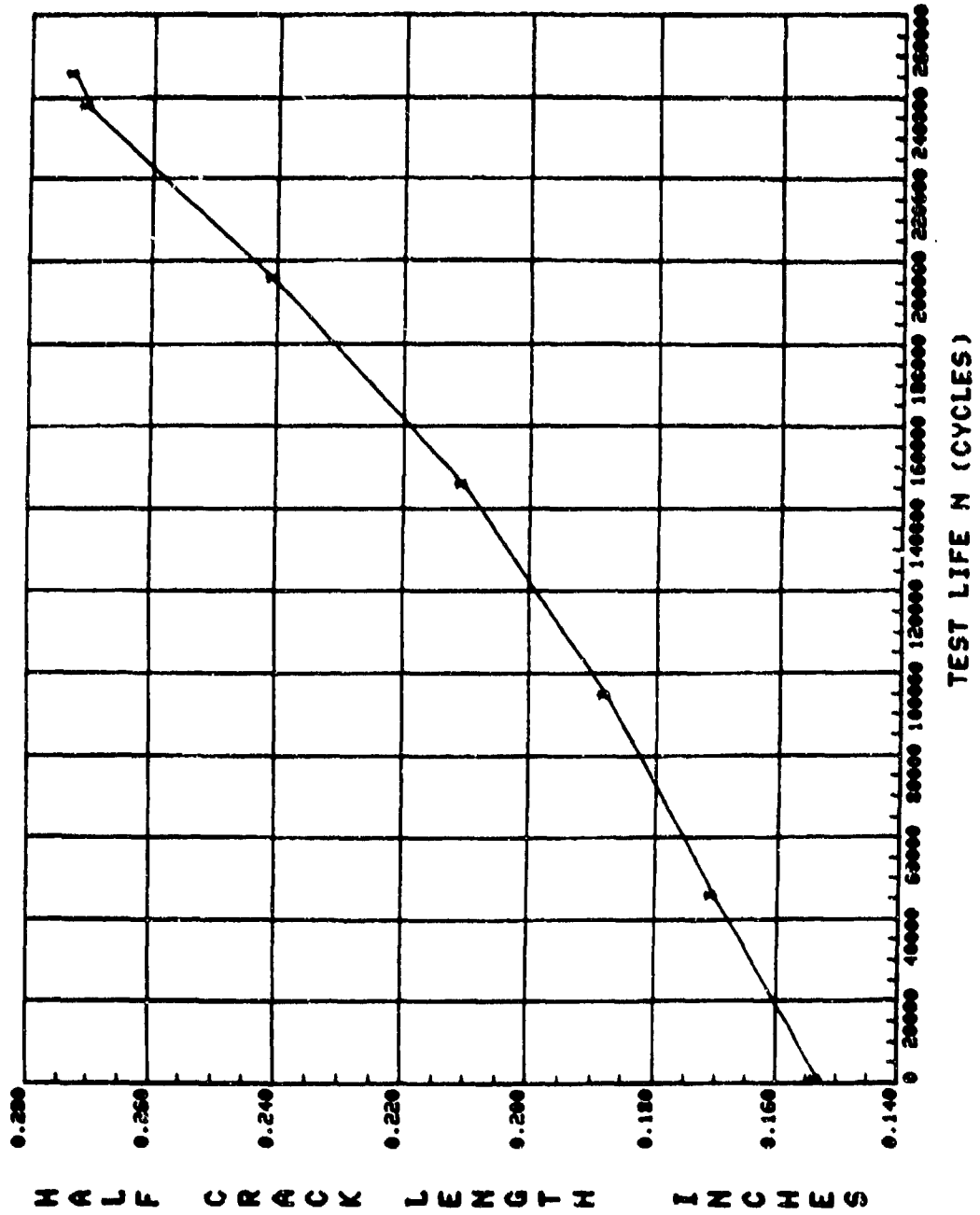

Figure 16. Crack growth curve for test M-2.

TABLE 13. DATA TABULATION FOR TEST M-3

SPECIMEN NO.: M-3 CONSTANT AMPLITUDE LOAD, STRESS = 8 1/2 - 8 KSI
 CCT SPECIMEN R = 0.250 IN. W = 6.000 IN. AR = 0.0 IM.
 P414 = -12.0 KIPS PMAX = 12.0 KIPS R = -1.00 TEST FREQ = 6.00 HZ.

ENVIRONMENT CONDITION: AMBIENT AIR

NO.	CYCLES	A (MEASURED)	A (REGRESSION)	MULT. CORR. COEFF	K-MAX	DELTA K	DA/DM
1	0.	0.385	0.385	0.99846	6.24	12.47	9.75E-07
2	13000.	0.415	0.413	0.987592	6.46	12.92	1.61E-06
3	18100.	0.435	0.427	0.987542	6.58	13.15	2.251E-06
4	28100.	0.470	0.488	0.974382	7.03	14.06	2.78E-06
5	33100.	0.520	0.527	0.968056	7.31	14.63	2.87E-06
6	39100.	0.585	0.566	0.974099	7.58	15.16	2.87E-06
7	50837.	0.635	0.636	0.981746	8.05	16.09	2.40E-06
8	60837.	0.660	0.670	0.965216	8.27	16.53	2.27E-06
9	65837.	0.680	0.646	0.981950	8.37	16.74	2.91E-06
10	70837.	0.707	0.711	0.998900	8.57	17.05	3.66E-06
11	75837.	0.750	0.751	0.998992	8.77	17.54	4.47E-06
12	80837.	0.803	0.801	0.999235	9.07	18.14	5.34E-06
13	85173.	0.855	0.851	0.999199	9.36	18.73	6.18E-06
14	89000.	0.857	0.901	0.994154	9.65	19.29	6.73E-06
15	92000.	0.940	0.962	0.999132	9.88	19.75	7.32E-06
16	95500.	1.000	0.996	0.998662	10.17	20.35	7.82E-06
17	99000.	1.050	1.053	0.998993	10.49	20.97	8.58E-06
18	102500.	1.120	1.114	0.998436	10.81	21.61	9.41E-06
19	106000.	1.175	1.180	0.998925	11.15	22.30	1.05E-05
20	109500.	1.255	1.258	0.998976	11.55	23.10	1.18E-05
21	112000.	1.320	1.318	0.999384	11.85	23.71	1.28E-05
22	114500.	1.350	1.309	0.999780	12.20	24.41	1.37E-05
23	116800.	1.450	1.449	0.998348	12.51	25.02	1.45E-05
24	119800.	1.545	1.517	0.957744	12.94	25.89	1.70E-05
25	122855.	1.635	1.665	0.998742	13.47	26.94	1.97E-05
26	125855.	1.770	1.772	0.998717	14.09	28.17	2.32E-05
27	129414.	1.910	1.897	0.998439	14.70	29.40	2.73E-05
28	129239.	1.940	1.942	0.998483	14.92	29.84	2.53E-05

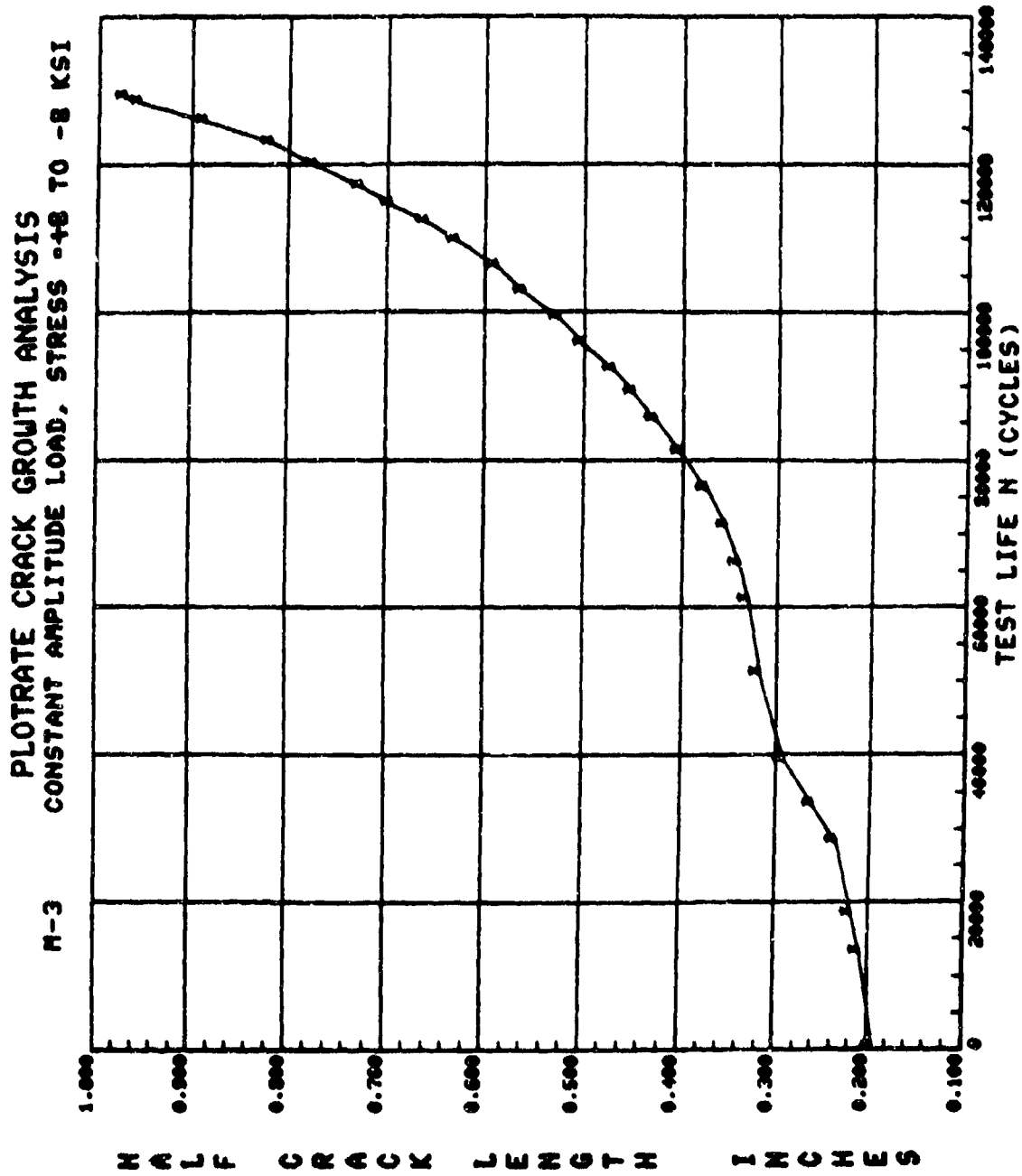

Figure 17. Crack growth curve for test M-3.

TABLE 14. DATA TABULATION FOR TEST M-4

SPECIMEN NO.: M-4 CENTER CRACK PANEL, STRESS -2.4 TO +8 KSI

CCT SPECIMEN R = 0.250 IN. W = 6.000 IN. AA = 0.0 IN.

PMIN = -3.6 KIPS PMAX = 12.0 KIPS R = -0.30 TEST FREQ = 6.000 HZ.

ENVIRONMENT CONDITION: ROOM AMBIENT

NO.	CYCLES	A (MEASURED)	A (REGRESSION)	MULT. CORR. COEFF	K-MAX	DELTA K	DA/DN
1	0.	0.305	0.305	0.999560	5.54	7.21	8.491E-07
2	17500.	0.327	0.327	0.998614	5.83	7.58	1.097E-06
3	40000.	0.400	0.355	0.997569	6.32	8.21	1.657E-06
4	55000.	0.445	0.452	0.998181	6.77	8.80	2.155E-06
5	65000.	0.455	0.497	0.998794	7.10	9.23	2.541E-06
6	75000.	0.555	0.549	0.999285	7.47	9.71	2.971E-06
7	85000.	0.610	0.613	0.998611	7.90	10.27	3.543E-06
8	95000.	0.685	0.687	0.999133	8.38	10.89	4.164E-06
9	102000.	0.745	0.747	0.999836	8.74	11.37	4.732E-06
10	108000.	0.810	0.807	0.999751	9.10	11.84	5.309E-06
11	113000.	0.860	0.861	0.999294	9.42	12.25	5.949E-06
12	118000.	0.920	0.922	0.998017	9.76	12.69	6.940E-06
13	122000.	0.975	0.977	0.999254	10.07	13.09	7.746E-06
14	126000.	1.040	1.044	0.997133	10.43	13.56	8.237E-06
15	129000.	1.105	1.099	0.997711	10.72	13.93	8.543E-06
16	132000.	1.155	1.150	0.997191	10.99	14.29	9.063E-06
17	135000.	1.198	1.203	0.997082	11.27	14.65	9.464E-06
18	138000.	1.255	1.258	0.999240	11.55	15.01	1.001E-05
19	141000.	1.325	1.320	0.999201	11.86	15.42	1.127E-05
20	144000.	1.350	1.350	0.999576	12.22	15.88	1.161E-05

PLOTRATE CRACK GROWTH ANALYSIS
M-4 CENTER CRACK PANEL, STRESS = -2.4 TO +8 KSI

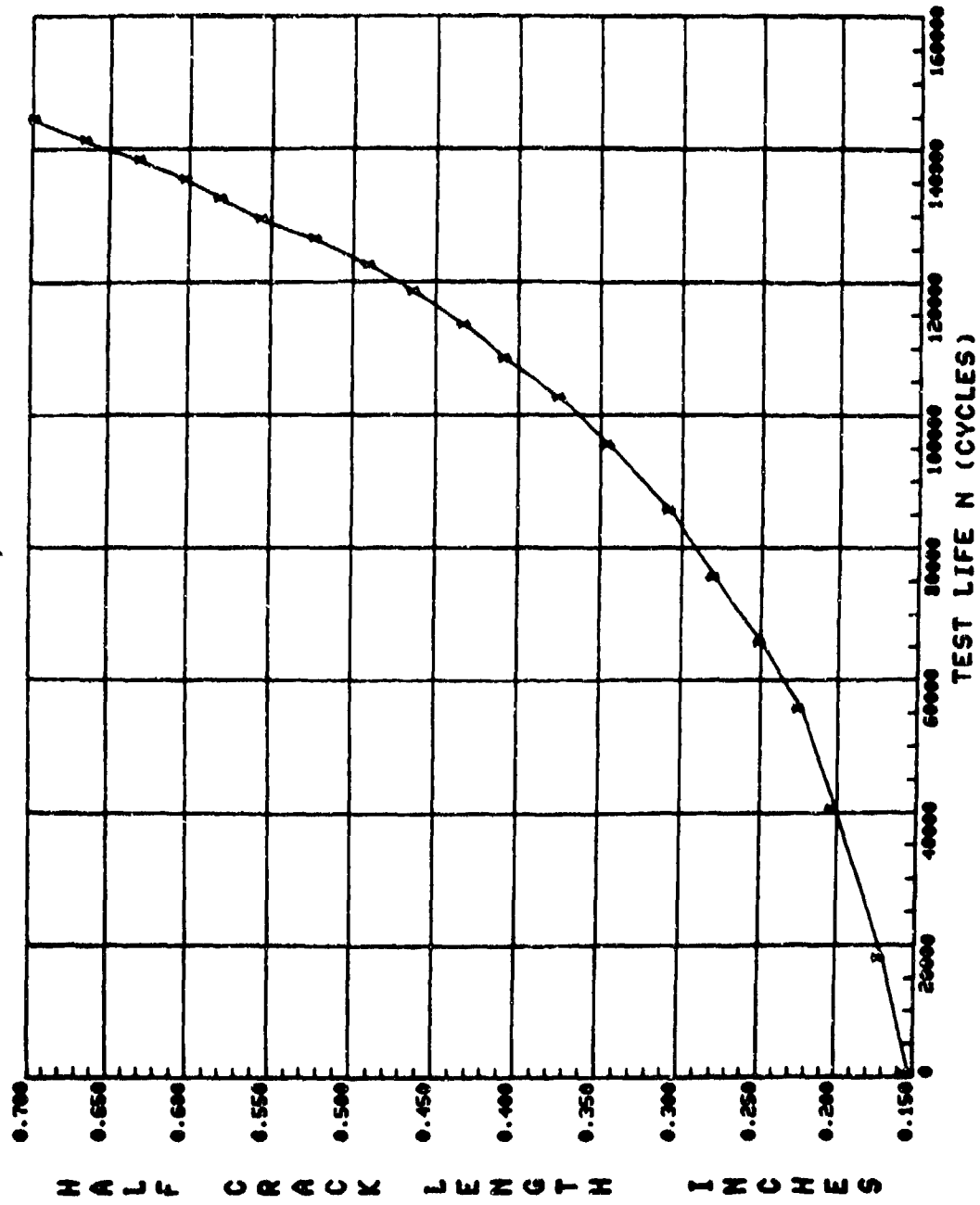

Figure 18. Crack growth curve for test M-4.

TABLE 15. DATA TABULATION FOR TEST M-5

SPECIMEN NO.: M-5 CENTER CRACKED PANEL, STRESS=40KSI

CCT SPECIMEN R= 0.250 IN. h= 6.000 IN. AN= 0.0 IN.
 PMIN= 0.6 KIPS PMAX= 60.0 KIPS R= 0.01 TEST FREQ= 6.00 HZ.

ENVIRONMENT CONDITION: ROOM AMBIENT

NO.	CYCLES	A (MEASURED)	A (REGRESSION)	MULT. COEFF.	K-MAX	DELTA K	DA/DN
1	0.	0.302	0.306	0.984567	27.80	27.52	8.140E-05
2	47.	0.335	0.313	0.991650	28.09	27.81	6.209E-05
3	406.	0.433	0.455	0.992547	33.16	32.83	3.178E-04
4	506.	0.505	0.505	0.987906	35.76	35.40	4.583E-04
5	606.	0.585	0.609	0.990902	39.37	38.97	6.120E-04
6	656.	0.655	0.665	0.996444	41.18	40.77	7.870E-04
7	706.	0.755	0.749	0.998657	43.80	43.36	1.037E-03
8	726.	0.750	0.752	0.998390	45.08	44.63	1.134E-03
9	746.	0.830	0.829	0.998081	46.45	45.99	1.251E-03
10	766.	0.895	0.888	0.998818	47.86	47.38	1.366E-03
11	806.	0.945	0.945	0.998162	49.46	48.97	1.580E-03
12	826.	1.010	1.012	0.998207	51.29	50.78	1.752E-03
13	846.	1.080	1.084	0.999706	53.23	52.70	2.089E-03
14	846.	1.175	1.175	0.999621	55.61	55.05	2.483E-03

PLOT RATE CRACK GROWTH ANALYSIS
M-5 CENTER CRACKED PANEL, STRESS-40KSI

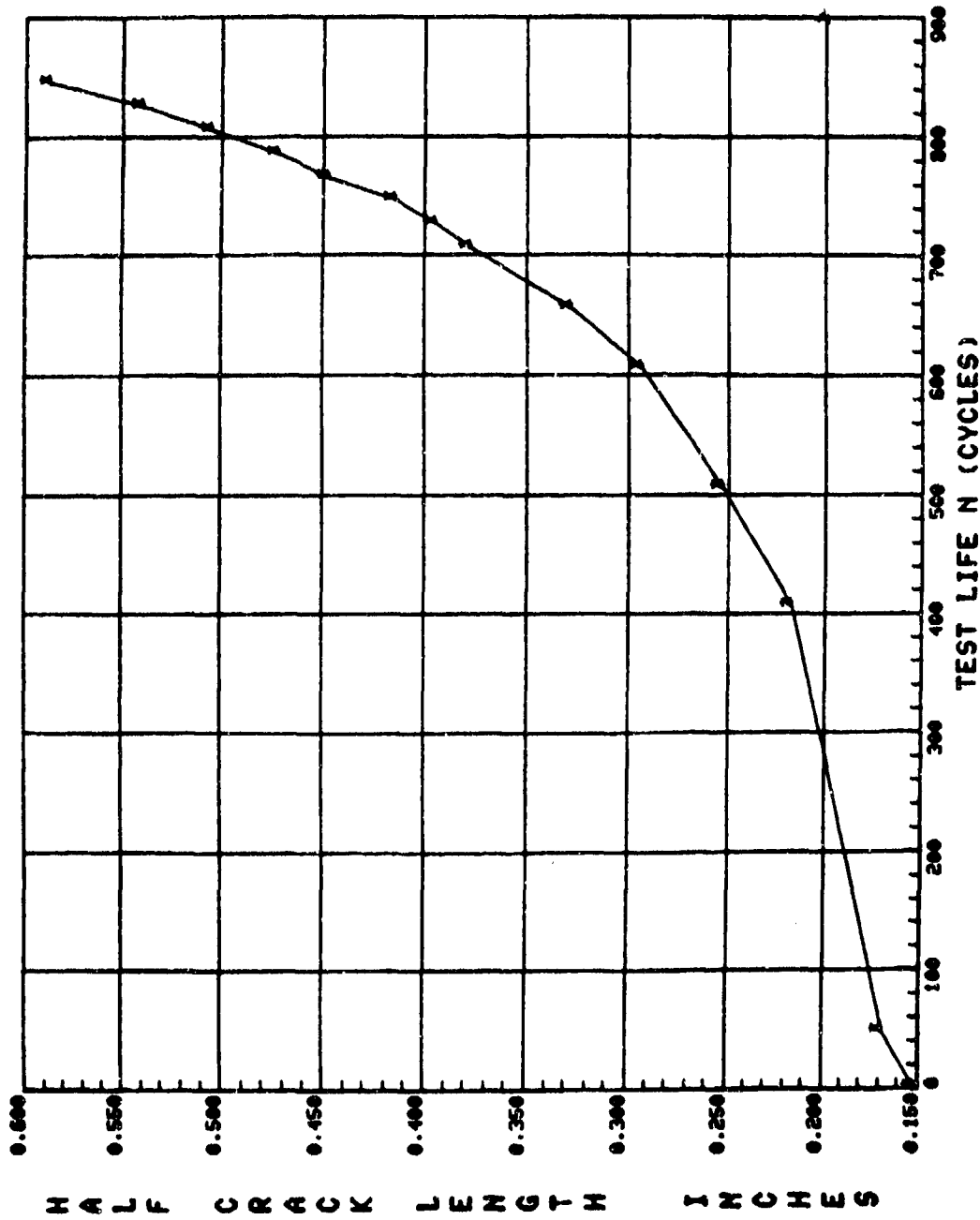

Figure 19. Crack growth curve for test M-5.

TABLE 16. DATA TABULATION FOR TEST M-6

SPECIMEN NO.:	M-6	CENTER CRACKED PANEL	STRESS 12 TO 40 KSI				
CCT SPECIMEN	a = 0.750 IN.	w = 6.000 IN.	AP = 0.50 IN.				
P/IN =	18.0 KIPS	P/IN = 60.0 KIPS	R = 0.30				
ENVIRONMENT CONDITION:	ROOM AMBIENT	TEST FREQ = 6.00HZ.					
NO.	CYCLES	A (MEASURED)	A (REGRESSION)	MULT. CORR. COEFF	K-MAX	DELTA K	DA/DN
1	0.	0.310	0.310	0.998037	27.97	19.58	1.545E-05
2	460.	0.355	0.353	0.998356	29.86	20.90	7.343E-05
3	793.	0.410	0.413	0.995816	32.32	22.62	1.221E-04
4	993.	0.470	0.470	0.984147	34.49	24.14	1.753E-04
5	1143.	0.505	0.522	0.981790	36.37	25.46	2.487E-04
6	1293.	0.580	0.567	0.990304	38.97	27.28	3.520E-04
7	1393.	0.665	0.668	0.997080	41.27	28.89	4.544E-04
8	1443.	0.730	0.716	0.995900	42.79	29.95	4.755E-04
9	1493.	0.770	0.770	0.997314	44.42	31.10	5.170E-04
10	1543.	0.820	0.870	0.995630	45.91	32.13	5.661E-04
11	1593.	0.870	0.874	0.999563	47.66	33.22	6.261E-04
12	1643.	0.940	0.940	0.999647	49.34	34.54	7.363E-04
13	1693.	1.020	1.070	0.999878	51.52	36.07	8.909E-04

PLOTRATE CRACK GROWTH ANALYSIS
M-6 CENTER CRACKED PANEL, STRESS = 12 TO 40 KSI

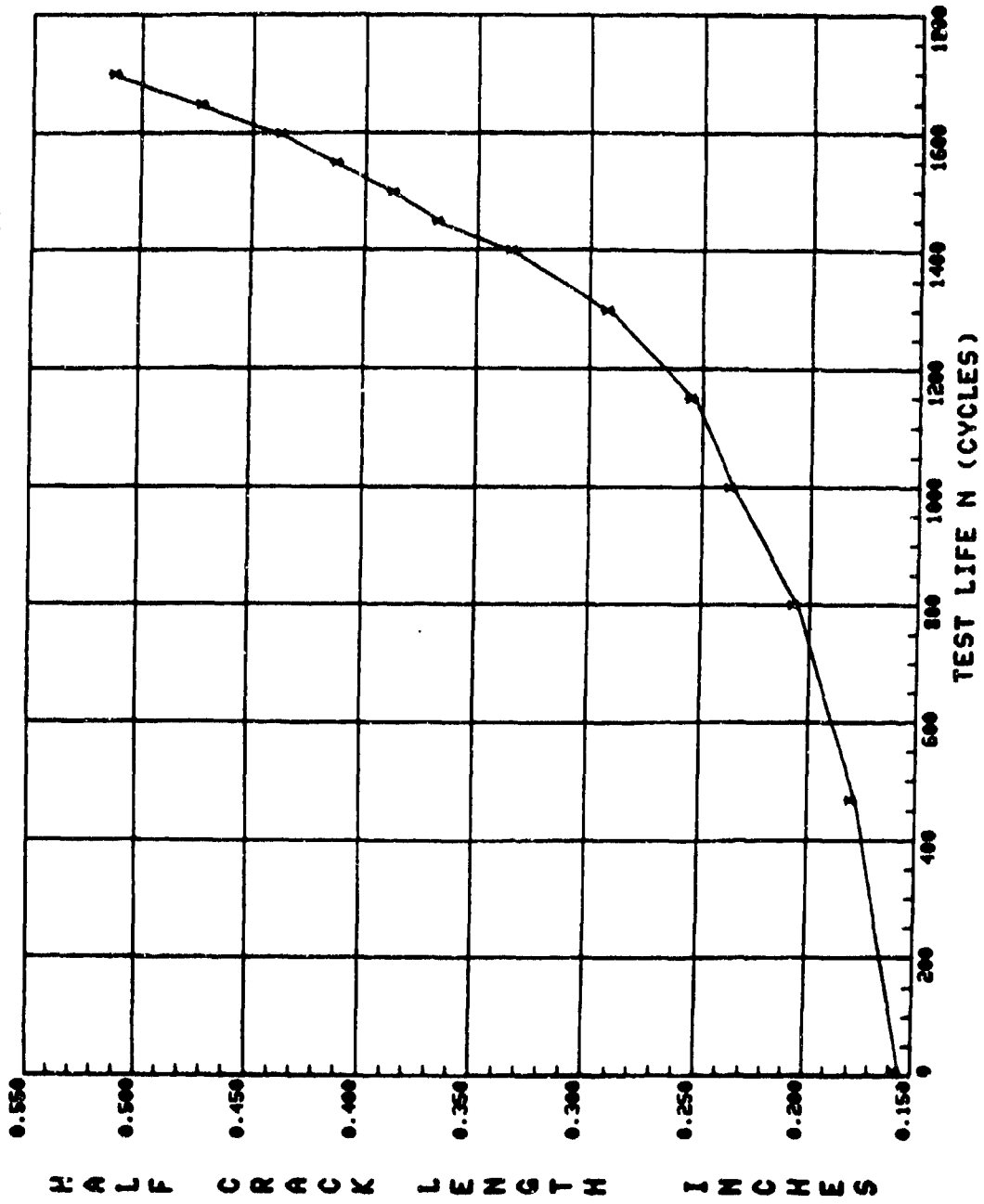

Figure 20. Crack growth curve for test M-6.

TABLE 17. DATA TABULATION FOR TEST M-7

SPECIMEN NO.: M-7 CENTER CRACKED PANEL STRESS 28 TO 40 KSI
 CCT SPECIMEN B= 0.250 IN. W= 6.000 IN. AN= 0.0 IN.
 PMIN= 42.0 KIPS PMAX= 60.0 KIPS R= 0.70 TEST FREQ= 6.00 HZ.

ENVIRONMENT CONDITION: ROOM AMBIENT

NO.	CYCLES	A (MEASURED)	A (REGRESSION)	MULT. CORR. COEFF	K-MAX	DELTA K	DA/DN
1	0.	0.310	0.310	0.999985	27.96	8.39	3.049E-07
2	5629.	0.350	0.392	0.999716	31.46	9.44	1.413E-05
3	7379.	0.450	0.449	0.999387	33.69	10.11	1.910E-05
4	8490.	0.455	0.497	0.993622	35.48	10.64	2.412E-05
5	9380.	0.530	0.538	0.991939	36.94	11.08	3.063E-05
6	10380.	0.550	0.600	0.996221	39.07	11.72	3.891E-05
7	10880.	0.645	0.640	0.996758	40.37	12.11	4.337E-05
8	11380.	0.655	0.697	0.997052	41.89	12.57	4.523E-05
9	11880.	0.735	0.740	0.993243	43.51	13.05	5.741E-05
10	12380.	0.750	0.796	0.995719	45.21	13.56	7.108E-05
11	12680.	0.835	0.838	0.999489	46.43	13.93	8.414E-05
12	12930.	0.885	0.882	0.998062	47.71	14.31	9.104E-05
13	13130.	0.925	0.922	0.998531	48.83	14.65	9.960E-05
14	13330.	0.965	0.963	0.997419	49.95	14.99	1.079E-04
15	13530.	1.000	1.006	0.998677	51.14	15.34	1.187E-04
16	13730.	1.055	1.054	0.998968	52.43	15.73	1.350E-04
17	13930.	1.115	1.110	0.999070	53.93	16.18	1.573E-04
18	14110.	1.165	1.171	0.999185	55.52	16.66	1.783E-04
19	14270.	1.230	1.229	0.999407	57.02	17.10	2.003E-04
20	14420.	1.255	1.290	0.994267	58.55	17.57	2.477E-04
21	14550.	1.350	1.357	0.989612	60.24	18.07	3.172E-04
22	14660.	1.410	1.428	0.986253	62.02	18.61	4.384E-04
23	14750.	1.500	1.515	0.988043	64.16	19.25	6.692E-04
24	14790.	1.555	1.570	0.995054	65.51	19.65	9.165E-04
25	14810.	1.605	1.608	0.971657	66.44	19.93	1.409E-03
26	14830.	1.655	1.656	0.981775	67.62	20.28	1.835E-03
27	14850.	1.700	1.730	0.985381	69.42	20.83	2.516E-03
28	14870.	1.850	1.849	0.991119	72.32	21.70	3.940E-03

PLOTRATE CRACK GROWTH ANALYSIS
M-7 CENTER CRACKED PANEL, STRESS = 28 TO 40 KSI

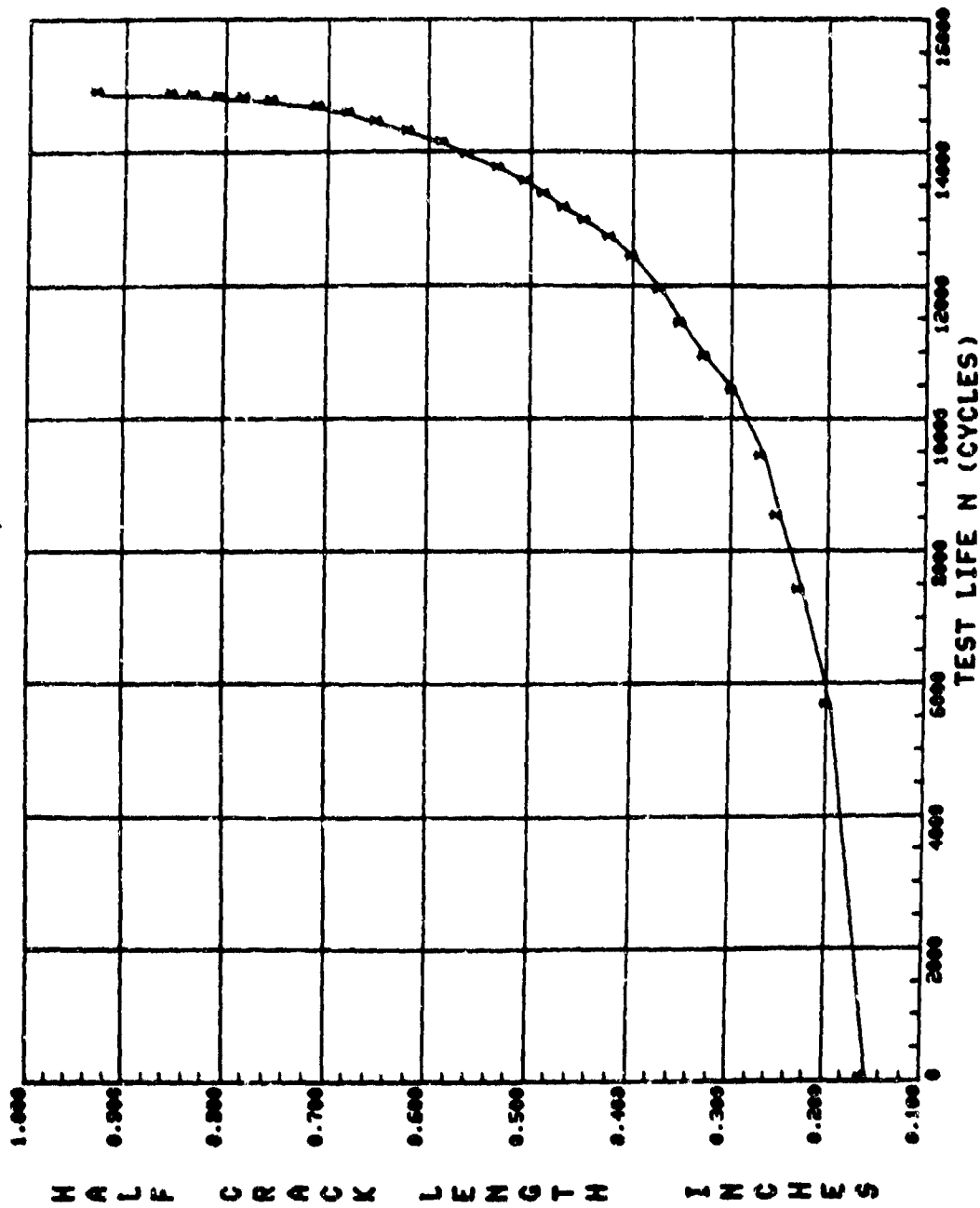

Figure 21. Crack growth curve for test M-7.

TABLE 18. DATA TABULATION FOR TEST M-8

SPECIMEN NO.: M-8 CENTER CRACKED PANFL STRESS -4 TO 40 KSI

CCT SPECIMEN R = 0.250 IN. W = 6.000 IN. AN = 0.20 IN.

PMIN = -6.00KIPS PMAX = 60.00KIPS R = -0.100 TEST FREQ = 6.000MHZ.

ENVIRONMENT CONDITION: ROOM AMBIENT

NO.	CYCLES	A (MEASURED)	A (REGRESSION)	MULT. CORR. COEFF	K-MAX	DELTA K	DA/DM
1	0.	0.310	0.310	0.999934	27.96	30.75	3.552E-05
2	200.	0.410	0.412	0.999915	32.28	35.50	5.238E-04
3	240.	0.460	0.457	0.998581	34.01	37.41	6.754E-04
4	280.	0.515	0.517	0.995239	36.21	39.83	8.633E-04
5	320.	0.575	0.581	0.995998	38.43	42.28	1.106E-03
6	360.	0.670	0.675	0.998361	41.51	45.66	1.476E-03
7	390.	0.765	0.770	0.998967	44.42	48.86	1.922E-03
8	410.	0.850	0.851	0.998622	46.82	51.50	2.321E-03
9	425.	0.915	0.924	0.998343	48.89	53.78	2.824E-03
10	435.	0.9E0	0.984	0.995601	50.54	55.59	3.592E-03
11	440.	1.015	1.017	0.996060	51.44	56.59	4.547E-03
12	445.	1.055	1.062	0.997902	52.65	57.91	5.259E-03
13	450.	1.115	1.116	0.997829	54.09	59.49	5.983E-03
14	455.	1.150	1.181	0.996910	55.78	61.36	7.222E-03
15	458.	1.225	1.274	0.980635	56.87	62.55	9.631E-03
16	461.	1.265	1.278	0.969738	58.25	64.07	1.348E-02
17	464.	1.335	1.349	0.975776	60.04	66.04	2.183E-02
18	467.	1.465	1.503	0.985814	63.86	70.25	3.647E-02
19	468.	1.565	1.576	0.993064	65.65	72.22	4.798E-02
20	469.	1.6E5	1.645	0.995936	68.33	75.16	6.778E-02

PLOT RATE CRACK GROWTH ANALYSIS
M-8 CENTER CRACKED PANEL, STRESS = -4 TO +40 KSI

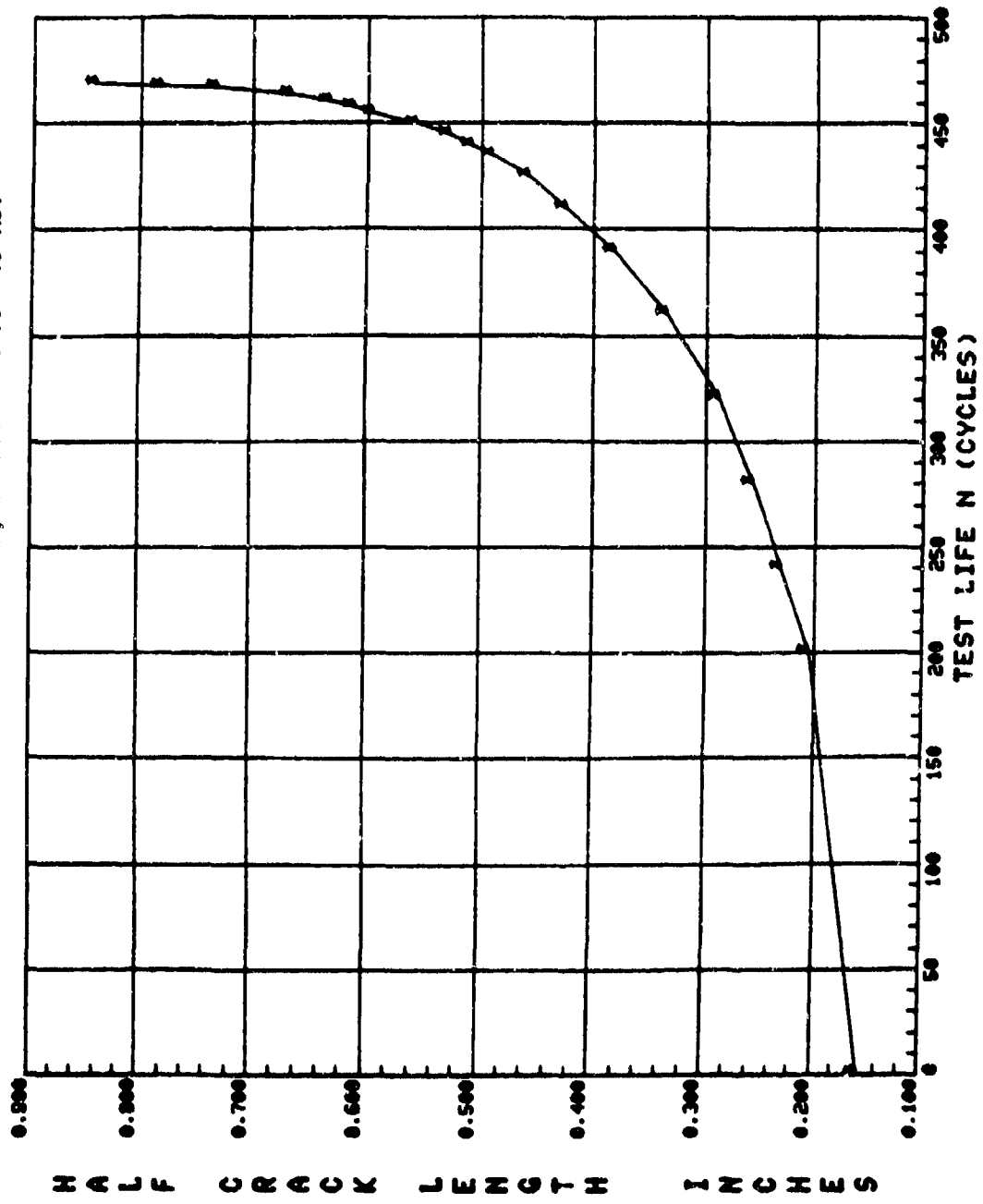

Figure 22. Crack growth curve for test M-8.

TABLE 19. DATA TABULATION FOR TEST M-9

SPECIMEN NO.: 4-9 CENTER CRACKED PANEL, STRESS -.8 TO +8 KSI

GCT SPECIMEN B= 0.250 IN. W= 6.000 IN. AN= 0.11 IN.

PMIN= -1.2 KIPS PMAX= 12.0 KIPS R=-0.10 TEST FREQ= 6.00 HZ.

ENVIRONMENT CONDITION: ROOM AMBIENT

NO.	CYCLES	A (MEASURED)	A (REGRESSION)	MULT. COEFF	K-MAX	DELTA K	DA/DM
1	0.	0.308	0.307	0.998623	5.57	6.12	1.249E-07
2	30000.	0.332	0.335	0.999348	5.81	6.39	8.092E-07
3	50000.	0.380	0.376	0.999588	6.17	6.78	1.283E-06
4	70000.	0.435	0.437	0.999693	6.65	7.32	1.759E-06
5	85000.	0.455	0.495	0.999292	7.08	7.79	2.176E-06
6	97000.	0.550	0.549	0.999469	7.47	8.22	2.596E-06
7	107000.	0.600	0.603	0.998408	7.83	8.62	3.092E-06
8	117000.	0.665	0.667	0.999192	8.25	9.07	3.720E-06
9	125000.	0.725	0.779	0.999446	8.63	9.50	4.243E-06
10	131000.	0.785	0.782	0.999323	8.96	9.85	4.761E-06
11	136000.	0.835	0.832	0.999037	9.25	10.17	5.266E-06
12	141000.	0.880	0.886	0.998999	9.56	10.52	5.783E-06
13	146000.	0.945	0.946	0.999341	9.90	10.89	6.201E-06
14	150000.	1.000	0.997	0.999454	10.18	11.20	6.676E-06
15	154000.	1.055	1.049	0.994642	10.46	11.51	7.496E-06
16	162000.	1.170	1.175	0.995914	11.12	12.23	9.704E-06
17	166000.	1.240	1.255	0.996434	11.53	12.69	1.093E-05
18	169000.	1.335	1.321	0.995348	11.87	13.06	1.174E-05
19	172000.	1.410	1.400	0.994419	12.26	13.49	1.203E-05
20	175000.	1.470	1.470	0.999973	12.61	13.87	8.410E-06

PLOTRATE CRACK GROWTH ANALYSIS
M-9 CENTER CRACKED PANEL, STRESS = -.8 TO +8 KSI

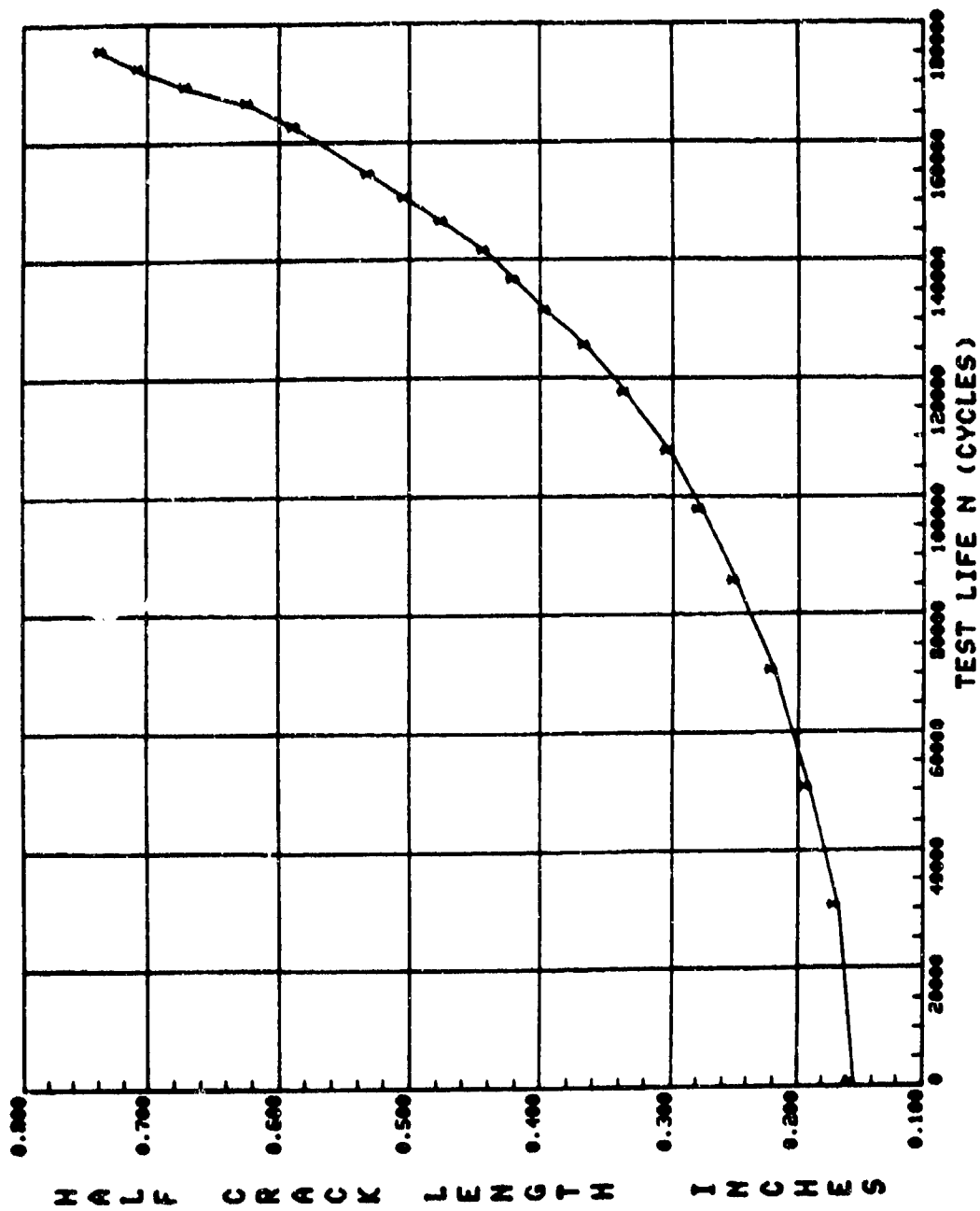

Figure 23. Crack growth curve for test M-9.

TABLE 20. DATA TABULATION FOR TEST M-10

SPECIMEN NO.:	M-10	CENTER CRACK PANEL, STRESS=12 TO +40 KSI					
CCT SPECIMEN	B= 0.250 IN.	h= 6.000 IN. AR= 0.0 IN.					
P4IN=	-18.0 KIPS	P MAX= 60.0 KIPS R=-0.30 TEST FREQ= 6.00 HZ.					
ENVIRONMENT CONDITION: ROOM AMBIENT							
NO.	CYCLES	A (MEASURED)	A (REGRESSION)	MULT. CORR. COEFF	K-MAX	DELTA K	DA/DN
1	0.	0.320	0.320	0.996380	28.39	36.90	9.603E-04
2	34.	0.375	0.381	0.997593	31.02	40.33	8.457E-04
3	64.	0.435	0.423	0.992860	32.72	42.54	7.983E-04
4	92.	0.465	0.464	0.987368	34.29	44.57	8.930E-04
5	120.	0.500	0.509	0.988557	35.91	46.68	1.063E-03
6	148.	0.565	0.566	0.997573	37.90	49.27	1.455E-03
7	174.	0.645	0.649	0.998784	40.66	52.85	2.012E-03
8	194.	0.730	0.736	0.998493	43.41	56.43	2.610E-03
9	208.	0.810	0.813	0.998240	45.64	59.40	3.294E-03
10	218.	0.875	0.881	0.993111	47.69	61.98	4.280E-03
11	226.	0.940	0.950	0.995107	49.60	64.49	5.380E-03
12	232.	1.005	1.015	0.996317	51.38	66.79	6.950E-03
13	236.	1.060	1.071	0.996626	52.88	68.74	8.527E-03
14	240.	1.130	1.143	0.990856	54.77	71.21	1.134E-02
15	243.	1.205	1.211	0.991814	56.54	73.51	1.513E-02
16	245.	1.260	1.261	0.968979	57.83	75.18	2.419E-02
17	247.	1.350	1.355	0.981197	60.18	79.24	3.327E-02
18	249.	1.445	1.490	0.990317	63.56	82.62	4.846E-02
19	251.	1.725	1.723	0.993434	69.24	90.02	7.477E-02

PLOTRATE CRACK GROWTH ANALYSIS
M-10 CENTER CRACK PANEL, STRESS = -12 TO +40 KSI

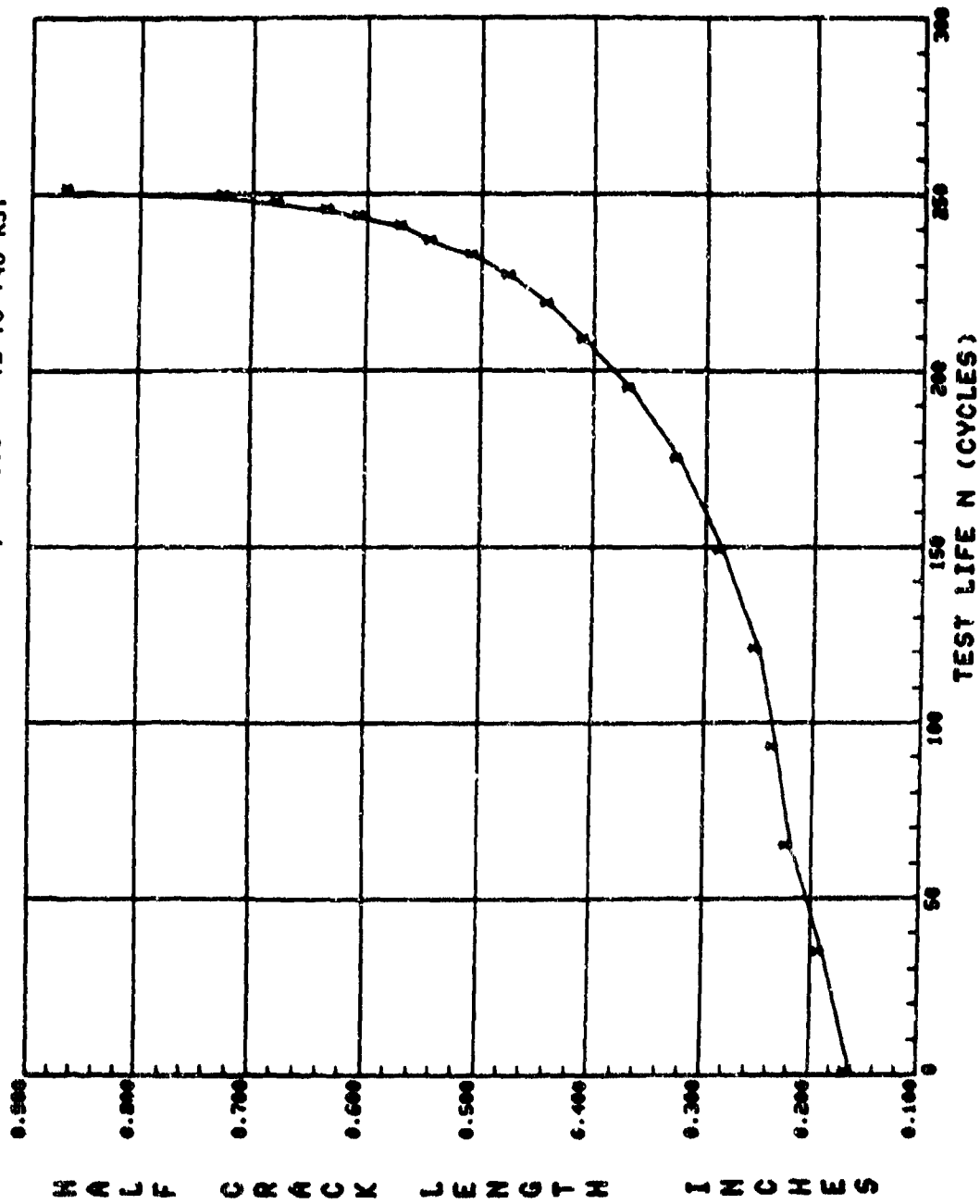

Figure 24. Crack growth curve for test M-10.

TABLE 21. METHODOLOGY DEVELOPMENT TESTING PROGRAM GROUP II - SINGLE OR PERIODICAL OVERLOAD/COMP LOAD







Test No.	Applied Base Load		Overload/Underload		N_I Cycle	N_{II} Cycle	Comments	
	Loading Profile	Max Ksi	Min Ksi	Max Ksi				Min Ksi
M-11		20	0	30	0	2,500	To failure	Single over-load effect
M-12		20	0	30	0	2,500	2,500	Periodically applied single load effect, $R_I = 0, R_{OL} = 1.5$
M-13		20	0	45	0	2,500	2,500	Periodically applied single load effect, $R_I = 0, R_{OL} = 2.25$
M-14		20	6	40	6	2,500	2,500	Periodically applied single load effect, $R_I = 0.3, R_{OL} = 2$
M-15		30	21	40	21	2,500	2,500	Periodically applied single load effect, $R_I = 0.7, R_{OL} = 1.33$
M-16		20	0	20	-6.0	2,500	2,500	Periodically applied comp load effect $R_I = 0$
M-17		20	6	20	-6.0	2,500	2,500	Periodically applied comp load effect $R_I = 0.3$
M-18		40	28	40	-12	2,500	2,500	Periodically applied comp load effect $R_I = 0.7$
M-19		20	0	30	-6.0	2,500	To failure	Single overload/comp load effect $R_I = 0, R_{OL} = 1.5$

TABLE 21. METHODOLOGY DEVELOPMENT TESTING PROGRAM GROUP II -
SINGLE OR PERIODICAL OVERLOAD/COMP LOAD (CONT)









Test No.	Applied Base Load		Overload/Underload		N_I Cycle	N_{II} Cycle	Comments	
	Loading Profile	σ_{Max} Ksi	σ_{Min} Ksi	σ_{Max} Ksi				σ_{Min} Ksi
M-20		20	0	30	-6.0	2,500	2,500	Periodically applied overload-comp load effect
M-21		20	0	40	-12	2,500	2,500	Periodically applied overload-comp load effect
M-22		20	0	30	-6.0	2,500	To failure	Single comp load-overload effect
M-23		20	0	30	-6.0	2,500	2,500	Periodically applied comp load-overload effect
M-24		20	-6	30	-6	2,500	2,500	Periodically applied overload effect, $R < 0$
M-25		20	-6	40	-6	2,500	2,500	Periodically applied overload effect, $R < 0$, higher stress
M-26		8	-2.4	8	-16	2,500	To failure	Single comp-overload effect $R < 0$
M-27		8	-2.4	8	-16	2,500	2,500	Periodically applied comp-overload effect
M-28		20	-6	30	-15	2,500	2,500	Periodically applied tension-comp overload effect

TABLE 21. METHODOLOGY DEVELOPMENT TESTING PROGRAM GROUP II -
SINGLE OR PERIODICAL OVERLOAD/COMP LOAD (CONCL)



Test No.	Applied Base Load			Overload/Underload		N_I Cycle	N_{II} Cycle	Comments
	Loading Profile	σ_{Max} Ksi	σ_{Min} Ksi	σ_{Max} Ksi	σ_{Min} Ksi			
M-29		20	-6	40	-15	2,500	2,500	Periodically applied tension-comp overload effect, higher stress
M-30		20	-6	40	-15	2,500	2,500	Period. ally applied comp-tension overload effect

TABLE 22. DATA TABULATION FOR TEST M-11

SPECIMEN NO.: M-11 BASE STRESS 0 TO 20 KSI, SINGLE OVERLOAD 0 TO 30 KSI

CCT SPECIMEN R= 0.250 IN. W= 6.000 IN. AA= 0.0 IN.

PMIN= P MAX= TEST FREQ= 6.00 HZ.

ENVIRONMENT CONDITION: ROOM AMBIENT

NO.	CYCLES	A (MEASURED)	A (REGRESSION)	MULT. CORR. COEFF	K-MAX	DELTA K	DA/DN
1	0.	0.255	0.295	0.999001	13.64	13.64	1.589E-05
2	1500.	0.345	0.335	0.995194	14.53	14.53	1.343E-05
3	3500.	0.355	0.389	0.994400	15.68	15.68	1.616E-05
4	5500.	0.450	0.457	0.986019	17.00	17.00	2.258E-05
5	7500.	0.543	0.556	0.990916	18.78	18.78	3.362E-05
6	8453.	0.605	0.619	0.996911	19.85	19.85	4.363E-05
7	9300.	0.700	0.696	0.998435	21.08	21.08	5.271E-05
8	9700.	0.745	0.740	0.998078	21.76	21.76	5.647E-05
9	10100.	0.750	0.789	0.998637	22.50	22.50	6.104E-05
10	10500.	0.831	0.837	0.999291	23.19	23.19	6.407E-05
11	10900.	0.850	0.688	0.998617	23.93	23.93	7.238E-05
12	11300.	0.950	0.947	0.998232	24.76	24.76	8.529E-05
13	11600.	0.992	1.001	0.998314	25.50	25.50	9.646E-05
14	11900.	1.060	1.060	0.999140	26.29	26.29	1.114E-04
15	12100.	1.110	1.106	0.999192	26.90	26.90	1.220E-04
16	12290.	1.153	1.156	0.999733	27.56	27.56	1.320E-04
17	12480.	1.208	1.204	0.997382	28.19	28.19	1.450E-04
18	12670.	1.262	1.263	0.998240	28.93	28.93	1.650E-04
19	12850.	1.317	1.327	0.998188	29.74	29.74	1.809E-04
20	13030.	1.405	1.396	0.998302	30.60	30.60	1.945E-04
21	13210.	1.470	1.470	0.998901	31.53	31.53	2.082E-04
22	13390.	1.545	1.548	0.999131	32.49	32.49	2.172E-04
23	13570.	1.625	1.623	0.999101	33.40	33.40	2.341E-04
24	13750.	1.710	1.710	0.996694	34.47	34.47	2.801E-04
25	13850.	1.755	1.765	0.997603	35.14	35.14	3.036E-04
26	13950.	1.825	1.828	0.997413	35.90	35.90	3.259E-04
27	14050.	1.910	1.897	0.997528	36.75	36.75	3.625E-04
28	14150.	1.970	1.974	0.997944	37.70	37.70	3.960E-04

TABLE 22. DATA TABULATION FOR TEST M-11 (CONCL)

SPECIMEN NO.: M-11 BASE STRESS 0 TO 20 KSI, SINGLE OVERLOAD 0 TO 30 KSI

CCY SPECIMEN R = 0.250 IN. W = 6.000 IN. AN = 0.0 IN.

MIN = P MAX = TEST FREQ = 6.000 HZ.

ENVIRONMENT CONDITION: ROOM AMBIENT

NO.	CYCLES	A (MEASURED)	A (REGRESSION)	MULT. CORR. COEFF	K-MAX	DELTA K	DA/DN
29	14250.	2.045	2.054	0.997580	38.68	38.68	4.135E-04
30	14350.	2.145	2.137	0.995985	39.71	39.71	4.218E-04
31	14400.	2.190	2.183	0.997636	40.30	40.30	4.149E-04
32	14450.	2.225	2.226	0.994590	40.84	40.84	4.362E-04
33	14500.	2.260	2.263	0.997327	41.30	41.30	4.536E-04
34	14550.	2.305	2.309	0.999201	41.89	41.89	4.964E-04
35	14600.	2.365	2.364	0.998110	42.60	42.60	5.411E-04
36	14650.	2.425	2.423	0.999281	43.37	43.37	5.750E-04
37	14700.	2.485	2.483	0.999748	44.16	44.16	5.946E-04
38	14750.	2.540	2.541	0.999599	44.93	44.93	6.089E-04
39	14800.	2.600	2.599	0.998633	45.72	45.72	6.571E-04
40	14850.	2.665	2.663	0.998940	46.60	46.60	7.429E-04
41	14900.	2.735	2.738	0.999241	47.65	47.65	8.750E-04
42	14950.	2.830	2.827	0.998848	48.91	48.91	1.073E-03
43	15000.	2.940	2.936	0.998586	50.54	50.54	1.357E-03
44	15050.	3.075	3.083	0.999208	52.79	52.79	1.692E-03
45	15100.	3.260	3.265	0.999793	55.79	55.79	2.112E-03
46	15150.	3.500	3.500	0.999996	60.01	60.01	2.655E-03

PLOTRATE CRACK GROWTH ANALYSIS

M-11 BASE STRESS 0 TO 20 KSI, SINGLE OVERLOAD 0 TO 30 KSI

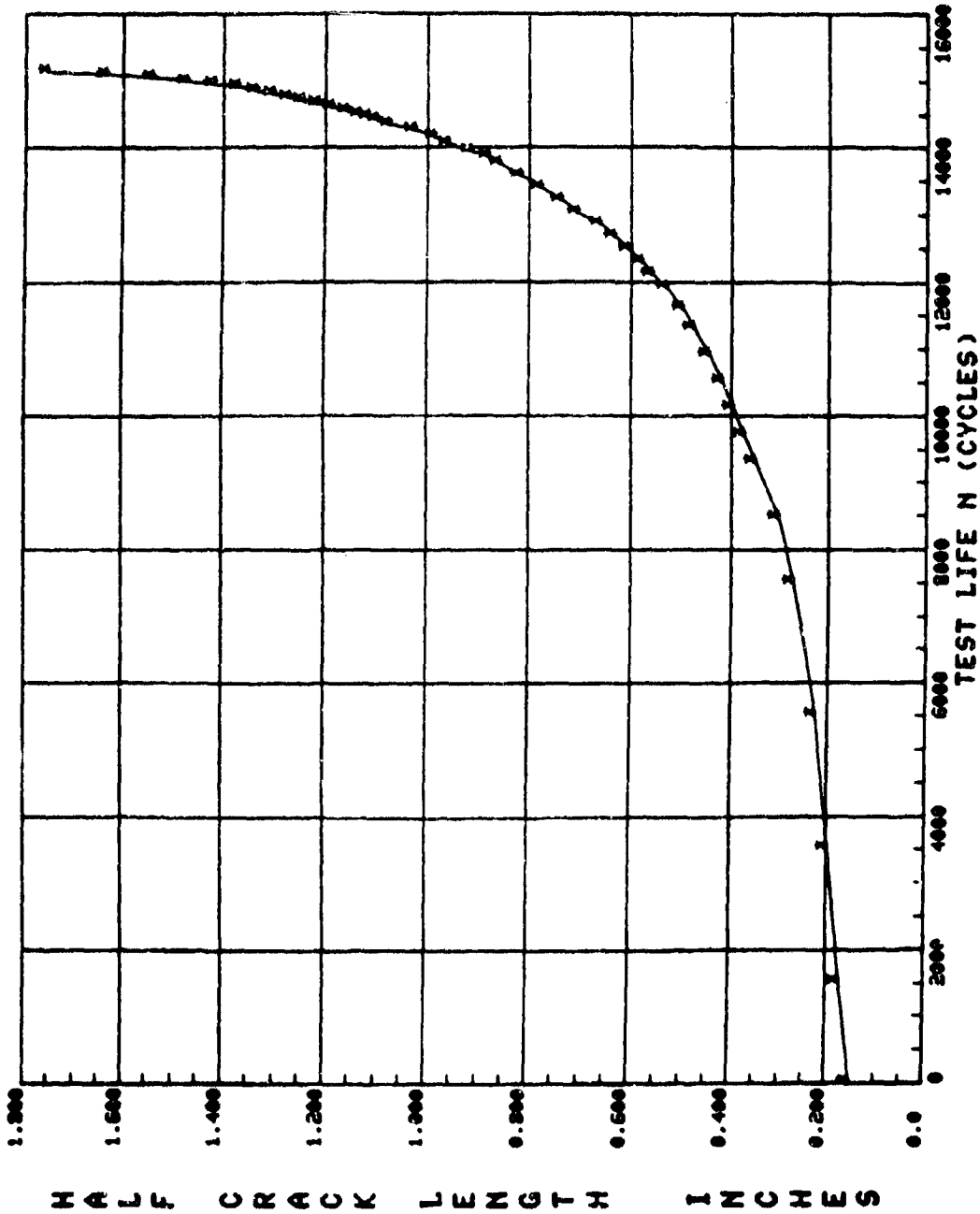

Figure 25. Crack growth curve for test M-11.

TABLE 23. DATA TABULATION FOR TEST M-12

SPECIMEN NO.: M-12 BASE STRESS 0 TO 20 KSI, PERIODIC OVERLOAD 0 TO 30 KSI

CCT SPECIMEN R= 0.250 IN. W= 6.000 IN. AN= 0.0 IN.
 PMIN= PMAX= TEST FREQ= 6.00 HZ.

ENVIRONMENT CONDITION: ROOM AMBIENT

NO.	CYCLES	A (MEAS/REF)	A (REGRESSION)	MULT. CORR. COEFF	K-MAX	DELTA K	DA/DN
1	0.	0.258	0.298	0.998715	13.70	13.70	9.732E-06
2	1598.	0.340	0.341	0.998889	14.66	14.66	1.526E-05
3	4108.	0.425	0.429	0.998953	16.47	16.47	2.083E-05
4	5000.	0.475	0.468	0.998861	17.21	17.21	2.324E-05
5	7120.	0.570	0.577	0.998740	19.15	19.15	2.876E-05
6	8000.	0.620	0.630	0.998281	20.02	20.02	3.212E-05
7	8500.	0.625	0.661	0.999074	20.53	20.53	3.400E-05
8	9000.	0.655	0.678	0.999543	21.11	21.11	3.559E-05
9	9500.	0.735	0.732	0.999136	21.64	21.64	3.768E-05
10	10000.	0.770	0.771	0.999450	22.22	22.22	4.018E-05
11	10500.	0.860	0.812	0.999492	22.84	22.84	4.375E-05
12	11000.	0.860	0.854	0.996476	23.44	23.44	5.071E-05
13	11500.	0.905	0.906	0.997414	24.18	24.18	6.016E-05
14	12000.	0.920	0.970	0.997843	25.07	25.07	6.962E-05
15	12500.	1.050	1.044	0.997047	26.09	26.09	7.830E-05
16	12900.	1.120	1.113	0.998000	27.00	27.00	8.329E-05
17	13200.	1.165	1.167	0.998661	27.70	27.70	8.808E-05
18	13500.	1.215	1.215	0.996898	28.33	28.33	9.665E-05
19	13800.	1.270	1.269	0.997616	29.02	29.02	1.130E-04
20	14100.	1.335	1.338	0.997895	29.89	29.89	1.426E-04
21	14400.	1.425	1.430	0.999184	31.03	31.03	1.839E-04
22	14600.	1.505	1.506	0.999919	31.97	31.97	2.188E-04
23	14800.	1.600	1.602	0.996569	33.14	33.14	2.821E-04
24	14900.	1.655	1.658	0.995654	33.83	33.83	3.013E-04
25	15000.	1.710	1.723	0.988892	34.62	34.62	2.980E-04
26	15100.	1.810	1.792	0.989597	35.47	35.47	2.911E-04
27	15200.	1.855	1.852	0.992110	36.20	36.20	2.670E-04
28	15300.	1.895	1.900	0.987773	36.79	36.79	2.366E-04

TABLE 23. DATA TABULATION FOR TEST M-12 (CONCL)

SPECIMEN NO.: M-12 BASE STRESS 0 TO 20 KSI, PERIODIC OVERLOAD 0 TO 30 KSI

CCT	SPECIMEN	A = 0.250 IN.	W = 6.000 IN.	AN = 0.0	IN.	TEST FREQ = 6.00 HZ.
PMIN =		PMAX =				
ENVIRONMENT CONDITION: ROOM AMBIENT						
NO.	CYCLES	A (MEASURED)	A (REGRESSION)	MULT. CORR. COEFF	K-MAX	DELTA K
29	15400.	1.935	1.935	0.999142	37.21	37.21
30	15500.	1.975	1.975	0.999538	37.70	37.70
31	15600.	2.015	2.017	0.999775	38.23	38.23
32	15700.	2.065	2.064	0.999913	38.80	38.80
33	15800.	2.115	2.114	0.999588	39.43	39.43
34	15900.	2.170	2.167	0.996875	40.09	40.09
35	16000.	2.230	2.229	0.997125	40.87	40.87
36	16100.	2.305	2.310	0.999066	41.90	41.90
37	16200.	2.415	2.412	0.998652	43.22	43.22
38	16300.	2.555	2.528	0.985241	44.76	44.76
39	16400.	2.720	2.733	0.990800	47.58	47.58
40	16500.	2.965	3.027	0.994833	51.91	51.91
41	16600.	3.480	3.478	0.998138	59.59	59.59
						DA/DN
						2.080E-04
						2.143E-04
						2.277E-04
						2.455E-04
						2.723E-04
						3.205E-04
						3.938E-04
						4.946E-04
						6.455E-04
						9.558E-04
						1.346E-03
						1.909E-03
						2.861E-03

PLOT RATE CRACK GROWTH ANALYSIS
M-12 BASE STRESS 0 TO 20 KSI, PERIODIC OVERLOAD 0 TO 30 KSI

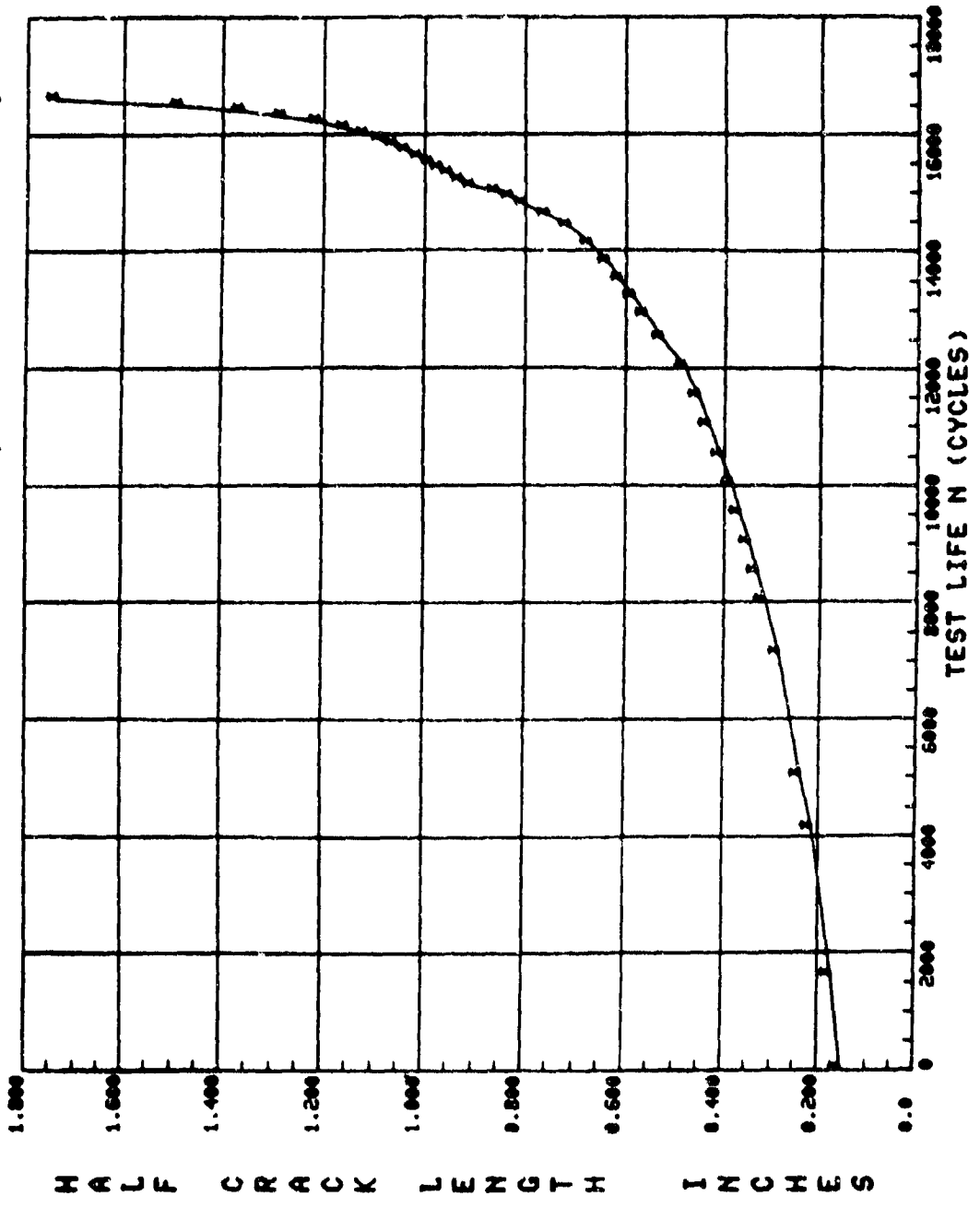

Figure 26. Crack growth curve for test M-12.

TABLE 24. DATA TABULATION FOR TEST M-13

SPECIMEN NO.: 4-13 BASE STRESS 0 TO 20 KSI, PERIODIC OVERLOAD 0 TO 45 KSI

CCT SPECIMEN B= 0.250 IN. W= 6.000 IN. AA= 0.0 IN. TEST FRQ= 6.000 HZ.

P MIN= P MAX=

ENVIRONMENT CONDITION: ROOM AMBIENT

NO.	CYCLES	A (MEASURED)	A (REGRESSION)	MULT. CORR. COEFF	K-MAX	DELTA K	DAY/N
1	0.	0.255	0.295	0.999788	13.63	13.63	1.477E-05
2	2000.	0.350	0.354	0.998803	14.95	14.95	1.382E-05
3	4000.	0.405	0.405	0.999003	15.99	15.99	1.147E-05
4	6000.	0.450	0.442	0.991809	16.73	16.73	1.013E-05
5	8000.	0.475	0.477	0.989418	17.38	17.38	9.330E-06
6	10000.	0.500	0.511	0.990720	18.00	18.00	9.437E-06
7	12000.	0.550	0.544	0.789619	18.58	18.58	8.036E-06
8	14000.	0.585	0.580	0.953214	19.19	19.19	7.723E-06
9	16000.	0.605	0.612	0.995374	19.73	19.73	6.607E-06
10	18000.	0.635	0.632	0.990529	20.06	20.06	5.402E-06
11	20000.	0.655	0.648	0.973712	20.32	20.32	5.625E-06
12	22000.	0.660	0.659	0.977973	20.65	20.65	5.536E-06
13	24000.	0.685	0.691	0.975601	21.01	21.01	5.561E-06
14	26000.	0.725	0.718	0.976767	21.41	21.41	5.294E-06
15	28000.	0.745	0.739	0.973757	21.74	21.74	6.300E-06
16	30000.	0.760	0.760	0.973757	22.06	22.06	8.477E-06
17	34000.	0.795	0.808	0.990253	22.78	22.78	1.312E-05
18	36000.	0.855	0.836	0.981283	23.19	23.19	1.704E-05
19	38000.	0.885	0.894	0.992315	24.01	24.01	2.103E-05
20	40000.	0.945	0.968	0.994644	25.05	25.05	2.959E-05
21	42500.	1.110	1.075	0.985892	26.49	26.49	4.336E-05
22	45300.	1.260	1.275	0.985767	29.09	29.09	5.131E-05
23	46800.	1.355	1.411	0.984426	30.79	30.79	6.227E-05
24	48000.	1.570	1.531	0.981658	32.27	32.27	5.937E-05
25	48200.	1.585	1.560	0.969951	32.63	32.63	3.979E-05
26	48800.	1.630	1.641	0.987913	33.63	33.63	4.735E-05
27	49000.	1.635	1.646	0.974998	33.69	33.69	5.100E-05
28	49200.	1.680	1.666	0.962926	33.93	33.93	

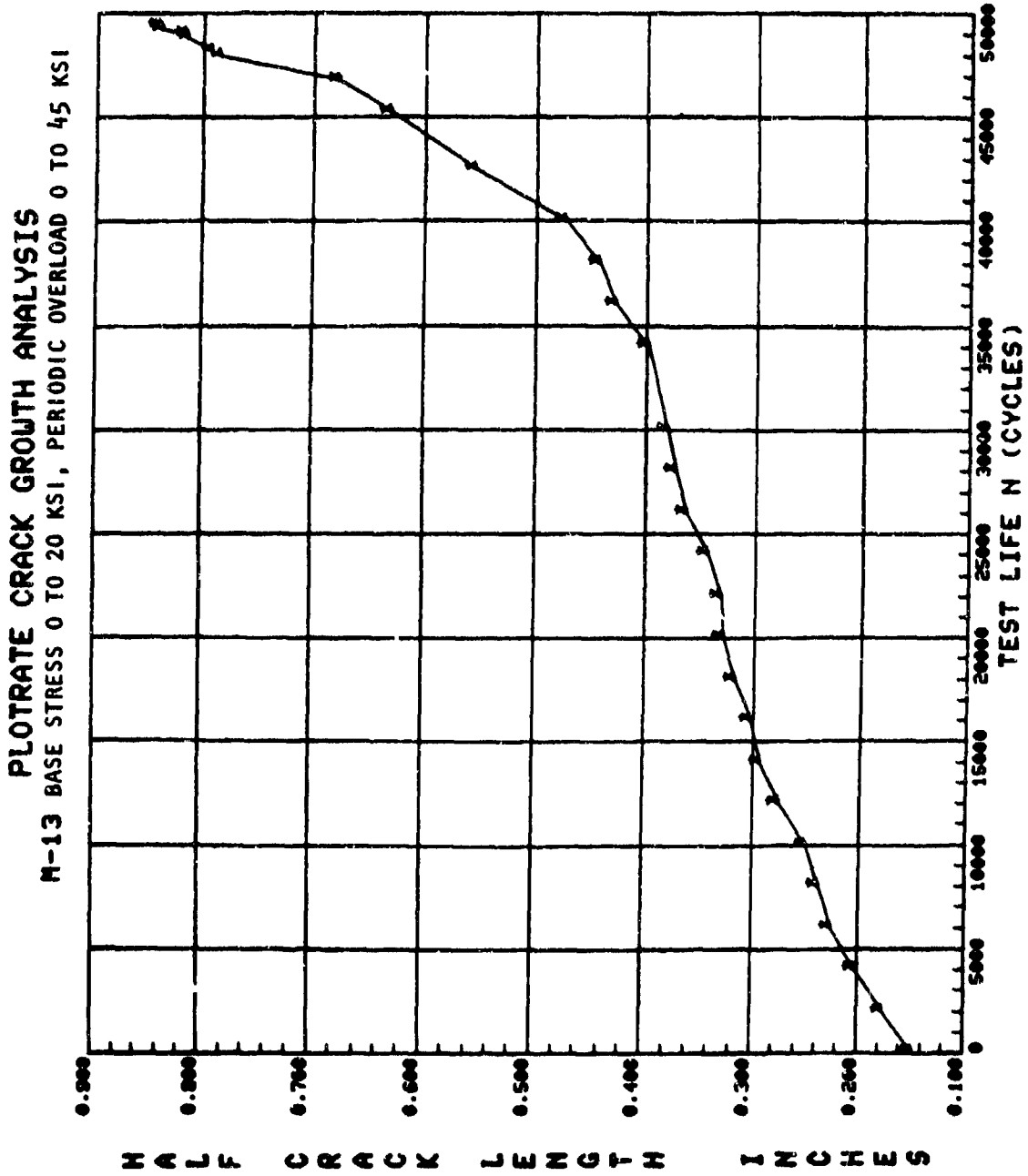

Figure 27. Crack growth curve for test M-13.

TABLE 25. DATA TABULATION FOR TEST M-14

SPECIMEN NO.: M-14 BASE STRESS = 6 TO 20 KSI • PERIODEIC OVERLOAD = 6 TO 40 KSI

CCT SPECIMEN B = 0.250 IN. h = 6.000 IN. AN = 0.0 IN.

PMIN = P MAX = TEST FREQ = 6.00 HZ.

ENVIRONMENT CONDITION: AMBIENT AIR

NO.	CYCLES	A (MEASURED)	A (REGRESSION)	MULT. CORR. COEFF	K-MAX	DELTA K	DA/DN
1	0.	0.310	0.315	0.965969	14.09	9.86	1.673E-06
2	2505.	0.345	0.323	0.981299	14.28	10.00	1.358E-06
3	29500.	0.355	0.393	0.988968	15.74	11.02	1.254E-06
4	51700.	0.445	0.448	0.993772	16.84	11.79	1.258E-06
5	70100.	0.455	0.493	0.998563	17.68	12.37	1.246E-06
6	90200.	0.550	0.548	0.998972	18.54	13.05	1.279E-06
7	112800.	0.610	0.607	0.994322	19.66	13.76	1.419E-06
8	121000.	0.625	0.629	0.994012	20.02	14.01	1.521E-06
9	131000.	0.650	0.658	0.995351	20.49	14.34	1.669E-06
10	141000.	0.700	0.693	0.994295	21.03	14.72	1.777E-06
11	151000.	0.730	0.728	0.991544	21.57	15.10	2.146E-06
12	161000.	0.775	0.771	0.993158	22.23	15.56	2.525E-05
13	171000.	0.810	0.818	0.997247	22.92	16.04	3.079E-06
14	184500.	0.915	0.914	0.997971	24.29	17.01	4.077E-06
15	192000.	0.975	0.977	0.994242	25.17	17.62	5.080E-06
16	200000.	1.070	1.066	0.993236	26.38	18.47	6.208E-06
17	208000.	1.145	1.171	0.991918	27.76	19.43	8.382E-06
18	211370.	1.235	1.229	0.991829	28.50	19.95	1.027E-05
19	214000.	1.275	1.280	0.995167	29.15	20.41	1.312E-05
20	216500.	1.345	1.342	0.962644	29.93	20.95	1.961E-05
21	219000.	1.420	1.434	0.986178	31.09	21.76	2.714E-05
22	220900.	1.510	1.543	0.989359	32.42	22.70	3.517E-05
23	222600.	1.715	1.670	0.988440	33.98	23.79	4.451E-05
24	224100.	1.810	1.813	0.984663	35.73	25.01	4.717E-05

PLOTRATE CRACK GROWTH ANALYSIS

M-14 BASE STRESS = 6 TO 20 KSI, PERIODIC OVERLOAD = 6 TO 40 KSI

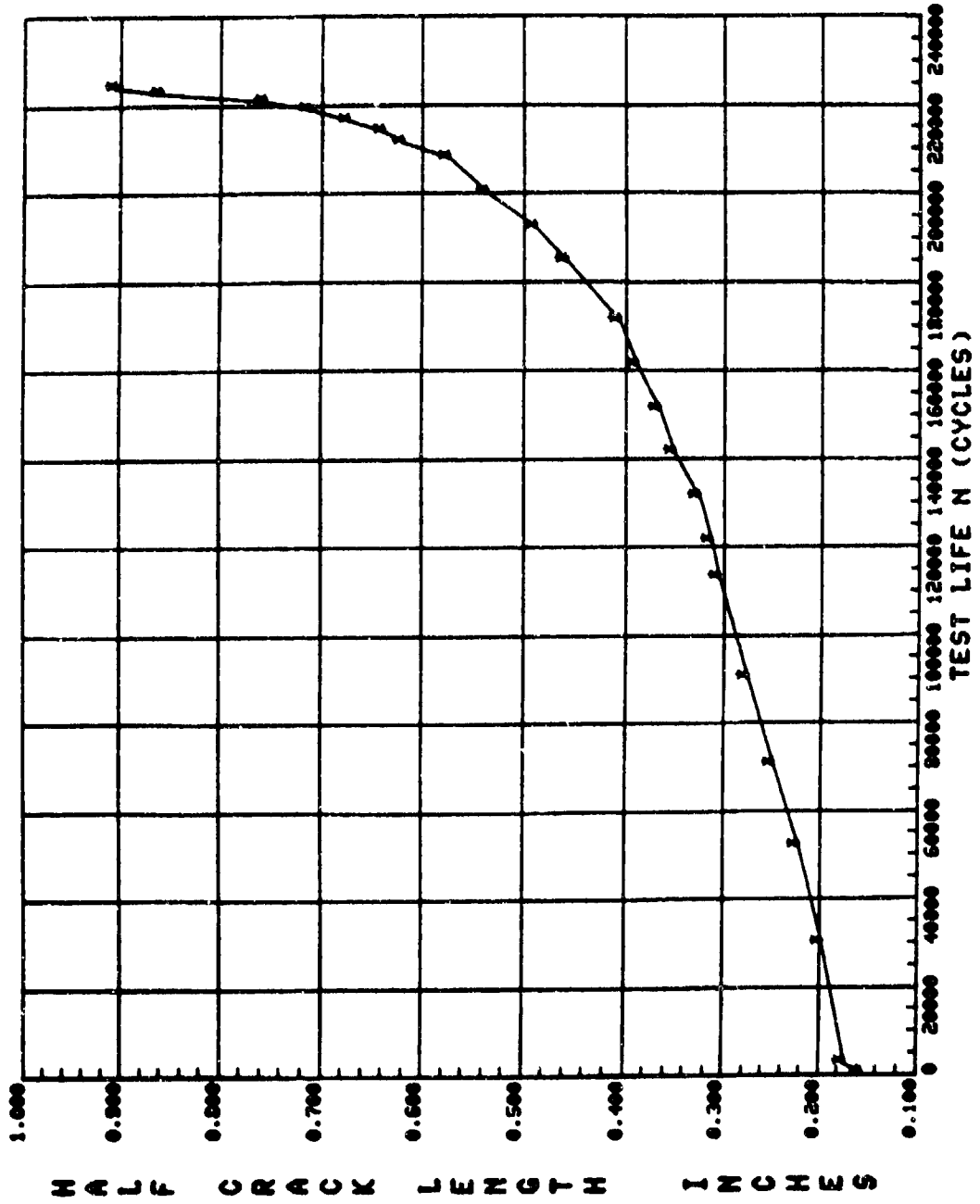

Figure 28. Crack growth curve for test M-14.

TABLE 26. DATA TABULATION FOR TEST M-15

SPECIMEN NO.: M-15 RATE = 21 TO 30 KSI PERIODIC OVERLOAD = 21 TO 40 KSI
 CCT SPECIMEN S = 0.250 IN. W = 6.000 IN. AA = 0.0 IN.
 P MIN = P MAX = TEST FREQ = 6.00 HZ.

ENVIRONMENT CONDITION: ROOM AMBIENT

NO.	CYCLES	A (MEAS/RED)	A (REGRESSION)	MULT. CORR. COEFF	K-MAX	DELTA K	DA/DN
1	0.	0.313	0.314	0.991682	21.12	6.34	2.778E-06
2	5500.	0.355	0.340	0.991384	21.97	6.59	2.103E-06
3	24500.	0.415	0.406	0.990727	24.02	7.21	1.782E-06
4	41000.	0.460	0.462	0.992130	25.64	7.69	1.904E-06
5	57000.	0.515	0.522	0.998202	27.28	8.18	2.137E-06
6	73500.	0.555	0.594	0.997203	29.15	8.74	2.775E-06
7	83500.	0.655	0.651	0.997523	30.56	9.17	3.281E-06
8	94000.	0.710	0.723	0.995701	32.24	9.67	4.144E-06
9	104000.	0.810	0.807	0.996264	34.15	10.25	5.472E-06
10	109000.	0.855	0.862	0.989216	35.34	10.60	6.905E-06
11	117000.	0.965	0.988	0.986656	37.98	11.39	9.351E-06
12	120000.	1.030	1.065	0.939224	39.55	11.87	1.744E-05
13	120500.	1.080	1.090	0.933219	40.05	12.02	2.778E-05
14	121000.	1.075	1.107	0.972333	40.39	12.12	4.431E-05
15	121500.	1.180	1.152	0.973995	41.26	12.38	5.554E-05
16	122000.	1.210	1.211	0.977290	42.41	12.72	6.444E-05
17	122500.	1.265	1.291	0.975680	43.94	13.18	6.694E-05
18	123000.	1.380	1.353	0.968828	45.12	13.54	6.266E-05
19	123300.	1.410	1.396	0.975443	45.92	13.78	6.883E-05
20	123600.	1.420	1.435	0.966886	46.63	13.99	7.399E-05
21	124000.	1.470	1.476	0.996353	47.40	14.22	8.103E-05
22	124500.	1.555	1.549	0.998859	48.75	14.62	1.150E-04
23	124700.	1.625	1.625	0.999415	50.15	15.05	1.347E-04

PLOTRATE CRACK GROWTH ANALYSIS
M-15 BASE = 21 TO 30 KSI, PERIODIC OVERLOAD = 21 TO 40 KSI

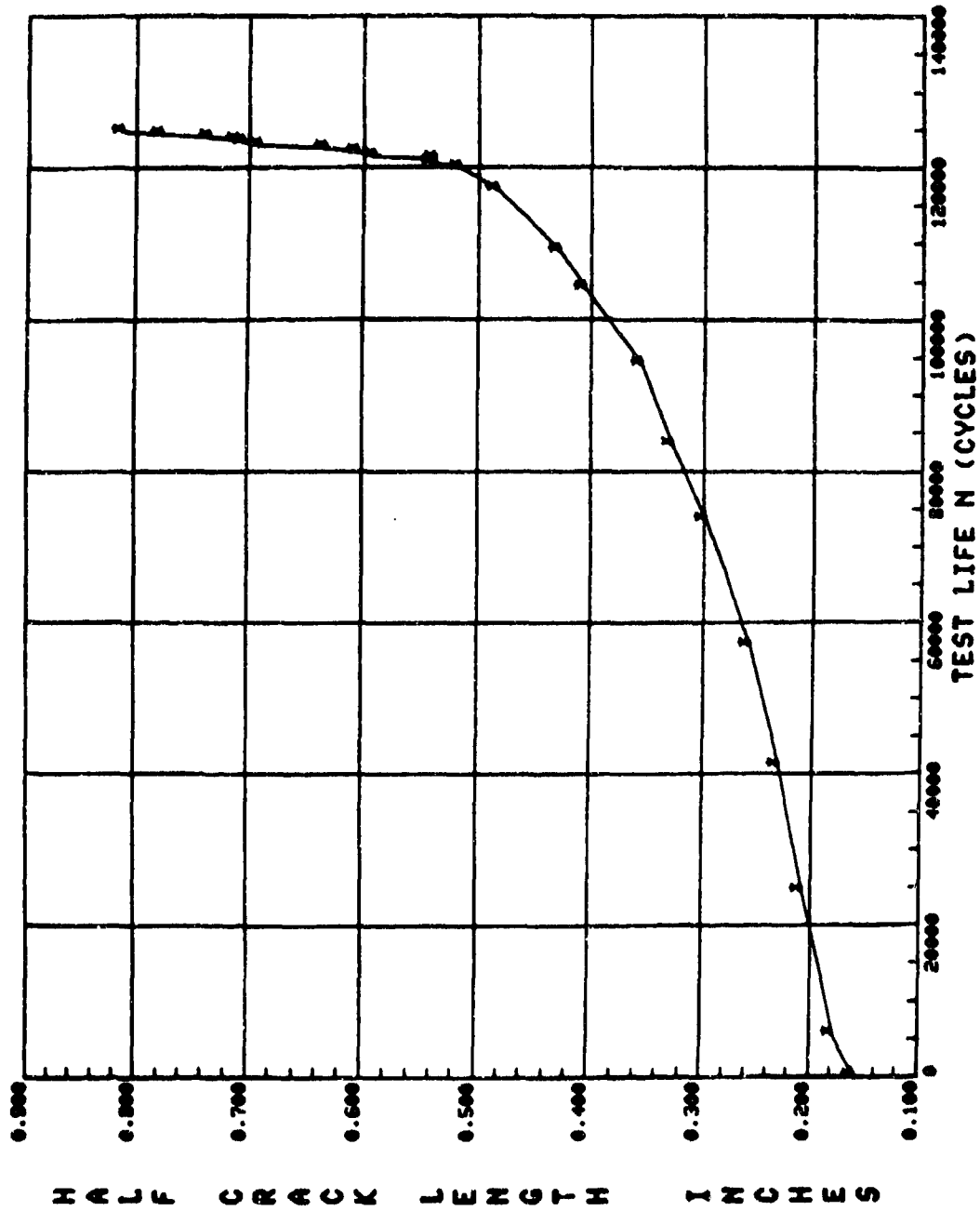

Figure 29. Crack growth curve for test M-15.

TABLE 27. DATA TABULATION FOR TEST M-16

SPECIMEN NO.: M-16 BASE STRESS 0 TO 20 KSI, OVERLOAD -6 KSI TO +20 KSI

CC1 SPECIMEN B= 0.250 IN. M= 6.000 IN. AN= 0.0 IN.

PMIN= PMAX= TEST FREQ= 6.00 HZ.

ENVIRONMENT CONDITION: AMBIENT AIR

NO.	CYCLES	A (MEASURED)	A (REGRESSION)	MULT. CORR. COEFF	K-MAX	DELTA K	Δ/ΔM
1	0	0.303	0.303	0.993037	13.81	17.96	1.834E-05
2	2000	0.375	0.383	0.995056	15.54	20.21	2.205E-05
3	2500	0.415	0.404	0.995297	15.98	20.77	2.395E-05
4	3500	0.450	0.455	0.994935	16.97	22.07	2.788E-05
5	4000	0.480	0.483	0.993698	17.48	22.73	3.092E-05
6	4500	0.515	0.512	0.992600	18.02	23.52	3.457E-05
7	5000	0.550	0.551	0.999746	16.70	24.30	3.947E-05
8	5500	0.590	0.590	0.999274	19.36	25.17	4.389E-05
9	6500	0.690	0.686	0.992105	20.92	27.20	5.653E-05
10	7050	0.745	0.750	0.998860	21.91	28.49	6.714E-05
11	7600	0.825	0.828	0.998353	23.07	29.99	8.129E-05
12	8050	0.960	0.901	0.997752	24.12	31.36	9.688E-05
13	8450	0.960	0.982	0.999191	25.25	32.82	1.129E-04
14	6750	1.055	1.051	0.999256	26.18	34.03	1.283E-04
15	9000	1.110	1.117	0.999325	27.05	35.17	1.443E-04
16	9240	1.190	1.188	0.999123	27.98	36.37	1.654E-04
17	9450	1.260	1.259	0.999540	28.89	37.56	1.851E-04
18	9640	1.330	1.335	0.999632	29.84	38.80	2.032E-04
19	9810	1.410	1.405	0.999002	30.72	39.93	2.283E-04
20	9950	1.470	1.471	0.998996	31.54	41.00	2.496E-04
21	10080	1.530	1.538	0.998771	32.37	42.06	2.666E-04
22	10200	1.610	1.603	0.998745	33.15	43.10	2.914E-04
23	10300	1.665	1.663	0.998691	33.90	44.07	3.165E-04
24	10390	1.715	1.722	0.998577	34.62	45.00	3.409E-04
25	10480	1.785	1.782	0.999666	35.35	45.96	3.654E-04
26	10560	1.845	1.844	0.999683	36.10	46.93	3.997E-04
27	10640	1.845	1.909	0.998763	36.90	47.97	4.490E-04
28	10720	1.980	1.961	0.999453	37.78	49.12	5.052E-04

TABLE 27. DATA TABULATION FOR TEST M-16 (CONCL)

SPECIMEN NO.: M-16 BASE STRESS 0 TO 20 KSI, OVERLOAD -6 KSI TO +20 KSI

CC1 SPECIMEN B= 0.250 IN. W= 6.000 IN. AN= 0.0 IN.

PHIN= PHAX= TEST FREQ= 6.00 HZ.

ENVIRONMENT CONDITION: AMBIENT AIR

NO.	CYCLES	A (MEASURED)	A (REGRESSION)	MULT. CORR. COEFF	K-MAX	DELTA K	DA/UN
29	10790.	2.050	2.055	0.999672	39.69	50.30	5.619E-04
30	10860.	2.140	2.138	0.998936	39.73	51.65	6.067E-04
31	10920.	2.220	2.216	0.999262	40.70	52.92	6.504E-04
32	10970.	2.285	2.284	0.999358	41.56	54.03	6.819E-04
33	11020.	2.345	2.350	0.998316	42.41	55.14	7.396E-04
34	11070.	2.425	2.422	0.996653	43.36	56.37	8.382E-04
35	11110.	2.485	2.490	0.999557	44.26	57.53	9.454E-04
36	11150.	2.570	2.570	0.999403	45.32	58.92	1.055E-03
37	11180.	2.640	2.636	0.998875	46.22	60.09	1.263E-03
38	11210.	2.710	2.716	0.998881	47.33	61.53	1.444E-03
39	11240.	2.800	2.805	0.999426	48.59	63.17	1.684E-03
40	11260.	2.880	2.874	0.999634	49.60	64.48	1.869E-03
41	11280.	2.950	2.953	0.999213	50.79	66.02	2.114E-03
42	11300.	3.040	3.041	0.997916	52.14	67.79	2.499E-03
43	11310.	3.035	3.089	0.999366	52.90	68.76	2.840E-03
44	11320.	3.145	3.147	0.998919	53.82	69.96	3.300E-03
45	11330.	3.215	3.213	0.999804	54.91	71.38	3.786E-03
46	11340.	3.290	3.282	0.987512	56.06	72.91	5.071E-03
47	11350.	3.390	3.388	0.991337	57.93	75.31	6.621E-03
48	11360.	3.495	3.529	0.994162	60.57	78.74	8.979E-03
49	11370.	3.740	3.738	0.995866	64.83	84.28	1.299E-02

M-16
PLOT RATE CRACK GROWTH ANALYSIS
 BASE 0 TO 20 KSI, OVERLOAD -6 KSI TO +20 KSI

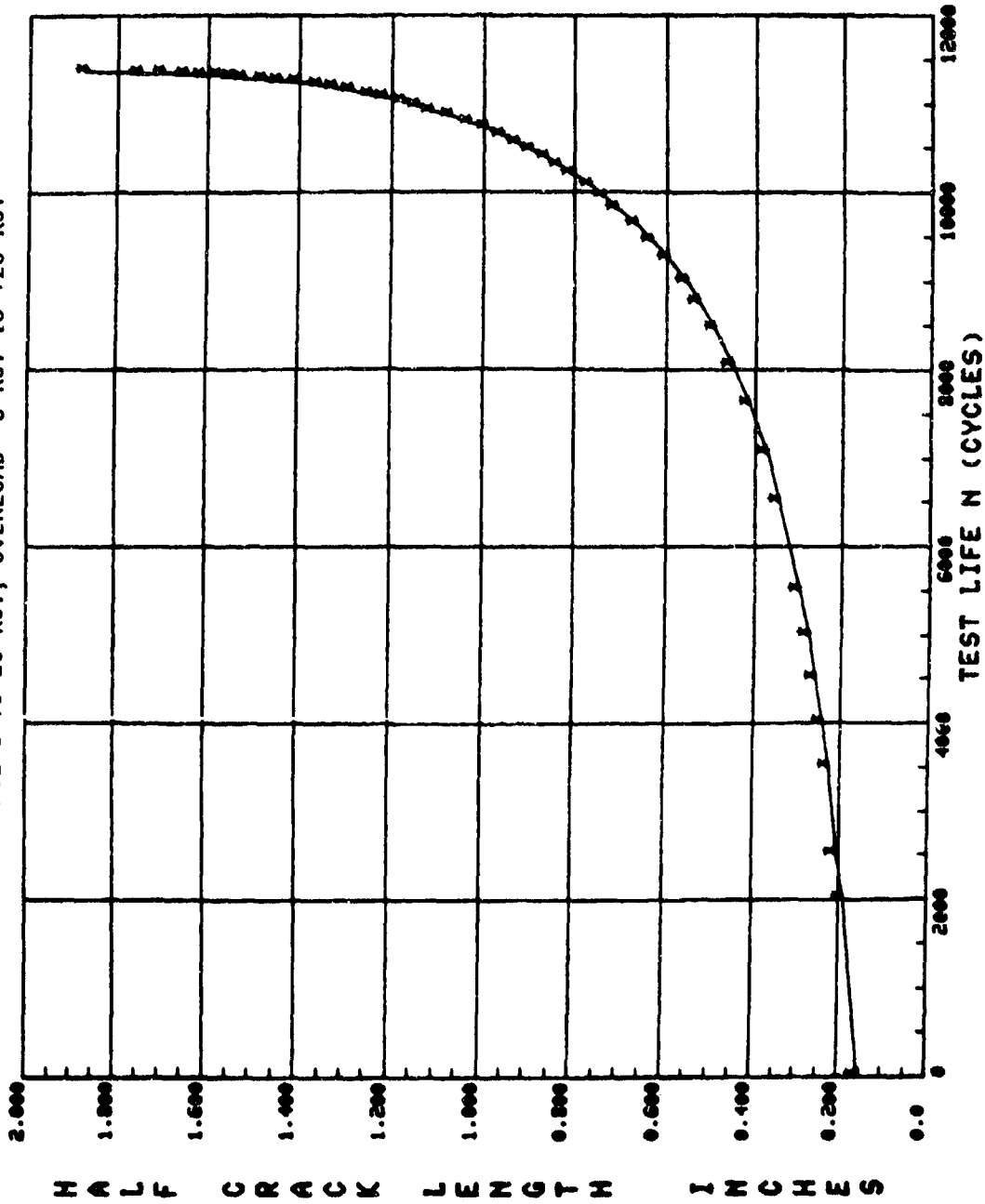

Figure 30. Crack growth curve for test M-16.

TABLE 28. DATA TABULATION FOR TEST M-17

SPECIMEN NO.: 4-17 BASE STRESS = 6 TO 20KSI, PERIODIC OVERLOAD = -6 KSI TO +20 KSI

CCT SPECIMEN B = 0.250 IN. W = 6.000 IN. AA = 0.0 IN. TEST FREQ = 6.00 HZ.
 PHIN = PMAX =

ENVIRONMENT CONDITION: AMBIENT AIR

NO.	CYCLES	A (MEASURED)	A (REGRESSION)	MULT. CORR. COEFF	K-MAX	DELTA K	DA/DN
1	0.	0.305	0.305	0.999958	13.86	9.71	3.979E-06
2	5000.	0.355	0.396	0.999899	15.81	11.06	2.162E-05
3	5900.	0.440	0.437	0.997064	16.62	11.64	2.346E-05
4	6200.	0.455	0.450	0.994487	16.88	11.81	2.289E-05
5	6400.	0.465	0.463	0.961774	17.12	11.98	2.496E-05
6	6600.	0.465	0.474	0.959726	17.32	12.12	2.346E-05
7	7000.	0.485	0.492	0.969851	17.65	12.35	2.190E-05
8	7000.	0.505	0.488	0.967877	17.57	12.30	1.789E-05
9	8600.	0.545	0.541	0.968787	18.11	13.09	1.854E-05
10	9000.	0.560	0.563	0.977275	18.5	13.24	1.956E-05
11	9500.	0.555	0.583	0.986447	19.25	13.48	2.029E-05
12	10000.	0.600	0.607	0.987656	19.65	13.75	2.207E-05
13	10500.	0.630	0.677	0.983531	19.97	13.98	2.464E-05
14	11000.	0.650	0.649	0.995477	20.34	14.23	2.786E-05
15	11500.	0.675	0.682	0.995881	20.85	14.60	3.268E-05
16	12000.	0.720	0.718	0.993017	21.42	14.99	3.429E-05
17	12500.	0.760	0.756	0.996744	22.00	15.40	3.656E-05
18	13000.	0.795	0.796	0.997403	22.50	15.82	3.607E-05
19	13500.	0.825	0.825	0.982298	23.03	16.12	3.929E-05
20	14000.	0.870	0.863	0.988799	23.57	16.50	4.357E-05
21	14500.	0.850	0.907	0.992907	24.20	16.94	5.125E-05
22	15000.	0.975	0.964	0.990496	24.99	17.49	5.794E-05
23	15500.	1.025	1.026	0.990687	25.83	18.08	6.616E-05
24	16000.	1.105	1.100	0.993929	26.83	18.78	7.101E-05
25	16200.	1.115	1.125	0.995739	27.16	19.01	7.330E-05
26	16500.	1.175	1.171	0.995806	27.76	19.43	7.944E-05
27	16700.	1.205	1.202	0.996146	28.15	19.71	8.213E-05
28	17000.	1.250	1.254	0.997348	28.82	20.18	9.362E-05

TABLE 28. DATA TABULATION FOR TEST M-17 (CONCL)

SPECIMEN NO.: M-17 BASE STRESS = 6 TO 20 KSI, PERIODIC OVERLOAD = -6 KSI TO +20 KSI

CCT SPECIMEN R = 0.250 IN. W = 6.000 IN. AK = 0.0 IN.

PMIN = P MAX = TEST FREQ = 6.00 HZ.

ENVIRONMENT CONDITION: AMBIENT AIR

NO.	CYCLES	A (MEASURED)	A (REGRESSION)	MULT. CORR. COEFF	K-MAX	DELTA K	OA/ON
29	17300.	1.310	1.308	0.999823	29.51	20.66	1.037E-04
30	17500.	1.350	1.352	0.999852	30.06	21.04	1.132E-04
31	17800.	1.425	1.424	0.999595	30.96	21.67	1.313E-04
32	18000.	1.480	1.481	0.998179	31.66	22.16	1.376E-04
33	18300.	1.565	1.567	0.997413	32.72	22.90	1.559E-04
34	18500.	1.640	1.632	0.996383	33.52	23.46	1.601E-04
35	18700.	1.685	1.695	0.995185	34.28	24.00	1.779E-04
36	18900.	1.780	1.764	0.995978	35.12	24.59	1.973E-04
37	19100.	1.830	1.844	0.997792	36.10	25.27	2.195E-04
38	19400.	1.950	1.991	0.998217	37.91	26.54	2.655E-04
39	19600.	2.110	2.101	0.998738	39.26	27.48	2.963E-04
40	19790.	2.220	2.223	0.999242	40.79	28.55	3.357E-04
41	19970.	2.340	2.341	0.998239	42.30	29.61	3.857E-04
42	20140.	2.470	2.471	0.999355	44.03	30.82	4.483E-04
43	20300.	2.615	2.621	0.998221	46.02	32.22	5.521E-04
44	20440.	2.785	2.783	0.997312	48.29	33.80	6.949E-04
45	20540.	2.905	2.926	0.997882	50.38	35.26	8.425E-04
46	20630.	3.075	3.087	0.995708	52.86	37.01	1.092E-03
47	20680.	3.155	3.196	0.995809	54.62	38.23	1.406E-03
48	20720.	3.285	3.314	0.991717	56.64	39.65	1.834E-03
49	20750.	3.410	3.421	0.963003	58.54	40.97	3.103E-03
50	20770.	3.510	3.531	0.981054	60.59	42.42	4.226E-03
51	20790.	3.640	3.704	0.988243	64.09	44.86	5.909E-03
52	20810.	3.985	3.983	0.995522	70.51	49.36	9.423E-03

PLOT RATE CRACK GROWTH ANALYSIS

M-17 BASE STRESS = 6 TO 20 KSI, PERIODIC OVERLOAD = -6 TO +20 KSI

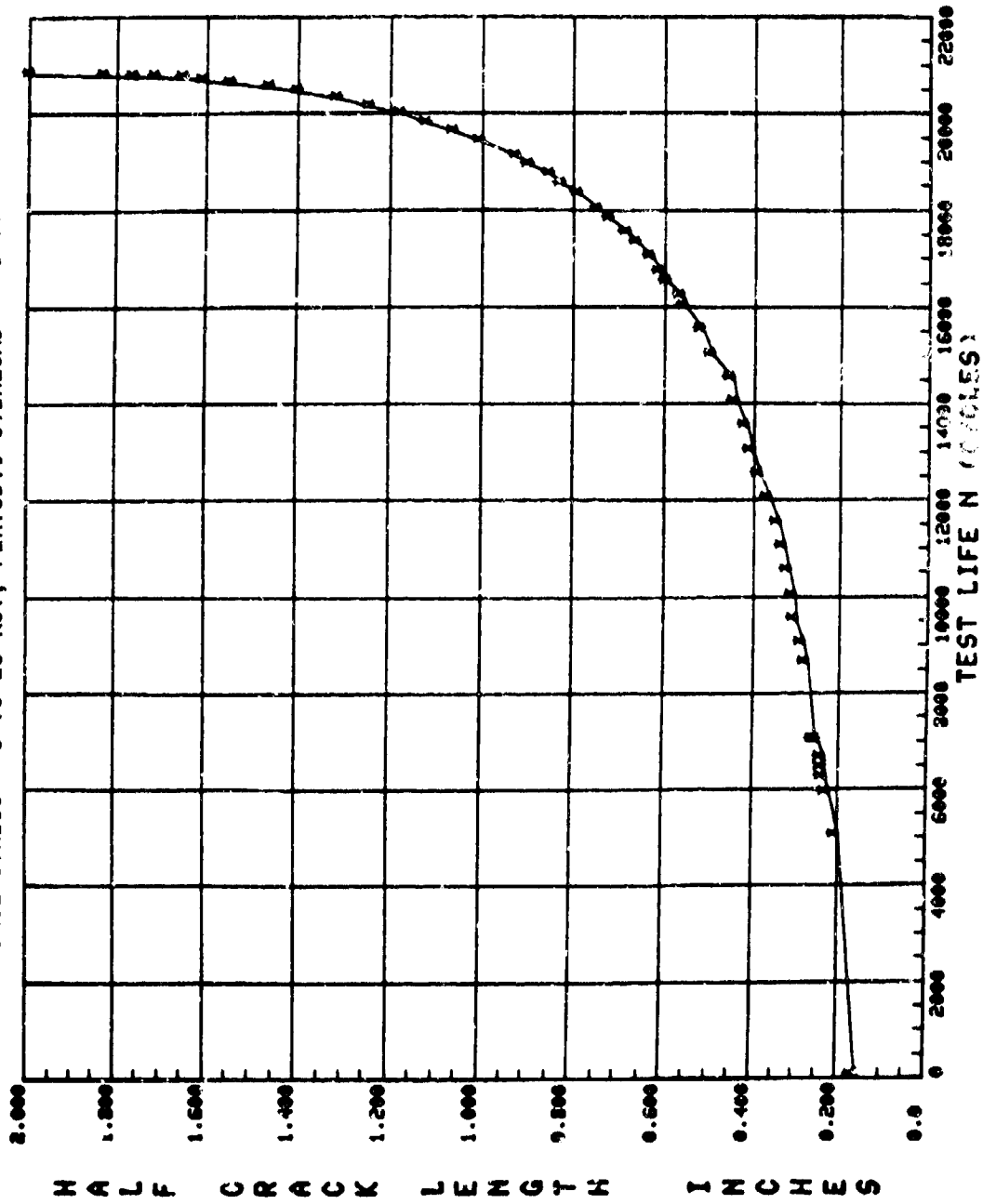

Figure 31. Crack growth curve for test M-17.

TABLE 29. DATA TABULATION FOR TEST M-18

SPECIMEN NO. M-18 BASE STRESS = 28 TO 40 KSI. PERIODIC OVERLOAD = -12 TO +40 KSI

CYCLE SPECIMEN R = 0.250 IN. W = 6.000 IN. AN = 0.0 IN. TEST FRQ = 6.00 HZ.

ENVIRONMENT CONDITION: AMBIENT AIR

NO.	CYCLES	A (MEASURED)	A (REGRESSION)	MULT. CORR. COEFF	K-MAX	DELTA K	DAY/ON
1	0	0.250	0.291	0.985698	27.06	8.12	3.843E-05
2	500	0.330	0.318	0.962512	28.31	8.49	2.273E-05
3	1000	0.340	0.329	0.959551	28.81	8.64	1.481E-05
4	2000	0.355	0.356	0.980147	29.96	8.99	1.322E-05
5	3000	0.375	0.373	0.995097	30.69	9.21	1.225E-05
6	5000	0.440	0.432	0.996104	33.07	9.92	2.076E-05
7	6500	0.450	0.500	0.995784	35.60	10.68	2.902E-05
8	7800	0.580	0.585	0.995644	38.55	11.57	3.919E-05
9	8800	0.660	0.660	0.998101	41.28	12.39	5.371E-05
10	9300	0.720	0.728	0.989783	43.14	12.94	7.167E-05
11	9600	0.760	0.766	0.996037	44.30	13.29	8.563E-05
12	9900	0.810	0.817	0.995326	45.83	13.75	1.032E-04
13	10200	0.855	0.883	0.995960	47.72	14.31	1.202E-04
14	10400	0.925	0.933	0.994227	49.14	14.74	1.423E-04
15	10600	0.955	0.993	0.993029	50.78	15.24	1.694E-04
16	10700	1.015	1.073	0.995312	51.59	15.48	1.773E-04
17	10900	1.105	1.195	0.981683	53.78	16.13	1.716E-04
18	11000	1.155	1.142	0.980473	54.75	16.42	1.747E-04
19	11100	1.185	1.177	0.979442	55.67	16.70	1.786E-04
20	11200	1.185	1.203	0.976929	56.35	16.91	1.763E-04
21	11350	1.260	1.253	0.992437	57.62	17.29	2.313E-04
22	11450	1.300	1.303	0.994275	58.88	17.66	2.935E-04
23	11500	1.335	1.337	0.997423	59.74	17.92	3.150E-04
24	11600	1.405	1.405	0.999213	61.45	18.43	4.146E-04

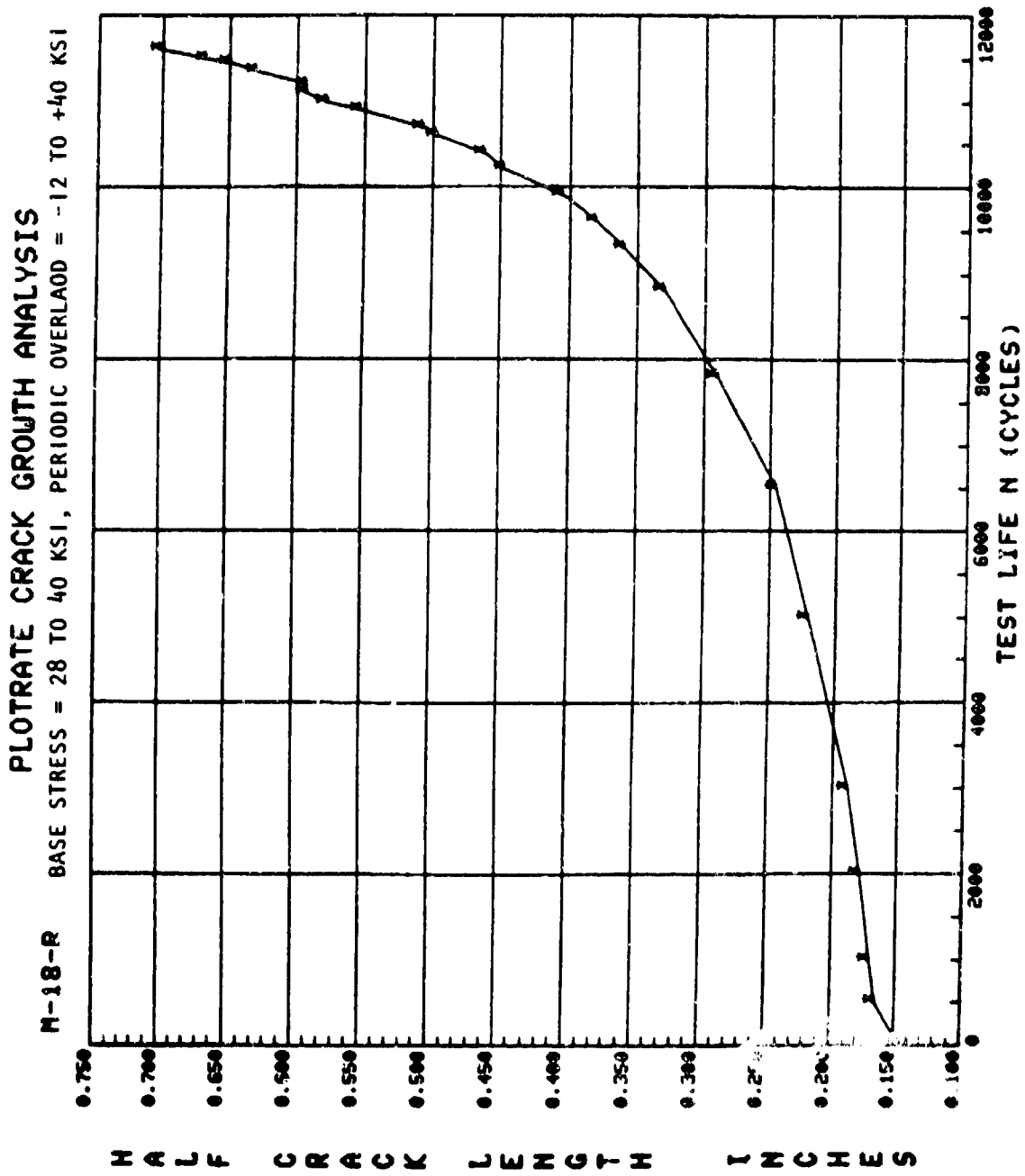

Figure 32. Crack growth curve for test M-18-R.

TABLE 30. DATA TABULATION FOR TEST M-19

SPECIMEN NO.: M-19 BASE STRESS = 0 TO 20 KSI, SINGLE OVERLOAD +30 KSI to -6 KSI

CCT SPECIMEN A = 0.250 IN. W = 6.000 IN. AN = 0.0 IN. TEST FREQ = 6.00 HZ.
 PMIN = PMAX =

ENVIRONMENT CONDITION: AMBIENT AIR

NO.	CYCLES	A (MEASURED)	A (REGRESSION)	MULT. CORR. COEFF	K-MAX	DELTA K	DA/DN
1	0.	0.250	0.290	0.997767	20.28	24.34	1.278E-05
2	824.	0.315	0.311	0.996318	21.00	25.20	1.543E-05
3	1550.	0.335	0.337	0.996727	21.87	26.25	2.096E-05
4	2000.	0.355	0.358	0.977831	22.55	27.05	1.904E-05
5	2500.	0.385	0.379	0.978077	23.19	27.83	1.697E-05
6	2501.	0.385	0.376	0.966317	23.10	27.72	1.756E-05
7	3101.	0.395	0.392	0.980926	23.60	28.32	1.380E-05
8	4501.	0.430	0.433	0.995246	24.82	29.78	2.063E-05
9	5501.	0.485	0.483	0.994702	26.24	31.49	2.638E-05
10	6001.	0.515	0.512	0.995362	27.02	32.42	2.959E-05
11	6501.	0.550	0.545	0.996066	27.89	33.47	3.333E-05
12	7001.	0.570	0.576	0.993440	28.69	34.43	3.854E-05
13	7501.	0.615	0.615	0.995983	29.66	35.59	4.677E-05
14	8001.	0.660	0.664	0.997178	30.85	37.03	5.672E-05
15	8301.	0.705	0.701	0.996347	31.74	38.08	5.777E-05
16	8501.	0.730	0.725	0.995094	32.30	38.76	6.127E-05
17	8701.	0.750	0.752	0.992081	32.90	39.48	6.616E-05
18	8901.	0.770	0.775	0.996394	33.44	40.13	7.000E-05
19	9101.	0.805	0.805	0.993535	34.10	40.92	7.249E-05
20	9201.	0.825	0.821	0.996042	34.46	41.35	7.599E-05
21	9401.	0.855	0.853	0.997629	35.15	42.18	7.996E-05
22	9601.	0.880	0.882	0.998393	35.78	42.94	8.067E-05
23	9801.	0.915	0.916	0.996770	36.49	43.79	8.109E-05
24	10001.	0.950	0.947	0.996656	37.14	44.57	9.413E-05
25	10201.	0.990	0.987	0.988977	37.97	45.57	1.019E-04
26	10351.	1.005	1.019	0.988465	38.61	46.33	1.059E-04
27	10501.	1.065	1.051	0.987709	39.27	47.12	1.153E-04
28	10651.	1.085	1.087	0.987051	39.98	47.98	1.261E-04

TABLE 30. DATA TABULATION FOR TEST M-19 (CONT)

SPECIMEN NO.:	M-19	BASE STRESS = 0 TO 20 KSI, SINGLE OVERLOAD +30 KSI TO -6 KSI	W = 6.000 IN.	AN = 0.0	IN.	TEST FREQ = 6.00 HZ.	
CCT SPECIMEN	α = 0.250 IN.	P MAX =	ENVIRONMENT CONDITION: AMBIENT AIR				
NO.	CYCLES	A (MEASURED)	A (REGRESSION)	MULT. CORR. COEFF	K-MAX	DELTA K	DA/DN
29	10801.	1.120	1.128	0.987798	40.80	48.96	1.296E-04
30	10901.	1.155	1.150	0.994530	41.23	49.47	1.374E-04
31	11001.	1.185	1.182	0.993887	41.85	50.22	1.393E-04
32	11101.	1.205	1.211	0.987620	42.40	50.88	1.496E-04
33	11201.	1.245	1.245	0.986925	42.93	51.52	1.638E-04
34	11301.	1.260	1.271	0.986344	43.57	52.28	1.837E-04
35	11351.	1.255	1.291	0.962466	43.94	52.73	1.826E-04
36	11401.	1.315	1.308	0.979623	44.27	53.12	1.967E-04
37	11451.	1.320	1.311	0.990745	44.69	53.63	2.187E-04
38	11501.	1.345	1.353	0.977170	45.12	54.14	1.981E-04
39	11550.	1.375	1.370	0.974356	45.44	54.52	2.004E-04
40	11690.	1.440	1.429	0.976594	46.53	55.83	2.203E-04
41	11750.	1.435	1.456	0.975584	47.03	56.43	2.251E-04
42	11800.	1.485	1.478	0.971796	47.44	56.93	2.113E-04
43	11850.	1.505	1.498	0.982762	47.81	57.37	2.192E-04
44	11900.	1.525	1.522	0.991851	48.24	57.89	2.471E-04
45	12000.	1.560	1.566	0.999177	49.07	58.88	2.310E-04
46	12200.	1.675	1.670	0.999380	50.96	61.16	2.886E-04
47	12300.	1.720	1.731	0.999496	52.08	62.49	3.198E-04
48	12400.	1.754	1.798	0.998663	53.31	63.98	3.509E-04
49	12500.	1.870	1.869	0.999942	54.61	65.53	3.804E-04
50	12600.	1.950	1.950	0.999951	56.10	67.31	4.143E-04
51	12700.	2.035	2.034	0.999528	57.66	69.19	4.562E-04
52	12800.	2.130	2.127	0.999535	59.38	71.26	5.053E-04
53	12900.	2.225	2.229	0.999327	61.31	73.58	5.763E-04
54	13000.	2.350	2.349	0.999644	63.60	76.32	6.670E-04
55	13090.	2.470	2.474	0.999867	66.05	79.26	7.712E-04
56	13170.	2.605	2.603	0.999406	68.66	82.39	8.984E-04

TABLE 30. DATA TABULATION FOR TEST M-19 (CONCL)

SPECIMEN NO.: M-19 BASE STRESS = 0 TO 20 KSI, SINGLE OVERLOAD +30 KSI TO -6 KSI

CCT SPECIMEN R = 0.250 IN. W = 6.000 IN. AR = 0.0 IN.

PMIN = PMAX = TEST FREQ = 6.00 HZ.

ENVIRONMENT CONDITION: AMBIENT AIR

NO.	CYCLES	A (MEASURED)	A (REGRESSION)	MULT. CORR. COEFF	K-MAX	DELTA K	DA/DN
57	13240.	2.730	2.730	0.995597	71.31	85.57	1.112E-03
58	13300.	2.855	2.866	0.994589	74.23	89.08	1.407E-03
59	13350.	2.985	3.007	0.992298	77.42	92.90	1.909E-03
60	13390.	3.155	3.165	0.991471	81.18	97.41	2.656E-03
61	13420.	3.255	3.334	0.990728	85.47	102.57	3.771E-03
62	13440.	3.465	3.491	0.993712	89.77	107.72	4.985E-03
63	13450.	3.585	3.588	0.999784	92.57	111.08	6.346E-03
64	13460.	3.725	3.725	0.999994	96.82	116.18	7.598E-03

M-19
 PLOTRATE CRACK GROWTH ANALYSIS
 BASE STRESS = 0 TO 20 KSI, SINGLE OVERLOAD +30 KSI TO -6 KSI

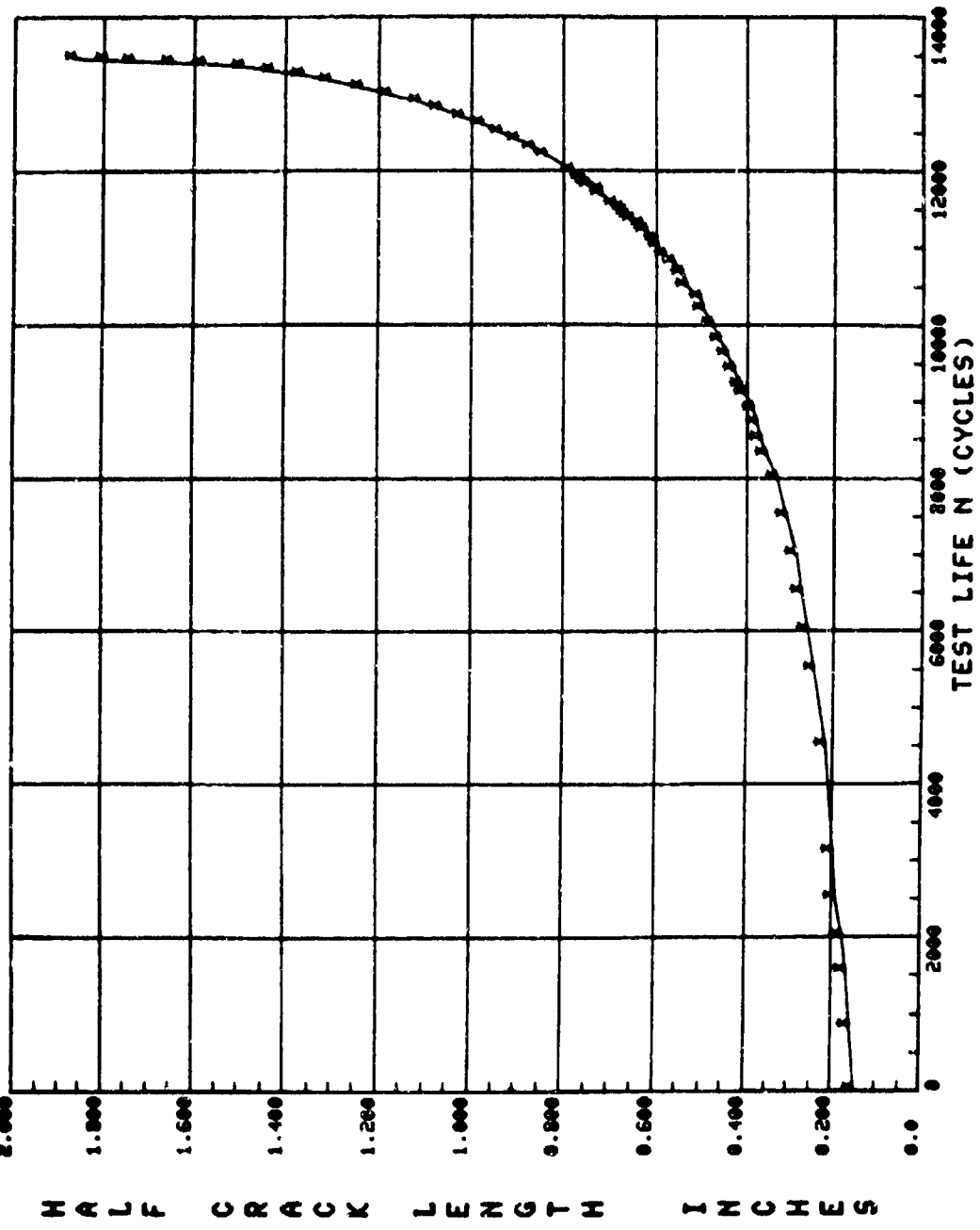

Figure 35. Crack growth curve for test M-19.

TABLE 31. DATA TABULATION FOR TEST M-20

SPECIMEN NO.: M-20-R RASE STRESS = 0 - 20 KSI, MULTIPLE LOAD RETARD. = -6.0 - 30 KSI

CCI SPECIMEN R = 0.250 IN. W = 6.000 IN. AN = 0.0 IN.

PMIN = -9.00 KIPS PMAX = 45.00 KIPS R = -0.200 TEST FREQ = 6.00 HZ.

ENVIRONMENT CONDITION: AMBIENT AIR

NO.	CYCLES	A (MEASURED)	A (REGRESSION)	MULT. CORR. COEFF.	K-MAX	DELTA K	DA/DM
1	0.	0.300	0.301	0.994308	20.66	24.79	1.159E-05
2	1000.	0.330	0.314	0.936248	21.11	25.33	6.004E-07
3	2500.	0.350	0.314	0.959168	21.09	25.31	-5.005E-07
4	18000.	0.410	0.415	0.966123	24.30	29.15	9.707E-06
5	23200.	0.520	0.539	0.987358	27.74	33.29	1.609E-05
6	24500.	0.570	0.582	0.994109	28.86	34.63	1.816E-05
7	25999.	0.650	0.637	0.985610	30.20	36.25	2.510E-05
8	27600.	0.710	0.719	0.984439	32.16	38.60	3.346E-05
9	28400.	0.745	0.771	0.988584	33.34	40.01	3.920E-05
10	29300.	0.860	0.841	0.989604	34.90	41.87	4.512E-05
11	30000.	0.920	0.916	0.993038	36.49	43.79	4.863E-05
12	30600.	0.990	0.990	0.995629	37.83	45.39	5.105E-05
13	31100.	1.070	1.070	0.992801	38.65	46.37	5.912E-05
14	31700.	1.090	1.094	0.995804	40.12	48.14	6.873E-05
15	32200.	1.155	1.167	0.996713	41.56	49.87	7.814E-05
16	32800.	1.290	1.270	0.997233	43.54	52.25	9.393E-05
17	33300.	1.365	1.368	0.994615	45.39	54.46	1.127E-04
18	33800.	1.670	1.486	0.992264	47.58	57.10	1.401E-04
19	34200.	1.585	1.593	0.995551	49.56	59.47	1.915E-04
20	34500.	1.705	1.714	0.997527	51.77	62.12	2.455E-04
21	34700.	1.800	1.814	0.989061	53.60	64.33	3.334E-04
22	34900.	1.945	1.953	0.992311	56.16	67.39	4.435E-04
23	35000.	2.010	2.037	0.993039	57.71	69.26	5.107E-04
24	35100.	2.175	2.143	0.986646	59.69	71.63	5.327E-04
25	35150.	2.215	2.208	0.981710	60.90	73.08	4.579E-04
26	35200.	2.255	2.259	0.990651	61.97	74.25	4.547E-04
27	35250.	2.295	2.291	0.999166	62.49	74.98	3.459E-04
28	35350.	2.350	2.348	0.995031	63.60	76.31	3.136E-04

TABLE 31. DATA TABULATION FOR TEST M-20 (CONCL.)

SPECIMEN NO.: M-20-R RASE STRESS = 0 - 20 KSI, MULTIPLE LOAD RETARD. = -6.0 - 30 KSI

CCI SPECIMEN R = 0.250 IN, W = 6.000 IN, AN = 0.0 IN,

PMIN = -9.00 KIPS PMAX = 45.00 KIPS R = -0.200 TEST FREQ = 6.00 HZ.

ENVIRONMENT CONDITION: AMBIENT AIR

NO.	CYCLES	A (MEASURED)	A (REFRFSSTION)	MULT. CORR. COEFF	K-MAX	DELTA K	DA/DM
29	35450.	2.410	2.406	0.994586	64.73	77.67	3.365E-04
30	35500.	2.430	2.438	0.997320	65.35	78.42	3.567E-04
31	35500.	2.510	2.512	0.996876	66.83	80.20	4.546E-04
32	35650.	2.565	2.558	0.998241	67.74	81.29	5.190E-04
33	35700.	2.605	2.614	0.998686	68.89	82.66	5.946E-04
34	35750.	2.690	2.675	0.998851	70.14	84.17	6.750E-04
35	35800.	2.745	2.744	0.999269	71.60	85.92	7.750E-04
36	35950.	2.825	2.825	0.997875	73.34	88.01	9.303E-04
37	35900.	2.920	2.917	0.997048	75.37	90.44	1.125E-03
38	35950.	3.030	3.039	0.997090	78.17	93.80	1.509E-03
39	35990.	3.155	3.166	0.996057	81.20	97.44	2.012E-03
40	36020.	3.285	3.294	0.994727	84.42	101.30	2.715E-03
41	36040.	3.385	3.405	0.995114	87.38	104.65	3.560E-03
42	36055.	3.500	3.513	0.997930	90.37	108.45	4.427E-03
43	36065.	3.605	3.601	0.999874	92.97	111.56	5.327E-03
44	36075.	3.715	3.715	0.999789	96.51	119.81	6.085E-03

PLOT RATE CRACK GROWTH DATA
M-20-R BASE STRESS = 0 - 20 KSI, MULTIPLE LOAD RETARD. = -6.0 - 30 KSI

LEGEND
: M-20-R

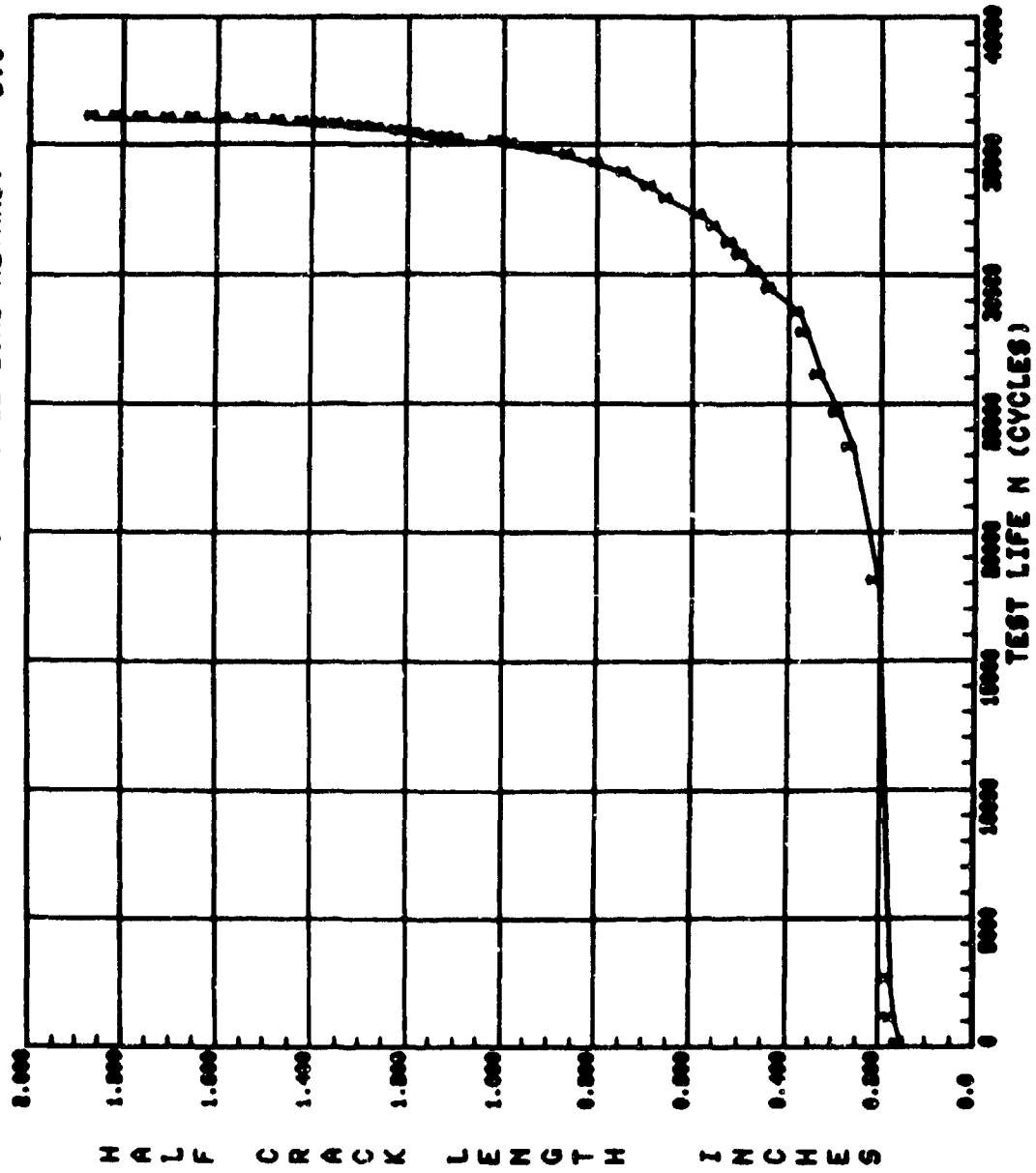

Figure 34. Crack growth curve for test M-20.

TABLE 32. DATA TABULATION FOR TEST M-21

SPECIMEN NO.: M-21 BASE STRESS = 0 TO 20 KSI, PERIODIC OVERLOAD +40 KSI TO -12 KSI

CCT SPECIMEN B = 0.250 IN. W = 6.100 IN. AN = 0.0 IN. TEST FREQ = 6.000 HZ.
 PMIN = PMAX =

ENVIRONMENT CONDITION: AMBIENT AIR

NO.	CYCLES	A (MEASURED)	A (REGRESSICN)	MULT. CORR. COEFF	K-MAX	DELTA K	DA/DN
1	0.	0.320	0.320	0.999984	18.94	26.04	1.329E-05
2	2000.	0.375	0.370	0.995668	20.38	28.02	1.540E-05
3	3000.	0.405	0.410	0.984296	21.46	29.50	1.569E-05
4	4000.	0.435	0.442	0.986748	22.28	30.64	1.615E-05
5	5025.	0.455	0.478	0.987782	23.20	31.90	1.656E-05
6	6500.	0.515	0.526	0.989047	24.35	33.49	1.598E-05
7	7525.	0.560	0.559	0.987805	25.12	34.54	1.490E-05
8	9000.	0.600	0.594	0.987397	25.91	35.63	1.432E-05
9	10500.	0.645	0.641	0.989029	26.95	37.06	1.525E-05
10	12000.	0.670	0.683	0.991426	27.84	38.27	1.648E-05
11	13500.	0.745	0.733	0.992718	28.87	39.70	1.966E-05
12	14500.	0.765	0.773	0.993936	29.68	40.81	2.178E-05
13	15500.	0.820	0.816	0.985533	30.56	42.02	2.752E-05
14	16500.	0.875	0.874	0.988940	31.64	43.50	3.062E-05
15	17500.	0.925	0.934	0.982561	32.77	45.06	4.152E-05
16	18500.	1.045	1.019	0.988872	34.33	47.20	5.281E-05
17	19500.	1.055	1.116	0.986980	36.40	50.05	6.332E-05
18	20500.	1.300	1.277	0.982479	38.82	53.38	6.787E-05
19	21000.	1.375	1.349	0.977000	40.03	55.04	6.617E-05
20	21500.	1.420	1.433	0.995450	41.42	56.96	6.141E-05
21	22000.	1.475	1.481	0.996438	42.22	58.06	6.777E-05
22	22500.	1.540	1.540	1.000000	43.19	59.38	6.999E-05

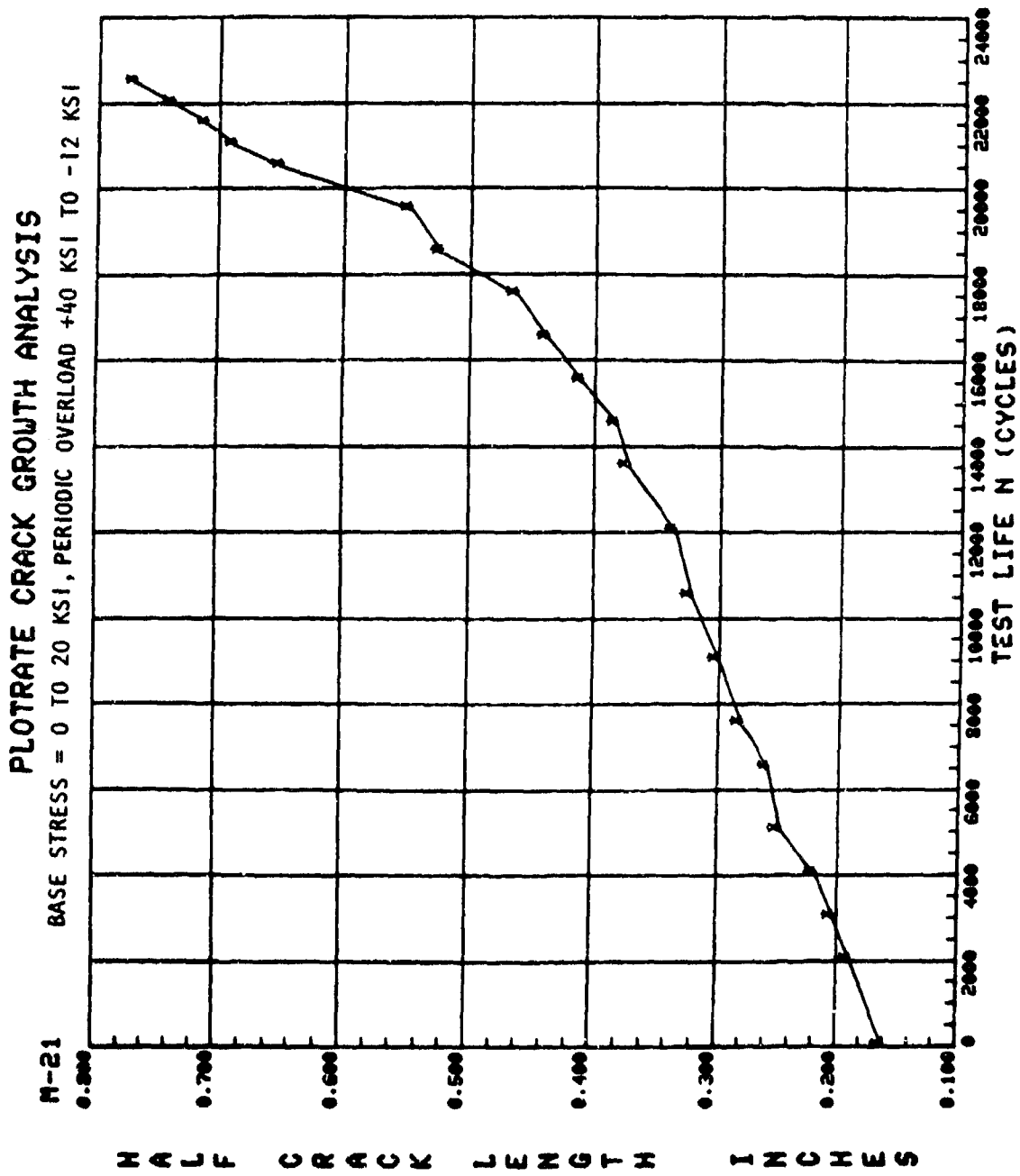

Figure 35. Crack growth curve for test M-21.

TABLE 35. DATA TABULATION FOR TEST M-22

SPECIMEN NO.: M-22 BASE STRESS = 0-20 KSI, SINGLE OVERLOAD = -6 TO +30 KSI
 CCT SPECIMEN R = 0.250 IN. W = 4.000 IN. AA = 0.0 IN.
 PMIN = PMAX = TEST FREQ = 6.00 HZ.

ENVIRONMENT CONDITION: AMBIENT AIR

NO.	CYCLES	A (MEASURED)	A (REGRESSION)	MULT. CORR. COEFF	K-MAX	DELTA K	DA/DN
1	0.	0.315	0.315	0.998749	14.09	14.09	1.196E-05
2	1830.	0.365	0.370	0.998842	15.28	15.28	1.656E-05
3	2500.	0.355	0.391	0.998143	15.71	15.71	1.804E-05
4	3700.	0.440	0.436	0.997344	16.60	16.60	2.154E-05
5	5350.	0.505	0.510	0.997115	17.98	17.98	2.823E-05
6	6470.	0.575	0.576	0.997730	19.14	19.14	3.638E-05
7	7360.	0.640	0.640	0.998027	20.19	20.19	4.998E-05
8	8050.	0.705	0.710	0.999387	21.29	21.29	5.684E-05
9	8630.	0.775	0.763	0.994534	22.11	22.11	6.418E-05
10	11130.	1.210	1.213	0.993944	28.29	28.29	1.316E-04
11	11630.	1.255	1.346	0.994775	29.98	29.98	1.650E-04
12	12130.	1.520	1.525	0.994865	32.20	32.20	1.998E-04
13	12230.	1.570	1.558	0.996096	32.61	32.61	2.564E-04
14	12330.	1.615	1.615	0.998723	33.30	33.30	2.354E-04
15	12430.	1.655	1.663	0.994270	33.90	33.90	2.204E-04
16	12500.	1.705	1.643	0.991361	34.26	34.26	2.240E-04
17	12570.	1.725	1.723	0.988220	34.62	34.62	2.415E-04
18	12640.	1.745	1.756	0.991075	35.03	35.03	2.506E-04
19	12710.	1.750	1.789	0.996726	35.43	35.43	2.555E-04
20	12810.	1.855	1.848	0.998426	36.15	36.15	3.082E-04
21	12910.	1.910	1.913	0.998683	36.95	36.95	3.540E-04
22	13010.	1.985	1.989	0.996900	37.88	37.88	3.714E-04
23	13110.	2.065	2.065	0.997104	38.82	38.82	4.045E-04
24	13210.	2.165	2.150	0.997564	39.88	39.88	4.446E-04
25	13310.	2.225	2.239	0.997571	40.99	40.99	4.902E-04
26	13410.	2.340	2.335	0.997967	42.23	42.23	5.595E-04
27	13510.	2.450	2.444	0.998180	43.64	43.64	6.777E-04
28	13610.	2.585	2.580	0.995084	45.46	45.46	8.911E-04

TABLE 33. DATA TABULATION FOR TEST M-22 (CONCL)

SPECIMEN NO.: M-22 BASE STRESS = 0-20 KSI, SINGLE OVERLOAD = -6 TO +30 KSI

CCT SPECIMEN R= 0.250 IN. W= 6.000 IN. AA= 0.0 IN.

P41V= PMAX= TEST FREQ= 6.000 HZ.

ENVIRONMENT CONDITION: AMBIENT AIR

NO.	CYCLES	A (MEASURED)	A (REGRESSION)	MULT. CORR. COEFF	K-MAX	DELTA K	DA/DN
29	13710.	2.755	2.765	0.998127	48.03	48.03	1.137E-03
30	13810.	2.955	3.013	0.999233	51.70	51.70	1.484E-03
31	13910.	3.350	3.349	0.999837	57.25	57.25	1.971E-03

PLOTRATE CRACK GROWTH ANALYSIS
M-22 BASE STRESS = 0 TO 20 KSI, SINGLE OVERLOAD = -6 TO +30 KSI

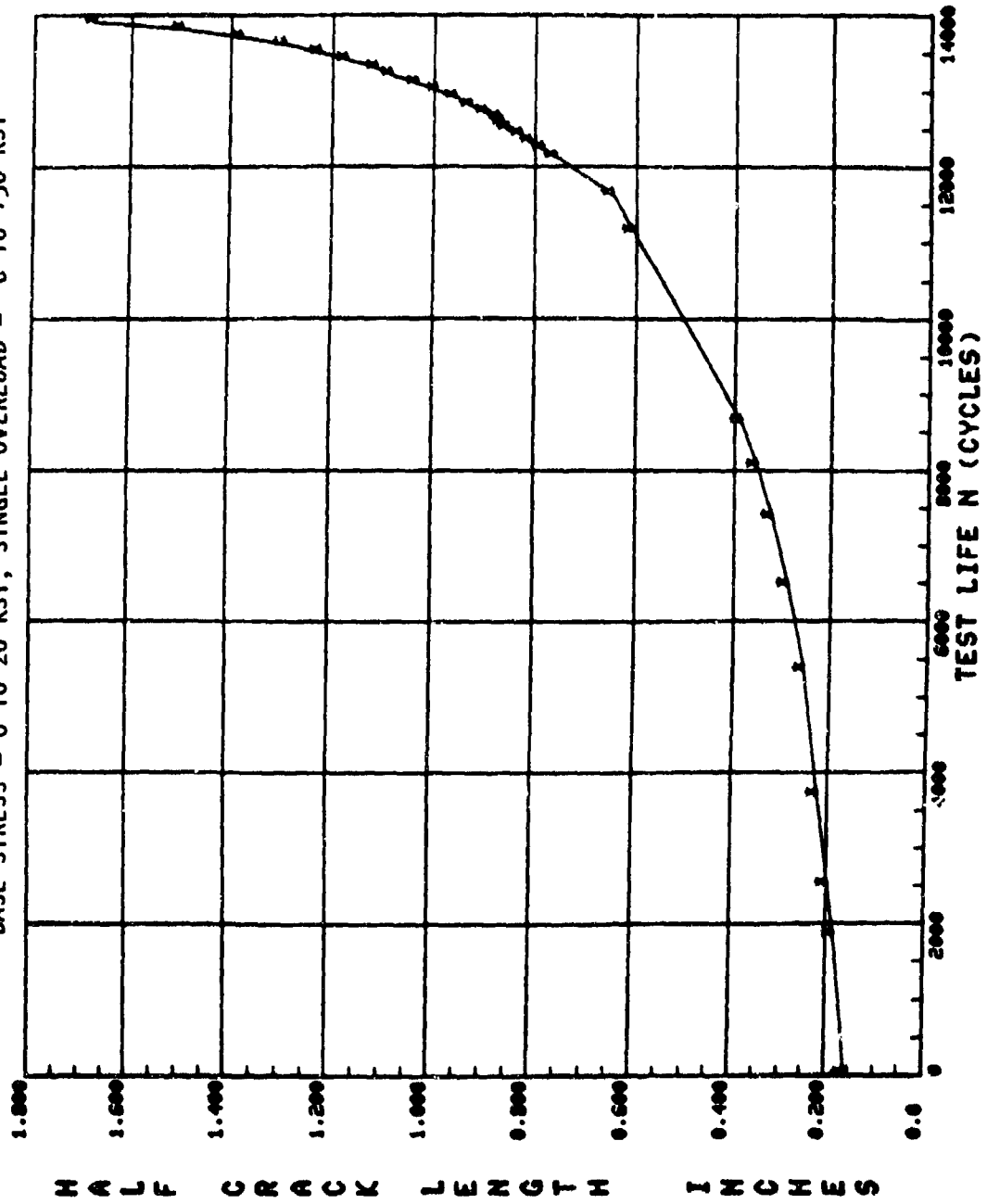

Figure 36. Crack growth curve for test M-22.

TABLE 34. DATA TABULATION FOR TEST M-23

SPECIMEN NO.: M-23 BASE STRESS 0 TO +20 KSI, PERIODIC OVERLOAD = -6 TO +30 KSI

CCT SPECIMEN B = 0.250 IN. w = 0.000 IN. AN = 0.0 IN.

PMIN = PMAX = TEST FREQ = 6.000 HZ.

ENVIRONMENT CONDITION: AMBIENT AIR

NO.	CYCLES	A(MFASURFD)	A(RFGRESSICN)	MULT. CORR. COEFF	K-MAX	DELTA K	DA/DN
1	0.	0.303	0.302	0.994853	13.80	13.80	1.602E-05
2	1000.	0.330	0.337	0.995219	14.59	14.59	1.743E-05
3	2000.	0.375	0.367	0.992651	15.23	15.23	1.724E-05
4	3000.	0.405	0.404	0.993911	15.97	15.97	1.790E-05
5	4000.	0.430	0.438	0.991913	16.64	16.64	1.982E-05
6	5000.	0.465	0.478	0.994452	17.39	17.39	2.090E-05
7	6000.	0.515	0.523	0.995605	18.20	18.20	2.322E-05
8	7000.	0.560	0.572	0.996403	19.05	19.05	2.599E-05
9	8000.	0.620	0.622	0.997744	19.90	19.90	2.855E-05
10	9000.	0.680	0.683	0.997982	20.88	20.88	3.266E-05
11	10000.	0.750	0.747	0.998857	21.86	21.86	3.858E-05
12	10900.	0.820	0.820	0.998203	22.96	22.96	4.702E-05
13	11700.	0.850	0.898	0.999089	24.08	24.08	5.535E-05
14	12400.	0.980	0.979	0.999477	25.20	25.20	6.362E-05
15	13000.	1.065	1.061	0.997852	26.30	26.30	6.712E-05
16	13400.	1.120	1.118	0.994735	27.06	27.06	7.583E-05
17	13800.	1.180	1.175	0.989396	27.80	27.80	8.967E-05
18	14200.	1.225	1.238	0.991485	28.61	28.61	1.161E-04
19	14600.	1.330	1.339	0.992011	29.90	29.90	1.404E-04
20	14900.	1.430	1.436	0.985602	31.10	31.10	1.485E-04
21	15200.	1.570	1.542	0.993914	32.41	32.41	1.574E-04
22	15500.	1.640	1.636	0.990815	33.57	33.57	1.663E-04
23	15800.	1.715	1.721	0.983036	34.60	34.60	1.903E-04
24	16100.	1.815	1.821	0.995603	35.82	35.82	2.408E-04
25	16380.	1.950	1.960	0.993492	37.53	37.53	3.494E-04
26	16630.	2.140	2.150	0.993528	39.88	39.88	5.058E-04
27	16800.	2.255	2.332	0.993928	42.18	42.18	6.877E-04
28	16940.	2.515	2.511	0.994684	44.93	44.93	9.485E-04

TABLE 34. DATA TABULATION FOR TEST M-23 (CONCL)

SPECIMEN NO.: 4-23 BASE STRESS 0 TO +20 KSI, PERIODIC OVERLOAD = -6 TO +30 KSI

CCT SPECIMEN R= 0.250 IN. W= 0.000 IN. AN= 0.0 IN.

PMIN= PMAX= TEST FREQ= 6.00 HZ.

ENVIRONMENT CONDITION: AMBIENT AIR

NO.	CYCLES	A (MEASURED)	A (REGRESSION)	MULT. CORR. COEFF	K-MAX	DELTA K	DA/DM
29	17010.	2.660	2.676	0.997957	46.77	46.77	1.262E-03
30	17050.	2.770	2.778	0.996840	48.22	48.22	1.552E-03
31	17090.	2.890	2.902	0.996394	50.02	50.02	1.998E-03
32	17120.	3.010	3.021	0.995740	51.83	51.83	2.647E-03
33	17140.	3.120	3.125	0.994022	53.46	53.46	3.424E-03
34	17160.	3.250	3.256	0.940157	55.64	55.64	5.875E-03
35	17180.	3.430	3.503	0.958807	60.07	60.07	9.810E-03
36	17190.	3.585	3.697	0.975031	63.94	63.94	1.415E-02
37	17200.	4.040	4.034	0.991930	71.84	71.84	2.275E-02

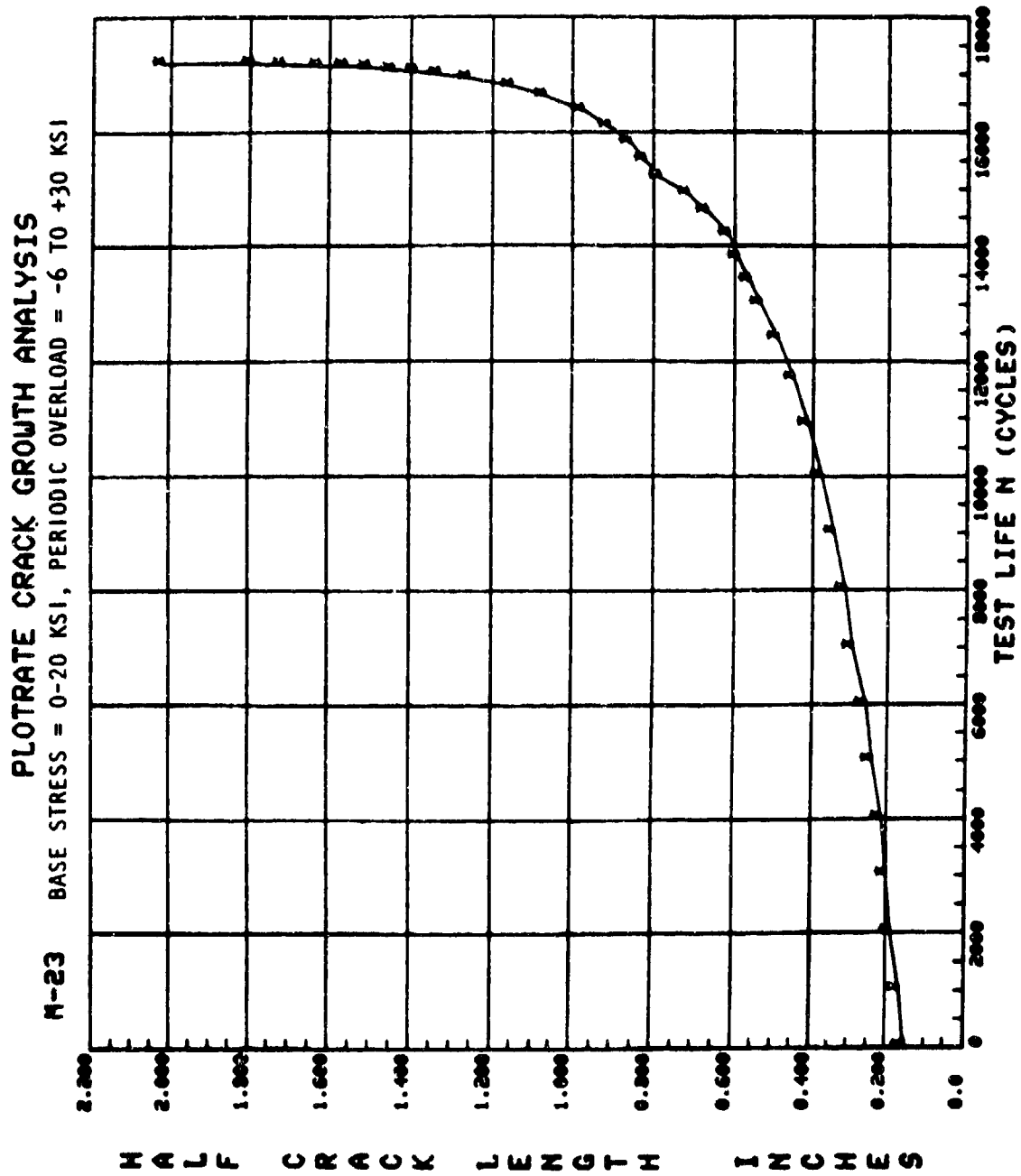

Figure 37. Crack growth curve for test M-23.

TABLE 35. DATA TABULATION FOR TEST M-24

SPECIMEN NO.: M-24 BASE STRESS -6 TO +20 KSI, PERIODIC OVERLOAD -6 TO +30 KSI

CCY SPECIMEN R = 0.250 IN. W = 6.000 IN. AN = 0.0 IN.

PMIN = P MAX = TEST FREQ = 6.000HZ.

ENVIRONMENT CONDITION: AMBIENT AIR

NO.	CYCLES n.	A (MFASLRED)	A (REGRESSION)	MULT. CORR. COEFF	K-MAX	DELTA K	DA/DN
1	0.440	0.440	0.440	0.999624	11.12	14.45	6.675E-06
2	1850.	0.480	0.480	0.999616	11.63	15.12	1.595E-05
3	3080.	0.530	0.526	0.997414	12.18	15.83	2.404E-05
4	4154.	0.520	0.586	0.997558	12.86	16.72	3.195E-05
5	4983.	0.635	0.641	0.998523	13.47	17.51	3.868E-05
6	5522.	0.650	0.684	0.998871	13.93	18.11	4.386E-05
7	6043.	0.735	0.733	0.997965	14.44	18.77	5.062E-05
8	6583.	0.785	0.789	0.994700	15.00	19.50	6.130E-05
9	7000.	0.835	0.839	0.998448	15.49	20.14	7.231E-05
10	7354.	0.890	0.893	0.997528	16.00	20.81	7.985E-05
11	7611.	0.945	0.939	0.997927	16.43	21.36	8.424E-05
12	7906.	0.995	0.992	0.998625	16.92	22.00	9.070E-05
13	8212.	1.045	1.047	0.998227	17.41	22.64	9.558E-05
14	8590.	1.115	1.118	0.996625	18.04	23.46	1.110E-04
15	8823.	1.170	1.169	0.996311	18.49	24.04	1.319E-04
16	9104.	1.235	1.251	0.993809	19.19	24.94	1.763E-04
17	9187.	1.280	1.276	0.996286	19.40	25.22	2.049E-04
18	9325.	1.330	1.335	0.991863	19.90	25.87	2.172E-04
19	9414.	1.385	1.301	0.995091	20.28	26.37	2.416E-04
20	9499.	1.430	1.420	0.996036	20.61	26.79	2.507E-04
21	9657.	1.450	1.498	0.990549	21.25	27.62	3.054E-04
22	9727.	1.545	1.531	0.993992	21.52	27.98	3.418E-04
23	9900.	1.650	1.677	0.987748	22.71	29.52	4.227E-04
24	10010.	1.785	1.788	0.989172	23.61	30.70	4.431E-04
25	10082.	1.890	1.858	0.990166	24.18	31.44	4.612E-04
26	10235.	1.955	1.999	0.991515	25.33	32.93	4.495E-04
27	10363.	2.055	2.092	0.990490	26.10	33.93	4.484E-04
28	10514.	2.205	2.224	0.993498	27.21	35.37	5.619E-04

TABLE 35. DATA TABULATION FOR TEST M-24 (CONCL)

SPECIMEN NO.: M-24 BASE STRESS -6 TO +20 KSI, PERIODIC OVERLOAD -6 TO +30 KSI

CCT SPECIMEN R= 0.250 IN. W= 6.000 IN. AN= 0.0 IN.

PMIN= PMAX= TEST FREQ= 6.00 HZ.

ENVIRONMENT CONDITION: AMBIENT AIR

NO.	CYCLES	A (MEASUREMENT)	A (REGRESSION)	MULT. CORR. COEFF	K-MAX	DELTA K	DA/DN
29	10609.	2.320	2.330	0.995920	28.11	36.54	7.296E-04
30	10678.	2.425	2.431	0.999758	28.98	37.68	8.967E-04
31	10733.	2.535	2.534	0.998225	29.89	38.85	1.094E-03
32	10785.	2.650	2.651	0.997174	30.95	40.24	1.354E-03
33	10830.	2.760	2.778	0.995115	32.14	41.78	1.756E-03
34	10867.	2.885	2.891	0.997622	33.24	43.21	2.218E-03
35	10886.	2.950	2.999	0.995688	34.32	44.62	2.908E-03
36	10905.	3.110	3.111	0.991907	35.50	46.14	3.817E-03
37	10922.	3.215	3.242	0.993038	36.93	48.00	5.138E-03
38	10936.	3.375	3.392	0.995767	38.68	50.20	6.807E-03
39	10945.	3.515	3.520	0.999822	40.27	52.34	8.859E-03
40	10950.	3.615	3.615	0.999878	41.50	53.95	1.013E-02

PLOTRATE CRACK GROWTH ANALYSIS

BASE STRESS -6 TO +20 KSI, PERIODIC OVERLOAD -6 TO +30 KSI

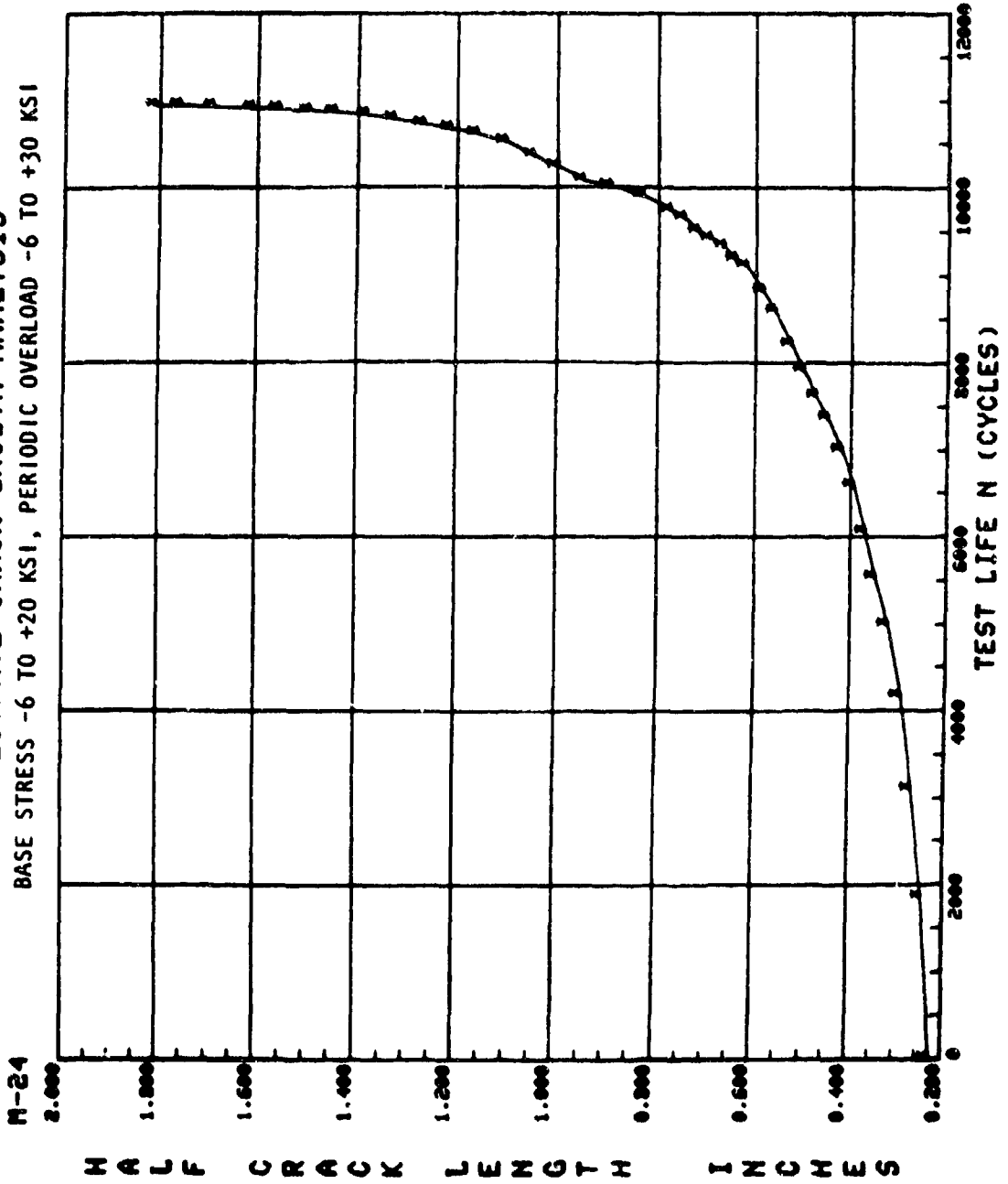

Figure 38. Crack growth curve for test M-24.

TABLE 36. DATA TABULATION FOR TEST M-25

SPECIMEN NO.: M-25 BASE STRESS = -6 TO +20 KSI, PERIODIC OVERLOAD -6 TO +40 KSI

CCT SPECIMEN R = 0.250 IN. W = 6.000 IN. AA = 0.1 IN.

PMTN= P MAX= TEST FREQ = 6.00 HZ.

ENVIRONMENT CONDITION: AMBIENT AIR

NO.	CYCLES	A1(MFASURED)	A1(REGRESSION)	MULT. CORR. COEFF	K-MAX	DELTA K	DA/DM
1	0.	0.303	0.301	0.965102	13.78	17.91	1.406F-05
2	1250.	0.327	0.338	0.983122	14.60	18.98	1.638E-05
3	2502.	0.400	0.387	0.985153	15.64	20.33	1.958E-05
4	3750.	0.428	0.435	0.988950	16.59	21.57	1.938E-05
5	5002.	0.455	0.447	0.991583	17.56	22.82	2.077E-05
6	6250.	0.530	0.517	0.990642	18.45	23.99	1.941E-05
7	7505.	0.585	0.592	0.991796	19.40	25.22	1.851F-05
8	8755.	0.650	0.633	0.987733	20.08	26.11	1.726F-05
9	10006.	0.675	0.676	0.986869	20.76	26.99	1.651E-05
10	11260.	0.700	0.709	0.984932	21.29	27.67	1.754E-05
11	12510.	0.755	0.747	0.997959	21.86	28.42	1.968E-05
12	13760.	0.755	0.804	0.992463	22.71	29.53	2.267E-05
13	15320.	0.885	0.881	0.990136	23.83	30.98	2.964E-05
14	16260.	0.950	0.916	0.991912	24.61	32.00	3.520E-05
15	17000.	0.965	0.911	0.992907	25.37	32.98	3.935E-05
16	18120.	1.050	1.073	0.965007	26.47	34.41	6.140E-05
17	18760.	1.155	1.147	0.981769	27.44	35.68	7.831F-05
18	19600.	1.235	1.309	0.968793	29.52	38.38	8.722E-05
19	20200.	1.475	1.433	0.970296	31.07	40.40	9.126E-05
20	20800.	1.600	1.580	0.975803	32.64	42.43	9.349E-05
21	21700.	1.700	1.747	0.985782	34.92	45.39	6.652E-05
22	22400.	1.825	1.823	0.992774	35.85	46.60	7.352E-05

PLOTRATE CRACK GROWTH ANALYSIS

M-25 BASE STRESS = -6 TO +20 KSI, PERIODIC OVERLOAD = -6 TO +40 KSI

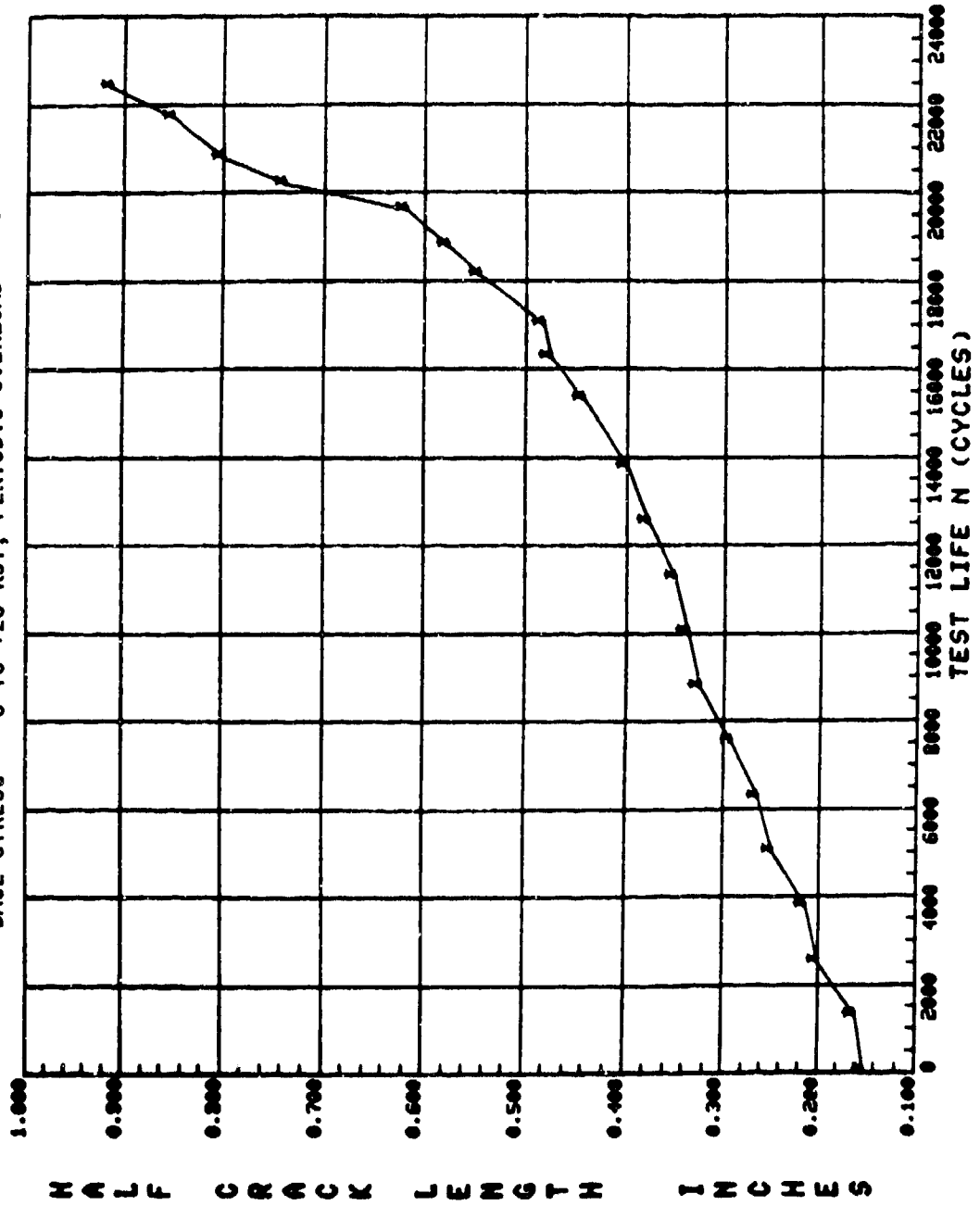

Figure 39. Crack growth curve for test M-25.

TABLE 37. DATA TABULATION FOR TEST M-26

SPECIMEN NO.: M-26 BASE STRESS = -2.4 TO 8 KSI, SINGLE OVERLOAD = +8 TO -16 KSI

CCT SPECIMEN R = 0.250 IN. W = 6.000 IN. AN = 0.0 IN. TEST FREQ = 6.000 HZ.
 PMIN = PMAX =

ENVIRONMENT CONDITION: AMBIENT AIR

NO.	CYCLES	A (MEASURED)	A (REGRESSION)	MULT. CORR. COEFF	K-MAX	DELTA K	DA/DN
1	0.	0.303	0.302	0.999987	5.52	7.18	5.487E-07
2	20015.	0.327	0.328	0.999955	5.76	7.48	7.284E-07
3	53000.	0.385	0.383	0.999256	6.22	8.09	1.015E-06
4	80000.	0.445	0.444	0.997847	6.70	8.72	1.353E-06
5	100000.	0.455	0.502	0.997924	7.13	9.28	1.669E-06
6	115000.	0.550	0.553	0.999156	7.49	9.74	1.944E-06
7	127000.	0.605	0.601	0.998483	7.82	10.17	2.117E-06
8	137000.	0.650	0.648	0.999007	8.13	10.56	2.313E-06
9	145000.	0.685	0.686	0.998886	8.37	10.88	2.424E-06
10	155000.	0.730	0.732	0.993547	8.66	11.25	2.913E-06
11	161000.	0.770	0.766	0.995967	8.86	11.52	3.206E-06
12	169000.	0.810	0.820	0.996510	9.18	11.94	3.770E-06
13	177000.	0.855	0.886	0.995131	9.56	12.43	4.141E-06
14	181000.	0.920	0.921	0.994578	9.76	12.68	4.335E-06
15	185000.	0.960	0.959	0.996428	9.97	12.96	4.601E-06
16	189000.	0.990	0.992	0.998905	10.15	13.20	4.651E-06
17	193000.	1.030	1.030	0.998283	10.36	13.47	5.209E-06
18	197000.	1.075	1.072	0.999317	10.58	13.76	5.706E-06
19	200513.	1.110	1.115	0.999429	10.81	14.05	6.251E-06
20	204513.	1.170	1.170	0.998202	11.10	14.43	6.546E-06
21	208500.	1.225	1.223	0.998302	11.37	14.78	6.954E-06
22	212500.	1.285	1.279	0.997324	11.66	15.15	7.468E-06
23	218500.	1.360	1.369	0.998386	12.11	15.74	8.291E-06
24	222500.	1.435	1.435	0.998854	12.44	16.17	9.358E-06
25	225300.	1.495	1.488	0.999416	12.70	16.51	1.016E-05
26	229750.	1.580	1.586	0.999507	13.18	17.14	1.175E-05
27	233750.	1.685	1.682	0.999597	13.65	17.75	1.332E-05
28	237460.	1.785	1.785	0.999817	14.15	18.40	1.513E-05

TABLE 37. DATA TABULATION FOR TEST M-26 (CONT)

SPECIMEN NO.:	M-26	BASE STRESS = -2.4 TO 8 KSI, SINGLE OVERLOAD = +8 TO -16 KSI					
CCT SPECIMEN	B = 0.250 IN.	M = 6.000 IN. AA = 0.0 IN.					
PMIN =	PMAX =	TEST FREQ = 6.00 HZ.					
ENVIRONMENT CONDITION: AMBIENT AIR							
NO.	CYCLES	A (MEASURED)	A (REGRESSION)	MULT. CORR. COEFF	K-MAX	DELTA K	DA/DN
29	240860.	1.890	1.894	0.999823	14.69	19.09	1.692E-05
30	243560.	1.950	1.987	0.999909	15.14	14.69	1.857E-05
31	246060.	2.025	2.083	0.999629	15.62	20.30	2.040E-05
32	248660.	2.150	2.195	0.999663	16.18	21.03	2.259E-05
33	250870.	2.255	2.296	0.999483	16.69	21.70	2.508E-05
34	252770.	2.400	2.345	0.999535	17.20	22.36	2.728E-05
35	254770.	2.500	2.509	0.999519	17.80	23.14	2.958E-05
36	256170.	2.600	2.593	0.999406	18.26	23.73	3.156E-05
37	257880.	2.705	2.703	0.998782	18.86	24.52	3.516E-05
38	259380.	2.805	2.812	0.998754	19.48	25.33	3.840E-05
39	260630.	2.905	2.908	0.999436	20.05	26.06	4.213E-05
40	261680.	3.010	3.009	0.994017	20.65	26.85	4.102E-05
41	262740.	3.055	3.107	0.973869	21.27	27.65	4.562E-05
42	263790.	3.210	3.203	0.951206	21.90	28.47	5.177E-05
43	265790.	3.325	3.439	0.944438	23.55	30.61	7.852E-05
44	265490.	3.420	3.382	0.948956	23.13	30.07	7.933E-05
45	266120.	3.525	3.483	0.952970	23.87	31.04	9.259E-05
46	266710.	3.625	3.610	0.954452	24.86	32.32	1.084E-04
47	267250.	3.730	3.734	0.999164	25.90	33.67	1.123E-04
48	267710.	3.840	3.839	0.999563	26.83	34.87	1.256E-04
49	268160.	3.955	3.961	0.999564	27.99	36.39	1.529E-04
50	268460.	4.055	4.054	0.998808	28.94	37.62	1.780E-04
51	268760.	4.160	4.164	0.999359	30.14	39.19	2.081E-04
52	269000.	4.260	4.266	0.999232	31.36	40.77	2.435E-04
53	269200.	4.370	4.366	0.998854	32.65	42.44	2.887E-04
54	269360.	4.455	4.461	0.998675	33.97	44.16	3.390E-04
55	269520.	4.565	4.574	0.996400	35.72	46.43	4.283E-04
56	269610.	4.650	4.647	0.994646	36.94	48.02	5.364E-04

TABLE 37. DATA TABULATION FOR TEST M-26 (CONCL)

SPECIMEN NO.:		M-26		BASE STRESS = -2.4 TO 8 KSI, SINGLE OVERLOAD = +8 TO -16 KSI			
CCT	SPECIMEN	B =	0.250 IN.	W =	6.000 IN.		
PMIN =		P MAX =		AN =	0.0 IN.		
ENVIRONMENT CONDITION: AMBIENT AIR							
NO.	CYCLES	A (MEASURED)	A (REGRESSION)	MULT. CORR. COEFF	K-MAX	DELTA K	DA/DN
57	269713.	4.745	4.764	0.995246	39.12	50.86	6.819E-04
58	269790.	4.860	4.873	0.996680	41.44	53.87	9.788E-04
59	269840.	4.970	4.970	0.999672	43.78	56.91	1.149E-03
TEST FREQ = 6.00 HZ.							

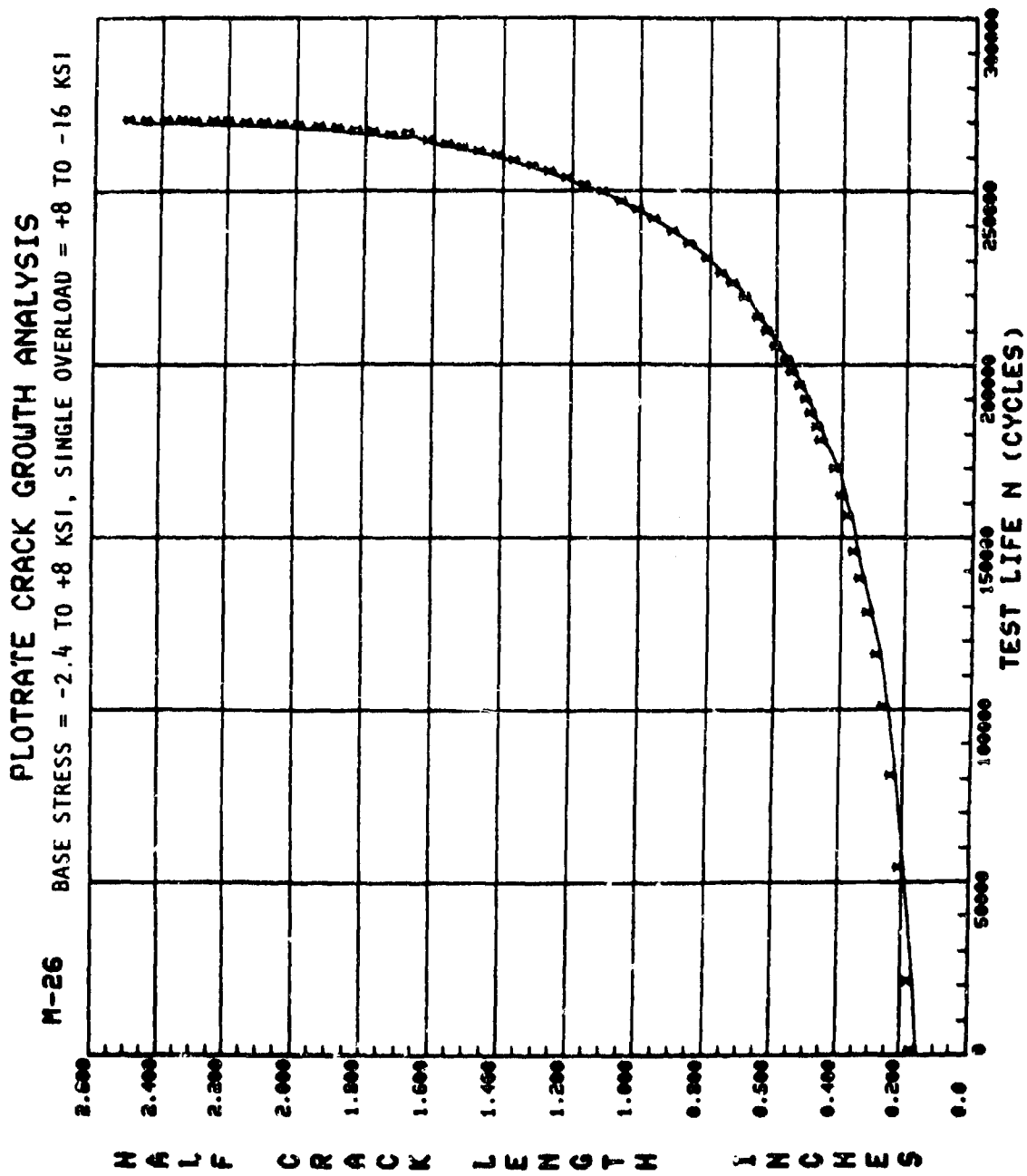

Figure 40. Crack growth curve for test M-26.

TABLE 38. DATA TABULATION FOR TEST M-27

SPECIMEN NO.: M-27 BASE STRESS = -24 TO +8 KSI, PERIODIC OVERLOAD = +8 TO -16 KSI

CT SPECIMEN R = 0.250 IN. W = 0.000 IN. AA = 0.0 IN.

PMIN = PMAX = TEST FREQ = 6.00 HZ.

ENVIRONMENT CONDITION: AMBIENT AIR

NO.	CYCLES	A (MEASLPE)	A (REGRESSION)	MULT. CORR. COEFF	K-MAX	DELYA K	DA/DN
1	0.	0.355	0.355	0.999981	5.99	7.78	4.369E-07
2	31000.	0.405	0.403	0.999561	6.38	8.29	1.181E-06
3	51000.	0.460	0.461	0.999713	6.83	8.88	1.715E-06
4	66000.	0.515	0.518	0.999660	7.25	9.42	2.087E-06
5	74000.	0.575	0.571	0.997127	7.62	9.90	2.565E-06
6	90000.	0.635	0.635	0.996554	8.04	10.46	3.174E-06
7	99500.	0.685	0.697	0.997559	8.44	10.97	3.665E-06
8	107200.	0.760	0.756	0.996281	8.80	11.44	3.962E-06
9	115400.	0.835	0.827	0.997086	9.22	11.99	4.380E-06
10	122500.	0.855	0.894	0.998066	9.61	12.49	4.704E-06
11	127900.	0.935	0.941	0.996717	9.87	12.83	5.141E-06
12	135000.	1.015	1.014	0.998778	10.27	13.35	5.965E-06
13	140000.	1.070	1.077	0.997198	10.61	13.79	6.396E-06
14	144500.	1.145	1.138	0.990796	10.93	14.21	7.685E-06
15	148000.	1.155	1.192	0.990697	11.21	14.57	8.571E-06
16	152000.	1.240	1.264	0.991054	11.58	15.05	9.874E-06
17	154271.	1.325	1.307	0.992777	11.80	15.34	1.056E-05
18	157256.	1.375	1.373	0.993067	12.13	15.77	1.249E-05
19	160015.	1.445	1.452	0.993193	12.52	16.28	1.365E-05
20	162917.	1.520	1.529	0.995793	12.90	16.77	1.419E-05
21	166000.	1.645	1.626	0.997543	13.38	17.39	1.555E-05
22	169200.	1.720	1.726	0.996309	13.86	18.02	1.712E-05
23	172000.	1.820	1.822	0.996458	14.33	18.63	1.879E-05
24	175000.	1.925	1.930	0.999404	14.86	19.32	2.159E-05
25	177586.	2.055	2.050	0.999449	15.45	20.09	2.511E-05
26	180000.	2.170	2.177	0.999654	16.08	20.91	2.848E-05
27	182000.	2.300	2.293	0.996616	16.68	21.68	3.436E-05
28	184000.	2.430	2.431	0.997824	17.39	22.61	4.245E-05

TABLE 38. DATA TABULATION FOR TEST M-27 (CONCL)

SPECIMEN NO.: M-27 BASE STRESS = -2.4 TO +8 KSI, PERIODIC OVERLOAD = +8 TO -16 KSI

CCT SPECIMEN R = 0.250 IN. W = 6.000 IN. AN = 0.0 IN.

P4TH = P MAX = TEST FREQ = 6.00 HZ.

ENVIRONMENT CONDITION: AMBIENT AIR

NO.	CYCLES	A (MEASURED)	A (REGRESSION)	MULT. CORR. COEFF	K-MAX	DELTA K	DA/DN
29	185029.	2.500	2.520	0.998671	17.86	23.22	4.580E-05
30	197008.	2.720	2.714	0.998825	18.92	24.60	5.530E-05
31	189000.	2.975	2.951	0.996900	20.30	26.39	6.966E-05
32	191000.	3.220	3.257	0.989541	22.26	28.93	9.770E-05
33	192026.	3.415	3.449	0.993349	23.62	30.71	1.199E-04
34	193002.	3.655	3.682	0.998936	25.46	33.09	1.526E-04
35	194016.	4.030	4.029	0.999662	28.68	37.28	2.023E-04

PLOTRATE CRACK GROWTH ANALYSIS

M-27 **BASE STRESS = -2.4 TO 8 KSI, PERIODIC OVERLOAD = +8 TO -16 KSI**

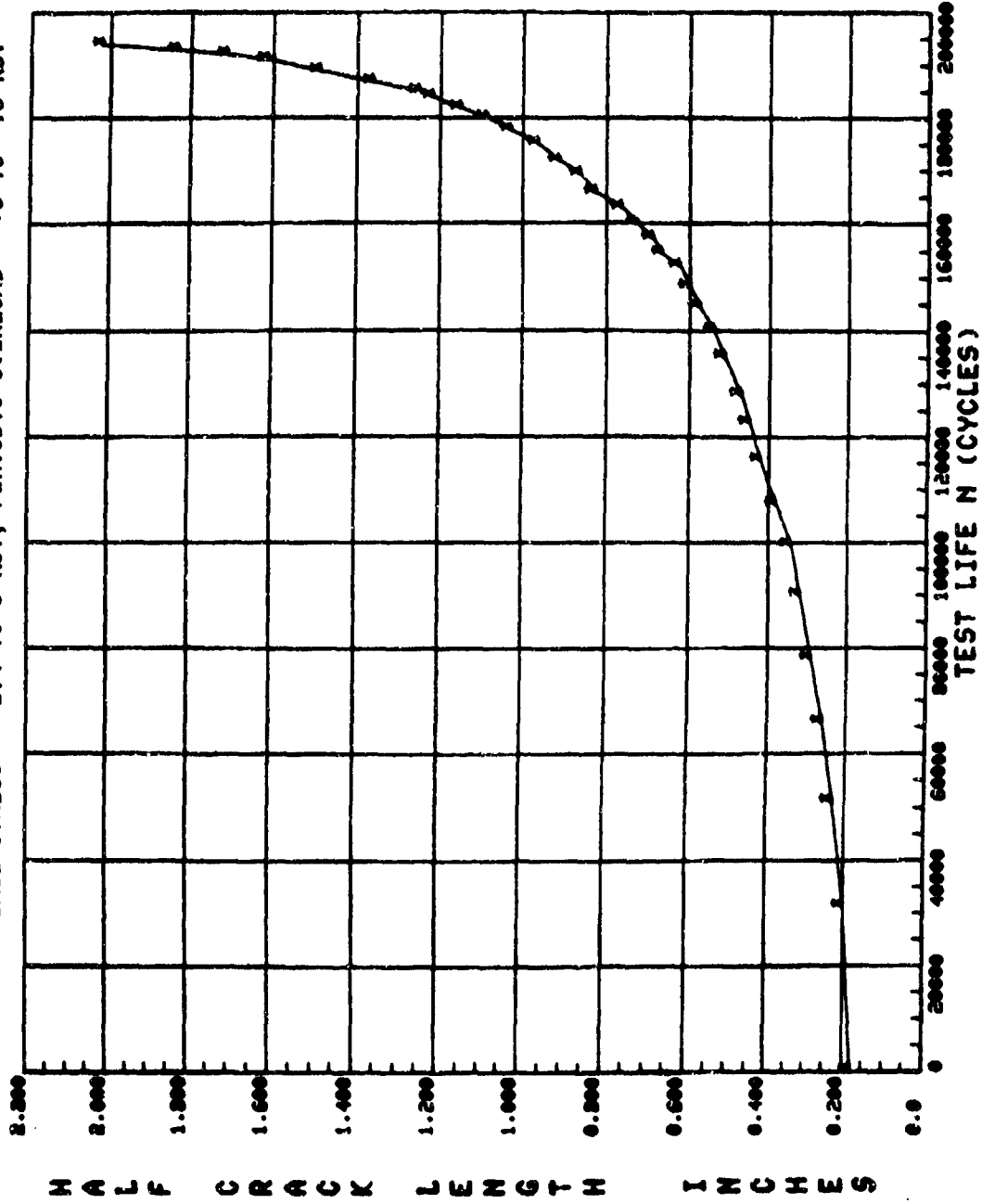

Figure 41. Crack growth curve for test M-27.

TABLE 39. DATA TABULATION FOR TEST M-28

SPECIMEN NO.: M-28 BASE STRESS -6 TO +20 KSI, PERIODIC OVERLOAD +30 TO -15 KSI

CCT SPECIMEN 9 = 0.250 IN. h = 6.000 IN. AA = 0.0 IN.

PMIV= PMAI=

TEST FREQ= 6.00 HZ.

ENVIRONMENT CONDITION: AMBIENT AIR

NO.	CYCLES	A (MEAS/FFD)	A (REGRESSION)	MULT. CORR. COEFF	K-MAX	DELTA K	DA/DM
1	0.	0.465	0.465	0.999841	11.44	20.01	1.196E-05
2	1300.	0.500	0.495	0.994142	11.81	20.66	1.542E-05
3	2300.	0.520	0.533	0.992550	12.26	21.46	1.898E-05
4	2700.	0.545	0.549	0.993813	12.45	21.78	2.050E-05
5	3200.	0.580	0.570	0.992744	12.69	22.20	2.286E-05
6	4000.	0.605	0.610	0.987842	13.13	22.99	2.824E-05
7	4500.	0.635	0.639	0.966965	13.45	23.54	4.236E-05
8	4850.	0.660	0.608	0.988630	13.76	24.08	5.615E-05
9	5005.	0.680	0.685	0.986667	13.94	24.40	5.826E-05
10	5250.	0.730	0.719	0.986849	14.29	25.01	6.324E-05
11	5500.	0.755	0.757	0.996515	14.68	25.69	6.467E-05
12	5750.	0.785	0.787	0.994514	14.97	26.21	5.909E-05
13	6000.	0.815	0.812	0.998639	15.22	26.64	5.357E-05
14	6250.	0.835	0.835	0.984021	15.45	27.03	6.143E-05
15	6500.	0.865	0.864	0.991806	15.73	27.52	7.000E-05
16	6750.	0.850	0.898	0.995678	16.05	28.08	8.786E-05
17	7000.	0.955	0.952	0.984647	16.55	28.96	9.821E-05
18	7250.	1.000	1.009	0.986134	17.07	29.88	1.039E-04
19	7500.	1.085	1.047	0.992887	17.60	30.80	1.041E-04
20	7750.	1.110	1.116	0.987862	18.03	31.55	1.005E-04
21	8000.	1.160	1.165	0.978795	18.46	32.30	1.070E-04
22	8200.	1.155	1.202	0.997300	18.77	32.85	1.372E-04
23	8300.	1.230	1.232	0.995331	19.03	33.30	1.354E-04
24	8400.	1.265	1.261	0.995359	19.28	33.73	1.515E-04
25	8500.	1.300	1.294	0.996807	19.55	34.22	1.692E-04
26	8740.	1.370	1.377	0.998119	20.25	35.44	1.902E-04
27	8800.	1.400	1.396	0.997678	20.41	35.71	2.068E-04
28	8960.	1.470	1.467	0.998823	20.99	36.73	2.475E-04

TABLE 39. DATA TABULATION FOR TEST M-28 (CONCL)

SPECIMEN NO.: M-28 BASE STRESS -6 TO +20 KSI, PERIODIC OVERLOAD +30 TO -15 KSI

CCT SPECIMEN A = 0.250 IN. W = 6.000 IN. AN = 0.0 IN.

PHIN = P MAX =

TEST FREQ = 6.00 HZ.

ENVIRONMENT CONDITION: AMBIENT AIR

NO.	CYCLES	A (MEASURED)	A (REGRESSION)	MULT. CORR. COEFF	K-MAX	DELTA K	DA/DN
29	9088.	1.525	1.533	0.999090	21.53	37.68	2.873E-04
30	9230.	1.625	1.620	0.999493	22.24	38.92	3.389E-04
31	9357.	1.710	1.710	0.999516	22.98	40.22	3.952E-04
32	9472.	1.805	1.807	0.999032	23.77	41.59	4.611E-04
33	9573.	1.900	1.901	0.999848	24.53	42.93	5.259E-04
34	9670.	2.005	2.008	0.999457	25.41	44.46	6.168E-04
35	9753.	2.115	2.113	0.999080	26.28	45.98	7.272E-04
36	9829.	2.220	2.228	0.999044	27.24	47.67	8.668E-04
37	9883.	2.320	2.323	0.999453	28.05	49.09	9.900E-04
38	9935.	2.430	2.430	0.999983	28.98	50.71	1.154E-03
39	9974.	2.525	2.525	0.999986	29.81	52.17	1.263E-03

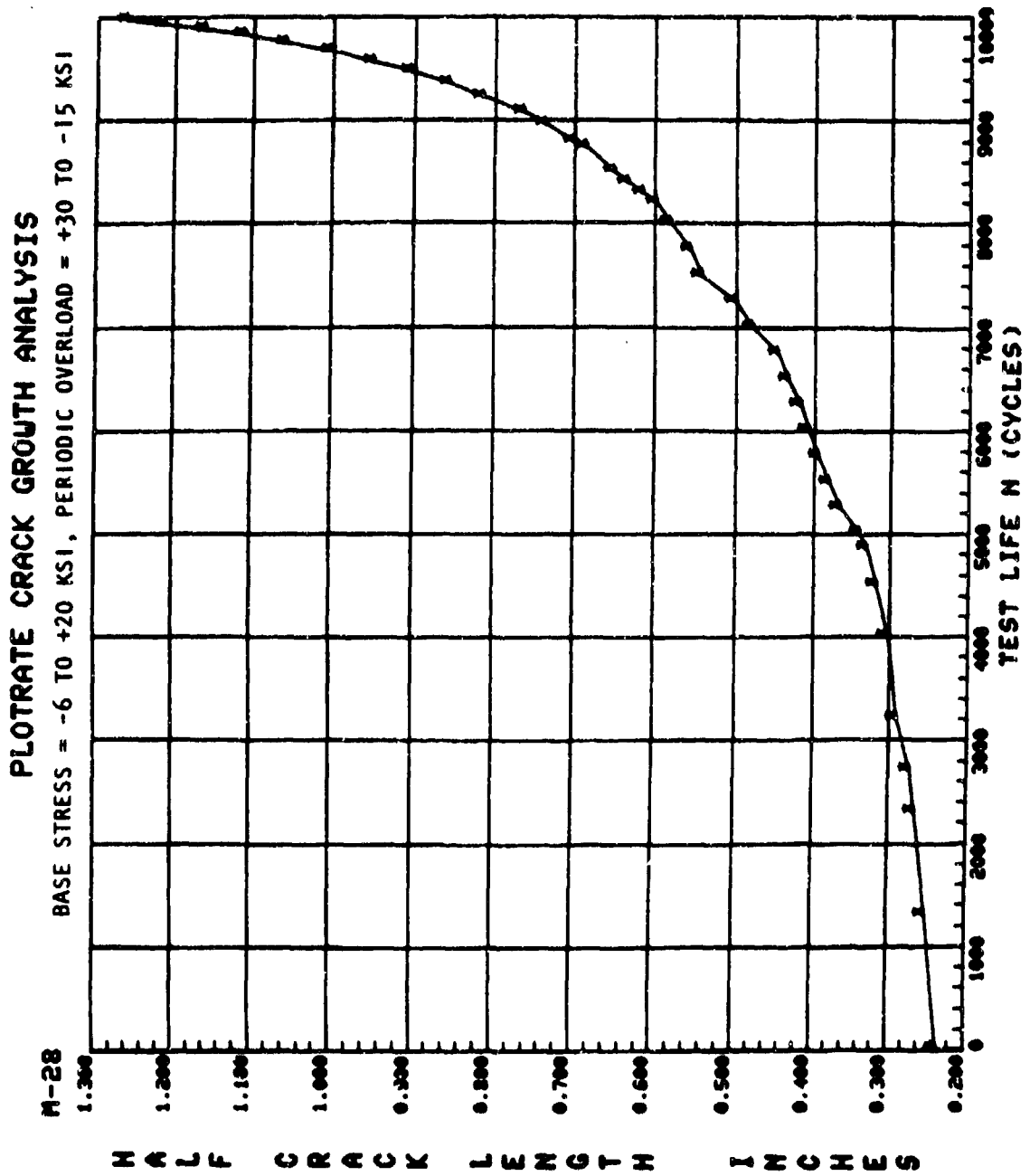

Figure 42. Crack growth curve for test M-28.

TABLE 40. DATA TABULATION FOR TEST M-29

SPECIMEN NO.: M-29 BASE STRESS = -6 TO +20 KSI, PERIODIC OVERLOAD = +40 TO -15 KSI

CCT SPECIMEN B = 0.250 IN. W = 6.000 IN. AA = 0.1 IN. TEST FREQ = 6.000 HZ.

PMIN= P MAX=

ENVIRONMENT CONDITION: AMBIENT AIR

NO.	CYCLES	A (MEASURED)	A (REGRESSION)	MULT. CORR. COEFF	K-MAX	DELTA K	DA/DN
1	0.	0.320	0.320	0.999960	14.21	18.47	2.215E-05
2	1000.	0.365	0.363	0.999861	15.14	19.68	2.172E-05
3	2501.	0.420	0.429	0.999826	16.47	21.41	2.304E-05
4	3500.	0.475	0.477	0.999870	17.37	22.58	2.400E-05
5	5001.	0.550	0.543	0.995726	18.55	24.12	2.861E-05
6	6000.	0.605	0.610	0.984448	19.70	25.61	2.957E-05
7	7510.	0.685	0.710	0.984965	21.30	27.68	3.278E-05
8	10000.	0.925	0.889	0.84234	23.94	31.12	3.236E-05
9	11300.	0.955	0.990	0.932555	25.35	32.95	4.375E-05
10	11900.	1.010	1.056	0.881468	26.24	34.11	5.956E-05
11	12500.	1.035	1.121	0.924874	27.10	35.23	1.180E-04
12	12683.	1.205	1.155	0.932257	27.55	35.82	1.337E-04
13	12900.	1.250	1.219	0.898432	28.37	36.88	1.278E-04
14	13150.	1.300	1.316	0.949495	29.61	38.49	1.074E-04
15	13300.	1.335	1.327	0.993056	29.75	38.67	8.566E-05
16	13450.	1.340	1.351	0.993450	30.04	39.06	6.003E-05
17	13600.	1.380	1.367	0.958643	31.25	39.33	6.967E-05
18	14000.	1.425	1.419	0.968140	30.89	40.16	7.488E-05
19	14600.	1.450	1.525	0.967826	32.21	41.87	1.056E-04
20	14700.	1.570	1.543	0.965492	32.43	42.16	1.220E-04
21	14900.	1.555	1.597	0.943554	33.09	43.01	1.551E-04

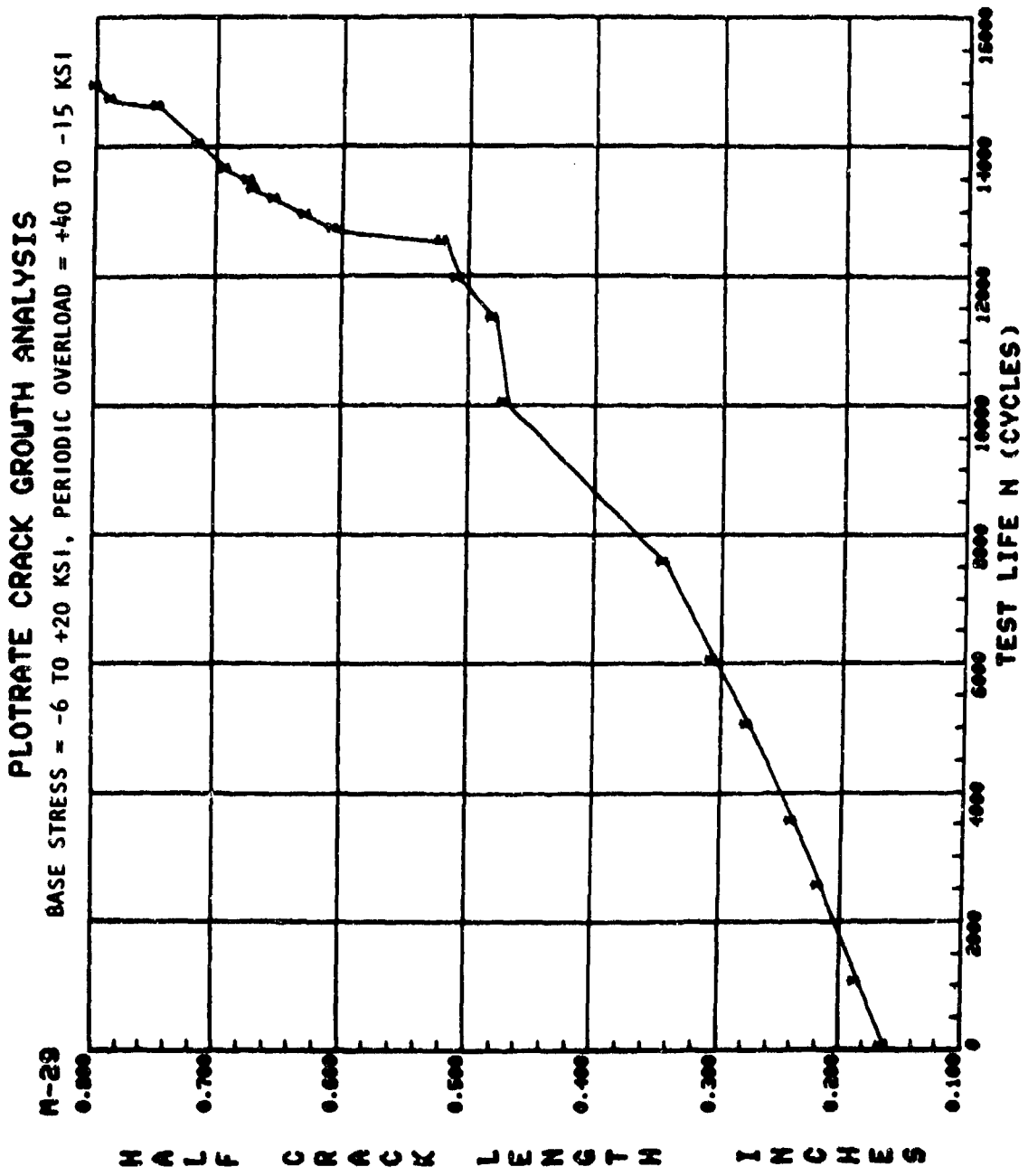

Figure 43. Crack growth curve for test M-29.

TABLE 41. DATA TABULATION FOR TEST M-30

SPECIMEN NO.:	M-30	BASE STRESS = -6 TO +20 KSI, PERIODIC OVERLOAD = -15 TO +40 KSI					
CCT SPECIMEN	B = 0.250 IN.	V = 6,000 IN. AA = 0.0 IN.					
PMIN =	P MAX =	TEST FREQ = 6.00 HZ.					
ENVIRONMENT CONDITION: AMBIENT AIR							
NO.	CYCLES	A (MEASURED)	A (REGRESSION)	MULT. CORR. COEFF	K-MAX	DELTA K	DA/DN
1	0.	0.290	0.290	0.999967	13.52	17.57	1.800E-05
2	1000.	0.330	0.336	0.995936	14.55	18.91	2.247E-05
3	2200.	0.385	0.387	0.996536	15.64	20.33	2.192E-05
4	3200.	0.440	0.432	0.996694	16.53	21.49	2.109E-05
5	4550.	0.480	0.487	0.995140	17.57	22.84	2.071E-05
6	5480.	0.530	0.524	0.995018	18.24	23.71	1.992E-05
7	7000.	0.575	0.581	0.995907	19.22	24.99	1.981E-05
8	7890.	0.625	0.617	0.994171	19.81	25.76	2.114E-05
9	9180.	0.665	0.671	0.995863	20.68	26.89	2.158E-05
10	10320.	0.720	0.723	0.994282	21.50	27.95	2.451E-05
11	10910.	0.760	0.749	0.995459	21.90	28.47	2.729E-05
12	12130.	0.810	0.824	0.993926	23.01	29.92	3.047E-05
13	12780.	0.865	0.863	0.993194	23.58	30.66	3.319E-05
14	13490.	0.925	0.910	0.985774	24.24	31.51	3.909E-05
15	14550.	0.980	1.000	0.983990	25.49	33.14	5.196E-05
16	15060.	1.040	1.053	0.985294	26.20	34.06	5.478E-05
17	15340.	1.100	1.086	0.979459	26.64	34.64	5.302E-05
18	15810.	1.160	1.131	0.940565	27.23	34.64	6.971E-05
19	16460.	1.220	1.211	0.967860	28.27	36.75	9.313E-05
20	17090.	1.280	1.350	0.974819	30.04	39.05	1.155E-04
21	17515.	1.505	1.468	0.972754	31.50	40.95	1.298E-04
22	18000.	1.660	1.621	0.981440	31.50	43.40	1.460E-04
23	18500.	1.770	1.794	0.987316	33.38	46.15	1.524E-04
24	19000.	1.905	1.926	0.990662	35.50	46.15	1.859E-04
25	19241.	1.995	2.007	0.998014	37.11	48.24	1.859E-04
26	19409.	2.085	2.081	0.998014	38.18	49.53	2.300E-04
27	19700.	2.245	2.081	0.999809	39.02	50.73	2.559E-04
28	19914.	2.355	2.248	0.999792	41.11	53.45	3.201E-04
			2.395	0.999720	43.00	55.90	3.603E-04

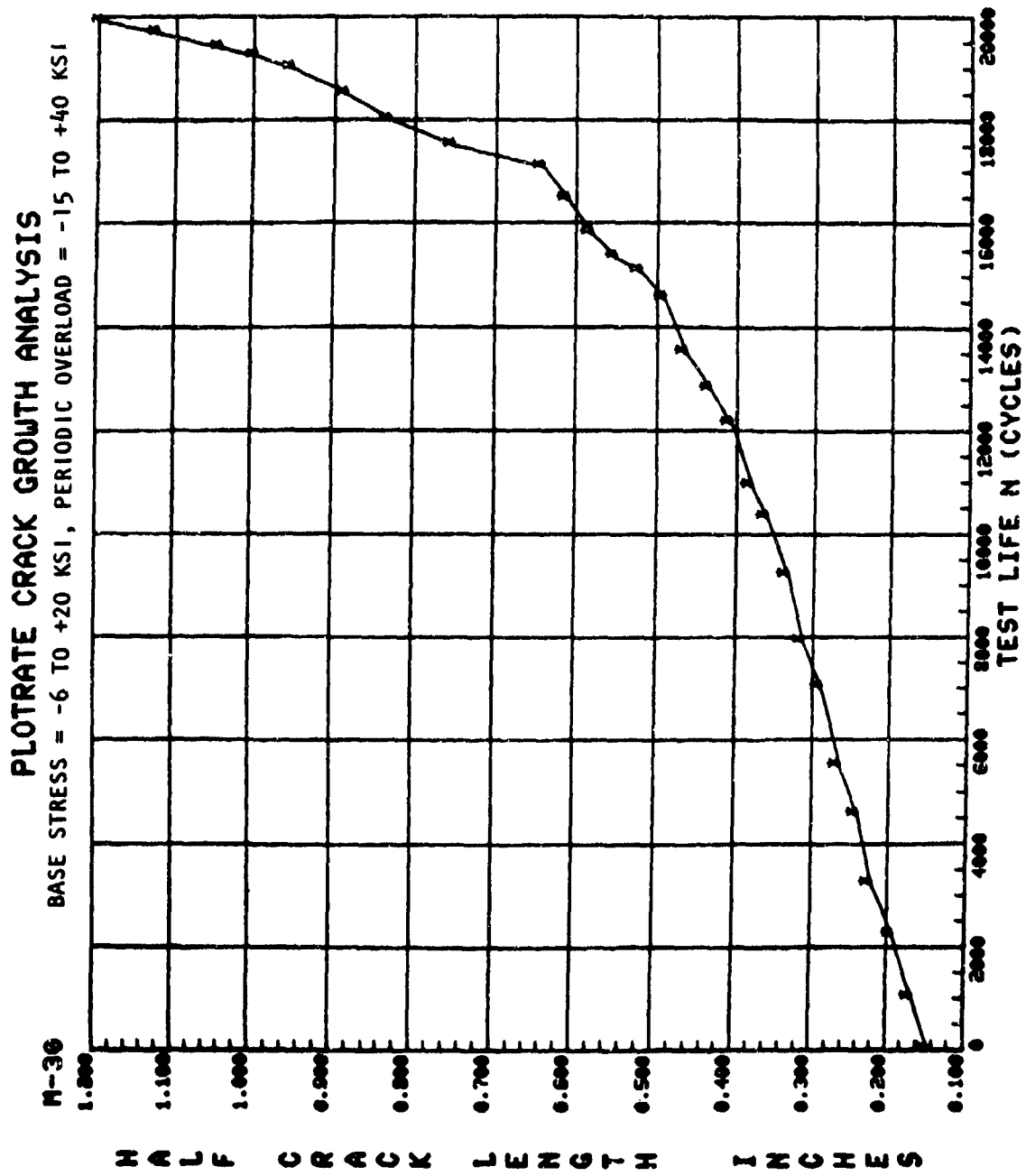

Figure 44. Crack growth curve for test M-30.

TABLE 42. METHODOLOGY DEVELOPMENT TESTING PROGRAM GROUP III -
MULTIPLE OVERLOAD/UNDERLOAD

Test No.	Loading Profile	STEP I		STEP II		N _I Cycle	N _{II} Cycle	Comments
		Max Ksi	Min Ksi	Max Ksi	Min Ksi			
M-31		8	0	20	0	10,000	To failure	Underload effect, low stress level
M-32		20	0	40	0	5,000	To failure	Underload effect, high stress level
M-33		8	2.4	20	2.4	10,000	To failure	Underload effect, low stress level
M-34		20	6	40	12	5,000	To failure	Underload effect, high stress level
M-35		8	0	20	14	10,000	To failure	Underload effect, two-level stress ratios, low stress
M-36		20	0	40	28	5,000	To failure	Underload effect, high stress level
M-37		8	-2.4	20	0	10,000	To failure	Comp/tension load effect, low stress level
M-38		20	-6	40	0	5,000	To failure	Underload effect, high stress level
M-39		0	-6	20	0	5,000	To failure	Comp - comp-load effect, low stress level
M-40		0	-12	40	0	5,000	To failure	Comp-comp load effect, high stress level

TABLE 42. METHODOLOGY DEVELOPMENT TESTING PROGRAM GROUP III
MULTIPLE OVERLOAD/UNDERLOAD (CONT)







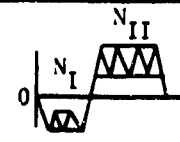
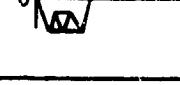
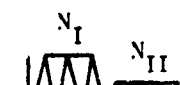
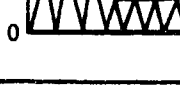
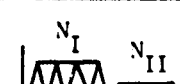
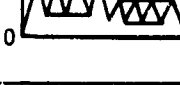

Test No.	Loading Profile	STEP I		STEP II		N _I Cycle	N _{II} Cycle	Comments
		Max Ksi	Min Ksi	Max Ksi	Min Ksi			
M-41		-3	-6	20	10	500	To failure	Comp-comp load effect
M-42		-3	-12	20	10	5,000	To failure	Comp-comp load effect
M-43		30	0	20	0	500	To failure	Multiple load retardation, R = 0
M-44		40	0	20	0	500	To failure	Multiple load retardation, R = 0
M-45		30	9	20	6	3,370	To failure	Multiple load retardation, R = 0.3
M-46		40	12	20	6	500	To failure	Multiple load retardation, R = 0.3
M-47		20	6	20	14	500	To failure	Stress ratio effect
M-48		40	12	40	28	500	To failure	Stress ratio effect
M-49		20	14	20	6	500	To failure	Stress ratio effect
M-50		40	28	40	12	500	To failure	Stress ratio effect
M-51		8	0	20	0	2,500	500	Repeat steps 1 & 2
M-52		20	0	40	0	500	50	Repeat steps 1 & 2
M-53		8	2.4	20	2.4	2,500	500	Repeat steps 1 & 2
M-54		20	6	40	6	500	50	Repeat steps 1 & 2

TABLE 42. METHODOLOGY DEVELOPMENT TESTING PROGRAM GROUP III -
 MULTIPLE OVERLOAD/UNDERLOAD (CONCL)

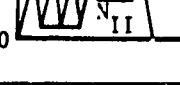

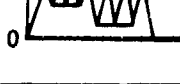

Test No.	Loading Profile	STEP I		STEP II		N_I Cycle	N_{II} Cycle	Comments
		Max Ksi	Min Ksi	Max Ksi	Min Ksi			
M-55		8	0	20 0	0 -6	2,500	50 50	Repeat steps 1 & 2
M-56		20	0	40 0	0 -12	2,500	50 50	Repeat steps 1 & 2
M-57		20	0	0 40	-12 0	2,500	50 50	Repeat steps 1 & 2
M-58		20	-6	40	-6	2,500	500	Repeat steps 1 & 2
M-59		8	-2.4	30	-2.4	5,000	2,500	Repeat steps 1 & 2
M-60		8	-2.4	8	-16	2,500	2,500	Repeat steps 1 & 2

TABLE 43. DATA TABULATION FOR TEST M-31

SPECIMEN NO.: M-31

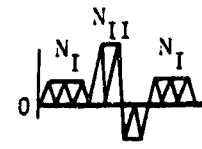
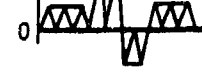
CCT SPECIMEN R= 0.250 IN. W= 6.000 IN. AN= 0.0 IN.

PMIN= PMAX= TEST FREQ= 6.00 HZ.

ENVIRONMENT CONDITION: AMBIENT AIR

NO.	CYCLES	A (MEASURED)	A (REGRESSION)	MULT. CORR. COEFF	K-MAX	DELTA K	DA/DM
1	0.	0.295	0.295	0.864219	13.63	13.63	1.559E-05
2	1000.	0.255	0.320	0.882522	14.20	14.20	1.251E-05
3	1100.	0.380	0.347	0.919649	14.80	14.80	1.417E-05
4	1200.	0.380	0.378	0.941843	15.44	15.44	1.629E-05
5	1300.	0.405	0.417	0.955811	16.23	16.23	1.867E-05
6	1390.	0.445	0.441	0.995861	16.70	16.70	1.916E-05
7	1490.	0.450	0.488	0.999590	17.59	17.59	2.430E-05
8	1590.	0.540	0.541	0.999673	18.53	18.53	2.831E-05
9	1690.	0.600	0.599	0.998843	19.52	19.52	3.335E-05
10	1780.	0.660	0.662	0.997928	20.54	20.54	4.061E-05
11	18570.	0.720	0.727	0.998640	21.56	21.56	4.868E-05
12	19010.	0.770	0.770	0.998777	22.21	22.21	5.289E-05
13	19410.	0.820	0.815	0.998480	22.88	22.88	5.609E-05
14	19810.	0.865	0.864	0.999568	23.59	23.59	5.990E-05
15	20210.	0.910	0.911	0.999055	24.25	24.25	6.317E-05
16	20610.	0.960	0.958	0.997264	24.92	24.92	7.137E-05
17	21010.	1.015	1.017	0.998598	25.71	25.71	8.284E-05
18	21410.	1.080	1.086	0.998213	26.64	26.64	1.018E-04
19	21710.	1.155	1.149	0.998808	27.47	27.47	1.182E-04
20	22020.	1.220	1.228	0.998919	28.49	28.49	1.370E-04
21	22220.	1.290	1.286	0.998581	29.22	29.22	1.469E-04
22	22400.	1.340	1.339	0.997234	29.89	29.89	1.660E-04
23	22580.	1.400	1.402	0.997082	30.68	30.68	1.867E-04
24	22680.	1.430	1.438	0.998496	31.14	31.14	1.926E-04
25	22780.	1.485	1.477	0.998252	31.61	31.61	2.097E-04
26	22980.	1.570	1.569	0.998360	32.74	32.74	2.382E-04
27	23180.	1.660	1.671	0.998600	33.99	33.99	2.591E-04
28	23330.	1.760	1.747	0.997778	34.92	34.92	2.856E-04

TABLE 43. DATA TABULATION FOR TEST M-31 (CONCL.)

SPECIMEN NO.: M-31

CCY SPECIMEN R = 0.250 IN. W = 6.000 IN. AN = 0.0 IN.

P417E P4AX =

TEST FREQ = 6.000 HZ.

ENVIRONMENT CONDITION: AMBIENT AIR

NO.	CYCLES	A (MEASURED)	A (REGRESSION)	MULT. CORR. COEFF	K-MAX	DELTA K	DAY/DM
29	23480.	1.835	1.835	0.996776	35.99	35.99	3.267E-04
30	23630.	1.920	1.915	0.996942	37.21	37.21	3.814E-04
31	23740.	2.020	2.016	0.999634	38.21	38.21	4.340E-04
32	23860.	2.130	2.128	0.999653	39.60	39.60	5.066E-04
33	23960.	2.235	2.237	0.998224	40.98	40.98	5.922E-04
34	24040.	2.330	2.334	0.998322	42.21	42.21	6.949E-04
35	24095.	2.400	2.411	0.998215	43.21	43.21	7.557E-04
36	24135.	2.460	2.473	0.997916	44.03	44.03	8.065E-04
37	24175.	2.550	2.539	0.995606	44.91	44.91	9.142E-04
38	24215.	2.605	2.607	0.986537	45.83	45.83	1.127E-03
39	24255.	2.665	2.701	0.986106	47.13	47.13	1.251E-03
40	24295.	2.800	2.809	0.987203	48.66	48.66	1.473E-03
41	24325.	2.950	2.907	0.985824	50.09	50.09	1.741E-03
42	24355.	2.985	3.020	0.980090	51.81	51.81	2.121E-03
43	24375.	3.080	3.101	0.974199	53.09	53.09	2.837E-03
44	24390.	3.180	3.174	0.994402	54.26	54.26	4.090E-03
45	24403.	3.270	3.288	0.995214	56.17	56.17	5.281E-03
46	24415.	3.405	3.421	0.997270	58.53	58.53	6.871E-03
47	24425.	3.575	3.575	0.999817	61.46	61.46	9.348E-03

PLOTRATE CRACK GROWTH ANALYSIS

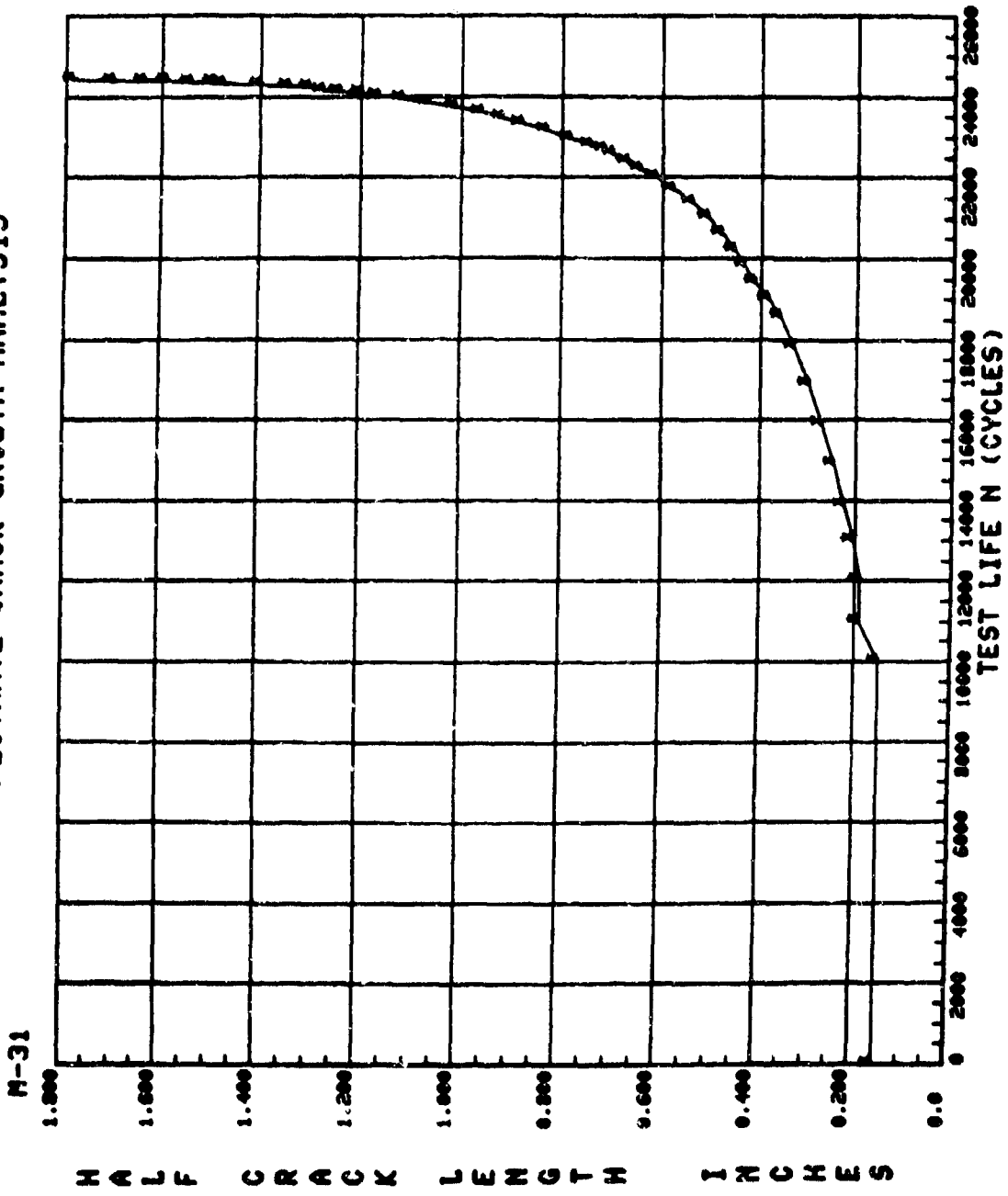

Figure 45. Crack growth curve for test M-31.

TABLE 44. DATA TABULATION FOR TEST M-32

SPECIMEN NO.: 4-32

CCT SPECIMEN R= 0.250 IN. W= 6.000 IN. AN= 0.0 IN.

PMIN= PMAX= TEST FREQ= 6.00 MZ.

ENVIRONMENT CONDITION: AMBIENT AIR

NO.	CYCLES	A (MEASURED)	A (REGRESSION)	MULT. CORR. COEFF	K-MAX	DELTA K	DA/DM
1	U.	0.310	0.310	0.993925	27.95	27.95	1.200E-06
2	1836.	0.355	0.365	0.977725	30.37	30.37	1.804E-05
3	2100.	0.380	0.375	0.985007	30.78	30.78	1.854E-05
4	2600.	0.405	0.395	0.987231	31.59	31.59	1.910E-05
5	3100.	0.410	0.411	0.886374	32.24	32.24	2.374E-05
6	4100.	0.460	0.467	0.788436	34.40	34.40	4.959E-05
7	5000.	0.455	0.611	0.751012	39.41	39.41	1.211E-04
8	5075.	0.550	0.656	0.699947	40.91	40.91	1.826E-04
9	5100.	0.685	0.677	0.984620	41.56	41.56	1.106E-03
10	5125.	0.730	0.725	0.992849	43.05	43.05	1.321E-03
11	5150.	0.780	0.795	0.992674	45.18	45.18	1.525E-03
12	5175.	0.875	0.866	0.999105	47.23	47.23	1.734E-03
13	5200.	0.960	0.952	0.990406	49.67	49.67	2.360E-03
14	5225.	1.070	1.070	0.959214	52.87	52.87	3.849E-03
15	5245.	1.180	1.224	0.971578	56.88	56.88	5.670E-03
16	5265.	1.355	1.481	0.980553	63.33	63.33	8.901E-03
17	5275.	1.695	1.688	0.990464	68.40	68.40	1.351E-02

PLOTRATE CRACK GROWTH ANALYSIS

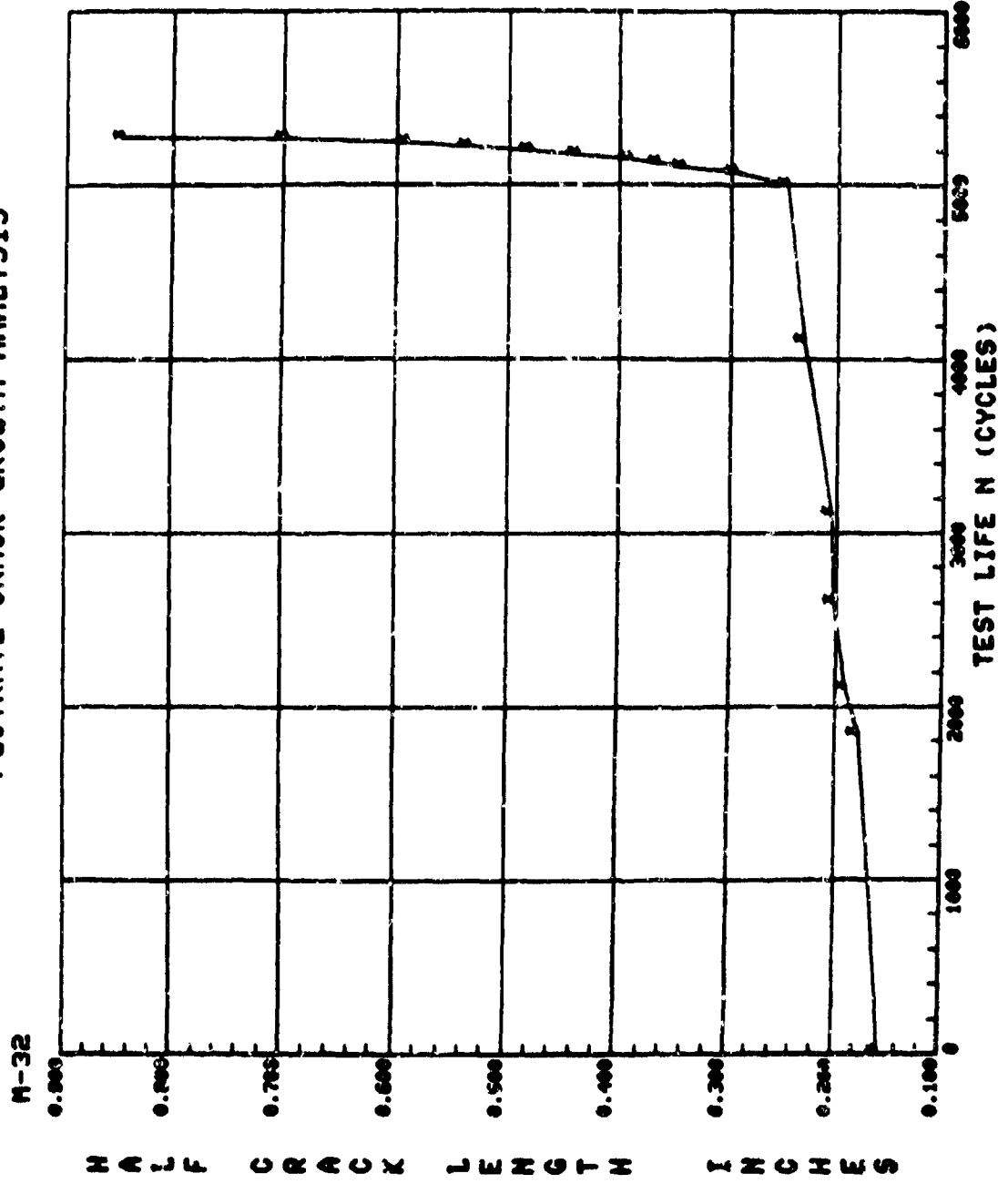

Figure 46. Crack growth curve for test M-32.

TABLE 15. DATA TABULATION FOR TEST N 55

SPECIMEN NO.: N-33

CCY SPECIMEN 8 = 0.250 IN.

W = 6.000 IN.

AN = 0.1 IN.

PMIN =

PMAX =

TEST FREQ = 6.000 HZ.

ENVIRONMENT CONDITION: AMBIENT AIR

NO.	CYCLES	A (MEASLPED)	A (REGRESSIEN)	MULT. COEFF.	Y-MAX	DELTA K	DA/DM
1	0.	0.255	0.295	0.999994	13.63	12.00	6.201E-06
2	10000.	0.313	0.308	0.991451	13.93	12.26	1.054E-05
3	11000.	0.330	0.321	0.995578	14.45	12.71	1.237E-05
4	12000.	0.350	0.358	0.997516	15.02	13.22	1.451E-05
5	13500.	0.410	0.405	0.996970	16.09	14.08	1.701E-05
6	15000.	0.460	0.460	0.996128	17.06	15.02	2.077E-05
7	16500.	0.530	0.527	0.995913	18.29	16.09	2.487E-05
8	17500.	0.565	0.576	0.997479	19.12	16.83	2.927E-05
9	18500.	0.640	0.637	0.997344	20.14	17.72	3.481E-05
10	19200.	0.685	0.686	0.998798	20.92	18.41	3.909E-05
11	19900.	0.745	0.746	0.999421	21.85	19.23	4.438E-05
12	20600.	0.810	0.809	0.999789	22.78	20.04	4.974E-05
13	21300.	0.880	0.881	0.998884	23.33	20.97	5.849E-05
14	21900.	0.950	0.953	0.999436	24.85	21.87	6.671E-05
15	22400.	1.020	1.022	0.999489	25.79	22.69	7.615E-05
16	22800.	1.050	1.086	0.999409	26.64	23.44	8.224E-05
17	23100.	1.135	1.137	0.999416	27.31	24.03	9.107E-05
18	23400.	1.155	1.192	0.998392	28.03	24.66	9.997E-05
19	23700.	1.245	1.251	0.999315	28.79	25.33	1.107E-04
20	24000.	1.325	1.321	0.995467	29.68	26.12	1.256E-04
21	24300.	1.400	1.400	0.999671	30.66	26.98	1.411E-04
22	24600.	1.490	1.489	0.999348	31.77	27.95	1.622E-04
23	24900.	1.550	1.589	0.999936	32.99	29.03	1.827E-04
24	25200.	1.700	1.700	0.997454	34.35	30.23	2.191E-04
25	25500.	1.840	1.840	0.997656	36.06	31.73	2.513E-04
26	25800.	1.985	2.001	0.997915	38.02	33.46	2.962E-04
27	26000.	2.150	2.122	0.997085	39.53	34.79	3.427E-04
28	26200.	2.245	2.262	0.997036	41.29	36.34	3.941E-04

TABLE 45. DATA TABULATION FOR TEST M-33 (CONCL)

SPECIMEN NO.: M-33		R = 0.250 IN.		W = 6.000 IN.		AN = 0.0 IN.		TEST FREQ = 6.00 HZ.	
CCY SPECIMEN		P MIN =		P MAX =		ENVIRONMENT CONDITION: AMBIENT AIR			
NO.	CYCLFS	A (MEASURED)	Δ (REGRESSION)	MULT. CORR. COEFF	K-MAX	DELTA K	DA/DM		
29	26400.	2.415	2.475	0.996611	43.39	38.18	4.683E-04		
30	26600.	2.620	2.606	0.984351	45.81	40.31	7.647E-04		
31	26700.	2.735	2.753	0.990615	47.85	42.11	9.346E-04		
32	26800.	2.875	2.930	0.995889	50.43	44.38	1.149E-03		
33	27000.	3.500	3.449	0.999342	60.00	52.80	1.998E-03		

PLOTRATE CRACK GROWTH ANALYSIS

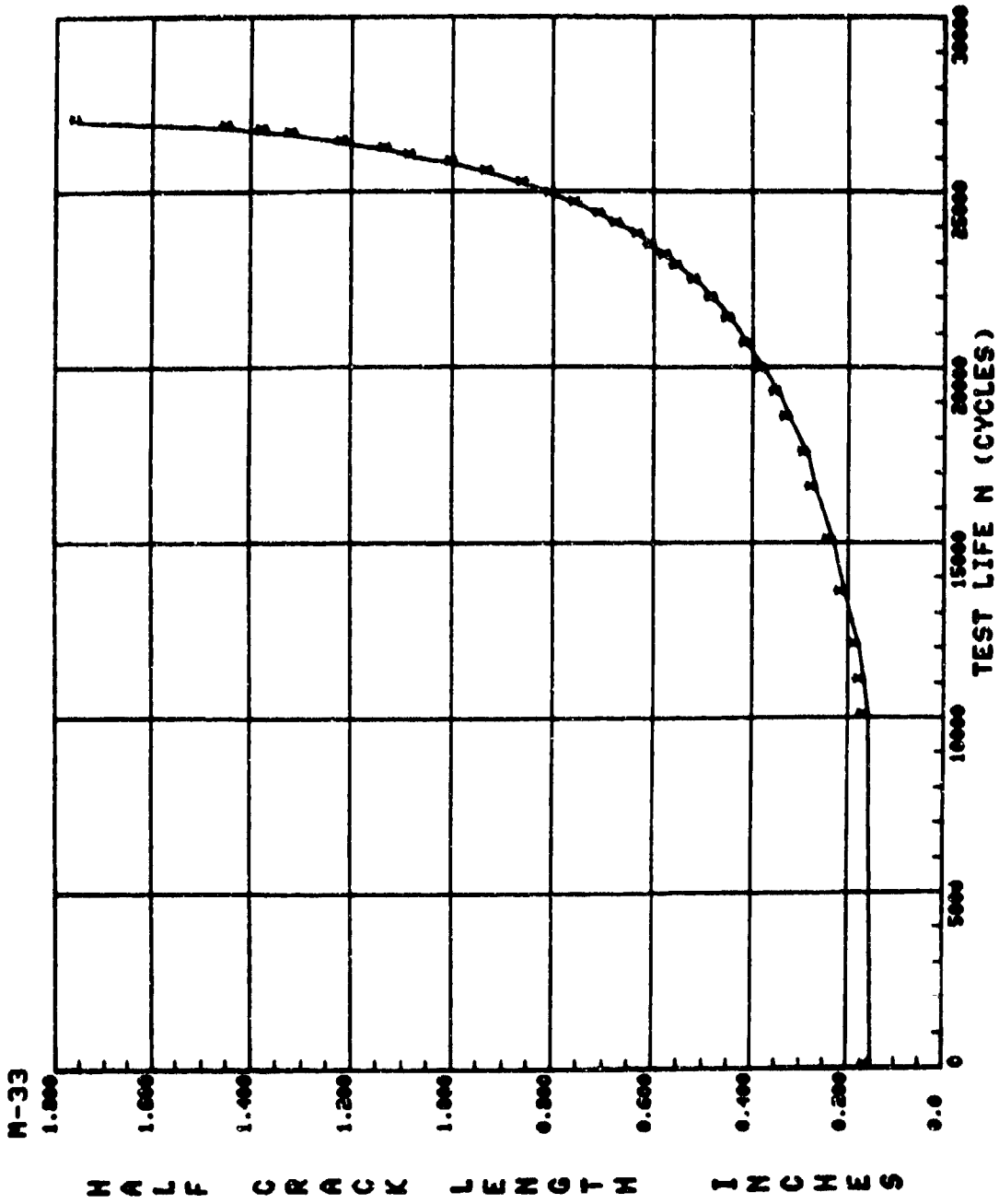

Figure 47. Crack growth curve for test M-33.

TABLE 46. DATA TABULATION FOR TEST M-34

SPECIMEN NO.: M-34

CT SPECIMEN R = 0.250 IN. W = 6.000 IN. AM = 0.0 IN.

PMIN = PMAX =

TEST FREQ = 6.00 HZ.

ENVIRONMENT CONDITION: AMBIENT AIR

NO.	CYCLES	A (MEASURED)	A (REGRESSION)	MULT. CORR. COEFF	K-MAX	DELTA K	DA/DM
1	0.	0.300	0.300	0.998633	27.50	19.25	7.890E-06
2	2725.	0.345	0.348	0.998714	29.62	20.73	8.750E-06
3	3304.	0.360	0.358	0.998802	30.05	21.04	8.852E-06
4	4225.	0.375	0.377	0.998929	30.86	21.60	1.204E-05
5	5725.	0.400	0.429	0.732601	32.92	23.04	2.669E-05
6	5925.	0.405	0.451	0.667694	33.77	23.64	4.854E-05
7	5951.	0.455	0.460	0.820723	34.12	23.89	1.860E-04
8	5976.	0.485	0.464	0.785204	34.27	23.99	2.067E-04
9	6001.	0.455	0.483	0.864622	34.99	24.49	3.156E-04
10	6041.	0.500	0.498	0.958593	35.51	24.86	1.604E-04
11	6101.	0.510	0.511	0.996851	36.00	25.20	1.260E-04
12	6201.	0.545	0.542	0.998902	37.09	25.96	1.781E-04
13	6301.	0.560	0.583	0.999198	38.49	26.94	2.403E-04
14	6401.	0.640	0.625	0.997077	40.22	28.16	3.187E-04
15	6501.	0.700	0.703	0.997299	42.37	29.66	4.189E-04
16	6601.	0.785	0.706	0.994668	45.19	31.63	5.820E-04
17	6658.	0.860	0.862	0.997603	47.12	32.59	7.400E-04
18	6708.	0.930	0.940	0.997494	49.33	34.53	9.633E-04
19	6735.	0.955	0.940	0.998426	50.70	35.49	1.121E-03
20	6769.	1.060	1.065	0.998833	52.72	36.90	1.351E-03
21	6806.	1.175	1.173	0.989939	55.58	38.90	1.866E-03
22	6835.	1.275	1.288	0.987149	58.50	40.95	2.695E-03
23	6856.	1.370	1.426	0.930705	61.95	43.37	4.782E-03
24	6866.	1.480	1.508	0.947289	63.99	44.79	7.049E-03
25	6879.	1.605	1.715	0.960018	69.06	48.34	1.161E-02
26	6884.	1.865	1.853	0.961027	72.41	50.69	1.822E-02

PLOTRATE CRACK GROWTH ANALYSIS

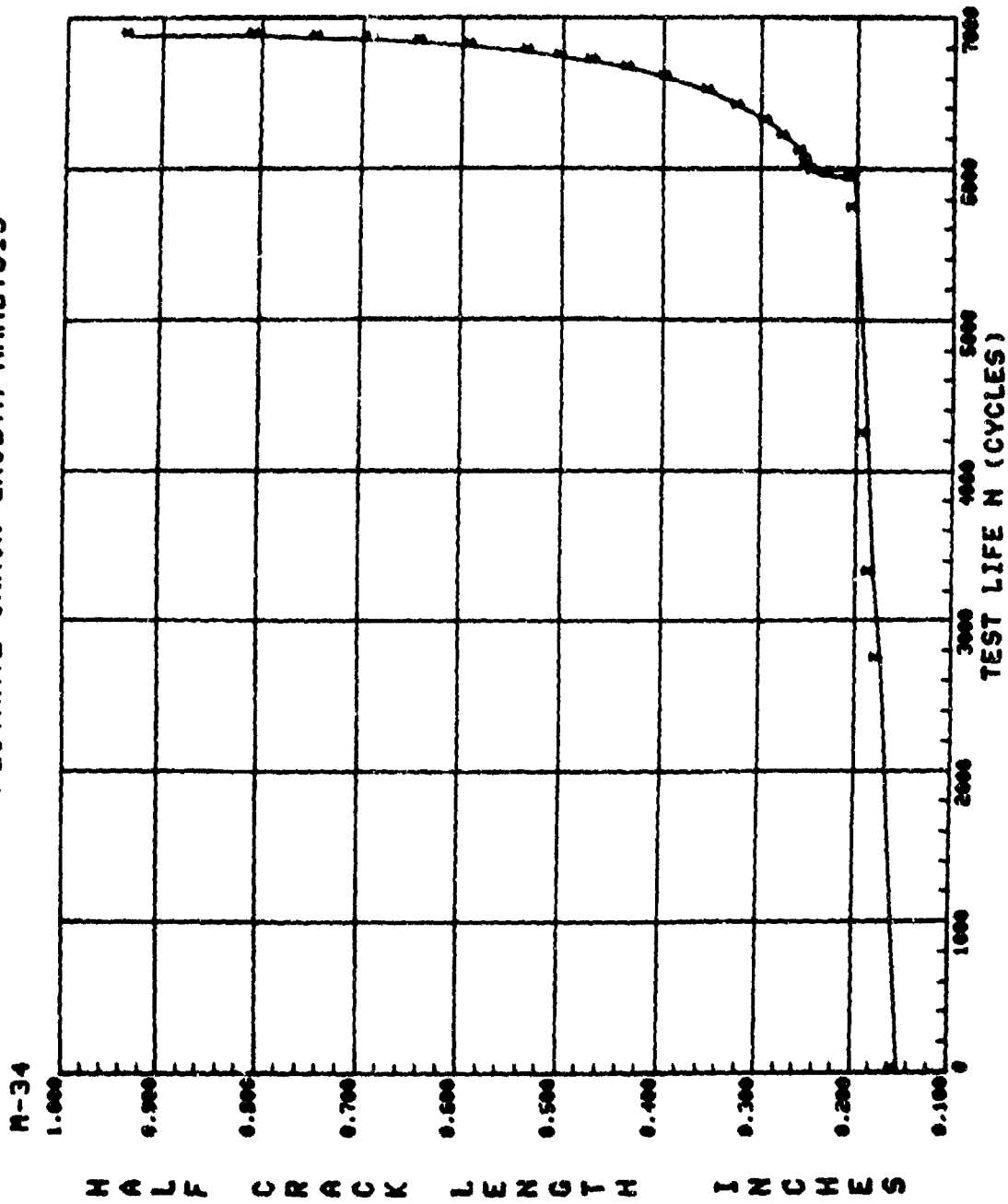

Figure 48. Crack growth curve for test M-34.

TABLE 47. DATA TABULATION FOR TEST M-35

SPECIMEN NO.:	CCT SPECIMEN		ENVIRONMENT CONDITION:		TEST FREQ= 6.00 HZ.			
	B = 0.250 IN.	M = 6.000 IN.	AMBIENT AIR	PMIN=	PMAX=			
NO.	CYCLES	A (MEASURED)	A (REGRESSION)	MULT. CORR. COEFF	K-MAX	DELTA K	DA/DM	
1	0.	0.290	0.290	0.975000	13.51	4.05	2.206E-06	
2	10000.	0.320	0.330	0.986665	14.42	4.33	1.874E-06	
3	11000.	0.345	0.330	0.988675	14.44	4.33	1.749E-06	
4	28500.	0.350	0.388	0.987367	15.66	4.70	1.844E-06	
5	40000.	0.425	0.429	0.991373	16.46	4.94	2.159E-06	
6	50000.	0.470	0.474	0.998544	17.33	5.20	2.627E-06	
7	56000.	0.510	0.507	0.995176	17.92	5.37	2.745E-06	
8	61500.	0.540	0.540	0.996850	18.52	5.56	2.859E-06	
9	67000.	0.580	0.575	0.997854	19.11	5.75	2.990E-06	
10	73000.	0.605	0.609	0.997682	19.69	5.91	3.024E-06	
11	78000.	0.640	0.641	0.994484	20.21	6.06	2.905E-06	
12	83000.	0.670	0.667	0.990050	20.63	6.19	3.094E-06	
13	88000.	0.705	0.700	0.991218	21.14	6.34	3.339E-06	
14	93000.	0.720	0.733	0.992463	21.65	6.50	3.446E-06	
15	98000.	0.775	0.768	0.993576	22.18	6.65	3.732E-06	
16	103000.	0.810	0.806	0.994598	22.75	6.83	4.071E-06	
17	108000.	0.845	0.851	0.996706	23.40	7.02	4.518E-06	
18	113000.	0.855	0.894	0.999722	24.01	7.20	4.768E-06	
19	118000.	0.945	0.943	0.999278	24.70	7.41	5.446E-06	
20	123000.	1.000	1.001	0.999428	25.50	7.65	6.125E-06	
21	128000.	1.060	1.064	0.999696	26.35	7.90	6.834E-06	
22	133000.	1.140	1.135	0.999183	27.28	8.19	7.904E-06	
23	138000.	1.215	1.219	0.999160	28.37	8.51	8.925E-06	
24	141000.	1.270	1.274	0.998505	29.08	8.72	9.834E-06	
25	144000.	1.340	1.314	0.998251	29.83	8.95	1.113E-05	
26	147000.	1.395	1.405	0.997649	30.72	9.21	1.267E-05	
27	148000.	1.430	1.430	0.997655	31.03	9.31	1.318E-05	
28	149000.	1.460	1.456	0.997763	31.36	9.41	1.336E-05	

TABLE 47. DATA TABULATION FOR TEST M-35 (CONCL)

SPECIMEN NO.: M-35

CCI SPECIMEN R= 0.250 IN. N= 6.000 IN. AA= 0.0 IN.

PMIN= PMAX=

TEST FREQ= 6.00 HZ.

ENVIRONMENT CONDITION: AMBIENT AIR

VO.	CYCLES	A (MEASURED)	A (REGRESSION)	MULT. CORR. COEFF	K-MAX	DELTA K	DA/DM
29	150500.	1.500	1.500	0.999232	31.89	9.57	1.478E-05
30	153000.	1.575	1.572	0.999725	32.78	9.83	1.545E-05
31	155500.	1.650	1.652	0.999901	33.76	10.13	1.655E-05
32	158000.	1.740	1.741	0.999931	34.84	10.45	1.865E-05
33	160500.	1.840	1.837	0.999749	36.01	10.80	2.075E-05
34	163000.	1.945	1.945	0.999535	37.24	11.20	2.330E-05
35	165392.	2.055	2.060	0.999693	38.76	11.63	2.656E-05
36	167131.	2.155	2.153	0.999679	39.92	11.98	2.994E-05
37	168831.	2.255	2.258	0.998911	41.24	12.37	3.498E-05
38	170148.	2.350	2.352	0.999152	42.45	12.73	3.933E-05
39	171544.	2.460	2.467	0.999174	43.94	13.18	4.358E-05
40	172344.	2.550	2.541	0.999155	44.93	13.48	4.631E-05
41	173144.	2.620	2.618	0.999194	45.98	13.79	4.903E-05
42	173944.	2.655	2.696	0.998150	47.06	14.12	5.318E-05
43	174844.	2.750	2.790	0.999530	48.38	14.51	5.883E-05
44	175669.	2.885	2.890	0.999313	49.84	14.95	6.880E-05
45	176352.	2.950	2.926	0.998373	51.29	15.39	9.204E-05
46	177041.	3.055	3.104	0.995341	53.12	15.94	1.053E-04
47	177548.	3.200	3.213	0.996854	54.91	16.47	1.257E-04
48	177906.	3.300	3.306	0.998821	56.50	16.95	1.588E-04
49	178173.	3.405	3.394	0.998903	58.05	17.41	1.822E-04
50	178423.	3.480	3.491	0.998385	59.84	17.95	2.043E-04
51	178673.	3.600	3.599	0.997152	61.94	18.58	2.273E-04

PLOTRATE CRACK GROWTH ANALYSIS

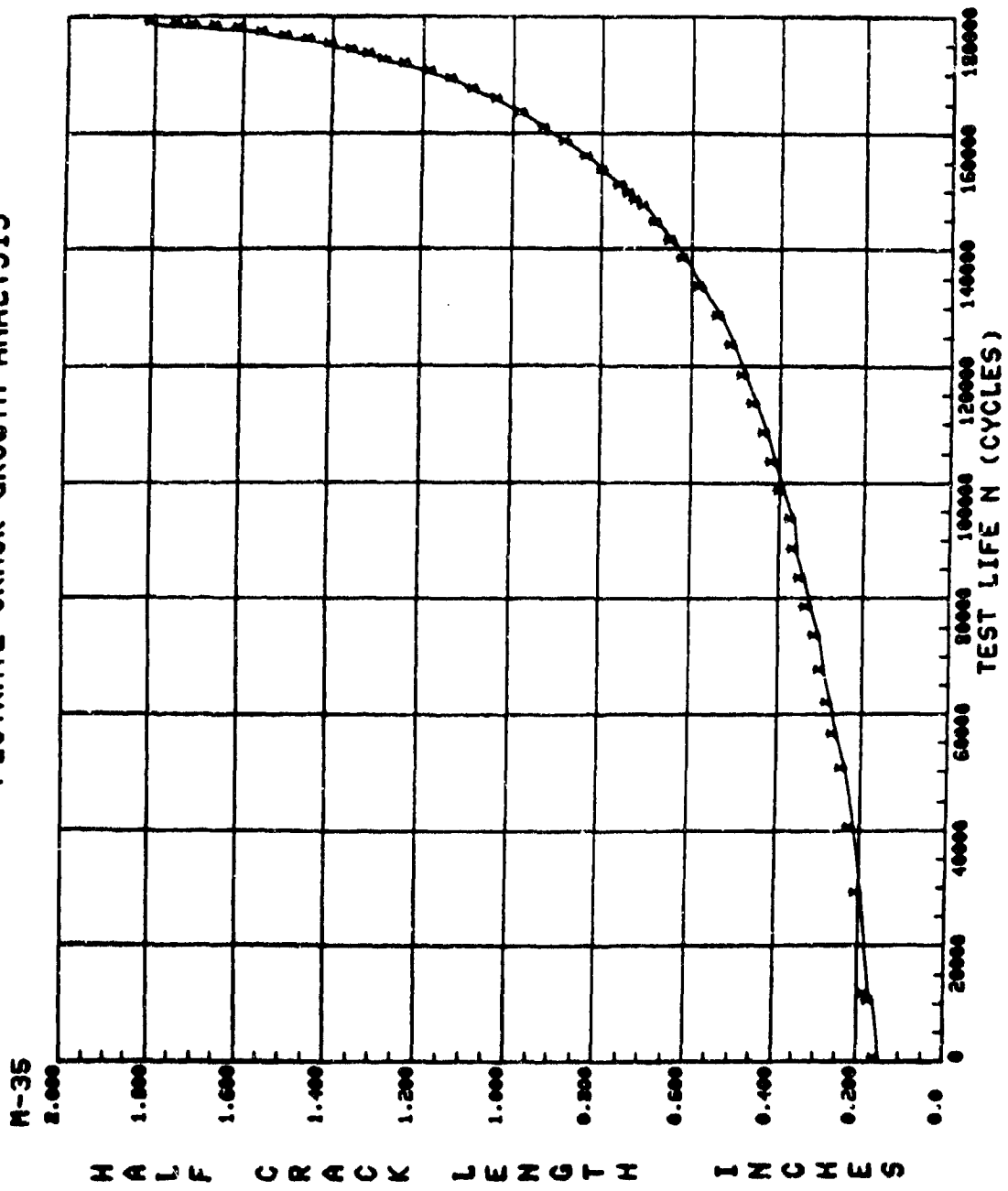

Figure 49. Crack growth curve for test M-35.

TABLE 48. DATA TABULATION FOR TEST M-36

SPECIMEN NO.: 4-36

CCT SPECIMEN R = 0.250 IN. W = 6.000 IN. A = 0.0 IN.

P41N= P MAX= TEST FREQ= 6.00 HZ.

ENVIRONMENT CONDITION: AMBIENT AIR

NO.	CYCLES	A (MEASURED)	A (REGRESSION)	MULT. CORR. COEFF	K-MAX	DELTA K	DA/DN
1	0.	0.300	0.300	0.999886	27.50	8.25	6.884E-06
2	2000.	0.350	0.355	0.998338	29.91	8.97	1.781E-05
3	3000.	0.395	0.395	0.998520	31.59	9.48	2.136E-05
4	3950.	0.445	0.429	0.998397	33.31	9.99	2.541E-05
5	5000.	0.455	0.407	0.996380	35.48	10.64	3.110E-05
6	5790.	0.540	0.546	0.994088	37.21	11.16	3.940E-05
7	6400.	0.550	0.593	0.996185	38.82	11.65	5.048E-05
8	6962.	0.645	0.651	0.998874	40.72	12.22	6.414E-05
9	7416.	0.710	0.717	0.998992	42.65	12.60	8.111E-05
10	7754.	0.770	0.769	0.998325	44.39	13.32	1.003E-04
11	8007.	0.815	0.871	0.997306	45.94	13.78	1.213E-04
12	8263.	0.860	0.885	0.997981	47.78	14.34	1.533E-04
13	8411.	0.930	0.930	0.999867	49.04	14.71	1.780E-04
14	8560.	0.985	0.986	0.999866	50.61	15.18	2.031E-04
15	8668.	1.035	1.033	0.999733	51.86	15.56	2.175E-04
16	8793.	1.050	1.069	0.998937	53.37	16.01	2.425E-04
17	8902.	1.145	1.141	0.995269	54.72	16.42	2.809E-04
18	9027.	1.205	1.211	0.988986	56.54	16.96	3.709E-04
19	9133.	1.280	1.291	0.993073	58.58	17.57	5.143E-04
20	9210.	1.360	1.376	0.970368	60.72	18.22	8.227E-04
21	9253.	1.440	1.441	0.976003	62.35	18.70	1.076E-03
22	9316.	1.535	1.533	0.977900	66.09	19.83	1.615E-03
23	9346.	1.710	1.705	0.978020	68.80	20.64	2.414E-03

PLOTRATE CRACK GROWTH ANALYSIS

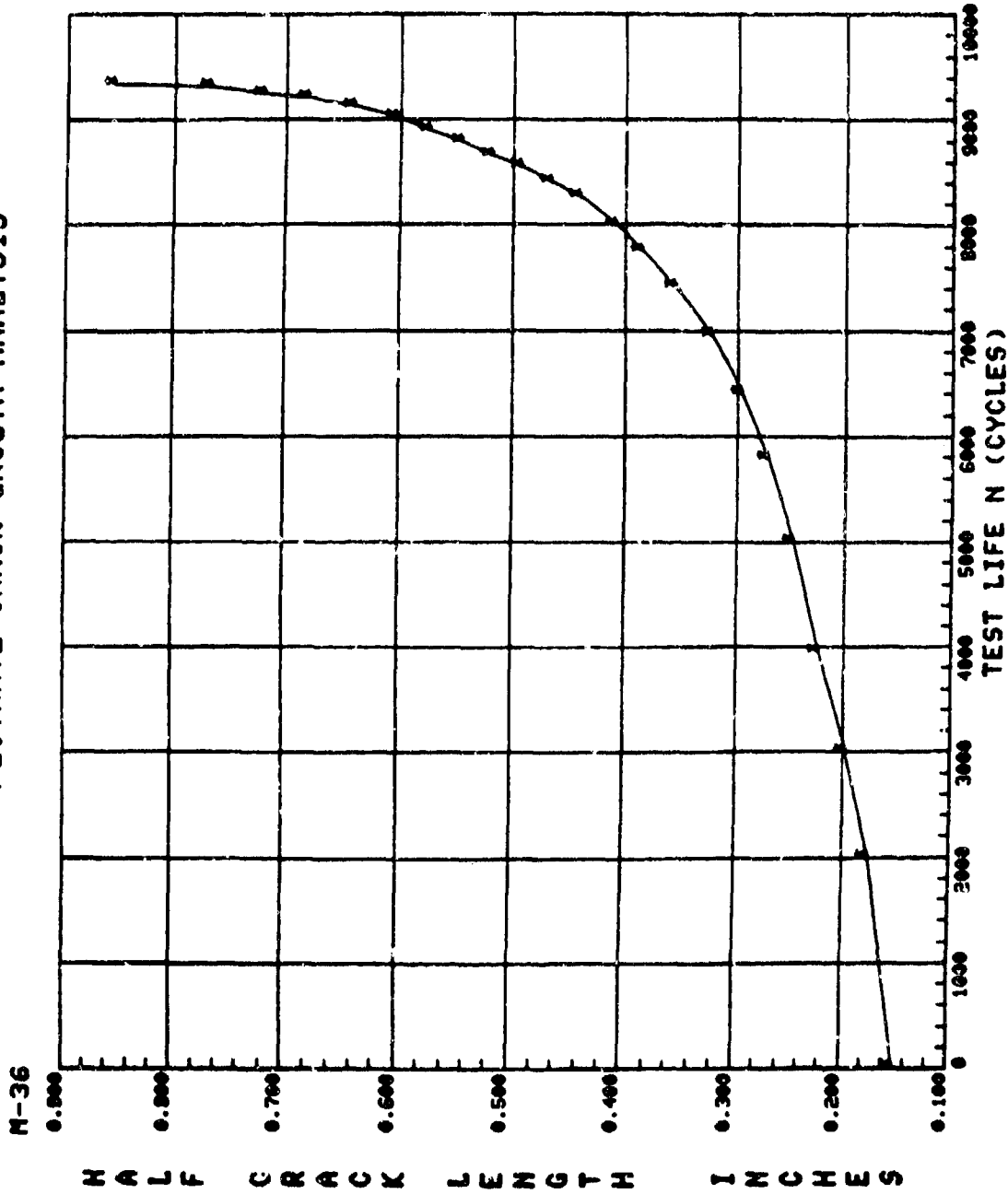

Figure 50. Crack growth curve for test M-36.

TABLE 49. DATA TABULATION FOR TEST M-37

SPECIMEN NO.:	M-37						
CCT SPECIMEN	R = 0.250 IN.	W = 6.000 IN.	AN = 0.0	IN.	TEST FREQ = 6.00 HZ.		
PMIN =	P MAX =						
ENVIRONMENT CONDITION: AMBIENT AIR							
NO.	CYCLES	A (MEASURED)	A (REGRESSION)	MULT. CORR. COEFF	K-MAX	DELTA K	DA/DM
1	0.	0.316	0.316	0.998182	14.10	14.10	1.039E-05
2	1000.	0.320	0.316	0.998124	14.12	14.12	1.122E-05
3	12466.	0.380	0.386	0.995982	15.61	15.61	1.784E-05
4	13740.	0.430	0.438	0.991933	16.64	16.64	2.24E-05
5	14944.	0.485	0.490	0.997081	17.62	17.62	2.687E-05
6	0.540	0.540	0.540	0.995959	18.51	18.51	3.129E-05
7	16342.	0.585	0.575	0.996048	19.11	19.11	3.388E-05
8	17350.	0.635	0.648	0.994550	20.31	20.31	4.044E-05
9	17828.	0.650	0.684	0.996079	20.90	20.90	4.376E-05
10	18576.	0.750	0.753	0.997603	21.96	21.96	5.169E-05
11	19000.	0.805	0.802	0.998220	22.68	22.68	5.608E-05
12	19500.	0.855	0.87	0.997566	23.49	23.49	6.322E-05
13	20000.	0.925	0.924	0.996030	24.44	24.44	7.542E-05
14	20401.	0.975	0.985	0.997892	25.29	25.29	8.778E-05
15	20550.	1.015	1.013	0.996956	25.66	25.66	8.645E-05
16	20850.	1.075	1.068	0.996929	26.40	26.40	9.657E-05
17	21150.	1.130	1.127	0.996695	27.19	27.19	1.082E-04
18	21450.	1.185	1.192	0.998609	28.02	28.02	1.197E-04
19	21750.	1.265	1.265	0.999729	28.96	28.96	1.391E-04
20	22050.	1.355	1.354	0.999809	30.08	30.08	1.623E-04
21	22201.	1.405	1.406	0.999686	30.73	30.73	1.773E-04
22	22350.	1.460	1.459	0.999785	31.40	31.40	1.905E-04
23	22500.	1.515	1.517	0.999587	32.11	32.11	2.090E-04
24	22650.	1.585	1.583	0.999340	32.92	32.92	2.245E-04
25	22800.	1.650	1.651	0.998362	33.75	33.75	2.512E-04
26	22950.	1.735	1.731	0.997420	34.73	34.73	2.690E-04
27	23100.	1.805	1.813	0.996384	35.72	35.72	3.022E-04
28	23250.	1.920	1.907	0.995857	36.87	36.87	3.528E-04

TABLE 49. DATA TABULATION FOR TEST M-37 (CONCL)

SPECIMEN NO.: M-37

CCT SPECIMEN R = 0.250 IN. W = 0.000 IN. AA = 0.0 IN.
 P MIN = P MAX = TEST FREQ = 6.000 HZ.

ENVIRONMENT CONDITION: AMBIENT AIR

NO.	CYCLES	A (MEASURED)	A (REGRESSICN)	MULT. CORR. COEFF	K-MAX	DELTA K	DA/DM
29	23350.	1.960	1.976	0.997075	37.72	37.72	3.97E-04
30	23450.	2.060	2.060	0.997436	38.76	38.76	4.442E-04
31	23550.	2.155	2.152	0.997831	39.90	39.90	4.848E-04
32	23650.	2.260	2.257	0.999034	41.23	41.23	5.545E-04
33	23750.	2.370	2.364	0.996721	42.60	42.60	6.391E-04
34	23850.	2.485	2.491	0.996929	44.26	44.26	7.819E-04
35	23950.	2.640	2.650	0.994981	46.42	46.42	1.052E-03
36	24025.	2.810	2.802	0.983416	48.56	48.56	1.547E-03
37	24100.	3.000	3.050	0.988708	52.27	52.27	2.179E-03
38	24150.	3.220	3.269	0.994030	55.85	55.85	2.911E-03
39	24200.	3.605	3.603	0.999145	62.03	62.03	4.208E-03

PLOTRATE CRACK GROWTH ANALYSIS

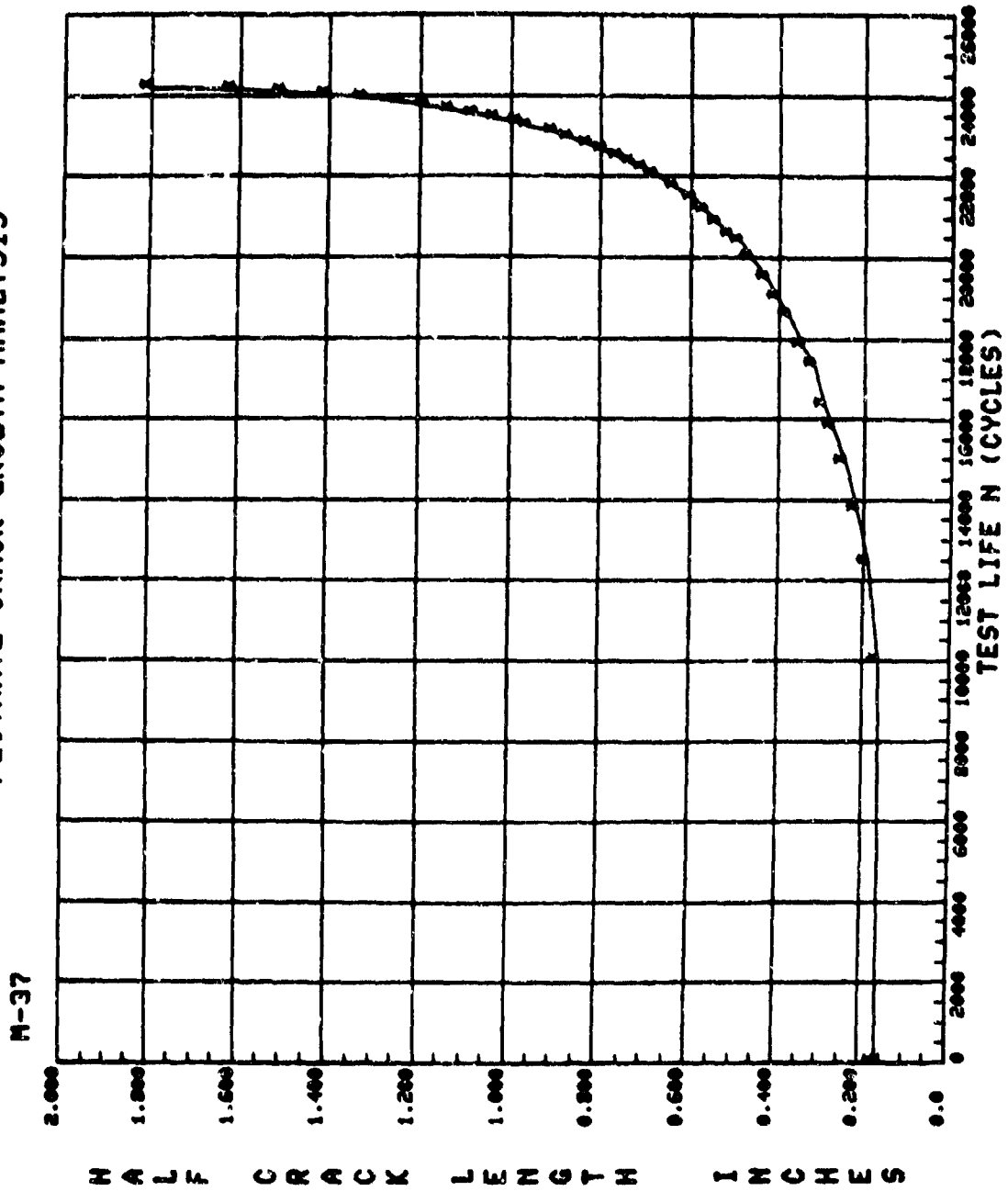

Figure 51. Crack growth curve for test M-37.

TABLE 50. DATA TABULATION FOR TEST M-38

SPECIMEN NO.: M-38

CCT SPECIMEN R= 0.250 IN.

h= 6.000 IN.

AA= 0.0 IN.

PHIN= P MAX=

TEST FREQ= 6.000 HZ.

ENVIRONMENT CONDITION: AMBIENT AIR

NO.	CYCLES	A (MEASURED)	A (REGRESSION)	MULT. CORR. COEFF	K-MAX	DELTA K	DA/DM
1	0.	0.300	0.300	0.998856	27.49	27.49	3.280E-07
2	1501.	0.325	0.331	0.997097	26.90	28.90	1.751E-05
3	2501.	0.380	0.379	0.994709	30.95	30.95	2.53E-05
4	3201.	0.425	0.419	0.994485	32.53	32.53	2.93E-05
5	3901.	0.470	0.471	0.957958	34.52	34.52	3.861E-05
6	4702.	0.520	0.552	0.853855	37.43	37.43	6.73E-05
7	5005.	0.540	0.621	0.759967	39.75	39.75	1.33E-04
8	5030.	0.605	0.653	0.732514	40.79	40.79	3.36E-04
9	5055.	0.670	0.665	0.994355	41.19	41.19	1.35E-03
10	5075.	0.715	0.725	0.994154	43.05	43.05	1.45E-03
11	5095.	0.775	0.783	0.793851	44.82	44.82	1.54E-03
12	5105.	0.835	0.812	0.986151	45.68	45.68	1.76E-03
13	5135.	0.910	0.934	0.961730	49.17	49.17	1.69E-03
14	5150.	0.985	0.984	0.911771	50.54	51.54	2.71E-03
15	5156.	1.050	1.007	0.927621	51.18	51.18	3.70E-03
16	5170.	1.020	1.106	0.947111	53.81	53.81	5.37E-03
17	5180.	1.230	1.200	0.970730	56.27	56.27	8.34E-03
18	5190.	1.400	1.404	0.979280	61.42	61.42	1.33E-02

PLOT RATE CRACK GROWTH ANALYSIS

M-38

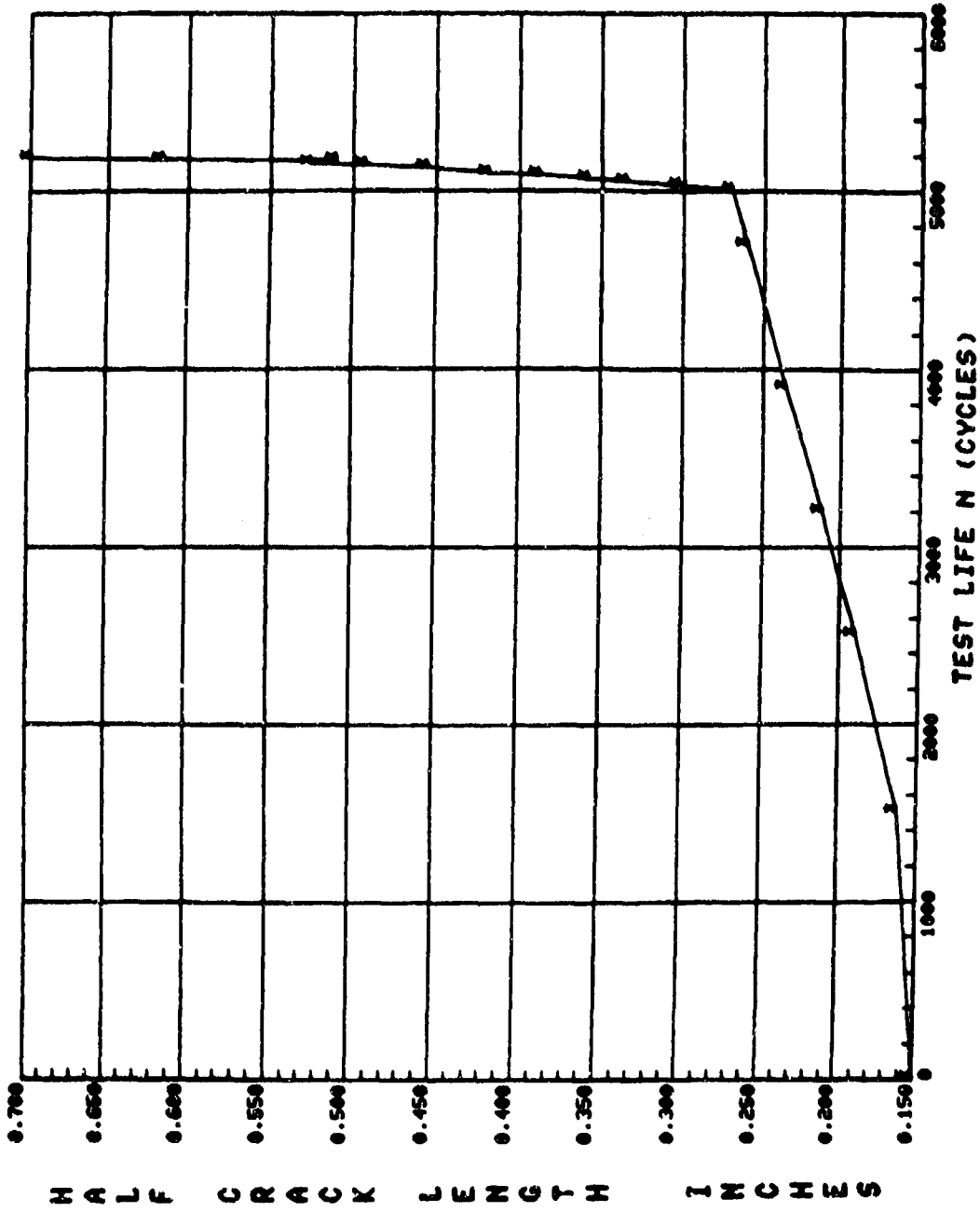

Figure 52. Crack growth curve for test M-38.

TABLE 51. DATA TABULATION FOR TEST M-39

SPECIMEN NO.: M-39

CCT SPECIMEN R = 0.250 IN. W = 6.000 IN. AN = 0.0 IN.

PMIN = PMAX =

TEST FREQ = 6.000 HZ.

ENVIRONMENT CONDITION: AMBIENT AIR

NO.	CYCLES	A (MEASURED)	A (REGRESSION)	MULT. CORR. COEFF	K-MAX	DELTA K	DAY/DM
1	0.	0.300	0.300	0.998979	13.75	13.75	9.084E-04
2	5000.	0.360	0.361	0.999581	13.78	13.78	9.349E-06
3	6500.	0.340	0.338	0.999234	14.61	14.61	1.643E-05
4	8000.	0.350	0.349	0.999340	15.68	15.68	1.942E-05
5	9000.	0.435	0.434	0.999831	16.56	16.56	2.217E-05
6	10000.	0.420	0.420	0.998622	17.43	17.43	2.593E-05
7	11000.	0.535	0.534	0.998448	18.40	18.40	3.019E-05
8	12000.	0.550	0.546	0.998867	19.47	19.47	3.625E-05
9	12600.	0.650	0.648	0.999275	20.32	20.32	4.148E-05
10	13100.	0.650	0.649	0.999175	21.00	21.00	4.473E-05
11	13600.	0.740	0.739	0.999474	21.74	21.74	4.923E-05
12	14100.	0.750	0.787	0.998021	22.47	22.47	5.535E-05
13	14600.	0.840	0.844	0.998070	23.30	23.30	6.424E-05
14	15111.	0.895	0.899	0.999053	24.09	24.09	7.584E-05
15	15451.	0.955	0.954	0.996364	24.85	24.85	7.998E-05
16	15750.	1.005	1.005	0.996364	25.56	25.56	8.905E-05
17	16000.	1.060	1.051	0.991734	26.18	26.18	9.999E-05
18	16367.	1.110	1.126	0.992387	27.17	27.17	1.176E-04
19	16567.	1.170	1.173	0.991242	27.79	27.79	1.247E-04
20	16600.	1.215	1.202	0.990036	28.15	28.15	1.267E-04
21	16855.	1.255	1.254	0.996044	28.82	28.82	1.400E-04
22	17030.	1.295	1.299	0.996673	29.40	29.40	1.392E-04
23	17205.	1.345	1.345	0.999259	29.98	29.98	1.503E-04
24	17355.	1.355	1.390	0.997961	30.54	30.54	1.768E-04
25	17505.	1.440	1.447	0.998245	31.25	31.25	1.976E-04
26	17605.	1.485	1.490	0.997885	31.78	31.78	2.085E-04
27	17755.	1.565	1.556	0.998369	32.58	32.58	2.298E-04
28	17955.	1.655	1.653	0.998577	33.77	33.77	2.588E-04

TABLE 51. DATA TABULATION FOR TEST M-39 (CONCL)

SPECIMEN NO.: M-39

CCT SPECIMEN R = 0.250 IN. W = 6.000 IN. AN = 0.0 IN.

PHIN: PMAX: TEST FREQ = 6.00 HZ.

ENVIRONMENT CONDITION: AMBIENT AIR

NO.	CYCLFS	A(MEASLRED)	A(REGRESSION)	MULT. CORR. COEFF	K-MAX	DELTA K	DA/DM
29	18155.	1.750	1.75R	0.997910	35.05	35.05	2.971E-04
30	18310.	1.850	1.850	0.999469	36.18	36.18	3.304E-04
31	18444.	1.940	1.944	0.999727	37.33	37.33	3.829E-04
32	18544.	2.030	2.024	0.999343	38.31	38.31	4.281E-04
33	18644.	2.110	2.113	0.999329	39.42	39.42	4.632E-04
34	18744.	2.205	2.209	0.998638	40.62	40.62	5.194E-04
35	18823.	2.300	2.291	0.998984	41.66	41.66	5.695E-04
36	18923.	2.400	2.411	0.997675	43.22	43.22	6.789E-04
37	18983.	2.455	2.493	0.998190	44.29	44.29	7.704E-04
38	19040.	2.575	2.581	0.999142	45.48	45.48	8.955E-04
39	19085.	2.670	2.664	0.996696	46.61	46.61	1.063E-03
40	19135.	2.765	2.773	0.998298	48.14	48.14	1.267E-03
41	19169.	2.855	2.863	0.998286	49.45	49.45	1.516E-03
42	19199.	2.965	2.956	0.997092	50.82	50.82	1.863E-03
43	19277.	3.055	3.065	0.996408	52.52	52.52	2.310E-03
44	19248.	3.150	3.165	0.995244	54.12	54.12	2.920E-03
45	19262.	3.250	3.243	0.996194	55.41	55.41	3.692E-03
46	19277.	3.345	3.360	0.996651	57.44	57.44	4.640E-03
47	19249.	3.465	3.478	0.996615	59.60	59.60	5.786E-03
48	19297.	3.580	3.580	0.999787	61.55	61.55	7.583E-03

PLOTRATE CRACK GROWTH ANALYSIS

M-39

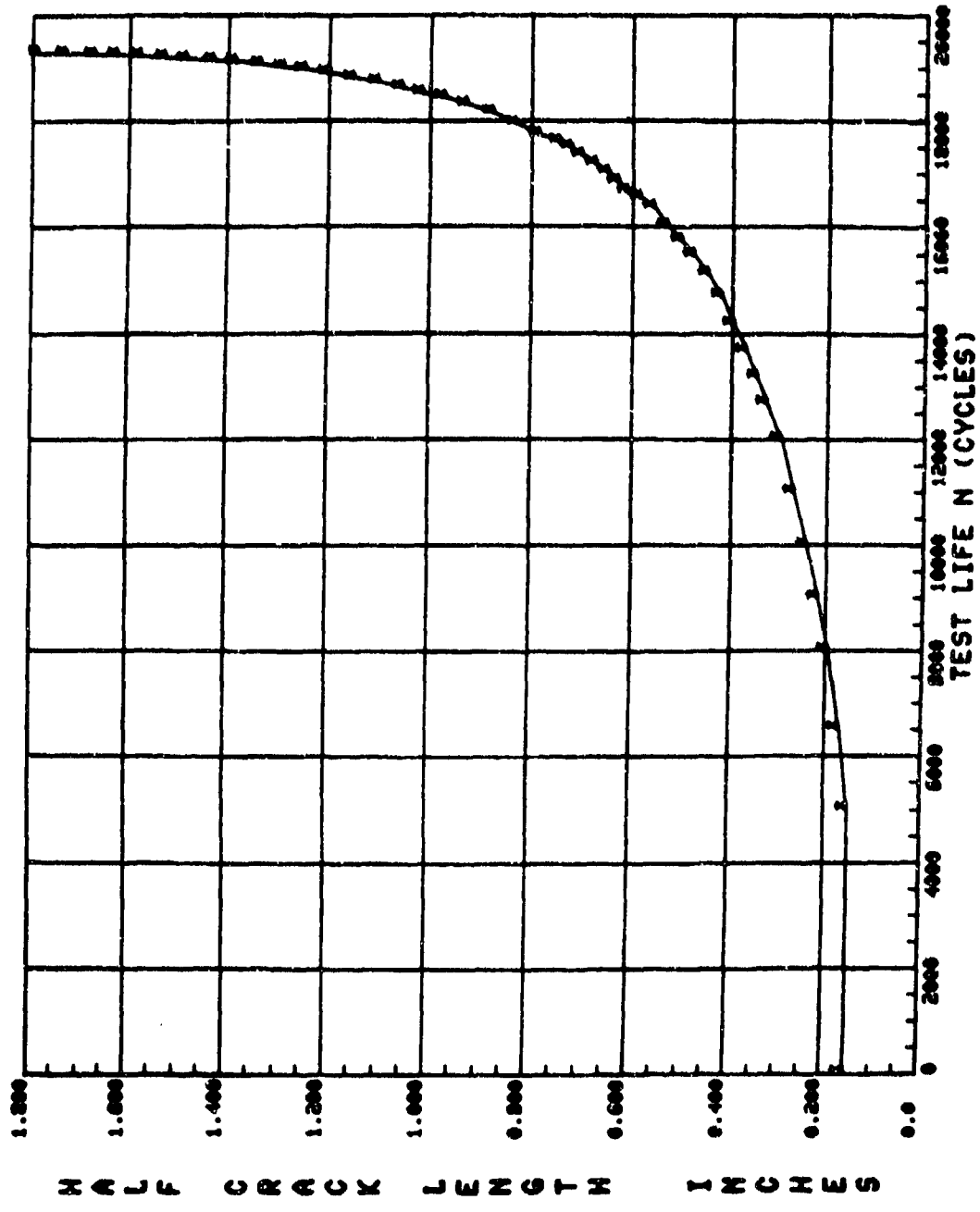

Figure 53. Crack growth curve for test M-39.

TABLE 52. DATA TABULATION FOR TEST M-40

SPECIMEN NO.: M-40		CCT SPECIMEN		PMTN=		ENVIRONMENT CONDITION: AMBIENT AIR		TEST FREQ= 6.00 HZ.	
NO.	CYCLES	A (MEASURED)	Δ (REGRESSION)	MULT. CORR. COEFF	K-MAX	DELTA K	DA/DM		
1	0.	0.300	0.300	0.983016	27.51	27.51	2.207E-04		
2	5000.	0.365	0.301	0.989762	27.53	27.53	2.478E-04		
3	5050.	0.320	0.326	0.993419	28.66	28.66	2.451E-04		
4	5100.	0.350	0.350	0.993711	29.71	29.71	2.381E-04		
5	5150.	0.380	0.375	0.995929	30.78	30.78	2.412E-04		
6	5200.	0.400	0.399	0.995754	31.73	31.73	2.515E-04		
7	5270.	0.430	0.425	0.986265	32.77	32.77	2.787E-04		
8	5340.	0.465	0.455	0.979195	33.94	33.94	3.956E-04		
9	5420.	0.515	0.525	0.981372	36.48	36.48	6.601E-04		
10	5500.	0.620	0.645	0.991839	40.53	40.53	1.073E-03		
11	5550.	0.755	0.763	0.996765	44.23	44.23	1.550E-03		
12	5570.	0.835	0.827	0.993932	46.10	46.10	2.019E-03		
13	5590.	0.850	0.905	0.986585	48.36	48.36	2.551E-03		
14	5610.	0.950	0.949	0.981321	50.94	50.94	3.823E-03		
15	5630.	1.140	1.169	0.973659	55.45	55.45	6.317E-03		
16	5645.	1.315	1.470	0.927491	61.82	61.82	1.142E-02		
17	5650.	1.465	1.505	0.920769	65.39	65.39	1.834E-02		
18	5652.	1.580	1.662	0.956451	67.76	67.76	3.574E-02		
19	5653.	1.770	1.762	0.981666	70.21	70.21	6.929E-02		

PLOTRATE CRACK GROWTH ANALYSIS

M-40

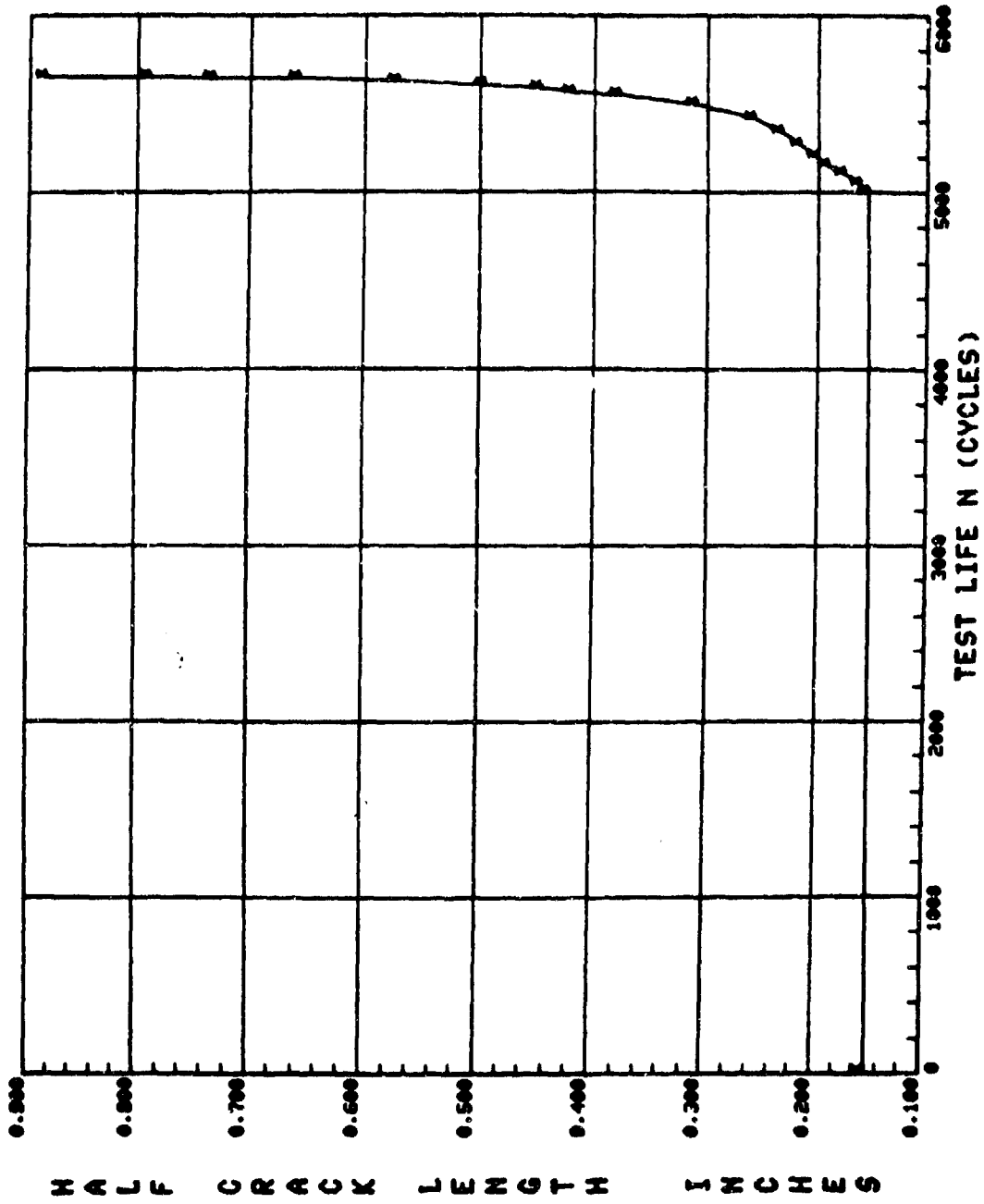

Figure 54. Crack growth curve for test M-40.

TABLE 53. DATA TABULATION FOR TEST M-41

SPECIMEN NO.: M-41		CCT SPECIMEN		ENVIRONMENT CONDITION: AMBIENT AIR		TEST FREQ= 6.00 HZ.	
		A= 0.250 IN.	W= 6.000 IN.	AA= 0.0	IN.		
		PMIN=	PMAX=				
NO.	CYCLES	A (MEASURED)	A (REGRESSION)	MULT. CORR. COEFF	K-MAX	DELTA K	DA/DN
1	0.	0.300	0.300	0.997107	13.74	6.87	3.330E-07
2	5000.	0.300	0.307	0.995081	13.91	6.96	1.366E-06
3	13300.	0.345	0.344	0.997381	14.72	7.36	3.111E-06
4	19461.	0.355	0.391	0.997439	15.72	7.86	4.227E-06
5	24911.	0.440	0.445	0.998444	16.77	8.38	5.253E-06
6	29070.	0.455	0.490	0.997911	17.61	8.81	6.212E-06
7	33737.	0.545	0.551	0.998561	18.69	9.35	7.449E-06
8	36751.	0.555	0.596	0.997644	19.47	9.74	8.766E-06
9	39614.	0.650	0.647	0.999344	20.30	10.15	1.004E-05
10	42551.	0.705	0.711	0.999369	21.31	10.66	1.150E-05
11	45051.	0.775	0.771	0.999282	22.27	11.11	1.259E-05
12	47051.	0.825	0.825	0.999345	23.02	11.51	1.412E-05
13	49051.	0.880	0.884	0.999079	23.87	11.94	1.566E-05
14	51051.	0.950	0.944	0.994594	24.72	12.36	1.864E-05
15	53051.	1.015	1.022	0.995416	25.79	12.89	2.261E-05
16	54551.	1.080	1.092	0.996028	26.73	13.36	2.702E-05
17	55550.	1.160	1.146	0.995789	27.44	13.72	2.975E-05
18	56250.	1.150	1.192	0.995926	28.03	14.02	3.057E-05
19	56950.	1.240	1.237	0.994522	28.61	14.30	3.357E-05
20	57650.	1.280	1.283	0.996281	29.19	14.60	3.381E-05
21	58350.	1.325	1.333	0.997347	29.82	14.91	3.707E-05
22	59050.	1.400	1.385	0.997347	30.47	15.24	3.939E-05
23	60000.	1.455	1.464	0.997808	31.45	15.72	4.352E-05
24	61000.	1.555	1.554	0.997633	32.56	16.28	4.935E-05
25	62000.	1.655	1.654	0.999357	33.79	16.89	5.771E-05
26	62650.	1.730	1.735	0.998334	34.77	17.39	6.703E-05
27	63000.	1.780	1.780	0.999531	35.32	17.66	7.151E-05
28	63500.	1.850	1.853	0.999121	36.21	18.10	8.222E-05

TABLE 53. DATA TABULATION FOR TEST M-41 (CONCL)

SPECIMEN NO.: M-41		R = 0.250 IN.		W = 6.000 IN.		AN = 0.0 IN.		TEST FREQ = 6.00 HZ.	
CCT	SPECIMEN	P MAX =	A (MEASURED)	A (REGRESSION)	MULT. CORR. COEFF	K-MAX	DELTA K	DA/DN	
ENVIRONMENT CONDITION: AMBIENT AIR									
V7.	CYCLES	A (MEASURED)	A (REGRESSION)	MULT. CORR. COEFF	K-MAX	DELTA K	DA/DN		
29	64000.	1.945	1.934	0.998272	37.20	18.60	9.759E-05		
30	64500.	2.030	2.015	0.997635	38.45	19.23	1.196E-04		
31	65000.	2.155	2.163	0.998227	40.03	20.02	1.437E-04		
32	65637.	2.360	2.365	0.998777	42.61	21.30	1.839E-04		
33	65800.	2.445	2.428	0.998528	43.43	21.72	1.975E-04		
34	66000.	2.500	2.509	0.997897	44.51	22.26	2.171E-04		
35	66200.	2.550	2.592	0.997465	45.63	22.81	2.424E-04		
36	66400.	2.655	2.690	0.999661	46.97	23.49	2.752E-04		
37	66600.	2.805	2.810	0.999592	48.67	24.34	3.259E-04		
38	66800.	2.950	2.945	0.997357	50.66	25.33	4.006E-04		
39	66950.	3.060	3.068	0.997779	52.55	26.28	4.766E-04		
40	67100.	3.200	3.220	0.995234	55.03	27.52	6.155E-04		
41	67200.	3.345	3.346	0.997829	57.19	28.59	7.966E-04		
42	67250.	3.410	3.425	0.997323	58.61	29.30	9.760E-04		
43	67300.	3.525	3.523	0.997980	60.44	30.22	1.139E-03		
44	67350.	3.630	3.639	0.998933	62.74	31.37	1.375E-03		
45	67400.	3.750	3.789	0.998513	65.94	32.97	1.609E-03		

PLOTRATE CRACK GROWTH ANALYSIS

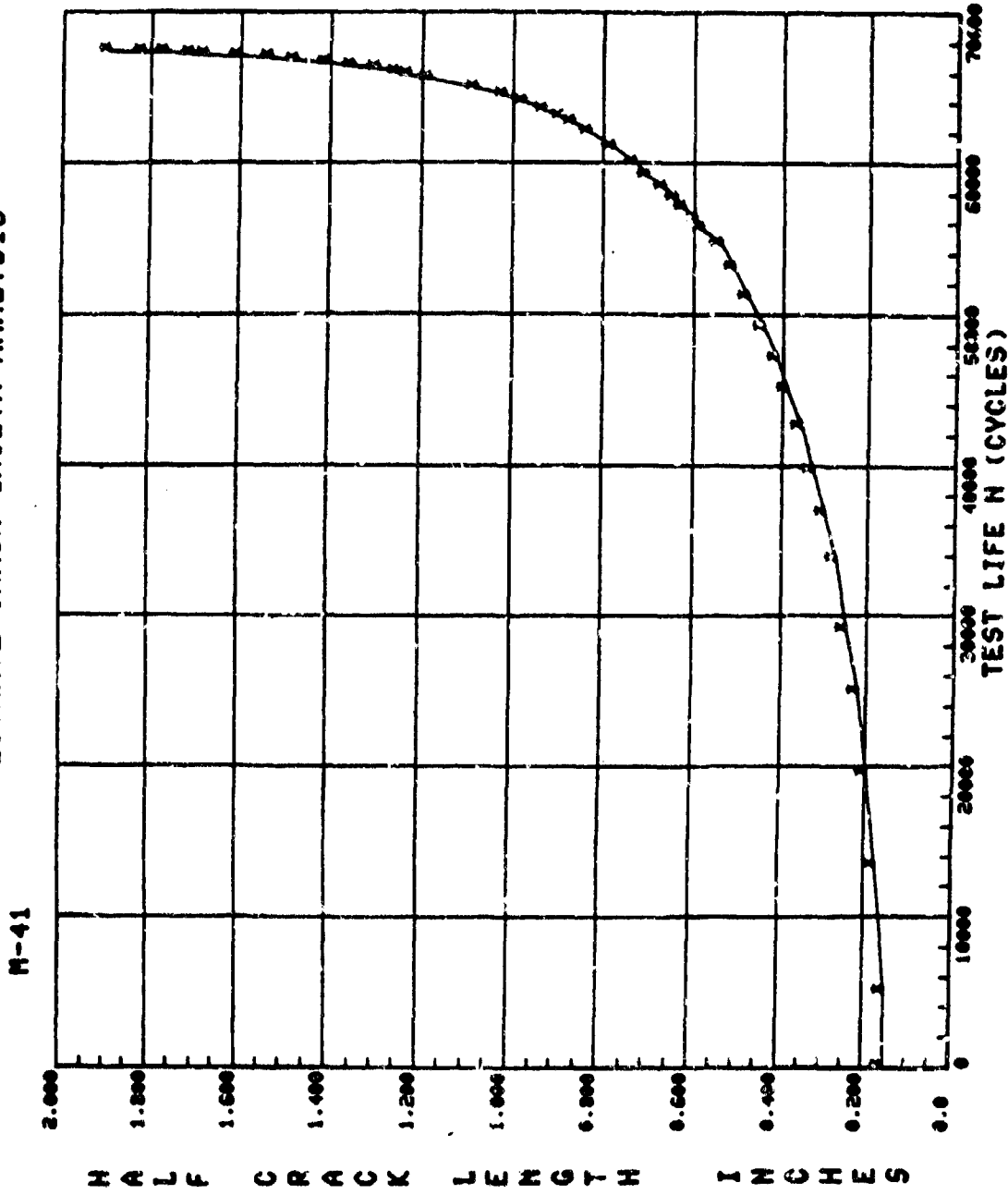

Figure 55. Crack growth curve for test M-41.

TABLE 54. DATA TABULATION FOR TEST M-42

SPECIMEN NO.:	M-42						
CCT SPECIMEN	B = 0.250 IN.	W = 6.000 IN.	AA = 0.0 IN.	TEST FREQ = 6.00 HZ.			
PMIN =	PMAX =						
ENVIRONMENT CONDITION: AMBIENT AIR							
NO.	CYCLES	A (MEASURED)	A (REGRESSION)	MULT. CORR. COEFF	K-MAX	DELTA K	DA/DN
1	0.	0.310	0.309	0.997740	13.97	6.92	3.449E-07
2	5000.	0.310	0.315	0.998859	14.09	7.05	1.343E-06
3	15000.	0.375	0.375	0.999318	15.31	7.66	4.381E-06
4	21000.	0.435	0.435	0.999058	16.58	8.29	6.399E-06
5	25500.	0.455	0.500	0.998247	17.80	8.90	8.154E-06
6	29000.	0.555	0.558	0.999554	18.82	9.41	9.961E-06
7	31800.	0.615	0.616	0.999968	19.79	9.90	1.159E-05
8	34200.	0.675	0.674	0.999975	20.74	10.37	1.300E-05
9	36400.	0.735	0.735	0.999984	21.68	10.84	1.425E-05
10	38400.	0.755	0.795	0.999996	22.58	11.29	1.532E-05
11	40300.	0.855	0.854	0.999514	23.45	11.72	1.674E-05
12	42100.	0.915	0.914	0.997976	24.31	12.15	1.906E-05
13	43800.	0.975	0.980	0.998792	25.22	12.61	2.195E-05
14	45100.	1.035	1.039	0.999442	26.00	13.00	2.511E-05
15	46200.	1.100	1.095	0.999518	26.77	13.38	2.774E-05
16	47350.	1.160	1.162	0.998990	27.64	13.82	3.165E-05
17	48200.	1.220	1.218	0.998990	28.37	14.18	3.460E-05
18	49350.	1.255	1.301	0.999473	29.41	14.71	3.937E-05
19	50000.	1.365	1.361	0.999349	30.17	15.09	4.369E-05
20	50640.	1.410	1.409	0.999180	30.77	15.38	4.846E-05
21	51280.	1.470	1.473	0.999360	31.57	15.78	5.388E-05
22	51860.	1.535	1.534	0.999568	32.31	16.16	5.954E-05
23	52690.	1.645	1.641	0.999650	33.62	16.81	7.144E-05
24	53480.	1.755	1.761	0.999250	35.09	17.54	8.598E-05
25	54160.	1.865	1.885	0.999504	36.60	18.30	9.980E-05
26	54670.	1.985	1.989	0.999152	37.88	18.94	1.162E-04
27	55050.	2.065	2.079	0.997678	38.99	19.50	1.339E-04
28	55500.	2.190	2.202	0.998819	40.53	20.26	1.568E-04

TABLE 54. DATA TABULATION FOR TEST M-42 (CONCL)

SPECIMEN NO.: M-42

CCT SPECIMEN B = 0.250 IN. W = 0.000 IN. AA = 0.0 IN.

PMIN = PMAX = TEST FREQ = 6.000 HZ.

ENVIRONMENT CONDITION: AMBIENT AIR

NO.	CYCLES	A (MEASURED)	A (REGRESSION)	MULT. CORR. COEFF	K-MAX	DELTA K	DA/DN
29	55890.	2.325	2.330	0.999107	42.16	21.08	1.823E-04
30	56140.	2.435	2.423	0.999283	43.36	21.68	2.027E-04
31	56510.	2.580	2.586	0.999414	45.55	22.77	2.342E-04
32	56777.	2.685	2.689	0.998720	46.95	23.48	2.627E-04
33	56885.	2.775	2.770	0.999458	48.10	24.05	2.866E-04
34	57148.	2.920	2.929	0.998204	50.42	25.21	3.525E-04
35	57278.	3.025	3.017	0.998109	51.76	25.88	4.079E-04
36	57443.	3.145	3.157	0.995756	53.99	27.00	5.157E-04
37	57590.	3.305	3.309	0.987023	56.54	28.27	7.329E-04
38	57710.	3.480	3.499	0.990316	59.99	29.99	1.013E-03
39	57772.	3.555	3.626	0.993110	62.49	31.25	1.259E-03
40	57829.	3.755	3.794	0.999245	66.05	33.03	1.848E-03

PLOTRATE CRACK GROWTH ANALYSIS

M-42

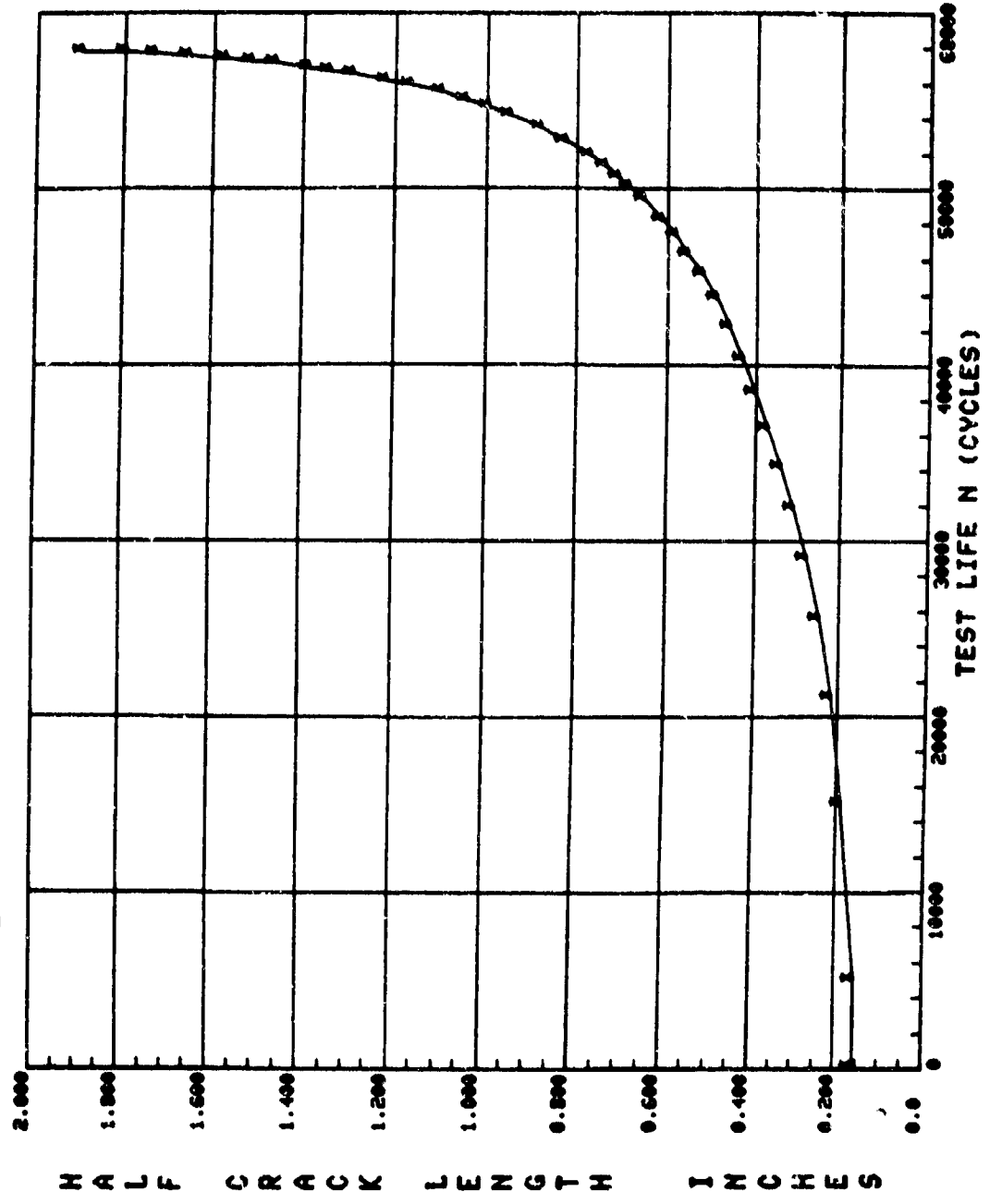

Figure 56. Crack growth curve for test M-42.

TABLE 55. DATA TABULATION FOR TEST M-43

SPECIMEN NO.: M-43

CCT SPECIMEN R = 0.250 IN. M = 6.000 IN. AA = 0.0 IN.
 PHIN = P MAX = TEST FREQ = 6.000 HZ.

ENVIRONMENT CONDITION: AMBIENT AIR

NO.	CYCLES	A (MEASURED)	A (REGRESSICN)	MULT. COEFF	K-MAX	DELTA K	DA/DM
1	0.	0.315	0.315	0.999543	14.09	15.09	8.613E-06
2	7800.	0.400	0.395	0.998735	15.79	15.79	2.038E-05
3	9600.	0.475	0.481	0.998202	17.46	17.46	2.863E-05
4	10750.	0.545	0.555	0.997091	18.77	18.77	3.472E-05
5	11500.	0.605	0.604	0.999519	19.60	19.60	4.238E-05
6	12265.	0.670	0.673	0.999533	20.71	20.71	5.032E-05
7	12800.	0.725	0.728	0.999637	21.57	21.57	5.705E-05
8	13190.	0.775	0.774	0.999572	22.27	22.27	6.102E-05
9	13700.	0.840	0.840	0.997654	23.24	23.24	7.074E-05
10	13970.	0.880	0.878	0.996506	23.80	23.80	7.786E-05
11	14420.	0.940	0.953	0.991879	24.85	24.85	1.041E-04
12	14578.	0.985	0.984	0.985449	25.27	25.27	1.036E-04
13	14728.	1.015	1.016	0.985974	25.71	25.71	1.119E-04
14	14928.	1.085	1.071	0.987821	26.45	26.45	1.184E-04
15	15128.	1.100	1.113	0.985305	27.00	27.00	1.177E-04
16	15328.	1.170	1.158	0.984117	27.58	27.58	1.278E-04
17	15528.	1.155	1.204	0.991999	28.18	28.18	1.459E-04
18	15728.	1.265	1.269	0.992846	29.02	29.02	1.720E-04
19	15878.	1.325	1.319	0.995475	29.65	29.65	1.919E-04
20	15978.	1.365	1.364	0.999866	30.21	30.21	2.010E-04
21	16078.	1.405	1.405	0.999881	30.73	30.73	2.047E-04
22	16178.	1.445	1.445	0.999899	31.22	31.22	2.117E-04
23	16278.	1.490	1.486	0.999245	31.73	31.73	2.231E-04
24	16378.	1.530	1.531	0.999595	32.28	32.28	2.374E-04
25	16578.	1.630	1.631	0.999349	33.51	33.51	2.852E-04
26	16728.	1.725	1.722	0.998749	34.61	34.61	3.191E-04
27	16828.	1.785	1.789	0.998635	35.43	35.43	3.467E-04
28	14928.	1.670	1.861	0.998222	36.31	36.31	3.775E-04

TABLE 55. DATA TABULATION FOR TEST M-43 (CONCL.)

SPECIMEN NO.: M-43

CCT SPECIMEN R = 0.250 IN. W = 6.000 IN. AN = 0.0 IN.

PMIN = PMAX = TEST FREQ = 6.00 HZ.

ENVIRONMENT CONDITION: AMBIENT AIR

NO.	CYCLES	A (MEASURED)	A (REGRESSION)	MULT. CORR. COEFF	K-MAX	DELTA K	DA/DM
29	16978.	1.890	1.899	0.998118	36.77	36.77	3.904E-04
30	17053.	1.960	1.959	0.997916	37.51	37.51	4.213E-04
31	17128.	2.025	2.021	0.998410	38.27	38.27	4.591E-04
32	17203.	2.090	2.096	0.999113	39.20	39.20	5.029E-04
33	17253.	2.145	2.145	0.999466	39.82	39.82	5.306E-04
34	17303.	2.205	2.200	0.998200	40.51	40.51	5.899E-04
35	17343.	2.245	2.250	0.996404	41.13	41.13	5.965E-04
36	17383.	2.250	2.293	0.993980	41.69	41.69	6.809E-04
37	17400.	2.330	2.318	0.995436	42.01	42.01	7.250E-04
38	17425.	2.345	2.358	0.993326	42.53	42.53	7.723E-04
39	17470.	2.435	2.433	0.993316	43.50	43.50	8.293E-04
40	17495.	2.485	2.476	0.993124	44.06	44.06	8.305E-04
41	17520.	2.515	2.516	0.990327	44.60	44.60	9.676E-04
42	17545.	2.560	2.566	0.990979	45.26	45.26	9.479E-04
43	17570.	2.600	2.608	0.993317	45.84	45.84	9.981E-04
44	17620.	2.745	2.717	0.995035	47.34	47.34	1.231E-03
45	17670.	2.825	2.842	0.993421	49.14	49.14	1.577E-03
46	17720.	3.010	3.015	0.986681	51.73	51.73	2.272E-03
47	17750.	3.125	3.146	0.979046	53.81	53.81	3.321E-03
48	17780.	3.305	3.367	0.978574	57.57	57.57	4.731E-03
49	17800.	3.510	3.571	0.987560	61.38	61.38	7.203E-03
50	17809.	3.710	3.703	0.991863	64.08	64.08	9.480E-03

PLOTRATE CRACK GROWTH ANALYSIS

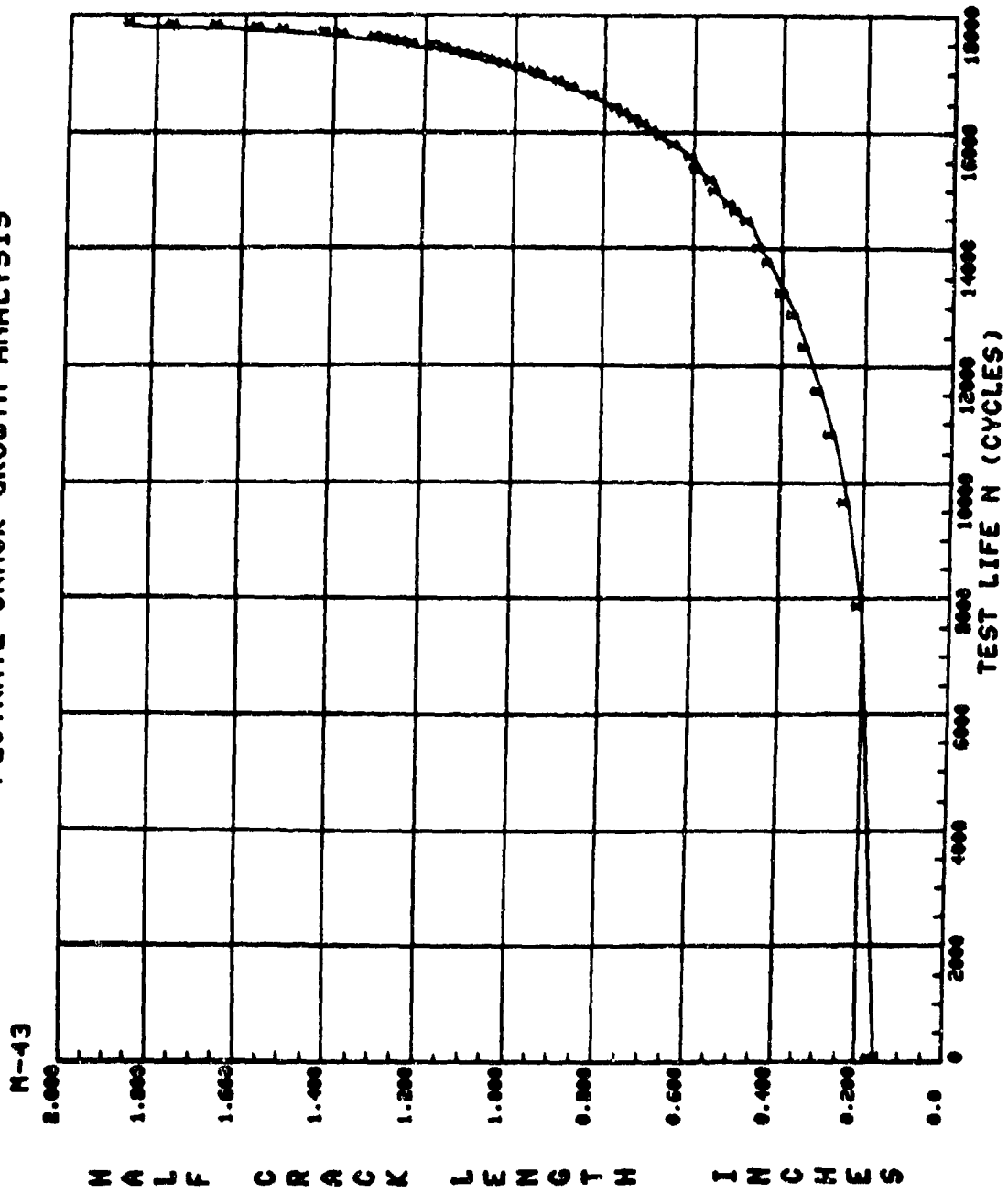

Figure 57. Crack growth curve for test M-43.

TABLE 56. DATA TABULATION FOR TEST M-44

SPECIMEN NO.:	M-44						
CCT SPECIMEN	A = 0.250 IN.	W = 6.000 IN.	AA = 0.0	IN.	TEST FRFQ = 6.00 HZ.		
PMIN =		P MAX =					
ENVIRONMENT CONDITION: AMBIENT AIR							
NO.	CYCLES	A (MEASURED)	A (REGRESSION)	MULT. CORR. COEFF	K-MAX	DELTA K	DA/DM
1	0.	0.305	0.305	0.999992	13.86	13.86	2.609E-04
2	50.	0.330	0.332	0.998255	14.47	14.47	2.600E-04
3	175.	0.365	0.354	0.968082	14.94	14.94	1.982E-04
4	275.	0.405	0.389	0.972113	15.67	15.67	2.538E-04
5	325.	0.420	0.472	0.932581	17.29	17.29	2.757E-04
6	475.	0.515	0.466	0.568418	17.16	17.16	2.682E-05
7	500.	0.610	0.504	0.616340	17.88	17.88	4.197E-06
8	4100.	0.620	0.548	0.762981	18.65	18.65	2.098E-06
9	24100.	0.635	0.640	0.915411	20.19	20.19	3.483E-06
10	38100.	0.755	0.780	0.962777	22.36	22.36	8.031E-06
11	41300.	0.810	0.848	0.943519	23.36	23.36	1.105E-05
12	47400.	0.865	0.896	0.978235	24.05	24.05	1.967E-05
13	45100.	0.950	0.959	0.992579	24.93	24.93	3.112E-05
14	46200.	1.020	1.030	0.994586	25.90	25.90	4.458E-05
15	46800.	1.075	1.083	0.994864	26.61	26.61	5.687E-05
16	47400.	1.145	1.150	0.998810	27.48	27.48	7.216E-05
17	47950.	1.230	1.234	0.997684	28.57	28.57	9.600E-05
18	48260.	1.255	1.295	0.997552	29.35	29.35	1.174E-04
19	48530.	1.350	1.360	0.997684	29.35	29.35	1.174E-04
20	48740.	1.425	1.422	0.998789	30.16	30.16	1.403E-04
21	48925.	1.485	1.480	0.999094	30.93	30.93	1.645E-04
22	49170.	1.575	1.573	0.998477	31.65	31.65	1.913E-04
23	49372.	1.675	1.690	0.983098	32.79	32.79	2.725E-04
24	49543.	1.785	1.807	0.978641	34.23	34.23	3.140E-04
25	49688.	1.950	1.807	0.978117	35.65	35.65	3.530E-04
26	49812.	1.955	1.922	0.978558	37.06	37.06	3.937E-04
27	49920.	2.100	2.028	0.975703	38.37	38.37	4.371E-04
28	50005.	2.200	2.122	0.970063	39.52	39.52	4.958E-04
			2.187	0.995798	40.34	40.34	5.992E-04

TABLE 56. DATA TABULATION FOR TEST M-44 (CONCL)

SPECIMEN NO.: M-44

CCT SPECIMEN B = 0.250 IN. W = 6.000 IN. AN = 0.0 IN.

PMIV = P MAX = TEST FREQ = 6.000 HZ.

ENVIRONMENT CONDITION: AMBIENT AIR

NO.	CYCLES	A (MEASURED)	A (REGRESSION)	MULT. CORR. COEFF	K-MAX	DELTA K	DA/DM
29	50086.	2.300	2.302	0.999166	41.80	41.80	7.261E-04
30	50150.	2.350	2.396	0.999113	43.01	43.01	8.472E-04
31	50205.	2.490	2.490	0.999750	44.26	44.26	9.771E-04
32	50255.	2.590	2.591	0.999363	45.61	45.61	1.151E-03
33	50298.	2.655	2.694	0.997700	47.03	47.03	1.388E-03
34	50337.	2.755	2.805	0.997452	48.60	48.60	1.727E-03
35	50365.	2.855	2.903	0.998864	50.03	50.03	2.068E-03
36	50388.	3.000	2.599	0.998954	51.48	51.48	2.512E-03
37	50409.	3.110	3.109	0.996078	53.21	53.21	3.142E-03
38	50427.	3.210	3.225	0.994396	55.12	55.12	4.063E-03
39	50442.	3.335	3.354	0.984738	57.33	57.33	6.009E-03
40	50450.	3.435	3.444	0.940977	58.96	58.96	7.725E-03
41	50459.	3.555	3.593	0.793219	61.81	61.81	1.040E-02
42	50465.	3.735	3.733	0.994362	64.71	64.71	1.444E-02

PLOTRATE CRACK GROWTH ANALYSIS

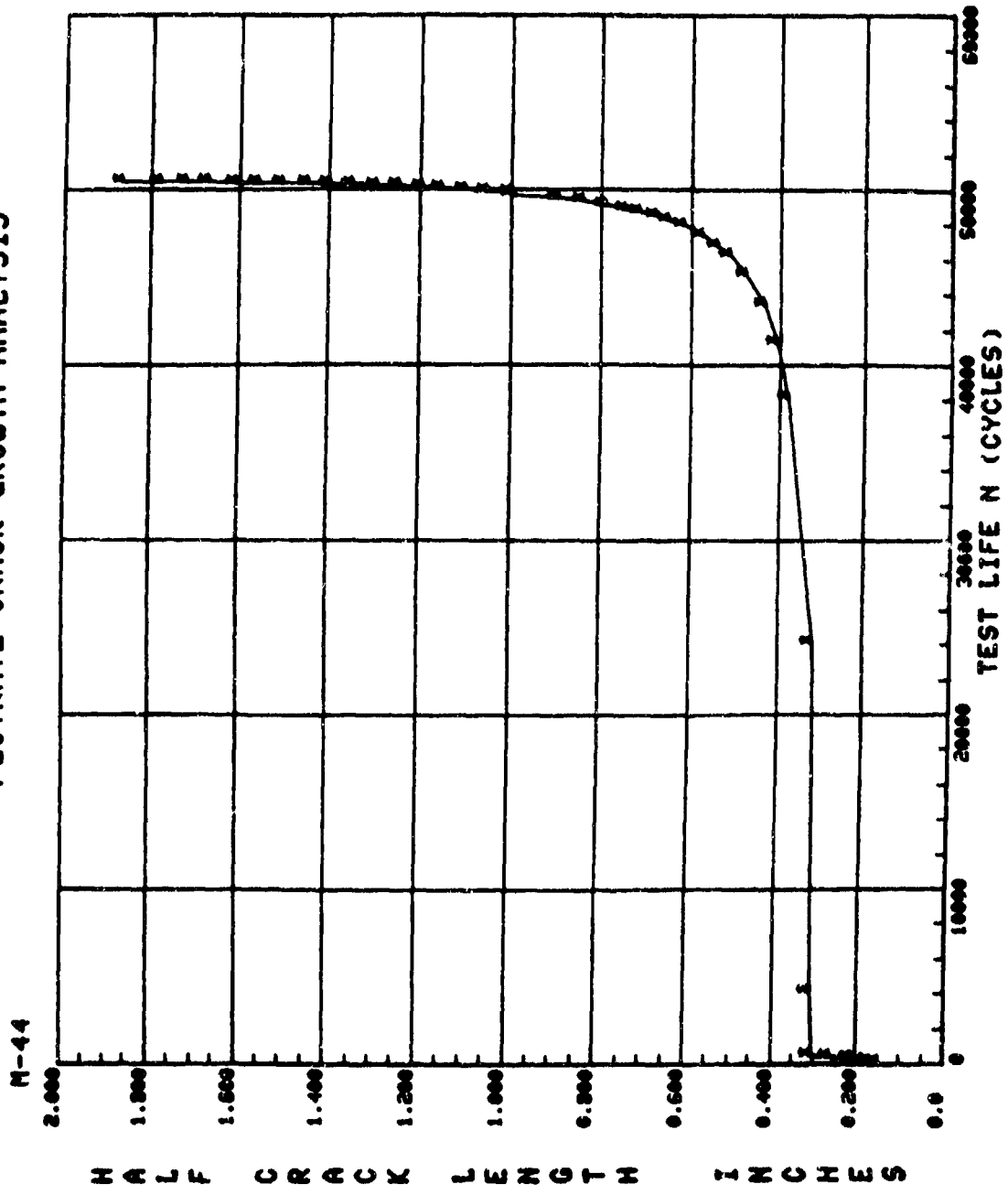

Figure 58. Crack growth curve for test M-44.

TABLE 57. DATA TABULATION FOR TEST M-45

SPECIMEN NO.: M-45		CCT SPECIMEN R= 0.250 IN. W= 6.000 IN. AN= 0.0 IN.		ENVIRONMENT CONDITION: AMBIENT AIR		TEST FREQ= 6.00 HZ.	
NO.	CYCLES	A (MEASURED)	A (REGRESSION)	MULT. CORR. COEFF	K-MAX	DELTA K	DA/DN
1	0.	0.250	0.290	0.998862	13.52	9.47	2.235E-05
2	800.	0.335	0.330	0.998811	14.43	10.10	2.921E-05
3	1300.	0.360	0.361	0.999053	15.09	10.56	3.513E-05
4	2300.	0.440	0.444	0.999121	16.76	11.73	4.851E-05
5	2800.	0.455	0.506	0.970864	17.91	12.54	3.887E-05
6	3300.	0.555	0.513	0.714755	18.03	12.62	2.332E-05
7	3370.	0.565	0.505	0.794342	17.89	12.52	3.056E-06
8	10961.	0.565	0.544	0.927139	19.26	13.48	2.388E-05
9	12739.	0.655	0.680	0.991185	20.83	14.58	3.469E-05
10	13802.	0.755	0.754	0.984280	21.97	15.38	3.744E-05
11	13902.	0.780	0.771	0.997039	22.23	15.56	3.455E-05
12	14602.	0.820	0.817	0.996423	22.91	16.04	3.414E-05
13	15302.	0.860	0.862	0.995665	23.57	16.50	3.594E-05
14	16302.	0.940	0.937	0.999274	24.62	17.23	4.145E-05
15	16802.	0.975	0.979	0.999012	25.20	17.64	4.689E-05
16	17302.	1.030	1.028	0.998600	25.86	18.10	5.358E-05
17	17802.	1.078	1.080	0.994771	26.56	18.59	6.425E-05
18	18302.	1.145	1.152	0.989223	27.51	19.26	6.833E-05
19	18802.	1.220	1.225	0.989128	28.45	19.91	7.357E-05
20	18902.	1.265	1.241	0.989148	28.66	20.06	7.812E-05
21	19402.	1.305	1.319	0.986660	29.64	20.75	8.805E-05
22	19702.	1.365	1.370	0.992458	30.28	21.20	9.214E-05
23	20002.	1.430	1.426	0.996439	30.50	21.69	1.004E-04
24	20302.	1.505	1.495	0.998704	31.84	22.29	1.173E-04
25	20862.	1.625	1.622	0.998622	33.52	23.46	1.389E-04
26	21197.	1.725	1.726	0.999277	34.67	24.27	1.582E-04
27	21499.	1.825	1.824	0.999925	35.86	25.10	1.807E-04
28	21790.	1.925	1.936	0.999880	37.22	26.06	2.051E-04

TABLE 57. DATA TABULATION FOR TEST M-45 (CONCL)

SPECIMEN NO.: M-45

CCT SPECIMEN R= 0.250 IN. W= 6.000 IN. ΔL= 0.0 IN.

PMIN= PMAX= TEST FREQ= 6.00 HZ.

ENVIRONMENT CONDITION: AMBIENT AIR

NO.	CYCLES	A (MEASURED)	A (REGRESSION)	MULT. CORR. COEFF	K-MAX	DELTA K	DATE
29	22040.	2.040	2.042	0.999907	38.53	26.97	2.303E-04
30	22286.	2.160	2.159	0.999577	39.99	27.99	2.630E-04
31	22495.	2.270	2.272	0.999447	41.42	28.99	3.030E-04
32	22669.	2.375	2.381	0.999663	42.82	29.97	3.361E-04
33	22818.	2.485	2.483	0.999288	44.16	30.91	3.797E-04
34	22959.	2.600	2.594	0.998505	45.65	31.95	4.366E-04
35	23097.	2.705	2.719	0.997754	47.38	33.17	5.182E-04
36	23192.	2.815	2.818	0.998847	48.79	34.16	5.915E-04
37	23267.	2.910	2.908	0.998937	50.11	35.08	6.915E-04
38	23324.	2.955	2.951	0.998748	51.36	35.96	7.714E-04
39	23388.	3.080	3.052	0.998949	52.94	37.06	8.768E-04
40	23442.	3.155	3.189	0.999226	54.52	38.16	9.944E-04
41	23484.	3.275	3.273	0.996455	55.93	39.15	1.186E-03
42	23521.	3.360	3.363	0.991345	57.50	40.25	1.458E-03
43	23561.	3.460	3.460	0.985446	59.64	41.74	2.092E-03
44	23591.	3.590	3.614	0.989326	62.25	43.57	2.977E-03
45	23606.	3.685	3.707	0.995235	64.15	44.91	3.938E-03
46	23617.	3.805	3.804	0.998174	66.27	46.39	5.289E-03

PLOTRATE CRACK GROWTH ANALYSIS

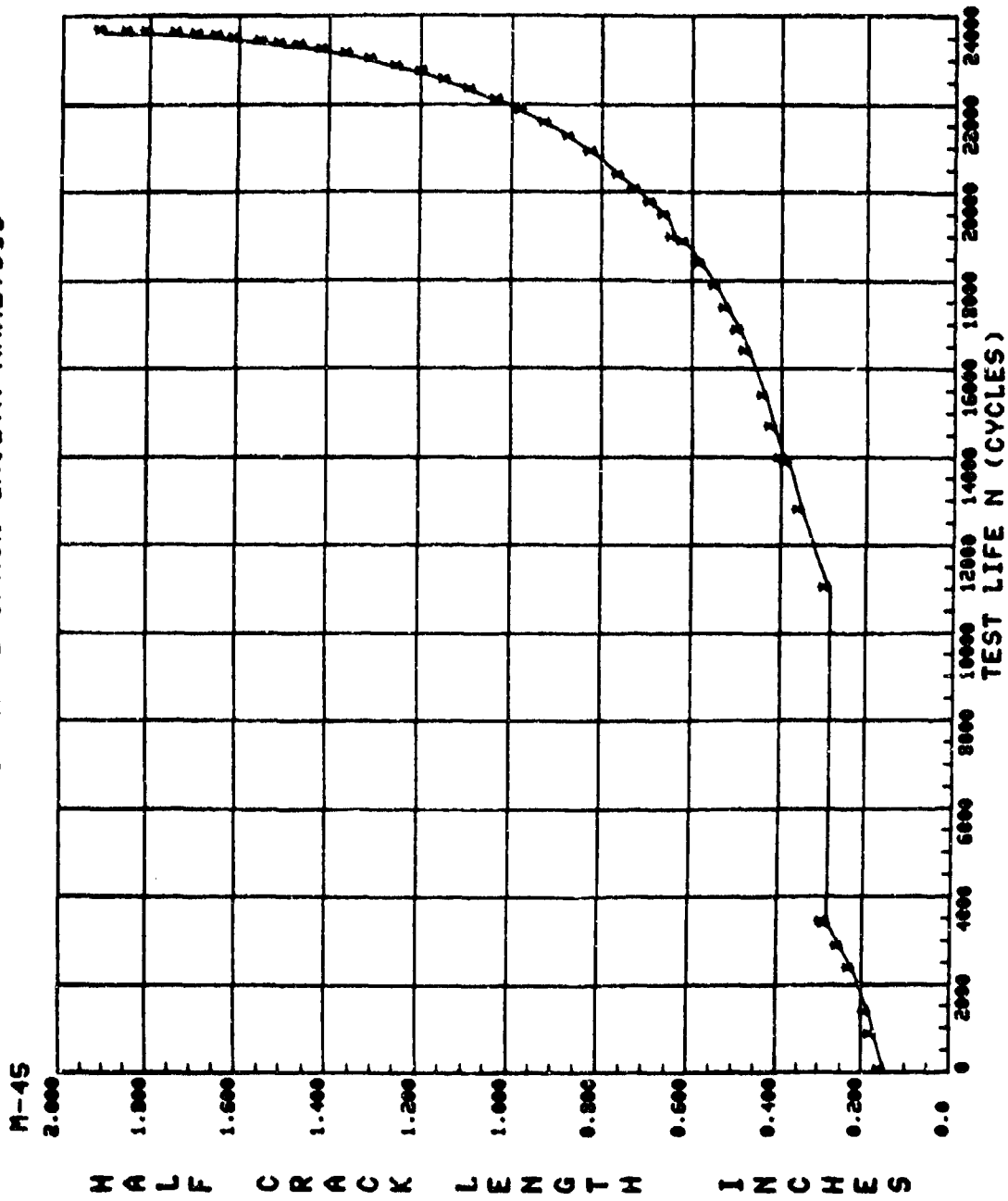

Figure 59. Crack growth curve for test M-45.

TABLE 58. DATA TABULATION FOR TEST M-46

SPECIMEN NO.: M-46		ENVIRONMENT CONDITION: AMBIENT AIR		TEST FREQ= 6.00 HZ.			
CCT	SPECIMEN	R= 0.250 IN.	W= 6.000 IN.	AN= 0.0	IN.		
PMIN=	PMAX=						
NO.	CYCLES	A (MEASURED)	A (REGRESSI CN)	MULT. CORR. COEFF	K-MAX	DELTA K	DA/DN
1	0.	0.300	0.296	0.986324	13.66	9.56	8.527E-05
2	370.	0.355	0.329	0.635731	14.40	10.08	6.438E-07
3	500.	0.390	0.326	0.743231	14.56	10.19	4.402E-07
4	67500.	0.400	0.369	0.792575	15.87	11.11	5.426E-07
5	112800.	0.435	0.478	0.751154	17.40	12.18	1.297E-06
6	114650.	0.465	0.499	0.647542	17.78	12.45	1.769E-06
7	115650.	0.480	0.494	0.985664	17.69	12.38	1.326E-05
8	117650.	0.550	0.542	0.994762	18.54	12.98	1.583E-05
9	118800.	0.575	0.582	0.994726	19.23	13.46	1.747E-05
10	119800.	0.625	0.619	0.995486	19.85	13.90	1.823E-05
11	120300.	0.635	0.638	0.990435	20.16	14.11	1.737E-05
12	121000.	0.665	0.662	0.986527	20.54	14.38	1.939E-05
13	121400.	0.655	0.668	0.993590	20.96	14.67	1.955E-05
14	122800.	0.720	0.730	0.994566	21.61	15.13	2.407E-05
15	123800.	0.785	0.780	0.997297	22.37	15.66	2.966E-05
16	124600.	0.830	0.831	0.997705	23.11	16.18	3.544E-05
17	125100.	0.870	0.870	0.996754	23.68	16.58	4.051E-05
18	125500.	0.900	0.901	0.993434	24.12	16.88	4.180E-05
19	125900.	0.935	0.937	0.991526	24.63	17.24	4.345E-05
20	126200.	0.975	0.964	0.992375	24.99	17.49	4.531E-05
21	126400.	0.975	0.982	0.995400	25.24	17.67	4.671E-05
22	126500.	0.950	0.960	0.996610	25.35	17.75	4.482E-05
23	127260.	1.065	1.057	0.997793	26.26	18.38	5.182E-05
24	128070.	1.145	1.150	0.998505	27.48	19.24	6.541E-05
25	128420.	1.200	1.204	0.998864	28.18	19.73	7.169E-05
26	128840.	1.275	1.276	0.998798	28.98	20.28	7.974E-05
27	129130.	1.312	1.316	0.998934	29.61	20.72	8.458E-05
28	129400.	1.360	1.361	0.996502	30.18	21.12	9.453E-05

TABLE 58. DATA TABULATION FOR TEST M-46 (CONCL.)

SPECIMEN NO.:	M-46						
CCT SPECIMEN	R= 0.750 IN.	W= 6.000 IN.	AA= 0.0 IN.	TEST FREQ= 6.000 HZ.			
PMIN=	PMAX=						
ENVIRONMENT CONDITION: AMBIENT AIR							
NO.	CYCLES	A (MEASURED)	A (REGRESSION)	MULT. CORR. COEFF	K-MAX	DELTA K	DA/DN
29	129660.	1.410	1.409	0.998876	30.77	21.54	1.017F-04
30	129900.	1.455	1.461	0.999281	31.42	21.99	1.138E-04
31	130140.	1.525	1.518	0.999467	32.12	22.49	1.242E-04
32	130570.	1.630	1.633	0.999572	33.53	23.47	1.442E-04
33	130930.	1.745	1.742	0.999741	34.86	24.40	1.651E-04
34	131240.	1.845	1.846	0.999434	36.13	25.29	1.887E-04
35	131520.	1.950	1.956	0.999513	37.47	26.23	2.147E-04
36	131770.	2.065	2.066	0.999919	38.83	27.18	2.356E-04
37	132000.	2.185	2.181	0.999672	40.27	28.19	2.718E-04
38	132200.	2.255	2.292	0.998117	41.67	29.17	3.156E-04
39	132390.	2.405	2.414	0.998882	43.25	30.27	3.583E-04
40	132570.	2.540	2.546	0.999493	45.00	31.50	4.119E-04
41	132750.	2.715	2.705	0.998663	47.18	33.02	5.009E-04
42	132850.	2.800	2.811	0.996786	48.69	34.08	5.884E-04
43	132910.	2.865	2.881	0.996699	49.71	34.80	6.599E-04
44	132970.	2.960	2.956	0.998905	50.84	35.59	7.437E-04
45	133020.	3.045	3.035	0.997908	52.04	36.43	8.646E-04
46	133070.	3.120	3.124	0.996897	53.44	37.41	1.012E-03
47	133120.	3.215	3.221	0.996117	55.05	38.54	1.245E-03
48	133170.	3.350	3.351	0.995966	57.27	40.09	1.680E-03
49	133210.	3.475	3.499	0.988853	55.99	41.99	2.391E-03
50	133235.	3.600	3.625	0.989152	62.47	43.73	3.159E-03
51	133252.	3.710	3.739	0.993794	64.95	45.40	4.336E-03
52	133260.	3.820	3.817	0.994577	66.57	46.60	5.740E-03

PLOTRATE CRACK GROWTH ANALYSIS

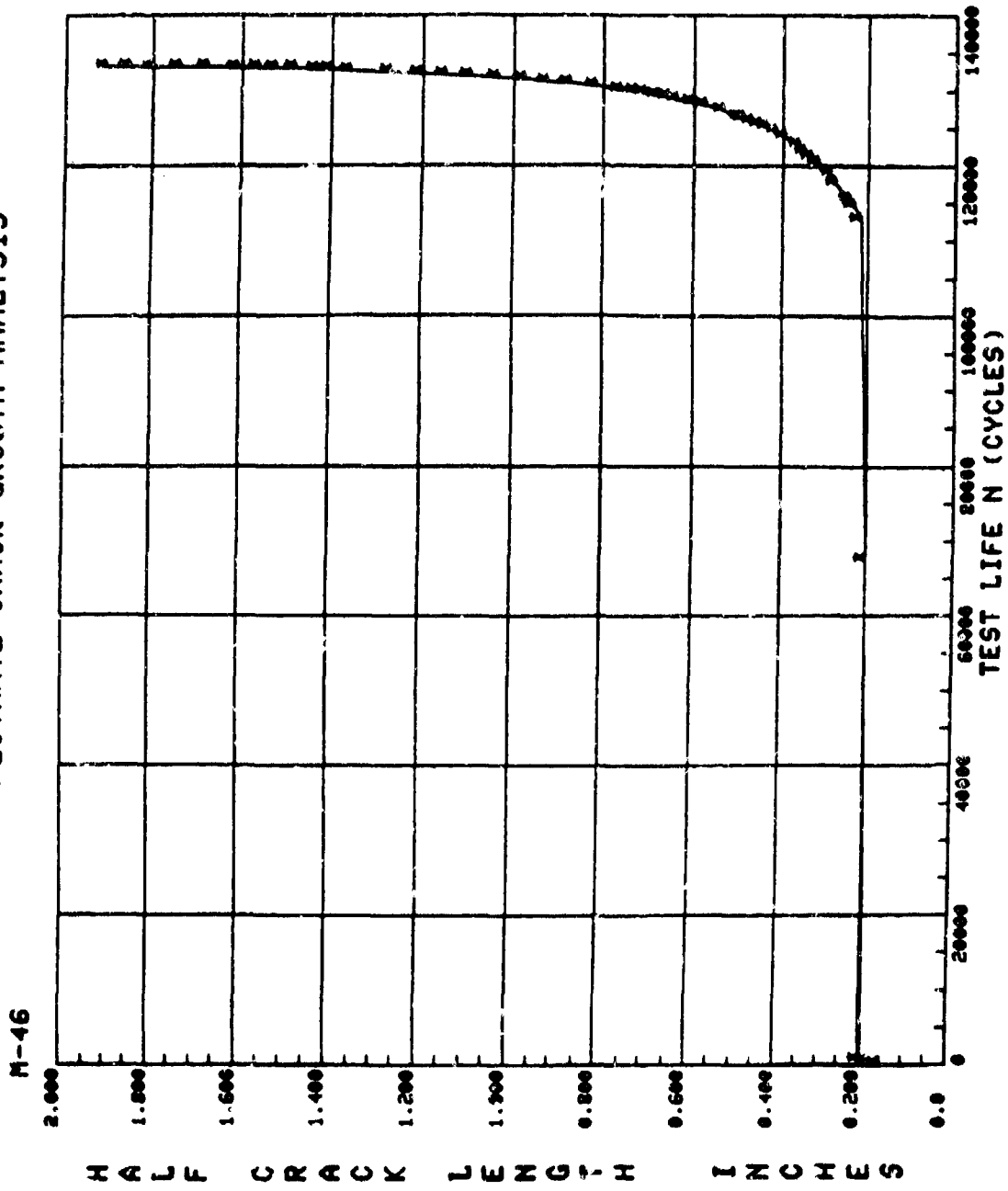

Figure 60. Crack growth curve for test M-46.

TABLE 59. DATA TABULATION FOR TEST M-47

SPECIMEN NO.: M-47

CCT SPECIMEN A= 0.250 IN. W= 6.000 IN. AA= 0.0 IN.
 PHIN= P MAX= TEST FREQ= 6.000 HZ.

ENVIRONMENT CONDITION: AMBIENT AIR

NO.	CYCLES	A (MEASURED)	A (REGRESSION)	MULT. CORR. COEFF	K-MAX	DELTA K	DA/DN
1	0.	0.305	0.306	0.994298	13.89	4.17	5.352E-05
2	200.	0.335	0.321	0.734712	14.23	4.27	4.008E-06
3	500.	0.355	0.332	0.891300	14.48	4.34	2.214E-06
4	16200.	0.430	0.375	0.902142	15.38	4.61	9.232E-07
5	89200.	0.475	0.491	0.934685	17.64	5.29	1.147E-06
6	105700.	0.520	0.529	0.953108	18.31	5.49	1.563E-06
7	122400.	0.575	0.580	0.993031	19.19	5.76	1.920E-06
8	132100.	0.625	0.622	0.990729	19.89	5.97	2.219E-06
9	141200.	0.675	0.664	0.987996	20.58	6.17	2.549E-06
10	152737.	0.705	0.727	0.985266	21.55	6.47	3.059E-06
11	157737.	0.760	0.755	0.989668	21.98	6.59	3.612E-06
12	162737.	0.795	0.790	0.993017	22.51	6.75	4.055E-06
13	167737.	0.835	0.839	0.997392	23.22	6.97	4.679E-06
14	172737.	0.885	0.883	0.999916	23.86	7.16	5.004E-06
15	177737.	0.935	0.936	0.999933	24.61	7.38	5.589E-06
16	182737.	0.995	0.993	0.998783	25.39	7.62	6.429E-06
17	187737.	1.060	1.058	0.998631	26.27	7.88	7.509E-06
18	192737.	1.130	1.137	0.998350	27.31	8.19	9.097E-06
19	197737.	1.230	1.234	0.998415	28.56	8.57	1.174E-05
20	200447.	1.255	1.299	0.999466	29.40	8.82	1.402E-05
21	201951.	1.340	1.343	0.999563	29.94	8.98	1.567E-05
22	203526.	1.355	1.395	0.999997	30.60	9.18	1.856E-05

PLOTRATE CRACK GROWTH ANALYSIS

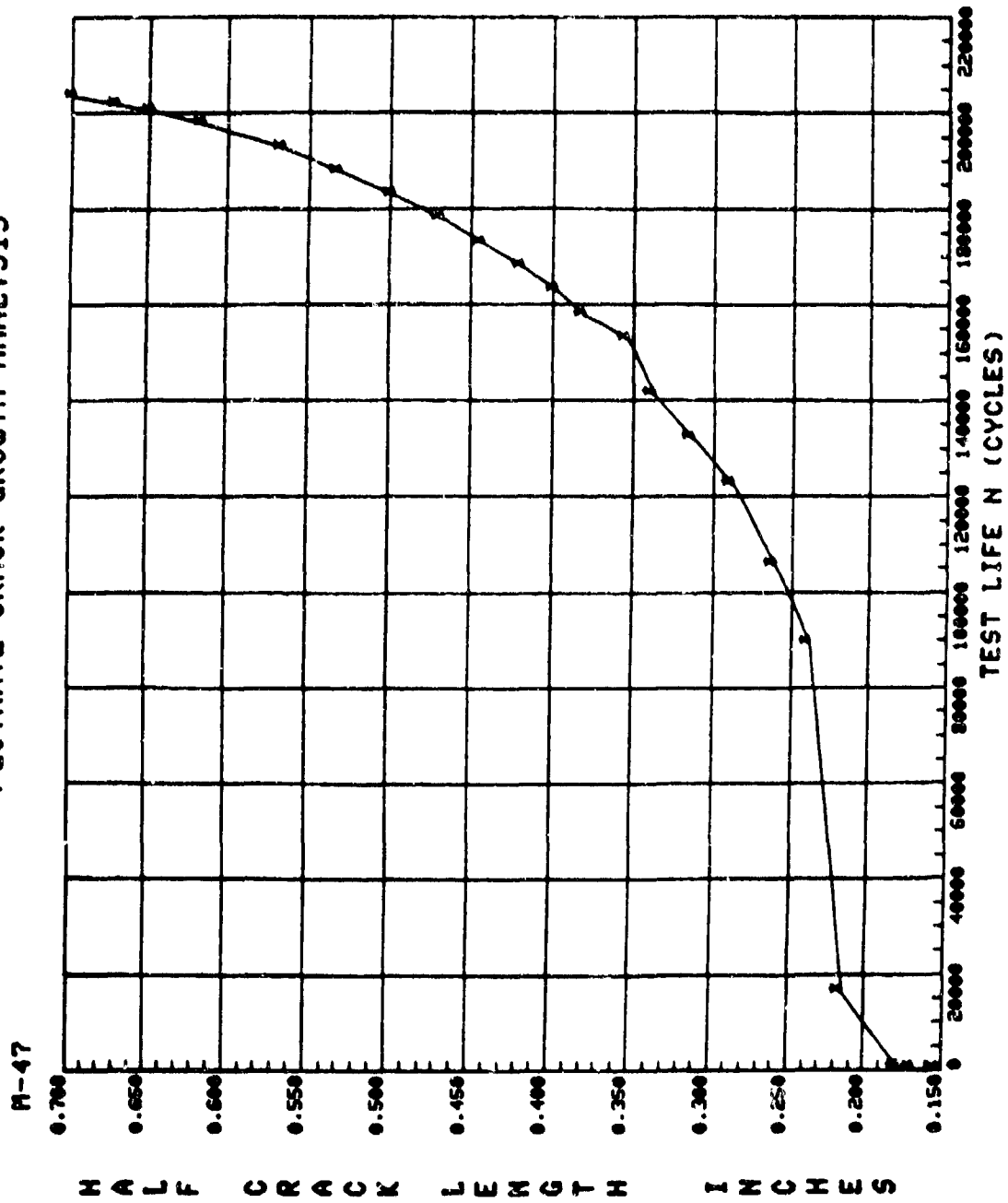

Figure 61. Crack growth curve for test M-47.

TABLE 60. DATA TABULATION FOR TEST M-48

SPECIMEN NO.:	M-48						
CCT SPECIMEN	R = 0.250 IN. W = 6.000 IN. AN = 0.0 IN.						
PMIN =	P MAX =						
ENVIRONMENT CONDITION:	AMBIENT AIR						
NO.	CYCLES	A (MEASURED)	A (REGRESSION)	MULT. CORR. COEFF	K-MAX	DELTA K	DA/DM
1	0.	0.315	0.314	0.985385	28.13	8.44	7.76E-05
2	300.	0.345	0.341	0.941602	29.33	8.80	2.489E-05
3	500.	0.350	0.350	0.962777	29.70	8.91	1.776E-05
4	3000.	0.440	0.437	0.977139	33.24	9.97	2.081E-05
5	5000.	0.520	0.529	0.990948	36.63	10.99	2.872E-05
6	6000.	0.590	0.589	0.997955	38.71	11.61	3.612E-05
7	7000.	0.665	0.667	0.997979	41.26	12.38	4.668E-05
8	7500.	0.705	0.713	0.995239	42.69	12.81	5.781E-05
9	8000.	0.770	0.769	0.998356	44.41	13.32	6.917E-05
10	9500.	0.835	0.840	0.999481	46.50	13.95	8.440E-05
11	9000.	0.935	0.933	0.996634	49.13	14.74	1.072E-04
12	9250.	0.985	0.986	0.998941	50.60	15.18	1.254E-04
13	9500.	1.045	1.050	0.994516	52.32	15.70	1.555E-04
14	9750.	1.125	1.121	0.995301	54.21	16.26	1.997E-04
15	10000.	1.215	1.229	0.997046	57.00	17.10	2.646E-04
16	10200.	1.335	1.342	0.998316	59.88	17.96	3.401E-04
17	10350.	1.455	1.455	0.999996	62.68	18.60	4.392E-04

PLOTRATE CRACK GROWTH ANALYSIS

M-48

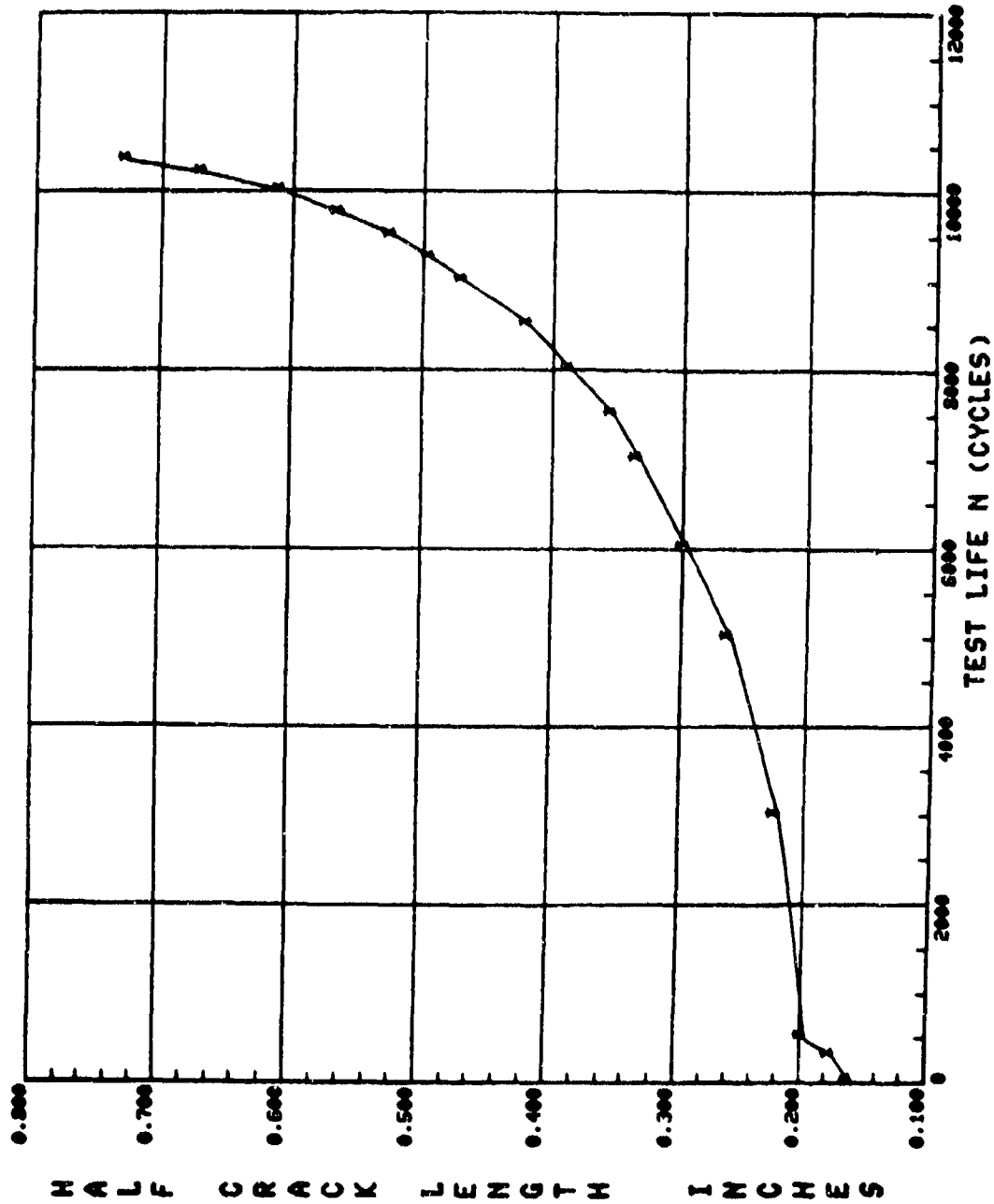

Figure 62. Crack growth curve for test M-48.

TABLE 61. DATA TABULATION FOR TEST M-49

SPECIMEN NO.:	M-49	CCT	SPECIMEN	g = 0.250 IN.	w = 6.000 IN.	AA = 0.0	IN.	TEST FREQ = 6.00 HZ.
PMIN =								
ENVIRONMENT CONDITION:	AMBIENT AIR							
NO.	CYCLES	A(FASLRED)	A(REGRESSION)	MULT. CORR. COEFF	K-MAX	DELTA K	DA/DN	
1	0.	0.310	0.309	0.997162	13.96	9.77	5.737E-06	
2	500.	0.310	0.314	0.998522	14.07	9.85	5.382E-06	
3	4057.	0.365	0.359	0.997511	15.04	10.53	8.150E-06	
4	7100.	0.415	0.417	0.998045	16.24	11.37	1.154E-05	
5	9600.	0.475	0.482	0.997407	17.47	12.23	1.494E-05	
6	11120.	0.530	0.527	0.999595	18.28	12.80	1.757E-05	
7	12598.	0.580	0.583	0.999588	19.24	13.47	2.019E-05	
8	13661.	0.630	0.628	0.999366	19.99	13.99	2.243E-05	
9	14871.	0.680	0.681	0.998862	20.84	14.59	2.585E-05	
10	15794.	0.730	0.733	0.998935	21.65	15.16	2.864E-05	
11	16627.	0.780	0.781	0.999255	22.38	15.67	3.200E-05	
12	17270.	0.830	0.825	0.999309	23.02	16.11	3.465E-05	
13	18229.	0.850	0.894	0.998529	24.02	16.81	3.975E-05	
14	19125.	0.970	0.967	0.998414	25.04	17.53	4.633E-05	
15	19797.	1.025	1.031	0.999244	25.91	18.14	5.199E-05	
16	20279.	1.085	1.083	0.998804	26.61	18.63	5.824E-05	
17	20729.	1.140	1.136	0.998896	27.30	19.11	6.453E-05	
18	21208.	1.155	1.207	0.998946	28.16	19.71	7.272E-05	
19	21663.	1.270	1.269	0.999420	29.02	20.31	8.166E-05	
20	21941.	1.320	1.314	0.998626	29.59	20.71	9.175E-05	
21	22329.	1.385	1.389	0.998429	30.52	21.36	1.080E-04	
22	22610.	1.445	1.448	0.999514	31.26	21.88	1.214E-04	
23	22956.	1.540	1.541	0.998022	32.40	22.68	1.356E-04	
24	23323.	1.650	1.649	0.997441	33.72	23.60	1.593E-04	
25	23511.	1.720	1.709	0.997297	34.45	24.12	1.732E-04	
26	23887.	1.825	1.844	0.997191	36.11	25.27	2.064E-04	
27	24115.	1.945	1.937	0.998434	37.24	26.07	2.361E-04	
28	24357.	2.055	2.057	0.999135	38.72	27.10	2.762E-04	

TABLE 61. DATA TABULATION FOR TEST M-49 (CONCL)

SPECIMEN NO.: 4-49

CCT SPECIMEN B= 0.250 IN. W= 6.000 IN. AN= 0.0 IN.

PHIN= PMAX= TEST FREQ= 6.000 HZ.

ENVIRONMENT CONDITION: AMBIENT AIR

NO.	CYCLES	A (MEASURED)	A (REGRESSI CN)	MULT. CORR. COEFF	K-MAX	DELTA K	DA/DM
29	24531.	2.160	2.160	0.998946	40.01	28.01	3.124E-04
30	24668.	2.245	2.244	0.999796	41.06	28.74	3.437E-04
31	24847.	2.370	2.373	0.999255	42.72	29.91	4.044E-04
32	24993.	2.455	2.495	0.999780	44.32	31.02	4.638E-04
33	25107.	2.600	2.605	0.999750	45.79	32.06	5.265E-04
34	25209.	2.720	2.716	0.999668	47.33	33.13	5.936E-04
35	25302.	2.825	2.828	0.998634	48.94	34.26	6.883E-04
36	25390.	2.950	2.954	0.998806	50.80	35.56	8.025E-04
37	25457.	3.055	3.063	0.999511	52.48	36.73	9.242E-04
38	25504.	3.160	3.151	0.998883	53.90	37.73	1.052E-03
39	25570.	3.290	3.248	0.989092	56.36	39.45	1.437E-03
40	25602.	3.375	3.386	0.990037	57.91	40.54	1.754E-03
41	25639.	3.450	3.523	0.993754	60.46	42.32	2.311E-03
42	25665.	3.660	3.658	0.996140	63.14	44.20	3.276E-03

PLOTRATE CRACK GROWTH ANALYSIS

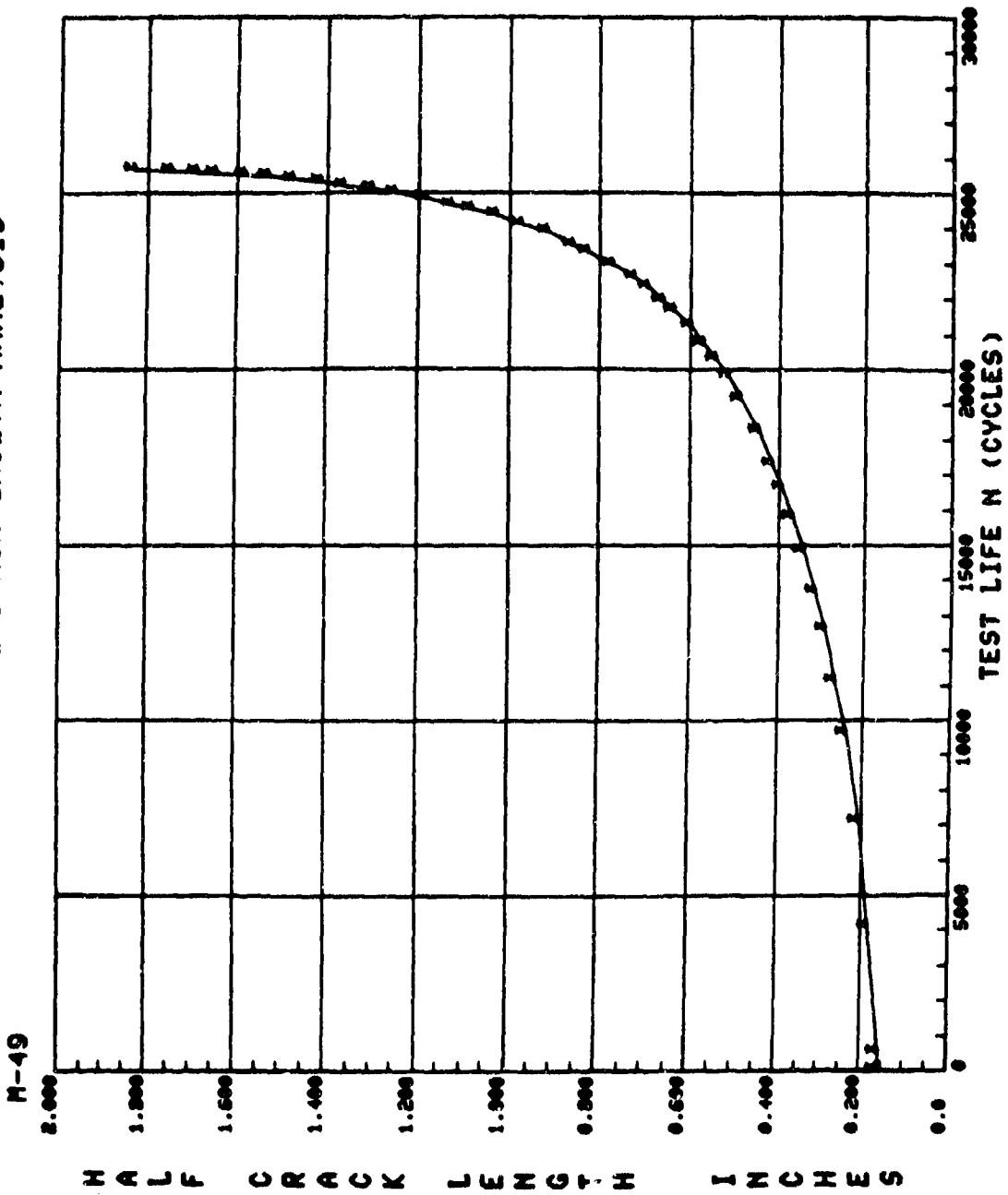

Figure 63. Crack growth curve for test M-49.

TABLE 62. DATA TABULATION FOR TEST M-50

SPECIMEN NO.: M-50		E = 0.750 IN.		W = 6.000 IN.		AN = 0.0 IN.		TEST FREQ = 6.00 HZ.	
ENVIRONMENT CONDITION: AMBIENT AIR		PMIN =	PMAX =						
NO.	CYCLES	A (MEASURED)	A (REGRESSION)	MULT. CORR. COEFF	K-MAX	DELTA K	DA/DM		
1	0.	0.310	0.310	0.998107	27.96	17.59	7.007E-07		
2	500.	0.330	0.323	0.993672	25.54	19.94	3.431E-05		
3	1000.	0.375	0.377	0.986119	30.85	21.54	9.152E-05		
4	1260.	0.420	0.435	0.972000	33.19	23.23	1.447E-04		
5	1430.	0.470	0.483	0.960203	34.99	24.43	2.033E-04		
6	1590.	0.540	0.548	0.977770	37.30	26.11	2.697E-04		
7	1690.	0.615	0.605	0.947814	39.24	27.47	3.195E-04		
8	1750.	0.555	0.653	0.947573	40.81	28.57	3.554E-04		
9	1820.	0.550	0.699	0.996710	42.23	29.56	3.920E-04		
10	1930.	0.745	0.742	0.996153	43.57	30.50	4.606E-04		
11	1980.	0.760	0.759	0.995395	44.99	31.49	5.498E-04		
12	1980.	0.840	0.848	0.998665	45.71	32.70	6.435E-04		
13	2025.	0.910	0.907	0.999100	46.40	33.88	7.591E-04		
14	2065.	0.975	0.972	0.999032	50.23	35.14	8.814E-04		
15	2100.	1.020	1.037	0.998348	51.99	36.39	1.018E-03		
16	2130.	1.100	1.099	0.999060	52.64	37.54	1.191E-03		
17	2150.	1.145	1.147	0.999614	54.90	38.43	1.327E-03		
18	2165.	1.190	1.189	0.998770	55.96	39.10	1.489E-03		
19	2180.	1.235	1.224	0.999198	57.13	39.99	1.620E-03		
20	2195.	1.250	1.256	0.998762	58.45	40.91	1.744E-03		
21	2210.	1.245	1.339	0.999256	59.60	41.86	1.940E-03		
22	2220.	1.350	1.379	0.997322	60.78	42.55	2.134E-03		
23	2230.	1.415	1.420	0.994505	61.83	43.28	2.503E-03		
24	2240.	1.470	1.451	0.993052	62.80	43.82	3.804E-03		
25	2250.	1.525	1.530	0.978237	64.53	45.17	5.655E-03		
26	2260.	1.610	1.654	0.996367	67.56	47.29	8.597E-03		
27	2270.	1.885	1.863	0.994323	72.67	50.67	1.414E-02		

PLOTRATE CRACK GROWTH ANALYSIS

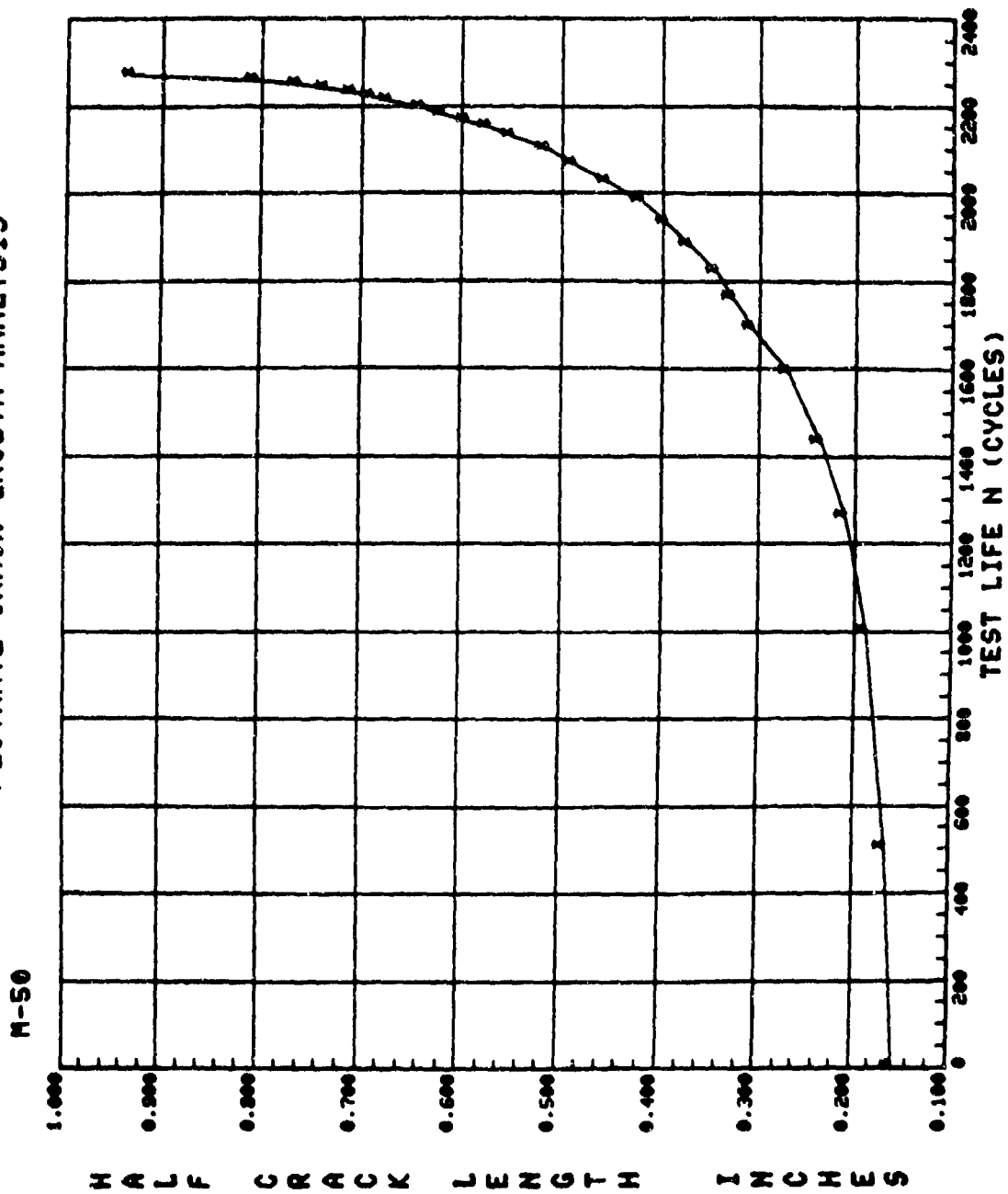

Figure 64. Crack growth curve for test M-50.

TABLE 63. DATA TABULATION FOR TEST M-51

SPECIMEN NO.: M-51		ENVIRONMENT CONDITION: AMBIENT AIR					
CCT	SPECIMEN	$\epsilon = 0.750$ IN.	$\nu = 6.000$ IN.				
PMIN=	PMAX=	R = 0.0.	TEST FREQ= 6.00 HZ.				
NO.	CYCLES	A (MEASURED)	A (REGRESSION)	MULT. CORR. COEFF.	K-MAX	DELTA K	DA/DM
1	0.	0.305	0.306	0.993106	5.55	5.55	2.100E-06
2	9000.	0.355	0.347	0.995866	5.91	5.91	2.627E-06
3	18000.	0.392	0.401	0.997208	6.37	6.37	3.330E-06
4	24000.	0.445	0.444	0.997917	6.70	6.70	3.784E-06
5	36000.	0.495	0.490	0.998289	7.04	7.04	4.383E-06
6	48000.	0.545	0.547	0.998525	7.46	7.46	5.081E-06
7	60000.	0.595	0.608	0.998978	7.87	7.87	5.952E-06
8	72000.	0.645	0.684	0.999598	8.36	8.36	7.044E-06
9	84000.	0.715	0.729	0.999556	8.63	8.63	7.723E-06
10	96000.	0.740	0.776	0.999516	8.92	8.92	8.307E-06
11	57600.	0.815	0.827	0.991230	9.22	9.22	9.655E-06
12	60000.	0.855	0.889	0.990303	9.58	9.58	1.047E-05
13	62700.	0.915	0.948	0.987738	9.91	9.91	1.233E-05
14	63300.	0.975	0.957	0.986474	9.96	9.96	1.213E-05
15	65700.	1.015	1.026	0.983456	10.33	10.33	1.380E-05
16	65600.	1.000	1.046	0.986402	10.45	10.45	1.480E-05
17	65750.	1.105	1.115	0.990322	10.81	10.81	1.611E-05
18	69500.	1.165	1.149	0.987170	10.99	10.99	1.879E-05
19	71900.	1.245	1.234	0.990769	11.42	11.42	2.186E-05
20	72500.	1.255	1.305	0.991370	11.80	11.80	2.622E-05
21	74500.	1.480	1.380	0.994367	12.17	12.17	2.938E-05
22	76500.	1.470	1.479	0.993830	12.66	12.66	3.626E-05
23	77760.	1.595	1.569	0.990231	13.10	13.10	4.571E-05
24	79500.	1.715	1.745	0.978872	13.96	13.96	5.111E-05
25	80750.	1.855	1.895	0.975904	14.69	14.69	5.234E-05
26	81920.	2.105	2.031	0.944047	15.36	15.36	6.343E-05
27	82940.	2.115	2.205	0.874120	16.23	16.23	8.645E-05
28	82550.	2.145	2.253	0.775431	16.98	16.98	1.799E-04

TABLE 63. DATA TABULATION FOR TEST M-51 (CONCL.)

SPECIMEN NO.: M-51		W = 6.250 IN.		AN = 0.0 IN.		TEST FREQ = 6.00 HZ.	
CCT	SPECIMEN	FMAX =	R = 0.0	MULT. CORR. COEFF	K-MAX	DELTA K	DAZDM
ENVIRONMENT CONDITION: AMBIENT AIR							
NO.	CYCLES	A(MEASURED)	A(REGRESSION)	MULT. CORR. COEFF	K-MAX	DELTA K	DAZDM
29	2700.	2.310	2.424	0.883381	17.35	17.35	4.440E-04
30	5700.	2.495	2.493	0.996289	17.72	17.72	8.447E-04
31	5390.	2.515	2.697	0.978571	18.82	18.82	7.386E-04
32	4290.	2.745	2.782	0.992663	19.31	19.31	8.393E-04
33	8400.	2.920	2.882	0.974332	19.89	19.89	9.529E-04
34	6550.	3.135	3.299	0.735525	22.55	22.55	1.293E-04
35	2650.	3.200	3.207	0.764142	22.46	22.46	2.698E-03
36	3650.	3.245	3.309	0.984181	22.62	22.62	5.662E-03
37	3650.	3.625	3.625	0.998329	24.98	24.98	9.414E-03

FROM DATA SUBMITTED TO DDQ

PLOTRATE CRACK GROWTH ANALYSIS

M-51

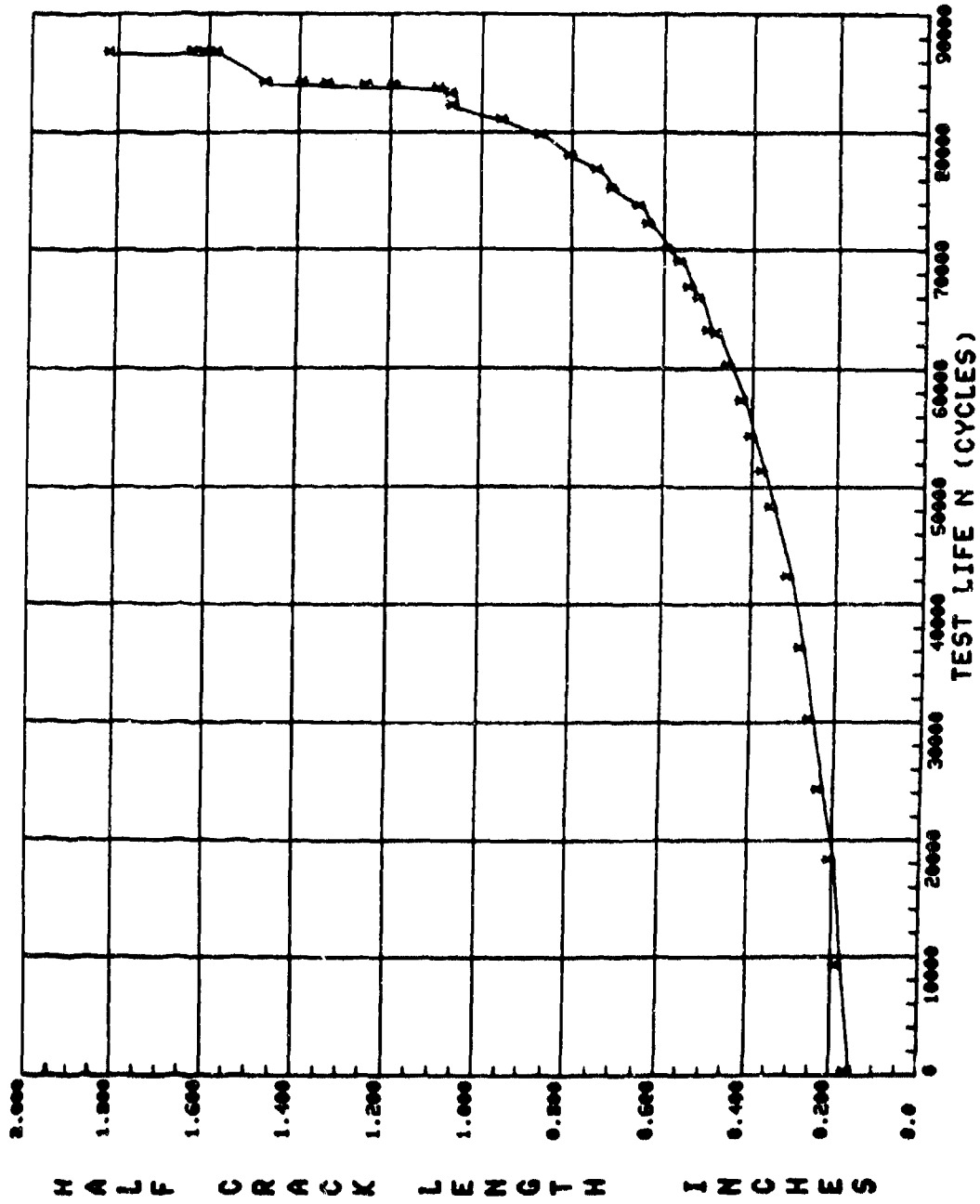

Figure 65. Crack growth curve for test M-51.

TABLE 64. DATA TABULATION FOR TEST M-52

SPECIMEN NO.: M-52		CCT SPECIMEN		ENVIRONMENT CONDITION: AMBIENT AIR		PHIN=		MULTI. CORR. C JEFF		DELTA K		DA/DN	
NO.	CYCLES	A (MEASURED)	A (REGRESSION)	F = C.O	AN = G.C	IN.	TEST FREQ = 5.00 HZ.	K-MAX					
1	0.	0.300	0.300					13.75	1.000000	13.75	1.322E-05		
2	1500.	0.246	0.246					14.78	0.999999	14.78	2.035E-05		
3	2600.	0.461	0.461					15.92	0.999997	15.92	2.681E-05		
4	3600.	0.465	0.460					17.05	0.999979	17.05	3.501E-05		
5	4400.	0.515	0.517					18.10	0.999962	18.10	4.707E-05		
6	5200.	0.575	0.595					19.45	0.999758	19.45	6.192E-05		
7	5800.	0.660	0.573					20.73	0.999064	20.73	8.144E-05		
8	6100.	0.740	0.722					21.48	0.999775	21.48	8.402E-05		
9	6574.	0.800	0.818					22.93	0.999984	22.93	1.023E-04		
10	6674.	0.850	0.843					23.29	0.999743	23.29	1.009E-04		
11	7119.	0.915	0.934					24.58	0.999364	24.58	1.201E-04		
12	7148.	0.970	0.925					24.60	0.999089	24.60	1.272E-04		
13	7570.	1.040	1.088					26.67	0.999292	26.67	1.519E-04		
14	7590.	1.125	1.097					26.79	0.994205	26.79	1.678E-04		
15	7975.	1.175	1.164					27.66	0.999360	27.66	2.157E-04		
16	8201.	1.255	1.362					30.43	0.782370	30.43	4.206E-04		
17	8217.	1.305	1.451					31.29	0.572359	31.29	8.549E-04		
18	8225.	1.475	1.474					31.58	0.999981	31.58	7.845E-03		
19	8232.	1.550	1.584					32.93	0.999471	32.93	1.224E-02		
20	8238.	1.725	1.722					34.62	0.994653	34.62	1.666E-02		

PLOTRATE CRACK GROWTH ANALYSIS

M-52

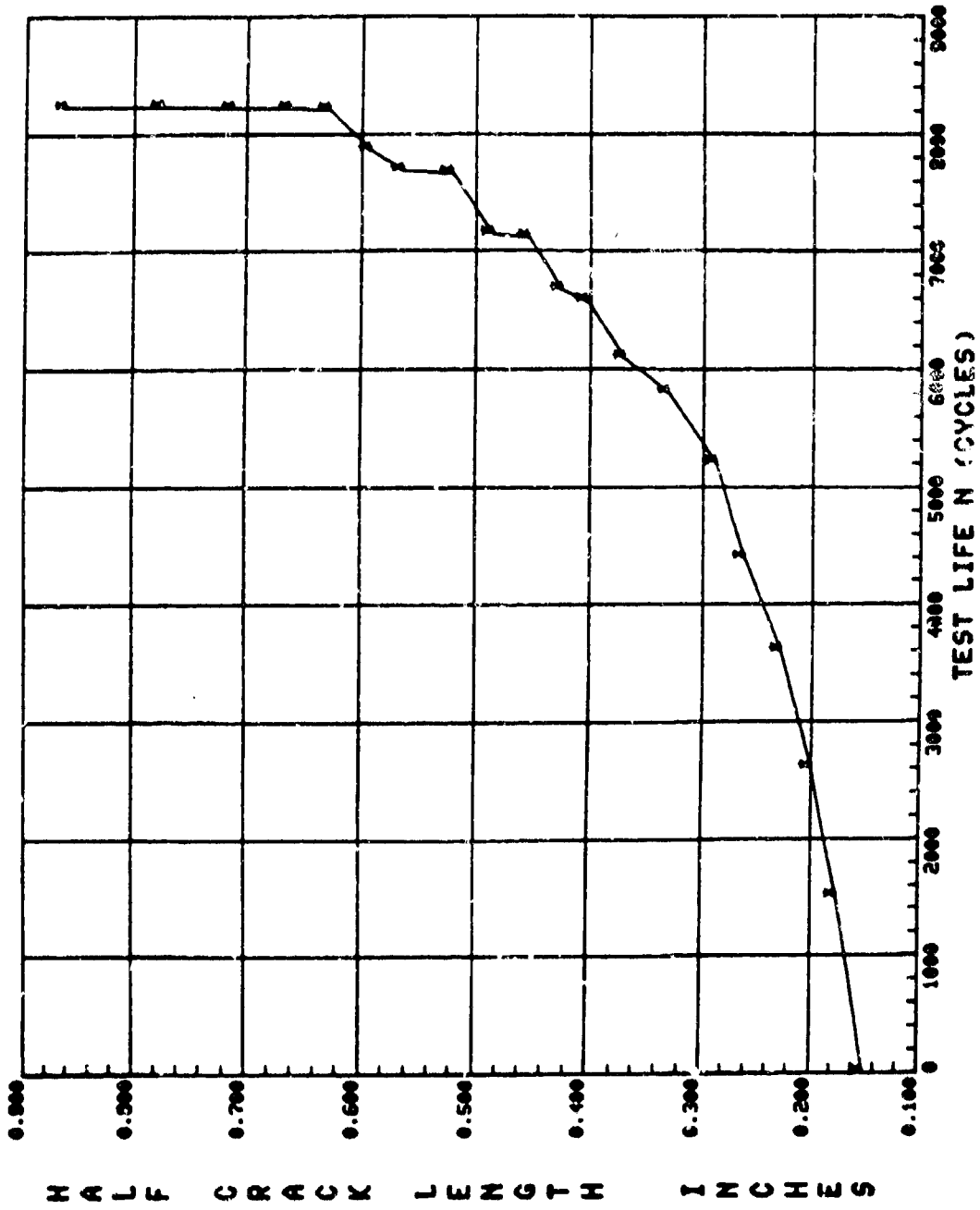

Figure 66. Crack growth curve for test M-52.

TABLE 65. DATA CORRELATION FOR TEST M-53

SPECIMEN NO.: M-53		CCT SPECIMEN		PHIN=		ENVIRONMENT CONDITION: AMBIENT AIR		TEST FREQ= 6.00 HZ.	
		W= 5.000 IN.	H= 0.250 IN.	FMAX=	AN= 0.0 IN.				
NO.	CYCLES	F (MEASURED)	A (REGRESSION)	MULT. CORR. COEFF	K-MAX	DELTA X	UA/DN		
1	0.	0.290	0.290	0.99565	5.41	3.75	4.156E-06		
2	3000.	0.315	0.314	0.990570	5.67	3.97	3.506E-06		
3	5500.	0.335	0.331	0.971477	5.76	4.05	3.020E-06		
4	6000.	0.340	0.333	0.972914	5.80	4.06	2.928E-06		
5	9000.	0.340	0.344	0.976443	5.90	4.13	1.916E-06		
6	15000.	0.370	0.367	0.959023	6.09	4.26	1.750E-06		
7	21000.	0.385	0.364	0.975170	6.24	4.37	2.110E-06		
8	27000.	0.415	0.413	0.932776	6.46	4.52	2.608E-06		
9	32500.	0.420	0.446	0.977671	6.70	4.69	2.700E-06		
10	36000.	0.470	0.446	0.944411	6.87	4.81	2.931E-06		
11	42000.	0.510	0.504	0.95391	7.15	5.00	3.025E-06		
12	47500.	0.520	0.536	0.977186	7.39	5.17	3.298E-06		
13	53500.	0.575	0.573	0.952442	7.63	5.34	4.402E-06		
14	57000.	0.590	0.602	0.933779	7.92	5.43	5.569E-06		
15	59500.	0.600	0.631	0.943129	8.02	5.61	6.119E-06		
16	62000.	0.600	0.660	0.971117	8.33	5.83	6.747E-06		
17	66000.	0.730	0.729	0.949414	8.64	6.04	7.156E-06		
18	69000.	0.770	0.769	0.948115	8.88	6.21	7.227E-06		
19	72000.	0.810	0.810	0.978505	9.12	6.35	7.470E-06		
20	75000.	0.830	0.854	0.949450	9.33	6.55	8.306E-06		
21	79000.	0.905	0.903	0.949752	9.66	6.76	8.809E-06		
22	81000.	0.940	0.960	0.949716	9.66	6.99	9.613E-06		
23	84000.	1.020	1.010	0.966395	10.29	7.21	1.101E-05		
24	87000.	1.090	1.087	0.947111	10.66	7.43	1.195E-05		
25	90000.	1.150	1.162	0.932016	11.06	7.74	1.354E-05		
26	93000.	1.260	1.253	0.933905	11.52	8.07	1.371E-05		
27	95820.	1.325	1.339	0.933941	11.95	8.37	1.611E-05		
28	96000.	1.370	1.331	0.939435	12.02	8.41	1.864E-05		

TABLE 65. DATA TABULATION FOR TEST M-53 (CONCL)

SPECIMEN NO.: M-53		CCI SPECIMEN		ENVIRONMENT CONDITION: AMBIENT AIR		TEST FREQ= 6.00 HZ.	
		B= 0.250 IN.	H= 6.000 IN.	AV= 0.0	IN.		
NO.	CYCLES	A(MEASURED)	A(REGRESSION)	MULT. CORR. COEFF	K-MAX	DELTA K	DA/DN
29	98500.	1.390	1.447	0.935646	12.50	8.75	2.362E-05
30	98891.	1.470	1.463	0.935446	12.58	8.80	2.696E-05
31	99000.	1.515	1.488	0.923463	12.70	8.89	2.503E-05
32	101829.	1.530	1.666	0.940869	13.57	9.50	3.109E-05
33	102000.	1.705	1.654	0.920019	13.56	9.49	3.260E-05
34	104625.	1.770	1.951	0.929420	14.47	10.13	3.518E-05
35	104847.	1.580	1.871	0.917119	14.57	10.20	4.005E-05
36	105000.	1.640	1.878	0.899337	14.61	10.23	4.271E-05
37	107667.	2.070	2.169	0.872125	16.04	11.23	1.201E-04
38	107832.	2.185	2.217	0.863147	16.29	11.40	4.565E-05
39	107977.	2.305	2.229	0.845641	16.35	11.44	4.978E-05
40	108156.	2.325	2.297	0.804021	16.69	11.69	1.460E-04
41	110600.	2.425	2.571	0.795427	18.14	12.70	2.418E-04
42	110700.	2.580	2.599	0.923736	18.29	12.80	6.614E-04
43	110800.	2.725	2.720	0.990328	19.12	13.39	9.340E-04
44	110850.	2.610	2.819	0.991396	19.52	13.67	1.052E-03
45	110950.	3.070	3.046	0.997595	20.89	14.62	1.391E-03
46	111000.	3.200	3.199	0.990707	21.87	15.31	1.633E-03

PLURATE CRACK GROWTH ANALYSIS

M-53

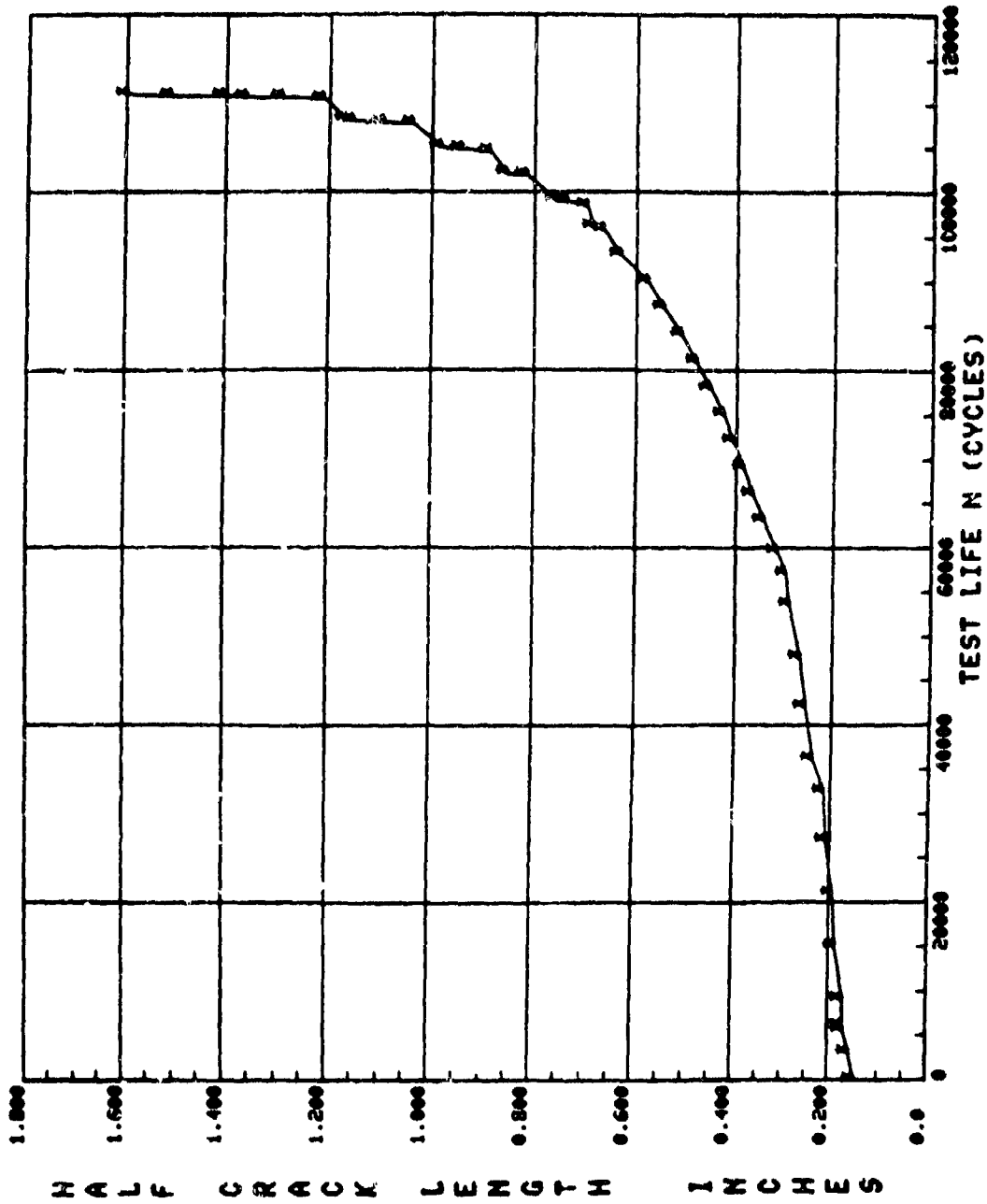

Figure 67. Crack growth curve for test M-53.

TABLE 66. DATA TABULATION FOR TEST M-54

SPECIMEN NO.:	M-4						
GCT	SPECIMEN	B= 0.750 IN.	W= 5.000 IN.	AN= 0.0	IN.		
PMIN=	PMAX=	TEST FREQ= 6.00 HZ.					
ENVIRONMENT CONDITIONS: AMBIENT AIR							
NO.	CYCLES	A (MEASURED)	A (REGRESSION)	MULT. CORR. COEFF	K-MAX	DELTA K	DA/DM
1	0.	0.300	0.300	1.00000	13.75	9.62	2.603E-05
2	500.	0.375	0.322	0.99623	14.25	9.98	2.091E-05
3	1644.	0.420	0.365	0.99454	15.19	10.63	2.027E-05
4	2337.	0.465	0.438	0.99546	16.65	11.65	2.280E-05
5	4421.	0.510	0.455	0.99492	17.59	12.31	2.746E-05
6	4982.	0.555	0.518	0.99527	18.13	12.69	3.367E-05
7	5515.	0.595	0.555	0.99623	18.76	13.13	3.627E-05
8	6064.	0.640	0.592	0.99602	19.41	13.56	4.836E-05
9	6613.	0.685	0.649	0.99138	20.33	14.23	5.906E-05
10	7237.	0.725	0.749	0.98136	21.90	15.33	8.687E-05
11	7709.	0.750	0.818	0.97594	22.92	16.04	9.072E-05
12	8222.	0.800	0.923	0.96924	24.42	17.09	1.104E-04
13	8297.	0.880	0.953	0.92921	24.85	17.39	1.254E-04
14	8761.	1.070	1.104	0.82273	26.87	18.81	2.052E-04
15	8771.	1.070	1.125	0.69133	27.16	19.01	6.820E-04
16	8781.	1.140	1.139	0.76093	27.33	19.13	2.122E-04
17	8792.	1.200	1.195	0.95102	26.07	19.65	2.711E-03
18	8806.	1.255	1.228	0.90575	28.49	19.94	2.307E-03
19	9309.	1.405	1.517	0.88067	32.10	22.47	2.322E-04
20	9314.	1.515	1.530	0.85776	32.26	22.58	5.191E-03
21	9316.	1.575	1.571	0.99836	32.77	22.94	1.241E-02

PLOTRATE CRACK GROWTH ANALYSIS

N-54

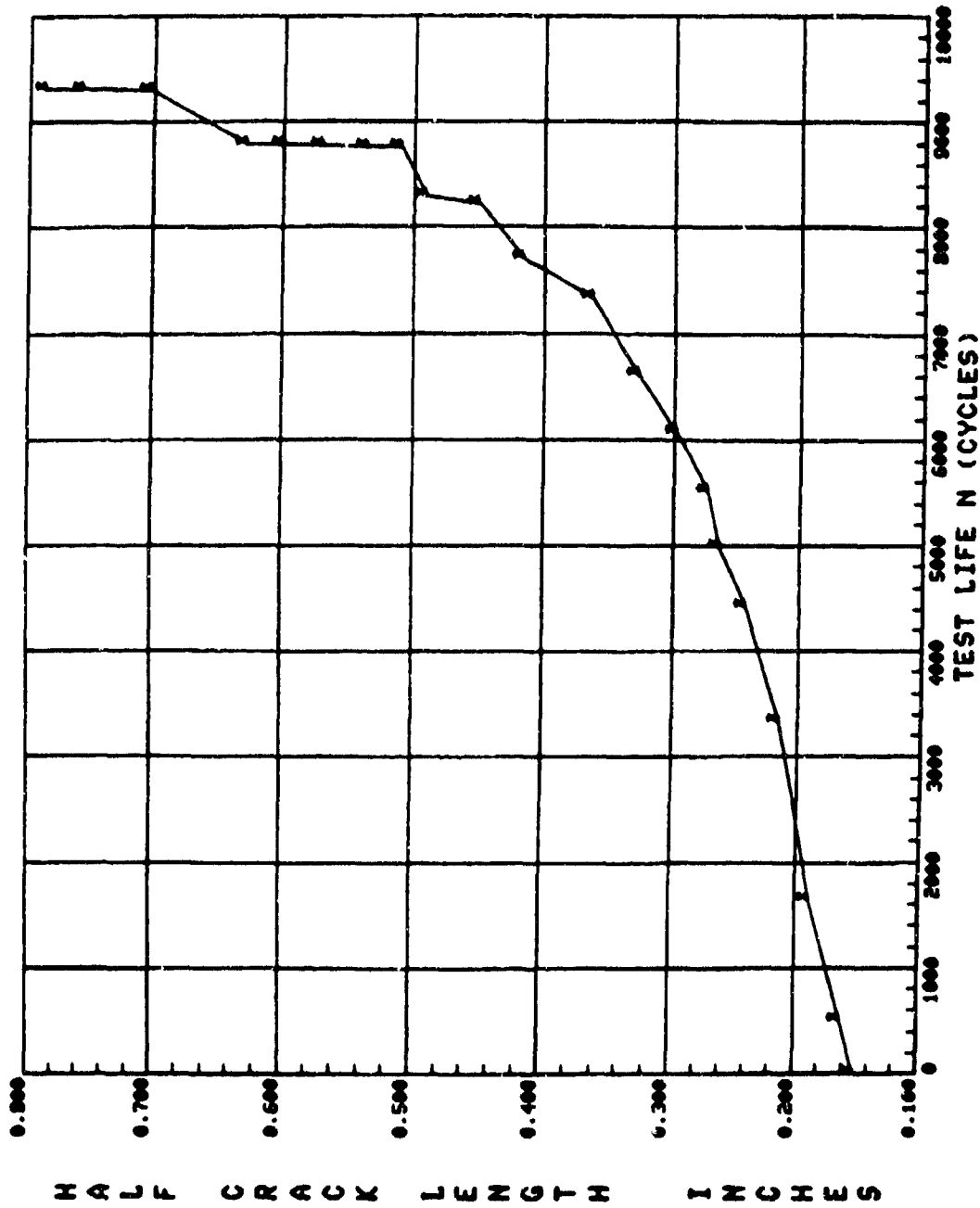

Figure 68. Crack growth curve for test M-54.

TABLE 67. DATA TABULATION FOR TEST M-55

SPECIMEN NO.:	M-55						
CCI SPECIMEN	E = 0.250 IN.	W = 6.000 IN.	AN = C.O.	IN.			
PHIN =	PMAX =	TEST FREQ = 5.00 HZ.					
ENVIRONMENT CONDITION: AMBIENT AIR							
NO.	CYCLES	A (MEASURED)	A (REGRESSION)	MULT. CORR. COEFF	K-MAX	DELTA K	DA/DN
1	0.	0.313	0.313	0.999653	14.04	14.04	2.112E-07
2	7900.	0.325	0.334	0.961949	14.51	14.51	1.431E-06
3	13000.	0.340	0.339	0.865194	14.62	14.62	7.136E-07
4	20000.	0.375	0.342	0.902307	14.65	14.65	3.092E-07
5	110000.	0.555	0.395	0.942072	15.80	15.80	3.640E-07
6	143000.	0.415	0.418	0.972504	16.26	16.26	4.796E-07
7	182986.	0.460	0.460	0.995674	17.07	17.07	6.185E-07
8	203000.	0.455	0.458	0.992640	17.58	17.58	6.368E-07
9	223000.	0.525	0.516	0.996297	18.09	18.09	5.680E-07
10	240000.	0.540	0.537	0.992418	18.45	18.45	7.425E-07
11	270000.	0.580	0.583	0.994102	19.25	19.25	8.316E-07
12	300000.	0.620	0.623	0.997616	20.07	20.07	9.892E-07
13	323000.	0.715	0.706	0.996629	21.24	21.24	1.155E-06
14	345166.	0.720	0.728	0.996635	21.72	21.72	1.174E-06
15	367300.	0.800	0.793	0.997261	22.55	22.55	1.251E-06
16	385000.	0.835	0.825	0.997210	23.17	23.17	1.302E-06
17	405000.	0.855	0.869	0.996599	23.94	23.94	1.453E-06
18	425000.	0.945	0.943	0.995582	24.71	24.71	1.635E-06
19	445000.	1.010	1.014	0.999623	25.65	25.65	1.866E-06
20	469000.	1.070	1.069	0.999412	26.41	26.41	2.122E-06
21	471000.	1.125	1.121	0.999132	27.10	27.10	2.359E-06
22	486200.	1.190	1.194	0.996070	28.05	28.05	2.957E-06
23	499600.	1.270	1.273	0.958471	29.06	29.06	3.457E-06
24	507000.	1.320	1.324	0.949727	29.70	29.70	3.874E-06
25	517400.	1.515	1.512	0.930701	30.80	30.80	5.264E-06
26	522600.	1.540	1.546	0.991602	31.48	31.48	5.675E-06
27	527800.	1.510	1.525	0.992757	32.24	32.24	6.463E-06
28	523000.	1.525	1.525	0.991025	33.06	33.06	7.483E-06

TABLE 67. DATA TABULATION FOR TEST M-55 (CONCL)

SPECIMEN NO.: M-55		W = 6.000 IN.		AN = 0.0 IN.		TEST FEFO = 6.00 HZ.						
CCT SPECIMEN	8 = 0.550 IN.	PMAX =	PMIN =	ENVIRONMENT CONDITION: AMBIENT AIR	NO.	CYCLES	A (MEASURED)	A (REGRESSION)	MULT. CORR. COEFF	K-MAX	DELTA K	DAY/DN
					29	540800.	1.705	1.724	0.990071	34.64	34.64	9.692E-06
					30	544000.	1.815	1.831	0.988493	35.94	35.94	1.173E-05
					31	546600.	1.895	1.889	0.999556	36.65	36.65	1.468E-05
					32	551042.	1.945	1.945	0.999351	37.59	37.59	1.632E-05

PLOTRATE CRACK GROWTH ANALYSIS

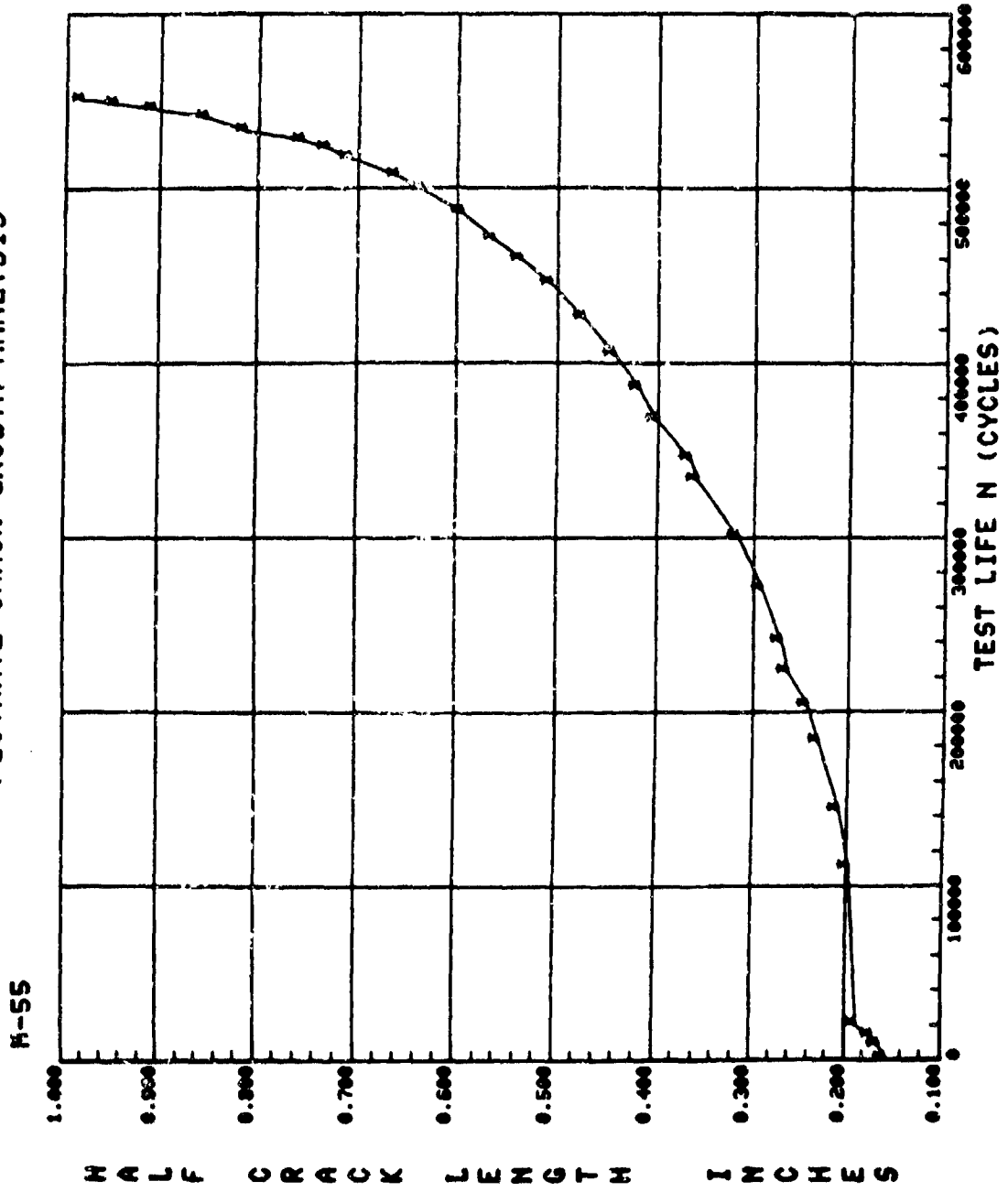

Figure 69. Crack growth curve for test M-55.

TABLE 68. DATA TABULATION FOR TEST M-56

SPECIMEN NO.: M-56

CCT SPECIMEN 6 = 0.250 IN. W = 6.000 IN. AN = 0.0 IN.

PMIN= PMAX= TEST FREQ= 6.00 HZ.

ENVIRONMENT CONDITION: AMBIENT AIR

NO.	(CYCLES	A (MEASURED)	A (REGRESSION)	MULT. CORR. COEFF	K-MAX	DELTA K	DA/DM
1	C.	0.308	0.306	0.984264	13.90	13.90	2.391E-05
2	1600.	0.350	0.372	0.932112	15.34	15.34	1.968E-05
3	2545.	0.425	0.405	0.987364	16.00	16.00	1.872E-05
4	3112.	0.480	0.500	0.990708	17.79	17.79	1.781E-05
5	5694.	0.575	0.520	0.989990	18.15	18.15	1.741E-05
6	7745.	0.595	0.585	0.982886	19.28	19.28	1.651E-05
7	10220.	0.575	0.678	0.932847	20.79	20.79	2.133E-05
8	12450.	0.720	0.775	0.952503	22.29	22.29	2.832E-05
9	12918.	0.785	0.801	0.941614	22.68	22.68	3.517E-05
10	13070.	0.865	0.805	0.919589	22.73	22.73	3.795E-05
11	15520.	0.960	1.056	0.936819	26.27	26.27	4.008E-05
12	15540.	1.070	1.056	0.918623	26.24	26.24	4.420E-05
13	15610.	1.120	1.061	0.859168	26.31	26.31	4.590E-05
14	16104.	1.220	1.358	0.738418	30.50	30.50	-1.126E-04
15	16114.	1.335	1.445	0.561292	31.22	31.22	1.128E-03
16	16170.	1.420	1.501	0.947409	31.91	31.91	1.109E-02
17	16125.	1.560	1.579	0.995637	32.67	32.67	1.626E-02
18	16129.	1.720	1.714	0.997467	34.51	34.51	2.080E-02
19	16135.	1.840	1.847	0.995964	36.14	36.14	2.368E-02

THIS PAGE IS BEST QUALITY PRINTING
FROM COPY FURNISHED TO DDC

M-56
PLOT RATE CRACK GROWTH ANALYSIS

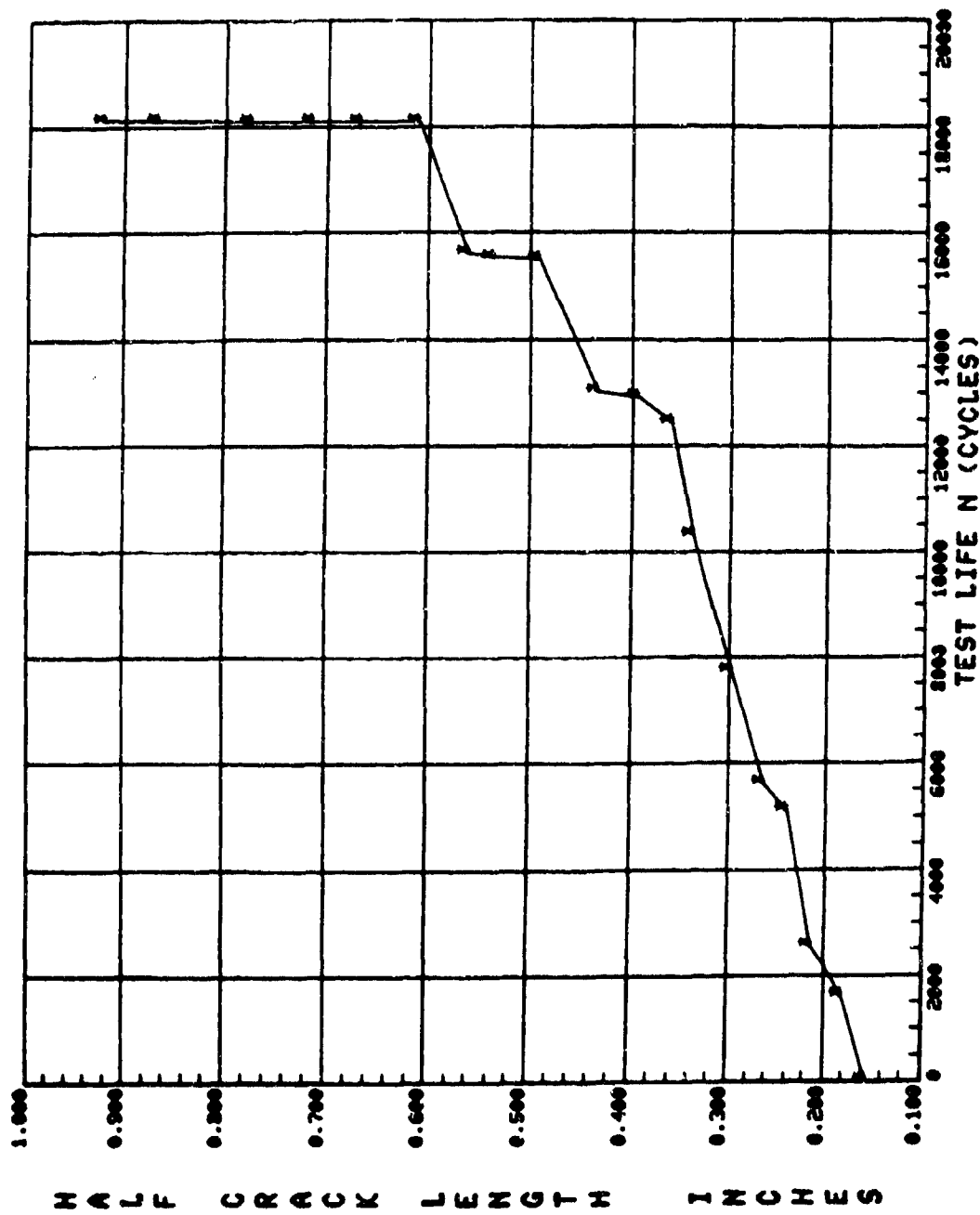

Figure 70. Crack growth curve for test M-56.

TABLE 69. DATA TABULATION FOR TEST M-57

SPECIMEN NO.: M-7		W = 5.000 IN.		AN = 0.0 IN.		TEST FREQ = 6.00 HZ.	
FCT SPECIMEN		E = 0.250 IN.		WMAX =		WMIN =	
ENVIRONMENT CONDITIONS: AM3 - VI AIP							
NO.	CYCLES	F (MEASURED)	A (REGRESSION)	MULT. CORR. COEFF	K-MAX	DELTA K	DAZDM
1	0.	0.390	0.289	0.979108	26.97	35.07	2.885E-05
2	1600.	0.370	0.364	0.983856	30.30	39.38	2.092E-05
3	2500.	0.425	0.395	0.981491	31.60	41.08	1.793E-05
4	5090.	0.560	0.469	0.976818	34.44	44.78	1.551E-05
5	7000.	0.515	0.537	0.984024	36.91	47.99	1.548E-05
6	9110.	0.580	0.582	0.995597	38.46	49.99	1.553E-05
7	10500.	0.645	0.632	0.972610	40.12	52.16	1.907E-05
8	12900.	0.720	0.735	0.974667	43.35	56.36	2.178E-05
9	15370.	0.815	0.827	0.965448	46.97	61.06	2.882E-05
10	15620.	0.905	0.858	0.933910	47.00	61.10	3.365E-05
11	17840.	0.945	1.067	0.833640	52.77	68.60	6.103E-05
12	18175.	1.055	1.102	0.824265	53.70	69.81	6.782E-05
13	18185.	1.135	1.088	0.941338	53.33	69.32	9.271E-05
14	18190.	1.200	1.090	0.961066	53.38	69.40	5.166E-05
15	19445.	1.355	1.288	0.983426	58.51	76.06	1.459E-04
16	20757.	1.905	1.905	0.993216	73.69	95.80	3.342E-04

PLOTRATE CRACK GROWTH ANALYSIS

M-57

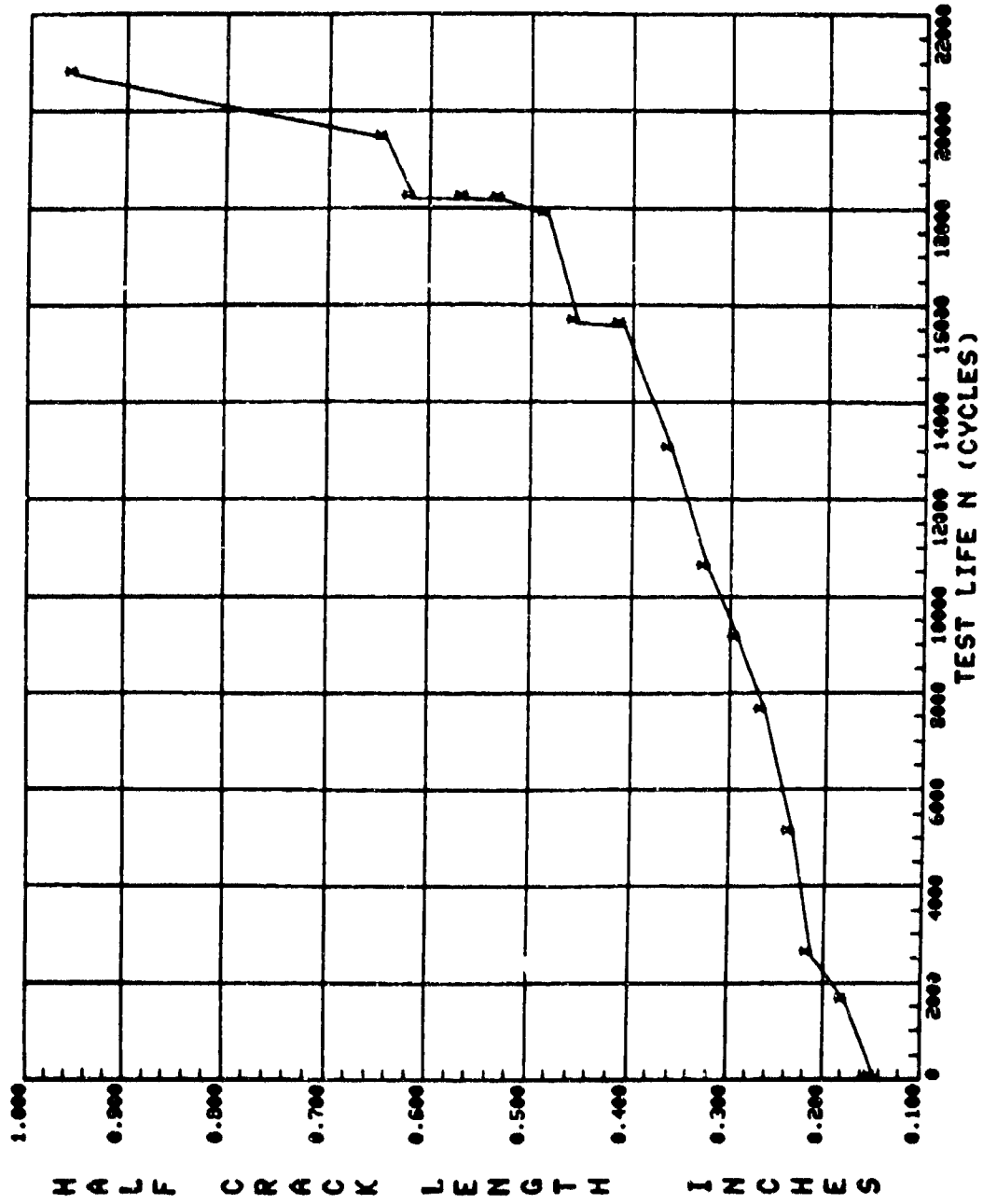

Figure 71. Crack growth curve for test M-57.

TABLE 70. DATA TABULATION FOR TEST M-58

SPECIMEN NO.: M-58		CCI SPECIMEN		ENVIRONMENT CONDITION: AMBIENT AIR		TEST FREQ= 6.00 HZ.	
		B= 0.250 IN.	W= 6.000 IN.	AV= 0.0	IN.		
PMIN=	PMAX=						
NO.	CYCLES	A (MEASURED)	A (REGRESSION)	MULT. CORR. COEFF	K-MAX	DELTA K	DA/DN
1	0.	0.305	0.305	0.97032	27.71	31.87	2.914E-05
2	717.	0.340	0.333	0.917268	29.97	33.32	2.264E-05
3	2000.	0.405	0.416	0.823051	32.42	37.28	5.987E-05
4	2500.	0.415	0.512	0.747817	36.03	41.43	1.101E-04
5	2550.	0.490	0.552	0.709693	37.42	43.04	2.326E-04
6	2600.	0.570	0.578	0.955909	38.33	44.06	9.924E-04
7	2630.	0.630	0.633	0.998028	40.17	46.19	1.186E-03
8	2660.	0.700	0.705	0.998732	42.45	48.61	1.449E-03
9	2690.	0.795	0.797	0.999490	45.22	52.00	1.820E-03
10	2705.	0.850	0.851	0.997774	46.80	53.83	2.197E-03
11	2723.	0.930	0.930	0.955445	49.04	56.40	3.171E-03
12	2735.	0.990	0.989	0.979851	50.69	58.28	4.289E-03
13	2750.	1.100	1.131	0.893295	54.47	62.64	8.118E-03
14	2767.	1.330	1.485	0.902184	63.43	72.95	1.711E-02
15	2772.	1.505	1.690	0.907675	68.44	78.70	2.627E-02
16	2774.	1.675	1.850	0.954914	72.36	83.22	5.170E-02

PLOTRATE CRACK GROWTH ANALYSIS

M-58

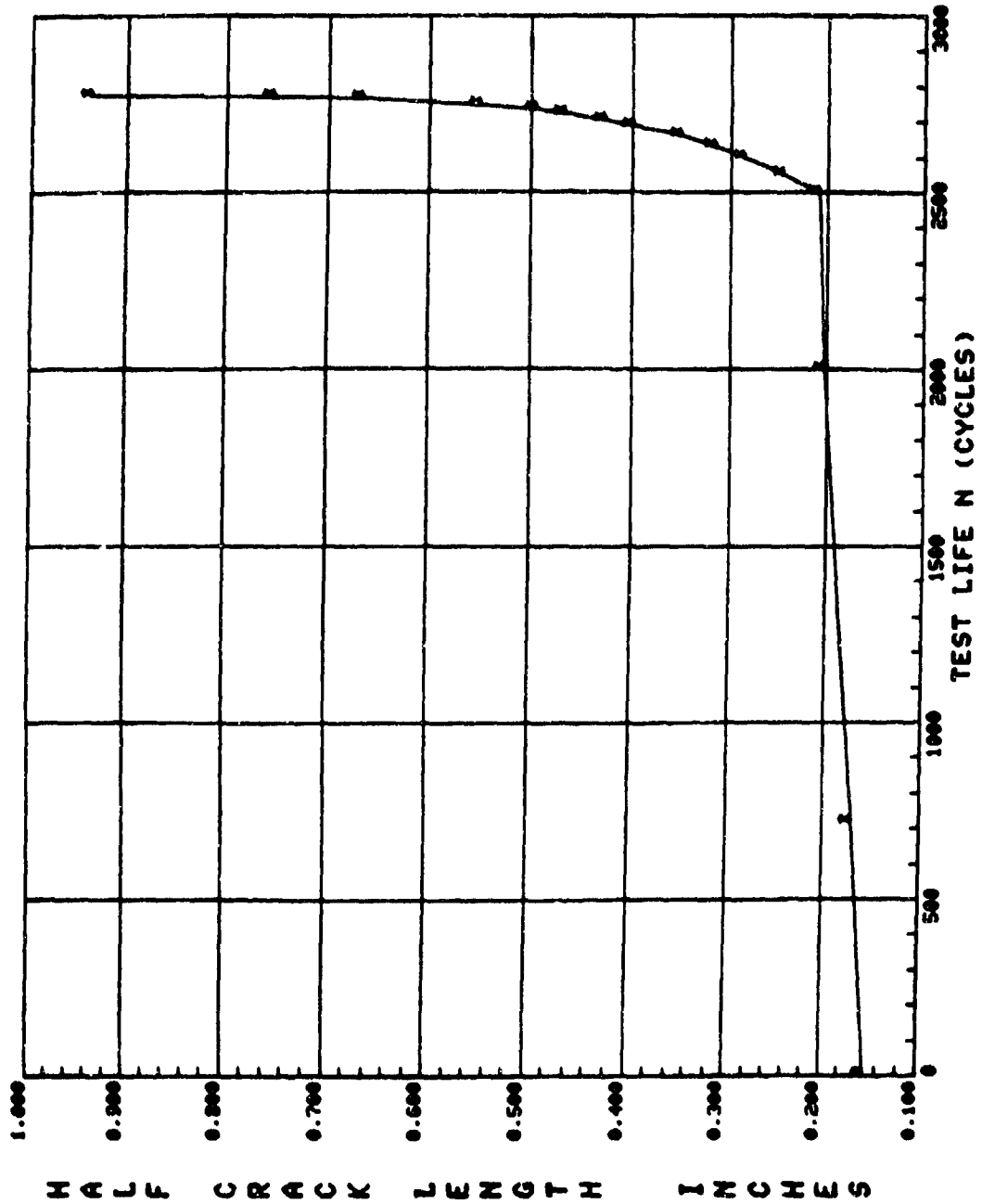

Figure 72. Crack growth curve for test M-58.

TABLE 71. DATA TABULATION FOR TEST M-59

SPECIMEN NO.: M-59

FACT SPECIMEN E = 0.250 IN.

W = 6.000 IN.

AN = 0.3 IN.

PMIN =

PMAX =

TEST FREQ = 6.000 HZ.

ENVIRONMENT CONDITION: AMBIENT AIR

NO.	CYCLES	A (MPASUR'D)	A (RECK'SSION)	MULT. CORR. COEFF	K-MAX	DELTA K	JA/ON
1	0.	0.315	0.315	0.999991	21.14	22.63	6.253E-05
2	5265.	0.350	0.351	0.999798	22.33	24.12	6.778E-05
3	5751.	0.425	0.424	0.995744	24.56	26.53	8.668E-05
4	6000.	0.445	0.475	0.975233	26.02	28.10	1.070E-04
5	6292.	0.515	0.531	0.977267	27.53	29.73	1.591E-04
6	6500.	0.550	0.589	0.952195	29.03	31.35	2.171E-04
7	6700.	0.670	0.684	0.965115	31.35	33.85	3.034E-04
8	6807.	0.765	0.753	0.966498	32.94	35.57	3.789E-04
9	6878.	0.800	0.813	0.989968	34.28	37.02	4.936E-04
10	6910.	0.835	0.844	0.955357	34.96	37.75	4.997E-04
11	6940.	0.870	0.873	0.936026	35.59	38.43	5.102E-04
12	6980.	0.940	0.921	0.993640	36.60	39.53	5.970E-04
13	7050.	0.995	1.002	0.993001	38.28	41.34	6.354E-04
14	7100.	1.000	1.063	0.942952	39.51	42.68	7.334E-04
15	7150.	1.125	1.137	0.995324	40.97	44.24	8.757E-04
16	7180.	1.140	1.142	0.999392	42.05	45.41	9.975E-04
17	7210.	1.240	1.254	0.993193	43.23	46.69	1.144E-03
18	7240.	1.320	1.324	0.997341	44.56	48.13	1.366E-03
19	7270.	1.405	1.410	0.978590	45.18	49.87	1.609E-03
20	7290.	1.475	1.475	0.999372	47.33	51.17	1.851E-03
21	7310.	1.560	1.549	0.994525	48.76	52.66	2.310E-03
22	7330.	1.675	1.640	0.955306	50.43	54.46	2.867E-03
23	7350.	1.745	1.757	0.995695	52.57	56.77	3.839E-03
24	7370.	1.920	1.923	0.986354	55.61	60.06	6.214E-03
25	7380.	2.025	2.049	0.977998	57.93	62.56	8.797E-03
26	7390.	2.170	2.232	0.91655	61.36	66.27	1.219E-02
27	7400.	2.450	2.510	0.985325	66.78	72.13	1.961E-02
28	7402.	2.610	2.600	0.950276	68.60	74.09	2.548E-02

PLOTRATE CRACK GROWTH ANALYSIS

M-59

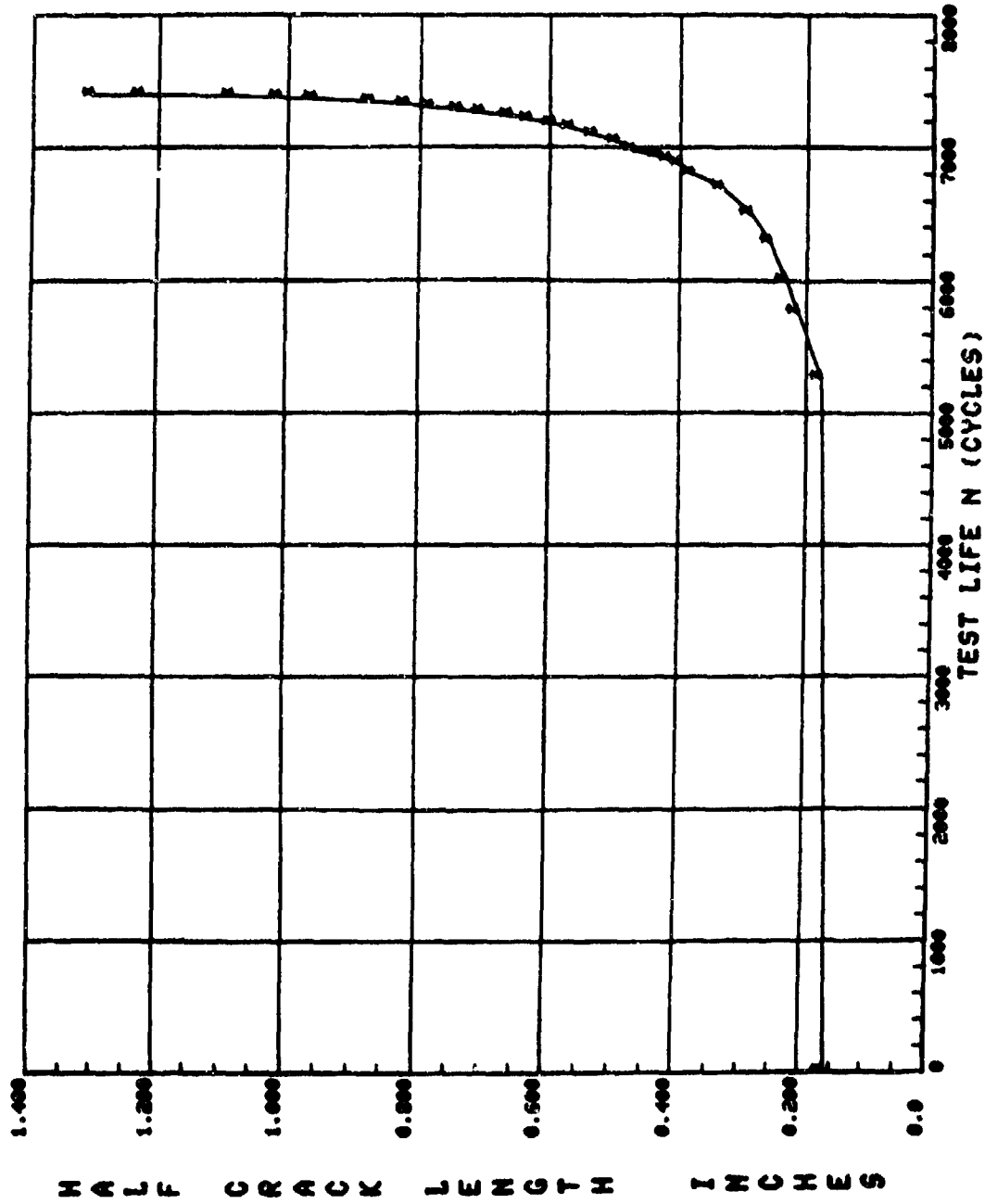

Figure 73. Crack growth curve for test M-59.

TABLE 72. DATA TABULATION FOR TEST M-60

SPECIMEN NO.: M-60		CCT SPECIMEN		ENVIRONMENT CONDITION: AMBIENT AIR		TEST FREQ= 6.00 HZ.	
PRIN=	PMAX=	B= 0.250 IN.	M= 6.000 IN.	AN= 0.0	IM=		
NO.	CYCLES	A (MEASURED)	A (REGRESSION)	MULT. CORR. COEFF	K-MAX	DELTA K	DAZOM
1	0.	0.300	0.300	0.999838	5.50	16.50	1.375E-06
2	21000.	0.360	0.354	0.996260	5.98	17.94	1.413E-06
3	34250.	0.395	0.391	0.994676	6.28	18.85	1.458E-06
4	56000.	0.460	0.473	0.994599	6.92	20.76	2.232E-06
5	68300.	0.525	0.526	0.998991	7.31	21.92	2.779E-06
6	76000.	0.575	0.571	0.999223	7.61	22.84	3.175E-06
7	84000.	0.625	0.625	0.997179	7.98	23.94	3.769E-06
8	91000.	0.675	0.678	0.997562	8.32	24.95	4.415E-06
9	98000.	0.735	0.741	0.998699	8.71	26.14	5.178E-06
10	102500.	0.795	0.790	0.993944	9.01	27.02	6.334E-06
11	107100.	0.850	0.852	0.994227	9.37	28.11	7.196E-06
12	108812.	0.865	0.877	0.990441	9.51	28.53	8.113E-06
13	110600.	0.910	0.894	0.991529	9.61	28.82	8.250E-06
14	116000.	0.945	1.006	0.991253	10.24	30.71	1.144E-05
15	118055.	1.065	1.057	0.990468	10.50	31.50	1.207E-05
16	119254.	1.065	1.065	0.993638	10.65	31.95	1.309E-05
17	120486.	1.125	1.123	0.993644	10.85	32.56	1.374E-05
18	122163.	1.160	1.166	0.995089	11.08	33.23	1.547E-05
19	123182.	1.200	1.199	0.992705	11.25	33.74	1.642E-05

PLOTRATE CRACK GROWTH ANALYSIS

M-60

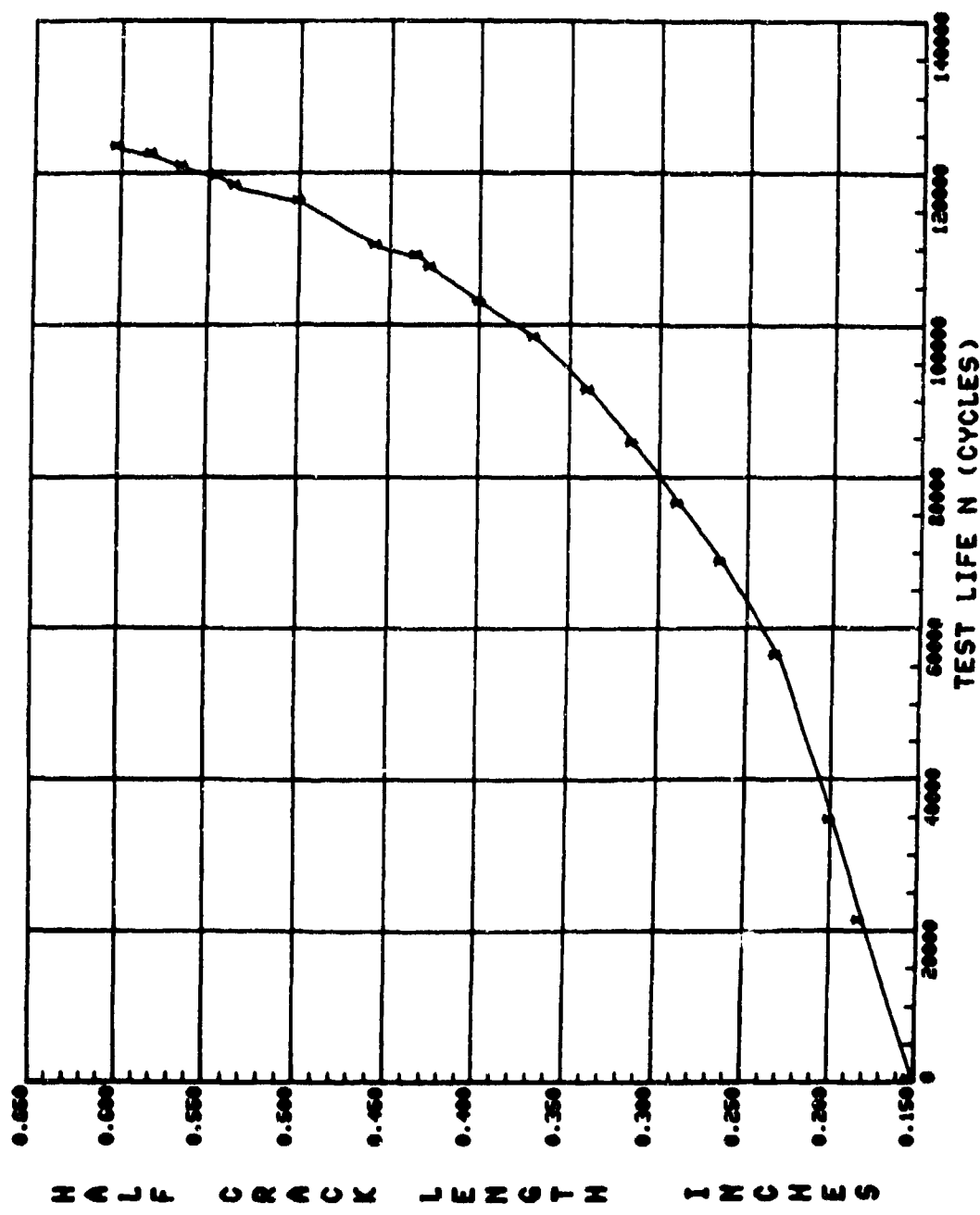

Figure 74. Crack growth curve for test M-60.

TABLE 73. METHODOLOGY DEVELOPMENT TESTING PROGRAM GROUP IV - SIMPLIFIED FLIGHT SPECTRUM

Test No.	Loading Profile	G-A-G Step		Flight Step		n ₁ Cycle	n ₂ Cycle	Comments
		σ_{Max} Ksi	σ_{Min} Ksi	σ'_{Min} Ksi	σ''_{Min} Ksi			
M-61		20	-2	4		25		Typical fighter, air-to-air $\sigma_{Lim} = 40$ Ksi & 30 Ksi
M-61a		15	-2	4		25		
M-62		18	-4	4		20		Typical fighter, air-to-ground $\sigma_{Lim} = 40$ Ksi & 30 Ksi
M-62a		14	-4	4		20		
M-63		14	-2	4		10		Typical fighter, instrumentation and navigation $\sigma_{Lim} = 40$ Ksi & 30 Ksi
M-63a		10	-2	4		10		
M-64		20	-3	4		22		Typical fighter, composite mission $\sigma_{Lim} = 40, 30$ & 20 Ksi
M-64a		15	-3	4		22		
M-64b		10	-3	4		22		
M-65			12	-7.5	11.5		133	
M-66		16.8	-10.5	16.1		133		Typical transport
M-69		20	-2	6	8	20	40	Typical fighter, air-to-air $\sigma_{Lim} = 40$ Ksi & 30 Ksi
M-69a		12	-2	3	4	20	40	
M-70		18	-4	6	8	15	30	Typical fighter, air-to-ground $\sigma_{Lim} = 40$ Ksi & 30 Ksi
M-70a		10	-4	3	4	15	30	

TABLE 73. METHODOLOGY DEVELOPMENT TESTING PROGRAM GROUP IV
SIMPLIFIED FLIGHT SPECTRUM (CONCL)

Test No.	Loading Profile	G-A-G Step		Flight Steps			n ₁ Cyc	n ₂ Cyc	n ₃ Cyc	n ₄ Cyc	Comments		
		σ_{Max} Ksi	σ_{Min} Ksi	σ'_{Min} Ksi	σ''_{Min} Ksi	σ'''_{Min} Ksi							
M-71		14	-2	6	8		10	20			Typical fighter, instrumentation and navigation		
M-72		19	-3	6	8		15	35			Typical fighter, composite mission $\sigma_{Lim} = 40, 30, \& 20$ Ksi		
M-72a		14	-3	4	6		15	35					
M-72b		8	-3	2	3		15	35					
M-74		16.8	-10.5	15.4	16.1		25	108			Typical transport		
M-77		20	-3	-1	6	8	2	4	15	35	Typical fighter $\sigma_{Lim} = 40$ Ksi & 30 Ksi		
M-77a		14	-6	1	4	6	4	8	20	40			
M-78		18	-6	-1	4	8	4	8	20	40	Typical fighter		
							σ'''_{Min}	σ'_{Max}	n ₅	n ₆	n ₃	n ₄	
M-79		12	-7.5	-3.0	10	11.5	3.2	2	4	25	108	Typical transport	
M-80		16.8	-10.5	-4.2	14	16.1	4.48	2	4	25	108	Typical transport	

TABLE 74. DATA TABULATION FOR TEST M-61

SPECIMEN NO.: M-61 AIR TO AIR FIGHTER MAX STRESS = 20 KSI

CCT SPECIMEN $\epsilon = 0.750$ IN. $N = 6,000$ IN. $AN = 0.0$ IN.

PHIN= PMAI= TEST FREQ= 6.00 HZ.

ENVIRONMENT CONDITION: AMBIENT AIR

NO.	CYCLES	A (MEASURED)	A (REGRESSION)	MULT. CORR. COEFF	K-MAX	DELTA K	DA/IN
1	0.	0.303	0.304	0.993863	13.83	22.13	7.586E-04
2	1000.	0.330	0.322	0.996639	14.24	22.79	1.002E-05
3	2500.	0.350	0.356	0.997810	14.99	23.99	1.291E-05
4	5500.	0.455	0.451	0.998363	16.90	27.03	1.904E-05
5	6500.	0.490	0.490	0.998902	17.62	28.20	2.142E-05
6	7500.	0.535	0.537	0.999290	18.45	29.53	2.413E-05
7	8500.	0.545	0.584	0.999760	19.26	30.81	2.710E-05
8	9500.	0.640	0.643	0.998921	20.23	32.38	2.982E-05
9	10500.	0.705	0.705	0.998700	21.22	33.95	3.347E-05
10	11200.	0.760	0.752	0.997957	21.94	35.11	3.732E-05
11	12000.	0.805	0.813	0.998133	22.85	36.57	4.193E-05
12	12800.	0.860	0.880	0.998120	23.81	38.10	4.950E-05
13	13600.	0.965	0.962	0.999247	24.97	39.96	6.123E-05
14	14100.	1.020	1.027	0.999221	25.86	41.37	7.022E-05
15	14600.	1.100	1.099	0.999623	26.82	42.91	7.887E-05
16	15100.	1.185	1.184	0.998907	27.92	44.68	8.583E-05
17	15500.	1.260	1.257	0.998787	28.86	46.18	9.433E-05
18	15800.	1.315	1.310	0.999222	29.53	47.25	1.149E-04
19	16100.	1.365	1.378	0.991441	30.38	48.61	1.273E-04
20	16400.	1.445	1.457	0.991647	31.37	50.19	1.436E-04
21	16700.	1.580	1.552	0.992069	32.53	52.05	1.603E-04
22	16900.	1.615	1.623	0.994626	33.40	53.45	1.723E-04
23	17100.	1.685	1.691	0.992379	34.24	54.78	1.883E-04
24	17300.	1.760	1.757	0.999582	35.04	56.06	2.054E-04
25	17500.	1.845	1.847	0.999726	36.14	57.82	2.451E-04
26	17700.	1.950	1.946	0.998687	37.35	59.76	2.946E-04
27	17900.	2.070	2.069	0.999050	38.87	62.19	3.567E-04
28	18100.	2.210	2.220	0.999096	40.76	65.22	4.416E-04

TABLE 74. DATA TABULATION FOR TEST M-61 (CONCL.)

SPECIMEN NO.: M-61		AIR TO AIR FIGHTER MAX STRESS = 20 KSI					
CCT SPECIMEN	R = 0.250 IN.	W = 6.000 IN.	AM = 0.0 IN.				
PMIN =	PMAX =	TEST FREQ = 6.00 HZ.					
ENVIRONMENT CONDITION: AMBIENT AIR							
NO.	CYCLES	A (MEASURED)	A (REGRESSION)	MULT. CORR. COEFF	K-MAX	DELTA K	DA/DM
29	18300.	2.410	2.410	0.997559	43.20	69.12	5.868E-04
30	18400.	2.520	2.528	0.998752	44.76	71.61	6.801E-04
31	18500.	2.655	2.670	0.997124	46.69	74.71	8.275E-04
32	18600.	2.650	2.640	0.995190	49.11	78.57	1.119E-03
33	18650.	2.925	2.951	0.995564	50.76	81.21	1.364E-03
34	18700.	3.075	3.090	0.992799	52.91	84.66	1.761E-03
35	18750.	3.265	3.268	0.997656	55.84	89.34	2.382E-03
36	18790.	3.395	3.423	0.996976	58.58	93.72	2.862E-03
37	18800.	3.550	3.548	0.997201	60.92	97.48	3.557E-03

PLOTRATE CRACK GROWTH ANALYSIS
M-61 AIR TO AIR FIGHTER MAX STRESS = 20 KSI

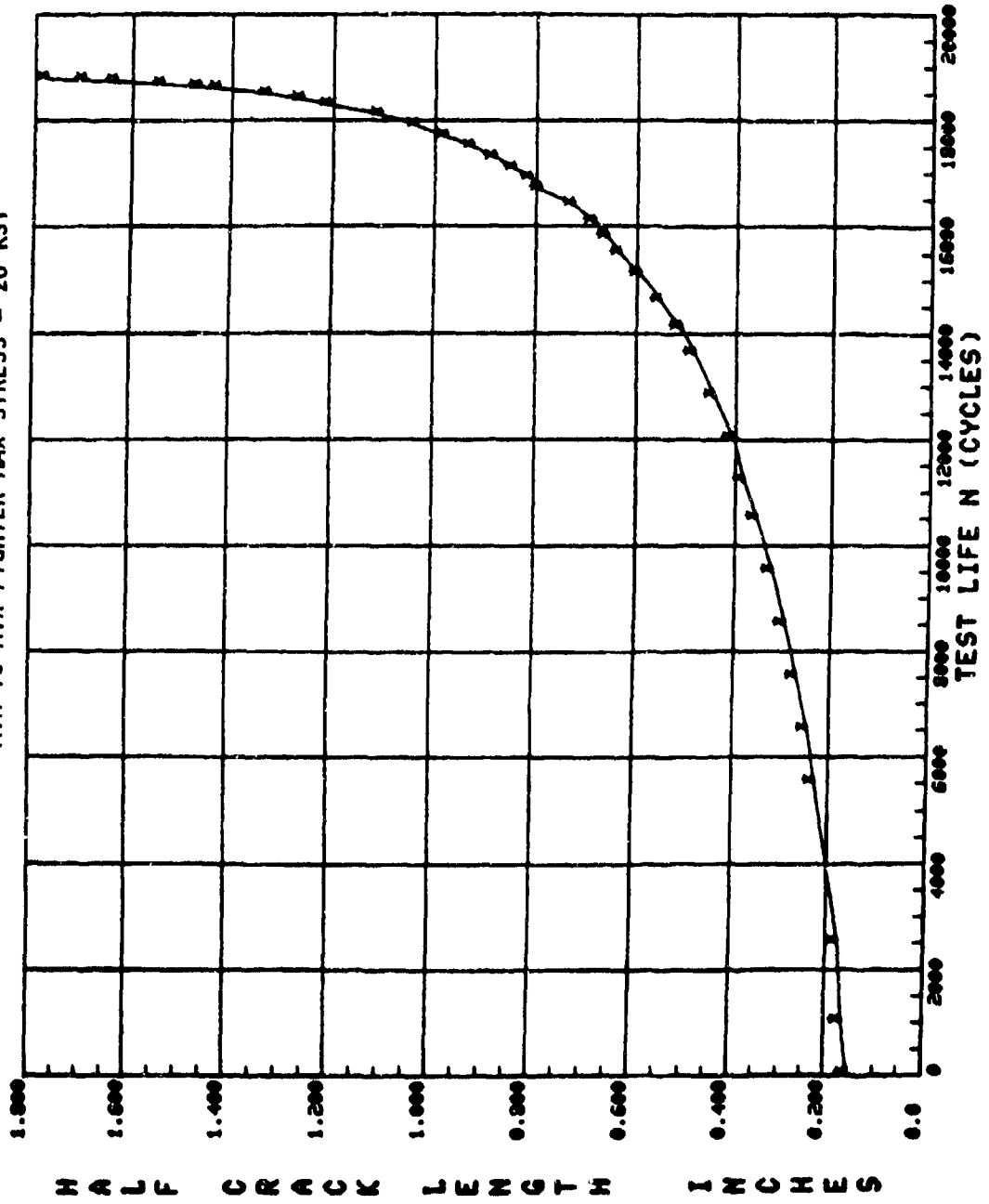

Figure 75. Crack growth curve for test M-61.

TABLE 75. DATA TABULATION FOR TEST M-61A

SPECIMEN NO.: M-61A TYP FIGHTER AIR TO AIR, STRESS = 15 KSI MAX

CCT. SPECIMEN R = 0.250 IN. W = 6.000 IN. AN = 0.0 IN.

PHIN = PMA = TEST FREQ = 6.00 HZ.

ENVIRONMENT CONDITION: AMBIENT AIR

NO.	CYCLES	A (MEASURED)	A (REGRESSION)	MULT. CORR. COEFF	K-MAX	DELTA K	UA/UM
1	0.	0.310	0.310	0.998174	10.49	11.69	2.933E-06
2	5700.	0.355	0.352	0.998970	11.17	12.66	4.287E-06
3	11306.	0.402	0.406	0.998036	12.00	13.61	5.805E-06
4	25100.	0.455	0.453	0.991713	12.70	14.39	7.696E-06
5	18800.	0.502	0.513	0.984474	13.52	15.33	8.244E-06
6	21000.	0.550	0.552	0.982699	14.04	15.92	9.255E-06
7	23000.	0.615	0.590	0.983134	14.53	16.47	1.070E-05
8	26500.	0.645	0.671	0.984361	15.52	17.59	1.285E-05
9	28400.	0.725	0.719	0.987962	16.07	18.22	1.420E-05
10	30500.	0.788	0.778	0.992302	16.75	18.99	1.643E-05
11	32300.	0.845	0.849	0.996843	17.53	19.87	1.866E-05
12	35000.	0.905	0.911	0.979496	18.20	20.62	2.323E-05
13	35500.	0.975	0.985	0.972593	18.96	21.49	2.381E-05
14	36700.	1.030	1.047	0.972365	19.59	22.20	2.448E-05
15	36700.	1.090	1.049	0.973126	19.61	22.23	2.614E-05
16	38600.	1.135	1.144	0.970966	20.56	23.30	2.676E-05
17	39600.	1.190	1.191	0.980270	21.01	23.81	2.833E-05
18	40600.	1.255	1.249	0.997804	21.57	24.44	3.102E-05
19	41500.	1.315	1.313	0.999498	22.16	25.13	3.293E-05
20	42400.	1.377	1.379	0.999458	22.80	25.83	4.004E-05
21	43300.	1.450	1.452	0.999677	23.48	26.61	4.484E-05
22	44300.	1.547	1.546	0.999819	24.34	27.59	5.232E-05
23	45200.	1.645	1.645	0.999864	25.26	28.62	6.007E-05
24	46050.	1.750	1.754	0.999889	26.25	29.75	6.829E-05
25	46850.	1.870	1.870	0.999020	27.32	30.96	7.310E-05
26	47500.	1.970	1.969	0.998797	28.22	31.98	7.934E-05
27	48100.	2.075	2.065	0.996676	29.12	33.00	8.797E-05
28	48870.	2.185	2.203	0.995949	30.41	34.46	1.057E-04

TABLE 75. DATA TABULATION FOR TEST M-61A (CONCL)

SPECIMEN NO.: M-61A TYP FIGHTER AIR TO AIR, STRESS = 15 KSI MAX		CCT SPECIMEN		D = 0.250 IN. N = 6.000 IN. AME 0.0 IN.		PMAE =		TEST FREQ = 6.00 HZ.							
ENVIRONMENT CONDITION: AMBIENT AIR		CYCLES		A (MEASURED)		A (REGRESSION)		MULT. CORR. COEFF		K-MAX		DELTA K		DA/DM	
29	49270.	2.280	2.285	0.997574	31.19	35.35	1.239E-04								
30	49636.	2.380	2.376	0.99767	32.07	36.35	1.460E-04								
31	49960.	2.475	2.477	0.999704	33.06	37.47	1.675E-04								
32	50257.	2.575	2.579	0.999832	34.08	38.62	1.871E-04								
33	50482.	2.670	2.667	0.999593	34.99	39.65	2.094E-04								
34	50706.	2.765	2.764	0.999448	36.01	40.81	2.355E-04								
35	50919.	2.860	2.867	0.999479	37.13	42.08	2.656E-04								
36	51077.	2.955	2.952	0.999800	38.08	43.15	2.937E-04								
37	51253.	3.060	3.059	0.999367	39.32	44.56	3.388E-04								
38	51400.	3.160	3.163	0.999187	40.56	45.97	3.867E-04								
39	51530.	3.260	3.265	0.999698	41.84	47.42	4.434E-04								
40	51626.	3.355	3.352	0.999071	42.97	48.70	5.098E-04								
41	51722.	3.450	3.452	0.997755	44.34	50.25	6.095E-04								
42	51812.	3.555	3.566	0.998117	45.96	52.09	7.460E-04								
43	51867.	3.645	3.648	0.999321	47.19	53.48	8.785E-04								
44	51913.	3.735	3.730	0.998757	48.48	54.95	1.036E-03								
45	51967.	3.840	3.848	0.997641	50.46	57.19	1.290E-03								
46	52003.	3.935	3.942	0.995746	52.12	59.07	1.628E-03								
47	52033.	4.035	4.042	0.997712	54.02	61.23	2.011E-03								
48	52057.	4.130	4.143	0.998274	56.08	63.56	2.482E-03								
49	52073.	4.230	4.229	0.998647	57.95	65.68	3.055E-03								

PLOTRATE CRACK GROWTH ANALYSIS
 TYP FIGHTER AIR TO AIR, STRESS = 15 KSI MAX

M-61A

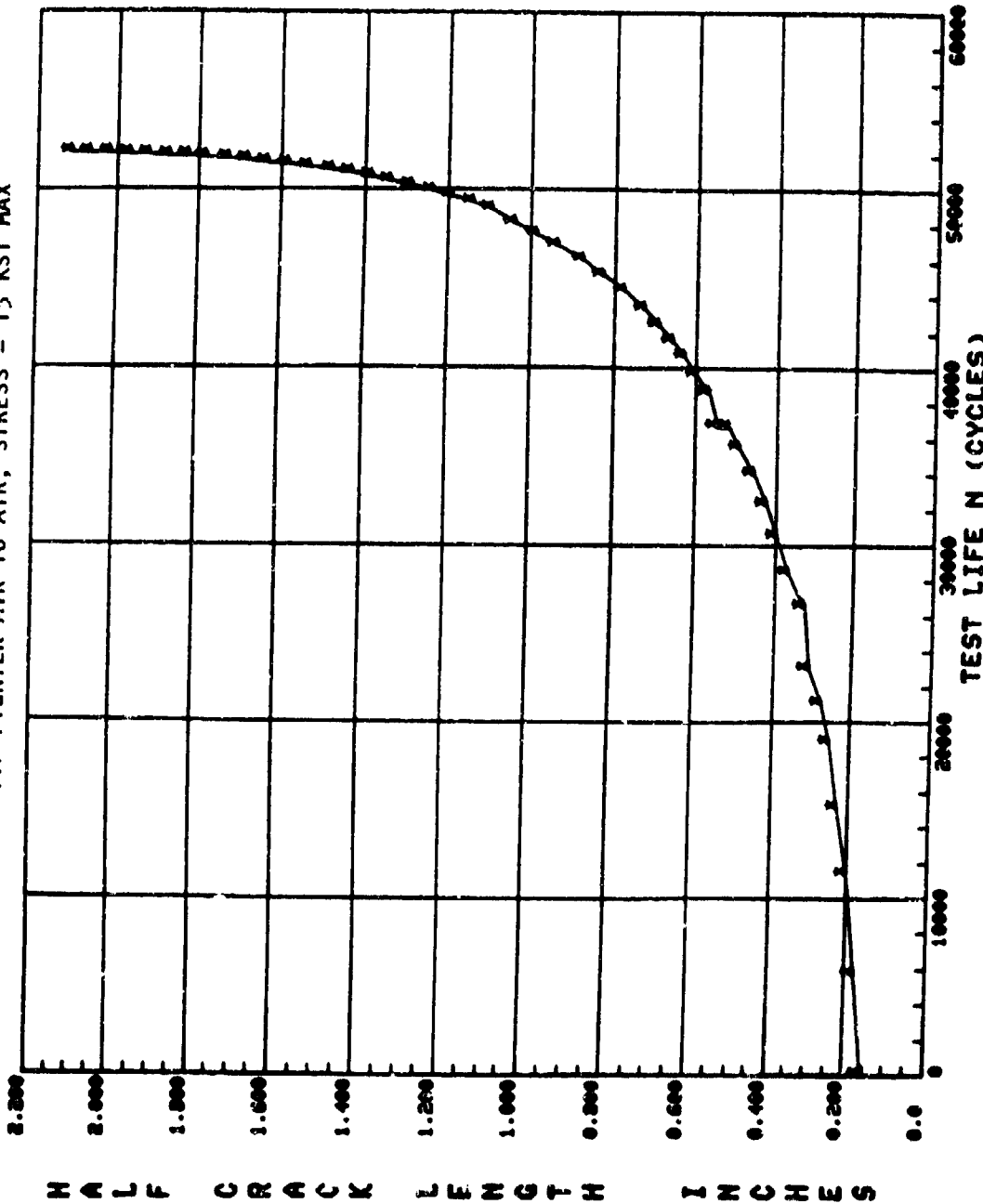

Figure 76. Crack growth curve for test M-61A.

TABLE 76. DATA TABULATION FOR TEST M-62

SPECIMEN NO.: M-62		TYPICAL FIGHTER, AIR-TO-GROUND, MAX STRESS = 18 KSI		TEST FREQ= 6.00 HZ.			
CCT	SPECIMEN	B= 0.250 IN.	K= 6.000 IN.	AM= 0.0	IM=		
PHIN=		PHAX=					
ENVIRONMENT CONDITION: AMBIENT AIR							
NO.	CYCLES	A (MEASURED)	A (REGRESSION)	MULT. CORR. COEFF	K-MAX	DELTA K	DA/DN
1	0.	0.290	0.290	0.99982	12.17	14.67	8.530E-06
2	3100.	0.350	0.349	0.99978	13.36	16.33	1.046E-05
3	5740.	0.410	0.410	0.999844	14.48	17.70	1.277E-05
4	7980.	0.470	0.471	0.999526	15.54	18.99	1.506E-05
5	9320.	0.510	0.511	0.999474	16.20	19.80	1.692E-05
6	11040.	0.570	0.571	0.999341	17.14	20.95	1.928E-05
7	12500.	0.630	0.631	0.999619	18.04	22.05	2.376E-05
8	13520.	0.680	0.683	0.996316	18.79	22.97	2.423E-05
9	14390.	0.730	0.728	0.996666	19.42	23.74	2.581E-05
10	15170.	0.780	0.770	0.995005	19.99	24.43	2.779E-05
11	16440.	0.830	0.840	0.992956	20.93	25.58	3.223E-05
12	17130.	0.880	0.882	0.99426	21.47	26.24	3.737E-05
13	17750.	0.930	0.929	0.999172	22.05	26.96	4.211E-05
14	18340.	0.985	0.985	0.999754	22.76	27.82	4.656E-05
15	18935.	1.045	1.043	0.998927	23.46	28.67	5.157E-05
16	19475.	1.100	1.099	0.998324	24.13	29.50	5.762E-05
17	20015.	1.155	1.162	0.997952	24.88	30.41	6.764E-05
18	20362.	1.210	1.209	0.992150	25.42	31.06	7.681E-05
19	20763.	1.270	1.272	0.998654	26.15	31.96	8.220E-05
20	21085.	1.335	1.330	0.998767	26.81	32.77	9.108E-05
21	21385.	1.385	1.384	0.998924	27.42	33.51	9.833E-05
22	2171E.	1.445	1.450	0.998242	28.16	34.41	1.112E-04
23	21922.	1.500	1.494	0.999462	28.64	35.01	1.179E-04
24	22371.	1.605	1.610	0.999573	29.92	36.57	1.436E-04
25	22701.	1.715	1.709	0.999260	31.01	37.90	1.682E-04
26	23009.	1.818	1.818	0.999688	32.20	39.36	1.915E-04
27	23300.	1.930	1.934	0.999461	33.49	40.93	2.192E-04
28	23615.	2.065	2.076	0.999642	35.08	42.88	2.567E-04

TABLE 76. DATA TABULATION FOR TEST M-62 (CONCL)

SPECIMEN NO.: M-62		TYPICAL FIGHTER, AIR-TO-GROUND, MAX STRESS = 18 KSI	
CCT	SPECIMEN	b = 0.750 IN.	W = 6.000 IN.
PRIN-		PHAX =	AN = 0.0 IM.
ENVIRONMENT CONDITION: AMBIENT AIR			
NG.	CYCLES	A (MEASURED)	A (REGRESSION)
29	23900.	2.275	2.233
30	24100.	2.355	2.358
31	24300.	2.445	2.498
32	24400.	2.540	2.579
33	24500.	2.670	2.665
34	24600.	2.750	2.759
35	24700.	2.670	2.860
36	24800.	2.990	2.989
37	24900.	3.125	3.153
38	25000.	3.265	3.360
39	25080.	3.546	3.590
40	25100.	3.645	3.664
41	25120.	3.735	3.741
42	25140.	3.820	3.959
43	25160.	4.005	4.005

TEST FREQ = 6.00 HZ.

DELTA K	J A/DK
45.02	3.008E-04
46.77	3.424E-04
48.80	3.886E-04
49.99	4.273E-04
51.28	4.705E-04
52.74	5.250E-04
54.34	6.295E-04
56.67	7.647E-04
59.51	9.650E-04
63.15	1.271E-03
67.94	1.636E-03
69.58	2.237E-03
71.37	2.825E-03
74.20	3.343E-03
76.18	4.222E-03

MULT. CORR. COEFF	K-MAX
0.999393	36.84
0.999241	38.27
0.999776	39.93
0.999206	40.90
0.999127	41.96
0.999112	43.15
0.996820	44.46
0.998482	46.20
0.997504	48.53
0.998024	51.70
0.993817	55.59
0.987980	55.93
0.999101	56.40
0.999970	60.78
0.999916	63.97

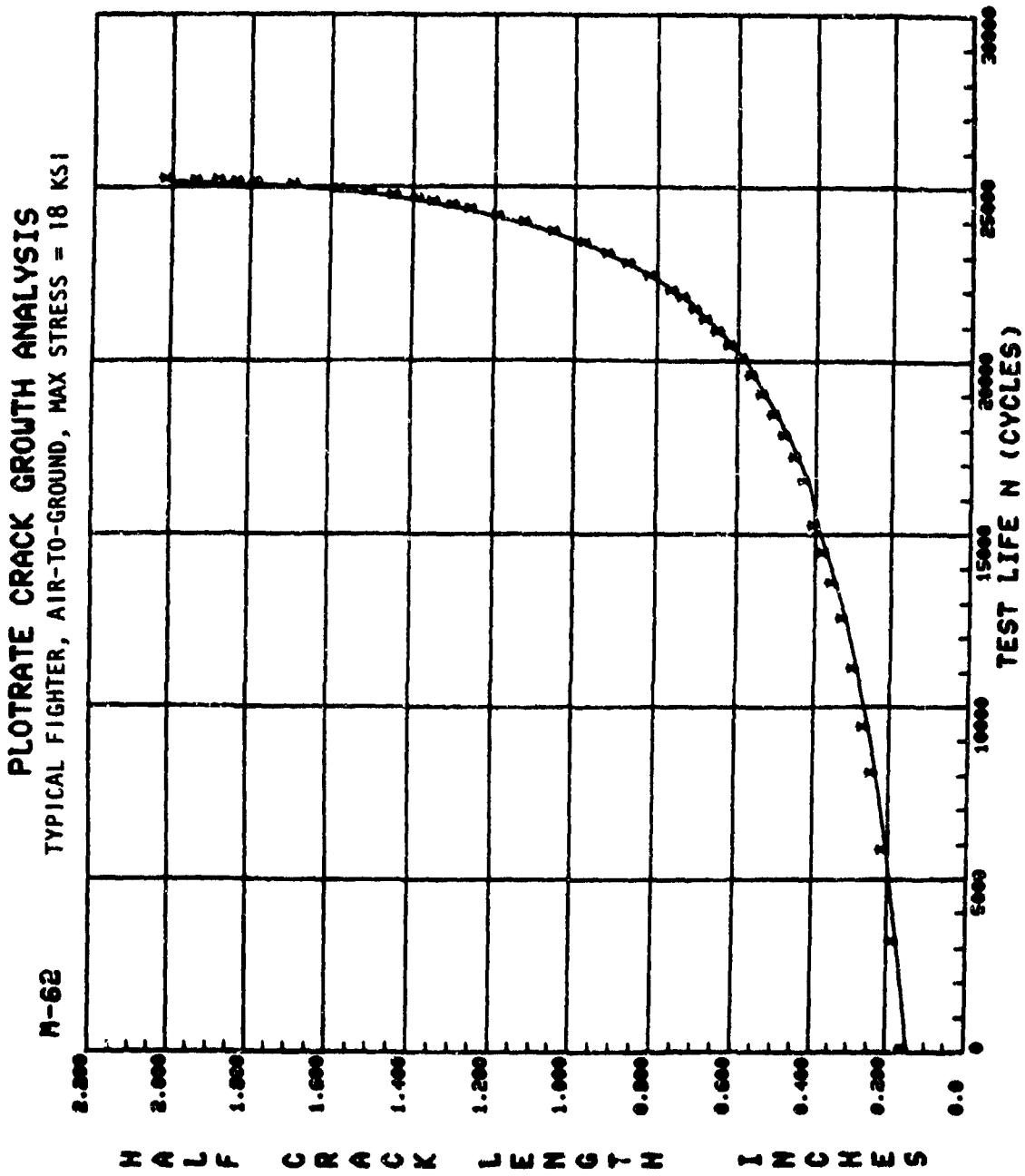

Figure 77. Crack growth curve for test M-62.

TABLE 77. DATA TABULATION FOR TEST M-62A

SPECIMEN NO.: M-62A TYP FIGHTER AIR TO GROUND, STRESS = 14 KSI MAX

CCT SPECIMEN B= 0.250 IN. M= 6.000 IN. AM= 0.0 IN.

PRIN= PMAX=

TEST FREQ= 6.00 HZ.

ENVIRONMENT CONDITION: AMBIENT AIR

NO.	CYCLES	A (MEASURED)	A (REGRESSION)	MULT. CORR. COEFF	K-MAX	DELTA K	DA/DM
1	0.	0.460	0.460	0.996191	11.95	15.36	4.721E-06
2	5700.	0.530	0.523	0.997571	12.74	16.38	6.535E-06
3	9500.	0.570	0.578	0.998299	13.41	17.25	7.925E-06
4	12500.	0.630	0.629	0.998589	14.01	18.01	9.078E-06
5	15300.	0.685	0.682	0.998206	14.60	18.78	9.924E-06
6	18000.	0.740	0.742	0.998223	15.25	19.61	1.081E-05
7	20250.	0.793	0.790	0.999358	15.75	20.26	1.159E-05
8	22690.	0.845	0.847	0.999166	16.34	21.01	1.285E-05
9	24661.	0.895	0.898	0.999341	16.85	21.66	1.432E-05
10	26429.	0.950	0.949	0.99945	17.35	22.31	1.587E-05
11	28106.	1.005	1.005	0.999792	17.89	23.00	1.748E-05
12	29367.	1.052	1.051	0.999927	18.32	23.56	1.922E-05
13	31000.	1.115	1.120	0.997676	18.95	24.38	2.137E-05
14	32358.	1.180	1.181	0.997569	19.52	25.10	2.367E-05
15	33328.	1.238	1.228	0.997448	19.94	25.64	2.377E-05
16	34658.	1.285	1.293	0.997166	20.53	26.39	2.523E-05
17	35246.	1.325	1.322	0.997387	20.78	26.71	2.594E-05
18	36320.	1.375	1.372	0.998218	21.24	27.31	2.768E-05
19	37305.	1.435	1.430	0.997790	21.72	27.93	3.207E-05
20	38225.	1.465	1.491	0.999338	22.25	28.61	3.532E-05
21	39273.	1.570	1.576	0.997861	22.98	29.54	3.964E-05
22	40373.	1.675	1.676	0.998447	23.76	30.58	4.322E-05
23	41450.	1.775	1.767	0.997939	24.61	31.64	4.770E-05
24	42635.	1.870	1.879	0.997627	25.27	32.87	5.280E-05
25	43550.	1.967	1.975	0.998280	26.40	33.94	6.099E-05
26	44274.	2.070	2.064	0.999561	27.16	34.92	6.921E-05
27	45010.	2.165	2.172	0.999357	28.11	36.14	8.037E-05
28	45580.	2.270	2.266	0.998795	28.94	37.21	9.209E-05

TABLE 77. DATA TABULATION FOR TEST M-62A (CONCL)

SPECIMEN NO.: M-62A TYP FIGHTER AIR TO GROUND, STRESS = 14 KSI MAX

CCI SPECIMEN B= 0.750 IN. W= 6.000 IN. AN= 0.0 IN. TEST FREQ= 6.00 HZ.

PHIN= PHAX=

ENVIRONMENT CONDITION: AMBIENT AIR

NO.	CYCLES	A (MEASURED)	A (REGRESSION)	MULT. CORR. COEFF	K-MAX	DELTA K	DA/DM
29	46079.	2.255	2.359	0.999489	29.77	38.28	1.040E-04
30	46557.	2.460	2.465	0.999462	30.74	39.52	1.197E-04
31	46895.	2.550	2.546	0.999848	31.50	-0.50	1.330E-04
32	47269.	2.650	2.651	0.999836	32.50	41.79	1.496E-04
33	47566.	2.740	2.742	0.999600	33.39	42.93	1.662E-04
34	47835.	2.835	2.833	0.999852	34.31	44.11	1.834E-04
35	48137.	2.945	2.946	0.999166	35.50	45.64	2.135E-04
36	48345.	3.040	3.039	0.999432	36.46	46.90	2.357E-04
37	48565.	3.140	3.146	0.999096	37.66	48.42	2.711E-04
38	48712.	3.235	3.227	0.999114	38.60	49.62	2.982E-04
39	48947.	3.345	3.374	0.998380	40.38	51.92	3.617E-04
40	49114.	3.500	3.499	0.997762	42.00	54.00	4.364E-04
41	49228.	3.590	3.601	0.997826	43.39	55.79	5.367E-04
42	49319.	3.695	3.700	0.998506	44.81	57.62	6.331E-04
43	49389.	3.785	3.787	0.999220	46.13	59.31	7.467E-04
44	49461.	3.905	3.902	0.997314	47.96	61.69	9.202E-04
45	49520.	4.000	4.015	0.994942	49.93	64.20	1.186E-03
46	49558.	4.092	4.107	0.995572	51.64	66.50	1.445E-03
47	49587.	4.155	4.192	0.999687	53.32	68.55	1.626E-03
48	49608.	4.275	4.275	0.999616	55.06	70.79	2.182E-03

N-62A PLOT RATE CRACK GROWTH ANALYSIS
TYP FIGHTER AIR TO GROUND, STRESS = 14 KSI MAX

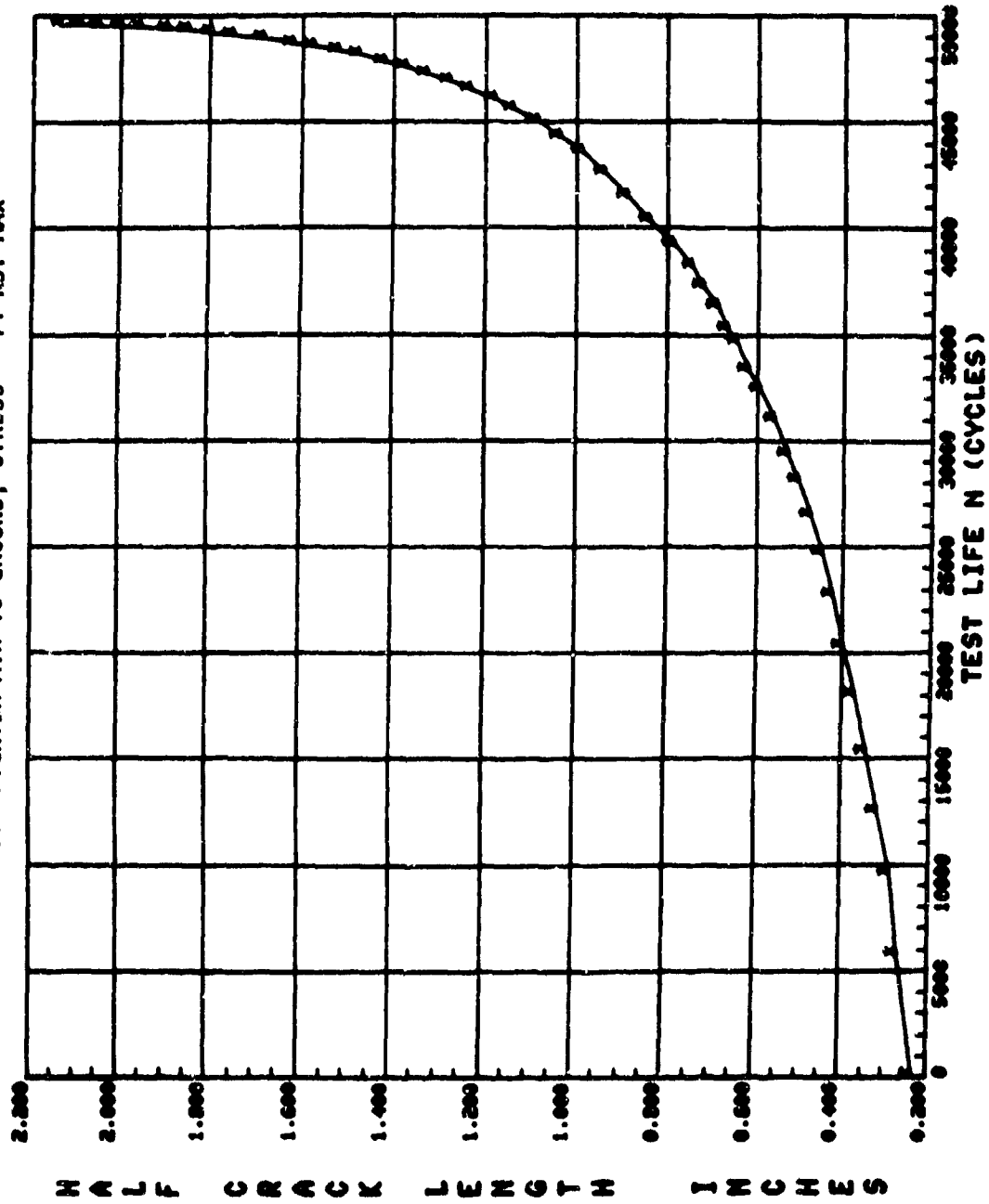

Figure 78. Crack growth curve for test M-62A.

TABLE 78. DATA TABULATION FOR TEST M-63

SPECIMEN NO.: M-63 TYPICAL FIGHTER, INSTRUMENTATION AND NAVIGATION, MAX STRESS = 14 KSI

CGI SPECIMEN B = 0.250 IN. M = 6.000 IN. AM = 0.0 IN. TEST FREQ = 6.00 HZ.
 PHIN = PMAX =

ENVIRONMENT CONDITION: AMBIENT AIR

NO.	CYCLES	A (MEASURED)	A (REGRESSION)	MULT. CORR. COEFF	K-MAX	DELTA K	DA/DN
1	0.	0.313	0.312	0.999973	9.82	11.46	3.240E-06
2	6350.	0.355	0.352	0.997616	10.43	12.17	3.463E-06
3	13000.	0.405	0.401	0.997158	11.15	13.00	4.472E-06
4	18750.	0.450	0.458	0.997603	11.92	13.90	5.595E-06
5	22500.	0.500	0.500	0.999016	12.46	14.54	6.438E-06
6	23900.	0.550	0.545	0.997646	13.02	15.19	7.649E-06
7	29300.	0.600	0.602	0.997717	13.70	15.98	8.828E-06
8	32350.	0.650	0.657	0.996153	14.33	16.72	9.580E-06
9	34300.	0.710	0.701	0.998314	14.81	17.28	1.101E-05
10	36900.	0.755	0.758	0.996361	15.42	17.99	1.213E-05
11	38850.	0.805	0.807	0.998246	15.94	18.59	1.317E-05
12	40600.	0.855	0.851	0.998946	16.38	19.11	1.455E-05
13	42600.	0.910	0.914	0.998164	17.01	19.84	1.593E-05
14	44100.	0.960	0.962	0.997718	17.48	20.40	1.762E-05
15	45200.	1.010	1.002	0.997228	17.86	20.84	1.843E-05
16	46100.	1.030	1.037	0.997264	18.19	21.23	1.934E-05
17	47100.	1.060	1.075	0.995245	18.55	21.64	2.095E-05
18	48100.	1.115	1.116	0.997713	18.93	22.08	2.231E-05
19	49100.	1.160	1.164	0.998480	19.37	22.60	2.500E-05
20	50100.	1.220	1.215	0.999243	19.83	23.13	2.677E-05
21	51100.	1.270	1.273	0.999501	20.35	23.74	2.908E-05
22	52100.	1.335	1.334	0.999555	20.88	24.36	3.097E-05
23	53500.	1.430	1.427	0.999656	21.70	25.32	3.402E-05
24	54100.	1.460	1.461	0.996720	21.99	25.66	3.661E-05
25	55100.	1.535	1.537	0.995082	22.65	26.42	3.945E-05
26	56100.	1.615	1.621	0.999059	23.36	27.26	4.284E-05
27	57100.	1.720	1.709	0.998733	24.11	28.13	4.768E-05
28	58100.	1.805	1.806	0.996709	24.94	29.10	5.304E-05

TABLE 78. DATA TABULATION FOR TEST M-63 (CONCL)

SPECIMEN NO.: M-63 TYPICAL FIGHTER, INSTRUMENTATION & NAVIGATION, MAX STRESS = 14 KSI

LCI SPECIMEN R = 0.250 IN. W = 6.000 IN. AN = 0.0 IN.

PHIN = PHAX = TEST FREQ = 6.00 HZ.

ENVIRONMENT CONDITION: AMBIENT AIR

NO.	CYCLES	A (MEASURED)	A (REGRESSION)	MULT. CORR. COEFF	K-MAX	DELTA K	0 AM/UM
29	59100.	1.905	1.911	0.998224	25.85	30.15	6.107E-05
30	60100.	2.040	2.032	0.999272	26.88	31.36	7.250E-05
31	61100.	2.180	2.179	0.997905	26.17	32.86	9.170E-05
32	62100.	2.370	2.355	0.993748	29.74	34.70	1.244E-04
33	63100.	2.605	2.585	0.974366	31.87	37.18	1.927E-04
34	64100.	2.940	3.001	0.981186	36.06	42.08	2.903E-04
35	65100.	3.485	3.670	0.986771	44.37	51.77	4.529E-04
36	65600.	4.205	4.188	0.991253	53.24	62.12	6.430E-04

PLOTRATE CRACK GROWTH ANALYSIS

M-63 TYPICAL FIGHTER, INSTRUMENTATION & NAVIGATION, MAX STRESS = 14 KSI

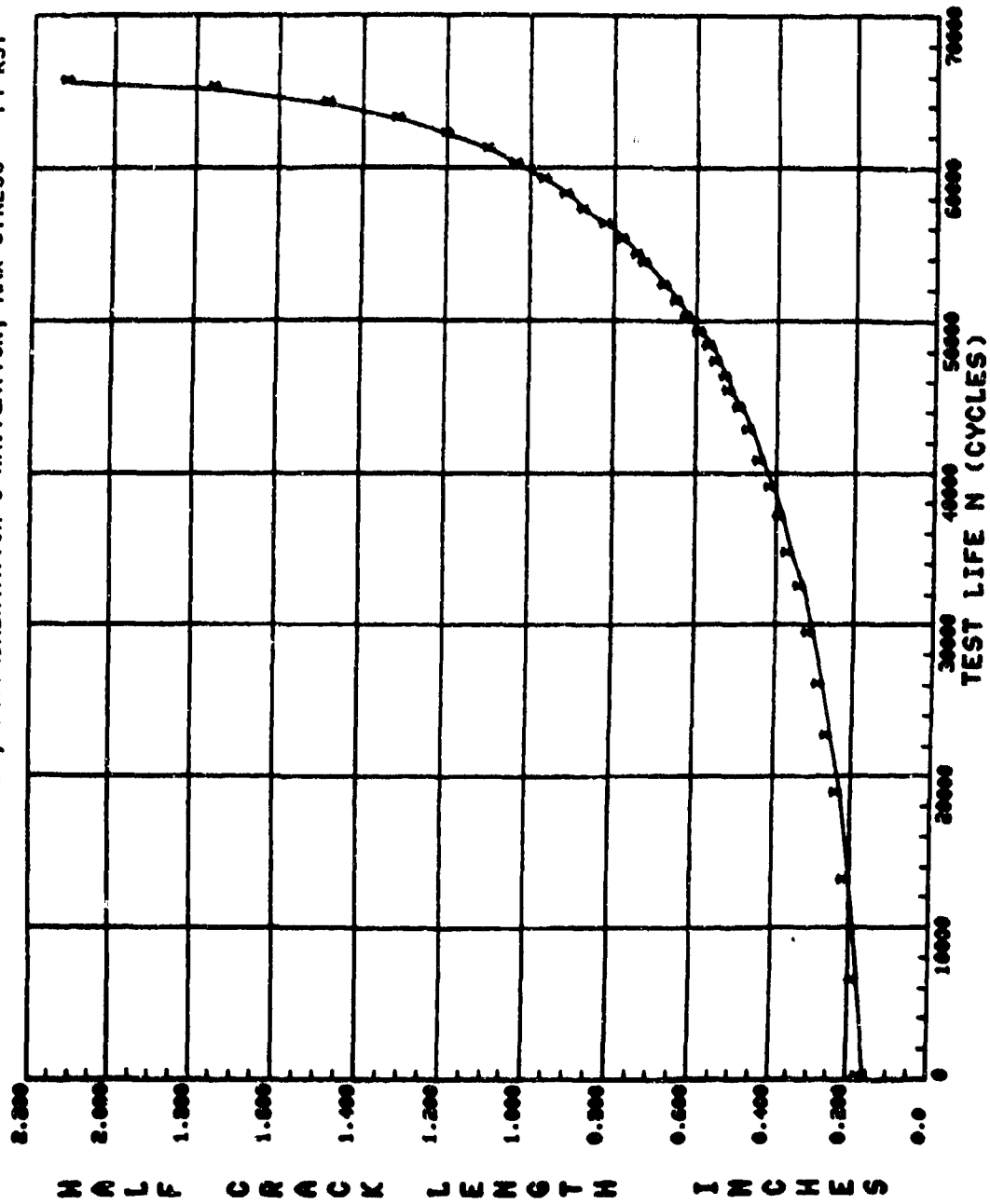

Figure 79. Crack growth curve for test M-63.

TABLE 79. DATA TABULATION FOR TEST M-63A

SPECIMEN NO.: M-63A IYP FIGHTER INSTR & NAVIGATION, STRESS = 10 KSI MAX

CCT SPECIMEN 0 = 0.250 IN. W = 6.000 IN. AME 0.0 IM. TEST FREQ = 6.00 HZ.

P MAX =

ENVIRONMENT CONDITION: AMBIENT AIR

NO.	CYCLES	A (MEASURED)	A (REGRESSION)	MULT. CORR. COEFF	K-MAX	DELTA K	DA/DN
1	0.	0.295	0.295	0.99878	6.82	8.18	1.114E-06
2	20000.	0.335	0.330	0.992748	7.21	8.66	8.786E-07
3	40000.	0.370	0.365	0.995344	7.59	9.11	9.425E-07
4	60000.	0.395	0.405	0.996665	8.00	9.59	1.020E-06
5	80000.	0.450	0.445	0.997538	8.39	10.06	1.132E-06
6	100000.	0.495	0.492	0.997254	8.83	10.59	1.323E-06
7	120000.	0.543	0.549	0.994295	9.34	11.20	1.621E-06
8	133700.	0.590	0.592	0.998134	9.70	11.64	1.943E-06
9	146582.	0.640	0.644	0.997076	10.13	12.15	2.164E-06
10	153000.	0.680	0.676	0.997470	10.38	12.46	2.219E-06
11	162400.	0.725	0.718	0.994629	10.71	12.96	2.450E-06
12	172360.	0.765	0.767	0.992154	11.09	13.30	2.641E-06
13	185000.	0.825	0.833	0.996231	11.57	13.89	3.178E-06
14	192600.	0.890	0.884	0.994940	11.94	14.32	3.395E-06
15	201700.	0.945	0.952	0.993882	12.42	14.90	3.589E-06
16	208000.	1.015	1.000	0.935240	12.74	15.29	4.100E-06
17	216000.	1.060	1.063	0.984401	13.17	15.80	4.748E-06
18	224000.	1.115	1.142	0.984524	13.69	16.42	5.598E-06
19	228000.	1.200	1.184	0.987462	13.96	16.75	6.028E-06
20	232000.	1.250	1.239	0.988194	14.31	17.18	6.319E-06
21	236000.	1.290	1.297	0.992630	14.68	17.62	6.746E-06
22	240000.	1.345	1.343	0.999150	14.97	17.97	6.763E-06
23	244000.	1.395	1.396	0.999605	15.32	18.38	7.297E-06
24	248000.	1.460	1.457	0.998765	15.68	18.82	8.260E-06
25	252000.	1.530	1.531	0.995985	16.14	19.37	8.869E-06
26	258000.	1.635	1.644	0.996894	16.83	20.19	9.950E-06
27	264000.	1.790	1.767	0.996869	17.58	21.10	1.120E-05
28	268000.	1.840	1.858	0.996963	18.14	21.76	1.226E-05

TABLE 79. DATA TABULATION FOR TEST M-63A (CONCL)

SPECIMEN NO.: M-63A TYP FIGHTER INSTR & NAVIGATION, STRESS = 10 KSI MAX

CC1 SPECIMEN B= 6.250 IN. V= 6.000 IN. AN= 0.0 IN. TEST FREQ= 6.00 HZ.

PHAX=

ENVIRONMENT CONDITION: AMBIENT AIR

NO.	CYCLES	A (MEASURED)	A (REGRESSION)	MULT. CORR. COEFF	K-MAX	DELTA K	DA/DM
29	273000.	1.960	1.904	0.996578	16.91	22.69	1.406E-05
30	277000.	2.100	2.093	0.998973	19.58	23.50	1.615E-05
31	280500.	2.210	2.218	0.999616	20.36	24.44	1.627E-05
32	283650.	2.335	2.335	0.999799	21.11	25.33	2.045E-05
33	286191.	2.445	2.442	0.999863	21.81	26.17	2.250E-05
34	288429.	2.542	2.547	0.999866	22.51	27.01	2.439E-05
35	290164.	2.635	2.632	0.999504	23.08	27.70	2.654E-05
36	292053.	2.735	2.734	0.999455	23.79	28.55	2.952E-05
37	293828.	2.835	2.856	0.989513	24.67	29.61	2.766E-05
38	295336.	2.945	2.954	0.956753	25.40	30.48	2.966E-05
39	296568.	3.040	3.036	0.916203	26.03	31.23	3.398E-05
40	299919.	3.140	3.302	0.660135	26.21	33.85	4.837E-05
41	298998.	3.240	3.191	0.676066	27.27	32.73	5.426E-05
42	300017.	3.35E	3.306	0.876150	28.25	33.89	6.799E-05
43	300628.	3.445	3.390	0.668521	28.99	34.78	7.412E-05
44	301325.	3.530	3.532	0.998721	30.31	36.37	7.350E-05
45	301876.	3.605	3.611	0.998765	31.09	37.31	8.192E-05
46	302562.	3.710	3.70E	0.999157	32.09	38.50	9.636E-05
47	302891.	3.792	3.792	0.999480	33.01	39.61	1.093E-04
48	303459.	3.917	3.926	0.999296	34.56	41.47	1.312E-04
49	303832.	4.032	4.026	0.998022	35.81	42.97	1.574E-04
50	304163.	4.125	4.135	0.998159	37.28	44.73	1.865E-04
51	304361.	4.200	4.209	0.997662	38.34	46.01	2.153E-04
52	304529.	4.290	4.279	0.998412	39.39	47.27	2.486E-04
53	304751.	4.387	4.396	0.994934	41.32	49.56	3.257E-04
54	304889.	4.460	4.486	0.992388	42.94	51.52	4.195E-04
55	305004.	4.570	4.584	0.996416	44.64	53.81	5.298E-04
56	305118.	4.700	4.715	0.997282	47.73	57.27	7.010E-04

PLOTRATE CRACK GROWTH ANALYSIS
TYP FIGHTER INSTR & NAVIGATION, STRESS = 10 KSI MAX

M-63A

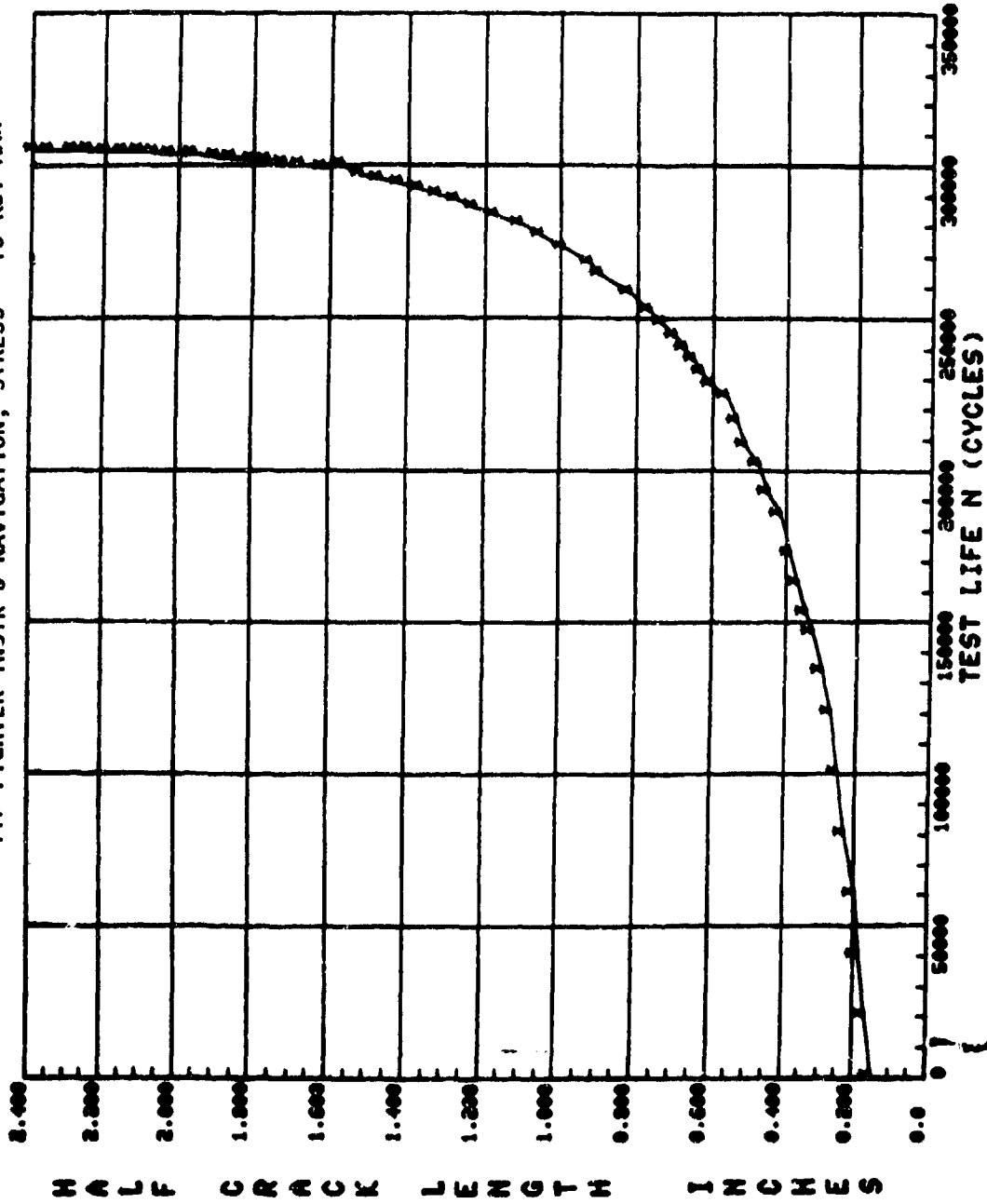

Figure 80. Crack growth curve for test M-63A.

TABLE 80. DATA TABULATION FOR TEST M-64

SPECIMEN NO.:		M-64		TYPICAL FIGHTER, COMPOSITE MISSION, MAX STRESS = 20 KSI			
C.C.T. SPECIMEN		R= 0.250 IN.	W= 6.000 IN.	AN= 0.0	IN.		
PHIN=		TEST FREQ= 6.00 HZ.					
ENVIRONMENT CONDITION: AMBIENT AIR							
NO.	CYCLES	A (MEASURED)	A (REGRESSION)	MULT. CORR. COEFF	K-MAX	DELTA K	DA/DM
1	0.	0.313	0.312	0.997779	14.03	16.13	8.727E-06
2	2000.	0.355	0.366	0.992110	15.21	17.49	1.467E-05
3	4000.	0.435	0.428	0.993908	16.46	18.93	1.643E-05
4	5000.	0.470	0.462	0.993320	17.10	19.66	1.845E-05
5	6000.	0.490	0.501	0.991999	17.81	20.48	2.072E-05
6	7000.	0.535	0.536	0.998065	18.44	21.21	2.330E-05
7	8000.	0.550	0.586	0.995241	19.29	22.19	2.786E-05
8	9000.	0.645	0.649	0.999683	20.34	23.39	3.279E-05
9	10000.	0.720	0.717	0.998855	21.41	24.62	3.640E-05
10	11000.	0.800	0.798	0.997270	22.62	26.02	4.703E-05
11	11700.	0.855	0.865	0.997351	23.61	27.15	5.510E-05
12	12400.	0.940	0.945	0.997470	24.73	28.44	6.985E-05
13	12800.	1.005	1.000	0.999080	25.46	29.30	8.065E-05
14	13200.	1.060	1.069	0.998897	26.41	30.38	9.123E-05
15	13600.	1.150	1.146	0.998308	27.43	31.54	1.064E-04
16	13800.	1.190	1.188	0.998567	27.98	32.17	1.162E-04
17	14000.	1.230	1.238	0.998730	28.61	32.91	1.244E-04
18	14200.	1.290	1.288	0.998626	29.25	33.64	1.291E-04
19	14400.	1.345	1.342	0.998992	29.94	34.43	1.390E-04
20	14600.	1.400	1.463	0.998965	30.64	35.24	1.496E-04
21	14820.	1.460	1.517	0.998651	31.44	36.16	1.611E-04
22	14990.	1.520	1.626	0.999857	32.10	36.92	1.755E-04
23	15280.	1.625	1.727	0.999650	33.44	38.46	2.077E-04
24	15510.	1.725	1.832	0.999773	34.67	39.87	2.411E-04
25	15720.	1.835	1.940	0.999422	35.96	41.36	2.762E-04
26	15907.	1.935	2.040	0.999603	37.27	42.87	3.199E-04
27	16059.	2.040	2.133	0.999727	38.51	44.29	3.546E-04
28	16186.	2.130			39.66	45.61	3.683E-04

TABLE 80. DATA TABULATION FOR TEST M-64 (CONCL.)

SPECIMEN NO.: M-64		TYPICAL FIGHTER, COMPOSITE MISSION, MAX STRESS = 20 KSI					
CCT SPECIMEN	B = 0.250 IN.	W = 6.000 IN.	AN = 0.0 IN.				
PNIN =	PMAX =	TEST FREQ = 6.00 HZ.					
ENVIRONMENT CONDITION: AMBIENT AIR							
NO.	CYCLES	A (MEASURED)	A (REGRESSION)	MULT. CORR. COEFF	K-MAX	DELTA K	DA/DM
29	16321.	2.250	2.243	0.999521	41.06	47.21	4.334E-04
30	16445.	2.350	2.352	0.998312	42.44	48.81	4.972E-04
31	16572.	2.475	2.484	0.997505	44.17	50.79	5.981E-04
32	16643.	2.560	2.565	0.999576	45.26	52.04	6.833E-04
33	16731.	2.690	2.693	0.999687	47.01	54.06	8.185E-04
34	16774.	2.770	2.759	0.996047	47.94	55.13	9.643E-04
35	16841.	2.885	2.896	0.997241	49.92	57.41	1.164E-03
36	16887.	2.990	3.000	0.996841	51.50	59.23	1.438E-03
37	16940.	3.175	3.160	0.983005	54.03	62.14	2.129E-03
38	16987.	3.375	3.375	0.986554	57.71	66.37	3.055E-03
39	17006.	3.450	3.488	0.989071	59.78	68.74	3.749E-03
40	17035.	3.740	3.740	0.999904	64.86	74.59	5.777E-03

M-64 TYPICAL FIGHTER, COMPOSITE MISSION, MAX STRESS = 20 KSI
PLOT RATE CRACK GROWTH ANALYSIS

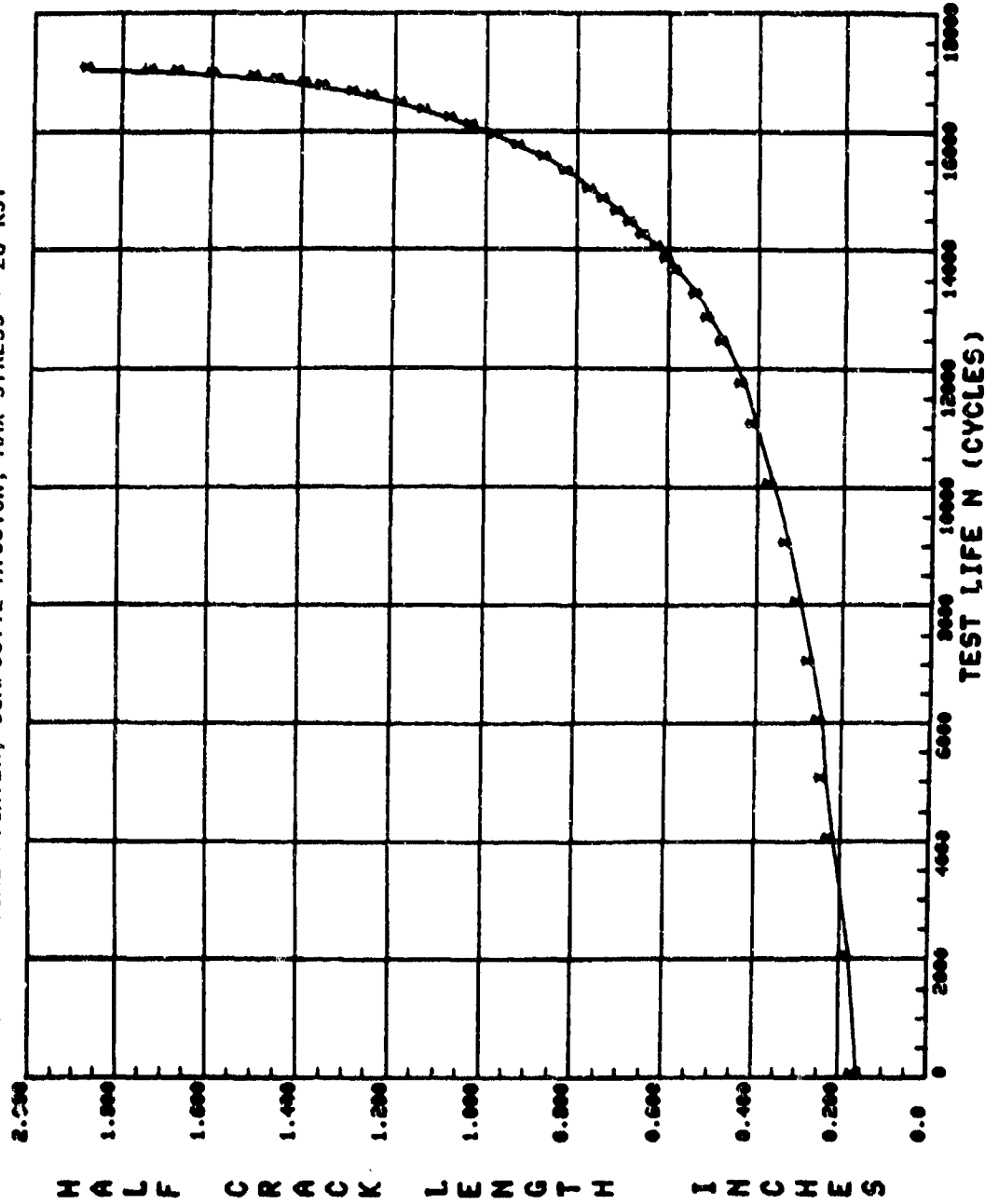

Figure 81. Crack growth curve for test M-64.

TABLE 81. DATA TABULATION FOR TEST M-54A

SPECIMEN NO.: M-64A TYP FIGHTER COMPOSITE MISS. STRESS = 15 KSI MAX

CCT SPECIMEN B= 0.250 IN. M= 6.000 IN. AM= 0.0 IN.

PHIN= PMAX= TEST FREQ= 6.00 HZ.

ENVIRONMENT CONDITION: AMBIENT AIR

NO.	CYCLES	A (MEASURED)	A (REGRESSION)	MULT. CORR. COEFF	K-MAX	DELTA X	DAVDM
1	0.	0.300	0.300	0.998883	10.41	12.47	8.89E-07
2	5450.	0.325	0.321	0.999565	12.91	12.91	3.014E-06
3	12000.	0.375	0.380	0.999007	11.72	14.02	5.428E-06
4	17628.	0.455	0.454	0.999907	12.82	15.36	7.394E-06
5	22700.	0.545	0.538	0.998540	13.98	16.75	9.382E-06
6	26000.	0.600	0.602	0.998336	14.84	17.19	1.068E-05
7	28200.	0.645	0.652	0.998396	15.42	18.48	1.193E-05
8	30400.	0.710	0.704	0.999280	16.04	19.22	1.356E-05
9	32400.	0.760	0.763	0.993135	16.73	20.05	1.724E-05
10	34000.	0.810	0.822	0.978650	17.39	20.84	1.743E-05
11	35500.	0.865	0.877	0.977584	17.99	21.55	1.880E-05
12	35600.	0.915	0.901	0.977654	18.04	21.61	2.002E-05
13	38000.	0.965	0.960	0.977601	19.08	22.86	2.248E-05
14	39000.	1.020	1.021	0.982207	19.51	23.37	2.343E-05
15	40000.	1.080	1.068	0.993082	19.98	23.94	2.422E-05
16	41000.	1.120	1.129	0.997156	20.58	24.66	2.813E-05
17	42050.	1.180	1.187	0.997127	21.16	25.35	3.038E-05
18	42750.	1.225	1.228	0.998770	21.56	25.83	3.258E-05
19	43300.	1.270	1.265	0.998641	21.91	26.26	3.421E-05
20	43900.	1.310	1.310	0.999641	22.35	26.78	3.638E-05
21	44600.	1.360	1.361	0.999281	22.63	27.32	3.803E-05
22	45300.	1.415	1.413	0.999752	23.32	27.94	4.044E-05
23	45900.	1.460	1.462	0.999718	23.78	28.49	4.389E-05
24	46600.	1.525	1.525	0.999887	24.37	29.20	4.844E-05
25	47533.	1.620	1.621	0.999976	25.26	30.26	5.565E-05
26	48243.	1.705	1.703	0.999675	26.02	31.17	6.285E-05
27	49021.	1.805	1.804	0.998589	26.95	32.29	7.378E-05
28	49759.	1.910	1.917	0.999113	27.99	33.54	8.659E-05

TABLE 81. DATA TABULATION FOR TEST M-64A (CONCL)

SPECIMEN NO.: M-64A JYP EIGHTER COMPOSITE MISS. STRESS = 15 KSI MAX

CCT SPECIMEN B = 0.250 IN. W = 6.000 IN. AME 0.0 IM. TEST FREQ = 6.00 HZ.

PHIN = PMAK =

ENVIRONMENT CONDITIONS: AMBIENT AIR

NO.	CYCLES	A (MEASURED)	A (REGRESSION)	MULT. CORR. COEFF	K-MAX	DELTA K	DA/DN
29	50283.	2.005	2.010	0.999618	28.85	34.57	9.817E-05
30	50739.	2.110	2.102	0.999710	29.72	35.62	1.096E-04
31	51234.	2.215	2.218	0.999759	30.83	36.94	1.225E-04
32	51620.	2.315	2.315	0.999042	31.76	38.05	1.368E-04
33	51962.	2.410	2.408	0.999464	32.67	39.15	1.526E-04
34	52338.	2.520	2.527	0.998672	33.66	40.57	1.698E-04
35	52601.	2.625	2.623	0.999329	34.84	41.74	2.079E-04
36	52865.	2.730	2.738	0.998717	36.06	43.20	2.291E-04
37	53064.	2.840	2.835	0.998366	37.10	44.46	2.549E-04
38	53282.	2.960	2.950	0.998237	38.39	46.00	2.820E-04
39	53483.	3.050	3.067	0.997231	39.76	47.64	3.218E-04
40	53637.	3.170	3.165	0.997500	40.94	49.06	3.740E-04
41	53765.	3.255	3.259	0.998855	42.14	50.45	4.382E-04
42	53897.	3.375	3.363	0.998450	43.77	52.45	5.278E-04
43	53987.	3.480	3.476	0.999644	45.07	54.00	6.176E-04
44	54069.	3.560	3.581	0.996524	46.60	55.84	7.548E-04
45	54151.	3.700	3.707	0.996819	48.56	58.18	9.332E-04
46	54225.	3.835	3.852	0.990403	50.98	61.05	1.341E-03
47	54271.	3.970	3.978	0.993632	53.27	63.83	1.731E-03
48	54300.	4.050	4.077	0.996707	55.21	66.15	2.131E-03
49	54336.	4.250	4.249	0.996907	58.92	70.60	2.848E-03

M-64A **PLOTRATE CRACK GROWTH ANALYSIS**
TYP FIGHTER COMPOSITE MISS, STRESS = 15 KSI MAX

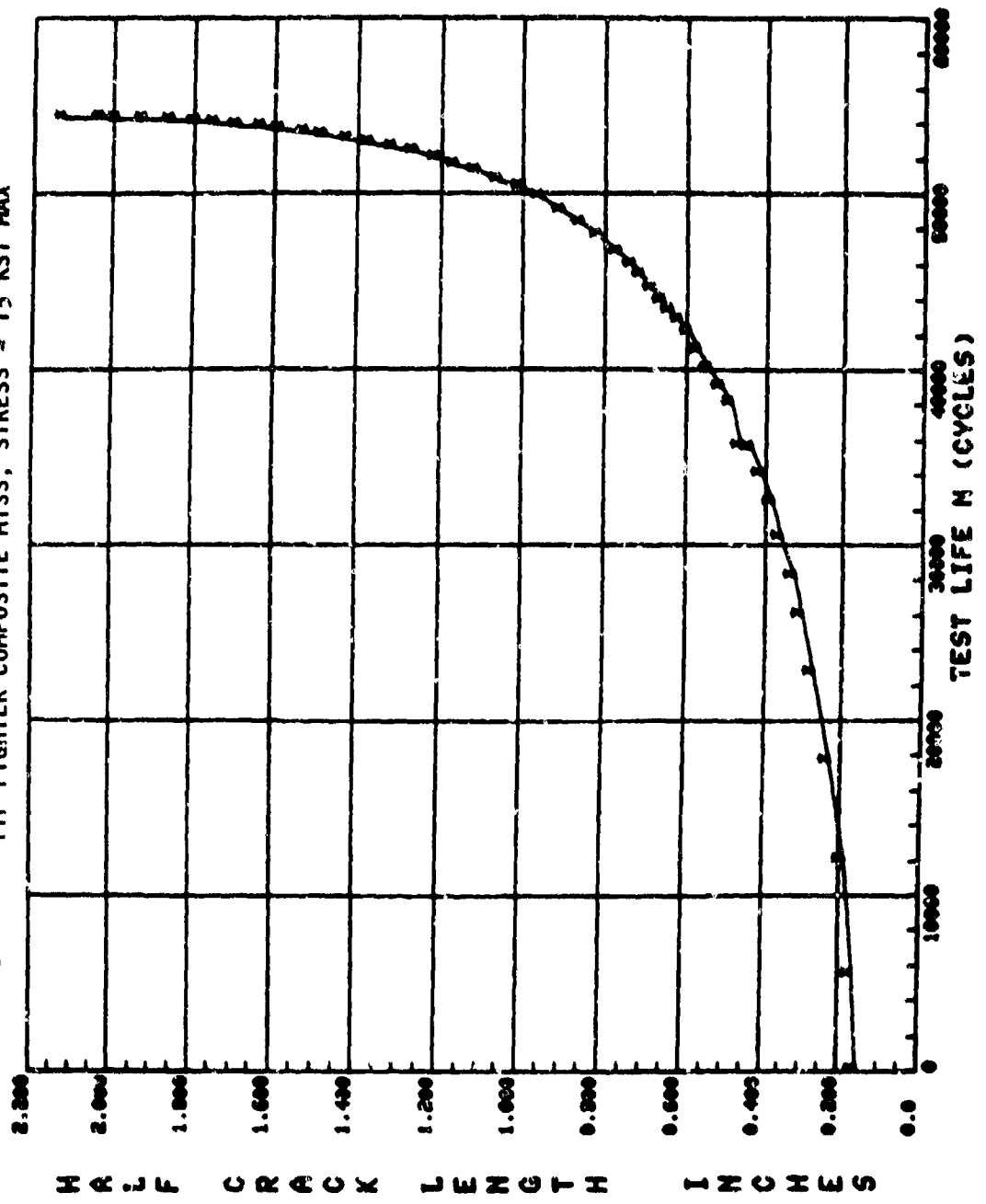

Figure 82. Crack growth curve for test M-64A.

TABLE 82. DATA TABULATION FOR TEST M-64B

SPECIMEN NO.: M-64B TYP FIGHTER COMPOSITE MISS, STRESS = 10 KSI MAX

CCT SPECIMEN B= 0.250 IN. V= 6.000 IN. AM= 0.0 IN. TEST FREQ= 6.00 HZ.

ENVIRONMENT CONDITION: AMBIENT AIR

NO.	CYCLES	AI MEASURED	AI (REGRESSION)	MULT. CORR. COEFF	K-MAX	DELTA K	DA/DM
1	0.	0.300	0.300	0.996382	6.67	0.93	1.579E-06
2	8500.	0.320	0.319	0.982537	7.09	9.22	9.384E-07
3	18000.	0.350	0.333	0.905073	7.25	9.42	7.621E-07
4	59100.	0.390	0.390	0.906907	7.85	10.20	7.920E-07
5	92450.	0.440	0.443	0.992995	8.37	10.84	1.044E-06
6	112450.	0.482	0.486	0.299102	9.77	11.40	1.279E-06
7	129500.	0.530	0.530	0.997877	9.17	11.92	1.586E-06
8	149350.	0.597	0.598	0.997536	9.75	12.68	1.889E-06
9	162600.	0.655	0.662	0.997271	10.27	13.32	2.116E-06
10	175300.	0.720	0.707	0.996042	10.63	13.82	2.363E-06
11	187000.	0.760	0.765	0.994294	11.07	14.39	2.734E-06
12	192000.	0.800	0.808	0.994140	11.39	14.81	3.070E-06
13	202400.	0.855	0.852	0.990066	11.71	15.22	3.356E-06
14	209000.	0.910	0.908	0.999252	12.11	15.74	3.784E-06
15	215370.	0.955	0.954	0.999310	12.43	16.15	4.185E-06
16	222200.	1.005	1.009	0.999604	12.80	16.64	4.377E-06
17	228500.	1.065	1.065	0.999704	13.18	17.14	4.750E-06
18	233800.	1.120	1.116	0.998996	13.52	17.59	5.299E-06
19	239000.	1.170	1.173	0.998910	13.89	18.06	5.876E-06
20	243700.	1.225	1.230	0.998965	14.24	18.53	6.389E-06
21	247600.	1.285	1.281	0.998908	14.56	18.97	6.755E-06
22	251200.	1.335	1.334	0.999134	14.91	19.39	6.939E-06
23	255000.	1.365	1.387	0.997742	15.25	19.83	7.337E-06
24	257800.	1.430	1.425	0.998114	15.49	20.13	7.726E-06
25	262100.	1.485	1.493	0.998955	15.90	20.68	8.705E-06
26	264300.	1.535	1.533	0.998998	16.15	21.00	9.172E-06
27	268200.	1.630	1.630	0.999193	16.74	21.77	1.041E-05
28	273500.	1.730	1.726	0.999467	17.33	22.53	1.166E-05

TABLE 82. DATA TABULATION FOR TEST M-64B (CONCL)

SPECIMEN NO.: M-64B		TYP FIGHTER COMPOSITE MISS. STRESS = 10 KSI MAX					
CCT SPECIMEN		B = 0.250 IN.	M = 6.000 IN.	A = 0.0 IN.	TEST FREQ = 6.00 HZ.		
PHIN =		PMAK =					
ENVIRONMENT CONDITION: AMBIENT AIR							
NO.	CYCLES	A (MEASURED)	A (REGRESSION)	MULT. CORR. COEFF	K-MAX	DELTA K	RAMM
29	278000.	1.830	1.834	0.999732	17.99	23.39	1.270E-05
30	281400.	1.920	1.923	0.999743	18.53	24.09	1.243E-05
31	284350.	2.010	2.004	0.999759	19.03	24.74	1.454E-05
32	288200.	2.120	2.121	0.999310	19.76	25.69	1.630E-05
33	291300.	2.220	2.222	0.998367	20.39	26.51	1.882E-05
34	293600.	2.305	2.309	0.999409	20.95	27.23	2.073E-05
35	295800.	2.400	2.404	0.999495	21.56	28.03	2.290E-05
36	298100.	2.525	2.515	0.999390	22.29	28.98	2.573E-05
37	299500.	2.605	2.608	0.998296	22.92	29.79	2.883E-05
38	301700.	2.710	2.718	0.998117	23.68	30.78	3.310E-05
39	303100.	2.805	2.809	0.999771	24.33	31.62	3.801E-05
40	304300.	2.910	2.906	0.999294	25.04	32.55	4.145E-05
41	305398.	3.000	3.003	0.999433	25.77	33.51	4.431E-05
42	306214.	3.065	3.076	0.998658	26.34	34.25	4.788E-05
43	307290.	3.175	3.176	0.997766	27.15	35.29	5.324E-05
44	308220.	3.270	3.277	0.998475	27.99	36.39	6.109E-05
45	309294.	3.410	3.415	0.999742	29.21	37.97	7.335E-05
46	309811.	3.509	3.491	0.999095	29.92	38.99	8.317E-05
47	310450.	3.635	3.641	0.998548	31.60	40.82	1.400E-04
48	311100.	3.723	3.730	0.999093	32.32	42.02	1.144E-04
49	311659.	3.865	3.863	0.998615	32.81	43.96	1.422E-04
50	312000.	3.960	3.956	0.997068	34.92	45.48	1.787E-04
51	312400.	4.065	4.100	0.997612	36.79	47.83	2.001E-04
52	312800.	4.265	4.275	0.999298	39.33	51.13	2.459E-04
53	313100.	4.450	4.450	0.999929	42.26	54.94	3.328E-04

M-64B **PLOT RATE CRACK GROWTH ANALYSIS**
TYP FIGHTER COMPOSITE MISS, STRESS = 10 KSI MAX

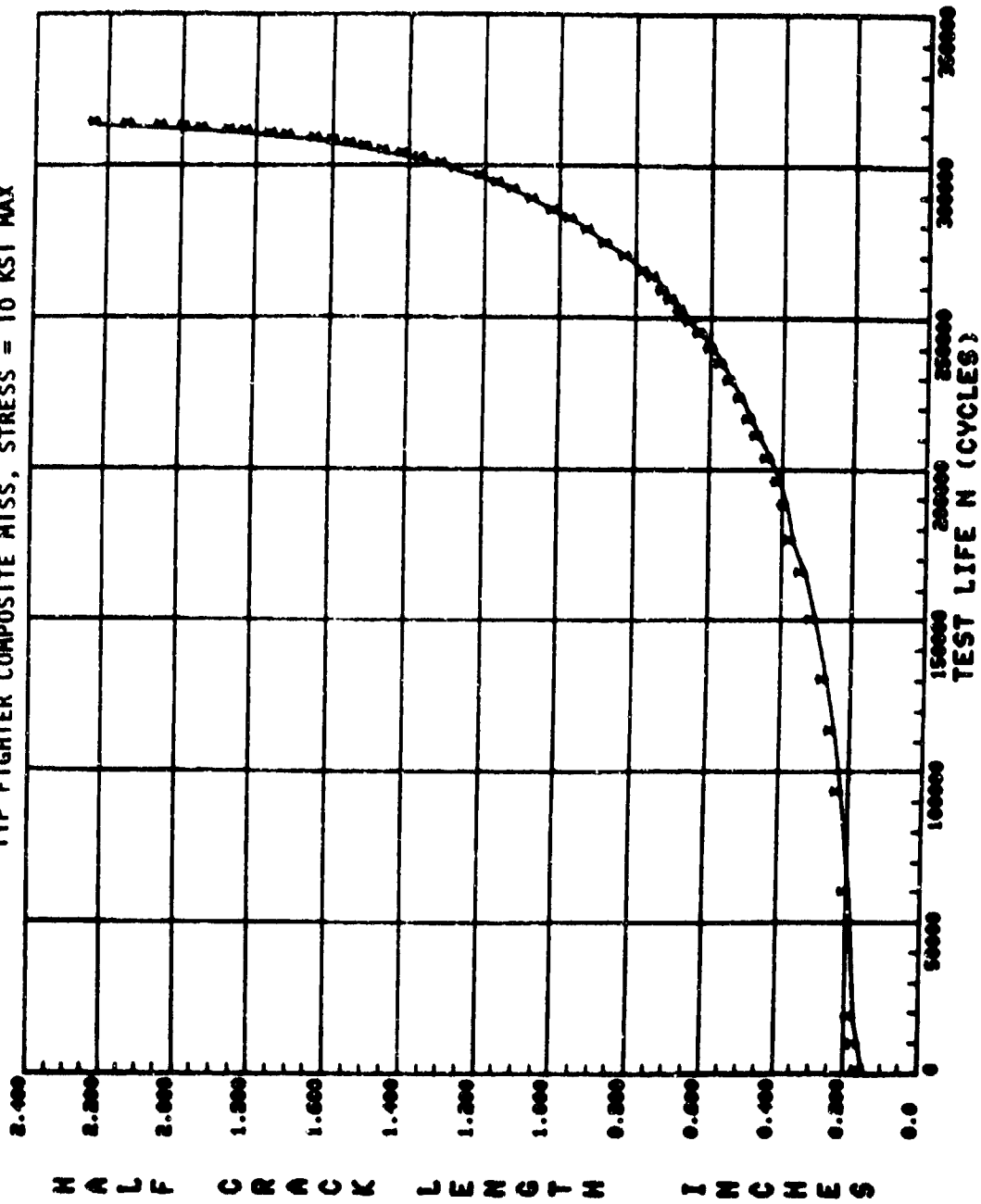

Figure 83. Crack growth curve for test M-64B.

TABLE 83. DATA TABULATION FOR TEST M-65

SPECIMEN NO.: M-65 TYPICAL TRANSPORT, MAX STRESS = 12 KSI

ECT SPECIMEN R = 0.750 IN. W = 6.000 IN. AN = 0.0 IN.

P4IN = P4MAX = TEST FREQ = 6.00 HZ.

ENVIRONMENT CONDITION: AMBIENT AIR

NO.	CYCLFS	A (MEASURED)	A (REGRESSION)	MULT. CORR. COEFF	K-MAX	DELTA K	DA/DM
1	0.	0.750	0.750	0.993805	13.14	21.26	2.741E-07
2	18700.	0.745	0.747	0.974807	13.30	21.61	1.917E-07
3	25000.	0.790	0.779	0.951955	13.40	21.75	1.331E-07
4	300500.	0.810	0.813	0.952491	13.71	22.25	2.764E-08
5	363400.	0.870	0.873	0.975649	13.80	22.47	8.640E-08
6	412000.	0.870	0.870	0.986299	13.66	22.52	9.556E-08
7	500000.	0.852	0.850	0.954923	14.03	22.80	1.053E-07
8	456000.	0.880	0.883	0.987693	14.37	23.26	1.120E-07
9	943000.	0.920	0.926	0.988052	14.46	23.86	1.191E-07
10	918000.	0.940	0.943	0.997938	14.82	24.09	1.219E-07
11	1076000.	0.985	0.994	0.997795	15.16	24.63	1.259E-07
12	1178000.	1.010	1.010	0.996773	15.38	24.99	1.420E-07

PLOTRATE CRACK GROWTH DATA

TYPICAL TRANSPORT, MAX STRESS = 12 KSI

M-65

LEGEND

● M-65

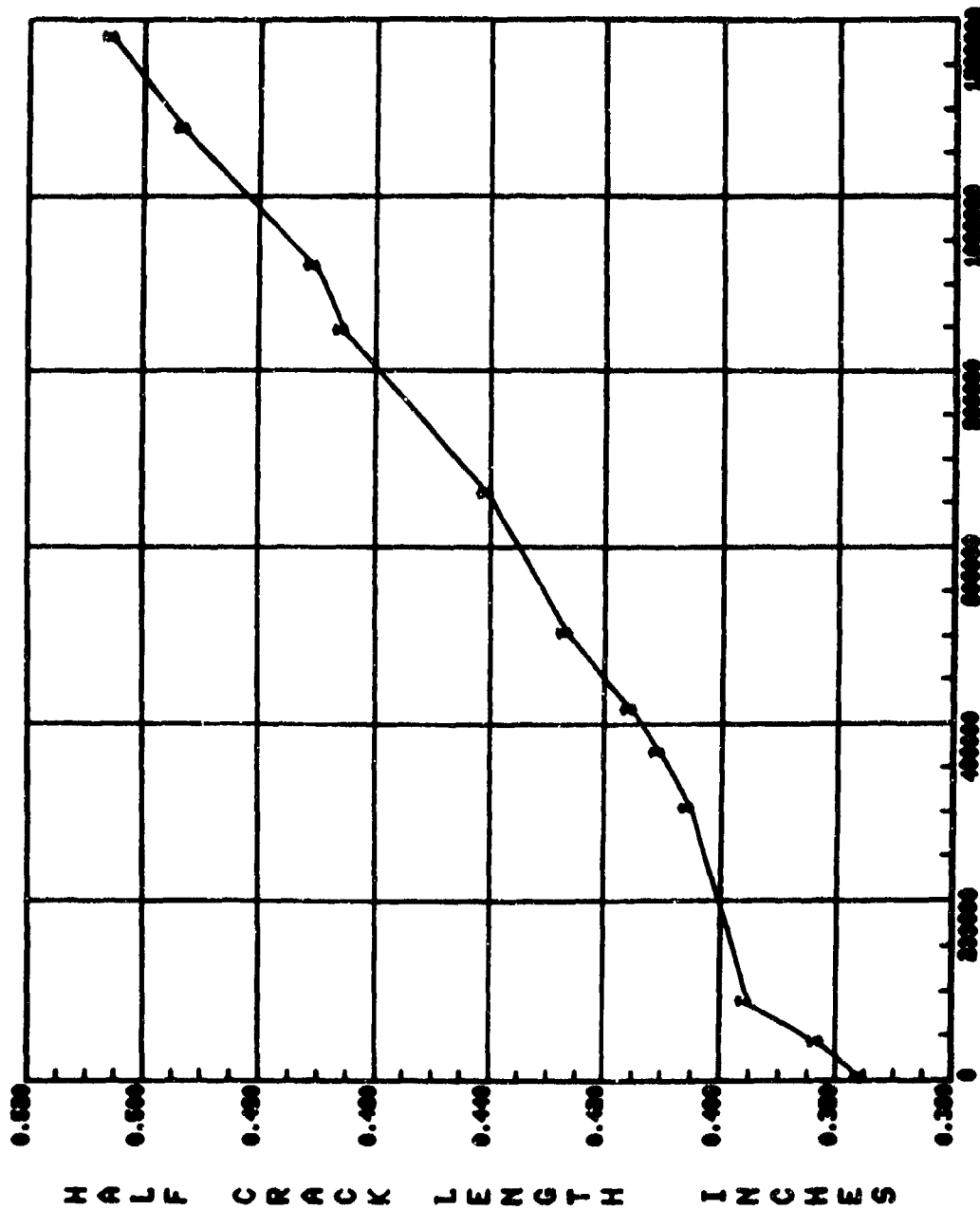

TEST LIFE N (CYCLES)

Figure 84. Crack growth curve for test M-65.

TABLE 84. DATA TABULATION FOR TEST M-66

SPECIMEN NO.: M-66 TYPICAL TRANSPORT, MAX STRESS = 16.8 KSI

CCT SPECIMEN B = 0.250 IN. b = 6.000 IN. AN = 0.0 IN.

PMIN = PMAX = TEST FREQ = 6.00 HZ.

ENVIRONMENT CONDITION: AMBIENT AIR

NO-	CYCLES	A (MEASURED)	A (REGRESSION)	MULT. CORR. COEFF	K-MAX	DELTA K	RA/DM
1	0.	0.500	0.500	0.945275	14.95	24.29	1.144E-07
2	71100.	0.510	0.516	0.967160	15.19	24.69	1.105E-07
3	86200.	0.525	0.519	0.975588	15.24	24.76	1.099E-07
4	161700.	0.535	0.535	0.951709	15.47	25.14	1.336E-07
5	211300.	0.545	0.549	0.955739	15.67	25.47	1.429E-07
6	250000.	0.555	0.559	0.965050	15.83	25.72	1.455E-07
7	268100.	0.575	0.567	0.970582	15.93	25.89	1.539E-07
8	335000.	0.587	0.588	0.971575	16.24	26.40	1.615E-07
9	362000.	0.595	0.596	0.967614	16.35	26.57	1.722E-07
10	396000.	0.605	0.607	0.989658	16.51	26.82	1.656E-07
11	428500.	0.620	0.620	0.992555	16.68	27.11	1.805E-07
12	447500.	0.630	0.627	0.993462	16.79	27.28	1.803E-07
13	500000.	0.645	0.645	0.998611	17.03	27.67	1.095E-07

PLOTRATE CRACK GROWTH DATA

M-66 TYPICAL TRANSPORT, MAX STRESS = 16.8 KSI

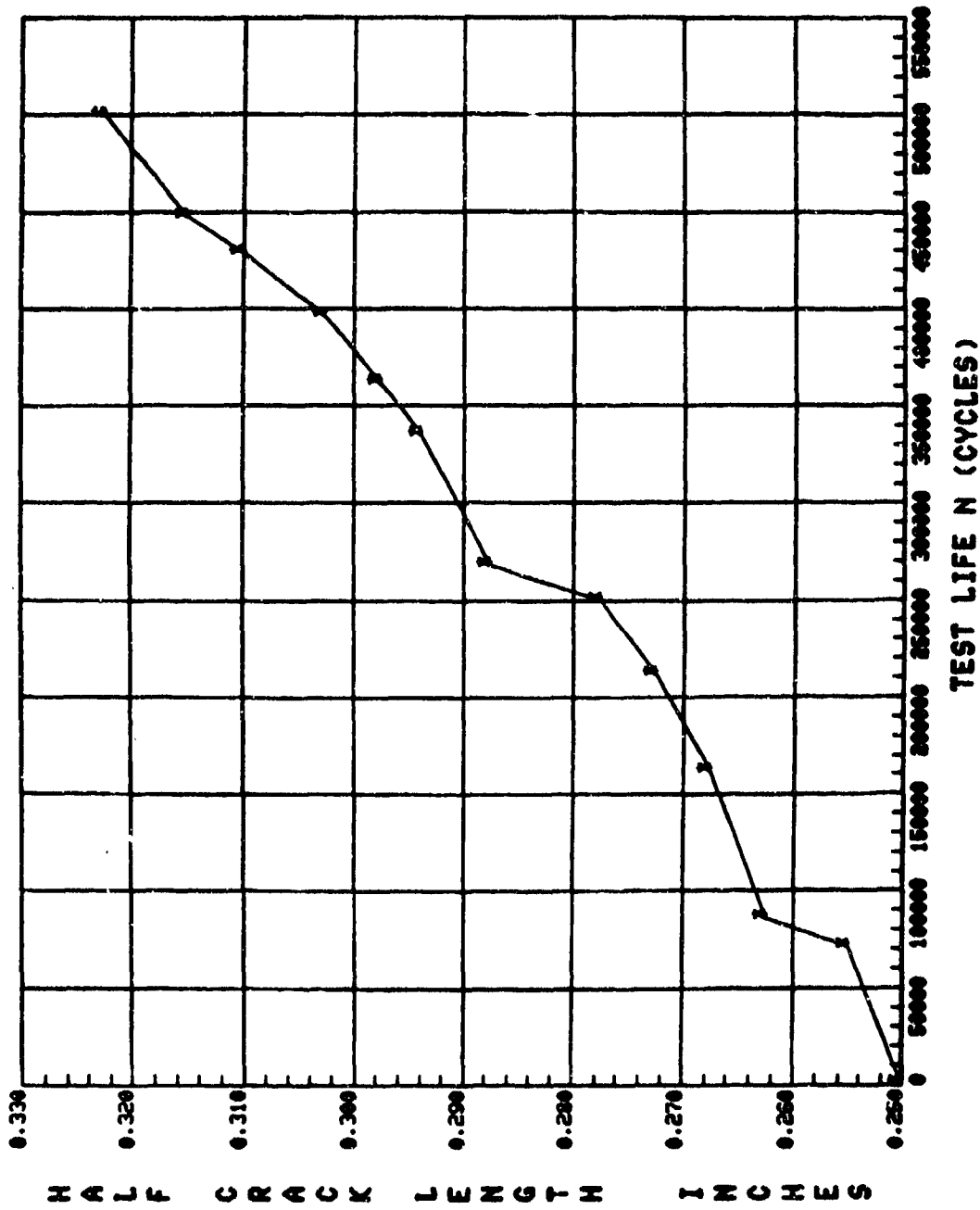

Figure 85. Crack growth curve for test M-66.

TABLE 85. DATA TABULATION FOR TEST M-69

SPECIMEN NO.: M-69 TYPICAL FIGHTER, AIR-TO-AIR, MAX STRESS = 20 KSI

CCT SPFCIMEN D= 0.250 IN. M= 6.000 IN. AM= 0.0 IN.

PMIN= PMAX= TEST FREQ= 6.00 HZ.

ENVIRONMENT CONDITION: AMBIENT AIR

NO.	CYCLES	A (MEASURED)	A (REGRESSION)	MULT. CORR. COEFF	K-MAX	DELTA K	DA/DM
1	0.	0.310	0.310	0.999997	13.98	15.61	4.607E-04
2	3500.	0.350	0.350	0.999998	14.85	16.59	6.977E-04
3	6600.	0.400	0.400	0.999951	15.89	17.72	9.249E-04
4	9050.	0.450	0.450	0.999163	16.87	18.84	1.168E-05
5	11350.	0.505	0.507	0.999498	17.92	20.01	1.401E-05
6	13100.	0.555	0.558	0.999707	18.82	21.01	1.613E-05
7	14700.	0.615	0.612	0.999399	19.72	22.02	1.868E-05
8	16250.	0.670	0.672	0.999278	20.71	23.12	2.167E-05
9	17500.	0.725	0.729	0.999129	21.59	24.11	2.366E-05
10	18300.	0.770	0.767	0.998716	22.16	24.75	2.579E-05
11	19400.	0.830	0.827	0.998470	23.05	25.74	2.900E-05
12	20500.	0.885	0.893	0.998313	24.00	26.80	3.215E-05
13	21100.	0.935	0.933	0.998850	24.56	27.43	3.522E-05
14	21800.	0.985	0.984	0.998836	25.26	28.21	3.864E-05
15	22400.	1.035	1.032	0.996407	25.92	28.94	4.413E-05
16	23050.	1.085	1.089	0.997991	26.69	29.80	5.014E-05
17	23550.	1.135	1.140	0.998625	27.35	30.55	5.760E-05
18	24000.	1.200	1.194	0.997092	28.06	31.33	6.193E-05
19	24350.	1.240	1.242	0.998046	28.67	32.01	6.601E-05
20	24700.	1.295	1.290	0.997857	29.28	32.69	7.014E-05
21	25000.	1.325	1.330	0.998458	29.78	33.26	7.407E-05
22	25300.	1.375	1.375	0.998447	30.35	33.89	8.146E-05
23	25600.	1.475	1.424	0.999608	30.95	34.56	8.958E-05
24	25900.	1.480	1.481	0.999797	31.67	35.36	1.018E-04
25	26200.	1.545	1.546	0.999818	32.46	36.24	1.109E-04
26	26500.	1.615	1.616	0.999854	33.32	37.21	1.208E-04
27	26800.	1.695	1.690	0.999441	34.23	38.22	1.327E-04
28	27200.	1.800	1.800	0.999049	35.56	39.71	1.522E-04

TABLE 85. DATA TABULATION FOR TEST M-69 (CONCL)

SPECIMEN NO.: M-69 TYPICAL FIGHTER, AIR-TO-AIR, MAX STRESS = 20 KSI

CGT SPECIMEN B= 0.250 IN. W= 6.000 IN. AN= 0.0 IN.

PMIN= PMAX= TEST FREQ= 6.00 HZ.

ENVIRONMENT CONDITION: AMBIENT AIR

NO.	CYCLES	A (MEASURED)	A (REGRESSION)	MULT. CORR. COEFF	K-MAX	DELTA K	DA/DN
29	27510.	1.890	1.895	0.998819	36.73	41.01	1.767E-04
30	27790.	1.995	1.997	0.999685	37.98	42.41	2.049E-04
31	28015.	2.090	2.091	0.999597	39.14	43.71	2.376E-04
32	28220.	2.195	2.193	0.998837	40.41	45.13	2.790E-04
33	28420.	2.300	2.308	0.999236	41.88	46.77	3.301E-04
34	28540.	2.400	2.402	0.999374	43.10	48.13	3.818E-04
35	28680.	2.500	2.496	0.999607	44.32	49.50	4.327E-04
36	28810.	2.610	2.614	0.999131	45.92	51.28	5.088E-04
37	28930.	2.740	2.740	0.997362	47.67	53.24	6.234E-04
38	29020.	2.845	2.855	0.997140	49.33	55.08	7.691E-04
39	29095.	2.960	2.975	0.997612	51.11	57.08	9.629E-04
40	29155.	3.070	3.070	0.999163	52.60	58.73	1.185E-03
41	29180.	3.155	3.155	0.999629	53.95	60.24	1.343E-03
42	29221.	3.265	3.272	0.995996	55.90	62.43	1.860E-03
43	29251.	3.375	3.371	0.994792	57.63	64.36	2.106E-03
44	29276.	3.455	3.480	0.996072	59.64	66.60	2.583E-03
45	29291.	3.560	3.557	0.996730	61.10	68.23	3.029E-03
46	29311.	3.690	3.691	0.997608	63.82	71.27	4.013E-03

PLOTRATE CRACK GROWTH ANALYSIS

M-69 TYPICAL FIGHTER, AIR-TO-AIR, MAX STRESS = 20 KSI

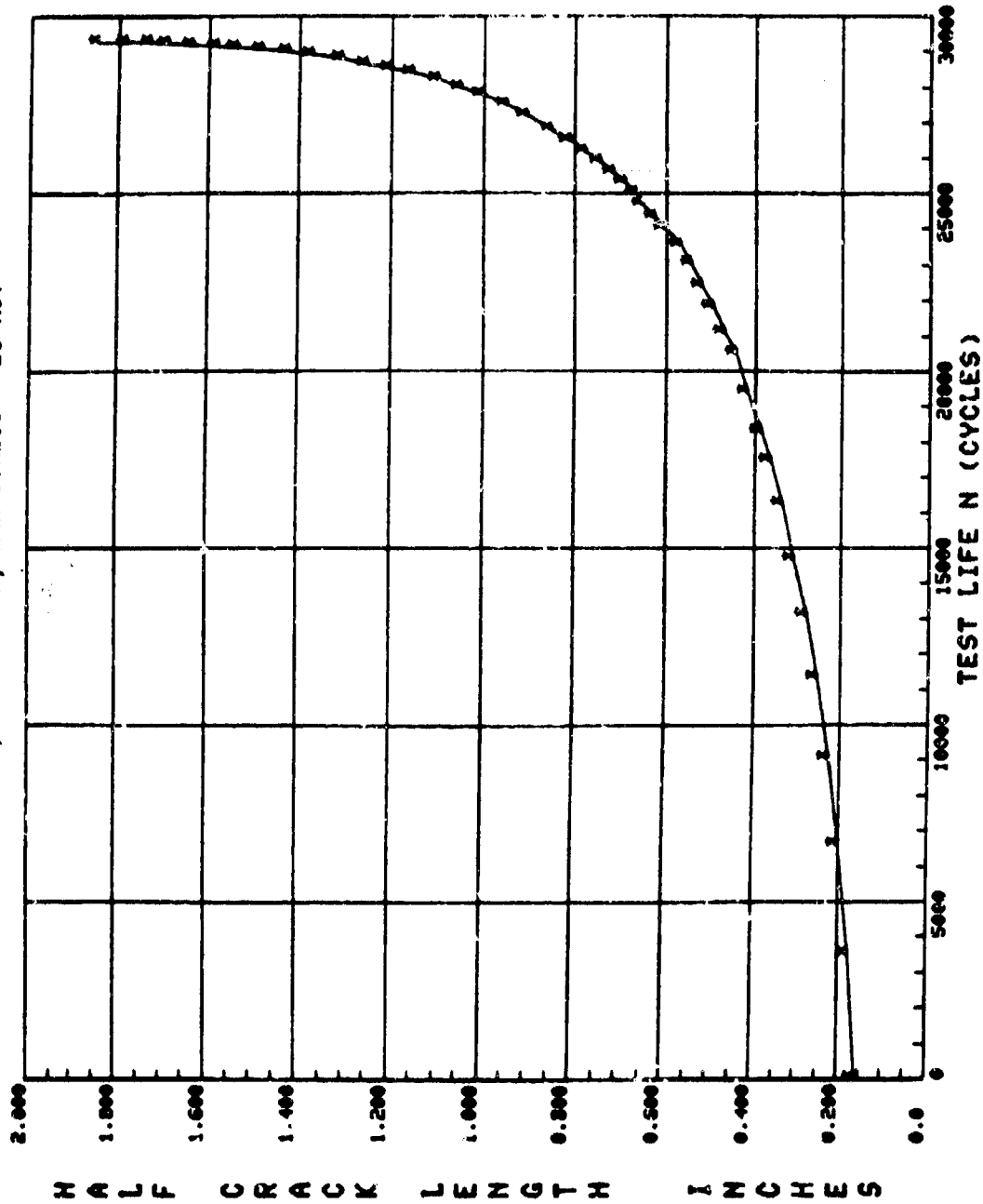

Figure 86. Crack growth curve for test M-69.

TABLE 86. DATA TABULATION FOR TEST M-69A

SPECIMEN NO.: M-69A SIMPLIFIED SPECTRUM, TYP FIGHTER-AIR TO AIR, MAX STRESS = 12 KSI

CCI SPECIMEN RE 0.250 IN. M= 6.000 IN. AN= 0.0 IN. TEST FREQ= 6.00 HZ.

ENVIRONMENT CONDITION: AMBIENT AIR

NO.	CYCLES	A (MEASURED)	A (REGRESSION)	MULT. CORR. COEFF	K-MAX	DELTA K	DA/DM
1	0.	0.310	0.310	0.998348	5.59	6.52	1.670E-06
2	11600.	0.345	0.346	0.997398	5.91	6.89	1.629E-06
3	24350.	0.395	0.383	0.991477	6.22	7.25	2.014E-06
4	37400.	0.435	0.442	0.992365	6.69	7.80	2.774E-06
5	47700.	0.490	0.500	0.996100	7.12	8.31	3.543E-06
6	59000.	0.590	0.587	0.999601	7.73	9.01	4.819E-06
7	64000.	0.640	0.636	0.999573	8.06	9.41	5.416E-06
8	68900.	0.690	0.695	0.999584	8.42	9.83	5.859E-06
9	72500.	0.740	0.737	0.998784	8.69	10.13	6.443E-06
10	75600.	0.780	0.777	0.998468	8.93	10.42	7.064E-06
11	80300.	0.840	0.847	0.995852	9.34	10.89	8.671E-06
12	82800.	0.890	0.890	0.995561	9.59	11.18	9.225E-06
13	85500.	0.940	0.943	0.995804	9.88	11.53	1.019E-05
14	87100.	0.990	0.979	0.996456	10.08	11.76	1.096E-05
15	89750.	1.030	1.038	0.996417	10.40	12.14	1.142E-05
16	91600.	1.080	1.080	0.996138	10.63	12.40	1.205E-05
17	93800.	1.140	1.133	0.997830	10.90	12.72	1.277E-05
18	96100.	1.190	1.197	0.998925	11.24	13.11	1.384E-05
19	97600.	1.240	1.237	0.998470	11.44	13.35	1.468E-05
20	99500.	1.295	1.293	0.998693	11.73	13.68	1.596E-05
21	101500.	1.355	1.361	0.998917	12.07	14.06	1.770E-05
22	102500.	1.400	1.396	0.999546	12.24	14.28	1.862E-05
23	103900.	1.450	1.450	0.999615	12.51	14.60	2.031E-05
24	105100.	1.500	1.502	0.999631	12.77	14.89	2.174E-05
25	107200.	1.595	1.595	0.999723	13.22	15.43	2.391E-05
26	109200.	1.700	1.698	0.999531	13.73	16.02	2.600E-05
27	111000.	1.790	1.793	0.998066	14.19	16.56	2.684E-05
28	112700.	1.900	1.891	0.996923	14.67	17.11	3.265E-05

TABLE 86. DATA TABULATION FOR TEST M-69A (CONCL)

SPECIMEN NO. 1 M-69A SIMPLIFIED SPECTRUM, TYP FIGHTER-AIR TO AIR STRESS - 12 KSI MAX

CCI SPECIMEN B = 0.250 IN. W = 6.000 IN. AN = 0.0 IN.

PHIN = PMAX = TEST FREQ = 6.00 HZ.

ENVIRONMENT CONDITION: AMBIENT AIR

NO.	CYCLES	A (MEASURED)	A (REGRESSION)	MULTI. CORR. COEFF	K-MAX	DELTA K	DA/DN
29	114800.	2.070	2.040	0.997690	15.40	17.97	3.867E-03
30	116000.	2.130	2.127	0.998190	15.84	18.48	4.274E-05
31	117150.	2.240	2.228	0.998353	16.34	19.07	4.829E-05
32	118200.	2.330	2.338	0.997631	16.90	19.72	5.468E-05
33	119250.	2.445	2.453	0.999074	17.50	20.42	6.224E-05
34	119940.	2.540	2.532	0.999825	17.96	20.95	6.997E-05
35	120540.	2.630	2.626	0.999506	18.43	21.51	7.674E-05
36	121210.	2.750	2.735	0.999445	19.04	22.22	8.944E-05
37	121795.	2.840	2.842	0.999544	19.65	22.93	1.024E-04
38	122298.	2.950	2.948	0.999885	20.28	23.67	1.162E-04
39	122754.	3.055	3.060	0.999872	20.97	24.47	1.292E-04
40	123136.	3.165	3.161	0.999627	21.62	25.23	1.435E-04
41	123498.	3.270	3.268	0.999020	22.34	26.06	1.629E-04
42	123797.	3.360	3.367	0.998550	23.03	26.87	1.863E-04
43	124080.	3.470	3.474	0.999519	23.80	27.77	2.176E-04
44	124284.	3.565	3.564	0.999693	24.50	28.58	2.482E-04
45	124490.	3.670	3.672	0.999775	25.37	29.60	2.857E-04
46	124695.	3.775	3.788	0.999831	26.37	30.76	3.246E-04
47	124800.	3.885	3.864	0.999373	27.06	31.57	3.684E-04
48	124921.	3.955	3.956	0.999310	27.94	32.59	4.175E-04
49	125050.	4.080	4.067	0.998442	29.08	33.52	5.056E-04
50	125120.	4.140	4.137	0.998513	29.84	34.51	5.865E-04
51	125200.	4.225	4.233	0.994309	30.94	36.11	7.476E-04
52	125268.	4.320	4.336	0.995346	32.24	37.61	9.375E-04
53	125325.	4.430	4.449	0.997297	33.79	39.43	1.201E-03
54	125363.	4.550	4.548	0.997243	35.30	41.19	1.505E-03

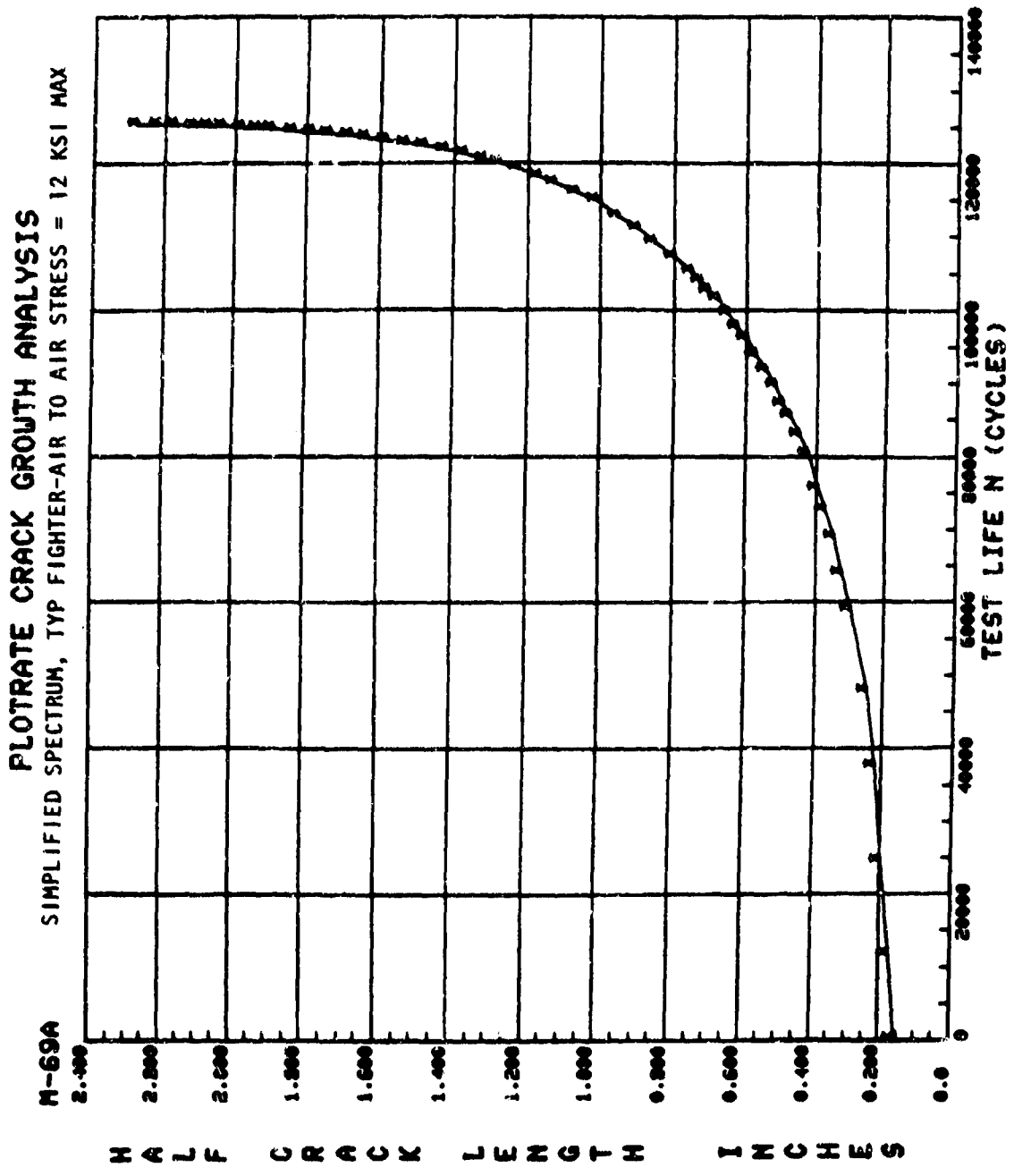

Figure 87. Crack growth curve for test M-69A.

TABLE 87. DATA TABULATION FOR TEST M-70

SPECIMEN NO.: M-70

TYPICAL FIGHTER, AIR-TO-GROUND, MAX STRESS = 18KSI

CCI SPECIMEN B = 0.250 IN.

N = 6.000 IN.

AN = 0.0 IN.

PHIN= PMAX=

TEST FREQ= 6.00 HZ.

ENVIRONMENT CONDITION: AMBIENT AIR

NO.	CYCLES	A(MEASURED)	A(REGRESSION)	MULT. CORR. COEFF	K-MAX	DELTA K	DA/DN
1	0.	0.298	0.297	0.999844	12.32	15.06	7.604E-06
2	2500.	0.330	0.325	0.989729	12.09	15.75	5.176E-06
3	5000.	0.355	0.351	0.993178	13.39	16.36	4.825E-06
4	8000.	0.370	0.373	0.984506	13.80	16.87	4.699E-06
5	12000.	0.415	0.406	0.993243	14.81	17.62	5.202E-06
6	16000.	0.440	0.450	0.996341	15.19	18.57	6.406E-06
7	20000.	0.510	0.507	0.996892	16.14	19.72	7.953E-06
8	24000.	0.580	0.576	0.997695	17.21	21.03	9.773E-06
9	26000.	0.615	0.619	0.998327	17.86	21.83	1.090E-05
10	28000.	0.640	0.661	0.999469	18.48	22.58	1.219E-05
11	30000.	0.710	0.712	0.999074	19.19	23.46	1.329E-05
12	32000.	0.770	0.770	0.999304	19.99	24.43	1.448E-05
13	34000.	0.835	0.830	0.998187	20.79	25.41	1.608E-05
14	35500.	0.875	0.879	0.997722	21.42	26.19	1.751E-05
15	37000.	0.925	0.932	0.998087	22.09	27.00	1.965E-05
16	38000.	0.975	0.970	0.999067	22.57	27.59	2.130E-05
17	39000.	1.015	1.015	0.998060	23.12	28.25	2.443E-05
18	40000.	1.065	1.066	0.998049	23.74	29.02	2.661E-05
19	41000.	1.115	1.119	0.998447	24.37	29.78	2.973E-05
20	42000.	1.190	1.183	0.998569	25.12	30.70	3.312E-05
21	43000.	1.245	1.252	0.998634	25.92	31.48	3.677E-05
22	44000.	1.335	1.329	0.997886	26.80	32.75	4.162E-05
23	45000.	1.410	1.415	0.998853	27.76	33.92	4.744E-05
24	45500.	1.460	1.463	0.998949	28.30	34.59	5.171E-05
25	46000.	1.520	1.513	0.999655	28.85	35.26	5.480E-05
26	47000.	1.630	1.628	0.998658	30.12	36.81	6.833E-05
27	48000.	1.770	1.770	0.998512	31.60	38.71	8.482E-05
28	48700.	1.885	1.894	0.999361	33.05	40.39	9.990E-05

TABLE 87. DATA TABULATION FOR TEST M-70 (CONCL)

SPECIMEN NO.: M-70 TYPICAL FIGHTER, AIR-TO-GROUND, MAX STRESS = 18 KSI

CCI SPECIMEN B = 0.250 IN. W = 6.000 IN. AN = 0.0 IM.

PMIN = TEST FREQ = 6.00 HZ.

ENVIRONMENT CONDITION: AMBIENT AIR

NO.	CYCLES	A (MEASURED)	A (REGRESSION)	MULTI-CORR. COEFF	K-MAX	DELTA K	DA/DN
29	49400.	2.040	2.043	0.999577	34.69	42.40	1.231E-04
30	49900.	2.175	2.170	0.998579	36.11	44.13	1.484E-04
31	50100.	2.220	2.228	0.998774	36.77	44.95	1.580E-04
32	50500.	2.350	2.359	0.999001	38.28	46.79	1.796E-04
33	50900.	2.525	2.510	0.998547	40.07	48.97	2.158E-04
34	51100.	2.595	2.600	0.998104	41.16	50.31	2.429E-04
35	51300.	2.645	2.698	0.997006	42.38	51.80	2.787E-04
36	51500.	2.810	2.805	0.999763	43.74	53.46	3.241E-04
37	51700.	2.940	2.946	0.999756	45.61	55.75	3.825E-04
38	51825.	3.050	3.047	0.996787	47.00	57.45	4.579E-04
39	51968.	3.175	3.182	0.997346	48.96	59.84	5.602E-04
40	52066.	3.275	3.293	0.996798	50.64	61.90	6.819E-04
41	52125.	3.385	3.370	0.995676	51.86	63.38	8.060E-04
42	52225.	3.525	3.546	0.993099	54.80	66.98	1.123E-03
43	52276.	3.645	3.662	0.994066	56.90	69.55	1.488E-03
44	52308.	3.750	3.752	0.999774	58.61	71.63	1.724E-03
45	52341.	3.875	3.875	0.999969	61.11	74.70	2.080E-03

M-70 TYPICAL FIGHTER, AIR-TO-GROUND, MAX STRESS = 18 KSI
PLOT RATE CRACK GROWTH ANALYSIS

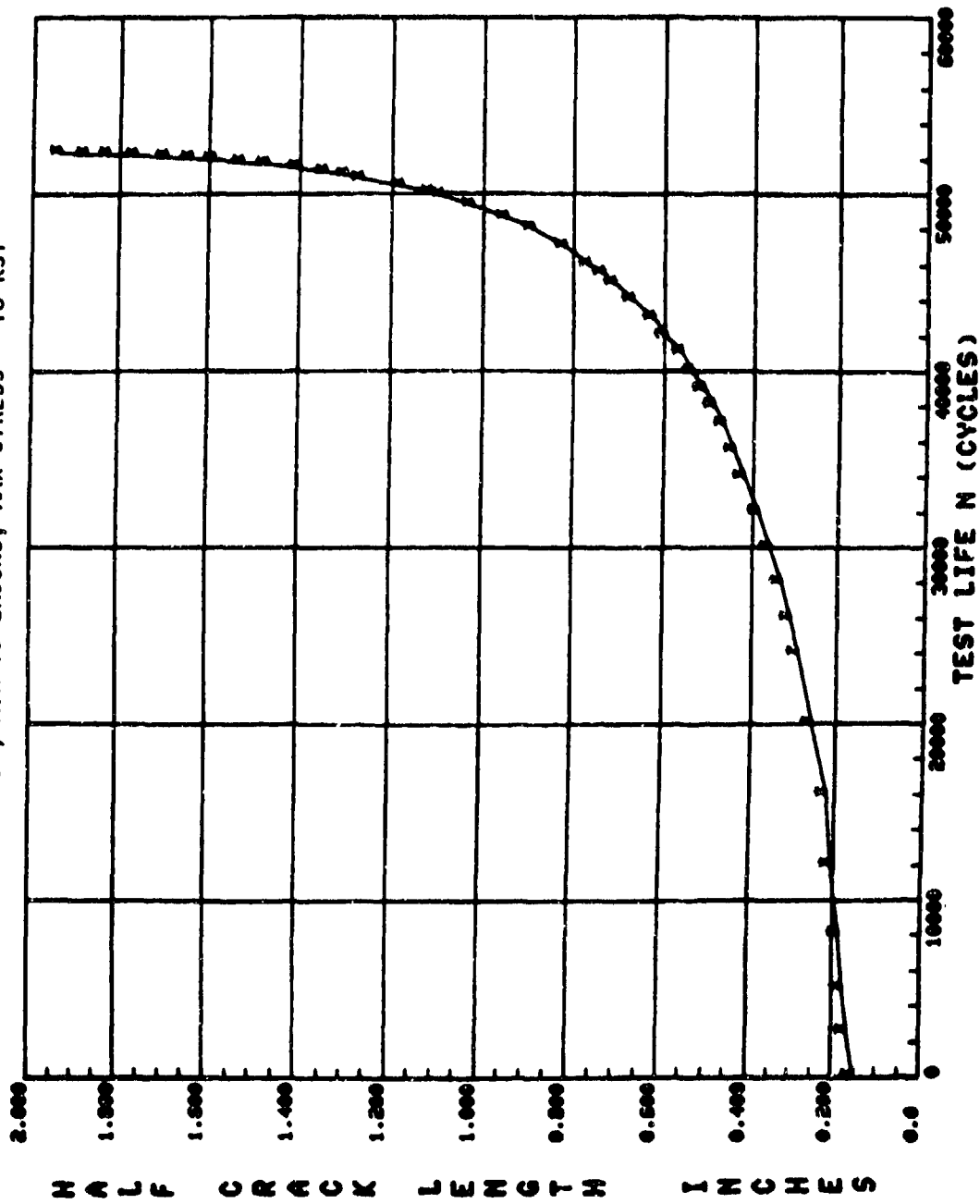

Figure 88. Crack growth curve for test M-70.

TABLE 88. DATA TABULATION FOR TEST M-70A

SPECIMEN NO.: M-70A SIMPLIFIED SPEC. TYP FIGHTER-AIR TO GROUND STRESS = 10 KSI MAX

CCY SPECIMEN B= 0.750 IN. M= 6.000 IN. AM= 0.0 IN.

PHIM= PMAX=

TEST FREQ= 6.00 HZ.

ENVIRONMENT CONDITION: AMBIENT AIR

NO.	CYCLES	A (MEASURED)	A (REGRESSION)	MULT. CORR. COEFF	K-MAX	DELTA K	RAZOR
1	0.	0.36P	0.308	0.999912	4.64	6.50	2.690E-07
2	33800.	0.335	0.332	0.998750	4.82	6.75	5.257E-07
3	59000.	0.365	0.365	0.999283	5.88	7.88	7.730E-07
4	66000.	0.410	0.416	0.999298	5.39	7.53	1.022E-06
5	107400.	0.465	0.461	0.998738	5.69	7.97	1.270E-06
6	126600.	0.515	0.514	0.998598	6.02	8.42	1.514E-06
7	144800.	0.565	0.573	0.998170	6.36	8.90	1.799E-06
8	157300.	0.620	0.618	0.999335	6.61	9.25	2.072E-06
9	167300.	0.660	0.660	0.997967	6.84	9.57	2.451E-06
10	175400.	0.700	0.702	0.997926	7.06	9.88	2.721E-06
11	184100.	0.745	0.750	0.998684	7.30	10.22	3.023E-06
12	190100.	0.795	0.786	0.998366	7.57	10.59	3.408E-06
13	197700.	0.840	0.843	0.998025	7.76	10.87	3.685E-06
14	203500.	0.885	0.888	0.997681	7.98	11.17	4.024E-06
15	207500.	0.925	0.919	0.998234	8.12	11.37	4.178E-06
16	214400.	0.975	0.961	0.998824	8.41	11.78	4.540E-06
17	218800.	1.025	1.020	0.998265	8.59	12.02	4.850E-06
18	224200.	1.075	1.073	0.998932	8.82	12.35	5.266E-06
19	229400.	1.125	1.131	0.998941	9.08	12.71	5.802E-06
20	235000.	1.200	1.197	0.999534	9.36	13.11	6.540E-06
21	239300.	1.255	1.255	0.999315	9.61	13.46	7.454E-06
22	242450.	1.300	1.304	0.999205	9.82	13.75	7.970E-06
23	244650.	1.340	1.339	0.999281	9.96	13.95	8.532E-06
24	247600.	1.395	1.394	0.998704	10.19	14.27	9.082E-06
25	250600.	1.445	1.449	0.998627	10.42	14.59	9.552E-06
26	252900.	1.500	1.491	0.998883	10.59	14.83	9.849E-06
27	258500.	1.600	1.606	0.999298	11.07	15.49	1.189E-05
28	261500.	1.675	1.673	0.999332	11.34	15.88	1.201E-05

TABLE 88. DATA TABULATION FOR TEST M-70A (CONCL.)

SPECIMEN NO.: M-70A SIMPLIFIED SPEC. TYP FIGHTER-AIR TO GROUND STRESS = 10 KSI MAX

CCT SPECIMEN B= 0.250 IN. N= 6.000 IN. AM= 0.0 IN.

PMIN= PMAX= TEST FREQ= 6.00 HZ.

ENVIRONMENT CONDITION: AMBIENT AIR

NO.	CYCLES	A (MEASURED)	AIR PROGRESSION	MULT. CORR. COEFF	K-MAX	DELTA K	DA/DB
29	266750.	1.610	1.807	0.999735	11.88	16.63	1.377E-05
30	269600.	1.685	1.868	0.999702	12.22	17.10	1.505E-05
31	272500.	1.980	1.977	0.999795	12.58	17.61	1.436E-05
32	275200.	2.065	2.066	0.999756	12.94	18.12	1.706E-05
33	279800.	2.240	2.243	0.999766	13.68	19.15	2.113E-05
34	282100.	2.340	2.342	0.999978	14.10	19.74	2.366E-05
35	284000.	2.435	2.432	0.999546	14.50	20.29	2.552E-05
36	286000.	2.535	2.533	0.998925	14.94	20.92	2.868E-05
37	288500.	2.675	2.684	0.999422	15.63	21.88	3.336E-05
38	290000.	2.785	2.784	0.998995	16.10	22.54	3.736E-05
39	292000.	2.950	2.942	0.998504	16.87	23.62	4.432E-05
40	294000.	3.110	3.131	0.998261	17.86	25.00	5.332E-05
41	295000.	3.240	3.240	0.998536	18.45	25.84	6.103E-05
42	295700.	3.330	3.224	0.999331	18.93	26.51	6.805E-05
43	296400.	2.420	3.424	0.997495	19.53	27.34	7.924E-05
44	297100.	3.530	3.533	0.999077	20.21	28.30	9.120E-05
45	297800.	3.660	3.666	0.999664	21.10	29.54	1.110E-04
46	298400.	3.810	3.809	0.999813	22.13	30.98	1.327E-04
47	298600.	3.860	3.861	0.999913	22.53	31.54	1.414E-04
48	299100.	4.010	4.014	0.997500	23.77	33.27	1.759E-04
49	299300.	4.080	4.078	0.998766	24.33	34.06	2.028E-04
50	299500.	4.150	4.161	0.998527	25.10	35.13	2.365E-04
51	299750.	4.285	4.275	0.994606	26.22	36.71	3.079E-04
52	299950.	4.460	4.403	0.993747	27.62	38.67	4.051E-04
53	300150.	4.545	4.581	0.993942	29.86	41.60	5.349E-04
54	300300.	4.745	4.755	0.997468	32.45	45.63	7.317E-04
55	300350.	4.835	4.835	0.999934	33.82	47.35	9.119E-04

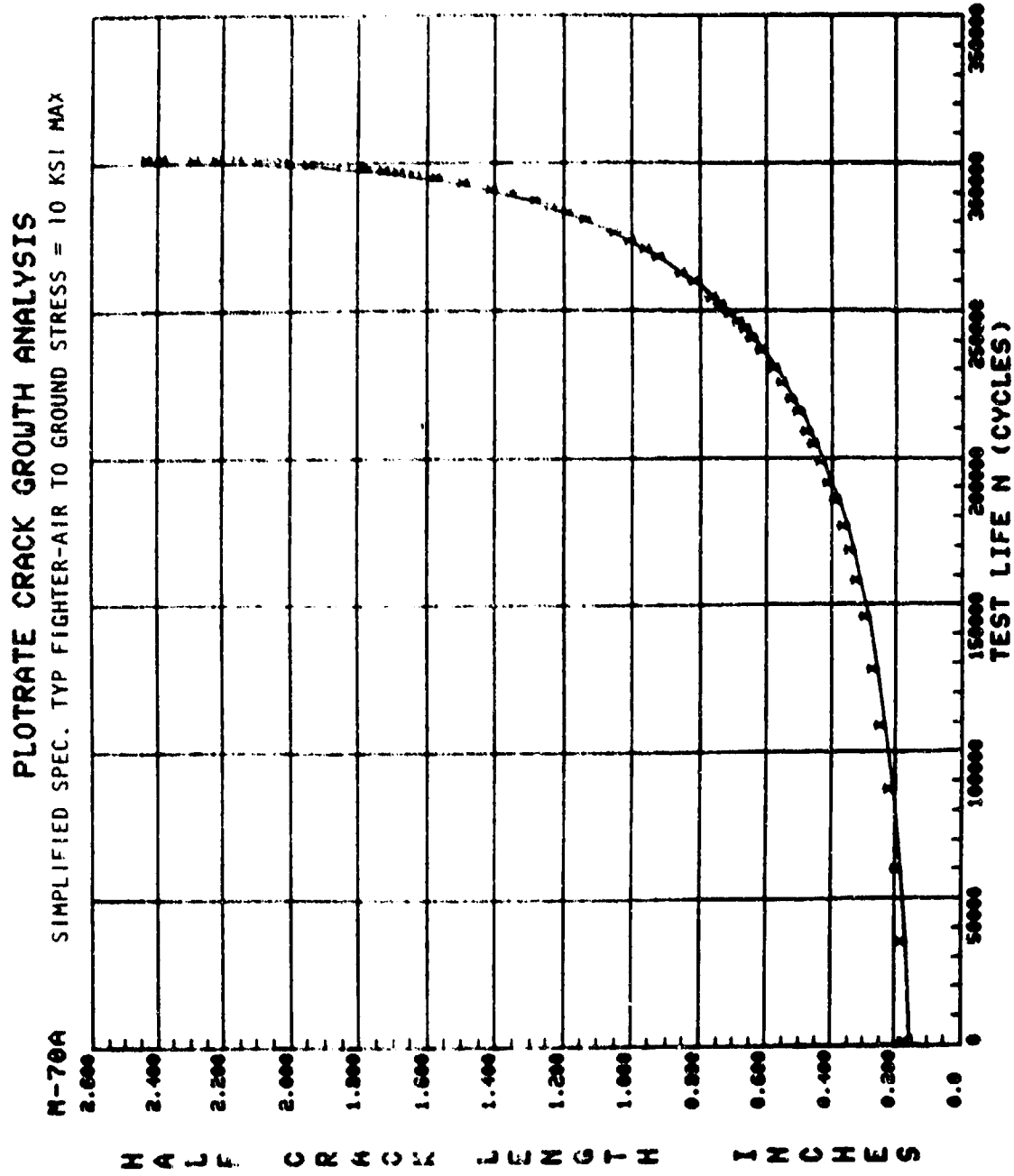

Figure 89. Crack growth curve for test M-70A.

TABLE 89. DATA TABULATION FOR TEST M-71

SPECIMEN NO.: M-71 TYPICAL FIGHTER, INSTRUMENTATION AND NAVIGATION, MAX STRESS = 14 KSI

CGT SPECIMEN B = 0.250 IN. W = 6.000 IN. AN = 0.0 IN.

PRIN = PMAX = TEST FREQ = 6.00 MZ.

ENVIRONMENT CONDITION: AMBIENT AIR

NO.	CYCLES	A (MEASURED)	A (REGRESSION)	MULT. CORR. COEFF	K-MAX	DELTA K	DA/DM
1	0.	0.295	0.295	0.996324	9.55	11.14	2.873E-06
2	5000.	0.325	0.320	0.996499	9.95	11.60	2.254E-06
3	10000.	0.340	0.337	0.988854	10.20	11.90	1.783E-06
4	20000.	0.370	0.365	0.962712	10.62	12.39	1.606E-06
5	30000.	0.390	0.393	0.994271	11.03	12.87	1.744E-06
6	40000.	0.425	0.430	0.996428	11.54	13.46	2.234E-06
7	48000.	0.470	0.466	0.999276	12.03	14.03	2.697E-06
8	54000.	0.500	0.503	0.999146	12.49	14.57	3.015E-06
9	61000.	0.550	0.550	0.999337	13.07	15.25	3.308E-06
10	68000.	0.600	0.596	0.997790	13.63	15.90	3.682E-06
11	75000.	0.650	0.649	0.997050	14.23	16.60	4.211E-06
12	82000.	0.700	0.709	0.996356	14.90	17.38	4.727E-06
13	88000.	0.770	0.767	0.998425	15.52	18.11	5.469E-06
14	93000.	0.830	0.825	0.998251	16.12	18.61	6.024E-06
15	98400.	0.890	0.894	0.998544	16.85	19.66	6.738E-06
16	101700.	0.945	0.939	0.998778	17.25	20.13	7.222E-06
17	105700.	0.995	0.997	0.998863	17.82	20.78	8.053E-06
18	109200.	1.060	1.061	0.998707	18.42	21.49	9.040E-06
19	113000.	1.125	1.125	0.999912	19.01	22.18	1.029E-05
20	116000.	1.190	1.191	0.999902	19.61	22.88	1.157E-05
21	117500.	1.225	1.226	0.999926	19.92	23.24	1.211E-05
22	120000.	1.290	1.290	0.998826	20.50	23.91	1.265E-05
23	122000.	1.345	1.343	0.998509	20.96	24.45	1.335E-05
24	124000.	1.400	1.397	0.998267	21.43	25.00	1.411E-05
25	125500.	1.430	1.438	0.997986	21.79	25.42	1.503E-05
26	127000.	1.485	1.482	0.998624	22.18	25.87	1.604E-05
27	128900.	1.545	1.546	0.998582	22.72	26.51	1.781E-05
28	130000.	1.590	1.588	0.999332	23.09	26.93	1.894E-05

TABLE 89. DATA TABULATION FOR TEST M-71 (CONT)

SPECIMEN NO.: M-71 TYPICAL FIGHTER, INSTRUMENTATION AND NAVIGATION, MAX STRESS = 14 KSI

CCI SPECIMEN R= 0.250 IN. W= 6.000 IN. AN= 0.0 IN.
 PMIN= PMAX= TEST FREQ= 6.000HZ.

ENVIRONMENT CONDITION: AMBIENT AIR

NO.	CYCLES	A (MEASURED)	A (REGRESSION)	MULT. CORR. COEFF	K-MAX	DELTA K	U/DM
29	131000.	1.625	1.625	0.999549	23.40	27.30	2.019E-05
30	132000.	1.665	1.667	0.999547	23.76	27.72	2.161E-05
31	133000.	1.710	1.711	0.999267	24.14	28.16	2.250E-05
32	134000.	1.760	1.759	0.999681	24.54	28.63	2.373E-05
33	135000.	1.810	1.808	0.999837	24.96	29.12	2.467E-05
34	136000.	1.855	1.856	0.999559	25.37	29.60	2.549E-05
35	137800.	1.950	1.949	0.999642	26.17	30.53	2.804E-05
36	139000.	2.015	2.018	0.999800	26.76	31.23	3.011E-05
37	140000.	2.080	2.079	0.999476	27.29	31.84	3.317E-05
38	141000.	2.150	2.146	0.999703	27.88	32.53	3.577E-05
39	142000.	2.215	2.224	0.999384	28.56	33.32	3.648E-05
40	143700.	2.365	2.361	0.999389	29.79	34.76	4.300E-05
41	144700.	2.455	2.448	0.998674	30.59	35.69	4.701E-05
42	145950.	2.560	2.571	0.998295	31.73	37.02	5.322E-05
43	146890.	2.665	2.668	0.999406	32.66	38.11	6.040E-05
44	147700.	2.770	2.768	0.999945	33.65	39.26	6.878E-05
45	148420.	2.870	2.872	0.999775	34.71	40.49	7.610E-05
46	149000.	2.965	2.965	0.999603	35.68	41.62	8.779E-05
47	149570.	3.065	3.068	0.999874	36.79	42.92	9.830E-05
48	150030.	3.160	3.162	0.999906	37.85	44.15	1.078E-04
49	150430.	3.255	3.249	0.998657	38.86	45.34	1.209E-04
50	150920.	3.370	3.372	0.997495	40.36	47.08	1.435E-04
51	151335.	3.480	3.495	0.996565	41.94	48.93	1.603E-04
52	151563.	3.575	3.575	0.998309	43.03	50.20	2.161E-04
53	151804.	3.675	3.662	0.999686	44.54	51.97	2.578E-04
54	151973.	3.775	3.773	0.999489	45.91	53.56	2.950E-04
55	152185.	3.905	3.905	0.998503	48.02	56.03	3.651E-04
56	152308.	3.990	3.995	0.995043	49.58	57.84	4.495E-04

TABLE 89. DATA TABULATION FOR TEST M-71 (CONCL)

SPECIMEN NO.: M-71 TYPICAL FIGHTER, INSTRUMENTATION AND NAVIGATION, MAX STRESS = 14 KSI

SCT SPECIMEN B= 0.250 IN. W= 6.000 IN. AN= 0.0 IN.

PMIN= PMAX= TEST FREQ= 6.000HZ.

ENVIRONMENT CONDITION: AMBIENT AIR

NO.	CYCLES	A (MEASURED)	A (REGRESSION)	MULTI. CORR. COEFF	K-MAX	DELTA K	DA/DW
57	152421.	4.085	4.096	0.968980	51.47	60.05	6.540E-04
58	152527.	4.205	4.234	0.976631	54.28	63.21	9.553E-04
59	152606.	4.335	4.397	0.982476	57.86	67.50	1.394E-03
60	152652.	4.550	4.545	0.988756	61.67	71.95	2.037E-03

M-71 TYPICAL FIGHTER, INSTRUMENTATION & NAVIG, MAX STRESS = 14 KSI
PLOTRATE CRACK GROWTH ANALYSIS

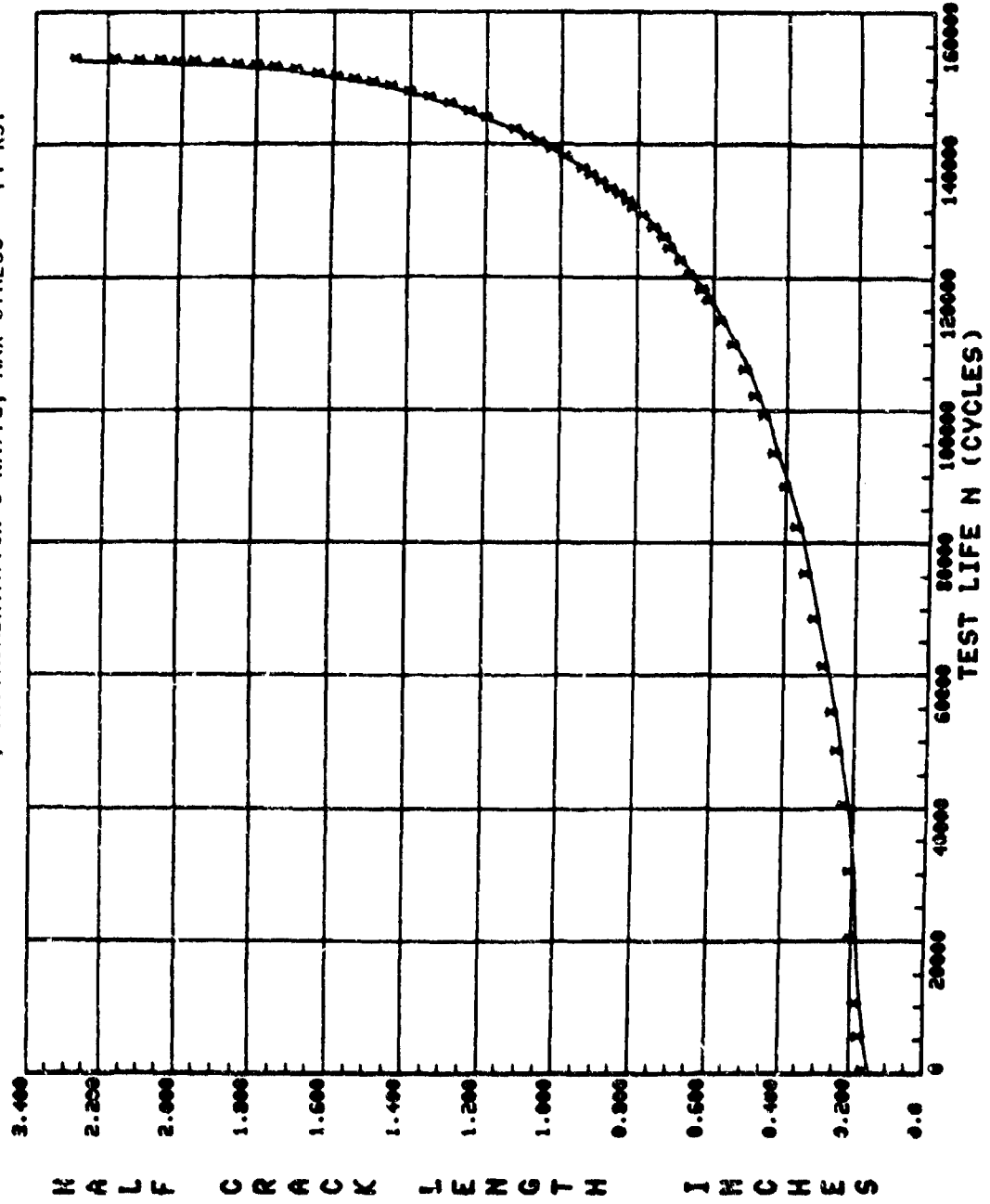

Figure 90. Crack growth curve for test M-71.

TABLE 90. DATA TABULATION FOR TEST M-72

SPECIMEN NO.: M-72 TYPICAL FIGHTER, COMPOSITE MISSION, MAX STRESS = 19 KSI

CCT SPECIMEN $\beta = 0.250$ IN. $W = 6.000$ IN. $AN = 0.0$ IN.

PMIN = PMAX = TEST FREQ = 6.000-HZ.

ENVIRONMENT CONDITION: AMBIENT AIR

NO.	CYCLES	A (MEASURED)	A (REGRESSION)	MULT. CORR. COEFF	K-MAX	DELTA K	DAZDM
1	U.	0.308	0.310	0.965737	13.29	15.39	9.709E-06
2	1000.	0.345	0.327	0.989414	13.64	15.80	7.372E-06
3	6000.	0.405	0.401	0.992576	15.13	17.52	9.209E-06
4	9750.	0.460	0.466	0.994756	16.32	18.89	9.752E-06
5	12700.	0.525	0.525	0.999620	17.34	20.08	1.154E-05
6	14750.	0.575	0.574	0.998445	18.14	21.01	1.273E-05
7	16600.	0.625	0.628	0.997739	18.99	21.99	1.618E-05
8	18250.	0.675	0.682	0.998464	19.82	22.95	1.949E-05
9	19000.	0.715	0.710	0.999193	20.24	23.52	2.123E-05
10	20350.	0.770	0.772	0.999209	21.13	24.46	2.461E-05
11	21350.	0.825	0.825	0.999251	21.88	25.33	2.661E-05
12	22250.	0.875	0.875	0.998776	22.56	26.12	2.714E-05
13	23000.	0.920	0.918	0.999564	23.14	26.77	2.860E-05
14	23600.	0.965	0.962	0.998969	23.72	27.47	2.962E-05
15	25000.	1.030	1.031	0.997537	24.62	28.50	3.399E-05
16	25800.	1.085	1.085	0.998974	25.29	29.29	3.901E-05
17	26600.	1.145	1.150	0.999535	26.11	30.23	4.435E-05
18	27570.	1.245	1.244	0.999563	27.26	31.56	5.215E-05
19	28300.	1.330	1.324	0.999025	28.23	32.69	5.950E-05
20	29070.	1.415	1.422	0.997004	29.39	34.03	7.176E-05
21	29500.	1.475	1.482	0.998610	30.09	34.84	8.027E-05
22	29800.	1.530	1.529	0.999500	30.64	35.46	8.665E-05
23	30300.	1.630	1.621	0.999108	31.72	36.73	1.024E-04
24	30800.	1.725	1.730	0.999317	32.98	38.19	1.162E-04
25	31300.	1.650	1.853	0.998771	34.41	39.84	1.407E-04
26	31700.	1.975	1.969	0.999324	35.75	41.39	1.632E-04
27	32100.	2.095	2.106	0.998661	37.38	43.28	1.957E-04
28	32400.	2.230	2.228	0.999092	38.62	44.95	2.268E-04

TABLE 90. DATA TABULATION FOR TEST M-72 (CONCL)

SPECIMEN NO.: M-72		TYPICAL FIGHTER, COMPOSITE MISSION, MAX STRESS = 19 KSI	
CCT	SPECIMEN	B = 0.250 IN.	W = 6.000 IN.
PMIN =	PMAX =	AN = 0.0	IN.
ENVIRONMENT CONDITION: AMBIENT AIR			
NO.	CYCLES	A (MEASURED)	A (REGRESSION)
29	32500.	2.315	2.319
30	32600.	2.430	2.426
31	33000.	2.540	2.544
32	33150.	2.645	2.642
33	33400.	2.675	2.842
34	33500.	2.975	2.938
35	33600.	3.055	3.054
36	33650.	3.115	3.120
37	33700.	3.195	3.196
38	33750.	3.265	3.275
39	33800.	3.370	3.367
40	33850.	3.490	3.506
41	33900.	3.655	3.724
42	33925.	3.690	3.890
43	33930.	3.540	3.941
			MULT. CORR. - CDEFF
			K-MAX
			DELTA K
			DA/DN

TEST FREQ = 6.000HZ.

PLOTRATE CRACK GROWTH ANALYSIS
M-72 TYPICAL FIGHTER, COMPOSITE MISSION, MAX STRESS = 19 KSI

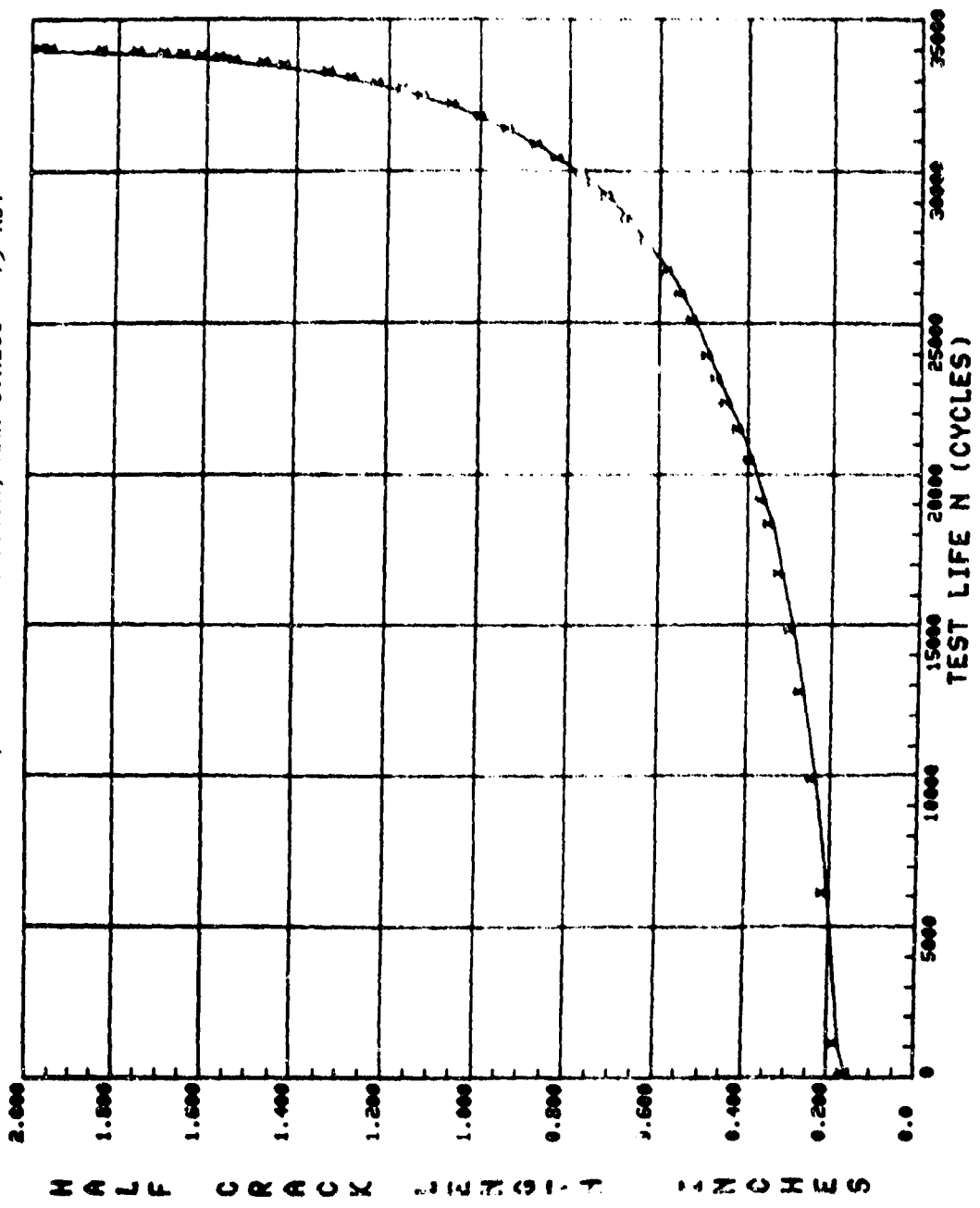

Figure 91. Crack growth curve for test M-72.

TABLE 91. DATA TABULATION FOR TEST M-72A

SPECIMEN NO.: M-72A SIMPLIFIED SPECTRUM, TYP FIGHTER-COMPOSITE MISSION, MAX STRESS = 14 KSI

LCI SPECIMEN b= 6.250 IN. W= 6.000 IN. AN= 0.0 IN.
 PMIN= PMAX= TEST FREQ= 6.000HZ.

ENVIRONMENT CONDITION: AMBIENT AIR

NO.	CYCLES	A(MEASURED)	A(REGRESSION)	MULT. CORR. COEFF	K-MAX	DELTA K	DA/LIN
1	0.	0.330	0.330	0.999831	3.25	5.29	2.462E-06
2	8800.	0.375	0.374	0.998645	4.10	5.63	2.790E-06
3	14400.	0.410	0.404	0.994942	4.26	5.86	3.339E-06
4	24000.	0.470	0.478	0.993745	4.64	6.30	4.609E-06
5	29100.	0.520	0.527	0.996611	4.87	6.70	5.646E-06
6	32800.	0.575	0.571	0.994530	5.08	6.96	5.992E-06
7	36800.	0.635	0.626	0.996745	5.32	7.32	6.753E-06
8	40800.	0.680	0.681	0.994305	5.56	7.64	7.514E-06
9	44800.	0.730	0.739	0.996012	5.80	7.97	8.501E-06
10	48400.	0.800	0.801	0.999448	6.05	8.31	1.046E-05
11	50600.	0.852	0.850	0.996238	6.24	8.56	1.078E-05
12	52500.	0.895	0.895	0.997326	6.41	8.81	1.175E-05
13	54200.	0.942	0.935	0.996267	6.56	9.02	1.252E-05
14	56700.	0.987	0.997	0.995999	6.78	9.33	1.434E-05
15	58500.	1.050	1.049	0.997403	6.97	9.59	1.632E-05
16	59900.	1.095	1.095	0.998258	7.14	9.81	1.794E-05
17	61200.	1.150	1.148	0.999107	7.32	10.07	1.860E-05
18	62400.	1.195	1.194	0.996928	7.48	10.29	1.954E-05
19	63600.	1.245	1.243	0.999117	7.65	10.52	2.007E-05
20	64800.	1.285	1.289	0.998515	7.80	10.73	2.067E-05
21	66000.	1.342	1.339	0.999136	7.97	10.96	2.232E-05
22	67200.	1.390	1.393	0.999578	8.15	11.21	2.427E-05
23	68400.	1.455	1.454	0.999696	8.36	11.47	2.671E-05
24	69600.	1.520	1.520	0.999869	8.57	11.79	2.893E-05
25	71200.	1.620	1.618	0.999625	8.84	12.23	3.256E-05
26	72700.	1.720	1.720	0.999731	9.22	12.68	3.707E-05
27	74100.	1.825	1.828	0.994533	9.57	13.16	4.240E-05
28	75245.	1.925	1.927	0.999717	9.90	13.61	4.937E-05

TABLE 91. DATA TABULATION FOR TEST M-72A (CONCL)

SPECIMEN NO.: M-72A SIMPLIFIED SPECTRUM, TYP FIGHTER-COMPOSITE MISSION, MAX STRESS = 14 KSI

LCI SPECIMEN B = 0.250 IN. W = 6.000 IN. AN = 0.0 IM. TEST FREQ = 6.000HZ.

PHIN = PMA =

ENVIRONMENT CONDITION: AMBIENT AIR

NO.	CYCLES	A (MEASURED)	A (REGRESSION)	MULT. CORR. COEFF	K-MAX	DELTA K	DA/DN
29	76300.	2.030	2.032	0.999837	10.24	14.09	5.546E-05
30	77034.	2.115	2.115	0.999344	10.52	14.46	6.169E-05
31	77899.	2.225	2.227	0.999857	10.89	14.98	6.875E-05
32	78587.	2.325	2.324	0.998506	11.22	15.43	7.924E-05
33	79100.	2.410	2.406	0.998667	11.50	15.82	8.667E-05
34	79665.	2.495	2.509	0.999082	11.87	16.32	9.498E-05
35	80220.	2.630	2.623	0.999110	12.28	16.88	1.130E-04
36	80755.	2.755	2.749	0.998369	12.75	17.53	1.327E-04
37	81212.	2.865	2.879	0.997863	13.25	18.21	1.533E-04
38	81549.	2.975	2.961	0.999235	13.66	18.78	1.716E-04
39	81809.	3.060	3.072	0.998943	14.03	19.31	1.919E-04
40	82017.	3.160	3.156	0.998232	14.39	19.79	2.133E-04
41	82340.	3.265	3.295	0.996444	15.03	20.67	2.628E-04
42	82500.	3.380	3.379	0.998074	15.41	21.19	3.046E-04
43	82660.	3.475	3.480	0.999774	15.90	21.87	3.536E-04
44	82800.	3.590	3.584	0.999095	16.44	22.60	4.106E-04
45	82950.	3.710	3.702	0.996660	17.11	23.53	5.056E-04
46	83100.	3.855	3.867	0.995066	18.38	24.83	6.613E-04
47	83200.	3.965	4.001	0.997683	18.92	26.02	8.163E-04
48	83300.	4.165	4.177	0.999174	20.19	27.77	1.048E-03
49	83350.	4.290	4.289	0.999747	21.10	29.01	1.267E-03

PLOTRATE CRACK GROWTH ANALYSIS

M-72A SIMPLIFIED SPECTRUM, TYP FIGHTER-COMPOSITE MISSION STRESS = 14 KSI MAX

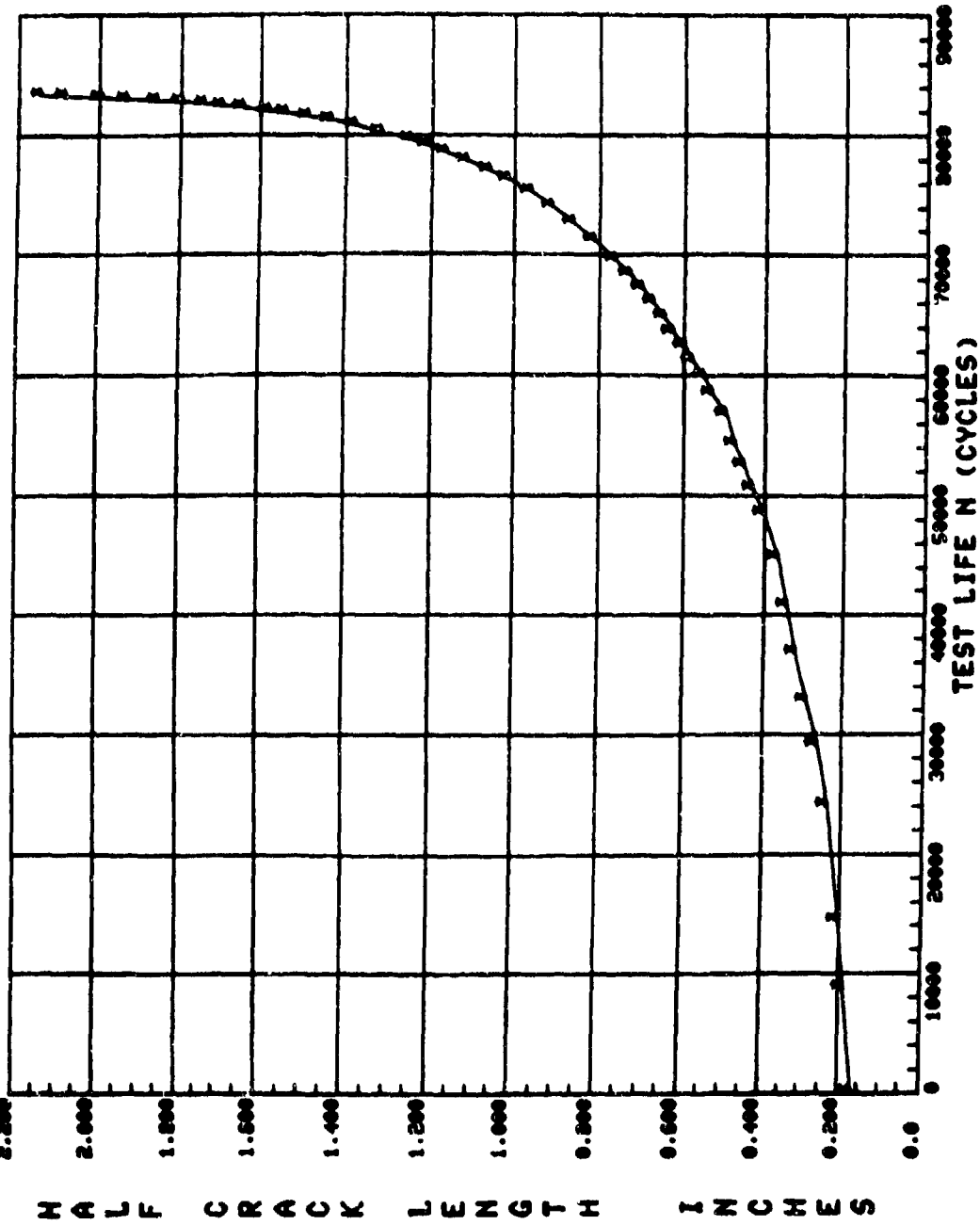

Figure 92. Crack growth curve for test M-72A.

TABLE 92. DATA TABULATION FOR TEST M-72B

SPECIMEN NO.: M-72B SIMPLIFIED SPECTRUM, TYP FIGHTER-COMPOSITE STRESS = 8 KSI MAX

CCT SPECIMEN 8= 0.250 IN. W= 6.000 IN. AN= C.O IN. TEST FREQ= 6.000HZ.

PMJN= PHAX=

ENVIRONMENT CONDITION: AMBIENT AIR

NO.	CYCLES	A(MEASURD)	A(REGRESSION)	MULT. CORR. COEFF	K-MAX	DELTA K	DA/DM
1	0.	0.305	0.305	0.997733	6.47	7.85	3.023E-07
2	52500.	0.335	0.342	0.995767	6.86	8.33	3.827E-07
3	93000.	0.350	0.374	0.997095	7.17	6.70	4.191E-07
4	139000.	0.415	0.414	0.997718	7.55	9.17	4.665E-07
5	179700.	0.450	0.454	0.997247	7.90	9.60	5.216E-07
6	222400.	0.500	0.496	0.997497	6.27	10.05	6.042E-07
7	294000.	0.535	0.534	0.995393	9.59	10.43	7.127E-07
8	312000.	0.615	0.626	0.995928	9.32	11.32	9.952E-07
9	339700.	0.680	0.682	0.997698	9.74	11.82	1.310E-06
10	354800.	0.725	0.722	0.996855	10.03	12.18	1.507E-06
11	373900.	0.775	0.783	0.998770	10.46	12.70	1.729E-06
12	385700.	0.830	0.825	0.998788	10.75	13.05	1.870E-06
13	401700.	0.890	0.886	0.997955	11.17	13.56	2.175E-06
14	415000.	0.945	0.950	0.997813	11.57	14.05	2.347E-06
15	425300.	0.995	0.998	0.998195	11.88	14.43	2.562E-06
16	432600.	1.045	1.036	0.998093	12.12	14.72	2.735E-06
17	444900.	1.100	1.108	0.998077	12.51	15.26	3.026E-06
18	451500.	1.150	1.149	0.998014	12.01	15.56	3.143E-06
19	459400.	1.200	1.197	0.997527	13.11	15.92	3.481E-06
20	466600.	1.250	1.250	0.996151	13.43	16.30	3.964E-06
21	473400.	1.295	1.304	0.997063	13.75	16.69	4.291E-06
22	477000.	1.340	1.336	0.997074	13.94	16.92	4.486E-06
23	481900.	1.390	1.384	0.998020	14.22	17.26	4.728E-06
24	487000.	1.430	1.433	0.998438	14.50	17.61	5.013E-06
25	493000.	1.495	1.488	0.998933	14.82	17.94	5.076E-06
26	505500.	1.620	1.627	0.998469	15.61	18.95	5.832E-06
27	512000.	1.705	1.711	0.995931	16.09	19.54	5.661E-06
28	518700.	1.805	1.782	0.993226	16.49	20.03	6.250E-06

TABLE 92. DATA TABULATION FOR TEST M-72B (CONCL)

SPECIMEN NO.: M-72B SIMPLIFIED SPECTRUM, TYP FIGHTER-COMPOSITE STRESS = 8 KSI MAX

CCI SPECIMEN B = 0.250 IN. W = 6.000 IN. AN = 0.0 IM.

PMIN= PMAX= TEST FREQ= 6.000MHZ.

ENVIRONMENT CONDITION: AMBIENT AIR

NU.	CYCLES	A (MEASURED)	A (REGRESSION)	MULT. CORR. COEFF	K-MAX	DELTA K	DA/TDM
29	523500.	1.650	1.827	0.994041	16.81	20.41	6.608E-06
30	533700.	1.945	1.966	0.996671	17.54	21.30	7.603E-06
31	548000.	2.210	2.200	0.999469	18.90	22.95	1.049E-05
32	555000.	2.355	2.359	0.999534	19.85	24.10	1.253E-05
33	559500.	2.470	2.478	0.999409	20.58	24.99	1.399E-05
34	563600.	2.595	2.591	0.999863	21.28	25.85	1.553E-05
35	568000.	2.735	2.736	0.999815	22.22	26.98	1.752E-05
36	573000.	2.915	2.922	0.999612	23.48	28.51	2.039E-05
37	575000.	3.005	3.003	0.999916	24.06	29.21	2.104E-05
38	579000.	3.090	3.092	0.999675	24.70	30.00	2.345E-05
39	579000.	3.192	3.188	0.999475	25.43	30.86	2.540E-05
40	581000.	3.285	3.290	0.999577	26.23	31.86	2.795E-05
41	582900.	3.400	3.399	0.998992	27.13	32.95	3.193E-05
42	584330.	3.490	3.491	0.999653	27.92	33.91	3.554E-05
43	585940.	3.605	3.612	0.999622	29.03	35.25	3.987E-05
44	587000.	3.765	3.699	0.999655	29.86	36.26	4.296E-05
45	588100.	3.800	3.798	0.999576	30.86	37.47	4.689E-05
46	589200.	3.900	3.903	0.998477	32.00	38.85	5.251E-05
47	590150.	4.000	4.002	0.999442	33.14	40.24	5.901E-05
48	591000.	4.100	4.105	0.999139	34.40	41.77	6.908E-05
49	591650.	4.295	4.195	0.998653	35.59	43.22	8.097E-05
50	592300.	4.295	4.304	0.998416	37.14	45.09	9.767E-05
51	592800.	4.400	4.402	0.997851	38.66	46.95	1.104E-04
52	593300.	4.500	4.526	0.997728	40.77	49.51	1.524E-04
53	593630.	4.620	4.630	0.996246	42.75	51.91	1.931E-04
54	593900.	4.725	4.736	0.992445	45.05	54.71	2.627E-04
55	594080.	4.870	4.830	0.996104	47.23	57.35	3.303E-04
56	594235.	4.970	4.936	0.998099	50.07	60.80	4.151E-04

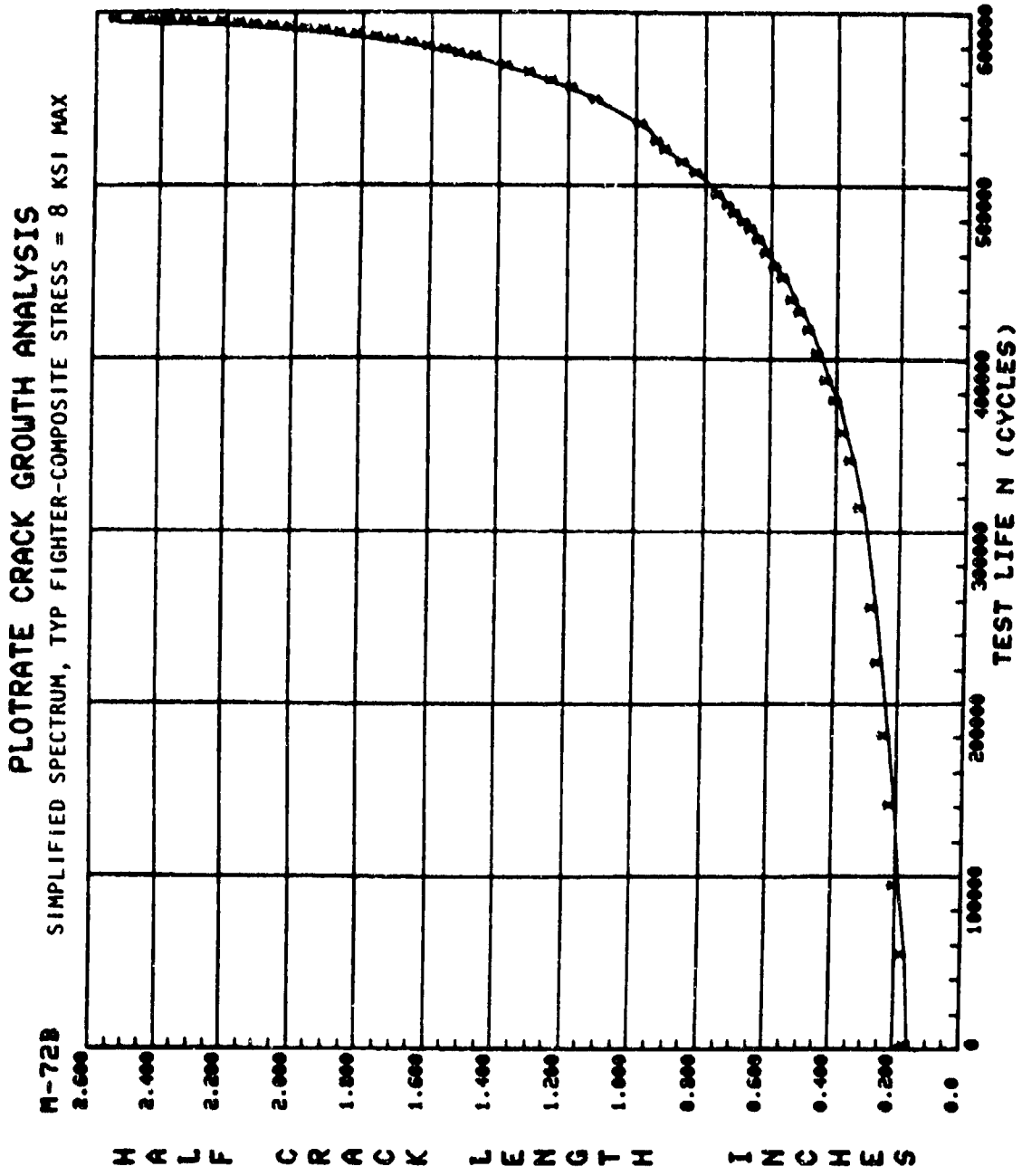

Figure 93. Crack growth curve for test M-72B.

TABLE 93. DATA TABULATION FOR TEST M-74

SPECIMEN NO.: M-74 SIMPLIFIED SPECTRUM. TYP. TRANSPORT, MAX STRESS = 16.8 KSI

CCT SPECIMEN B = 0.250 IN. b = 6.000 IN. AN = 0.0 IN.
 PHIN = PHAX = TEST FREQ = 6.00 HZ.

ENVIRONMENT CONDITIONS: AMBIENT AIR

NO.	CYCLES	A(MEASURED)	A(REGRESSION)	MULT. CORR. COEFF	K-MAX	DELTA K	DA/DN
1	0.	0.440	0.440	0.999283	14.01	22.77	2.021E-07
2	106712.	0.495	0.493	0.999312	14.84	24.11	2.227E-07
3	284000.	0.555	0.557	0.994854	15.79	25.66	1.734E-07
4	303000.	0.565	0.562	0.986208	15.87	25.79	1.055E-07
5	415944.	0.590	0.602	0.980200	16.44	26.71	2.052E-07
6	488720.	0.625	0.634	0.984567	16.88	27.42	3.679E-07
7	500000.	0.645	0.643	0.984962	17.00	27.63	4.251E-07

M-74
 PLOTRATE CRACK GROWTH DATA
 SIMPLIFIED SPECTRUM, TYP TRANSPORT, STRESS = 16.8 MAX

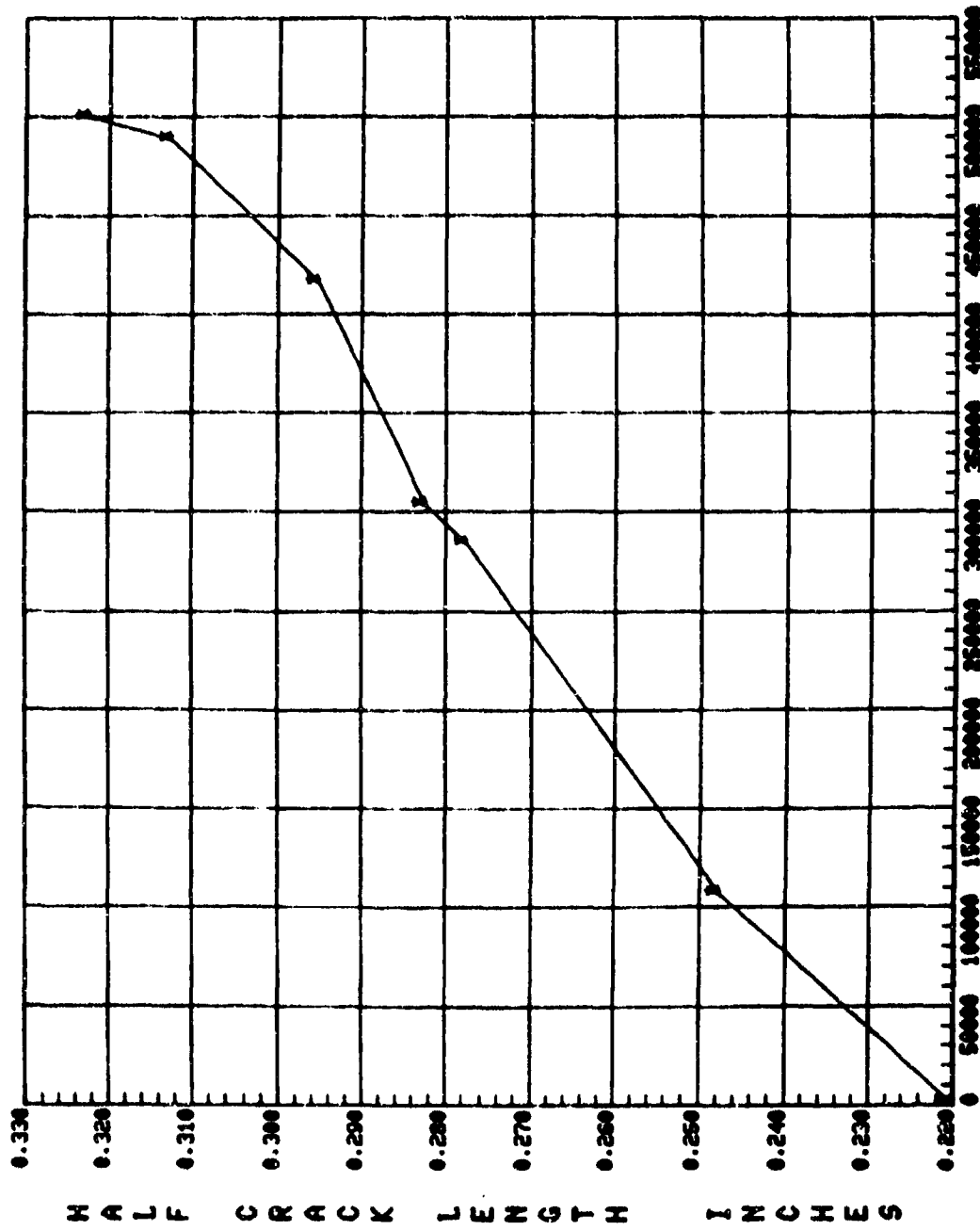

TEST LIFE N (CYCLES)
 Figure 94. Crack growth curve for test M-74.

TABLE 94. DATA TABULATION FOR TEST M-77

SPECIMEN NO.: M-77 SIMPLIFIED FLIGHT SPECTRUM, TYPICAL FIGHTER, MAX STRESS = 20 KSI

SCT. SPECIMEN $\delta = 0.250$ IN. $N = 6.000$ IN. $AN = 0.0$ IN. TEST FREQ = 6.000 CHZ.

ENVIRONMENT CONDITION: AMBIENT AIR

NO.	CYCLES	A(MEASURED)	A(REGRESSION)	MULT. CORR. COEFF	K-MAX	DELTA K	DA/DM
1	0.	0.300	0.301	0.98299E	13.79	15.85	2.794E-06
2	700.	0.315	0.309	0.990741	13.96	16.06	6.448E-06
3	2980.	0.335	0.346	0.994241	14.78	17.00	8.630E-06
4	4781.	0.385	0.378	0.995916	15.45	17.77	9.806E-06
5	7500.	0.440	0.436	0.996776	16.60	19.09	1.201E-05
6	10000.	0.495	0.503	0.997692	17.85	20.53	1.394E-05
7	11500.	0.545	0.543	0.998051	18.56	21.34	1.569E-05
8	13400.	0.610	0.604	0.997657	19.60	22.54	1.864E-05
9	15450.	0.675	0.685	0.998061	20.91	24.05	2.281E-05
10	16700.	0.745	0.745	0.999050	21.79	25.06	2.600E-05
11	18280.	0.830	0.829	0.998782	23.08	26.54	3.187E-05
12	19750.	0.925	0.931	0.998655	24.53	28.21	3.907E-05
13	20520.	0.965	0.989	0.999385	25.34	29.14	4.164E-05
14	21140.	1.050	1.042	0.998824	26.06	29.97	4.659E-05
15	21790.	1.105	1.106	0.998761	26.93	30.94	5.089E-05
16	22470.	1.170	1.177	0.998562	27.63	32.01	5.855E-05
17	23100.	1.255	1.248	0.998642	28.75	33.06	6.557E-05
18	23625.	1.315	1.320	0.998383	29.66	34.11	7.652E-05
19	24010.	1.375	1.381	0.998685	30.43	34.99	8.533E-05
20	24275.	1.420	1.425	0.999430	30.97	35.62	9.206E-05
21	24615.	1.495	1.493	0.999672	31.61	36.58	1.036E-04
22	25145.	1.605	1.607	0.999010	33.21	38.20	1.222E-04
23	25575.	1.720	1.716	0.999491	34.54	39.72	1.422E-04
24	25950.	1.820	1.828	0.999294	35.90	41.29	1.669E-04
25	26255.	1.935	1.932	0.999243	37.18	42.76	1.925E-04
26	26575.	2.055	2.060	0.999597	38.75	44.57	2.279E-04
27	26810.	2.170	2.172	0.999534	40.15	46.17	2.612E-04
28	27005.	2.275	2.274	0.999455	41.45	47.67	3.002E-04

TABLE 94. DATA TABULATION FOR TEST M-77 (CONCL)

SPECIMEN NO.: M-77 SIMPLIFIED FLIGHT SPECTRUM, TYPICAL FIGHTER, MAX STRESS = 20 KSI

CCT SPECIMEN B= 0.250 IN. W= 6.000 IN. AN= 0.0 IN.

PHIN= PMA= TEST FREQ= 6.00HZ.

ENVIRONMENT CONDITION: AMBIENT AIR

NO.	CYCLES	A (MEASURED)	A (REGRESSION)	MULT. CORR. COEFF	K-MAX	DELTA K	DA/DN
29	27200.	2.395	2.396	0.998922	43.02	49.47	3.531E-04
30	27375.	2.515	2.523	0.999256	44.69	51.39	4.195E-04
31	27507.	2.634	2.636	0.999300	46.23	53.16	4.951E-04
32	27620.	2.750	2.751	0.999169	47.83	55.00	5.888E-04
33	27715.	2.865	2.872	0.998622	49.58	57.02	7.030E-04
34	27794.	2.975	2.978	0.996445	51.17	58.84	8.832E-04
35	27857.	3.085	3.090	0.997415	52.91	60.85	1.103E-03
36	27904.	3.180	3.193	0.993409	54.57	62.76	1.400E-03
37	27956.	3.340	3.346	0.994693	57.18	65.76	1.889E-03
38	27996.	3.475	3.509	0.994254	60.18	69.20	2.629E-03
39	28015.	3.590	3.580	0.994765	61.56	70.80	3.039E-03
40	28033.	3.710	3.726	0.995495	64.62	74.31	3.911E-03
41	28045.	3.830	3.877	0.991942	66.80	76.82	4.711E-03

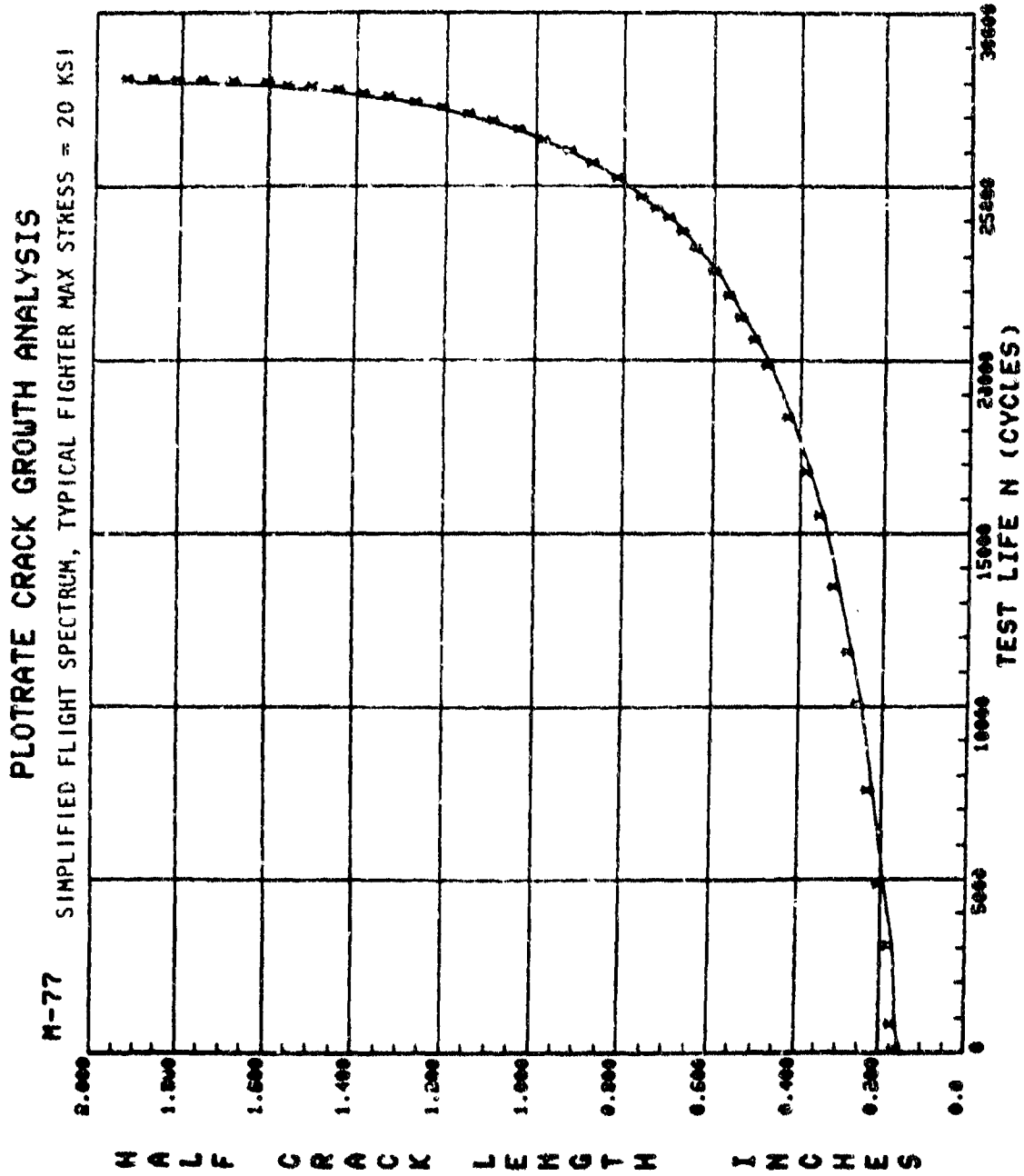

Figure 95. Crack growth curve for test M-77.

TABLE 95. DATA TABULATION FOR TEST M-77A

SPECIMEN NO.: M-77A SIMPLIFIED SPECTRUM, TYP FIGHTER STRESS = 14 KSI MAX

CCT SPECIMEN B = 0.250 IN. W = 6.000 IN. AN = 0.0 IN.

PHIN = PMAX = TEST FREQ = 6.00HZ.

ENVIRONMENT CONDITION: AMBIENT AIR

NO.	CYCLES	A (MEASURED)	A (REGRESSION)	MULT. CORR. COEFF	K-MAX	DELTA K	JANUM
1	0.	0.295	0.295	0.999561	6.36	9.09	1.005E-06
2	21900.	0.370	0.371	0.999640	7.14	10.21	2.551E-06
3	34400.	0.450	0.446	0.999559	7.54	11.20	3.544E-06
4	43200.	0.510	0.516	0.998613	8.44	12.05	4.426E-06
5	49000.	0.565	0.568	0.999059	8.85	12.66	5.109E-06
6	54700.	0.625	0.626	0.999556	9.32	13.31	5.973E-06
7	59500.	0.695	0.691	0.999291	9.80	14.00	6.989E-06
8	65300.	0.765	0.769	0.999264	10.36	14.80	8.259E-06
9	70300.	0.855	0.856	0.999395	10.55	15.65	9.569E-06
10	75200.	0.955	0.957	0.999939	11.62	16.60	1.165E-05
11	78000.	1.025	1.025	0.999880	12.05	17.22	1.266E-05
12	81500.	1.120	1.119	0.999790	12.63	18.05	1.427E-05
13	82710.	1.155	1.154	0.999695	12.55	18.36	1.488E-05
14	84525.	1.205	1.209	0.999419	13.16	18.83	1.615E-05
15	86062.	1.240	1.258	0.999532	13.47	19.25	1.788E-05
16	87261.	1.360	1.302	0.999321	13.74	19.62	1.903E-05
17	88466.	1.350	1.352	0.999277	14.03	20.04	2.003E-05
18	89543.	1.400	1.395	0.999310	14.26	20.59	2.109E-05
19	90823.	1.450	1.449	0.999008	14.59	20.84	2.273E-05
20	92006.	1.500	1.502	0.999544	14.90	21.28	2.407E-05
21	94057.	1.605	1.606	0.999517	15.49	22.13	2.755E-05
22	95608.	1.700	1.697	0.999911	16.01	22.87	3.089E-05
23	97355.	1.810	1.810	0.998797	16.65	23.79	3.617E-05
24	98626.	1.900	1.904	0.999058	17.19	24.56	3.969E-05
25	99936.	2.005	2.012	0.999302	17.81	25.44	4.434E-05
26	100981.	2.120	2.108	0.999256	18.36	26.23	4.870E-05
27	102190.	2.225	2.232	0.999277	19.09	27.27	5.423E-05
28	103219.	2.345	2.346	0.998247	19.77	28.24	6.166E-05

TABLE 95. DATA TABULATION FOR TEST M-77A (CONCL)

SPECIMEN NO.: M-77A SIMPLIFIED SPECTRUM, TYP FIGHTER STRESS = 14 KSI MAX

ENVIRONMENT CONDITION: AMBIENT AIR W = 6.000 IN. AN = 0.0 IN.

P MIN = P MAX = TEST FRQ = 6.00HZ.

ENVIRONMENT CONDITION: AMBIENT AIR

NO.	CYCLES	A (MEASURED)	A (REGRESSION)	MULT. CORR. COEFF	K-MAX	DELTA K	U A / D M
29	104111.	2.455	2.455	0.999317	23.44	29.19	7.138E-05
30	104812.	2.550	2.559	0.999348	21.08	30.12	7.939E-05
31	105417.	2.660	2.655	0.997240	21.69	30.99	9.904E-05
32	106015.	2.775	2.771	0.997731	22.45	32.08	1.110E-04
33	106450.	2.850	2.870	0.998057	23.13	33.04	1.257E-04
34	106924.	3.005	2.994	0.998523	23.99	34.27	1.432E-04
35	107297.	3.110	3.107	0.996165	24.82	35.45	1.624E-04
36	107592.	3.205	3.210	0.995241	25.60	36.57	1.797E-04
37	107898.	3.310	3.317	0.999354	26.45	37.79	2.047E-04
38	108101.	3.405	3.400	0.999149	27.14	38.77	2.326E-04
39	108361.	3.520	3.527	0.999328	28.24	40.34	2.701E-04
40	108521.	3.615	3.616	0.996360	29.07	41.52	3.228E-04
41	108693.	3.730	3.730	0.999254	30.17	43.19	3.755E-04
42	108867.	3.860	3.871	0.996487	31.64	45.20	4.724E-04
43	108950.	3.955	3.949	0.998973	32.52	46.45	5.280E-04
44	109050.	4.050	4.059	0.999063	33.84	48.32	6.094E-04
45	109150.	4.190	4.189	0.998349	35.51	50.73	6.942E-04

M-77A
PLOT RATE CRACK GROWTH ANALYSIS
 SIMPLIFIED SPECTRUM, TYP FIGHTER STRESS = 14 KSI MAX

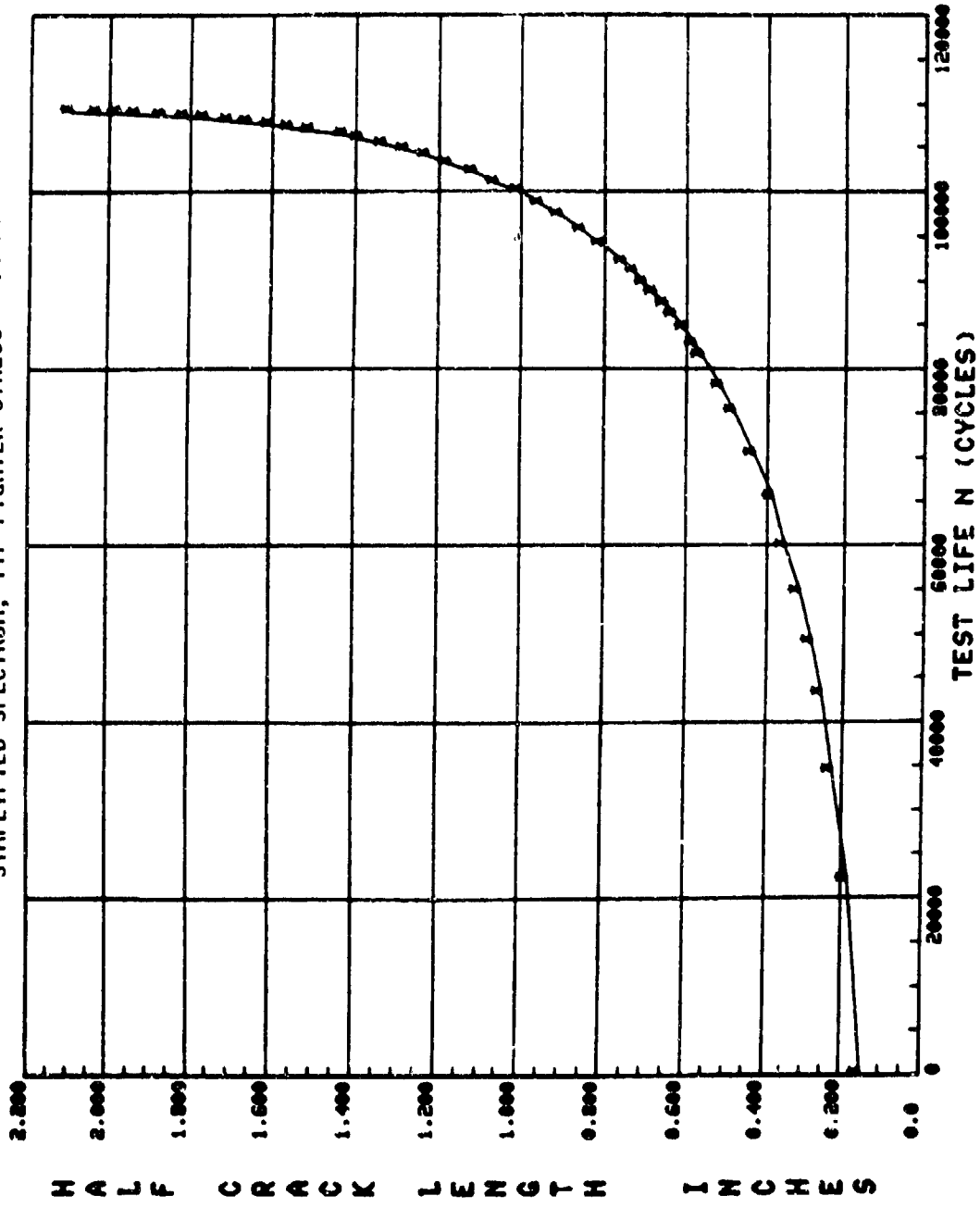

Figure 96. Crack growth curve for test M-77A.

TABLE 96. DATA TABULATION FOR TEST M-78

SPECIMEN NO.: M-78		TYPICAL FIGHTER, MAX STRESS = 18 KSI					
CCT SPECIMEN	R = 0.250 IN.	W = 6.000 IN.	AM = 0.0	IN.	TEST FREQ = 6.00HZ.		
PMIN =	PMAX =						
ENVIRONMENT CONDITION: AMBIENT AIR							
NO.	CYCLES	A (MEASURED)	A (REGRESSION)	MULT. CORR. COEFF	K-MAX	DELTA K	DA/DM
1	C.	0.295	0.295	1.00000	12.27	16.36	4.500E-06
2	5000.	0.340	0.336	0.99648	13.10	17.47	4.391E-06
3	10000.	0.385	0.382	0.997507	13.98	16.65	5.203E-06
4	15000.	0.430	0.436	0.997154	14.98	19.97	6.410E-06
5	18000.	0.480	0.476	0.998720	15.62	20.62	7.290E-06
6	22000.	0.515	0.528	0.996818	16.63	22.17	9.235E-06
7	25000.	0.545	0.558	0.994334	17.54	23.39	1.161E-05
8	27000.	0.635	0.644	0.996776	18.23	24.31	1.341E-05
9	28000.	0.675	0.673	0.995495	18.64	24.66	1.356E-05
10	3000.	0.710	0.701	0.99593.	19.04	25.38	1.470E-05
11	30700.	0.752	0.751	0.995499	19.74	26.32	1.610E-05
12	33000.	0.870	0.828	0.997915	20.76	27.68	1.795E-05
13	35000.	0.905	0.903	0.998403	21.73	28.97	2.112E-05
14	36000.	0.955	0.947	0.998415	22.29	29.72	2.260E-05
15	37500.	1.010	1.020	0.996299	23.18	30.90	2.520E-05
16	38800.	1.090	1.064	0.998163	23.96	31.95	2.839E-05
17	39800.	1.140	1.142	0.998789	24.64	32.85	3.182E-05
18	40800.	1.205	1.210	0.998126	25.44	33.91	3.647E-05
19	41397.	1.255	1.252	0.999627	25.92	34.56	3.983E-05
20	42055.	1.305	1.309	0.999355	26.55	35.40	4.506E-05
21	42491.	1.350	1.347	0.999506	27.00	36.00	4.842E-05
22	43292.	1.425	1.429	0.999760	27.92	37.22	5.501E-05
23	43803.	1.490	1.467	0.999673	28.56	38.08	6.041E-05
24	44752.	1.610	1.609	0.999798	29.91	39.86	7.099E-05
25	45483.	1.715	1.718	0.999348	31.11	41.46	8.246E-05
26	45993.	1.805	1.804	0.999473	32.05	42.73	9.276E-05
27	46579.	1.910	1.916	0.999640	33.26	44.38	1.077E-04
28	47000.	2.010	2.010	0.999757	34.32	45.76	1.191E-04

TABLE 96. DATA TABULATION FOR TEST M-78 (CONCL)

SPECIMEN NO.: M-78 TYPICAL FIGHTER, MAX STRESS = 18 KSI

CC1 SPECIMEN P = 3.50 IN. W = 6.000 IN. AN = 0.0 IN.

PMIN = PMAX = TEST FREQ = 6.00HZ.

ENVIRONMENT CONDITION: AMBIENT AIR

NO.	CYCLES	A (MEASURED)	A (REGRESSION)	MULT. CORR. COEFF	K-MAX	DELTA K	DA/DM
29	47363.	2.105	2.104	0.999406	35.37	47.16	1.348E-04
30	47737.	2.205	2.203	0.999383	36.49	48.66	1.501E-04
31	48047.	2.290	2.297	0.999227	37.57	50.09	1.684E-04
32	48329.	2.400	2.394	0.998925	38.69	51.50	1.921E-04
33	48637.	2.510	2.517	0.998546	40.14	53.53	2.329E-04
34	48852.	2.615	2.621	0.996631	41.41	55.21	2.669E-04
35	49001.	2.700	2.701	0.999811	42.41	56.54	3.015E-04
36	49165.	2.810	2.805	0.999807	43.74	58.33	3.404E-04
37	49326.	2.915	2.919	0.999428	45.25	60.33	3.877E-04
38	49464.	3.030	3.030	0.999539	46.77	62.37	4.283E-04
39	49587.	3.125	3.132	0.997413	48.31	64.42	4.994E-04
40	49683.	3.240	3.236	0.992852	49.76	66.35	6.046E-04
41	49780.	3.340	3.348	0.995192	51.83	69.11	7.755E-04
42	49830.	3.430	3.429	0.996474	52.82	70.43	8.913E-04
43	49885.	3.545	3.527	0.992453	54.48	72.63	1.149E-03
44	49949.	3.665	3.669	0.991497	57.40	76.53	1.515E-03
45	49976.	3.755	3.774	0.954180	59.05	78.73	1.819E-03
46	50017.	3.935	3.935	0.999610	62.39	83.19	2.576E-03

M-78 M-78 TYPICAL FIGHTER, MAX STRESS = 18 KSI
PLOTRATE CRACK GROWTH ANALYSIS

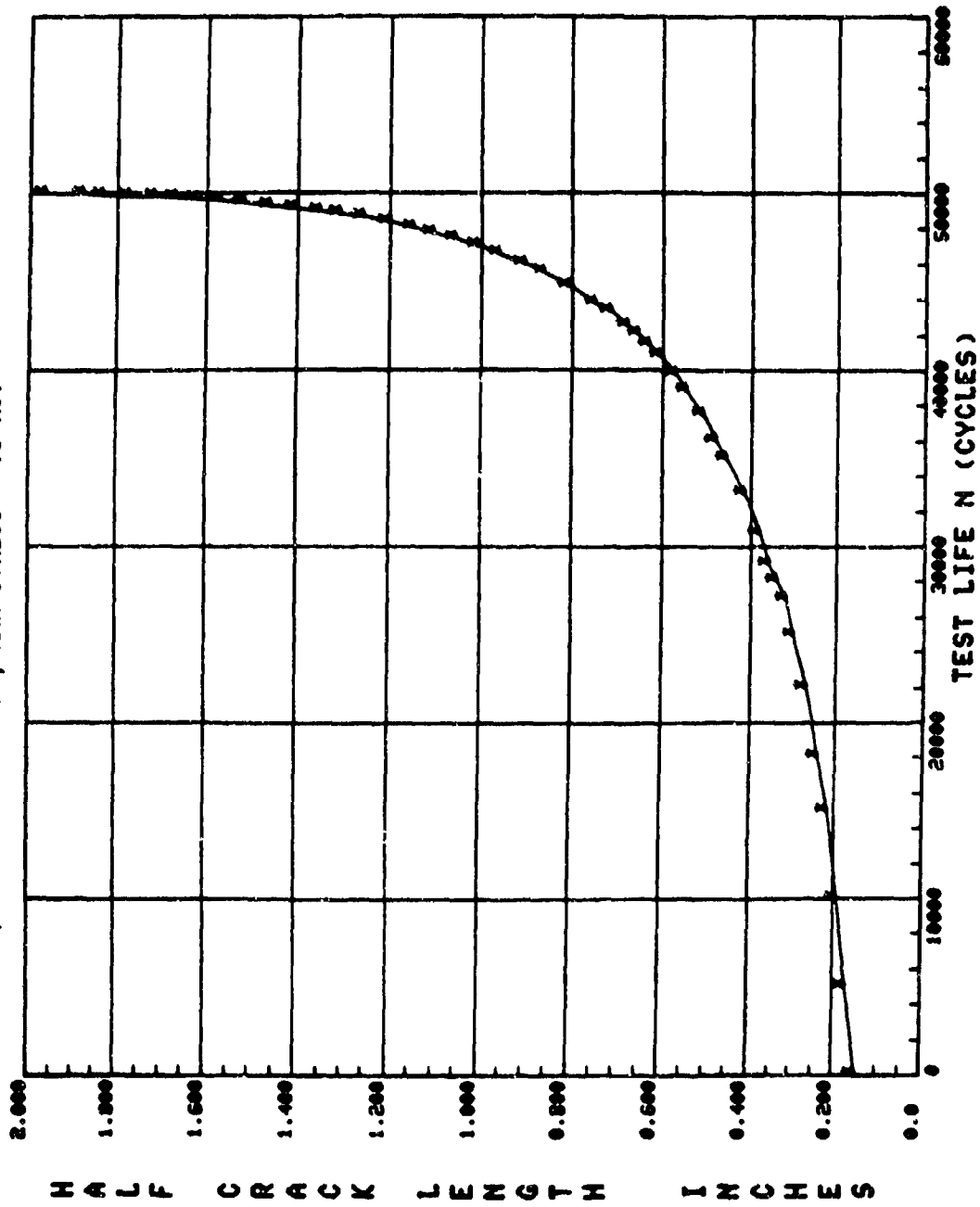

Figure 97. Crack growth curve for test M-78.

TABLE 97. DATA TABULATION FOR TEST M-79

SPECIMEN NO.: M-79 SIMPLIFIED SPECTRUM, TYP. TRANSPORT, MAX STRESS = 12 KSI

CCT SPECIMEN B = 0.250 IN. b = 6.000 IN. AN = 0.0 IN. TEST FREQ = 6.00 HZ.
 PMIN = PMAX =

ENVIRONMENT CONDITION: AMBIENT AIR

NO.	CYCLES	A(MEASURED)	A(REGRESSION)	MULT. CORR. COEFF	K-MAX	DELTA K	DA/DW
1	0.	0.815	0.817	0.983832	13.74	22.33	5.350E-07
2	42000.	0.870	0.852	0.979546	14.05	22.83	3.656E-07
3	128567.	0.905	0.901	0.979792	14.47	23.52	2.716E-07
4	213000.	0.935	0.940	0.982489	14.80	24.05	2.385E-07
5	291000.	0.970	0.969	0.995944	15.04	24.44	2.495E-07
6	361447.	1.005	1.004	0.997278	15.33	24.91	2.897E-07
7	431746.	1.040	1.047	0.997231	15.68	25.47	3.488E-07
8	500000.	1.100	1.100	0.997915	16.09	26.15	4.542E-07

PLOTRATE CRACK GROWTH DATA

M-79 SIMPLIFIED SPECTRUM, TYP TRANSPORT, MAX STRESS = 12 KSI

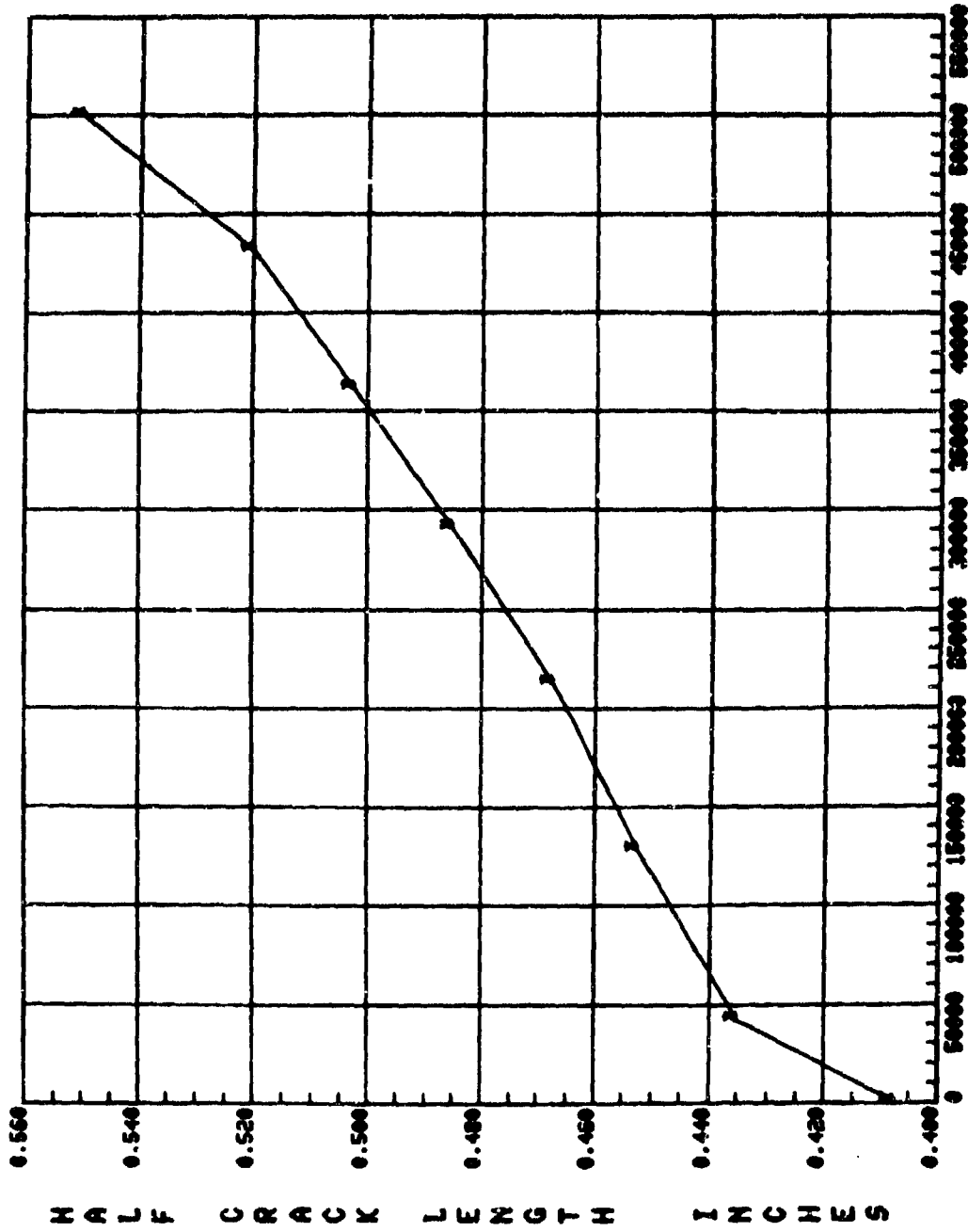

TEST LIFE N (CYCLES)

Figure 98. Crack growth curve for test M-79.

TABLE 98. DATA TABULATION FOR TEST M-80

SPECIMEN NO.: M-80 SIMPLIFIED SPECTRUM, TYP. TRANSPORT. MAX STRESS = 16.8 KSI

CCT SPECIMEN B = 0.250 IN. h = 6.000 IN. AN = 0.0 IN.
 PHEN = PMAK = TEST FREQ = 6.00 HZ.

ENVIRONMENT CONDITION: AMBIENT AIR

NO.	CYCLES	A(MEASURED)	A(REGRESSION)	MULT. CORR. COEFF	K-MAX	DELTA K	DA/DW
1	0.	0.500	0.500	0.996806	14.95	24.30	3.464F-08
2	40000.	0.510	0.514	0.977437	15.16	24.63	1.896E-07
3	71000.	0.520	0.527	0.986788	15.36	24.96	2.013E-07
4	112000.	0.550	0.543	0.990907	15.60	25.35	1.970F-07
5	194600.	0.575	0.575	0.992579	16.05	26.08	1.839F-07
6	294000.	0.605	0.608	0.987650	16.51	26.83	1.752E-07
7	342000.	0.620	0.622	0.995796	16.71	27.15	2.039F-07
8	395000.	0.640	0.644	0.991012	17.02	27.66	2.663F-07
9	416000.	0.655	0.653	0.995051	17.14	27.86	2.992F-07
10	462000.	0.680	0.684	0.994376	17.55	28.52	3.800E-07
11	476000.	0.700	0.695	0.991942	17.70	28.76	3.952F-07
12	500000.	0.715	0.715	0.986881	17.96	29.18	4.500F-07

PLOTRATE CRACK GROWTH DATA

M-80 SIMPLIFIED SPECTRUM, TYP TRANSPORT, MAX STRESS = 16.8 KSI

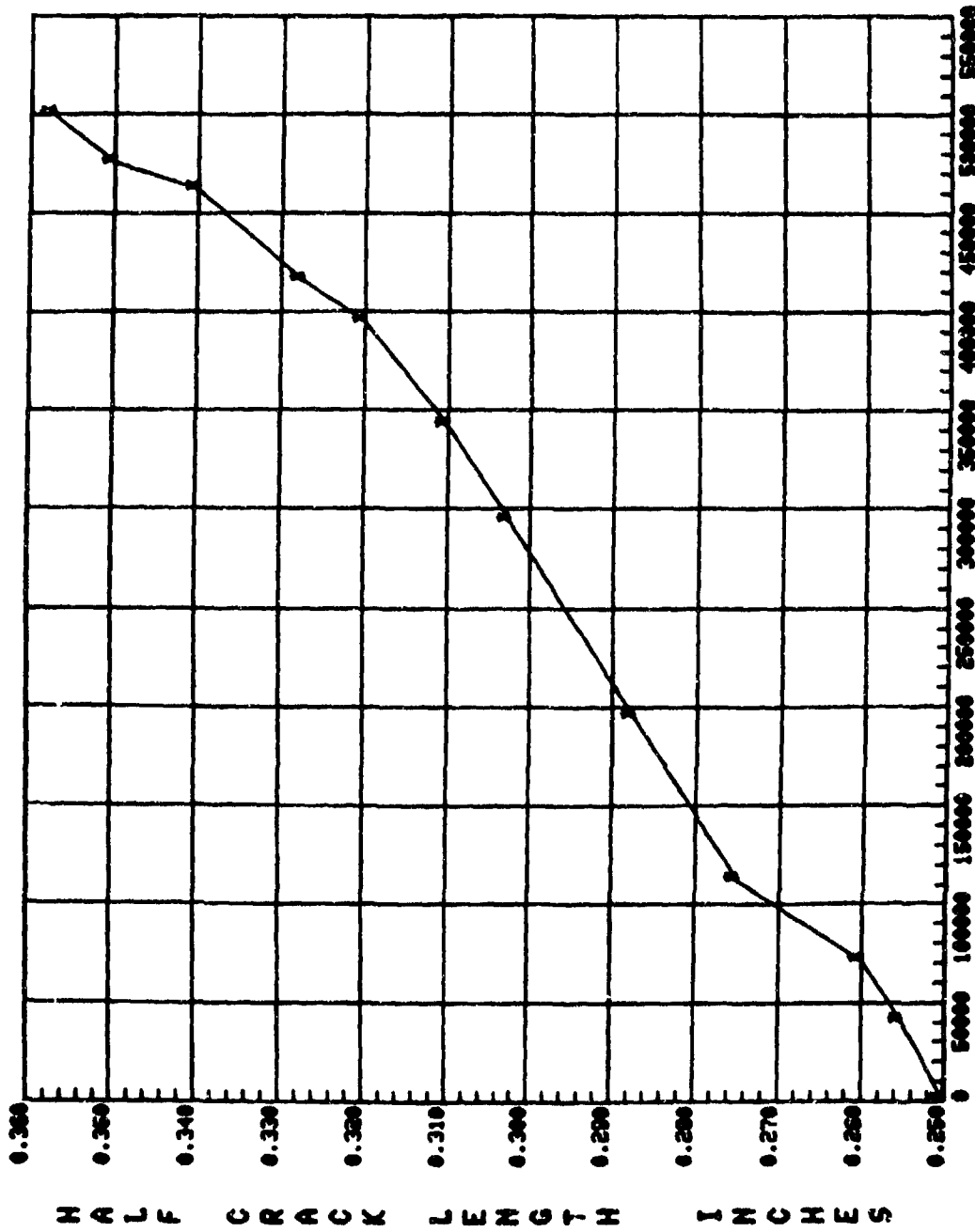

TEST LIFE N (CYCLES)

Figure 99. Crack growth curve for test M-80.

TABLE 99. METHODOLOGY DEVELOPMENT TEST PROGRAM GROUP V - RANDOM FLIGHT-BY-FLIGHT SPECTRUM LOADING TEST, AIR-TO-AIR MISSION, A TYPICAL FIGHTER

Test M-81 $\sigma_{lim} = 20$ ksi, M-82 $\sigma_{lim} = 30$ ksi, M-83 $\sigma_{lim} = 40$ ksi

READR 100000 IS ON LI 05

0001	C....	MANUUA	A-A	(N=1500)															
0002	-5.00*	70.0	10.1	54.1	20.1	45.5	25.0	52.3	30.0	50.7									
0003		20.2	44.5	18.6	40.6	24.5	41.9	8.6	29.4	17.6	52.4								
0004		17.5	24.5	10.2	74.9	10.8	50.6	32.5	53.7	17.3	65.7								
0005		50.0	63.5	3.1	67.5	10.4	60.6	44.0	54.9	10.2	45.1								
0006		14.7	34.0	20.4	58.4	31.2	45.6	27.9	63.5	9.4	69.7								
0007		36.1	50.2	-5.0	79.4	27.0	42.9	27.9	41.0	9.4	33.5								
0008		10.0	40.2	5.2	39.1	19.5	51.9	9.3	31.4	19.1	40.6								
0009		0.4	27.6	10.9	36.2	11.0	20.7	9.3	33.2	1.0	13.2								
0010		1.4	50.2	10.0	31.0	19.1	40.0	34.0	63.7	20.9	86.8								
0011		22.5	42.7	12.2	40.0	22.0	41.9	21.2	42.2	16.3	26.0								
0012		-3.0	27.3	11.9	45.3	-5.0	40.0	14.7	40.6	23.0	57.2								
0013		30.4	50.3	32.7	40.7	27.1	41.5	29.7	81.1	29.3	60.7								
0014		19.0	43.5	28.5	74.9	19.2	40.5	22.4	30.3	5.1	52.0								
0015		34.0	45.0	14.7	40.4	3.0	34.0	19.8	40.7	33.4	54.2								
0016		25.4	30.7	10.3	36.0	10.5	03.7	-17.0	50.1	11.7	29.3								
0017		-7.5	41.4	15.3	33.0	9.7	36.1	-5.0	61.7	10.3	50.9								
0018		30.1	47.9	25.4	52.1	24.9	65.2	-10.3	50.7	12.6	44.6								
0019		32.1	47.0	24.3	36.4	19.0	40.2	23.4	42.3	3.5	52.9								
0020		35.0	64.4	16.9	30.0	19.1	47.2	6.4	74.1	12.2	50.2								
0021		20.0	45.6	12.7	40.2	15.3	39.2	20.2	46.4	30.3	50.6								
0022		5.0	60.0	11.9	44.6	29.5	41.3	11.5	40.4	-5.0	47.4								
0023		0.9	44.3	32.4	50.2	10.3	55.1	-4.6	83.3	0.6	57.5								
0024		24.1	57.7	10.2	34.0	22.2	65.7	24.8	47.5	13.4	55.9								
0025		42.5	64.5	24.4	30.5	-22.0	01.0	30.2	66.4	39.4	60.9								
0026		35.4	50.0	25.5	51.2	34.5	54.9	26.0	39.5	-3.7	01.0								
0027		-1.0	47.0	12.5	59.0	0.3	53.9	7.7	45.3	29.7	66.4								
0028		-5.0	49.2	5.5	33.5	15.0	36.1	2.7	50.5	2.0	40.9								
0029		13.0	30.1	13.2	51.7	4.0	33.3	9.4	29.3	11.9	60.5								
0030		14.0	45.4	30.9	45.9	13.5	40.1	21.1	57.3	13.6	35.2								
0031		10.7	37.3	19.3	40.6	1.1	25.0	0.3	67.1	32.0	71.0								
0032		21.5	51.4	12.5	42.0	11.3	41.4	22.0	47.5	17.9	40.9								
0033		17.5	55.1	-5.0	41.4	12.2	74.3	15.1	50.4	20.7	45.0								
0034		54.3	59.1	20.3	45.5	29.1	52.9	12.0	65.1	30.9	40.0								
0035		4.7	60.0	47.0	01.0	15.0	31.1	14.3	50.6	7.7	53.2								
0036		34.7	00.1	6.0	20.5	6.2	50.5	9.3	75.7	12.6	52.7								
0037		31.3	55.7	17.4	57.7	22.3	61.7	29.0	51.7	39.0	55.5								
0038		12.2	42.6	0.1	25.0	-5.0	60.0	13.5	56.0	14.0	63.7								
0039		21.0	32.0	20.3	43.4	9.7	40.1	33.5	45.2	-7.3	47.1								
0040		0.4	77.4	45.9	50.0	10.3	71.0	10.6	30.2	23.3	46.2								
0041		-4.0	40.3	4.9	41.1	17.9	42.7	5.1	41.0	27.2	50.7								
0042		24.0	42.4	13.3	40.0	1.2	20.5	-4.5	51.3	5.4	20.6								
0043		15.4	30.3	6.0	39.0	5.3	60.3	-5.0	42.2	13.0	34.4								
0044		15.0	55.0	12.7	40.0	23.0	09.4	36.7	53.9	25.7	41.0								
0045		10.2	33.3	22.5	40.5	3.0	44.7	6.4	39.0	22.5	64.3								
0046		24.5	57.0	20.3	53.4	9.0	33.3	0.9	40.4	0.3	60.9								
0047		24.5	47.4	22.3	47.2	0.3	77.4	25.9	74.7	10.7	64.1								
0048		22.7	50.0	4.7	72.1	7.0	72.3	17.5	53.0	-5.0	59.3								
0049		15.0	42.4	27.0	41.0	17.3	70.0	12.9	47.5	25.4	60.3								
0050		50.3	09.4	-0.2	69.5	47.1	00.2	13.1	66.1	11.0	71.4								
0051		10.7	53.3	10.2	35.5	10.7	42.3	5.0	61.4	23.5	49.3								
0052		14.1	51.0	1.3	45.7	15.9	32.5	20.9	43.4	20.4	47.3								
0053		22.5	40.1	21.0	52.4	30.4	61.3	0.7	57.3	30.5	54.9								
0054		-5.0	39.9	20.4	50.2	0.4	31.0	13.0	55.9	42.0	75.9								
0055		10.0	50.3	34.0	40.2	11.4	66.4	11.7	55.5	-0.0	50.9								
0056		37.0	51.0	22.5	37.5	14.0	24.7	1.2	33.1	6.7	20.0								
0057		1.5	42.0	0.5	41.0	11.2	47.0	19.5	37.0	9.6	09.7								
0058		-0.4	40.1	29.0	44.2	23.4	00.0	14.2	40.4	23.3	09.3								
0059		24.3	50.0	-5.0	07.0	22.0	60.0	32.9	52.2	29.9	50.5								

* % of σ_{lim}

TABLE 99. METHODOLOGY DEVELOPMENT TEST PROGRAM GROUP V - RANDOM FLIGHT-BY-FLIGHT SPECTRUM LOADING TEST, AIR-TO-AIR MISSION, A TYPICAL FIGHTER (CONT)

Test M-81 $\sigma_{lim} = 20$ ksi, M-82 $\sigma_{lim} = 30$ ksi, M-83 $\sigma_{lim} = 40$ ksi

0060	28.3	58.5	25.0	55.4	36.0	60.4	23.8	68.7	24.0	61.6
0061	16.6	65.3	21.5	49.1	6.0	50.4	1.0	54.5	17.4	29.3
0062	8.6	42.3	31.6	49.6	34.8	48.4	25.7	46.8	16.8	41.3
0063	-0.7	61.2	8.6	42.7	5.1	44.4	16.0	59.0	-0.7	64.7
0064	21.5	55.4	17.6	36.6	-5.0	36.4	7.5	55.0	29.6	51.4
0065	2.2	72.7	1.3	32.2	-3.8	70.1	8.8	73.8	21.9	49.6
0066	38.6	54.0	41.3	56.3	27.5	38.1	25.3	49.5	9.6	60.9
0067	13.9	53.4	14.9	36.7	15.9	41.8	15.3	38.3	19.8	58.7
0068	28.7	46.8	19.0	55.2	8.9	44.2	5.9	49.6	19.9	55.6
0069	-0.1	21.5	-8.9	27.4	12.2	51.4	-5.0	59.9	16.8	78.8
0070	-2.5	48.2	3.7	80.4	7.5	62.3	31.2	60.0	37.3	54.7
0071	28.2	42.3	30.5	57.2	13.4	26.6	9.6	29.9	12.5	23.8
0072	-0.7	55.7	-4.2	37.7	18.1	56.9	36.3	56.8	27.5	41.8
0073	-0.6	47.4	23.3	62.3	10.0	50.8	30.6	50.0	15.0	37.6
0074	20.2	37.6	21.7	53.2	37.1	65.4	18.7	57.7	-5.0	37.8
0075	24.6	42.7	1.6	40.1	13.4	62.1	4.4	52.7	2.6	68.3
0076	6.2	34.7	-0.9	38.9	24.2	59.2	2.4	47.6	12.3	36.2
0077	4.1	52.4	2.4	16.6	-5.1	56.3	35.8	53.2	1.7	52.1
0078	35.6	70.2	28.3	40.0	25.2	49.2	20.9	35.2	17.6	37.4
0079	26.4	53.7	20.7	54.3	8.1	45.5	34.6	48.7	23.9	68.7
0080	-5.0	82.4	21.1	54.4	30.2	60.1	5.8	35.7	14.5	60.4
0081	23.2	48.4	19.9	44.7	5.5	68.3	42.8	54.4	24.5	48.8
0082	23.6	42.7	5.8	43.6	26.00	74.2	12.6	34.2	23.3	37.5
0083	24.9	36.9	26.5	55.5	22.5	66.8	52.5	65.0	23.9	56.2
0084	12.7	61.0	27.4	53.4	13.3	37.9	20.5	33.2	22.3	40.3
0085	25.7	62.8	-5.0	53.4	21.5	67.9	24.8	48.5	6.9	31.1
0086	18.1	41.4	14.8	27.1	10.4	61.2	8.5	53.4	3.1	27.7
0087	15.0	44.5	14.9	66.4	35.8	59.1	30.2	71.3	24.0	76.1
0088	28.3	52.1	14.8	64.1	40.5	73.0	8.4	56.3	22.4	37.6
0089	17.2	60.1	6.2	36.5	16.9	57.2	10.1	42.2	21.2	67.9
0090	5.3	63.4	34.3	47.4	-5.0	52.9	21.4	57.5	17.5	38.7
0091	10.0	56.2	26.1	45.5	27.9	60.4	25.5	41.8	19.7	56.5
0092	24.4	37.0	24.6	47.5	17.2	92.5	5.3	44.1	5.4	20.5
0093	-0.3	37.7	26.0	39.8	3.3	23.9	3.2	42.6	-1.9	57.6
0094	42.5	62.9	19.4	74.2	13.4	46.8	23.2	52.5	26.4	37.2
0095	4.1	35.9	22.0	64.2	32.4	54.8	-5.0	54.0	14.5	53.6
0096	12.8	38.9	21.4	53.7	28.6	49.5	39.2	60.8	26.1	52.9
0097	6.7	61.4	21.5	43.1	19.7	31.6	4.8	24.1	11.9	47.8
0098	14.6	34.3	10.4	55.8	10.2	21.6	9.0	41.6	12.7	51.6
0099	10.1	36.5	16.7	54.3	35.0	73.8	34.4	71.1	38.3	52.0
0100	20.4	58.5	28.7	48.7	24.9	44.6	28.0	48.0	-5.0	62.3
0101	45.4	74.7	33.8	46.3	21.4	53.4	8.9	45.9	-3.5	48.8
0102	15.6	58.4	32.2	48.8	9.6	48.7	15.3	26.4	3.0	57.5
0103	15.4	51.7	15.3	41.5	7.4	27.7	14.7	71.6	6.4	24.7
0104	3.0	54.2	-0.8	46.7	11.5	34.2	-2.9	32.1	-0.3	47.4
0105	3.1	31.1	9.6	55.2	5.7	50.7	27.8	38.6	4.6	63.1
0106	-5.0	44.0	31.0	61.7	43.5	65.7	6.3	47.8	23.1	71.9
0107	10.0	76.6	22.7	38.0	5.2	31.1	17.5	70.8	35.3	61.6
0108	26.8	56.5	7.2	54.9	17.4	30.1	9.2	19.9	5.9	17.9
0109	6.2	65.2	-1.4	76.0	5.9	55.4	13.8	63.4	37.4	59.9
0110	33.4	45.6	23.8	50.1	21.7	54.7	12.2	46.3	32.0	44.1
0111	6.6	70.8	-5.0	48.4	23.4	45.7	20.3	52.5	6.2	35.3
0112	20.3	61.8	8.1	47.5	28.7	41.5	16.8	34.2	6.3	84.1
0113	25.8	47.9	30.3	59.6	20.5	64.6	38.3	55.0	27.8	43.2
0114	20.0	62.8	17.1	40.1	17.6	30.6	12.8	65.8	4.5	59.6
0115	34.4	67.6	-4.2	60.6	0.9	63.5	12.8	37.9	7.7	69.5
0116	10.7	42.4	25.9	42.3	-5.0	54.1	24.7	66.4	23.2	49.9
0117	12.4	34.5	23.5	50.5	25.5	44.1	22.4	45.7	26.1	74.2
0118	39.4	61.1	28.2	45.7	18.3	53.7	20.6	54.1	32.1	67.6
0119	23.4	62.3	28.4	80.2	19.1	48.7	29.4	55.4	19.7	79.2
0120	11.2	43.8	21.7	46.2	20.9	71.4	33.9	63.3	34.9	52.7
0121	24.8	60.6	10.7	65.8	17.5	64.4	-5.0	41.7	11.5	34.0
0122	-22.0	26.3	11.0	36.7	19.0	40.1	29.5	47.3	2.7	60.1
0123	26.0	59.6	28.2	64.4	21.4	52.8	34.7	45.6	27.3	51.8

TABLE 99. METHODOLOGY DEVELOPMENT TEST PROGRAM GROUP V - RANDOM FLIGHT-BY-FLIGHT SPECTRUM LOADING TEST, AIR-TO-AIR MISSION, A TYPICAL FIGHTER (CONT)

Test M-81 $\sigma_{lim} = 20$ ksi, M-82 $\sigma_{lim} = 30$ ksi, M-83 $\sigma_{lim} = 40$ ksi

0124	30.2	57.5	23.3	62.3	3.2	46.9	11.1	35.2	16.7	35.3
0125	7.1	45.4	15.4	46.9	22.0	50.0	24.0	36.6	13.6	52.0
0126	4.1	17.7	-4.2	36.9	6.0	36.1	5.3	59.4	-5.0	67.1
0127	14.0	48.0	14.8	78.5	21.8	45.9	21.9	45.8	9.5	67.8
0128	17.6	37.8	18.5	85.2	24.5	35.3	20.3	56.2	31.6	62.8
0129	8.7	50.2	10.5	65.9	20.0	42.2	5.2	34.2	11.9	52.6
0130	21.4	64.7	-0.1	10.4	-3.7	62.3	6.6	44.1	9.8	41.6
0131	24.3	34.6	19.4	31.1	15.6	32.8	-0.2	48.3	15.5	45.0
0132	-5.0	41.0	16.2	45.2	34.1	58.6	26.5	48.3	10.5	59.9
0133	9.8	61.8	5.4	53.0	26.9	44.4	2.1	57.4	28.3	49.5
0134	18.3	56.5	-2.9	49.3	36.9	68.0	49.3	74.5	34.2	44.8
0135	21.6	54.1	12.5	52.3	12.8	46.1	29.1	71.4	34.0	69.0
0136	30.4	42.4	14.7	34.9	6.6	27.4	11.9	77.7	27.1	53.9
0137	16.3	70.1	-5.0	67.1	43.0	63.1	7.7	27.8	8.7	46.0
0138	8.8	54.7	25.8	53.5	22.6	48.9	33.4	47.8	35.2	74.6
0139	43.2	53.3	21.5	69.1	21.7	83.4	10.9	43.6	18.4	34.3
0140	7.6	45.9	32.7	54.3	9.3	50.3	2.6	35.7	16.2	43.8
0141	29.4	52.5	13.8	58.6	16.2	63.3	29.5	49.1	9.2	38.3
0142	16.4	57.4	-0.1	65.3	-5.0	65.0	32.1	53.7	27.4	45.1
0143	33.7	65.3	15.4	31.6	5.3	22.3	7.8	45.0	-3.7	25.6
0144	2.1	68.4	7.4	63.3	10.5	22.3	2.8	58.8	13.3	45.8
0145	8.0	56.9	7.5	38.5	-1.1	41.8	12.8	61.7	3.3	36.2
0146	25.1	51.8	20.6	58.3	42.7	63.7	25.9	49.2	11.7	48.3
0147	28.4	54.7	23.2	48.2	14.7	46.7	-5.0	18.7	-10.0	48.8
0148	-5.8	39.7	-2.7	64.8	1.0	41.2	29.8	49.8	20.4	39.5
0149	9.1	40.2	4.5	51.5	20.8	54.8	22.4	59.8	2.8	25.2
0150	5.6	24.8	13.5	38.4	28.2	43.7	12.3	29.3	12.3	63.5
0151	30.4	45.0	22.7	75.1	30.8	49.9	23.8	43.8	2.1	70.7
0152	3.5	36.2	10.4	48.9	25.1	41.5	28.6	44.1	-5.0	66.4
0153	21.8	44.5	28.1	56.1	6.9	44.9	20.3	65.4	44.0	71.0
0154	11.6	51.9	6.3	58.1	22.0	41.8	24.6	53.5	14.2	63.4
0155	11.1	41.1	13.7	32.6	11.4	75.6	2.5	64.5	10.0	43.3
0156	28.8	57.7	-4.2	73.5	12.7	41.9	18.6	46.0	24.6	34.9
0157	14.6	41.7	30.7	67.3	28.5	71.2	15.4	49.9	21.4	59.2
0158	-5.0	47.4	22.9	66.1	15.4	47.0	31.7	43.6	20.8	34.2
0159	8.5	20.4	0.0	42.3	-14.3	48.6	21.2	43.3	7.2	80.1
0160	27.6	55.3	32.2	66.5	2.1	43.4	9.2	62.8	22.8	51.9
0161	0.4	43.6	19.7	56.8	8.7	20.8	3.0	45.7	13.3	36.2
0162	15.4	41.4	4.1	47.4	18.6	29.4	12.8	66.8	7.5	45.6
0163	29.6	61.3	-5.0	46.3	19.5	35.3	11.4	55.4	2.4	22.3
0164	7.2	48.1	33.8	50.1	23.3	49.8	19.3	42.2	25.2	57.0
0165	43.1	58.5	15.9	52.5	29.0	58.1	23.5	40.2	23.0	70.8
0166	27.9	52.1	14.5	44.8	16.6	44.7	28.1	66.9	10.2	43.4
0167	21.1	41.8	2.0	62.5	9.6	36.1	3.5	60.9	21.4	46.7
0168	33.7	47.5	14.4	54.5	-5.0	60.9	16.4	32.1	17.3	60.2
0169	6.8	26.9	9.9	55.7	13.5	65.1	41.8	53.3	20.7	39.4
0170	28.2	40.6	8.6	63.2	23.0	45.3	22.3	36.1	21.0	65.7
0171	27.6	40.2	22.5	43.0	31.8	77.5	-0.2	74.3	24.8	53.4
0172	28.1	45.1	31.2	67.5	21.2	35.4	4.1	25.5	14.0	36.3
0173	10.3	56.6	7.7	31.4	7.3	47.6	-5.0	15.1	1.1	36.7
0174	7.4	49.4	16.9	45.9	10.4	22.4	10.6	23.1	6.4	20.8
0175	6.4	50.6	1.5	34.4	-6.0	58.3	3.1	43.3	26.1	38.2
0176	21.4	42.4	27.1	48.3	11.2	34.4	21.0	69.4	14.2	79.2
0177	-10.1	67.3	11.1	44.8	8.9	51.4	18.2	52.6	15.8	61.3
0178	30.8	48.6	15.3	56.3	15.2	49.6	22.6	48.5	-5.0	51.9
0179	11.8	59.0	14.9	43.0	31.9	43.1	24.1	39.9	8.1	53.9
0180	5.4	55.0	21.7	49.9	18.2	46.0	6.7	47.9	27.4	43.8
0181	11.1	46.1	34.6	77.4	-8.6	64.6	4.6	70.9	19.1	48.6

TABLE 99. METHODOLOGY DEVELOPMENT TEST PROGRAM GROUP V - RANDOM FLIGHT-BY-FLIGHT SPECTRUM LOADING TEST, AIR-TO-AIR MISSION, A TYPICAL FIGHTER. (CONT)

Test M-81 $\sigma_{lim} = 20$ ksi, M-82 $\sigma_{lim} = 30$ ksi, M-83 $\sigma_{lim} = 40$ ksi

0182	32.6	65.4	8.5	64.2	32.6	54.4	10.5	34.7	3.0	37.7
0183	27.3	38.1	24.3	50.3	24.5	43.4	4.1	42.8	19.6	57.9
0184	-5.0	50.8	37.0	47.6	3.3	57.6	28.1	44.6	36.7	51.1
0185	0.0	49.8	32.6	64.5	11.3	50.7	10.6	23.4	11.1	56.2
0186	38.8	54.4	14.5	27.6	7.9	30.8	20.4	45.0	14.3	54.4
0187	18.2	34.0	8.0	56.3	15.7	48.5	14.5	56.7	44.3	62.6
0188	13.3	49.0	22.7	42.1	16.1	38.2	8.0	49.6	7.1	24.9
0189	6.5	45.2	-5.0	67.7	15.7	37.8	4.3	57.4	19.5	61.6
0190	24.1	48.8	17.7	49.8	3.0	66.9	14.6	26.9	-0.5	35.5
0191	13.6	25.7	15.2	60.6	1.1	35.8	14.5	61.0	30.4	46.5
0192	4.8	19.9	7.2	44.2	22.7	33.6	11.6	40.9	4.8	67.1
0193	16.2	74.6	10.0	23.2	1.0	21.3	1.9	73.4	1.8	42.2
0194	30.1	61.6	13.6	34.7	-5.0	50.3	32.4	70.4	20.6	66.0
0195	25.8	56.5	42.0	55.6	10.4	48.5	17.1	37.8	3.4	32.5
0196	4.2	41.9	16.4	46.4	11.8	46.7	20.5	52.1	1.7	52.4
0197	35.4	49.1	24.7	70.4	18.8	64.8	-1.8	44.5	9.3	23.9
0198	12.0	48.2	22.9	37.3	10.8	31.5	16.8	40.2	20.3	48.5
0199	26.7	59.9	21.7	52.3	11.1	35.8	-5.0	49.2	5.4	25.2
0200	12.6	47.9	25.5	41.9	3.4	57.8	28.0	39.6	-0.2	31.0
0201	7.8	37.0	8.3	37.0	13.0	67.2	5.6	45.6	8.9	33.7
0202	4.4	67.4	15.9	46.6	36.1	46.6	18.3	59.3	38.2	64.7
0203	13.5	39.2	16.4	49.9	12.1	54.3	20.9	42.1	17.3	43.1
0204	11.5	51.2	19.2	39.1	12.0	44.9	23.4	34.3	-5.0	61.3
0205	4.0	48.7	8.8	39.1	24.4	42.4	15.5	45.6	21.5	35.9
0206	24.8	38.5	13.4	47.2	20.6	52.2	17.6	53.4	35.2	53.7
0207	19.6	38.5	22.5	67.3	8.2	38.0	25.5	44.1	30.3	42.3
0208	23.4	46.6	35.0	68.8	40.8	52.6	13.5	32.7	12.0	60.7
0209	32.0	49.7	33.7	46.6	27.7	49.5	38.1	55.1	-2.3	44.9
0210	-5.0	41.7	22.2	47.1	33.8	55.4	10.8	49.0	38.4	49.8
0211	4.8	56.9	27.4	53.7	31.4	60.6	8.0	51.0	26.1	61.8
0212	39.7	77.7	34.8	53.2	22.6	34.4	9.2	35.0	20.2	42.3
0213	15.6	41.5	18.8	45.7	34.1	45.0	26.0	47.5	26.0	44.1
0214	11.6	33.2	26.2	37.6	13.5	39.3	23.0	48.7	7.5	33.7
0215	22.6	43.5	-5.0	44.7	16.3	64.5	7.8	55.8	8.2	30.6
0216	20.2	44.8	34.1	54.0	20.7	41.1	26.6	72.3	25.5	55.5
0217	30.0	72.5	7.3	38.1	25.1	39.0	17.6	62.8	8.2	35.2
0218	-4.4	19.3	0.8	53.2	6.3	50.2	5.7	63.9	5.0	49.7
0219	27.7	38.3	-1.0	27.3	2.3	55.9	16.5	59.5	26.0	50.6
0220	4.5	41.5	2.8	39.0	-5.0	52.2	16.0	50.4	35.2	56.7
0221	-2.4	52.7	8.3	26.1	12.6	32.6	15.1	60.6	6.6	62.7
0222	-1.8	43.9	14.7	50.2	33.8	56.7	24.2	56.4	1.3	53.8
0223	41.4	69.1	31.5	41.7	23.0	48.9	38.5	78.3	10.6	37.5
0224	23.0	55.0	31.9	48.0	9.4	35.6	15.7	65.1	35.2	51.4
0225	11.2	45.0	33.1	46.8	23.9	53.5	-5.0	58.2	-3.1	82.8
0226	13.1	72.2	19.6	76.3	36.8	68.3	17.9	68.6	0.7	64.9
0227	35.0	67.2	17.1	35.1	6.8	29.4	12.4	45.8	15.1	43.2
0228	2.7	40.8	9.7	50.0	20.4	46.0	23.2	50.5	15.4	83.0
0229	17.4	30.2	19.6	38.4	26.5	77.5	19.8	52.2	10.0	83.5
0230	6.3	79.2	16.0	29.4	4.1	48.5	31.2	50.6	-5.0	52.4
0231	4.4	40.1	10.5	24.4	13.1	34.5	23.7	53.5	7.6	74.8
0232	16.7	68.6	4.8	44.5	28.1	45.7	25.4	47.0	13.1	54.6
0233	24.4	56.8	27.4	49.7	34.2	65.5	17.2	69.9	-8.2	30.7
0234	11.8	51.1	31.7	48.1	19.2	29.3	18.8	65.6	23.8	68.8
0235	56.2	74.6	38.4	56.8	28.1	54.3	31.5	59.4	45.9	61.3
0236	-5.0	57.0	36.9	71.7	34.1	67.1	43.7	61.0	28.7	47.3
0237	33.4	66.3	30.3	43.7	21.8	47.6	14.4	43.6	-6.8	55.2
0238	2.5	37.8	19.4	46.3	9.8	63.4	-12.7	5.0	-5.2	39.6
0239	12.1	30.3	17.4	53.8	21.6	55.5	17.7	45.1	16.8	54.3
0240	3.8	53.0	12.7	38.0	21.5	50.1	33.6	66.7	17.5	35.4
0241	25.0	44.8	-5.0	40.6	29.8	47.3	11.3	40.7	23.7	68.7
0242	3.4	43.4	19.9	50.6	5.7	51.8	-1.3	55.1	17.0	82.5

TABLE 99. METHODOLOGY DEVELOPMENT TEST PROGRAM GROUP V - RANDOM FLIGHT-BY-FLIGHT SPECTRUM LOADING TEST, AIR-TO-AIR MISSION, A TYPICAL FIGHTER (CONCL)

Test M-81 $\sigma_{lim} = 20$ ksi, M-82 $\sigma_{lim} = 30$ ksi, M-83 $\sigma_{lim} = 40$ ksi

0243	34.2	61.6	30.6	54.5	14.1	60.9	34.2	50.4	19.4	62.3
0244	2.9	74.2	41.9	53.9	11.6	28.1	13.2	26.9	8.2	50.6
0245	7.4	44.3	4.8	14.4	-10.2	43.7	24.5	40.3	13.6	41.3
0246	15.3	47.4	12.3	71.6	-5.0	50.6	24.0	51.6	32.4	44.4
0247	17.2	55.1	13.3	37.0	15.0	34.3	1.3	27.7	7.3	36.7
0248	7.6	41.3	30.3	47.2	26.2	41.0	4.7	61.4	18.3	35.5
0249	23.3	33.4	10.2	43.5	27.0	51.8	16.3	26.9	11.7	69.1
0250	0.6	54.4	-2.9	58.6	-1.1	45.4	34.8	53.7	22.4	40.4
0251	23.4	55.2	44.5	60.2	21.6	70.7	-5.0	56.3	18.4	61.4
0252	28.2	41.1	20.6	58.0	37.0	49.1	13.4	45.3	-0.6	59.0
0253	7.5	64.9	17.6	53.6	34.1	63.7	14.1	51.0	-0.6	39.2
0254	15.4	61.8	16.6	60.2	24.8	52.2	26.5	57.3	9.5	21.4
0255	4.3	55.0	2.4	44.4	16.5	41.8	10.1	47.6	33.7	67.7
0256	4.4	53.3	32.4	47.5	11.9	74.1	25.2	59.0	-5.0	54.6
0257	18.7	52.7	12.7	28.1	17.1	41.8	8.5	44.7	30.1	49.6
0258	0.5	48.1	24.0	40.5	21.4	35.5	13.4	38.2	10.0	57.7
0259	16.6	35.8	23.4	42.0	26.4	52.8	23.8	36.5	-5.6	55.1
0260	14.3	43.4	30.1	44.8	23.4	58.1	18.4	44.6	7.8	51.0
0261	35.9	59.7	37.2	51.7	33.6	47.7	37.0	59.2	32.5	54.9

TABLE 100. DATA TABULATION FOR TEST M-81

SPECIMEN NO.: H-61 RANDOM SPECTRUM, TYPICAL ER, AIR-TO-AIR MISSION, LIMIT STRESS = 20 KSI

CCT SPECIMEN B = 0.750 IN. W = 6.000 IN. AN = 0.0 IN. TEST FREQ = 6.00HZ.

PMIR= PMAX=

ENVIRONMENT CONDITION: AMBIENT AIR

NO.	CYCLES	A (MEASURED)	REGRESSION	MULT. CORR. COEFF	K-MAX	DELTA K	UA/UN
1	0.	0.310	0.321	0.992870	6.41	10.49	1.417E-00
2	15099.	0.370	0.358	0.990507	6.89	11.09	1.364E-06
3	36500.	0.420	0.424	0.992570	9.68	12.68	1.914E-06
4	50001.	0.470	0.481	0.993158	10.32	12.88	2.481E-06
5	56100.	0.515	0.509	0.998289	10.62	13.25	2.728E-06
6	65750.	0.565	0.568	0.998689	11.23	14.02	3.142E-06
7	74300.	0.630	0.627	0.999418	11.82	14.75	3.501E-06
8	84475.	0.700	0.696	0.994452	12.47	15.26	4.023E-06
9	97640.	0.805	0.810	0.994846	13.49	16.83	5.004E-06
10	105150.	0.870	0.387	0.996126	14.15	17.65	5.934E-06
11	109500.	0.955	0.939	0.995198	14.77	18.19	6.616E-06
12	115700.	1.025	1.026	0.990369	15.28	19.07	7.404E-06

PLOT RATE CRACK GROWTH ANALYSIS

M-81 RANDOM SPECTRUM, TYPICAL FIGHTER, AIR-TO-AIR MISSION, LIMIT STRESS = 20 KSI

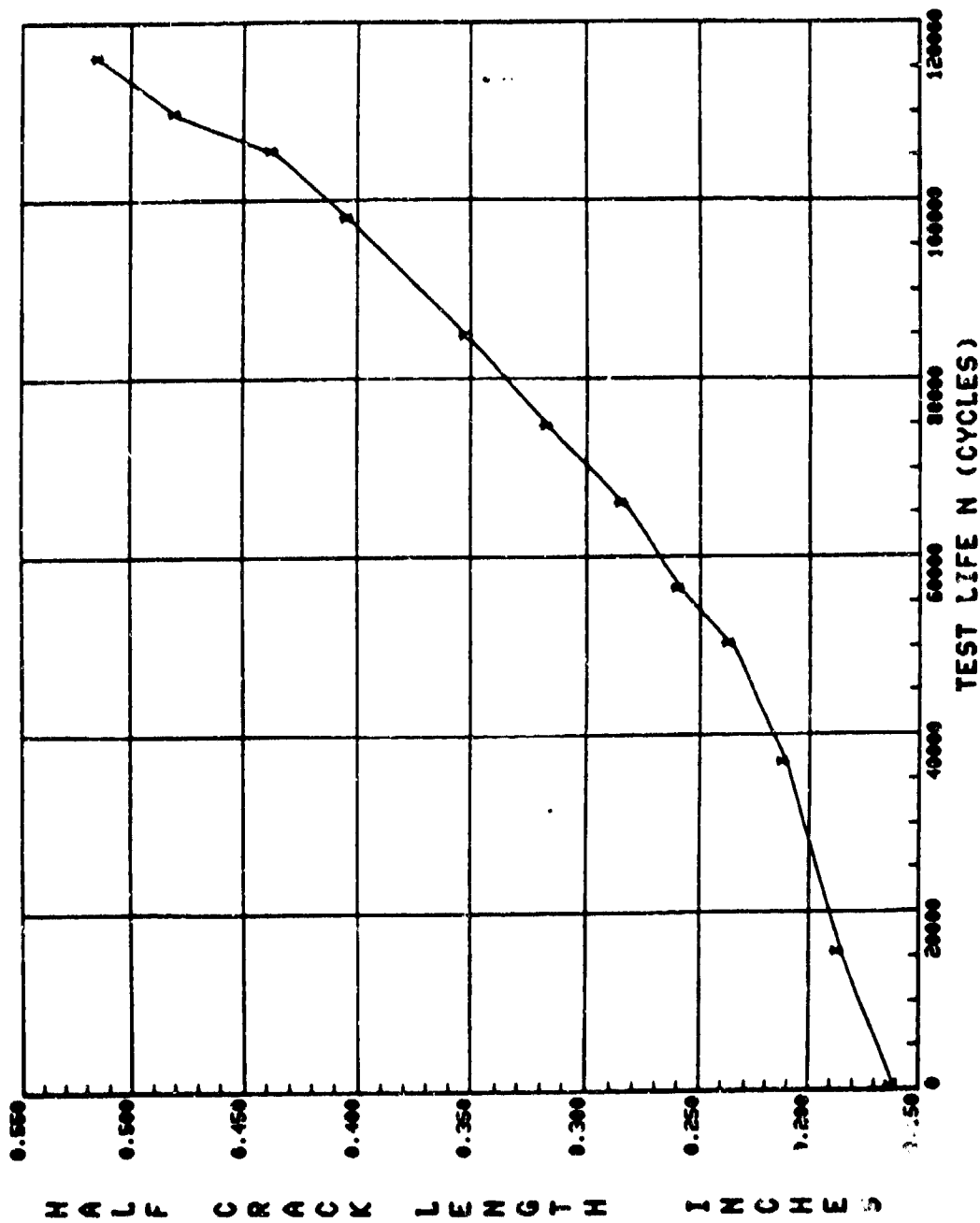

Figure 100. Crack growth curve for test M-81.

TABLE 101. DATA TABULATION FOR TEST M-82

SPECIMEN NO.: M-82 RANDOM SPECTRUM, TYPICAL FIGHTER, AIR-TO-AIR, LIMIT STRESS = 30 KSI

CCT SPECIMEN b = 0.250 IN. W = 6.000 IN. AN = 0.0 IN.
 PMIN = PMAX = TEST FREQ = 6.00HZ.

ENVIRONMENT CONDITION: AMBIENT AIR

NO.	CYCLES G.	A (MEASURED)	A (REGRESSION)	MULT. CORR. COEFF	K-MAX	DELTA K	DA/ON
1	0.300	0.300	0.300	0.996825	12.20	15.23	4.015E-06
2	2335.	0.327	0.327	0.997643	12.73	15.69	5.615E-06
3	5487.	0.355	0.356	0.991722	13.50	16.59	4.999E-06
4	8463.	0.355	0.365	0.993429	13.83	17.26	5.028E-06
5	17421.	0.465	0.477	0.994544	15.41	19.24	5.925E-06
6	21295.	0.530	0.524	0.995326	16.16	20.17	6.784E-06
7	23312.	0.550	0.550	0.997644	16.57	20.68	7.506E-06
8	26221.	0.555	0.596	0.994926	17.26	21.55	8.942E-06
9	28327.	0.630	0.632	0.998623	17.75	22.20	9.485E-06
10	31542.	0.695	0.700	0.999065	18.75	23.40	1.141E-05
11	34471.	0.780	0.771	0.998993	19.72	24.61	1.321E-05
12	37580.	0.855	0.862	0.994346	20.90	26.09	1.355E-05
13	39957.	0.930	0.930	0.993607	21.75	27.15	1.449E-05
14	41792.	1.000	0.982	0.990469	22.38	27.94	1.564E-05
15	44209.	1.035	1.056	0.987477	23.30	29.06	1.843E-05
16	46012.	1.120	1.121	0.992475	24.05	30.01	2.166E-05
17	47151.	1.175	1.169	0.996482	24.59	30.69	2.453E-05
18	48547.	1.250	1.249	0.999401	25.51	31.83	2.828E-05
19	49706.	1.310	1.315	0.999704	26.25	32.76	3.065E-05
20	50644.	1.375	1.372	0.998099	26.86	33.55	3.462E-05
21	51584.	1.440	1.436	0.998612	27.59	34.44	3.914E-05
22	52991.	1.545	1.556	0.999217	28.90	36.07	4.755E-05
23	53884.	1.650	1.640	0.995965	29.62	37.21	5.654E-05
24	55038.	1.780	1.782	0.997316	31.35	39.12	6.965E-05
25	55953.	1.895	1.916	0.995231	32.81	40.54	8.573E-05
26	56477.	2.020	2.008	0.994746	33.81	42.20	1.094E-04
27	57005.	2.105	2.125	0.995790	35.10	43.80	1.373E-04
28	57481.	2.250	2.263	0.996291	36.63	45.72	1.675E-04

TABLE 101. DATA TABULATION FOR TEST M-82 (CONCL)

SPECIMEN NO.: M-82 RANDOM SPECTRUM, TYPICAL FIGHTER, AIR-TO-AIR, LIMIT STRESS = 30 KSI

CCI SPECIMEN B= 0.250 IN. W= 6.000 IN. AM= 0.0 IN.

PMIN= PMAX= TEST FREQ= 6.00HZ.

ENVIRONMENT CONDITION: AMBIENT AIR

NO.	CYCLES	A (MEASURED)	A (REGRESSION)	MULT. CORR. COEFF	K-MAX	DELTA K	DA/DM
29	57715.	2.350	2.338	0.998273	37.49	46.79	1.659E-04
30	57998.	2.460	2.455	0.993116	38.84	48.48	2.285E-04
31	58194.	2.535	2.543	0.991209	39.88	49.77	2.626E-04
32	58444.	2.650	2.582	0.992267	41.56	51.87	3.390E-04
33	58565.	2.750	2.788	0.995264	42.89	53.53	4.763E-04

PLOTRATE CRACK GROWTH ANALYSIS

M-82 RANDOM SPECTRUM, TYPICAL FIGHTER, AIR-TO-AIR, LIMIT STRESS = 30 KSI

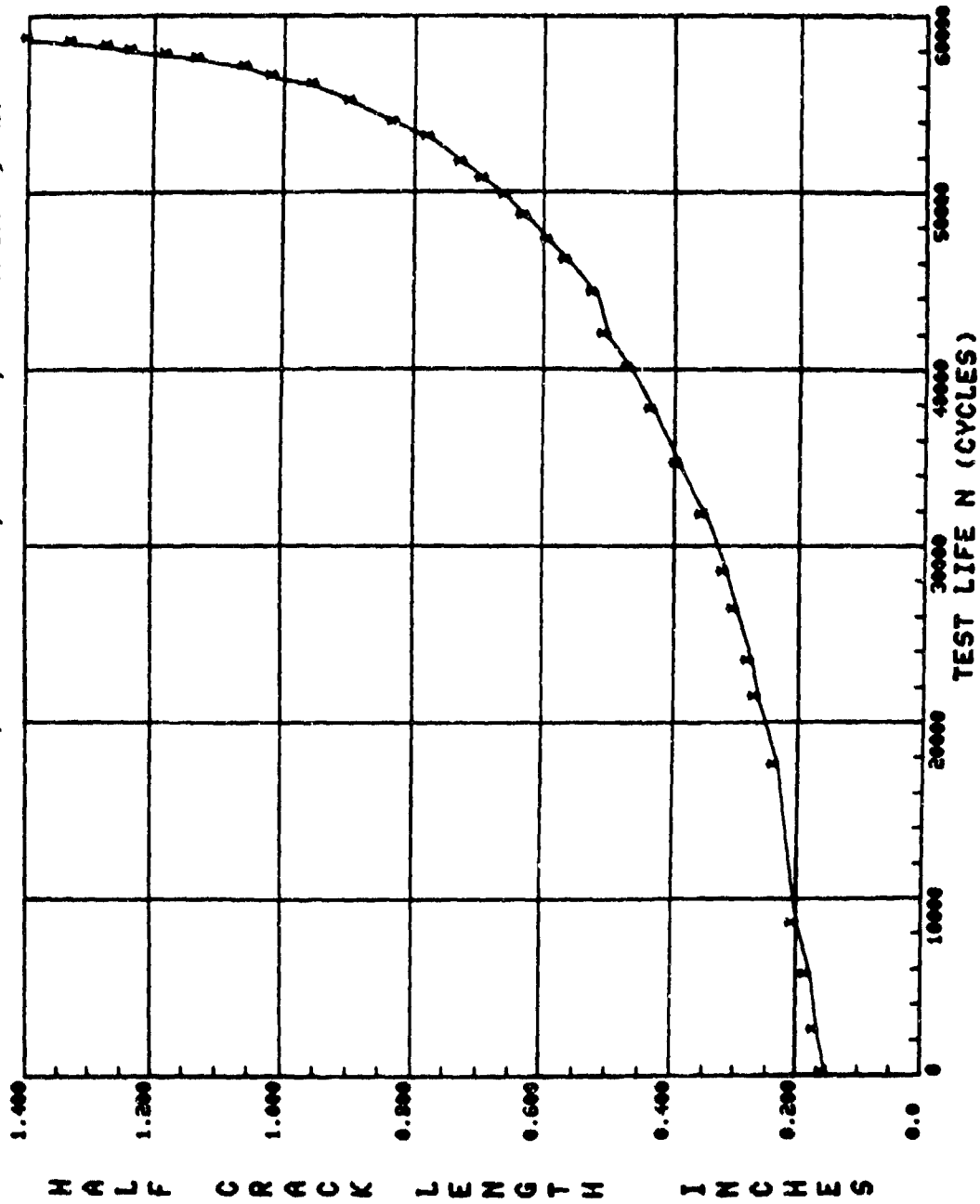

Figure 101. Crack growth curve for test M-82.

TABLE 102. DATA TABULATION FOR TEST M-83

SPECIMEN NO.: M-83 RANDOM SPECTRUM, TYPICAL FIGHTER, AIR-TO-AIR, LIMIT STRESS = 40 KSI

CCT SPECIMEN B= 0.750 IN. W= 6.000 IN. AN= 0.0 IN.

PP'X= TEST FREQ= 6.00HZ.

ENVIRONMENT CONDITION: AMBIENT AIR

NO.	CYCLES	A (MEASURED)	A (REGRESSION)	MULT. CORR. COEFF	K-MAX	DELTA K	DA/DN
1	0.	0.300	0.301	0.998104	16.28	20.32	1.759E-05
2	411.	0.320	0.315	0.998903	16.66	20.61	1.707E-05
3	2167.	0.370	0.368	0.998205	18.01	22.48	1.459E-05
4	4183.	0.425	0.425	0.998641	19.40	24.21	1.347E-05
5	5270.	0.450	0.453	0.997672	20.01	24.96	1.315E-05
6	6919.	0.500	0.492	0.998646	20.88	26.06	1.394E-05
7	9399.	0.550	0.562	0.990394	22.53	27.87	1.749E-05
8	10265.	0.585	0.591	0.989402	22.92	28.61	2.100E-05
9	11129.	0.625	0.627	0.997417	23.63	29.44	2.627E-05
10	11935.	0.665	0.674	0.997636	24.52	30.61	3.015E-05
11	12675.	0.725	0.720	0.997556	25.57	31.67	3.445E-05
12	13428.	0.775	0.774	0.998121	26.34	32.67	3.861E-05
13	14096.	0.825	0.829	0.997614	27.30	34.08	4.475E-05
14	14738.	0.840	0.884	0.994219	28.24	35.25	5.595E-05
15	15250.	0.915	0.945	0.991477	29.26	36.51	6.076E-05
16	15764.	1.005	1.012	0.992597	30.34	37.66	6.920E-05
17	16202.	1.100	1.073	0.990368	31.31	39.08	6.081E-05
18	16692.	1.140	1.157	0.988207	32.62	40.71	9.932E-05
19	17148.	1.235	1.248	0.990066	34.01	42.45	1.205E-04
20	17446.	1.325	1.317	0.987937	35.03	43.71	1.318E-04
21	17689.	1.405	1.390	0.994676	36.11	45.06	1.581E-04
22	17807.	1.430	1.420	0.975641	35.55	45.62	1.583E-04
23	17983.	1.455	1.459	0.982458	37.13	46.53	1.741E-04
24	18434.	1.610	1.651	0.978118	39.91	49.61	3.941E-04
25	18569.	1.745	1.772	0.984747	41.65	51.98	5.773E-04
26	18612.	1.835	1.831	0.995449	42.51	53.05	7.752E-04

PLOT RATE CRACK GROWTH ANALYSIS

M-83 RANDOM SPECTRUM, TYPICAL FIGHTER AIR-TO-AIR, LIMIT STRESS = 40 KSI

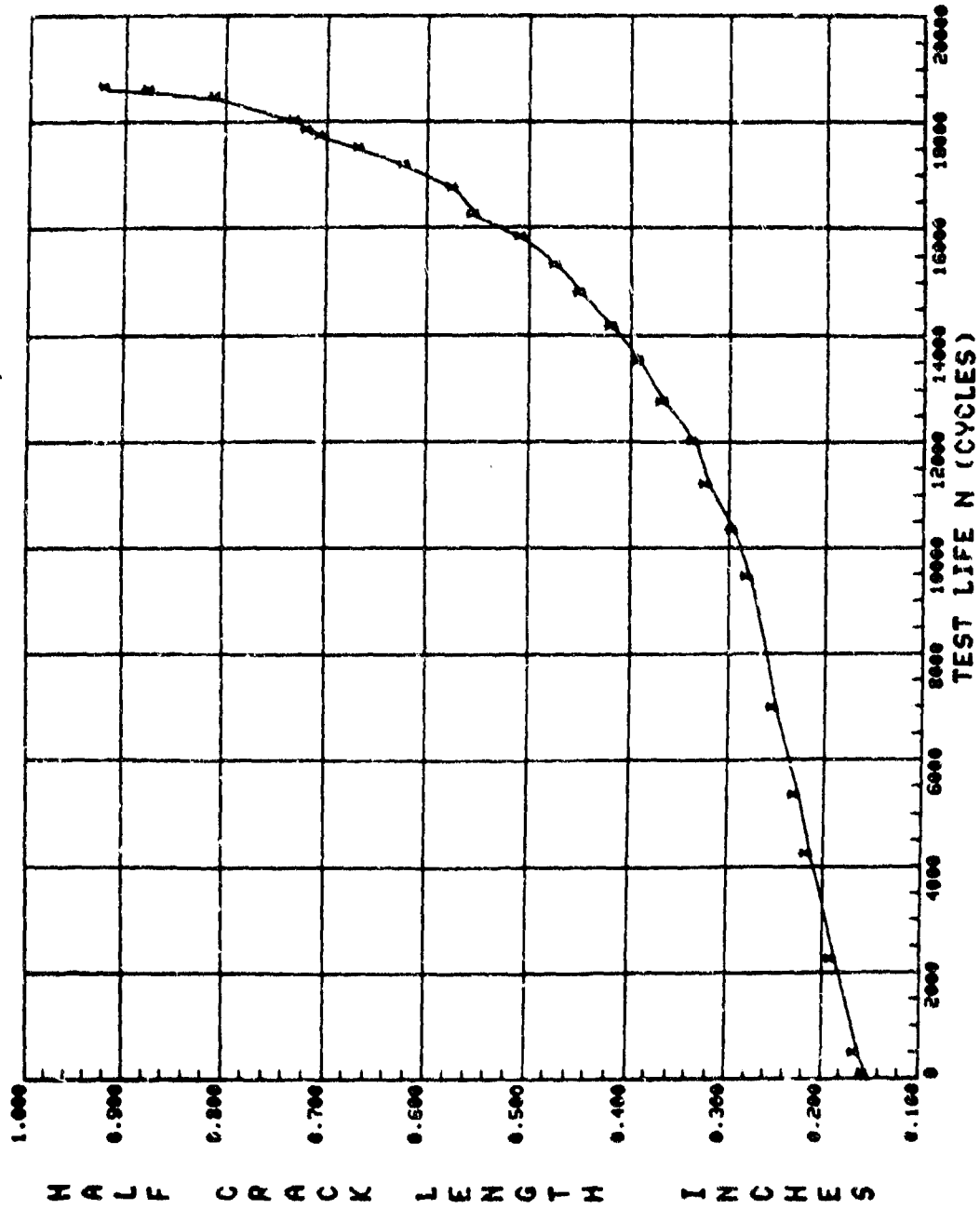

Figure 102. Crack growth curve for test M-83.

TABLE 103. METHODOLOGY DEVELOPMENT TEST PROGRAM GROUP V - RANDOM FLIGHT-BY-FLIGHT SPECTRUM LOADING TEST, AIR-TO-GROUND MISSION, A TYPICAL FIGHTER

Test M-84 $\sigma_{lim} = 30$ ksi, M-85 $\sigma_{lim} = 30$ ksi, M-86 $\sigma_{lim} = 40$ ksi

HEADR T=00000 IS ON LU 05

0001	C.....	KANUUM	A-G	(N=450)																
0002	-10.0*	70.0	29.0	41.9	4.2	20.1	7.0	48.9	6.3	37.1										
0003	8.8	37.8	16.4	28.6	17.0	49.5	13.8	26.9	4.0	42.9										
0004	11.4	74.1	20.3	34.5	1.5	21.0	7.8	39.5	11.9	23.8										
0005	2.1	71.5	11.3	43.6	6.5	33.1	10.9	56.3	-10.0	51.4										
0006	0.6	18.4	7.0	55.4	31.7	48.6	3.0	17.3	6.9	44.1										
0007	30.6	42.4	25.3	44.3	2.9	31.2	4.9	28.6	8.6	29.7										
0008	18.0	28.4	14.4	44.2	16.4	35.2	8.0	51.8	8.1	23.3										
0009	2.8	21.7	8.7	59.5	12.3	47.3	-10.0	67.1	42.2	57.2										
0010	14.5	35.4	11.8	27.8	5.5	19.6	3.7	27.7	8.9	31.1										
0011	0.6	28.6	9.2	22.6	12.5	41.6	0.5	26.4	10.3	39.3										
0012	-0.1	19.5	5.1	28.7	5.7	31.4	4.3	22.3	10.7	24.5										
0013	1.6	12.4	0.0	48.2	-10.0	31.1	7.1	23.7	6.6	35.2										
0014	12.1	49.2	11.0	78.4	4.4	29.2	5.2	29.5	6.7	30.6										
0015	16.1	26.3	11.0	37.8	5.8	17.2	-1.2	23.6	3.2	42.5										
0016	22.8	40.3	6.5	33.6	8.5	49.9	21.0	43.2	22.5	45.2										
0017	13.1	33.6	-10.0	25.1	8.4	78.6	11.3	42.4	5.5	34.6										
0018	10.6	71.7	5.1	35.1	11.2	32.1	1.4	46.3	15.4	37.3										
0019	5.4	46.4	0.1	24.1	8.5	40.8	21.2	42.7	9.4	23.3										
0020	3.8	28.4	5.1	48.1	26.2	38.5	4.4	46.0	3.8	28.0										
0021	-10.0	19.0	7.0	35.6	5.2	31.1	4.0	28.6	-0.0	53.1										
0022	7.2	36.8	11.1	35.7	11.3	40.1	9.0	29.8	16.0	51.5										
0023	-5.6	25.4	14.3	36.9	6.5	30.1	17.0	38.5	14.5	32.3										
0024	6.4	38.1	8.6	35.2	-0.0	37.7	18.1	37.0	-10.0	38.5										
0025	8.5	23.8	5.7	37.7	3.0	30.6	18.3	62.8	1.9	36.7										
0026	10.6	39.3	3.6	38.0	4.0	32.3	7.2	35.1	19.6	55.2										
0027	-0.0	47.4	3.0	38.1	14.6	32.0	7.5	21.2	2.7	29.6										
0028	12.2	37.9	0.3	33.8	15.3	45.0	-10.0	32.5	8.6	46.5										
0029	-0.4	75.6	-0.3	33.5	10.8	27.1	14.8	48.9	17.9	35.1										
0030	2.6	57.0	10.8	38.9	2.2	48.3	26.3	64.1	12.6	34.4										
0031	-14.7	53.9	17.3	62.1	27.3	39.1	8.7	38.5	6.6	45.3										
0032	23.4	47.8	10.3	33.8	-10.0	70.0	-0.5	35.3	1.7	50.0										
0033	3.1	41.4	0.8	25.8	13.4	30.7	15.9	53.5	1.3	38.9										
0034	0.2	28.1	10.0	25.0	2.2	58.8	1.6	36.8	4.5	30.2										
0035	3.3	48.7	0.3	26.9	2.5	18.9	2.5	58.5	17.3	27.6										
0036	4.5	33.0	-10.0	32.8	3.0	35.7	7.5	41.9	27.8	39.7										
0037	6.2	19.5	8.2	32.1	11.4	31.7	-0.4	18.6	2.5	60.7										
0038	13.5	64.0	5.0	29.6	16.9	41.6	1.8	36.2	3.9	28.9										
0039	9.2	34.1	7.4	32.0	14.8	37.9	13.5	26.1	6.8	25.7										
0040	-10.0	46.1	22.5	38.5	3.2	33.0	13.9	25.0	15.3	30.9										
0041	2.5	69.4	5.2	34.4	17.5	30.2	10.0	36.3	16.1	45.6										
0042	11.8	36.6	11.8	35.7	12.0	24.8	5.8	21.0	7.0	54.0										
0043	11.6	42.4	1.5	59.3	24.6	47.9	6.2	25.6	-10.0	38.6										
0044	3.7	20.9	6.3	47.2	18.9	63.4	1.1	15.5	0.8	48.6										
0045	3.6	68.2	0.7	46.1	16.9	43.4	12.6	28.2	3.7	45.9										
0046	5.8	49.5	10.8	35.5	16.7	44.8	3.4	34.2	1.0	16.6										
0047	5.1	53.6	3.8	45.8	4.6	34.8	-10.0	60.2	8.6	19.7										
0048	8.2	33.9	2.9	44.4	19.5	40.1	-1.2	37.2	0.8	40.0										
0049	22.3	58.4	23.3	46.6	1.7	54.0	3.0	28.2	11.0	38.3										
0050	-1.7	12.3	0.8	33.7	-10.0	30.6	5.0	27.0	6.4	39.0										
0051	12.2	45.2	10.1	29.5	2.4	38.9	16.8	31.7	-0.0	18.9										
0052	6.5	19.8	-0.0	53.7	0.4	25.0	10.8	28.7	2.2	32.1										
0053	0.1	49.5	-4.5	29.5	5.8	21.5	5.2	21.5	5.4	46.0										
0054	4.6	28.3	9.3	41.0	19.3	44.9	8.9	33.0	5.9	24.7										
0055	12.3	38.7	-10.0	28.5	15.8	35.7	1.2	27.9	8.6	50.4										
0056	21.5	31.8	7.7	46.9	14.3	46.1	3.4	32.2	0.3	37.9										
0057	-0.8	24.9	14.0	43.8	10.2	37.5	7.9	36.1	0.9	67.2										
0058	13.9	51.4	4.0	25.9	15.2	54.6	7.7	54.2	0.5	69.2										
0059	-10.0	68.4	2.5	35.4	13.6	42.3	15.1	27.0	6.1	38.1										
0060	11.4	33.4	7.6	58.4	7.5	24.5	11.4	34.9	8.4	54.6										
0061	25.4	74.1	-0.5	60.5	21.8	44.7	7.6	43.6	2.5	36.1										
0062	20.4	60.9	6.0	34.3	19.3	41.3	27.0	37.0	-10.0	24.5										

* % of σ_{lim}

TABLE 103. METHODOLOGY DEVELOPMENT TEST PROGRAM GROUP V - RANDOM FLIGHT-BY-FLIGHT SPECTRUM LOADING TEST, AIR-TO-GROUND MISSION, A TYPICAL FIGHTER (CONT)

Test M-84 $\sigma_{lim} = 20$ ksi, M-85 $\sigma_{lim} = 30$ ksi, M-86 $\sigma_{lim} = 40$ ksi

0063	2.0	31.5	0.2	57.5	4.4	41.5	7.9	46.4	5.1	19.0
0064	0.4	37.8	27.0	40.1	6.0	21.4	6.4	28.4	11.2	34.7
0065	4.3	42.2	8.2	40.7	17.5	48.7	0.3	41.1	19.1	49.3
0066	11.4	24.8	12.3	42.9	0.7	23.8	-10.0	45.0	18.3	62.5
0067	2.2	40.2	14.0	34.1	3.2	52.1	4.0	24.4	11.9	48.6
0068	-3.8	34.7	23.2	38.4	9.5	25.3	10.1	25.0	7.4	21.2
0069	-0.1	31.6	0.9	18.4	1.4	36.4	-0.0	32.5	4.9	35.9
0070	7.1	33.5	2.0	39.4	-10.0	28.4	13.1	36.3	10.8	55.1
0071	34.6	44.6	1.9	28.3	7.3	35.7	8.3	50.6	13.3	57.1
0072	8.3	54.5	14.2	36.6	14.2	39.5	21.6	41.5	10.5	46.9
0073	9.5	41.6	19.7	47.7	11.3	54.6	6.1	51.4	10.7	28.5
0074	3.7	57.1	-10.0	30.4	11.7	41.0	8.3	33.2	0.7	24.9
0075	-0.1	49.3	8.4	24.5	0.5	30.6	12.4	33.0	16.2	40.0
0076	14.4	42.4	3.6	31.4	0.1	49.6	2.2	29.4	0.8	44.6
0077	3.7	46.6	0.2	58.4	9.1	44.5	5.4	25.8	10.5	31.7
0078	-10.0	20.5	8.3	44.4	22.2	34.1	16.6	38.9	0.0	78.9
0079	-0.7	25.1	-2.0	63.6	3.5	62.1	15.4	27.9	12.2	31.0
0080	16.7	40.8	20.4	41.0	11.2	28.5	12.7	23.8	-12.2	35.6
0081	2.4	49.9	5.3	46.4	5.4	29.2	7.8	35.1	-10.0	26.7
0082	5.0	49.3	15.3	41.5	5.0	46.0	1.6	43.3	0.5	45.7
0083	5.0	47.8	12.0	26.2	-0.4	18.9	-2.3	31.1	10.4	38.6
0084	5.6	47.6	4.0	70.0	-1.7	35.5	0.2	27.0	16.4	76.0
0085	0.0	34.9	18.4	52.3	9.1	49.6	-10.0	40.3	8.4	38.4
0086	12.5	47.7	6.0	27.2	4.3	17.7	4.2	19.6	4.2	22.5
0087	-0.1	51.6	5.3	19.1	-1.0	23.0	6.4	24.1	13.3	50.7
0088	16.3	46.0	11.8	30.9	-1.5	37.6	7.4	50.7	2.9	34.1
0089	21.3	36.1	13.5	35.7	-10.0	28.0	4.4	25.2	14.2	25.3
0090	10.2	45.1	20.0	58.0	15.3	30.9	6.2	53.2	0.5	33.2
0091	12.5	38.3	-0.9	35.1	4.8	62.4	-0.8	26.0	11.3	47.7
0092	24.6	41.6	0.0	60.3	0.6	22.5	-1.8	31.9	14.7	44.9
0093	0.7	37.4	-10.0	24.8	2.3	29.9	5.1	46.6	0.3	14.5
0094	-1.5	16.9	2.0	45.5	20.0	50.8	-0.5	17.8	5.4	39.8
0095	22.4	67.4	9.6	25.2	6.4	38.2	8.0	27.6	9.5	47.3
0096	11.3	27.7	0.4	28.4	18.5	39.5	8.6	75.1	7.4	21.2
0097	-10.0	64.0	8.1	35.0	14.4	52.9	0.6	26.2	4.1	28.0
0098	14.2	53.4	10.1	35.6	4.3	38.1	-0.9	56.0	23.9	45.6
0099	7.1	37.1	6.3	31.2	1.5	22.9	7.9	32.1	10.9	65.9
0100	4.4	24.4	12.5	31.8	14.9	27.7	14.1	41.1	-10.0	50.8
0101	32.4	55.2	7.6	40.4	1.5	54.3	11.0	40.8	20.5	36.5
0102	4.6	35.7	14.7	25.6	7.7	24.0	9.1	33.3	11.2	48.6
0103	18.1	37.1	5.5	49.5	11.9	35.8	0.2	21.1	8.1	31.8
0104	6.0	17.4	6.5	18.4	2.4	33.8	-10.0	52.3	0.7	36.0
0105	0.1	24.6	7.5	37.1	5.1	56.4	21.0	33.7	19.5	39.3
0106	24.1	40.1	8.6	60.3	4.2	68.0	23.7	37.9	18.1	38.4
0107	4.9	21.3	6.7	54.4	21.4	58.2	8.2	23.5	0.9	44.3
0108	11.7	29.6	5.4	26.2	-10.0	54.0	1.8	29.8	5.8	48.9
0109	3.6	30.5	5.8	54.9	0.8	40.7	27.2	38.8	22.9	52.3
0110	13.6	34.8	7.9	32.5	7.4	49.2	6.3	27.7	1.8	49.1
0111	8.9	36.0	16.0	47.7	11.1	30.0	6.0	45.9	15.8	28.9
0112	10.4	28.4	-10.0	35.4	3.0	70.0	25.2	46.6	0.0	19.5
0113	8.3	26.4	12.4	34.8	2.1	18.5	0.2	35.0	12.5	29.8
0114	2.8	26.8	2.8	17.3	5.7	39.5	0.2	44.0	21.5	49.0
0115	9.3	56.5	15.8	30.6	5.0	42.6	9.1	39.2	12.9	32.2
0116	-10.0	25.4	8.4	57.0	14.6	39.9	13.9	45.7	6.0	48.8
0117	6.1	24.7	7.9	33.7	14.4	41.2	21.9	56.4	10.7	40.2
0118	2.7	49.3	34.3	48.0	8.0	26.1	8.8	24.9	3.6	15.8
0119	-5.5	38.4	11.0	28.7	6.7	28.7	1.7	24.9	-10.0	15.1
0120	4.4	35.4	21.0	34.3	5.7	47.2	2.6	25.9	4.9	42.8
0121	21.7	32.0	15.0	64.2	11.4	53.0	15.5	38.1	5.1	56.6
0122	13.2	37.0	10.7	33.0	11.6	35.4	15.2	46.3	22.9	72.8
0123	14.6	35.3	5.6	43.2	3.0	22.0	-10.0	34.2	0.0	12.5
0124	1.1	34.4	11.0	25.7	6.4	27.6	14.5	42.6	12.2	46.5
0125	3.7	44.8	4.7	21.1	0.6	47.3	8.6	21.0	3.0	29.4
0126	2.0	24.0	5.1	65.6	0.7	21.5	0.1	46.8	0.1	37.1
0127	3.4	38.7	1.0	27.1	-10.0	14.6	-0.0	35.4	18.7	37.2
0128	-0.0	25.1	1.4	45.5	2.0	37.2	10.2	27.7	3.6	44.6
0124	32.8	45.9	4.9	35.1	15.4	51.3	23.2	54.1	0.2	40.2

TABLE 103. METHODOLOGY DEVELOPMENT TEST PROGRAM GROUP V - RANDOM FLIGHT-BY-FLIGHT SPECTRUM LOADING TEST, AIR-TO-GROUND MISSION, A TYPICAL FIGHTER (CONCL)

Test M-84 $\sigma_{lim} = 20$ ksi, M-85 $\sigma_{lim} = 30$ ksi, M-86 $\sigma_{lim} = 40$ ksi

0130	8.9	61.9	1.0	57.0	43.9	65.0	6.5	31.6	0.1	26.9
0131	3.8	57.9	-10.0	40.8	30.1	49.7	9.7	40.5	17.4	31.0
0132	0.8	47.4	10.4	24.1	2.1	13.9	1.2	17.1	3.9	52.1
0133	36.8	53.2	-0.2	65.2	13.3	30.8	3.7	39.2	4.3	47.5
0134	15.8	46.3	15.3	33.4	4.2	43.1	6.4	49.6	5.6	33.3
0135	-10.0	31.4	0.2	24.1	13.4	42.0	23.1	66.0	-2.5	13.3
0136	1.4	34.3	11.2	45.2	9.6	40.2	0.9	30.7	10.2	47.7
0137	1.1	40.6	13.2	30.6	6.0	30.2	0.4	67.9	10.4	37.5
0138	14.1	46.3	7.4	29.1	17.6	54.0	21.6	40.2	-10.0	28.1
0139	8.5	55.8	27.1	48.0	2.4	31.0	8.0	22.0	3.6	63.9
0140	4.1	50.7	11.4	60.4	-0.7	46.1	5.7	20.5	0.3	46.6
0141	3.3	25.5	-0.2	70.2	2.0	32.4	19.8	31.5	12.0	34.3
0142	1.3	33.5	19.1	44.1	9.7	55.8	-10.0	40.0	4.6	5.5
0143	8.3	45.3	10.4	35.4	9.3	32.7	6.0	64.3	18.7	47.0
0144	13.4	37.0	8.6	42.4	6.3	45.4	16.5	30.2	15.8	58.0
0145	7.1	49.5	11.5	74.8	8.5	34.8	11.9	48.8	5.2	71.6
0146	26.4	50.1	3.6	28.8	-10.0	44.1	10.1	58.0	11.3	52.7
0147	20.4	33.3	17.6	46.8	11.2	45.2	18.0	31.4	1.8	50.0
0148	6.4	20.3	6.3	48.5	2.4	35.9	4.3	27.5	13.0	23.8
0149	-10.2	20.2	3.6	24.5	12.3	28.6	13.0	29.5	14.1	36.1
0150	0.3	49.4	-10.0	53.1	10.7	50.9	8.4	41.6	15.0	29.9
0151	9.7	47.0	14.6	41.4	21.7	35.9	7.3	52.3	0.7	45.0
0152	2.7	26.0	7.0	29.6	2.5	34.6	6.8	40.4	6.8	36.3
0153	9.0	29.4	4.2	38.4	1.3	16.4	-1.4	15.6	4.4	29.2
0154	-10.0	21.4	2.0	32.3	0.2	50.4	5.9	55.7	7.2	20.8
0155	6.5	40.2	17.1	35.5	9.1	22.5	11.5	77.7	5.5	32.4
0156	10.3	41.3	1.7	59.7	5.2	25.4	5.8	23.3	8.7	76.7
0157	7.5	23.4	6.1	38.6	11.5	63.2	2.2	18.1	-10.0	35.0
0158	1.4	48.8	35.1	63.2	4.2	28.4	-0.1	21.6	1.9	48.6
0159	12.7	56.1	14.4	35.1	-2.3	60.0	10.8	25.4	3.0	39.5
0160	1.3	25.7	12.2	32.4	8.9	19.4	5.4	29.0	0.0	41.3
0161	7.8	24.0	10.4	37.0	-0.0	25.7	-10.0	33.5	18.2	58.0
0162	11.5	32.5	2.3	45.4	16.5	29.8	0.3	48.9	2.1	39.7
0163	8.2	30.4	0.3	44.1	8.7	37.5	17.9	34.3	7.5	47.2
0164	24.7	37.9	-3.1	32.4	14.9	60.1	28.6	68.8	14.3	27.7
0165	7.6	39.5	3.4	53.3	-10.0	31.5	11.9	63.8	15.4	68.5
0166	15.6	34.7	2.5	26.3	1.2	19.0	4.0	67.3	11.1	34.9
0167	4.6	27.3	15.6	64.3	20.4	32.3	6.0	32.6	21.3	55.6
0168	24.5	54.4	0.6	24.2	2.5	20.8	6.8	41.4	2.4	41.7
0169	11.9	44.4	-10.0	24.8	14.3	34.5	17.0	35.1	14.4	62.1
0170	23.5	43.5	6.5	54.4	9.6	71.3	2.3	36.5	9.9	26.7
0171	1.7	36.4	16.4	34.2	1.0	38.0	24.6	37.2	0.0	28.5
0172	7.3	27.4	15.5	35.2	14.5	38.9	3.3	44.8	2.6	51.0
0173	-10.0	37.2	9.5	27.1	3.3	26.1	6.5	26.6	10.6	24.1
0174	13.7	49.1	-0.5	51.4	26.2	53.0	9.9	38.4	6.7	25.3
0175	13.8	54.9	7.4	20.8	0.0	16.7	4.3	33.0	-1.2	23.2
0176	0.4	14.2	3.7	56.0	1.2	52.7	29.8	42.2	-10.0	15.7
0177	0.3	63.3	16.5	30.5	3.2	34.5	1.9	62.0	1.4	24.8
0178	-1.7	34.0	3.7	56.3	33.3	47.5	0.7	25.5	12.3	42.1
0179	4.4	21.3	10.9	42.6	18.5	49.1	26.2	40.4	12.0	39.5
0180	4.8	43.3	12.0	44.5	7.4	33.8	-10.0	36.2	0.5	15.6
0181	-0.4	40.4	-0.6	28.6	3.4	17.0	0.1	52.9	-1.1	25.4
0182	11.1	41.3	4.2	32.8	3.7	30.0	-0.0	43.7	6.6	36.3
0183	5.3	50.0	1.7	17.1	0.3	20.2	4.5	39.3	20.3	34.3
0184	4.4	17.1	3.0	56.4	-10.0	35.3	6.8	73.5	16.2	46.3
0185	7.4	34.0	0.4	64.6	1.6	36.0	2.3	36.5	15.5	35.4
0186	15.5	34.4	6.4	56.3	4.7	34.5	14.6	40.5	0.7	27.8
0187	17.0	36.6	6.7	58.4	21.8	54.5	1.8	43.1	-0.4	43.4
0188	22.6	33.8	-10.0	26.6	4.4	40.2	2.1	56.5	2.2	40.2
0189	3.5	22.5	10.7	21.3	4.6	70.5	26.5	45.3	0.1	22.5
0190	9.2	57.0	7.0	24.0	8.6	45.1	-0.4	69.8	4.7	37.5
0191	6.0	37.7	27.3	40.4	11.5	25.1	6.5	28.1	11.5	57.0

TABLE 104. DATA TABULATION FOR TEST M-84

SPECIMEN NO.: M-84 RANDOM SPECTRUM TYPICAL FIGHTER, AIR TO GROUND LIMIT STRESS = 20 KSI

CCT SPECIMEN R = 0.250 IN. W = 6.000 IN. AN = 0.0 IN. TEST FREQ = 6.000HZ.

ENVIRONMENT CONDITION: AMBIENT AIR

NO.	CYCLES	A (MEASURED)	A (REGRESSICN)	MULT.	CORR. COEFF	K-MAX	DELTA K	DA/DN
1	0.	0.315	0.316	0.996543		7.24	8.56	1.082E-06
2	19551.	0.365	0.356	0.997048		7.70	9.10	1.139E-06
3	44550.	0.415	0.419	0.997485		8.35	9.87	1.472E-06
4	59995.	0.465	0.467	0.998215		8.83	10.43	1.709E-06
5	74900.	0.520	0.519	0.999005		9.31	11.01	1.975E-06
6	88400.	0.580	0.577	0.996636		9.83	11.62	2.386E-06
7	102117.	0.640	0.646	0.996494		10.42	12.31	2.645E-06
8	107597.	0.670	0.675	0.996235		10.66	12.59	2.851E-06
9	113754.	0.725	0.715	0.992219		10.97	12.96	2.915E-06
10	128683.	0.800	0.809	0.994200		11.70	13.82	3.126E-06
11	136642.	0.870	0.956	0.993259		12.05	14.24	3.280E-06
12	144520.	0.895	0.906	0.995361		12.42	14.67	3.447E-06
13	153199.	0.965	0.967	0.995216		12.86	15.19	3.772E-06
14	160152.	1.025	1.017	0.997689		13.21	15.61	4.150E-06
15	167203.	1.080	1.082	0.997807		13.65	16.13	4.838E-06
16	174275.	1.145	1.151	0.998027		14.12	16.68	5.276E-06
17	181860.	1.235	1.235	0.997481		14.67	17.34	5.811E-06
18	185016.	1.285	1.274	0.997388		14.92	17.64	6.156E-06
19	189002.	1.320	1.325	0.996138		15.26	18.03	6.704E-06
20	192241.	1.360	1.369	0.994310		15.54	18.37	6.665E-06
21	196250.	1.425	1.423	0.995847		15.88	18.77	6.852E-06
22	199407.	1.480	1.467	0.997359		16.17	19.11	7.375E-06
23	204442.	1.535	1.542	0.998145		16.64	19.66	7.718E-06
24	210701.	1.635	1.639	0.999154		17.25	20.38	8.227E-06
25	216224.	1.740	1.732	0.999488		17.83	21.07	9.000E-06
26	223022.	1.860	1.865	0.999652		18.67	22.06	9.911E-06
27	228275.	1.970	1.971	0.999161		19.33	22.85	1.070E-05
28	233679.	2.057	2.087	0.998590		20.06	23.71	1.180E-05

TABLE 104. DATA TABULATION FOR TEST M-84 (CONCL)

SPECIMEN NO.: M-84 RANDOM SPECTRUM, TYPICAL FIGHTER, AIR TO GROUND, LIMIT STRESS = 20 KSI

CCT SPECIMEN B = 0.250 IN. W = 6.000 IN. AN = 0.0 IN.

PMIN = PMAX = TEST FREQ = 6.000HZ.

ENVIRONMENT CONDITION: AMBIENT AIR

NO.	CYCLES	A (MEASURED)	A (REGRESSICA)	MULT. CORR. COEFF	K-MAX	DELTA K	DA/DN
29	241285.	2.260	2.277	0.998498	21.29	25.16	1.356E-05
30	244515.	2.365	2.366	0.998894	21.88	25.86	1.545E-05
31	247962.	2.480	2.474	0.999613	22.60	26.71	1.736E-05
32	251404.	2.555	2.601	0.999340	23.48	27.75	1.966E-05
33	253917.	2.700	2.700	0.999580	24.18	28.58	2.153E-05
34	256205.	2.800	2.800	0.998510	24.91	29.44	2.546E-05
35	258258.	2.965	2.907	0.998712	25.72	30.39	2.854E-05
36	260624.	3.040	3.049	0.998734	26.83	31.71	3.272E-05
37	262291.	3.160	3.167	0.992592	27.80	32.85	4.086E-05
38	263018.	3.215	3.225	0.991925	28.29	33.43	4.725E-05
39	263963.	3.285	3.316	0.991036	29.09	34.37	5.176E-05
40	264527.	3.355	3.371	0.991393	29.59	34.96	5.597E-05
41	265584.	3.515	3.505	0.993686	30.85	36.46	6.724E-05
42	266341.	3.550	3.612	0.991726	31.94	37.73	7.751E-05
43	266834.	3.685	3.682	0.997801	32.87	38.61	8.845E-05
44	267449.	3.750	3.794	0.998322	33.91	40.07	1.115E-04
45	267791.	3.875	3.872	0.992124	34.82	41.16	1.367E-04
46	268229.	3.960	3.997	0.976954	36.39	43.00	2.068E-04
47	268561.	4.160	4.137	0.986097	38.30	45.26	3.038E-04
48	268701.	4.200	4.217	0.994667	39.48	46.66	3.837E-04
49	268908.	4.400	4.400	1.000000	42.49	50.21	5.604E-04

PLOTRATE CRACK GROWTH DATA

M-84 RANDOM SPECTRUM, TYPICAL FIGHTER, AIR TO GROUND, LIMIT STRESS = 20 KSI

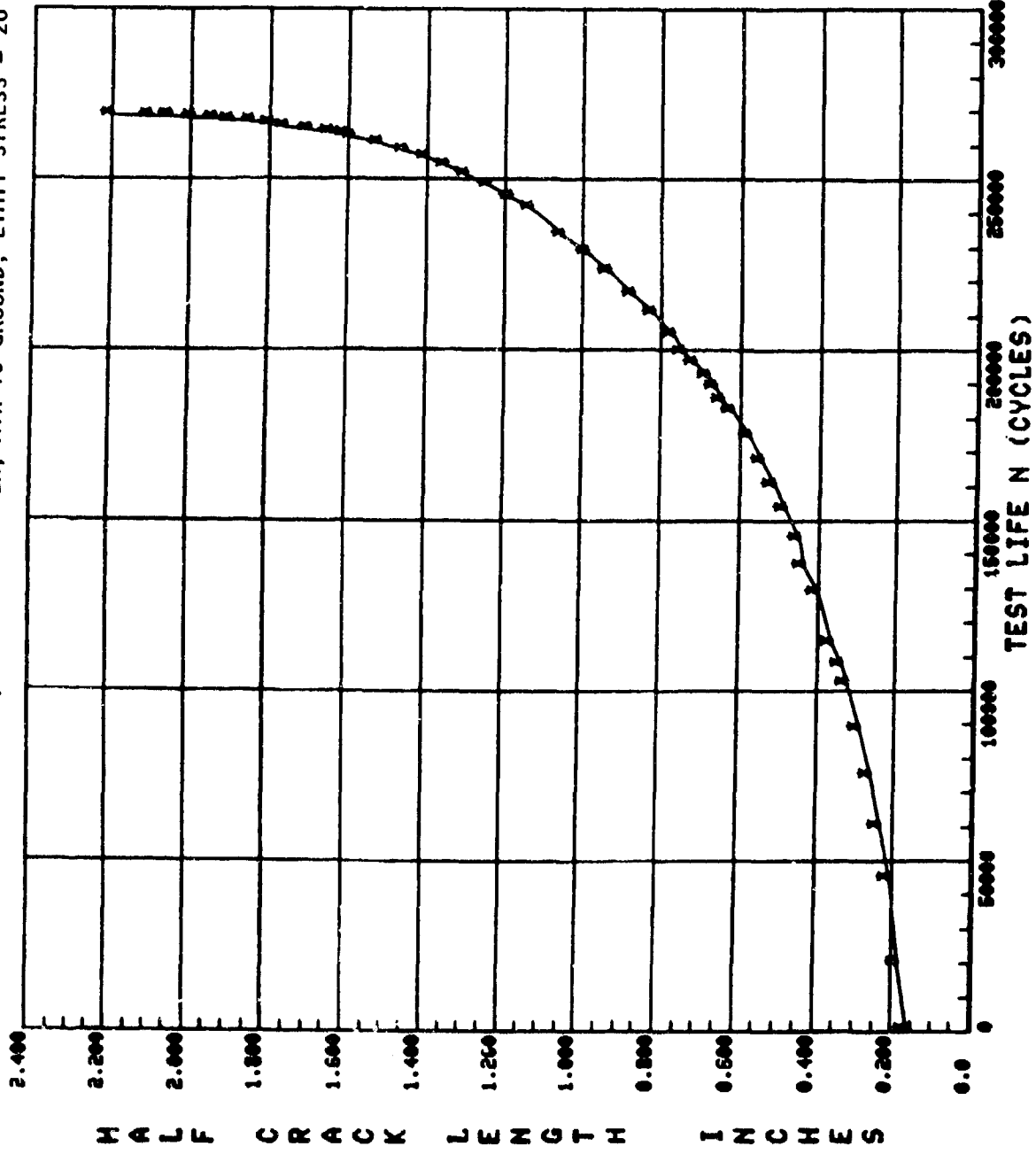

Figure 103. Crack growth curve for test M-84.

TABLE 105. DATA TABULATION FOR TEST M-85

SPECIMEN NO.: M-85 RANDOM SPECTRUM, TYPICAL FIGHTER, AIR TO GROUND, LIMIT STRESS = 30 KSI

CCT SPECIMEN B = 0.250 IN. b = 6.000 IN. AN = 0.0 IN. TEST FREQ = 6.00 HZ.
 PMIN = PMAX =

ENVIRONMENT CONDITION: AMBIENT AIR

NO.	CYCLES	A (MEASURED)	A (REGRESSION)	MULT. CORR. COEFF	K-MAX	DELTA K	DA/DN
1	0.	0.288	0.288	0.995998	10.37	12.25	1.261E-06
2	14532.	0.340	0.344	0.997163	11.35	13.41	2.928E-06
3	22575.	0.410	0.401	0.998073	12.26	14.48	3.971E-06
4	32606.	0.485	0.494	0.998440	13.62	16.09	5.231E-06
5	39198.	0.575	0.569	0.998530	14.64	17.30	6.059E-06
6	45203.	0.645	0.645	0.998743	15.60	18.44	7.012E-06
7	49820.	0.710	0.714	0.997826	16.44	19.43	8.008E-06
8	53902.	0.775	0.777	0.999324	17.19	20.31	9.405E-06
9	56717.	0.830	0.832	0.999251	17.81	21.05	1.018E-05
10	60148.	0.905	0.908	0.998874	18.65	22.04	1.113E-05
11	63495.	0.995	0.985	0.999489	19.51	23.05	1.199E-05
12	67197.	1.080	1.080	0.999086	20.45	24.17	1.285E-05
13	70438.	1.160	1.164	0.998852	21.31	25.18	1.373E-05
14	72811.	1.225	1.228	0.999031	21.94	25.92	1.551E-05
15	74730.	1.290	1.288	0.998953	22.53	26.63	1.656E-05
16	76233.	1.335	1.340	0.998951	23.03	27.22	1.763E-05
17	78055.	1.415	1.405	0.997961	23.66	27.96	1.963E-05
18	79908.	1.475	1.479	0.998620	24.36	28.79	2.164E-05
19	81621.	1.550	1.555	0.997792	25.08	29.64	2.477E-05
20	83473.	1.655	1.649	0.998979	25.97	30.69	2.815E-05
21	85271.	1.750	1.759	0.999305	27.00	31.90	3.259E-05
22	86280.	1.835	1.825	0.999155	27.62	32.64	3.543E-05
23	87763.	1.930	1.931	0.999183	28.62	33.82	3.978E-05
24	90113.	2.130	2.134	0.998598	30.55	36.11	5.094E-05
25	91299.	2.255	2.257	0.999733	31.75	37.52	5.950E-05
26	92178.	2.360	2.367	0.996353	32.83	38.80	7.140E-05
27	93096.	2.495	2.500	0.995676	34.17	40.39	8.990E-05
28	93747.	2.595	2.618	0.996882	35.41	41.84	1.139E-04

TABLE 105. DATA TABULATION FOR TEST M-85. (CONC.)

SPECIMEN NO.: M-85		RANDOM SPECTRUM, TYPICAL FIGHTER, AIR TO GROUND, LIMIT STRESS = 30 KSI					
CCJ SPECIMEN	B = 0.250 IN.	b = 6.000 IN.	AN = 0.0 IN.				
PMIN =	PMAX =	TEST FREQ = 6.00 HZ.					
ENVIRONMENT CONDITION: AMBIENT AIR							
NO.	CYCLES	A (MEASURED)	A (REGRESSION)	MULT. CORR. COEFF	K-MAX	DELTA K	DA/DM
29	94174.	2.720	2.718	0.994132	36.47	43.10	1.465E-04
30	94510.	2.810	2.813	0.997103	37.52	44.34	1.759E-04
31	94862.	2.925	2.948	0.991402	39.04	46.14	2.304E-04
32	95084.	3.060	3.047	0.989070	40.22	47.53	3.062E-04
33	95313.	3.155	3.196	0.990765	42.06	49.71	3.776E-04
34	95413.	3.275	3.273	0.987142	43.05	50.88	4.080E-04
35	95507.	3.390	3.349	0.979993	44.07	52.08	4.445E-04
36	95642.	3.470	3.471	0.998006	45.78	54.10	2.233E-04

PLOTRATE CRACK GROWTH DATA

M-85 RANDOM SPECTRUM, TYPICAL FIGHTER, AIR TO GROUND, LIMIT STRESS = 30 KSI

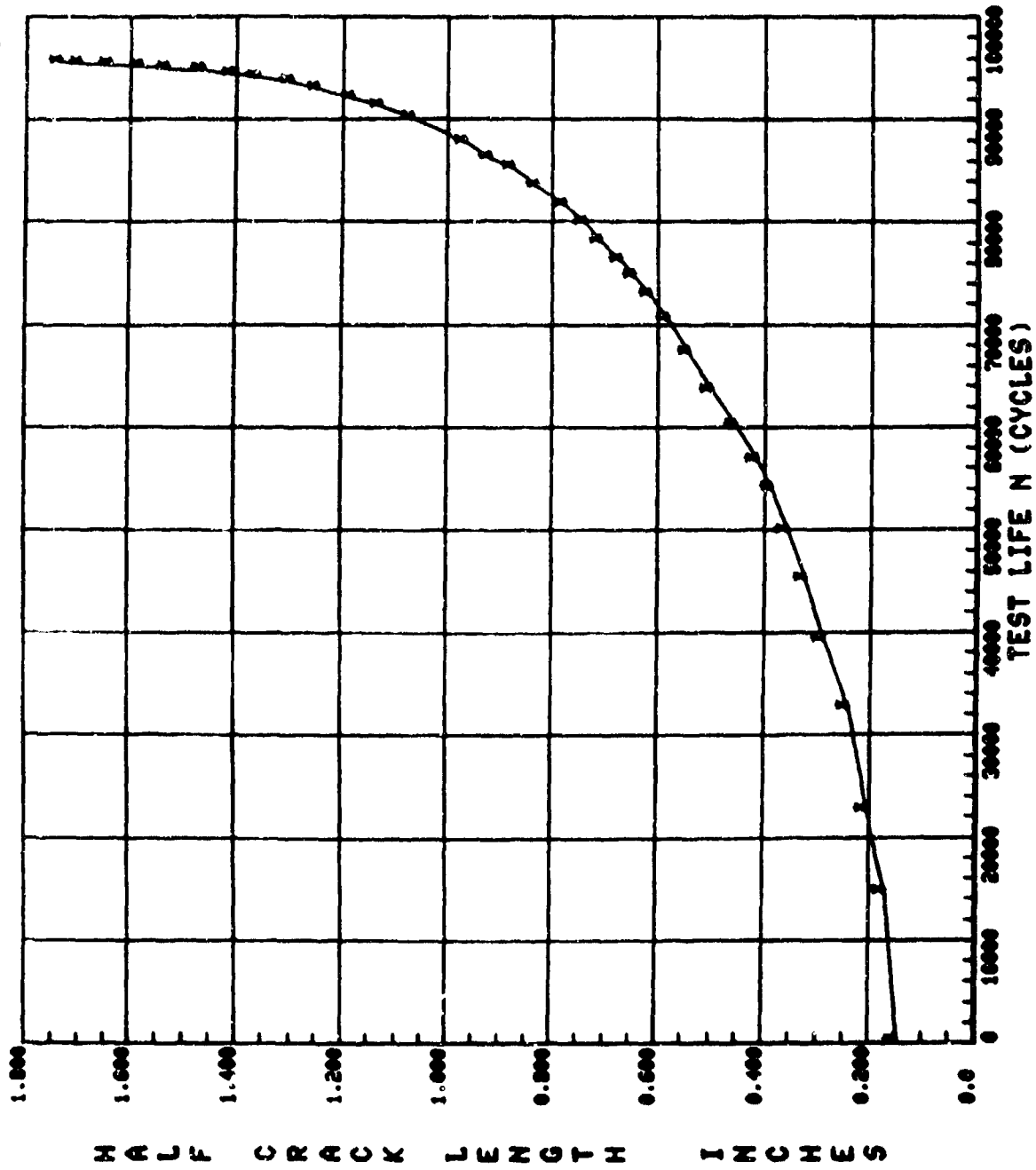

Figure 104. Crack growth curve for test M-85.

TABLE 106. DATA TABULATION FOR TEST M-86

SPECIMEN NO.: M-86 RANDOM SPECTRUM, TYPICAL FIGHTER, AIR-TO-GROUND, LIMIT STRESS = 40 KSI

CCT SPECIMEN Ø = 0.250 IN. W = 0.000 IN. AN = 0.0 IN.
 PMIN= PMAX= TEST FREQ= 6.000MHZ.

ENVIRONMENT CONDITION: AMBIENT AIR

NO.	CYCLES	A (MEASURED)	A (REGRESSION)	MULT. CORR. COEFF	K-MAX	DELTA K	DATA/ON
1	0.	0.305	0.305	0.999709	14.44	17.21	2.444E-06
2	5149.	0.245	0.352	0.997512	15.58	18.50	5.72E-06
3	10072.	0.420	0.417	0.995451	16.97	20.15	8.245E-06
4	13301.	0.480	0.476	0.996220	18.14	21.54	1.000E-05
5	16461.	0.530	0.546	0.995121	19.45	23.10	1.226E-05
6	17586.	0.550	0.570	0.996140	19.69	23.61	1.342E-05
7	20023.	0.635	0.635	0.996755	21.33	25.04	1.612E-05
8	21632.	0.695	0.694	0.995715	22.60	26.13	1.878E-05
9	23395.	0.760	0.762	0.998962	23.09	27.42	2.149E-05
10	24394.	0.805	0.809	0.998780	23.63	28.30	2.254E-05
11	25242.	0.855	0.847	0.996102	24.40	28.98	2.483E-05
12	26840.	0.930	0.927	0.997612	25.54	30.59	2.751E-05
13	28215.	0.995	1.004	0.996250	26.70	31.71	3.109E-05
14	29457.	1.085	1.083	0.999192	27.51	33.03	3.650E-05
15	30371.	1.155	1.152	0.999262	28.76	34.15	4.226E-05
16	31098.	1.210	1.217	0.999242	29.63	35.19	4.698E-05
17	31865.	1.290	1.290	0.999696	30.61	36.35	5.211E-05
18	32428.	1.355	1.345	0.998506	31.39	37.27	5.626E-05
19	33133.	1.435	1.434	0.997556	32.49	38.58	6.092E-05
20	33904.	1.535	1.536	0.996257	33.83	40.17	6.550E-05
21	34448.	1.635	1.634	0.993227	35.06	41.63	1.162E-04
22	35003.	1.755	1.767	0.992050	36.75	43.64	1.575E-04
23	35681.	1.970	2.016	0.985116	39.94	47.63	2.543E-04
24	35946.	2.130	2.161	0.986579	41.82	49.67	3.577E-04
25	36117.	2.250	2.288	0.994652	43.51	51.67	4.705E-04
26	36163.	2.355	2.326	0.992203	44.04	52.30	4.935E-04
27	36242.	2.430	2.415	0.988963	45.22	53.70	5.232E-04
28	36397.	2.580	2.580	0.993966	47.51	56.42	6.926E-04

PLOTRATE CRACK GROWTH ANALYSIS

M-86 RANDOM SPECTRUM, TYPICAL FIGHTER, AIR TO GROUND, LIMIT STRESS = 40 KSI

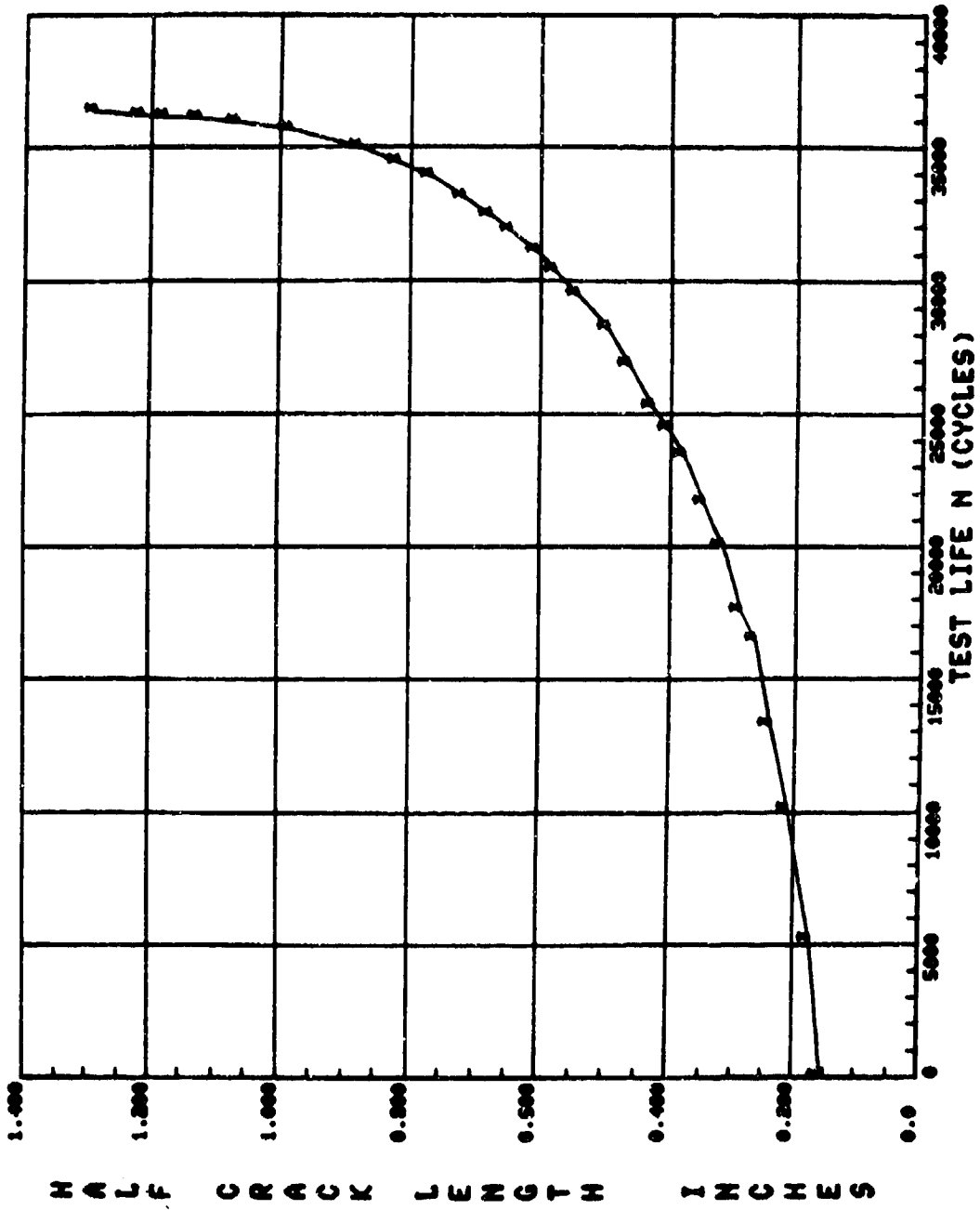

Figure 105. Crack growth curve for test M-86.

TABLE 107. METHODOLOGY DEVELOPMENT TEST PROGRAM GROUP V - RANDOM FLIGHT-BY-FLIGHT SPECTRUM LOADING TEST, INSTRUMENTATION AND NAVIGATION MISSION, A TYPICAL FIGHTER

Test M-88 $\sigma_{lim} = 30$ ksi, M-89 $\sigma_{lim} = 40$ ksi

HEADM 1800000 IS UN LI 05

0001	C....	RANDOM	I-R	(#300)																
0002	-5.0*	70.0	16.0	20.9	16.2	31.7	13.9	33.1	13.4	20.4										
0003	16.0	41.0	-5.0	29.4	14.4	31.3	16.3	31.7	13.7	29.2										
0004	9.0	33.2	13.9	26.3	-5.0	33.0	14.6	26.7	7.3	31.4										
0005	10.9	30.3	13.0	27.8	14.7	32.3	-5.0	23.4	10.2	27.4										
0006	14.7	32.4	17.9	28.0	11.7	23.8	7.1	29.8	-5.0	34.1										
0007	15.3	44.5	11.8	35.8	8.2	25.8	6.3	24.5	13.2	28.6										
0008	-5.0	24.6	11.5	26.1	8.8	30.0	14.4	26.2	15.3	29.7										
0009	14.7	28.8	-5.0	30.1	7.4	29.7	17.1	29.3	11.3	25.8										
0010	13.8	31.5	13.7	28.1	-5.0	34.1	16.8	31.6	12.0	32.1										
0011	19.2	34.1	9.4	25.0	7.4	27.4	-5.0	24.4	12.1	23.4										
0012	12.3	22.7	10.4	31.0	19.2	30.7	18.1	29.2	-5.0	36.3										
0013	10.8	23.0	13.0	28.3	10.2	33.4	14.3	32.4	11.5	27.0										
0014	-5.0	23.0	9.4	26.3	11.6	30.8	10.4	30.0	16.6	28.4										
0015	15.9	29.3	-5.0	31.7	13.3	30.4	11.9	32.2	13.3	23.5										
0016	8.6	35.8	16.4	30.5	-5.0	40.8	16.2	27.8	13.7	32.6										
0017	15.6	27.5	14.5	27.4	5.8	33.9	-5.0	35.1	14.7	28.2										
0018	17.2	28.9	17.1	28.7	10.4	37.2	7.1	25.9	-5.0	32.1										
0019	16.4	28.4	13.5	30.7	18.6	39.1	16.2	27.2	10.5	22.1										
0020	-5.0	40.1	11.7	24.2	11.5	31.1	18.7	38.7	10.1	29.3										
0021	17.6	28.4	-5.0	33.8	10.0	36.7	14.5	28.9	12.4	30.7										
0022	17.8	37.3	13.8	27.4	-5.0	27.7	15.6	25.7	15.2	26.7										
0023	13.0	34.0	16.1	26.3	13.6	29.8	-5.0	36.8	16.9	27.6										
0024	12.7	28.2	9.4	29.4	19.2	28.8	6.3	39.3	-5.0	30.6										
0025	11.9	35.7	10.7	26.7	14.9	34.0	15.1	35.7	16.4	32.8										
0026	-5.0	39.8	10.5	28.5	7.8	25.8	9.1	35.7	9.3	29.8										
0027	14.6	29.6	-5.0	25.4	15.7	40.4	15.1	28.4	17.2	30.4										
0028	15.2	30.8	14.6	25.4	-5.0	34.1	18.0	31.8	14.2	27.2										
0029	16.0	29.7	10.2	24.4	10.0	34.4	-5.0	31.5	11.5	25.5										
0030	15.0	31.6	15.9	36.9	16.9	38.6	11.1	29.5	-5.0	31.3										
0031	14.3	30.6	9.4	33.2	16.7	29.5	12.7	34.3	15.6	28.7										
0032	-5.0	27.3	13.0	28.6	3.7	30.1	17.1	35.2	11.3	39.1										
0033	14.2	24.8	-5.0	24.1	13.3	31.3	15.4	29.8	10.9	21.6										
0034	9.1	32.3	11.5	45.4	-5.0	32.9	14.2	37.7	16.1	36.9										
0035	16.8	43.4	13.5	24.6	13.4	24.7	-5.0	41.2	6.8	30.9										
0036	20.1	37.0	16.1	34.8	14.0	27.7	12.5	32.8	-5.0	29.1										
0037	10.5	27.1	12.0	36.0	14.1	28.5	17.6	34.8	17.0	31.4										
0038	-5.0	27.1	10.2	35.9	17.8	31.1	6.0	35.7	18.7	38.6										
0039	15.8	36.5	-5.0	27.1	14.7	39.9	18.9	29.9	14.3	34.1										
0040	12.7	37.6	15.3	32.0	-5.0	34.3	16.0	33.7	13.8	24.5										
0041	15.2	32.4	18.5	29.0	8.8	35.1	-5.0	31.2	11.7	29.5										
0042	14.4	26.4	9.6	29.7	9.1	28.9	12.3	23.9	-5.0	25.9										
0043	13.1	33.0	9.0	28.0	9.4	35.6	15.2	34.0	12.5	26.6										
0044	-5.0	24.8	12.1	41.3	20.9	32.6	20.3	34.6	12.7	29.0										
0045	12.4	26.7	-5.0	25.5	12.9	33.4	11.2	35.3	12.3	26.7										
0046	10.6	24.9	14.2	30.5	-5.0	27.8	16.4	30.9	8.2	25.1										
0047	12.3	32.3	14.2	35.8	10.5	35.4	-5.0	26.8	11.6	27.0										
0048	15.1	28.0	16.0	28.7	12.8	23.9	8.5	32.9	-5.0	34.1										
0049	13.8	31.5	16.5	42.7	18.3	28.3	6.2	35.2	14.1	31.7										
0050	-5.0	29.8	16.5	32.6	12.8	27.8	13.8	34.3	10.6	27.2										
0051	9.7	38.0	-5.0	27.5	7.4	30.7	13.8	32.7	16.6	35.4										
0052	6.2	34.1	14.5	35.5	-5.0	27.3	14.7	37.9	30.9	42.1										
0053	17.5	26.4	9.7	27.2	20.4	36.3	-5.0	29.9	4.1	32.7										
0054	13.1	26.5	14.4	35.8	17.4	39.0	8.9	52.3	-5.0	23.7										
0055	9.4	34.2	23.7	34.7	9.8	19.9	13.0	19.0	8.9	23.2										
0056	-5.0	46.4	17.7	31.8	11.2	23.2	10.8	18.1	8.3	39.8										
0057	25.2	42.5	-5.0	23.5	8.4	32.9	11.4	21.3	12.0	33.2										
0058	15.1	31.8	9.0	37.0	-5.0	38.5	13.3	29.3	10.6	27.7										
0059	14.0	43.2	4.0	37.2	22.3	37.8	-5.0	38.0	14.1	25.3										
0060	14.2	35.6	18.7	30.4	37.9	47.1	11.2	18.4	-5.0	48.8										
0061	18.9	30.5	17.4	25.3	12.5	21.6	7.9	17.0	2.6	27.2										

* % of σ_{lim}

TABLE 108. DATA TABULATION FOR TEST M-88

SPECIMEN NO.: M-18 RANDOM SPECTRUM, TYPICAL FIGHTER, INSTRUMENTATION AND NAVIGATION, LIMIT STRESS = 30 KSI

GCT SPECIMEN B = 0.750 IN. W = 6.000 IN. AN = 0.0 IN.
 PMIN = PMAX = TEST FREQ = 6.000 HZ.

ENVIRONMENT CONDITION: AMBIENT AIR

NO.	CYCLES	A (MEASURED)	A (REGRESSION)	MULT. CORR. COEFF	X-MAX	DELTA K	QAJUM
1	0.	0.300	0.301	0.954750	9.64	10.33	6.739E-07
2	21035.	0.335	0.315	0.960857	9.86	10.57	3.605E-07
3	65990.	0.360	0.401	0.974422	11.14	11.93	1.044E-06
4	92358.	0.470	0.413	0.982441	11.31	12.12	1.163E-06
5	110797.	0.465	0.457	0.994752	11.91	12.76	1.474E-06
6	127691.	0.510	0.512	0.995132	12.68	13.57	1.718E-06
7	143558.	0.570	0.574	0.996951	13.36	14.32	1.790E-06
8	165107.	0.670	0.657	0.998823	14.32	15.35	2.036E-06
9	184205.	0.735	0.741	0.997057	15.24	16.33	2.166E-06
10	198731.	0.795	0.805	0.996400	15.92	17.05	2.242E-06
11	206348.	0.860	0.847	0.994457	16.34	17.51	2.440E-06
12	219281.	0.960	0.900	0.987715	16.67	18.06	2.515E-06
13	228174.	0.940	0.944	0.984083	17.30	18.54	2.647E-06
14	233995.	0.960	0.974	0.991254	17.59	18.85	2.964E-06
15	239522.	1.020	1.009	0.991346	17.92	19.20	3.390E-06
16	245847.	1.060	1.059	0.991616	18.40	19.71	3.672E-06
17	254683.	1.115	1.126	0.992864	19.03	20.39	3.858E-06
18	258937.	1.170	1.157	0.995713	19.30	20.68	3.840E-06
19	267413.	1.220	1.225	0.995519	19.91	21.34	4.148E-06
20	271544.	1.260	1.257	0.993475	20.20	21.65	4.570E-06
21	277677.	1.310	1.312	0.999073	20.69	22.17	5.077E-06
22	282883.	1.365	1.371	0.997512	21.21	22.72	5.516E-06
23	287893.	1.435	1.431	0.996483	21.73	23.28	5.563E-06
24	292416.	1.490	1.485	0.999279	22.20	23.79	5.742E-06
25	296480.	1.530	1.528	0.997769	22.57	24.18	5.699E-06
26	303816.	1.620	1.625	0.998863	23.40	25.08	5.618E-06
27	315094.	1.725	1.733	0.999454	24.32	26.06	6.085E-06
28	321987.	1.820	1.819	0.999572	25.06	26.85	6.554E-06

TABLE 108. DATA TABULATION FOR TEST M-88 (CONCL)

SPECIMEN NO.: M-88 RANDOM SPECTRUM, TYPICAL FIGHTER, INSTRUMENTATION AND NAVIGATION, LIMIT STRESS = 30 KSI

CCI SPECIMEN B = 0.250 IN. M = 6.000 IN. AN = 0.0 IN.

PMIN = PMAX = TEST FREQ = 6.000HZ.

ENVIRONMENT CONDITION: AMBIENT AIR

NO.	CYCLES	A (MEASURED)	A (REGRESSION)	MULT. CORR. COEFF	K-MAX	DELTA K	DA/DM
29	328954.	1.920	1.914	0.999582	25.87	27.72	7.017E-06
30	336739.	2.025	2.030	0.999794	26.87	28.79	7.566E-06
31	342931.	2.125	2.124	0.999810	27.69	29.67	7.937E-06
32	349757.	2.235	2.234	0.999801	28.66	30.7J	8.564E-06
33	354301.	2.315	2.313	0.999645	29.36	31.46	9.074E-06
34	359161.	2.400	2.404	0.995088	30.18	32.34	1.142E-05
35	364506.	2.510	2.529	0.996745	31.34	33.56	1.437E-05
36	366884.	2.605	2.599	0.998087	32.00	34.28	1.647E-05
37	370162.	2.715	2.714	0.996468	33.12	35.46	2.051E-05
38	372331.	2.815	2.805	0.993279	34.02	36.45	2.470E-05
39	374623.	2.895	2.917	0.993441	35.17	37.68	3.176E-05
40	376796.	3.050	3.059	0.993364	36.69	39.31	4.555E-05
41	378199.	3.175	3.194	0.980433	38.18	40.91	6.554E-05
42	379698.	3.345	3.419	0.977509	40.96	43.85	9.647E-05
43	380131.	3.450	3.505	0.922105	42.07	45.06	1.375E-04
44	380443.	3.610	3.610	0.999919	43.51	46.61	2.195E-04

PLOT RATE CRACK GROWTH ANALYSIS

M-88 RANDOM SPECTRUM, TYPICAL FIGHTER, INSTRUMENTATION AND NAVIGATION, LIMIT STRESS = 30 KSI

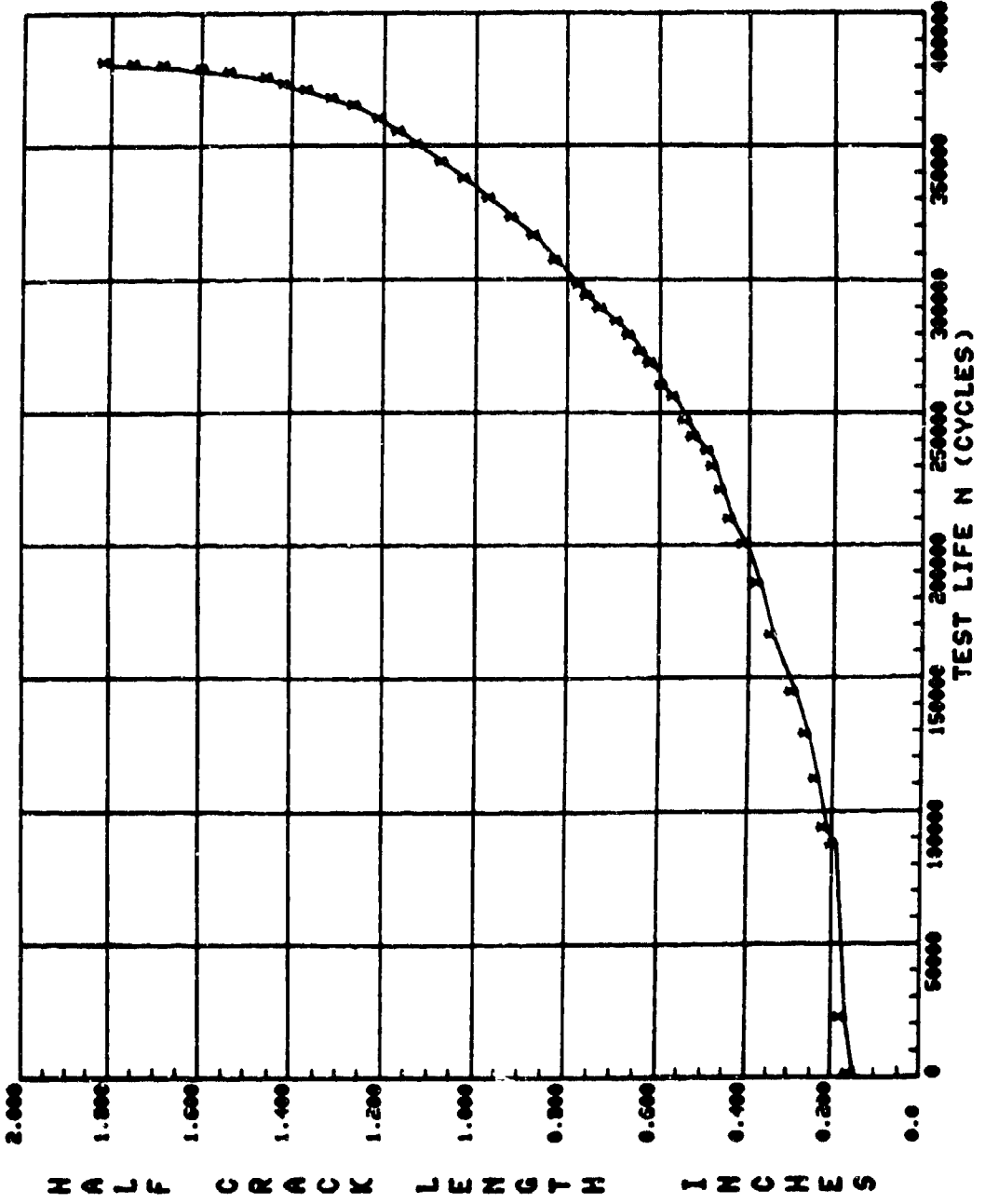

Figure 106. Crack growth curve for test M-88.

TABLE 109. DATA TABULATION FOR TEST M-89

SPECIMEN NO.: M-89 RANDOM SPECTRUM, TYPICAL FIGHTER, INSTRUMENTATION AND NAVIGATION, LIMIT STRESS = 40 KSI

CCT SPECIMEN B = 0.250 IN. W = 0.000 IN. AN = 0.0 IN. TEST FREQ = 6.000HZ.

PMIN = PMAX =

ENVIRONMENT CONDITION: AMBIENT AIR

NO.	CYCLFS	A (MEASURED)	A (REGRESSION)	MULT. CORR. COEFF	K-MAX	DELTA K	DA/DM
1	0.	0.300	0.300	0.996664	12.84	13.76	7.333E-07
2	25075.	0.300	0.353	0.997923	13.92	14.92	1.428E-06
3	48450.	0.430	0.438	0.996397	15.53	16.64	2.310E-06
4	60470.	0.495	0.496	0.996981	16.54	17.72	2.750E-06
5	72439.	0.560	0.566	0.997247	17.70	18.96	3.508E-06
6	76324.	0.605	0.598	0.997006	18.20	19.50	3.715E-06
7	86460.	0.645	0.674	0.994946	19.35	20.73	4.023E-06
8	90737.	0.720	0.712	0.994824	19.90	21.32	4.262E-06
9	98224.	0.760	0.776	0.994845	20.81	22.30	4.353E-06
10	107382.	0.805	0.814	0.992926	21.34	22.87	4.689E-06
11	106339.	0.855	0.847	0.995143	21.79	23.35	5.012E-06
12	112725.	0.945	0.915	0.995759	22.69	24.31	5.750E-06
13	115969.	0.955	0.954	0.995139	23.20	24.86	6.479E-06
14	116576.	0.995	0.990	0.991425	23.66	25.35	6.479E-06
15	124360.	1.065	1.073	0.993262	24.71	26.48	6.479E-06
16	126751.	1.120	1.108	0.993543	25.13	26.93	7.340E-06
17	131171.	1.160	1.173	0.992876	25.93	27.78	7.926E-06
18	133849.	1.225	1.214	0.990639	26.43	28.32	8.673E-06
19	137455.	1.270	1.277	0.994541	27.17	29.11	9.687E-06
20	139807.	1.315	1.326	0.995122	27.78	29.76	1.065E-05
21	141305.	1.365	1.358	0.997332	28.12	30.13	1.107E-05
22	143650.	1.415	1.414	0.998633	28.78	30.83	1.263E-05
23	145773.	1.465	1.467	0.999593	29.39	31.49	1.344E-05
24	147915.	1.525	1.525	0.999970	30.06	32.21	1.469E-05
25	151873.	1.655	1.649	0.998324	31.48	33.72	1.861E-05
26	155096.	1.775	1.775	0.996746	32.91	35.26	2.400E-05
27	157614.	1.885	1.904	0.994992	34.36	36.83	3.089E-05
28	159477.	2.010	2.016	0.996686	35.67	38.22	3.960E-05

TABLE 109. DATA TABULATION FOR TEST M-89 (CONCL)

SPECIMEN NO.: M-89		RANDOM SPECTRUM, TYPICAL FIGHTER, INSTRUMENTATION AND NAVIGATION, LIMIT STRESS = 40 KSI	
CCT	SPECIMEN	B = 0.750 IN.	W = 6.000 IN.
PHIN =	MAX =	AN = 0.0	IN.
ENVIRONMENT CONDITION: AMBIENT AIR			
NO.	CYCLES	f (MEASURED)	A (REGRESSION)
29	161303.	2.155	2.170
30	162402.	2.260	2.295
31	163282.	2.400	2.446
32	163861.	2.535	2.562
33	164434.	2.740	2.819
34	164736.	2.075	3.013
		MULT. CORR. COEFF	K-MAX
		0.994282	37.65
		0.984200	38.93
		0.957976	40.76
		0.973569	42.45
		0.985255	45.55
		0.990911	48.33
		DELTA K	DA/DM
		40.13	5.507E-05
		41.71	7.940E-05
		43.67	1.304E-04
		45.48	1.888E-04
		48.80	2.695E-04
		51.79	4.256E-04
		TEST FREQ = 6.000HZ.	

PLOTRATE CRACK GROWTH ANALYSIS

M-89 RANDOM SPECTRUM, TYPICAL FIGHTER, INSTRUMENTATION AND NAVIGATION, LIMIT STRESS = 40 KSI

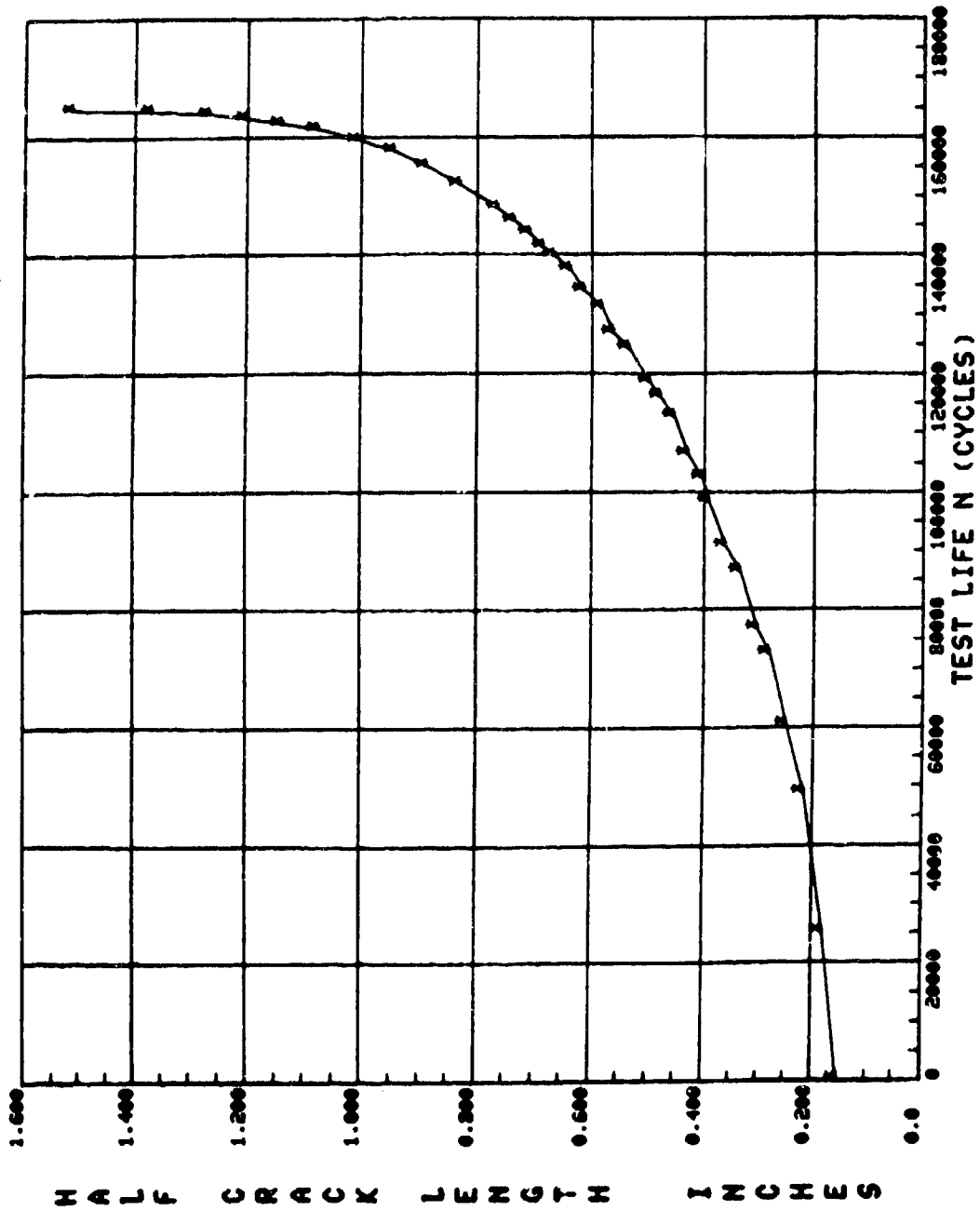

Figure 107. Crack growth curve for test M-89.

TABLE 110. METHODOLOGY DEVELOPMENT TEST PROGRAM GROUP V - RANDOM FLIGHT-BY-FLIGHT SPECTRUM LOADING TEST, COMPOSITE MISSION, A TYPICAL FIGHTER

Test M-90 $\sigma_{lim} = 20$ ksi, M-91 $\sigma_{lim} = 30$ ksi, M-92 $\sigma_{lim} = 40$ ksi

MEAN THROUGH IS (IN LB US)

0001	C.... RANDOM COMPOSITE (N=1055)										
0002	-05.0*	70.0	16.1	54.1	20.1	45.5	25.0	52.3	36.0	50.7	
0003	28.2	44.5	16.6	48.6	24.5	61.4	8.6	29.4	17.4	52.4	
0004	17.5	29.5	10.2	74.4	14.4	50.6	32.5	53.7	17.3	65.7	
0005	50.6	63.5	3.1	67.5	10.9	60.6	44.0	54.9	16.2	45.1	
0006	14.7	34.0	20.4	58.4	31.2	45.6	27.8	63.5	9.4	49.7	
0007	36.1	58.2	-5.0	74.4	27.6	42.9	27.4	41.0	9.4	37.5	
0008	16.0	40.2	5.2	39.1	19.5	51.9	9.3	31.4	19.1	48.6	
0009	0.4	27.6	16.9	36.2	11.8	28.7	9.3	33.2	1.8	13.2	
0010	1.4	50.2	18.6	31.8	19.1	48.8	34.0	63.7	24.4	86.8	
0011	22.5	42.7	12.2	40.8	22.0	41.9	21.2	42.2	16.3	26.6	
0012	-3.6	27.3	11.9	45.3	-5.0	48.8	14.7	48.6	23.6	57.2	
0013	36.4	58.3	32.7	48.7	27.1	41.5	29.7	81.1	29.3	60.7	
0014	19.8	43.5	28.5	74.9	19.2	48.5	22.4	38.3	5.1	52.8	
0015	34.0	45.0	14.7	46.4	3.0	34.8	14.8	48.7	33.4	54.2	
0016	29.4	38.7	18.3	36.0	18.5	63.7	17.7	56.1	11.7	29.3	
0017	-7.5	41.4	15.3	33.8	0.7	36.1	-5.0	61.7	16.3	50.9	
0018	30.1	47.9	25.4	52.1	24.4	65.2	-10.3	50.7	12.6	44.6	
0019	32.1	47.0	24.3	38.4	19.6	46.2	23.4	42.3	3.5	52.9	
0020	39.8	64.4	16.9	30.6	19.1	47.2	6.4	74.1	12.2	50.2	
0021	28.8	45.6	12.7	46.2	15.3	39.2	20.2	46.4	36.3	58.6	
0022	3.8	60.0	11.9	44.6	29.5	41.3	11.5	40.4	-5.0	47.4	
0023	6.4	44.3	32.4	58.2	16.3	55.1	-4.6	83.3	0.6	37.5	
0024	24.1	57.7	18.2	34.8	22.2	65.7	24.8	47.5	13.4	55.9	
0025	42.5	64.5	24.9	38.5	-22.0	61.8	36.2	66.4	39.4	60.9	
0026	35.4	56.8	25.5	51.2	34.5	54.9	26.8	34.5	-3.7	81.0	
0027	-1.8	47.0	12.5	59.6	8.3	53.9	7.7	45.3	29.7	66.4	
0028	-5.0	49.2	5.5	33.5	15.0	36.1	2.7	58.5	2.8	40.9	
0029	13.8	38.1	13.2	51.7	4.0	33.3	9.4	29.3	11.6	68.5	
0030	14.0	45.4	30.9	45.9	13.5	48.1	21.1	57.3	13.9	35.2	
0031	18.7	37.3	19.3	40.6	1.1	25.6	8.3	67.1	32.8	71.0	
0032	21.5	51.4	12.5	42.8	11.3	41.4	22.8	47.5	17.9	48.9	
0033	17.5	55.1	-5.0	41.4	12.2	79.3	15.1	50.4	28.7	45.8	
0034	34.3	59.1	28.3	45.5	29.1	52.9	12.0	65.1	30.9	48.0	
0035	9.2	66.8	47.6	61.6	15.0	31.1	14.3	50.6	7.7	53.2	
0036	34.7	68.1	6.8	20.5	6.2	56.5	9.3	75.7	12.6	52.7	
0037	31.3	55.7	17.4	57.7	22.3	61.7	29.0	51.7	39.8	55.5	
0038	12.2	42.6	8.1	25.8	-5.0	60.0	13.5	56.0	14.8	63.7	
0039	21.6	32.8	20.3	43.4	9.7	48.1	33.5	45.2	-7.3	47.1	
0040	8.4	77.9	45.9	58.8	10.3	71.8	10.6	38.2	23.3	46.2	
0041	-4.8	40.3	4.9	41.1	17.9	42.7	5.1	41.8	27.2	58.7	
0042	24.8	42.9	13.3	46.0	1.2	26.5	-4.5	51.3	5.4	26.6	
0043	15.4	38.3	8.6	39.0	5.3	60.3	-5.0	42.2	13.0	34.4	
0044	15.4	55.6	12.7	40.8	23.6	49.4	36.7	53.9	25.7	41.0	
0045	18.2	33.3	22.5	46.5	3.0	44.7	6.4	39.8	22.5	64.3	
0046	24.5	57.0	26.3	53.4	9.8	33.3	0.9	46.4	0.3	46.9	
0047	24.5	47.4	22.3	47.2	6.3	77.9	25.4	74.7	16.7	64.1	
0048	22.7	53.6	4.7	72.1	7.6	72.3	17.5	53.0	-5.0	59.3	
0049	15.0	42.4	27.8	41.6	17.3	70.0	12.9	47.5	25.4	66.3	
0050	50.3	89.4	-0.2	69.5	47.1	60.2	13.1	66.1	11.6	71.4	
0051	18.7	53.3	16.2	35.5	10.7	42.3	5.6	61.4	23.5	49.3	
0052	19.1	51.0	1.3	45.7	15.9	52.5	20.9	43.4	28.9	47.3	
0053	22.5	46.1	21.8	52.4	36.4	61.3	8.7	57.5	38.5	54.9	
0054	-5.0	34.4	26.4	50.2	8.9	31.0	13.8	55.9	42.8	75.9	
0055	16.6	50.3	34.6	46.2	11.4	66.4	11.7	55.5	-6.0	58.9	
0056	37.6	51.0	22.5	37.5	14.6	24.7	1.2	33.1	6.7	26.8	
0057	1.5	42.0	0.5	41.0	11.2	47.8	19.5	37.6	9.6	49.7	
0058	-0.4	40.1	29.0	44.2	23.4	60.8	14.2	40.4	23.3	45.3	
0059	-10.0	70.0	29.6	41.9	4.2	20.1	7.8	48.9	6.3	37.1	

* % of σ_{lim}

TABLE 110. METHODOLOGY DEVELOPMENT TEST PROGRAM GROUP V - RANDOM FLIGHT-BY-FLIGHT SPECTRUM LOADING TEST, COMPOSITE MISSION, A TYPICAL FIGHTER (CONT)

Test M-90 $\sigma_{lim} = 20$ ksi, M-91 $\sigma_{lim} = 30$ ksi, M-92 $\sigma_{lim} = 40$ ksi

0060	8.4	37.8	16.4	28.6	17.8	49.5	13.8	26.9	4.0	42.9
0061	11.4	74.1	20.3	34.5	1.5	21.0	7.8	34.5	11.9	23.8
0062	2.1	71.5	11.3	43.6	8.5	33.1	10.4	56.3	-10.0	51.4
0063	0.6	18.9	7.0	55.9	31.7	48.6	3.0	17.3	6.9	44.1
0064	30.6	42.4	25.3	44.3	2.9	31.7	4.4	28.6	8.6	29.7
0065	18.0	28.4	14.4	44.2	16.4	35.2	8.0	51.8	8.1	23.3
0066	2.8	21.7	8.7	54.5	12.3	47.3	-10.0	67.1	42.2	57.2
0067	14.5	35.4	11.8	27.8	5.5	19.6	3.7	27.7	8.9	31.1
0068	0.6	28.8	9.2	22.8	12.5	41.6	0.5	26.4	10.3	34.3
0069	-0.1	14.5	5.1	28.7	5.7	31.4	4.3	22.3	10.7	24.5
0070	1.6	12.0	0.0	48.2	-10.0	31.1	7.1	23.7	6.6	35.2
0071	12.1	49.2	11.0	78.4	4.4	24.2	5.2	29.5	6.7	30.6
0072	16.1	28.3	11.0	37.8	5.8	17.2	-1.2	23.6	3.2	42.5
0073	22.8	40.3	6.5	33.6	8.5	49.9	21.0	43.2	22.5	45.2
0074	13.1	33.6	-10.0	25.1	8.4	78.6	11.3	42.4	5.5	34.6
0075	10.6	71.7	5.1	35.1	11.2	32.1	1.4	46.3	15.4	37.3
0076	5.4	46.9	0.1	24.1	8.5	48.8	21.2	42.7	9.4	23.3
0077	3.8	28.4	5.1	48.1	26.2	38.5	4.4	40.0	3.8	28.0
0078	-10.0	19.0	7.0	35.8	5.2	31.1	4.0	28.8	-0.0	53.1
0079	7.2	36.8	11.1	35.7	11.3	40.1	4.0	29.8	16.0	51.5
0080	-5.6	25.4	14.3	36.9	6.5	30.1	17.0	38.5	14.5	32.3
0081	6.9	38.1	8.6	35.2	-0.0	37.7	18.1	37.0	-10.0	50.5
0082	8.5	23.8	5.7	37.7	3.0	30.6	18.3	62.8	1.4	36.7
0083	10.6	39.3	3.6	38.0	4.0	32.3	7.2	35.1	19.6	55.2
0084	-0.0	47.4	3.0	38.1	14.6	32.0	7.5	21.2	2.7	29.6
0085	12.2	37.9	0.3	33.8	15.3	45.0	-10.0	32.5	8.6	46.5
0086	-0.4	75.8	-0.3	33.5	10.8	27.1	14.8	48.9	17.9	35.1
0087	2.8	57.0	10.8	38.4	2.2	48.3	26.3	64.1	12.8	34.4
0088	-14.7	53.4	17.3	62.1	27.3	39.1	8.7	38.5	6.4	45.3
0089	23.4	47.8	10.3	33.8	-10.0	70.0	-0.5	35.3	1.7	50.0
0090	3.1	41.4	0.8	25.8	13.4	30.7	15.9	53.5	1.3	38.9
0091	0.2	28.1	10.0	25.0	2.2	58.8	1.6	36.8	4.5	30.2
0092	3.3	48.7	0.3	26.9	2.5	18.9	2.5	58.5	17.3	27.6
0093	4.5	33.0	-10.0	32.8	3.0	35.7	7.5	41.9	27.8	39.7
0094	6.2	19.5	8.2	32.1	11.4	31.7	-9.4	18.6	2.5	60.7
0095	13.5	64.0	5.0	24.8	16.9	41.6	1.8	36.2	3.9	28.9
0096	9.2	34.1	7.4	32.0	14.8	37.9	13.5	26.1	6.8	25.7
0097	-10.0	46.1	22.5	38.5	3.2	33.0	13.9	25.0	15.3	30.9
0098	2.5	69.4	5.2	34.4	17.5	30.2	10.0	36.3	16.1	45.8
0099	11.8	36.8	11.8	35.7	12.0	24.8	5.8	21.0	7.0	54.0
0100	11.8	42.4	1.5	59.3	24.6	47.9	6.2	25.6	-10.0	38.6
0101	-5.0	70.0	16.8	28.4	18.2	31.7	13.9	33.1	13.4	28.4
0102	16.0	41.0	-5.0	29.4	14.4	31.3	16.3	31.7	13.7	28.2
0103	9.0	33.2	13.9	26.3	-9.0	33.0	14.6	26.7	7.3	31.4
0104	10.9	30.3	15.0	27.8	14.7	32.3	-5.0	23.4	10.2	27.4
0105	24.3	56.8	-5.0	67.8	22.8	66.6	32.4	52.2	29.4	56.5
0106	28.3	58.5	25.0	55.9	38.0	60.4	23.8	68.7	24.0	61.8
0107	18.6	65.3	21.5	44.1	6.8	38.4	1.0	58.5	17.4	29.3
0108	8.8	42.3	31.8	44.8	34.8	48.4	25.7	46.8	16.8	41.3
0109	-0.7	61.2	8.6	42.7	5.1	44.9	14.8	59.0	-0.7	64.7
0110	21.5	55.4	17.8	36.8	-5.0	36.9	7.5	55.0	29.8	51.4
0111	2.2	72.7	1.3	32.2	-3.8	70.1	8.8	73.8	21.9	49.8
0112	38.6	54.0	41.3	56.3	27.5	38.1	25.3	49.5	9.6	60.9
0113	13.9	53.4	14.9	36.7	15.4	41.8	15.3	38.3	19.8	58.7
0114	28.7	46.8	19.0	55.2	8.9	49.2	5.9	49.6	14.9	55.6
0115	-0.1	21.5	-8.9	27.4	12.2	51.4	-5.0	59.9	16.8	78.8
0116	-2.5	48.2	3.7	80.9	7.5	62.3	31.2	68.0	37.3	54.7
0117	28.2	42.3	30.5	37.2	13.4	28.8	9.6	29.9	12.5	23.8
0118	-0.7	55.7	-4.2	37.7	18.1	56.8	36.3	56.8	27.5	41.8
0119	-0.6	47.0	23.3	62.3	10.0	58.8	30.6	50.0	15.8	37.8
0120	20.2	37.6	21.7	53.2	37.1	65.4	18.7	57.7	-5.0	37.8

TABLE 110. METHODOLOGY DEVELOPMENT TEST PROGRAM GROUP V - RANDOM FLIGHT-BY-FLIGHT SPECTRUM LOADING TEST, COMPOSITE MISSION, A TYPICAL FIGHTER (CONT)

Test M-90 $\sigma_{lim} = 20$ ksi, M-91 $\sigma_{lim} = 30$ ksi, M-92 $\sigma_{lim} = 40$ ksi

0121	24.6	42.7	1.6	40.1	13.4	62.1	4.4	52.7	2.6	68.3
0122	6.2	34.7	-0.9	38.9	24.2	59.2	2.4	47.6	12.3	36.2
0123	9.1	52.4	2.4	16.6	-5.1	56.3	35.8	53.2	1.7	52.1
0124	35.6	70.2	28.3	40.0	25.2	44.2	20.4	35.2	17.6	37.4
0125	26.4	53.7	20.7	34.3	8.1	45.5	34.6	48.7	23.4	88.7
0126	-5.0	82.4	21.1	54.4	30.2	60.1	5.8	35.7	14.5	60.4
0127	23.2	48.4	19.4	49.7	5.5	68.3	42.8	54.4	24.5	48.8
0128	23.6	42.7	5.8	43.6	26.00	74.2	12.6	34.2	23.3	37.5
0129	24.4	36.4	26.5	55.5	22.5	66.8	52.5	65.0	23.9	56.2
0130	12.7	61.0	27.4	53.4	13.3	37.9	20.5	33.2	22.8	40.3
0131	25.7	62.8	-5.0	53.4	21.5	67.4	24.8	48.5	6.9	31.1
0132	18.1	41.4	14.8	27.1	10.4	61.2	8.5	53.4	3.1	27.7
0133	15.0	44.5	14.9	66.4	35.8	59.1	30.2	71.3	24.0	76.1
0134	28.3	52.1	14.8	69.1	40.5	73.0	8.4	56.3	22.9	37.6
0135	17.2	60.1	6.2	36.5	16.4	57.2	10.1	42.2	21.2	67.9
0136	5.3	63.4	34.3	47.4	-5.0	52.4	21.4	57.5	17.5	38.7
0137	10.0	56.2	26.1	45.5	27.4	60.4	25.5	41.8	19.7	56.5
0138	24.4	37.0	24.6	47.5	17.2	92.5	5.3	44.1	5.4	20.5
0139	-0.3	37.7	26.0	39.8	3.3	23.4	3.2	42.6	-1.9	57.6
0140	42.5	62.9	19.4	74.2	13.4	46.8	23.2	52.5	26.4	37.2
0141	9.1	35.4	22.0	69.2	32.4	54.8	-5.0	54.0	14.5	53.6
0142	12.8	38.4	21.4	53.7	28.6	49.5	39.2	60.8	26.1	52.9
0143	6.7	61.4	21.5	43.1	19.7	31.6	4.8	24.1	-11.9	47.8
0144	14.6	34.3	10.4	55.6	10.2	21.6	9.0	41.6	12.7	51.6
0145	10.1	36.5	16.7	54.3	35.0	73.8	34.4	71.1	36.3	52.0
0146	20.9	58.5	28.7	48.7	24.4	44.6	28.0	48.0	-5.0	62.3
0147	45.4	74.7	33.8	46.3	21.4	53.4	8.9	45.9	-3.5	48.8
0148	15.6	58.4	32.2	48.8	9.6	48.7	15.3	26.4	3.0	57.5
0149	15.4	31.7	15.3	41.9	7.4	27.7	14.7	71.6	6.4	24.7
0150	3.0	54.2	-0.8	46.7	11.5	34.2	-2.9	32.1	-0.3	47.9
0151	3.1	31.1	9.6	55.2	5.7	50.7	27.8	38.6	9.6	43.1
0152	-5.0	49.0	31.0	61.7	43.5	65.7	6.3	47.8	23.1	71.9
0153	10.0	76.6	22.7	38.0	5.2	31.1	17.5	70.8	35.3	61.6
0154	26.8	56.5	7.2	54.9	17.4	30.1	9.2	19.9	5.9	17.9
0155	6.2	65.2	-1.9	76.0	5.9	55.9	13.8	63.4	37.4	59.9
0156	33.4	45.6	23.8	50.1	21.7	54.7	12.2	46.3	32.0	44.1
0157	6.6	70.8	-5.0	48.4	23.9	45.7	20.3	52.5	6.2	35.3
0158	20.3	61.8	8.1	47.5	28.7	41.5	16.8	34.2	6.3	84.1
0159	25.8	47.9	30.3	59.6	20.5	64.6	38.3	55.0	27.8	43.2
0160	26.0	62.8	17.1	40.1	17.6	30.6	12.8	65.8	9.5	54.6
0161	34.4	67.6	-4.2	60.6	0.9	63.5	12.6	37.9	7.7	69.5
0162	10.7	42.4	25.9	42.3	-5.0	54.1	24.7	66.4	23.2	49.9
0163	12.4	34.5	23.5	50.5	25.5	44.1	22.4	45.7	26.1	74.2
0164	39.4	61.1	28.2	45.7	18.3	53.7	20.6	54.1	32.1	67.6
0165	23.4	62.3	28.4	80.2	19.1	48.7	29.4	55.9	19.7	79.2
0166	11.2	43.8	21.7	48.2	20.4	71.9	33.9	63.3	34.9	52.7
0167	29.8	60.6	10.7	65.8	17.5	64.9	-5.0	41.7	11.5	34.8
0168	3.7	20.4	6.3	47.2	18.4	63.4	1.1	15.5	3.8	48.6
0169	3.6	68.2	0.7	46.1	16.9	43.4	12.6	28.2	3.7	45.9
0170	5.8	49.5	10.8	35.5	16.7	44.8	3.4	34.2	1.0	16.6
0171	5.1	53.8	3.8	45.8	4.6	34.8	-10.0	60.2	8.6	19.7
0172	6.2	33.4	2.9	44.4	19.5	48.1	-1.2	37.2	0.8	40.0
0173	22.3	58.4	23.3	46.6	1.7	54.8	3.0	28.2	11.0	38.3
0174	-1.7	12.3	0.8	33.7	-10.0	38.6	5.0	27.8	0.4	39.0
0175	12.2	45.2	10.1	24.5	2.4	38.4	16.8	31.7	-0.0	18.9
0176	6.5	19.8	-0.0	53.7	8.9	25.0	10.8	28.7	2.2	32.1
0177	0.1	44.5	-4.5	29.5	5.8	21.5	5.2	21.5	5.4	46.0
0178	4.6	28.3	9.3	41.0	19.3	44.9	8.9	33.0	5.4	24.7
0179	12.3	38.7	-10.0	28.5	15.8	35.7	1.2	27.9	8.6	58.4
0180	21.5	31.8	7.7	46.4	14.3	46.1	3.4	32.2	0.3	37.9
0181	-0.8	24.9	14.0	43.8	10.2	37.5	7.9	36.1	0.4	67.2

TABLE 110. METHODOLOGY DEVELOPMENT TEST PROGRAM GROUP V - RANDOM FLIGHT-BY-FLIGHT SPECTRUM LOADING TEST, COMPOSITE MISSION, A TYPICAL FIGHTER (CONCL)

Test M-90 $\sigma_{lim} = 20$ ksi, M-91 $\sigma_{lim} = 30$ ksi, M-92 $\sigma_{lim} = 40$ ksi

0182	13.9	51.4	4.0	25.9	15.2	54.6	7.7	54.2	0.5	64.2
0183	-10.0	60.4	2.5	35.4	13.6	42.3	15.1	27.0	6.1	30.1
0184	11.4	33.9	7.6	58.4	7.3	24.5	11.9	39.9	8.4	54.6
0185	25.4	74.1	-0.5	60.3	21.8	44.7	7.6	43.6	2.5	36.1
0186	20.4	60.9	6.0	34.3	19.3	41.3	27.0	37.0	-10.0	24.5
0187	2.0	31.5	0.2	57.5	9.4	41.5	7.9	46.4	5.1	19.0
0188	0.4	37.8	27.0	40.1	6.0	21.9	6.4	28.4	11.2	34.7
0189	9.3	42.2	8.2	40.7	17.5	46.7	0.3	41.1	19.1	49.3
0190	11.9	24.8	12.3	42.9	0.7	23.8	-10.0	45.0	18.3	62.5
0191	2.2	40.2	14.0	34.1	3.2	52.3	4.0	24.4	11.9	48.6
0192	-3.8	34.7	23.2	38.9	9.5	25.3	10.1	25.0	7.4	21.2
0193	-0.1	31.6	0.9	18.9	1.4	36.4	-0.0	32.5	4.9	35.9
0194	7.1	33.5	2.0	39.9	-10.0	28.4	13.1	36.3	10.8	58.1
0195	34.6	49.6	1.9	28.3	7.3	35.7	8.3	50.6	13.3	57.1
0196	8.3	54.5	14.2	36.6	14.2	39.5	21.6	41.5	10.5	48.9
0197	9.5	41.6	19.7	47.7	11.3	59.6	6.1	51.4	10.7	28.5
0198	3.7	57.1	-10.0	30.4	11.7	41.0	6.3	23.2	0.7	24.9
0199	-0.1	49.3	8.4	24.5	0.5	30.6	12.4	33.0	16.2	40.0
0200	14.4	42.4	3.6	31.9	0.1	49.6	2.2	29.4	0.8	44.6
0201	3.7	46.6	0.2	58.4	9.1	44.5	5.4	25.8	10.5	31.7
0202	-10.0	20.5	8.3	44.4	22.2	34.1	16.6	38.9	0.0	78.4
0203	-0.7	25.1	-2.0	63.6	3.5	62.1	15.4	27.9	12.2	31.0
0204	16.7	40.8	20.9	41.0	11.2	28.5	12.7	23.8	12.2	35.6
0205	2.9	49.9	5.3	46.9	5.4	29.2	7.6	35.1	-10.0	26.7
0206	5.0	49.3	15.3	41.5	5.0	46.0	1.6	43.3	0.5	45.7
0207	5.0	47.8	12.0	26.2	-0.4	18.9	-2.3	31.1	10.4	38.6
0208	5.6	47.6	4.0	70.0	-1.7	35.5	0.2	27.0	16.4	70.0
0209	0.0	34.9	18.4	52.3	9.1	49.6	-10.0	40.3	8.4	30.4
0210	14.7	32.4	17.9	28.0	11.7	23.8	7.1	29.8	-5.0	34.8
0211	15.3	44.5	11.8	35.8	8.2	25.8	6.3	24.5	13.2	28.6
0212	-5.0	24.6	11.5	28.1	8.8	30.0	14.4	26.2	15.3	29.7

TABLE III. DATA TABULATION FOR TEST M-90

SPECIMEN NO.: M-90 RANDOM SPECTRUM, TYPICAL FIGHTER COMPOSITE MISSION, LIMIT STRESS = 20 KSI

CCT SPECIMEN B= 0.250 IN. W= 6.000 IN. AN= G.O IN. TEST FREQ= 6.000HZ.

ENVIRONMENT CONDITION: AMBIENT AIR

NO.	CYCLES	A(MEASURED)	AIR(FRESSIGN)	MULT. CORR. COEFF	K-MAX	DELTA K	DA/DM
1	0.	0.305	0.305	0.997195	7.78	9.81	5.456E-07
2	22618.	0.345	0.341	0.998449	8.23	10.38	1.079E-06
3	41134.	0.385	0.390	0.998924	8.80	11.11	1.571E-06
4	51136.	0.425	0.423	0.998491	9.16	11.57	1.820E-06
5	63116.	0.470	0.469	0.997518	9.64	12.19	2.070E-06
6	73981.	0.515	0.519	0.997554	10.17	12.83	2.375E-06
7	82165.	0.565	0.558	0.997807	10.55	13.32	2.641E-06
8	90240.	0.595	0.603	0.997951	10.97	13.85	2.881E-06
9	95490.	0.635	0.632	0.994665	11.25	14.20	3.192E-06
10	104687.	0.695	0.693	0.995802	11.80	14.89	3.624E-06
11	113091.	0.750	0.760	0.996655	12.37	15.61	4.189E-06
12	116050.	0.795	0.784	0.997452	12.57	15.87	4.351E-06
13	123106.	0.845	0.849	0.997709	13.10	16.54	4.889E-06
14	128997.	0.910	0.912	0.997107	13.61	17.17	5.186E-06
15	135098.	0.975	0.972	0.997125	14.08	17.77	5.673E-06
16	141450.	1.055	1.050	0.997149	14.67	18.52	6.083E-06
17	147371.	1.110	1.123	0.997689	15.21	19.20	6.497E-06
18	152591.	1.205	1.193	0.997513	15.72	19.84	6.851E-06
19	157346.	1.255	1.257	0.997116	16.18	20.43	7.408E-06
20	163995.	1.360	1.359	0.996617	16.90	21.34	8.538E-06
21	168015.	1.420	1.427	0.999082	17.38	21.93	9.085E-06
22	173273.	1.530	1.531	0.999365	18.09	22.84	1.025E-05
23	177311.	1.625	1.618	0.999250	18.70	23.60	1.097E-05
24	182356.	1.730	1.734	0.999231	19.49	24.60	1.199E-05
25	186635.	1.840	1.836	0.999126	20.19	25.48	1.301E-05
26	190676.	1.935	1.943	0.999608	20.92	26.40	1.432E-05
27	193932.	2.040	2.039	0.999554	21.59	27.24	1.543E-05
28	196874.	2.135	2.132	0.999458	22.23	28.06	1.689E-05

TABLE III. DATA TABULATION FOR TEST M-90 (CONCL.)

SPECIMEN NO.: M-90 RANDOM SPECTRUM, TYPICAL FIGHTER COMPOSITE MISSION, LIMIT STRESS = 20 KSI

CCT SPECIMEN B= 0.250 IN. W= 6.000 IN. AN= 0.0 IN.

PRIN= PMAX= TEST FREQ= 6.000HZ.

ENVIRONMENT CONDITION: AMBIENT AIR

NO.	CYCLES	A (MEASURED)	A (REGRESSION)	MULT. CORR. COEFF	K-MAX	DELTA K	DA/DN
29	199493.	2.225	2.223	0.998575	22.87	28.87	1.891F-05
30	201859.	2.305	2.312	0.999333	23.51	29.67	2.061F-05
31	204342.	2.415	2.417	0.999649	24.27	30.64	2.313F-05
32	206624.	2.535	2.528	0.999626	25.13	31.68	2.555E-05
33	208293.	2.615	2.617	0.998680	25.77	32.52	2.853F-05
34	210233.	2.730	2.725	0.998561	26.64	33.63	3.215E-05
35	211948.	2.830	2.838	0.998495	27.52	34.73	3.805F-05
36	213598.	2.970	2.977	0.997011	28.63	36.14	4.808F-05
37	214531.	3.050	3.060	0.997454	29.60	37.11	5.931F-05
38	215428.	3.160	3.172	0.997893	30.40	38.37	7.299E-05
39	215979.	3.250	3.249	0.999997	31.13	39.29	8.383F-05
40	216555.	3.355	3.353	0.996515	32.14	40.56	1.027F-04
41	216980.	3.440	3.440	0.994172	33.22	41.67	1.246F-04
42	217477.	3.545	3.579	0.956589	34.51	43.55	2.001F-04
43	217700.	3.645	3.655	0.955049	35.41	44.70	3.023F-04
44	217982.	3.755	3.854	0.965366	37.80	47.71	4.785E-04
45	218068.	3.945	3.930	0.973865	38.81	48.98	6.892F-04
46	218151.	4.060	4.064	0.987464	40.71	51.39	1.064E-03

PLOTRATE CRACK GROWTH DATA

M-90 RANDOM SPECTRUM, TYPICAL FIGHTER COMPOSITE MISSION, LIMIT STRESS = 20 KSI

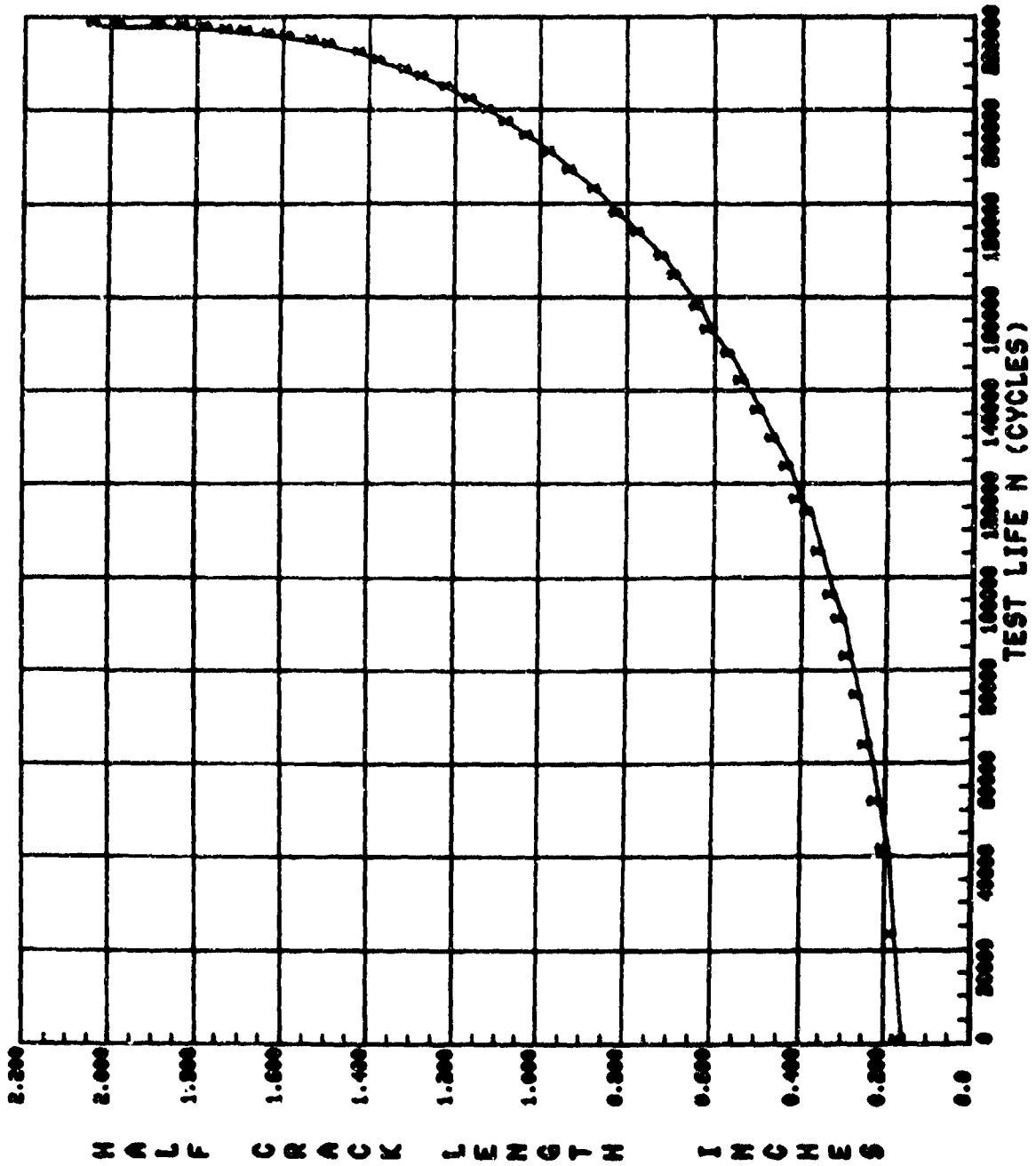

Figure 108. Crack growth curve for test M-90.

TABLE 112. DATA TABULATION FOR TEST M-91

SPECIMEN NO.: M-91 RANDOM SPECTRUM, TYPICAL FIGHTER COMPOSITE MISSION, LIMIT STRESS = 30 KSI

CCT SPECIMEN B = 0.250 IN. W = 6.000 IN. AN = 0.0 IN.

PHIN = PMAK = TEST FREQ = 6.00GHZ.

ENVIRONMENT CONDITION: AMBIENT AIR

NO.	CYCLES	A (MEASURED)	A (REGRESSION)	MULT. CORR. COEFF	K-MAX	DELTA K	UJ/UM
1	0.	0.300	0.300	0.999497	11.56	14.59	2.572E-06
2	8647.	0.350	0.348	0.997970	12.46	15.72	3.503E-06
3	14667.	0.400	0.395	0.997967	13.28	16.75	4.698E-06
4	20724.	0.450	0.459	0.998263	14.33	18.06	6.061E-06
5	26304.	0.500	0.531	0.998896	15.44	19.48	7.245E-06
6	30212.	0.545	0.551	0.999031	16.31	20.57	8.165E-06
7	33612.	0.655	0.653	0.999785	17.15	21.64	9.002E-06
8	38941.	0.750	0.753	0.998507	18.47	23.30	1.051E-05
9	42146.	0.870	0.820	0.996348	19.30	24.35	1.222E-05
10	44881.	0.880	0.868	0.999212	20.13	25.40	1.390E-05
11	46642.	0.945	0.943	0.998734	20.78	26.21	1.577E-05
12	48773.	1.010	1.006	0.996980	21.50	27.13	1.753E-05
13	51086.	1.085	1.093	0.999021	22.49	28.37	2.065E-05
14	52599.	1.160	1.155	0.999154	23.17	29.23	2.143E-05
15	54191.	1.225	1.226	0.996759	23.94	30.20	2.371E-05
16	55656.	1.300	1.299	0.998629	24.72	31.19	2.576E-05
17	56764.	1.350	1.356	0.998499	25.32	31.94	2.871E-05
18	57388.	1.395	1.391	0.996965	25.69	32.62	3.182E-05
19	58368.	1.450	1.456	0.997918	26.37	33.26	3.541E-05
20	59144.	1.510	1.513	0.997945	26.96	34.02	4.020E-05
21	59416.	1.545	1.533	0.998534	27.17	34.27	4.143E-05
22	60817.	1.655	1.661	0.998158	28.48	35.93	5.337E-05
23	61615.	1.750	1.746	0.996952	29.36	37.04	6.340E-05
24	62452.	1.855	1.860	0.997325	30.53	38.51	8.096E-05
25	63089.	1.960	1.966	0.996145	31.61	39.28	9.414E-05
26	63662.	2.070	2.078	0.996565	32.78	41.35	1.114E-04
27	64133.	2.205	2.189	0.998446	33.94	42.82	1.402E-04
28	64565.	2.290	2.317	0.977759	35.52	44.56	1.953E-04

TABLE 112. DATA TABULATION FOR TEST M-91 (CONCL)

SPECIMEN NO.: M-91 RANDOM SPECTRUM, TYPICAL FIGHTER COMPOSITE MISSION, LIMIT STRESS = 30 KSI

CCT SPECIMEN R = 0.250 IN. W = 6.000 IN. AN = 0.0 IM.

PHIN = P MAX = TEST FREU = 6.000HZ.

ENVIRONMENT CONDITION: AMBIENT AIR

NO.	CYCLES	A (MEASURED)	A (REGRESSION)	MULT. CORR. COEFF	K-MAX	DELTA K	DA/DB
29	65000.	2.435	2.490	0.976210	37.21	46.95	2.366E-04
30	65097.	2.550	2.530	0.980642	37.66	47.52	2.561E-04
31	65173.	2.625	2.578	0.979273	38.21	48.20	2.710E-04
32	65479.	2.725	2.777	0.976385	40.54	51.14	2.366E-04
33	65627.	2.845	2.843	0.985645	41.34	52.15	3.299E-04

PLOTRATE CRACK GROWTH ANALYSIS

M-91 RANDOM SPECTRUM, TYPICAL FIGHTER COMPOSITE MISSION, LIMIT STRESS = 30 KSI

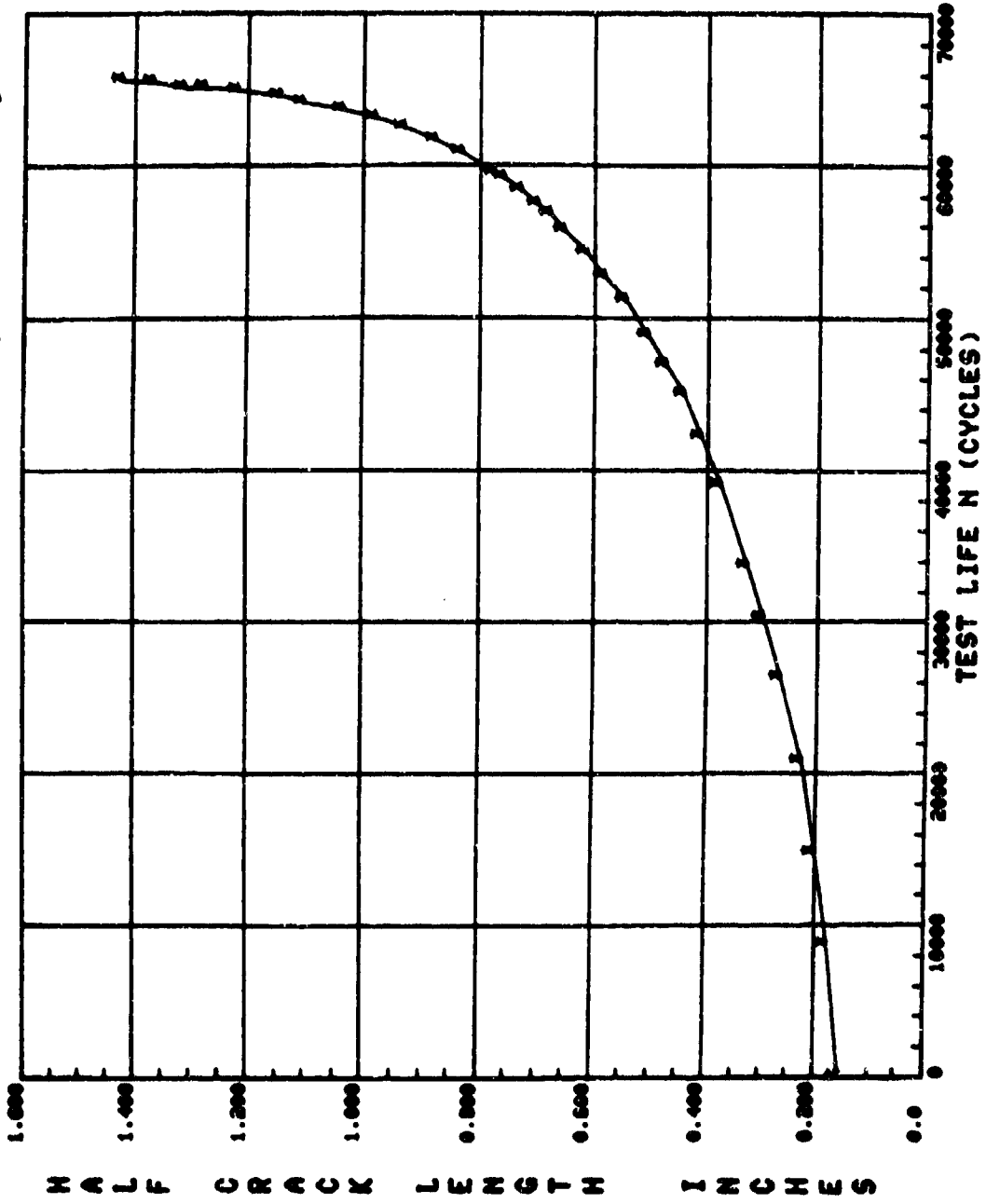

Figure 109. Crack growth curve for test M-91.

TABLE 113. DATA TABULATION FOR TEST M-92

SPECIMEN NO.: M-92 RANDOM SPECTRUM, TYPICAL FIGHTER COMPOSITE MISSION, LIMIT STRESS = 40 KSI

CCT SPECIMEN B = 0.250 IN. h = 6.000 IN. AN = 0.0 IN. TEST FREQ = 6.00 HZ.

PMIN = PMAX =

ENVIRONMENT CONDITION: AMBIENT AIR

NO.	CYCLES	A (MEASURED)	A (REGRESSION)	MULT. CORR. COEFF	K-MAX	DELTA K	DA/DW
1	0.	0.300	0.300	0.999148	15.42	19.45	5.831E-06
2	4116.	0.360	0.362	0.999393	16.95	21.38	9.432E-06
3	6043.	0.405	0.402	0.999562	17.86	22.54	1.119E-05
4	7931.	0.445	0.447	0.999554	18.86	23.79	1.273E-05
5	9115.	0.480	0.479	0.999436	19.53	24.64	1.390E-05
6	10839.	0.530	0.528	0.999498	20.52	25.89	1.570E-05
7	12486.	0.580	0.582	0.992164	21.56	27.20	2.020E-05
8	13381.	0.615	0.619	0.992699	22.25	28.06	2.153E-05
9	14683.	0.660	0.665	0.985360	23.15	29.21	2.680E-05
10	15244.	0.725	0.714	0.985110	23.94	30.21	2.867E-05
11	16387.	0.765	0.785	0.982067	25.16	31.74	3.427E-05
12	16576.	0.815	0.757	0.981602	25.36	31.99	3.614E-05
13	17734.	0.870	0.884	0.985312	26.77	33.77	4.534E-05
14	17973.	0.915	0.907	0.985044	27.14	34.23	4.698E-05
15	18662.	0.975	0.973	0.993635	28.17	35.54	5.622E-05
16	18974.	1.015	1.013	0.993987	28.78	36.30	6.142E-05
17	19421.	1.060	1.067	0.998459	29.60	37.34	6.956E-05
18	19687.	1.110	1.107	0.997491	30.19	38.08	7.305E-05
19	20003.	1.155	1.154	0.992929	30.87	38.94	8.427E-05
20	20306.	1.210	1.207	0.985605	31.64	39.92	1.028E-04
21	20653.	1.260	1.281	0.987375	32.70	41.26	1.201E-04
22	20800.	1.320	1.317	0.987021	33.22	41.90	1.305E-04
23	20902.	1.365	1.344	0.986520	33.60	42.39	1.385E-04
24	21151.	1.410	1.420	0.990810	34.66	43.73	1.627E-04
25	21269.	1.455	1.436	0.917912	34.89	44.01	2.139E-04
26	21425.	1.510	1.497	0.938292	35.72	45.07	3.157E-04
27	21733.	1.635	1.750	0.946027	39.20	49.46	5.282E-04
28	21826.	1.915	1.857	0.955927	40.66	51.29	5.629E-04

TABLE 113. DATA TABULATION FOR TEST M-92 (CONCL.)

SPECIMEN NO.: M-92 RANDOM SPECTRUM, TYP. FIGHTER COMPOSITE MISSION, LIMIT STRESS = 40 KSI

CCT SPECIMEN B = 0.250 IN. b = 6.000 IN. AN = 0.0 IN.

PHIN = PMAX = TEST FREQ = 6.00 HZ.

ENVIRONMENT CONDITION: AMBIENT AIR

NO.	CYCLES	A (MEASURED)	A (REGRESSION)	MULT. CORR. COEFF	K-MAX	DELTA K	DA/DN
29	21897.	2.035	1.946	0.953953	41.88	52.84	6.041E-04
30	22043.	2.110	2.194	0.967804	45.33	57.19	5.588E-04
31	22182.	2.325	2.323	0.982004	47.17	59.51	7.398E-04

PLOTRATE CRACK GROWTH DATA

M-92 RANDOM SPECTRUM, TYPICAL FIGHTER COMPOSITE MISSION, LIMIT STRESS = 40 KSI

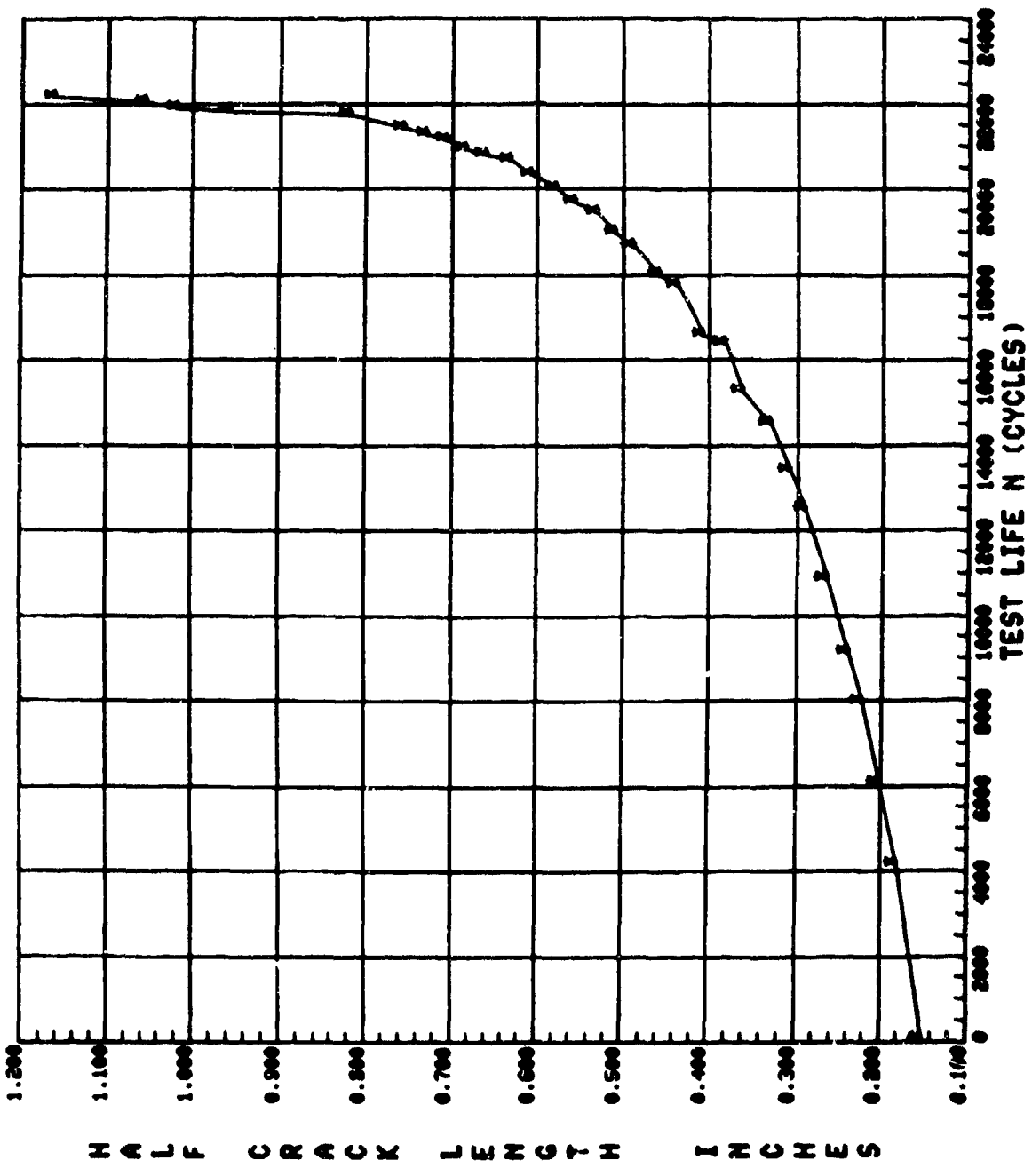

Figure 110. Crack growth curve for test M-92.

TABLE 114. METHODOLOGY DEVELOPMENT TEST PROGRAM, GROUP V,
RANDOM FLIGHT-BY-FLIGHT SPECTRUM LOADING TEST
COMPOSITE MISSION, TYPICAL TRANSPORT

Test M-93: This table as shown
M-94: 1.4 factor on this table

Line	Stresses in KSI									
001	6.0	-6.4	10.8	10.7	10.9	10.8	10.8	10.3	12.5	8.4
	12.7	9.8	11.3	10.3	11.1	10.7	10.8	10.7	10.8	10.8
	10.8	10.7	11.2	9.3	12.2	10.2	10.9	10.5	11.4	10.8
	11.5	9.6	11.5	10.3	11.5	9.9	11.2	10.7	11.0	10.0
	11.4	10.7	10.7	10.7	11.1	10.7	10.8	10.7	10.8	10.7
	10.9	10.7	10.9	10.4	11.3	10.5	10.9	10.5	11.3	10.4
	11.0	10.1	12.5	8.6	12.3	10.1	11.0	10.8	10.8	10.6
	11.0	10.7	10.8	10.8	11.0	10.5	11.1	10.8	10.8	10.7
	11.3	10.0	11.2	10.6	11.3	9.8	11.7	9.9	11.9	10.1
010	10.8	10.8	11.0	10.2	11.5	10.3	11.1	10.8	10.8	10.8
	10.8	10.8	10.8	10.4	12.2	9.2	11.6	10.7	10.8	10.7
	11.0	10.6	11.0	10.7	10.8	10.8	10.9	10.7	10.8	10.7
	11.4	9.2	12.2	10.3	10.9	10.6	11.1	10.4	11.5	9.1
	9.8	9.0	9.1	9.0	9.2	9.1	9.1	8.7	10.7	8.5
	10.8	8.2	9.6	8.7	9.4	9.0	9.1	9.0	9.1	9.0
	9.1	9.0	9.4	7.7	10.4	8.5	9.2	8.9	9.6	8.8
	9.5	9.0	9.0	9.0	9.0	9.0	9.0	8.8	10.2	7.2
	10.4	8.4	9.3	8.7	9.2	8.9	9.0	9.0	9.0	9.0
	9.0	9.0	9.2	8.0	10.0	8.6	9.0	8.9	9.4	8.9
	9.4	8.2	9.4	8.8	9.4	8.4	9.2	9.0	9.1	8.5
	9.4	9.0	9.0	9.0	9.1	9.0	9.0	9.0	9.0	9.0
020	11.4	10.6	10.6	10.5	10.7	10.6	10.6	10.2	12.3	8.3
	12.5	9.7	11.2	10.2	10.9	10.5	10.7	10.6	10.7	10.6
	10.6	10.6	11.0	9.2	12.0	10.0	10.7	10.4	11.2	10.4
	11.3	9.5	11.3	10.2	11.3	9.7	11.0	10.6	10.8	9.8
	11.2	10.5	10.8	10.8	10.9	10.5	10.7	10.8	10.8	10.8
	10.7	10.6	10.7	10.3	11.1	10.4	10.7	10.4	11.1	10.2
	10.9	9.9	12.3	8.5	12.1	10.0	10.8	10.6	10.6	10.5
	10.9	10.6	10.8	10.8	10.9	10.3	10.9	10.5	10.6	10.5
	11.1	9.8	11.0	10.4	11.1	9.7	11.5	9.8	11.7	-6.4
030	12.9	9.1	11.5	10.6	10.8	10.7	10.8	10.8	10.8	10.7
	11.2	9.8	12.4	9.6	11.2	10.6	11.1	10.4	10.9	10.2
	11.2	10.7	10.8	10.7	11.3	10.1	11.2	10.6	10.9	10.7
	11.2	10.2	11.2	10.5	11.0	10.6	11.3	9.4	12.7	9.1
	11.5	10.5	11.0	10.6	11.0	10.6	10.9	10.7	10.8	10.6
	11.1	10.7	10.8	10.7	11.4	10.1	11.0	10.2	12.1	9.5
	11.6	10.2	11.6	9.9	11.4	9.8	12.1	10.1	10.8	10.8
	11.0	9.8	12.8	8.5	12.3	10.1	11.2	10.4	11.2	10.4
	11.1	10.8	11.1	10.5	11.0	10.7	10.8	10.8	11.0	10.1
040	11.8	9.9	11.1	10.7	10.9	10.6	11.5	9.9	11.7	9.3
	11.9	10.8	11.0	10.8	11.1	10.8	11.0	10.8	10.8	10.7
	11.0	10.8	11.0	10.6	11.1	10.2	11.4	10.4	10.9	10.8
	10.8	10.6	11.2	10.3	11.2	10.5	10.9	10.8	10.8	10.6

TABLE 114. METHODOLOGY DEVELOPMENT TEST PROGRAM, GROUP V,
RANDOM FLIGHT-BY-FLIGHT SPECTRUM LOADING TEST
COMPOSITE MISSION, TYPICAL TRANSPORT (CONT)

Test M-93: This table as shown
M-94: 1.4 factor on this table

Line	Stresses in KSI									
	9.7	8.0	9.7	8.7	9.7	8.3	9.5	9.0	9.3	8.3
	9.8	9.0	9.0	9.0	9.3	9.0	9.1	9.0	9.1	9.0
	9.1	9.0	9.2	8.8	9.5	8.8	9.2	8.9	9.5	8.7
	9.0	9.0	9.1	8.8	9.3	8.9	9.0	8.9	9.3	8.8
	9.1	8.8	10.2	7.3	10.0	8.8	9.1	9.0	9.0	8.9
050	9.1	9.0	9.0	9.0	9.1	8.8	9.2	8.9	9.0	9.0
	9.3	8.5	9.2	8.9	9.3	8.4	9.6	8.5	9.7	8.6
	9.0	9.0	9.1	8.8	9.4	8.7	9.1	9.0	9.0	9.0
	10.7	10.6	10.8	10.0	11.3	10.1	10.9	10.6	10.6	10.6
	10.7	10.6	10.6	10.3	12.0	9.1	11.4	10.5	10.6	10.6
	10.8	10.4	10.8	10.6	10.6	10.6	10.7	10.5	10.6	10.6
	11.2	9.1	12.0	10.2	10.7	10.4	11.0	10.3	11.3	9.0
	12.7	9.0	11.3	10.4	10.7	10.6	10.7	10.6	10.6	10.6
	11.0	9.4	12.2	9.5	11.0	10.4	11.0	10.3	10.8	10.1
	11.0	10.5	10.6	10.5	11.1	10.0	11.0	10.4	10.7	10.5
	11.0	10.1	11.0	10.4	10.8	10.4	11.1	9.3	12.5	9.0
060	11.3	10.3	10.8	10.8	10.8	10.5	10.7	10.6	10.7	-6.4
	11.3	10.3	11.0	10.8	10.8	10.7	10.9	10.7	10.8	10.4
	11.8	9.8	11.3	10.7	10.9	10.5	11.6	9.2	12.4	10.1
	11.0	10.8	11.2	10.8	10.8	10.7	11.7	9.4	11.3	10.1
	12.0	10.3	10.9	10.6	11.4	10.2	11.0	10.7	11.0	10.4
	11.0	10.7	10.9	10.7	11.0	10.6	10.9	10.6	10.9	10.7
	11.0	10.3	11.8	10.0	11.1	10.6	11.0	10.5	10.9	10.7
	10.9	10.7	10.9	10.5	11.6	9.9	11.0	10.9	11.0	9.9
	11.6	10.6	10.9	10.3	11.4	10.6	11.3	10.3	11.2	10.5
070	10.8	10.8	10.8	10.7	10.8	10.8	10.9	10.1	11.8	10.0
	11.0	10.6	11.6	9.5	11.8	10.5	10.8	10.7	11.2	10.3
	11.1	10.7	10.8	10.8	10.9	10.5	11.2	10.3	10.9	10.7
	11.1	10.5	10.8	10.8	10.8	10.6	10.8	10.8	10.9	9.8
	12.7	9.1	11.6	10.1	12.2	9.2	11.5	10.8	10.8	9.5
	9.3	8.4	10.7	7.0	10.5	8.5	9.2	9.1	9.1	8.9
	9.3	9.0	9.1	9.1	9.3	8.8	9.4	8.9	9.1	9.0
	9.6	8.3	9.4	8.9	9.5	8.2	9.9	8.3	10.1	8.5
	9.0	9.0	9.0	8.8	9.9	7.9	9.5	9.0	9.0	9.0
	9.1	8.9	9.1	9.0	9.0	9.0	9.0	9.0	9.0	9.0
080	9.3	7.9	10.0	8.7	9.0	8.9	9.2	8.8	9.4	7.8
	10.6	7.8	9.4	8.9	9.0	9.0	9.0	9.0	9.0	9.0
	9.2	8.2	10.1	8.2	9.2	8.9	9.2	8.8	9.1	8.7
	10.9	10.5	10.6	10.6	11.2	10.0	10.8	10.0	11.9	9.3
	11.4	10.0	11.4	9.8	11.3	9.6	11.9	10.0	10.6	10.6
	11.8	9.6	12.5	8.4	12.1	10.0	11.0	10.2	11.1	10.2
	10.9	10.3	10.9	10.3	10.8	10.5	10.6	10.6	10.8	10.0
	11.6	9.8	11.0	10.5	10.7	10.4	11.3	9.8	11.5	9.2

TABLE 114. METHODOLOGY DEVELOPMENT TEST PROGRAM, GROUP V,
 RANDOM FLIGHT-BY-FLIGHT SPECTRUM LOADING TEST
 COMPOSITE MISSION, TYPICAL TRANSPORT (CONT)

Test M-93: This table as shown
 M-94: 1.4 factor on this table

Line	Stresses in KSI									
	11.7	10.4	10.8	10.4	10.9	10.3	10.8	10.6	10.6	10.5
	10.9	10.4	10.8	10.5	10.9	10.1	11.2	10.2	10.7	10.6
090	10.7	10.4	11.0	10.1	11.1	10.3	10.8	10.6	10.6	10.5
	11.1	10.2	10.8	10.6	10.6	10.5	10.8	10.6	10.7	10.9
	7.2	6.5	6.6	6.5	6.6	6.6	6.6	6.2	7.8	4.9
	7.9	5.9	7.0	6.2	6.8	6.5	6.6	6.5	6.6	6.5
	6.6	6.5	6.9	5.5	7.6	6.1	6.7	6.4	7.0	6.3
	7.1	5.7	7.1	6.2	7.1	5.9	6.9	6.5	6.7	5.9
	7.0	6.5	6.5	6.5	6.8	6.5	6.6	6.5	6.6	6.5
	6.6	6.5	6.7	6.3	6.9	6.4	6.6	6.4	6.9	6.3
	8.8	8.0	7.8	5.0	7.6	8.1	6.7	6.6	6.6	6.4
	6.8	6.5	6.6	6.5	6.7	6.3	6.8	6.4	6.6	6.5
	6.7	6.1	6.2	6.1	6.2	6.2	6.2	5.9	7.2	4.7
100	7.4	5.5	6.5	5.9	6.4	6.1	6.2	6.1	6.2	6.1
	9.2	8.9	9.0	9.0	9.3	8.6	9.2	8.9	9.0	9.0
	9.2	8.7	9.2	8.9	9.1	8.9	9.3	8.1	10.4	7.8
	9.4	8.8	9.1	8.9	9.1	8.9	9.0	9.0	9.0	8.9
	9.1	9.0	9.0	9.0	9.3	8.6	9.1	8.6	9.9	8.1
	9.5	8.7	9.5	8.4	9.4	8.4	9.9	8.6	9.0	9.0
	9.1	8.3	10.4	7.3	10.0	8.6	9.2	8.8	9.3	8.8
	9.2	8.9	9.2	8.8	9.1	9.0	9.0	9.0	9.1	8.6
	9.6	8.5	9.2	9.0	9.0	8.9	9.4	8.5	9.6	8.0
110	9.7	8.9	9.1	8.9	9.2	8.8	9.1	9.0	9.0	9.0
	9.3	8.6	8.7	8.6	8.7	8.6	8.7	8.3	10.1	6.5
	10.4	7.8	9.1	8.3	8.9	8.5	8.7	8.6	8.7	8.6
	8.7	8.6	8.9	7.4	10.0	8.1	8.7	8.5	9.2	8.4
	9.3	7.6	9.2	8.3	9.3	7.8	9.0	8.6	8.8	8.9
	7.0	5.9	6.9	6.4	6.9	5.8	7.3	5.9	7.4	6.0
	6.6	6.6	6.7	6.1	7.1	6.2	6.8	6.5	6.5	6.5
	6.6	6.6	6.6	6.3	7.6	5.4	7.2	6.5	6.6	6.5
	6.7	6.4	6.7	6.5	6.6	6.6	6.6	6.5	6.6	6.5
120	7.0	5.4	7.6	6.2	6.7	6.4	6.8	6.3	7.1	5.3
	8.1	5.3	7.1	6.4	6.6	6.5	6.6	6.6	6.6	6.5
	6.9	5.7	7.7	5.7	6.9	6.4	6.8	6.3	6.7	6.1
	6.9	6.5	6.6	6.5	6.9	6.1	6.9	6.4	6.6	6.5
	6.2	6.1	6.4	5.2	7.2	5.7	6.2	6.0	6.6	5.9
	6.7	5.4	6.6	5.9	6.7	5.5	6.4	6.1	6.4	5.6
	9.1	8.9	9.1	8.9	9.2	8.7	9.3	8.8	9.0	9.0
	9.0	8.9	9.2	8.7	9.3	8.8	9.1	9.0	9.0	8.9
	9.3	8.7	9.1	9.0	9.0	9.0	9.1	9.0	9.0	8.8
	9.7	8.4	9.3	8.9	9.0	8.9	9.5	7.9	10.1	8.6
	9.1	8.9	9.2	8.9	9.0	9.0	9.6	8.0	9.3	8.6
	9.8	8.7	9.0	8.9	9.4	8.6	9.1	9.0	9.1	8.8

TABLE 114. METHODOLOGY DEVELOPMENT TEST PROGRAM, GROUP V,
RANDOM FLIGHT-BY-FLIGHT SPECTRUM LOADING TEST
COMPOSITE MISSION, TYPICAL TRANSPORT (CONT)

Test M-93: This table as shown
M-94: 1.4 factor on this table

Line	Stresses in KSI									
130	9.1	8.9	9.0	9.0	9.1	8.9	9.0	8.9	9.1	9.0
	9.1	8.7	9.6	8.5	9.2	8.9	9.1	8.8	9.1	9.0
	9.0	9.0	9.0	8.9	9.5	8.4	9.1	9.1	9.1	8.4
	9.2	8.6	8.6	8.6	8.8	8.6	8.7	8.6	8.7	8.6
	8.7	8.6	8.8	8.3	9.0	8.5	8.7	8.4	9.0	8.4
	8.9	7.9	10.3	6.8	9.8	8.2	8.8	8.6	8.7	8.6
	8.8	8.6	8.6	8.6	8.8	8.4	8.9	8.5	8.7	-6.4
	11.6	10.7	10.8	10.7	10.9	10.8	10.8	10.3	12.5	8.4
	12.7	9.8	11.3	10.3	11.1	10.7	10.8	10.7	10.8	10.8
	10.8	10.7	11.2	9.3	12.2	10.2	10.9	10.5	11.4	10.5
	11.5	9.6	11.5	10.3	11.5	9.9	11.2	10.7	11.0	10.0
	11.4	10.7	10.7	10.7	11.1	10.7	10.8	10.7	10.8	10.7
140	10.9	10.7	10.9	10.4	11.3	10.5	10.9	10.5	11.3	10.4
	11.0	10.1	12.5	8.8	12.3	10.1	11.0	10.8	10.8	10.8
	11.0	10.7	10.8	10.8	11.0	10.5	11.1	10.6	10.8	10.7
	11.3	10.0	11.2	10.6	11.3	9.8	11.7	9.9	11.9	10.1
	11.8	10.8	11.0	10.2	11.5	10.3	11.1	10.8	10.8	10.8
	10.8	10.8	10.8	10.4	12.2	9.2	11.6	10.7	10.8	10.7
	11.0	10.6	11.0	10.7	10.8	10.8	10.9	10.7	10.8	10.7
	11.4	9.2	12.2	10.3	10.9	10.6	11.1	10.4	11.5	9.1
150	9.8	9.0	9.1	9.0	9.2	9.1	9.1	8.7	10.7	6.8
	10.8	8.2	9.6	8.7	9.4	9.0	9.1	9.0	9.1	9.0
	9.1	9.0	9.4	7.7	10.4	8.5	9.2	8.9	9.6	8.8
	9.5	9.0	9.0	9.0	9.0	9.0	9.0	8.8	10.2	7.2
	10.4	8.4	9.3	8.7	9.2	8.9	9.0	9.0	9.0	9.0
	9.0	9.0	9.2	8.0	10.0	8.8	9.0	8.9	9.4	8.9
	9.4	8.2	9.4	8.8	9.4	8.4	9.2	9.0	9.1	8.5
	9.4	9.0	9.0	9.0	9.1	9.0	9.0	9.0	9.0	9.0
160	11.4	10.6	10.6	10.5	10.7	10.6	10.6	10.2	12.3	8.3
	12.5	9.7	11.2	10.2	10.9	10.5	10.7	10.6	10.7	10.6
	10.6	10.6	11.0	9.2	12.0	10.0	10.7	10.4	11.2	10.4
	11.3	9.5	11.3	10.2	11.3	9.7	11.0	10.8	10.8	9.8
	11.2	10.5	10.6	10.6	10.9	10.5	10.7	10.6	10.6	10.6
	10.7	10.6	10.7	10.3	11.1	10.4	10.7	10.4	11.1	10.2
	10.9	9.9	12.3	8.5	12.1	10.0	10.8	10.6	10.6	10.5
	10.9	10.6	10.6	10.6	10.9	10.3	10.9	10.5	10.6	10.5
	11.1	9.8	11.0	10.4	11.1	9.7	11.5	9.8	11.7	-6.4
	12.9	9.1	11.5	10.8	10.8	10.7	10.8	10.8	10.8	10.7
	11.2	9.6	12.4	9.6	11.2	10.6	11.1	10.4	10.9	10.2
	11.2	10.7	10.8	10.7	11.3	10.1	11.2	10.6	10.9	10.7
170	11.2	10.2	11.2	10.5	11.0	10.6	11.3	9.4	12.7	9.1
	11.5	10.5	11.0	10.6	11.0	10.6	10.9	10.7	10.8	10.6
	11.1	10.7	10.8	10.7	11.4	10.1	11.0	10.2	12.1	9.5

TABLE 114. METHODOLOGY DEVELOPMENT TEST PROGRAM, GROUP V,
RANDOM FLIGHT-BY-FLIGHT SPECTRUM LOADING TEST
COMPOSITE MISSION, TYPICAL TRANSPORT (CONT)

Test M-93: This table as shown
M-94: 1.4 factor on this table

Line	Stresses in KSI									
	11.6	10.2	11.6	9.9	11.4	9.8	12.1	10.1	10.8	10.8
	11.0	9.8	12.8	8.5	12.3	10.1	11.2	10.4	11.2	10.4
	11.1	10.5	11.1	10.5	11.0	10.7	10.8	10.8	11.0	10.1
	11.8	9.9	11.1	10.7	10.9	10.6	11.5	9.9	11.7	9.3
	11.9	10.6	11.0	10.5	11.1	10.5	11.0	10.8	10.8	10.7
	11.0	10.5	11.0	10.6	11.1	10.2	11.4	10.4	10.9	10.8
	10.8	10.6	11.2	10.3	11.2	10.5	10.9	10.8	10.8	10.6
180	9.7	8.0	9.7	8.7	9.7	8.3	9.5	9.0	9.3	8.3
	9.6	9.0	9.0	9.0	9.3	9.0	9.1	9.0	9.1	9.3
	9.1	9.0	9.2	8.8	9.5	8.8	9.2	8.9	9.5	8.7
	9.0	9.0	9.1	8.8	9.3	8.9	9.0	8.9	9.3	8.8
	9.1	8.6	10.2	7.3	10.0	8.6	9.1	9.0	9.0	8.9
	9.1	9.0	9.0	9.0	9.1	8.8	9.2	8.9	9.0	9.0
	9.3	8.4	9.2	8.9	9.3	8.4	9.6	8.5	9.7	8.6
	9.0	9.0	9.1	8.6	9.4	8.7	9.1	9.0	9.0	9.0
	10.7	10.6	10.8	10.0	11.3	10.1	10.9	10.6	10.6	10.6
190	10.7	10.6	10.6	10.3	12.0	9.1	11.4	10.5	10.6	10.6
	10.8	10.4	10.8	10.6	10.6	10.6	10.7	10.5	10.6	10.6
	11.2	9.1	12.0	10.2	10.7	10.4	11.0	10.3	11.3	9.0
	12.7	9.0	11.3	10.4	10.7	10.8	10.7	10.5	10.6	10.8
	11.0	9.4	12.2	9.5	11.0	10.4	11.0	10.3	10.8	10.1
	11.0	10.5	10.6	10.5	11.1	10.0	11.0	10.4	10.7	10.5
	11.0	10.1	11.0	10.4	10.8	10.4	11.1	9.3	12.5	9.0
	11.3	10.3	10.8	10.5	10.8	10.5	10.7	10.6	10.7	-6.4
	11.3	10.3	11.0	10.8	10.8	10.7	10.9	10.7	10.8	10.4
	11.0	9.8	11.3	10.7	10.9	10.5	11.2	9.2	12.4	10.1
200	11.0	10.6	11.2	10.6	10.8	10.7	11.7	9.4	11.3	10.1
	12.0	10.3	10.9	10.6	11.4	10.2	11.0	10.7	11.0	10.4
	11.0	10.7	10.9	10.7	11.0	10.6	10.9	10.6	10.9	10.7
	11.0	10.3	11.8	10.0	11.1	10.6	11.0	10.5	10.9	10.7
	10.9	10.7	10.9	10.5	11.6	9.9	11.0	10.9	11.0	9.9
	11.8	10.8	10.9	10.3	11.4	10.8	11.3	10.3	11.2	10.5
	10.8	10.8	10.8	10.7	10.8	10.8	10.9	10.1	11.3	10.0
	11.0	10.6	11.6	9.5	11.8	10.5	10.8	10.7	11.2	10.3
	11.1	10.7	10.8	10.8	10.9	10.5	11.2	10.3	10.9	10.7
	11.1	10.5	10.8	10.8	10.8	10.6	10.8	10.8	10.8	9.8
	12.7	9.1	11.6	10.1	12.2	9.2	11.5	10.8	10.8	9.8
210	9.3	8.4	10.7	7.0	10.5	8.5	9.2	9.1	9.1	8.9
	9.3	9.0	9.1	9.1	9.3	8.8	9.4	8.9	9.1	9.0
	9.6	8.3	9.4	8.9	9.5	8.2	9.4	8.3	10.1	8.5
	9.0	9.0	9.0	8.8	9.9	7.9	9.9	9.0	9.0	9.0
	9.1	8.9	9.1	9.0	9.0	9.0	9.0	9.0	9.0	9.0
	9.3	7.9	10.0	8.7	9.0	8.9	9.2	8.8	9.4	7.8

TABLE 114. METHODOLOGY DEVELOPMENT TEST PROGRAM, GROUP V,
RANDOM FLIGHT-BY-FLIGHT SPECTRUM LOADING TEST
COMPOSITE MISSION, TYPICAL TRANSPORT (CONT)

Test M-93: This table as shown
M-94: 1.4 factor on this table

Line	Stresses in KSI									
	10.6	7.8	9.4	8.9	9.0	9.0	9.0	9.0	9.0	9.0
	9.2	8.2	10.1	8.2	9.2	8.9	9.2	8.8	9.1	8.7
	10.9	10.5	10.6	10.6	11.2	10.0	10.8	10.0	11.9	9.3
	11.4	10.0	11.4	9.8	11.3	9.6	11.9	10.0	10.6	10.6
220	10.8	9.8	12.5	9.4	12.1	10.0	11.0	10.2	11.1	10.2
	10.9	10.3	10.9	10.3	10.8	10.5	10.6	10.6	10.8	10.5
	11.6	9.8	11.0	10.5	10.7	10.4	11.3	9.8	11.5	9.2
	11.7	10.4	10.8	10.4	10.4	10.3	10.8	10.8	10.8	10.5
	10.9	10.4	10.8	10.5	10.9	10.1	11.2	10.2	10.7	10.6
	10.7	10.4	11.0	10.1	11.1	10.3	10.8	10.6	10.6	10.5
	11.1	10.2	10.8	10.0	10.8	10.5	10.8	10.6	10.7	10.2
	13.1	10.2	10.8	10.6	10.6	10.5	10.8	10.6	10.7	-8.9
	7.2	8.5	6.6	6.5	6.6	3.6	6.6	6.2	7.6	4.9
230	7.9	8.9	7.0	8.2	8.8	8.5	8.8	8.5	8.8	8.5
	6.6	6.5	6.9	5.5	7.6	8.1	6.7	6.4	7.0	6.3
	7.1	5.7	7.1	6.2	7.1	5.9	6.9	6.5	6.7	5.9
	7.7	8.5	6.5	6.5	8.8	6.5	6.6	6.5	6.8	6.5
	6.6	8.5	6.7	6.3	6.9	6.4	6.6	6.4	6.9	6.3
	6.8	6.0	7.8	5.0	7.6	6.1	6.7	6.6	6.6	6.4
	8.8	8.5	8.8	8.8	8.7	8.7	8.8	8.4	8.8	8.5
	8.7	6.1	6.2	6.1	6.2	6.2	6.2	5.9	7.2	4.7
	7.4	5.5	6.5	5.9	6.4	6.1	6.2	6.1	6.2	6.1
240	9.2	8.9	9.0	9.0	9.3	8.6	9.2	8.9	9.0	9.0
	9.2	8.7	9.2	8.9	9.1	8.9	9.3	8.1	10.4	7.8
	9.4	8.8	9.1	8.9	9.1	8.9	9.0	9.0	9.0	8.9
	9.1	9.3	9.0	9.0	9.3	8.8	9.1	8.6	9.9	8.1
	9.5	8.7	9.5	8.4	9.4	8.4	9.9	8.6	9.0	9.0
	9.1	8.3	10.4	7.3	10.0	8.6	9.2	8.8	9.3	8.8
	9.2	8.9	9.2	8.8	9.1	9.0	9.0	9.0	9.1	8.0
	9.6	8.5	9.2	9.0	9.0	8.9	9.4	8.5	9.6	8.0
	9.7	8.9	9.1	8.9	9.2	8.8	9.1	9.0	9.0	9.0
	9.3	8.8	8.7	8.8	8.7	8.8	8.7	8.5	10.1	8.5
	10.4	7.8	9.1	8.3	8.9	8.5	8.7	8.6	8.7	8.6
	8.7	8.6	8.0	7.4	10.0	8.1	8.7	8.5	9.2	8.4
250	9.3	7.8	9.2	8.3	9.3	7.8	9.0	8.6	8.8	-0.9
	7.0	8.9	6.9	6.4	6.9	5.8	7.3	5.9	7.4	6.0
	6.6	8.6	6.7	6.1	7.1	6.2	6.8	6.5	6.5	6.5
	8.8	8.8	8.8	8.3	7.8	5.4	7.2	8.5	8.8	8.5
	8.7	8.0	6.7	6.5	6.6	6.6	6.6	6.5	6.6	6.5
	7.0	5.4	7.6	6.2	6.7	6.4	6.8	6.3	7.1	5.3
	8.1	8.3	7.1	8.4	8.8	8.5	6.6	6.6	8.8	6.5
	6.9	5.7	7.7	5.7	8.9	6.4	6.8	6.3	6.7	6.1
	6.9	6.5	6.6	6.5	6.9	6.1	6.9	6.4	6.8	6.5

TABLE 114. METHODOLOGY DEVELOPMENT TEST PROGRAM, GROUP V,
RANDOM FLIGHT-BY-FLIGHT SPECTRUM LOADING TEST
COMPOSITE MISSION, TYPICAL TRANSPORT (CONT)

Test M-93: This table as shown
M-94: 1.4 factor on this table

Line	Stresses in KSI									
260	8.2	8.1	8.4	8.2	7.2	8.7	8.2	8.0	8.6	8.9
	8.7	8.8	8.8	8.9	8.7	8.5	8.4	8.1	8.5	8.8
	9.1	8.9	9.1	8.9	9.2	8.7	9.3	8.8	9.0	9.0
	9.0	8.9	9.2	8.7	9.3	8.8	9.1	9.0	9.0	8.9
	9.3	8.7	9.1	9.0	9.0	9.0	9.1	9.0	9.0	8.8
	9.7	8.4	9.3	8.9	9.0	8.9	9.5	7.9	10.1	8.6
	9.1	8.9	9.2	8.9	9.0	9.0	9.6	8.0	9.3	8.6
	9.6	8.7	9.0	8.9	9.2	8.8	9.1	9.0	9.1	8.8
	9.1	8.9	9.0	9.0	9.1	8.9	9.0	8.9	9.1	9.0
	9.1	8.7	9.6	8.5	9.2	8.9	9.1	8.8	9.1	9.0
	9.0	9.0	9.0	8.9	9.5	8.4	9.1	9.1	9.1	8.4
	9.2	8.6	8.6	8.6	8.8	8.6	8.7	8.6	8.7	8.6
270	8.7	8.6	8.8	8.3	9.0	8.5	8.7	8.4	9.0	8.6
	8.9	7.9	10.3	8.8	9.8	8.2	8.8	8.5	8.7	8.8
	8.8	8.6	8.6	8.6	8.8	8.4	8.9	8.5	8.7	8.4
	11.6	10.7	10.8	10.7	10.9	10.8	10.8	10.3	12.5	8.4
	12.7	9.8	11.3	10.3	11.1	10.7	10.8	10.7	10.8	10.8
	10.8	10.7	11.2	9.3	12.2	10.2	10.9	10.5	11.4	10.5
	11.5	9.6	11.5	10.3	11.5	9.9	11.2	10.7	11.0	10.0
	11.4	10.7	10.7	10.7	11.1	10.7	10.8	10.7	10.8	10.7
280	10.9	10.7	10.9	10.4	11.3	10.5	10.9	10.5	11.3	10.4
	11.0	10.1	12.5	8.6	12.3	10.1	11.0	10.8	10.8	10.6
	11.0	10.7	10.8	10.8	11.0	10.5	11.1	10.6	10.8	10.7
	11.3	10.0	11.2	10.6	11.3	9.8	11.7	9.9	11.9	10.1
	10.8	10.8	11.0	10.2	11.5	10.3	11.1	10.8	10.8	10.8
	10.8	10.8	10.8	10.4	12.2	9.2	11.6	10.7	10.8	10.7
	11.0	10.6	11.0	10.7	10.8	10.8	10.9	10.7	10.8	10.7
	11.4	9.2	12.2	10.3	10.9	10.6	11.1	10.4	11.5	9.1
	9.8	9.0	9.1	9.0	9.2	9.1	9.1	8.7	10.7	8.8
	10.8	8.2	9.6	8.7	9.4	9.0	9.1	9.0	9.1	9.0
	9.1	9.0	9.4	7.7	10.4	8.5	9.2	8.9	9.6	8.8
	9.5	9.0	9.0	9.0	9.0	9.0	9.0	8.8	10.2	7.2
290	10.4	8.4	9.3	8.7	9.2	8.9	9.0	9.0	9.0	9.0
	9.0	9.0	9.2	8.0	10.0	8.6	9.0	8.9	9.4	8.9
	9.4	8.2	9.4	8.8	9.4	8.4	9.2	9.0	9.1	8.5
	9.4	9.0	9.0	9.0	9.1	9.0	9.0	9.0	9.0	9.0
	11.4	10.6	10.6	10.5	10.7	10.6	10.6	10.2	12.3	8.3
	12.5	9.7	11.2	10.2	10.9	10.5	10.7	10.6	10.7	10.8
	10.6	10.6	11.0	9.2	12.0	10.0	10.7	10.4	11.2	10.4
	11.3	9.5	11.3	10.2	11.3	9.7	11.0	10.6	10.8	9.8
300	11.2	10.5	10.6	10.8	10.9	10.5	10.7	10.6	10.6	10.8
	10.7	10.6	10.7	10.3	11.1	10.4	10.7	10.4	11.1	10.2
	10.9	9.9	12.3	8.5	12.1	10.0	10.8	10.6	10.6	10.5

TABLE 114. METHODOLOGY DEVELOPMENT TEST PROGRAM, GROUP V,
RANDOM FLIGHT-BY-FLIGHT SPECTRUM LOADING TEST
COMPOSITE MISSION, TYPICAL TRANSPORT (CONT)

Test M-93: This table as shown
M-94: 1.4 factor on this table

Line	Stresses in KSI									
	10.9	10.6	10.6	10.6	10.9	10.3	10.9	10.5	10.6	10.8
	11.1	9.8	11.0	10.4	11.1	9.7	11.5	9.8	11.7	10.8
	12.9	9.1	11.5	10.6	10.8	10.7	10.8	10.6	10.8	10.7
	11.2	9.6	12.4	9.6	11.2	10.6	11.1	10.4	10.9	10.2
	11.2	10.7	10.8	10.7	11.3	10.1	11.2	10.6	10.9	10.7
	11.2	10.2	11.2	10.5	11.0	10.6	11.3	9.4	12.7	10.7
	11.5	10.5	11.0	10.6	11.0	10.6	10.9	10.7	10.8	9.1
310	11.1	10.7	10.8	10.7	11.4	10.1	11.0	10.2	12.1	9.8
	11.6	10.2	11.6	9.9	11.4	9.8	12.1	10.1	10.8	10.8
	11.0	9.8	12.8	8.5	12.3	10.1	11.2	10.4	11.2	10.4
	11.1	10.5	11.1	10.5	11.0	10.7	10.8	10.8	11.0	10.1
	11.8	9.9	11.1	10.7	10.9	10.6	11.5	9.9	11.7	9.3
	11.9	10.6	11.0	10.5	11.1	10.5	11.0	10.8	10.6	10.7
	11.0	10.5	11.0	10.6	11.1	10.2	11.4	10.4	10.9	10.8
	10.8	10.6	11.2	10.3	11.2	10.5	10.9	10.8	10.8	10.6
	9.7	8.0	9.7	8.7	9.7	8.3	9.5	9.0	9.3	8.3
320	9.6	9.0	9.0	9.0	9.3	9.0	9.1	9.0	9.1	9.0
	9.1	9.0	9.2	8.8	9.5	8.8	9.2	8.9	9.5	8.7
	9.0	9.0	9.1	8.8	9.3	8.9	9.0	8.9	9.3	8.8
	9.1	8.8	10.2	7.3	10.0	8.8	9.1	9.0	9.0	8.9
	9.1	9.0	9.0	9.0	9.1	8.8	9.2	8.9	9.0	9.0
	9.3	8.5	9.2	8.9	9.3	8.4	9.6	8.5	9.7	8.6
	9.0	9.0	9.1	8.6	9.4	8.7	9.1	9.0	9.0	9.0
	10.7	10.6	10.8	10.0	11.3	10.1	10.9	10.6	10.6	10.6
	10.7	10.6	10.6	10.3	12.0	9.1	11.4	10.5	10.6	10.6
	10.8	10.4	10.8	10.8	10.8	10.8	10.7	10.5	10.8	10.8
	11.2	9.1	12.0	10.2	10.7	10.4	11.0	10.3	11.3	9.0
	12.7	9.0	11.3	10.4	10.7	10.6	10.7	10.6	10.6	10.6
330	11.0	9.4	12.2	9.5	11.0	10.4	11.0	10.3	10.8	10.1
	11.0	10.5	10.6	10.5	11.1	10.0	11.0	10.4	10.7	10.5
	11.0	10.1	11.0	10.4	10.8	10.4	11.1	9.3	12.5	9.0
	11.3	10.3	10.8	10.5	10.8	10.5	10.7	10.8	10.7	10.4
	11.3	10.3	11.0	10.8	10.8	10.7	10.9	10.7	10.8	10.4
	11.8	9.8	11.3	10.7	10.9	10.5	11.6	9.2	12.4	10.1
	11.0	10.6	11.2	10.6	10.8	10.7	11.7	9.4	11.3	10.1
	12.0	10.3	10.9	10.6	11.4	10.2	11.0	10.7	11.0	10.4
	11.0	10.7	10.9	10.7	11.0	10.6	10.9	10.6	10.9	10.7
340	11.0	10.3	11.8	10.0	11.1	10.8	11.0	10.5	10.9	10.7
	10.9	10.7	10.9	10.5	11.6	9.9	11.0	10.9	11.0	9.9
	11.6	10.6	10.9	10.3	11.4	10.8	11.3	10.3	11.2	10.5
	10.8	10.8	10.8	10.7	10.8	10.8	10.9	10.1	11.8	10.0
	11.0	10.6	11.6	9.5	11.8	10.5	10.8	10.7	11.2	10.3
	11.1	10.7	10.8	10.8	10.9	10.5	11.2	10.3	10.9	10.7

TABLE 114. METHODOLOGY DEVELOPMENT TEST PROGRAM, GROUP V,
RANDOM FLIGHT-BY-FLIGHT SPECTRUM LOADING TEST
COMPOSITE MISSION, TYPICAL TRANSPORT (CONT)

Test M-93: This table as shown
M-94: 1.4 factor on this table

Line	Stresses in KSI									
	11.1	10.5	10.8	10.8	10.8	10.8	10.8	10.8	10.9	9.8
	12.7	9.1	11.8	10.1	12.2	9.2	11.8	10.8	10.8	9.2
	9.3	8.4	10.7	7.0	10.3	8.5	9.2	9.1	9.1	8.9
	9.3	9.0	9.1	9.1	9.3	8.8	9.4	8.9	9.1	9.0
350	9.4	8.3	9.4	8.9	9.5	8.2	9.9	8.3	10.1	8.8
	9.0	9.0	9.0	8.8	9.9	7.9	9.5	9.0	9.0	9.0
	9.1	8.9	9.1	8.7	9.0	9.0	9.0	9.0	9.4	7.8
	9.3	7.9	10.0	8.7	9.0	8.9	9.2	8.8	9.0	9.0
	10.6	7.8	9.4	8.9	9.0	9.0	9.0	9.0	9.0	9.0
	9.2	8.2	10.1	8.2	9.2	8.9	9.2	8.8	9.1	8.7
	10.9	10.5	10.6	10.6	11.2	10.0	10.8	10.0	11.9	9.3
	11.4	10.0	11.4	9.8	11.3	9.6	11.9	10.0	10.6	10.6
	10.8	9.6	12.5	8.4	12.1	10.0	11.0	10.2	11.1	10.2
360	10.9	10.3	10.9	10.3	10.8	10.5	10.6	10.8	10.8	10.0
	11.6	9.8	11.0	10.5	10.7	10.4	11.3	9.8	11.5	9.2
	11.7	10.4	10.8	10.4	10.9	10.3	10.8	10.6	10.6	10.5
	10.9	10.4	10.8	10.5	10.9	10.1	11.2	10.2	10.7	10.6
	10.7	10.4	11.0	10.1	11.1	10.3	10.8	10.6	10.6	10.5
	11.1	10.2	10.8	10.6	10.6	10.5	10.8	10.6	10.7	8.9
	7.2	8.5	8.8	8.5	8.8	8.8	8.8	8.2	7.8	6.9
	7.9	8.9	7.0	8.2	8.8	8.5	8.6	8.5	8.6	6.5
	8.6	8.5	8.9	8.5	7.8	8.1	8.7	8.4	7.0	6.3
	7.1	8.7	7.1	8.2	7.1	8.9	8.9	8.5	8.7	8.9
	7.0	8.5	8.5	8.5	8.8	8.5	8.8	8.5	8.6	8.5
	8.6	8.5	8.7	8.3	8.9	8.4	8.8	8.4	8.9	8.3
370	8.8	8.0	7.8	9.0	7.6	8.1	8.7	8.8	8.8	8.4
	8.8	8.5	8.6	8.5	8.7	8.3	8.8	8.4	8.6	8.2
	8.7	8.1	8.2	8.1	8.2	8.2	8.2	8.9	7.2	6.7
	7.4	8.5	8.5	8.9	8.4	8.1	8.2	8.1	8.2	8.1
	9.2	8.9	9.0	9.0	9.3	8.8	9.2	8.9	9.0	9.0
	9.2	8.7	9.2	8.9	9.1	8.9	9.3	8.1	10.4	7.8
	9.4	8.8	9.1	8.9	9.1	8.9	9.0	9.0	9.0	8.9
	9.1	9.0	9.0	9.0	9.3	8.6	9.1	8.6	9.9	8.1
	9.5	8.7	9.5	8.4	9.4	8.4	9.9	8.6	9.0	9.0
380	7.1	8.3	10.4	7.3	10.0	8.6	9.2	8.8	9.3	8.8
	9.2	8.9	9.2	8.8	9.1	9.0	9.0	9.0	9.1	8.6
	9.6	8.5	9.2	9.0	9.0	8.9	9.4	8.5	9.6	8.0
	9.7	8.9	9.1	8.9	9.2	8.8	9.1	9.0	9.0	9.0
	9.3	8.6	8.7	8.6	8.7	8.6	8.7	8.3	10.1	6.5
	10.4	7.8	9.1	8.3	8.9	8.5	8.7	8.6	8.7	8.6
	8.7	8.6	8.9	7.4	10.0	8.1	8.7	8.5	9.2	8.4
	9.3	7.6	9.2	8.3	9.3	7.8	9.0	8.6	8.8	8.9
	7.0	8.9	8.9	8.4	8.9	8.8	7.3	8.9	7.4	6.0

TABLE 114. METHODOLOGY DEVELOPMENT TEST PROGRAM, GROUP V,
RANDOM FLIGHT-BY-FLIGHT SPECTRUM LOADING TEST
COMPOSITE MISSION, TYPICAL TRANSPORT (CONT)

Test M-93: This table as shown
M-94: 1.4 factor on this table

Line	Stresses in KSI									
390	6.6	6.6	6.7	6.1	7.1	6.2	6.8	6.5	6.5	6.5
	6.8	6.8	6.8	6.3	7.6	5.4	7.2	6.5	6.8	6.8
	6.7	6.4	6.7	6.5	6.6	6.6	6.6	6.5	6.6	6.5
	7.0	6.4	7.6	6.2	6.7	6.4	6.8	6.3	7.1	6.3
	6.1	6.3	7.1	6.4	6.8	6.5	6.6	6.6	6.6	6.5
	6.9	6.7	7.7	5.7	6.9	6.4	6.8	6.3	6.7	6.1
	6.9	6.5	6.6	6.5	6.9	6.1	6.9	6.4	6.6	6.5
	6.2	6.1	6.4	5.2	7.2	6.7	6.2	6.0	6.6	6.9
	6.7	5.4	6.6	5.9	6.7	5.5	6.4	6.1	6.4	5.6
	9.1	8.9	9.1	8.9	9.2	8.7	9.3	8.8	9.0	9.0
400	9.0	8.9	9.2	8.7	9.3	8.8	9.1	9.0	9.0	8.9
	9.3	8.7	9.1	9.0	9.0	9.0	9.1	9.0	9.0	8.8
	9.7	8.4	9.3	8.9	9.0	8.9	9.5	7.9	10.1	8.6
	9.1	8.9	9.2	8.9	9.0	9.0	9.6	8.0	9.3	8.6
	9.8	8.7	9.0	8.9	9.4	8.6	9.1	9.0	9.1	8.8
	9.1	8.9	9.0	9.0	9.1	8.9	9.0	8.9	9.1	9.0
	9.1	8.7	9.6	8.5	9.2	8.9	9.1	8.8	9.1	9.0
	9.0	9.0	9.0	8.9	9.5	8.4	9.1	9.1	9.1	8.4
	9.2	8.6	8.6	8.6	8.8	8.6	8.7	8.6	8.7	8.6
	8.7	8.6	8.8	8.3	9.0	8.5	8.7	8.4	9.0	8.4
	8.9	7.9	10.3	6.8	9.8	8.2	8.8	8.6	8.7	8.6
	8.8	8.6	8.6	8.6	8.8	8.4	8.9	8.5	8.7	-6.4
410	11.6	10.7	10.8	10.7	10.9	10.8	10.8	10.5	12.5	8.4
	12.7	9.8	11.3	10.3	11.1	10.7	10.8	10.7	10.8	10.8
	10.8	10.7	11.2	9.3	12.2	10.2	10.9	10.5	11.4	10.5
	11.5	9.6	11.5	10.3	11.5	9.9	11.2	10.7	11.0	10.0
	11.4	10.7	10.7	10.7	11.1	10.7	10.8	10.7	10.8	10.7
	10.9	10.7	10.9	10.4	11.3	10.5	10.9	10.5	11.3	10.4
	11.0	10.1	12.5	8.6	12.3	10.1	11.0	10.8	10.8	10.6
	11.0	10.7	10.8	10.8	11.0	10.5	11.1	10.6	10.8	10.7
	11.3	10.0	11.2	10.6	11.3	9.8	11.7	9.9	11.9	10.1
420	10.8	10.8	11.0	10.2	11.5	10.3	11.1	10.8	10.8	10.8
	10.8	10.8	10.8	10.4	12.2	9.2	11.6	10.7	10.8	10.7
	11.0	10.6	11.0	10.7	10.8	10.8	10.9	10.7	10.8	10.7
	11.4	9.2	12.2	10.3	10.9	10.6	11.1	10.4	11.5	9.1
	9.8	9.0	9.1	9.0	9.2	9.1	9.1	8.7	10.7	6.8
	10.8	8.2	9.6	8.7	9.4	9.0	9.1	9.0	9.1	9.0
	9.1	9.0	9.4	7.7	10.4	8.5	9.2	8.9	9.6	8.8
	9.5	9.0	9.0	9.0	9.0	9.0	9.0	8.8	10.2	7.2
	10.4	8.4	9.3	8.7	9.2	8.9	9.0	9.0	9.0	9.0
	9.0	9.0	9.2	8.0	10.0	8.6	9.0	8.9	9.4	8.9
430	9.4	8.2	9.4	8.8	9.4	8.4	9.2	9.0	9.1	8.5
	9.4	9.0	9.0	9.0	9.1	9.0	9.0	9.0	9.0	9.0

TABLE 114. METHODOLOGY DEVELOPMENT TEST PROGRAM, GROUP V,
 RANDOM FLIGHT-BY-FLIGHT SPECTRUM LOADING TEST
 COMPOSITE MISSION, TYPICAL TRANSPORT (CONT)

Test M-93: This table as shown
 M-94: 1.4 factor on this table

Line	Stresses in. KSI									
	11.4	10.6	10.6	10.5	10.7	10.6	10.6	10.2	12.3	8.3
	12.5	9.7	11.2	10.2	10.9	10.5	10.7	10.6	10.7	10.6
	10.6	10.6	11.0	9.2	12.0	10.0	10.7	10.4	11.2	10.4
	11.3	9.5	11.3	10.2	11.3	9.7	11.0	10.6	10.6	9.8
	11.2	10.5	10.6	10.6	10.9	10.5	10.7	10.6	10.6	10.6
	10.7	10.6	10.7	10.3	11.1	10.4	10.7	10.4	11.1	10.2
	10.9	9.9	12.3	8.5	12.1	10.0	10.8	10.6	10.6	10.5
	10.9	10.6	10.6	10.6	10.9	10.3	10.9	10.5	10.6	10.5
440	11.1	9.8	11.0	10.4	11.1	9.7	11.5	9.8	11.7	-6.4
	12.9	9.1	11.5	10.6	10.8	10.7	10.8	10.8	10.8	10.7
	11.2	9.6	12.4	9.6	11.2	10.6	11.1	10.4	10.9	10.2
	11.2	10.7	10.6	10.7	11.3	10.1	11.2	10.6	10.9	10.7
	11.2	10.2	11.2	10.5	11.0	10.6	11.3	9.4	12.7	9.1
	11.5	10.5	11.0	10.6	11.0	10.6	10.9	10.7	10.8	10.6
	11.1	10.5	11.1	10.5	11.0	10.7	10.8	10.8	11.0	10.1
	11.6	10.2	11.6	9.9	11.4	9.8	12.1	10.1	10.8	10.8
	11.0	9.8	12.8	8.5	12.3	10.1	11.2	10.4	11.2	10.4
	11.1	10.7	10.8	10.7	11.4	10.1	11.0	10.2	12.1	9.5
	11.8	9.9	11.1	10.7	10.9	10.6	11.5	9.9	11.7	9.3
450	11.9	10.8	11.0	10.5	11.1	10.5	11.0	10.8	10.8	10.7
	11.0	10.5	11.0	10.6	11.1	10.2	11.4	10.4	10.9	10.8
	10.8	10.6	11.2	10.3	11.2	10.5	10.9	10.8	10.8	10.6
	9.7	8.0	9.7	8.7	9.7	8.3	9.5	9.0	9.3	8.3
	9.6	9.0	9.0	9.0	9.3	9.0	9.1	9.0	9.1	9.0
	9.1	9.0	9.2	8.8	9.5	8.8	9.2	8.9	9.5	8.7
	9.0	9.0	9.1	8.8	9.3	8.9	9.0	8.9	9.3	8.8
	9.1	8.6	10.2	7.3	10.0	8.6	9.1	9.0	9.0	8.9
	9.1	9.0	9.0	9.0	9.1	8.8	9.2	8.9	9.0	9.0
460	9.3	8.5	9.2	8.9	9.3	8.4	9.6	8.5	9.7	8.6
	9.0	9.0	9.1	8.6	9.4	8.7	9.1	9.0	9.0	9.0
	10.7	10.6	10.8	10.0	11.3	10.1	10.9	10.6	10.6	10.6
	10.7	10.6	10.6	10.3	12.0	9.1	11.4	10.5	10.6	10.6
	10.8	10.4	10.8	10.6	10.6	10.6	10.7	10.5	10.6	10.6
	11.2	9.1	12.0	10.2	10.7	10.4	11.0	10.3	11.3	9.0
	12.7	9.0	11.3	10.4	10.7	10.6	10.7	10.6	10.6	10.6
	11.0	9.4	12.2	9.5	11.0	10.4	11.0	10.3	10.8	10.1
	11.0	10.5	10.6	10.5	11.1	10.0	11.0	10.4	10.7	10.5
	11.0	10.1	11.0	10.4	10.8	10.4	11.1	9.3	12.5	9.0
470	11.3	10.3	10.4	10.5	10.8	10.5	10.7	10.6	10.7	10.4
	11.3	10.3	11.0	10.8	10.8	10.7	10.9	10.7	10.8	-6.4
	11.8	9.8	11.3	10.7	10.9	10.5	11.8	9.2	12.4	10.1
	11.0	10.6	11.2	10.6	10.8	10.7	11.7	9.4	11.3	10.1
	12.0	10.3	10.9	10.6	11.4	10.2	11.0	10.7	11.0	10.4

TABLE 114. METHODOLOGY DEVELOPMENT TEST PROGRAM, GROUP V,
RANDOM FLIGHT-BY-FLIGHT SPECTRUM LOADING TEST
COMPOSITE MISSION, TYPICAL TRANSPORT (CONT)

Test M-93: This table as shown
M-94: 1.4 factor on this table

Line	Stresses in KSI									
	11.0	10.7	10.9	10.7	11.0	10.6	10.9	10.6	10.9	10.7
	11.0	10.3	11.8	10.0	11.1	10.6	11.0	10.5	10.9	10.7
	10.9	10.7	10.9	10.5	11.6	9.9	11.0	10.9	11.0	9.9
	11.6	10.6	10.9	10.3	11.4	10.6	11.3	10.3	11.2	10.5
480	10.8	10.8	10.8	10.7	10.8	10.8	10.9	10.1	11.8	10.0
	11.0	10.6	11.6	9.5	11.8	10.5	10.8	10.7	11.2	10.3
	11.1	10.7	10.8	10.8	10.9	10.5	11.2	10.3	10.9	10.7
	11.1	10.5	10.8	10.8	10.8	10.6	10.8	10.8	10.9	9.8
	12.7	9.1	11.6	10.1	12.2	9.2	11.5	10.8	10.8	9.5
	9.3	8.4	10.7	7.0	10.5	8.5	9.2	9.1	9.1	8.9
	9.3	9.0	9.1	9.1	9.3	8.8	9.4	8.9	9.1	9.0
	9.6	8.3	9.4	8.9	9.5	8.2	9.9	8.3	10.1	8.5
	9.0	9.0	9.0	8.8	9.9	7.9	9.5	9.0	9.0	9.0
	9.1	8.9	9.1	9.0	9.0	9.0	9.0	9.0	9.0	9.0
	9.3	7.9	10.0	8.7	9.0	8.9	9.2	8.8	9.4	7.8
	10.6	7.8	9.4	8.9	9.0	9.0	9.0	9.0	9.0	9.0
490	9.2	8.2	10.1	8.2	9.2	8.9	9.2	8.8	9.1	8.7
	10.9	10.5	10.6	10.6	11.2	10.0	10.8	10.0	11.9	9.3
	11.4	10.0	11.4	9.8	11.3	9.6	11.9	10.0	10.6	10.6
	10.8	9.8	12.5	8.4	12.1	10.0	11.0	10.2	11.1	10.2
	10.9	10.3	10.9	10.3	10.8	10.5	10.6	10.6	10.8	10.0
	11.6	9.8	11.0	10.5	10.7	10.4	11.3	9.8	11.5	9.2
	11.7	10.4	10.8	10.4	10.9	10.3	10.8	10.6	10.6	10.5
	10.9	10.4	10.8	10.5	10.9	10.1	11.2	10.2	10.7	10.6
	10.7	10.4	11.0	10.1	11.1	10.3	10.8	10.6	10.6	10.5
500	11.1	10.2	10.8	10.8	10.8	10.5	10.8	10.6	10.7	8.9
	7.2	6.5	6.6	6.5	6.6	6.6	6.6	6.2	7.8	4.9
	7.9	5.9	7.0	6.2	6.8	6.5	6.6	6.5	6.6	6.5
	6.6	6.5	6.9	5.5	7.6	6.1	6.7	6.4	7.0	6.3
	7.1	5.7	7.1	6.2	7.1	5.9	6.9	6.5	6.7	5.9
	7.0	6.5	6.5	6.5	6.8	6.5	6.6	6.5	6.6	6.5
	6.8	6.5	6.7	6.3	6.9	6.4	6.6	6.4	6.9	6.3
	6.8	6.0	7.8	5.0	7.6	6.1	6.7	6.6	6.6	6.4
	6.8	6.5	6.6	6.5	6.7	6.3	6.8	6.4	6.6	6.5
510	6.7	6.1	6.2	6.1	6.2	6.2	6.2	5.9	7.2	4.7
	7.4	5.5	6.5	5.9	6.4	6.1	6.2	6.1	6.2	6.1
	9.2	8.9	9.0	9.0	9.3	8.6	9.2	8.9	9.0	9.0
	9.2	8.7	9.2	8.9	9.1	8.9	9.3	8.1	10.4	7.8
	9.4	8.8	9.1	8.9	9.1	8.9	9.0	9.0	9.0	8.9
	9.1	9.0	9.0	9.0	9.3	8.6	9.1	8.6	9.9	8.1
	9.5	8.7	9.5	8.4	9.4	8.4	9.9	8.6	9.0	9.0
	9.1	8.3	10.4	7.3	10.0	8.6	9.2	8.8	9.3	8.8
	9.2	8.9	9.2	8.8	9.1	9.0	9.0	9.0	9.1	8.6

TABLE 114. METHODOLOGY DEVELOPMENT TEST PROGRAM, GROUP V,
RANDOM FLIGHT-BY-FLIGHT SPECTRUM LOADING TEST
COMPOSITE MISSION, TYPICAL TRANSPORT (CONCL)

Test M-93: This table as shown

M-94: 1.4 factor on this table

Line	Stresses in KSI									
	9.6	8.5	9.2	9.0	9.0	8.9	9.4	8.5	9.6	8.0
	9.7	8.9	9.1	8.9	9.2	8.8	9.1	9.0	9.0	9.0
	9.3	8.6	8.7	8.6	8.7	8.6	8.7	8.3	10.1	6.5
520	10.4	7.8	9.1	8.3	8.9	8.5	8.7	8.6	8.7	8.6
	8.7	8.6	8.9	7.4	10.0	8.1	8.7	8.5	9.2	8.4
	9.3	7.6	9.2	8.3	9.3	7.8	9.0	8.6	8.8	-8.9
	7.0	5.9	6.9	6.4	6.9	5.8	7.3	5.9	7.4	6.0
	8.8	8.6	8.7	8.1	7.1	8.2	8.8	8.5	8.5	8.5
	8.6	8.6	8.6	8.3	7.6	5.4	7.2	6.5	8.6	6.5
	6.7	6.4	6.7	6.5	6.6	6.6	6.6	6.5	6.6	6.5
	7.0	5.4	7.6	6.2	6.7	6.4	6.8	6.3	7.1	5.3
	8.1	5.3	7.1	6.4	6.6	6.5	6.6	6.6	6.6	6.5
	6.9	5.7	7.7	5.7	6.9	6.4	6.8	6.3	6.7	6.1
530	8.9	8.5	8.6	8.5	8.9	8.1	6.9	8.4	8.6	6.5
	6.2	6.1	6.4	5.2	7.2	5.7	6.2	6.0	6.6	5.9
	6.7	5.4	6.6	5.9	6.7	5.5	6.4	6.1	6.4	5.6
	9.1	8.9	9.1	8.9	9.2	8.7	9.3	8.8	9.0	9.0
	9.0	8.9	9.2	8.7	9.3	8.8	9.1	9.0	9.0	8.9
	9.3	8.7	9.1	9.0	9.0	9.0	9.1	9.0	9.0	8.2
	9.7	8.4	9.3	8.9	9.0	8.9	9.5	7.9	10.1	8.5
	9.1	8.9	9.2	8.9	9.0	9.0	9.6	8.0	9.3	8.6
	9.8	8.7	9.0	8.9	9.4	8.6	9.1	9.0	9.1	8.8
540	9.1	8.9	9.0	9.0	9.1	8.9	9.0	8.9	9.1	9.0
	9.1	8.7	9.6	8.5	9.2	8.9	9.1	8.8	9.1	9.0
	9.0	9.0	9.0	8.9	9.5	8.4	9.1	9.1	9.1	8.4
	9.2	8.6	8.8	8.6	8.8	8.6	8.7	8.6	8.7	8.6
	8.7	8.6	8.8	8.3	9.0	8.5	8.7	8.4	9.0	8.4
	8.9	7.9	10.3	6.8	9.8	8.2	8.8	8.6	8.7	-11.5
	11.9	8.6	9.5	8.5	10.2	9.4	9.6	7.5	13.0	5.0
	13.2	6.6	11.4	7.4	10.9	8.4	9.9	8.7	9.9	8.9
	9.5	6.8	7.6	6.8	8.2	7.5	7.7	5.9	10.4	4.0
550	9.5	8.9	9.1	8.7	9.4	8.9	9.3	8.7	9.2	8.9
	9.0	9.0	9.0	9.0	9.0	9.0	9.1	8.6	9.7	8.5
	9.1	8.9	9.5	8.2	9.6	8.9	9.0	9.0	9.2	8.7
	9.1	9.0	9.0	9.0	9.0	8.9	9.2	8.8	9.1	8.4
	9.2	8.9	9.0	9.0	9.0	8.9	9.0	9.0	9.0	8.4
	10.4	7.8	9.5	8.6	9.9	7.9	9.4	9.0	9.0	8.2
	11.2	7.2	9.4	8.8	9.4	8.9	9.1	8.5	9.3	9.0
	9.0	8.9	9.6	7.6	10.7	7.6	9.7	8.7	9.0	8.6
	9.8	8.5	9.2	8.9	9.1	9.0	9.0	8.8	—	—
	12.8	9.5	10.4	9.4	11.2	10.3	10.6	8.6	13.8	6.1
	14.0	7.6	12.3	8.4	11.9	9.3	10.9	9.6	10.8	9.8

TABLE 115. DATA TABULATION FOR TEST M-93

SPECIMEN NO.: M-93 RANDOM SPECTRUM, TYPICAL TRANSPORT, MAX SPECTRUM STRESS = 14 KSI

CCT SPECIMEN E = 0.250 IN. b = 6.000 IN. AN = 0.0 IM, TEST FREQ = 6.00 HZ.
 PMIN = PMAX =

ENVIRONMENT CONDITION: AMBIENT AIR

NU.	CYCLES	A (MEASURED)	A (REGRESSION)	MULT. CORR. COEFF	K-MAX	DELTA K	DA/DN
1	0.	0.500	0.500	0.999865	8.31	13.59	1.244E-07
2	173380.	0.550	0.550	0.998907	8.71	14.26	1.788E-07
3	198193.	0.560	0.564	0.990058	8.83	14.44	1.634E-07
4	281790.	0.590	0.592	0.989765	9.05	14.80	1.579E-07
5	335088.	0.620	0.608	0.988674	9.18	15.01	1.657E-07
6	491969.	0.655	0.657	0.990822	9.55	15.67	1.588E-07
7	558000.	0.670	0.675	0.993863	9.68	15.83	1.625E-07
8	682690.	0.720	0.715	0.999036	9.98	16.32	1.854E-07
9	775550.	0.750	0.752	0.999031	10.24	16.75	2.134E-07
10	860629.	0.790	0.791	0.999175	10.51	17.19	2.375E-07
11	980335.	0.850	0.850	0.998301	10.92	17.86	2.622E-07
12	1037066.	0.885	0.883	0.999143	11.13	18.21	2.712E-07
13	1108137.	0.925	0.922	0.998565	11.39	18.64	2.703E-07
14	1146757.	0.940	0.941	0.992619	11.52	18.84	2.993E-07
15	1208901.	0.980	0.979	0.991254	11.76	19.24	3.074E-07
16	1266536.	0.995	1.002	0.988626	11.91	19.48	3.165E-07
17	1313740.	1.060	1.048	0.986884	12.19	19.95	3.241E-07
18	1359024.	1.075	1.076	0.979614	12.37	20.24	2.508E-07

PLOTRATE CRACK GROWTH DATA

N-93 RANDOM SPECTRUM, TYPICAL TRANSPORT, MAX SPECTRUM STRESS = 14 KSI

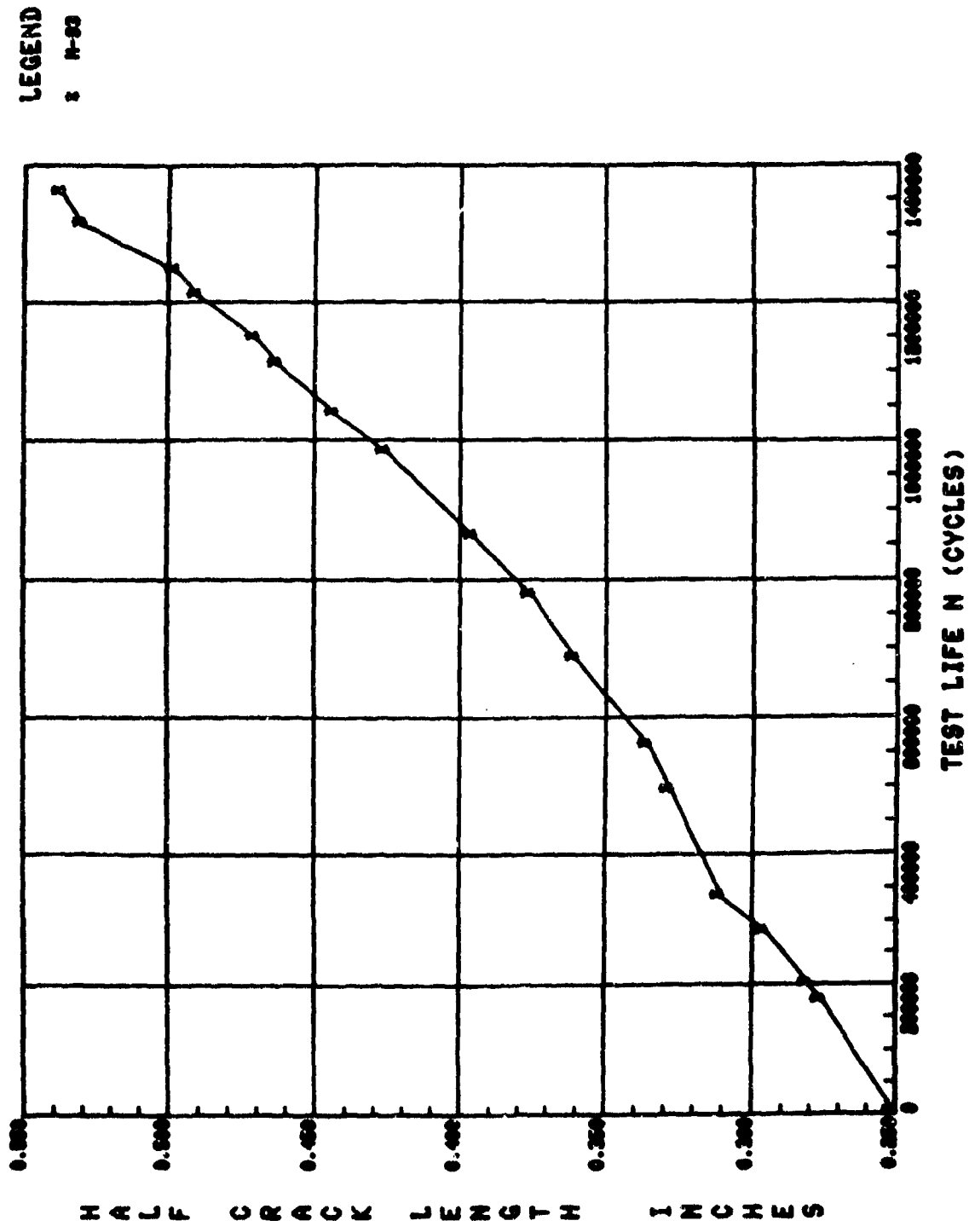

Figure 111. Crack growth curve for test M-93.

TABLE 116. DATA TABULATION FOR TEST M-94

SPECIMEN NO.: M-94 RANDOM SPECTRUM, TYPICAL TRANSPORT, MAX SPECTRUM STRESS = 19.6 KSI

CCT SPECIMEN B = 0.250 IN. b = 6.000 IN. AN = 0.0 IN.
 PRIM = TEST FREQ = 6.00 HZ.

ENVIRONMENT CONDITION: AMBIENT AIR

NO.	CYCLES	A (MEASURED)	A (REGRESSION)	MULT. CORR. COEFF	K-MAX	DELTA K	DA/DM
1	0.	0.515	0.516	0.996742	11.81	21.98	4.437F-07
2	52467.	0.565	0.556	0.996031	12.27	22.84	3.730F-07
3	122275.	0.605	0.603	0.992595	12.80	23.82	3.877E-07
4	186640.	0.650	0.656	0.992480	13.36	24.85	4.424F-07
5	244690.	0.700	0.708	0.997491	13.89	25.85	5.586F-07
6	279000.	0.750	0.749	0.998112	14.31	26.63	7.001F-07

M-94 **PLORATE CRACK GROWTH DATA**
TRANSPORT, RANDOM SPECTRUM, MAX STRESS = 19.6 KSI

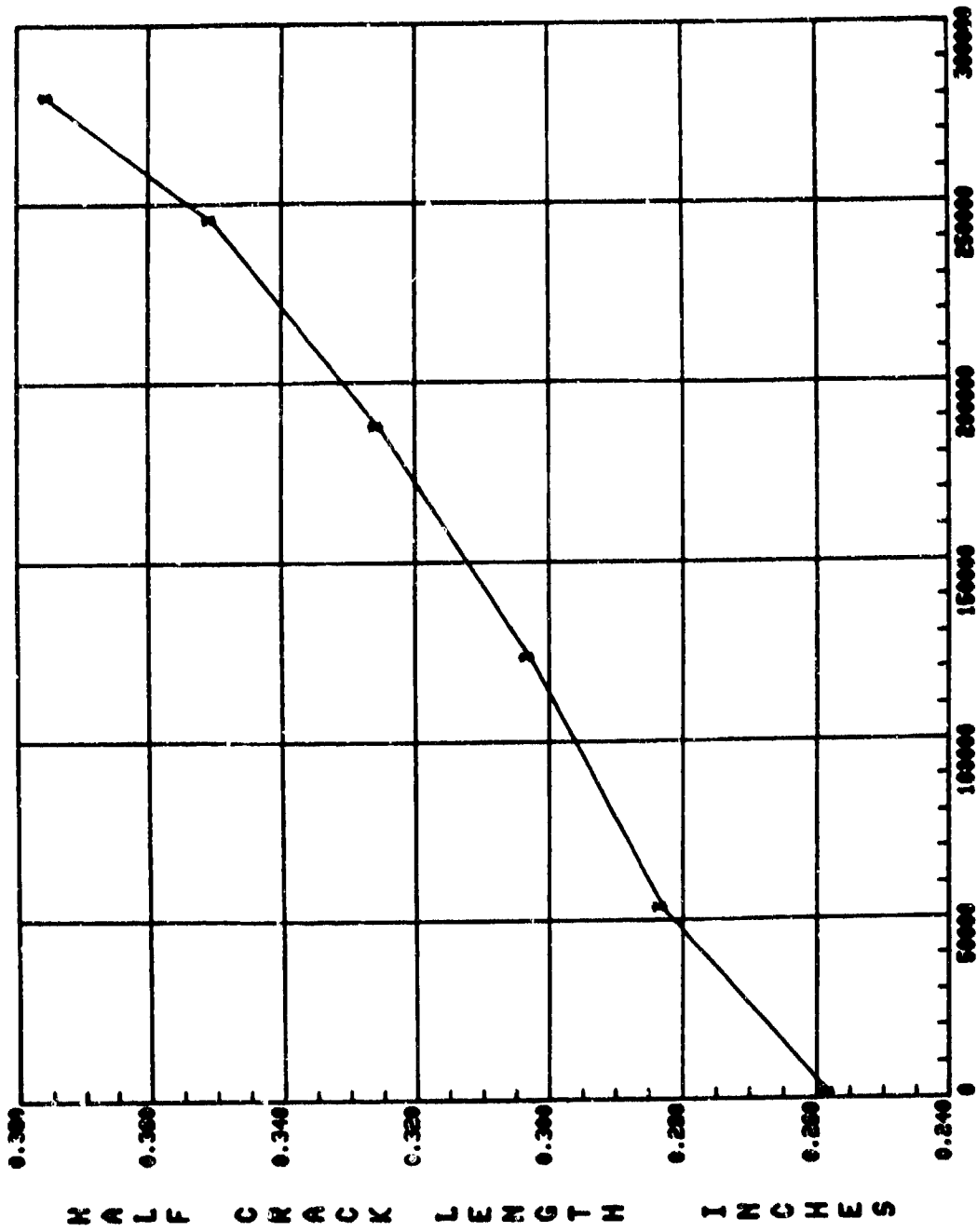

TEST LIFE N (CYCLES)

Figure 112. Crack growth curve for test M-94.