

AD-A012 164

INFANTRY APPLICATIONS OF THE NIGHT VISION GOGGLES, AN/PVS-5.
(A PILOT STUDY-SEPTEMBER 1974)

Human Engineering Laboratory
Aberdeen Proving Ground, Maryland

February 1975

DISTRIBUTED BY:

NTIS

National Technical Information Service
U. S. DEPARTMENT OF COMMERCE

203079

AD

ADA012164

U. S. ARMY

Technical Note 3-75

INFANTRY APPLICATIONS OF THE NIGHT VISION GOGGLES,
AN/PVS-5

(A PILOT STUDY - SEPTEMBER 1974)

Personnel Systems Team
Night Vision Systems Team
Systems Performance and Concept Directorate

February 1975

HUMAN ENGINEERING LABORATORY

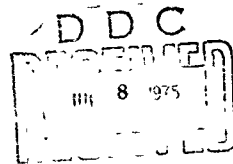

ABERDEEN PROVING GROUND, MARYLAND

Reproduced by
NATIONAL TECHNICAL
INFORMATION SERVICE
US Department of Commerce
Springfield, VA 22151

Approved for public release;
distribution unlimited.

REPORT DOCUMENTATION PAGE		READ INSTRUCTIONS BEFORE COMPLETING FORM
1. REPORT NUMBER	2. GOVT ACCESSION NO.	3. RECIPIENT'S CATALOG NUMBER
Technical Note 3-75		
4. TITLE (and Subtitle) Infantry Applications of the Night Vision Goggles AN/PVS-5 (A Pilot Study - September 1974)		5. TYPE OF REPORT & PERIOD COVERED Final
		6. PERFORMING ORG. REPORT NUMBER
7. AUTHOR(s) Personnel Systems Team Night Vision Systems Team Systems Performance and Concept Directorate		8. CONTRACT OR GRANT NUMBER(s)
9. PERFORMING ORGANIZATION NAME AND ADDRESS US Army Human Engineering Laboratory Bldg. 520 Aberdeen Proving Ground, MD 21005		10. PROGRAM ELEMENT, PROJECT, TASK AREA & WORK UNIT NUMBERS
11. CONTROLLING OFFICE NAME AND ADDRESS		12. REPORT DATE February 1975
		13. NUMBER OF PAGES 78
14. MONITORING AGENCY NAME & ADDRESS (if different from Controlling Office)		15. SECURITY CLASS. (of this report) Unclassified
		15a. DECLASSIFICATION/DOWNGRADING SCHEDULE
16. DISTRIBUTION STATEMENT (of this Report) Approved for public release; distribution unlimited.		
17. DISTRIBUTION STATEMENT (of the abstract entered in Block 20, if different from Report)		
18. SUPPLEMENTARY NOTES		
19. KEY WORDS (Continue on reverse side if necessary and identify by block number) AN/PVS-5 Night Vision Goggles Mobility Compatibility Helmet/Goggle Interaction Human Factors Engineering		
20. ABSTRACT (Continue on reverse side if necessary and identify by block number) Mobility and compatibility tests of the AN/PVS-5 night vision goggles for infantry applications were conducted during August 1974 at Aberdeen Proving Ground, MD. Daylight observations of static relationships between the goggles and selected clothing/equipment ensembles were made. In addition, field observations, attitudinal measures and obstacle times are reported for 12 soldiers performing with the goggles at night, in combat ensemble, over a 500-meter assault course. Recommendations for improvement of goggle design and further research are provided.		

INFANTRY APPLICATIONS OF THE NIGHT VISION GOGGLES,
AN/PVS-5

(A PILOT STUDY - SEPTEMBER 1974)

Personnel Systems Team
Night Vision Systems Team
Systems Performance and Concept Directorate

February 1975

APPROVED:

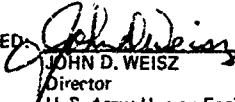
JOHN D. WEISZ
Director

U. S. Army Human Engineering Laboratory

U. S. ARMY HUMAN ENGINEERING LABORATORY
Aberdeen Proving Ground, Maryland

CONTENTS

INTRODUCTION	3
System Description	3
Subjects	3
MOBILITY TEST	8
Objective	8
Method	8
RESULTS AND DISCUSSION	10
COMPATIBILITY TEST	30
Objective	30
Method	30
DISCUSSION	33
Retention Harness	34
Facial Contact Area	34
Control Operation, Location and Actuation	34
Weight	35
NVG/M1 Helmet	35
CONCLUSIONS	35
RECOMMENDATIONS	36
Design	36
General	36
REFERENCES	38
APPENDIXES	
A. HEL Mobility/Portability Course Description	39
B. Night Vision Goggles Rating Form	65
C. Operator Debriefing Form	67

TABLES

1. Test Ensemble, Combat Assault	7
2. Anthropometric Statistical Values	7
3. Experimental Design	9
4. ANOVA Goggles Versus No Goggles Obstacle Times - Independent (Matched) Groups	11
5. Mean Improvement Times for Obstacles (Secs), First Night Minus Second Night	12
6. ANOVA Goggles Versus No Goggles Obstacle Times - Single Group Repeated Measures	26
7. Mean Obstacle Time (Secs), Repeated Measures Design, Goggles Versus No Goggles	29
8. Obstacle Course Total Times (Minutes)	35

FIGURES

1. Night Vision Goggles, AN/PVS-5	4
2. Assault Configuration, Hot-Wet/Hot-Dry Environment (Front View)	5
3. Assault Configuration, Hot-Wet/Hot-Dry Environment (Side View)	6
4. Total Course Time	13
5. Obstacle Times - Logs	14
6. Obstacle Times - Up and Down	15
7. Obstacle Times - Low Wall	16
8. Obstacle Times - High Fence	17
9. Obstacle Times - High Crawl	18
10. Obstacle Times - Low Crawl	19
11. Obstacle Times - Down and Out	20
12. Obstacle Times - High Hurdles	21
13. Obstacle Times - Tubes	22
14. Obstacle Times - High Wall	23
15. Obstacle Times - House	24
16. Obstacle Times - Zig-zag	25
17. Obstacle Performance on Second Night (Matched Groups)	27
18. Obstacle Performance on Third Versus First Night (Same Group)	28
19. Semantic Differential: Display, Controls, Safety Clusters	31
20. Semantic Differential: Fit and Comfort Clusters	32

INFANTRY APPLICATIONS OF THE NIGHT VISION GOGGLES, AN/PVS-5

(A PILOT STUDY -- SEPTEMBER 1974)

INTRODUCTION

There is a question as to the best way to introduce the AN/PVS-5 to the infantry. The question involves new equipment training, basis of issue (BOI), and tactical applications, among other aspects.

During August 1974 the Night Vision Laboratory furnished two sets of night vision goggles (NVG), complete with face masks and batteries, to the U. S. Army Human Engineering Laboratory (HEL) for use in infantry field tests. Troops from the 82d Airborne Division and 58th Infantry Division (M) were available at Aberdeen Proving Ground and participated in the tests of personnel equipment (2). These troops were very familiar with the HEL obstacle course and cross-country course from their repeated daytime runs with various equipment ensembles. These daytime runs also provided reliable standards for comparison of individual performances. A test plan was developed to take advantage of the known performance capabilities of the troops in a pilot test of the application of NVGs in various infantry tasks.

The test can be conveniently divided into two areas: mobility and compatibility. Compatibility was further subdivided into static and dynamic assessments. These two major divisions will be discussed separately although they are overlapping in nature; i.e., observations on subjects (Ss) maneuvering during the mobility segment would verify compatibility interactions determined during the static assessment and/or lead to the discovery of additional problems.

System Description

The night vision goggles, AN/PVS-5, are a head-mounted, binocular, image-intensifying viewing system (Fig. 1). The goggles: weight with head-strap and universal face mask is 0.86 kg (1.9 pounds). The field-of-view is 40 degrees and they can be focused from 10 inches to infinity. The goggles are equipped with an infrared emitting diode system. Under all test conditions, the goggles were worn in conjunction with a hot-wet, hot-dry clothing ensemble with the soldier equipped for a combat assault (Figs. 2 and 3). Table 1 lists the entire ensemble.

Subjects

Twenty-three infantrymen, MOS 11B, (12 men from the 82d Airborne Division, Fort Bragg, NC, and 11 men from the 58th Infantry (M), 197th Br., Fort Benning, GA) served as test subjects. The average age of this group was 21.2 years (minimum 19, maximum 32 years) and grades ranged from E2 to E5. Ten members of this group had served in Southeast Asia (SEA) as infantrymen. Table 2 presents selected anthropometric statistical values of the group. (Note: The NCOIC was not included as an S.)



Figure 1. Night Vision Goggles AN/PVS-5



Figure 2. Assault Configuration
Hot-Wet/Hot-Dry Environment (Front View)



Figure 3. Assault Configuration
Hot-Wet/Hot-Dry Environment (Side View)

TABLE 1
Test Ensemble, Combat Assault

<u>ITEM</u>	<u>WEIGHT</u>	
	<u>LB</u>	<u>KG</u>
1. M16 Rifle w/30-round magazine and sling	9.22	4.18
2. 180 rounds ammo w/six 30-round magazines	6.06	2.75
3. Pouch, ammo, 2 ea (for three 30-rd mag ea)	.76	0.34
4. Canteen w/carrier (full)	3.60	1.63
5. Belt, pistol, w/suspenders	1.36	0.62
6. Tool, entrenching, w/carrier	2.50	1.13
7. Pouch, first aid, w/packet	.16	0.07
8. Bayonet-knife, M7, w/scabbard, M8A1	1.30	0.59
9. Grenades, M26 (2 ea)	2.00	0.91
10. Helmet, steel, M1, w/ballistic nylon liner	3.25	1.47
11. Fatigue clothing w/underwear	2.86	1.30
12. Boots, combat, leather	3.36	1.52
13. Night Vision Goggles (AN/PVS-5)	<u>1.90</u>	<u>0.86</u>
TOTAL WEIGHT	38.33	17.37

TABLE 2
Anthropometric Statistical Values - Subjects

	<u>N</u>	<u>MEAN</u>	<u>SD</u>	<u>MIN</u>	<u>MAX</u>
1. Weight (kg)	23	70.09	2.49	66.75	74.50
2. Height (cm)	23	168.00	23.13	133.00	228.00

MOBILITY TEST

Objective

The objective of this portion of the study was to determine the effects of wearing night vision goggles on the ability of infantrymen to negotiate obstacles and marches comprising the HEL mobility/portability course. In addition to collecting objective performance times, it was desired to obtain quantified subjective evaluations of the goggles for such categories as fit, comfort and operational suitability.

Method

Subjects

From the 23 subjects previously described, 12 infantrymen were selected for this portion of the experiment (six from the 82d Airborne Division and six from the 58th Infantry (M), 197th Br.). Chosen on the basis of similar daytime obstacle course performance scores, the 12 subjects were divided into two matched groups and their photopic static acuities obtained in daylight using the Armed Forces Visual Acuity Test. Immediate analysis of these measurements indicated no significant differences in visual acuity between the two groups. Far acuities ranged from 20/10 to 20/30 with a median of 20/10 to 20/15 in both groups. Near acuities ranged from 14/7 to 14/14 with a median of 14/10.5. Physically, subjects were all in good health with no medical profiles on record.

Apparatus

All tests were conducted using the HEL mobility/portability obstacle course. Basically, the course consists of three portions: (1) a cross-country portion which is a trail 1,219 meters long, and has fallen trees, heavy brush, a two-log bridge, thick woods, and a stream to ford and is marked on both sides with white engineer tape; (2) a road-march portion consisting of a marked walk on dirt and hardtop roads 2,255 meters long which extends from the cross-country section to the obstacle course proper; and (3) the 500-meter obstacle course made up of 12 obstacles to be negotiated by each subject. Two lanes are provided so that two subjects can run simultaneously in a competitive atmosphere if desired. Appendix A provides a complete picture of the overall course layout and of each obstacle.

Each of the 12 major obstacles, in each lane, is equipped with electronic pressure pads to record start and stop times for each individual. These times are transmitted to a central data collection console where they are digitized and recorded via punched paper tape and teletype printout. Tapes can then be analyzed by computer to produce permanent records of total course time and times for each obstacle, for each subject.

The purpose of the cross-country course is twofold. First, it is intended to fatigue an individual. Second, by allowing him to wear the test equipment or clothing while moving at a self-determined pace through varying foliage and terrain, this segment provides the individual with a greatly expanded background usage upon which to base his subjective evaluations. The road-march portion of the course serves a similar function, but the emphasis is on acquiring evaluations based upon a more operationally standardized, sustained interaction with the test equipment or clothing. The obstacle course itself is designed to subject each man to those kinds of circumstances likely to be encountered across a variety of fighting situations and to measure his ability to perform infantry-relevant tasks such as running, jumping, swinging, balancing, vaulting and crawling. Evaluations here are based on relatively short-term, high-energy expenditure performances in which body/equipment interactions are apt to be more pronounced.

Additional instrumentation for the present study included two night vision sights (AN/PVS-4() and AN/PVS-5) used by monitors to help identify those incompatibilities occurring as a result of equipment (goggle)/obstacle interactions.

Procedure

The two matched groups of subjects were assigned to cells in the experimental design shown in Table 3. This design was chosen for a number of reasons. First, the Night 1 versus Night 2 comparison between groups provides an estimate of the magnitude and direction of performance change attributable to the wearing of night vision goggles. Second, a within group comparison of Night 1 and Night 2 is available to give a measure of the relative amount of learning or adaptation (performance improvement over time) which may have occurred within each group. The cross-over portion of the design for Nights 2 and 3 was incorporated to provide both a partial replication of the Night 1 versus Night 2 comparison and a measure of transfer of training effects. Since transfer effects are a joint function of equipment complexity and length and type pre-performance training, when coupled with learning data they furnish a more detailed description of the NVG operator interaction upon which to base instructional and/or design modifications. In addition, use of the cross-over design increases the sensitivity of statistical analysis of the goggle-no goggle effects by doubling the sample size available for the comparison; i.e., by the end of Night 3, all 12 subjects have performed with and without goggles - each subject serving as his own control. In order to control for experience, this 12-subject analysis is based on the Night 1 scores for subjects 1-6 and Night 3 scores for subjects 7-12.

TABLE 3
Experimental Design

Twilight Qualification Run		Night 1	Night 2	Night 3
All Subjects (1-12)	Goggles Full Combat Assault Load	Subjects Nos. 1-6 X Group	Subjects Nos. 1-6 X Group	Subjects Nos. 7-12 C Group
No Goggles, Full Combat Assault Load	No Goggles Full Combat Assault Load	Subjects Nos. 7-12 C Group	Subjects Nos. 7-12 C Group	Subjects Nos. 1-6 X Group

On Night 1, following the plan in Table 3, all subjects were given a familiarity walk through the course (as a group) and then sent in pairs on a night qualification run on the obstacle portion of the course using unaided vision only. Upon completion of these runs, the NVG group (subjects 1-6) received 1 hour of group introduction to the system followed by individual, "hands on" instruction on fit, adjustment and control. Alternating pairs of subjects from each group were then sent out to run the entire mobility/portability course. As soon as each NVG pair completed the final obstacle portion, they were asked for their subjective evaluations of the goggles with regard to such factors as fit, comfort and operational suitability.

Night 2 was a replication of Night 1 with two exceptions: there were no preliminary qualifying runs and the order in which subject pairs were sent onto the course was rotated.

On Night 3 the subjects changed conditions; all other procedures involving measurement, NVG instruction and debriefing interviews were identical to those used on Nights 1 and 2.

Weather observations and measurements of ambient illumination levels were made hourly each night during all performance trials.

Quantitative measures consisted of time scores, elapsed times on the woods path and on the entire obstacle course, as well as elapsed times on 12 individual obstacle sections. The time measures obtained on the cross-country path were too imprecise for statistical handling, so only obstacle course elapsed-times are reported below. Subjective attitude measures included the semantic differential and the debriefing form, a patterned interview (Appendixes B and C). These were intended to provide a basis of reference for attitudes toward the system and to elicit critiques of the NVG in these applications. The semantic differential was devised as a measure of the connotative meaning of a concept. The test consists of a set of polar opposites on a seven-point scale, ranging from one extreme through neutrality or indifference to an opposite extreme of attitude or feeling. The polar concepts are typically presented as a list in a more or less random order and directional arrangement. After a sufficient number of S responses have been obtained, the ratings can be subjected to correlational analyses. The debriefing form was designed to elicit evaluations on a wide range of night vision systems from users, but was abbreviated for this application to night vision goggles.

RESULTS AND DISCUSSION

Since the subjects assigned to the experimental group (Group X with night vision goggles) and the control group (Group C with unaided vision) were originally matched on the basis of daytime performance scores, an analysis of variance was first performed on the two groups' night qualification runs. This analysis revealed no significant differences between groups for any of the obstacles and thus substantiated the validity of the matching procedure with regard to nighttime performance.

Next, an overall analysis of variance was performed on performance times for the first and second nights to determine the effects of goggles versus no goggles, replications, and type of obstacle. The results of this analysis appear in Table 4. There were no significant differences between the performance of the X and C groups which could be attributed solely to the presence or absence of night vision goggles. The significant main effect for replications indicates that both groups were able to improve their performance during a second exposure to the course. Further, the significant replications x obstacle interaction shows that the learning or improvement in performance for both groups tended to vary according to the type of obstacle. This differential change in performance can be seen in Table 5 which lists mean improvement times for each group. (Note that although improvement for total course time is virtually identical for the two groups, the C group improved more in the logs, up and down and low wall events, while the X group improved most in the down and out, high hurdles, tubes, house and zig-zag events. The groups were approximately equal in improvement for the high fence, high crawl, low crawl and high wall obstacles.)

Figures 4 through 16 show the total course time and performances of the two groups across the 12 metered obstacles. Both X and C groups were unaided during the qualifying trial. (Note the shifts on the third night's performance when X and C groups were exchanged.)

ADDENDUM

The Ambience (This information should have appeared following paragraph 2, page 10.)

The weather conditions and ambient light levels for each of the three test nights are listed in Table 9. Illumination measurements were taken using vertically oriented cosine heads which had been photoptically corrected. During the tests, occasional light interference from nearby roadways and aviation beacons was experienced.

TABLE 3a
Ambient Light and Weather Conditions

Test Night	Time	Illumination (Foot Candles)	Weather
1	2100	4.4×10^{-4}	Complete overcast, no haze, humid, little wind.
	2200	4.4×10^{-4}	
	2300	3.1×10^{-4}	
2	2100	1.5×10^{-3}	Partial overcast, light ground haze, humid, no wind.
	2200	1.2×10^{-3}	
	2300	1.2×10^{-3}	
3	2100	1.4×10^{-3}	Complete overcast, light drizzle, slight wind.
	2200	1.1×10^{-3}	
	2300	1.2×10^{-3}	

TABLE 4

ANOVA Goggles Versus No Goggles Obstacle Times
Independent (Matched) Groups

SOURCE	df	SS	MC	F	P
<u>Between Subjects</u>	<u>11</u>	<u>4737.9</u>			
A (Goggles/No Goggles)	1	704.2	704.2	1.746	NS
Subject w/Groups (Error A)	10	4033.7	403.4		
<u>Within Subjects</u>	<u>300</u>	<u>840392.6</u>			
B (Replications)	1	722.3	722.3	17.298	P<.01
AB (Goggles X Replications)	1	16.3	16.3	.390	NS
B X Subject w/Groups (Error B)	10	417.6	41.8		
C (Obstacle Type)	12	812266.2	67688.9	447.413	P<.01
AC (Goggles X Obstacles)	12	3180.4	265.0	1.752	NS
C X Subject w/Groups (Error C)	120	18154.7	151.3		
BC (Replications X Obstacle Type)	12	3039.5	253.3	12.237	P<.01
ABC (Goggles X Replications X Obstacle Type)	12	111.8	9.3	.450	NS
PC X Subject w/Groups (Error BC)	120	2483.9	20.7		

NS - Not Significant

TABLE 5

Mean Improvement Times for Obstacles (Secs), First Night Minus Second Night^a

	OBSTACLE												
	Total Time	Logs	Up & Down	Low Wall	High Fence	High Crawl	Low Crawl	Down & Out	High Hurdles	Tubes	High Wall	House	Zig-Zag
Control	20.2	1.20	0.71	1.34	0.62	3.62	5.43	0.35	-0.64	-0.05	0.64	0.14	0.08
Night Vision Goggles	20.7	-0.92	0.38	0.66	0.54	3.00	5.86	1.51	3.33	1.39	0.72	0.68	0.44

^aA minus sign indicates performance decrement; i.e., second night score worse than first night.

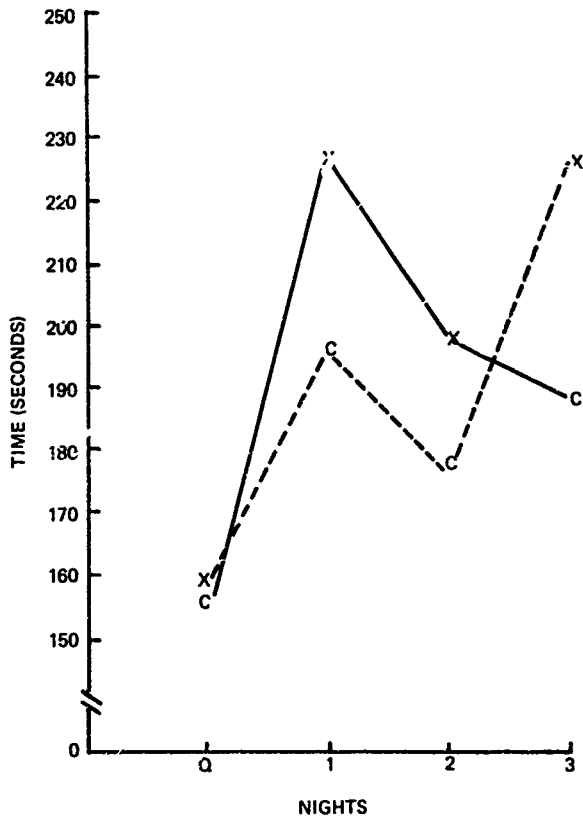

Figure 4. Total Course Time

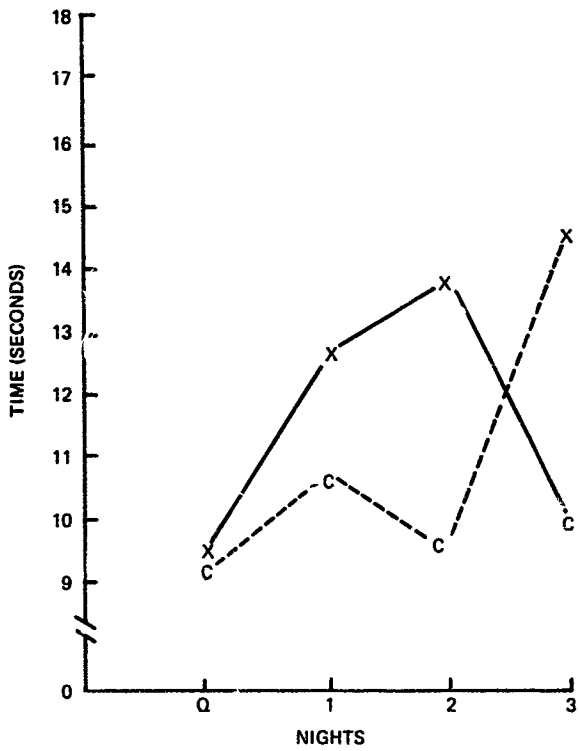

Figure 5. Obstacle Times - Logs

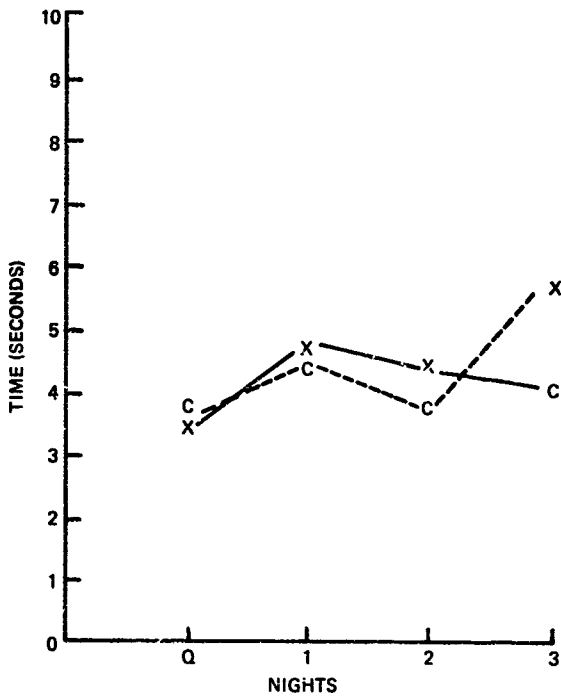

Figure 6. Obstacle Times - Up and Down

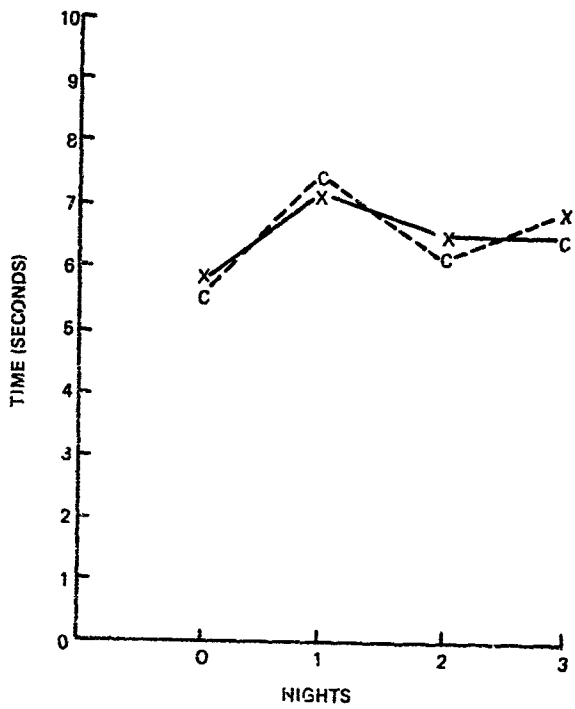

Figure 7. Obstacle Times - Low Wall

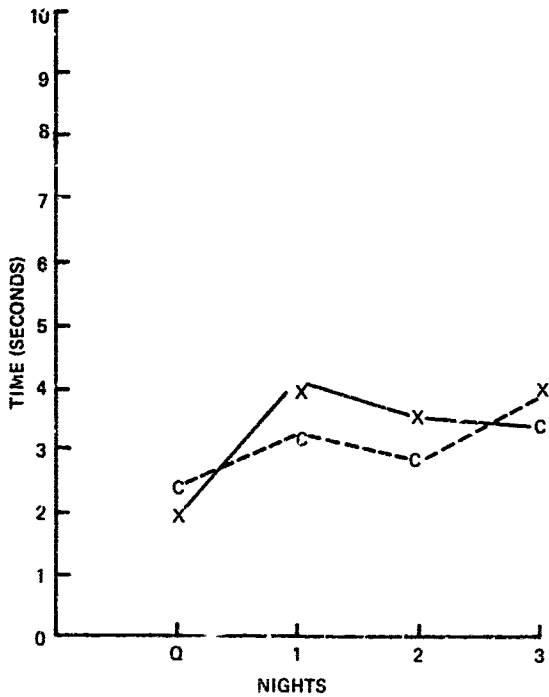

Figure 8. Obstacle Times - High Fence

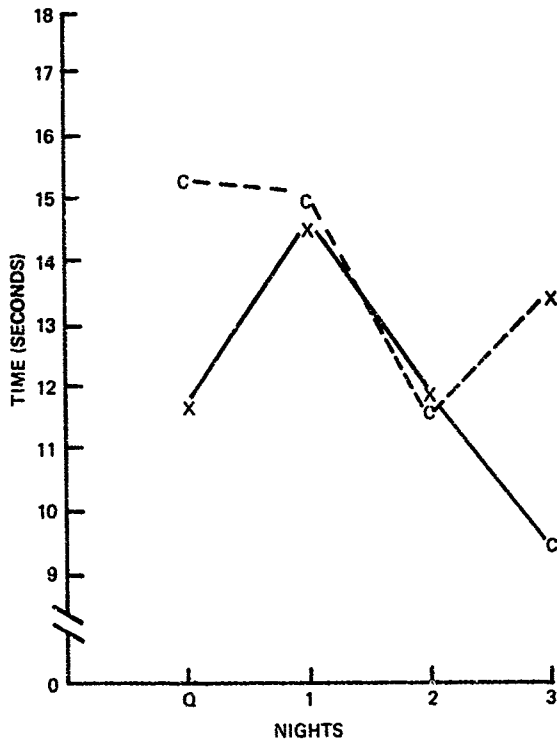

Figure 9. Obstacle Times - High Crawl

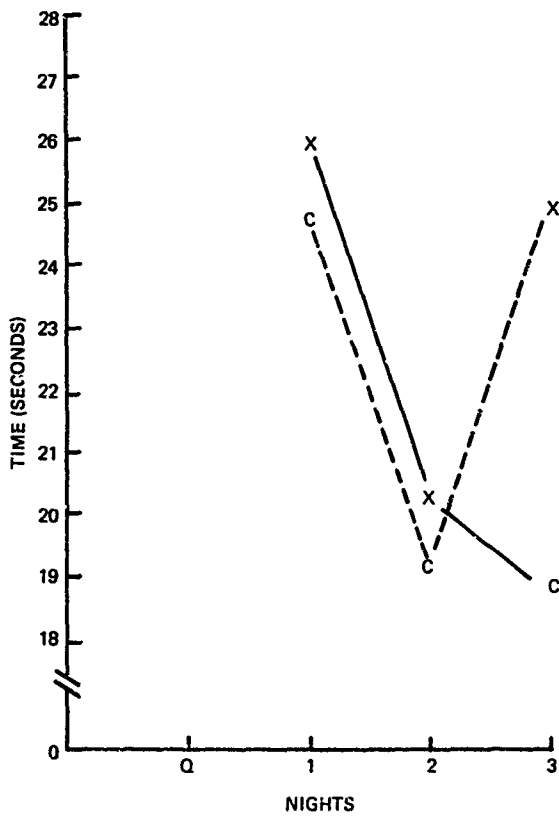

Figure 10. Obstacle Times - Low Crawl

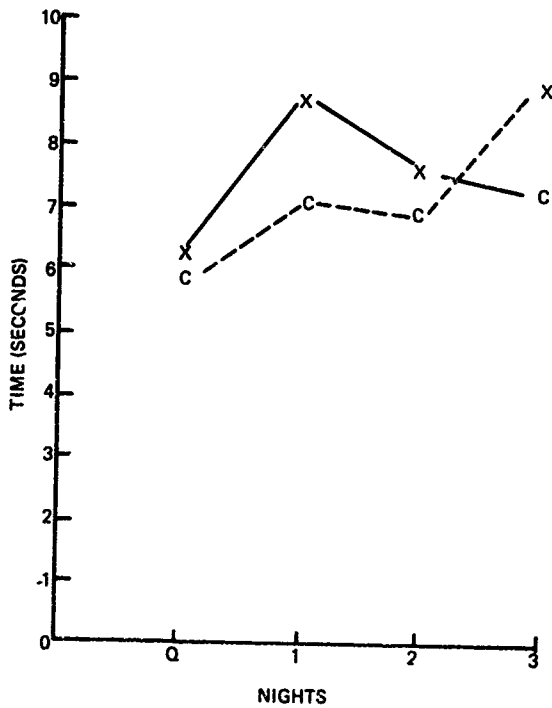

Figure 11. Obstacle Times - Down and Out

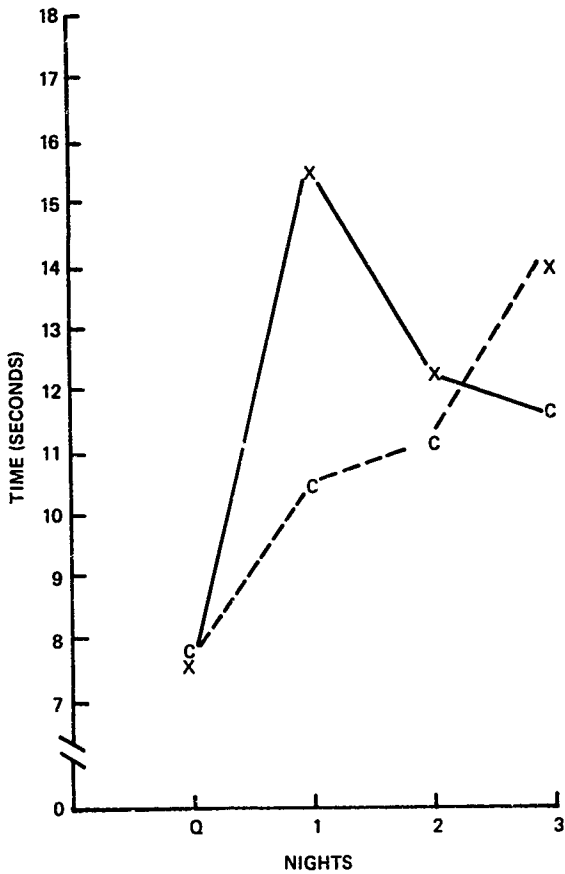

Figure 12. Obstacle Times - High Hurdles

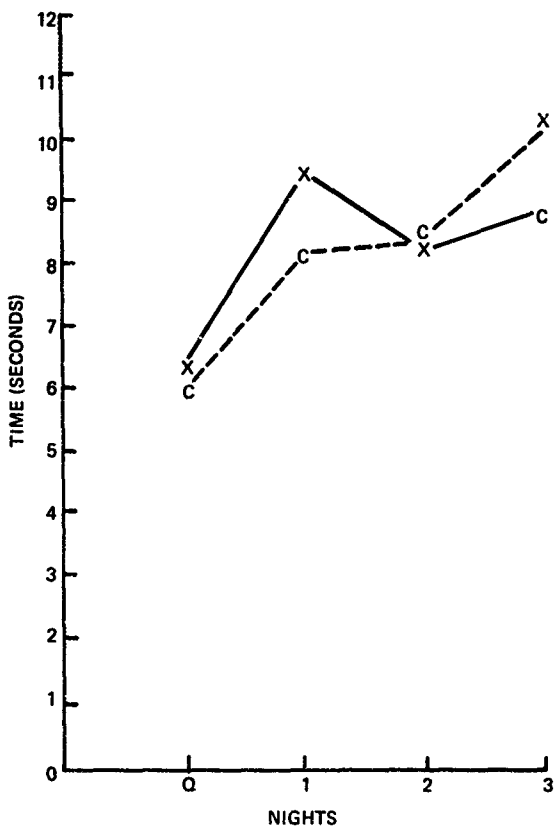

Figure 13. Obstacle Times - Tubes

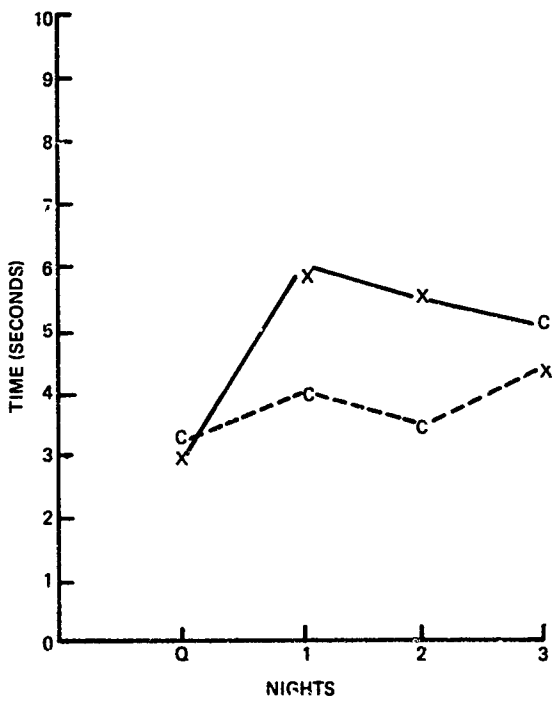

Figure 14. Obstacle Times - High Wall

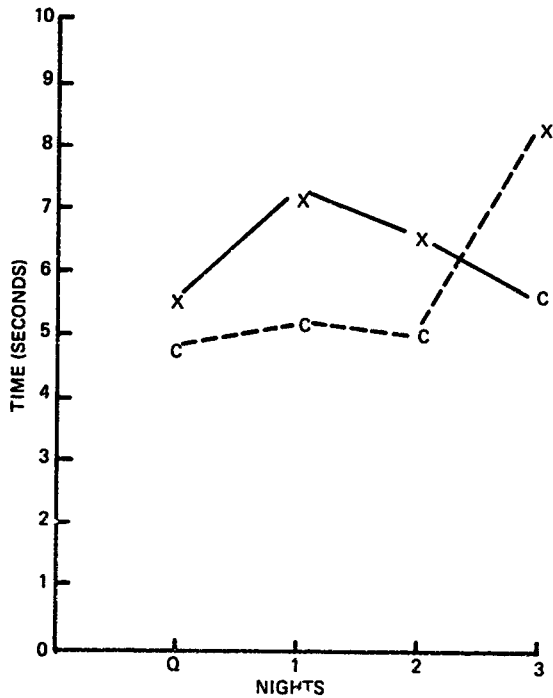

Figure 15. Obstacle Times - House

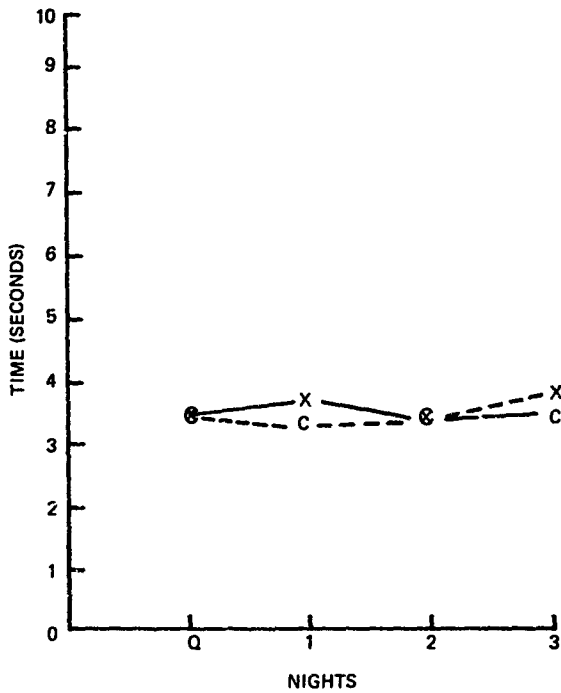

Figure 16. Obstacle Times - Zig-Zag

Comparison of the trials of the first and second night showed reduced within-groups variances, though the variances remained nearly equal. Semantic differential scores moved toward more moderate and slightly more positive scores, suggesting increased user acceptance of the NVGs with increased experience.

The effects of training were evident. The hour of "hands-on" familiarity at dusk, followed by individual instruction on fit, adjustments, and controls, plus the first night's experience on the course, resulted in significant improvements in the second night's trials.

Differences between the X and C groups in mean obstacle elapsed times were small in general, except for certain tasks which were especially difficult for the soldier wearing the NVGs. The log walk, requiring balance and depth perception over a low contrast object, was most obviously difficult. Some of the Ss could not complete this without assistance. [See Figure 17 for comparison of second night's trials elapsed times on the obstacle course.

Since roles were reversed on the third night, the previous control group became the experimental group and wore the night vision goggles. This permitted comparison of this group with the same group's performance without goggles on the first night (Fig. 18). Thus, as opposed to the independent groups' portion of the experiment, this crossover phase allowed the effects of wearing NVG to be examined with the variance due to differences between individual subjects partitioned out. The analysis of variance for obstacle-time data (Table 6) indicates that the repeated-measures design has allowed the detection of a significant interaction effect showing that the magnitude of performance decrement depends upon the obstacle being examined. This relationship can be clearly seen in Table 7.

TABLE 6
ANOVA Goggles Versus No Goggles Obstacle Times
Single Group Repeated Measures

SOURCE	df	SS	MS	F	P
<u>Between Subjects</u>	<u>11</u>	<u>3799.5</u>			
<u>Within Subjects</u>	<u>300</u>	<u>902830.6</u>			
A (Goggles/No Goggles)	1	2237.1	2237.1	22.043	P < .01
Error A	11	1116.4	101.5		
B (Obstacle Type)	12	866846.3	72237.2	539.904	P < .01
Error B	132	17661.1	133.8		
AB (Goggles X Obstacle Interaction)	12	9017.4	751.5	16.664	P < .01
Error AB	132	5952.3	45.1		

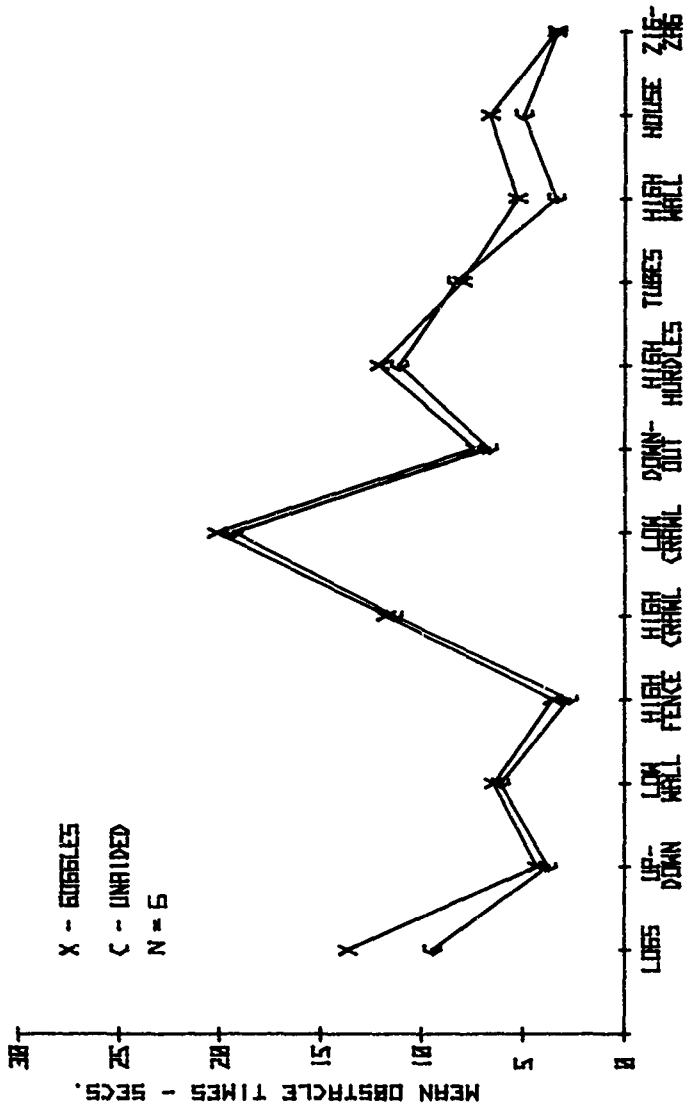

Figure 17. Obstacle Performance on Second Night (Matched Groups).

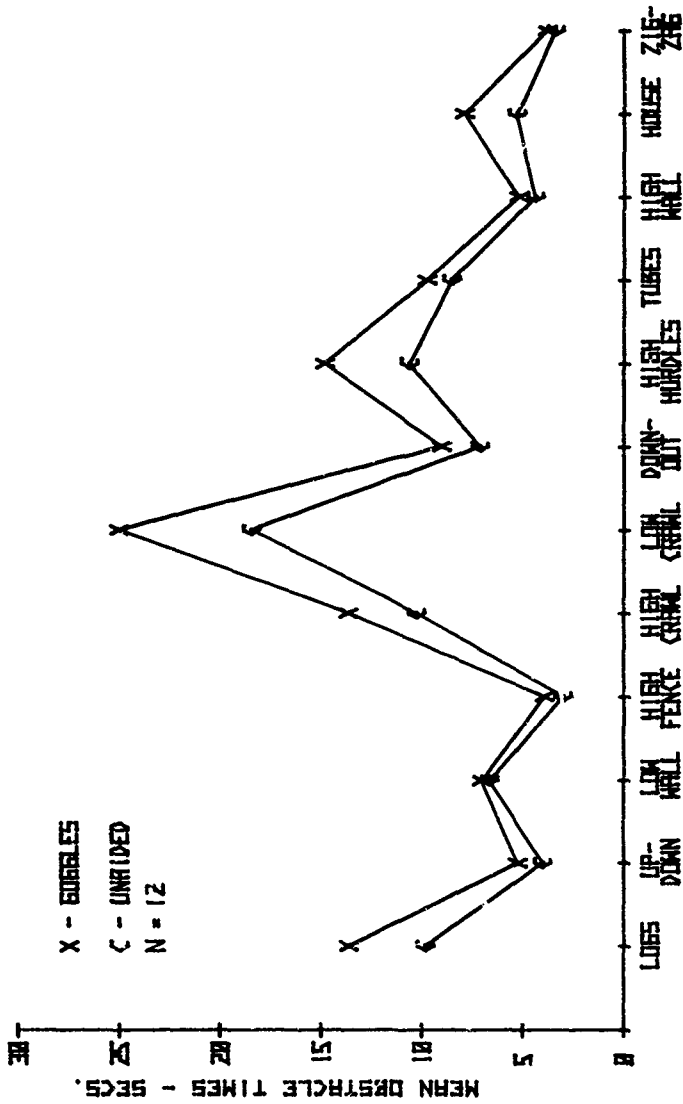

Figure 18. Obstacle Performance on Third Versus First Night (Same Group)

TABLE 7
 Mean Obstacle Time (Secs), Repeated Measures Design, Goggles Versus No Goggles

	OBSTACLE												
	Total Time	Logs	Up & Down	Low Wall	High Fence	High Crawl	Low Crawl	Down & Out	High Hurdles	Tubes	High Wall	House	Zig-Zag
Goggles	226.8	13.6	5.2	7.0	4.0	13.6	25.0	9.0	14.8	9.8	5.2	7.9	3.8
No Goggles	184.7	9.8	4.0	6.6	3.0	10.3	18.4	7.1	10.6	8.5	4.4	5.3	3.4
Mean Performance Decre- ment	42.1	2.8	1.2	0.4	1.0	3.3	6.6	1.9	4.2	1.3	0.8	2.6	0.4

N=12

The NVG-aided performance was poorer on the low crawl and the high hurdles, but the low crawl showed most significant difficulty for the NVG-aided runs. Since the second night's performance was a repetition of a practiced performance and the own-control comparison represented a relatively novel experience (especially for the X group which had had little previous goggle experience) one can draw inferences about training effects from examination of the figures.

Examination of the semantic differential ratings and the criticisms offered in debriefing clarified these quantitative results.

Semantic differential ratings of all 12 Ss (first and third night X groups) are summarized in Figures 19 and 20. In these figures, the polar opposites are regrouped into coherent clusters representing display, controls, safety-utility, fit and comfort.

Depth perception was a special problem at close ranges, perhaps because the soldier rarely took the time to refocus for intermediate or near ranges as he approached a hurdle or a step. Some Ss did report using near focus and the IR lamp in crawling through the tubes. This probably contributed to the considerable improvement in tubes by the X group on the second night.

Discomfort and pain were experienced by about 25 percent of the Ss over the front of the face and the bridge of the nose. This appeared to be a special problem for individuals with relatively narrow faces.

Under the mild but humid night weather conditions, along with the exertion and sweat of climbing, running and crawling, many Ss had severe problems with moisture accumulating inside the eyepiece and complained of "fogging up." In the semantic differential results, this shows as "hot, sweaty, fogs up."

Some criticisms were double-edged; as one soldier put it, "I think the goggles are very effective when observation is needed, but when needed to move out, it slows you down."

Many attitudes were very positive. [Note that almost all felt the system was very useful and helpful (Fig. 19).] Several Ss found the IR lamp very helpful under the dark canopy in the wooded section of the course as well as in the tubes.

COMPATIBILITY TEST

Objective

The objective of the test was to assess NVG compatibility with a selected infantry-worn combat ensemble.

Method

Twenty-two infantrymen, MOS 11B, served as Ss. The assessment was divided into two segments separated by time and degree of activity. All Ss participated in the first segment, the static test, and 12 participated in the second test, the dynamic test. The first segment was designed to familiarize the soldier with operating and using the NVG. The Ss practiced device donning, adjustment, techniques for changing body position, running, and jumping. The second segment employed the HEL mobility course, described previously. Each S was fitted with an NVG, M1 helmet, M16 rifle, and combat assault load (Table 1).

SEMANTIC DIFFERENTIAL

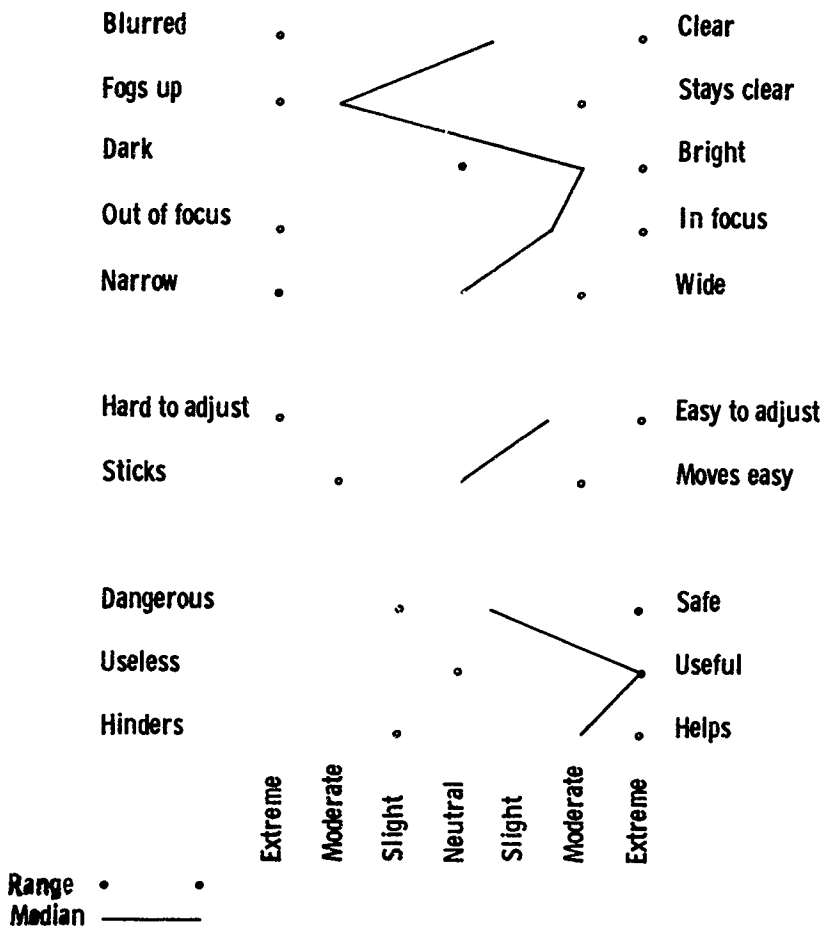

Figure 19. Semantic Differential: Display, Control, and Safety Clusters

SEMANTIC DIFFERENTIAL

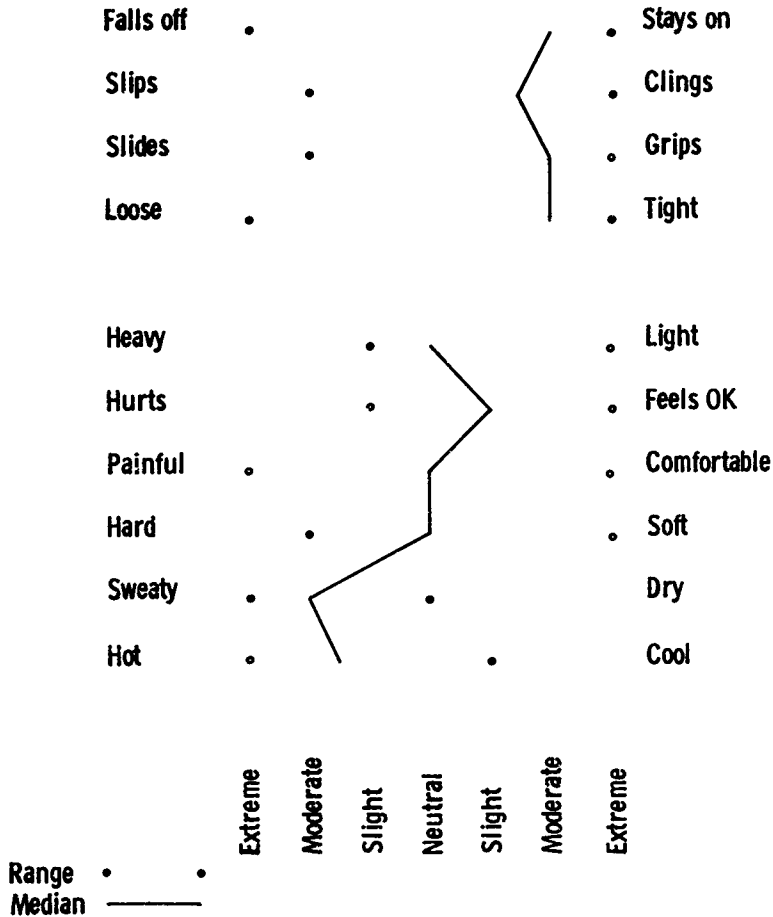

Figure 20. Semantic Differential: Fit and Comfort Clusters

Compatibility was conceptualized as ranging along a continuum from completely compatible (no problem) through slightly, moderately, and severely incompatible. In order to implement this scheme, compatibility was operationally defined in terms of the subject's ability to use and operate the NVG when wearing the assault ensemble and while performing operational types of body movements. The S's body posture was altered from the standing to kneeling, crouching, and prone positions in both segments of the assessment. During these sequences, the observers and NCOIC recorded interactions with the NVG, S's body and the ensemble. The Ss were asked to verbalize their feelings about compatibility. Ss were instructed to report these feelings using word modifiers to denote problem severity. The modifiers used were slight, moderate, and severe. They were defined to the subject as follows:

- Slight — Low pressure, light contact, occurs occasionally and does not detract from task performance.
- Moderate — Medium pressure (annoying), medium contact, some binding, occurs frequently but can be dealt with through adaptation and does not detract from task performance in a manner which would alter effectiveness.
- Severe — Painful pressure, hard contact, binding, occurs continually, alters task performance or makes the task impossible to perform and reduces or eliminates effectiveness.

It should be noted that the choice of modifiers, as they were defined, allowed evaluation of both gear-to-gear and gear-to-body interaction.

DISCUSSION

All Ss reported problems with goggle/helmet interactions. Furthermore, goggle/nasal contact was considered a severe problem, instability during rapid maneuvering was considered a moderate problem and control/focus difficulty was considered a slight problem. These problems, reported by S and observed by monitors, were the result of several design factors acting alone or in combination. These factors can be conveniently categorized as follows:

NVG retention harness

NVG facial contact area

NVG control operation, location and actuation forces.

NVG weight

NVG/M1 helmet interface

Each of the above factors will be discussed separately. However, it should be noted that the resulting problem may have been caused by just a single factor, combinations or factors or all factors acting in unison.

Retention Harness

The existing harness design is not a successful solution for goggle security. Three separate sub-factors were identified as causing problems. The first is harness configuration. The lower transverse (horizontal) band did not extend below the occipital bulge of the skull. This resulted in no anchor point for the harness and allowed the goggle to rotate forward and downward, exerting the full weight of the device on the user's zygomatic and nasal areas. The addition of the M1 helmet did not improve the condition, but, in fact, contributed to the problem. The helmet suspension catches the NVG head band and helps it in rotating forward. This is a result of M1 instability about the pitch axis, and is particularly evident during running or rapid body posture changes. The second is goggle harness surface texture. The smooth surface provides very little friction. Additionally, as this surface becomes coated with hair oil and perspiration, it becomes nearly frictionless. The result is the inability of the user to maintain a constant goggle position and weight distribution around the facial area. The third is the single longitudinal top head band. This band contributes little to goggle retention. If this band is tightened sufficiently to support the goggle unit off the nasal area, it lifts the rear band, resulting in an unstable goggle position.

Facial Contact Area

The facial contact surface is not satisfactory. The non-porous material encourages perspiration. This results in instability (slipping) and general discomfort (excessive facial perspiration). The contact area appears larger than is necessary at the forehead, temporal and zygomatic areas and is nonexistent in the nasal bulge area. The pad thickness is constant and contributes to the instability and tendency for the goggle to rotate downward onto the nose. Recontouring with a thicker section in the zygomatic and nasal area would force the goggle upward into the forehead. The lack of padding in the nasal area was the primary complaint reported by all Ss. Hard running, jumping and rapid changes in direction or body posture caused painful pressure or sharp painful blows to the nasal area. The most common operational attitude was one hand holding the NVG unit and the other hand holding the weapon as the soldier negotiated the obstacle course. This made crawling, hurdling or climbing (requiring handholds) very difficult.

Control Operation, Location and Actuation

Primary areas of concern were interpupillary adjustment range, angular declination adjustment (from the S's visual horizon), focus and diopter adjustment. Interpupillary adjustment was marginal for Ss with low interpupillary distances. Diopter adjustment was satisfactory.

Difficulties were experienced with angular declination adjustment and with focus changes. The infantryman's body goes through drastic postural changes in his normal activities. The Ss reported that they did not have time to make appropriate changes in declination angle and focus for such activities as climbing a wall, hurdling or crawling. These changes required both hands, unless one eyepiece is refocused after the other. The infantryman's hands were busy with adjustments of his personal weapon and other gear, and he rarely took the time to make appropriate adjustments when changing from a standing or walking to a prone or crawling position or on approach to a barrier. All Ss experienced degraded vision and groped for near objects while closing on them.

Weight

Weight problems did not become apparent until rapid activity was required. Then, weight in combination with the NVG moment arm became a problem for the user. The possibility of personal injury (nasal area) became the overriding concern of the Ss. When running, jumping and climbing, one hand was required on the NVG to assure stability and retention. Goggle weight interacting with helmet weight during maneuvers resulted in forces estimated to be in excess of 15 pounds acting on the nasal area. It should be noted that the helmet weighs 3.25 pounds, the NVG 1.90 pounds, for a total of 5.15 pounds. This, combined with 1- and 2-meter jumps, probably resulted in a minimum force of 3 g's acting downward on the user's face. Rotational forces were also considered high; again a combination of helmet moment plus NVG moment resulted in perceivable changes in mass stability. As a result, obstacle course times were proportionally higher.

NVG/M1 Helmet

The interface between the NVG and M1 spanned the range from unacceptable to acceptable. This range is a direct interaction of S head size and resultant helmet standoff. Smaller headed Ss experienced only slight problems while large headed Ss experienced severe to moderate problems. All Ss had to wear the M1 tilted rearward in order to accommodate the NVG periphery. The rearward tilt increased with head size and caused collar/helmet contact in the prone position. The larger headed individuals' helmet brims were in contact with the forehead support area of the NVG. In general, the described interactions were magnified during dynamic maneuvers.

CONCLUSIONS

In general, there is sufficient evidence to indicate that the NVG offers the infantryman highly improved night vision (other agency reports and subjective elements of this report) for defense, road march and cross-country march applications. However, for dynamic use (rapid movement, rapid changes in body posture as in an assault) the NVG design has severe limitations.

Table 8 presents the mean obstacle course times for day, twilight and night performances. The difference between the no-NVG and the NVG condition can be largely attributed to poor human factors design and to electro-optical performance.

TABLE 8
Obstacle Course Total Times (Minutes)

	Day	Twilight	Night	NVG
Mean	2.64	2.62	3.08	3.78
S.D.	.42	.28	.48	.66

No attempt was made to quantify shoulder-fired weapon employment or infantry-type weapon maintenance.

RECOMMENDATIONS

Design

The NVG retention harness should be reconfigured to optimize head surface/strap locations at appropriate anatomical areas of the skull. This would assure maximum NVG retention with minimum strap interference and discomfort.

The NVG facial contact surface should be reconfigured for minimum area and the material section should be angled appropriately to reduce downward pressure on the nose. In addition, padding should be provided around the nasal area.

NVG control operation, location and actuation should be optimized for minimum actuation forces and an increased minimum interpupillary adjustment provided.

Weight-problem elimination should be approached in three ways. The first is by reducing NVG moment of inertia by minimizing component(s) standoff from the face. The second is by reducing frame size and face contact area. The third is by considering relocation of the power cells from the NVG face piece rearward on the harness or to another portion of the user's anatomy.

Helmet/goggle interaction can be minimized or eliminated by both harness and goggle redesign as suggested above.

General

The principal finding of this investigation of the AN/PVS-5 is that additional research is required in a number of problem areas. Specific recommendations based on this pilot study are necessarily limited to the following population/performance situation: trained subjects, relatively familiar with the course layout, performing under ambient light conditions of less than total darkness with mainly high contrast obstacles. Generalization of current findings with respect to objective performance times cannot be made until training, obstacle contrast ratios, course familiarity, etc., are examined as experimental variables. Though the Ss' subjective evaluations generally showed face validity, they were not entirely consistent with the measured task results. A larger sample of S experience will contribute to reliability and validity. The following are outlined studies intended to explore these problems, clarify training needs and illustrate limitations and advantages in infantry applications of the AN/PVS-5.

Quick-Shot Study

A small number of infantrymen (e.g., 20-30) should be given a review of their basic rifle training, and then split into two groups on a random or systematic (unbiased) basis to be sent through the pop-up target course, one at a time, under conditions of darkness, about 1×10^{-3} fc. Troops should be advised that their scores will be based upon speed and accuracy of response to target presentations in relation to ammunition expenditure, so that pointing the weapon (at close-in targets) may or may not be more effective than aiming, but they should be permitted to use their own preferred quick-shot technique, in any case. Soldiers wearing night vision goggles should be alternated with soldiers using unaided night vision. Targets should be set to trip at controlled ranges from the approaching infantrymen, so that the number and sum of the ranges will be constant even though different targets can be presented on different occasions.

Soldiers wearing night vision goggles on their first run through the course would wear no goggles on their second run, and soldiers using unaided vision on the first run would wear goggles on their second run, so that each soldier could be matched with himself in an own-control design.

Urban Training Study

The emphasis in this study should be on training effects on operations in confined spaces and man-made structures. It must involve instruction for the infantrymen-subjects in the manipulation of all controls and adjustments on the AN/PVS-5, including careful training in the use of the IR lamp and focus at intermediate and near ranges. It must also involve repeated experiences in maneuvering a patrol through confined spaces such as halls, stairs, sewer pipes, windows, hedgerows, and culverts, with no two sequences of experience alike even though generally matched for total difficulty. Measures should be made in consideration for desired training effects, including statistical measures of performance improvement, reliability and retention. Independent variables may include the nature and duration of training as well as comparison of aided with unaided performances.

Basis-of-Issue Study

In conducting the Air-Scout Night Goggle Test reported in TM 14-74 (1), we found that the interaction of panel lighting glare and legibility with head-up control of the helicopter in low-level night flight established that the pilot generally chose to wear night vision goggles in flight, and invariably did so when the copilot was required to wear them for his part in the observation experiment. In ground patrol tests reported by a U. S. Marine Corps (USMC) representative at the July, 1974 Night Vision Symposium, certain problems were observed in the performance of squads led by an individual wearing the AN/PVS-5. In view of present Army plans for a limited purchase of the goggles, it is imperative to get answers to such questions as the best BOI for a motorized reconnaissance patrol or an infantry foot-patrol as well as an ambush or roadblock situation. Comparisons should involve a single AN/PVS-5 per crew or patrol versus complete equipping of every crew member. Combinations could also include a single pocketscope (using a model with similar optical characteristics to the AN/PVS-5), an individual or crew served weapons night sight or a combination of one AN/PVS-5 with any one of the above. Tests should be run after thorough training of the Ss in the control and use of the respective devices so that reliability of personnel performances can be assured. The experiments should be so planned as to permit variation in results across missions.

REFERENCES

1. Bauer, R. W., & Pettit, G. D. Air-scout night goggle test. Technical Memorandum 14-74, U. S. Army Human Engineering Laboratory, Aberdeen Proving Ground, MD, July 1974.
2. Corona, B. M., Jones, R. D., Randall, R. B., Eilis, P. H., & Bruno, R. S. Human factors evaluation of two proposed army infantry/marine fragmentation protective systems (April through June 1974). Technical Memorandum 24-74, U. S. Army Human Engineering Laboratory, Aberdeen Proving Ground, MD, October 1974.

APPENDIX A
HEL MOBILITY/PORTABILITY COURSE DESCRIPTION

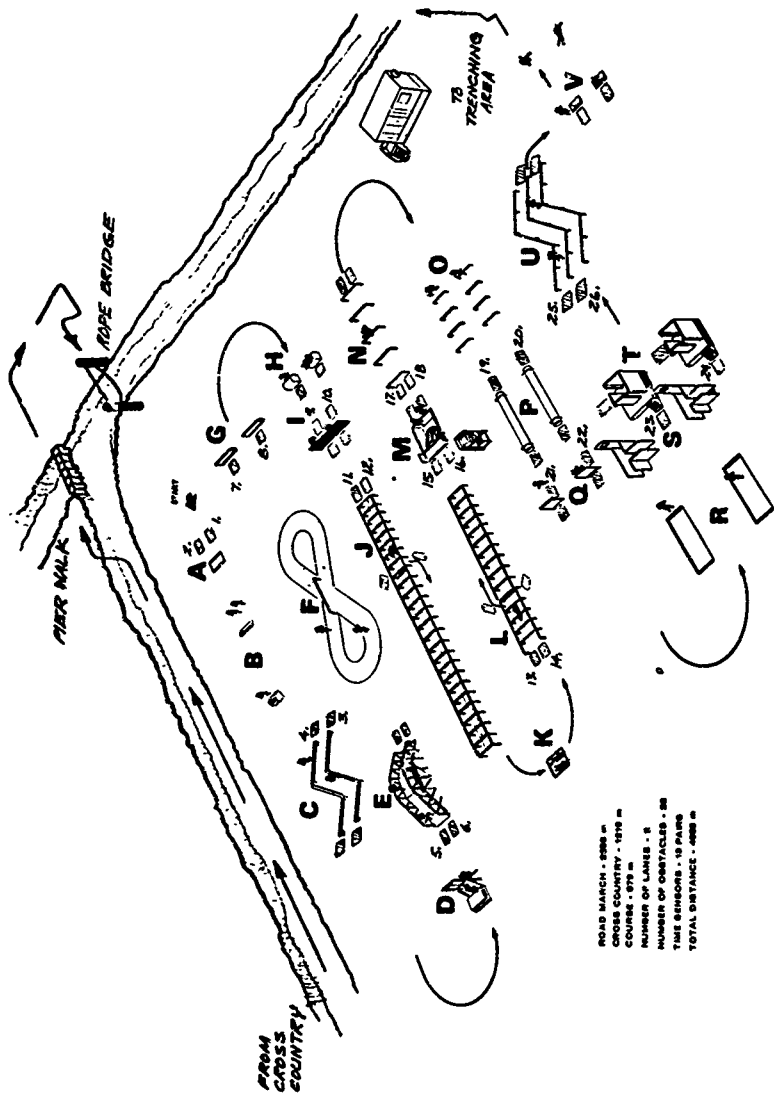

Fig. 1A. Mobility/portability course.



Fig. 2A. Cross-country.

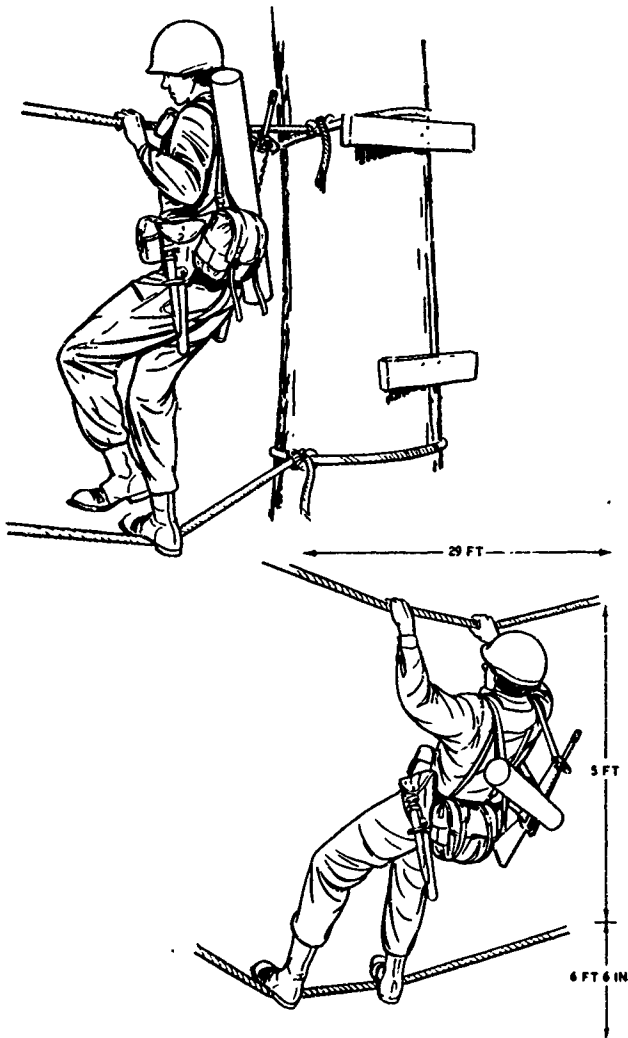

Fig. 3A. Two line rope bridge.

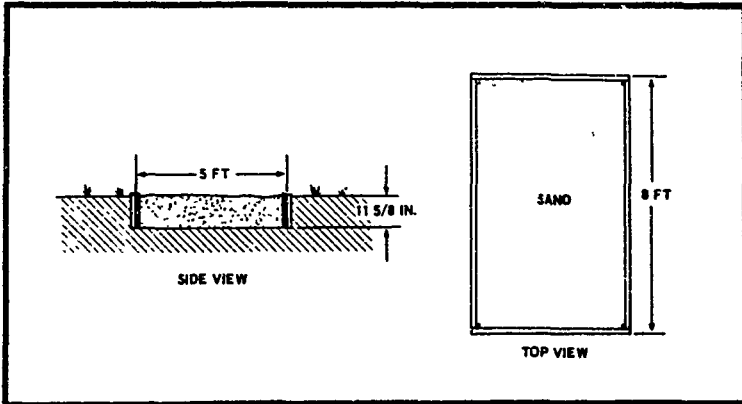

Fig. 4A. Broad jump.

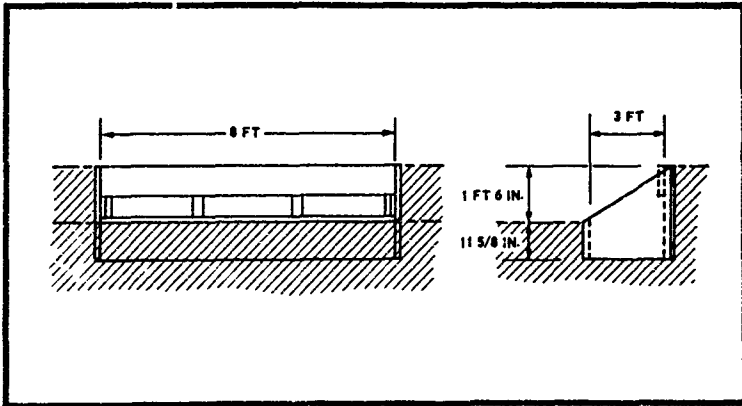
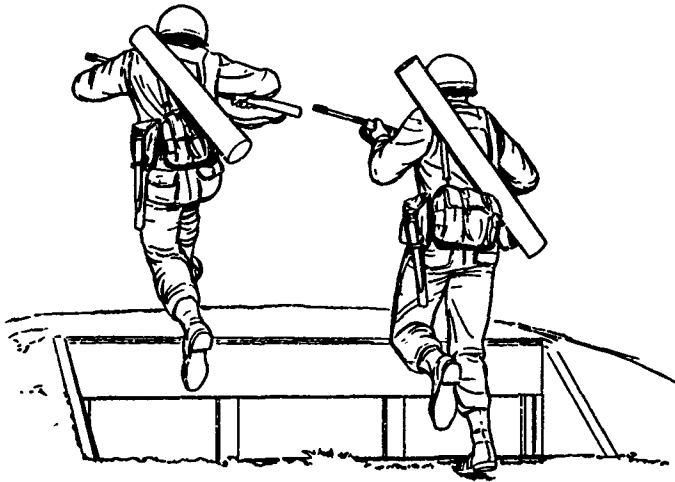

Fig. 5A. Jump up.

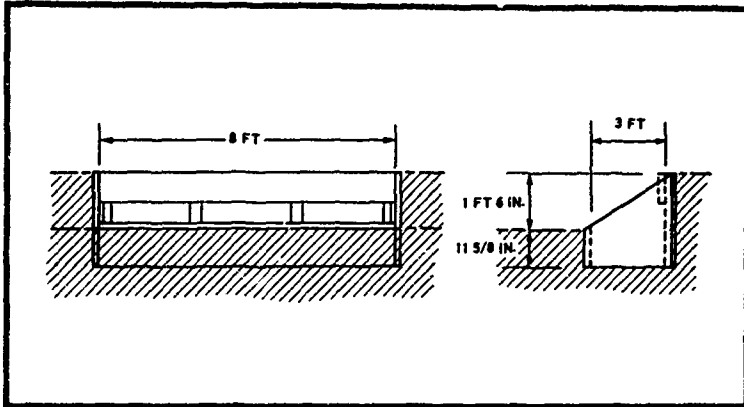

Fig. 6A. Jump down.

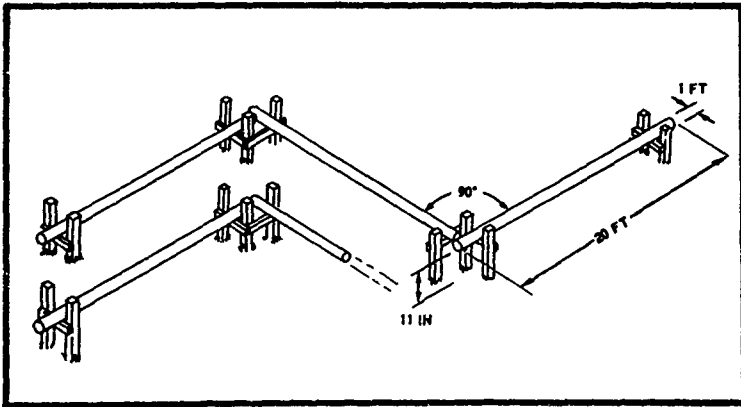

Fig. 7A. Log balance.

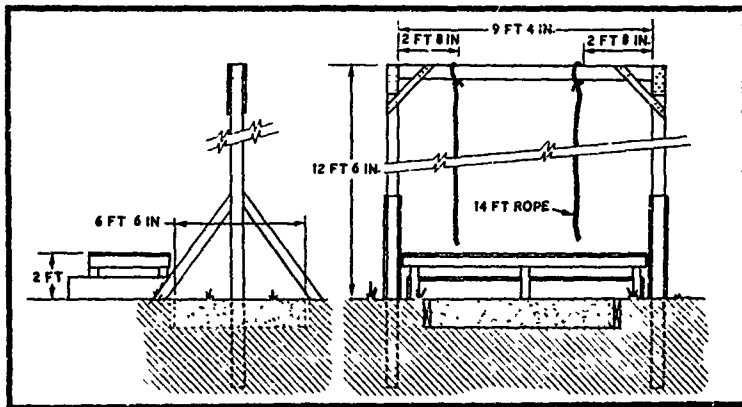
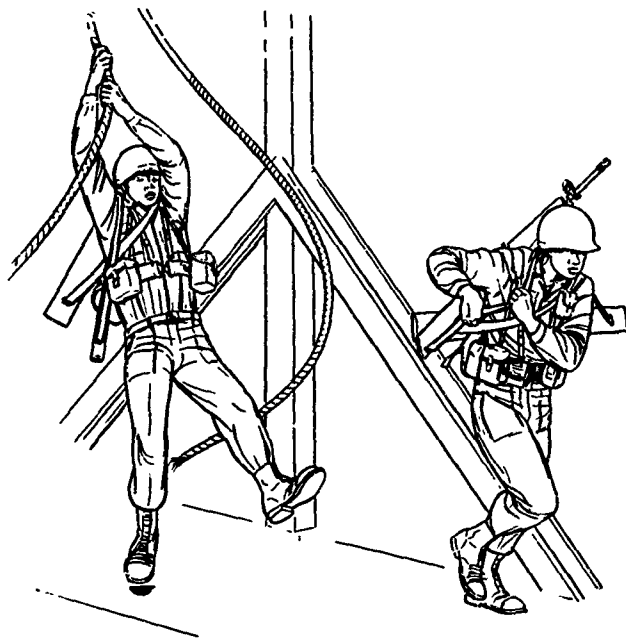

Fig. 8A. Rope swing.

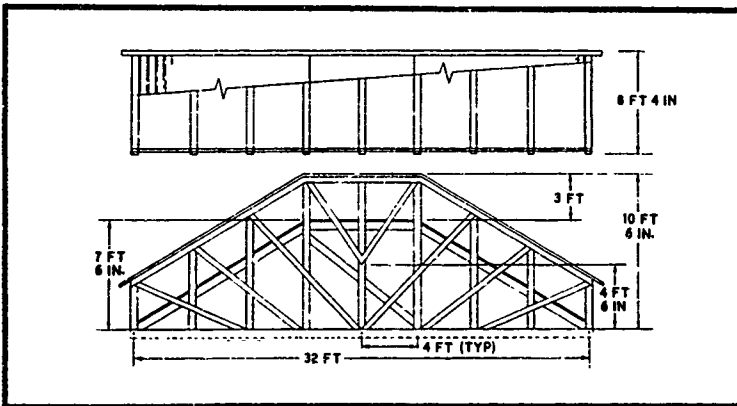
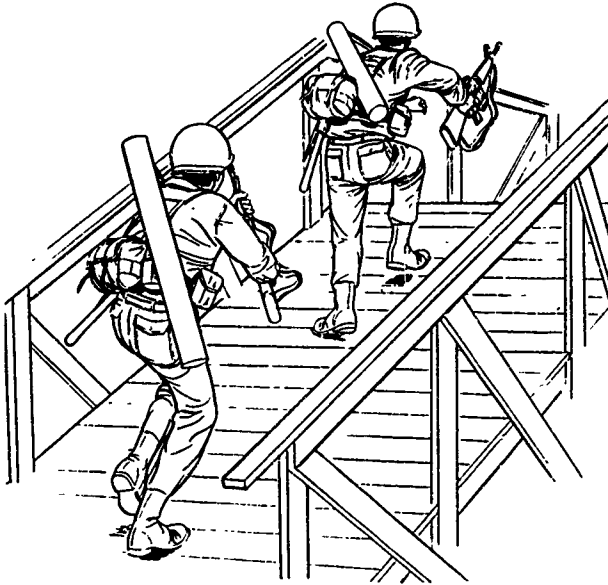

Fig. 9A. Up and down.

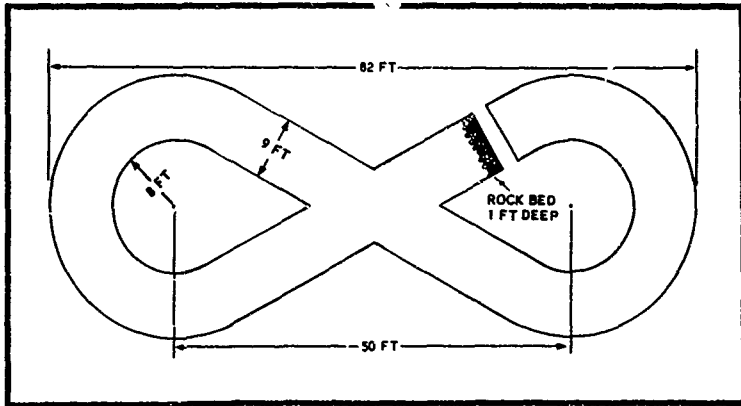

Fig. 10A. Rock bed.

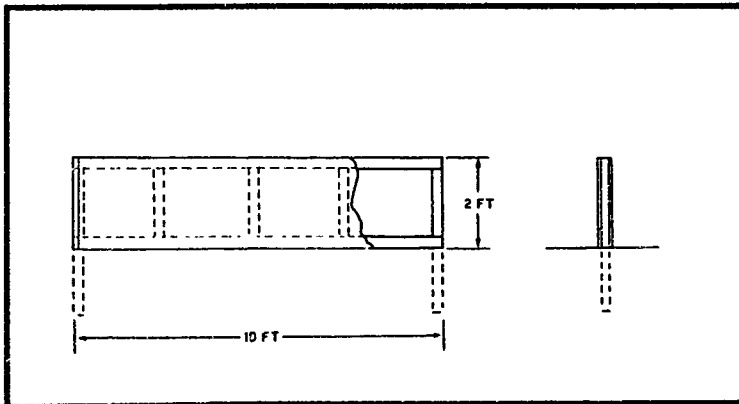
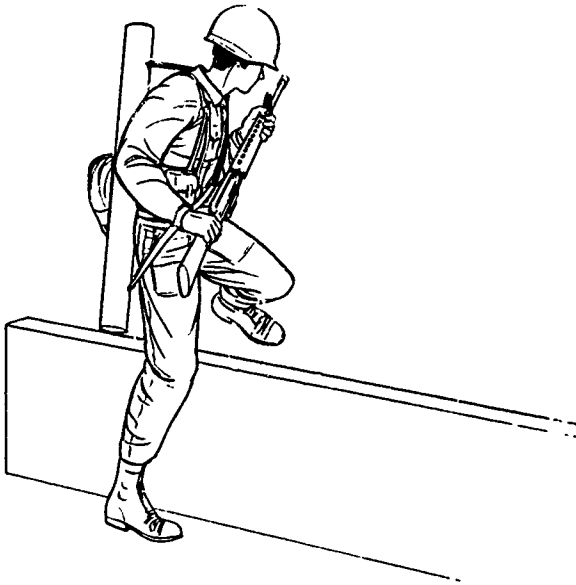

Fig. 11A. Low wall.

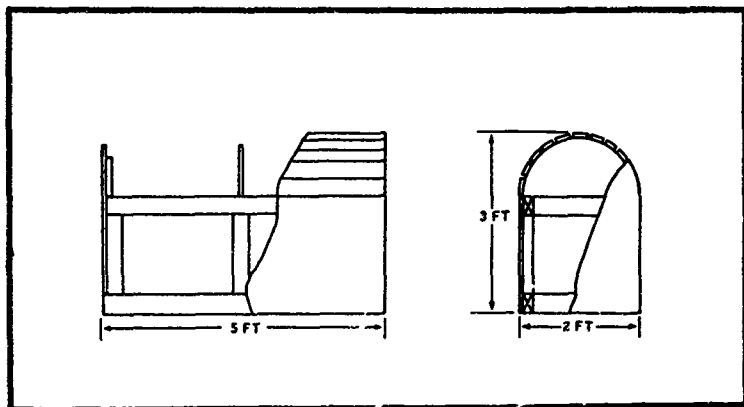
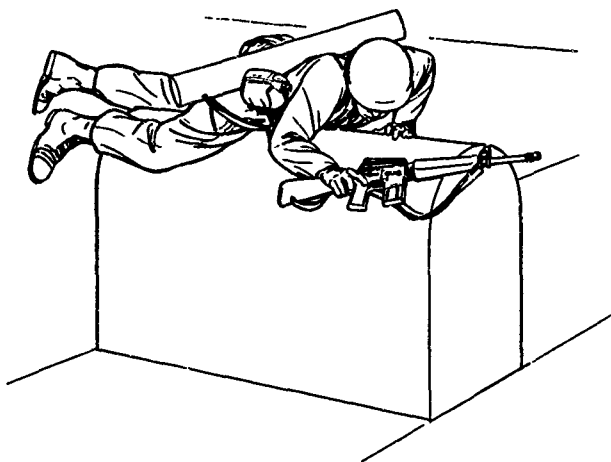

Fig. 12A. Belly buster.

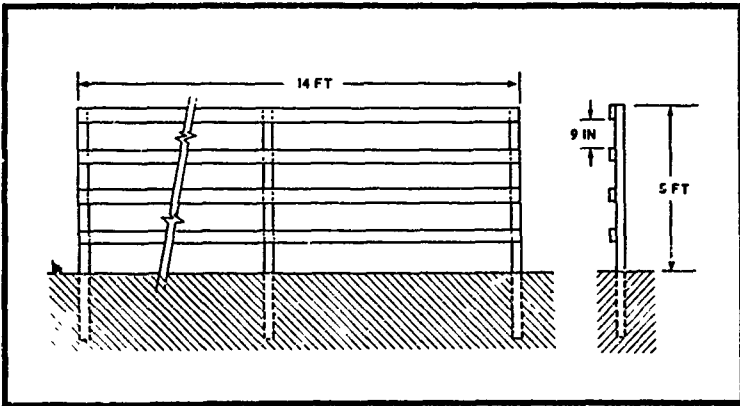
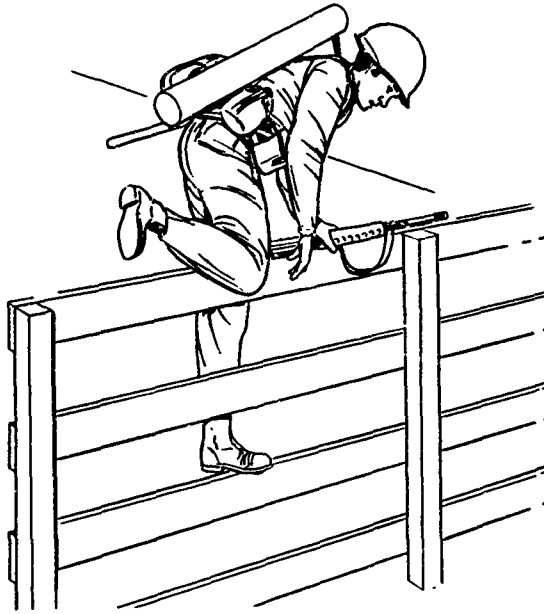

Fig. 13A. High fence.

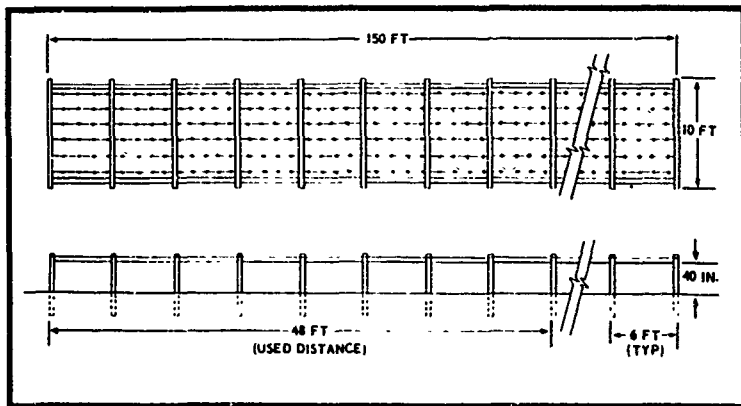
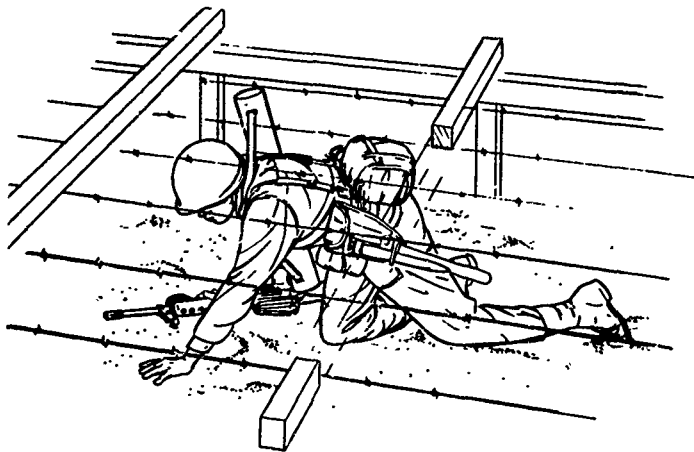

Fig. 14A. High crawl.

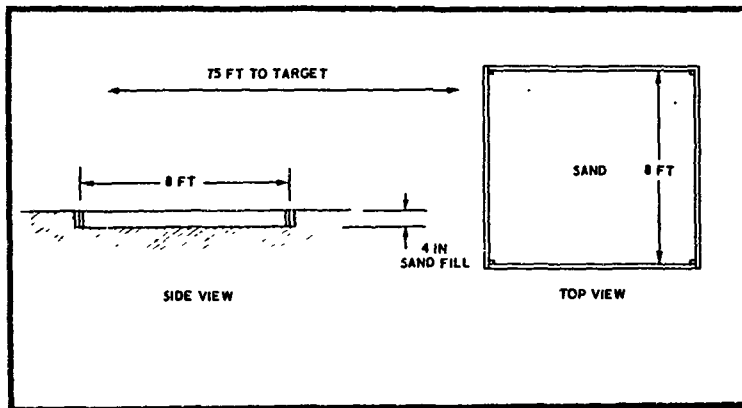
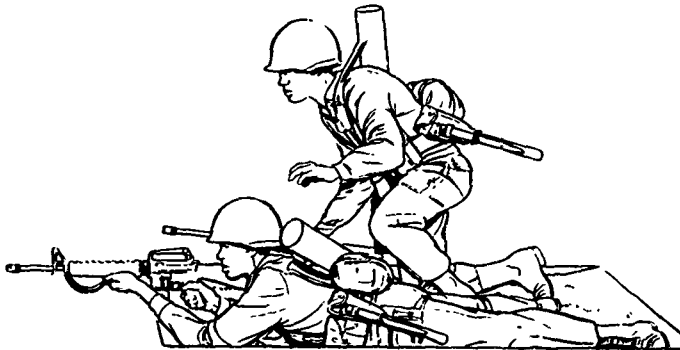

Fig. 15A. Simulated firing - charging - reloading.

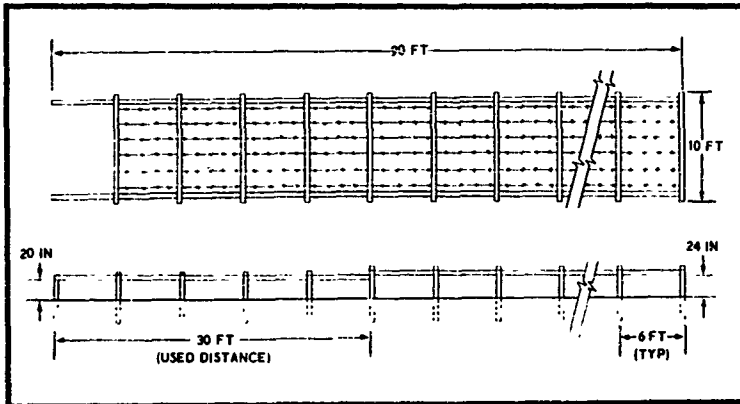
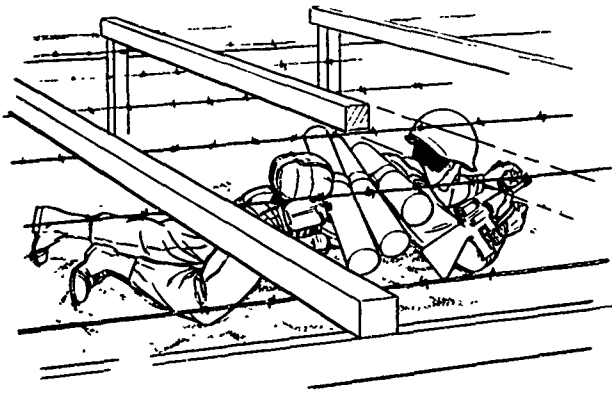

Fig. 16A. Low crawl.

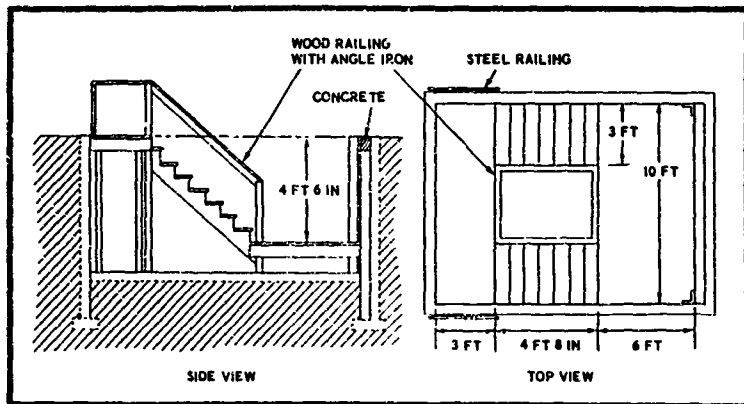
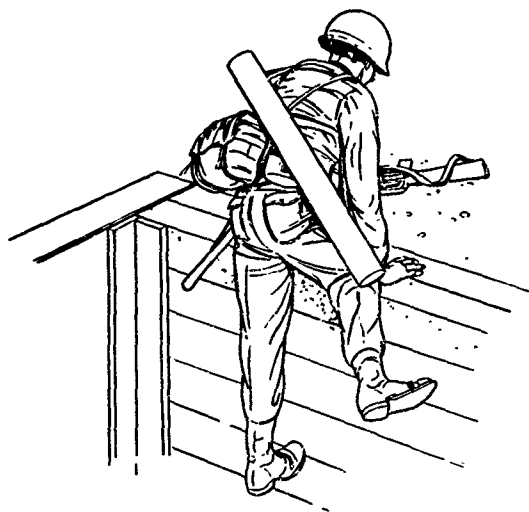

Fig. 17A. Down and out.

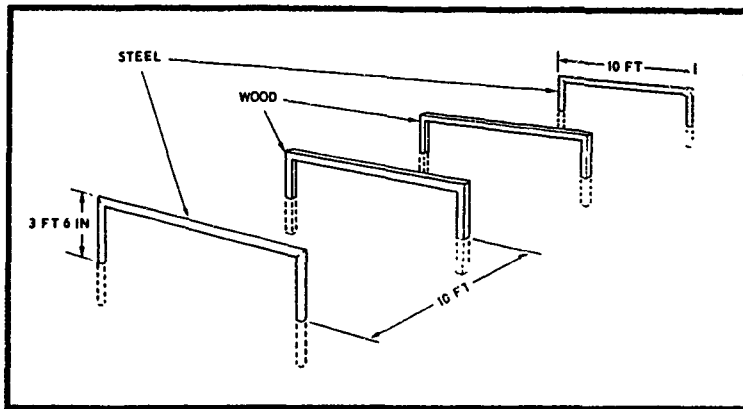
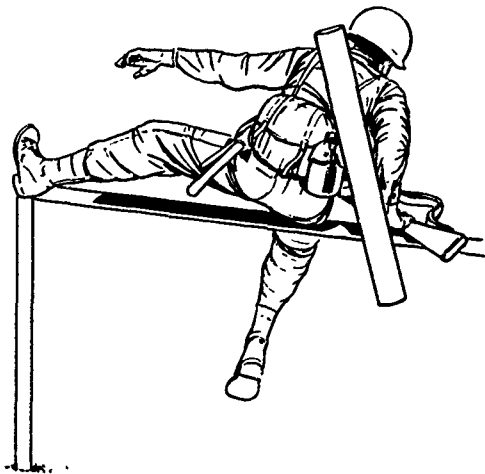

Fig. 18A. High rail vault.

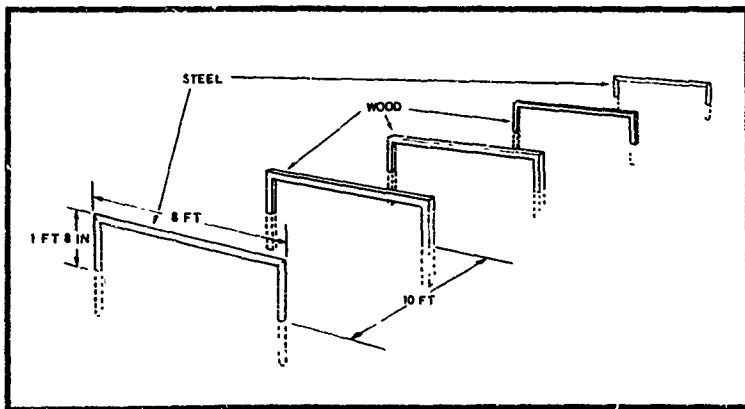

Fig. 19A. Low rail.

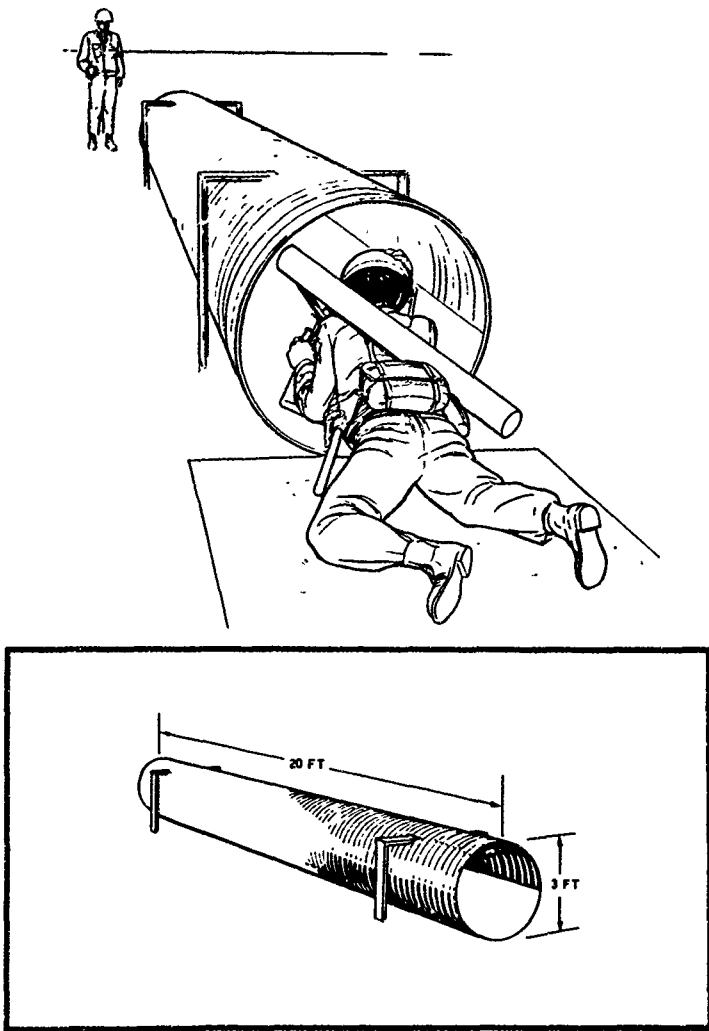

Fig. 20A. Pipe crawl.

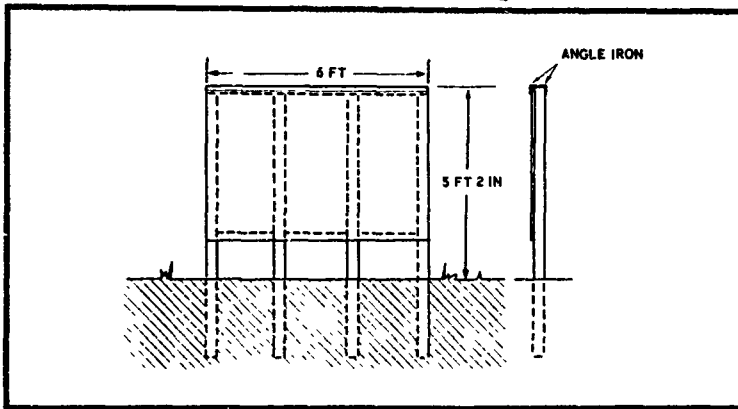
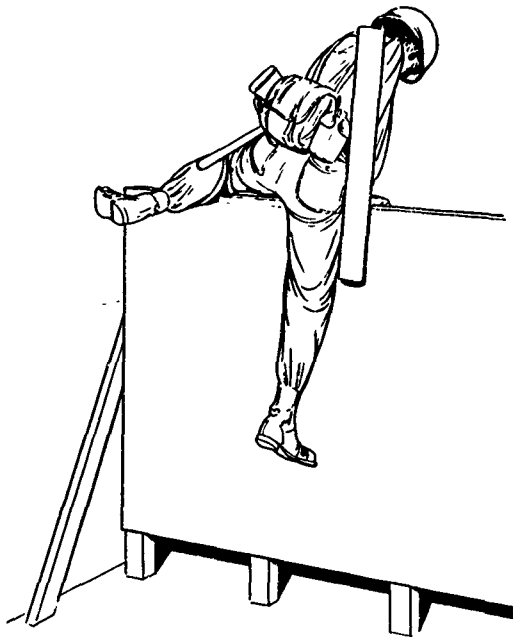

Fig. 21A. Wall.

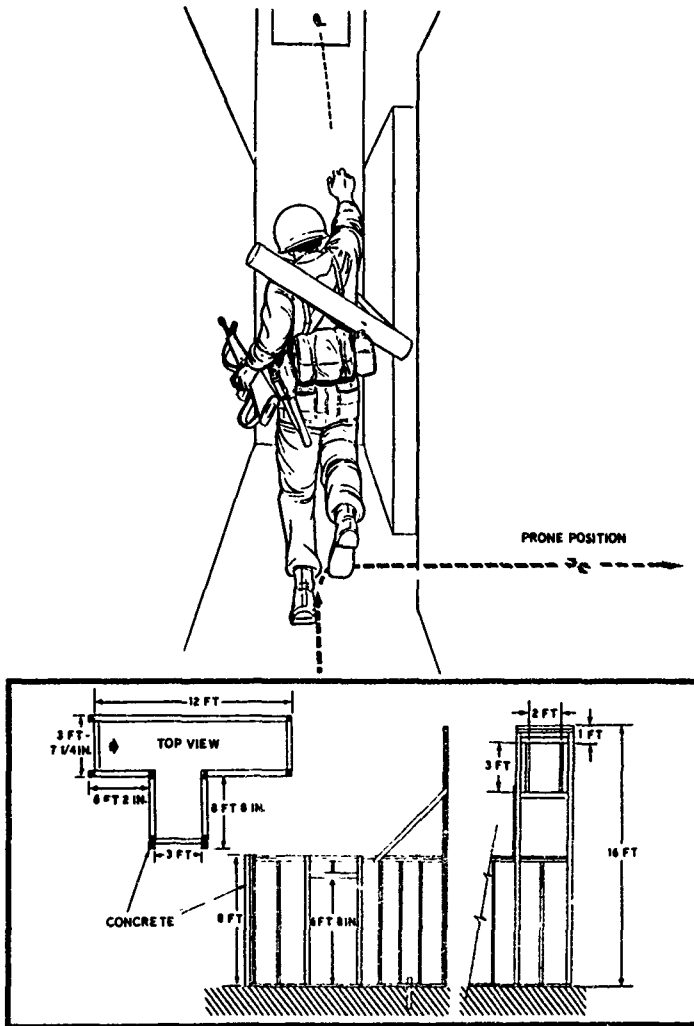

Fig. 22A. Alley grenade throw.

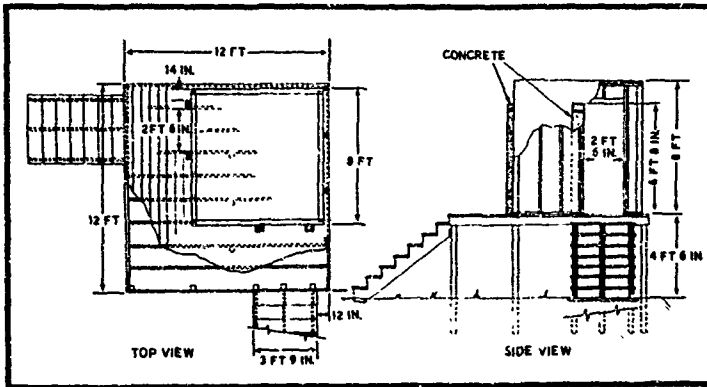

Fig. 23A. Stairs and doorways.

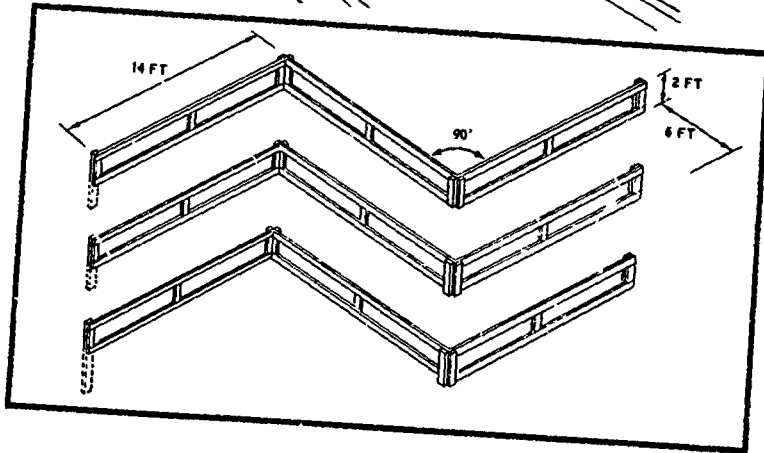
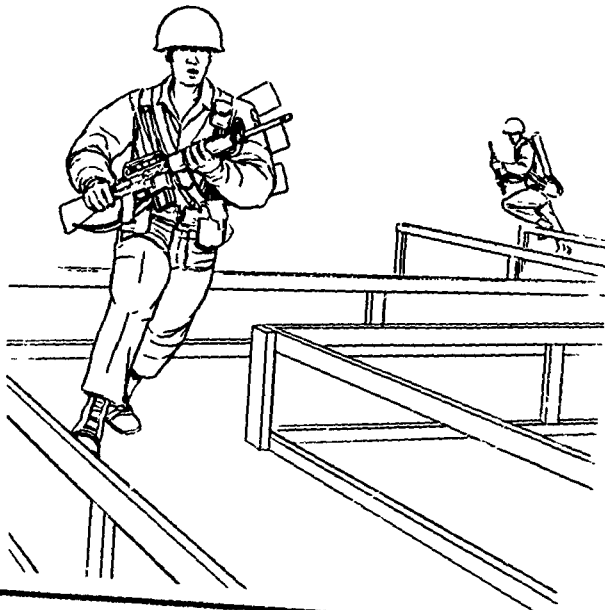

Fig. 24A. 90° passways.

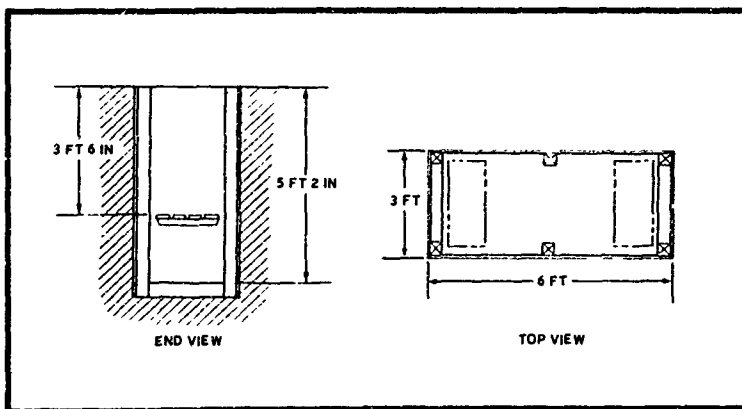
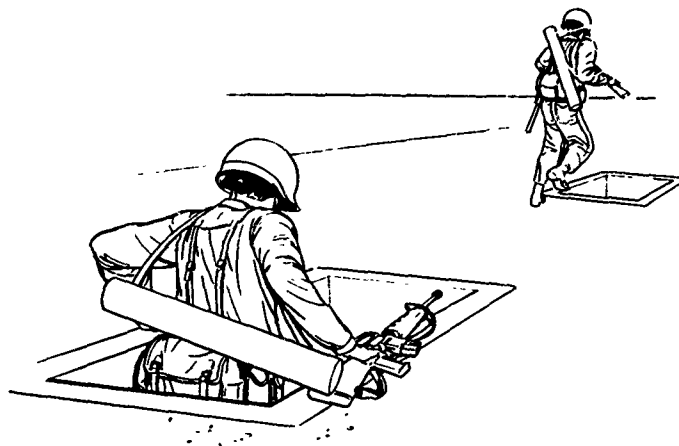

Fig. 25A. Two-man foxhole.

APPENDIX B

NIGHT VISION GOGGLES RATING FORM

SUBJECT GROUP _____ CONDITION _____

NAME _____ SUBJECT NO. _____ DATE & TIME _____

	EXTREME	MODERATE	SLIGHT	NEUTRAL	SLIGHT	MODERATE	SLIGHT	
HARD TO ADJUST	0	0	0	0	0	0	0	EASY TO ADJUST
STAYS ON	0	0	0	0	0	0	0	FALLS OFF
SWEATY	0	0	0	0	0	0	0	DRY
DANGEROUS	0	0	0	0	0	0	0	SAFE
LIGHT	0	0	0	0	0	0	0	HEAVY
OUT-OF-FOCUS	0	0	0	0	0	0	0	IN FOCUS
USEFUL	0	0	0	0	0	0	0	USELESS
TIGHT	0	0	0	0	0	0	0	LOOSE
FEELS OK	0	0	0	0	0	0	0	HURTS
FOGS UP	0	0	0	0	0	0	0	STAYS CLEAR
GRIPS	0	0	0	0	0	0	0	SLIDES
HARD	0	0	0	0	0	0	0	SOFT
WIDE	0	0	0	0	0	0	0	NARROW
HINDERS	0	0	0	0	0	0	0	HELPS
CLEAR	0	0	0	0	0	0	0	BLURRED
HOT	0	0	0	0	0	0	0	COOL
BRIGHT	0	0	0	0	0	0	0	DARK
PAINFUL	0	0	0	0	0	0	0	COMFORTABLE
CLINGS	0	0	0	0	0	0	0	SLIPS
MOVES EASY	0	0	0	0	0	0	0	STICKS

APPENDIX C
OPERATOR DEBRIEFING FORM
SYSTEM INTERFACE

Preceding page blank

OPERATOR DEBRIEFING FORM
SYSTEM INTERFACE

MODIFIED FOR NVG

1. OPERATOR IDENTIFICATION

(D) _____ Unit or agency to which crew or operator belongs.

(D) _____ Civilian or military occupational specialty of primary operator (applied in test or mission).

Visual acuity of primary operator

_____ 20/20 (1.00) or better without corrective lenses
_____ 20/30 (.67) with glasses
_____ 20/40 (.50) with contact lenses
_____ 20/50 (.40) or worse

_____ in. ht.
_____ lbs. wt.
_____ yrs. age

(D) What night vision system did you operate? Date _____

Have you ever operated this equipment before?

Yes. No.

If yes, about how many times? _____

Data collection officer is responsible for checking to see that this form is properly completed at the end of a night cycle with the night vision system. Data collection officer consults with operators and fills in items marked (D) from their reports and his own evaluations. He is also secondarily responsible for checking the entire debriefing form for completeness and accuracy. He is to be very concise and consistent in completing open-ended items requiring language.

Each completed form represents the accumulated experience of one or more operators in one complete night cycle (one or more missions) of one night vision system. Thus, the debriefing form represents a sampling of system/night cycles, not individual operators. Do not identify individuals by name or serial number.

This section is intended to provide minimum description of operator to allow crude anthropometric classification and inferences about interactions with personal corrective lenses. Operator may estimate his acuity or report on his last eye examination. If vision is excellent without correction, or corrected to normal, check 20/20. If more than one person served as primary operator in one night cycle, this physical description data may be omitted.

2. AMBIENT CONDITIONS

(D) Sk

- ___ Clear, very bright moonlight
- ___ Clear, less than 10% covered
- ___ Scattered, 10-50% covered
- ___ Broken, 60-90% covered
- ___ Overcast, over 90% covered

(D) Surfaces obscuration

- ___ Partially obscured, 10-90%
- ___ Obscured, over 90%

(D) Ground

- ___ Snow cover
- ___ Desert sand, limestone
- ___ Lightly wooded or semi-arid
- ___ Riverine, lake or coastal
- ___ Forest cover
- ___ Sea or ocean

(D) Atmosphere transmission (per mile)

- ___ Exceptionally clear, not less than .88
- ___ Very clear, not less than .73
- ___ Clear, not less than .53
- ___ Light haze, not less than .21
- ___ Haze or precipitation, less than .21

(D) Precipitation

- ___ None
- ___ Rain
- ___ Freezing rain
- ___ Sleet or ice crystals
- ___ Hail
- ___ Snow

Nomenclature from TM-1-300, DA Meteorology for Army Aviation, 10 Jun 63, 11-6, with "clear, very bright moonlight" category added to allow for extra high brightness of moonlight conditions overlapping day brightness conditions. Make best selection.

Graded from high reflectant through moderate reflectance, high contrast, to low reflectant, low contrast. Reference J. Johnson, K. Cooper, E. Bienz, and J. Eunor, Optical Properties of Targets and Backgrounds at Night, U. S. Army Engineer R&D Labs, Ft. Belvoir, Va., Nov 65. Check best approximate description.

Classification system used in describing visual properties of the atmosphere, from the International Visibility Code, T. H. Projector. The Role of Exterior Lights in Mid-Air Collision Prevention, Final Report No. 4, Contract FAA/BRD-177, prepared for FAA by Applied Psychol. Corp., Jul 62. Each level is related to a daylight visual range; e.g., .88 implies range in excess of 31 mi., .73 implies range of 12 to 31 mi., .53 implies range of 6.2 to 12 mi., .21 implies range of 2.5 to 6.2 mi. Estimate--make best selection.

This is a simplified classification based on TM 1-300, referenced above, p. 11-9.

2. AMBIENT CONDITIONS (Cont'd)

Was it excessively difficult to set up (assemble, emplace, and level or adjust) system under tactical conditions (e.g., rough terrain, blackout)?

Not Difficult | Moderately Difficult | Very Difficult

Was it excessively difficult to remove (disassemble, extricate, pack) system under tactical conditions?

Not Difficult | Moderately Difficult | Very Difficult

As a result of your experience, can you offer any observations or criticisms of this night vision system with its associated equipment?

Yes. No.

3. INTERACTIONS WITH OTHER SYSTEMS (e.g., WEAPONS, COMMUNICATIONS, OTHER PERSONNEL)

(D) _____ Other system used with night vision system.

Was time required for target acquisition fast enough for weapons delivery? Acquisition time was . . .

Too Slow | Some | Much

Was target acquisition range adequate for range of weapon system?

Too Short | Fair | Long Enough

If acquisition time is too slow (too long), then weapons delivery may be impossible on first pass necessitating a turnaround or reacquisition phase during which operator may be vulnerable to enemy action.

Range of operation of night vision system must be similar or greater than that of coordinated weapon system. Inadequate range in the night vision system will limit or foreshorten operational range of weapon system.

3. INTERACTIONS WITH OTHER SYSTEMS (e.g., WEAPONS, COMMUNICATIONS, OTHER PERSONNEL)

Was tracking movement . . .

Very Erratic | Fair | Very Smooth

Not | Fairly | Very

relatively smooth and continuous?

compatible with vehicle and/or weapons system movement?

If angular limits in azimuth and elevation and tracking angular velocities are not similar to those of weapon system, or, in the case of angular velocities, not consistent with the mission modes and velocities of the vehicle (e.g., aircraft), then an incompatibility with tracking movement of night vision system is indicated.

Was magnification sufficient or excessive for efficient operation?

Magnification was . . .

Too Little | Correct | Too Large

Did realignment or recalibration require excessive attention from operator? Adjustment problems were . . .

Very frequent | Occasional | Very Rare

Very difficult | Difficult

3. INTERACTIONS WITH OTHER SYSTEMS (e.g., WEAPONS, COMMUNICATIONS, OTHER PERSONNEL) (Cont'd)

Did muzzle flash, gases, or weapon system vibration interfere with use of system for continuous fire control or damage assessment?

None | Some | Much

What caused most interference?

Muzzle flash _____ Vibration _____
Gases _____ Noise _____

Did the use of the system, make communications with gunner (or commander) difficult or impossible?

No | Some | Very
Difficulty | Difficulty | Difficulty

(D) Make additional comments here, in as few words as possible, detailing criticisms indicated in Section 5 above:

4. DISPLAYS

Image was . . .

Poorly | Fairly | Finely | detailed,
sharp.

Poor | Adequate | Too | in brightness
Tc: low | High

4. DISPLAYS (Cont'd)

Too Small | Adequate | Too Large
in size.

Poor Low | Adequate | Too High
in contrast with field.

Field of view was . . .

Too Small | Adequate | Too Large
for target size.

Too Small | Adequate | Too Large
for target movement.

Were optics easy to reach?

Awkward | Fair | Easy

Were optics easy to handle, hold?

Awkward | Fair | Easy

Did use of the system distort distance and/or size estimates?

Much Distortion | Somewhat, Occasionally | Not at all

Did use of system interfere with dark adaptation, reducing sensitivity of unaided night vision?

Yes No

4. DISPLAYS (Cont'd)

Was there annoying or disabling glare?

None _____ In daylight _____
Direct (light source) _____
Reflected, indirect _____ During other conditions _____

Glare reported above was

_____ annoying _____ temporarily disabling

Did use of system result in a persistent after-image which interfered with other (subsequent) duties?

None _____ Some, but not interfering _____ Considerable interference _____

Did use of system result in headaches or other symptoms (e.g., eye discomfort, muscle fatigue)?

_____ headaches _____
_____ other symptoms (indicate . . .) _____

Did use of system for more than a half minute at a time or for more than twenty minutes of concentrated attention result in symptoms or other discomfort?

_____ headaches _____
_____ other symptoms (indicate . . .) _____

(D) Make additional comments here, in as few words as possible, detailing criticisms indicated in Section 6 above:

Experience with the Weapon Sight, Night Vision, Individual, showed consistent errors (excessive negative) in diopter settings, resulting in "eyestrain" and headache, reported in George Harker, "Headache resulting from use of weapon sight, night vision, individual," Letter Report No. 4, USAMRL, Ft. Knox, Ky., Nov 64.

5. CONTROLS

Were controls easy to reach?

Inaccessible | Somewhat | Accessible
Difficult | | Easy

Were controls easy to handle, move?

Awkward | Fair | Easy

Under tactical or low light level conditions were controls reliably identified by touch alone?

Uncertain | Fair | Certain
Ambiguous | | Easy

Were functional positions or modes identified by touch alone?

Uncertain | Fair | Certain
Ambiguous | | Easy

Were any controls ever inadvertently operated?

Yes. No.

If "Yes," identify control: _____

(D) Which control-display feature(s) most enhanced information (detection, identification, tracking) or was (were) most useful?

- _____ Image stabilization
- _____ Variable magnification
- _____ Target illumination
- _____ Illumination gating
- _____ Variable display brightness
- _____ Other, explain: _____

5. CONTROLS (Cont'd)

(D) Which control-display feature did you not use?

(D) Make additional comments here, in as few words as possible, detailing criticisms indicated in Section 7 above: