

ACCURACY OF THE UNIVERSAL PORTABLE ANESTHESIA COMPLETE
DRAWOVER VAPORIZER WHEN USING THE ANESTHESIA SIMULATOR

Richard A. Williamson
CAPTAIN, USA, NC

APPROVED:

Chair; Maura McAuliffe, CRNA, Ph.D.

Date

Member; Cynthia Cappello, CRNA, CAPT., USN, NC

Date

Member; Eugene Levine, Ph.D.

Date

APPROVED:

Faye G. Abdellah, Ed.D. ScD., RN, FAAN
Dean

Date

DISCLAIMER STATEMENT

Department of Defense

This work was supported by the Uniformed Services University of the Health Sciences Protocol No. T-061AZ-01. The opinions or assertions contained herein are the private opinions of the author and are not to be considered as official or reflecting the views of the Department of Defense or the Uniformed Services University of the Health Sciences.

COPYRIGHT STATEMENT

The author hereby certifies that use of any copyrighted material in this thesis entitled:

ACCURACY OF THE UNIVERSAL PORTABLE ANESTHESIA COMPLETE
DRAWOVER VAPORIZER USING THE ANESTHESIA SIMULATOR

beyond brief excerpts is with the permission of the copyright owner, and will save and hold harmless the Uniformed Services University of the Health Sciences from any damage which may arise from such copyright violations.

ABSTRACT

Drawover anesthesia is not a new concept, it dates to the earliest use of volatile anesthetic agents. William T.G. Morton used ether and a drawover vaporizer on October 16, 1846 in the first public demonstration of volatile agent anesthesia. Ether was widely used as a volatile anesthetic in the military from 1846 until the end of World War II. Drawover vaporizers were used on a limited basis during the Viet Nam War. As a result of success with drawover anesthesia experienced by British Armed Forces during the Falklands War the United States military gained a renewed interest in this device. Currently the Ohmeda Universal Portable Anesthesia Complete (UPAC) drawover device is used by the United States military. Patient simulation is a relatively new tool in teaching anesthesia students. Teaching drawover anesthesia using the patient simulator may have potential advantages. In this study the accuracy of anesthetic delivery by the UPAC as measured by the RASCAL was assessed. The anesthesia patient simulator provided an accurate source of negative inspiratory force to operate the UPAC. The study found that the UPAC delivers accurate and consistent concentrations of isoflurane when used with the anesthesia simulator. However at tidal volumes of 900ml after prolonged use expired concentrations of isoflurane exceeded inspired. This may be a result of absorption of isoflurane into the rubber and plastic components of the anesthesia simulator. It may also have been the result of large tidal volumes and increased amounts of isoflurane drawn into the mechanical lung of the simulator resulting in a concentration effect due to ventilatory limitations of the simulator.

Key Words: **Drawover anesthesia vaporizer** **Anesthesia simulator**
Anesthetic uptake and distribution

ACCURACY OF THE UNIVERSAL PORTABLE ANESTHESIA COMPLETE
DRAWOVER VAPORIZER WHEN USING THE ANESTHESIA SIMULATOR

by

Richard A. Williamson, RN, BSN, CCRN

THESIS

Presented to the Graduate School of Nursing Faculty of

the Uniformed Services University of the Health

Sciences in Partial Fulfillment

of the Requirements

for the Degree of

MASTER OF SCIENCE

UNIFORMED SERVICES UNIVERSITY OF THE HEALTH SCIENCES

OCTOBER 2000

DEDICATION

I dedicate this work to my wife and best friend Pamela Christine. Without her help, unwavering support, love, and willingness to sacrifice this educational opportunity would have been less meaningful.. To my children Sarah Christine, Seth Richard, Rachael Ann and Eliza Pearl. Your smiles, love and radiant personalities have lifted me up. To my Heavenly Father for blessing me with enough intelligence to accomplish this task and the tenacity to survive the process. To the faculty and staff at the Uniformed Services University of the Health Sciences for your encouragement, council and teaching. To the clinical preceptors who took a personal interest in me and shared their expertise so that I could progress.

If one advances confidently in the direction of their dreams and endeavors to live the life they have imagined they will meet with a success unexpected in common hours."

Henry David Thoreau

When the unbreakable sword strikes the un-cutable stone, the sword is sharpened.

Author unknown

TABLE OF CONTENTS

CURRICULUM VITAE.....	ii
DISCLAIMER STATEMENT.....	iii
COPYRIGHT STATEMENT.....	iv
ABSTRACT.....	v
DEDICATION.....	vii
CHAPTER I : INTRODUCTION.....	1
Background and Significance.....	1
Problem Statement.....	1
Purpose of the Study.....	2
Research Question.....	2
History.....	2
Conceptual Framework.....	4
Conceptual Definition Drawover Vaporizer.....	8
Operational Definitions of Drawover Vaporizer.....	8
Assumptions.....	9
Limitations.....	9
CHAPTER II: REVIEW OF THE LITERATURE.....	11
Introduction.....	11
Anesthesia Patient Simulator.....	11
History of the Drawover Vaporizer.....	13
Summary.....	18
CHAPTER III : METHODS.....	19
Introduction.....	19
Research Design.....	19
Data Analysis.....	20
CHAPTER IV : DATA ANALYSIS.....	21
Summary.....	30

CHAPTER V: SUMMARY, CONCLUSIONS AND RECOMMENDATIONS.....	31
Recommendations.....	34
Summary.....	34
REFERENCES	35
APPENDICES	40

LIST OF FIGURES

Figure 1	Field Configuration (Courtesy of O Sullivan & Ciresi,1999)	4
Figure 2	Draw-over vaporizer schematic (Courtesy of Ohmeda, Inc., West Yorkshire, England, U.K.).....	5
Figure 3	RASCAL II (Courtesy of Longnecker, Tinker, & Morgan, 1998).....	7
Figure 4.	Tidal volume 500ml , respiratory rate 10 breaths per minute, isoflurane concentration 1%. IPCFI represents 1% fraction of inspired concentration. IPCFE represents the fraction of expired concentration.....	22
Figure 5.	Tidal volume 500ml , respiratory rate 10 breaths per minute, isoflurane concentration 2%. IIPCFI represents 2% fraction of inspired concentration. IIPCFE represents the fraction of expired concentration.....	23
Figure 6.	Tidal volume 500ml , respiratory rate 10 breaths per minute, isoflurane concentration 3%. IIIPCFI represents 3% fraction of inspired concentration. IIIPCFE represents the fraction of expired concentration.....	24
Figure 7.	Tidal volume 500ml , respiratory rate 10 breaths per minute, isoflurane concentration 4%. IVPCFI represents 4% fraction of inspired concentration. IVPCFE represents the fraction of expired concentration.....	25
Figure 8.	Tidal volume 900ml , respiratory rate 10 breaths per minute, isoflurane concentration 1%. IPCFI represents 1% fraction of inspired concentration. IPCFE represents the fraction of expired concentration.....	26
Figure 9.	Tidal volume 900ml , respiratory rate 10 breaths per minute, isoflurane concentration 2%. IIPCFI represents 2% fraction of inspired concentration. IIPCFE represents the fraction of expired concentration.....	27
Figure 10.	Tidal volume 900ml , respiratory rate 10 breaths per minute, isoflurane concentration 3%. IIIPCFI represents 3% fraction of inspired concentration. IIIPCFE represents the fraction of expired concentration.....	28
Figure 11.	Tidal volume 900ml , respiratory rate 10 breaths per minute, isoflurane concentration 4%. IVPCFI represents 4% fraction of inspired concentration. IVPCFE represents the fraction of expired concentration.....	29

CHAPTER I : INTRODUCTION

Background and Significance

A major part of mission readiness for deployable military anesthesia providers is the proficient use of field anesthesia equipment. It is essential that reliable data and training opportunities be provided regarding the utilization of the currently available drawover anesthesia vaporizers: a small, portable inhalational anesthesia machine (Brown, Murdock, Galeas, & Smith, 1998). Drawover anesthesia equipment is usually reserved for use in austere conditions that include war, natural disasters, and humanitarian missions to developing countries (Kingsley, 1992). Drawover equipment is used in austere conditions because of its portability, simplicity in operation, and durability. The Tri-Service component of the United States Military Medical Department (DEPMEDS) has selected the Ohmeda Universal Portable Anesthesia Complete (UPAC) drawover vaporizer for use in these extreme environments. There is limited use of drawover vaporizers in mainstream anesthesia practice because these devices do not meet current Food and Drug Administration (FDA) standards (CFR 51,60, 10673, Federal Register 52: 36-37, 1987). It is imperative that safe and predictable levels of inhalation anesthetic agents be administered in the field environment where state of the art monitoring equipment is not always available.

Problem Statement

The accuracy of the UPAC drawover vaporizer when used during anesthesia simulation has not been determined.

Purpose of the Study

The purpose of this study was to determine the accuracy of the delivery of an inhalational anesthetic agent using the UPAC drawover vaporizer with a computerized anesthesia patient simulator.

Research Question

How accurate is the administration of 1%, 2%, 3%, and 4% concentrations of isoflurane when using the UPAC drawover vaporizer with the anesthesia simulator to create the negative inspiratory force?

History

Drawover anesthesia dates to the earliest use of volatile anesthetic agents. Drawover anesthesia is not a new concept. William T.G. Morton used a drawover vaporizer on October 16, 1846 in the first public demonstration of volatile agent anesthesia. The agent he used was ether (Talbot, 1965). Ether continued to be widely used as a volatile anesthetic in the military from 1846 until the end of World War II. Ether was administered by dripping the solution onto a gauze covered mask and placing the mask over the nose and mouth of the patient. Drawover vaporizers were used on a limited basis during the Viet Nam conflict (Petty, 1995). As a result of the success with drawover anesthesia experienced by British Armed Forces during the Falklands War the United States military gained a renewed interest in this device. The Falklands war epitomized the flexibility of using portable, rugged, and simple anesthesia devices as evidenced by the following factors: The war was short, featured highly mobile forces, and long standing field hospitals were not required. The United States military engaged in research and development that resulted in the selection of the Ohmeda Universal Portable

Anesthesia Complete (UPAC) as the drawover vaporizer for the U.S. military. The FDA authorized the UPAC s use prior to troop deployment to Saudi Arabia during Operation Desert Storm as a backup to the larger 885A Field Anesthesia Machine.

Within the last decade the concept of using the anesthesia patient simulator to train anesthesia providers has evolved from the work of David M. Gaba, M.D., a professor of anesthesiology at Stanford University School of Medicine (Gaba & DeAndra, 1988). The simulation of anesthesia delivery is hands-on and requires actual performance of anesthesia tasks and interventions using anesthesia equipment. The administration of anesthesia, although frequently said to be routine, requires both vigilance and the ability to handle problems that can immediately become life threatening. Simulation training has been proposed as a means to reduce the incidence of patient anesthetic mishaps and their impact.

Opportunities to use the UPAC and the simulator as training devices are valuable for military anesthesia providers. In 1994, Casinelli and Reynolds adapted the UPAC to meet FDA safety requirements for clinical use in the United States. This was accomplished by attaching a waste gas scavenger system and required machine and patient monitors to the UPAC. A back up modern anesthesia machine is to be on standby when this device is used clinically. The patient is continually monitored by the required state of the art devices to assure compliance of FDA guidelines. This was done to give anesthesia care providers practical experience with the device before using it in the field. Use of the anesthesia simulator provides valuable training in the practical use of the UPAC device without placing any patient at undo risk. Simulators may be used in training personel for situations when consequences of inappropriate actions could be dangerous to patients. Mishaps and accidents in connection with the use of biomedical instrumentation are

frequently a result of technical malfunction, human error, or improper use the equipment (Arne, Stale, Ragna, & Petter, 1996).

Conceptual Framework

The UPAC drawover vaporizer (see Figure 1) functions as a result of negative inspiratory force generated by the respiratory effort of a spontaneously breathing patient. A one way valve at the face mask, endotracheal tube or laryngeal mask airway, combined with a non return valve at the vaporizer outlet, ensures one way movement of air from the air inlet valve to the patient. Air is drawn through the UPAC by recoil negative pressure.

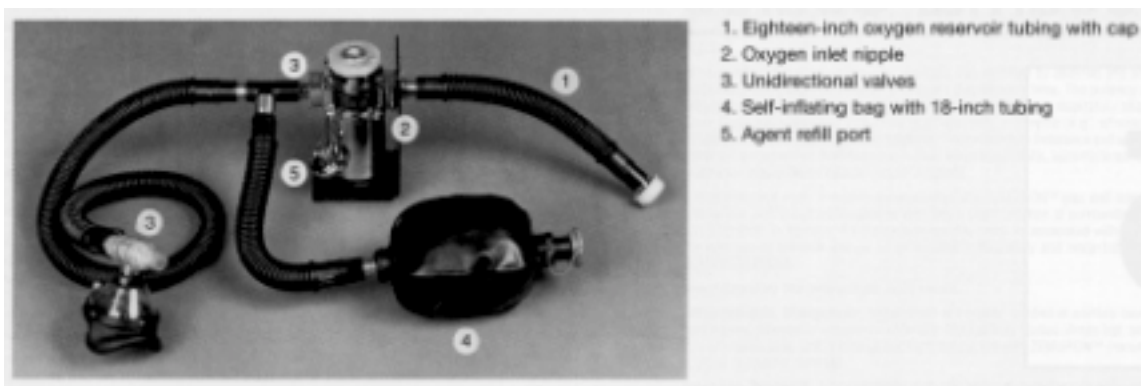

Figure 1. Field Configuration. (From O Sullivan & Ciresi,1999).

Air flow within the UPAC is governed by a rotary valve, which is controlled by adjusting the concentration setting dial (see Figure 2). As air enters the vaporizer, the vertical rotary valve divides the stream; some air enters the vaporizer chamber and some bypasses the vaporizer. As the UPAC bypass gap is reduced, greater proportions of air enter the vaporizing chamber. A wick in the vaporizing chamber increases the surface area for evaporation. Heat is required for evaporation of the liquid anesthetic agent. A

temperature compensation valve controls the orifice where the mixture of air and anesthetic agent exits the vaporizing chamber to mix with the air bypassing the vaporizing chamber. Output from the vaporizer is dependent on flow rate (tidal volume and respiratory rate), inspiratory / expiratory rate, and temperature. High flow rates do not allow enough time for temperature compensation, so the liquid cools rapidly and output falls. Temperature compensation in the UPAC is accomplished by a bimetallic strip that controls the vaporizing chamber outlet orifice (O Sullivan & Ciresi, 1999 ; Petty, 1995).

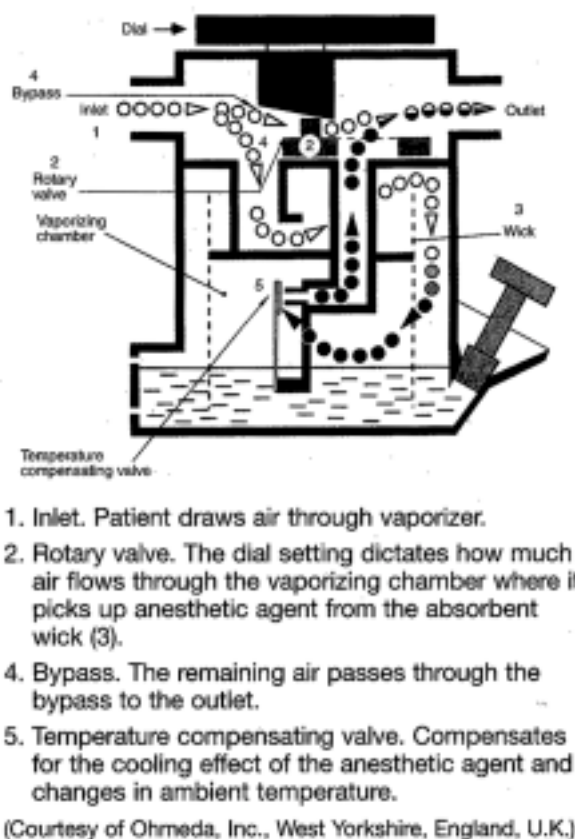
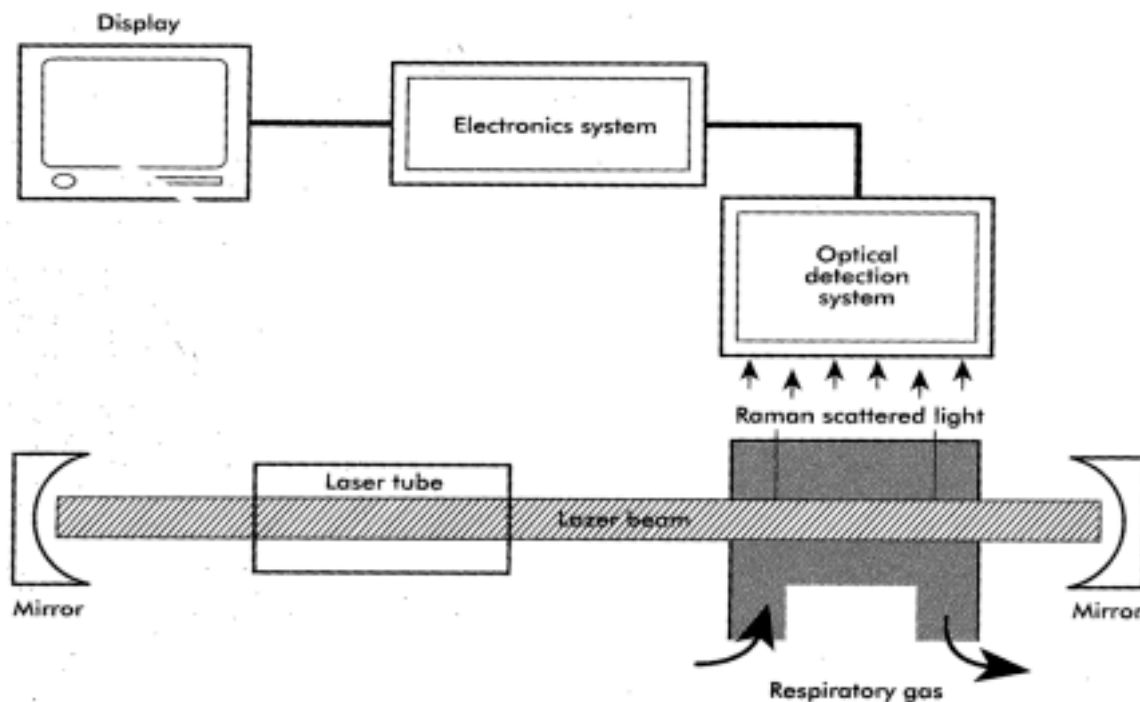

Figure 2. Draw-over vaporizer schematic.

A major premise for testing the accuracy of the UPAC is grounded in the theory of time constants. A time constant is the time required for the flow through a container to equal the capacity of the container. It is also the time required for a 63 percent washin or

washout of a new gas from the lungs (Eger, 1974). Time constants are represented by the formula: capacity divided by flow equals time constant ($\text{Capacity/Flow} = \text{TC}$). The following example from the text *Anesthetic Uptake and Action* by Edmond I. Eger, II, M.D., clearly illustrates this principle. Imagine a lung with a functional residual capacity of 2 liters (FRC-2/L) and alveolar ventilation of 4 liters per minute (VA- 4L/minute flow rate). The time constant for this example is 1/2 minute, since in 1/2 minute the flow (4L/minute) through the container (2L- FRC) equaled the container capacity (2L-capacity / 4L per minute-flow = 1/2). In 1/2 minute, a 63 percent rise in alveolar concentration was obtained (500ml breaths or continuous flow). Doubling the time caused a 63 percent rise in the remaining difference between 63 and 100 percent. Similarly, each succeeding time constant (1/2 minute) would reduce the remaining difference by 63 percent. Thus, at one minute the change in alveolar concentration was 86 percent complete ($63 + [63/100] [100 - 63]$). At one and one half minutes the change would reach 95 percent ($86 + [63/100] [100 - 86]$) and at two minutes, 98 percent ($95 + [63/100] [100 - 95]$). This represents virtually complete washin. Limitations to its use lie in the assumptions on which it is based: a constant inflow of constant gas concentration and complete mixing within a container of constant capacity.

For the purpose of this study a general purpose gas analyzer for anesthetic agents and inert gases was used to evaluate Isoflurane concentrations (see Figure 3). The instrument used was a RASCAL II (RASCAL is an acronym for Raman-Scattering-AnaLyzer). The identification number is L8253, serial number FAZX-01865. It was calibrated 10/1999, and that calibration was good through 04/2000.



Block diagram of Raman-scattering respiratory gas analyzer (Raman spectrometer). The laser tube generates monochromatic light that is contained within a cavity by mirrors. Respiratory gas from patient is sampled and passes through laser beam. Gas molecules scatter small amount of light at wavelengths different from those of incoming beam. Wavelength shift is characteristic of the gas species. The scattered light is detected, and gas composition is computed and displayed in appropriate units of measure.

Figure 3. (Rascal adapted from Longnecker, Tinker, & Morgan, 1998).

The RASCAL II technology is based on the phenomenon of spectral shift scattering described by Raman and Krishnan in 1923 (Longnecker, Tinker, & Morgan, 1998). In Raman spectrometry (light scattering gas analysis) an argon or helium laser emits monochromatic light. When the light interacts with a gas molecule that has inter-atomic molecular bonds, some of the gases energy is converted into vibrational and rotational energy within the molecule. A fraction of the absorbed energy is re-emitted at differing wavelengths in a phenomenon called Raman scattering. The magnitude of this shift is specific for particular gas molecules, enabling their identification. A complex optical system detects the Raman-scattered radiation. Sensitive photon detectors, including photon multiplier tubes are used to detect scattered photons for each gas present at

specific wave lengths. The resulting photon count is proportional to the partial pressure of the gases present. Gas analysis is an essential element in the administration of inhalational anesthetic agents. In anesthesia practice Raman spectrometry is used to measure oxygen, carbon dioxide, nitrogen, nitrous oxide, water vapor and up to three volatile anesthetic agents at one time (Dorsch & Dorsch, 1999; Sosis, 1997).

Conceptual Definition Drawover Vaporizer

Drawover vaporizer anesthesia device is a small, light weight, rugged unit that can operate independently of a powered ventilator or pressurized gas cylinder. In the austere medical environment inhalational anesthetic agents can be effectively delivered using a drawover anesthesia device (Kingsley, Olsen, Nelson, & Danley, 1991).

Operational Definitions of Drawover Vaporizer

1. Accuracy of the Ohmeda Universal Portable Anesthesia Complete: Isoflurane percent concentration (F_1I) delivered as measured by the RASCAL using the anesthesia simulator to generate negative pressure.
2. Isoflurane: An FDA approved volatile inhalational anesthetic agent (Morgan & Mikhail, 1996).
3. Minute volume: The volume of gas expired or inspired per minute in quiet breathing, usually measured as expired ventilation (Thomas, 1994).
4. Patient simulator: Full featured human mannequin with operator s work station, interface cart, operational software describing patient physiology and users guide. Features include: A rugged, portable system which can be serviced, if necessary, by any hospital equipment engineering staff. Over 25 simulated cardiovascular, pulmonary, and metabolic events can be performed. Simulated physiological reactions to over 70 drugs,

along with their medically established side effects can also be demonstrated. In addition to the pre-programmed simulations, specific scenarios can be generated by the instructor /operator to test the students ability to adapt to changes in simulated homeostasis (Huse, 1997).

5. Rascal: A general purpose gas analyzer for anesthetic and inert gases. This device utilizes the phenomenon of spectral shift scattering as described by Raman and Krishnan in 1923 (Longnecker et. al 1998).
6. Tidal volume: The volume of air inspired and expired in a normal breath (Thomas, 1994).
7. Ventilatory pattern: The rate, volume, and pressure of inspired air. Can be assessed via normal spontaneous negative pressure inspiration or via mechanical positive pressure ventilation (Nagelhaut & Zaglaniczny, 1997).

Assumptions

The following assumptions apply to this study:

1. Delivery of the inhalational anesthetic agent isoflurane by the UPAC vaporizer to the anesthesia patient simulator is similar to its clinical delivery.
2. The Rascal accurately measures the concentration of isoflurane at the distal tip of the endotracheal tube.

Limitations

The following limitation applies to this study:

The austere medical environment is not part of the study. In environments that include military medical operations, disaster relief and humanitarian aid, it is difficult to control for ambient temperature which is the primary effector on the

vaporization rate of anesthetic agents. In the patient simulator laboratory the ambient temperature will be 68 to 70 degrees Fahrenheit. The use of the anesthesia simulator will, by definition, be performed in a highly controlled environment.

CHAPTER II: REVIEW OF THE LITERATURE

Introduction

Automation, electronics and computer aided systems have increased society's reliance on these systems. What of the contingencies when electronic or complex devices are not available or nonfunctioning due to a loss or absence of electrical power? These contingencies exist, especially for those who practice military medicine (Pylman & Teiken, 1997). There remain in the world, special conditions where the comforts and convenience of modern equipment becomes useless. In military anesthesia there are provisions made for such events, specifically in the realm of delivery of volatile anesthetic agents. The drawover vaporizer is such a provision. It requires no electrical power, no computer chips or megabits to operate. It is purely a manual device that can assist anesthesia caregivers in the delivery of safe, effective field anesthesia under austere conditions. This older established method of anesthetic delivery can be enhanced by training with the aid of modern computerized anesthesia patient simulators.

The patient simulator is achieving increasing popularity and wide spread use. Many studies exist that demonstrate the effectiveness of the simulator in enhancing the proficiency training of anesthesia providers.

Anesthesia Patient Simulator

Simulators have been effectively used in the training of aviation pilots, astronauts, and ship pilots for many decades. They are now coming of age in medicine, especially in anesthesia training and anesthesia crisis management (Howard, Gaba, Fish, Young & Sarnquist, 1992). The sentinel work in anesthesia

simulation dates to the late 1960s. In 1969, Abrahamson, Wolf and Denson developed the initial anesthesia patient simulator project called SIM 1. This project produced a simulator system that mimicked the anesthesia provider work station. The goal was to determine whether simulator training could speed certification of anesthesia residents in tracheal intubation. Five resident physicians participated in the initial trials. The results were not significant. The SIM 1 had no electronic or invasive monitoring and could only evaluate six drugs. SIM 1 was somewhat limited by the technology of that time.

In 1988, Gaba and DeAnda began the development of a automated expansive anesthesia patient simulation model. Gaba and DeAnda created a system that was realistic of the anesthesia provider s tasks and environment. They re-created the environment of an operating room and the anesthesia provider was required to physically perform tasks required by the computer generated scenarios. Human errors can be measured using anesthesia simulation, providing the anesthesia providers feedback about their strengths and weaknesses without compromising patient safety.

Some nurse educators support use of the patient simulator as an effective tool to assess and teach critical performance and thinking skills. Computer simulations can be an efficient method of teaching students content and critical thinking skills without exhausting severely limited clinical time or actually placing patients in jeopardy (Wies & Guyton - Simmons, 1998).

Holzman et. al (1995) embraced the concept of anesthesia crisis resource management (ACRM) which was introduced in 1998 by Gaba and DeAndra as an

essential part of anesthesia patient simulation. In 1995, Holzman recognized the weakness in formal anesthesia education programs to develop skills in resource management and decision making during a crisis in practice. Utilizing ACRM principles he developed a 75 day program that was attended by 68 anesthesiologists and 4 nurse anesthetists. The anesthesia environment was recreated in a real operating room. Utilizing an anesthetic simulator, a full spectrum of crisis scenarios were played out. The goal was to develop and enhance the skills of anesthesia care providers in a controlled exercise environment.

O'Donnell, Fletcher, Dixon and Palmer (1998), discussed ACRM skills as being desirable attributes of a nurse anesthesia educational program. They noted that access to ACRM courses are limited due to cost, availability of a teaching center, time constraints and a lack of adequately prepared CRNA faculty.

The simulator can accurately replicate much of the anesthetist's work environment, including the patient, anesthesia machine, monitors and drugs. Students can be given opportunities to develop and refine skills in anesthesia management in a safe and realistic environment (Fletcher, 1995).

History of the Drawover Vaporizer

Published use of the drawover vaporizer dates to October 16, 1864, when William T.G. Morton demonstrated a rudimentary drawover device using ether as the volatile anesthetic agent (Talbot, 1965). To date, there is no published literature relative to training and testing of the drawover vaporizer utilizing an actual anesthesia patient simulator.

In 1956, during the Soviet invasion of Hungary, there was a world wide depletion in oxygen. The New York State civil defense department, in preparation for possible catastrophe, purchased 400 drawover anesthesia devices. These devices were a standard inventory item of the U.S. civil defense hospital units during the 1960s. At that time anesthesia providers were trained to administer anesthesia without supplies of compressed gasses (Brown et. al , 1998). The Israeli armed forces during the Yom Kippur War in October, 1973, and British forces during the 1982 Falklands war used drawover anesthesia devices successfully (Jowit & Knight, 1983).

The renewed interest of the United States military in the drawover vaporizer began during the Vietnam War, although there was little use of these devices by the United States medical forces at that time (Petty, 1995). The interest grew out of allied forces influence as American observers witnessed the success that Israeli and British medical forces had with the devices. The San Francisco earthquake of 1989 spawned further renewed interest as did the mobilization of anesthesia providers during Operation Desert Storm in the Middle East (Kingsley, 1992). The increasing military activity in the Persian Gulf necessitated that anesthesia care providers from the United States gain practical familiarity with the use of drawover vaporizers (Brock - Utne, 1992).

The successful use of this valuable anesthesia tool for austere and combat situations spurred further desire to improve the vaporizers. An inherent strength of the device is that they are simple, effective, and require no oxygen source to function. The inherent weakness is that this can produce dangerous hypoxemia for

the patient. Mackie (1987) found that a simple 4 liter per minute flow of oxygen and a reservoir consistency of one meter of corrugated tubing with an internal volume of 415 ml was sufficient to deliver a safe inspired oxygen concentrate. This conclusion was also dependent on a mask fit that was air leak free.

In 1991, Jarvis and Brock-Utne devised a method to affix an oxygen concentrator to the drawover vaporizer. The fractional oxygen concentration from this equipment was dependent on the minute ventilation, oxygen output of the concentrator, and the presence of an oxygen economizer tube (OET). They discovered that with the use of a 900 ml internal volume corrugated OET, fractional oxygen concentrations were higher than without an OET. They also concluded that without the OET the performance of the system was impaired. The OET was essential to provide consistent oxygen concentration to the patient at any given minute volume.

In 1994, Casinelli and Reynolds received clearance from the FDA to use the drawover UPAC in a modern operating room at a US Army medical center. They affixed fresh flow oxygen, and a waste gas scavenger system to the device. This was done to give anesthesia providers hands-on experience using the UPAC on human subjects.

There have been numerous volatile agents tested in the drawover vaporizer. These include ether, trichloroethylene, halothene, isoflurane, sevoflurane, enflurane. The majority of the studies were conducted by British researchers. The results have been mostly satisfactory and predictable (Borland et. al., 1983 ; Craig, Berry & Yates, 1995 ; Hollis, 1986 ; Kocan, 1987 ; ; Pylman & Teiken, 1997; Schaefer &

Farman, 1984; Tighe & Pethybridge, 1987 ; Yoganathan, Haughton, Graveston & Thorton, 1988). Not all vaporizers have a multi agent application. There are older configurations specifically designed for one agent. The majority of currently used drawover vaporizers are capable of using multiple volatile anesthetic agents.

Currently there are strategies to develop positive pressure ventilators that change the drawover vaporizer into a pushover vaporizer. This provides greater flexibility to the device. In 1994, Taylor and Restal bench-tested the British drawover vaporizer - OMV/50 - to assess efficacy in the pushover configuration. They concluded their device showed no clinically significant differences in concentrations of volatile agent output.

In 1997, McIndol, Stewart and Wilson set out to test the efficacy of drawover vaporizers adapted to positive pressure ventilation for sedation in an intensive care. This was accomplished by connecting the drawover vaporizer into the inspiratory limb of the ventilator circuit. They tested the Oxford Miniature Vaporizer (OMV) and Ohmeda TEC vaporizer. The OMV was found to be predictable and safe, but the Ohmeda TEC was unreliable. Currently there is no mechanical ventilator specifically adapted to the UPAC.

Two studies associated with the United States military in 1998 demonstrated that the UPAC could be successfully used in a pushover mode, provided an appropriate non-rebreathing valve assembly was used (Hawkins, Ciresi, & Phillips, 1998 ; Hawkins, Ciresi, & Reynolds,1998). The conclusions of these two studies were that there was no significant differences in vaporizer output between drawover and pushover configurations. It further concluded that vaporizer output could be

reliably predicted in either mode and was correlated with both tidal volume and respiratory rate (Hawkins, Ciresi, & Phillips, 1998). With the use of established concentration curves, knowledge of the variables that affect vaporizer performance and an understanding of the essential equipment, anesthesia providers can safely administer inhalation anesthetics with the UPAC using mechanical ventilation in a pushover mode with the equipment currently available to them (Hawkins, Ciresi, & Reynolds, 1998).

In 1985, Mahla, McCarthy and Price at the Uniformed Services University of the Health Sciences in Bethesda, Maryland tested the Triservice Anesthesia Apparatus and OMV on 13 canine models. They concluded that pulse oximetry was essential for the use of the drawover vaporizers tested, and that supplemental oxygen must be available to reduce the risk of hypoxemia. They determined that the devices can safely deliver known concentrations of anesthesia and the devices would be of benefit to military anesthetists who perform anesthesia in an unfavorable environment. They concluded that a final recommendation must come after the completion of human studies. They also noted there was no theoretical reason to expect their results among humans would be different.

Kingsley et. al. (1991) working at the U.S. Army Biomedical Research and Development Laboratory located at Fort Detrick, Maryland, tested the UPAC utilizing porcine models. They concluded the following: Drawover anesthesia can be administered effectively without pressurized gas or supplemental oxygen. Data from these animal studies and clinical trials indicate that oxygen saturation may drop significantly when halogenated anesthetic agents are used. This problem may

be alleviated by intubating patients, rapidly inducing patients with high concentrations of agent followed by a rapid reduction in agent delivery, administering supplemental oxygen, and using controlled ventilation.

Summary

Drawover anesthesia is a safe, simple effective way to deliver anesthesia in the austere medical environment. This method is not inferior to other methods, just a different way of delivering anesthesia (Baskett, 1990). It requires adaptation and implementation of critical thinking skills, familiarity with the drawover device, and special field anesthesia techniques. It is obvious from all the cited studies that use of the anesthesia patient simulator is an invaluable resource in teaching and training of anesthesiologists to help them gain competency with the UPAC. In this study we will test the UPAC on a anesthesia simulator in a highly controlled setting.

CHAPTER III : METHODS

Introduction

In this study using an anesthesia patient simulator to control the respiratory rate and tidal volume, the effect of minute volume on the concentration of isoflurane delivered by the UPAC drawover vaporizer was measured.

Research Design

1. The UPAC in accordance with the manufactures instructions and without modifications was assembled.
2. The UPAC drawover vaporizer inhalational agent reservoir from a previously unopened and non expired bottle of isoflurane, was then filled.
3. The simulated anesthesia patient was then intubated and cuff inflated. The air seal was ensured.
4. A preset respiratory rate of 10 breaths per minute was set and then tidal volume determined for the simulated patient via the simulator control system and checked that the external Rascal and the gas analyzer within the anesthesia simulated patient was functioning.
5. The inspiratory tube from the UPAC drawover vaporizer to the endotracheal tube of the anesthesia simulator was affixed.
6. Simulated spontaneous respiration of the simulated patient was begun.
7. The UPAC drawover vaporizer control was adjusted to deliver the desired concentration of isoflurane and timing of the procedure was begun.
8. The percent concentration of isoflurane delivered at 15, 30, 45, 60, 90, 120, and 180 seconds was recorded.

9. Tidal volumes of 500ml (minute volume of 5,000ml), and 900ml (minute volume of 9,000ml) were used. The percent concentrations of isoflurane dialed into the UPAC were 1%, 2%, 3%, and 4%.
10. The effect of each tidal volume setting and percent concentration setting were recorded at 15 , 30 , 45 , 60, 90, 120, and 180 seconds.

Data Analysis

Descriptive statistics showing the relationship of variables of interest were portrayed in graphs and charts. Statistical package of social sciences (SPSS) was used for data processing and analysis.

CHAPTER IV : DATA ANALYSIS

In this study the UPAC was assembled in accordance with manufactures guidelines and connected the UPAC to the endotracheal tube of the anesthesia simulator. The simulator was preset to specific tidal volumes and respiratory rates. Ambient air temperature was recorded. The RASCAL was calibrated to assure beginning airway gas concentrations were zero. The simulator operator then started the respiratory cycle on the simulator and the UPAC was adjusted to the specific percent concentration to be assessed. Two observers recorded the percent concentration of isoflurane delivered by the UPAC as measured by the RASCAL. The inspired and expired concentrations of isoflurane at 15, 30, 45, 60, 90, 120, and 180 seconds was recorded. The tidal volumes delivered at the specified time intervals were also recorded. Eight separate inspired and expired concentration tests were performed. The first four tests were performed at a tidal volume of 500ml . The concentrations assessed were at 1%, 2%, 3%, and 4% isoflurane. The second four tests were performed at a tidal volume of 900ml. The concentrations assessed were at 1%, 2%, 3%, and 4% isoflurane.

The results of this study are represented Figures 4-11. Each accuracy trial of the UPAC vaporizer is represented by graphic time sequence plots (TSPLIT). The recorded data are in the appendix (see Appendix I-VIII). As expected the UPAC delivered accurate inspired concentrations of isoflurane in all tests (see Figures 4-11). In Figures 4-7 the expired concentrations parallel the inspired concentrations of isoflurane. However in Figures 8-11 the expired concentration exceeds the inspired concentration of isoflurane.

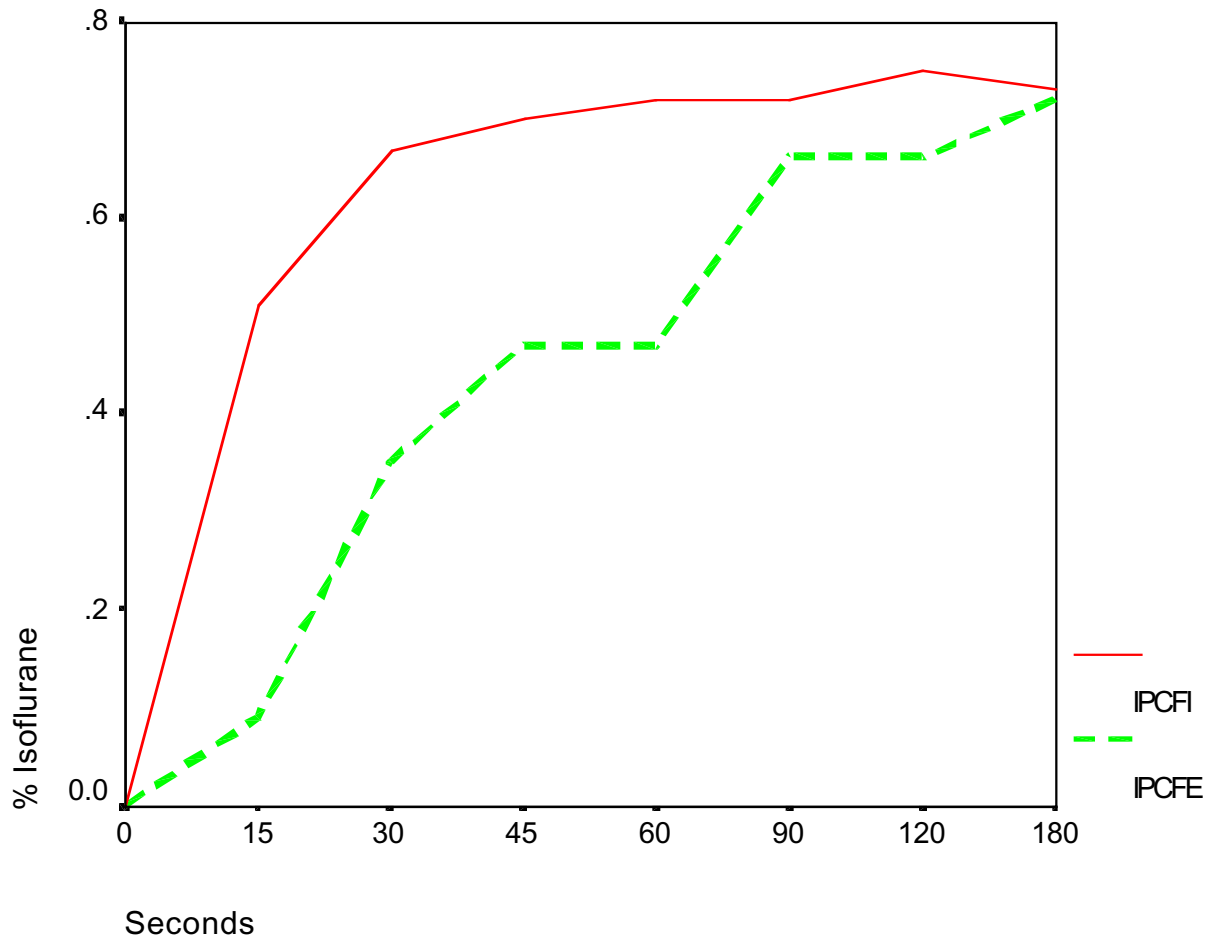

Figure 4. Tidal volume 500ml , respiratory rate 10 breaths per minute, isoflurane concentration 1%. IPCFI represents 1% fraction of inspired concentration. IPCFE represents the fraction of expired concentration.

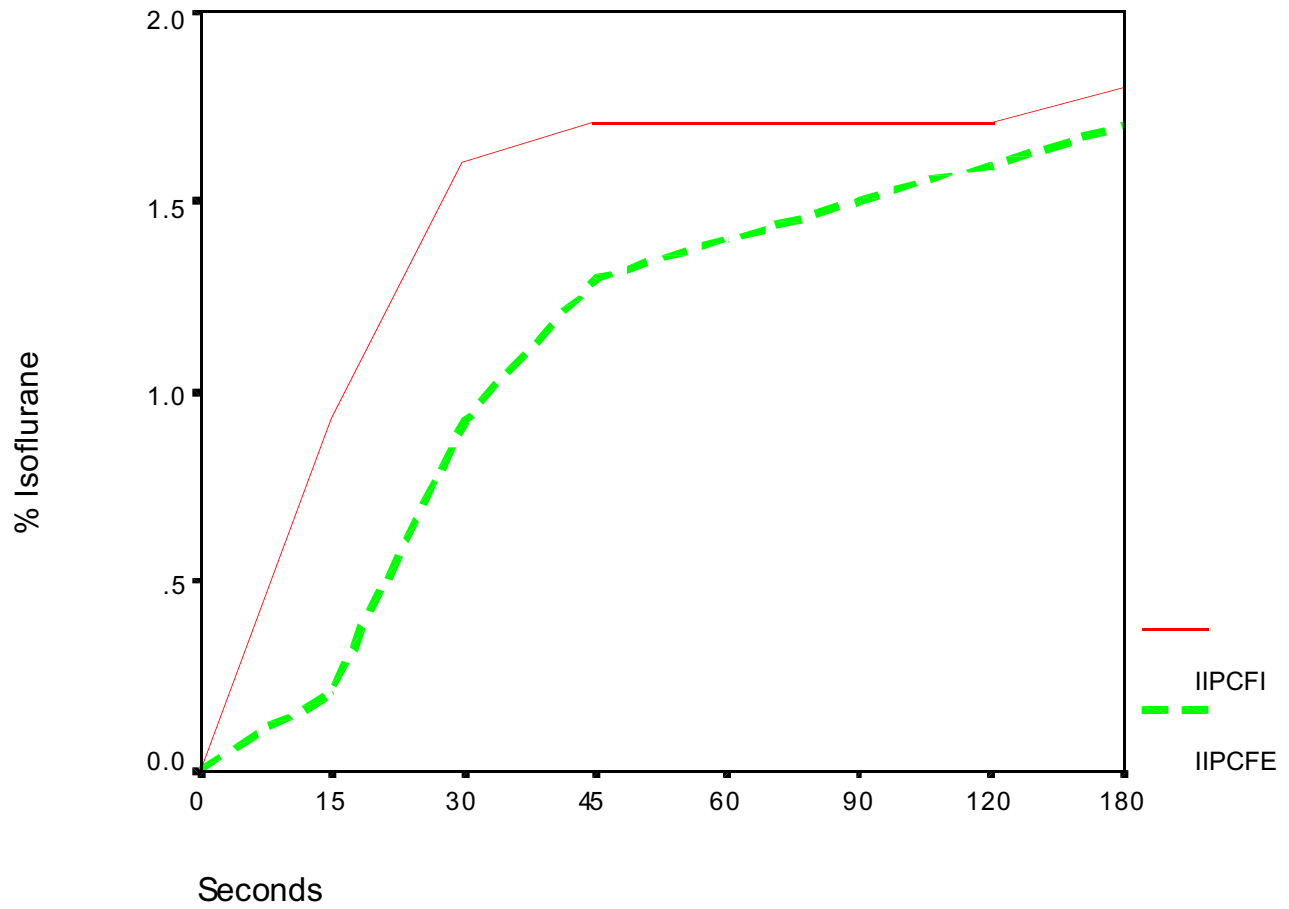

Figure 5. Tidal volume 500ml , respiratory rate 10 breaths per minute, isoflurane concentration 2%. IIPCFI represents 2% fraction of inspired concentration. IIPCFE represents the fraction of expired concentration.

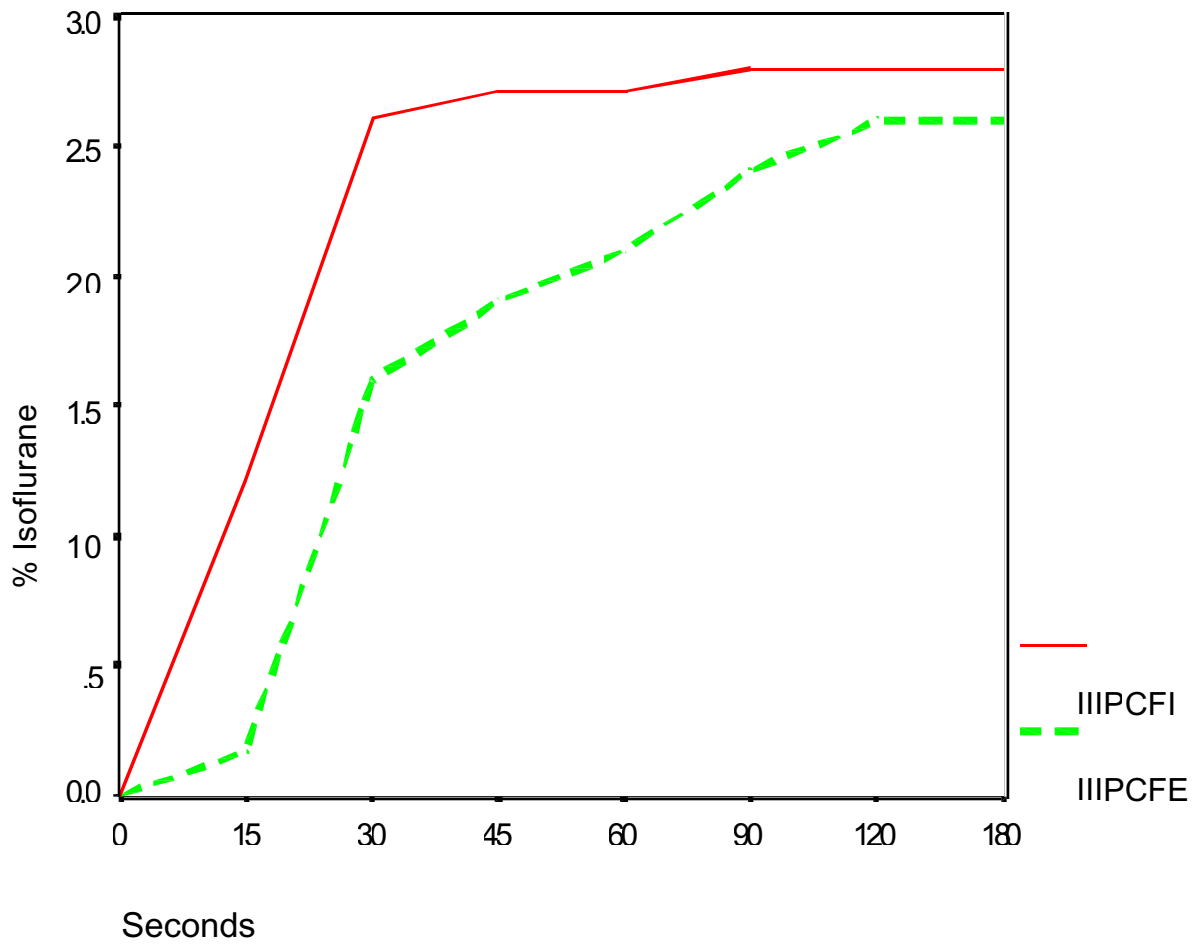

Figure 6. Tidal volume 500ml , respiratory rate 10 breaths per minute, isoflurane concentration 3%. IIIPCFI represents 3% fraction of inspired concentration. IIIPCFE represents the fraction of expired concentration.

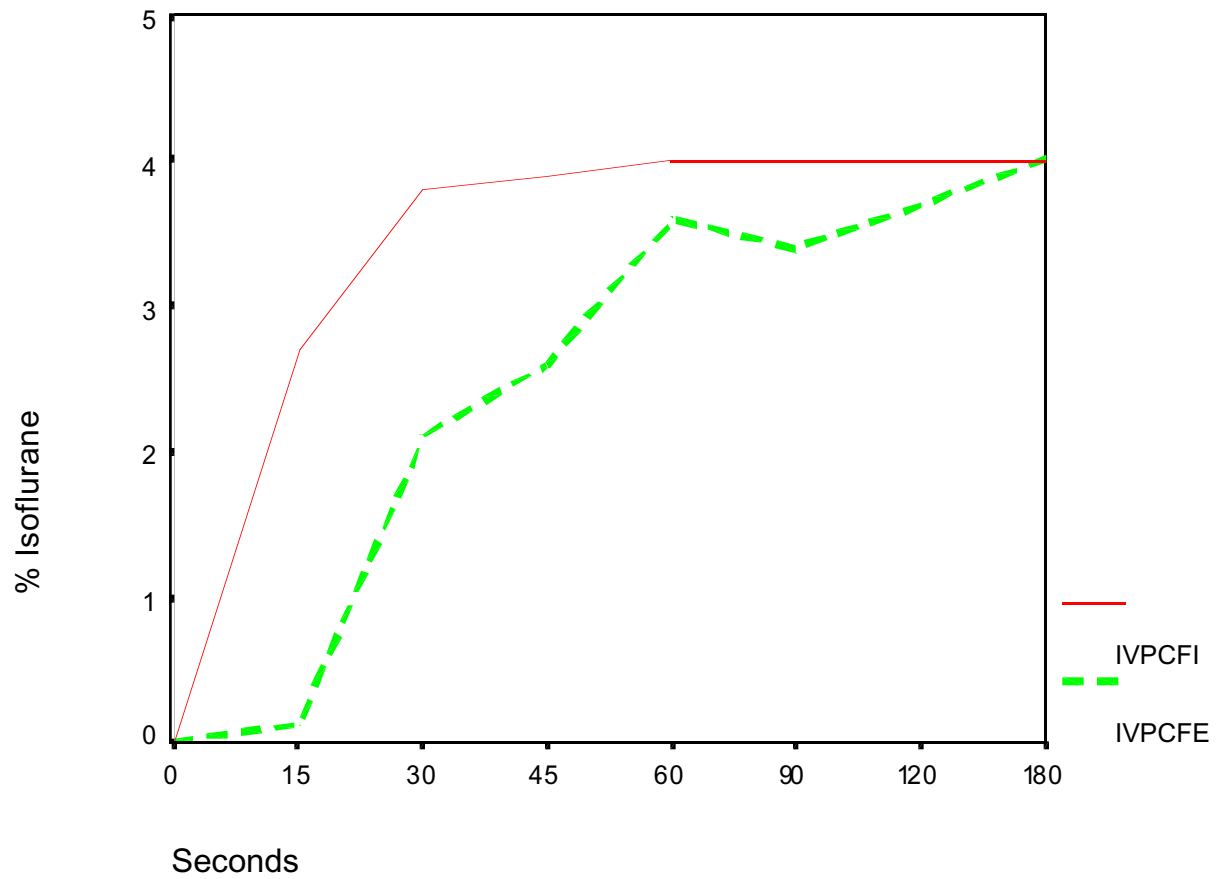

Figure 7. Tidal volume 500ml , respiratory rate 10 breaths per minute, isoflurane concentration 4%. IVPCFI represents 4% fraction of inspired concentration. IVPCFE represents the fraction of expired concentration.

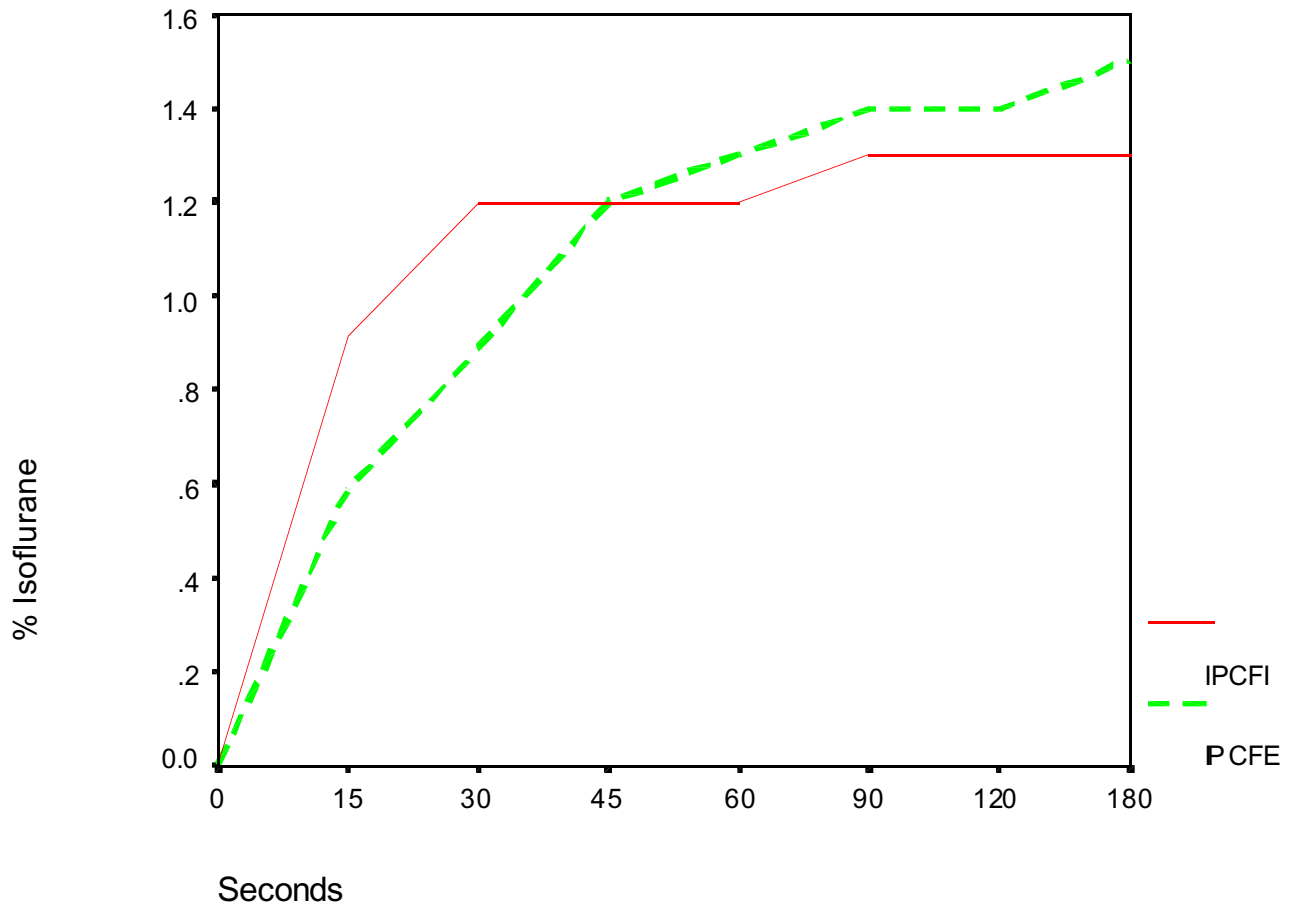

Figure 8. Tidal volume 900ml , respiratory rate 10 breaths per minute, isoflurane concentration 1%. IPCFI represents 1% fraction of inspired concentration. IPCFE represents the fraction of expired concentration.

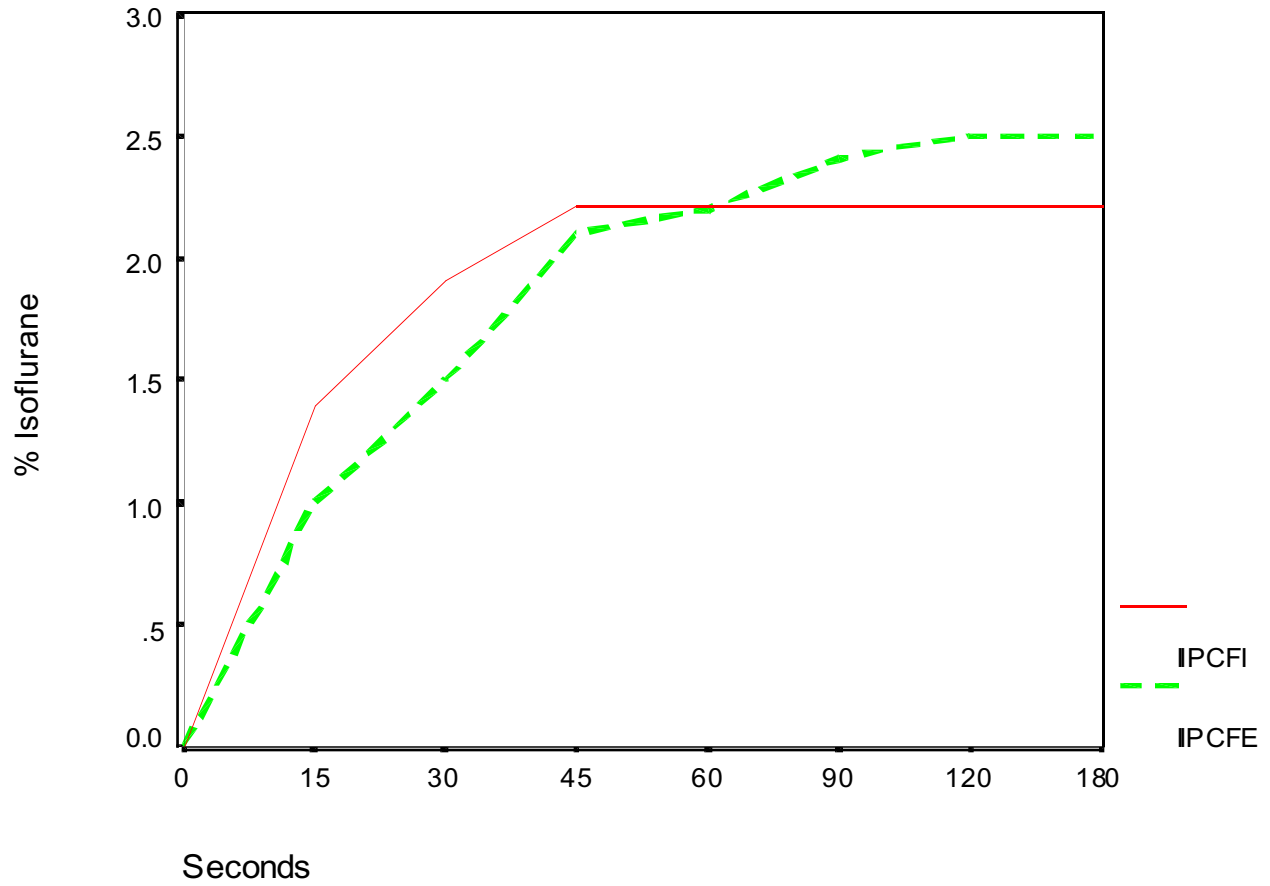

Figure 9. Tidal volume 900ml , respiratory rate 10 breaths per minute, isoflurane concentration 2%. IIPCFI represents 2% fraction of inspired concentration. IIPCFE represents the fraction of expired concentration.

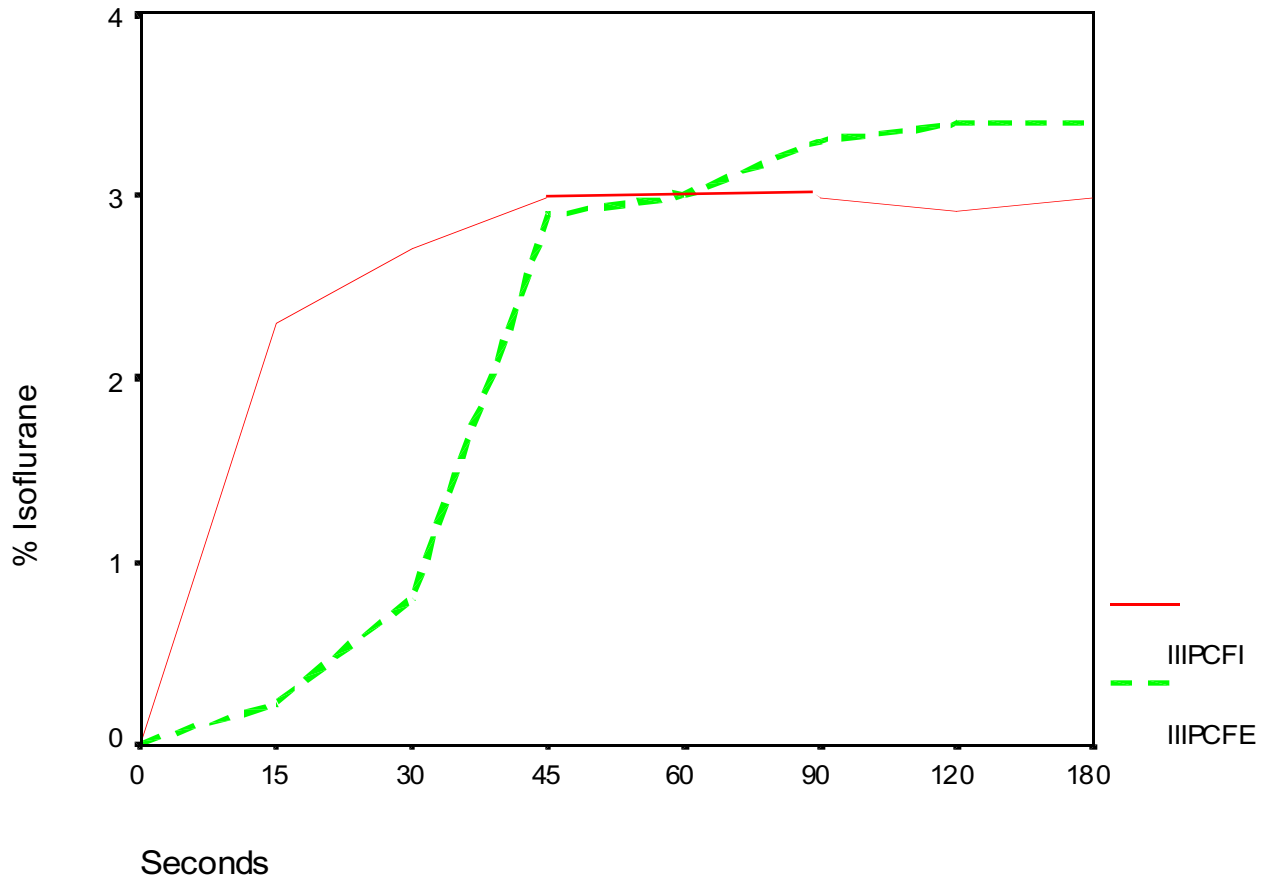

Figure 10. Tidal volume 900ml , respiratory rate 10 breaths per minute, isoflurane concentration 3%. IIIPCFI represents 3% fraction of inspired concentration. IIIPCFE represents the fraction of expired concentration.

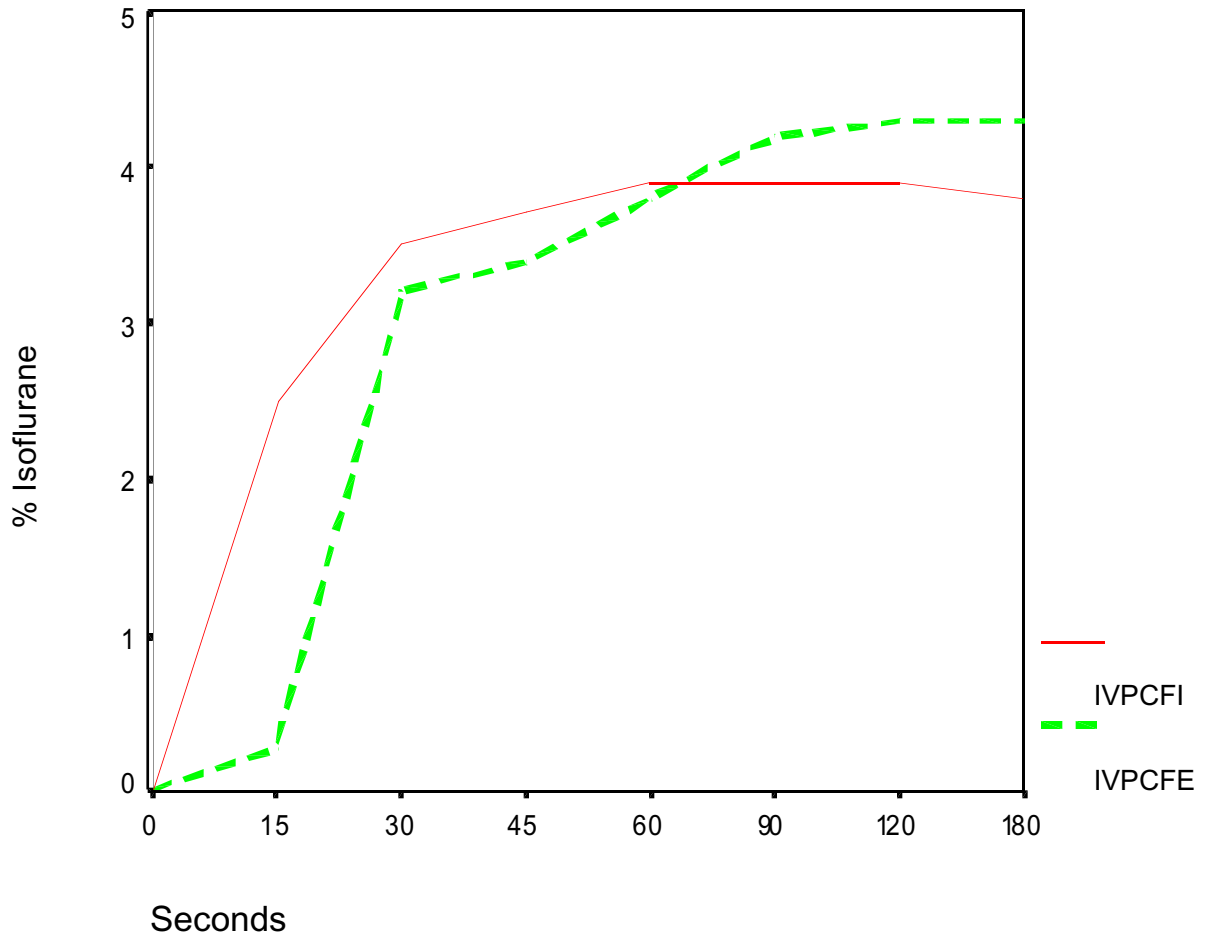

Figure 11. Tidal volume 900ml , respiratory rate 10 breaths per minute, isoflurane concentration 4%. IVPCFI represents 4% fraction of inspired concentration. IVPCFE represents the fraction of expired concentration.

Summary

The UPAC delivered consistent and accurate inspired concentrations of isoflurane as measured by the RASCAL in all tests. The delivered inspired concentrations represent preset vaporizer dial settings of 1%, 2%, 3% and 4% isoflurane. During the 900 tidal volume trials expired concentration of isoflurane exceeded inspired concentrations. In TSPLIT one percent VT 900 at 45 seconds the expired concentration exceeded inspired concentration and the trend continued until the conclusion of that trial (see Figure 8). In TSPLIT two percent VT 900 at 60 seconds the expired concentration exceeded inspired concentration and the trend continued until the conclusion of that trial (see Figure 9). In TSPLIT three percent VT 900 at 60 seconds the expired concentration exceeded inspired concentration and the trend continued until the conclusion of that trial (see Figure 10). In TSPLIT four percent VT 900 at approximately 75 seconds the expired concentration exceeded inspired concentration and the trend continued until the end of that trial (see Figure 11).

CHAPTER V: SUMMARY, CONCLUSIONS AND RECOMMENDATIONS

In this study we demonstrated that the percent concentration of isoflurane delivered by the UPAC as measured by the RASCAL was consistent and accurate. The accuracy trials completed at 500VT were consistent. The concentration of isoflurane inspired neatly paralleled the expired concentration at the conclusion of each time sequence. During accuracy trials completed at 900VT inconsistent measurements occurred in inspired and expired concentrations of isoflurane. We did not anticipate the excessive end tidal concentrations of isoflurane that occurred during the 900VT trials. As tidal volume was increased to 900ml there was a rapid rise in isoflurane concentration. The attainment of preset inspired concentration of isoflurane was achieved rapidly for each 900VT trial.

We theorize that the additional concentration of expired gas was a result of isoflurane that was sequestered in the rubber and polyethylene / polyvinylchloride (plastic) components of the patient simulator. Isoflurane has a rubber gas partition coefficient of 49, a polyethylene plastic gas coefficient of 58 and a polyvinylchloride plastic gas coefficient of 114 (Eger, 1974 ; Miller et al., 1994). The rubber and plastic components of the patient simulator may have absorbed isoflurane throughout the UPAC trials, and once they became sufficiently saturated there was a release of isoflurane into the expired mixture creating a measurable additive effect in the expired concentration.

These are important differences in uptake and delivery of volatile anesthetic agents in a human patient versus a simulator. In humans volatile anesthetics distribute into four body compartments: vessel rich group (VRG), muscle group (MG), fat group (FG), and the vessel poor group (VPG). The vessel rich group (VRG) is composed of the

brain, heart, splanchnic bed (including the liver), kidney, and endocrine glands. These organs comprise less than 10% of the body weight yet receive 75% of the cardiac output. Equilibration of the VRG with anesthetic partial pressure in arterial blood is 90% complete in 4-8 minutes. Uptake beyond 8 minutes is principally determined by the muscle group (MG) (muscle and skin). While 50 % of body mass is represented by the MG it receives 19% of the cardiac output. Time to 50% equilibration of the MG is 20 - 25 minutes with nitrous oxide and 70-80 minutes with sevoflurane or halothane. The muscle group reaches equilibration in a maximum of 4 hours. When the MG is equilibrated only the fat group (FG) continues to serve as a depot of volatile anesthetic uptake. In a lean 70kg patient the FG represents 20% of body mass and receives 6% of the cardiac output. Of the four tissue groups fat has the highest affinity for volatile anesthetic agents and a prolonged ability to absorb the anesthetic agent. Maximal fat group absorption of volatile anesthetic agent is reached beyond 30 hours of continual volatile anesthetic delivery. The vessel poor group (VPG) is comprised of tendon, ligament, bone and cartilage. While it comprises 20% of body mass it receives a negligible amount of the cardiac output (Eger, 1974 ; Miller et al., 1994 ;).

This sequence of distribution in the human patient is a serial event, it occurs on a continuum. All tissue groups receive a portion of volatile anesthetic agent from the moment the agent is absorbed by the blood from the alveoli in the lung and distributed by systemic blood flow. Cardiac output continually distributes blood to the various tissue compartments and uptake occurs as previously described.

In the simulated patient the uptake and distribution is quite different. Volatile anesthetic agents flow into the mechanical lung (container), and in 3-4 half times the

concentration of agent is near equilibration (Eger,1974). There are no varied tissue groups to which the agent can distribute. Simulated uptake and delivery is a reliable academic exercise to help evaluate the accuracy and consistency of equipment being tested.

However we think the simulator may provide a depot for anesthetic agent because it is made with rubber, and polyethylene / polyvinylchloride (plastic) materials.

These materials can absorb and later leach volatile anesthetic agent back into the system once saturation of the material has occurred.

In this study we demonstrated that the percent concentration of isoflurane delivered by the UPAC as measured by the RASCAL was predictable and consistent. Variability in end expired concentrations was found at the later portion of the study, when expired concentrations of isoflurane were higher than inspired concentrations. We theorize that this is a result of sequestered volatile anesthetic agent and maybe explained by the rubber/plastic gas solubility of volatile anesthetic agents. It may have been the result of larger tidal volumes (900ml) and increased amounts of isoflurane drawn into the mechanical lung of the simulator resulting in a concentration effect due to ventilatory limitations of the simulator.

The UPAC vaporizer appears to be consistent and accurate in the delivery of preset concentrations of isoflurane when negative inspiratory flow is provided by the anesthesia patient simulator.

Recommendations

There are many studies that could be undertaken to determine the usefulness of simulator training with drawover equipment utilizing volatile anesthetic agents. One recommendation is to repeat the drawover tests with other volatile agents and evaluate the theory of rubber gas absorption and contribution of anesthetic agent to end tidal concentration. Another area of study could be the development of a training program that would instill safe and efficient use of drawover equipment. Once basic proficiency using the UPAC is established, anesthesia providers could use UPAC with supervision on human patients at one of the authorized military medical centers.

Summary

The UPAC was found to be a consistent and accurate anesthesia delivery system as assessed by simulated trials utilizing negative inspiratory pressure to deliver isoflurane. Further evaluations using isoflurane and other volatile anesthetics could be conducted to evaluate the proposed theory of rubber/plastic gas coefficient as a contributing factor to elevated end tidal concentrations. Anesthesia simulators can be effective tools in training anesthesia providers to use the UPAC for use on human patients.

REFERECNES

Abrahamson, S., Wolf, R.M., & Denson, J. S. (1969). A computer based patient simulator for training anesthesiologists. Education Technology 9, 55-59

American Association of Nurse Anesthetists. (1987). Bylaws of the American Association of Nurse Anesthetists. Park Ridge, IL: American Association of Nurse Anesthetists.

Arne, R., Stale, F., Ragna, K., & Petter, L. (1996). PatSim-simulator for practising anesthesia and intensive care. Development and observations. International Journal Clinical Monitor Computers 13 (3), 147-152.

Baskett, P. J. (1990). The trauma anesthesia/critical care specialist in the field. Critical Care Clinics 6 (1), 13-24.

Borland et.al. (1983). Evaluation of a new range of air drawover vaporizers-the PAC series-laboratory and field studies. Anesthesia 38 (9), 852-861.

Brock-Utne, J. G. (1992). Anesthesia in military conflicts:Toward simpler, safer, and higher standards. Military medicine157 (5), 229-230.

Brown, M. C., Murdock, E. J. , Galeas, D. , & Smith, A. M. (1998). Readiness concerns in operational anesthesia. Naval Medicine. July-August, 1998. 10-13.

Casinelli, P.E., & Reynolds, P. C. (1994). Adapting the Ohmeda UPAC draw-over vaporizer for use in the modern operating room. Military Medicine 159 (9), 600-602.

Craig, G. R., Berry, C. B., & Yeats, M. J. (1995). An evaluation of the universal PAC and Oxford Miniature Vaporizers for pediatric field anaesthesia. Anaesthesia 50 (9). 789-793.

Dorsch, J. A. & Dorsch, S.E. (1999). Understanding Anesthesia Equipment (4thed.). Baltimore : Williams & Wilkins.

Eger, E. I. (1974). Anesthetic Uptake and Action. Williams & Wilkins : Baltimore.

Fletcher, J. L. (1995). AANA journal course: update for nurse anesthetists-anesthesia simulation:tool for learning and research. AANA 63 (1), 61-67.

Gaba, D. M., & DeAnda, B. S. (1988). A comprehensive anesthesia simulation environment: Re-creating the operating room for research and training. Anesthesiology 69 (3), 387-394.

Gaba, D. M., & DeAndra, A. (1989). The response of anesthesia trainees to simulated critical incidents. Anesthesia & Analgesia 68, 444-451.

Howard, S. K., Gaba, D. M., Fish, K. J., Yang, G. S., & Sarnquist, F. H. (1992). Anesthesia crisis resource management training:teaching anesthesiologists to handle critical incidents. Aviation, Space and Environmental Medicine 63, 763-770.

Hawkins, J. K., Ciresi, S. A., & Phillips W. J. (1998). Performance of the universal portable anesthesia complete vaporizer with mechanical ventilation in both drawover and pushover configurations. Military Medicine163 (3), 159-163.

Hawkins, J. K., Ciresi, S. A., & Reynolds, P. C. (1998). Airway pressure effects on the performance of the Ohmeda Universal Portable Anesthesia complete Vaporizer with pushover mechanical ventilation. Military Medicine 163 (8), 540-543.

Hollis, N. (1986). Halothane & Trichloroethylene-two agents in a single vaporizer. Anaesthesia 41 (3), 309-315.

Holzman, R. S., et. al. (1995). Anesthesia crisis resource management:real-life simulation training in operating room crisis. Journal of Clinical Anesthesia 7 (8), 675-687.

Huse, J. (1997). Medical Simulation & Training-Patient simulator users guide. Binghamton, NY: Eagle Simulations Inc.

Jarvis, D. A., & Brock-Utne, G. (1991). Use of an oxygen concentrator linked to a drawover vaporizer (anesthesia delivery systems for underdeveloped nations). Anesthesia Analgesia 76 (2), 805-810.

Jowitt, M. D.,& Knight, R. J. (1983). Anaesthesia during the Falklands campaign. Anaesthesia 38. 776-783.

Kingsley, C. P., Olson, K.W., Nelson, J. H., & Danley, D. L. (1991). Evaluation of Agent-Specific and Universal PAC Drawover Anesthesia Devices Using a Porcine Model: Technical Report 9105. US Army Biomedical Research & Development Laboratory. Frederick, MD, : Fort Detrick.

Kingsley, C. P. (1992). Drawover anesthesia equipment for austere conditions. Wellcome Trends in Anesthesiology, 10 (1), 3-8.

Kocan, M. (1987). The triservice anaesthesia apparatus-trial of isoflurane and enflurane as alternatives to halothane. Anaesthesia 42 (10), 1101-1104.

Longnecker, D.E., Tinker, J.H., & Morgan, G.E. (1998). Principles and Practice of Anesthesia Vol.I (2nded.) St Louis: Mosby.

Mahala, M., & McCarthy, E. J. (1985). Physiologic studies of the OMV Tri Service anesthesia machine. USUHS Research Colloquium, Bethesda, MD.

- Makie, A. M. (1987). Drawover anesthesia systems-factors determining the inspired oxygen concentration. Anesthesia 42, 299-304.
- McIndol, A. K., Stewart, P., & Wilson, I. H. (1997) Drawover vaporizers for sedation in intensive care. Intensive Care Medicine 23 (6), 704-707.
- Miller, R. D., et. al. (1994). Anesthesia (4th.Ed.) Churchill Livingstone: New York.
- Monti, E. J., Wren, K., Haas, R., & Lupien, A.E. (1998). The use of the anesthesia simulator in graduate and undergraduate education. CRNA 9 (2), 59-66.
- Morgan, G. E., & Mikhail, M. S. (1996). Clinical anesthesiology. (2nd ed.) Stamford: Appleton & Lange.
- Nagelhaut, J. J., & Zaglaniczny, K. L. (1997). Nurse anesthesia. Philadelphia: W.B. Saunders.
- O Donnell, J., Fletcher, J., Dixon, B., & Palmer, L. (1998). Planning and implementing an anesthesia crisis resource management course for student nurse anesthetists. CRNA 9 (2), 50-58.
- O Sullivan, J.C., & Ciresi, S.A. (1999). AANA Journal course: Update for nurse anesthetists-Utilizing the Ohmeda drawover vaporizer in the operating room. AANA Journal 67 (6), 533-538.
- Petty, C. W. (1995). Anesthesia and perioperative care of the combat casualty. Washington, D C : Office of the Surgeon General at TMM Publications Borden Institute.
- Pylman, M. L., & Teiken, P. J. (1997). Sevoflurane concentrations available from the universal drawover vaporizer. Military Medicine 162 (6), 405-406.
- Schafer, H. G., & Farman, J. V. (1984). Anesthesia vapor concentrations in the EMO system. Anaesthesia 39 (2), 171-180.

Sosis, M. B. (1997). Anesthesia Equipment Manual. Philadelphia : Lippincott-Raven.

Talbott, J. H. (Ed.). (1965). William T.G. Morton (1819-1868) Demonstrator of Ether Anesthesia. Journal of the American Medical Association , 194:190

Taylor, J. C., & Restall, J. (1994). Can drawover vaporizer be a pushover? Anaesthesia 49 (10), 892-894.

Thomas, C. L. (Ed.), (1997). Tabers cyclopedic medical dictionary. (18th ed.) Philadelphia: W.B. Saunders.

Tighe, S. Q., & Pethybridge, R. J. (1987). A comparison of halothane and trichloroethylene with isoflurane. A study of drawover air anaesthesia with the triservice anaesthesia apparatus. Anaesthesia 42 (8), 887-891.

Yoganathan, S., Houghton, I.T., Graveston, N. H., & Thornton, J. A. (1988). Ventilating effects of isoflurane:a comparison with halothane in drawover systems. Journal of the Royal Army Medical Corps 134 (1), 27-30.

Weis, P. A., & Guyton-Simmons, J. (1998). A computer simulator for teaching critical thinking skills. Nurse Educator 23 (2), 30-33.

APPENDICES

Appendix A: 500 VT, 1% Isoflurane.....	41
Appendix B: 500 VT, 2% Isoflurane.....	41
Appendix C: 500 VT, 3% Isoflurane.....	42
Appendix D: 500 VT, 4% Isoflurane.....	42
Appendix E: 900 VT, 1% Isoflurane.....	43
Appendix F: 900 VT, 2% Isoflurane.....	43
Appendix G: 900 VT, 3% Isoflurane.....	44
Appendix H: 900 VT, 4% Isoflurane.....	44

Appendices A-H.

Sec.	0	15	30	45	60	90	120	180
VT	446	442	447	446	442	440	443	432
FI	.00	.51	.67	.70	.72	.72	.75	.73
FE	.00	.09	.35	.47	.47	.66	.66	.72

Appendix A. 500VT, 1% Isoflurane, 10 breaths per minute. FI represents fraction of inspired concentration of isoflurane. FE represents fraction of expired concentration of isoflurane. Time is represented in seconds.

Sec	0	15	30	45	60	90	120	180
VT	441	449	451	449	453	452	447	449
FI	.00	.92	1.60	1.70	1.70	1.70	1.70	1.80
FE	.00	.21	.92	1.30	1.40	1.50	1.60	1.70

Appendix B. 500VT, 2% Isoflurane, 10 breaths per minute. FI represents fraction of inspired concentration of isoflurane. FE represents fraction of expired concentration of isoflurane. Time is represented in seconds

Sec	0	15	30	45	60	90	120	180
VT	448	451	446	451	443	451	452	456
FI	.00	1.20	2.60	2.70	2.70	2.80	2.80	2.80
FE	.18	1.60	1.90	1.90	2.10	2.40	2.60	2.60

Appendix C. 500VT, 3% Isoflurane, 10 breaths per minute. FI represents fraction of inspired concentration of isoflurane. FE represents fraction of expired concentration of isoflurane. Time is represented in seconds

Sec	0	15	30	45	60	90	120	180
VT	459	454	453	463	465	461	459	468
FI	.00	2.70	3.80	3.90	4.00	4.00	4.00	4.00
FE	.00	.12	2.10	2.60	3.60	3.40	3.70	4.00

Appendix D. 500VT, 4% Isoflurane, 10 breaths per minute. FI represents fraction of inspired concentration of isoflurane. FE represents fraction of expired concentration of isoflurane. Time is represented in seconds

Sec	0	15	30	45	60	90	120	180
VT	874	868	874	871	869	867	875	874
FI	.00	.91	1.20	1.20	1.20	1.30	1.30	1.30
FE	.00	.59	.89	1.20	1.30	1.40	1.40	1.50

Appendix E. 900VT, 1% Isoflurane, 10 breaths per minute. FI represents fraction of inspired concentration of isoflurane. FE represents fraction of expired concentration of isoflurane. Time is represented in seconds

Sec	0	15	30	45	60	90	120	180
VT	875	868	871	868	864	868	866	867
FI	.00	1.40	1.90	2.20	2.20	2.20	2.20	2.20
FE	.00	1.00	1.50	2.10	2.20	2.40	2.50	2.50

Appendix F. 900VT, 2% Isoflurane, 10 breaths per minute. FI represents fraction of inspired concentration of isoflurane. FE represents fraction of expired concentration of isoflurane. Time is represented in seconds

Sec	0	15	30	45	60	90	120	180
VT	873	869	860	864	862	868	870	867
FI	.00	2.30	2.70	3.00	3.00	3.00	2.90	3.00
FE	.00	.23	.80	2.90	3.00	3.30	3.40	3.40

Appendix G. 900VT, 3% Isoflurane, 10 breaths per minute. FI represents fraction of inspired concentration of isoflurane. FE represents fraction of expired concentration of isoflurane. Time is represented in seconds

Sec	0	15	30	45	60	90	120	180
VT	868	864	865	865	870	860	864	863
FI	.00	2.50	3.50	3.70	3.90	3.90	3.90	3.80
FE	.00	.28	3.20	3.40	3.80	4.20	4.30	4.30

Appendix H. 900VT, 4% Isoflurane, 10 breaths per minute. FI represents fraction of inspired concentration of isoflurane. FE represents fraction of expired concentration of isoflurane. Time is represented in seconds