

F22447

AFRPL-TR-71-81

**SHELL 405 CATALYST IMPROVEMENT  
SUBSTRATE EVALUATION  
PHASE 1-1 JULY 1970 TO 1 APRIL 1971**

N. C. NEWTON, SGT, USAF 2  
P. R. RICE, JR., CAPT, USAF  
D. D. HUXTABLE, CAPT, USAF

**TECHNICAL REPORT AFRPL-TR-71-81**

JULY 1972

DEC 8 - 1972

Distribution Statement A:  
Approved for public release;  
distribution is unlimited.

~~Distribution limited to U.S. Gov't agencies only; Test and Evaluation; 4 May 1972.  
Other requests for this document must be referred to AFRPL Office of Technical  
Information (DOZ), Edwards, California 93523.~~

**AIR FORCE ROCKET PROPULSION LABORATORY  
DIRECTOR OF SCIENCE AND TECHNOLOGY  
AIR FORCE SYSTEMS COMMAND  
UNITED STATES AIR FORCE  
EDWARDS, CALIFORNIA**

1973-0052

73-0052

AD 904 921

F22447

**Private STINET**[Home](#) | [Collections](#)[View Saved Searches](#) | [View Shopping Cart](#) | [View Orders](#)[Add to Shopping Cart](#)

Other items on page 1 of your search results: 1

[View XML](#)

Citation Format: Full Citation (1F)

**Accession Number:**

AD0904921

**Citation Status:**

Active

**Citation Classification:**

Unclassified

**Fields and Groups:**

070200 - Inorganic Chemistry

210801 - Liquid Propellant Rocket Engines

**Corporate Author:**

AIR FORCE ROCKET PROPULSION LAB EDWARDS AFB CA

**Unclassified Title:**

(U) Shell 405 Catalyst Improvement Substrate Evaluation.

**Title Classification:**

Unclassified

**Descriptive Note:**

Technical rept. 1 Jul 70-1 Apr 71 on Phase 1,

**Personal Author(s):**

Newton, N C

Rice, P R, Jr

Huxtable, D D

**Report Date:**

Jul 1972

**Media Count:**

59 Page(s)

**Cost:**

\$9.60

**Report Number(s):**

AFRPL-TR-71-81

**Project Number:**

AF-314802DSA

**Report Classification:**

Unclassified

**Descriptors:**

(U) \*LIQUID PROPELLANT ROCKET ENGINES, \*CATALYSTS, SUBSTRATES, LIQUID ROCKET PROPELLANTS, ALUMINATES, IRIIDIUM, RUTHENIUM, HYDRAZINES, ALTITUDE CHAMBERS, CAPTIVE TESTS, PERFORMANCE(ENGINEERING), DEGRADATION, PROCESSING, SILICON COMPOUNDS, DIOXIDES

**Identifiers:**

(U) LOW TEMPERATURE, STARTING, SHELL 405 CATALYST.

**Identifier Classification:**

Unclassified

**Abstract:**

(U) Fourteen hydrazine catalyst samples on five different substrates provided by Shell Development

Company were evaluated in an altitude test chamber. The samples were test fired to determine cold-start life in nominal 5-pound-thrust engines. The new substrates were compared against the standard RA-1 alumina substrate.

**Abstract Classification:**

Unclassified

**Distribution Limitation(s):**

01 - APPROVED FOR PUBLIC RELEASE

**Source Code:**

307720

**Document Location:**

DTIC AND NTIS

**Change Authority:**

ST-A PER AFRPL LTR, 22 JUL 74



---

[Privacy & Security Notice](#) | [Web Accessibility](#)

[private-stinet@dtic.mil](mailto:private-stinet@dtic.mil)



## NOTICES

When U.S. Government drawings, specifications, or other data are used for any purpose other than a definitely related Government procurement operation, the Government thereby incurs no responsibility, nor any obligation whatsoever, and the fact that the Government may have formulated, furnished or in any way supplied the said drawings, specifications, or other data, is not to be regarded by implication or otherwise, or in any manner as licensing the holder or any other person or corporation, or conveying any rights or permission to manufacture, use, or sell any patented invention that may in any way be related thereto.

AFRPL-TR-71-81

SHELL 405 CATALYST IMPROVEMENT  
SUBSTRATE EVALUATION

PHASE I - 1 JULY 1970 TO 1 APRIL 1971

N.C. Newton, Sgt, USAF  
P.R. Rice, Jr., Capt, USAF  
D.D. Huxtable, Capt, USAF

July 1972

Distribution limited to U.S. Government agencies only; Test and Evaluation; 4 May 1972. Other requests for this document must be referred to AFRPL Office of Technical Information (DOZ), Edwards, California 93523.

AIR FORCE ROCKET PROPULSION LABORATORY  
DIRECTOR OF SCIENCE AND TECHNOLOGY  
AIR FORCE SYSTEMS COMMAND  
UNITED STATES AIR FORCE  
EDWARDS, CALIFORNIA

## FOREWORD

This report covers work on "Phase I, Substrate Evaluation, of Project 314802DSA, Shell 405 Catalyst Improvement," by the Test and Support Division of the Air Force Rocket Propulsion Laboratory from 1 July 1970 to 1 April 1971. The project engineer was Capt Douglas D. Huxtable, Liquid Components Branch, Liquid Rocket Division; the test engineers were: Capt Pony R. Rice Jr. and Sgt Neil C. Newton, Propellant Evaluation Facility Section, Test Branch B Test and Support Division. The authors wish to acknowledge the outstanding support of Mr. Milford Hall and TSgt Eulie Soper, Rocket Engine Testers.

This technical report has been reviewed and is approved.

WILLIAM H. EBELKE, Colonel USAF  
Chief, Test and Support Division

## ABSTRACT

Fourteen hydrazine catalyst samples on five different substrates provided by Shell Development Company were evaluated in an altitude test chamber. The samples were test fired to determine cold-start life in nominal 5-pound-thrust engines. Although some of the new substrates showed promise, the standard RA-1 alumina substrate remains the best substrate currently available.





## TABLE OF CONTENTS

<u>Section</u>		<u>Page</u>
I	INTRODUCTION . . . . .	1
II	SUBSTRATE EVALUATION . . . . .	3
	Approach . . . . .	3
	Test Facility . . . . .	4
	Test Procedure . . . . .	5
	Catalyst Description . . . . .	7
III	DISCUSSION OF RESULTS . . . . .	12
IV	CONCLUSIONS AND RECOMMENDATIONS . . . . .	21
	REFERENCES . . . . .	42
	AUTHORS' BIOGRAPHIES . . . . .	43
	APPENDIX A - LABORATORY TEST METHODS . . . . .	45
	APPENDIX B - STANDARD DUTY CYCLE . . . . .	49
	DD FORM 1473 . . . . .	51

## LIST OF ILLUSTRATIONS

<u>Figure</u>		<u>Page</u>
1	Catalyst Test Cell . . . . .	23
2	Mechanical Schematic . . . . .	24
3	5-Pound-Thrust Catalyst Engine . . . . .	25
4	Engine Instrumentation . . . . .	26
5	Firing Data for Sample 1 (Hand Packed) . . . . .	27
6	Firing Data for Sample 1 (Vibration Pack) . . . . .	28
7	Firing Data for Sample 2 . . . . .	29
8	Firing Data for Sample 3 . . . . .	30
9	Firing Data for Sample 4 . . . . .	31
10	Firing Data for Sample 5 . . . . .	32
11	Firing Data for Sample 6 . . . . .	33
12	Firing Data for Sample 7 . . . . .	34
13	Firing Data for Sample 8 . . . . .	35
14	Firing Data for Sample 9 . . . . .	36
15	Firing Data for Sample 10 . . . . .	37
16	Firing Data for Sample 11 . . . . .	38
17	Firing Data for Sample 12 . . . . .	39
18	Firing Data for Sample 13 . . . . .	40
19	Firing Data for Sample 14 . . . . .	41

LIST OF TABLES

<u>Table</u>		<u>Page</u>
I	Purity of Hydrazine and Helium . . . . .	6
II	Substrate Materials . . . . .	7
III	Physical Properties of Substrates and Catalysts . . . . .	9
IV	Baseline for Shell 405 Degradation . . . . .	12
V	Summary of Firing Data . . . . .	16

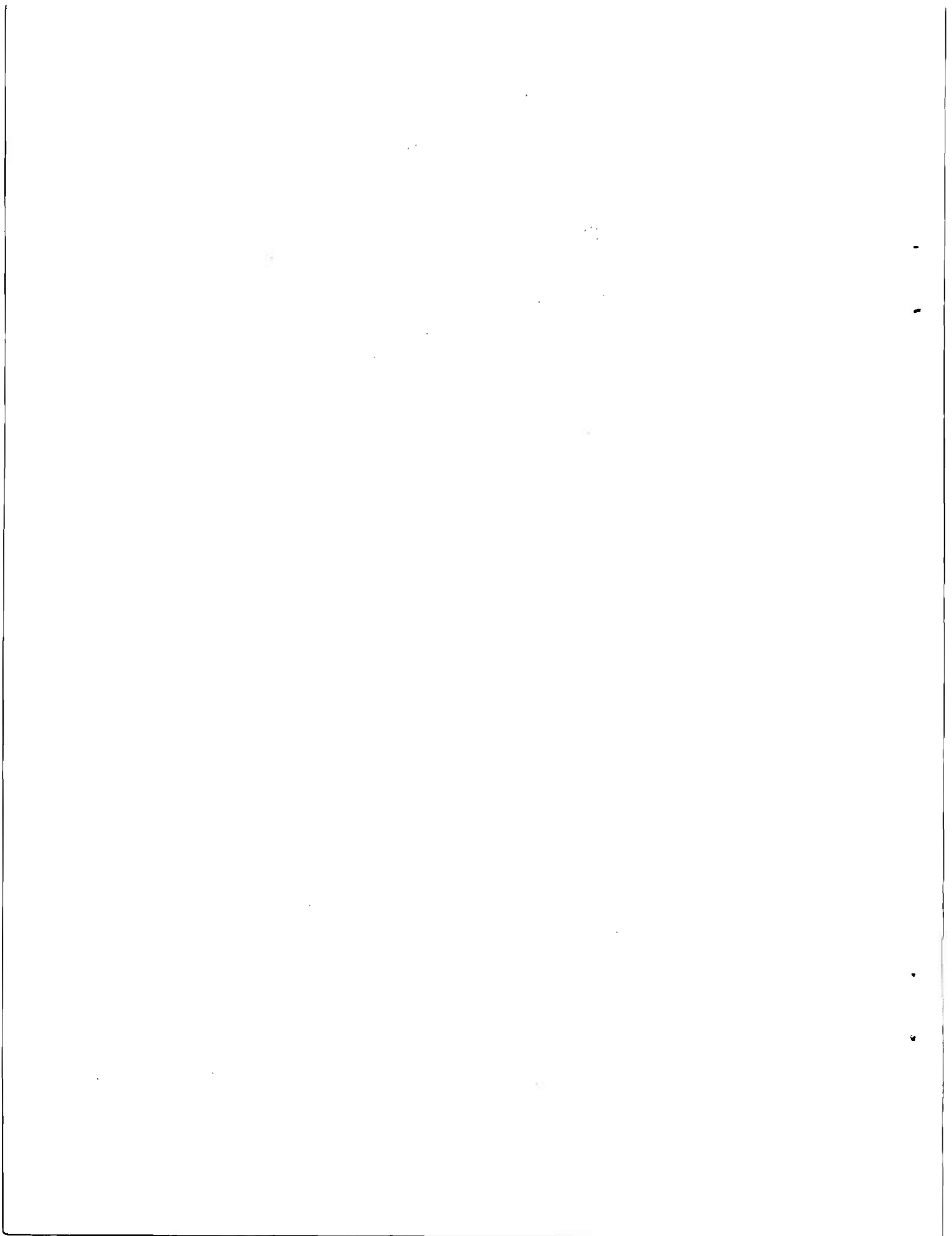

## SECTION I

### INTRODUCTION

Many satellite systems to be launched within the foreseeable future will require active propulsion systems aboard to control the orbital parameters and attitude. Since many forces are applied to space vehicles (solar pressure, gravity, magnetic, etc.), the control and/or negation of these forces by active propulsion units for these satellite missions will likely be monopropellant hydrazine thrusters. The current capability of these systems has exceeded 10,000 lb-sec total impulse and 100,000 pulses. However, the total number of cold starts achieved on any single thruster has been limited to approximately 40; whereas, in the near future, a 400 cold-start capability will be required. One of the important modes of failure of the propulsion units has been catalyst degradation.

The Air Force Rocket Propulsion Laboratory has maintained an active hydrazine catalyst program in an attempt to improve catalyst life for the past 3 years (Ref. 1). This program has provided assessment capability through thruster firings and chemical analyses. Initial catalyst studies were concerned with ruthenium and other non-iridium catalysts for potential postboost propulsion applications (Ref. 2). As the understanding of the capabilities limitations of monopropellant systems increased, the requirements for catalysts for Air Force vehicles were firmly directed toward the straight iridium catalyst with the potential long-life and multiple cold-start capability.

This report covers Phase I Substrate Evaluation, of the current Shell 405 Catalyst Improvement Program. Various substrates, including the current standard substrate, were examined in an attempt to find a material better suited to long life. Phase II of the program, "Physical Property Variation," will be an effort to change the physical properties of the current production catalyst to increase its cold-start life. Factors

to be evaluated are iridium metal loading, iridium impurity content and processing techniques. Based upon the effects of the physical property variation, an optimum catalyst will be produced and tested.

SECTION II  
SUBSTRATE EVALUATION

APPROACH

The objective of this program was to investigate new substrate materials and/or catalyst production methods in an attempt to increase the cold-start life of the catalyst.

Under Contract F04611-70-C-0020, Shell Development Company provided 14 catalyst samples prepared on 5 different substrate materials. The new substrates were alumina-based materials, offering potentially better physical properties, such as improved surface area or pore volume when exposed to elevated temperatures. Shell also provided the prefire laboratory analytical work for each sample.

All catalysts were test fired at Test Cell 26 (Figure 1)\*, Test Area 1-30 at the AFRPL to determine cold-start life. Test firings were accomplished using 5-pound-thrust engines with cold propellant and an altitude startup condition. The AFRPL Chemical Laboratory provided laboratory reactor data and post-fire analysis. (See Appendix A.)

This program was intended to give a rough indication of the areas for catalyst improvement. Consequently, each catalyst was normally test fired only once. No attempt was made to obtain a statistically valid measure of the cold-start life of a catalyst, and only gross differences in performance were sought.

---

\*Figures are presented sequentially beginning on page 23.

## TEST FACILITY

The catalyst evaluation system (Figure 2) consists of four 5-pound-thrust engines manifolded to a small altitude chamber. All four engines are normally fired simultaneously. The system, however, can be fired with any desired number of combination of engines.

The altitude chamber is evacuated with a standard laboratory vacuum pump to a 100,000-foot altitude condition (8.0 mm Hg) prior to startup. Following startup, the chamber pressure rises rapidly to atmospheric pressure. Build-up above atmospheric is prevented by a simple flapper-type check valve.

Hydrazine is supplied from a 20-gallon run tank equipped with a cooling water jacket controlled by a constant-temperature bath. Propellant run lines are traced and insulated to maintain a constant propellant temperature. Provisions are also available to bleed the run lines up to the engine propellant valves prior to a run if the run line temperatures are higher than desired.

The run tank and run lines are pressurized with nitrogen up to the engine propellant valves. The hydrazine flow to each engine is controlled by a cavitating venturi (0.020-inch diameter) with a 500-psig upstream pressure. Single poppet solenoid valves with an 8- to 15-millisecond response time are used as propellant valves. Purge facilities using helium are provided for each engine.

The 5-pound nominal thrust engines (Figure 3) are constructed of a high-temperature cobalt alloy (Haynes 25). The chambers are 0.925 inch in diameter and 1.35 inches long. The catalyst bed occupies about 0.85 inch of the total chamber length and is held in place by a retainer backed with screens in the aft end and by a standoff basket-type screen retainer in the fore end. The screen is 60 by 60 mesh and fabricated of



cobalt alloy. A standoff-type injector is flanged to the chamber using an annealed copper crush gasket. The injector uses a 1/16-inch-diameter tube equipped with a swirler at the injector face designed to produce a spray of hydrazine that covers the upstream face of the catalyst bed.

The engine is equipped with two thermocouples, one in the center of the catalyst bed and the other in the exhaust immediately downstream of the retainer screen. A transducer used to monitor chamber pressure is located upstream of the chamber throat as shown in Figure 4.

#### TEST PROCEDURE

The catalyst chambers are filled with the catalyst to a level that permits insertion of the basket retainer in the injector end of the engine (Figure 3). The catalyst weights and bulk densities indicate that the volume of the catalyst pack averages about 0.525 cubic inch. To ensure uniform packing, the engines are vibrated on an oscillating table for 10 to 15 minutes prior to reassembly.

The test firings are controlled by an SEL 810 computer. The standard duty cycle consists of an initial 5-second warm-up pulse followed by a series of 50 pulses varying in length from 20 to 100 milliseconds; Appendix A gives the standard duty cycle. Four types of firing data are available for each test run. The first two types, available immediately after a firing, are an oscillograph trace and a sheet of "quick look" data. The oscillograph trace records hydrazine flow rate, chamber pressures and valve signal. The "quick look" sheet is produced by the digital data acquisition and control system and consists of the following items versus time: venturi pressure (upstream), chamber pressures, catalyst bed temperatures, run tank temperature and run line temperature. Reduced data are later available in the form of computer-drawn graphs and printouts. The graphs show chamber pressure, exhaust temperature and bed temperature for each engine as a function of time. The printouts

consist of run tank pressure, venturi pressure, altitude chamber pressure, engine chamber pressure, run line temperature, bed temperature, exhaust temperature and calculated characteristic velocity at 6-millisecond intervals.

The propellant temperature is maintained at  $55 \pm 5^\circ \text{F}$  throughout the test run.

Throughout the program, effort was made to keep hydrazine and helium purity levels on a consistent basis. The purity levels for these two materials (worst case) are listed in Table I.

TABLE I. PURITY OF HYDRAZINE AND HELIUM

	<u>Hydrazine</u>	<u>Helium</u>
Purity	98.6%	99.99%
H <sub>2</sub> O	0.9%	2 ppm
Aniline	0.40%	--
Low Boiling Fractions (NH <sub>3</sub> , CH <sub>3</sub> , NH <sub>2</sub> )	0.40%	--
Cu Detected (Capability at 0.01 $\mu\text{g}/\text{ml}$ )	None	
Fe Detected	0.96 ppm	--
Total Solids	15 ppm	--

The criteria for catalyst failure were chosen to permit catalyst performance comparisons to be made and, consequently, the failure criteria may not reflect true complete failure of the catalyst. Two catalyst failure modes were established as follows:

1. A 10 percent degradation of the steady-state chamber pressure ( $P_c$ ) from the nominal steady-state chamber pressure of the initial cold starts.

2. Consistent chamber pressure spiking on startup to a level 50 percent above steady-state chamber pressure.

The failure modes were restricted further to the first start of any day which was deemed the most severe and thought to be the most reliable. Although ignition delay, chamber pressure rise time and chamber and exhaust temperatures were also monitored, no failure criteria were established for these parameters. Testing was generally carried beyond the failure point to ensure that failure had actually occurred.

#### CATALYST DESCRIPTION

Fourteen catalysts on the five different substrates listed in Table II were prepared by Shell Development Company for evaluation at the AFRPL.

TABLE II. SUBSTRATE MATERIALS

- A. Reynolds RA-1 Alumina - current standard substrate.
- B. Esso 500 and 504 - alumina silicas containing alkaline earth oxides.
- C. Harshaw AL-1602 - alumina silica containing an alkaline earth oxide.
- D. Reynolds "strengthened" RA-1 - experimental alumina.
- E. Reynolds "eta" phase - experimental alumina.

Each of these support materials had one or more physical characteristics expected to favorably influence catalyst activity and durability. Of particular interest were surface area, pore volume, pore size distribution, bulk density, and crush strength. Retention of surface area at high temperatures was thought to be a key factor. The following guidelines were used in preparing the test catalysts:

- 1. Increased surface area and/or pore volume should give increased activity and life.

2. Retention of surface area at high temperatures should prolong catalyst activity.

3. Greater attrition of the support with smoother and harder catalyst granules should result in increased catalyst life through more uniformly packed beds and higher resistance to breakage.

4. Calcination treatments should "preshrink" the substrate materials to give a more stable base which should resist further shrinkage leading to bed movement and abrasion.

5. Increased bulk density is desirable because of the greater total metal content and/or better packing that may result.

6. Higher crush strength materials should be more resistant to fracture and attrition in use.

All the catalysts tested were prepared with qualified raw materials in accordance with the established Shell 405 catalyst manufacturing procedure (Ref. 1 and 3). Physical property data on the substrates and the finished catalyst are summarized in Table III. All of the catalyst samples, except the baseline standard (Sample 1), which was a standard plant-manufactured product, were produced in the laboratory in relatively small (50 to 100 gram) lots. Each catalyst sample and any modification in the preparation techniques are described below.

Reynolds RA-1 (Ref. 4) is an activated "gamma" alumina that is used in the manufacture of all standard grades of Shell 405 catalyst. This material was used in five catalyst preparations, the standard plant preparation (Sample 1) and four laboratory prepared samples (Samples 2 through 5). A single Reynolds production lot was used for all of the above preparations.

TABLE III. PHYSICAL PROPERTIES OF SUBSTRATES AND CATALYSTS

Sample No.	Lot No.	Mesh	SUBSTRATE							CATALYST				
			Description	Percent Attrition	Calcination °C (hr)	Surface Area m <sup>2</sup> /g	Pore Volume (ml/g)	Bulk Density (g/cc)	Crush Strength Percent Survival	Iridium (Weight Percent)	Pre-/Post Fire/Fire Surface <sup>a</sup> Area (m <sup>2</sup> /g)	Pore <sup>b</sup> Volume (ml/g)	H <sub>2</sub> <sup>**</sup> Chemisorption (moles/g)	Bulk Density (g/cc)
1	12-MEM 403	14-18	Reynolds RA-1 Alumina (Plant Preparation)	50	-	278	0.23	1.02	99.7	31.7	100/34.2	0.12	403	1.58
2	11724-51	14-18	Reynolds RA-1 Alumina	50	-	278	0.23	1.01	97.7	31.2	133/68.2	0.13	470	1.52
3	11724-64	14-18	Reynolds RA-1 Alumina	50	900(1)	95	0.23	1.01	94.2	31.7	62/52.5	0.13	343	1.55
4	11724-60	14-18	Reynolds RA-1 Alumina	90	-	263	0.23	1.02	98.8	31.6	122/64.7	0.13	454	1.55
5	11724-28	25-30	Reynolds RA-1 Alumina	90	-	258	0.22	1.04	99.9	31.4	133/N/A	0.12	382	1.61
6	11724-56	14-18	Esso-type	50	-	193	0.36	0.90	92.7	32.2	143/130.0	0.23	483	1.40
7	11724-57	14-18	Esso-type	50	900(1)	130	0.33	0.90	98.2	32.0	123/N/A	0.23	409	1.40
8	11724-12	20-30	Esso-type	50	-	223	0.39	0.81	91.6	31.9	147/104.6	0.23	450	1.27
9	11724-34	20-30	Esso-type	50	900(1)	190	0.36	0.82	92.8	31.0	134/114.1	0.21	424	1.25
10	11724-7	14-18	Harshaw AL-1602	50	-	240	0.44	0.76	90.6	31.7	163/123.3	0.27	504	1.20
11	11724-13	14-18	Harshaw AL-1602	50	900(1)	194	0.43	0.79	95.1	31.6	137/118.4	0.25	400	1.23
12	11724-48	14-18	Harshaw AL-1602 (carbonized)	50	1100(1)	161	0.36	0.94	91.4	31.9	105/95.2	0.23	284	1.32
13	11724-47	14-18	Reynolds Exp. (Strengthened RA-1)	50	900(2)	78	0.24	1.00	97.9	31.4	48/50.8	0.16	243	1.55
14	11724-40	14-18	Reynolds "eta" Alumina	50	700(48)	111	0.45	0.75	94.1	31.5	90/80.3	0.25	307	1.19

<sup>a</sup>Surface area and pore volume by BET N<sub>2</sub> adsorption using Aminco Adsorptomat.

<sup>\*\*</sup>H<sub>2</sub> chemisorption at 0°C on catalyst conditioned at 500°C.

Sample 2 was a laboratory duplicate of a plant-prepared standard catalyst. This sample was prepared to determine whether a laboratory-prepared catalyst differed from the standard plant-prepared product in properties or performance since process differences are inherent in the use of the small-scale laboratory equipment.

An effort to produce a preshrunk, more-stabilized substrate resulted in the preparation of Sample 3. Prior to catalyst preparation, the substrate was calcined at  $900^{\circ}\text{C}$  for 1 hour under a nitrogen blanket. Several engine manufacturers employ such a calcining or pre-reducing step on finished catalyst into the engine in hopes of stabilizing catalyst activity.

Samples 3 and 4 were prepared on 90 percent attrited RA-1 Alumina. The substrate was first air attrited to the extent of about 80 percent weight loss through an 18 mesh sieve; further attrition in water resulted in a final total weight loss of  $90 \pm 2$  percent. This extended attrition process was expected to produce harder more rounded substrate by eliminating all but the strongest granules of substrate. Two different mesh sizes, 14 to 18 mesh (Sample 4) and 25 to 30 mesh (Sample 5), were prepared to compare the effect of mesh size on engine performance.

Esso-type alumina was used in four of the samples tested. The Esso alumina (Ref. 5) is a heat-stabilized, high-purity alumina-silica doped with approximately 5 percent BaO and 6 percent  $\text{SiO}_2$ . Two standard preparations were prepared using the Esso material, [one using 14 to 18 mesh material (Sample 6), and the other 20 to 30 mesh material (Sample 8)]. Two additional samples, again 14 to 18 mesh (Sample 7), and 20 to 30 mesh (Sample 9), were prepared on substrates that had been calcined at  $900^{\circ}\text{C}$  for 1 hour.

The Harshaw AL-1602 (Ref. 6) is a commercial alumina-silica containing approximately 6 percent  $\text{SiO}_2$  which is calcined at  $600^{\circ}\text{C}$  to

700°C. Three 14 to 18 mesh catalysts were prepared on this substrate. The first preparation (Sample 10) was prepared on the Harshaw material in the conventional manner. Sample 11 was prepared on substrate that had been calcined for 1 hour at 900°C after attrition. The final Harshaw preparation (Sample 12) was first carbonized and then calcined at 1100°C for 1 hour to partially convert the alumina to the more stable alpha form.

Sample 13 was prepared on a Reynolds experimental RA-1 alumina. This substrate is an activated alumina especially treated by Reynolds to "strengthen" it (Ref. 4). The substrate was calcined at 900°C for 2 hours to harden it further prior to catalyst preparation.

The final catalyst sample was prepared on an experimental Reynolds "eta" phase alumina. This material has shown extraordinarily high stability with respect to surface area and pore volume when held at high temperature (700°C), Ref. 4. This material was calcined at 700°C for 48 hours prior to catalyst preparation (Sample 14).

A complete description of these catalysts and the processing techniques used in their preparation is given by Dr. P. H. Williams of Shell Development Company in Ref. 3.

SECTION III  
DISCUSSION OF RESULTS

Thruster testing began with Sample 1, a 14 to 18 mesh plant-prepared Shell 405 catalyst. Two different baseline tests were run to determine the effect of packing. (See Table IV).

TABLE IV. BASELINE FOR SHELL 405 DEGRADATION

	Baseline No. 1 Handpacked Non-vibrated	Baseline No. 2 Vibration Packed
Catalyst Temperature	Ambient	Ambient
Propellant Temperature	65°F	50°F
No. of Cold Starts to Failure	20	117
Initial Catalyst Surface Area	104 m <sup>2</sup> /gm	104 m <sup>2</sup> /gm
Final Catalyst Surface Area	49 m <sup>2</sup> /gm	39 m <sup>2</sup> /gm

The catalyst pack in baseline No. 1 (Figure 5) was handpacked into the chamber, and for baseline No. 2 (Figure 6), the handpacked chamber was randomly vibrated for 15 minutes to settle the granules. Vibrating enabled approximately 10 percent more catalyst to be loaded into the same chamber. It was hoped that the increased catalyst load accompanied by the decrease in void space would substantially increase the operational life. The results show the dramatic increase in life that is possible due to proper packing and stresses the importance of reproducible packing to obtain reproducible test results. All of the remaining samples were vibration packed.

The vibrated Sample 1 (Baseline No. 2) was used as the standard for comparison against all other samples. Five engine parameters shown in



Figure 6 were tracked to determine their change with life: (1) ignition delay-pressure rise time from valve signal to 10 percent  $P_c$ , (2) pressure rise time - 10 percent  $P_c$  to 90 percent  $P_c$ , (3) exhaust temperature, (4) catalyst bed temperature, and (5) steady-state chamber pressure. For the baseline sample, the ignition delay values were very reproducible. The rather long ignition delays of approximately 200 msec were caused by a combination of cold temperatures and long run lines from the valve to the catalyst pack. Since a hot start normally takes approximately 40 msec to ignition, the cold environment alone caused an ignition delay increase of 5 times. As seen from Figure 6, almost no lengthening of ignition delay occurred with catalyst degradation. The pressure rise times (10 to 90 percent) were not reproducible. The present system configuration causes a gradual  $P_c$  rise from 10 to 90 percent. Part of the difference in time to 90 percent may have been caused by inability to read the oscillograph accurately.

The two temperature probes provided data that were very reproducible. Degradation of catalyst activity could be followed as the bed temperature dropped slightly and exhaust temperatures increased slightly with each test. This reaction is caused by the decomposition front (corresponding to flame front in bipropellant engines) moving downstream, decreasing the ammonia decomposition and raising the exhaust temperatures.

Degradation in steady-state chamber pressure determined the failure point for this sample. Figure 6 depicts the steady loss in chamber pressure which passes through the 10 percent loss point at the 117th start. Testing on the engine was continued until total engine failure which was characterized by catalyst fines clogging the outlet screens. This caused a new reduced throat area to form which increased the steady-state chamber pressure. The increased shear stress on the screen increased the nitriding and caused the screen to crack, allowing the catalyst to blow out the chamber.

The first experimental catalyst (Sample 2) tested was a standard Shell 405 catalyst prepared on a laboratory scale. As can be seen from Table II, this catalyst exhibited somewhat higher surface area and hydrogen chemisorption values (indicative of active metal area) than the standard plant preparation. The laboratory reactivity was also significantly higher for this sample.

The firing data for this sample are presented in Figure 7. The catalyst failed at 60 cold starts based on a 10 percent decline in steady-state chamber pressure. This result was rather disturbing in that, despite the more promising physical properties of the laboratory sample, the total number of cold starts was about half the number delivered by the plant-prepared baseline. It was originally believed that the laboratory processing techniques would be more reproducible and, therefore, increased life would result.

Little reason can be offered for the shortened life of the laboratory sample except for the following two differences in preparation:

1. **Drying Step.** The plant material is spread over a bed several inches deep and the  $H_2O$  steaming off it rises through the bed. In the laboratory, a thin layer of catalyst is laid directly on a section dish which is heated on a metal heater and little of the sample is steamed.

2. **Reduction Step.** The catalyst samples are reduced by passing  $H_2$  through a tube containing catalyst. In the plant, the reduction tube is longer so that the reducing step takes about 1 hour; in the laboratory, this step takes only 15 minutes.

Both of these differences cause the laboratory-prepared catalyst to experience a much larger temperature gradient with more severe thermal conditioning during processing. Thus, plausible reasons for decreased

life are that the temperature gradient weakens the substrate and also that the lack of thermal conditioning does not allow for complete stabilization. Further analysis of this subtle production step will be pursued in Phase II of this program.

The third sample (Sample 3) tested for life was a standard Shell 405 catalyst with an additional calcining step on the substrate. Several engine manufacturers employ a similar calcining or pre-reducing step on the finished catalyst prior to loading engines in hopes of stabilizing the catalyst activity. The substrate for this sample was heated at 900°C under a nitrogen blanket for 1 hour. As noticed from Table III the surface area and H<sub>2</sub> chemisorption value of this sample were appreciably lower than those of the uncalcined catalysts. This is a normal effect of the calcining treatment.

The engine firings were conducted using the normal procedures and Figure 8 illustrates the results. Only 51 cold starts were obtained as compared to 60 from the laboratory-prepared baseline and 117 from the plant-prepared material. The exhaust temperature plot shows a shift occurring around start 35, approximately the same location that chamber pressure began to drop. Table V lists the bed weights on the pre- and post-packs. After 90 starts, over 30 percent of the catalyst pack had been lost. These results show that prestabilization does not help, but in essence puts the equivalent of several cold starts on the catalyst, thus lessening, not lengthening, total life.

The next samples tested (Samples 4 and 5) were prepared on RA-1 alumina that has been attrited to 90 percent. Except for the lower H<sub>2</sub> chemisorption value for Sample 5, the physical properties of these two catalysts did not differ significantly from the standard laboratory samples. The substrate granules, however, were much rounder and more uniform, and their crush strength was increased slightly over the standard

TABLE V. SUMMARY OF FIRING DATA

Sample Number	(1)	(2)	(3)	(4)	(5)	(6)	(7)
Chamber Pressure (psia) (initial/failure)	195/176	184/166	190/171	185/166	195/175	160/220	700/210
T <sub>BED</sub> (°F) (initial/failure)	1800/1800	1800/1580	450/1720	1700/1700	1640/1460	1600/500	400/400
T <sub>EXHAUST</sub> (°F) (initial/failure)	1670/1700	1640/1660	1650/1520	1650/1560	1480/1530	1660/1600	1660/1660
Ignition Delay (msec) t <sub>10</sub> (initial/failure) t <sub>90</sub> (initial/failure)	200/170 1300/1300	180/300 1200/1000	180/180 600/1100	200/200 750/1050	150/300 840/1100	180/240 780/1000	180/180 700/800
Bed Weight (gms)	13.47	13.50	13.90	13.55	15.05	11.40	11.40
Laboratory Reactivity (ml/gm/sec) (initial/final)	300/200	400/(N/A)	200/(N/A)	400/(N/A)	500/700	600/(N/A)	600/(N/A)
Total Starts	164	102	82	82	162	3	5
Life (No. Starts)	117	60	51	60	102	3	5
Failure Mode	Pc Drop	Pc Drop	Pc Drop	Pc Drop	Pc Drop	Pc Increase	Spiking

Sample Number	(8)	(9)	(10)	(11)	(12)	(13)	(14)
Chamber Pressure (psia) (initial/failure)	192/182	195/180	165/169	200/200	160/152	168/151	164/164
T <sub>BED</sub> (°F) (initial/failure)	1810/1750	1700/1640	380/380	390/380	1650/1580	350/1200	350/1200
T <sub>EXHAUST</sub> (°F) (initial/failure)	1460/1600	1500/1360	1700/1720	1700/1750	1650/1600	1650/1350	1660/1700
Ignition Delay (msec) t <sub>10</sub> (initial/failure) t <sub>90</sub> (initial/failure)	200/170 700/1400	170/190 700/1400	160/170 1600/1300	150/140 900/1100	150/180 1400/1400	180/200 1200/1200	200/300 1800/1500
Bed Weight (gms)	10.25	11.40	10.55	10.85	11.65	12.40	9.70
Laboratory Reactivity (ml/gm/sec) (initial/final)	600/100	500/(N/A)	600/300	800/250	200/(N/A)	250/(N/A)	800/(N/A)
Total Starts	18	8	8	12	8	20	3
Life (No. Starts)	12	8	8	12	8	14	3
Failure Mode	Spiking	Spiking	Spiking	Spiking	Spiking	Pc Drop	Spiking

material. Since the nature of the catalyst indicated increased life, the 14 to 18 mesh sample (Sample 4) was test fired (Figure 9) for direct comparison with the baseline sample.

The initial runs on Sample 4 presented a problem of Pc oscillation. From runs 7 through 25, the engine tended to approach operating pressure in the normal manner, but then began sinusoidal Pc oscillations for the next 4 seconds, varying from 240 to 180 psi. The quantity of catalyst in the chamber for this test was identical to the baseline quantity. The engine operation was checked after this sequence of testing and no unusual conditions were noted. One answer to this unusual operation can be obtained from the change in catalyst structure; the 90 percent attrition may have closed up some of the larger pores of the catalyst that are used on startup (the 500 to 1000<sup>o</sup>Å pores). This closing down of the porous structures may have caused pressure to build up within the particle, which let loose intermittently, causing the measured pressure oscillation. As firing time was accumulated on the engine, the system began approaching more normal operational characteristics with failure occurring at 60 starts equal to the laboratory standard but far short of the production catalyst life. The failure mode was Pc drop, but long ignition delays had started as depicted in Figure 9. One other interesting point is the substantial drop in bed temperatures after the defined failure occurred. The catalyst at this time was either undergoing severing of packing or loss in reactivity. Either way, unreacted hydrazine was reaching the location of the thermocouple, causing the drop in temperature.

Although the failure of this catalyst may indicate that the increased attrition is of no substantial value, it should be noted that the established failure criteria may overshadow the true results. If for instance, the failure point were defined as a 15 percent Pc drop rather than the 10 percent point used, then the standard laboratory sample would have failed at 70 starts, whereas this 90 percent attrited sample would still not have

failed when testing was stopped at 82 starts. Thus, the contribution of greater attrition should not be judged as negligible at this point.

Although no direct comparison was possible with the 14 to 18 mesh baseline, the 25 to 30 mesh catalyst (Sample 5) was also test fired (Figure 10). The smaller mesh size was expected to give increased life primarily as a result of better packing which lessens Pc roughness. A total of 104 cold starts were accomplished before failure occurred. This long life may be due in part to the increased attrition although this cannot be established.

The other nine catalyst samples all had certain physical properties which were individually better than those of the standard catalyst. These same samples, however, also had associated deficient properties which apparently more than offset their advantageous properties.

The catalysts prepared on the Esso alumina-silica material (Samples 6, 7, 8 and 9) all had surface areas and  $H_2$  chemisorption values equal to or greater than any of the RA-1 alumina catalysts. In addition, the pore volumes were nearly double those of the latter catalysts and the activity, as measured in the laboratory, was exceptionally high. Unfortunately, however, all of the Esso samples had low crush strength and low bulk density.

In firing tests, all of the Esso samples exhibited fast rise times, but failed rather quickly (3 to 12 starts) with severe spiking. Sample 6 (Figure 11) failed at three starts due to excessive spiking. Only four starts were obtained on Sample 7 (Figure 12) before severe spiking occurred. The smaller mesh samples (Samples 8 and 9) performed slightly better (Figure 13 and 14) as was expected. Sample 8 failed after 12 starts while Sample 9 underwent 8 starts before failure.

Two of the Harshaw catalysts (Samples 10 and 11) exhibited high surface areas and pore volume, but like the Esso samples suffered decreased bulk density and crush strength. The engine performance was also similar to Esso samples. Sample 10 (Figure 15) failed after eight runs with severe spiking. Twelve starts were attained on Sample 11 (Figure 16) before failure again due to spiking.

The final Harshaw catalyst (Sample 12) was carbonized in an attempt to produce a highly stabilized, high-porosity, "alpha" phase material. The resulting catalyst had physical properties that were inferior to the RA-1 alumina catalyst in almost every respect. Consequently, engine performance (Figure 17) was very poor with failure after only eight starts with severe spiking.

The Reynolds "strengthened" alumina substrate produced a catalyst (Sample 13) with good crush strength and bulk density, but with very low surface area and a lower than average reactivity. The initial engine performance (Figure 18) was very satisfactory but failure occurred at 14 starts.

The final catalyst (Sample 14) was another Reynolds experimental alumina that was predominantly "eta" phase alumina. This sample was evaluated primarily because of its reported stability at high temperatures. The physical characteristics (Table III) were slightly inferior to those of the RA-1 alumina catalysts. The laboratory reactor measurement, however, indicated an extremely reactive catalyst. The engine performance (Figure 19) was very poor with failure at the three start level due to severe spiking.

The firing data on the 14 samples catalysts are summarized in Table V. The engine tests demonstrate the marked superiority of the RA-1 alumina over the several other substrates which supposedly exhibited

better physical properties. The RA-1 alumina catalyst apparently has an optimum combination of activity and physical strength characteristics.

Scanning electron micrographs of the catalyst samples indicate that the key to the RA-1 alumina's superiority may be due, at least in part, to its crystalline structure (Ref. 3 and 7). The RA-1 alumina consists of conglomerates of pseudomorphic crystalline particles with crevices and fissures throughout the structure. All of the surfaces are covered with small pores. In direct contrast, micrographs of the other substrates indicate that they all have similar amorphous structures with a marked absence of the macro openings and pores.

The open structure of the RA-1 alumina permits easy ingress of hydrazine vapor (or liquid) to the catalytic surfaces and correspondingly easy exit of the decomposition gases. The amorphous structure of the other catalysts probably permits penetration of the hydrazine, but the exiting of the decomposition gases appears to be hindered and fracturing of the support results. Examination of fired catalysts indicates that severe breakage does indeed occur (Ref. 3 and 7).

The results of the laboratory reactivity measurements (Appendix B) are not directly applicable to predicating engine life performance. The higher reactivities encountered generally were confirmed in the engine tests through reduced ignition delays and pressure rise times. These samples, however, showed very poor cold start survivability. This is probably a result of the extremely severe startup conditions imposed by the high reactivity.



## SECTION IV

### CONCLUSIONS AND RECOMMENDATIONS

#### CONCLUSIONS

Reynolds RA-1 alumina remains the best substrate material of those tested since it provides an apparent optimum combination of activity and physical strength characteristics.

The key to the superiority of the RA-1 alumina may be its crystalline structure.

Catalysts of increased activity can be prepared, but they suffer a drastic loss in cold-start life.

Laboratory reactor measurements of catalyst activity do not accurately indicate the cold-start life of a catalyst. A highly reactive catalyst may have a very short life.

High-temperature calcination treatment of substrates does not increase the cold-start life of the catalyst.

Plant-prepared catalysts offer better cold-start life than those prepared on a laboratory scale, although the laboratory product may be more active initially.

Additional substrate attrition (90 percent) may be a means of providing better packing and of increasing catalyst mechanical strength.

## RECOMMENDATIONS

The catalyst failure criteria require further definition and/or expansion. Possibly ignition delay criteria should be included.

The crystalline structure of RA-1 alumina warrants further examination.

The 90 percent attrited substrate should be examined in more detail; JPL and Marquardt have done some work in this area.

The engine packing criteria should be investigated and a definite procedure established for packing the engines used in future programs.

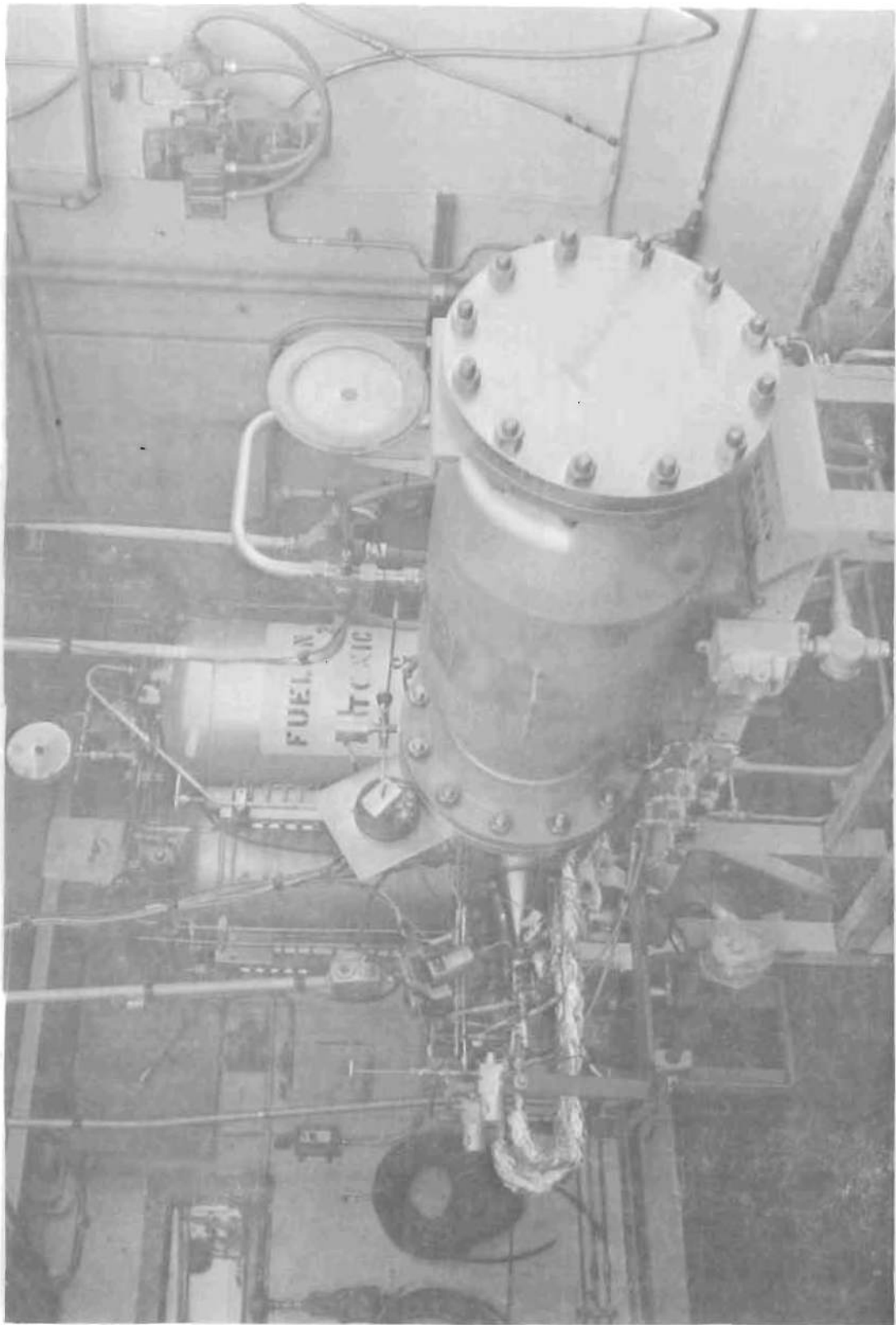

Figure 1. Catalyst Test Cell

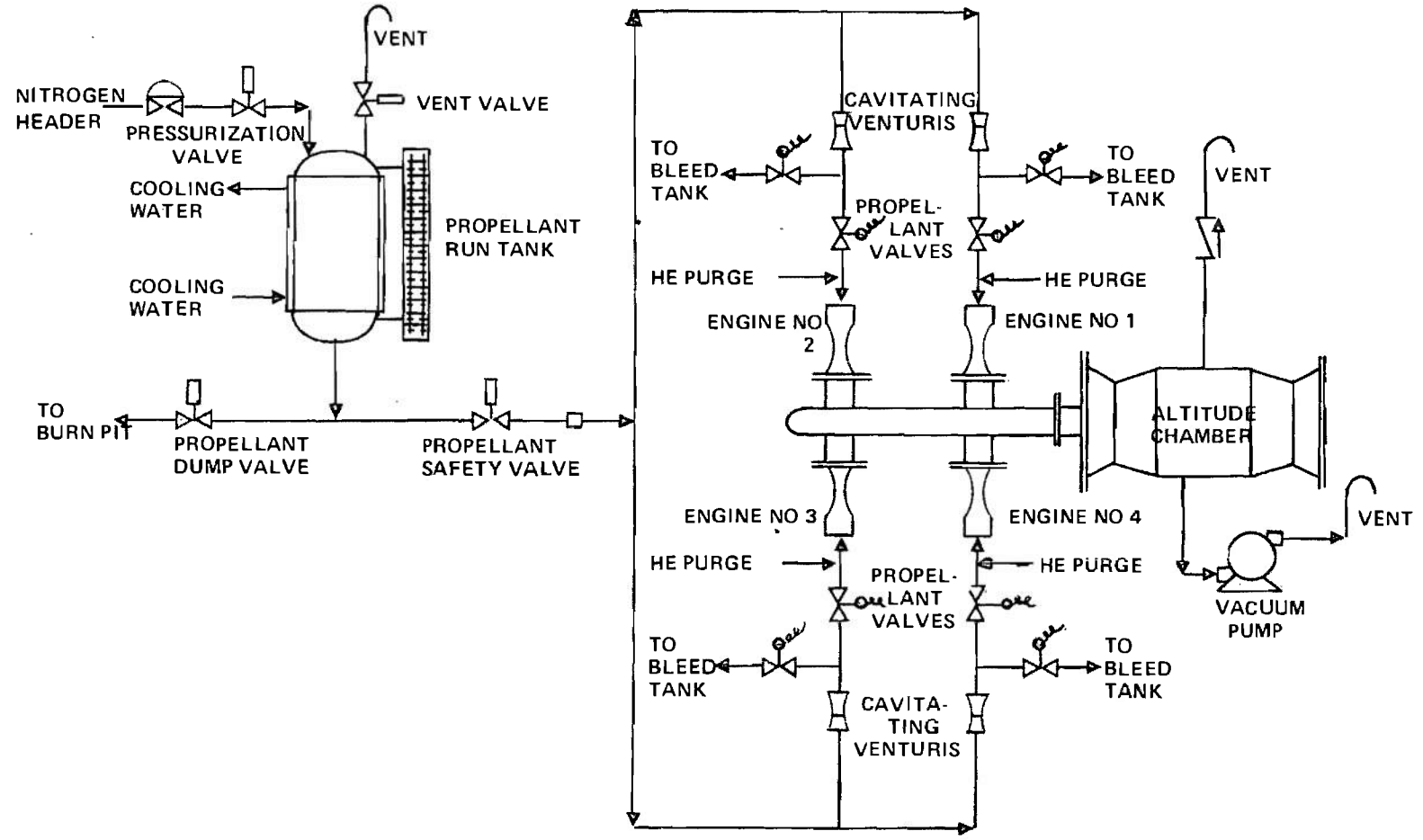

Figure 2. Catalyst Test System Mechanical Schematic

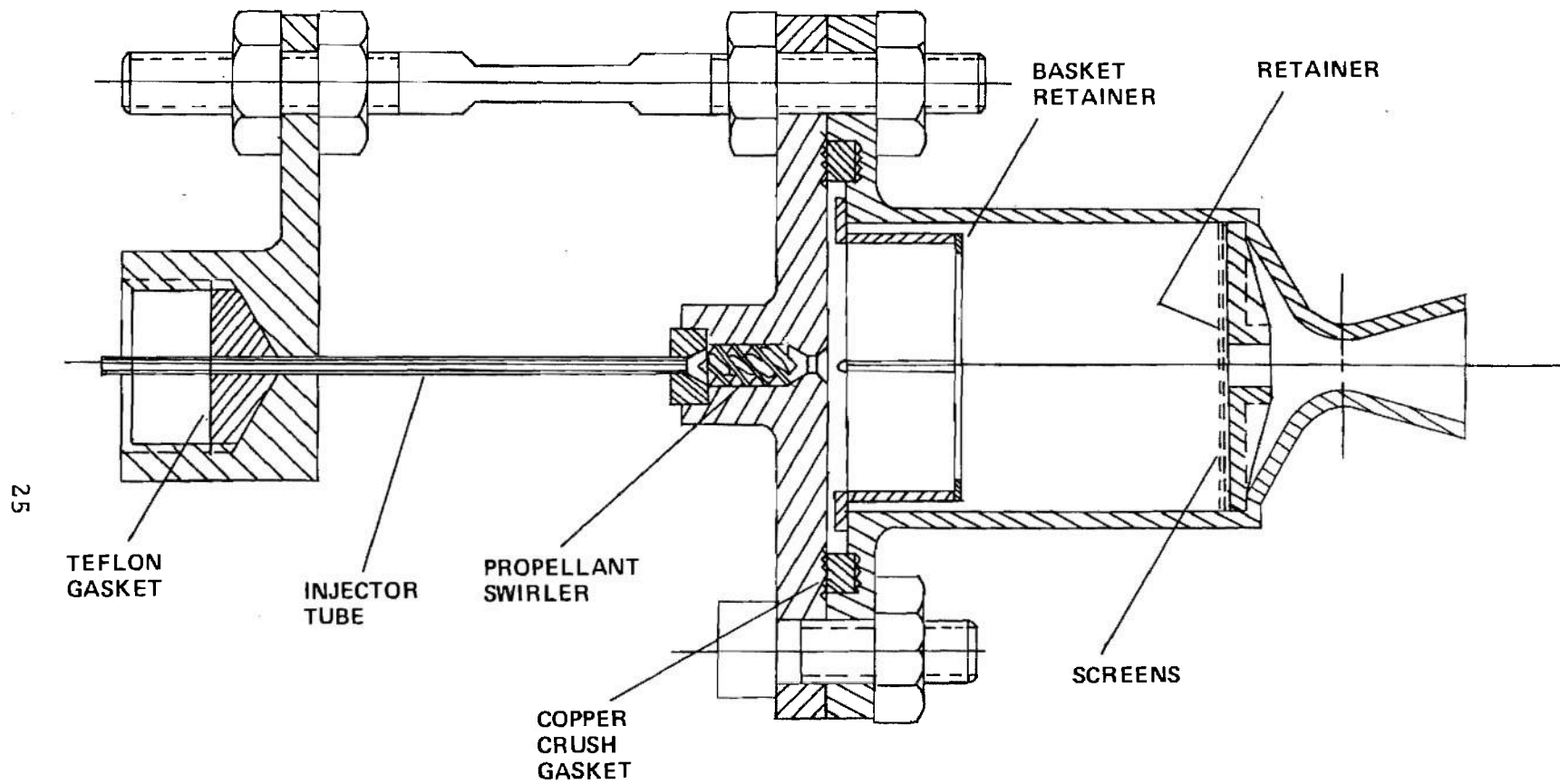

Figure 3. 5-Pound-Thrust Catalyst Engine

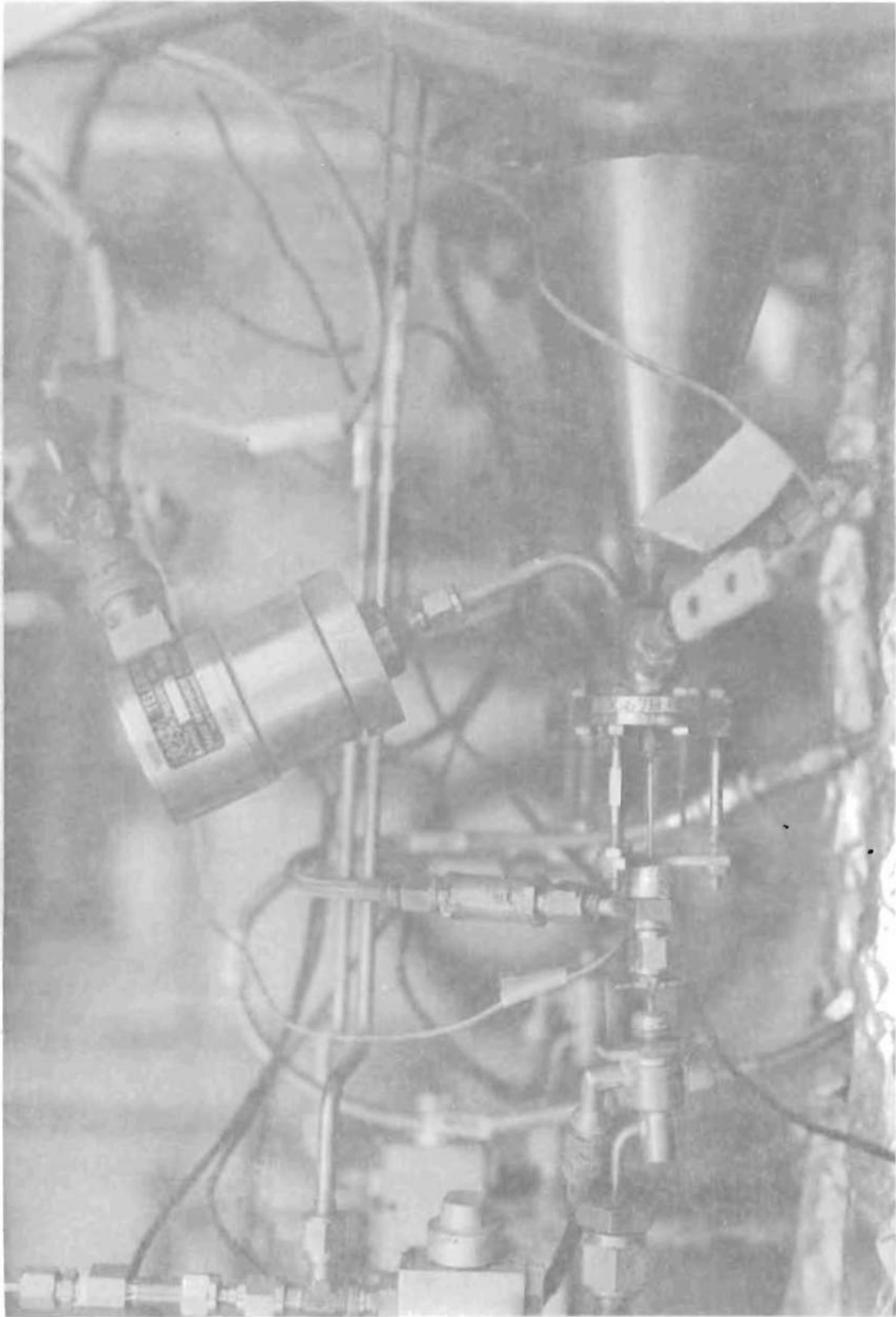

Figure 4. Engine Instrumentation

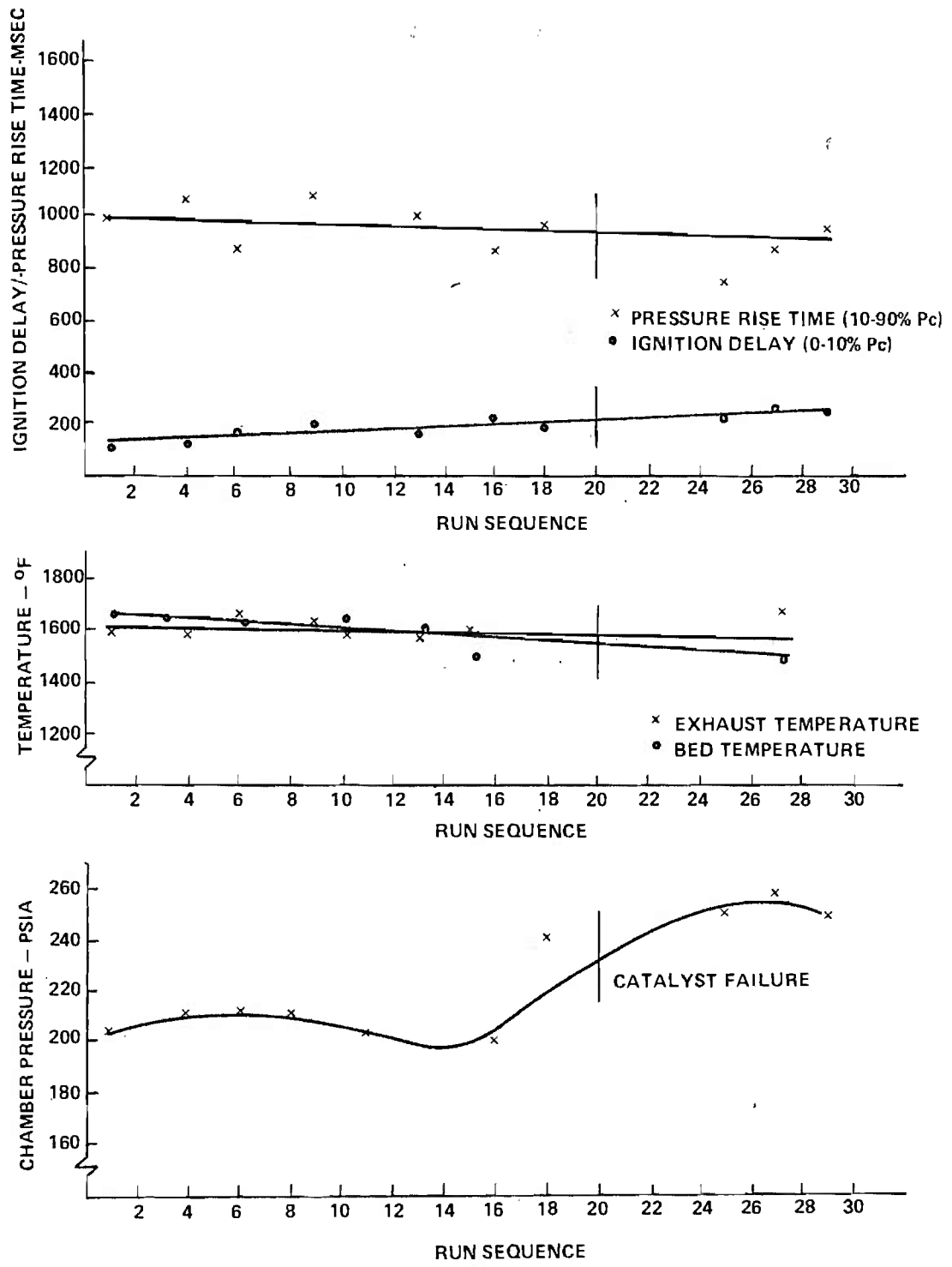

Figure 5. Firing Data for Sample 1 (Handpacked)

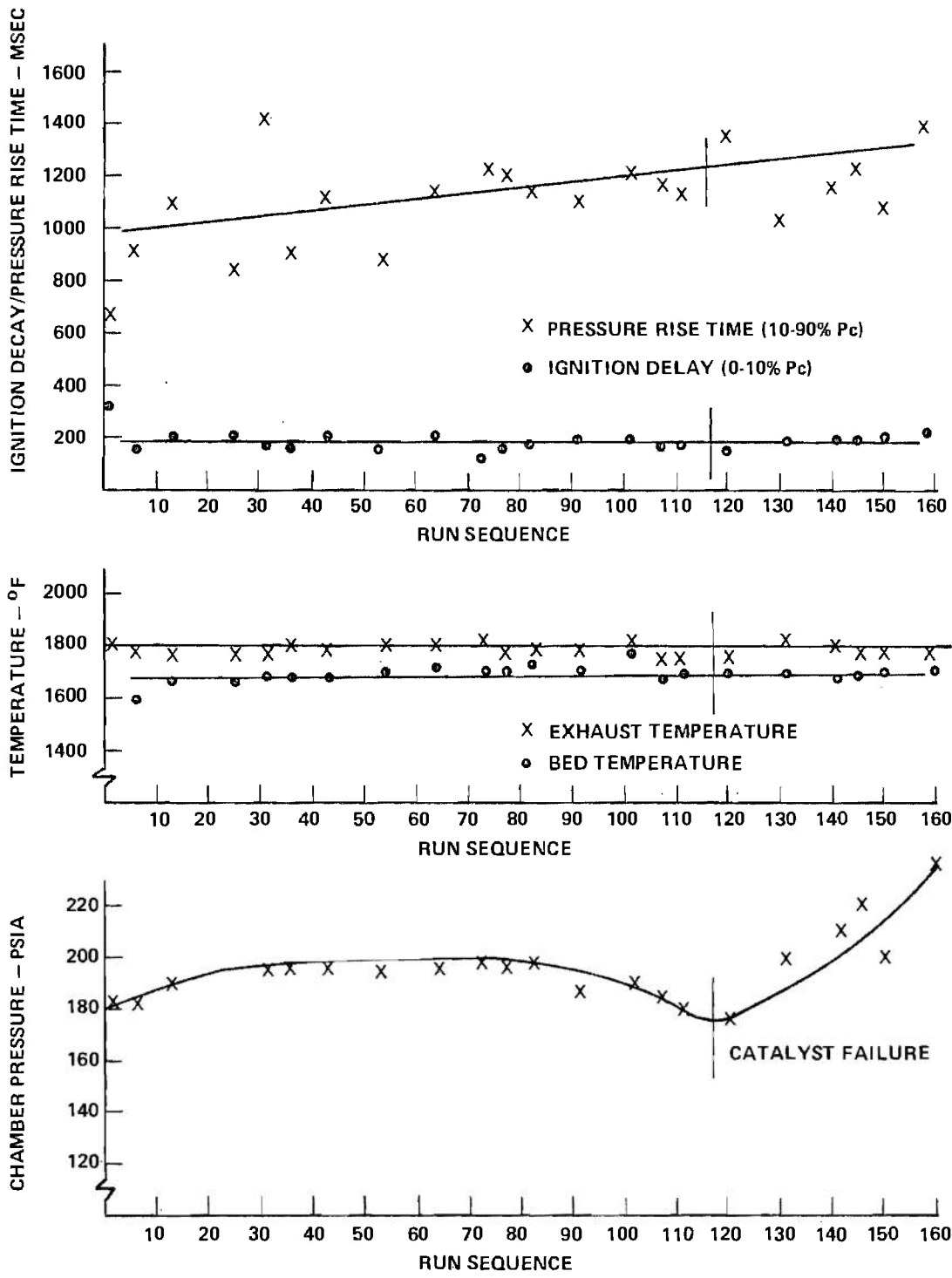

Figure 6. Firing Data for Sample 1 (Vibration Pack)



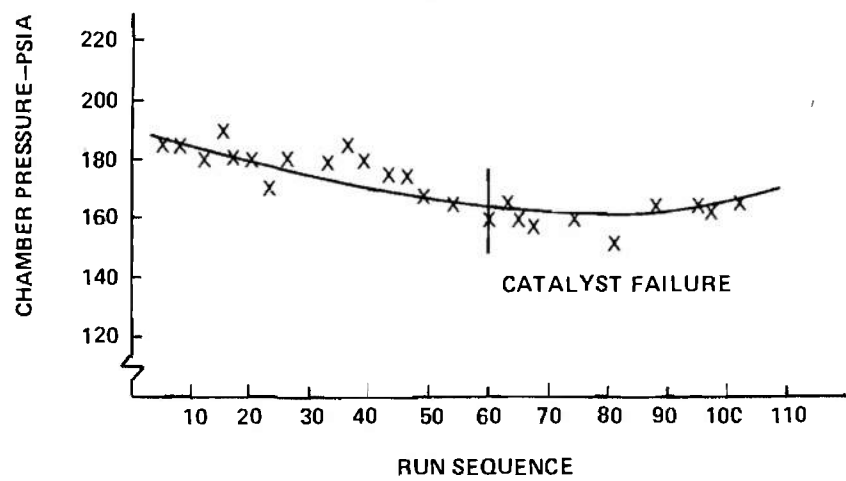
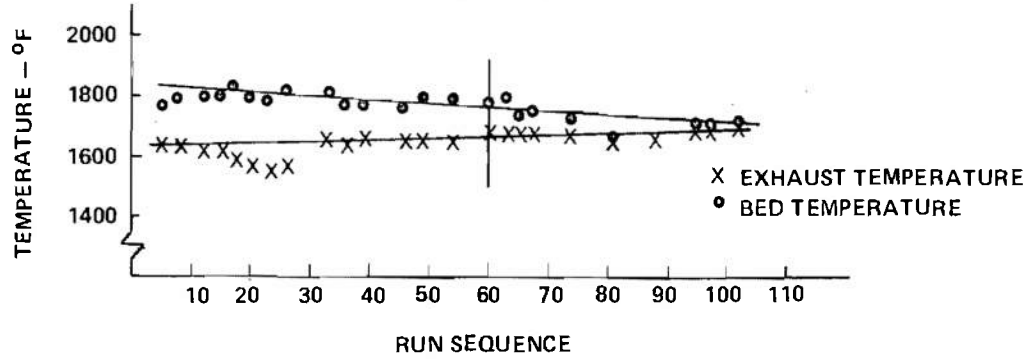
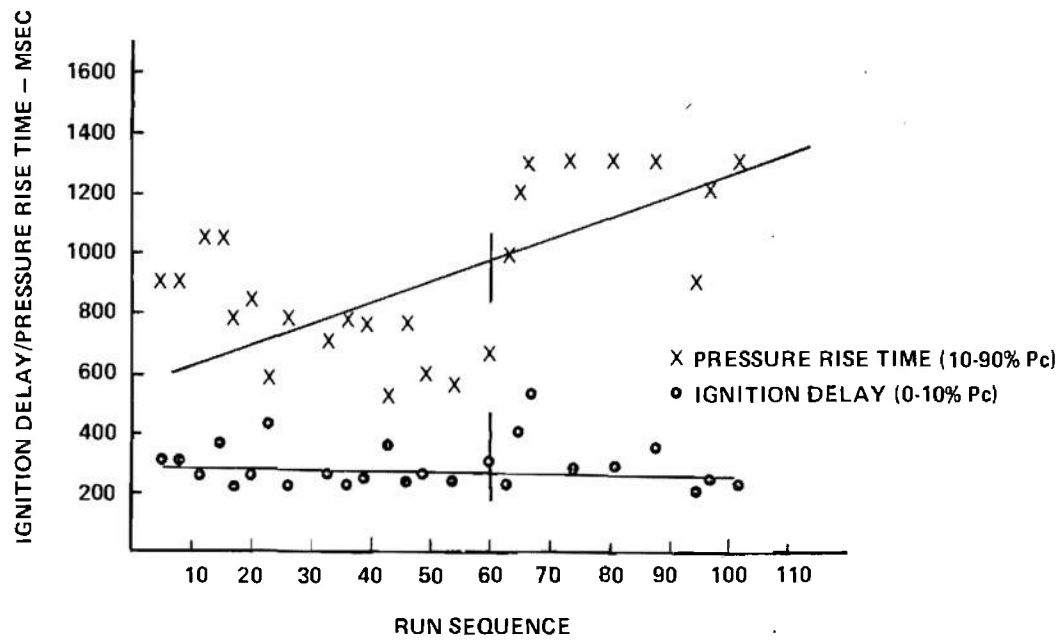

Figure 7. Firing Data for Sample 2

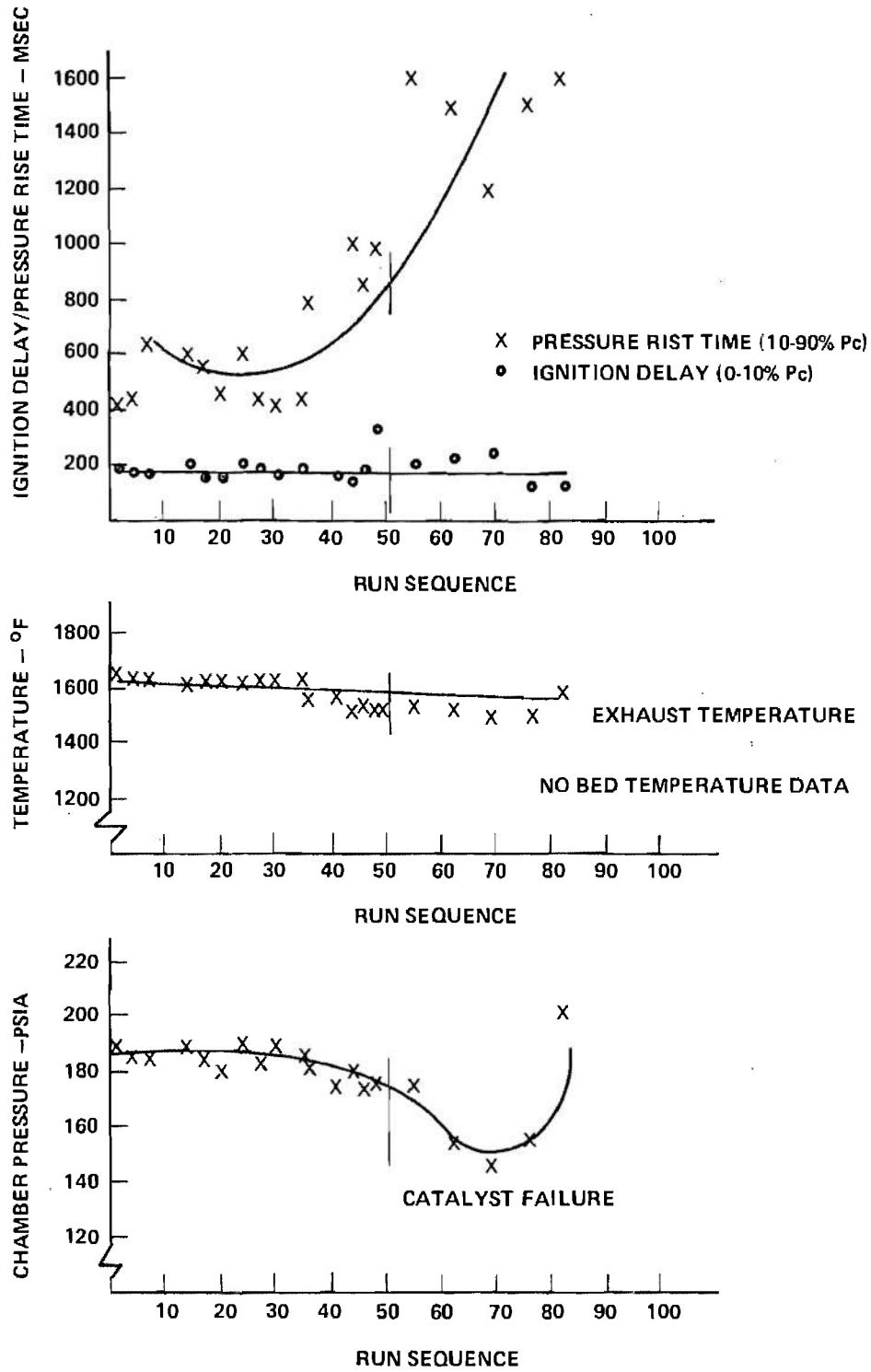

Figure 8. Firing Data for Sample 3

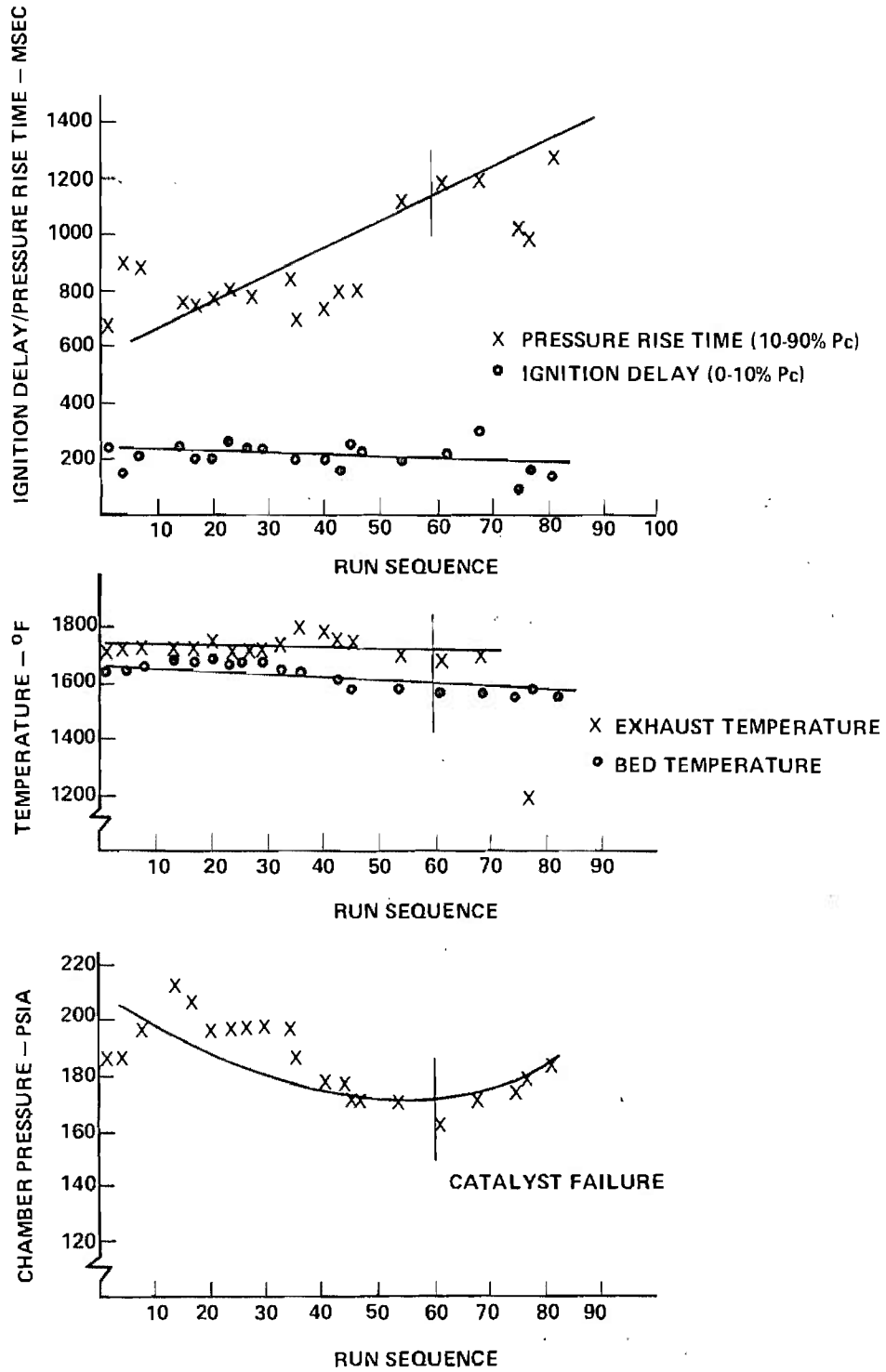

Figure 9. Firing Data for Sample 4.

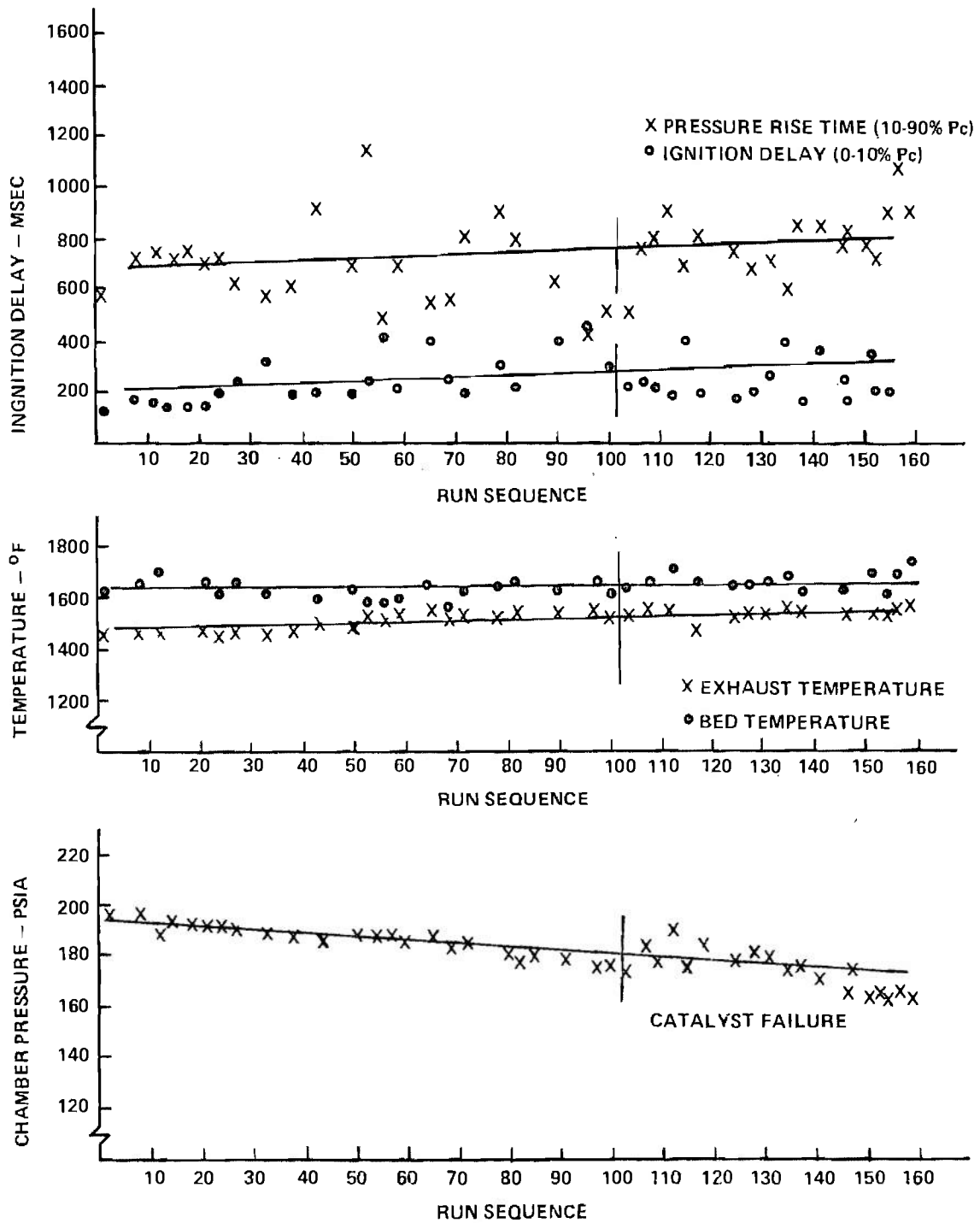

Figure 10. Firing Data for Sample 5.

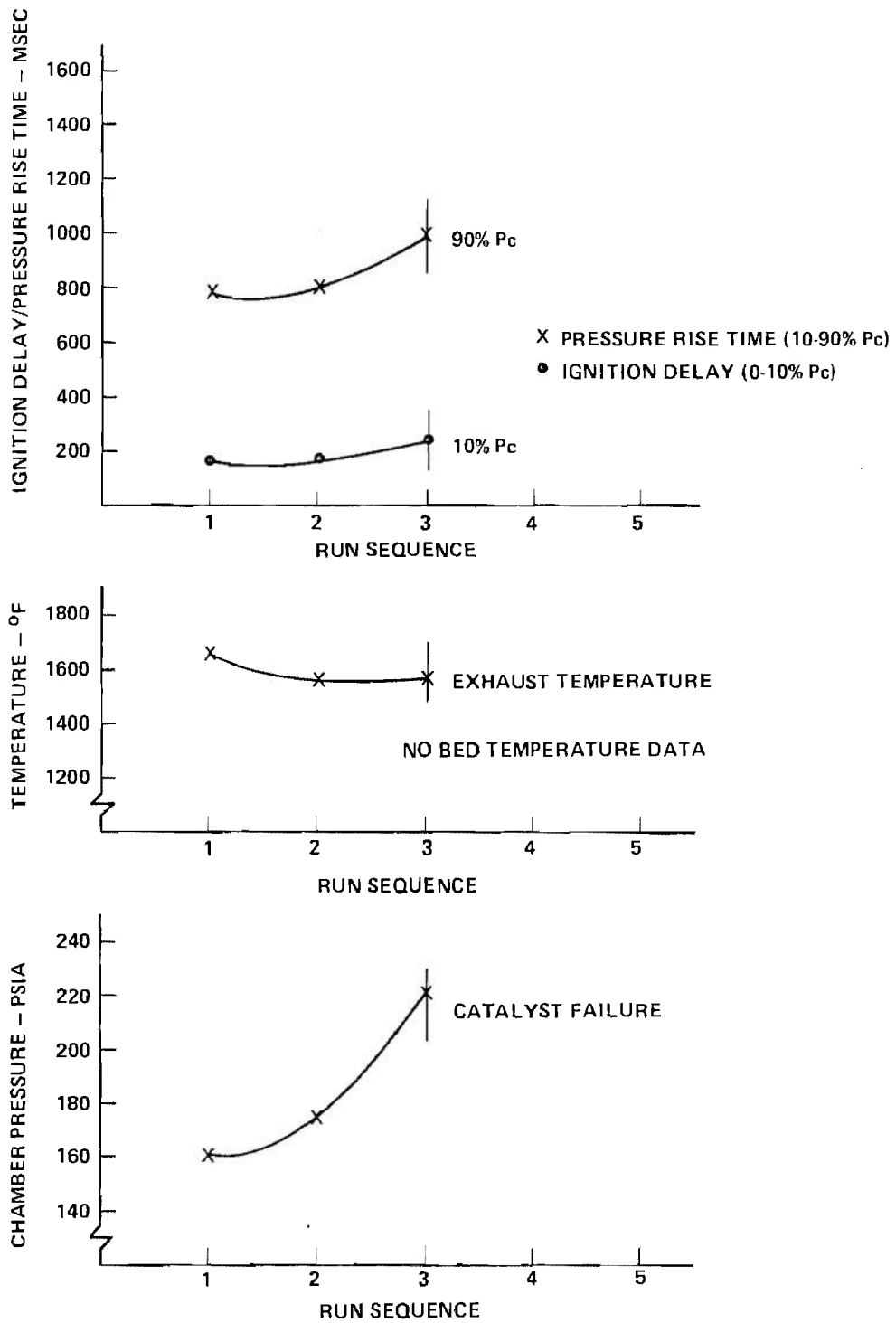

Figure 11. Firing Data for Sample 6.

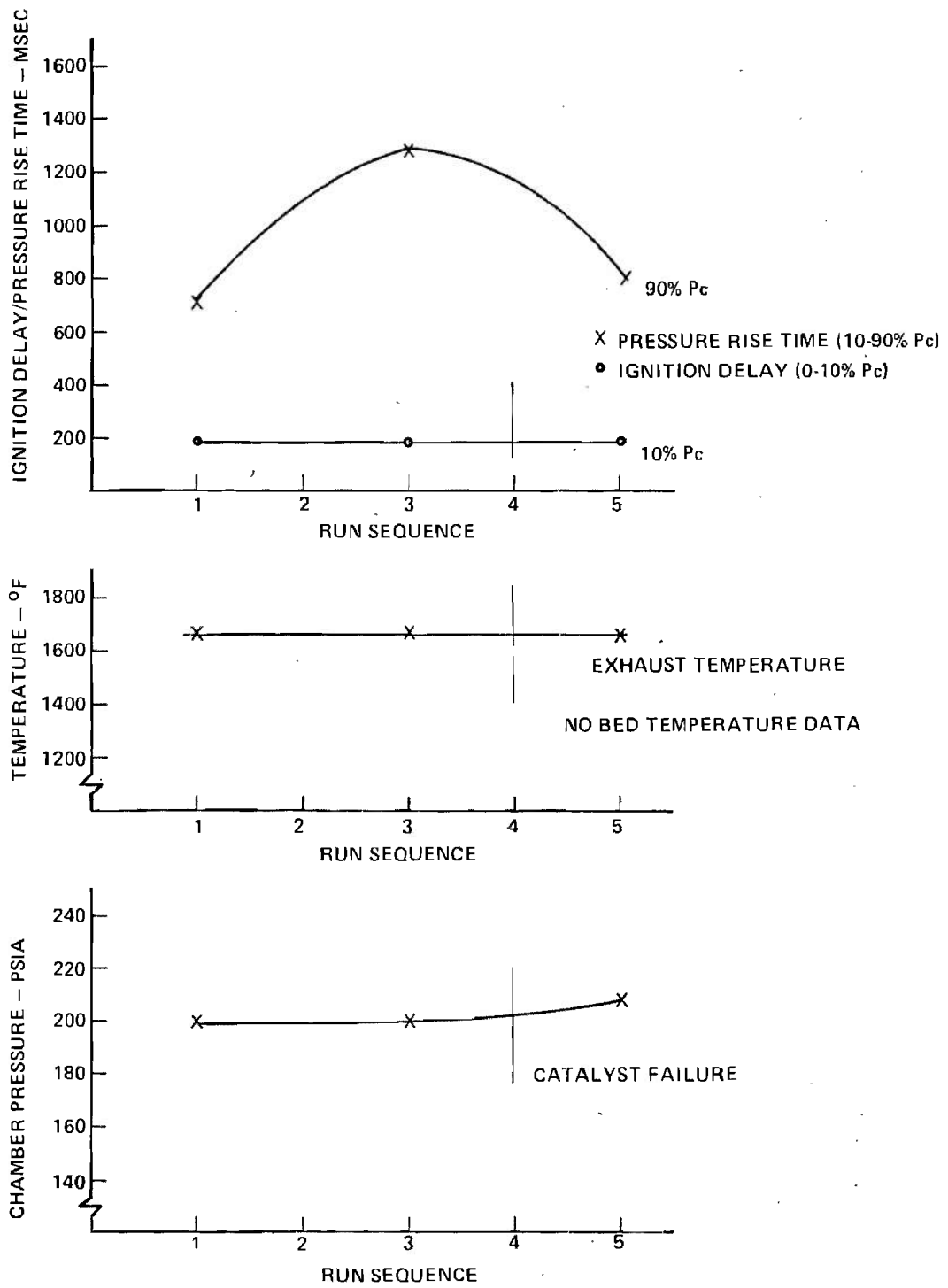

Figure 12. Firing Data for Sample 7

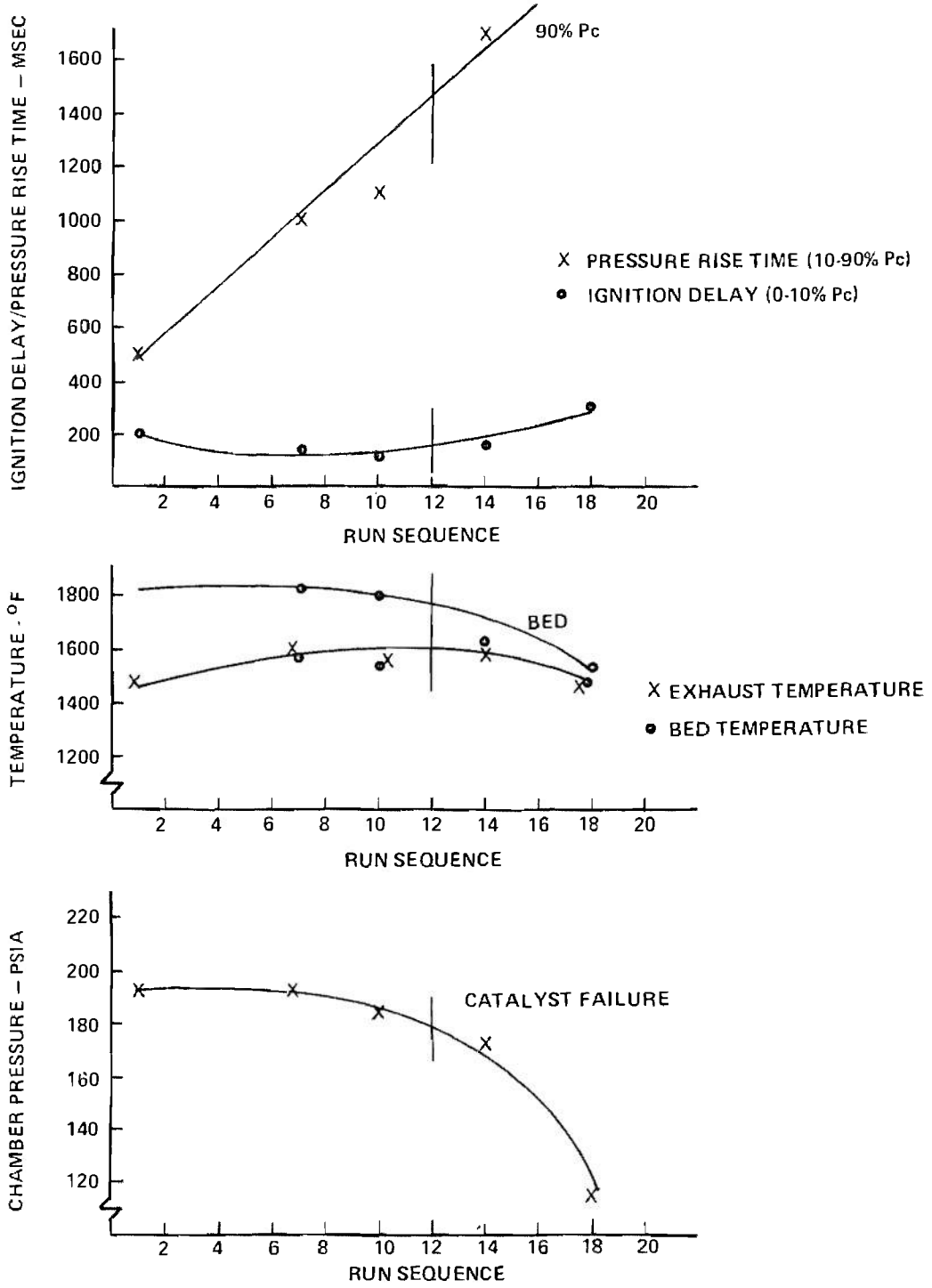

Figure 13. Firing Data for Sample 8

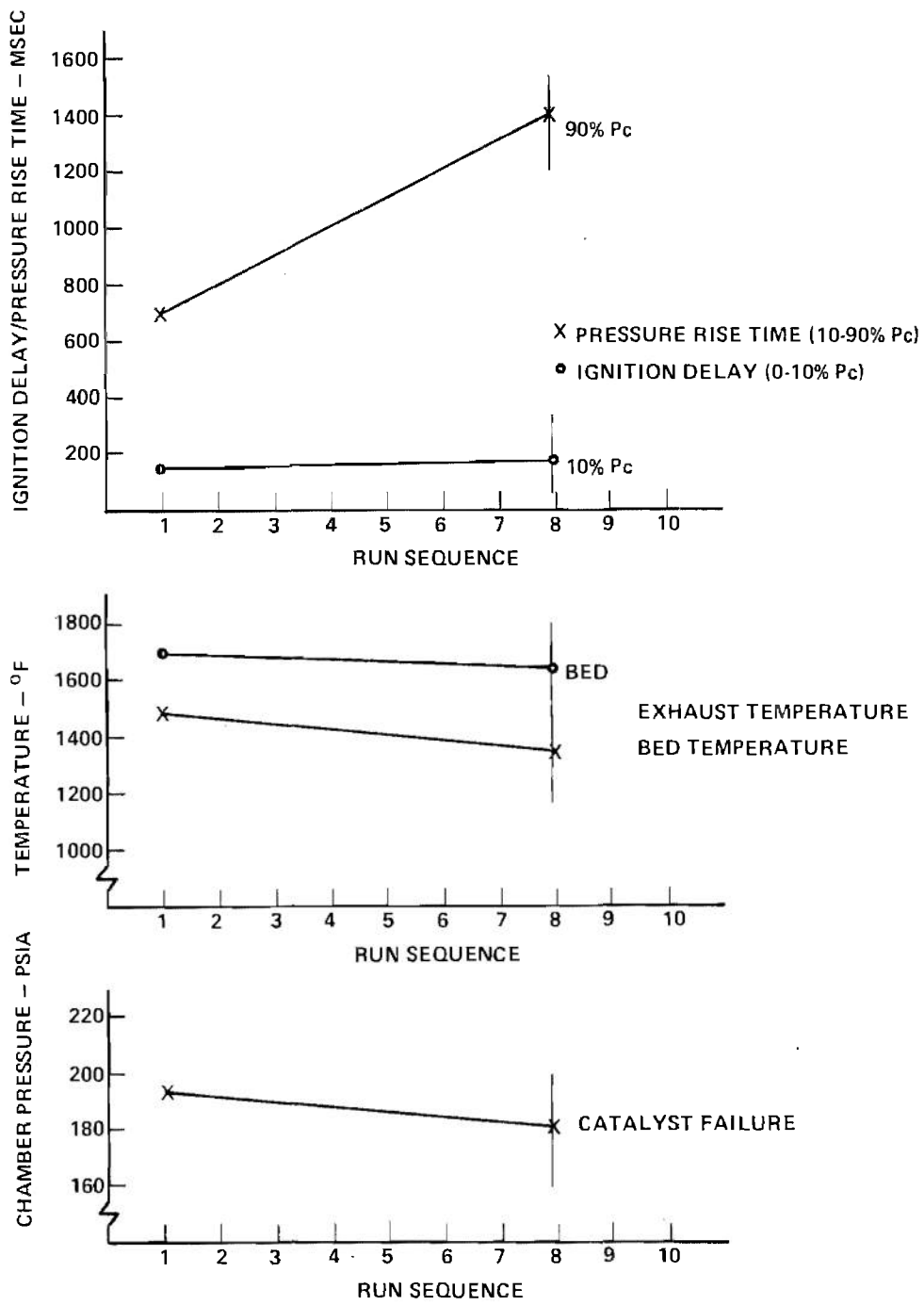

Figure 14. Firing Data for Sample 9.



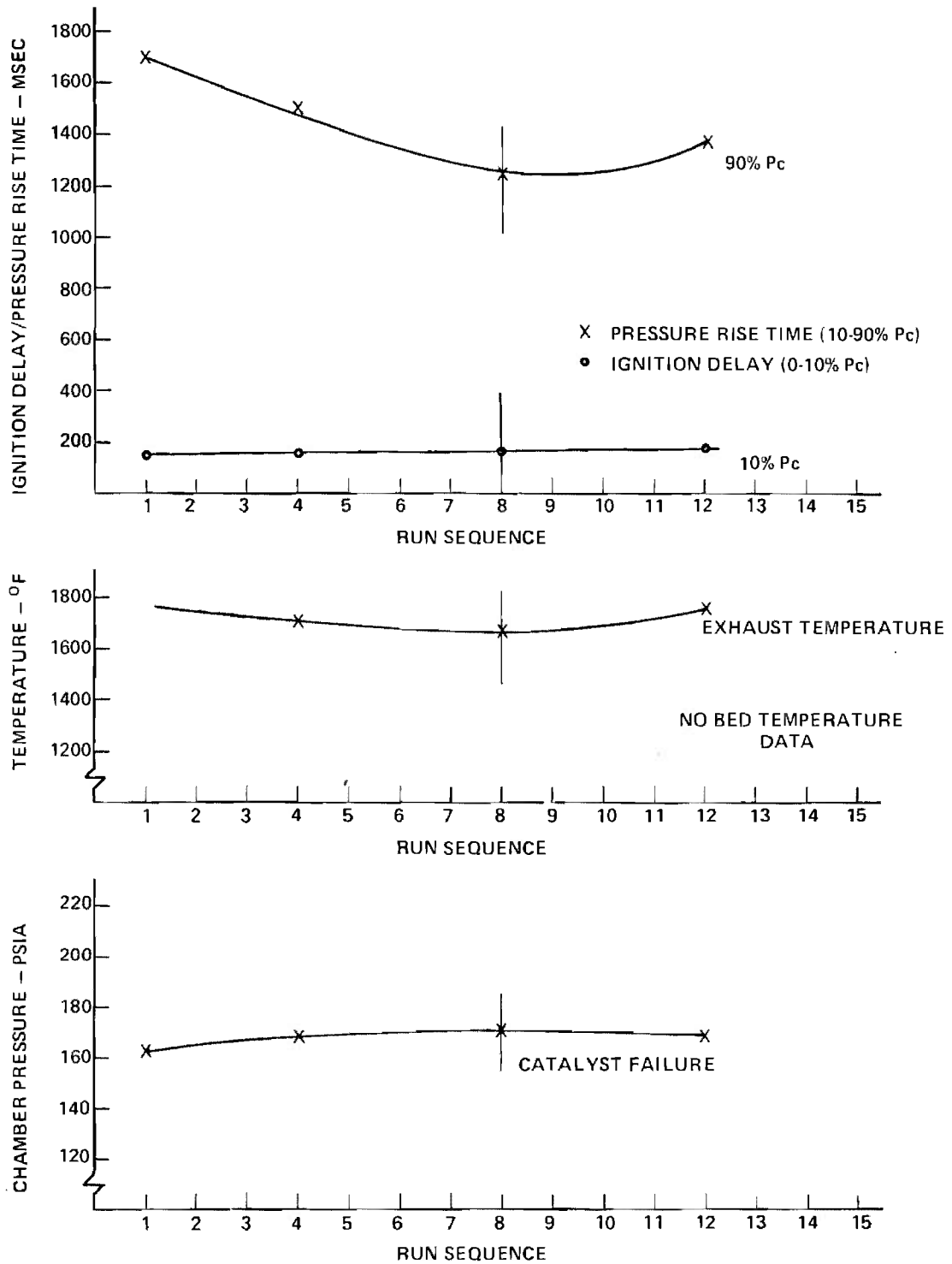

Figure 15. Firing Data for Sample 10.

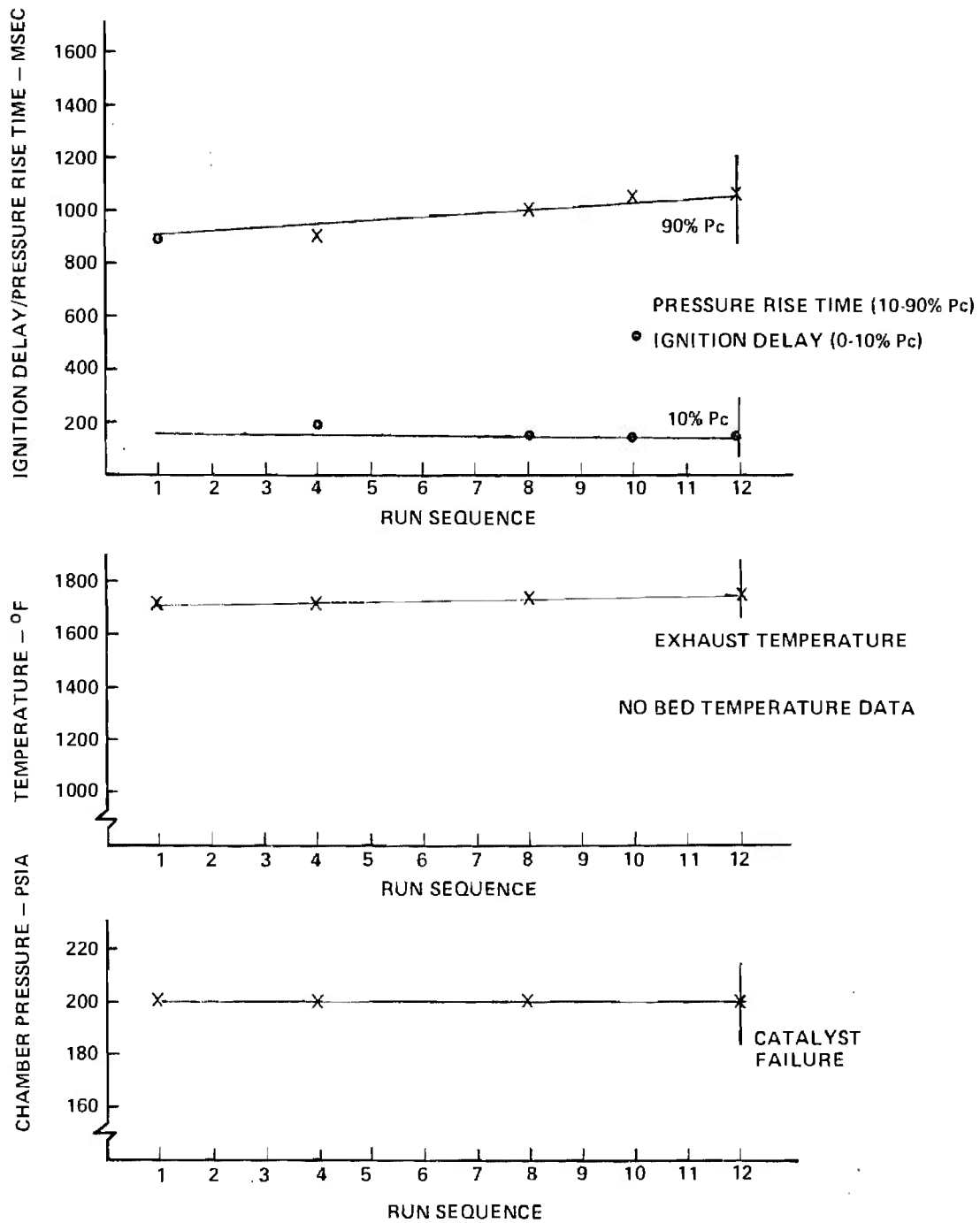

Figure 16. Firing Data for Sample 11

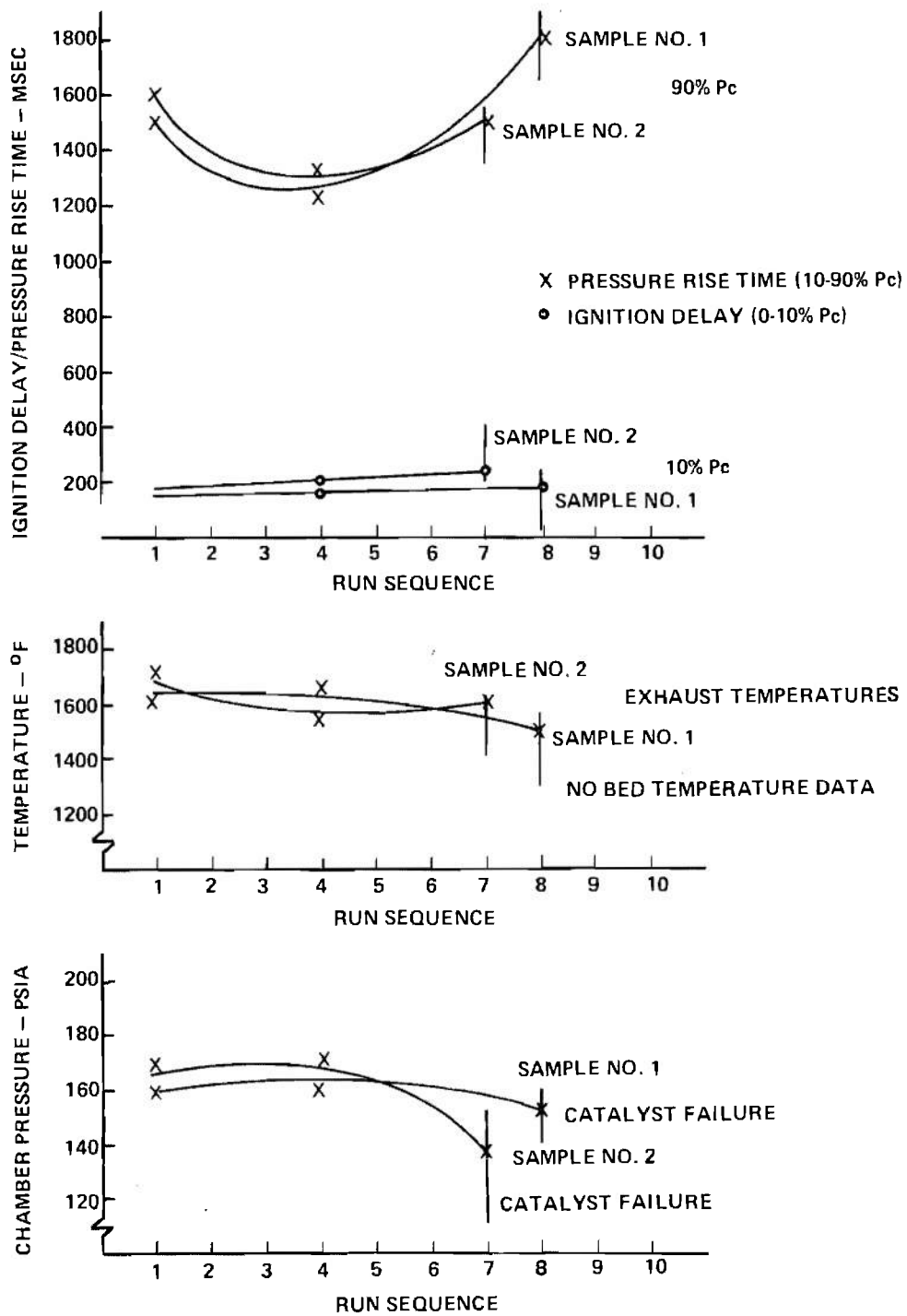

Figure 17. Firing Data for Sample 12

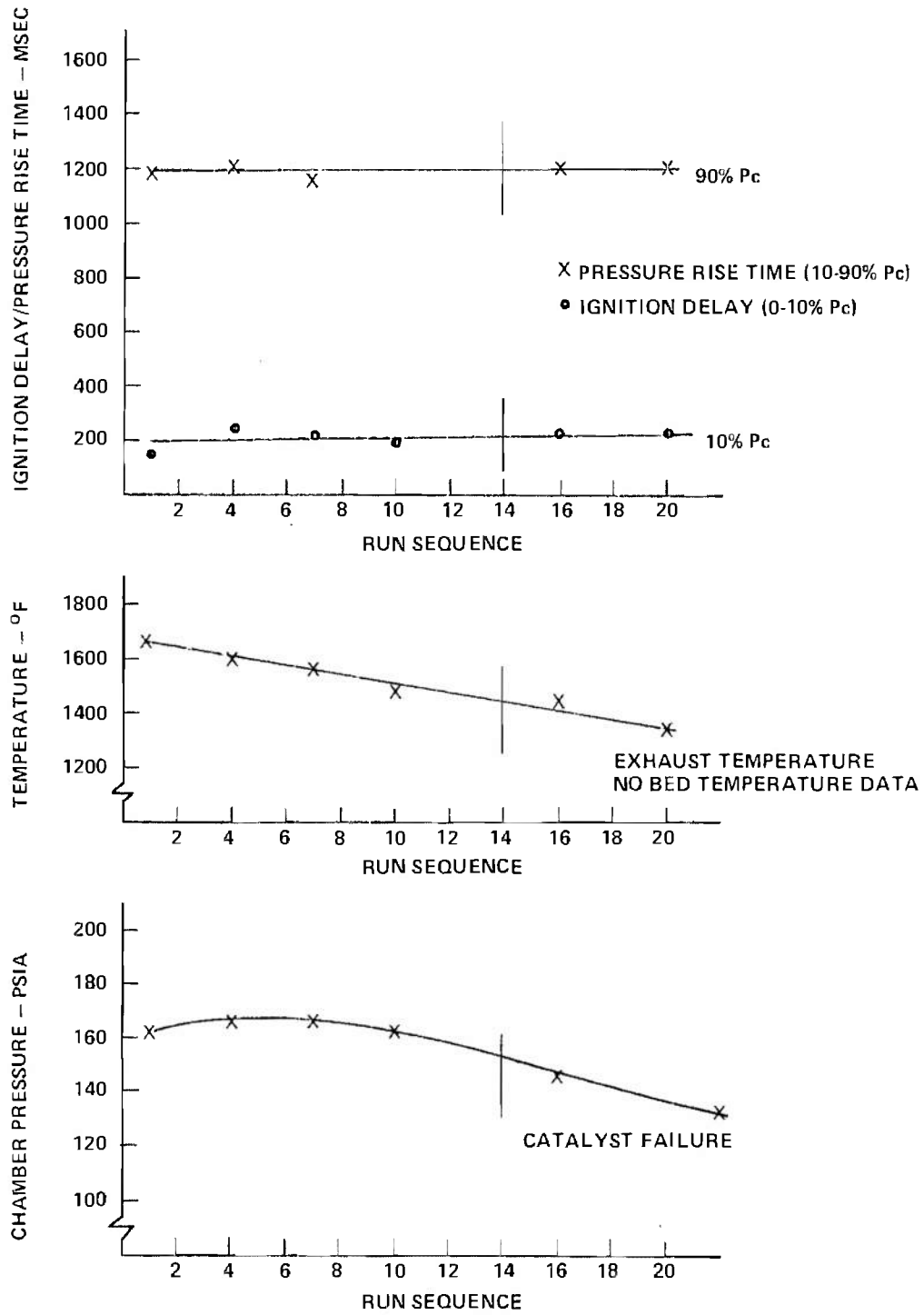

Figure 18. Firing Data for Sample 13

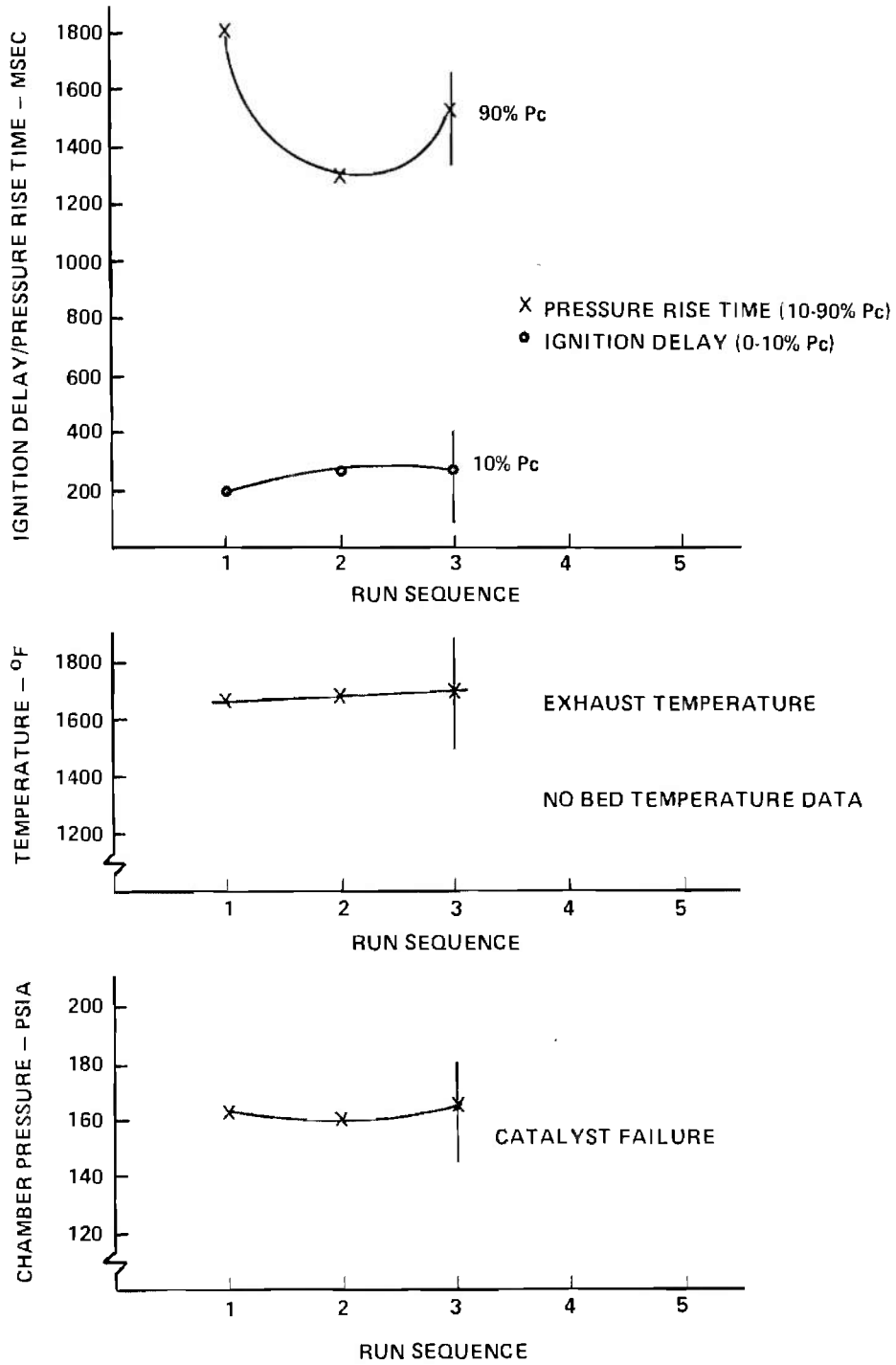

Figure 19. Firing Data for Sample 14

## REFERENCES

1. Armstrong, W.E., Morgan, C.Z. and Ryland, L.B. Development of Catalysts for Monopropellant Decomposition of Hydrazine (U) Shell Development Company Report S-13947 (Confidential), 1964.
2. Huxtable, D.D., Rice, P.R., Jr, and Smith, O.I., Hydrazine Catalyst Evaluation, AFRPL-TR-70-107, November 1970.
3. Williams, P.H., Modification of Shell 405 Catalyst - Test Catalyst Preparation (U), AFRPL-TR-72-7. (Confidential).
4. Reynolds Metals Company, Bauxite, Arkansas.
5. Lieberman, M. and Taylor, W.F., Development of a Low Cost Catalyst for Hydrazine (U), AFRPL-TR-70-7, (Confidential), January 1970.
6. The Harshaw Chemical Company, Cleveland, Ohio.
7. Rice, P.R., Jr, and Williams, P.H., "Hydrazine Catalyst Improvement," presented at the AIAA/SAE 7th Propulsion Joint Specialist Conference, Salt Lake City, Utah, June 14-18, 1971.

## AUTHORS' BIOGRAPHIES

NEIL C. NEWTON, SGT, USAF

Education:

Bachelor of Science in Chemical Engineering  
University of Pittsburgh, 1968

Part-Time Graduate study in Business Administration  
(Management), Golden Gate College

Professional Experience:

April 1967 - September 1967  
Research and Development Engineer, Shell Chemical Company

September 1968 - September 1969  
Process Engineer, Shell Chemical Company

December 1969 - Present  
Test Engineer, Air Force Rocket Propulsion Laboratory

PONY RICE, JR, CAPT, USAF

Education:

Bachelor of Science in Chemical Engineering  
University of Louisville, 1967

Professional Experience:

June 1967 - January 1968  
Process Engineer, Stauffer Chemical Company

January 1968 - August 1971  
Test Engineer, Air Force Rocket Propulsion Laboratory

AUTHORS' BIOGRAPHIES (Cont'd)

DOUGLAS D. HUXTABLE, CAPT, USAF

Education:

Bachelor of Science in Chemical Engineering  
University of Virginia, 1967

Master of Science in Mechanical Engineering  
University of Southern California, 1971

Professional Experience:

June - August 1966  
Research in viscous mixing, "Turbulent Mixing in a Vertical  
Flat-Blade Agitator," University of Virginia

June 1967  
Process Engineer, Hercules Chemical Company

July 1967 - June 1971  
Project Engineer, Air Force Rocket Propulsion Laboratory



APPENDIX A  
LABORATORY TEST METHODS

• PORE VOLUME DISTRIBUTION

• Pore volume distributions and surface areas are calculated from nitrogen adsorption isotherms measured with the aid of a volumetric gas and sorption apparatus, the Aminco "Adsorptomat" (Ref. A-1). This instrument is based on the design of Ballou and Doolen (Ref. A-2) and automatically measures the amount of nitrogen adsorbed by a weighed sample at  $-196^{\circ}\text{C}$  as a function of relative pressure over the range of 0.01 to 0.995. The isotherm data are reduced by the method of Barrett, Joyner and Halenda (Ref. A-3) as modified by Emig and Hoffman (Ref. A-4) to obtain a cumulative pore volume distribution over the range of 16 to 850 angstroms. Volumes of pores between various size boundaries are calculated and plotted as functions of the average size. The computations and plot are made with the aid of a computer. Many assumptions are involved in this and other methods for the determination of pore volume distribution in this pore size range, and no general statement can be made about precision and accuracy.

SURFACE AREA

• Surface areas are determined from the amounts of nitrogen adsorbed (using the Aminco Adsorptomat) by the sample at  $-196^{\circ}\text{C}$  at several relative pressures in the range 0.05 to 0.3. The least squares estimates of the parameters of the Brunnauer-Emmet-Teller (Ref. A-5) equation, which represent these data, are found numerically and used to calculate the surface area of the sample. Precision of the surface area values is  $\pm 2$  percent.

## HYDROGEN CHEMISORPTION

The amount of hydrogen chemisorbed by a weighed sample is measured by the dynamic method of Nelsen and Eggertsen (Ref. A-6). The apparatus used consists of a sample cell, thermal conductivity bridge, recorder and associated equipment as needed to pass gas over the sample under various conditions. The sample is reduced in hydrogen at 500°C and then cooled to 0°C in an argon stream containing 1 percent hydrogen while the composition of the exit gas is recorded. Hydrogen is taken out of the gas stream by chemisorption in this step. After the chemisorption is complete, as shown by the return of the gas composition to its original level, the sample is heated to 500°C to release the chemisorbed hydrogen. The amount evolved is measured by referring the area under the peak in the composition-time curve to a calibration curve prepared from areas obtained by the addition of known amounts of hydrogen to the gas stream. The precision is ±5 percent. The accuracy has not been established.

## CRUSH STRENGTH

A 10-gram quantity of support or catalyst is poured into a heavy-walled, stainless steel cylinder of internal dimensions 0.875-inch diameter and 1.5-inches depth. A stainless steel plunger 3 inches in length and machined to smooth-sliding diameter is inserted into the cylinder and the assembly is placed in a hand-operated hydraulic press. A force of 375 pounds (625 psi) is applied, held for 10 seconds, and released.

The compressed sample is removed and sieved in a 3-inch-diameter U.S. Standard sieve (W.S. Tyler Company, manufacturer). The fraction retained on the sieve next greater in number (next smaller in screen opening) than the greater number sieve defining the original sample of support is recorded as Percent Survival.

## BULK DENSITY

Packed bulk density,  $B_D$ , is determined by weighing a quantity of support or catalyst into a graduated glass cylinder to determine its volume. (In the standard procedure for Shell 405 Catalyst, 200 grams of catalyst are weighed into a 250 cc graduate; for this program, because of lesser amounts available, the total amount of support or catalyst prepared was weighed into a 100 cc graduated cylinder.) The bottom of the cylinder is tapped for 3 minutes and the volume of material is then noted. Bulk density is reported on a dry basis, i. e., corrected for loss on ignition (L.O.I.) and calculated as follows:

$$B_D \text{ (dry basis)} = \frac{\text{Weight} - \text{Weight (L.O.I. /100)}}{\text{Volume}}$$

[L.O.I. (weight percent) is determined by heating a weighed (1 to 2 gram) sample of support in a small porcelain crucible at approximately 700°C for 30 minutes, cooling in a desiccator and reweighing.]

## REFERENCES

- A-1. American Instrument Company, Inc., 8030 Georgia Avenue, Silver Spring, Md., Catalog Nos. 4-4680 (basic instrument) and 4-4685 (multi-sample accessory for 5 samples).
- A-2. Ballou, E.V., and I.K. Doolen, Anal. Chem. 32, 532 (1960).
- A-3. Barrett, E.P., Joyner, L.G., and P. Halenda, J. Am. Chem. Soc., 73, 373 (1951).
- A-4. Emig, G, and H. Hoffman, J. Catalysis, 8, 303 (1967).
- A-5. Brunnauer, S., Emmet, P.H., and E. Teller, J. Am. Chem. Soc., 60, 309 (1938).
- A-6. Nelsen, F.M., and F.T. Eggertsen, Anal. Chem., 30, 1387 (1958).

APPENDIX B  
STANDARD DUTY CYCLE

<u>Time (seconds)</u>	<u>Propellant Valve Position</u>
0.000 to 5.000	OPEN
5.000 to 5.025	CLOSED
5.025 to 5.125	OPEN } A
5.125 to 5.225	CLOSED }
5.225 to 7.025	REPEAT A, 9 TIMES
7.025 to 7.075	OPEN } B
7.075 to 7.175	CLOSED }
7.175 to 8.525	REPEAT B, 9 TIMES
8.525 to 8.550	OPEN } C
8.550 to 8.650	CLOSED }
8.650 to 9.775	REPEAT C, 9 TIMES
9.775 to 9.785	OPEN } D
9.785 to 9.835	CLOSED }
9.835 to 10.915	REPEAT D, 18 TIMES
10.915 to 10.925	OPEN
10.925 to (end of run)	CLOSED
Total Run Time = 10.925 seconds	
Total Open Time = 6.950 seconds	
Number of Pulses = 51	

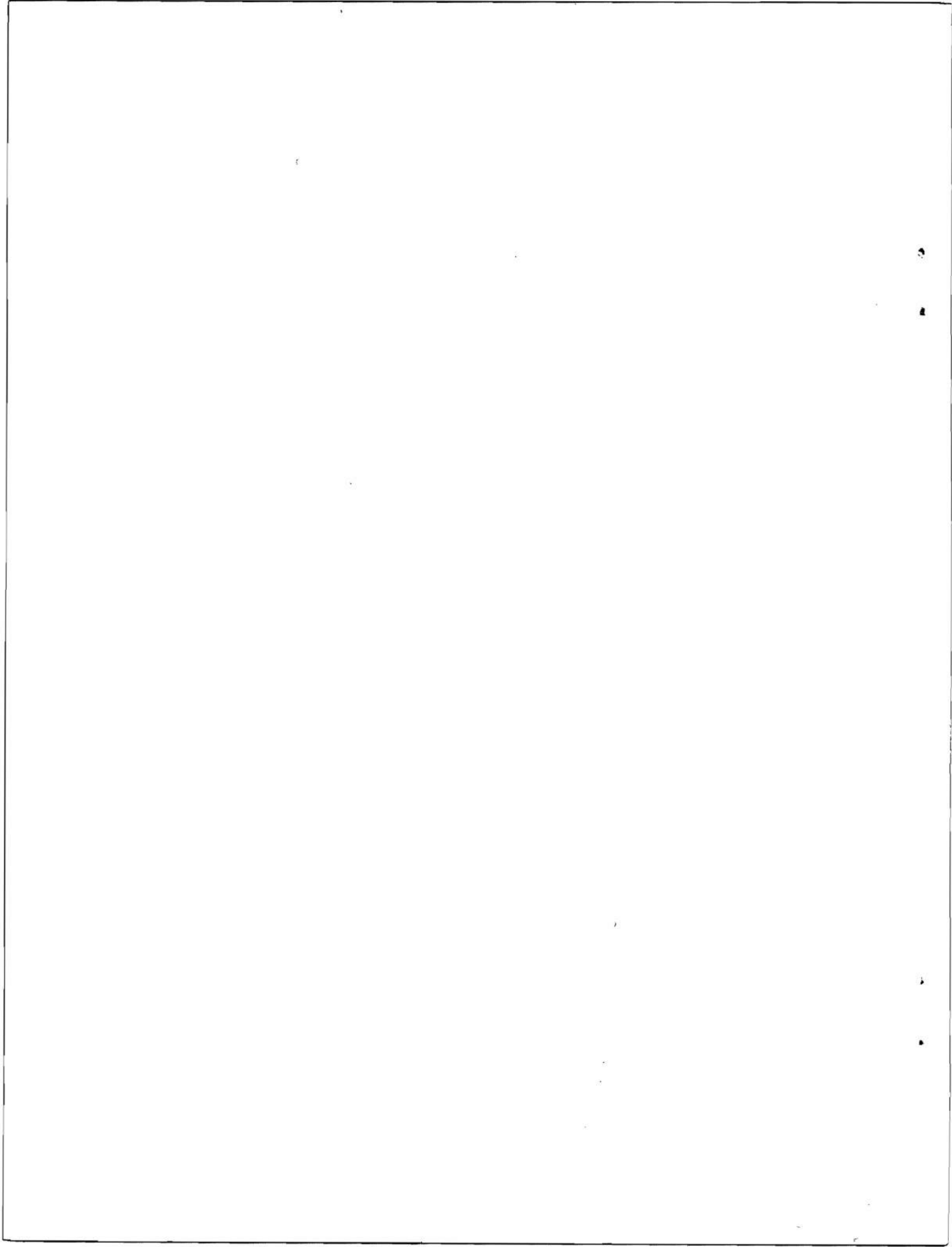

UNCLASSIFIED

Security Classification

DOCUMENT CONTROL DATA - R & D		
<i>(Security classification of title, body of abstract and indexing annotation must be entered when the overall report is classified)</i>		
1. ORIGINATING ACTIVITY (Corporate author)  Air Force Rocket Propulsion Laboratory Edwards, California 93523		2a. REPORT SECURITY CLASSIFICATION <b>UNCLASSIFIED</b>
		2b. GROUP
3. REPORT TITLE  Shell 405 Catalyst Improvement Substrate Evaluation		
4. DESCRIPTIVE NOTES (Type of report and inclusive dates) Phase I - 1 July 1970 to 1 April 1971		
5. AUTHOR(S) (First name, middle initial, last name) N.C. Newton, Sgt, USAF P.R. Rice, Jr., Capt, USAF D.D. Huxtable, Capt, USAF		
6. REPORT DATE July 1972	7a. TOTAL NO. OF PAGES 59	7b. NO. OF REFS 7
8a. CONTRACT OR GRANT NO.	9a. ORIGINATOR'S REPORT NUMBER(S)  AFRPL-TR-71-81	
b. PROJECT NO. 314802DSA		
c.	9b. OTHER REPORT NO(S) (Any other numbers that may be assigned this report)	
d.		
10. DISTRIBUTION STATEMENT <del>Distribution limited to U.S. Government agencies only; Test and Evaluation; 4 May 1972. Other requests for this document must be referred to AFRPL Office of Technical Information (DOZ), Edwards, California 93523.</del>		
11. SUPPLEMENTARY NOTES		12. SPONSORING MILITARY ACTIVITY Air Force Rocket Propulsion Laboratory Air Force Systems Command, USAF Edwards CA 93523
13. ABSTRACT  Fourteen hydrazine catalyst samples on five different substrates provided by Shell Development Company were evaluated in an altitude test chamber. The samples were test fired to determine cold-start life in nominal 5-pound-thrust engines. Although some of the new substrates showed promise, the standard RA-1 alumina substrate remains the best substrate currently available.		

DD FORM 1 NOV 65 1473

51

UNCLASSIFIED  
Security Classification

14. KEY WORDS	LINK A		LINK B		LINK C	
	ROLE	WT	ROLE	WT	ROLE	WT
Rocket Engines Liquid Propellants Catalysts Substrates Ruthenium Iridium						