

AD-775 803

HELICOPTER ICING SPRAY SYSTEM  
QUALIFICATION

James S. Hayden, et al

Army Aviation Systems Test Activity  
Edwards Air Force Base, California

October 1973

DISTRIBUTED BY:

**NTIS**

**National Technical Information Service**  
**U. S. DEPARTMENT OF COMMERCE**  
5285 Port Royal Road, Springfield Va. 22151

REPORT DOCUMENTATION PAGE		READ INSTRUCTIONS BEFORE COMPLETING FORM										
1. REPORT NUMBER <b>USAASTA PROJECT NO. 72-35</b>	2. GOVT ACCESSION NO.	3. RECIPIENT'S CATALOG NUMBER										
4. TITLE (and Subtitle) <b>HELICOPTER ICING SPRAY SYSTEM QUALIFICATION</b>		5. TYPE OF REPORT & PERIOD COVERED <b>FINAL 13 April through 5 July 1973</b>										
		6. PERFORMING ORG. REPORT NUMBER <b>USAASTA PROJECT NO. 72-35</b>										
7. AUTHOR(s) <b>JAMES S. HAYDEN JOSEPH C. WATTS EDWARD E. BAILES CPT LARRY K. BREWER</b>		8. CONTRACT OR GRANT NUMBER(s)										
9. PERFORMING ORGANIZATION NAME AND ADDRESS <b>US ARMY AVIATION SYSTEMS TEST ACTIVITY EDWARDS AIR FORCE BASE, CALIFORNIA 93523</b>		10. PROGRAM ELEMENT, PROJECT, TASK AREA & WORK UNIT NUMBERS										
11. CONTROLLING OFFICE NAME AND ADDRESS <b>US ARMY AVIATION SYSTEMS COMMAND ATTN: AMSAV-EF PO BOX 209, ST. LOUIS, MISSOURI 63166</b>		12. REPORT DATE <b>OCTOBER 1973</b>										
		13. NUMBER OF PAGES <b>90</b>										
14. MONITORING AGENCY NAME & ADDRESS (if different from Controlling Office)		15. SECURITY CLASS. (of this report)  <b>UNCLASSIFIED</b>										
		15a. DECLASSIFICATION/DOWNGRADING SCHEDULE <b>NA</b>										
16. DISTRIBUTION STATEMENT (of this Report)  <b>Approved for public release; distribution unlimited.</b>												
17. DISTRIBUTION STATEMENT (of the abstract entered in Block 20, if different from Report)												
18. SUPPLEMENTARY NOTES												
19. KEY WORDS (Continue on reverse side if necessary and identify by block number) <b>Droplet size measurements</b> <table border="0"> <tr> <td>Engineering evaluation</td> <td>Short boom configuration</td> </tr> <tr> <td>CH-47C helicopter icing spray system</td> <td>Divergent lateral oscillation</td> </tr> <tr> <td>Handling qualities</td> <td>Cloud depth measurements</td> </tr> <tr> <td>Water droplet size and distribution calibrations</td> <td>Instrumentation frequency response</td> </tr> <tr> <td>Long boom configuration</td> <td>limitations</td> </tr> </table>			Engineering evaluation	Short boom configuration	CH-47C helicopter icing spray system	Divergent lateral oscillation	Handling qualities	Cloud depth measurements	Water droplet size and distribution calibrations	Instrumentation frequency response	Long boom configuration	limitations
Engineering evaluation	Short boom configuration											
CH-47C helicopter icing spray system	Divergent lateral oscillation											
Handling qualities	Cloud depth measurements											
Water droplet size and distribution calibrations	Instrumentation frequency response											
Long boom configuration	limitations											
20. ABSTRACT (Continue on reverse side if necessary and identify by block number) <p>The United States Army Aviation Systems Test Activity conducted an engineering evaluation of the CH-47C helicopter incorporating the icing spray system designed and built by All American Engineering Company of Wilmington, Delaware under contract DAAJ 01-72-C-0854. The evaluation was conducted during the period 13 April through 5 July 1973 at Edwards Air Force Base, California. This evaluation consisted of handling qualities and water droplet size and distribution calibrations, and involved 38 test flights totaling 27.5 productive flight hours. The</p>												

## 20. Abstract

CH-47C icing spray system handling qualities were evaluated in the long boom configuration and an attempt was made at evaluation in the short boom configuration. The short boom configuration was found to be deficient, due to a divergent lateral oscillation driven by the CH-47C stability augmentation system. The long boom configuration was, however, satisfactory for all conditions evaluated and was qualified for flight. It has been determined that the cloud depth measurements were accurate, but that frequency response limitations of the instrumentation invalidated the droplet size measurements. Two deficiencies and five shortcomings were identified during the evaluation. The first deficiency was the lateral oscillation of the short boom configuration and the second was the inadequate size of the spray window. The five shortcomings identified existed in the area of icing spray system operation.

ia

UNCLASSIFIED

SECURITY CLASSIFICATION OF THIS PAGE(When Data Entered)

**DISCLAIMER NOTICE**

The findings of this report are not to be construed as an official Department of the Army position unless so designated by other authorized documents.

**DISPOSITION INSTRUCTIONS**

Destroy this report when it is no longer needed. Do not return it to the originator.

**TRADE NAMES**

The use of trade names in this report does not constitute an official endorsement or approval of the use of the commercial hardware and software.

ACCESSION for		
RTIS	White Section	<input checked="" type="checkbox"/>
DIG	Buff. Section	<input type="checkbox"/>
UN/ CINDEX		<input type="checkbox"/>
JUSTIFICATION .....		
BY .....		
DISTRIBUTION/AVAILABILITY CODES		
Dist.	AAIL. num./or SPECIAL	
A		



**ERRATA**

**USAASTA PROJECT NO. 72-35**

**FINAL REPORT**

**HELICOPTER ICING SPRAY  
SYSTEM QUALIFICATION**

Page 19: Correct the vertical axis label to read

**g X GROSS WEIGHT/DENSITY RATIO**  
**g (W/ $\sigma$ ) X 10<sup>-3</sup>**

# TABLE OF CONTENTS

	<u>Page</u>
<b>INTRODUCTION</b>	
Background . . . . .	5
Test Objectives . . . . .	5
Description . . . . .	5
Test Scope . . . . .	8
Methods of Test . . . . .	8
Chronology . . . . .	10
<b>RESULTS AND DISCUSSION</b>	
General . . . . .	11
Level Flight Performance . . . . .	11
Flight Envelope Development . . . . .	12
Boom Modal Excitation Tests . . . . .	12
Trim Control Position Characteristics . . . . .	13
Static Lateral-Directional Stability . . . . .	13
Dynamic Stability . . . . .	13
Maneuvering Stability . . . . .	14
Damping . . . . .	17
Flight Envelope . . . . .	17
Loads Survey . . . . .	21
System Suitability . . . . .	21
CH-47C Wake Characteristics Survey . . . . .	26
Liquid Water Content . . . . .	27
Liquid Water Droplet Size and Distribution . . . . .	27
Miscellaneous . . . . .	28
Weight and Balance . . . . .	28
Airspeed Calibration . . . . .	30
System Operation . . . . .	30
Reliability and Maintainability . . . . .	30
<b>CONCLUSIONS . . . . .</b>	<b>33</b>

	<u>Page</u>
RECOMMENDATIONS . . . . .	34

**APPENDIXES**

A. References . . . . .	35
B. Safety-of-Flight Release . . . . .	36
C. Handling Qualities Rating Scale . . . . .	46
D. Test Instrumentation . . . . .	47
E. Methods of Test. . . . .	54
F. Test Data . . . . .	57
G. Equipment Performance Reports . . . . .	82

**DISTRIBUTION**

## **PREFACE**

The qualification of the helicopter icing spray system was unique in the expanded role the United States Army Aviation Systems Test Activity (USAASTA) played in its development. The USAASTA made the first flight and developed the flight envelope in an experimental flight test program. The project was handled as a joint development project of All American Engineering Company (AAE), the United States Army Aviation Systems Command (AVSCOM), Ames Directorate, United States Army Air Mobility Research and Development Laboratory (USAAMRDL), and USAASTA, with the support and cooperation of the Vertol Division, The Boeing Company. It was only through an excellent working spirit of cooperation that the effort was completed successfully in the extremely tight time schedule. Appreciation is expressed to all participants, but particularly to Frank M. Highley Jr, Bruce R. Sheaffer, and Albert Russo of AAE; James E. Schmidt, Robert A. Wolfe, and Stanley C. Jones of AVSCOM; David A. Peters of USAAMRDL; and William P. Brown, Herbert H. Steinmann, and Milton I. Gerstine of Boeing-Vertol.

**THIS PAGE LEFT BLANK INTENTIONALLY**

# INTRODUCTION

## BACKGROUND

1. Present artificial icing systems have severe limitations when applied to rotorcraft. Current methods using fixed wing spray systems for forward flight testing and stationary systems for hover testing do not permit icing investigation at normal helicopter speeds. Forward flight testing is conducted using fixed wing icing spray equipment which is deployed from a United States Air Force C-130/KC-135 aircraft. Minimum airspeeds for the C-130/KC-135 fixed wing aircraft correspond to near-limit airspeeds for most Army helicopters; consequently, the icing spray system presently available to the Army is not compatible with Army aircraft. All American Engineering Company (AAE) of Wilmington, Delaware, was contracted by the United States Army Aviation Systems Command (AVSCOM) to develop and demonstrate an airborne icing system, deployed from an Army CH-47C helicopter, capable of providing an icing test environment suitable for Army helicopters. The United States Army Aviation Systems Test Activity (USAASTA) was directed by AVSCOM to evaluate the CH-47C icing system handling qualities and to monitor spray calibrations (ref 1, app A).

## TEST OBJECTIVES

2. The objectives of this test program were as follows:
  - a. Establish the flight envelope of the CH-47C aircraft with the icing spray system installed.
  - b. Support contractor demonstrations of the icing spray system.
  - c. Evaluate the suitability of the icing spray system to create clouds of desired size, liquid water content (LWC), and droplet size distribution.

## DESCRIPTION

3. The icing spray system is designed for use with a CH-47C helicopter and consists of a 75-foot spray boom with supporting booms and structure, a boom hydraulic actuator, an 1800-gallon water tank (unpressurized), and operator control equipment. The total system has a gross weight of approximately 4700 pounds and has boom and water jettison capability in both the stowed and extended positions. The spray boom has two primary positions, stowed against the underside of the fuselage, and extended. The system was required to provide cloud widths of both 25 feet and 75 feet. The system configurations delivered are as shown in figures A and B. The system is designed for icing condition simulation in forward flight, and the desired LWC and droplet size distribution required to simulate a

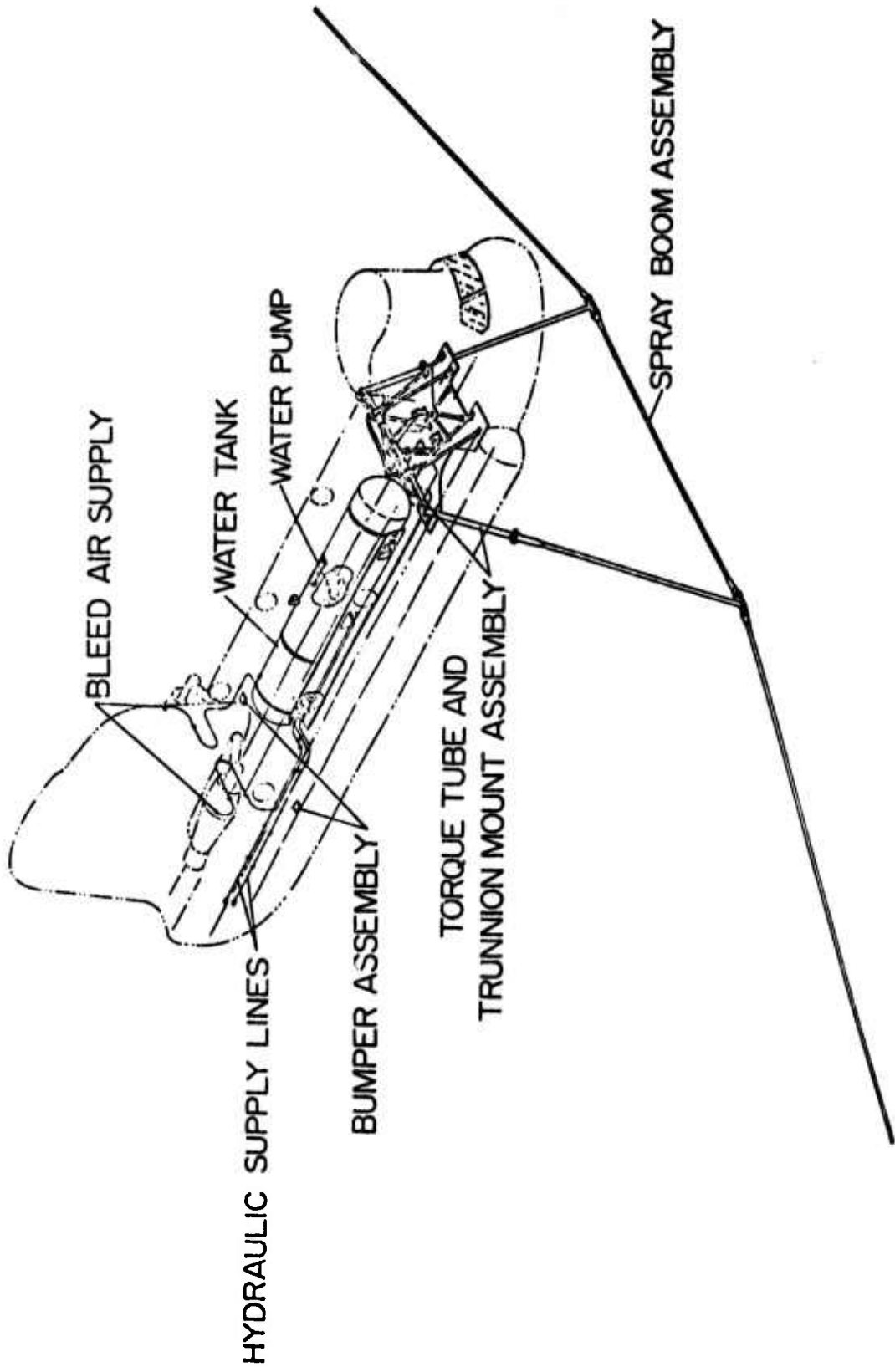

Figure A. Icing Spray System (75-foot spray boom).

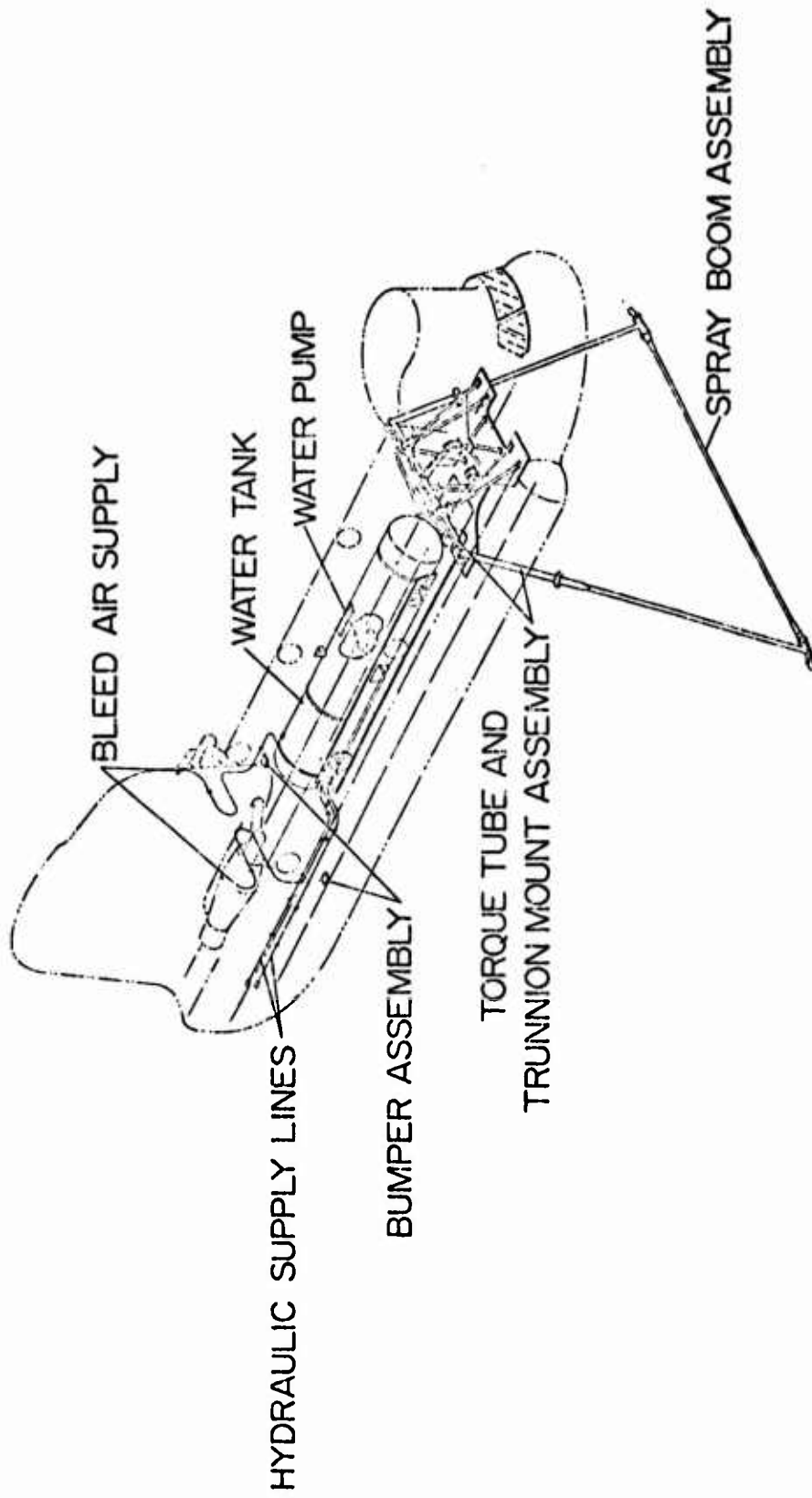

Figure B. Icing Spray System (25-foot spray boom).



given type of icing condition are obtained by controlling the water flow rate and engine bleed air pressure. A complete description of the icing spray system may be found in AAE Report SM-280A (ref 2, app A). Also, a complete description of the CH-47C helicopter and its subsystem may be found in the operator's manual (ref 3).

#### **TEST SCOPE**

4. During the test program, 23 flights consisting of 31 productive flight hours were flown for icing spray system qualification and 15 flights consisting of 11.1 productive flight hours were utilized for spray system calibration. Testing was conducted at Edwards Air Force Base, California (2302-foot elevation) from 13 April through 5 July 1973. Maintenance and instrumentation support were provided by USAASTA personnel in conjunction with icing spray system installation and maintenance provided by AAE.

5. The CH-47C icing spray system was evaluated with respect to airworthiness and icing condition simulation capability. A qualitative stability and control evaluation and a spray system loads survey were completed in hover, level flight, and maneuvering flight. An outline of tests conducted is shown in table 1. Flight restrictions and operating limitations observed during the test program were as specified in the operator's manual, as modified by the safety-of-flight release (app B) issued by AVSCOM. Test conditions, safety, and support considerations are detailed in references 4 and 5, appendix A. Qualitative ratings of handling qualities were based on the Handling Qualities Rating Scale (HQRS) (app C).

#### **METHODS OF TEST**

6. The icing spray system evaluation involved flight envelope development and, therefore, fell within the scope of AVSCOM Regulation 70-11, 30 July 1969 (ref 6, app A). The required engineering analysis, as defined in AVSCOM Reg 70-11, consisted of a critical technical review of AAE reports on loads/stress, dynamics, jettison test, and weight and balance, as well as independent analysis by AVSCOM and Ames Directorate, United States Army Air Mobility Research and Development Laboratory (USAAMRDL). This review was performed by AVSCOM Flight Standards and Qualification Division personnel and the USAASTA Technical Committee. The test aircraft and spray system were instrumented as described in appendix D. The envelope development was facilitated with real time data monitoring by telemetry and use of the advanced instrumentation and data analysis system (AIDAS). The aircraft was operated within the limits specified in the safety-of-flight release. Detailed methods of test are presented in appendix E.

Table 1. Test Outline.

Test <sup>1</sup>	Pressure Altitude (ft)	Flight Condition	True Airspeed (kt)	Boom Position	Water Tank
Functional	2,200 (OGE) <sup>2</sup>	Forward flight	Zero to 10	S, E <sup>3</sup>	F, EM <sup>4</sup>
		Water jettison	10		
Expansion	2,200 (OGE)	Sideward and rearward	Zero to 35	S, E	F
		Water jettison	35		
Expansion	4,000	Level flight	30, 40, and 50	S, E	F, EM
Expansion	7,000	Climb	50, 60, 70, 80, 90, and 100	S, E	F, EM
		Descent	50, 60, 70, 80, 90, and 100		
		Level flight	80 to $V_{max}$ <sup>5</sup> in 10-knot increments		
		Water jettison	110		
Spray technique	7,000	Level flight	80	E	--
Expansion	10,000	Level flight	80 to $V_{max}$ in 10-knot increments	S, E	F, EM
	8,000	Descent	165		
		Water jettison	120		
Expansion	14,000	Climb	40, 50, 60, and 70	S, E	F, EM
		Descent	40, 50, 60, and 70		
		Level flight	60, 70, 80, and 90		
		Water jettison	90		
Base line	7,000	Climb	50, 60, 70, 80, 90, and 100	BRS, BRE <sup>6</sup>	F, EM
		Descent	50, 60, 70, 80, 90, and 100		
		Level flight	80 to $V_{max}$ in 10-knot increments		

<sup>1</sup> Average estimated takeoff configuration gross weight: 42,000 pounds.

Center-of-gravity location (stowed boom): FS 328.0

Center-of-gravity location (extended boom): FS 322.8.

<sup>2</sup> Out of ground effect.

<sup>3</sup> S: Stowed boom.

E: Extended boom.

<sup>4</sup> F: Full water tank.

EM: Empty water tank.

<sup>5</sup>  $V_{max}$ : Maximum speed as determined by power available ( $V_H$ ) or by a cruise guide indicator (CGI) indication of top of yellow range ( $V_{NE}$ ).

<sup>6</sup> BRS: Boom removed at jettison joint, in stowed position.

BRE: Boom removed at jettison joint, in extended position.

## **CHRONOLOGY**

7. The chronology of the CH-47C icing spray system flight qualification and spray system calibration program is as follows:

Test request received	September	1972
Test aircraft received	February	1973
Test plan submitted	March	1973
Flight test initiated	April	1973
Qualification flights completed	June	1973
Spray system calibration flights completed	July	1973

# RESULTS AND DISCUSSION

## GENERAL

8. Flights were conducted on a production model CH-47C helicopter incorporating an icing spray system to obtain data for system qualification. Spray system flights were also made to support AAE's efforts in determining the water flow rates and bleed air pressures required for desired droplet size and distribution. Qualification flights were completed only for the long boom configuration, due to a coupling between the short boom and the CH-47C stability augmentation system (SAS), resulting in divergent lateral boom oscillations. An attempt to correct this condition by disconnecting the attitude hold feature of the roll SAS was successful for only the long boom configuration. The roll attitude hold modification did not completely eliminate the problem in the short boom configuration and as a result, tuning of the short boom natural frequency was investigated. The primary purpose for the long and short boom configurations was the requirement for versatility of cloud size and concentration. Because equal cloud size and concentration versatility was possible with the long boom system, through selective blocking of atomizers, and because the long boom oscillations were damped by the CH-47C lateral SAS, the short boom configuration was eliminated and the remainder of the qualification flights were completed with the long boom system. The handling characteristics of the CH-47C in the long boom configuration were not appreciably degraded, although an increase in power required in forward flight was noted. Water droplet size and distribution calibration flights were completed. It has been determined that the cloud depth measurements were accurate, but that frequency response limitations of the instrumentation invalidated droplet size measurements. Two deficiencies and five shortcomings were identified during the evaluation. The first deficiency was the lateral oscillation of the short boom configuration and the second was the inadequate size of the spray window. The five shortcomings identified existed in the area of icing spray system operation.

## LEVEL FLIGHT PERFORMANCE

9. Level flight performance for the CH-47C icing spray system was evaluated in conjunction with level flight envelope expansion because of the limited time available. The performance data available were used in conjunction with torsional loads data to establish the increase in the aircraft equivalent flat plate area resulting from the addition of the icing spray system. The power required to compensate for the added drag of the icing system in level flight, as well as the increase in the moment at the support tube during level flight, were both used in the calculation of a Delta equivalent flat plate area of 23 square feet.

10. The effects of bleed air on power turbine inlet temperature (PTIT) were evaluated during level flight, and a maximum Delta PTIT of 15°C was recorded when bleed air was utilized. No significant power loss was noted.

## FLIGHT ENVELOPE DEVELOPMENT

### Boom Modal Excitation Tests

11. Boom modal excitation tests were performed with the CH-47C icing spray system on the ground to verify AVSCOM and USAAMRDL modal frequency predictions (ref 7, app A). The short and long booms were retracted and clear from contact with the ground and the underside of the aircraft fuselage during the test. A ground strip recorder was used to direct-record the hand-induced excitations and a summary of the results, given in table 2, indicates fairly close correlation between the AVSCOM and USAAMRDL prediction and USAASTA test results.

Table 2. Results of Ground Modal Excitation Tests.

Configuration	Mode	Description	Prediction (Hz)	Test Results (Hz)
Full boom	1	(X) Asymmetrical (yaw)	.66	.7
	2	(X) Symmetrical (fwd/aft)	.67	.77
	3	(Z) Asymmetrical (roll)	.90	.85
	4	Z + X symmetrical	1.21	1.25
	5	2nd Z + X symmetrical	1.58	1.49
	6	2nd Z asymmetrical (roll)	1.84	1.86
	7	2nd X asymmetrical (yaw)	2.61	2.42
Reduced boom	8	Forward, aft	1.38	1.02
	9	Lateral	1.82	<sup>1</sup> 2.0
	10	Yaw	2.12	1.77

<sup>1</sup>1.85 driven divergence.

### Trim Control Position Characteristics

12. Trim control position characteristics were investigated to determine control positions and control margins. Control trim change with respect to boom configuration and position, as well as pitch attitude variation, were determined. The pitch stability augmentation system was set in the normal mode and the longitudinal stick positioner trim wheel remained at a zero setting for the duration of testing.

13. Trim control positions were evaluated in conjunction with the level flight envelope expansion and the results are given as figures 1 through 4, appendix F. The trim control requirements were within military specification limits for all conditions evaluated, with a minimum forward longitudinal control margin of 2.5 inches, or 17.5 percent, occurring in the long boom retracted configuration at 60 knots calibrated airspeed (KCAS) (fig. 1, app F). Although the test conditions were not identical, figure 1 also shows a longitudinal trim change of approximately 1 inch between the long boom retracted configuration and the boom removed at the jettison joint and in the stowed position, indicating that the trim shift following a spray boom jettison would not present a problem in the retracted position. The variation in pitch attitude with airspeed remained relatively constant for all spray boom configurations and positions. Within the scope of this evaluation, the trim control position characteristics of the CH-47C incorporating the icing spray system are satisfactory.

### Static Lateral-Directional Stability

14. The static lateral-directional stability characteristics of the CH-47C with the icing spray system installed were qualitatively evaluated in level flight. Tests were conducted with the spray boom in both the retracted and extended positions. The aircraft was first trimmed for level flight with ball centered and then sideslip angles were increased in approximate 5-degree increments, both left and right, while maintaining a constant ground track.

15. The lateral-directional stability characteristics of the CH-47C appeared to be unaffected by the installation of the icing spray system. There was no discernible difference in the directional control position gradient, dihedral effect, or side-force characteristics with the boom in either the retracted or extended position. With the boom in either position, minimal pilot effort was required to maintain the desired flight heading and ground track. Within the scope of this evaluation, the lateral-directional stability characteristics of the CH-47C with the icing spray system installed are satisfactory.

### Dynamic Stability

16. The dynamic stability characteristics of the CH-47C helicopter equipped with the short and long boom icing spray systems were investigated in hover, sideward, rearward, and level flight. The short boom system was tested first and found unsatisfactory in the extended position due to divergent lateral boom oscillation

at all conditions evaluated. Boom lateral divergence in the extended position was only present with the aircraft SAS operating and was discovered to be a lateral SAS-reinforced oscillation occurring at a frequency of approximately 2 Hz, which, as seen in figure 5, appendix F, diverged following a lateral pulse in a hover. Figure 6 shows the same condition with SAS OFF and a very low positive damping was present. With SAS OFF, moderate pilot effort is required to obtain the desired flight condition (HQRS 4). Level flight with the SAS operating was not possible with the short boom in the extended position without lateral boom oscillations, which were excited by natural aircraft motion (fig. 7). Operating with the SAS disabled eliminated boom lateral divergence but low damping was still present (fig. 8).

17. Short boom divergence following a left lateral pulse and involving a boom retraction is shown in figure C. The growth rate of the lateral oscillation after an initial 3 seconds was low and followed closely the growth characteristics of the roll SAS. The long-term divergence seen in figure C was arrested by retracting the boom, resulting in growth of the oscillatory and mean stress levels at gage "At." From a close look at figure 2, appendix D, one can see that during retraction of the boom, lateral bending at gage "BBy" transfers to torsional loading at gage "At." The system totally damped following the snubbing of the boom against the undercarriage of the aircraft. The divergent lateral oscillation of the short boom configuration is a deficiency.

18. The dynamic stability of the CH-47C helicopter was degraded in all three aircraft axes with the SAS inoperative; consequently, flight with SAS OFF was avoided as a solution for SAS-induced lateral divergence in the short boom configuration. However, disconnecting the roll attitude feature was done in an attempt to reduce the lateral SAS driving function; the results were positive, but lateral damping was still insufficient. Figures 9 and 10, appendix F, show the response following a lateral pulse in a hover of the extended short boom with 400 pounds of ballast added. The dynamic stability of the CH-47C helicopter incorporating the short spray boom system was unsatisfactory in a hover with the SAS ON and ballast removed. Further testing of the short boom system was terminated to allow time to thoroughly evaluate the long spray boom configuration. Testing of the long boom system gave favorable results, as shown in figure 11. Lateral oscillations following a lateral pulse in level flight damped to one-half amplitude in less than two cycles with the SAS operational. Figure 12 shows low damping at the same conditions with the SAS disabled. The dynamic stability in level flight of the CH-47C helicopter equipped with the long boom system did comply with paragraph 3.2.11(a) of MIL-H-8501A about the longitudinal axes. The CH-47C spray system dynamic characteristics are essentially unaffected by the installation of the long boom icing spray system and are satisfactory.

### Maneuvering Stability

19. The maneuvering stability characteristics of the CH-47C icing spray system in the long boom configuration were evaluated in conjunction with maneuvering envelope expansion, and the results are shown in figure D. The CH-47C icing spray

FIGURE C  
 SHORT BOOM DIVERGENCE  
 CH-47C S/N 15814

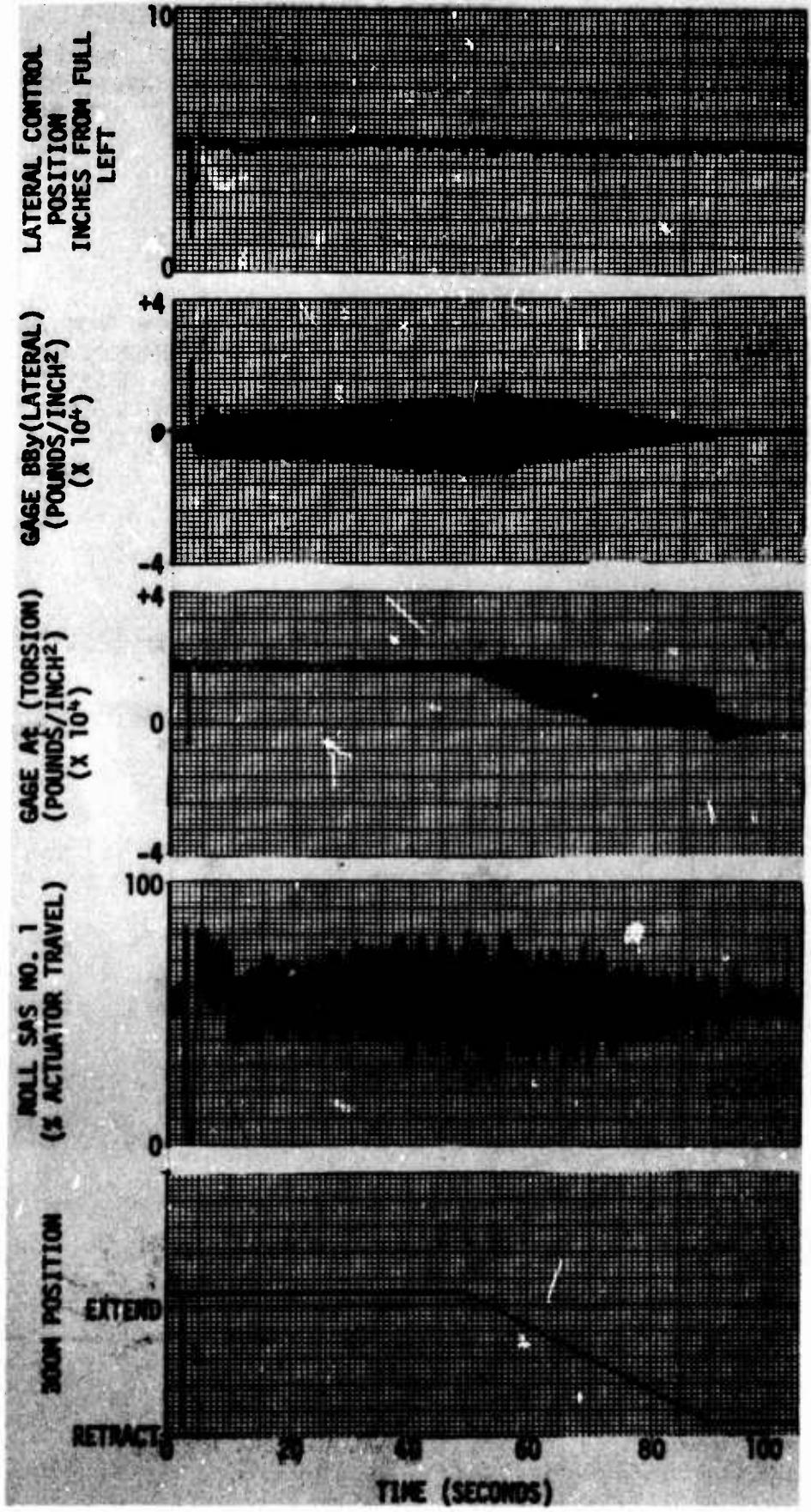

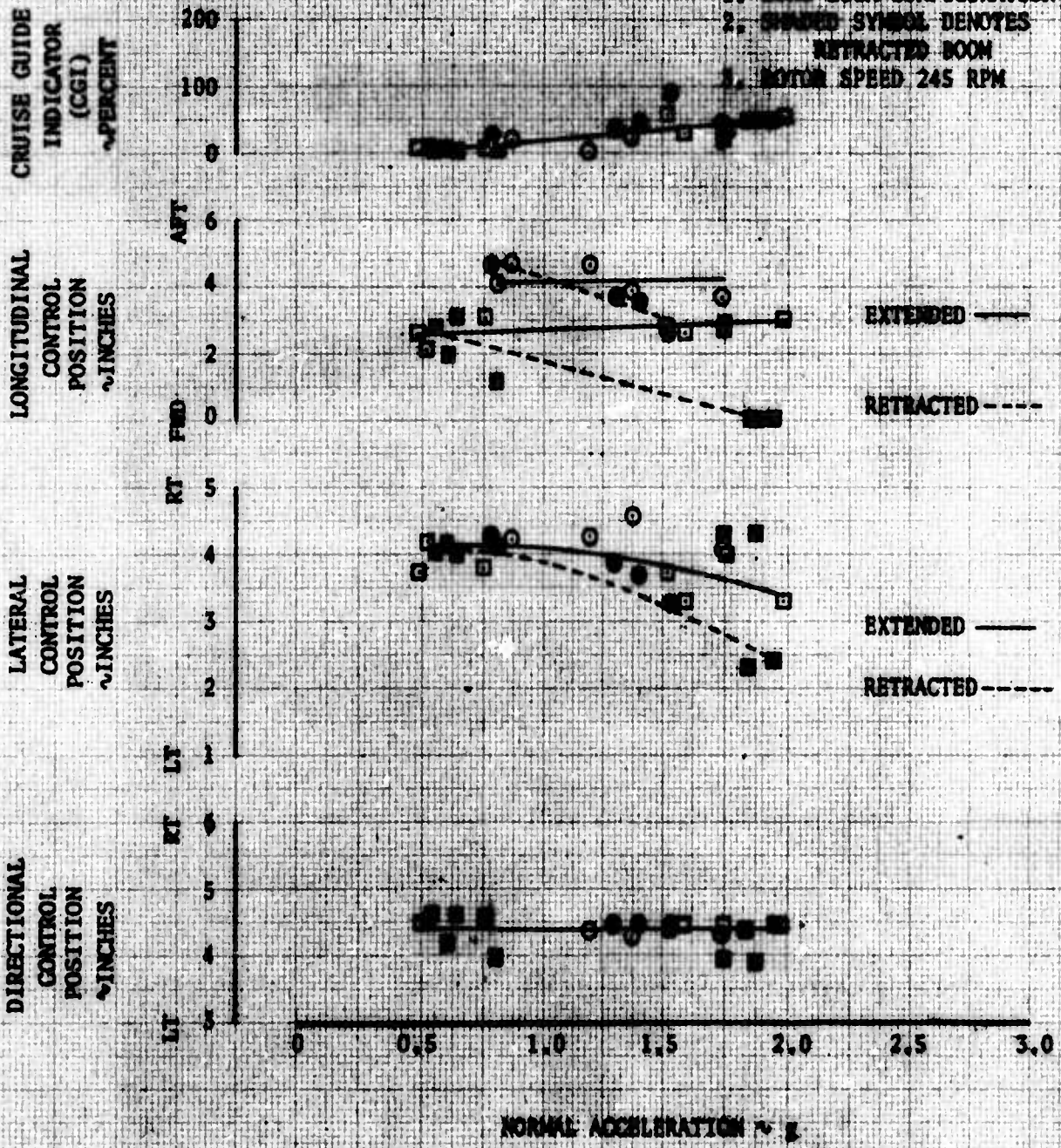

**FIGURE 1**  
**MANEUVERING STABILITY**  
 CS-17C S/N 66-15014

SYMBOL	AVG CG STATION (INCHES)	AVG Wt (POUNDS)	AVG DENSITY ALTITUDE (FEET)	AVG WEIGHT DENSITY RATIO (POUNDS)	THRUST COEFFICIENT (C <sub>T</sub> X10 <sup>6</sup> )	OAT °C
○	327.7	39400	8500	53010	66.5	18.0
□	327.0	40700	8500	49340	62.1	18.0

**NOTES:**

1. LONG BOOM CONFIGURATION
2. SHAPED SYMBOL DENOTES RETRACTED BOOM
3. MOTOR SPEED 245 RPM



system possessed negative longitudinal maneuvering stability in the retracted boom configuration, as evidenced by an increased forward longitudinal control requirement with increasing load factor. No gradient change was experienced with variation in airspeed, although a pronounced gradient change was noted with variation in boom position. The longitudinal maneuvering stability of the CH-47C icing spray system was weakly positive for the extended boom configuration and appeared not to be a function of airspeed.

### Damping

20. During envelope expansion, the short and long boom configurations were evaluated for dynamic response and divergent lateral oscillations were excited in the short boom configuration. Lateral spray boom divergence was first encountered in a hover when the natural frequency of the short spray boom in the extended position (- 1.85 Hz) coupled with the response frequency of the lateral SAS (- 2.0 Hz). The average damping ratio for this condition, as seen from figure E, was -0.005. No divergence was present with the SAS OFF, but the damping was insufficient. For normal operations pilot workload was moderate with the SAS inoperative (HQRS 4). Modification to the lateral SAS was limited to disconnecting the roll attitude feature, which, as seen in figure E, increased damping with the boom extended to -0.002. No further SAS modifications were made, due to possible degradation of aircraft handling qualities.

21. The short boom natural frequency was lowered from 1.85 Hz to 1.60 Hz by the addition of 400 pounds of ballast at the lower joint, and as seen from figure E, the combination of the added ballast and the roll attitude SAS modification increased the damping ratio for the lateral axis to 0.01. The outer sections of the long boom, which attach at the lower joint, weigh approximately 400 pounds, and when installed resulted in a driven lateral natural frequency of the long boom icing spray system of 1.95 Hz. The damping ratio also increased and the long boom spray system damped to one-half amplitude in less than two cycles with the SAS ON (fig. 11, app F). The damping ratio for the long boom configuration was acceptable for all conditions evaluated with the SAS ON or OFF, but damping was unacceptable in the short boom configuration for the same conditions.

### Flight Envelope

22. The flight envelope for the CH-47C helicopter incorporating the icing spray system was defined in level and maneuvering flight and the results are presented in figures F and G. The ordinate for figure F is the gross weight to density ratio ( $W/\sigma$ ) multiplied by normal load factor ( $g$ ) and is presented as a function of true airspeed. Figure G gives normal load factor directly as a function of true airspeed. A flight envelope was not defined for the short boom system because the dynamic characteristics of the CH-47C equipped with the short boom system are not acceptable for flight. The level flight and maneuvering flight envelope for the CH-47C long boom system was defined for the retracted and extended profile and was only a function of power available and aircraft vibration levels. The CGI.

**FIGURE E  
DAMPING IN A ROVER  
ICING SPRAY RIG SHORT BOOM CONFIGURATION**

NOTES:  $\odot$  ~ 400 lb DETUNING WEIGHT INSTALLED  
 $\square$  ~ NO DETUNING WEIGHT INSTALLED  
 $\nearrow$  ~ STANDARD SAS ON  
 $\nwarrow$  ~ SAS ON, ATTITUDE HOLD FEATURE DISABLED (ROLL)

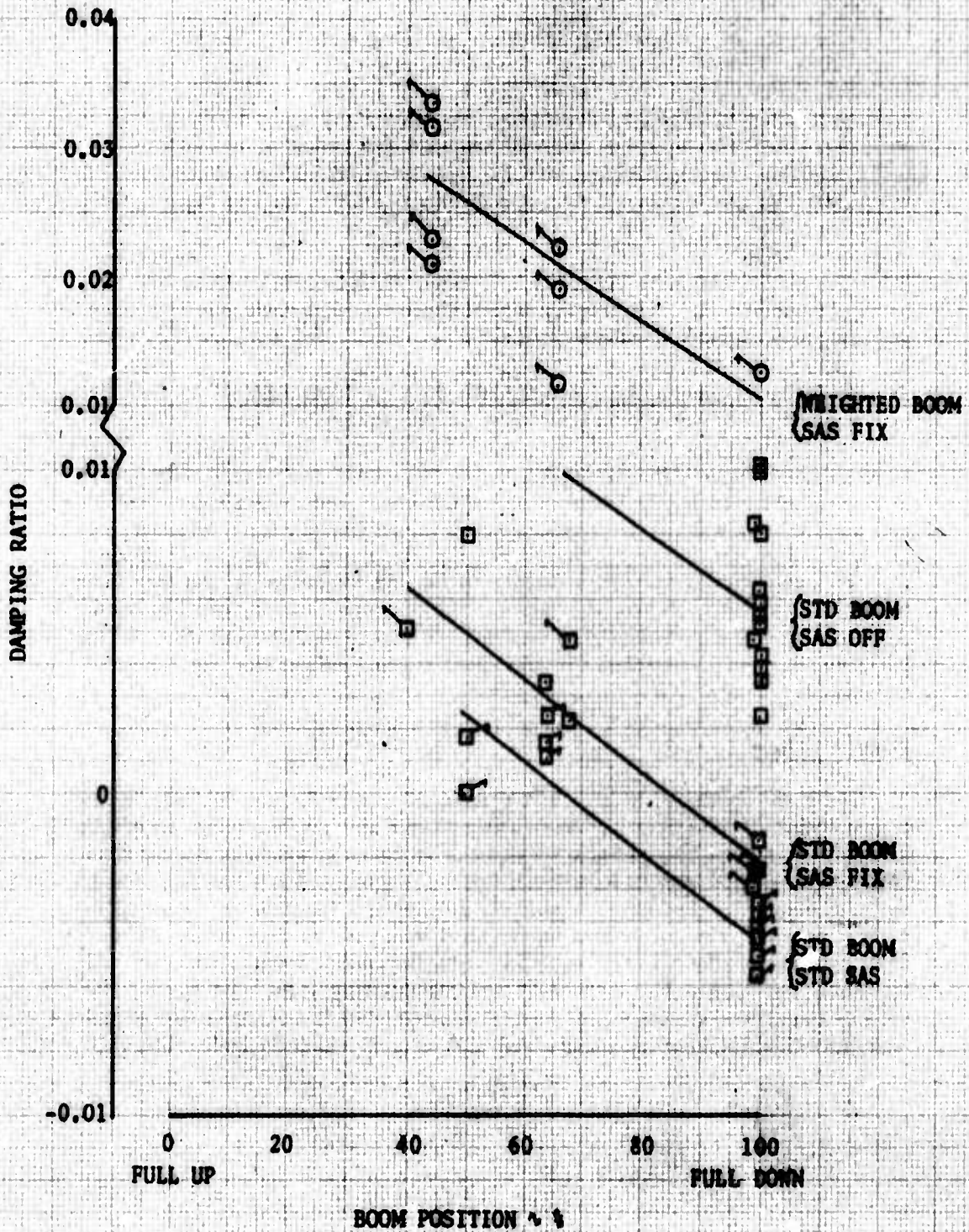



FIGURE F  
 HELICOPTER ICING SPRAY SYSTEM  
 FLIGHT ENVELOPE SUMMARY  
 CH-47C USA S/N 69-15814

SYMBOL	AVG GROSS WEIGHT ↘ POUNDS	AVG DENSITY ALTITUDE ↘ FEET	AVG OAT ↘ °C	AVG CT X 10 <sup>3</sup>
○	40750	6500	17.7	62.2
□	40210	14000	7.7	77.7
△	39350	10240	18.0	67.4
⊙	39370	6710	20.0	60.4
◇	40250	6500	18.0	61.4

NOTES: 1. SHADED SYMBOLS DENOTE BOOM EXTENDED  
 2. ROTOR SPEED 245 RPM

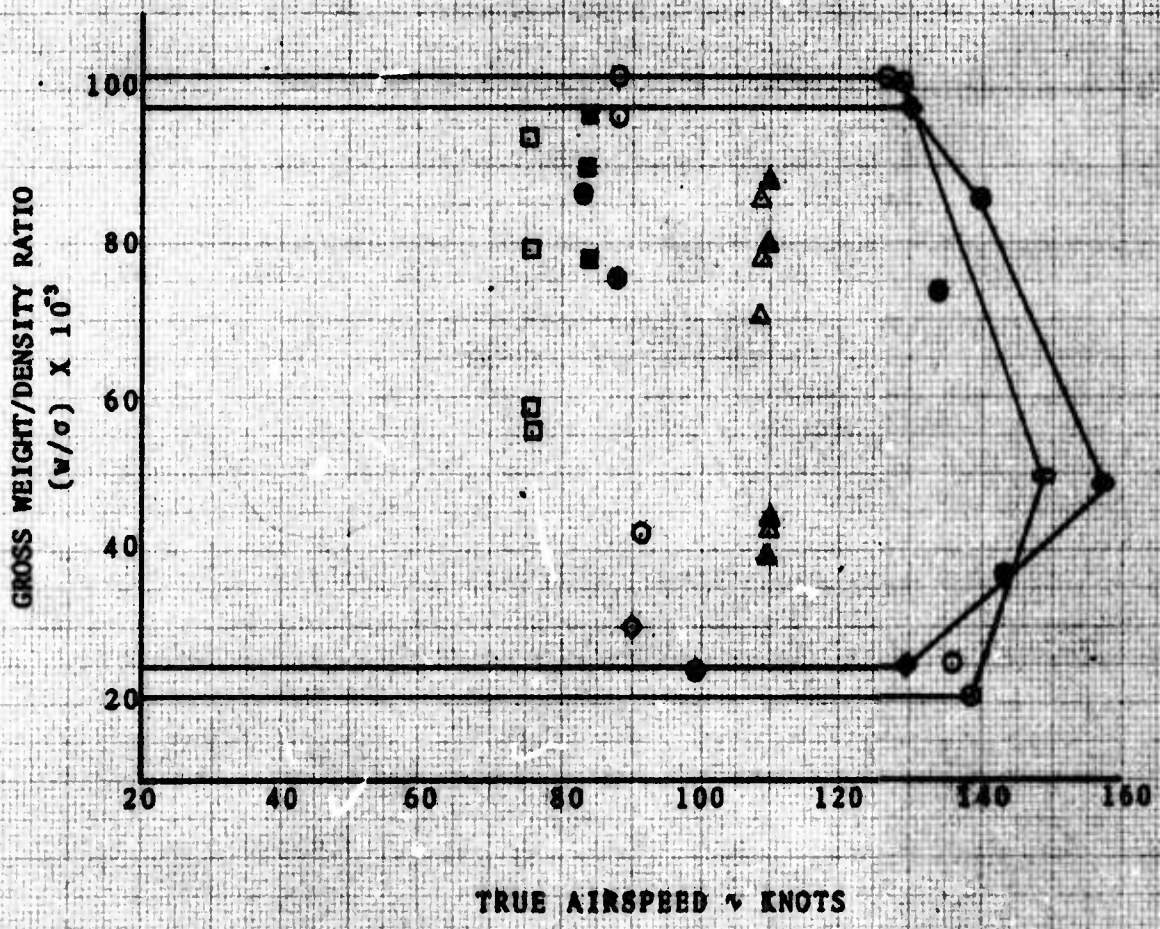
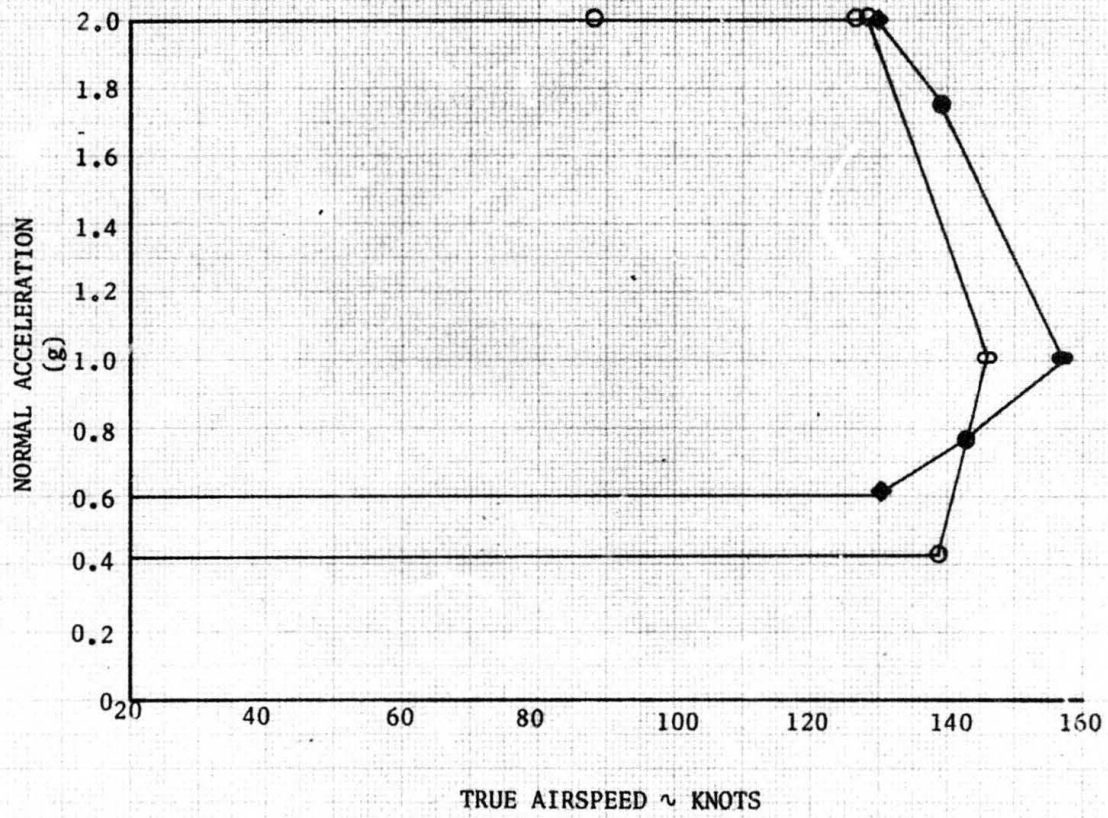

FIGURE G  
MANEUVERING FLIGHT ENVELOPE SUMMARY



as shown by figures I and J of the Loads Survey section (para 29), never limited the level flight or maneuvering flight envelope. The level flight envelope for the long boom extended configuration is 158 knots true airspeed (KTAS) and 149 KTAS with the long boom retracted. Maximum-allowable airspeed ( $V_{max}$ ) in level flight was less with the boom retracted, due to excessive aircraft vibration terminating airspeed envelope expansion prior to reaching maximum power-available limits. Maximum-allowable level flight airspeed with the long boom extended was established by maximum power available. The maximum normal acceleration defining the maneuvering envelope was 2.0g in the long boom extended configuration and 1.98g in the retracted configuration. The minimum normal acceleration defining the maneuvering envelope was 0.68g and 0.42g in the long boom extended and retracted configurations, respectively.

### Loads Survey

23. The icing spray boom mean and oscillatory stress levels were monitored in real time during envelope expansion and the results are shown in figures 13 through 24, appendix F. The results are presented for straight level flight, level flight in a sideslip, and maneuvering flight. The CGI, aircraft vibration levels, spray boom stress levels, and power available were monitored in real time for each envelope expansion point. The CGI was used to establish aft rotor loads for fatigue life considerations. The boom stress levels and aft rotor loads were well below endurance limits during steady maneuvers. Maximum airspeed for level flight ( $V_H$ ) with the spray boom extended was limited by power available and maximum level flight airspeed with the boom retracted was limited by high aircraft vibration levels.

24. The icing spray system stress levels during level flight are shown as figures 13 through 16, appendix F. The peak-to-peak stress levels, with the boom extended or retracted, were nominal at all airspeeds throughout the established airspeed envelope. The mean stress levels, however, increased with increasing airspeed, and stress levels at maximum airspeed for level flight (134 KCAS) of 22,000 psi were noted at gage "CBZ" (fig. 14). The vector sum of the longitudinal and lateral stress at gage location "CB" is presented in the above-mentioned figures and a maximum vector sum of 32,000 psi at 144 KCAS was recorded (fig. 14). A vector sum for gage location "AB" is also presented but the stress levels are nominal. The yield stress levels for gage locations "CB" and "AB," respectively, are 75,000 psi and 132,000 psi as given by AAE Report P-278A (ref 8, app A).

25. Approximately 60 degrees of rotation exists between the spray boom retracted and extended positions and as a result, the stress levels at gages "AT," "ABX," and "CBX" varied substantially with respect to boom position. Figures 15 and 16, appendix F, show a reversal in the mean stress of 25,000 psi at gage "AT" between the retracted and extended boom positions for maximum level flight airspeed and a corresponding reversal in the mean stress of 32,000 and 18,000 psi at gages "CBX" and "ABX," respectively. The variations in stress level with boom position for the remaining gage locations were nominal.

26. The icing spray system loads during level flight in a sideslip are shown as figures 17 and 18, appendix F. The spray boom stress levels during sideslip had low oscillatory values but a maximum mean stress value of 27,000 psi was recorded at gage "CB" strain location during left sideslip at 120 KTAS. The vector sum of the loads at gage "CB" was 32,000 psi, which occurred in a 10- and 20-degree left sideslip at 120 KTAS with the boom extended. A vector sum of 32,000 psi was the highest stress level encountered during envelope expansion. This level was equaled once during maneuvering flight and once at maximum level flight airspeed. The stress values in a sideslip decreased with decreasing airspeed and generally increased with sideslip.

27. The mean and peak-to-peak loads during maneuvering flight are shown as figures 19 through 24, appendix F. The maximum mean stress value encountered during maneuvering flight was 32,000 psi, which occurred at gage "CB" for a normal acceleration of 0.8g and a trim airspeed of 130 KTAS. The gage "CB" vector sum at this condition was 32,000 psi, which remained relatively constant with increasing acceleration. The maximum reversal in stress between the extended and retracted boom position at gage locations "AT" and "BX" was 23,000 and 15,000 psi, respectively (figs. 19 and 20).

28. The long boom tip acceleration was 1.0 to 2.0g during level and maneuvering flight but increased substantially during transition to a landing. The high vertical vibration levels generated by the CH-47C during transition to a landing resulted in bending in the third mode of the long boom, and vertical tip accelerations of 6 to 8g were recorded. The frequency of oscillation for the boom tip was 12 Hz which corresponds to an amplitude of 0.543 inch. Figure H gives an example of the tip accelerations during transition.

29. During envelope expansion, the CGI was used to indicate aft rotor stress levels. The CGI indicator dial face is divided into three areas: zero to 100 percent (green) or infinite fatigue life; 100 percent to 146 percent, for which 146 percent (yellow) represents a summation of 5.4 hours maximum operation time; and 146 percent to 196 percent, for which 196 percent (barber pole) represents a summation of 2 hours maximum operation time. The CGI was never above an indication of 100 percent for any point flown in the established envelope, although during recoveries from the windup turns used to establish the desired normal accelerations, the CGI did spike to values of 196 percent. A total time of less than 40 seconds above a CGI indication of 100 percent was recorded. Less abrupt recovery methods could have possibly reduced the magnitude of the spikes. Figures I and J, respectively, show the CGI indications during level flight and maneuvering flight. Use of the CGI permitted significant expansion of the flight envelope over that given in the operator's manual.

FIGURE H  
LONG BOOM TIP ACCELERATION  
CH-47C S/N 68-15814

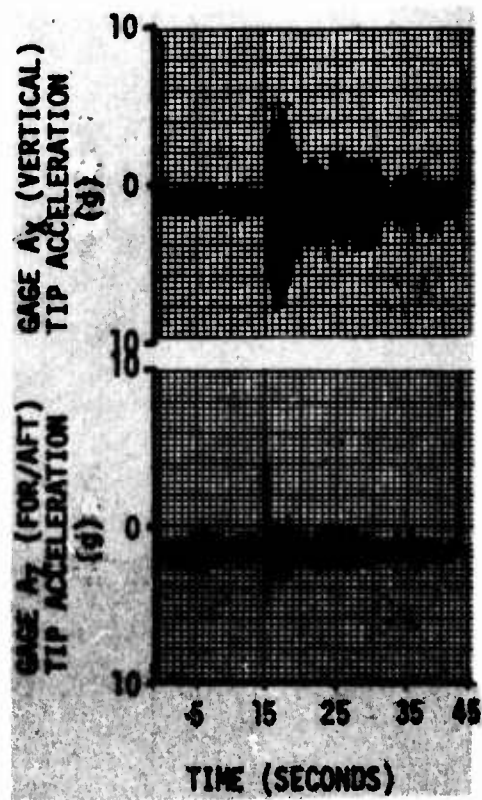



**FIGURE 1**  
**CRUISE GUIDE INDICATOR VS**  
**CALIBRATED AIRSPEED**

- W/G = 48,000
- W/G = 61,500
- △ W/G = 51,000

- NOTES:**
1. INFINITE FATIGUE LIFE EQUALS 100%
  2. FUEL SCALE = 196%
  3. 100% ~ 146% ~ 5.4 HOUR LIFE
  4. 146% ~ 196% ~ 2.0 HOUR LIFE
  5. AIRSPEED = 120 KCAS

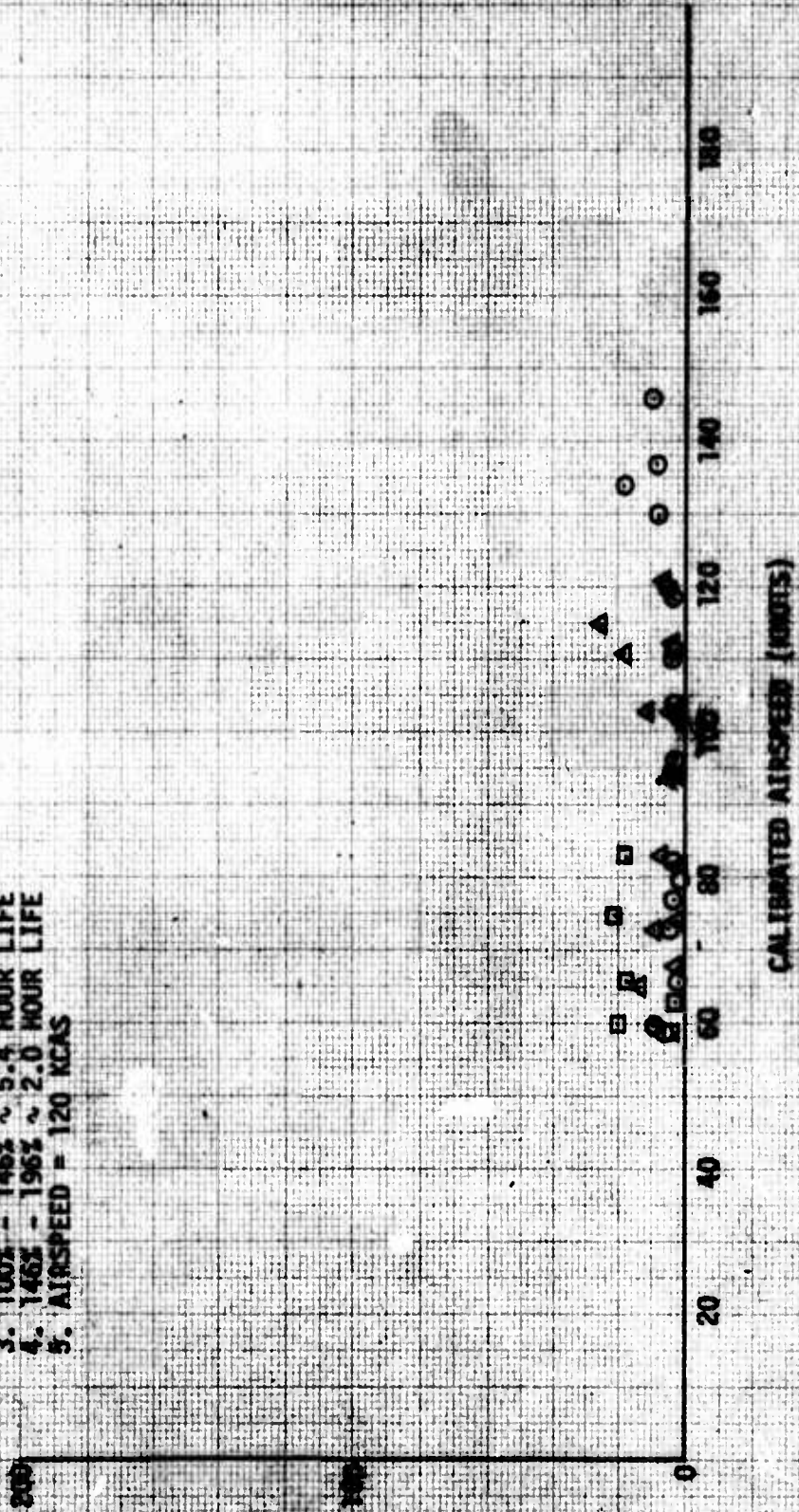
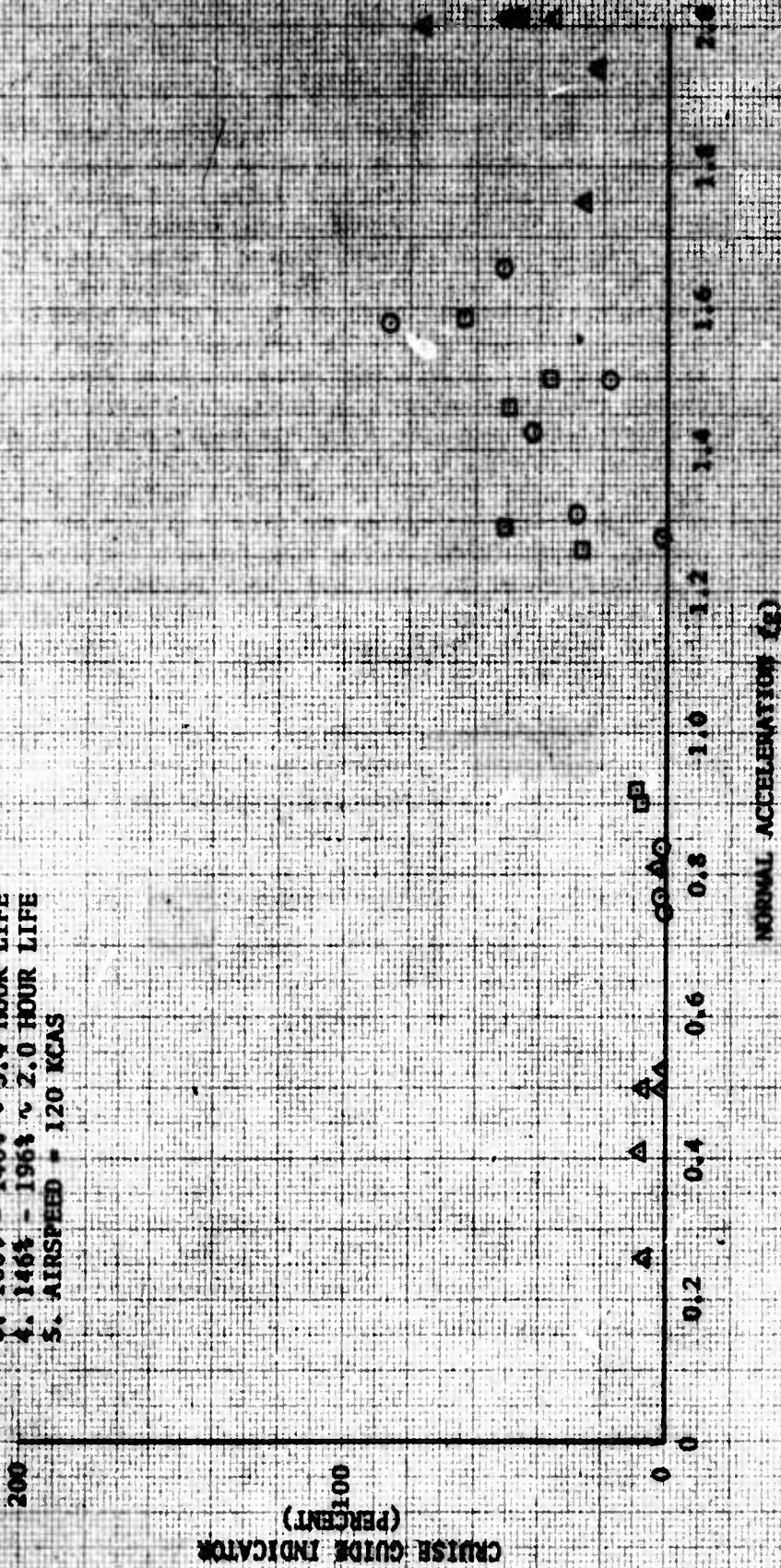

FIGURE J  
CRUISE GUIDE INDICATOR VS  
NORMAL ACCELERATION

○ w/a = 51,500  
 □ w/a = 53,500  
 △ w/a = 47,000

- NOTES: 1. INFINITE FATIGUE LIFE EQUALS 100%  
 2. FULL SCALE = 196%  
 3. 100% = 146% ~ 5.4 HOUR LIFE  
 4. 146% = 196% ~ 2.0 HOUR LIFE  
 5. AIRSPEED = 120 KCAS



## SYSTEM SUITABILITY

### CH-47C Wake Characteristics Survey

30. The CH-47C helicopter wake characteristics were evaluated by flying uninstrumented T-28B, UH-1M, and OH-6A aircraft behind the CH-47C helicopter. Test conditions are presented in table 3. The T-28B airplane was flown at estimated distances from 500 feet to 2 miles directly behind the CH-47C. The vortices were being shed by each of the rotor discs in a manner similar to tip vortices being shed by a fixed wing aircraft. The two vortices on the right joined in a counterclockwise rotation, while the two on the left joined in clockwise rotation. At a distance of approximately 700 feet behind the CH-47C the vortices appeared to flow together, causing a very strong downflow. These vortices were able to produce moderate turbulence at distances up to approximately 2 miles behind the helicopter before dissipating. Rotor downwash also produced an area of moderate turbulence behind the helicopter in the region from 300 to 700 feet before the tip vortices joined. The UH-1M and OH-6A helicopters were flown at distances from 100 to 700 feet behind the CH-47C at airspeeds of 60 and 80 knots indicated airspeed (KIAS). During these flights, it was noted, as anticipated, that the rotor downwash angle increased with a decrease in airspeed. Results of these tests indicated that the best entry and exit with respect to the spray cloud would be from below the CH-47C helicopter and that the best station-keeping location in the cloud was from 150 feet to 300 feet behind the CH-47C.

Table 3. Wake Turbulence Survey Test Conditions.

Aircraft	Gross Weight (lb)	Pressure Altitude (ft)	Outside Air Temperature (°C)	Indicated Airspeed (kt)	Range Evaluated <sup>1</sup>
CH-47C	39,000 to 28,000	5000	20	60 to 120	--
T-28B	7,500	5000	20	100 to 120	300 ft to 2 mi
UH-1M	7,700	5000	20	60 to 80	100 ft to 1000 ft
OH-6A	2,200	5000	20	60 to 80	200 ft
OH-58A	2,800	5000	20	60 to 80	200 ft

<sup>1</sup>Optimum range: 200 feet.

31. The desired lower limit airspeed for these tests was 25 KIAS. The downwash below 60 KIAS dispersed the spray cloud before the test aircraft could enter it. The failure to achieve the desired low airspeed limit is a shortcoming. The downwash velocity (500 to 1000 feet per minute) encountered at higher airspeeds still created significant vertical velocities, requiring the following test aircraft to experience a continuous climbing flight condition while maintaining its position in the spray cloud. Stabilized flight in the spray cloud could not be achieved due to continuous light-to-moderate turbulence (app G). This turbulence could affect icing formation and accretion rates, as well as shedding characteristics, and is a shortcoming. Station keeping in the spray cloud required increased pilot workload.

32. The usable spray cloud dimensions were limited by a combination of wake turbulence and rotor downwash to a length of 200 feet (from 100 to 300 feet behind the aircraft) and a width of 60 feet. Tip vortices did tend to curl up the ends of the spray pattern during long boom configuration spraying. The boom's spray nozzle configuration further restricted the total spray cloud dimensions to a volume of approximately 200 feet long by 25 feet wide by 12 feet deep. This test volume failed to encapsulate the test helicopter, allowing only portions of the main rotor system and fuselage to be covered simultaneously. The inadequate size of the spray window is a deficiency.

#### Liquid Water Content

33. The determination of LWC of the spray cloud was the responsibility of AAE. The USAASTA supported AAE by providing a test survey aircraft, equipment for recording the root mean square (RMS) voltage output of three AAE-supplied hot-wire anemometer probe systems, and ground decoding and computation to reconstruct engineering unit data. Liquid water content was sensed as RMS voltage output of the anemometer systems and was encoded on board in digital (PCM) format on magnetic tape. The depth of the cloud and relative LWC through the cloud was determined by successively ascending and descending through the cloud at various lateral and longitudinal stations. The ground-decoded signal from each probe resembled a bell-shaped curve when presented as a function of time. The signals of the three probes when presented together showed a time shift between the entry, maximum value, and departure of each probe from the cloud. The time shift, known spacing of the probes, and total traverse time of each probe was used to calculate total cloud width. (The ambient level of RMS voltage due to air turbulence was subtracted before determining relative LWC.) Average LWC was determined from measured cloud depth, cloud width, water flow rate, and true airspeed. The decoded data are presently being analyzed by AAE and will be reported separately by them. The system was unable to achieve low enough water flow rates to produce the lower level of LWC required by the contract (.285 gram/meter<sup>3</sup>), which is a shortcoming.

#### Liquid Water Droplet Size and Distribution

34. The determination of liquid water droplet size and distribution was the responsibility of AAE. The USAASTA supported AAE by providing a test survey



aircraft and equipment for recording the voltage output of two of the three AAE-supplied hot-wire anemometer probe systems at data frequencies of up to 4000 Hz. Additionally, USAASTA was tasked with ground decoding and subsequent computation of the data to provide droplet size population distributions. It was subsequently determined that the cloud depth measurements were accurate but that frequency response limitations of the instrumentation invalidated the droplet size measurements.

## MISCELLANEOUS

### Weight and Balance

35. Prior to testing, the aircraft gross weight and longitudinal cg were determined, utilizing the weight and balance hangar located at Edwards Air Force Base, California. The weight and balance hangar incorporates ground-level platform scales so situated as to allow the aircraft landing gear loads to be determined independently. Also, the platform scale variable height feature enables the aircraft to be weighed at various pitch attitudes. The aircraft was weighed with the boom stowed with total instrumentation at the following fuel and water loadings:

- a. No fuel, no water.
- b. No fuel, 1100 gallons water.
- c. Full main fuel tanks, 1100 gallons water.
- d. Full main fuel tanks, 1100 gallons water, 7-degree nose-up attitude.
- e. Full main fuel tanks, 1500 gallons water.
- f. Full main fuel tanks, no water.

36. All the above weighings were completed at a level aircraft attitude except for configuration d, where a 7-degree nose-up attitude was attained to verify aircraft center-of-gravity (cg) shift with water transfer in a partially full water tank (1100/1800 gallons). As shown by figure K, the water transfer resulted in an aircraft aft cg transfer of approximately 9 inches, which moved the cg beyond the aft limit. As a result, the forward auxiliary fuel tanks were filled in addition to the main fuel tank, resulting in an additional 1650 pounds of fuel at fuselage station (FS) 214.0. The final configuration with the boom retracted resulted in an aircraft cg located at FS 339.5 for a 41,200-pound takeoff gross weight in a 7-degree nose-up attitude. Configuration c, plus 1650 pounds of fuel in the forward auxiliary tanks, was used for the duration of the test and, as seen in figure K, was 7 inches aft of the aft cg limit in a takeoff configuration (7 degrees nose-up). This condition was cleared for flight by an amendment to the safety-of-flight release.

**FIGURE K  
CH-47C CENTER OF GRAVITY SUMMARY  
BOOM STOWED**

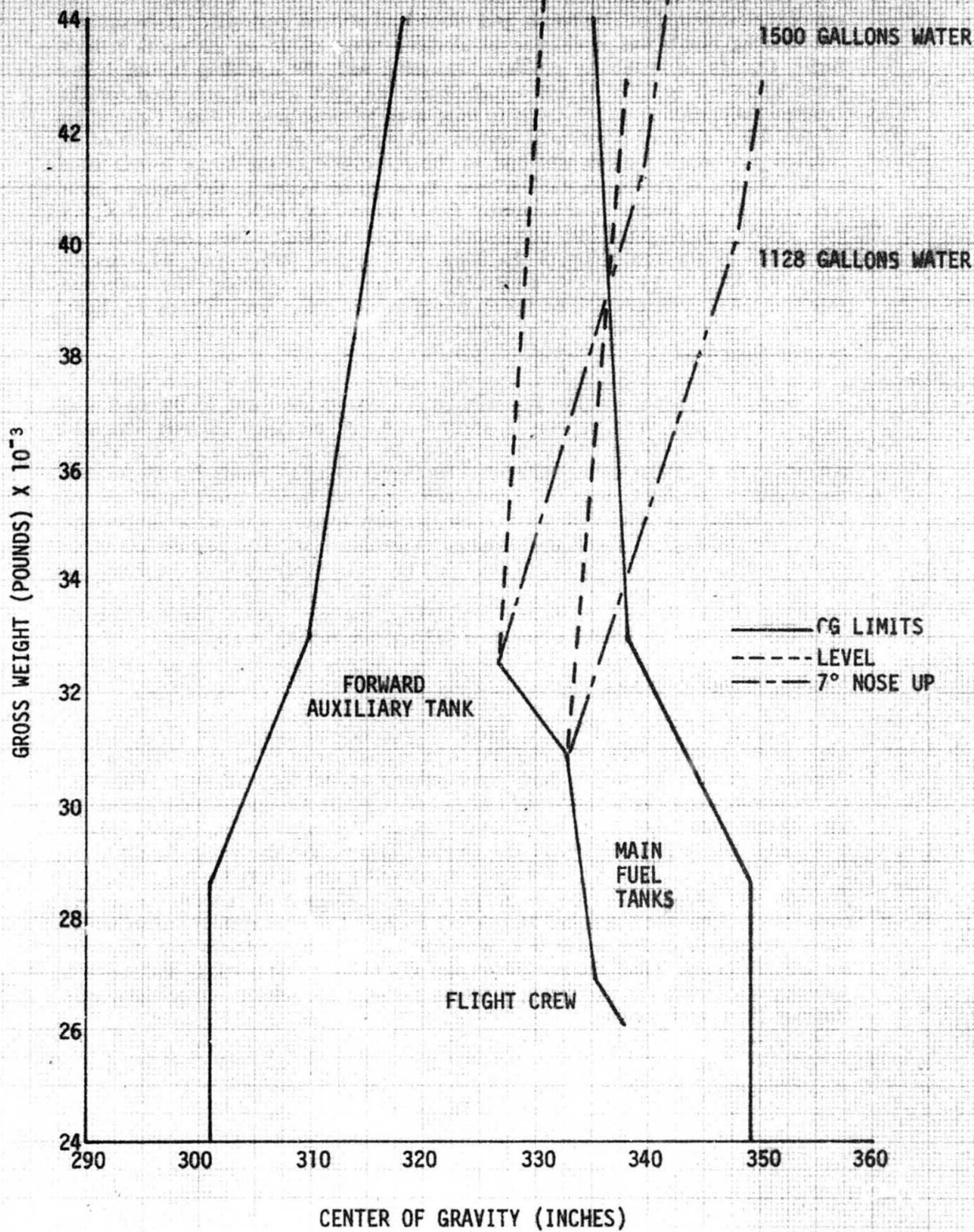

### Airspeed Calibration

37. The airspeed calibration was done in two parts: the first incorporated the use of the calibrated trailing bomb, and the second utilized a calibrated pace aircraft. The trailing bomb was used over an airspeed range of 25 to 75 knots in level flight. Due to an instability problem associated with the low drag trailing bomb when subjected to CH-47C wake turbulence, the pace aircraft was used for the airspeed calibration from 90 knots to maximum airspeed in level flight. Calibration of the ship's airspeed pitot-static system was required, due to the absence of an isolated pitot-static system and due to the protrusion of the boom torque tube in the vicinity of the ship's static source. As noted by figure L, the position error was different from the position error for a standard CH-47C above 130 KCAS and below 60 KCAS. The pitot-static system between these airspeeds was unaffected by the protrusion of the icing spray system torque tube. At airspeeds below 40 KCAS, the CH-47C pitot-static system was unreliable. The calibrated ship's airspeed system was used for all out-of-ground-effect tests in forward flight.

### System Operation

38. Operating procedures for the icing spray system conform to the operating instructions listed in reference 2, appendix A. A modified aircraft checklist (TM 55-1520-227-10CL) has been prepared in duplicate and is located in the aircraft. This checklist incorporates the icing spray system operational checks into the standard preflight, start-up, shut-down, and emergency procedures for the CH-47C helicopter. The automatic boom jettison feature was made inoperative during the conduct of the flight envelope expansion tests. This feature was made operative again after completion of the flight tests. An explanation of the operation of the automatic boom jettison feature is included in the operational checklists described above. Because of system complexity, the icing spray system should be operated only by personnel trained by USAASTA or the contractor.

### Reliability and Maintainability

39. The CH-47C helicopter icing spray system experienced minor parts failures and significant water tank corrosion during the conduct of these tests. During two flights, a flexible air supply hose disconnected at the joint directly above the trunnion support located on the right side of the aircraft. On one of these occasions, the disconnected hose and clamp thrashed around the cargo compartment, causing a 1/8-inch diameter puncture in the fuselage skin before the bleed air could be turned off (app G). The AAE promptly developed a satisfactory fix and no further problem was present. The boom nozzles became clogged at random on several occasions and required cleaning. During the course of normal system maintenance, the inner surface of the water tank was discovered to be corroded and the inner surface of the boom had become rusty (app G). Flaking rust particles and shedded particles of corrosion accumulating in the nozzle areas and resulting in partial nozzle stoppage is a shortcoming.

AIRSPEED CALIBRATION  
 DATE: 8/14/54  
 FOR THE 1000 - 1015 SYSTEM

AIRSPEED SYSTEM  
 1000 - 1015 SYSTEM

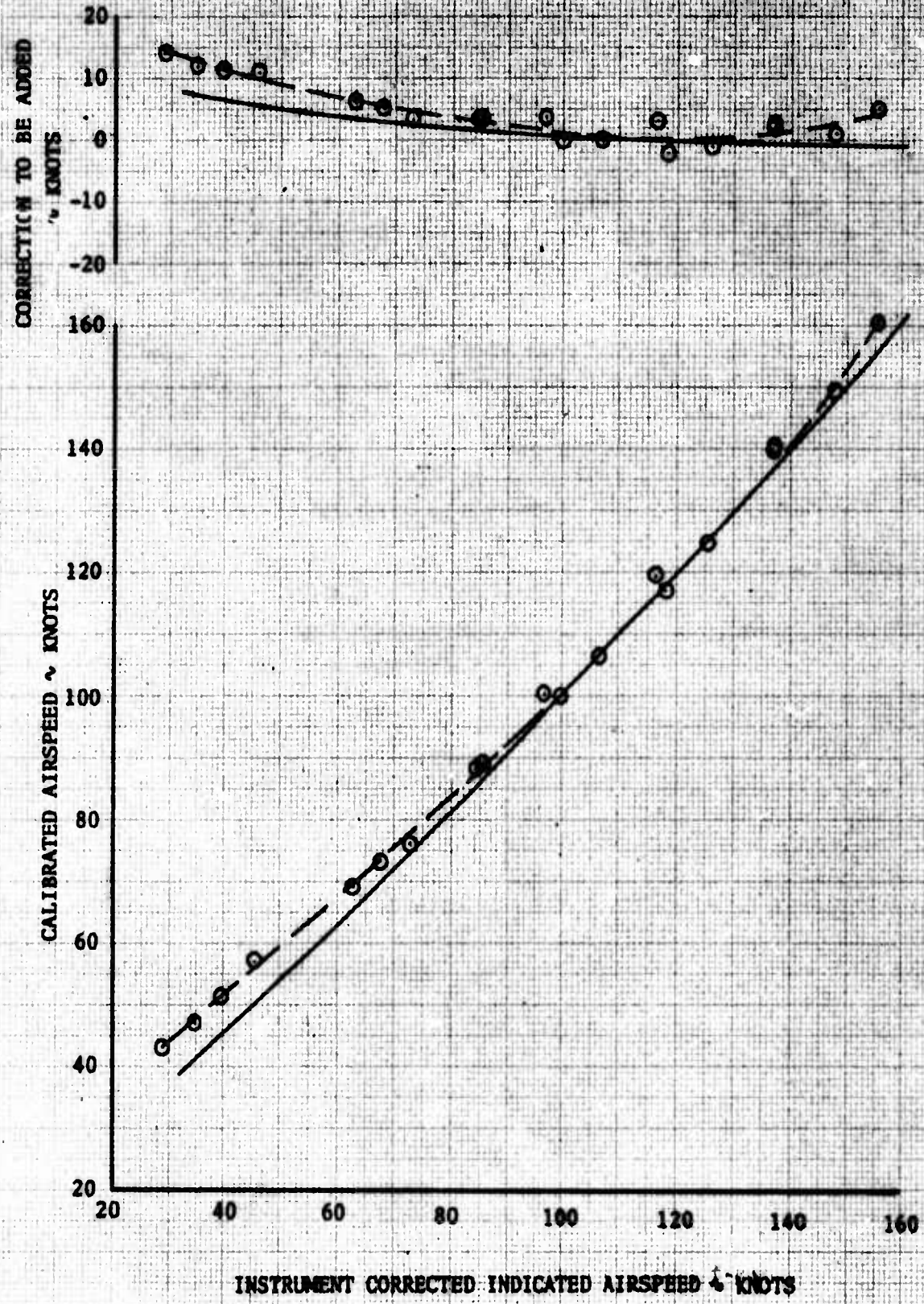



40. On several occasions, the boom stop adjustment failed to operate properly. Normal airspeed for boom extension and retraction was determined to be 50 KIAS. However, airspeeds below 35 KIAS were required before the boom lock/unlock pin would operate on these occasions. The boom lock/unlock pin malfunction is a shortcoming.

## CONCLUSIONS

41. The flying qualities of the CH-47C helicopter incorporating the long boom icing system were satisfactory. The CH-47C helicopter incorporating the short boom system possessed divergent SAS-driven lateral oscillations and was unsatisfactory for flight under all conditions evaluated. Calibration of the icing spray cloud is incomplete, with completion expected following a product improvement program.

42. The following specific conclusions were reached:

a. Maximum level flight airspeed with the spray boom extended was limited by power available ( $V_H$ ) and maximum level flight airspeed with the boom retracted was limited by high aircraft vibration levels (para 22).

b. Use of the CGI permitted significant expansion of the flight envelope over that given in the operator's manual (para 29).

c. It has been determined that the cloud depth measurements were accurate but that frequency response limitations of the instrumentation invalidated the droplet size measurements (para 34).

d. Two deficiencies and five shortcomings were noted.

43. The following deficiencies were identified:

a. Divergent lateral oscillation of the short boom configuration (para 17).

b. Inadequate size of the spray window (para 32).

44. The following shortcomings were identified:

a. Failure to achieve the desired low airspeed limit (para 31).

b. Excessive wake turbulence during forward flight (para 31).

c. Failure to achieve desired low water flow rates (para 33).

d. Excessive water tank corrosion and nozzle stoppage (para 39).

e. Malfunction of boom lock/unlock pin during boom extension and retraction (para 40).

## **RECOMMENDATIONS**

45. The icing spray system should be operated only by personnel trained by USAASTA or the contractor.
46. The deficiencies should be corrected as soon as possible.
47. The shortcomings should be corrected as soon as practicable.

## APPENDIX A. REFERENCES

1. Letter, AVSCOM, AMSAV-EFT, 28 September 1972, subject: AVSCOM Test Request No. 72-35, Icing Spray Rig Evaluation.
2. Handbook, All American Engineering Company, SM-280A, *Installation, Operation, and Maintenance Instructions With List of Parts, Icing Conditions Simulation Equipment*. Undated.
3. Technical Manual, TM 55-1520-227-10, *Operator's Manual. Army Model CH-47B and CH-47C Helicopters*, 30 April 1969.
4. Disposition Form, USAASTA, SAVTE-CT, 19 April 1973, subject: Test Operations, Safety, Support, and Conduct Plan for Helicopter Icing Spray System Qualification.
5. Standing Operating Procedure, All American Engineering Company, 1401-SM-A-9, 28 March 1973, "Armament Loading Procedures, Explosive Bolts."
6. Regulation, AVSCOM, No. 70-11, *Experimental Flight Testing by US Army Aviation Systems Test Activity*, 30 July 1969.
7. Memorandum, AVSCOM, AMSAV-EFS, February 1973, subject: Vibration Analysis of Icing Spray Rig as Installed on the CH-47C Helicopter.
8. Structures Report, All American Engineering Company, Report P-278A, Revision B, *Helicopter In-Flight Icing Test Facility*, Volumes I and II, January 1973.
9. Test Plan, All American Engineering Company, TP-333, *Helicopter In-Flight Icing Test Facility*, with Revision B, 10 November 1972.

# APPENDIX B. SAFETY -OF-FLIGHT RELEASE



DEPARTMENT OF THE ARMY  
US ARMY AVIATION SYSTEMS COMMAND  
PO BOX 209, ST. LOUIS, MO 63166

25 APR 1973

AMSAV-EFD

SUBJECT: Safety of Flight Release (SOFR) for CH-47C Performing a Flight Envelope Expansion on the Icing Spray Rig in the Small Spray Pattern Configuration (ASTA Project No. 72-35)

Commander  
US Army Aviation Systems  
Test Activity  
ATTN: SAVTE-CT (Mr. Hayden)  
Edwards AFB, California

1. This letter constitutes a Safety of Flight Release (SOFR) for the CH-47C helicopter S/N 68-15814 with an icing spray rig, as depicted on All American Engineering Company drawing #85500 installed, except that the outer booms as depicted on All American Engineering Company drawing #85501 will be removed. The purpose for this SOFR is to allow for the progressive, incremental development of a flight envelope for use during further testing and operational use of the icing spray rig. During the development of this flight envelope the flight conditions depicted in Table 1 of the ASTA Icing Spray System Qualification Test Plan, dated April 1973, as approved by AVSCOM letter AMSAV-EF, dated 25 April 1973, will be used.

2. During the conduct of the tests cited in paragraph 1 above, the operating procedures for the CH-47C helicopter as provided in the Operator's Manual TM 55-1520-227-10 will be used except for the following additional restrictions and limitations:

a. The load factor for all flight regimes shall be kept within a +0.5 and a +1.75 band. A build-up in load factor will be performed in increments of approximately 0.25g.

b. Forward speed shall not exceed 165 KTAS using the trim collective setting for 150 KTAS.

c. An operational cruise guide indicator will be required for any envelope expansion at speeds exceeding 50 KTAS.

d. Bank angles shall not exceed 45°.

AMSAV-EFD

SUBJECT: Safety of Flight Release (SOFR) for CH-47C Performing a Flight Envelope Expansion on the Icing Spray Rig in the Small Spray Pattern Configuration (ASTA Project No. 72-35)

e. No practice autorotations shall be conducted for the subject configuration.

f. Loss of TM signal, intermittent TM signal, or loss of critical data channels will cause termination of envelope expansion until the problem has been resolved.

g. Water jettison system will not be live-armed on ground or within 500 feet horizontal distance of any building or personnel.

h. When spray water is equipped with dye, water jettison will not be performed unless an aircraft MAYDAY condition exists.

i. All testing of the icing spray system in the reduced configuration will be performed with the automatic boom jettison feature disabled.

j. The following criteria for TM termination of a test shall be in effect:

(1) Peak loads in boom components in excess of 80% of those demonstrated static tests.

(2) Mean plus or minus alternating loads for boom components that reach the limit of the suitably calculated Goodman diagram.

(3) Any large amplitude boom motion (greater than  $+2 \frac{1}{2}$  feet at the boom tip) in response to a spurious disturbance (one over and above the continuance disturbance supplied by helicopter) which requires more than 2.2 cycle to damp to  $1/2$  amplitude ( $\zeta = .05$ ).

(4) Cruise guide indicator (CGI) readings of 196 percent (Peg) will be avoided by reducing collective or the severity of the maneuver. Cumulative life damage calculations will be made for all the time spent above 100% (top of green zone) CGI indication using Miner's theorem and the Boeing-Vertol supplied S-N curve.

(5) Control positions (except collective) closer than 15 percent (of total travel) to their respective stops.

25 APR 1973

AMSAV-EFD

SUBJECT: Safety of Flight Release (SOFR) for CH-47C Performing a Flight Envelope Expansion on the Icing Spray Rig in the Small Spray Pattern Configuration (ASTA Project No. 72-35)

(6) Further criteria which may be developed as experience is gained in the test program.

3. Tests shall be conducted in accordance with the small spray pattern configuration test portion of the ASTA Icing Spray System Qualification Test Plan.

4. This SOFR is terminated after completion of the small spray pattern configuration tests of Paragraph 3.

FOR THE COMMANDER:

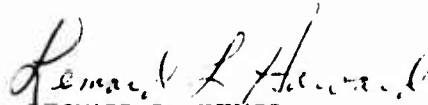

LEONARD L. HOWARD

Act'g Chief, Flt Stds & Qual Div  
Directorate for Rsch, Dev & Engr

DEPARTMENT OF THE ARMY  
US ARMY AVIATION SYSTEMS COMMAND  
PO BOX 209, ST. LOUIS, MISSOURI 63166

27 APR 1973

R. Peskar/pls/5736/27 Apr 73

AMSAV-EFS

SUBJECT: Safety of Flight Release (SOFR) for CH-47C Performing a Flight Envelope Expansion on the Icing Spray Rig in the Small Spray Pattern Configuration (ASTA Project No. 72-35)

Commander  
US Army Aviation Systems  
Test Activity  
ATTN: SAVTE-CT (Mr. Hayden)  
Edwards AFB, California

1. Reference AVSCOM letter AMSAV-EFD, subject as above, dated 25 April 1973.
2. The referenced SOFR is amended as follows:
  - a. The engine torque limit shall be 95% dual engine operation.
  - b. Para 2.d of the ref letter is changed to read: "The bank angle limitation is 55° and this limit will be approached in a progressive incremental build-up from established -10 limits.
  - c.  $V_{NE}$  shall be determined by the Cruise Guide Indicator (CGI). CGI limits will be 150% endurance for steady state and 190% endurance for transient maneuvers.

FOR THE COMMANDER:

s/Leonard L. Howard  
LEONARD L. HOWARD  
Acting Chief, Flt Stds & Qual Div  
Directorate for RD&E





DEPARTMENT OF THE ARMY  
US ARMY AVIATION SYSTEMS COMMAND  
PO BOX 209, ST. LOUIS, MO 63166

4 MAY 1973

AMSAV-EFD

SUBJECT: Safety of Flight Release for CH-47C Performing a Flight  
Envelope Expansion on the Icing Spray Rig in the Small Spray  
Pattern Configuration (ASTA Project No. 72-35)

Commander  
US Army Aviation Systems  
Test Activity  
ATTN: SAVTE-CT (Mr. Hayden)  
Edwards AFB, CA

1. Reference is made to letter, AMSAV-EFD (AVSCOM), 25 Apr 73, subject as above.
2. The referenced safety of flight release is amended as follows:  
ASTA may make necessary modifications to the CH-47 SAS system with prior coordination with contractor (Boeing-Vertol) and AMSAV-EF.

FOR THE COMMANDER:

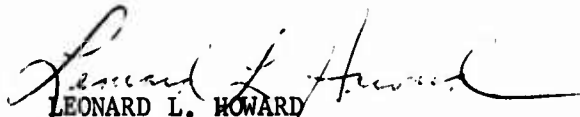
  
LEONARD L. HOWARD  
Act'g Chief, Flt Stds & Qual Div  
Directorate for Rsch, Dev & Engr

DEPARTMENT OF THE ARMY  
US ARMY AVIATION SYSTEMS COMMAND  
PO BOX 209, ST. LOUIS, MISSOURI 63166

AMSAV-EFS

SUBJECT: Safety of Flight Release (SOFR) for CH-47C Performing a  
Flight Envelope Expansion on the Icing Spray Rig in the  
Small Spray Pattern Configuration (ASTA Project 72-35)

Commander  
US Army Aviation Systems  
Test Activity  
ATTN: SAVTE-CT (Mr. Hayden)  
Edwards AFB, California

1. References is made to:
  - a. AVSCOM letter AMSAV-EFD, subject as above, dated 25 Apr 73.
  - b. AVSCOM letter AMSAV-EFS, subject as above, dated 27 Apr 73.
2. The reference a SOFR as amended by reference b is amended as follows:

Flight conditions 3 and 4 of Table 1 of the approved ASTA Icing Spray System Qualification Test Plan may be conducted at the required airspeeds with only one sensing circuit of the Cruise Guide Indicator operative (i.e. Aft pivoting actuator strain gage circuit inoperative). Condition 4 shall be conducted at a pressure altitude of 4,000 feet with brief check flights permitted at 7,000 feet provided that the 4,000 feet flight data trends indicate that flight safety is not jeopardized at 7,000 feet.

FOR THE COMMANDER:

s/Leonard L. Howard  
LEONARD L. HOWARD  
Acting Chief, Flt Stds & Qual Div  
Directorate for RD&E



DEPARTMENT OF THE ARMY  
HEADQUARTERS, US ARMY AVIATION SYSTEMS COMMAND  
PO BOX 209, ST. LOUIS, MO 63166

AMSAV-EFS

21 MAY 1973

SUBJECT: Safety of Flight Release (SOFR) to Conduct Flight Envelope Expansion Testing for the CH-47C with the Icing Spray Rig Installed in the Large Spray Pattern Configuration (ASTA Project No. 72-35)

Commander  
US Army Aviation Systems  
Test Activity  
ATTN: SAVTE-CT (Mr. Hayden)  
Edwards AFB, California

1. This letter constitutes a SOFR for the CH-47C helicopter S/N 68-15814 with an icing spray rig installed. This rig is configured as depicted on All American Engineering Company drawing number 85500. The purpose for this SOFR is to allow for the commencement of a progressive, incremental development of a flight envelope for use during icing spray tests of aircraft utilizing the CH-47C/icing spray rig test facility. Flight conditions 1, 2, and 3 of Table 1 of the approved ASTA Icing Spray System Qualification Test Plan, dated April 1973, may be conducted in sequence. Condition 3 may be conducted after a detailed review of conditions 1 and 2 flight data provided that the data trends indicate that flight safety is not jeopardized.
2. During the conduct of the tests cited in paragraph 1 above, the operating procedures for the CH-47C helicopter as provided in the Operator's Manual TM 55-1520-227-10 will be used except for the following additional restrictions and limitations:
  - a. The load factor for all flight regimes shall be kept within a +0.5 and a +1.50 band.
  - b. Forward speed shall not exceed 50 KTAS.
  - c. A operational cruise guide indicator (CGI) sensing as a minimum the fixed link strains will be required for any flights. CGI limits will be 150% endurance for steady state and 190% endurance for transient maneuvers.
  - d. Bank angles shall not exceed 25°.

AMSAV-EFS

21 May 1973

SUBJECT: Safety of Flight Release (SOFR) to Conduct Flight Envelope Expansion Testing for the CH-47C with the Icing Spray Rig Installed in the Large Spray Pattern Configuration (ASTA Project No. 72-35)

- e. The engine torque limit shall be 95% dual engine operation.
- f. No practice autorotations shall be conducted for the subject configuration.
- g. Loss of TM signal, intermittent TM signal, or loss of critical data channels will cause termination of envelope expansion until the problem has been resolved.
- h. The spray boom jettison system will not be live-armed on ground or within 500 feet horizontal distance of any building or personnel.
- i. When spray water is equipped with dye, water jettison will not be performed unless an aircraft MAYDAY condition exists.
- j. The automatic boom jettison feature shall be operable.
- k. The following criteria for TM termination of a test shall be in effect:
  - (1) Peak loads in boom components in excess of 80% of those demonstrated by static tests.
  - (2) Mean plus or minus alternating loads for boom components that reach the limit of the suitably calculated Goodman diagram.
  - (3) Any large amplitude boom motion (greater than  $+2 \frac{1}{2}$  feet at the boom tip) in response to a spurious disturbance (one over and above the continuance disturbance supplied by helicopter) which requires more than 2.2 cycle to damp to  $1/2$  amplitude ( $\zeta = .05$ ).
  - (4) CGI readings exceeding those specified in Paragraph c will be avoided by reducing collective or the severity of the maneuver. Cumulative life damage calculations will be made for all the time spent above 100% (top of green zone) CGI indication using Miner's theorem and the Boeing Vertol supplied S-N curve.
  - (5) Control positions (except collective) closer than 15 percent (of total travel) to their respective stops.
  - (6) Further criteria which may be developed as experience is gained in the test program.
3. This SOFR is terminated after completion of the large spray pattern configuration tests in Paragraph 1.

FOR THE COMMANDER:

  
LEONARD L. HOWARD  
Acting Chief, Flt Stds & Qual Div  
Directorate for Resch, Dev & Engr

DEPARTMENT OF THE ARMY  
US ARMY AVIATION SYSTEMS COMMAND  
PO BOX 209, ST. LOUIS, MISSOURI 63166

Mr. Schmidt/cmw/5365  
23 May 1973

AMSAV-EFD

SUBJECT: Safety of Flight Release (SOFR) to Conduct Flight Envelope  
Expansion Testing for the CH-47C with the Icing Spray Rig  
Installed in the Large Spray Pattern Configuration  
(ASTA Project No. 72-35)

Commander  
US Army Aviation Systems  
Test Activity  
ATTN: SAVTE-CT (Mr. Hayden)  
Edwards AFB, California

1. Reference is made to letter, AMSAV-EFD, 21 May 73, subject as above.
2. The referenced Safety of Flight Release is amended as follows:  
Paragraph 2b is changed to read: "Forward speed up to  $V_H$ ".

FOR THE COMMANDER:

s/Leonard L. Howard  
LEONARD L. HOWARD  
Act'g Chief, Flt Stds & Qual Div  
Directorate for Rsch, Dev & Engr



DEPARTMENT OF THE ARMY  
HEADQUARTERS, US ARMY AVIATION SYSTEMS COMMAND  
PO BOX 209, ST. LOUIS, MO 63166

AMSAV-EFD

1973 JUL 10

SUBJECT: Amendment to Safety of Flight Release (SOFR) to conduct Flight Envelope Expansion Testing for the CH-47C with the Icing Spray Rig Installed in the Large Spray Pattern Configuration (ASTA Project No. 72-35)

Commander  
US Army Aviation Systems  
Test Activity  
ATTN: SAVTE-CT (Mr. Hayden)  
Edwards AFB, California

1. Reference is made to:

a. Safety of Flight Release for Large Spray Boom Configuration, AMSAV-EF letter of 21 May 73, amended 23 May 73.

b. ASTA message of 4 July 73, subject: SOFR Amendment, Helicopter Icing Spray System Qualification - ASTA, Project No. 72-35.

2. Based on the demonstrated safety shown in previous flights as stated in reference 1.b, the SOFR reference 1.a is amended as follows:

The aircraft aft c.g. limit for subject aircraft is STA 342 at gross weights of 45,000 lbs. and below, at speeds up to 60 KIAS.

FOR THE COMMANDER:

  
LEONARD L. HOWARD  
Acting Chief, Flt Std & Qual Division

# APPENDIX C. HANDLING QUALITIES RATING SCALE

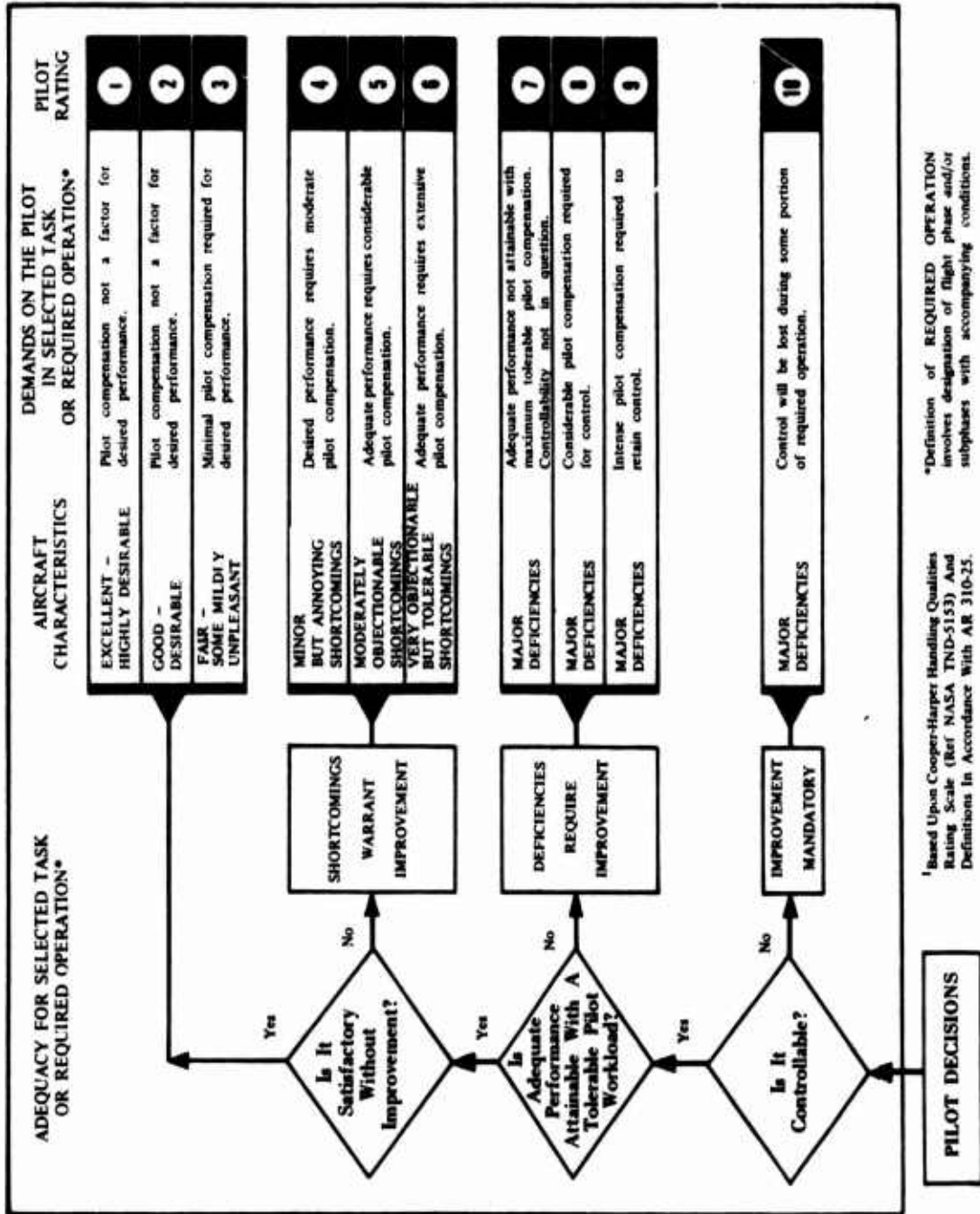

\*Based Upon Cooper-Harper Handling Qualities Rating Scale (Ref NASA TND-5153) And Definitions In Accordance With AR 310-25.

\*Definition of REQUIRED OPERATION involves designation of flight phase and/or subphases with accompanying conditions.

## APPENDIX D. TEST INSTRUMENTATION

### SYSTEM DESCRIPTION -- CH-47C DATA ACQUISITION

1. The data acquisition system employed on the CH-47C helicopter incorporated a magnetic tape unit to record flight parameters. Some of the advantages of a magnetic tape system were (1) data reduction time was markedly reduced, (2) a consistently high degree of data accuracy was maintained, and (3) maintenance was typically less than that of a comparable oscillograph system. A block diagram of the CH-47C data acquisition system is presented in figure 1. Although individual units of the system are complex in operation, the general data flow is relatively simple. The following paragraphs provide an explanation of the data flow and describe functions performed by each unit within the system.

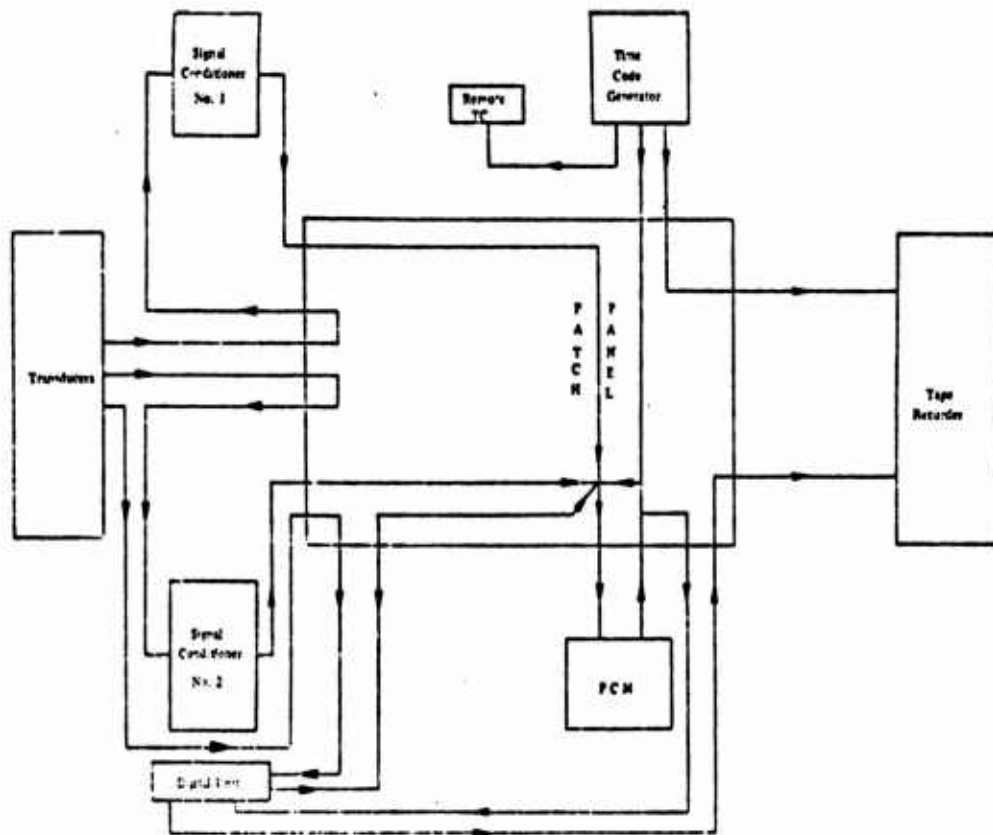

Figure 1. CH-47C System Block Diagram.



2. The CH-47C data acquisition system is capable of recording 40 analog and 15 bilevel channels of information. Two signal conditioners, each containing 20 channels of transducer excitation, amplification, and filtering, are used to tailor the new analog transducer signal outputs for interface with the pulse code modulation (PCM) unit. Transducers requiring a precision DC voltage excitation utilize the self-contained signal conditioner DC voltage supply. Amplification for each channel is adjustable to provide a zero- to 5-volt output from the signal conditioning unit, while variable low-pass filtering is available for reducing undesirable frequency components of the transducer signal. Also provided within these two units, on an individual channel basis, are calibration resistors which, when momentarily placed in the transducer circuitry by means of a remotely keyed relay, result in a fixed and repeatable voltage output to act as a system channel check.

3. After undergoing signal conditioning, the analog signals are introduced to the PCM unit. Bilevel data channels are also provided to the PCM unit via the digital function (DF) unit, omitting any analog signal conditioning. This DF unit provides to the PCM unit only parallel binary channel information. They include such parameters as fuel flow, engineer and pilot event marks, touchdown switch, etc. The PCM unit provides two primary functions. First, it assigns a binary weighted value to each analog signal input in proportion to the voltage amplitude. Secondly, it time-multiplexes all input signals, including bilevel, to form a single serial binary output signal containing the value of each individual input. Grouped together in a "frame," the binary values of all inputs for one time sample are presented in a sequential manner. Each frame contains a total of 78 data channels, one per signal input, and two additional channels designated as a "frame sync pattern." Acting as a marker for decommutation equipment, these two channels of frame sync indicate the end of one frame of data and the beginning of another within the serial PCM output. Although the PCM unit has 78 available data channels, only 40 analog and 15 bilevel data channels were incorporated in the CH-47C system configuration.

4. A nonreturn to zero level (NRZL) binary code is employed for the serial binary PCM output. In order to ensure correct PCM data recording by the magnetic tape recorder, the serial NRZL output code is converted to a biphasic (Bi- $\phi$ ) code. By changing output levels during each binary count of the output, the Bi- $\phi$  code increased the data frequency. The magnetic tape recorder incorporated in the system is incapable of recording low-frequency data; therefore, this addition in frequency is required prior to data recording. To perform this transformation, the PCM serial output, NRZL-coded, is routed through the DF unit. Internal circuitry changes the code form to the final Bi- $\phi$  serial output.

5. For storage of the flight data, the Bi- $\phi$  serial output from the DF unit is fed to track 2 of the magnetic tape recorder. The Genisco tape recorder employed on this system is capable of recording approximately 1 hour of data on standard 14-inch tape reels with 1-mill magnetic tape. Timing information developed by a time code generator is recorded simultaneously with the Bi- $\phi$  coded data. This unit acts as an in-flight clock set to the time of day and provides an IRIG-B DC

voltage code representation of the time directly recorded on track 3 of the tape unit. Another serial binary code of the time is also provided by the time code generator. Introduced to the bilevel section of the PCM unit, this output is used for timing information in the Bi- $\phi$  serial data output. Therefore, timing data are recorded on two tracks of the tape recorder. The IRIG-B coded time data supplies the ground station flight time display with the required input and facilitates time search. The bilevel timing information contained within the serial data output is used by the ground station for computer input of flight times. Remote time display is also available from the time code generator by use of a remote cockpit digital display.

6. The magnetic tape recorder is operated at a speed of 30 inches per second. A voice track is incorporated within this system to provide in-flight annotation of the data tape. Input to this voice track is provided through the intercommunication system of the ship.

#### **PILOT TEST INSTRUMENTATION**

7. The following test instrumentation was provided on the pilot instrument panel:
- a. Main rotor speed.
  - b. Gas producer speed (one per engine).
  - c. Airspeed.
  - d. Altitude.
  - e. Outside air temperature.
  - f. Fuel-flow rate and total fuel used.
  - g. Time code display.
  - h. Pilot event switch.

#### **ENGINEER CONTROLS**

8. The following switches were provided for the engineer:
- a. Event switch.
  - b. Record switch.
  - c. Stop switch.

9. These switches were housed within a metal unit which could be strapped to the engineer's leg. The wiring harness was detachable at the unit or at the instrumentation system.

### TEST TRANSDUCERS

10. The following test transducers with the ranges indicated were incorporated:

a. Longitudinal cyclic stick position: Buffalo position transducer, Model D17. Mounted beneath the forward cockpit area. Range: zero to 100 percent.

b. Lateral cyclic stick position: Buffalo position transducer, Model D17. Mounted beneath the forward cockpit area. Range: zero to 100 percent.

c. Rudder pedal position: Buffalo position transducer, Model D17. Mounted beneath the forward cockpit area. Range: zero to 100 percent.

d. Collective stick position: Buffalo position transducer, Model D17. Mounted beneath the forward cockpit area. Range: zero to 100 percent.

e. Pitch attitude: Humphrey K-3 gyro, Model VM 0201201. Mounted on the spray system platform. Range: +45 degrees to -45 degrees.

f. Roll attitude: Humphrey K-3 gyro, model VM 0201201. Same gyro as pitch attitude, but using roll axis. Range: +60 degrees to -60 degrees.

g. Pitch rate: Humphrey Model RG 28-0195-1 rate gyro. Mounted within the crane hook bay. Range: +60 deg/sec to -60 deg/sec.

h. Roll rate: Humphrey Model RG 28-0189-1 rate gyro. Mounted within the crane hook bay. Range: +60 deg/sec to -60 deg/sec.

i. Yaw rate: Humphrey Model RG 28-0195-1 rate gyro. Mounted within the crane hook bay. Range: +60 deg/sec to -60 deg/sec.

j. Center-of-gravity normal acceleration: Statham Model A 404TC-3. Mounted on spray system platform. Range: -1.5g to +1.9g.

k. Gas producer speed: N<sub>1</sub> engine No. 1: range, 70 percent to 105 percent; N<sub>1</sub> engine No. 2: range, 70 percent to 105 percent.

l. Longitudinal AFCS position: Bourns linear motion potentiometer, Model 156. Mounted within cockpit and linked to AFCS servo linkage. Range: zero to 100 percent.

m. Lateral AFCS position: Bourns linear motion potentiometer, Model 156. Mounted within cockpit and connected to AFCS servo linkage. Range: zero to 100 percent.

n. Directional AFCS position: Bourns linear motion potentiometer, Model 156. Mounted within cockpit and connected to AFCS servo linkage. Range: zero to 100 percent.

o. Collective AFCS position: Bourns linear motion potentiometer, Model 156. Mounted within cockpit and connected to AFCS servo linkage. Range: zero to 100 percent.

p. Airspeed: Rosemount Engineering Company, Model 831L4. Plumbed into the static and airspeed air lines. Range: zero to 145 knots.

q. Altitude: Rosemount Engineering Company, Model 830J14. Plumbed into the static air line. Range: zero to 5000, 5000 to 10,000, 10,000 to 15,000.

r. Outside air temperature: Rosemount Engineering Company, Model 102AU2CK. Mounted beneath the nose of the ship. Range:  $-22^{\circ}\text{C}$  to  $48^{\circ}\text{C}$ .

s. Fuel flow: Flow Technology, Inc., Model FT10F-1000 turbine flow sensor. Plumbed into the engine fuel line and mounted in the engine compartment. Range: zero to 1000 gal/hr.

t. Rotor speed: Range: 150 to 255 rpm.

u. Pilot seat acceleration (vertical, lateral, longitudinal): Range:  $\pm 2g$ , all axes.

v. Center-of-gravity acceleration (vertical, lateral, longitudinal): Range:  $\pm 2g$ , all axes.

w. The following strain gage information is supplemented by figure 2.

(1) AB $\chi$  (bending) gage factor 2.4. Range:  $\pm 1350$  microinches per inch ( $\mu\text{in./in.}$ ).

(2) ABZ (bending) gage factor 2.4. Range:  $\pm 1350$   $\mu\text{in./in.}$

(3) AT (torsion) gage factor 2.8. Range:  $\pm 1000$   $\mu\text{in./in.}$

(4) BBy (bending) gage factor 2.4. Range:  $\pm 1230$   $\mu\text{in./in.}$

(5) BT (torsion) gage factor 2.8. Range:  $\pm 260$   $\mu\text{in./in.}$

(6) CBZ (bending) gage factor 2.4. Range:  $\pm 1350$   $\mu\text{in./in.}$

(7) CB $\chi$  (bending) gage factor 2.4. Range: 1350  $\mu\text{in./in.}$

x. Boom tip lateral acceleration, Endevco piezoresistive accelerometer.  
Range:  $\pm 10g$ .

y. Boom tip longitudinal acceleration, Endevco piezoresistive accelerometer.  
Range:  $\pm 10g$ .

FIGURE 2. SPRAY BOOM INSTRUMENTATION SCHEMATIC.

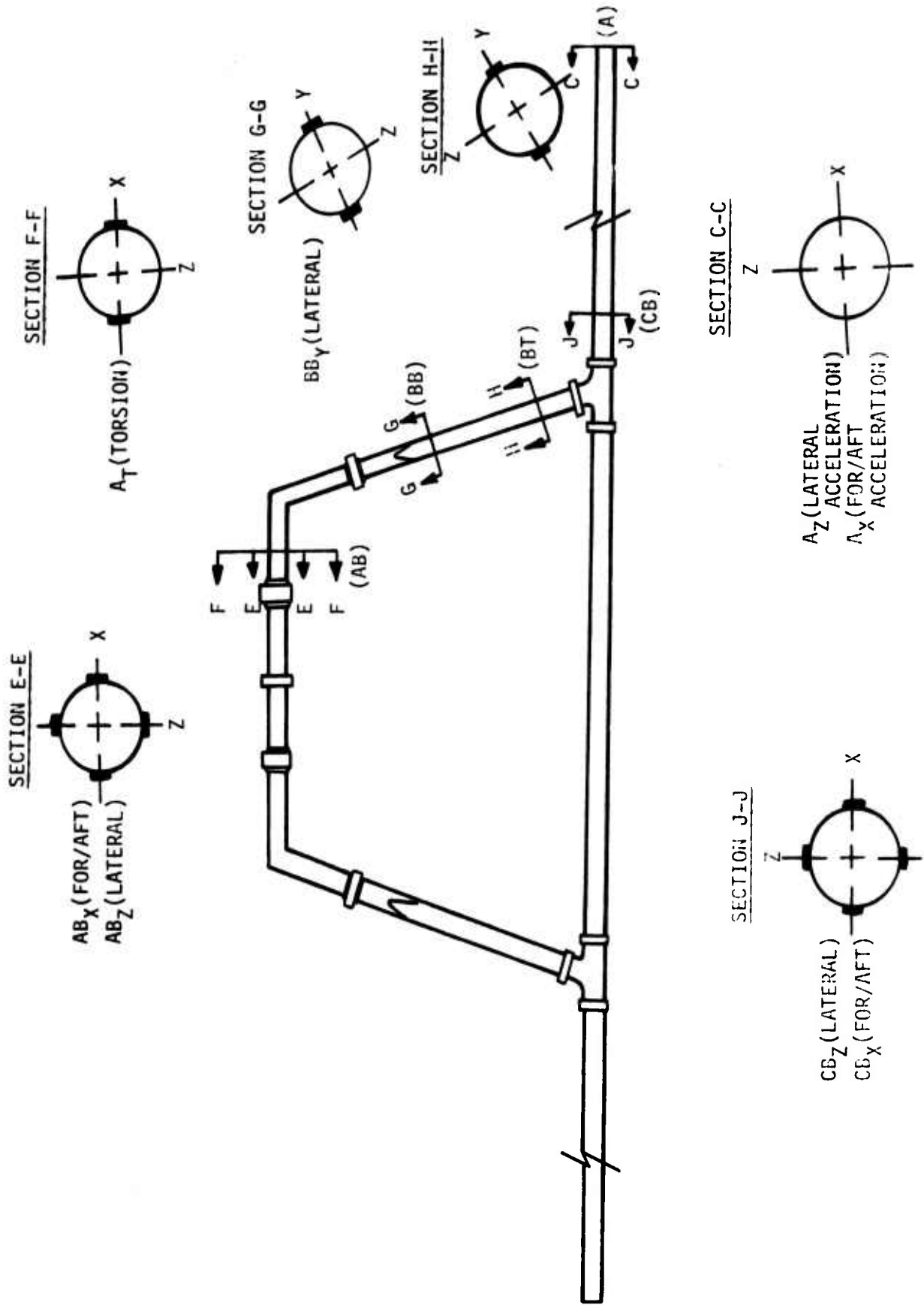



# **APPENDIX E. METHODS OF TEST**

## **GENERAL**

1. The evaluation was divided into two major parts, ground functional tests and flight envelope expansion, for each of the two proposed spray boom configurations.

## **GROUND FUNCTIONAL TESTS**

### **Boom Positioning**

2. Boom positioning was functionally checked with the jettisonable section of the boom removed. The remaining torque tube and boom supports were cycled to demonstrate the actuating and locking mechanism. The actuating and locking mechanism was also evaluated with the complete boom system installed during hovering flight.

### **Boom Static Loading**

3. The outer section of the boom was statically loaded to the equivalent of the critical loading demonstrated by the AAE proof load tests conducted at Wilmington, Delaware. This loading was used to calibrate the outer boom strain gages and provide a never-exceed stress level which was monitored in real time for the duration of the evaluation. No static load calibration was performed with the long booms removed (short boom configuration) due to the low calculated stress levels.

### **Electromagnetic Interference**

4. An electromagnetic interference (EMI) check was made to eliminate the possibility of any unknown voltage generation causing accidental boom or water jettison, or of boom operation causing any interference with vital aircraft systems. The test was performed by monitoring the boom and water jettison system terminal connectors for voltage fluctuations while operating all aircraft electronic systems, and by monitoring the aircraft system instruments as the boom was actuated. The voltage across the terminal connectors for both jettison systems was checked daily prior to completing the circuit in accordance with documented safety procedures (ref 5, app A).

### **Water and Boom Jettison**

5. A load of water was gravity jettisoned on the ground to demonstrate actuation of the system and to determine drainage time. Boom jettison tests of the spray boom system were conducted by AAE personnel and monitored by AVSCOM and USAASTA personnel at Wilmington, Delaware. The tests were conducted from a

test tower using a 10-foot section of the spray rig hardware incorporating the actual jettison joint. Tests were conducted in accordance with the AAE Test Plan (ref 9, app A).

### Ground Run-Up

6. Freedom of the boom from resonance was demonstrated during ground run-up with the boom in a near stowed position. As a precautionary measure during the ground run-up, the long booms were rigged with rope in such a manner as to curtail any divergent resonance that might have been encountered, yet allow free movement of the outer booms. Boom frequency, boom stress, and aircraft response were monitored in real time during the ground run, and rotor speed was varied to investigate the full range of rotor driving frequencies. The amplitude of the boom motion at the tip was determined by recording resultant tip accelerations as a function of time. Monitoring with videotape and motion picture camera was also provided.

### Bleed Air Supply

7. The operation of the engine compressor bleed to supply air to the atomizing nozzles was demonstrated during ground run-up. A maximum collective setting without becoming airborne was utilized in an attempt to develop an increased quantity of bleed air. Bleed air capacity was later demonstrated at high power settings during spray atomization calibrations in forward flight.

### Spray Tests

8. Function and operation of the spray system in the stowed position was demonstrated during ground tests. Personnel from AAE performed preliminary calibration of the system flow rate indicator during this test and made a brief water atomization investigation at various water flow rates and air pressure ratios.

### Taxi Tests

9. Freedom of the aircraft and icing spray system from resonance or excessive boom response was demonstrated by taxiing on smooth, hard surfaces throughout the normal taxi speed range. The taxi tests were performed with the water tank empty and with 1135 gallons of water.

### FLIGHT ENVELOPE EXPANSION

10. All flight operations were monitored in real time from a remote ground station which provided strip chart recordings for a team of USAASTA and AAE personnel who approved each flight condition prior to further envelope expansion. For reasons of safety, boom strain, control position, SAS movement, aircraft attitude, and aircraft angular rate were monitored in real time for all expansion points. The conditions evaluated and the order in which the tests were conducted to expand

the envelope are presented in table 1 in the Test Scope section of this report (para 4). Gross weight and cg location were "as configured" and no attempt was made to maintain a constant W/o or cg location. Where indicated in table 1, the CGI was utilized during the flight envelope expansion as a basis for establishing flight limitations.

#### **Low-Speed Flight Expansion**

11. Boom behavior and functional operation of the spray boom system were examined in a hover and at low speed. Each buildup test point incorporated mild maneuvering about all axes to determine boom response and apparent damping ratio. Translational flight was investigated utilizing a ground pace vehicle for airspeed reference. Boom extension and retraction were also evaluated during low-speed forward flight up to 50 KTAS, utilizing a pace vehicle. Ground motion picture coverage was provided during all phases of the low-speed tests.

#### **Forward Flight Expansion**

12. Aircraft and spray boom system behavior were evaluated in forward flight at the conditions shown in table 1. During each expansion flight, the effect of the spray boom system on aircraft trimmability, dynamic stability, and static lateral-directional stability was briefly investigated. Water jettison tests were conducted to evaluate the water jettison capability at various airspeeds and to determine trim change effects. The following tasks were performed to determine boom stress levels (peak-to-peak and mean) and damping ratios during each expansion flight:

- a. Dynamic stability tests were conducted using free hand pulse-type control inputs about the pitch, roll, and yaw axes.
- b. Lateral-directional stability tests were conducted up to a sideslip angle of 80 percent of flight envelope limits.
- c. A structural demonstration was performed as explained in the following paragraph.

#### **Structural Demonstration**

13. The structural integrity of the icing spray system was demonstrated to an aim flight envelope of +0.75g and +1.50g at a maximum speed of 150 KTAS. A buildup in load factor was performed in increments of approximately 0.25g and the techniques used included constant airspeed steady-state turns and symmetrical pushovers. All structural demonstrations were monitored in real time and analyzed closely before continuing to the next point with a target extreme load factor of +0.5g and +1.75g.

## **APPENDIX F. TEST DATA**

FIGURE 1

CONTROL POSITIONS IN TRIMMED LEVEL FLIGHT  
CH-47C USAF S/N 15814

SYMBOL	AVG C.G. STATION (INCHES)	AVG G.W. (POUNDS)	AVG DENSITY ALTITUDE (FEET)	AVG WEIGHT DENSITY RATIO (POUNDS)	ROTOR SPEED (RPM)	AVG THRUST COEFFICIENT (CTXL0 <sup>2</sup> )	QAT DEGREE(S)
□	327.7	39130	5990	48990	245	61.5	20.0
○	320.8	30190	5700	35950	235	49.1	17.0

NOTES  
 □ RETRACTED LONG BOOM CONFIGURATION  
 ○ BOOM JETTISONED AND RETRACTED

PITCH ATTITUDE (DEGREES)

DIRECTIONAL CONTROL POSITION (INCHES FROM FULL LEFT)

LATERAL CYCLIC CONTROL POSITION (INCHES FROM FULL LEFT)

COLLECTIVE POSITION (INCHES FROM FULL DOWN) SHADED SYMBOL

LONGITUDINAL POSITION (IN. FROM FWD) RET

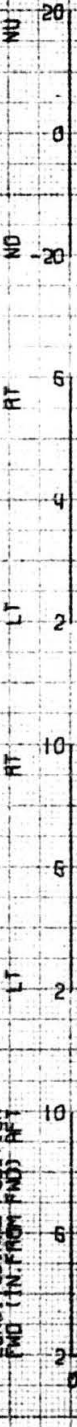

TOTAL DIRECTIONAL CONTROL TRAVEL = 2.0 INCHES

TOTAL LATERAL CONTROL TRAVEL = 3.82 INCHES

TOTAL COLLECTIVE TRAVEL = 11.6 INCHES. LONGITUDINAL TRAVEL = 14.2 INCHES

CALIBRATED AIRSPEED (KNOTS)



FIGURE 2

CONTROL POSITIONS IN TRIMMED LEVEL FLIGHT  
CH-47C USA S/N 15814

SYMBOL	AVG. C.G. STRIKE POSITION (INCHES)	AVG. G.M. (POUNDS)	AVG. DENSITY ALTITUDE (FEET)	AVG. HEIGHT DENSITY ALTITUDE (POUNDS)	AVG. SPEED (KNOTS)	AVG. THRUST COEFFICIENT (CYCLE)	AVG. GROSS WEIGHT (POUNDS)
□	324.4	40090	3080	48170	245	55.5	72.0
○	324.4	39650	6760	48750	245	61.3	73.0

NOTES  
EXTENDED SHORT BODY CONFIGURATION

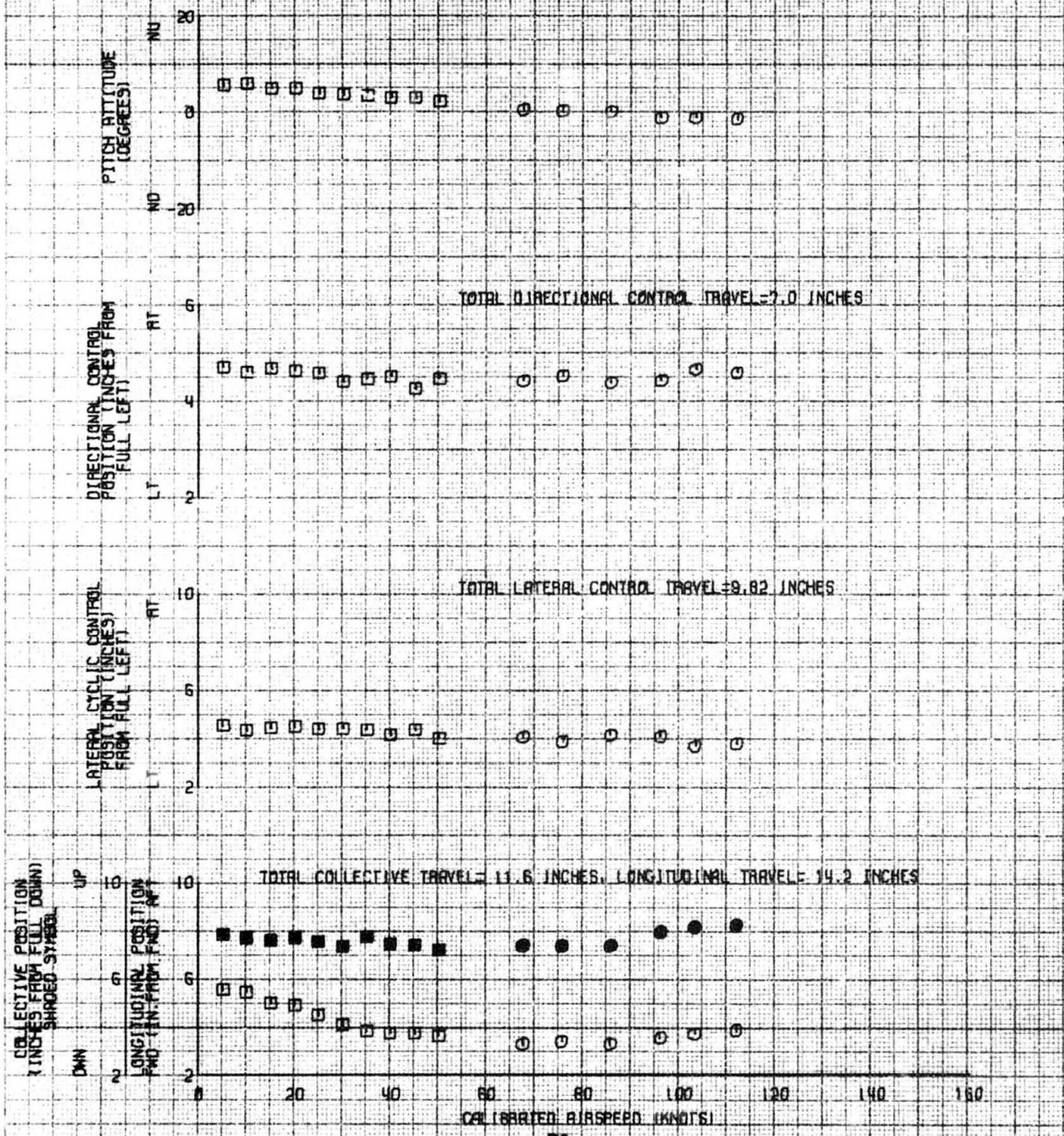



FIGURE 3 CONTROL POSITIONS IN TRAINED LEVEL FLIGHT  
 CV-440 USA S/N 15814

SYMBOL	AVG C.G. STATION (INCHES)	AVG C.W. (POUNDS)	AVG DENSITY ALTITUDE (FEET)	AVG WEIGHT DENSITY ALTITUDE (POUNDS)	ROTOR SPEED (RPM)	AVG THRUST COEFFICIENT (CTX10 <sup>4</sup> )	BAT DEGREE CENTIGRADE
□ ○	320.8	30390	5700	35950	235	0.3	17.0

NOTE  
 BOTH JETTISONED AND RETRACTED

PITCH ATTITUDE (DEGREES)

DIRECTIONAL CONTROL POSITION (INCHES FROM FULL LEFT)

LATERAL CYCLIC CONTROL POSITION (INCHES FROM FULL LEFT)

COLLECTIVE POSITION (INCHES FROM FULL DOWN) SHARDED SYMBOL

LONGITUDINAL POSITION (INCHES FROM FULL FORWARD)

TOTAL DIRECTIONAL CONTROL TRAVEL-7.0 INCHES

TOTAL LATERAL CONTROL TRAVEL-9.82 INCHES

TOTAL COLLECTIVE TRAVEL-11.6 INCHES. LONGITUDINAL TRAVEL-14.2 INCHES

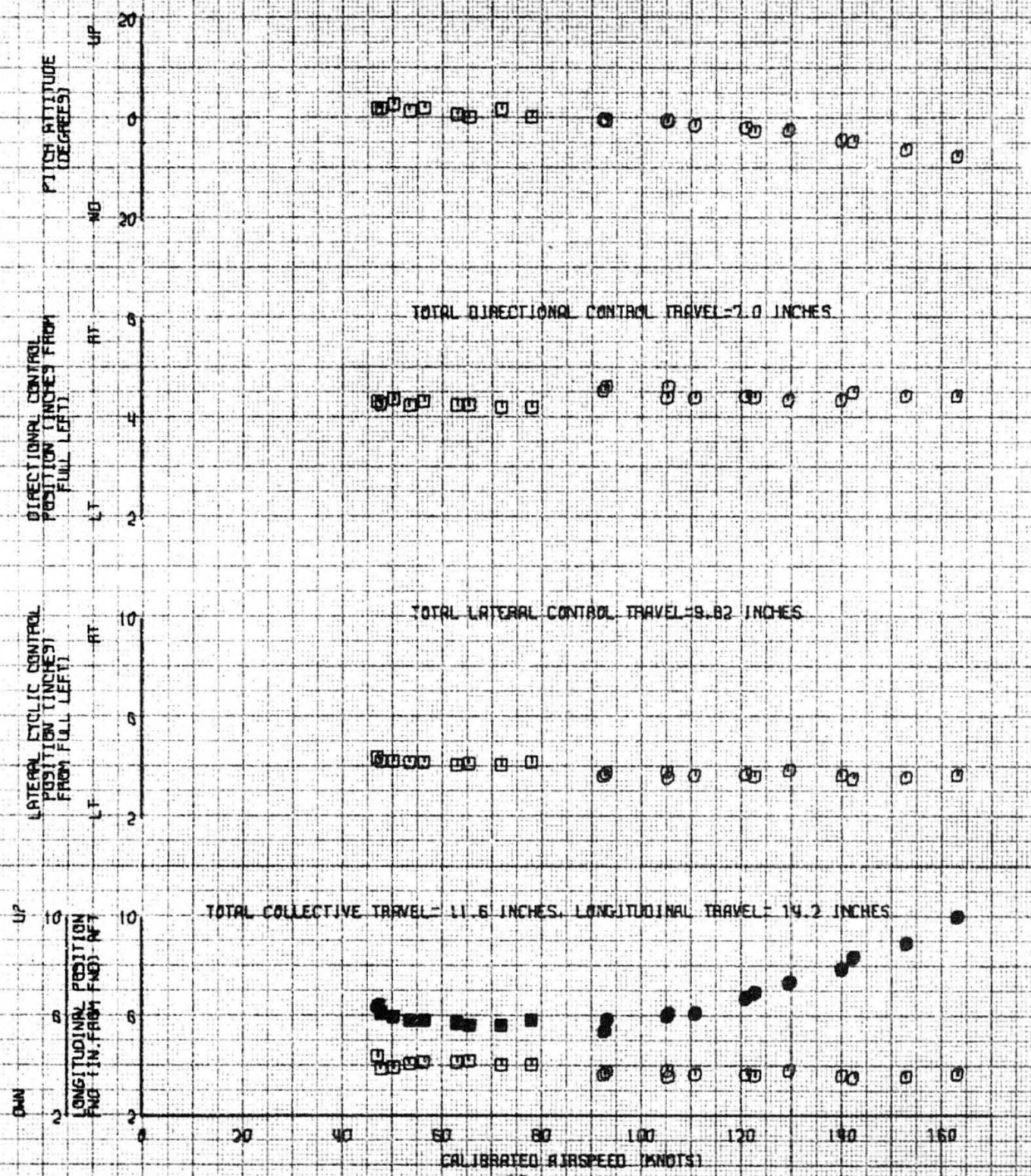

FIGURE 4 CONTROL POSITIONS IN TRIMMED LEVEL FLIGHT  
CH-47C USA S/N 15814

SYMBOL	AVG C.G. STATION (INCHES)	AVG G.M. (POUNDS)	AVG DENSITY ALTITUDE (FEET)	AVG WEIGHT DENSITY RATIO (POUNDS)	ROTOR SPEED (RPM)	AVG THRUST COEFFICIENT (CTX10 <sup>4</sup> )	BAT BEGINS (CENTIGRADE)
□	322.8	38360	3300	42290	245	53.1	13.5
○	322.8	39730	6990	48930	245	61.5	20.0

NOTE EXTENDED LONG BOOM CONFIGURATION

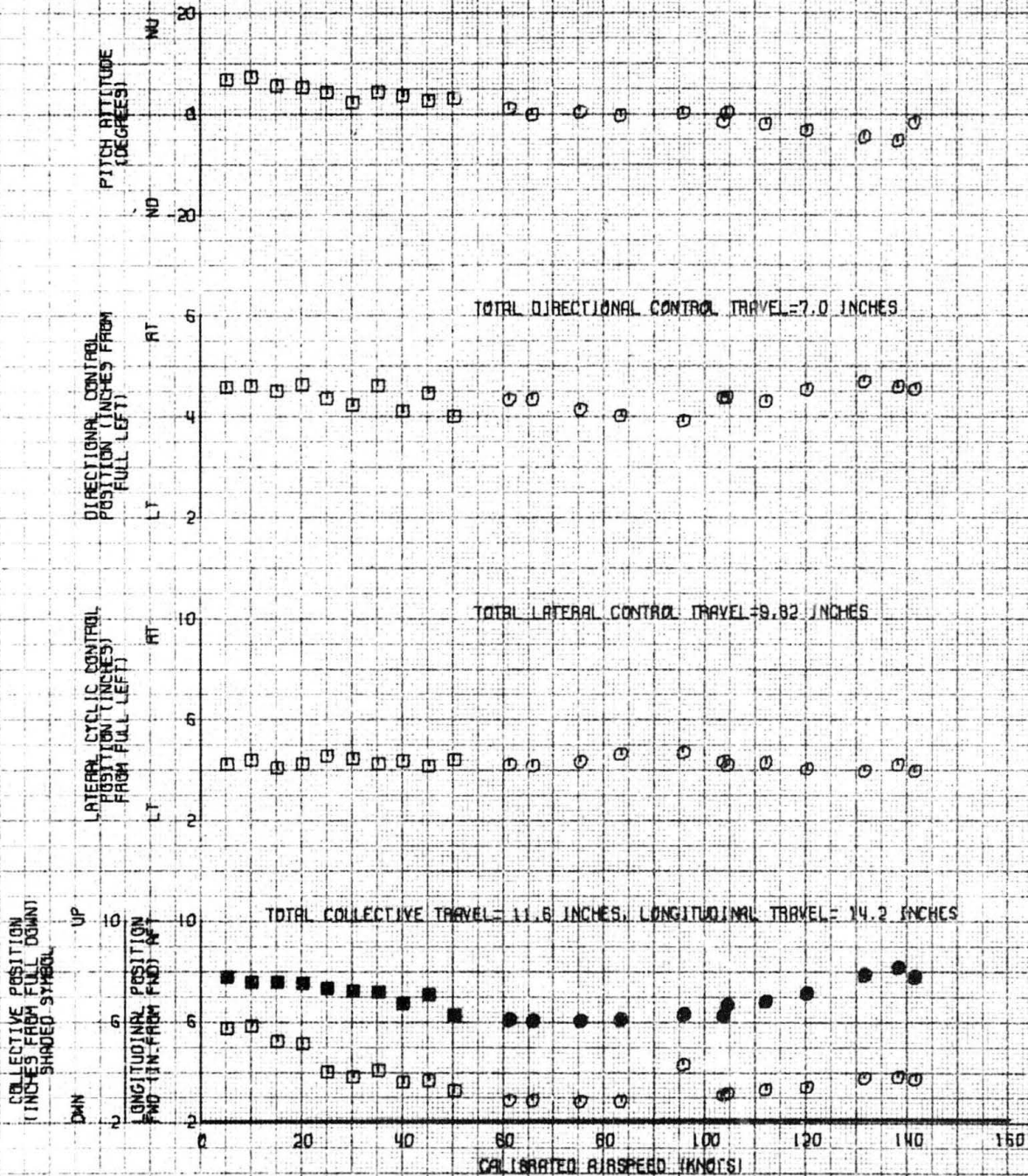

FIGURE 5 ENVELOPE EXPANSION IN LEVEL FLIGHT  
CH-47C USA S/N 15814

CONFIGURATION	AVG C.G.	AVG G.W.	ORT	DENSITY	WEIGHT/	ROTOR	TRIM	THRUST	SRS
SHORT BOOM	STATION (INCHES)	(POUNDS)	(°C)	ALTITUDE (FEET)	DENSITY RATIO (POUNDS)	SPEED (RPM)	AIRSPEED (KTAS)	COEFFICIENT (CX10 <sup>-4</sup> )	ON
	328.4	39000.	22.0	3450.	43200.	235.0	.0	59.0	

LEFT LATERAL (HOVER)  
BOOM EXTENDED

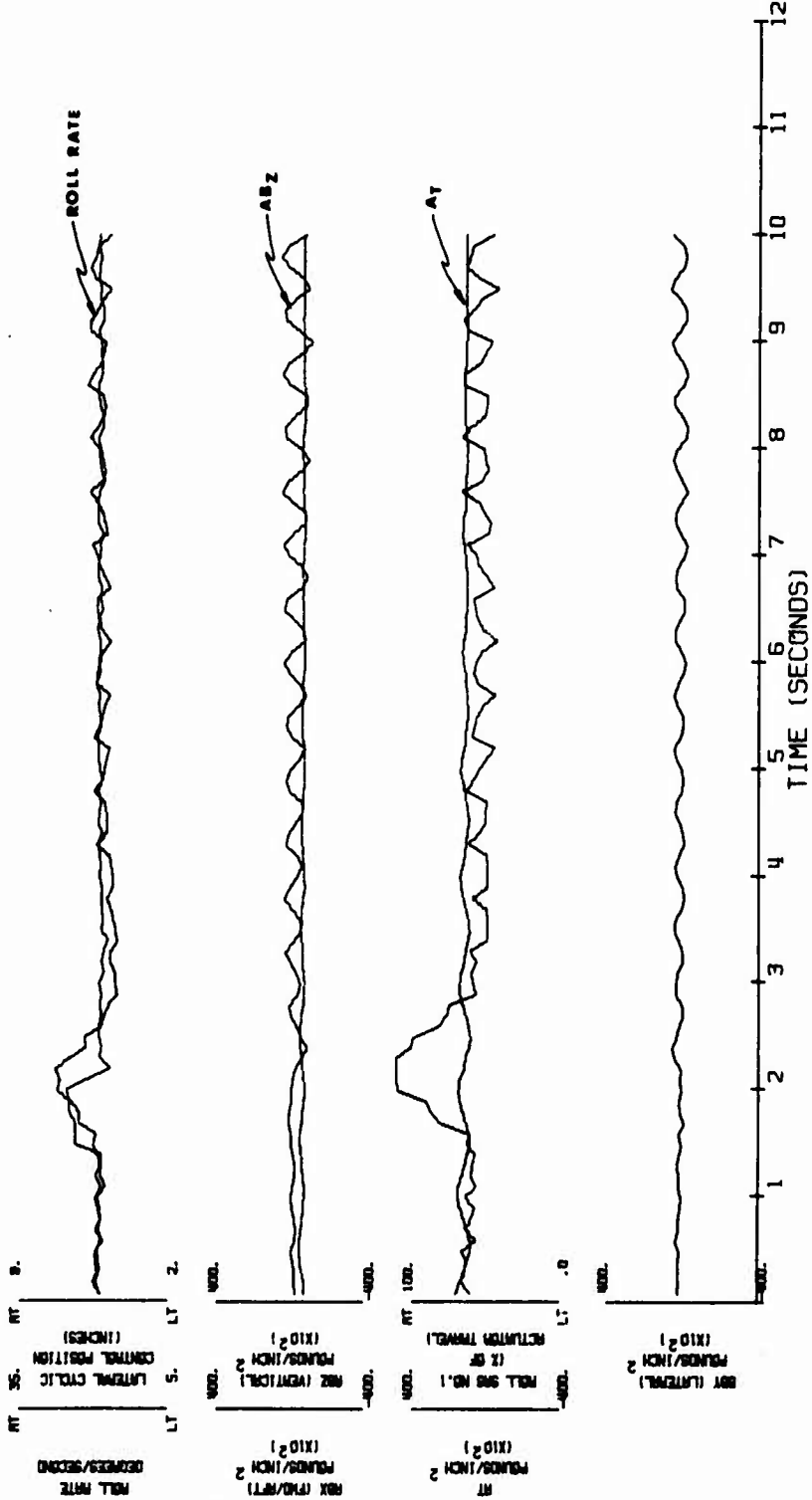

FIGURE 6 ENVELOPE EXPANSION IN LEVEL FLIGHT

CH-47C USA S/N 15814

CONFIGURATION	AVG C.G. STATION (INCHES)	AVG C.M. (POUNDS)	ORT (°C)	DENSITY (POUNDS/FEET)	WEIGHT/ALTI (POUNDS)	RATIO	ROTOR SPEED (RPM)	TRIM SPEED (KTAS)	THRUST COEFFICIENT (CTX10 <sup>-4</sup> )	SAS
SHORT BOOM	328.4	36800.	22.0	3450.	43000.		235.0	.0	58.7	OFF

LEFT LATERAL (HOVER)  
BOOM EXTENDED

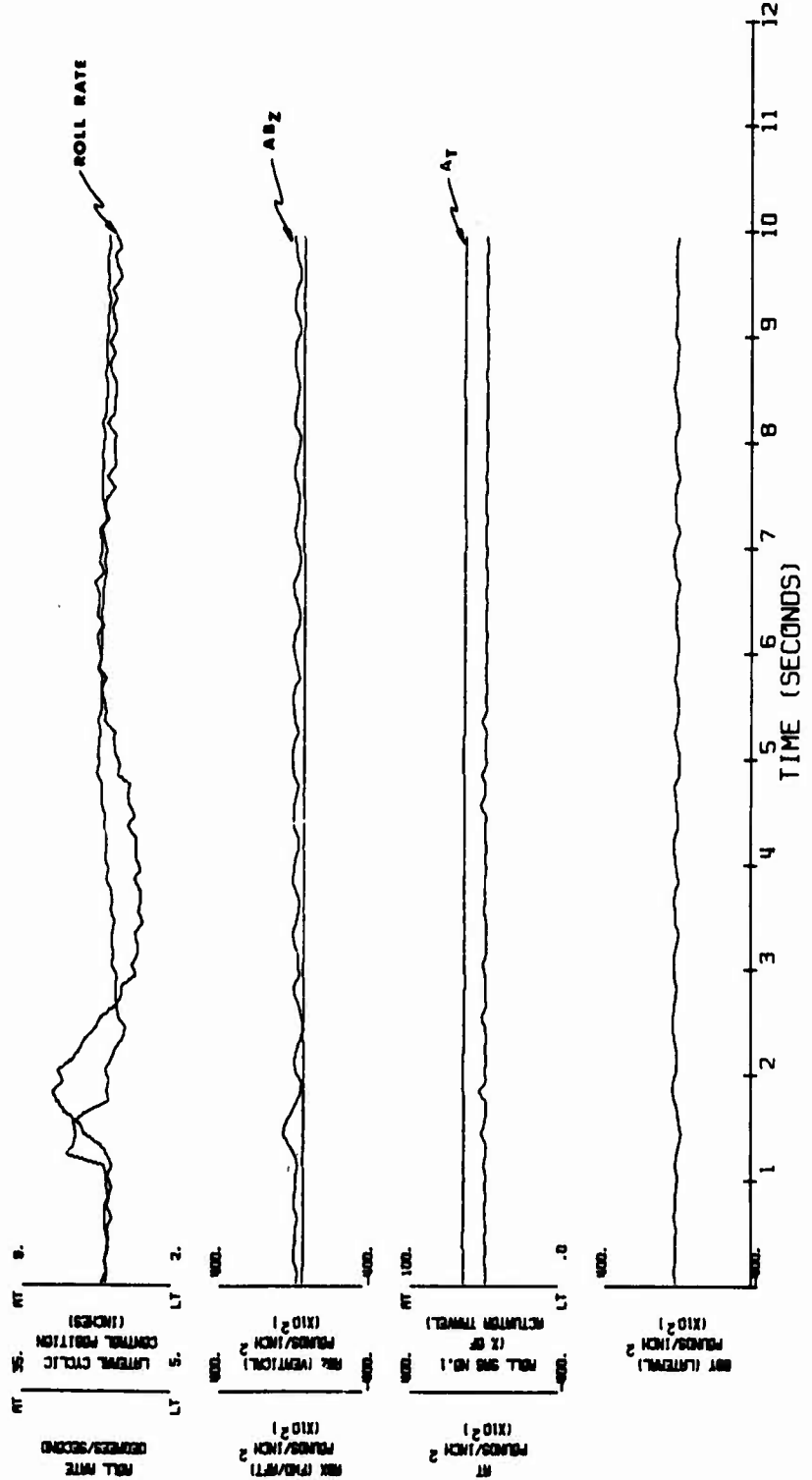
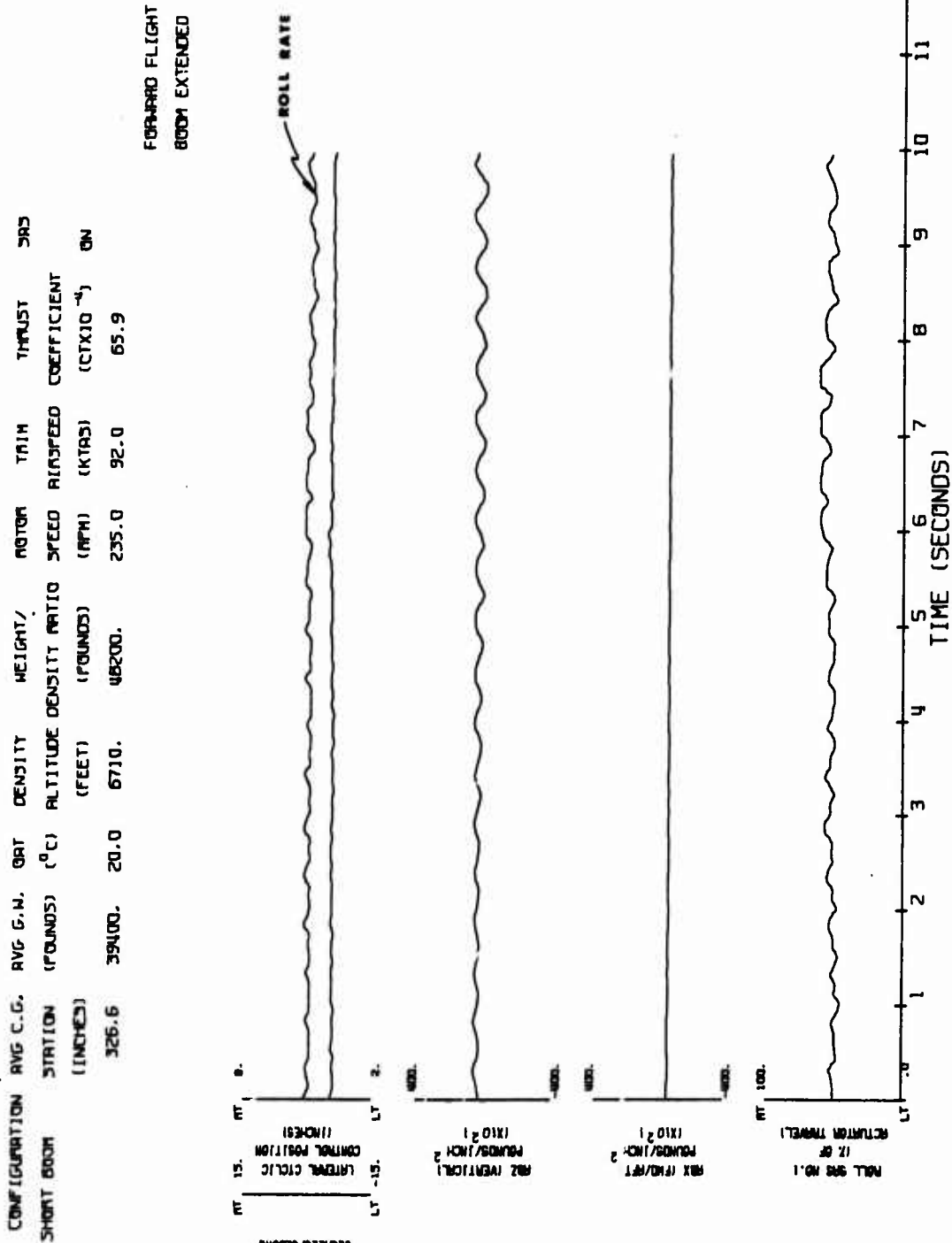

FIGURE 7 ENVELOPE EXPANSION IN LEVEL FLIGHT

CH-47C USA S/N 15814



PLT 12  
START  
9 26 20.000

FIGURE 8 ENVELOPE EXPANSION IN LEVEL FLIGHT

CH-47C USA S/N 15814

CONFIGURATION	AVG C.G.	AVG G.M.	ORT	DENSITY	WEIGHT/	ROTOR	TRIM	THRUST	SRS
SHORT BOOM	STATION (INCHES)	(POUNDS)	(°C)	ALTITUDE DENSITY RATIO (FEET)	(POUNDS)	SPEED (RPM)	AIRSPED (KTAS)	COEFFICIENT (CTX10 <sup>-4</sup> )	OFF
	326.6	39700.	18.0	5270.	46400.	235.0	111.0	63.5	

FORWARD FLIGHT  
BOOM EXTENDED

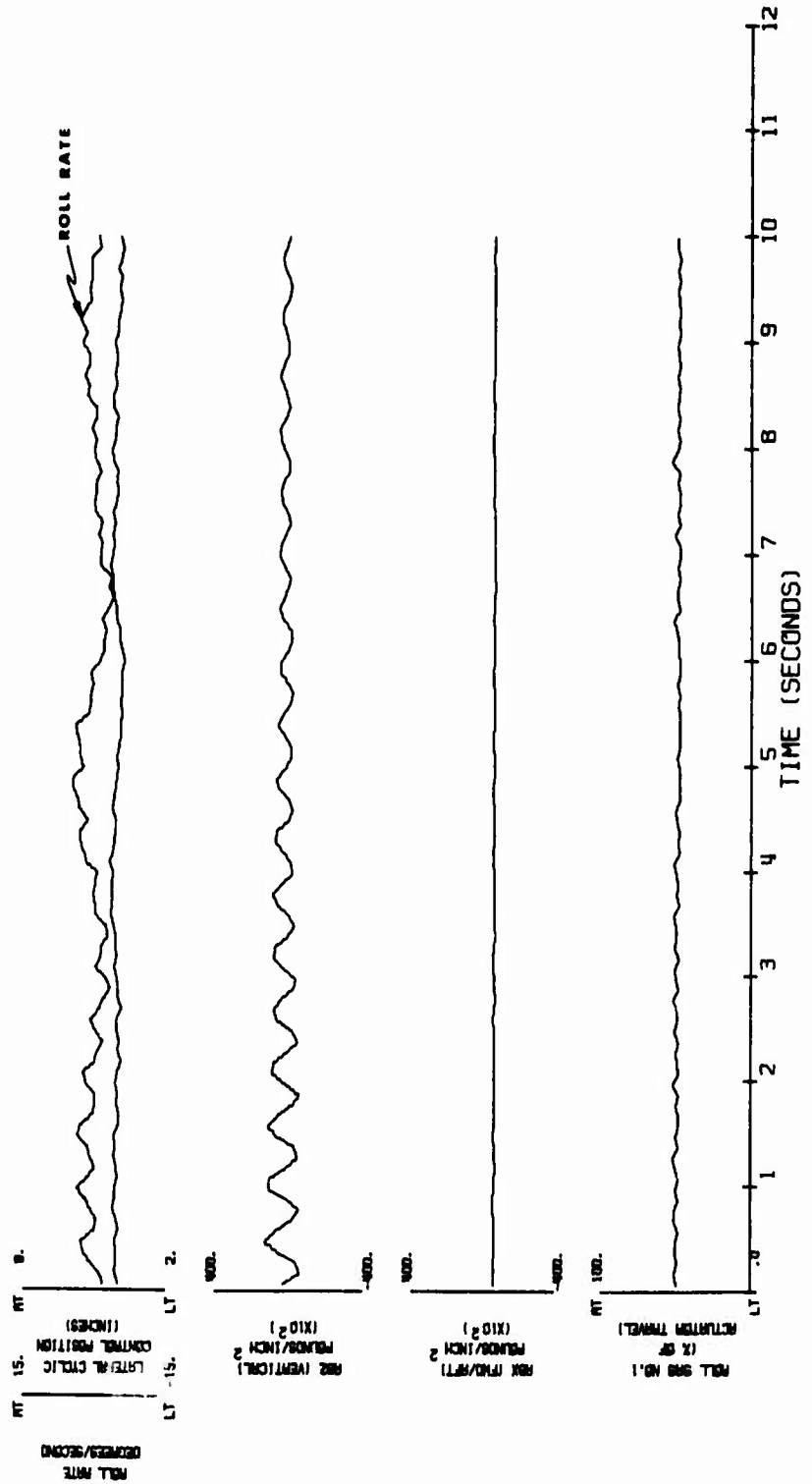

FIGURE 9 ENVELOPE EXPANSION IN LEVEL FLIGHT

CH-47C USA S/N 15814

CONFIGURATION	AVG C.G. STATION (INCHES)	AVG G.M. (POUNDS)	GRT (°C)	DENSITY (POUNDS)	WEIGHT/ALTITUDE DENSITY RATIO (FTAS)	ROTOR SPEED (RPM)	TRIM AIRSPEED (CTX10 <sup>-4</sup> )	THRUST COEFFICIENT	SRS
	328.2	41200.	15.0	2650.	44600.	235.0	.0	55.9	ON

LEFT LATERAL (HOVER)  
 ROLL SRS MODIFIED  
 BOOM EXTENDED

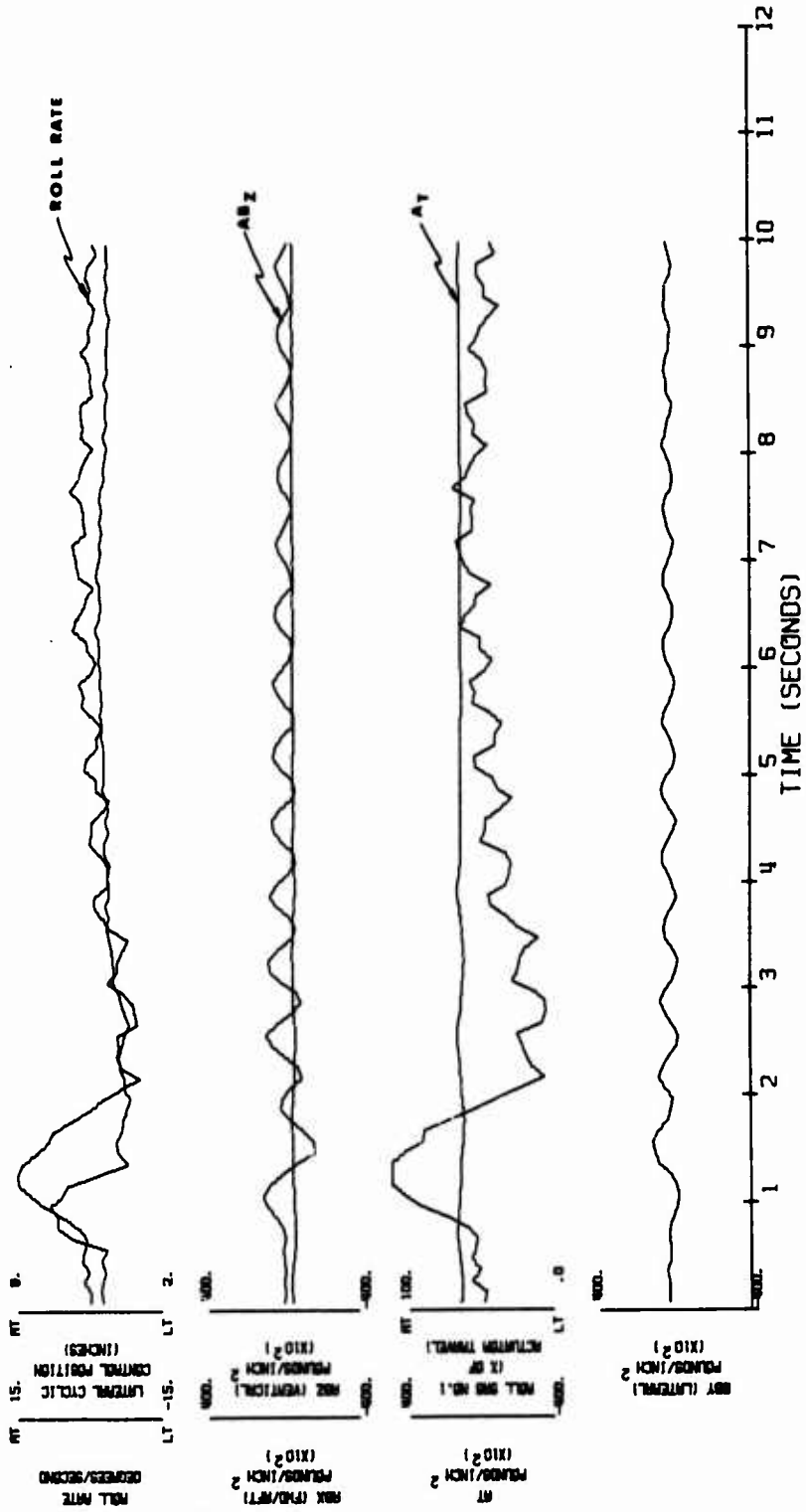

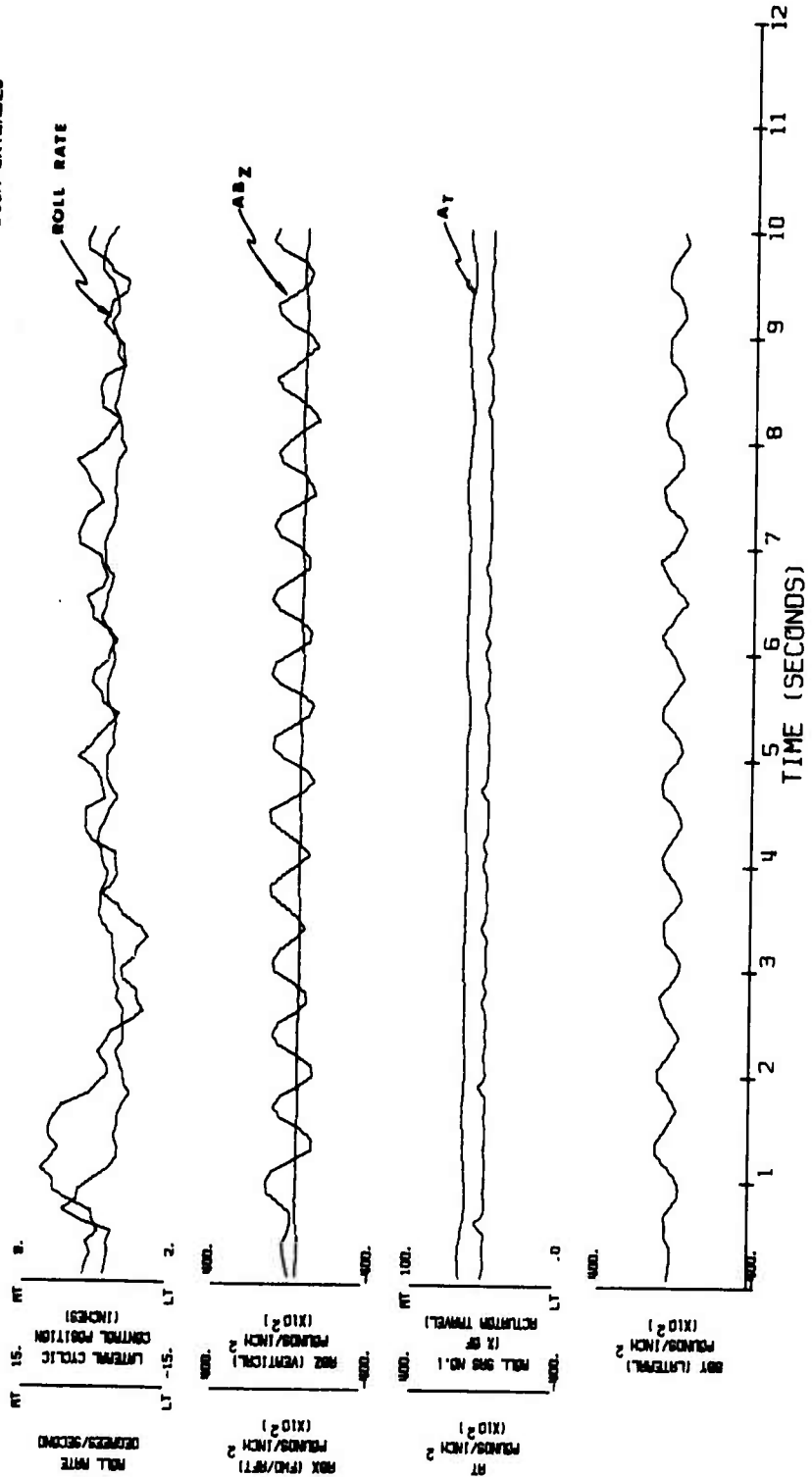

FIGURE 10 ENVELOPE EXPANSION IN LEVEL FLIGHT

CH-47C USA S/N 15814

CONFIGURATION	AVG C.G.	AVG G.W.	QAT	DENSITY	WEIGHT/	ROTOR	TRIM	THRUST	SAS
SH. BM. WEIGHTED STATION (INCHES)	(POUNDS)	(POUNDS)	(°C)	ALTITUDE DENSITY RATIO (FEET)	(POUNDS)	SPEED (RPM)	AIR SPEED (KTAS)	COEFFICIENT (CTX10 <sup>-4</sup> )	OFF
328.2	40900.	15.0	2650.	44300.	235.0	.0	55.9		

LEFT LATERAL (HOVER)  
ROLL SAS MODIFIED  
BOOM EXTENDED



# FIGURE 11 ENVELOPE EXPANSION IN LEVEL FLIGHT

CH-47C USA S/N 15814

CONFIGURATION	AVG C.G. STATION (INCHES)	AVG G.W. (POUNDS)	OAT (°C)	DENSITY (POUNDS)	WEIGHT/ALTI (POUNDS)	RATIO (RPM)	ROTOR SPEED (KIAS)	TRIM AIRSPEED (KIAS)	THRUST COEFFICIENT (CTX10 <sup>-4</sup> )	SAS
LONG BOOM	327.7	39700.	20.0	6710.	48500.	245.0	113.0	60.9		ON

LEFT LATERAL (FWD FLT)  
ROLL SAS MODIFIED  
BOOM EXTENDED

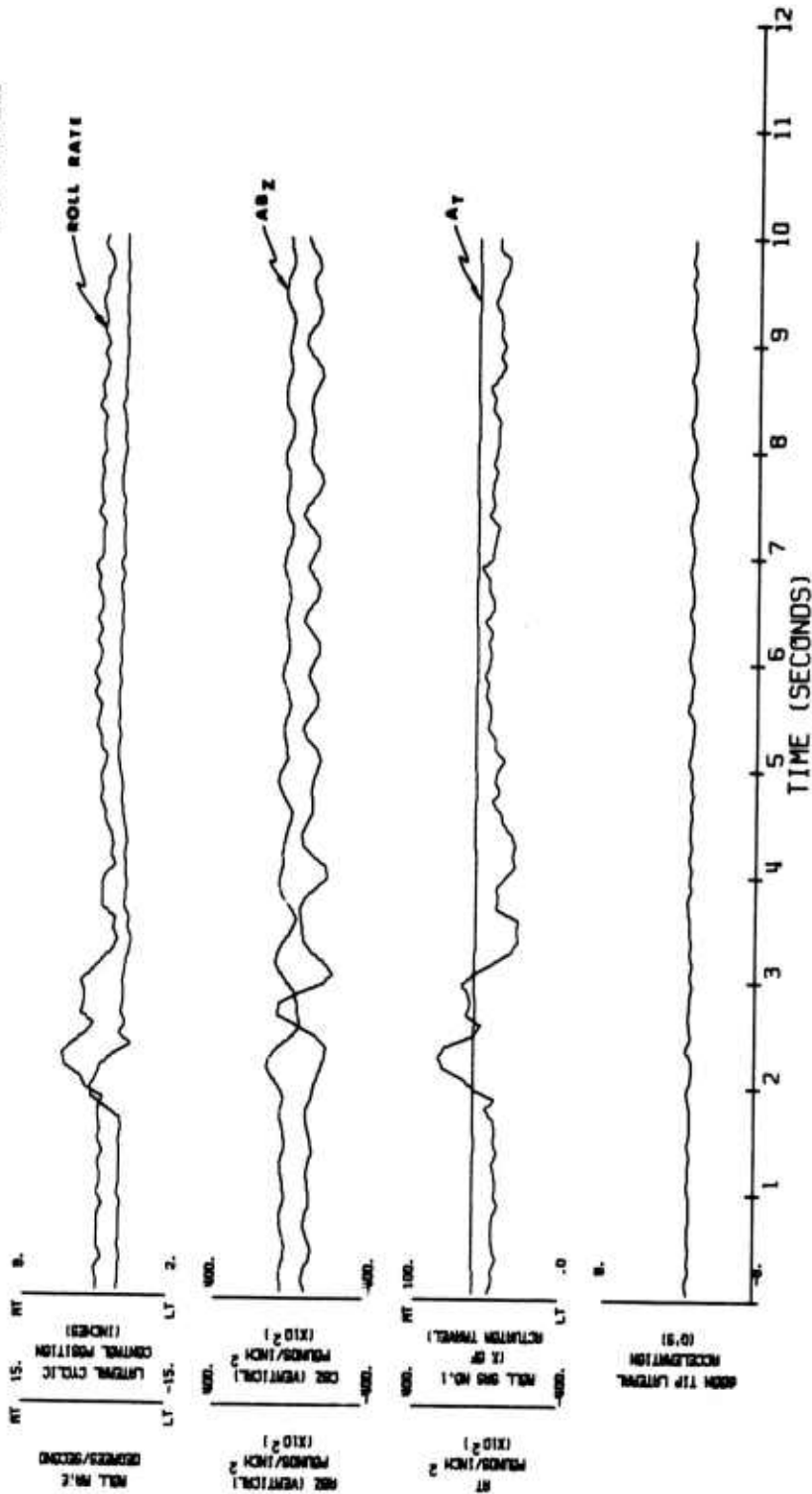

# FIGURE 12 ENVELOPE EXPANSION IN LEVEL FLIGHT

CH-47C USA S/N 15814

CONFIGURATION	AVG C.G. STATION (INCHES)	AVG G.M. (POUNDS)	ORT (°C)	DENSITY (POUNDS)	WEIGHT/ALTITUDE RATIO (PPM)	ROTOR SPEED (RPM)	TRIM AIRSPEED (KTAS)	THRUST COEFFICIENT (CTX10 <sup>-3</sup> )	SAS
LONG BOOM	327.7	38000.	20.0	6710.	46500.	245.0	113.0	58.5	OFF

LEFT LATERAL (FWD FLT)  
ROLL SAS MODIFIED  
BOOM EXTENDED

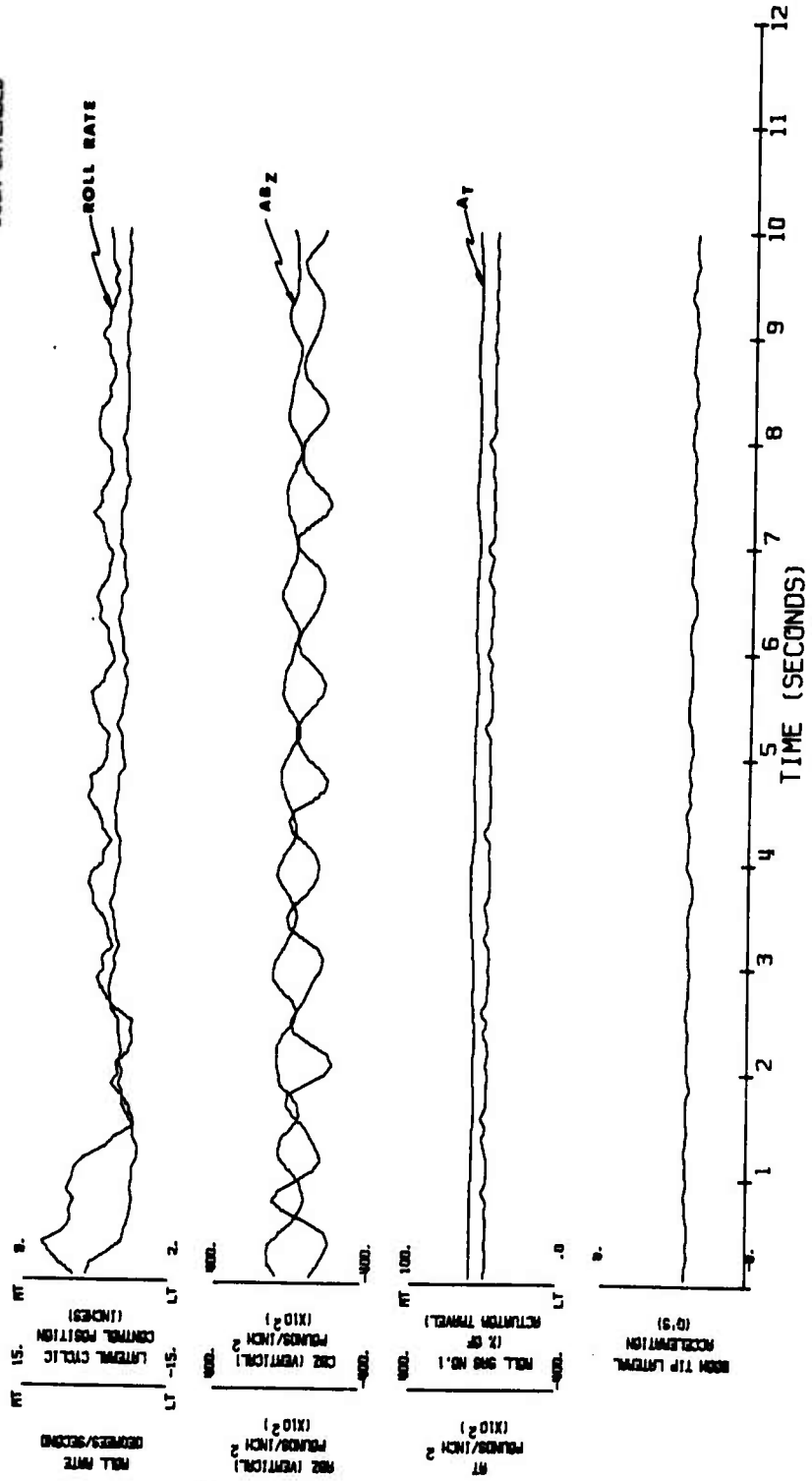
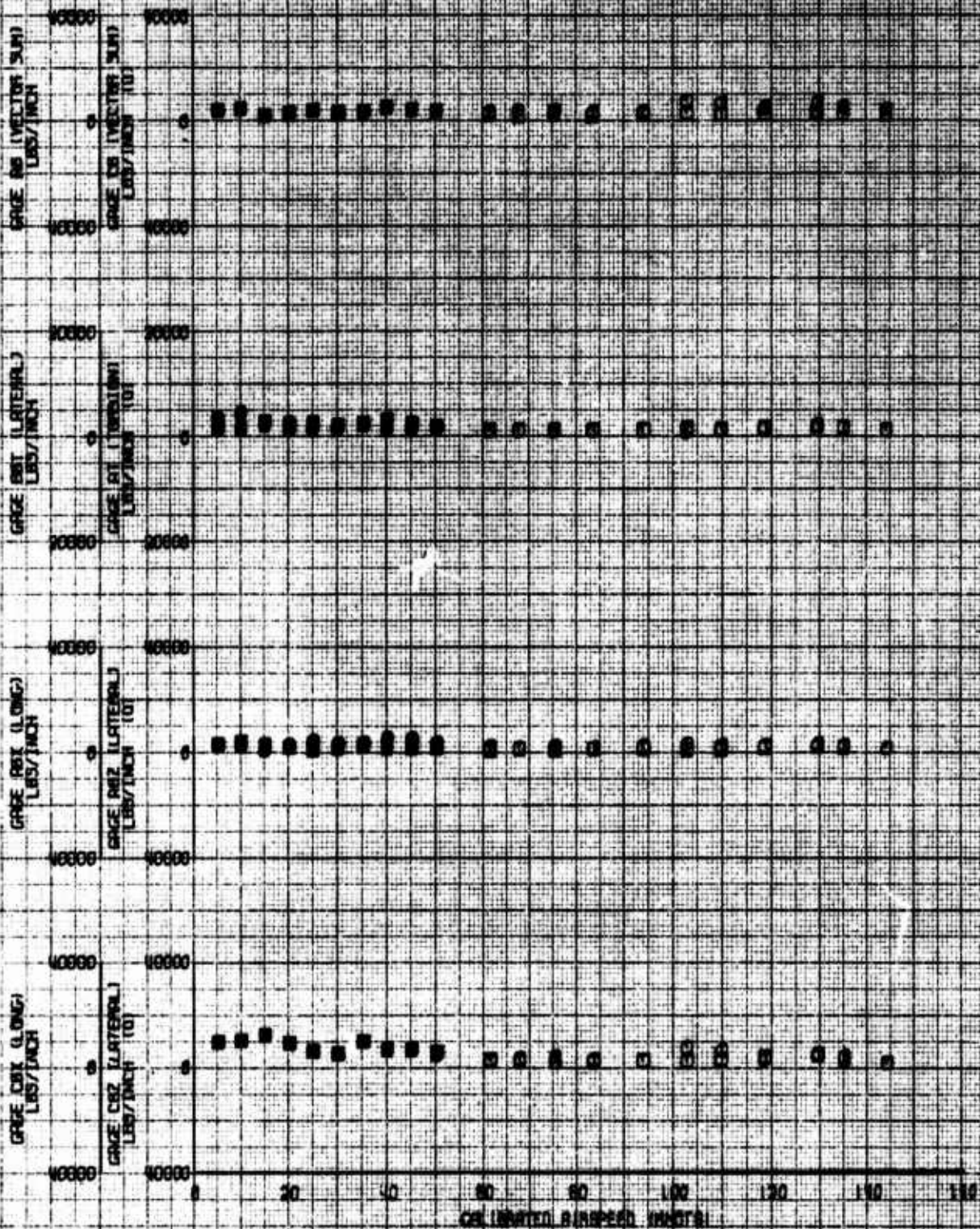

FIGURE 3. LONG-TERM TESTS ON THE RIGHT  
 GAGE MATERIAL

778 779 780 781 782 783 784 785 786 787 788 789 790 791 792 793 794 795 796 797 798 799 800 801 802 803 804 805 806 807 808 809 810 811 812 813 814 815 816 817 818 819 820 821 822 823 824 825 826 827 828 829 830 831 832 833 834 835 836 837 838 839 840 841 842 843 844 845 846 847 848 849 850 851 852 853 854 855 856 857 858 859 860 861 862 863 864 865 866 867 868 869 870 871 872 873 874 875 876 877 878 879 880 881 882 883 884 885 886 887 888 889 890 891 892 893 894 895 896 897 898 899 900 901 902 903 904 905 906 907 908 909 910 911 912 913 914 915 916 917 918 919 920 921 922 923 924 925 926 927 928 929 930 931 932 933 934 935 936 937 938 939 940 941 942 943 944 945 946 947 948 949 950 951 952 953 954 955 956 957 958 959 960 961 962 963 964 965 966 967 968 969 970 971 972 973 974 975 976 977 978 979 980 981 982 983 984 985 986 987 988 989 990 991 992 993 994 995 996 997 998 999 1000

100000





# FIGURE 30. - GRADE AND INJECTION DATA FOR WELLS 1, 2, 3, 4, 5, 6, 7, 8, 9, 10, 11, 12, 13, 14, 15, 16, 17, 18, 19, 20, 21, 22, 23, 24, 25, 26, 27, 28, 29, 30, 31, 32, 33, 34, 35, 36, 37, 38, 39, 40, 41, 42, 43, 44, 45, 46, 47, 48, 49, 50, 51, 52, 53, 54, 55, 56, 57, 58, 59, 60, 61, 62, 63, 64, 65, 66, 67, 68, 69, 70, 71, 72, 73, 74, 75, 76, 77, 78, 79, 80, 81, 82, 83, 84, 85, 86, 87, 88, 89, 90, 91, 92, 93, 94, 95, 96, 97, 98, 99, 100.

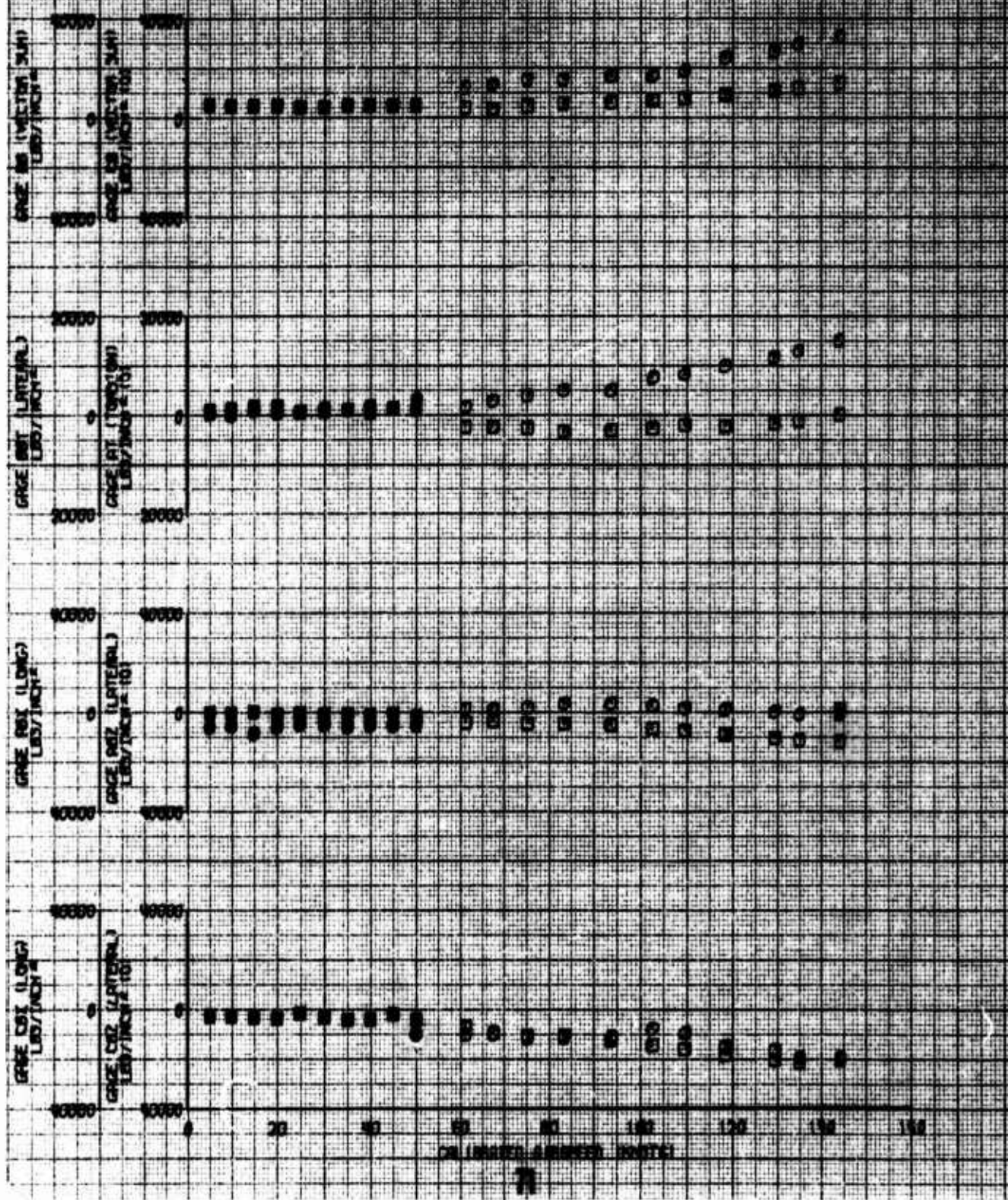





# GRAPE VIBRATION TESTS

DATE: \_\_\_\_\_

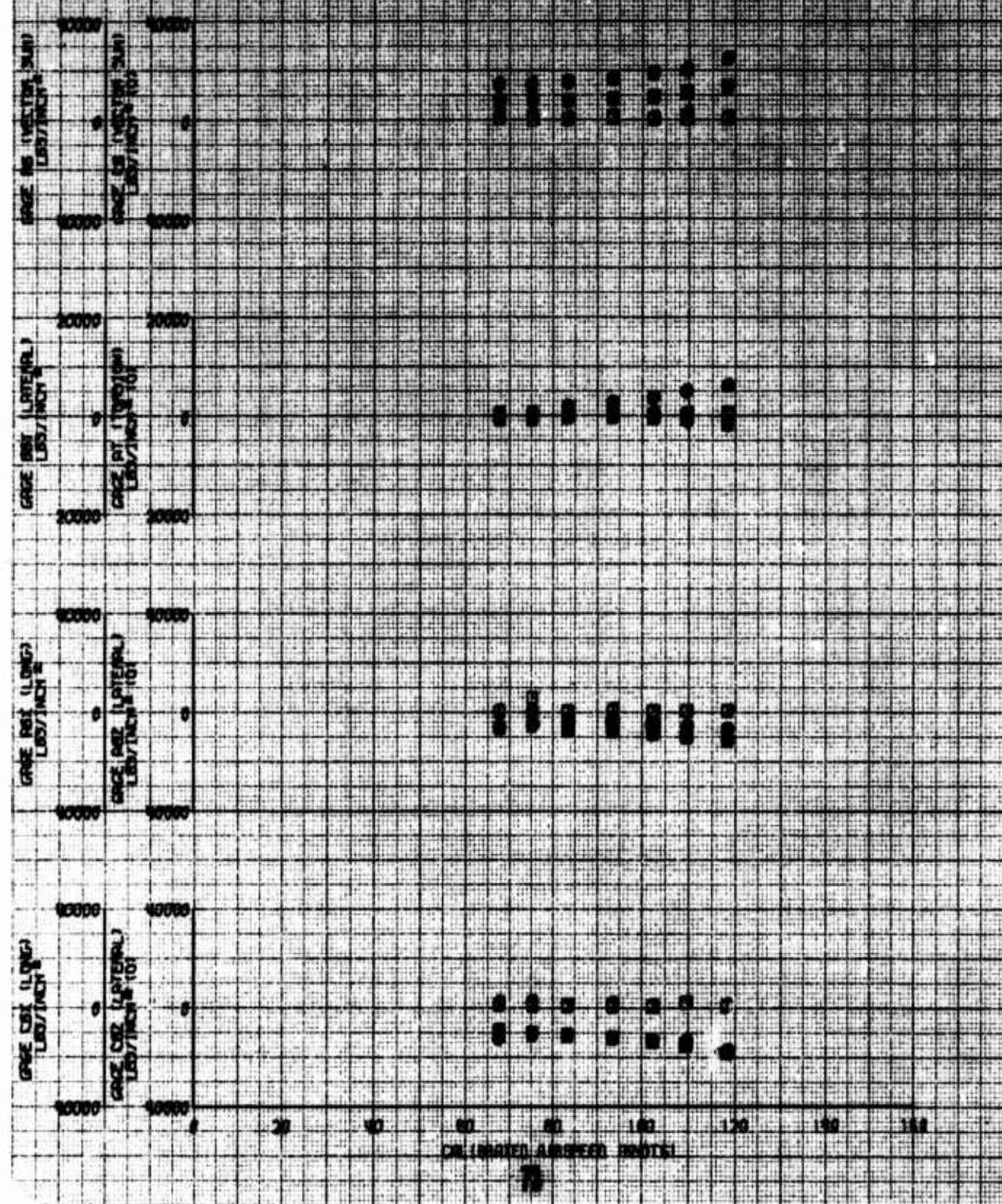

CALCULATED AIRSPEED (KNOTS)

STRENGTH OF CONCRETE UNDER COMPRESSION

TESTS MADE AT THE UNIVERSITY OF CALIFORNIA

REPORT NO. UCRL-10317

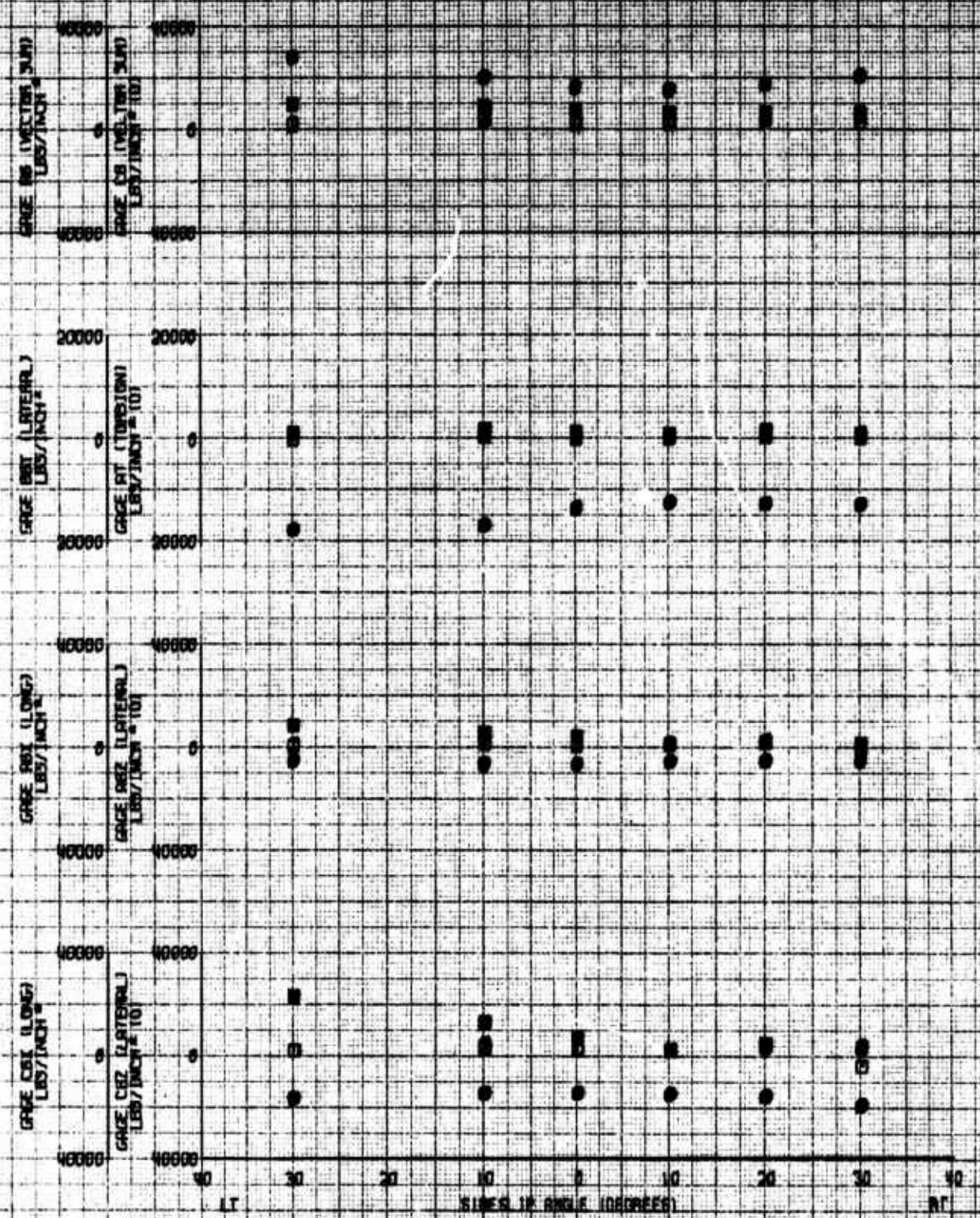



FIGURE 4. TWT 5000 SHEET LOADS IN LEVEL FLIGHT  
 CASE 2 (A)

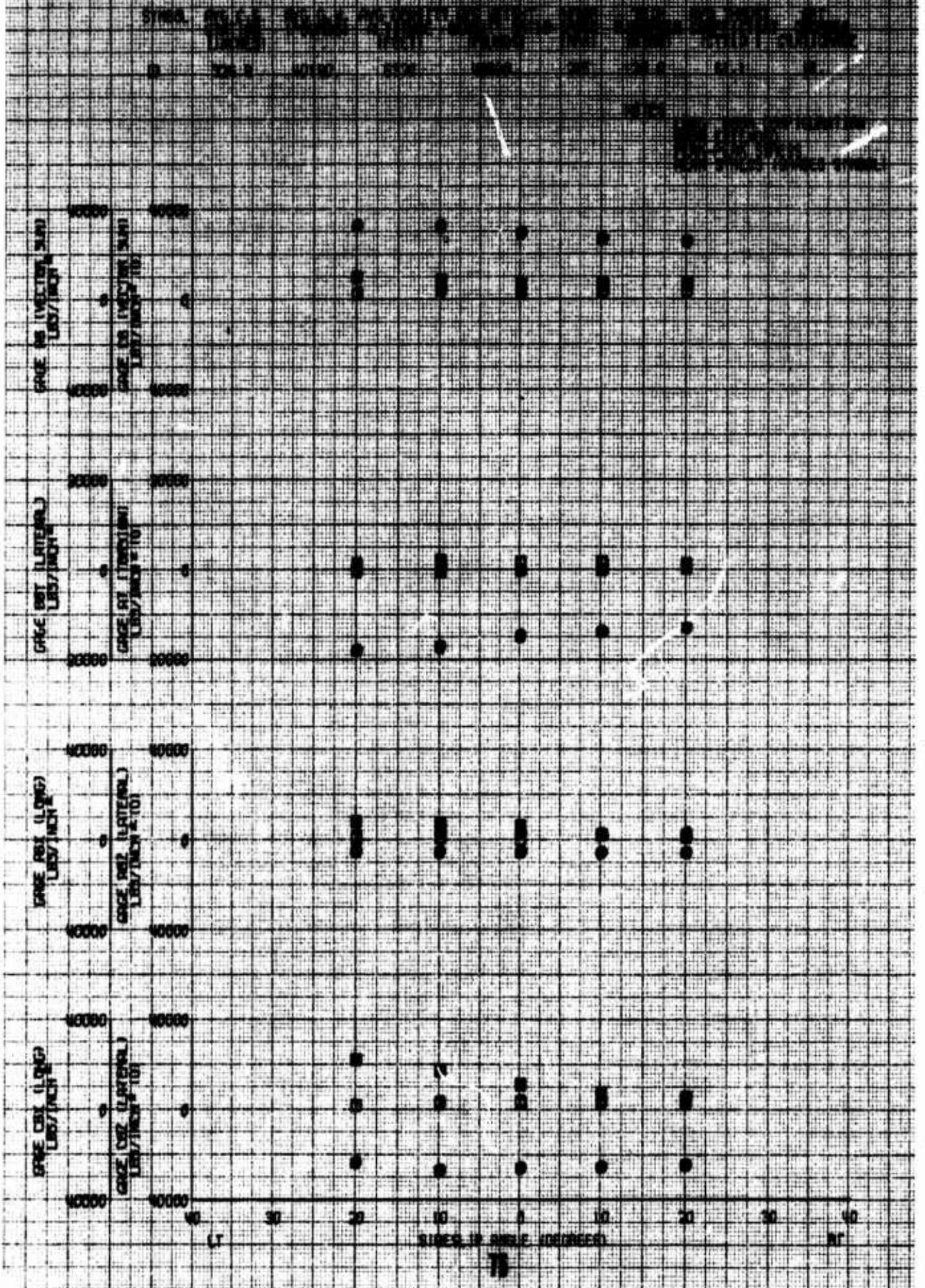

FIGURE 79. EFFECT OF GRADE ON THE RATE OF GRADE EROSION

STATION NO. 1000 1050 1100 1150 1200  
 DATE 10/10/50 10/10/50 10/10/50 10/10/50 10/10/50

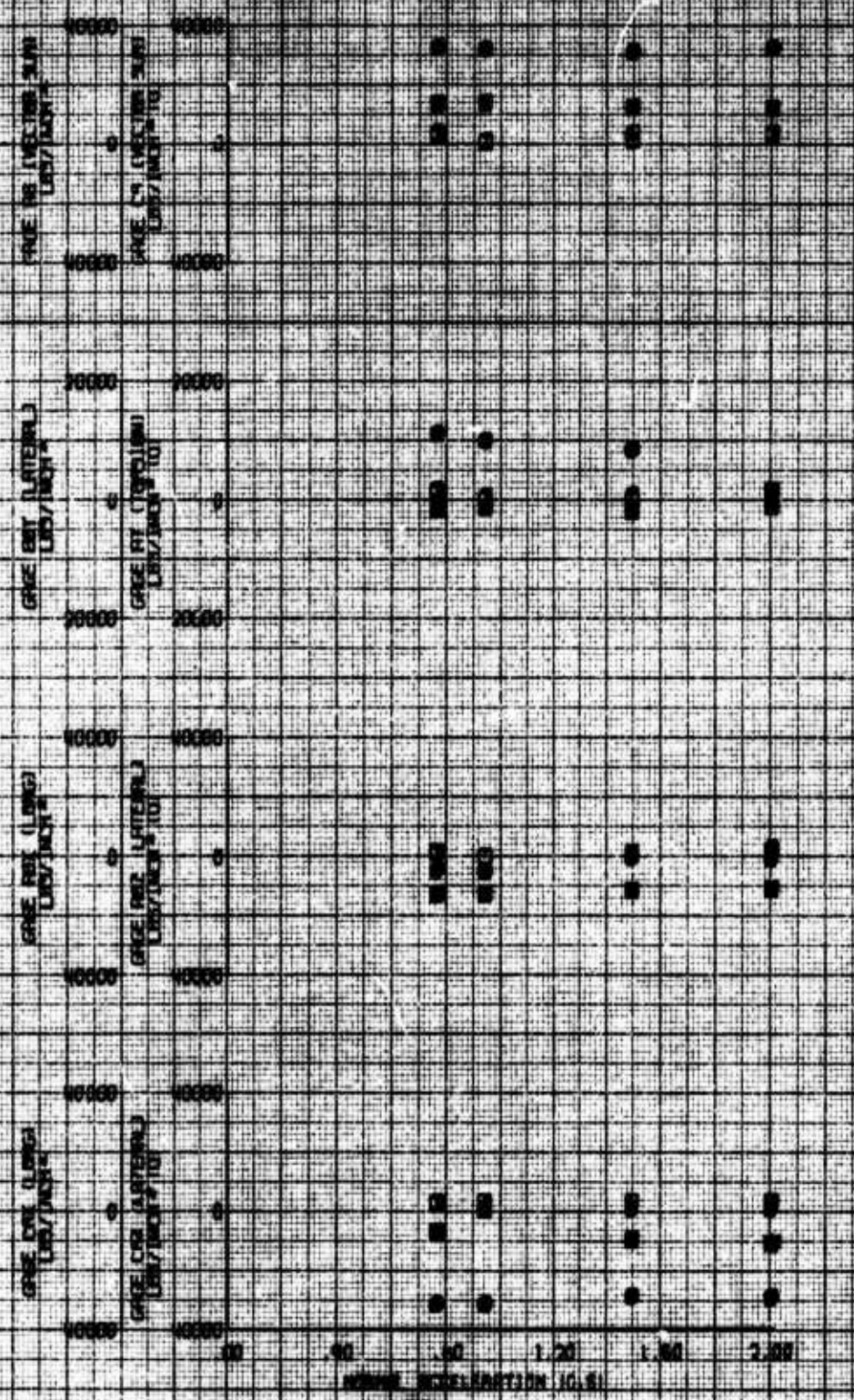
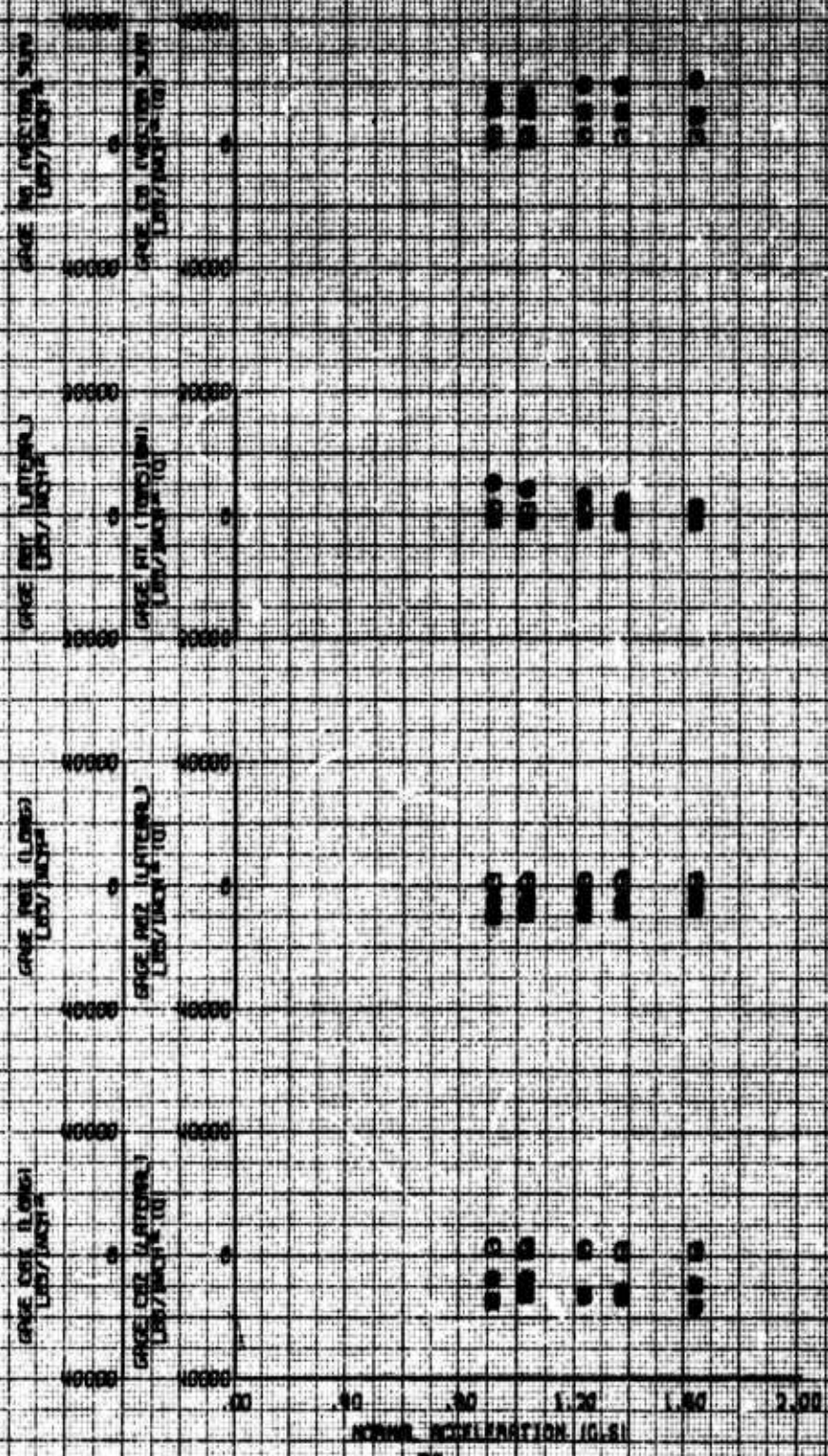





FIGURE 12. ICING RISK DISEMPOWERED IN LEVEL FLIGHT

SINCE THE F-16 IS A SINGLE ENGINE AIRCRAFT, THE RISK OF LOSS OF CONTROL DURING A LEVEL FLIGHT IS HIGH. THE RISK OF LOSS OF CONTROL DURING A LEVEL FLIGHT IS HIGH. THE RISK OF LOSS OF CONTROL DURING A LEVEL FLIGHT IS HIGH.



NORMAL ACCELERATION (G)



FIGURE 22.7 ICING SPRAY SYSTEM LOADS IN LEVEL FLIGHT  
 ON A TC 540 (1800)

SYMBOL	NO. OF GALLONS PER HOUR	NO. OF GALLONS PER HOUR	NO. OF GALLONS PER HOUR	NO. OF GALLONS PER HOUR	NO. OF GALLONS PER HOUR	NO. OF GALLONS PER HOUR	NO. OF GALLONS PER HOUR
●	229.7	344.0	458.3	572.6	686.9	801.2	915.5

NOTE:  
 1. ALL LOADS ARE IN POUNDS PER SQUARE FOOT.  
 2. ALL LOADS ARE BASED ON A 1000 SQ. FT. AREA.

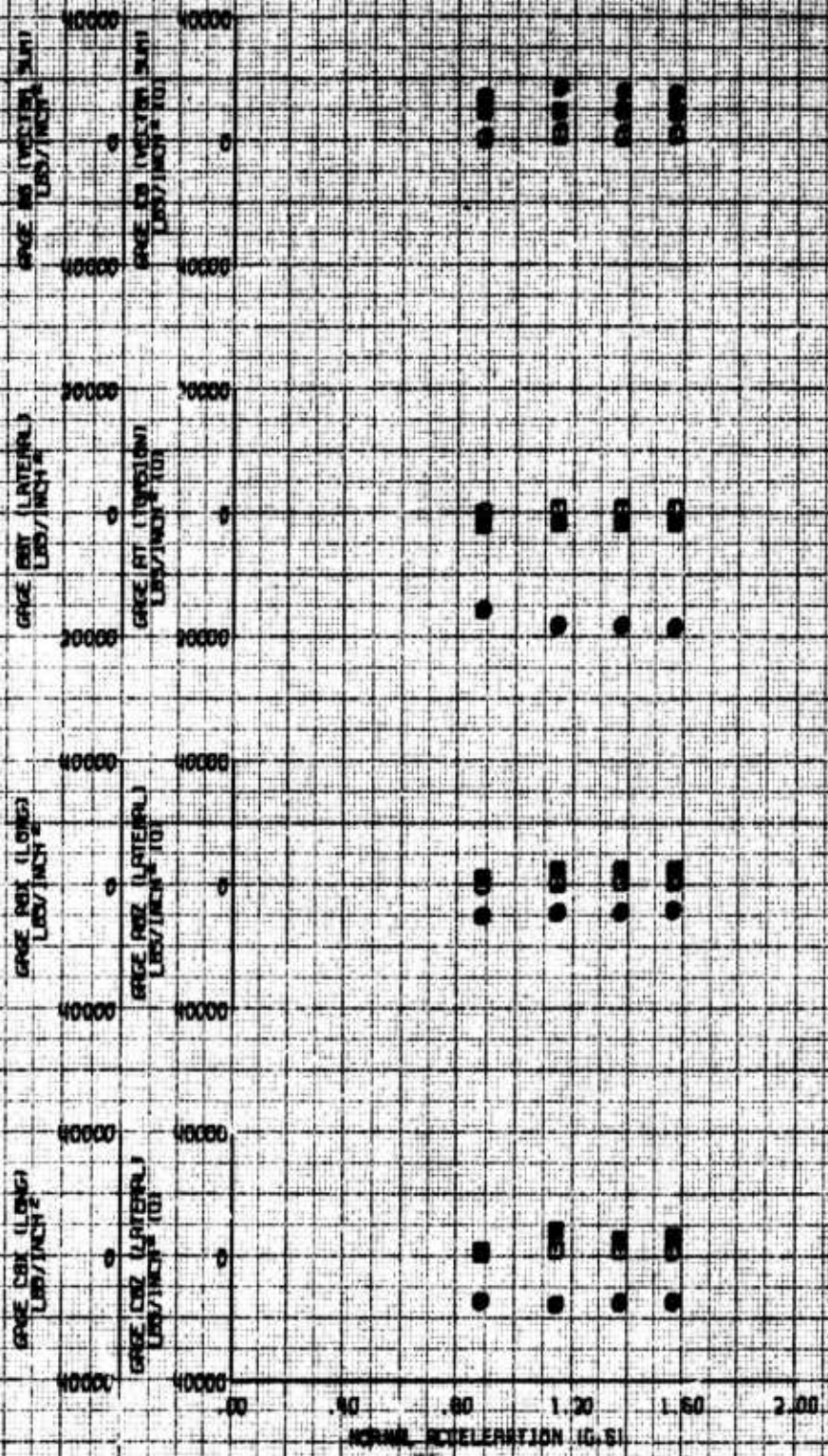
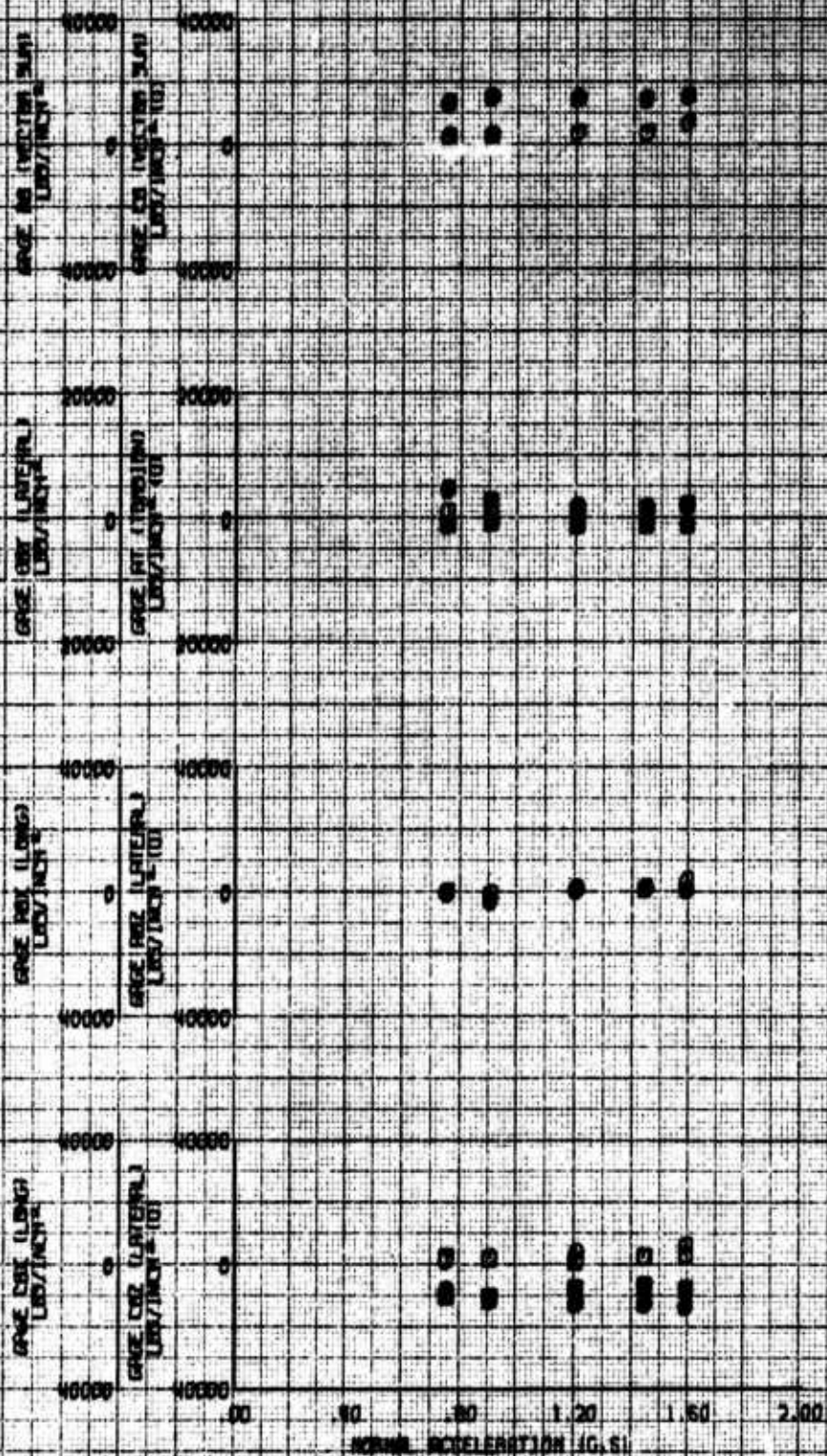

FIGURE 2.5 ICING DATA FROM TESTS IN LEVEL FLIGHT  
ON 17C 5/8 5013

STRAKE 100 FT 200 FT 300 FT 400 FT 500 FT 600 FT 700 FT 800 FT  
 1000 FT 1100 FT 1200 FT 1300 FT 1400 FT 1500 FT 1600 FT 1700 FT  
 1800 FT 1900 FT 2000 FT 2100 FT 2200 FT 2300 FT 2400 FT 2500 FT  
 2600 FT 2700 FT 2800 FT 2900 FT 3000 FT 3100 FT 3200 FT 3300 FT  
 3400 FT 3500 FT 3600 FT 3700 FT 3800 FT 3900 FT 4000 FT 4100 FT  
 4200 FT 4300 FT 4400 FT 4500 FT 4600 FT 4700 FT 4800 FT 4900 FT  
 5000 FT 5100 FT 5200 FT 5300 FT 5400 FT 5500 FT 5600 FT 5700 FT  
 5800 FT 5900 FT 6000 FT 6100 FT 6200 FT 6300 FT 6400 FT 6500 FT  
 6600 FT 6700 FT 6800 FT 6900 FT 7000 FT 7100 FT 7200 FT 7300 FT  
 7400 FT 7500 FT 7600 FT 7700 FT 7800 FT 7900 FT 8000 FT 8100 FT  
 8200 FT 8300 FT 8400 FT 8500 FT 8600 FT 8700 FT 8800 FT 8900 FT  
 9000 FT 9100 FT 9200 FT 9300 FT 9400 FT 9500 FT 9600 FT 9700 FT  
 9800 FT 9900 FT 10000 FT



NORMAL ACCELERATION (G.S.)



FIGURE 24 ICING SPRAY SYSTEM LOADS IN LEVEL FLIGHT  
C4-A7C S/N 15814

STABIL	AVG I.C. D. INCHES	AVG D.W. INCHES	AVG DENSITY LB/FT <sup>3</sup>	AVG VELOCITY FT/SEC	AVG WEIGHT POUNDS	WIND MPH	TEMP °F	REL. HUMIDITY %	WIND DIRECTION CENTIGRADES
0-0	323.8	404.87	2888	50240	265	25	75.8	78.2	7

NOTES:  
 1. DATA FROM INSTRUMENTATION  
 2. DATA FROM STRESS GAUGES  
 3. DATA FROM STRESS (SAMPLED STROBES)

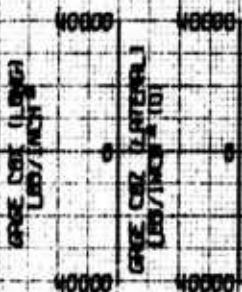
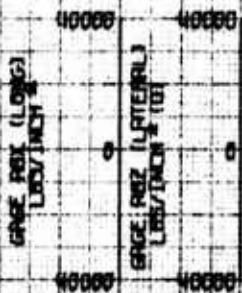
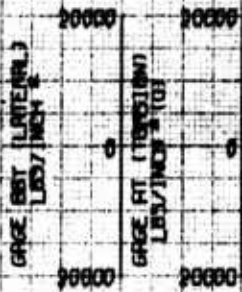
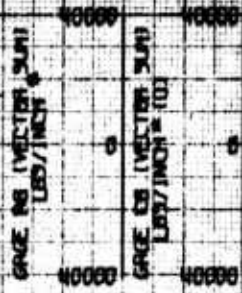

NORMAL ACCELERATION (G, SI)

## **APPENDIX G. EQUIPMENT PERFORMANCE REPORTS**



EQUIPMENT PERFORMANCE REPORT (AVSCOM Reg 70-2)		DATE 6 June 1973	
		OFFICE SYMBOL SAVTE-TA	
TO: COMMANDING GENERAL US ARMY AVIATION SYSTEMS COMMAND ATTN: AMSAV-EF PO BOX 209 ST. LOUIS, MISSOURI 63166		FROM: Commander US Army Aviation Systems Test Activity ATTN: SAVTE TA Edwards Air Force Base, CA 93523	
1. EPR NUMBER 72-35-01	2. PROJECT NUMBER Project 72-35	3. TEST TITLE Helicopter Icing Spray System Qualification	
SECTION A - MAJOR ITEM DATA			
4. MODEL CH-47C	5. SERIAL NO 15914		
6. QUANTITY 1	7. MANUFACTURER Boeing		
SECTION B - PART DATA			
8. NOMENCLATURE/DESCRIPTION N/A	9. P/N N/A		
10. MFR PART NO N/A	11. MANUFACTURER N/A		
12. QUANTITY N/A	13. NEXT ASSEMBLY N/A		
SECTION C - INCIDENT DATA			
14. OBSERVED DURING	15. TEST ENVIRONMENT	16. INCIDENT CLASS	17. ACTION TAKEN
<input checked="" type="checkbox"/> a. OPERATION	hp = 5000 fwt OAT = 18 deg C	<input checked="" type="checkbox"/> a. DEFICIENCY	<input type="checkbox"/> REPAIRED
<input checked="" type="checkbox"/> b. MAINTENANCE		<input type="checkbox"/> b. SHORTCOMING	<input checked="" type="checkbox"/> REPAIRED
<input type="checkbox"/> c.		<input type="checkbox"/> c. SUGGESTED IMPROVEMENT	<input type="checkbox"/> ADJUSTED
<input type="checkbox"/>		<input type="checkbox"/> d. OTHER	<input type="checkbox"/> DISCONNECTED
			<input type="checkbox"/> REMOVED
			<input type="checkbox"/> NONE
18. DATE AND HOUR OF INCIDENT			
SECTION D - INCIDENT DESCRIPTION			
19. DESCRIBE INCIDENT FULLY (Deficiencies and Shortcomings are subject to reclassification)			
<p>During flight 19 flown on 31 May 1973, a flexible silicon air supply hose disconnected at the joint directly above the trunnion support located on the right side of the aircraft (facing forward). The hose and clamp thrashed around the cargo compartment resulting in a 1/8 inch diameter puncture in the fuselage skin before the bleed air could be turned off.</p>			
20. DEFECTIVE MATERIAL SENT TO		SIGNATURE	
NAME, TITLE, TITLE OF PREPARER JAMES S. HAYDEN PROJECT OFFICER			

SAV Form  
20 Dec 71 1002

Edition of 7 Apr 70, may be used.

EQUIPMENT PERFORMANCE REPORT (AVSCOM Form 70-12)		DATE 6 June 1973	
		OFFICE SYMBOL SAVTE-TA	
TO: COMMANDING GENERAL US ARMY AVIATION SYSTEMS COMMAND ATTN: AMSAV-EP PO BOX 209 ST. LOUIS, MISSOURI 63166		FROM: Commander US Army Aviation Systems Test Activity ATTN: SAVTE-TA Edwards Air Force Base, CA 93523	
1. EPR NUMBER 72-35-02	2. PROJECT NUMBER Project 72-35	3. TEST TITLE Helicopter Tank Spray System Qualification	
SECTION A - MAJOR ITEM DATA			
4. MODEL CH-47C	6. SERIAL NO 15814	7. MANUFACTURER	
SECTION B - PART DATA			
8. NOMENCLATURE/DESCRIPTION Tank Assembly	9. P/N SPEC 00-A-3-7		
10. MFR PART NO 5-41166-3	11. MANUFACTURER Benson		
12. QUANTITY ONE (1)	13. NEXT ASSEMBLY		
SECTION C - INCIDENT DATA			
14. OBSERVED DURING	15. TEST ENVIRONMENT	16. INCIDENT CLASS	17. ACTION TAKEN
a. OPERATION	System maintenance	b. DEFICIENCY	REPLACED
<input checked="" type="checkbox"/> c. MAINTENANCE		<input checked="" type="checkbox"/> d. SHORTCOMING	REPAIRED
e.		e. SUGGESTED IMPROVEMENT	ADJUSTED
		f. OTHER	DISCONNECTED
			REMOVED
			<input checked="" type="checkbox"/> g. <del>xxxx</del> Monitoring
18. DATE AND HOUR OF INCIDENT 5 June 1973, 1030 hours			
SECTION D - INCIDENT DESCRIPTION			
19. DESCRIBE INCIDENT FULLY (Deficiencies and Shortcomings are subject to reclassification)			
During system maintenance, the inner surface of the water tank was discovered to be corroded.			
20. DEFECTIVE MATERIAL SENT TO: NAME, TITLE, ADDRESS OF PREPARER L/AVM K. BREWEL, CPT Flight Test Division B		SIGNATURE	

SAV Form  
70 Oct 71 1002

Edition of 7 Apr 70, may be used.

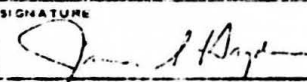
EQUIPMENT PERFORMANCE REPORT (AVSCOM Form 70-12)		DATE 6 JUNE 1973	
		OFFICE SYMBOL SAVTE-TA	
TO: COMMANDING GENERAL US ARMY AVIATION SYSTEMS COMMAND ATTN: ANSAV-EF PO BOX 209 ST. LOUIS, MISSOURI 63166		FROM: Commander US Army Aviation Systems Test Activity ATTN: SAVTE-TA Edwards Air Force Base, CA 93523	
1. EPR NUMBER 72-35-03	2. PROJECT NUMBER Project 72-35	3. TEST TITLE Helicopter Icing Spray System Qualification	
SECTION A - MAJOR ITEM DATA			
4. MODEL UH-1M	6. SERIAL NO 105	7. MANUFACTURER Bell	
5. QUANTITY 1	SECTION B - PART DATA		
8. NOMENCLATURE/DESCRIPTION N/A	9. FSM N/A		
10. MFR PART NO N/A	11. MANUFACTURER N/A		
12. QUANTITY N/A	13. NEXT ASSEMBLY N/A		
SECTION C - INCIDENT DATA			
14. OBSERVED DURING	15. TEST ENVIRONMENT	16. INCIDENT CLASS	17. ACTION TAKEN
a. OPERATION	Hp 5000 ft OAT 13 deg C Airspeeds 80 KTAS 60 KTAS	b. DEFICIENCY	REPLACED
b. MAINTENANCE		c. SHORTCOMING	REPAIRED
c.		d. SUGGESTED IMPROVEMENT	ADJUSTED
		e. OTHER	DISCONNECTED
			REMOVED
			X NONE
18. DATE AND HOUR OF INCIDENT 2 June 1973 1000 hours			
SECTION D - INCIDENT DESCRIPTION			
19. DESCRIBE INCIDENT FULLY (Deficiencies and Shortcomings are subject to reclassification)			
<p>On 2 June 1973 a UH-1M helicopter was flown behind a CH-47C to investigate wake turbulence. The CH-47 was equipped with a spray boom located 15' below the bottom of the helicopter and was spraying water during the tests. Extensive vertical turbulence was noted just below and in the spray cloud. Essentially no rolling tendencies were noted during the flight in the wake. The downwash while flying from 700' to 300' behind the CH-47 was of such strength that at 80 KTAS the UH-1M did not have sufficient power to penetrate the spray cloud from below. At 60 KTAS slightly more power was available however complete penetration of the spray cloud was not possible. Entry into the cloud was also attempted from the top however there was not sufficient power to stay in the cloud and the downwash ejected the UH-1M out through the bottom of the cloud before descent could be arrested.</p>			
20. DEFECTIVE MATERIAL SEE 11.19			
NAME, TITLE, TEL EXT OF PREPARER JAMES S. HAYDEN PROJECT OFFICER		SIGNATURE 	

SAV Form  
20 Oct 71 1002

Edition of 7 Apr 70, may be used.