

AD-773 351

PROJECT TEKTITE I: A MULTIAGENCY 60-DAY SATURATED DIVE CONDUCTED BY THE UNITED STATES NAVY, THE NATIONAL AERONAUTICS AND SPACE ADMINISTRATION, THE DEPARTMENT OF THE INTERIOR, AND THE GENERAL ELECTRIC COMPANY

D. C. Pauli, et al

Office of Naval Research  
Arlington, Virginia

16 January 1970

DISTRIBUTED BY:

**NTIS**

National Technical Information Service  
U. S. DEPARTMENT OF COMMERCE  
5285 Port Royal Road, Springfield Va. 22151

Best Available Copy

AD 773 351

Security Classification		
DOCUMENT CONTROL DATA - R & D		
<i>Security classification of title, body of abstract and indexing annotation must be entered when the overall report is classified</i>		
1. ORIGINATING ACTIVITY (Corporate author)		2a. REPORT SECURITY CLASSIFICATION
Office of Naval Research Washington, D.C. 20360		Unclassified
		2b. GROUP
3. REPORT TITLE		
PROJECT TEKTITE I: A Multiagency 60-Day Saturated Dive Conducted by the United States Navy, the National Aeronautics and Space Administration, the Department of the Interior, and the General Electric Company		
4. DESCRIPTIVE NOTES (Type of report and Inclusive Dates)		
Final report		
5. AUTHOR(S) (First name, middle initial, last name)		
Edited by D. C. Pauli and H. A. Cole		
6. REPORT DATE	7a. TOTAL NO. OF PAGES	7b. NO. OF REFS
January 16, 1970	413	79
8a. CONTRACT OR GRANT NO	9a. ORIGINATOR'S REPORT NUMBER(S)	
N00014-68C-0356	ONR Report DR 153	
b. PROJECT NO		
c.	9b. OTHER REPORT NO(S) (Any other numbers that may be assigned this report)	
d.		
10. DISTRIBUTION STATEMENT		
This document has been approved for public release and sale; its distribution is unlimited.		
11. SUPPLEMENTARY NOTES		12. SPONSORING MILITARY ACTIVITY
		Department of the Navy Office of Naval Research Washington, D.C. 20360
13. ABSTRACT		
<p>Project Tektite I, under the overall cognizance and management of the Chief of Naval Research, involved the Departments of the Navy and Interior, the National Aeronautics and Space Administration, the General Electric Company, and other government, industry, and academic organizations. An ocean floor habitat at a 49-foot depth and the supporting facilities were established and evaluated for 60 days at a carefully selected, isolated site in the Virgin Islands from February 15 to April 15, 1969. Four marine scientists lived in and worked out of the habitat for the 60-day period, during which their research emphasized marine biology and geology. This was twice as long as men had previously lived under saturated diving conditions and the only such experiment to use a controlled nitrogen/oxygen atmosphere with a normal 0.2-atmosphere oxygen partial pressure. Through continual television and auditory monitoring, medical doctors, psychologists, and diving engineers studied the aquanauts' biomedical responses to the 60-day saturation dive and their behavioral and other psychological responses to each other, to their work, and to their isolated, hostile environment.</p> <p>The Tektite I experiment was completed with a perfect safety record within minutes of the time scheduled many months previously. The successful operation demonstrated that men can live together and perform safely and effectively on the ocean floor for extended periods and provided specific psychological, physiological, and marine scientific results which can be applied to future space and undersea missions.</p>		
Reproduced by <b>NATIONAL TECHNICAL                      INFORMATION SERVICE</b> U. S. Department of Commerce Springfield VA 22151		

ia

KEY WORDS	LINK A		LINK B		LINK C	
	ROLE	WT	ROLE	WT	ROLE	WT
Project management						
Public relations						
Habitability						
Underwater environments						
Humidity control						
Divers						
Confinement (psychology)						
Behavior						
Electroencepalography						
Group dynamics						
Interpersonal relations						
Isolation						
Psychomotor tests						
Animal ecology						
Aquatic animals						
Aquatic biology						
Geology						
Crustacea						
Lobsters						
Aerobiology						
Mycology						
Hematology						
Blood chemical analysis						
Decompression sickness						
Otitis						
Hypobaric medicine						
Hypobaric oxygenation						
Sleep						
Disease vectors						
Breathing apparatus						
Life support systems						
Oxygen supply equipment						
Undersea habitat atmospheres						
Underwater life support systems						
Staphylococcus						
Proteus						
Coliform bacteria						
Aeromonas						
Achromobacter						
Pseudomonas						
Aerobater aerogenes						
Corynebacterium						
Acinetobacter						
Streptococcus						
Sarcina						
Bacillus						
Candida						
Marine biology						
Recording instruments						
Data processing						
Punched cards						
Card punches (data processing)						
Data tapes						
Data storage						
Electric power distribution						
Humidity control						
Amphibious operations						
Potable water						
Water supply						
Cranes (hoists)						
Pile drivers						
Anchoring						
Dock landing ships						
Barges						
Diving						
Marine engineering						
Transports (ships)						
Hoses						
Sump pumps						
Observation cupolas						
Docks						
Hulls (structures)						
Cylindrical						
Offshore structures						
Pile caps						
Pile driving						
Pile extraction						
Pile foundations						
Prefabrication						
Underwater construction						
Underwater foundations						
Data acquisition						
Environmental tests						
Gas sampling						
Mass spectrometers						
Partial pressures control						
Pressure vessels						
Space environment simulation						
Communicating						
Food supply						
Logistics						
Supplying						
Local purchasing						
Marine transportation						
Naval procurement						
Underwater telephones						
Underwater television						
Television cameras						
Television display systems						
Radio communication						

16

## FOREWORD

Tektite I was this country's first multiagency program to exploit man's ability not only to live on the bottom of the sea but to perform meaningful scientific work. Previous man-in-the-sea programs have concentrated on the advancement of under-sea technology, whereas the mission of Tektite emphasized existing technology as a means for obtaining scientific results.

The national interest in future use of the sea, and the significance of Tektite I of furthering this interest, is summarized in President Nixon's message to the aquanauts at the end of their historic mission:

"Your record breaking venture into inner space is another milestone in human achievements. The aquanauts join the astronauts as space pioneers. Congratulations!"

The success of Tektite I constitutes a major step in using man in the sea for the scientific exploration of the nation's continental shelf. The Navy, as the Tektite I lead agency and cosponsor with the National Aeronautics and Space Administration the Department of the Interior, and the General Electric Company, is pleased to present this Tektite I final report.

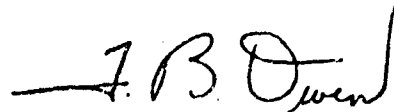

Chief of Naval Research



## CONTENTS

Abstract	ix
Chapter 1 - HISTORY AND OBJECTIVES	1
INTRODUCTION	1
HISTORY	2
AGENCY INTERESTS	3
Navy Interests	3
NASA Interests	4
Department of the Interior Interests	4
INTERAGENCY COOPERATION	4
Chapter 2 - SYNOPSIS	8
MISSION	8
SITE	8
CREW	9
HABITAT	10
BASE CAMP	10
PROJECT ORGANIZATION	10
SAFETY	14
Chapter 3 - SCIENTIFIC AND ENGINEERING PROGRAMS	15
INTRODUCTION	15
MARINE SCIENCE PROGRAM	15
LIFE SCIENCES BEHAVIORAL PROGRAM	15
LIFE SCIENCES BIOMEDICAL PROGRAM	19
INTEGRATED OCEAN FLOOR PROGRAM	24
ENGINEERING PROGRAM	26
Habitat and Support Systems Assembly	27
Habitat Transportation	27
Engineering Evaluation	28
Chapter 4 - FACILITIES	30
INTRODUCTION	30
HABITAT	30
Air Supply, Pressure, and Atmospheric Control	37
Atmosphere Monitoring System	37
Thermal Control	37
Emergency Air Systems	37
Communication, Electrical, and Sanitary Systems	39
Alarm System	40

<b>SUPPORT BARGE</b>	<b>40</b>
Surface Control-Center Van	40
Environmental Control and Supply System	42
Electrical Generation and Distribution System	45
Water Storage and Distribution System	45
<b>CRANE BARGE</b>	<b>45</b>
<b>CAUSEWAY PIER</b>	<b>45</b>
<b>BASE CAMP</b>	<b>45</b>
<b>LOGISTICS, TRANSPORTATION, AND COMMUNICATIONS</b>	<b>48</b>
<b>REPAIRS</b>	<b>50</b>
<b>HABITAT AND AQUANAUT SUPPORT EQUIPMENT</b>	<b>50</b>
<b>Chapter 5 - CONCLUSIONS AND RECOMMENDATIONS</b>	<b>51</b>
<b>INTRODUCTION</b>	<b>51</b>
<b>CONCLUSIONS</b>	<b>51</b>
<b>RECOMMENDATIONS</b>	<b>52</b>
<b>Appendix A - SCIENTIFIC PROGRAMS</b>	<b>A1</b>
<b>A1 MARINE SCIENCE PROGRAM</b>	<b>A1</b>
<b>A1.1 Introduction</b>	<b>A1</b>
Richard Waller, Department of the Interior	
<b>A1.2 Spiny Lobster Study</b>	<b>A2</b>
John G. Van Derwalker, Department of the Interior	
<b>A1.3 Cleaner Shrimp Ecology</b>	<b>A7</b>
Conrad Mahnken, Department of the Interior	
<b>A1.4 Marine Geology</b>	<b>A8</b>
H. Edward Clifton, Department of the Interior	
<b>A2 PSYCHOLOGICAL SCIENCES PROGRAM</b>	<b>A11</b>
<b>A2.1 Overview of the Program</b>	<b>A11</b>
G. C. Tolhurst, Office of Naval Research	
<b>A2.2 Behavioral Program</b>	<b>A13</b>
Roland Radloff and Lt. Richard Mach, Naval Medical Research Institute, and Nicholas Zill, Bellcomm, Inc.	
<b>A2.3 Sleep Patterns</b>	<b>A47</b>
Paul Naitoh, Laverne Johnson, and Marion Austin, Naval Medical Neuropsychiatric Research Unit	
<b>A2.4 Automatic EEG Acquisition and Data-Analysis System</b>	<b>A54</b>
M. R. De Lucchi, National Aeronautics and Space Admin- istration, and J. D. Frost, Jr., and P. Kellaway, Baylor College of Medicine, and the Methodist Hospital	
<b>A2.5 Psychomotor Performance</b>	<b>A70</b>
Rayford Saucer, National Aeronautics and Space Admin- istration	
<b>A3 BIOMEDICAL SCIENCES</b>	<b>A76</b>
<b>A3.1 Introduction</b>	<b>A76</b>
C. J. Lambertsen, University of Pennsylvania, and S. Kronheim, Office of Naval Research	

### **A3 BIOMEDICAL SCIENCES (continued)**

- A3.2 General and Special Medical Examinations** A79  
C. J. Lambertsen, University of Pennsylvania, Cdr. T. N. Markham, Naval Submarine Center, T. W. Clark, W. K. H. Sundmaker, A. M. Klingman, R. R. Marples, M. Reivich, W. S. Masland, and C. W. Nichols, University of Pennsylvania
- A3.3 Hematology** A86  
C. L. Fischer and C. Leach Huntoon, National Aeronautics and Space Administration; P. C. Johnson, Baylor College of Medicine; and S. Ritzman and W. Levin, University of Texas
- A3.4 Microbiology of the Aquanauts and Their Environment** A103  
Lt. Andre Cobet, John P. Hresko, R. L. Dimmick, D. N. Wright, H. B. Lavine, and J. M. Cobb, Naval Biological Laboratory
- A3.5 Respiratory and Pulmonary Studies** A137  
C. J. Lambertsen, J. D. Dickson, R. Gelfand, R. W. Hyde, A. B. Fisher, A. B. DuBois, and C. J. Knight, University of Pennsylvania
- A3.6 Decompression** A150  
Cdr. T. N. Markham, Naval Submarine Medical Center, and Peter O. Edel, J and J Marine Diving Company
- A3.7 Biomedical Program Summary** A165  
C. J. Lambertsen, University of Pennsylvania, and S. Kronheim, Office of Naval Research

### **A4 DATA MANAGEMENT AND THE DIGITAL DATA BANK** A166

- A4.1 Introduction** A166  
Nicholas Zill, Bellcomm, Inc.
- A4.2 Description of the Data System** A167  
Nicholas Zill and Anita Cochran, Bellcomm, Inc., and Lt. Richard Mach, Naval Medical Research Institute
- A4.3 Use of the Data System by Mission Programs** A172  
Nicholas Zill, Bellcomm, Inc., Lt. Richard Mach, NMRI, and A. G. Mitchell, General Electric Company
- A4.4 Secondary Processing and Retrieval** A182  
Nicholas Zill, Bellcomm, Inc.
- A4.5 Conclusions and Recommendations** A183  
Nicholas Zill, Bellcomm, Inc.
- A4.6 Acknowledgments** A184  
Nicholas Zill, Bellcomm, Inc.

### **Appendix B - ENGINEERING** B1

#### **B1 DESCRIPTION OF THE FACILITIES SYSTEM** B1 Cdr. W. J. Eager, Naval Facilities Engineering Command

- B1.1 Introduction** B1
- B1.2 The System** B1
- B1.3 Engineering and Construction Activity** B4

#### **B2 THE TEKTITE I HABITAT** B5 B. P. Thompson and J. B. Tenney, General Electric Company

- B2.1 Design** B5
- B2.2 Structure** B5
- B2.3 Equipment** B6

<b>B3 HABITAT SUBSYSTEMS</b>	<b>B9</b>
D. Withey, E. Batutis, R. Swartley, A. Quinn, and R. Cockfield, General Electric Company	
B3.1 Environmental Control Subsystem	B9
B3.2 Atmosphere Monitoring Subsystem	B19
B3.3 Electrical Power Distribution Subsystem	B21
B3.4 Communications Subsystems	B28
B3.5 Ancillary Equipment	B33
<b>B4 SUPPORT BARGE</b>	<b>B36</b>
Cdr. W. J. Eager, M. Yachnis, D. H. Potter, F. L. Allen, and M. Sassani, Naval Facilities Engineering Command	
B4.1 Introduction	B36
B4.2 Design Conditions	B36
B4.3 Site and Structural Concept Selection	B37
B4.4 Barge Structure	B40
B4.5 Foundation and Elevating Mechanism	B44
B4.6 Electrical Power Subsystems	B46
B4.7 Breathing Gas Subsystem	B47
B4.8 Potable Water Subsystem	B49
<b>B5 CONTROL VAN</b>	<b>B50</b>
C. C. Meigs, General Electric Company, and Lt. Richard Mach, Naval Medical Research Institute	
B5.1 Introduction	B50
B5.2 Operational Control Station	B51
B5.3 Behavioral Monitoring Station	B52
B5.4 Discussion and Recommendation	B54
<b>B6 ASSEMBLY OF TEKTITE HABITAT</b>	<b>B55</b>
L. Goldstein, C. Lorenz, and C. Meigs, General Electric Company	
B6.1 General	B55
B6.2 Phase A	B55
B6.3 Phase B	B58
<b>B7 CRANE BARGE</b>	<b>B60</b>
Cdr. W. J. Eager and D. H. Potter, Naval Facilities Engineering Command	
B7.1 Introduction	B60
B7.2 Mooring Conditions	B60
B7.3 Safety Center	B61
B7.4 Decompression Facilities	B62
<b>B8 UNDERSEAS CONSTRUCTION SYSTEMS AND OPERATIONS</b>	<b>B62</b>
Cdr. W. J. Eager, Naval Facilities Engineering Command	
B8.1 Introduction	B62
B8.2 Habitat Launch	B63
B8.3 Habitat Emplacement	B71
B8.4 Support Barge Emplacement	B74

**B8 UNDERSEAS CONSTRUCTION SYSTEMS AND OPERATIONS (continued)**

B8.5 Umbilical Emplacement B77  
B8.6 Way Station Emplacement B78

**B9 INSTALLATION, INTEGRATION, AND CHECKOUT OF THE HABITAT SYSTEM B79**

**B10 SYSTEM CERTIFICATION B85**  
Leonard A. Melka, Naval Ship Systems Command

B10.1 Need for Material Safety Review B85  
B10.2 Procedures and Criteria B85  
B10.3 Material Deficiencies B86

**B11 ENGINEERING EVALUATION OF HABITAT DURING OPERATIONS B90**  
J. B. Tenney, D. Withey, E. Batutis, R. Klammer, R. Swartley  
and R. Cockfield, General Electric Company

B11.1 Introduction B90  
B11.2 Structure B90  
B11.3 Umbilical Cables B92  
B11.4 Electrical Power Distribution Subsystem B93  
B11.5 Environmental Control Subsystem B95  
B11.6 Communications Subsystem B101  
B11.7 Atmosphere Monitoring Subsystem B102  
B11.8 Operations Data B103  
B11.9 Testing B105

**B12 FACILITIES WITHDRAWAL B106**  
Cdr. W. J. Eager and H. E. Hodge, Naval Facilities  
Engineering Command

B12.1 Introduction B106  
B12.2 Removal of Launch System B106  
B12.3 Removal of Support Barge B107  
B12.4 Deballasting and Removal of the Habitat B107  
B12.5 Removal of Umbilicals B109  
B12.6 Bottom Cleanup B109  
B12.7 Engineering Research Postscript B110

**B13 BASE CAMP B110**  
Lt. (jg) Gerard Fuccillo, Amphibious Construction Battalion Two

B13.1 General Description B110  
B13.2 Buildings B110  
B13.3 Water Systems B112  
B13.4 Electrical System B112  
B13.5 Causeway Pier B113  
B13.6 Base Camp Operation B113

<b>Appendix C - SUPPORTING ACTIVITIES</b>	<b>C1</b>
<b>C1 COMMUNICATIONS, LOGISTICS, AND TRANSPORTATION</b>	<b>C1</b>
Cdr. F. L. Looney, Naval Administrative Command (Great Lakes) and Office of Naval Research	
C1.1 Communications	C1
C1.2 Logistics	C2
C1.3 Transportation	C3
<b>C2 AQUANAUT SAFETY</b>	<b>C4</b>
Lt. (jg) Joseph J. McClelland, U.S. Coast Guard Headquarters, and Richard Waller, Department of the Interior	
C2.1 Introduction	C4
C2.2 Aquanaut Safety Procedures	C4
C2.3 Surface Safety Procedures	C5
<b>C3 WATCH STRUCTURE</b>	<b>C7</b>
Cdr. F. L. Looney, Naval Administrative Command (Great Lakes) and Office of Naval Research	
C3.1 General	C7
C3.2 Organization	C7
C3.3 Watch Instructions	C8
<b>C4 MEDICAL SUPPORT</b>	<b>C11</b>
Cdr. T. N. Markham, Naval Submarine Medical Center	
C4.1 Habitat and Support Van	C11
C4.2 Base Camp	C14
<b>C5 PUBLIC AFFAIRS</b>	<b>C15</b>
R. S. Greenbaum and A.M. Sinopoli, Office of Naval Research	
C5.1 General	C15
C5.2 Preoperation Activity	C16
C5.3 Tektite I Information Center	C17
C5.4 Dissemination of News During the Operation	C17
C5.5 Photography	C18
C5.6 End of the Mission	C19
C5.7 Conclusions	C20
<b>C6 TECHNICAL ASSISTANCE</b>	<b>C20</b>
D. E. Adkins and A. J. Coyle, Battelle Memorial Institute	
C6.1 Introduction	C20
C6.2 Mission Observations	C21
C6.3 Recommendations	C21
C6.4 Hardware Evaluation	C25

<b>Appendix D - AQUANAUTS</b>	<b>D1</b>
Richard Waller, Department of the Interior	
<b>D1 BIOGRAPHIES OF THE TEKTITE I AQUANAUTS</b>	<b>D1</b>
D1.1 Primary Crew Members	<b>D1</b>
D1.2 Alternate Crew	<b>D3</b>
<b>D2 SELECTION CRITERIA</b>	<b>D4</b>
<b>D3 TRAINING AND PREPARATIONS</b>	<b>D5</b>
<b>D4 DAILY ROUTINES</b>	<b>D5</b>
<b>Appendix E - CHRONOLOGY</b>	<b>E1</b>
D. C. Pauli and H. A. Cole, Office of Naval Research	

## ABSTRACT

Project Tektite I, under the overall cognizance and management of the Chief of Naval Research, involved the Departments of the Navy and Interior, the National Aeronautics and Space Administration, the General Electric Company, and other government, industry, and academic organizations. An ocean floor habitat at a 49-foot depth and the supporting facilities were established and evaluated for 60 days at a carefully selected, isolated site in the Virgin Islands from February 15 to April 15, 1969. Four marine scientists lived in and worked out of the habitat for the 60-day period, during which their research emphasized marine biology and geology. This was twice as long as men had previously lived under saturated diving conditions and the only such experiment to use a controlled nitrogen/oxygen atmosphere with a normal 0.2-atmosphere oxygen partial pressure. Through continual television and auditory monitoring, medical doctors, psychologists, and diving engineers studied the aquanauts' biomedical responses to the 60-day saturation dive and their behavioral and other psychological responses to each other, to their work, and to their isolated, hostile environment.

The Tektite I experiment was completed with a perfect safety record within minutes of the time scheduled many months previously. The successful operation demonstrated that men can live together and perform safely and effectively on the ocean floor for extended periods and provided specific psychological, physiological, and marine scientific results which can be applied to future space and undersea missions.





## Chapter 1

### HISTORY AND OBJECTIVES

"If, instead of sending the observations of seamen to able mathematicians on land, the land would send able mathematicians to sea, it would signify much more to the improvement of navigation and to the safety of men's lives and estates on that element."

Sir Isaac Newton, 1692

### INTRODUCTION

The U.S. Navy, the National Aeronautics and Space Administration, the Department of the Interior, the General Electric Company, and many other participating organizations were brought together in project Tektite I with very much the same theme as that given in Sir Isaac Newton's statement of 1692, but with a variety of professions involved. In Tektite I the marine scientist removed himself from his shore laboratory and home and became an in-situ partner with the in-vivo marine life. The behavioral psychologist directly observed this marine scientist removed from his normal environment to determine his responses to the real isolation, stresses, and hazards that were part of his new environment.

The synergistic use of saturation\* diving from a habitat to conduct marine science and the observation of the habitat occupants as subjects for behavioral studies evolved from the U.S. Navy's Sealab II man-in-the-sea project.† Two of the conclusions of that project, conducted by the Office of Naval Research in August-September 1965, were:

"In situ living offers a new and important methodology to scientific, biological, and geological ocean-floor investigations."

---

\*"Saturation" refers to the state of the dissolved gases in the tissues of the diver. Under a saturated tissue condition, the diver works out of a habitat whose atmosphere is maintained at approximately the same pressure as that of the water in which he will be working. His habitat may be an ocean floor installation maintained at the ambient outside water pressure or may be a pressurized deck decompression chamber on board a surface vessel from which he travels to his work location in a pressurized personnel transfer capsule. In either case he does not undergo decompression between working dives; he is decompressed only after his total dive sequence. Whether a series of conventional, nonsaturated, short dives are used or a saturated dive is used depends on many factors (even assuming that the equipments necessary for each are available). The primary factors, however, are the time required to accomplish the diving tasks, the number of divers available who are qualified for the specific tasks, and the depths of water of the task.

†D. C. Pauli and G. P. Clapper, "An Experimental 45-Day Undersea Saturation Dive at 205 Feet," ONR Report ACR-124, March 8, 1967.

"Based on the analysis of the overall performance of the aquanauts, criteria can be developed to assist in the selection of future aquanauts."

Analysis of the Sealab II behavioral observations yielded significant information for understanding the behavior of small groups of men conducting real work while isolated in a hazardous environment.

To the behavioral psychologist the undersea laboratory becomes an exciting observational situation. Closed-circuit television provides one of the usual modes for operational and engineering monitoring of the habitat as well as a vital communication link between the occupants and the surface support personnel. By simple remote extensions these closed-circuit links can be used at observational stations. The behaviorist thus is enabled to collect voluminous, valid data on a real situation. The subjects are engaged in real work in a hazardous environmental situation which involves stress and isolation.

To the marine scientist the habitat-laboratory affords the opportunity to investigate biological and ecological processes unencumbered by the need to return to the surface. Thus, by not being encumbered by the restrictions of repetitive surface dives, he can return to the site of his investigations as many times during the day and night that his life support systems will permit. He is no longer physiologically restricted; he is limited only by life-support equipment and human endurance. This becomes a very important factor in considering the applicability of saturated diving to the research to be undertaken. Thus, in Tektite I the study of the behavior of lobsters, for example, was integrated with many other scientific dives which occurred at various times during both day and night. In this manner a cohesive 2-month marine science program became a reality for four scientists to conduct.

## HISTORY

The similarity between crew behavioral aspects of a long-duration operational saturation dive and a space mission was suggested in November 1966, in a side discussion between Office of Naval Research and National Aeronautics and Space Administration psychologists at a NASA Symposium on Isolation and Confinement. This suggestion led to ONR/NASA meetings, later in 1966 and early in 1967, to develop a rationale for the validation of a hypothesis that behavioral, habitability, and crew effectiveness data obtained in observations of undersea teams could be used to predict and understand similar problems involving space teams.

Based on these early meetings NASA in June 1967 awarded two study contracts concerning the validation of extrapolating marine mission data to space missions. Technical progress under these contracts was jointly watched and monitored by NASA and Navy technical and management personnel. The results of these study contracts strongly supported what had been suggested in the original NASA/Navy discussions - that behavioral, crew effectiveness, and habitability data could be obtained in underseas operations.

During the concluding months of the contracted studies it became evident that missions involving real work were required to obtain valid extrapolative data. The Department of Interior, who over the course of 1967 had come to an agreement with the Navy for "cooperative study of problems of mutual interest," was invited to participate in monitoring the NASA sponsored studies and formally became the third member in November 1967.

In December 1967 the General Electric Company formally submitted to the Office of Naval Research, lead agency for the government, an unsolicited proposal to conduct the undersea space/marine mission recommended in the concluding studies. The mission would be of 60 days duration and would study the ability of a small group of saturated

divers to successfully carry out a scientific mission under hazardous, isolated conditions. The project title Tektite comes from the name for small particles of space-born matter which survive the fiery plunge through the earth's atmosphere and come to rest on the ocean's floor. Tektite I would be jointly sponsored by the Navy, NASA, and Interior Department. In addition the basic Tektite I habitat would be furnished by General Electric, financed primarily by company Industrial Research and Development funds.

### AGENCY INTERESTS

The interests in Tektite of the three agencies - Navy, NASA, and the Department of the Interior - relate to their national responsibilities. Generally the Navy's interests were the study of diving physiology and small-crew psychology, for future submersible and saturated diving missions and advances that could be made in ocean technology. NASA's interests of small-crew psychology and behavior were oriented toward long-duration space flight, as in orbiting laboratory or post-Apollo missions. The Interior Department's interest was the use of saturated diving to broaden man's capability to conduct scientific work in the sea. A closer look at the roles of each agency shows the areas of interest and responsibility of each.

#### Navy Interests

The Navy interests in Tektite I were reflected in overall project coordination and management, development of techniques for accomplishing the behavioral and biomedical scientific mission objectives, engineering evaluation of the shallow-water Tektite I habitat, and operational and technological procedures, including safety.

The Navy was the "lead agency" of the three agencies supporting Tektite I. Through the Office of Naval Research, the Navy had the responsibility for overall program and scientific management and for administration of the General Electric Tektite I contract. An additional Navy responsibility in Tektite I, and perhaps the most important, was mission safety, both in the operational and scientific conduct of the program.

The Office of Naval Research was responsible for the overall planning of the behavioral and biomedical programs and integration and coordination of the overall Tektite I scientific program. The Navy, during the Sealab II program, developed basic field observation techniques for the behavioral studies of small crews living in undersea habitats. Tektite I presented opportunity for further development of these techniques and acquisition of additional data. The key scientists from the Sealab II program developed the Tektite I behavioral program in conjunction with NASA and Interior. The Tektite I biomedical program, likewise, was developed by Navy medical personnel and by contract research scientists of ONR (such as the University of Pennsylvania) working with Navy and NASA biomedical personnel. In addition to the stated scientific goals in the mission objectives, Tektite I also provided the Navy the opportunity for exploration in related areas of underwater technology, such as saturation diver safety, ocean engineering, and construction.

The Navy provided the operational direction for implementation of the Tektite I program. Naval command experience provided the operational experience necessary to support the scientific program. Transportation, logistics, communication, and support construction and facility requirements operation were supplied by various naval organizations.

### NASA Interests

NASA's primary interest in Tektite I was the study of the performance of highly qualified scientists under conditions of stress for use in understanding and predicting man's behavior on long-duration space flights.

The four Tektite I aquanauts experienced true locked-in isolation due to their saturated diving condition, which prohibited vertical ascents to the water's surface. Reactions to their living, working, and recreation environments were recorded by systematic observation, by automatic event recording, and by subjective opinion. Measures were made of group cohesiveness and the adjustment of each crew member to the others, to his environment, and to his assigned duties. The marine scientific mission plan provided the scientific crew the goals necessary for maintaining a continuous high level of motivation required for meaningful extrapolation of the behavioral data to space flight. The ability of the crew to conduct their own mission and their willingness to attempt tasks not directly related to their scientific training were evaluated as well as the extent of their dependence on an outside technical crew. Biomedical measures were made to assure crew safety and to evaluate the psychological effects of activities inside and outside the habitat on the measurable physiological functions of the crew.

The NASA scientific responsibilities were reflected in the hematology portion of the biomedical research program and in the sleep and psychomotor studies in the behavior program. The Tektite I data collection program, developed under NASA contract, was the primary means of accumulating daily the crew behavior, biomedical, and habitability and engineering data required by each investigator. NASA management responsibilities were in the development of the behavioral program and in overall program management in concert with the other agencies.

### Department of the Interior Interests

The Department of the Interior's fundamental interest in Tektite I was to accomplish a diversified research program with a small group of marine scientists using saturated diving techniques. The two primary objectives were: evaluate saturated diving as a research technique for marine science studies, and conduct an operational research program on the ocean floor to demonstrate that scientists can live and work effectively on the ocean floor.

For years marine scientists have recognized the advantages of having direct access to the undersea environment for extended periods of time. To this end, self-contained underwater breathing apparatus (scuba) equipment and research submersibles have provided only partial solutions to depth, time, and mobility limitations. Manned habitats, such as the Tektite I habitat, using saturated diving have offered a research tool which appears to have many advantages for prolonged studies of the ocean floor.

### INTERAGENCY COOPERATION

Although Tektite I was preceded by several underwater living experiments, some at greater depths, several distinguishing features set it apart from these earlier experiments. Primary among these is that Tektite I was the first major venture undertaken whose objectives were primarily scientific rather than technological. Close liaison and communication between participating members from all organizations involved was necessary to accomplish a cohesive program. For example, the behavioral and biomedical studies conducted by the Navy and NASA, concurrent with Interior's ocean floor program, were designed for the minimum interference with the marine research activities

of the crew. The mutual Navy and NASA interests in the behavioral and biomedical portions of Tektite I required a high degree of interaction between scientists of both agencies for optimization of efforts and results. General Electric integrated the program needs into a habitat system that could satisfy the divergent requirements placed on it. The success of Tektite I was due largely to the spirit of cooperation that prevailed throughout the entire project, from conception through execution.

The major participating activities and their primary responsibilities and contributions were:

#### NAVY

##### Office of Naval Research

Headquarters: Overall project management, scientific program coordination, direction of on-site operations, funding support, logistic coordination, overall safety responsibility.

Naval Biological Laboratory: Planning and execution of the Tektite I microbiological studies.

Naval Research Laboratory: Laboratory analysis of habitat atmosphere, logistic support throughout operation.

##### Naval Facilities Engineering Command

Headquarters: Design of habitat installation methods, design habitat surface support Ammi barge facility, on-site installation and retrieval of habitat and other equipment, operational responsibility for emplacement and retrieval of habitat and support systems.

##### U.S. Atlantic Fleet

Amphibious Construction Battalion Two: Implementation of habitat installation methods and equipment, assembly of support Ammi barge, design and construction of base camp, operation and maintenance of habitat support system.

Amphibious Force, Atlantic Fleet: Transportation of habitat system, base camp equipment and materials, and project personnel to the Tektite I site and return.

##### Bureau of Medicine and Surgery

Chief, Bureau of Medicine and Surgery: Review and approval of medical and safety plans, assignment of medical personnel to project.

Naval Submarine Medical Center: Development of Tektite I decompression schedule, participation in biomedical program, aquanaut physical and psychiatric examinations, medical personnel on site.

Naval Medical Research Institute: Planning and execution of behavioral program, equipment and technical assistance for behavioral program, on-site monitors and supervisors, data reduction.

Naval Medical Neuropsychiatric Research Unit: Planning and execution of Navy sleep studies.

## PROJECT TEKTITE I

## Naval Ship Systems Command

Supervisor of Salvage: Decompression facilities and personnel, diving personnel assistance, small boat and equipment support.

Experimental Diving Unit: Atmospheric monitoring equipment and operators, diving officers and personnel.

Philadelphia Naval Shipyard: Assembly of Tektite habitat, services for assembly of habitat support barge, dock facilities for loading and unloading of Tektite I hardware at beginning and end of project.

Supervisor of Shipbuilding, Conversion, and Repair, Tenth Naval District: Critical repair facilities for boats and electronic equipments, logistic support.

Submarine Acquisition Project Office: Material safety review of habitat and support systems.

## DEPARTMENT OF INTERIOR

Planning and management of marine science program, program management, funding support, aquanaut crew and two backup crew members, surface scientific and diving support for marine science program, scientific and diving equipment for aquanaut crew, operational site in the Virgin Islands National Park.

## NATIONAL AERONAUTICS AND SPACE ADMINISTRATION

Headquarters: Program management, funding support, data management program, behavioral program support.

Manned Spacecraft Center: Planning and execution of NASA sleep studies, development of hematology program, develop emergency decompression tables.

Marshall Spaceflight Center: Crew habitability program.

Langley Research Center: Furnish, install and maintain mass spectrometer atmosphere analyzer, implementation of psychomotor experiment.

## GENERAL ELECTRIC COMPANY

Missile and Space Division: Habitat design and fabrication, scientific program integration assistance, preparation of scientific program planning documents, personnel and technical support for on-site operations.

## COAST GUARD

Safety diver support personnel, diving watch officer on-site, support in implementation and assessment of safety program.

## ASSOCIATED SUPPORT

University of Pennsylvania: Biomedical program coordination and support, biomedical pre-dive base-line data, post-dive biomedical diver assessment.

College of the Virgin Islands: Marine science program support, site survey support, backup aquanaut.

Battelle Memorial Institute: Engineering support to the Office of Naval Research, engineering review of Tektite I program.

Particular mention is made of the Navy Seabees' extensive and energetic work in Tektite I. The Seabee force was comprised of officers and men from Amphibious Construction Battalion Two, with additional Seabee divers from both the Atlantic and Pacific fleets. The Seabees were active through the project, both in implementing the Navy's engineering program and in supplying construction and maintenance services for all on-site Tektite facilities.



## Chapter 2

### SYNOPSIS

#### MISSION

The missions of Tektite I were threefold: (a) to study the behavior and effectiveness of a small group of highly trained men to real work under stressed, isolated conditions, (b) to study biomedical responses of men living under high-nitrogen-partial-pressure saturated conditions in the marine environment for an extended period, and (c) for the men under study in (a) and (b) to conduct meaningful marine science research from an undersea habitat under the advantageous and disadvantageous boundary conditions imposed by saturation diving. Since the three missions are interdependent, equal emphasis had to be placed on each. Coincident with those three scientific missions was a Navy ocean engineering program to advance the scientific utilization of underwater habitats.

The selected mission duration was 2 months, from February 15 to April 15, 1969. During this time the aquanaut scientists were saturated to a water depth of 43 feet. At the end of the mission a decompression schedule approximately 20 hours long was required to return the aquanauts safely to the surface.

#### SITE

The site selected for Tektite I was Lameshur Bay, St. John Island, U.S. Virgin Islands (Fig. 1). This site is in the southeast quadrant of the island and within the boundaries of the Virgin Islands National Park, which includes two-thirds of St. John Island and most of the offshore waters. Because Lameshur Bay is within the park, a special "use permit" was required from the National Park Service to conduct the project. The site selection was based on five primary factors:

1. Shallow water. The acceptable depth range of the habitat for conducting the saturation dive on a mixture of  $O_2$  and  $N_2$  over the 60-day period was set at 40 to 60 feet.
2. Biological activity. The biological activity of the area selected had to be abundant to assure the ability to develop a valid continuous, long-duration marine science program. There was a great biological diversity of marine plant and animal species in Lameshur Bay enhanced by the presence of extensive coral reefs. Since the waters of Lameshur are characteristic of the tropical waters of the Caribbean, South Pacific, and Indian Oceans, marine research conducted there would be applicable to many parts of the world.
3. Shelter from storm. In the January-to-May period required for the total Tektite I startup, operation, and withdrawal the Lameshur Bay area was historically expected to be extremely sheltered from the sea. With the exception of one unseasonable storm the predicted weather conditions prevailed.
4. Low subsurface water currents. Subsurface current conditions were less than 0.25 knot except during the unseasonable southerly sea condition experienced, when surge currents were estimated to be of the order of 0.5 knot.

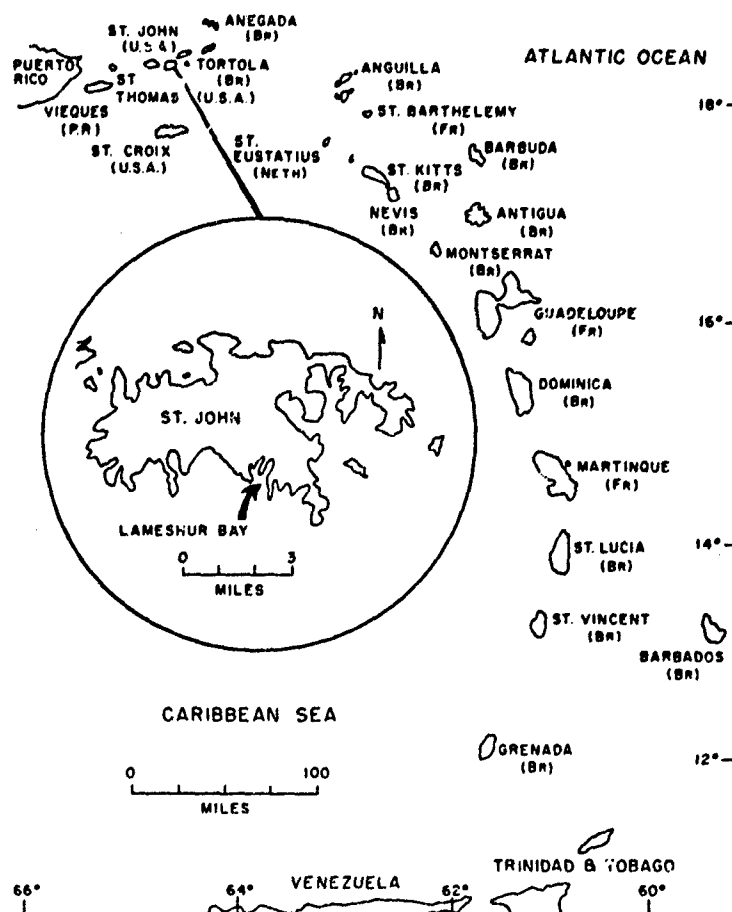

Fig. 1 - Location of Lameshur Bay, Virgin Islands, the Tektite I site

5. Logistics supportability. Logistics is a major problem to a project conducted in a remote location. This was a contributing factor in selecting the Virgin Islands site over other islands in the vicinity. Even so logistics were considerably more difficult than was envisaged. While nearby St. Thomas was the source of most operating supplies that were not originally brought in the installation phase, many components and services unique to this type of operation had to be obtained from the mainland and Puerto Rico, which entailed detailed expediting to minimize time and in-transit loss of materials.

#### CREW

Four marine scientists from the Department of the Interior were the Tektite I aquanauts (Fig. 2):

Richard A. Waller - Oceanographer, Bureau of Commercial Fisheries,  
 Conrad V. W. Mahnken - Oceanographer, Bureau of Commercial Fisheries,  
 John G. Van Derwalker - Fishery Biologist, Bureau of Commercial Fisheries,  
 H. Edward Clifton - Geologist, U.S. Geological Survey.



Fig. 2 - Tektite I crew: left to right are aquanauts Clifton, Mahnken, Waller, and Van Derwalker

#### HABITAT

The Tektite I habitat (Fig. 3) was designed and constructed by the General Electric Company and was furnished to the Navy under a bailment agreement. The habitat was installed on the bottom of Lameshur Bay at a depth of 49 feet. The habitat hatch, 6 feet above the bottom, established the saturation depth of 43 feet.

#### BASE CAMP

To conduct the total Tektite I scientific mission, approximately 35 scientists and 65 support personnel were required. A base camp was constructed adjacent to Lameshur Bay (Fig. 4). This camp functioned as the living quarters for all Tektite I personnel, military and civilian, except the four aquanauts.

#### PROJECT ORGANIZATION

Although the Tektite I mission was 60 days in duration, the total time required to plan, execute, and evaluate the project was in excess of a year and a half. Project activities during this time were divided into five phases which describe the evolution of Tektite I.

**Phase I:** Detailed program plans, equipment design and fabrication, and base camp construction. During phase I, begun in early 1968, the habitat and its supporting systems were designed and built, and the project's scientific programs were planned and coordinated. The facilities required for support at Lameshur Bay were designed and constructed. Base-line biomedical and psychological data were obtained. This phase ran through January 8, 1969, when the Tektite I habitat was loaded aboard the *USS Hermitage* for shipment to the Virgin Islands.

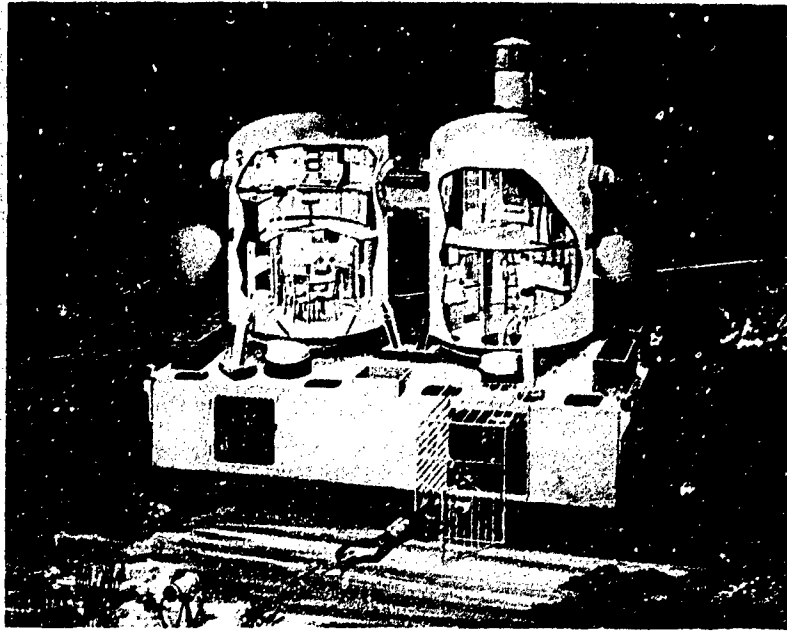

Fig. 3 - Artist's rendering of the Tektite I habitat. At the left are the bridge and the crew's quarters, and at the right are the machinery room and the wet room, with a cupola on top which allows a 360-degree view.

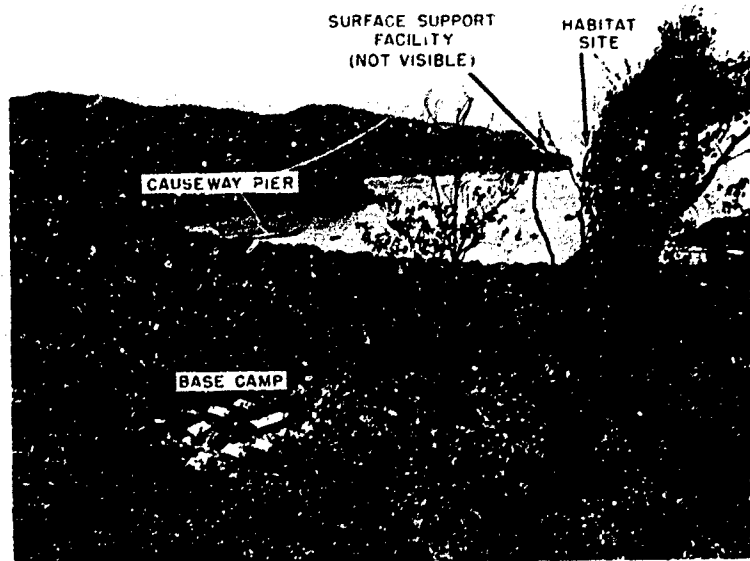

Fig. 4 - Tektite I experiment site, Lameshur Bay, St. John, Virgin Islands

Phase II: On-site preparation, equipment installation, and checkout. The major work during phase II began in January 1969, when the Tektite I habitat and its supporting equipment and personnel arrived at Lameshur Bay. The habitat and supporting equipment were installed. The marine science equipments were readied. The major remaining supporting logistics problems were solved. Upon final approval of the results of the systems checkout of the habitat/surface control complex, phase III was initiated.

Phase III: Major experiment phase. Phase III was, essentially, the 60-day mission. Phase III began when the Tektite I habitat became operational and ended when the four aquanauts completed their decompression on April 16, 1969.

Phase IV: Equipment withdrawal and dispersal. Phase IV was, essentially, the inverse of phase II. Phase 4 began on April 16, 1969, and was completed on June 10, 1969, when the last of the Tektite I material was removed from Lameshur Bay.

Phase V: Reduction, analysis, and distribution of data and results. Efforts during phase V were primarily directed toward the preparation and distribution of this Tektite I final report.

The Tektite I Program Plan and Operation Plan documented the scientific and operational organization and conduct of the project. The Tektite I Program Plan was prepared by General Electric as a part of their contract task, and contained four parts: Scientific Mission Requirements Plan, Safety Plan, Transportation and Assembly Plan, and Emplacement Plan.

The Tektite I Operation Plan was promulgated by the Chief of Naval Research. The Operation Plan implemented the on-site portions of the project, designated command structures, and delineated standard and emergency bills. A primary function of the Operation Plan was the establishment and implementation of project safety standards and procedures.

The Operation Plan identified two distinct organizational authorities: administrative and operational (Fig. 5). The administrative authority (Fig. 5a) was primarily concerned with the scientific management of Tektite I and remained constant throughout all of the project's five phases. The operational authority was in effect only during the three operational phases (i.e., Phases II, III, and IV). The operational authority for Phases II and IV (Fig. 5b) reflects the requirement for engineering responsibility during these phases. The operational organization for the 60-day major experiment phase, Phase III, is shown in Figure 5c.

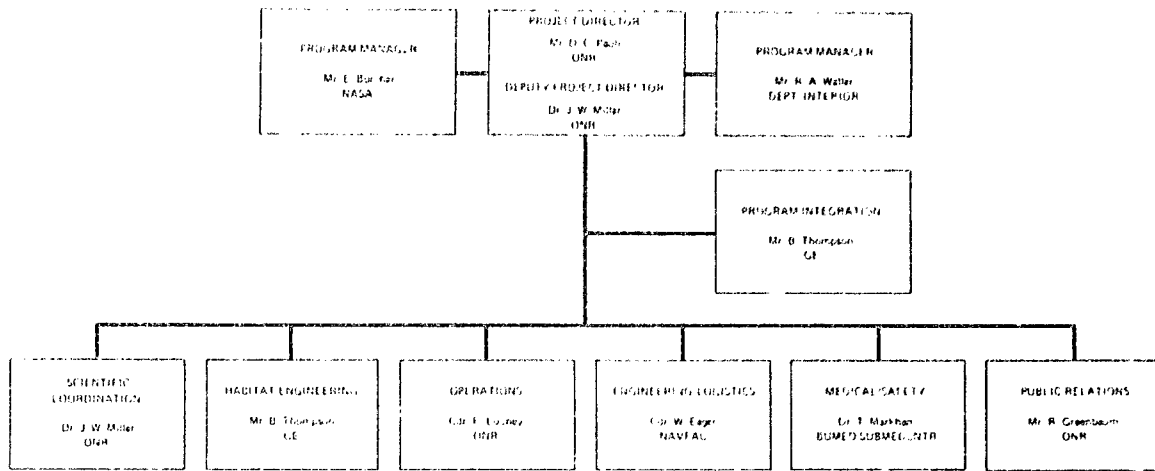

Fig. 5a - Scientific management organization structure

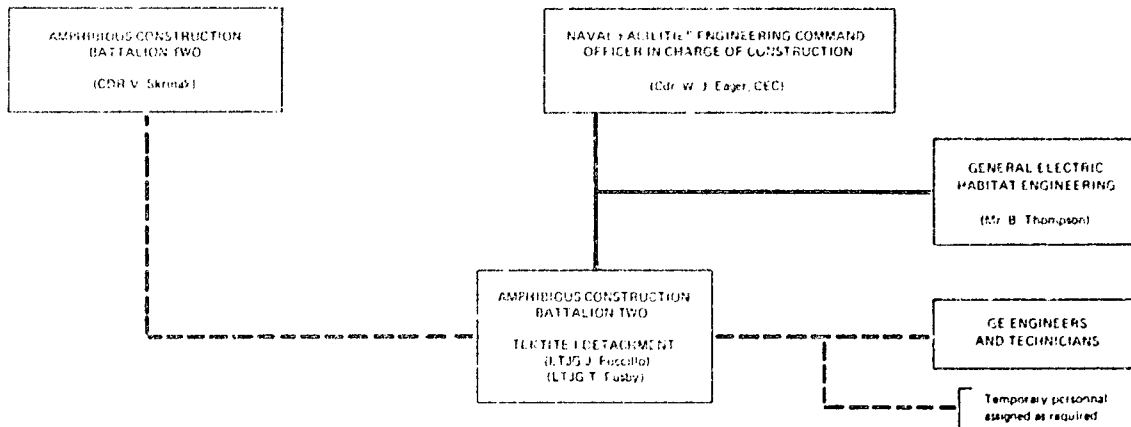

Fig. 5b - Operational command structure (Phase II and IV)

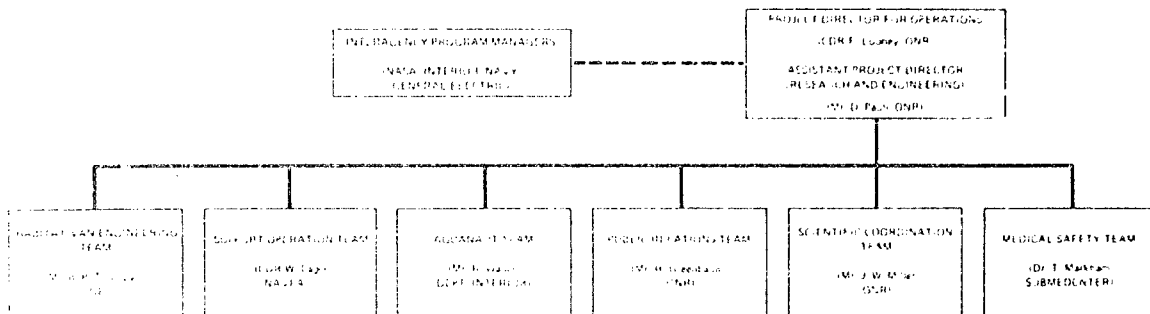

Fig. 5c - Operational organization structure (Phase III)

## SAFETY

The foremost consideration throughout Tektite I was the safety of the personnel involved, particularly the aquanauts. The impact of extensive safety consciousness is evident in all aspects of Tektite I.

Because the aquanauts were saturated to a depth of 43 feet, the biggest potential hazard was decompression sickness (bends) resulting from inadvertent surfacing. As part of the biomedical research program, emergency decompression schedules were prepared as treatment for accidental surfacing. In addition, particular emphasis was placed on preventing situations that might cause the aquanauts to surface.

The situations considered most likely to cause aquanaut surfacing (other than a habitat disaster) were an aquanaut's becoming lost or his losing or expiring his air supply. Way stations, equipped with an air supply and sound-powered phones linked to the habitat, were located near to the habitat. When the aquanauts made excursions from the habitat, they would be accompanied by a surface craft manned by divers ready to offer immediate assistance. The aquanauts carried colored floats which they would release to signal that assistance was required. On routine aquanaut swims near the habitat, lookouts stationed on the support barge replaced the surface boat crews.

The Tektite I aquanaut safety program was highly organized. The operation plan designated the individuals responsible for safety, and these persons organized watch schedules, safety procedures, and emergency bills. In addition to the diving boat crews which accompanied the aquanauts on their excursions, watch crews manned the surface decompression facility, the watch director's post and medical watch post, and support barge equipment around the clock. Training drills were conducted frequently to minimize the time required to recover and treat a surfaced aquanaut.

No on-site project accidents involving personnel injury were experienced during the entire Tektite I operation. Thus it was shown that saturation dives of the Tektite type can be conducted safely, provided that a rigorous safety program is implemented. As further experience is gained, the safety factor added for uncertainty can be reduced to a degree, and the advantages of saturation diving may be more fully exploited.

## Chapter 3

### SCIENTIFIC AND ENGINEERING PROGRAMS

#### INTRODUCTION

The major program elements of Tektite I were marine science, life sciences, and ocean engineering. The goals and known accomplishments of each of these program elements are given in the following paragraphs.

#### MARINE SCIENCE PROGRAM

The goal of the marine science program as planned was twofold: (a) a number of individual marine ecological, biological, and geological studies integrated into a 60-day time period, and (b) an evaluation of the use of saturation diving techniques from an undersea habitat to accomplish the studies planned in (a). The wide variety of planned experiments and observations are summarized in Table 1.

The marine science program was developed to explore the wide range of potential research made possible by undersea habitation. More research was planned than could be accomplished during the mission so the aquanauts could select those areas best suited to the situation. Thus several of the experiments shown in Table 1 were not carried out because the aquanauts decided to use their time in studies resulting from their exploratory surveys of the ocean floor. The aquanauts' decisions to exclude certain planned studies in favor of unplanned studies were based on their assessments of the relative importance of the particular work. In addition, time available to carry out scientific work was limited by a variety of other reasons, such as equipment malfunction and other unforeseen circumstances. For example, habitat operational problems at the beginning of the mission consumed a great deal of the aquanauts' time.

During the 60-day mission the aquanauts spent 432 man-hours outside of their habitat. Toward the end of the mission individual aquanauts were spending as much as 5 hours per day in the water. The limiting factor on this time and on the range of operations was the endurance capability of the equipment and the time required for recharging the scuba tanks.

The aquanauts were assisted in their marine research tasks by a surface diving scientific support team. This team, composed of three alternates for the aquanauts in the habitat, complemented the studies conducted from the habitat by extending the marine research into areas beyond the horizontal range or vertical limits of the aquanauts. This surface team was augmented during the mission by visiting scientists from the Department of the Interior.

#### LIFE SCIENCES BEHAVIORAL PROGRAM

The behavioral program was planned to provide data on the characteristics of crew behavior which could be extrapolated to future manned missions in space and undersea research. The emphases of the behavior study were: crew size and selection criteria, quarters size and habitability, and use of time in mission performance. The restraint of



isolation (saturated diving) and the reality of the crew's mission (marine science) both contributed to the significance of the study. A qualitative summary of the behavioral program is given in Table 2.

Table 1  
Tekite I Marine Science Program

Experiment	Objective
<b>Oceanography</b>	
Environmental factors	Record water temperature, salinity, pressure, current vectors, surface and internal waves, and bioluminescence at the habitat and remote locations. Determine the types and relative abundance of planktonic organisms in the water column, their fluctuations in time, and the extent of their vertical migrations (Fig. 6). Evaluate a side-scanning sonar for signatures of separate fish species, for animal and diver tracking, and for the effects of environmental variations on sonar performance. (This experiment was not initiated due to equipment difficulties.)
Plankton analysis	
Acoustics	
<b>Ecology</b>	
Spiny lobster behavior	Validate tagging techniques for general marine population studies (Figs. 7 and 8). Understand population size, growth, and mortality. Compare effectiveness and selectivity of different gear for catching lobsters and reef fish. Understand foraging, mating, and predatory activities during the full diurnal cycle. Calibrate the influence of the habitat on the local fauna and flora. Evaluate multicolored underwater lights as artificial attractants. Evaluate through periodic sampling the population on prepositioned artificial reefs.
Spiny lobster population	
Lobstering and fishing	
Day-night periodicity	
Effects of the habitat	
Light attraction	
Artificial reefs	
<b>Geology</b>	
Geological bottom mapping	Obtain control data for geological experiments. Relate biogenous sand to the source organisms and study reef growth and destruction. Study the reef structure and history.
Biogenous sand	
Reef diagenesis and lithification	Study the mechanisms and rates of the reworking of sediments by organisms. Study the degree of modification of bottom sediments by storms. Determine the rate and type of changes in the composition of carbonate mud as the result of organic decay.
Effects of organisms on sedimentation	
Storm modifications	
Carbonate mud	
Bottom rock weathering	Compare submarine and subaerial weathering of rocks. Develop habitat-based sedimentology experimental techniques and evaluate surface-operated instruments.
Sedimentology techniques	

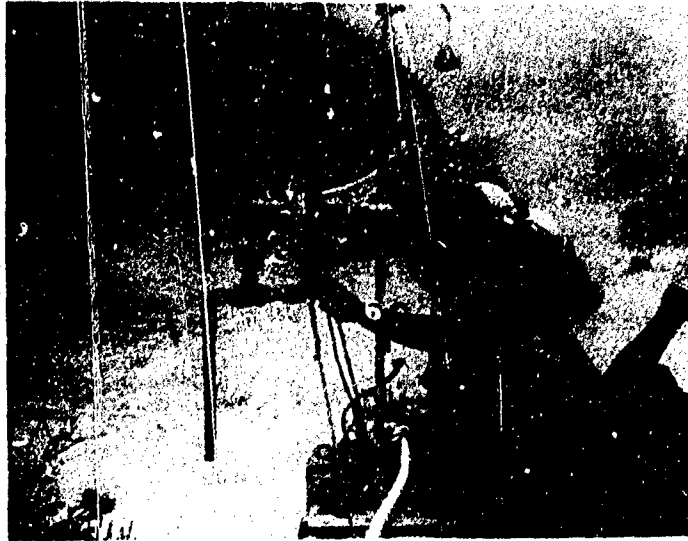

Fig. 6 - Aquanaut adjusting a standpipe in an experiment to measure plankton in the water column at various heights above the ocean floor



Fig. 7 - Aquanauts engaged in spiny lobster studies. The lobsters were captured and tagged with identifying metal tags or tiny acoustic transmitters, and released. They could then be observed and identified to study their migratory habits.



Fig. 8 - Aquanaut tracking a tagged lobster with an acoustic directional receiver

Table 2  
Tektite I Behavior Program

Experiment	Objectives
Crew behavior measures: general activity, task performance efficiency, social relations, operational and interpersonal communications, personal habits, emotional adjustment, psychological traits, psychomotor performance, and sleep (electroencephalography)	Evaluate long-term work performance under hazardous, isolated conditions. Relate observed crew behavior to physiological and medical indices.
Crew selection study	Obtain crew selection, composition, and training data for use in later space and undersea missions.
Human performance study	Determine human performance criteria for application to long-duration, high-stress situations.
Habitability study	Measure individual and crew response to features of working and living facilities.
Data collection study	Develop and refine data collection methods in an operational environment.

Paramount to the success of the behavioral program was the accurate identification and collection of data which could be used as a measure of behavior functions. Data collection was automated to the maximum extent. For example the times that the divers were out of the habitat were automatically recorded. Data based on the observation of the aquanauts were also recorded in real time. Teams of observers monitored the crew for up to 18 hours per day and recorded the visual (television) and audio (open microphone) observations of parameters such as mood, status, and preferences directly on computer cards using predetermined formats (Figs. 9 and 10). During the 60-day mission over 400,000 individual observations were made and recorded for subsequent evaluation (Fig. 11). In addition to observation by television and open microphones, behavioral and habitability data were obtained from records, logs, and questionnaires completed before, during, and after the operation by the aquanauts.

Another source of behavioral data was sleep research to evaluate the quality and quantity of the aquanauts' sleep for possible correlation with observed behavior. Of particular interest were the possible effect of hyperbaric conditions upon sleep and the relationship of sleep patterns to waking activities. Sleep logs and electrophysiological (EEG) recordings were used for sleep evaluation. Sleep logs were maintained by all four aquanauts, and EEG recordings were obtained from aquanauts Clifton and VanDerwalker using somewhat standard electrodes. Electrodes were fitted to make contact with aquanaut Waller's cranium via a newly developed skull cap, developed by NASA, which incorporated contact electrodes. Brain wave data were recorded on both magnetic tape and paper.

Electronic, real-time, partial processing on-site by NASA neuropsychophysicologists of the sleep log and other EEG data indicated that the aquanauts did not have major sleep difficulties. They slept longer (3-plus hours) and stayed in deeper sleep (slow sleep wave) for a longer time as the mission progressed. The Tektite I sleep data indicate that man can adapt to nitrogen saturation and live on the ocean floor for productive work without suffering from sleep deprivation.

#### LIFE SCIENCES BIOMEDICAL PROGRAM

The biomedical program had as its twofold purpose the aquanauts' medical safety and the evaluation of possible physiological effects of long-term saturated diving on the aquanauts. Throughout mission planning and execution the safety of the aquanauts was always foremost. Prior to the mission each aquanaut was given a detailed medical examination. During the mission daily and weekly medical status assessments of each of the aquanauts were made to assure their continuing health. Upon decompression a detailed postdive examination was made of each of the divers to ascertain any changes in the aquanauts' physiological condition.

Because of the exploratory nature of a saturated dive using a nitrogen/oxygen mixture, a major objective of the biomedical program was to obtain physiological data on the possible effects of this type of saturation under closely controlled conditions. The aquanauts were saturated at a depth of 43 feet on a habitat gas mixture of 92% nitrogen, 8% oxygen. Their scuba tanks, used for excursions from the habitat, contained compressed air with a composition of 80% nitrogen, 20% oxygen. Particular attention was given to the functioning of the pulmonary, blood, and nervous systems of the aquanauts. A week of detailed medical examinations was administered prior to the mission at the University of Pennsylvania Hospital Research Center by a select group of medical specialists, which provided base-line measurements for each aquanaut. A summary of the biomedical areas of investigation is given in Table 3.

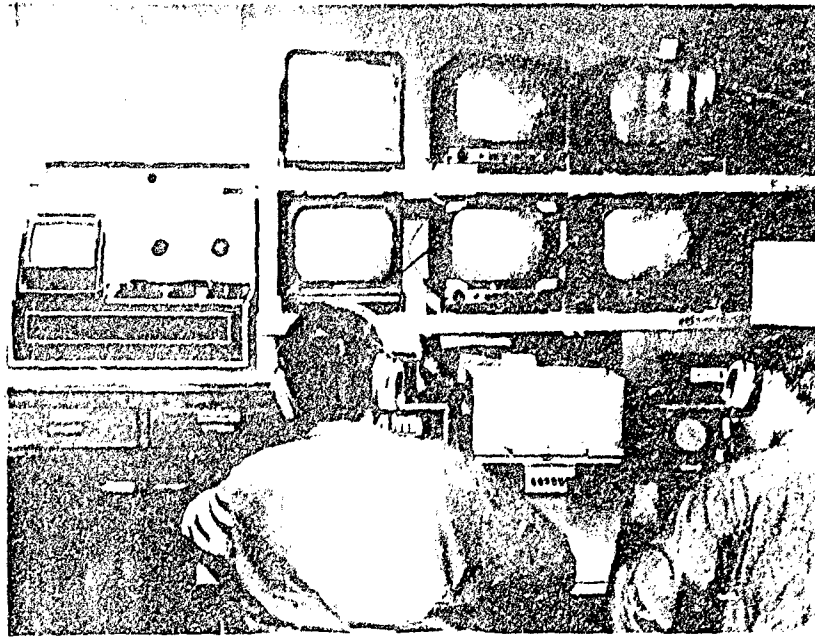

Fig. 9 - Behavioral observers monitoring and recording the aquanauts interactions with the habitat and environment. Four of the six TV monitors present views of each of the four habitat compartments, and two were available for underwater TV cameras. A videotape recorder (left) stands ready to record significant events.

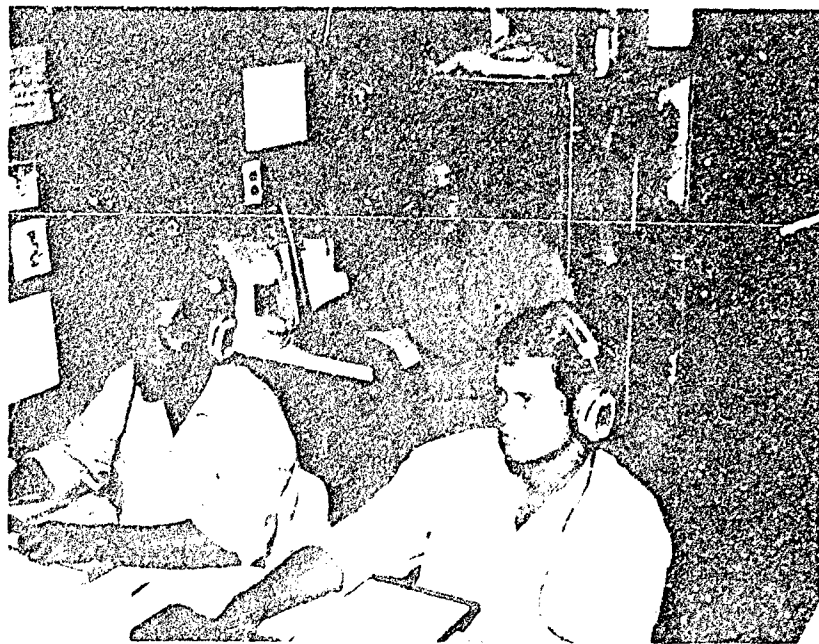

Fig. 10 - Behavioral observers shown in Fig. 9 and a behavioral scientist supervisor. Automatically recorded data is processed by the consoles behind the supervisor's post.

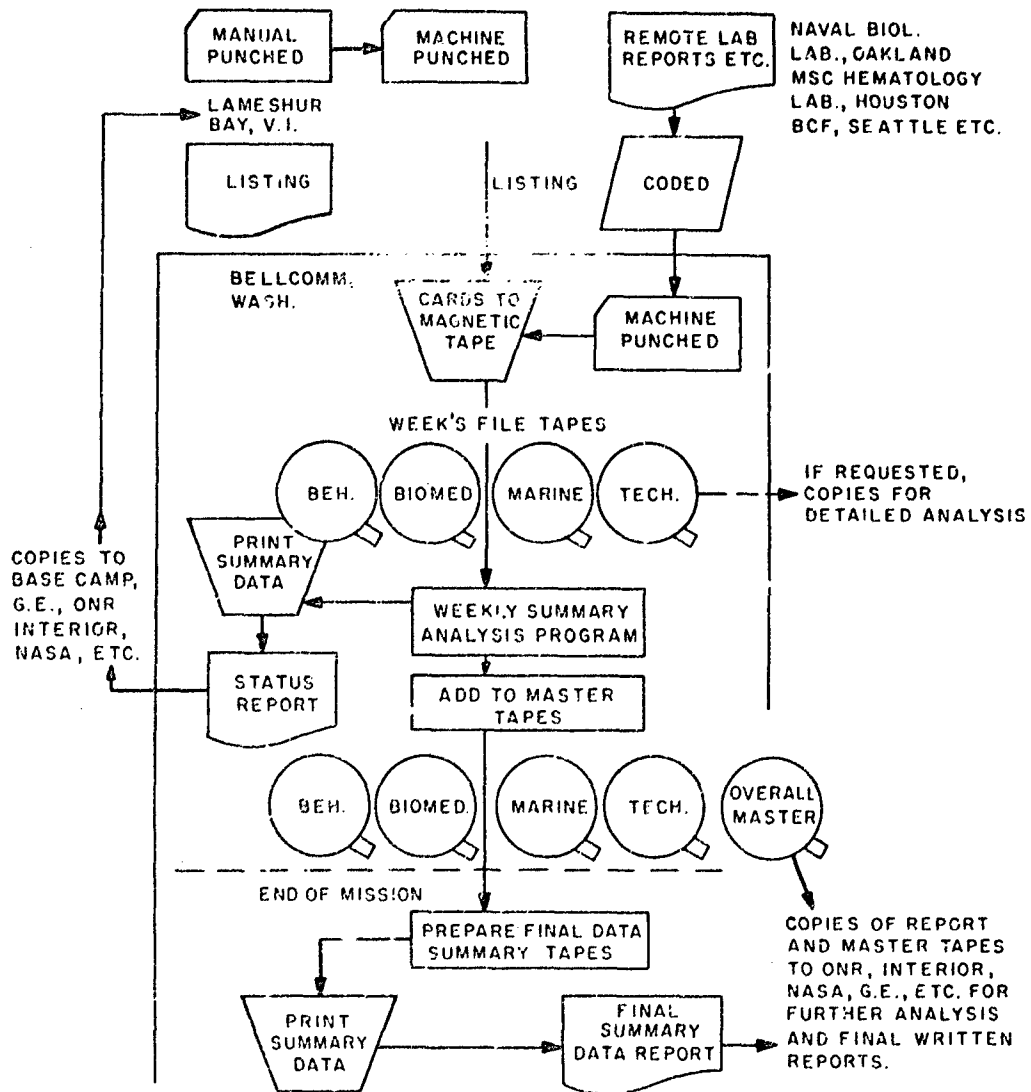

Fig. 11 - Tektite I digital data flow

Table 3  
Tektite I Biomedical Program

Experiment	Objective
<b>Special Medical Examinations</b>	
General medical exams, ophthalmology, dermatology, neurology, and audio-vestibular studies	Determine the physical status of the aquanauts as a health safeguard. Obtain physiological data to assess possible effects of the hyperbaric nitrogen/oxygen environment and prolonged immersion on vision, hearing acuity, skin, etc.
<b>Hematology</b>	
Physical characterization of red-blood-cell populations, studies of red cell metabolism, red-blood-cell radioisotope studies, immuno-hematology, and microtrauma and antigen induced inflammation	Determine the effects of pressure and gas mixture on blood composition and cell production.
<b>Microbiology</b>	
Bacteriology, virology, mycology, aerobiology, and marine microbiology	Determine the effect of prolonged immersion on man's natural organism balance.
<b>Respiratory/Pulmonary</b>	
Respiratory control, pulmonary diffusion, ventilatory function, and pulmonary resistance and compliance	Determine the effects of pressure and gas on lung ventilation, respiratory response, and carbon monoxide diffusion into the diver's system.
<b>Diver Safety Studies</b>	
Decompression  Health assessment	Develop standard and emergency decompression tables for a high-nitrogen, hyperbaric atmosphere. Determine vertical excursion limits within which the divers can operate. Monitor diver health and possible effects of hyperbaric environment.
<b>General Observations</b>	
Data correlation	Correlate monitored physiological and medical data to observed crew behavior and performance.

Certain functions were monitored during the mission by weekly examinations and samples. In addition, a round-the-clock medical watch maintained close observation of the aquanauts via television. The primary medical difficulty of the aquanauts during their 60-day stay was ear infection, and the primary organism that caused the divers' ear infections was *Pseudomonas*. Fungi did not appear to be involved.

The extensive postdive medical examination conducted on-site was not able to determine any significant variations in life functions which possibly could be attributed to the hyperbaric environment. The postdive examination revealed only one possible detrimental

facit—the discovery of a small occlusion in the right eye lens of aquanaut Clifton. This occlusion was off axis and did not interfere with Dr. Clifton's visual acuity. Dr. Clifton was the only aquanaut of the four having high-normal intraocular tension. Whether or not this occlusion was due to the 2-month saturation dive is not known. There has been no known similar occurrence of occlusions in over 50 divers who have been saturated in the Navy's man-in-the-sea program. Examination several months after the postdive examination indicated the size of the occlusion had diminished considerably, making it difficult for the ophthalmologists to find it.

A closely related portion of the biomedical program was a microbiology study in which water, air, and swab samples were taken regularly in and around the habitat to ascertain the presence and relative occurrence of various types of microorganisms (Fig. 12). A number of questions had been raised with respect to prolonged isolated saturation diving, such as: (a) would the microbial population build up, (b) what changes would occur within the normal microflora of the aquanauts, and (c) would organisms indigenous to the aquanauts and their marine environment present a health problem?



Fig. 12 - Mobile laboratory in a van at the base camp being used for on-site processing of microbiology samples taken in and around the habitat

The microbial carrier state of the aquanaut did not play a part in the transmission of disease in the Tektite I program. This is borne out by a *Staphylococcus* carrier study and the evidence that *Candida* and *Proteus* remained associated with a single individual throughout the entire program.

The microbial population did not build up on the walls of the habitat during the 59 days of the study. The sample sites had not been swabbed prior to obtaining the sample; thus the sample represented the microflora of the wall over an increasingly longer period of time. This microflora was in a state of flux with new organisms continually becoming associated with the wall surface while the older organisms were dying.



The level of coliform organisms from the disposal of sewage into the environment did not attain a level sufficient to become a health hazard to the aquanauts.

Conditions imposed in maintaining the habitat did not induce a latent virus infection, nor did the aquanauts acquire any demonstrable virus infection from the marine environment.

The answers to the questions posed at the beginning of the program show that the prolonged application of the environmental conditions and aquanaut interactions, as carried out in the Tektite I program, did not result in any unusual microbiological hazard. The possible intrusion of a marine organism (*Acinetobacter* phenon 4-1) into the habitat and its establishment was of interest and may present a problem in future long-term studies of this type. Ear infections are common to this type of program and will probably remain so unless adequate prophylactics are used.

The development of normal and emergency decompression schedules was another area of significant biomedical research. The tables developed are shown in Table 4. Although the normal decompression schedule developed for Tektite was prepared for an operational program, it became evident that the controlling tissue for nitrogen saturation decompression is far beyond the 240-minute level suggested by Workman.\* The data collected during this series of dives supports the much longer controlling tissue described by Buhlmann.† Preparation of the emergency decompression tables by NASA subcontract‡ indicated that, should a nitrogen-saturated aquanaut inadvertently surface (explosively decompress from a saturation depth of 43 feet), a 15-minute period was available for safe recompression. The emergency decompression table used an overpressure return and early oxygen decompression for treatment of explosive decompression.

#### INTEGRATED OCEAN FLOOR PROGRAM

The Tektite I project required a detailed intermeshing of the scientific programs. A daily scenario covering the full 60 days was prepared prior to the project's start, scheduling the scientific programs in train with appropriate operational and administrative tasks. Sample scenarios for the first and last days of the mission as well as typical days during the mission are shown in Fig. 13. The biomedical and psychological events were to the maximum possible extent concentrated on one day per week (Wednesday). This allowed the aquanauts maximum uninterrupted time for their own research on the other days of the week. A typical biomedical examination day is shown in Fig. 13 as day 5. Day 17 is typical of the week's remaining days.

The biomedical and psychological programs closely followed the scenario. Although the biomedical samplings on the first such days took longer than planned, the aquanauts and surface personnel soon established smooth routines for taking samples and for promptly transferring them to the surface. The behavioral program was primarily conducted by monitoring from the surface, with minimum interference to the aquanaut crew.

\*R. D. Workman, "Calculation of Decompression Schedules for Nitrogen-Oxygen and Helium-Oxygen Dives," U.S. Navy Experimental Diving Unit Research Report 6-65, 1965.

†A. A. Buhlmann, P. Frei, and N. Keller, "Saturation and Desaturation with N<sub>2</sub> and He at 4 Atmospheres," *J. Appl. Physiol.* 23:458-462 (1967).

‡P. O. Edel, "Delineation of Emergency Surface Decompression and Treatment Procedures for Project Tektite Aquanauts," *J and J Marine Diving Co., Inc., Pasadena, Texas*, Apr. 20, 1969.

**Table 4**  
**Tektite I Decompression Schedules**

Depth (ft)	Time at Stop (min)	Decompression Time (min)		Breathing Media
		Total	Oxygen	
<b>Normal Decompression Schedule</b>				
42*		12	0	Air
↓	12†	132	0	Air
30		137	0	Air
↓	5	337	0	Air
25		342	0	Air
↓	5	512	0	Air
20		542	30	Oxygen
↓	30	547	35	Oxygen
15		567	35	Air
↓	20	597	65	Oxygen
15		617	65	Air
↓	30	647	95	Oxygen
15		667	95	Air
↓	20	697	125	Oxygen
15		717	125	Air
↓	30	747	155	Oxygen
15		752	160	Oxygen
↓	5	812	160	Air
10		842	190	Oxygen
↓	30	862	190	Air
10		892	220	Oxygen
↓	20	912	220	Air
10		952	260	Oxygen
↓	40	957	265	Oxygen
10		957	265	Oxygen
↓	5	1157	265	Air
5		1162	265	Air
↓	200			
↓	5			
Surface		(19 hr 22 min)	(4 hr 25 min)	
<b>Emergency Recompression and Decompression</b> <b>Following an Explosive Decompression (Inadvertent Surfacing)</b>				
60†		20	20	Oxygen
↓	20	25	25	Oxygen
55		45	25	Air
↓	5	50	25	Air
50		70	45	Oxygen
↓	20	75	50	Oxygen
45		95	50	Air
↓	5	100	50	Air
40		120	70	Oxygen
↓	20	135	70	Air
25		195	70	Air
↓	15	200	70	Air
20		290	70	Air
↓	30	320	100	Oxygen
15		325	105	Oxygen
↓	5	415	105	Air
15		475	165	Oxygen
↓	60	480	165	Air
10		600	165	Air
↓	120	660	225	Oxygen
10		665	230	Oxygen
↓	60	815	230	Air
5		875	290	Oxygen
↓	150	880	290	Air
5				
↓	60			
↓	5			
Surface		(14 hr 40 min)	(4 hr 50 min)	

\*Aquanauts will be transferred via the personnel transfer capsule to the deck decompression chamber and held at a depth of 42 f et until all are transferred and topside crew is ready for decompression.  
 †All depth changes during the decompression will be made at a rate of 1 foot per minute. In the event the depth changes occur slower the time will be added onto total decompression.  
 ‡An over-pressure is applied on recompression when an aquanaut inadvertently surfaces.

## PROJECT TEKTITE I

Time	Day 1	Day 5	Day 17	Day 59	Day 60
0015					Depart habitat
0400			Sleep		Begin decompression
0430					
0500		Biomedical		Marine science	
0630		Breakfast; baralyme change			
0800		Biomedical	Breakfast; Baralyme Change; Psychomotor Test		
0830					
1100	Aquanauts occupy habitat		Marine science		
1130	Emergency drills and habitat familiarization				
1200		Lunch		Lunch; psychomotor test	
1300	Lunch	Biomedical	Marine science		
1500					
1700	Habitat engineering evaluation; check emergency air bottles; change baralyme				
1800	Supper; crew conference				
1900	Medical status evaluation			Medical status evaluation; prepare to leave habitat	
2000	Transfer samples to surface; charge scuba tanks; psychomotor test; marine science				Complete decompression
2100	Secure operations; set night watch				
2130	Mood adjective checklist (behavioral); attach EEG leads			Mood adjective checklist	
2200	Crew retires; sleep				
2400	Complete decompression				

Fig. 13 - Typical days from the Tektite I integrated ocean floor program scenario

Postmission analysis has shown that the aquanauts were able to spend almost a third of their bottom time conducting mission-oriented work. The total bottom time was categorized into six major activities and average daily times, in hours per aquanaut, were found for each activity: Scientific work (5.5 hours), habitat maintenance (1.9), self maintenance (2.7), recreation (3.0), rest and relaxation (10.7), and transit (0.2).

#### ENGINEERING PROGRAM

The Tektite I engineering program had a twofold objective: (a) to provide a habitat system within which the Tektite I scientific programs could be conducted, and (b) to gain experience in ocean engineering and in the conduct of underwater programs that would be of future benefit to others. This entailed designing and fabricating the habitat and its supporting systems, transporting the habitat to the project site in the Virgin Islands and emplacing it in Lameshur Bay, maintaining the habitat during the 2-month mission, evaluating its performance during this period, and recovering and returning the habitat and its supporting systems.

General Electric Company was tasked, under Office of Naval Research Contract N00014-68C-0356, with furnishing the Tektite I habitat, integrating the program scientific equipment into the habitat, defining the support service (power, air, water) requirements

for the habitat, assisting in the integration of the habitat with its support systems, and maintaining the habitat for the duration of the mission.

The Navy had project responsibility for designing and constructing support systems to meet the habitat service requirements, integrating the habitat service requirements, integrating the habitat with its support systems, transporting the entire assemblage to the Virgin Islands site and returning it, preparing the ocean floor at the experiment site, and emplacing the habitat and its supporting systems at the experiment site.

#### Habitat and Support Systems Assembly

The Tektite I habitat was designed and constructed by the General Electric Company at the Missile and Space Division, Valley Forge, Pennsylvania. The habitat was fabricated in three sections: the two habitat cylinders and the base (Fig. 3). The two cylinders were assembled and tested as components in Valley Forge. The base was fabricated under General Electric subcontract in Philadelphia. A more complete description of the habitat will be given in Chapter 4.

The habitat support systems were designed by the Naval Facilities Engineering Command to meet habitat service specifications provided by General Electric. Fabrication of these systems on the support barge (to be described in Chapter 4) was by Amphibious Construction Battalion Two. Fabrication was initiated at the Amphibious Construction Battalion Two facility in Norfolk, and completed at the Tektite I embarkation point, the Philadelphia Naval Shipyard.

The three major habitat components were individually transported to the Philadelphia Naval Shipyard, where the habitat was totally assembled for the first time. After assembly of the two cylinders on the base, the base was ballasted and the assembled habitat pneumostatically tested to 28 psig. After completion of the pressure test, each habitat subsystem was operationally tested.

#### Habitat Transportation

The Tektite I habitat was assembled on a Navy Ammi barge (Fig. 14), and for transportation to the Virgin Islands the barge and habitat were floated into the well-deck of a ballasted-down landing ship dock (LSD) (Fig. 15). Upon loading, the LSD was deballasted, leaving the habitat/barge on the dry floor of the LSD well for the open-sea trip to the site. Upon arrival in Lameshur Bay the LSD was again ballasted down, and the habitat and barge were floated to the habitat launch site. There the habitat and the support systems were fully integrated and checked. The habitat was "launched" by controlled sinking of the Ammi barge from under the habitat (using pilings driven into the Bay bottom as guides) until the habitat floated (Fig. 16). The habitat was towed to the experiment site, and winched to the bottom and the floodable ballast tanks flooded.

Newly developed Navy Ammi barges were selected for the habitat launch barge and the support barge. The Ammi barge, in addition to floating like an ordinary barge, may also be jacked up out of the water on pilings which act as stilts. The Ammi barge is also compartmented, which with only minor modification allows it to be progressively flooded for controlled sinking.

The Tektite I habitat could not be floated directly into the LSD well-deck because the 24-foot draft of the ballasted and assembled habitat (310,000 lb) was deeper than the maximum water depth in a fully-ballasted-down LSD well-deck. Therefore, a shallow-draft barge was required to carry the habitat and to launch it, since high-capacity crane service was not available in Lameshur Bay. The use of the Ammi barge to transport and launch

the Tektite I habitat demonstrated the capability of the Ammi to handle deep-draft, heavy loads, such as habitats and submersibles. It must be recognized, however, that the Ammi launch system is limited to shallow water, since guide pilings to assist in controlling descent must be driven into the bottom. Also, the Ammi launch system is sensitive to sea motions and requires calm water such as found in Lameshur Bay.

#### Engineering Evaluation

An engineering evaluation was made of how well the habitat and the supporting systems met the requirements of the scientific users. It is generally agreed that the habitat as a whole provided a comfortable and livable home for the Tektite I long-duration, shallow-water, saturated dive. As a laboratory it was not optimum, but it was adequate. Although small problems did occur, the majority of the habitat and support systems equipment functioned as designed, and this contributed significantly to the safe completion of the project.

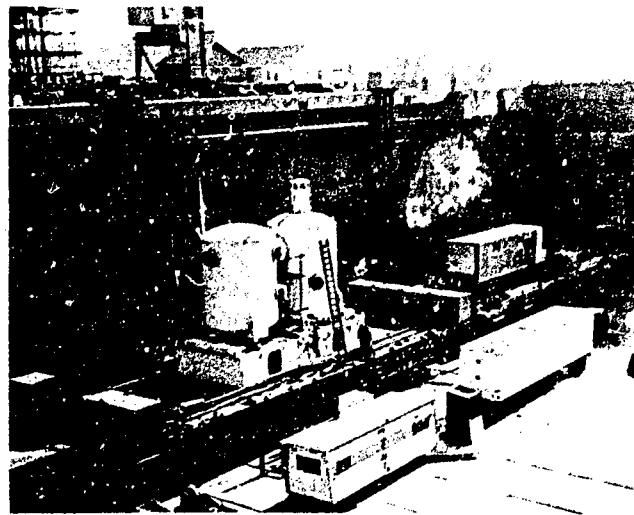

Fig. 14 - Tektite I habitat being assembled on a Navy Ammi barge at the Philadelphia Naval Shipyard. At the right is the support barge with habitat support systems.

A serious problem was in the  $\text{CO}_2$  scrubber system. About 36 hours after the aquanauts entered the habitat the  $\text{CO}_2$  level rose to 10.2 torr (1.34% surface equivalent by volume), higher than the generally accepted upper limit of 1% surface equivalent in closed hyperbaric environments and higher than the design value of 2 torr. Corrective action, including removal of  $\text{CO}_2$  fire extinguishers and use of a makeshift scrubber, lowered the  $\text{CO}_2$  to an acceptable level. For the next 2 weeks the baralyme absorbent was changed every 4 hours to keep the  $\text{CO}_2$  at a nominal level of 6 to 7 torr. A portable scrubber installed on March 1 allowed 8 hours between baralyme changes. Under actual mission conditions, the scrubber efficiency was considerably lower than during prior tests. The removal of  $\text{CO}_2$  from a closed hyperbaric environment remains a critical problem in ocean habitation.

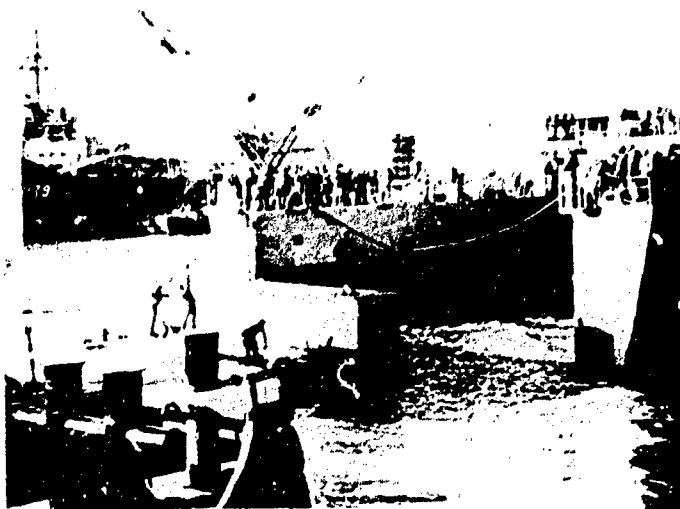

Fig. 15 - Habitat (just entering photograph at left) on an Ammi barge being floated aboard the *USS Hermitage* at the Philadelphia Naval Shipyard for transportation to the Virgin Islands.

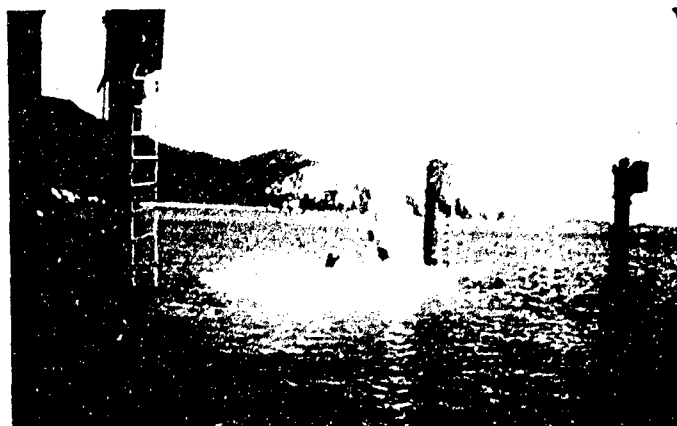

Fig. 16 - Habitat being launched by sinking the Ammi barge out from under it. The four pilings at the barge corners guided and controlled the descent of the flooded barge.

Other lesser engineering problems were encountered. Initially it was planned to place two underwater television cameras outside the habitat. One of these malfunctioned prior to the mission and was not used. The other camera functioned only part of the time during the mission and was of little real value. The sound-powered phones in the way stations were susceptible to water seepage through their protective cases, and were seldom used by the aquanauts.

In general, the initial stabilization of the habitat systems, and subsequent maintenance, required more time than planned. This resulted in a reduction of time available for scientific work by the aquanauts. This situation could be alleviated by including an engineer or technician as an aquanaut in future scientific missions where crew isolation is a criterion. Otherwise, maintenance and repairs could be accomplished in diving visits by a surface-based engineer or technician.

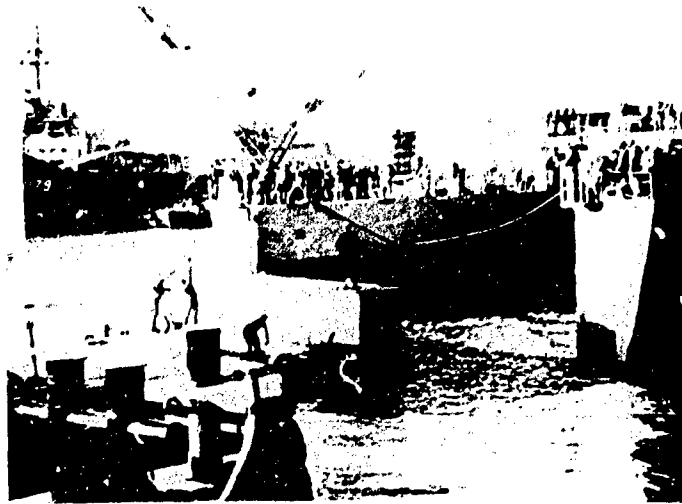

Fig. 15 - Habitat (just entering photograph at left) on an Ammi barge being floated aboard the *USS Hermitage* at the Philadelphia Naval Shipyard for transportation to the Virgin Islands.

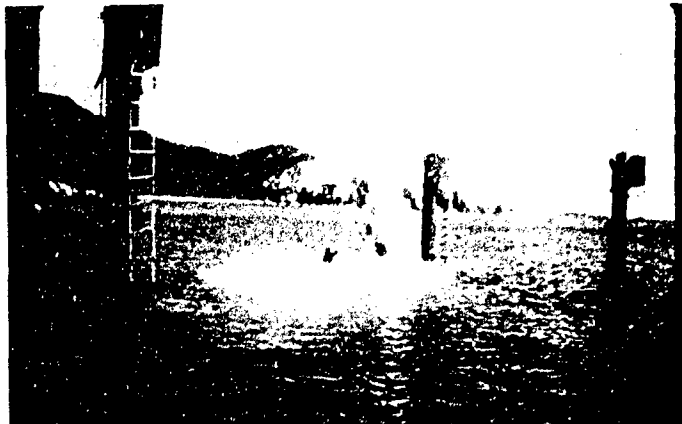

Fig. 16 - Habitat being launched by sinking the Ammi barge out from under it. The four pilings at the barge corners guided and controlled the descent of the flooded barge.

Other lesser engineering problems were encountered. Initially it was planned to place two underwater television cameras outside the habitat. One of these malfunctioned prior to the mission and was not used. The other camera functioned only part of the time during the mission and was of little real value. The sound-powered phones in the way stations were susceptible to water seepage through their protective cases, and were seldom used by the aquanauts.

In general, the initial stabilization of the habitat systems, and subsequent maintenance, required more time than planned. This resulted in a reduction of time available for scientific work by the aquanauts. This situation could be alleviated by including an engineer or technician as an aquanaut in future scientific missions where crew isolation is a criterion. Otherwise, maintenance and repairs could be accomplished in diving visits by a surface-based engineer or technician.

## Chapter 4

### FACILITIES

#### INTRODUCTION

The Tektite I facilities, shown in Fig. 17, consisted of the Tektite I habitat, a support barge, a crane barge (with decompression facilities), a causeway pier, and a base camp. In addition to these major facilities, transportation, communications, and logistics systems were vital supporting functions provided. These facilities provided support for the four aquanauts in their undersea research mission, support for surface personnel involved in the collection and analysis of marine science, life science, and engineering data, and support for all other personnel directly associated with the project.

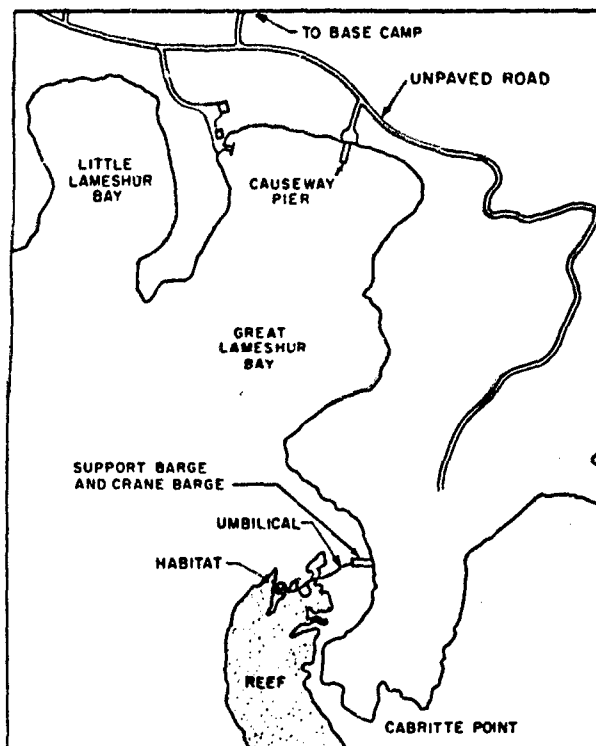

Fig. 17 - Tektite I site at St. John, Virgin Islands

#### HABITAT

A cutaway view of the habitat was shown in Fig. 3. Elevation and plan views of the habitat are shown in Figs. 18 and 19. The habitat consisted of two pressure hulls attached



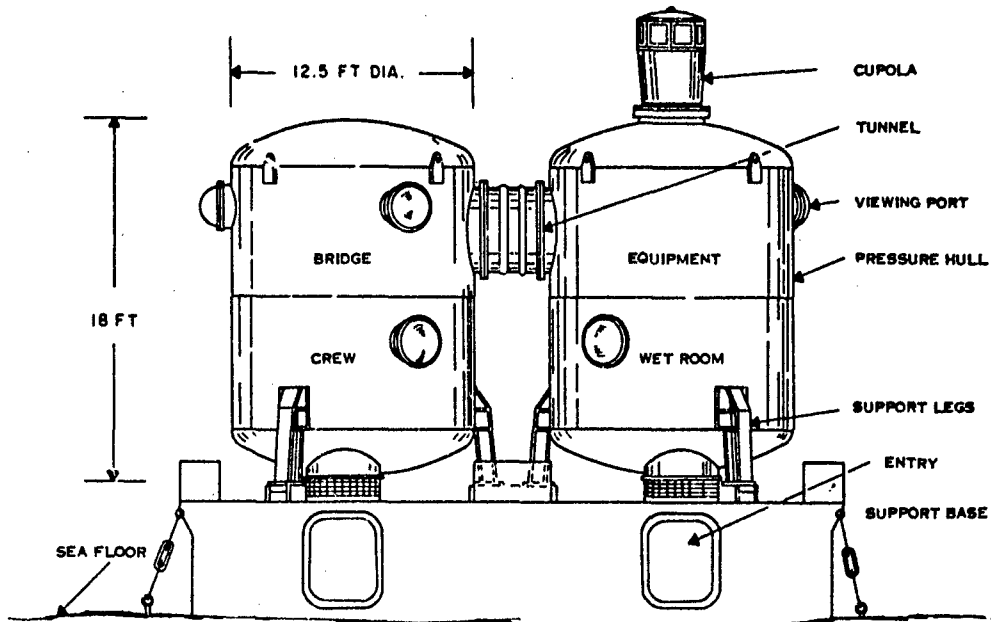

Fig. 18 - Side view of the Tektite I habitat

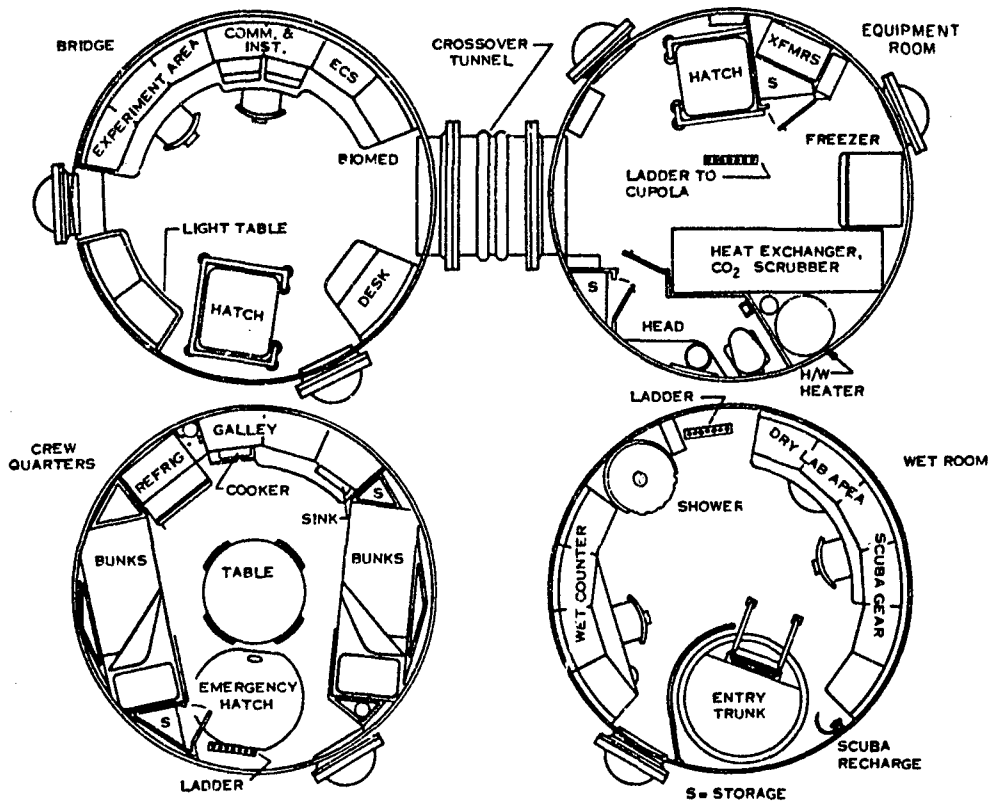

Fig. 19 - Plan views in the habitat of the habitat compartment

to a rigid base, connected by a pressurized crossover tunnel. The two cylinders were divided into two compartments each: bridge, crew quarters, equipment room, and wet room. Six hemispherical viewing ports and a cupola were provided for crew observation and safety monitoring purposes.

The bridge served a dual purpose: as control center for the habitat system and as a dry laboratory for the aquanauts (Figs. 20 through 22). The crew quarters (Fig. 23) contained four bunks, a small galley, storage space for personal gear, and entertainment facilities (radio and television). In addition, an emergency exit hatch was located in the crew quarters (Fig. 24). The equipment room (Figs. 25 and 26) contained the environmental control system, the primary electrical transformers and switches, the frozen food locker, and the crew toilet facilities. The cupola was mounted above the equipment room. The wet room (Figs. 27 and 28) served a dual role: a place for the aquanauts to don, doff, and store their scuba gear and a wet laboratory for specimen preparation.



Fig. 20 - Aquanauts Van Derwalker and Waller checking the habitat systems on the bridge of the habitat. Note the psychomotor test device at the lower right and the emergency escape bottles under the circular port to the left

The atmospheric pressure inside the habitat was maintained at water pressure in the entry trunk, which was left open to provide an air-sea interface for diver entry and exit. Because the habitat was secured and pressurized during emplacement the pressure hull of the habitat was designed in accordance with the American Society of Mechanical Engineers (ASME) Boiler and Pressure Vessel Code for Unfired Pressure Vessels.

The base of the habitat rested directly on the ocean floor. When emplaced, the total negative buoyancy of the habitat was 10 tons to assure stability under normal sea conditions. Jetted and clump anchors, to which the habitat was tied, constituted a redundant bottom moor for additional holding force to meet unusual sea conditions.



Fig. 21 - Habitat bridge (during construction)

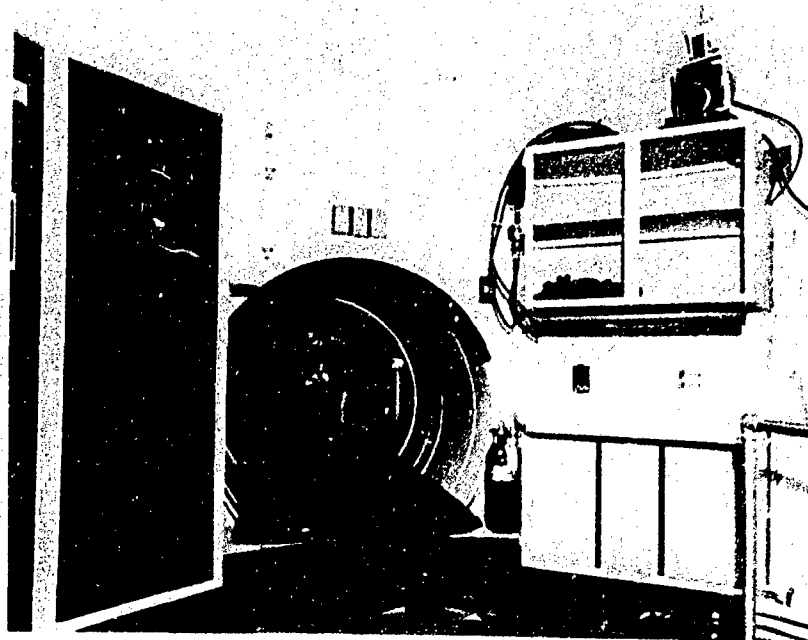

Fig. 22 - Crossover tunnel from the bridge to the equipment room (during construction)



Fig. 23 - Crew quarters (prior to launching) with sleeping, cooking, and entertainment facilities

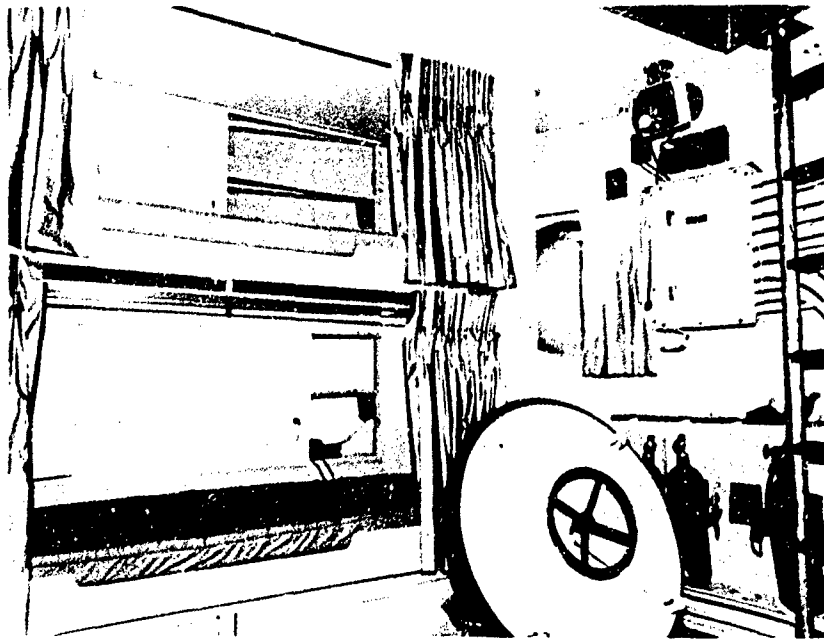

Fig. 24 - Crew quarters (prior to launching) with the emergency escape hatch shown open). Note the storage spaces behind the two bunks and the TV camera at the upper right.



Fig. 25 - Equipment room and crossover tunnel to the bridge (during construction). On the left is air conditioning equipment, and on the right is a ladder to the cupola.

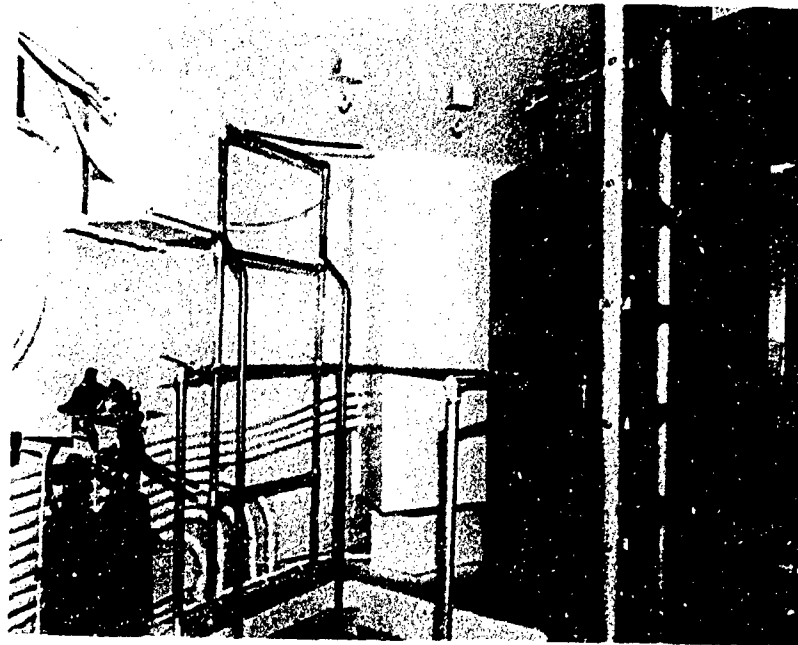

Fig. 26 - Equipment room (during construction). Left to right are emergency air bottles, the entrance from the wet room, the ladder to the cupola, and the freezer.

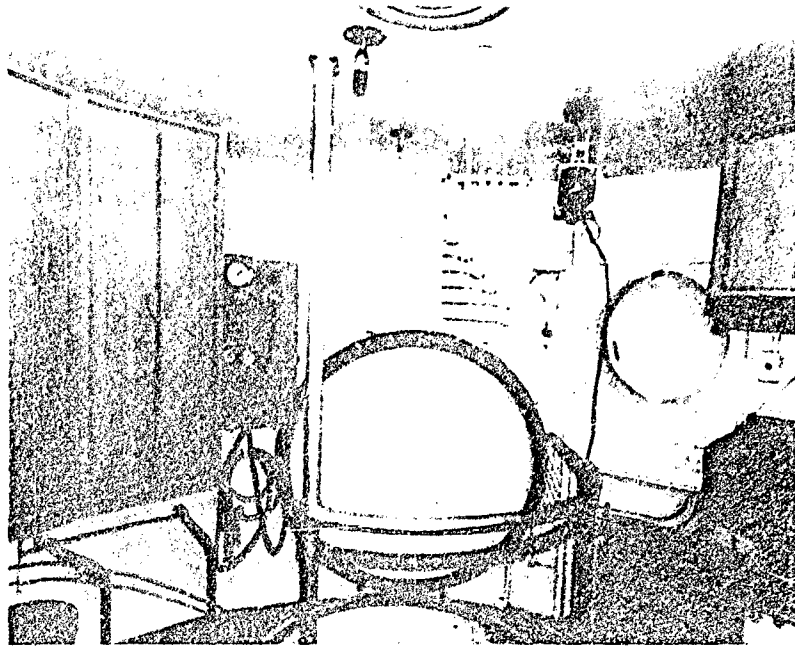

Fig. 27 - Entry hatch into the wet room (during construction). Left of the hatch is the scuba charging station.

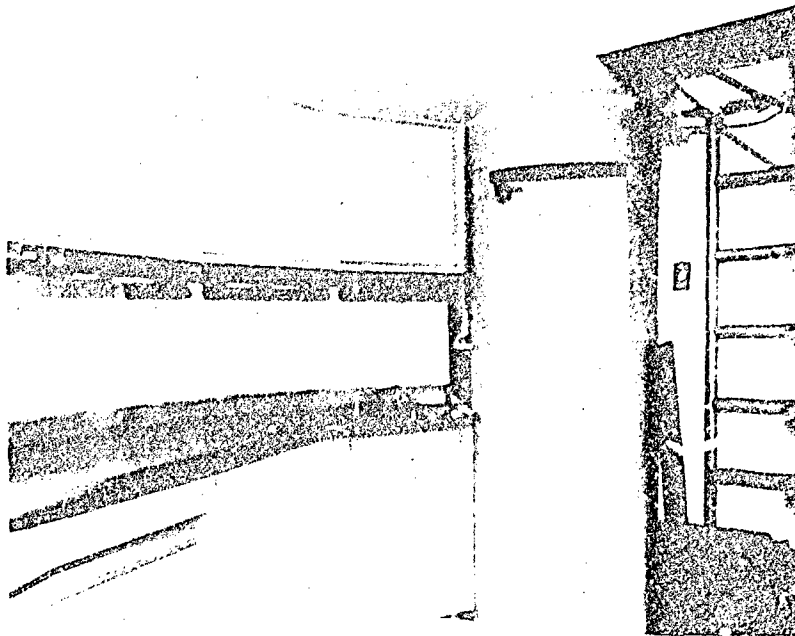

Fig. 28 - Wet room (during construction). Left to right are the wet laboratory counter, the fresh-water hot shower, and the exit to the equipment room.

### Air Supply, Pressure, and Atmospheric Control

The habitat was initially pressurized on the surface to the emplacement depth pressure of approximately 2.3 atmospheres by compressed air. The operational habitat nominal oxygen partial pressure ( $pO_2$ ) of 160 torr (mm Hg) was obtained by displacing air with nitrogen after the habitat was secured to the ocean floor. This resulted in a mixture of 92% nitrogen, 8% oxygen.

During the operation, compressed air was continually supplied to the habitat via an umbilical by low-pressure air compressors on the support barge to provide metabolic oxygen to the inhabitants and to maintain the  $pO_2$  between 151 and 165 torr. The required flow rate of inlet air to the habitat was 16 to 24 SCF/hr (standard cubic feet per hour). The flow rate was manually controlled but was based on measured  $pO_2$  levels. A continual stream of the habitat atmosphere was dumped through vents in the entrance trunk to the sea, thus maintaining the habitat pressure at the sea pressure at these trunk vents.

Carbon dioxide ( $CO_2$ ) generated by the crew was removed by a baralyme scrubber. The scrubber system consisted of two blowers (one redundant), a baralyme canister, and associated valves and piping. Habitat air was forced by the blower through the baralyme, where  $CO_2$  was absorbed, and the air then was directed in proportional parts to each of the four compartments. The habitat baralyme system was designed to operate 12 hours on a chemical charge. However, to maintain an acceptable  $CO_2$  level (8 torr or less) during the mission, it became necessary for the crew to change the chemical approximately every 4 hours. An additional  $CO_2$  scrubber was subsequently used; this reduced the frequency of baralyme change to once every 12 hours. Baralyme resupply from the surface was necessary because of lack of storage space.

### Atmosphere Monitoring System

The habitat atmospheric monitoring equipment, the monitored parameters, and the acceptable parameter limits are shown in Table 5. Early in the mission, the mass spectrometer (NASA atmosphere analyzer) in the habitat failed, requiring additional surface monitoring equipment. After removal by the aquanauts and transfer topside, the mass spectrometer was repaired, retransferred below, and put back into operation. After malfunction again on day 46 of the mission, the unit was no longer used.

### Thermal Control

The thermal control system maintained the habitat air temperature and humidity, removing heat and excess moisture from the air. Four heat exchangers were used, one per compartment. Connected to each heat exchanger were a blower for air circulation, a charcoal filter for odor removal, and an electrical reheater. The air was dehumidified by condensing water vapor on the heat exchanger coils, thus requiring reheating the air to the desired temperature. Relative humidity was maintained between 42% and 60%.

### Emergency Air Systems

Emergency air systems provided were a surface air supply system, a purge system, a habitat emergency air supply system, a built-in breathing (BIB) system, and escape air bottles. Upon the first failure of the mass spectrometer, the emergency BIB was used, since the carbon dioxide levels rose abruptly.

The surface emergency air supply was aboard the support barge and consisted of two 8000-SCF (at 2200 psi) compressed air cylinders. This system served as a backup

Table 5  
Tektite I Atmosphere Monitoring Parameters and Equipment

Constituent	Equipment Monitoring Range	Acceptable Operating Range	Equipment		Backup Equipment	
			Habitat	Surface	Habitat	Surface
O <sub>2</sub>	0-450 torr	151-165 torr	Mass spectrometer	Servomex AO150 O <sub>2</sub> analyzer	MSA O <sub>2</sub> meter	Beckman F3 O <sub>2</sub> analyzer
CO <sub>2</sub>	0-15 torr	0-8 torr	Mass spectrometer	Perkin-Elmer 810 gas chromatograph	Detector tube	Beckman IR-215 infrared
H <sub>2</sub> O	0-100% RH	30-70% RH	Mass spectrometer	Perkin-Elmer 810 gas chromatograph	RH gage	CO <sub>2</sub> analyzer
N <sub>2</sub>	0-2000 torr	1570-1600 torr	Mass spectrometer	Perkin-Elmer 810 gas chromatograph	Pressure gage	-
CO	10-3000 ppm	0-15 ppm	Detector tube	Perkin-Elmer 810 gas chromatograph	-	Detector tube
Hydrocarbons	1-5 times acceptable	See Spec. TEK 17-5001	Detector tube	Perkin-Elmer 810 gas chromatograph	-	Sample to Puerto Rico
Freon 12 and 22	0-2000 ppm	0-1500 ppm	Detector tube	Perkin-Elmer 810 gas chromatograph	-	-
Particulates	0-100 mg/m <sup>3</sup>	0-25 mg/m <sup>3</sup>	Air Sampler	-	-	Detector tube

to the support barge air compressors. In the event of compressor failure, compressed air would have been supplied automatically from these tubes.

The purge system was designed to change 90% of the air within the habitat within 4 hours in the event of major contamination of the habitat atmosphere and return the habitat atmosphere to 8% O<sub>2</sub>, 92% N<sub>2</sub>. The system used a 125-SCF/min, 100-psi diesel-driven air compressor and nitrogen storage cylinders located on the support barge to supply gas to the habitat via the air supply umbilical. In operation, air from the compressor would replace habitat air until gas sampling indicated a satisfactory atmosphere had been attained. Nitrogen would then be introduced to the system to reduce the pO<sub>2</sub> to within allowable limits. If practical, normal operation of the habitat would then have been resumed.

The habitat emergency air supply consisted of 23 240-SCF compressed air cylinders in the habitat base. This emergency air supply could be activated by the crew in the event of normal air supply failure. This system was designed such that the emergency air would be introduced into the normal habitat air distribution system in the event of topside compressor or umbilical failure. In the event of atmospheric contamination within the habitat, this emergency air could be supplied to the BIB system.

The BIB system provided 12 breathing stations within the habitat to be used in the event of atmospheric contamination. In this mode, air was available for 12 hours duration. The line pressure to each BIB station was maintained at 100 psi, and demand regulator/hose assemblies and face masks were attached at each station. Of the 12 BIB stations, four were in the crew quarters, four were in the wet room, and two each were in the bridge and equipment rooms. Each BIB had a hose long enough to reach to adjacent compartments.

Eight escape air bottles with regulators, hoses, and mouthpieces were available to provide capability to move about inside the habitat under conditions requiring BIB breathing, and to escape from the habitat to the personnel transfer capsule. Each bottle had an 18-SCF capacity, sufficient for approximately 7 minutes breathing. Four bottles were in the crew quarters, and two each were in the bridge and equipment room. None were required in the wet room, since scuba gear stored there could serve the same purpose.



### Communication, Electrical, and Sanitary Systems

The communication systems (Table 6) provided aural and visual communication between the habitat and the support barge. The bridge, which was the habitat communication center, was connected to the surface command facility via intercom, sound-powered phones, and voice sonar. Each compartment was equipped with an intercom station connecting it with the other compartments and the surface, an open mike and closed-circuit television camera for the behavioral program, and audible and visible alarms. The bridge could monitor the open mikes and the closed-circuit television cameras. In the wet room was a timer for recording the times that each diver left and entered the habitat, for the behavioral program.

Table 6  
Tektite I Communication Systems

Purpose	Quantity	Habitat Equipment
Behavioral data acquisition	4	TV cameras in habitat
	2	TV monitors in habitat
	4	Open microphones in habitat
	1	Diver-in/out panel in wet room
	1	Crew activity monitoring switch set in crew quarters
Normal or emergency communication to shore	1	Sound-powered phone link in bridge
	1	Intercom system in habitat
	1	Emergency alarm panel in bridge
	2	Warning bells and horn in bridge
Diver-to-diver communications	1	Hardwire communication to way stations
Entertainment	1	Commercial TV monitor
	1	Commercial radio
Biomedical data acquisition	4	EEG electrodes and amplifiers in crew quarters
	1	EKG recorder/amplifier in bridge

Electrical power was furnished to the habitat via an umbilical from two 100-kilowatt generators (one redundant) mounted on the support barge. The habitat electrical system was a three-wire grounded system. The habitat and all equipment cases and chassis were thus grounded. Flooding sensors were provided to shut off surface power in the event of major habitat flooding. Each compartment was lighted by two separate circuits, and emergency battery-powered lights were available in each compartment.

Potable water was pumped from the support barge to the habitat via a hose. The toilet facilities were of marine type, and waste was chemically treated prior to discharge to the sea through a 1000-foot drain hose laid out along the ocean floor away from the habitat.

### Alarm System

The alarm sensors used to monitor the habitat life support systems and the displays triggered by these alarms are summarized in Table 7. Difficulty was experienced with the entry-trunk-water-level alarm, which was replaced.

Table 7  
Tektite I Alarm System

Sensor	Habitat-Bridge Alarm		Surface-Control-Center Alarm	
	Visual	Audible	Visual	Audible
CO <sub>2</sub> partial pressure	Meter/light	Buzzer*	Meter	-
O <sub>2</sub> partial pressure	Meter/light	Buzzer*	Meter	-
N <sub>2</sub> partial pressure	Meter	-	Meter	-
H <sub>2</sub> O partial pressure	Meter	-	Meter	-
120-V power loss	Light	Buzzer*	TV	Speaker
Entry trunk water level	Light	Buzzer*	TV	Speaker
Wet room flooding <sup>†</sup>	Light	Horn <sup>‡</sup>	TV	Horns <sup>§</sup>

\*The buzzer could be manually activated in the bridge.

†The wet-room-flooding alarm automatically turned off power to the habitat at the shore end.

‡The habitat horn could be manually activated from the bridge only.

§The control-center horn could be manually activated from the van only.

### SUPPORT BARGE

The support barge (Fig. 29) was located at the nearest shore point adjacent to the habitat location. This barge was a Navy Ammi pontoon jacked up above the water surface on driven piles to minimize reactions with waves and to minimize machinery noise being transmitted into the water. The barge was the shore terminus for all habitat umbilicals and provided the platform upon which were mounted the surface-control-center van and all habitat life support equipment. Access to this barge was by boat from the causeway pier adjacent to the base camp. The facilities located aboard this barge were the surface control-center van, the environmental control and supply system, the electrical generation and distribution system, and the water storage and distribution system.

### Surface Control-Center Van

The surface control-center van (Fig. 30) was an air-conditioned instrumentation van divided into two compartments: the behavioral monitoring station and the watch director's station.

The behavioral monitoring station, effectively isolated from the watch director's station by a folding partition, accommodated three behavioral observers and the behavioral scientist supervisor. Displayed before the observers were six television monitors, four of which continuously covered televised input from each of the four habitat compartments and two of which were available for external habitat cameras. A video tape recorder was available for recording significant events. Audio monitoring of the open microphones in the habitat's compartments could be recorded on two audio tape recorders. Automatic data recording equipment monitored important behavioral parameters such as time out of habitat, sleep time, stove and oven usage, and entertainment facility usage (Fig. 31).

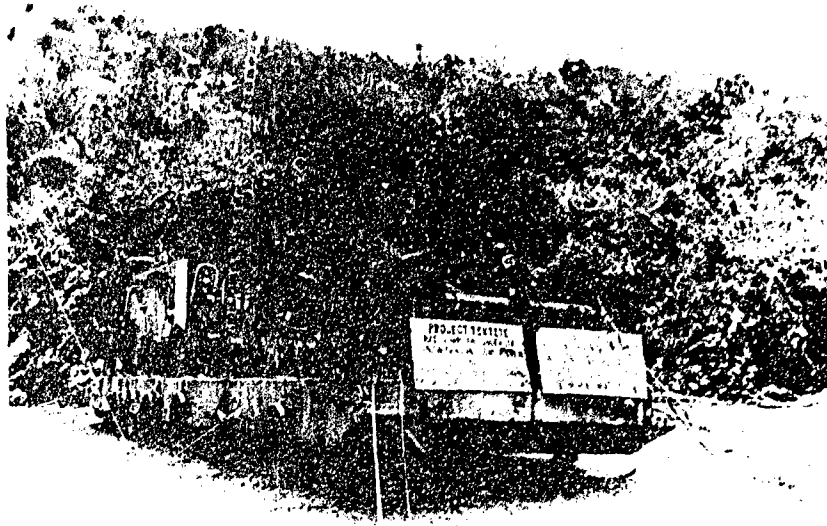

Fig. 29 - Tektite I support barge, which provided all utilities and services for the habitat. The watch director's station and the behavioral monitoring station were in the trailer at the left. The electric generators in the right foreground provided all power for the barge and the habitat. The barge is supported on four pilings for noise control.

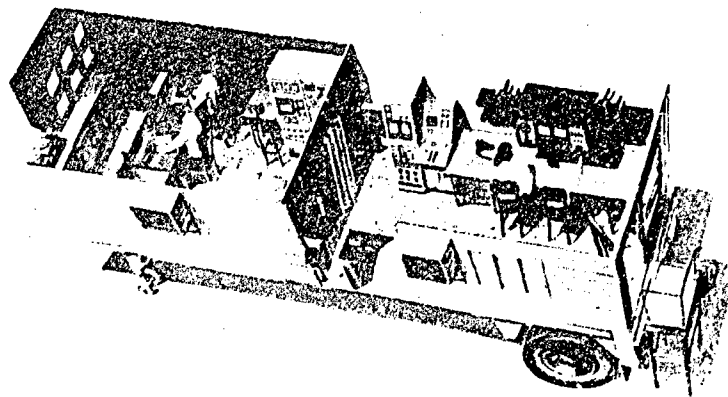

Fig. 30 - Surface control-center van on the support barge. The partition between the behavioral monitoring station at the left and the watch director's station at the right provided privacy and quiet for the behavioral program.



Fig. 31 - Recording equipment used in collecting EEG data from the aquanauts. This equipment is in the behavioral monitoring station, with the folding partition (Fig. 30) at the left.

The watch director's station was the command center for the Tektite I operation. A control panel, at which the watch director and the medical watch officer were stationed, provided audio, video, and environmental monitoring capability for these two officers (Fig. 32). The habitat alarm system displays were located at the watch director's station, which also served as the control point for all communications to the habitat, base camp, mainland, and the immediate surface area.

#### Environmental Control and Supply System

The environmental control and supply system, aboard the support barge, provided the habitat all normal and emergency surface gas supplies (Figs. 33 and 34). This system included: an on-line and a backup habitat supply air compressor (3.1 SCF/min at 50 psi), a purge compressor (125 SCF/min at 100 psi) with air aftercooler and moisture trap, a surface emergency air supply (two tubes, each 8000 SCF at 2200 psi), a nitrogen habitat charging and purge gas supply (four tubes, each 8000 SCF at 2200 psi), a pneumatic control console (Fig. 35) at which one man could monitor and control the total gas supply to the habitat, and all necessary valves, regulators, and piping.

In addition, the compressors for charging the aquanauts' scuba tanks were located on the support barge, and the high-pressure charging air was sent to the habitat via the umbilical for storage in volume tanks in the habitat base.

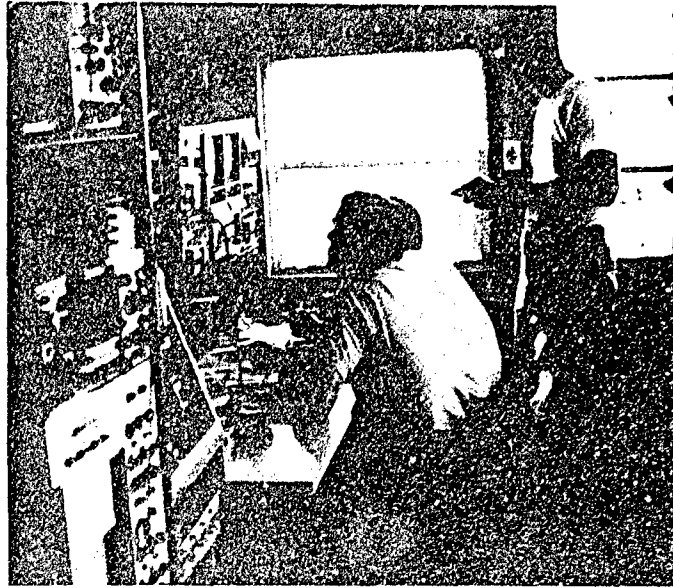

Fig. 32 - Watch director's station in the surface control-center van. The two TV monitors could be switched to any of the six signals from the habitat. The intercom provided for audio monitoring of each of the habitat's rooms, and measurements of the habitat atmosphere were also presented on the console. In the foreground are gas analysis equipments.

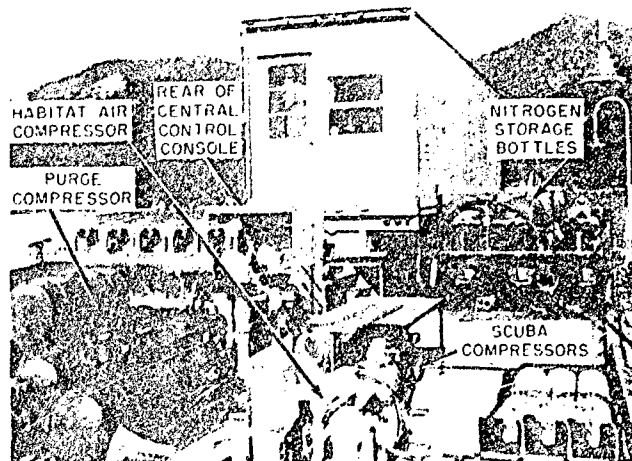

Fig. 33 - Surface control-center van and gas supplies for the habitat

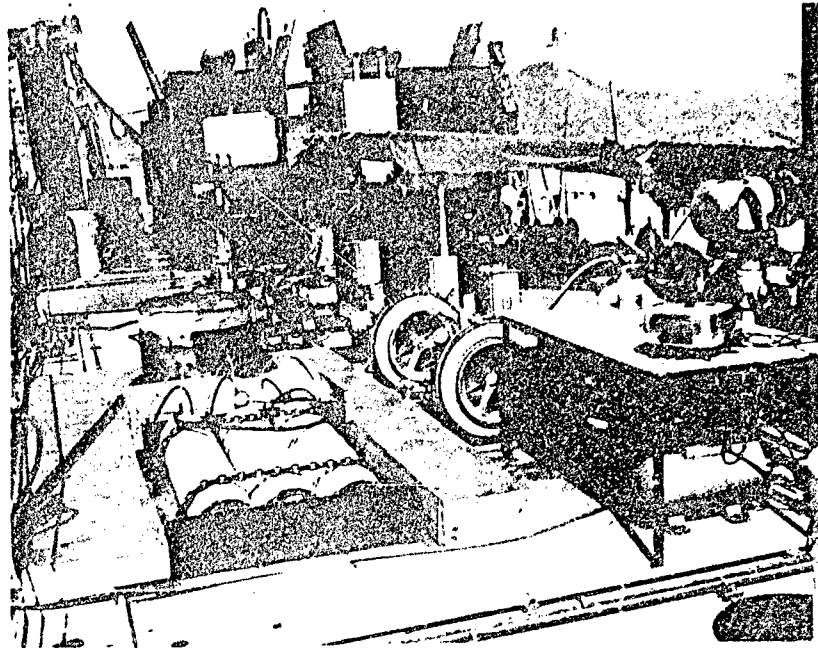

Fig. 34 - Utility sources on the support barge. Scuba charging compressors are beneath the table in the right foreground, and air supply compressors are immediately past the table. Water is stored in a large pillow tank beneath the canopy. Diesel-driven generators are in the rear, with power transformers hanging from the rack at the left center.

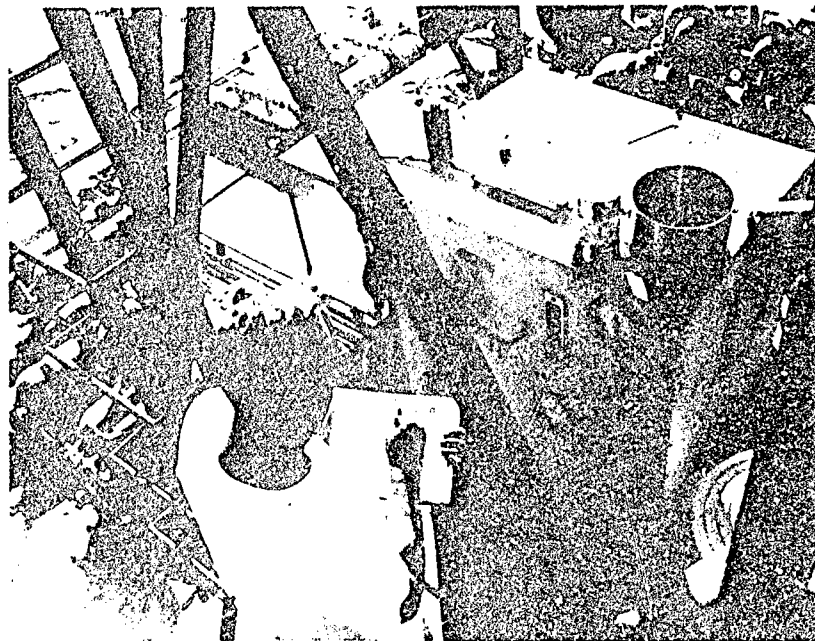

Fig. 35 - Central control console, where flow and pressure of all atmosphere gas to the habitat was controlled, monitored, and recorded

### Electrical Generation and Distribution System

The electrical generation and distribution system provided electrical power for the support barge and the habitat. Two 100-kilowatt diesel-powered generators (one redundant) furnished all required power for the habitat, environmental compressors, water pumps, and lighting.

### Water Storage and Distribution System

Potable water for the habitat was stored on the support barge in a 3000-gallon pillow tank and was pumped to the habitat via the water umbilical. The pillow tank was refilled from a tank truck, aboard a Navy LCM boat, when required.

### CRANE BARGE

The crane barge (Fig. 36), moored adjacent to the support barge, was the platform on which was located the Tektite I decompression system and a 35-ton-capacity crane for handling this system.

The decompression system (Fig. 37) was an Ocean Systems, Inc., ADS IV system consisting of a double-lock deck decompression chamber with its environmental support unit and personnel transfer capsule. This ADS IV system was man-rated to a depth of 600 feet. The decompression mode was that of ventilation, with occasional periods when the aquanauts were on pure oxygen supplied through a mask/regulator breathing system (the decompression schedule used was given in Table 4).

Personnel for the operation of the decompression facility, handling crane, and small boat support were maintained on a 24-hour alert watch, with frequent drills so that if necessary an aquanaut could have been moved from the water into decompression in less than 5 minutes.

### CAUSEWAY PIER

The causeway pier (Fig. 38) was the sea/shore interface between the support barge and the base camp. The draft at the end of this pier was such that most craft transporting personnel and supplies from St. Thomas could tie up. This pier was the terminus of the shuttle boat service between the support barge and the shore.

### BASE CAMP

The Tektite I base camp (Fig. 5) was a semipermanent facility to house and mess the scientific and support personnel who were on site throughout the mission. Because of the remoteness of the Tektite I site, the base camp was required to be self-supporting. Additionally, because the camp was located in a National Park, great care was required to preserve the beauty and nature of the park. The camp was set back from the Lameshur Bay beach and beach road to maintain the unspoiled beauty of the beach area.

The camp consisted of 13 wooden tropical huts, 16 by 32 feet (Fig. 39), and one portable, prefabricated aluminum building, 20 by 48 feet, with supporting utility services. Eleven tropical huts were used as barracks, one as the command (OOD) hut, and one as the galley. The framing was treated timber, and the siding was redwood. All were screened for ventilation except for the OOD hut, which was enclosed and air conditioned.



Fig. 36 - Crane barge, moored alongside the support barge with a hand-powered ferry barge between

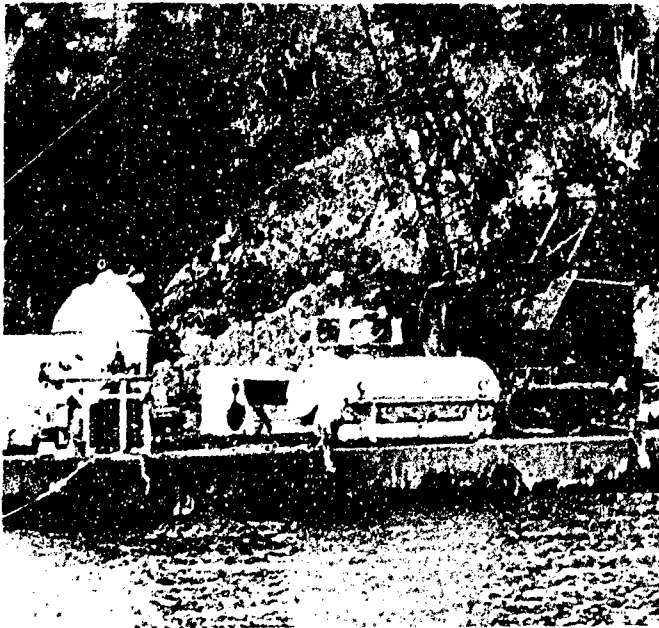

Fig. 37 - ADS IV deck decompression chamber (center), personnel transfer capsule (left), and lifting crane for the personnel transfer capsule

The aluminum building (Fig. 40) was partitioned into three compartments: dispensary, marine science laboratory, and recreation area. During the postdive medical debriefings, this building housed the medical examination facilities. The tropical huts of the base camp will be used in the future by the College of the Virgin Islands, for use as a laboratory and dormitory facility in conjunction with their Marine Ecological Station, also on Lameshur Bay and partly visible at the far right center in Fig. 5.



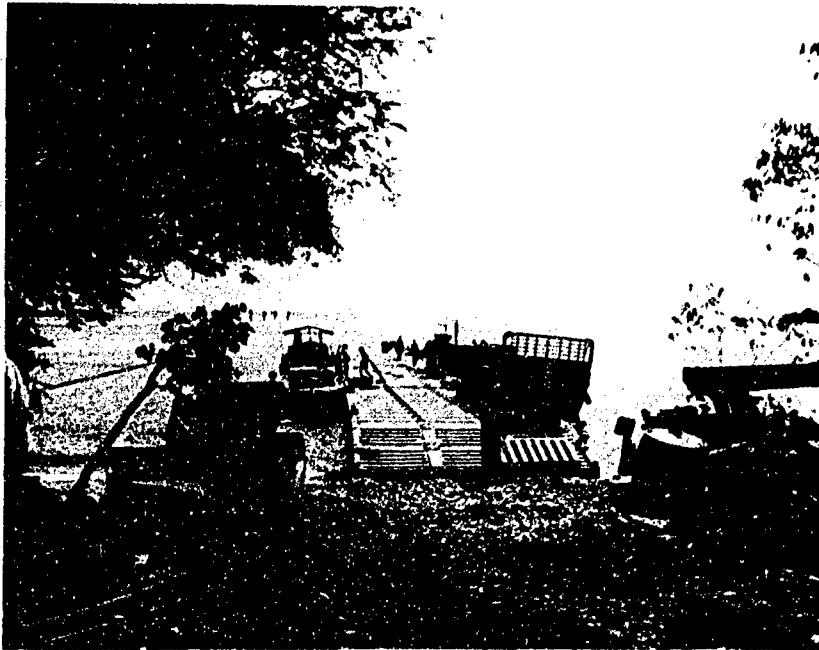

Fig. 38 - Pier, consisting of causeway sections tied end to end, serving as the offloading point for personnel and supplies arriving at Lameshur Bay. The small craft left of the pier shuttled personnel between the base camp and the support barge adjacent to the habitat.



Fig. 39 - Base camp which housed the approximately 60 support and 35 scientific personnel at the site

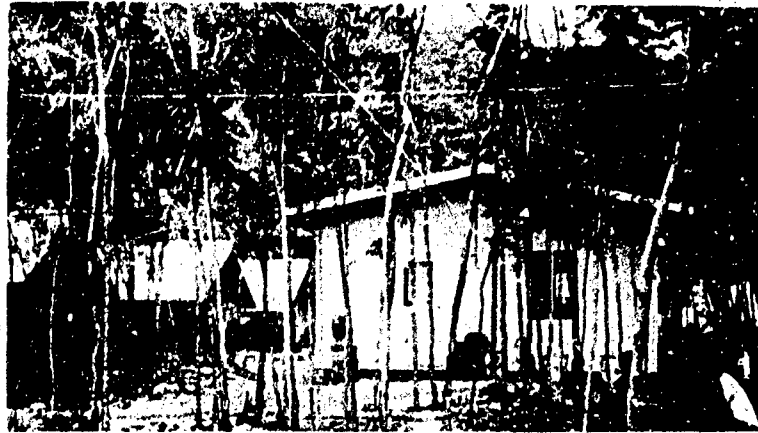

Fig. 40 - Aluminum building in the base camp which was partitioned into the infirmary, marine science laboratory, and recreation room

Potable water for the camp was stored in two 10,000-gallon underground tanks. Water for these tanks was pumped from a water barge alongside the causeway pier to the camp via "invasion piping" over a distance of approximately 1/4 mile. Water was pumped from the storage tanks into a camp distribution system. A well adjacent to the base camp had been outfitted with a pump and plumbing for shower water supply, but this well proved too unreliable for use.

Human waste was burnt on a daily basis in half-drums (55 gallons) by covering the waste with fuel-oil and igniting. This system was quite efficient. Waste water from the showers, galley, and dispensary was drained into the ground via a grease trap and drain field.

Electric power was generated in the camp by two 100-kilowatt generators (one redundant) and distributed, where possible, by underground cables.

#### LOGISTICS, TRANSPORTATION, AND COMMUNICATIONS

The remoteness of the Tektite I site required some degree of resourcefulness and a wide variety of military and civilian resources in the coordination of logistics, transportation, and communication.

Logistics requirements were primarily in the areas of food, water, and petroleum. For the most part, sufficient dry food was landed with the Tektite I party in January 1969. Resupply of dry foods, and continuing resupply of frozen foods, was obtained from visiting Navy ships. Fresh provisions, such as bread and milk, were procured from local vendors on St. Thomas. Water was delivered to the Lameshur Bay site on a weekly basis by the government of the Virgin Islands via water barge. Petroleum was purchased under Defense Contract in St. Thomas. Diesel fuel and gasoline were loaded into 55-gallon drums at Red Hook (St. Thomas) and transported by a Tektite I LCM boat to the site on a weekly basis.

Transportation to the Tektite I site was by two routes: via water over an open 8-mile unmarked and unlighted course from Red Hook Harbor, St. Thomas, and a torturous over-land route from Cruz Bay (Fig. 41). The water route was the more desirable of the two.

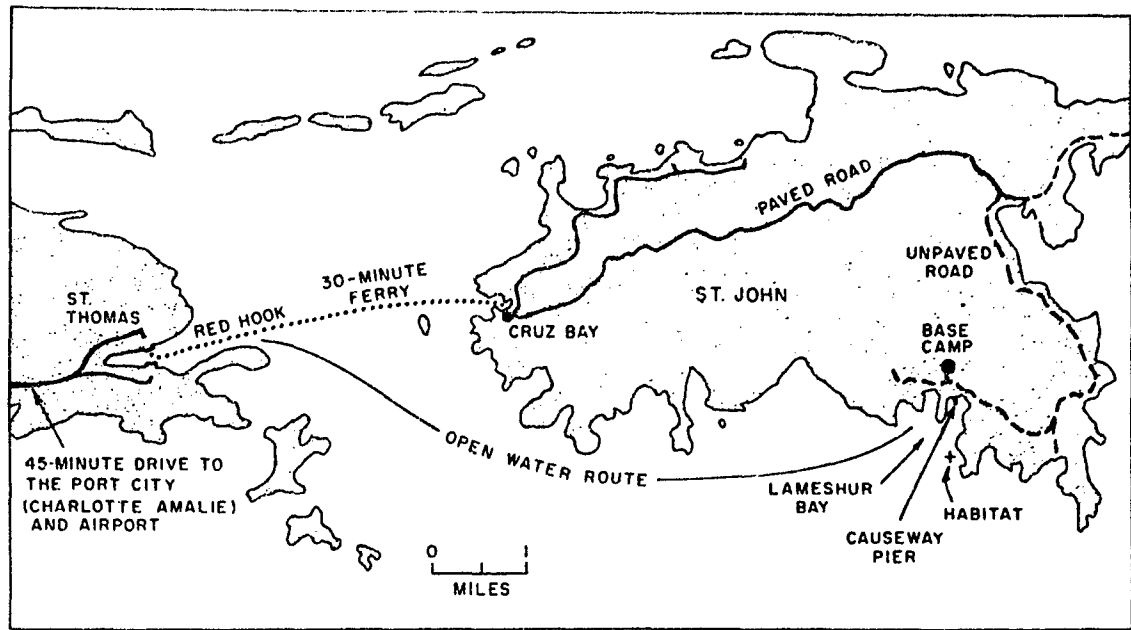

Fig. 41 - Transportation to the Tektite I site

and all supplies and most personnel were transported via this mode. The Tektite I fleet consisted of two LCM-class cargo boats, three LCPL-class personnel boats, and two 18-foot outboard runabouts (primarily for safety diver use). Land transportation on the base camp consisted of one 6 by 6 truck and two 4 by 4 ordnance carriers. One 4 by 4 ordnance carrier was stationed on St. Thomas. These vehicles were furnished and operated by Amphibious Construction Battalion Two.

External communications were by radio, telephone, and commercial marine-operator service. Internal communications (within the base camp area) were by radio, field phones, and sound-powered phones. Mail service was handled through the U.S. Post Office, St. Thomas.

External radio communication using AN/PRC-47 single-sideband radios was on local NORATS frequency 2114 kHz, on which contact was maintained with the St. Thomas Coast Guard Station and with Ft. Allen, Puerto Rico. Telephone service (two lines) into the base camp was furnished by VITELCO. Commercial marine-operator service, which was patched into the VITELCO system in St. Thomas, was leased by General Electric. Telephone service was approximately 60% reliable.

Internal communication was used to exercise command control over the base camp and adjacent areas. Additional AN/PRC-47 radios, located in vehicles, boats, the base camp, and the surface control center operated on the upper sideband on 4073 kHz. Contact between the watch director and the diving and safety watches was maintained on the 39-MHz band using Motorola PT-200 FM transceivers. Field phones linked the causeway pier to the base camp and were a backup to the PT-200 transceivers between the crane barge and the support barge. Sound-powered phones provided an emergency communication link between the watch director and the habitat.

## REPAIRS

Repairs to boats, electronic equipment, and vehicles which required facilities or personnel not available in the base camp were accommodated by the Supervisor of Shipbuilding, Conversion and Repair, Tenth Naval District in San Juan, Puerto Rico (Fig. 1).

## HABITAT AND AQUANAUT SUPPORT EQUIPMENT

Additional equipments available for aquanaut use included a series of underwater way stations and a navigational grid system. Five way stations were located around the habitat to provide the aquanauts a series of landmarks and places of refuge. Each way station consisted of a clear-plastic hemispherical shell mounted on a cylindrical steel cage. A charged set of scuba bottles and sound-powered phones linked to the habitat were located in each way station. The main use of the way stations was in the transfer of air bottles between the aquanauts and the surface, although they did serve as reassuring landmarks to the aquanauts.

The navigational grid system was installed on the Lameshur Bay floor prior to the beginning of the project. However, because of the clarity of the water and the rapidity with which the aquanauts could visually familiarize themselves with their surroundings, the navigation system was not used to any great extent.

The aquanauts used standard twin-tank scuba rigs. Each 72-cubic-foot-capacity tank had its own reserve valve and single hose regulator. This double-tank combination had a little over an hour's air capacity at a 50-foot depth. For longer excursions, extra tanks were pre-positioned by surface divers along the excursion route. Before the mission it was anticipated that newly developed, Navy-procured closed-circuit rigs, with approximately a 6-hour capacity, would be available for aquanaut use. These, however, were not delivered to the Navy in time for completion of evaluation and certification, and thus were not used in Tektite I.

The Tektite I aquanauts had available, in addition to standard scuba equipment, hookah masks with built-in communications equipment. A hookah system is one in which breathing gas is supplied to the diver via an umbilical. In the case of Tektite I the gas was supplied from a low-pressure source in the habitat through a 200-foot hookah hose. Thus the aquanauts could swim up to 200 feet from the habitat without having to suit-up in full scuba gear. The hookah mask contained communications equipment, linked to the habitat via hardwire cables along the hookah hose. The hookah was used for 41 man-hours of diving, about 1/10 of the total man-hours in the water.

In addition to the tethered hookah communications, the Tektite I aquanauts had two sets of untethered underwater communications equipment. These included two tender and three diver units. These units were seldom used due to range and reliability limitations.

A dumbwaiter system was provided for the dry transfer between the habitat and the surface of items such as food, CO<sub>2</sub> absorbent, mail, and garbage. The system consisted of a floating platform with an A-frame and winch which could raise and lower a series of pressure and waterproof canisters. The canisters were vented for pressure equalization after each transit. Two sizes of transfer pots were used during the Tektite I project. The larger size was capable of moving 300 pounds, but the size and weight of the pot made it awkward to handle. The smaller sized pots, of which there were two, were of 30-pound capacity, and these canisters saw considerable service before and during the project.

## Chapter 5

### CONCLUSIONS AND RECOMMENDATIONS

#### INTRODUCTION

Tektite I project personnel were able to achieve their primary missions of (a) keeping an undersea habitat in operation for a continuous 2-month period, (b) safely conducting a sustained 2-month series of marine science studies from the habitat, and (c) collecting a voluminous quantity of consistent data on the behavior of a small team of men isolated and working in a continuously hazardous environment.

Tektite I was the third major program in this country (preceded by Sealabs I and II) to study the responses of men to the isolated, hazardous, quasi-operational environment of extended undersea habitation. For this reason, certain of the Tektite I conclusions and recommendations may be recognized as having been identified in these earlier programs. To the maximum possible extent, recommendations from these previous programs were incorporated into Tektite I, but schedule and budget limitations precluded inclusion of specifically recognized desirable considerations. Consequently, certain of the conclusions and recommendations to follow indicate areas in the Tektite I program where desirable features were sacrificed. It is emphasized that in no respect was the safety of the aquanaut crew or other project personnel compromised where schedule/budget tradeoffs occurred.

#### CONCLUSIONS

1. Saturation dives of the Tektite type can be conducted safely, provided that a rigorous safety program is implemented. As further experience is gained, the safety factor added for uncertainty can be reduced to a degree, while freedom from restraints may be more fully exploited.

2. Saturated diving offers great advantages to investigations of marine science. The most impressive feature was the wide range of studies during the project. The application of undersea habitation to studies of marine geological processes, to exploration and exploitation of mineral and other marine resources, and to studies of the sea floor are potentially unlimited.

3. Long excursions by aquanauts from undersea habitats appear feasible and would be applicable to civilian and military needs. The Tektite I aquanauts, swimming in warm tropical water, were physiologically bound only by vertical limits imposed by decompression. Their horizontal ranging from the habitat increased throughout the mission. The horizontal excursion limit on time in the water limit became a function of equipment, not aquanaut, endurance. It should be realized, however, that a similar mission in cold water would have the additional requirements of adequate diver heating.

4. Studies to prepare the Tektite I normal decompression schedule indicated that the controlling tissue for nitrogen saturation is beyond the 240-minute limit. The preparation and experimental validation of the emergency decompression (treatment) schedules indicated that a surface time of 15 minutes was safely available to a diver nitrogen saturated at the Tektite I depth (43 feet) before emergency recompression and decompression treatment was required.

5. Divers can safely live and work in a hyperbaric nitrogen atmosphere saturated at 43 feet with excursions to 22 and 85 feet. Thus, for these depths, which are of considerable interest to the scientific community, expensive three-gas helium-oxygen-nitrogen life support systems are not required to support saturated scientific diving.

6. Man can adapt to the stresses that accompany undersea habitation at 43 feet and the various behavioral interactions involved therein. The aquanauts experienced no severe sleep loss or disruption of sleep cycles. Instead of obtaining less sleep as the mission progressed, the aquanauts appear to have slept longer and deeper.

7. The prolonged application of the environmental conditions and aquanaut interactions, as carried in the Tektite I program, did not result in any unusual microbiological hazard to the aquanauts.

8. The use of mass spectrometer instrumentation in a hyperbaric environment is a technological advance in undersea exploration, where monitoring and control of the life support atmosphere is essential.

9. The aquanauts spent 432.15 man-hours in the water during the mission. This represented an average of 7.2 man-hours per day. Maximum range (horizontal) from the habitat exceeded 1800 feet in the latter stages of the mission. This range was limited by the available gas in the aquanauts' scuba bottles.

10. The Tektite I hookah hose and masks allow the aquanauts ready access to an area within 200 feet of the habitat without requiring them to suit-up in full scuba gear. The masks and communication system allowed the aquanauts to communicate with the habitat bridge while they were out on the hookah. The aquanauts used the hookah system for more than 41 diving hours, about 1/10 of the total diving time.

#### RECOMMENDATIONS

1. Crew composition for future extended underwater missions should include a diver-engineer to assume responsibility for equipment maintenance and habitat upkeep and resupply. This would allow the marine investigators more diving time and would minimize training and familiarization problems.

2. A longer aquanaut training program in habitat operation than that of Tektite I is recommended if a trained diver/engineer is not part of the crew. The training period should provide the aquanauts a more detailed familiarization with the habitat systems and hardware as well as with aquanaut support equipment. Training should be conducted under conditions simulating as nearly as possible actual mission conditions, and an in-water training exercise is highly recommended.

3. Long-duration (closed-circuit or semiclosed-circuit) breathing equipments, operational swimmer delivery vehicles, and free-swimmer communication units should be developed for use of scientific divers operating from undersea habitats. This would enable them to take fuller advantage of their saturated condition by allowing them longer excursions from their habitat.

4. Medical preparations for future missions should emphasize thorough usage of preventive measures to curb aquanaut ear infections common to this type of program.

5. Design of habitats for future missions should reflect the need for work areas compatible with the needs of the aquanaut users. Where possible, storage space should not encroach upon scientific work space, and maximum effort should be made to make storage spaces in otherwise wasted spaces.

6. Provisions should be incorporated in the design of future habitats to allow leveling of the habitat after it has been secured to the ocean floor.

7. Habitats for future undersea projects should be designed with consideration for transportation and launch in less-than-favorable seas. The use of the Ammi barge/LSD transportation and launch system, while successful in the calm water of Lameshur Bay, would not be as successful in deep or heavy seas.

8. Although Tektite I proved that saturated diving can be a useful tool for marine research, other modes of saturated diving should be considered for scientific work. These include mobile habitats, PTC (personnel transfer capsule) diving from deck chambers to the sea bottom for work, and a habitat in which the aquanauts are compressed and decompressed enroute to and from the working site.

9. Based on the demonstrated capability of construction-battalion divers in Tektite I, these personnel should be included in future Navy experimental/research activities where applicable.

10. Further development of mass spectrometer instrumentation for undersea application is recommended. Instrument design should provide for simplified calibration techniques. Special emphasis is required in designing a sturdy instrument package that will withstand the operational rigors of an undersea mission. Modular component design would enable aquanauts to make module replacements without specialized training.

11. Special emphasis in future missions should be placed on establishing fully adequate surface and free-swimmer communication systems.

12. Hookah masks, with communication capability between divers and back to the habitat, should be provided in subsequent programs. Adequate, convenient space should be provided outside the habitat for stowage of the long hookah hoses while not in use.

## Appendix A

### SCIENTIFIC PROGRAMS

#### A1 MARINE SCIENCE PROGRAM

##### A1.1 Introduction

Richard Waller, Bureau of Commercial Fisheries, Department of the Interior, Washington, D.C.

The sea becomes increasingly important as a source of man's vital resources, particularly food and minerals. The successful exploitation of these resources requires careful preliminary research that in many cases can be done effectively only within the marine environment itself. Project Tektite I was designed to test the research capability of a small team of scientists over an extended saturation dive. The project afforded the first opportunity for a primarily scientific team to live under water in a man-in-the-sea program. The project successfully terminated on April 15, 1969, after the scientific team, composed of two biological oceanographers, a fisheries biologist, and a marine geologist, had spent 2 months nearly 50 feet beneath the surface of the sea.

The experiment took place in Greater Lameshur Bay on the south side of St. John, U.S. Virgin Islands (Fig. 1 on p. 9). Location here minimized the potential problems of poor visibility and cold, common to the sea in more temperate areas. Visibility generally ranged from 60 to 80 feet in the morning, but diminished to 30 to 50 feet by later afternoon. Temperature of the water outside the habitat was about 77 degrees throughout the dive; exposure suits, however, were required for extended periods of underwater work.

The habitat was situated in a reentrant in a coral reef (Fig. 17 on p. 30). A wide variety of coral composes the reef, which has a relief of 10 to 15 feet above adjacent sand flats. It is crossed by several linear sets of grooves partly filled with carbonate sand. Landward from the reef is an extensive patch-reef area of isolated coral heads on sandy bottom. The patch-reef area is bordered in turn on the landward side by a zone of slightly-coral-encrusted bedrock cobbles and boulders which locally adjoins submerged outcrops of bedrock, largely volcanic rock of possible Lower Cretaceous age. On the seaward side of the reef lie extensive sand flats either barren or vegetated by grass (*Thalassia*) or by algae (largely *Udotea*) and sprinkled with sporadic patches of *Penicillus*. An unvegetated sand strip 30 to 50 feet wide along the reef separates it from the grass and algal flats.

The aquanauts were assisted in their tasks by a surface scientific support team. This team was composed of alternates for the scientists in the habitat (R. L. Phillips, U.S. Geological Survey, G. Davis, National Park Service, and Ian Koblick, College of the Virgin Islands) and the surface scientific coordinator (R. Clark, Bureau of Commercial Fisheries). This team complemented the studies conducted from the habitat by extending the research into areas beyond swimming range from the habitat or into water shallower than 20 feet, from which the habitat-based divers were excluded because of the hazard of decompression sickness. The surface team was assisted by visiting scientists from the Bureau of Commercial Fisheries and the Geological Survey and other project personnel during off-duty periods.



### A1.2 Spiny Lobster Study

John G. Van Derwalker, Bureau of Commercial Fisheries,  
Department of the Interior, Seattle, Washington

#### A1.2.1 Primary Objectives of the Spiny Lobster Study

The primary objectives of the spiny lobster study were to describe the diurnal activity of the lobster, to ascertain the movement of individual lobsters during the 60-day period, to describe molting and reproductive activity, and to estimate the spiny lobster population of Lameshur Bay.

#### A1.2.2 Study Area and Methods

An area from White Cliffs east to Grootpan Bay, designated as the lobster study area, was divided into 12 sections (Fig. A1). Sections 8 and 9 were the areas in which the scientist-aquanauts conducted their phase of the lobster study. The remaining sections were studied by the surface scientific support personnel.

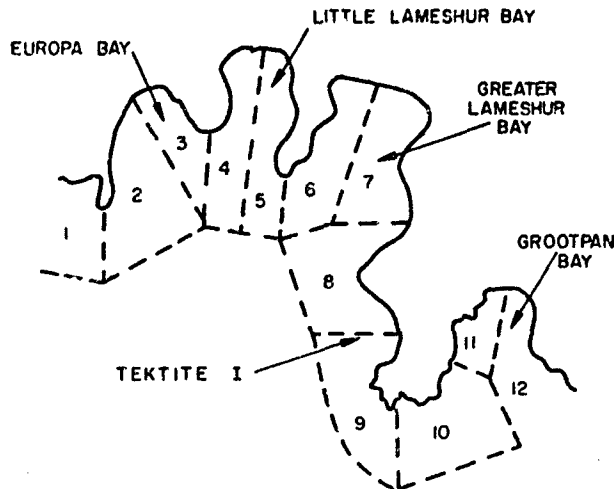

Fig. A1 - Map of Lameshur Bay area showing the lobster study area divided into sections

To meet the stated objectives it was necessary to mark a large percentage of the lobsters in the area. Two kinds of markers were used: sphyron tags and sonic pingers. The sphyron tag as described by Scarrett\* was modified to provide a color-coded element in place of the printed element. Each sphyron tag used had a unique color code (four segments of different colors) which could be used to identify an individual lobster. These tags were easily read underwater without disturbing the lobster. When a lobster was tagged with a sphyron tag, the following data were recorded: the section in which the lobster was caught, the tag color code, the date and time of capture, the method of

\*D. J. Scarrett and P. F. Elson, "Preliminary Trial of a Tag for Salmon and Lobsters," J. Fish Res. Bd. Canada 22(2), 421-424 (1965).

capture, the habitat description, the depth of capture, the sex and sexual condition, the shell condition (soft, hard, encrusted), the carapace length, the number of lobsters in the associated group, and the description of any injuries. When a previously tagged lobster was resighted, his location, the tag code and any data that could be obtained without handling the lobster were recorded. These data were used to fulfill the first two primary objectives.

A second tagging program using a pinger which emits a sonic signal aided the study of the diurnal activity of lobsters. This pinger and a variety of receivers were developed by the Bureau of Commercial Fisheries laboratory in Seattle, Washington. The primary use for these pingers has been the study of adult salmon migrations in the Columbia River,\* although they have been used for tracking other animals including sharks, turtles, and lobsters. The pinger used during this study was a two-transistor oscillator driving a disk-shaped lead zirconate crystal. The electronic components were contained in a plastic cylinder 19 mm in diameter and 73 mm long with rounded ends. The pinger had a signal strength of 45 dB above 1 microbar at 1 meter and a life of 1500 hours.

The pinger was attached to the dorsal surface of the lobster along the midline of the carapace. This was done by attaching a piece of 3/16-inch-thick rubber to the side of the pinger and then gluing the rubber to the carapace. This cushion between the tag and carapace took up the mismatch between the surfaces. Eastman 910 adhesive was used to cement these surfaces together because of its 60-second drying time and initial strength.

Two kinds of receivers were used to monitor the signals emitted by the sonic pinger. Both were solid-state tuned radio-frequency receivers with a beat frequency oscillator to develop an audio output. The surface receiver was separated into two parts: the monitor, which contained the electronic components and loudspeaker (earphones were also available), and the hydrophone. The hydrophone was designed to give maximum output when pointed directly toward the pinger. Its viewing window was cone shaped, providing a 10-dB attenuation at 5 degrees. An omnidirectional hydrophone was also available.

The second type of receiver used was a diver-held receiver in which the receiver and hydrophone were contained in a stainless steel cylinder 50 mm in diameter and 312 mm long. A pistol-grip handle was mounted on the cylinder along with an on-off switch. The switch had low and high gain positions in the on mode. The dynamic range of the receivers was 0.3 microvolt to 3 millivolts. A modified bone-conducting hearing-aid transducer was connected to the receiver by a coaxial cable. By placing this unit behind the ear under the face-plate strap the diver could hear a signal when the unit was pointed toward the pingers. The diver-held receiver-hydrophone had the same directional receiving characteristics as the surface unit.

The aquanauts were able to relocate lobsters carrying these pingers and carefully monitor their movement. Larger and more powerful pingers were used along with the diver-held receiver as a navigation aid. These were particularly valuable at night or when working out on the sand-algal plains adjacent to the reefs.

A total of 137 lobsters were tagged with sphyron tags, 39 by the scientist-aquanauts and 98 by the surface scientific support personnel. Forty-two of these sphyron-tagged lobsters were resighted; one lobster was resighted six times over a 20-day period. The aquanauts recorded 40 resightings, and the surface personnel recorded 31. Of the 39 lobsters tagged by the aquanauts, 18 were resighted at least once; of the 98 lobsters tagged by the surface support personnel, 24 were resighted.

\*James H. Johnson, "Sonic Tracking of Adult Salmon at Bonneville Dam, 1957," U.S. Fish and Wildlife Service, Fish Bulletin 176, 471-485 (1960).

Eight lobsters were tagged with sonic transmitters by the aquanauts. Two of these eight were never relocated. One lobster was relocated periodically over a 24-day period; the remaining five were relocated periodically over periods of 2 to 10 days.

#### A1.2.3 Observations on Diurnal Behavior

Spiny lobsters normally spend the daylight hours on the reef in a den. The lobsters observed during this study showed definite preferences for particular areas on the reef and for particular dens. In the two sections studied by the aquanauts (sections 8 and 9 in Fig. A1) no lobsters were ever found in the patch reef area northeast of the habitat. Within the reef area south of the habitat 17 lobster dens were found. Nine of these dens frequently contained two or more lobsters; the largest group found in one den was 20. The eight remaining dens would accommodate only one lobster. The lobsters found in these dens were usually large males or females with eggs. Although certain caves and holes were preferred by the lobsters, the aquanauts could not describe why they were selected instead of others.

It is generally accepted that by staying in a den during the daylight hours the lobster will be protected from predators. The lobsters observed usually had their entire body hidden from view, but had their antennae projecting out through the opening of the den. As an aquanaut approached, they would generally point their antennae toward him and try to whip him with them. If he approached slowly, the larger males would frequently come out of the den toward him in a threatening manner; however, if he approached more rapidly, they would retreat, always keeping the antennae pointed toward him. If he put a hand into the den, the lobster would try to catch it between the antennae and hold it. Occasionally when the lobster had a hand between the antennae, it would push or jump forward and drive the spines that ring the antennae into the hand. If the aquanaut continued to threaten the lobster, it would push up with its legs and press the spines on its back into the roof of the cave, thus firmly anchoring himself inside. Once in this position it was not possible to pull the lobster out of the den without damaging it. Lindberg\* has noted that a denned lobster would come out of its den and move to another den soon after the antagonist had left. The aquanauts also saw this happen on one or two occasions.

When a cave or hole contains lobsters, it is seldom inhabited by any other large animals. Although almost every niche contained spiny sea urchins, they were seldom found in a den occupied by lobsters. The aquanauts did not see lobsters actively removing sea urchins from a den or preventing them from entering. Their studies show that the lobsters move into the dens well before the first light of morning; this may result in their occupying the dens first. If so, it would be quite easy for them to keep the spiny sea urchins out by using their antennae. The aquanauts observed fish trying to enter occupied dens on various occasions, and the fish were always repelled. The lobsters were extremely aggressive toward the fish, lashing them with their antennae. Lobsters and fish, including moray eels, were never seen occupying the same den.

Most of the lobster dens south of the habitat were so limited in size, particularly in the vertical dimension, that a large predator such as a grouper or shark would be unable to enter the den; however, off the tip of Cabritte Horn Point (near the boundary of sections 9 and 10) a group of large lobsters were discovered living under ledges several feet long, two of them 3 feet deep and one 2 feet deep. Shortly after the aquanauts discovered this population, a group of seven nurse sharks, 8 to 12 feet long, moved into the area and occupied these ledges along with the lobsters. Even after the sharks had been in the area

\*Robert G. Lindberg, "Growth, Population Dynamics, and Field Behavior in the Spiny Lobster, *Panulirus interruptus* (Randall)," Univ. of Calif. publication Zool. 59(6), 157-248 (1955).

over 24 hours, the lobsters were still remaining under these ledges. Three days later the sharks had left and no lobsters were in the area. None of the three lobsters of this group that had been sphyron tagged were ever resighted. The act of entering a confined area during the daylight hours certainly must have survival value, but the factors that stimulate the lobsters to respond in this way must be quite variable or this group of lobsters would not have selected such open ledges (unless there were no other dens available). No effort was made to observe these lobsters at night, but if they left their dens, the sharks probably could have caught them quite easily.

The question of what causes the lobsters to select particular dens and particular areas of the reef warrants study. Few lobsters were found living in complete isolation; even those that occupied solitary dens, including berried females, usually were within a few feet of other lobsters.

Very few small lobsters were found on the reef, and those were in very shallow water. However, several small lobsters were seen living within a colony of spiny sea urchins out on the sand-algal plains. This commensal relationship, observed several times, apparently affords the young lobster a mobile shield from predators, with the shield continuously moving onto new feeding grounds. When these lobsters were removed from the colony and released, they immediately returned to the colony. The dark purple spiny sea urchin colony is easily seen on the gray sand-algal plains, and it must provide a strong visual stimulus to the small lobster. The ecology of this association should be studied to determine if immature lobsters seek these colonies as their first home on the bottom and to determine what stimulates them to enter the colony.

Soon after the sun sets, the lobsters begin to move out into the entrances of their dens. They are sometimes very aggressive during this time of day and may come out of the den waving their antennae toward an approaching diver. As the diver comes in closer, the lobster will begin to back up and seek refuge. Many times they will move across the reef to a new shelter instead of returning to their former den. Although the lobsters appeared to be more active during this period, they did not move out onto the sand-algal plains until 2 or 3 hours after sunset. The lobster is capable of walking very fast across the plains and were found moving as far as 300 feet from the reef. One walked over 800 feet in 3 hours and 45 minutes. Observations of lobsters feeding on the plains were not made, but feeding is assumed the primary reason for their migration into that area. While the lobster is out on the plains, it does not display the aggressive behavior it does on the reef. When approached it either walks away very fast or stops and lays its antennae over its body and remains very still. This response to divers, working without lights, indicates it would be extremely easy for a predator to catch a lobster once it had found it. One of the pinger-tagged lobsters was killed and eaten out on the plains. Its carapace was crushed and the majority of the tissue was removed from the cephalothorax and abdomen, but neither the skeletal parts of the legs nor the abdomen were badly damaged.

The lobster's migration out onto the plains and his subsequent return to the reef seem to be well-directed movements. One female carrying eggs was followed as she returned to the reef about 4:30 a.m. Her walking carried her around the tip of the reef west of the habitat and directly to a den 225 feet east of the habitat. The following morning this same lobster was found returning to the same den along the same route. This incident along with several others observed during the 60-day period indicates the lobster has a well-developed navigational ability.

#### A1.2.4 Range of Lobsters during the 60-Day Period

Two methods of describing the range of the lobsters was attempted during the 60-day mission; one was to plot the movement of sphyron-tagged lobsters using the resighting data. Of the 137 lobsters tagged, 42 were resighted. Only four of these were found in a

*section other than the one they were tagged in, and none of them had moved more than 1500 feet from the place they were initially tagged.*

The second method of determining the range and possible migration was the tracking of the lobsters tagged with sonic pingers. None of these lobsters were found to move out of the sections they were tagged in, and generally stayed within a few hundred feet of the place they were found initially.

Both of these methods indicate the lobsters stayed within a limited area of the reef during this 60-day period; however, our inability to locate more of the sphyron-tagged lobsters and the loss of two of the lobsters tagged with sonic pingers leaves this statement open to question.

#### A1.2.5 Molting and Reproduction

Seebee divers reported seeing many lobsters cut in half and lying on the bottom during the period they were emplacing the habitat. Upon examination, however, these were found to be exuviae. The aquanauts continued to find recently cast exuviae during the first half of the mission, but no exuviae were found in the latter half. Only one soft-shelled lobster was found during the dive. Most of the lobsters found during the first part of the mission had very clean exoskeletons. Toward the end of the 60 days some lobsters were found with encrusting organisms growing on them, particularly on the carapace close to the base of the fifth legs.

Thirteen of the 57 females tagged with sphyron tags had eggs; an additional ten had been plastered with sperm. Twenty-two had short eroded setae, which indicates they would not be receptive to breeding. Although an increase in the percentage of berried females was expected as the 60-day period progressed, the data did not indicate this. One reason may be the tendency of the berried female to isolate herself in a well-concealed burrow. One lobster that was tagged with a sonic pinger when carrying sperm deposited eggs a few days later and moved inshore to a well-concealed burrow; without the sonic tag the aquanauts would not have relocated her. Another berried lobster carrying a sonic tag also moved inshore shortly after being tagged. Because of the 20-foot upward depth limit the aquanauts were not able to follow this animal.

#### A1.2.6 Population Estimation

During the Tektite I mission the aquanauts attempted to estimate the lobster population in eight of the 12 study sections by surveying transects. The number of lobsters counted, both tagged and untagged, was small. No conclusions have been drawn from these data, but it is doubtful that this is a satisfactory method to use in future studies of this type unless more and longer transects are used. This method along with two other methods that should be considered for future studies are described in the following paragraphs.

Before the transects were laid out, each section was inspected, and the different types (sand-algal plains, patch reef, coral reef, rock reef, and thalassia) were described. Transects 300 feet long were then laid out in the different types by placing two anchors on the bottom at each end of the transect and stretching a polypropylene line between them. All the area within 20 feet of this line was inspected each time the transect was surveyed. To help the surveyor keep within the prescribed width, a 20-foot line that had one end attached to a sliding ring on the transect line was carried by the surveyor. Theoretically this kept him within 20 feet of a straight line between the two anchors, but it was found that the surveyor might pull on this rope, thus pulling the transect line off center, and survey a larger area than intended.

Transect surveys are used frequently as a method of estimating populations, and the statistical methods for analysis are available. In spite of this advantage it appears that this method will not be satisfactory for lobster surveys unless a much larger area is surveyed.

Another method of estimating the population may be to search an entire section and record tagged and untagged individuals. On April 12 the four aquanauts spent the day searching the reef from the habitat, south 700 feet, and from the 20-foot depth contour to the western margin of the reef. A total of 38 lobsters, including 14 tagged individuals, were found. By scheduling a series of tagging dives with a survey of this type following each one, a satisfactory number of individuals would be counted to make a good population estimate.

A third method of estimating the population may be built around the habit of lobsters selecting particular dens on the reef. Of the 38 lobsters found on the April 12 survey 25 were in previously recognized dens. The advantage of a method like this would be the short time it takes to inspect a series of known dens on a reef as opposed to searching the entire reef. On the reef area mentioned it takes about 1-1/2 swimmer-hours to inspect all the dens identified. The search of the entire area took 14 swimmer-hours. The disadvantage of this method is that the berried females and some solitary males may avoid these dens and therefore be excluded from the estimate. This method as well as the first two would exclude from the estimate the immature individuals living in the spiny sea urchin colony.

Before a comprehensive method of estimating the population of lobsters can be developed, it is necessary to describe the behavior of the animal from the time he settles to the bottom to adulthood. Because of the many different niches the lobster occupies during its life cycle, it may be necessary to develop different techniques of population estimation for each mode.

### A1.3 Cleaner Shrimp Ecology and Plankton Studies Conrad Mahnken, Bureau of Commercial Fisheries, Department of the Interior, Seattle, Washington

#### A1.3.1 Cleaner Shrimp Ecology

An interesting symbiotic cleaning behavior exists between certain brightly colored shrimp and cooperating reef fishes. The shrimp, which are almost invariably associated with an anemone, have been observed to pick and eat parasites, injured tissue, and other undesirable particles from a large variety of reef fishes and probably are the primary agent in the control of gill, oral, and external parasites. This seemingly unusual activity may play a major role in maintaining local concentrations of many species of reef and pelagic fishes. Indeed, the abundance of such fishes may be directly related to the abundance of the anemone, *Bartholomea annulata*, to which cling the two most abundant cleaners, the Pederson cleaning shrimp *Periclimenes pedersoni* and the spotted cleaning shrimp *P. yucatanicus*.

Ecological studies were carried out during Tektite I on the distribution of cleaner shrimp and anemones with relation to various reef environments. To this end, five topographic features on the reef and sand flats south of the habitat were chosen as representing the major ecological zones. Anemones and shrimp were completely enumerated within each zone at least once during the study. In addition, shrimp populations on 26 anemones in the sand strip at the reef base were monitored each week. The shrimp were found to be rather fearless and could easily be enticed to browse along the back of a diver's hand, where they assiduously picked at hairs. It therefore became a matter of

routine for a diver to measure the length of living shrimp either on the anemone or on the back of his hand.

It was found that the anemones were equally abundant in all five of the habitat types, but the abundance of shrimp varied. *P. pedersoni* was most abundant along the sand strip, an area at the reef base grazed clean of algae by fishes to about 10 meters from the cover of the reef. The sand strip is the major corridor for fish movement along the reef and therefore supports larger numbers of cleaning stations. One of the most frequented stations contained 26 *P. pedersoni*. *P. yucatanicus* on the other hand was most abundant on the sand flat beyond the limit of grazing, an area of scattered coral rubble and heavy algal growth.

Additional observations were made on precleaning behavior, intraspecific size dominance, interspecific competition, shrimp-host anemone dependence, shrimp repopulation studies, and the relationship between anemones and other caridean associates. One species, and possibly two species, of *Periclimenes* collected from anemones during Tektite I may be new to science.

#### A1.3.2 Plankton Studies

Diel (24-hour) variations in the vertical distribution of zooplankton were studied with the aid of a plankton pump. A nonmetallic pump of 50-gal/min capacity was used to pump water from a vertical standpipe about 10 meters from the habitat. The base of the polyvinyl chloride standpipe was anchored to a 2500-pound cement clump, and the upper end was attached to a surface buoy. Hydraulic-pressure-operated valves were arranged along the pipe at ten depths and could be operated one at a time from the habitat. The pipe entered the habitat through a 10-inch floor trunk in the wet room, and water was pumped into a filtration barrel containing a set of nested nitex nets.

#### A1.4 Marine Geology

H. Edward Clifton, U.S. Geological Survey,  
Department of the Interior, Menlo Park, California

The specific objectives for the marine geology program in Tektite I included: the evaluation of saturation diving and sea-floor habitation in geological research, compilation of a detailed map of the sea floor delineating the various types of substrate in the vicinity of the habitat, and research on specific geological problems as found feasible.

The area surrounding the habitat was mapped using large-scale colored aerial photographs and infrared images, which delineated the geometric relationships among the larger features such as sand flat, bedrock, bedrock rubble, coral reef, and major groove or canyon systems. Details were added underwater by tape and compass procedures or by sketching. The completed map provided a basis for further geologic investigations and for biologic research.

An interesting aspect of the sea-floor map is the presence of two sets of linear grooves (or canyons) through the coral reef proper. The most distinctive trends N25°E; the other set, which appears to be less well defined but consists of larger grooves, trends N45°E. Both sets presumably formed in response to the direction of wave approach but possibly at different times or under different conditions. Gorgonians (sea fans) and platy milliporids (fire coral) dominantly grow normal to the present-day average of wave approach. The orientation pattern of these organisms in and adjacent to the grooves trends about N15°E, suggesting that both sets of grooves may either be relic features formed when wave approach followed a different pattern or result from unusual large-scale wave conditions.

Other geological research dealt largely with the interaction of organisms with the bottom sediment. The Tektite I project afforded an excellent opportunity to study the modification of the sand floor by crawling and burrowing creatures in the absence of sand transport by waves or currents. Black sand (composed largely of the mineral magnetite) was artificially layered with light-colored indigenous carbonate sand, and the effect of organisms on the layering was observed daily or bi-daily by coring the layered sand. These observations revealed a rapid rate of bioturbation. The uppermost 5 mm of sand in some areas was totally reworked in 4 days. Manually constructed sand ripples 1.5 cm high and 15 cm long similar to those produced by waves on the sea floor were obliterated within a week. The rate of lateral transport of sediment by organic reworking was checked using fluorescent tracer sands. During the time span of the experiment lateral transport proved to be negligible. The burial of solid objects by undermining organisms was also noted. One of the metal plates defining a locational grid intersection was buried 2 to 3 cm during the course of Tektite I.

Examination of more than 2300 empty pelecypod valves showed marked tendency for the valves to lie concave-up on the sea floor (in contrast to the generally accepted notion in geology that concave-convex particles lie dominantly concave-down). The orientation pattern seemed largely independent of the nature of the substrate. The percentage of concave-up shells rose with increasing shell size. Under the influence of waves or currents this relationship is reversed, suggesting that determination of the shell orientation pattern in relation to shell size constitutes a useful tool for identifying ancient environments. In an experiment 200 valves of different sizes were placed concave-up in a small area and 200 matching valves were placed concave-down nearby. Over a period of 2 weeks bottom dwelling organisms rotated shells of all sizes, but turned more concave-up than concave-down. Predators of the pelecypods and attendant scavengers probably also contribute to the observed orientation.

A joint study by aquanauts Clifton and Mähnken provided data on the amount of fine calcium carbonate (aragonite needles) contributed to the sediment by the calcareous algae *Penicillus* and *Udotea*. Immature specimens of these algae were tagged with carbon-14 and harvested 24 days later to determine the volume added. In addition, re-population rates were determined for a totally depopulated 2-square-meter area. These observations indicate that the abundant *Udotea* in particular has a very rapid growth rate and may contribute substantially to the carbonate sediment.

Other joint geological-biological investigations centered on the origin of the unvegetated strip of sand that borders the reefs and on the influence of the sand tilefish on the bottom sediment. Textural analysis showed the sand from most of the sandstrip contains less material finer than 0.062 mm than does the sand from the vegetated areas beyond the strip. This difference may be due to entrapment of fine material by the algae or grass or result from winnowing of the fine material from the strip by reef-based fish who stir the sand while feeding on small organisms in it. Sand at the very edge of the reef contains abundant fine material, which appears to be "dust" produced by organisms that feed in and on the reef coral. The absence of vegetation from the sand strip seems not to result from inhibition of plant growth caused by chemical or biological agents in the sand near the reef. Experiments indicated that algae seemed, if anything, to grow more rapidly when growing through a cover of fine material from the reef edge. To test the effect of grazing by herbivorous fish, mature *Udotea* was transplanted at 10 foot intervals across the sand strip. Half of each transplant was covered with transparent screening, and half was left unprotected. In a matter of hours the unprotected algae nearer the reef was devoured by parrot fish, and the unprotected algae at the outer edge of the strip disappeared within a few days. The covered algae in contrast continued to grow luxuriantly for 2 weeks, when the experiment was ended.



These observations support the conclusion that the unvegetated sand strip is produced by grazing of fish that live on the reef. Interestingly, the sharpness of the seaward border of the strip depends more on the vegetation present than on reef characteristics. Where turtle or eel grass borders the reef the outer edge is far more sharply drawn than where *Udotea* or other algae is the dominant vegetation. This situation is probably due to the denser growth of the grass compared to the algae.

The sand tilefish is an interesting geological agent in the distribution of coarse shell and coral fragments on the flats adjacent to the reef. The fish builds nests by depositing shells and coral around large dead coral heads exposed on the sand flat. Geologically it is important to know if the fish concentrates the shells from the substrate where the nest is built (a sorting process) or by carrying them in from the flats adjacent to the nest (transport and deposition). Observation of one fish via an underwater TV camera for several days indicated that most of the material is transported to the nest. This conclusion was supported by incorporation into the nests of fresh *Acropora cervicornis* fragments that were placed on the sand near the nests. The fish seems to construct his nest by sweeping the sand clear with his belly and tail and building a roof by dropping shells and coral over the top. The shells in a sand tilefish nest nearby all lie concave-up. A single fish seems to continuously build and abandon a nest within a matter of days. Over a period of time these fish obviously can greatly modify the distribution of coarse fragments on the flats near the reefs.

Other geologic studies pertained to the history of sea-level changes in the Virgin Islands. Standby aquanaut R. L. Phillips of the Geological Survey identified and mapped an extensive beachrock submerged about 20 feet below the present sea level. Rounded pebbles of the volcanic bedrock, generally restricted to the beach, were abundant in about 400 feet of water around 400 feet north of the habitat. This observation not only indicates a previous stand of the sea some 40 feet below the present surface but also suggests that limited subsequent deposition in Lameshur Bay, a conclusion supported by the presence of coral pebbles and cobbles 60 to 65 feet beneath the surface about 1000 feet south of the habitat in an area where present-day sediment should be much finer. Acoustical sub-bottom profiles taken across Lameshur Bay under the direction of L. E. Garrison of the U.S. Geological Survey prior to the dive show a flat bedrock platform, probably an ancient wave-cut platform underlying greater Lameshur Bay. Recent marine fossils were found and collected from about 65 feet above sea level at White Point, attesting also to higher stands than at present.

A complex recent history of Lameshur Bay is indicated by the three-dimensional relationship between coral reef and carbonate sand. Near the habitat the living coral of the reef is growing laterally over the sand floor, suggesting that reef growth presently exceeds reef destruction. Similarly, in the patch reef area northeast of the habitat, isolated living coral heads are expanding laterally over the sand substrate. The sand, however, forms but a veneer over a solid mass of buried dead reef. These observations suggest a complex history of reef growth and destruction. The reef on the southeastern side of Lameshur Bay originally extended much farther than at present. North of the habitat the original reef was largely killed and covered with a veneer of sand. Renewed present coral growth is indicated by the lateral growth of living coral heads over the sand and by the coalescing of the larger heads in the eastern part of the patch reef into crude spurs parallel to the present direction of wave approach.

Of very recent origin are blocks of volcanic bedrock that lie scattered atop the coral reef proper. The blocks are of similar size, roughly 10 to 20 inches long, 6 to 12 inches wide and 2 to 6 inches thick. Most are crudely rectangular and have unrounded edges and corners. Each is cemented into place and is 10 to 50 percent covered by coralline growth. The blocks show no obvious variation in size with distance from the nearest outcropping bedrock, and grooves or topographic lows lie between the blocks and the

outcrops. Rubble obviously derived from the outcrops, in contrast, grades into sub-rounded pebbles a short distance from the source and show no evidence of upslope transport. These data suggest the blocks were artificially emplaced; perhaps they are ballast stones dropped separately from vessels in the days when Lameshur was an active plantation, or possibly they were weights for native fish traps.

Tektite I demonstrated that underwater habitation offers great advantages to investigations of marine geology. Perhaps the most impressive feature was the wide range of geological studies that could be made during the project. Only a small number of these could be attempted, and fewer still could be completed within the time of the underwater habitation. The possibility of nearly continuous observation offers tremendous advantage to the marine geologist. The application to studies of marine geological processes, to underwater exploration of mineral resources, and to geologic studies of the relationship of the *underwater* sea floor to man's environment (such as earthquake hazards) are manifold.

Several persons contributed to the geological program. The role of R. L. Phillips deserves particular mention. In addition to discovering the submerged beachrock, he mapped the bottom types over a wide portion of the southeast coast of St. John. He also supported the habitat-based program by conducting necessary analytical and preparatory work. Two other geologists from the Geological Survey visited the project site. Joshua I. Tracey helped greatly in the establishment of an offshore 1000-foot grid system used for navigation and location and in preparation of a bathymetric chart of the area, and Gil Corwin examined the bedrock in the area of the experiment and contributed to the bathymetric chart by photogrammetric techniques.

## A2 PSYCHOLOGICAL SCIENCES

### A2.1 Overview of the Program

G. C. Tolhurst, Physiological Psychology Branch, Office of Naval Research, Washington, D.C.

#### A2.1.1 Introduction

Historically, Project Tektite I was conceived because of speculation concerning the behavior of small groups of highly motivated, scientifically oriented individuals who must live and work together over a prolonged time (60 days) in a real, "hostile" environment from which they cannot be extricated easily. The crew would be occupied with real tasks which would be almost entirely self-generated and with minimal external direction (interference) except for safety considerations.

Data relating to the total psychological sciences program were collected in three phases: pre-dive, during the 60-day saturation dive, and post-dive. The types of data can be categorized broadly into four general subprograms (to be discussed in sections A2.2, A2.3, A2.4, and A2.5 respectively): behavioral program, sleep electroencephalographic (EEG) records on two of the crew on magnetic tape and on paper (ink-writeout), sleep EEG records on a third crew member using an electrode cap and an automatic sleep-stage analyzer, and psychomotor testing using a device that presented complex visual-motor-cognitive tasks.

#### A2.1.2 Pre-dive Tests

##### A2.1.2.1 Behavioral Program

The major portion of the pre-dive testing consisted of a detailed and in-depth interview to obtain demographic information to serve as a base for all subsequent observations.

The pre-dive testing was done during the base-line biomedical data collection period at the University of Pennsylvania hospital. Also, this period was used for indoctrination of the divers concerning what measures would be taken, the noninterfering anonymity, and the reasons for each and all observations.

Base-line mood scales were obtained each day during this 10-day period. The rationale for these pencil and paper tests were given and their importance to the program stressed in order that each diver would complete one each day of the dive.

Additionally, a Rorschach protocol was administered to each diver and backup diver in the same way as given in the space program to each astronaut. The results showed no indications which would compromise the 60-day mission. Incidentally, no further discussion will be made of these data.

#### A2.1.2.2 Sleep EEG (Navy)

One set of EEG data were obtained from two of the divers (designated divers 1 and 3). Base-line recordings were made at the U.S. Navy Neuropsychiatric Research Unit in San Diego. Personnel from this laboratory designed and assembled the instrumentation, collected the data, and made the analysis. Six channels of data include two of EEG data, two of EOG data, one of EKG data and one of muscle potential. During the acquisition of the base-line data both divers obtained instruction on electrode positioning and emplacement. The adequacy of the instruction and the learning was demonstrated in the quality and high consistency of the recordings.

#### A2.1.2.3 Sleep EEG (NASA)

The second set of sleep EEG data was obtained by a system designed for space application. Base-line recordings on diver 2 were made in Houston at the Baylor University hospital using an electrode cap developed for NASA and feeding recording devices and an automatic sleep-stage analyzer which Baylor scientists had designed and assembled for NASA. The analyzer provides a direct readout of the sleep stage an individual is in during any period of his total sleep cycle. The stages are labeled 1 through 4.

#### A2.1.2.4 Psychomotor Test

The divers were indoctrinated on a psychomotor device during the biomedical base-line testing at the University of Pennsylvania hospital. The device, designed and built by NASA Langley scientists and called the complex coordinator, presents complex psychomotor tasks involving the matching of a sequence of lights by the manipulation of four controls (one for each extremity). The display of lights is programmed to be adaptive; i.e., when the patterns are rapidly matched by the individual, the sequences become more difficult, and if the tasks become too difficult, the patterns become easier. The device is portable and self-contained. Initial measures were obtained during this period, and a suggested, but not rigid, schedule was agreed on.

#### A2.1.3 Testing During Operations

##### A2.1.3.1 Behavioral Program

The data collection system was designed to obtain objective behavioral observations (records) capable of sufficient detail that analyses could reveal consistencies and variations of the life and work of the four crew members, over time, across men, subgroups, and the total group during the 60-day mission. Highly detailed, noninterfering observations were made each 15 minutes during the total mission on general activity, task performance, social relations, communications, personal habits, and emotional adjustments.

Section A2.2 will give the preliminary findings and projections for the complete analysis of the 500,000 individual data points.

#### A2.1.3.2 Sleep EEG (Navy)

The sleep EEG data obtained by the Navy system on two of the divers yielded 52 man-nights of sleep records. Recordings were made on each man each night during the first 10 days, then were made every third night during the midperiod of the mission and each night during the last 10 days. The records, with the exception of a single channel (out of six channels) which became noisy for a couple of nights, were of exceptional clarity and quality. This was in spite of self-applied electrodes, 1000 feet of cable underwater from the habitat to the recording site in the control van, and the frequency and duration of the recordings. Exhaustive analyses will not be accomplished, even using computer reduction, for some time.

#### A2.1.3.3 Sleep EEG (NASA)

The NASA sleep EEG system obtained data on diver 2 on the same schedule of nights of recording as outlined above for divers 1 and 3. Data accumulating to 24 man-nights of sleep were collected from diver 2. As with the Navy system the NASA system yielded records of exceptional quality. One minor difficulty was that the cap containing the electrodes was not as comfortable at the normal gravity state of the habitat as it would be in a zero-gravity state. However, in spite of the comfort factor, the quality of the recordings remained excellent.

#### A2.1.3.4 Psychomotor Test

The psychomotor test series can partly be considered nonscheduled in that there was no set time for each aquanaut to test himself on the device but partly considered scheduled in that each was recommended to devote some time per day to match his skill with the instrument.

#### A2.1.4 General Comments

Each of the major sections of the behavioral program were designed to be able, upon analysis, to interrelate with each other. Because of the computer-oriented data-handling capabilities provided to the project, intercorrelations of almost infinite permutations are possible. Many will be made in subsequent publications planned by each major investigator. It will also be possible to relate behavioral data to biomedical data and each, or both, to the various aspects of operational data. The results given in this overall Tektite I report are general and broad in scope. They will serve to identify areas of interest and the scientists who will ultimately provide the complete analyses.

#### A2.2 Behavioral Program

Roland Kadioli and Lt. Richard Mann, Behavioral Sciences  
Department, Naval Medical Research Institute, Bethesda, Maryland  
and Nicholas Zill, Bellcom, Inc., Washington, D.C.

##### A2.2.1 Purpose of the Behavioral Program

The purpose of the behavioral program must be understood in the context of the purposes of other programs on Project Tektite I, whose goals are outlined briefly as follows:

- Collection of marine scientific data from an ocean floor habitat employing saturation divers.

- Demonstration of the capabilities of saturation diving techniques.
- Study of the physiological reactions of man to long-term exposure to a shallow-depth nitrogen-enriched atmosphere.
- Testing of an underwater habitat and support facilities.
- Demonstration and test of the capabilities of Navy personnel in a diving operation at a remote site.
- Collection of electroencephalographic data on sleep during long periods of isolation and confinement in an unusual environment.
- Collection of microbiological data on a closed environment over a relatively long period of time.
- Study of the behavioral reactions of individuals and a group to long-term isolation and confinement in a real setting. In addition the results of the behavioral program were intended to provide an understanding of the reactions of men to undersea and space environments.

Because of the multiple purposes of Tektite I, the behavioral program was potentially subject to interferences from and compromises with other goals and requirements. Recognition of and accommodation to other requirements of the program was an essential part of planning data collection for the behavioral program.

Ironically, however, the greatest difficulties grew out of misconceptions of the psychological concepts of isolation and confinement and of the ways in which Tektite I data were applicable to space flight and other extreme environments. The problems stemming from inadequate understanding or misinterpretation of the purposes of the behavioral program are simple and yet profound. These problems were pervasive in the extreme, affecting almost every other aspect of the program.

What is meant by saying that the purposes of the behavioral program themselves had the greatest potential for interfering with the success of that program? This question has many facets, and complete and detailed consideration of it is not appropriate to this report. However, it is necessary in understanding the execution of the behavioral program to discuss some illustrative aspects of the question.

Let us consider what is meant by isolation. To someone not interested in studying the effects of isolation, this may seem to be a simple question. A brief analysis will demonstrate that it is highly complex. The phrase "the lonely crowd" implies that persons may be isolated even though they are physically close to large numbers of their fellow human beings. Psychological isolation is difficult if not impossible to define as a concept, since it is subject to individual and experiential definition. Physical isolation, on the other hand, is quite easy to define; and it is relatively easy to design a situation which will produce physical isolation. However, physical isolation cannot define, even though it will affect significantly, the individual definitions of psychological isolation. Furthermore, there is potentially a vast difference in psychological reaction to physical isolation produced artificially as compared to naturally occurring physical isolation. Lack of understanding of this and a number of other factors by various persons in Project Tektite I were potentially very disrupting to the behavioral data collection program.

When studying isolation as a variable in a real setting, the only way of cutting through the confusing dilemmas posed by attempting to define isolation in the abstract is to accept the natural influences on the phenomenon produced by considerations other than

those of a behavioral science program. The principle here is a variation of the Heisenberg principle, that the act of measurement interferes with the phenomenon being measured. With psychological variables, Heisenberglike effects are more pervasive than they are with physical variables. In many instances, artificial attempts to produce a variety of phenomena in real life settings for the purpose of studying them will have self-defeating effects on the phenomena under study.

The camel has been described as a horse designed by a committee. In some respects Project Tektite I was such a creature. The multiple purposes of the project produced minor anomalies in all phases of the program. Since we are interested here in the behavioral program, let us consider an example which will illustrate how the major purpose of the behavioral program was in danger of subversion by the multiple purposes of Project Tektite I. The illustrative example is crew composition.

At one point in the proposal for Project Tektite I, the following crew composition was entertained: one marine scientist, one scientist assistant who was also an astronaut trainee and a diver, a habitat engineer-diver, and a physician-diver. This crew composition was proposed in an attempt to simulate the composition of a space flight crew. The consideration of such a crew illustrates a basic misunderstanding of the purposes of the behavioral program. Since one of the purposes of the behavioral program was to generalize conclusions regarding crew productivity, interaction, and adjustment to outer space crews, it might seem reasonable that the best way to do this would be to simulate a space crew in composition, and so it did seem to many persons.

However, the simulation of a space crew by artificial composition overlooks one fundamental class of variables, intrinsic attractions to the environment. It seems relatively easy for most persons to understand that simulations lack the realistic stresses of natural environments. However, the fact that simulations also lack the realistic attractions of natural environments is quite frequently overlooked. It is a mistake to suppose that overall realism can be achieved if only the stresses or the attractions are permitted to vary naturally. If either factor (stresses or attractions) is artificially manipulated, a simulation rather than a natural environment is the result. It is clear that a saturation diving environment contains some real stresses which are of interest to persons wishing to make a generalization to outer space environments. Furthermore these real stresses are very difficult if not impossible to produce in a simulation both because of ethical and practical considerations. By the same logic the intrinsic attractions of a saturation diving environment are difficult if not impossible to simulate. Hence intrinsic attractions as well as intrinsic stresses both must be permitted natural variation, since the validity of reactions to a natural situation depends upon the presence of both.

The basic position here is that the undersea environment is *analogous* to outer space but cannot be a *simulation* of a space environment. Understanding the behavior of men and crews in exotic environments will be severely degraded if an attempt is made to create a simulation of an outer-space environment under the sea. This has proved to be a very difficult concept to grasp; however, its appreciation is important, not only in understanding the present study but in planning future programs. Therefore let us examine it a bit further by use of an analogy.

Suppose that a researcher was interested in investigating success or failure of basketball teams. Suppose further that for some reason, it was impossible to study basketball teams directly to develop predictive information on effectiveness but that it was possible to study hockey teams. Hockey teams might appear to be a reasonably analogous group to study in order to better understand the general variables influencing the success of basketball teams. Both games are played indoors, basketball teams have five players and hockey teams have six, offensive and defensive strategies are roughly similar, both sports are fast paced and have time-limited periods, and so on. Further

examinations of alternative approaches might indicate that hockey teams are more similar on relevant variables to basketball teams than are either football or baseball teams.

By studying hockey teams as hockey teams, we could investigate influences on success in areas such as team cohesiveness, coaching, morale, group interaction outside of the game, rate and kinds of substitutions during the game (bench strength), ability of players, variability in ability, and a variety of variables conceptually similar to those influencing the success of basketball teams. If hockey teams were to be studied to develop information predictive of the success of basketball teams, it is unlikely that anyone would propose that basketball players be inserted into the hockey teams under study. It should be clear that such a move would undermine the purpose of developing information on influences predictive of the success of hockey teams specifically and of athletic teams in general. The situation would be degraded even further if, in the interests of studying extreme variations in team composition, football and baseball as well as basketball players were added to a hockey team.

The foregoing analogy is incomplete and may be inaccurate in some respects, as all analogies are. However, it may serve to illustrate the point that the value of Project Tektite I for generalization to outer space is its similarity in conceptual rather than in purely physical dimensions. Variations in crew composition or any other variables of operational significance in natural settings must be dictated by and consistent with the operational requirements of the situation. Crews should be composed of persons whose background, interest, and training are appropriate for the environment in which they work. Furthermore, in natural environments, crew members must have roles which are essential to their participation in the program. Fortunately, such was the case in Project Tektite I. There was natural rather than artificial crew composition.

Considerable time has been spent in discussing a point which may appear to many to be quite esoteric and beside the central purpose of the behavioral program. It is important to an understanding the behavioral program that there is a full appreciation of the centrality of this point. Behavioral scientists felt that throughout the program there was an inadequate understanding, or in some cases a complete misunderstanding, of the purpose of the behavioral program on Project Tektite I. These misunderstandings resulted in inevitable compromises for the behavioral program. The points at issue are so central and pervasive and at the same time so subtle and seemingly contradictory that a full appreciation of them is unlikely. Their understanding is especially crucial to follow-on programs. There is a distinct danger that follow-on programs will err in the direction of greater simulation of physically real but psychologically unreal approximations of outer space environments. The result would be not only inefficient and inadequate marine science but also invalid or meaningless results for generalization to the space program.

Crew composition was only one of the many areas in which misunderstanding of the behavioral program produced pseudo-problems and compromises in the conduct of Project Tektite I. In numerous other areas the behavioral program was inappropriately asked to carry the burden of a decision either in whole or in part. In some instances decisions were made, and in others decisions remained in limbo; and there was no clear-cut policy.

For example, regarding food questions were raised as to the type of meals and frequency of resupply. These questions should have been decided on the basis of convenience to the crew, cost, storage facilities, crew preferences, time required of support personnel, the overall impact on the marine science program, or similar considerations. If nutritionists or physiologists wished to learn of the adequacy of various diets from the standpoint of supplying energy or of palatability or similar interests, the studies could have been designed with those purposes in mind, and they would have had a minimal

impact on the behavioral program. Such studies should be designed by specialists in the areas of nutrition or physiology. As in the case of crew composition, however, food should *not* be viewed as something on which global behavioral reactions can be studied by manipulating various diets or methods of preparation for the purpose of studying *psychological* reactions to such variations.

Similar questions arose concerning communications, how much to permit and what restrictions to impose. Communications should not be viewed as an aspect of the behavioral program. Whatever communications were economically feasible and necessary for the marine science program, for health and safety monitoring, and for like interests, should have been included with no question of restriction to produce feelings of isolation. Resupply of the capsule also raised inappropriate questions in the behavioral area. Some initial suggestions were made that the habitat have no resupply from the surface to increase the feeling of isolation. When it was noted that such a restriction would necessitate stocking the capsule with supplies of dry towels and baralyme to the extent that the structure would be bursting at the seams, the proposal was dropped. Once again, however, it is instructive to note that such a restriction was proposed on the basis of false assumptions about the behavioral program. Questions of entertainment facilities and equipment, which could and should have been answered on the basis of space and reasonable needs of the occupants also became confused by misunderstanding of the concept of isolation. Issues such as whether the aquanauts should communicate with family, have visitors to the habitat, and have discussions with scientific colleagues, some issues being trivial but some important and some ludicrous but some serious, were needlessly considered and discussed as to their impact on the behavioral program.

Not all artificial manipulative interventions in the name of producing this or that psychological state are equally disturbing; and there appear to have been no serious interventions in Project Tektite I. However, the sheer number of questions raised in considering the study of reactions to long-term isolation and confinement meant that crew members reacted unnaturally to perceived or actual attempts to produce certain psychological variables. Fortunately it seems that naturally existing influences inherent in Project Tektite I were of sufficient strength to minimize the participants' reactions to extraneous pseudo-psychological variables.

In summary, in studying psychological reactions to phenomena in real settings, it is imperative that the manipulation of variables not be instituted for the sole or even the primary purpose of producing an intended psychological effect. This is so because the artificial manipulation of psychomimetic variables in natural environments creates the danger that reactions will be influenced less by the variable which has been manipulated than by the fact of the manipulation of the variable itself — a Heisenberg effect in spades! This position does not mean that variables cannot be manipulated. It means simply that such interventions must be effected for other than academic psychological interest. Planned interventions will be most successful when they are demonstrably consistent with the primary goals of the person whose behavior is being studied. The proper posture for a behavioral program in a natural environment is piggyback not monkey-on-the-back.

The preceding orientation guiding the conduct of the behavioral program can be correctly perceived as radical and uncompromising. It is probably also relevant and correct to note that this orientation is a minority position within the field of psychology. Most research psychologists are trained and practice in the laboratory. The orientation of laboratory training and practice is toward manipulation and control of variables. There is no conflict between the manipulation and control orientation, which is appropriate for laboratory studies, and a hands-off naturalistic observational approach, which is appropriate for most field settings. (There are studies which are true field experiments, but they are so rare and the conditions of their execution are so involved that it would only



confuse the present discussion to consider such studies in detail here. We do recognize the existence of field experiments but maintain that the orientation guiding such studies is inappropriate to the studies of saturation diving.) The approach guiding the behavioral program of Project Tektite I maintains only that radically different methods are necessitated by the different environments of the laboratory and the field. Maintaining the need for different approaches in the laboratory and the field does not imply that one approach is better than the other. The use of either approach will depend upon the goals of the research project. Since in Project Tektite I the objective was to observe the behavior of a natural group in a real setting, the approach employed followed naturally from that objective. Many of the specific decisions and actions taken by persons connected with the behavioral program may have seemed to others to be illogical and arbitrary. The above discussion is intended to explain the way in which they followed naturally from the basic guiding orientation of the program.

This detailed discussion of potential pitfalls should not obscure the fact that the basic goals of the behavioral program were fully realized. Although the orientation expounded here may not have been fully understood, it was sufficiently appreciated and practiced that the basic purpose of the behavioral program was realized beyond the most optimistic expectations of the investigators. A major contribution to the success of the behavioral program was the understanding by the four crew members themselves of the purposes of the program. In the final analysis we were able to study the behavioral reactions of individuals and a group to long-term isolation and confinement in a real setting.

#### A2.2.2 Conceptual Orientation of the Behavioral Program

Considerable attention has been devoted to explaining the "why" of the behavioral program. "What" was done was rather simple and straightforward. Just as the design phase of a field study requires natural rather than artificial production of the effects under study, so also does measurement of the variables require a reliance on unobtrusive or nonreactive measures of real events. Operations of the data collection phase of the program involved the collection of simple, objective records of ongoing behavior in a regular systematic fashion. The conceptual orientation guiding data collection was initially developed on Antarctic wintering-over parties studied by Gunderson and Nelson;\* it was applied to the study of Project Sealab II;† and its use in Project Tektite I represents a refinement of concepts and methods used in the Sealab II research, taking into consideration the similarities and differences in the Sealab and Tektite I environments and the data collection facilities available. Maximum reliance was placed on observations of ongoing behavior, with minimum reliance on measures involving subjective self-report such as responses to checklists, diaries, and the like. When behavior can be observed, there is no need to ask the participants to record and interpret their own actions. Similarly, responses were measured on real rather than artificial tasks. If participants have meaningful work to perform of intrinsic interest to themselves, there is no need to insert artificial tasks to obtain measures of performance. The key concept behind the behavioral observation was nonintervention or unobtrusive measurement. This approach can perhaps be best appreciated by conceiving of the behavioral data collection on Project Tektite I as similar to keeping a score card on a team in an athletic contest.

Tektite I provided unexcelled opportunities for collection of on-line data from an operational group in the real world. The data collection program was designed to take maximum advantage of these opportunities. Continuous TV and audio access to all

\*E. K. E. Gunderson and P. D. Nelson, "Criterion Measures for Extremely Isolated Groups," *Personnel Psychology* 19, 67-80 (1966).

†R. Radloff and R. L. Heimreich, "Groups Under Stress: Psychological Research in Sealab II," New York, Appleton-Century-Crofts, 1968, chapter 5.

sections of the capsule were available. Tektite I provided an opportunity to collect data of laboratory quality in a field setting. Another way of stating the goal of data collection was that it was designed to observe and record data in sufficient detail so that analysis could reveal consistencies and variations over time and across men, subgroups, and the total group and reveal responses to significant environmental events. In brief the system was designed to obtain objective behavioral records capable of describing and explaining the life and work of the four-man crew of Project Tektite I over the 60 days of their mission.

### A2.2.3 Psychologically Distinctive Features of Project Tektite I

Psychologists were interested in studying Project Tektite I because the opportunity to study any group is of interest to psychologists. However, Project Tektite I had some distinctive features of especial interest to psychologists.

Of primary interest was that Project Tektite I was a saturation diving project. This meant that the men were subject to naturally existing conditions of interest to psychologists desiring to study humans under stress. There is no question that the saturation divers were under stress; furthermore those stresses were not imposed or contrived by psychologists. Since they were saturation divers, the Tektite I aquanauts lived in an exotic environment. They were separated by 19 hours from a return to the normal world. Their extended temporal separation was, of course, due to the long and careful decompression required after their body tissues became saturated with gas under pressure. They were subject to danger from equipment failure or human error which could have resulted in fatal or disabling accidents. They breathed an exotic gas mixture under pressure. Although the divers in Project Tektite I were not subject to the severe thermal stresses characteristic of many diving ventures, passage through the benthic barrier into the world of water occurred daily for them. Tektite I divers, as all saturation divers, depended highly on each other and on surface support personnel. Although the stresses in Project Tektite I were not as severe as they have been in other saturation diving groups, the novelty of the situation, the isolation from family and normal society, the dangers involved in saturation diving, and the temporal separation of 19 hours from normal society required by decompression were interesting naturally existing variables in their environment.

On the other side of the coin were the attractions of Project Tektite I for the aquanauts. Marine scientists are interested in using saturation diving techniques primarily for their own purposes. While previous saturation diving programs had included projects designed to collect some marine science data, this was the first project specifically designed to collect marine science data as the major purpose of the project. This meant that the divers in Project Tektite I were eager volunteers whose motivation was high, and there was assurance that their motivation would be sustained by tasks of intrinsic interest to them. Such motivation may be contrasted for example with the reluctant participation of volunteers in laboratory and simulation studies of isolation and confinement. Such men perform, for the most part, tasks of little interest or meaning to them personally. Project Tektite I represented the fulfillment of long-standing ambitions of the participants.

The opportunity to collect real data by unobtrusive means was another attractive feature of Project Tektite I. Since safety and medical monitoring necessitated TV and audio coverage of the habitat, psychologists could observe the behavior with a minimum likelihood of reactions to their observations. The divers realized that the watchful eye of big brother was there for their safety. It is true the Tektite I aquanauts knew that they were being observed by psychologists and that records of their reactions were being made, but it is also true that they would have been observed had psychologists not been there and that their reactions would have been noted, although not on a systematic basis.

Thus observations are, in a sense, normal features of saturation diving environments, and the presence of psychologists can be expected to affect the reactions minimally.

#### A2.2.4 Data Collection System

##### A2.2.4.1 On-Site Punching of Direct Observations on Data Cards

The system of collecting behavioral observation data was designed to demonstrate that simple, objective observational measures can produce a rich, meaningful picture of human behavior in a field setting, provided that the number and frequency of these measures is large enough to do justice to the complexity of the situation. This prototype system was an engineered gamble for expanded capability over more conventional collection procedures. A direct observational approach was employed, an extension of the method used by ethologists and anthropologists. The guiding philosophy is: given a field, naturalistic setting wherein exercising of controls is difficult if not impossible, the researcher builds his study not around controlled experimentation but around measures which make sense in describing the natural, on-going behavior *within* the constraints of the particular territory, area, or situation being investigated. The hope is that reduced reliability due to lack of experimental control is more than compensated for by the robustness or validity of the observed behavior. Methodological difficulties appear not in designing the conditions of the research but in developing and implementing measures which preserve the naturalness of behavior by not intruding or manipulating in any way the object of observation in his domain yet get inside what is going on through a deceptively simple, descriptive procedure.

Within the Tektite I project were a number of built-in elements challenging the observation program in general and the data collection program in particular. Some strictly operational aspects were very early defined, and others arose from the investigators' particular orientation tempered by the context of those operations. This array of factors served to shape the boundaries within which the collection system had to evolve and operate. Briefly they were as follows:

- The entire undersea mission would actually take place just off an island remote from any civilization center. This assured a relatively pure, stable, marine ecology for scientific inquiry but also insured a plethora of logistical difficulties inherent to such a removed site.
- The aquanauts would live exclusively under the sea for a considerable duration, be generally isolated from the topside world, and be physically separated from the behavioral investigators.
- A large pool of attractive, descriptive behavioral measures unusual and often unique to conventional psychological assessment was available, as a result of prior research and continued development, for further validation as well as initial testing.
- The measures would be collected through systematic direct observation and, for certain indicators, with high frequency so as to emphasize a comprehensive view of behavior.
- The behavioral program policy was to employ an unobtrusive, noninterference collection methodology such that the natural, on-going activity of the aquanauts in the habitat would not be disturbed. Signals from the closed-circuit TV cameras and open microphones in the habitat would furnish the majority of the observational data.
- An experimental instrumentation package designed to electronically monitor and automatically record certain activities in the habitat would be implemented.

- Slated for concentrated training in a highly synchronized, involved data collection procedure as behavioral observers were enlisted seamen of predominantly untested and thus unknown quality.
- Program policy dictated that almost all behavioral data leaving the site would be on punched computer cards to eliminate time-consuming off-line reduction, speed information feedback from the computer to the site, and maximize use of observer time.
- Sizable time and cost constraints would prevent implementing elaborate instrumentation and procedures for data collection but instead would foster an elegantly simple, inexpensive, easily imitated system.

Within the context of these major considerations then the collection system was designed, developed, and finally implemented. The following description of the system will become more meaningful when integrated with the description of the data management program in section A4. Data flow from the project reached Washington once a week to be sorted and analyzed by already existent computer programs and promptly returned to the site. Access to analytic and storage computer facilities played an integral part in the construction of the collection system.

The heart of the data acquisition system was the recording of directly observed events by a trained observer using an IBM information recorder. Although described in detail in section A4, the information recorder can briefly be characterized here as a small, portable, plastic unit which allowed different information-filled templates to be superimposed over partially preperforated data cards. These cards could be punched on-line, with the resultant record being fully compatible with the specially composed read programs of the Washington computer. The device was untried, but its potential advantages over the gathering of the more conventional paper and pencil records were convincing. Dealing with the quantity of behavioral information under active consideration during the planning phase made handling of the projected mountains of paper undesirable. Location of the one appropriate checklist in 25 during a frantic recording session is time consuming. Trying to maintain a reasonable ordering of checklists during recording sessions and a cataloging procedure which allows relocating any specific piece of information would have been virtually impossible. Finally the reduction of huge amounts of paper and pencil data to a format compatible with computer devices is such a formidable task as to have surely been delayed until after the active collection phase, preventing any comprehensive feedback of analyzed data during the mission.

The information recorder solved most of these problems. As will be detailed in section A4 the different templates required design and setting-up procedures far more detailed than a paper and pencil checklist, because of the necessity to optimize the use of available space on the compact template field. Beyond this was a complicated, time-consuming procedure in the manufacture of each separate template. These two factors in turn operated on two aspects in the conceptual stages of behavior measure development. First, the rationale concerning which measures would finally be used and how elaborate each would be demanded continued scrutiny throughout their development to prevent wasting valuable time on measures that would never be used. In short, the investigators were forced into rigorous, well-reviewed decisions about measures. Second, checklists would have allowed flexibility for change right at the site, in the midst of the collection phase if need be. The prepared template did not. Flexibility is usually desirable, but not at the expense of putting off decisions which should be made prior to the data collection phase. The researcher, with the promise of easy modifiability, often excuses himself from the difficult task involved in making a commitment to his final family of measures.

The standardized format across templates cut down on search time for the observer recording any particular event and permitted a data acquisition rate (recording speed) commensurate with the more familiar medium of paper and pencil. Error rate proved to be low. Recorders were always reloaded with blank cards after use, and templates that were frequently used remained in their respective recorders, saving the time otherwise spent changing templates. Storage of the punched cards was simple. Data punched on site were partially reduced, eliminating the usual reductive steps of reordering and key punching the data before analysis. Deciding on the content of the measures and design of the templates well in advance of the mission's commencement allowed for an early start to the writing and debugging of computer programs for data sorting and analysis. As a result analyzed data could be returned to the site during the mission. These data provided insight into on-going individual and group processes and permitted evaluation of, and corrective feedback to, observer personnel through a variety of checks built into the measures.

#### A2.2.4.2 Choice of the Objective Measures

The majority of measures finally settled on for Tektite I were extensions of those used in research on Sealab II and were based on directly observable, objective events. The major focus of the measures was directed at assessing task performance, social interaction, and emotional adjustment. In fact, six general categories of information were collected: time coding of a variety of events either in terms of time of occurrence or time to accomplish; performance evaluation using both quantitative and more subjective, qualitative measures; description of aquanaut disposal in terms of habitat location, general activity, and communication status; aquanauts' conversations within the habitat and with topside; a simple frequency count of certain prespecified events; and aquanaut mood. These measures were carefully developed to insure redundancy on some crucial indicators by partially overlapping certain of them. During development, stress was placed on simplicity and directness of meaning for the eventual observer. This face validity made intuitive sense to our observers and their work all the more meaningful to them.

#### A2.2.4.3 The Observers and their Training

The behavioral program had six observers available at all times to support the collection phase and from one to three supervisors on-site maintaining the program. Six Navy seamen apprentices just out of a training command in Orlando, Florida, had been selected through regular channels on the basis of a minimum General Classification Test score of 60 (placing them intellectually in the top 10 to 15 percent of the general population), a clerical interest, and strong motivation toward and interest in the project.\*

The observers arrived at the base camp 2-1/2 days before the mission's start. Their training began immediately, with reading of a detailed 44-page manual which defined every behavioral indicator, described use of the equipment, and contained a glossary of terms and an overview of the project. During the first full day at the base camp, except for a short trip to view the behavioral station, the men concentrated on the manual. On the second day, as fragments of understanding fell into place, possible collection situations were simulated in a base camp classroom, since the behavioral station was much too small for simultaneous use by the six observers. The manual was in frequent use during the first few days of the mission, then, as the observers' understanding matured, served as a handy clarifier of the finer points of collection.

---

\*Because of their excellent contributions as observers as well as their valuable and ingenious suggestions which furthered the technical efficiency of the overall collection program we take pleasure in citing the names of the six observers: Thomas Boyd, Robert Holston, William Quintard, Joseph Mayberry, Dan Friar, and Robert Littlewood.

Since the quality of the men could hardly be known 4 to 6 months in advance, a concerted effort had been made to create collection procedures as simple as was reasonable without jeopardizing the main thrust of the program. Such emphasis proved to be fortunate in that the complete procedure proved somewhat difficult to learn within the short time allotted. The observer was asked to consider himself the scorer of a ball game, being sensitive to recording certain important events while disregarding others. He was to serve as a chronicler of on-going activities, answering who, what, when, and where kinds of questions.

As the mission started with but 2 days of instruction and simulation behind them, further team training was accomplished on-line with each pair of observers, particularly during the first 2 days of the mission. With the supervisors providing extensive support the quality of the data was not seriously affected during that time, although frenzy abounded within the behavioral station those first few days.

In retrospect the actual training phase went very quickly. After the first few days of the mission the observers were thoroughly competent to deal with every operational aspect and general maintenance of the topside instrumentation complex. In general they were highly motivated, had excellent esprit de corps, and attacked the challenge with relish. This competence was such that later in the mission the major supervisory problem was dealing with the boredom of the observers and its ramifications for degradations in vigilance and ensuing reduction in data quality.

#### A2.2.4.4 Active Phase

Although both the behavioral station and its monitoring and recording equipment will be described in detail in Appendix B (section B5.2), brief coverage is warranted here. The behavioral station was one of two sections of a van mounted on a barge winched above the surface of Lameshur Bay on pilings (Figs. 29 and 30, page 41). The watch director's section provided safety personnel with instrumented monitoring of the atmosphere and visual monitoring of the aquanauts in the habitat plus a centralized communication system with the habitat, crane barge, safety boats, and base camp. Aquanaut behavior within the habitat was monitored and recorded in the behavioral station.

General Electric personnel responsible for equipping the support van received substantial inputs concerning overall design and equipment placement within the station from the Naval Medical Research Institute. Such personalized decisions about floor plan layouts and design of the central equipment control consoles and switches in the habitat allowed a configuration of the station best suiting the peculiar demands of the collection program. The Naval Medical Research Institute's Behavioral Sciences Department instrumentation laboratory meanwhile was developing the fundamental equipment package for the van. Installation took place in General Electric's Valley Forge facility, in the Philadelphia Navy Yard, and on site in Lameshur Bay. Pre-mission hookup and comprehensive checkout were accomplished on site. Detailed maintenance instructions and critical spare parts were available as precautionary measures.

Once the station was fully operational, it was literally packed with equipment and support instrumentation. Behavioral observers manned six closed-circuit TV monitoring screens and audio inputs from habitat compartment cameras and open microphones as well as audio tape recorders for recording conversation and a video tape recorder for visual records. They operated this array of equipment from centralized control consoles, employing the information recorders and checklists in their collection.

Meanwhile an equipment package automating the monitoring and recording of the use of certain habitat facilities unobtrusively collected its information at the rear of the station. This electronic monitoring was certainly the exemplar of the behavior program's

unobtrusive guidelines garnering performance indicators, use of time, and use of entertainment facilities. It provided a backup account of diving time *when* aquanauts punched "in" and "out" buttons on a dive panel near the rim of the ingress-egress hatchway. On-off piggyback switches on the habitat's entertainment TV, AM-FM radio, and stove switches supplied information illustrating the patterns of use of facilities and gave possible indication of the well-being of the crew and its individual members. Finally, microswitches on each aquanaut's bunk headphone signaled disclosures of the private use of entertainment facilities. In short the system allowed thorough monitoring of highly specified units of behavior, some of which occurred almost instantaneously and others of which were screened from observer view by the location of the operator aquanaut between the particular facility and the TV camera.

#### A2.2.4.5 Collection

On occasion the aquanauts were continuously monitored around the clock, but over the greater part of the mission data were collected continuously from 6:15 a.m. until 11:45 p.m., 17-1/2 hours per day. This period was found to cover about 97% of the aquanaut's waking hours. The observer work shifts, between 2 and 6 hours long, depended on the evolving boat transportation and chow schedules. Observer performance depended not only on personal motivation and competence but on the capacity to maintain considerable vigilance over prolonged periods of time. Early in the mission it was obvious that watch periods 2-1/2 to 3-1/2 hours long appeared to optimize the tradeoff between constantly shifting the observers, causing a loss in continuity of recording, and the overly long periods where the likelihood of poor-quality data is increased because of a reduction in observer vigilance.

Watch schedules and thus boat transportation to and from the support barge were designed by the command for the convenience of the watch-director contingent. This schedule, because of an acute boat shortage, was changed repeatedly over the first few weeks of the mission along with accommodating changes in chow schedules. The behavioral watch schedule had to be adjusted continually to fit these permutations. As a result protracted observer watches had to be maintained. Later in the mission a special early morning shuttle was instituted for the observers to accommodate the needs of the behavioral program. It was pointed out that a late night shuttle would prevent the loss of valuable data being generated by the aquanauts, who were staying up beyond the midnight change of the topside watch, the point at which the observers had to return to the base camp or be left on the support barge overnight. For the ubiquitous and convenient reason of "safety" this request was unacceptable to the command. Such a lack of appreciation for what doing science involves interfered with the on-going scientific endeavor.

The information recorder, a small number of backup checklists, the audio recorders, and the electronic monitoring system were employed as primary devices for gathering information either as it materialized (on line) or sometime after its occurrence (off line). Checklist data were punched off-line onto cards as were the paper-tape records generated by the digital printer of the automated monitoring system and the crew responses on the mood adjective checklists. Two primary behavior sampling procedures were employed during the collection. Event sampling required the recording of prespecified activities as they occurred in the context of on-going behavior and time sampling noted certain standard components of aquanaut behavior at prespecified intervals. These intervals, generated on a random basis to prevent introduction of a sampling bias, were short enough to insure that the data collected were representative of the continuity of the on-going behavior within those intervals.

The flavor of the actual collection situation can best be conveyed by describing a few moments of activity within the behavior station. Both observers are seated at the working table monitoring the TV screens. It appears the four aquanauts are just finishing





Vernon Lindzey Scale of Values and the Edwards Personal Preference Inventory were administered. Team members completed two other questionnaires, a biographical inventory, derived from research on Antarctic groups, and a swimming questionnaire, recently developed for divers. The information from these questionnaires is intended for use in a data bank for comparison with other groups of men in similar environments, including other diving groups. The information is largely technical and will not be reported here. Descriptive information obtained from a structured biographical interview which was administered at the same time, will be reported. Brief, preliminary, and tentative interpretations of the biographical information will be made to indicate its possible use in predicting behavior.

The structured biographical interview was a 1-1/2-hour interview with broad questions followed by specific probes depending upon the answers given. It investigated such areas as education, employment (including work as a child), family, finances, hobbies, and sports. The information will be reported for the group as a whole with indications of similarities and differences given for specific responses.

#### A2.2.5.2 Age

The Tektite aquanauts were all in their middle and early thirties. The senior man of the group was 35 and the others were 34, 32, and 31. Thus, the group was quite homogeneous in age. Furthermore their ages are similar to those of other groups of men entering unusual environments for first-of-type ventures, such as Project Mercury astronauts, the American Mount Everest climbing team, and the aquanauts of Sealabs I and II. It is quite likely that in all the instances cited the age of the men was a highly influential factor in their selection. That is, in selecting men for unusual environments, it is necessary to have men who have sufficient experience such that their potential is known, yet who are young enough that they have sufficient stamina and resilience to withstand the rigors of unusual environments. It can therefore be expected that most of men entering such environments will be in the age range of the Tektite I aquanauts.

#### A2.2.5.3 Education

One of the men held a Ph.D. degree, two others held Master's degrees, and the fourth held a Bachelor's degree. Their education from their earliest years through college was comparatively smooth and regular. As can be expected of college graduates, they all did quite well in their early years of schooling, with the exception of one of the men, who was a high school dropout. However, his intellectual ability enabled him to qualify for his high school degree in the Navy through general education courses. Upon leaving the Navy he entered college and continued in a smooth course toward his degree. None of the other men had had any difficulties while in school, and the man who had earned a Ph.D. had been an outstanding student throughout his educational career. The others were in the top 1/4 to 1/3 of their classes as a general rule from high school years on. Thus in the area of education we have a group with a history of comparatively regular and even progress toward degrees.

While the attainment of advanced education was desired by their parents, the men were required for the most part to finance their education by themselves. Only one of the men did not work during the school years while in college, and he earned a portion of his college expenses through summer employment. The rest of the men financed their education through a variety of part-time jobs, scholarships, and assistantships. Thus they are a comparatively highly educated group, who worked for what they attained. Only two of the men had their education interrupted by military service, and in both cases the military service was not exactly an interruption. One of the men learned diving while he was a Navy enlisted man, and this skill proved to be highly consistent with and helpful in his later education as a marine biologist. The other man served as an officer in the

chemical corps of the army. Hence there was some professional involvement in his military service. All the men attended large public coeducational colleges as undergraduates. The entire educational experience of all these men was in public schools, with the exception of one of the men who attended a private school for his graduate degree.

#### A2.2.5.4 Employment

All four of the men have worked for the Department of the Interior since completing their education. One is a staff oceanographer, another is a marine geologist, and the other two are marine biologists. It is interesting to note that even though the four men as a group had a wide variety of part-time jobs during their college years, including summer work, and several of them during their high school years, that their only employment since completing their education has been with the Department of the Interior.

#### A2.2.5.5 Present Family

All four of the aquanauts are married. Two of them have three children, one has two children, and the fourth has no children. Two of the men were married at a fairly young age, one at age 20 and the other at age 21. The other two men were married at ages 24 and 26. The men who are fathers were ages 23, 25, and 27 at the birth of their first child. In all cases their first child was born after they had finished their Bachelor's degree. This situation may indicate the ability to plan rationally and to delay gratification, since these men found it necessary to finance most of their undergraduate education, which would have been much more difficult had they been family men at the time. The marital and family status of these men is quite similar to the status of other men entering unusual environments such as the Mercury astronauts, the Mount Everest climbing team, and the Sealab II divers.

#### A2.2.5.6 Childhood Experience and Adult Interests

All four of the men were born during the middle or late depression. Although they were raised in different areas of the nation, many of their childhood experiences were quite similar. They were raised in Florida, Ohio, the state of Washington, and Colorado. Each of the four men spent his entire childhood and youth in a relatively small geographic area, with one minor exception of a long-distance move in infancy for one of the men. Even though two of the men were raised in or near medium-sized cities, the childhood experiences had an outdoors, semirural quality for three of the men. Three of the men were earning regular incomes by the age of 11, two of them by paper routes and one by working in a store. After that age they held a wide variety of part-time jobs during the school years and during the summers. They were all given some regular household chores at the age of 6 or 7, including chores such as taking care of the family garden, mowing the lawn, and feeding chickens. Hence learning the responsibilities and discipline of work began at a comparatively early age for all four of the men, especially for the three who began earning regular incomes at a young age. All four of the men attended church regularly in childhood and through adolescence, and all four were quite active in the Boy Scouts.

Interest in outdoor activities has carried over into adulthood. They also have in common an interest in working with their hands. All four of the men share wood working as a hobby in one form or another, ranging from constructing buildings as a hobby to refinishing antique furniture. Two of the men were avid collectors as children; one of them specialized in rock and leaf collections, and the other maintained as many as 35 aquaria. One of the men was a gourmet cook, a fact that was greatly appreciated by his team mates. All of the men were quite healthy during childhood with the exception of one relatively long term respiratory illness for one man. All four were quite active in sports in their youth, participating in athletic activities much more for the personal enjoyment or

satisfaction and camaraderie involved than for status enhancement or recognition of outstanding performance.

#### A2.2.5.7 Parents

The parents of all four of the men are living and living together. This objective indication of stable family background is supported by many of the comments of the men. For all four men the father appeared to be the strong figure in the family. The ages of their fathers at the birth of each man were 26, 29, 34, and 36. All four of the men are the first-born males in their families; one man has an older sister. Each of the men has exceeded his father in education, income, and job status. However, since this upward mobility was achieved with the support and encouragement of their parents, each man spoke of his father with respect and warm affection. They all recognized that economic conditions in the depression set limits on their fathers' achievements. Thus the fact that they have been able to achieve a higher status than their fathers has made them grateful for and respectful of their parents' efforts and encouragement.

#### A2.2.5.8 Summary

This brief global description of these four men presents far from a complete picture of the path which ended in their participation in Project Tektite I. Nevertheless some indications of the major influences in their lives emerge from this description. Each of the men came from a relatively stable, secure family background. They all had records of quite steady and smooth achievement, educationally and vocationally, not exceptionally brilliant or outstanding in any case but in all cases successful and leading them to higher stages of development and accomplishment. Their fathers especially seemed to have been strong and positive models — companions but yet distant enough to provide authority and guidance during their formative years. Stability, solid accomplishment, and an even development are the major themes in all cases, beginning with early childhood and continuing from adolescence. Experiences in their families of origin are seen again in their present families and in their stable work situations. While it may be a slight deviation from scientific objectivity, it is relevant to observe that these men are easy to know, to like, and to respect.

#### A2.2.6 Results

##### A2.2.6.1 Location of the Total Crew

Where did the men spend their time? The data presented in this section are taken from the location record. This was a record of the location of each man taken on a random basis once within every 15-minute period throughout the course of the mission, 17-1/2 hours per day. The data in Fig. A2 give the percentage of time spent in each of the major compartments, or in the water, each day. Superimposed on these percentages is a 7-day moving average to smooth out variations in proportions in time spent in various areas. It excludes a small proportion of time spent in the tunnel and in the cupola.

There are several interesting trends in these several graphs. Note first of all the decrease in the amount of time spent in the bridge area, which is compensated for by an increase in the amount of time in the wet laboratory and in the water over the course of the mission. The men became increasingly efficient in their biomedical measurement tasks, which were conducted in the bridge, as the mission progressed, and less time was spent for habitat maintenance and repair, allowing them more time for diving and related activities in the wet laboratory. Note that the two curves representing time in the wet laboratory and in the water are almost identical. This is not surprising, since the more time the men spent diving, the more time they spent preparing for and securing from dives and processing specimens brought in from dives.

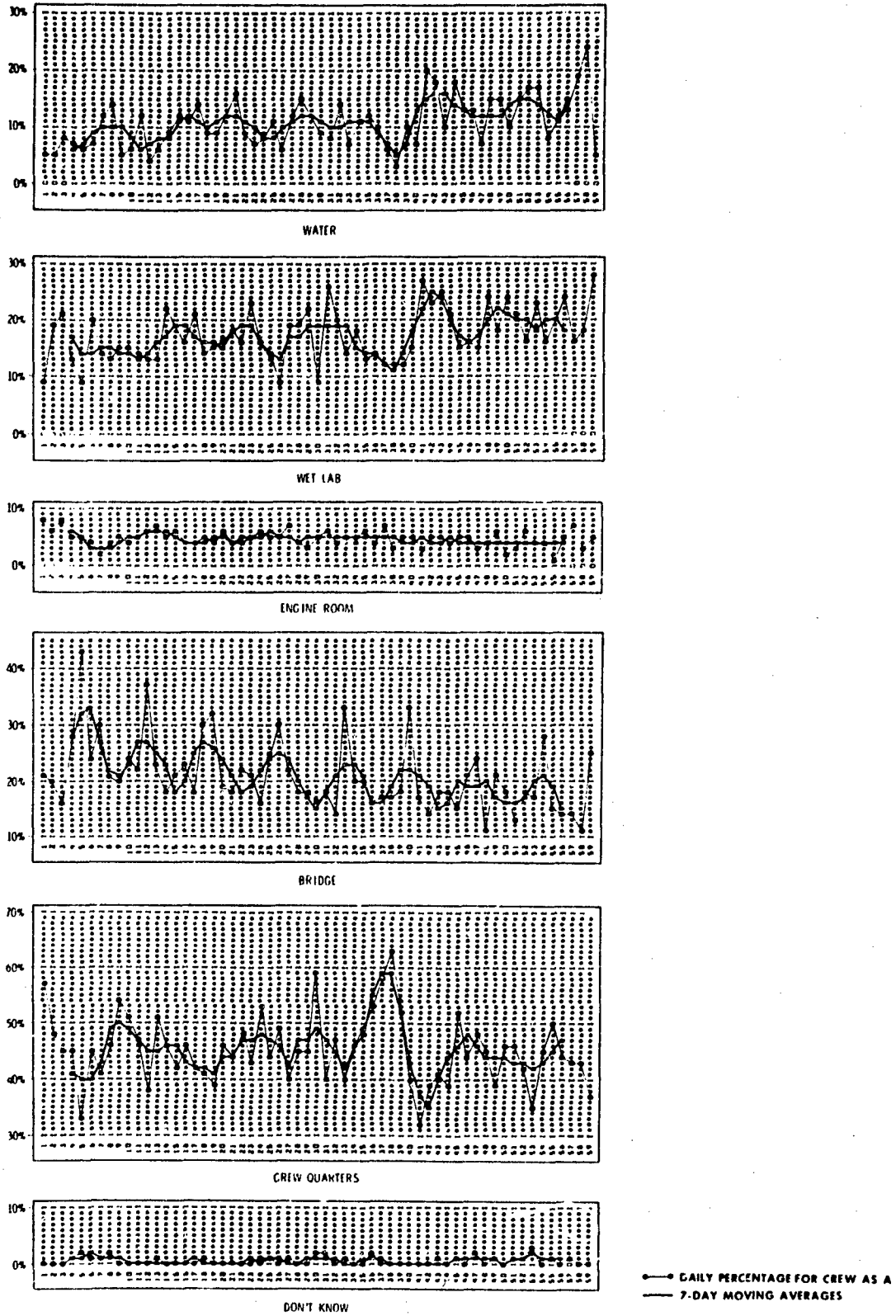

Fig. A2 - Daily percentages of crew time (from 6:15 a.m. to 11:45 p.m.) by location

Perhaps the most interesting feature of the data on the crew quarters graph is the sharp rise followed by an equally sharp decline just prior to and after the beginning of the last third of the mission. This feature of the graph was accounted for by ear infections, which afflicted several of the men simultaneously. After recovery the crew entered the water with renewed vigor. Other than this one striking excursion in this line graph, consistency is remarkable over the period of the mission in the time spent in the crew quarters compared with the decline in the amount of time spent in the bridge area and the rise in time in the wet laboratory and water. Use of the engine room was quite stable over the mission. This was a very noisy area, and few activities relevant to the mission were carried out in this space. The major work done in the engine room was to change the baralyme canisters. The other principal reason for entering the wet room was to use the toilet facilities.

#### A2.2.6.2 Crew Activities

How did the men spend their time? Figure A3 shows a comparison between the amounts of time devoted to various work and personal activities by the average Tektite I crewman on a mean mission day with similar data on an average day for a national sample of American men and women. The latter information was derived from a survey\* conducted for the Mutual Broadcasting System. It is based on self-report diaries from more than 1500 individuals (20 to 59 years of age) covering every quarter-hour period from 6 a.m. to midnight during March and April 1954. Both the Tektite I and the average-American hours are for an average day, incorporating both weekdays and weekends.

The activity status of the Tektite crewmen was sampled in conjunction with the location records described above: four times an hour from approximately 6:15 a.m. to 11:45 p.m. the behavior observers, guided by a randomized schedule, would record in one of ten categories the activity in which each aquanaut seemed to be engaged. Thus these data are the combined results of some 4300 records taken during the mission.

The activity categories presented are those used in collecting the Tektite I data. The data from the Ward study were regrouped to be roughly comparable to the Tektite I categories. The top four categories represent time spent working, which for the American male generally encompasses his work at the office or shop plus labor expended in maintenance, repair, and modification of his domicile. The work category for the average American really represents "at work," and as such is an overestimate of time spent actually working. In fact, in data from a work sampling of scientists and engineers at a government research and development installation,† approximately 25% of this "at work" time was spent in personal activity at the office or absent from the office. The average American female, many of whom do not work outside the home, shows much less "at work" time, but much more habitat/house maintenance time than the male or, for that matter, any individual Tektite I crew member.

In the category breakdown for the aquanauts, included as work are direct marine research, marine science support activities, biomedical and behavioral self-monitoring, and habitat maintenance and repair. "direct marine research" involved working (primarily in the water) on tagging lobsters, observing lobster and fish behavior, taking measurements for a geological map, etc. "Marine science support" encompassed activities like filling tanks, preparing for and securing from dives, reading reference material, and handling equipment logistics with topside. Participation in the biomedical monitoring tasks, mood adjective checklist completion, or testing with the psychomotor device

\*J. A. Ward, Inc., "A Nationwide Study of Living Habits," New York, 1954; data published in S. de Grazia, "Of Time, Work, and Leisure," New York, The Twentieth Century Fund, Inc., 1962 pp. 422-423.

†P. S. Strauss, "Psychology of the Scientist: XXIV - Perceptual Distortion of Job Activities among Engineers and Scientists," *Perceptual and Motor Skills* 25, 79-80 (1967).

comprised the "biomedical-behavioral science" activities, the predominant percentage of this time being biomedical. Finally, gage reading, standing watch, repairing equipment, and changing the baralyme are representative of the "habitat maintenance" category.

The "don't know" category simply indicates the percentage of times the behavioral observers were not aware of, or could not decide on, what the aquanauts were doing. The "in-transit" category for the crew includes only those sampled times during which the aquanauts were walking or climbing about the habitat. It does not include the swimming outside the habitat. For the average Americans, "in transit" includes walking to the store, traveling to and from work, and Sunday driving.

The remaining three categories, "self maintenance," "recreation," and "resting and sleeping," conceptually hang together as personal time, contrasting with work time. "Self maintenance" in the habitat included cooking and eating meals, handling and transporting foodstuffs, and personal hygiene. "Recreation" meant social conversation after dinner, playing cards or a guitar, reading for pleasure, etc. "Resting and sleeping" in the Tektite I data includes passive daytime relaxing. In the Ward diary study, some of this relaxing time falls within the recreation category, which encompasses a variety of leisure activities. Note also that because of the sampling times the bulk of the night's sleep is not included in the graphs.

The first point to note in these comparisons is the basic similarity between the average day of the Tektite I crew member and that of the average American man in terms of work and personal time distribution. Overall, life in the habitat was clearly comparable to the day-to-day life of the normal, dry American male, despite the fact that the crew had to carry housekeeping burdens as well as perform marine science. For the mission as a whole the habitat maintenance workload of the Tektite I crew members averaged twice that of the American man but only half that of the American woman. However, much of this maintenance and repair occurred early in the mission, so the mean figure is somewhat misleading. This is illustrated in Fig. A4, which presents the percentages of time allocated to each of the activity categories by the average crewman on each day of the mission. To emphasize trends 7-day moving averages have been superimposed on the daily percentages. Note that after the first third of the mission the repair and maintenance time expenditure becomes much more comparable to that for the American male. In terms of hours per day for the average aquanaut, habitat maintenance time went from 2.5 hours in the first third of the mission to 1.1 hours in the last third.

A more thorough premission checkout of the habitat could very likely have lessened this initial maintenance and repair load, which exerted a profound negative effect on crew productivity. As time spent in habitat maintenance decreased over the mission, marine science diving and support activity times rose. Because of ear infection problems during the second third of the mission, which afflicted all of the crewmen to varying degrees, the increase was dampened during that period. The dip in time in the water during the period of simultaneous ear infections, the postinfection peak, and the subsequent leveling-off which was seen in the "water" curve of the location data (Fig. A2) appears as well in the "direct marine science" curve of the present figure. Likewise parallels can be seen between the "marine science support" curve of Fig. A4 and the "wet laboratory" usage curve of Fig. A2.

Another aspect of the maintenance and repair problem were the all-night watches which the crew stood on a 3-hour rotating schedule during the first third of the mission, until confidence in the reliability of habitat systems could be established. (Watch-standing time is shown separately in Fig. A4. In the other figures it has been incorporated into the habitat maintenance category.) This watch standing reflects itself in the large fraction of the day spent in resting and sleeping during the first third of the mission. This disruption of circadian rhythms, the hectic pace of premission preparations,

and the continual confrontation with one malfunction after another all served to get the mission off to a decidedly lethargic start. The nature and timing of these occurrences may well have set a tone for the entire mission. As the habitat systems settled down and watches were discontinued, daytime resting and sleeping decreased, although remaining at a level above that of the American male norm. Because of increases in recreation and self-maintenance time, the total personal time showed a net increase over the course of the mission. Again, the fluctuations in recreation and resting and sleeping over days 35 through 45 reflect the effects of ear infections. Not apparent from the present graphs is a gradual shift which occurred over the course of the mission toward later arising and retiring times. This worked against the increasing diving trend, since it meant the loss of some prime daylight diving hours.

However, in comparison with the average American male, the Tektite I crew's greater number of resting and sleeping hours is counterbalanced by the lesser time spent in recreational pursuits. Only during the ear infection periods of the middle third of the mission did the Tektite I total of resting and sleeping plus recreation time exceed the same total for the American male. Self-maintenance time in Tektite I was consistently higher than for the average male, primarily because the crew had to cook and clean up after its own meals.

#### A2.2.6.3 Individual Differences in Time Utilization

Table A1 presents the individual aquanaut's time utilization on an average mission day. Note that there is nearly an hour's difference per day between the total work time of the highest and lowest aquanaut. The aquanaut who showed the highest total work time also spent strikingly less time than the others in resting and sleeping. His higher self-maintenance time reflects the fact that he prepared more meals than others.

The aquanaut who was lowest in marine science time was highest in time devoted to habitat maintenance and to the conduct of the biomedical tests. In terms of time spent he functioned more as an engineer-technician than as a marine scientist. The other three aquanauts show similar patterns of worktime allocations, in which marine science predominates. In postmission debriefings the aquanauts all expressed the suggestion that an actual habitat engineer would be desirable on future missions, particularly if he could also provide diving support. In line with this a slightly larger crew size (five or six) was thought to be advisable. Again, however, these opinions may well reflect the unreliability of these particular habitat systems during the first third of the mission.

In comparing the time utilization of the different aquanauts one should bear in mind the differences in the number of days on which each aquanaut was medically restricted from diving because of ear infections or, in one case, a sore arm. Aquanauts 1 through 4 were medically restricted from diving on 12, 1, 3, and 7 days respectively. The data presented here have not been corrected for these differences. Partly because of inadequate contingency planning, these were essentially lost days as far as the individual's marine science work was concerned.

#### A2.2.6.4 Day of the Week Patterns

As explained the data thus far have dealt with an "average" day, both for the Tektite I crew and for the Ward study comparisons. As shown in Table A2 the Tektite I crew did not follow the American pattern of taking the weekends off from work. There was less total worktime on Sundays, but not strikingly so. During the concentrated diving activity in the last third of the mission, more diving was actually done on Sundays than on the surrounding days.

## PROJECT TEKTITE I

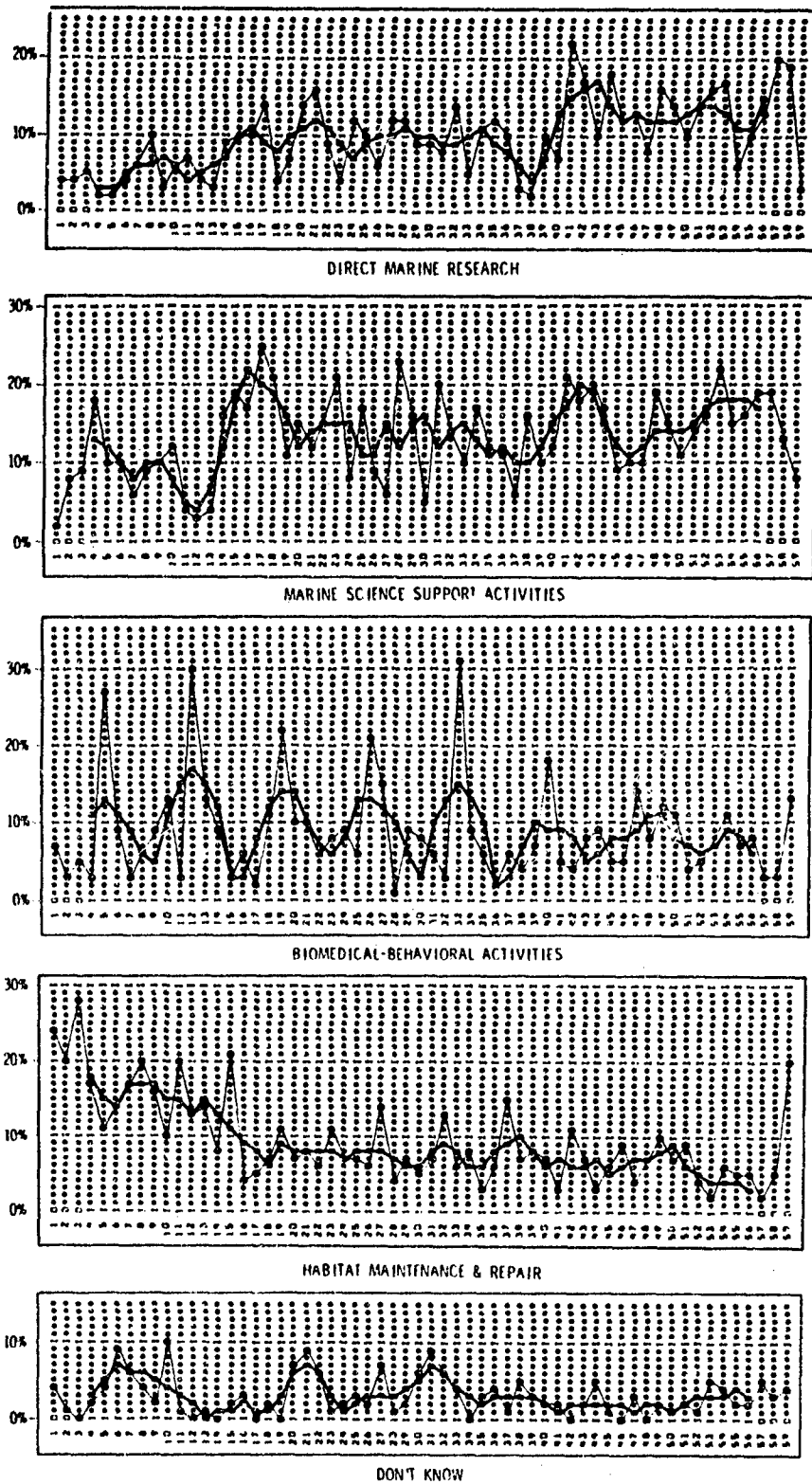

Fig. A4 - Daily percentages of the time from 6:15 a.m. to 11:45 p.m. that the Tektite I crew spent in activities. The curves show daily averages and 7-day moving averages. This figure continues on the next page.



1870

1871

1872

1873

1874

2

Table A1  
Average Day's Time Utilization From 6:15 a.m. to 11:45 p.m. by Individual Crew Members

Aquanaut Number	Work Time (hr)					In Transit (hr)	Don't Know (hr)	Personal Time (hr)				Total (hr)
	Direct Marine Research	Marine Science Support	Biomedical-Behavioral Science	Habitat Maintenance and Repair	Total			Self Maintenance	Recreation	Resting and Sleeping	Total	
1	1.2	1.3	1.8	2.2	7.0	0.2	0.6	2.7	3.2	3.8	9.7	17.5
2	1.9	2.6	1.7	1.7	7.9	0.1	0.5	3.1	3.1	2.8	9.0	17.5
3	1.7	2.5	1.4	1.7	7.3	0.1	0.4	2.5	2.8	4.4	9.7	17.5
4	1.9	2.4	1.3	1.9	7.5	0.1	0.6	2.6	2.9	3.8	9.3	17.5
AV	1.7	2.3	1.5	1.9	7.4	0.2	0.5	2.7	3.0	3.8	9.4	17.5

Table A2  
Time Utilization From 6:15 a.m. to 11:45 p.m. by Day of the Week for Aquanauts and Average American Man

Day of Week	Work Time (hr)				In Transit (hr)	Don't Know (hr)	Personal Time (hr)				Total (hr)
	Direct Marine Research	Marine Science Support	Biomedical Behavioral Science	Habitat Maintenance and Repair			Total	Self Maintenance	Recreation	Resting and Sleeping	
Average Tektite I Crewman											
Mon, Tue, Thur, Fri, and Sat	1.9	2.5	1.2	1.9	0.2	0.5	2.7	3.0	3.6	9.3	17.5
Wed (biomedical day)	1.0	1.7	3.8	1.6	0.2	0.4	2.8	3.0	3.0	8.8	17.5
Sunday	1.6	2.2	1.0	2.0	0.2	0.5	2.9	3.0	4.1	10.0	17.5
Average American Man											
Av weekday	At Work (hr)				1.4	-	2.2	3.6	2.3	8.1	17.5
	7.2										
	4.3										
Sat	1.2				1.4	-	2.5	5.5	2.6	10.6	17.5
Sun	1.0				1.3	-	2.2	7.9	3.9	14.0	17.5

A much more distinct difference from the daily pattern occurred on Wednesdays; on these biomedical monitoring days the structure of the monitoring schedule was imposed on the crew's activities. Note that although these medical procedures did cut into marine research and marine support time, the overall work time was higher on Wednesday, than on the other days of the week. Resting and sleeping was less on Wednesdays, again reflecting the scheduled arising time enforced by topside on these biomedical days.

#### A2.2.6.5 Activity and Location

The preceding two sections discussed the location of the men and some of their activities. This section will examine the influence of activities on the location of the men and the crew. The capsule was divided into four compartments. The compartments were further subdivided for purposes of data collection such that 30 total sections, most with functionally distinct characteristics, were identified on the location record. Since the men were in the capsule approximately 90% of their waking hours, each compartment would have been used 22.5% had they been occupied equally. Further, if each of the 30 areas for which data were collected had been occupied an equal proportion of the time, each area would have been occupied 3% of the time. There are obvious reasons to expect some compartments and some areas within those compartments to have been used more than others.

This was the case. We have seen in the location data for the total crew that the crew quarters and the bridge were occupied more than other areas. The men were in the crew quarters almost 45% of their waking hours and 51% of the time they were in the capsule. The bridge was occupied 21% of the total waking hours during the mission and approximately 23% of the time the men were in the capsule. Thus the men were in either the crew quarters or the bridge 66% of their waking hours and 74% of the time they were in the capsule. Since most of the time was spent in the crew quarters and in the bridge, we will examine representative data from these two compartments to illustrate the manner in which the functional configuration of the space and the use of that space by individuals and the group determined its occupancy.

Tables A3 and A4 present data on the average time spent in the crew quarters and the bridge as well as occupation of the most heavily used space in each. The man spending the greatest amount of time in each compartment and its most heavily used section is compared with average occupancy of that compartment and that particular section by the other crew members. That is, this detailed analysis will focus on the compartment and the space within the compartment most utilized.

Table A3 gives the average amount of time spent in the bridge and the mission experiment area (section 4) of the bridge for diver 2 and the other crew members. The following interpretation of these data demonstrates a situation approaching the establishment of territorial dominance, over the course of the mission, of the most desirable space by the man appearing to have had most need of that space.

For the total mission diver 2 was in the bridge 1 hour more per day on the average than were the other three men, who were fairly equal in their occupancy. This additional hour per day was spent by diver 2 in the mission experiment area of the bridge (Fig. A5). This area was by far, the most preferred sitdown area in which to work within the capsule. Its average usage by the crew was 9% of the total time in the habitat, three times that of the use of that space expected from a random distribution of usage. Diver 2 had a particular task which required his frequent use of this area. Week 1 data in Table A3 show that during the first week diver 2 was not in the bridge or in section 4 of the bridge more than were the other men. However, in the second week he had begun to use both the bridge and mission experiment area more than the other men. By the third week of the mission his additional occupancy of the bridge and experiment area had reached its

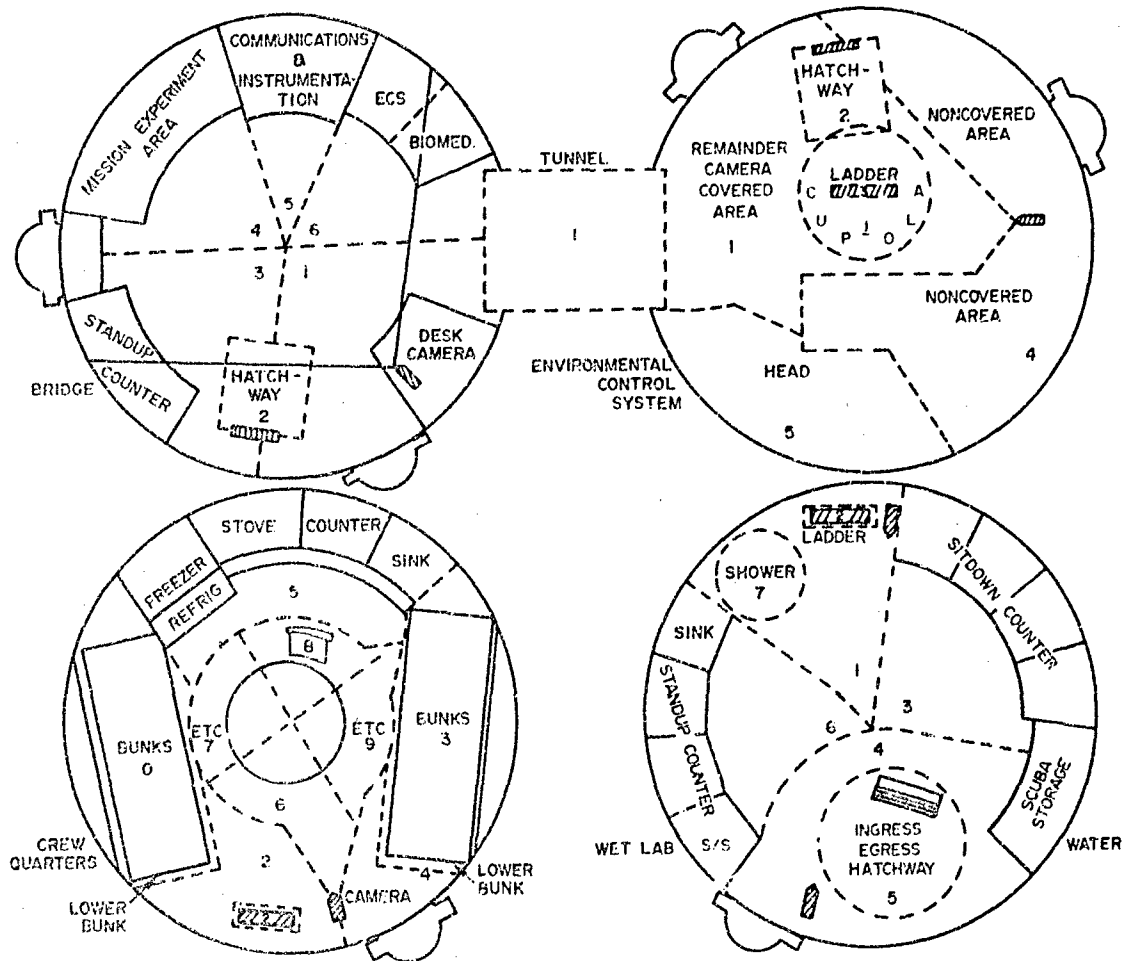

Fig. A5 - Habitat compartments and subdivisions

mission mean level of 1 hour. During weeks 4, 5, and 6 his dominance in use of that particular section was quite marked; he spent as much time in section 4 during these three weeks as did all other men in the crew combined. During weeks 7 and 8 diver 2 devoted less time to the task requiring his use of section 4 in the bridge. During these last two weeks his use of this space fell off considerably over his heavy use during the middle of the mission. However, the other men did not increase occupancy of this space as he turned to other activities.

Table A3  
Average Daily Time in the Bridge Compartment and Section 4 of the Bridge  
(Mission Experiment Area) for Diver 2 Versus the Other Divers

Week	Time in Bridge (hr)		Time in Section 4 (hr)	
	Diver 2	Others	Diver 2	Others
1	4.29	4.47	1.64	1.66
2	4.29	3.63	1.89	1.26
3	4.32	3.24	2.14	1.02
4	5.46	2.80	3.50	1.12
5	3.64	3.00	2.14	0.69
6	4.61	2.74	2.42	0.92
7	3.14	2.94	1.61	1.06
8	3.57	2.52	1.93	0.81
Total	233	532	121	180
Mean	4.17	3.17	2.16	1.07

It should be pointed out that in describing the occupancy of the most desirable working space in the bridge by diver 2 there is no implication that the other men were shoved out of this area. Rather there seemed to have been a general recognition, either implicit or explicit, concerning the special requirements of diver 2 for this working space. The way in which he acquired this prerogative to the mission experiment area was quite clear to the behavioral observers. After the evening meal had been finished, he frequently would leave the table before the other men and go to work in the bridge. It is quite likely that this fairly regular use of the space was recognized as a "right" to that space by the other men.

The next most heavily used area of the capsule was section 5 in the crew quarters (Fig. A5). This area was used with almost the same overall frequency as was section 4 in the bridge. It is not surprising that section 5 of the crew quarters was heavily used, since it contained the stove, counter, sink, freezer-refrigerator, and telephone for communicating with topside. The multipurpose nature of this area could explain why the man who used it most frequently did not dominate this area nearly to the extent diver 2 dominated the mission experiment area in the bridge.

The data for the use of the crew quarters and of section 5 in the crew quarters are shown in Table A4. The mean time spent in the crew quarters as a whole both for the man most frequently occupying those quarters and for the other three men as well was approximately double the time spent in the bridge area. Furthermore the time spent in section 5 of the crew quarters was a far smaller proportion of the total time spent in the crew quarters than was the time spent in section 4 of the bridge as a proportion of the total time spent in the bridge. The extra time spent in section 5 of the crew quarters by diver 1 was spent largely in talking to topside. Others in the crew spent as much or more

time in section 5 either preparing for or cleaning up after meals as did diver 1. This diver 1 did not establish anything approaching territorial dominance either explicit or implicit over section No. 5. While diver 1 spent the greatest amount of time in this heavily trafficked area, the additional time which he spent there was very nearly the same during each of the eight weeks of the mission. That is, diver 1's time in section 5 of the crew quarters did not increase, as did diver 2's time in section 4 of the bridge.

Table A4  
Average Daily Time in the Crew Quarters and in Section 5 of the Crew Quarters  
(Food and Topside Telephone) for Diver 1 Versus the Other Divers

Week	Time in Crew Quarters (hr)		Time in Section 5 (hr)	
	Diver 1	Others	Diver 1	Others
1	7.36	7.64	1.46	1.16
2	8.25	7.39	1.50	1.13
3	7.82	6.45	1.71	1.27
4	9.57	7.53	1.71	1.19
5	8.43	7.70	1.46	1.20
6	8.18	6.88	1.64	1.13
7	8.21	7.04	1.29	1.13
8	8.46	6.87	1.61	1.21
Total	464	1205	87	195
Mean	8.29	7.18	1.55	1.16

In this analysis we have attempted to indicate the complex interrelationships between functional characteristics of two areas of the capsule, particular requirements for the use of these spaces, and trends over time in their use. Similar analyses applied to other areas of the capsule will round out the picture of life and work in Tektite I.

#### A2.2.6.6 Social Interaction

Previously we have examined where the men were and what they did in general terms. This was followed by a detailed analysis of two of the most frequently used areas of the capsule. In this section we will consider another important aspect of behavior in Project Tektite I, social interaction.

The men did not act as individuals in a vacuum. Life and work were importantly influenced by their fellow team members. While at times the men worked and spent time alone, the majority of their time was spent with all four of the men together or in one of the many possible subgroups. Eleven possible group combinations were possible among the four men in the capsule: a tetrad (the group as a whole), four triads (any three men together, one man by himself), and six dyads (any two men together in one area; the other two men could be together in another area or separate in two other areas). In considering the Tektite I team as potential subgroups, it is apparent that even though we are dealing with a group of only four men, the total situation is highly complex.

An appreciation of the complexity inherent in the Tektite I team may be conveyed by noting that in any group of four men there exists 65 possible individual and group influences to be considered to describe the behavior of the men and the groups. We will not list all such combinations but cite examples to clarify what we mean. First, there are

the personal influences on behavior in which each of the four men is considered as an individual. Next in level of complexity are dyadic influences, the effects of man A on B and of man B on A for all six pairs. In the four possible triads, it is necessary to consider the effects of individual A on pair BC and the effects of pair BC on individual A for all possible combinations. Finally, for the tetrad there exists the possibility of the influence of all four individuals on the four possible triads within the tetrad and their reciprocals plus the influences of all possible dyads on the other possible dyads. Add to this formidable array of within-group influences social interaction with persons outside the group and the situation appears to be one of bewildering complexity. The human social group may well be the most complex subject which science can aspire to analyze and understand.

This explanation of the complexity of social interaction may clarify several important aspects of the behavioral program. First, with regard to group composition, it should now be clear that the insertion of one group member into a crew, say a less-qualified or less-essential member for a more-qualified or a more-essential member, means far more than the addition or substitution of one crew member. It means a change in each and all of the subgroups of which the new person is a member, and it changes influences within those subgroups. This will be the case either if a member is substituted for another one in the group or if he is added to an already existing group.

Second, the above explanation may help to clarify the reliance on simple objective measures in the behavioral program. It would be impossible for a single observer, no matter how expert, to take in the group situation on a global level, to simultaneously perceive, comprehend, compare and synthesize the variety of interactions taking place at any one time, much less to do so over a long period of time. Thus, it was necessary to have many observers, all of whom collected similar data with a common frame of reference. Since these observers were of necessity relatively unskilled in collecting and interpreting behavioral data, it was necessary to use the simple straightforward objective measures. These systematically collected, quantitative measures of individual and group behavior then enable the researcher to understand the dynamics of the group by reconstructing it in the analysis phase of the study. It was the central thesis of the behavioral program orientation of Project Tektite I that the understanding of such group dynamics are best achieved by the collecting objective data relating to ongoing behavior of the group.

Third (a point of special relevance to this section of the report), not all subgroups or interactions are of equal importance. A systematic analysis of the data, guided by broad concepts regarding social interaction and understanding of the specific situation, will direct the attention of the investigator toward those relatively few relationships, out of the many possible relationships, which fit together in a meaningful fashion. One cannot study everything in an overwhelmingly complex situation. In the area of social interaction it is especially important to select carefully the behavior to be studied. It is also necessary to select carefully the behavior to be analyzed. At the time of writing this appendix the process of analysis had just begun for social interaction data on Project Tektite I. Therefore, this report will present only a few representative examples to illustrate the lawful relationships governing social interaction. The next section will be concerned mainly with dyadic interaction, examining the interrelations of various aspects of social interaction over time within the six dyads.

#### A2.2.6.7 Dyadic Interaction

The data in Table A5 present illustrative information on three aspects of dyadic interaction on Project Tektite I: time spent diving together, time spent together in the habitat, and the amount of time talking when men were together in the habitat as pairs. For our purposes a dyad is defined as two men together in the same compartment of the



Table A5  
Correspondence of Dyadic Activities from 6:15 a.m. to 11:45 p.m.

Dyad or Pair	Diving Together		In Habitat Together		Total Together		Talking Together		Talking Together Relative to Time in Habitat Together	
	Time (min)	Rank	Time (min)	Rank	Time (min)	Rank	Time (min)	Rank	Per- cent	Rank
A	8	5	66	5	74	6	15	6	23	5
B	5	6	69	4	74	5	16	5	23	4
C	43	2	127	2	170	1	39	2	31	3
D	53	1	110	3	163	2	49	1	45	1
E	31	3	63	6	94	4	25	3	40	2
F	18	4	130	1	148	3	22	4	17	6
Av	26	—	91	—	117	—	28	—	31	—

habitat or in the water with the other two men elsewhere. Thus, two dyads could be formed simultaneously in different parts of the habitat, or one dyad could be in the water and one could be in the habitat, or one dyad could be in the water or the capsule with the other two men each off by himself.

There was a close correspondence between diving together, talking together, and being together in the capsule as dyads. This is especially true of the amount of time spent diving together and Talking. Table A5 presents the time spent in each of these categories on an average mission day. The average amount of time spent talking together and diving together for the total group over the entire mission are very nearly the same, 26 minutes for diving and 28 minutes for talking. For each dyad the amount of time spent talking together shows a close correspondence to the amount of time spent diving. This relationship is seen by comparing the rank numbers. Although the range of the distribution for time spent talking is less than for time spent diving, the ordering of the dyads is in almost exact correspondence, as is illustrated in Fig. A6. The ratios of time diving together are greater than 10 to 1 for the highest compared to the lowest pair.

The correspondence between the amount of time spent together in the habitat (Table A5) and the amount of time spent together diving as dyads is much lower than it is between diving and talking. Even though members of a dyad could spend considerable time in each other's company in the habitat, if they did not often dive together, they may have had relatively little to talk about. This situation could occur in a number of ways. If one pair were diving together, the other would be left in the habitat together and might be in the same space. Similarly if one pair had work to do together in the habitat, they might go to one compartment, leaving the other pair together in another compartment. However, the pair left together, almost by default as it were, was in a less than optimum social interaction situation. This appears to have happened in the case of dyad F. Note that although this pair is below average on diving time, they spent a greater amount of time together in the habitat than any other pair. However, the amount of time they spent talking is nearly equal in absolute amount to the time they spent diving. Furthermore, compared to other dyads on diving and talking, the two figures are in an equal relationship, both ranking fourth among the six dyads. As a result, the percent of time this pair spent conversing when they were together was the lowest of any dyad.

## PROJECT TEKTITE I

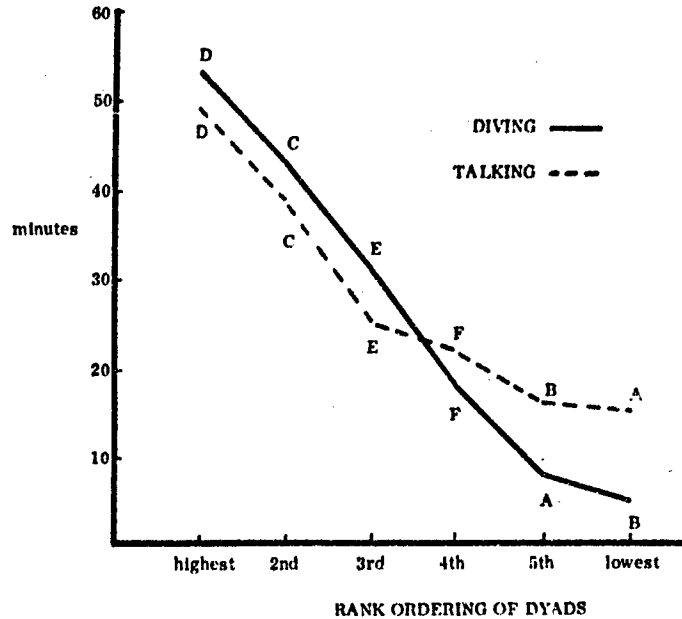

Fig. A6 - Consistency of the crew dyads in time diving together and talking together

The other major discrepancy between diving time and being together in the habitat is seen in the case of dyad E. This pair was above average in diving time, but they were the lowest in time together in the habitat. However, they ranked third in the amount of talking. Note that they spent more absolute time talking than did pair F, although they spent less than half as much time together. For dyad E, then, it appears that social interaction was voluntary. They got together as much as was required by their work together in the water and permitted by their activities in the habitat.

Thus we see in the data in Table A5 a strikingly close correspondence between diving time and conversation — a highly consistent relationship between work and social interaction. The apparent exceptions to the lawful relationship prove the rule. Two pairs, whose amount of time spent together as a dyad in the capsule was discrepant from the time they spent together in the water, used their social interaction opportunities in the capsule in a manner consistent with their work time in the water. In one case the amount of talking was markedly suppressed, and in the other it was enhanced.

Other data, not shown in tabular form here, document the formation and stability of dyadic interactions over the course of the mission. During the first 2 weeks of the mission there was little correspondence between diving and talking. Men who dived together most and least did not talk together most and least during this period. Furthermore, for both diving and talking the rank order of dyads on both variables shows little relationship to the rank order for the dyads for the total mission. That is, the men did not show clear preferences in either diving or talking during the first 2 weeks of the mission. Intra-group preferences were not clearly established until the third week. From the third week on, with minor exceptions, the patterns of interaction characterizing the total mission held steady until the end of the mission.

### A2.2.7 Overview

In this report the conception and execution of the behavioral program on Project Tektite I has been presented along with illustrative examples of the results. We feel that the present report gives the most detailed objective account of the behavior of a group in a natural environment to date. Yet in two ways this report is only a beginning. First, extensive work remains to be done to complete the analysis of the present data. Second, this approach must be extended and applied to more as well as different natural groups to solidify and establish the psychological principles emerging from this work.

Further analyses of Project Tektite I data will extend and elaborate on the analyses presented here. Some other types of data not reported here will be added to the analysis. These other data include things such as times of arising and retiring, times of sleep, meal behavior, times of communications with topside, and data from the mood adjective checklist. Also, an analysis of interactions in the total group and in triads along with a great deal of additional work on dyads remains to be done. Much of the information in the present report, and the additional data to be analyzed, has yet to be synthesized and intercorrelated. Correlations and factor analyses are being applied to quantify the dynamic relationships between different aspects of the same man's behavior from day to day. The data obtained from Project Tektite I are capable of providing an account containing "clinical richness" hitherto available only on a global and impressionistic level. The advantage of the data from Project Tektite I is that the methods by which this rich account has been achieved are objective and scientific. That is, the data and analyses on Project Tektite I are independent of the unique experiences of the observers and interpreters, which is the opposite of the subjective clinical approach, where observations and interpretations are unique to the observer.

The second sense in which this report is only a beginning is in its report of the behavior of only a single group of four men. In response to this or even a more comprehensive report of the data on Project Tektite I a "so what" reaction is not unexpected. So we have data on the behavior of one group of men for 60 days. In response to such a reaction the authors would like to make two observations. First, this report presents more detailed behavioral data than has previously been available on any natural group. Second, the present methods can be applied to other groups to realize their potential. To know how specific men and groups spend their days, weeks, and months together, and to know it in detail, is a necessary first step toward a general understanding of adjustments to the environment in which their time is spent. The present methods, if used repeatedly, are capable of providing increasingly precise and lawful explanations of individual and group behavior. While it is important to collect information on other diving groups using the present techniques, it is even more important to extend the methods employed here to the measurement of behavior in other groups. An ideal opportunity for such an extension is the space program's proposed orbital workshop crews. While the exact opportunities and facilities are not available for studying space crews, the basic techniques can be adapted to that situation. Highly comparable data can be gathered on future undersea and outer space missions. Some advantages of this joint opportunity are the similarities of the men, crews, duration of missions, and psychological characteristics of the environments. Thus a number of variables affecting behavior are under natural control in that they are relatively equal. A common conceptual and methodological approach to data collection in the two environments will greatly accelerate the understanding of adjustment to and performance in both environments. Further, it is not necessary to limit the employment of the present methods to exotic environments. Many features of the methods developed on Project Tektite I can be used in the investigations of prosaic earthbound groups.

A topic of interest both to the present report and its extension to the future is the impact of the methods of measurement on the behavior being measured. That is, how

reactive on Tektite I behavior were the measurement techniques used and what problems might be encountered in other environments? This is a question of considerable magnitude and will not be dealt with in detail here. However, a few relevant comments are appropriate.

In Project Tektite I, problems of reactivity were minimized in the collection methods employed, and reactions to the data collection methods were successfully controlled. This opinion is substantiated by subjective impressions based on observations and on objective data and comments from the aquanauts themselves.

The Tektite I crew appears to have adjusted quickly to being under constant surveillance. There were overt reactions to behavioral observation during the first few days in the form of hand-lettered signs and comments. Such overt reactions rapidly decreased, and throughout the bulk of the mission there were only occasional and universally good-natured verbal references to the "shrinks." These reactions stand in contrast to some pointedly negative reactions to actions that the crew regarded as unjust intrusions by operating personnel. These impressions gained during the mission were substantiated by postmission comments from the aquanauts themselves.

Objective indications of reactions to observation are provided by the number of times the TV cameras and the microphones were manipulated. Television was turned off on six different occasions, most of them relatively brief, less than 1 hour, to obtain privacy. The microphones, on the other hand, were turned off 54 times. These manipulations involved only one microphone each, with one exception, and again most of the interruptions were relatively brief. While in some cases there was a desire for privacy to discuss intimate personal topics, many of the manipulations of the microphones were directed toward operating personnel and not toward the behavioral program. Crew members wanted to discuss in critical vein their reactions to topside events without being overheard by the persons who were subject of the discussion. Thus the evidence indicates that microphones are more intrusive than is TV, the probable reason being that conversations are regarded as more private than is overt behavior.

Special efforts were taken to secure the cooperation of the Tektite I crew and to minimize their reactions to the behavioral observation program. Detailed explanations of the types of data recorded and the reasons for it were given to the crew prior to the mission. The men were all scientists and understood the importance of the behavioral program. Furthermore, it is likely that the objective nature of behavioral data made its collection acceptable to the men.

Since only four men were in the Tektite I crew, it was possible for the investigators to get to know them and to establish confidence and trust in the behavioral program and the way in which the data would be used. However, in future programs involving more men in which operations might become more routine, investigators may not be able to establish similar levels of confidence. If such is the case, the fact remains that some method of surveillance is necessary for the safety and the health of the crew. It is possible for behavioral observers to tap into such facilities. It is not necessary, though, to rely completely on facilities used for other purposes. There are a number of state-of-the-art methods of increasing the automation and decreasing the intrusiveness of behavioral data collection. Only insight, imagination, and money are required to make such methods operational. The possibilities in automating data collection can be appreciated by considering the sophistication which has been achieved in sensing and transmitting psychophysiological information. Surely, if it is possible to sense and transmit minute signals emanating from neurological or fine muscular responses, it should be a relatively simple matter to sense and transmit signals produced by gross muscular or whole body responses. Thus, for example, it should be feasible through the use of a variety of automated sensors to obtain records of location and activity similar to those obtained by

observations on Project Tektite I. Such an application should be of special interest to the space program. The potential for increased automation indicates the final sense in which the behavioral program on Project Tektite I was only a first step in new directions.

### A2.3 Sleep Patterns

Paul Naitoh, Laverne Johnson, and Marion Austin, Navy Medical Neuropsychiatric Research Unit, San Diego, California

#### A2.3.1 Introduction

Loss of sleep and disturbed sleep have been observed in many studies which involved confinement of human subjects in hostile environments.\* Although practical operational significance of sleep loss and disturbed sleep in field conditions is not clearly determined with respect to human reliability and efficiency, altered sleep patterns have resulted in performance decrement and undesirable psychological changes during the waking period under laboratory conditions.†

The primary purpose of the sleep research in Tektite I was to evaluate the quantity and quality of sleep of the aquanauts. Of particular interest was the possible effect of hyperbaric conditions on sleep and the relation of sleep patterns to waking activities.

#### A2.3.2 Procedure and Instrumentation

The sleep log of Hartman and Cantrell‡ was modified for use in this study. From the sleep log, which was scheduled to be distributed each day to all four aquanauts, the following information was obtained: duration of daytime nap, time of retiring and arising, trouble in going to sleep (on a four-point scale), how rested on awakening (on a

\*W. R. Adey, R. T. Kado, and D. O. Walter, "Computer Analysis of EEG Data From Gemini Flight GT-7," *Aerospace Med.* **38**, 345-359 (1967); E. K. E. Gunderson, "Adaptation to Extreme Environments: Prediction of Performance," Navy Medical Neuropsychiatric Research Unit Report 66-17, 1966; R. W. Hamilton, J. B. MacInnis, A. D. Noble, and H. R. Schreiner, "Saturation Diving at 650 Feet," Ocean Systems, Inc., Tech. Memo. B-411, Mar. 1966; L. C. Johnson and M. T. Long, "Neurological, EEG, and Psychophysiological Findings Before and After Sealab II," Navy Medical Neuropsychiatric Research Unit Report 66-19, 1966; H. E. Lewis and J. P. Masterson, "Sleep and Wakefulness in the Arctic," *Lancet* **1**, 1262-1266 (1957); G. C. Luce and J. Segal, "Sleep," New York, Coward-McCann, 1966; P. Naitoh, "Sleep Loss and Its Effects on Performance; Commentary and Bibliography," Navy Medical Neuropsychiatric Research Unit Report 68-5, 1969; P. Naitoh, R. Townsend, and M. Greenwood, "Sleep Requirements of Man-in-the-Sea," Navy Medical Neuropsychiatric Research Unit Report 68-22, 1969; J. T. Shurley, K. Natani, and C. M. Pierce, "Sleep Stage Patterns at South Pole," paper presented at APSS meeting, Boston, 1969; R. L. Maulsby, "Electroencephalogram During Orbital Flight," *Aerospace Med.* **37**, 1022-1026 (1966); H. L. Williams, "Sleep Starvation and You," *Army Information Digest*, pp. 11-18, June 1964; E. S. Williams, "Sleep and Wakefulness at High Altitudes," *British Med. J.* **1**, 197-198 (1959).

†N. Kleitman, "Sleep and Wakefulness," revised edition, University of Chicago Press, 1963; E. J. Murray, "Sleep, Dreams and Arousal," New York, Appleton-Century-Crofts, 1965; P. Naitoh, "Sleep Loss and Its Effects on Performance; Commentary and Bibliography," Navy Medical Neuropsychiatric Research Unit Report 68-5, 1969; R. P. Tucker, "A Review of the Effects of Sleep Deprivation," *Univ. Michigan Med. Center J.* **34**, 161-164 (1968); R. T. Wilkinson, "Sleep Deprivation," pp. 399-430 in "The Physiology of Human Survival," O. G. Edholm and A. L. Bacharach, editors, New York, Academic Press, 1965; H. L. Williams, A. Lubin, and J. Goodnow, "Impaired Performance With Acute Sleep Loss," *Psychol. Monogr.* **73**, No. 14 (whole No. 484) (1959).

‡B. O. Hartman and G. K. Cantrell, "Sustained Pilot Performance Requires More Than Skill," *Aerospace Med.* **38**, 801-803 (1962); "MOL: Crew Performance on Demanding Work/Rest Schedule Compounded by Sleep Deprivation," USAF School of Aerospace Medicine Report SAM-TR-67-99, Nov. 1967.

four-point scale), today's mood (on a three-point scale), number of awakenings during the previous night, and need for more sleep (yes or no).

An electrophysiological recording system was assembled.\* This uniquely stable and yet sensitive data acquisition system recorded two channels of EEG (left and right central derivations referenced to right and left mastoids), two channels of EOG (for monitoring eye-movements — left and right lateral canthi of eyes referenced to the right and left mastoids) and one channel for an electrocardiogram (EKG) (a sternal derivation).

The sleep data acquisition system consisted of two subsystems: one system was in the Tektite habitat, and the other was in the control van secured on the support barge. A harness electrode array with a quick-disconnect terminal was developed to lessen problems associated with attaching electrodes. The signals were amplified in the Tektite I habitat with Tektronix differential amplifiers, Type 2A61. The amplified single-ended biological signals were transmitted out of the habitat through a 1000-foot communication umbilical to the van. The Tektronix differential amplifiers were kept continuously on for 60 consecutive days and nights. In the control van two Beckman Type R dynographs (with six channels of Type 9806A dc/ac couplers and dual amplifiers Type 482M8 for each of Beckman recorders) received the transmitted biological signals and reconditioned and routed them to two folded vertical chart drives for ink recording on paper and to two Hewlett-Packard seven-channel FM instrumentation magnetic tape recorders, Model 3917B.

To synchronize paper and magnetic tape recordings and also to make computer retrieval of sleep data possible an IRIG compatible time code was generated by an Astrodata Model 5400 and recorded on both tape and paper. A Wavetek function generator, Model 110B, was left on in the Tektite I habitat and plugged into the amplifiers continuously, except the time when the aquanauts were using the amplifiers. A Wavetek function generator was set to feed calibrated 100- $\mu$ V sinusoidal waves at 10 Hz into the data acquisition system, thus providing checks on electronic characteristics of the recording system. The shorted channel was added to the data acquisition system, so that any noises caused by ac power fluctuation and magnetic tape wow and flutter can be removed from the EEG recordings.

All-night recordings on two aquanauts, Edward Clifton and John Van Derwalker, were obtained as follows: every night for the first 10 days of underwater habitation (February 15 to February 24), every night for the last 8 days of underwater habitation (April 6 to April 13), and every Sunday and Thursday during the remaining period of underwater habitation. All-night recording was arbitrarily cut off at 7 a.m. The two aquanauts applied the electrodes to each other before retiring.

Two nights of sleep recording were obtained before and after Tektite I. The facilities of the sleep laboratory at the Navy Medical Neuropsychiatric Research Unit, San Diego, California, were used to obtain pre- and post-Tektite I sleep records.

### A2.3.3 Results

#### A2.3.3.1 Sleep Log

The 60-day dive was divided into four 2-week periods: February 15-28, March 1-14, March 15-28, and March 29-April 15. The sleep log was not completed each day; the number of logs completed decreased for all aquanauts during the second half of the dive.

\*The assistance of Dr. Ralph Ritchie in designing this recording system is gratefully acknowledged.

Table A6  
Selected Data from the Sleep Log

Subject	2-Week Period*	Trouble in Going to Sleep?*	Rested?†	Need More Sleep? Percent "Yes"	Mood‡	Number of Sleep Cards Used
Clifton	Feb. 15-28	3.46	2.91	100	2.0	11
	Mar. 1-14	3.00	2.83	100	2.0	12
	Mar. 15-28	3.14	3.00	100	2.0	7
	Mar. 29-Apr. 15	3.33	3.00	100	2.0	6
Manken	Feb. 15-28	3.50	3.13	63	2.3	8
	Mar. 1-14	3.46	3.09	91	2.0	11
	Mar. 15-28	3.86	3.29	43	2.0	7
	Mar. 29-Apr. 15	3.33	3.67	100	2.0	3
Van Derwalker	Feb. 15-28	3.90	3.00	50	2.3	10
	Mar. 1-14	3.18	3.55	13	2.0	11
	Mar. 15-28	3.00	3.20	0	2.0	5
	Mar. 29-Apr. 15	3.00	2.75	75	2.0	4
Waller	Feb. 15-28	2.17	2.67	100	2.8	6
	Mar. 1-14	3.64	3.18	82	2.7	11
	Mar. 15-28	3.00	3.00	100	3.0	2
	Mar. 29-Apr. 15	3.00	3.00	100	3.0	1

\*4 (none); 3 (slight); 2 (moderate); 1 (considerable).

†4 (well rested); 3 (moderately rested); 2 (slightly rested); 1 (not at all).

‡3 (good); 2 (average); 1 (poor).

Table A6 shows the subjective evaluation of sleep as reflected from the sleep logs. The four aquanauts reported satisfactory sleep during the mission, experiencing no severe difficulty in going to sleep and waking up moderately rested. One of the aquanauts consistently reported he could have used more sleep, but he gave similar reports on pre- and post-Tektite I sleep nights. The first 2 weeks was the period in which one aquanaut reported more trouble going to sleep and all reported feeling less rested relative to the remainder of the dive. The fact that this was the period when watch schedules led to interrupted sleep was probably a factor.

Table A7 presents a summary of data for "time of retiring" and "time of arising." These data were collected by the behavioral observation team.\* To evaluate the degree of agreement between the sleep logs and the data obtained by the behavioral observation team, product-moment correlation coefficients were computed between times of retiring and arising as recorded by the behavioral team and times of retiring and arising as shown on the sleep logs for each of four aquanauts. Correlation coefficients ranged from 0.994 to 0.997. A separate statistical test (*t* test) indicated no significant differences between the sleep logs and the report by the behavioral team with respect to times of retiring and arising. These findings suggest that the sleep log, when completed, was adequate for recording time of returning and arising and in estimating hours of sleep.

\*We appreciated the excellent cooperation of Dr. Roland Radloff and his staff during the dive and for providing these data.

**Table A7**  
**Summary of Time of Retiring and Arising and Total Sleep Time**  
**as Obtained by the Behavioral Observation Team**

Period	Mean Time of Retiring		Mean Time of Arising		Total Sleep		Nap Time (hr)	Number of Sleep Cards		
	Time of Night	Std Dev (hr)	Time of Morning	Std Dev (hr)	Duration (hr)	Std Dev (hr)		Retiring	Arising	Total Sleep
<b>Richard Waller</b>										
Feb. 15-28	11:05	1.757	6:57	1.903	7.426	1.326	—	10	8	14
Mar. 1-14	11:06	0.950	7:49	0.469	8.735	1.012	—	14	13	14
Mar. 15-28	11:56	1.307	8:14	0.762	8.076	1.222	—	13	11	13
Mar. 29-Apr. 15	12:08	1.606	9:00	1.244	8.576	1.555	—	14	14	14
Eight weeks	—	—	—	—	8.205	1.363	7.1	—	—	55
<b>Edward Clifton</b>										
Feb. 15-28	11:25	1.447	6:50	1.738	7.161	1.473	—	11	11	14
Mar. 1-14	10:46	0.695	7:15	1.063	8.365	0.966	—	13	13	14
Mar. 15-28	11:40	0.731	7:53	1.014	8.256	0.919	—	14	14	14
Mar. 29-Apr. 15	12:10	1.170	8:01	1.108	7.877	1.259	—	15	15	15
Eight weeks	—	—	—	—	7.914	1.239	0	—	—	57
<b>Conrad Mahnken</b>										
Feb. 15-28	11:19	1.740	7:14	1.701	8.015	1.640	—	10	9	14
Mar. 1-14	10:16	1.122	7:17	1.111	9.005	1.294	—	13	13	13
Mar. 15-28	11:09	1.125	7:52	1.385	8.655	1.236	—	13	12	13
Mar. 29-Apr. 15	12:01	1.341	8:43	0.890	8.741	1.146	—	15	14	15
Eight weeks	—	—	—	—	8.598	1.354	4.6	—	—	55
<b>John Van Derwalker</b>										
Feb. 15-28	10:40	1.809	6:01	1.745	7.369	1.684	—	11	11	14
Mar. 1-14	10:18	1.175	7:09	0.867	8.713	1.179	—	14	12	14
Mar. 15-28	10:45	1.105	7:38	1.263	8.346	0.686	—	12	8	12
Mar. 29-Apr. 15	11:46	1.106	8:06	1.008	8.288	1.145	—	15	14	15
Eight weeks	—	—	—	—	8.175	1.306	2.3	—	—	55

Table A7 shows that the aquanauts averaged roughly 8 hours of sleep. Total sleep time during the first 2-week period was shorter than that during the remaining weeks. One of the aquanauts, Edward Clifton, on whom sleep records were collected pre- and postsaturation dive, slept longer hours during the dive.

The aquanauts went to bed progressively at a later hour. Analysis of data in Table A7 showed that the average retiring and arising times for the first 2-week period were 11:07 p.m. and 6:45 a.m. with a mean total sleep time of 7.5 hours. During the last 2 weeks the average retiring and arising times were 12:02 a.m. and 8:27 a.m., with mean total sleep time of 8.4 hours. The nap time varied for each aquanaut, with a high of 7.1 hours and a low of 0 hours over the 60-day period.



### A2.3.3.2 Electrophysiological Patterns of Sleep

#### A2.3.3.2.1 Hand Scoring of Sleep Stages

The EEG sleep records of aquanauts Edward Clifton and John Van Derwalker were scored according to the sleep scoring manual of Rechtschaffen and Kales.\* Twenty-two nights of scorable records were obtained from John Van Derwalker, and 32 nights of sleep records were obtained from Edward Clifton. Table A8 shows the summary of some of the critical sleep parameters, together with normative sleep data obtained by Webb and Agnew.†

The data shown in Table A8 indicate no dramatic changes in the proportion of time spent in the various sleep stages during hyperbaric nitrogen saturation, except perhaps that the aquanauts spent more time in slow-wave sleep (the sum of sleep stages 3 and 4).

#### A2.3.3.2.2 Analog Computer Analysis of Sleep EEG Data

In visual scoring of sleep stages, all 2-Hz or slower brain waves which exceed 75  $\mu$ V are handled identically, regardless of actual amplitudes. Visual inspection of sleep records during the dive suggested that the delta waves during slow-wave sleep were very high in amplitude, indicating some possible alteration of "intensity" of slow-wave sleep. To obtain absolute intensity of the delta EEG activity during sleep, an analog computer (Systron-Donner 10/20) was programmed to compute the envelope of squared voltage of bandpassed brain waves of 1 to 2 Hz with an electronic filter.‡ Details of the analog computer analysis and the results will be made available in a separate report. The rhythmicity of the REM-non-REM cycles will also be obtained from this analysis.

#### A2.3.3.2.3 Digital Computer Analysis

Under an Office of Naval Research contract, S. Viglione of Astropower Laboratories, McDonnell-Douglas, will apply his pattern recognition technique to the tape-recorded sleep data to obtain automatic EEG staging of sleep.§ The details of methods and results will also be made available in a separate report.

#### A2.3.3.2.4 Analysis of EKG Data

The EKG data obtained during Tektite I habitation will be analyzed by generating frequency histograms of heart rate (sleep stage 2 only) with a Computer of Average Transients (CAT 400C) plus additional hard-wired instrumentation. The details of method and results will be made available in a separate report.

\*A. Rechtschaffen and A. Kales, editors, "A Manual of Standardized Terminology, Techniques and Scoring System for Sleep Stages of Human Subjects," U.S. Government Printing Office, Washington, D.C., 1968 (NIH Publication 204).

†W. Webb and H. W. Agnew, Jr., "Measurement and Characteristics of Nocturnal Sleep," pp. 2-27, in L. E. Abt and B. F. Riess, editors, "Progress in Clinical Psychology," Vol. 8, New York, Grune and Stratton, 1968.

‡D. F. Caldwell, "Differential Levels of Stage IV Sleep in a Group of Clinically Similar Chronic Schizophrenic Patients," paper presented at the 23rd meeting of the Society of Biological Psychiatry, Washington, D.C., June 16, 1968.

§D. B. Drane, W. B. Martin, and S. S. Viglione, "The Application of Pattern Recognition Techniques to the Scoring of EEG Sleep Patterns," paper presented at APSS meeting, Boston, 1969.

Table A8  
Comparison of Sleep Stages of John Van Derwalker and of Edward Clifton with a Base-Line Sample of 12 Adult Males, 30-39 Years Old, Obtained by Webb and Agnew

Time Period	Total Sleep Time (min)	Total Wake (%)	Total Sleep (%)	Stage 1 Sleep (%)	REM (%)	Stage 2 Sleep (%)	Stage 3 Sleep (%)	Stage 4 Sleep (%)	Time to First REM (min)	Number of Nights
<b>John Van Derwalker</b>										
Pre-dive	420	1	98	7	25	52	4	9	82	2
Feb. 15-19	390*	1	99	4	26	48	10	11	52	5
Feb. 20-24	399*	2	98	4	27	44	10	12	57	5
Mar. 23, 27, 31	373*	2	97	4	24	46	10	13	126	3
Apr. 8-9	474*	0	99	2	25	53	12	8	119	2
Apr. 10-13	368*	1	98	5	28	45	10	10	73	3
Post-dive	394	2	98	3	32	44	7	12	46	2
<b>Base-Line Sample</b>										
—	443	2	98	8	22	53	5	10	100	—
<b>Edward Clifton</b>										
Pre-dive	384	10	89	5	21	45	7	10	129	2
Feb. 15-19	366*	1	98	4	22	43	13	17	106	5
Feb. 20-24	360*	2	96	5	19	45	12	15	139	5
Feb. 27; Mar. 6, 9, 13, 16	437*	1	97	3	22	54	7	12	82	5
Mar. 20, 23, 27, 31; Apr. 3	426*	1	97	5	20	50	10	13	101	5
Apr. 6-9	390*	1	98	4	24	47	12	11	73	4
Apr. 10-13	376*	1	99	3	19	56	7	14	93	4
Post-dive	351	0	98	6	21	43	9	19	133	2

\*From retiring to 7:00 a.m.

#### A2.3.3.2.5 Relation to Waking Behavior

To enable a correlational study between sleep quality and efficiency in waking activities, a quantitative index of "goodness" of sleep was developed. The details of this analysis will be made available to the behavioral team after it is completed.\*

#### A2.3.4 Discussion

Preliminary analyses of sleep data from both the sleep logs and electrophysiological recordings indicated that the aquanauts experienced no severe sleep loss or disruption of sleep cycles during Tektite I. Instead of obtaining less sleep the aquanauts appeared

\*EEG sleep recordings were made on Richard Waller during the first 10 days and last 8 days of the dive by a NASA research team headed by Milton DeLucchi. These data will be reported in a separate paper.

to have slept longer and deeper. Even though their sleep was longer, they generally desired more sleep, suggesting that more than their usual amount of sleep was required. The reasons for this increased sleep need are not clear; it could have been caused by the vigorous excursion dives,\* by the effect of hyperbaric nitrogen saturation, or as a result of the absence of rigid time schedules for retiring and arising† and probably by other undetermined factors.

Time of retiring shifted progressively toward a later hour with a consequent shift in time of arising. The aquanauts were aware of the altered time of retiring and arising, and they attempted to go to bed earlier so that they could wake up earlier and use the early morning hours for excursion dives. Yet they persisted in retiring later despite their manifest wish to do otherwise. Similar shift in times of retiring and arising was reported by Webb and his associates under a condition of sensory isolation (personal communication).

The two aquanauts who were electrophysiologically monitored for sleep gave EEG evidence of longer and deeper sleep. Since electrophysiological sleep recordings were cut off roughly at 7:00 a.m., and the aquanauts continued to sleep on occasions 1 hour or more, we do not have recordings of complete sleep. Usually this morning sleep consists of sleep stages REM, 2, or 1. Thus, our computed values of proportions for each sleep stage (Table A8) would tend to underestimate proportions of REM, 2, and 1 and to overestimate somewhat the proportion of slow-wave sleep. For this reason, and because of the limited number of recordings, we must regard our finding of increased slow-wave sleep in these two aquanauts as tentative.

The finding that the aquanauts slept longer and desired more sleep during Tektite I poses some logistical problem in planning future underwater habitation. First, there is increasing evidence indicating that excessive sleep may be detrimental to waking performance. Subjects generally tend to feel groggy when sleeping in excess of their usual amounts.‡ Thus excessive sleep rather than sleep loss may be a major problem. Second, with the increased time asleep, work efficiency will have to increase to compensate for the shorter work hours. Third, research should be undertaken to determine whether the hours of sleep are crucial and, if so, whether the sleep could be shortened by imposition of a more rigid schedule of retiring or arising or whether the efficiency of sleep can be increased. How and if the latter can be achieved is a question for study on its own.

The absence of sleep difficulties contrasted with the majority of reports on sleep under hostile environments, which have reported sleep loss and disturbed sleep. Tektite I was the first long-term confinement experiment under hostile environment in which the subjects showed no significant sleep problems. Reasons for the absence of sleep difficulties could be many. The fact that the aquanauts maintained an ad lib type of work/rest schedule, the fact that the habitat design excluded excessive noise in the crew quarters, and the motivation and emotional stability of the aquanauts were probably important factors.

\*F. Baekeland and R. Lasky, "Exercise and Sleep Patterns in College Athletes," *Percept. Motor Skills* 23, 1203-1207 (1966); G. A. Leinert and E. Othmer, "Objective Correlates of the Refreshing Effects of Sleep," *Prog. Brain Res.* 18, 170-174 (1956); J. A. Hobson, "Sleep After Exercise," *Science* 162, 1503-1505 (1968).

†E. A. Aluisi, W. D. Chiles, and R. P. Smith, "Human Performance in Military Systems: Some Situational Factors Influencing Individual Performance," *Performance Research Laboratory, Department of Psychology, University of Louisville, Louisville, Kentucky, Aug. 1964.*

‡G. G. Globus, "Sleep Duration and Feeling State," in E. Hartman, editor, "International Psychiatric Clinics," Boston, Little Brown; J. M. Taub and R. J. Berger, "Extended Sleep and Performance: the Rip Van Winkle Effect," *Psychonomic Science* 16, 204-205 (1969).

The absence of sleep difficulties encourages us to take a closer look at the subjectively reported difficulties in sleep encountered in deeper ocean floor excursion under helium-oxygen saturation dives.\* The findings from Tektite I suggest that sleep disturbances and sleep loss under helium-oxygen saturation dives may not be caused by living under water per se. Tektite I sleep data suggest that man can adapt to nitrogen saturation and live on the ocean floor for productive work.

#### A2.3.5 Summary

Sleep logs and electrophysiological recordings were used to evaluate the sleep patterns of the aquanauts in Tektite I. Sleep logs were completed by all four aquanauts; all-night EEG recordings were obtained from two aquanauts. Comparison with the data made available by the behavioral observation team indicated that the sleep log was accurate in reporting times of retiring and arising and in estimating the hours of sleep. Analyses of sleep log and electrophysiological data indicated that the aquanauts did not have major sleep difficulties. They slept for longer hours (8 plus hours) and stayed in deeper sleep (slow-wave sleep) for a longer time during the dive period. The absence of sleep difficulties and increased need for sleep have implications in terms of future dives under nitrogen or helium saturation.

#### A2.4 Automatic EEG Acquisition and Data Analysis System

M. R. DeLucchi, National Aeronautics and Space Administration, Manned Spacecraft Center, Houston, Texas, and J. D. Frost, Jr., and P. Kellaway, Baylor College of Medicine and the Methodist Hospital, Houston, Texas

##### A2.4.1 General Description

###### A2.4.1.1 Introduction

In the last 3 years a number of component assemblies have been developed, under NASA contracts, which are related to acquisition and analysis of EEG data. Specific interest in the EEG focuses upon its critical role in the evaluation of neurophysiological alterations associated with sleep/wake states. Examination of the biomedical results of the Mercury, Gemini, and Apollo series indicates that sleep and sleep/work cycles are significant factors in manned spaceflight. It may be anticipated that increase in flight duration and lunar surface exploration will perpetuate the importance of the phenomenon of sleep and may well accentuate its role in successful mission accomplishment.

Tektite I provided an opportunity to operationally test a prototype system specifically directed toward the task of monitoring and evaluating sleep during manned spaceflight. Because of potential future development as flight-qualified items, it was required that the prototype components be significantly reduced in size from those conventionally utilized in the clinical laboratory. It was decided to attempt to record, and analyze on-line, the sleep patterns of one member of the Tektite I crew during the initial 10 days and again during the final 10 days of the 60-day mission.

Three basic subassemblies were to be evaluated: an EEG-EOG-EMG electrode cap, preamplifier, and tape-recorder systems, and an automatic EEG sleep analyzer. The

\*R. J. Hock, G. F. Bond, and W. F. Mazzone, "Physiological Evaluation of Sealab II: Effects of Two Weeks Exposure to an Undersea 7-Atmosphere Helium-Oxygen Environment," Deep Submergence Systems Project, U.S. Navy, Dec. 1964; R. Radloff and R. Helmreich, "Group Under Stress: Psychological Research in Sealab II," New York, Appleton-Century-Crofts, 1968.

answers to a number of specific and practical questions were sought with respect to each subassembly, but with particular regard to the way in which the components performed as part of the complete system.

#### A2.4.1.2 Electrode Cap

The electrode cap assembly was designed to permit detection of EEG, EOG, and EMG activity from the head of the subject. Recording of such electrical activity in prolonged extralaboratory situations, especially when the observer cannot have direct physical contact with the subject, requires several modifications of the usual methodology. The electrodes must be easily applied by the subject himself and with little loss of time. They should be accurately but automatically positioned to ensure reliability of data. The electrodes must be durable and not easily dislodged by pulling, motion, or scraping. They should not be susceptible to movement artifact. Damage, irritation, or maceration of the skin cannot be tolerated because of the risk of infection. Finally, the array must be comfortable, even while the subject is sleeping or attempting to fall asleep. Evaluation of the electrode cap with respect to these requirements during the Tektite I project will provide useful insight into the proper directions for further development.

#### A2.4.1.3 Preamplifier and Tape-Recorder Assemblies

The Gemini series EEG preamplifiers had been extensively tested in laboratory situations and were known to perform well even with the relatively high interelectrode impedances presented by the electrode cap. The susceptibility to extraneous electrical interference was not so well known, however, and the conditions of the Tektite I experiment, where recording was to be carried out in the subject's unshielded bunk in close proximity to other equipment, would provide a good test of this aspect.

A new series of EEG preamplifiers, developed for the Apollo program, were also included in the system to allow comparison and evaluation of improvements in noise rejection as well as any adverse effects of the environmental situation (increased atmospheric pressure) upon the electrical characteristics.

The reliability of the long-term magnetic-tape-recording system developed during the Gemini program would also be evaluated, as would the quality of the recorded data.

#### A2.4.1.4 Automatic Sleep Analyzer

The automatic sleep analyzer has been developed to permit continuous, automatic, on-line evaluation of a subject's state of consciousness. Its use during Project Tektite I will permit an evaluation of its reliability under circumstances when the sleep periods might be expected to be altered because of unusual stresses and working conditions. The influence of unsuspected artifacts or environmental conditions will also be of importance in further development of the system.

#### A2.4.2 Equipment

##### A2.4.2.1 Electrode Cap

The electrode cap developed by W. R. Adey\* and tested by P. Kellaway† was used with only minor modifications during the initial 10-day recording period. Further changes which became necessary in the electrode system will be detailed in section A2.4.3.

\*W. R. Adey, "Development of an Electrode-Amplifier-Harness System for Physiological Data Acquisition," final report, NASA contract NAS 9-7282.

†P. Kellaway, "Development of an Electrode-Amplifier-Harness System for Physiological Data Acquisition," NASA contract NAS 9-7237.

As illustrated in Figs. A7 and A8 the electrode cap contained six conventional EEG electrodes ( $F_1$ ,  $F_2$ ,  $C_3$ ,  $C_4$ ,  $O_1$ ,  $O_2$ ), two EOG electrodes (left outer canthus and central forehead), and two neck EMG electrodes, in addition to a ground located near the vertex. Also visible in Fig. A7 are foam-rubber pads, which were added in the posterior region of the head to increase comfort.

The scalp side of the electrode-cap assembly is demonstrated in Fig. A9, and the silicone-rubber sponge contacts are visible. These foam-rubber contacts were presaturated with an electrolyte gel, and, as indicated in Fig. A10, were easily replaced by the subject. An exploded view of one of the cap electrodes is shown in Fig. A11 beside an assembled electrode. An Ag/AgCl pellet is contained in the clear plastic plug, which also supports the amplifier lead cable. This component fits into the silicone-rubber housing molded into the fabric of the cap. The housing also accepts the foam-rubber sponge as illustrated in Fig. A10. The complete electrode assembly is approximately 3 cm long. The material of the cap itself is elastic (Lycra), and thus a constant light pressure is exerted on the electrodes, maintaining contact between the foam-rubber sponges and the scalp.



Fig. A7 - Electrode cap worn by aquanaut

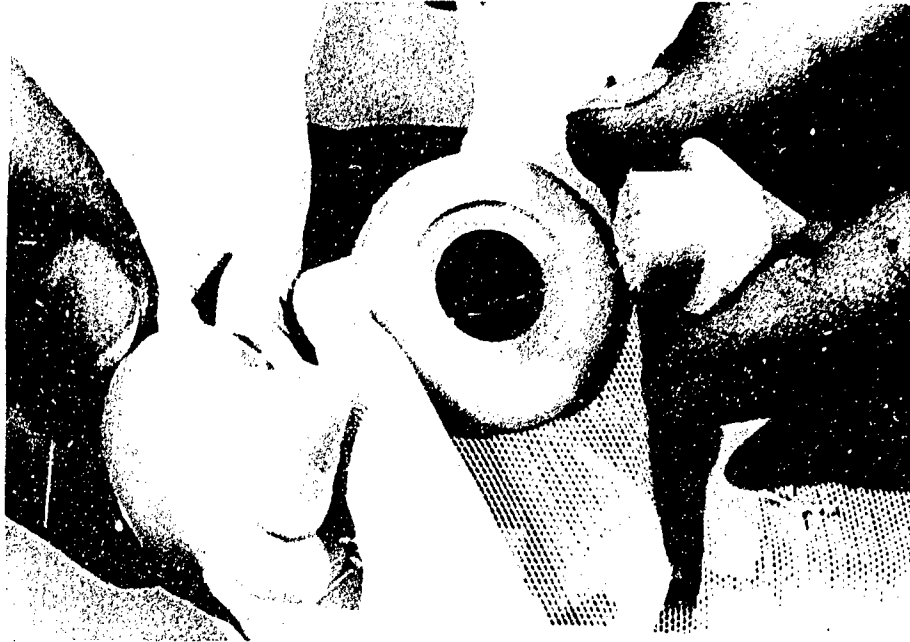

Fig. A10 - Two electrodes on the cap: one is shown with the sponge contact removed

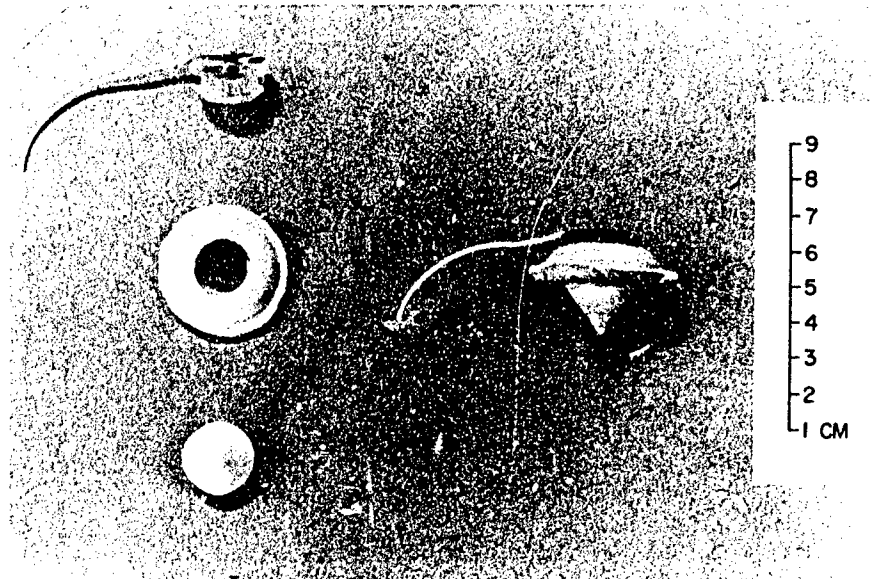

Fig. A11 - Exploded view (left) and assembled view (right) of a single electrode. The clear plastic plug (upper left) contained an Ag/AgCl pellet, and the foam rubber contact (lower left) was presaturated with an electrolytic gel before each sleep period.

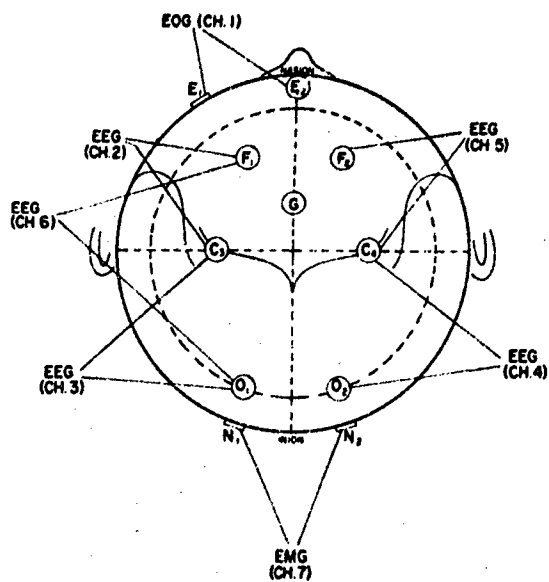

Fig. A8 - Montage used during the first ten recording nights

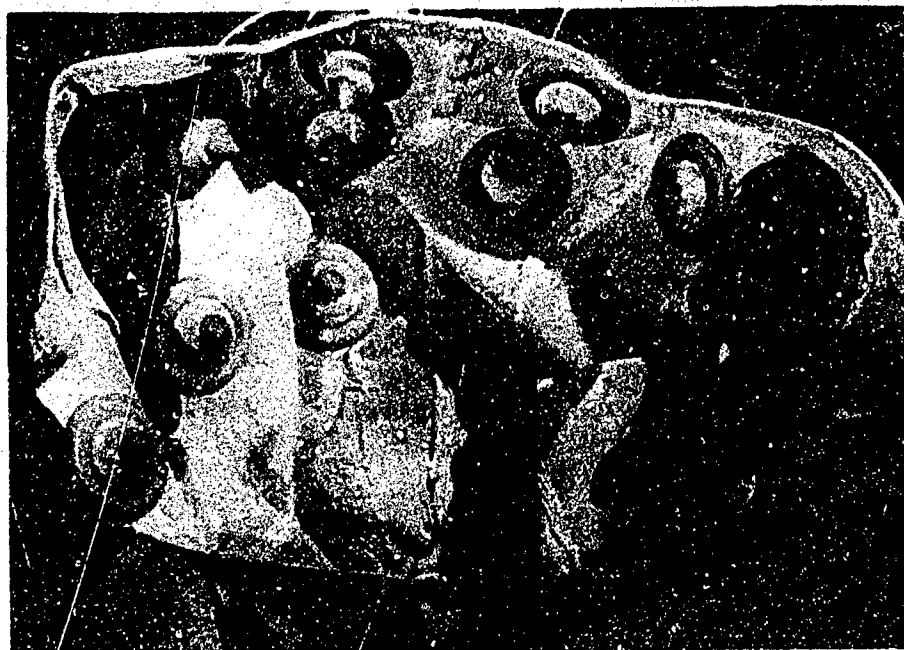

Fig. A9 - Scalp view of electrode cap



To prepare the assembly for use before each sleep period, the subject removes and discards the old sponge contact (Fig. A10), injects 1 ml of electrolyte gel into the housing, and reinserts a new, presaturated sponge. This procedure requires approximately 10 minutes for the electrode montage (Fig. A8). The cap is then positioned on the head and secured with a padded chin strap.

An isotonic electrolyte gel is used in order to minimize the possibility of skin irritation and infection. This gel also reduces the contact potential between body fluids and electrolyte and thus diminishes the magnitude of electrical artifacts associated with movements of the head. Interelectrode resistance is usually around 100,000 ohms when the cap is first donned, but this drops to around 30,000 ohms within a few minutes. However, even after 8 to 12 hours of continuous wear, the resistance is usually still 20,000 ohms, indicating preservation of the usual skin resistance.

#### A2.4.2.2 Automatic Sleep Analyzer

The automatic sleep analyzer was initially developed under NASA grant NGR-44-003-025, and a detailed description of the principles of operation is contained in the final report submitted to NASA.\* Further development is underway† to adapt this system for on-board EEG analysis and evaluation of sleep/waking cycles during manned spaceflight.

The general approach has been to determine the minimum amount of EEG and EOG information actually needed to make a proper decision and to determine the most direct way in which this information can be automatically extracted from the total EEG. The system tested in this operational situation is a laboratory prototype which uses conventional transistorized circuitry, occupies about 1-1/2 cubic feet of space, and provides an output in terms of the standardized clinical stages of sleep (awake, stages 1 through 4, and REM). The system is essentially an amplitude-weighted, dominant-frequency meter for the EEG bandwidth (0.7 to 14 Hz), with the output restricted to six distinct voltage levels. Since the device considers essentially the same criteria as those used in visual scoring (a combination of dominant frequency and amplitude), the results are in very close agreement with those of expert visual interpretation. An example of the output is provided in Fig. A12, which shows the sleep pattern for the aquanaut during project night 50.

#### A2.4.2.3 General Scheme of the Operational Situation

The physical locations and interconnections of the data acquisition, recording, and analysis equipment are indicated in Fig. A13. Within the Tektite I undersea habitat, the EEG, EOG, and EMG activity was detected with the electrodes of the cap assembly, and the signals were led to preamplifiers. Seven channels (five EEG, one EMG, and one EOG channel) were amplified by the Gemini series NASA preamplifiers (Beckman) and recorded on a miniature magnetic-tape recorder (Cook/NASA) located near the subject's bunk. Four channels (three EEG and one EOG channel) were also led from the cap to Apollo series preamplifiers (Spacelabs) and transmitted to the surface monitoring van. Within the monitoring van the data were displayed at selected paper speeds on a four-channel Brush graphic recorder and simultaneously recorded on a conventional magnetic-tape recorder (Ampex SP300) at 1-7/8 inches per second (this served as a backup system to the recorder in the undersea habitat). One EEG channel and one EOG channel entered the automatic sleep analyzer, and the results of the electronic analysis were displayed on the two-channel graphic recorder (Brush) as illustrated in Fig. A12.

\*P. Kellaway, "An Electronic EEG Sleep Analyzer," NASA Grant NGR-44-003-025.

†J. D. Frost, Jr., "Development of a Prototype Onboard EEG Analysis System," NASA contract NAS 9-9418.

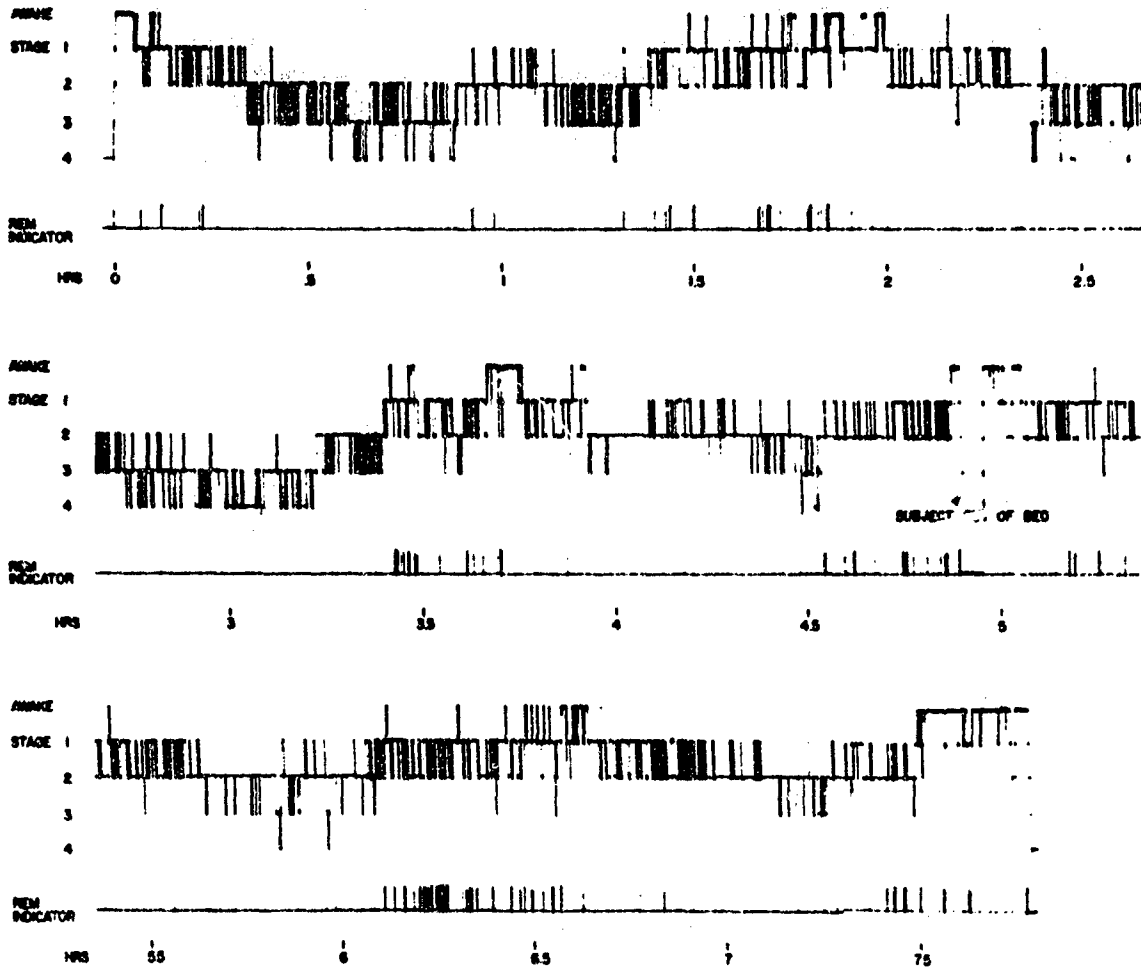

Fig. A12 - Output of the automatic sleep analyzer (night 50)

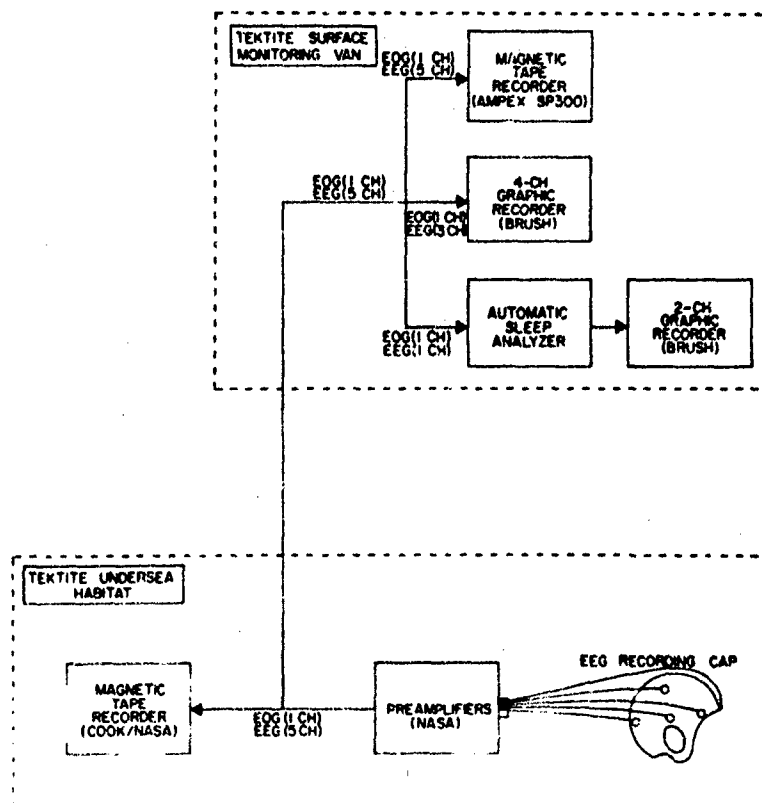

Fig. A13 - Automatic EEG acquisition and data-analysis equipment used during the Tektite I project

The performance of the automatic analyzer was constantly evaluated throughout the sleep period by a human electroencephalographer who observed the EEG and EOG on the four-channel graphic recorder and noted any areas of disagreement or any type of artifactual activity which might influence the results.

#### A2.4.3 Results

##### A2.4.3.1 General

In general all components of the system performed well, and no problems were encountered which could be attributed to specific environmental conditions. In spite of the fact that recording was carried out in an unshielded bunk in close proximity to other electrical apparatus, electrical interference was never serious. Data were lost through equipment failure during only one recording period, recording night 51, when both the habitat recorder and surface equipment detected only random-appearing electrical noise. Although the reason could not be established with certainty, a transient fault in the pre-amplifier power supply is suspected. Approximately 1-1/2 hours of recording were lost during the initial portion of night 58, when the subject retired for the night (unobserved by surface monitors) and neglected to turn on his power switch. This was corrected later by another crew member when the situation was recognized. As will be discussed, no recording was attempted on days 3 and 7.

The quality of the recordings is illustrated in Fig. A14, which recordings were made by playing the tape-recorded data from the habitat recorder back through a conventional

PROJECT TEKTITE I

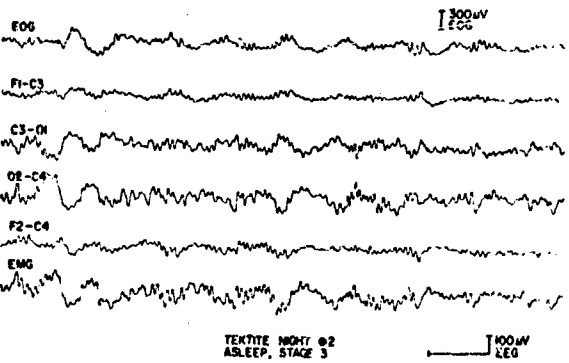
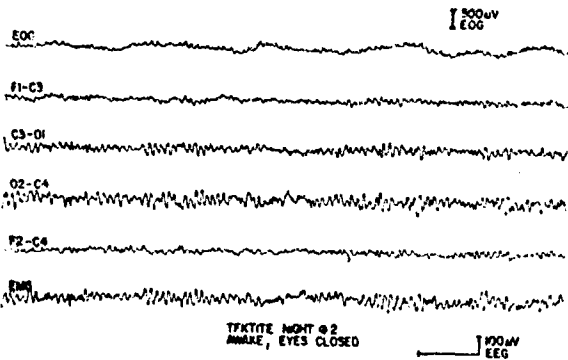
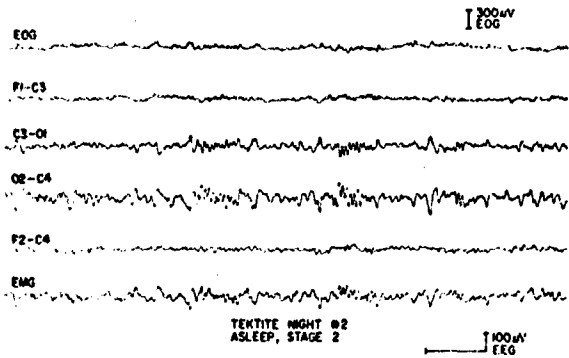
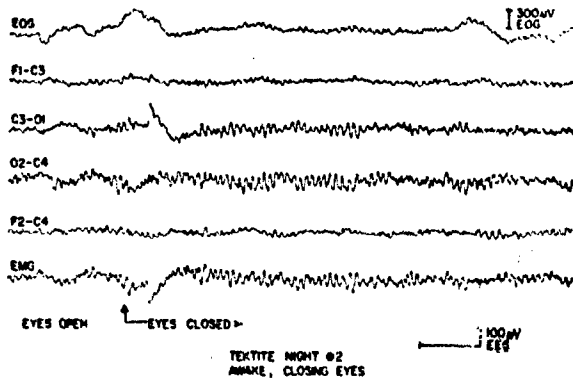
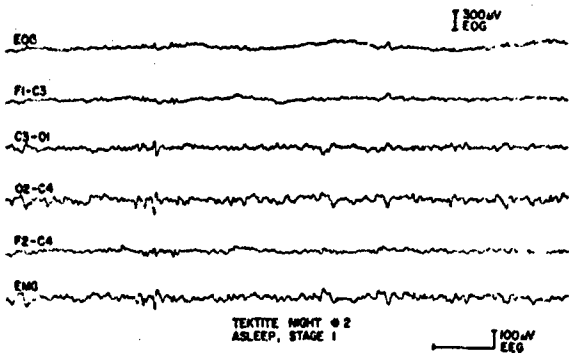
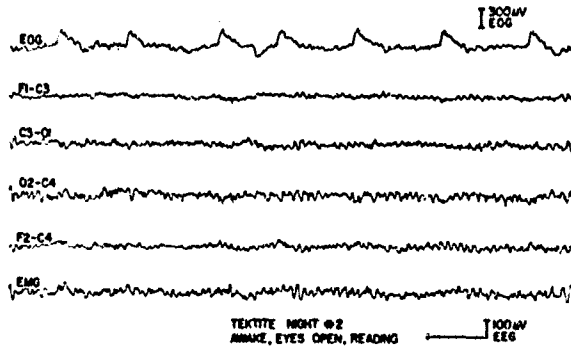

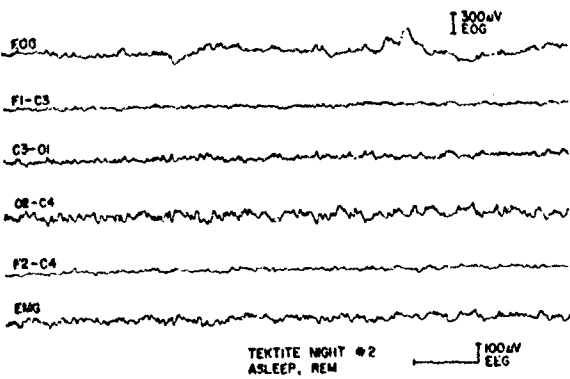
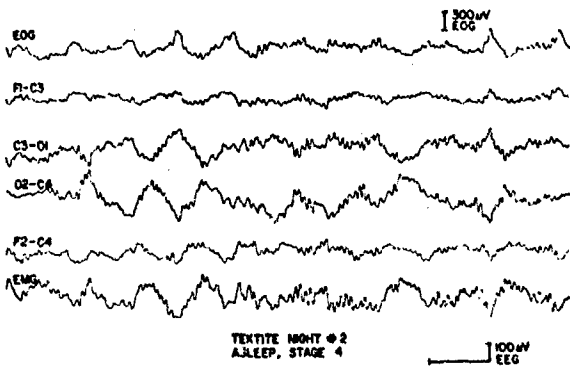
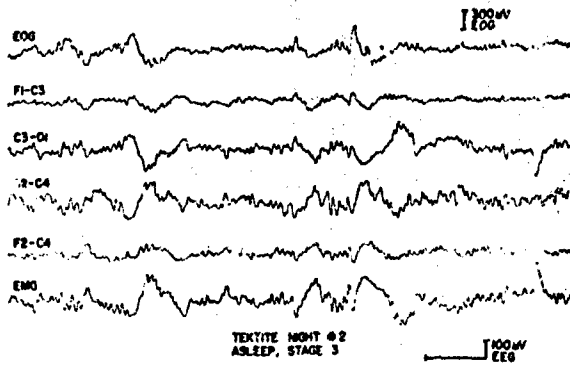

Fig. A14 - Samples of data played back from the habitat recorder (Fig. A13)

Grass EEG machine. The sample at the upper left in Fig. A14 shows the EEG pattern with the subject awake, reading in bed. The EOG channel demonstrates the typical scanning-type eye movements associated with reading. Occipital alpha activity is present intermittently in this eyes-open recording. The sample at left center shows a high-amplitude burst of alpha waves which occurs when the subject closes his eyes, and the sample at the lower left is from a long segment during which time the eyes were constantly closed. The sample at the top of the middle column in Fig. A14 illustrates the change with onset of sleep, showing the slower background activity and occasional vertex ( $C_3$  and  $C_4$ ) transient forms and lack of alpha activity. Stage 2 (center of middle column of Fig. A14) is characterized by the appearance of 14-Hz spindle activity, and stage 3 by increasing amounts of intermittent delta activity. During stage 4 almost continuous delta activity is evident. The last sample is from a period of REM sleep, showing the stage 1 EEG and occasional abrupt eye movements in the EOG channel.

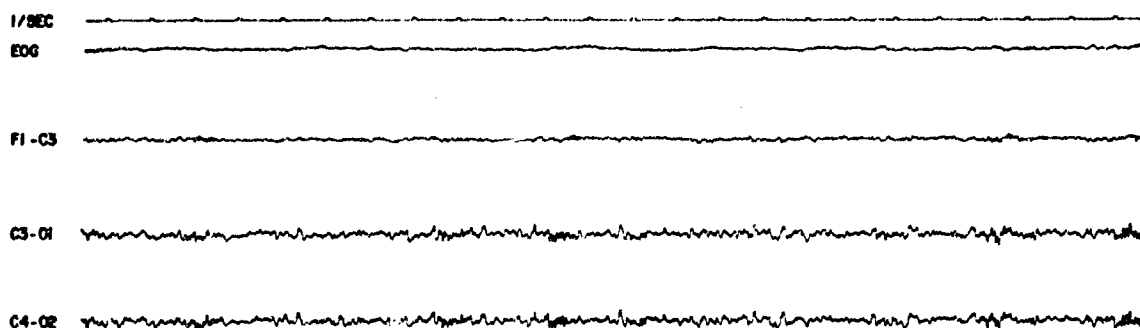

Fig. A15 - Sample of data from the graphic recorder in monitoring van (night 2, stage 2 sleep)

Figure A15, from the same recording night, demonstrates the way in which the data were displayed on-line in the monitoring van (by a four-channel Brush recorder) for interpretation by the electroencephalographer. The output of the automatic sleep analyzer was shown in Fig. A12.

#### A2.4.3.2 Problems Encountered

##### A2.4.3.2.1 Recording Cap

During the first recording night the EMG electrodes, low in the occipital region, were found to be quite uncomfortable by the subject in spite of the foam-rubber padding in this area. The discomfort was severe enough to require the subject to remove the cap before the end of the sleep periods of the first and second nights. Consequently, recording was suspended for the third night, and the caps were modified by removal of the EMG electrodes.

This only slightly improved the comfort, and the occipital electrodes were now the most bothersome, although the quality of the recordings continued to be good on nights 4, 5, and 6. Because the subject began to notice discomfort persisting on throughout the day in the area where the occipital electrodes contacted the scalp at night, recording was not carried out on night 7. The cap was tried again on night 8, but since discomfort persisted, conventional chlorided silver-disk electrodes (Grass) were substituted for the cap on the

Grass EEG machine. The sample at the upper left in Fig. A14 shows the EEG pattern with the subject awake, reading in bed. The EOG channel demonstrates the typical scanning-type eye movements associated with reading. Occipital alpha activity is present intermittently in this eyes-open recording. The sample at left center shows a high-amplitude burst of alpha waves which occurs when the subject closes his eyes, and the sample at the lower left is from a long segment during which time the eyes were constantly closed. The sample at the top of the middle column in Fig. A14 illustrates the change with onset of sleep, showing the slower background activity and occasional vertex ( $C_3$  and  $C_4$ ) transient forms and lack of alpha activity. Stage 2 (center of middle column of Fig. A14) is characterized by the appearance of 14-Hz spindle activity, and stage 3 by increasing amounts of intermittent delta activity. During stage 4 almost continuous delta activity is evident. The last sample is from a period of REM sleep, showing the stage 1 EEG and occasional abrupt eye movements in the EOG channel.

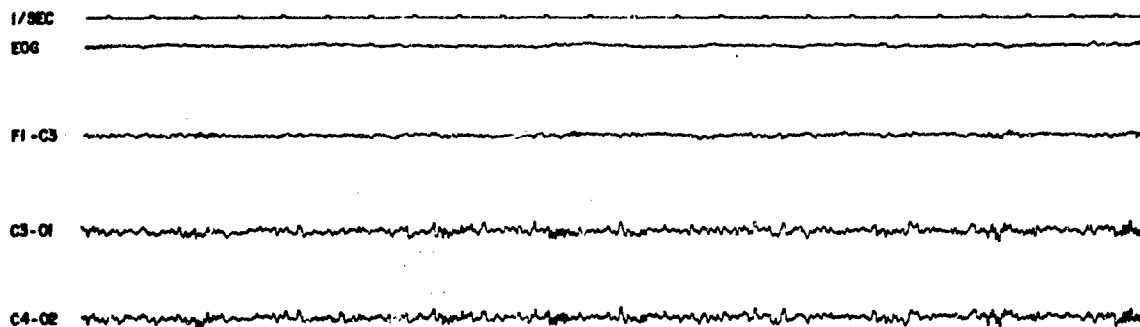

Fig. A15 - Sample of data from the graphic recorder in monitoring van (night 2, stage 2 sleep)

Figure A15, from the same recording night, demonstrates the way in which the data were displayed on-line in the monitoring van (by a four-channel Brush recorder) for interpretation by the electroencephalographer. The output of the automatic sleep analyzer was shown in Fig. A12.

#### A2.4.3.2 Problems Encountered

##### A2.4.3.2.1 Recording Cap

During the first recording night the EMG electrodes, low in the occipital region, were found to be quite uncomfortable by the subject in spite of the foam-rubber padding in this area. The discomfort was severe enough to require the subject to remove the cap before the end of the sleep periods of the first and second nights. Consequently, recording was suspended for the third night, and the caps were modified by removal of the EMG electrodes.

This only slightly improved the comfort, and the occipital electrodes were now the most bothersome, although the quality of the recordings continued to be good on nights 4, 5, and 6. Because the subject began to notice discomfort persisting on throughout the day in the area where the occipital electrodes contacted the scalp at night, recording was not carried out on night 7. The cap was tried again on night 8, but since discomfort persisted, conventional chlorided silver-disk electrodes (Grass) were substituted for the cap on the

last two nights (9 and 10) of the first 10-day recording period. These electrodes were applied by other crew members who had previously been trained in the technique of application.

Between the first and second 10-day recording periods, an extensive redesign of the electrode-cap assembly was made in an attempt to improve the comfort while still maintaining the prime requirements of durability, nonirritability, and satisfactory data acquisition. The major change was made in the electrode itself by reducing its size to 1/3 of the original length and removing all rigid plastic components. Figure A16 compares the original electrode (model 1) with the redesigned (model 2) version. The large plastic assembly incorporating the Ag/AgCl pellet electrode was eliminated, and a flatter Ag/AgCl electrode disk was molded into a flexible silicone-rubber housing. The sponge was reduced in size and permanently attached to the housing. This electrode thus compromised the separation of body fluids and electrode - a feature of the original model - in favor of a flatter, more comfortable shape.

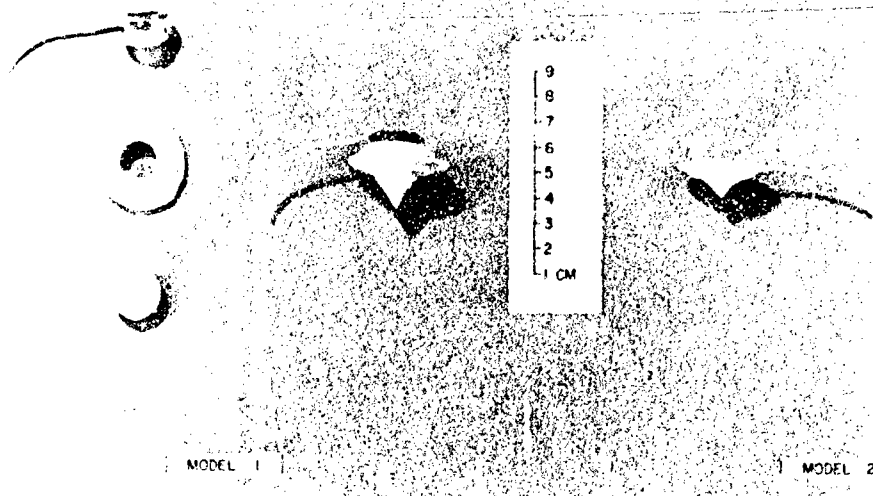

Fig. A16 - Comparison of the original electrodes (model 1) and the modified version (model 2) used during the final series of recordings

Figure A17 shows the new cap on a subject in the laboratory. In preparing this system for use before a sleep period, the electrolyte gel is injected through a hypodermic needle inserted into the center of the foam rubber until the entire sponge is saturated. Figure A18 shows the modified montage used in the model 2 cap for the final 10-day recording period. The frontal electrodes have been eliminated, since they were unnecessary for the evaluation of sleep recordings. The model 2 cap was worn by the subject during recording nights 50 through 58.

A considerable improvement in comfort was reported by the subject ("80% better"), although he did continue to experience some discomfort in the scalp areas contacted by the electrodes. During the last day he also reported the presence of swellings or bumps in the occipital areas which he felt were related to the electrodes. The quality of the recordings continued to be good, and the increased comfort permitted uninterrupted records during this final period of the project.





Fig. A17 - Model 2 electrode cap

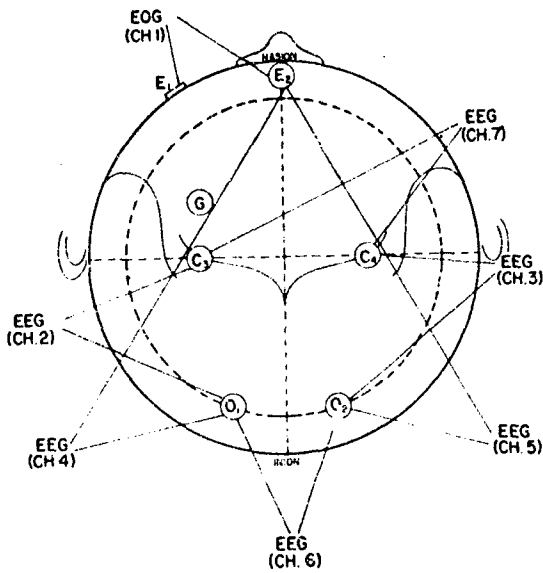

Fig. A18 - Modified montage used in the model 2 electrode cap during the final ten-day period

(Since completion of the Tektite I project, further modification has been made in the electrode-cap system to increase the comfort, and the revised model was used successfully in the Gulf Stream drift mission aboard the submerged research vessel *Benjamin Franklin*. A crew member wore this cap assembly during 15 preselected nights of the 30-day mission and did not experience either discomfort or scalp bumps.)

#### A2.4.3.2.2 Electrodermal Artifacts

Figure A19 illustrates a phenomenon often seen during stages 3 and 4 of sleep, occasionally during stage 2, but never in stage 1 at the onset of sleep or during REM. These high-amplitude, slow transients often occurred in long runs, becoming almost continuous, and lasting up to an hour in some cases

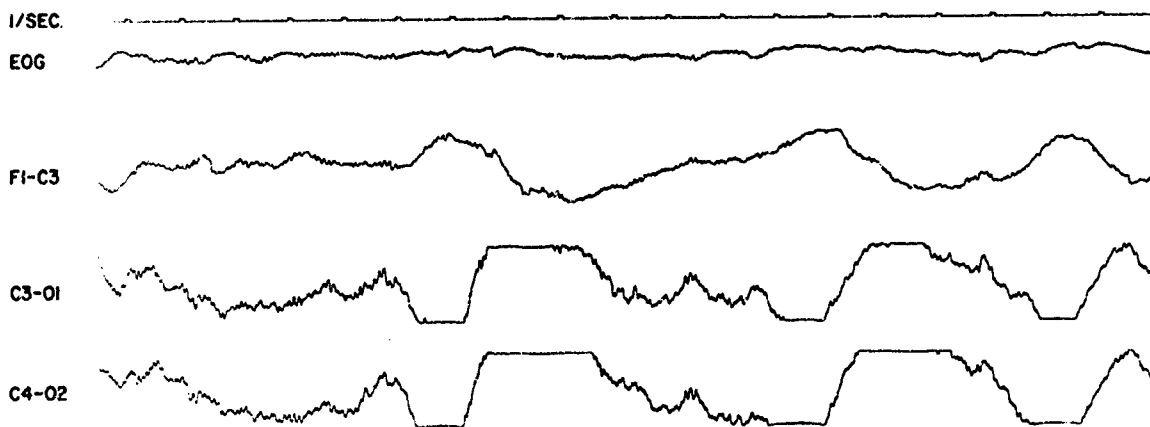

Fig. A19 - Sample showing electrodermal artifacts in the EEG recording (night 2)

Although the galvanic skin resistance was not monitored in this subject, these events are probably related electrodermal responses similar to those described by Burch\* and studied in detail by Johnson and Lubin.† They were not seen in the two base-line studies of this subject; however, these two laboratory recordings were made using conventional EEG electrodes and routine skin preparation which results in low interelectrode resistance and destruction of the skin's ability to produce electrodermal responses. In contrast, the electrode cap preserves the integrity of the skin and presumably its ability to produce the responses.

#### A2.4.3.3 Evaluation of Sleep Recordings

##### A2.4.3.3.1 Introduction

Although the significance of alterations in sleep patterns was not the primary goal of our participation in the Tektite I project, several points are worthy of mention and further

\*N. Burch, "Data Processing of Psychophysiological Recordings," pp. 165-180 in "Symposium on the Analysis of Central Nervous System and Cardiovascular Data Using Computer Methods," L. D. Proctor and W. R. Adey, editors, Washington, D.C., NASA, 1965.

†L. C. Johnson and A. Lubin, "Spontaneous Electrodermal Activity During Waking and Sleeping," *Psychophysiology* 3, 8-17 (1966).

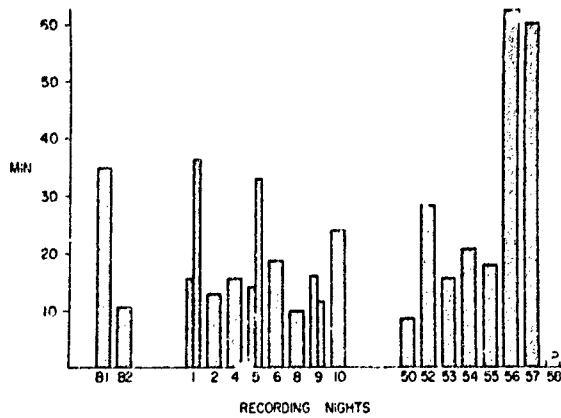

(a) Time to attain stage 2 sleep

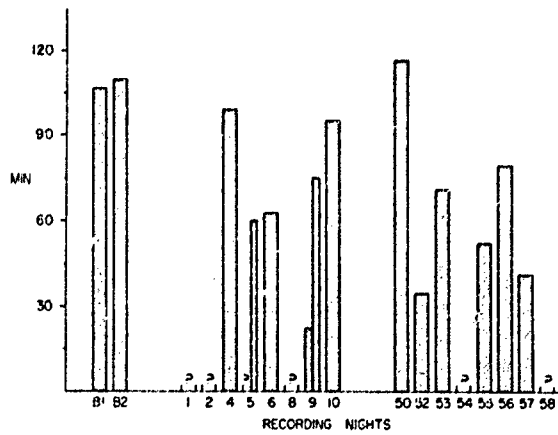

(d) Total REM time

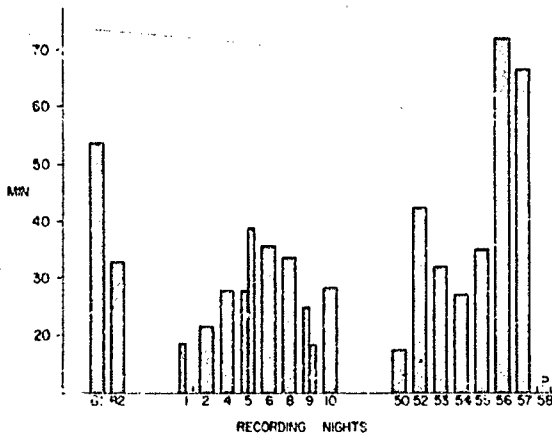

(b) Time to attain stage 4 sleep

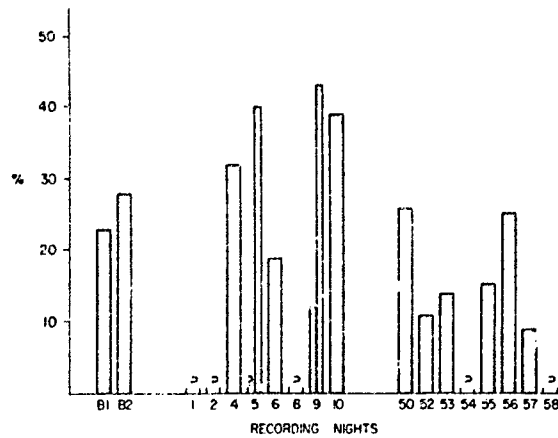

(e) Percent REM time

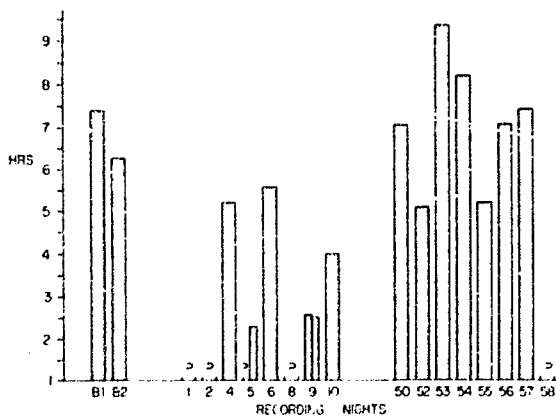

(c) Total sleep time

Fig. A20 - Comparisons of selected aspects of subject's sleep during base-line nights (B1 and B2), the first ten-day recording series (nights 1 through 10), and the final ten-day recording series (nights 50 through 58). (Split bars during the first ten nights indicate two sleep periods because of watch schedules.)

consideration. Figure A20 compares selected aspects of the subject's sleep during the first and last recording sessions with the findings during the two base-line nights (B1 and B2) spent in the laboratory.

#### A2.4.3.3.2 Time to Fall Asleep

Figure A20a shows the amount of time which the subject spent in bed before falling asleep for the first time. This time was measured from the point at which he was observed to get into the bunk until the first EEG signs of stage 2 sleep (vertex transients and spindles). Thus, for this measure, brief periods of drowsiness (stage 1) were included in the cumulative time.

The subject thus experienced no difficulty going to sleep during the first 10-day period, although the time does not appear to be significantly shorter than the base-line times. During the final days of recording, however (nights 56 and 57), there was a marked increase in the time before sleep onset -- in both cases, exceeding an hour. This same information is also shown in Fig. A20b, which indicates the time required to reach stage 4. It might be postulated that perhaps this increase in time before sleep onset was related to the anticipation of events associated with the end of the mission.

#### A2.4.3.3.3 Total Sleep Time

Although the data are incomplete for the first ten nights because of the problem encountered with the recording cap, in general the subject's sleep time was considerably reduced below the base-line values during the first ten nights; the sleep time during the final ten-day period was generally normal or more than normal (Fig. A20c). This situation reflects the workload of the subject, which was heavy during the initial part of the project, when a number of minor difficulties were present and night watches were required, and which was relatively light during the final phases, when most systems were running smoothly.

#### A2.4.3.3.4 REM Time

Although the total sleep time was generally reduced below normal during the first ten days, as indicated in Fig. A20d there was a definite tendency for the total REM time to approach the base-line values. This effect is seen more clearly in Fig. A20e, which shows the percentage of total sleep time occupied by the REM stage. It is obvious from this figure that there was a marked increase above the base-line values in the percent REM time during many of the nights in the first 10-day session. During the final 10 days, the percent REM time was similar to or slightly below base-line values. The significance of this finding is unknown, but again it could be related to the increased workload, and perhaps stress, of the initial portion of the project.

#### A2.4.4 Conclusions

The operational testing situation provided by the Tektite I project led to three major conclusions or accomplishments:

1. The compatibility of all phases of the EEG acquisition and analysis system was assured, and no significant problems were encountered with respect to extraneous electrical interference.
2. The problems encountered with the electrode-cap assembly in the early phases of the mission led to extensive redesign and miniaturization of this unit. Further improvement since the end of Project Tektite I has resulted in a much more satisfactory recording cap with respect to wearer comfort and ease of application.
3. The performance of the automatic analysis system demonstrated the ability to obtain reliable information concerning the subject's quantity and quality of sleep. Because of the immediate availability of the results, this information could theoretically be used to optimally regulate the subject's next work/rest period.

## A2.5 Psychomotor Performance

Rayford Saucer and Stanley Deutsch, National Aeronautics and Space Administration, Langley Research Center, Hampton, Virginia

### A2.5.1 Introduction

Man, with his rapidly advancing technology, will venture farther and longer into the hostile and semihostile environment of inner and outer space to perform useful tasks. One of the major objectives of Project Tektite I was to study the ability of aquanauts to adapt to the environment and confinement in an undersea habitat and the effects on their capabilities for completing complex psychomotor tasks. The factors of confinement and isolation were assumed to be analogous to conditions that may exist in future manned space flight of similar duration.

### A2.5.2 Development of Psychomotor Performance Tester

Complex psychomotor coordination was measured on the National Aeronautics and Space Administration complex coordinator developed at the Langley Research Center (LRC) by Jim Scow. The LRC complex coordinator is a human performance measurement device originally developed to measure small changes in psychophysiological functions in drug and environment studies. This test device was based on a concept developed in 1939 at the University of California for the selection of aviation cadets and studies of anoxemia.

While searching for a psychomotor test instrument that could be used in closed environments, such as space cabin simulators, it was decided to determine whether this device could provide sufficiently sensitive differences to measure slight decrements in performance as an indication of stress. The LRC complex coordinator was initially used in a 28-day chamber run in which an integrated life support system was being tested.

The LRC complex coordinator was deemed to be sufficiently reliable to warrant its use on the 60-day Tektite I mission and on the 30-day Gulf Stream mission aboard the *Benjamin Franklin*. To meet the operational requirements of these two underwater studies the test device had to have the capability for self-administration and self-scoring, requiring a built-in programmer, counters, and chronoscope.

### A2.5.3 Use of the Langley Complex Coordinator in Tektite I

The test equipment (Fig. A21) can be programmed to require the subject to respond by matching lights on the display. The response can require one or two hands, one or two feet, or any combination of hands and feet, either concurrently or sequentially. In Tektite I all four banks of stimulus lights were used, requiring concurrent alignment of the response lights. During any one trial it was necessary to hold the controls steady while hunting for any remaining responses to complete the set of four. The display panel contains 45 lights, 40 of which are used to match pairs. The other five lights are used to provide information to the operator or to add complexity to the response required. There are four banks of colored lights, each of which presents a position stimulus, and parallel to them are four banks of matching color lights activated by the responding operator.

In addition there is an interval timer that can be set for varying periods up to 15 seconds. The timer automatically returns to zero when each trial is successfully concluded. A red light goes on if this interval is exceeded by the operator. The operator can reduce or increase this time period as desired, thus pacing his efforts. The test program is preset on a revolving drum attached to an electromechanical timer (Fig. A22). The operator received immediate knowledge of this performance on each trial and for the complete cycle of 50 trials.

Fig. A21 - Operator in position to use the Langley Research Center complex coordinator

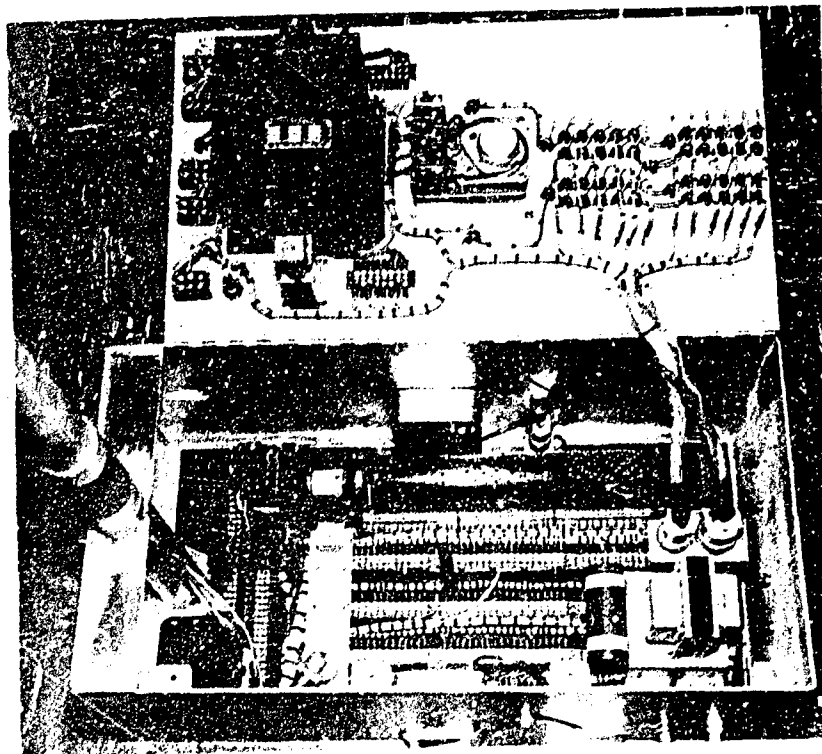
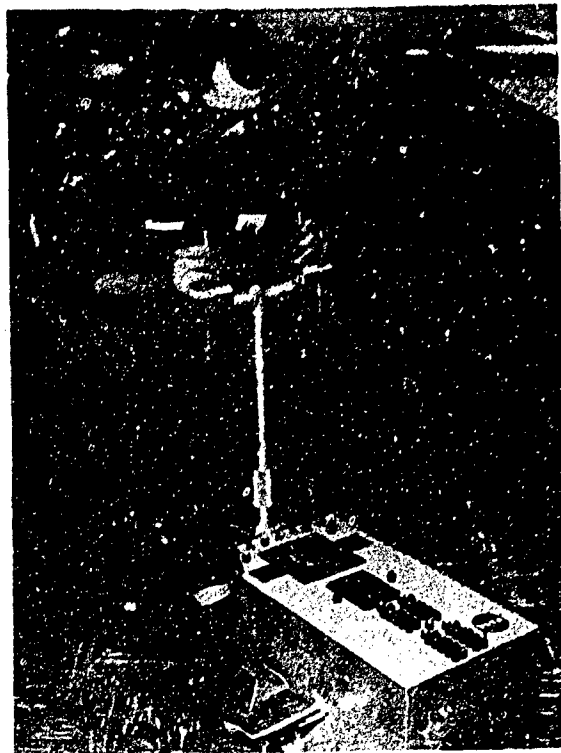

Fig. A22 - Programming drum and electronic features of the LRC complex coordinator

#### A2.5.4 Preliminary Results

It was planned that each of the four aquanauts in the Tektite I habitat and the three backup aquanauts at the base camp would perform the series of psychomotor tests daily. The backup aquanauts acted as a control group for the underwater divers. Due to the ear infection of the aquanauts and other overriding factors the tests were not performed as frequently as scheduled. The actual days during which the Langley complex coordinator was used is shown in Fig. A23. The dates on which the underwater crew, composed of Clifton, Mahken, Van Derwalker, and Waller (not in that order), performed on the psychomotor tester, during the actual dive, are shown in Fig. A24.

The frequency of performance and number of cycles attempted are shown in Table A9 for each aquanaut. A cycle consists of a series of 50 trials and represents one rotation of the programmer drum. A trial is the solution to one problem, i.e., the matching of one group of four lights concurrently. For analysis purposes the data for the trials and cycles were gathered on the data cards shown in Fig. A25. The testing series was introduced during the orientation and training phases starting on December 11, 1968, and continuing up to a few days prior to the 60-day dive.

Table A9  
Total Use of the Langley Research Center Complex Coordinator

Aquanaut		Total Number of Cycles*	Training Cycles	Cycles During the Test		Days Used During the Test
Diving	Backup			Diving Aquanauts	Backup Aquanauts	
VII		151	17	134		14
	V	50	28		22	7
	VI	38	29		9	5
III		73	15	58		7
	IV	49	20		29	4
I		72	18	54		10
II		15	9	6		5

\*A cycle is 50 trials of matching one group of four lights concurrently.

In almost all cases the aquanauts achieved a plateau (asymptote) on the performance curves shown in Fig. A26. In every case, performance on the complex coordinator by the surface aquanauts deteriorated during the 60-day mission. In one case, one of these backup aquanauts no longer used the test device after the second week of the dive. On the other hand the four aquanauts living in the habitat continued to show improving performance throughout the mission, although frequency of self-testing varied greatly among them. This improving performance, in contrast to that of the surface crew, probably indicates a higher level of motivation.

The possibility that the habitat crew had more time to devote to this task has been discounted by an analyses of the mutual activities of the two crews. If anything, the habitat crew had less time available for this peripheral task than the surface group. The undersea crew continually expressed their willingness and desire to use the complex

DECEMBER 1968

S	M	T	W	T	F	S
1	2	3	4	5	6	7
8	9	10	(11)	(12)	(13)	14
15	16	17	18	19	20	21
22	23	24	25	26	27	28
29	30	31				

At  
General  
Electric

JANUARY 1969

S	M	T	W	T	F	S
			1	2	3	4
5	(6)	(7)	(8)	(9)	(10)	11
12	13	14	15	16	17	18
19	20	21	22	23	24	25
26	27	28	29	30	31	

At the  
University  
of  
Pennsylvania  
Hospital

FEBRUARY 1969

S	M	T	W	T	F	S
						1
2	3	4	5	(6)	(7)	8
9	10	(11)	(12)	13	14	15
16	(17)	(18)	(19)	20	(21)	22
(23)	24	(25)	(26)	27	28	

MARCH 1969

S	M	T	W	T	F	S
						1
(2)	3	4	(5)	(6)	7	(8)
9	10	(11)	(12)	13	14	15
16	(17)	18	(19)	20	21	22
23	(24)	(25)	(26)	(27)	(28)	29
30	(31)					

At  
St.  
John  
Island

APRIL 1969

S	M	T	W	T	F	S
		1	(2)	(3)	(4)	(5)
6		8	(9)	10	(11)	(12)
(13)	(14)	15	16	17	18	19
20	21	22	23	24	25	26
27	28	29	30			

Fig. A23 - Days the complex coordinator was used by the seven aquanauts



## PROJECT TEKTITE I

## FEBRUARY 1969

S	M	T	W	T	F	S
						1
2	3	4	5	6	7	8
9	10	11	12	13	14	15
16	17	18	19	20	21	22
23	24	25	26	27	28	

Day submerged;  
no use of test  
on this day

## MARCH 1969

S	M	T	W	T	F	S
						1
2	3	4	5	6	7	8
9	10	11	12	13	14	15
16	17	18	19	20	21	22
23	24	25	26	27	28	29
30	31					

## APRIL 1969

S	M	T	W	T	F	S
		1	2	3	4	5
6	7	8	9	10	11	12
13	14	15	16	17	18	19
20	21	22	23	24	25	26
27	28	29	30			

Day surfaced

Fig. A24 - Days the complex coordinator was used by the four aquanauts while underwater in the Tektite I habitat

coordinator. In fact two of the aquanauts competed with each other by trying to beat the score of the other diver. At the end of the 60-day dive their scores were comparable and still improving at a slow rate.

#### A2.5.5 Conclusions

It can be concluded that the experience in the Tektite I habitat did not affect performance on a complex psychomotor task as measured by the Langley complex coordinator. These tests were made prior to and after swimming excursions. Therefore, it may be assumed that the scores were not directly affected by fatigue caused by the submerged swimming. In fact several of the aquanauts felt that the complex coordinator presented an interesting and challenging activity that tended to provide relaxation and a unique change in activity.



This is a preliminary analysis prepared for this overall Tektite I report. Additional analyses are underway to compare periods of activity and test scores with other observations, time spent in the water, mood adjective checklist data, and other performance measures for a more detailed evaluation. More detailed analysis comparing scores across cycles, preceding tasks, and times of the day, is planned.

The Langley complex coordinator worked well throughout the mission. Data from additional testing with the six-man crew of the *Benjamin Franklin* are still being analyzed. It is also planned to use this psychomotor tester in the long-term test and evaluation of integrated life support equipment in which four subjects will be confined in a chamber for 90 days.

### A3 BIOMEDICAL SCIENCES

#### A3.1 Introduction

C. J. Lambertsen, Institute for Environmental Medicine, University of Pennsylvania, Philadelphia, Pennsylvania, and S. Kronheim, Physiology Branch, Office of Naval Research, Washington, D.C.

Project Tektite I, while ultimately applied to marine sciences programs, had its origins in two interrelated fields of human bioscience. U.S. Navy psychologists proposed to the National Aeronautics and Space Administration that open-water, undersea habitats should provide more realistic restriction of subjects than have simulated laboratory confinement studies to date, to aid in appraisal of the effects of the prolonged, enforced restriction in isolated compartments to be encountered in future space flights.

Extension of this suggestion was made by physiologists of the University of Pennsylvania's Institute for Environmental Medicine, who recommended study and use of exposure to nitrogen with normal oxygen pressure at 4 atmospheres ambient pressure to provide a true "physiological entrapment" of the subjects. It was predicted that saturation exposure to this pressure of nitrogen would absolutely necessitate programmed decompression for any subject wishing to leave the submerged habitat for the surface (hence "physiological entrapment"). It would also represent a borderline state for study of the effects of the sustained increases in respiratory work associated with elevated gas density and would simultaneously represent a borderline between tolerable and disadvantageous central nervous influences of nitrogen narcosis.

Since all of these physiological influences represent phenomena of extreme importance to the advance of manned undersea activity, it was urged that detailed biomedical study of sustained exposure to high nitrogen partial pressure be carried out. While the overall project plan for Tektite I deviated from the Institute's proposal for the nitrogen-oxygen saturation exposure at a depth of about 100 feet of sea water, it was clear that even the secondarily planned 60-day exposure to nearly 50 feet of sea water required detailed biomedical study.

##### A3.1.1 Purposes

The purposes of the biomedical program for Tektite I included:

1. Stimulation of interest in detailed physiological study of nitrogen as a diluent for oxygen in prolonged, shallow-water diving.
2. Performance of the specific medical, physiological, hematological, and microbiological examinations and measurements required to (a) assure qualification of the

subjects to serve as aquanauts, (b) obtain the detailed base-line measures required to assess the importance of any pathological or physiological changes which might develop over the course of the 60-day exposure and (c) obtain clues to possible physiological or pathological alterations which might be encountered in future exposures of greater depth or greater duration.

It was expected from the beginning that, regardless of whether a particular manned open sea project such as Tektite I or Sealab were to continue, the full biomedical exploration of nitrogen-oxygen and nitrogen-helium-oxygen atmospheres will remain important to the extension of general undersea activity.

### A3.1.2 Selection of the Program

A biomedical experiments/medical safety planning group was recommended and formed to devise the experiment program, to assure safe diving and decompression procedures, and to anticipate potential risks to the health and safety of the aquanauts and support personnel. This group, representing the several major participating organizations, was comprised of: C. J. Lambertsen (Institute for Environmental Medicine, University of Pennsylvania), biomedical/medical safety program coordination; S. Kronheim (Physiology Branch, Office of Naval Research), biomedical experiments program coordination; Cdr. T. N. Markham (Naval Medical Research Laboratory), on-site medical monitoring; Capt. E. L. Beckman (Manned Spacecraft Center, NASA), NASA liaison; and S. Gottlieb (General Electric Company), human engineering liaison.

Conceptual and practical planning of the biomedical experiments/medical safety program for the 50-foot exposure was based on the following:

- It was considered that the degree of inert gas narcosis to be expected at a depth of 50 feet or less would be undetectable and not dangerous. Therefore, no physiological or performance studies specifically directed toward inert gas narcosis were included.
- It was considered unlikely that major circulatory derangements would result from the moderate increase in ambient and nitrogen pressure. Therefore, no extensive circulatory studies were included.
- It was considered that the increased atmospheric density would be the primary physiological stress, but would be of small degree. Respiratory control and detailed pulmonary function measurements were planned as the most sensitive indices of such stress, and selected respiratory measurements were followed throughout the exposure.
- Changes in red blood cell formation or destruction or in blood chemical composition were not expected, since the inspired oxygen pressure was kept near a normal sea-level value and nitrogen has previously not been found to produce changes in formed or chemical constituents. Complete blood cell and chemical studies were nevertheless conducted to provide a part of a multifaceted study of abnormal atmospheres ranging from aerospace to deep undersea exposures. In particular it was considered that, since nitrous oxide induces suppression of white cell formation, study of the effects of chronic exposure to nitrogen on white cell formation was essential.
- Study of microbiological alterations of the habitat interior surfaces, the respired atmosphere, and especially the skin, upper respiratory tract, gastrointestinal tract, and auditory canals of the subjects was considered desirable. This interest stemmed from the conditions of closely confined residence and repeated wetting of the skin and included the potential for exchange of organisms with the surrounding environment.

- Detailed dermatological studies with quantitative microbiological counts were included to assess the reasonable possibility that skin softening, chronic skin wetting, and bacterial or mold infections of the skin might prove a major limiting factor in prolonged submergence.

- Study of sensory functions, including vision, hearing, and vestibular function, was prompted not only by concern for any neurological influences of nitrogen at increased partial pressure but out of concern for subtle influences of bubble formation.

- Study of special decompression requirements was considered essential, since no evaluation of decompression procedure for nitrogen saturation diving at depths greater than 30 feet had previously been carried out.

Responsibilities for execution of studies in each major area were assigned by the biomedical experiment/medical safety group to individual investigators who carried out the detailed planning, supervision, and measurement.

#### A3.1.3 Facilities and Personnel

Successful conduct of the biomedical experiments/medical safety program depended on several organizations and a large number of dedicated investigators.

General medical and medical specialty examinations depended on the following investigators from the University of Pennsylvania: C. J. Lambertsen, Institute for Environmental Medicine; H. M. Rawnsley and C. Shute, Clinical Research Center; T. W. Clark, Diagnostic Clinic; W. S. Masland, Electroencephalography Unit; A. M. Kligman and R. R. Marples, Department of Dermatology; M. Reivich, Department of Neurology; C. W. Nichols, Department of Ophthalmology; W. K. H. Sundmaker, Department of Otolaryngology; and R. H. Chamberlain, Department of Radiology.

Decompression studies were by the Medical Research Laboratory, U.S. Naval Submarine Medical Center, New London, Connecticut (Cdr. T. N. Markham); National Aeronautics and Space Administration, Manned Spacecraft Center, Houston, Texas (Capt. E. L. Beckman); and J and J Marine Diving Company, Inc., Pasadena, Texas (Peter O. Edel).

On-site medical monitoring was by Cdr. T. N. Markham, U.S. Naval Submarine Medical Center; Lt. P. V. Van Tassel, Bureau of Medicine and Surgery; J. G. Dickson and C. J. Knight, Institute for Environmental Medicine, University of Pennsylvania Medical Center; Cdr. M. E. Bradley and Lt. Cdr. J. Vorosinarti, Deep Submergence Systems Project, San Diego; and Cdr. J. C. Rivera, 10th Naval District, San Juan.

Hematology studies were by C. L. Fischer, Manned Spacecraft Center, NASA, and P. C. Johnson, College of Medicine, Baylor University.

Microbiological studies were by Lt. A. B. Cobet, Naval Biological Laboratory, Oakland.

Respiratory/pulmonary and physiological studies were by investigators from the Institute for Environmental Medicine and Department of Physiology, University of Pennsylvania Medical Center: J. G. Dickson, A. B. DuBois, A. B. Fisher, R. Gelfand, R. W. Hyde, C. J. Knight, and C. J. Lambertsen.

### A3.2 General and Special Medical Examinations

#### A3.2.1 General Objectives, Rationale, and Procedures

C. J. Lambertsen, Institute for Environmental Medicine,  
University of Pennsylvania, Philadelphia, Pennsylvania, and  
Cdr. T. N. Markham, Naval Submarine Medical Center,  
New London, Connecticut

##### A3.2.1.1 General Objectives

A dominant purpose of Tektite I was to establish the general safety and operational usefulness of prolonged undersea exposure to high nitrogen pressures. To make real determination of physiological or medical risk it was necessary to design and execute exceptionally detailed and comprehensive biomedical studies of both a clinical and fundamental nature. These correlated evaluations of the aquanaut subject group were conducted in full detail prior to acceptance of a subject for the submerged exposure and again during the 2 days immediately following ascent to the surface. During the period of exposure a more limited, but still extensive, appraisal was conducted.

Because of the extent of the special clinical and physiological examinations employed, these preexposure studies were carried out by a combined staff of the University of Pennsylvania's Institute for Environmental Medicine and Clinical Research Center. In all of these special examinations the individual specialists who performed the initial, pre-exposure evaluation also performed the same special examination for the postexposure period at the diving site. Medical monitoring at the diving site was carried out by a team of physicians representing the U.S. Navy and the University of Pennsylvania.

##### A3.2.1.2 Preexposure and Postexposure Clinical Studies

The biomedical experiments/medical safety committee considered that, aside from the general clinical appraisal, respiratory and pulmonary measurements, microbiological studies, and hematological monitoring that were part of the overall program, several clinical specialty examinations deserved to be included in the aquanaut assessment. These were: ophthalmological, to involve complete study of ophthalmological and visual status; dermatological, to include detailed quantitative study of skin flora and skin permeability characteristics, as well as development of skin disease; neurological, to include complete neurological examination and clinical electroencephalograms; audio-vestibular, to involve quantitative measurement of hearing and determination of vestibular function; and radiological, to include examination of the lungs, skull, and gastrointestinal system.

##### A3.2.1.3 Status Assessment Examinations During Submergence

Because overall design of the Tektite I project required nearly complete isolation of the aquanauts during submergence, medical status examinations were performed by the aquanauts themselves. They were trained to use simple diagnostic equipment such as the aneroid sphygmomanometer and stethoscope for blood pressure measurement, otoscope, oral probe for a telethermometer, and electrocardiographic leads. A medical questionnaire was devised to permit systematic review and reporting of any positive responses.

#### A3.2.2 General Medical Examinations

##### A3.2.2.1 Preexposure Examinations

T. W. Clark, Diagnostic Clinic, University of Pennsylvania

The general medical appraisal examinations prior to exposure were conducted at the Diagnostic Clinic of the University of Pennsylvania hospital. They included: medical

history; physical examination; electrocardiogram, both resting and double Masters exercise recordings; ballistocardiogram; radiological examination of the skull (as part of neurological examination), chest (anterior-posterior and lateral), and upper gastrointestinal tract; laboratory examinations of blood elements (hemoglobin concentration, red cell count, white cell count, differential white cell count, and platelet count); blood chemistry (urea nitrogen, creatinine, protein-bound iodine, cholesterol, and glucose 2-hour postprandial concentration); blood serology; urinalysis; and stool-occult blood.

Results of these examinations, stored as part of the Tektite I program record, indicated that no limiting abnormalities were present in the subject group. As normal precautionary measures each aquanaut was brought to current immunization against smallpox, typhoid fever, tetanus, poliomyelitis, and Hong Kong influenza.

#### A3.2.2.2 Examinations During Submergence and Immediately Postexposure Cdr. T. N. Markham, Naval Submarine Medical Center

Initially the medical status was reviewed by the subjects daily, to include a report to the surface medical watch of body weight, oral temperature, blood pressure, pulse frequency, dermatological inspection, and auditory canal, drum, and throat inspection. After the first 2 weeks these reports were made only every 2 days. Once weekly each subject had an electrocardiogram (six leads weekly, 12 leads once per month); these tracings were sent to the surface for interpretation. Throughout the exposure any specific complaints or symptoms were reported and investigated when they arose. Weekly the pulmonary-function information was made available to the medical monitors, as was complete blood-count information from the hematology study. Bacterial culture results were available immediately following incubation and isolation at the site. On decompression, general medical appraisal was made immediately, then followed over the succeeding 2 days by detailed clinical examination.

The general medical monitoring throughout the exposure, together with the postexposure examinations uncovered no limiting abnormalities. The only significant medical conditions arising during the saturation exposure included the following:

- Aquanaut 1 reported paresthesias and weakness of his right hand and wrist during the first week on a day following extensive manual labor with his right arm. During this manual labor his arm had been in an abnormal position. The condition was diagnosed as radial nerve palsy and gradually cleared over the following 10 days. The subject was restricted from diving for 1 day.

- During the saturation phase between March 3 and March 23, 1969, all four subjects developed otitis externa; aquanauts 1 and 4 had bilateral infections with each ear infection separated by 5 to 7 days. Planned prophylactic use of ethanol cleaning and drying of the ear canal was not routinely carried out at the beginning of the exposure. The infections responded poorly to chemotherapy with corticosteroid otic drops, possibly because of the presence of the corticosteroid. They responded rapidly to systemic tetracycline and colymycin otic drops. Following the infections each aquanaut instilled a mixture of ethanol and boric acid in each ear after each dive. This procedure appeared to prevent further recurrence.

Table A10 summarizes the average values of general vital signs over the period of submergence.

Table A10  
Vital Signs During the Saturation Phase

Aqua-naut	Weight (lb)			Temperature (°F)*		Radial Pulse		Blood Pressure			
	Initial	Final	Mean	Std Dev	Range	Mean	Range	Systolic		Diastolic	
								Range	Mean	Range	Mean
1	155.0	157.0	156.9	1.5	98.0-99.9	98.8	104-76	130-106	117	86-64	75
2	161.0	157.0	158.5	1.0	97.3-99.5	98.4	100-72	130-110	117	84-50	73
3	185.0	183.0	183.9	1.0	97.8-99.2	98.5	84-58	130-102	116	88-68	77
4	158.0	150.0	153.6	1.9	98.2-99.4	98.8	92-72	138-105	125	106-68	85

\*The thermometers were not calibrated for the 42' depth; the 'above normal' temperatures are due to the increased pressure.



### A3.2.3 Auditory-Vestibular Examination

W. K. H. Sundmaker, Department of Otolaryngology,  
University of Pennsylvania

#### A3.2.3.1 General Objectives

The purpose of the complete ear, nose, and throat examination was to detect pre-existing abnormalities which would limit performance during or be exacerbated by prolonged submergence. The scope of the special examination was expanded to include audiometric survey and study of vestibular function by neurological and caloric methods.

#### A3.2.3.2 Results

Full documentation of pre- and postexposure examinations is stored with the Tektite I records. No limiting defects were found on preexposure examination. Postexposure examinations were made between 13 and 20 hours after the end of decompression. No subject showed any sign of vestibular dysfunction, and there were no subjective changes in hearing or other signs of auditory disturbance. For technical reasons a postexposure audiogram could not be done at the test site. Although no permanent threshold shift should have resulted from the exposure, all subjects were advised to have a repeat audiogram within 2 months.

The labyrinthine responses to cold calorization were generally depressed in all subjects as compared to the preexposure tests. This is in agreement with the observation made by others that vestibular nystagmus is enhanced by arousal and diminished by fatigue.

Although all subjects had had external otitis during the early period of submergence in the habitat, this had subsided at the time of the post exposure examination. Only aquanaut 3 had traces of grayish-green pigmented debris in his ear canals, presumably residua of *Pseudomonas* infection.

#### A3.2.3.3 Conclusion

Within the limits of this examination and in the absence of subjective complaints that would have called for more specialized tests, none of the subjects appeared to have sustained any damage to the vestibular apparatus or conductive auditory system, and no permanent changes in neurosensory auditory function are to be expected.

### A3.2.4 Dermatological Examinations

A. M. Klignan and R. R. Marples, Department of  
Dermatology, University of Pennsylvania

#### A3.2.4.1 General Objectives

It was considered probable that repeated and prolonged wetting of the skin could lead to deterioration of cutaneous function, susceptibility to trauma, and increased likelihood of infection. Complete dermatological examination was used as a preexposure base line for determining the nature and degree of any alterations which might be produced by the prolonged submergence. General inspection throughout the exposure was performed by the subjects. The detailed postexposure examinations were conducted within the first morning after completing decompression.

#### A3.2.4.2 Qualitative Aspects

The four participants had no noteworthy dermatologic disorders prior to immersion. They even lacked signs of athlete's foot, which is common in young men. After surfacing, each was in a state of excellent dermatologic health. Careful search failed to disclose even dandruff or an occasional folliculitis of the beard hairs. Obviously the habitat provided excellent opportunities for prophylactic care of the skin. Cleanliness and especially drying out between dives and at night are deemed to be the crucial factors which enabled the aquanauts to emerge with fewer skin conditions than they would have developed in the base camp for the same period.

Two subjective features should be mentioned. Three of the four subjects thought that there was slower growth of scalp and beard hair. This is inexplicable and may or may not be a reliable observation. Secondly all reported softer nails which were easily torn. The subjects did not have to cut their nails, but this may reflect the work they performed, which probably wore away the free edge of the nail plates. The softer nails doubtless resulted from hydration and not from internal factors which might result in defective nail formation.

Skin biopsy was taken from the volar surface of the forearm before immersion, but repetition of biopsy was eliminated from possibility after decompression.

#### A3.2.4.3 Preexposure and Postexposure Quantitative Tests

##### A3.2.4.3.1 Introduction

Scrub samples for corneocyte counting and quantitative bacteriology were taken using the methods of McGinley, Marples, and Plewig\* and Williamson and Kligman† from each side of the forehead and each volar forearm. These studies were intended to provide quantitative measures of changes in flora to supplement the qualitative studies comprising the microbiology program. Swab samples from the fourth interspace of each foot were taken by ten full strokes of a Triton X-100 moistened swab which was returned to 1 ml of wash fluid. The samples obtained at the diving site were transported in a vacuum flask containing ice and were plated the same evening in Philadelphia.

##### A3.2.4.3.2 Corneocytes

On the forearm the geometric mean corneocyte count fell from 168,500 to 139,500. This is of borderline significance. No nucleated cells were seen.

On the forehead the geometric mean count rose from 61,200 to 79,200. This rise is not significant. The level of nucleated corneocytes decreased slightly.

In the toeweb samples the geometric mean count fell markedly from 315,000 to 54,200 ( $p < 0.01$ ). However, the initial samples were taken in Philadelphia, where the subjects had been wearing shoes, and in the submerged habitat this was not the case.

\*K. J. McGinley, R. R. Marples, and G. Plewig, "A Method for Visualizing and Quantitating the Desquamating Portion of the Human Stratum Corneum," *J. Invest. Dermatol.* 53, 107-111 (1969).

†P. Williamson and A. M. Kligman, "A New Method for the Quantitative Investigation of Cutaneous Bacteria," *J. Invest. Dermatol.* 45, 498-503 (1965).

#### A3.2.4.3.3 Bacterial Densities

The scrub samples taken for corneocyte counts were also examined by techniques of quantitative bacteriology.

On the forearm the aerobic bacterial density rose from a geometric mean of 223 to 558. The flora included more aerobic spore formers and fewer cocci in the postimmersion samples. The density of *C. acnes* on the forearm fell from 3560 to 670.

On the forehead the aerobic density rose slightly from 14,300 to 54,600. However, the density of *C. acnes* fell sharply from  $42.3 \times 10^6$  to  $4.07 \times 10^6$ . This fall is highly significant. Perhaps this is due to the prolonged and motivated use of hexachlorophene antibacterial soap, although the rise in aerobic density does not confirm this hypothesis.

#### A3.2.4.3.4 Conclusions

The four participants had no noteworthy dermatologic disorders prior to immersion. The postulated occurrence of severe dermatologic disorders was not encountered.

It is probable that the maintenance of normal skin condition was related to the combination of relatively low humidity in the habitat, avoidance of excessive temperature in the habitat, relatively short periods of work in the water as compared with time spent in the gaseous environment, the ready availability of fresh water for washing of skin and clothing, and the use of a bacteriocidal soap for the frequent showers. The major dermatologic failure can be considered the infections which occurred in the skin of the ear canal. These sites were initially allowed to remain wet instead of being dried and had instillations of water-holding glycerine instead of the more rational water-removing and bacteriocidal ethanol.

It should be recognized that, from a dermatologic standpoint, conditions in the habitat were nearly ideal — certainly superior to conditions in the base camp. While no problems developed in the aquanaut-subjects, it can be expected that warmer climate, higher humidity, poorer hygiene, and increased daily duration of diving will lead to dermatological changes including infection and physical breakdown.

#### A3.2.5 Neurological Examination

M. Reivich, department of Neurology, and W. S. Masland,  
Electroencephalography Unit, University of Pennsylvania

Since exposure to increased nitrogen pressure in saturation diving or the use of oxygen at high pressure in bends therapy could induce central nervous system effects, complete neurological examination was performed as part of the base-line selection appraisal of each subject. The objective of these clinical neurological examinations was to detect preexisting neurological abnormalities, whether limiting or not.

The preexposure studies included skull x-rays, electroencephalograms, and detailed neurological examinations. The latter consisted of an assessment of each subject's mental status, station and gait, cranial nerves, cerebellar function, motor function, sensory function, and reflexes and an examination of the extracranial cerebral vessels. No limiting abnormalities were found in the preexposure examination.

Following decompression a second complete neurological examination was carried out within 48 hours by the same neurologist who had performed the preexposure examinations. No changes from the preexposure examination were found.

### A3.2.6 Ophthalmological Examinations

C. W. Nichols, Department of Ophthalmology, University of Pennsylvania

#### A3.2.6.1 General Objectives

The initial examination was devised to assure that all individuals taking part in the Tektite I Project had not had or did not have any significant ocular disease such that a recurrence or exacerbation would threaten their vision. This examination, additionally, provided an extensive base line so that any deviation from the individual's ocular norm could be adequately investigated. The major investigative task of the ophthalmologic program was to determine if any changes in visual function occurred during the saturation dive and to evaluate the eye for structural changes that might occur during diving and subsequent decompression.

#### A3.2.6.2 Content of the Examination

The initial examination was carried out in the eye clinic of the University of Pennsylvania hospital. The tests used were those which constituted part of the routine workup of all patients as well as certain specialized examinations so chosen that conceivably they could be repeated in a field situation. The requirement to be able to repeat the test at the project site eliminated certain electrophysiological measurements (electroretinogram measurements), which although possibly desirable have not proved of significance in past investigations. An outline of the initial examination follows.

- Ocular history with emphasis on: history of injury to the eye or adnexa; previous visual difficulty, particularly if associated with diving or other hyperbaric exposure; and recurrent infections of cornea, conjunctiva, or lids.

- Visual acuity with and without correction at distance (20 feet) and near (14 feet) and measurement of accommodative ability.

- External examination: notations made of lids, lashes, fissures, conjunctiva, cornea, and lacrimal system.

- Pupillary responses to light and accommodation.

- Evaluation of extraocular muscle balance to include: primary position and versions, measurement of near and distant phorias (tropias if indicated), and vertical and horizontal fusional amplitudes.

- Central visual fields by tangent screen with white and colored test objects.

- Slit-lamp examination of the undilated pupil.\*

- Shiotz and/or applanation tonometry\*.

- Slit-lamp examination of the dilated pupil.\*

- Refraction - cycloplegic (Mydracvl).

- Photography of disk and macular areas.\*

\*Could not be done at the project site.

- Fluorescein angiography (arm to eye circulation time) and photography of the macular pattern (to be repeated at project site if indicated).
- Examination of the fundus and ocular media by direct and indirect ophthalmoscopy.

#### A3.2.6.3 Summary of Significant Findings

In all cases the preexposure findings were typical of those found in young healthy individuals. No ocular abnormalities of any type were noted in the subjects except for a moderate myopic astigmatism correctible by lenses in aquanaut 3 and a higher than normal intraocular tension in aquanaut 2. Neither of these was felt to have significance in terms of the planned saturation diving exposure.

There was no postdecompression alteration in the visual function of any of the subjects as evaluated by the parameters measured. Three alterations were detected, however. In aquanaut 1 marked injection and mild chemosis of the conjunctivae were present. This was attributed to a sensitivity to environmental contaminants in the habitat. This subject found that the condition was exacerbated while changing the baralyme canisters, and presumably chemical dust produced in this activity was a cause of much of his problem. It was in no way incapacitating.

Aquanaut 3 was found to have a decrease in his convergence amplitude. He was accustomed to using stereoscopic equipment in his work before the dive and "crossing his eyes" to obtain a stereoscopic effect. He did not do this during his period in the habitat, and presumably lack of practice accounted for his decreased total convergence amplitude.

During the preexposure examination of aquanaut 2 no abnormalities were noted in his lens by either direct ophthalmoscopy or slit-lamp examination. However, after decompression a small spherical region approximately 0.5 mm in diameter was easily noticed by two observers by means of a direct ophthalmoscope to be present in the lens of the right eye. This was at about 10 o'clock peripherally and did not affect vision. He was referred upon returning home to an ophthalmologist, who reported only a very small peripheral spherical defect in the right eye at about 12:30 seen with great difficulty with the slit lamp. The originally detected spherical area was at that time not present. Followup examination by the original observers 6 months after exposure also showed only the unrelated minute defect seen at 12:30 by the consultant ophthalmologist. This was extremely small and difficult to see; it was not in the area of the defect noted immediately postdecompression. From the structure and normal progression of lens changes, it can be surmised that the defect observed on return to the surface was related to decompression and was most probably a gas bubble which went on to complete resolution. The unfortunate inability to follow up this observation on a continuous, day-by-day basis was due to scattering of personnel from the diving site following completion of the operation.

### A3.3 Hematology

#### A3.3.1 General Objectives

C. L. Fischer, Preventive Medicine Division,  
NASA Manned Spacecraft Center, Houston, Texas

The general objectives of the hematology program were to describe the hematologic, immunologic, and biochemical implications incident to 60 days of continuous submersion, exposure to a nitrogen/oxygen atmosphere at increased pressure, and confinement in a semiclosed environment and the hazards of prolonged saturation diving. Specifically the studies were designed to provide the following:

- Documentation of participating crew members' physical qualifications, related to the dive, and detection of problems which would require remedial or preventive action.
- Information relative to the etiology, time course and extent of any alterations in red cell mass and/or leukocyte function.
- Information referable to the humoral and cellular components of immunity from crew members exposed to the rigors of long-term saturation diving.
- Data referable to any alterations in fluid and electrolyte balance and musculo-skeletal metabolism as reflected by selected biochemical constituents of blood.
- Information about the endocrine system required to objectively quantitate the "physiological costs" or "stresses" incurred by long-term saturation diving.

#### A3.3.2 Hematology and Radioisotope Studies

P. C. Johnson, Division of Nuclear Medicine,  
Baylor University College of Medicine, Houston, Texas

##### A3.3.2.1 Objectives, Measurements, and Methods

The specific objectives of the radioisotope studies were to study the time course, extent, and etiology of any alterations in circulating red cell mass, red cell survival, and plasma volume incurred by the Tektite I environment.

The following measurements were made (with the methods in parentheses): hematocrit (micromethod), hemoglobin (cyanomethemoglobin), red cell indices (calculation), reticulocyte count (wet and dry methods), white cell count (Coulter counter Model F), differential and morphology (routine methods), photomicroscopy as required (Carl Zeiss Ultraphot), platelet counts (phase microscopy), red cell mass ( $^{51}\text{Cr}$  in vitro tag), red cell survival ( $^{51}\text{Cr}$  half-life; glycine  $^{14}\text{C}$  in vivo tag), and plasma volume ( $^{125}\text{I}$ -HSA).

##### A3.3.2.2 Results

The results are given in Tables A11, A12, and A13.

##### A3.3.2.3 Discussion

###### A3.3.2.3.1 Hematology Studies

The routine hematologic parameters (Table A11) demonstrated an unexpected stability, with very few significant trends or isolated findings. An initial intradive decrease in the hematocrit values of John Van Derwalker and increases to levels above predive values for a couple of the divers was seen; however, the postdive hematocrits were slightly below predive norms. The significance of these intradive trends is tenuous; however, the postdive decrease in hemoglobin and hematocrit is related to increases in plasma volume rather than decreases in red cell mass. An asymptomatic, transient eosinophilia occurred in Richard Waller during the dive, the significance of which is not obvious at this time.

Table A11  
Hematology Results

Date Relative to D (Dive)	Hemo-globin (g/100 ml)	Hema-toxist (%)	Total Count	White Blood Cells												Platelet Count	Mean Corpuscular Hemo-globin	Mean Corpuscular Volume	Mean Cell Hemo-globin Content					
				Neuro-pitils		Lympho-cytes		Mono-cytes		Eosino-pitils		Baso-pitils		Others						Reticu-lyocytes				
				Pet	Count	Pet	Count	Pet	Count	Pet	Count	Pet	Count	Pet	Count									
																					Red Blood Cells	Reticu-lyocytes	Platelet Count	Mean Corpuscular Hemo-globin
Clifton (Diver)																								
D-30	14.8	43	6380	54	3445	37	2361	5	319	4	255	0	0	0	0	0	0	0	0	165,000	31	91	34	
D-11	14.3	43	5060	59	2985	29	1467	1	354	4	202	1	51	0	0	0	0	0	0	247,000	ND	ND	33	
D-5	12.3	41	3520	62	2182	35	1232	1	35	2	70	0	0	0	0	0	0	0	0	ND	ND	ND	32	
D+14	14.7	44	5500	54	2970	33	1815	6	330	6	330	1	55	0	0	0	0	0	0	180,000	ND	ND	34	
D+21	16.2	47	5509	52	2860	40	2200	3	165	4	220	1	55	0	0	0	0	0	0	190,000	ND	ND	36	
D+28																								
D+35	14.8	45	7150	50	3575	41	2932	3	215	6	429	0	0	0	0	0	0	0	0	120,000	ND	ND	34	
D+42	14.2	43	7510	43	3229	48	3605	4	300	5	376	0	0	0	0	0	0	0	0	230,000	ND	ND	33	
D+49	14.8	45	6160	53	3265	35	2156	8	493	4	246	0	0	0	0	0	0	0	0	230,000	ND	ND	33	
D+56	14.7	46	6820	58	3956	35	2387	4	273	3	205	0	0	0	0	0	0	0	0	250,000	ND	ND	32	
D+60 (bottom)	13.1	40	10000	52	5200	43	4300	4	400	1	100	0	0	0	0	C	0	0	0	153,000	ND	ND	33	
D+60 (surface)	13.3	41	7260	56	4066	38	2759	4	290	2	145	0	0	0	0	0	0	0	0	226,000	ND	ND	33	
Mahaska (Diver)																								
D-30	14.8	42	5720	52	2974	38	2174	2	144	6	343	1	57	1	57	1	57	1	57	189,000	31	88	35	
D-11	15.2	45	5780	45	2601	48	2774	3	173	2	116	1	58	1	58	1	58	1	58	151,000	ND	ND	34	
D-5	14.4	42	3850	64	2464	32	1232	5	0	3	116	1	39	0	39	0	39	0	39	ND	ND	ND	34	
D+14	15.8	46	7480	57	4264	26	1945	5	374	9	673	1	75	2	75	2	75	2	75	166,000	ND	ND	34	
D+21	15.0	45	6160	40	2464	49	3018	2	123	6	370	1	62	2	62	2	62	2	62	185,000	ND	ND	35	
D+28	15.1	46	5060	46	2328	48	2439	0	0	6	304	0	0	0	0	0	0	0	0	175,000	ND	ND	33	
D+35	15.2	46	6050	57	3449	37	2239	2	121	4	242	0	0	0	0	0	0	0	0	150,000	ND	ND	35	
D+42	15.0	45	6600	43	2838	49	3234	4	264	3	198	0	0	0	0	0	0	0	0	150,000	ND	ND	33	
D+49	15.5	44	6600	44	2904	49	3234	3	198	4	264	0	0	0	0	0	0	0	0	185,000	ND	ND	35	
D+56	15.1	45	5170	49	2533	40	2068	7	362	3	155	1	52	0	52	0	52	0	52	200,000	ND	ND	33	
D+60 (bottom)	14.0	42.5	7920	64	5069	31	2455	3	238	1	79	1	79	1	79	1	79	1	79	140,000	ND	ND	33	
D+60 (surface)	13.8	43.0	7150	54	3861	45	3218	1	72	3	215	1	72	0	72	0	72	0	72	156,000	ND	ND	32	
Van Derwalker (Diver)																								
D-30	15.8	43.0	7260	53	3848	39	2831	4	290	3	218	1	73	0	73	0	73	0	73	235,000	32	87	37	
D-11	14.4	42.0	3780	47	1399	51	1928	7	265	3	113	1	38	1	38	1	38	1	38	194,000	ND	ND	34	
D-5	14.0	42.0	3190	37	1499	49	1563	1	32	3	116	1	32	0	32	0	32	0	32	ND	ND	ND	33	
D+14	12.2	35.0	3080	45	1396	42	1294	6	185	6	185	1	31	0	31	0	31	0	31	*13,000	ND	ND	35	
D+21	15.2	45.0	5500	54	2970	42	2310	2	110	2	110	0	0	0	0	0	0	0	0	250,000	ND	ND	34	
D+28	15.8	47.0	6050	44	2662	52	3146	2	121	2	121	0	0	0	0	0	0	0	0	200,000	ND	ND	34	
D+35	15.4	46.0	8140	48	3907	48	3907	2	163	2	163	0	0	0	0	0	0	0	0	149,000	ND	ND	33	
D+42	15.5	46.0	5830	35	2041	55	3207	4	233	4	233	1	58	1	58	1	58	1	58	200,000	ND	ND	34	
D+49	15.6	46.0	4940	38	1881	51	2525	10	495	2	99	0	0	0	0	0	0	0	0	225,000	ND	ND	34	
D+56	15.2	45.0	4950	41	2030	50	2475	6	297	3	149	0	0	0	0	0	0	0	0	150,000	ND	ND	34	
D+60 (bottom)	14.3	41.0	7590	70	5313	28	2125	1	76	1	106	0	0	0	0	0	0	0	0	120,000	ND	ND	35	
D+60 (surface)	14.3	42.5	5280	62	3274	32	1690	4	211	2	106	0	0	0	0	0	0	0	0	196,000	ND	ND	34	

(Table Continues)

Table A11 (Continued)

Date Relative to D (Dive)	Hemo- globin (g/ 100 ml)	Hema- tocrit (%)	White Blood Cells												Red Blood Cells	Reticu- locytes	Platelet Count	Mean Corpus- cular Hemo- globin	Mean Corpus- cular Volume	Mean Cell Hemo- globin Content	
			Total Count	Neuro- phils		Lympho- cytes		Mono- cytes		Eosino- phils		Baso- phils		Others							
				Pet	Count	Pet	Count	Pet	Count	Pet	Count	Pet	Count	Pet							Count
				Waller (Diver)																	
D-30	15.7	45.0	5930	44	3049	46	3188	4	277	5	347	0	0	0	1	69	5.04	158,000	31	89	35
D-11	15.4	46.5	6380	61	3892	33	2105	4	255	4	64	0	0	0	1	64	ND	175,000	ND	ND	33
D-5	15.2	45.5	5940	41	2435	48	2851	3	178	7	416	1	59	0	0	0	5.35	123,000	28.4	ND	33
D+14	15.7	46.0	8030	47	3774	40	3212	3	241	10	803	0	0	0	0	0	ND	168,000	ND	ND	34
D+21	15.2	45.0	6510	42	2734	44	2864	4	260	8	521	0	0	2	130	0	ND	260,000	ND	ND	33
D+28	15.2	46.0	6930	53	3673	39	2703	1	69	7	485	0	0	0	0	0	ND	138,000	ND	ND	33
D+35	15.3	46.0	5720	47	2688	36	2059	3	172	13	744	1	57	0	0	0	ND	208,000	ND	ND	33
D+42	15.2	45.0	7370	37	2727	51	3759	8	221	8	590	1	74	0	0	0	ND	150,000	ND	ND	34
D+49	15.6	46.0	6270	41	2571	42	2633	6	376	9	564	1	63	1	63	0	ND	200,000	ND	ND	34
D+56	15.2	46.0	5500	38	2090	45	2475	8	440	3	480	1	55	0	0	0	ND	189,000	ND	ND	33
D+60 (bottom)	14.2	43.0	8300	39	3237	52	4316	4	332	5	415	0	0	0	0	0	ND	132,000	ND	ND	33
D+60 (surface)	13.8	42.5	7590	35	2657	54	4099	3	228	8	607	0	0	0	0	0	ND	200,000	ND	ND	32
Davis (Backup)																					
D-30	15.2	43.0	4510	36	1624	51	2300	7	316	5	226	1	45	0	0	0	4.92	178,000	31	37	35
D-11	15.9	42.5	3575	38	1359	51	1823	3	107	5	179	2	72	1	36	0	ND	235,000	ND	ND	34
D-5	15.4	45.0	2640	51	1346	42	1109	1	26	5	132	1	26	0	0	0	ND	ND	ND	ND	36
D+14	16.0	44.0	6430	54	3472	35	2251	8	514	3	193	0	0	0	0	0	ND	306,000	ND	ND	36
D+21	15.8	44.0	4730	47	2223	44	2081	5	237	1	47	0	0	3	142	0	ND	205,000	ND	ND	36
D+28	15.0	45.0	8580	77	6607	13	1115	2	172	7	601	0	0	1	86	0	ND	167,000	ND	ND	33
D+35	14.8	42.0	4840	56	2710	38	1839	1	48	4	194	1	48	0	0	0	ND	191,000	ND	ND	35
D+42	15.1	45.0	4620	46	2125	26	2125	4	185	3	39	1	46	0	0	0	ND	190,000	ND	ND	34
D+49	14.7	44.0	6270	47	2947	39	2445	7	439	5	314	2	125	0	0	0	ND	230,000	ND	ND	33
D+56	15.3	44.0	5060	61	3087	28	1417	8	405	2	101	1	51	0	0	0	ND	178,000	ND	ND	35
D+60 (bottom)	13.5	42.5	3575	48	1716	40	1430	4	143	5	179	3	107	0	0	0	ND	158,000	ND	ND	32
D+60 (surface)	13.8	40.0	3740	51	1907	34	1272	7	262	6	224	2	75	0	0	0	ND	201,000	ND	ND	35
Koblick (Backup)																					
D-30	15.2	43	6270	40	2508	52	3260	6	376	1	63	1	63	0	0	0	4.82	205,000	32	69	35
D-11	14.9	46	8360	78	6521	16	1338	31	251	1	84	0	0	2	167	0	ND	194,000	ND	ND	32
D-5	14.4	43	5500	65	3575	32	1760	0	0	3	165	0	0	0	0	0	ND	ND	ND	ND	34
D+14	15.8	44	7700	52	4004	40	3080	6	462	2	154	0	0	1	68	0	ND	170,000	ND	ND	35
D+21	15.2	45	6820	57	3887	36	2455	4	273	0	0	0	0	0	0	0	ND	160,000	ND	ND	35
D+28	14.3	43	5170	59	3050	39	2016	1	52	1	52	0	0	0	0	0	ND	192,000	ND	ND	33
D+35	14.3	43	6160	58	3573	36	2218	4	246	2	123	0	0	0	0	0	ND	167,000	ND	ND	33
D+42	15.7	46	7700	56	4312	40	3080	2	154	0	0	0	0	0	0	0	ND	236,000	ND	ND	34
D+49	14.4	42	6160	57	3511	36	2218	2	123	4	246	0	0	1	62	0	ND	217,000	ND	ND	35
D+56	14.6	43	6160	61	3758	31	1910	6	370	2	123	0	0	0	0	0	ND	200,000	ND	ND	34
D+60 (bottom)	13.3	41	6710	47	3154	45	3020	4	268	3	201	1	67	0	0	0	ND	189,000	ND	ND	32
D+60 (surface)	13.2	40	7260	50	3630	46	3340	2	145	2	145	0	0	0	0	0	ND	237,000	ND	ND	33

(Table Continues)



Table A11 (Continued)

Date Relative to D (Dive)	Hemo- globin (g/ 100 ml)	Hema- toerit (%)	Total Count	White Blood Cells												Red Blood Cells	Reticu- locytes	Platelet Count	Mean Corpus- cular Hemo- globin	Mean Corpus- cular Volume	Mean Cell Hemo- globin Content						
				Neutro- phils			Lympho- cytes			Mono- cytes			Eri- thro- phils									Baso- phils			Others		
				Pet	Count	Pet	Count	Pet	Count	Pet	Count	Pet	Count	Pet	Count							Pet	Count	Pet	Count	Pet	Count
				Phillips (Backup)			Phillips (Backup)			Phillips (Backup)			Phillips (Backup)									Phillips (Backup)					
D - 30	15.3	44.0	8580	61	5234	35	3003	2	172	2	172	0	0	0	0	0	0	0	0	4.92	1.2	213,000	31	89	38		
D - 11	15.4	44.0	6160	63	3881	30	1848	2	123	2	123	0	0	0	0	0	0	0	0	ND	0.8	224,000	ND	ND	35		
D - 5	14.9	43.0	3960	60	2376	33	1307	0	0	6	238	1	40	0	0	0	0	0	0	ND	ND	ND	ND	ND	35		
D + 14	15.9	46.0	7480	60	4488	31	2319	5	374	3	224	1	75	0	0	0	0	0	0	ND	0.8	1,300,000	ND	ND	35		
D + 21	14.8	43.0	5830	50	2915	37	2157	6	350	3	175	2	117	2	117	0	0	0	0	ND	ND	240,000	ND	ND	34		
D + 28	15.0	45.0	8250	64	5280	30	2475	1	83	5	413	0	0	0	0	0	0	0	0	ND	ND	177,000	ND	ND	33		
D + 35	14.5	42.0	7480	51	3815	42	3142	3	224	3	224	1	75	0	0	0	0	0	0	ND	ND	320,000	ND	ND	35		
D + 42	14.5	43.0	5790	68	5161	24	1822	3	228	4	304	0	0	0	0	0	0	0	0	ND	0.4	300,000	ND	ND	33		
D + 49	15.0	45.0	7370	68	5012	25	1843	6	442	1	74	0	0	0	0	0	0	0	0	ND	0.1	300,000	ND	ND	33		
D + 56	16.0	47.0	7480	70	5236	24	1795	2	150	4	299	0	0	0	0	0	0	0	0	ND	0.8	230,000	ND	ND	34		
D + 60 (bottom)	14.3	43.0	5500	65	3575	24	1320	5	275	6	330	0	0	0	0	0	0	0	0	ND	0.2	222,000	ND	ND	33		
D + 60 (surface)	14.3	41.0	5600	67	3752	24	1344	7	392	1	56	1	56	0	0	0	0	0	0	ND	0.1	254,000	ND	ND	35		

Table A12  
Radiolotope Results

Date Relative to Dive (D)	Red Cell Mass (ml)	Red Cell Mass Increment*		Plasma Volume (ml)	Plasma Volume Increment*		Blood Volume (ml)	Blood Volume Increment*		Total Body Hema- tocrit (%)	Periph- eral Hema- tocrit (%)	Ratio of Total Body Hematocrit to Peripheral Hematocrit
		Ml	Pct		ml	Pct		ml	Pct			
Clifton (Diver)												
D - 30	2040	-	-	3055	-	-	5095	-	-	40	44	0.90
D - 11	1921	-119	6	3322	+267	9	5243	+148	3	37	40	0.92
D + 60 (bottom)	2131	+210	11	3575	+253	8	5706	+463	9	37	44	0.84
D + 60 (surface)	2180	+259	13	3370	+58	2	5550	+307	6	39	42	0.93
Mehnken (Diver)												
D - 30	2469	-	-	3371	-	-	5840	-	-	42	44	0.95
D - 11	2468	- 1	< 1	3587	+216	6	6050	+210	4	41	42	0.98
D + 60 (bottom)	2377	- 91	4	3624	+ 37	1	6001	- 49	1	40	43	0.93
D + 60 (surface)	2320	-148	6	3619	+ 32	1	5939	-111	2	39	44	0.89
Van Derwäker (Diver)												
D - 30	1975	-	-	2689	-	-	4664	-	-	42	45	0.93
D - 11	1992	+ 17	< 1	3079	+390	15	5068	+404	7	39	42	0.93
D + 60 (bottom)	1881	-111	6	†	-	-	-	-	-	-	42	-
D + 60 (surface)	1886	-106	5	3752	+673	22	5638	+570	11	33	43	0.77
Waller (Diver)												
D - 30	2109	-	-	2636	-	-	4797	-	-	44	46	0.96
D - 11	2186	+ 77	< 1	2725	+ 37	1	4911	+114	2	44	47	0.94
D + 60 (bottom)	1998	-188	9	3328	+603	22	5326	+415	8	39	43	0.88
D + 60 (surface)	1981	-205	9	3158	+413	15	5119	+208	4	39	43	0.91
Davis (Backup)												
D - 11	2236	-	-	3163	-	-	5399	-	-	41	45	0.91
D + 60 (bottom)	2192	- 44	2	3566	+403	13	5758	+359	7	38	42	0.90
D + 60 (surface)	2210	- 26	1	3736	+573	18	5946	+547	10	37	42	0.88
Koblick (Backup)												
D - 11	2103	-	-	3014	-	-	5117	-	-	41	42	0.98
D + 60 (bottom)	2096	- 7	< 1	3422	+408	4	5518	+401	8	38	42	0.90
D + 60 (surface)	2098	- 5	< 1	3493	+479	16	5591	+474	9	38	42	0.90
Phillips (Backup)												
D - 11	2013	-	-	3025	-	-	5038	-	-	40	43	0.93
D + 60 (bottom)	2077	+ 64	3	3148	+123	4	5225	+187	4	40	44	0.90
D + 60 (surface)	2108	+ 95	5	3522	+497	16	5630	+592	12	37	44	0.84

\*The D + 60 (bottom) and D + 60 (surface) increments are both with reference to the D-11 values.

†Dose infiltrated the plasma volume.

Table A13  
Red Cell Survival

Date Relative to Dive (D)	<sup>14</sup> C - Glycine* (disintegrations/min per mg hemoglobin)						
	Clifton	Mahnken	Van Der-walker	Waller	Davis	Koblick	Phillips
D - 30	5.9	4.9	6.2	5.3	—	5.9	7.8
D - 11	6.4	4.9	7.0	—	6.1	6.4	8.9
D - 5	6.6	5.3	7.0	5.9	6.2	6.5	8.3
D + 14	6.0	5.1	7.1	5.5	6.3	6.4	8.3
D + 21	6.6	4.9	6.9	5.7	6.2	6.4	8.0
D + 28	6.2	4.8	6.6	5.5	6.0	6.0	7.2
D + 35	6.0	5.0	6.0	5.7	6.3	5.9	6.3
D + 42	6.4	5.3	6.1	5.8	5.8	6.2	6.2
D + 49	5.6	4.2	6.0	6.1	5.8	6.7	6.3
D + 56	5.8	4.2	6.0	5.6	5.4	6.3	6.4
D + 60 (bottom)	5.7	4.4	6.0	5.4	6.3	5.6	6.4
D + 60 (surface)	6.1	4.7	3.8	5.7	—	—	—
Half Life - <sup>51</sup> Cr in Vitro (days)							
Pre-dive	28	29	29	27	—	—	—
Intradiave	28	27	28	27	31	28	28

\*Plotted in Fig. A27.

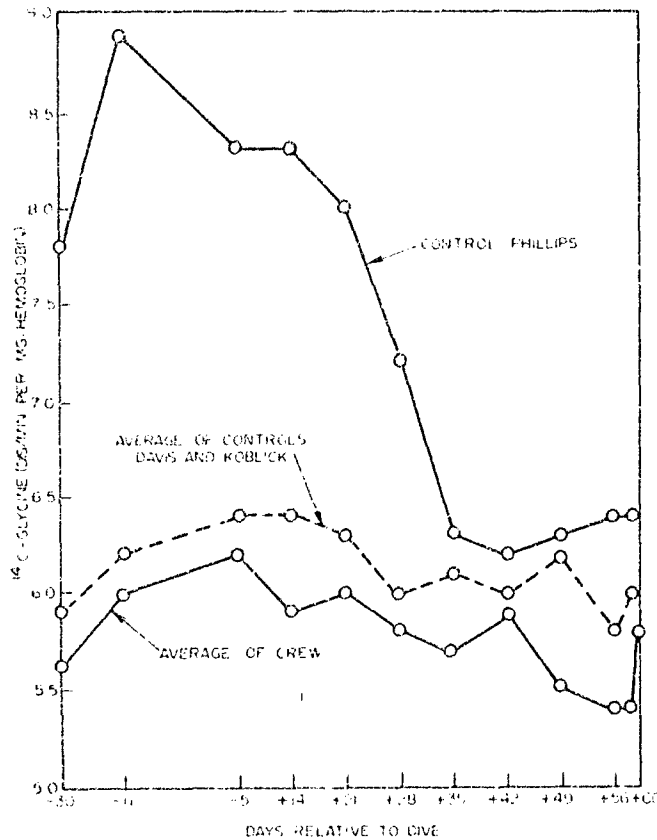

Fig. A27 - Red cell survival as determined by the glycine <sup>14</sup>C in vivo tag

#### A3.3.2.3.2 Radioisotope Studies

Red cell mass, plasma volume, and red cell survival studies were performed on four occasions: twice during the pre-dive control period, on the last day of the dive prior to the decompression, and after surfacing and decompression. The radioisotope methodology used in these studies has been demonstrated sensitive to changes in red cell mass of 2% or more. After consideration of the normal biologic variance and problems encountered by field operations, a variance of 6% is equal to two standard deviations. Plasma volume measurement accuracy is inherently greater; however, the biologic variance of this parameter is considerably larger than that of the red cell mass. This lability is due to the fact that plasma volume responds to certain environmental factors, particularly increased ambient temperatures.

Three of the four divers lost red cell mass (Mahnken, Waller, and Van Derwalker), whereas the fourth individual (Clifton) actually gained red cell mass (Table A12). The control group showed essentially no change in this parameter. Although the red cell mass losses exhibited by three of the divers were at the margin of significance, it must be noted that they are distinctly separable from the control population. The one diver (Clifton) may have had an abnormal transient reduction in his red cell mass at the time of the D - 11 examination; when his D - 30 value is compared to his postdive results, he falls in line with the other divers (+91 ml or 4%). No significant changes in red cell mass were observed as a result of the decompression.

All divers showed alterations in their plasma volumes at some time during the pre-dive, intradive, or postdive intervals. Three of the four exhibited a significant elevation in plasma volume between the D - 30 and D - 11 examinations. The fourth diver (Waller) showed essentially no change during this period. It is probable that the alterations in plasma volumes seen during the pre-dive control period were secondary to the concurrent change in climate experienced by the dive team. During the dive one individual showed essentially no change in plasma volume (Mahnken); whereas, the other divers showed significant increases. It is interesting to note that the diver showing the least loss of red cell mass (Mahnken) was also the man who exhibited the least plasma volume increase. The control group showed similar increases in plasma volume during the pre-dive and intradive periods as did the majority of the dive team.

The  $^{51}\text{Cr}$  red cell survival (Table A13) showed no changes throughout the study. The  $^{14}\text{C}$  in vivo cohort tag studies showed no differences between the divers and controls, and all values were within the range of normal. It is noteworthy, however, that Mr. Phillips showed (Fig. A27) a very different curve from the other men measured, although his curve is still within the limit of normal.

#### A3.3.2.4 Conclusions

- No statistically significant changes in red cell mass or red cell survival were detected as a result of the Tektite I dive exposure.
- Plasma volumes increased over the pre-dive and dive intervals in both the control and diver population. This is a probable result of increased ambient temperatures experienced by these personnel after moving to the Tektite I site.
- No significant change in any routine hematologic parameter occurred, with the single exception of a transient eosinophilia in one diver.

### A3.3.3 Immunohematology

S. Ritzman and W. Levin, Division of Immunohematology,  
University of Texas, Galveston, Texas

#### A3.3.3.1 Objectives, Measurements, and Methods

Specific objectives of the immunohematology studies were to determine the time course, extent, and etiology of any changes in the humoral and/or cellular immune status of divers exposed to conditions of prolonged saturation diving. This effort will provide the needed data for the safe committal of man to extended dives, particularly those in which prolonged contact with the ocean and ocean floor may be involved.

The following measurements were made (with the methods in parentheses): total serum protein (Goldberg, temperature compensated refractometer), serum electrophoresis (cellulose acetate), immunoglobulin quantitation including IgG, IgA, and IgM (single radial immunodiffusion), lymphocyte blastoid transformation (phytohemagglutinin stimulation), lymphocyte RNA-DNA synthesis rates (in vitro,  $^{14}\text{C}$  and  $^3\text{H}$  tagging), neuramidase (turbidometric method),  $\alpha 2\text{M}$ -globulin (single radial immunodiffusion), transferrin (single radial immunodiffusion), and C'3 - compliment (single radial immunodiffusion).

#### A3.3.3.2 Results

The results are given in Table A14.

#### A3.3.3.3 Discussion

No evidence of significant trends is recognized in the immunohematology data, referable to the dive interval. Three of the four divers have consistently abnormal values specifically with respect to  $\gamma\text{M}$ -globulin (Vanderwalker and Mahnken) and  $\alpha 2\text{M}$ -globulin (Clifton) fractions. The significance of these values is not known.

The significant findings, referable to the cellular immunohematology system, concerns John Van Derwalker, who exhibited a significant reduction in RNA synthesis to PHA stimulation postdive. Since this was not a common finding within the dive group, no overall significance is associated with this event.

#### A3.3.3.4 Conclusions

The following are the conclusions regarding the divers.

For John Van Derwalker, elevated gamma-globulin levels were recorded during pre-dive intervals, with transient return to normal range on the occasion of the D+60 (bottom) sample. The subsequent D+60 (surface) sampling showed return to the elevated pre-dive levels. This elevated gamma-globulin level was due to a markedly increased  $\gamma\text{M}$ -globulin level. A transient decrease in lymphocyte RNA synthesis subsequent to PHA stimulation was seen postdive. The significance of this latter finding is unknown.

For Conrad Mahnken, a significantly decreased  $\gamma\text{M}$ -globulin level was present on all sampling occasions. No significance, referable to the dive, is inferred.

For Richard Waller, no significant abnormalities or changes were noted throughout the examining period.

For Edward Clifton, significant elevations in the  $\alpha 2\text{M}$ -globulin protein fraction was seen throughout the pre-dive and postdive intervals. No protein changes, referable to the dive, were observed.

Table A14  
Immunohematology Measurements

Date Relative to D (Dive)	Serum Protein										Muramidase (Lysozyme) (µg/m)	Lymphocyte Response (dis/min per 10 <sup>6</sup> viable cells)			
	TSP (g%)	Albumin (g%)	α <sub>2</sub> -globulin (g%)	γ <sub>2</sub> -globulin (g%)	γ <sub>1</sub> -globulin (mg-%)	γM-globulin (mg-%)	α <sub>2</sub> M-globulin (mg-%)	Transferrin	C'3 (mg-%)	RNA Synthesis Unstimulated		PHA Stimulation	DNA Synthesis Unstimulated	PHA Stimulation	
Clifton (Diver)															
D-30	6.8	3.7	0.7	1.5	1125	187	185	476	229	77	5.9	1.478	13.386	2.069	16.185
D-11	7.7	3.6	0.9	2.1	1259	215	206	516	224	64	6.2	4.178	16.047	1.006	20.506
D-4	7.0	3.6	0.8	1.6	1184	189	182	444	—*	78	5.3	2.300	15.765	1.579	18.807
D+60 (bottom)	7.1	3.9	0.7	1.5	965	183	147	477	—*	65	4.1	3.000	13.659	0.578	13.028
D+60 (surface)	7.5	4.0	0.7	1.7	1021	192	168	498	—*	73	5.3	8.066	15.553	3.275	21.568
Mahnken (Diver)															
D-30	5.7	3.9	0.5	1.3	1027	123	60	335	251	77	7.1	2.865	17.829	1.904	26.036
D-11	7.7	3.8	0.9	1.9	1197	136	67	335	263	71	10.4	2.305	18.522	2.791	13.048
D-4	7.2	3.8	0.8	1.6	1080	132	282	228	228	79	6.5	2.500	17.076	2.176	25.958
D+60 (bottom)	6.7	3.9	0.6	1.2	963	128	61	307	208	62	4.3	5.134	15.914	0.623	11.966
D+60 (surface)	7.0	4.0	0.6	1.3	997	135	64	328	209	72	4.5	3.017	22.023	4.740	12.968
Van Derwalker (Diver)															
D-30	7.8	3.6	0.9	2.3	1653	324	364	327	201	74	11.9	2.130	14.873	1.710	11.813
D-11	7.7	3.7	0.6	2.3	1661	309	368	296	191	62	8.5	0.951	20.011	3.844	23.293
D-4	7.2	3.7	0.5	2.0	1563	310	328	284	192	62	6.5	1.570	18.695	3.650	25.432
D+60 (bottom)	7.5	4.1	0.5	1.8	1555	320	336	319	191	51	6.0	4.072	12.083	0.477	13.158
D+60 (surface)	8.3	4.3	0.6	2.2	1659	366	336	331	207	62	7.4	0.984	12.144	1.631	13.543
Walter (Diver)															
D-30	7.1	3.8	0.6	1.5	949	132	73	368	261	69	3.8	2.139	13.977	4.875	25.125
D-11	8.2	4.0	0.9	2.0	1195	153	95	370	285	76	8.2	4.701	14.034	0.628	16.242
D-4	7.3	3.8	0.7	1.6	979	131	78	315	255	65	5.1	ND	ND	ND	ND
D+60 (bottom)	7.0	3.9	0.7	1.3	912	135	75	315	244	69	3.0	2.919	19.885	1.937	14.233
D+60 (surface)	7.3	3.9	0.7	1.5	939	139	75	372	265	78	3.7	4.622	10.416	3.341	11.703
Davis (Backup)															
D-30	6.9	3.8	0.7	1.2	931	105	182	359	247	81	7.8	3.800	27.325	4.619	16.513
D-11	7.5	3.8	0.7	1.7	1280	127	260	449	303	101	8.2	2.931	20.560	2.589	10.714
D-4	7.0	4.2	0.5	1.4	995	107	177	333	245	83	7.0	3.404	21.500	3.599	20.876
D+60 (bottom)	6.3	3.5	0.6	1.1	848	93	154	320	195	73	5.5	4.284	20.434	0.922	22.602

(Table Continues)

Table A14 (Continued)

Date Relative to D (Dive)	Serum Proteins										Muramidase (Lysozyme) ( $\mu\text{g}/\text{m}$ )	Lymphocyte Response (dis/min per 106 viable cells)			
	TSP (g-%)	Albumin (g-%)	$\alpha_2$ -globulin (g-%)	$\gamma$ -globulin (g-%)	$\gamma\text{-G}$ -globulin (mg-%)	$\gamma\text{-A}$ -globulin (mg-%)	$\gamma\text{-M}$ -globulin (mg-%)	$\alpha_2\text{M}$ -globulin (mg-%)	Transferrin	C'3 (mg-%)		RNA Synthesis		DNA Synthesis	
												PHA Stimulation	Unstimulated	PHA Stimulation	Unstimulated
Koblick (Backup)															
D-30	6.8	3.6	0.6	1.5	1035	264	118	301	223	59	5.359	25.477	4.427	15.538	
D-11	8.0	4.0	0.8	1.9	1259	297	146	312	267	49	4.255	27.326	1.089	12.579	
D-4	7.9	4.2	0.6	1.8	1171	256	134	284	259	47	4.952	24.870	3.259	14.202	
D+60 (bottom)	7.2	4.0	0.5	1.5	1048	273	122	293	232	49	5.206	16.725	2.489	12.290	
Phillips (Backup)															
D-30	7.6	3.7	0.7	2.2	1472	314	200	263	181	65	2.208	15.219	5.261	18.806	
D-11	8.3	4.0	0.7	2.5	1781	378	260	311	216	65	4.322	16.181	2.404	17.520	
D-4	7.8	4.0	0.6	2.1	1541	326	182	284	207	69	3.764	16.787	2.956	16.392	
D+60 (bottom)	7.0	4.0	0.5	1.5	1131	282	180	257	195	53	4.820	15.430	0.379	20.773	
Normal Ranges of Values ( $\pm 2$ standard deviations for plasma proteins and 90th percentile for lymphocyte response)															
Lower value	6.5	3.3	0.5	0.7	700	70	70	—	170	50	0.660	12.600	0.585	10.230	
Upper value	8.5	5.2	1.0	1.9	1700	350	210	—	420	140	8.700	32.950	9.370	30.730	
Mean	—	—	—	—	—	—	—	—	—	—	2.856	18.660	2.830	19.368	

\*Data accidentally omitted from manuscript.

†CRP (titers) and CRP (mg-%) are negative at 1:1 dilution. Other ranges (g-%) are: 45. S-A-comp., 5.4-6.9; 7S-G-comp., 0.6-1.2; and 19S-M-comp., 0.12-0.44.

The following are the conclusions regarding the controls.

For Lawrence Phillips, pre-dive values on three occasions showed elevations of total gamma globulin associated with concomitant increases in  $\gamma$ G-globulin,  $\gamma$ A-globulin, and  $\gamma$ M-globulin. On one occasion (D-30) a reduced transferrin value was obtained. These findings are compatible with an acute infectious disease on or about the D-30 examination. No significant post-dive abnormalities were observed.

For Ian Koblick and Gary Davis, no abnormalities were observed in any parameters throughout the observed periods.

No significant changes in any humoral or cellular immunologic parameters were identified relative to the dive interval.

#### A3.3.4 Blood Chemistries

C. L. Fischer and C. Leach Huntoon, NASA Manned Spacecraft Center,  
Biomedical Research Office, Houston, Texas

##### A3.3.4.1 Objectives, Measurements, and Methods

Specific objectives of the blood chemistry studies were (a) to determine the extent and time course of alterations in fluid and electrolyte balance and metabolism as reflected in selected biochemical constituents of the mission and (b) to document the physical qualifications of the crew members for the mission and to detect problems which could require remedial or preventive action, thereby insuring optimum performance and comfort.

The following measurements were made (with the methods in parentheses): true serum glucose (autoanalyzer); blood urea nitrogen (autoanalyzer); creatine (autoanalyzer); Na, K, Mg, Ca, and Cl (flame photometry and atomic absorption spectrometer); phosphorus (autoanalyzer); SGOT (Babson method); alkaline phosphatase (Babson and Phillips method); creatine phosphatase (Nuttall and Wedin method); uric acid (autoanalyzer); bilirubin, total and direct (Diazo method); serum and/or plasma osmolarity (freezing point osmometer); total red blood cell (RBC) and plasma lipid content\* (gravimetric analysis); neutral lipid fractionation to include RBC and plasma: cholesterol, cholesterol ester,\* free fatty acids,\* monoglycerides,\* diglycerides,\* and triglycerides (thin-layer chromatography and gas-liquid chromatography); phospholipid fractionation to include RBC and plasma: phosphatidic acid, phosphatidyl serine, phosphatidyl ethanolamine, phosphatidyl choline, phosphatidyl inositol, sphingomyelin, and lysolecithin (column chromatography, thin-layer chromatography, and gas-liquid chromatography); RBC and plasma steroids:\* tocopherol, i.e., vitamin E, and vitamin A (fatty acid pattern on all neutral and gas-liquid chromatography phospholipids, RBC, and plasma listed above); and hydrocortisone (cortisol-binding globulin).

##### A3.3.4.2 Results

The results are given in Tables A15, A16, and A17.

##### A3.3.4.3 Discussion of Results

The clinical biochemical parameters sampled showed no diagnostic abnormalities; however, several significant trends are evident.

\*The test was still in progress when this was written, and the results will be reported in other documents.



Table A15  
Serum/Chemistry Results

Date Relative to D (Dive)	Glucose	Blood Urea Nitrogen	Bili-rubin	Crea-tinine	Uric Acid	Alka-line Phos-phatase	Crea-tine Phos-phatase	LDH	SGOT	Na	K	Mg	Ca	Cl	PO <sub>4</sub>	Choles-terol	Trigly-cerides	Osmo-larity
Clifton (Diver)																		
D-30	98	17	0.5	1.0	5.7	24	7	41	17	141.0	4.9	2.4	9.6	110	4.5	223	159	289
D-11	78	15	0.2	1.0	5.6	28	28	52	24	142.5	4.4	2.6	9.6	109	3.8	223	82	288
D-5	78	15	0.6	0.9	5.2	26	28	54	29	140.5	3.9	2.6	9.2	104	3.0	206	22	309
D+14	78	19	0.4	1.1	5.1	32	34	54	28	141.0	4.0	2.5	9.1	102	3.9	187	65	286
D+21	80	15	0.9	1.0	5.5	32	30	61	30	141.5	4.2	2.5	9.8	104	3.2	235	103	286
D+28	85	18	0.6	1.0	5.5	31	26	55	31	143.0	3.8	2.4	9.5	104	3.4	210	88	290
D+35	82	18	0.9	1.1	5.9	29	26	25	32	143.5	4.1	2.5	10.2	104	3.8	247	126	288
D+42	84	16	0.3	1.1	5.0	19	28	50	29	139.5	4.3	2.4	9.7	104	3.9	205	138	282
D+49	86	22	0.6	1.1	6.1	30	20	55	31	143.0	4.5	2.5	10.0	105	3.2	235	115	295
D+56	93	21	0.7	1.0	5.3	29	22	53	27	144.0	4.4	2.5	9.7	109	3.6	222	98	308
D+60 (Bottom)	76	19	0.6	1.1	5.3	27	32	45	28	140.5	3.8	2.5	9.2	104	3.4	205	43	287
D+60 (Surface)	82	19	0.7	1.0	5.1	25	18	51	38	140.0	4.4	2.5	9.0	102	3.4	205	85	284
Mahnken (Diver)																		
D-30	81	17	0.9	1.0	4.9	29	11.9	51	25	140.0	4.4	2.4	9.7	108	3.4	155	125	292
D-11	71	17	0.9	1.0	6.6	33	ND	61	32	143.0	3.9	2.3	10.5	110	3.2	168	50	290
D-5	131	16	0.5	1.0	7.2	31	21	65	37	143.5	3.8	2.6	9.9	105	3.1	145	<10	302
D+1	104	19	0.8	1.0	5.4	32	53	53	39	138.0	4.4	2.3	9.4	105	2.9	200	77	280
D+14	74	17	0.5	1.0	5.3	40	15	57	31	143.0	4.2	2.5	10.0	103	3.6	148	39	293
D+21	79	17	0.8	1.0	5.5	36	15	12	30	143.0	4.2	2.3	9.8	104	3.0	197	94	282
D+28	87	18	0.7	1.0	5.5	39	17	49	33	144.0	4.4	2.4	10.1	106	3.6	175	75	296
D+35	75	19	0.8	1.1	5.7	35	12	56	33	144.0	4.4	2.4	10.1	105	3.6	175	95	289
D+42	82	16	0.6	1.1	5.4	20	17	53	33	143.5	4.5	2.5	10.1	105	3.2	153	90	291
D+49	83	21	0.8	1.1	5.6	32	15	54	35	144.0	4.6	2.6	10.3	103	3.2	162	124	299
D+56	93	20	0.6	1.0	5.1	33	ND	50	31	145.0	4.5	2.6	10.1	112	3.7	153	113	248
D+60 (Bottom)	69	17	0.5	1.0	4.6	31	20	60	25	139.5	4.0	2.3	9.2	101	3.2	151	59	234
D+60 (Surface)	85	20	0.9	1.0	5.4	29	19	55	41	140.0	4.0	2.5	9.5	104	3.2	153	50	234
Van Derwalker (Diver)																		
D-30	86	15	1.2	1.1	5.6	18	3	43	16	141.0	4.0	2.4	10.0	104	4.7	144	128	288
D-11	101	16	1.5	1.1	5.7	14	ND	46	29	138.0	3.7	2.2	9.8	105	2.8	145	34	283
D-5	82	10	0.8	1.0	5.4	15	19	52	23	141.5	3.6	2.2	9.8	103	2.8	135	37	280
D+1	97	21	1.1	1.1	5.4	13	5	46	31	137.5	3.8	2.3	9.5	99	3.3	171	72	280
D+14	94	18	1.4	1.1	5.3	18	43	65	35	141.5	3.8	2.4	9.4	102	2.8	138	38	283
D+21	81	17	1.5	1.0	5.7	16	18	48	24	142.0	4.1	2.1	9.2	101	2.9	164	101	287
D+28	82	19	1.2	1.0	6.0	17	21	53	30	142.5	4.0	2.3	10.0	103	3.2	204	730	294
D+35	74	18	1.9	1.2	6.4	16	14	49	26	142.5	4.0	2.2	9.8	102	3.6	175	72	286
D+42	74	17	1.0	1.2	5.9	27	14	46	30	139.0	4.1	2.2	9.8	100	3.7	153	147	282
D+49	81	20	0.9	1.1	6.1	16	11	51	35	141.0	4.2	2.3	9.6	103	3.1	175	139	293
D+56	94	22	1.0	1.1	6.0	16	12	49	32	144.5	4.2	2.4	9.8	108	3.2	175	70	310
D+60 (Bottom)	76	19	0.8	1.1	5.7	13	6	48	31	138.5	3.6	2.3	9.3	102	2.9	163	61	284
D+60 (Surface)	90	18	1.7	1.1	5.7	13	5	47	35	139.0	4.0	2.4	9.6	103	3.0	146	32	282
Waller (Diver)																		
D-30	89	14	0.5	1.1	5.2	15	5	40	22	142.0	5.0	2.5	9.9	110	4.2	195	220	286
D-11	84	13	0.8	1.1	5.5	17	16	45	20	142.5	3.9	2.5	9.8	106	2.9	194	40	280
D-5	67	12	0.3	1.0	5.5	17	16	37	23	140.0	4.0	2.3	9.5	108	2.8	205	ND	276
D+1	67	17	1.0	1.1	6.0	15	8	44	28	136.5	3.8	2.6	9.6	100	3.1	142	80	274
D+14	76	21	ND	1.1	4.9	8	12	45	29	143.0	3.8	ND	9.4	105	ND	200	73	284
D+21	80	14	0.7	1.0	5.9	17	10	75	55	143.0	4.4	2.4	9.7	106	3.3	231	101	284
D+28	84	18	0.6	1.0	5.8	16	7	52	35	143.0	4.0	2.5	9.7	104	3.2	240	ND	297
D+35	75	19	0.7	1.1	5.8	16	16	58	35	142.5	4.0	2.4	10.2	103	4.1	236	126	285
D+42	80	15	0.3	1.1	5.3	20	14	43	26	142.5	4.0	2.4	9.6	105	4.4	215	117	287
D+49	88	18	0.9	1.0	6.1	18	12	66	36	142.5	4.2	2.4	10.0	105	3.4	225	139	295
D+56	84	22	0.7	1.0	5.7	18	20	48	39	144.5	4.0	2.6	9.9	108	3.1	195	85	297
D+60 (Bottom)	78	18	0.5	1.0	5.5	16	18	50	26	138.0	3.3	2.5	9.4	100	2.9	203	48	282
D+60 (Surface)	88	16	0.3	1.0	5.7	17	8	47	22	140.5	3.8	2.6	9.4	106	3.4	203	ND	280

(Table continues)

Table A15 (Continued)

Date Relative to D (Dive)	Glucose	Blood Urea Nitrogen	Bilirubin	Creatinine	Uric Acid	Alkaline Phosphatase	Creatine Phosphatase	LDH	SGOT	Na	K	Mg	Ca	Cl	PO <sub>4</sub>	Cholesterol	Triglycerides	Osmolarity
Davis (Control)																		
D-30	105	14	0.4	1.2	6.2	20	104	57	79	142.0	4.8	2.4	10.6	106	3.7	172	85	285
D-11	74	17	0.5	1.1	6.1	20	23	51	32	141.0	4.0	2.4	10.0	105	2.9	185	41	293
D-5	84	15	0.8	1.0	5.7	21	53	57	24	140.5	3.6	2.3	9.9	103	3.0	176	10	280
D+14	82	21	0.4	1.3	6.0	24	50	57	26	144.0	4.3	2.4	10.2	104	3.2	153	39	294
D+21	84	16	0.9	1.1	6.0	24	30	69	43	142.0	4.6	2.2	10.2	104	2.6	168	79	284
D+28	92	13	0.7	1.2	6.3	25	58	57	30	141.5	3.8	2.0	10.2	104	2.6	168	QNS	284
D+35	82	18	0.7	1.1	6.2	19	23	55	38	143.0	4.2	2.3	10.1	105	3.4	177	101	292
D+42	88	17	0.5	1.1	5.9	21	32	54	33	141.0	4.0	2.1	10.1	104	2.8	183	121	285
D+49	77	16	0.6	1.1	5.0	20	24	57	34	141.5	3.8	2.2	9.9	103	3.4	173	131	286
D+56	95	18	0.5	1.1	5.7	24	20	71	35	139.5	4.4	2.3	10.3	107	3.1	183	98	293
D+60 (Bottom)	85	16	0.4	1.2	6.1	25	19	44	28	143.5	3.6	2.2	9.6	107	2.1	153	105	288
D+60 (Surface)	96	14	0.7	1.1	5.6	22	16	48	34	140.5	4.0	2.2	9.6	106	2.6	151	68	283
Koblick (Control)																		
D-30	106	14	0.2	1.2	6.0	20	16	36	18	139.5	4.6	2.1	9.9	105	3.6	164	148	289
D-11	80	16	1.3	1.2	6.0	21	27	47	24	140.0	3.6	2.0	9.6	101	2.7	192	34	282
D-5	90	14	0.5	1.1	6.3	20	32	50	32	141.5	4.3	2.2	9.8	104	3.6	178	35	288
D+14	90	15	1.2	1.2	5.9	22	50	49	36	142.5	4.4	2.2	9.7	104	3.3	193	24	295
D+21	88	17	0.6	1.1	6.0	21	30	55	34	141.5	4.9	2.1	10.0	104	3.4	184	75	282
D+28	91	17	0.6	1.2	6.5	22	23	58	33	140.5	4.6	2.0	10.3	102	3.0	204	24	285
D+35	78	18	1.2	1.2	5.7	29	42	43	34	140.0	4.2	2.1	9.9	100	3.7	210	96	285
D+42	86	16	1.2	1.2	6.3	20	38	50	35	140.0	4.2	4.2	10.1	103	3.5	213	115	284
D+49	75	18	0.8	1.2	6.5	18	46	51	38	141.0	3.9	2.2	9.8	103	4.5	185	120	287
D+56	113	19	0.7	1.1	6.6	19	28	59	35	139.0	4.6	2.1	9.9	108	3.3	193	118	299
D+60 (Bottom)	91	18	0.8	1.2	6.0	16	32	41	26	141.5	4.1	2.3	9.5	106	3.4	182	65	284
D+60 (Surface)	82	13	0.6	1.1	6.8	18	32	49	32	139.0	4.5	2.1	9.5	104	2.5	185	131	279
Phillips (Control)																		
D-30	112	15	<0.8	0.8	4.1	20	7	43	20	140.0	5.0	2.4	9.9	109	3.4	109	280	QNS
D-11	88	14	0.6	0.9	5.5	22	21	50	11	141.5	4.3	2.7	9.8	108	3.8	176	218	289
D-5	84	14	ND	0.7	4.9	26	9	59	31	140.0	3.8	2.6	9.6	106	3.4	186	285	284
D+14	78	17	0.9	1.0	5.4	28	17	56	31	142.0	4.2	2.6	9.7	102	4.1	140	220	284
D+21	97	17	1.2	0.8	5.3	26	23	52	28	140.5	3.9	2.4	9.8	106	3.4	164	226	284
D+28	85	16	0.7	0.9	5.3	25	13	59	21	140.0	4.2	2.4	10.2	103	3.8	178	QNS	293
D+35	79	14	0.9	0.9	5.2	21	18	56	26	140.5	3.9	2.5	9.7	106	3.9	167	357	286
D+42	74	15	0.5	0.9	4.7	26	15	47	26	141.0	3.8	2.4	9.5	105	3.7	157	>250	288
D+49	73	15	0.8	1.0	5.1	22	6	54	33	141.0	3.9	2.4	9.8	104	4.3	158	162	287
D+56	99	20	0.8	0.9	5.3	23	13	69	33	138.5	4.4	2.5	10.1	108	3.9	163	125	298
D+60 (Bottom)	88	18	1.0	1.0	5.3	20	15	49	31	141.5	4.0	2.6	9.4	107	4.0	148	141	287
D+60 (Surface)	88	18	1.2	0.9	5.6	20	12	48	29	139.0	4.2	2.5	9.8	107	3.3	151	115	284

The blood urea nitrogen (BUN) appears generally to increase over the last weeks of the dive interval, with return toward pre-dive control values after decompression (Table A15). Rising BUN values are often associated with prerenal diversion of water, increased protein catabolism, and impaired renal function. No evidence of renal impairment is found in the associated chemistry data, and dehydration is not indicated. Increased protein catabolism, or dietary factors are probably contributory.

Serum glutamic oxalacetic transaminase (SGOT) levels showed an unexplained increase during the dive interval (Table A15). Since these elevations were not associated with other enzyme shifts, this isolated finding is of no diagnostic importance.

Table A16  
Electrophoresis Results

Date Relative to D (Dive)	Lipo $\alpha_1$	Pre $\beta$	$\beta$	LDH					TP	Albu- min	$\alpha_1$	$\alpha_2$	$\beta$	$\gamma$
				1	2	3	4	5						
Clifton (Diver)														
D - 30	27	22	43	23	29	22	3	1	6.8	4.1	0.2	0.6	0.8	1.1
D - 11	30	24	47	35	19	34	7	4	7.4	4.5	0.1	0.6	0.8	1.3
D - 5	26	17	59	25	26	29	14	4	6.9	4.2	0.1	0.7	0.6	1.2
D + 14	ND	ND	ND	28	37	26	6	4	7.3	4.4	0.1	0.8	0.8	1.2
D + 21	31	23	46	27	26	27	7	12	7.7	4.6	0.2	0.8	0.9	1.2
D + 28	22	23	55	36	32	20	4	7	7.3	4.3	0.1	0.9	0.8	1.2
D + 35	27	16	57	ND	ND	ND	ND	ND	7.7	4.4	0.1	0.7	0.7	1.7
D + 42	ND	ND	ND	ND	ND	ND	ND	ND	7.4	4.6	0.1	0.6	0.6	1.3
D + 49	28	13	60	25	35	28	8	5	7.7	4.6	0.4	0.7	0.8	1.3
D + 56	27	18	55	26	34	20	11	9	7.8	5.2	0.1	0.6	0.7	1.2
D + 60 (bottom)	ND	ND	ND	ND	ND	ND	ND	ND	7.2	4.5	0.2	0.6	0.7	1.2
D + 60 (surface)	ND	ND	ND	ND	ND	ND	ND	ND	7.0	4.5	0.2	0.6	0.6	1.1
Mahnken (Diver)														
D - 30	26	23	39	19	29	21	3	5	6.6	4.5	0.2	0.4	0.6	0.8
D - 11	40	21	37	28	39	28	6	2	7.2	4.7	0.2	0.5	0.8	1.0
D - 5	39	19	44	22	30	38	5	4	7.0	4.3	0.2	0.7	0.7	1.1
D + 1	ND	ND	ND	ND	ND	ND	ND	ND	6.6	4.3	0.2	0.5	0.6	1.0
D + 14	ND	ND	ND	27	39	26	4	3	7.3	5.0	0.1	0.6	0.7	0.9
D + 21	26	23	55	25	36	19	10	10	6.9	4.3	0.2	0.6	0.8	1.0
D + 28	30	23	45	34	38	21	3	4	7.0	4.3	0.1	0.7	0.8	1.0
D + 35	27	22	51	ND	ND	ND	ND	ND	7.1	4.5	0.1	0.9	0.6	1.0
D + 42	ND	ND	ND	ND	ND	ND	ND	ND	7.0	4.5	0.2	0.7	0.6	1.0
D + 49	34	21	44	23	37	22	11	8	7.3	4.7	0.4	0.6	0.6	1.0
D + 56	28	16	56	24	39	20	9	8	7.1	4.8	0.1	0.7	0.5	1.0
D + 60 (bottom)	ND	ND	ND	26	42	17	9	6	6.8	4.4	0.2	0.4	0.6	1.1
D + 60 (surface)	ND	ND	ND	ND	ND	ND	ND	ND	6.5	4.2	0.2	0.5	0.6	1.0
Van Derwalker (Diver)														
D - 30	33	17	45	22	35	29	8	2	7.9	4.8	0.2	0.5	0.8	1.5
D - 11	31	23	50	30	28	38	5	3	7.5	4.5	0.1	0.5	0.8	1.5
D - 5	32	19	49	27	28	32	4	9	7.0	4.1	0.1	0.4	0.7	1.6
D + 1	ND	ND	ND	ND	ND	ND	ND	ND	7.8	4.6	0.3	0.5	0.6	1.8
D + 14	ND	ND	ND	25	37	29	5	4	7.5	4.5	0.2	0.6	0.8	1.5
D + 21	36	30	38	23	42	16	10	9	7.2	4.2	0.2	0.6	0.8	1.4
D + 28	27	25	49	37	31	20	4	8	7.9	4.4	0.2	0.7	0.9	1.7
D + 35	32	18	50	ND	ND	ND	ND	ND	7.8	4.5	0.1	0.7	0.8	1.7
D + 42	ND	ND	ND	ND	ND	ND	ND	ND	7.9	4.8	0.2	0.5	0.6	1.7
D + 49	34	19	46	24	35	22	9	10	7.8	4.5	0.4	0.6	0.8	1.6
D + 56	33	16	50	23	35	25	9	9	7.7	4.9	0.2	0.4	0.5	1.5
D + 60 (bottom)	ND	ND	ND	17	36	27	14	6	7.4	4.6	0.2	0.4	0.6	1.6
D + 60 (surface)	ND	ND	ND	ND	ND	ND	ND	ND	7.3	4.4	0.2	0.5	0.6	1.6

(Table continues)

Table A16 (Continued)

Date Relative to D (Dive)	Lipo $\alpha_1$	Pre $\beta$	$\beta$	LDH					TP	Albu- min	$\alpha_1$	$\alpha_2$	$\beta$	$\gamma$
				1	2	3	4	5						
Waller (Diver)														
D - 30	23	17	56	21	33	22	4	1	6.9	4.0	0.3	0.6	1.0	1.0
D - 11	26	21	53	31	28	34	5	3	7.5	4.5	0.2	0.7	0.8	1.2
D - 5	34	14	53	32	23	30	10	0	7.1	4.5	0.2	0.6	0.8	1.1
D + 1	ND	ND	ND	ND	ND	ND	ND	ND	6.8	4.3	0.2	0.6	0.7	1.0
D + 14	ND	ND	ND	25	37	26	7	5	7.2	4.7	0.2	0.6	0.8	0.9
D + 21	22	24	55	27	33	24	6	9	7.1	4.3	0.2	0.7	0.8	1.0
D + 28	20	21	58	28	33	23	6	10	7.1	4.3	0.2	0.7	0.9	1.0
D + 35	23	21	56	ND	ND	ND	ND	ND	7.8	4.7	0.2	0.8	0.9	1.2
D + 42	ND	ND	ND	ND	ND	ND	ND	ND	7.1	4.7	0.1	0.6	0.7	1.0
D + 49	25	19	55	24	36	23	10	8	7.7	4.8	0.4	0.8	0.8	1.0
D + 56	29	15	56	22	36	18	13	10	7.6	4.8	0.1	0.7	0.8	1.2
D + 60 (bottom)	ND	ND	ND	18	36	27	14	5	7.2	4.7	0.2	0.6	0.7	1.1
D + 60 (surface)	ND	ND	ND	18	36	27	14	5	7.2	4.7	0.2	0.6	0.7	1.1
Davis (Control)														
D - 30	25	20	55	17	27	30	4	1	6.8	4.1	0.3	0.7	0.7	1.0
D - 11	25	22	53	34	29	29	5	4	7.0	4.5	0.2	0.5	0.7	1.0
D - 5	22	27	49	24	34	23	11	6	6.7	4.4	0.1	0.6	0.6	0.9
D + 14	ND	ND	ND	26	35	21	9	9	7.1	4.5	0.2	0.6	0.8	1.0
D + 21	28	30	44	27	37	27	5	4	7.2	4.6	0.3	0.6	0.8	0.9
D + 28	26	18	55	28	33	22	7	11	6.7	4.3	0.2	0.6	0.7	0.9
D + 35	19	18	63	ND	ND	ND	ND	ND	6.8	4.4	0.2	0.6	0.7	0.9
D + 42	ND	ND	ND	ND	ND	ND	ND	ND	7.2	4.7	0.2	0.6	0.6	1.1
D + 49	20	19	61	24	35	23	9	9	6.8	4.0	0.4	0.6	0.8	1.0
D + 56	29	22	49	23	33	28	9	8	7.4	5.0	0.2	0.6	0.6	0.9
D + 60 (bottom)	ND	ND	ND	22	42	24	11	9	6.6	4.2	0.2	0.5	0.7	1.0
D + 60 (surface)	ND	ND	ND	ND	ND	ND	ND	ND	6.2	3.8	0.2	0.5	0.8	0.9
Koblick (Control)														
D - 30	31	23	45	27	24	23	5	2	6.8	3.9	0.4	0.6	0.6	1.2
D - 11	45	14	41	29	30	33	7	4	7.2	4.7	0.2	0.5	0.8	1.1
D - 5	29	22	50	35	31	24	5	5	7.1	4.5	0.1	0.5	0.7	1.2
D + 14	ND	ND	ND	27	33	26	9	5	7.3	4.7	0.1	0.5	0.7	1.2
D + 21	37	27	35	22	33	28	9	8	7.1	4.2	0.2	0.6	0.9	1.1
D + 28	39	21	40	31	32	21	7	9	7.2	4.2	0.2	0.8	1.0	1.1
D + 35	33	15	52	ND	ND	ND	ND	ND	6.9	4.4	0.1	0.5	0.7	1.2
D + 42	ND	ND	ND	ND	ND	ND	ND	ND	7.7	5.0	0.1	0.4	0.8	1.4
D + 49	41	20	39	22	33	25	9	11	6.7	4.1	0.4	0.5	0.6	1.1
D + 56	37	17	46	28	36	20	7	8	7.6	5.0	0.2	0.5	0.8	1.2
D + 60 (bottom)	ND	ND	ND	19	39	22	14	6	7.3	4.6	0.2	0.4	0.6	1.4
D + 60 (surface)	ND	ND	ND	ND	ND	ND	ND	ND	6.9	4.2	0.2	0.5	0.8	1.2
Phillips (Control)														
D - 30	20	25	52	14	32	22	6	2	7.2	3.7	0.3	0.8	0.7	1.6
D - 11	24	30	46	30	35	24	7	5	7.9	4.9	0.1	0.4	0.9	1.5
D - 5	15	24	62	17	36	25	15	5	7.6	4.6	0.1	0.6	0.8	1.5
D + 14	ND	ND	ND	27	37	21	8	6	7.8	4.9	0.2	0.6	0.8	1.4
D + 21	25	61	20	22	38	18	12	11	7.5	4.7	0.1	0.6	0.8	1.3
D + 28	25	44	30	26	31	32	6	5	7.5	4.6	0.2	0.6	0.8	1.4
D + 35	18	13	69	ND	ND	ND	ND	ND	7.5	4.6	0.2	0.7	0.7	1.3
D + 42	ND	ND	ND	ND	ND	ND	ND	ND	6.8	4.2	0.2	0.6	0.5	1.3
D + 49	27	13	60	21	35	25	10	9	7.1	4.3	0.4	0.5	0.7	1.2
D + 56	29	39	32	22	35	22	12	9	7.9	5.3	0.1	0.4	0.7	1.3
D + 60 (bottom)	ND	ND	ND	25	39	23	11	3	6.8	4.5	0.1	0.5	0.6	1.2
D + 60 (surface)	ND	ND	ND	ND	ND	ND	ND	ND	6.9	4.2	0.2	0.5	0.6	1.4

Table A17  
Hydrocortisone Results

Date Relative to D (Dive)	Plasma Hydrocortisone* ( $\mu\text{g}/100\text{ ml}$ )						
	Clifton	Mahnken	Van Der-walker	Waller	Davis	Koblick	Phillips
D - 30	9.8	11.5	11.2	9.5	10.8	8.2	15.3
D - 11	21.0	4.8	24.6	8.5	14.6	11.9	20.0
D - 5	10.4	10.5	13.0	15.9	10.2	12.0	7.0
D + 28	19.0	19.4	19.8	19.0	9.4	10.0	6.2
D + 56	12.2	9.0	15.5	14.5	10.1	9.2	9.5
D + 60 (bottom)	18.5	16.8	12.8	16.0	10.8	11.3	11.0
D + 60 (surface)	10.0	9.8	11.0	6.2	11.8	23.2	20.8
D + 61	24.8	17.0	23.5	30.8	6.8	6.0	15.0

\*Normal values = 10 to 20  $\mu\text{g}/100\text{ ml}$ ; 1 standard deviation = 0.5.

The plasma hydrocortisone values (Table A17) demonstrate considerable interindividual variability. Although there are no abnormal results, certain trends are of interest and merit further discussion and investigation. There is a suggestion of a decrease in values during the in-dive phase (between the fourth and eighth week) on all four divers which does not appear in the control values. The significance of this is not apparent, although one explanation could be the operation of an adaptative process. The apparent increase subsequent to the eighth-week sample could be due to the "expectation" excitement and anticipation of leaving the habitat.

Another interesting trend is the slight decrease in values seen from the sample drawn on the bottom and that drawn immediately after decompression. This same sort of trend has been noted, but unexplained, in the Apollo flights subsequent to splashdown. Further work is being planned to consider the control mechanisms involved in this neuroendocrine process.

#### A3.3.5 Instructions to Aquanauts on Blood Drawing and Processing

The following were the instructions given to the aquanauts concerning blood drawing and processing:

##### A. Basic principles of blood drawing

1. Set the crewman's arm in a comfortable position, fully extended.
2. Place a tourniquet on the upper arm — not too tight.
3. Have the crewman pump his hand for several seconds or until a prominent vein appears.
4. Cleanse the area around the vein selected.
5. Maintaining the sterility of the needle, enter the vein through the area cleansed and aspirate the syringe until blood freely flows. (If on two successive occasions, the vein is not entered, have another crewman perform the venapuncture.)
6. Then RELEASE TOURNIQUET and draw an appropriate sample into the syringe (see the sample chart).

Sample Chart

Indive Week	Date	Volume of Draw (ml)	Indive Week	Date	Volume of Draw (ml)
2	2/26/69	24	6	3/26/69	31
3	3/05/69	31	7	4/02/69	24
4	3/12/69	34	8	4/09/69	34
5	3/19/69	24			

7. When a sample has been acquired, place a clean dry sponge over the needle puncture site and withdraw the needle quickly.

8. Distribute the blood into the tubes provided. Invert the tubes gently ten times for adequate anticoagulation.

#### B. Blood Processings

All samples tubes are provided and pre-labeled for each weekly sampling period. Different amounts are required on various weeks, with different anticoagulants. For sample tube selection, each tube is color-coded. Select a set of color-coded tubes according to the sample chart. Fill each tube to the red mark, and gently oscillate it ten times. *Push a needle through each tube top, thereby providing a vent for decompression!*

### A3.4 Microbiology of the Aquanauts and Their Environment

#### A3.4.1 Introduction

Andre B. Cobet and John P. Hresko, Naval Biological Laboratory, Oakland, California

The relationship between man and his environment is important in maintaining a proper balance among those microorganisms which comprise his indigenous microflora and hence his health and well being. Slight changes in the environment may reflect themselves as an alteration in this balance. The conditions necessary to sustain the Tektite I habitat in the submerged state from an engineering standpoint, the confinement of the aquanauts to the habitat and marine environment, and the interactions of the aquanauts, both with each other and the environment are major factors, each with its myriad of minor interacting elements, that can affect man's indigenous microflora. A study of the effect of these conditions in prolonged submergence is necessary to define the effects of such an environment on the microorganisms associated with the aquanauts.

An extensive study was carried out to determine the types, the numbers, and the frequency of occurrence of microorganisms in five body sites, two areas on the interior surface of the habitat, and the air within the habitat during the 59-day period of the Tektite I program. Samples of microbiological analysis were taken before and during the period of submergence. The continued sampling through the entire program allows for evaluation of the various experimental conditions in terms of their influence on the microflora.

### A3.4.2 General Sampling Procedures

Andre B. Cobet and John P. Hresko,  
Naval Biological Laboratory

#### A3.4.2.1 Aquanauts

To determine changes in the bacterial and fungal flora associated with the aquanauts samples were collected at various body sites with the aid of saline-wetted, cotton-tipped sterile swabs. The sites sampled were the forearm (approximately 9 sq in.), behind the knee (approximately 5 sq in.), the throat, the ear, and the rectum (immediately after defecation). The swab tips were broken off in 1-dram vials containing 1.2 ml of media composed of brain-heart infusion broth (Difco) containing 10% horse serum and 5% glycerol. The sampling of each aquanaut was made twice weekly, on Wednesday and Saturday, in the morning before entry into the water and not before 4 hours had elapsed since showering.

Samples were also obtained from the throat and rectum of each aquanaut for virological analysis. The swabs were collected as above, and for each sample one swab was rinsed in a 1-dram vial with 1.2 ml of veal infusion broth (Difco) containing 0.5% bovine albumin and a second swab was placed in a test tube containing the charcoal viral transport medium (CVTR) of Leibovitz.\* Sampling was performed on a 10-day schedule to coincide with the bacterial and fungal sampling.

Serum samples were obtained from each aquanaut before the start of the program and on a weekly basis during the dive. The serum was collected as part of the hematology program. The sera were maintained at -60°C and sent to the Naval Biological Laboratory (NBL) with the virus samples.

#### A3.4.2.2 Habitat

To determine if changes in population or an accumulation of bacteria and fungi occurred during the 59 days of the program the habitat walls were sampled at intervals in the crew quarters and in the wet lab. These sites were sampled on the same schedule and handled in a similar manner as the samples obtained from the aquanauts. The site sampled had not previously been swabbed in order that an accumulation of bacteria could be detected. The sites are depicted in Figs. A28 and A29 and represent an area of 8 sq in.

At the completion of the program, small patches of rug were removed from the various spaces in the habitat and sent to the surface for mycological examination.

The swabs and vials for aquanaut and habitat sampling were transferred to the aquanauts on the afternoon of the day prior to sampling. In the event that the rectal sample was collected during the day or night before the sample day, the vial was stored in the refrigerator until returned to the surface with those samples obtained at the scheduled time.

#### A3.4.2.3 Aerobiology

Habitat air was sampled four times weekly in the wet lab using two six-stage Andersen samplers.† Half-strength trypticase soy agar (TSA), a general-purpose medium, was

\*A. Leibovitz, "A Transport Medium for Diagnostic Virology," Proc. Soc. Exptl. Biol. Med. 131, 127-130 (1969).

†A. Andersen, "A New Sampler for the Collection, Sizing and Enumeration of Viable Airborne Particles." J. Bacteriol. 76, 471-484 (1958).

### A3.4.2 General Sampling Procedures

Andre B. Cobet and John P. Hresko,  
Naval Biological Laboratory

#### A3.4.2.1 Aquanauts

To determine changes in the bacterial and fungal flora associated with the aquanauts samples were collected at various body sites with the aid of saline-wetted, cotton-tipped sterile swabs. The sites sampled were the forearm (approximately 9 sq in.), behind the knee (approximately 5 sq in.), the throat, the ear, and the rectum (immediately after defecation). The swab tips were broken off in 1-dram vials containing 1.2 ml of media composed of brain-heart infusion broth (Difco) containing 10% horse serum and 5% glycerol. The sampling of each aquanaut was made twice weekly, on Wednesday and Saturday, in the morning before entry into the water and not before 4 hours had elapsed since showering.

Samples were also obtained from the throat and rectum of each aquanaut for virological analysis. The swabs were collected as above, and for each sample one swab was rinsed in a 1-dram vial with 1.2 ml of veal infusion broth (Difco) containing 0.5% bovine albumin and a second swab was placed in a test tube containing the charcoal viral transport medium (CVTR) of Leibovitz.\* Sampling was performed on a 10-day schedule to coincide with the bacterial and fungal sampling.

Serum samples were obtained from each aquanaut before the start of the program and on a weekly basis during the dive. The serum was collected as part of the hematology program. The sera were maintained at -60°C and sent to the Naval Biological Laboratory (NBL) with the virus samples.

#### A3.4.2.2 Habitat

To determine if changes in population or an accumulation of bacteria and fungi occurred during the 59 days of the program the habitat walls were sampled at intervals in the crew quarters and in the wet lab. These sites were sampled on the same schedule and handled in a similar manner as the samples obtained from the aquanauts. The site sampled had not previously been swabbed in order that an accumulation of bacteria could be detected. The sites are depicted in Figs. A28 and A29 and represent an area of 8 sq in.

At the completion of the program, small patches of rug were removed from the various spaces in the habitat and sent to the surface for mycological examination.

The swabs and vials for aquanaut and habitat sampling were transferred to the aquanauts on the afternoon of the day prior to sampling. In the event that the rectal sample was collected during the day or night before the sample day, the vial was stored in the refrigerator until returned to the surface with those samples obtained at the scheduled time.

#### A3.4.2.3 Aerobiology

Habitat air was sampled four times weekly in the wet lab using two six-stage Andersen samplers.† Half-strength trypticase soy agar (TSA), a general-purpose medium, was

\*A. Leibovitz, "A Transport Medium for Diagnostic Virology," *Proc. Soc. Exptl. Biol. Med.* 131, 127-130 (1969).

†A. Andersen, "A New Sampler for the Collection, Sizing and Enumeration of Viable Airborne Particles," *J. Bacteriol.* 76, 471-484 (1958).



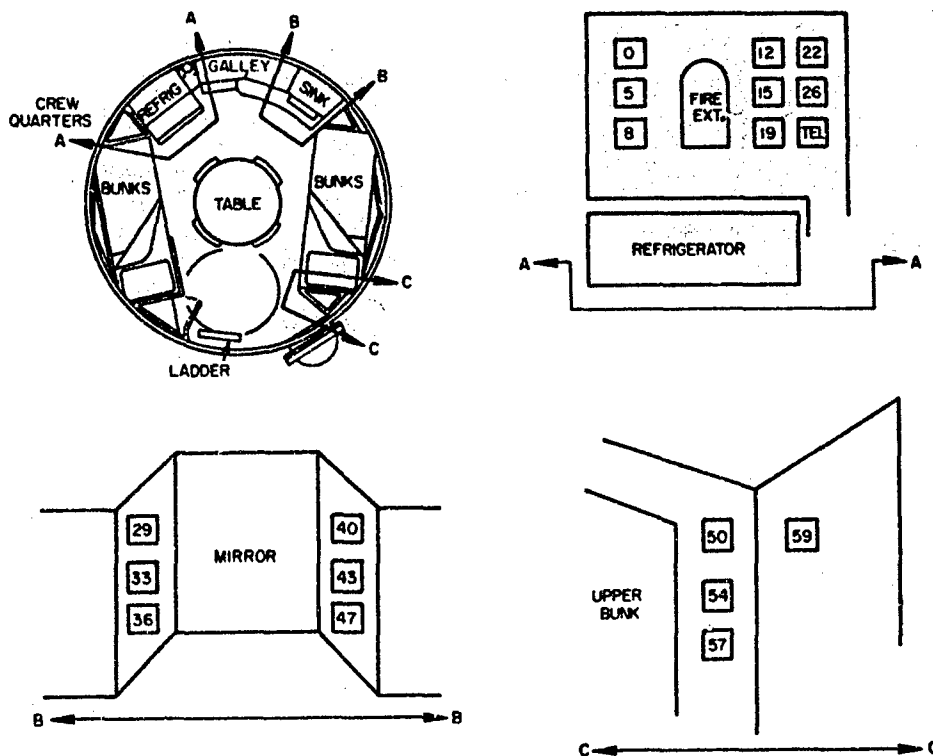

Fig. A28 - Placement of sampling sites on the walls of the crew quarters. The number in each square represents the day of the dive that the square was sampled.

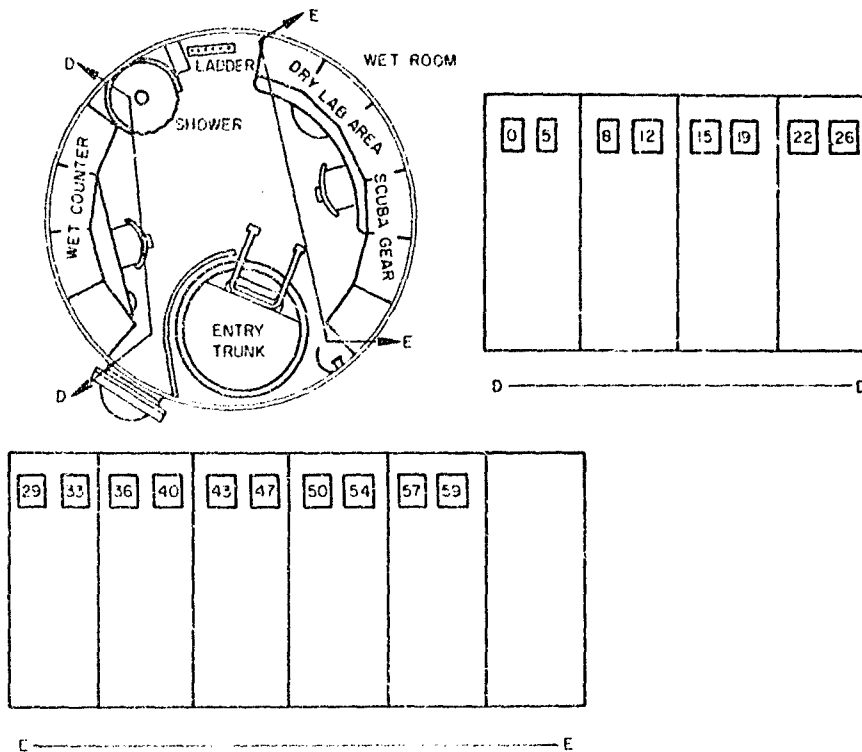

Fig. A29 - Placement of sampling sites on the walls in the wet lab. The number in each square represents the day of the dive that the square was sampled.

used to obtain the background population at each sampling. The second sampler employed a selective medium to include either Tergitol-7 (Difco), BAGG (Difco), Staph 110 (Difco), marine agar (Difco), mannitol salt (Difco), EMB (Difco), or modified Sierra's *Pseudomonas* medium\* on a rotational basis. The Andersen samplers were loaded with the appropriate media on the surface and lowered to the aquanauts in sealed containers just prior to the taking of the air sample. They were taken by the aquanauts for a predetermined period of time, returned to the surface, and subsequently taken to the base camp for incubation. The schedule for air sampling was on Tuesday and Friday evenings and Wednesday and Saturday mornings.

#### A3.4.2.4 Marine Microbiology

Sea-water samples were collected from depths greater than 30 feet at four sites in the area of the habitat using the Cobet water sampler (Hydro Products) (Fig. A30). The sea water was analyzed by the membrane filter technique as outlined in "Standard Methods for the Examination of Water and Waste-Water"<sup>†</sup> using m-Endo Medium (Difco) for coliform enumeration.

\*A. H. Wahba and J. H. Darrell, "The Identification of Atypical Strains of *Pseudomonas aeruginosa*," J. Gen. Microbiol. 38, 329-342 (1965).

<sup>†</sup>Standard Methods for the Examination of Water and Waste-Water," 12th edition, Amer. Pub. Health Assoc. Inc., New York, 1965.

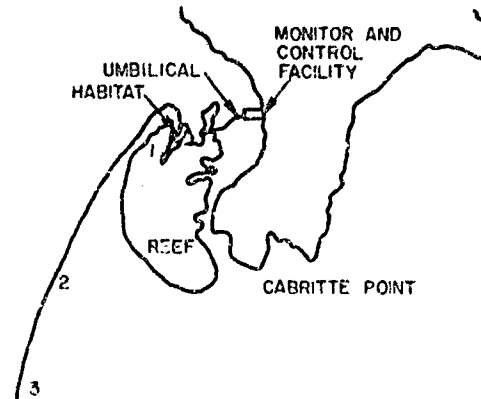

Fig. A30 - Sampling sites of sea water for the presence of coliform organisms

Oysters were obtained for virological analysis from two locations (Fig. A31), one in the area of the habitat in 47 feet of water and the second on the walls at the end of canyon 1 in 40 to 55 feet of water. The oysters, *Pteria colymbus* and *Ostrea frons*, were associated with the sea whips in the shaded areas depicted in Fig. A31.

The entire sampling schedule is presented according to microbiological discipline in Table A18.

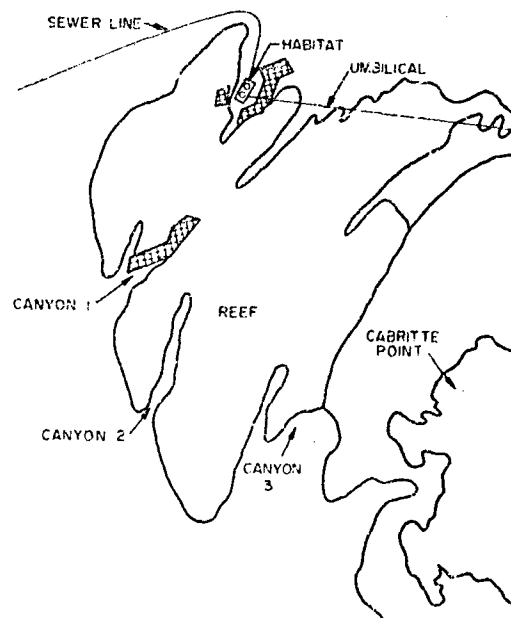

Fig. A31 - Collection sites of oysters for virological analysis. A single sample was collected from one of the two shaded areas near the habitat, and a second sample was collected from canyon 1.

Table A18  
 Schedule of Microbiology Sampling of the Aquanauts and Environment:  
 Aerobiology (A), Bacteriology (B), Mycology (M), Virology (V), Marine  
 Microbiology (P), Nasal Staphylococcus (N)

Day	A	B	M	V	P	N	Day	A	B	M	V	P	N	Day	A	B	M	V	P	N
0	X	X	X	X	X	X														
1							22	X	X	X			X	43						
2							23							44						X
3					X		24							45						
4	X						25	X						46	X					
5	X	X	X				26	X	X	X				47	X	X	X	X		
6							27					X		48						X
7	X				X		28	X						49	X					X
8	X	X	X	X			29	X	X	X	X			50	X	X	X			
9					X		30					X		51						X
10							31							52						
11	X						32	X						53	X					
12	X	X	X				33	X	X	X				54	X	X	X	X		
13					X		34							55						X
14	X						35	X				X		56	X					
15	X	X	X				36	X	X	X	X			57	X	X	X			
16					X		37					X		58					X	
17							38							59	X	X	X	X		X
18	X			X			39	X						60						
19	X	X	X	X			40	X	X	X			X	61	X					
20					X		41					X								
21	X						42													

#### A3.4.3 Sample Handling

Andre B. Cobet and John P. Hresko,  
 Naval Biological Laboratory

##### A3.4.3.1 Aerobiology

The two sets of agar plates in the Andersen samplers were removed and incubated at 30°C for 72 hours. The number of colonies of bacteria and fungi were recorded using a Quebec colony counter. Starting on day 35 and on each subsequent sampling day the most common colony appearing on stage 4 of the TSA sample-set was subcultured. The subcultures were returned to NBL and identified using standard bacteriological techniques.

##### A3.4.3.2 Mycology

The vials containing the sample swabs were shaken vigorously to suspend the bacteria and fungi in the holding medium. A 0.1-ml aliquot of the sample was plated to the surface of the three media: Sabouraud's glucose agar (Difco) containing penicillin and streptomycin, mycosel agar (Difco), and malt agar (Difco). The inoculated plates were placed in plastic bags with uninoculated control plates, packaged, and sent via air mail to NBL.

On selected occasions, sea water collected in the area of the habitat at site 1 (Fig. A30) was membrane-filtered in 100-ml aliquots, and the filter was placed on the surface of the three media above and sent to NBL.

#### A3.4.3.3 Bacteriology

The above vials were shaken to resuspend the material, and with a calibrated loop 0.01 ml was plated to the surface of a blood agar plate (BAP). The BAP was incubated at 37°C for 24 hours, and the resulting growth was quantitated and recorded for on-site evaluation. The vial with the remaining material was frozen at -60°C in an NBL miniature deepfreezer and held for shipment to NBL.

#### A3.4.3.4 Virology

Sample vials containing veal infusion broth were frozen to -60°C in an NBL miniature deepfreezer. The swab placed in CVTR holding medium was returned to NBL by air mail with the mycology samples.

The vials containing the bacteriology and virology samples were sealed in No. 10 tin cans and shipped on dry ice via air freight to NBL. On arrival the tins were distributed to the respective investigators, who maintained the samples at -70°C until analysis was started.

#### A3.4.4 Aerobiology

R. L. Dimmick and Andre B. Cobet, Naval Biological Laboratory

##### A3.4.4.1 Introduction

The microbial flora of an individual is composed of a variety of bacteria, viruses, and fungi. This flora can be shed into the environment in quantity enough to be hazardous. Fortunately the predominant types of microorganisms comprising the individual's flora are harmless, enjoying a commensal existence with the host. A few microbial species are potential pathogens, eliciting infection when the hosts' defense mechanisms decline.

One important method of transfer of microorganisms from one person to another is aerosolization. This may result from a variety of conditions including motion of objects, both inanimate and human, or through coughing and sneezing. In a confined environment such as that of Tektite I, the airborne microflora will depend on an interrelation between the activity of the divers, input from external sources, effects of humidity and temperature, and removal by air filtration and settling. The assay of the air microflora in the Tektite I habitat was an attempt to gain an understanding of the rate of dispersion and equilibrium of the microbial population in the environment.

##### A3.4.4.2 Results

The number of airborne bacteria growing on the general purpose medium (TSA) increased from 3.5/ft<sup>3</sup> prior to the entry of the aquanauts on day 1 to over 100/ft<sup>3</sup> on three occasions, days 19, 22, and 42 (Fig. A32). A best-fit line through the data points reveals a continued increase in the number of organisms recovered to day 42 followed by a decrease. The values range from a low of 7.7 organisms/ft<sup>3</sup> after day 18 to a high of 189/ft<sup>3</sup> on day 42. The average count for the 59-day period was 44/ft<sup>3</sup> (standard error of mean = 10.1). The air in the habitat 48 hours after the completion of the program contained 0.3 organism/ft<sup>3</sup>. There was no activity in the habitat during this period, although the engineering systems remained in operation.

The number of organisms which grew on marine agar was steady at about 10/ft<sup>3</sup> through day 33. An increase is noted on day 40, with a peak on day 46 at 483/ft<sup>3</sup> and decline at day 57. These organisms are capable of growing in a low-nutrient medium with sea-water salts incorporated in the formulation. This does not mean these organisms are necessarily marine organisms, but they represent a different population than that found on TSA.

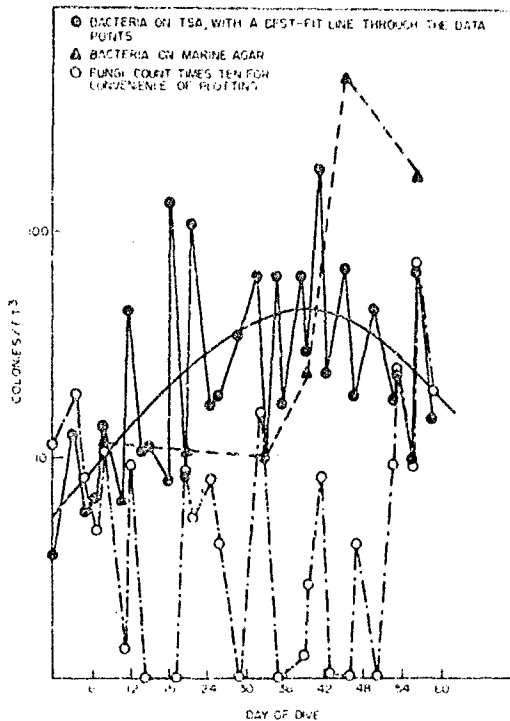

Fig. A32 - Concentration of airborne microbes in the Tektite I habitat

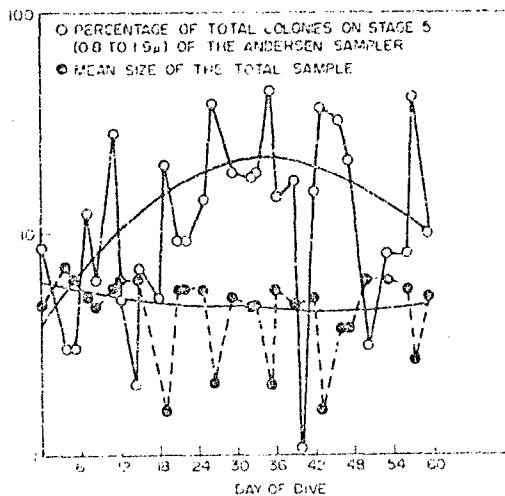

Fig. A33 - Particle size of airborne microbes in the Tektite habitat. Best-fit lines are shown.

The number of airborne fungi were increased during six peak periods. The data points in Fig. A32 are presented at 10 times the value found. The habitat had a moderate level of fungi during the first 12 days followed by moderate peaks from day 21 through day 25, at day 32, and at day 42, a low peak at day 47, and a high level from day 53 through day 59. The fungi count was always less than  $10/\text{ft}^3$  on the TSA medium.

The average particle size was  $4.6 \mu\text{m}$  with a range from  $7.0 \mu\text{m}$  on day 4 down to  $1.5 \mu\text{m}$  on two occasions (Fig. A33). On 11 occasions the particle size was less than  $5.0 \mu\text{m}$ . This is important, since it has been shown that particles less than  $5.0 \mu\text{m}$  are capable of penetrating the alveolar spaces of the lung.\*

The average percentage of bacteria found on stage 5, compared with the total number of bacteria on all six stages of the samples was 13%. These values ranged from a low of 1% on day 40 to a high of 43% on day 35. The fifth stage of the Andersen sampler retains particles in the size range  $1.9$  to  $0.8 \mu\text{m}$ .† Here again the size is important as related to the capability of lung penetration of the particle. The trend showed an increase in percentage to day 35 followed by a decrease.

The first few days of sampling revealed a wide variety of colony types but low numbers of organisms on the agar plates. As the program progressed, the number of colonies increased and the variety of colonies decreased. No attempt was made to identify the organisms appearing on the various stages. It was reasoned that with the reduction in variety there may be an emergence of a single group or species of bacteria. On day 35, and from day 39 through day 57, the most common colony type was subcultured from stage 4 of the sampler and later identified. The 12 samples on further analysis produced 15

\*H. A. Druett, "The Inhalation and Retention of Particles in the Human Respiratory System," in P. H. Gregory and J. L. Monteith, editors, "Airborne Microbes," University Press, Cambridge, England, 1967.

†A. Andersen, "The New Sampler for the Collection, Sizing and Enumeration of Viable Airborne Particles," *J. Bacteriol.* 76, 471-484 (1958).

different isolates due to multiple impingement at the same loci. The results are presented in Table A19. The most common organism is *Acinetobacter*, and its most common phenon is 4-1.\*

Table A19  
Identification of Isolates from Stage 4 of the Andersen Samplers

Day	Organism	Day	Organism
35	<i>Bacillus pulvifaciens</i>	50	<i>Acinetobacter</i> 4-1
39	<i>Aeromonas</i> sp	53	<i>Acinetobacter</i> 4-1
40	<i>Acinetobacter</i> 4-1	54	<i>Acinetobacter</i> 4-2
42	<i>Acinetobacter</i> 4-1	56	<i>Acinetobacter</i> 4-3
43 - 1	<i>Acinetobacter</i> 4-1	57 - 1	<i>Acinetobacter</i> 4-2
43 - 2	<i>Aeromonas</i> sp	57 - 2	<i>Micrococci</i> sp
46	<i>Enterobacteria</i> sp	57 - 3	<i>Proteus rettgeri</i>
47	<i>Acinetobacter</i> 4-3		

On two occasions in the course of the study the general bacterial population may have contained potentially pathogenic organisms. On day 15 there were 0.6 mannitol-fermenting organism/ft<sup>3</sup> (as revealed on mannitol salt agar). On day 19 the green-pigment-producing organisms on the *Pseudomonas* medium were at a level of 8/ft<sup>3</sup>. (These organisms did not appear at any other time on these media during the program.) Definitive identification of the types of organisms was not made; however, the presumption is that these organisms were *Staphylococcus* and *Pseudomonas* respectively.

#### A3.4.4.3 Discussion

The number of airborne bacteria in the Tektite I habitat was found to be higher than that found in normal environmental air. A range of values from 7.3 to 29.4/ft<sup>3</sup> were found to be normal by Miller et al.<sup>†</sup> The peak levels in the habitat exceeded the upper value by 3 to 6 times, and the levels frequently exceeded the upper value by 1 to 2 times. The best-fit line of the general microbial population growing on TSA was higher than 30/ft<sup>3</sup> for 26 consecutive days.

The repeated isolation of *Acinetobacter* subcultured at random from the common colony type appearing on stage 4 reveals a high incidence of that organism in the air. It is unfortunate that the random isolation of the most common colony type was not instituted earlier. Consequently it has been impossible to determine whether the group of *Acinetobacter* isolates from the air were present initially or were introduced during the first half of the study.

During the latter half of the program there was an increase in organisms capable of growth on the marine agar. This increase was greater than that found on the trypticase soy agar (general population) and represents the occurrence of a second, different microbial population that required the marine media. However, this does not in itself necessarily define that group as of marine origin.

\*M. J. Thornley, "Properties of *Acinetobacter* and Related Genera," pp. 19-28 in B. M. Gibbs and D. A. Shapton, editors, "Identification Methods for Microbiologists, Part B," Academic Press, London, 1968.

†R. L. Miller, W. E. Burton, and R. W. Spore, "Aerosols Produced by Dental Instrumentation," pp. 97-120 in "First International Symposium on Aerobiology," Naval Biological Laboratory, Naval Supply Center, Oakland, California, 1963.

Some of the organisms growing on the TSA may also have grown on the marine agar. The *Aeromonas* isolates may well be from the marine environment, as some *Aeromonas* species have been found to be fish pathogens.\* A number of genera were studied by Thornley† who proposed a provisional genus for a group of similar organisms including a number of *Achromobacter* species. The number of *Achromobacter* in sea water was found to be 26% of the cultures examined by Wood.‡ On the surface of fish it has been shown to vary from 53.7% of cultures examined from salmon§ to 23% on haddock.¶ Thus, the incidence of *Achromobacter*, which are partially included in the group *Acinetobacter*, has been shown to be quite common in the marine environment.

The high incidence of *Acinetobacter* on the air samples and the increase in numbers of organisms growing on the marine medium may indicate an intrusion into the habitat by an organism of marine origin.

The demonstration of the mannitol-fermenting organisms in the air on day 15 does not correlate with any entries in the medical log during that period. However, the presence in air of organisms presumed to be *Pseudomonas*, at a level of 8/ft<sup>3</sup> on day 19, is followed on the next day by complaints of ear infections in three divers. Three alternatives seem evident: the *Pseudomonas* in the air may have originated from the infected ears, the ears may have been infected by the organism from the air as a result of its aerosolization from another source, or the infected ears and aerosol *Pseudomonas* may be unrelated. Because of the low frequency of air sampling the particular alternative could not be determined.

The actual numbers of bacteria per cubic foot may have been slightly higher than those expressed. The mean relative humidity was between 50 and 55%, a moisture level generally most detrimental for vegetative airborne bacteria.¶ The resulting growth from the air sampled included only those that survived or were able to recover from the shock of humidity exposure. The bacteria in the smaller particle sizes are more sensitive, again resulting in reduced counts.

#### A3.4.4.4 Conclusion

The level of airborne bacteria in the habitat was above normal by day 24 of the program. This level stayed elevated for the following 26 days. On two occasions potentially pathogenic organisms may have been present in the air: on day 15 there were 0.6 mannitol-fermenting organism/ft (Staphylococci), and on day 19 *Pseudomonas*-like organisms were present at a level of 8 organisms/ft<sup>3</sup>.

*Acinetobacter* phenon 4-1 was the most common organism occurring on stage 4 of the Andersen sampler from day 35 to the completion of the program. This organism may have had its origin in the marine environment, establishing itself on the aquanauts or in the habitat during the latter half of the program.

\*I. W. Smith, "The Classification of *Bacterium salmonicida*," J. Gen. Microbiol. 33, 263-274 (1953).

†Op. cit.

‡E. I. F. Wood, "Studies on the Marketing of Fresh Fish in Eastern Australia, Part 2 - The Bacteriology of Spoilage of Marine Fish," Australia Council Sci. Ind. Res., Melbourne, Pamphlet 100, 1-92, 1940

§J. E. Snow and P. J. Beard, "Studies on Bacterial Flora of North Pacific Salmon," Food Res. 4, 563-595 (1939).

¶G. B. Peed and C. M. Spence, "The Intestinal and Slime Flora of the Haddock. A Preliminary Report," Contr. Canad. Biol. Fish., N.S., 4, 257-264 (1929).

¶F. W. Dunklin and T. T. Puck, "The Lethal Effect of Relative Humidity on Airborne Bacteria," J. Exptl. Med. 87, 87-101 (1948).



Some of the organisms growing on the TSA may also have grown on the marine agar. The *Aeromonas* isolates may well be from the marine environment, as some *Aeromonas* species have been found to be fish pathogens.\* A number of genera were studied by Thornley† who proposed a provisional genus for a group of similar organisms including a number of *Achromobacter* species. The number of *Achromobacter* in sea water was found to be 26% of the cultures examined by Wood.‡ On the surface of fish it has been shown to vary from 53.7% of cultures examined from salmon§ to 23% on haddock.¶ Thus, the incidence of *Achromobacter*, which are partially included in the group *Acinetobacter*, has been shown to be quite common in the marine environment.

The high incidence of *Acinetobacter* on the air samples and the increase in numbers of organisms growing on the marine medium may indicate an intrusion into the habitat by an organism of marine origin.

The demonstration of the mannitol-fermenting organisms in the air on day 15 does not correlate with any entries in the medical log during that period. However, the presence in air of organisms presumed to be *Pseudomonas*, at a level of 8/ft<sup>3</sup> on day 19, is followed on the next day by complaints of ear infections in three divers. Three alternatives seem evident: the *Pseudomonas* in the air may have originated from the infected ears, the ears may have been infected by the organism from the air as a result of its aerosolization from another source, or the infected ears and aerosol *Pseudomonas* may be unrelated. Because of the low frequency of air sampling the particular alternative could not be determined.

The actual numbers of bacteria per cubic foot may have been slightly higher than those expressed. The mean relative humidity was between 50 and 55%, a moisture level generally most detrimental for vegetative airborne bacteria.¶ The resulting growth from the air sampled included only those that survived or were able to recover from the shock of humidity exposure. The bacteria in the smaller particle sizes are more sensitive, again resulting in reduced counts.

#### A3.4.4.4 Conclusion

The level of airborne bacteria in the habitat was above normal by day 24 of the program. This level stayed elevated for the following 26 days. On two occasions potentially pathogenic organisms may have been present in the air: on day 15 there were 0.6 mannitol-fermenting organism/ft (Staphylococci), and on day 19 *Pseudomonas*-like organisms were present at a level of 8 organisms/ft<sup>3</sup>.

*Acinetobacter* phenon 4-1 was the most common organism occurring on stage 4 of the Andersen sampler from day 35 to the completion of the program. This organism may have had its origin in the marine environment, establishing itself on the aquanauts or in the habitat during the latter half of the program.

\*I. W. Smith, "The Classification of *Bacterium salmonicida*," J. Gen. Microbiol. 33, 263-274 (1963).

†Op. cit.

‡E. I. F. Wood, "Studies on the Marketing of Fresh Fish in Eastern Australia, Part 2 - The Bacteriology of Spoilage of Marine Fish," Australia Council Sci. Ind. Res., Melbourne, Pamphlet 100, 1-92, 1940

§J. E. Snow and P. J. Beard, "Studies on Bacterial Flora of North Pacific Salmon," Food Res. 4, 563-595 (1939).

¶G. B. Peed and C. M. Spence, "The Intestinal and Slime Flora of the Haddock, A Preliminary Report," Contr. Canad. Biol. Fish., N.S., 4, 257-264 (1929).

¶F. W. Dunklin and T. T. Puck, "The Lethal Effect of Relative Humidity on Airborne Bacteria," J. Exptl. Med. 87, 87-101 (1948).

**A3.4.5 Bacteriology**  
**D. N. Wright and Andre B. Cobet,**  
**Naval Biological Laboratory**

**A3.4.5.1 Introduction**

The health and welfare of the aquanauts was of prime importance in achieving the desired performance and effort in the underwater program. The microbial flora associated with the aquanaut can, under adverse circumstances, impair the performance of the divers to the point that they must be removed from the program. Hence it was necessary to study the microflora of the aquanauts and determine the effects of the environmental conditions in the submerged habitat on the aquanaut/bacteria relationship.

An extensive study was made of the type and numbers of bacteria present at five body areas of the four aquanauts and on the walls of two compartments of the habitat. The frequency of occurrence of the various bacteria at the start, during the 59-day program, and at the termination of the underwater period was determined.

**A3.4.5.2 Procedure**

The samples were received at the laboratory under dry ice and were maintained at  $-70^{\circ}\text{C}$  until the time of analysis. Prior to culture the sample was thawed at room temperature and the swab expressed into the vial. The contents of the vials were taken as a  $10^{-3}$  dilution. Tenfold dilutions were made of the contents, with a range of dilutions plated on the surface of selected media; the type of media was determined by the source of the sample, as shown in Table A20. All media were procured commercially (Difco) except blood agar, which was prepared locally with 5% defibrinated sheep red blood cells.

Table A20  
 Media Used in the Microbial Analysis of the Bacterial Samples

Site	Medium			
	EMB	Blood Agar	Mitis Salivarius Agar	Mannitol Salt Agar
Ear	X	X		X
Forearm skin	X	X	X	X
Skin behind knee	X	X	X	X
Throat	X	X	X	
Rectum	X	X	X	X
Habitat	X	X		X

The inoculated media were incubated aerobically at  $37^{\circ}\text{C}$  for 30 hours. No effort was made to determine the anaerobic or microaerophilic flora. Each bacterial colony type growing on the media was enumerated and subcultured for identification.

Identification of the organisms found on primary isolation was by standard bacteriological procedures, based on selected growth requirements, biochemical reactions, and

morphological characteristics as outlined in the "Manual of Microbiological Methods"\* and "Bergey's Manual of Determinative Bacteriology".† No attempt was made to identify all organisms at the species level. When species were indicated as a result of differential procedures, they were recorded. The organisms listed as *Acinetobacter* were gram-negative, nonmotile, largely nonfermentative coccobacilli.‡ Organisms reported as *Staphylococcus albus* included all mannitol-negative, gram-positive cocci with the exception of *Streptococcus* and *Sarcina*. The determination of *Staphylococcus aureus* was made on the basis of mannitol fermentation. No attempt was made to determine the classification of the few yeast and fungal isolates, as a separate section of this report covers their identification.

#### A3.4.5.3 Results

The scope of the work can be appreciated by observing a few figures: over 500 samples were taken from the body areas and the environment, which resulted in over 2500 different primary cultures to be identified, which in turn required over 4000 plates and tubes of media for final identification.

The method of obtaining the samples by swabbing of surfaces on different occasions places certain restrictions on the direct comparison of the data. Since the total area swabbed in one instance may not equal the area swabbed at another time, the resulting quantitative populations will differ even though qualitatively they may have been the same. Consequently some of the data have been assigned a numerical value based on the quantitative standing of the microbe in relation to others from that same sample rather than as an absolute value.

The recovery of bacteria from the rectal samples of the aquanauts is presented in Table A21. It is apparent that there were no unexpected organisms recovered from these specimens. No bacteria were recovered during the latter portion of the dive which were not also seen in the early phases of the study. Common bowel organisms such as *Escherichia coli*, *Staphylococci*, and *Streptococci* were found consistently during the entire program. *Proteus vulgaris* was recovered from aquanaut 1 periodically through the study but not from other divers. *Aerobacter aerogenes* was recovered during only the early portion of the dive. Whether this organism was lost completely or simply not recovered is unknown.

The recovery of bacteria from the ears during the first third of the study was very good. Antibiotic treatment was given to the aquanauts for external ear infections throughout the latter two thirds of the dive; consequently many samples yielded no growth (Table A22).

Throughout the study *Corynebacterium* and *Staphylococcal* species were consistently isolated from all ears sampled. Aquanaut 4 may have entered the program with *Pseudomonas aeruginosa* as part of the ear flora. The *Pseudomonas* persisted until the antibiotic therapy was instituted for ear infection. It was found again on day 33, followed by a second ear infection in that ear (Table A23). *Pseudomonas aeruginosa* was isolated once from the ears of aquanaut 1, occurring between two episodes of ear infection. *Proteus* was isolated from the ears of aquanaut 1 during periods of ear infection and before antibacterial therapy. *Corynebacterium* was found only sporadically in the ear of

\*Manual of Microbiological Methods," Soc. of Amer. Bact., McGraw-Hill, New York, 1957.

†R. S. Breed, E. G. D. Murray, and N. R. Smith, editors, "Bergey's Manual of Determinative Bacteriology," 7th edition, Williams and Wilkins, Baltimore, 1957.

‡M. J. Thornley, "Properties of *Acinetobacter* and Related Genera," pp. 29-50 in B. M. Gibbs and D. A. Shapton, editors, "Identification Methods for Microbiologists," Academic Press, New York, 1968.



Table A22  
Bacterial Flora in the Ear Samples Collected From the Tektite I Aquanauts

Aquanaut	Organism	Quantitative Ranking of Occurrence of Organism For Each Aquanaut For Each Day of Dive a Sample Was Taken																
		0	5	8	12	15	19	22	26	29	33	36	40	43	47	50	54	57
1	<i>S. albus</i>		1	1	1	1	1	1									2	1
	<i>Corynebacterium</i>		3	2	2	2	2	2	1								1	
	<i>Pseudomonas</i>			3				3										
	<i>E. coli</i>																	
	<i>Mima</i>		2		3													
	<i>Proteus</i>				4	4	4											
	<i>Neisseria</i>				5	3												
2	<i>Aerobacter</i>						3											
	<i>S. albus</i>	2	1	2	1	1	2	1	1	1	1			2				
	<i>Corynebacterium</i>	1		1		2	1	2	2									
	<i>S. aureus</i>						3	3		2								
	<i>S. lutea</i>			3														
	<i>Bacillus</i>								3									
3	<i>Acinetobacter</i>			4														
	<i>S. albus</i>	1	1	2	1	1	1	1	1					1	1	1		1
	<i>Corynebacterium</i>		2			2		2										
	<i>Pseudomonas</i>					4	2	2										
	<i>S. aureus</i>			1														
	<i>E. coli</i>			4	2													
	<i>Proteus</i>				4													
	<i>Aerobacter</i>					3		3										
4	<i>Acinetobacter</i>			3	3													
	<i>S. albus</i>	2	1	1	2	2	1	1				3		1			1	1
	<i>Corynebacterium</i>	1			1	1	3					2	2					
	<i>Pseudomonas</i>		2	2	3			3			1							
	<i>S. aureus</i>						2	2									2	
	<i>E. coli</i>				4													
	<i>Mima</i>					4												
	<i>S. lutea</i>					3												
<i>Bacillus</i>														1			1	

aquanaut 3. *Pseudomonas aeruginosa* was isolated just prior to symptoms of ear infection and before antibiotic therapy as in aquanaut 4. *Corynebacterium* and *Staphylococci* were regularly isolated from aquanaut 2. No gram-negative organisms were isolated from his ear with the exception of a single isolation of *Acinetobacter*. However, this aquanaut also experienced ear infection, even though no etiological organisms were apparent.

There were no unexpected isolations from the throats of the aquanauts, with *Streptococci*, *Corynebacteria*, and *Neisseria* being consistently recovered. *Diplococcus pneumoniae* was isolated from aquanaut 4 during only the first half of the dive (Table A24).

Table A23  
 Medical Status of Aquanauts' Ears During the Tektite I Program  
 (Data Obtained From the Medical Status Reports in the Medical Log)

Day of Dive	Status of Ear							
	Aquanaut 1		Aquanaut 2		Aquanaut 3		Aquanaut 4	
	Right	Left	Right	Left	Right	Left	Right	Left
2	-	-	-	-	-	-	Questionable	-
3	-	-	-	-	-	-	Questionable	-
7	-	-	-	-	-	-	Surge effect	
9	-	-	-	-	-	-	-	-
10	-	-	-	-	-	-	-	-
12	-	Squeeze	-	Squeeze	-	-	-	-
14	-	-	-	-	-	Squeeze	-	-
15	-	-	-	-	-	-	-	-
16	-	Squeeze	Squeeze	-	-	-	-	-
18	Squeeze	-	-	-	-	-	-	-
20	Infected	-	Squeeze	-	Infected	-	Infected	-
22	-	-	Squeeze	-	Infected	-	Infected	Infected
25	-	-	-	-	Healing	-	Infected	-
27	Infected	-	Infected	-	Healing	-	Infected	-
29	Infected	-	-	-	-	Squeeze	-	Redness
31	Infected	Infected	-	-	-	-	-	-
33	-	-	-	-	-	-	-	Infected
34	Infected	-	-	-	-	-	-	Infected
36	Infected	Infected	Swollen	-	-	Squeeze	Infected	Infected
37	-	Infected	Redness	-	-	-	Infected	Infected
38	-	Infected	Infected	-	-	-	Infected	Infected
39	-	Infected	Infected	-	-	-	Redness	Redness
40	-	Swollen	Swollen	-	-	-	Redness	-
41	-	-	-	-	-	-	-	-
42	-	-	-	-	-	-	-	-
44	-	-	-	-	-	-	-	-
46	-	-	-	-	-	-	-	-
49	-	-	-	-	-	-	-	-
52	-	-	-	-	-	-	-	-
53	-	-	-	-	-	-	Squeeze	-
54	-	-	-	-	-	-	-	-
55	-	-	-	-	-	-	-	-
57	-	Squeeze	Squeeze	-	-	-	Squeeze	Squeeze
58	-	Squeeze	Squeeze	-	-	-	Squeeze	Squeeze

The greatest variety of microbial flora was found on the skin of the forearm and behind the knee. The bacteria from these sample sites was similar, both in types and numbers with the routine isolation of *Staphylococcus*, *Corynebacterium*, and some *Streptococcus* (Tables A25 and A26). On occasion a number of organisms from the genera *Bacillus*, *Mima*, *Aerobacter*, and *Escherichia* were isolated and may represent a transient population associated with the skin. A third population was evident on the skin of aquanauts 1, 2, and 4. This group, consisting of members from the genera *Sarcina* and *Acinetobacter* were not found until the latter phase of the study. In contrast, these organisms were isolated with regularity during the entire study from the knee of aquanaut 3. These two groups of organisms may represent a progressive change in the skin flora of







the aquanauts. A second change in skin flora is suggested by failure to recover mannitol-fermenting *Staphylococci* during the last half of the study. The relationship, if any, between the loss of this organism and the appearance of *Acinetobacter* and *Sarcina* is not known.

The samples collected from the skin sites (forearm and behind the knee) before entry of the aquanauts into the habitat yielded no *Acinetobacter* isolates (Table A27). As the study progressed, the frequency of isolation increased, ultimately involving all four aquanauts and the habitat.

Table A27  
Frequency of Isolation of *Acinetobacter* From the  
Two Skin Sites of the Aquanauts and in the Habitat

Day of Dive	Occurrence of <i>Acinetobacter</i> Isolates									
	Aquanaut 1		Aquanaut 2		Aquanaut 3		Aquanaut 4		Habitat	
	Arm	Knee	Arm	Knee	Arm	Knee	arm	Knee	Wet Lab	Crew Quarters
0										
5										
8			X			X				
12						X				
15					X	X			X	
19		X								
22			X		X		X			
29	X	X	X				X			
33	X						X	X		
36			X							
40		X	X		X					
43	X	X	X			X	X	X		
47			X					X		
50						X	X	X	X	X
54	X	X	X					X		
57	X	X	X			X	X	X		
59	X	X	X			X	X	X	X	X

The recovery of organisms from the wall surfaces of the wet lab was irregular. In the crew quarters microbial flora was more apparent, as judged by the greater frequency of isolation. In both rooms the predominant genera were *Staphylococcus* and *Bacillus* (Table A28).

#### A3.4.5.4 Discussion

The aquanauts were active in two entirely different environments during the course of the Tektite I program. They each had marine science programs requiring their presence in the wet marine environment as well as in-habitat chores required by both the marine science program and their daily living. The two environments and the introduction of new or reintroduction of familiar organisms with food and equipment by way of the daily transfers from the surface and the continuous input of air via the umbilical from the surface removes the study from the isolated-environment group. Thus it is not surprising that a unity in the type of flora of the divers did not occur. It was not expected, however, that normal flora would be isolated in the latter phase of the study which were not present in the early samples.

Table A23  
Bacterial Flora in the Samples Collected From the Two Spaces in the Tekite I Habitat

Day of Dive	Population (10 <sup>4</sup> organisms)												
	Wet Lab					Crew Quarters							
	<i>S. albus</i>	<i>Bacillus</i>	<i>Corynebacterium</i>	<i>S. lutea</i>	<i>Mima</i>	<i>S. mitis</i>	<i>Acinetobacter</i>	<i>S. albus</i>	<i>Bacillus</i>	<i>Corynebacterium</i>	<i>S. lutea</i>	<i>Mima</i>	<i>Acinetobacter</i>
0	-	-	-	-	-	-	-	3.0	-	-	-	-	-
5	-	-	-	-	-	-	-	-	-	-	-	-	-
8	-	-	-	-	-	-	-	1.0	1.0	-	-	-	-
12	1.0	-	-	-	-	-	-	1.0	1.0	-	-	-	-
15	-	1.0	-	-	-	-	2.0	2.0	11	-	-	-	-
19	-	-	-	-	-	-	-	1.0	16	-	-	-	-
22	1	-	-	-	-	-	-	3.0	-	1.0	-	-	-
26	-	190	-	-	-	-	-	-	0.1	-	-	-	-
29	-	-	-	-	-	-	-	-	-	-	-	-	-
33	-	-	8.0	-	-	-	-	-	-	-	-	-	-
36	-	-	-	-	-	-	-	2.0	-	-	-	-	-
40	3.0	-	-	-	-	-	-	1.0	2.0	-	-	2.0	-
43	-	-	-	-	-	-	-	2.0	-	-	-	-	-
47	-	-	-	-	-	-	-	2.0	-	-	-	-	-
50	-	-	-	-	2.0	8.0	1.0	6.0	-	10	1.0	1.0	1.0
54	-	4.0	-	-	-	-	-	2.0	-	-	-	-	-
57	-	-	-	-	-	-	-	-	-	-	-	-	-
59	-	-	-	1.0	-	-	4.0	-	-	-	-	-	1.0

In several instances some organisms were not found in each sample of a series. It is possible that they were present but not recovered from the sample, although this is unlikely, since the isolation procedures were adequate throughout most of the work. Another explanation may be the existence of a cycle with a succession of organisms, as has been demonstrated in the intestine.\* There may have been periods during which the number of a particular organism was low and was not recovered by this technique; alternately it may have been completely eliminated and reappeared only after reinfection. This phenomenon would explain the disappearance of *A. aerogenes* from the rectal samples and may also shed light upon the disappearance of mannitol-fermenting *Staphylococci* from the skin.

The transmission of bacteria between the men in the habitat will be presented in section A3.4.9 (on nasal *Staphylococcus*). Tracer organisms were not introduced into the habitat, nor were the organisms recovered in this study phage or serotyped. However, there were several isolates of *P. aeruginosa* from the ears of three aquanauts, although it appears that this organism was present at the outset in only one aquanaut. Whether the subsequent appearance of this organism from the ears, skin, and feces or the other aquanauts represents man-to-man as opposed to environment-to-man transmission is unknown.

There was one organism which occurred consistently in one aquanaut only, that being *Proteus*, which was isolated from rectal samples from aquanaut 1. This organism was apparently not transmitted to the other aquanauts, even though all were in intimate contact. This supports the concepts that each person has his own bacterial profile and that the establishment of a new organism largely depends on the organisms already present within that environment.

An infection of the aquanauts by organisms from the ocean environment did not occur. The organisms of the genus *Acinetobacter* are common in terrestrial and water environments,† and their establishment on the skin of the aquanauts appears to have been a commensal association. Had the aquanauts been subjected to mechanical injury or other stress factors, it is possible that these organisms may have become involved in a pathogenic situation. *Staphylococcus lutea* increased as part of the skin flora; although normally found as part of this flora, it is of interest primarily because of its emerging dominance. What possible health involvement could result from the continued high numbers of these two organisms is as yet to be learned.

One of the most interesting findings is concerned with the isolation of *P. aeruginosa* from the ears of the aquanauts. External ear infections are of particular concern among men who do a great deal of marine diving or swimming. These ear infections respond to antibiotic therapy with no unusual sequelae and are commonly thought to be due to *P. aeruginosa*. This organism may have been responsible for the external ear infections suffered by aquanauts 3 and 4. It is unlikely, however, that the ear infections of aquanauts 1 and 2 resulted from such an infection. *Proteus*, which was isolated from both rectum and ears of aquanaut 1 may have been responsible for the infection in his ears, but aquanaut 2 at no time demonstrated any unusual flora which would suggest the etiology of ear infection. It is perhaps significant that this aquanaut had two ear infections and that the longest persisted for only 4 days. An explanation as to the cause of such ear infections is not available. Ear samples were obtained from swabs of the right ear only. In aquanauts 1 and 4, the right ear was initially infected, and in aquanauts 2 and 3 only the right ears were involved. It is possible that swabbing improved the opportunity for infection, although it was not the sole predisposing factor.

\*R. J. Dubos and J. G. Hirsch, editors, "Bacterial and Mycotic Infections of Man," 4th edition, Lippincott, Philadelphia, 1958.

†M. Ingram and J. M. Shewan, "Introductory Reflections on the *Pseudomonas-Achromobacter* Group," J. Appl. Bacteriol. 23(3), 373-378 (1960); M. J. Thornley, "A Taxonomic Study of *Acinetobacter* and Related Genera," J. Gen. Microbiol. 49, 211-257 (1967).

No attempt was made to restrict medication to the divers during the program. While the aquanauts suffered from these ear infections, they were restricted from diving and were given a therapeutic regimen of cortisporin ear drops. On day 38 all aquanauts were started on colymycin ear drops and oral achromycin. The achromycin therapy was discontinued on day 43, but the colymycin was used throughout the remainder of the dive.

This study suggests that no saprophytic species of bacteria were present in the Tektite I environment which became pathogenic or which were predisposed to enhanced virulence as a result of the environmental conditions surrounding the aquanauts. Other studies, however, have shown numerous situations where changes in the normal flora result in disease.\* The ultimate effect of long-term changes of skin flora as noted above are of course not known and subject to understanding only by prolonging such an experimental condition.

The use of systemic antibiotics may have resulted in possible alteration of oral and intestinal flora. It is suggested that in future situations internal antibiotic therapy be reserved until other procedures were deemed ineffective. Of the external medications, colymycin appeared to be most effective in reducing the otitis externa. However, this antibiotic was used concomitantly with an alcohol-boric acid wash of the ear, so that a true evaluation of effectiveness was not possible.

#### A3.4.5.6 Conclusions

A number of conclusions can be drawn from the data obtained during this study. The most obvious result suggested by the data is that man can exist, live, and work under conditions of this experiment relatively free from microbial hazards. The fact that there was little or no change in the microbial flora of the oral cavity and intestinal tract suggests that the imposed external environment had little or no effect on these body areas in terms of their ability to support microbial life.

The study also suggested that those areas of the body with the greatest exposure to the environment were most readily affected in terms of their microbial flora. The increase in the number and frequency of isolation of *Acinetobacter* is evidence of change in the normal flora of these areas, and this buildup in the habitat and on the skin represents a significant alteration in the environmental microflora of unknown consequence. The question as to whether or not this condition represents a hazard to men in this environment has not been answered.

The ear infections from microbial flora of the external ear canal represent the only recorded incidences of microbial illness during the dive. However, these infections were not significantly different from those ear infections seen in divers who were operating under less severe environmental circumstances. Indeed, in view of the frequency of this disease among divers, the occurrence of some otitis was to be expected.

#### A3.4.5.7 Acknowledgments

The authors acknowledge the assistance of Lt. Phyllis Warren, and HM3 Charles Williston.

\*R. J. Dubos and J. G. Hirsch, editors, "Bacterial and Mycotic Infections of Man," 4th edition, Lippincott, Philadelphia, 1958.

### A3.4.6 Mycology

H. B. Levine, James M. Cobb, and Andre B. Cobet,  
Naval Biological Laboratory

#### A3.4.6.1 Introduction

The microflora associated with man, and his environment, plays an important role in his well being. This association becomes quite important when man is restricted to an environment of an unusual nature for an extended period. The mycological aspects of the microflora were studied during the 59-day program.

It was not the intent of the survey to determine quantitatively or qualitatively the total fungal and yeast flora of certain sites on aquanauts and their environment but rather to ascertain the predominant genera or types and their relative numbers and changes during the program. In particular the early detection of dermatophytes was sought if skin infections proved to be a problem.

#### A3.4.6.2 Procedures

The mycology media were prepared and inoculated at the base camp and shipped by air to the Naval Biological Laboratory, where total numbers of fungi and yeasts were determined on arrival and after incubation at 37°C for 8, 14, 21, and 42 days. In most cases each morphologically distinguishable colony type was isolated and characterized generically in the case of fungi or with reference to tribe or section in the case of yeasts. The systematic key of Wilson and Plunkett\* was employed largely for fungal taxonomy, but use was made also of criteria outlined by Skinner, Emmons, and Tsuchiya† and in the National Communicable Diseases Center Manual.‡ The classification of yeasts followed that described by Henrici.§

Predive samples were taken from some of the aquanauts 38 days before the dive and from all of them on the morning of the dive (day 0) shortly before entering the water. The total numbers of fungi and yeast from all media are reported. It was believed that this procedure provided the best available approximation of relative numbers. In those instances where one of the three media showed too many colonies to be counted, a value of 100 was assigned; to distinguish that the 100 was an approximate value the graph point representing it was drawn with an arrow through it. Where two or more plates were uncountable, a value of 200 was assigned and the same symbol was used. The letters and numbers alongside each point show the numbers of each category of fungus and/or yeast (by code) represented by the point.

#### A3.4.6.3 Results and Discussion

The mycofloral pattern of the aquanauts and of the walls in the wet lab and crew quarters of the Tektite I habitat are presented in Table A29 and Figs. A34 through A39. Table A30 shows the frequency with which the 53 fungal or yeast varieties identified during the study were recovered. It should be emphasized that changes in the varieties and

\*I. W. Wilson and O. A. Plunkett, "The Fungus Diseases of Man," Univ. of Calif. Press, Berkeley, 1965.

†C. E. Skinner, C. W. Emmons, and H. M. Tsuchiya, "Henrici's Molds, Yeasts and Actinomycetes," Wiley, New York, 1948.

‡L. Ajello, L. K. Georg, W. Kaplan, and L. Kaufman, "Laboratory Manual for Medical Mycology," U.S. Dept. of Health, Education, and Welfare, Atlanta, Public Health Service Publication 994, 1963.

§A. T. Henrici, "The Yeasts: Genetics, Cytology, Variation, Classification and Identification," Bact. Rev. 5, 97-179 (1941).



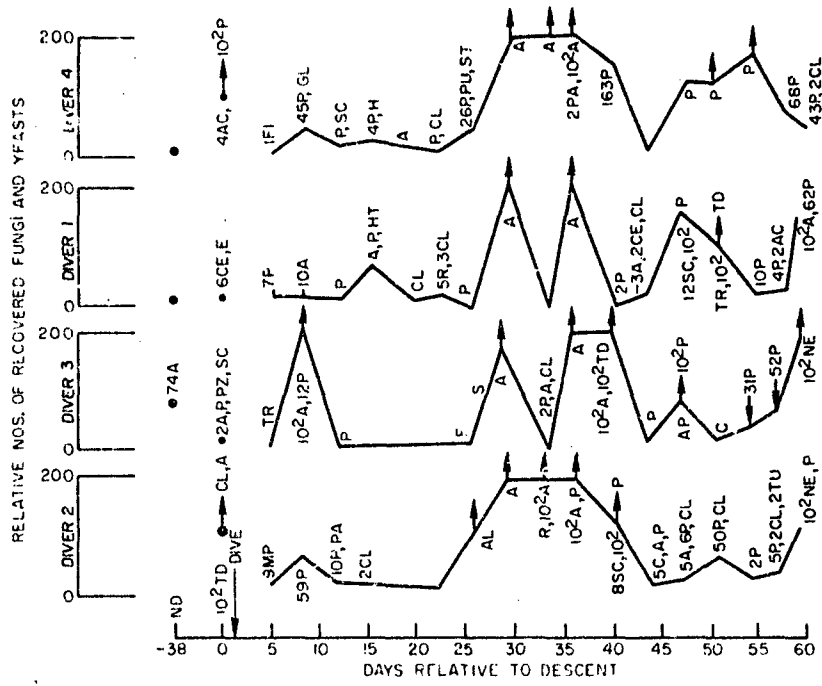

Fig. A36 - Recovery of mycoflora from skin (forearm) samples

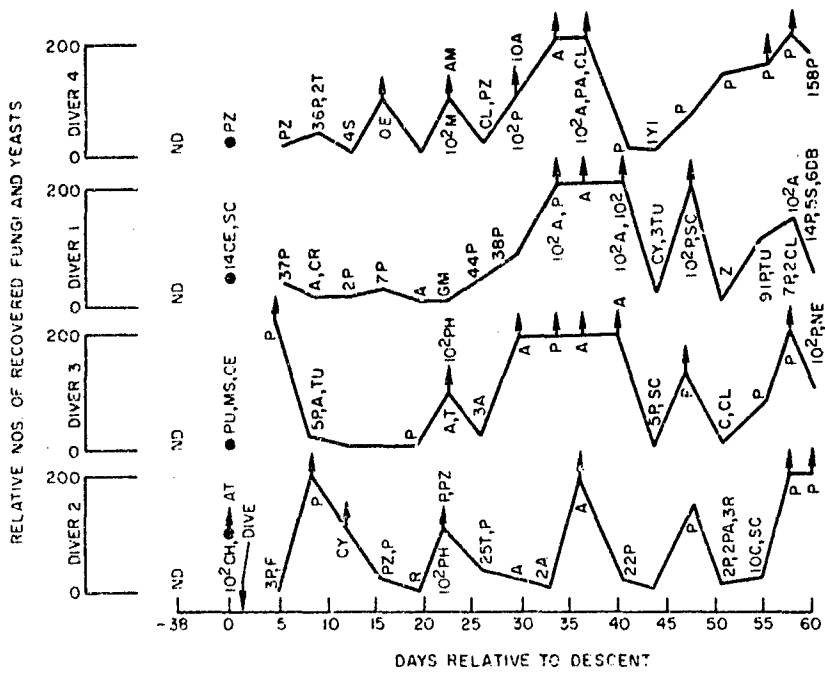

Fig. A37 - Recovery of mycoflora from skin (back of knee) samples

PROJECT TEKTITE I

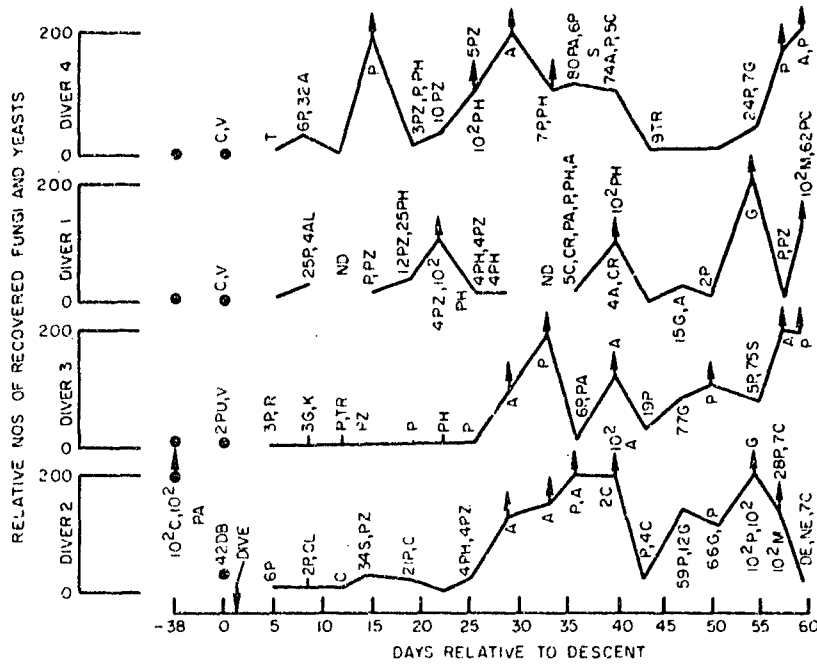

Fig. A38 - Recovery of mycoflora from rectum samples

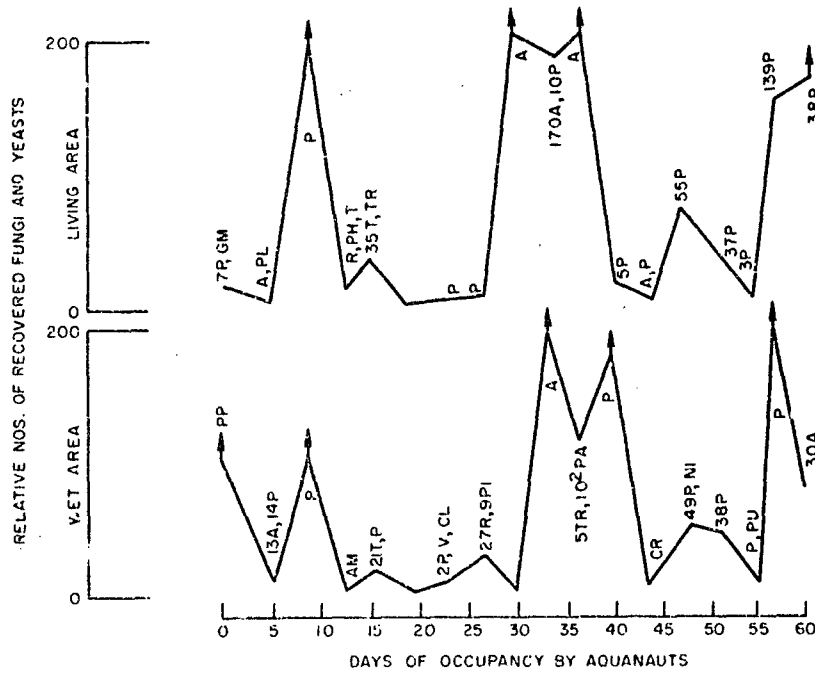

Fig. A39 - Recovery of mycoflora from habitat wall samples



Table A29

Legend of Types of Fungi and Yeasts Recovered From Tektite I Aquanauts and Their Environment as Presented in Figs. A35 through A39. (The absence of a number implies that it is 1 or, if only 1 microbial type is presented, that the number is as indicated on the ordinate.)

Abbreviation	Type (Spelled Out)	Abbreviation	Type (Spelled Out)
A	<i>Aspergillus</i> species	N	<i>Nadsonieae</i> tribe
AC	<i>Acremonium</i> species	ND	No data
AL	<i>Alternaria</i> species	NE	<i>Neurospora</i> species
AM	<i>Amerosporae</i> section	NI	<i>Nigrospora</i> species
AP	<i>Aleurospora</i> tribe	OE	<i>Oedocephalum</i> species
AT	<i>Actinomyceteae</i> tribe	OS	<i>Oosporeae</i> tribe
B	<i>Botrytidae</i> tribe	P	<i>Penicillium</i> species
C	<i>Candida</i> species	PA	<i>Paecilomyces</i> species
CE	<i>Cephalosporium</i> species	PC	<i>Pichia</i> species
CH	<i>Chaetomium</i> species	PH	<i>Phoma</i> species
CL	<i>Cladosporium</i> species	PI	<i>Phialophora</i> species
CR	<i>Cryptococcus</i> species	PL	<i>Pleospora</i> species
CY	<i>Chrysosporium</i> species	PP	<i>Papularia</i> species
D	<i>Dematium</i> species	PU	<i>Pullularia</i> species
DB	<i>Debaryomyces</i> species	PZ	<i>Plenozythia</i> species
DE	<i>Dendrostilbella</i> species	R	<i>Rhodotorula</i> species
E	<i>Epicoccum</i> species	RZ	<i>Rhizopus</i> species
F	<i>Fusarium</i> species	S	<i>Saccharomyces</i> species
FI	Fungus, unidentified	SC	<i>Scopulariopsis</i> species
G	<i>Geotrichum</i> species	SP	<i>Sporobolomycetaceae</i> family
GL	<i>Gliocladium</i> species	ST	<i>Stilbaceae</i> family
GM	<i>Gymnoascaceae</i> family	T	<i>Torula nigra</i>
H	<i>Hansenula</i> species	TB	<i>Tuberculariaceae</i> family
HT	<i>Heterosporium</i> species	TD	<i>Trichoderma</i> species
K	<i>Kloeckera</i> species	TR	<i>Trichosporon</i> species
M	<i>Mucor</i> species	TU	<i>Torulopsis</i> species
MS	<i>Mycelia sterilata</i> group	V	<i>Verticillium</i> species
		YI	Yeast, unidentified
		Z	<i>Zygosaccharomyces</i> species

numbers of organisms may not be ascribed to influences of what may at first appear to be a closed environment. The Tektite I habitat was a very open environment: an unfiltered gas mixture was pumped into it continuously; food, newspapers, and other items were introduced on a daily basis by transfer pots; and the aquanauts themselves were free to enter and return from the marine environment surrounding the habitat at frequent intervals.

Thus the particularly high numbers of *Aspergillus* and *Penicillium* spores dominating almost all samples of days 26 to 36 may not be referable necessarily to population

Table A30  
Frequency of Recovery of Fungi and Yeasts as a Function of  
Submersion Time From all Loci of Aquanauts

Organism	Number of Times Recovered*					
	Total	Days 5, 8, 12, 15	Days 19, 22, 26, 29	Days 33, 36, 40, 43	Days 47, 50, 54, 57	Day 59
<i>Penicillium</i> species	191	48	30	29	67	17
<i>Aspergillus</i> species	94	13	22	46	10	3
<i>Cladosporium</i> species	26	3	7	5	9	2
<i>Candida</i> species	26	5	4	7	8	2
<i>Plenozythia</i> species	15	5	9	0	1	0
<i>Phoma</i> species	14	0	10	4	0	0
<i>Geotrichum</i> species	10	2	0	0	8	0
<i>Paecilomyces</i> species	14	3	1	8	2	0
<i>Saccharomyces</i> species	9	2	2	1	3	1
<i>Scopulariopsis</i> species	9	1	2	3	3	0
<i>Rhodotorula</i> species	7	2	3	0	2	0
<i>Mucor</i> species	6	2	2	0	1	1
<i>Trichosporon</i> species	6	3	0	2	1	0
<i>Torulopsis</i> species	5	1	6	0	4	0
<i>Torula nigra</i>	5	3	2	0	0	0
Others†	< 5					

\*Values show number of samples that were positive without regard for the number of organisms recovered from each positive sample.

†See Table A29.

dynamics originating within the habitat. The organisms could have been introduced via the air or, unknowingly, by the introduction of food, such as fruit, that soon underwent fungal spoilage. In this regard the high numbers that were detected in the living quarters on day 29 were detected in only the wet lab on the next sampling occasion, which was day 33 of the dive (Fig. A39).

Of considerable interest was the consistency with which the elevated numbers of *Aspergillus* and *Penicillium* of days 29 to 36 were recovered. The organisms were found in all of the aquanauts (at virtually all of the sampling loci) and on the walls of the habitat. This observation suggests that the methods employed were adequate to detect gross population changes and that any tendency for certain varieties of fungi or yeast to become established preferentially in the habitat would have been detected.

It was anticipated that the wet lab, through which the aquanauts and materials gained entry into the habitat, would develop high humidity. This high humidity could then be expected to favor fungal growth. However, neither contingency occurred during the dive; the air conditioning system performed well, and the wet lab, like the rest of the habitat, showed mean temperatures of 25 to 27°C and mean relative humidity values of 52 to 54%.

A concern with possible mycologic consequences that also did not materialize pertained to skin disease. The aquanauts showered frequently and washed with a soap containing hexachlorophene; they were little bothered with skin disease. On day 7 of the dive aquanaut 2 showed skin irritation on the lower anterior portion of the neck. This was attributed to a close fitting nylon collar on his underwater clothing.

Irritations of the ear, however, did present a continuing problem beginning on day 11 of the dive. The resulting otitis externa in all of the divers appears to have been entirely of bacterial origin, as no mycological basis was found for the infection.

On different occasions some of the aquanauts experienced sore throats and diarrhea. Neither of these disorders was associated with remarkable changes in fungal or yeast numbers or varieties. Aquanaut 2 yielded a *Candida* species from the throat or rectum on numerous occasions; however, he was not afflicted with either throat or bowel disorders.

Aquanaut 2 first experienced ear symptoms (slight squeeze, left ear) on day 11 of the dive, and both ears showed this symptom on day 15. He also showed slight inflammation of the right canal on day 26, and his medical status report shows that both ears were "infected" on day 33. He was treated with cortisporin and tetracycline beginning on day 36. *Candida* was first isolated from his throat on day 20 and, again, on days 26 and 36. It does not appear to have been potentiated by the antibacterial treatment, and the data are insufficient to ascribe an etiologic or commensal role to it in the ear infection.

At the completion of the program rug samples were removed from various localities in the habitat and studied for the presence of fungi (Fig. A40). The results are not

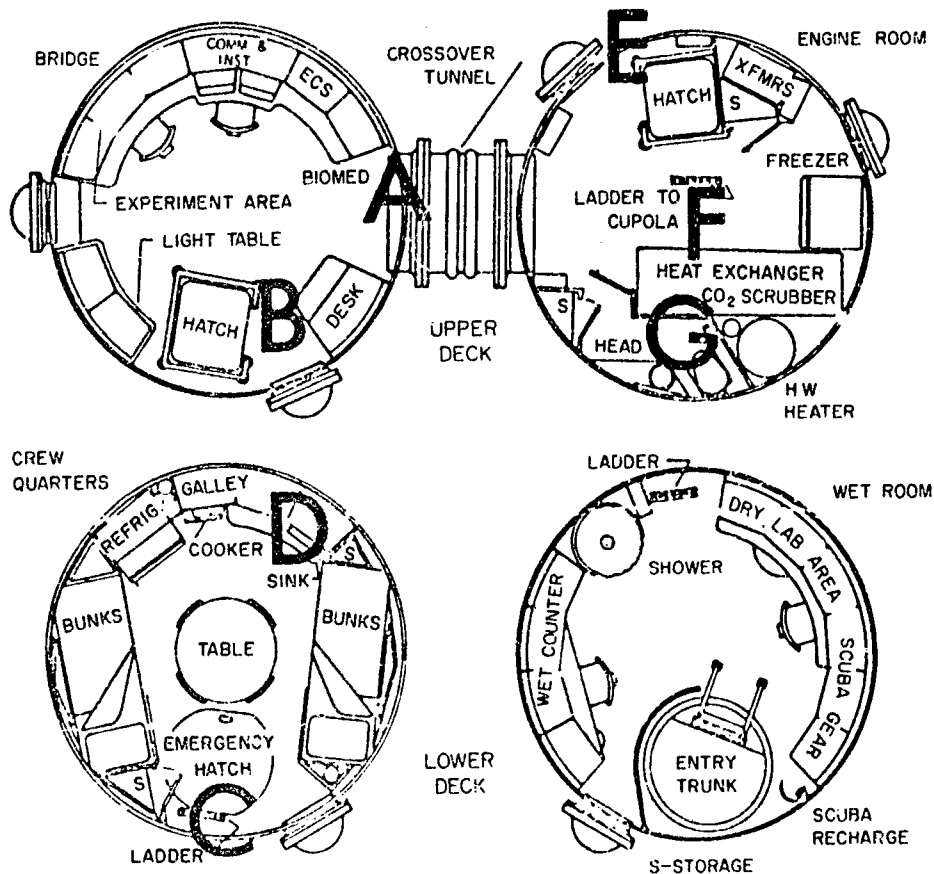

Fig. A40 - Localities from which rug samples were removed and studied for fungi. The organisms found were *Penicillium* ( $1.5 \times 10^2$  organisms/g at site A and 5.1 organisms/g at site F), *Rhodotorula* (4.5 organisms/g at site G), and *Mucor* (6.9 organisms/g at site C and  $4.0 \times 10^7$  at site D). No organisms were recovered at sites B and E.

remarkable with the exception of the high number of *Mucor* (a common bread mold) at site D. This is in front of the galley area and most probably results from food and bread crumbs dropped in that area. The fungi isolated from the sea-water samples were the ubiquitous saprophytes typically found in nature.

#### A3.4.6.4 Conclusion

The varieties of organisms isolated from those aboard the habitat (Table A30) and from the structure itself (Figs. A39 and A40) do not appear to be unusual. The absence of fungus- or yeast-related disease among the divers also suggests that the habitat did not present a mycologically stressful situation.

#### A3.4.7 Marine Microbiology

Andre B. Cobet, Naval Biological Laboratory

##### A3.4.7.1 Introduction

The sewage from the habitat was macerated, piped through 1000 feet of 4-inch hose, and disposed into the marine environment. Due to the bottom contour and the desire not to go over rises the end of the sewer line was about 850 feet from the habitat. To assess the problem posed by placing untreated sewage in the proximity of the habitat, periodic sampling of the waters for coliform organisms at selected sites was undertaken (as was described in section A3.4.2.4).

##### A3.4.7.2 Results and Discussion

The results are presented in Table A31, with positive isolation of coliform bacteria obtained on three occasions. Day 7 showed a decreasing level as the habitat was approached from the outfall, with negative results on the shoreward side. The screen at the end of the sewer line had been removed on day 6 due to overgrowth by algae, thus releasing into the environment accumulated wastes. The organisms isolated on day 7 may be residual from the heavy load of sewage from the day before. At site 2 on day 20 and sites 2 and 4 on day 48, extremely low counts were found. The remaining samples were negative for the presence of coliform.

The numbers of coliforms considered safe in drinking water is less than 4/100 ml.\* For bathing in the marine surf the safe level varies, but according to State regulations it is generally above 100/100 ml. Therefore, these low numbers of coliforms observed in the waters around the habitat are well within acceptable standards from the standpoint of public health.

##### A3.4.7.3 Conclusion

The disposal of the sewage from the habitat without an added disinfectant did not produce a public health hazard to the aquanauts. The placement of the outfall was sufficiently distant to disperse the organisms in water away from the habitat.

\*Standard Methods for the Examination of Water and Wastewater," 12th edition, Amer. Pub. Health Assoc. Inc., New York, pp. 569-570, 1965.

Table A31  
Quantity of *Coliform* Organisms per 100 ml of Sea Water Collected at Four Sites\* in the Area of the Habitat

Day of Dive	Quantity of Organisms (count/100 ml)			
	Site 1	Site 2	Site 3	Site 4
0	N <sup>†</sup>	N	N	N
3	N	N	N	N
7	2	3	6	N
9	N	N	N	N
13	N	N	N	N
16	N	N	N	N
20	N	1	N	N
23	N	N	N	N
30	N	N	N	N
35	N	N	N	N
41	N	N	N	N
48	N	3	N	2
55	N	N	N	N

\*Figure A30 shows the site locations.

<sup>†</sup>Negative results.

#### A3.4.8 Virology

H. M. S. Watkins, Naval Biological Laboratory

##### A3.4.8.1 Introduction

The viral study was designed to detect any significant impact of human viral agents exacerbated by the 59-day submergence. Onset of a viral infection was sought by regular sampling of two sites, throat and rectum, and by collection of sera before and after submergence. In the event of disease outbreak it was planned to collect an additional acute serum. In this manner it was hoped that we might detect: (a) onset of viral disease carried into the habitat during incubation, (b) activation of a latent viral infection by environmental factors inherent in the submerged environment (altered stress, pressure, gas mixture, etc.), or (c) acquisition or transmission of viral infection between aquanauts.

##### A3.4.8.2 Procedures

The frozen samples from Tektite I, in veal infusion broth and the CRTV holding media, were kept at  $-70^{\circ}\text{C}$  until the time of analysis. The thawed specimens were passed twice at approximately 14-day intervals in (a) primary human embryonic kidney cells, (b) established human embryonic lung, and (c) established monkey embryonic kidney cell lines. The inoculated cell lines were observed for evidence of cytopathological effects and tested for hemadsorption of human type O red blood cells. The samples obtained during the stay of aquanauts at the University of Pennsylvania hospital, the oyster samples, and a throat sample from diver 7 collected during the onset of the first respiratory infection following completion of the trial were passed three times as outlined.

### A3.4.8.3 Results and Discussion

The specimens collected in the base-line studies at the University of Pennsylvania and at the Tektite I site were all negative for cytopathological effects and hemadsorption. No virus was demonstrated in the samples, and no clinical viral disease was reported during the study.

### A3.4.8.4 Conclusion

The conditions imposed by environmental changes inherent in the Tektite I submergence did not activate a latent virus infection, nor did the aquanauts acquire a demonstrable virus infection from the marine environment.

### A3.4.9 Nasal *Staphylococcus* "Carrier"

Andre B. Cobet and John Hresko, Naval Biological Laboratory

#### A3.4.9.1 Introduction

The carrier of a pathogenic organism living in close association with other people presents a potential hazard to his associates. The degree of hazard depends on such conditions as the type of organism,\* degree of crowding, and number of susceptibles,† on environmental factors such as relative humidity and the degree and type of lighting,‡ on the temperature of the environment,§ and on other factors.

The association of the four aquanauts in the Tektite I environment provided an opportunity to study the transmission of a tracer organism. None of the aquanauts were carriers of *Neisseria meningitidis*; however, both aquanauts 2 and 4 were nasal carriers of coagulase-positive *Staphylococcus aureus*.

#### A3.4.9.2 Procedure

The sample swab was obtained by the aquanaut placing a dry sterile swab high into the nose. Isolation of nasal *Staphylococcus aureus* was made by streaking the surface of a plate of mannitol salt agar (Difco) with the nasal swab and incubating the inoculated plate at 37°C for 24 hours. Colonies which fermented mannitol were subcultured and returned to NBL for identification by standard methods of identification.

Specimens were obtained from all aquanauts on days 22, 40, and 59.

#### A3.4.9.3 Results and Discussion

A carrier state was found to exist in aquanauts 2 and 4 at the beginning of the program. Aquanaut 2 on subsequent analysis did not yield the nasal *Staphylococcus*. Aquanaut 4 was found to be a carrier through day 40 but not on day 59. The other two aquanauts were not found to carry nasal *Staphylococcus* on the sampling days.

\*P. H. Gregory and T. L. Monteith, editors, "Airborne Microbes," Cambridge University Press, England, 1967.

†L. F. Miller, "Acute Respiratory Infections in Naval Personnel," pp. 3-23 in "A Symposium on Aerobiology," Naval Biological Laboratory, Naval Supply Center, Oakland, 1963.

‡S. J. Webb, "Factors Affecting the Viability of Airborne Bacteria, IV - The Inactivation and Reactivation of Airborne *Serratia marscescens* by Ultraviolet and Viable Light," Can. J. Microbiol. 7, 607-619 (1961).

§D. N. Wright, G. D. Bailey, and L. J. Goldberg, "Effect of Temperature on Survival of Airborne Mycoplasma pneumoniae," J. Bacteriol. 99 (1969).

The close association of the aquanauts and environmental factors were not optimal for the transmission of *Staphylococcus aureus* from the two carriers to the two non-carriers. At the completion of the 59-day program there were no nasal *Staphylococcus aureus* carriers remaining. The similar loss of the carrier state has been demonstrated by other investigators.

#### A3.4.9.4 Conclusion

The two aquanauts who were nasal *Staphylococcus* carriers at the beginning of the program had lost their carrier state when examined at intervals during the 59-day study. The two noncarriers remained uninfected.

#### A3.4.10 General Discussion of Results and Conclusions

Andre B. Cobet and John P. Hresko, Naval Biological Laboratory

At the beginning of the Tektite I program several questions were unanswered concerning the microbiology associated with a prolonged saturation dive. These were questions such as: Would the microbial population in the environment build up during the program and, if so, in what manner? Would changes occur within the normal microflora of the aquanauts? Would organisms indigenous to the aquanauts and the environment, both habitat and marine, present a health problem? Were the aquanauts healthy carriers of potentially pathogenic organisms, and, if so, would transmission to other aquanauts occur? What degree of health hazard would be present from the disposal of untreated sewage into the marine environment? Would the prolonged application of the conditions necessary to maintain the Tektite I program (increased pressure, altered atmosphere, etc.) result in a change in the normal relationship between the aquanaut and his microflora? Only a comprehensive study could give answers to these questions.

There were certain correlations in the data collected in the various sections, particularly between aerobiology, bacteriology, and mycology.

During the latter half of the program the *Acinetobacter*, which was frequently isolated from the air samples and samples from the skins of the aquanauts, may have had its origin from the marine environment. This is based on the following evidence. The aquanauts appeared to have acquired the organism after the start of the program, as all samples were negative for this organism before entry in the habitat. Aquanauts 2 and 3 were first to demonstrate the organism in samples from the skin, followed on days 19 and 22, when the two other aquanauts demonstrated the organism. They could have acquired the organism directly from the marine environment or from the aerosol resulting from the activity of the other aquanauts. The marine agar showed a relatively constant background of organisms until day 33, at which point the level rapidly increased. From day 33 to day 38 at least two of the aquanauts were restricted to the habitat at any one time due to ear infections. During this period of restriction there was a reduction in frequency of showering, which allowed for a buildup of population on the skin. An increase in the in-house activity resulted in shedding of the organism and consequently aerosolization. This would be reflected as an increase in frequency of isolation of the particular organism from the air and skin samples which was found. The *Acinetobacter* had established itself in the skin flora of all four aquanauts midway through the program. That the organisms originated from the aquanauts and their activity is demonstrated by the decrease in the number of organisms in the air 48 hours after the exit of the aquanauts from the habitat to 0.3/ft<sup>3</sup>. During this 48 hours there was no activity in the habitat.

Potentially pathogenic organisms were isolated from the air during the program; had they become established in the air in large numbers, the health of the aquanauts could have been jeopardized.

There were instances of increased levels of fungi in the air which coincided with peaks found associated with the aquanauts and the habitat walls. The peaks of fungi in the air during days 0 through 12, 19 through 29, 29 through 35, 46 through 50, and 50 through 59 all coincided with at least five peaks occurring at these same times in the mycological results. The peaks occurring between days 39 through 43 coincided with the results obtained from the wet lab wall, the location of the air sampler. Thus there was a close association between the incidence of fungi in the air and on the personnel.

There were no major medical complaints from the aquanauts; thus revolutionary changes in the microbial population were not expected. The only medical problems of consequence were the ear infections. Their frequency did not seem aggravated by the environmental conditions imposed by the program. Such ear infections are common among divers working in warm and humid conditions. The most common infecting organism in the ears of the divers is *Pseudomonas*, the same organism found to produce infection in two aquanauts and possibly a third. Fungi did not appear to be involved in the ear infections in the Tektite I program.

There were no prominent changes in the indigenous microbial population of the aquanauts. The only exception was the ear infection and skin as noted above.

The microbial carrier state of the aquanaut did not play a part in the transmission of disease in the Tektite I program. This is borne out by the *Staphylococcus* carrier study and the evidence that *Candida* and *Proteus* remained associated with a single individual throughout the program.

The microbial population did not build up on the walls of the habitat during the 59 days of the study. The sample sites had not been swabbed prior to obtaining the sample; thus the sample represented the microflora of the wall over an increasingly longer period of time. This microflora was in a state of flux, with new organisms continually becoming associated with the wall surface, while the older organisms were dying.

The level of coliform organisms from the disposal of sewage into the environment did not attain a level sufficient to become a health hazard to the aquanauts.

Conditions imposed in maintaining the habitat did not induce a latent virus infection, nor did the aquanauts acquire any demonstrable virus infection from the marine environment.

The answers to the questions posed at the beginning of the program show that the prolonged application of the environmental conditions and aquanaut interactions in the Tektite I program did not result in any unusual microbiological hazard. The possible intrusion of a marine organism into the habitat and its establishment was of interest and may present a problem in future long-term studies of this type. Ear infections are common to this type of program and will probably remain so until an adequate prophylactic remedy is developed.

#### A3.4.11 Acknowledgments

Andr  B. Cobet and John P. Hresko, Naval Biological Laboratory

Thanks are extended to the technical staff at the Naval Biological Laboratory for the prompt and efficient completion of the numerous details involved in this study. Particular thanks are also extended to Mr. Steve Dunn for the contributions he made at the on-site facility at St. John Island.



### A3.5 Respiratory and Pulmonary Studies

#### A3.5.1 Objectives, Rationale, and Procedures

C. J. Lambertsen, Institute for Environmental Medicine,  
University of Pennsylvania, Philadelphia, Pennsylvania

Detailed and varied studies of pulmonary function and respiratory control were conducted to determine the degree to which chronic exposure to a high-density atmosphere with a high partial pressure of inspired nitrogen would modify the mechanical properties of the lungs, the efficiency of pulmonary air movement, the exchange of gas across the pulmonary capillary membrane, and the reactivity of the control system which regulates respiration.

The lungs, the alveolar membrane, and the respiratory tract represent the interfaces between man and his gaseous environment. Gases in an artificial atmosphere such as is employed in diving can affect respiration through local or systemic physiological or toxic effects of individual respired gases, through acute stresses such as respiratory resistance due to increase in gas density at high pressure, and through adaptations or deteriorations resulting from prolonged exposure to any of these influences.

The experimental design for the biomedical studies of Tektite I took into specific account the known and postulated effects of exposure to a nitrogen-oxygen atmosphere at increased ambient pressure. Considerations which guided the choice of atmosphere and the studies to be performed were as follows:

- At the planned working depth of nearly 50 feet of sea water, respiration of air (20.94% oxygen in nitrogen, with traces of rare gases) would be expected to induce pulmonary and probably other forms of oxygen toxicity over the course of several days.
- By maintaining an oxygen percentage at the working depth low enough to provide an inspired oxygen partial pressure equivalent to the natural oxygen pressure in air at sea level, all forms of oxygen poisoning should be preventable.
- The increased gas density at the working depth would result in an increase in pulmonary airway resistance and in work of respiration. The degree of, consequences of, and adaptations to this respiratory stress were to be determined.
- Since nitrogen is largely an inert gas, it is unlikely that even high nitrogen pressures should exert toxic effects upon the pulmonary capillary membrane. However, since increased airway resistance can conceivably indirectly alter gas exchange across the pulmonary capillary membrane by inducing pulmonary edema, studies of gas diffusion across the alveolar membrane were included.
- Because the nitrogen in air has demonstrable narcotic properties at high partial pressures, sustained exposure to increased  $pN_2$  was conceived as potentially depressing the respiratory control mechanisms. This, together with the possibly additive influences of adaptations to a sustained increase in work of breathing, led to measurement of the overall reactivity of the carbon dioxide-responsive components of respiratory control.

The control measurements, the pulmonary monitoring throughout the exposure, and the detailed postexposure measurements were incorporated in the study to provide a basis for evaluating whether the prolonged shallow exposure to high-density, high-nitrogen pressure was in fact thereafter to be considered safe for practical operations.

The aquanauts were subjected to meticulous clinical evaluation in parallel with study of respiratory and pulmonary functions. Since participation as physiological subjects

required close familiarity with the measurement procedures to be employed, each aquanaut received preliminary indoctrination and training for his part in obtaining the desired information.

For the specific studies that would be conducted repeatedly undersea during the exposure period, the subjects were trained to perform the measurements required. These included use of pulmonary-ventilation and intrathoracic-pressure recording apparatus for determining ventilation, esophageal pressure, pulmonary airway resistance, work of breathing, vital capacity, and maximal ventilatory volume. This training made it possible to provide for the periodic measurement needed to assure early detection of any abnormalities of function and to do so without imposing direct contact with other individuals.

For those studies done only before and after exposure a team of investigators conducted control measurements at the University of Pennsylvania's Institute for Environmental Medicine. The same team then transported the apparatus to the base camp for postexposure studies.

The technique and quality of performance of respiratory and pulmonary measurements during the undersea phase was monitored by having two of the investigators from the Institute for Environmental Medicine also serve as medical monitors at the diving site. Performance and recording by the subjects was observed in detail by closed-circuit TV. Recordings made in the undersea habitat were transmitted to the Institute for analysis, and the results were reported to the on-site monitors.

#### A3.5.2 Respiratory Control Study

J. G. Dickson, R. Gelfand, and C. J. Lambertsen, Institute for Environmental Medicine, University of Pennsylvania

##### A3.5.2.1 Specific Objective

The specific objective of the respiratory control study was to determine whether the combined effects of increased respiratory work and inert gas narcosis produced by continuous, prolonged respiration of a nitrogen-oxygen atmosphere at more than twice normal atmospheric density leads to altered respiratory response to carbon dioxide. To determine this, pre- and postexposure measurements were made of frequency, depth, and minute volume of respiration during inhalation of 0, 2, 4, and 6% carbon dioxide in 21% oxygen under resting, stable conditions.

##### A3.5.2.2 Methods

The apparatus employed for the measurement of the respiratory parameters and for gas administration in this study was functionally equivalent to that employed for studies of respiratory depressant effects of narcotic drugs in man.\* This apparatus was first assembled in Philadelphia and employed there for the control measurements. Subsequently the entire apparatus was transported to the diving site for the postdive measurements.

Inspired gas, supplied premixed from 2000-psi cylinders, was reduced to 50 psig by two-stage regulators (Oxweld type R-65). A demand valve (Mine Safety Appliances 10-81070) provided control of inspired gas to the subject via a low-dead-space (25-cc), plastic, two-way valve. The volume of expired air was measured by a dry gasometer

\*J. J. Downes, R. A. Kemp, and C. J. Lambertsen, "The Magnitude and Duration of Respiratory Depression Due to Fentanyl and Meperidine in Man," *J. Pharmacol. Exptl. Therap.* 158, 416-420 (1967).

(Parkinson-Cowan type CD-4) with inlet and outlet gas temperatures monitored by bi-metal dial thermometers. Respirations were manually registered on a digital counter, and time was measured with a stopclock. End-tidal  $\text{CO}_2$  tension was measured and recorded for each breath (Beckman Model LB-1 infrared  $\text{CO}_2$  analyzer; Esterline-Angus Model AW recorder). Premixed gases, accurate to  $\pm 0.03\%$   $\text{CO}_2$  by analysis (Scholander 0.5-cc analyzer) and stored in high-pressure cylinders, were used to calibrate the  $\text{CO}_2$  analyzer.

End-tidal gas samples were selectively trapped in the measuring cell of the  $\text{CO}_2$  analyzer by causing the inspiratory pressure change to activate a pressure-sensitive switch (Fairchild PSF 100) connected to an end-tidal alveolar gas sampler.\* The switch initiated a sequence involving momentary activation of a solenoid valve, causing a sample of end-tidal gas (trapped distal to the expiratory valve in the two-way breathing valve) to be drawn into the  $\text{CO}_2$  analyzer. Subsequent closure of the solenoid valve caused the end-tidal sample to remain in the analyzer until the succeeding expiration was completed.

Each subject was studied in duplicate on each of two days. The series therefore included duplicate exposures to 0, 2, 4, and 6% inspired  $\text{CO}_2$ . He was placed in a supine position and made to rest for a 30-minute period prior to administering the succession of gases for  $\text{CO}_2$ -response measurements. Rectal temperature was measured with a thermistor thermometer. Each point on a respiratory  $\text{CO}_2$ -response curve required a 15-minute period of gas administration which was composed of two periods; an initial 10-minute segment was used to permit the respiratory response to  $\text{CO}_2$  inhalation to reach a new steady state, and the data were collected in the succeeding 5 minutes. The subject was allowed a brief respite (4 to 5 minutes) after each exposure to a  $\text{CO}_2$  mixture and a 10-minute rest midway in the series of eight runs comprising the duplicate determination of  $\text{CO}_2$ -ventilatory response.

After correction of the measured expired air volume to standard conditions, respiratory 1-minute volume, tidal volume, and respiratory frequency were calculated as averages for the 5-minute periods of data measurement. The average end-tidal  $\text{CO}_2$  tension was obtained by planimetry from the strip chart recording, and a correction was made for dead-space error as previously determined at the Institute for Environmental Medicine† to obtain the values for alveolar  $\text{pCO}_2$  needed in plotting the alveolar  $\text{pCO}_2$ -ventilation response curves.

### A3.5.2.3 Results and Discussion

Mean values for duplicate measurements of end-tidal  $\text{CO}_2$  tension, respiratory 1-minute volume, tidal volume, and respiratory frequency for individual subjects are given in Table A32. Individual graphs for respiratory parameters plotted against  $\text{CO}_2$  tension for pre- and postexposure measurements are shown in Figs. A41, A42, and A43.

Comparison of postexposure data with control data reveals that three subjects (aquanuts 1, 3, and 4) showed a tendency toward an increase in respiratory reactivity to  $\text{CO}_2$  at higher levels, as reflected by respiratory rate and 1-minute volume. The remaining subject (aquanut 2), however, displayed a tendency toward a reduction in reactivity.

\*C. J. Lambertsen and J. M. Benjamin, Jr., "Breath-by-Breath Sampling of End-Expiratory Gas," *J. Appl. Physiol.* 14, 711-716 (1959).

†C. J. Lambertsen, "The Atmosphere and Gas Exchanges With the Lungs and Blood," p. 639, Fig. 36-6, in "Medical Physiology," V. B. Mountcastle, editor, St. Louis, Mosby, 1968.

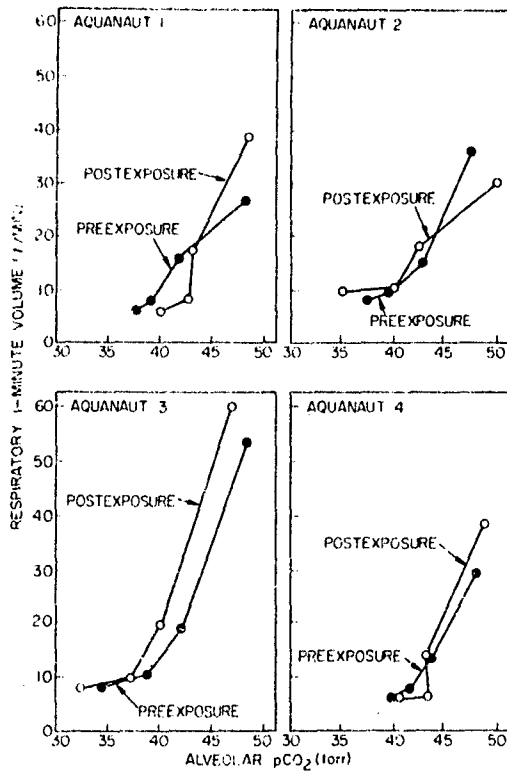

Fig. A41 - Response of the respiratory 1-minute volume to changes in alveolar pCO<sub>2</sub>

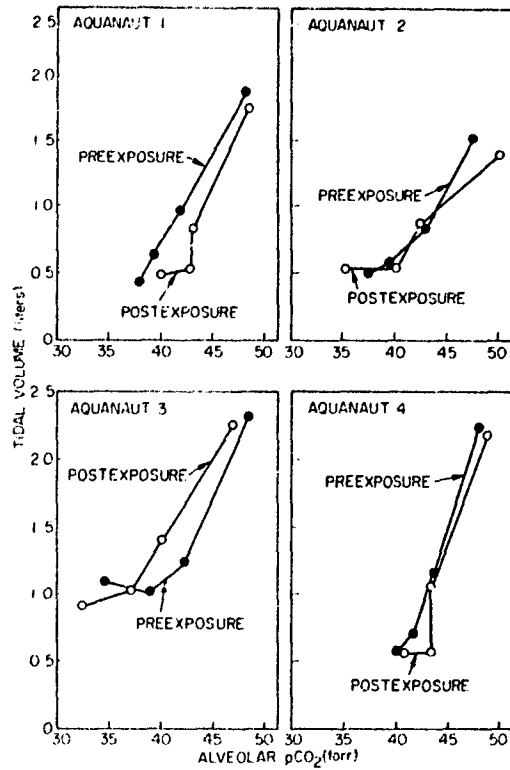

Fig. A42 - Response of the tidal volume to changes in alveolar pCO<sub>2</sub>

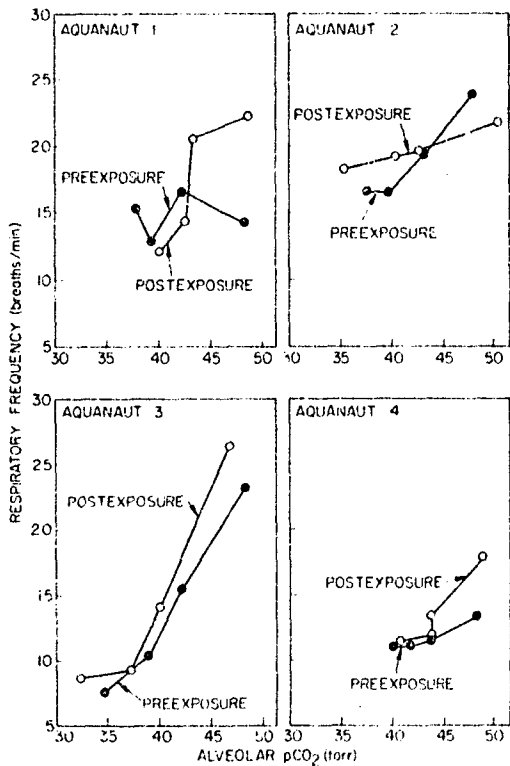

Fig. A43 - Response of the respiratory frequency to changes in alveolar pCO<sub>2</sub>

Table A32  
Respiratory Response to Changes in Alveolar pCO<sub>2</sub>  
Before and After the 2-Month Saturation Dive

Aqua- naut	Inspired CO <sub>2</sub> (%)	pCO <sub>2</sub> (torr)	Respiratory 1-Minute Volume (l/min)	Tidal Volume (l)	Respiratory Frequency (breaths/min)
Preexposure					
2	0	37.4	8.39	0.504	16.7
	2	39.5	9.64	0.582	16.6
	4	42.8	15.26	0.832	18.4
	6	47.6	36.32	1.521	23.9
3	0	34.6	8.16	1.096	7.6
	2	38.9	10.38	1.011	10.4
	4	42.2	18.75	1.216	15.4
	6	48.4	53.24	2.308	23.2
4	0	40.0	6.12	0.560	11.0
	2	41.7	7.70	0.694	11.1
	4	43.7	13.12	1.160	11.4
	6	48.2	29.30	2.218	13.2
1	0	37.8	6.52	0.438	15.3
	2	39.2	8.22	0.639	12.8
	4	41.8	15.98	0.974	16.6
	6	48.2	26.93	1.884	14.3
Postexposure					
2	0	35.3	9.95	0.544	18.3
	2	40.2	10.51	0.538	19.6
	4	42.5	18.13	0.874	20.7
	6	50.1	30.37	1.395	21.8
3	0	32.4	7.70	0.899	8.6
	2	37.3	9.50	1.017	9.3
	4	40.2	19.56	1.396	14.1
	6	46.9	59.29	2.243	26.4
4	0	40.8	6.39	0.554	11.4
	2	43.4	6.55	0.562	11.8
	4	43.2	14.04	1.052	13.4
	6	48.9	38.54	2.177	17.7
1	0	40.1	5.98	0.493	12.1
	2	42.8	8.22	0.536	14.4
	4	43.2	17.18	0.838	20.5
	6	48.5	38.77	1.748	22.2

Since only four subjects were studied, it was known that even if gross changes in respiratory reactivity occurred, the observations would have to be extended in additional subjects to determine statistical significance. Since no evident gross trend occurred in these four subjects, it can be predicted that demonstration of any obscure effect of this relatively small increase in ambient pressure would require a number of subjects several times larger than the group studied. Moreover, any effect thus uncovered would be too small to have practical significance in diving safety. However, it should also be considered that, as depth of chronic exposure is increased to the point of severe respiratory work and narcosis, it is inevitable that changes in respiratory reactivity and regulation will occur.

#### A3.5.2.4 Conclusions

In conclusion, chronic exposure to a high-nitrogen, normal-oxygen mixture with a density approximately 2 times that of air at sea level induces no detectable increase or decrease in reactivity to the respiratory stimulus, carbon dioxide. It remains likely that exposure to higher densities and nitrogen pressures will induce practically important alterations of respiratory control.

#### A3.5.3 Diffusion Capacity of the Pulmonary Membrane

R. W. Hyde, A. B. Fisher, and A. B. DuBois, Institute for Environmental Medicine, University of Pennsylvania

##### A3.5.3.1 Specific Objective

The specific objective of studying the diffusion capacity of the pulmonary membranes was to determine whether prolonged exposure to increased nitrogen pressure and increased gas density affects the alveolar pulmonary capillary membrane and transmembranal diffusion of gases.

##### A3.5.3.2 Methods

Measurements included pulmonary diffusing capacity, determined by the single-breath carbon monoxide method,\* and functional residual capacity, determined by closed-circuit helium equilibration.† From the primary measurements it is possible to calculate the total lung capacity, the mixing efficiency of the gas-containing pulmonary compartment, and the occurrence of any diffusion limitation in the passage of oxygen from alveoli to the pulmonary capillary blood.

Measurements were performed in duplicate during the preexposure control week and repeated in duplicate within 2 days after ascent during the postexposure measurement period at the diving site. No attempt was made to perform the determinations during the high-pressure exposure, since it was judged that the pulmonary membrane characteristics were not likely to change as a physiological limitation.

\*C. M. Ogilvie, R. E. Forster, W. S. Blakemore, and T. W. Morton, "A Standardized Breath-Holding Technique for the Clinical Measurement of the Diffusing Capacity of the Lung for Carbon Monoxide," *J. Clin. Invest.* 36, 1-17 (1957).

†C. D. Needham, M. C. Rogan, and I. McDonald, "Normal Standards for Lung Volumes, Intrapulmonary Gas Mixing and Maximum Breathing Capacity," *Thorax* 9, 313-325 (1954).

Since only four subjects were studied, it was known that even if gross changes in respiratory reactivity occurred, the observations would have to be extended in additional subjects to determine statistical significance. Since no evident gross trend occurred in these four subjects, it can be predicted that demonstration of any obscure effect of this relatively small increase in ambient pressure would require a number of subjects several times larger than the group studied. Moreover, any effect thus uncovered would be too small to have practical significance in diving safety. However, it should also be considered that, as depth of chronic exposure is increased to the point of severe respiratory work and narcosis, it is inevitable that changes in respiratory reactivity and regulation will occur.

#### A3.5.2.4 Conclusions

In conclusion, chronic exposure to a high-nitrogen, normal-oxygen mixture with a density approximately 2 times that of air at sea level induces no detectable increase or decrease in reactivity to the respiratory stimulus, carbon dioxide. It remains likely that exposure to higher densities and nitrogen pressures will induce practically important alterations of respiratory control.

#### A3.5.3 Diffusion Capacity of the Pulmonary Membrane

R. W. Hyde, A. B. Fisher, and A. B. DuBois, Institute for Environmental Medicine, University of Pennsylvania

##### A3.5.3.1 Specific Objective

The specific objective of studying the diffusion capacity of the pulmonary membranes was to determine whether prolonged exposure to increased nitrogen pressure and increased gas density affects the alveolar pulmonary capillary membrane and transmembranal diffusion of gases.

##### A3.5.3.2 Methods

Measurements included pulmonary diffusing capacity, determined by the single-breath carbon monoxide method,\* and functional residual capacity, determined by closed-circuit helium equilibration.† From the primary measurements it is possible to calculate the total lung capacity, the mixing efficiency of the gas-containing pulmonary compartment, and the occurrence of any diffusion limitation in the passage of oxygen from alveoli to the pulmonary capillary blood.

Measurements were performed in duplicate during the preexposure control week and repeated in duplicate within 2 days after ascent during the postexposure measurement period at the diving site. No attempt was made to perform the determinations during the high-pressure exposure, since it was judged that the pulmonary membrane characteristics were not likely to change as a physiological limitation.

\*C. M. Ogilvie, R. E. Forster, W. S. Blakemore, and T. W. Morton, "A Standardized Breath-Holding Technique for the Clinical Measurement of the Diffusing Capacity of the Lung for Carbon Monoxide," *J. Clin. Invest.* 36, 1-17 (1957).

†C. D. Needham, M. C. Rogan, and I. McDonald, "Normal Standards for Lung Volumes, Intrapulmonary Gas Mixing and Maximum Breathing Capacity," *Thorax* 9, 313-325 (1954).

## A3.5.3.3 Results and Discussion

Table A33 summarizes the actual determinations made in this phase of the study. None of the parameters studied appeared to have been detrimentally or even detectably affected by the 2-month undersea exposure.

Table A33  
Pulmonary Diffusion Measured Before and After the 2-Month Saturation Dive

Aqua- naut	Pulmonary Diffusing Capacity (ml/min/torr)		Total Lung Capacity (l)		Mixing Efficiency (%)	
	Pre-dive*	Post-dive†	Pre-dive	Post-dive	Pre-dive	Post-dive
2	30	29	7.9	7.8	87	93
3	36	35	8.3	8.7	89	100
4	27	32	7.5	8.3	93	89
1	28	35	6.3	7.1	90	93
Mean	30	33	7.5	8.0	90	94

\*Measurements made 1 month prior to the start of the exposure.

†Measurements made 1 day after the end of the exposure.

With the nearly identical values found in control and postexposure periods, additional studies under the same conditions using many more subjects would be unlikely to show statistically significant changes. On this basis, and because there is no positive indication that membrane characteristics would change due to high nitrogen pressure or due to the increase in gas density associated with residence at an ambient pressure of about 2 atmospheres absolute, it is not considered that extension of this study is needed.

## A3.5.3.4 Conclusion

In conclusion, the capacity for exchange of gas by diffusion across the pulmonary capillary membrane is not detectably modified by the chronic exposure to high nitrogen pressure or the increased density of the respired gas.

## A3.5.4 Pulmonary Mechanics

A. B. DuBois, A. B. Fisher, C. J. Knight, and C. J. Lambertsen,  
Institute for Environmental Medicine, University of Pennsylvania

## A3.5.4.1 Specific Objectives

The specific objectives of studying pulmonary mechanics were to determine whether prolonged, continuous respiration of gas of increased density will result in functionally important alterations of the pulmonary mechanics through changes in pulmonary compliance or airway resistance and to determine whether, during the exposure, adaptations to increased gas density will restore respiratory resistance toward normal.



## A3.5.4.2 Methods

Airway resistance was determined by simultaneously and continuously measuring transpulmonary pressure and ventilatory flow. From measurements of the change in transpulmonary pressure required to produce a change in lung volume, lung compliance could be calculated. Transpulmonary pressure during spontaneous respiration was measured with a differential pressure transducer (Statham P23-2D-300) connected to a thin-walled, 10-cm-long latex balloon containing 0.2 to 0.5 ml of air and positioned in the esophagus 10 cm cephalad (i.e., upward) from the cardioesophageal junction. The reference port of the pressure transducer was connected to the subject's mouthpiece.

Both the transpulmonary pressure and the change in lung volume measured with the Stead-Wells spirometer were recorded on a two-channel direct-writing recorder during normal tidal respiration. Pressure-vs-volume curves were constructed from these data, and total lung resistance and lung compliance were calculated.\* In aquanauts 3 and 4 the pulmonary resistance was calculated as the mean of inspiratory and expiratory resistances. However, aquanauts 1 and 2 had a high and variable expiratory resistance, and in these subjects the pulmonary resistance was calculated during inspiration only. The esophageal pressure at full lung inflation was also recorded.

## A3.5.4.3 Results and Discussion

No definite trend was observed in the lung compliance (Table A34 and Fig. A44). Since the preceding phase of the study indicated no significant change in the mean pulmonary diffusing capacity (section A3.5.3.4), there was no evidence that elevated nitrogen pressure or resistance to breathing, alone or together, had deleterious effects on the lungs or led to adaptive changes in the lung tissue. A slight trend toward a decrease in pulmonary resistance from the moderately elevated value at the beginning of exposure to increased ambient pressure occurred over the 60-day study period at diving depth (Table A34 and Fig. A45). No evidence of this persisted after return to 1 atmosphere.

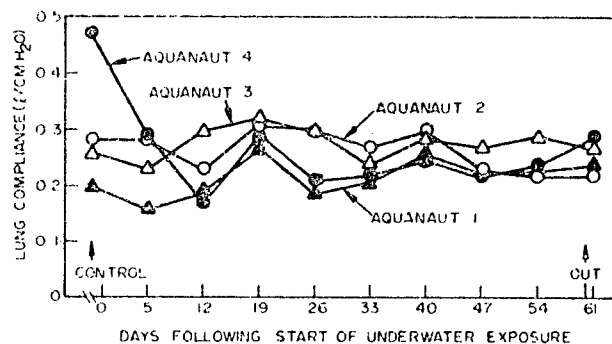

Fig. A44 - Lung compliance during the 60-day saturation dive

\*R. Marshall, E. H. Lanphier, and A. B. DuBois, "Resistance to Breathing in Normal Subjects During Simulated Dives," J. Appl. Physiol. 9, 5-10 (1956).

Table A34  
Pulmonary Compliance and Resistance Before,  
During, and After the 2-Month Saturation Dive

Day of Dive	Lung Compliance (l/cm H <sub>2</sub> O)					Pulmonary Resistance (cm H <sub>2</sub> O/(l/sec))				
	Diver 2	Diver 3	Diver 4	Diver 1	Mean	Diver 2	Diver 3	Diver 4	Diver 1	Mean
Predive	0.28	0.26	0.47	0.20	0.30	2.5	1.3	1.6	2.4	2.0
5	0.28	0.23	0.29	0.16	0.24	2.4	3.3	2.4	1.8	2.5
12	0.23	0.30	0.17	0.19	0.22	2.3	2.9	3.0	2.9	2.8
19	0.31	0.32	0.29	0.27	0.30	1.9	2.4	2.7	4.3	2.8
26	0.30	0.30	0.21	0.19	0.25	2.2	1.8	2.0	3.0	2.2
33	0.27	0.24	0.22	0.21	0.24	1.4	3.0	2.0	1.6	2.0
40	0.30	0.29	0.25	0.26	0.28	2.1	2.0	1.6	1.6	1.8
47	0.23	0.27	0.22	0.23	0.24	0.8	1.9	2.1	2.7	1.9
54	0.22	0.29	0.24	0.23	0.24	1.8	2.1	1.2	2.1	1.8
Postdive	0.22	0.27	0.29	0.24	0.26	0.7	2.2	2.6	2.2	1.9

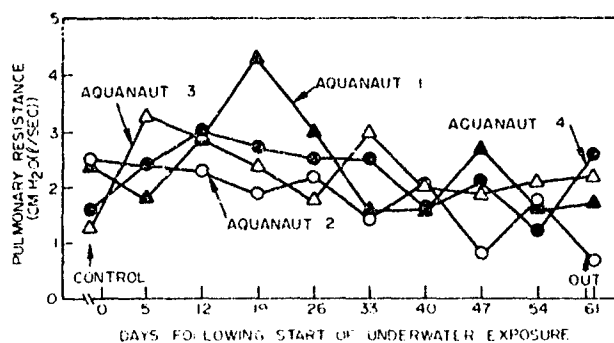

Fig. A45 - Pulmonary resistance during the 60-day saturation dive

The moderate elevation of respiratory resistance due to increased gas density was not expected to produce a major change in the compliance of the lung. The initial and partially sustained increase in pulmonary resistance can be considered as reflecting gas-density effects on airway resistance rather than changes in the lungs or bronchioles themselves. When exposure to increasingly higher atmospheric densities occurs, it is inevitable that sustained increases in airway resistance and work of breathing will induce more gross alterations of the respiratory function.

#### A3.5.4.4 Conclusion

In conclusion, no effect on pulmonary mechanics was observed that should impose an obstacle to full operational exploitation of undersea activity using nitrogen with a sea-level-equivalent oxygen partial pressure at the depth employed for Tektite I.

### A3.5.5 Ventilatory Function

C. J. Knight, C. J. Lambertsen, and A. B. DuBois, Institute for Environmental Medicine, University of Pennsylvania

#### A3.5.5.1 Specific Objective

The specific objective of studying the ventilatory function was to determine whether continuous prolonged exposure to a respiratory environment of increased density and viscosity, represented by a nitrogen-oxygen mixture at about 2.15 atmospheres absolute, would result in progressive changes in pulmonary ventilatory volume and function. Such changes could result from respiratory exhaustion or from improvement in conditioning of the respiratory muscles.

#### A3.5.5.2 Methods

An electrically driven Stead-Wells spirometer equipped with a recording drum was employed for preexposure and postexposure examinations, and an identical unit was installed in the habitat for use during the undersea exposure phase. Full study of the pulmonary ventilatory function prior to exposure to increased ambient pressure included measurements of vital capacity, residual volume, maximum voluntary ventilation and maximum expiratory and inspiratory flow rates, intrathoracic pressure, pulmonary airway resistance, work of breathing, and pulmonary compliance.

The subjects received extensive training in spirometric methods, so that each subject had the technical capability of conducting the tests on his fellow subjects during the underwater exposure. It was intended by this training to provide understanding of the nature of these tests and to ensure continuing high motivation in personal performance throughout the undersea exposure.

The investigators conducted the entire series of measurements in the control period at the Institute for Environmental Medicine and in the postexposure period (within the first day after decompression) using portable laboratory facilities especially designed for the purpose and transported to the diving site. During the exposure phase in the undersea habitat, two subjects worked together under the closed-circuit-TV supervision of an investigator, with one subject being studied and one conducting the actual tests.

All measurements were performed before and after the 60-day exposure. In addition certain measurements were obtained at regular weekly intervals during submergence to determine the rate of development of any changes in vital capacity, maximal ventilatory capacity, transpulmonary pressure, flow rate, airway resistance, work of breathing, and pulmonary compliance.

#### A3.5.5.3 Results and Discussion

The ventilatory function measurements obtained before, during, and after the 60-day exposure are summarized in Table A35 and Figs. A46 through A50.

Preexposure studies of the four subjects confirmed normal pulmonary function in these individuals. On beginning the 2-month underwater period, maximal midexpiratory rates and maximal voluntary ventilation decreased by about 25%. The initial changes are compatible with the effects of an increased airway resistance due to the increased gas density at the depth of the habitat.\* These earliest measures after beginning the exposure

\*A. B. Fisher, A. B. DuBois, R. W. Hyde, C. J. Knight, and C. J. Lambertsen, "Effect of 2 Months' Undersea Exposure to N<sub>2</sub>-O<sub>2</sub> at 2.2 atm on Lung Function," *J. Appl. Physiol.* **28**, 70-74 (1970); R. Marshall, E. H. Lanphier, and A. B. DuBois, "Resistance to Breathing in Normal Subjects During Simulated Dives," *J. Appl. Physiol.* **9**, 5-10 (1956).

Table A35  
Pulmonary Functions Before, During, and After the 2-Month Saturation Dive

Day of Dive	Vital Capacity (ℓ)	Expiratory Reserve Volume (ℓ)	Inspiratory Capacity (ℓ)	Forced Expired Volume (%/sec)	Forced Expired Volume (%/3 sec)	Maximal Midexpiratory Flow Rate (ℓ/sec)	Maximal Midinspiratory Flow Rate (ℓ/sec)	Maximal Voluntary Ventilation (ℓ/min)
Aquanaut 2								
Predive	5.81	1.53	4.29	87.1	98.4	5.92	7.34	191.8
5	5.62	1.96	3.66	80.0	99.2	4.60	5.63	125.1
12	5.57	1.94	3.63	81.8	99.6	4.62	5.82	146.7
19	5.74	2.10	3.64	81.4	100.0	4.42	6.10	158.4
26	5.50	1.64	3.87	79.8	99.1	4.16	5.98	151.1
33	5.47	1.64	3.84	82.0	100.0	4.20	6.20	154.0
40	5.71	2.18	3.53	82.2	99.4	4.45	5.69	149.0
47	5.63	1.86	3.76	78.9	99.6	4.35	5.90	154.3
54	5.80	1.95	3.86	83.5	99.6	4.86	6.66	172.4
Postdive	5.72	2.02	3.70	82.4	99.1	5.00	10.00	233.0
Aquanaut 3								
Predive	6.18	1.77	4.42	75.7	95.8	3.80	6.65	168.7
5	6.52	1.79	4.73	68.8	96.9	3.05	5.32	104.4
12	6.17	2.14	4.03	69.6	96.4	3.14	4.26	127.4
19	6.21	2.80	3.41	65.1	92.5	2.80	4.54	125.7
26	6.31	1.69	4.63	68.6	93.6	3.10	4.62	122.5
33	6.47	1.67	4.80	67.2	92.7	3.11	4.76	120.2
40	6.44	2.67	3.77	65.5	92.5	2.96	4.78	128.4
47	6.61	2.25	4.36	64.8	93.8	3.13	5.12	119.5
54	6.50	2.66	3.83	57.5	93.6	2.93	4.61	120.5
Postdive	6.82	2.48	4.34	73.2	95.5	3.90	7.09	184.5
Aquanaut 4								
Predive	6.22	1.90	4.33	84.5	96.9	6.52	7.90	175.1
5	6.34	2.79	3.54	73.6	96.3	4.18	6.32	154.9
12	6.52	2.52	4.00	75.7	96.9	4.37	6.70	198.0
19	6.40	2.52	3.87	70.8	96.3	4.18	6.98	181.7
26	6.49	2.50	3.99	69.0	96.5	4.02	6.52	175.8
33	6.42	2.50	3.92	75.0	97.4	4.47	6.27	190.3
40	6.44	2.53	3.90	75.9	96.7	4.50	6.51	187.8
47	6.68	2.73	3.96	76.2	98.4	4.61	7.07	208.3
54	6.70	3.17	3.52	72.6	97.4	4.42	6.92	195.6
Postdive	6.50	2.65	3.85	86.5	99.2	6.04	10.6	260.6
Aquanaut 1								
Predive	4.72	1.64	3.08	76.5	94.3	3.05	7.51	170.8
5	4.56	1.40	3.16	69.8	93.6	2.38	4.82	133.1
12	4.62	1.62	3.01	71.6	95.1	2.40	4.82	133.3
19	4.68	1.90	2.78	70.4	92.9	2.58	5.20	139.1
26	4.67	1.50	3.17	70.4	93.4	2.56	5.97	118.9
33	4.58	1.59	2.99	70.5	91.8	2.60	5.25	123.5
40	4.64	1.54	3.10	71.5	92.7	2.59	5.20	116.3
47	4.74	1.45	3.29	70.2	94.0	2.55	5.57	127.1
54	4.78	1.41	3.37	67.7	90.9	2.32	4.83	130.3
Postdive	4.79	1.49	3.30	73.7	90.3	2.92	7.98	187.4
Mean of the Four Aquanauts								
Predive	5.73	1.71	4.03	81.0	96.4	4.82	7.35	176.5
5	5.76	1.98	3.77	73.0	96.5	3.55	5.52	129.4
12	5.72	2.06	3.67	74.7	97.0	3.63	5.40	151.4
19	5.76	2.33	3.42	71.9	95.4	3.50	5.70	151.2
26	5.74	1.83	3.92	72.0	95.6	3.46	5.77	142.1
33	5.74	1.85	3.89	73.7	95.5	3.60	5.62	147.0
40	5.81	2.23	3.58	73.8	95.3	3.62	5.54	145.4
47	5.92	2.07	3.84	72.5	96.4	3.66	5.91	152.3
54	5.94	2.30	3.64	70.3	95.4	3.63	5.76	154.7
Postdive	5.96	2.16	3.80	79.0	96.0	4.46	8.92	216.4

PROJECT TEKTITE I

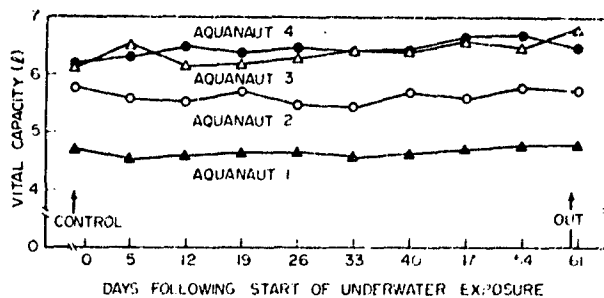

Fig. A46 - Vital capacity during the saturation dive

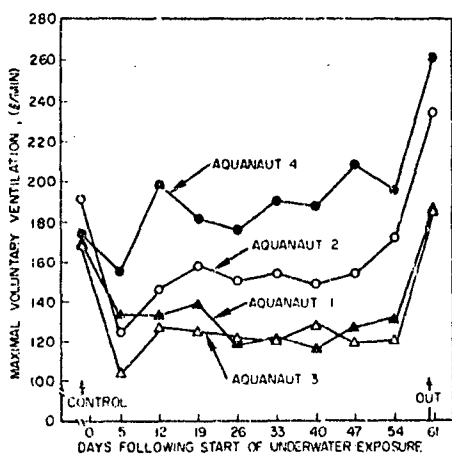

Fig. A47 - Maximum voluntary ventilation during the saturation dive

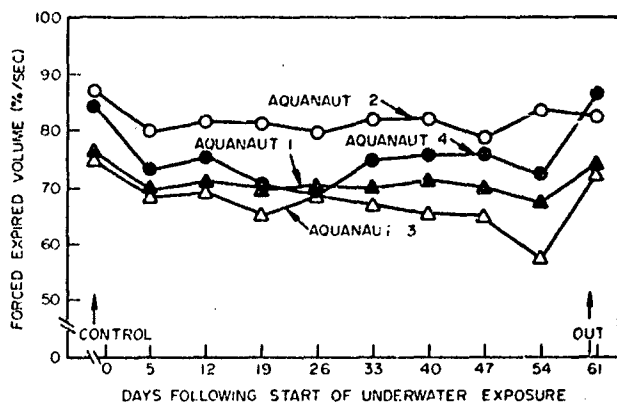

Fig. A48 - Forced expiratory volume during the saturation dive

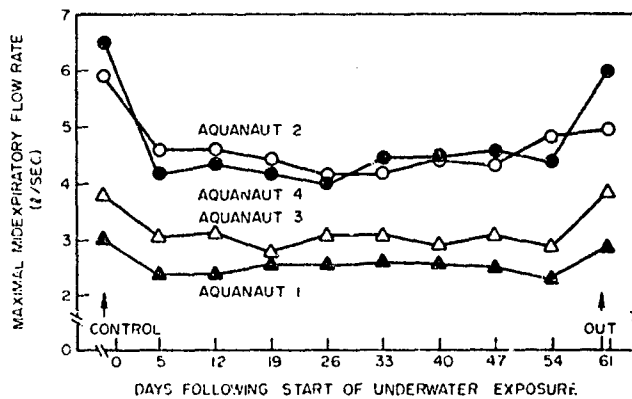
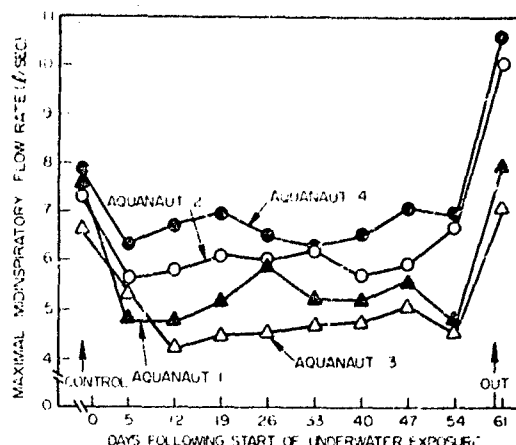

Fig. A49 - Maximal midexpiratory flow rate during the saturation dive

Fig. A50 - Maximal midinspiratory flow rate during the saturation dive



can be considered as controls for the subsequent period of continuous exposure. After the initial effect of entry into the positive pressure environment, maximal voluntary ventilation in two of the subjects increased progressively during the underwater period, suggesting increase in efficiency of the respiratory muscles as a result of physical training.\* Vital capacity during this time also showed a slight increase of about 10% in two subjects and remained unchanged in the other two. The small vital-capacity changes are also consistent with the known effects of training and exercise on vital capacity.

Ventilatory-function tests were repeated in the immediate postexposure phase. The results of these measurements are essentially unchanged from those obtained during the control week 4 months previously. The small rise in vital capacity of two subjects and the increase in maximal voluntary ventilation suggested by the measurements obtained during the actual underwater phase were confirmed.

#### A3.5.5.4 Conclusions

The four aquanauts had normal lungs at the start of the study. During the underwater exposure, resistance to breathing was increased approximately 25%, compatible with increase in gas density. There is a suggestion that physical training, possibly due to the sustained elevation of work of breathing, resulted in improved respiratory muscular performance and increased vital capacity of some subjects. The pulmonary function returned to normal after the exposure.

There was no evidence of deleterious effect upon ventilatory function as a result of a 2-month habitation at 2.15 atmospheres absolute in the nitrogen-oxygen mixture employed.

\*J. Mead, "Measurement of Inertia of the Lungs at Increased Ambient Pressure," J. Appl. Physiol. 9, 208-212 (1956).

### A3.6 Decompression

Cdr. T. N. Markham, Naval Submarine Medical Center,  
New London, Connecticut

#### A3.6.1 Standard Decompression Schedule

The design of the biomedical program was based on an oxygen partial pressure of  $153 \pm 7$  torr. Therefore, the initial desire was to develop a decompression schedule which maintained this partial pressure throughout decompression. Further the decompression facility was designated several months after schedule preparation and testing began at the Naval Submarine Medical Center. To accommodate both these restraints it was elected to use a stage decompression. It was also determined that if any cases of decompression sickness arose during the schedule testing, a revision of the schedule would be required prior to further testing.

After the first test, which maintained  $pO_2$  at  $158 \pm 7$  torr during decompression, it became evident such a tight control of oxygen would be very difficult in an operational setting. Therefore the decompression media was changed to air. With this change four more test dives were calculated by the method of Workman\* and conducted until the schedule had been extended to 19 hours and 25 minutes of decompression and only one dive free of decompression sickness had been performed. It then appeared necessary to incorporate some oxygen decompression within the schedule to prevent further prolongation. Following the addition of 4 hours and 25 minutes of oxygen breathing to the schedule the two most susceptible subjects were safely decompressed after a 42-foot saturation dive. The final decompression schedule used in Tektite I is seen in Table A36. At the conclusion of Tektite I the four aquanauts were decompressed using this schedule without any development of decompression sickness.

#### A3.6.2 Emergency Decompression Schedule

Under contract to NASA, J and J Marine Diving Company, Inc., Pasadena, Texas, conducted a series of test dives to determine the safe surface interval between direct surfacing from the 42-foot saturation depth and the onset of decompression sickness. This series of dives resulted in the shortest surface interval being 18 minutes. Therefore a 15-minute safe period was considered possible in which to return a subject to pressure.† During these test dives a decompression schedule was developed which used an overpressure return and early oxygen decompression. This schedule was successful in treating all their cases of decompression sickness and after slight modification was employed as the Tektite I emergency decompression schedule (Table A37).

#### A3.6.3 Decompression Facilities and Procedures

The decompression complex used in Tektite I was the Advanced Diving System IV (ADS IV) leased from Ocean Systems, Inc. This system consisted of a twin-lock deck decompression chamber (DDC), a submersible decompression chamber (SDC), a control console, an air compressor, an air conditioning unit for the deck chamber, and a bottled oxygen supply. Each lock of the DDC measured 4-1/2 feet in diameter and was 7 feet long. Carbon dioxide was controlled by ventilation with air whenever  $pCO_2$  values approached 4 torr. Oxygen was supplied to the DDC through masks via demand regulators.

\*R. D. Workman, "Calculation of Decompression Schedules for Nitrogen-Oxygen and Helium-Oxygen Dives," U.S. Navy Experimental Diving Unit Research Report 6-65, 1965.

†P. O. Ediel, "Delineation of Emergency Surface Decompression and Treatment Procedures for Project Tektite Aquanauts," J and J Marine Diving Co., Inc., Pasadena, Apr. 20, 1969.

Table A36  
Regular Decompression Schedule for Tektite I

Depth (ft)	Breathing Media	Time at Stop (min)	Decompression Time (min)	
			Total	Oxygen
42	Air	—*	0	0
↓	Air	12†	12	0
30	Air	120	132	0
↓	Air	5	137	0
25	Air	200	337	0
↓	Air	5	342	0
20	Air	170	512	0
20	Oxygen	30	542	30
↓	Oxygen	5	547	35
15	Air	20	567	35
15	Oxygen	30	597	65
15	Air	20	617	65
15	Oxygen	30	647	95
15	Air	20	667	95
15	Oxygen	30	697	125
15	Air	20	717	125
15	Oxygen	30	747	155
↓	Oxygen	5	752	160
10	Air	60	812	160
10	Oxygen	30	842	190
10	Air	20	862	190
10	Oxygen	30	892	220
10	Air	20	912	220
10	Oxygen	40	952	260
↓	Oxygen	5	957	265
5	Air	200	1157	265
↓	Air	5	1162 (19 hr 22 min)	265 (4 hr 25 min)
Surface	Air	—	—	—

\*Aquanauts will be transferred via the personnel transfer capsule to the deck decompression chamber and held at a depth of 42 feet until all are transferred and the topside crew is ready for decompression.

†All depth changes during the decompression will be made at a rate of 1 foot per minute. If the depth changes occur slower, the time will be added to the total decompression time.



**Table A37**  
**Emergency Recompression and Decompression Following**  
**an Explosive Decompression (Inadvertent Surfacing)**

Depth (ft)	Breathing Media	Time at Stop (min)	Decompression Time (min)	
			Total	Oxygen
60*	Oxygen	20	20	20
↓	Oxygen	5	25	25
55	Air	20	45	25
↓	Air	5	50	25
50	Oxygen	20	70	45
↓	Oxygen	5	75	50
45	Air	20	95	50
↓	Air	5	100	50
40	Oxygen	20	120	70
↓	Air	15	135	70
25	Air	60	195	70
↓	Air	5	200	70
20	Air	90	290	70
20	Oxygen	30	320	100
↓	Oxygen	5	325	105
15	Air	90	415	105
15	Oxygen	60	475	165
↓	Air	5	480	165
10	Air	120	600	165
10	Oxygen	60	660	225
↓	Oxygen	5	665	230
5	Air	150	815	230
5	Oxygen	60	875	290
↓	Air	5	880 (14 hr 40 min)	290 (4 hr 50 min)
Surface	Air	—	—	—

\*An overpressure is applied on recompression when an aquanaut inadvertently surfaces.

There were two masks in each compartment. Each lock of the DDC and the SDC contained communication with the control console. All gas supplied to or exhausted from either the DDC or SDC was controlled at the console. The entire system could be pressurized to an equivalent depth of 600 feet of sea water and was provided with mixed-gas diving capability, although mixed gas was not available during Tektite I.

During the daily operation the decompression complex was under the direct supervision of the senior enlisted diver on watch and manned by either another diver or an Ocean Systems representative. The crane was manned at all times in the event an emergency habitat evacuation was required. Further daily drills were conducted by each watch section exercising the decompression complex, the crane, or the small boats used for surface support in the event of an inadvertent aquanaut surfacing.

#### A3.6.4 Excursion Diving Decompression Schedules

Due to the nitrogen/oxygen mixture used in the habitat ( $pO_2$   $158 \pm 7$  torr), the saturation depth of Tektite I was an air equivalent depth of 49 feet. Therefore the vertical excursions on air scuba were calculated from that depth. This allowed a shallower excursion of approximately 30 feet without decompression.\* This upper limit was set at a depth of 20 feet of sea water. Excursions shallower than this were not allowed due to the hazard of decompression sickness and the possibility of inadvertent surfacing.

No-decompression and decompression schedules were established for deeper excursions by modifying the U.S. Navy Standard Air Table 1-6, "No decompression" limits and repetitive group designation table for "no decompression" dives, and Table 1-5, U.S. Navy Standard Air Decompression Table (Tables A38 through A41).† The modifications were made in a conservative direction. These tables are used in accordance with directions given in the U.S. Navy Diving Manual for Table 1-5, 1-6, 1-7, and 1-8 with the exception that the surface interval noted in Table 1-7 is considered the interval taken in the habitat. Further, when following a deep excursion by a shallow excursion (i.e., above the 42-foot saturation depth) the diver must have been in repetitive group E or lower to go to 30 feet of sea water and in group B or lower to go to 20 feet of sea water depth. The aquanauts attempted to plan their daily diving schedules in order to make any anticipated shallow excursions prior to deep excursion. During the entire operation it was never necessary for aquanauts to make decompression dives to return to the habitat from depth. There were no cases of decompression sickness occurring under pressure during the saturation phase of Tektite I.

#### A3.6.5 Summary of Decompression

Although the decompression schedule preparation for Tektite I was prepared for an operational program, it became evident during its preparation that the controlling tissue for nitrogen saturation decompression is far beyond the 240-minute level suggested by Workman. The data collected during this series of dives supports the much longer controlling tissue described by Buhlmann et al.‡ The schedule prepared and used for Tektite I is not an optimum schedule but does appear safe from an air saturation depth equivalent to 49 feet of sea water.

\*R. D. Workman, "Calculation of Decompression Schedules for Nitrogen-Oxygen and Helium-Oxygen Dives," U.S. Navy Experimental Diving Unit Research Report 6-65, 1965.

†U.S. Navy Diving Manual, General Principles of Diving," NavShips 250-538, Navy Department, Washington, U.S. Government Printing Office, 1963.

‡A. A. Buhlmann, P. Frei, and N. Keller, "Saturation and Desaturation with  $N_2$  and He at 4 Atmospheres," J. Appl. Physiol. 23, 458-462 (1967).

Table A38  
No-Decompression Limits and Repetitive Group Designations for Aquanaut  
Vertical Excursions (Downward) From a Saturated Depth of 42 Feet

Depth From Surface (ft)	Limit of Time at Depth (min)	Repetitive Group														
		A	B	C	D	E	F	G	H	I	J	K	L	M	N	O
60	300	60	120	200	300	—	—	—	—	—	—	—	—	—	—	—
65	300	30	60	100	150	200	300	—	—	—	—	—	—	—	—	—
70	300	20	40	60	90	120	150	200	300	—	—	—	—	—	—	—
75	300	15	30	40	60	90	110	145	180	200	300	—	—	—	—	—
80	300	10	20	30	50	60	80	100	120	150	180	200	300	—	—	—
85	300	5	10	20	30	40	50	70	90	100	120	140	180	200	240	300
90	180	5	10	20	25	30	40	50	70	90	100	110	130	150	180	—
100	90	—	5	10	20	25	30	40	50	60	70	80	90	—	—	—
120	40	—	—	5	10	15	20	25	30	35	40	—	—	—	—	—
140	25	—	—	—	5	10	15	20	25	—	—	—	—	—	—	—
160	10	—	—	—	—	—	5	10	—	—	—	—	—	—	—	—

Table A39  
Standard Decompression for Aquanauts Exceeding  
the No-Decompression Limits of Table A38

Depth (ft)	Bottom Time (min)	Time to First Decompression Stop (min)	Time at Stop (min)			Total Decompression Time (min)	Repetitive Group at End of Decompression
			80 ft	70 ft	60 ft		
90	200	1	—	—	2	3	N
	220	1	—	—	7	8	N
	240	1	—	—	11	12	O
	260	1	—	—	15	16	O
100	100	1	—	—	3	4	L
	120	1	—	—	7	8	M
	140	1	—	—	12	13	M
	160	1	—	—	25	26	N
	180	1	—	—	35	36	O
	200	1	—	—	40	41	O
120	50	1	—	—	8	9	K
	60	1	—	—	14	15	L
	80	1	—	—	24	25	N
	100	1	—	2	41	44	O
	120	1	—	6	52	59	O
150	1	—	13	72	86	Z	
140	30	2	—	—	7	9	J
	40	2	—	—	18	20	L
	60	2	—	10	30	42	N
	80	2	—	20	50	72	O
160	20	2	—	—	5	7	H
	40	2	—	10	30	42	M
	60	2	1	25	50	78	O



Table A41  
 Repetitive Dive Timetable: Influence of Repetitive Group  
 on the Allowable Time at a Given Depth

Repetitive Group	Repetitive Dive Depth*				
	90 ft	100 ft	120 ft	140 ft	160 ft
A	7	6	4	3	3
B	17	13	9	7	6
C	25	21	15	11	10
D	37	29	20	16	13
E	49	38	26	20	16
F	61	47	31	24	20
G	73	56	37	29	24
H	87	66	43	33	27
I	101	76	50	38	31
J	116	87	57	43	34
K	138	99	64	47	38
L	161	111	72	53	42
M	187	124	80	58	47
N	213	142	77	64	51
O	241	160	96	70	55
Z	257	169	100	73	57

\*The numbers in the columns are times in minutes to be deducted from the maximum allowable times at depth.

A3.6.6 Delineation of Emergency Surface Decompression and Treatment Procedures for Project Tektite I Aquanauts  
 Peter O. Edel, J and J Marine Diving Co., Inc.,  
 Pasadena, Texas

A3.6.6.1 Summary

Project Tektite I required that four scientist-aquanauts were to live for 2 months in a habitat at a depth of 43 feet in Lameshur Bay, St. John, Virgin Islands, during which time their breathing mixture was to be 91% N<sub>2</sub>, 9% O<sub>2</sub>. A series of experiments was therefore conducted to determine to what degree of safety the scientists could make a no-decompression ascent to surface from the habitat and the maximum surface decompression interval they could safely undergo.

From these experiments it was determined that a 15-minute surface interval was safe for six subjects and that one subject developed serious neurocirculatory symptoms after 19 minutes on the surface.

Recompression-decompression schedules were calculated for treatment of these subjects after their exposure to surface intervals of various lengths of time. All subjects were successfully treated according to these tables. A safe surface interval of 15 minutes and use of the recompression-decompression schedules that were developed as a result of this experimentation are recommended for incorporation into the Project Tektite I operational procedures.

#### A3.6.6.2 Introduction

Project Tektite I required four scientist/aquanauts to live 60 days in a habitat on the sea floor at a depth of 43 feet. The scientists made frequent excursion dives from the habitat, during the day and at night, to study the flora and the fauna of nearby coral reefs. The excursion dives were made with standard scuba equipment, and two 71-cu-ft scuba bottles provided the air supply. This supply of air permitted the scientists to swim for about 1 to 2 hours at this depth, or to travel about 1000 feet from the habitat before returning to it.

The possibility that equipment failure, injury, or shark attack might force the swimmers to surface had to be anticipated. Since their bodies were saturated with the inert gas of their habitat breathing mixture (91% nitrogen, 9% oxygen) at the habitat pressure of 43 feet of seawater (FSW), ascent to the surface would have constituted an emergency situation requiring immediate pressurization.

To what degree of safety a diver, breathing air at a depth greater than 33 FSW (1 atmosphere), could make a no-decompression ascent to surface when his slowest tissues are totally nitrogen saturated had never been established. Furthermore the length of time that a diver can remain at surface pressure following such an ascent before experiencing the serious effects of decompression sickness had never been determined, and this exposure time was critical to the safety of the Tektite I divers and will continue to be critical in future Tektite dives. There are no valid decompression tables indicating the appropriate procedures to be followed in decompressing a diver from a state of total nitrogen saturation. Neither are there any published tables indicating the appropriate recompression and decompression procedures to be followed in the event of emergency surfacing in the circumstances under which Tektite divers live and work.

#### A3.6.6.3 Purpose

The present experimentation was conducted (a) to determine the maximum safe surface interval that the Tektite I divers could sustain without developing symptoms of decompression sickness after remaining at a depth of 42 FSW\* in a habitat in which they would be totally saturated with a breathing mixture of 160 torr O<sub>2</sub> in nitrogen and (b) to determine safe recompression-decompression schedules that would permit the Tektite I divers to return to their habitat after this maximum safe surface interval, or that would allow their being brought to surface for emergency treatment, if such became necessary.

#### A3.6.6.4 Method

Six tests were performed involving two subjects each. All of the subjects were divers whose ages varied from 20 to 52 years. The subjects were pressurized in a double-lock pressure chamber that was 4 feet in diameter and 14 feet long, in accordance with the compression-decompression schedules described hereafter. The small chamber limited the movements of the subjects; they were, however, instructed to engage in mild physical activity for 15 minutes prior to any scheduled reduction in pressure.

The partial pressure of carbon dioxide in the chamber atmosphere was maintained between 0.6 and 5 torr during periods of intermittent ventilation (with air) and at less than 4 torr during continuous ventilation. In addition the pressure chamber's content of carbon dioxide was reduced through a more rapid ventilation with air to an even lower level prior to any reduction in pressure. In each test, accuracy was held to within 1/2

\*Decompression tables were based on a planned saturation depth of 42 FSW. The actual saturation depth was nominally 43 FSW, but the difference was considered negligible.

foot of the prescribed simulated depth. The 91% nitrogen, 9% oxygen gas mixture used in the final 2 hours of compression at the 42-FSW level was purchased from commercial suppliers and was tested to assure that accuracy was maintained to within 0.1% of the prescribed ratio.

After a change in the partial pressure of nitrogen in a breathing mixture, the change in nitrogen saturation of bodily tissues occurs at an exponential rate that is limited by the slowest tissue's half-saturation time. This half-saturation time, of course, varies greatly among individuals, but the time selected — 360 minutes — is widely accepted in diving practices as accommodating the slowest tissues of the vast majority of the diving population.

Three days at 42 FSW would be required to bring the 360-minute tissues to an almost total state of nitrogen equilibrium with the proposed breathing atmosphere of the Tektite I habitat. Because of the cost of doing so and the discomfort that the divers would have to endure it would have been impractical to saturate the Tektite I divers for such a length of time in a chamber on a breathing mixture of 91% N<sub>2</sub>, 9% O<sub>2</sub>. A shortened exposure period at greater depth, based upon the following theoretical considerations, was therefore calculated: Breathing air at a pressure of 1 atmosphere (which equals 33 FSW absolute) produces a partial pressure of nitrogen in the tissues equal to that of 26 FSW (absolute) pressure — 79% of the total pressure of 1 atmosphere.

The Project Tektite I breathing atmosphere was to be a mixture of oxygen and nitrogen, the oxygen limited to 7 FSW (160 torr) partial pressure and the nitrogen to a partial pressure of 68 FSW. (The gage pressure of 42 FSW is equal to 75 FSW absolute pressure; i.e., 42 FSW plus 33 FSW (1 atmosphere) equals 75 FSW absolute.) The Tektite I divers were therefore to undergo an increase in nitrogen partial pressure upon changing from breathing air on the surface to breathing the atmosphere in the Tektite habitat — a pressure of 42 FSW (68 FSW minus 26 FSW, or 42 FSW).

If the 42-FSW increase in nitrogen partial pressure in the Tektite I breathing atmosphere were doubled, the nitrogen partial pressure in the slowest half-saturation time tissue would, theoretically, be increased to 50% of the 84-FSW change in the atmospheric nitrogen partial pressure during the period that the slowest tissues half-saturate, namely, 360 minutes. Under a pressure of 139 FSW absolute (106 FSW gage pressure) air has a nitrogen partial pressure of 110 FSW. The nitrogen pressure at 110 FSW is 84 FSW over that of air at surface pressure (1 atmosphere); it is twice the difference between the nitrogen partial pressure of air at 1 atmosphere and that of the atmosphere that was planned for the Tektite I habitat. In 6 hours, therefore, it is theoretically possible to bring about total equilibrium between the nitrogen partial pressure in the slowest tissues and that of the Tektite I breathing atmosphere that would be approximated by a diver's breathing the Tektite I atmosphere for 3 days (or more) at 42 FSW.

The tissues with a half-saturation time of less than 360 minutes will attain higher levels of nitrogen tissue tension during the 360-minute pressurization at 106 FSW but will eliminate nitrogen more rapidly when the pressure is decreased. In the present experimentation it was necessary that the nitrogen partial pressure of all the tissues be approximately equal to that in the Tektite I atmosphere (68 FSW); chamber pressure was therefore decreased from 106 FSW to 53 FSW gage after 360 minutes to desaturate the faster half-saturation-time tissues.

Breathing air at 53 FSW produces the same nitrogen partial pressure in the tissues as is produced by breathing a 91% N<sub>2</sub>, 9% O<sub>2</sub> mixture at a depth of 42 FSW. The nitrogen partial pressure is equal to the gage depth in the breathing mixture plus the equivalent absolute depth at sea level (33 feet) multiplied by the percentage of nitrogen in the mixture. For the Tektite I atmosphere the equation is as follows:

$$(42 \text{ FSW} + 33 \text{ FSW}) \times 0.91 \text{ N}_2 = 68 \text{ FSWA}.$$

Breathing air at 53 FSW nitrogen partial pressure is

$$(53 \text{ FSW} + 33 \text{ FSW}) \times 0.79 \text{ N}_2 = 68 \text{ FSW}.$$

As far as the nitrogen partial pressure is concerned, therefore, both conditions are equal.

Calculations indicate that 16 hours at 53 FSW pressure are required so that the tissues with shorter half-saturation times desaturate to approximate the Tektite I tissue nitrogen partial pressure. Some of the slower tissues will have nitrogen partial pressures slightly in excess of the Tektite I habitat's nitrogen content at the end of this time. To prevent any possible contributory effects resulting from the increased partial pressure of oxygen, the final 2 hours prior to testing the surface interval were spent at 42 FSW, during which time the subjects breathed the specified mixture of 91% N<sub>2</sub>, 9% O<sub>2</sub>.

The following schedule of pressure exposure was used to establish total equilibrium between the nitrogen saturation in the bodily tissues having a half-saturation time of 360 minutes and the nitrogen content of the Project Tektite I breathing atmosphere:

1. Breathing air at 106 FSW for 6 hours.
2. Breathing air at 53 FSW for 16 or 35 hours.
3. Breathing a 91% nitrogen, 9% oxygen mixture at 42 FSW for 2 hours.

The first three tests used a minimum desaturation period of only 16 hours. This period was increased to 35 hours in the last three tests to determine the validity of the shorter desaturation interval. The allowable safe surface interval following the above schedule was determined by decompressing the subjects from 42 FSW to surface pressure in 1 minute and then observing them for periods lasting 10, 15, and 20 minutes.

Following the interval at surface pressure, the subjects were recompressed in accordance with the schedule in Table A42. These decompression schedules were calculated so that the Tektite I scientists could be safely recompressed and decompressed to habitat depth after any emergency exposure that they might be forced to undergo.

Table A42  
Surface Decompression Treatment Schedules for Return to Habitat

Schedule	Surface Interval (min)	Decompression Stages					Total Time (min)
		60 ft	55 ft	50 ft	45 ft	40 ft	
A	0-10	—	20 min (O <sub>2</sub> )	20 min (air)	20 min (O <sub>2</sub> )	—	60
B	10-20	20 min (O <sub>2</sub> )	20 min (air)	20 min (O <sub>2</sub> )	20 min (air)	20 min (O <sub>2</sub> )	100

Safe decompression schedules are also needed so that the scientists could be further decompressed from the habitat depth to surface should emergency medical treatment be required. Two decompression procedures were therefore tested, one using air breathing only, and the other using alternate periods of air and oxygen breathing (Table A43). Four subjects were decompressed according to the air table, and six according to the air-oxygen schedule. A typical dive profile is shown in Fig. A51. The two decompression schedules that were used in these tests are shown in Fig. A52.



Table A43  
Decompression Schedules for Return to Surface After Use of Table A42

Schedule	Decompression Stages					Total Time (hr)
	25 ft	20 ft	15 ft	10 ft	5 ft	
Air decompression		2 hr	2 hr	2 hr	3 hr	9
Air-oxygen decompression	1 hr (O <sub>2</sub> )	1 hr (air)	1 hr (O <sub>2</sub> )	1 hr (air)	1 hr (O <sub>2</sub> )	5

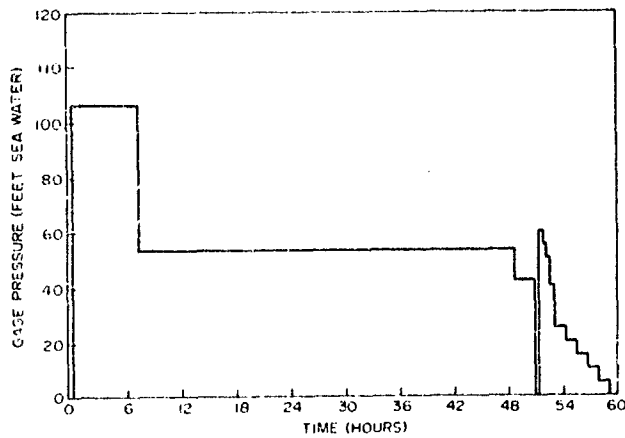

Fig. A51 - Test profile for Tektite I with approximately 35 hours at 55 FSW

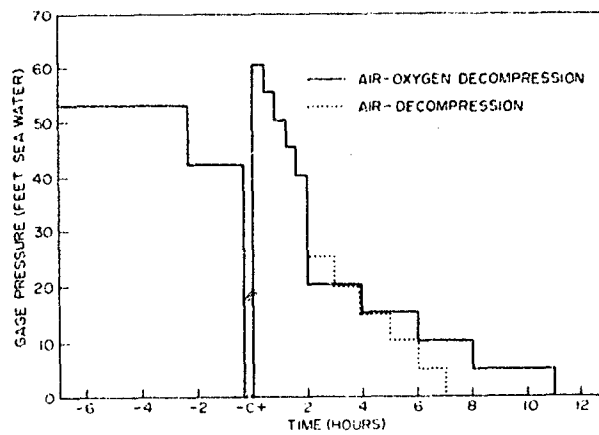

Fig. A52 - Treatment and decompression schedules after surfacing from total saturation at 42 FSW

An additional test, involving two Navy subjects, was carried out to compare the efficacy of the emergency decompression schedules proposed herein with that of the regular decompression schedule adopted for use in the Tektite I Program (Fig. A53 and Table A36).

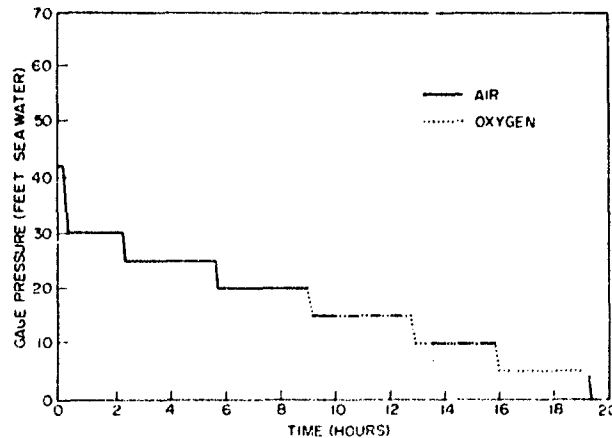

Fig. A53 - Regular decompression schedule for Tektite I

#### A3.6.6.5 Results

A schedule of the test procedures is shown in Table A44. One of the two subjects exposed to the 10-minute simulated surface interval noticed a very mild pain (grade 1) in his right shoulder. Complete relief was obtained upon recompression to a simulated depth of 55 FSW. The other subject remained symptom-free. There were no symptoms reported by the six subjects who were exposed to the 15-minute surface interval.

Of the two subjects exposed to the 20-minute surface interval, one subject remained symptom-free. The other subject experienced marked neurocirculatory symptoms in the 19th minute of his surface interval. He was immediately recompressed and reported complete relief of symptoms upon arrival at a recompression depth of 60 FSW.

Two Navy volunteer subjects, both qualified divers, were compressed in accordance with the previously tested nitrogen saturation schedule and were then decompressed on the prolonged air-oxygen schedule (Fig. A52 and Table A36). One of the two subjects suffered grade 1 bends in the right ankle upon surfacing. The symptom disappeared without treatment after 4 hours of breathing air at surface pressure.

The tables used to recompress the subjects from surface pressure to 55 or 60 FSW and then to decompress them to the simulated habitat pressure (42 FSW) were apparently safe and effective in the treatment of the two cases (out of 10 subjects) of decompression sickness that occurred during the surface interval. No incidence of decompression sickness occurred during the phase in which the subjects were returned to simulated habitat pressure.

None of the four subjects who were decompressed from 42 FSW on the air decompression table (Table A43) experienced decompression sickness. However, of the six subjects decompressed from 42 FSW on the air-oxygen decompression schedule, one subject suffered very mild (grade 1) bends pain in his right ankle upon surfacing. This

Table A44  
Test Profiles

Test No.	Time at 106 FSW on Air* (hr)	Time at 53 FSW on Air†	Time at 42 FSW on 91% N <sub>2</sub> , 9% O <sub>2</sub> ‡	Surface Interval§ (min)	Treatment Schedule	Individual Decompression Schedules
1	6	16 hr 5 min	1 hr 48 min	10	A	One diver on air; one diver on air-oxygen
2	6	15 hr 55 min	2 hr	20	B	One diver on air; one diver on air-oxygen
3	6	35 hr 25 min	2 hr	15	B	Both divers on air
4	6	34 hr 25 min	2 hr	15	B	Both divers on air-oxygen
5	6	35 hr 24 min	2 hr	15	B	Both divers on air-oxygen
6	6	35 hr 23 min	2 hr	None		Decompressed on schedule in Table A36

\*Compression to 106 feet: 2 minutes.

†Ascent from 106 feet to 53 feet: 5 minutes.

‡Ascent from 53 feet to 42 feet: 2 minutes.

§Ascent from 42 feet to surface: 2 minutes.

symptom persisted and eventually involved the subject's right knee as well, requiring compression to 60 FSW and treatment according to the modification of Table 6 of the U.S. Navy Diving Manual shown in Fig. A54. This subject has an old injury to the ankle and suffered similar bends symptoms when he was decompressed according to the standard Project Tektite I decompression schedule (test 6, Table A44). He had also suffered previous attacks of bends in this ankle. Shortly after his arrival at 30 FSW the subject complained of "soreness in his chest" and mild substernal distress when he breathed, which were interpreted as being caused by oxygen toxicity. He was then brought to 25 FSW and remained at that pressure breathing air overnight, or 10 hours. In the morning he was brought to 20 FSW, where he remained for 50 minutes breathing air. He was given oxygen for 60 minutes at the 20-FSW depth and remained on oxygen during his 20-minute ascent to surface.

#### A3.6.6.6 Discussion

The test results indicate that after total saturation at 42 FSW with the proposed Tektite I breathing mixture of 91% N<sub>2</sub>, 9% O<sub>2</sub>, a surface interval lasting no longer than 15 minutes is reasonably safe against an attack of decompression sickness. One subject in the present investigation experienced serious symptoms of decompression sickness 19 minutes after being brought to surface following the experimental saturation exposure. His symptoms might well have proved fatal had not immediate recompression been possible. A 20-minute surface interval therefore appears to be unsafe. The possibility that

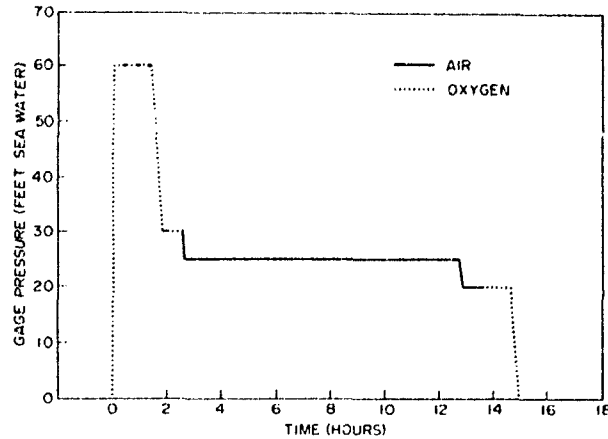

Fig. A54 - Treatment for decompression sickness resulting from test 5

decompression sickness will occur in some subjects during a 15-minute surface interval following saturation with the Tektite I habitat atmosphere cannot be ruled out, since only six tests were made in the present experimentation using the same decompression schedules as used in Project Tektite I.

Although symptoms did not manifest themselves in the other subjects who were exposed to the 15- and 20-minute intervals, there was undoubtedly bubble formation in their tissues which, had the surface interval been extended, would eventually have caused decompression sickness. When tissues are supersaturated with inert gas, the stage is set for an attack of decompression sickness should any further reduction in pressure occur. If supersaturation is great enough, the solution of the gas in the tissues becomes unstable, resulting in a separation into gas and liquid phases. The bubbles thus formed continue growing and create sufficient pressure to cause tissue damage or symptoms of decompression sickness or both.

Once a critical reduction in ambient pressure has taken place, it is only a matter of time before symptoms of decompression sickness become manifest. It must therefore be assumed that some degree of bubble growth would have occurred during the surface interval following any emergency ascent from the Tektite I habitat, whether or not the subject experienced any symptoms of it. The air-oxygen treatment tables shown in Table A42 were calculated to dissolve this bubble formation during decompression to habitat pressure.

By means of a further pressure reduction, according to the schedule shown in Fig. A53, from the equivalent of habitat to surface pressure, the effectiveness of the treatment schedule outlined in Table A43 was tested. Any nitrogen bubbles that form during a surface interval, even symptomatic ones, that are not dissolved through treatment can be expected to become aggravated by further pressure reduction. During decompression or following a diver's return to sea-level pressure, symptoms of previous silent bubble formation may become evident, or symptoms that had disappeared may reassert themselves.

One case of decompression sickness occurred during testing of the standard decompression schedule and one also during the testing of the emergency decompression schedule for Tektite I. As previously noted both instances involved the same individual, who is believed to be unusually susceptible to decompression sickness in this type of pressure exposure. All the other test subjects were able to tolerate the programmed decompression schedules without difficulty.

It is interesting to note that decompression time can be sharply reduced in emergency decompression schedules through breathing air and oxygen alternatively. When air alone was breathed in the present experimentation, a decompression time of 9 hours was required, whereas the interval was reduced to 5 hours when pure oxygen and air were breathed intermittently (Table A43). The effectiveness of denitrogenization via oxygen breathing in Tektite I emergency procedures is obvious.

In tests requiring near-total saturation of the tissues with nitrogen a major difficulty lies in the prolonged period of time required to achieve that saturation level. Because of the exponential rate at which nitrogen is absorbed and discharged by bodily tissues the process of attaining complete equilibrium between the inert gas in the inspired breathing medium and in the bodily tissues is never completed with pressure exposure at a single level. In the Tektite I experimentation the required level of nitrogen partial pressure in the bodily tissues was 68 FSW (absolute). After a diver has remained three days at 42 FSW breathing the Tektite I atmosphere, his slowest half-time tissue (360 minutes) will theoretically attain a nitrogen partial pressure of 67 to 68 FSW (absolute).

The method used in the present investigation to produce maximum nitrogen partial pressure in the slowest tissue — i.e., doubling the nitrogen partial gradient of the breathing atmosphere — was apparently effective. After a diver spends 16 hours breathing air at 53 FSW, his slower tissues — those having a faster half-saturation time than do the 360-minute tissues — has a nitrogen partial pressure of 68 to 69 FSW. This small excess in nitrogen partial pressure over the Tektite I nitrogen pressure would have, at most, a very slight effect on the required Tektite I decompression, and if anything would impose a slightly more rigid test of the decompression table to be followed.

There was no significant difference between the test results involving 16 hours of desaturation at 53 FSW and those involving 35 hours of desaturation at 53 FSW. Extending the period of time spent at 53 FSW from 16 to 35 hours reduces the nitrogen partial pressure in the slower tissues so negligibly that the extension of time beyond 16 hours cannot be considered significant in the results of any decompression schedule used.

#### A3.6.6.7 Conclusions and Recommendations

The following conclusions and recommendations were made for Project Tektite I on the basis of the preceding experimentation.

- In the event that Project Tektite I aquanauts make a planned or accidental ascent to surface after maximum nitrogen saturation at 42 FSW, a surface interval not to exceed 15 minutes is considered safe. This surface interval is recommended for use in formulating Project Tektite I emergency procedures.

- The emergency recompression and decompression schedules shown in Tables A42 and A43 were proven effective and are suggested for use in treatment of Tektite I aquanauts after emergency surfacing. It is also recommended that these schedules be used to return Tektite I divers to their habitat or to the surface under nonemergency circumstances.

- The decompression schedule formulated for the standard (as opposed to emergency) decompression of Project Tektite I divers at the end of their 60-day submergence was found to be satisfactory. Its use is therefore recommended.

- Doubling the nitrogen partial pressure gradient for a period of time equal to that of the half-saturation time of the slowest tissue demonstrated empirically that a desired tissue tension can be reached by the end of that time period. The use of this technique is recommended in experimentation involving total saturation of the tissues with nitrogen or other inert gases.

- The effectiveness of the schedules for treatment (Table A42) and decompression (Table A43) that were developed and tested was in part dependent on adherence to the established CO<sub>2</sub> partial-pressure limits set. Effectiveness likewise depended on the subjects doing mild exercise prior to each decompression phase, and also on the subjects not deviating more than 1/2 foot from the prescribed pressure at any time.

- The decompression schedule set out in Table A36 was tested under the same conditions as those in Tables A42 and A43. Its successful use also depends on the divers following the decompression procedures detailed in it, never deviating more than 1/2 foot from the prescribed pressure. Its successful use furthermore depends on the divers staying within the CO<sub>2</sub> partial-pressure limits as well as on the divers doing mild exercise during decompression.

### A3.7 Biomedical Program Summary

C. J. Lambertsen, Institute for Environmental Medicine, University of Pennsylvania, Philadelphia, Pennsylvania, and S. Kronheim, Physiology Branch, Office of Naval Research, Washington, D.C.

The composite of successfully concluded special clinical, physiological, hematological, and microbiological studies is considered to represent the pattern of study required for selection and monitoring in any comparable exploration of unusual chronic exposure to altered gaseous environment. By holding oxygen pressure at normal levels it was possible to prevent all forms of oxygen toxicity. Since no practically important deviations from normal were detected during the prolonged but rather shallow exposure, it can be considered that neither the high nitrogen pressure nor the increased gas density presented important stresses. It should therefore be possible to proceed with free employment of saturation diving under the conditions of Tektite I for operational purposes. However, while the exposure itself induced no detrimental changes, the occurrence of what appeared to be a bubble in the lens of one subject requires careful reappraisal of the decompression requirements for ascent after nitrogen or other saturation diving.

It should be considered inevitable that, as deeper diving with nitrogen-oxygen mixtures is carried out, there will be progressive further increases in respiratory airway resistance, increases in work of breathing, and also progressive increase in the degree of nitrogen narcosis. These all will reduce exercise tolerance, performance, judgment, and the safety of diving operations. At elevated density and nitrogen partial pressure of the gas breathed, the tolerable duration of exposure must be expected to become shorter. Also to be anticipated is the likelihood of a composite of adaptative, compensatory and decompensatory effects, none of which can be clearly predicted in quantitative terms in advance of detailed and comprehensive laboratory experimentation.

A related pattern of conclusions can be derived from dermatological and microbiological observations. While the skin, as a barrier between external and internal environment, was generally unaffected by the clean, usually dry, and only intermittently aqueous overall exposure involved in Tektite I, the skin lining the external auditory canal promptly became infected in each subject. This, actually representing a dermatological rather than an auditory problem, illustrated the natural and well-known consequence of continued wetness of skin difficult to keep clean and free of organic debris. It should be expected that, under conditions of even intermittent diving, similar infections of the skin lining the auditory canal will occur unless scrupulous cleanliness and drying, with avoidance of trauma and crossinfection, are practiced. This circumstance of exceptional susceptibility to infection of the skin of the auditory canal is independent of depth but more likely to be prominent in warmer than in colder environments. It should also be considered that, in future circumstances where cleanliness and drying of skin and clothing are not practiced, where water is contaminated, and where ambient temperature is high enough to

maintain high moisture content of skin, general dermatological breakdown and infection can be expected to be a frequent and severe potential complication of prolonged undersea operations.

#### A4 DATA MANAGEMENT AND THE DIGITAL DATA BANK

##### A4.1 Introduction

Nicholas Zill, Bellcomm, Inc., Washington, D.C.

##### A4.1.1 The Data Bank Concept

In an operation of the scope of Tektite I it seemed desirable to have a facility available which could function as a central repository for data generated by the various scientific and engineering components of the operation. Such a facility could serve a number of useful functions, such as (a) organizing the data for rapid access and analysis at the end of the mission, (b) reducing redundant collection of data of common interest to a number of investigators, (c) providing for collection of secondary or background data which individual investigators would not collect, (d) providing feedback during the mission of quick-look analyses of key data for investigators and mission management, (e) encouraging and simplifying the process of correlating data from different investigators, and (f) providing a base for a systems-analysis overview of the operation for planning of and comparison with similar operations in the future.

Naturally, such a facility had to be computer-based for real effectiveness in dealing with the quantity of digital data anticipated. Although the term "data bank" is usually reserved for much larger collections of data than here discussed, the term seemed appropriate for two reasons. First, like other data banks the facility was to have overall cognizance of collection procedures as well as serving as a repository. Second, it was hoped that the Tektite I effort would stimulate the development of much larger and more sophisticated data banks in the areas of marine ecology, human performance in extreme environments, and the physiology and technology of man in the sea.

##### A4.1.2 Genesis of the Data System

Both conceptually and in its physical details the Tektite I data system grew out of the project's behavioral program. The predominant orientation of this program was toward the systematic collection of unobtrusive, objective measurements. At the same time the goal was to collect a sufficient number of these measures to produce a full, multidimensional picture of the men and their environment. Because of the anticipated large volume of data that the behavioral observation program would generate, planning for that program was always computer oriented. When it became apparent that other programs would require data management support, it was suggested and agreed that the system being devised for behavior study be extended to include data from those programs. Although this decision was made rather late in the mission planning process (specifically in late July 1968), the intent was not only to provide a means of collecting and handling data but to set up a digital data bank for Tektite I. Those investigators from the other programs who had already established their collection procedures would make their data available for inclusion in the data bank after the mission, along with the measurements that were generated within the system. Thus the behavioral records would form one set (albeit the largest set) in a multicomponent file that also incorporated information from the biomedical, marine science, and habitat engineering programs of Tektite I.

The constraints operating on the development of the data system were severe, so the resulting system could hardly be termed the latest word in data-processing sophistication. The short lead-time has already been mentioned. This time pressure was aggravated

by delays in receiving measure specifications from various participants. Budgetary restrictions were definitely a factor, but they proved far less limiting in equipment purchase or computer time than in the shortage of available programming man-hours. The remote and primitive Tektite I site on St. John in the Virgin Islands imposed its own restrictions, such as cramped space, heat and humidity, fluctuating power, unreliable telephone service, and reliable logistic nightmares. On-site transcription and reproduction services were minimal, as was available training time for those who would be recording the data. Obviously the system had to be kept simple and robust in the face of these afflictions.

#### A4.2 Description of the Data System

##### A4.2.1 Data Collection

Nicholas Zill, Bellcomm, Inc., Washington, D.C., and  
Lt. Richard Mach, Naval Medical Research Institute,  
Bethesda, Maryland

##### A4.2.1.1 General Description

Machine-readable data were generated at the Tektite I site by manual punching of special, preperforated IBM cards. The cards were punched in IBM 3000 information recorder boards. The information recorder (Fig. A55) is a compact (10 by 9 by 1-1/2

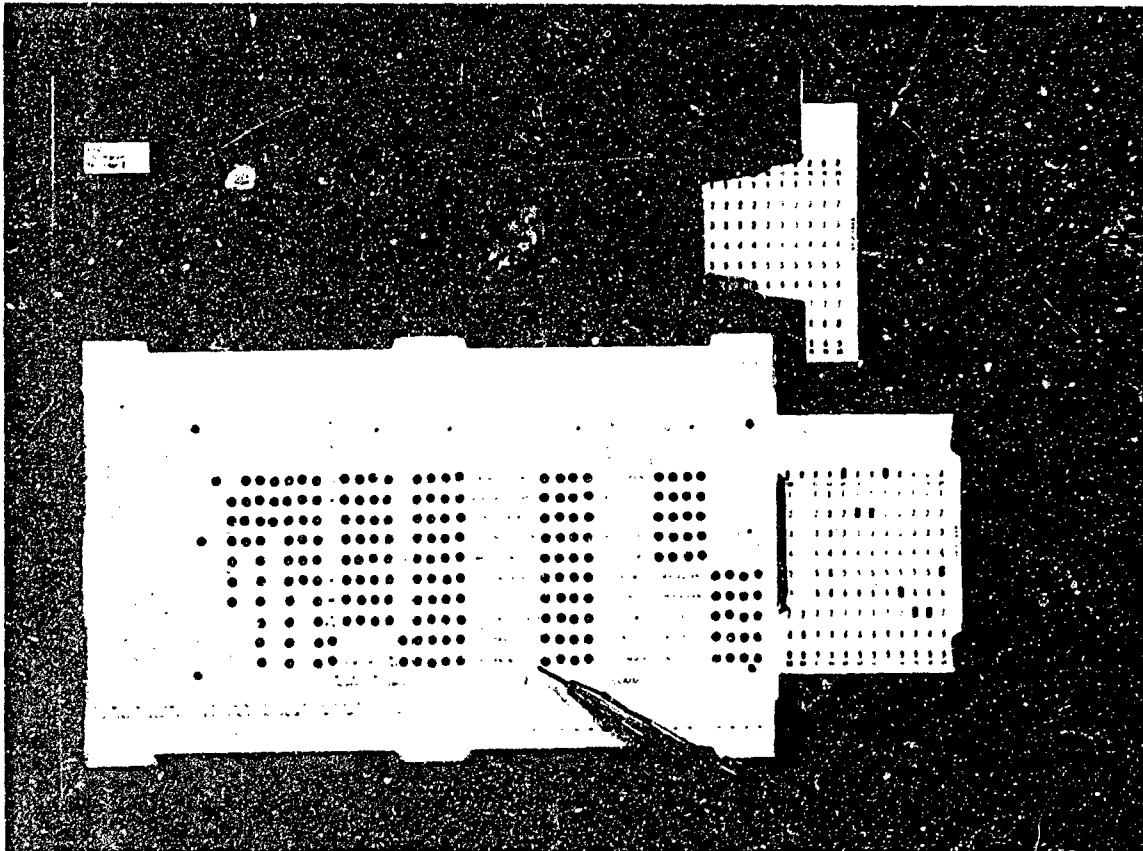

Fig. A55 - The Model I information recorder, with a stylus for punching, preperforated cards, and a sample template, namely, the behavior program's location record



inches) predominantly plastic unit with a sliding tray for card insertion, an attached stylus for punching holes, and a template which overlays the card and indicates where and how the data should be entered.

Stock cards were used which contained 40 columns of 12 punch-positions each, the equivalent of every other column on a standard 80-column IBM card. The templates are exchangeable sheets of plastic or treated cardboard which have the same configuration of preperforated areas as the cards. However, in designing a template for a particular series of measures, only those holes are punched in the template which expose meaningful punch positions on the card below. The margins and unpunched areas of the template permit the designer to include instructions and definitions of measure categories on the overlay. Not exposing inappropriate punch positions also eliminates the possibility of certain kinds of punching errors.

A standard template format was imposed to allow identification and sorting of each data card: The first two columns contained a unique identification number indicating to which program the data belonged and to which set of measurements within that program the card contributed. The third column indicated the month, and the fourth and fifth columns indicated the day of the month on which the data were collected. This format also provided the basis for organization of the data bank files. The remaining 35 columns of a card were used as specified by the relevant investigators and varied from template to template. However, most templates also included the time of day that the data were recorded. With only a few exceptions a procedural rule of only one punch per column was also imposed on template design. This cut down on the amount of information that could be squeezed into a record, but it simplified user instructions and permitted the sorting program to flag cards with multiple punches in a column as erroneous.

The principal measures in the behavior program were recorded by direct, on-line punching of cards with the information recorders. For the remainder of the behavior records, and for the records from the other programs, data were transferred on site but off-line, from checklists, logs, or paper-and-pencil forms to IBM cards, again by means of the information recorders. The source records for this off-line punching remained on site until the end of the mission, for reference and as a safeguard against data loss in transit. It had been planned to duplicate the on-line cards at a computer service facility in the Caribbean to provide similar safety backups for these data. However, the nearest available facility was in Puerto Rico, and since it was judged that the chance of data loss in transit from St. John to Puerto Rico and in Puerto Rico was at least as great as the same chance between St. John and Washington, this plan was dropped.

#### A4.2.1.2 Evaluation of the Collection Procedures

##### A4.2.1.2.1 Advantages

The advantages of the data collection procedures were:

1. Machine-readable data. The information recorder system produced machine-readable data, thus eliminating the time and labor involved in data coding and keypunching. Moreover, and in contrast to a mark-sense system, no special machine was required to read the data; the card reader of the Univac 1108 computer at Bellcomm accepted the cards directly. The lack of intermediate steps created the potential for rapid turnaround from receipt of the data to shipment of organized output and quick-look analyses back to on-site mission personnel. Because of programming-time limitations, this potential was not fully realized during the Tektite I mission.

2. Low cost. The total equipment cost for 11 information recorders, 30,000 stock cards, 70 template cards (prime templates plus spares), card receptacles, and miscellaneous ancillary apparatus was approximately \$1400. The bulk of this cost was for the

information recorders (approximately \$100 per unit). Substantial effort was involved in design of the individual templates, but similar effort would be required with practically any system -- if not in the design of recording forms, then in postrecording coding decisions. Costs were held down by obtaining treated cardboard template blanks which were then prepared in-house at Bellcomm and at the Naval Medical Research Institute, instead of using the plastic templates also available from IBM, which require costly composition and printing. The cardboard templates proved quite durable under extensive use (e.g., in the case of the behavior program's location record, 43,000 record completions).

3. Minimal training required. An adequately designed template provides extensive guidance to the user while he is punching the data. As was mentioned, this is achieved through definitions and labels on the face of the template and through selective masking of inappropriate punching areas on the card. Furthermore the perceptual motor skills involved in punching with the stylus were relatively simple. Thus the training requirements for use of the information recorders are not significantly greater than with paper-and-pencil forms.

4. Speed of data entry. The speed of data entry attainable with the information recorder is less than but comparable to average keystroke rates of experienced keypunch operators. It was certainly adequate for the Tektite I requirements. For example, one of the behavior observers, after about 10 days of experience, punched out the location record shown in Fig. A55 in 12 seconds.

5. Compactness. Because the template eliminates the necessity of repeating descriptive information on each recording form or card, the sheer bulk of needed materials is considerably reduced. Moreover a number of different templates can be used with the same recorder board. Consequently organization of the recording station is simplified.

#### A4.2.1.2.2 Disadvantages

The disadvantages of the data collection procedures were:

1. Self-checking and correction difficulties. Visual feedback to the user of what has been entered is substantially less convenient with the punchboard than with pencil or keyboard entry systems. It is necessary to look down through the template at the card below and to discriminate which holes have been punched. Once an error has been caught, correction is also more difficult. An entire new card must be punched, which, when one makes an error in the 39th column, can be frustrating. The behavior team developed certain shortcuts, such as using the error-containing card itself as a template for repunching the correct columns, but the process was still tedious.

2. Hanging chads. The tiny pieces of the preperforated cards that are punched out do not always detach completely from the card. Unless these hanging chads are removed, they can refill the punched holes and, when the card is machine read, cause jamming or data loss. Fanning through the stack of punched cards eliminated most of these chads.

3. Format restrictions. The 40-column limitation per card proved restrictive in some of the Tektite I applications. Use of a Model II information recorder, in which two cards are placed under a single larger template, permitted easing of this restriction. However, this meant that at least the first five columns of card-identifying data had to be punched out separately on both cards. Standard Hollerith coding of alphabetic information is impractical with the information recorder because of the difficulty of presenting the necessary instructions on the template. However, it is possible to have meaningful multiple punches in a single column, if a program is written to properly interpret such punching.

4. Reformatting difficulties. The capability of adding new types of data to a pre-designed template to meet unforeseen possibilities depends on how full that template is already. A template employing all 40 columns allows little improvisation. However, a template with unutilized columns can incorporate new data by punching out some of these columns and typing or writing new labels on the template. Even with 40 columns, categories can be added to an existing column by punching out an additional hole in the template. However, such midstream changes, a small number of which were necessary in Tektite I, caused headaches for the programmer preparing programs to interpret these cards.

#### A4.2.1.2.3 Conclusion

In summary, balancing these advantages and disadvantages, the data collection procedures proved quite workable, particularly for the on-line behavior observations.

#### A4.2.2 Data Logistics

Nicholas Zill, Bellcomm, Inc.

The stock cards were stored in the air-conditioned support van at the Tektite I site in Lameshur Bay. This is also where most of the data entry took place. The total number of cards required over all programs was 30,000 (including a 50% surplus margin). The storage space required was less than 10 cubic feet.

Punched cards were shipped out approximately once a week. Cards from the various programs were packed together (for minimum package size) in one box, which had also been used for stock card storage. Because of the vagaries of Caribbean cargo handling, cards were shipped out only when they could go as the personal luggage of an individual returning to Washington from the mission site. Even then the courier was encouraged to carry the box aboard the plane with him. The only data casualties sustained in-transit occurred when an overzealous Pan Am clerk stapled a baggage check onto a card box, mutilating the tops of a number of cards. Happily the data on those cards were saved, but at a cost of repunching duplicate cards by hand.

In Washington the cards were incorporated into the digital data bank at Bellcomm. When computer printouts were available, they were flown back to St. John with mission personnel returning from Washington.

#### A4.2.3 Data Processing

Anita Cochran, Bellcomm, Inc.

The computer installation at Bellcomm consists of a Univac 1108 with two Fastrand drums, five 423H high-speed drums, eight VII-C tape drives, one 758 high-speed printer, and three Univac 1004's used primarily as peripheral devices for the computer. The 1108 is a 36-bit-word machine with an add speed of 750 nanoseconds. The Bellcomm installation has a core of 165,000 bits.

The first step in processing, reproduction of the manually punched cards into standard machine-punched cards, was attempted on the 1108. At the high speed required, however, many cards jammed, and the process of recovering the data was long and painful. A 1004 computer was then taken off-line. With the resulting decrease in speed of the card reader the problems almost disappeared, and reproduction of the remaining data cards was accomplished with relative ease. Less than 0.1% of the data cards were partly or wholly lost due to mechanical difficulties. The card images were written on magnetic tape from the reproduced cards.

CREATE COMPLETE DATA TAPE							DATE	120569	PAGE	297
63220	2315	21	1	1	1	1				
63222	0230	21	1	1	1	1				
63224	2330	21	1	1	1	1				
63227	0930	21	1	1	1	1				
63305	2230	21	1	1	1	1				
63306	1203	1	509+							
63306	2200	21	1	1	1	1				
63307	2200	21	1	1	1	1				
63308	2015	21	1	1	1	1				
63309	2320	21	1	1	1	1				
63310	2200	21	1	1	1	1				
63311	2300	21	1	1	1	1				
63312	2130	21	1	1	1	1				
63313	2320	21	1	1	1	1				
63314	2520	21	1	1	1	1				
63315	2230	21	1	1	1	1				
63316	2215	21	1	1	1	1				
63317	2115	21	1	1	1	1				
63317	2123	3					73			
63318	2255	21	1	1	1	1		7+		
63319	2350	21	1	1	1	1				
63323	2115	21	1	1	1	1				
63325	0030	21	1	1	1	1				
63325	2230	29	9	9	9	9				
63326	2330	21	1	1	1	1				
63327	2300	31	1	1	1	1				
63328	2330	21	1	1	1	1				
63329	2330	21	1	1	1	1				
63331	2330	29	9	9	9	9				
63401	2300	29	1	1	1	1				
63402	2400	29	1	9	9	9				
63403	2200	39	1	9	9	9				
63404	2100	29	1	9	9	9				
63405	2330	29	1	9	9	9				
63406	2400	21	1	9	9	9				
63407	2330	21	1	9	9	9				
63408	2300	21	1	9	9	9				
63410	2235	29	9	9	9	9				
63411	2340	21	1	9	9	9				
63412	2320	21	1	9	9	9				
63413	2400	21	1	9	9	9				
64000	00									
64216	23552	2 652	25078	08750	44086	54850	83148			
64218	03152	2 602	25077	08750	43756	44849	82147			
64218	16152	2 602	25078	08751	43086	44750	83147			
64220	2320	2 652	25 77	8752	45 76	44950	84148			
64222	0230	2 602	50 77	8952	48 76	45049	84147			
64224	2330	2 652	30 77	8751	45 76	34950	84148			
64225	16454					5252	86			
64227	0930	2 602	45 77	8850	42 56	24850	83147			
64302	1715	2 572	47 77	8948	39046	04849	82147			
64305	1900	2 552	48 78	8950	39 76	34749	82147			
64306	2200	2 602	28 77	8752	43 76	44950	83147			
64307	2200	2 522	50 77	8954	41147	14849	83147			
64308	2030	2 602	55 78	8954	43157	14950	84148			
64309	2330	3 572	52 78	9053	43147	35149	85147			
64310	2200	2 552	52 78	9053	43147	24950	84147			
64311	2300	2 632	56 78	8954	43157	24950	8414			

Fig. A56 - A sample page of output from TKSORT, the computer program which sorted the card images by record identification number and date and stored them on magnetic tape

Two major programs were written to handle the raw data. The first of these, called TKSORT (approximately 1200 statements), was designed to read the card images from tape, eliminate cards with obvious errors, sort the data according to measure identification number, put them in chronological order within the measure groups, and in some cases sort again within the dated measure groups with respect to certain parameters. The sorted data were then stored on magnetic tape. A sample of the output from TKSORT is presented in Fig. A56.

The second major program, called TKPRNT (approximately 3000 statements) was designed to print the sorted data in appropriately labeled tables. It had been planned to incorporate checks of error in magnitude of certain entries and include notations of such

error in the tables. However, the short time available made it impractical to include this capability. A sample of the output from TKPRNT is presented in Fig. A57.

Documentation is available from Bellcomm for both programs, including listings of the programs.

The sorted Tektite I data have been stored in three files on tape. File 1 contains the biomedical data. File 2 contains the behavioral data, and file 3 contains the habitat technology data. Within each file, data are stored 32 records to a block, where each record is the equivalent of one data card. Blocks are 256 words long, except that the last block in the file may contain fewer records, hence fewer words. The data cards were punched in even-numbered columns on 80-column cards. Each card image was packed into eight words, with each word containing five characters and a blank as follows, where  $\alpha$  is an alphanumeric character, b is the blank, and a number is the number of the bit at the beginning of the character:

0	6	12	18	24	30
$\alpha$	$\alpha$	$\alpha$	$\alpha$	$\alpha$	b

Records are written in Univac field-data character codes. There are no extraneous words on the records or in the record blocks. The tape is seven-track, written at 556 bits per inch with odd parity.

#### A4.3 Use of the Data System by Mission Programs

##### A4.3.1 Biomedical Data

Nicholas Zill, Bellcomm, Inc.

Two templates were designed at Bellcomm in cooperation with Dr. T. Markham for recording data on the general medical condition of the aquanauts. Template 11, the medical status assessment, is illustrated in Fig. A58. The symptoms and treatment record (template 12) made use of a page overlay assembly instead of the single-sheet templates used in the other records. This is a bookletlike arrangement which opens to expose a limited number of punching columns. It permits a great deal more descriptive information to surround the columns and guide punching. Data for both of these records were punched off-line in the support van from information in the medical log.

Microbiology data were punched postmission with information recorder templates designed by Lt. A. Cobet. Respiratory parameter data from Dr. C. J. Lambertsen and hematology measures from Dr. C. Fischer were entered into the data bank postmission via conventional keypunching.

A listing of the biomedical program records is presented in Table A45. All of these records contain relevant values from pre- and postmission medical examinations.

LEGEND:

HEAD BY  
 1=TOPSIDE  
 1=4=AGUANAUT IDENTIFICATION  
 9=MORE THAN TWO AGUANAUTS

COMPRESSOR OIL LEVEL  
 1=NORMAL  
 2=LOW  
 3=LOW, OIL ADDED

COOLANT LEVEL-TANK  
 4=NORMAL  
 5=FLUID ADDED  
 6=FLUID DRAINED

FREON LIQUID LINE  
 7=CLEAR  
 8=SOME BUBBLES  
 9=MANY BUBBLES

\*NOTE: FLOW RATE=COOLANT FLOW RATE TO HEAT EXCHANGER  
 OIL LEVEL=COMPRESSOR OIL LEVEL

DATE	TIME	READ BY	COMPRESSOR PRESSURE		CONDENSER TEMP		COOLANT TEMP		COOLANT PRESS.		FLOW RATE		OIL COOLANT			
			A	B	SUCTION	DISCHARGE	INLET	OUTLET	INLET	OUTLET	INLET	OUTLET	FM10	FM10	LEVEL	LEVEL
0700	00															
2/14	2355	2	2	225	078	087	50	44	08	65	4.8	5.0	8.3	1	1	8
2/18	0315	2	2	225	077	087	50	43	08	64	4.8	4.9	8.2	1	1	7
2/18	1615	2	2	225	078	087	51	43	08	64	4.7	5.0	8.3	1	1	7
2/20	2320	2	2	255	77	87	52	45	7	64	4.9	5.0	8.4	1	1	8
2/22	0230	2	2	250	77	89	52	48	7	64	5.0	4.9	8.4	1	1	7
2/24	2330	2	2	230	77	87	51	45	7	63	4.9	5.0	8.4	1	1	8
2/25	1645	4														
2/27	0430	2	2	245	77	88	50	42	5	62	4.8	5.0	8.3	1	1	7
3/02	1715	2	2	247	77	89	48	39	04	60	4.8	4.9	8.2	1	1	7
3/05	1909	2	2	248	78	89	50	39	7	63	4.7	4.9	8.2	1	1	7
3/06	2200	2	2	228	77	87	52	43	7	64	4.9	5.0	8.3	1	1	7
3/07	2400	2	2	250	77	89	54	41	14	71	4.8	4.9	8.3	1	1	7
3/08	2030	2	2	255	78	89	54	43	15	71	4.9	5.0	8.4	1	1	6
3/09	2330	3	3	252	76	90	53	43	14	72	5.1	4.9	8.5	1	1	7
3/10	2200	2	2	250	78	90	53	43	14	72	4.9	5.0	8.4	1	1	7
3/11	2300	2	2	256	78	89	54	43	15	72	4.9	5.0	8.4	1	1	7
3/12	2130	2	2	232	78	88	52	44	15	71	4.9	4.9	8.3	1	1	7
3/13	2325	2	2	255	78	90	52	41	15	71	4.8	5.0	8.3	1	1	7
3/14	2330	2	2	230	78	88	50	41	14	72	4.8	5.0	8.3	1	1	7
3/15	2245	2	2	225	78	88	50	42	15	71	4.9	5.0	8.3	1	1	7
3/16	2225	2	2	230	78	88	52	43	15	72	4.9	5.0	8.4	1	1	7
3/17	2210	2	2	252	078	89	52	42	15	72	4.8	5.0	8.3	1	1	7
3/18	2250	2	2	255	78	89	54	43	15	72	4.9	5.1	8.5	1	1	7
3/19	2355	2	2	225	78	87	51	43	14	72	5.0	4.9	8.4	1	1	7
3/20	2330	2	2	253	78	89	52	41	14	72	4.8	5.0	8.3	1	1	7
3/21	2355	2	2	255	78	92	54	43	14	72	4.9	5.0	8.3	1	1	7
3/22	2330	2	2	253	78	89	51	40	14	72	4.8	5.0	8.2	1	1	7
3/23	2315	2	2	237	78	88	51	35	14	72	4.8	5.0	8.2	1	1	7
3/25	0030	2	2	254	078	89	52	41	15	72	4.8	5.0	8.3	1	1	7
3/25	2330	2	2	255	078	89	52	41	15	72	4.9	5.0	8.4	1	1	7
3/26	2330	2	2	235	078	87	53	44	15	72	5.0	5.1	8.5	1	1	7
3/27	2300	2	2	233	077	88	53	44	15	72	4.9	5.0	8.4	1	1	7
3/28	2345	2	2	232	077	88	51	45	15	72	4.9	5.1	8.4	1	1	7
3/29	2330	2	2	253	077	88	52	44	15	72	5.0	5.1	8.5	1	1	7
3/31	2340	2	2	255	077	89	49	40	14	71	4.7	5.0	8.3	1	1	7
4/01	2300	2	2	254	077	89	49	40	14	72	4.8	5.0	8.3	1	1	7
4/02	2400	2	2	257	077	89	48	40	14	72	4.8	5.0	8.3	1	1	7
4/03	2200	2	2	260	076	89	47	40	14	72	4.8	5.0	8.3	1	1	7
4/04	2100	2	2	256	078	88	45	42	14	72	4.9	5.1	8.5	1	1	7
4/05	2330	2	2	260	077	89	50	42	14	72	4.9	5.0	8.4	1	1	7

Fig. A57 - A sample page of output from TKPRNT, the computer program which printed the sorted data in appropriately labeled tables

MFR ID = 11.  
MEDICAL STATUS ASSESSMENT

Aquanauts	M.R. I.D.	Mo. D	Time of Day Measured	Aquanaut	Body Weight (lbs)	Oral Temperature (°F)	Pulse Rate (bpm)	Blood Pressure						Respiration Rate	General Health	Skin	Left Ear	Right Ear	Left Eye	Right Eye	Nose	Throat	ECG
								Systolic mmHg	Change mmHg	Diastolic mmHg	H	T	U										
1		0																					
2		1																					
3		2																					
4		3																					
5		4																					
6		5																					
7		6																					
8		7																					
9		8																					
		9																					

Fig. A58 - The medical status assessment record, a sample template from the biomedical program. (Aquanaut names have been deleted.)

Table A45  
 Medical Program Records (File 1) in the Data Bank Tape

Measure Records Identification Number	Record Name	Responsible Investigator
11	Medical status assessment	Markham
12	Symptoms and treatment record	Markham
13	Hematology record (I)	Fischer
14	Hematology record (II)	Fischer
15	Serum/chemistry record	Fischer
16	Electrophoresis record	Fischer
17	Humoral and cellular immune responses	Fischer
18	Red cell mass and survival	Fischer
19	Pulmonary function record (I)	Lambertsen
20	Pulmonary function record (II)	Lambertsen
21	Aerobiology record	Cobet
22	Bacteriology record	Cobet
23	Interchange record	Cobet
24	Mycology record	Cobet
25	Pollution record	Cobet
26	Virology record	Cobet

A4.3.2 Behavioral Data

Lt. Richard Mach, Naval Medical Research Institute,  
Bethesda, Maryland, and Nicholas Zill, Bellcomm, Inc.

A listing of the types of records employed in the behavior program is presented in Table A46. This table also indicates the input mode of each record. "On-line" indicates behavioral data that were punched onto the preperforated cards as it was observed. "Off-line" indicates data that were collected in checklists or logs and then transferred to cards by manual punching at the mission site. The rest of the records were transferred from data sheets by conventional keypunching after the mission was over. Since a thorough description of behavioral collection procedures was given in section A2.2, the present consideration will be confined to design and fabrication of the behavioral templates.

In designing the formats of on-line observation templates the purpose was to organize each different record in as simple and straightforward a manner as possible. Most often the chronology or strict time-sequence of particular events was employed in preparing the format. The order on the template, from left to right, of the separate aspects of the measure mimicked the actual order of occurrence of those aspects. This is illustrated in the dive record (Fig. A59). Space on the card was saved by not repeating the hours

**DIVE RECORD**

EVENT	MSR ID#	DEC	NOV	DAY	DIVER ID#	PRER START		PREP STOP MIN	PREP ASSIST		DIVE START HR	DIVE START MIN	DIVE STOP HR	DIVE STOP MIN	SECURE START MIN	SECURE STOP MIN	SECURE ASSIST	SHOWER START MIN	SHOWER STOP MIN	SHOWER STOP SEC	
						HR	MIN		MAJOR	MINOR											MAJOR
PREP START TIME - START COLLECT EQUP FOR DIVE																					
PREP STOP TIME - PREP COMPLETE - MAN OUTFITTED W TANKS, GEAR	0																				0
PREP ASSISTANCE MAJOR - ID# MAN DIVING	1																				1
MINOR - ID# MAN DIVING	2																				2
DIVER MOST ASSISTANCE FOR DIVE. IF NO ASSISTANCE GIVEN, DO NOT PUNCH	3																				3
SECURE - ID# MAN DIVING	4																				4
SECONDARY ASSISTANCE. IF ONLY ONE MAN DIVES ASSISTANCE, PUNCH AS MAJOR	5																				5
EGRESS ORDER ORDER	6																				6
DIVERS ENTER WATER FOR DIVE	7																				7
DO ID# DIVING OFFICER	8																				8
SB ID# STANDBY DIVER	9																				9

**SECURE ASSIST**

EVENT	MSR ID#	DEC	NOV	DAY	DIVER ID#	PRER START		PREP STOP MIN	PREP ASSIST		DIVE START HR	DIVE START MIN	DIVE STOP HR	DIVE STOP MIN	SECURE START MIN	SECURE STOP MIN	SECURE ASSIST	SHOWER START MIN	SHOWER STOP MIN	SHOWER STOP SEC	
						HR	MIN		MAJOR	MINOR											MAJOR
SECURE STOP WHEN GEAR STOWED	0																				0
SECURE ASSISTANCE MAJOR - ID# MAN DIVING	1																				1
MINOR - ID# MAN DIVING	2																				2
DIVERSIFICATION	3																				3
SECURE ASSISTANCE MAJOR - ID# MAN DIVING	4																				4
MINOR - ID# MAN DIVING	5																				5
SECURE ASSISTANCE MAJOR - ID# MAN DIVING	6																				6
MINOR - ID# MAN DIVING	7																				7
SECURE ASSISTANCE MAJOR - ID# MAN DIVING	8																				8
MINOR - ID# MAN DIVING	9																				9

Fig. A59 - The dive record, a sample of a double-card template from the behavior program



Table A46  
Behavior Program Records (File 2) in the Data Bank Tape

Measure Record Identification Number	Record Name	Input Mode	Responsible Investigator
27	Maintenance and repair record	Off-line	Zill
29	Psychomotor test record	Keypunched from data sheets	Saucer-Scow
30	Location record	On-line	Radloff, Mach, Zill, and Helmreich
31	Transit record	On-line	Radloff, et al.
32	Meal behavior	On-line	Radloff, et al.
33	Dive record	On-line	Radloff, et al.
34	Audio-video disruptions record	Off-line	Mach
35	Communication with topside	On-line	Radloff, et al.
36	Time of arising	On-line	Radloff, et al.
37	Time of retiring	On-line	Radloff, et al.
38	Electronically monitored facilities usage	Off-line	Radloff, et al.
39	Maintenance of self and habitat	Off-line	Radloff, et al.
40	Adherence to watch	Off-line	Radloff, et al.
41	Pressure-pot usage	Off-line	Radloff, et al.
42	Pieces-of-mail record	Off-line	Radloff, et al.
43	Mood adjective checklist record	Off-line	Radloff, et al.
44	Winch usage	Off-line	Radloff, et al.
45	Biomedical monitoring	Off-line	Radloff, et al.
46	Medical restriction record	Keypunched from medical log	Zill
47	EEG hookup record	On-line	Radloff, et al.
48	EEG sleep staging record	Keypunched from data sheets	Naitoh-Johnson, DeLucchi-Frost
49	Sleep questionnaire data	Keypunched from data sheets	Naitoh-Johnson

columns for time of occurrence when it could be anticipated that the hour designation would be redundant, and the hours columns could instead be filled in by card reading and analysis programs. During the collection of records that involved the start and stop times of lengthy actions (e.g., a dive) the observers found it convenient to leave the stylus in the last hole punched, as a reminder of where they were in the punching sequence when data entry resumed.

The recording of specific events when and only when they occurred was not the only sampling technique employed. For instance the location, activity, and communicative status of the individual aquanauts were noted and punched at certain prespecified times. Chronology was no longer a factor here, since sampling of these different considerations was to be theoretically simultaneous. The question then was how to organize a template that treated four men over a number of parameters. Although the observer procedure was to be man locked, i.e., observing everything required about a given aquanaut before proceeding to the next aquanaut, it proved more convenient to set up the template in an event-locked format. As is shown in Fig. A55 this format had four columns for the four aquanauts clustered together under the first parameter, then four more columns for the next parameter, etc. This allowed more descriptive information about the parameters to be printed on the template and did not interfere significantly with the observation procedure. Note also in Fig. A55 the way in which punching fields can be staggered to maximize space for punching instructions.

The use of this on-line card punching system forced the investigators into hardheaded decisions as to what was worthy of measurement and recording. These judgments had to be made well before the mission start, since manufacture of the templates was time consuming and templates could not be designed until commitments had been made as to what they would and would not contain. All the details of mission procedures could not be known at that early stage, so there of course were regrets during the mission about measures left out and others needlessly included. But the overall effect of the forced decision-making was definitely salutary. A workable well-organized system was ready at mission start. Given this solid framework, minor corrections and additional information could be, and were, comfortably handled. Provisions for incorporating additional data included video and audio tape recorders, slight template revisions, and an unusual-events log, from which data were coded and punched both during and after the mission.

Once the various aspects of each measure had been decided on, image overlay sheets, twice the final template's linear dimensions, were used in developing the orientation and final organization of the descriptive material. This accomplished, a draftsman prepared a final, legible copy which was photoreduced to 1/2 size and printed. The resultant photograph was glued to a stock cardboard template, and the appropriate recording holes were punched through the finished product. For other, less frequently used, templates an even simpler fabrication procedure was employed. The definitions, labels, and separating lines were typed directly on the blank template with an electric typewriter. The template was coated with a protective spray, and the appropriate holes were punched out. The results of this process were also highly satisfactory.

#### A4.3.3 Habitat Engineering Data

A. G. Mitchell, General Electric Apollo Systems Department,  
Houston, Texas

The primary objective of data management was to provide the systems engineers with adequate data to determine the habitat power profile, thermal systems performance, atmospheric constituents, ambient noise and light levels, structural performance, marine corrosion and fouling, and equipment failure occurrence. The data management charters stipulated that Bellcomm would be the program data managers and processing agency and General Electric, Houston, would be the G.E. engineering data manager and the interface

Table A47  
 Habitat Engineering Records (File 3) in the Data Bank Tape (Responsible  
 Investigators: A. G. Mitchell and B. P. Tenney of General Electric)

Measure Record Identification Number	Record Name	Parameters Contained
60	Habitat environmental survey	Temperature; humidity; noise levels
61	Thermal adjustments record	Thermostat resettings
62	Emergency air measures	Emergency air supply pressure and breathing system pressure. Bibb line pressures. Status of Bibb flow control valve and emergency bottles.
63	Alarms, Drills, and Emergencies	Time; nature; time required to perform or correct
64	Engine room measures	Compressor pressures; condenser temperatures; coolant temperatures, pressures, flow rates, and level; oil level; Freon liquid line status
65	Paralyne change record	
66	Communication, appliances, anomalies	Intercom supply voltage; communication battery voltage; isolated ac voltage and current; freezer temperature; nature and correction time of anomalies
67	Topside measures	Instantaneous 440-V power to habitat; maximum power demand, total power supplied; water consumed; nitrogen bottle and line pressures; nitrogen flow rate
68	Atmosphere monitoring and mass spectrometer status	Absolute pressure in habitat; partial pressures of oxygen, carbon dioxide, water vapor, and nitrogen. Flow rate into habitat. Flowmeter discharge pressure. Purge valve status; mass spectrometer status; ion and anode current; battery voltage.
69	Backup atmosphere monitoring	Percent oxygen; carbon dioxide from backup meters; hydrocarbons; carbon monoxide; particulate matter; detector tube readings
70	Diving systems and underwater maintenance	(Not recorded after mission start)
71	Maintenance and repair record	(Repeat of Record 27)
72	Daily weather report from St. Thomas	



spectrometer data from the medical log were entered into the data bank by Bellcomm after the mission. These additional data are flagged with a "+" in the data-recorder column. A calibration history of the mass spectrometer is also available from G.E. or the data bank.

General Electric data management was also remiss in thoroughly checking out the readability (for recording accuracy) of the habitat and surface instrumentation indicators. Consequently, the information-recorder overlays did not, in several cases, allow for transferring data onto IBM cards as accurate as was available.

Early in the mission it became apparent that the water-partial-pressure indication of the mass spectrometer was erroneous. The sensor was the culprit, and this reading should be ignored. Additional habitat atmospheric instrumentation was added to the gas chromatograph sample line (to the author's knowledge, the gas chromatograph never functioned properly). For a period of time the habitat atmospheric monitor was provided with three oxygen and two carbon dioxide partial-pressure indications.

The information-recorder overlay provided very stringent data formats. Several innovations were required to enter special-case information into the data processing system. For example it was not anticipated that additional CO<sub>2</sub> scrubbers would be required, so the template containing the baralyme change history (template 65) did not differentiate between the prime or auxiliary baralyme scrubbers (not to mention the vacuum cleaner). Therefore special flags were used to indicate prime, auxiliary, or both baralyme scrubber changes.

Engineering data output was reviewed at a meeting in Washington approximately midway through the mission. This review provided a thorough analysis of the output procedures and formats and allowed the recovery of several pieces of mispunched data. Bellcomm was instructed to withhold distribution of these data and submit only the final complete data listing, as the concerned G.E. data users were busily involved with mission operation.

In summary, sufficient Tektite I habitat and surface engineering data were obtained to permit a generalized qualitative engineering evaluation of the habitat and the performance of its subsystems. A quantitative engineering evaluation of the electrical power system can be accomplished. However, the accuracy of approximately 10% of the instantaneous power calculations are questioned because of recording technique. The habitat atmosphere and airflow data can be quantitatively evaluated using the data compiled in the computer printout. The evaluation of the remaining habitat systems should be generalized due to the few recorded data.

In future operations a greater commitment must be made by program management and habitat systems engineering to engineering data management services. These services should provide a check and countercheck mechanism, through the instrumentation system, to determine the adequacy of measurements and to provide an interface between the data processing facility and the design engineers. Data management personnel should be participating parties of early program definition meetings. Data management participation would: establish a data awareness, determine if existing instrumentation is adequate, and provide ample data-programming lead time.

Data management must meet with all data recording personnel, including the aquanauts, to emphasize the importance of faithful and accurate data recording. Data management should provide written data-recording instructions. Data-recording forms should be formulated with both the data recorder and data transcriber in mind and be simple to interpret and complete.

#### A4.3.4 Marine Science Data Nicholas Zill, Bellcomm, Inc.

A major disappointment to aspirations for the data system was the limited attempt to incorporate measures from the marine sciences into the collection scheme and the subsequent failure to realize inputs of such information into the data bank. The potential benefit to the marine science program and the project as a whole from coordination of marine science with the data system was considerable, but that potential was not fulfilled. For example, systematic observations from the habitat of underwater environment parameters and ecological censuses would have been quite compatible with the data procedures described. Although such data were stated goals of the marine science endeavor, appropriate procedures remained undefined at the start of the mission; consequently, observations were not carried out systematically during the mission.

Two information-recorder templates were prepared, in cooperation with members of the prime crew, for use by topside marine-science support personnel on site. Neither was used successfully. The projected sequence saw the scientist-divers, in one case, collecting sediment samples from various areas around the habitat and, in the other, recording lobster population data on velum pads with crayon. The labeled samples and the lobster data, transferred to prepared forms, would be regularly sent to topside in the pressure pots. At the base camp, size and composition analysis would be performed on the sediment; the lobster notations would be combined with parallel information collected by the backup aquanauts; both types of data would then be punched onto cards with the prepared templates.

In both cases the difficulties that prevented the completion of this plan were changes in the scientific programs as a result of conditions and experience in the habitat. Time required for other, more primary, geological work did not permit collection of a substantial number of sediment samples. For the lobster program the suitable descriptions and important aspects of lobster behavior were so extensively redefined due to the knowledge gained in the habitat that the template was no longer appropriate. Communication inadequacies prevented the necessary extensive revision of the template.

These difficulties were, however, only specific aspects of a more general and significant problem. The aquanauts were not allotted the sufficient premission time and assistance by the Tektite I project in general, and by their agency in particular, necessary to define and develop a well-integrated, systematic program of research. Coordination between the crew members and data management personnel was hampered by geographical distance and the press of obligations. Conducting marine science from undersea habitats is, of course, a new and evolving endeavor. Tektite I was but a preliminary exploration of optimum ways to use such habitats for marine biological, geological, and oceanographic research. However, those optimum ways will not be found unless future programs allow for thought, preparation, and resources for data collecting and analysis to match the complex interrelationships of the marine environment. It is not sufficient to put scientists underwater and see what they come up with.

#### A4.4 Secondary Processing and Retrieval Nicholas Zill, Bellcomm, Inc.

An initial postmission distribution to appropriate Tektite I participants was made of copies of the data tape and computer-printed data tabulations. As of this writing, secondary processing of the data bank contents is nearing completion. This includes:

1. Editing of recoverable errors. Recoverable errors and omissions in the original punching of data are being corrected within a complete, sorted deck of cards punched from the data tape. When correction is complete, the deck will form the basis for a new

tape. Recovery is made possible through reference to raw data sheets, mission logs, and checking against data from other record types. Most errors involving missing identification numbers or dates were caught and, when possible, corrected before the initial distribution of tapes and printouts. Unrecoverable but obviously erroneous data are being deleted.

2. Insertion of additional data. The final data tape will contain additional data which consist either of analyzed results from the present raw data or new data coded from mission logs, audio tape recordings, and other analog records. The logs of which there are copies at Bellcomm include: the watch director's log, G.E. engineering logs, medical log, pressure pot log, decompression log, behavior observers' unusual-events log, and the scientific coordinator's log.

The contents of the data bank are available from Bellcom in the form of magnetic tape, punched cards, or printout. Prior approval must be obtained, however, from the investigator responsible for the particular records desired. A list of these investigators is included in Tables A45, A46, and A47. Further documentation of the data system procedures, including reproductions of all the template formats, is also available from Bellcomm.

#### A4.5 Conclusions and Recommendations Nicholas Zill, Bellcomm, Inc.

Although original conceptions were optimistically ambitious, the goals of an integrated data system and a digital data bank were substantially realized for three of the four technical programs in Tektite I. Of the useful functions that a data bank can serve, listed in the introduction, all were performed to at least a limited degree by the Tektite I system. Particularly gratifying has been the crossreferencing between biomedical, behavioral, and engineering data that has already occurred for extension and clarification of various analyses. Certainly, more sophisticated systems than the present one can be envisaged and should be attempted in future undersea habitat operations. However, the reader with visions of on-line computers and cathode-ray-tube displays should realize that the cost of such a system would probably approach the total cost of the Tektite I project.

In conclusion the following suggestions are offered to those who would attempt data management of multidisciplinary field operations in the future:

- An integrated data system and a digital data bank are desirable and achievable goals for such projects.
- The achievement of these goals does not require a vast expenditure of funds but does require realistic allotments of manpower and preparation time.
- The data collection and processing systems should be kept simple and employ devices and procedures that do actually, rather than potentially, work.
- Programming elegance should be sacrificed for flexibility and ease in modifying programs to meet necessary changes in data formats.
- The process of editing data for errors and omissions should be made as streamlined as possible.
- Finally, data management personnel should be prepared for an experience similar to that of the Little Red Hen in the nursery tale. When the Little Red Hen asked, "Who

will help me bake my bread?", she found few takers. But when the bread was baked and she asked, "Who will help me eat my bread?", the helpers flocked in insistent abundance.

#### A4.6 Acknowledgments

Nicholas Zill, Bellcomm, Inc.

The principal members of the data management team for Tektite I and contributors to this section A4 of this report were Lt. Richard S. Mach, MSC, of the Naval Medical Research Institute, who had primary responsibility for behavioral data collection but participated extensively in the coordination and execution of all of the data management endeavor, A. G. Mitchell of the General Electric Apollo Systems Department, who served as the engineering data manager, and Mrs. Anita J. Cochran of Bellcomm who accomplished a great deal of programming in a very short time. Mrs. Cochran was assisted in part of her effort by Miss Nancy Robinson. Thanks are due to also the following individuals for their exceptional cooperation in various parts of this effort: W. A. Clark and R. Ohls of IBM; R. Scarlatta of General Electric; A. P. Lepera, N. R. Farmer, and W. O. Robinson of Bellcomm Reproduction Services; and E. E. Hilyard and members of his Computer Operations Group at Bellcomm.



## **Appendix B**

### **ENGINEERING**

#### **B1 DESCRIPTION OF THE FACILITIES SYSTEM** Cdr. W. J. Eager, Naval Facilities Engineering Command, Washington, D.C.

##### **B1.1 Introduction**

The function of the Tektite I facilities system was: (a) to support four aquanauts in their undersea research mission, (b) to support surface personnel in collection and analysis of engineering and scientific data and, (c) to support personnel who constructed, operated, and maintained the complete facilities system. The Office of Naval Research (ONR) was the overall Tektite I project manager, and ONR managed development of the habitat and way station systems. The Naval Facilities Engineering Command and Amphibious Construction Battalion Two developed the remainder of the facilities system.

##### **B1.2 The System**

The Tektite I facilities consisted of the several major subsystems shown schematically within Greater Lameshure Bay, St. John, Virgin Islands in Fig. B1. The base camp provided hotel, medical, and administrative facilities for a maximum of 110 support and scientific personnel. The base camp (with water and electrical systems) and the road were designed, constructed, operated, and maintained by the Seabees of Amphibious Construction Battalion Two. The causeway pier served as a terminal for transportation of material and personnel between St. Thomas Island, the base camp, and the support barge. The causeway sections, which are standard for Seabee-supported amphibious operations, were used as barges for the original movement of material and personnel from the Landing Ship Dock to the shore and then were formed into the floating pier.

The primary facilities for directly supporting the aquanauts and the project mission were located in Beehive Cove as shown in Fig. B1. The support barge consisted of an Ammi pontoon upon which the communication and scientific-data-collection systems and the breathing-gas and utility-supply systems were assembled by Seabee personnel. The communication and data-monitoring systems were preassembled in a trailer van (surface control center van) by General Electric under project management by and contract with ONR. The support barge was located adjacent to the shore and hoisted out of the water on pile legs. Electrical power, generated and transformed on the support barge, was conducted to the habitat by a 1000-foot armored submarine cable. Breathing gases and potable water were carried to the habitat by hoses. Communication and data signals were transmitted between the support barge and habitat by another 1000-foot armored submarine cable. All umbilicals were designed and manufactured or procured by General Electric and were installed by the Seabees.

The habitat provided the hotel and laboratory facilities for supporting the life and work of the aquanauts. It was designed and fabricated by General Electric and was assembled by personnel from General Electric and the Philadelphia Naval Shipyard, all under ONR project management.

## PROJECT TEKTITE I

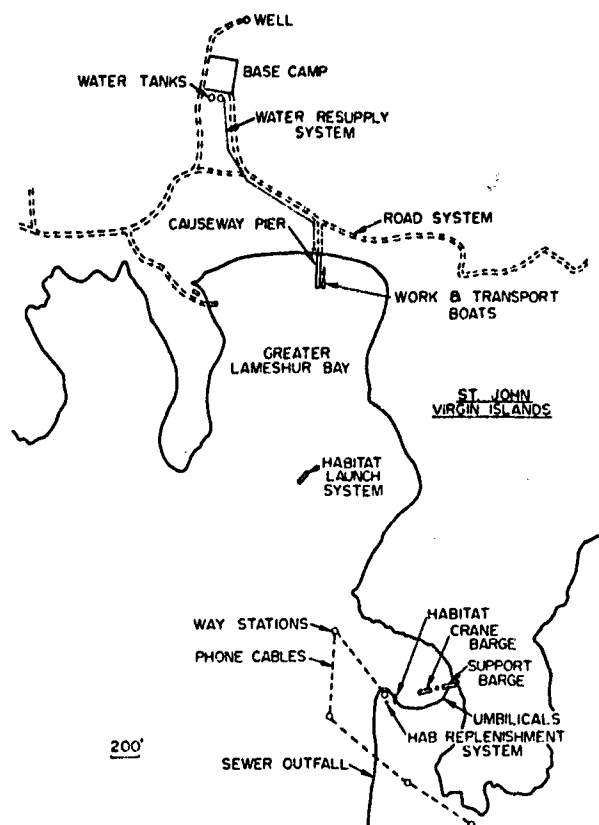

Fig. B1 - The Tektite I facilities system

Ranging out from the habitat and interconnected by sound-powered phones were five way-stations, designed and fabricated by General Electric under ONR contract. The way stations (Fig. B2) consisted of a Plexiglas, hemispherical shell mounted on a cylindrical steel cage. The base of the cage was a steel plate 1/2 inch thick and 5 feet square, the weight of which prevented the assembly from rising to the surface when the plastic dome was filled with air from a scuba bottle located in the way station. A valve on the top of the dome vented out the air after each use. The way station provided a means for the aquanauts to gain protection from a possible predator attack and to communicate with aquanauts in the habitat or in another way station through the sound-powered phones.

To resupply the habitat with such items as food and CO<sub>2</sub> absorbent and to dispose of garbage, pressure- and waterproof canisters were provided, the largest of which was capable of moving 300 pounds between the surface and the habitat (Fig. B3). The largest canister was designed and fabricated by General Electric under ONR contract. The Sea-bees fabricated a platform float with a center well from 55-gallon fuel drums and planking, and anchored it near the habitat. It was provided with an A-frame and hand winch to lower the canisters to the bottom near the habitat entrance. Air-inflated lift bags were used to swim the heavier canisters to a position under the habitat access trunk. An electric hoist in the habitat was used to raise the canister into the dry space for loading and unloading.

Extending seaward from the habitat was a 1000-foot sewer outfall. It carried macerated, chemically treated sewage to a point where ocean currents would disperse it, thereby eliminating shark attraction and biotic contamination from the region around the habitat.

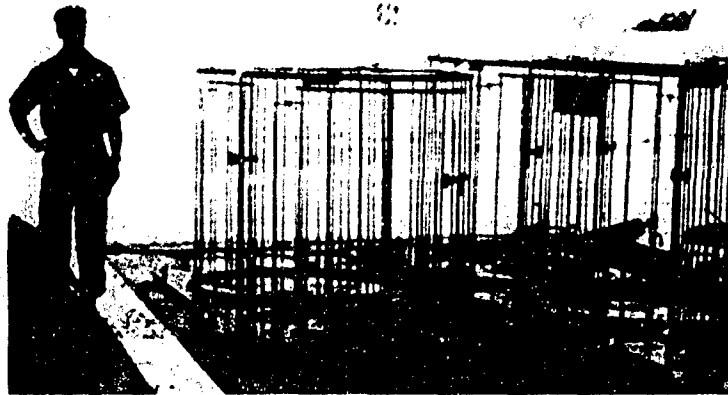

Fig. B2 - Way stations prior to outfitting with scuba tanks and sound-powered phones



Fig. B3 - Canister for dry transfer between the surface and the habitat

The possibility of accidental surfacing, decompression or other sickness, or drowning was countered by use of a continuous safety diver watch. A moored barge between the support barge and the habitat in approximately 26 feet of water was used as a base for the safety operations. It was called the crane barge, since it mounted a 35-ton mobile crane used in construction operations. A depth of 26 feet was required since the upward excursion limit for aquanauts saturated at 43 feet was to a 20-foot depth. The safety center consisted of the Ocean Systems, Inc., advanced diving system (ADS IV, provided under the Supervisor of Salvage contract), the crane to handle the personnel transfer capsule, storage facilities for safety diving equipment, and small boats to carry divers to the rescue site. A float was provided to transport personnel between the support barge and the crane barge.

The habitat and all other undersea and supporting facilities were installed and integrated by Seabee construction divers and Seabee surface operations personnel. All construction operations were performed by Seabee personnel under the direction of the Naval Facilities Engineering Command.

A radio communication system was provided. It consisted of AN/PRC-47 sets in the support van, the base camp, the Coast Guard station on St. Thomas Island, and personnel boats used for interisland transportation. As an auxiliary system, Motorola PT/200 hand sets were located in the support van, the base camp, the crane barge, the diving barge, and the safety diving boats. A commercial marine radio-telephone set was provided in the support van. Commercial telephones, with access to the U.S. mainland, were provided in the base camp and sometimes worked. A single-sideband transceiver was provided in the base camp for intermittent communications with ONR in Washington, D.C. Emergency evacuation could be accomplished by a Navy or Coast Guard helicopter, with the causeway pier serving as the landing pad.

### B1.3 Engineering and Construction Activity

Site surveys to provide a basis for detailed facilities design were completed in early September 1968, at which time facilities design commenced, except that the detailed design of the habitat was initiated in early 1968. Procurement of materials and prefabrication of the base camp was completed in Norfolk in October 1968, and on-site construction was completed by late November. Site preparation of the habitat and launch sites was completed by the advance party late in November.

Operational test of the prototype habitat launch system was completed in late October. The undersea construction systems, including the habitat launch system, were essentially completed in late December. Assembly and testing of the habitat and support barge were completed by the first week in January 1969. The landing ship dock, *USS Hermitage*, departed the Philadelphia Naval Shipyard with all facilities components, construction systems, and personnel on January 8 as scheduled. It arrived in Lameshure Bay, St. John Island, the morning of January 12, 1969, at which time off-loading commenced. Construction activity commenced on January 13. The facilities construction was essentially completed and the facilities system checked out by February 13 to permit commencement of the Tektite I operations on February 15 as scheduled.

The possibility of accidental surfacing, decompression or other sickness, or drowning was countered by use of a continuous safety diver watch. A moored barge between the support barge and the habitat in approximately 26 feet of water was used as a base for the safety operations. It was called the crane barge, since it mounted a 35-ton mobile crane used in construction operations. A depth of 26 feet was required since the upward excursion limit for aquanauts saturated at 43 feet was to a 20-foot depth. The safety center consisted of the Ocean Systems, Inc., advanced diving system (ADS IV, provided under the Supervisor of Salvage contract), the crane to handle the personnel transfer capsule, storage facilities for safety diving equipment, and small boats to carry divers to the rescue site. A float was provided to transport personnel between the support barge and the crane barge.

The habitat and all other undersea and supporting facilities were installed and integrated by Seabee construction divers and Seabee surface operations personnel. All construction operations were performed by Seabee personnel under the direction of the Naval Facilities Engineering Command.

A radio communication system was provided. It consisted of AN/PRC-47 sets in the support van, the base camp, the Coast Guard station on St. Thomas Island, and personnel boats used for interisland transportation. As an auxiliary system, Motorola PT/200 hand sets were located in the support van, the base camp, the crane barge, the diving barge, and the safety diving boats. A commercial marine radio-telephone set was provided in the support van. Commercial telephones, with access to the U.S. mainland, were provided in the base camp and sometimes worked. A single-sideband transceiver was provided in the base camp for intermittent communications with ONR in Washington, D.C. Emergency evacuation could be accomplished by a Navy or Coast Guard helicopter, with the causeway pier serving as the landing pad.

### B1.3 Engineering and Construction Activity

Site surveys to provide a basis for detailed facilities design were completed in early September 1968, at which time facilities design commenced, except that the detailed design of the habitat was initiated in early 1968. Procurement of materials and prefabrication of the base camp was completed in Norfolk in October 1968, and on-site construction was completed by late November. Site preparation of the habitat and launch sites was completed by the advance party late in November.

Operational test of the prototype habitat launch system was completed in late October. The undersea construction systems, including the habitat launch system, were essentially completed in late December. Assembly and testing of the habitat and support barge were completed by the first week in January 1969. The landing ship dock, *USS Hermitage*, departed the Philadelphia Naval Shipyard with all facilities components, construction systems, and personnel on January 8 as scheduled. It arrived in Lameshure Bay, St. John Island, the morning of January 12, 1969, at which time off-loading commenced. Construction activity commenced on January 13. The facilities construction was essentially completed and the facilities system checked out by February 13 to permit commencement of the Tektite I operations on February 15 as scheduled.

**B2 THE TEKTITE I HABITAT**

B. P. Thompson and J. B. Tenney, General Electric Company,  
Missile and Space Division, Philadelphia, Pennsylvania

**B2.1 Design**

The design for the Tektite I habitat was the responsibility of the General Electric Missile and Space Division, Philadelphia, Pennsylvania. This task was begun in January 1968 and was completed except for necessary liaison and engineering development tests by July 1968. For convenience in design the system was considered to consist of seven major subsystems: habitat structure and base structure, environmental control subsystem, electrical subsystem, water and sanitation subsystem, communications subsystem, atmospheric monitoring subsystem, and interior and furnishings.

In each area a responsible subsystem engineer was responsible for design, specification writing, hardware selection, component and subsystem testing, and subsystem startup in the field. This emphasis on total responsibility assured continuity of effort and was responsible in part for the successful performance of the habitat in the field. Each engineer was responsible for performing all component and subsystems tests necessary to verify adequacy of design.

**B2.2 Structure****B2.2.1 Pressure Hulls**

The habitat structure consisted of two pressure hulls interconnected by a pressurized crossover tunnel and attached to a rigid base. Each pressure vessel was a vertical cylinder with torispherical heads and had a maximum diameter of 12.5 feet and a maximum height of 18 feet.

The pressure hulls were designed for pressurization on the surface to a level equal to the water pressure at the emplacement depth. The 1/2-inch-thick welded SA285-Grade C steel hull was designed in accordance with the requirements for an internally pressurized, unfired pressure vessel as described in Section VIII of the ASME Boiler and Pressure Vessel Code for Unfired Pressure Vessels. Hull structures were designed for a maximum operating pressure of 33 psig and hydrostatically tested to 50 psig, or 1.5 times operating pressure.

**B2.2.2 Viewing Ports**

The habitat contained six 2-foot-diameter Plexiglas hemispherical windows located around the habitat to provide nearly full 360-degree visual coverage. The hemispherical windows were for observational use for scientific, recreational, and diver safety purposes. Hemispherical windows in addition to being structurally efficient provided a wide field of view and a normal image which was neither greatly magnified nor distorted. Each window was proof tested at 50 psig. An observation cupola atop the equipment room had eight flat-plate, Plexiglas windows around its circumference providing a full 360-degree visibility.

**B2.2.3 Access Openings**

Normal entry into the habitat was provided by an open 4-foot-diameter entry trunk in the wet room. A normally closed 3-foot-diameter hatch in the crew quarters was provided for emergency underwater egress.

#### B2.2.4 Shark Cage

At the main entry into the wet room a screened shark barrier and door were provided. This cage permitted the aquanauts to leave the base and survey the surrounding area without exposure to attack by predators.

#### B2.2.5 Service Penetrations

Service penetrations for feeding in the electrical, water, communication, and air umbilicals were made in a removable plate bolted to a trunk in the lower head of the wet room. All other hull penetrations were located low in the hull to minimize loss of atmosphere and flooding in the event of external line damage. Each hull penetration was equipped with a manual shutoff valve inside the habitat.

#### B2.2.6 Support Structure and Base

Each pressure hull had three support legs which bolted directly to the habitat base structure. The base was a welded steel reinforced rectangular box weighing 68,000 pounds with approximate dimensions of 15 by 34 by 6 feet serving as a structural interconnection of the two pressure vessels, a mounting platform for fixed and variable ballast, a mounting base for ancillary equipment such as emergency air bottles, and a passageway for diver entry and egress.

#### B2.2.7 Ballast Tanks

Incorporated in the base were buoyancy tanks which allowed adjustment of overall system buoyancy from a positive 5000 pounds to a negative 5000 pounds. Fixed ballast in the form of 133,000 pounds of scrap steel punchings was located in the base. The base was designed to be placed directly on the leveled ocean bottom and securely moored to clump anchors. Winches mounted on the base pulled it down to the anchors under a 5000-pound positive buoyancy. After the base was secured, the buoyancy tanks were flooded to add to the overall negative buoyancy. A total net negative buoyancy of 20,000 pounds on the bottom assured stability in any normal sea conditions at the site. Ancillary equipment mounted on the base included air storage bottles, external storage racks, towing bits, chocks, and cleats.

#### B2.2.8 Crossover Tunnel

The tunnel connecting the habitat cylinders was a standard industrial expansion gasket designed for long service at temperatures and pressures in excess of the Tektite I service environment. The unit selected was designed for service at an internal pressure of 33 psi.

### B2.3 Equipment

#### B2.3.1 Introduction

Mechanical equipment and components selected for use in the Tektite I habitat were of commercial quality. Each component was carefully evaluated by the engineer responsible for its selection to determine its suitability. In cases where the ability to perform under pressure was questionable the component was tested prior to the start of the mission. Very few equipment items required modifications as a result of increased pressure. Control devices on both the refrigerator and the freezer were modified.

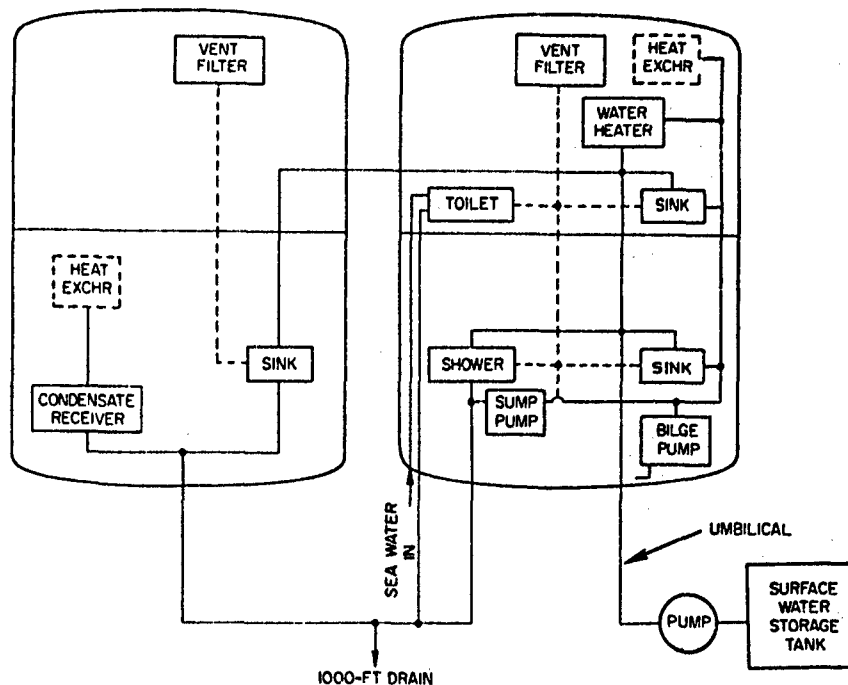

Fig. B4 - The plumbing system, which transmitted fresh, potable water from the surface and provided sea water for operation of the waste disposal facilities

The plumbing system (Fig. B4) transmitted fresh, potable water from the 3000-gallon pillow tank aboard the habitat support barge, provided personal hygiene facilities, and provided a drain hose for waste disposal. It also provided sea water to operate the toilet.

### B2.3.2 Fresh Water Supply

Fresh water entered the habitat through a penetration in the umbilical plate (wet room). Water from the storage tank on the control barge provided water at 100 psig to meet a maximum habitat demand of 10 gallons per minute and a total maximum usage of 280 gallons per day. The supply umbilical was clear, 3/4-inch nylon-braid-reinforced PVC flexible hose with a minimum working pressure of 125 psi. Two-way-shutoff quick-connecting fittings were installed on each end of the 1000-foot umbilical. A hose bib allowed connection of a 25-foot garden hose in the wet room.

### B2.3.3 Hot-Water Heater

Hot water was provided by a fully automatic 80-gallon heater (General Electric Model WRW4 82). The automatic thermostat was adjustable from 120°F to 170°F and was nominally set at 150°F.

### B2.3.4 Sinks

The Tektite habitat was provided with three sinks. In the crew quarters the sink in the galley area was a stainless steel basin in a Textolite countertop. In the engine room a stainless steel basin was provided adjacent to the toilet area. In the wet room a large single-basin stainless steel sink was built into a stainless steel counter top for use in scientific work.



### B2.3.5 Drains

All waste fresh water from tank 2 (Fig. B4) drained into a plastic sump tank under the floor. A sump pump (Weil Co. Model SS-550 PH) in the tank automatically pumped water out through the drain line when water in the sump tank reached a preset level.

The plastic tank had penetrations for venting and for electrical power to the sump pump as well as for water entering and exiting. Waste (fresh water) from tank 1 drained directly through a penetration in the tank dome.

### B2.3.6 Bilge Pump

Rise of water in the lower wet room bilge was sensed by increased pressure in the air bell of the automatic bilge-level switch which turned on the bilge pump mounted under the sink. Water was pumped from the bilge into the sump tank. The bilge pump and motor (Peters and Russell Model 6600) had a three-position switch permitting operation in either the manual or automatic mode. The output flow rate of the bilge pump was 9 gallons per minute. The intake strainer was located directly below a grate in the wet room floor, which permitted diving gear to be washed off with fresh water in the wet room.

### B2.3.7 Condensate Tank

Condensed water from the environmental-control-system heat exchangers in tank 1 flowed into a small receiver tank. A pump unit (Hartell Centiflo Model A-1) rated at 2 gallons per hour (10-ft head) pumped condensate through a check valve and into the fresh-water drain line. In tank 2 condensate drained directly into the sump tank.

### B2.3.8 Vent Lines

All internal plumbing lines were vented inside the habitat into charcoal filters (Mine Safety Appliance Type N, Model SW), which eliminated many vent gas odors.

### B2.3.9 Toilet

A crown head marine toilet (Raritan Deep Draft Model, 110-120 volts, 60-Hz ac, single phase) was located in the engine room. This toilet used sea water and was equipped with a macerator and a chlorinator.

### B2.3.10 Shower

A stall-type shower in the wet room was used to warm divers after each excursion. The shower drained into the plastic sump tank.

### B2.3.11 Refrigerator-Freezer

A refrigerator-freezer (General Electric Model CAF-13CD) with a capacity of approximately 13 cubic feet was located in the crew quarters. For storage of frozen food and specimens such as blood and urine an upright freezer (General Electric Model TBF-12DD) with a capacity of approximately 12 cubic feet was located in the engine room. Control elements of both units required slight modifications to operate at increased pressure.

### B2.3.12 Oven-Range

An electric oven-range in the crew quarters had four surface elements.

### B2.3.13 Other Subsystems

Details of the electrical, communications, and environmental-control subsystems will be discussed in the next section; however, in general the requirements of these subsystems were carefully integrated to provide an interior arrangement that was both functional and comfortable. Interior furnishings included carpeting, acoustic ceiling tile, selected color schemes, window curtains, individual bunk ventilation fans, and recreational radio and TV.

## B3 HABITAT SUBSYSTEMS

D. Withey, B. Batutis, R. Swartley, A. Quinn, and R. Cockfield,  
General Electric Company, Missile and Space Division,  
Philadelphia, Pennsylvania

### B3.1 Environmental Control Subsystem

The environmental control subsystem regulated the atmospheric pressure, composition, temperature, and humidity within the Tektite I habitat. It also provided air for charging scuba tanks and for a direct hookah connection to a diver outside the habitat. The basic elements of the environmental control subsystem (Fig. B5) were functionally divided into five subsystems: air-supply, pressure, and  $pO_2$  control;  $CO_2$  scrubber; thermal control; scuba tank charging subsystem; and emergency systems.

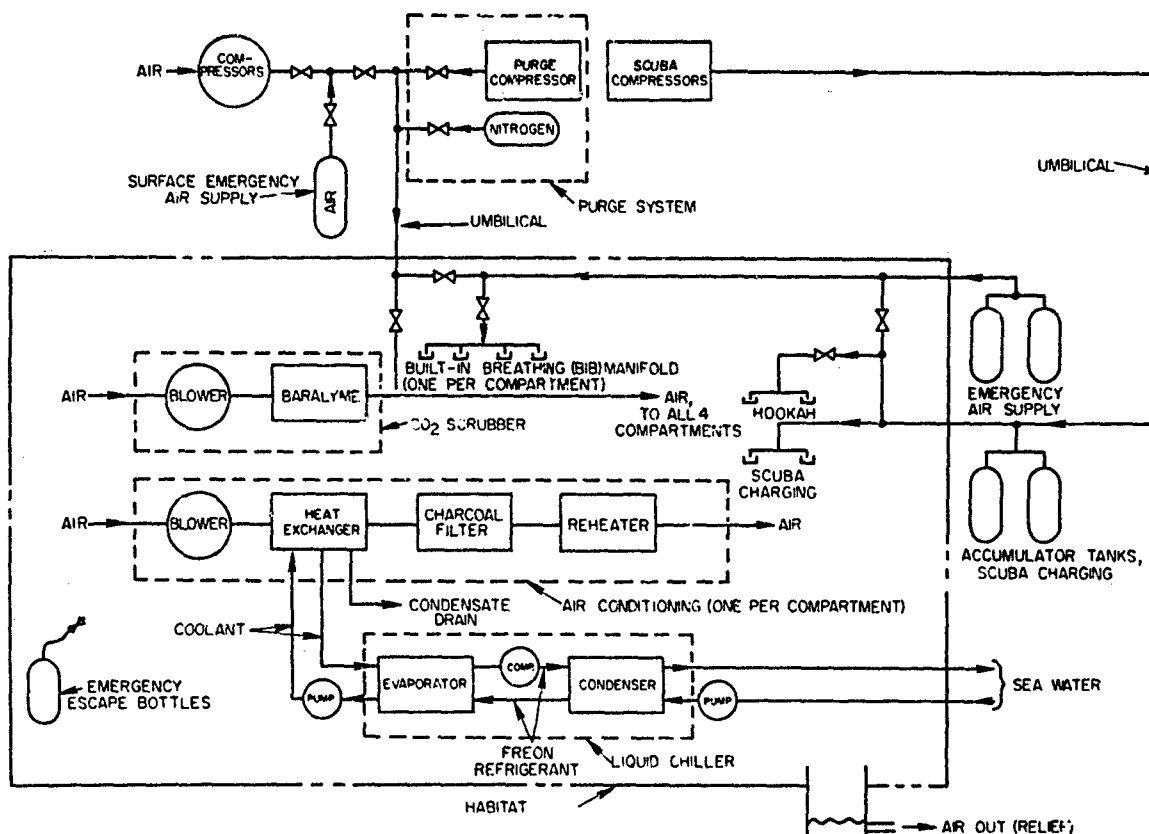

Fig. B5 - Basic elements of the environmental control subsystem

B3.1.1 Air Supply, Pressure, and pO<sub>2</sub> Control

The habitat was initially pressurized on the surface with air to the emplacement depth pressure. After emplacement and prior to the start of the mission the atmosphere was diluted with nitrogen to reduce the oxygen partial pressure (pO<sub>2</sub>) to 160 torr. This nominal level was maintained throughout the mission by continuously bleeding compressed air to the habitat via an umbilical from one of two air compressors at the surface support barge. Figure B6 shows the schematic for the gas supply systems, Fig. B7 shows the main air control valve in the wet room, and Fig. B8 shows the control panel in the bridge where the inlet air flow was monitored by the aquanauts. The pO<sub>2</sub> limits established for the mission were 151 torr to 165 torr. These extremes allowed the aquanauts external excursion to the maximum height above their saturation depth while maintaining the controlled atmosphere required for biomedical studies.

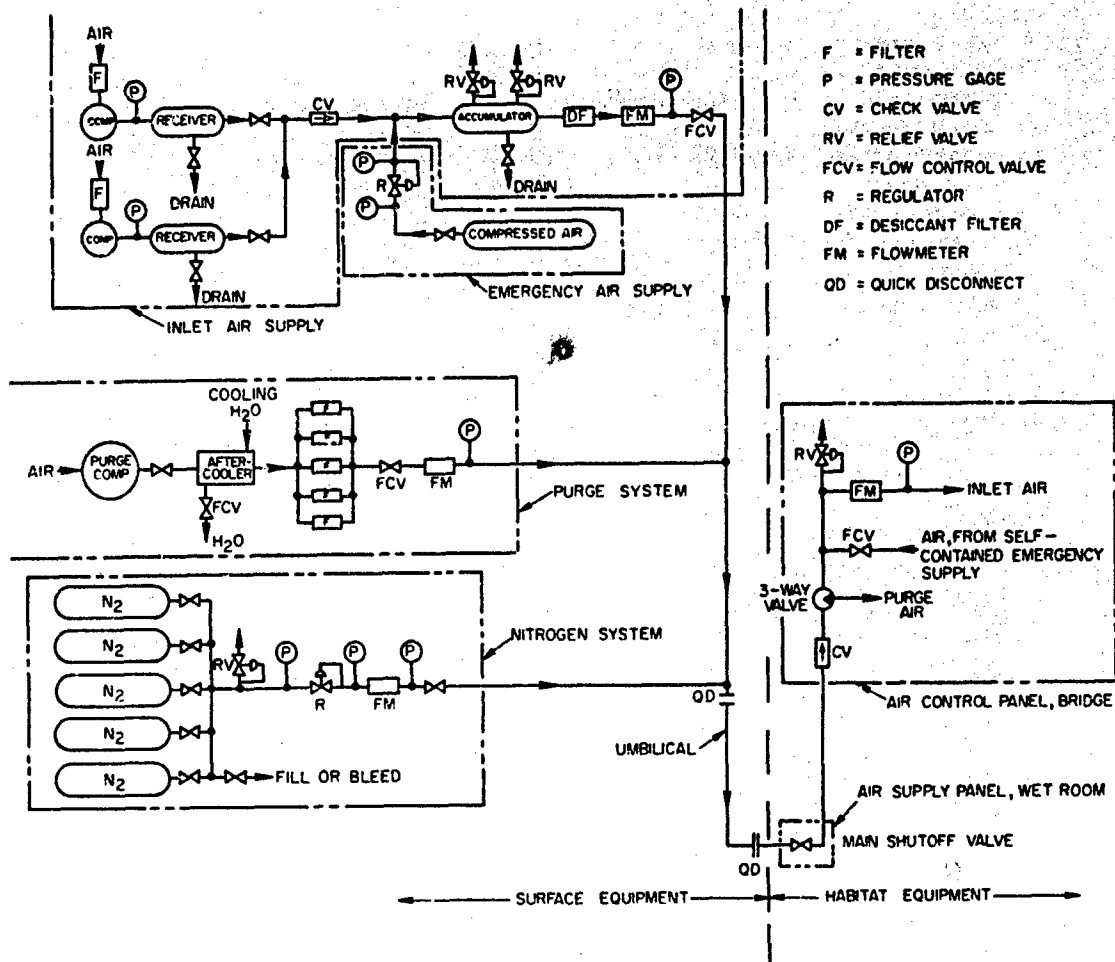
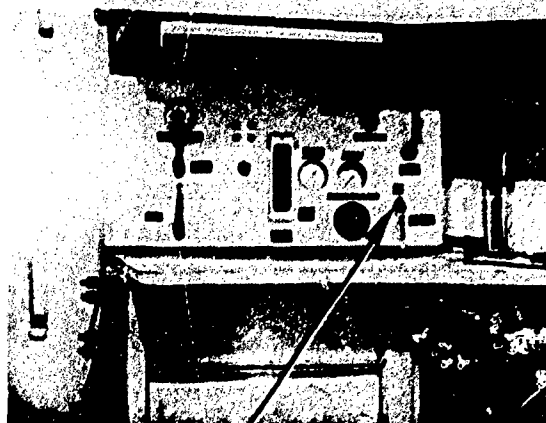

Fig. B6 - Habitat gas supply systems

Fig. B7 - Habitat air supply panel, located in the habitat wet room. The valve shown is the main air shutoff valve for the entire habitat.



MAIN AIR SHUTOFF VALVE

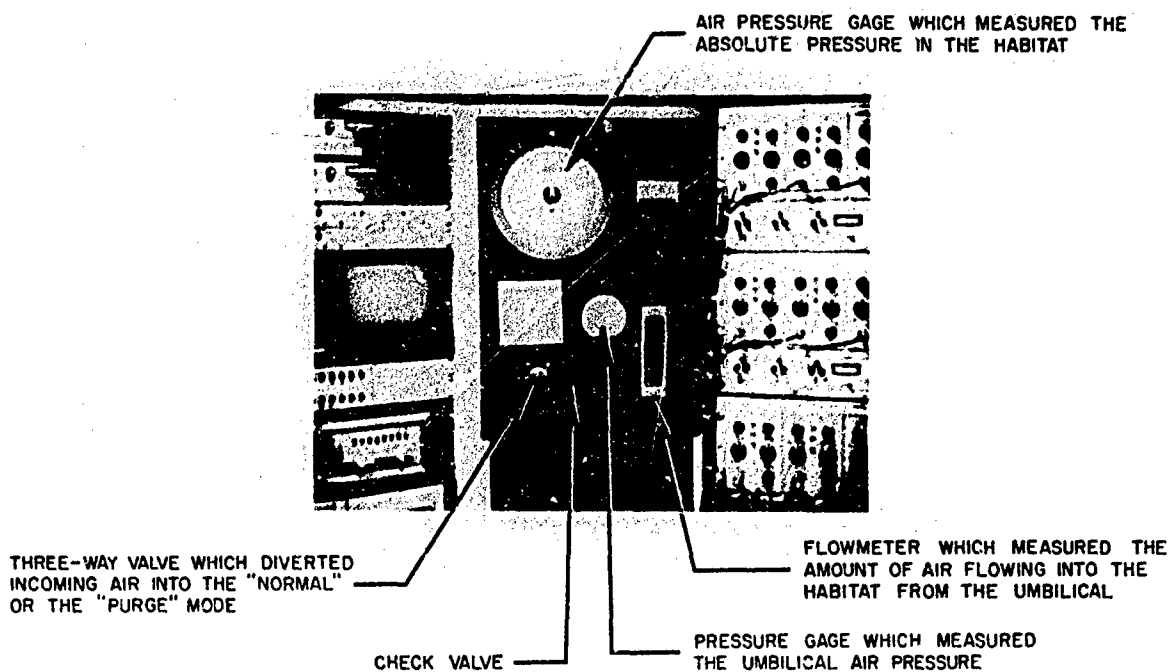

Fig. B8 - Habitat air control panel, located on the habitat bridge

The  $pO_2$  was regulated by controlling the flow rate of compressed air into the habitat. Increasing the flow rate would increase the equilibrium  $pO_2$ , and vice versa. The flow control valves for this function were located on the support barge. Due to the large free volume per man, the  $pO_2$  in the habitat would vary very slowly, and frequent adjustments of the inlet air flow were therefore not required.

This small, continuous bleed of compressed air into the habitat was also sufficient to maintain the atmosphere total pressure in equilibrium with the water depth pressure; i.e., as the tide or barometric pressure increased, the habitat pressure also increased due to the addition of inlet air. Pressure relief was provided by three side ports in the

entry trunk. When the water level uncovered these ports due to increasing habitat pressure, excess air simply bubbled out. Thus, during the mission there was a small relatively continuous flow of air from the habitat.

### B3.1.2 CO<sub>2</sub> Scrubber

The scrubber removed CO<sub>2</sub> produced in the habitat by chemical absorption with baralyme. The system consisted of two blowers (one redundant), a baralyme canister, and associated valves and piping. The blower provided forced circulation of the habitat air through the baralyme, where CO<sub>2</sub> was absorbed. The processed air was then directed in equal parts to each of the four compartments. The baralyme canister (Fig. B9) was sized to hold sufficient chemical for 8 hours of use, after which time it would require replenishment.

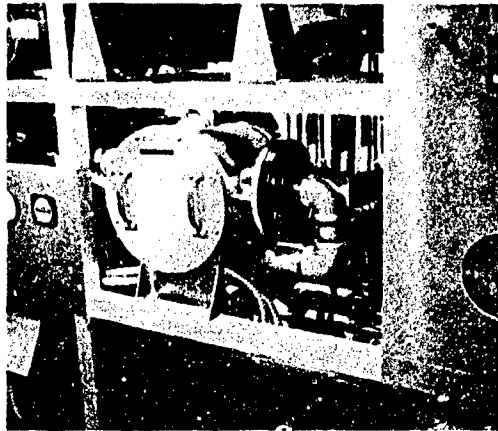

Fig. B9 - Baralyme canister, located in the mechanical equipment room

### B3.1.3 Thermal Control

The thermal control system shown schematically in Fig. B10 regulated the habitat air temperature and relative humidity. Since the water temperature surrounding the habitat was 77 to 78°F, the walls of the habitat were essentially adiabatic; that is, heat loss to the water was negligible. Thus heat generated by the men and equipment had to be removed by an active cooling system. A cabin heat exchanger served each compartment, although the output of the two heat exchangers in each cylinder were connected so that additional capacity could be obtained for the peak loads. Each heat exchanger loop included a blower for air circulation, a charcoal filter for odor and trace contaminant control, and an electrical heater (Figs. B11 and B12). The blower forced air over cold coils in the heat exchanger, removing sensible heat; excess water vapor condensed on the coil surface, removing latent heat (dehumidification). The cool dehumidified air then passed through the reheater (Fig. B13), where the air temperature was increased depending on the desired room air temperature and the internal heat generation rate. Therefore, this system provided dehumidification of the air, even during periods of low sensible heat load. During periods of high internal heat generation, little or no reheat of the air was necessary. Low heat generation conditions, however, required the maximum reheater power to maintain comfortable air temperatures. The power applied to the reheaters was controlled by room air thermostats, which allowed selection of air temperatures between 75 and 90°F.

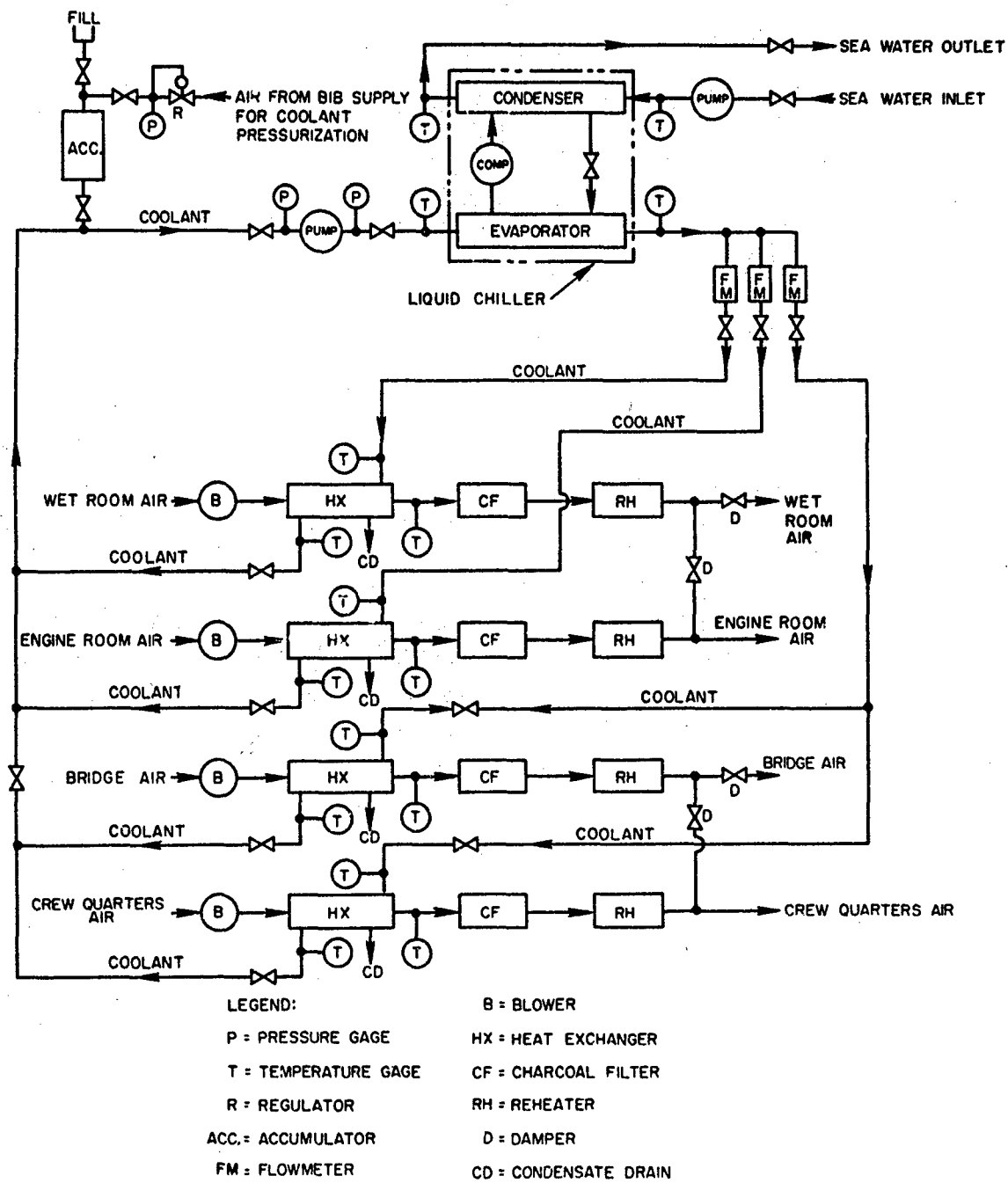

Fig. B10 - Thermal control system

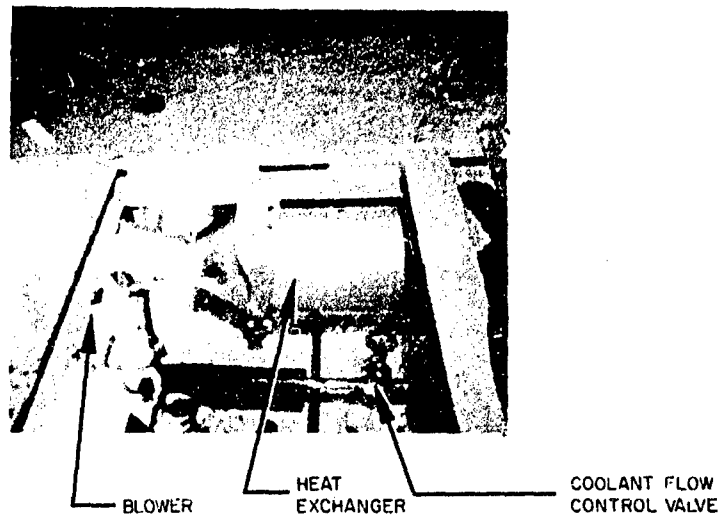

Fig. B11 - Blower and heat exchanger (typical)

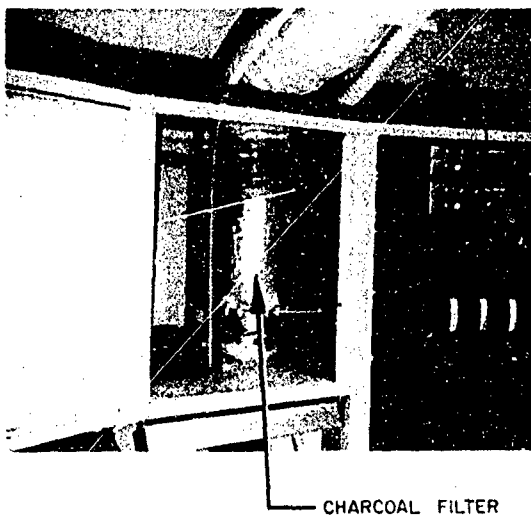

Fig. B12 - Charcoal filter (typical)

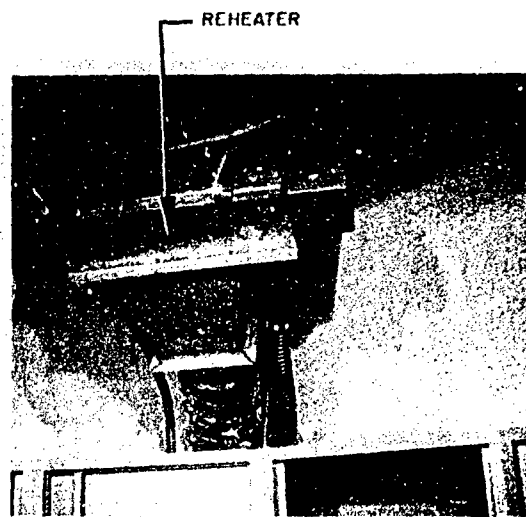

Fig. B13 - Reheater which heated dehumidified air to the desired room temperature

Coolant for the heat exchangers was supplied by a liquid chiller in the engine room (Fig. B14). Associated pump, valves, flowmeters, piping, etc., circulated 30% glycol/water coolant to the four heat exchangers and return. The liquid chiller itself was a conventional Freon compressor refrigeration unit, with modifications to the controls to allow operation at the high ambient pressure. Ultimate heat rejection from the system was to the sea water via the sea-water condenser on the refrigerator unit.

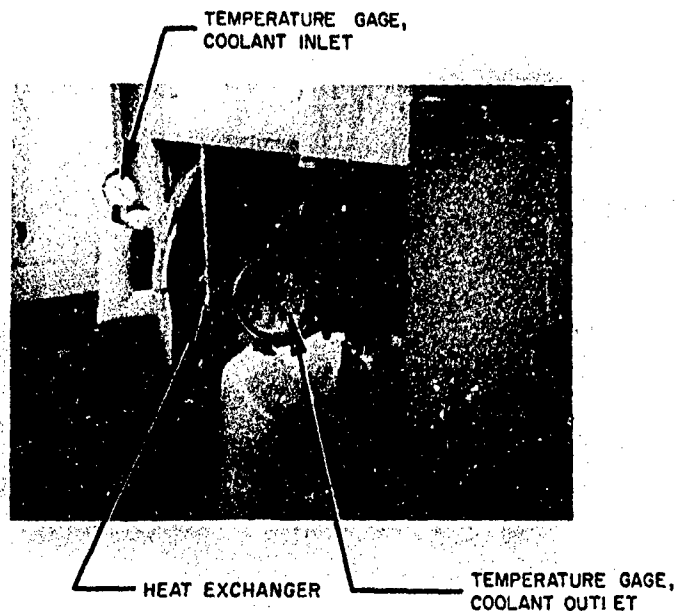

Fig. B14 - Liquid chiller which cooled the coolant fluid in the thermal control system

#### B3.1.4 Scuba Charging Equipment

The scuba charging equipment, shown schematically in Fig. B15 consisted of two high-pressure compressors on the support barge, a high-pressure umbilical from the compressors to the habitat, three 270-standard-cubic-foot accumulator tanks mounted external to the habitat, and associated valves, piping, and charging lines within the habitat. The air compressors maintained 2400 psi within the accumulator storage tanks. The charging line consisted of a bleed valve, shutoff valve, pressure gage, and yoke for attachment to the cylinder. When the aquanauts charged the tanks, the two compressors on the support barge were operated. The output of the compressors plus the air stored in the accumulator tanks was sufficient to maintain a satisfactory charge rate. A hookah system also drew air from the scuba charging equipment, through a stepdown pressure regulator. When an aquanaut was on the hookah, the compressors on the support barge were also operated and maintained an adequate supply of air for this open cycle system. Figure B16 shows the scuba charging and hookah panel in the wet room.

#### B3.1.5 Emergency Systems

The environmental control system provided several subsystems for use during possible emergencies: surface emergency air system, purge system, self-contained emergency air supply, emergency built-in breathing system, and escape air bottles. The surface emergency air system (Fig. B15) consisted of a compressed air storage tank at the support barge. In case both normal air supply compressors failed, or there was a power failure, air from the supply could be delivered to the habitat in the normal manner. The air supply was more than sufficient to last the specified 24 hours. Its use was not required during the mission.

The purge system (Fig. B6) was designed to completely change the air within the habitat should it become contaminated. The system used an engine-driven compressor and a compressed nitrogen gas storage tank on the support barge, supplying gas to the



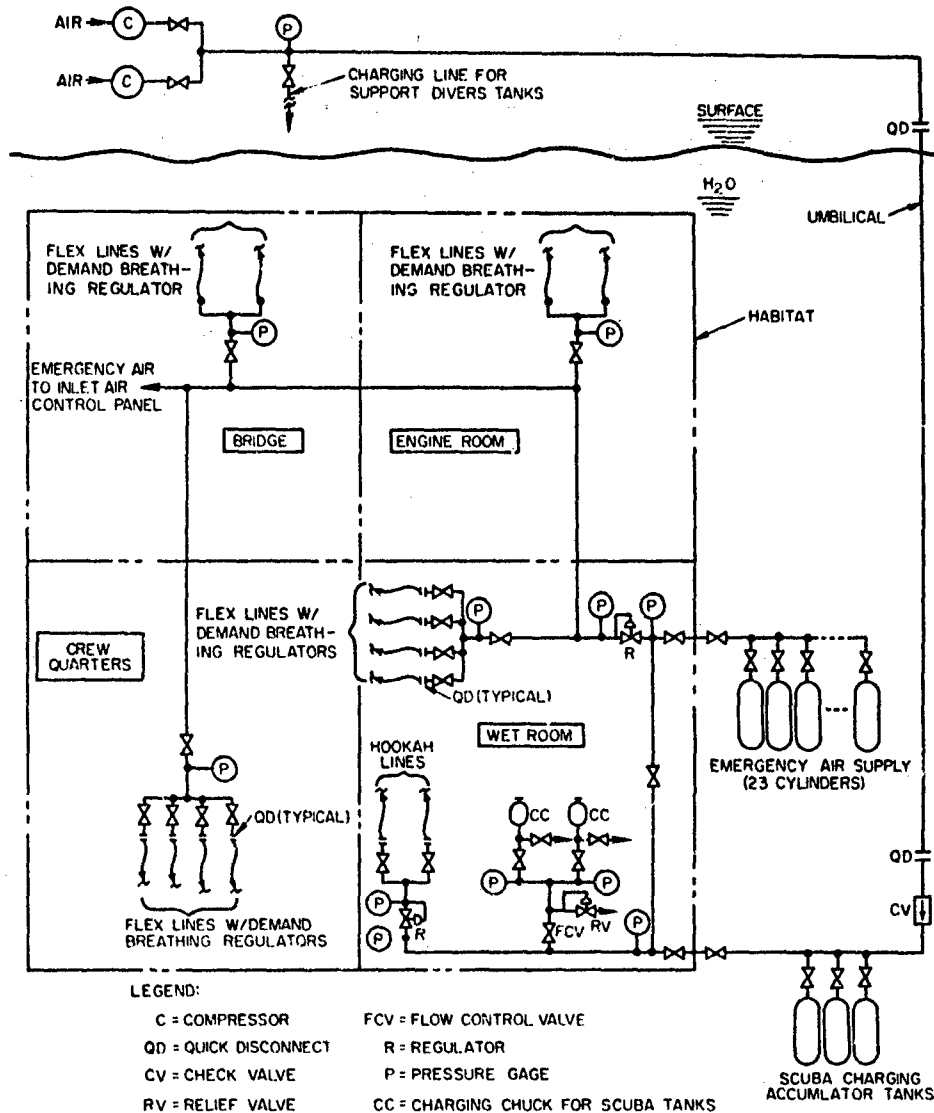
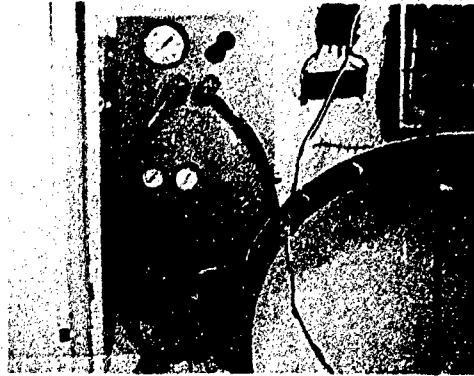

Fig. B15 - Emergency breathing and scuba charging systems

habitat via the air supply umbilical. In operation the air compressor flushed out the habitat atmosphere and replaced it with compressed air (suitable filters were used to remove any oil, CO, or other contaminants from the air that might be produced by the compressor). Then nitrogen was added to the habitat to reduce the  $pO_2$  to a normal level. The purge system was not required during the mission. However, just prior to beginning the mission, nitrogen was added to the atmosphere within the habitat to establish the proper mixture of  $O_2$  and  $N_2$ , and after the mission the habitat was purged with compressed air to allow a greater diving time for the support personnel. No problems were encountered with either purge.

The habitat also had a self-contained emergency air supply consisting of twenty-three 270-standard-cubic-foot compressed air cylinders in the base of the habitat (Fig. B15). This air could be used instead of the normal air supply from the surface or for supplying the emergency breathing system. This air supply was also crossconnected to

Fig. B16 - Scuba charging and hookah panel in the habitat wet room



the scuba charging system, so that it could be recharged or supplemented by the scuba charging compressors.

The emergency built-in breathing system (Fig. B15) provided 12 breathing stations within the habitat (four in the crew quarters, four in the wet room, two in the equipment room, and two in the bridge) to be used in case of atmosphere contamination. Each breathing station consisted of a hose of sufficient length to reach the stations in adjacent compartments, terminating with a scuba type demand breathing regulator (Fig. B17). Each breathing station, less the hose and demand regulator, is shown in Fig. B18. The line pressure to each regulator was maintained at 100 psi. If used, the aquanauts would breathe air directly from the self-contained emergency supply, which would last for 12 hours.

Fig. B17 - Hose and regulator for built-in breathing stations to be used in case of atmosphere contamination

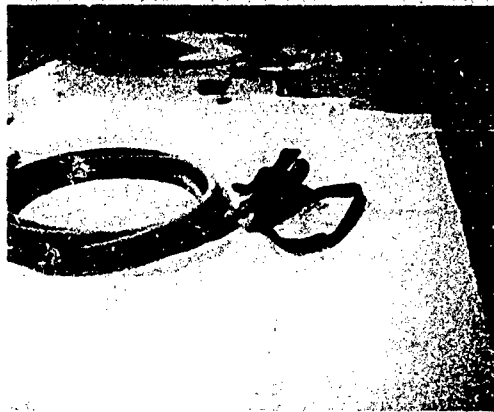

Escape air bottles (Fig. B19) complete with regulators, hoses, and mouthpieces, were located in all compartments except the wet room, where scuba equipment was available. Four were in the crew quarters, and two were in the bridge, and two were engine room. These bottles provided the capability to move about or escape from the habitat in the case of a severe emergency, such as flooding. Each bottle contained 18 standard cubic feet of air, which would provide a useful life of 7 to 8 minutes.

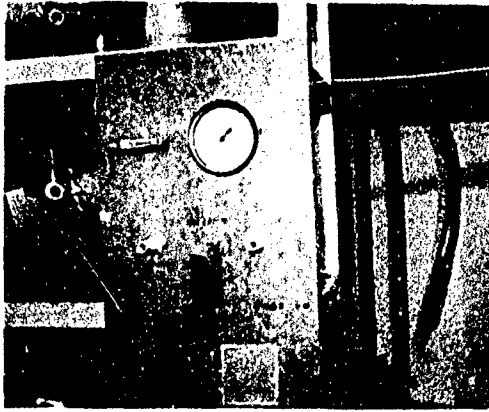

(a) Equipment room

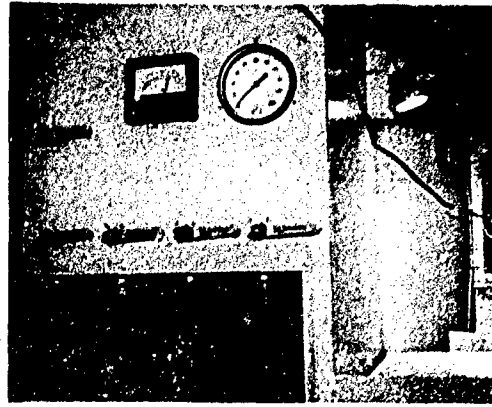

(b) Crew quarters

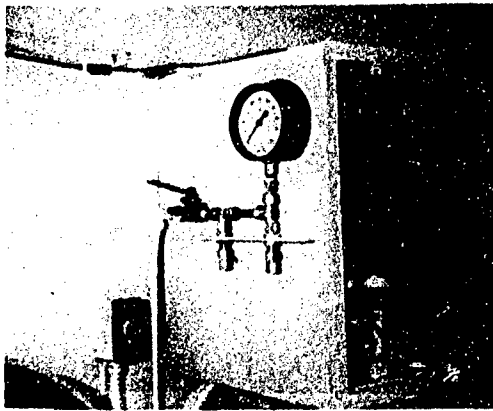

(c) Bridge quarters

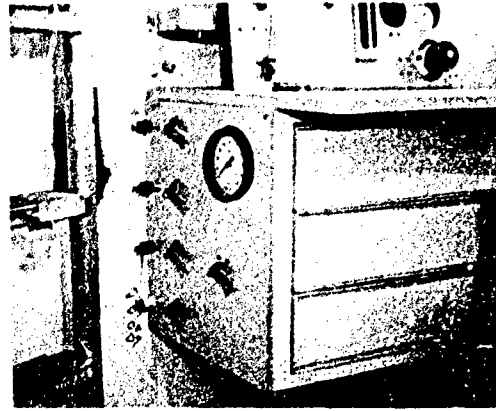

(d) Wet room

Fig. B18 - Built-in breathing stations to be used in case of atmosphere contamination



(a) Crew quarters

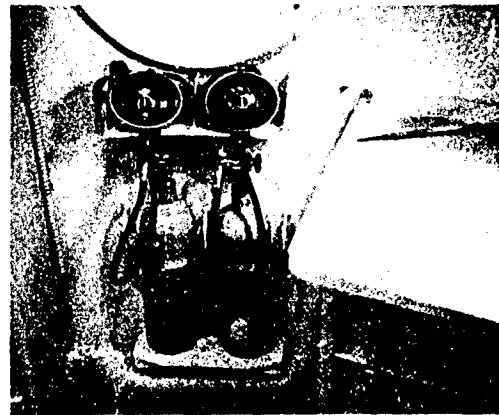

(b) Bridge

Fig. B19 - Escape air bottles

## B3.2 Atmosphere Monitoring Subsystem

### B3.2.1 Background

The atmosphere monitoring subsystem served two objectives: first, and most important, the Tektite I mission made it highly desirable to automatically and continuously monitor the major life support gases with readout both in the habitat and on shore. Second, the more insidious buildup of any toxic, flammable, or obnoxious gases, vapors, or particulates had to be detected reliably and well within safety limits to the satisfaction of all concerned, especially to the isolated aquanauts. Other considerations such as logistics, calibration, maintenance, simplicity, and cost were also necessary in the selection of the instruments ultimately used in Tektite I. The subsequent sections will deal with the details of the particular package of instruments selected for Tektite I. Table 5 (chapter 4, page 38) showed this list of instruments and the location and functional priority of each in the analytical scheme.

Some discussion of analytical limits and safety limits will be presented in following sections. These are included to also more clearly explain the basis for selection of the various instruments.

Another important facet in the maintenance of a high-purity atmosphere involved choice of materials used in the habitat. All materials and components, paints, insulations, soundproofing, and various chemicals were screened to avoid contamination as much as possible. All interior painting was completed well in advance of the mission (at least 30 days). One possible source which was more difficult to control involved the scientific and personal gear of the aquanauts, such as formaldehyde for specimen preservation and various paints for specimen marking. Minor amounts of these and other possible contaminants could be easily handled by the charcoal scrubbers and by ventilation of the habitat atmosphere. Major spills would be another matter, so safety procedures allowed only small quantities to be used at any one time. Another source of concern involved the charcoal scrubbers, which could eventually be a source of contamination. This could occur if some contaminant originally adsorbed early in the mission was displaced by a more actively adsorbed contaminant generated later in the mission. This was checked by removing part of the charcoal midway in the mission and analyzing it for amounts and types of contaminants present in order to determine whether the charcoal was near the end of its useful life.

A final point in this subsystem and the Tektite I mission involved the need for rapid and precise measurement of contaminants not readily identified by the equipment available or due to equipment failure or malfunction. This was solved by arranging off-site standby facilities at Puerto Rico, where a complete analytical laboratory was available. Mainland facilities were inappropriate because of the long turnaround time involved.

### B3.2.2 Discussion

The major constituents of the atmosphere were nitrogen, oxygen, carbon dioxide, and water vapor. These gases (vapors) were monitored onboard between the limits and with the accuracies given in Table 5 (page 38). Suitable backup and standby equipment was provided both on board and on shore.

Anticipated trace constituents of the atmosphere were carbon monoxide, varied hydrocarbons, ozone, particulates, Freon, etc. These gases, solids, and aerosols were monitored to insure that they did not exceed safety and comfort limits. The threshold limit values for the more likely constituents are shown in Table B-1. A complete review of all gases and compounds which were potentially harmful was made using the list provided by the American Conference of Governmental Industrial Hygienists, 1966. Tektite I

Table B1  
Acceptable Threshold Limit Values\* (TLV) of Objectionable Constituents  
in the Habitat Atmosphere

Constituent	Tektite Limit Value During Operations <sup>†</sup>	Emergency Value <sup>‡</sup>
Carbon dioxide	3,000 to 15,000	>15,000
Carbon monoxide	15 to 80	>80
Hydrocarbons (toxic)	1/4 to 5/4 of TLV	>5/4 of TLV
Hydrocarbons (obnoxious)	By smell	NA
Ozone	<0.06 to 0.30	>0.30
Particulates (inert)	5 to 25	>25
Particulates (toxic):		
Lead	0.06 to 0.30	>0.30
Mercury	0.01 to 0.05	>0.05
Freon 12	1500 to 7500	>7500
Freon 22	1500 to 7500	>7500

\*These values were 1/4 the threshold limit values set for a normal 8-hour working day by the American Conference of Governmental Industrial Hygienists, 1966.

<sup>†</sup>If the contaminant level was detected in this range, steps were to be taken to locate the source and initiate the appropriate corrective action.

<sup>‡</sup>If this concentration was detected, an immediate habitat purge was to be initiated with the crew on the built-in breathing system.

mission limits were set at 1.4 the values given in this list, since the aquanauts were exposed on a full 24-hour day basis versus the 40-hour-week basis for the limits given.

### B3.2.3 Monitoring Equipment

A single onboard instrument was used to continuously monitor the oxygen, carbon dioxide, water vapor, and nitrogen content of the habitat atmosphere. This instrument was a miniaturized mass spectrometer supplied by NASA (Langley Research Center) which allowed simultaneous subsurface and onshore readout. The concentration levels as noted onshore were logged at periodic intervals, and habitat readouts were logged by the habitat crew. The instrument was calibrated by the crew as required. Each constituent gas was indicated on an edge meter. The oxygen and carbon dioxide meters had adjustable set points connected to audible and visual alarms.

Onboard backup instruments monitored oxygen and carbon dioxide in the event of power or prime equipment failure. These instruments used reliable chemical and physical principles to analyze O<sub>2</sub> and CO<sub>2</sub> and were simple to calibrate and read out. For oxygen monitoring, a Mine Safety Appliance (MSA) Model E oxygen indicator was used in conjunction with two General Electric O<sub>2</sub>-partial-pressure sensors. An MSA detector tube with a Universal Test hand pump was used for backup CO<sub>2</sub> sensing. For probable toxic gases, an MSA portable air-sampling test kit applying colorimetric chemical analytical techniques was used. The test kit was equipped with the chemical detector tubes

for: ammonia, carbon monoxide, chlorine, phosgene, mercury vapor, organic nitrogen compounds, nitrogen dioxide, hydrogen chloride, unsaturated hydrocarbons, sulphur dioxide, carbon dioxide, hydrogen sulphide, halogenated hydrocarbons (Groups A, B, C, and D), hydrogen cyanide, aromatic hydrocarbon, ozone, alcohol, aldehyde, styrene, dimethyldiethyl sulfate, carbon disulfide, hydrogen fluoride, and lead.

It was not expected that all of these tests would be required during mission operations. In addition, an air-particulate sampler was also provided. These particulate samples were to be taken as required and placed in suitable dusttight polyethylene envelopes and sent topside for analysis. The need for particulate sampling never arose, so samples were taken only before and after the mission. A simple halide detector to be used only in emergencies provided Freon leak-source detection.

On the surface both a Beckman and a Servomex oxygen meter fitted with suitable valving and appropriate absorbents were used to monitor habitat O<sub>2</sub> concentration via a vent line. The vent line umbilical sampled the atmosphere near the CO<sub>2</sub> scrubber inlet in the habitat. Later in the mission a Beckman CO<sub>2</sub> analyzer was added to the onshore instrumentation to monitor CO<sub>2</sub>. A gas chromatograph was also available for major gas analysis as an additional backup and could also monitor carbon monoxide or any buildup of hydrocarbon vapors whose concentrations were within detection limits of the instrument. These analyses were to be conducted using batch bottle samples taken in the habitat. Additional batch samples were taken and analyzed at the Naval Research Laboratory in Washington, D.C., for trace compounds developed during the mission. In case of equipment or power failure, a simple Orsat gas apparatus was also available in the watch director's station on the support barge to monitor oxygen and nitrogen. Arrangements were also made for emergency analytical services at the Puerto Rico Nuclear Center whereby complete, more precise chemical and instrumental analyses could be quickly provided.

Samples of particulate filtration were analyzed ashore using simple weight-change measurements and a microscope. Suitable chemicals also were available for spot tests if required. Samples were also taken of the charcoal and filters used onboard to purify the atmosphere. These samples were in airtight plastic containers for later analysis as part of postoperation analyses. Finally, an occasional sniff test was conducted on the gases from the oxygen sampling umbilical to qualitatively evaluate the habitat atmosphere, since the aquanauts' sense of smell could have been deadened by constant exposure to the habitat conditions.

### B3.3 Electrical Power Distribution Subsystem

#### B3.3.1 General

The electrical power distribution subsystem depicted by a one-line diagram in Fig. B20 was specifically defined as that which transmitted, transformed, controlled and distributed power to all habitat electrical loads. The power subsystem derived its electrical power from one of two identical 100-kW diesel generators mounted on the habitat support barge, which also supplied power to the surface control center van and all other barge loads. One of these generators operated while the other was on standby. The load was transferred from one generator to another manually after the standby generator was started. Power from the operating generator was fed through a distribution circuit breaker and was stepped up to 480 volts by transformers mounted on the surface support barge. The power flow then interfaced with the power distribution subsystem. The total power being transmitted to the habitat was monitored by a watt-hour demand meter before being fed through a 1000-foot-long power umbilical cable.

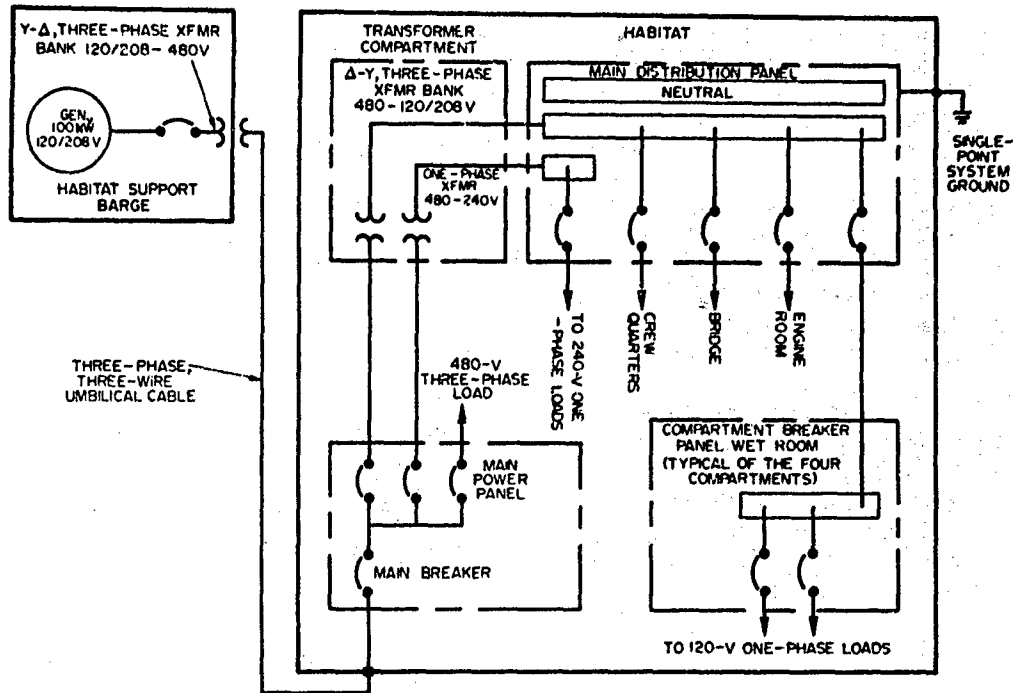

Fig. B20 - Single-line diagram of the Tektite electrical power distribution system

### B3.3.2 Main Power Panel

The power umbilical cable entered the habitat through a penetration plate and was fed directly to the main power panel, which controlled all power at three different voltage levels (120, 240, and 480 volts) for electrical loads in the habitat. Power for the 480-volt load was controlled directly at the main power panel. Power at 480 volts was distributed on separate circuits to transformers which stepped down the voltage to 120 volts and 240 volts. Power was then transmitted at these voltage levels to the main distribution panel. The main distribution panel provided centralized control and distribution of power to all 240-volt loads. It also provided control for and distributed all 120-volt power to four individual compartment breaker panels, which provided centralized, local control and power distribution to all 120-volt loads in the respective compartments.

### B3.3.3 System Ground

The electric power distribution subsystem was a grounded system except for the 480-volt circuit, which was ungrounded. This provided selective, positive operation of a circuit breaker to deenergize and completely isolate any circuit or load on which a fault had occurred. An equipment grounding system was also utilized to hold all electrical equipment enclosures at hull ground potential to prevent dangerous electrical shock. Each piece of electrical equipment had a grounding strap bolted to it for this purpose. Grounding straps were also used to hold the floor structures, cabinets and bunk frames at hull ground potential, since all of these structures had electrical equipment mounted on them. Mechanical mounting interfaces were not relied on to assure proper grounding.

### B3.3.4 Power Umbilical Cable

The power umbilical cable, which transmitted 480-volt three-phase power from the surface support barge to the habitat, was armored between strain termination fittings, with an unarmored section beyond the strain termination fittings.

The 1000-foot cable assembly was composed of three waterproof, insulated, size 1/0 copper conductors with No. 8BWG polyethylene-coated galvanized steel wires wound around them. This outside armor protected the conductor insulation from abrasion and provided strain relief by supporting the weight of the cable. At both ends of the cable the armor wires were circumferentially clamped by a steel cable support fitting (O-Z Electrical Mfg. Co. Part FS0830). This cable support was bolted to the base structure of the habitat at one end and the surface support barge on the other end.

The waterproof connector plug at the habitat end (Burton Electrical Engineering Co. Part 5801-3804) was a four-pin connector with the umbilical cable conductors molded to its shell. The connector was supplied with a protective cap, which when mated to the connector provided a waterproof seal to 3000 psi. A mating cable and connector inside the habitat carried power from the umbilical plate to the main breaker panel.

The bulkhead connector mounted to the umbilical plate under the cabinets in the wet room. A nut screwed onto the connector shell from the water side secured the connector O-ring flange against the umbilical plate to provide a watertight seal. This connection was done on the water side; however since it was required that connectors be dry, it was necessary to lift the umbilical plate when mating them. Although the connector fittings were pressure resistant and watertight, after the connection was made the umbilical trunk was blown dry and remained dry during the mission.

### B3.3.5 Power Distribution Sequence

All distribution panels in the power subsystem were of heavy-gauge steel construction and painted with a corrosion resistant nonflammable paint. Molded-case circuit breakers provided control and overcurrent protection for all circuits in the subsystem. A wiring shield prevented access to all internal wiring when the front door was open.

The main power panel in the engine room contained four 480-volt, three-pole molded-case circuit breakers and three current-limiting fuses. The main power panel provided a door-on-door feature. The 125-ampere main breaker controlled all electrical power being fed to the habitat by the power umbilical cable. It had an external operating lever at the top of the full-front-panel door. This operating lever was interlocked such that the main breaker had to be opened to secure all electrical power to the habitat before the full door could be opened. Wired in series with each pole of the main breaker was a 600-ampere current-limiting fuse. A voltage-sensing element wired across each fuse tripped the three-pole main breaker to prevent damaging a three-phase load had any one fuse burned out. The combination of the main breaker and the current-limiting fuses provided adequate overcurrent protection and selectivity with the remaining three circuit breakers in the panel.

The main distribution panel in the engine room (upper right in Fig. B20) provided overcurrent protection and distributed power for all the 120-volt and 240-volt circuits in the habitat. The main distribution panel obtained 120/208-volt power from the stepdown transformer bank on a three-phase, four-wire circuit and 120/240-volt power from the stepdown transformer on a single-phase, three-wire circuit. A simplified one-line schematic of the main distribution panel is shown in Fig. B21.



## PROJECT TEKTITE I

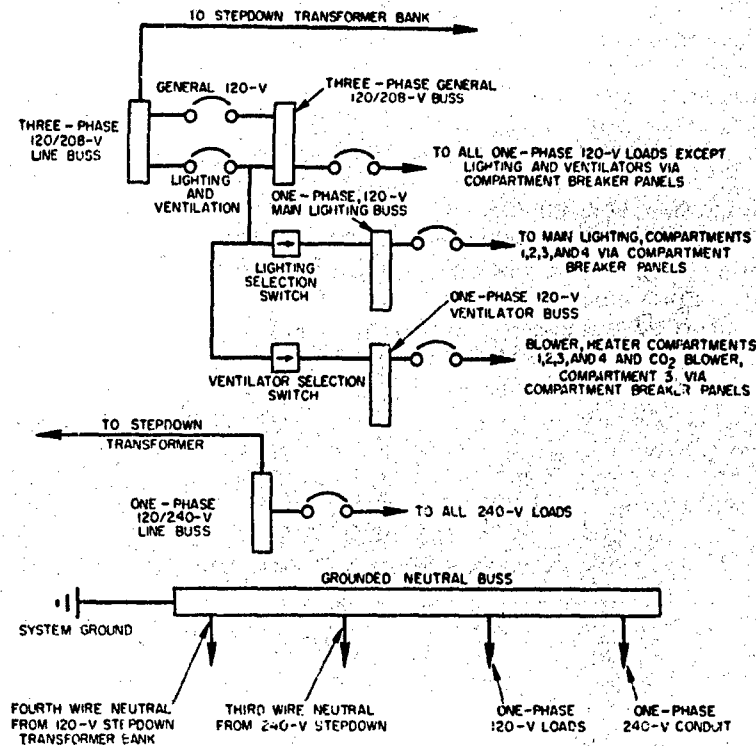

Fig. B21 - Single-line diagram of the main distribution panel. All 120-volt power from this panel is distributed on multiple one-phase, three-wire circuits to the individual compartment breaker panels. All 240-volt power from this panel is distributed on multiple one-phase, three-wire circuits directly to 240-volt loads.

A grounded neutral buss was provided to pick up the neutral and ground wire on all 120-volt and 240-volt circuits on both the line and load side. The system was grounded to the hull by a ground strap fastened to the neutral buss.

The compartment breaker panels, one in each compartment, obtained 120-volt power from the main distribution panel in the engine room on multiple, single-phase circuits which were enclosed in conduit. Each compartment breaker panel was identical in construction except for the number of circuit breakers which it contained. Table B2 indicates the breakers and ratings for each compartment and indicates the types of 120-volt services provided to the habitat.

Four 25-kVA 120/240-43/450/460/480/500/510-volt single-phase transformers (General Electric Model 9T21Y9615) were mounted in a ventilated enclosure behind the freezer in the engine room. Three of these transformers, wired in a delta-wye bank, stepped down the three-phase, three-wire, 480-volt power obtained from the main power panel to 120/208-volt power which was transmitted on a three-phase, four-wire circuit to the main distribution panel. The fourth transformer stepped down the one-phase, two-wire, 480-volt power obtained from the main power panel to 120/240-volt power which was transmitted on a one-phase, three-wire circuit to the main distribution panel.

Table B2  
Breaker Panel Circuits

Breaker Number	Bridge		Crew Quarters		Equipment Room		Wet Room	
	Function	Rating (amp)	Function	Rating (amp)	Function	Rating (amp)	Function	Rating (amp)
1	Main lighting	15	Main lighting	15	Main lighting	10	Main lighting	15
2	Gen. outlet	20	Heater blower 1	20	CO <sub>2</sub> blower	15	Heater blower 4	20
3	Gen. outlet	20	Heater blower 2	20	CO <sub>2</sub> blower	15	Gen. outlet	20
4	Communications panel	15	Gen. outlet	20	Heater blower 3	20	Gen. outlet	20
5	Biomedical panel	5	Gen. outlet	20	Gen. outlet	20	Spare	-
6	Environmental control system panel	5	Spare	-	Gen. outlet	20	Exterior lighting	20
7	Reheater	50	Spare	-	Freezer/toilet blower	15	Exterior lighting	20
8	Spare	-	Refrig.	10	Toilet	10	Exterior lighting	20
9	Spare	-	Stove	40	Spare	-	Exterior lighting	20
10	-	-	Reheater	50	Reheater	50	Reheater	50
11	-	-	Condensate pump	5			Sump/bilge pumps	15
12	-	-	Spare	-			Spare	-

### B3.3.6 Lighting and Assorted Fixtures

The interior lighting system contained four ceiling fixtures in each compartment to provide area illumination. These lighting fixtures could be continuously controlled from maximum to zero intensity with a dimmer switch in each compartment.

Supplementary lighting fixtures were used to provide additional illumination over countertops, bunks, and sinks. A shallow lighting fixture was mounted under all the wall cabinets to provide added illumination on the countertops. A swiveled lighting mixture was mounted at the head of all the bunks to provide individual lighting for each aquanaut.

Three 500-watt quartz iodide external lighting fixtures (Hydro Products Part LQ-10) were mounted on the habitat. The lighting fixtures were provided with a short three-wire waterproof lead which was terminated with an underwater connector. An extension cord, which was provided with a mating underwater connector on the water end, and a conventional three-prong (grounding) plug on the dry end carried power to each external lighting fixture. The extension cord entered the wet room through a 12-inch-diameter trunk and plugged into the special external-light-receptacle panel. This panel provided seven, three-prong (grounding) single receptacles (Hubbel No. 5261) rated for 15 amperes at 125 volts ac, each with a weatherproof lift cover plate. The maximum power available on any one circuit was 2000 watts.

Small rubber-bladed fans were mounted at the head of each bunk and in the cupola to provide additional ventilation.

Three-prong (grounding) duplex utility receptacles with a weatherproof lift cover plate were provided in each compartment for general-purpose portable loads. These receptacles were rated for 15 amperes at 125 volts ac.

### B3.3.7 Alarms

An alarm was provided at the bridge alarm panel to provide visual and audible indication if power were lost on any one or more of the phases on the three-phase, 120/208-volt line buss in the main distribution panel. A functional schematic diagram of this alarm is shown in Fig. B22. If power were lost at the line buss, the amber alarm and the bridge buzzer would be energized. The buzzer was secured during an alarm condition by moving switch S1 to the "disable" position. Immediately the white disable light was energized. When the alarm condition was over, switch S1 would be reset to the "on" position. A "test" position was provided on switch S1 to test the function of the buzzer. Both the amber alarm light and the white disable light were provided with a "press to test" feature.

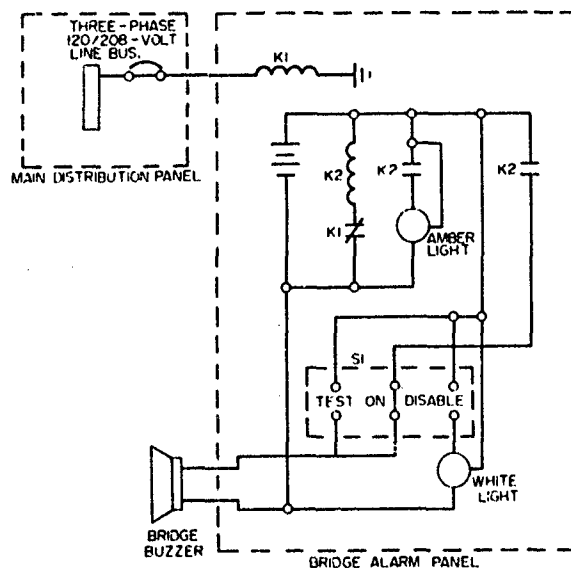

Fig. B22 - Power loss alarm. Relay K1 is one of three identical relays, each of which receives power from one phase of the three-phase buss. The normally closed K1 contacts of these relays are wired in parallel.

An alarm and control function was located in the habitat and the surface control center van to provide audible and visual indication and to secure all electrical power to the habitat if major flooding occurred in the wet room. A functional schematic diagram of this alarm and control function is shown in Fig. B23.

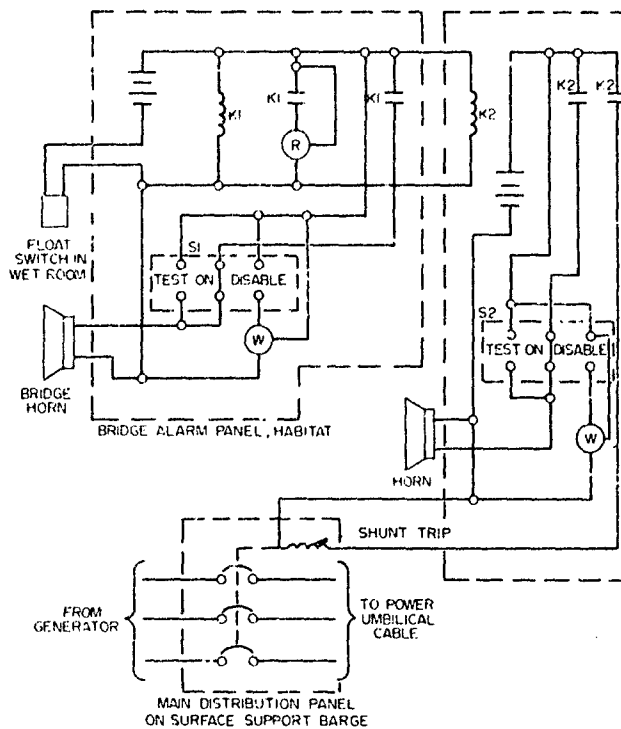

Fig. B23 - Wet room flood alarm

The float switch for the wet room flood alarm was mounted on the pressure hull in the wet room. Had the water level risen within the compartment to submerge the float switch, the following events would have taken place simultaneously:

- All power to the habitat would be secured through the operation of a trip device to open the three-pole circuit breaker feeding the power umbilical cable.
- A red alarm light in the bridge alarm panel would be energized.
- The bridge horn would be energized.
- The horn in the surface control center van would be energized, indicating that the habitat was flooding.

### B3.4 Communications Subsystem

#### B3.4.1 General

The Teklite I communication plan required that voice communication be provided between the following locations or activities. The safety-relevant links were:

Surface control center	—	habitat
Surface control center	—	base camp
Surface control center	—	safety boats
Surface control center	—	crane barge
Personnel transfer capsule	—	crane barge
Habitat	—	swimmer
Swimmer	—	swimmer.

The Administrative or morale-relevant links were:

Surface control center	—	commercial telephone facilities via St. Thomas
Surface control center	—	Naval administrative radio links via the St. Thomas Coast Guard Station.

Elements of the various networks are shown in Fig. B24.

#### B3.4.2 Control Center-Habitat Communications

The communications system provided voice and visual control communication between the surface control center van and the habitat. The communication link from the van to the habitat was a 1000-foot high-quality submarine cable which contained 51 shielded twisted-pair and 12 triaxial video circuits. All audio, video, and data signals flowed through this link. These elements are shown schematically in Fig. B25.

#### B3.4.3 Umbilical Communications Cable

The communications umbilical was an armored submarine cable containing 51 shielded 22-gauge twisted-pair and 12 triaxial video cables which were RG 59/U equivalents in electrical characteristics. The cable cross section is shown in Fig. B26. The nominal air weight of the cable was 2.79 lb/ft, and the weight of the cable in water was 0.92 lb/ft. Both ends of the cable were terminated in multipin connectors for ease in field deployment and recovery. The habitat end used three 51-pin, high-density, subminiature connectors to terminate the 51 shielded pairs in a volume small enough to pass through the communication umbilical stuffing tube after being given a waterproof wrapping. Each end of the cable was connected to a set of mating connectors at a communication cable junction box.

#### B3.4.4 Communication Centers

The bridge functioned as the communication center for the habitat, and the watch director's station in the van functioned as the surface communications center.

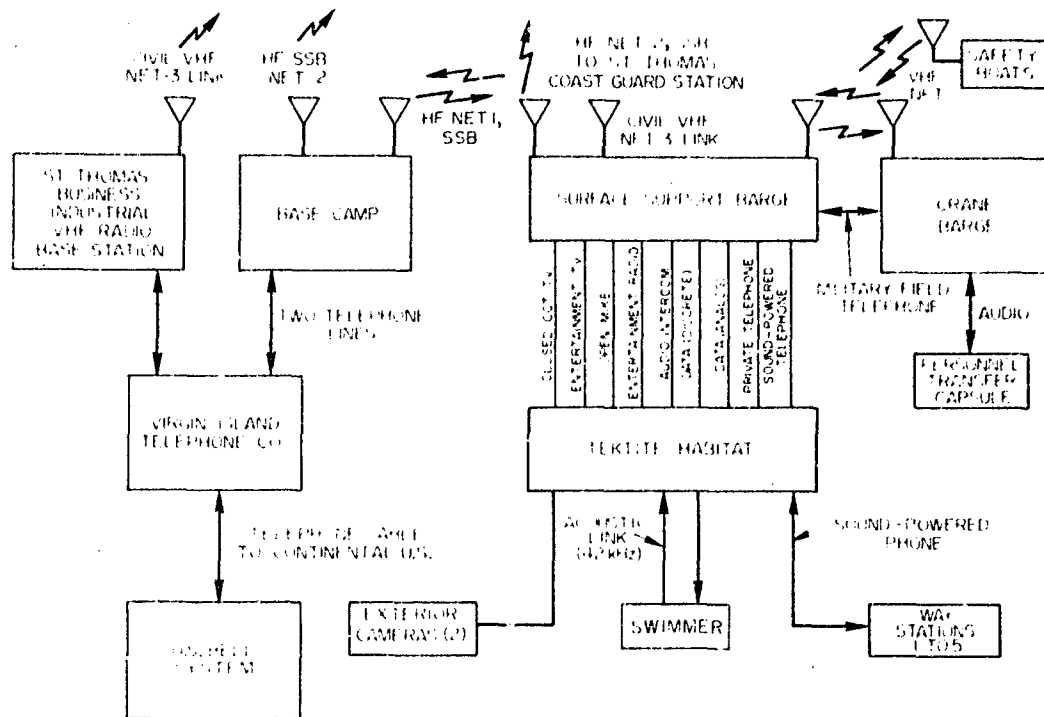

Fig. B24 - Tektite I communications

A technical control panel was provided at the bridge which featured a convenient grouping of communication facilities as well as displays and readouts pertaining to environmental control and crew safety. Displayed information included  $pN_2$ ,  $pH_2O$ ,  $pO_2$ ,  $pCO_2$ , water level in the entry trunk, flooding, and power loss. The partial pressures of the three important atmospheric gases were displayed on meters. The  $pCO_2$  and the  $pO_2$  meters incorporated solid-state relays controlled by movable set points to permit crew adjustment of alarm actuating values. The data essential to crew safety and for mission control was displayed at and controlled from the habitat and from the watch director's station of the van.

The behavioral observation station was located in a closed-off area of the van. Here the television monitors, audio facilities, video and audio recorders, and associated technical control consoles were conveniently and compactly arranged for the behavioral staff. The television monitors were six 14-inch studio-type monitors with video recording capability. The behavioral station could not communicate directly with the habitat.

### B3.4.5 Communication Modes

#### B3.4.5.1 Open Microphones

One cardioid microphone centrally located in each of the four habitat compartments fed one of a set of four audio amplifiers on the bridge which raised the audio level sufficiently to overcome umbilical cable losses and minimize other distortion and noise effects incidental to wire distribution. At the surface additional amplifiers and attenuators were employed to permit high-quality sound distribution in the behavioral monitor station.

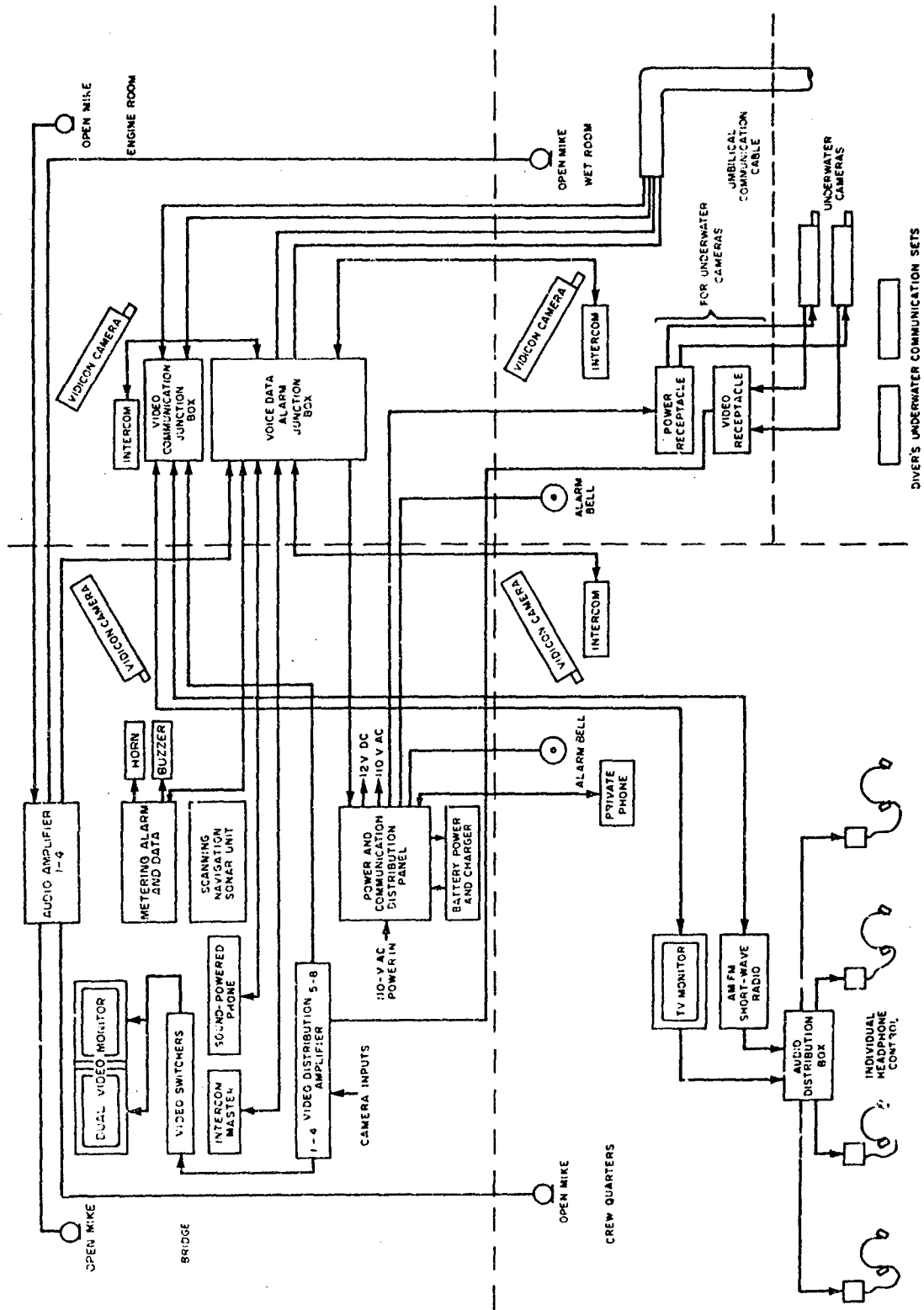

Fig. B25 - Elements of the communication links between the control center and the habitat

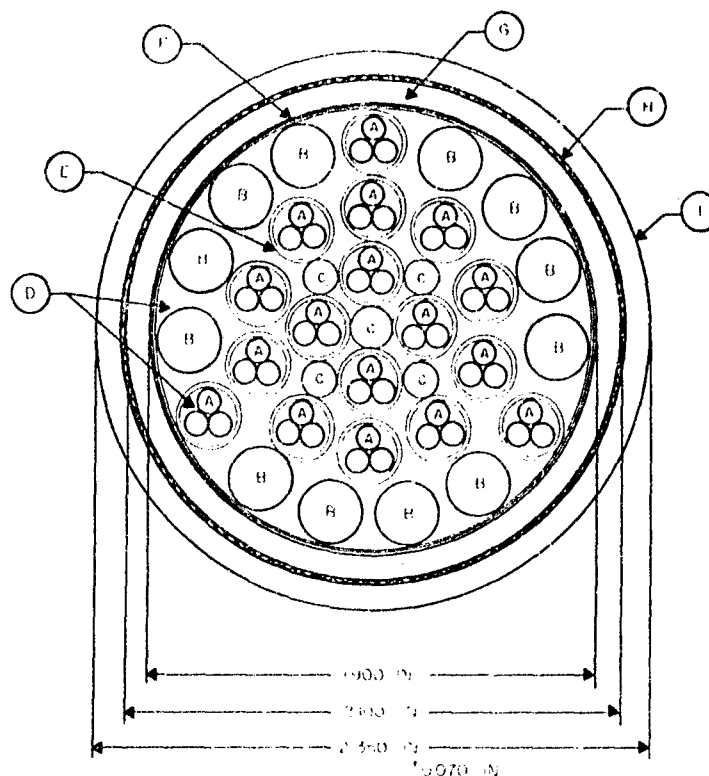

Fig. B2b - Communications umbilical cable: A -- 102 No. 22 AWG 7/0.0.010 T.C., BIW (Boston Insulated Wire and Cable Co.) E-08 insulation, BIW N-01 jacket of 0.052-in. O.D. (51 pairs), BIW T-31 tape binder, No. 36 AWG T.C. shield, BIW T-34 printed tape, and BIW N-06 jacket of 0.145-in. O.D.; B -- twelve 75-ohm triaxial, No. 22 AWG 6-30 T.C. over 1-30 T.C. WLD, BIW P-02 insulation, No. 36 AWG T.C. shield, BIW E-08 insulation, BIW N-06 jacket, No. 36 AWG T.C. shield, and BIW E-08 jacket of 0.288-in. O.D.; C -- BIW HF rubber core and fillers; D -- BIW AF-17 blocking compound; E -- BIW T-34 printed tape binder; F -- BIW T-39C tape binder; G -- BIW E-09 belt; H -- BIW A-44 flat SST armor; I -- BIW V-19 PVC jacket

#### B3.4.5.2 Closed Circuit TV

Four TV cameras, one in each habitat compartment, fed a video distribution system similar to the open microphone audio system. Two more cameras were available for use outside the habitat. The video system was used for mission operations and control as well as for behavioral observations, and for this reason dual monitors with separate video switches were furnished in the watch director's station in the van and also on the bridge for aquanauts. The TV cameras in the compartments were commercial videcon types provided with wide-angle lenses to permit a large compartment viewing area and to avoid crew distraction from pan and tilt camera motion.



### B3.4.5.3 Intercom

The primary voice communication link was the intercom. The van was connected via the communication umbilical to the habitat bridge (which functioned as the habitat communication control center). The intercom was powered by a custom-designed sealed 12-volt nickel-cadmium battery equipped with an accessory two-level charger. The battery was designed to survive accidental overcharging without the need for outgassing ports. It could also survive repeated full discharges. An intercom station was furnished in each compartment, the cupola, and each way station. Master stations were located at the watch director's station in the van and on the habitat bridge.

### B3.4.5.4 Private Phone

A common battery telephone was available in the crew quarters for private conversations with a companion instrument at the surface. A two-wire/two-wire telephone repeater was provided in the van for commercial telephone system interfacing.

### B3.4.5.5 Sound-Powered Phones

Backup voice communication between the bridge and the watch director's station or the way stations was by sound-powered phones. In normal operation the way stations were connected into the intercom system. For emergency operation the way stations could be patched into the habitat-van sound-powered phone link using a patch cord provided at the bridge. Thus communications could be maintained between the surface and crew inside or outside the habitat during a complete power loss.

Sound-powered phones were the only device that could meet the requirements for a voice communication instrument that would function in the event of a power loss, would be economical, survive the marine environment, and integrate into the intercom system with minimum interface impact. The unit selected had provisions for plug-in transducer elements, since this was the part most likely to fail. The sound-powered handsets in the way stations were stored in dry boxes, which were merely inverted containers designed to trap air to protect the handsets from immersion when the way stations were flooded after use. The dry boxes were provided with underwater pluggable connectors permitting easy removal of the boxes and at the same time permitting closure of the party-line link by joining the mating line connectors.

### B3.4.5.6 Links

Analog output voltages in the 0-to-V-dc range from the mass spectrometer were fed to the surface for meter display at the watch director's station through isolation amplifiers. The same displays were available on the bridge. Discrete voltages were also fed to the van over the umbilical cable to furnish records for behavioral accounting of selected housekeeping and other activities. These were recorded by a Franklin printer located in the behavioral monitor's station.

### B3.4.5.7 Entertainment

Entertainment radio and TV sets were provided in the crew quarters. The signals were transmitted from the surface antenna to the habitat using triaxials in the umbilical.

### B3.4.5.8 Morale Telephone

A morale telephone link was provided in the field by adapting the intercom to a rented VHF mobile communications system. This system had interface capabilities with the local Virgin Islands Telephone Company.

#### B3.4.5.9 Way Station Audio

The five way stations were equipped with sound-powered handsets. Each station was connected as a party line and then tied into the van-habitat intercom to boost the line levels. In an emergency the system could function without external power. It could also be patched into the sound-powered phone link between the habitat and the watch director's station.

#### B3.4.6 Other Communication Networks

##### B3.4.6.1 Support Barge-Base Camp

The support barge communicated to the base camp using an AN/PRC-47 HF single-sideband field radio set. Two sets were available to provide for backup operation.

##### B3.4.6.2 Support Barge-Safety Boats-Crane Barge

The diver safety boats, the support barge, and the crane barge were linked in a VHF net which employed military VHF for portable transceivers. Net control was the watch director on the support barge.

The crane barge was moored away from the support barge and operated in the VHF net with the safety boats and the support barge. Wire communications were a secondary means using an EE8 military field telephone, and voice communication was also possible since the distance between the support barge and the crane barge was in tens of yards.

##### B3.4.6.3 Habitat-Swimmer

An Aquasonic 420 acoustic communicator was provided for habitat-diver and diver-diver communications. This unit operates using AM modulation on a 42 kHz carrier.

#### B3.5 Ancillary Equipment

##### B3.5.1 Transfer Pots

Two sizes of transfer pots were used during the Tektite I mission to make dry transfer of materials between the surface and the habitat. Two of the smaller size and one of the larger size were used; an intermediate size was available but not used because of the greater handling ease of the smallest pot.

The small pots were commercial paint tanks of 3-gallon capacity. A valve was installed in the lid to permit pressure equalization after each transit. The lid was secured with four T-bolts having large wing nuts that were tightened to effect a seal. The lid also incorporated a wire-rod handle. Lead weights were added inside the pot as required so that it was close to neutral buoyancy. The small pots proved to be extremely useful and saw much service during the startup and checkout phase as well as during the mission. The only difficulties encountered were procedural problems. After several occasions when the pot was flooded, a more thorough check procedure was adopted before each transfer; the wing nuts and equalization valve were verified as secure.

The larger pot (Fig. B27) was fabricated from 2-foot-diameter steel pipe and incorporated a standard hinged closure, secured by T-bolts. A pressure equalization valve was installed in the closure. The inside height of the pot was approximately 3 feet, sized to take the largest replaceable component in the habitat. The pot was intended to be neutrally buoyant but was made overweight in error. As a result the pot was awkward to



Fig. B27 - The large dry-transfer pot used; two small pots were also used

handle in the water. To facilitate handling, a raft was moored on the surface near the habitat so that the pot could be lowered on a line. The pot was then manhandled by divers into the entry trunk, where it was lifted by the chain hoist installed over the hatch in the wet room.

Despite its awkwardness the large pot proved to be invaluable, and saw almost daily use during the mission. Its most significant role was enabling the mass spectrometer to be returned to the surface for repairs during the early part of the mission. As with the small transfer pots it became necessary to adopt a rigid procedure of checking the bolts and equalization valve before each transfer to prevent accidental flooding of the pot.

#### B3.5.2 Way Stations

Each of the five way stations provided as part of the ancillary equipment for the habitat consisted of a base structure, cage enclosure and Plexiglas dome (Fig. B28). Inside the dome a sound-powered phone was mounted.

The base structure consisted of a square steel plate, 1-1/4 inch thick, providing sufficient ballast to maintain negative buoyancy of the way station when the dome was filled with air. The cage structure was fabricated from 1/2-inch-diameter steel rods, welded to 4-foot-diameter rings and bolted to the base structure. A section of the cage structure was hinged to swing outward as a door. A stainless-steel-bar latch on the door was located so that it would be easily operated from either side of the door. The hinges for the door consisted of simple stainless steel pins. On the door was mounted a plate with a number, from 1 to 5, identifying the particular way station.

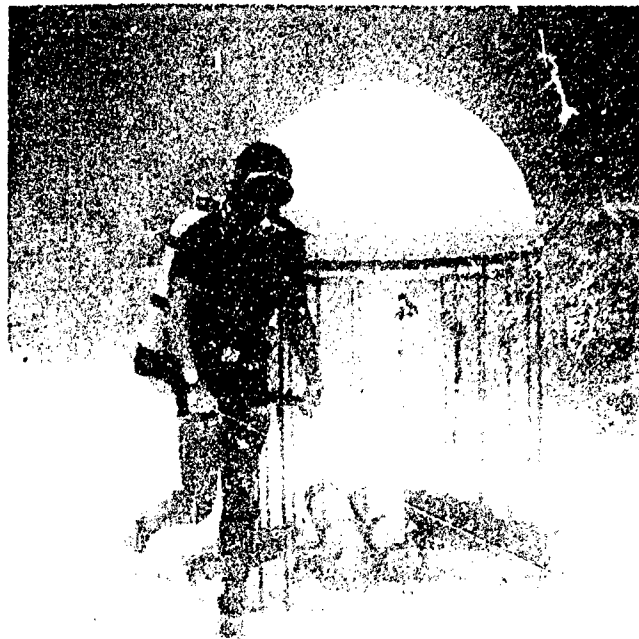

Fig. B28 - One of the five way stations, which served as shark cages and as rest and communication stations. The spare scuba tanks were maintained by surface support divers.

The dome was clamped to the upper ring of the cage enclosure at its flange. The dome was 4 feet in diameter, free blown from 1/4-inch-thick acrylic sheet (Plexiglas G). Inside the dome was mounted an inverted box that enclosed the sound-powered phone. This enclosure trapped air to keep the handset dry when the dome was flooded with water. This approach was chosen as being more economical than providing a phone designed to withstand immersion in the water. The phones in the five way stations were wired into a patch panel in the habitat in such a way that they tied in with the intercom system and hence to the surface support barge, and yet they could be operated independently of habitat power. A small brass valve was located inside the dome of the way station at the apex, so that the air in the dome could be vented.

All steel parts of the way station were painted with a nonmarine anticorrosive paint, the finish coat being a black enamel to provide a visible contrast with the sandy bottom. Because the steel parts did not receive the appropriate surface preparation prior to painting, it was not possible to apply the same anticorrosive, antifouling paint system that the habitat received. The Plexiglas domes received no special treatment prior to emplacement, other than a strippable protective coating that was removed at the last possible opportunity.

The way stations were used as a temporary shelter by the aquanauts when working outside the habitat. One way station was located near the habitat and the other four were located in the most frequently visited work sites remote from the habitat. During the Tektite I mission the way stations were used by the aquanauts to rest, converse, and adjust breathing equipment. Spare scuba bottles were kept at the way stations to extend the excursions of the aquanauts and to fill the dome of the way station with air before each

use. The spare bottles were delivered and the empties returned by surface support divers. The way stations provided emergency protection from sharks and a means of calling for assistance for an injured diver. Fortunately no such emergency conditions occurred during the mission.

The way stations performed satisfactorily during the mission. Difficulties that were encountered with the sound-powered phones were in most instances procedural problems. On one occasion the phones were removed from all five way stations and returned to the surface for inspection. Two of the phones showed indications of damage due to accidental immersion, and the other three were in proper operating condition. The vent valve in a dome was replaced on one occasion because of a missing handle.

Postmission inspection of the way stations revealed that they were coated with an easily removable marine growth. No attempt had been made during the mission to clean the way stations, with the result that the domes were clouded with marine growth.

#### B4 SUPPORT BARGE

W. J. Eager, M. Yachnis, D. H. Potter, F. L. Allen, and M. Sassani,  
Naval Facilities Engineering Command, Washington, D.C.

##### B4.1 Introduction

The support barge supplied the habitat with breathing gases, electrical power, and potable water. It provided for several forms of audio and visual communications between the aquanauts and personnel located at the support barge, the crane barge, the base camp, and the outside world. It provided for readout of scientific, engineering, and operational data from the habitat. It served as a center for monitoring and controlling all primary mission operations and safety.

##### B4.2 Design Conditions

A set of conditions was preselected which had to be met in the design of the support barge and its systems. The design conditions were divided into the following categories:

1. Vertical loads, movable as well as static, which included the weight of the structure, equipment, facilities, and supplies. A list of the design vertical loads is given below:

Weight of structure	85,120 lb
Generators, transformers, and distribution panel	13,440 lb
Control van with instrumentation and TV	13,440 lb
Two main-supply air compressors	224 lb
Purge air compressor	3,000 lb
Purge air aftercooler	896 lb
Two seal-charging air compressors	448 lb
Bank of five nitrogen bottles and one emergency air bottle	31,360 lb

Control console	291 lb
Fresh-water pillow tank (full)	29,120 lb
Two fresh-water pumps	224 lb
Fuel tanks (full)	4,480 lb
Piping and valves	2,240 lb
Outfitting	8,960 lb
Gear	2,240 lb
Personnel	2,240 lb
Total vertical load	<u>197,723 lb</u>

2. Lateral loads, which included wind, waves, hydrostatic pressure, currents, tides, earthquake forces, berthing impacts by support vessels, and other lateral loads due to operating equipment. Environmental data for the site were meager. The historic weather data collected for the months of operation involved, January through May, were: maximum wind velocity, 10 to 15 knots; predominant wind direction, east; average tides, 1 foot; maximum tides, 2 feet; maximum current, 1 knot; and predominant sea state, 0 to 1. The parameters used for design were: maximum wind velocity, 20 knots from any direction; maximum wave height of wind-generated surface waves, 3 feet; maximum period of wind generated surface waves, 6 seconds; maximum height of swells, 6 feet; maximum period of swells, 15 seconds; hydrostatic pressure, from 0 to 10 feet in depth; currents, 1 knot; tides, 2 feet; earthquake zone, 1; and berthing impact, 500 pounds per linear foot. The disturbance generated by the swells close to shore line presented acute problems during the site preparation. The day before the emplacement of the support equipment center the tide was approximately 2 feet. During the emplacement of the support barge the maximum swell observed was 2 feet with a period of 15 seconds, and the wind velocity was 8 knots in the bay with gusts up to 12 knots. Outside of the bay the wind velocity was between 20 and 25 mph.

3. Ocean bottom soil and topography. The near-shore ocean bottom in the vicinity of the habitat site was predominantly coral and rock, with many outcroppings of each and some limited areas of coral sand.

4. Water temperature. The average surface temperature of the water was 75 to 80°F; the average bottom temperature was 70 to 75°F.

5. Underwater visibility. The visibility was 20 to 40 feet.

6. Surface topography. In the vicinity of the habitat site nearly vertical rock cliffs lined the shore. Farther into the bay the land became flat and low. This area was filled with an overgrowth of large and small trees, shrubs, and plants.

#### B4.3 Site and Structural Concept Selection

During the selection of the site for the support equipment center various functional requirements, specific conditions, and specific constraints had to be taken into consideration. The functional requirements included ample space for equipment and personnel, berthing of support boats for transfer of personnel and supplies, and replenishment of

water and fuel. Some of the specific conditions which had to be dealt with were wave action, wind action, surface and subsurface currents, the soil conditions, and the bottom and shore topography.

Three alternatives were possible for the support center: an onshore platform, an offshore floating platform, or an offshore elevated platform. Two constraining factors led to dropping the floating platform from further consideration. These were stability considerations and noise and vibration. An elevated platform would provide a more stable platform for the control van with all its instrumentation. It would also keep the noise and vibration transmitted into the water to a minimum and thus prevent any gross disturbances to the ecology of the reef which the aquanauts wanted to study, and it would be less disturbing to the aquanauts themselves.

There were other conditions and constraints which affected the final choice of site and type of platform. Procurement of umbilicals had to be initiated in advance of site selection due to a long lead time. The specified 1000-foot length of the umbilicals made it mandatory to locate the support equipment center within 900 feet of the habitat. The Tektite I operation was in a U.S. National Park. To preserve the natural beauty of the area, no clearing of sites of their natural vegetation could be done without the consent of the Park authorities.

Three sites were investigated (Fig. B29). On each site the possibilities of using an onshore platform or an elevated platform above the water were considered. To make a sound decision, the following evaluation was necessary:

At site 1 the advantages of an onshore platform were that it would be outside the influence of waves, swells, and current; construction would be easier out of the water; and it would be within the limit of 900 feet from the habitat site (450 ft). The disadvantages were a rough terrain, expensive construction, and problems in transferring equipment and personnel. The advantages of an elevated platform were the availability of an elevated platform, ample area to work, accessibility by boats and platforms for transfer operations, and a location within the limit of 900 feet (400 feet). The disadvantages were construction problems in water, a rough ocean bottom, requirement of mooring, and exposure to wind, waves, swells, and current.

At site 2 the terrain was too rough for an onshore platform, and the approaches were blocked by large rocks. The advantages of an elevated platform were that the area seemed to be protected by a natural breakwater and the platform would be within the limit of 900 feet (750 feet). The disadvantages were a rough ocean bottom; requirement of mooring; construction problems in water; swells that were channeled into a smaller opening resulting in their magnification; a longer distance from the habitat site than site 1; and hazardous conditions for small-boat operations.

At site 3 the advantage of an onshore platform was a level terrain. The disadvantages were that the distance from the habitat was greater than 900 feet and that clearing of trees and plants from the site was not allowed by Park authorities. The advantages of an elevated platform were a smooth bottom and small waves and swells. The disadvantage was that the distance from the habitat was greater than 900 feet.

Site 3 was ruled out completely, since it was outside the 900-foot radius from the habitat. At site 2 there was no possibility of an onshore platform due to the rough terrain. There were more disadvantages and fewer advantages for an offshore elevated platform at site 2 than at site 1; therefore site 1 was chosen. The next problem was to choose between the onshore platform and the offshore platform at site 1.

Fig. B29 - Three sites investigated in selecting the site of the support barge

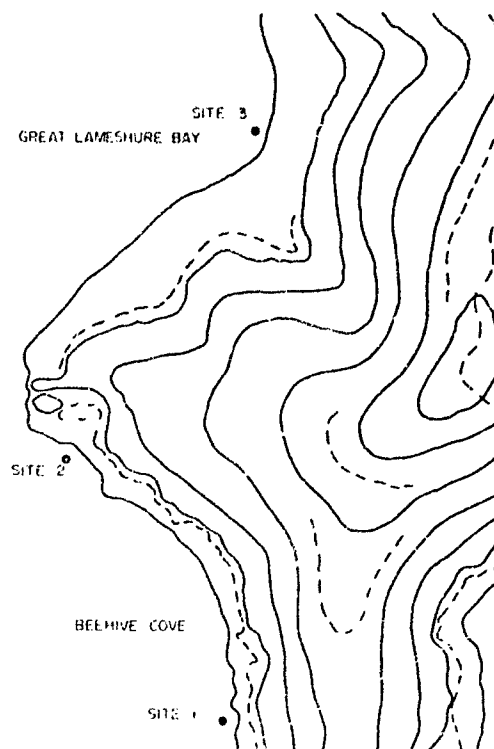

The site for the onshore platform was at the mouth of a draw which ended in Beehive Cove. This spot offered the only relatively flat area in the vicinity, the remaining area being the steep rock cliffs mentioned. After a further on-site survey of the area it was determined that at least one leg of any platform built there would have to be out in the water in order to have the estimated deck area required for all of the support equipment.

To make a final choice the time element had to be taken into account. There were 6 months at the maximum in which to do all design work, site layout, procurement, assembly, and on-site construction. This time frame was not just for the habitat support center but for all of the support systems for the project. This time limit made for very tight scheduling of all phases of the project. It was, therefore, mandatory in the design stage to go to off-the-shelf or all-ready-built items as much as possible. The time element would not allow time for the proper testing of new or improved hardware or construction methods.

Another problem was logistics. The location of the project was in an isolated area with access by ship only. There were no wholesale or retail distributors of most materials for fabrication in the area. The closest naval base was at Roosevelt Roads, Puerto Rico. For all practical purposes all materials and hardware would have to be procured in the continental United States.

Consideration of the time element, tight scheduling, and logistics problems and other problems involved in building an onshore platform on site and transferring all of the machinery, the control van, and other support items to the platform discouraged use of this scheme. It was decided to use an offshore elevated platform at site 1 with all support systems preassembled in the continental United States. This site (Fig. B1) was approximately 400 feet from the habitat site, near shore in Beehive Cove. Figure B30 shows the site as photographed during the initial site survey.



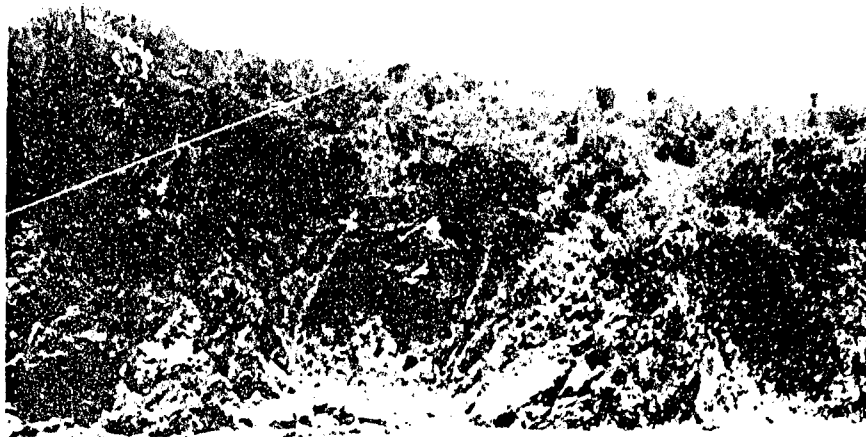

Fig. B30 - Site selected for the support barge

The support center subsystems would be mounted on an Ammi pontoon and would be assembled at the Philadelphia Naval Shipyard, where adequate facilities and logistics were available. The whole barge-mounted system could be transported to St. John, Virgin Island, in an LSD and then towed to its final site and hoisted up on piles.

The final position of the support barge was determined in the following manner: The Ammi pontoon has six 24-inch-I.D. spudwells in it. These are holes through the pontoon, top to bottom, through which pile legs can be placed. The four corner spudwells would be used on the support barge. A template was made using four inflated inner tubes with connecting lines. The inner tubes were spaced the same distances apart (length, beam, and diagonal) as the four corner spudwells of the Ammi pontoon. The template was floated over the site and manipulated by swimmers until a position was found at which all four pile legs would be sitting on a relatively flat surface amid the rocks and coral outcroppings on the bottom (Fig. B31). Markers (plastic-bottle floats) were then placed at the pile leg spots for future reference in positioning the support barge.

A topography of the bottom was obtained by Seabee divers using elevations of the tops of large rock and coral outcroppings. This was done to be sure that the support barge would not come in contact with any obstruction while floating over its site and suffer possible damage. The divers also marked with plastic floats the rock outcroppings in the vicinity which would be hazardous to small-boat operations.

#### B4.4 Barge Structure

The support barge platform was a 90-foot-long by 22-foot-wide by 4-foot-deep Ammi pontoon. It weighed 38 tons, drew 9 inches of water unloaded, and was capable of supporting 172 tons with 10 inches of freeboard. This pontoon, one of a family of sizes, is named after its principal designer, Dr. Arsham Amirikian of the Naval Facilities Engineering Command. The Ammi pontoon was conceived as a cargo offloading functional component for use in advance base areas lacking deep-water port facilities. This pontoon furnishes the Navy's Seabees with a unique component for rapid port construction.



Fig. B31 - Template for locating the positions of the support barge legs

The shell and interior bulkheads are 1/4-inch steel plating. The framing members (Fig. B32) of the Ammi pontoon are unique sections formed of 3/16-inch steel plate serrated along both edges and bent to form a U shape. This configuration gives high strength while decreasing the total weight of the structure. Spudwells are provided in the pontoons through which pipe piles can be driven into the ocean bottom to provide secure anchoring of the pontoon. The pontoon may also be raised on the pile legs by the use of hoisting pile caps and a tackle arrangement and winching the pontoon up.

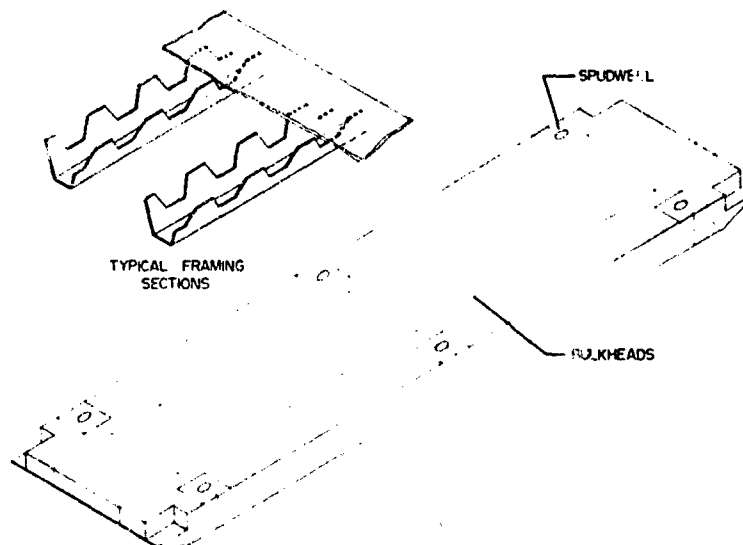

Fig. B32 - Typical Ammi pontoon

Mounted on the pontoon were all of the subsystems required for the support and monitoring of the habitat and its occupants. Supports, connection methods, and tiedowns were designed for all pieces of equipment or subsystems, piping, and other appurtenances. These supports were designed not only to withstand the on-site design load but also to withstand the forces during transit from Philadelphia Naval Shipyard to St. John, Virgin Islands (Fig. B33). Typical support types used were skid mounts, bolted bases, column bases and vibration isolators. All connections made between base plates and pontoon deck were by welding.

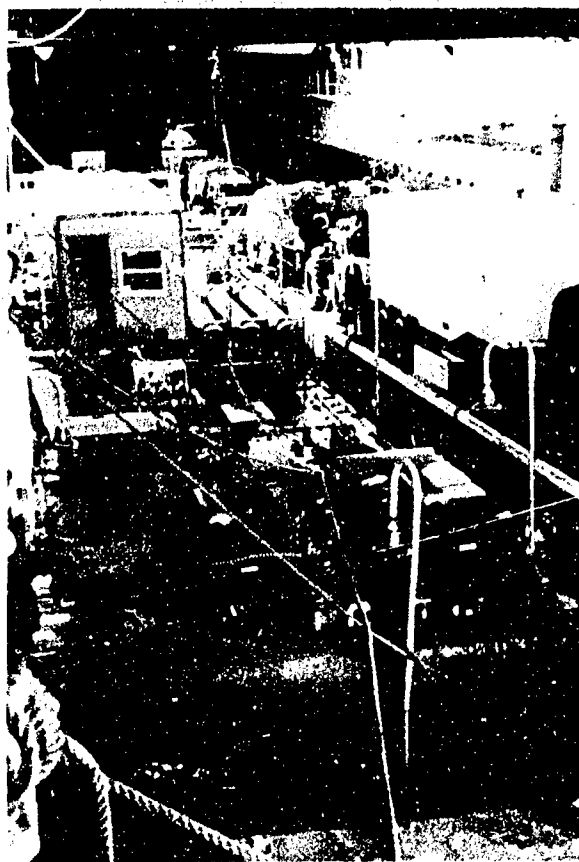

Fig. B33 - Habitat support systems on barges aboard the USS Hermitage for the trip to the Virgin Islands

The 100-kW diesel-electric generators were fastened to the deck of the pontoon through vibration spring isolators. The base of the isolator was welded to a larger plate, which in turn was welded to the deck of the pontoon. The larger plates were used to distribute the load over a larger area and thus decrease the pressure on the pontoon decking. The purge air compressor was mounted in the same manner. The electric transformers and distribution panel were mounted chest high on frames made up of braced steel-pipe legs. The base plates of the legs were welded to the deck of the pontoon. The antenna support consisted of short sections of pipe, to receive the three legs of the antenna, welded to a base plate, which was welded to the deck of the pontoon.

The 275-gallon fuel tanks were elevated on their usual steel-pipe legs. For transportation, flat steel bar braces were used across the legs. The bases of the pipe legs were welded to the deck of the pontoon. The 3000-gallon fabric pillow tank for fresh water was placed on the pontoon deck with no supports required, since the tank was empty during transit.

The support van was tied down using wire rope and turnbuckle guys. Both vertical and diagonal tiedowns were designed. The guys consisted of 3/8-inch-diameter wire rope and 5/8-inch jaw-ended turnbuckles. Each guy was connected to the van through a 1/2-inch anchor shackle to an eyebolt connected to a girder of the van's deck framing. At the other end of the guy the jaw end of the turnbuckle was connected to a padeye welded to the pontoon deck.

All other equipment used one of the typical skid, bolted, or column bases. Equipment having a bolted base was bolted to I-beams welded to the deck. All piping and conduit were raised off the deck to decrease corrosion. The piping was clipped onto short pieces of channel welded to the pontoon deck. Sanitary facilities were provided on the barge by a portable, skid-mounted chemical toilet.

All tiedowns and supports were either designed for or analyzed using forces developed by a 15-degree roll with a period of 2.091 seconds. Capability of the supports was also analyzed for the forces from the wind and wave loadings on site.

Strain reliefs for the umbilicals were provided on the side of the pontoon. For the power umbilical the armor was peeled back and clamped between two collars in turn bolted to the fuse. The pneumatic umbilicals were secured to the side of the support barge with hose clamps. An alternate method designed for the strain reliefs, but not used, was a method incorporating woven cable grips.

Other appurtenances included towing padeyes, mooring bits, chocks, and cleats. The chocks were placed at the ends of the pontoon with the towing padeyes in line behind them. The mooring bits were placed along the sides of the pontoon at intermediate distances from the ends. These hardware items were used during towing, for mooring the pontoon in position, for mooring two barges together, and for use in mooring small boats to the pontoon. They were all welded to the deck of the pontoon.

A guard rail consisting of pipe stanchions and fiber ropes was provided around the perimeter of the pontoon for safety. Lighting for the barge was provided by light poles around the perimeter of the pontoon. For fire protection dry-chemical and water extinguishers were mounted at various places on the barge.

A steel lookout tower with a searchlight was erected on site on the barge so that the watch personnel would have good visibility of the water surface in the vicinity of the habitat. The tower was located over the pneumatic control console with its leg base plates welded to the pontoon deck. The intermediate bracing on the tower provided a framework over which a tarpaulin could be stretched to keep the sun and rain off of the console and its operator. A tarpaulin was also stretched across the pipe frame built around the pillow tank for potable water to keep the sun from excessively heating the water.

Various arrangements of the equipment on the pontoon were studied. The final arrangement used (Fig. B34) was based on stability considerations, minimizing list and trim, and providing as much space as possible around equipment for operation and maintenance.

The measured total weight of the support barge with a full load of water and fuel was 88.27 tons. The pontoon had an average draft of 1 foot 8 inches, 3.68 inches of trim, and

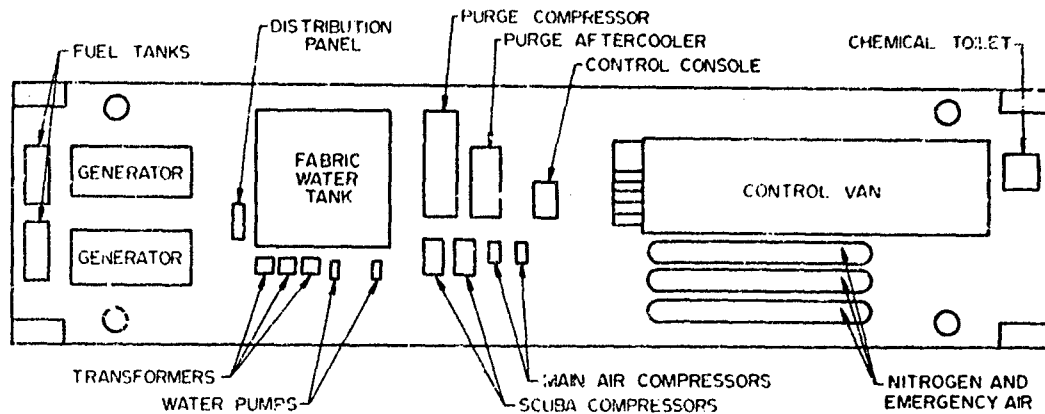

Fig. B34 - Support barge layout

list of 1.7 inches. With no water or fuel aboard, which was the condition most of the time while afloat on site, the total weight of the barge was 70.47 tons. In this condition the mean draft was 1 foot 4 inches, the average trim was 3 inches, and the average list was 10 inches.

#### B4.5 Foundation and Elevating Mechanism

The Ammi pontoon contains six 24-inch-I.D. spudwells through which pipe piles can be inserted, and since the support platform was to have legs at only the four corner spudwells, the remaining two were covered over with plate for safety. Moments, shears, and deflections of the pontoon were analyzed based on the four leg supports, and all stresses were within allowable working strength limits.

The legs to be used were 20-inch-O.D. pipe piles with a 3/8-inch wall thickness. Normally the piles for the Ammi pontoons (and for most nonfloating ocean platforms) are driven into the bottom, but at the support barge site the ocean bottom was hard rock. Since the legs would be sitting on the bottom, a bracing arrangement was designed to hold the legs plumb while the pontoon was being winched up. Out of seven methods of support investigated, a guy cable system was chosen for ease of fabrication and assembly. Each leg was to have three guys 120 degrees apart. The guy cables were made up of 1/2-inch 6 by 19 wire rope and 3/4-inch shackle-end turnbuckles. Three-quarter-inch anchor shackles were used on the ends to make the connections. With the bottom being rock, the bottom connection point for the guys would incorporate rock bolts. The three holes per pile leg would be drilled in the bottom rock by divers. Rock bolts were to be inserted in the holes, and bent plates, with holes burned in them to receive a shackled end of the guy, would be bolted to the bottom (Fig. B35). For the pile-leg connection of the guys, a connecting ring (two half rings) was designed to fit around the pipe leg. The rings were made of 1-inch plate. Padeyes were welded on the rings to take the guy-connecting shackle. The two half rings would be bolted around the pile legs by divers after the piles had been inserted through the spudwells. To keep the rings from sliding down the piles, four stopper plates would be welded on the pile at the proper elevation for the ring to rest on.

The elevating mechanism for the support barge consisted of a pile cap, a ten-part line assembly, a winch, and safety chains (Fig. B36). There was a complete mechanism on each pile leg. The pile caps were made up of 18-inch-O.D. pipe and 1/2-inch steel plate. Reinforced holes were provided for sheave and chain connections. The winches

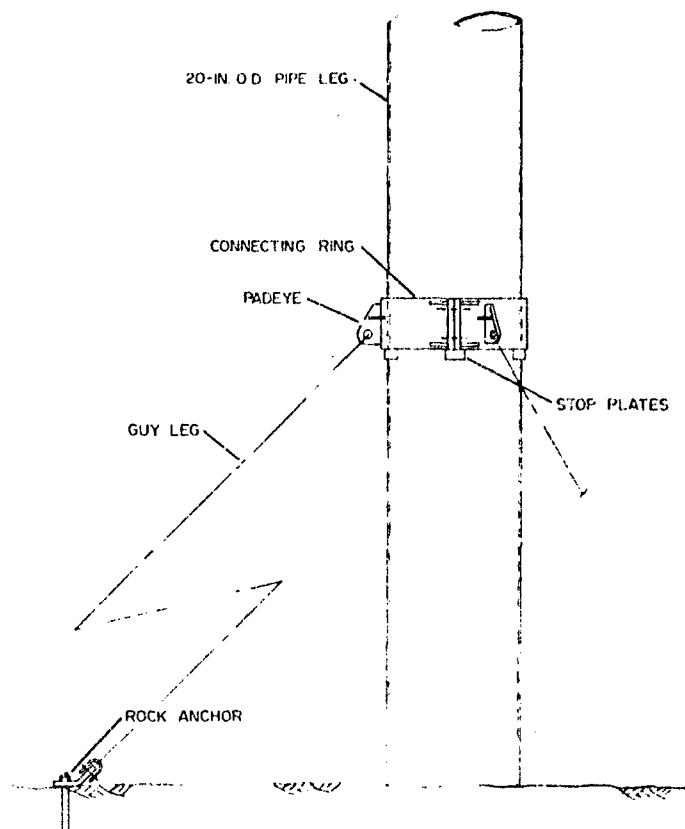

Fig. B35 - Bracing for the legs of the support barge

were 10-kip, hand-operated gear winches welded to the pontoon deck in such a position that they would be in line with the wire rope coming off the last sheave. Single, double, and triple 8-inch heavy-duty blocks were used to make the ten-part line system. Some of the blocks were connected to the pile caps and the others to the pontoon through reinforced eyes provided around the outside of the spudwells. The line for the hoisting arrangement was 1/2-inch 6 by 19 wire rope reeved through the blocks to form the ten-part line. This arrangement provided a mechanical advantage of about 10 to 1, not considering friction. The line loads were calculated to be about 6 kips. To check this during lifting, a tensiometer was placed in the system on one of the legs. Two 3/4-inch safety chains were connected to the pile cap on opposite sides of a leg, were run through an anchor shackle connected to the pontoon, and were attached to themselves by grab hooks. During the lifting operation the chains were designed to hold the pontoon and keep it from falling if one of the elevating mechanisms failed.

Welding rings with wedges were provided to make a more permanent structure. The plate rings, with wedges attached, could be placed around the pile at the barge deck and bottom, with the pontoon at its final elevation, and welded to both the pipe legs and the pontoon to form a rigid structure.

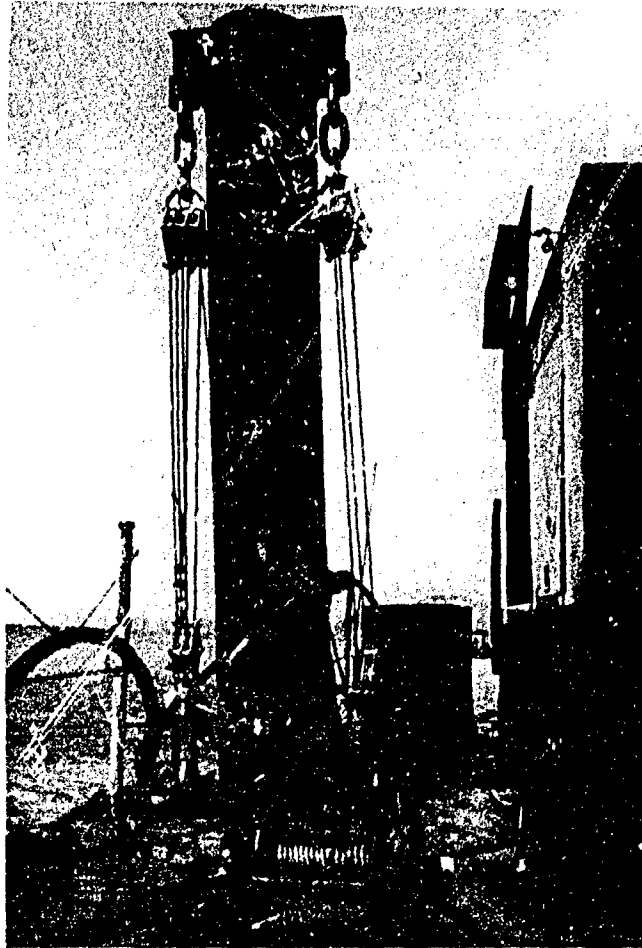

Fig. B36 - Hoist, with safety chains, at each of the four legs to lift the support barge out of the water

## B4.6 Electrical Power Subsystems

### B4.6.1 Design Conditions

The peak electrical load for the habitat, support barge, and crane barge was expected to be in excess of 50 kilowatts. The habitat demanded a 480-volt three-phase supply at the support barge end of the 1000-foot, three-wire power cable. Provisions existed in the habitat for voltage transformation for those systems requiring lower voltages. The support barge and crane barge systems required 208-volt and 115-volt supply, all at 60 hertz. Habitat power consumption was to be monitored. The loads were to be balanced, insofar as practicable, across the three phases of the generator supply. The generator regulation was not to exceed  $\pm 1\%$ .

Penetrations of the support barge were not permitted; therefore, all electrical installations were above deck and exposed to the marine atmosphere. Normally the materials and installations would have been the types suitable for exposure to this environment. However, due to the limited time schedule for procurement, construction, and operations the majority of the materials specified were weatherproof commercial types.

### B4.6.2

### B4.6.2 Power Source

Two portable weather-protected diesel-engine generator sets rated 100 kW at 0.8 power factor, 208Y/120 volts, 60 hertz were specified for installation on the support barge. These units, part of the Seabee Functional Component System, contain synchronizing equipment to permit parallel operation or transfer of loads from one to the other. Normally one set was to be operating and the other used as a standby for unscheduled outages and preventive maintenance. These functions were interchanged between the units on a 66%-33% time basis. This time sharing tends to prevent simultaneous failure of the same part on each generator which could result from 50% time sharing and, thereby, provides for timely procurement of unstocked parts.

### B4.6.3 Distribution System

The 208Y/120-volt service from the switch-gear of each generator was connected to the main lugs of the main distribution circuit breaker panel. From this panel, circuits were installed in rigid steel conduits to deck lights, receptacles, searchlight, air compressors, fresh-water pumps, crane barge receptacle, instrument and control van, and stepup transformers for 480-volt, three-phase service to the habitat. The habitat service was provided via a three-connector submarine-type cable from 3-25-KVA, one-phase, 120/240-480-volt, dry transformers connected wye-delta. The circuit breaker in the main distribution circuit breaker panel for this bank of transformers was provided with a 12-volt dc shunt trip with the trip energy supplied from the instrument and control van. This trip was energized when a signal from the habitat indicated flooding. All three-phase motors on the support barge were provided with a combination magnetic motor starter and disconnect. A watt-hour meter was provided at the support barge terminus of the habitat power cable.

### B4.6.4 Assembly and Testing

The installation of electrical equipment aboard the support barge was in accordance with the design and applicable portions of the National Electric Code. Prior to operating, the following system tests were performed: (a) a check to assure that the system and equipment were properly grounded, (b) a check for circuit continuity and insulation integrity, (c) a check to assure that the circuiting, loading, wire sizes and protective devices are in accordance with the design, (d) a check to assure that the proper motor starters are installed for the motors involved, (e) a check of the generator phase rotation, lead connections, and synchronizing equipment to assure proper operation for paralleling or transfer of loads, (f) a check of the phase rotation at three-phase motors to assure proper operation, (g) energizing of the system and check of all components for proper operation, and (h) paralleling of the generators, under load conditions, to assure proper operations.

## B4.7 Breathing Gas Subsystems

### B4.7.1 Introduction

Breathing gases were provided to the habitat under controlled conditions to (a) purge the habitat with pure air after inadvertent contamination, (b) dilute the habitat atmosphere to approximately 9% oxygen with pure nitrogen, (c) supply the habitat with low-pressure air to compensate for metabolic oxygen consumption and volume decreases due to temperature and tide, and for surge-caused pressure changes, (d) make up habitat atmosphere volume for emergency compensation of rapid leakage, and (e) provide high-pressure air to storage bottles in the habitat used for scuba bottle charging, tethered breathing systems, and emergency supply. All gas systems were cleaned with detergent



and hot water and dried with oil-free air. All systems were open-flow checked for obstructions and leak checked with liquid detergent.

#### B4.7.2 Purge Air Supply

Habitat purge air was supplied by a diesel-driven Ingersoll Rand compressor (IR-105). To compensate for the high oil contamination associated with this compressor, a water-cooled trap, dessicant filter assembly was installed (Fig. B37). From the filter, purge air was routed through a pneumatic control console, designed and fabricated by General Electric. The console monitored and manually controlled flow rate to the habitat. Standard 3/4-inch, schedule-40 galvanized piping and 150-psi fittings were used between the purge compressor and the console. The line from the console to the low-pressure umbilical was also fabricated from these materials.

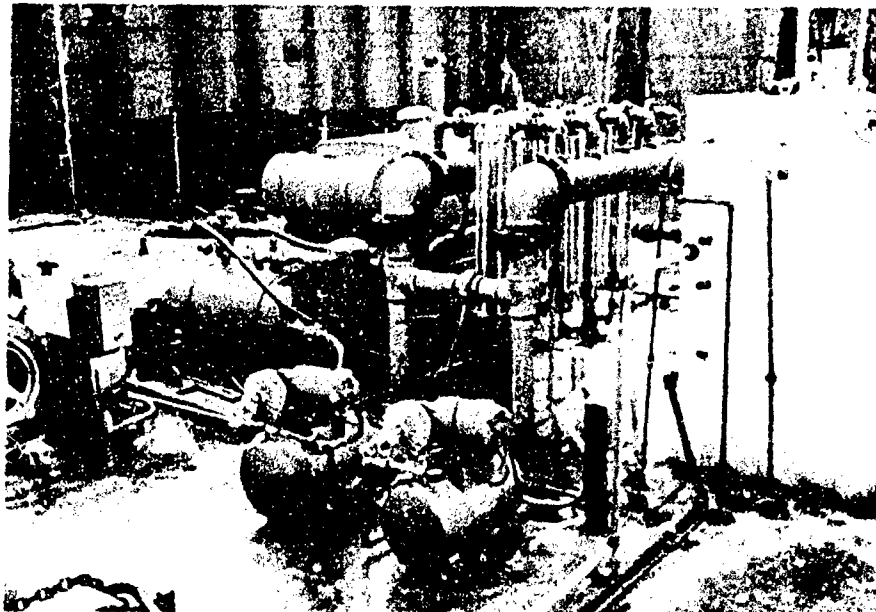

Fig. B37 - Purge air after-cooler and filter

#### B4.7.3 Nitrogen Supply

Nitrogen for habitat atmosphere dilution was provided by five flasks which contained 8500 standard cubic feet at 2450 psi. The flasks were manifolded as shown in Fig. B6. Schedule-160, 3/4-inch steel pipe and 3000-psi fittings conducted the nitrogen to the pneumatic control console. A regulating valve reduced the pressure of the nitrogen, which then passed through a flowmeter, manual control valve, the common low-pressure line, and the low-pressure umbilical to the habitat. Through use of the nitrogen supply system the habitat atmosphere was reduced to approximately 9% oxygen. With the habitat ambient pressure at 43 feet of water this percentage corresponded to an oxygen partial pressure of approximately 160 torr, considered suitable for long-duration, saturation exposure.

#### B4.7.4 Low-Pressure Air

To replenish oxygen consumed in the habitat, and to compensate for water level rises in the entry trunk due to habitat temperature and pressure changes, low-pressure air was supplied to the habitat under controlled conditions. The source was two electric-driven Johnson Model M600 78F-RE, low-pressure, diaphragm compressors, each capable of 2.1 cfm at 50 psi (Fig. B6). Each compressor was equipped with a volume tank which additionally served as a moisture trap. Air was conducted from one of these pumps through 3/8-inch, schedule-40, black steel pipe and 150-psi fittings to the pneumatic control console. In the console, air passed through a regenerable dessicant filter to a volume tank. Flow was controlled by a manual valve and flowmeter. Pressure was also monitored, so that umbilical leakage could be detected. The common low-pressure line and umbilical conducted flow to the habitat. A weather cover was provided for the compressors, since their motors were not weatherproof.

#### B4.7.5 Emergency Air Supply

An 8500-standard-cubic-foot, 2450-psi flask, identical to the nitrogen flasks, supplied the emergency air supply to the habitat (Fig. B6). This supply backed up the low-pressure compressor supply. With a high flow capability it could be used to prevent flooding in the habitat in the event of a large leak. Air from the flask passed through a manual pressure regulating valve and flowed to the pneumatic control console through 3/8-inch, schedule-40, black steel pipe. A manual pressure-regulating valve in the console reduced its pressure to the desired level. The low-pressure line and umbilical carried emergency air to the habitat as shown in Fig. B15.

#### B4.7.6 Scuba Air Supply

Volume tanks in the habitat base were used to charge scuba bottles. These bottles were supplied with 2600-psi air from two scuba compressors on the support barge. This same system was used to charge an emergency air bank in the habitat base. This bank provided makeup air to prevent flooding or terminations of operations in event of temporary interruption of the surface, low-pressure supply. This bank also supplied air for tethered, open-circuit diving apparatus.

The scuba compressors were electrically driven Mako Model K14.85E1 units of 8-cu-ft/min capacity at 3200 psi. They supplied high-pressure air through flexible pig-tails, stop valves, and a brass high-pressure manifold to the high-pressure umbilical.

### B4.8 Potable Water Subsystem

#### B4.8.1 Design Conditions

Potable water was required at a maximum flow rate of 10 gallons per minute with a total capacity of 280 gallons per day. The water pressure at the umbilical was to be  $100 \pm 10$  psi. Habitat water consumption was to be monitored.

#### B4.8.2 The System

The reservoir was chosen to be the 3000-gallon fabric, collapsible pillow tank, an element in the Seabee advanced-base functional component system. It was positioned on the support barge and filled approximately every 10 days from shore with potable water. Two Colt Industries Model BR615-AB-6830, K2N3-476331 pumps were provided to take suction from a common pipe header connected to the bottom of the water tank by a 2-inch hose. Each pump had a capacity of 10 gallons per minute against a total dynamic head of

250 feet (107.5 psi). Because the pumps cavitated under no-flow conditions, a small flow of water was continuously discharged back to the water tank through a throttling valve on the bypass line. Water flow was routed through a filter unit, water meter, stop valve, and water umbilical to the habitat. A deck outlet was provided ahead of the water meter.

The habitat was furnished potable water at a maximum rate of 10 gallons per minute at the 43-foot back pressure. Only one pump was operated at a time, and the pumps were alternated on a 66%-33% time sharing.

#### B4.8.3 Assembly and Testing

The system was assembled according to standard practice. It was cleaned with detergent and hot water and flushed with fresh water. All fittings and external seams were covered with soapsuds and the tank examined for leaks. The piping system was tested for 1-1/2 times the working pressure of 125 psi, or 180 psi, from the discharge of the pumps to the fixtures in the habitat.

### B5 CONTROL VAN

C. C. Meigs, General Electric Company, Missile and Space Division,  
Philadelphia, Pennsylvania, and Lt. Richard Mach, Behavioral Sciences  
Department, Naval Medical Research Institute, Bethesda, Maryland

#### B5.1 Introduction

The surface support barge served as the control center for the entire Tektite I project. The control functions were performed in a standard 30-foot trailer which had been outfitted for this purpose, called the surface control center van. Figure B38 shows the general location of equipment in the surface control center. An artist's rendering of this van was shown in Fig. 30 on page 41.

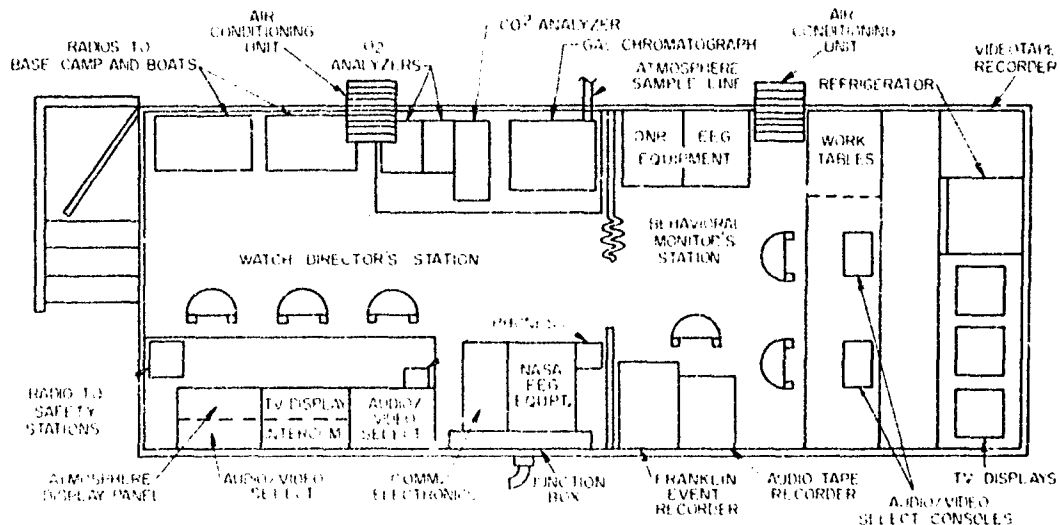

Fig. B38 - Floor plan of the surface control center van

The surface control center van was divided into two compartments: the watch director's station and the behavioral monitor's station.

## B5.2 Watch Director's Station

The watch director's station was equipped to provide continuous monitoring of aquanauts and their environment. The following equipment was provided for this purpose.

### B5.2.1 TV Monitors

Two TV monitors were used in conjunction with selector switches to display the video on the camera in each compartment of the habitat and on the outside camera. Two monitors proved quite adequate to cover the activity of four men at four primary (habitat) stations and one secondary (outside) station.

### B5.2.2 Meter and Alarm Panel

The meter and alarm panel provided continuous remote readout from the mass spectrometer covering partial pressures of  $N_2$ ,  $O_2$ ,  $CO_2$ , and  $H_2O$ . For this purpose four edge meters, driven from the panel in the habitat, were provided. The panel, in addition, was equipped with a two-way intercom station which could communicate with each compartment of the habitat or with all compartments at once. This intercom was the primary link between the surface watch and the aquanauts.

A speaker was located in the panel and could be cut in to any one or all open microphone circuits using a selector switch on the panel. This speaker normally was cut out to preserve the privacy of the aquanauts. It was used on occasion as an alternate to the intercom for receipt of messages from the habitat.

### B5.2.3 Alarms

The panel was equipped with switches to sound a bell in the bridge and wet room, a buzzer in the bridge, and a horn on the exterior of the van.

### B5.2.4 Telephones

Adjacent to the panel was a sound-powered phone connecting to the bridge in the habitat. This phone was used for communications between surface personnel in communicating with aquanauts without interference with operational communications over the intercom.

On the wall behind the NASA EEG was a private phone connecting to the living compartment in the habitat. This phone was used for private and semiprivate communications between the surface and the habitat.

### B5.2.5 Communications Electronics

Between the NASA EEG and the meter and alarm panel was the communications electronics rack for the audio and video circuits. This rack contained all electronic components used on the surface to condition signals coming in from the umbilical. These components were in replaceable modules to facilitate maintenance or repair.

At the bottom of the communications electronics rack was a voltmeter to indicate potential in the battery which furnished backup power to the instrumentation in the habitat.

### B5.2.6 NASA EEG

The NASA EEG was used during the first and last 10 days of the mission to record the sleep characteristics of one aquanaut. It was operated by NASA personnel.

### B5.2.7 Gas Analysis Equipment

The control room was equipped with the following instrumentation to monitor habitat breathing atmosphere: a gas chromatograph, a Lira CO<sub>2</sub> analyzer, a Beckman O<sub>2</sub> analyzer, and a General Electric O<sub>2</sub> analyzer. The instruments received gas from a 1/2-inch atmosphere sample line from the habitat. The accuracy of the instruments was checked using samples bottled in the habitat and analyzed in a chemical laboratory.

### B5.2.8 Communications Equipment

The watch director's station was equipped with the following voice communications equipment: For surface operations, VHF/FM equipment (Navy PT 200 Handi-Talkies) was used to communicate with the crane barge, diver boats, the base camps, and the control van. For local operations, 3HF single-sideband equipment (Navy AN/PRC-47 SSB transceivers) was used to communicate with the base camp and the control van. For administration, local marine radio was used to communicate with St. Thomas control and the control van. This equipment was used for telephone calls until the telephones were installed at the base camp. It was then connected to the intercom so that aquanauts could use it for telephone contact to families.

## B5.3 Behavioral Monitor's Station

### B5.3.1 Introduction

The behavioral monitor's station of the support van contained a variety of electronic monitoring equipment in the 8 by 15-foot area occupying the back half of the van (Fig. B30). These devices for maintaining visual, audio, and automated monitoring of the aquanauts included TV monitors, video and audio tape recorders, dynagraphs, and a digital printer.

### B5.3.2 Bioelectric Monitoring

Immediately to the left as one entered the behavioral section was the Navy Medical Neuropsychiatric Research Unit's bioelectrical monitoring and recording system equipment. This system monitored two aquanauts, Edward Clifton and John Van Derwalker, and was divided into two distinct subsystems, one in the support van and one in the habitat.

Sensor signals were accepted by in-habitat equipment (Tektronix Differential Amplifiers type 2A61) which magnified the brain-wave, eye-movement, and heartbeat signals and then channeled them topside through the power communication umbilical. The topside system served primarily to record the incoming information. Two Beckman Type-R dynagraphs (with type-9806A dc/ac couplers and dual amplifiers type 482M8) reconditioned and rerouted the incoming signals to two folded-chart drives and two Hewlett-Packard Model 3917B seven-channel FM magnetic tape recorders. An IRIG compatible time code translator/generator (Astrodata Model 5400) insured later synchronization of paper and tape recordings by coding both in clock time. Other instruments were available to assure system calibration and maintain FM tape recorders.

### B5.3.3 Behavioral Monitoring

The remainder of the equipment in the behavioral monitor's station supported the Naval Medical Research Institute's behavioral observation program.

#### B5.3.3.1 Video and Audio Monitoring

Six 14-inch Conrac CKD TV monitors were mounted on the far wall of the van in a three wide by two deep configuration. These screens provided real-time displays of incoming signals from four habitat TV cameras as well as from two, usually unoperative, underwater TV cameras positioned near the habitat. Three of the four compartment cameras were individually fitted with a wide-angle lens with 96 degree horizontal by 76 degree vertical coverage. Trained Navy enlisted personnel seated at a working table systematically recorded a selected variety of aquanaut activity using an on-line data card punching system described in detail in section A4. The majority of data was derived from the closed circuit TV display of on-going observable crew behavior as well as the crew conversations. Such conversations were monitored through the use of a centrally located supercardioid microphone in each compartment; each microphone was connected to a central, high-fidelity, audio distribution network.

Two observer control consoles at the working table provided selector switching access to any habitat microphone, with separate volume controls for headphone output and an external speaker. The console also supplied remote controls for the Ampex PR10-2 (two-channel) audio tape recorder and backup, located in equipment racks behind the observers. These recorders tapped back into the consoles and incoming signals from the habitat microphones. While samples of aquanaut conversation were recorded on one channel of the audio recorder, the parallel channel was recording tones generated by a bank of tuned solid-state audio oscillators (B.R.S. Electronics Model AO-201), controlled and routed to the recorder by pushbutton switching located in a small, separate control box. Each unique tone identified a different aquanaut. Only during his actual speech was that aquanaut's tone recorded. Such a record first coded by an elapsed time device allows computer evaluation of the duration and sequencing of each aquanaut's conversational contribution. An observer's desk microphone allowed on-line identifying comments to be placed on the conversation channel.

During data collection the observers used Penwood Model 100 real-time digital readout clocks set atop the consoles for time placement of each record. Also for permanent visual records a Sony video tape recorder (Model TCV 2110), with remoted video switcher, permitted selection of desired source camera input and provided video recording as well as playback capability.

#### B5.3.3.2 Automated Electronic Monitoring

An event-recording subsystem, in a rack alongside the audio recorders, allowed automated monitoring and recording of individual aquanaut diving time and bunk headphone usage as well as crew usage of the entertainment facilities and the stove. Habitat switches, topside logic modules, and a digital printer maintained an around-the-clock record.

Near the rim of the ingress-egress hatchway in the habitat each aquanaut had a personal switch to push when entering the water and another when leaving. Each bunk was provided with a private headphone tapping into the radio and TV in the crew quarters. An attached microswitch activated when the headband was stretched. The stove, radio, and TV were each modified with a relay switch on the power line. Onset of the respective relay indicated which appliance was on. Finally an operator switch controlled by the topside observer served as a real-time stopwatch for timing aquanaut work performance.

Each switch was wired to close a -12-volt dc line to a separate buffer module, which in turn produced a shaped trigger pulse for each circuit (-12 V dc to ground, 1 microsecond wide).

Topside a package of B.R.S. Electronics (Series 200) solid-state logic modules was used as central control system of all switch lines. Each separate line triggered unique binary information, which the digital printer (Franklin Model 1200) with its logic circuitry converted to a decimal printout. The paper-tape printout provided a continuous record of each switch modification in the form of 12 digits worth of coded information indicating an individual switch being on or off; the operator aquanaut when possible; the date; and the real time to the nearest second, derived from a B.R.S. Electronics (Series 200) binary clock.

#### B5.3.3.3 Support Accessories

The primary storage area allowed a space for boxes and other large items, a cupboard for storage of recording materials, and two small drawers for incidentals. A small elevated desk immediately to the right and behind the observer team with matching stool provided a supervisory position for over-the-shoulder viewing of recordings, especially during the observer training phase. The behavioral section of the van was kept cool and dry by an 18,000-BTU wall air conditioner. The incandescent, 30-ft-candle illumination of the station was usually dimmed to fairly low levels to insure optimum television viewing. Finally a small refrigerator below the TV monitors allowed temporary food storage for watch-standing personnel.

#### B5.4 Discussion and Recommendations

The consensus of the behavioral investigators is that the behavioral monitoring section provided, on the whole, reasonable accommodations. The location of the section away from the entry door insured in most cases no unauthorized entries during monitoring hours, thus maintaining the conversational privacy of the aquanauts. Having no windows in this section proved to be of considerable value. Interested visitors and reporters peering into the van would have distracted the observers. The heat of the afternoon sun streaming through such windows would have greatly elevated the interior temperatures. The only price paid was having an observer, during low-density crew activity, momentarily leave the somewhat claustrophobic environment.

Hooded overhead van lighting would have prevented considerable reflectance off the TV monitoring screens, a difficult situation when the TV signals were somewhat less than optimal. Appreciable dimming of the lights was not practical, since the observers needed to see and read the recording they were accomplishing at the work table. Habitat camera controls remoted to topside would have allowed adjustment by topside technicians and have prevented requesting aquanaut adjustment of a camera drifting off optimal settings.

Safety monitoring for the watch-director personnel could be implemented by adding cue lights topside responding to signals from the habitat dive panel. Such an aid would provide excellent backup monitoring in the future if the dive panel is configured properly. During the actual mission the aquanauts punched in and out on dives less than 50% of the time. For the most part this was due to an unusual disregard for panel design on the part of the contractor. Separate pushbutton switching for each aquanaut (an in and out button with an adjoining cue light which lit up upon punched out into the water and reminded the incoming aquanaut to punch back in) had been specified but was omitted. Independently the aquanauts commented while in the habitat on the difficulty of knowing

what the status of their buttons was, since no cue light had been provided and the push-buttons immediately returned to a full-out status after being punched.

The other switching problem encountered was a spurious number of stove switch signals being printed topside, the result of either a short or the actual stove setting switch being multidirectional.

The section had a capacity for only three working personnel; often six individuals were required in the space. The present configuration and amount of equipment in a wider van would have eased the space shortage considerably. Storage areas were relatively inadequate. The tops of equipment racks proved to be favorite places for storage, since accessibility to available storage was difficult.

Overall, however, the station and instrumentation therein combined to form an outstanding system. Other than the space problem this complete environment provided an excellent base for collecting behavioral data - much beyond that hoped for.

#### B6 ASSEMBLY OF TEKTITE HABITAT

L. Goldstein, C. Lorenz, and C. C. Meigs, General Electric Company,  
Missile and Space Division, Philadelphia, Pennsylvania

##### B6.1 General

The assembly of the Tektite habitat consisted of two major phases: (phase A) Assembly of tank 1 (crew quarters and bridge), tank 2 (wet room and engine room), and the control van from April 15, to November 15, 1968, in General Electric facilities at Valley Forge, Pennsylvania, and (phase B) mating of the tanks to the base and the interconnection of the habitat systems to the control van and support barge from November 13, 1968, to January 5, 1969, in the Philadelphia Naval Shipyard. The schedule is outlined in Table B3.

##### B6.2 Phase A

Phase A started with fabrication of a full-size mockup consisting of lumber and cardboard. The visualization and familiarization gained with this mockup aided considerably in getting the hardware portion of the program off to a fast start.

The tanks used for the habitat were purchased from a local steel fabricator and hydrostatically tested prior to delivery to General Electric. In parallel with the tank fabrication, in-house activity was devoted to the prefabrication of cabinets, bunks, counter-tops, shower, and a variety of brackets, ducts, etc.

Tank 1 arrived on May 25, 1968. As received the tank had been assembled with the legs, the three port flanges, the entry scuttle flange, and the tunnel mounting flange, all of which had been sandblasted and painted with one coat of red lead vinyl primer. From this point the logical sequence of assembly would be very similar to building a house once the framing and enclosing was complete, that is, install the services (plumbing, heating, wiring, wall covering, and finish work). Unfortunately, due to schedule requirements, design completion date, and material availability, a logical assembly sequence was often not possible. There were continual decisions regarding schedule versus cost and schedule versus esthetics, without compromising quality and reliability. For example, cabinetry was installed prior to plumbing and wiring, because the cabinets were available several weeks ahead of wiring and plumbing information and material. Another assembly planning problem was to schedule manpower to keep personnel fully utilized without losing work continuity. Although this is a natural assembly problem, it was



Table B3  
Fabrication and Assembly Schedule, 1968-1969

Schedule Element	Time Stay During Which Work Was Accomplished									
	May	June	July	Aug	Sept	Oct	Nov	Dec	Jan	
<b>Phase A – Assembly in GE Facility at Valley Forge</b>										
Receive tank 1	Δ									
Weld bracketry to walls	_____									
Paint interior walls	_____									
Fabricate and install floors	_____									
Install cabinetry	_____									
Plumbing	_____									
Wiring	_____									
Environmental control system	_____									
Communications and alarm	_____									
Ceiling and trim parts	_____									
Paint interior cabinets, etc.	_____									
Changes, modification, rework	_____									
Paint exterior	_____									
Receive tank 2	Δ									
Fabricate and install floors	_____									
Install cabinetry	_____									
Plumbing	_____									
Wiring	_____									
Environmental control system	_____									
Install ceiling	_____									
Communications and alarms	_____									
Paint interior	_____									
Paint exterior	_____									
Join tanks 1 and 2 together	Δ									
Interconnections	_____									
Receive van	Δ									
Insulation, floor, ceiling	_____									
Install equipment, and wire	_____									
Test all subsystems	_____									
Pack for shipment	_____									
Ship to Philadelphia Navy Yard	_____									
<b>Phase B – Assembly at the Philadelphia Navy Yard</b>										
Reinstall equipment removed	_____									
Check out habitat subsystems	_____									
Paint base and assemble ballast tanks	_____									
Mount base on barge and tanks on base	_____									
Interconnect all systems	_____									
Test and training	_____									
Changes, modification and rework	_____									
Leave Philadelphia Navy Yard	_____ Δ									

magnified during the early assembly stages, as a 12-1/2-foot-diameter tank provides a limited work area. It was advantageous to keep a small group of people throughout the program with overtime rather than crash some phase of the work by applying additional manpower unfamiliar with the habitat and the prior work effort. As the work progressed, few prefabricated components fitted as planned and most required on-the-scene modifications. In most cases, sheet metal work and fabrication of panels, drawers, sliding doors, etc., was best done on a make-to-fit basis rather than prefabricated-to-print dimensions. Ready access to shop equipment and facilities was a necessity.

Tank 2 was received on July 2, 1968, and work progressed more smoothly. The majority of material had been received, the lessons learned from tank 1 were not lost, and more work space was available.

By early September both tanks had been essentially assembled as individual components. On September 5, 1968, the tanks were joined together with the crossover tunnel installed as shown in Fig. B39. The necessary power, plumbing, and communication connections between the two tanks were then made so the various subsystems could be tested.

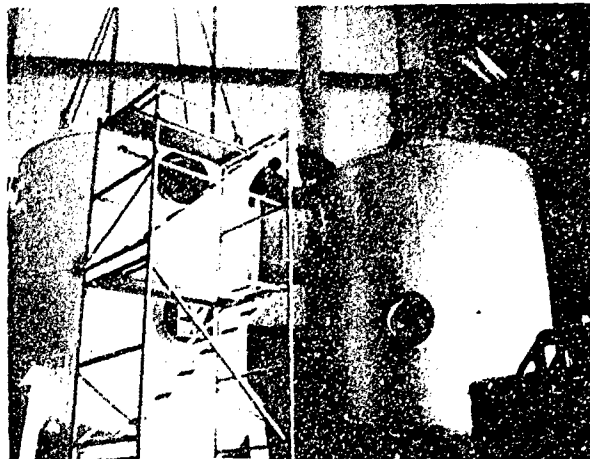

Fig. B39 - The tektite habitat under construction at the General Electric plant in Valley Forge. This view shows the crossover tunnel being positioned between the habitat cylinders.

The final assembly task at General Electric was outfitting the control van, interconnecting the van with the habitat, and testing the complete system. The van as received was a standard 8-by-30-foot trailer van. The first step was to insulate it and furnish the interior, since the van would be occupied continuously for the period of the mission, and the general comfort level of the occupants was of some importance. As a consequence some thought was given to layout, decor, and work volume to provide the best conditions within the constraints of cost and space.

On October 24, 1968, a 4-hour live-in was conducted with tasks assigned similar to those performed by the aquanauts. Based on the live-in minor modifications were suggested: removal of locking pins from the drawers in the crew quarters; mounting of towel bars, paper-cup dispensers, tooth-brush holder, and paper-towel dispensers; installation of a fan in the cupola; mounting of a curtain between the engine room and the bridge; replacement of the cooking unit.

After removing some of the electronics, disconnecting the two tanks, and shoring some of the heavier items such as the freezer, and the refrigerator, each tank was laid on its side and moved by truck to the Philadelphia Naval Shipyard. Figure B40 shows one tank being lifted prior to loading on a trailer, and Fig. B41 shows the cabin on the trailer.

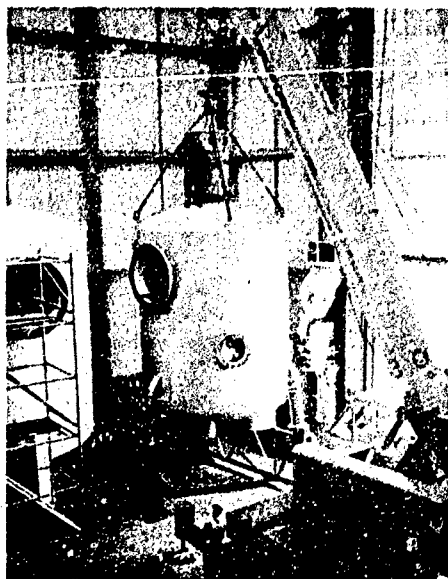

Fig. B40 - Habitat cylinder being lifted aboard a truck for transportation to the Philadelphia Naval Shipyard

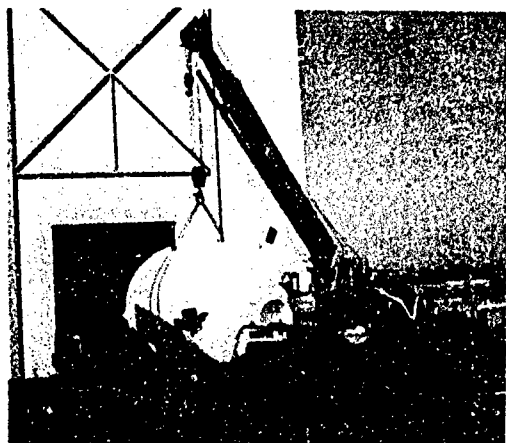

Fig. B41 - Habitat aboard a truck ready for transportation to the Philadelphia Naval Shipyard

### B6.3 Phase B

Upon arrival at the shipyard the habitat tanks were set up on stands at the east side of drydock 5. The trailers (control van, storage van, and office trailer) were located nearby. The habitat and trailers were unloaded, the crates were unpacked, and outfitting of the habitat was resumed. Major installations at this stage were the mass spectrometer and all view ports.

While the tanks were being outfitted, the base and ballast were brought to the shipyard. The base was sandblasted and painted in drydock 5. At the same time, the Ammi barges (launch barge and support barge) were located on keel blocks in the drydock. Upon completion of painting, the base was weighed and placed on the launch barge and secured with turnbuckles. Chocks were used to compensate for irregularities in the deck of the support barge. Once the base was located on the barge it was loaded with steel ballast punchings. The total weight of punchings, 113,280 pounds, was distributed in the base to compensate for unbalance between tanks. Next the deckplates were welded in place over the ballast holds.

Tanks 1 and 2 were lifted, weighed, and placed on the base, held by clamps on the feet. The crossover tunnel was attached to tank 1. Tank 2 was attached to the crane using four chain falls and was lifted just enough to keep a slight load on the feet. It was then rotated (by chain falls) around the axis of the crossover tunnel to align bolt holes in tunnel and tank flanges and rotated around the tank axis for parallelism of flanges using chain falls attached between tank legs and base. When flange face alignment was correct, the flanges were bolted together.

The position of the tanks had been maintained temporarily by steel chocks under the feet when crane and chain falls were removed. It now was necessary to attach the tanks permanently to the base in the alignment and position existing at conclusion of attachment of the crossover tunnel. This was done by shoring the tanks in position, cutting off the feet (Fig. B42), adjusting leg length, and rewelding tank legs to feet. The tanks were now secured firmly to the base with their axes perpendicular to the base. The entire assembly weighed 277,240 pounds divided as follows: tank 1, 34,760 pounds; tank 2, 40,020 pounds; base, 69,180 pounds; and ballast, 133,280 pounds.

Fig. B42 - Temporary feet of the habitat. These were cut off according to the scribe marks and rewelded to the proper length for permanent attachment to the base.

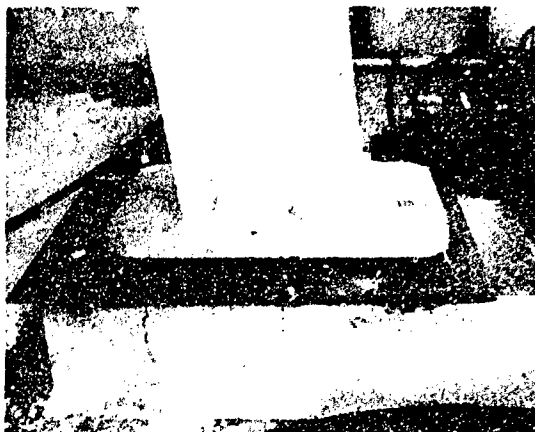

As soon as the crossover tunnel was in place, the plumbing and wiring between tanks was connected, making the habitat ready for test. It was connected to yard services for air and water, and the first test was a pneumostatic pressure test of the structural envelope.

While the habitat was being assembled, the support barge was outfitted by technicians from Amphibious Construction Battalion Two, and the control van outfitting was completed by G.E. technicians. The diesel generators on the support barge were connected to the habitat using a short section of the power umbilical (the umbilical itself could not be used as it was on a reel and inductive heating would have resulted). The communications umbilical was partly unreel and connected to the habitat and control van. After the pressure test was completed, each subsystem was given an operational performance test and minor deficiencies were corrected.

Upon arrival of the *USS Hermitage* (LSD 34) the habitat on the launch barge and the support barge were floated in the drydock and towed to pier 4, where they were loaded into the ship. The storage van, house trailer, umbilicals, extra ballast, and other miscellaneous gear were loaded onto pontoon causeways and into the ship. Food for the aquanauts was purchased at the commissary store and delivered to the ship, frozen food being placed in the reefer.

During the voyage from Philadelphia to St. John the first 2 days were mainly occupied in securing equipment in the control van and habitat against heavy rolling. Although some equipment received rough treatment, none was damaged. The habitat and control van were connected to ship power for lighting and for operation of equipment.

Work continued in readying the habitat for emplacement. Food was inventoried and stored, habitat equipment and lockers were labeled, the intercom system was checked out, and subsystems were rechecked.

## B7 CRANE BARGE

W. J. Eager and D. H. Potter, Naval Facilities Engineering Command,  
Washington, D.C.

### B7.1 Introduction

The crane barge was the safety and decompression center but was called the crane barge, since its 35-ton crane was used in support of underwater construction and to lower and raise the personnel transfer capsule. A system was required to respond to the aquanaut-related emergencies of (a) atmospheric contamination in the habitat, (b) injury or disease, (c) decompression sickness or air embolism, (d) inadvertent excursion above the upward depth limit, (e) shark attack, (f) loss of scuba air, and (g) loss of bearings. The corresponding action may have been removal, treatment, and decompression of the aquanauts for events (a) through (e), dispatch of filled scuba bottles for event (f), and presentation of direction and guidance for event (g). The system used for this function consisted of qualified safety divers, specific operational procedures, and facilities to support these divers. The system had also to provide for decompression of the aquanauts at the end of their mission.

### B7.2 Mooring Conditions

The crane barge (safety diving and decompression center) was required to remain on station near the habitat site throughout the operational phase of the project except under severe storm. Under severe storm the habitat was to be evacuated and the aquanauts placed in the decompression chamber; then the crane barge was to be moved to a protected location. Under normal conditions the crane barge was to be moored in water about 26 feet deep, which was the minimum depth for avoiding risk of decompression sickness as the aquanauts moved from the habitat to the personnel transfer capsule.

The equipment was to be securely mounted on the barge to withstand the environmental conditions, and a mooring system was to be designed which would hold the crane barge secure under these conditions. From historic weather data the environmental conditions for the months of operation involved, January through May, were as follows: maximum wind velocity, 10 to 15 knots; predominant wind direction, east; average tides, 1 foot; maximum tides, 2 feet; current, less than 1 knot; and predominant seastate, 0 to 1. The design of the mooring was based on loading from a 20-knot wind and 4-foot wave height.

The mooring configuration used was a four-leg spread mooring with each leg coming off a corner of the barge at 45 degrees. The legs were made up of anchors, chain, buoys and wire rope. The two legs off the shoreward end of the barge used 500-pound anchors. These were positioned on the rocky bottom by divers to insure that they were placed in a position to develop their capacity. Between the anchor and the barrel buoy, was one shot of 1-inch chain. One-half-inch wire rope was used from the buoy to the barge; it was passed through a chock on the end of the barge and connected to a cleat. Five-inch nylon

had been tried for the buoy-to-barge connection, but after excessive rubbing and chaffing was noted, the nylon line was replaced by wire rope. The seaward legs were identical to the shoreward legs except that 1500-pound Danforth anchors were used. The ocean bottom at these anchor locations was sand.

### B7.3 Safety Center

The crane barge (Fig. B43) was an Ammi pontoon measuring 90 feet by 28 feet by 5 feet deep. Mounted on the crane barge as part of the safety center was a diving system consisting of a deck decompression chamber, a personnel transfer capsule, a control console van, a base collar for mating the personnel transfer capsule to the deck decompression chamber, an air compressor, banks of oxygen and air bottles, a spare parts chest, and an air conditioning unit. An air line was run from the purge compressor on the support barge as a backup to the diving system compressor.

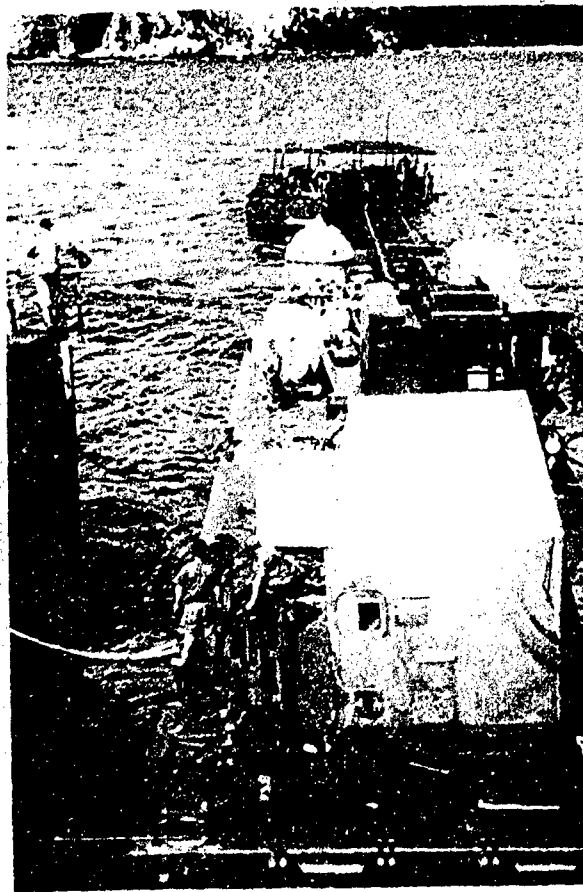

Fig. B43 - Crane barge prior to mooring

Mounted on the crane barge was a 35-ton P&H 640 crawler crane with an 80-foot boom. The crane, used in the construction operations, was used on the safety center for handling the personnel transfer capsule. A van was mounted on the barge for storing safety diving equipment, first aid equipment, and spare parts. It also provided a suitable maintenance space. A 15-kW generator was provided as an emergency backup to the power line from the support barge.

To provide for mooring and moving the crane barge and to provide for docking boats up to the size of an LCM-6, mooring bitts, chocks, cleats, and rubber-tire fenders were installed on the barge. Equipment installed on the crane barge was arranged to insure a positive stability, to keep list and trim to a minimum, and to provide compatibility between the components of any particular system such as the decompression complex. The total weight of the barge with installed equipment was 116 tons.

Maintained at the crane barge were two 18-foot outboards used by the safety divers to follow the aquanauts on all excursion dives from the habitat.

A wooden platform, constructed using 55-gallon drums for floatation and propelled manually with lines, provided transportation between the crane barge and the support barge.

#### B7.4 Decompression Facilities

The aquanauts, saturated at 43 feet on the 92% N<sub>2</sub>, 8% O<sub>2</sub> mixture, were limited to an upward no-decompression excursion of 23 feet to a 20-foot depth. From this depth, they had to be transferred under pressure to the decompression chamber for either a 19-hour decompression at the end of the 60-day project or an emergency decompression under the conditions stated.

The system used was the Ocean Systems, Inc., advanced diving system (ADS IV), which is rated to 600 feet for helium-oxygen diving as well as for air diving to shallow depths. The ADS IV consisted of a double lock surface decompression chamber with medical lock, a personnel transfer capsule, a breathing gas compressor, air conditioner, a control van, and related equipment. The transfer capsule was used to transfer the aquanauts from their undersea environment to the deck decompression chamber, under bottom pressure. The P&H crane would pick up the personnel transfer capsule from its cradle on the barge deck and lower it into the 26-foot depth of water over the port side of the barge.

### B8 UNDERSEAS CONSTRUCTION SYSTEMS AND OPERATIONS

Cdr. W. J. Eager, Naval Facilities Engineering Command,  
Washington, D.C.

#### B8.1 Introduction

The functions of the undersea construction systems used in Project Tektite I were: to emplace moorings for all barges, to provide for on-site checkout of surface support barge systems prior to submerging the habitat, to submerge or launch the habitat to its buoyant position, to prepare a foundation for the habitat at its operational site, to move the submerged habitat to this site and emplace it securely on the foundation, to prepare foundations for the support barge, to emplace and secure the support barge on its foundations, to emplace, anchor, and connect the habitat-support barge umbilicals, to emplace and connect the habitat sewer outfall, to emplace the way stations, to install cable for and connect the way station sound-powered phone system, and to inspect for damage or malfunction.

These functions were performed by a detachment of Seabees from Amphibious Construction Battalion Two augmented by 12 Seabee construction divers from Atlantic and Pacific mobile construction battalions. They were directed by a Naval Facilities Engineering Command Officer in Charge of Construction (Cdr. W. J. Eager).

Lt. Cdr. N. Monney was responsible for the initial site engineering survey. M. Yachnis and D. H. Potter, who contributed to facilities design, served as on-site as technical observers and engineering assistants. Lt. (jg) Scott Stevenson was on-site as a technical observer for the Naval Civil Engineering Laboratory and acted as the assistant diving officer for certain operations. Lt. (jg) C. J. Fucillo supervised the base camp construction and operations, and power and communications cable laying. Lt. (jg) T. M. Fusby was a general assistant. Senior Chief R. G. Miller was the construction diving supervisor for Project Tektite I. Numerous other personnel of the Naval Facilities Engineering Command and Amphibious Construction Battalion Two contributed to design and procurement efforts.

The undersea construction systems were designed by the Naval Facilities Engineering Command and fabricated, tested, and assembled by personnel of Amphibious Construction Battalion Two under direction of the Naval Facilities Engineering Command. The crew was trained intensively prior to operations. Construction and integration checkout was completed as originally scheduled within an extremely limited, 30-day period. Meeting optimistic schedules is an uncommon event in undersea operations. This success resulted from: careful planning for equipment and material requirements, good forecast of contingencies, careful critical-path scheduling and rescheduling of equipment and personnel for simultaneous operations at the habitat-launch, support-barge, habitat, and way-station sites, and good fortune.

The only problems with marine life occurred when exceptionally large (6-foot) remoras, which resemble sharks, interrupted work operations by persistently trying to attach to the construction divers. Unloaded bang sticks, which were maintained at each site for protection from sharks, were used to prod the remoras away. Occasionally very large baracuda momentarily interrupted work until their ferocity was determined to be subordinate to curiosity. Although two close encounters with sharks were experienced during the construction operations, neither evidenced hostility, and no interference with construction operations resulted from sharks.

Except for ear infections no sickness or accidents caused lost time. All diving was accomplished on no-decompression tables, and work was scheduled to obtain efficient and safe use of the small crew. Officer engineers closely directed and supervised all underwater work; officer and design engineers carefully inspected all work.

## B8.2 Habitat Launch

### B8.2.1 Design and Operations Conditions

The habitat was a new development, and concern existed over the effects of vibration and dynamic forces induced by the transporting ship. An on-site checkout of the systems on the habitat and support barge was considered necessary before submerging the habitat. The habitat was therefore mounted on a barge for movement to and from the well deck of the transporting landing ship dock (LSD) and remained on this platform during on-site checkout. To avoid the high cost of a floating crane to lift the 310,000-pound habitat from the barge into the water, an Ammi pontoon barge was used and the Ammi lift dock concept was employed for launching. The barge was progressively sunk through controlled compartment flooding, thereby lowering the habitat into the sea. Cylindrical



steel piles were inserted through spudwells in the barge and driven into the seafloor. Winch mechanisms attached to the piles maintained stability during lowering operations.

Other conditions which influenced launch systems design, site selection, and launch operations were: weights (habitat with punching ballast installed, 310,000 pounds; launch barge, 120,000 pounds; support barge, 198,000 pounds; crane barge, 259,000 pounds), environmental loading, visibility (20 to 40 feet), and the minimum sediment depth required for piles (15 feet).

The habitat draft when floating was about 24 feet. The launch barge depth was 5 feet. Therefore, a bottom depth of about 32 feet was required for the launch to provide a separation of 3 feet. To prevent the barge from jamming on the piles at the bottom, the ocean bottom pile pattern had to be within  $\pm 1$  inch of the barge spudwell pattern. These tolerances resulted from spudwell diameters of 22-1/2 inches and pile diameters of 20 inches.

Because Greater Lameshure Bay is part of a National Park all construction had to be such that all launching foundations and structures could be removed and the seafloor returned to its original condition at the end of the project.

#### B8.2.2 Site Selection and Preparation

Site survey and selection for launch operations was accomplished during advanced party operations before the facilities construction operations commenced. A prospective 32-foot-deep, level site was located in the approximate center of Greater Lameshure Bay (Fig. B1) using standard diver depth gauges and confirmed by surveyor tape measurements to the surface. The prospective location was selected for its approximate equal distance between rock outcropping and coral reefs in the bay, suggesting maximum depth of sand for pile emplacement. The launching site was about 1/3 mile from the operational site.

The barge spudwell pattern was laid out and marked on the ocean bottom using a steel surveyor tape. The pattern was directionally oriented so that prevailing waves would be taken on a corner of the launch barge. The sediment bottom was proved at each pile penetration point, using a water-jet-driven lance. A lance could be driven to the required 15-foot depth and was left in place to mark each pile point at the confirmed site. Surface sediment samples were taken and analyzed to be well-graded coral sand, suitable for pile driving and retention. Bottom obstructions were removed, and a standard Seabee four-point moor was set using 1500-pound Danforth anchors, chain, and mooring cans. Five-inch nylon line was used between the cans and the barges.

#### B8.2.3 Launch Facility and Operations

Upon completion of the prelaunch systems checkout the habitat hatches were sealed, the habitat pressurized to 20 psi, and a check made for pressure loss in preparation for launch. Using the concept called the Ammi lift dock the barge was lowered under controlled conditions to the seafloor, permitting the habitat to float free.

Cylindrical piles of 20-inch diameter and 3/8-inch wall thickness were inserted by the crane on the crane barge through the four corner spudwells of the launch barge (Fig. B44). The piles were lowered to within 1 foot of the 32-foot ocean bottom. Construction divers placed a 1/4-inch rectangular steel plate with a 22-inch-diameter hole (Figs. B45 and B46) over the end of each pile, and the pile was lowered to the bottom. The four plates were connected by 1/2-inch wire ropes with turnbuckles. Hand winches attached to jetted anchors at one end and the plates at the other spread the four plates and the piles with them into a rectangular pattern which matched that of the barge spudwells. The piles were oriented vertically using a spirit level and then driven to approximate refusal depth

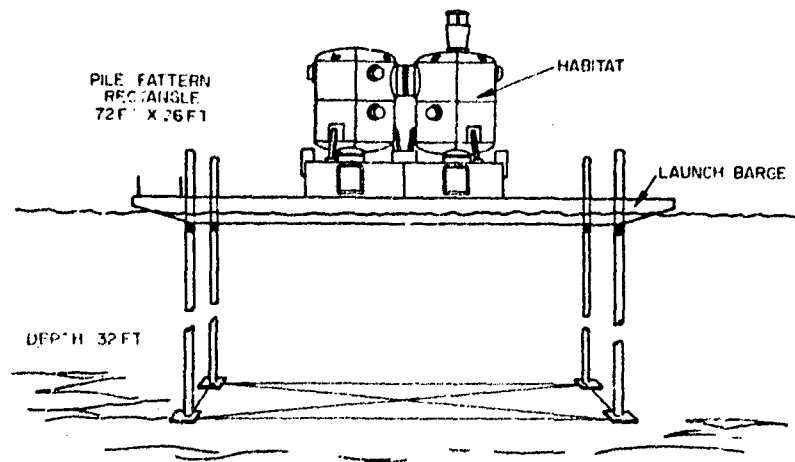

Fig. B44 - Placement of the piles for the habitat launching

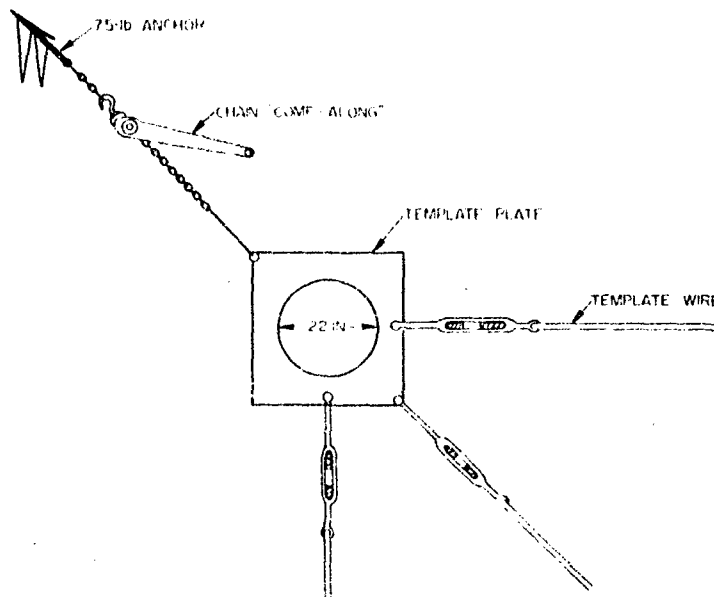

Fig. B45 - One of the four corners of the template for the four piles to launch the habitat

of 17 feet using a diesel-driven pile driver. Using this technique the piles were em-  
planted within  $\pm 1$  inch of the ideal pattern of the barge spudwells and within 1 foot in 100  
in vertical position.

The interior of the barge was divided into 12 individual airtight compartments. Two  
10-inch-diameter holes through the bottom skin into each of the major compartments and  
one 6-inch-diameter hole into each small end compartment were provided for flood-water  
access. Gasketed plates covering these holes were removed just prior to launch. To  
vent air from each compartment so that water could enter through the flood holes the



Fig. B46 - Construction diver positioning a corner of the launch template

upper skin of each compartment was tapped by a vent line, which ran to a common side of the launch barge and a stop valve (Fig. B47). Vent air from the line from each compartment passed through a hose to a control manifold on the crane barge (Fig. B48). In addition to venting the launch-barge compartments the manifold provided for blowing each compartment individually. Air for blowing the launch-barge compartments was supplied to the manifold by the 600-cu-ft/min diesel-driven compressor used later for pile extraction.

The habitat base was provided with access holes to make it free flooding. Therefore when the barge deck came awash the system would be unstable until the water line reached the habitat cylinders. This was compensated for by one string of 5-by-5-by-7-foot pontoons, approximately 28 feet long by 5 feet wide by 5 feet high, installed across each end of the launch barge (Fig. B49).

If small forces generated by wind, waves, and swell did not exist and great care was taken in balancing the flooding of symmetrical compartments of the barge, the system described to this point could be used to launch the habitat. However, such forces cause differential motion of the sides, ends, or corners of the barge. Once the barge and pontoon strings are submerged, the habitat cylinders alone could not have produced the necessary restoring moments to correct this motion. The water within the large compartments would have moved to produce additional differential motion and the barge sputwells would have jammed on the piles.

To overcome the small initiator forces and thereby maintain the launch barge in a horizontal position, the mechanisms shown in Fig. B50 were used. A manual 4000-pound winch was mounted on top of each pile. One-half-inch wire rope from each winch was routed down through a block attached to the deck of the barge and to a tensiometer attached to the pile cap. As air was vented from selected, symmetrical compartments, water entering flood holes in the barge bottom produced forces on the wire rope that



Fig. B47 - Vent lines from the launch-barge compartments connected to hoses running to the crane barge

were measured by the tensiometers. Balanced flooding of symmetrical compartments could be achieved by balancing the tensiometer readings. Since wave and swell forces were producing oscillations in the tensiometers readings, average forces had to be observed. When average forces on all tensiometers approached 3000 pounds, operators on command winched out equal amounts of wire rope, and the barge would be moved to a lower horizontal position (Fig. B51).

To ascertain that the barge was advancing equally on all four corners, depth-marking-tape readings were observed and compared before flooding was repeated. Differential elevation of the corners was corrected by winch adjustment. The process was repeated until the habitat approached its buoyant draft (Fig. B52). At this point 12 1-inch turnbuckles holding the habitat to the launch barge were released, and constraining lines were attached from the habitat to the piles. The launch barge was then lowered to rest on the ocean bottom, allowing the habitat to float free. Observations of habitat pressure loss was made throughout launch and emplacement operations.

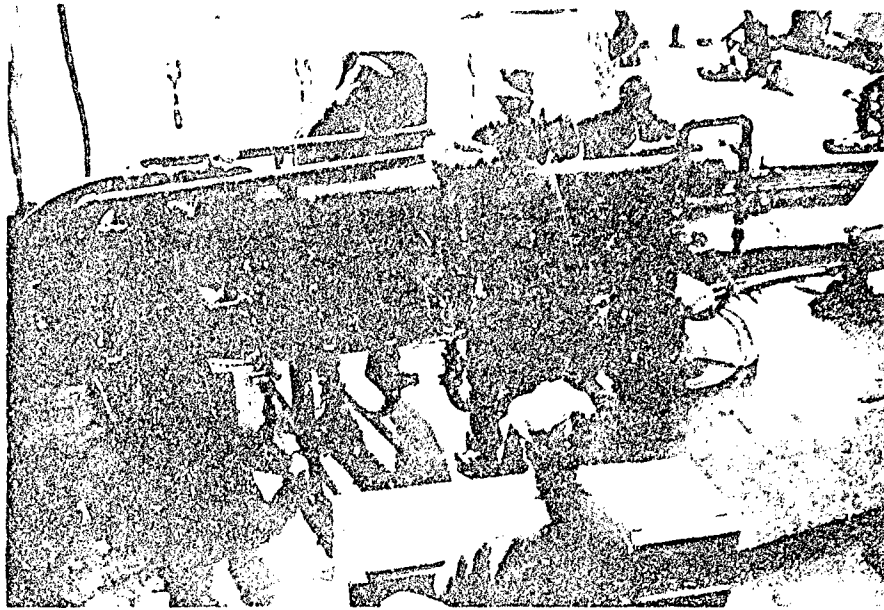

Fig. B48 - Vent control manifold on the crane barge connected to the hoses shown in Fig. B47

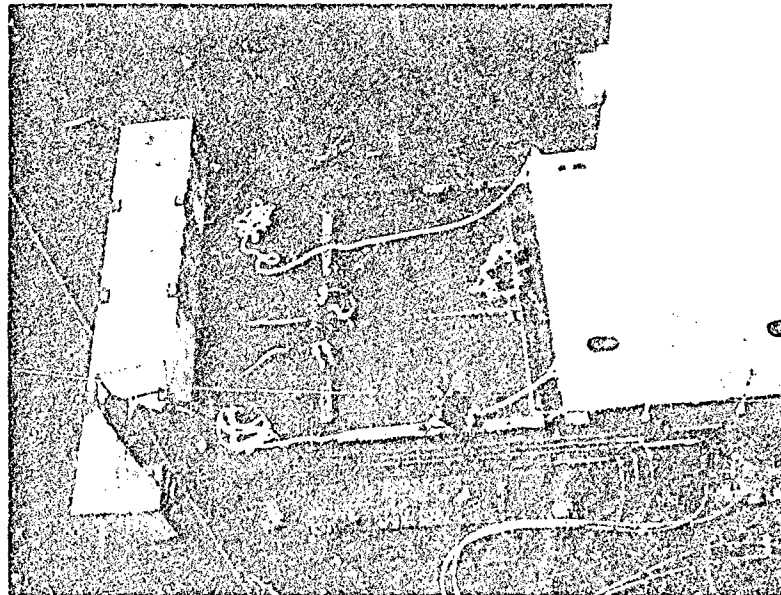

Fig. B49 - Manifold assembly along one end of the launch pipe

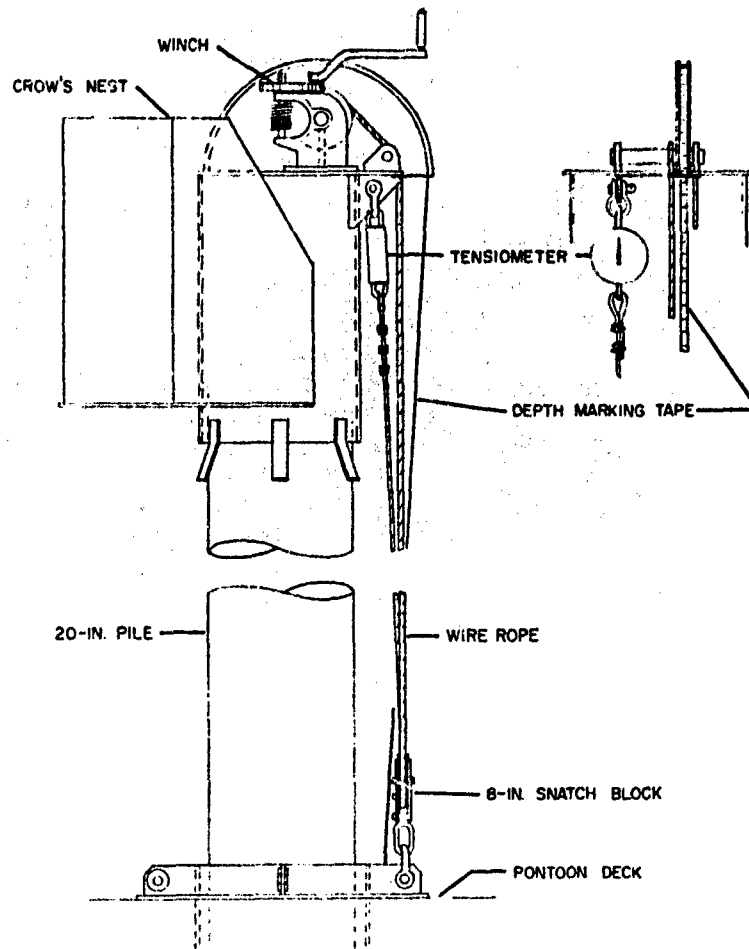

Fig. B50 - Launch system mechanism

The self-propelled diving barge was used to tow the habitat from the launch site to a position over the habitat site (Fig. B1). A personnel boat was attached by tow line to trail the habitat. Thus fore and aft control of its motion was provided. The tow path had been checked by construction divers, who again scouted for obstruction during the tow.

#### B8.2.4 Performance Evaluation

Environmental data on Greater Lameshure Bay was sparse. All observations and reports indicated calm conditions. With trade winds and waves blocked by high land masses, 5-foot swells with 30-second period were not expected until the summer months. However, such conditions worked against the assembled 400 tons of barges and equipments over a 5-day period to produce fatigue failure of the first set of launch system pilings a few inches below the sea floor. The natural period of the system approximated the long period swells. Pile failure was produced by a combination of inadvertent stress raisers in the piling, delayed delivery of 1/2-inch wall piling, and unexpected delays in completing the prelaunch habitat system tests, and the unexpected sea conditions. Spare piling sections on hand were welded into the required 60-foot lengths in the field with superior alignment. Stress raisers were eliminated, and the replacement piles were driven the day prior to predictable completion of systems checkout and during a predicted



Fig. B51 - Tensionometer in use to control the descent of the launch barge

period of good weather. The result was a successful and timely launch of the habitat at a cost substantially lower than for known alternatives.

Minor difficulties were encountered with winch cables jamming in pulley blocks of the lowering mechanism when waves caused cables to go slack. Brackets to hold the blocks in their inverted vertical positions were installed to correct the problem. One jam-up of the barge on the piling was experienced as a result of an avoidable operator error. This was corrected by applying a force to the jammed corner with the 35-ton crane.

Good information was not available on wave-imposed barge dynamics. In spite of timing the launching with relatively calm seas, transient loads were experienced in excess of 4000-pound ratings of the lowering winches. Occasionally these dynamic forces reached 10,000 pounds. This did not produce problems in launch operations. However, a system for repetitive use would suffer. This could be overcome by increasing the winch capacity.

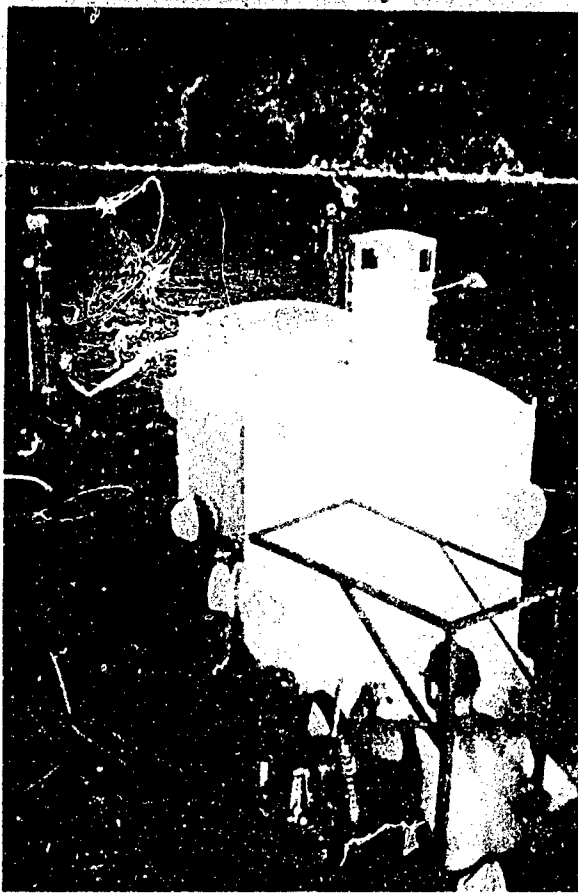

Fig. B52 - Tektite habitat during launch

### B8.3 Habitat Emplacement

#### B8.3.1 Emplacement Conditions and Site Selection

To satisfy the requirements of the marine biology program the habitat was to be located within or adjacent to a biologically active, coral reef structure. The location was to permit saturated diver access to a broad expanse of reef at a depth below 20 feet. Biomedical requirements for saturated divers set a 23-foot upward excursion dive limit from the saturation depth (internal habitat pressure). These two requirements uniquely determined that the water surface in the habitat access trunk had to be at a 43-foot depth. Since the midheight of the trunk was 6 feet above the bottom of the habitat base, the habitat was placed on the seafloor at an approximate 49-foot depth. A site at this depth, in a narrow U-shaped valley between very abundant reefs, satisfied engineering requirements as well.

The valley was relatively level with a coral-sand overburden about 2 feet deep, suitable for site grading. A continuously downward sloping path was available for routing the sewer outfall. An inverted U in the line would collect sewer gases which would back up to the habitat under certain circumstances.



The habitat with water ballast tanks dry, when totally submerged, displaced 5000 pounds more than its weight. With the ballast tanks flooded it was 5000 pounds negative. An additional 25,000 pounds of pig iron ballast was available to secure the habitat to the bottom. The bottom of the habitat base was a heavy flat steel plate, so no problems with the bearing capacity of the coral-sand bottom were encountered.

The environmental conditions at the site were approximately those cited in section B4.2. The visibility at the habitat site was a minimum of 30 feet. Even during severe storms significant currents were not experienced at the habitat site. Since the operational site was in a National Park, all construction techniques had to provide for easy restoration of the natural conditions at the end of the project.

#### B8.3.2 Site Preparation

During the advance party operations in November 1968, two 1000-pound concrete clump anchors were placed 75 feet from the center of the habitat site at opposite ends. They were to be used for mooring the habitat temporarily, while down-haul equipment was being attached.

For use in leveling the bottom a rectangular aluminum frame was entrenched in a level orientation. The frame, which had the dimensions of the habitat base, was fabricated from 4-inch square tubular stock. The tubular frame was provided with flood and blow fittings to facilitate handling in the water. The sand bottom was graded by moving a bar over the frame much as a concrete flood is leveled during pouring (Fig. B53). The frame was removed before habitat emplacement.

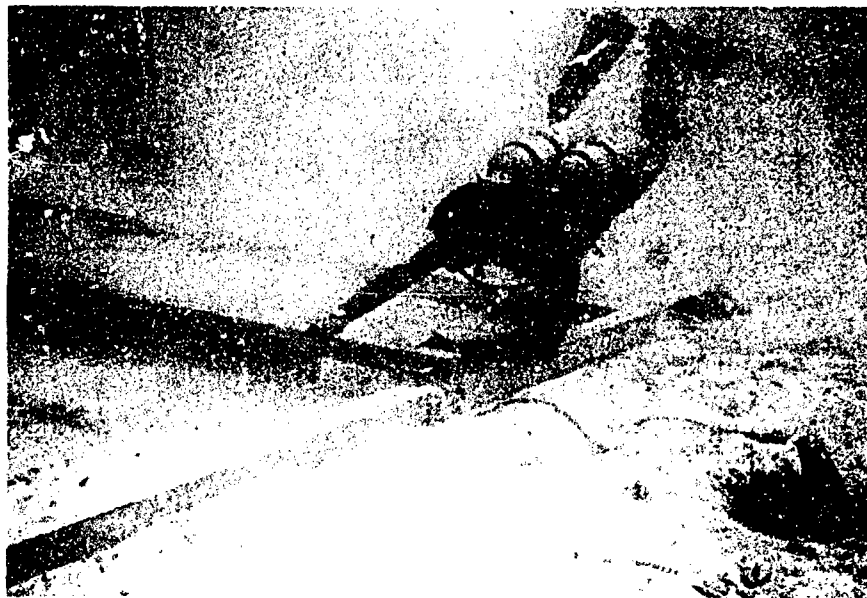

Fig. B53 - Habitat site being leveled by moving a screed bar along a level frame

Immediately adjacent to the frame four anchor clumps fabricated from steel plate were emplaced. They were used to haul the habitat to the bottom and became part of the foundation. Each weighed approximately 2500 pounds and were provided with two pad-eyes for attachment (Fig. B54). They were lowered to the bottom by the crane barge and were moved into position by construction divers using six 500-pound lift bags. Stakes cut from 1/2-inch pipes were driven through holes in the plates to hold them in lateral position during habitat winch down.

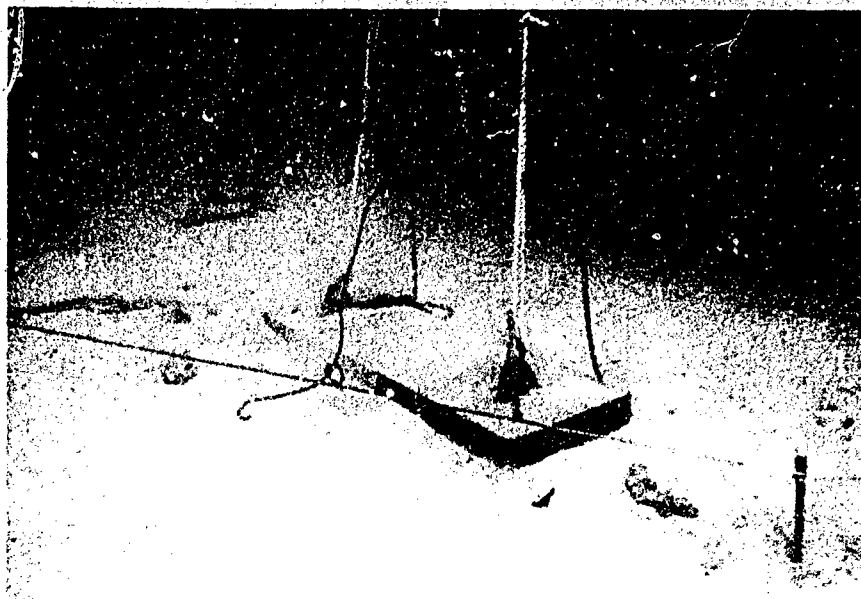

Fig. B54 - Anchor clump used to haul the habitat to the bottom

### B8.3.3 Emplacement Operations

With the habitat in its moor and floating at the surface, pig ballast was placed in habitat ballast trays to adjust its orientation and to give it a 5000-pound buoyancy when wholly submerged. Upon completion of trimming operations, eight 3000-pound chain falls were symmetrically attached and moused to shackles on the habitat base. The hook end of the chain falls were attached and moused to shackles on the steel anchor clumps through nylon leaders. The latter were used to reduce surge forces on the chain falls. As shown in Fig. B55, eight construction divers hand-winch the habitat 20 feet to the bottom while spirit levels were used to ascertain level submergence.

When the habitat reached the bottom, vent and flood valves on the ballast tanks were opened. The habitat went from 5000 pounds positive to 5000 pounds negative buoyancy. Winches were replaced one by one with turnbuckles. Steel (25,000 pounds in approximate 10-pound pigs) was lowered to the top of the habitat base and distributed in the ballast trays. At first pallets of pigs were lowered to the habitat ballast trays from the diving barge. Difficulties in this method were overcome through the use of a chute constructed of 4-inch steel pipe (Fig. B56).

The habitat was periodically repressurized and checked for leakage using the Bolstad Lister breathing air compressor on the diving barge. The shark cage and three doors



Fig. B55 - Divers winching the habitat to the bottom

were attached to the habitat with the aid of lift bags. The first sewer outfall hose section was connected to the appropriate fitting from the habitat and rolled out from its reel along the course shown in Fig. B1. Additional sections were rolled out and connected at the bottom to complete the outfall.

#### B8.3.4 Performance Evaluation

The simple and low-cost site preparation and habitat emplacement systems worked quite effectively. By using this haul-down technique the motion of the habitat was coupled with the bottom while it was still at the surface, thereby avoiding impact forces with the bottom as is the case with objects lowered from the surface. Surface conditions were very calm, which simplified the lowering operations.

#### B8.4 Support Barge Emplacement

##### B8.4.1 Introduction

The 22-by-90-foot support barge with all habitat support systems except the TV and radio antennas, installed and checked out was to be emplaced as an elevated platform about 15 feet offshore in Beehive Cove. Large boulders and coral which came within a foot of the surface were immediately adjacent to the area where the barge was to be emplaced. A few coral heads approached the surface in the area where the support barge was to lie. Two-foot swells moved into this protected region. Prevailing open-sea waves, swells, and wind were blocked by a high land mass. The bedrock and boulders had the hardness and strength of granite and were grown over with fire coral. This stinging material forced construction divers to clothe in wet suits and gloves for protection in spite of high water temperatures.

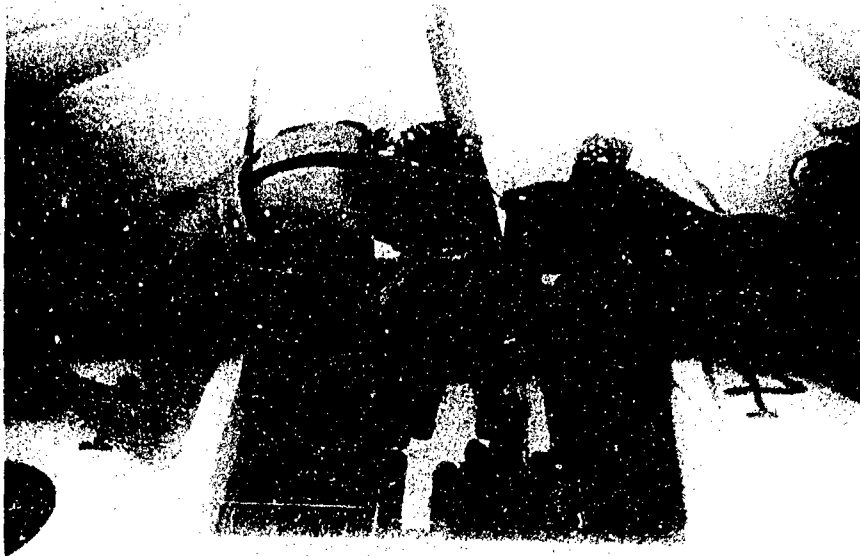

Fig. B56 - Ballast being placed on the habitat base

#### B8.4.2 Site Preparation

During advance party operations a template was made using four inflated inner tubes spaced by lines in the same pattern as the four-corner spudwells of the support barge. The template was floated over the proposed site until a position was found at which all four piles would be sitting on a relatively flat bedrock surface and the barge would avoid interaction with the rock and coral outcroppings. Markers were then placed at the pile points for future reference in placing rock bolt anchors and in positioning the support barge.

To stabilize the pile legs of the support barge for hoisting, the guying system of Fig. B35 was to be used. Three rock bolts were installed in the bedrock surrounding each pile location. The rock was a metamorphosed lava and pyroclastic deposit with great strength and hardness. An electric underwater rotary tool, developed by the Battelle Memorial Institute, was used with tungsten carbide masonry bits to drill the holes for 3/4-inch bolt expansion jackets. A sample of the installed bolts was tested with a specially fabricated tripod tensiometer to 5000 pounds without evidence of pullout.

Two coral heads which would have interacted with the bottom of the support barge were broken off with a sledge hammer on approval of the National Park Service's representative.

Two 1500-pound anchor-surface can moors were emplaced to constrain the seaward end of the support barge during emplacement operations. To constrain the shoreward end a 75-pound anchor with a wire-rope leader, was emplaced between boulders on shore. For the other corner of the barge a wire rope was wrapped around and secured to a 30-ton boulder.

### B8.4.3 Emplacement Operations

The support barge was moved into and connected to its moor by a causeway tender boat. This is a modified landing craft mechanized (LCM-6) used by the Seabees in amphibious operations. It has a shallow draft, twin screws, and adequate power for moderate surf operations. A standard LCM-6 assisted in positioning the barge. The crane barge was then moved into a position adjacent to the support barge. Steel pilings, 20 inches in diameter, were inserted through the support barge spudwells using the 35-ton crane. Swells caused substantial movement in the support barge. The mooring lines were adjusted until the spudwell lined up with the pile point marked on the bottom. The pile was dropped. This was repeated until all piles were in place.

The surge produced sufficient barge motion that installation of the guying system (Fig. B35) on the shoreward piles for hoisting would have endangered the construction divers. This plan was abandoned on the shoreward piles, although guys were installed on the seaward piles. The barge elevation mechanism (Fig. B36) was installed. In normal operations the piles are driven into a sediment bottom, which constrains them to a vertical position when the barge is winched up. Tektite I was the first application in which the piles were set on a rocky ocean bottom. Without pile guys on the shoreward piles, it was decided to jack the barge out of the water on the canted piles and attempt to erect the assembly by pushing with the tender boats. Sleeves were to be welded in the spudwells to maintain the vertical orientation.

The barge was jacked out until the lower side was 6 inches out of the water and the high side 20 inches. At this point, binding in the spudwells became excessive. Attempts to force the piles into an erect position were not successful. The bedrock possessed a fracture plane at approximately the same angle as the pile cant and piles penetrated approximately a foot into the ocean bottom along this plane. Observations and calculations showed that the support barge was in a stable configuration with the 4-foot-long spudwells capable of balancing the moments caused by surf and wind conditions in this protected cove. It was decided not to attempt to correct the cant or raise the barge higher. Four safety chains were attached between barge padeyes and the pile caps at each pile. The winch cables were slacked to approximately a half load. The support van was shimmed to a level position compensating for the 4-degree lateral cant of the barge's deck, to complete the support barge emplacement as shown in Fig. B57.

### B8.4.4 Performance Evaluation

Preassembling the support system on a barge at a suitable fabrication facility rather than attempting to assemble them in a remote area on a land-mounted platform was unquestionably advantageous to operational schedules and construction costs. Also advantageous was the elevation of the platform even apart from the requirements for minimizing noise in the water. Continuous checking and adjustment of the moors and motion of the operational platform was thereby avoided.

Development of the Ammi lift dock concept for use on rocky ocean bottoms is required. The value of such development is in the large cost savings over drilling the piles in. Increasing the diameter of the piles or decreasing the spudwell diameter, providing a bearing plate or shoe for the pile to set in and guying of the pile tops are to be considered in the development effort.

Techniques and equipment used for drilling into hard rock underwater were not adequate. A minimum of 1 hour of hard work by three construction divers was required on each hole drilled.



Fig. B57 - Support barge in its final position

The tripod tensiometer developed specially by the Seabees for testing the static pullout strength of water jetted anchors works very well for that purpose. In shallow water, however, it was difficult to position. For use on rock surfaces the forces do not require spread footings, and a more compact unit could be developed.

## B8.5 Umbilical Emplacement

### B8.5.1 Introduction

The umbilicals consisted of two heavy armored cables and four air and water hoses which float in water. The 1000-foot armored cables were to be laid on the bottom over the 400-foot distance between the support barge and the habitat. To prevent navigational difficulties and risk of severing hoses the air and water hoses, which could be swum out on a straight path at the surface, had to be anchored to the bottom.

### B8.5.2 Emplacement Operations

The electrical power cable and the communications cable were provided on their reels with the habitat ends free. The reels were mounted on two reel stands by means of a pipe shaft through the reel center. The reel stands were welded to the deck in the center of a causeway section. A standard Naval Facilities Engineering Command fairlead was modified to suit and welded at one end of the causeway. A reel brake was to have been provided with each reel but was not. Rather than delay the project, and in view of the shallow water into which the cables were to be laid, a crude brake was devised from a piece of timber. The causeway was maneuvered into a position adjacent to the strain relief mounts on the habitat. The habitat end of the power cable was payed out to construction divers. The strain relief had been previously connected to the armor on the cable and the unarmored end had been waterproofed with shrink tubing. Seabee construction divers bolted the strain relief to the mount on the habitat base and threaded the unarmored end up through the cable trunk into the habitat.

The causeway was maneuvered in a flanking pattern to lay the 1000-foot cable over a 400-foot distance and place the end at the support barge with no substantial excess. The bottom throughout the area was composed of very rugged bedrock and coral formations. An error in laying would have taken substantial time and effort to correct. At the support barge the strain relief on the cable end was bolted to its mounting plate and the unarmored end connected to the habitat power distribution system. The communication and signal cable was laid in the same way as the power cable. An attempt was made to avoid crossing over the power cable, which may have produced signal interference, but once crossover occurred. It was compensated for by installing a wooden separator.

The ends of the air and water hoses were secured in strain reliefs and connected at the habitat. They were swum out individually in a straight path at the surface to the support barge, secured in strain reliefs there, and connected to the support barge fittings. They were then married into a bundle every 20 feet, swum to the bottom, and tied with manila line to coral heads and to the power and communication cables where they crossed them. During systems integration checkout the hoses were inspected for leaks.

### B8.5.3 Performance Evaluation

Umbilical laying operations were totally successful. No damage to hoses or cable occurred, and the ends came out right on station. The presence of a substantial reel brake or reel drive, such as was used to recover the umbilical, would have reduced the overactivity of the adrenal glands of construction personnel. Under the conditions of having to flank two heavy 1000-foot cables over a 400-foot distance, a crossover was virtually unavoidable but was easily remedied.

## B8.6 Way Station Installation

### B8.6.1 Introduction

The way stations (Fig. B28) were to provide a refuge for the aquanauts if they became threatened by predators while on excursion dives from the habitat and also allowed aquanauts to communicate by voice with each other while diving and with aquanauts in the habitat. Each way station was equipped with a bang stick loaded with a 12-gauge shotgun shell, and twin 72-cubic-foot scuba tanks for displacing the water in the plastic dome.

### B8.6.2 Emplacement Operations

The way stations were lowered to the bottom using a sling and the crane barge. The units, with air in the domes, were positioned on the bottom by swimming them into position using a lift bag.

Sound-powered phones were installed in each way station. Phone wire was spooled off along the bottom from the farthest way station around the loop (Fig. B1) to the habitat and connected by construction divers.

### B8.6.3 Performance Evaluation

Construction equipment and techniques were straightforward and adequate.

**B9 INSTALLATION, INTEGRATION AND CHECKOUT OF  
THE HABITAT SYSTEM**

**J. B. Tenney, General Electric Company, Missile and Space Division,  
Philadelphia, Pennsylvania**

At 9:00 p.m. on January 27, 1969, the Tektite habitat floated clear of the Ammi barge used to transport and launch it. The habitat was sealed, internally pressurized to 20 psig, and positively buoyant by 15,000 pounds. On the following day the Tektite habitat was towed to its emplacement site at Beehive Cove, where it was secured to preplaced bottom anchors made from steel plates. At this point, cast-iron ballast pigs were added by Sea-bee construction divers to reduce the reserve buoyancy by 10,000 pounds. With the habitat positively buoyant by 5000 pounds it was winched to the bottom, where ballast tanks in the base were flooded to reverse the buoyancy to 5000 pounds negative.

Additional ballast pigs were added and the habitat was secured to the bottom anchors using turnbuckles. At 10:30 a.m. on January 30 General Electric divers opened the habitat and began the installation and checkout procedures that were completed on February 14. The mission began on February 15.

All integration and checkout tasks were accomplished in accordance with prepared checklists that reflected careful study of experience in Sealab II. Checkout tasks during various conditions of the habitat, both above and below the surface, required close cooperation between all of the participating agencies.

The checklist for when the habitat was on the deck of the Ammi barge with its base secured to the barge, had been removed from the well deck of the LSD, was in its shipping configuration including protective coverings on the windows, did not have the power line connected, and had the shark doors and screens in place but did not have the cage at the entrance to the wet room attached was as follows:

1. Tow the Ammi barge and the habitat to the launch site.
2. Moor the Ammi barge on preplaced moors.
3. Locate the template.
4. Thread and drive the four piles.
5. Inspect the piles for depth and perpendicularity.
6. Connect temporary lights inside the habitat.
7. Transfer to the habitat all spares not transferred at the Philadelphia Naval Shipyard, all dry goods (excluding frozen food), all tools, and all expendables (e.g., linens, towels, baralyme, charcoal, and colorimetric tubes).
8. Check the pressure on all emergency scuba bottles and secure the bottles to wall brackets.
9. Check the pressure on all habitat fire extinguishers and secure them in the habitat.
10. Stock spare coolant.
11. Install all charcoal in the filters of the environmental control system.



12. Install fresh batteries in all emergency lighting devices and secure the devices in the habitat.
13. Transfer the aquanauts' personal gear to the habitat.
14. Transfer spare scuba bottles and equipment to the habitat.
15. Determine the weights for all components added to the habitat and adjust the ballast accordingly.
16. Install and test the Perkin-Elmer gas analyzer.
17. Preposition the O<sub>2</sub> and CO<sub>2</sub> monitoring equipment in the crew quarters.
18. Perform a leak test.
19. Clean the windows with antistatic solution.
20. Check quantities and location for all supplies, including baralyme, food, expendables, personal gear, and scientific mission equipment. Adjust ballast as required.

The checklist for when the outfitting was complete, all stores, personal gear, spares, and dry (nonfrozen) provisions were stored aboard, all emergency air bottles were charged, the Ammi was floating secured on four piles, and leak testing was completed was as follows:

1. Check all windows and protective window covers.
2. Charge the coolant system to 50 psig.
3. Open the purge valve on the bridge and the valve at hull penetration. Close the pressure equalization valve, the sea water inlet condenser, the sea water outlet condenser, the drain for tank 1 (crew quarters and bridge) under the sink in the crew quarters, the drain for tank 1 below the floor at the outlet of the condensate pump, the fresh water drain in tank 2 (equipment room and wet room), the sea water drain in tank 2, the sea water inlet for the toilet in tank 2, the Freon overflow valve, the water inlet valve at the umbilical plate, the three high-pressure inlet valves for emergency air, scuba air, and bypass air, and the low-pressure air-return valve in the "sniffer" line.
4. Cap both differential-pressure penetrations (1/4-inch nipples) outside the habitat.
5. Close all handwheels on the 26 emergency air bottles.
6. Open all water faucets and assure that no water is present in the system or hot water heater before closing the drain valves.
7. Operate pumps until the bilges are dry and the sump tank is empty before closing the drain valves.
8. Check the main power panel to assure circuit breakers CB1, CB2, and CB3 are in the ON position. Check the main distribution panel to assure that the lighting breakers are in the ON position.
9. Check each compartment breaker panel to assure that all breakers are in the OFF position except the main lighting circuits in each compartment, the freezer circuit in the equipment room, and the refrigeration circuit in the crew quarters.

10. Check the light switches to assure that all the overhead light switches are in the ON position and all others are in the OFF position.
11. Close the 10-inch umbilical penetration.
12. Close the main umbilical plates and check the bolt torques.
13. Close the stuffing tube penetration.
14. Close the main entry trunk and check the bolt torques.
15. Locate the chain fall and wrench in the wet room for use when the habitat is opened.
16. Check the condition of all batteries in the habitat.
17. Preposition all tools for startup of the environmental control system, communication cable installation, electric cable installation and packing, etc.
18. Remove temporary lighting equipment.
19. Exit via the scuttle and secure the scuttle tightly.
20. Close the pressure equalization valve.
21. Close the flood and vent valves in the base.
22. Connect the low-pressure air hose from the Bolstad-Lister compressor on the diver barge. Check the hookup for leaks to the umbilical plate.
23. Pressurize the habitat to 10 psig.
24. Submerge the Ammi barge in accordance with the predetermined plan (extended weather forecasts were obtained before beginning this phase of the emplacement).
25. Disconnect the low-pressure air umbilical at the quick disconnect on the habitat.
26. Add trim ballast as required for the habitat to float free of the Ammi barge with 15,000 pounds positive buoyancy.

The checklist for when the habitat was floating free of the Ammi barge resting on the bottom, the reserve buoyancy was 15,000 pounds, all umbilical cables at the emplacement site had been prepared for subsequent laying, and the control center on the support barge was operational was as follows:

1. Perform an external visual check of the habitat and the buoyancy tanks in the base for leaks.
2. Attach two lines to the tender boat; cast off the mooring lines from the habitat.
3. Tow the habitat to the emplacement site. The speed should not exceed 2 knots, and the sea should be calm.
4. Position the habitat over the emplacement site and secure it with nylon lines and downhaul winches. Continue quickly with events 5 through 12 to minimize time at the interface.

## PROJECT TEKTITE I

5. Attach low-pressure air to the umbilical quick connect.
6. Pressurize to 20 psig.
7. Check the buoyancy.
8. Perform a visual check of the habitat and base for leaks.
9. Attach winches between the habitat base and the anchors.
10. Divers haul down on the comealongs until the habitat is on bottom.
11. Open the flood and vent valves to the ballast tank in base.
12. Connect the base to the anchors and check the connections.
13. Disconnect and return the winches (or comealongs) to the surface.
14. Blow the umbilical trunk.
15. Blow the main entry trunk.
16. Shut off the low-pressure air at the surface.
17. Perform a visual inspection for leaks, anchor tightness, base location, etc.

The checklist for when the habitat was sealed, pressurized, secured to the sea bottom 49 feet deep, negatively buoyant by 20,000 pounds, and low-pressure air had been connected but there was no flow into the habitat was as follows:

1. Two divers from the surface perform visual inspection of the habitat.
2. Divers open the pressure equalization valve in the crew quarters.
3. Open the scuttle and enter the habitat.
4. Read the O<sub>2</sub> sensors in the crew quarters.
5. Enter the wet room and remove the bolts from the entry trunk hatch.
6. Use the chain fall or hoist to raise the cover approximately 45 degrees.
7. With the hatch cover at approximately 45 degrees, lift the cover and push it back against the tank wall.
8. Secure the cover to the wall using the snap hook and remove the chain fall.
9. Use the shackle on the hatch cover to secure the cover to the wall bracket.
10. Remove the chain fall from its position over the trunk.
11. Install the diving ladder in the main entry trunk.
12. Close the scuttle and secure it, replace the floor cover over the scuttle, and replace the carpet over the hatch.

13. Close the pressure equalization valve.
14. Start the low-pressure air from the diver barge compressor on the surface.
15. Open the 26 emergency air cylinder valves.
16. Open the valve to the high-pressure air inlet line.
17. Secure the electrical cable to the strain relief fitting on the base.
18. Enter the habitat and connect the electrical umbilical from the inside.
19. Connect the electrical umbilical to the bulkhead fitting with the umbilical plate raised.
20. Perform a resistance check.
21. Energize the habitat by starting the generators on the support barge and closing the breaker to the electrical umbilical.
22. Perform a visual inspection (lights on in the habitat).
23. Start the CO<sub>2</sub> scrubber.
24. Switch the mass spectrometer off battery power and on the main power.
25. Remove the plug from the stuffing tube in the umbilical plate.
26. Insert the end of the communications cable through the stuffing tube.
27. Connect the cable pull ring to the preplaced line from the equipment room.
28. Pull the communications cable into the habitat until the white line appears at the top of the stuffing tube.
29. Position the packing in the stuffing tube.
30. Tighten the gland nut on the sleeve and packing.
31. Secure the strain relief of the communications cable to the base fitting.
32. Secure the communications cable to the brackets in the equipment room.
33. Strip off the waterproof end of the communications cable.
34. Connect the communications umbilical in the junction box. Energize the communications circuit by closing circuit breaker CB-4 of the breaker panel in the bridge.
35. Verify communications with the control center.
36. Start up and calibrate the mass spectrometer gas analyzer.
37. Connect the fresh water umbilical hose (quick disconnect fitting).
38. Open the water valve at the umbilical plate.

39. Connect the vent line to the disconnect fitting and strain relief.
40. Install the ladder in the wet room entry trunk.
41. Install the diver handrail in the wet room
42. Install the water level detector in the wet room entry trunk and wire it into the junction box.
43. Test the trunk water level detector.
44. Test the wet room water level detector.
45. Uncoil and deploy the preplaced habitat drain lines.

The checklist for when the habitat was secured to the bottom, the power was on and all umbilicals were connected, the habitat was opened and illuminated but final adjustments had not been made to the environmental-control, communications, or other systems, and the bottom complex had not been completed was as follows:

1. Emplace way stations.
2. Connect communications wires between the way stations and the habitat.
3. Operate the intercom between the way stations and the habitat.
4. Connect all underwater lights mechanically and electrically and verify their operation.
5. Emplace the underwater TV camera.
6. Connect the power and coaxial cables from the underwater TV camera to the habitat.
7. Operate the underwater TV camera.
8. Emplace the navigation aids.
9. Remove the protective covers from the windows.
10. Attach the shark cage at the entry to the habitat base.
11. Set up the location for transfer pots.
12. Perform a final check of the environmental control system by a functional test of all system elements: normal air, purge air, emergency air, scuba recharge, and built-in breathing stations.
13. Adjust the thermal control system by operating as required and making final adjustments to thermostats, reheaters, etc.
14. Verify all alarm system elements: bell from bridge, buzzer for gas analyzer power loss, and horn for wet room flooding.
15. Operate the gas analysis equipment.

16. Verify the communications system components: TV monitors, open mikes, all intercom stations including the way stations, sound-powered phones, entertainment radio, private phone, and entertainment TV.
17. Test the trunk flooding alarm.
18. Test the wet room flooding alarm.
19. Install the wet room flooding alarm including a connection to the audible alarm and power disconnect switch on the Ammi barge.
20. Test the wet room flooding alarm after the installation.

With the successful operation of all on-board systems the habitat was ready for occupancy by the aquanauts. Many of the tests and checkout steps previously described required their own detailed checklists, and considerable reliance was placed on written checklists. No unusual or unexpected problems were encountered during the checkout.

#### B10 SYSTEM CERTIFICATION

Leonard A. Melka, Naval Ship Systems Command,  
Submarine Ship Acquisition Project Office, Washington, D.C.

##### B10.1 Need For Material Safety Review

The Department of the Navy, as the lead agency in the multiagency Tektite I project, decided that to assure the maximum degree of safety of the four Department the Interior civilian aquanauts and to insure documentation of all appropriate features which might represent technological improvements in the growing field of ocean engineering, it would conduct a material safety review of the habitat and the associated support systems. Therefore, the Chief of Naval Research requested that the Commander, Naval Ship Systems Command, assist in the establishment of a material safety review board to determine the material adequacy of the habitat and its support systems. This responsibility was delegated to the Supervisor of Salvage, Code OOC, who subsequently passed it to the Deep Submergence Certification Group, code PMS381D, which has cognizance of material certification for safety of deep submergence vehicles manned by Navy personnel.

##### B10.2 Procedures and Criteria

By strict interpretation of existing directives Navy material certification of Tektite I was not required, since neither military nor civilian Navy personnel would occupy the habitat at any time during the 60-day saturation diving experiment. However, the Navy as lead agency was morally obligated to assure the same degree of material safety for the four non-Navy aquanauts as would be afforded Navy personnel. To do this a material review was conducted in accordance with Navy material certification criteria. The two documents used for guidance were NavShips 0900-028-2010 (Material Certification Procedures and Criteria Manual for Manned Non-Combatant Submersibles) and NavShips 0900-028-2020 (Pre-Survey Outline Booklet for Manned Non-Combatant Submersibles).

It was unfortunate that the decision for conducting a material safety review came so late in the Tektite I schedule of events. The material certification process for assuring people's safety is not something to be rushed through, and performing this task within the remaining time frame was a real challenge. Working the project under a high priority allowed the NavShips safety review board to cover a great deal of the normal certification process; however, even with this kind of priority it was soon evident that the

remaining time frame would preclude them from carrying out the full Navy certification effort. As a result the group was instructed to perform as much of the certification effort as was physically possible within the time remaining and to present a statement of the findings on the material safety conditions prior to the submerged operation.

An initial project familiarization conference was held on November 25, 1968, at the General Electric plant in Philadelphia, during which time a brief technical description of the habitat and its support systems was outlined by the General Electric personnel and a preliminary scope and schedule for the material safety review was established by the NavShips representatives. In addition, the NavShips representatives explained the Navy's procedures and criteria for noncombatant submersible certification.

A subsequent conference on December 6, 1968, was held in NavShips, Washington, D.C., to acquaint the technical personnel of NavShips and the Naval Ship Engineering Center with the design of the habitat and its support systems. NavShips noted that the primary emphasis would be to review all aspects of the habitat relevant to the scope for the material safety review; if time permitted the review would include the support barge systems which affect the safety of the aquanauts. The conference also established Table B4 by using NavShips 0900-028-2010 as a guide. The scope was designed to include all systems and components of systems of the habitat which through a noncatastrophic failure would affect the safety of the aquanauts. Another accomplishment of the conference was a review of NavShips 0900-028-2020 concerning its applicability and identification of the recordable evidence that could be submitted by the General Electric Company in support of the material safety review. The habitat and its supporting systems were designed, fabricated, and assembled by the General Electric Company using standard commercial methods of fabrication and testing. Also, General Electric documented all the areas of design, fabrication, and testing which they deemed necessary.

Following the conference on December 6, documentation was forwarded by the General Electric Company to NavShips for evaluation. The General Electric Company was most cooperative with NavShips in this effort. By submitting all of their documentation in the scope areas to NavShips according to the prescribed methods of NavShips 0900-028-2010, the time required for review was minimized.

As part of the review two on-site surveys of the habitat and support systems were conducted at the Philadelphia Naval Shipyard (December 19, 1968, and January 6, 1969). During these surveys the NavShips and Naval Ship Engineering Center personnel inspected the systems and components aboard the habitat and the support barge and talked with their General Electric systems engineering counterparts.

### B10.3 Material Deficiencies

As part of the material safety review, NavShips produced two reports of findings of the material deficiencies identified on the habitat and its support systems. The first report (Table B5) stated all of the material deficiencies identified prior to the departure on January 8, 1969, of the habitat and its support systems from the Philadelphia Naval Shipyard. This departure date was a very critical milestone in the review, because if there were any material deficiencies in the habitat which were of sufficient magnitude to stop the program or require shipyard facilities for correction, they had to be identified prior to the habitat leaving the shipyard. It was recommended by NavShips that the Chief of Naval Research correct the deficiencies noted prior to habitat occupancy. Admiral T. B. Owen, the Chief of Naval Research, directed the General Electric Company to take positive action to either correct these deficiencies, provide the necessary data requested, or conduct sufficient on-site monitoring, depending on the individual deficiency, and to have the actions approved by the Operational Project Director of Project Tektite I, Cdr. F. Looney.

16. Verify the communications system components: TV monitors, open mikes, all intercom stations including the way stations, sound-powered phones, entertainment radio, private phone, and entertainment TV.
17. Test the trunk flooding alarm.
18. Test the wet room flooding alarm.
19. Install the wet room flooding alarm including a connection to the audible alarm and power disconnect switch on the Ammi barge.
20. Test the wet room flooding alarm after the installation.

With the successful operation of all on-board systems the habitat was ready for occupancy by the aquanauts. Many of the tests and checkout steps previously described required their own detailed checklists, and considerable reliance was placed on written checklists. No unusual or unexpected problems were encountered during the checkout.

#### B10 SYSTEM CERTIFICATION

Leonard A. Melka, Naval Ship Systems Command,  
Submarine Ship Acquisition Project Office, Washington, D.C.

##### B10.1 Need For Material Safety Review

The Department of the Navy, as the lead agency in the multiagency Tektite I project, decided that to assure the maximum degree of safety of the four Department the Interior civilian aquanauts and to insure documentation of all appropriate features which might represent technological improvements in the growing field of ocean engineering, it would conduct a material safety review of the habitat and the associated support systems. Therefore, the Chief of Naval Research requested that the Commander, Naval Ship Systems Command, assist in the establishment of a material safety review board to determine the material adequacy of the habitat and its support systems. This responsibility was delegated to the Supervisor of Salvage, Code OOC, who subsequently passed it to the Deep Submergence Certification Group, code PMS381D, which has cognizance of material certification for safety of deep submergence vehicles manned by Navy personnel.

##### B10.2 Procedures and Criteria

By strict interpretation of existing directives Navy material certification of Tektite I was not required, since neither military nor civilian Navy personnel would occupy the habitat at any time during the 60-day saturation diving experiment. However, the Navy as lead agency was morally obligated to assure the same degree of material safety for the four non-Navy aquanauts as would be afforded Navy personnel. To do this a material review was conducted in accordance with Navy material certification criteria. The two documents used for guidance were NavShips 0900-028-2010 (Material Certification Procedures and Criteria Manual for Manned Non-Combatant Submersibles) and NavShips 0900-028-2020 (Pre-Survey Outline Booklet for Manned Non-Combatant Submersibles).

It was unfortunate that the decision for conducting a material safety review came so late in the Tektite I schedule of events. The material certification process for assuring people's safety is not something to be rushed through, and performing this task within the remaining time frame was a real challenge. Working the project under a high priority allowed the NavShips safety review board to cover a great deal of the normal certification process; however, even with this kind of priority it was soon evident that the



Table B4  
Scope for Material Safety Review

1. Pressure hull: two habitat cylinders, cupola, and tunnel.
2. Viewports: six hemispherical viewports and the flat windows of the cupola.
3. Hatches: normal egress, emergency egress (scuttle), and tube turn.
4. Inserts (penetrations): air, communication, electrical, and water umbilicals; sanitary line; and sea water lines.
5. Support framing and foundations: legs, base, and anchors.
6. Surface air supply and surface emergency air supply (backup).
7. CO<sub>2</sub> removal system: baralyme canisters.
8. Monitoring system: pN<sub>2</sub>, pH<sub>2</sub>O, pO<sub>2</sub>, and pCO<sub>2</sub>.
9. Diluent gas system: N<sub>2</sub>.
10. Emergency breathing systems: self-contained emergency air (built-in breathing system) and emergency and scuba charging air cylinders, and escape air bottles.
11. Contaminant removal system: charcoal filters (information only).
12. CO removal system: purge system.
13. Toxic and flammable material identification (information only): waste management and food and water supply.
14. Noncompensated equipment subject to implosion: six TV and movie cameras (interior and exterior), three TV picture tubes, lights (interior and exterior), and transfer (dumbwaiter) pots.
15. Four CO<sub>2</sub> fire extinguishers.
16. Communication systems: open microphones, intercom, and sound-powered phone; TV cameras and display units; and environment display console.
17. Accessibility to vital equipment, such as the emergency air system, and fire extinguishers, and the ease of opening the emergency escape hatch.
18. Habitat stability and buoyancy.
19. Electric power systems (normal or emergency): transmission cable; transformer box, distribution panel, and switch boxes; lighting systems; and fusing lineup (fault isolation).
20. Operating procedures.

Table B5  
Report of Findings of the January 6, 1969, Material Safety Review

1. Pressure Hull: The effects of sea water on the rubber expansion joint should be determined. Also, a daily survey of this joint should be made during the Tektite I operation.
2. Viewports: The hemispherical viewports have numerous defects in the Plexiglas which may cause failure after long-term loads. The viewports were never subjected to long-term loading nor can it be assured that all existing defects were present before the hydrostatic test. One of the viewports which contains the worst defects should be tested under long-term loading conditions similar to the Tektite I project conditions.
- 3-5. Hatches, Inserts, Support Framing and Foundations: Satisfactory.
- 6-13. Life Support Systems: (a) Proof should be provided that all high-pressure air and nitrogen cylinders have been hydrostatically tested and cleaned. The proof should include the test pressure, the test date, and the cleaning procedure. It was noted that the date on one air cylinder indicated it was tested in 1962. ICC requires retesting every 5 years. (b) Proof should be provided that the high-pressure umbilical line has been tested to 1-1/2 times the working pressure. (c) All high-pressure air and nitrogen piping should be hydrostatically tested to 1-1/2 times the working pressure. (d) Proof should be provided that all high-pressure regulator valves have built-in relief valves. (e) Tightness tests on all high-pressure piping systems should be completed. All leaks should be corrected and the systems retested. During the on-site inspection of January 6, 1969, leaks were noted in the high-pressure nitrogen system, and some test results indicated leaking in the air and nitrogen systems. For system pressure over 1000 psi the pressure-drop test should be a 24-hour test and the pressure drop should not exceed 1% of the test pressure corrected for temperature.
14. Noncompensated Equipment Subject to Implosion: The implodable items have only been tested to 1.25 times the working pressure. This does not meet NavShips criteria of 1.5 times working pressure for undersea habitats. Therefore all glass noncompensated volumes should be contained by a protective shielding for assurance of material adequacy.
15. Fire Extinguishers: Satisfactory.
16. Communication Systems: Information should be submitted on the operation and maintenance of the emergency battery for the alarm system. Information should include the load on the battery, how long the load is expected to be on the battery, and the charging characteristics of the battery.
17. Accessibility to Vital Equipment: Satisfactory.
18. Habitat Stability and Buoyancy: Satisfactory.
19. Electrical Power Systems: (a) At least one relay-operated hand lantern should be added to each compartment to come on automatically upon failure of power to the lighting system in the compartment. (b) The power failure mode should be analyzed to show that a power failure will not jeopardize the aquanauts. There is a standby generator but no spare umbilical cable or transformer. A casualty to the umbilical cable or one of the transformers will result in loss of power to the habitat.
20. Operating Procedure: Satisfactory.

Table B5  
Final Report of Findings of the February 11, 1969, Material Safety Review

- 1-5. Pressure Hull and Appurtenances: Satisfactory except for the testing of the hemispherical viewports and that the rubber expansion joint should have daily surveillance noted in the report of findings of January 6, 1969.
- 6-13. Life Support Systems: Satisfactory except for the items noted in the report of findings of January 6, 1969. The submittal of recordable evidence was incomplete. Detailed discussion of outstanding items follows labeled as in the previous report: (a) The hydrostatic strength testing criteria of the air cylinders at 5/3 times the maximum operating pressure per ICC Specifications is satisfactory, but PMS381D has not received the hydro strength testing history (pressure and date) and the cleaning history (procedure and date) of each air cylinder. (The high-pressure air system's maximum operating pressure is 2400 psi.) Even though ASME specifications do not require the nitrogen cylinder (six pack tubes) which are designed for 2400 psi working pressure to be hydrostatically strength tested, PMS381D believes that to insure material adequacy these cylinders should have been hydrostatically strength tested to 5/3 times the system's maximum operating pressure. (The nitrogen system's maximum operating pressure is 1100 psi.) Also, the cleaning history (procedure and date) of each of these nitrogen cylinders should be submitted. (d) The Air Products' letter did not contain a statement that the high-pressure air system regulators have built-in safety relief valves. Proof should be provided that these built-in relief valves do exist and are preset to relieve at 20% above the system's maximum operating pressure. (The high pressure air system's maximum operating pressure is 2400 psi.) The Air Products' letter did contain a statement that the nitrogen system regulators have built-in safety relief valves. The information is satisfactory, but proof should be provided that the relief valves are preset to relieve at 20% above the system's maximum operating pressure. (The nitrogen system's maximum operating pressure is 1100 psi.) (e) No data have been received on the tightness testing of the nitrogen system. These data are requested by PMS381D. The data received on the tightness testing of the high pressure air system is also incomplete. The leak test does meet the criteria of 24 hours and a pressure drop not exceeding 1% of the test pressure (the pressure drop was zero), but there was no correction for temperature. The following information should be submitted: Why there was not a temperature correction, a diagram indicating alignment of system for testing, and a description of the pressure gage which was used including its pressure increments.
14. Noncompensated Equipment Subject to Implosion: Satisfactory except for the items noted in the report of findings of January 6, 1969.
15. Fire-Fighting Provisions: Satisfactory.
16. Communication Systems: Satisfactory except for the submittal of information noted in the report of findings of January 6, 1969.
17. Accessibility to Vital Equipment: Satisfactory.
18. Habitat Stability and Buoyancy: Satisfactory.
19. Electrical Power Systems: Satisfactory except for the items noted in the report of findings of January 6, 1969.
20. Operating Procedure: Satisfactory.

The second report (Table B6) reported all of the material deficiencies of the habitat and its support systems identified and the status of each of the material safety review scope items given in Table B4. Furthermore, it was noted that there was only a partial submittal of recordable evidence to NavShips on the disposition of the earlier findings of Table B5. Also, NavShips requested results of the operational proof tests to the installed systems under actual environmental conditions, and these were never received.

The report of findings of February 11, 1969 (Table B6) was not forwarded prior to habitat occupancy, but instead a message was sent to report NavShips disposition. The message concurred with the Operational Project Director that no material deficiencies were uncovered to preclude operations as planned and that the habitat and support systems had been evaluated and were operational but recommended surveillance efforts as stated in the January 6 report.

#### B11 ENGINEERING EVALUATION OF HABITAT DURING OPERATIONS

J. B. Tenney, D. Withey, E. Batutis, R. Klammer, R. Swartley, and  
R. Cockfield, General Electric Company, Missile and Space Division,  
Philadelphia, Pennsylvania

##### B11.1 Introduction

The 60-day saturation mission in Tektite I ended on April 14, 1969. After the aquanauts had departed from the habitat, inspection teams from both the Navy and the General Electric Company began an engineering evaluation which preceded preparation of the habitat for final pullout. This section briefly describes this evaluation and is based on observations made inside and outside the habitat, interviews with the aquanauts, and recorded data collected during the mission.

##### B11.2 Structure

###### B11.2.1 Hull

The Tektite pressure hull was designed to be pressurized on the surface at full working-depth pressure. In the initial phases of the program this working depth was assumed to be 75 feet. However, as program definition improved, actual emplacement depth was determined to be 49 feet. For convenience, the hull structure was hydrostatically tested at an internal pressure of 50 psig. These tests were conducted at the fabricator's plant, where all hull penetrations were blanked off. The fully assembled habitat with all internal systems installed, the rubber crossover tunnel in place, and all Plexiglas viewing ports emplaced was pneumostatically tested at 28 psig in the Philadelphia Naval Shipyard. For safety this test was conducted at the bottom of the drydock during the night shift after the dock had been evacuated. No problems were anticipated, and none were encountered. Leak rates encountered during these preliminary tests were relatively low and were quickly stopped using permagum. After the habitat was delivered to the site at Lameshure Bay, a final leak test immediately prior to final pressurization revealed a small leak at the handwheel in the emergency escape scuttle of the crew quarters. The hand wheel spindle was repacked, and the leak was stopped. During the mission no leaks were detected in the habitat. A light coating of growth that built up on the structure during the mission was easily removed with a cloth. There was little evidence of rusting on painted portions of the habitat, and paint adherence was good.

### B11.2.2 Ports

In spite of the minor defects pointed out in Table B5, the six 2-foot-diameter hemispherical viewports performed well during the mission. There was no evidence of cracking, crazing, discoloration, or heavy growth buildup. Growth occurred slowly and was easily removed using a cloth. On two windows the aquanauts permitted growth to occur so that growth rates of various marine organisms could be determined. On these windows the aquanauts recorded growth rates of the colonies by marking the windows with ink. The eight flat-plate windows in the cupola also performed well, and there was no evidence of cracks, crazing, or growth buildup. At the end of the mission all windows were carefully cleaned before the precise date for removal from the water of the habitat was determined. To prevent marine organisms from building up again all windows were lightly coated with vaseline. This technique was effective in preventing further growth build-up. Bolts which held the flange rings securing the hemispherical windows were not painted prior to emplacement, and these bolts rusted considerably.

### B11.2.3 Access Openings

The cover to the 4-foot-diameter entry trunk providing access to the wet room remained open and bolted to the wall during the mission. The bolt holes for the flanged cover were therefore exposed to salt water dripping from the suits and the equipment of the aquanauts. These bolt holes rusted, and at the end of the mission it was necessary to retap many of the holes before the cover could be bolted shut.

On subsequent missions where open tapped holes in flanges or other structural elements are exposed to sea water, it is recommended that holes be cleaned and filled with threaded filler plugs set in paint or similar suitable protective material.

The 3-foot-diameter hatch in the crew quarters was normally closed during the mission. There was concern that a buildup of marine growth on the spindle of this hatch could interfere with proper functioning after 60 days. To prevent growth buildup the hatch trunk was blown dry at the beginning of the mission and was periodically inspected during the mission. No growth occurred in the hatch, and it functioned properly at the end of the mission.

### B11.2.4 Shark Cage

The shark cage at the habitat entrance was constructed so that its bottom did not rest directly on the sea floor. Consequently, there was no tendency for sand or other particles to accumulate inside the entry trunk. Some slight rusting occurred on the shark cage but not enough to constitute a serious problem.

### B11.2.5 Service Penetrations

Hull penetrations functioned properly and presented no problems. Growth buildup on quick-disconnect fittings was prevented by simply blowing the umbilical trunk dry. The stuffing tube used for the communication umbilical was not required to withstand a significant pressure differential, and there were no leaks. To eliminate the requirement for lines or cables passing through the main entry trunk a separate 10-inch umbilical trunk was provided in the wet room. This trunk was normally left open and was used for cables to underwater lights, underwater TV cameras, plankton samplers, and similar external equipments. This is considered to be a good feature of the wet room, and its use is recommended in subsequent habitat configurations.

## B11.2.6 Ballast

The steel punchings used for ballast in the Tektite base rusted slightly. There was some concern that these small punchings might in time rust together in such a manner as to make subsequent removal difficult. However, these punchings had been lightly coated with oil prior to delivery, and their subsequent removal presented no unusual problems. Cast-iron pigs used for trim ballast rusted considerably, but no unusual problems were encountered with the ballast. Steel ballast plates used to winch the habitat to the bottom did not experience significant corrosion, showed no evidence of shifting, and showed very little evidence of scour. On two of the four anchor plates scour at one corner was on about 3 inches, but in general these anchors were highly successful.

## B11.3 Umbilical Cables

Several characteristics of the umbilical cables are shown in Table B7. No problems were experienced during the laying of the large-diameter power cable and communication cable from the support barge using the simple unsophisticated reel stands and braking mechanisms. The smaller diameter water hose and high and low pressure air hoses and a small-diameter air return line used under certain conditions to permit continuous gas sampling from the habitat were easy to lay. All cables were stopped off at specially prepared strain termination fittings at both ends. A cable route along the bottom was surveyed in advance, and in certain areas where the cables were required to pass over coral heads, protection in the form of boards or lashings were provided.

Table B7  
Characteristics of Tektite I Umbilical Cables

Item	Outside Diameter (in.)	Dry Weight (lb/100 ft)	Wet Weight (lb/100 ft)	Buoyancy
Communications cable	2.5	279	92	Neg.
Fresh Water hose	1.125	31	6.4	Neg.
Electrical cable	2.1	390	250	Neg.
High-pressure air hose	≈1.25	44	10.6	Pos.
Low-pressure air-supply hose	≈0.687	64	47.6	Neg.
Low-pressure air-return hose	≈0.50	—	—	Pos.

During the mission the cable was periodically inspected along its length for any signs of chafing or damage. Marine growth was slight, and there was no significant chafing on any of the cables. At one point during the mission the water hose parted, causing the loss of considerable fresh water from the pillow tank on the support barge. The quick-connect fittings were simply reconnected and carefully observed in case of further trouble. However no further problems were encountered. The high-pressure air hose was observed near the end of the mission to be leaking small quantities of air through pinhole leaks. But this did present a serious or significant problem.

Recovery of the small-diameter cables was simple and straightforward. To recover the electrical cable and the communication cable a complex electromechanical cable puller with provisions for constant tension recovery was employed by the Navy. Recovery of these cables was a simple and straightforward task using this equipment, and total recovery occurred in approximately 1 hour.

## B11.4 Electrical Power Distribution Subsystem

### B11.4.1 General

The electrical power distribution subsystem operated satisfactorily during the Tek-tite I mission. No design deficiencies were revealed, and no failures occurred beyond those normally anticipated.

The average power consumption was 700 kW-hr per day, with the greatest variations from the average occurring during the early part of the mission (Fig. B58). The minimum daily consumption was 455 kW-hr, and the maximum consumption was 860 kW-hr. The daily variation in power is shown in Fig. B59, based on readings of peak power taken at 2-hour intervals through the day for the duration of the mission. The average power load, shown by the data points, varied from 26 kW during the night to 32 kW during the daylight hours, with an average of 29 kW. The peak power never at any time during the mission exceeded 38 kW, well within the design capacity of the electrical subsystem. The power required for lighting was less than anticipated, since the large viewing ports provided considerable light during the daylight hours. At night the lights were cut to a generally low level to reduce fish attraction, and individual lights were used as required.

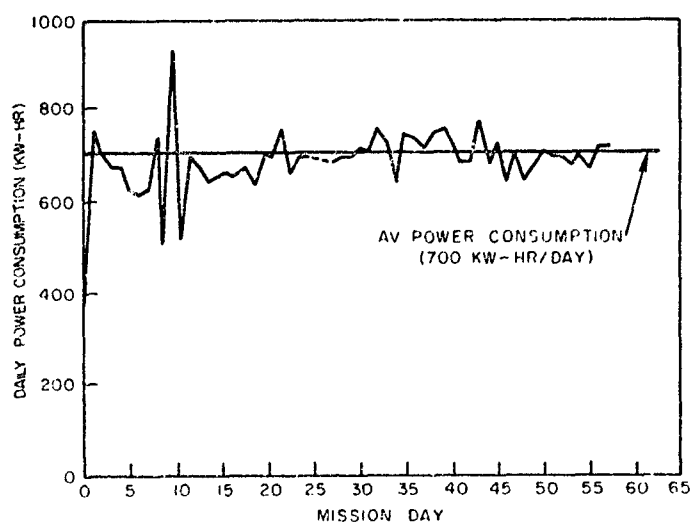

Fig. B58 - Daily power consumption

### B11.4.2 Underwater Lights

All of the underwater lights mounted externally on the habitat operated satisfactorily, and no bulbs required replacement. The lights were connected at receptacles in the wet room and passed through the 10-inch service trunk, so that it was necessary to make only a mechanical attachment to the habitat in the water.

### B11.4.3 Power Losses

Electrical power to the habitat was lost on five occasions during the mission, for durations ranging from 2 to 3 seconds to 13 minutes. Three instances of power loss for short durations occurred when switching from one generator to another. On one occasion

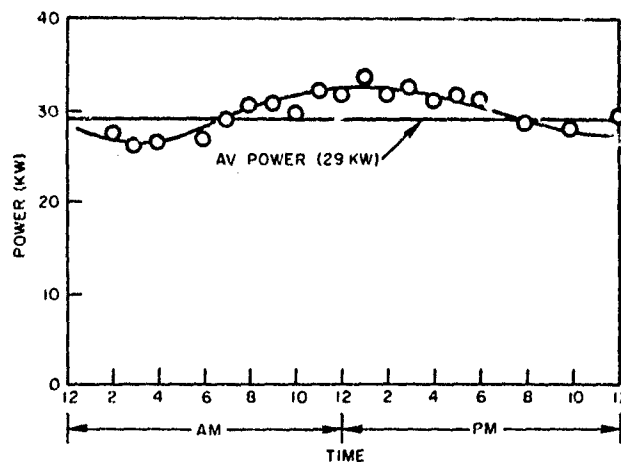

Fig. B59 - Average power load through the day

the generator shut down due to failure of a fuel pump, and on another occasion the power was interrupted by actuation of the wet room flood switch in error when a test of the entry trunk water level switch was called for. In every instance when the power loss was complete, the audible alarm sounded as intended and the battle lanterns operated automatically. Once power loss had occurred, it was necessary to shut down loads in the habitat so that the generator could be put back on the line, using a procedure similar to that used for the original startup of the habitat subsystems.

#### B11.4.4 Frequency Control

The frequency of the electrical power from the generators on the control barge was adjusted to a nominal 60 Hz but varied as much as 0.5 Hz about the nominal setting. The result was that electrical clocks in the habitat control center and in the habitat did not keep accurate time. A clock in the habitat lost approximately 1 hour during the first 28 days of the mission (approximately 0.1%), indicating that the average frequency was on the low side. It is recommended that chronometers be used to keep official mission times on subsequent missions.

#### B11.4.5 Bulb and Fuse Replacement

The frequency of replacement of fuses and bulbs in the habitat did not exceed that anticipated. The undercounter lights in the bridge and wet room were of a style that was not optimum for long bulb life, so that the bulbs in these fixtures required the most frequent replacement. The spares provided in the habitat were adequate.

#### B11.4.6 Unexpected Incidents

During the mission an aquanaut reported that the connector on the umbilical plate in the wet room was hot to the touch, suspecting a short. A review of the power consumption and the extent of the heating led to the conclusion that the heating was due to normal  $I^2R$  losses through the connector.

Early in the mission it was discovered that one of the heating elements in the oven had a faulty connection. It was surmised that the terminal connection had been loosened



during shipment and that the local high resistance had caused the wire to burn through. The wire was redressed by one of the aquanauts and the connection secured.

### B11.5 Environmental Control Subsystem

#### B11.5.1 Air Supply, Pressure, and $pO_2$ Control

The inlet air supply system (Fig. B6) was designed to supply a small (approximately 30 std cu ft/hr) air bleed into the habitat to both provide the makeup oxygen required and maintain the habitat atmosphere pressure in equilibrium with the water pressure in the entry trunk. The inlet air flow rate was varied during the mission in accordance with the  $pO_2$  of the habitat atmosphere. Increasing the flow rate would increase the  $pO_2$  and vice versa. Because of the long time constant involved, due to the large free volume of the habitat, the  $pO_2$  changed very slowly; thus frequent adjustments of the inlet air flow rate were not required.

Figure B60 shows the habitat  $pO_2$  plotted against mission time. In general, the  $pO_2$  was adequately controlled within the specified limits of 151 to 165 torr. The largest out-of-specification reading occurred on day 19, when the mass spectrometer indicated a  $pO_2$  of 170 torr (5 torr over the specified limit). However, at the same time the Servomex analyzer indicated a  $pO_2$  of 158 torr; hence this data point is questionable. Discounting day 19 the  $pO_2$  varied from a high of 166 torr to a low of 149 torr during the mission and was within the specified limits of 151 to 165 torr approximately 93% of the total mission time.

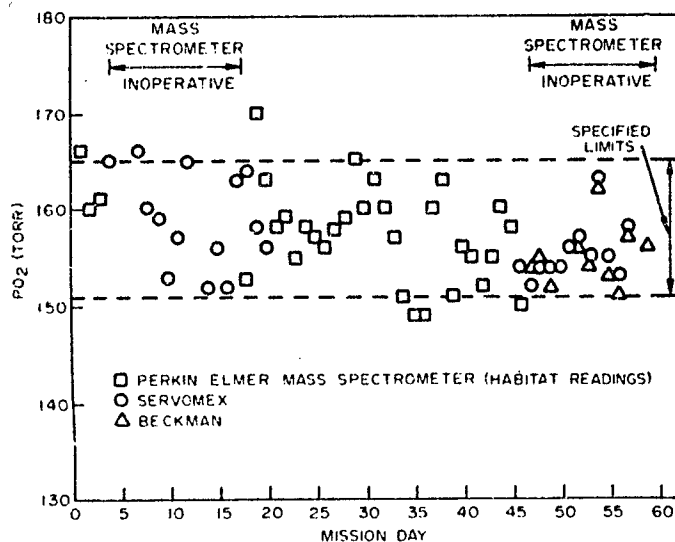

Fig. B60 - Daily oxygen partial pressures (read at 11:00 p.m.)

Calculations showed that the minimum inlet air flow required for  $pO_2$  control was more than sufficient to maintain the habitat pressure in equilibrium with the water pressure under conditions of rising tide or barometric pressure. This was verified by the water level in the entry trunk remaining relatively constant.

On two occasions, however, the water level in the trunk rose and tripped the high-level alarm, indicating a loss of habitat pressure. On the first occasion it was discovered that the valve on the end of the gas sample return line at the surface support center was inadvertently left wide open, thus bleeding air from the habitat at a relatively rapid rate. Adjustment of the valve to its normal, slightly opened, setting remedied the problem. The second occurrence resulted from starting up the air conditioning after it had been shut down for a period for repair. The air conditioning cooled the atmosphere and condensed water vapor, thus dropping the internal pressure rapidly. In this case, the aquanauts opened the scuba charging line and added compressed air to the habitat until the air temperature and humidity stabilized.

Prior to the mission the inlet air supply system was leak checked, using a halogen leak detector, soap bubble solution, and pressure decay methods. The system was also checked at several points for proper operation of the components (valves, pressure gages, flowmeters, compressors, etc), and the system as a whole was tested. The tests indicated the need for a dessicant filter upstream of the flowmeters, as condensed moisture was making the flowmeters erratic. A dessicant filter was therefore installed in the system on the surface support center. The dessicant was periodically renewed and regenerated by heating by the watch standers as part of their routine.

No problems were experienced with any components in the air supply system, except that one small air compressor became noisy and was replaced during the mission. This did not affect the inlet air flow in any way, since two air compressors were provided in the system with one redundant for this very contingency.

#### B11.5.2 CO<sub>2</sub> Scrubber

The CO<sub>2</sub> scrubber was designed to remove the CO<sub>2</sub> produced by the four aquanauts and maintain the atmosphere pCO<sub>2</sub> below 8 torr. The design air flow for the scrubber was 40 cu ft/min, and the design CO<sub>2</sub> removal rate was 2.25 lb/man-day.

The CO<sub>2</sub> removal system was tested prior to installation in the habitat. The system, consisting of the blower, baralyme cannister, and venturi flowmeter were connected to a pressure chamber and internally pressurized to 18 psig (equivalent to 40 feet of sea water). The blower circulated the air at 40 cu ft/min from the chamber through the flowmeter and baralyme cannister, which held 15 lb of baralyme and back to the chamber. CO<sub>2</sub> was added to the chamber at the rate of 9 lb/day, and the pCO<sub>2</sub> in the chamber and outlet of the baralyme cannister was monitored. Two runs were made with essentially identical results. Chamber pCO<sub>2</sub> remained constant at 1.5 torr for 7 hours. After 8 hours the pCO<sub>2</sub> in the chamber increased to 2.2 torr. The chamber pCO<sub>2</sub> reached 8 torr in 10.25 hours. Based on the test it was concluded that a change frequency of 8 hours for the baralyme would be sufficient to maintain the habitat pCO<sub>2</sub> below 8 torr.

During the mission, however, problems were experienced with the CO<sub>2</sub> scrubber from the start. The baralyme change frequency required to maintain a pCO<sub>2</sub> below the specified upper limit of 8 torr was 3 to 4 hours. The air flow through the scrubber was adequate; thus the problem was one of either inadequate canister capacity or overproduction of CO<sub>2</sub> within the habitat. In attempting to solve the problem the pCO<sub>2</sub> was allowed to exceed 8 torr on several occasions. Also, CO<sub>2</sub> fire extinguishers in the habitat were suspected of leaking and were removed. This helped some and allowed the canister change time to increase to 4 to 5 hours while keeping the pCO<sub>2</sub> to the 8 torr upper limit. Since this change interval was still too frequent, additional portable baralyme CO<sub>2</sub> scrubbers were obtained and installed in the habitat. Figure B61 shows the pCO<sub>2</sub> maintained in the habitat during the mission.

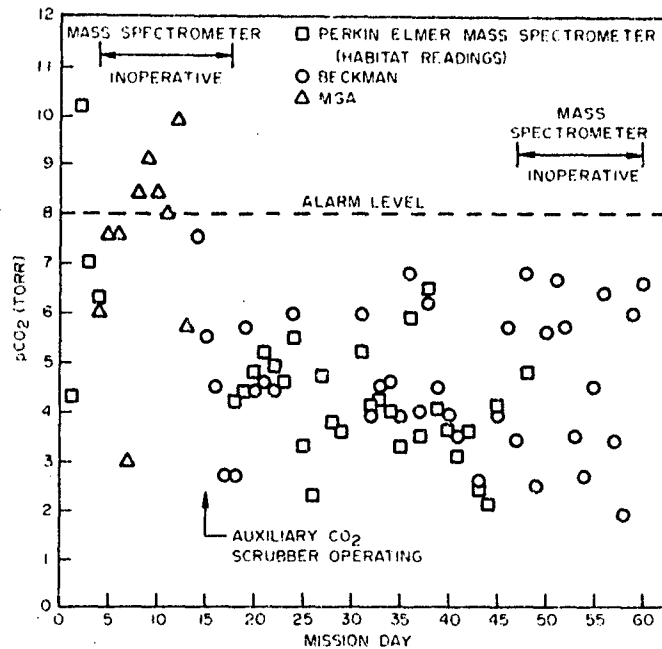

Fig. B61 - Daily carbon dioxide partial pressures (read at 11:00 p.m.)

The additional scrubber allowed longer change intervals; however, approximately 90 lb of baralyme per day was used to remove the CO<sub>2</sub>. Assuming an absorption efficiency of 15% (which is reasonable and is less than the 20% exhibited in the scrubber tests), 13.5 lb of CO<sub>2</sub> per day would be absorbed. Obviously, either the CO<sub>2</sub> production within the habitat was higher than the design value of 9 lb/day or the baralyme adsorption efficiency was very low or both.

Several lessons can be learned from this experience. First, it is highly desirable to test a CO<sub>2</sub> scrubber in the habitat chamber in which it is used and under actual operating conditions. Second, consideration has to be made of possible CO<sub>2</sub> sources other than metabolic within the habitat, such as cooking and plumbing vents. Investigation is required to determine the CO<sub>2</sub> production rates from these processes for use in determining a realistic design value for CO<sub>2</sub> generation. Third, some analytical and experimental work is required to study the absorption efficiency of baralyme and canister designs under conditions of varying total pressure. That is, the absorption efficiency of the baralyme, which theoretically should not be affected by total pressure, may be affected by such factors as retention time, mass velocity, and temperature of the bed, which are influenced by pressure. Optimum canister designs for hyperbaric use may therefore be different than those used at atmospheric pressure.

### B11.5.3 Thermal Control System

The thermal control system (Fig. B10) was designed to remove the total internal heat load from the habitat while controlling and maintaining comfortable air temperatures and relative humidity. The total maximum sensible heat load was estimated to be 68,400 Btu/hr. The latent heat load was more difficult to predict, due to the unknown influence of the open hatch and the wet equipment carried into the habitat. The approach was taken therefore of providing maximum dehumidification under all conditions of sensible heat load, minimum to maximum, by cooling the air in the heat exchangers, condensing out

the water vapor to maintain a relatively constant dew point, and adding reheat as required to maintain comfortable temperatures. During periods of maximum internal sensible heat load, little or no reheat is required. Since the heat rejection by the heat exchanger is relatively constant, however, as the internal sensible heat load decreases, reheat is added to maintain an even compartment temperature.

Each heat exchanger was designed for a total heat rejection capacity of 20,000 Btu/hr at an air flow of 260 cu ft/min, coolant inlet temperature of 38° F, and coolant flow rate of 4 gal/min. The nominal rating of the liquid chiller was 7 tons (84,000 Btu/hr). The chiller operated between 2/3 capacity and full capacity, without shutting off. This prevented any shut-cycling effects. The coolant used was a mixture of 25% ethylene glycol and water to guard against freezing.

A three-stage electrical reheater was selected for each heat exchanger loop. Cycling of the reheater was therefore in increments of 1/3 the total capacity, rather than completely on or off. This prevented shut cycling of the reheater with attendant rapid variations in compartment temperature. Each stage of the reheater was controlled by adjustable separate room thermostats set at 2° F differentials. Thus there were three thermostats in each compartment. The use of a single three-stage thermostat, which is the normal approach to a system of this type, could not be applied in this case, since the three-stage thermostats typically had either a mercury switch and/or a bellows rather than bimetallic control.

The thermal control system was tested at Valley Forge, at the Philadelphia Naval Shipyard, and at Lameshure Bay. The coolant system was leak tested by pressurizing and observing for coolant leakage. All components were checked out for proper operation, and the thermostats and temperature gages were calibrated and adjusted. The air flow through the heat exchangers was determined using a velimeter, and the dampers were adjusted to balance the system. Since the capacity of the heat exchangers depends on the total ambient pressure, the performance of the thermal control system could not be tested in a 1-atmosphere environment. Therefore, the system was not performance tested until the habitat was pressurized and emplaced.

After emplacement the controls of the liquid chiller were adjusted to compensate for the increased ambient pressure. Adjustment and recalibration was required on the operating temperature control, low temperature shutoff, and high and low pressure switches. The suction and discharge pressure gages were also recalibrated to allow use of standard charts for evaluation of evaporator and condenser temperatures. The refrigerant charge (Freon 22) was also checked. The system performance was then evaluated, and the air dampers were adjusted to balance the heat load in each compartment as required.

The performance of the thermal control system was rated as excellent by the aquanauts. Table B8 shows the temperatures and humidities maintained in each compartment. Since the air temperature was adjustable by the aquanauts, the values can be considered optimum for comfort under the Tektite I conditions. The total heat rejection by the system is shown in Figure B62, and averaged 66,500 Btu/hr. The only criticism expressed by the aquanauts concerning the system was the relatively high noise level in the engine room due to the air conditioning fans, pumps, liquid chiller, and CO<sub>2</sub> scrubber. However, although distracting, the noise was not serious enough to affect their performance.

Two problems were experienced with the thermal control system during the mission. The first occurred early in the mission, when condensate from the crew quarters heat exchanger was blowing up the air duct and dripping from the ceiling. The problem was fixed by propping up the duct at the exit of the heat exchanger to form a vertical slope, thus allowing the condensate to drain back into the heat exchanger and ultimately flow out

Table B8  
Compartment Temperature and Humidity at 11:00 p.m.  
(not valid as the daily average)

Compartment	Temperature (°F)		Relative Humidity (%)	
	Mean	Range	Mean	Range
Crew quarters	77.4	75-78	57.3	55-60
Bridge	81.2	75-85*	46.4	42-52
Engine room	78	76-80	55.2	50-60
Wet room	78	75-83†	50.3	42-58

\*The  $\pm 5^\circ$  F temperature deviation in the bridge is believed due to sensor movement.

†The  $\pm 4^\circ$  F temperature deviation in the wet room is due to the clothes dryer.

Fig. B62 - Heat rejection by the thermal control system in the habitat

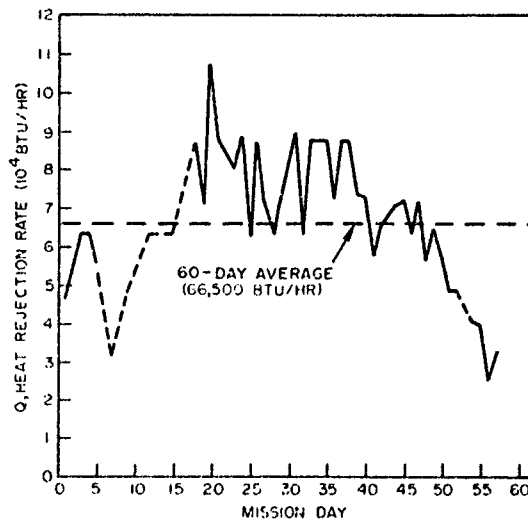

the drain in the bottom of the exchanger. The second problem involved failure of a flow switch installed in the sea water condenser line. The switch was a safety interlock provided to shut down the chiller if the condenser coolant flow stopped. The switch failed due to a leaking seal, which allowed salt water to enter and short out the switch. A spare switch of the same type was installed, which operated for about 2 weeks, when it failed in the same manner. A third switch, procured in the meantime from a different manufacturer, was then installed in the sea water line. No problems were experienced with the new switch. During the times the sea water switch was inoperative, the air conditioning system was kept operating by electrically bypassing the switch.

#### B11.5.4 Scuba Tank Charging Subsystem

The scuba charging system was originally designed to charge two 72-cu-ft scuba tanks to 2250 psi in 5 minutes, with a 1-hour recovery before charging two additional tanks. The original working pressure of the system was 2700 psi. However, the accumulator tanks provided for the system were rated at 2400 psi; hence the maximum

allowable working pressure was lowered to 2400 psi. Because this increased the bottle charging time, the procedure for charging was altered to include topping off the scuba tanks from the emergency breathing supply. The scuba compressors on the surface would then recharge both the scuba accumulator tanks and the small portion used from the emergency supply. This allowed rapid recharge of scuba tanks and did not seriously offset the emergency air supply, which was generously sized to provide 12 hours of emergency breathing.

The system underwent pressure and leak-tightness testing at 2700 psi. These tests were conducted pneumatically with air. As a note to future designers, this testing should include a hydrostatic proof pressure test of 1-1/2 times operating pressure, in this case  $2400 \times 1.5 = 3600$  psi, if Navy certification is required. (As was pointed out in section B10.2 it was not strictly required for Tektite I.)

The performance of the system was satisfactory. The scuba bottles were charged rapidly and conveniently. Topping the accumulator tanks with the surface compressor did not require an excessive amount of time. The first of two problems experienced during the mission occurred when the system was accidentally overpressurized with the compressors. This caused the safety relief valve in the habitat to open. Unfortunately the dust cap on the relief pot had not been removed, so that when the valve blew, the cap became a missile. Although no damage was done, the lesson from this experience is obvious.

The second problem occurred when the nut securing the charging chuck to the end of the flexible charging line loosened and eventually fell off as a bottle was being charged. The loose end of the line whipped around the wet room until the pressure was shut off. The choker cable provided at the end of the charging line which would have prevented the line from whipping had not been attached to the bottle. Luckily no one was injured. This experience points out both the need for and proper use of safety devices (the choker cable) and a deficiency in this particular charging chuck (the nut should not have come off in the first place).

#### B11.5.5 Emergency Systems

The surface emergency air supply was designed as a backup for the normal air compressors. The air supply was to last a minimum of 24 hours. All lines and piping were leak tested and subjected to a hydrostatic proof pressure of 1.5 times normal working pressure. Aside from checkout tests to insure the functioning of the components, regulators, valves, and gages the emergency air supply was not required to be used during the mission.

The purge system was designed to change 90% of the air within the habitat within 4 hours, requiring an air flow calculated to be 79 std cu ft/min. The main air umbilical was sized to flow 70 std cu ft/min at an inlet pressure of 100 psig. Following the air purge, nitrogen was added to dilute the atmosphere and restore an oxygen partial pressure of 156 torr.

The air compressor supplied for the purge system was a rotary, oil-flooded type. Filters were therefore required to remove any oil carryover as well as possible CO or NO<sub>2</sub> from the air prior to delivery to the habitat. The purge system was leak and pressure tested at 100 psi. The high-pressure lines of the N<sub>2</sub> system were hydrostatically tested to 1.5 times the working pressure. The purge system was checked out and observed to deliver air flows lower than calculated, 62 std cu ft/min at 95 psig. This increased the estimated time for a purge from 4 to 5 hours. This was considered acceptable, since an emergency built-in-breathing system was designed to last 12 hours.

The purge system was not required during the mission. However, prior to the mission  $N_2$  was added with the purge system to dilute the existing habitat compressed air atmosphere to the proper  $O_2/N_2$  level. No problems were experienced, and the quantity of  $N_2$  required closely matched predicted results. After the mission the habitat was purged with compressed air. The purge required 4 hours for completion and was stopped when the oxygen level approached 21%. This indicated the purge was more efficient than the predicted results, due to the conservative method of calculation.

The emergency built-in-breathing system was designed to provide four aquanauts with open-cycle demand breathing from a stored, compressed air supply for 12 hours. The gas storage system consisted of 23 279-std-cu-ft compressed air tanks in the base of the habitat. This supply could be supplemented by the scuba air accumulators and could also be recharged by the scuba compressors on the surface. The lines and fittings were leak tested but did not undergo the 1.5-times-working-pressure proof test necessary if Navy certification were required.

System performance was tested by instructing four men to breathe simultaneously from the system. The performance was very good, air flows were adequate, and the line size, regulators, valves, etc., were large enough to provide minimal pressure drop.

## B11.6 Communications Subsystem

### B11.6.1 General

The performance of the communications subsystem, which included the various alarms as well as the TV and voice links between the habitat, way stations, and surface control center, was generally adequate and met design requirements. The loss of one or more modes of communication and the incidences of false alarms that occurred during the mission were in most cases the result of human error or improper procedures. The few instances of component failure were within the frequency of occurrence anticipated for equipment of this type. In all cases where there was a loss of communications, backup systems provided alternate modes of communication to permit continuation of the mission without jeopardy. The experience of the Tektite I mission vindicated the degree of redundancy provided.

### B11.6.2 Effect of Hyperbaric Environment

An unexpected benefit of the hyperbaric environment was that the ambient noise effects on the open microphones in the habitat were significantly reduced over what had been experienced in operating at 1 atmosphere. Whereas the pressure assisted in squelching noise, the additional energy required to move air at hyperbaric pressure was detrimental to speakers in the same environment. As a result an amplifier substitution in the intercom system was necessary to provide sufficient volume. The increased audio level had the advantage of facilitating a link via radio to commercial facilities on St. Thomas.

### B11.6.3 Equipment Operation

#### B11.6.3.1 TV Cameras

The interior TV cameras provided a satisfactory video link during the mission. Adjustments to the cameras to obtain clear and steady pictures were made by the aquanauts to the extent practical, but on occasion it was necessary to transfer the camera via the transfer pot to a technician on the surface. On only one occasion was complete video contact with the habitat lost. During the 24 minutes required to restore a picture, contact with the habitat was maintained via the intercom.

Having the interior cameras easily accessible permitted the aquanauts to relocate the cameras as required. On several occasions it proved extremely valuable to have a camera located so that a particular gage could be monitored by personnel in the surface control center van.

#### B11.6.3.2 Underwater TV Cameras

Of the two underwater TV cameras furnished by the government for the Tektite I mission one leaked and could not be repaired in time to be used during the mission. The second camera was inadvertently damaged by exposure to a photographer's flash bulb and was available for only a short period during the mission. However, the lack of external video coverage of the habitat did not prevent achieving mission objectives. Adequate monitoring of the aquanauts' arrivals and departures from the habitat were provided by an internal camera, and observation from inside the habitat was more than adequately provided by the viewing ports and cupola.

#### B11.6.3.3 Alarms

The alarm to signal the rise of water level in the wet room entry trunk functioned as intended and provided a useful warning on a couple of occasions. On one occasion the valve on the air sampling line had been left open, allowing pressure in the habitat to drop.

All alarms were tested periodically throughout the mission. On two occasions the alarms failed to operate because of low battery voltage. This was attributed to the battery charger switch in the surface control center van being inadvertently placed in the off position. Corrective action was taken by placing the battery on fast charge.

#### B11.6.3.4 Sound-Powered Phones in the Way Stations

The most frequent difficulties in the communications subsystem were encountered with sound-powered phones in the way stations, since they were subject to accidental water immersion and most prone to failure due to improper handling. On one occasion none of the phones could be made to operate, and all were returned to the surface for inspection. Of the five phones two were found to have salt encrustment on the grids of the transducer units, indicating possible accidental immersion. The other three phones appeared to be operable, with no evidence of corrosion or marine growth. It was concluded that the apparent inoperable condition of these phones was due to failure to follow proper operating instructions.

### B11.7 Atmosphere Monitoring Subsystem

#### B11.7.1 General

There was very little real concern with atmosphere monitoring during the mission, even though the mass spectrometer (prime major gas analyzer) malfunctioned on two occasions. After the first occasion several additional backup instruments were obtained to monitor  $CO_2$  and  $O_2$ , so that when the second failure occurred, no effort was made to get the mass spectrometer back on the line.

The mass spectrometer used was originally designed for an aerospace application and was modified for Tektite I. This instrument still represents a most attractive method for major gas analysis by virtue of its continuous analysis, ease of calibrating, stability, versatility, and specificity. Several minor modifications to the same mass spectrometer will be required for future Tektite missions or for similar habitats. Its continued use was encouraged by the aquanauts during postmission debriefing.



During the two failures mentioned oxygen was monitored on board by the Mine Safety Appliance O<sub>2</sub> meter and two General Electric oxygen sensors. The carbon dioxide was monitored on-board by using the MSA universal test kit with hand pump and Part 85976 CO<sub>2</sub> detector tube. Both CO<sub>2</sub> and O<sub>2</sub> were monitored on the surface via the gas sampling umbilical using a Beckman O<sub>2</sub> meter, Servomex O<sub>2</sub> meter, and a Beckman CO<sub>2</sub> analyzer. An MSA Lira 300 CO<sub>2</sub> analyzer was delivered to the habitat as a standby backup but was never put into use during the mission. There were no particular problems encountered with any of these backup instruments other than those which would normally be experienced under atmospheric situations. In other words the Tektite I operating conditions did not impose any new problems in the use of the backup analytical methods.

#### B11.7.2 Trace Contaminants

Real care was taken to avoid contamination by trace contaminants, such as CO, hydrocarbons, and dusts. All materials, paints, equipment, chemicals, etc., were carefully selected beforehand. Painting was done well in advance of the mission, for example, to avoid any buildup of paint solvents. Some chemicals such as tagging paints and formaldehyde were taken into the habitat as part of necessary mission items, but care was taken to keep the potential spillage quantities low. Auxiliary charcoal scrubbers were also kept on standby to alleviate any spillage problem, but none occurred. Also, the 22 pounds of charcoal in the environmental control system was sufficient to take care of a large amount of contaminant.

Activated charcoal will take up to 20% to 50% of its weight of most odor-causing substances. Some reactive substances such as halogen acids, ammonia, and formaldehyde are not highly absorbed by charcoal but are taken up in sufficient quantity to be satisfactory. Gases such as CO<sub>2</sub>, CO, and methane are not satisfactorily absorbed by charcoal; however, the CO and methane were never found to be present at levels high enough to be of concern.

Particulate contaminants were not very much in evidence. The dust content before and after the mission was found to be quite low (< 0.1 mg/cu ft). However, baralyme dust was found on various surfaces in the engine room and wet room. Apparently this dust becomes airborne during baralyme canister changes and spillage. Vacuum sweeping of the work area after each baralyme change probably helped to hold this airborne dust down.

Prior to the mission the quality of the air was checked by running through about 20 color detector tubes in the MSA universal test kit (Table B9). None of the tubes showed any significant amount of contaminant. The same series was run after the mission, with a few exceptions, with similar negative results.

#### B11.8 Operations Data

The Tektite I daily logs were studied to identify trends developed during the mission which could be used in subsequent habitat design and operations. These essentially centered on how the habitat design promoted in-water time for the aquanauts or, put another way, how much attention the operation of the habitat required from the aquanauts at the expense of in-situ mission time. (This is distinct from the habitability investigation, which will be covered in Appendix C.)

Figure B63 gives the total aquanaut time spent in maintenance and repair activities during the 60-day mission. The shaded area is the time spent on night watch for the first 18 days of the mission. What is interesting about this plot is the magnitude of the time spent in habitat housekeeping and the extent of the break-in period. (The break-in

Table B9  
Detector Tube Analyses Before and After the Mission

Contaminant	Before	After	Detection Limit* (ppm)
Ozone	ND <sup>†</sup>	ND	0.05
SO <sub>2</sub>	ND	ND	1
Ammonia	ND	ND	10
Alcohols	ND	ND	25
Phosgene	ND	ND	0.1
Halogenated hydrocarbons:			
Group A	ND	ND	50
Group B	10 ppm	ND	10
Group C	ND	ND	10
Group D	ND	ND	25
Hydrogen sulfide	ND	ND	1
Chlorine, bromine	ND	ND	0.5
Hydrochloric acid	ND	ND	2
Nitrogen dioxide	ND	ND	0.1
Aromatic hydrocarbons	ND	ND	10
Butadiene, styrene	ND	ND	100
Acetaldehyde, formaldehyde	ND	ND	1
Diethyl-dimethyl sulfide	ND	ND	1
Ethylene, propylene, acetylene	ND	ND	0.5
Dimethyl sulfoxide	ND	ND	10
Organic nitrogen compounds	ND	ND	5
Carbon disulfide	5 ppm	ND	5
Lead in air	ND	ND	0.05 mg/m
Mercury in air	ND	ND	0.05 mg/m
Carbon monoxide	5 ppm	5 ppm	10
Carbon dioxide	0.5%	0.5%	0.01%

\*Based on 1 atmosphere pressure.

<sup>†</sup>Not detected.

Fig. B63 - Maintenance and repair time spent by the aquanauts

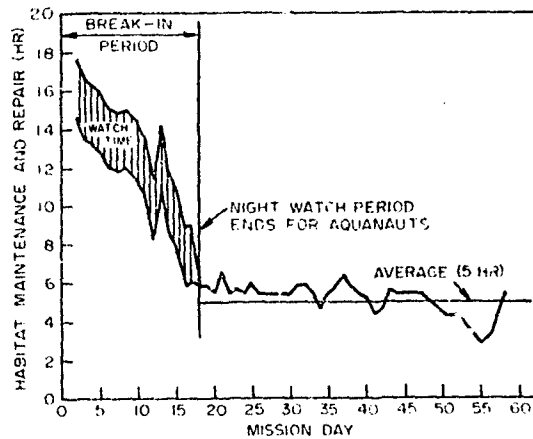

period is approximately twice as demanding on aquanaut time as the remainder of the mission.) It indicates that an aquanaut training period in the habitat prior to operations startup is essential to shorter missions (1 or 2 weeks). In fact during the postmission debriefing the aquanauts indicated a live-in premission period would have been profitable. The magnitude of the maintenance and repair curve suggests that a full-time habitat engineer to replace one of the marine scientists may not be warranted until a much greater degree of habitat autonomy, with its subsequent complexity, is achieved.

Establishing the degree to which this maintenance and repair activity limited water time is more difficult. However, in examining wet time the buddy pair which included the informal habitat engineer had approximately 1/2 the water time of the second team of divers. But it should be noted that this engineer-scientist also was prime topside communicator, and the demands of this function were almost as time consuming as habitat maintenance. This emphasizes the inherent inefficiency of pairing a scientist full time with someone serving as habitat engineer, and it is recommended that an engineer aquanaut for future missions rotate his spare time in teaming with the scientific investigators.

Examination of the program data also reveals the correlation of water consumption with diver excursions. Figure B64 gives water consumption as a function of mission date and shows the trend of increasing consumption with mission extent. Since most fresh water consumption resulted from showers, it is directly relatable to water excursions by the aquanauts. The graph indicates that this is correct and that water consumption correlates better with the number of excursions rather than total wet time.

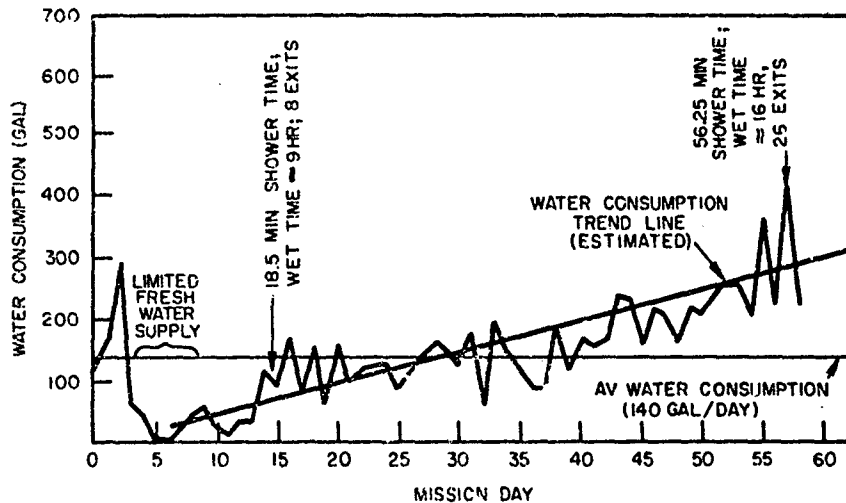

Fig. B64 - Habitat water consumption

### B11.9 Testing

With few exceptions all of the equipment and components used on Tektite I were tested thoroughly prior to starting the mission. More than 75 separate tests of components or subsystems were performed and documented, and a greater number of tests were performed informally by the engineer responsible for the subsystem.

For example the installation of the communications and electrical umbilical cables was required to take place on the bottom after the habitat was emplaced. Prior to emplacement these cables were connected in a dry run of the proposed underwater sequence by the people who would ultimately make the connections at the site. This simple informal test permitted the actual connection to be made in a smooth, routine fashion. Numerous similar informal tests were conducted, and it is recommended that maximum use be made of this technique in subsequent habitat designs.

Noise testing of the habitat during a scheduled live-in test at Valley Forge indicated that ambient noise in the immediate vicinity of the coolant flow pump was 74 dB (A scale on a General Radio sound level meter Type 1551-A). This level, although not harmful even for prolonged periods, was above the annoyance threshold and was considered highly undesirable. Consequently the noisy pump was replaced, new mounting provisions were made for several blowers fans, and sound insulation was placed behind metal panels covering environmental control system equipment. Subsequent noise testing was performed at the Philadelphia Naval Shipyard, where the ambient noise level surrounding the habitat was high (45 to 51 dB around the base). In this noisy environment the highest noise level in the habitat was 56 dB (adjacent to the coolant flow pump) and noise in the crew quarters was well below 38 dB.

Following emplacement the sound-level meter on board consistently recorded much higher levels, but this is attributable to increased pressure in the habitat. Noise was not a problem, and it was possible to speak normally at all locations except in the immediate vicinity of the equipment panel for the environmental control system.

It is recommended that in the design of subsequent habitats emphasis be placed on testing all components subsystems and systems using techniques that closely duplicate actual field service. It is also recommended that engineering personnel responsible for system design be employed in the testing and field installation of underwater equipments to the maximum possible extent.

## B12 FACILITIES WITHDRAWAL

Cdr. W. J. Eager and H. E. Hodge, Naval Facilities Engineering Command,  
Washington, D.C.

### B12.1 Introduction

Facilities withdrawal was in general the reverse of installation, but there were several notable exceptions. All wooden buildings in the base camp were left for use by the College of the Virgin Islands, as were sanitary facilities and the water supply system. The habitat launch system was not used to recover the habitat. Instead, the habitat was totally deballasted, and flexible pontoons were used to decrease the draft sufficiently to float the habitat directly into the LSD. The electrical power and communication cables were recovered using a powered reel drive in place of the stands used for emplacement.

### B12.2 Removal of Launch System

Instead of using the launch system in a reverse mode to raise the launch barge, four 8.4-ton rubberized-fabric Navy salvage pontoons were used to raise the barge a portion of the distance to the surface. This was accomplished as a test of the salvage pontoons and the inflation system, preparatory to later use on the habitat. The pontoons were attached to the deck padeyes previously used to constrain the habitat. The pile-mounted winch system and the 35-ton barge-mounted mobile crane were used to augment the lift. The launch barge was raised the remainder of the distance to its floating

position on the surface by the normal launch system. In this system a 600-cu-ft/min diesel-driven mobile compressor supplied air to the manifold on the crane barge. By suitable positioning of three-way and stop valves air could be routed individually to each of the barge compartments.

After the launch barge was completely dewatered, and gasketed cover plates were installed over the holes in the barge bottom, the vent-blow system was disassembled. Using the 35-ton barge-mounted mobile crane the winch mechanisms were removed from the piles. Using the crane and an attached pneumatic extractor the four cylindrical piles were removed. These, with the four barge moors, were lifted and loaded aboard the launch barge and returned to the causeway pier.

One stub of 20-inch pile protruded from the bottom. This one pile had failed at a welded joint rather than at the bottom surface when the first set of launch system piles failed. It was cut off well below the sea floor by placing concentric charges of C-4 and primacord at adjacent interior and exterior positions in the pile. Jetted anchors, used to spread the pile-position template, were extracted with a tripod tensiometer as part of an experimental test.

### B12.3 Removal of Support Barge

To remove the support barge the habitat systems were secured and the power communications umbilical were disconnected. The ends were waterproofed and lifted to the surface, where they were tied off to a replenishment system float. The habitat entry trunks were secured, and the habitat was pressurized to 20 psi. The water and air hoses were disconnected and recovered. The support barge end of the power and communication cables were disconnected and tied off to a float anchored near the support barge. Radio and TV antennas were removed.

The support barge was winched up to remove the load on the safety chains. The chains were then removed. The barge was lowered to a floating condition by winch payout of wire ropes on all four corners of the barge. The barge was lowered in 2-inch intervals. The piles were marked after each interval, so that differential lowering of barge corners could be detected and corrected.

The mooring lines from the support barge were then tightened, and the crane barge was used to remove hoist mechanisms and pile caps. Construction divers removed the guying system on the seaward legs. The piles were then lifted out of the spudwells and aboard the crane barge. The causeway tender boat was used to move the support barge to the causeway pier, and the crane barge, moved by an LCM-6, picked up the crane barge and support barge moors.

### B12.4 Deballasting and Removal of the Habitat

The habitat sewer outfall was disconnected and the habitat ports were covered with their protective cans. The habitat was monitored for leaks twice each day. Visual inspection as well as monitoring and replenishing of the pressure was accomplished. The pressure loss was approximately 2 psi per day from a hatch-handwheel packing gland. This leak, because of its location, and a pinhole leak in the rubber transfer tunnel, because of its size, posed no flooding problem.

The shark cages and doors were removed from the habitat base. The extra 25,000 pounds of pig iron ballast were thrown from the ballast trays and inside the base to the sea floor, where it would rust away. It was later neatly arranged to satisfy National

Park Service requirements. The turnbuckles holding the steel anchor clumps were replaced with the hand winches used previously for hauldown. The habitat ballast tanks were blown, using air from the diving barge compressors. With the habitat exerting about a 5000-pound force against the eight chain falls the habitat was winched to the surface. The two 1000-pound clump moors provided lateral constraint. The chain falls were removed when the habitat was at the surface.

The diving barge took the habitat in tow with a personnel boat in a towed trailing position. With divers monitoring the course for obstructions the habitat was moved to a protected cove nearer the causeway and on the east shore of the bay. The habitat was anchored with two 1000-pound anchors in a region where the ocean bottom was sandy and only a few feet beneath its base. It remained here, under surveillance for pressure leaks, until a few days before the LSD came to pick it up.

The habitat was to be transported in the well deck of an LSD which could ballast down to achieve a depth of water over sill of about 14 feet. The habitat base contained bins of steel punching ballast weighing 160,000 pounds. These punching were removed and disposed of overboard with an airlift and manually by divers to reduce the habitat draft to about 16 feet. Stability calculations indicated a metacentric height of about 1.9 feet for this condition. Six rubber collapsible salvage pontoons were symmetrically arranged and attached by divers to brackets on the base structure, three on each side, with the bottom of the pontoons about 7 feet above the keel of the habitat base. The pontoons were inflated with air, and the habitat rose to a draft of about 13 feet. Stability calculations indicated a minimum metacentric height of about 5.6 feet for this condition.

The habitat was taken in tow by a personnel boat with a second personnel boat in a trailing tow. The LSD stern gate was held into the bay by a fleet tug. The personnel boats towed the habitat directly aft of the open stern gate (Fig. B65). A light wind acted on the large sail area of the habitat to move it gracefully into a position where line handlers on the LSD could gain control of its movement and place it over cribbing installed on the well deck. The LSD was then deballasted.

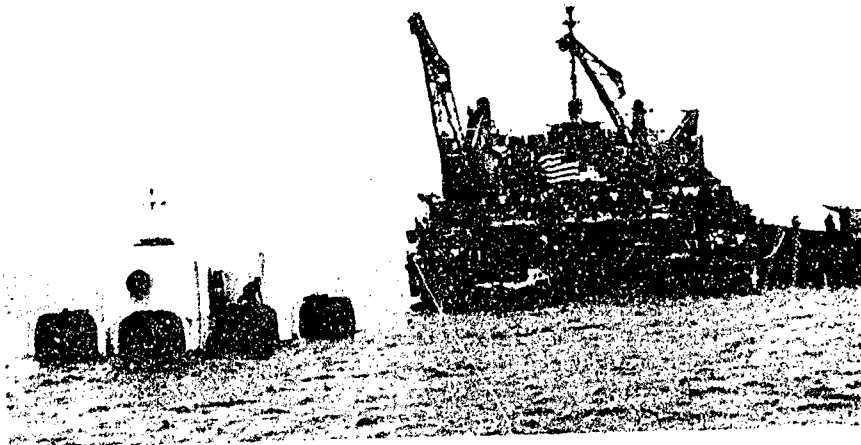

Fig. B65 - Habitat supported by salvage pontoons and being floated into an LSD well-deck for the return trip

With the support barge, crane barge, and causeway sections forward of it in the LSD well the habitat was transported to the Philadelphia Naval Shipyard. There it was hoisted out of the well deck using a high-capacity crane with belly bands placed under the ends of the habitat base (Fig. B66).

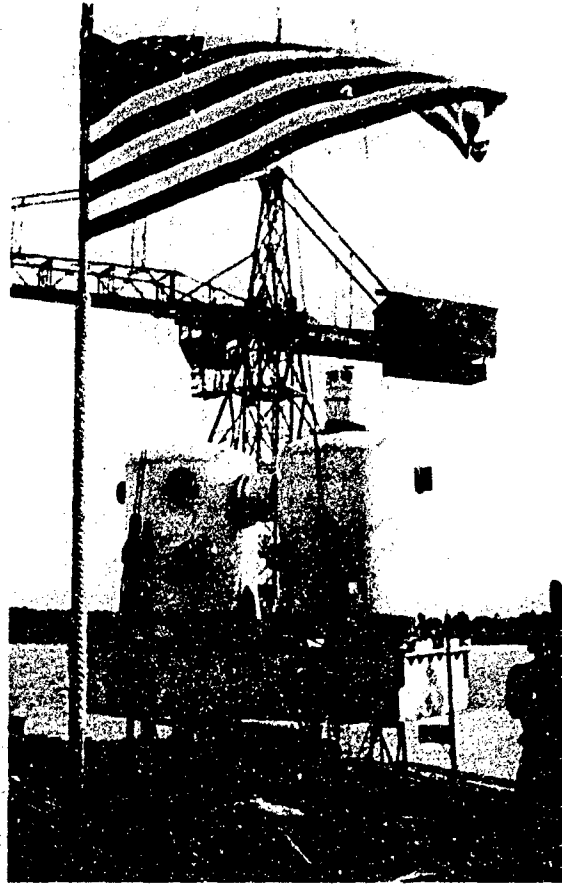

Fig. B66 - Habitat being lifted from the LSD well-deck upon return to the Philadelphia Navy Yard

#### B12.5 Removal of Umbilicals

While awaiting arrival of the LSD for transporting the habitat and other equipment the power and communications cables were recovered through use of the equipment used for laying, except that a powered reel drive was furnished by ONR. A 15-kilowatt gasoline-driven generator was used to drive the unit. Construction divers freed the umbilicals from coral heads as the barge was maneuvered over the circuitous path, and a combination of the reel drive and manpower placed the cables back on their reels. The circuit breaker for the reel drive disengaged occasionally, indicating that the generator was somewhat underrated for the job.

#### B12.6 Bottom Cleanup

After removal of the way stations, umbilicals, floats, sewer outfalls, moors, and anchors a task remained uncommon to underwater construction operations. Because this was a National Park, every unnatural object above and below the water line had to be

removed with the exception of designated base camp structures, the steel pigs left neatly piled at the habitat site, and steel punchings spread over and soon to be swallowed by the sandy bottom at the habitat holding site. This was accomplished by a formation of Seabee construction divers swimming a search pattern hand-to-hand. The coup de grace occurred when a Park Ranger (and former Navy man) became the proud owner of a 50-pound anchor overlooked in this search.

#### B12.7 Engineering Research Postscript

While awaiting ship arrival, evaluations were made on an underwater facilities component and an underwater laser-beam surveying system. Both are under development for Seabee use in underwater construction.

Seabees originated a concept for increasing the holding strength of jettied anchors. Cement slurry was injected through the anchor shaft by compressed air to bond the anchor cone to undisturbed sediment. Through use of this technique, static pullout forces in excess of 7000 pounds were achieved in coral sand from this inexpensive anchor.

The underwater laser-beam surveying system, in a preliminary evaluation during Tektite I, showed promise. Distances out to 30 feet were surveyed in spite of a visibility limit at the time of the test of 20 feet. Improvements in stadia rod design are required, and the laser unit must be made rigid before this system can be used operationally.

#### B13 THE TEKTITE I BASE CAMP

Lt. (jg) Gerard J. Fuccillo, Amphibious Construction Battalion Two,  
Norfolk, Virginia

##### B13.1 General Description

The Project Tektite I base camp (Fig. 4 on page 11) consisted of 13 Vietnam-type tropical huts (Fig. 39 on page 47) and one prefabricated aluminum building (Fig. 40 on page 48). The camp was inland from Great Lameshure Bay about 1 mile from the habitat site. It was complete with its own generators, water distribution and supply system, galley and freezer storage, toilets, showers, sick bay, laboratory, and bar. The base camp was built by a construction crew of 45 Seabees from Amphibious Construction Battalion Two in 3 weeks during November 1968.

##### B13.2 Buildings

Each typical hut of the base camp was constructed of wood treated against termites, redwood siding, and transite roofing (Fig. B67). The huts used for barracks were 16 by 32 feet and housed up to ten people. Eight people per barracks would have been more comfortable, although the number of personnel required for Project Tektite I precluded this. The galley was 16 by 48 feet and could seat up to 36 people. All of the 11 barracks plus the galley were fully screened and remained fairly cool with the addition of fans. The 16-by-32 foot OOD storage hut was insulated and air conditioned.

In the center of the base camp stood a 20-by-48-foot prefabricated aluminum building supplied by Naval Facilities Engineering Command. This was a relocatable commercial-type structure which was being evaluated for future use in Vietnam. This building was divided into three sections: sickbay, marine science laboratory, and recreational lounge (bar). All interior partitioning, shelving, and furnishings were built by the Seabees on site. The marine science laboratory housed the aquanauts before and after their underwater venture.



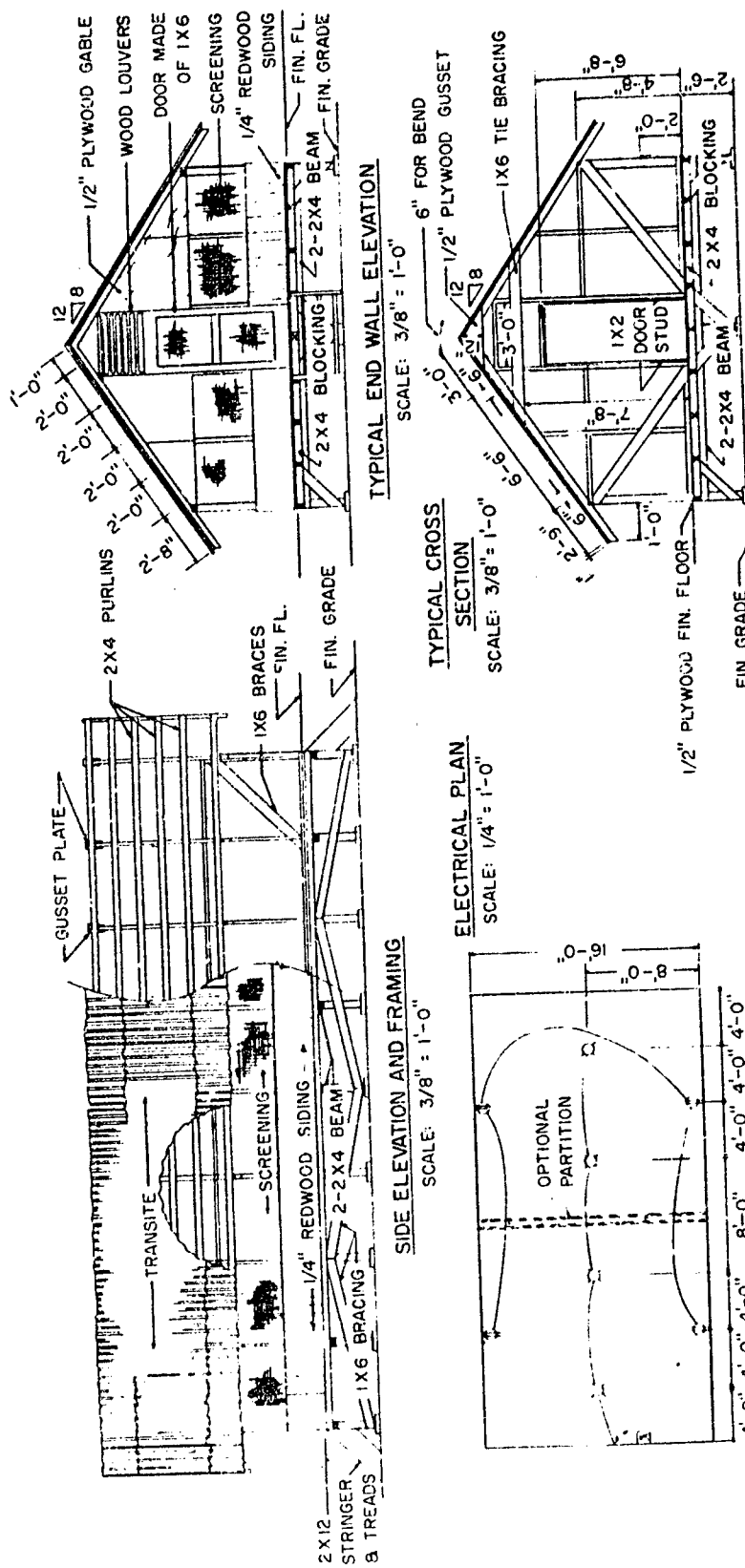

Fig. B67 - Hut construction

### B13.3 Water Systems

The base camp had two water systems: fresh water and slightly brackish. Fresh water was stored in two 10,000-gallon bolted steel tanks emplaced mostly below ground level (Fig. B68) and filled on a weekly basis by a water barge through 1500 feet of 4-inch invasion piping which connected the tanks with the causeway pier on the beach. Water from the tanks was pumped to the galley and laboratories. The slightly brackish water came from a well just north of the base camp and was used to supply water to the showers and lavatories. This water was not potable and was used for washing purposes only. Sanitary facilities in the base camp consisted of one eight-man shower with four lavatories and two four-man burnout toilets.



Fig. B68 - Water tanks

### B13.4 Electrical System

The base camp was powered by two Fermont 100-kilowatt generators, which were alternately used. These generators were more than adequate, since the power consumption of the camp varied between 20 to 30 kilowatts. Three overhead power lines were strung throughout the camp to make up a 220-volt, three-wire system. By tapping a pair of these lines, either 110 volts or 220 volts could be supplied to each building in the camp.

### B13.5 Causeway Pier

Although not a part of the base camp the causeway pier (Fig. 38 on page 47) was essential to its construction and operation. All materials and equipment used for the construction phase of the project were initially brought to St. John loaded on this floating pier. Anchored with a TD25 bulldozer on the beach and two 500-pound anchors seaward, the causeway pier provided the necessary pier space for all waterborne craft arriving at the project and was also used as a helicopter-landing platform. The pier was assembled from three standard pontoon causeway sections each 21 by 90 feet. Each causeway section is made up of 45 individual pontoons, which makes it unsinkable. Pontoon causeways are normally deployed by Amphibious Construction Battalion Two as part of an amphibious assault force.

### B13.6 Base Camp Operation

The base camp provided food, berthing, and transportation for up to 80 military personnel and 40 civilians attached to Project Tektite I. The galley operated as a Navy-commissioned general mess, and all food was purchased through Navy channels. Frozen food was requisitioned through the Navy supply system and delivered to St. John by various ships in the area. Fresh food and other supplies were locally purchased through Navy blanket-purchase agreements with S.A.L. and Quality Foods, Inc., in St. Thomas.

Water was supplied by the Public Works Department of the Virgin Islands government at no cost to the Navy and was delivered by water barge on a weekly basis. The water consumption for the base camp was about 20,000 gallons per week, although it is felt that almost half of this figure was lost due to leaks in the tanks.

Diesel fuel and gasoline were procured through government contracts with The West Indian Company, Ltd., and The Caribbean Merchandising Corporation respectively. Deliveries were made by tank truck to the National Park Service pier at Red Hook, St. Thomas, where the LCM-6 boat from the base camp would meet it with empty drums. Diesel and gas consumption for the project were 2200 gallons per week and 500 gallons per week respectively.

Transportation to and from the project was provided by Navy boats and trucks attached to the base camp. Boats were run from Lameshure Bay to the National Park Service pier at Red Hook, St. Thomas, twice daily. Trucks were run from the base camp to Cruz Bay, St. John, also twice daily.

The 46 personnel required for the operation of the base camp are listed below. The number and rates of the personnel represent an ideal crew which would have operated most efficiently and does not represent the actual short-handed crew used on site. The crew is for base camp operations only and does not include watch standers and maintenance personnel for the support barge, crane barge, and habitat.

1. Base camp staff: one Lt. (Jg) base camp commander, one CWO4 maintenance officer, one CPO chief master-at-arms, one YN3 yeoman, two RM3 radiomen, one SK2 logistics petty officer in St. Thomas, and three EO3 truck drivers.

2. Base camp maintenance: one EO2 leading petty officer, two BU3 builders, and four CN/SN non-rated workers.

3. Equipment maintenance: one CM1 leading mechanic, two CM2 mechanics, two UT3 utilitiesmen, two CE3 electricians, and two SW3 steelworkers.

B114

PROJECT TEKTITE I

4. Galley operation: one CS1 leading cook, one SK3 storekeeper, two CS3 cooks, and four CN/SN messcooks.

5. Waterfront and boat operation: one BM2 leading boatswain's mate, three BM3 coxswains, one EN2 engineman, two EN3 enginemen, one FN fireman, and four SN non-rated workers.

## Appendix C

### SUPPORTING ACTIVITIES

**C1 COMMUNICATIONS, LOGISTICS, AND TRANSPORTATION**  
Cdr. F. L. Looney, Naval Administrative Command, Great Lakes,  
Illinois, and Ocean Science and Technology Division, Office of  
Naval Research, Washington, D. C.

#### C1.1 Communications

##### C1.1.1 External Communications

External communications were by radio, telephone, and Virgin Islands communications.

Two AN/PRC-47 radios located in the base camp and the support barge maintained a 24-hour watch on 2114 kHz. Primary contact was the Navy representative at the Coast Guard Station, St. Thomas; however, that station was only manned during normal working hours. The Navy Radio Station at Ft. Allen, Puerto Rico, maintained a 24-hour watch on this circuit as well as ships in the area. This circuit was unreliable to both stations.

The Virgin Islands Telephone Company (VITELCO) installed two telephones in the base camp, which required them to run lines about 5 miles to the nearest terminal. The installation was complete February 15, 1969. These telephones were the primary means of communication for Project Tektite I. Most message traffic was called to the Navy radioman at the Coast Guard Station, St. Thomas, who forwarded traffic by teletype. Telephone service was sporadic and frustrating. No records were kept; however, the telephone service was out of commission about 15% of the time. When in commission the service was poor and the circuits were noisy or weak.

Radiotelephone service was leased from the Virgin Islands Communications Company by General Electric Company and placed on the support barge. The system consisted of a radio patch service located in St. Thomas connected with the VITELCO system. This was more reliable than the telephone lines on St. John; however, it was secured at 9:00 p.m. each evening.

The Park Service furnished a portable radio capable of contacting the local ranger station. This circuit was of little use.

##### C1.1.2 Internal Communications

Internal communications consisted of radio, field telephones, intercom units, and sound-powered telephones.

Two radio circuits were manned on a 24-hour basis for internal communications. AN/PRC-47 radios were located in the base camp, support van, and all LCPL boats, tuned to 4073 kHz. This was strictly an internal net for general and emergency communications. This net was very effective though noisy in the support van. Motorola PT-200 walkie-talkie radios were used in the 39-MHz range primarily to connect the watch

director with the diving supervisor and safety diving boat. Additional sets were used on an as-available basis by the base camp and project director. These sets proved very reliable; however, on one frequency severe interference was encountered from as far away as New Mexico.

Field telephones were used between the causeway and the base camp office. They were usually reliable and were useful for coordinating water deliveries and transportation requirements to the causeway. An additional field telephone was used as a backup to the PT-200 radio communications between the support barge and the crane barge.

Primary communications with the habitat was by installed intercom units located in the support van and bridge area of the habitat with stations in each compartment. Monitoring of any of the habitat compartments was possible via this circuit; however, monitoring was not routinely employed. This system ended up in a jury-rigged mode that was barely acceptable due to inability of technical personnel to effect repairs in the habitat.

Sound-powered telephones provided backup communications for the intercom system. The two-sound-powered telephone circuits were both located in the support van and terminated at the habitat end in the crew quarters and the bridge.

## C1.2 Logistics

### C1.2.1 General

The remote location of Tektite I created a difficult problem in logistic support. There was no regular Navy support short of Roosevelt Roads Naval Station. Limited commercial support was available in St. Thomas, but no support was available in St. John. The route to the nearest harbor in St. Thomas covered 8 miles of unmarked and unlighted waters, most of it being open sea from at least one direction (Fig. 41 on page 49). All supplies had to be brought in by boat. Visiting ships to Lameshur Bay and Charlotte Amalie were used to the fullest when available.

### C1.2.2 Provisions

An initial supply of provisions to last approximately 1 month (except fresh) was landed on arrival January 13, 1969. Resupply of fresh provisions, bread, and milk was procured from local vendors in St. Thomas on contract executed by the Supply Officer, Naval Station, San Juan. Frozen and dry stores were obtained from visiting Navy ships. Due to Operation Springboard a plentiful supply of visiting ships was always available in St. Thomas.

### C1.2.3 General Stores

An initial supply of general stores was landed on arrival. Resupply was from visiting ships and by open purchase on the local market. A small revolving cash fund of about 500 dollars would have been a great help for these items.

### C1.2.4 Fuel

Fuel was obtained by Defense contract with local petroleum dealers. Diesel and gasoline was loaded into 55-gallon drums at Red Hook and transported by an LCM to the site. Diesel deliveries were made at least weekly.

### C1.2.5 Water

All potable water for the camp was supplied by the Virgin Islands government. Delivery was effected by tug and barge from Charlotte Amalie. Initial deliveries were at 2-week intervals; however, due to a casualty to one water tank, weekly deliveries became necessary. Potable water for the habitat was initially delivered by pillow tank aboard an LCM; but since this was tedious, a local water-delivery company was then employed. The water delivery truck had its own gasoline-powered water pump, which required about 25 minutes to deliver 1500 gallons of fresh water. The truck was driven into the LCM, and the whole delivery took about 1 hour as compared with several hours by pillow tank.

### C1.2.6 Mail

The official mailing address for the project was in care of the Postmaster, Charlotte Amalie. The postmaster maintained a special box for Tektite I mail, and relations with the post office were excellent. In general air mail service was good; however, unexplainable instances were prevalent in which an inordinate delay was encountered. Surface mail service was very poor. Air mail was generally more reliable than air freight.

### C1.2.7 Repairs and Miscellaneous Services

Through funds placed at his disposal by the Supervisor of Salvage, SupShip 10 performed a myriad of functions for Tektite I. Repairs to boats and electronic equipment, services of a electronic technician on site, and procurement as well as delivery of miscellaneous supplies comprised most of these services. The effort of SupShip 10 was outstanding at all times.

## C1.3 Transportation

### C1.3.1 General

Transportation of men and materials to the site normally was by a combination of air, water, and land modes. In all cases getting to and from the site was a chore that meant putting up with poor and infrequent schedules, rough water, rough roads, canceled or late flights, lost baggage, and boat breakdowns. Air freight had a tendency to become lost in one of several air freight offices.

### C1.3.2 Air

Commercial air transportation from the continental United States direct to St. Thomas was available from Miami and New York. Other flights either stopped or made connection with other carriers in San Juan. No regularly scheduled military flights were made to St. Thomas except for a biweekly Coast Guard logistic flight from San Juan. There is no air field on St. John. Military air service terminated at Roosevelt Roads and Ramey Air Force Base in Puerto Rico. Commercial air freight had a tendency to be side-tracked in San Juan, John F. Kennedy, and Miami cargo terminals. The most reliable way to ship supplies or parts was to check them as baggage and personally escort them to the site.

### C1.3.3 Water

No regularly scheduled Navy water transportation existed to either St. Thomas or St. John. Roosevelt Roads Naval Station sent YFU type vessels to the site on request, and the Supply Officer, San Juan, effected a few shipments via commercial steamship line. Water transportation from St. Thomas to the site was furnished by Tektite I boats. The Tektite I boat fleet consisted of: one LCPL Mk 1 for personnel and light cargo, one

LCPL Mk 4 for personnel and light cargo, one LCPL Mk 11 for personnel and light cargo, one LCM Mk 6 for cargo, one LCM Mk 9 for cargo and use as a causeway tender boat, and two 18-foot outboard runabouts for safety diving boats. Several ships were diverted to Lameshur Bay to deliver miscellaneous supplies.

#### C1.3.4 Land

Vehicle transportation was furnished by Amphibious Construction Battalion Two and consisted of: one 6 by 6 truck for general use in the base camp, two 4 by 4 ordnance carriers for general use in the base camp and transportation on St. John, and one 4 by 4 ordnance carrier for cargo and transportation in St. Thomas. In addition, one jeep was rented from a local agency for use on St. John.

The trip to Cruz Bay, St. John, from Lameshur took about 45 minutes by jeep and 1 hour by 4 by 4 over a rough and winding road on which four-wheel drive was a necessity. The trip from Charlotte Amalie to Red Hook was usually about 30 minutes, depending on traffic conditions.

## C2 AQUANAUT SAFETY

Lt. (jg) Joseph J. McClelland, U.S. Coast Guard Headquarters, Washington, D. C., and Richard Waller, Bureau of Commercial Fisheries, Department of the Interior, Washington, D. C.

### C2.1 Introduction

The safety of the Tektite I aquanauts was a primary factor throughout the planning and operational phases to both the aquanauts themselves and to the surface watch director and the surface diving watch. Comprehensive safety procedures and emergency bills were formulated in accordance with the U.S. Navy Diving Manual to insure coordinated, quick response by the surface watch to meet any situation. The aquanauts did not follow as regimented a routine but were always motivated by their concern for the welfare of their diving partners and themselves and by a desire to successfully complete the 60-day mission.

### C2.2 Aquanaut Safety Procedures

Before each excursion away from the habitat the aquanaut team would discuss their objective and one of the members would be designated the lead diver for that excursion. The team leader would outline the dive plan and effect any changes during the dive. After the dive plan had been formulated, the team leader would inform the surface support personnel which quadrant they would be working in, how far away from the habitat they would travel, and approximately how long they would be out. If they were to make a long excursion away from the habitat, they could ask the surface support divers to place additional air bottles at a designated location. It was the responsibility of the lead aquanaut to confirm the placement of these bottles before leaving on the dive. Failure to confirm a requested deployment of additional air bottles before one excursion dive resulted in the only emergency request for aid from surface support divers by the aquanauts.

After informing the surface support personnel of the dive plan, the aquanauts would suit up. The gear normally worn was: a full 3/16-inch wet suit, a faceplate, fins, two 72-cubic-foot scuba bottles, two single hose regulators, a sea-vue pressure gage, a weight belt, a watch, a compass, a depth gage, an emergency float, and a diver's knife. Each of the 72-cubic foot bottles had its own regulator; one of the bottles also had a sea-vue pressure gage connected to it. Using this system the aquanauts were provided



with four complete breathing units for each buddy-pair. If one unit were to fail, they still had two units to use with one backup available.

In addition special equipment was available for night dives or excursion dives. This included: sonic pingers and direction-sensing receivers for navigation, strobe lights which attached to the scuba bottles to enable the surface support divers to track the aquanauts at night, bang sticks to protect divers from sharks, battery-powered underwater lights, and emergency floats, each with a strobe light attached.

After the aquanauts were suited up, each checked his gear and then checked his buddy's gear. They then confirmed their dive plan with the surface and proceeded to dive as soon as they were told the surface support divers were in position and ready to follow them in the surface support boat.

The general rule during the first part of the mission was that the team would go out and work until they were down to the reserve on their first tank. They would then switch to the second tank and proceed back to the habitat. Later in the dive, after the aquanauts had become familiar with the topography and the distances of various landmarks from the habitat, this rule was relaxed to the extent that if they were within 400 to 600 feet of the habitat, they could work off the second tank until the sea-view gage indicated approximately 1000 pounds in their second tank, with both reserve supplies intact, before proceeding to the habitat.

Although working dives were conducted during the night as well as during daylight, the navigational aids used were similar. If the aquanauts were going to stay on the reef, they navigated by compass, but if they were going to make excursion dives out onto the sand-algal plains, the sonic pinger-receiver homing device was used.

All other safety rules followed were those commonly recommended to scuba divers.

### C2.3 Surface Safety Procedures

#### C2.3.1 Surface Diving Watch Organization

A commissioned officer was in charge of each of the four watch sections, and he reported directly to the project director. The watch director functioned in an OOD capacity and stood his watches in the control van on the support barge. At all times the watch director was assisted in his duties by a diving or submarine medical officer who monitored all life support readings, received the daily aquanaut health assessments, and provided medical advice when necessary. Also on the support barge were a General Electric representative, who was to provide technical advice regarding habitat systems, and an enlisted life support systems operator, who was responsible for maintaining the generators and air compressors on the support barge.

The crane barge was administered by a chief petty officer, who was the diving supervisor or chief of the watch. The chief reported to the watch director and was responsible for the correct operation of the safety diver organization and keeping the deck decompression chamber and the personnel transfer capsule ready. The section led by the chief of the watch was comprised of a diving systems operator, a crane operator to handle the personnel transfer capsule, two safety (rescue) divers, and a safety diving boat coxswain. A second safety boat was maintained in a ready standby status.

Watches were 8 hours in duration, and each section stood 5 days of 1-in-3 duty, after which they received a minimum of 48 hours on liberty, followed by a watch rotation.

### C2.3.2 Normal Operating Procedures

Prior to each excursion from the habitat the aquanauts advised the watch director of the names of the aquanauts excursions, the nature of the dive, the intended operating area and expected duration of the excursion. The diving supervisor was notified, and during excursions away from the habitat the aquanauts were escorted by a diving safety boat carrying two safety divers. When the aquanauts were using shallow-water gear or were using scuba within 100 feet of the habitat, the boat was not usually stationed overhead, but lookouts were posted.

In addition to the safety diving organization the aquanauts had at their disposal the five way stations provided for diver protection against aggressive marine life but whose Plexiglas domes could be blown dry for diver-diver conversation. Auxiliary air bottles and regulators were provided should the aquanauts overextend themselves or experience equipment failure.

Upon relieving the watch the chief of the watch would ascertain that the safety diving boat was in immediate standby status, that the air bottles were gaged, that the safety divers were properly equipped, and that the deck decompression chamber and personnel transfer capsule were operational. A report of this information would be made via radio or field telephone to the watch director.

### C2.3.3 Emergency Procedures

During daylight operations the aquanauts were located and followed by the exhaust bubbles from their scuba. The aquanauts were directed to stop swimming and to release a yellow carbon-dioxide-inflated float if they needed aid from the safety divers. In general the release of a yellow float by an aquanaut required that the safety divers dive to the aquanauts, determine the nature of the distress, provide assistance, return to the boat for equipment, and advise the watch director. This general procedure was altered as necessary to be best prepared for such emergencies as: aquanaut out of air, aquanaut lost, mechanical injury, animal menace, and emergency surfacing. After an excursion time of 45 minutes the safety divers were instructed to assume that a yellow float would indicate that the aquanauts needed air and to take fully charged bottles with regulators to the aquanauts.

At night, rescue or assist procedures were essentially the same as for daylight operations except that the aquanauts taped a flashing strobe light to their tanks to make it easy to locate them. Also a strobe-float combination was rigged for night divers.

On one occasion the aquanauts released a balloon when they became disoriented and required a heading back to the habitat. Accidental releases of the floats occurred several times, and rescue divers were interrogating the aquanauts within 20 seconds of sighting the float.

### C2.3.4 Exercises and Drills

When escort duties permitted, exercises and drills were carried out during every watch. These exercises were for the most part concerned with recovering a surfaced aquanaut and with bringing an aquanaut into the deck decompression chamber via the personnel transfer capsule.

During emergency surface drills a diver simulating a conscious or unconscious aquanaut would be pulled out of the water 100 yards or so from the crane barge, transferred to the deck decompression chamber with a medical officer, and run to 60 feet in

the chamber on oxygen. Times for this exercise were frequently under 4 minutes from the time the boat was called away to the time the standing aquanaut was at 60 feet.

For deck decompression chamber drills a diver would be put into the personnel transfer capsule on the bottom, and then the capsule would be raised and mated to the deck decompression chamber. Then the two units would be equalized, and the diver would be moved to the deck decompression chamber.

### C2.3.5 Conclusion

Safety divers had to enter the water only once at the request of the aquanauts, and this was just to indicate a return heading to the habitat. The safety divers had to spend many long hours in the diving safety boat escorting the aquanauts, but they did a good job of staying prepared and retaining some enthusiasm for the job.

At times when one aquanaut was outside of the habitat on lightweight gear, no standby diver was ready to enter the water; and it was not unknown for aquanauts to leave the habitat alone on scuba for work in the immediate vicinity of the habitat. The watch directors were usually aware of these occurrences and always tried to prevent them from happening, as they were contrary to the U.S. Navy Diving Manual, Tektite I diving regulations, and good diving practice. If contrary practice could not be prevented, the safety diving crew was put on a ready status and a lookout posted, or the boat was sent out to stand by overhead of the diver.

## C3 WATCH STRUCTURE

Cdr. F. L. Looney, Naval Administrative Command, Great Lakes, Illinois, and Ocean Science and Technology Division, Office of Naval Research, Washington, D. C.

### C3.1 General

An alert watch was maintained on a 24-hour basis, with its primary mission being the safety of the aquanauts. This watch was under the supervision of a watch director. The watch director was selected by the project director from those qualified personnel available to the project. The commanding officer of the experimental diving unit augmented this watch at all times with a qualified diving officer and four divers. The watch director's authority and responsibility was parallel to that of an underway officer of the deck aboard a Navy ship. Four watch sections were maintained, which allowed each watch section 2 days off after 6 days of standing watch.

### C3.2 Organization

The organization of the watch and a brief description of their duties are as follows:

A watch director was in overall charge of the watch section.

A medical doctor was responsible to the watch director for treatment or advice on medical matters. When qualified, this individual also assumed the duties as watch director.

A General Electric engineer maintained console communications with the habitat, recorded engineering data, and advised the watch director on habitat systems.

A support systems operator operated and maintained the support systems on the support barge under the direction of the watch director.

A behavioral watch recorded behavioral data as directed by the scientific coordinator and assistants. The behavioral watch was responsible to the watch director for all other aspects of the watch.

A safety diving supervisor supervised the safety divers, crane operator, safety boat coxswain, and diving systems operator in providing alert coverage of the aquanauts at all times. He reported directly to the watch director.

The team leader of the aquanauts reported directly to the watch director on planned excursions, habitat atmosphere control, and other matters concerning the safety and well-being of the aquanauts.

### C3.3 Watch Instructions

The following are detailed instructions to the watch director which were supplementary to and updated those found in the Tektite I Operations Plan dated January 28, 1969.

"1. General: The primary mission of the watch organization is the safety of the aquanauts and other personnel at the site. The watch director will ensure an alert watch is maintained at all times, ready to cope with any possible emergency.

"2. Watch Routine: Watches will be stood on an 8-hour shift basis and will be divided as follows: 0000-0800, 0900-1600, 1600-2400. Rations will be sent to the site for those on watch at noon, and the evening and midwatches will take rations with them prior to assuming the watch.

a. It is important that each watch relieve on time. Watches should depart the base camp by 2330, 0730, and 1530 to ensure prompt relief. All watch standers should be mustered in the base camp prior to leaving for the boat and vice versa prior to leaving site.

b. Boat transportation will be determined by the base camp commander subject to the availability of boats. The safety diving boat and standby safety diving boat will not normally be used for transportation to and from the site and should be controlled by the watch director through the diving supervisor. Only one crew member is necessary for operation of this boat; however, he shall be fully qualified to run the boat and certified so by the safety diving supervisor.

c. Waking of reliefs will be the responsibility of the diving supervisor, who will place a call with the OOD office in time to assure he is able to call the remainder of the watch in time.

"3. Training: Each watch director shall conduct training and drills on each watch to ensure proficiency of his watch section. Each exercise should be logged, and the watch director should keep a record of drills and training held to ensure rotation of exercises. Every drill should be critiqued in order to achieve maximum benefits. Drills and training should include, but not be limited to: accidental surfacing, injured aquanaut (emergency decompression treatment table), sick aquanaut, lost aquanaut, fire in habitat, contaminated atmosphere, flooding of habitat, loss of power, and safety boat training. When possible and consistent with the aquanauts' schedule, they should participate in nonscheduled drills. Drills involving those outside the immediate on-site watch should be coordinated with the project director. Do not exercise the personnel transfer capsule in rough weather.

"4a. Atmospheric Monitoring: The atmosphere should be monitored at least hourly for O<sub>2</sub>, CO<sub>2</sub>, and N<sub>2</sub>, and the results should be recorded in the atmosphere and medical log. CO should be read daily. (Note that the MSA colorimetric tubes are calibrated at 1 atmosphere; therefore, when used at depth in the habitat, they must be corrected to indicate the true value. This true value is determined by dividing the recorded (value measured with the tube) by the absolute number of atmospheres of pressure. Example: The Tektite habitat is in 38 feet of water, equivalent to 2.15 atmospheres absolute. If the CO value recorded at depth is 25 ppm, the actual value is: true CO = 25 ppm/2.15 = 11.6 ppm.)

Primary Monitors

<u>Gas</u>	<u>Van</u>	<u>Habitat</u>
CO <sub>2</sub>	IR215 and Mass spec. (remote read)	Mass Spec., MSA Lira IR, and CO <sub>2</sub> analyzer
CO	Gas chromatograph	MSA (colorimetric tubes)
O <sub>2</sub>	Servomex, Beckman F-3, and Mass Spec.	Mass spec.
N <sub>2</sub>	Mass Spec.	Mass Spec.
H <sub>2</sub> O	Mass Spec.	Mass Spec.

Secondary Monitors

CO <sub>2</sub>	Gas chromatograph and Kitegawa tubes	MSA (colorimetric tubes)
O <sub>2</sub>	Gas chromatograph	GE and MSA meter
N <sub>2</sub>	Gas chromatograph	None

"4b. Atmospheric Limits: The atmospheric limits are the following:

<u>Gas</u>	<u>Optimum</u>	<u>Acceptable Range</u>
O <sub>2</sub>	158 torr	151-165 torr
CO <sub>2</sub>	2 torr	0-8 torr
N <sub>2</sub>	1470 torr	1450-1550 torr
CO	0 ppm	0-15 ppm

Readings which are consistently outside the given range should be reported to the project director and senior medical officer. The nitrogen value is an exception to this rule. (The nitrogen value depends on absolute pressure and will vary directly with changes in sea state and atmospheric pressure.)

"4c. CO<sub>2</sub> readings which exceed 8 torr by either the mass spectrometer or IR215 should require a baralyme change within 1/2 hour.

"5. Support Machinery: The watch director should insure that the support systems operator maintains an alert watch on the machinery for life support and associated equipment. He should ensure that all required readings are recorded, preventative maintenance is accomplished, and safety checks are thorough. The watch report should be diligently filled out by each watch and turned into the support operations officer. This shall not be a perfunctory task but shall insure fuel and water supply is accurately recorded and the watch is in readiness for the next section.

"6. Behavioral Studies: The behavioral portion of the support van is open to authorized personnel only. Intrusion into the van is disturbing to the behavioral monitors, who must concentrate closely to perform their mission. Indiscriminate eavesdropping in this portion of the van not only compromises the behavioral program but violates the confidence of the aquanauts. Behavioral monitors shall be instructed and reminded to report any conversation or occurrence to the watch director if it appears a matter of urgency if safety is involved. The watch director and the assigned behavioral monitors are the only members of the watch normally admitted to the behavioral section of the support van. Other individuals will enter on a case basis, subject to the concurrence of the watch director. When visitors are in this section, the monitors will use earphones and turn the audio speakers off until the van is clear. Information learned from the behavioral section will not be discussed or disclosed except by authorization of the project director.

"7. Aquanaut Relations: Topside contact with the aquanauts must be tempered in order to accomplish the different aspects of the Tektite I program. On the one hand the study of isolated personnel must yield to the fact that the marine science and other phases of the program require daily contact with marine scientists supporting the program from topside and other logistic support required of technical and diving personnel. In this regard the watch director shall exercise good judgment in controlling contact with the habitat. Normal voice contact should be initiated by the habitat personnel except for necessary communications on operation of safety. Idle banter shall not be initiated by topside or usually replied to from topside. Aquanaut spaces shall not be monitored by audio means, either speaker or earphones, at the watch director's station except for purposes of safety. Invasion of privacy by open mike monitoring will not be permitted at the watch director's station. If aquanauts do not furnish diving information to the watch director before commencing to don diving gear, the watch director may, at his discretion, monitor the wet room or request the systems monitor to monitor the wet room. Prior to a dive the watch director shall request the aquanauts to provide vital diving information. However, open-mike monitoring will be used when aquanauts are asleep and compartments empty in order to enhance the safety of aquanauts.

"8. Safety Diving Routine: Each time the aquanauts are outside the habitat, except when using the hookah, a safety boat shall cover their excursion. The safety boat shall normally carry a boat coxswain and two divers; however, if the coxswain is also a diver, only two persons are required if a shortage of personnel exists. The boat shall keep as far away from the aquanauts as possible as long as their bubbles are in sight. During choppy sea conditions the boat must, of necessity, remain closer to the bubbles. When the Safety Diving Boat is engaged in covering an excursion, the standby safety diving boat shall remain at the crane barge unless specifically dispatched by the watch or project director. The watch director shall insist that aquanauts follow normal diving safety practices consistent with the peculiar environment of the habitat. Each watch director, safety diving supervisor, and safety diver will be aware of the treatment table contained in appendix II to the annex of the Operations Plan, letter of January 28, 1969.\* This table shall be a part of the on-watch training program.

---

\*See Table A33.

"8a. Special Safety Instructions: When the aquanauts are sleeping at night, the following actions shall be taken prior to their turning in:

- (1) Test all battle lanterns.
- (2) Test the trunk high-water alarm.
- (3) Test the CO<sub>2</sub> alarm.
- (4) Test the emergency general alarm from the van and the habitat.
- (5) Record necessary engineering reading in the habitat, primarily in the environmental control system.
- (6) Turn on lights in all spaces except crew compartment.
- (7) Record in the habitat and send to the van the CO<sub>2</sub> and O<sub>2</sub> readings, and compare them with those in the van.
- (8) Energize the portable scrubber.
- (9) Test the open mikes and intercoms from each space.

After these tests and checks and after the aquanauts have turned in, the wet room should be continuously monitored and the other spaces monitored on a rotational basis, using open mike and video, until the aquanauts arise in the morning.

"9. Communications: It is important that all communication channels be kept operative at all times. Frequent tests are necessary to insure reliable communications. During slack periods when normal communications are not used, an hourly check on all channels should be made. The primary means of communication are 4073, Motorola PT 200's, field phones, and 2114. Frequency 2114 should be checked once each watch.

"10. Visitors: Visitors to the support barge and crane barge will be cleared only by the project director. The watch director will extend visitors every courtesy consistent with operational requirements. He may limit the number of persons in the van at any one time, and if necessary he may terminate the visit in order to carry on the mission efficiently and safely. Visitors may be permitted brief visits into the behavioral section, provided the behavioral monitors are notified in advance and speakers are turned off."

#### C4 MEDICAL SUPPORT

Cdr. T. N. Markham, Naval Submarine Medical Center, New London, Connecticut

##### C4.1 Habitat and Support Van

###### C4.1.1 Medical Facilities

The Tektite habitat was provided with three drawers, two in the bridge and one in the wet laboratory, which were filled with a supply of basic therapeutic agents. Each drawer in the bridge contained a color coded styrofoam liner, and the drugs were recessed into the liner (Fig. C1). Each drug was numbered, named, and grouped by general therapeutic purposed. These therapeutic categories were then color coded. The drawer in the wet laboratory contained topical cleansing agents and dressing supplies. Each drawer was prepared and the drugs packaged by Smith, Kline, and French Laboratories, Philadelphia. Although a large reserve of drugs was maintained in the support van, the initial supply was sufficient except for additional tetracycline and supplemental colymycin otic (Warner-Chilcott) introduced during the operation.

The bridge compartment also had an installed Gulton telethermometer and a Beckman Type RS portable dynograph recorder with interchangeable input couplers. Each aquanaut was provided with an oral temperature probe for the Gulton telethermometer and input couplers for electrocardiograms, and pulmonary function studies were provided

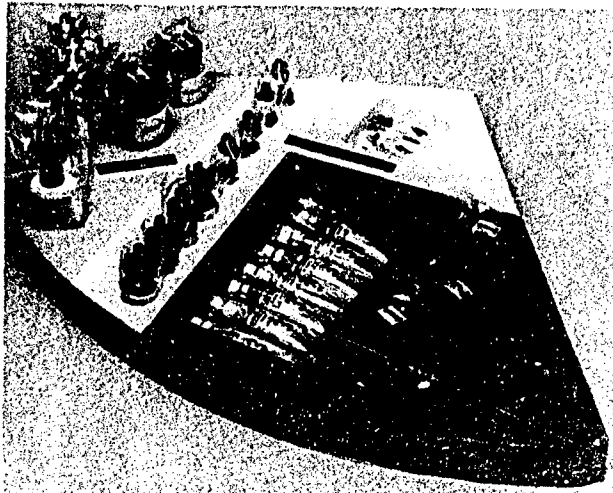

(a) Bridge

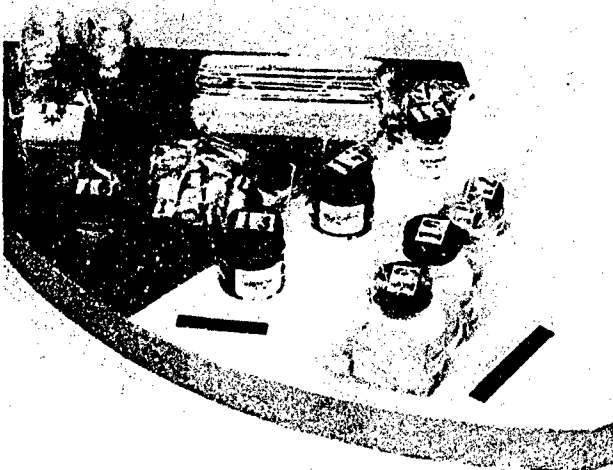

(b) Bridge



(c) Wet room

Fig. C1 - Habitat medical supplies, located in styrafoam liners in two drawers in the bridge and one in wet room



for the Type RS dynograph. A stethoscope and sphygmomanometer were supplied in an equipment drawer in the bridge compartment.

A general Tektite Biomedical Information Manual was prepared with subsections dealing with both the experimental studies and general health maintenance examinations conducted by the aquanauts themselves. These examinations were performed under observation by the medical officer of the watch via closed circuit television.

#### C4.1.2 Atmosphere Monitoring

In addition to the installed and portable atmosphere monitoring equipment detailed in Appendix B, backup equipment was provided within the support van, and samples were taken through the 3/16-inch-I.D. umbilical tube. This equipment included: a Perkin-Elmer 810 gas chromatograph, a Beckman IR215 infrared carbon dioxide analyzer, a Beckman F-3 oxygen analyzer, a Servomex AO 150 oxygen analyzer, and Kitagawa carbon dioxide detector tubes.

The samples were recorded at approximately 1-hour intervals from the installed mass spectrometer, oxygen analyzers, and/or Mine Safety Appliance portable detector tubes in the habitat, while similar recordings were made in the support van through the atmosphere gas sampling umbilical. Experience demonstrated that there was a lag of approximately 6 to 8 minutes in the topside readings when flow was maintained at 500 ml per minute through the sample line. Due to the large volume and adequate mixing of gas within the habitat, this lag was considered insignificant.

#### C4.1.3 Medical Support Personnel

The permanent on-site medical team consisted of at least three physicians and one hospital corpsman at all times. The physicians were both military and civilian. A medical officer of the watch was present in three of the four watch sections. When the section not covered by a physician was on watch, a physician was available at the base camp on immediate call. During the latter 2 weeks of the operation a physician was available for each section.

#### C4.1.4 Daily Health Maintenance Examinations

Initially daily health assessment examinations were performed by the aquanauts themselves, under direct observation by the medical officer of the watch via TV. This examination consisted of a systemic review questionnaire with any positive responses reported to the medical officer and further history obtained by him when considered necessary. Following the systemic review the aquanauts recorded their body weight, blood pressure, pulse, temperature, skin condition, and results of an ear examination and a mouth and throat examination. After a short period it was determined that these data could be taken every 2 days rather than daily. Immediate medical conditions were examined and discussed as required.

#### C4.1.5 Aquanaut Training

During the pre-dive base-line study week in January at the University of Pennsylvania Medical Center, familiarization instruction was given to both primary and backup aquanauts in the use of a stethoscope, sphygmomanometer, otoscope and electrocardiography attachment for the Type RS dynograph. The aquanauts then practiced the use of these diagnostic instruments until proficient in their use. They further were shown the preparation and operation of the Type RD dynograph, spirometer, and esophageal balloon and pressure transducer required for the pulmonary ventilation and esophageal pressure measurements.

During the pre-dive period at Lameshur Bay the primary aquanauts practiced veno-puncture and microbiological sample collection.

The overall training required for the biomedical studies, although held several weeks in advance, appeared adequate, and aquanaut performance was satisfactory.

#### C4.1.6 Potable Water Sampling

Bacteriological samples for coliform bacteria were collected from the water bag on the support barge twice weekly and also each time the bag was resupplied. Following the introduction of water purchased from a supplier on St. John Island midway through the operation, high bacterial counts were obtained from the supplier's tank. However, at no time did coliform organisms appear, and chlorination rapidly reduced the total bacterial count to insignificant levels. Pathological organisms were never isolated from the potable water system on the support barge or within the habitat.

#### C4.1.7 Significant Medical Conditions

During the saturation portion of Tektite I two medical conditions arose of significant note. These conditions were described in detail in section A3.2.1.2.

### C4.2 Base Camp

#### C4.2.1 Medical Facilities

The base camp was provided with 1/3 of the central building for a medical dispensary. This facility measured 16 by 20 feet and was supplied with potable water, an autoclave, and sufficient medical supplies to meet most general or emergency requirements. The dispensary was supplemented by the laboratory facilities in the U.S. Army mobile laboratory in the camp used for the hematological and microbiological scientific experiments. The dispensary contained four bunks used to house the medical staff and provided the ability to handle inpatients, if necessary. Hospitalizations were referred to Knut Hansen Hospital on St. Thomas. All radiological examinations were performed and interpreted at this hospital.

#### C4.2.2 Medical Support Personnel

The same personnel described in section C4.1.3 were available to man the base camp facilities. One of the physicians not on duty aboard the support barge was designated the base camp medical officer. He remained in the immediate vicinity on call for either emergency or routine conditions. Because of the limited number of personnel within the camp, no specific sick call was held daily. The hospital corpsman's prime responsibility was the health of the base camp personnel and maintenance of the dispensary. The hospital corpsman conducted periodic sanitation inspections of base camp facilities and brought any deficiencies to the attention of the base camp commander or the duty medical officer.

#### C4.2.3 Potable and Shower Water

Periodic samples of both potable and shower water were collected and cultured for coliform or other pathological organisms. Initially the shower water contained an organism which gave presumptive evidence on culture of *Pseudomonas*. Due to limited identification facilities a positive identification could not be made. Following this isolation both shower and potable water was chlorinated to a residual level of greater than 2 ppm chlorine. The chlorine level was then measured and replenished periodically to insure sufficient residual.

#### C4.2.4 Significant Medical Conditions

The general health of base camp personnel was good during the entire operation. Five men were evacuated to the continental United States over a 3-month period. The conditions requiring evacuation included two knee injuries, a fractured femur, a traumatic temporal hernianopsia, and chronic hypertension. One automobile accident occurred resulting in hospitalization of two men, one with a fractured femur and the other with a concussion and temporal hernianopsia. Both of these men were subsequently transferred to the continental United States. The latter was treated with hyperbaric oxygen therapy at the Tektite I site in an attempt to clear his hernianopsia. Following his first treatment he showed improvement in his central vision, but no further improvement was demonstrated with subsequent treatments over a 4-day period.

Base camp personnel and support divers acquired a significant number of external otitis infections which cultured a presumptive *Pseudomonas* organism. These infections responded poorly to cortisporin otic drops (Burroughs Wellcome) but responded well to colymycin otic drops (Warner-Chilcott). In one case system colymycin was required along with frequent local debridement of the external auditory canal to bring the external otitis under control.

#### C5 PUBLIC AFFAIRS

R. S. Greenbaum and A. M. Sinopoli, Public Affairs Office,  
Office of Naval Research, Washington, D. C.

##### C5.1 General

The public information operation for Tektite was unprecedented in that it was the first time in which a group of major federal agencies (Navy, Interior, and NASA) were joined by industry (General Electric Co.) as partners in a major field operation expected to receive first-hand coverage by national news media. The Navy was designated as the lead agency, and the Office of Naval Research specifically had the chief managerial responsibility for the program, although it was accepted that no individual group, agency, or activity would serve as a unilateral source of news. The goal was to focus the attention of news media on the Tektite I program as a whole, with credit for the operation dispersed equally among the four organizations.

The official public-affairs plan for Tektite I stated that the public information program would be a coordinated interagency effort under the direction of ONR. The head of the ONR Public Affairs Office (Mr. R. S. Greenbaum) acted as public relations team leader with the prime responsibility for all public information matters. The plan also stated that all material would be released to news media in the name of the Tektite I program. A special Tektite I letterhead together with special stationery carrying the names of all four organizations was printed for this purpose. The first news release, issued before the special stationery was available, was made simultaneously by all four activities.

It was planned that each organization would contribute equally in manpower and effort to the public information program. At least two information officers were to staff the information center in the Virgin Islands at all times, starting about January 27 until the end of the mission, a period of nearly 3 months. Personnel were to be provided by the participating agencies on a scheduled rotation basis, with additional personnel available during key news-generating periods, particularly the start and end of the mission. These staffing needs were not met, however, in the actual operation. NASA's Office of Manned Space Flight, assigned the responsibility for the operation within NASA, provided no personnel at all for the information center. The Department of the Interior, drawing

from the three major participating departments (Bureau of Commercial Fisheries, Geological Survey, and National Park Service) provided three men, with each staying 10 days to 2 weeks but none during the start and end of the mission. General Electric provided personnel for longer periods, but the requirement fell upon ONR to provide the full-time information officer (Mr. Anthony Sinopoli) to man the information center continuously from January 26 to April 21.

General Electric played a special role in the public information operation, using its Madison Avenue public relations firm to provide assistance. General Electric also provided Tektite I letterhead stationery and Tektite I decals. General Electric leased quarters on St. Thomas, which served as the public information center as well as quarters for information officers and news media, and leased commercial boats which provided a vital supplement to the limited boat transportation provided by the Navy. This additional boat service was particularly useful in providing transportation for news media and television camera crews to the operation site on St. John.

Throughout the operation personnel of all four organizations sincerely endeavored to assure that all four received equal publicity and recognition and that no individual participant would stand out more than any of the others. For example, major policy decisions on public information matters were validated by agreement among the four program managers. The Navy officer-in-charge at the site, however, had the sole responsibility for deciding whether activities by news media might interfere with or hamper operations. Concern with the safety and efficiency of the operation led him on occasion to limit the activities of news media in what appeared to some to be an arbitrary Navy decision to bar newsmen on the grounds that they are an unnecessary nuisance. The Tektite I public affairs group attempted to maintain cordial relations with the press to avoid any impression of managing the news or suppressing legitimate information.

General Electric adopted a dynamic, aggressive attitude in promoting publicity, taking advantage of the resources at its disposal not available to government public information officers. This was done in the name of the Tektite I program and in consultation with ONR representatives, and the net result was that coverage by news media was significantly greater than might otherwise have occurred. Close communications and liaison were maintained at all times between G.E.'s public information coordinator, and G.E. was careful to take no unilateral action in releasing information. Coordination was also good with Interior, although that department tended to play a less active role than ONR or G.E. Interior delegated the chief responsibility for its participation in the program to its Bureau of Commercial Fisheries, although the public affairs offices of the other Interior departments involved in the program contributed personnel to the Tektite I information center and provided a photographer at the start of the mission.

## C5.2 Preoperation Activity

The first release announcing the Tektite I program was made on April 25, 1968, 10 months before the scheduled start of the operation. This date was considered appropriate both in permitting enough time for gradual buildup of press interest and to avoid gradual leakage of news about the operation, which had started to occur. The release avoided reference to an exact date for the start of the operation and did not reveal the names of the four aquanauts, who had not yet been completely selected. The release also established the name Tektite for the program.

The next release was originally planned for July or August, at which time the names of the aquanauts would be revealed. This was to be followed by a press conference in November, where full details of the project would be announced. A delay in the aquanaut selection process, however, delayed the release of these names. Further announcements or release of information were postponed until the Tektite I press conference held on December 17 at the Philadelphia Navy Yard, where the habitat was available for press inspection prior to its shipment to the Virgin Islands. Presided over by the Chief of Naval Research (R. Adm. Thoms Owen), the conference proved quite successful, resulting in nationwide press, magazine, and television coverage.

### C5.3 Tektite I Information Center

Early in the program it was determined that space would not be available at the base camp on St. John, adjacent to the operation site, to provide quarters for information officers. It appeared more desirable for information officers to be quartered on St. Thomas, where news media would be staying, thus assuring control of news media visits to the operation site. The Tektite I Information Center on St. Thomas was located in a seven-bedroom house, known as Berger House, leased by G.E. This residence provided quarters for both information officers and news personnel, in addition to providing temporary quarters to technical personnel on their way to or from the site. One room doubled as the information officer's room. It also contained a portable electric typewriter and a Telex machine, which did not work properly and was later removed. The house had one telephone with an extension, with one of the instruments in the information officer's room. Telephone service was erratic and unreliable and made communications with the base camp and the operation difficult.

The boat dock where the Navy boat departed for St. John was about 15 minutes from Berger House, and the trip to St. John was usually about 45 minutes, although sometimes an hour. The boat was scheduled to leave at 9:15 a.m. but often left later. The Navy boat returned to St. Thomas from St. John at 3:00 p.m. The short time between arrival and departure was often insufficient for preparation of a daily report and its clearance for release by the on-site commander. Thus daily releases could not always be made. Occasionally, when circumstances permitted, the information officer stayed overnight at the base camp. Ideally, one information officer at the base camp and one or two information officers at the information center on St. Thomas would have improved the information coverage. Aside from staff limitations mentioned earlier, however, the unreliable telephone service meant loss of communications at times between the base camp and the information center. The only way to assure a steady flow of news between the operation site and the information center and stateside news media was for an information officer to travel back and forth each day.

### C5.4 Dissemination of News During the Operation

All three national television networks, AP, UPI, Reuters, and several major newspapers and magazines (including Life) had top correspondents at the site covering directly the beginning and termination of the mission. A key problem was arranging interviews with Tektite I personnel and the filming of scenes by the TV networks without hindering operations. Four information officers were available to handle this: two from ONR and two from G.E. (including a representative of G.E.'s public relations firm, Young and Rubicam). There was some unhappiness among news media over limitations imposed on coverage, particularly in the last hectic day or two before the operation began. Generally speaking, however, all news media got good stories, and excellent detailed coverage resulted, including a front page story in the New York Times and a major display in Life

magazine. A major element in this success was the availability of G.E.-leased boats to transport the news media between St. Thomas and St. John.

The Tektite operations plan called for the preparation of a daily progress report which would be "mailed daily to the home public information offices of each participating organization via overseas airmail," thereby giving those offices information to answer queries from the news media. This proved to be impractical. No clerical help was available at the information center to type out smooth copies and mail out the material. The closest mail drop was in Charlotte Amalie, about an hour from the Berger House. It proved to be more expeditious to phone in the daily report to the ONR public affairs office. Ideally this should have been done the first thing every weekday morning, so that ONR could then send it out that day to the participating organizations, with a copy to ONR's front office. The two major difficulties, however, were the mechanics of obtaining a daily report approved for release to news media and the unreliable telephone service. The information officer visiting the base camp found that he could not always get a news-worthy report (other than the routine "everything-is-going-fine") before he had to leave on the boat back to St. Thomas at 3:00 p.m. When problems began showing during the early days, although not serious, there was a reluctance to release this news. At the same time, it became quickly apparent that daily press interest in the project dropped off sharply after the first few days. The only press interested in a daily story on the program was the Virgin Islands news media and the San Juan press. The Tektite I information center reported regularly to the AP stringer in St. Thomas and also to the Commandant, Tenth Naval District, in San Juan, which relayed news to the San Juan press. It turned out, therefore, that a daily report to Washington had little value as far as servicing news media was concerned.

As an alternate plan it was decided to prepare a long weekly report which would be phoned into Washington on Monday mornings and then relayed to G.E., Valley Forge, for reproduction and mailing out to the master mailing list. This meant a long telephone call to ONR while dictation was taken over a sometimes bad connection and then a second telephone call to G.E., Valley Forge, which was usually able to have the release in the mail by the next day. (It should be noted that neither ONR nor Interior had facilities to accomplish such a frequent rapid and massive mailout.) This system, as cumbersome as it was, worked fairly well. Few national stories were carried, however, until Tektite I passed the halfway mark, setting a new duration record, and as the mission and approached. On the other hand the Tektite I story blanketed the nation on those occasions, with two and three-column headlines frequently used by the newspapers. Several stories were carried abroad, particularly by the London press. Except for these high points, news media interest in the project was limited to magazine and feature writers, who visited the operation site at various times.

### C5.5 Photography

Without question the most frustrating public information problem encountered throughout the Tektite I operation was in photography, both still and motion pictures. In planning the program it was assumed that the most spectacular photography would be the underwater activities of the operation. However, since Tektite I was considered to be an experiment in isolation, photography by divers coming down from the surface was not allowed during the actual operation. All underwater photography was to be taken by the aquanauts. In actual practice this did not work. Aside from a series of problems involved in supplying the aquanauts with film, it became apparent that the aquanauts could not regularly carry underwater cameras with them and still perform the work which was the major purpose of the program. (In Sealab II, for instance, this problem was resolved by assigning two Navy underwater photographers as members of the crew.) Some underwater photography was obtained by showing the backup aquanauts at work, although care

was taken not to identify them as the four Tektite I aquanauts. Toward the end of the mission the backup aquanauts were to photograph the four aquanauts both in underwater scenes and inside the habitat. This was the primary source of still and motion pictures of the aquanauts themselves during the operation. One unfortunate result was that there was no film to release to the TV networks except at the end of the project.

A Navy combat camera group was assigned to photograph the operation prior to its start primarily for technical documentation of the preparatory phase. The two-man team took mostly motion-picture film. For some reason much of their surface photography was out of focus, although their underwater photography turned out well. G.E. and Interior had still photographers shooting at the start of the mission, and the pictures shot by the Interior photographer were particularly good and readily accessible. However, everything was shot in color, whereas most news media, particularly the daily press, required black-and-white photographs. Printing in black and white from color slides was time consuming and often unsatisfactory in quality. The result was that virtually no still photographs taken of the actual operation were made available to the press during the operation. Stories carried by newspapers throughout the operation (except at the end) carried old photographs taken of the aquanauts inside the habitat back at the Philadelphia Navy Yard.

There was no plan to provide surface photography throughout the operation, since it was assumed there would be little of news interest to shoot on the surface or at the base camp. About midway through the project, however, ONR did send down a still photographer from its Naval Research Laboratory to take photos for documentation purposes. This turned out to be fortunate, because it resulted in the solution of the problem of establishing a central place for processing still photography. The NRL photographer was also an expert in processing color photography. He not only processed his own photographs at NRL but also began to gather the film shot by others, particularly the underwater photography taken by the backup aquanauts. As a result the NRL photographic laboratory acquired virtually a complete file of all color and black-and-white still photography taken during Tektite I. Although the requirement for processing photography had been discussed during the planning stages, it had never been pinned down. It was understood, for example, that Interior was going to arrange for commercial processing of the aquanauts' underwater photography, but this never materialized.

#### C5.6 End of the Mission

The news media interest in covering the end of the mission was quite high. For technical reasons the aquanauts were brought up from the habitat in the personnel transfer capsule near midnight. Since the aquanauts would not be visible during this process and would not be seen until they emerged from the deck decompression chamber some 19 hours later, it was assumed that there would be few news media interested in covering the splashup directly. As it turned out, all three television networks sent crews down to witness this, and a large group of national news media also wanted to cover this event as well as the aquanauts' emergence from decompression the following night. General Electric rented a large boat for use on both nights for press transportation. The presence of high Navy and Interior officials at the end of the decompression, and a message from President Nixon, added news value to the emergence. The aquanauts made brief statements, and the news media were willing to await a full-scale press conference following the 2-day debriefing of the aquanauts.

The press conference was scheduled to be held on Friday morning, April 18, 1969, the third day after the end of the mission and immediately following the aquanauts' debriefing. The most desirable and logical location for the press conference was a large room in the Governor's House, but there was some question as to whether the room would be

available on Friday. The alternative was a restaurant where G.E. had scheduled a press reception that afternoon. Fortunately the Governor's House was available, and the participation of the acting governor provided a satisfactory ceremonial flavor. Although the press conference was recorded, no public address system was available. Only the major participants had microphones hooked into the recorder, so that several questions and comments from the floor were lost. The press conference resulted in another series of major nationwide stories.

The high point of publicity was achieved when Hugh Downs of NBC's Today show came to the Virgin Islands and on the day after the press conference interviewed the chief aquanaut, who took him on a tour of the habitat. Since the habitat was still on the bottom of Lamester Bay, this required Downs to dive down with Mr. Waller. This major feat was generated by the New York office of the Chief of Naval Information with assistance from General Electric. The Navy provided a special sound-on-film camera for this interview and also contributed the services of an underwater photographer. The results was an unusually long segment, about 18 minutes, which appeared on the Today show a week later.

About a month later a final major flurry of publicity resulted when Vice President Agnew presented special awards to the four aquanauts, followed the next day by a special hearing before a Congressional committee. This completed about a 6-month period of fairly steady and intensive publicity. As Rear Admiral Owen, Chief of Naval Research, noted, never before had a government project costing so little received so much publicity.

#### C5.7 Conclusions

The fact that by far the majority of news stories contained the names of all four participating organizations demonstrated that the goal of equal credit was largely achieved. The major failure was the lack of still and motion pictures available for release to news media during the operation. A problem of lesser magnitude but critical at times was lack of sufficient personnel to staff the information center. There were actually three information officers, two from ONR and one from G.E., who carried the major burden of the operation continuously throughout the program. The dedication and energy of this small group was the key factor in achieving a high degree of success in this pioneering public information effort involving an interagency program in conjunction with industry.

#### C6 TECHNICAL ASSISTANCE

D. E. Adkins and A. J. Coyle, Battelle Memorial Institute,  
Columbus, Ohio

##### C6.1 Introduction

Tektite I was a cooperative program between government agencies and industry conducted to determine the capability of a small group of men to satisfactorily perform a scientific research mission while living isolated on the ocean floor for a long period of time. Battelle-Columbus participated in the program under Navy/Industry Cooperative Research and Development Agreement R-485-91. Battelle-Columbus responsibilities in Tektite I were to: (a) provide technical and engineering assistance to the Office of Naval Research, (b) coordinate the acquisition and deployment of a decompression complex, (c) review the habitat systems and subsystems to assist in assuring proper performance, (d) monitor the habitat systems and subsystems on site to provide an unbiased evaluation, (e) provide hardware integration and program planning support, (f) supply the hookah system, two types of coring tools, and built-in-breathing equipment for habitat use, (g)



coordinate on-site aquanaut training, (h) rebuild, modify, and test the dated two-man wet submersible (mini sub) to be used by the aquanauts on excursions from the habitat, (i) provide diving support during the construction and habitat deployment phase of the program and during the research studies of the three standby aquanauts performed outside their excursion limits, and (j) assist with responsibilities associated with the control van and support equipment.

This section deals mainly with problem areas uncovered during the mission with habitat and support equipment hardware as well as with the evaluation of certain procedural items. Only the problem areas and possible improvements for future missions are expounded herein. Although the remarks are directed specifically toward the Tektite I program, they also pertain to typical areas for improvement in equipment for other experiments of this type.

## C6.2 Mission Observations

The following observations were made.

1. The total aquanaut time on the bottom was divided into the following general areas, with each area assigned an approximate average percentage figure: scientific work, 32%; sleep, rest, and relaxation, 22%; recreation, 16%; self-maintenance activities, 16%; habitat maintenance and repair, 10%; and in transit, 4%.
2. The scientist/divers spent 432:15 man-hours in the water during the 60-day mission. This represents an average of 7.2 man-hours per day.
3. The hookah arrangement of full-face mask with communications was usable up to 200 feet from the habitat. The mask and communications package were more than adequate and were used more than 41 diving hours during the mission, about 1/10 of the total diving time.
4. Saturated swimmers, in water with average visibility of 50 to 75 feet and between depth limits of 21 to 100 feet, can perform excursion dives from the habitat to distances exceeding 1800 feet and return safely.
5. The performance by a number of support scientist-divers of research work to no-decompression limits around the perimeter of aquanaut excursion limits significantly adds to the total scientific coverage of the area.

## C6.3 Recommendations

### C6.3.1 Introduction

The recommendations that follow are based on a survey of the overall program. Many of the suggestions deal with minor problems, but unless the small problems are recognized at this time, they may become major problems in future programs. Although specific suggestions included in this section are directly applicable to the Tektite I habitat, they may be used as typical examples for consideration during retrofit or the design of additional habitats.

### C6.3.2 Habitat Systems

Recommendations concerning the structure and interior design are as follows:

1. A hatch that opens from the cupola into the engine room that remains dogged when the cupola is not in use could be installed for safety. If a cupola window were broken, the hatch would seat firmly because of higher habitat pressure and prevent loss of gas and flooding of the habitat.
2. Storage areas and work spaces could be redesigned to provide more study and laboratory space.
3. Mechanical leveling legs could be installed to level the habitat base.
4. Holes in the base should be screened off to prevent dangerous marine animals from entering the shark cage area.
5. Emergency air bottles could be placed other than in the passage under the wet room, where they were obstacles.
6. The habitat decks should be primed and painted well in advance of mission start to allow complete drying and eliminate peeling and formation of rust.

Recommendations concerning the environmental control system are as follows:

1. The CO<sub>2</sub> scrubbing system should be redesigned to include an efficient canister to prevent channeling, to provide sufficient absorbent bed capacity, and to increase the dwell time of gas in the absorbent.
2. The use of Sodasorb or lithium hydroxide as the CO<sub>2</sub> absorbent may be considered.
3. The NASA mass spectrometer should be analyzed, redesigned, and completely evaluated for hyperbaric applications prior to the next mission.
4. To eliminate heavy gases layering and collecting in low points, adequate exhaust and gas removal should be provided.

Recommendations concerning the thermal control system are as follows:

1. The sea-water switch used to control coolant flow to the compressor could be made of corrosion-resistant material and be protected by a waterproof container to reduce maintenance time.
2. The problem of dripping condensate water may be avoided by installing more insulation on the airflow ducts and drain lines and by more direct routing of heat-exchanger drain lines to the sump.
3. Fuses should be protected from possible condensate formation, which causes failure, by enclosing them in a more tightly sealed fuse box.
4. Soundproof paneling could be installed in the engine room to attenuate machinery noise.

Recommendations concerning the scuba-charging, low-pressure, and emergency air systems are as follows:

1. The scuba-charging panel could be moved and plumbed in a more convenient location.
2. Rather than using the emergency air bank to charge scuba tanks, a larger bank of receivers could be installed topside to maintain a constant supply of high-pressure air to the charging station.
3. Low-pressure air lines could be plumbed near the 10-inch trunk to permit easy exit of the hookah hoses.

Recommendations concerning the plumbing and sanitary system are as follows:

1. A gooseneck fitting should be installed in the sewer outfall line near the toilet discharge to trap sewer gas and eliminate introduction of methane and other harmful gases into the habitat atmosphere. In addition an air fitting may be provided on the outfall line to permit the aquanauts to blow out the line to remove built-up material.
2. The bilge pump in the wet room could be reoriented to allow the bilge to be pumped dry. In addition, all components known to be vibration sensitive should be locked or wired to prevent vibration failures.
3. The inlet to the sea-water pump could be screened to eliminate small fish from being sucked into the rotor blades and possibly clogging the pump.

Recommendations concerning the communications system are as follows:

1. The intercom sets in the habitat should be reconditioned or replaced before the next mission to eliminate speaker noise and feedback.
2. Casings for sound-powered phones in the way stations could be redesigned to keep the phones dry, and operating procedure to receive communications from way stations should be clearly delineated.
3. Underwater TV cameras could be repaired and evaluated before they are brought on the site. It may be possible to provide pan and tilt mechanisms for more effective use of the cameras.
4. The sound-powered phone on the bridge should be replaced by a Bogen or equivalent.

Recommendations concerning the electrical system areas follows:

1. For future missions, habitat electricity could be grounded at the surface support facilities.
2. The reheater circuit breaker in the crew quarters should be replaced with a less noisy model and/or be relocated in a more remote area.
3. The clothes dryer could be replaced with a washer/dryer combination for convenience. This change will take up very little additional space.

General recommendations concerning the habitat are as follows:

1. The aquanaut crew consisting of four aquanaut-scientists could be expanded to include one engineer to assume responsibility for equipment maintenance, habitat re-supply, and housekeeping chores, thus freeing the aquanauts to conduct their primary research mission.
2. The habitat could be given a dry run in the shipyard at bottom pressure, not only to check the workability of the systems, but also to help train the new aquanauts before the start of a future mission.

#### C6.3.3 Habitat Interfaces

Recommendations concerning habitat interfaces are as follows:

1. The navigation grid system was not used by the aquanauts during the mission and may be eliminated in future programs.
2. Provisions could be made on or in the habitat for stowing 200 feet of hookah hose and the masks in a convenient manner.
3. More reliable, longer range, free-swimmer communications are needed for the next mission.
4. New, noncorrosive transfer pots should be supplied.
5. A closed-circuit, shallow-water dumbwaiter system could be designed and developed to speed up transfer of supplies.

#### C6.3.4 Habitat Support Equipment

Recommendations concerning habitat support equipment are as follows:

1. Larger capacity pumps could be used to transfer water and diesel fuel to the support facilities. This would significantly reduce transfer time.
2. A critical spare-parts inventory should be established for important machinery, such as the crane on the crane barge, to eliminate lengthy downtimes due to failures.

#### C6.3.5 Aquanaut Support Equipment

Recommendations concerning aquanaut support equipment are as follows:

1. Longer range, more accurate pinger/receiver sets would be useful for underwater lobster research.
2. Additional equipment could be used for studying lobster habits, including an underwater photocell-light-source movement detector and a phosphorescent grease or paint with a black light for identifying lobsters and landmarks at night.
3. Development of plankton-sampling equipment should continue.
4. Storage space could be made available in the wet room of the habitat for dry storage of the underwater electric coring tool, if it is used on future missions.

5. Research could be undertaken to develop a long-duration, semiclosed breathing device capable of lasting 4 hours at 50 feet using an  $N_2-O_2$  breathing mixture.

6. Reliable, operational swimmer delivery vehicles could be provided for aquanaut excursions, which are capable of maintaining 3 to 5 knots for at least 4 hours.

#### C6.3.6 Habitat-Deployment Procedure

Recommendations concerning the habitat-deployment procedure are as follows:

1. When using the Tektite habitat for future missions where a landing ship dock must be used for transportation, it is recommended that the same emplacement procedure be used. The LSD does not have sufficient water depth in her launch well to float the habitat out without being mounted on a sinkable barge.

2. A more efficient method of habitat ballasting could be incorporated for future missions.

#### C6.3.7 Aquanaut Training

A longer, more extensive training period could be provided for future aquanauts that deals both with the habitat hardware and with aquanaut support equipment.

### C6.4 Hardware Evaluation

#### C6.4.1 Introduction

Hardware in the Tektite I program can be divided conveniently into four main areas: habitat systems, interfaces, habitat support equipment, and aquanaut equipment. Base-camp machinery will not be discussed in this hardware evaluation.

A basic objective of the program was that minimum development money would be expended in an attempt to keep costs low. Each habitat system was fabricated with many off-the-shelf components; only the dual-can concept with a crossover tunnel indicated significant change from previous habitat designs. In conjunction with this structure some of the subsystem routings had to be different to accommodate standard conditions in each cabin. In addition the emplacement environment (shallow, warm water) allowed further simplification in design, eliminating expensive breathing gas and extensive insulation and thus further reducing costs.

#### C6.4.2 Habitat Systems

##### C6.4.2.1 Introduction

The habitat as a whole provided a comfortable and very livable home for long-duration, shallow-water, saturation dives. As a laboratory it was not optimum, but adequate. A number of small problems occurred, some caused by human error and some by design or equipment faults, most of which required remedial action and some of which caused a large degree of concern. In pointing out problems and faults, it must be borne in mind that the majority of equipment functioned as designed and that the design success of most aspects of the habitat provided major contribution to the overall success of the program.

### C6.4.2.2 Structure and Interior Design

The basic structural design of the habitat was good. The brightness of the paint clouded somewhat with marine growth over the 60-day duration, but no significant external corrosion was noticed. However, paint and primer flaked off the deck in the wet room, allowing rust to form on the exposed steel. This rust and paint falling into the bilge clogged the strainer to the bilge pump and thus restricted water removal. The problem can be eliminated by priming and painting the decks well in advance of mission start.

The most consistent complaint involved lack of adequate work space and crowded study conditions in the bridge and the wet room. Since the habitat cannot be made larger without excessive expenditure, two avenues are open. First, storage areas and work spaces may be redesigned so that seldom-used supplies are stored in remote areas (in tanks below the crew quarters) and seldom-used cabinets are eliminated. The resulting space may be used for separate work spaces. Second, a separate chamber (garage) could be constructed to provide wet laboratory work space having vented hoods or absorbents for use of toxic research chemicals as well as to provide a service area for charging and maintaining an excursion submersible.

Water collected in puddles behind the sinks in both the engine room and the wet room, and the cabinet doors swung open in the same sloping direction both in the crew's quarters and in the wet room. It may be that the habitat was not level on the ocean bottom. Even though the bottom was leveled by the Seabees prior to emplacement, over the 74-day time the habitat was on the bottom, the habitat may have settled. Mechanical leveling legs could be installed to level the habitat, and an internal needle valve in the escape hatch could quickly equalize any pressure differentials that might occur due to the habitat being out of level.

Holes in the base of the structure should be either screened off or welded shut to prevent dangerous marine animals from entering the shark cage area. In addition to covering the access holes, the emergency bottles could be moved and plumbed for use in the area under the crew's quarters, leaving clear space in the passage under the wet room.

The crossover tunnel held up well as a structural item. The four pinhole leaks noticed in the beginning of the mission gave no trouble. However these should be repaired for future missions. In addition, inconvenience in using the tunnel was noted. The occupants must duckwalk or crawl through the tunnel many times a day. Since, functionally, it proved effective, the problem of crossing is a matter for personal adaptation.

The cupola was seldom used as an observation station because of poor visibility. If the water were clearer or if a sonar were available for signature studies, it would have been used more extensively in the marine sciences program. However, since the cupola was the highest point on the habitat, if a window were broken the  $N_2-O_2$  mixture would escape and be displaced by water very quickly. A hatch that opens from the cupola into the engine room could be installed that would remain dogged when the cupola is not being used. Higher habitat pressure would seat the hatch and keep water from entering the open trunk if a window were broken.

### C6.4.2.3 Environmental-Control System

#### C6.4.2.3.1 Introduction

The environmental-control system is divided into five subsystems: gas supply,  $CO_2$  scrubber, thermal control, scuba charging, and emergency air.

#### C6.4.2.3.2 Gas Supply

No problems occurred during the initial nitrogen fill or while supplying makeup air at flow rates between 12 and 29 std cu ft/hr to the habitat. However, many times during the program the dessicant container on the low-pressure compressors was not tightened or the bleed valve was loose. This resulted in line leakages and high pressures when the components were finally secured.

#### C6.4.2.3.3 CO<sub>2</sub> Scrubber, Instruments, and Contaminant Gases

A significant problem developed with the CO<sub>2</sub> scrubber. The habitat was occupied at 11:55 a.m. on Saturday, February 15, 1969. At 11:30 p.m. on Sunday, February 16, 1969, the CO<sub>2</sub> level rose to 10.2 torr or 1.34 percent surface equivalent by volume. Threshold limits for CO<sub>2</sub> published by the Bureau of Medicine and Surgery are 3.8 torr or 0.5 percent. In addition, it is generally accepted that the CO<sub>2</sub> level should not rise above 1 percent surface equivalent in closed hyperbaric environments.

As seen in Fig. C2, both blowers were used, and eventually a vacuum cleaner was connected to an auxiliary canister to supplement scrubbing, but still the baralyme had to be changed twice as often as planned to keep the CO<sub>2</sub> level under control. Habitat design specifications indicate that the environmental-control-system canister, holding 15 pounds of baralyme, should hold CO<sub>2</sub> at a nominal operating level of 2 torr with changes every 12 hours. The aquanauts used from 40 to 45 pounds of baralyme daily, changing baralyme more often to keep the nominal level at about 6 to 7 torr. At no time during the project did the CO<sub>2</sub> come down to the projected nominal operating value of 2 torr, even with small auxiliary scrubbers helping out. Incidentally, both blowers were forcing air through the single canister, and this was probably more harmful than helpful. Increased airflow detracts from scrubbing in that it promotes channeling through the absorbent and reduces dwell time, thereby reducing baralyme efficiency. This can be noticed in Fig. C2. Baralyme was changed more frequently, but the CO<sub>2</sub> level continued to increase.

On the fourth day of the mission the aquanauts asked to be notified when the CO<sub>2</sub> level reached 7 torr so baralyme could be changed. They had noticed symptoms resulting from a high concentration of CO<sub>2</sub>: shortness of breath, increased respiration, and uncomfortable feelings.

It is a foregone conclusion that the CO<sub>2</sub> scrubbing system should be completely redesigned. In addition, prior to shipping the habitat for new missions the habitat could be given a dry run in the shipyard at bottom pressure, not only to check the workability of the systems but also to help train the aquanauts before mission start.

On March 1, 1969, an auxiliary scrubber from the U.S. Navy Experimental Diving Unit (EDU) was installed in the engine room. Later in the program a scrubber from Duke University replaced the EDU scrubber. These helped to keep the CO<sub>2</sub> level in check, allowing longer time periods between baralyme changes for primary mission research. A comparison, made by the aquanauts on day 17, of the effectiveness of the environmental-control-system scrubber and the EDU scrubber is shown in Fig. C3. Both scrubbers use a 15-pound absorbent charge, but the EDU scrubber quickly reduced the CO<sub>2</sub> level to 1.5 mm Hg, while the environmental-control-system scrubber gradually lowered the level only to 1.0 torr.

At two different times during the project, samples of baralyme were analyzed at Battelle to determine CO<sub>2</sub> per pound of absorbent. The results are given in Table C1. Reasons for subpar performance include inefficient canister design, insufficient baralyme-bed capacity, high flow rate of atmosphere gas through the canister giving rise to channeling in the absorbent, and low dwell time of gas in the bed.

## PROJECT TEKTITE I

Fig. C2 - Profile of the CO<sub>2</sub> level early in the mission

Table C1  
Baralyme Analysis to Determine CO<sub>2</sub> Per Pound of Absorbent

Day the Sample Was Taken From the Habitat	CO <sub>2</sub> Content in the Experimental Diving Unit Scrubber		CO <sub>2</sub> Content in the Environmental-Control-System Scrubber		Manufactured Suggested Performance	
	Weight Per-cent	Lb CO <sub>2</sub> /Lb Baralyme	Weight Per-cent	Lb CO <sub>2</sub> /Lb Baralyme	Weight Per-cent	Lb CO <sub>2</sub> /Lb Baralyme
February 20, 1969	Not in use		11.6	1/8.62	39.0	1/2.56
March 25, 1969	13.2	1/7.6	14.9	1/6.72	—	—

Three days into the mission the mass spectrometer malfunctioned. The fault was determined to be an overheated transformer. It was disassembled into two parts by the aquanauts and sent topside for repairs. The fact that this complicated instrument could be taken apart, sent up, and reinstalled is significant not only to underwater research, but also to space exploration. If equipment is even partially serviceable by inexperienced researchers in isolation, then astronauts can perform similar work under analogous space conditions.



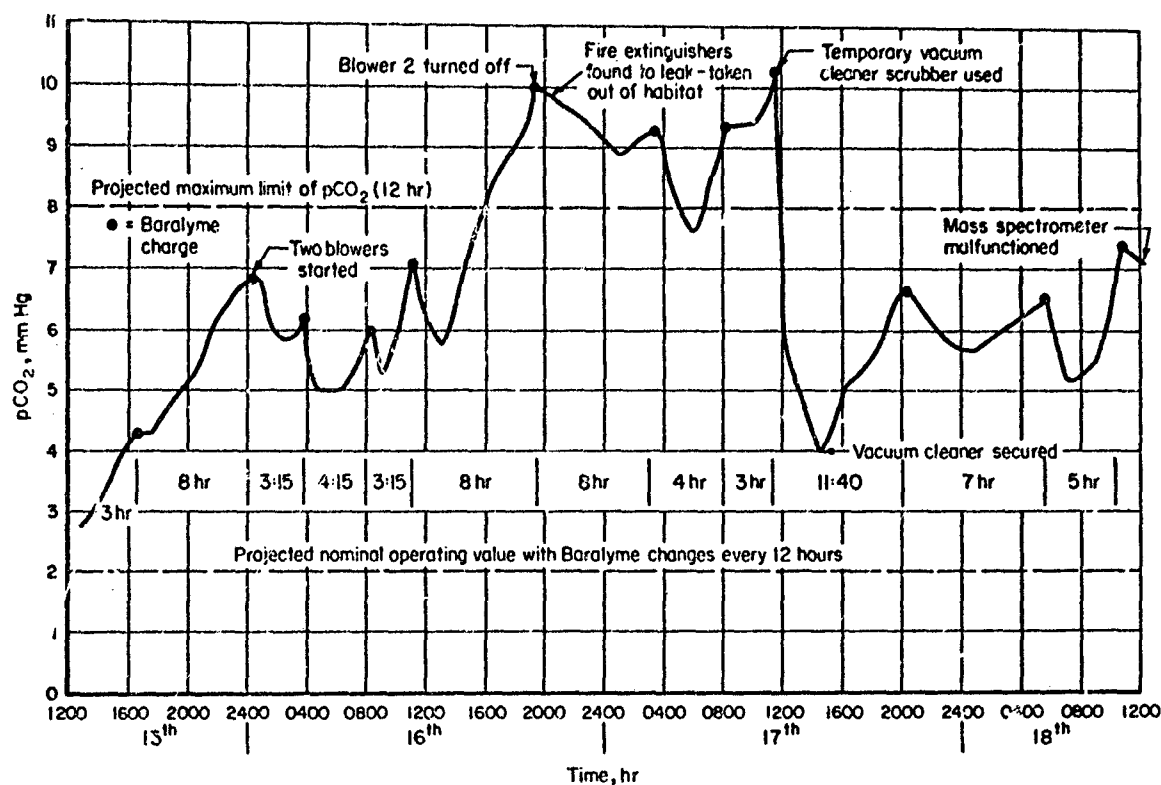
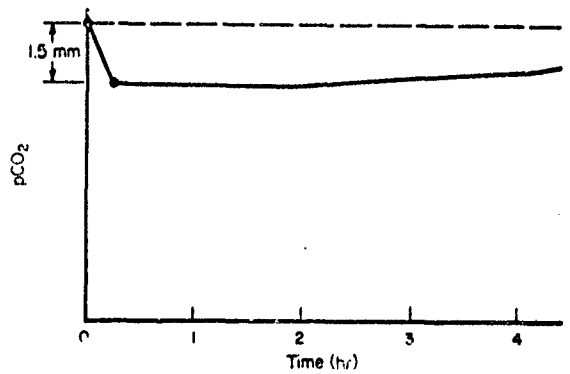

(a) Auxiliary scrubber

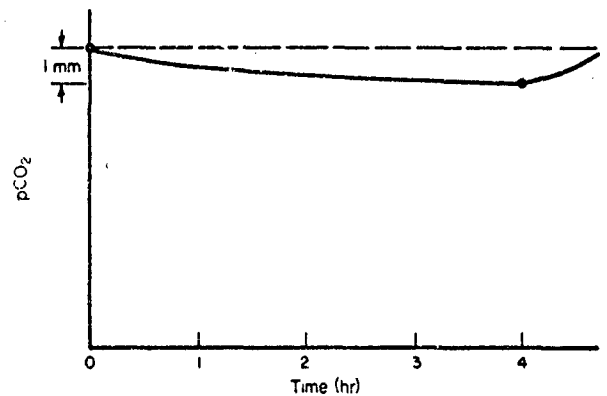

(b) Environmental-control-system scrubber

Fig. C3 - Comparison of the effectiveness of the environmental-control-system scrubber installed by General Electric and the auxiliary scrubber obtained from the Navy Experimental Diving Unit

While the mass spectrometer was being repaired (11 days), colorimetric tubes, infrared analyzers, and a gas chromatograph were used to monitor gas partial pressure in the habitat. This equipment provided adequate, but not continuous, gas analysis, although some discrepancies were noticed in the gas values among the different analyzers. Most significant, however, were the readings taken first near the floor and then near the ceiling of different rooms. These showed that  $\text{CO}_2$  stratified in the cabins; on February 22, 1969, there was 7.6 torr at table level and 5.3 torr at the ceiling in the crew quarters. The partial pressure of  $\text{CO}_2$  also varied between two rooms in the same cylinder; on February 24, 1969, it was 6.1 torr in the crew quarters and 3.8 torr in the bridge. This indicates that circulation in the cabins was not adequate to eliminate stratification of heavier gases.

The mass spectrometer malfunctioned again on day 46 of the mission. This time the fault was attributed to failure of the ion pump. It remained out of service for the duration of the program. The mass spectrometer was down for 25 days of the 60-day mission.

Samples of the closed atmosphere gas from day 13 of the mission were taken to the Naval Research Laboratory for breakdown analysis. Results showed the following quantities of undesirable gas present: 2.1 mg total hydrocarbon/meter<sup>3</sup>, 8.4 ppm methane, and 9.3 ppm CO. The NASA specification for breathing air in hyperbaric chambers lists maximum allowable contamination to be: 50 ppm gaseous hydrocarbons (e.g., methane) and 20 ppm CO. The Bureau of Medicine and Surgery has become even more stringent, allowing no detectable gaseous hydrocarbons and 20 ppm CO.

#### C6.4.2.3.4 Thermal-Control System

The thermal-control system was used to maintain the habitat air temperature and humidity by cooling the gas flow in a heat exchanger and removing condensate, then passing the gas through charcoal filters to remove odors, and finally reheating it, when necessary, to nominal cabin temperature. Sea water was pumped into the habitat to remove heat from the Freon compressor. Cool glycol and water solution was then pumped from the compressor to the separate cabin heat exchangers.

The thermostat in the crew quarters was lowered only once during the mission, and the average habitat temperature fluctuated only a few degrees on either side of 80°F. Relative humidity averages varied from cabin to cabin (wet room 50 percent, engine room 55.4 percent, bridge 48.2 percent, and crew quarters 57.3 percent), and the average relative humidity was 52.1 percent.

Two times during the mission the sea-water-flow switch in the wet-suit cabinet shorted out, blowing a fuse and automatically turning off the environmental control system. The first time, while investigating the failure, one of the aquanauts received a minor shock. The shock was not at all harmful, but it shows that the switch could be dangerous. After each failure the switch was replaced with a new, copper-diaphragm switch. A third time the aquanauts noticed the copper diaphragm was getting badly corroded and eaten through by salt water. It was replaced before failure with a flow switch having a stainless steel diaphragm. Much time was involved in replacing this switch. In the future, if the switch remains in the wet-suit cabinet, where it is subject to saltwater corrosion, it should be made of corrosion-resistant material and should be protected by a waterproof container.

During the mission considerable condensate formed in the crew quarters, the crossover tunnel, and the engine room. Condensate formed at a rate of about 3 gallons per day in the crew quarters, at times becoming a considerable nuisance. The highest humidity and maximum heat load occurred in the crew quarters and the engine room. When periods of maximum heat load occurred (all four aquanauts aboard cooking dinner), temperature and humidity increased. Cooler air coming through the ducts seemed to condense moisture in the warmer, more humid air surrounding the ducts, allowing condensate to run down the outside of the ducts and into cabinets or through the acoustic tile. This problem could be eliminated by better insulation of air and drain ducts and more direct routing of heat-exchanger drain lines.

While the condensate problem was being dealt with, fuses started blowing in the reheater in the crew quarters. After the fuses were changed a few times, it was determined that the condensate was shorting the fuses. At this time the heat exchanger drain ducts were repositioned for better drainage, the airflow damper was adjusted, and the fuse plugs were dried. The aquanauts then turned all the thermostats down below ambient temperature and then raised them one at a time. All fuses held up, and the reheater was functional

again. However, while adjusting temperature and gas flow from the heat exchangers in the bridge and the crew quarters, disproportionate flow conditions resulted and humidity began to rise. This caused rapid cycling of the compressor solenoid until, eventually, the environmental control system shut off automatically. Adjustments were made for 30 minutes before the environmental control system was started again. Each time the environmental control system shut down, temperature would increase, expanding the gas in the habitat. When the environmental control system was again started, the gas would cool and water would rise in the trunk, thus tripping the flood alarm. High-pressure air from the scuba line then would be released to restore habitat pressure.

In addition to the condensate problem, noise levels in the cabins were annoying to the aquanauts. Noise from auxiliary scrubbers in the engine room in conjunction with installed equipment noise prohibited all but shouted conversation in the engine room. When the reheater circuit breaker in the crew quarters closed, it was annoying to the extent that sleep was disturbed. However, there is a breakeven point in system design where the designer must weigh relative advantages and disadvantages between creating a cost-effective system and providing creature comforts. In the case of the engine room, sound-proof paneling should be installed, but system redesign to reduce noise is probably not in order.

#### C6.4.2.3.5 Scuba-Charging, Low-Pressure Air, and Emergency Air Systems

A suggestion was made by the aquanauts to provide more utility and increase available space by reorienting the scuba-charging and low-pressure air station. It was mentioned that gages and hose reels be mounted near the ceiling of the wet room over the trunk with valves mounted on the trunk railing. The hoses would be reeled down and attached to bottles for charging, and reeled back up when not being used. From an engineering standpoint, it would be difficult to reel high-pressure charging hose, but the charging panel could be moved and plumbed in a more convenient location. Low-pressure air lines could be plumbed near the 10-inch trunk to permit easy exit of hookah hoses.

Rather than permit emergency air to be used for normal charging purposes, a larger bank of receivers should be installed topside to provide a constant supply of high-pressure air to the charging station. The emergency air bottles could be moved under the crew quarters to keep the lower trunk under the wet room clear.

#### C6.4.2.4 Plumbing and Sanitary System

Each time the toilet was flushed, gas bubbles backed up through the water. The gas was described as sewer gas. Complete gas analysis performed 13 days after the mission began showed 8.4 ppm methane in the closed atmosphere, indicating that sewer gas was clearly detectable early in the program. Methane, formed by decomposing organic material, is only a part of a group of gaseous hydrocarbons that NASA specifications indicate should be less than 50 ppm in hyperbaric applications and that the Bureau of Medicine and Surgery indicates should be undetectable (letter of June 7, 1968). A gooseneck installed in the sewer line to trap gas and an air fitting attached downstream to enable the divers to blow air into the outfall line to remove built-up material would eliminate the problem on future missions.

The bilge pump in the wet room did not pump the bilges dry because the inlet orifice was on the side of the pump. In addition, early in March, the allen screws that hold the pump impeller tight vibrated loose. Before the problem had been diagnosed and rectified, it was necessary to hand-pump the bilge. A similar problem developed with the blower impeller on the CO<sub>2</sub> scrubber from Duke University. All components known to be vibration sensitive should be locked or wired to prevent such failures.

#### C6.4.2.5 Communications System

The intercom was the most critical communications system in that it was the primary means of communication between the aquanauts and the test director. It was backed up with the sound-powered phone in the bridge and the Bogen in the crew quarters. However, if the intercom were lost, verbal interaction would greatly decrease, impairing safety as well as data collection. Five times during the mission the intercom went out of service unexpectedly. In three of these cases the circuit breaker had snapped open. In the first case the batteries ran down, providing a voltage too small to hold the breaker in. The breaker was set again after the batteries were recharged. In the second case the wet-room trunk alarm shorted out, throwing the circuit breaker in the bridge again. The alarm was bypassed to restore intercom communications. In the third case the breaker went out for no apparent reason; when the breaker was reset, communications were restored. The other two intercom failures did not involve the habitat breaker. One occurred when the press-to-talk switch in the van malfunctioned. It was replaced with a hand microphone. The other involved loss of communication from the habitat for 90 minutes while communication from the van to the habitat remained in service. It was found that the habitat console microphone was turned off to increase the clarity and volume from the bridge speaker.

The closed-circuit TV monitors were almost as important as the intercoms. They, as well as the open microphones, provided the major input to the very successful behavioral program. The cameras functioned well throughout the mission, with occasional replacement of the videcon tubes. The engine room camera failed twice. After the second failure, all cameras had to be turned off for 24 minutes while repairs were made to the panel.

The sound-powered phones in the way stations were used more by the surface support divers for communications checks than they were by the aquanauts. These phones were seldom in working order. The protective casings, open at the bottom, were makeshift and in many cases admitted water to the phone components. Conversations from the phones that worked after emplacement were garbled and not easily understood. Half-way through the mission all phones were removed from the way stations to determine the reason for their failure. They were replaced, but they still did not work. Near the end of the mission it was found that intercom key 8 must be depressed to receive the way-station phones. Following this discovery, occasional repairs had to be made to keep the phones working in a nominal fashion.

Although not specifically a habitat subsystem the underwater cameras will be mentioned here. One underwater TV worked for a short while near the middle of the mission, and the other was never put into service. When the camera worked, it was not positioned correctly to monitor diver egress and entry, and it was of marginal use in the marine science program. The shark cage was adequate for determining whether dangerous animals were near; the camera was not needed for this purpose.

The intercom, the sound-powered phone, and the Bogen were unsatisfactory from a habitability standpoint. Much whining and screaming was reported coming through the intercom on the bridge, and the intercom in the engine room was ineffective unless ear-phones were used to reduce noise and feedback. The sound-powered phone on the bridge was not as easy for communications as was the Bogen in the crew quarters. The Bogen was intended for use primarily for personal outside telephone calls. Since the commercial telephone link was never completed, it served as a supplementary habitat/topside communicator. One had to speak in a loud voice to talk over the sound-powered phone, and communications were not clear.

Convenience items (the commercial TV, the AM/FM radio, and the tape recorder) did not provide the service intended. The TV was in good working order, but the antenna was mounted in the wrong direction for receiving available stations. Since the antenna was not moved during the mission, the TV was useless. The FM portion of the radio received music only about 10 days, and it was used during that time. Then it ceased to function. The volume control on the tape recorder appeared to need adjustment. The music was either too low or so loud it was annoying. Since these are convenience items and not critical to the mission, normal maintenance and repair between missions and proper setup procedure on-site would restore the service.

#### C6.4.2.6 Electrical System

Before the mission began there was considerable discussion concerning the disadvantages of using a center-Y ground to the habitat. It is considered safer to take the ground back through the umbilical and ground to support facilities to eliminate not only a potential mild-shock situation in the habitat, but also galvanic corrosion effects. Although the grounding system was not changed, only the shock received from the seawater flow switch was reported, and only very mild corrosion was noticed.

Many times when the generators were switched over, a momentary loss of power was experienced. On days 5 and 19 habitat power failed because of a generator fuel-pump malfunction. All emergency systems worked well, and emergency procedures were applied as planned. Power was switched back within 15 minutes, and all systems resumed normal functioning.

It has been mentioned that the reheater circuit breaker in the crew quarters had a noisy and annoying action. This breaker could be replaced with a less noisy model in a different location.

In terms of habitability, the dryer, which worked well throughout the mission, could be replaced with a washer/dryer combination for convenience. Only a nominal amount of additional vertical space would be needed.

#### C6.4.3 Habitat Interfaces and Connected Equipment

##### C6.4.3.1 Introduction

A number of interfaces and government-furnished equipment have already been considered in the preceding section, as they seem an integral part of the habitat though not specifically supplied with the habitat per se. These include the underwater TV cameras, the NASA mass spectrometer, and the emergency air supply. Other items, to be considered in this section, include umbilicals, way stations, built-in breathing system, hookah system, aquasonics, and the dumbwaiter system.

##### C6.4.3.2 Umbilicals

All umbilicals were layed and connected at either end with few problems. In connecting the communications umbilical no strain relief could be found; this was corrected before the mission start. No chafing gear was provided for the plastic water umbilical on the support barge, and the connection at the habitat slipped off twice, once before the mission and once during the mission. In each case this was corrected quickly and the line was flushed. Prior to mission start the casing of the high-pressure-air umbilical ruptured because of entrained gas, but it was repaired and provided uninterrupted service for the duration of the mission.

#### C6.4.3.3 Way Stations and Navigation Markers

The five way stations in strategic positions on the ocean bottom were to be used to resupply breathing air, to communicate with the habitat and the control van, and as protection against dangerous sea animals if encountered. The only use of the stations was in transfer of air bottles, and this was done infrequently. As mentioned, the phones did not work consistently and were used little by the aquanauts.

The way stations were used during the mission as landmarks to the aquanauts. Conversely, the navigational grid system, which took days to fabricate and days to lay out properly, was not used. Obviously, considerable time and effort can be saved by eliminating this system.

#### C6.4.3.4 Built-in-Breathing System

For some reason the built-in-breathing hoses and regulators in the bridge and engine room were supplied by General Electric, and those in the crew quarters and wet room were furnished by the Naval Facilities Engineering Command. During the construction phase it was found that the latter were not of the water-immersible type. Since the main reason for installing an emergency built-in-breathing system was to provide life support in the event of flooding or contaminated atmosphere, last-minute procurement from Battelle and replacement was necessary. This and similar problems may have been avoided by disseminating a list of equipment to each agency for comment and return to the central agency. In this manner each person in each agency would know his equipment responsibilities, and discrepancies could be ironed out in the planning phase.

#### C6.4.3.5 Hookah System

The hookah, supplied by Battelle, was a full-face mask with communications in each mask (Fig. C4) and a central tender control unit on the bridge of the habitat. The system was recently developed under contract with the U.S. Navy. It permitted tethered excursions up to 200 feet from the habitat.

The mask and communications worked well throughout the duration of the program, but the hookah system could be made more convenient to use. In Tektite I the hookah hose was attached to the low-pressure-air source in the habitat, routed through the 10-inch truck from the wet room, and coiled on makeshift chocks outside the shark cage; then the mask was brought back into the wet room through a crack in the shark cage door and hung on a bracket for the aquanaut's use. The hose leading through the shark cage and wet-room trunk was fastened to the screening by short pieces of coated wire to keep it out of the way of swimmer traffic. The hookah could have been either coiled and stored inside the wet room or be wound on a reel outside the shark cage with cleats to hold the hose to the side wall. Either of these methods would make the hookah more convenient to use.

The hookah was used for 41 man-hours of diving, about one-tenth of the 453 man-hours in the water.

#### C6.4.3.6 Aquasonics

Two sets of aquasonic gear were supplied to the project. These included three diver units and two tender units. These underwater-communication units were used infrequently because of lack of reliability. More reliable, longer range swimmer communications are required.

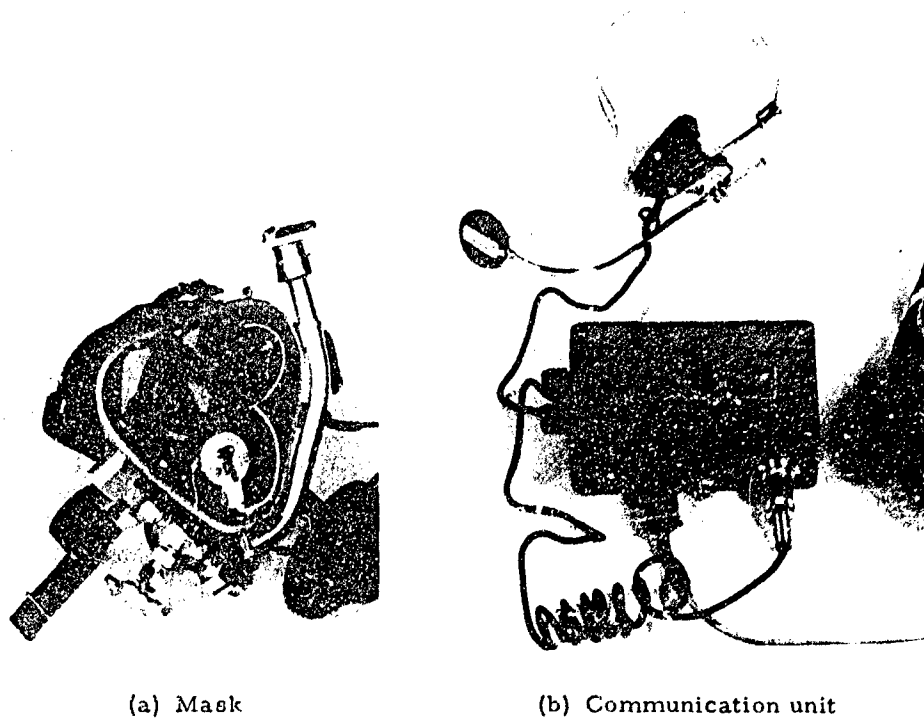

Fig. C4 - Full-face mask with communication unit

#### C6.4.3.7 Dumbwaiter System

The large transfer pot, a heavy steel can, was oversized for use at 50-foot depths. It was too heavy for convenient handling and had a tendency to rust. Considerable bottom time and energy was expended in simply transferring materials. Constant maintenance was necessary; with each of the steel pots, not only to reduce external rust but also to clean up sealing surfaces to effect proper seals. Furthermore, many items arrived in the habitat wet or crushed.

It is suggested that new noncorrosive transfer pots be bought or fabricated which are negatively buoyant when loaded. Small lead weights can be used to adjust the buoyancy for light loads.

#### C6.4.4 Habitat Support Equipment

The variety of equipment on both the control barge and crane barge to supply power, gas, water, and monitoring support to the aquanauts functioned very well and allowed few interruptions in service.

The fabric pillow tank for fresh water and the redundant electric generators both presented minor servicing problems. It took considerable time to replenish water to the tank and fuel to the diesel generators. During the time the supply boat was moored to the control barge, wave and wind action would knock the boat into the barge, jarring sensitive instrumentation. On future missions, regardless of whether or not Ammi barges are used, higher capacity pumps will be needed for transfers. In addition, as mentioned before, the electric fuel pump on the generator failed twice during the mission, causing power outages in the habitat.

The decompression complex, supplied through the office of U.S. Navy Supervisor of Salvage, functioned well throughout the mission, and the Seabee divers and equipment operators are to be commended on their proficiency gained over the short period of time. However problems occurred with the lift crane. Two times during the project the crane was inoperable for considerable periods of time owing to failure of parts, that required much time to procure. First the hydraulic accumulator failed; then midway through the mission a hydraulic valve failed. Fortunately the crane was not needed during these periods for emergency withdrawal of the aquanauts.

The support barge was raised out of the water away from wave action by winching it onto piles in the corner spudwells. Since the bottom along the east shore was rocky, the piles were to be held upright by guy wires attached to rock bolts in the bottom. Fourteen holes were drilled underwater in the igneous volcanic rock for installing rock bolts. Unfortunately the winches used to pull the barge out of the water did not have a capacity equal to the heavy load. The barge was barely out of the water in calm weather and was cocked on the pilings. In heavy weather, the barge was shaken by wave action.

#### C6.4.5 Aquanaut Support Equipment

##### C6.4.5.1 Introduction

A variety of equipment was brought or shipped to the site to aid the aquanauts in conducting their marine science program. Included were lobster detection and tagging devices, plankton standpipe, coring tools, diving equipment, and the Aerojet General mini sub.

##### C6.4.5.2 Lobster Detection and Tagging Devices

Two means were available for tagging the lobster population in Lameshur Bay and surrounding bays: sonic pingers and barbed spaghetti tags (sphyron tags) of different color combinations. The colored tags did a fine job of marking individual lobsters in the population, but to find a particular lobster over and over again to study migration, range, feeding cycles, etc., a sonic tag was used. The sonic tags had an effective range of only 50 to 100 feet. Part of this problem may have been the extreme directionality of the receiver, but most of the problem was the low-intensity output of the pinger.

Other equipment can be developed to study lobster habits. A small underwater photocell and light source, when placed near the lobster burrow, can indicate entry and exit of the animal. Perhaps phosphorescent grease or paint applied to the animal would permit simple detection of the lobster at night by means of an underwater black light.

##### C6.4.5.3 Plankton Standpipe

Near the start of the mission it was found that the plastic water pump for the standpipe had been run dry and was useless. It was necessary to acquire another from the mainland. On day 18 of the mission the plankton standpipe was carried away from its moor by the current. It was recovered, cleaned, and placed in position once again. Half-way through the mission the pump arrived and was installed, making the system operational. The first plankton experiment was started with 15 days left in the mission. Owing to the late date, the plankton experiment was cut short to allow more time for research in a more productive area.

##### C6.4.5.4 Coring Tools

Two types of coring tools were supplied to the aquanauts.(Fig. 5). The first was an electric underwater drill with two 14-inch diamond-tipped core barrels, 3/4 inch in



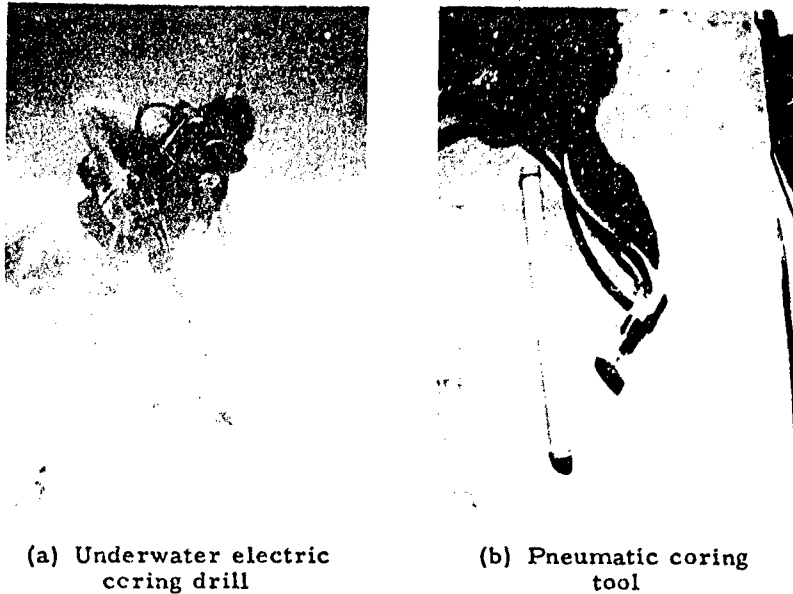

Fig. C5 - Coring Tools

diameter. The electric tool was to be used primarily for taking geological core samples in hard rock and coral. It worked well during training, and halfway through the mission it was used to take rock core samples. During this experiment the diamond tip on the barrel broke off. The spare barrel was located, but the coring tool was not used again.

The second coring tool supplied was a pneumatic impacting tool designed to operate with air from a scuba bottle. One-inch-diameter plastic core barrels of varying length were supplied with a core catcher. The air tool was to be used for coring in sand and mud. This was the same tool that was used in Sealab II with much success. The geological research did not require the use of this tool during the mission, and it was not used except in training.

#### C6.4.5.5 Diving Equipment

The diving equipment available to the aquanauts consisted of open-circuit scuba and the hookah discussed previously. The scuba equipment functioned very well; however, considerable time and energy was expended charging tanks. Furthermore, double-tank scuba is limited to a little over an hours' duration at a depth of 50 feet. As a result, working dives were short and excursions were limited. The bubbles from the regulators frightened the animals being studied.

Future marine research could be enhanced by procurement of dependable semiclosed breathing apparatus allowing dive times of up to 4 hours. Three brands of equipment that may be satisfactory are the U.S. Navy Mark VI, the Drager, the Stark Electrolung, and the G.E. backpack. In each case the duration of the dive is limited by CO<sub>2</sub> removal. It may be valuable to perform research to develop a long-duration, semiclosed breathing system using N<sub>2</sub>-O<sub>2</sub> breathing mix. Tektite I has proved the worth of shallow-water saturation work for scientific purposes, but without the use of dependable, inexpensive, long-duration breathing apparatus designed specifically for that purpose, progress could be hindered.

#### C6.4.5.6 Mini Sub

Since diving time was limited by the available breathing equipment, a swimmer delivery vehicle was procured from the Office of Naval Research to allow longer excursions from the habitat. The sub was an Aerojet General free-flooding design (Mark VII, Model P, 1955 vintage) propelled either by electric power or by foot pedaling.

The sub had not been overhauled or evaluated before it arrived on-site. As a result it was found to be defective in many areas. The original batteries were useless, the old-fashioned floating switch gear for selecting motor speeds was corroded, interconnecting wires were missing, steering linkages were disconnected, the steering wings were out of adjustment, the variable water ballast tank had a hole in it, the dogs on the stainless steel clutch in the electric motor were broken off, and insufficient Styrofoam buoyancy material was included. The sub had to be completely overhauled from stem to stern before it would be of any use, a difficult task without the proper tools and replacement parts. Batteries were replaced with semisealed lead-acid marine batteries, dogs were welded on the clutch, and the switch gear was rebuilt and rewired so the electric mechanism was in working order. Linkages were repaired and greased, the wings were aligned, and the ballast tank was silver-soldered.

However, during the first trial run, acid leaked from the batteries, ruining much internal wiring. No replacement batteries suitable for the job could be found in the area, so electric power was not used. Packing Styrofoam was assembled in the sub to provide neutral buoyancy; however, at a depth of 50 feet, this Styrofoam compressed, decreasing buoyancy. An attempt was made to replace the Styrofoam with inflatable life jackets, but none were available. Because of the poor condition of the sub and the unavailability of replacement parts, the mini sub was not used by the aquanauts for excursions.

#### C6.4.6 Aquanaut Training

Habitat-system training was completed in Philadelphia, and support-equipment training and habitat familiarization were conducted on-site in the Virgin Islands.

Aquanaut training on habitat systems, 1 week in duration, was conducted by General Electric engineers in the Philadelphia Naval Shipyard, where final assembly was being completed. Classroom lectures discussing system and subsystem schematics were followed by familiarization with the actual hardware in the habitat. With the pressure of many visitors and work still being completed on habitat assembly, training suffered somewhat, but in general the acquainting of the aquanauts, standby aquanauts, and support divers with hardware intricacies was successful. However, a longer, more intensive training period, with fewer distractions, possibly could have reduced some of the maintenance problems encountered at the start of the 60-day mission.

Table C2 shows the training schedule prepared for use on-site. The schedule was not closely adhered to, but the major items were covered. Marine-science-equipment preparation and study as well as aquanaut physical training was carried on at the discretion of the individual aquanauts.

Habitat schematics were reviewed generally by the aquanaut responsible for respective habitat subsystems; however, the most useful experience was gained through two short (no-decompression) habitat live-ins. During the first practice session the aquanauts stowed gear, established contact with topside, filled out sample logs, changed baralyme, charged scubas, used the hookah and checked communications, took CO<sub>2</sub> readings with colorimatic tubes, had lunch, and conducted a simulated contaminated-atmosphere drill before coming back to the surface. The second live-in occurred the day before mission start and included a startup of the environmental control system and practice

Table C2  
On-Site Training Schedule

Training Items	February									
	7	8	9	10	11	12	13	14	15	
Review of habitat schematics	Nights									
Biomedical items (EEG, EKG, spirometer, first aid, etc.)			Night							
Dumbwaiter operation			Morning							
Hookah mask with communications					Morning					
Aquasonics training					Morning					
Underwater electrical tool					Morning					
Mini-sub training					Afternoon		Afternoon			
Habitat live-in					Afternoon		Morning			
Decompression complex					Afternoon		Morning			
Start of experiment									●	

emergency procedures including habitat flooding, fire, and power loss. After each session two of the aquanauts were picked up from the ocean bottom near the crane barge in the personnel transfer capsule and were locked into the deck decompression chamber as a training drill.

Biomedical refamiliarization was accomplished on a casual basis between individual aquanauts and the medical personnel on-site. This effort could have been more structured. Each Wednesday (biomedical day) during the mission completion of the biomedical tests became more efficient, but for the first 2 or 3 weeks, excessive time was expended completing these tests.

Dumbwaiter-operation training was completed on schedule; however it was determined to be a difficult, time-consuming job when using the large transfer pot. Intermediate size pots were procured and used much of the time during the mission.

Experience was gained with the hookah during the habitat live-ins rather than at the scheduled time. Most useful experience was obtained during the mission when the aquanauts used the hookah for 41 total diving hours, 1/10 of the total dive time. Much of this on-the-job training with different items ironed out gray areas in the total training programs at some expense to the efficient use of saturated dive times.

Training with aquasonics units and with the miniature two-man submersible was completed by only one aquanaut. At the time, lack of training with certain equipment prior to mission start seemed unfortunate, but in retrospect valuable time was saved. Neither of these items were used to advantage during the mission. The aquasonics were unreliable, and the mini sub could not be restored to a useful condition.

The electric coring tool also was used only by the lead aquanaut before the mission started. It is important that the safety procedure is observed when the tool is used and that the current leakage detector is on-line. Operating procedures for the electric tool were reviewed before it was used during the mission.

A structure training program, however disagreeable, inconvenient, or distasteful, could be planned and executed with care in future missions, especially where a number of marine scientists may cycle through the habitat. When a group of people have different levels of underwater experience, training can be adjusted to satisfy the needs of the least experienced member at the unfortunate expense of the more experienced. No training program can satisfy each participant, but valuable knowhow may be absorbed, seeming unimportant at the time, that during the mission may help to evolve a more meaningful and more efficient program. Training is an effort where, by organization, doubtful and potentially dangerous situations can be avoided.

## **Appendix D**

### **AQUANAUTS**

**D1 BIOGRAPHIES OF A TEKITE I AQUANAUTS**  
Richard Waller, Bureau of Commercial Fisheries,  
Department of the Interior, Washington, D. C.

#### **D1.1 Primary Crew Members**

**D1.1.1 Richard A. Waller,**  
Oceanographer, Department of the Interior



**Fig. D1 -**  
**Richard Waller**

Mr. Waller (aquanaut 1) has been with the Bureau of Commercial Fisheries since 1961 and has worked in various research positions with the Bureau's marine programs. Currently he is attached to the Bureau Central Office staff in Washington, D. C. He was the Project Manager for Interior's part of the Tektite I Project and served as crew chief during the operation.

Mr. Waller grew up in Jacksonville, Florida, and took his B.S. and M.S. degrees in marine biology at Florida State University. He was 34 years old during the mission and is married to the former Marilyn Shepherd of Jacksonville, Florida. They live, with their two children, near Washington, D. C., in Oxon Hill, Maryland.

**D1.1.2 Conrad V. W. Mahnken,  
Oceanographer, Department of the Interior**



**Fig. D2 -  
Conrad Mahnken**

Mr. Mahnken (aquanaut 3) has worked with the Bureau of Commercial Fisheries since 1963. His principal research efforts have been in marine zooplankton studies, and he is currently working on a marine aquaculture project at the Bureau's Biological Laboratory in Seattle, Washington.

Mr. Mahnken grew up in Seattle, Washington, and earned his B.S. and M.S. degrees in biological oceanography at the University of Washington. He was 31 years old during the mission and is married to the former Tamsin Kirk of Glendale, California. They live on Bainbridge Island near Seattle.

**D1.1.3 H. Edward Clifton,  
Geologist, Department of the Interior**



**Fig. D3 -  
Edward Clifton**

Dr. Clifton (aquanaut 2) has worked with the Geological Survey since 1963, assigned to the Marine Geology Laboratory in Menlo Park, California. For the past couple of

years, his research efforts have been directed toward investigations of the origin and economic potential of black-sand deposits on the continental shelf of Southern Oregon.

Mr. Clifton grew up in Jefferson, Ohio, and earned his B.S. degree in geology at Ohio State University and his Ph.D. in geology at the Johns Hopkins University. He was 34 years old during the mission and is married to the former Ann Pearch of Chagrin Falls, Ohio. He and his wife and their three children live in Los Altos, California.

**D1.1.4 John G. Van Derwalker**  
Fishery Biologist, Department of the Interior



Fig. D4 -  
John Van Derwalker

Mr. Van Derwalker (aquanaut 4) has been with the Bureau of Commercial Fisheries since 1958 and has worked at various of the Bureau's field laboratories. He is presently assigned to the Bureau of Commercial Fisheries' Biological Laboratory in Seattle, Washington, where he has been studying the response of fingerling salmon to various hydraulic conditions and to pressure and temperature changes.

Mr. Van Derwalker grew up in Pueblo, Colorado, and received his B.S. degree in zoology in 1958 from Colorado State University. He was 32 years old during the mission and is married to the former Norma Koch of Castleford, Idaho. They live in Lynnwood, Washington, with their three children.

**D1.2 Alternate Crew Members**

**D1.2.1 R. Lawrence Phillips,**  
Geologist, Department of the Interior

Mr. Phillips has worked for the Geological Survey since 1966 and is assigned to the Marine Geological Laboratory in Menlo Park, California. His primary research efforts have been directed toward placer deposits off the Southern Oregon coast.

Mr. Phillips grew up in Vancouver, B.C., and Tacoma, Washington. He received his B.S. in geology from the University of Puget Sound in 1960 and his M.S. in geology from the University of Oregon in 1968. He was 30 years old during the mission and is married to the former Carol Wiley of Tacoma, Washington. They have three children and live in Cupertino, California.

**D1.2.2 Ian Gregory Koblick,  
Marine Biologist, College of the Virgin Islands**

Mr. Koblick is with the Caribbean Research Institute on St. Thomas in the Virgin Islands where he is coordinator for field studies at the Virgin Island Ecological Research Station. His research efforts have been directed toward marine ecological surveys on the coastal shelf of the Virgin Islands.

Mr. Koblick was born in San Francisco, California, and received a B.S. in biology from Chico State University in 1964. He was 29 years old during the mission and is married with two children. He and his wife, the former Tonya Ann Smithousen of Chico, California, live on St. Thomas, U.S. Virgin Islands.

**D1.2.3 Gary Everett Davis  
Park Ranger, Department of the Interior**

Mr. Davis, an aquatic ecologist, has been employed by the Park Service since 1963. He is serving in the U.S. Army at Fort Ord, California. His primary research effort has been directed toward the development of computer models for predicting primary productivity in the lakes of Southern California.

Mr. Davis grew up in San Diego, California, where he received both his B.S. and M.S. degrees in biology from San Diego State College. At 24 he was the youngest Tektite I aquanaut. He is married to the former Deborah Friend.

## **D2 SELECTION CRITERIA**

### **D2.1 General**

Members of the Tektite I crew of aquanauts were all scientists actively engaged in marine oriented research programs when selected to participate in the program. All had used scuba to accomplish their particular research program. They were selected as aquanauts primarily because this previous marine research experience would enable them to conduct a valid research program while living on the ocean floor. The only physical examinations they were required to pass were the standard navy diving physical, pressure test, and O<sub>2</sub> tolerance tests.

It was recognized before the dive that an aquanaut who is to be submerged for 60 days must have, in addition to professional competence, a kind of personality that would enable him to cope with the peculiar constraints of the Tektite I program. In addition to conducting a research program he would also have to cook, wash dishes, and do general housework. Every crew member had to be prepared to do his share of this kind of work. The aquanauts also would be subjected to a program of psychological and biomedical research which would be trying and would take time away from their particular interests. This meant the aquanauts would have to be patient and contribute to programs from which they would get no direct benefit. The aquanauts would also be expected to assume the responsibility of troubleshooting the various habitat systems, since no engineer would be on board during the mission.

Although no formal psychological selection tests were given to potential aquanauts, there was a subjective evaluation of their personalities and these were related to the unique problems that would occur during the Tektite I program.



### D3 TRAINING AND PREPARATIONS

#### D3.1 Medical

Two months before the beginning of the Tektite I mission the aquanauts entered into a program in which biomedical base lines were established. All seven aquanauts spent 1 week at the University of Pennsylvania Hospital where the majority of the base-line work was done. In addition aquanauts Clifton and Van Derwalker spent 2 nights at the Medical Neuropsychiatric Research Unit in San Diego, California, where sleep records (electroencephalograms) were recorded. Aquanaut Waller spent two nights at the Baylor University Hospital establishing similar records.

#### D3.2 Habitat

All seven aquanauts also spent a considerable amount of time at General Electric, Valley Forge, and at the Philadelphia Naval Yard becoming familiar with the various habitat systems and safety equipment. Each aquanaut was assigned one or two specific systems that he was to have a working knowledge of. As an example, one aquanaut was assigned the environmental control system. He was instructed in its operation by the General Electric engineer who was responsible for its design. The aquanaut was to become so familiar with that particular system that in case of a system failure he could diagnose the problem and make minor repairs. If the problem was serious, he could consult with the engineers on the surface before making repairs.

#### D3.3 Marine Scientific

In the early planning stages the selection of a suitable site for conducting a marine research program was given considerable attention. The Lameshur Bay site was selected because it met all the requirements of the other cooperating agencies and because the biological and geological information gathered in that area would have application to other parts of the Caribbean as well as parts of our southeastern coastlines.

About 3 weeks before the four primary aquanauts began the 60-day mission the marine scientists arrived on site and began preparing for the mission. A marine sciences laboratory was set up in one of the huts, and the preliminary work began. The geologists surveyed and mapped the shore line and adjacent parts of the island. Descriptions of the topography and geologic formations were made. A system of buoys were placed in Lameshur Bay around the habitat site on a 1000-ft grid. They were to be used as reference points during many phases of the program.

It was during this pre-dive period that the lobster study area was defined and divided into the different study sections. The sphyron tagging of lobsters was also started during this period.

These surface activities were continued by the surface scientific support personnel throughout the program.

### D4 DAILY ROUTINES

The 60-day ocean floor program can, for the purposes of describing daily routines, be divided into three parts: the first 2 weeks when the aquanauts were becoming familiar with the habitat and the various systems, the middle 4 weeks when they were allowed to have one team in the water at a time, and the last 2 weeks when all the aquanauts could be out diving at the same time.

For the first 10 days of the 60-day program the aquanauts were instructed to maintain a bridge watch 24 hours a day. Bridge watches were manned during the day on an informal basis, but from the hours of 10 p.m. to 7 a.m. an assigned watch schedule was maintained. This period of 9 hours was divided into three watches, 11 p.m. to 1 a.m., 1 a.m. to 4 a.m., and 4 a.m. to 7 a.m. This enabled each crew member to get an uninterrupted night's sleep once every 4 days.

The amount of time spent on the marine research program was minimal during this period for a variety of reasons. Besides spending time learning how to operate the habitat systems, the aquanauts also spent a great deal of time repairing, replacing, or recalibrating many of the life-support systems. They also discovered that the CO<sub>2</sub> scrubber system was not as efficient as anticipated, which meant they had to spend more time maintaining this system than was planned.

The aquanauts became more efficient operators of the various habitat systems, and the frequency of equipment failure declined. At the end of the day 10 they decided the habitat systems and all safety devices were working properly, and the night watches were suspended.

Starting about this time the amount of time spent in the water began to increase significantly. The aquanauts were also becoming more aware of the potential of saturation diving, and they began to change their research programs to take advantage of this new insight.

On a typical day during the middle part of the mission, they would rise between 8 and 9 a.m. Two members would plan the first dive and begin laying out their equipment, while the other members fixed breakfast, changed baralyme, and made routine checks of the habitat systems. After breakfast the first team would go out, while the other aquanauts cleaned up the habitat and prepared for their first dive. No formal schedule of dives were made; the teams might alternate dives during the day, or one team could dive in the morning and the other in the afternoon and evening. A midday meal was eaten but not necessarily together. While one team was out diving, the other maintained the habitat systems and worked on the data they had collected on previous dives. The last dive of the day ended between 5 and 7 p.m., and the aquanauts gathered in the crew quarters for the happy hour and dinner. After the dinner dishes were washed, a final check of the habitat and the warning devices was made. On alternate nights a brief medical status report of each aquanaut was given to the surface support personnel along with the normal systems report. The aquanauts usually went to bed sometime between 11 p.m. and 1 a.m.

On Wednesday of each week this routine was disrupted because of commitment to the biomedical program. Until the aquanauts had refined their techniques of manipulating the various pieces of equipment used in this program, it took the entire day to complete the tests. There was a gradual improvement toward the end of the dive, and they were able to complete the tests in time to make one or two dives before the day was over.

A typical day during the latter part of the dive was similar to that just described except all four divers could dive at the same time.

## **Appendix E**

### **CHRONOLOGY**

D. C. Pauli and H. A. Cole,  
Ocean Technology Branch, Office of Naval Research,  
Washington, D. C.

As discussed in Chapter 1 the first suggestion that behavioral studies of divers living on the ocean floor would have value to the nation's space program as well as to undersea program occurred at a NASA symposium on Isolation and Confinement in November 1966. In the following month the first of a series of meetings were held between NASA and ONR to explore the possible types of behavioral studies which could be conducted and the various approaches by which the studies could be implemented. The following chronology starts after that initiating meeting and marks significant events which subsequently occurred up through the completion of the Tektite I mission:

- January 16, 1967: First working meeting between ONR and NASA.
- June 1967: NASA study contracts let to General Electric and Grumman.
- October 30, 1967: Assistant-secretary-level agreement between the Navy and the Interior Department for a cooperative study of problems of mutual interest.
- November 27, 1967: Bureau of Commercial Fisheries requests to join Navy and NASA in the study program.
- December 27, 1967: Unsolicited proposal from General Electric to ONR for Tektite I.
- January 7, 1968: Survey of potential sites, including Lameshur Bay, St. John, Virgin Islands.
- January 10, 1968: Bureau of Commercial Fisheries invited by ONR to join the Navy and NASA in Tektite I as a scientific participant.
- January 18, 1968: ONR initiates Tektite I contract with General Electric.
- February 20, 1968: Interior Department formally invited by Navy to help sponsor the Tektite I project.
- March 6, 1968: Naval Medical Research Institute invited by ONR to participate in the development of the Tektite I behavioral program.
- March 19, 1968: Participation of Navy amphibious construction battalions and mobile construction battalions in Tektite I requested by ONR.
- March 22, 1968: Initial BuMed support requested by ONR for: (a) review of life support systems and operational procedures, (b) recommendation of decompression procedures, (c) recommendations concerning personnel safety, and (d) BuMed participation in the biomedical research program.

- April 5, 1968: ONR formally requests NASA support to jointly sponsor Tektite I.
- April 11, 1968: February 15, 1969, established as the mission-start day.
- April 25, 1968: BuMed tasks the Naval Submarine Medical Center to assist ONR as requested on March 22.
- April 26, 1968: NASA formally becomes a Tektite I sponsor.
- May 1, 1968: Interior Department formally becomes a Tektite I sponsor.
- June 11, 1968: Chief of Naval Operations authorizes construction-battalion support for Tektite I.
- June 25, 1968: ONR requests the Commander in Chief, Atlantic Fleet, for transportation and logistics support for Tektite I.
- July 16, 1968: First draft of General Electric program plans submitted: (a) Program Plan, (b) Safety and Emergency Procedures Plan, (c) Transportation and Assembly Plan, and (d) Scientific Mission Requirements Plan.
- October 8, 1968: Chief of Naval Research invites Coast Guard participation in Tektite I.
- October 16, 1968: CNO tasks the Commander in Chief, Atlantic Fleet, to provide construction-battalion and fleet transportation and logistics support to Tektite I.
- October 24, 1968: Arrival of the Tektite habitat cylinders, base, and other major components to the Philadelphia Naval Shipyard.
- October 26, 1968: Arrival of Amphibious Construction Battalion Two advance party at St. John Island aboard the USS Casa Grande (LSD 13) to construct the base camp.
- October 29, 1968: Operational readiness review group formed to review nonhard-ware aspects of Tektite I.
- November 8, 1968: Coast Guard formally becomes a Tektite I participant.
- November 13, 1968: Chief of Naval Research requests Secretary of Navy approval on the use of human subjects in the Tektite I project.
- November 14, 1968: Aquanaut primary and backup crews officially designated.
- November 18, 1968: Arrival of the launch Ammi barge to the Philadelphia Naval Shipyard.
- November 21, 1968: Arrival of the support Ammi barge at the Philadelphia Naval Shipyard.
- December 2, 1968: Amphibious Construction Battalion Two advance party returns from St. John aboard the USS Shadwell (LSD 15).
- January 5-11, 1969: Physiological and psychological base-line studies conducted on the Tektite I aquanauts at the University of Pennsylvania hospital.

- January 8, 1969: Tektite I habitat and support equipment depart from Philadelphia to Lameshur Bay aboard the USS Hermitage (LSD 34).
- January 10, 1969: The Tektite I base camp activated at St. John.
- January 13, 1969: Habitat and support equipment offloaded at Lameshur Bay.
- January 20, 1969: Pilings, used for the lowering of the launch barge, driven in Lameshur Bay.
- January 22, 1969: Wave action shears off launch barge pilings at bottom of bay.
- January 26, 1969: New launch barge pilings driven.
- January 27, 1969: Tektite habitat successfully launched from launch barge.
- January 31, 1969: ONR promulgates the Tektite I Operation Plan. Tektite habitat towed to site, ballasted, and emplaced on ocean floor. Power, water, and air umbilicals layed and secured from the support barge to the habitat.
- February 4, 1969: Instrumentation and communication umbilical layed and secured.
- February 11, 1969: Final report of the habitat material safety review issued.
- February 12, 1969: Habitat and support systems become operational. Phase II (see page 12) completed; Phase III begins. Aquanauts conduct the habitat-systems-check live-in.
- February 13, 1969: Secretary of the Navy approves the use of human subjects for Tektite I.
- February 15, 1969: Aquanauts enter the Tektite habitat at 10:55 a.m., Eastern Standard Time, to begin the 60-day mission.
- February 17, 1969: Carbon-dioxide fire extinguishers removed from the habitat due to possible leakage. Aquanauts use vacuum cleaner as a CO<sub>2</sub> scrubber to lower CO<sub>2</sub> level. Water umbilical parted, quickly repaired.
- February 18, 1969: Mass spectrometer experiences its initial failure; backup atmosphere monitoring systems used.
- February 21, 1969: First long excursion from the habitat by the aquanauts.
- February 22, 1969: Aquanauts disassemble the mass spectrometer and send it to the surface for repairs. Gas chromatograph and IR-215 become operational as additional atmosphere monitoring equipment.
- February 24, 1969: Initial EEG recordings completed.
- March 1, 1969: Aquanauts kill a moray-eel interloper; additional CO<sub>2</sub> scrubber installed in habitat.
- March 2, 1969: Aquanauts reinstall the mass spectrometer.
- March 4, 1969: Aquanauts send a good-luck message to the crew of Apollo 9.

## PROJECT TEKTITE I

- March 8, 1969: Aquanaut Mahnken develops an infection in his right ear.
- March 16, 1969: Aquanaut Waller develops an ear infection.
- March 18, 1969: Aquanauts receive a message from Vice President Agnew marking the midpoint of the mission.
- March 21, 1969: Aquanaut Van Derwalker develops an ear infection.
- March 22, 1969: Aquanaut Clifton develops an ear infection.
- March 30, 1969: Mass spectrometer experiences its final failure.
- April 15, 1969: Aquanauts leave the habitat at the end of the mission, enter the deck decompression chamber at 12:46 a.m. (local time), and emerge at 8:00 p.m.
- April 16, 1969: Two days of medical and psychological debriefings begin.
- April 17, 1969: Phase III ends; Phase IV begins.
- April 22, 1969: USS Raleigh departs St. John with first of three return lifts.
- April 26, 1969: Umbilicals recovered and support barge lowered from the support pilings.
- April 28, 1969: Habitat raised from Lameshur Bay floor in preparation for return.
- May 14, 1969: Aquanauts and participants receive commendation awards from Vice President Agnew and agency secretaries.
- May 22, 1969: Tektite habitat returned to the Philadelphia Naval Shipyard aboard the USS Plymouth Rock.
- May 23, 1969: Custody of the Tektite habitat returned to General Electric.
- June 6, 1969: Last Seabee detachment departs from Lameshur Bay.
- June 10, 1969: Phase IV ends; Phase V begins, including preparation of this report.