

AD-768 016

ON BALANCED GAMES WITHOUT SIDE PAYMENTS

L. S. Shapley

RAND Corporation

Prepared for:

National Scientific Foundation

September 1972

DISTRIBUTED BY:

NTIS

**National Technical Information Service
U. S. DEPARTMENT OF COMMERCE
5285 Port Royal Road, Springfield Va. 22151**

AD 768016

ON BALANCED GAMES WITHOUT SIDE PAYMENTS

D. S. Shapley

September 1972

P-4910

AD-768 016

ia

ACCESSION OF	
RTD	White Section <input checked="" type="checkbox"/>
D'C	Buff Section <input type="checkbox"/>
WASH. FORCE	<input type="checkbox"/>
JUSTIFICATION	
BY	
DISSEMINATION/AVAILABILITY CODES	
Dist.	AVAIL. and/or SPECIAL
A	

Any views expressed in this paper are those of the authors. They should not be interpreted as reflecting the views of The Rand Corporation or the official opinion or policy of any of its governmental or private research sponsors. Papers are reproduced by The Rand Corporation as a courtesy to members of its staff.

Correction sheet for P-4910, On Balanced Games Without Side Payments, L. S. Shapley, September 1972

- On page 7, line 12, insert "and positive" after "unique."
- On page 11, line 7, change all three "+" signs to "-."
- On page 18, replace Lemma 6.3 and its "proof" by:*

Lemma 6.3. If π is in general position and if $\mathcal{B} \subset \mathcal{N}$ has exactly n members and is π -balanced, then every n members of the set $\{m_S(\pi) : S \in \mathcal{B}\} \cup \{m_N\}$ are linearly independent. Moreover, if K is the affine set spanned by any $n - 2$ members of $\{m_S(\pi) : S \in \mathcal{B}\}$, then $K \cap (m_N, m_{N-\{n}\}) = \emptyset$.

The first statement is proved using the fact that \mathcal{B} is minimal π -balanced, the second by showing that the line including $(m_N, m_{N-\{n}\})$ either misses K or meets it in just the point $m_{\{n\}}$. For details, see Shapley (1973).

- On page 19, replace lines 11 and 12 by:
 vertices would span an affine set K that intersects $(m_N, m_{N-\{n}\})$, in violation of Lemma 6.3.
- On page 38, add:
 Shapley, L. S. (1973), On Balanced Games Without Side Payments--A Correction, P-4910/1, The Rand Corporation, Santa Monica, California.

*We are indebted to L. J. Billera for pointing out the difficulty with the original form of Lemma 6.3 and helping to resolve it.

/

ON BALANCED GAMES WITHOUT SIDE PAYMENTS^{*}

L. S. Shapley

The Rand Corporation, Santa Monica, California

1. INTRODUCTION

In this paper we present a new proof of a basic theorem of game theory, due to Scarf, which states that every balanced game without side payments has a nonempty core.^{**} Our main tool is a generalization of Sperner's celebrated topological lemma concerning triangulations of the simplex, which we believe will be of independent interest.[†]

Like Scarf, we base our proof on a "path-following" algorithm, descended from the Lemke-Howson procedure for finding equilibrium points in bimatrix games.[‡] Despite this and perhaps other similarities, we believe that our proof is not only shorter than Scarf's original but more intuitive, or at least easier to follow, since it stays close to familiar ground most of the way and specializes

^{*} Presented at the Advanced Seminar on Mathematical Programming, Mathematics Research Center, University of Wisconsin, September 1972, and in an earlier version at the Second International Workshop in Game Theory, University of California, Berkeley, August 1970. The support of the National Science Foundation, Grant GS-31253, is gratefully acknowledged. Any views expressed are the author's own.

^{**} Scarf (1967a); see also Billera (1970, 1971).

[†] Sperner (1928); also Knaster, Kuratowski, and Mazurkiewicz (1926).

[‡] Lemke and Howson (1964); see also Cohen (1967), Scarf (1967b), and Kuhn (1968, 1969). Similar techniques are now widespread in mathematical programming.

to the game context only at the very end. On the other hand, Scarf's proof breaks important new ground in the area of "ordinal programming." At any rate, this re-proof of a known result will serve an expository purpose for readers new to the subject of balanced sets and n-person games; we have accordingly tried to make the presentation as self-contained as possible.

The section titles should be a sufficient guide to the contents. The economic example in Section 4 may be skipped without loss of continuity. Two items of special note are (1) the simple but very useful geometric characterization of balanced sets, described in Section 3, and (2) the handy notational scheme for iterated barycentric partitions of the simplex, described in the Appendix.

2. GAMES AND CORES

Let N denote the set $\{1, \dots, n\}$, and let \mathcal{N} denote the set of all nonempty subsets of N ; thus $|\mathcal{N}| = 2^n - 1$. Let E^N denote the n -dimensional euclidean space with coordinates indexed by the elements of N , and for $S \in \mathcal{N}$ let E^S denote the corresponding $|S|$ -dimensional subspace of E^N . A subset X of E^N will be called comprehensive if $\alpha \in X$ and $\beta \leq \alpha$ imply $\beta \in X$. If $X \subseteq E^N$ then \bar{X} will denote the closure of X , and \hat{X} will denote the "comprehensive hull" of X , i.e., the smallest comprehensive set that contains X . If $\alpha \in E^N$ and $S \in \mathcal{N}$, then α^S will denote the projection of α on E^S , i.e., the restriction of α to the coordinates indexed by the elements of S .

In this paper, a game* will be an ordered triple (N, F, D) . Here N is as above, F is a closed subset of E^N , and D is a function from \mathcal{N} to open, comprehensive, nonempty, proper subsets of E^N that satisfies

$$(2.1) \quad D(N) \subseteq \hat{F},$$

$$(2.2) \quad \text{if } \alpha \in D(S) \text{ and } \alpha^S = \beta^S, \text{ then } \beta \in D(S), \text{ and}$$

$$(2.3) \quad \{\alpha^S : \alpha \in \overline{D(S)} - \bigcup_{i \in S} D(\{i\})\} \text{ is bounded and nonempty.}$$

Condition (2.1) will be discussed presently. Condition (2.2) states that $D(S)$ is a "cylinder," parallel to the subspace E^{N-S} . The sets $D(\{i\})$, $i \in N$, are therefore open half-spaces of the form $\{\alpha : \alpha_i < v_i\}$; it is sometimes convenient to

* Cf. Aumann (1961), Scarf (1967a), Billera (1971).

normalize the game by setting all the $v_i = 0$ and shifting the other $D(S)$ accordingly. If this is done, then (2.3) states that the closure of each $D(S)$, intersected with the nonnegative orthant of E^S , is bounded and nonempty.

In the standard interpretation, the elements of N are players, the elements of \mathcal{N} coalitions, and the elements of E^N payoff or utility vectors. The elements of F represent feasible outcomes and the elements of $D(S)$ represent outcomes that S can improve upon, in the sense that the players in S can through their coordinated actions ensure better payoffs for themselves, regardless of the actions of players outside S .

In view of this interpretation, it would be natural to specialize (2.1) to

$$(2.4) \quad \overline{D(N)} = \hat{F},$$

and also to assume that the function D is superadditive, in the sense that

$$(2.5) \quad D(S) \cap D(T) \subseteq D(S \cup T), \text{ all } S, T \in \mathcal{N} \text{ with } S \cap T = \emptyset.$$

These assumptions do not figure in our work, however, and so we do not make them here. Similarly, it is often the case in applications that the sets $D(S)$ are convex. But convexity uses the structure of E^N as a real linear space, while we shall

be concerned only with the ordinal and topological structure of E^N .

The core of the game (N, F, D) is defined to be the set

$$(2.6) \quad F - \bigcup_{S \in \mathcal{N}} D(S).$$

The core represents the set of feasible outcomes that cannot be improved upon by any coalition. It is a closed set, and bounded as well if (2.4) holds or if F is bounded. The core may, however, be empty. A central problem of game theory is to determine significant classes of games that have nonempty cores.*

The reader with an eye for such things may find Fig. 1 helpful in visualizing the foregoing definitions. The sets $D(S)$ are represented for $|S| = 1$ by the coordinate planes, for $|S| = 2$ by the truncated "quarter rounds," and for $|S| = 3$ by the spherical surface. The core, assuming (2.4) holds, is the shaded area.

*The games described here are "games without side payments." Games "with side payments" have a parallel but simpler theory; they correspond to games in the present sense in which each $D(S)$ is a half-space of the form $\{\alpha : \sum_S \alpha_i < v(S)\}$, where v is any function from \mathcal{N} to the reals. Bondareva (1962, 1963) proved (in effect) that such games have nonempty cores if and only if they are "balanced" in the sense of the next section; see also Shapley (1967).

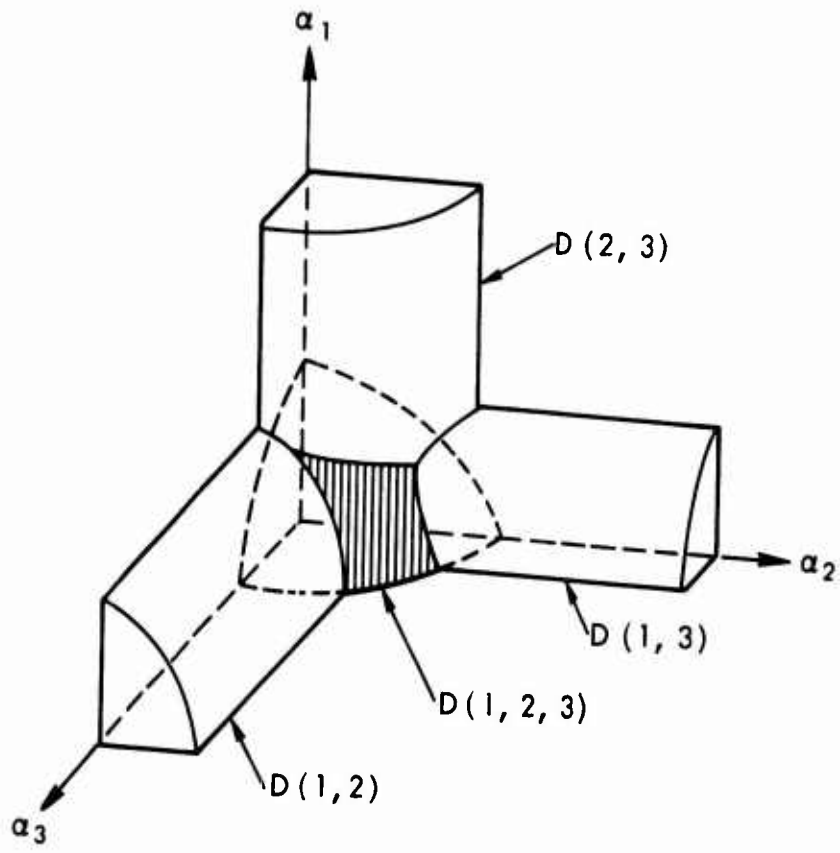

Fig. 1

3. BALANCED SETS AND BALANCED GAMES

Let \mathcal{B} be a subset of \mathcal{N} , and let $\mathcal{B}_i = \{S \in \mathcal{B} : i \in S\}$. The set \mathcal{B} is said to be balanced (with respect to N), if there exist nonnegative "balancing weights" $\{w_S : S \in \mathcal{B}\}$ such that

$$(3.1) \quad \sum_{S \in \mathcal{B}_i} w_S = 1, \quad \text{all } i \in N.$$

For example, $\{\{1, 2\}, \{1, 3\}, \{1, 4\}, \{2, 3, 4\}\}$ is balanced with respect to $\{1, 2, 3, 4\}$, by virtue of the weights $1/3, 1/3, 1/3, 2/3$. If the weights are all 1, then \mathcal{B} is a partition; thus balanced sets may be regarded as generalized partitions. It is not difficult to show that the balancing weights are unique if and only if the balanced set is minimal, i.e., has no proper subset that is balanced, and that a minimal balanced set has at most n members. Of course, any superset of a balanced set is balanced.*

Balanced sets can be given a geometric interpretation. Take any set of n linearly independent vectors in E^N , for example, the unit vectors e^1, \dots, e^n . For each $S \in \mathcal{N}$ define A^S to be the convex hull of the points $\{e^i : i \in S\}$ and let m_S denote their center of gravity, and hence the center of gravity of A^S as well. Then it is easily shown from the

* This is not true if positive weights are required, as in the original definition of balanced set (see Shapley (1967)). The minimal balanced sets, however, are the same under either definition.

above definition that β is balanced if and only if m_N lies in the convex hull of $\{m_S : S \in \beta\}$. Fig. 2 illustrates.

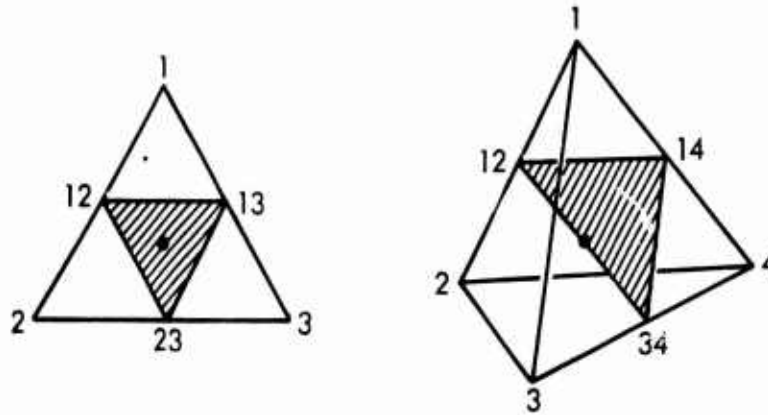

Fig. 2

A balanced game is defined to be a game (N, F, D) in which the relation

$$(3.2) \quad \bigcap_{S \in \beta} D(S) \subseteq \hat{F}$$

holds for every balanced set β . The reader can verify by inspection that the game in Fig. 1 is balanced, and that if the surface representing $D(N)$ and F is pulled back towards the origin until the core disappears the game is not balanced.

Theorem 3.1. (Scarf) Every balanced game has a nonempty core.

This will be proved in Sec. 8.

4. AN APPLICATION TO ECONOMICS

Balanced games arise naturally in economics, as the following model illustrates.* Let each economic agent (player) $i \in N$ have a set C^i of possible final holdings which is a nonempty compact convex subset of a linear space C . Similarly, let him have a nonempty compact convex set $Y^i \subseteq C$ of possible productions.** An initial holding $a^i \in C^i - Y^i$ (algebraic subtraction) is also given, and a utility function U^i from C^i to the reals, assumed continuous and quasi-concave.†

Members of a consenting group can trade freely with one another; a feasible final S-holding is defined to be a set of possible final holdings $\{x^i \in C^i : i \in S\}$ that satisfy

$$(4.1) \quad \sum_S x^i = \sum_S a^i + \sum_S y^i$$

for some S-production schedule $\{y^i \in Y^i : i \in S\}$. Thus, it is assumed that during the process each trader makes exactly one "production move," adding a selected element of Y^i to his holding; it does not matter for our purposes when this happens. Under our assumptions the set of feasible final S-holdings is convex, compact, and nonempty.

Turning to the payoff space, we define $F(S)$ to be the set of $\alpha \in E^S$ for which a feasible final S-holding $\{x^i : i \in S\}$ exists with

* Compare Scarf (1967a).

** If the reader wishes to simplify, he may eliminate production from the model by setting all Y^i equal to $\{0\}$.

† A function $f(x)$ is quasi-concave if the sets $C_z = \{x : f(x) \geq z\}$ are all convex. A concave function is quasi-concave.

$$U^i(x^i) = \alpha_i, \quad \text{all } i \in S.$$

Under our assumptions $F(S)$ is nonempty and compact for each $S \in \mathcal{N}$.

The game (N, F, D) associated with this economic model can now be defined. Indeed, we merely take F to be $F(N)$ and take $D(S)$, for each $S \in \mathcal{N}$, to be the set of $\alpha \in E^N$ such that α^S is majorized (strictly) by a member of $F(S)$. Then F is closed and $D(S)$ is open, comprehensive, nonempty and proper, as required. Properties (2.1) and (2.2) can be immediately verified, as well as (2.4) and (2.5). Finally, in (2.3) the boundedness follows from the boundedness of $F(S)$ and the nonemptiness follows from superadditivity (2.5). Thus, all the defining conditions for a game are fulfilled.

Theorem 4.1. The game described is balanced.

Proof. Let \mathcal{B} be a balanced set with weights $\{w_S : S \in \mathcal{B}\}$, and let $\alpha \in \bigcap_{S \in \mathcal{B}} D(S)$. We wish to show that $\alpha \in \hat{F}$.

For each $S \in \mathcal{B}$ we can find a feasible final S -holding $\{x^i \in C^i : i \in S\}$ satisfying (4.1) for some S -production schedule $\{y^i \in Y^i : i \in S\}$ and such that

$$U^i(x^i) > \alpha_i, \quad \text{all } i \in S.$$

For each $i \in N$, define

$$x^i = \sum_{S \in \mathcal{B}_i} w_S x^i.$$

By quasi-concavity and (3.1) we have $U^i(x^i) > \alpha_i$, for each $i \in N$. Hence it remains only to show that $\{x^i : i \in N\}$ is a feasible final N-holding.

To this end, for each $i \in N$ define

$$y^i = \sum_{S \in \beta_i} w_S S y^i.$$

By (3.1) we have $x^i \in C^i$ and $y^i \in Y^i$. Finally, we have

$$\begin{aligned} \sum_{i \in N} x^i + \sum_{i \in N} y^i &= \sum_{i \in N} \sum_{S \in \beta_i} w_S (S x^i + S y^i) = \sum_{S \in \beta} \sum_{i \in S} w_S (S x^i + S y^i) \\ &= \sum_{S \in \beta} \sum_{i \in S} w_S a^i = \sum_{i \in N} \sum_{S \in \beta_i} w_S a^i = \sum_{i \in N} a^i. \end{aligned}$$

This completes the proof.

5. SIMPLICIAL PARTITIONS, SPERNER'S LEMMA, AND THE K-K-M THEOREM

A face of a closed convex set C is either C itself or the intersection of C with one of its supporting hyperplanes.

A facet of C is a face of dimension one less than the dimension of C . A simplex can be characterized as the convex hull of a finite set of "affinely independent" points; a test for the affine independence of r points in E^N being that the $r \times n + 1$ matrix obtained from their coordinates with a column of 1's adjoined should have rank r . A simplex has finitely many faces, all of them simplices.

As before, let A^S denote the convex hull of the unit vectors $\{e^i : i \in S\}$. Then the A^S comprise the faces of the $(n-1)$ -dimensional simplex A^N . By a simplicial partition of A^N we shall mean a finite collection Σ of subsets of A^N , called cells, such that*

(5.1) each cell is a simplex,

(5.2) each face of a cell is a cell,

(5.3) the union of all the cells is A^N , and

(5.4) the intersection of any two cells is either empty or a face of both of them.

*Of course, Σ is not a true partition of A^N , because of the overlapping. But the relative interiors of the cells in a simplicial partition do form a partition.

The term "simplicial subdivision" is often employed instead, usually in reference to the subcollection we call Σ_n (see below).

The mesh of Σ is the diameter of its largest cell. We take it for granted that simplicial partitions of A^N exist of arbitrarily small mesh.

Let Σ_d denote the set of members of Σ of dimension $d - 1$. Then Σ_n comprises the "full-dimensional" cells in Σ , so that Σ is precisely the set of all faces of members of Σ_n ; we shall therefore say that Σ is generated by Σ_n . The following proposition is geometrically fairly obvious; we omit the proof.

Lemma 5.1. If Σ is a simplicial partition of A^N and if $\tau \in \Sigma_{n-1}$, then τ is a facet of either exactly one or exactly two members of Σ_n , depending on whether τ is or is not contained in the relative boundary of A^N .

Let Σ^S denote the set of elements of Σ that are contained in A^S . Then it is not hard to verify that if Σ is a simplicial partition of A^N then Σ^S is a simplicial partition of A^S ; we shall say that Σ^S is induced on A^S by Σ . Moreover, if $R \subset S \subset N$ then $(\Sigma^S)^R = \Sigma^R$.

We now recall two well-known theorems. Let $V(\Sigma)$ denote the set of vertices of Σ , that is, the set of points in E^N that are extreme points of members of Σ . (Note that $v \in V(\Sigma)$ if and only if $\{v\} \in \Sigma_1$.) Let f be a "labelling" function from $V(\Sigma)$ to N , such that for every $S \in \mathcal{N}$

$$(5.5) \quad v \in V(\Sigma) \cap A^S \Rightarrow f(v) \in S.$$

In other words, the labels in the relative interior of A^N are unrestricted, but in the relative boundary the label on v must

be a member of the set S that defines the smallest face A^S to which v belongs. It is convenient to define an auxiliary function F by $F(\sigma) = \{f(v) : v \in \sigma\}$. If $F(\sigma) = N$ then we shall say that σ is completely labelled.

Theorem 5.2. (Sperner's Lemma) If Σ is any simplicial partition of A^N and if f satisfies (5.5), then at least one cell of Σ is completely labelled.

A straightforward limiting argument on the mesh of Σ leads to the next proposition, due to Knaster, Kuratowski and Mazurkiewicz, which can in turn be used to obtain the Brouwer fixed-point theorem.*

Theorem 5.3. (K-K-M Theorem) Let $\{C_i : i \in N\}$ be a family of closed subsets of A^N such that for all $S \in \mathcal{N}$

$$(5.6) \quad \bigcup_{i \in S} C_i \supseteq A^S.$$

Then $\bigcap_{i \in N} C_i \neq \emptyset$; in other words, at least one point in A^N is completely covered.

In Section 7 we shall prove generalizations of these two propositions, with the labels drawn from \mathcal{N} rather than N and completeness replaced by balancedness.

* See for example Burger (1963), p. 194 ff, where the Sperner, K-K-M, Brouwer, and Kakutani theorems are proved elegantly in sequence. Historically, Brouwer's work (1909, 1910) preceded the K-K-M paper (1926), which preceded Sperner's paper (1928).

6. SUBBALANCE AND π -BALANCE

Two extensions of the balanced set concept will be required in the sequel. The first depends on specifying a "last" element of N , say n . The set $\beta \subseteq \mathcal{N}$ is then defined to be subbalanced (with respect to N, n) if nonnegative weights $\{w_S : S \in \beta\}$ exist such that

$$(6.1) \quad \sum_{S \in \beta_i} w_S = 1, \quad \text{for } i \in N - \{n\},$$

and

$$(6.2) \quad \sum_{S \in \beta_n} w_S < 1.$$

This should be compared with (3.1). Note that any set of subsets of $N - \{n\}$ that is balanced w.r.t. $N - \{n\}$ is trivially subbalanced w.r.t. N, n .

In our geometric interpretation, to say that β is subbalanced means that the convex hull of the points $\{m_S : S \in \beta\}$ has nonempty intersection with the half-open line segment $(m_N, m_{N-\{n\}})^1$. Figure 3 illustrates this for the subbalanced set $\{\{1, 2\}, \{1, 3\}, \{2, 3, 4\}\}$ w.r.t. $N = \{1, 2, 3, 4\}$, $n = 4$.

For the second extension, let there be given an array of positive numbers:

$$\pi = \{\pi_{S,i} : S \in \mathcal{N}, i \in N\}.$$

The set $\beta \subseteq \mathcal{N}$ is defined to be π -balanced (w.r.t. N) if

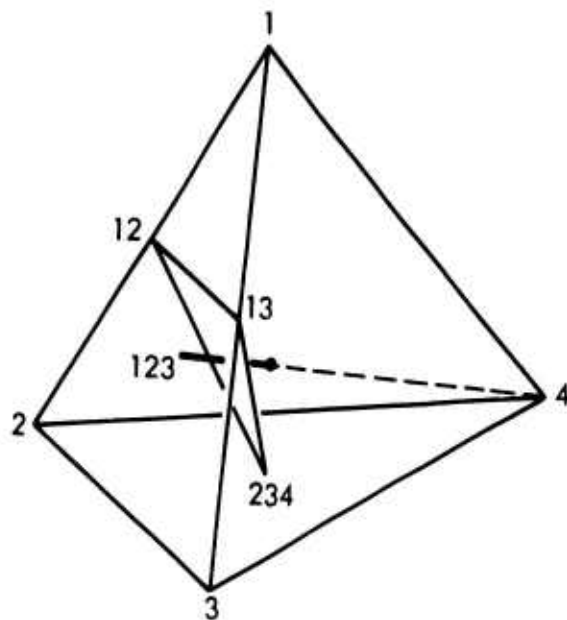

Fig.3

nonnegative weights $\{w_S : S \in \mathcal{B}\}$ exist such that

$$(6.3) \quad \sum_{S \in \mathcal{B}_i} w_S \pi_{S,i} = 1, \quad \text{all } i \in N.$$

Note that because of the homogeneity of this definition a set is π -balanced if and only if it is $\bar{\pi}$ -balanced, where $\bar{\pi}$ is the "normalization" of π given by

$$\bar{\pi}_{S,i} = \pi_{S,i} / \sum_{j \in S} \pi_{S,j}.$$

Ordinary balanced sets are of course $\underline{1}$ -balanced, where $\underline{1}$ denotes the array consisting of all 1's.

In the geometric model, π -balancing replaces each centroid m_S by the point

$$m_S(\pi) = \sum_{i \in S} \bar{\pi}_{S,i} e^i$$

which can lie anywhere in the relative interior of A^S . If we let $M(\beta, \pi)$ denote the convex hull of $\{m_S(\pi) : S \in \beta\}$, then we see that β is π -balanced if and only if $M(\beta, \pi)$ includes the point m_N . Note that " m_N " appears in this statement, rather than " $m_N(\pi)$." Thus, the set $\{N\}$, which is trivially balanced, is in general not π -balanced.

Combining these two extensions, we define π -subbalanced in the obvious way, changing $=$ to $<$ in (6.3) for $i = n$. The π -balanced and π -subbalanced sets will be used primarily to get around a certain degeneracy that afflicts ordinary balanced and subbalanced sets, but they will also provide us with a more general final result.

Let Π denote the set of all positive arrays π . We shall say that $\pi \in \Pi$ is in general position if no subset of the numbers $\pi_{S,i}$ satisfies any nontrivial algebraic equation with rational coefficients. It is clear that the arrays in general position are dense in Π , regarded as a subset of a euclidean space of suitable dimension.

Lemma 6.1. For each $\beta \subseteq \eta$, the set of $\pi \in \Pi$ such that β is π -balanced is closed in* Π .

Proof. Let β be $\pi^{(k)}$ -balanced for $k = 1, 2, \dots$. Suppose $\pi^{(k)} \rightarrow \pi \in \Pi$ and let $\{w^{(k)}\}$ be weight vectors for the normalizations $\{\bar{\pi}^{(k)}\}$. These weight vectors lie in a bounded region in

*Note that Π is an open cone.

E^N , so we may extract a convergent subsequence; the limit will serve as a weight vector for $\bar{\pi}$, showing that β is $\bar{\pi}$ -balanced and hence π -balanced. Q.E.D.

Corollary 6.2. For any $\pi_0 \in \Pi$ there exists a π in general position such that π -balance implies π_0 -balance.
In particular, there exists a π in general position such that π -balance implies balance.

The proof is straightforward.

Lemma 6.3. If π is in general position, then no $(n-2)$ -dimensional affine set contains more than $n - 1$ members of the set $\{m_S(\pi) : S \in \mathcal{N}\} \cup \{m_N, m_{N-\{n\}}\}$.

Proof. If any n of the points mentioned lay in the same $(n-2)$ -dimensional affine set,^{*} then the determinant composed of their coordinates would vanish, establishing a rational algebraic relationship among the $\pi_{S,i}$. Q.E.D.

Lemma 6.4. If π is in general position and if $\beta \subseteq \mathcal{N}$ has exactly n members and is π -balanced, then there is a unique subset of β that has exactly $n - 1$ members and is π -subbalanced.

Proof. Write M for $M(\beta, \pi)$, the convex hull of $\{m_S(\pi) : S \in \beta\}$. We must examine the intersection of M with the half-open segment $(m_N, m_{N-\{n\}}]$. First we note that M is full-dimensional^{**} and hence a simplex, since otherwise

^{*} Note that all the points in question lie in the $(n-1)$ -dimensional set A^N .

^{**} In these proofs, "full-dimensional," "interior," etc. refer to A^N , not E^N .

the n points $\{m_S(\pi) : S \in \beta\}$ would violate Lemma 6.3. Next we note that m_N must be interior to M , since it is in M and if it were in a facet of M then the $n - 1$ vertices of that facet together with the point m_N would violate Lemma 6.3. Thirdly we note that $m_{N-\{n\}}$ is not interior to M , since it lies in the boundary of A^N itself while the interior of M is contained in the interior of A^N . Therefore the segment $(m_N, m_{N-\{n\}}]$ pierces the boundary of M at a unique point; call it m_0 . Moreover, m_0 belongs to a unique facet F_0 of the simplex M , for if there were two such facets, then their $n - 2$ common vertices, together with m_N and $m_{N-\{n\}}$, would lie in an affine set of dimension $n - 2$, again in violation of Lemma 6.3. This facet F_0 determines a unique β' with $n - 1$ members such that $M(\beta', \pi)$ meets $(m_N, m_{N-\{n\}}]$. Q.E.D.

Lemma 6.5. If π is in general position and if $\beta \subseteq \pi$ has exactly n members and is π -subbalanced but not π -balanced, then there are precisely two subsets of β that have exactly $n - 1$ members and are π -subbalanced.

The proof is similar to the previous one. The set $M = M(\beta, \pi)$ is again a full-dimensional simplex, but m_N and $m_{N-\{n\}}$ are now both outside M . However $(m_N, m_{N-\{n\}}]$ contains at least one point of M ; in fact, it contains an interior point, since a grazing contact would have to include a point common to two facets, a situation which violates Lemma 6.3. as we saw above. Therefore the segment pierces the boundary twice, intersecting a single facet each time; these two facets yield the desired $(n-1)$ -member subbalanced subsets of β . Q.E.D.

7. GENERALIZATION OF SPERNER'S LEMMA AND THE K-K-M THEOREM

Let Σ be a simplicial partition of A^N and let f be a "labelling" function from $V(\Sigma)$ to \mathcal{N} such that for every $S \in \mathcal{N}$

$$(7.1) \quad v \in V(\Sigma) \cap A^S \Rightarrow f(v) \subseteq S$$

(compare (5.1)). As before, define $F(\sigma) = \{f(v) : v \in \sigma\}$. Given f , we shall say that the cell σ is balanced if $F(\sigma)$ is balanced; similarly subbalanced, π -balanced, and π -subbalanced.

Theorem 7.1. If π is in general position and if f satisfies (7.1), then the number of π -balanced cells of Σ_n is odd.

Proof. We consider the collection \mathcal{L} of all π -balanced and π -subbalanced cells of Σ . With π in general position, it follows from Lemma 6.3 that the π -balanced cells must belong to Σ_n while the π -subbalanced cells must belong to Σ_n or Σ_{n-1} . We distinguish four types of cells in \mathcal{L} :

a) $\sigma \in \Sigma_n$ is π -balanced. Then by Lemma 6.4 it has exactly one facet $\tau \in \Sigma_{n-1}$ that is π -subbalanced, and hence in \mathcal{L} .

b) $\sigma \in \Sigma_n$ is π -subbalanced but not π -balanced. Then by Lemma 6.5 it has exactly two facets $\tau, \tau' \in \Sigma_{n-1}$ that are π -subbalanced, and hence in \mathcal{L} .

c) $\tau \in \Sigma_{n-1}$ is π -subbalanced and intersects the interior of A^N . Then by Lemma 5.1 there are exactly two cells σ ,

$\sigma' \in \Sigma_n$ of which τ is a facet; moreover, each of these cells is π -subbalanced, and hence in \mathcal{L} .

d) $\tau \in \Sigma_{n-1}$ is π -subbalanced and lies in the boundary of A^N . Then by Lemma 5.1 there is exactly one $\sigma \in \Sigma_n$ of which τ is a facet; moreover, it is π -subbalanced, and hence in \mathcal{L} .

By the above we see that the elements of \mathcal{L} are not isolated, but are "chained" together, with the "facet of" relation linking each element of $\mathcal{L} \cap \Sigma_n$ with one or two elements of $\mathcal{L} \cap \Sigma_{n-1}$ and vice versa. Each connected component of \mathcal{L} therefore consists either of an endless loop, containing cases (b) and (c) only, or of a path, having case (a) or (d) at each end and all the rest (b) or (c). The important fact is that the total number of instances of (a) and (d) is even.

Let us examine case (d) more closely. Since τ is π -subbalanced, the union of its labels must include all of $N - \{n\}$. Hence, by (7.1), the only facet in the boundary of A^N that can contain τ is $A^{N-\{n\}}$, moreover, all of the labels $S \in F(\tau)$ must be subsets of $N - \{n\}$, i.e., must exclude n . This means that $F(\tau)$ is π -balanced w.r.t. $N - \{n\}$. Conversely, any cell in $A^{N-\{n\}}$ that is π -balanced w.r.t. $N - \{n\}$ is π -subbalanced w.r.t. N , and so falls under case (d). Hence (d) identifies precisely the π -balanced cells of the induced simplicial partition $\Sigma^{N-\{n\}}$ on $A^{N-\{n\}}$.

To finish the proof, let $k \leq n$ and define $K = \{1, \dots, k\}$. Denote by a_k the number of cells in Σ^K that are π -balanced w.r.t. K . We have shown that $a_n - a_{n-1}$ is even. Similarly, since (7.1) implies the analogous condition in lower dimensions,

we have that $a_k + a_{k-1}$ is even for $k = 2, \dots, n - 1$. Hence all the a_k have the same parity. But clearly $a_1 = 1$; hence a_n is odd. Q.E.D.

Theorem 7.2. (Generalized Sperner's Lemma) For any $\pi \in \Pi$, if f satisfies (7.1) then Σ_n has at least one π -balanced cell. In particular, Σ_n has at least one balanced cell.

Proof. Theorem 7.1 and Corollary 6.2.

The examples in Fig. 4 show that we cannot assert that the number of balanced cells in Σ_n is odd, nor that the number of balanced cells in Σ is odd.

To see that Theorem 7.2 includes Sperner's lemma, we restrict the values of f to the singletons in \mathcal{N} . Then the only balanced set (or π -balanced set for that matter)

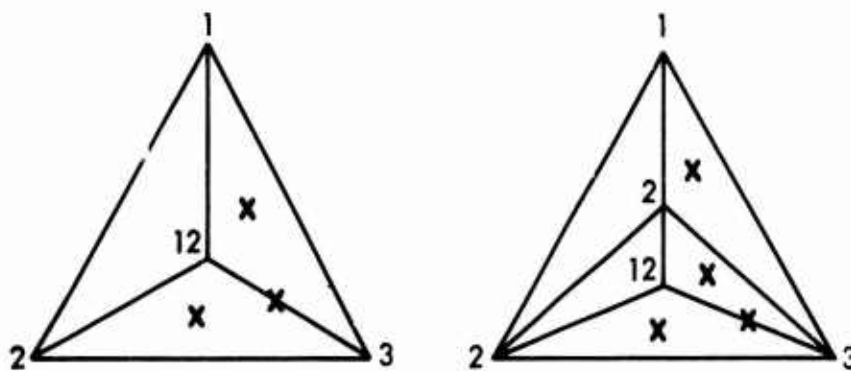

Fig. 4

is $\{\{1\}, \dots, \{n\}\}$, and a cell is balanced if and only if it is completely labelled.

Theorem 7.3. (K-K-M-S Theorem) Let $\{C_S : S \in \mathcal{T}\}$ be a family of closed subsets of A^N such that for each $T \in \mathcal{T}$

$$(7.2) \quad \bigcup_{S \subseteq T} C_S \supseteq A^T$$

(compare (5.6)). Then for every $\pi \in \Pi$ there exists a π -balanced set \mathcal{B} such that

$$\bigcap_{S \in \mathcal{B}} C_S \neq \emptyset.$$

Proof. Let $\pi \in \Pi$ be fixed, and let $\{\Sigma^{(k)}\}$ be a sequence of simplicial partitions of A^N whose mesh converges to zero. For each $v \in V(\Sigma^{(k)})$ let $A^{T(v)}$ be the smallest face of A^N that contains v and define $f^{(k)}(v)$ to be any S such that $v \in C_S$ and $S \subseteq T(v)$; by (7.2) such an S can always be found. By Theorem 7.2 there is a π -balanced cell $\sigma^{(k)} \in \Sigma^{(k)}$ for each k . By taking subsequences we can ensure that the $\sigma^{(k)}$ converge to some point $v_0 \in A^N$ and that the $F(\sigma^{(k)})$ in the subsequence are all equal to the same π -balanced set \mathcal{B} . Then for each $S \in \mathcal{B}$, v_0 is the limit of a sequence of points that bear the label S and hence belong to C_S . Since the C_S are closed, we have $v_0 \in \bigcap_{S \in \mathcal{B}} C_S$. Q.E.D.

8. PROOF OF THE SCARF-BILLERA THEOREM

Although games have not yet appeared in the argument, we are close to our goal of proving that the core of a balanced game is not empty. Let (N, F, D) be a game (see Sec. 2), and for any $\pi \in \Pi$ let us call the game π -balanced if (3.2) holds for all π -balanced sets \mathcal{B} . Without loss of generality, let the game be normalized, so that $D(\{i\}) = \{\alpha \in E^N : \alpha_i < 0\}$ for all $i \in N$. Let M be a number chosen so large that for each $S \in \mathcal{N}$ and $\alpha \in E^N$

$$(8.1) \quad \alpha \in \overline{D(S)} - \bigcup_{i \in S} D(\{i\}) \Rightarrow \alpha_i \leq M, \text{ all } i \in S;$$

this is possible because of (2.3). Define $\gamma^i = -nMe^i$, $i \in N$; in other words

$$\gamma_j^i = 0 \text{ if } j \neq i, \text{ and } \gamma_i^i = -nM.$$

For each $S \in \mathcal{N}$, redefine A^S to be the convex hull of $\{\gamma^i : i \in S\}$; the new simplex A^N will provide the setting for our application of Theorem 7.3.

First we must define the sets C_S . We do this, intuitively speaking, by "looking down" on $UD(S)$ from a vantage point far out in the positive orthant of E^N . To make this precise, define

$$(8.2) \quad t(\alpha) = \sup \{t : \alpha + t\underline{1} \in \bigcup_{S \in \mathcal{N}} D(S)\},$$

where $\underline{1}$ is the vector of all 1's. Since the $d(S)$ are proper and comprehensive the supremum in (8.2) is finite and is a continuous function of $\alpha \in E^N$. Now define

$$C_S = \{\alpha \in A^N : \alpha + t(\alpha)\underline{1} \in \overline{D(S)}\}.$$

In other words, α is in C_S if S is a "most effective" coalition along the diagonal line $L_\alpha = \{\alpha + t\underline{1}\}$, in the sense that $D(S) \cap L_\alpha \supseteq D(T) \cap L_\alpha$ for all $T \in \mathcal{N}$. Since $t(\alpha)$ is continuous, the C_S are closed sets. We shall now show that they satisfy condition (7.2).

Let $\alpha \in C_S \cap A^T$; we shall show that $S \subseteq T$. We may assume that $T \neq N$. Since $\alpha \in A^T$ we have $\sum_T \alpha_i = -nM$. This implies that for at least one $j \in T$ we have $\alpha_j \leq -nM/|T| < -M$. Hence, considering just $S = \{j\}$ in (8.2) we obtain

$$(8.3) \quad t(\alpha) > M.$$

The point $\alpha + t(\alpha)\underline{1}$ belongs to $\overline{D(S)}$ but not to any of the open sets $D(R)$, $R \in \mathcal{N}$, and in particular not to any of the $D(\{i\})$, $i \in S$. Hence, by (8.1),

$$\alpha_i + t(\alpha) \leq M, \quad \text{all } i \in S.$$

With (8.3) this yields $\alpha_i < 0$ for all $i \in S$. But $\alpha \in A^T$ implies $\alpha_i = 0$ for all $i \notin T$. Hence $S \subseteq T$, and (7.2) follows from the fact that every $\alpha \in A^N$ belongs to at least one set C_S .

Theorem 7.3 now asserts for any $\pi \in \Pi$ the existence of a point $\alpha \in A^N$ and a π -balanced set \mathcal{B} such that $\alpha \in C_S$ for all $S \in \mathcal{B}$. The point $\beta = \alpha + t(\alpha)\underline{1}$ therefore belongs to $\bigcap_{S \in \mathcal{B}} \overline{D(S)}$ but not to $\bigcup_{S \in \mathcal{B}} D(S)$. Suppose the game is π -balanced. By (3.2) β then belongs to \hat{F} , so there is a point $\gamma \geq \beta$ that belongs to F but not to $\bigcup_{S \in \mathcal{B}} D(S)$. By (2.6), γ is in the core, so the core is not empty.

We have therefore proved Theorem 3.1 in particular, and more generally*

Theorem 8.1. (Billera) Every π -balanced game, $\pi \in \Pi$, has a nonempty core.

* However, Billera (1970) permits some of the $\pi_{S,i}$ to be zero.

9. SOME REMARKS ON PATH FOLLOWING

The proof of Theorem 7.1 may seem to be nonconstructive, but in fact it gives rise to a computationally effective algorithm.* The following remarks apply equally to the problem of finding balanced cells (using Corollary 6.2), π -balanced cells, or completely-labelled (Sperner) cells; we shall refer to them indiscriminately as "solutions."

Denote by $\mathfrak{L}_n(a)$ the class of cells of Σ corresponding to case (a) in the proof of Theorem 7.1, i.e., the sought-for solutions, and denote by $\mathfrak{L}_k(a)$ the analogous class for the induced partition Σ^K on the face A^K , $k = 2, \dots, n-1$. Similarly define $\mathfrak{L}_k(b)$, $\mathfrak{L}_k(c)$, $\mathfrak{L}_k(d)$, and combine them all in

$$\mathfrak{L}^* = \bigcup_{k=1}^n [\mathfrak{L}_k(a) \cup \mathfrak{L}_k(b) \cup \mathfrak{L}_k(c) \cup \mathfrak{L}_k(d)].$$

In the proof we showed that $\mathfrak{L}_k(d) = \mathfrak{L}_{k-1}(a)$ for $k = 2, \dots, n$. Hence each cell in \mathfrak{L}^* is linked (by the "facet of" relation) to exactly two other cells in \mathfrak{L}^* , with the sole exception of the cells in $\mathfrak{L}_n(a)$ and $\mathfrak{L}_1(d)$. But $\mathfrak{L}_1(d)$ has just the one member, $A^{\{1\}}$. Thus, if we start at that cell and simply follow the path, we must arrive at an element of $\mathfrak{L}_n(a)$, i.e., a solution.**

*The path-following idea is implicit in the standard elementary proof of Sperner's lemma (e.g., Burger (1959, 1963)); for a very clear, explicit statement see Cohen (1967).

**Thus, primary paths provide a truly constructive proof. The proofs by induction (even Cohen's proof, though he depicts a primary path in his paper) are not constructive, since the

Let us call this path the primary path in \mathcal{L}^* ; in general \mathcal{L}^* may also contain closed loops, as well as other paths that link the remaining solutions in pairs.

Despite the dimension changes both up and down that may be encountered en route, a path-following algorithm is easy to program for a computer. It is necessary, however, to use simplicial partitions that admit a systematic description. In particular, we must be able to identify without too much trouble the cell which lies on the "other side" of a given facet of a given cell. Kuhn (1968, 1969) has described one such class of partitions; another is described in the Appendix.

The arbitrary choice of a "last" element of N in the definition of subbalance (see Sec. 6) gives us a chance to expand the search for solutions. Indeed, each of the $n!$ orderings of N will give us a different class \mathcal{L}^* and a different primary path. Of course, if there is only one solution, all primary paths must lead to it. But conceivably we might reach $n!$ distinct solutions just by following primary paths. Moreover, whenever we find a solution that is not on the primary path for a given \mathcal{L}^* , we can use it as the starting point of a "secondary" path of \mathcal{L}^* and thereby reach another solution.

Were we to go deeper into the subject, we could show how to define an orientation on the solutions (including an

set of all solutions in $A^{K-\{k\}}$ is needed to be sure of finding some solutions in A^K . If we are given only some solutions in $A^{K-\{k\}}$, it may happen that none of them lie on a path that leads to a solution in A^K .

abstract, starting-point "solution" consisting of all the $A^{(i)}$ together), in such a way that every path in every \mathcal{L}^* has one end oriented "+" and one end oriented "-".* Thus, if we define an abstract graph G by taking the paths of the various \mathcal{L}^* as edges and the solutions as nodes, then G is a bipartite graph--i.e., it can be two-colored. If G happens to be connected, then path-following will eventually yield all solutions, if we are careful to account for all paths issuing from all solutions that we find.** But there is no reason for G to be connected. For example, if a balanced cell in Σ is completely enclosed by vertices bearing a single label, as in Fig. 5, then there is no way for a path to penetrate the protective shell. This example shows that an exhaustive search of Σ is necessary if we wish to be sure of finding all solutions.

* In the Sperner case, the orientation is determined by whether the vertices of the solution cell can be mapped onto the corresponding vertices of A^N without having to turn the cell "inside out."

** In general, many edges of G may join the same pair of nodes by the same path in Σ . Only n actual paths start from each solution, depending on which "last" element of N is chosen. Only if a path reaches the boundary of A^N does it split into $n - 1$ continuations, depending on the "next-to-last" element of N ; only if one of these hits a lower-dimensional face of A^N will it split again; etc. But no two primary paths coincide exactly, since primary paths necessarily run the whole gamut of dimensions.

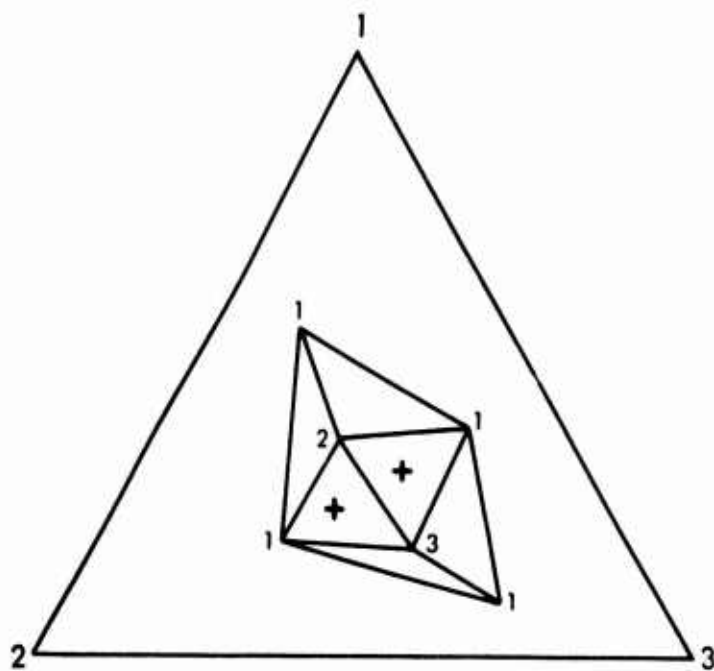

Fig. 5

APPENDIX. ITERATED BARYCENTRIC PARTITIONS

Let $N = \{1, \dots, n\}$ and let A denote the simplex $\{\alpha \in E^N : \alpha_i \geq 0 \text{ and } \sum \alpha_i = 1\}$. Denote by $N!$ the set of all permutations of N . If $p = p_1 p_2 \dots p_n$ is an element of $N!$, define

$$A_p = \{\alpha \in A : \alpha_{p_1} \geq \alpha_{p_2} \geq \dots \geq \alpha_{p_n}\}.$$

The simplices A_p , $p \in N!$, generate a simplicial partition of A which we denote by $\Sigma^{(1)}$ and call the barycentric partition. In accordance with our previous usage, the collection $\{A_p : p \in N!\}$ is denoted $\Sigma_n^{(1)}$.

The barycentric coordinates in any simplex are the relative weights (summing to 1) that must be placed at the vertices so that the center of mass will be at the desired point. In A , the barycentric coordinates of α are simply $(\alpha_1, \dots, \alpha_n)$, because of the way we positioned A in E^N . In A_p , it may be verified that the barycentric coordinates of α are $(\beta_1, \dots, \beta_n)$, given by

$$(A.1) \quad \left\{ \begin{array}{l} \beta_{p_l} = l\alpha_{p_l} - l\alpha_{p_{l+1}}, \text{ for } l = 1, \dots, n-1, \\ \beta_{p_n} = n\alpha_{p_n}. \end{array} \right\}$$

The linear transformation (A.1) will be denoted T_p ; thus $\beta = T_p(\alpha)$. Its inverse T_p^{-1} is given explicitly by

$$(A.2) \quad \alpha_{p_l} = \sum_{j=l}^n \beta_{p_j} / j, \text{ for } l = 1, \dots, n.$$

We now repeat this construction. Let $p \in N!$, $q \in N!$ and define

$$A_{p,q} = \{ \alpha \in A_p : \beta_{q_1} \geq \beta_{q_2} \geq \dots \geq \beta_{q_n} \},$$

where $\beta = T_p(\alpha)$. If we define $T_{p,q}(\cdot) = T_q(T_p(\cdot))$, then the barycentric coordinates of α in $A_{p,q}$ are $(\gamma_1, \dots, \gamma_n)$ where $\gamma = T_{p,q}(\alpha)$. For each $p \in N!$ the collection $\{A_{p,q} : q \in N!\}$ generates the barycentric partition of A_p . Moreover, the union over all $p \in N!$ of these collections generates a simplicial partition of A , which we call the barycentric partition of order 2 and denote by $\Sigma^{(2)}$. (Note that if A_p and $A_{p'}$ have a face in common (of any dimension), then their barycentric partitions induce the same simplicial partition on that face.)

In general, let $k > 1$ and let P represent the sequence p^1, p^2, \dots, p^k . Denote p^1, p^2, \dots, p^{k-1} by P' and define

$$A_P = \{ \alpha \in A_{p^k} : \beta_{p^k_1} \geq \beta_{p^k_2} \geq \dots \geq \beta_{p^k_n} \}.$$

where $\beta = T_p(\alpha) = T_{p^k}(T_{P'}(\alpha))$. The barycentric partition of order k, denoted $\Sigma^{(k)}$, consists of all the $(n!)^k$

simplices A_p for $P \in (N!)^k$, together with all their lower-dimensional faces.

Figure 6 illustrates this construction for $n = 3$ and various values of k . Note that each cell in $\Sigma_n^{(k)}$ receives an unambiguous name, consisting of k "n-letter words" $p^j \in N!$. Note also that the mesh of the partition decreases by at least $1/3$ at each iteration. In general we have that the mesh is less than $(1 - 1/n)^k$ times the diameter of A ; since n is fixed this goes to zero as $k \rightarrow \infty$.

We now number the vertices of $\Sigma^{(k)}$ in a special way. Let A_p be an element of $\Sigma_n^{(k)}$. The i -th vertex of A_p is defined to be the unique point in A_p whose i -th barycentric coordinate in A_p is 1, in other words, the point α such that $T_p(\alpha) = e^i$. This numbering is illustrated in cell 123 in Figure 6. Note that the same vertex may receive different numbers in different cells; thus, we find that the second vertex of 123 is the first vertex of 213. As an exercise, the reader may verify that the point "X" is the first vertex of 231 123 and the third vertex of 213 321, while the point "Y" is second in each of these cells.

The i -th facet of A_p is defined to be the facet opposite the i -th vertex, that is, the set of points in A_p whose i -th barycentric coordinate in A_p is zero. In path-following, we are interested in what lies on the "other side" of a given facet of a given cell. The rule is in fact quite simple:

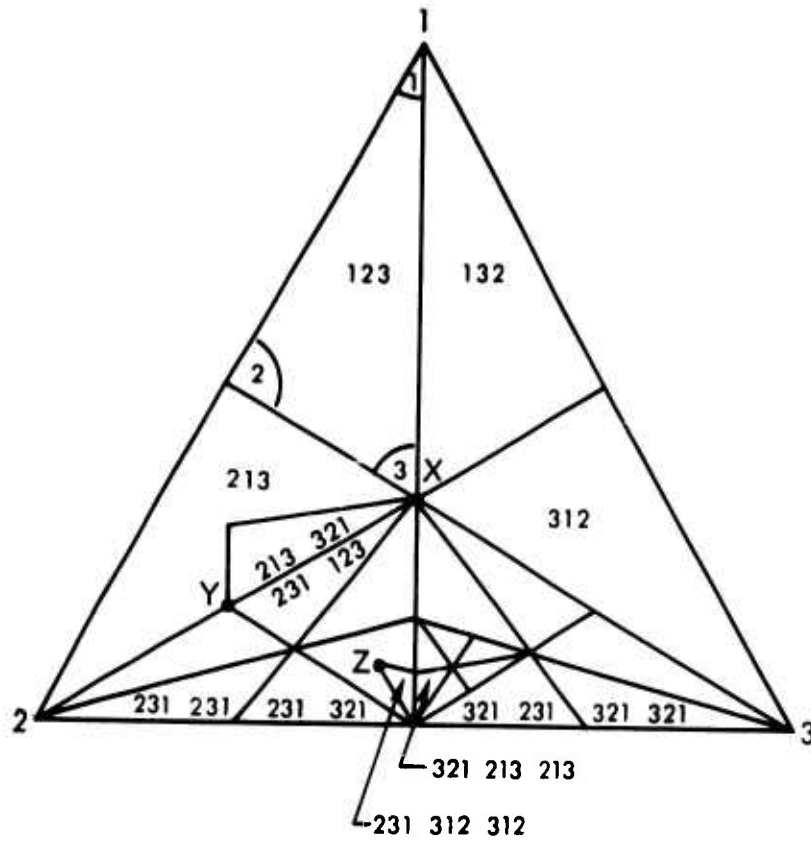

Fig. 6

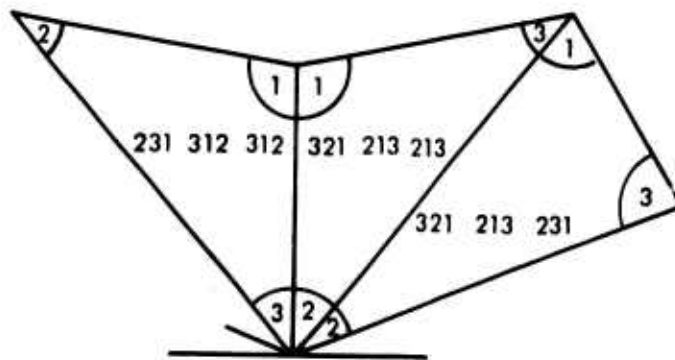

Fig. 7

FACET RULE: Let $P = p^1, p^2, \dots, p^k \in (N!)^k$, let A_p be the corresponding cell of $\Sigma_n^{(k)}$, and let $F_i(A_p) \in \Sigma_{n-1}^{(k)}$ be the i -th facet of A_p .

Case 1: Not every word in the name of A_p ends in i . Define l to be the highest index such that $p_n^l \neq i$ and define i' to be the immediate successor of i in p^l . Then $F_i(A_p) = F_{i'}(A_Q)$, where Q is obtained from P by transposing i and i' in p^l and in all subsequent words (if any). Moreover, the j -th vertex of A_Q is the j -th vertex of A_p for all j except i and i' ; the i -th vertex of A_Q is the i' -th vertex of A_p ; and the i' -th vertex of A_Q is the new one.

Case 2: Every word in the name of A_p ends in i . Then $F_i(A_p)$ is in the boundary of A and is not a facet of any other cell in $\Sigma_n^{(k)}$. Instead, we have $F_i(A_p) = B_{p'}$, where $B = A^{N-\{i\}} = A \cap E^{N-\{i\}}$ and the words in P' (which is a k -tuple of permutations of $N - \{i\}$) are obtained from those in P by dropping the i at the end. Moreover, each vertex of $B_{p'}$ has the same number in $B_{p'}$ as in A_p .

This rule is illustrated at several places in Figure 6. For example, in cell 231 312 312 we might want to "pivot on 2", i.e., eliminate that vertex and pass through the opposite facet to the cell beyond. Since 2 is the second vertex, Case 1 applies with $i = 2$, $l = 1$, and $i' = 3$; the new cell is therefore 321 213 213 and its vertices are numbered as shown in Figure 7. If next we pivot on 1, we have $l = 3$ and $i' = 3$, making the new name 321 213 231.

The reader may like to verify that three more pivots on 1 will bring the path to the boundary of A, specifically to cell 32 23 23 in the induced partition on $B = A^{\{2,3\}}$.

In a computer program, one would calculate the actual coordinates of a vertex v only when needed to determine $f(v)$, using (A.2) k times. At any given time, never more than n f -values are kept in storage, indexed by their vertex-numbers in the current cell. The dimension changes, both up and down, are easy to effect if we adopt the device of always using n -letters words, filling out the shorter words with the idle "letters" in order. Thus, we can write 23145 21345 (3) instead of 231 213, the (3) indicating that the current cell is in the face $A^{\{1,2,3\}}$ and only the first three "letters" are to be read. To "step up" one dimension we merely change the "(3)" to "(4)" and calculate the f -value for the new vertex, which will be the fourth vertex of 2314 2134. "Stepping down" (Case 2 above) is even easier since there is no new vertex to consider.

A possible drawback to the iterated barycentric partitions is their rough texture. Most of the cells are far from equilateral (though their volumes are equal); hence an unnecessarily large number of cells may be required to achieve a given mesh. Presumably this means that more pivot steps are needed to reach a solution of prescribed accuracy.

A possible advantage to the iterated barycentric partitions--as compared, say, with those used in Kuhn (1968, 1969)--

is the ease with which the geometry can be distorted in order to increase the cell density in the vicinity of a desired "target" point in A. Indeed, by a projective transformation of the original coordinates we can put the center node of the first partition directly on the target. Then by suitable adjustments of the transformations (A.1), (A.2) we can bring the center nodes of the second-order partitions as close as we please to the target, and so on. This geometric distortion (note that the combinatorial structure of the partition is unchanged!) would be worth the trouble if we had prior knowledge of the probable location of a solution. Such knowledge might arise from a "first pass" at the problem with a coarse grid, or from a known solution of a similar problem with slightly varied parameters (as when one is following a solution through time), or from special properties of the problem itself.

REFERENCES

- Aumann, R. J. (1961), "The core of a cooperative game without side payments," Trans. Amer. Math. Soc. 98, 539-552.
- Billera, L. J. (1970), "Some theorems on the core of an n-person game without side payments," SIAM J. Appl. Math. 18, 567-579.
- Billera, L. J. (1971), "Some recent results in n-person game theory," Mathematical Programming 1, 58-67.
- Bondareva, O. N. (1962), "Theory of the core in the n-person game" (Russian), Vestnik L. G. U. (Leningrad State University) 13, 141-142
- Bondareva, O. N. (1963), "Some applications of linear programming methods to the theory of cooperative games," Problemy Kibernetiki 10, 119-139.
- Brouwer, L. E. J. (1909), "On continuous vector distributions on surfaces," Amsterdam Proc. 11.
- Brouwer, L. E. J. (1910), Amsterdam Proc. 12, 13.
- Burger, E. (1963), Introduction to the Theory of Games (trans. J. E. Freund), Prentice-Hall, Englewood Cliffs, New Jersey. (Original German edition published by Walter de Gruyter, Berlin, 1959.)
- Cohen, D. I. A. (1967), "On the Sperner Lemma," J. Combinatorial Theory 2 (1967), 585-587.
- Knaster, B., C. Kuratowski, and S. Mazurkiewicz (1926), "Ein Beweis des Fixpunktsatzes für n-dimensionale Simplexe," Fundamenta Mathematica 14.
- Kuhn, H. W. (1968), "Simplicial approximation of fixed points," Proc. Nat. Acad. Sci. 61, 1238-1242.
- Kuhn, H. W. (1969), "Approximate search for fixed points," in Computing Methods in Optimization, 2, Academic Press, New York.
- Lemke, C. E., and J. T. Howson, Jr. (1964), "Equilibrium points of bimatrix games," SIAM J. 12, 413-423.
- Scarf, H. E. (1967a), "The core of an N person game," Econometrica 35, 50-69.
- Scarf, H. E. (1967b), "The approximation of fixed points of a continuous mapping," SIAM J. Appl. Math. 15, 1328-1343.
- Shapley, L. S. (1967), "On balanced sets and cores," Nav. Res. Log. Q. 14, 453-460.
- Sperner, E. (1928), "Neuer Beweis für die Invarianz der dimensionszahl und des Gebietes," Abh. Math. Sem. Univ. Hamburg 6.