

AD-761 972

MILITARY APPLICATIONS OF V/STOL AIRCRAFT.
VOLUME 1

Advisory Group for Aerospace Research
and Development
Paris, France

April 1973

DISTRIBUTED BY:

NTIS

National Technical Information Service
U. S. DEPARTMENT OF COMMERCE
5285 Port Royal Road, Springfield Va. 22151

DISCLAIMER NOTICE

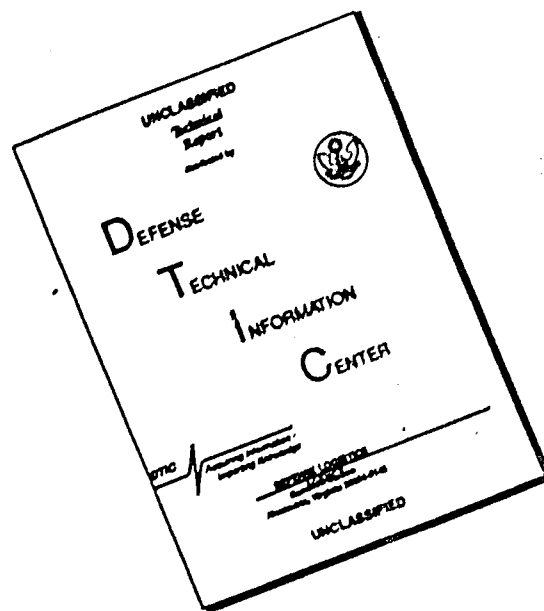

THIS DOCUMENT IS BEST QUALITY AVAILABLE. THE COPY FURNISHED TO DTIC CONTAINED A SIGNIFICANT NUMBER OF PAGES WHICH DO NOT REPRODUCE LEGIBLY.

AGARD-CP-126

AGARD-CP-126

AD 761972

AGARD

ADVISORY GROUP FOR AEROSPACE RESEARCH & DEVELOPMENT

7 RUE ANCELLE 92200 NEUILLY SUR SEINE FRANCE

AGARD CONFERENCE PROCEEDINGS No. 126

on

Military Applications of V/STOL Aircraft

Volume 1

NORTH ATLANTIC TREATY ORGANIZATION



Reproduced by
NATIONAL TECHNICAL
INFORMATION SERVICE
U S Department of Commerce
Springfield VA 22151

DISTRIBUTION AND AVAILABILITY
ON BACK COVER

146

AGARD-CP-126
Volume I

NORTH ATLANTIC TREATY ORGANIZATION
ADVISORY GROUP FOR AEROSPACE RESEARCH AND DEVELOPMENT
(ORGANISATION DU TRAITE DE L'ATLANTIQUE NORD)

AGARD Conference Proceedings No.126
MILITARY APPLICATIONS OF V/STOL AIRCRAFT

Volume I

Unclassified papers presented at the 41st Meeting of the Flight Mechanics Panel of AGARD
held at NATO Headquarters, Brussels, Belgium, on 23-25 October 1972.

THE MISSION OF AGARD

The mission of AGARD is to bring together the leading personalities of the NATO nations in the fields of science and technology relating to aerospace for the following purposes:

- Exchanging of scientific and technical information;
- Continuously stimulating advances in the aerospace sciences relevant to strengthening the common defence posture;
- Improving the co-operation among member nations in aerospace research and development;
- Providing scientific and technical advice and assistance to the North Atlantic Military Committee in the field of aerospace research and development;
- Rendering scientific and technical assistance, as requested, to other NATO bodies and to member nations in connection with research and development problems in the aerospace field;
- Providing assistance to member nations for the purpose of increasing their scientific and technical potential;
- Recommending effective ways for the member nations to use their research and development capabilities for the common benefit of the NATO community.

The highest authority within AGARD is the National Delegates Board consisting of officially appointed senior representatives from each member nation. The mission of AGARD is carried out through the Panels which are composed of experts appointed by the National Delegates, the Consultant and Exchange Program and the Aerospace Applications Studies Program. The results of AGARD work are reported to the member nations and the NATO Authorities through the AGARD series of publications of which this is one.

Participation in AGARD activities is by invitation only and is normally limited to citizens of the NATO nations.

The material in this publication has been reproduced directly from copy supplied by AGARD or the author.

Published April 1973

623.746:629.735.3.014.16:533.652.6



*Printed by Technical Editing and Reproduction Ltd
Harford House, 7-9 Charlotte St, London. W1P 1HD*

PREFACE

V/STOL aircraft and their applications have held the attention of AGARD/NATO for many years and have been the subject of several studies and conferences. The last conference was held at NATO Headquarters in December 1969.

Since that time a background of operational experience has been acquired, additional operational requirements appear to be emerging, and new capabilities resulting from advances in technology are surfacing. With these developments in mind, the Flight Mechanics Panel considered it timely and appropriate to reintroduce the subject of V/STOL aircraft into the ongoing and continuing dialogue among researchers, aircraft designers, military planners and military users concerning the nature and character of future military aircraft systems.

This conference, titled "Military Applications of V/STOL Aircraft", was intended to provide a forum for this dialogue. To encourage candor and hopefully to foster lively discussions, attendance at this meeting was limited, in general, to those having a direct involvement in V/STOL aircraft and/or their military applications.

The conference was structured to highlight past developments on experimental V/STOL aircraft as well as current military doctrine and operational experience. Ongoing and new development programs were reviewed to provide visibility to potential new capabilities. Finally, an attempt was made to project future military applications for V/STOL aircraft in terms of currently perceived operational requirements.

The conference was concluded with a vigorous panel discussion centered around four basic questions:

- What are the two most important advantages of any V/STOL system?
- What are the current most serious limitations to the advancement and further development of V/STOL aircraft?
- What can the industry and customer do to overcome these obstacles?
- Among technology trends in aerodynamics, structures, flight control, etc., which are considered most important?

The formal papers of the conference are contained in this Conference Proceedings. Volume I contains the unclassified papers and Volume II contains the classified papers.

Special appreciation is due to General J. Steinhoff, Chairman of the North Atlantic Military Committee, for his cooperation and active participation in the conference activities. The efforts and assistance of the other Program Technical Coordinators, Prof. Dr.-Ing. X. Hafer, Mr Ph. Poisson-Quinton and Mr J. B. Scott-Wilson, are gratefully acknowledged.

William Koven
Member
Flight Mechanics Panel

CONTENTS

	Page
PREFACE	iii
	Reference
A REVIEW OF PAST AGARD/NATO ACTIONS ON V/STOL AIRCRAFT AND THEIR APPLICATIONS by R.H.Miller	1
<u>SESSION I – PAST EXPERIENCES</u>	
<u>PART I – TACTICAL AIRCRAFT</u>	
HARRIER – AN INDUSTRY VIEW by B.P.Laight	In Volume II
ETUDE ET MISE AU POINT EN SOUFFLERIE ET EN VOL DE L'AVION DASSAULT MIRAGE III V par G. de Richemont	2
THE US/FRG V/STOL TACTICAL FIGHTER PROGRAM (AVS) by K.-H.Heilmann	In Volume II
<u>PART II – LOGISTICS AIRCRAFT</u>	
A REVIEW OF THE US TRI-SERVICE V/STOL PROGRAMS by B.Lindenbaum and D.E.Fraga	3
PROGRAMME EXPERIMENTAL DO 31 – RESULTATS OBTENUS ET CONCLUSIONS A TIRER POUR L'AVENIR par R.Draganow et H.Max	4
<u>SESSION II – PRESENT OPERATIONS</u>	
<u>PART I – TACTICAL AIRCRAFT</u>	
OPERATIONAL EXPERIENCE WITH THE HARRIER IN THE ROYAL AIR FORCE by H.A.Merriman	In Volume II
AV-8A HARRIER CONCEPT AND OPERATIONAL PERFORMANCE – US MARINE CORPS by T.H.Miller, Jr, and C.M.Baker	5
VAK 191B EXPERIMENTAL PROGRAM FOR A V/STOL STRIKE-RECCE AIRCRAFT by R.Riccus and W.Sobotta	6
TESTING AND EVALUATION OF THE CANADAIR CL-84 TILT-WING V/STOL AIRCRAFT by F.C.Phillips	7
<u>PART II – LOGISTICS AIRCRAFT</u>	
EXPERIENCE ACQUISE AU COURS DES ESSAIS EN VOL ET EN UTILISATION OPERATIONNELLE DE L'AVION STOL BREGUET 941 par J.Czinczenheim	8

	Reference
NASA PROPULSIVE-LIFT STOL TECHNOLOGY PROGRAM by G.G.Kayten and W.S.Aiken, Jr	9
THE BUFFALO/SPEY JET-STOL RESEARCH AIRCRAFT by D.C.Whittley	10
MILITARY ASPECTS OF CIVIL V/STOL AIRCRAFT by N.W.Boorer	11
 <u>SESSION III – FUTURE REQUIREMENTS</u> 	
OUTLOOK FOR V/STOL AIRCRAFT IN THE US NAVY AND MARINE CORPS by G.G.O'Rourke	In Volume II
SOME EFFECTS OF V/STOL REQUIREMENTS ON FUTURE CLOSE SUPPORT AIRCRAFT by K.W.Newby	In Volume II
SELECTING A STOL TRANSPORT by F.D.Orazio, Sr	12
GERMAN COMMENTS ON FUTURE V/STOL REQUIREMENTS by U.Köster	13

A Review of Past AGARD/NATO Actions on V/STOL Aircraft
and Their Applications

R. H. Miller

Massachusetts Institute of Technology
Cambridge, Mass., U.S.A.

Just about three years ago, in December 1969, an AGARD/NATO meeting was held here in Brussels with the theme "V/STOL Aircraft and Their Applications." I am not sure how many from this audience were present at that meeting, or how many of you may have had a chance to read the published proceedings of that meeting (AGARD Conference Proceedings No. 69), a most interesting document and particularly when viewed from the perspective of today. In many ways it will be our function during this meeting to assess the progress, or should I say lack of progress, in the development of VTOL aircraft as operational vehicles, and it therefore seems appropriate to start by briefly reviewing the results and conclusions from the previous meeting.

The 1969 meeting was convened in order to review the results of an AGARD study, V/STOL COMPARISON STUDY, conducted by an ad hoc group of specialists in late 1968 and 1969 and published as AGARD Advisory Report No. 18. This study reviewed the status of existing technology, giving details of the many VTOL vehicles which had been built and the lessons learned from their flight experiences. The report then reviewed the manner in which further research could be expected to increase the effectiveness of such vehicles and the potential mission improvements which would result. The missions considered were attack, transport and rescue. Finally a research program was outlined which hopefully would ensure achieving these improvements.

The report arrived at the following conclusions:

1. Most fundamental technical problems have been solved for a wide range of experimental V/STOL aircraft. These aircraft could be developed with little greater risk than would be anticipated for new advanced CTOL aircraft concepts.
2. The jet lift and tilt wing configurations are in the most advanced state of development and ready for operational exploitation. The tilt rotor and stowable rotors require some further development work.
3. A reduction in maintenance manhours per flight hour could be expected as the VTOL aircraft evolved through the same evolutionary phases experienced in the past with CTOL aircraft.
4. In selecting from the wide choice of V/STOL configurations available, it is most important to define carefully the initial requirements and relate these requirements to the peculiar capabilities of V/STOL aircraft.

The report also recommended that:

1. demonstration programs and operation analyses be conducted to establish the cost effectiveness of VTOL aircraft for military missions.
2. all promising VTOL aircraft configurations be retained in development status and one or two specific configurations brought to full operational status for the military transport mission.
3. a meeting be called between groups of operationally cognizant personnel and VTOL design and development specialists at the earliest possible date, under NATO auspices, for the purpose of implementing these recommendations.

This last recommendation, being the simplest to execute of the three, promptly resulted in the meeting of December 1969 referred to earlier.

During this meeting about 100 experts convened to discuss and critique the report, to present the results of cost effectiveness studies and of such operational experience as existed at the time, and to outline the requirements of the various NATO nations for VTOL aircraft. The meeting was lively and generated a great deal of discussion but, not unexpectedly, no clear-cut agreement was reached as to the requirement for VTOL aircraft.

The cost in gross weight for a VTOL capability, as estimated by the various investigators, varied from 9% to 30%, depending to a great extent on the mission. However, when mission effectiveness was considered, this picture changed radically, and many studies showed as much as a three-fold reduction in cost when satisfying a given mission by using VTOL aircraft in place of CTOL or STOL. This reduction in cost arose from the faster reaction time by virtue of the forward deployment of aircraft closer to the FEBA; the higher productivity for the same reason; the reduced vulnerability of the aircraft. This reduction in vulnerability is due to the possibility of concealment on remote sites and the difficulty of detecting single aircraft so concealed. One study predicted a 15% probability of detection for VTOL vs 97% for STOL. Flight trials showed a 1% probability of site detection. Similarly, a reduced base vulnerability from ground attack could be expected with dispersion. Also, the fast acceleration possible with higher installed thrust of VTOL permits reduced time during the highly exposed period of landing and takeoff. Finally it was pointed out that the ability of VTOL to fly at reduced speeds in valleys and concealed by terrain reduced the probability of radar detection.

The results of the flight investigations on detectability and on dispersion were discussed at some length and questions were raised as to whether dispersion would actually increase or decrease base vulnerability because of the ability to ensure better perimeter defense of a larger base than of a small

concealed site. Experience seems to indicate that large bases are vulnerable, while the vulnerability of small dispersed sites depends on the degree to which they are organic with the ground forces.

Matters such as productivity and vulnerability were relatively easily quantified and lent themselves to analysis by existing techniques of operational analysis. However, less easily defined and quantified advantages were also cited such as the true all-weather capability of VTOL because of the possibility of achieving automatic takeoff and landing with a minimum of ground facilities. The relative insensitivity of VTOL aircraft to ground condition was mentioned. It was pointed out that rain could rapidly make any STOL aircraft inoperable off unprepared sites because of the ruts rapidly formed in soft ground and the restrictive effects of mud. Also, such landing fields become saturated at high utilization rates, a problem which would not exist with VTOL requiring only minimal site preparation and hence permitting a multiplicity of sites.

Against these manifold advantages, some quantifiable some not, the one basic disadvantage of VTOL--its increase in gross weight for a given mission load--stands out loud and clearly. Many speakers questioned why a supersonic capability, as currently required of most tactical aircraft, does not have to be justified nearly to the extent that a vertical takeoff capability must be before being accepted by the operational community. Discussers pointed out that a supersonic capability required a 40% increase in gross weight for a given mission load, whereas VTOL required only 10-20%. The interesting argument was put forth that frequently the supersonic capability was required not so much for the ability to fly at supersonic speed, but because of the improved energy maneuverability which the greater thrust installed to achieve supersonic flight allowed in the aircraft. Manifestly, the same is true for VTOL, since the penalty for VTOL is primarily due to the higher installed thrust. This higher installed thrust not only permits better acceleration in the climbout and approach modes, hence, as mentioned above, reduced vulnerability because of reduced exposure time, but also permits a higher rate of climb and tighter turns without loss of altitude. In addition, for those configurations in which deflected thrust is used, an increase in effective lift coefficient is also possible and this has proven from experience to be a highly desirable factor as we may hear later during this meeting.

And yet despite all the advantages discussed and analyzed at the meeting, there remains probably no more controversial question in aircraft technology today than that of when to take the step from conventional to vertical takeoff, whether to take this step through the deceptively easy path of short takeoff, or indeed whether to take the step at all.

The reason, if not the rationale for this controversy, may be deduced from the result of the 1969 meeting just reviewed. To repeat the point made above, the penalty for V/STOL is clearly defined, and few will argue that this penalty would be much less than a 20% increase in gross weight, and hence operating costs, and could be higher for certain missions. The important point is that given certain clearly defined assumptions as to the state of technology and the mission requirements in fuel and payload, the penalty can be computed in an unequivocal fashion. On the other hand, the advantages of V/STOL aircraft as briefly summarized above are not subject to such exact computational definition, and consequently no simple numerical measure of effectiveness can be developed on which to base tradeoff studies. The question of base vulnerability; the need for quick reaction time; the need to penetrate into inaccessible areas; the relative difficulty in preparing a runway for STOL which, it was pointed out in the meeting, could be from one day to six months, depending on terrain qualities; the further need of having a cleared approach for STOL or CTOL in addition to a landing strip, all of which establishes a clear signature for the base; the advantages of dispersion and concealment, are all topics capable of generating endless hours of discussion, but defy specific quantification in terms of mission effectiveness. In the final analysis if concealment results in a 1% probability of destruction of VTOL aircraft vs close to 100% for aircraft on STOL or CTOL strips, discussion of the penalty for VTOL becomes academic when the difference is the ability to maintain a retaliatory capability versus sure destruction of all air power.

Since conclusive numerical studies on such matters cannot be generated because of the difficulty in agreeing on the basic assumptions used in the operational analyses, few have faith in the results and no requirement evolves. Again this was brought out clearly in the discussions at the meeting of 1969. Let me go back further in time and quote from a paragraph in a U.S. Air Force SAB report submitted in April 1960 by the so-called Perkins Committee.

"The state of the art of vertical and short takeoff and landing has advanced to the point where V/STOL aircraft capable of meeting operational requirements can be developed. The full military usefulness of V/STOL must now be demonstrated through operational evaluation. Unless a program for operational suitability is initiated, the state of uncertainty that exists today will continue."

This 1960 statement almost paraphrases the conclusions of our 1969 report and probably will be one of the conclusions which will come from this meeting. And yet only two VTOL aircraft have been built in anything approaching operational quantity, the Harrier and the XCL42. Operational tests of these aircraft under simulated field conditions have indicated no serious problems, yet of all VTOL aircraft built, only the Harrier, an aircraft whose history goes back 10 years, is approaching any true operational use. Understandably the true potential or limitations of any aircraft can only be established by extensive operational experience because of the difficulty in anticipating by any other means the innumerable problems of field operation and because of the inability to anticipate the products of the inventiveness and imagination of the user. I am sure all of us here hope that the promise of VTOL which we can readily articulate but find so difficult to quantify will become clearly visible as a result of the recent extensions in the Harrier program.

Finally let me say a few words about the technical conclusions of the earlier report and the advances which one could enumerate since that time. Progress in developing tilt rotor technology has been promising and most of the aeroelastic problems have been defined, are now understood, and solutions are available. We have become increasingly aware of the noise reduction potential of VTOL aircraft which is of particular importance in commercial operations. There is the promise of achieving possibly 85 PNdB for rotor and 95 PNdB for jet lift aircraft in the near future at representative distances of the order of 500 feet for takeoff from built-up communities. We have advanced rapidly in the development of automatic control

equipment which will permit all-weather operation of these vehicles from unprepared sites. We have established the potential of VTOL aircraft to carry a very large STOL overload, at least double the VTOL payload at much shorter takeoff distances, of the order of 500 feet, than could be achieved with comparable pure STOL aircraft. This is not only because of the higher installed thrust but also because of the reaction control capability of VTOL aircraft which permits safe operation at much lower speeds than is the case for STOL aircraft not so equipped. It was pointed out at the meeting, and is now well accepted, that the design minimum takeoff distance of STOL is seldom achievable in practice, particularly in gusty weather, and a large margin in lift coefficient must be maintained in order to ensure adequate control, particularly in roll. VTOL aircraft properly configured for hovering flight suffer from no such constraints.

In summary, we have continued to advance on the technological front and those of us in the technical community are even more convinced as to the feasibility and lack of risk in the development of operational VTOL aircraft. We feel that it is most important that these technological advances be clearly defined so that they may be considered in future force planning and that intensive dialogue between those interested in operations and those interested in development should continue. For this reason I, for one, welcome the opportunity to participate at meetings such as this one.

ETUDE ET MISE AU POINT EN SOUFFLERIE ET
EN VOL DE L'AVION DASSAULT MIRAGE III V

par

G. de RICHEMONT

AVIONS MARCEL DASSAULT - BREGUET-AVIATION

92214 - SAINT-CLOUD

RESUME.

Cet exposé a pour but de présenter les problèmes de contrôle en transition des avions DASSAULT MIRAGE III V, et de montrer comment nous les avons abordé et partiellement résolus en soufflerie.

L'auteur montre d'abord de quelle façon ces problèmes sont apparus en vol - puis expose comment la simulation des jets et de l'aspiration des réacteurs de sustentation a été réalisée en soufflerie - et comment les résultats d'essais étaient transposés à l'avion.

L'analyse en soufflerie des effets aérodynamiques dus aux jets d'une part - à l'aspiration des entrées d'air d'autre part - a permis de comprendre le mécanisme des actions induites, et donc de guider la recherche d'améliorations, qui a porté principalement sur la diminution du roulis-dérapiage.

Une comparaison rapide montre que les résultats d'essais en soufflerie étaient assez voisins de ceux obtenus en vol, ce qui paraît valider le système de simulation utilisé.

1. INTRODUCTION

Le but de cet exposé est de présenter les principaux problèmes qui ont surgi au cours des essais en vol des avions DASSAULT BALZAC et MIRAGE III V - et de montrer de quelle façon nous avons étudié ces problèmes en soufflerie -

Le BALZAC V 001 (photo n° 1) était le prototype du MIRAGE III V ; cet avion expérimental à voilure delta était sustenté, en vol stationnaire, par huit réacteurs verticaux ROLLS ROYCE RB 108 de 1 000 kg de poussée chacun et propulsé par un BRISTOL - SIDDELEY-ORPHEUS - La masse au décollage vertical était de 6 800 kg. Les essais en vol se sont déroulés en 1962-1963.

L'avion DASSAULT MIRAGE III V (photo n° 2) semblable au BALZAC mais de plus grande taille était un monoplan à décollage et atterrissage verticaux, sustenté par huit réacteurs verticaux ROLLS ROYCE RB 162 de 1 750 kg de poussée unitaire ; deux avions ont été réalisés :

- le MIRAGE III V 01, propulsé par un réacteur SNECMA TF 106 (dérivé du TF 30)
- le MIRAGE III V 02, propulsé par un réacteur PRATT et WHITNEY TF 30 double flux avec réchauffe.

La masse au décollage était d'environ 12 000 kg. Ces trois avions étaient équipés d'un système de stabilisation alimenté par les compresseurs des réacteurs verticaux au travers de clapets de prélèvement.

2. LES PROBLEMES DU VOL DE TRANSITION

2.1. Dès les premiers vols de transition du BALZAC en atmosphère turbulente, il apparut des difficultés de contrôle transversal, qui se manifestaient par des embarquements en roulis progressifs, en cours d'accélération à cap constant. Ce phénomène était lié au dérapage que prenait l'avion du fait du vent de travers imposé par un cap déterminé - ou du fait de la turbulence - Les couples de roulis correspondants étaient de l'ordre des couples de manoeuvre fournis par les tuyères de roulis. Tout se passait donc comme si "l'effet dièdre" était très élevé et de sens tel que l'aile dans le vent était soulevée.

2.2. Le problème le plus important après celui du comportement transversal était celui du tangage : en transition, l'avion était soumis à un moment cabreur croissant avec la vitesse et l'incidence, et obligeant le pilote à pousser de plus en plus sur le manche, même à incidence constante, donc ce moment n'avait rien à voir avec la stabilité statique longitudinale.

C'était un problème pour deux raisons :

- a) Il fallait fournir un contrôle en tangage assez puissant pour que l'avion soit pilotable même en cas de panne de moteur.
- b) La réduction et la coupure des moteurs verticaux en fin de transition produisait un couple à piquer très important qui compliquait la tâche du pilote.

2.3. Un troisième problème important pour le contrôle transversal était celui de la stabilité de route : en vol de transition, aux faibles vitesses et aux petits dérapages, le BALZAC et le MIRAGE III V 01 présentaient une légère instabilité de route ; la stabilité réapparaissait vers 180 kts, et redevenait normale en fin de transition. Cette caractéristique, associée au grand effet dièdre signalé précédemment, était responsable de l'instabilité oscillatoire de l'avion aux vitesses moyennes de transition.

2.4. Du point de vue des performances, le problème le plus important était celui de la "douche" : on appelait ainsi la perte de sustentation à laquelle l'avion était soumis en vol stationnaire ou de transition, du fait des dépressions créées à l'intrados par l'écoulement induit par les jets des réacteurs verticaux ; sur le MIRAGE III V 01, cette perte représentait environ 6 % de la poussée verticale en vol stationnaire ; elle augmentait avec la vitesse, ce qui obligeait à augmenter l'incidence au cours d'une transition accélérée - malgré l'accroissement de portance du planeur.

- Le roulis et le tangage n'étaient d'ailleurs, comme on le verra, que des conséquences directes de l'excentrement de la douche par rapport au centre de gravité de l'avion -

2.5. Mentionnons enfin le problème de la forte traînée due à la déviation à 90° du débit d'air aspiré par les réacteurs verticaux qui réagit sur les performances en augmentant la durée de la transition et donc le carburant nécessaire.

L'ensemble de ces problèmes a conduit à développer un système d'essais en soufflerie qui permette de simuler correctement le fonctionnement des réacteurs verticaux, et d'analyser séparément les effets des jets de sustentation, et de la captation du débit d'air alimentant ces huit réacteurs.

3. ESSAIS EN SOUFLERIE

3.1. Principe de la simulation des réacteurs verticaux, et moyens d'essais

Le problème, qui était entièrement nouveau en 1961, consistait donc à mesurer les efforts aérodynamiques dus à l'aspiration et aux jets des réacteurs verticaux, ces efforts étant jugés responsables des défauts de l'avion en vol de transition.

Pour cela, il fallait réaliser des maquettes comportant des entrées d'air et des tuyères d'éjection géométriquement et aérodynamiquement semblables à celles de l'avion : BALZAC V 001, puis MIRAGE III V 01.

La première solution expérimentée fut celle de trompes à injection : le réacteur était simulé par un canal vertical, avec une trompe annulaire débitant vers le bas, et aspirant l'air par induction à travers l'entrée supérieure du canal ; cette solution s'avéra mauvaise, car on n'était pas maître du rapport des débits entrée/sortie, à vitesse de vol variable.

La deuxième solution, qui a été adoptée, consiste à séparer l'aspiration et les jets : un depresseur aspire l'air à travers les huit entrées par un canal débouchant à l'arrière de la maquette, et un compresseur alimente (par l'intermédiaire de réservoirs), les huit tuyères par un canal indépendant du précédent (figure n° 1).

Ces deux canaux et les boîtes d'aspiration et de soufflage qui les terminent, forment un bloc rigide sur lequel est accroché la maquette par l'intermédiaire d'une balance à strain-gauges : on ne pèse donc pas les poussées de jets, mais seulement les efforts aérodynamiques sur la surface externe de la maquette, dus aux actions combinées du vent de la soufflerie, de l'aspiration et des jets.

Quatre maquettes ont été réalisées :

- une demi-maquette au 1/10 du BALZAC pour l'étude préliminaire des efforts à dérapage nul, des effets de sol, et de l'influence de l'inclinaison des tuyères vers l'arrière .
- une maquette complète au 1/10 du BALZAC, pour l'étude complète des efforts dans toutes les conditions de vol.
- une maquette complète au 1/13 du MIRAGE III V 01, qui présentait par rapport au BALZAC des différences notables : pas d'inclinaison des tuyères vers l'arrière. Rapport de surface d'éjection sur surface voilure deux fois plus grand. Pas de cambrure du bord d'attaque voilure (photos n° 3 et 4).
- une demi-maquette à l'échelle 1 pour l'étude du fonctionnement des réacteurs de sustentation et du contrôle par jets, dans toute la gamme de vitesses et d'incidence du vol de transition. (Photo n° 5).

Les deux maquettes complètes étaient équipées :

- soit d'une bi-boîte aspiration et soufflage permettant de réaliser la simulation complète des réacteurs verticaux.
- soit d'une monoboîte de soufflage ne simulant que les jets.
- soit d'une monoboîte d'aspiration ne simulant que le fonctionnement des entrées d'air.

Les monoboîtes ont été réalisées pour des raisons de technologie : la place très restreinte disponible à l'intérieur de la maquette conduit à des dimensions trop faibles pour les tuyères d'éjection et les entrées d'air de la bi-boîte ; ceci rend difficile la déviation à 90° du débit soufflé, ou aspiré - d'où il résulte de grandes difficultés pour obtenir des répartitions de vitesses correctes dans les jets et les entrées d'air. La simulation des jets seuls, ou de l'aspiration seule, facilite ce problème.

3.2. Similitude aérodynamique, et transposition des résultats à l'avion.

La similitude des efforts s'exerçant sur la maquette et sur l'avion exige au moins l'égalité des coefficients :

$$C_{\mu s} = \frac{q_m V_j}{\frac{1}{2} \rho S V^2} \quad \text{coefficient de soufflage}$$

$$C_{\mu e} = \frac{q_e V_e}{\frac{1}{2} \rho S V^2} \quad \text{coefficient d'aspiration}$$

où

q_m = débit de soufflage

V_j = vitesse moyenne des jets } $q_m V_j$ = poussée des jets

q_e = débit d'aspiration

V_e = vitesse moyenne dans les entrées d'air

ρ = masse spécifique de l'air

S = surface voilure

V = vitesse amont (vitesse vraie avion, ou vitesse soufflerie).

Ce ne sont pas les seuls paramètres théoriquement influents :

on peut en particulier se demander si les jets froids de la maquette peuvent simuler correctement les jets chauds de l'avion, ou du moins leurs interactions sur la cellule ; d'autre part les nombres de Reynolds de l'aile et des jets ont théoriquement un rôle à jouer, d'autant qu'il s'agit essentiellement de phénomènes d'entraînement visqueux de l'air à faible vitesse entourant la maquette par les jets à grande vitesse.

Cependant, les essais ont montré que ces deux coefficients sont nettement les plus importants, et donc définissent pratiquement le résultat, avec les paramètres géométriques : incidence et dérapage.

Nous les avons donc pris comme base de similitude ; dans la pratique chaque essai était effectué avec :

- une poussée π_m constante
- un débit d'aspiration q_e constant

et on réglait les vannes de manière à obtenir le même rapport de quantités de mouvement $q_e V_e / q_m V_j$ que sur l'avion.

On faisait varier la vitesse soufflerie V_m ; à chaque vitesse V_m il correspondait une vitesse avion V_a définie par l'égalité des coefficients de soufflage, soit :

$$\frac{\pi_a}{\frac{1}{2} \rho S_a V_a^2} = \frac{\pi_m}{\frac{1}{2} \rho S_m V_m^2}$$

ce qui donnait, en supposant les ρ égaux (atmosphère standard)

$$\frac{V_a}{V_m} = \sqrt{\frac{\pi_a \cdot S_m}{\pi_m \cdot S_a}} = \lambda \sqrt{\frac{\pi_a}{\pi_m}}$$

où λ = échelle de la maquette.

3.3. Explication sommaire des actions aérodynamiques dues aux réacteurs verticaux.

L'ensemble des essais en soufflerie a permis de comprendre les phénomènes du vol de transition. Il est nécessaire de distinguer les effets des jets et ceux de l'aspiration des entrées d'air.

Les effets des jets sur la cellule sont dus à l'entraînement de l'air ambiant par viscosité ; du fait que la vitesse des jets est très grande vis à vis de celle de l'écoulement général, celui-ci est accéléré dans la zone entourant le jet, sauf en avant du jet par suite d'un phénomène d'impact fluide - analogue à celui de l'impact fluide - solide - Cet air accéléré est donc en dépression, principalement dans la zone aval et les zones latérales ; il existe par contre en amont du jet une zone de faibles pressions juste devant le jet, et plus en amont des dépressions ou pressions faibles suivant que la vitesse avion est faible, ou grande (supérieure à 60 m/s).

Ces observations concordent avec celles que l'on tire des essais de principe tel que jet débouchant d'une plaque plane dans un vent parallèle à la plaque.

Ceci permet d'expliquer :

a) La douche : les dépressions produites sur l'intrados de la voilure par l'accélération de l'air entraîné par les jets donnent une perte de sustentation.

b) Le moment cabreur croissant avec la vitesse (figure 2) : à l'intrados, les fortes dépressions aval augmentent et s'étendent, tandis qu'à l'amont les faibles dépressions se transforment en pressions quand la vitesse avion augmente.

c) Le grand moment de roulis positif dû au dérapage : les jets induisent de fortes dépressions sous la voilure placée "sous le vent" - tandis que l'intrados de la voilure "dans le vent" est soumis à de faibles dépressions ou pressions (figure 3).

Les effets de l'aspiration sont dus principalement à la déviation à 90° et à l'accélération du débit masse aspiré.

a) La déviation à 90° a pour effets :

- de créer une traînée MV_0 suivant l'axe avion proportionnelle à la vitesse V_0 de l'avion (égale à la quantité de mouvement captée - figure 4 -).

- de donner un moment de tangage cabreur et un moment de roulis -dérapage positif (figures 2 et 4), du fait que cette traînée MV_0 s'exerce au-dessus du centre de gravité.

b) L'accélération de l'air aspiré crée aussi un moment de roulis - dérapage positif, mais sur les ailes au lieu du fuselage : ceci résulte du fait que la vitesse latérale à l'extrados est augmentée sur l'aile dans le vent, et diminuée sur l'aile sous le vent (figure 4).

3.4. Recherche d'améliorations.

A côté des essais destinés à comprendre les problèmes du vol de transition, et à identifier les caractéristiques aérodynamiques de l'avion, plusieurs centaines d'heures de soufflerie ont été consacrées à essayer des dispositifs variés anti-roulis, anti-tangage, et d'autres destinés à améliorer le rappel de l'avion en lacet.

a) Les dispositifs anti-roulis étaient (figure 5) :

- des spoilers d'intrados et d'extrados.
- des spoilers à déflecteur (du type "VIGILANTE")
- des barrières d'intrados
- des trappes de sortie réacteurs agrandies et ouvertes à plus de 90° .
- des casquettes pour dévier les jets vers l'intérieur.

cette liste étant loin d'être complète.

b) Pour améliorer le contrôle en tangage, nous avons surtout essayé des élevons doubles, et le pincement des jets vers l'intérieur à l'aide de casquettes.

c) Pour améliorer le rappel en lacet, les essais ont porté principalement sur des agrandissements de la dérive, et sur des quilles.

Les résultats de ces essais ont été souvent positifs sur un point, et négatifs sur d'autres : ainsi plusieurs dispositifs anti-roulis réduisaient effectivement le roulis-dérapage, mais accroissaient le couple cabreur de tangage, et la traînée.

Finalement, les modifications proposées pour améliorer les qualités de vol en transition des MIRAGE III V 01 et 02 ont été (figure 6) :

- de nouvelles tuyères déviant les jets latéralement vers le plan de symétrie
- de nouvelles trappes réacteurs s'ouvrant vers l'extérieur jusqu'à 40° par rapport à l'horizontale.
- des quilles latérales.

La déviation des jets vers l'intérieur avait les avantages suivants :

a) Améliorer la stabilité de l'écoulement ; en effet le couple de tangage présentait, en soufflerie comme en vol, une dispersion importante, qui paraissait liée à une instabilité de mélange des jets : en forçant le mélange à se faire beaucoup plus près de l'avion, il semble que cette instabilité ait disparu.

b) Diminuer nettement le roulis-dérapage.

c) Diminuer la perte de portance due à l'entraînement de l'air vers le bas.

Les nouvelles trappes servaient également à réduire le roulis-dérapage. Les quilles permettaient d'obtenir un rappel en lacet plus franc.

4. COMPARAISON BALZAC-MIRAGE III V.

Les essais en vol et en soufflerie ont montré que le MIRAGE III V était soumis en vol de transition à des moments de tangage et de roulis proportionnellement plus élevés que ceux du BALZAC.

Nous avons donc analysé en soufflerie l'influence des différences existant entre ces deux avions ; en particulier, la section d'éjection des 8 R.B. 162 du MIRAGE III V est relativement plus importante - par rapport à la surface de la voilure - que celle des 8 R.B. 108 du BALZAC. Ceci est dû au fait que le taux de compression des R.B. 162 est inférieur à celui des R.B. 108.

Or les essais en soufflerie ont montré qu'une augmentation de la section d'éjection était défavorable : les effets des jets sur le roulis-dérapiage et le tangage augmentent nettement avec leur diamètre.

De ce point de vue, et aussi pour diminuer les sections des tuyaux et vannes alimentant les tuyères de contrôle par jets, les réacteurs donnant les pressions génératrices les plus élevées sont les plus intéressants - Mais la conclusion est inverse si l'on cherche à réduire le bruit et l'érosion dus aux jets -

5. COMPARAISON DES RESULTATS DE VOL ET DE SOUFFLERIE.

Cette comparaison s'est heurtée aux difficultés suivantes :

- dispersion des mesures à faible vitesse, en vol comme en soufflerie, due aux imprécisions sur la mesure de la pression dynamique et des efforts, en vol et surtout en soufflerie, où les vitesses imposées par la similitude étaient encore plus faibles que celles de l'avion.

- étalonnage en vol de transition des indicateurs d'incidence et de dérapage.

Ceci nous a obligé à établir des moyennes.

La Figure n° 7 compare les rapports roulis/lacet en dérapage obtenus en soufflerie et en vol pour le BALZAC : on remarque que ce rapport décroît rapidement quand la vitesse croît, et que la soufflerie donne des valeurs assez voisines de celles des vols, à même incidence.

La figure n° 8 compare les couples de tangage obtenus en soufflerie et en vol sur MIRAGE III V01 ; on constate ici encore que la soufflerie donne des valeurs assez correctes, et on remarque la croissance rapide du couple avec la vitesse, à faible incidence.

6. CONCLUSIONS

Les comparaisons paraissent valider l'outil d'étude et de recherche que nous avons mis au point en soufflerie : il convient de noter à ce sujet la mise au point des tuyères-maquettes pour obtenir un écoulement à la sortie assez proche de celui mesuré dans le jet du réacteur réel, excepté ce qui concerne le champ de températures.

Ce système de simulation en soufflerie a permis de comprendre l'essentiel des phénomènes aérodynamiques qui sont à la base des difficultés de contrôle en vol de transition - et de définir un ensemble de modifications permettant d'améliorer les qualités de vol pendant cette phase intermédiaire entre le vol stationnaire et le vol conventionnel -



Photo No. 1 Avion BALZAC V 001



Photo No. 2 Avion MIRAGE III V 02

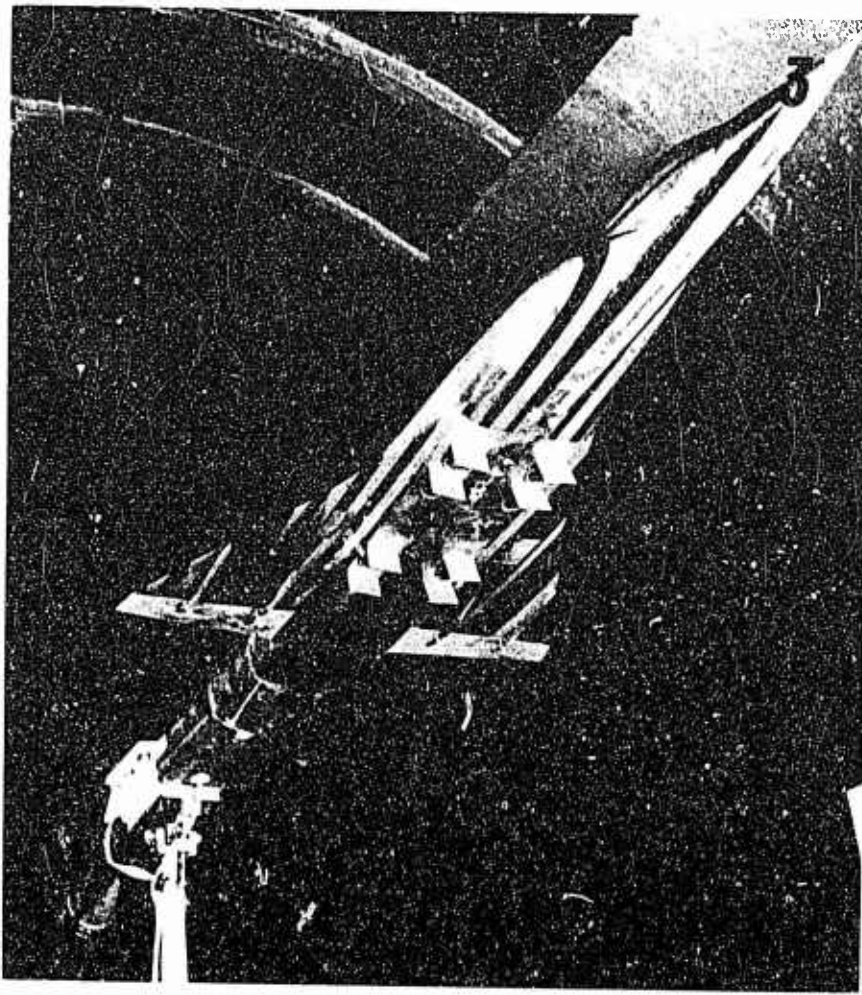

Photo No. 3 Maquette de soufflerie du MIRAGE III V

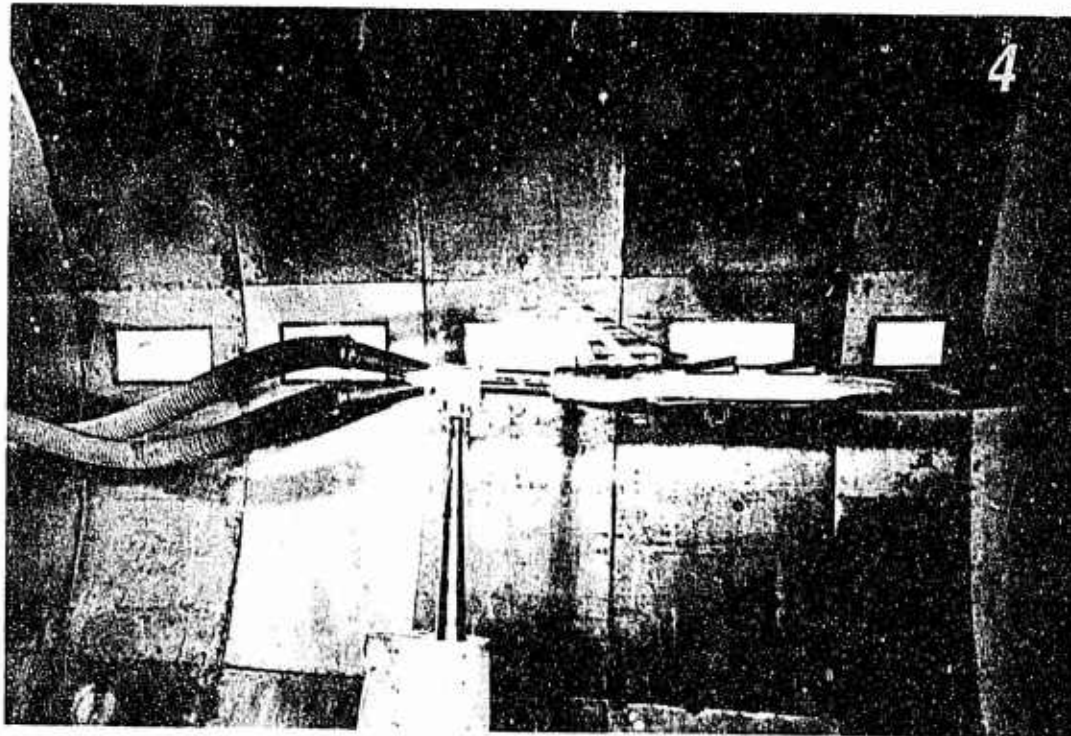

Photo No. 4 Maquette de soufflerie du MIRAGE III V

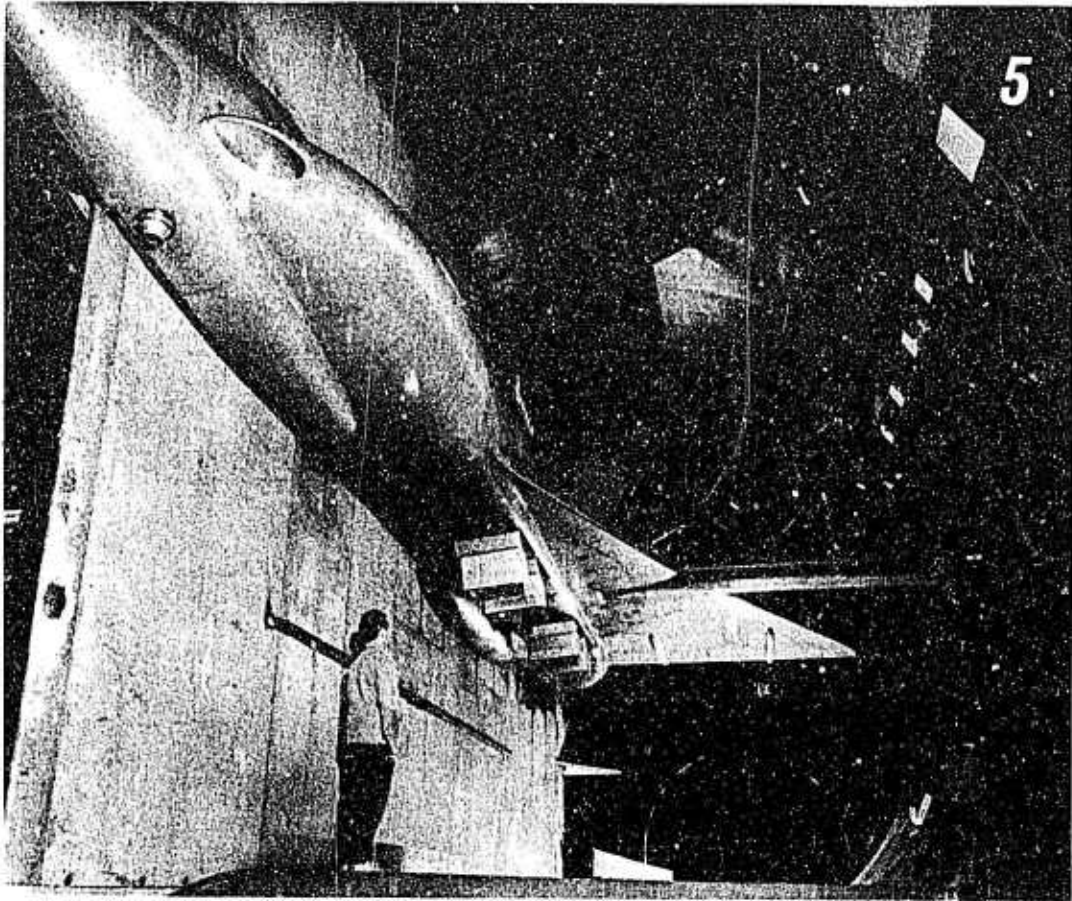

Photo No. 5 Demi-maquette du MIRAGE III V dans la grande soufflerie de MODANE

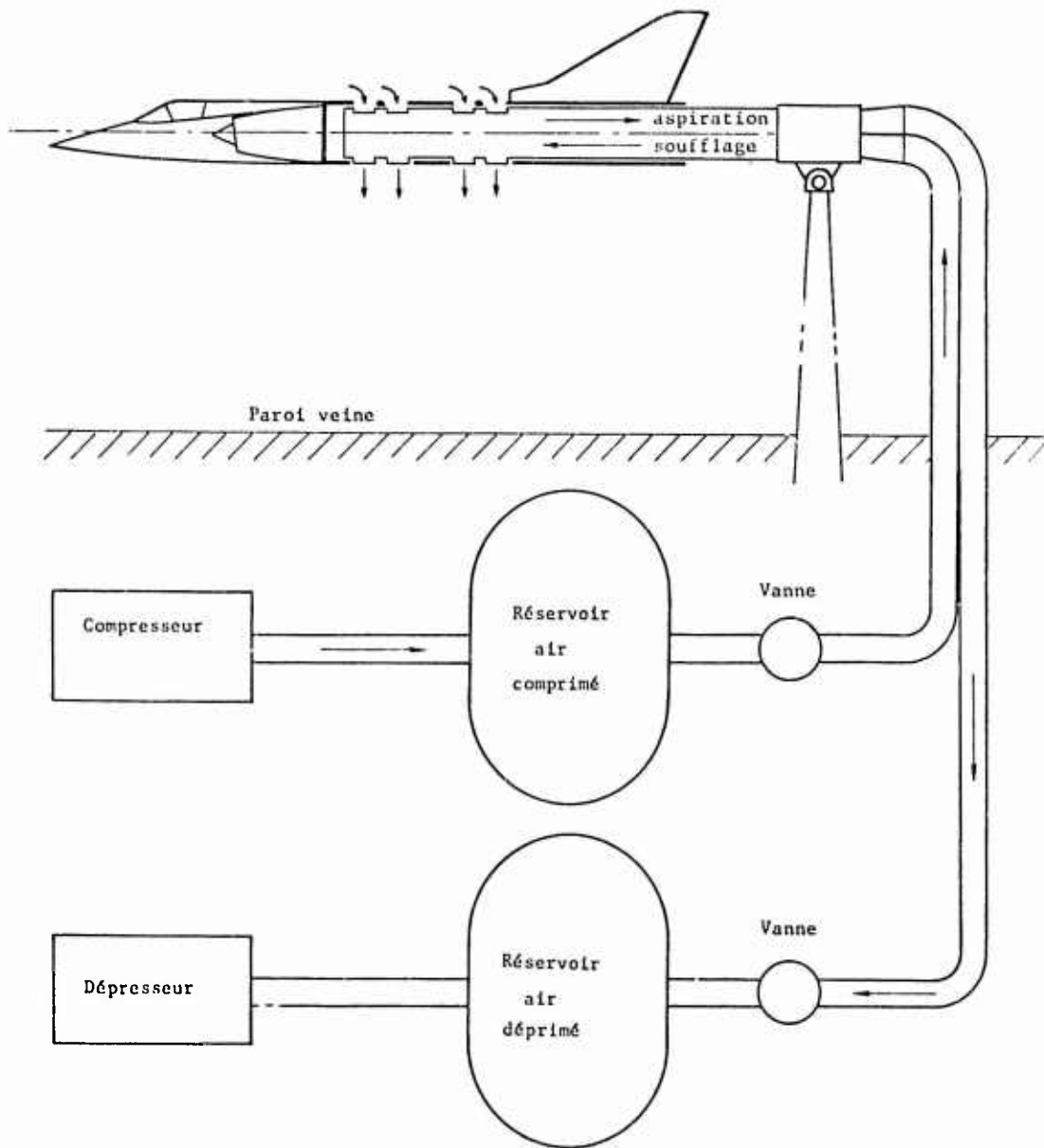

Fig. No. 1 Système de simulation de l'aspiration et des jets des réacteurs verticaux

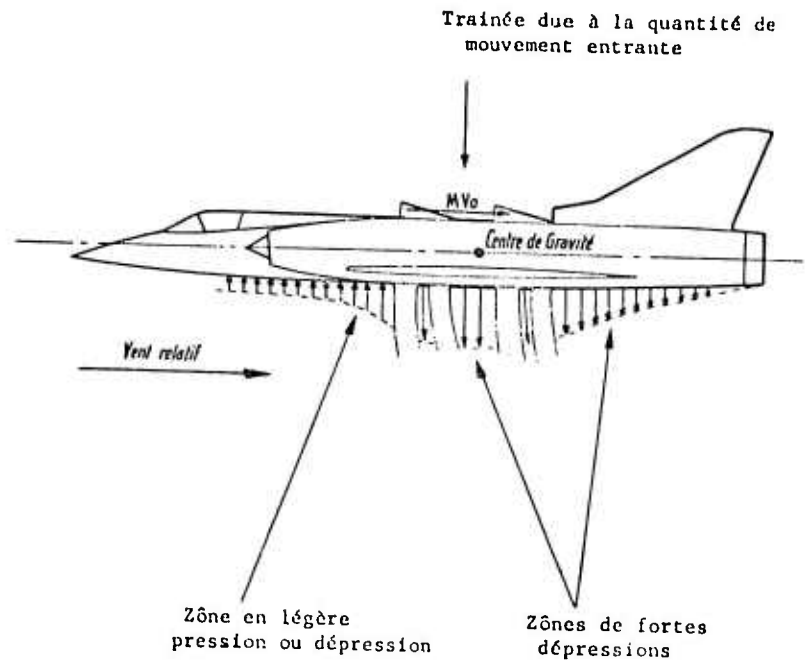

Fig. No. 2 Origine du moment de tangage cabreur

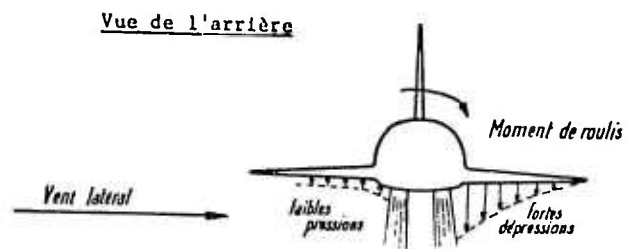
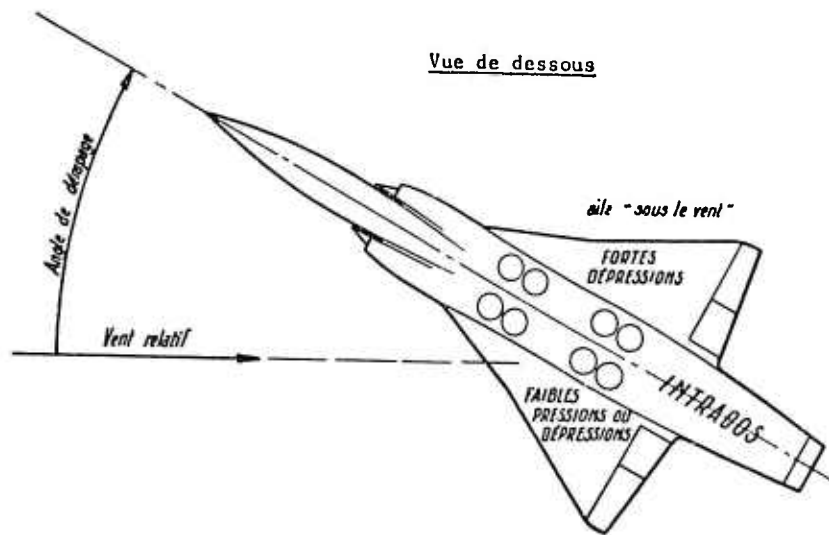
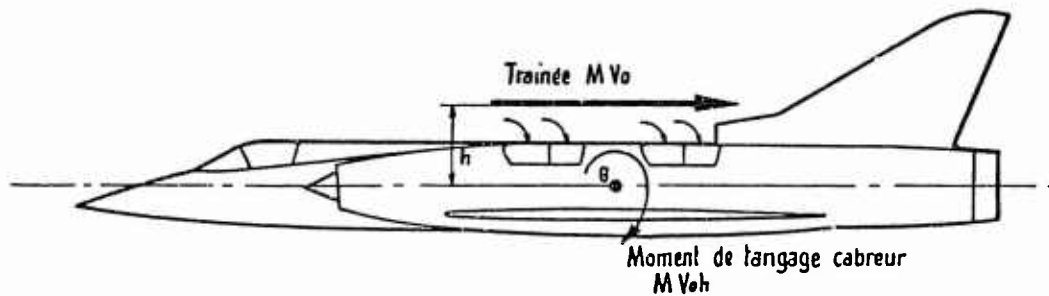

Fig. No. 3 Origine du moment de roulis -- dérapage positif dû aux jets des réacteurs verticaux

1.- Effets longitudinaux



2.- Effets latéraux en dérapage

ΔV = Variation de vitesse extrados due à l'aspiration

ΔP = Variation de pression extrados due à l'aspiration.

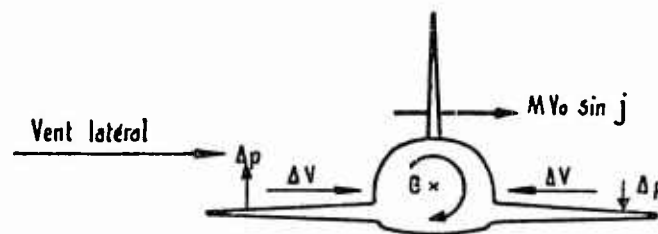

Moment de roulis - dérapage positif

$d\dot{\omega}$ { - à la composante de la trainée MVo en dérapage
 - aux différences de pression sur l'extrados en dérapage.

Fig. No. 4 Effets de l'aspiration

Vue de l'arrière

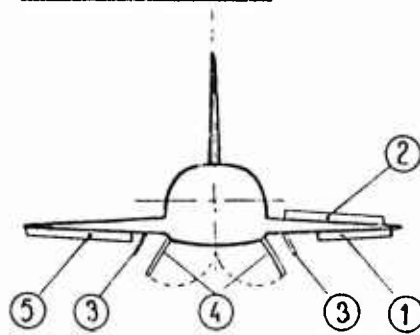

- | | |
|--|-----------------------------------|
| ① - Spoilers d'intrados | ⑤ - Spoilers de bord de fuite |
| ② - Spoilers d'extrados | ⑥ - Bouts d'ailes cassés |
| ③ - Barrières d'intrados | ⑦ - Soufflage de la couche limite |
| ④ - Trappes externes agrandies | ⑧ - Grilles d'intrados |
| ⑨ - Déviation des jets par casquettes. | |

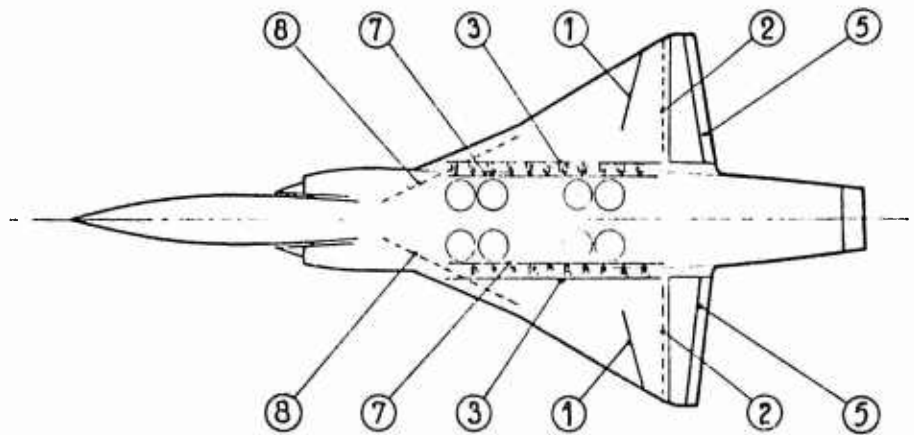
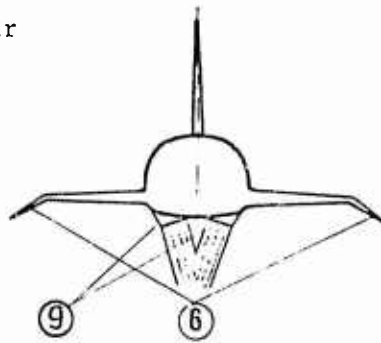

Vue de l'intrados

Fig. No. 5 Dispositifs anti-roulis essayés

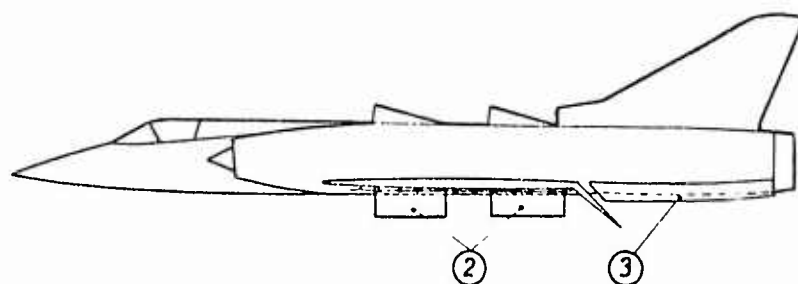

- ① - Tuyères déviées de 8°
- ② - Trappes réacteurs externes avec 40° de dièdre
- ③ - Quilles latérales.

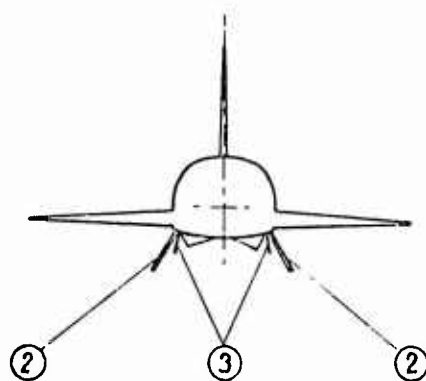
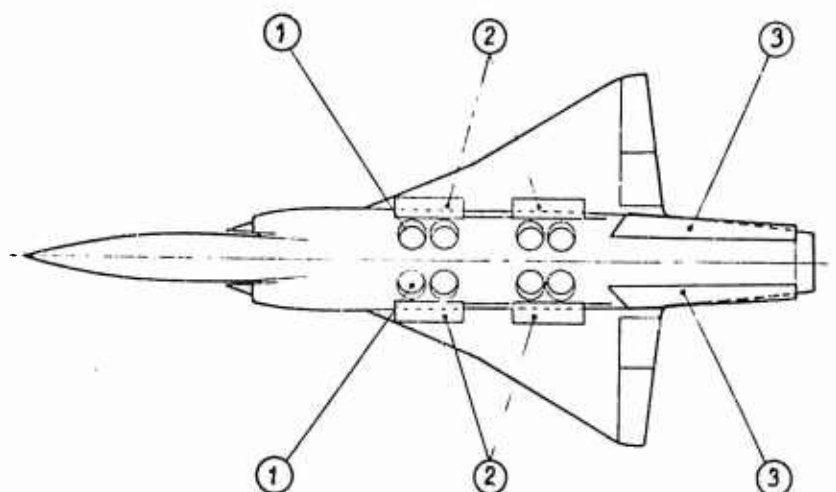

Fig. No. 6 Dispositifs proposés pour l'amélioration des qualités de vol en transition des MIRAGE III V 01 et 02

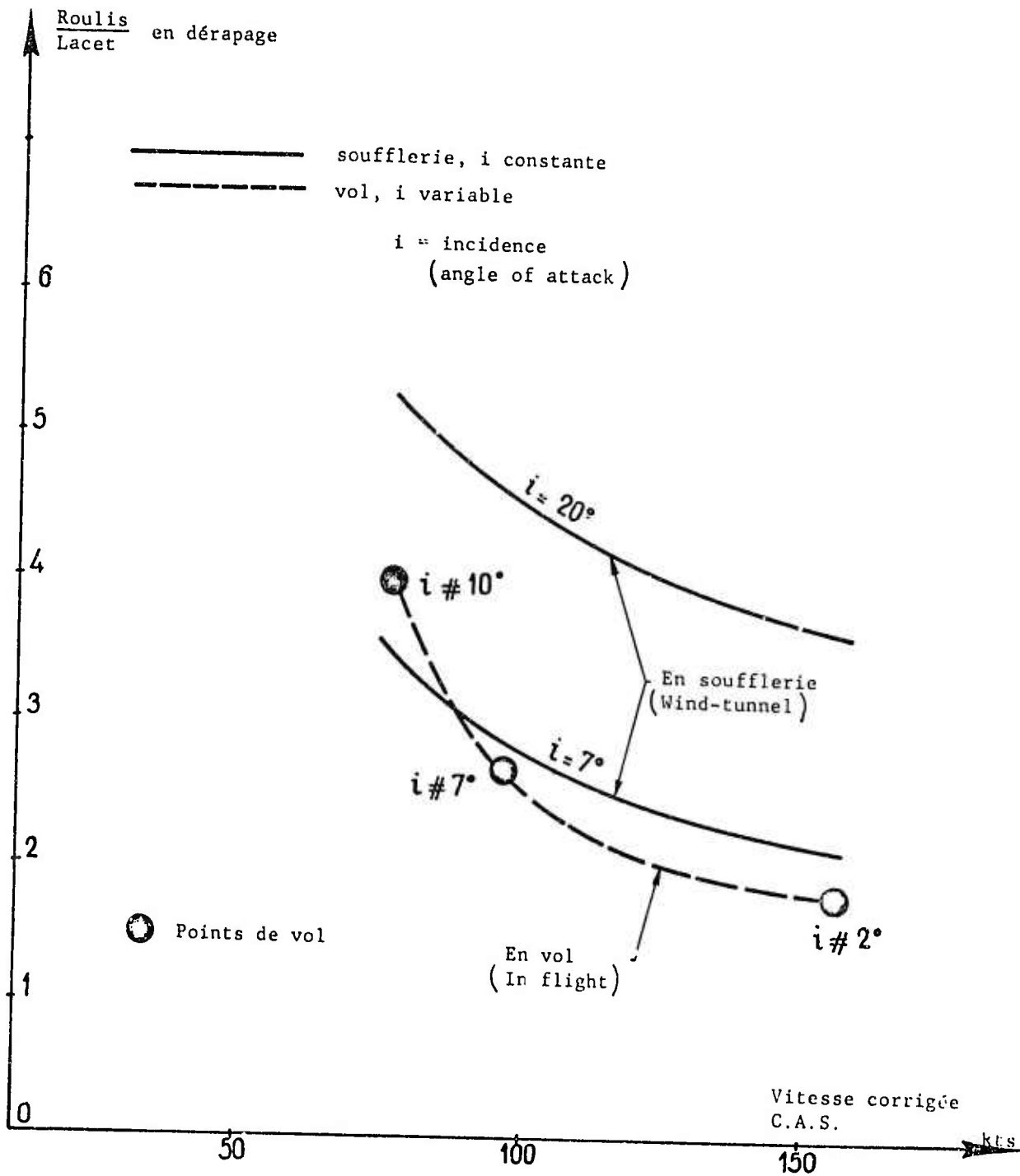

Fig. No. 7 Comparaison des rapports roulis/lacet en soufflerie et en vol, sur BALZAC V 001

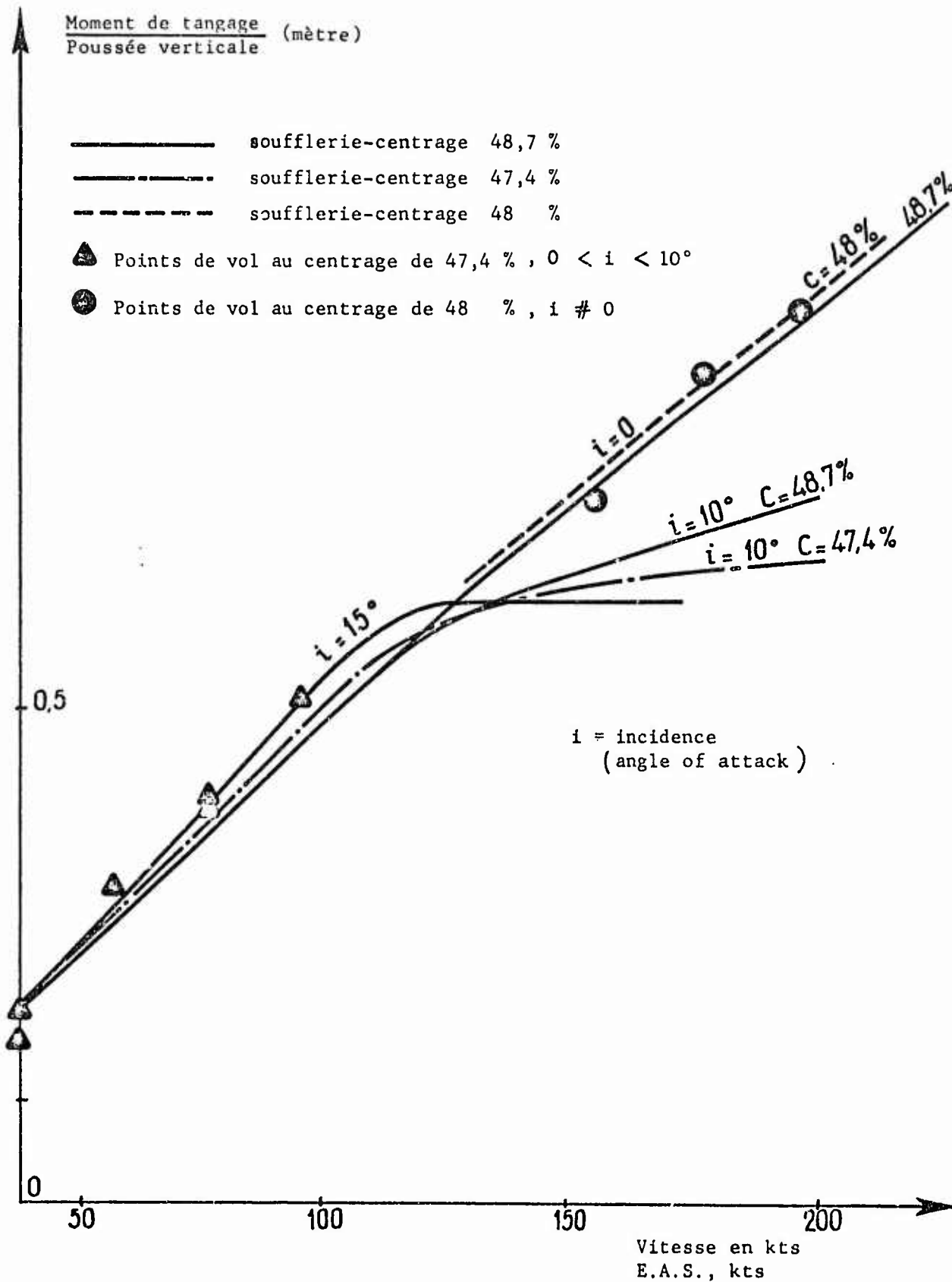

Fig. No. 8 Comparaison des couples de tangage obtenus en soufflerie et en vol, sur MIRAGE III V 01

A REVIEW OF THE U.S. TRI-SERVICE
V/STOL PROGRAMS

Bernard Lindenbaum
Deputy for Studies and Analyses
Prototype Division
AF Flight Dynamics Laboratory
Wright-Patterson AFB, Ohio 45433

Daniel E. Fraga
Program Manager, TAT ADPO
Prototype Division
AF Flight Dynamics Laboratory
Wright-Patterson AFB, Ohio 45433

SUMMARY

This paper provides a brief history of the U.S. Tri-Service V/STOL Programs and examines aspects of propeller-based propulsion systems for VTOL aircraft as represented by the three distinctly different design concepts found in the XC-142A, X-19 and X-22A. A comparison of the basic characteristics of these aircraft is provided in hover and vertical flight, transition and STOL flight and flight in the conventional mode. This includes a discussion of vehicle performance and efficiencies, handling qualities, and method of flight control. In addition a summary of the major accidents associated with these programs is presented as well as a brief discussion of the impact of technology improvements on future propeller driven VTOL designs.

I. INTRODUCTION AND BACKGROUND

While the propeller, as a device for V/STOL aircraft propulsion, seems to have been abandoned for the present, it still provides a highly viable basis for certain categories of V/STOL aircraft and is worthy of further consideration. This is particularly true for the military who do not have to contend with passenger preferences. However, even in the military, prejudice does exist against the propeller, which probably comes from the experience with conventional propellers based on 1940-1950 technology. Recent exploratory and advanced developments in propellers and transmissions provide evidence that they can provide reliable, efficient and effective VTOL propulsion systems. Studies conducted by the U.S. Air Force in recent years have shown that a propeller-driven, tilt wing concept was the most cost effective approach for the Light Intratheater Transport against many other VTOL concepts based on other propulsion approaches. With this in mind, an examination of the U.S. Tri-Service efforts, all of which involved propeller-driven VTOL concepts, should provide insight into the problems and potentials of such aircraft, particularly if consideration is given to recent propeller and propeller-rotor technology advancements.

Starting in 1961, the United States Department of Defense undertook development of three V/STOL aircraft concepts, as "Tri-Service" programs. These were the XC-142A, X-19 and X-22A and are examined in this paper. During the same time period there was another tri-service program based on the P-1127. This will not be included, because the nature and objectives of this effort differed substantially from the other three and also because the P-1127 basically was not a U.S. development. This paper will examine aspects of propeller-based propulsion systems for VTOL aircraft as represented by the three distinctly different design concepts found in the XC-142A, X-19 and X-22A.

While there was no specific overall plan to undertake all of the three tri-service efforts which ultimately developed, the Fall of 1959 can be identified as the starting point for this activity. At that time an Ad Hoc group (called the Perkin's Committee) was convened by Dr Herbert York, then Director of Defense Research and Engineering (DDR&E), to review military requirements and the state-of-the-art and to make recommendations regarding U.S. national policy on further development of V/STOL aircraft. This resulted in the report "Evaluation of V/STOL Aircraft" issued on 15 April 1960. The following quoted passage, extracted from the report, set the stage for the program which was to become the XC-142A:

"The U.S. VTOL research aircraft program (test beds) demonstrated the technical feasibility that V/STOL aircraft can be built in a number of configurations which contain the vertical take off and landing capability of rotary wing aircraft, yet do not have the limitations of speed, range and complexity of helicopters; however, the operational suitability of V/STOL to meet military requirements must now be demonstrated. Unless a program for operational suitability is initiated, the uncertainty that exists today will continue."

One of the actions recommended in the report was the initiation of a program for the development of a tilt-wing assault transport aircraft, designed to satisfy effectively the requirements of the three services.

The VTOL research aircraft program referred to was the series of developments which had taken place during the previous decade wherein numerous configurations were built and flown with varying degrees of success and which proved that there were many promising approaches to VTOL. These efforts covered many concepts from propeller driven tail sitters through tilting rotors, tilting wings, deflected slipstream, lift fans and jet lift types; efforts which represented a substantial monetary investment. It was this proliferation of efforts aimed at finding the "solution" to VTOL, which led to the formation of the Perkin's Committee. That many of these were based upon propeller propulsion is noteworthy.

In consequence of the Committee's recommendation, the three services undertook definition of the requirements and the development of a cargo-assault transport type of VTOL airplane. Size and performance were selected to permit establishment of the operational capability and flight characteristics of a reasonably-sized VTOL airplane. It was decided to develop an airplane of approximately 40,000 lb gross weight which would be capable of carrying an 8,000 lb payload one way, outboard, on a 200 NMI radius mission.

The Navy was given the responsibility for managing the ensuing competition, with participation by the other two services. Hence, the requirements which were circulated to industry in January 1961 were put out as a Navy Type Specification (TS-152). Nine companies responded to the request for proposal, and the designs represented an interesting array of concepts. The range covered single tilt wing, tandem tilting wings, tilting ducted propellers, tilting propeller-rotor, direct jet lift and compound helicopter approaches.

Each service made its own evaluation of the proposals and, initially, the services chose different winners. A compromise choice was arrived at, however, in the Vought-Hiller-Ryan design, which was to be later designated as the XC-142A. It was this initial disagreement in concept selection which later led to the other two tri-service programs. In the original evaluation, the Army favored the approach of a single tilt wing with four-propellers because of its superior STOL capability; the Navy preferred the four-ducted propeller tandem wing arrangement because of compactness and inherent safety for shipboard personnel during operations and the Air Force selected a four-open-propeller tandem tilt wing arrangement because it believed this to be the best configuration for a high speed VTOL machine. It should be noted that the requirements against which the proposals were made, basically were aimed at VTOL operation; STOL was not a requirement.

After the evaluation was completed and a single selection was made, the Air Force assumed management of the program. The contract for the XC-142 was awarded to Chance-Vought (which later became Ling-Temco-Vought) in January 1962 with Hiller and Ryan as major subcontractors. Estimated cost of the program, which was to provide five aircraft, was 76 million dollars; a cost which was to be equally shared by the three services. However, the actual cost came to approximately 140 million dollars.

Because the original Navy and Air Force preferences differed from the selected concept, the Department of Defense later approved two additional but smaller tri-service programs, the X-19 and X-22A.

The X-19 began as an entirely private development of Curtiss-Wright with the company designation M-200. It was to be a high speed VTOL airplane for the executive transport market. Curtiss-Wright had done considerable development work on the concept, starting with the two-propeller X-100 (Figure 1) and culminating in the M-200. After considerable development effort on this machine, the company decided to seek U.S. Government aid, and the Department of Defense agreed to help fund the completion of the M-200 (X-19) with the objective of obtaining data for evaluation of this VTOL approach. Since the M-200 configuration was similar to the Air Force's initial concept preference in the XC-142 competition, program management responsibility was assigned to the Air Force's XC-142 organization in 1962. Because of the advanced state-of-the-development prior to the contract, the government agreed to exercise only minor control over the design and construction of the machine, the major interest being in the flight test and evaluation of the aircraft. The government funding for the effort was to have been about 8 million dollars and cover both the development and the test phases. Curtiss invested at least as much in the program.

The X-22A program began with the Navy and was based on their need for an aircraft suitable for shipboard operation and one which could be used to explore the area of V/STOL flight control. Since future Navy use of VTOL aircraft would be primarily on ships, the Navy's preference was the shrouded propeller approach. Compared with the open-propeller types, this was considered to be much safer for deck personnel during shipboard operations. A competition was held by the Navy between Bell Aerospace corp. and Douglas Aircraft Co. Bell won, and in November 1962 was given a 17 million dollar contract to build two vehicles. Bell undertook an extensive development effort and in March 1966 flew an X-22A for the first time. However, it was not until January of 1971 that the Navy accepted the aircraft (one only, the first having been severely damaged in an accident in August 1966). Operation of the X-22A as a flight control research vehicle was contracted to the Cornell Aeronautical Laboratory in January 1971 and that program is still active.

Of the three tri-service programs, only the X-22A is still in use. The XC-142A program was completed and the knowledge gathered was to have provided the basis for the development of a new tilt wing airplane to meet the Air Force's Light Intratheater Transport requirement. But change in emphasis from V/STOL to STOL in 1970 caused abandonment of the effort. With regard to the X-19, the contract was terminated shortly after the first aircraft crashed. The second machine was never completed and the program was abandoned.

While these three concepts differed substantially from each other, all were based on the philosophy that the propeller is a highly effective device for providing both good hover capability and efficient cruise flight.

II. BASIC DESIGN FEATURES OF THE THREE CONCEPTS

Disc loading is a key characteristic of propellers. While it is commonly thought that VTOL propellers must have very high disc loadings compared with helicopter rotors, e.g. 30 to 50 lb/sq ft against 4 to 10 lb/sq ft, this is no longer correct. The recent and continuing development work on propeller-rotor aircraft and the effort on large diameter propellers, clearly show that propellers can be built for practically any disc loading, even 10 to 15 lb/sq ft. Present aerodynamic, dynamic and structural technologies are such that the previous limits on size are not realistic.

With acceptance of this viewpoint, the designer's options are broadened and he can create a propeller-driven VTOL aircraft to optimally meet a given set of requirements. These may be represented by hover endurance, cruise and high speed, STOL capability, downwash velocity, etc. Also, the designer has other options in terms of aircraft layout, e.g. tandem wing versus single wing, tilting wing versus fixed wing, in number of propellers to be used, whether they are open or shrouded, number and location of engines, and how hover control is obtained.

When the tri-service efforts were started these design options were, perhaps, not clearly understood and each of the three concepts was aimed at satisfying certain objectives, such as simplification of hover flight control or attainment of good STOL characteristics. They were not in competition with each other, still comparison of the characteristics of these aircraft will shed light on what was achieved by the designers and, perhaps provide some guidance for future propeller driven V/STOL efforts. Before making the comparisons, it is useful to describe the aircraft from a basic information viewpoint. Table 1, 2, and 3 summarizes the characteristics of the three machines for ready comparison.

a. LING-TEMCO-VOUGHT XC-142A (Illustrated in Figure 2)

This was a conventionally configured aircraft with four engines driving four propellers through gearboxes and interconnect shafting, all mounted on a single tilting wing. A horizontal tail rotor for longitudinal control was located aft of the fuselage and was driven by shafting connecting to the engine interconnect shaft, located in the wing. Figure 5 illustrates the drive arrangement. The machine was designed to represent an assault-transport type aircraft which would be capable of operating both on land and aircraft carriers. As a consequence, the fuselage length was dictated by the carrier elevator size and the original XC-142A design incorporated wing folding for Navy use, but this was later eliminated. The aircraft was equipped with a stability augmentation system. Basic characteristics are given in Table 1. This cargo-assault aircraft had a gross weight of 38,000 lb and was primarily designed for sea level operation with a 200 NM radius of action at a cruising speed of 250 knots.

b. CURTISS-WRIGHT X-19 (Illustrated in Figure 3)

The X-19 was basically a tandem wing airplane designed as an executive transport. It had a propeller mounted at or near each of the four wing tips. The center of gravity was located about midway between the wings and, since the rear wing was considerably larger than the front wing, the latter was more heavily loaded, a condition necessary for longitudinal static stability. These wings were non-tilting. The propellers, which were mounted on nacelles containing gear boxes, tilted with the nacelles. Twin engines were located in the fuselage toward the rear and drove all four propellers through additional gear boxes and shafting, as illustrated in Figure 6. A basic design factor was the use of propeller radial force to help provide lift during transition and allow the wing area to be sized by cruise flight requirements instead of transition. It is to be noted that Curtiss-Wright had demonstrated the effectiveness of radial force as a transition approach on their X-100 (Figure 1) twin-propeller demonstration vehicle when it was flown to a speed of 152 knots, with the propeller producing 1100 lb of lift due to radial force. The propeller shaft angle of attack was 25 degrees. A large vertical tail mounted above the X-19 fuselage was used to provide directional stability and control. Initially, an all-mechanical stability augmentation system was used but this was later replaced by a more conventional electronic system. Table 1 gives basic information for the aircraft and shows that its design weight was 13660 lb and cruising speed was to be 350 knots.

c. BELL X-22A (Illustrated in Figure 4)

The X-22A was designed as a light transport of 14,830 lbs gross weight but was to be used as a flight control research vehicle, and therefore incorporated a variable stability system. The aircraft is based on the use of tilting shrouded propellers, two located near the front of the fuselage and two aft. The forward shrouds are close to the fuselage while those at the rear are mounted at the ends of a short span, non-tilting wing with short tip panels extending beyond the outboard shroud walls. Since the shrouds act as ring wings in forward flight, the system can be considered as a tandem wing arrangement somewhat similar to the X-19. All four shrouded propellers are identical, except for direction of rotation. Inside the shroud are a center body containing the propeller gear box, a horizontal wing-like stator which houses the transverse drive shaft, and a vertical stator or strut to provide additional bracing between shroud and center body. Four engines are used to provide power and these are located at the rear wing leading edge and adjacent to the fuselage. Transmission shafting and gearing are arranged similarly to the X-19 (See Figure 7). A large vertical tail is mounted above the fuselage. Because the X-22A was to be used for flight control research, it was provided with large amounts of engine power and control power for use in hover and low speed flight. Hover on three engines at design gross weight is possible.

Table 3 shows the basic differences among the three designs, and the underlying philosophies are clearly evident. The XC-142A was arranged to have a large span wing bathed by the propeller slipstreams, so that a system was created capable of generating high lift efficiently at low forward speed. Flaps were used to improve transition characteristics. Pitching moments were balanced by a horizontal tail rotor which also provided longitudinal control.

III. HOVER AND VERTICAL FLIGHT

Because of the uncertainty associated with V/STOL requirements and mission definition, one of the key considerations that should be given to a first generation V/STOL transport aircraft is mission flexibility and versatility. An essential ingredient for this capability is effective hover capability combined with a reasonably good cruise speed and cruise efficiency. The cruise aspects of these aircraft are discussed in a later section of this paper. The hover characteristics and considerations are discussed in this section.

a. PERFORMANCE

There are various parameters by which hover performance can be measured. Since the three aircraft were all designed to different requirements, it is difficult to compare them directly. One measure of the total aircraft's hover effectiveness is the amount of fuel required to hover as a percentage of the hover gross weight per unit time. This not only takes into account the efficiency of the thrust producing mechanism and the efficiency of the engine but in addition, accounts for aerodynamic interference effects and other losses. A comparison of the tri-service aircraft hover effectiveness can be seen in Figure 8. Although one would expect the X-19, with its lower disc loading, to have the best hover effectiveness, the combination of higher specific fuel consumption and the wing propeller interference losses actually gave it the worst effectiveness of the three. A comparison of the engines used and their specific fuel consumption is shown below, which helps explain this situation:

<u>AIRCRAFT</u>	<u>ENGINE</u>	<u>SPECIFIC FUEL CONSUMPTION (SFC)</u>
		<u>lbs</u> <u>SHP-HR</u>
XC-142A	T64-GE-1	.502
XC-22A	T58-GE-8	.610
X-19	T55-L-5	.672

As can be seen from Figure 8, these three propeller-driven aircraft provide a relatively good hover effectiveness, especially when compared to the typical values shown for lift fans and jets.

Another measure of the hover effectiveness is the ability of a given propulsive system to convert shaft horsepower into thrust. Figure 9 presents a comparison of the propulsive system's efficiency in providing thrust. As can be seen, even though the X-19 has the lowest figure of merit (C.73), it still has the best thrust producing capability because of its lower disc loading. The X-22A, with its shrouded propeller achieved the best figure of merit (0.81), however, because of its relatively high disc loading it had the poorest capability in converting power to thrust.

A comparison of the aircraft's design hover ceiling is shown in Figure 10. The X-22A had the ability to hover at weights considerably higher than its design vertical take off weight. This can also be translated into an ability to hover at higher altitudes and/or temperatures. This increased hover capability of the X-22A is a direct result of the aircraft being designed to have a one-engine-out hover capability at sea level, standard day conditions. The X-19 and XC-142A have very similar hover ceiling capability, except that the X-19 was limited by an inadequate transmission and not by engine power.

A primary consideration in the design of a propeller for V/STOL is to provide an optimum compromise between cruise and hover efficiencies. Prior to the advent of propeller driven V/STOL aircraft, the concern of the designer was to optimize the propeller for cruise; static thrust was only a secondary consideration and was essentially ignored. With the development of V/STOL aircraft, there was a need to optimize the static thrust for increased hover or vertical take off performance. Prior to the U.S. tri-service program there was very little experience in either optimizing the design for static thrust or in predicting the propeller static thrust performance. In general, this led to the hover performance of propeller driven aircraft falling below expectations. Recognition of this design deficiency led to various test programs to improve propeller performance and, also, the prediction methods.

This problem existed with the XC-142A. The measured performance of the original propeller blades, designated 2FE16A3-4A, was approximately 10% less than the predicted value. A program was undertaken to recover the loss, resulting in a new blade, designated the 2FF16A1-4A. The basic design differences between these two propellers were that the 2FF propeller had a round tip and a substantial increase in blade activity factor (from 86 to 105). It also had a higher integrated lift coefficient with the peak camber distribution located further outboard. With the new propeller design, the performance was reasonably close to the predicted value as shown in Figure 11. Most of the original thrust deficiency was recovered for the typical operating conditions. However, the maximum predicted figure of merit still was not reached.

b. THRUST-TO-WEIGHT (T/W)

The thrust allowances that must be considered in accounting for such things as control, maneuver margin, and engine loss have a significant impact on the vehicle design and weight. These thrust allowances are generally used to establish the thrust-to-weight ratio. However, in addition to those items there are also additional thrust losses unique to V/STOL aircraft and, which to some degree reflect a particular configuration, that must be allowed for during the design of the aircraft. These losses come from such items as wing download and tail rotor power used.

In the case of the three tri-service vehicles, there was a wide variation in the thrust-to-weight (T/W) ratios. For the XC-142A a minimum T/W of 1.17 was required for VTOL operations so that the landing gear sink rate limit of 12 feet per second would not be exceeded upon loss of an engine. However, the minimum T/W required for a vertical take off, with consideration of control forces and maneuver margin was only 1.10. In addition to these thrust allowances, the XC-142A expended 6.7% of its power to drive the tail rotor. Because of the pitching moment characteristics in transition, the tail rotor was not used to produce lift in hover. Of the three tri-service aircraft, this loss was unique to the XC-142A.

The X-22A was designed to have a T/W of 1.04 after loss of one engine in hover. This produced a T/W of approximately 1.35 with all four engines operating. In the case of the X-22A this extremely high T/W was provided primarily to aid in the aircraft's basic research mission as a variable stability and control vehicle. Both of these aircraft were designed to engine-out criteria; the X-19, however, was not designed to an engine-out criteria, primarily because it used only two engines. It did require sufficient excess thrust to provide adequate control and maneuver margins and this was accomplished

with a T/W of 1.10. An additional thrust loss that had to be considered during the design of the X-19 was that associated with the wing interference with the propeller slipstream. This amounted to a 6.5% loss on the front wing and a 9.5% on the rear wing. Of the three concepts, only the X-19 had this type of loss since the wing of the XC-142A tilted with the propeller as did the control surfaces in the X-22A ducts.

VTOL aircraft can benefit from use of engines with an emergency power rating, since this would allow operation at lower T/W to meet the engine-out condition. Such a capability would be achieved by over-temperaturing for a few seconds allowing increased torque from the remaining engines for landing during an emergency. The over-temperature operation may or may not result in engine damage, but even if so, this would still be justifiable considering the weight savings or the payload/range improvement that could be obtained without sacrificing aircraft safety.

c. GROUND EFFECT

All of the tri-service aircraft experienced positive ground effect in hover, however, there was a significant difference in degree. On the X-19 a positive ground effect was observed at wheel heights up to only 4 or 5 feet. However, the controls were deficient and caused pilotage difficulties. This offset the performance gain due to ground effect, but this control problem is not necessarily characteristic of the concept. No actual test data were taken on the X-19 ground effects due to the limited flight time and the control system difficulties.

Ground effect measurements were not made on the X-22A; only a qualitative assessment was made. Ground effect produced random accelerations about all axes. With near calm winds or above 15 knots these random accelerations were not nearly as prominent. A steady hover was very easy to maintain and, under good conditions, hands-off hover could be held for a considerable time with the stability augmentation system on. When clear of ground effect, the X-22A was easy to hover. On these two aircraft the ground effect was considered to be small compared with that of a helicopter.

The XC-142A program was the only one in which ground effect data were obtained. It was determined that positive ground effect was evident up to 30 feet wheel height. This positive ground effect, up to approximately two propeller diameters, was thought to be the result of the "fountain" effect on the fuselage, however, the greatest effect was found at approximately 0 to 7 feet. The data showed that hovering at a 7 foot wheel height resulted in approximately 3.4% less power than was required out-of-ground effect. In addition to the power reduction due to ground effect it was also noted that, although a stable hover could be maintained, an increase in control activity was evident at the lower wheel heights. While there were no serious instabilities for the XC-142A in the hover configuration, a divergent lateral-directional oscillation was encountered in ground effect during STOL operation. This region of instability was identified as between the wing conversion angles of 80 to 35 degrees, below 25 feet. Although the aircraft could be used effectively while avoiding this region, it is evident that investigation of the particular design is necessary, not only to better define the regions but to design the aircraft so that the instabilities are either eliminated or made controllable.

IV. TRANSITION AND STOL CAPABILITY

For purposes of this review, transition can be divided into accelerating transition (take off and climb) and decelerating transition (descent and landing). These pose entirely different problems for the aircraft.

Accelerating transition: Here the aircraft goes from a hover to forward flight, transferring lift from the propeller to the wing, or it makes a run and takes off using wing and propeller forces to provide the required lift. In both of these cases the propellers operate at high thrusts and produce large slipstream velocities over the wings or in the ducts. For the tilt wing and tilt duct systems, this is beneficial because it allows large angles of attack to be used at low speeds, resulting in high lift coefficients; the propeller slipstream acts to suppress wing stall. In these two types of aircraft there is a substantial increase in lift with speed and, correspondingly, the wing or duct tilt angle can be lowered rapidly with speed (Figure 12). This reduction in angle is most pronounced for the XC-142A which uses its flaps effectively to help this occur, essentially passing rapidly from a propeller supported condition to operation as a deflected slipstream aircraft. Although this angle reduction is not as pronounced for the X-22A, it generally follows the shape of the tilt wing curve. In contrast, the X-19 maintains high shaft angles up to substantial speeds, for example 60 degrees at 80 knots, after which the angle reduces rapidly. This is a consequence of the design approach followed, that is, the use of non-tilting wings and high wing loadings. While the X-19 could successfully negotiate the accelerating transition, the use of the propellers instead of wings to produce lift at the lower speeds does not result in efficient flight. This impacts not only on the STOL capability of the machine but on its ability to perform special flight operations. Operational flexibility is reduced. Such flexibility generally is an important and desirable characteristic of V/STOL machines. Another detrimental effect of high shaft angles is the increase in fatigue loading of the blades. This loading is a function of shaft angle and flight speed (called A_q factor). However, this same effect produces the radial lift force. In conventional aircraft, efforts are made to keep propeller shaft angles low at higher speeds, to reduce blade fatigue bending loads. However, the X-19 blades, because they exploited the propeller radial force, were designed to handle the fatigue loads. This is one reason for the large chord near the blade root.

Figure 13 shows how the X-19's radial force is used to help supplement wing lift. It is commonly expected that the propeller slipstream on an X-19 type airplane wing will produce negative angles of attack and large downloads on the wings during transition. However, Figure 13 shows that the wing actually starts producing positive lift at 40 knots and increases its lift rapidly with speed, despite the high angle of the propeller shaft (e.g. 4000 lb of lift at 80 knots). It is theorized that this unexpected result is due to the skewing of the propeller wake, which then acts to increase wing circulation, particularly with the flaps depressed.

As the aircraft acquires forward speed, the power required decreases, primarily due to the reduction in induced power (Figure 14). Because of the large span of the XC-142A, power required decreases rapidly, dropping to 30 percent of the hover value at 100 knots. As would be expected, both the X-19 and X-22A show a much lower power decrease with speed. Interestingly, the X-19 follows the X-22A curve shape but falls somewhat above it. However, it does not do as badly as critics of the concept predicted. It should be noted that the X-19 data was derived from powered models tested in the wind tunnel while the other two curves were obtained from full scale flight tests.

Since these same speed-power curves are indices of the STOL capability of the aircraft, it is obvious why the XC-142A had such good STOL capability. The large excess of power (power available less power required) allows much greater loads to be carried with a running take off than with either the X-22A or X-19.

Decelerating transition: This poses quite a different problem for these aircraft, particularly during descent, since this must be done with the power reduced. For tilt wing aircraft, the reduction in propeller slipstream velocity has highly detrimental effects on descent velocity. Although the tilting duct system also is affected adversely by power reduction during descent, it still has phenomenal capabilities such as a 1600 fpm vertical descent under full control. No data were available on the X-19 but its fixed wing-tilting propeller arrangement should result in higher descent rates than possible with the XC-142A. Generally, the descent limits are expressed in terms of rate of descent vs airspeed and are defined by buffet onset, as shown in Figure 15, for the XC-142A and X-22A. Descents are kept above the lines shown if stall buffet or limiting vibration is to be avoided. It is seen that the descent capabilities of the X-22A are superior to the XC-142A. Further, descent angles greater than 10 to 12 degrees can be disconcerting to pilots and are not accepted at present.

V. CONVENTIONAL MODE FLIGHT

After transition to high speed forward flight, the propeller axes and wings are aligned with the flight path and cruising flight takes place. It is now of interest to examine the flight efficiencies of these machines in their conventional flight mode. The comparative standings in aerodynamic efficiency (cleanness and induced drag) can almost be deduced from the appearances of the machines. Comparisons must be tempered, however, by the realization that because of imposed constraints, the X-22 may not be representative of what could be really accomplished using the shrouded propeller approach. And even the XC-142A, if permitted to have a fuselage of more optimum shape, might have had lower drag. Also, it must be realized that each aircraft was designed to do different jobs, hence, their physical arrangement, performance requirements and weights differed substantially.

Figure 16 shows the variation of lift/drag ratio against speed for the three aircraft at sea level and 10,000 ft altitudes. Despite the large span of the XC-142A, its best lift-to-drag (L/D) ratio is only 8.6, at 200 kts, not a particularly challenging value for a modern transport. By way of comparison, the C-123 has a maximum L/D of 12; this reaches 16 for the C-130 airplane. It should be possible to improve on the XC-142A L/D appreciably with a more optimum design. On the other hand, the X-19, despite its short wings and tandem configuration is close to 6.5 at its design cruise speed of 350 kt and 7.5 at 300 kt based on wind tunnel model tests. The X-22A shows a best L/D of 6.7 at 175 kt. At 300 kt the X-22A L/D falls to about 4.0. Even taking into account the poorer streamlining of the X-22A fuselage compared with that of the X-19, it should be possible to significantly improve its drag characteristics through careful and astute design, but it would still be difficult to make it competitive with the open-propeller approach of the X-19.

Further evidence of the inferiority of the XC-142A and X-22A can be seen in Figure 17. Based on Table 1 information, it is seen that the skin friction drag coefficient is 0.009. The C-123 and DeHavilland Caribou, not particularly clean airplanes, have about 0.0068. The X-22A has a slightly higher value than the XC-142A, in excess of 0.009. In sharp contrast, the X-19 appears to have a value of 0.0048. However, it must be remembered that the X-19 value is based only on wind tunnel data.

Propeller Efficiency: As has already been noted, a VTOL airplane propeller is a compromise between hover and cruise/high speed requirements. In hover, it must produce the needed thrust efficiently while still providing additional thrust for control. The thrust available obviously must be greater than the aircraft weight, consequently large blade areas with high unit loadings are used (a typical blade loading is about 130 lbs/sq ft). Hover efficiency of the propeller is of great importance since it affects diameter and weight, assuming available power is fixed. In cruise, however, blade loading is relatively low because the required propulsive force is determined by the machine's lift-to-drag ratio and is only a fraction of the hover thrust. Consequently, the blades are forced to operate at small lift coefficients and reduced section lift-to-drag ratios. The result is lower cruise efficiency than is normally found with conventional propellers. An effective approach to minimizing this problem is to reduce propeller rotational speed during cruise well below the value used in hover. Further, the hover-cruise efficiency compromise is reduced by increasing the difference between hover and cruise altitude. Aircraft lift-drag ratio also affects the compromise, lower L/D acting to benefit the compromise.

A supposed advantage of the shrouded propeller lies in its ability to provide high static thrust by using the shroud as well as the propeller to produce the total force. Thus, the propeller blade area need not be compromised as much as with the open propeller. However, the shroud itself becomes the critical element in cruise and, if not properly designed, can seriously affect propulsive efficiency. Tests by Hamilton Standard show that a shrouded propeller can produce the same propulsive efficiency as an open propeller up to Mach 0.5 speeds, provided a thin lip is used. Unfortunately, a well-rounded lip is required in hover and a good, fixed geometry compromise is difficult to achieve.

Figure 18 shows that the XC-142A has propulsive efficiency of about 90% at its design cruise speed (250 kt), while still achieving a good figure of merit, 74.5%. The X-19 propeller propulsive efficiency is a few percent inferior in both propulsive and hover efficiency. These are 87.5% and 73.0%, respectively. Note that the hover efficiency includes downwash interference of the wings. The X-22A ducted propeller had only a 74.5% cruise efficiency, however, its hover efficiency was 81%, significantly better than that of the XC-142A.

VI. FLIGHT CONTROL

a. Vertical Flight

One of the basic reasons for selection of the X-19 and X-22A propeller arrangement, the four-corner lift system, was that the configuration made it easy to obtain the required longitudinal and lateral control moments during vertical and low speed flight, with only a small penalty in vertical lift capability. While the XC-142A propeller arrangement could generate large rolling moments efficiently, a tail rotor was used to produce the pitching moments. Because of the added weight and complexity, this is basically a less efficient approach to longitudinal control than the four-corner arrangement. The directional control system of the XC-142A, which is based on using the ailerons, is efficient and effective.

Figures 19, 20, and 21 illustrate the methods of producing control moments for the three aircraft. For the X-19 and X-22A only, the methods of obtaining directional control are illustrated. In both aircraft pitch and roll control are obtained by increasing and decreasing the thrust of the fore and aft pairs of propellers respectively or the left and the right pairs respectively. The methods of obtaining control are summarized in the following table.

CONTROL	XC-142A	X-19	X-22A
<u>Pitch</u>	Horizontal tail rotor thrust change	Differential thrust change between fore and aft propeller sets	Differential thrust change between fore and aft propeller sets
<u>Roll</u>	Differential thrust change between left and right propellers	Differential thrust change between left and right propeller sets	Differential thrust change between left and right propeller sets
<u>Yaw</u>	Deflection of wing ailerons in propeller slipstream	Increased thrust on one set of diagonally opposite propellers, decreased thrust on other diagonal set	Deflection of ailerons in ducts
<u>Height</u>	Direct control of propeller blade angle, engines were governed	Change in engine power. Speed governor on propellers, blade pitch change cause thrust change	Direct control of propeller blade angle, engines were governed in vertical/low speed mode. In cruise propellers were governed and engine throttle controlled.

These control systems were designed to have the following control powers in terms of initial angular accelerations, radians/sec².

MOTION	XC-142A	X-19	X-22A
<u>Pitch</u>	+0.94, -0.7	+ 0.68	+ 4.0
<u>Roll</u>	1.01	1.75	3.0
<u>Yaw</u>	0.55	0.12	0.7

Neither AGARD 408 nor MIL-F-83300 specify control power directly, therefore, these values cannot be compared with these specifications. At the time that these aircraft were being developed, the U.S. thinking was that V/STOL controls should be capable of producing accelerations of 0.6 (rad/sec²) longitudinal, 1.0 lateral and 0.5 directional. The exceptionally large pitch and roll control powers of the X-22A are the result of its projected use as a research vehicle to investigate STOL and V/STOL aircraft flying qualities. Neither the XC-142A nor the X-19 had any problem in providing adequate roll control; further the XC-142A exceeded the pitch requirements. For the X-19 the propeller blade angle change in roll per cent control displacement was three times that of the value in pitch. This, combined with the much larger longitudinal moment of inertia, led to the disparity between pitch and roll. Perhaps the gearing between lateral and longitudinal stick-blade angle change should have been changed. As it was, the longitudinal/lateral control response harmony was only marginally acceptable.

Yaw control in the X-19 was entirely inadequate. The system used to produce yawing moments (Figure 20) was a simple approach wherein the horizontal components of the canted propeller thrust added to the differential torques between propellers. More effective systems are possible such as the use of differential nacelle tilt or use of vanes/aileron in the slipstream; but these were not developed.

Difficulties in hovering the X-19 were experienced, despite its stability augmentation system (SAS), because of large amounts of slop (dead bands) in the control system. This appeared as stick motion without corresponding propeller blade angular motion. It is estimated that the dead bands were from ± 4 to ± 8 percent of available stick travel longitudinally, ± 12 to ± 25 percent laterally, and ± 8 to ± 14 percent directionally. The spread is due to the difficulty of determining the values from the test data; no direct in-flight measurements of propeller blade angle motions were made. This problem is characteristic of mechanical control systems and points up one of the difficulties found in such systems. These slops were equivalent to a 0.3 degree blade angle change; this corresponds to a free-play of only 0.013 inches of mechanical motion at the connection to the hydraulic propeller pitch valves.

The XC-142A and X-22A did not have the problems of the X-19. For the XC-142A, handling qualities during VTOL and hovering flight, with all pitch, roll and yaw SAS on, were considered to be very good. However, longitudinal control power was considered to be insufficient to overcome propeller pitching moments under certain high inflow angles (flow upwards with respect to propeller axis when propellers are near the hover position).

The X-22A was found to behave well in hover and low speed flight, but this should not be surprising considering the high control power and effective SAS system incorporated into the machine. Hovering in ground effect did produce random accelerations about all-axes but caused no difficulties.

b. Stability Augmentation Systems (SAS)

All three aircraft employed stability augmentation systems which were used during selected flight modes. However, there were differences among the systems. In the XC-142A the SAS provided rate and attitude damping in pitch and roll and rate damping in yaw and altitude. For safety two identical electrical channels were used in pitch, roll and yaw with the outputs of each being monitored. Failure to compare electrically caused both channels to deactivate, locking the SAS actuators to neutral. The pilot then could engage the good channel which provided half-gain stability augmentation in the control axis involved in the malfunction. A single channel SAS was used for altitude stabilization with actuator over-travel cutoff which, when activated, locked the actuator to center.

As the XC-142A proceeded from hover and low speed flight to conventional flight, the influence of the stability augmentation systems on the aircraft behavior changed. Pitch stabilization ceased when the tail rotor was switched off. While operating, each pitch channel had 25% control authority. The roll stabilization system was similar to the pitch system, however, it was not shut off in cruise flight, but instead, the gains were phased to zero when the wing reached zero incidence. Yaw stabilization provided damping augmentation only and, except for the absence of attitude stabilization, was similar to the roll system. Stabilization gains reduced to zero with zero wing incidence. Unlike the previous three channels, the altitude damper system used a single electrical channel and provided height damping only during low speed and vertical mode flight. Its gain reduced to zero when the wing dropped to 60 degree incidence.

In the X-19, the electronic stability augmentation system provided rate plus integral of rate stabilization commands in series with the pilots' pitch and roll inputs. No SAS was provided for yaw. System gain was non-linear with high gain in the initial 30 percent of output to compensate for control system slop. SAS control authority was limited to 30 percent of pilot's authority. Single channel systems were used with an emergency SAS disengage button located on the pilot's control stick, which deactivated both longitudinal and lateral channels when pressed. Upon disengagement hydraulic power was removed from the SAS channels and the output servo pistons were driven to neutral by centering springs. The pilot then had complete authority.

The X-22A uses a dual electrical SAS which provides simple rate damping in pitch, roll and yaw during hover, transition and lower conventional mode flight speeds. SAS authority is limited to 20 percent and is phased out by a "q" sensitive servo as speed is increased to 160 knots. In the event of a failure in one channel, the pilot can switch that channel off and retain the remaining one for stability augmentation at one-half dual system authority. Alternatively, he can switch off both channels.

In addition to the SAS, a variable stability system (VSS) was installed in the X-22A. There is no mechanical link between the two cockpit controls; the right seat controls (safety pilot) remain mechanically connected to the primary flight control system and always follow the motion of the aircraft. The left seat controls, however, are connected electrically to the flight control system through the VSS.

The stability and control characteristics of the X-22A are made variable by controlling feedback of selected parameters. To the evaluation pilot, in the left hand seat, these modified characteristics appear to be those of the actual aircraft. Safety circuits are used to disengage the VSS and give control to the safety pilot when a failure or excessively high signal is detected. The VSS provides the following functions: variable control power about all three axes, variable damping about these axes, variable height damping, variable attitude stabilization, variations in the dynamic modes of motion, variations in rolling, pitching and yawing moment changes with such parameters as speed, variation in control feel and friction, and control cross couplings. In addition, a fly-by-wire system is provided. This allows the evaluation pilot to fly the basic X-22A through electrical connection of the two sticks while bypassing most of the VSS equipment.

From the foregoing it can be seen that, of the three, the XC-142A had the most highly developed and complete stability augmentation system and that the X-19 could be considered to be rudimentary in comparison. Because of the nature of the X-22A as a variable stability aircraft, the SAS system used was less sophisticated than that of the XC-142A.

c. Conversion (Transition) Flight

In all three aircraft the flight controls had to change function in going from hover to cruise. This was accomplished through a mixing linkage system or control coordinator which phased and interchanged controls, a generally complex system from a design viewpoint, but mechanically reliable.

Regarding flying qualities, the flight tests of the XC-142A revealed that the handling qualities during conversion were very good overall with pitch, roll and yaw SAS on. While there were a number of deficiencies in the particular design of this aircraft, it was concluded that none came from the tilt wing concept.

In the case of the X-19, very limited flight testing was done. It was found that high static longitudinal stability existed throughout the speed range tested. This indicated that the transition corridor would be narrow and limited by the available longitudinal control. It appears that this could be corrected by reducing the stability or by increasing control power.

The X-22A was judged to be easy to fly through transition and had a wide conversion corridor. In transition the control stick is used as an attitude control and duct rotation is used to command speed. There was a large latitude in duct angle and speed. The pilot found flight in transition to be very comfortable.

d. Conventional Mode Flight

The handling qualities of the XC-142A, in the conventional flight regime, were unsatisfactory due to a number of significant deficiencies. Many of these arose from the compromises made to meet the stringent requirements of flight in the powered lift regime. The deficiencies ranged from: weakly positive to neutral longitudinal stick free and stick fixed stability, to unacceptable longitudinal maneuvering characteristics and longitudinal control characteristics, through excessive lateral directional aircraft response. This implies that it is difficult to design such an aircraft to have a good balance in flight characteristics and handling qualities between powered-lift flight and conventional mode flight. It is believed, however, that the knowledge gained from the XC-142A effort and use of the capabilities of modern aircraft design techniques, should make it possible to develop satisfactory tilt wing aircraft.

No flight test data exist for the X-19 in the conventional flight mode. From analyses of wind tunnel model tests data and because of the unconventional aircraft configuration, it was believed that problems could exist in such areas as the longitudinal control system (stick force gradient for maneuvering flight), strong lateral directional coupling due to the high fin area and rudder location, and weak directional control.

Flight test reports indicate that the X-22A operates well in the conventional flight mode, which is in the speed range of 80 to 220 knots. It is easy to fly due to the feel and trim system and the SAS system. Even with these turned off, it is readily controllable throughout its conventional flight envelope. Take offs and landings with the ducts in cruise position can be made in the conventional manner. While it would be logical to expect the high vertical tail to produce lateral-directional coupling, no adverse reports have been made. This may be because favorable yaw due to roll is present by having some propeller blade angle change retained in the roll control system as the duct tilts down from hover to cruise attitude. The X-22A was found to have one major detrimental characteristic: A very high sideforce. Since the ducts were symmetrical about the thrust axis, sideforce produced by sideslips was of the same magnitude as the lift produced by angle of attack. No method was provided for reducing sideforce. The sideforce characteristic detracts from the vehicle's capability for lateral-directional handling qualities investigations.

VII. ACCIDENT SUMMARY

All three of the tri-service V/STOL aircraft were involved in major accidents resulting in aircraft loss. However, what must be kept in perspective is that most of these accidents were not the result of any inherent limitation in the basic concepts or due to the use of VTOL. In most cases, they were either attributable to the failure of some component unrelated to the primary V/STOL operation or due to pilot error.

Two V/STOL-related items that may have had an influence on these accidents were vibration and pilot unfamiliarity. The failures attributable to vibration were caused by the vibratory environment exceeding that for which the component was designed. Thus, it appears that design criteria were inadequate. This can be corrected only through adequate qualification testing and by accumulating experience. In all of the vibration induced failures, it was found that acceptable components could have been fabricated with very little increase in weight.

With regard to pilot unfamiliarity this, too, is a problem of accumulating sufficient experience. Some of the pilots who flew these vehicles had very little V/STOL experience and were sometimes unfamiliar with capabilities or limitations of the aircraft. There are many human-factor considerations that have been and are being resolved in the operation of V/STOL aircraft. These are primarily concerned with pilot workload, the physical location of instruments and controls, and the degree of automaticity incorporated into the cockpit functions. There are no reasons why pilots with adequate experience should have appreciable difficulty in flying these vehicles.

A review of the accidents which resulted in serious damage to the aircraft is worthwhile:

a. X-19

This program originally was intended to test two aircraft, however, the number one aircraft was destroyed in an accident on 25 August 1965; the program was terminated before the second vehicle was completed. The X-19 had completed a total of 50 flights for 3.85 hours of flying time and 269 ground runs for 129.4 hours of ground testing prior to its destruction. The vehicle was never flown in the conventional aircraft mode and only partial transition down to 41 degrees nacelle tilt angle had been accomplished.

The accident that destroyed the X-19 was precipitated by a fatigue failure of the left rear nacelle gear case. The pilots, after noticing a transmission temperature warning light attempted to return the aircraft to the landing strip; in so doing, the transmission power limits were inadvertently exceeded, and the transmission casing failed. Subsequently the propeller separated from the aircraft, which caused the aircraft to immediately pitch up and roll to the left with a roll rate of approximately 180 degrees per second. The crew members successfully ejected from an inverted attitude at approximately 390 feet above the terrain. The aircraft crashed and was totally destroyed.

b. X-22A

The X-22A program also involved two aircraft. The flight test program began in March 1966 with aircraft number one. However, after 15 flights for a total flight time of slightly over 3 hours, the machine suffered severe damage while making an emergency landing following sequential failure of the dualized hydraulic system. The aircraft was not repaired. The second aircraft, however, is still being used as part of the tri-service V/STOL research program to establish V/STOL handling qualities design criteria.

The accident was caused by improper manufacture of hydraulic lines which led to their failure in fatigue during flight. The X-22A has a dual hydraulic control system, whose purpose is to provide redundancy to handle a malfunction or failure, however, in this case both sets of hydraulic lines had the same manufacturing defect. Failure of one line was followed by failure of the second line after about one minute. The first failure occurred approximately 5 miles from the airfield and triggered a warning light, whereupon the pilots headed for the runway at about 2000 ft altitude. When they were still approximately 3.5 miles from the runway and at about 1000 ft altitude, the second hydraulic failure occurred. Since the pilot still had control, he attempted to make an emergency landing in the shortest possible time in an attempt to save the aircraft. However, upon making a hard landing, the fuselage broke in half. It is worth noting that safety in a dual hydraulic system is predicated on the assumption that the probability of both systems failing simultaneously is extremely remote.

c. XC-142A

This program involved five separate aircraft with flight testing starting in October 1964. Four hundred and twenty hours of testing were accomplished during the tri-service program. This program was completed in late 1967. During this time four of the five aircraft were lost due to accident. Upon completion of the tri-service program, the remaining aircraft was tested at NASA Langley for approximately two years and then was retired to the Air Force Museum.

The aircraft accidents resulting in the loss of the aircraft or in severe damage are listed below:

Aircraft #2 - On 19 October 1965, this aircraft experienced a ground loop on landing which caused extensive damage to the wing and propellers. The hydraulic system had a fatigue failure which caused the left outboard propeller actuator to fail during a flare-out and landing. This caused an asymmetrical thrust and a ground loop to the left.

Aircraft #3 - On 4 January 1966 this aircraft made a hard landing in the vertical mode. The aircraft sustained major damage to the fuselage. The cause of this accident was the pilot's failure to select the proper propeller speed for vertical mode flight. The pilot procedures were revised subsequently to assure the proper propeller speeds would be selected. The wing of this machine was later mated with the fuselage of the #2 aircraft for further flight testing.

Aircraft #4 - On 27 January 1966 there was a turbine failure in the #1 engine caused by the failure of the overriding clutch to engage. This caused extensive damage to the wing, the outboard aileron, the number 2 nacelle, the aft engine shroud and to the fuselage. This aircraft was repaired, used by NASA for flight research, and is now the one which is in the Air Force Museum.

Aircraft #5 - On 28 December 1966 this vehicle was taxied into a hangar door causing major damage to the fuselage nose, the wing, the wing hinge and the propellers. This accident was caused by the pilot failing to actuate the hydraulic system; he, therefore, had no brakes or nose wheel steering available.

Aircraft #1 - On 10 May 1967 the failure of the spring capsule in the tail rotor pitch control system gave full pitch to the tail rotor, as the aircraft approached the hover configuration. It nosed over at about 200 ft altitude and crashed in an inverted attitude killing the pilots. This is the only accident during the tri-service program that could be directly attributable to the V/STOL configuration.

Aircraft #2 - On 9 October 1967 this aircraft experienced a hard landing due to a high sink rate at low forward speed. The pilot reduced power while attempting to go into a hover configuration causing a high rate of descent which could not be stopped prior to ground impact. The hard landing broke the fuselage and the wing and the aircraft was considered beyond repair.

VIII. TECHNOLOGY IMPROVEMENTS

While improvements in aircraft aerodynamics, structural weight, and subsystem reliability will impact V/STOL aircraft, as well as the conventional types, the propeller-propulsion system is the heart of the V/STOL concepts and hence, improvements in this area are selected for discussion. A major area of concern in the development of future propeller driven aircraft involves: (1) propulsion system weight; (2) system complexity; (3) reliability and maintainability; (4) and propeller performance. In the late sixties considerable propeller development was prompted by the interest in developing a tilt wing Light Intratheater Transport (LIT). This work drew heavily from the experience with the XC-142A and resulted in significant weight reductions to the propeller system and its integral gearbox. With continued work in this area, it is believed that the propeller systems of the 1970's can reach weights of approximately 1/2 that of the 1960 era propellers. (See Figure 22) The weight reduction in the propulsion system comes from:

1. Development of fiberglass shell/metal spar blade (steel spar proven in mid '60's, titanium and boron composite spars projected for future development).
2. Refinement of the one piece barrel hub design.
3. Better packaging of gear reduction power transmission by integrating the propeller and the gearbox.
4. Use of the integral gearbox for more efficient packaging of the propeller control and more efficient structural support of the propeller loads.
5. The use of titanium and composites in the control and power transmission components.
6. Continued integration of other associated components into the propeller/gearbox system.

These developments not only lead to a reduction in weight, but also will significantly reduce propeller complexity. This reduction in complexity primarily comes from the elimination of interfaces by integrating the propeller with the gearbox and by simplifying the control system components. It also results in a large reduction in the number of parts. This reduction in complexity and number of parts feeds directly into significant improvements in maintainability, reliability and safety as well as overall improved design. A projection of the expected improvements in maintainability and reliability are shown in Figure 23.

Improvements in propeller cruise performance efficiency are rather limited. However, the development of higher speed capability while retaining high efficiency is an area for consideration. Developments such as the variable camber propeller could prove to be attractive candidates for future subsonic aircraft that require optimum performance over a wide range of operating conditions. Improvements in propeller static thrust efficiency have been continuing and offer a fruitful area for further effort. Figure 24 presents a projection of this improvement in terms of figure of merit.

An extensive amount of effort has gone into developing a large diameter (26.4 ft) propeller with a cyclic pitch capability. This effort has recently been completed and included full scale testing in the NASA Ames 40 x 80 ft wind tunnel. It was established that a cyclic pitch propeller could be built and have acceptable performance and fatigue life and that it would contain no unusual blade structural behavior ascribable to cyclic pitch. This type of propeller will minimize the performance penalties imposed by tail rotor type control considerations on V/STOL propeller driven aircraft. In addition to the development of the cyclic pitch propeller, there are continuing efforts in fly-by-wire and stability augmentation systems (SAS) that will improve the overall capability of these aircraft.

With regard to the ducted propeller development efforts to improve the duct aerodynamic compromises should offer increased performance capability. These improvements include such items as a variable geometry duct lip and the use of boundary layer control to improve the internal aerodynamics of the duct. It is worth noting that other ducted concepts such as the Lippisch (Dornier) Aerodyne may benefit from these technology improvements.

IX. CONCLUSIONS

Based on the experience from these programs, certain conclusions of a general nature are made and these can be of benefit in possible future V/STOL development programs.

To begin with, the wisdom of trying to build an aircraft to satisfy the requirements of three different services is questionable. The design requirements and operational philosophies are sufficiently different to impose major compromises in the aircraft design which can result in an aircraft that is not satisfactory to any of the services. This dissatisfaction may be unfairly associated with the concept rather than the result of the design compromises.

In developing a V/STOL concept the need for adequate qualification testing of components cannot be overemphasized. At least four of the major accidents sustained by these aircraft could be attributed to the failure of a component that was not considered a critical development problem. A related conclusion is the need to establish validated design criteria prior to aircraft development. The failed components could have been fabricated to an adequate life with very little weight increase if the design environment had been fully understood.

In the design of future V/STOL aircraft a significant weight savings or performance improvement can be realized if the engine out thrust-to-weight ratio is based on an engine emergency power rating. This would be a capability to operate the engines at over-temperature for a few seconds and thus increase the torque and power from the remaining engines for recovery from an emergency.

An area of V/STOL design that needs added attention is ground effect. The influence of the ground effect on vehicle stability is generally peculiar to a particular configuration. As experienced by the XC-142A there are possibilities of serious instabilities associated with ground effect. With the availability of V/STOL wind tunnels with a moving ground plane this area should be thoroughly investigated prior to full scale aircraft development to determine whether instability exists so that the aircraft can be modified to reduce or eliminate such instabilities. It is not sufficient merely to define the region of instability as an area to be avoided. During the flight test of the XC-142A The instability region was inadvertently entered into twice after the region had been defined. This could lead to even more serious problems in an operational environment.

With regard to the relative capabilities of the three aircraft discussed in this paper some general conclusions can be made. These conclusions are limited, however, due to the vastly different design objectives and requirements for these three aircraft. It can be concluded that the open propellers offer a higher speed potential than the ducted propeller concept because of the compromises associated with trying to design a duct to give both good static and cruise performance. It can also be concluded that the tilt wing concept offers a greater operational flexibility in that it not only has comparatively good hover and cruise performance but, because of its good span loading it has good STOL performance as well. However, the tilt wing approach of the XC-142A poses difficult design problems in providing good flying qualities in both powered lift flight and in cruise. The ducted propeller aircraft of the X-22A configuration has proven to have surprisingly good handling qualities and might be worthy of further consideration.

The final conclusion is that there have been large improvements in the state-of-the-art of propellers in the last ten years with regard to weight reduction, performance, structural and fabrication techniques, maintainability and reliability, and a reduction in complexity. The application of this technology and further advancements that are currently underway can provide very effective propeller driven V/STOL concepts for use in various military missions.

BIBLIOGRAPHY

1. Hendrickson, Clendon L.
Jones, Gary E., Lt/Col, USAF
XC-142A V/STOL Transport Category II Performance Evaluation. AFFTC-TR-68-21, October 1968
2. Fluk, Harold
"et al"
The X-19 V/STOL Technology - A Critical Review. AFFDL-TR-66-195, May 1967
3. -
X-22A Performance Data Report, Bell Aerosystems Report No 2127-917006, July 1965
4. Mort, Kenneth W.
Gamse, Berl
A Wind Tunnel Investigation of a 7-Foot Diameter Directed Propeller, NASA-TN-D-4142, August 1967
5. Chopin, Matthew H.
Propeller Static Performance Tests for V/STOL Aircraft. ASD-TR-69-15, January 1970
6. -
Demonstration Data Report (X-22A), Bell Aerosystems Report No 2127-931002, May 1969
7. Ward, J.P.
Lessons Learned from the XC-142 Program Paper presented at the V/STOL Technology and Planning Conference, September, 1969
8. -
X-19 Category I Limited Flight Evaluation. AFFTC-TR-66-27, October 1966.
9. Kakol, Stanley J.
Development Flight Tests of the First Dual Tandem Ducted Propeller V/STOL - The X-22A Bell Aerosystems Paper
10. Ziegler, Donald
History of the XC-142A Tri-Service Program, 1967. Prepared for the Aeronautical Systems Division, USAF.

TABLE 1
BASIC AIRCRAFT CHARACTERISTICS

	<u>XC-142A</u>	<u>X-19</u>	<u>X-22A</u>
Design Gross Weight, VTOL (lbs)	37,500	13,660	14,830
Maximum STOL (lbs)	43,700	14,750	18,420
Empty Weight (lbs)	25,550	10,150	11,150
Design Cruising Speed (kts)	250	350	185
Total Shaft Horsepower, (Max, S.L., Std Day)	12,320	3440/4440 ⁽¹⁾	500/3750 ⁽²⁾
Propeller Diameter (Ft)	15.63	13.0	7.0
Tip Speed, Hover (Ft/Sec)	1,010	819	950
Cruise (Ft/Sec)	755	650	800
Activity Factor, Total Per Propeller	420	498	510
Total Propeller Blade Area Per Propeller (Sq Ft)	29.6	25.2	7.3
Wing Area, Front (Sq Ft)	534.4	56.1	139 ⁽³⁾
Rear	-	98.5	286 ⁽³⁾
Horizontal Tail Area (Sq Ft)	163.5	-	-
Tail Rotor Diameter (Ft)	8.2	-	-
Vertical Tail Area (Sq Ft)	130	46.2	68.5
Equivalent Flat Plat Area (Sq Ft) ⁽⁴⁾	32.6	5.3	14.4
Zero Lift Drag Coefficient, C_{D0} (based on total wing area)	.061	.0342	.064

NOTES

1. Transmission Limit/Max SHP
2. 4 Engines/3 Engines
3. Lifting Surface Area, Include Duct
4. X-19 Based on Wind Tunnel Test, X-142A and X-22A Based on Flight Test

TABLE 2
COMPARATIVE LOADINGS & RATIOS

	<u>XC-142A</u>	<u>X-19</u>	<u>X-22A</u>
Disc Loading (lbs/sq ft)	49	27.7	96.3 ⁽¹⁾
Blade Loading (lbs/sq ft)	127	134	510 ⁽²⁾
Power Loading (lb/shp)	3.9	4.8	3.1
Hover Figure of Merit (percent)	74.5	73	81
Hover Thrust to Weight Ratio	1.17	1.10	1.35/1.04 ⁽³⁾
Empty Weight/Hover Weight (percent)	68.0	74.3	75.1
Hover Weight/Horizontal Surface Area (lbs/sq ft)	53.7	88.5	35.0 ⁽⁴⁾

Notes

1. X-22A Disc Loading Based on Duct Exit Area
2. Duct Carries Substantial Part of the Thrust, which makes this value misleading
3. 4 Engines/3 Engines
4. X-22A Horizontal Surface Area Includes Duct

TABLE 3

AIRCRAFT DESIGN CHARACTERISTICS

	<u>XC-142A</u>	<u>X-19</u>	<u>X-22A</u>
Propeller	Open	Open	Ducted
Wing Arrangement	Single (Conventional)	Tandem	Tandem
No of Propellers	5 ⁽¹⁾	4	4
Wing Tilting	Yes	No	Ring Wing (Duct) Tilts, Inner Panels (Rear Wing) Do not
No of Blades Per Propeller	4 ⁽²⁾	3	3
Propeller Arrangement	Along Wing	At or Near Wing Tips	Within Ducts Which Act as Ring Wings At or Near Wing Tips
Engines Mounted With Respect to Propellers	At Props	Remotely	Remotely
No of Engines	4	2	4
No of Primary Gearboxes	11 ⁽³⁾	7	11
Basic Design Requirement	V/STOL	VTOL	VTOL
Method of Transition	Wing Primarily	Wing and Radial Force	Ring Wing Lift (Shrouded Propellers)
Design For:	Transport, Moderate Speed	Executive Transport High Speed (400 Kts)	V/STOL Flying Qualities Research

Notes:

1. Includes Tail Rotor
2. Tail Rotor Has Three
3. Includes Three For the Tail Rotor

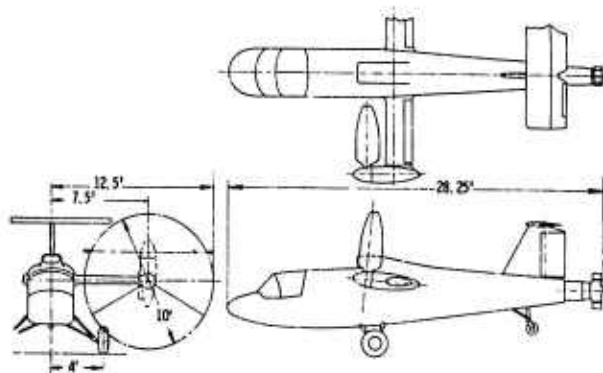

FIGURE 1. X-100 THREE-VIEW

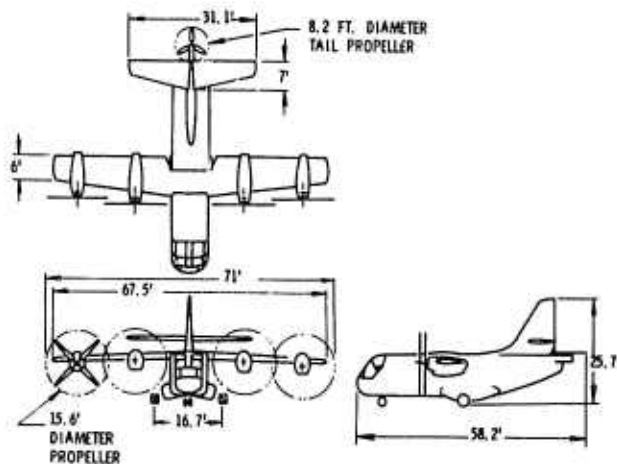

FIGURE 2. XC-142 THREE VIEW

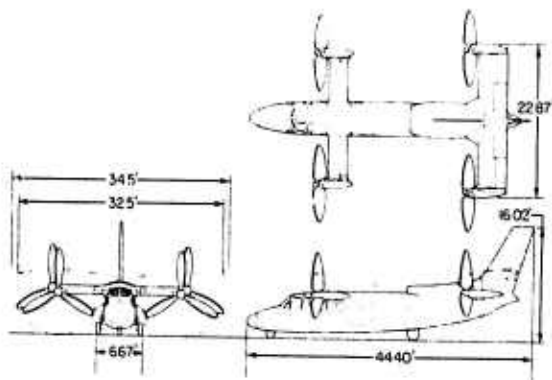

FIGURE 3. X-19 THREE VIEW

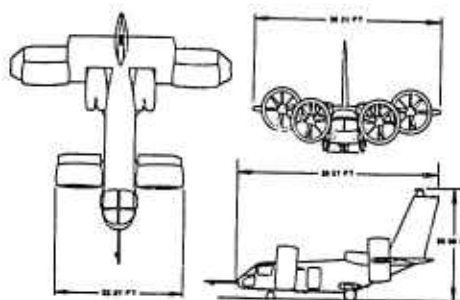

FIGURE 4. X-22 THREE - VIEW

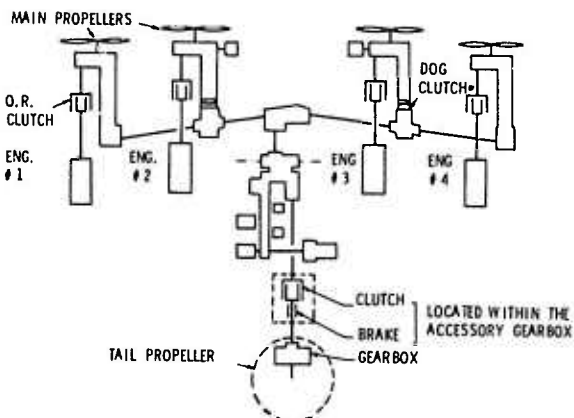

FIGURE 5. XC-142 DRIVE SYSTEM

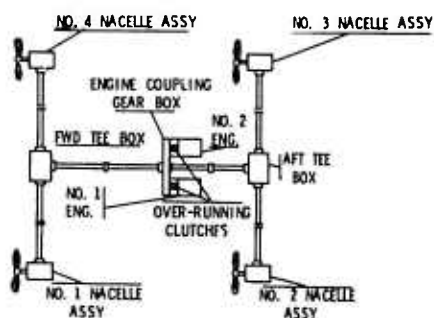

FIGURE 6. X-19 DRIVE SYSTEM

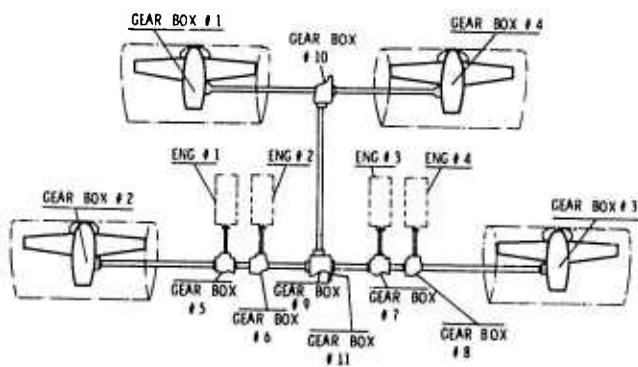

FIGURE 7. X-22A DRIVE SYSTEM

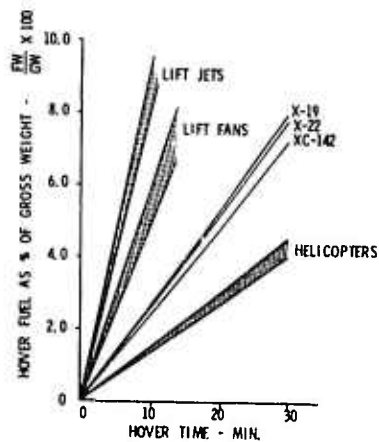

FIGURE 8. AIRCRAFT HOVER EFFECTIVENESS

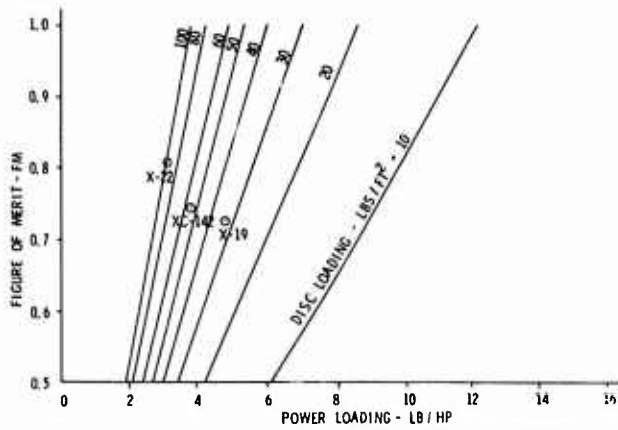

FIGURE 9. FIGURE OF MERIT VS POWER LOADING FOR VARIOUS DISC LOADINGS (SEA LEVEL, STANDARD DAY)

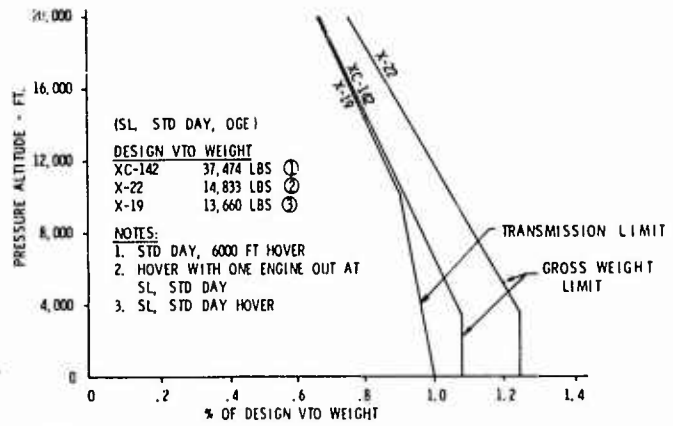

FIGURE 10. DESIGN HOVER CEILING

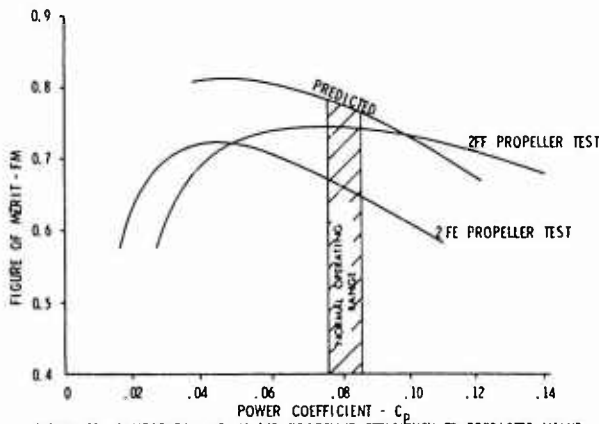

FIGURE 11. COMPARISON OF XC-142 PROPELLER EFFICIENCY TO PREDICTED VALUE

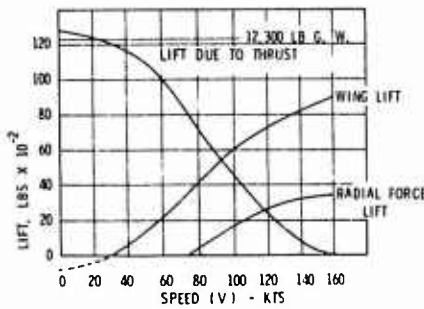

FIGURE 13. X-19 LIFT DISTRIBUTION IN TRANSITION FLIGHT (CONSTANT POWER LEVEL FLIGHT)

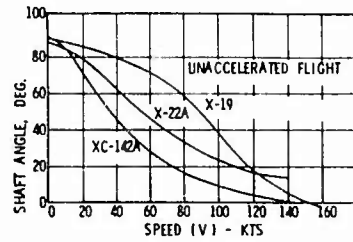

FIGURE 12. SHAFT ANGLE VS SPEED

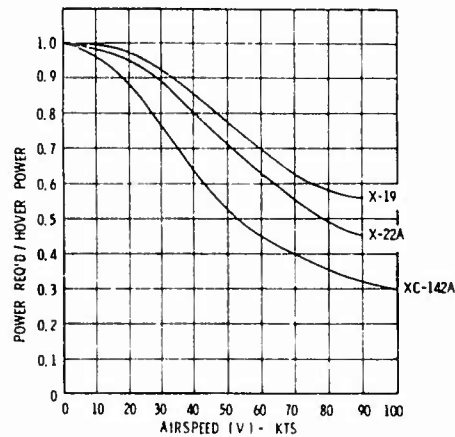

FIGURE 14. POWER REQUIRED CHANGE WITH SPEED

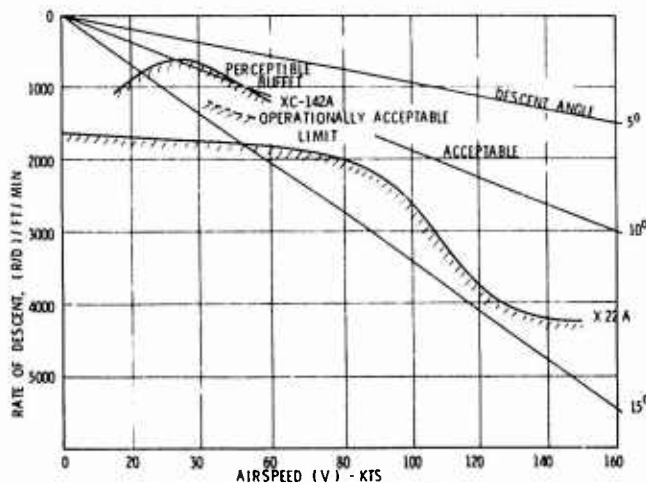

FIGURE 15. RATE OF DESCENT VS AIRSPEED

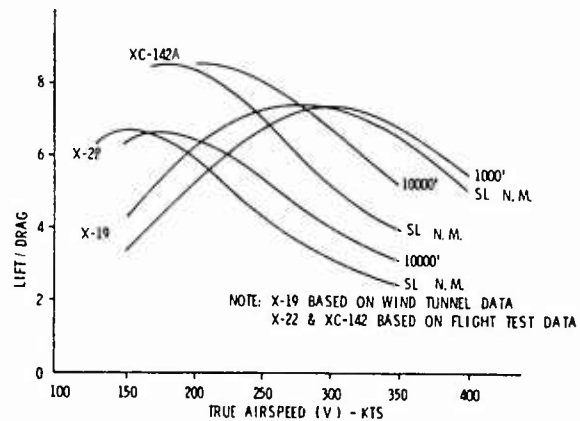

FIGURE 16. L/D VS SPEED

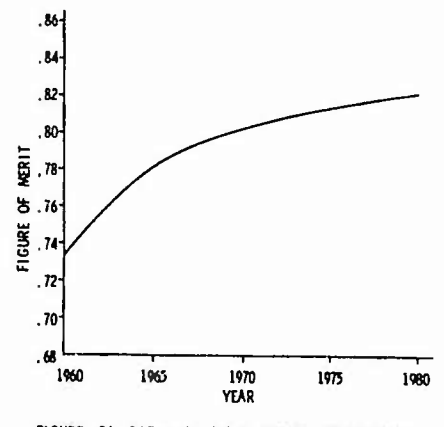
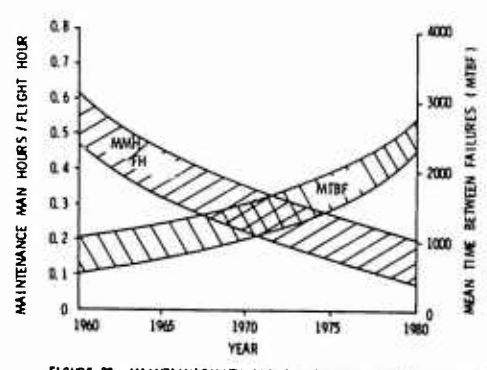
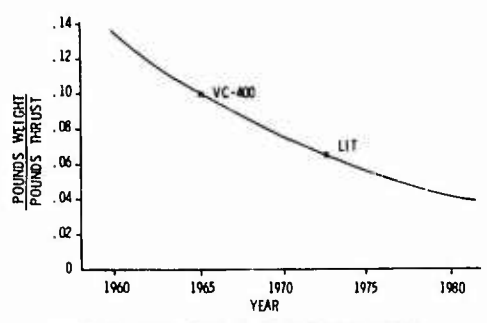
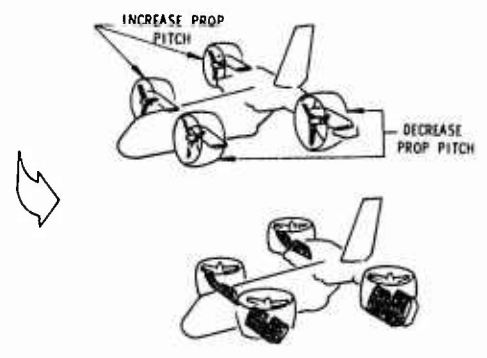
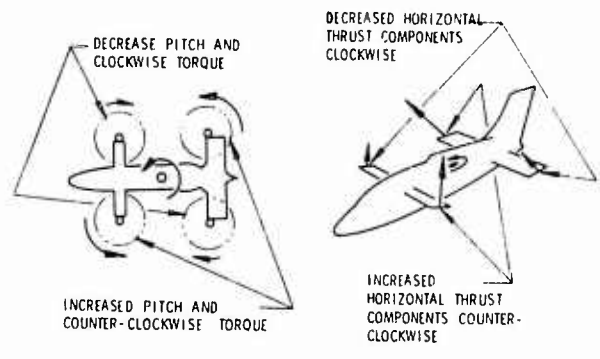
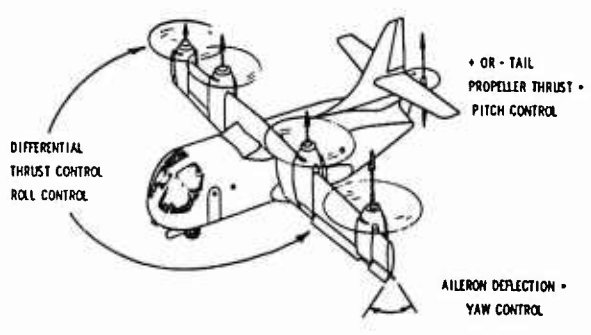
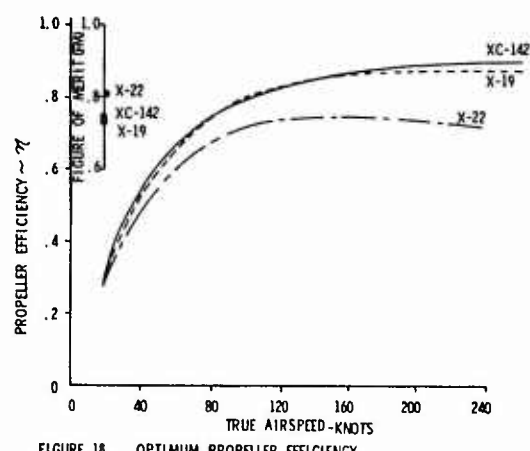
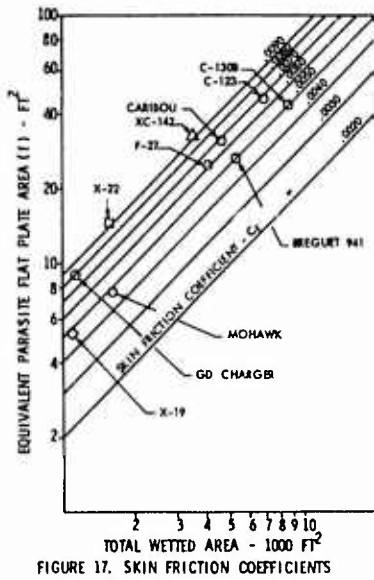

FIGURE 23. MAINTAINABILITY AND RELIABILITY TRENDS DIRECTIONS

FIGURE 24. POTENTIAL STATIC THRUST IMPROVEMENT

PROGRAMME EXPERIMENTAL
DO 31

Résultats obtenus et conclusions à tirer pour l'avenir

Radoslav Draganov
Dornier AG
Abt. Flugversuch
D 7990 Friedrichshafen
Postfach 317
Germany

Heinz Max
Dornier AG
Abt. Aerodynamik-Flugmechanik
D 7990 Friedrichshafen
Postfach 317
Germany

Résumé:

A l'heure actuelle, le Do 31 est le seul avion de transport à réaction doté de caractéristiques V/STOL. Conçue initialement pour une utilisation purement militaire, la formule retenue pour cet avion trouve actuellement un écho de plus en plus important dans l'aviation civile.

La description succincte de la technique de l'avion et de ses caractéristiques principales est suivie d'un aperçu sommaire sur le déroulement de ce programme expérimental dans les années 1962 à 1970, programme qui s'est terminé, au moins provisoirement, par les essais en vol entièrement réussis.

Les problèmes nouveaux, qui se présentent avec l'introduction de la technique V/STOL, sont traités par la suite, à savoir:

- o commande du groupe moteurs d'une complexité supérieure
- o commandes de vol et stabilisation en vol stationnaire et transitoire
- o effets de l'interférence des jets
- o effets du recyclage et de l'érosion du sol
- o problèmes concernant le bruit.

Ces données sont également à respecter d'une manière appropriée pendant les opérations de vol. Ceci est démontré à l'aide d'exemples pour le déroulement des transitions après le décollage et à l'approche.

Il ressort très nettement, que l'un des avantages les plus importants de la formule "sustentation par réaction" consiste non seulement dans la simplicité de cette conception, mais aussi dans le grand domaine de vol couvert en configuration V/STOL.

Ces exemples mettent aussi en évidence les améliorations qui restent à apporter, pour garantir dans l'avenir un service opérationnel complètement satisfaisant.

Summary:

The Do 31 is the only V/STOL jet transport realized to date. This design, originally intended for military applications, is gaining increasing significance in the field of civil aviation.

After briefly describing the technical aspects of the aircraft and its design data, the paper provides a short survey on the sequence of this experimental program, which was performed from 1962 to 1970 and was finished for the present with the successful flight testing of the aircraft.

Subsequent to this, the paper gives a more detailed description of all the new problems related to the V/STOL-technique:

- o control of the complex engine-system
- o stability and control in hover and transition
- o jet-interference effects
- o recirculation and ground erosion effects
- o noise problems.

In flying the aircraft all these points had to be taken into account and solutions found allowing an economic and safe operation of the aircraft.

As an example, take-off and landing procedures are shown and the methods selected demonstrated.

The most important advantages of the jet-V/STOL concept such as the Do 31 can be seen: the simplicity of this formula and the enlarged flight envelope in the V/STOL configuration without almost any limitation.

Furthermore it is shown that a number of improvements still remain to be done, before a real and safe military and civil operational service of this type of jet-V/STOL-transport can be guaranteed.

1. INTRODUCTION

En Février 1962, la société Dornier a commencé sous contrat du Ministère Fédéral de la Défense, l'étude et le développement d'un avion de transport à réaction, capable de décoller et d'atterrir verticalement, portant la désignation Do 31.

La conception de base de cet avion était dictée à la fois par l'exigence d'une propulsion par réaction et par les moteurs alors disponibles à cet effet. Prévu à l'origine en programme expérimental devant préparer le terrain aux futurs cargos militaires, le programme Do 31 avait pour but principal de démontrer que le décollage et l'atterrissage vertical, ainsi que les transitions du vol stationnaire au vol aérodynamique, et vice versa, étaient réalisables en raison des techniques disponibles.

Pour pouvoir combiner les bonnes performances de vitesse d'un avion à voilure fixe avec l'aptitude VTOL de l'hélicoptère - jusqu'alors le seul matériel VTOL fabriqué en série -, il fallait trouver une solution à de nombreux problèmes jusqu'alors inconnus. D'autre part on ne voulait pas pénaliser ce développement, déjà suffisamment complexe, par des recherches supplémentaires d'une conception avancée pour le vol aérodynamique. C'est pourquoi on a renoncé d'emblée à atteindre des vitesses de croisière élevées transsoniques, quoique celles-ci constituent normalement un des principaux avantages de l'avion de transport à réaction.

Le plan trois vues du Do 31 (fig. 1) montre que la définition de cet avion est relativement conventionnelle, si l'on fait abstraction de l'installation propulsive assez extraordinaire.

Pour un poids maximum au décollage vertical de 22,5 t on disposait avec le réacteur RR Pegasus 5 - à poussée vectorielle - du seul réacteur propulsif qui entrait en ligne de compte; bien qu'il fut en principe trop puissant pour un avion de cette catégorie. La poussée sustentatrice supplémentaire pour les opérations V/STOL est fournie par 8 réacteurs RR RB 162-4, groupés dans des nacelles placées aux extrémités des ailes.

Pour assurer le contrôle de l'avion dans les phases de vol stationnaire et transitoire, on fait également appel au groupe propulseur de la manière suivante:

- o Pour la commande en tangage, de l'air comprimé prélevé sur les réacteurs principaux, est transmis à une tuyère de commande située à l'arrière du fuselage;
- o La commande en roulis est effectuée par modulation de la poussée des réacteurs de sustentation;
- o La commande en lacet est assurée par l'intermédiaire des tuyères orientables des réacteurs de sustentation.

Une description détaillée de l'avion, du groupe propulseur et des différents systèmes est donnée sous les références [1] et [2].

2. DEROULEMENT DU PROGRAMME

Pour la réalisation de l'ensemble du programme expérimental Do 31, 4 appareils d'essai volants ont été utilisés (v. planche 2):

- o Le petit banc d'essai volant, doté de caractéristiques dynamiques analogues à l'avion, équipé de quatre réacteurs de sustentation RR RB 108, était destiné à l'étude et à la mise au point du système de commande et de stabilisation;
- o Le grand banc d'essai volant était déjà équipé des réacteurs définitifs et des systèmes hydraulique, électrique, de stabilisation et de commande définitifs. Cet appareil d'essai était surtout destiné à la vérification des caractéristiques de commande en vol stationnaire et à la mise au point des procédures de décollage et d'atterrissage vertical.

Lors des premiers essais ces deux bancs volants ont été suspendus au centre de gravité à un "pylône télescopique", donnant liberté aux mouvements autour des 3 axes de rotation, évitant ainsi tout risque d'accident. Ces essais "sur pylône" et les différents vols libres, qui furent entrepris par la suite, ont apporté des expériences et des connaissances très précieuses sur les problèmes spécifiques de la technique VTOL et ont permis un déroulement rapide et continu des essais entrepris sur les deux avions proprement dits:

- o le Do 31-E1, destiné aux essais en vol conventionnels et
- o le Do 31-E3, véritable avion V/STOL.

Le Do 31-E1, équipé de moteurs principaux du type Pegasus 5-2 avec tuyères orientables, n'avait, à la place des réacteurs de sustentation, que des masses de compensation (devant

assurer le maintien correct des moments d'inertie). Dans le cadre des essais en vol conventionnels, qui n'ont demandé aucune modification sur l'avion, on a essayé avec succès l'utilisation des tuyères de poussée orientables dans leur fonction d'"aéro-freins".

Le nombre et les heures de vol totalisés avec les différents appareils d'essai se récapitulent comme suit:

- o Petit banc d'essai: premier vol libre en avril 1964; 243 vols libres plus 390 essais sur pylône
- o Grand banc d'essai volant: premier vol libre le 11.1.1967, 31 vols libres plus 315 essais sur pylône
- o Do 31-E1: premier vol le 10.2.1967; 101 vols, 58 heures de vol
- o Do 31-E3: premier vol stationnaire le 10.2.1967; premier circuit de piste en VTOL le 28.2.1968, 154 sorties V/STOL, totalisant 39 heures de vol.

Dans le cadre général du programme Do 31 il avait été prévu initialement de faire suivre à la phase expérimentale V/STOL un programme d'essais opérationnels. Ce programme devait permettre de constituer un dossier sur l'infrastructure nécessaire à l'utilisation opérationnelle d'avions de transport V/STOL. Pour satisfaire à ces exigences l'avion devait disposer d'une certaine capacité de transport, et il devait posséder un rapport charge utile/autonomie déterminé pour pouvoir simuler certaines missions de transport. Ces exigences ont été prises en considération dès la définition de l'avion. A titre explicatif, le tableau no. 1 récapitule les performances principales du Do 31, en mission conventionnelle, ainsi qu'en mission STOL ou VTOL.

Comme l'indique les deux dernières lignes, à une vitesse de croisière de 625 km/h l'avion est capable de franchir une distance de 430 km avec une charge utile de 2 tonnes en mission VTOL; une distance de 420 km avec une charge utile de 4 tonnes en mission STOL et 4 tonnes également sur 1.80 km en mission conventionnelle.

Pour des raisons budgétaires et en raison d'un changement des conceptions politiques du Ministère de la défense cette dernière partie du programme n'a pu être réalisée jusqu'à présent. C'est ainsi que le programme expérimental Do 31 a eu une fin provisoire en avril 1970, après la réalisation d'un programme d'évaluation en commun avec la NASA. Le coût total du programme Do 31 s'est élevé à env. 250 millions de DM.

	SYMB.	DIMENS.	CTOL	STOL	VTOL
poids maxi au décollage	P_{TO}	kp	27 500	24 300	22 500
longueur de décollage (sur 15m)	L_d	m	2 760	455	35
longueur de roulement	L_r	m	1 460	198	0
vitesse verticale (avec P_{TO} , alt. 0m)					
2 - moteurs	v_2	m/sec	22.5	26.0	29.2
1 - moteur	v_1	m/sec	4.9	7.0	8.5
mach maxi	M	-	0.7		
vitesse de croisière	V	km/h	625		
poids maxi à l'atterrissage	P_o	kp	21 800		
longueur d'atterrissage (depuis 15 m)	L_o	m	980	380	0
longueur de roulement à l'atterrissage	L_r	m	700	230	0
charge utile	P_u	kp	4 000	4 000	2 000
distance franchissable avec P_u (10% de réserve)	D	km	1 180	420	430
 DORNIER	Do 31 - Performances				Tableau 1

3. PARTICULARITES DES OPERATIONS V/STOL

Dans les phases de vol stationnaire et transitoire d'un avion V/STOL, l'ensemble des problèmes à résoudre dépendent de deux facteurs qui sont:

- o d'une part la manière de produire la sustentation,
- o et d'autre part le mode de commande et de stabilisation retenu.

Pour le Do 31 il en résultaient 5 groupes de problèmes qui ont tous fait l'objet, au cours des phases de développement et d'essais en vol, d'études et d'examens très détaillés. Il s'agit notamment des problèmes suivants:

- o définition et mise au point du système de commande pour les réacteurs,
- o définition et mise au point des commandes de vol pour les phases stationnaire et transitoire,
- o examen des effets d'interférence des jets,
- o examen des effets de recirculation et de l'érosion du terrain,
- o examen des problèmes concernant le bruit.

Différemment des avions conventionnels, le groupe moteurs du Do 31 remplit des fonctions multiples; aux tâches normalement attribuées aux moteurs d'avions conventionnels, c'est-à-dire

- o génération de la poussée propulsive, et
- o génération de l'énergie de servitude,

s'ajoutent des tâches tout à fait nouvelles, à savoir:

- o génération de la poussée sustentatrice, et
- o génération des forces de commande.

Il va de soi que pour la définition des organes de commande il fallait également tenir compte de ces nouvelles données. C'est pourquoi, outre les deux manettes de gaz, dont chacune est associée à l'un des moteurs principaux, il y a une troisième manette, commandant les 8 réacteurs de sustentation, et un 4^e levier faisant pivoter les tuyères d'éjection des moteurs principaux. La nouvelle tâche, résidant dans la commande et le contrôle simultanés de 8 moteurs, n'a posé de problèmes sérieux à aucun moment. L'expérience acquise permettrait de résoudre ces problèmes même pour des groupes propulseurs encore plus complexes. Un inconvénient mineur rencontré était la commande par timonneries des réacteurs de sustentation. A savoir, les distorsions de la cellule, de l'aile et des nacelles engendrent des imprécisions de synchronisation des moteurs. La solution idéale serait donc la transmission électrique ou electro-hydraulique.

Une autre caractéristique particulière, c'est l'intégration des réacteurs de sustentation dans le système de commande de vol pendant les phases de vol stationnaire et transitoire, par la superposition différentielle des mouvements de commande à la régulation des réacteurs. Le Do 31 est commandé comme un avion conventionnel par l'intermédiaire d'un manche et de pédales. La préférence a été donnée au manche plutôt qu'au volant pour faciliter la commande à une main, mais aussi pour assurer un espace suffisant en cas d'éjection. Le déplacement du manche en roulis règle de façon différentielle la poussée des moteurs de sustentation, en tangage l'ouverture de la tuyère arrière. Les mouvements des pédales sont transférés aux tuyères orientables des réacteurs de sustentation. Toutes les gouvernes sont braquées en même temps, ceci également lors des phases de vol stationnaire et transitoire. La fig. 3 montre un schéma du système de commande du Do 31.

Etant donné l'absence d'un amortissement aérodynamique en vol stationnaire, un système de stabilisation a été installé, facilitant la tâche du pilote. En roulis et en tangage l'assiette est stabilisée, en lacet la vitesse de rotation.

Pour des raisons de sécurité, l'autostabilisateur intervient par l'intermédiaire d'une articulation différentielle, c'est à dire qu'un déplacement de la commande agit directement sur la gouverne et sert en même temps de signal de référence pour l'autostabilisateur, son action étant superposée au braquage initial. Etant donné l'important moment d'inertie de l'avion, il a été admis que le pilote serait capable, en cas de panne de l'autostabilisateur, de stabiliser manuellement au moins un des trois axes. Pour cette raison les trois axes de l'avion sont équipés d'un stabilisateur à chaîne unique. Au cours des essais au banc volant il s'est avéré très vite que cette hypothèse était erronée, tout au moins en ce qui concerne l'axe de roulis en raison du temps de réponse des réacteurs. On a donc procédé à l'installation d'un amortisseur supplémentaire en roulis qui, par la suite, a permis au pilote de maîtriser l'avion, même en cas de panne de l'autostabilisateur. Pour simplifier le travail du pilote dans les phases de transition au décollage et en approche on a installé un dispositif permettant le préaffichage de l'assiette longitudinale. Grâce à ce dispositif le pilote peut, avant d'entamer une manoeuvre, préafficher à l'aide d'un sélecteur l'assiette correspondante, et la commander au moment voulu à l'aide d'un bouton-poussoir monté sur le manche; l'avion adoptera alors cette assiette avec une vitesse de rotation de 5°/sec.

La mise au point de l'autostabilisateur a demandé un nombre important d'essais, à cause du grand domaine de vol à couvrir par un seul réglage, car l'autostabilisa-

teur manque de propriétés auto-adaptatives. Les différentes gouvernes étant braquées parallèlement aux commandes de vol VTOL, l'efficacité et le temps de réponse de la commande globale varie considérablement avec la vitesse de vol, sans parler du changement du comportement dynamique de l'avion. En plus il faut respecter le cas d'une panne de moteur, qui a pour conséquence la réduction de l'efficacité d'environ 50 %.

Ces exigences ont conduit à un certain compromis, concernant la constante de temps de la commande, comprise entre 2 et 3 secondes en vol stationnaire. Il est vrai que les recommandations de l'AGARD préconisent des régimes transitoires plus courts, mais ni la précision des œuvres, ni l'opinion des pilotes n'a donné lieu à critiques. Il semble d'ailleurs, que cette réaction un peu lente de l'avion est mieux adaptée à sa taille.

Les caractéristiques mécaniques du système de commande sont très importantes pour l'appréciation des qualités de vol. Le tableau 2 donne à cet effet les valeurs principales relevées sur le Do 31 en comparaison avec les directives proposées par AGARD et MIL. Les chiffres proposés par MIL correspondent au domaine de vitesse de moins de 50 noeuds et ne sont valables que pour le "Level 1", c'est-à-dire qu'ils présentent les conditions optimales à rechercher.

	DIMENS.	ROULIS			TANGAGE			LACET		
		Do 31	AGARD	MIL*	Do 31	AGARD	MIL*	Do 31	AGARD	MIL*
„Seuil“ de l'effort au neutre	lbs	2.1	0.5-3.0	0.5-1.5	3.3	0.5-3.0	0.5-1.5	19.5	10-100	20-7.0
Effort à la commande par braquage	lb/in	2.7	0.5-1.5	0.5-2.5	3.6	1.0-3.0	0.5-3.0	12.9	25-100	50-100
Efforts aux commandes maxi.	lbs	12.2	15	7.0	piqué 20 cabré 23	15 25	± 10.0	46	15-50	30
Braquages maxi. des commandes	in	± 4.65	3.0-6.5	/	± 5.2	4.0-6.5	/	± 2.05	2.5-4.5	/
Variation d'assiette par braquage de la commande	%in non lin.	7.0 non lin.	3.0-5.0	4.0-20.0	6.0 non lin.	3.0-5.0	3.0-20.0	-	-	-
Assiette maxi. au braquage maxi. de la commande	°	± 18	/	/	± 22	/	/	-	-	-
temps de réponse pour 90% de l'assiette commandée	sec	2-3	1-2	/	2-3	1-2	/	-	-	-
Fréquence propre du système de commande	1/sec	2.5	/	/	2.5	/	/	-	-	-
Coeff. d'amortissement	-	1.0	/	/	1.0	/	/	-	-	-
Variation de la vitesse angulaire par braquage de la gouverne	%sec/in	-	-	-	-	-	-	8.5 non lin.	/	/
Vitesse angulaire maxi. au braquage maxi. de la commande	%sec	-	-	-	-	-	-	14.5	/	10.0
Durée pour une variation du cap de 15°	sec	-	-	-	-	-	-	1.1	10-25	/
Constante de temps	sec	-	-	-	-	-	-	1.3	/	/



Caractéristiques du système de commande et de stabilisation du Do 31 en comparaison avec des consignes VSTOL

*) MIL - F 83300, LEVEL 1 et V < 35 kts

Tableau 2

Ce tableau fait également apparaître que les caractéristiques du système de commande du Do 31 rentrent bien dans l'ordre de grandeur des valeurs recommandées, à la seule exception du seuil des efforts au neutre et des efforts aux commandes, valeurs qui sont plus importantes sur le Do 31, notamment pour la commande en lacet. Toutefois, ce comportement, n'a jamais été critiqué par les pilotes, mais plutôt jugé comme satisfaisant [cf. réf. 9], ce qui permet de conclure qu'il est préférable, dans le cas d'un avion à stabilisation d'assiette, d'avoir des efforts de commande plus élevés, empêchant que le pilote puisse trop facilement intervenir dans le fonctionnement de l'autostabilisateur.

Le tableau fait apparaître en plus, qu'il reste toujours un nombre considérable de caractéristiques qui n'ont pas encore fait l'objet d'une recommandation AGARD ou MIL pour la simple raison qu'il n'existe pas encore suffisamment d'informations à ce sujet.

Les moments de commande installés pour le vol stationnaire et la transition étaient largement suffisants dans tous les cas de manoeuvre exécutés, et les valeurs maximales n'ont pratiquement jamais été atteintes. Une comparaison détaillée des moments de commande installés avec, d'une part les valeurs considérées effectivement nécessaires, et d'autre part les valeurs recommandées par AGARD, a été effectuée dans d'autres compte-rendus (voir réf. [2], [4] et [8]). Inutile donc de la répéter.

La génération de la sustentation à l'aide des jets des réacteurs orientés vers le sol, entraîne des influences supplémentaires dans les phases de vol stationnaire et de transition des avions V/STOL. Ces différents effets, connus sous les désignations:

- o Interférence des jets
- o Recyclage des gaz chauds et
- o Erosion du sol

dépendent très largement :

- o de la configuration de l'avion et
- o de la manière de produire la sustentation.

Par "interférence des jets" on entend l'influence exercée sur le comportement aérodynamique de l'avion par les jets des réacteurs. Cet effet est dû à la présence d'un écoulement secondaire induit par un jet et à l'interaction de plusieurs jets à proximité du sol.

Le phénomène de l'interférence a des répercussions très différentes selon les phases de vol, soit :

- o en vol stationnaire à proximité du sol,
- o en vol stationnaire en dehors du domaine de l'effet de sol,
- o et dans la phase de transition.

Une explication détaillée des causes pour ce phénomène est donnée dans le compte-rendu (réf. [6]).

L'interférence des jets rencontrée sur le Do 31 en vol stationnaire à proximité du sol est représentée fig. 4. Les conséquences de ce phénomène sont : une perte de sustentation, un changement du moment de tangage ainsi que du moment de roulis. Sa conséquence la plus grave est la perte de sustentation à proximité du sol, de l'ordre de 8 % de la poussée nominale.

Le moment de tangage induit par les jets est fonction non seulement de la distance par rapport au sol, mais aussi de l'assiette longitudinale de l'avion. Il est à noter cependant que l'effet du changement du moment de tangage est très faible par rapport au moment de commande disponible en tangage.

Le moment de roulis ne dépend également pas uniquement de la distance du sol, mais aussi de l'angle de roulis respectif. Malgré la tendance instable, c'est-à-dire malgré l'augmentation du moment de roulis avec l'angle de roulis, cet effet particulier ne s'est jamais avéré comme gênant au cours des essais en vol, étant donné que le changement du moment de roulis est très faible.

Dans la phase de transition les effets de l'interférence des jets dépendent essentiellement de l'angle de pivotement des tuyères des réacteurs principaux. La fig. 5 montre l'évolution de la portance et la variation du moment de tangage avec la vitesse de vol, pour plusieurs angles de pivotement. Dans la figure est représenté en plus, le déroulement d'une transition au décollage et à l'atterrissage. Par rapport à la poussée verticale installée, la perte de sustentation varie entre 2,5 % (en vol stationnaire) et environ 10 % (dans la phase de transition); toutefois cet effet se trouve plus que compensé grâce au croisement de la portance aérodynamique avec le carré de la vitesse de vol. Il n'est pas de même pour la variation du moment de tangage qui se manifeste très nettement dans la phase de transition sous forme de changement de trim, et qui demande, suivant le déroulement de la transition au décollage ou en approche, une partie considérable du moment de commande disponible en tangage.

Alors que les effets de l'interférence se manifestent principalement par une diminution des performances au décollage vertical ainsi qu'à l'atterrissage, le phénomène de recyclage est susceptible de rendre impossible toute opération VTOL, lorsque la configuration cellule-moteurs est défavorable.

Par "recyclage" on entend la réabsorption de gaz d'échappement ou d'air chaud par les moteurs. Le jet des gaz d'échappement d'un réacteur, dirigé vers le bas forme une couche d'écoulement sur le sol. C'est en fonction de la densité et de la vitesse du jet, et bien sûr en fonction de la direction et de la vitesse du vent, que l'air chaud remonte à une certaine distance de l'avion et peut être ramenée par le vent vers l'entrée d'air du réacteur. Ce phénomène est appelé recyclage de champ éloigné et il peut se produire dès qu'il n'y a qu'un seul réacteur qui souffle vers le bas.

Les avions V/STOL, tels que le Do 31, possèdent normalement plusieurs générateurs de sustentation. Dans ce genre d'aménagement, les jets déviés parallèlement au sol se heurtent l'un contre l'autre et se redressent, donnant lieu à des "fontaines", qui peuvent être aspirées par voie courte par les réacteurs. C'est donc ce phénomène dans le champ proche qui constitue le problème plus grave du recyclage.

En effet, l'aspiration des gaz chauds fait augmenter la température à l'entrée d'air et entraîne une diminution de la poussée des réacteurs. Mais ceci peut aussi avoir une conséquence encore plus grave: les mauvais fonctionnements des réacteurs en raison du pompage des compresseurs ou en raison de détériorations par surchauffage.

Pour éviter ces phénomènes de recyclage il fallait mettre au point pour le Do 31 des procédures de décollage et d'atterrissage vertical particuliers. Alors que les entrées d'air des réacteurs de sustentation ne sont presque pas affectées par le

phénomène du recyclage, des augmentations de température non négligeables peuvent se manifester aux entrées d'air des réacteurs principaux selon la distance au sol, les angles de pivotement des tuyères principales et selon le régime des réacteurs. La planche 6 montre en fig. 1 l'augmentation de la température aux entrées d'air des réacteurs principaux en fonction de l'orientation des tuyères, en fig. 2 en fonction de la distance de l'avion par rapport au sol, et en fig. 3 en fonction du régime des réacteurs principaux, la position des tuyères étant tenue fixe. Dans tous ces cas les moteurs de sustentation fonctionnent au niveau de poussée normalement retenu pour le décollage vertical. Dans le dernier diagramme les résultats obtenus dans le cadre des essais de maquette sont complétés par des valeurs mesurées au cours des essais en vol. On note que les augmentations de température relevées avec tuyère orientée vers le bas ou même vers l'avant atteignent 50° , à proximité du sol. C'est pourquoi au décollage l'on a limité l'angle de pivotement des tuyères à 75° , donnant des surtempératures très acceptables. L'augmentation du régime des réacteurs principaux fait, que la "fontaine" se déplace vers le bout de l'aile et que, par conséquent, la surtempérature aux entrées d'air des réacteurs principaux décroît. D'autre part, à partir d'une altitude par rapport au sol d'environ 3 m, les effets de recyclage enregistrés aux entrées d'air sont pratiquement nuls.

L'effet d'une augmentation de la température aux entrées d'air des réacteurs principaux, est illustré dans la planche 7, représentant le poids maximal au décollage vertical en fonction de la surtempérature aux entrées d'air. On conçoit immédiatement la nécessité de mettre au point une procédure de décollage et d'atterrissage appropriée.

Un autre problème des avions VTOL, étant en relation étroite avec le recyclage, est le phénomène de l'érosion du sol. La pression dynamique et la température élevée des jets orientés vers le sol, peuvent entraîner l'érosion du sol et, par la suite, arracher des particules, susceptibles d'être aspirées par les réacteurs où ils peuvent causer des dommages très graves. En ce qui concerne ce problème, les essais en vol ont démontré que la résistance des pistes conventionnelles en béton est suffisamment grande pour assurer les opérations VTOL, même en retenant des réacteurs à flux simple, comme c'est le cas pour les réacteurs de sustentation du Do 31. Un certain nombre de décollages et d'atterrissages verticaux ont été effectués à partir d'une plaque en matière plastique de 45 sur 45 m, réalisée par la société américaine Ling Temco Vought, prouvant également, que le Do 31 est capable d'opérer à partir de telles pistes aménagées provisoirement. Cependant, pour pouvoir décoller ou atterrir sur des pistes en herbe, on devrait au moins permettre un roulage de quelques longueurs d'avion, ou bien, pour exclure tout risque, employer des réacteurs à double flux et à vitesse d'éjection nettement inférieure.

Il est, bien sûr, également possible d'éviter les problèmes du recyclage et de l'érosion du sol, en effectuant les décollages et atterrissages verticaux à partir d'une grille métallique, permettant l'évacuation des gaz d'échappement. A l'occasion des essais sur le pylône avec le grand banc d'essai volant on a déjà pu acquérir des expériences dans ce domaine.

Quelques mots enfin sur un autre problème particulier à un avion de transport VTOL, tel que le Do 31. La poussée installée d'un avion de transport VTOL est à peu près quatre fois plus grande que celle d'un avion conventionnel de la même catégorie. Le niveau de bruit, par conséquent, est également beaucoup plus élevé. Il faut distinguer deux problèmes: celui de la fatigue de la structure de l'avion par ondes sonores, et celui de la pollution sonore de l'environnement.

La résistance acoustique de la structure doit être assurée en prenant des mesures appropriées lors de la définition et de la construction. Les études menées à ce sujet ont permis de déterminer des structures d'une tenue acoustique satisfaisante, sans pénalisation excessive du poids.

L'émission de bruit, nécessairement plus élevée d'un avion VTOL, ne se ressent toutefois que sur une zone relativement petite à proximité immédiate de la piste, ceci notamment en raison des trajectoires d'approche et de départ très inclinées. Ceci est illustré par la planche 8, dans laquelle sont comparées les zones soumises à une intensité sonore supérieure à 95 PNdb au cours du décollage et de l'atterrissage d'un avion conventionnel Boeing 727 et d'un avion VTOL du type Do 31. Afin d'avoir une véritable base de comparaison, les valeurs mesurées sur le Do 31 ont été augmentées pour correspondre à un avion du même poids que le Boeing 727, c'est-à-dire à 60 tonnes. Ce graphique montre très nettement que, la zone touchée par ce niveau de bruit dans le cas d'un avion VTOL équivaut à moins que la moitié de la surface touchée dans le cas d'un avion conventionnel; ceci grâce aux approches et départs à pente raide de l'avion VTOL et grâce à la possibilité de le faire décoller et atterrir toujours dans le même sens, indépendamment de la direction du vent. L'utilisation de réacteurs à double flux plus silencieux modifierait ce rapport encore considérablement en faveur de l'avion V/STOL.

4. DEROULEMENT DES TRANSITIONS AU DECOLLAGE ET A L'ATTERRISSAGE

Toute ce qui vient d'être décrit comme particularité, restriction ou inconvénient inhérent à la technique V/STOL doit être pris en considération lors du déroulement des opérations V/STOL. La bonne réussite des essais en vol du Do 31 prouve, que ceci est bien possible.

Parlons d'abord du déroulement d'un décollage vertical. La procédure retenue est un compromis entre les problèmes de recyclage des gaz chauds, de la consommation de carburant, du patinage intempestif de l'avion sur la piste et de la sollicitation du pilote. Le critère le plus important à respecter étant d'éviter le recyclage des gaz chauds. Au bout de nombreux essais on a trouvé un compromis permettant des manoeuvres de décollage vertical et de transition presqu'optimales.

Pour mieux illustrer le déroulement du décollage vertical, la planche 9 donne un aperçu sur les essentiels paramètres, concernant l'état de vol, les activités du pilote et les actions de l'autostabilisateur en fonction du temps. La procédure retenue peut être décrite de la façon suivante:

Après la mise en marche et l'affichage d'un régime moyen des réacteurs principaux, les tuyères principales sont pivotées à 75° . Ensuite on fait démarrer les réacteurs de sustentation, en les faisant tourner au ralenti. En augmentant successivement le régime des réacteurs principaux et de sustentation au niveau prévu, on fait décoller l'avion. Au moment du déléstage du train, l'autostabilisateur est branché automatiquement, et l'avion adopte l'assiette préaffichée par le pilote. La phase de transition, qui succède au décollage proprement dit, est facile à réaliser par le pilote, qui n'a qu'à changer progressivement, suivant l'augmentation de la vitesse de vol, l'angle de pivotement des tuyères principales jusqu'à la position finale de 10° . La seule condition à respecter, c'est de ne pas dépasser un certain angle d'incidence. L'arrêt des moteurs de sustentation, la rentrée des volets et l'affichage du régime de montée aux réacteurs principaux concluent la phase de transition après décollage. La durée de cette phase est d'environ 20 secondes. Le moment de tangage apparaissant dans cette phase, dû à l'influence du jet et aux influences aérodynamiques, est automatiquement compensé, sans intervention du pilote, comme on peut le voir par la représentation des actions de l'autostabilisateur. Cette action est d'ailleurs la seule intervention importante sur la commande de l'avion pendant toute la phase de transition.

Cependant, la réalisation d'une transition en approche est beaucoup plus difficile pour le pilote. C'est la raison pour laquelle au cours des essais en vol l'intérêt principal a été porté sur ce domaine. On s'est très vite rendu compte que parmi tous les facteurs susceptibles d'être optimisés, la tâche primordiale était de réduire la sollicitation du pilote. Il n'est donc pas possible d'optimiser la consommation du combustible en réduisant la durée de la transition d'approche, sans introduire une certaine automatisation du système de commande des réacteurs.

La procédure pour la transition d'approche, issue de nombreux essais en vol, décrite ci-après, constitue donc un compromis entre les possibilités offertes par l'actuel système de commande et une sollicitation acceptable du pilote. La planche 10 représente, comme au paravent, les principaux paramètres, fonction du temps, illustrants le déroulement d'une transition d'approche. Une telle opération, effectuée dans des conditions IFR simulés, est décrite à continuation:

Après l'intersection du faisceau ILS, l'avion est stabilisé sur la pente du faisceau (7° à 12°) à 140 kts environ, en utilisant les tuyères principales comme freins. A une distance déterminée, les réacteurs de sustentation sont mis en marche, les tuyères principales sont pivotées en avant (120°), tout en adoptant immédiatement les régimes définitifs d'atterrissage pour les réacteurs de sustentation et principaux. En même temps il faut diminuer l'incidence, en commandant l'assiette préaffichée, pour éviter une montée, due à la poussée verticale supplémentaire. On obtient ainsi une descente décélérée le long d'une trajectoire rectiligne. Les corrections de la trajectoire sont effectuées, si nécessaire, par changements d'incidence, par l'intermédiaire du manche, mais surtout par variation de la poussée des réacteurs de sustentation. L'arrondi de l'avion et la décélération finale s'effectuent par la suite en commandant une assiette positive préaffichée. En s'approchant du vol stationnaire, les tuyères principales sont pivotées vers leur position finale pour l'atterrissage (110°). La descente finale jusqu'à l'atterrissage vertical de l'avion est commandée uniquement par modulation de la poussée des réacteurs de sustentation. Au moment de l'atterrissage, l'autostabilisateur est débranché automatiquement, tandis qu'immédiatement le pilote arrête les réacteurs de sustentation et fait pivoter les tuyères principales vers l'arrière afin d'éviter le recyclage des gaz chauds.

En employant la procédure décrite, la durée moyenne des transitions était d'environ 2 minutes, entre le démarrage des réacteurs de sustentation et le contact au sol. Comme on peut le voir, la sollicitation du pilote et bien plus élevée qu'au décollage. L'activité de l'autostabilisateur en est également augmentée puisqu'il intervient plus fréquemment pour compenser les perturbations causées par les manoeuvres de commande, nécessaires pour maintenir l'avion sur sa trajectoire de descente.

Un problème pénalisant beaucoup d'avions VTOL ne s'est pas du tout posé au Do 31, à savoir la tendance à un moment excessif en roulis dû au dérapage, rencontré fré-

quement dans les phases de vol stationnaire et transitoire et ayant pour origine la configurations des jets. La planche 11 montre les paramètres mesurés au cours d'un vol destiné à l'examen de la stabilité latérale à une vitesse de 70 noeuds. Moyennant une sollicitation à échelon aux pédales on a établi un angle de dérapage permettant d'observer le comportement de l'avion. On peut voir que l'assiette latérale, étant tenue inchangée par l'autostabilisateur, celui-ci ne subit aucun signal unilatéral, ce qui prouve l'absence complète d'un moment en roulis, qui serait dû au dérapage. Ce résultat a d'ailleurs été confirmé dans le domaine du vol stationnaire.

Les degrés de complexité différents d'un décollage et d'un atterrissage vertical s'expriment très nettement dans les durées de transition. Le procédé pour la transition d'approche, décrit au paravent, est un compromis pour rendre acceptable la sollicitation du pilote à détriment de la durée de la transition, c'est à dire, que la capacité de décélération de l'avion est loin d'être exploitée complètement. Ceci est d'ailleurs illustré dans la planche 12, qui contient, d'une part la comparaison de l'accélération horizontale possible théoriquement avec l'accélération réalisée après le décollage, d'autre part la décélération théoriquement possible avec celle réalisée en vol d'approche. Alors que les valeurs optimales de l'accélération sont presque atteintes au cours du décollage, la figure montre nettement que dans la phase d'approche l'écart entre la décélération optimale et celle réalisée en vol est encore assez important. On peut donc dire qu'on peut gagner encore un temps précieux pendant la transition. La même conclusion est à faire pour la phase de descente finale en vol stationnaire. Moyennant l'intégration et l'automatisation des différentes commandes, la durée de la phase de transition d'approche pourrait être réduite à moins qu'un tiers de la valeur actuelle.

La planche 13 finalement, montre la raison, pour laquelle on préfère la modulation de la poussée des réacteurs de sustentation comme moyen de correction de la trajectoire de l'avion dans la phase de transition d'approche. La modulation de la poussée donne en effet l'avantage d'une commande directe de la portance et entraîne le minimum de couplages entre l'accélération verticale et l'accélération horizontale. Toute autre intervention de commande confronterait le pilote avec des problèmes de coordination très compliqués qu'il ne serait pas en mesure de résoudre avec le système de commande actuellement installé.

5. PERSPECTIVES POUR L'AVENIR

Les essais en vol du Do 31 ont pu être menés à bonne fin sans accident et sans graves incidents techniques. Ce résultat satisfaisant pouvait seulement être atteint grâce au développement et à l'expérimentation soigneusement préparés et réalisés en plusieurs étapes progressives. En commençant par les études sur maquettes et par simulation, en passant par les essais sur pylône et les vols libres des différents bancs d'essais, ainsi que par les essais en vol conventionnels, pour aboutir à l'expérimentation VTOL proprement dite. Les essais en vol du Do 31, qui ont trouvé leur fin - au moins provisoire - en avril 1970 ont apporté la preuve que cette conception d'avion de transport V/STOL est très prometteur. Cette partie de l'expérimentation a permis de trouver une réponse aux questions principales qui sont déterminantes pour la définition, le développement et l'exploitation d'un avion de transport VTOL à réaction. Ceci ne veut pourtant pas dire que tous les problèmes soient complètement résolus, permettant une exploitation immédiate des avions VTOL d'une façon économique et en toute sécurité.

Un nombre important de problèmes pouvaient seulement être abordés d'une manière superficielle et un certain nombre de problèmes ont surgi au cours des essais.

On peut noter deux grands domaines, dans lesquels devront se concentrer les activités dans l'avenir, à savoir:

- o le développement de réacteurs offrant à la fois un niveau de bruit et une consommation spécifique plus faibles,
- o et l'amélioration de la technique de transition en vue d'assurer l'exploitation économique et par tout temps.

On connaît, dès aujourd'hui, des possibilités qui pourraient mener à une solution satisfaisante de ces problèmes, et dans un avenir relativement proche on pourra mettre en service des avions à réaction V/STOL répondant à toutes les exigences d'économie et de sécurité. Des avions du genre Do 231 (planche 14) pourront alors contribuer à résoudre les sérieux problèmes de la circulation aérienne.

BIBLIOGRAPHIE

- [1] Entwicklung des Transportflugzeuges Do 31 und die Herstellung und Erprobung von zwei Experimentierflugzeugen
Dornier Rep. GE 51-481/69, Dez. 1969
- [2] H. Max
Do 31 Test Results
AGARD-CP-69, Dec. 1969, Bruxelles
- [3] R. Draganow
Essais sur les qualités de vol du Do 31
AGARD-CP-85, Mai 1971, Toulouse
- [4] H. Wünnenberg - G.K. Kissel
V/STOL handling qualities criteria compared with flight test results of the V/STOL-transport-aircraft Do 31-E
AGARD-CP-106, Sept. 1971, Ottawa
- [5] H. Friedel
Technik und Problematik des V/STOL-Übergangsfluges beim Strahltransportflugzeug Do 31 und ihre Bedeutung für die V/STOL-Technik
BMVg, FB aus der Wehrtechnik, April 1972
- [6] D. Welte
Ergebnisse und Erfahrungen zur aerodynamischen Strahlinterferenz beim V/STOL-Strahltransportflugzeug Do 31 und ihre Anwendung auf zukünftige V/STOL-Entwicklungen
BMVg, FB aus der Wehrtechnik, April 1972
- [7] P. Dick
Heissgasrezirkulation beim V/STOL-Strahltransportflugzeug Do 31 und ihre Bedeutung für zukünftige V/STOL-Entwicklungen
BMVg, FB aus der Wehrtechnik, April 1972
- [8] H. Wünnenberg
Stabilität und Steuerbarkeit von V/STOL-Flugzeugen nach Verfahren und Ergebnissen aus der Do 31 - Flugerprobung
BMVg, FB aus der Wehrtechnik, April 1972
- [9] C.A. Holzhauser et.al.
A flight evaluation of a VTOL Jet transport under visual and simulated instrument conditions
NASA TN D-6754, March 1972
- [10] J. Münch
Ergebnisse zur Bodenerosion beim V/STOL-Strahltransport-Flugzeug Do 31 und ihre Bedeutung für die V/STOL-Technik
BMVg, FB aus der Wehrtechnik, April 1972

$S = 57 \text{ m}^2$
 $b = 17 \text{ m}$
 $\Lambda = 50^\circ$

Réacteurs
 2 Bristol - Siddeley BS Pg 5-2
 2 Rolls Royce RB 162-4D

Avion de transport V/STOL Do 31

1

petit-banc d'essai volant grand banc d'essai volant

Do 31-E3 (conventionnel) Do 31-E3 V/STOL

Appareils d'essai en vol

2

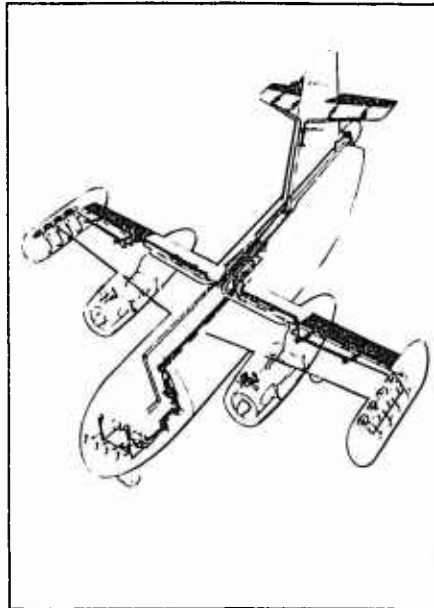

 Dessin d'ensemble des commandes 3

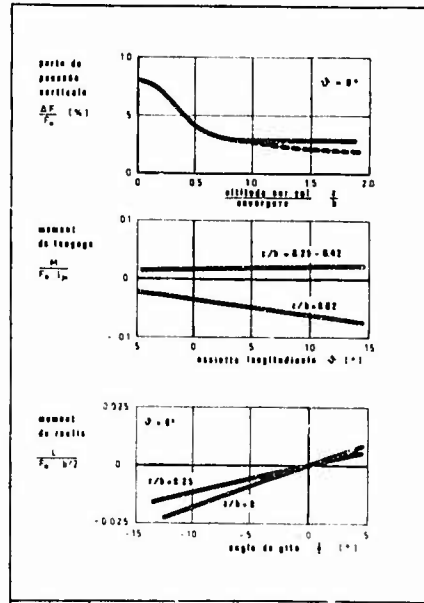

 Interférence due aux jets en vol stationnaire aux voisinage du sol 4

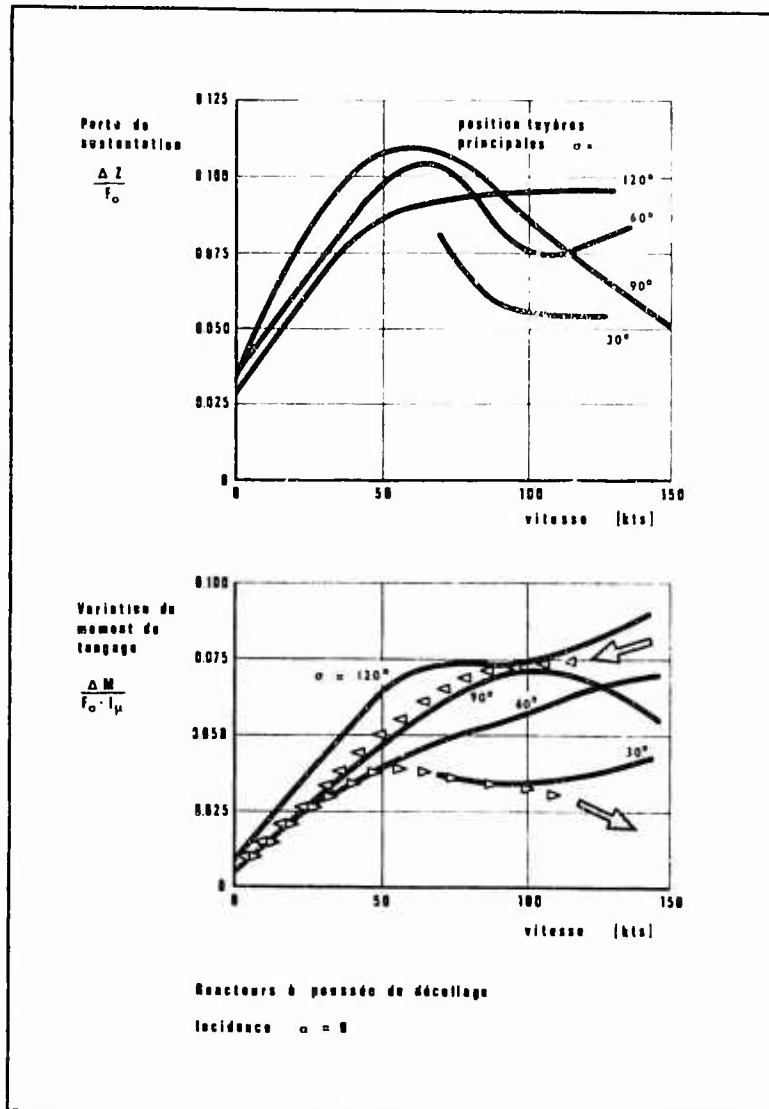

 Interférence due aux jets en vol transitoire 5

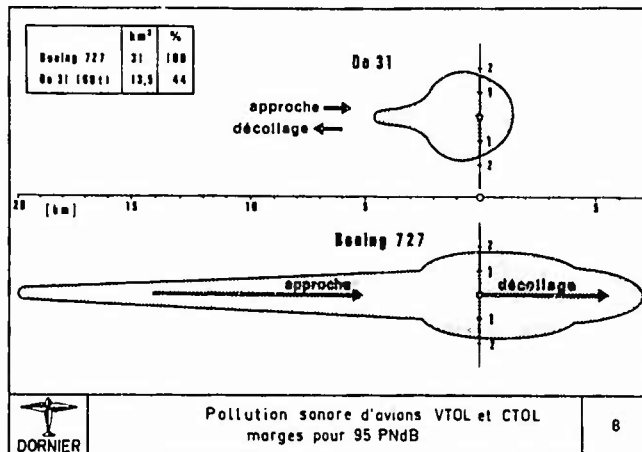
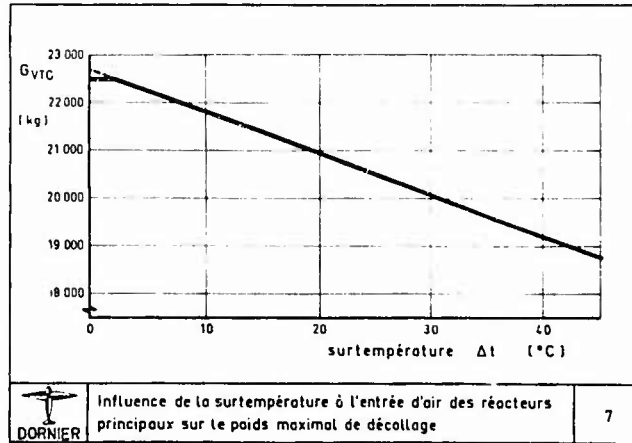
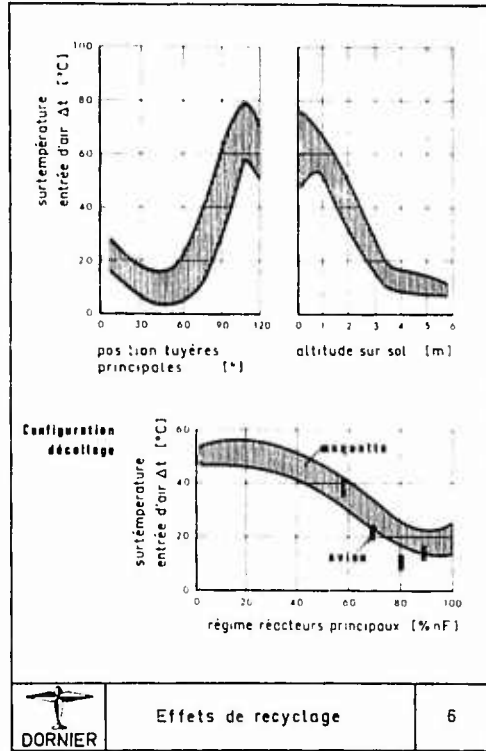

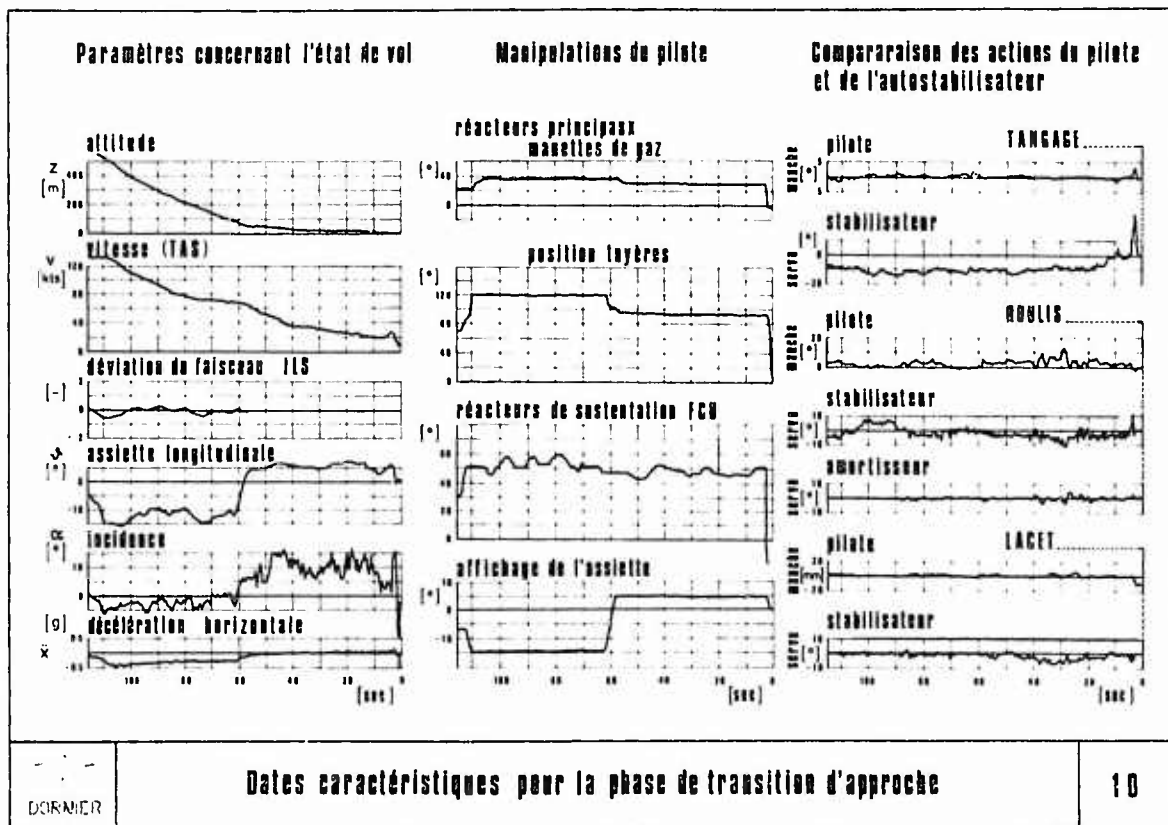
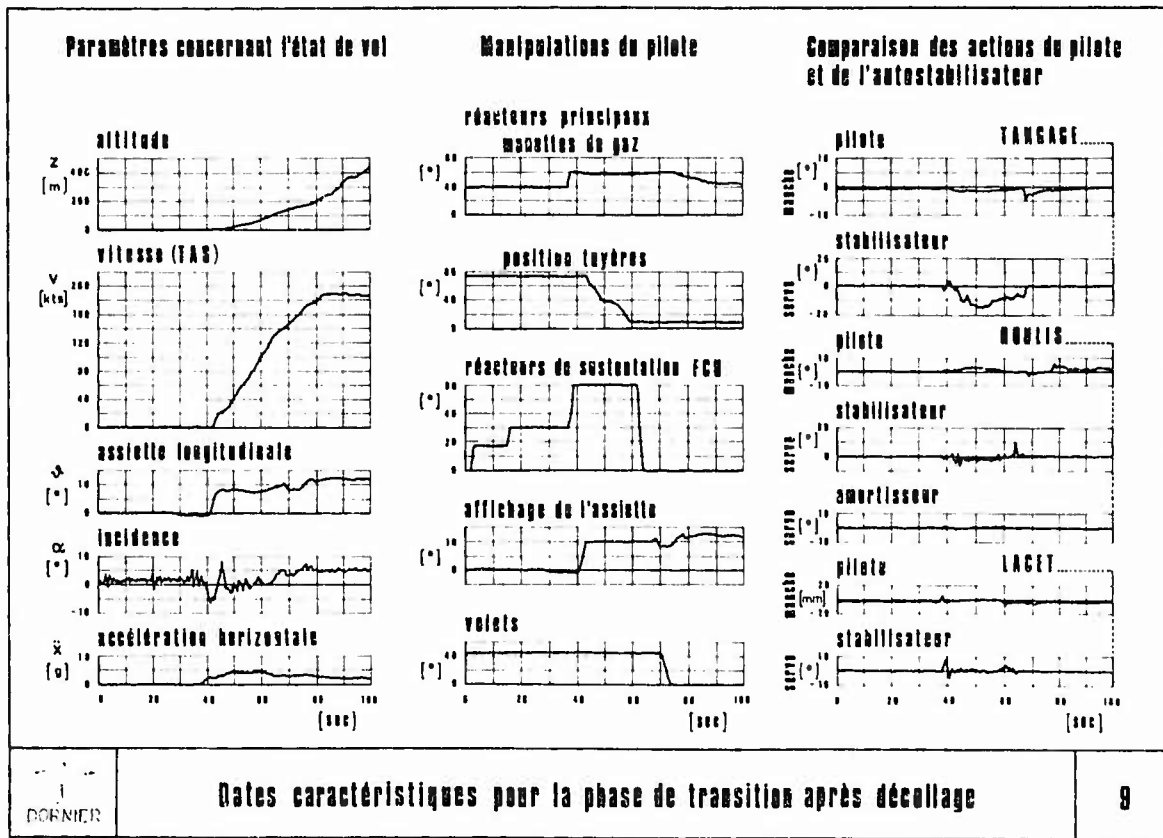

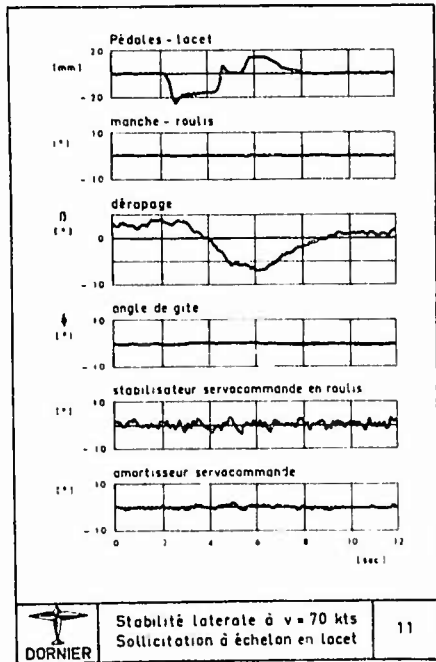

DORNIER Stabilité latérale à v = 70 kts
Solllicitation à échelon en lacet 11

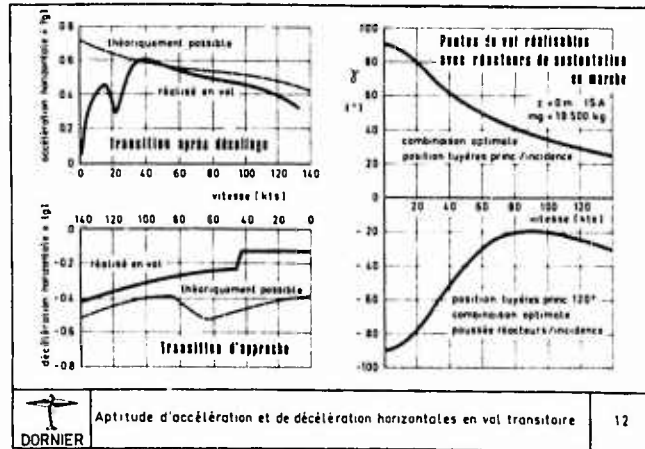

DORNIER Aptitude d'accélération et de décélération horizontales en vol transitoire 12

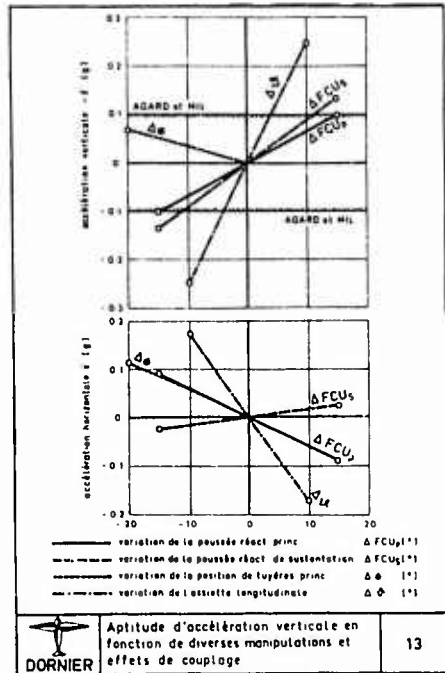

DORNIER Aptitude d'accélération verticale en fonction de diverses manipulations et effets de couplage 13

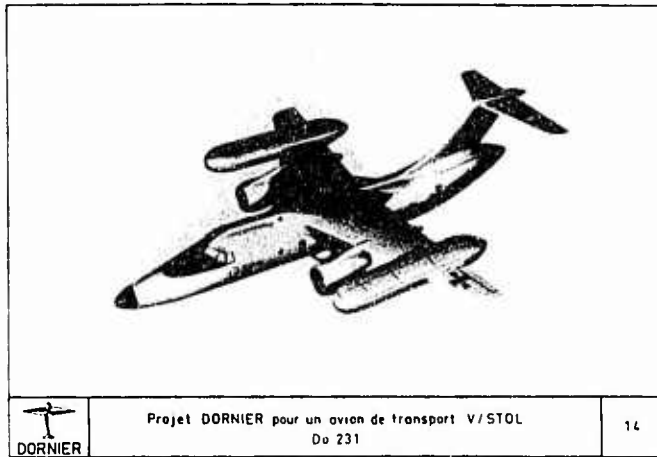

DORNIER Projet DORNIER pour un avion de transport V/STOL Do 231 14

AV-8A HARRIER CONCEPT AND OPERATIONAL PERFORMANCE - U.S. MARINE CORPS

by

Major General T. H. Miller, Jr., USMC
 Commanding General
 Second Marine Aircraft Wing
 MCAS, Cherry Point, North Carolina 28533

and

Lieutenant Colonel C. M. Baker, USMC
 Marine Aircraft Group 32
 MCAS, Beaufort, South Carolina 29902

SUMMARY

The U. S. Marine Corps is a V/STOL oriented force due to the unique nature of its amphibious mission and the requirements of its air-ground team construction. The singular purpose of Marine air is to support Marine ground forces. Direct combat support of these forces demands basing flexibility if operational response times are to be consistent with the application of optimum firepower at the most effective times. V/STOL vehicles provide basing flexibility when properly employed.

Since the Marine Corps introduced the helicopter to U. S. military service in 1948, it had desired a complementary fighter/attack airplane to further exploit the improved responsiveness as it related to basing flexibility. All V/STOL developments in the U. S. and abroad were monitored. In 1963, the Marine Corps stated a firm requirement for procurement of this capability. The only aircraft in the world which has come to operational fruition out of all the high performance V/STOL development efforts is the Hawker Siddeley Harrier (AV-8A). The Marine Corps has an objective of three tactical squadrons and a training squadron of AV-8A's.

The Marine concept of employment of the AV-8A is aimed toward achieving maximum operational flexibility and aircraft utilization at sea and in the field. It employs existing Marine organizations and materials in a system of simplistic logistics. It is organized such that the complex support for dispersed basing do not constrain the operational potential of the force. A three-tiered basing/support structure: Main Base, Facility, and Forward Site, was examined and successfully demonstrated in a recent exercise, proving its conceptual viability. During this exercise, sortie rates and response times never heretofore achievable were demonstrated. The improvement in operational effectiveness was apparent.

When discussing V/STOL aircraft capabilities it is important to understand that this unique capability is neither limited to or restricted from helicopters. In other words, it is applicable to any flying machine. V/STOL is neither a kind of aircraft or mission in itself; it is merely a capability of some aircraft where missions may be as different as for any diverse conventional aircraft.

It is the intent of the Marine Corps to pursue V/STOL growth to a long range conclusion of a whole V/STOL force. Although the Marine Corps encourages diverse V/STOL developments and is always seeking to improve capabilities and reduce inherent limitations it is increasingly convinced of the military advantages offered by the vectored thrust concept. Vectored thrust is far more than just a device to provide V/STOL, it is applicable to all portions of the aircraft flight envelope, and will in time be routinely employed in bomb deliveries and in air combat maneuvering. The universality of use of vectored thrust appears to provide a measure of system effectiveness unequalled by other concepts and virtually demands exploitation of the principle in the next generation V/STOL aircraft.

* * * *

The U. S. Marine Corps is unique amongst military service in that it is tasked under the National Security Act of 1947, for primary performance of an amphibious mission as a force of combined arms. The mission is one which demands that intensive concentrations of firepower be brought to bear against an entrenched hostile force in order to transit a viable ground force to effective positions ashore. Once ashore, expansion of the beachhead demands a capability to move rapidly in order to exploit the advantages of force concentration which have been gained, and further demands a capability to sustain the effectiveness of the force by proportional logistical growth. The force of combined arms must then be capable of striking and suppressing enemy emplacements from seaward bases, providing a sure means for transiting the ground force from ship to shore, providing heavy and sustained close fire support for ground maneuver elements, providing a network of air defense, providing a system of rapid logistical growth, and sustaining itself for periods of time in the event seaward support is for any reason denied. In order to meet these requirements the Marine Corps is constructed as an air-ground team. The singular purpose of Marine air is to support Marine ground forces, and every aircraft in the Marine fleet must provide some element of this support in order to achieve a position in the inventory.

Meeting the amphibious mission requirements means that Marine tactical air-

craft must be equally adaptable to both ship and shore bases. They must be capable of rapid translocation from one expeditionary base to another. They must not impose excessive demands upon the logistic system in providing this sort of flexibility and must not be measurably degraded in operational capability as a result of these movements. The firepower and movement demands of the ground forces which are being supported also dictate that Marine tactical aircraft provide a high measure of responsiveness in order to assure the application of an appropriate level of force at the optimum time. Marine Corps experience, as well as many studies of Platoon and Company level operations, have shown that providing firepower at the proper time is as at least as important as the weight of firepower which is provided. Obviously, no matter what the weight of ordnance, it will be to no avail once the ground force has either won or lost the battle. Again, Marine Corps experience has shown that in order to provide effective air in support of a Platoon or Company action we must be capable of placing the weight or ordnance on target within a very few minutes of the initiation of the engagement. It is seldom indeed when an encounter of this size will not be decided within some 20 to 25 minutes, and the time of really effective air support is somewhat prior to the critical decision point. It is consideration of these factors which has led the U. S. Marine Corps to be a pioneer in expeditionary airfield development, and had resulted in our now refined Short Airfield for Tactical Support, (SATS). And it is consideration of these same factors which leads the Marine Corps to be a V/STOL oriented force. Flexibility of basing and operating is vital to effective performance of the Marine mission.

Since the Marine Corps introduced the helicopter into U. S. military service in 1948, it had desired complimentary fighter and attack aircraft to exploit the apparent advantages of basing flexibility and derive the commensurately improved close air support responsiveness. Obviously, during the 1950's, the state of the art was such that a high performance vehicle with these capabilities could not be achieved. All developments in the U.S. and abroad were carefully monitored. In the early 1960's it was becoming apparent that meeting the high performance V/STOL design goal was on the horizon. In 1963 the Marine Corps stated a firm requirement for procurement of this capability within the Marine Mid-Range Objectives Plan. Out of all the development efforts, the only high performance V/STOL aircraft in the world which has come to operational fruition is the Hawker Siddeley AV-8A Harrier. Therefore, in 1968 the Marine Corps set about efforts to procure this aircraft for operational introduction into the Marine Corps fleet. The total procurement objective was for 114 aircraft to support three tactical squadrons of 20 aircraft each plus a training squadron. Thus far, approval has been given by the Congress for procurement of 90 aircraft. One procurement year remains pending.

A summary of Harrier characteristics is as follows:

AV-8A HARRIER CHARACTERISTICS

EMPTY WEIGHT	12,400 LB
MAX WEIGHT	25,600 LB
VMAX (635 KEAS)	0.96M
LIMIT MACH	1.2+M
STRUCTURAL DESIGN	7.8 G
FERRY RANGE (400 GAL. DROP TANKS)	1,800 NM
THRUST/WEIGHT RATIO RANGE	0.78/1 to 1.5/1
MAX PAYLOAD	8,000 LB
CLIMB TO 40,000 FT	142 SEC.

Harriers payload/range capability looks something like this:

AV-8A HARRIER ATTACK PERFORMANCE

<u>TAKEOFF (FT)</u>	<u>ORDNANCE (LBS)</u>	<u>RADIUS (NM)</u>
VTO	3000	50
600	5000	125
1000	3000	360
1150	5000	225
1500	8000	220

It is important to note here that the missions the Marine Corps is most interested in are those with shorter radius of action. Certainly it may be useful for the airplane to have the capability to operate at the longer radii, these will be used primarily from ships

when enroute to or first arriving in the objective area. The short radii, however, are those where the Marine mission has needed V/STOL for so long. Here, Harrier begins to solve the problems of response time which are so crucial to the Marine on the ground.

As mentioned earlier, the singular purpose for Marine air is the support of the Marine ground force. Because of the peculiar demands of the Marine mission, Marine air must be a self sufficient force, capable of rapid response, providing a very high level of firepower, and conducting sustained operations if required. In order for a tactical aircraft to be effective for the Marine Corps, it should be capable of providing air support during all phases of an amphibious operation. Flexible basing is the only realistic means to fulfill this requirement. Achievement of maximum operating flexibility through flexible basing is the premise of the Marine concept of employment of the Harrier airplane.

In the concept of employment three kinds of bases are need. It is important to recognize that the differences between these bases are not necessarily visible. One kind of base might look exactly like another, yet be much different. The differences are in the capabilities of the base, not the appearance. The basing structure is three tiered, and employs existing Marine Corps personnel and materials in a system of simplistic logistics.

The first base is the Main Base. This may be a full conventional jet airfield. It may be an LPH or a CVA. It may be a SATS field some 1500 feet long. It will, however, be a day and night operating base, with all-weather capabilities the same as any conventional jet base. It will further be a full logistic support base for Harrier. It will have full servicing and arming capabilities and aircraft maintenance through the Intermediate Level, from the Marine Aircraft Group, which provides an in depth component repair. The Main Base would be "home" for one or more squadrons.

The next base is the Facility. This base, although it may look like the Main Base, is a squadron base. It is a day and night operating base, but it will probably not have radar to the extent of the Main Base, and as a consequence will probably not have the ability to launch and recover aircraft when the weather is below that required to get in and out visually. It will have the full capability to service and arm Harriers, and provide aircraft maintenance to the Organizational Level, which provides for replacement of defective components. The facility is to a Main Base as child to parent. Logistic support and heavier maintenance are provided to the Facility by the parent Main Base.

The smallest of the Harrier Bases is the Forward Site. The Forward Site is for day only operations as we now use it, because of the difficulties attendant to night operations into very small unsupported areas. The Forward Site may be logistically supported to a minor degree, a 500 gallon fuel bladder and a few bombs perhaps, or it may be completely unsupported. The basing concept in itself is thoroughly flexible, and must always be applied to a particular situation in order to define it's parts beyond conceptual descriptions. It is important to recognize also, that it is a concept of expansion. What is a Forward Site today may be a Facility tomorrow, and what is a Facility may be a Main Base. Flexibility lies in the capability to exploit these tenets.

An amphibious operation can also be thought of in three elements. Phase One, where operations are conducted from the Main Base at sea. Phase Two, where operations are still being conducted from the Main Sea Bases but they have also commenced from Facilities being constructed ashore. And finally, Phase Three, where the Main Base has moved ashore, and the same operations are being carried on as were previously done at sea. To amplify this somewhat:

During Phase One the Main Base is perhaps an LPH. The full facilities of the ship are being used to provide day and night operations and for all-weather as required. Harrier sorties are being launched directly from the ship to targets ashore, returning to the ship for servicing, arming and maintenance. At this time, however, an important corollary action is taking place in that Forward Sites are being constructed ashore. These are being established in the first hours of the first day of the operation, at locations as near as possible to the Forward Edge of the Battle Area (FEBA). Sorties may also be launched from the ship to ground loiter at a Forward Site, to launch from there to the target and return to the ship for servicing. The Forward Sites may also be used for defensive dispersal if such is required at any time. One or more of the Forward Sites will probably be planned to grow into a Facility, and eventually possibly into a Main Base. The Forward Sites may be roads, they may be small pads of AM-2 or AM-6 SATS Matting, they could be most any hard surface area of adequate size. They will always, however, be close to the FEBA, to reduce the distance to the target and minimize the commensurate response time to support of the ground forces.

During Phase Two the Harrier Facility is emplaced. The ship remains the Main Base and in addition to providing logistic and maintenance support to the Facility, sorties are being launched from the ship to the target and from the ship to the Forward Sites, returning to the ship for arming and servicing. In addition, however, aircraft have also been located at the Facility ashore, and sorties are being launched from the Facility to targets and to the Forward Sites. Regardless of from which base an aircraft is launched, Main Sea Base or Facility, it might return to either for rearming and servicing, depending entirely upon the demands of the situation. The scope of possible launch and target response situations has increased considerably as a result of the diverse basing. During this period also, Forward Sites have been expanded in number and kept pace with the expanding FEBA, always keeping the distance to the targets to the minimum practical.

In Phase Three the Main Base has been established ashore, and the same operations are being carried on as from the Main Sea Base. The number of Facilities may have increased and Forward Sites have probably both increased in number and moved forward with the FEBA. (It should be noted here that each Marine Harrier squadron, with the aid of a parent Marine Aircraft Group, has the capability to operate simultaneously from two Facilities and a Main Base.) The scope of possible response situations has become quite large at this point. Main Base to target, Main Base to Facilities or to Forward Sites, Facilities to target or Forward Sites, Forward Sites to targets to return to either Main Base or Facilities for arming and servicing. And although it is a complex system it is not a difficult system. It has been proven well within the capability of the existing Marine Air Command and Control System to manage.

As an example of how forward basing might benefit an operation; during the years in the I Corps area of South Vietnam we had two jet capable airfields; Danang and Chu Lai. In a worst case, an aircraft launched in support of ground action could be required to fly in excess of 130 NM within I Corps area. This required well in excess of 30 minutes from on-call to on-target no matter what the alert status. Had we had Harriers available, the number of usable airfields would have been some eighteen rather than two. The worst case radius of action would have been 42 NM, and the response time under 10 minutes. And it is worth noting that these eighteen bases need not have been just Forward Sites, each was capable of being a Main Base. Thus, the Marine Corps is convinced that forward basing is responsive. And because it is responsive it is economical. It provides a greater ratio of ordnance delivered to aircraft usage time, or any measurement factor such as that, than any other system we know. This results, of course, from the always short distance to the target, the resulting short missions, and the ensuing very high sortie rate.

Marine Harriers have participated in several air-ground exercises to date. The most interesting of these was a Sortie Rate Validation Test, code named Versatile Warrior. The purpose of this test, done at the direction of the Secretary of Defense and coordinated under the Commander, U. S. Navy Operational Test and Evaluation Force, was to determine just what kind of sortie rate could be expected from an airplane such as Harrier operating in a realistic forward area environment. It had been estimated that the AV-8A could produce four sorties per aircraft per day on a sustained basis, and when required surge to six sorties per aircraft per day for limited times. The ten day exercise was conducted during late March 1972, and an elaborate statistical model was constructed to extrapolate the results of the rather short term test into longer perspective. Several ground rules were established to assure realism, amongst which were that full turn-around servicing and rearming were required on each sortie, as was complete pilot briefing. Aircraft up or down status was carefully controlled against a Mission Essential Equipment List. Two hundred fifty two simulated combat sorties were required (six aircraft - four sorties per aircraft per day, for nine days, six sorties per aircraft per day for one day), in addition to whatever support sorties were necessary. At least 50% of the sorties were required to be preplanned and prescheduled, 10% had to be flown at night, 15% from Forward Sites, full scale ordnance was required on 20% and the surge day required all full size ordnance. Rules for weather were also established in the event that it became grossly bad. Sortie radii which were established were conceptually quite realistic. Sorties from the Main Base flew radii of 50 NM. From the Facility a radius of 40 NM was used. And from Forward Sites the radius was 20 NM.

The exercise was conducted in the Camp Lejeune/Cherry Point locale near Cape Hatteras, North Carolina, using target complexes already established for training use in the area. The Marine Corps 4000 ft. AM-2 Matting SATS at Bogue, North Carolina, was designated the Main Base, and Marine Aircraft Group 32 set up the Intermediate Maintenance Activity at that location. Air Control activities from the Second Marine Aircraft Wing were also housed at Bogue. A Facility was constructed in the southern Camp Lejeune area of AM-2 Matting, measuring 1600 ft. by 72 ft. with a parking ramp at one end of the field. A normal Marine Tactical Airfield Fuel Dispensing System, expeditionary tower, field lighting and such were installed at the Facility. On the eighth day of the operations, the squadron moved from the Main Base to the Facility, and operated from there during the remainder of the exercise.

Six Forward Sites were also constructed and utilized during Versatile Warrior. Five of these were constructed of AM-2 Matting, and ranged in size from about 96 ft. square to 200 ft. square. One of these sites, of about 120 ft. square was actually helicopter inserted and engineer emplaced during the first five hours of the exercise. This included leveling the surface where the matting was laid by means of a bulldozer and grader which had also been helo lifted in during the same period. The sixth Forward Site was a standard 22 ft. wide macadam road, which was quite successfully used for exploiting the heavier loading provided by Short Takeoff Techniques. The only improvement to the road was to stabilize the shoulders for a distance of some 1500 ft. with tamped common clay taken from the surrounding marshland. The reason for this was simply that the edges of the road at 22 ft. corresponded almost exactly to the width of the Harrier outriggers, and the road edges chewed up the outrigger tires.

During the ten day period of the Sortie Rate Validation Test, the Second Marine Aircraft Wing and the Second Marine Division thoroughly exercised the operability, command and control, maintainability and logistic supportability of the AV-8A in a realistic forward area environment. The results were impressive: 376 total sorties were flown against 252 required; 126 preplanned sorties were required, 166 were flown; 51 scramble sorties were required, 210 were flown; 38 sorties were required from the Forward Sites, 92 were flown; 26 night sorties were required, 33 were flown; full scale ordnance was required on

51 sorties, it was flown on 141. A total result greater by half again that what was required.

The conclusion of the Commander, Operational Test and Evaluation Force regarding this effort was:

"The Av-8A is the only operational high performance attack aircraft in the Armed Forces of the United States capable of operating from forward austere bases using V/STOL technique. This capability represents a significant increase in providing responsive, effective close air support to the ground forces. The concept of the AV-8A land operations can be supported with no significant changes in Marine Corps doctrine, equipment or organization."

And we feel strongly that the airplane establishes the fact that the long term Marine goal of a whole V/STOL force is well grounded and will be a reality if properly pursued.

Considering, then, the structuring of a V/STOL force it is important to recognize that the term V/STOL is neither limited to or restricted from any mission design aircraft. V/STOL is not a kind of aircraft in itself. A V/STOL aircraft can be a fighter, a light attack, a transport, an ASW vehicle or virtually any other mission design aircraft conceivable. Furthermore, many techniques to achieve V/STOL capabilities now exist, most entirely more suitable for some missions than for other. A helicopter is a V/STOL vehicle as certainly is a Harrier, but mission wise they remain drastically different. In short, it is no longer prudent to think of building a V/STOL airplane, we must think of building a fighter with V/STOL capabilities or a cargo hauler with V/STOL capabilities, or the like. The kind of technique used to achieve V/STOL capabilities will probably be dictated by the mission design more than anything else. In some case the mission design will even be considerably enhanced, beyond just takeoff and landing flexibility, by the V/STOL technique applied. This is the case with vectored thrust as applied to tactical fighter and/or attack aircraft such as the AV-8A.

Pure vectored thrust aircraft, as opposed to some other V/STOL techniques, have a markedly high thrust-to-weight ratio inherent throughout their operating regime. This results from the singular fact that all the thrust required for the airplanes V/STOL capability is contained in one propulsion system which operates throughout the flight since no other propulsion systems are carried. Thrust-to-weight ratio is in itself a military advantage as any combat experienced pilot will agree, since it provides a measure of agility which cannot be attained otherwise.

Vectored thrust allows a design simplicity which other techniques can probably not attain. For instance, in Harrier a single lever in the cockpit controls the positioning of the engine nozzles, this is done through a simple airmotor and mechanical drives arrangement. As the engine nozzles transit downward from the horizontal position, a butterfly valve mechanically opens and diverts engine burner air into the reaction control ducting. Simple push-pull rods attach to the conventional flight control surfaces and actuate the reaction control valves responding to the pilots normal control inputs. Simply flown, simply maintained! It must also be noted that in terms of flying qualities a very excellent job of matching the reaction control systems to the aerodynamic control system has been accomplished, and this without resort to sophisticated equipment of any sort. Other systems in the AV-8A are similar, fuel, hydraulics, and the like are all uncomplicated. Because of this simplicity we have been able to achieve a direct Maintenance Man Hour per Flight Hour factor of just over 20 Man Hours to date, and we expect this to improve further with time. This sort of simplicity and Maintainability is vital to the achievement of operability in expeditionary environments.

We are finding the AV-8A a formidable opponent in the realm of defensive air combat maneuvering. This has been proven over the past several months against various types of adversaries, both supersonic and subsonic, high and low wing loaded. Although not at all optimized by basic mission design for air combat maneuvering, Harrier does very well for itself indeed if properly employed. The AV-8A is not an interceptor, and we have no intention of trying to make it into one. It is, however, an exceptionally agile airplane in it's flight regime of nominally 20,000 ft. downward, due partially to it's very high thrust-to-weight ratio, but mainly due to the ability to apply the thrust vector where it is most effective for the demands of the fight. Very briefly, thrust vectoring is used to destroy an opponents tracking, force overshoots, minimize altitude loss in split-S maneuvers, reduce turn radius and perhaps most important increase turn rate. Harrier has shown that the nose of a vectored thrust airplane can, in most cases, be brought to bear on a conventional opponent more quickly than a conventional aircraft can accomplish the same. That, after all, is the essence of air-combat-maneuvering! bringing your nose to bear on your opponent within your weapons envelope more quickly than he can bring his nose to bear upon you. There is much remaining to do in this area, and certainly all the answers are not yet in, but what has been learned thus far is building a strong case for a next generation vectored thrust fighter capability.

We now have a cogent beginning to V/STOL operations in the U. S. military. In the Marine Corps we are proud that our mission has been suited to introduction of this new capability. It has now been firmly established that the V/STOL AV-8A is providing a new kind of effectiveness. Effective because it provides us with basing flexibility. Because of the basing flexibility we can achieve the responsiveness which we have needed for so long. Because of the responsiveness we can achieve a measure of weapons effectiveness never heretofore possible, one which is measured not just by the accuracy and payload of a weapons system, but by the ability to have ordnance on target when it is needed, not

after the fact. And finally, the effectiveness of survivability. A small, fleeting, agile airborne system, and one which can rapidly be positioned to appropriate locations when passive defense on the ground is required.

The Marine Corps is increasingly convinced that the potential of a V/STOL force will at least equal that provided by the greatest aviation breakthroughs of the past, and that long range developments of diverse V/STOL techniques need to be pursued for eventual application to operational vehicles. We are equally convinced, however, that the real growth of V/STOL technology is dependent upon the same base as any other aircraft system. A viable fleet of aircraft fulfilling the demanding requirements of day by day operations in the field.

VAK 191 B EXPERIMENTAL PROGRAM FOR A V/STOL STRIKE-RECCE AIRCRAFT

ROLF RICCIUS

Prof. Dr. Ing.,
Director Research and Systems Analysis,
VAK 191 B Program Manager

WERNER SOBOTTA

Dr. Ing.,
Chief Engineer Flight Test Evaluation

assisted by

Ludwig Obermeier, Chief Test Pilot VAK 191 B
Bernhard Wolf, Chief Project Engineer VAK 191 B
Gerhard Bock, Deputy Program Manager VAK 191 B

VFW-Fokker GmbH, 2800 Bremen, Germany

SUMMARY

A summarizing description of the VAK 191 B VSTOL-Strike-Recce-Aircraft and its Development Program will be given, highlighting the applied advanced technology with special attention to the fly-by-wire flight control system. Latest flight test results and the aircraft growth potential with respect to operational application will be discussed.

1. INTRODUCTION AND PROGRAM STATUS

The introductory remarks to Session II of this AGARD Symposium explain that papers will be given here, which review current operational experience and proposed application of currently developed hardware. The VAK 191 B experimental aircraft program belongs to the latter group, since the three aircraft (1) which have been built by VFW-Fokker and Aeritalia's Fiat Division as a subcontractor (Fig. 1) are at present undergoing flight testing at VFW-Fokker flight test facility at German Air Force Test Center Manching near Munich. This paper therefore will mainly deal with results achieved so far during the test program and will review the possibilities of application of the VAK 191 B as an operational aircraft and/or the use of the applied and very modern VAK-technology for other V/STOL design.

2. VAK 191 B, TECHNICAL DESCRIPTION

A number of publications so far have described the aircraft (Fig. 2) in very much detail (2), (3), (4), and AGARD has discussed and published technical details about the aeroplane in the 1969 and 1970 proceedings in The Hague and in Brussels (5), (6), (7). Therefore only a summarizing technical description will be given, highlighting the build-in advanced technology.

Based on bilateral military requirements the aircraft VAK 191 B (Fig. 3) has been designed for V/STOL operation from dispersed semi-prepared sites, for a wide mission spectrum flying at high subsonic speeds at low level. Independence from external ground power supply was to be provided as well as an internal exchangeable armament/equipment package. Crew safety had to be guaranteed under all engine power loss conditions.

The VAK 191 B is designed as a single-seat aircraft and has a total weight depending on the mission of between 7 and 9 tons. Jet propulsion is generated by a MTU/Rolls-Royce RB 193-12 - 10000 lb of thrust - swivelling nozzle engine, and two Rolls Royce RB 162-81 lift engines, each delivering a thrust of 6000 lb and whose exhaust jets can also be partially deflected by deflector doors attached to the fuselage bottom. In addition to the demand for high subsonic speed and good maneuverability, particular attention was paid to ensure that the pilot is only subjected to an endurable amount of g-loads during his mission near the ground. For this reason, wings with high wing loading and small aspect ratio plus a relatively large leading edge sweepback were used, which are mounted high due to the central position of the swivelling-nozzle engine. To reduce the landing speed and shorten the transition distances, trailing-edge flaps were attached to the wings and ailerons can be deflected downwards for the same purpose. The empennage consists of a horizontal flying tail while the vertical tail is made up of a fixed fin and the rudder. During the design of the aircraft it became apparent that a symmetrical configuration of lift engines plus a lift/cruise engine located in the center of the fuselage satisfactorily would meet the requirements best and, due to minimum engine weight and low specific fuel consumption, made for the smallest aircraft take-off weight. The symmetrically arranged engines, opened up the possibility of future use of improved engine thrust of either the lift or the lift/cruise engine. Crew safety in engine failure could be met and partial jet deflection on lift engines does allow the aircraft to maintain flying after lift/cruise engine failure (get you home case). Last not least the aircraft is capable of performing inflight thrust vectoring and thus improves its maneuverability.

The forward lift engine is installed in the slender fuselage directly behind the cockpit (Fig. 4). The forward group of fuel tanks, through which the cruise engine intakes run, connects up with this. The swivelling-nozzle engine is in the center of the fuselage, and beneath it there is a large exchangeable bay to accommodate reconnaissance equipment, guns, extendable rocket containers, extra fuel tanks, bombs or guided missiles. During flight testing, this container holds the flight recording and data link system.

There is a second group of tanks in the rear section of the fuselage, and behind this follows the rear lift engine and the equipment compartments. The tanks hold a total of 2.600 liters of fuel, but in addition to this various sizes of external tanks could be carried.

In order to make the aircraft independent from external power supply, there is a 140 HP auxiliary gas turbine installed in the rear fuselage and connected to it a hydraulic pump and a 15-KVA generator. This auxiliary power unit supplies electrical, hydraulic and pneumatic power, which allows the equipment systems to be checked and, if necessary, the electronic equipment to be air-conditioned without the engines running. Furthermore, the cruise engine can be hydraulically started with the aid of this APU. In flight, the APU serves to provide emergency power or, while running, duplicates power generation.

The VAK 191 B has a tandem landing gear with low pressure tires, nose wheel steering, and a brake system consisting of wheel brakes on the nose and main landing gear plus a drag chute to provide additional deceleration for short landings.

For control and stabilisation during hover and transition flight, air is tapped from all engines and expelled separately via two systems at the wing tips and the fuselage nose and tail through air nozzles (Fig. 5).

The flight control system operates on the basis of "fly-by-wire" with triplicated electrical signal transfer, duplicated hydraulics and with a mechanical back-up in all axes which can be clutched in, when the total electrical signal transfer should fail (Fig. 6). In addition, thrust modulation in pitch is available which caters for lift-engine-out-case as well. Built-in test equipment for the flight control system will provide the pilot with a go/no go signal within 30 seconds.

Amongst other items, a 5 liter lox-converter is connected to the cockpit pressurization and air conditioning system and a zero-zero ejection seat is installed for safe escape when speed and altitude are at zero or the aircraft is at even a high rate of descend.

Special attention has to be paid to sonic and thermal loads of V/STOL aircraft (7). Therefore, the wing which is a multi-spar construction and the fuselage are both made of high-strength heat-resistant aluminum alloys. In areas subject to high temperatures, titanium is used. The wing leading edges and flaps, fin, horizontal stabilizer, fuselage covers and doors are of aluminum sandwich construction, while the deflector doors at the fuselage side walls are of fibre construction.

3. RESEARCH AND DEVELOPMENT TEST PROGRAM

In accordance with the aircraft aerodynamic and structural design, the engine/airframe integration as well as with respect to the very advanced technology such as the fly-by-wire system, Control and Stability Augmentation System (CSAS), built-in test equipment, 4000 psi hydraulic system and APU (Fig. 7), a rather extensive research and development test program was carried through during the course of the development, design and construction of the aircraft. This included wind tunnel testing in the order of 8000 hours in subsonic and transonic regime and testing of secondary aerodynamics such as ground suction and jet induced downwash. 2000 hours were spent for recirculation tests. Engine bay ventilation, thermal and sonic load distribution of the aircraft structure were further items of the test program. A number of aircraft subsystems have been built into test rigs to check their function and reliability, e.g. flight controls, hydraulic system, electrical system, fuel system, bleed air system, airmotor/air conditioning system. For the design and development of the flight control system extensive use has been made of a fixed base simulator with hybrid computation which as well did allow to include the hardware of the flight control/hydraulic and electrical test rig into the simulation. The tables in Fig. 8 and Fig. 9 are summarizing the number and hours of tests performed so far. A hovering test rig, designated SG 1262, which was flown successfully for more than two years during the development of the aircraft, was an excellent tool to test the new components of the flight control system, optimize the system, get a good judgement of the handling qualities and design new suitable displays.

Last not least, static structural testing of the complete aircraft, designated V4, was performed at the Lemwerder facility of VFW-Fokker (Fig. 10), where the ultimate load case, a couple of weeks ago, met the specified value.

4. FLIGHT TEST PROGRAM

Flight testing (8) of 3 experimental VAK 191 B aircraft started in sequence for V1 in October 1970, V2 in April 1971 and V3 in September 1971. After engine and APU setting tests, taxi tests did follow before the aircraft was mounted onto a pedestal to undergo final engine runs and to have the flight control system tested and calibrated (Fig. 11).

This pedestal, which is capable of lifting the aircraft 6 ft off the ground, does allow rotation of the aircraft in pitch and roll axis over a range of $\pm 15^\circ$ and in yaw over the full 360° . A jet blast deflector is combined with this pedestal, but was never used, because there was no danger of hot gas reingestion. Here it may be worthwhile to mention that it took 40 tests on the pedestal to clear the hovering test rig for first flight whereas only 5 tests for aircraft V1, 3 for V2 and only 2 for V3 were necessary. In addition lift-off tests were performed before first vertical takeoff. Here the aircraft was lifted just within the undercarriage stroke to let the pilot get adjusted to engine response. Then, vertical takeoff did follow, the first time on September 10, 1971 for aircraft V1 and three weeks later for V2, followed by V3 in early 1972 (Fig. 12).

For flights in hovering and transition up to 130 kn, especially when flown in and out of ground effect, inlet debris guards are being used to prevent engine foreign object damage and at the same time monitor inlet temperatures by means of thermocouples which are mounted onto these.

Flight test instrumentation is mainly carried in the central equipment bay which houses onboard recording and telemetry equipment. The PCM-FM/FM system can record and telemeter up to 450 parameters, 60 to 70 of which can be observed on quick-look displays at the ground station to monitor the proper function of aircraft, engines and subsystems, which is permanently reported to the pilot.

Flight test in hovering and up to 80 kn forward speed was performed at Bremen Airport. Then the 3 aircrafts were transferred to German Air Force Test Center at Manching by means of US Army crane helicopters CH 54 (Fig. 13). This dislocation over a distance of more than 500 miles proved to be also an excellent training for the helicopter crews, which could demonstrate their ability to transfer such valuable freight with two to three intermediate stops without any damage to the aircraft. While continuing testing in Manching, transition has been opened and the general flight test results which are achieved so far can be summarized from Fig. 14 in saying that:

- Aircraft flight control system provides excellent aircraft handling qualities.
- Engine control permits perfect altitude hold in hovering.
- Aircraft has good weathercock stability, thus the aircraft is less sensitive to yaw-roll couplings in transition.
- Aircraft has positive ground effect up to 10 feet above the ground.
- Aircraft is virtually free of engine exhaust gas recirculation.
- Engines and energy supply including APU operate satisfactorily.
- Aircraft subsystems are working within their specified range.
- There are no problems due to sonic or thermal loads onto the aircraft.

5. V/STOL HANDLING QUALITIES AND FLIGHT TEST RESULTS (9)

5.1. Flight Envelope and Transition Corridor

Because of limited knowledge of high speed and reflight characteristics of the lift engines the flight envelope was opened from VTOL through transition into the conventional flight regime. The opened part until today is the complete V/STOL range, including 33 kn lateral translation speed and the transition up to 240 kn and 1000 ft altitude.

An illustrative representation of the handling and flight performance characteristics is the transition corridor (Fig. 15) in which the

nozzle angle of the main engine is plotted versus flight speed. The lower boundary represents the minimum nozzle angle for level flight with maximum angle of incidence (about 15°). The upper boundary is the maximum nozzle angle for stationary level flight. These boundaries were generated in a simulator study. For a speed range from 100 kn up to 180 kn two curves for angle of attack of 0° and 10° are given within the boundaries to represent the configuration flexibility between main engine thrust vector, lift engine thrust and angle of attack for a given point.

Several flown configurations are plotted within the flyable range presenting a fair to good correspondence between the simulator results and the flight test data.

5.2. Stability and Control Characteristics

The stability and control characteristics of the VAK 191 B are derived from system data gained in ground and flight test investigations. They are presented here in comparison with the AGARD Report 577 'Criteria for V/STOL Handling'. All data are still to be interpreted as preliminary because the optimization process is not yet finished.

5.2.1. CHARACTERISTICS OF THE CONTROL SYSTEMS

On the table of Fig. 16 the main characteristics of the flight control system in pitch, roll, and yaw are summarized and compared with the AGARD recommendations represented in Report 577. All data are related to the fly-by-wire mode (no emergency back-up).

The breakout forces meet the requirements with 1.2 lb in pitch, 1.0 lb in roll and 3.1 lb in yaw. Absolute centering into the trim position of the stick and pedals is provided. Friction of the control linkages is negligible.

The control force gradient meets the recommendations with 2.7 lb/in in pitch, but is somewhat higher than the recommendations with 1.7 lb/in in roll and 15.3 lb/in in yaw. Control force gradients are linear over the whole range for all three axes. The control system free play is negligible because of the fly-by-wire technique.

The peak control forces are below the specified maximum forces. The maximum control travel meets the recommendation in pitch with 4.2 inch and with 2.6 inch in yaw but with 2.6 inch in roll is little smaller than the specified limit.

Maximum control power demand in pitch is determined by trim requirements and stabilization of a lift engine failure. Maximum control power in roll and yaw is required for compensating roll-moments due to sideslip and sufficient yaw rate control in hovering. These VAK-values exceed the requirements by far.

Control sensitivity for pitch and roll is expressed in attitude change per unit control deflection. The installed values are 3.6 deg/in in roll. Because the recommended data are minimum levels for satisfactory operation, the criterion is met for both axes. During the optimization of the Control and Stability Augmentation System a control sensitivity of 7.15 deg/in was meanwhile used. Flight tests, however, have shown that it is also necessary to define maximum control sensitivity criteria depending on the roll damping factor, because the sensitivity is limited due to PIO (Pilot Induced Oscillations).

The maximum attitude at maximum control deflection results in 15 deg pitch and 16 deg bank, which is found to be sufficient for maneuvering in hovering and transition.

The time to 90 % of demanded attitude change was found to be optimal during the CSAS optimization at 1.6 sec for both pitch and roll.

Due to non-linearities in the pitch control system (dead-zone of the thrust modulation) the transient overshoot varies between zero and 15 % which is within the AGARD recommendations and was proven to be satisfactory also during several abrupt flare maneuvers between 10 and 100 knots. The overshoot in roll was set to zero to suppress any PIO tendency at the given roll control sensitivity.

In the yaw rate control system a rate change per unit control deflection of 11.5 deg/sec/in and a maximum rate at maximum control deflection of 30 deg/sec were installed. With a transient time constant of 2 sec, 1.7 sec are needed for a 15 deg heading change. This meets the AGARD criteria.

The data for control harmony assessment are represented in Fig. 17. The control force gradient ratio pitch over roll is within the recommended data near the optimum. The gradient ratio yaw over roll satisfies the criteria for STOL-operation. Because a fixed spring gradient is installed for VTOL and STOL, the control harmony ratio for VTOL is slightly higher than the recommended maximum. But there is no negative pilot comment on this fact. The reason may be the reduced workload gained with the attitude stabilization system.

The height control is fixed at all times unless moved by the pilot. An adjustable friction damper is installed and provides nearly a constant force during movement of the throttle lever.

5.2.2. LONGITUDINAL RESPONSE

The pitch attitude transient following an abrupt step displacement of the stick is presented in Fig. 18. The upper part of the diagram is a record of a simulator study during the pre-optimization of the CSAS. Stick input pitch attitude and duplex servo output are plotted over time. In the lower part, the results of one of the latest flight test evaluations are presented for the same parameters. The comparison demonstrates a good agreement between simulator and flight test results.

During recent flight tests it was experienced that with increasing forward speed an increasing nose-up moment did build up due to jet-induced down-wash, which was bigger than calculated and model tested. This nose-up moment therefore had to be compensated by a bigger elevator control moment. In Fig. 19 the pitch servo output for a typical accelerated transition is plotted versus speed. Additionally the angle of attack, the nozzle angle of the main engine and the lift engine throttle lever position can be read from the diagram. The maximum servo output is about 45 % of the available. Two problems did arise from this finding:

1. The deadzone of the thrust modulation is $\pm 20\%$ of the servo output. At higher control signals the thrust modulation is used for moment generation. If the takeoff is performed with relative low thrust margin, the rear engine is modulated to maximum rating whereas the front engine is throttled down during the complete transition. This consumes lift engine life time of the rear lift engine and front lift engine throttling may eat the thrust to weight margin.
2. At about 40 % servo output, the intermittent bleed of the main engine is used for moment generation. If this bleed consumption exceeds the specified bleed cycle, a temperature increase in the main engine arises. This consumes main engine life time.

Special flight investigations were performed to determine the different components of the higher out of trim moments. Load on the elevator could be determined by means of strain gauges and resultant from this flying tail was given a higher incidence to solve this

problem. Tail downwash of course will be reduced with down rating of lift engines while flying through transition.

An interesting result is that the out of trim moment disappears as well when the aircraft is in the ground effect zone (< 10 ft). See Fig. 20, where a takeoff history does show this clearly.

5.2.3. LATERAL RESPONSE

The roll attitude transients following abrupt step displacements of the stick are presented in Fig. 21. Roll stick position, bank angle and servo output are plotted versus time. When the pilot holds the stick deflection for a given time, the aircraft builds up a translatory speed in wing direction. This sideslip motion generates a rolling moment, that reduces the demanded attitude if the pilot holds the stick in a constant position. The slope of the bank angle reduction can be seen in Fig. 21. The result is a reduced side force, so that a constant side speed is achieved. This effect can be optimized by the overall loop gain of the attitude stabilization system and is designated as 'Error Proportional Attitude Control'. If the pilot wants to compensate the roll moment due to sideslip at constant bank angle, he has to increase the stick deflection. This gives him a good indication of the control moment margin. Fig. 22 is another presentation of this effect. The required bank angle for a stationary cross wind condition is plotted versus cross wind (side speed). In the same plot, the necessary stick commanded bank angle and the required roll servo output is presented. It is obvious, how the difference between the commanded and the required bank angle increases with cross wind in the safe sense.

A wellknown problem for V/STOL aircraft especially those with small wing aspect ratio is the sideslip limitation in transition because of the high rolling moments due to sideslip in relation to the available roll control power. In Fig. 23 the allowable sideslip angle for different angles of attack is plotted over airspeed based on 50 % roll control power consumption for compensating the rolling moment due to sideslip. The boundaries are derived from simulator studies. A number of available points from flight test evaluation are summarized in the table of Fig. 23 to give a first survey of this range which meanwhile has been proven during flight test. Final updating will be performed during following evaluation.

The yaw rate transients following different displacements of the pedals are presented in Fig. 24 for the hovering condition. With increasing forward speed up to 20 kn there is a slightly divergent behaviour around the yaw axis. This is based on the destabilizing effect of the main engine air intake momentum drag. With increasing airspeed over 20 kn an increasing weathercock stability is built up as shown in Fig. 25, so that a proportional relation between pedal deflection and sideslip angle is given comparable with the lateral behaviour of conventional aircraft. For coordinated turns below 100 kn the pilot uses the pedals for coordination. At speed higher than 100 kn no coordination is necessary because of sufficient weathercock stability, therefore the pilot does not use the pedals.

5.2.4. HOVERING AND VERTICAL FLIGHT PATH CHARACTERISTICS

Several tests were devoted to ground effect in hovering flight. These tests gave the confirmation, that there are no recirculation or reingestion problems in the AGARD defined VTOL range up to 30 kn. Recirculation investigations were performed by measuring the engine air intake temperatures while flying in and out of the ground effect.

When approaching the ground below 10 ft altitude a positive remarkable ground effect (increasing lift) builds up, so that in a constant speed descent the pilot must reduce the engine power further when diving into the ground effect to make his vertical landing. Otherwise the aircraft will stay hovering a few feet above the ground. In Fig. 26 the time history of a constant speed, constant throttle lever position descent into the ground effect zone represents the positive lift effect.

During the hovering tests the height control sensitivity was evaluated. The results are presented and compared with AGARD recommendations in Fig. 27. All derived flight test data are within the recommended boundaries and the 'pilot ratings' approve these recommendations.

5.2.5. FLIGHT CONTROL SYSTEM TRANSITION CHARACTERISTICS

Basic concept for the CSAS was to find a simple and reliable solution for each single control chain and keep the necessary degree of redundancy of the complete system on triplex. Use of the operational amplifier principle was made, in which the transfer functions and/or the aircraft dynamic behaviour are generated by resistors and capacitors in the external networks in a simple and clear manner. To avoid continuous parameter variation as function of the dynamic pressure or the use of an adaptive control system because of its complexity a discontinuous parameter change was selected for three specified flight ranges called

- VTOL from 0 to 120 kn
- TRANSITION from 120 to 180 kn and
- DAMPER for speed larger than 180 kn.

Within these flight ranges the control parameter are constant because the behaviour of the CSAS is sufficient insensitive against variations of the aircraft parameters like frequency, damping, time constants and control surface effectiveness. The change-over can be done either manually by the pilot on the CSAS control unit in the cockpit or automatically by a dynamic pressure sensing unit. The change-over mode can be selected by the pilot.

In Fig. 28 the transfer functions for the three flight ranges for pitch, roll, and yaw are represented. In the VTOL mode up to 120 kn a pure attitude control in pitch and roll and a rate control in yaw is realized. By adding of an integrator into feedback of the stabilizing amplifier output signal is automatically trimmed to zero with a certain time constant. In this case the pilot must follow up the stick to maintain the attitude flight condition, synchronizing the control stick with the control surface deflection. This guarantees a shock-free change-over from TRANSITION to DAMPER mode under all flight conditions. Additionally the integrator changes the attitude control mode to a rate control mode which gives the pilot the possibility during the transition to adapt already to conventional flight characteristics.

In the yaw axis the same rate control arrangement is used for TRANSITION as for VTOL.

In the DAMPER control mode the attitude reference is switched off in pitch and roll. The main sensor is the rate gyro, which feeds into a lead/lag network producing a rate control behaviour in pitch and roll. In yaw axis a conventional damper network in form of a wash-out filter is used, performing a conventional damper function.

6. GROWTH POTENTIAL AND FUTURE DEVELOPMENT

Based on the original design and taking into consideration the emphasis on improved battlefield maneuverability it is the companies intention to find ways for further development of this aircraft into an operational version. An analysis towards a number of suitable

close-air-support and strike missions as well as air combat capability studies did bring forward a number of growth versions (Fig. 29). Based on the Rolls Royce RB 193 engine which can be improved in thrust by about 30 % and furnished with "Plenum Chamber Burning" using either the lift engines RB 162 or XJ 99 an aircraft with a smaller wing loading, higher fuel and weapon load i.e. improved payload/range capability can be derived with increased performance, the better the engine combination is in thrust to weight ratio and fuel consumption. Performance of VAK 191 B/Mk1 through Mk4 version for a given payload of 3000 lb can be read for a Lo-Lo-Lo mission from Fig. 30.

It is of course no intention to go into too much performance detail of the improved VAK 191 B versions but highlight those areas where from present test experience, improvements and revisions could be considered with respect to better handling, improved reliability and better economy.

Thus intermittent bleed from lift/cruise engine may be reduced to gain a higher maximum thrust. Larger amount of bleed is taken only in emergency. For compensation, the dead zone of lift engine thrust modulation may be made smaller and modulation regime may be increased. Non-linear Control and Stability Augmentation System (CSAS) may help in reducing bleed demand further and finally it may be considered to get rid of the mechanical back-up system in the flight control system and replace this with considerable weight saving against an electrical back-up.

7. CONCLUDING SUMMARY

The VAK 191 B V/STOL Experimental Aircraft designed for Strike-Reconnaissance application has been described and discussed especially with respect to optimum handling qualities designed into the aircraft and proven by flight test results achieved so far. Future development improvements have been touched and finally the following can be summarized:

- The VAK 191 B demonstrates to be a versatile lift plus lift/cruise V/STOL concept incorporating very advanced technology. It has built in
 - design flexibility with respect to engine thrust improvement,
 - engine out-get-you-home capability
 - crew safety in engine out condition and
 - inflight thrust vectoring for improved maneuverability
- VAK 191 B handling qualities are optimized for minimum pilot workload and safe operation especially under bad weather conditions
- VAK 191 B growth potential is attractive, it offers operational use with increased payload/range capability and improved maneuver performance in subsonic and supersonic aircraft versions.

8. REFERENCES

- (1) Germany builds strong VTOL Expertise
Aviation Week & Space Technology, April 24, 1972
- (2) VAK 191 B Germany's V/STOL Fighter
Flight International, April 13, 1972
- (3) R. Riccius, F. Giura
VFW/FIAT VAK 191 B, Interavia 9, 1967
- (4) R. Riccius
Zur Flugerprobung der VAK 191 B, Interavia 9, 1971
- (5) V/STOL Comparison Study
AGARD Advisory Report 18, 1969
- (6) V/STOL Aircraft and Their Applications,
AGARD-CP-69-70, July 1970
- (7) R. Riccius
Designer's View on Structural Problems
AGARD-CP-62, March 1972
- (8) R. Riccius
Flugerprobung VAK 191 B
Flugrevue/Flugwelt Februar 1972
- (9) L. Obermeier
Schwebeflug und Transitionserprobung der VAK 191 B
DFVLR-Vortrag 26. 9. 72, Oberpfaffenhofen

9. ACKNOWLEDGEMENT

The authors are indebted to the German Ministry of Defense and to the Management of VFW-Fokker GmbH, Bremen, for approval to deliver this paper. They further wish to express their sincerest thanks to the members of the VAK 191 B-staff and especially to the gentlemen listed on the front page for their valuable help and support.

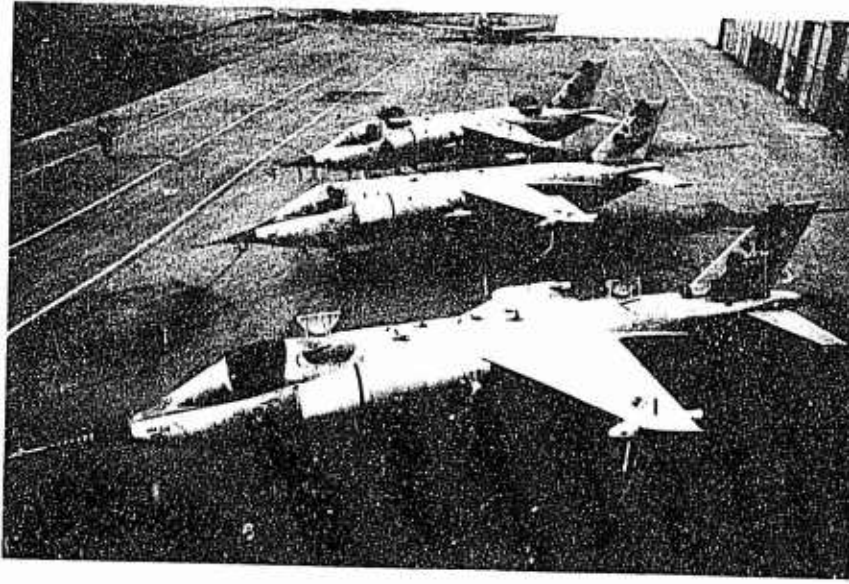

FIG. 1 VAK 191 B - V/STOL STRIKE-RECCE AIRCRAFT, 3 EXPERIMENTAL AEROPLANES AT VFW-FOKKER, BREMEN, GERMANY

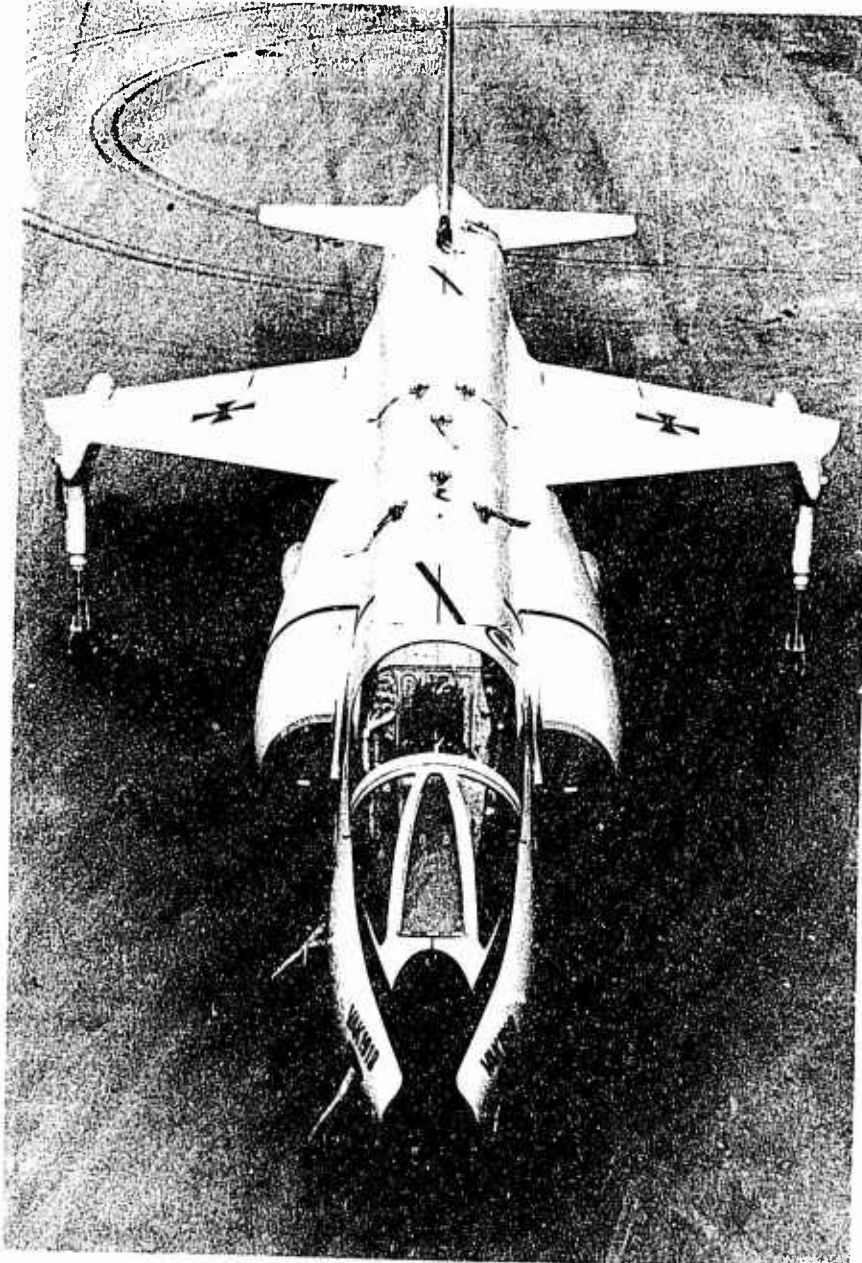
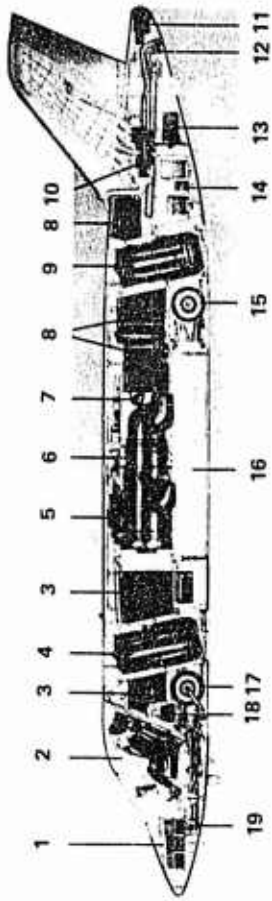
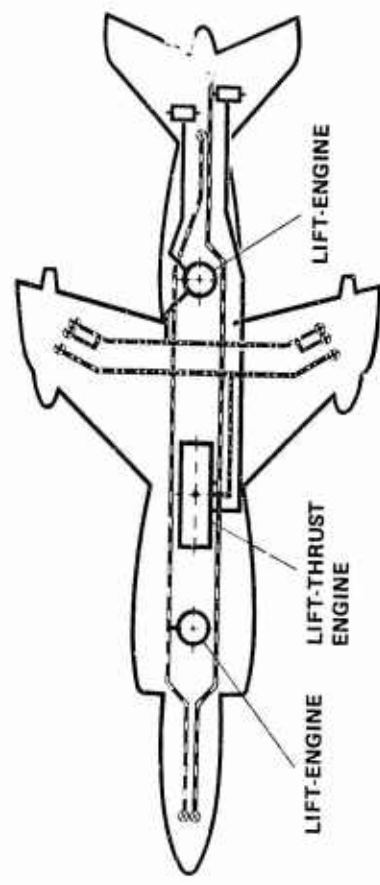

FIG. 2 VAK 191 B, FRONT VIEW



- 1 ELECTRONICS COMPARTMENT
- 2 COCKPIT
- 3 FRONT FUEL TANKS
- 4 FRONT LIFT ENGINE
- 5 ACCESSORY DRIVE
- 6 LIFT-THRUST ENGINE
- 7 SWIVELLING NOZZLES DRIVE
- 8 REAR FUEL TANKS
- 9 REAR LIFT ENGINE
- 10 AUXILIARY POWER UNIT (APU)
- 11 DRAG CHUTE
- 12 PITCH AND YAW CONTROL NOZZLES
- 13 INTEGRATED HYDRAULIC COMPONENT
- 14 ELECTRONICS COMPARTMENT
- 15 MAIN UNDERCARRIAGE
- 16 LOAD COMPARTMENT
- 17 NOSE UNDERCARRIAGE
- 18 AIR CONDITIONING AND OXYGEN SUPPLY
- 19 PITCH CONTROL NOZZLES

FIG. 4 LONGITUDINAL SECTION THROUGH FUSELAGE OF VAK 191 B



- 1 PITCH CHANNEL
- 2 ROLL CHANNEL
- 3 YAW CHANNEL

FIG. 5 VAK 191 B, BLEED AIR SYSTEM

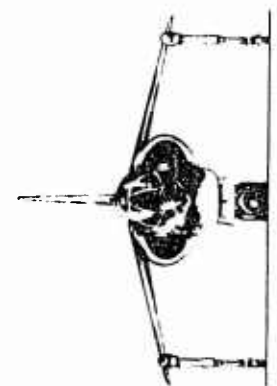

Dimensions:

Wing span	6.18 m
Overall length	14.72 m
Height on the ground	4.295 m
Height in flight	3.495 m
Wing area	12.5 m ²
Dihedral angle of wings	-12.5°
Dihedral angle of horizontal tail	-8°



FIG. 3 VAK 191 B, THREE-VIEW DRAWING

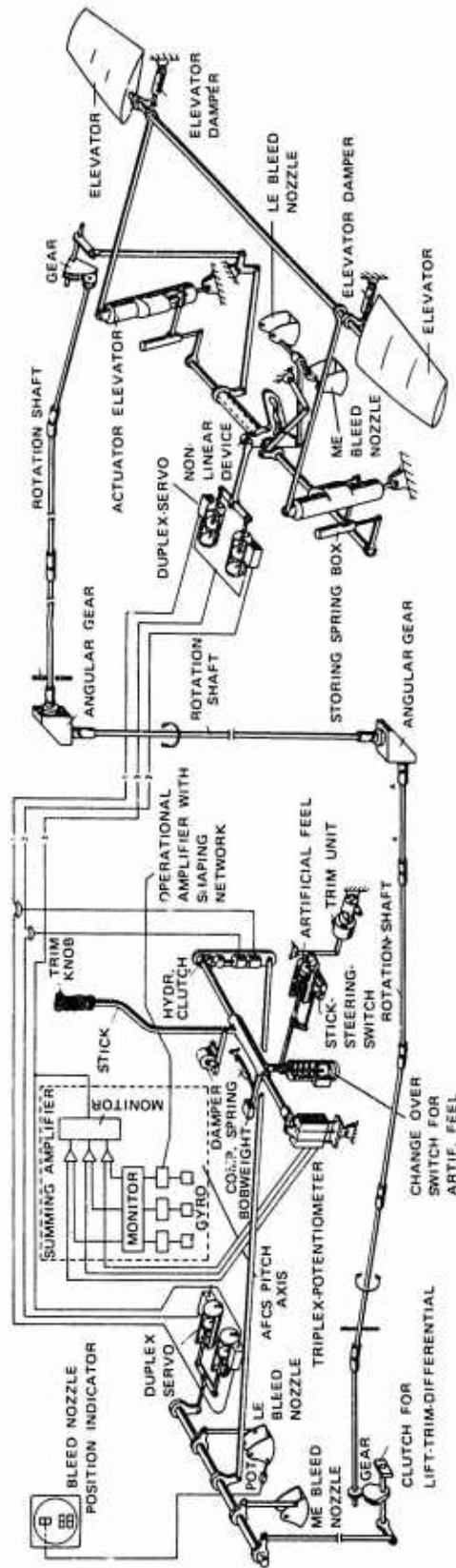

FIG. 6 VAK 191 B, FLIGHT CONTROL SYSTEM (PITCH AXIS)

- FLY - BY - WIRE
- CONTROL AND STAB. AUGM. SYSTEM (CSAS)
- BUILT-IN TEST EQUIPMENT (BITE)
- HIGH PRESSURE HYDRAULIC SYSTEM
- AUXILIARY POWER UNIT FOR
 - SYSTEM CHECK-OUT AND AIR COND. ON THE GROUND
 - ENGINE STARTING
 - EMERGENCY POWER IN FLIGHT

FIG. 7 VAK 191 B, TECHNOLOGY

1. WIND TUNNEL TEST HOURS		
SUBSONIC	4400 h	7350 h
VTOL - AND TRANSITION EFFECT RECIRCULATION INVESTIGATIONS	2950 h	2000 h
TRANSONIC		500 h
2. TEST-RIGS		
2.1 HYDRAULIC- AND FLIGHT-CONTROL TEST RIG		
TOTAL TESTS		340
SYSTEM RUNNING TIME		750 h
2.2 ELECTR. TEST RIG		
TOTAL TESTS		200
SYSTEM RUNNING TIME		650 h
2.3 BLEED AIR TEST RIG		
TOTAL TESTS		430
SYSTEM RUNNING TIME		345 h
2.4 FUEL TEST RIG		
TOTAL TESTS		345
SYSTEM RUNNING TIME		220 h
2.5 STARTER-AIR CONDITIONING-AIR MOTOR TEST RIG		
TOTAL TESTS		17
SYSTEM RUNNING TIME		280 h

FIG. 8 VAK 191 B, WIND-TUNNEL TEST AND SUBSYSTEM TEST RIG PROGRAM

TOTAL NUMBER OF SIMULATIONS	492
TOTAL SIMULATION TIME	996 h
• SOFTWARE SIMULATIONS WITHOUT PILOT	732 h
• HARDWARE SIMULATIONS	183 h
• SIMULATIONS WITH PILOT	81 h

FIG. 9 VAK 191 B, SIMULATION PROGRAM

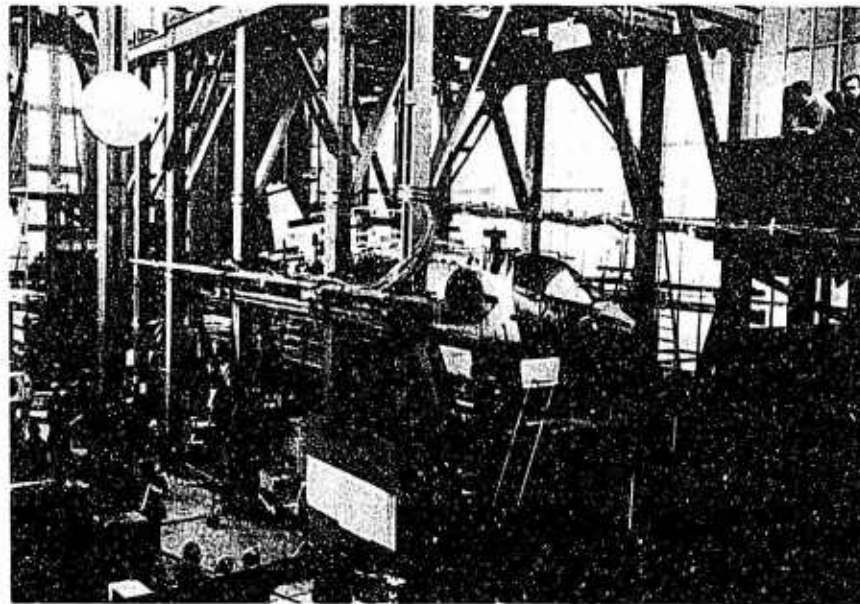

FIG. 10 VAK 191 B, AIRFRAME V4 STRUCTURAL TEST

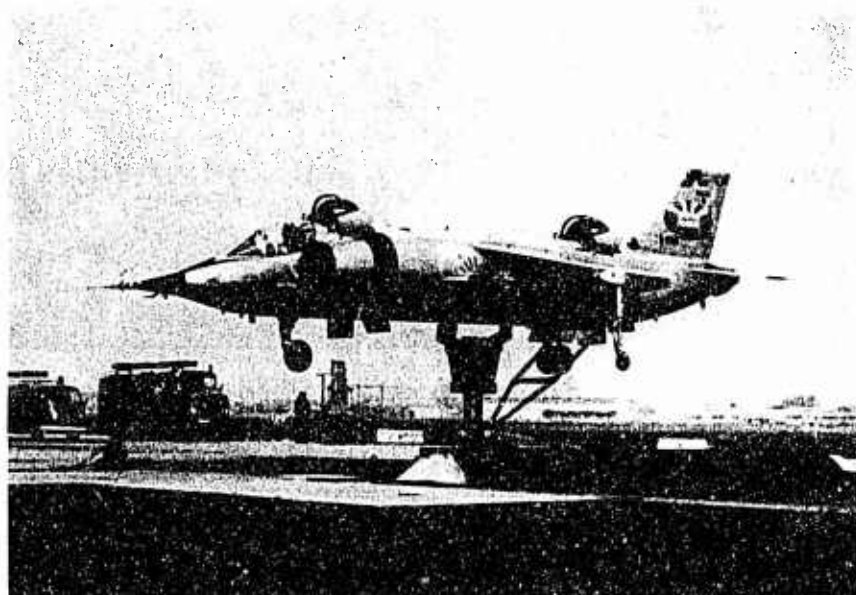

FIG. 11 VAK 191 B, TETHERED TEST

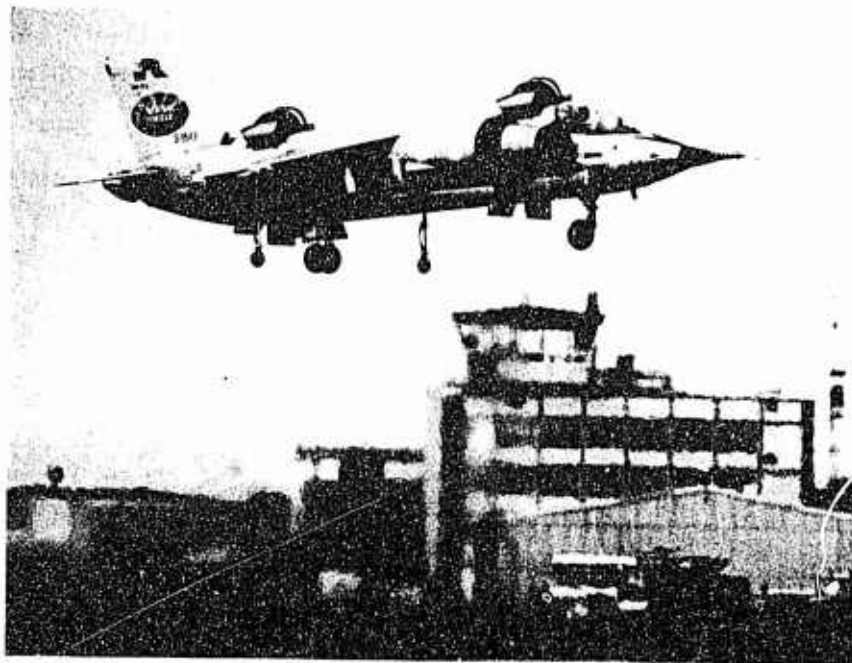

FIG. 12 VAK 191 B IN HOVERING

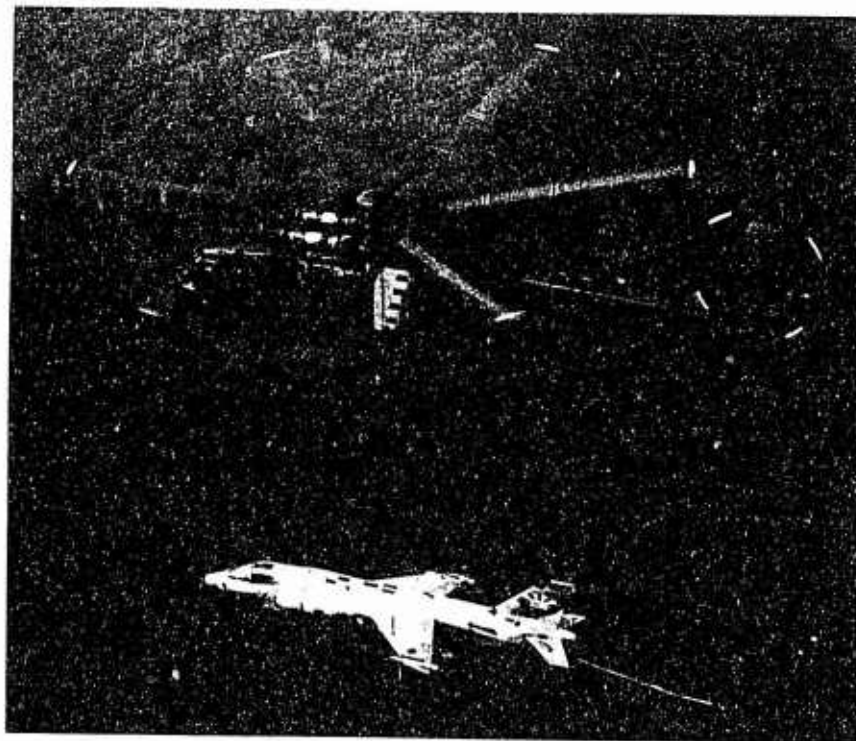

FIG. 13 VAK 191 B, TRANSFER TO GERMAN AIR FORCE TEST CENTER AT MANCHING WITH CRANE HELICOPTER CH54

THE VAK 191 B PROTOTYPE FLIGHT TESTING.

Until October 1972 the following data have been achieved:

- speed range 0 - 240 kn
- aircraft attitudes in hovering and transition
 - ± 45° in roll
 - + 15° in pitch
 - 15° in pitch
- 360° yawing manoeuvres during hovering with a maximum rate of 30°/s
- maximum crosswind during hovering manoeuvres 33 kn

THE TESTS HAVE DEMONSTRATED THE FOLLOWING RESULTS:

- Aircraft flight control system provides excellent aircraft handling qualities
- engine control permits perfect altitude hold in hovering
- good weather cock stability, thus the aircraft is less sensitive to yaw-roll couplings in transition
- positiv ground effects up to 10 feet above the ground
- the aircraft is virtually free of engine exhaust gas recirculation
- engines and energy supply including APU operate in satisfactory manner
- the a/c subsystems are working within their specified range
- there are no problems due to sonic or thermal loading.

FIG. 14 VAK 191 B, GENERAL FLIGHT TEST RESULTS

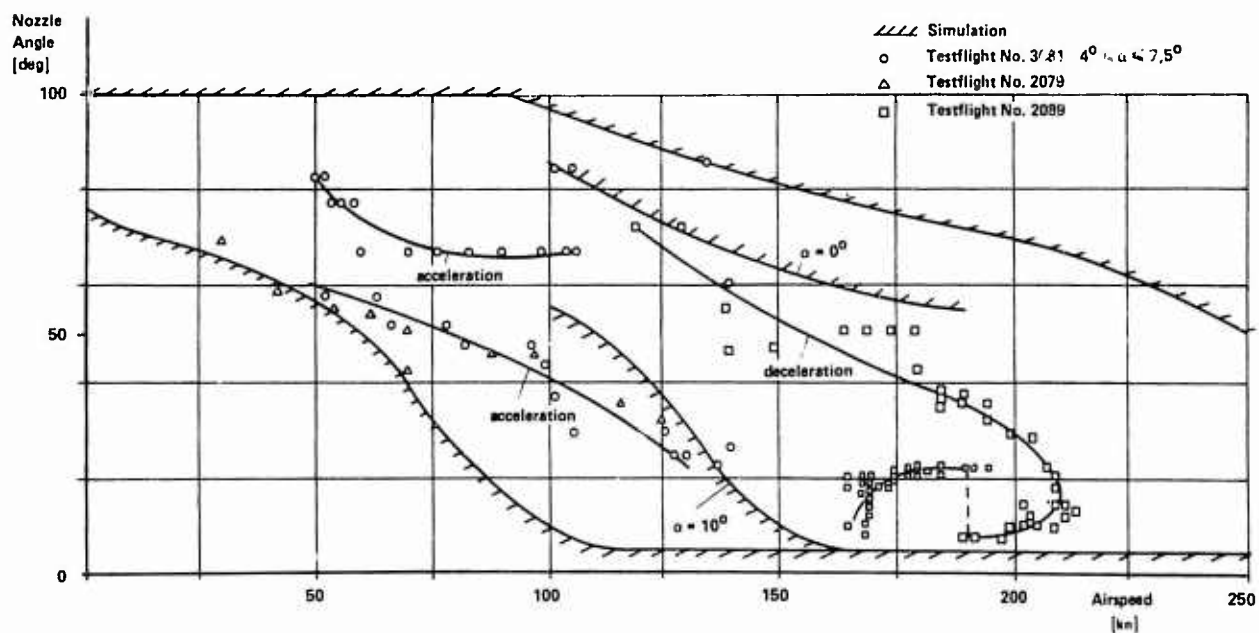

FIG. 15 VAK 191 B, TRANSITION CORRIDOR

	Pitch-Attitude-System		Roll-Attitude-System		Yaw-Rate-System	
	AGARD Rep. 577	VAK 191 B	AGARD Rep. 577	VAK 191 B	AGARD Rep. 577	VAK 191 B
VSTOL Breakout Force [lb]	0,5 - 3,0	1,2	0,5 - 3,0	1,0	1,0 - 10,0	3,1
Control Force Gradient [lb/in]	1,0 - 3,0	2,7	0,5 - 1,5	1,7	2,5 - 10,0	15,3
Peak Control Force [lb]	push 15 pull 25	13,3	15	8,9	15 - 50	47
Max. Control Travel [in]	4,0 - 6,5	4,2	3,0 - 6,5	2,6	2,5 - 4,5	2,6
Attitude Change per Unit Control Deflection [deg/in]	3,0 - 5,0 Minimum	3,6	3,0 - 5,0 Minimum	5,7 (7,15)	-	-
Max. Attitude at Max. Control Deflection [deg]	-	15	-	16	-	-
Time to 90 % of the Demanded Attitude Change, T_{90} [sec]	1 - 2	1,6	1 - 2	1,6	-	-
Transient Overshoot [%]	< 15	< 15 variable	< 15	~ 0	-	-
Rate Change per Unit Control Deflection [deg/sec/in]	-	-	-	-	-	11,5
Max. Rate at Max. Control Deflection [deg/sec]	-	-	-	-	-	30
Time for 15° Heading Change [sec]	-	-	-	-	1,0 - 2,5	1,7
Time Constant [sec]	-	-	-	-	-	2
Angular Acceleration [rad/sec ²]	0,1 - 0,3 Minimum	1,2	0,2 - 0,4 Minimum	1,4	0,1 - 0,5 Minimum	0,35

FIG. 16 VAK 191 B, FLIGHT CONTROL AND STABILITY CHARACTERISTICS IN HOVER, COMPARISON WITH AGARD-REPORT 577 CRITERIA

Control Force Ratio	AGARD Report 577			VAK 191 B
	Minimum Ratio	Optimum Ratio	Maximum Ratio	
$\frac{\text{Pitch}}{\text{Roll}}$ (VSTOL)	1	2	4	1.59
$\frac{\text{Yaw}}{\text{Roll}}$ (VTOL)	4	6	8	9
$\frac{\text{Yaw}}{\text{Roll}}$ (STOL)	4	8	16	9

FIG. 17 VAK 191 B, CONTROL FORCE HARMONY RATIO CRITERIA, COMPARISON WITH AGARD-REPORT 577

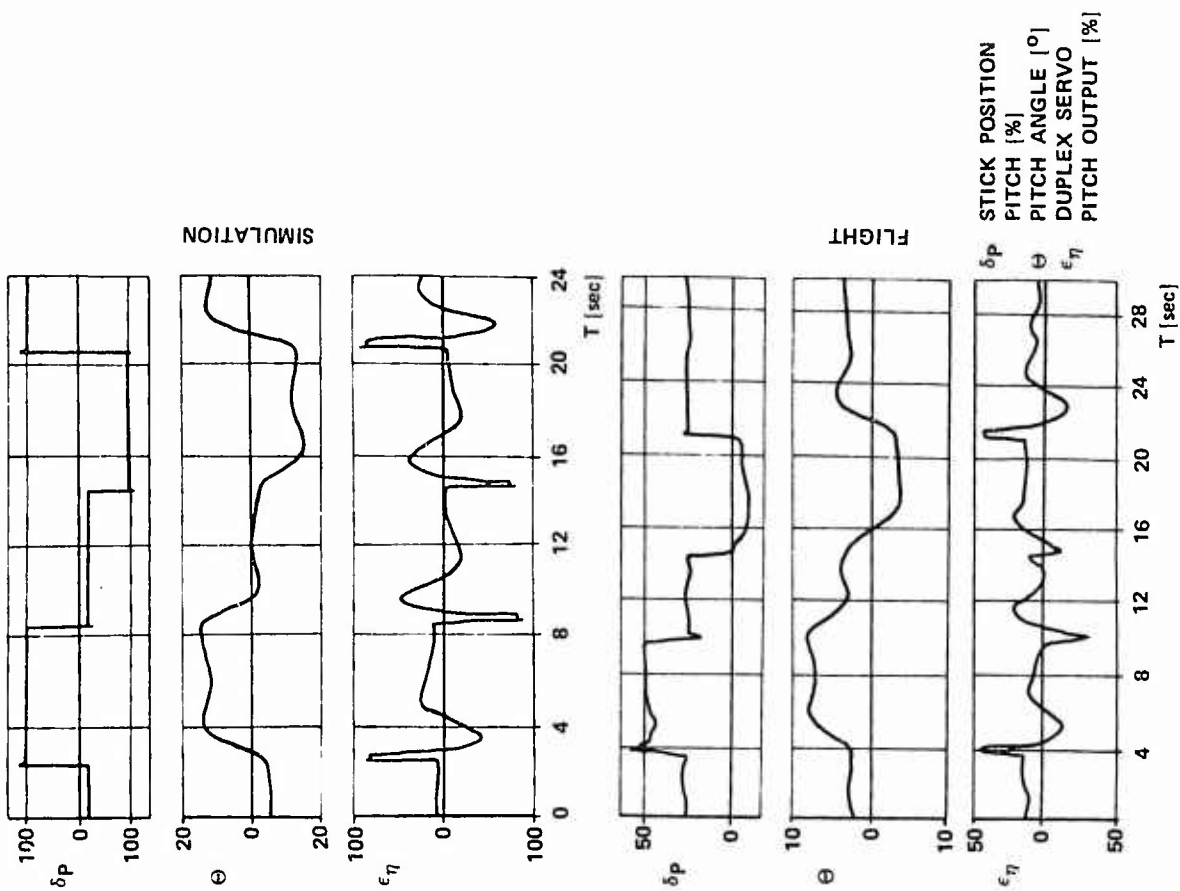

FIG. 18 VAK 191 B, HANDLING QUALITIES, PITCH CONTROL IN SPOT HOVER

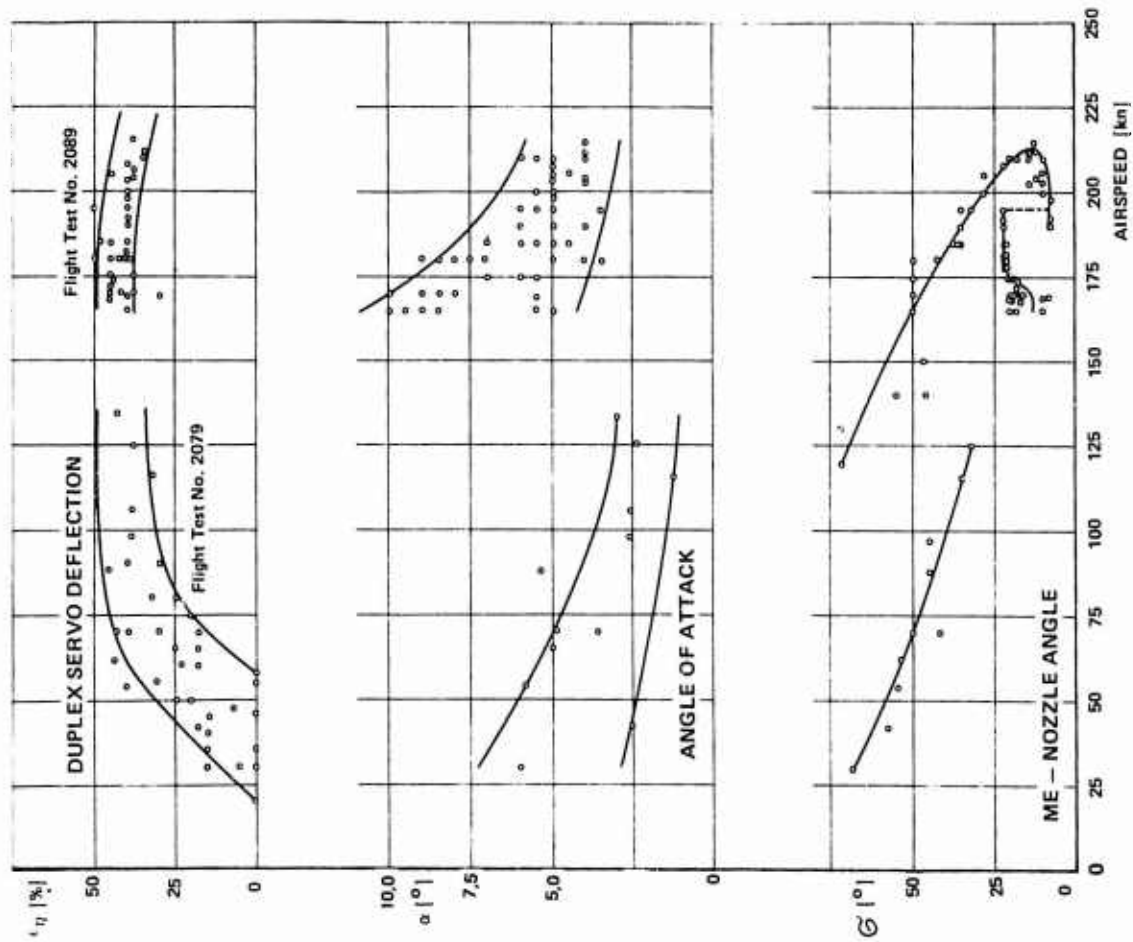

FIG. 19 VAK 191 B, PITCH TRIM DURING ACCELERATION

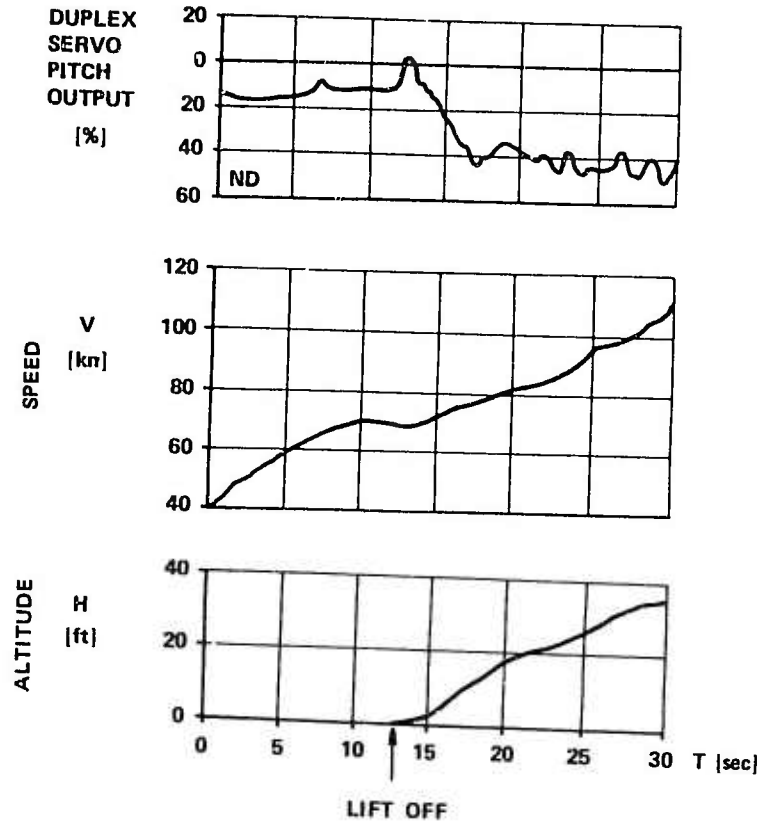

FIG. 20 VAK 191 B, INFLUENCE OF GROUND EFFECT ON PITCH TRIM

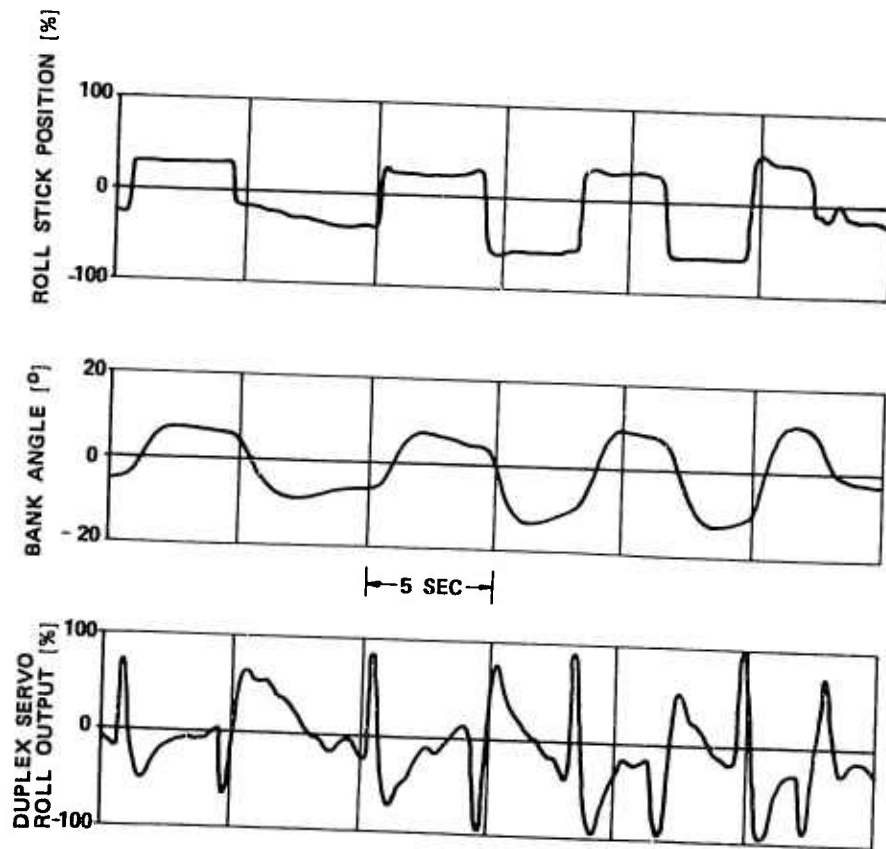

FIG. 21 VAK 191 B, HANDLING QUALITIES, ROLL CONTROL IN SPOT HOVER

FLIGHT TEST RESULTS

Test No.	1194	1195	2067	2069	2089	2089	2089	2089	3081	3081	3081	3081
Symbol	⊙	⊙	Δ	Δ	Δ	Δ	Δ	Δ	Δ	Δ	Δ	Δ
kn	25	23	40	70	168	180	190	130	105	125	145	
angle of attack	15	2	7.5	14	4	3	6	7	4.5	7	6	
angle of sideslip	25	80	20	10	2	1.5	1.5	2	1.5	1.5	2	
roll control power	95	45	60	100	12	5	7.5	13	10	8	9	

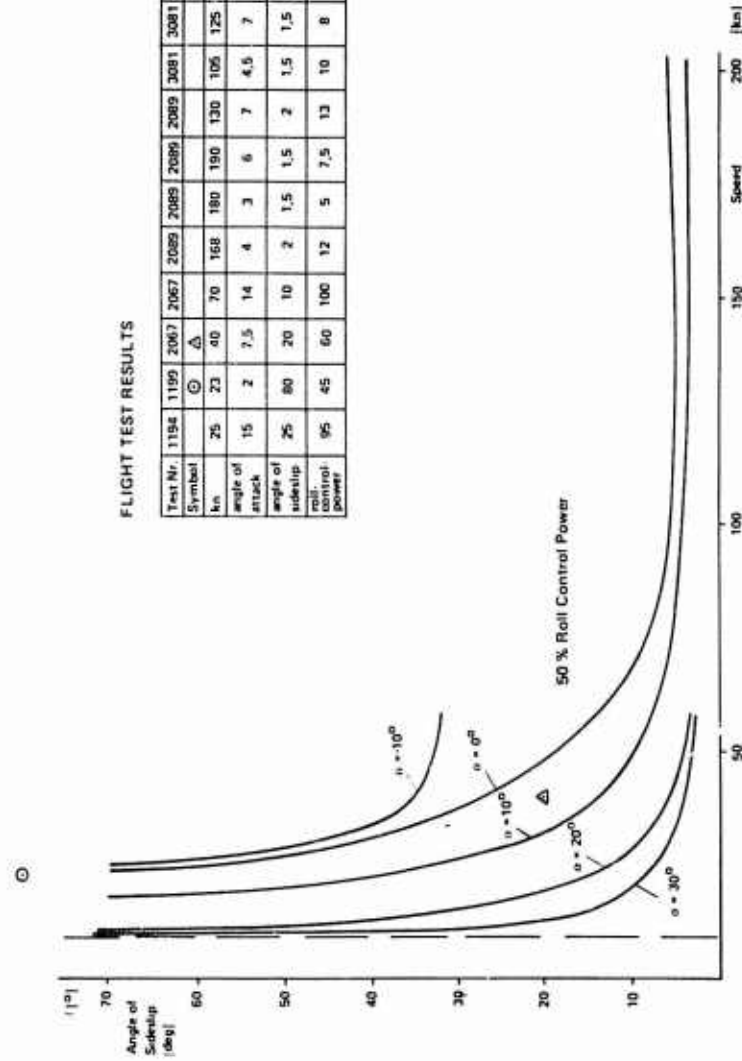

Fig. 23 VAK 191 i , ROLLING MOMENT IN STEADY SIDESLIP

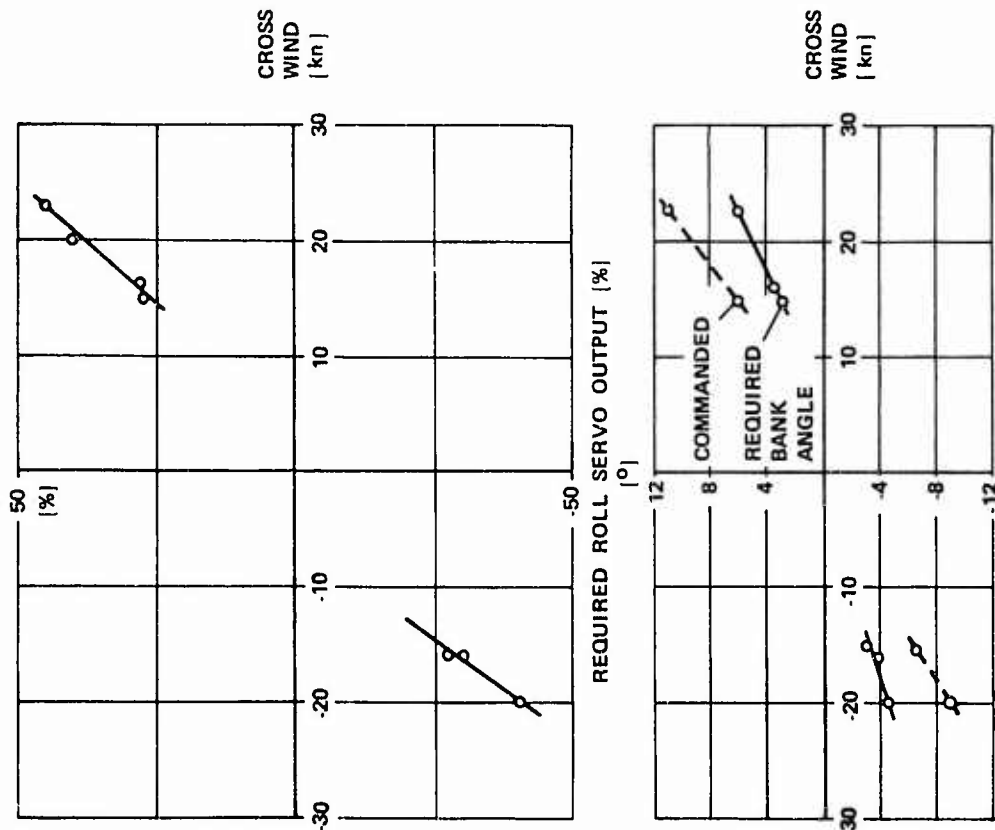

FIG. 22 VAK 191 B, ROLL CONTROL REQUIREMENTS FOR CROSS WIND CONDITIONS

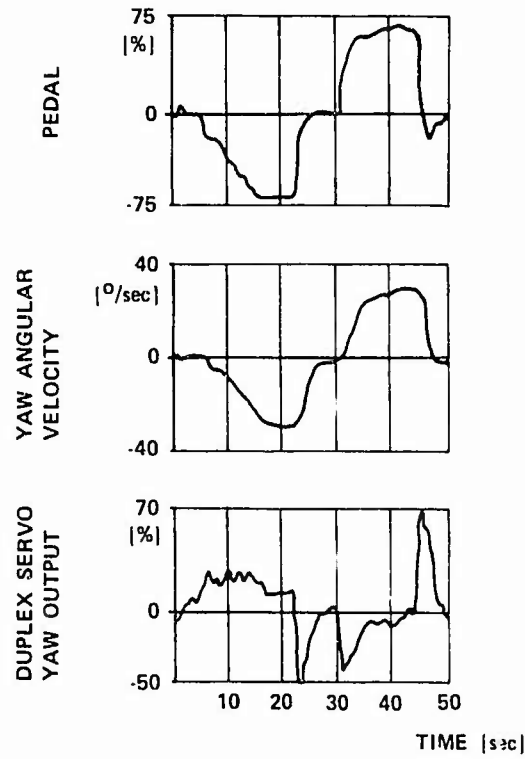

FIG. 24 VAK 191 B, HANDLING QUALITIES, YAW CONTROL IN SPOT HOVER

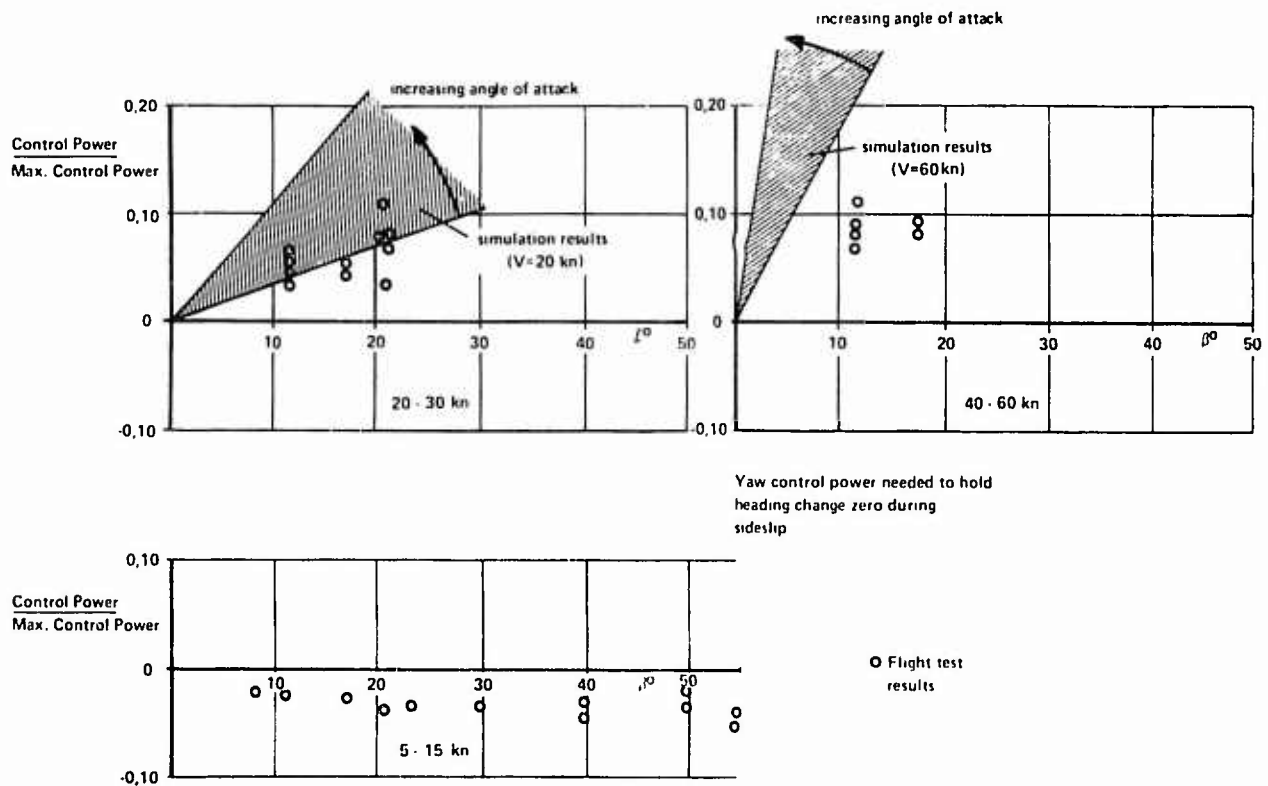

FIG. 25 VAK 191 B, LOW SPEED WEATHERCOCK STABILITY

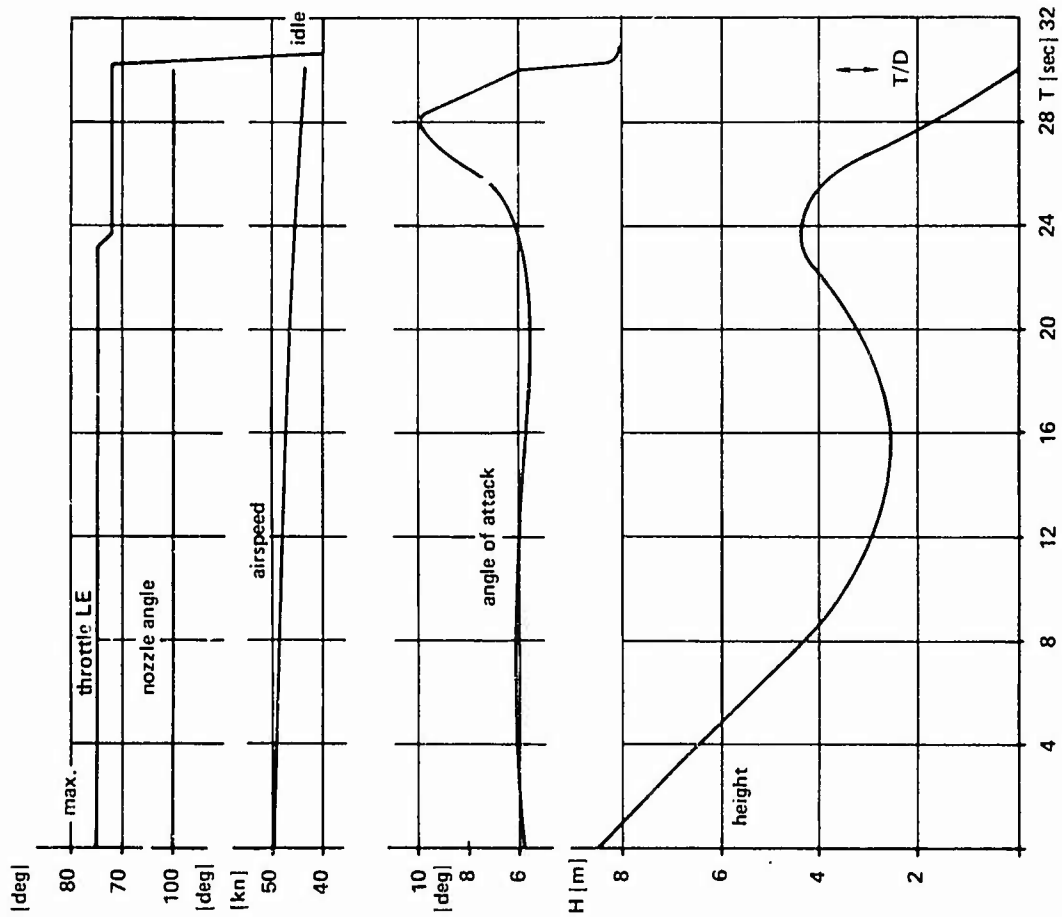

FIG. 26 VAK 191 B, LIFT IN GROUNDEFFECT

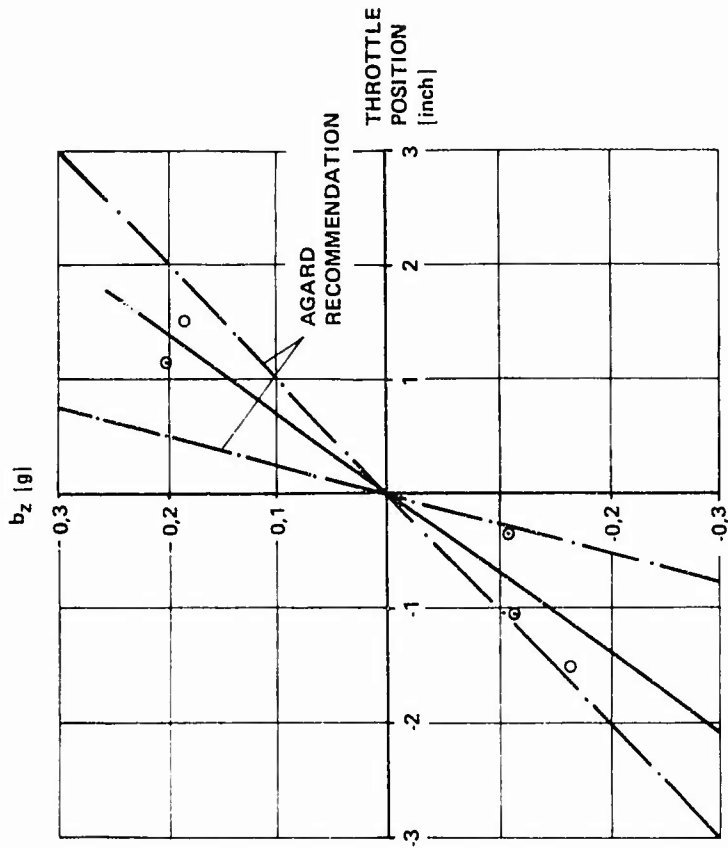

FIG. 27 VAK 191 B, HEIGHT CONTROL SENSITIVITY

	PITCH-AXIS	ROLL-AXIS	YAW-AXIS
VTOL MODE	$\epsilon = \left(0,927 - \frac{0,344}{1+1,65s} \right) \frac{V}{\delta_{\theta k}}$ $- \left(1,834 \frac{V}{\delta_{\theta}} + 0,589 \frac{1+0,078s}{1+0,032s} \frac{V}{\delta_{\omega_y}} \right)$	$\epsilon = (0,472 + 0,376 \frac{1+1,8s}{1+2,29s}) \frac{V}{\delta_{\phi k}}$ $- \left(0,965 \frac{V}{\delta_{\phi}} + 0,634 \frac{V}{\delta_{\omega_x}} \frac{1+1,8s}{1+2,29s} \right)$ <p>$\epsilon_{c \max} = 16^\circ$</p>	$\epsilon = 0,131 \frac{V}{mmp} - 0,267 \frac{V}{\delta_{\omega_z}}$
TRANSITION MODE	$\epsilon = 0,927 \frac{V}{\delta_{\theta k}} + \left(\frac{0,714}{1+1,65s} \frac{V}{\delta_{\theta}} - 1,73 \frac{V}{\delta_{\theta}} - 1,22 \frac{1+0,0782s}{1+0,032s} \frac{V}{\delta_{\omega_y}} \right) \frac{s(1+1,09s)}{1+3,07s+3,95s^2}$	$\epsilon = 0,472 \frac{V}{\delta_{\phi k}} + \left(0,111 \frac{V}{\delta_{\phi}} - 0,29 \frac{V}{\delta_{\phi}} - 0,159 \frac{V}{\delta_{\omega_x}} \right) \frac{s(1+2,7s)}{1+2,98s+1,46s^2}$	
DAMPER MODE	<p>DAMP I</p> $\epsilon = 0,927 \frac{V}{\delta_{\theta k}} - 0,587 \frac{1+0,0588s+1+0,33s}{1+0,0103s+1+0,8s} \frac{V}{\delta_{\omega_y}}$ <p>DAMP II</p> $\epsilon = 0,927 \frac{V}{\delta_{\theta k}} - 0,346 \frac{1+0,0588s+1+0,33s}{1+0,0103s+1+0,8s} \frac{V}{\delta_{\omega_y}}$	<p>DAMP I</p> $\epsilon = 0,472 \frac{V}{\delta_{\phi k}} - 0,0705 \frac{1+0,112s}{1+0,0102s} \frac{V}{\delta_{\omega_x}}$ <p>DAMP II</p> $\epsilon = 0,189 \frac{V}{\delta_{\phi k}} - 0,0282 \frac{1+0,112s}{1+0,0102s} \frac{V}{\delta_{\omega_x}}$	$\epsilon = 0,131 \frac{V}{mmp} - \frac{0,585s}{1+1,25s} + \frac{1+0,107s}{1+0,01s} \frac{V}{\delta_{\omega_z}}$
SYMBOLS	<ul style="list-style-type: none"> ϵ = CSAS PITCH OUTPUT SIGNAL δ_k = PITCH STICK DEFLECTION θ = PITCH ATTITUDE ANGLE ω_y = PITCH RATE 	<ul style="list-style-type: none"> ϵ = CSAS ROLL OUTPUT SIGNAL δ_k = ROLL STICK DEFLECTION ϕ = ROLL ATTITUDE ANGLE ω_x = ROLL RATE 	<ul style="list-style-type: none"> ϵ = CSAS YAW OUTPUT SIGNAL p = PEDAL DEFLECTION ω_z = YAW RATE

FIG. 28 VAK 191 B, CSAS TRANSFER FUNCTIONS FOR THE THREE CONTROL MODES

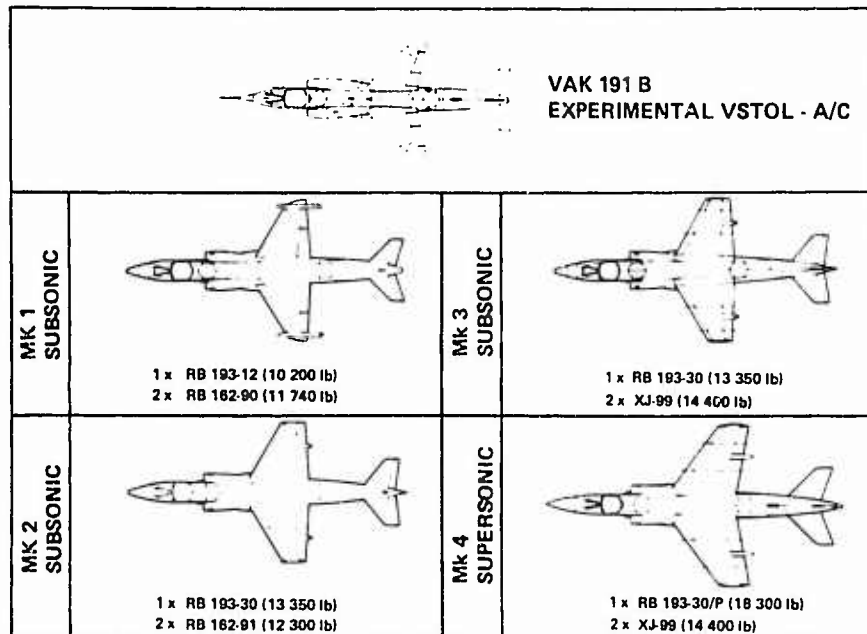

FIG. 29 VAK 191 B, GROWTH POTENTIAL VARIANTS

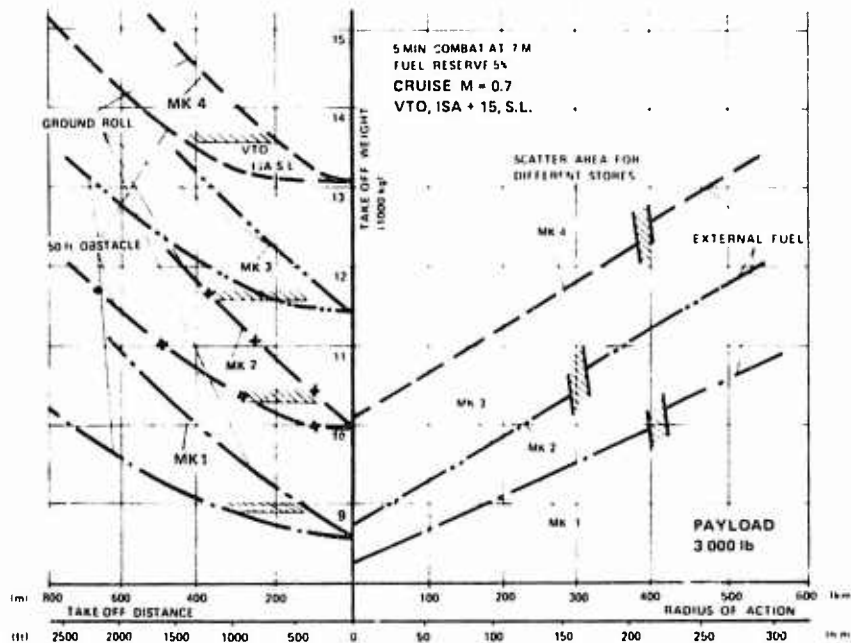

FIG. 30 VAK 191 B, GROWTH POTENTIAL, PERFORMANCE IMPROVEMENT

TESTING AND EVALUATION OF THE CANADAIR CL-84 TILT-WING V/STOL AIRCRAFT

by F.C. Phillips, Program Manager, Canadair Ltd.

1.0 Summary

In 1957 Canadair and the Canadian Government selected the tilt-wing/slipstream-deflection concept as the basis for a continuing V/STOL program. The CL-84 two-engine tactical utility prototype was developed and demonstrated in 1965-67 to potential users. Its success led to construction of three similar CL-84-1 aircraft intended for military evaluation.

The first CL-84-1 has been evaluated by military pilots during a 100-hour flight test program, which has included dropping of external stores, minigun firing, simulated rescues from hover, use of cargo sling, joint operations with a helicopter carrier at sea, and hover downwash assessment tests together with a comparable helicopter. Total operating time on the CL-84 type is now over 650 hours, including more than 250 flight hours. Further testing is anticipated for 1973.

The second CL-84-1 has been fitted with U.K. terminal-guidance electronic display systems, and in Fall 1972 at the U.S. Naval Air Test Center will begin a one-year U.K./U.S./Canada simulated-IFR test program. Further carrier evaluation tests will also be done.

This extensive testing has proved the outstanding operational flexibility of the two-engine tilt-wing and its broad applicability to roles in support of surface forces. A family of growth variants of the CL-84 has been developed to correspond to the various appropriate military requirements.

2.0 Introduction

2.1 Initial Canadair Work

Under the joint financial sponsorship of the Canadian Government and Canadair Limited (a wholly-owned subsidiary of the General Dynamics Corporation), Canadair has been active in research and development of V/STOL support aircraft since 1956. The first work was a determination of the optimum V/STOL aircraft concept for support of dispersed ground forces; the tilt-wing/slipstream-deflection principle was chosen as promising the most effective aircraft from the overall point of view. The period through 1962 was taken up with acquisition of capability in the technologies of particular importance to development of full-scale tilt-wing aircraft, specifically: concepts and detail design of appropriate control systems; powered-model testing in the open air and otherwise under truly representative conditions; static testing of model propellers and parallel analytical work toward design of propellers for maximum static performance; flight simulation, making use of outputs from the above activities and preliminary design studies to arrive at synthetic aircraft having high probability of good flying qualities. During this period proposed Canadair tilt-wing aircraft, e.g. the CL-62 in the NATO NBMR-4 design competition, were well-received, indicating achievement of a satisfactory level of V/STOL capability.

2.2 The CL-84 Prototype Program

In 1963, with financial aid from the Government, Canadair undertook to design and manufacture a prototype tilt-wing vehicle, and to develop it to the point of flight demonstration to potential military customers. The CL-84 prototype (Fig. 1) was a two-engine aircraft of 12-14000 lb. gross weight, configured such that it could be used for evaluation in transport and other support roles. The design and its rationale are explained fully in Reference 1. The most notable design features were:

- (a) Large, lightly-loaded (30-35 psf) main propellers.
- (b) Large-chord wing (45-50 psf) immersed in the propeller slipstream.
- (c) Engines, propellers and tail rotor interconnected by gearboxes and shafts.
- (d) Airplane-type controls in cockpit.
- (e) Direct control of propeller blade angles via cockpit power lever in low-speed flight.

- (f) Programming with wing tilt angle of important functions: leading and trailing-edge flaps; tailplane incidence; tail rotor blade angle; controls gains and authorities.
- (g) Stability augmentation system to reduce pilot work load in low-speed flight.

The prototype made its first flight in May 1965, after 36 hours of developmental ground testing. During the ensuing 28 months, 145 hours of flight were accomplished with the one aircraft; total testing time grew to 405 hours. A substantial and very gratifying amount of V/STOL operating experience was obtained; see Reference 1. Figure 2 provides some statistics in this regard. A significant event in the life of the prototype was simulated rescue of a live subject from land and water in September 1966; it is believed that these were the first live simulated rescues from V/STOL aircraft other than helicopters. This and later (Reference 2) experience showed the CL-84 to have outstanding potential in search and rescue. Another notable event was an unofficial evaluation in October 1966 by two NASA research pilots, reported in Reference 3. The NASA pilots found the CL-84 "...well engineered...", and felt that "...In general, based on the limited evaluation performed, most of the flying qualities in the hover, transition and cruise modes of flight were considered good...". A third notable prototype event was a 21-hour evaluation during 1967 by a team of V/STOL pilots and engineers from all U.S. military services. The prototype was found to be a "...mechanically simple, generally easy to maintain, and easy to fly...". The official report (Reference 2) concludes: "...The tilt-wing concept, exemplified by the CL-84 aircraft, is suitable for search and rescue, surveillance, light-transport, and utility type missions...". Suffice it to say that the prototype CL-84 program exceeded the objective of developing an aircraft to the point of demonstration to military agencies.

The prototype was lost in September 1967 during conventional fixed-wing flight at 130 knots; a series of small yaw excursions led to a slow divergence in sideslip, which increased beyond the capability of rudder and aileron control. The aircraft then entered a spiral dive, the two crewmen successfully ejected, and the aircraft crashed and burned. The extensive accident investigation determined beyond reasonable doubt that the accident was caused by a substantial difference in propeller blade angles brought on by a progressive jam or deformation in elements of the propeller control circuit in the right-hand nacelle. Clearly the fault had been in detail design rather than aircraft concept. This finding was accepted, and consequently, while loss of the single aircraft halted flight development, the overall program continued.

3.0 The CL-84-1 Aircraft Evaluation Program

In February 1968 Canadair received from the Canadian Government a go-ahead to build three CL-84-1 aircraft for purposes of military evaluation. The CL-84-1 design was closely related to the prototype in order to obtain maximum advantage of equipment proving and other valuable experience gained during the earlier program. Funding was very restricted, with the result that many improvements desirable for an operational version could not be incorporated. Nevertheless, over 150 engineering changes of some significance were made to the prototype design, although the general outline of Figure 1 was practically unchanged. Figure 3 lists the more important design changes. The most significant change of all was redesign for increased strength, fatigue resistance and reliability of many details of the control system; substitution of rolled for machined threads, thicker lugs, reduced operating loads, and improved fail-safety are indicative of the sorts of changes made and checked out on a full-scale controls rig before beginning of aircraft testing.

The first (8401) and second (8402) CL-84-1 aircraft were placed on test status in mid-1969. The first flights of 8401 and the rollout of 8403 took place in early 1970. The many small changes in the CL-84-1 design resulted in summation in considerable rework, which was developed on the first aircraft from late 1969 into mid-1970. During this period it became evident that the original funding would not be adequate, and it was decided to alter the objectives pro tem to develop 8401 to the point of readiness for military evaluation, and then to prove this by a series of demonstrations of various roles. The program took up this new direction and proceeded successfully, as evidenced by flight experience outlined below.

4.0 CL-84-1 Operational Experience

The comprehensive ground test program planned for aircraft 8401 was substantially complete by the end of August 1970. The most serious problem encountered in ground testing was the discovery of a quality deficiency in a number of specimens of

lift-propulsion system shafting. This deficiency was in the form of tiny surface cracks on the interior of the shafts, and was extremely difficult to detect by normal quality control methods; the flaws were the results of changes in manufacturing techniques from those used for the prototype CL-84 shafts. Replacement of the scrapped shafts, re-inspection of all shafts by improved non-destructive methods, and static testing of a typical shaft to rupture have resulted in improved, consistent quality and high confidence in the adequacy of the shafting. In addition, inertia damping and modified clutch dynamic characteristics have substantially reduced the transient stresses in the highest-stressed portions of shafting.

In fall 1970 flight testing began in earnest. During the 1970-71 winter a comprehensive scheduled inspection was made, and during the same period numerous modifications were made on the basis of test experience to date. Flying resumed in March 1971. Since that time 105 aircraft operating hours, including 75 flight hours, were accumulated during 8 months on test status (11½ months including planned inspection and modification periods). At present aircraft 8401 flight time totals slightly more than 100 hours.

Several portions of the engineering test program are worthy of reporting here. Whereas the CL-84-1 aircraft was designed to a V-n_z envelope encompassing limit load factors to 4.0 at airspeeds to 360 knots EAS, the contract objective was to demonstrate n_z = 3.0 at 275 KEAS and n_z = 1.5 at 300 KEAS. This objective was exceeded without difficulty; n_z = 3.6 was achieved at 170 and 286 KEAS, and n_z = 2.2 at 300 KEAS. In addition, n_z = 3.2 was demonstrated at 130 KEAS in V/STOL flight with 15° wing tilt angle. These final conditions were reached by increments in load factor and airspeed (see Figure 4) during wind-up turns, with frequent structural inspections and analysis of test data. Particular attention was paid to measured stresses in propeller blades and propeller gearbox shells, and in the fitting attaching both the engine and propeller gearbox to the airframe. This work was an extension of that accomplished during the prototype program. Analysis of the test data, and extrapolation to the design limits, indicated no conditions of extreme stress and no conditions incompatible with attainment of the CL-84-1 design life of 1000 flight hours.

The reduced slipstream energy corresponding to rapid deceleration and/or steep descent in V/STOL flight tends to result in local flow separation. While the condition is non-critical and can always be eliminated by application of power, the related aircraft response, e.g. buffeting, at least inhibits the aircrew or otherwise results in a reduced operational envelope. The prototype CL-84 had demonstrated an excellent V/STOL deceleration/descent capability without buffeting (12° minimum descent angle; see Reference 1). On the other hand, aircraft 8401 exhibited premature buffeting, although penetration into steep descent angles did not result in severe buffeting, marginal aircraft control or other operational limitation. The apparent discrepancy is not yet fully understood. However, development testing on 8401 led to a considerably improved buffet boundary for a configuration with increased Krüger flap chord on the inner wing and increased deflection of leading- and trailing-edge flaps. This modification has been refined in detail and installed in aircraft 8402 (see under 5 below) for evaluation and possibly further development. It is felt that with present knowledge, a comprehensive model investigation followed by flight development would pay further dividends in terms of low-speed deceleration/descent characteristics.

The V/STOL handling qualities criteria used in design of the CL-84 prototype were strongly influenced by the recommendations of Reference 4. As wind tunnel and flight simulation results became available, the design was modified on an ad hoc basis. While considerable pains were taken to provide good flying qualities, the favorable flight test results were nevertheless highly gratifying. The CL-84-1 design benefited from the prototype experience in terms of reduced control system friction and backlash, and improved kinematics, as well as in modification of aerodynamic parameters, e.g. elevator area. CL-84-1 flying qualities testing has been by no means exhaustive, but nevertheless a great deal of information is now available. Recently a comparison was made (Reference 5) between CL-84-1 handling qualities and the revised AGARD criteria (Reference 6). The comparison shows that the CL-84-1 qualities are in general accord with Reference 6; this is not to say that there would be no changes made in a new design, since there are a number of desirable refinements, e.g., low-speed height rate damping and reduction of dihedral effect in hover for gross lateral translations. With respect to flying qualities in conventional flight, the CL-84 has been designed in general accord with the U.S. military specification for utility aircraft. The stability of the CL-84-1 as an airplane conforms to the MIL specification except for static directional stability at high angles of attack, a regime of little importance since an operational aircraft would normally operate at low speeds with wing tilt and quite satisfactory stability. Maneuverability of the CL-84-1, e.g. rates of climb, turning performance, roll and pitch response, exceed utility criteria and approach those of combat aircraft.

The advent of V/STOL aircraft, having disk loadings considerably beyond those of the helicopter, has caused considerable argument and some rather inconclusive testing, related to the nature of the various sorts of downwash fields and their compatibilities with V/STOL missions. Many have been satisfied to state that personnel operation of any sort beneath aircraft with disk loadings beyond, say, 10 lbs./sq.ft., is impracticable, whereas in truth downwash is a very complex function of disk loading, absolute thrust level, rotor number and disposition, hover height, etc. Simulated rescue of a live subject from hover over land and water was demonstrated by the CL-84 prototype in September 1966; this proved to many in the technical community that the tilt-wing is a viable rescue vehicle. In a further attempt to shed light on the downwash problem, a series of hover tests was made in December 1970 using the CL-84-1 and a CHSS-2 single-rotor helicopter of the Canadian Armed Forces. The concept of the test was to evaluate downwash beneath and outflow from two V/STOL vehicles of approximately the same gross weight but of very considerably different disk loadings; in point of fact the gross weights were within 15-20% and the disk loadings were in a ratio of 8:1. The downwash beneath the two vehicles was assessed qualitatively by a group including experienced U.S. and Canadian military personnel; the members of the group carried loads, kneeled, ran and otherwise simulated military tasks in the downwash. The conclusions of the group were that: (a) at or beyond a hover height of 60 feet it was possible to work satisfactorily beneath or beyond either vehicle, and (b) at a hover height of 40 feet there are relatively small areas beneath the CL-84-1 within which some training is needed for effective execution of tasks. In the second part of the test, the outflow field for each vehicle was defined by measurement of maximum and minimum horizontal velocities along radials for four probe heights at two aircraft hover heights. The conclusions reached were (Reference 7): (1) close to the aircraft, there was a marked difference in velocity-height profile, with the CL-84-1 having higher velocities than the helicopter near the ground and lower velocities at head level, (2) the CL-84-1 outflow velocity dissipates much more rapidly with radial distance, such that beyond a radial distance of 50 to 70 feet, the CL-84-1 generates smaller forces and moments on objects in the flow than does the equivalent helicopter, (3) the unsteady aerodynamic forces and moments induced by each vehicle were of the order of twice the corresponding mean values for that vehicle, (4) the unsteady forces and moments for the helicopter were as large as those for the CL-84-1, and corresponded to greater radial distances from the aircraft. Subsequent to these tests, U.S. Navy hover downwash data, obtained using the Harrier V/STOL strike aircraft, were analyzed in part, and compared (Reference 7); these data definitely tend to confirm the above relationships between disk loading, velocities and flow field dimensions for constant gross weight. Correlation of these flight test data with wall-jet theory was good for the helicopter and tilt-wing, and indicated promise for future methods of prediction.

During the engineering test program, measurements were made of vibration levels in nacelle, wing, fuselage and cockpit; vibratory stresses in control system elements were measured, and a correlation was established between local vibration and control system stress. These data indicated a surprisingly low level of vibratory stress (only several thousands of pounds per sq.in.) in the control system, i.e. effectively infinite life. With respect to cockpit vibration, the crew felt that the levels were compatible with anticipated exposures in military missions, except for prolonged periods at high speed. Very careful equalization of propeller blade angles is required for smooth operation at high speed. Means of reducing vibration in this condition are part of the current test program; for example, stiffening of the mechanical elements of the propeller control unit is being investigated.

During summer 1971 a new phase of the test program was begun, namely assessment of CL-84 capability in tasks related to various potential roles of the tilt-wing aircraft. The first task undertaken was carrying and dropping of external stores. The CL-84-1 can carry beneath the fuselage three stores, or alternatively two stores as large as 1000 lb. bombs or 120 U.S. gallon (100 Imp. gal.) fuel tanks. The fuel tanks were chosen for testing in that they could also represent, when filled, weapons stores of relatively low density (and hence critical with respect to separation characteristics); see Figure 5. Since the flow beneath the fuselage is smooth because of the flat contours, there was no real concern aerodynamically; accordingly, unmodified F-86 Sabre tanks were used. Handling tests were performed with two full tanks installed (1800 lbs. increase in gross weight); the only noticeable effects were a slight reduction in roll acceleration and a decrease in static directional stability at low airspeeds. Brief drop tests were then carried out, building up to the following end conditions:

- a) Two full tanks were dropped with landing gear down and wing 15° (approx. 100 KEAS), to simulate the case of an emergency immediately after takeoff.

- b) Two full tanks were dropped at 170 KEAS in conventional flight to obtain stores trajectory data and establish a safe jettisoning condition for emergency use early in a flight.
- c) Two empty tanks were dropped at approximately 45 KEAS with wing 40°, to establish a safe jettisoning condition for emergency use later in a flight.

In each case, high-speed movies showed clean separation of the stores, with no tendency for the stores to strike each other or the airframe. In no case was the crew able to sense a response of the aircraft to the release of the store. Trajectory analysis showed that, in all probability, clean separation would occur for all tank dropping conditions except possibly empty tanks at high fuselage angles; clean separation was indicated for weapons under all practicable circumstances. The conclusion of the tests was that carrying and dropping of external stores by the CL-84 is quite practicable.

During September 1971 the CL-84 capability of carrying external weapons was evaluated by a series of tests using a standard General Electric 7.62 mm. podded Mini-gun, mounted rigidly to an under-fuselage hard point (Figure 6) with a firing rate of 6000 rounds/min.. The weapon was made available by the U.S. Air Force. A simple reflector sight was used. Firing tests were conducted at a Canadian Armed Forces range about 100 miles from Montreal; the aircraft was operated for six days from a 70-foot-diameter pad without hangar or support facilities other than a large truck. The canvas ground targets used were standard Canadian Armed Forces issue, 14.5 feet square. Weather conditions for flying were good. The CL-84-1 crew found that the flying qualities were essentially unchanged by the gun installation, although a slight reduction in static directional stability could be discerned in the engineering data. The following firings at single targets were made, without any practice runs by a pilot with no recent gunnery experience:

Regime	Airspeed-KEAS	Rounds Fired	% Target Strikes
Conventional	200	1285	30.5
V/STOL	40	1365	84.0
Hover	0	1392	71.0

The ease of handling and the accuracy in this first attempt were very gratifying. Firings at a series of targets spaced along the line of attack were made during maneuvering flight with good control and accuracy. Laying down of suppressive fire was simulated in hovering over a spot through use of directional and wing tilt controls. Throughout the tests the effects of gun firing on trim were negligible; noise and vibration levels during firing were moderate. This exercise together with the tank tests reported above, demonstrated that the CL-84 has a definite potential as a tactical support aircraft.

During February 1972, following an official invitation from the U.S. Navy Chief of Naval Operations, aircraft 8401 spent three weeks in the areas of Washington, D.C. and Norfolk, Va. on a demonstration/evaluation tour. Using the external fuel tanks, 8401 flew non-stop from Montreal to Washington (480 n. mi.) with sufficient fuel remaining to attain 600 n. mi. total range plus 15 minutes reserve fuel, thus confirming test data which had indicated good cruising efficiencies for the configuration. On February 14 four flights were made, using the 100-foot-square helicopter pad at the side of the Pentagon building in Washington (Fig. 7). A post-frontal weather condition caused winds gusting to 30 knots and veering 180° in direction, but nevertheless all regimes of flight were demonstrated to many Department of Defense senior military and civilian personnel. After a ferry flight to the Norfolk area and briefings by USN and Canadair with respect to the U.S.S. Guam helicopter carrier and the CL-84-1 respectively, 8401 on Feb. 22 flew out to sea about 20 miles to a rendezvous with the U.S.S. Guam. Again, a weather front which had just passed brought high, gusty winds for much of the joint operation. A series of approaches, simulated waveoffs and touch-and-go landings terminated in a vertical landing near the stern of the ship in view of a large group of observers. Two subsequent flights included sorties (Figure 8) with VTOL operation, STOL operation with various wing tilt angles, and V/STOL operation from various positions on the deck. The effects of variation in wind velocity and direction were explored. A slow air-taxi operation from stern to bow was conducted to determine if there were turbulence around the superstructure, the edge of the deck, or the bow, to a degree that would cause significant aircraft control demands. The joint operation went beautifully, thanks to the cooperation and skill of the U.S. Navy personnel involved; it produced much evidence that the CL-84 can be based very satisfactorily aboard vessels of the Guam size (approx. 600' deck length) and smaller.

The above testing and evaluation flying fulfilled the revised objectives of the Evaluation Program (paragraph 3 above). Aircraft 8401 has since been utilized in the Tripartite program described below.

5.0 The CL-84-1 Tripartite Simulated IFR Program

Early experience with a CL-84 flight simulation with no motion cues and only a conventional instrument-flight (IFR) instrumentation presentation indicated that the CL-84 had a potential IFR capability. During 1970 discussions took place with U.K. government officials to explore the possibility of using the CL-84-1 in the development of electronic display equipment for V/STOL IFR terminal guidance and control. Subsequently the U.S. Navy became an interested party to the discussion. It was agreed that the CL-84-1 could be an effective simulated-IFR vehicle because: (a) flying qualities were generally good; (b) both an IFR pilot under the hood and a safety pilot could be accommodated; (c) electronic payload weight and volume presented no problems; and (d) low-speed endurance ensured relatively long, effective flights. In Summer 1971 specific evaluations by RAF, USN and Canadian Armed Forces pilots confirmed this judgment, and negotiations began in earnest for a Tripartite program involving "Operating Experience with V/STOL Aircraft and Flight Evaluation of an Electronic Display System". A UK/US/Canada Memorandum of Understanding was signed, in which the following program objectives were stated:

(1) to investigate the instrument-flight Head-Up Display and Head-Down Display requirements, i.e. parameters, symbology, etc., for V/STOL aircraft terminal-area guidance and control.

(2) to investigate handling characteristics of the CL-84-1 for terminal-area instrument flight.

(3) to investigate the degree of aircraft control required for V/STOL aircraft instrument-flight terminal-area guidance and control and the displays associated therewith.

(4) to investigate instrument-flight transition and steep-angle approach flight profile parameter limits imposed by V/STOL aircraft, through the use of CL-84-1 with the installed Electronic Display System (EDS).

(5) to investigate operating and design parameters of the CL-84-1 as they might apply to the Sea Control Ship concept.

It was decided to use the second CL-84-1 (8402) for the program. The installation of the EDS and associated radar and test instrumentation was to be approximately as shown in the diagram of Figure 9. In December 1971 Canadair began preparations for the updating of 8402 and for installation of the EDS; the instrument panel is shown in Figure 10. Ground testing of 8402 began in July 1972 and the first flight occurred during September. Much of the planned pre-delivery flying is completed, and 8402 will proceed shortly to the U.S. Naval Air Test Center at Patuxent River, Maryland to begin a full year of simulated-IFR testing toward the above objectives. There is every expectation that this work will contribute significantly to the development of V/STOL IFR equipment, and will prove conclusively an IFR capability in the CL-84.

6.0 Application of the Tilt-Wing to Specific Military Roles

The two-engine tilt-wing, in the form of the CL-84, has proved itself an operationally flexible aircraft. It can hover well, has outstanding overload performance in the STOL mode, is able to convert the high installed power into correspondingly high climb performance, loiters and cruises efficiently, has good forward speeds as an airplane; this very broad spectrum of performance is nevertheless available without excess piloting demands, by virtue of good stability, control, maneuverability, vibration characteristics and cockpit arrangement. These attributes give the tilt-wing aircraft an applicability to numerous tactical roles; in fact, wherever the V/STOL mission does not require either largely hovering, or forward speeds beyond the capability of the propeller, the tilt-wing is likely to excel.

The general arrangement of the prototype and CL-84-1 (Fig. 1), with side-by-side crew and correspondingly generous fuselage volume, lends itself well to designs for most support roles. However, while the existing CL-84-1 is quite adequate for evaluation duties, an operational aircraft would be somewhat larger and considerably more powerful in order to hover at higher altitudes and/or temperatures, carry defensive equipment

such as armor and self-sealing tanks, and carry appropriate mission equipment for extended range or endurance. Such an operational version is shown in Figure 11 relative to the -1; the difference in size is primarily the result of an increase in propeller diameter from 14 to 16.5 feet. The engine horsepower is about 4000, as in current versions of the General Electric T-64 turboshaft engine, and the corresponding hover gross weight is approximately 29000 lbs.

This tilt-wing design has been proposed for several applications, for example search and rescue. The broad capabilities in operating altitude, speed and range, combined in a hovering vehicle with acceptable downwash characteristics, are not available in other V/STOL aircraft. Figure 12 is typical of CL-84 mission profiles available. The aircraft is fully outfitted with 625 lb. of armor, armament and other defensive equipment, and has 400 lb. of communications/navigation equipment aboard. Performance calculations include the standard allowances required by the U.S. military services.

This same aircraft, or variations of it, can perform well as a utility transport. For example, there is space available for twelve litters and an attendant in a medical evacuation role. Transport of critical personnel or cargo can be accomplished using a VTOL pad or perhaps a very short strip for the overload case; the operation may involve a carrier or other vessel in naval applications. Figure 13 is indicative of the CL-84 capability in the utility transport role for an arbitrary 250 n.mi. radius. Figure 14 illustrates the tradeoffs available between range and payload for the various modes of operation. Not shown is the carrying of bulky loads over short distances by means of a cargo sling attached to the fuselage strong points; exploratory CL-84-1 flight testing was carried out to show that cargo sling operation is practicable.

Considerable preliminary design work has been done to apply the tilt-wing concept to the surveillance role in its many ramifications in army, air force and naval operations - anti-submarine warfare, airborne early warning, forward air control, target acquisition, etc. The STOL overload, high transit speed, and the efficient loitering capabilities over a broad altitude band relate well to this area of application. This can be illustrated well by describing a variant studied for operation in conjunction with the U.S. Navy Sea Control Ship concept (or the "through-deck" cruiser in the U.K.), which involves a small aircraft carrier without catapults or arrestor gear, i.e., designed on the basis of V/STOL aircraft exclusively. This vessel would carry V/STOL fighter aircraft, but in addition V/STOL aircraft for anti-submarine, early warning, aerial re-supply and other support duties. Figure 15 illustrates a CL-84 variant to execute these support missions; the general arrangement and propulsion parameters are as mentioned above. Figure 16 gives a tabulation of performance and other data for this version. STOL overload performance is shown in Figure 17 as a function of deck run for various wind velocities. Figure 18 follows on with endurance/radius data for two operating weight conditions. The tilt-wing as an element of the Sea Control Ship system provides an ASW/AEW capability not possible with any other current V/STOL technology, and approaches the capability of conventional ASW/AEW aircraft operating from large carriers.

The CL-84-1 testing reported above demonstrated that it is quite practicable to make use of bombs, guns and other armament in the aircraft as presently configured. Preliminary design studies have been made of operational aircraft carrying all sorts of armament, including turrets. Such a vehicle could be utilized for support of surface forces in a number of ways, for example: helicopter escort and destroyer; destroyer of tanks, vehicle convoys, small boats, gun emplacements and other point targets; suppressive fire and other usage against area targets. As helicopter escort, the CL-84 enjoys a large speed advantage over the aircraft it is protecting, hence it can move from side to side of the convoy route, or divert to targets of opportunity and overtake. Its dash capability not only increases operational flexibility, but also reduces vulnerability to enemy action, hence it would have reasonable survivability in a more sophisticated theater of war. The combination of stability with maneuverability across the entire speed spectrum has been demonstrated by the above CL-84-1 firing accuracies against point targets. The field of armed close support offers a variety of interesting applications for the CL-84.

In general the armed aircraft would not require large payload volume, hence where the aircraft need not be capable of usage as, say, a transport or rescue aircraft, the bulky fuselage could be avoided. Figure 19 illustrates an armed CL-84 with tandem seating, with the same operating weights as for the side-by-side version above, but with substantially less weight empty. With reasonable care given to the aerodynamic design of this aircraft, the dash speed as a combat aircraft would exceed 400 knots at low altitude. The ability to operate efficiently at low speeds and in VTOL and STOL operation would be preserved, making this aircraft particularly flexible over a very broad band width in the spectrum of close support operations.

7.0 Conclusions

Over 250 flight hours of experience to date with the Canadair CL-84 prototype and the CL-84-1 military evaluation vehicle have shown that the two-engine tilt-wing V/STOL aircraft is a viable concept and can be effective in a number of tactical roles. Specifically, hovering downwash tests and simulated rescues with a live subject from land and water have demonstrated feasibility as a search and rescue aircraft; tests involving dropping of stores and firing a minigun at ground targets in all three regimes of flight proved the practicability as an armed support aircraft; VTOL and STOL operations at sea in conjunction with the U.S.S. Guam helicopter carrier indicated applicability to anti-submarine, early warning and other naval missions; VTOL operations from confined spaces, STOL experience, and cruising operation (e.g., Montreal-Washington non-stop) showed capability in the utility transport role; agility in flight, and ease and efficiency of operation over a broad band of speeds recommended the tilt-wing for forward air control and other surveillance missions.

While the CL-84-1 is a fully-adequate evaluation vehicle, the projected operational aircraft will be somewhat larger and substantially heavier and more powerful. A family of practicable two-engine tilt-wing tactical aircraft designs are available for specific mission applications. Without loss of hovering and low-speed-flight capabilities, the speed spectrum can be extended to beyond 400 knots at low altitude. The operational flexibility of this class of aircraft is felt to be quite exceptional and probably unequalled.

References

1. F.C. Phillips "The Canadair CL-84 Tilt-Wing V/STOL Program", The Aeronautical Journal (Royal Aeronautical Society), August 1969.
2. Anon. "Tri-Service Evaluation of the Canadair CL-84 Tilt-Wing V/STOL Aircraft", USAAVLABS Technical Report 67-84, November 1967.
3. H. L. Kelley
J.P. Reeder
R.A. Champine "Summary of a Flight-Test Evaluation of the CL-84 Tilt-Wing V/STOL Aircraft", NASA Technical Memorandum X-1914, March 1970.
4. Anon. "Recommendations for V/STOL Handling Qualities", AGARD Report 408, October 1962.
5. O.E. Michaelsen "Application of V/STOL Handling Qualities Criteria to the CL-84 Aircraft", AGARD Conference Proceedings No. 106, June 1972.
6. Anon. "V/STOL Handling Qualities Criteria - I - Criteria and Discussion", AGARD Report 577, December 1970.
7. O.E. Michaelsen "A Comparison of Outflows from a Helicopter, Tilt-Wing and Jet-Lift Hovering Aircraft", American Institute of Aeronautics and Astronautics Paper 71-992, October 1971.

Acknowledgement

The measure of technical success achieved by the CL-84 program is largely the result of the professional skill and devotion of a relatively few engineers, pilots and shop personnel in Canadair and subcontractor plants. The author is pleased to acknowledge an indebtedness to these people for their personal contributions to the program, and for the standard of excellence they have provided to program management.



FIGURE 2

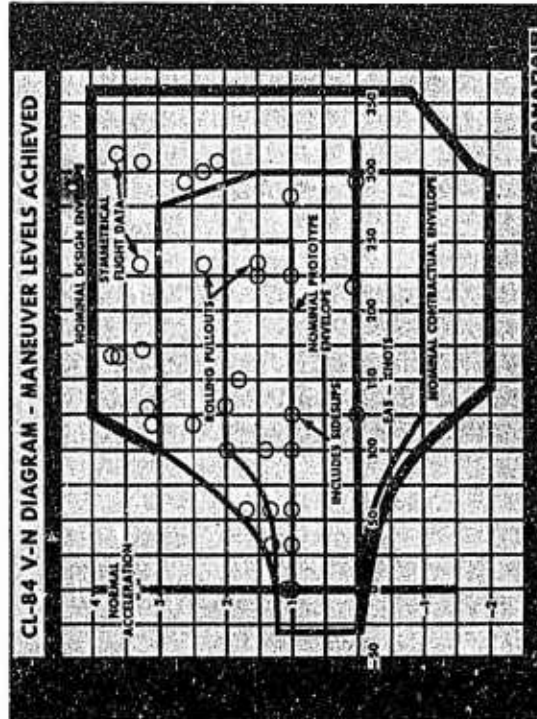

FIGURE 4

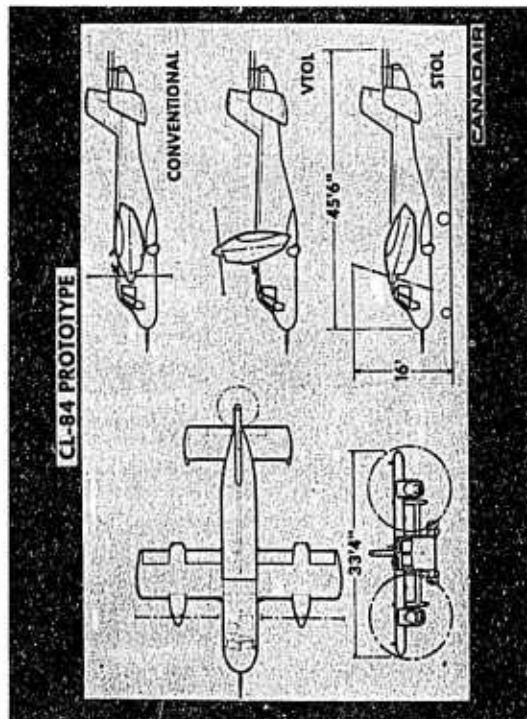

FIGURE 1



FIGURE 3

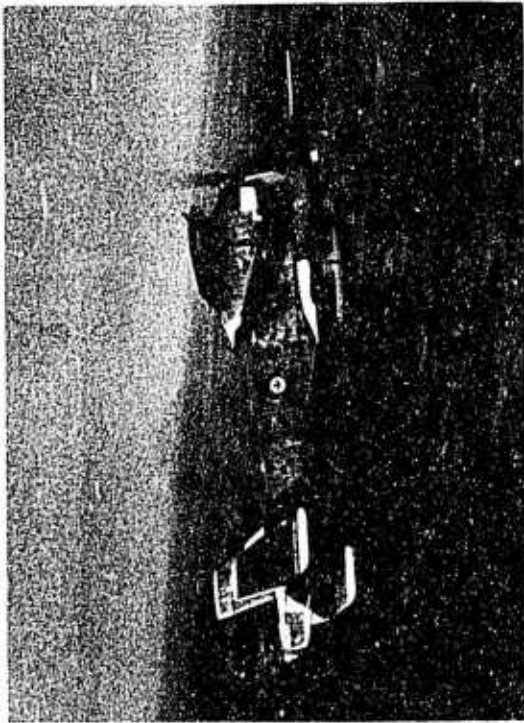

FIGURE 5 CL-84-1 WITH EXTERNAL TANKS

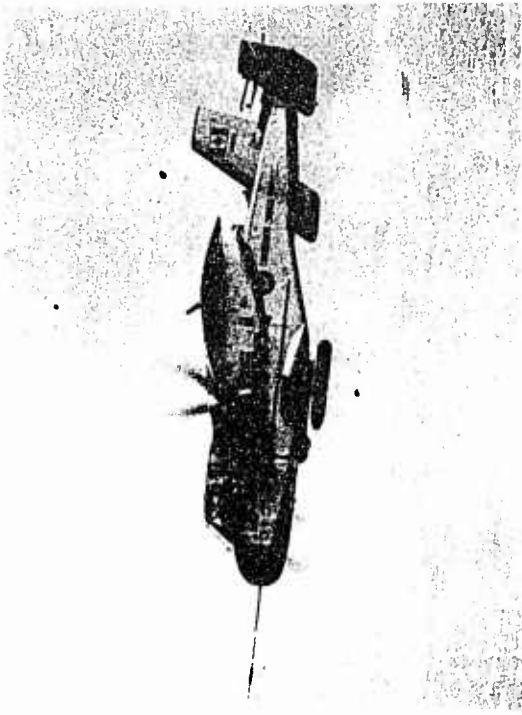

FIGURE 6 CL-84-1 WITH MINIGUN POD



FIGURE 7 CL-84-1 OPERATING FROM PENTAGON PAD



FIGURE 8 CL-84-1 LEAVING THE USS GUAM

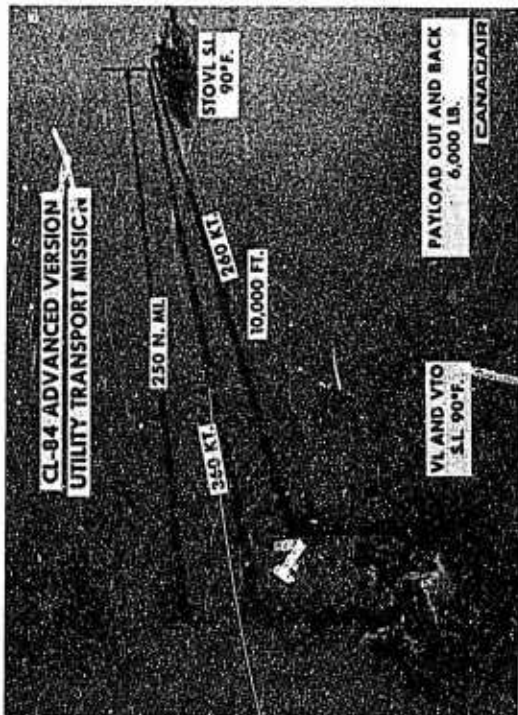

FIGURE 13

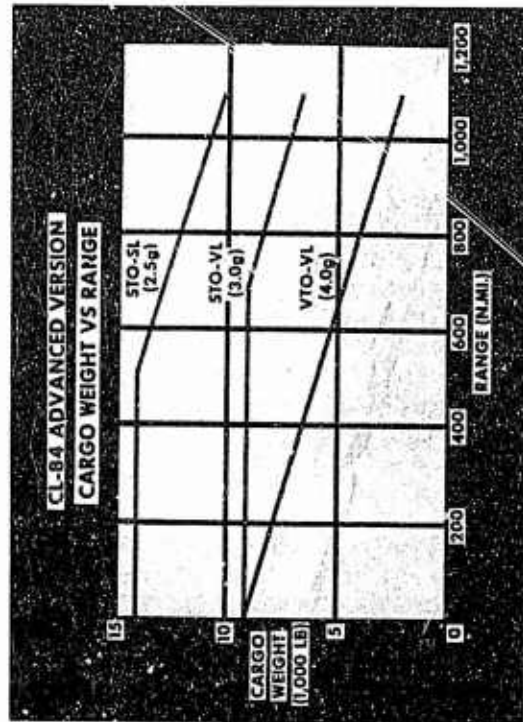

FIGURE 14

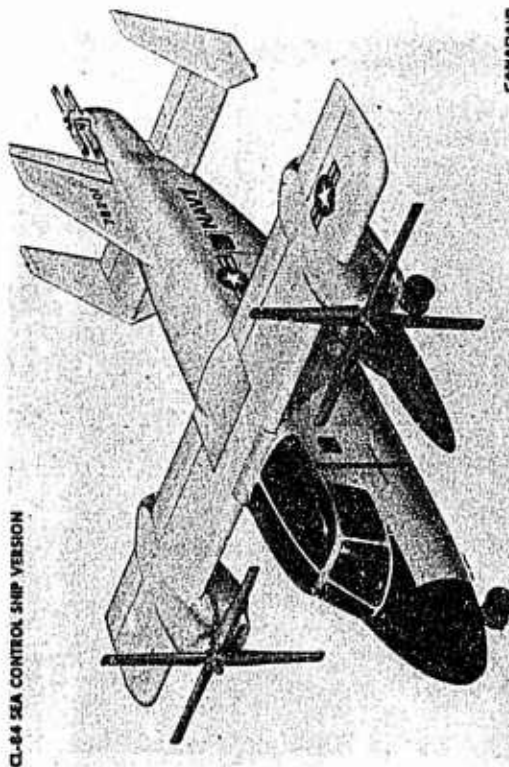

FIGURE 15

**CL-84 SEA CONTROL SHIP VERSION
BASELINE PERFORMANCE**

MAXIMUM SPEED	375 KT.
BEST RANGE SPEED	265 KT.
BEST ENDURANCE SPEED	220 KT.
RATE OF CLIMB	6,500 FT./MIN.
SERVICE CEILING	30,000 FT.
FERRY RANGE	2,650 N.M.I.
OPERATING WEIGHT EMPTY	16,500 LB.
VTO WEIGHT - STD. DAY 90°F	29,000 LB. 26,500 LB.
STO WEIGHT - 250 FT. DECK ROLL ZERO WIND STD. DAY OR 20-KT. WIND 90°F	36,000 LB.

CANADAIR

FIGURE 16

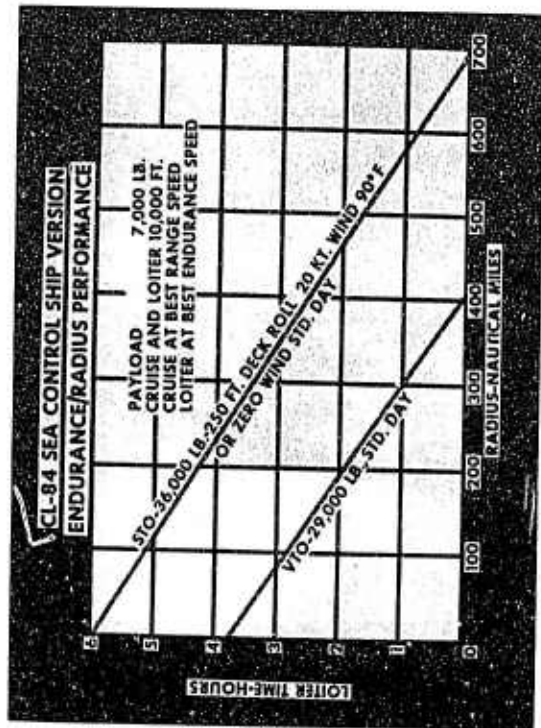

FIGURE 18

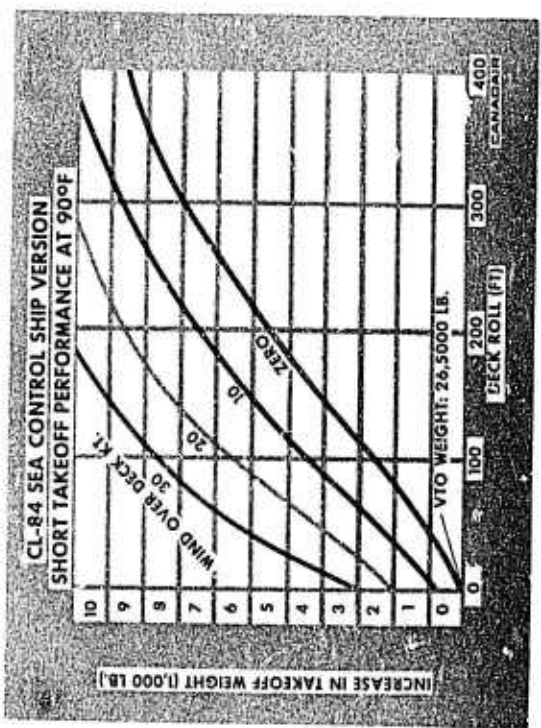

FIGURE 17

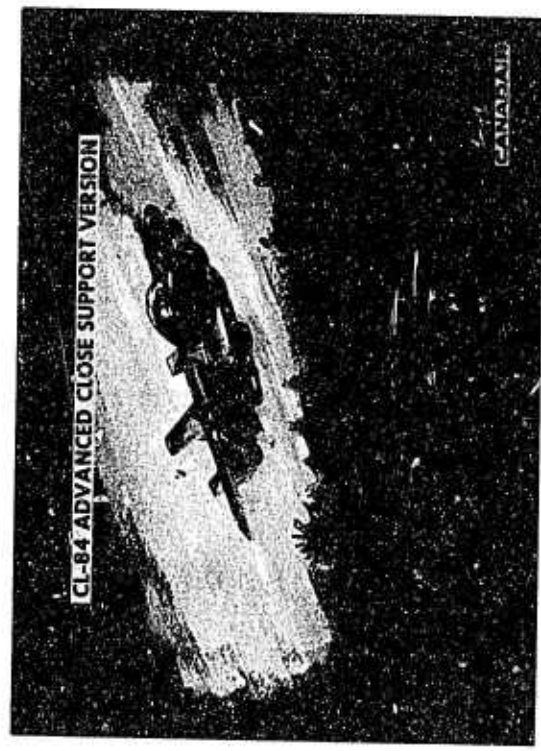

FIGURE 19

EXPERIENCE ACQUISE AU COURS DES ESSAIS EN VOL ET EN
UTILISATION OPERATIONNELLE DE L'AVION STOL BREGUET 941

par

J. CZINCZENHEIM

AVIONS MARCEL DASSAULT - BREGUET-AVIATION
92214 - SAINT-CLOUD

RESUME.

Historique du déroulement du programme et présentation succincte des performances principales. Problèmes rencontrés au cours de la mise au point en vol et solutions adoptées. Mise en service des quatre appareils de présérie et essais tous terrains. Missions types réalisables à partir de terrains variés.

La communication sera suivie de la projection d'un film illustrant différentes phases du programme.

1. HISTORIQUE

Les études d'un avion à décollage et atterrissage courts ont été entreprises à la Société BREGUET il y a une vingtaine d'années. Elles portaient en premier lieu sur la déflexion du souffle d'hélice et sur les gains de portance réalisables en association avec de forts braquages des volets hypersustentateurs. Parallèlement les problèmes de contrôle et d'asymétries rencontrés aux régimes de vol à faible vitesse en cas de panne de moteur ont conduit à l'adoption d'une interconnexion mécanique.

Les deux concepts, souffle d'hélice défléchi et hélices interconnectées, associés aux progrès réalisés à la même époque dans le domaine des turbopropulseurs de faible puissance, ont permis à la Direction Technique de l'Aéronautique de commander en 1955 un appareil expérimental, destiné à valider la formule et de dimensions suffisantes pour permettre l'extrapolation à un appareil opérationnel.

L'appareil, le BREGUET 940, d'un poids de 7 tonnes, équipé de 4 Turmo II de 400 CH, a effectué son premier vol en mai 1958 (photo). Vu la nouveauté de la formule, ce premier vol a été précédé par des études spéciales (réf 2) :

- a) Essais sur banc grandeur du système de propulsion, d'interconnexion et de contrôle d'hélice
- b) Essais d'une maquette volante télécommandée dans la grande Soufflerie de Chalais-Meudon de l'O.N.E.R.A.
- c) Etude des problèmes de pilotage sur simulateur.

Les essais en vol de la machine ont rapidement démontré que les performances de décollage et d'atterrissage estimées ont été réalisées, avec des passages de l'obstacle de 15 m inférieurs à 200 m.

Les Qualités de Vol, sans être tout à fait acceptables, ne présentaient pas de défauts fondamentaux et il y avait tout lieu de penser que l'expérience acquise permettrait de les améliorer sensiblement.

En conclusion, fin 1959 l'étude d'un avion opérationnel de transport tactique a été entreprise et le prototype correspondant, le BREGUET 941-01, a effectué son premier vol en juin 1961.

Les problèmes rencontrés au cours des deux ans de mise au point qui ont suivi sont rappelés en référence 3. Nous ne mentionnerons ci-dessous que les plus importants et ceux qui ne se sont révélés que plus tard au cours des essais opérationnels.

Les principaux résultats obtenus à ce stade, relatifs aux Performances et aux Qualités de Vol sont exposés en référence 5.

Après cette première phase de mise au point le prototype a servi de banc d'essais STOL et a effectué en outre une série de démonstrations opérationnelles :

- 1961-1962 : En coopération avec le C.E.V., définition des techniques de pilotage STOL ; influence de certaines aides à l'atterrissage.
- 1963 : Première série d'essais NASA (référence 5).
Tournée européenne (Italie, Suisse, Norvège, Suède, Hollande, Belgique, Angleterre).
- 1964-1965 : Essais US Air Force et Army.
- 1966 : Deuxième série d'essais NASA (Essais IFR, référence 12).
- 1967 : Tournée de présentation au Moyen-Orient.

Ces démonstrations ont continué, après la sortie des quatre avions 941 S de présérie, aussi bien en France qu'aux Etats-Unis :

- 1968 : STOL Demonstrator, avec Eastern Airlines et Essais FAA.
- 1969 : STOL Demonstrator, avec American Airlines, Essais FAA.
- 1969 : Mise en service des 4 avions présérie dans l'Armée de l'Air.
- 1969-1970 : Expérimentation sur terrains opérationnels minimaux.
- 1971 : Campagne Altiports.
- 1972 : Vols FAA-NASA, entraînement de pilotes et validation de la simulation.

2. PERFORMANCES PRINCIPALES

Le BREGUET 941 est un appareil trop connu maintenant pour nécessiter une description détaillée (référence 3, 5). Nous nous limiterons donc à la présentation d'un ensemble trois vues schématique (fig 2) et de deux vues assez similaires à l'atterrissage, l'une à Bruxelles, à l'Allée Verte, l'autre à Issy-les-Moulineaux.

Les tableaux I et II donnent les principales caractéristiques et les performances de décollage, de croisière et d'atterrissage. La figure 5 indique la capacité d'emport en fonction de l'étape.

On peut voir que l'appareil est capable d'une charge maximale de près de 10 tonnes sur étape courte, mais ceci ne constitue pas sa vocation principale. En configuration STOL, c'est-à-dire à une masse de décollage inférieure à 24 tonnes, il peut transporter une charge de 5 tonnes sur 1 500 km. En décollant d'une piste en béton à la masse de 26,5 tonnes il peut également transporter la même charge à 2 200 km et atterrir sur un terrain de moins de 300 m. Moyennant une pénalité sur le rayon d'action il peut effectuer une partie de sa croisière à très basse altitude à sa vitesse de croisière normale (Mission assaut).

3. QUALITES DE VOL.

Les Qualités de Vol du Bréguet 941 sont également connues pour avoir été largement publiées (références 1, 2, 3, 5, 8, 12, 14 et 23). Dans l'ensemble elles sont considérées comme exceptionnellement bonnes, aussi nous nous limitons à l'exposé des quelques points où des difficultés ont été rencontrées.

3.1. Stabilité et contrôle longitudinal.

Comme sur tout appareil volant à faible vitesse, la stabilité statique est relativement faible dans la gamme de centrage autorisée (22 à 32 %). Les changements de trim dus à la puissance et aux volets ont été corrigés par des conjugaisons plan horizontal-volets et manette-trim d'effort. Le contrôle longitudinal, satisfaisant dans le domaine normal de vol, devient marginal en dessous de 50 kts auxquels on peut arriver à faible masse et à forte puissance. Il est donc recommandé de ne pas pratiquer des vitesses inférieures à 50 kts, qui sans être dangereux demandent une attention particulière au pilote.

Si on voulait étendre le domaine de vol vers des vitesses de 40 kts, on devrait non seulement accroître sensiblement l'efficacité de la gouverne de profondeur, mais également faire appel à la stabilisation artificielle.

3.2. Contrôle en latéral et en lacet.

Satisfaisant au stade final, le contrôle latéral a beaucoup évolué au cours de la mise au point de l'appareil. Sur le BREGUET 940 le contrôle latéral a été initialement assuré par des ailerons (flaperons) et différentiel de pas d'hélice ; l'installation de spoilers s'était soldée par un échec à la suite d'une réalisation mécanique défectueuse. Cependant il apparaissait clairement qu'une solution satisfaisante pour le 941 ne pouvait être trouvée qu'en faisant appel aux spoilers. Effectivement, les premiers vols du BREGUET 941 ont démontré la nécessité de faire appel aux spoilers, et prouvé qu'avec des commandes correctement réalisées, leur efficacité et leur linéarité sont satisfaisantes. Par contre aux braquages élevés les flaperons, tout en donnant peu de roulis, fournissaient un lacet inverse prohibitif.

Les ailerons ont donc été éliminés, le contrôle latéral étant assuré par les spoilers et le différentiel d'hélice. Ce système était satisfaisant du point de vue efficacité mais conduisait à du pompage piloté autour du neutre en configuration approche avec transparence. La cause du phénomène résidait dans un jeu, très difficile à éliminer, du système de commande de pas d'hélice. Après avoir vérifié que l'efficacité des spoilers seuls était suffisante, la commande du différentiel de pas d'hélice a été reportée sur le palonnier où son apport de roulis est fort utile.

Il y a lieu de remarquer que le gauchissement n'est utilisé normalement sur le 941 que pour les manoeuvres et le contré des rafales, l'appareil étant symétrique. Il n'en est pas de même en cas de panne nécessitant la mise en drapeau d'une hélice. Dans ce cas on est d'une part obligé de réduire le braquage des volets en approche, d'autre part la vitesse minimum praticable se trouve conditionnée par l'efficacité du gauchissement.

En ce qui concerne le contrôle en lacet, le système de double gouverne est surtout nécessaire en cas de mise en drapeau d'une hélice, c'est-à-dire seulement dans le cas d'une panne mécanique extrêmement peu probable.

Au-dessus de 110 kts la partie supérieure est immobilisée, évitant à la fois l'hypersensibilité et des charges de structure prohibitives.

L'absence de roulis induit, en configuration d'approche, est partiellement compensée par le différentiel sur le palonnier.

3.3. Stabilité dynamique latérale.

Le faible amortissement du roulis hollandais est la qualité de vol la moins satisfaisante du BREGUET 941 (Pilot Rating 4). C'est une caractéristique assez générale des STOL, et qui risque encore de s'aggraver avec la taille des avions.

Sur une suggestion de la NASA un amortisseur de lacet en $\frac{d\beta}{dt}$ a été essayé et a donné de bons résultats. Néanmoins, il a été considéré que l'appareil était acceptable sans stabilisation artificielle et le système n'a pas été installé sur les quatre avions de présérie.

Notons enfin pour mémoire que l'appareil présente une faible stabilité en spirale en approche alors que la plupart des STOL sont instables dans cette configuration.

4. STABILITE AU ROULEMENT AU SOL, VENT DE TRAVERS

Le comportement de l'appareil est satisfaisant au roulement au sol jusqu'à un vent de travers de 15 kts. Au delà le contrôle de l'appareil est rendu difficile par :

- a) l'étroitesse de la voie du train.
- b) les amortisseurs de grande course.
- c) la position relativement haute du centre de gravité.
- d) la faible garde disponible entre le sol et l'hélice externe.

Quelques incidents sérieux s'étant produits au cours des essais en vol, des améliorations ont été définies.

La principale est une augmentation de la voie du train, portée de 3,72 m à 5 m environ. L'addition de destructeurs de portance, également retenue, permettrait de mieux contrôler l'assiette latérale et le freinage par fort vent de travers.

5. EXPERIENCE OPERATIONNELLE

5.1. Technique de pilotage et expérimentation réalisées sur le prototype.

Du premier vol en Juin 1961 jusqu'en Novembre 1968 l'appareil a effectué 1 200 heures de vol, comprenant quelques 1 400 décollages et atterrissages dans des conditions de vol et de terrains variés. La technique de pilotage au décollage et à l'atterrissage a été développée pendant ces essais, en particulier les marges minimales permettant d'obtenir les meilleures Performances dans des conditions de sécurité satisfaisantes. Ces techniques, tout en s'inspirant des avions conventionnels introduisent certaines nouveautés, comme le pilotage en incidence, la distinction entre marge de vitesse et de facteur de charge, la remise des gaz, etc (référence 16). La similarité entre les performances prévues et celles réalisées s'explique précisément par la similarité des marges estimées au cours de l'étude et des marges effectivement acceptées.

Notons enfin qu'à l'exception des phases de décollage, d'atterrissage et de remise des gaz l'appareil se comporte comme un avion classique et que son pilotage est conventionnel.

5.2. Utilisation opérationnelle des BREGUET 941 S.

La livraison à l'Armée de l'Air Française des quatre BREGUET 941 S s'est échelonnée entre Juin 1969 et Juillet 1970.

Leur mise en oeuvre, nécessairement progressive, s'est effectuée sans problèmes particuliers à la formule. Après entraînement des pilotes, les appareils ont effectué de nombreuses missions de transport, très souvent sur des terrains inaccessibles même à des avions légers.

Le nombre d'heures de vol annuel est en augmentation régulière. On totalise actuellement quelques 4000 atterrissages.

Les qualités les plus appréciées en opérations sont :

- a) Excellente maniabilité, en particulier en latéral.
- b) La simplicité de pilotage pour obtenir les performances STOL.
- c) La bonne précision d'impact (+ 25 m).
- d) La réversion instantanée.
- e) La remise des gaz très rapide.
- f) Les évolutions et stabilisations confortables permises par le pilotage en incidence.

Néanmoins, les modifications suivantes augmenteraient encore la valeur opérationnelle de l'appareil :

- a) Augmentation de la voie du train (vent de travers).
- b) Augmentation de la puissance des moteurs pour améliorer les performances aux poids élevés, par temps chaud et en altitude.
- c) Développement d'aides à l'atterrissage (en cours).

Pour terminer sur le plan opérationnel nous présentons quelques résultats tirés de la référence 18, relatifs à l'expérimentation sur terrains sommaires. Ils sont basés sur 60 heures de vol au cours desquelles 358 atterrissages ont été effectués sur terrains argileux, sableux, caillouteux, recouverts ou non de végétation.

Les essais consistaient en roulements, avion tracté ou non, accélérations-arrêts, décollages sans et avec panne de moteur, atterrissages.

Nous citons ci-dessous les résultats les plus importants :

§"3.3.1. Le BREGUET 941 S est un avion de transport réellement capable d'utiliser des terrains dits "sommaires". Son train d'atterrissage, parfaitement adapté aux sols naturels, lui permet un excellent comportement dans tous les cas. Les roulements au sol, décollages et atterrissages restent toujours très souples avec cependant une tendance parfois marquée au roulis.

Sur terrains argileux, l'expérimentation a pu être menée jusqu'à la limite d'utilisation de l'appareil. La plate-forme de NOGARO a été fréquentée régulièrement jusqu'à une portance très faible, le sol étant recouvert, en partie, de flaques d'eau. Etant donné son état, cette surface n'aurait pu être utilisée, par aucun autre avion, même léger (dans des conditions semblables, une jeep chargée se déplace avec difficulté malgré l'utilisation de ses deux ponts embrayés). Les différents essais ont pu être poursuivis jusque dans des conditions exceptionnelles d'emploi :

- roulement avec un bourrage de terre à l'avant du train atteignant le phare de roulage,
- atterrissages et décollages dans des sables de plus de 30 cm de profondeur et atteignant parfois 60 cm.

Sur l'ensemble des autres terrains pratiqués, on n'a jamais été amené à utiliser le BREGUET 941 S à ses limites d'emploi.

Cependant, sur la bande de CAPTIEUX (terrain sableux sans végétation) les essais ont dû être interrompus après vérification des groupes turbo-propulseurs et des hélices en raison de :

- usure prématurée des compresseurs,
- érosion anormale des bords d'attaque et des extrémités des hélices.

L'appareil, pouvant évoluer dans des volumes très restreints, a eu facilement accès à des terrains encaissés dans d'étroites vallées même par visibilité réduite".

§ "5.1. Terrain naturel minimum pour les missions d'assaut.

Les performances mesurées et ramenées en conditions standard et vent nul, pour des masses voisines de 22 tonnes, (poids maximum sur terrains sommaires), donnent les chiffres suivants :

- distance moyenne de roulement au décollage	: 228 m
- distance moyenne de décollage (passage des 35 ft)	: 358 m
- longueur moyenne de roulement à l'atterrissage	: 191 m

Pour tous les vols effectués à des poids allant jusqu'à 22 Tonnes (conditions standard et vent nul) et sur des terrains d'I.C.E. très variable, les performances les plus défavorables relevées sont de :

- 280 m pour la distance de roulement au décollage (vitesse de rotation non respectée) ;
- 405 m pour la distance totale d'envol (vitesse de décollage trop forte, incidence trop faible après la rotation) ;
- 233 m pour le roulement à l'atterrissage (réversion utilisée tardivement, non emploi des freins) ;
- 407 m pour la longueur d'atterrissage (pente faible, incidence négative, mauvaise technique de décélération après l'impact).

L'utilisation courante de bandes naturelles de 400 m de longueur et 50 m de largeur peut donc être normalement envisagée pour les missions d'assaut. De nuit et avec un balisage réduit (5 balises) ces plates-formes devront de plus avoir une approche immédiate dégagée (pente en approche plus faible lorsque les phares d'atterrissage ne sont pas employés)."

Avec des aides relativement simples (par exemple vecteur vitesse) la dispersion pourrait encore être sensiblement réduite.

5.3. Autres types d'utilisation.

La masse maximale de l'appareil pour les pistes en dur étant de 26,5 tonnes, des missions variées peuvent être envisagées en décollant et en atterrissant sur piste en dur, sur terrains de type aéroclub, sur terrains sommaires ou en utilisant une combinaison quelconque de ces possibilités.

Les missions les plus significatives sont :

- a) Mission logistique normale.
Décollage sur piste d'aéroclub, au poids de 24 t, charge transportée de 4,5 t sur 1 200 km.
- b) Mission logistique lourde.
Décollage sur piste d'aéroclub, au poids de 25,5 t, charge transportée de 7,5 t sur 700 km.
- c) Missions logistiques grande distance.
Décollage sur piste en dur, à la masse maximale de 26,5 t et atterrissage sur terrain sommaire ou d'aéroclub.
La distance franchissable varie de 500 à 2 400 km pour des charges allant de 8,6 t à 3,4 t.

d) Missions tactiques avec décollage sur piste en dur et atterrissage sur terrain sommaire ou d'aéroclub.

Dans ces conditions, compte tenu du terrain prévu pour l'atterrissage, le rayon d'action varie de 500 à 1000 km pour des charges allant de 6 t à 2.5 t.

5.4. Formation et entraînement des équipages.

La conversion des pilotes aux techniques STOL ne semble pas présenter de difficultés particulières. Après 30 à 40 décollages et atterrissages, des performances raisonnables sont obtenues et après un entraînement plus poussé comportant 50 à 100 heures de vol, les pilotes effectuent des atterrissages tous terrains et réalisent les performances normales de l'appareil. Ce temps pourrait être sensiblement réduit par l'utilisation de diverses aides à l'atterrissage.

6. CONCLUSIONS

Malgré le nombre limité d'appareils construits, le programme STOL Breguet 941 a atteint le stade opérationnel et l'appareil satisfait aux objectifs du programme tant du point de vue des Performances que des Qualités de Vol. Les nombreuses campagnes d'essais et des missions effectuées jusqu'aux limites d'utilisation ont démontré la valeur opérationnelle de l'appareil. Toutefois les quelques déficiences qui ont été mises en évidence seront corrigées pour tirer le maximum d'efficacité de la formule.

REFERENCES

1. G. Ricard, J. Czinczenheim, P.E. Jaillard, G. de Richemont - The Breguet Family of STOL Aircraft, S.A.E. Rep. 428A, 1961.
2. G. de Richemont - Méthodes utilisées pour la mise au point de l'avion Bréguet 940 à ailes soufflées, Rapport AGARD n° 371, 1961.
3. J. Czinczenheim - Etude aérodynamique et mise au point en vol de l'avion STOL Bréguet 941, Technique et Science Aéronautiques et Spatiales, 1963.
4. P.E. Lecomte - Recent French experience in the field of V/STOL Aircraft, S.A.E. Rep. 670 B, 1963.
5. H.C. Quigley, R.C. Innis, C.A. Holzhauser - A flight investigation of the Performance, Handling Qualities, and Operational Characteristics of a deflected dipstream STOL transport airplane having four interconnected propellers, NASA TND 2231, 1964.
6. G. Leblanc et G. Klopstein - Etat actuel des études sur le V/STOL en France, Rapport AGARD n° 487, 1964.
7. H.D. Fowler - Determination of Breguet 941 STOL aircraft transition velocities with various flap deflections, S.A.E. Rep. 960C, 1965.
8. S.B. Anderson, H.C. Quigley, R.C. Innis - Stability and Control considerations for STOL aircraft, AGARD Rep. 504, 1965.
9. M. Bruyère - Solutions modernes des problèmes d'accouplements de transmission pour machines tournantes aéronautiques, 18 ème Journée Franco-Britannique Louis Blériot, 1965.
10. D.S. Findley, J.M. Cawthorn, D.A. Hilton - Ground noise measurements for various flight conditions of the Breguet 941 airplane, NASA LWP 245, 1966.
11. S.A. Kondoleon - Reliability with STOL, Journal of Aircraft, vol. 5, n° 5, 1968.
12. R.C. Innis, C.A. Holzhauser, R.P. Gallant - Flight tests under IFR with an STOL transport aircraft, NASA TND-4939, 1968.
13. A.S. Crossfield - STOL demonstration program, Eastern Airlines, S.A.E. Rep. 690420, 1969.
14. R.C. Innis, C.A. Holzhauser, H.C. Quigley - Airworthiness considerations for STOL aircraft, NASA TND-5594, 1970.
15. Proposed STOL system definition, American Airlines, 1970.
16. J. Bastidon - Etablissement des marges de sécurité au décollage et à l'atterrissage pour le Bréguet 941, AGARD Conference Proceedings n° 76, 1970.
17. M.J. Taylor - Lessons from operation and trials of twin turboprop aircraft on rough airfields, AGARD Proceedings n° 76, 1970.
18. Experimentation sur terrains sommaires du Bréguet 941 S, Rapport n° 5 de l'Etude 2897, BA 118-CEAM, 1970.
19. D.E. Drake, R.A. Berg, G.L. Teper, W.A. Shirley - A flight simulator study of STOL transport lateral control characteristics, FAA-RD-70-61, 1970.
20. R.A. Berg et al. - A flight simulator study of STOL transport directional control characteristics, FAA RD-71-81, 1971.
21. D.A. Hilton, H.R. Henderson, D.J. Maglieri - Ground noise measurements during landing, take-off, and flyby operations of a four engine turbopropeller STOL airplane, NASA TND-6486, 1971.
22. Mesures de bruit sur l'Altiport de Méribel, Service Technique de la Navigation Aérienne, 1971.
23. S.B. Anderson, L.G. Schroers - Considerations for stability and control of V/STOL aircraft - A review of AGARD Report 577, 40 th FMP Meeting, 1972.
24. J.F. Rudolph - V/STOL Certification, Journal of Aircraft vol. 9 n° 3, 1972.

TABLEAU I**CARACTÉRISTIQUES BREGUET 941 S**

Dimensions extérieures		
Envergure	23,40 m	(76.77 ft)
Longueur	24,35 m	(80.00 ft)
Hauteur	9,65 m	(31.65 ft)
Surface de l'aile	83,78 m ²	(901.8 sq. ft)
Allongement	5,56	(6.56)
Dimensions intérieures		
Longueur de la soute	11,17 m	(36.6 ft)
Gabarit Hauteur	2,25 m	(7.4 ft)
Largeur	2,60 m	(8.5 ft)
Volume correspondant	66 m ³	(2,330 cu. ft)

Poids		
Poids maximum au décollage	26 500 kg	58,500 lbs
Poids maximum à l'atterrissage	25 500 kg	56,000 lbs
Poids vide équipé	14 165 kg	31,200 lbs
Charge marchande maximum ..	9 800 kg	21,600 lbs
Groupe turbopropulseur		
4 turbines du type	TURBOMECA « Turmo III D3 »	
Puissance	4 × 1 500 CV (4 × 1,480 HP)	
4 hélices	BREGUET/RATIER	
Diamètre d'hélice	4,50 m	(14.76 ft)
Atterrisseur		
Tricycle rétractable		
type	MESSIER « JOCKEY »	
Voie	3,72 m	(12.20 ft)

TABLEAU II**BREGUET 941 S
PERFORMANCES**

Décollage	20 T	24 T
	(44,000 lbs)	(52,900 lbs)
Roulement	175 m (575 ft)	310 m (1,020 ft)
Passage de l'obstacle		
(10,50 — 35 ft)	275 m (900 ft)	440 m (1,440 ft)
Pente de montée avec 4 moteurs ..	26 %	17 %
Pente de montée avec 3 moteurs ..	17 %	10 %
Croisière:		
Vitesse de croisière maximum :		
au niveau de la mer	470 km/h	(254 kts)
à 3 000 m — 10,000 ft	480 km/h	(260 kts)
Vitesse de croisière normale		
à 3 000 m — 10,000 ft	430 km/h	(230 kts)
Atterrissage	19 T	21 T
	(41,900 lbs)	(46,300 lbs)
Du passage des 15 m (50 ft) à l'arrêt	200 m (610 ft)	240 m (730 ft)
Roulement	80 m (250 ft)	100 m (305 ft)

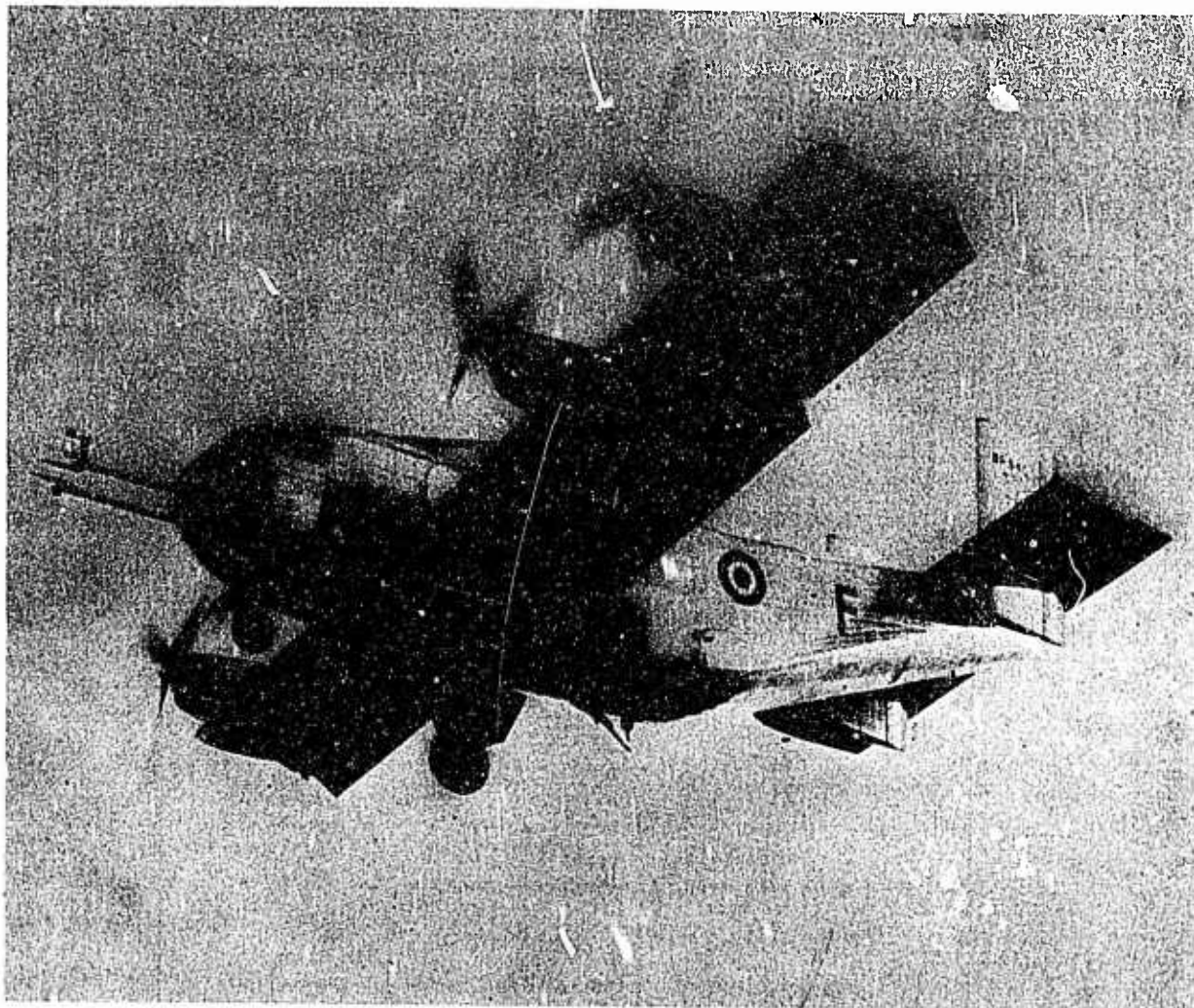
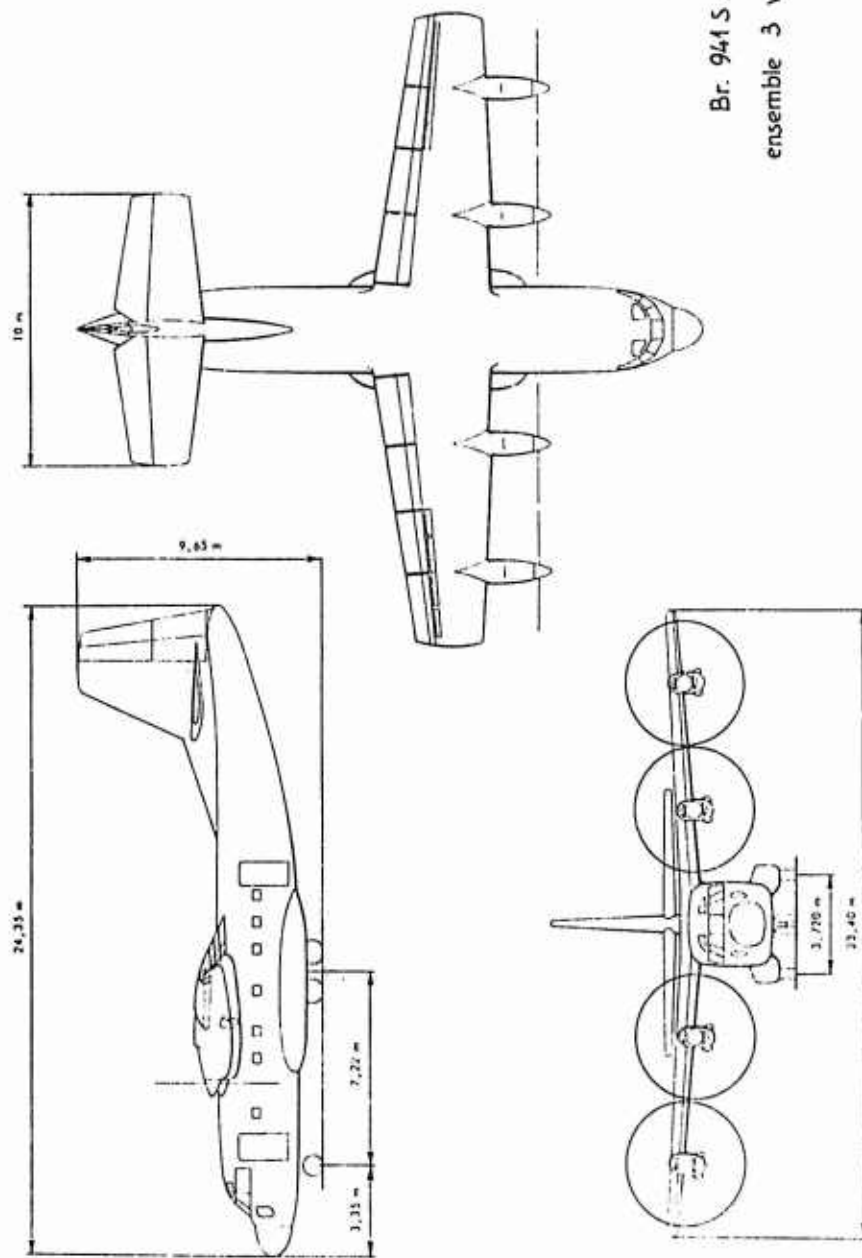

FIGURE 1

FIGURE 2



Br. 941 S.
ensemble 3 vues.

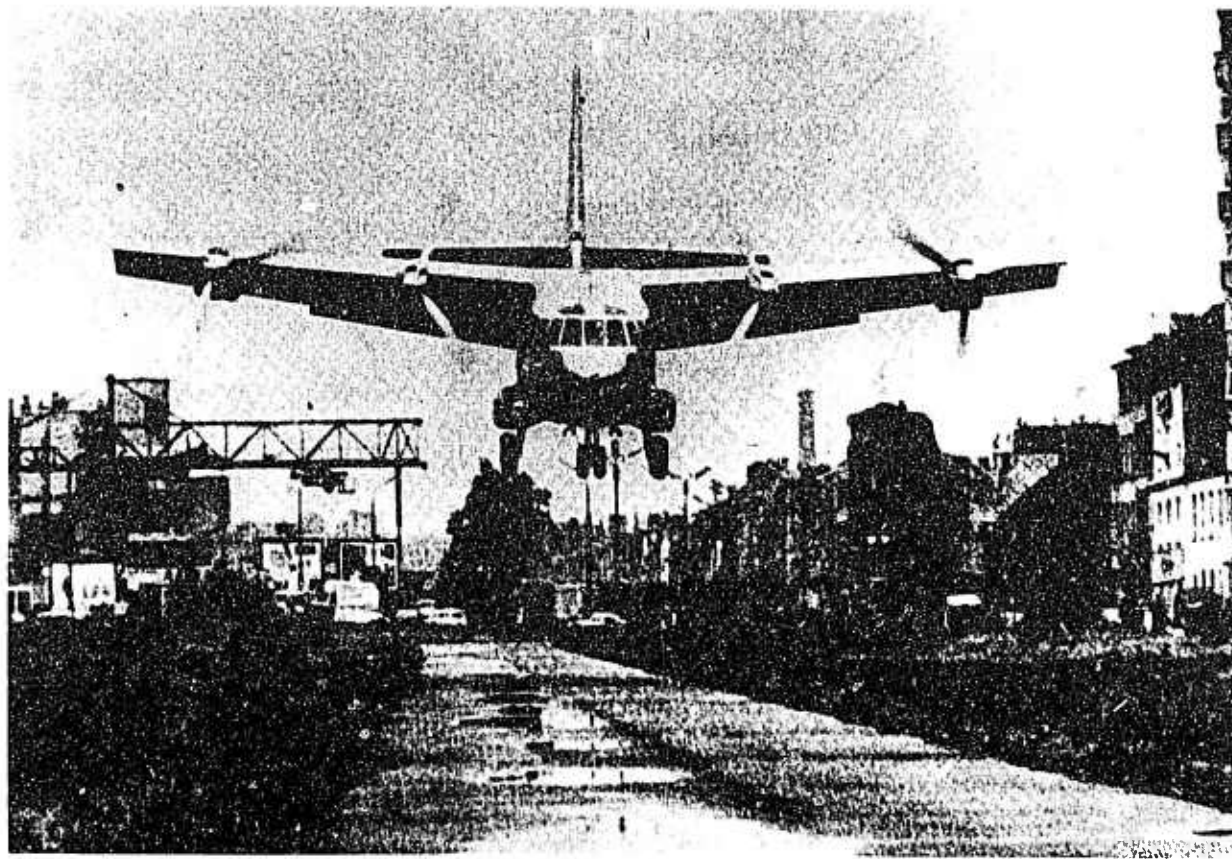

FIGURE 3

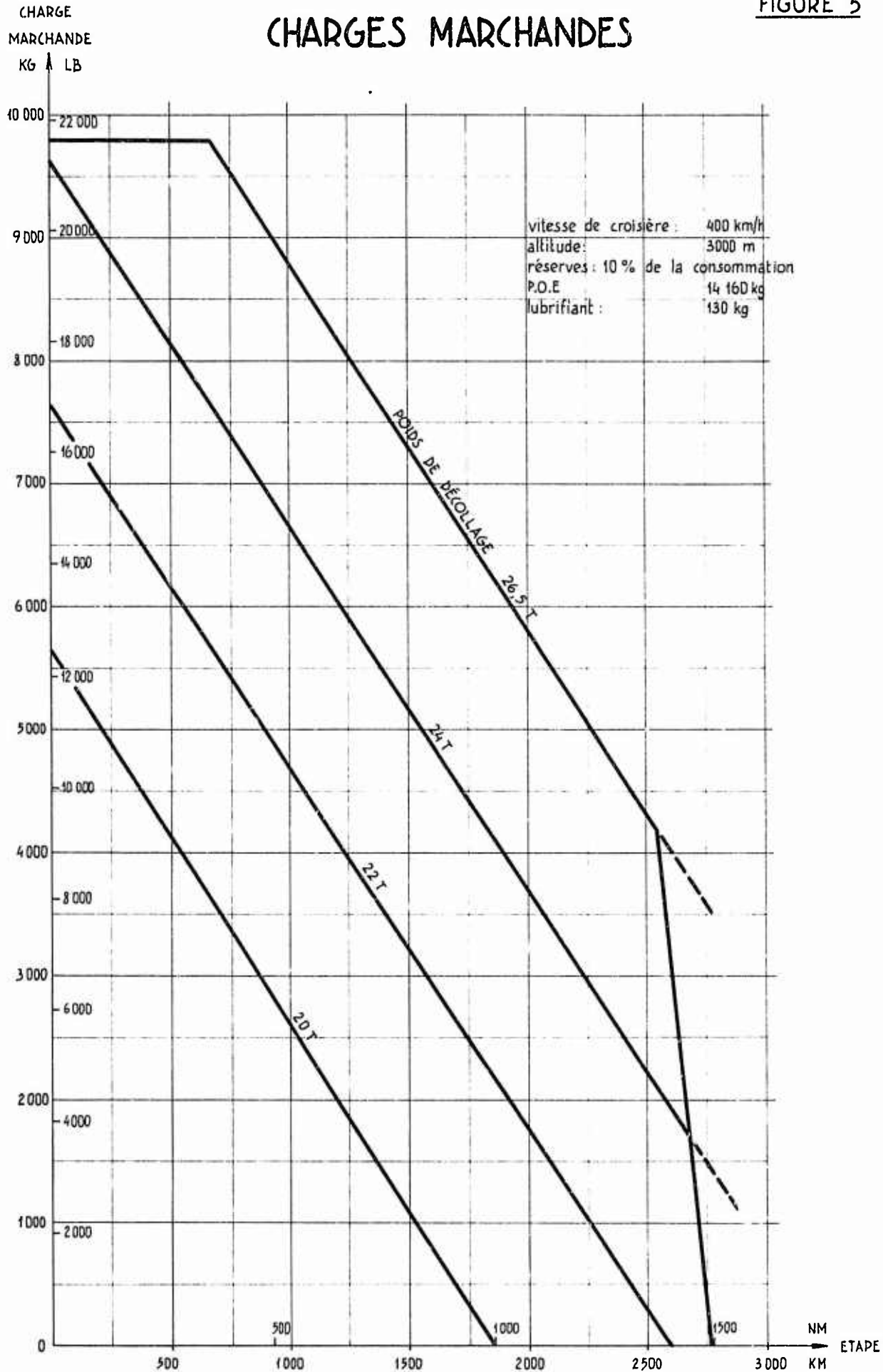

FIGURE 4

BREGUET 941 S

CHARGES MARCHANDES

FIGURE 5



NASA PROPULSIVE-LIFT STOL TECHNOLOGY PROGRAM

by

Gerald G. Kayten
Director, Transport Experimental Programs Office
Office of Aeronautics and Space Technology
National Aeronautics and Space Administration
Washington, DC 20546

William S. Aiken, Jr.
Director, Advanced Supersonic Technology/
Hypersonic Research Office
Office of Aeronautics and Space Technology
National Aeronautics and Space Administration
Washington, DC 20546

INTRODUCTION

When it was first suggested that we present a paper at this meeting of the Flight Mechanics Panel, the paper was to have been a description, in some detail, of the "QUESTOL" propulsive-lift flight research airplane. The presentation appeared appropriate considering our schedule as it appeared at that time. Unfortunately, it has been necessary to alter that schedule, with the result that the competition among companies bidding to build the research airplane is still in progress. Also, some fundamental considerations regarding the relationship between the planned QUESTOL flight research airplane and the planned Air Force AMST (Advanced Medium STOL Transport) prototype program still remain to be resolved. For both these reasons, it is premature to discuss details of the research airplane at this point in time. It may be of interest to this group, however, to review briefly the philosophy of the flight research program which will be conducted when the remaining administrative hurdles have been cleared and -- perhaps more importantly -- to discuss the overall propulsive-lift technology program, of which the flight research project is only a part.

DISCUSSION

In this Panel's frame of reference, the NASA propulsive-lift technology program is a STOL program. VTOL technology is being pursued in related but separate NASA programs on rotorcraft and lift-fan concepts. In the propulsive-lift program, we are concerned with the use of turbofan engine power to augment the lift of essentially conventional wings. Our objective is not to promote any individual lift concept, nor is it to advocate any particular degree of STOL performance or dictate the length of a STOL runway. We believe propulsive lift has potentially important applications for very short-field STOL, for moderately short-field STOL, for RTOL, and even for CTOL. Our objective is to provide -- for the manufacturers, the users, and the Government rulemakers -- a thorough technical basis to support the design, development, operation, and regulation of propulsive-lift aircraft.

With so broad an objective, we must obviously guard against spreading the effort too thinly. Therefore, although we are interested in a variety of lift concepts, we have identified a smaller number of promising approaches for which to generate our most complete data bases. Also, to assure that the research data covers the most critical conditions, we are concentrating on STOL flight at the highest lift coefficients achievable without dependence on VTOL features such as reaction controls. Specifically, this means maximum lift coefficients on the order of 9.0, and -- with prudent margin allowances -- usable approach lift coefficients of 4.5 or more.

Given this extreme of propulsive-lift performance capability, a modern high-speed high-wing-loading jet transport could operate safely and routinely from a 2000-foot STOL strip. The extent to which a transport designer uses this capability in a particular application will depend on numerous mission, system, and economic considerations. However, there are reasons to believe that, even if the 2000-foot runway capability is not a requirement, this degree of high-lift performance may be essential for certain transport applications -- both military and civil.

Military STOL applications have been reviewed quite thoroughly in previous AGARD Panel meetings and are also being covered in other papers being presented at this meeting. There are, of course, significant similarities between military and civil needs and solutions -- but there are also significant differences which must be recognized in structuring a research program responsive to both.

The two major civil transport concerns which have influenced the planning of the NASA propulsive-lift program -- and, incidentally, which will also exert a major influence on design decisions affecting civil applications -- are traffic congestion and noise. Both of these problems have been the subject of much recent discussion in the public press as well as the aeronautical literature. The Civil Aviation Research and Development (CARD) study conducted recently by the U.S. Department of Transportation and NASA revealed that a tremendous growth in short-haul air traffic could be expected over the next two decades, and suggested that the increasing congestion could be relieved by establishment of a new short-haul system which would be independent of -- and separable from -- the long-haul system. The study recommended a vigorous program of STOL research and technology.

Whether the eventual congestion solution involves additional short runways at hub terminals, or additional "reliever" airports, or STOLports close to central business districts, the ability to fly at low speeds in the terminal area will be a critical necessity. At a wing loading typical for high-performance transports, an approach lift coefficient of 4.5 results in an approach speed of approximately 75 knots -- almost a 50 percent reduction compared with an equivalent transport without propulsive lift. Climb-out speeds are similarly reduced. The low flight speeds permit safe and comfortable operation at steep ascent and descent flight-path angles, and while the steep angles are important for short-field operation, they provide even greater benefits in terms of community noise abatement and increased flight-path flexibility for high-density traffic management. In addition to the steeper flight-path angles, the lower terminal-area flight speeds permit very significant improvements in maneuverability and reduction of airspace utilization. These features, in combination with appropriately improved terminal navigation aids, make it possible to increase capacity both at the terminal and in the control area. They make possible, for example, the use of small auxiliary STOL strips at major hub airports, with traffic separation problems (including wing-tip vortex avoidance) minimized by virtue of the curved, steep, decelerating STOL approaches. To provide the technical basis for development of the navigation, guidance, and control systems required for full utilization of these unique characteristics of STOL aircraft, NASA and DOT are engaged in a joint effort consisting of air traffic control simulation and flight testing. The flight testing will combine the modified C-8 "Buffalo" airplane, an experimental NASA avionics system (STOLAND), and a microwave scanning-beam landing guidance system, in a program of terminal operation experiments with various degrees of automation -- from manual to fully automatic. A follow-on program using the QUESTOL airplane is also being planned.

The point has already been made that the steep flight paths have the beneficial effect of reducing the area of noise intrusion on the community. This noise relief effect is further enhanced by the ability to use the improved maneuverability and low speed to change course and avoid overflying noise-sensitive areas. Offsetting these advantages, however, are the higher power requirement, and the disconcerting discovery that additional noise sources are introduced in the process of converting propulsive energy to lift. In addition, if we are ever to take maximum advantage of the potential STOL benefits and utilize the downtown or near-town STOLport solution, the requirement for noise reduction will be more severe simply because we will be operating so much nearer to the community.

The noise penalty associated with the increased power is quite small -- on the order of 1 or 2 db relative to an equivalent CTOL airplane. The additional noise sources (for example, the flap interaction noise associated with the externally-blown flap or the exit slot noise in an internally-blown system) are demanding considerable attention in our research activities, but all indications thus far are that these noise contributions can be treated satisfactorily. Since the difficulty and effectiveness of the treatment vary with the lift concept employed, however, this factor could be a major concern in selecting a configuration for a specific civil transport.

With respect to operation close to the community, there are no established STOL noise regulations. In fact, the data required for establishment of noise regulations will be among the most valuable outputs of the propulsive-lift flight research. As an interim goal, we have adopted the severe noise limit target of 95 EPNdB at 500-foot sideline distance. In effect, this goal if applied to the quietest of the new wide-bodied CTOL transports would require noise reduction of more than 20 EPNdB. It is likely that noise regulations will eventually be based not on measurements at discrete points, but rather on a more meaningful criterion such as the total ground area exposed to a rationally defined annoyance threshold. As an example of the ambitious improvement sought for civil STOL, the 95 EPNdB noise footprint of a 727 transport measures more than 9 square miles; the same footprint for a STOL transport meeting the interim noise goal would be 0.2 square mile.

This noise reduction goal is reflected in our propulsion technology programs as well as in the design requirements for the research airplane. Thus far, the effort has been devoted primarily to analysis and component testing. Now we plan during 1973 to start a Quiet, Clean STOL Experimental Engine (QCSEE) program similar to the CTOL Quiet Engine program now nearing completion at Lewis Research Center. Like the Quiet Engine program, QCSEE will be devoted to technology generation and demonstration, rather than to actual engine development. In this case, however, emphasis will be on the more demanding noise reduction associated with STOL requirements. Specifications for the experimental engine will be based largely on the results of STOL transport airplane, engine, and systems studies we are currently conducting with the help of the manufacturing industries and the airlines.

For civil transport operations involving single-strip STOLports or runways, the cross-wind problem may become increasingly important, particularly with the magnification of the cross-wind effect encountered at the much lower flight speeds. We are conducting an investigation to determine the relationships among airplane control and response, piloting technique, flight safety margins, and cross-wind conditions during STOL-type landings, under both visual and instrument approach. A secondary purpose of this investigation, which is being conducted at Langley and Wallops Island on a DeHavilland Twin Otter airplane, is the determination of ground loads during the cross-wind landings. Later testing will incorporate a NASA-developed cross-wind landing gear to minimize maneuvering requirements near the ground.

The military problem of unprepared-field operation may require a considerably different solution. In this connection, NASA is supporting the Department of Defense in investigation of an air cushion landing gear system. A follow-on to flight tests on a light airplane conducted several years ago, the present program involves installation and testing of the air cushion landing gear on a larger and heavier airplane of the logistic support type.

The propulsive-lift program, of course, continues to depend heavily on the ongoing aerodynamics activity in which a variety of lift concepts -- externally-blown flaps, augmentor wing, jet flaps, upper-surface-blowing -- undergo static, dynamic, and free-flight model testing in various facilities at the Langley and Ames Research Centers. This testing provides basic data on high-lift aerodynamics, stability, control, engine-out characteristics, ground effects, and the effects, on performance, of various noise-reduction approaches such as velocity-reducing, jet-spreading, multiple-tube exhaust nozzles. The data obtained from these tests provide necessary inputs to the ground and in-flight flying qualities programs with which members of the Flight Mechanics Panel are very familiar.

A recent addition to our activity in this area is a program in which NASA and the FAA are jointly conducting simulations on the Ames Flight Simulator for Advanced Aircraft (FSAA) to support development of civil airworthiness certification standards for propulsive-lift STOL transports. The program is intended to provide not only an improved basis for the establishment of certification standards, but also an improved background of understanding and design criteria. The program is a cooperative effort involving the airworthiness authorities of France and the United Kingdom as well as the FAA. It will include simulation of various propulsive-lift concepts. The Breguet 941S was selected as the first airplane to be studied in this program. Although the concept does not represent the high-speed turbofan design approaches, the 941S is a well-developed and proven STOL transport. It provides both an excellent starting point for the program and a unique opportunity for correlation between the simulation results and actual flight experience.

Flight research has long been an important tool in the development of aeronautical technology, and its importance has been well recognized in the V/STOL area -- there are, in fact, some who would argue that it has been over-recognized. Nevertheless, we concluded about two years ago that to achieve full technology readiness for propulsive-lift systems, we needed to extend our efforts beyond the capability of the wind tunnels and the simulators, and even beyond the capability of the valuable exploratory flight research or proof-of-concept vehicles such as the X-22, the OV-10, and the modified C-8 Buffalo which will be discussed in Mr. Whittley's paper.

We have identified the need for an intensive flight research program on an experimental airplane which would be reasonably representative of high-performance turbofan propulsive-lift transport design with respect to general configuration, handling qualities, noise, inertia, dynamics, flight control systems, information displays and operating environment. The objectives of the flight program are:

- To define requirements and criteria for propulsive-lift transports in the areas of performance, stability and control, handling qualities, propulsion system control and response, guidance and display systems, and operational procedures and safety margins;
- To investigate propulsive-lift noise footprints, and provide a data base for use by regulatory agencies in establishing noise rules;
- To determine operational criteria relative to flight path control precision, touchdown dispersion, field length definition, runway acceptance rates, gust effects and ride comfort, cross-wind and shear effects, and terminal area operating procedures including ground handling;
- To determine functional requirements for STOL guidance, navigation, and other airborne avionics systems, and to evaluate experimental systems designed to satisfy these requirements; and
- To investigate and validate promising propulsive-lift concepts, and obtain data to facilitate application of these concepts to practical transport design.

The flight research planned for QUESTOL is an ambitious but straightforward extension of propulsive-lift technology programs which have been under way for many years. It requires a versatile, flexible, sophisticated experimental airplane which must meet the severe noise goal even though it must utilize existing engines. This is the airplane we have been studying for the past year. We believe the program is a necessary and important step, and are optimistic that the results will contribute significantly to the development of a new breed of transport aircraft for service in the 1980s.

THE BUFFALO/SPEY JET-STOL RESEARCH AIRCRAFT

by

D. C. Whittley
Deputy Director - Research
The De Havilland Aircraft of Canada, Limited
Downsview, Ontario, Canada

SUMMARY

The paper describes the formative stages of the program to design and build a Buffalo/Spey Augmentor-Wing research aircraft and then goes on to discuss the program objectives. The propeller turbine engines of the Buffalo were replaced by turbo-fan engines which have been integrated with the airframe to form an internally blown flap system and to generate "powered lift" for short take-off and landing. The design problems of integration of airframe and engine represent an important aspect of the concept while modification, testing and development of the Rolls-Royce Spey engine are particularly relevant. Brief mention is made of the ground tests and first flights of the aircraft and finally, consideration is given to the application of an internally blown flap concept, such as the Augmentor-Wing, to the design and operation of a jet-STOL tactical military transport.

INTRODUCTION

The Buffalo/Spey Augmentor-Wing Jet STOL aircraft (Figure 1) is an example of the NASA "proof of concept" philosophy which was successfully promoted by NASA Headquarters, Washington, during the years 1965 - 1970 and has been described in the yearly reports of the Senate Committee on Aeronautics and Space Sciences. It represented an attempt to re-focus attention on advances in aeronautics because initiative had largely been lost during a decade of emphasis in space research. In the early years this philosophy was brought to fulfilment largely through the work of Mr. Woodrow L. Cook, then head of the Advanced Concepts Programs Office, at the Ames Research Center.

As an example of this "proof of concept" philosophy the Buffalo/Spey aircraft falls short of being a prototype but represents much more than a research vehicle. In the role of a research aircraft it will be used to investigate flight at low speed with specific reference to handling qualities and control requirements. The test plan also includes an extensive study of flight operations into the terminal area as a function of the environment with varying degrees of assistance from avionic displays and automatic glide path control systems.

As a vehicle to study the Augmentor-Wing concept attention must be focussed on the engineering aspects of the airframe/engine integration and on certain specific aspects of the performance and behaviour of the aircraft. It is these aspects of the program with which the paper is largely concerned.

A comprehensive description of the research aircraft has been given in reference 1.

THE FORMATIVE STAGES OF THE DESIGN

The collaboration between de Havilland (Canada) and NASA (Ames) in STOL dates back to early 1964, at which time, generally, there was much preoccupation with VTOL but very little real interest in STOL. However, in that period, de Havilland, Canada, designed and built a large 42 foot span model of a transport based on the Augmentor-Wing concept for tests in the Ames 40' x 80' tunnel with funding assistance from the Canadian Defence Research Board. (Fig. 2.) The first two series of tests in the NASA 40' x 80' tunnel took place in November 1965 and March 1966. It was the immediate success of these tunnel tests which prompted NASA to approach the Canadian Defence Department with a view to establishing a joint program to design and build a "proof of concept" aircraft based on the de Havilland Buffalo airframe incorporating the augmentor flap principle.

The original design study for such an aircraft was carried out by de Havilland during the first six months of 1967. The Rolls-Royce Spey was identified as being the most suitable engine available for the conversion. De Havilland proposed a "split-flow" version of the engine separating the two jet streams so that all the by-pass flow could be ducted to the wing for flap blowing. The engine would be fitted with a thrust reverser which could be modulated in flight to give partial reverse and thereby achieve control of flight path angle during approach to land. The design incorporated a completely new wing and required relocation of the landing gear from the nacelles to the fuselage - otherwise the fuselage and empennage remained essentially unchanged. (Fig. 3.) Upon review, the program was found to be too costly and therefore it was temporarily abandoned.

The program was re-started in 1968 when NASA let a study contract to North American Rockwell to investigate a minimum cost, one aircraft program which retained the Buffalo wing box and landing gear. De Havilland assisted NAR in a consultant capacity for that study. Consideration was

given to the use of separate engines for propulsion and blowing as well as to various types of "split-flow" engines. In the former case, using readily available hardware, the design solutions showed a requirement for four turbo-compressor units plus two propulsion engines. This resulted in a rather cumbersome arrangement. In the latter case, the Rolls-Royce Spey was identified again as the most suitable engine but the layout required an off-set relative to the existing landing gear to avoid conflict with the jet. Once again, the resulting configuration was not particularly attractive. (Fig. 4.)

A compromise solution was suggested by the author early in 1969 which formed the basis of the final configuration, that was, to fit existing Pegasus type vectoring nozzles to the Spey engine and leave the landing gear locked down at all times. The bifurcated jet pipe arrangement would permit the engine to remain in line with the landing gear while deflection and vectoring of the jet would be used for descent and flight path control. With this solution, the vectored hot thrust would introduce a roll imbalance if an engine failed during approach to land but this could be off-set by the large roll control power available due to blowing the wing, and, in particular, by augmentor choke control. A general arrangement of the final configuration as developed by de Havilland and the Boeing Company is shown in Fig. 5. The research aircraft is a joint Canada/USA project which is funded by The Canadian Department of Industry, Trade and Commerce and by the Ames Research Center of NASA.

Some of the engineering design aspects of the Buffalo/Spey aircraft are now reviewed with specific reference to the integration of airframe and engine.

INTEGRATION AND THE PROPULSION SYSTEM

The implications of engine/airframe integration on the engine have been considered in references 2 and 3 with respect to such factors as a choice of engine cycle, specific fuel consumption, noise etc. However, here the intent is to consider the feasibility in terms of mechanical complexity and risk as illustrated by experience gained from the split-flow Spey development program.

Fig. 6 shows a cross section of the Rolls-Royce Spey Mk 511 turbo-fan engine. Fig. 7 shows a cross section of the split flow version of the engine which has been designated as the Spey Mk 801 SF. The main modifications involved in the conversion were as follows:

- Fit a new by-pass duct with twin off-takes.

Normally the by-pass is contained within an annulus around the high pressure compressor and combustors and it is mixed with the hot stream just downstream of the turbine to form a single exhaust. The main modification was to fit a new rear section of the by-pass duct with twin off-takes to isolate the cold stream so that it could be ducted to the wing flaps (Fig. 8.) A modification of similar kind had been carried out by de Havilland on the compressor of the Viper engine in two previous instances (reference 4) and this aspect of the work was judged as having a low risk.

- Exchange the compressor for a Mk 512 type.

In order to protect the compressor from possible non-uniformities which might be induced from the downstream ducting and/or the asymmetry of the off-takes, it was decided to exchange the Mk 511 compressor with a Mk 512 type. The Mk 512 compressor has snubbers fitted to the first and fifth stages which makes the engine more tolerant to flow distortion. Having introduced this change, it was then deemed unnecessary to measure the stress level in the blades of the final compressor stage and thereby a costly test program was avoided.

- Fit Pegasus tail pipe and vectoring nozzles.

Tail pipes and vectoring nozzles belonging to the Pegasus engine were in the inventory of NASA, and in order to save cost and reduce development risk, it was decided to adapt these units to the Spey even though both the pipe diameter and the nozzle area were too great by factor of about two.

The mismatch in pipe diameter was accommodated by installation of a colander plate which is described in more detail in the following section. The fitting of this plate permitted the engine to be closely coupled to the pipe by avoiding the need for a lengthy diffuser.

The nozzle area was reduced by modifying the internal guide vanes as shown in Fig. 9.

The Pegasus nozzle drive system was adapted for use with the Spey. The drive motor was mounted on a shelf-like structure which in turn was fixed to the nacelle. This represented a departure from previous experience in which the nozzle drive motor is mounted on the engine itself, as in the Harrier.

The vanes of the Pegasus nozzle suffered fatigue cracks during the engine development test program. Apparently the environment imposed by the Spey engine downstream of the colander plate was more adverse than that of the Pegasus engine itself. This represented the only major problem encountered during the engine development program and two solutions were sought: one was to add stiffeners to the vanes to form an "egg crate" type structure, the other was to design and manufacture completely

new conical type nozzles which did not contain turning vanes. Both avenues proved to be successful and the conical type nozzles were chosen for flight trials since it was judged that they would produce more thrust and create less noise.

- Addition of a Colander plate in the hot exhaust stream.

A perforated plate was fitted just downstream of the turbine. This became known as the colander plate. It deserves special attention because it turned out to be a rather controversial element of the engine. (Fig. 10) It was decided to fit this colander or loss plate for a combination of reasons:

- (i) It avoids a lengthy diffuser section between the engine and Pegasus jet pipe thus permitting the two components to be very closely coupled in spite of the mismatch in diameter of engine and exhaust pipe.
- (ii) It permits the Spey engine to operate very close to its original design running line and thereby reduces development risk.
- (iii) It generates a pressure drop and therefore helps to accommodate the large exit area and brings the problem of trimming the nozzle within manageable proportions.
- (iv) It reduces the noise associated with the exhaust flow simply because it de-rates the most noisy component of thrust.

Therefore, in order to understand the role of the colander plate, merits and demerits must be viewed as a whole. During the design phase there was a tendency to emphasize the thrust penalty without due consideration being given to other factors. However it must be emphasized that it is not an essential feature of the conversion to the split-flow configuration. For example, had sufficient funds been available, the colander plate could have been eliminated by building a two thirds scale version of the Pegasus jet pipe and exhaust nozzles.

- Provision of surge protection for the compressor.

In the standard mixed flow version of the Spey the effective discharge area of the mixing chutes (which are located just downstream of the turbine) varies with engine speed. Separation of the two streams in the split flow version of the engine had the effect of changing the running line of the compressor so that it came close to surge at low to moderate speeds. A bank of small blow-off valves were fitted in the by-pass duct which are triggered in sequence by the by-pass pressure in such a way as to provide adequate surge margin.

It was realized that the addition of a large duct volume between the compressor and the wing nozzle could possibly lead to compressor surge during the rapid deceleration of the engine because of a transient back pressure condition. This difficulty was overcome by adjusting the engine controls to preclude the possibility of a very sudden deceleration.

Difficulty was anticipated in providing the correct nozzle discharge area for the compressor because it consisted of the long slot of the augmentor flap, a segmented nozzle array to blow the aileron and other supplementary discharge ports including those used for "fuselage blowing". However, using the experience gained by de Havilland in design of the half scale Ames 40' x 80' models, test results showed that the calculated areas were very close to optimum and little adjustment was necessary even though provision was made in the design for a 12 1/2% variation in nozzle thickness.

It is worth noting that, although the two by-pass flow off-take pipes on each engine are equal in diameter, one pipe passes about 64% of the flow while the other pipe passes the remaining 36%. The larger flow is ducted to the opposite wing, of which 7% is used for fuselage blowing, 13% goes to the aileron and the remaining 44% is ducted to the augmentor nozzles. (Fig. 11)

- Summation

The conversion of the mixed flow Spey engine to the split flow version has proved to be relatively uneventful. The engine successfully completed a 50 hour preliminary flight rating test on the bed in Montreal at first attempt. The program was completed by Rolls-Royce Canada on time and within budget.

Subsequently, after installation in the airframe with the by-pass flow off-takes connected to wing ducting, the engines completed a 30 hour ground test program with very little difficulty being experienced.

Therefore, the evidence presented here suggests that the task of integration of engine and wing when using by-pass air for an internally blown flap does not introduce major difficulties with respect to the powerplant. The lack of "teething troubles" during the ground tests and in the early states of the flight program suggests that a good degree of reliability can be expected in the long term. The experience gained by de Havilland and NASA in extended operation of the half scale powered model

in the Ames 40' x 80' wind tunnel would serve to confirm this view.

It is believed that the ease of development arises from the fact that a multi-stage (relatively high pressure) compressor is tolerant to changes downstream and that modifications to the propulsion system for application to the concept does not require modifications or additions to the standard rotating parts of the engine.

INTEGRATION AND THE AIRFRAME

In this section, consideration is given to some aspects of the airframe design which relate directly to engine/airframe integration. In the discussion, the air ducting system and nozzle assemblies are considered to be part of the airframe.

- Wing ducting

Airframe modifications were the responsibility of The Boeing Company and very careful consideration was given to methods of connecting adjacent lengths of ducting and to means of mounting to the airframe. The ducting must accommodate structural deflections of the wing and expansion of the ducts due to temperature. One particular requirement was that the ducting should transmit only very small loads into the by-pass casing of the engine.

A schematic of the flexible connector is shown in Fig. 12. Quite substantial loads may be induced in the connectors due to static pressure and momentum change in the duct particularly at points where bends occur. Such loads in the duct are transmitted through the connector via links on the centre line. The main considerations in the choice of coupling design concerned a desire to keep friction loads low by avoiding the possibility of binding and to permit ease of assembly with minimum of adjustment.

Small relative motions between ducting and wing structure must be permitted and yet the augmentor nozzle must hold a fairly close tolerance to the Coanda surface of the flap so as to maintain satisfactory operation of the augmentor. The method of connecting the ducting to the spar is shown in Fig. 13.

The engine mounting structure was designed to minimize deflection of the by-pass off-take pipes relative to the wing structure, but nevertheless the ducting must accommodate this motion and do so without subjecting the engine to any substantial loading. Fig. 14 shows that this was accomplished by introducing three flexible couplings in the duct between the engine and the rear spar. Similar freedom of motion was allowed for in design of the cross-over ducting which is located ahead of the front spar.

The ducts were manufactured using aluminum of fairly generous gauge so as to maintain low stress levels and thereby avoid the likelihood of fatigue failure. It was advisable to follow this philosophy in the design because some parts of the ducting are not easily accessible and are therefore difficult to inspect routinely.

- Augmentor nozzles

The "cross-over" feature of the design required the use of a double duct and a twin nozzle arrangement. (Fig. 13) Guide vanes are located in the nozzle by means of retaining bolts which also carry the "bursting" loads. The nozzles contain more vanes than would be required from aerodynamic considerations; this greater number of vanes provided a redundancy in load path so as to give adequate strength should a retaining bolt fail.

In the section of ducting between the fuselage and nacelle, air supplying the twin nozzle actually flows in opposite directions in the inner and outer ducts. For this reason, the guide vanes are of opposite hand in this section of the duct.

- Augmentor flap and choke control

The augmentor flap rotates about a single hinge line with no provision being made for flap extension. Therefore it is basically simple and essentially fault-free. In order to maintain low costs, no attempt was made to incorporate a mechanism to collapse the two elements of the flap to form a simple aerofoil shape. Thus one area of possible difficulty was avoided for the present experiment.

The augmentor choke control represents one new element in the design. This has been described previously in reference 5 and is shown in schematic form in Fig. 15. The choke control is fitted to the full span of the augmentor flap; in the outer bays it operates in an asymmetric fashion to generate rolling moment whereas, after touchdown it operates in a "collective" manner to destroy lift and permit the wheel brakes to become more effective.

- Summation

Careful thought and attention to detail was given to the task of airframe design in the early

stages of the program. A seven tenths scale model of the augmentor ducting, nozzle and flaps was used to confirm the design choice and to optimize augmentor flap geometry. As a result, (and bearing in mind that the system is made up of fixed assemblies) there have been essentially no development type problems associated with the conversion of the airframe for powered-lift.

FLIGHT TRIALS - SOME EARLY IMPRESSIONS

As part of the taxi trials, the aircraft executed short skips just a few feet above the runway with flap settings of 30° and 65° . These tests demonstrated that the aircraft was essentially in trim both longitudinally and laterally, that ground effects were small and that the aircraft was virtually free of buffet. These skips provided very valuable experience so that the pilot, T. Edmonds of The Boeing Company, was able to carry out the first flight with a great degree of confidence. Boeing completed the contractors flight trials in which the extremities of flight envelope were explored and in due course the aircraft was delivered to NASA, Ames Research Center, where an extensive research program is now in progress.

- Approach to the stall

So far, no attempt has been made to stall the aircraft, but in approaches to the stall with flaps 30° and 65° the angle of attack has reached 23° . For example, with $\delta_f = 65^\circ$, power setting 93%, nozzle vector angle 60° and $\alpha = 23^\circ$ the aircraft has demonstrated a steady flight speed of 48 kt approximately.

- Take-off

Estimated take-off distances for the research aircraft are shown in Fig. 16 and it is expected that performance will be close to prediction. A ground roll of 600 ft. with a corresponding distance of 900 ft. to the 35 ft. barrier have been demonstrated in trials to date.

- Approach and landing

The approach and landing manoeuvre represents the most difficult aspect of STOL operation and optimum flare techniques for the aircraft must be established experimentally. Steep approach STOL type landings have been carried out at the Ames Research Centre at an airspeed of 60 kt, approximately, with glide slope angle in the range 6° to 8° . Vectoring the nozzle has proved to be a powerful means of glidepath control.

The trim position of the elevator for the approach is just a few degrees down, thus a large range of elevator travel is available for flare and touch down.

- Lateral/Directional Control

A powered lift system such as the Augmentor-Wing makes possible flight at very low speed. This introduces a potential difficulty with respect to minimum control speed with one engine failed, especially in a twin-engine design. Whereas the conventional aircraft must cope primarily with directional control (rudder power available), the powered lift STOL aircraft must cope with both roll and yaw asymmetries because it employs vectored thrust.

In the case of the Buffalo/Spey research aircraft special provisions are made to take care of this potential difficulty. Firstly, the thrust of the Spey is separated into two streams forming a hot jet (which can be vectored) and a cold jet (which is ducted to the wing). In the single engine case, the rolling moment generated by this asymmetric distribution of cold thrust serves to offset the asymmetry caused by vectoring the hot thrust thus avoiding any substantial roll imbalance in the event of engine loss (Fig. 16). The distribution of the cold flow in this manner also serves to partially off-set the asymmetric yawing moment with one engine failed when the nozzles are at zero deflection (this being the conventional V_{mc} case).

Clearly these arguments only hold true provided that the cold thrust represents a substantial proportion of the whole. In the case of the Spey Mk 801 SF the cold thrust represents about 35 to 45% of the total depending upon engine speed, the former figure relating to take-off conditions and the latter to landing.

The overall result of these provisions has been demonstrated on the flight research aircraft under conditions with one engine at emergency power level and with the opposite engine at idle setting. The tests included take-off flap with nozzles aft and landing flap with nozzle downward and aft. The results are illustrated in Fig. 17. It can be seen that for "take-off", control was achieved with no more than half available rudder angle whereas for "landing" the rudder required was between 5° and 7° with pilot's wheel angle of 20° . In general it has been shown that the minimum speed with engine out is limited by high angle of attack (in excess of 20°) and not by control power.

- Roll Acceleration

Flight at low speeds leads inevitably to sluggish response from aerodynamic controls. As a result, handling qualities suffer and even the introduction of a stability augmentation system becomes of limited value because of the poor effectiveness of control surfaces. In order to offset such difficulties, special tests were carried out in the Ames 40' x 80' wind tunnel to develop a powerful roll control system. Naturally enough, elements of the blown wing were used to develop a system comprising blown aileron, spoilers ahead of the aileron and augmentor choke controls. (Reference 5). All these elements rely on wing blowing to increase effectiveness. They are actuated by the control wheel in a progressive manner and in the order mentioned, so as to provide a fairly linear response to pilot input.

In hard-over control manoeuvres the aircraft has achieved a roll acceleration $\ddot{\phi}_{\max} = 0.5 \text{ radian/sec.}^2$ at 60 kt. in the landing configuration. This corresponds to a rolling moment coefficient $C_l \approx .16$ generated by the lateral control system.

- Lateral stability augmentation

Prior to flight, there was considerable doubt regarding the likely value of the stability derivative $C_{l\beta}$ - this being a measure of effective dihedral. It was feared that $C_{l\beta}$ might be close to zero and therefore the lateral SAS was designed to correct for this expected deficiency. Flight experience has shown that in fact there is a reasonable degree of dihedral stability and that, in a steady side slip, rudder angle versus sideslip angle is linear and in a one to one ratio, approximately. Thus the main benefit of the stability augmentation system is to improve turn co-ordination and to improve the turn entry parameter $\Delta\beta/\Delta\phi$ from 0.6 SAS off to 0.3 SAS on, approximately.

APPLICATION TO MILITARY AIRCRAFT

The development of the Buffalo research aircraft can be considered from two points of view, either as an attempt to use the by-pass flow of a twin-spool engine to blow the wing to develop high lift for STOL or as a vectored thrust aircraft (like the Harrier) in which the hot jet is vectored at the engine and the cold jet is vectored at the wing.

Experience gained as a result of the Augmentor-Wing proof of concept aircraft leads quite naturally to the consideration of a relatively simple twin engined configuration which is suitable for a light military jet-STOL tactical transport. Such an aircraft would inherit the flight characteristics of the present research vehicle. The wing planform could be straight or swept because quite extensive wind tunnel test data is now available for both planforms. (Fig. 2 and 18).

Fig. 19 illustrates one such proposal based on the Rolls-Royce Spey Mk 801 SF. The aircraft was designed with a mid-mission STOL design weight of 59,000 lb and a gross weight of approximately 70,000 lb. A radius mission of 1000 n.m. was considered without refuelling at the mid-point. Payload for the mission would be about 15,000 lb with a capacity at reduced range of 20,000 lb.

The proposed aircraft combines high cruise speed with short field capability and therefore can be used in the role of a medium range transport and as a tactical support aircraft in forward areas. Good handling qualities at low speed combined with a precise and powerful means of glide path control makes the aircraft suitable for supply operations to naval carriers. Rapid thrust vectoring is available for the "wave-off" manoeuvre.

CONCLUSIONS

Previous papers have described the foundation of the Augmentor-Wing concept from the standpoint of aerodynamics. (Refs. 5, 6 and 7). This paper deals with the concept more in terms of practical engineering and reviews some early impressions of the flight program.

An internal blown flap STOL design has many inherent advantages particularly when applied to a twin engined aircraft. It is argued that the "proof of concept" aircraft already has essentially met its performance goals and has demonstrated that the Augmentor-Wing concept, being based on simple engineering, is therefore inherently reliable. Thus, an aircraft based on such principles forms a natural choice for the next generation light military jet-STOL tactical transport.

REFERENCES

1. H. C. Quigley
S. R. M. Sinclair
T. C. Nark Jr.
J. V. O'Keefe
A Progress Report on the Development of an Augmentor-Wing Jet STOL Research Aircraft. S. A. E. Meeting, Los Angeles, California. September, 1971. S. A. E. Paper No. 710757.

REFERENCES (Continued...)

2. E.A. White
G.L. Wilde Engines for Civil V/STOL.
C.A.S.I. AIAA/RAeS/CASI 12th Anglo-American
Aeronautical Conference, Calgary. July 1971.
3. R.M. Denning Variable Pitch Ducted Fans for STOL Transport
Aircraft.
Gas Turbine and Fluids Engineering Conference,
San Francisco, California, March 1972.
A.S.M.E. Paper 72-GT-61
4. J.A. Conway
K.A.J. Lockwood A description of two low cost Turbo-Compressors,
built for powered lift research.
C.A.S.I. Annual General Meeting,
Toronto, May 1972.
C.A.S.I. Journal, November 1972.
5. D.C. Whittley The Aerodynamics of High Lift Illustrated by
Augmentor-Wing Research.
AIAA/RAeS/CASI 12th Anglo-American
Aeronautical Conference, Calgary, July 1971.
6. D.C. Whittley The Augmentor-Wing Research Program,
Past, Present and Future.
AIAA/RAeS/CASI 10th Anglo-American
Aeronautical Conference,
Los Angeles, October 1967.
Paper No. 67-741.
7. D.C. Whittley Some Aspects of Propulsion for the Augmentor-
Wing Concept.
AGARD Conference Proceedings No. 91,
Norway, September 1971.

ACKNOWLEDGEMENTS

The author wishes to acknowledge the contribution made by the de Havilland research team over many years to make the Augmentor-Wing research aircraft a reality and to note the assistance of various government agencies which made it financially possible, namely, D.I.T.C., N.A.S.A., and D.R.B. Finally, thanks are due to Mr. J.A. Conway and Mr. V. L. Gregg for valuable help in the preparation of this paper.

AUGMENTOR-WING FLIGHT RESEARCH AIRCRAFT

FIRST FLIGHT MAY 1, 1972



FIGURE 1

D.H.

AUGMENTOR-WING

STRAIGHT WING MODEL IN THE AMES 40' X 80' TUNNEL



FIGURE 2

D.H.

BUFFALO/SPEY RESEARCH AIRCRAFT

ORIGINAL DESIGN (DHC) 1967

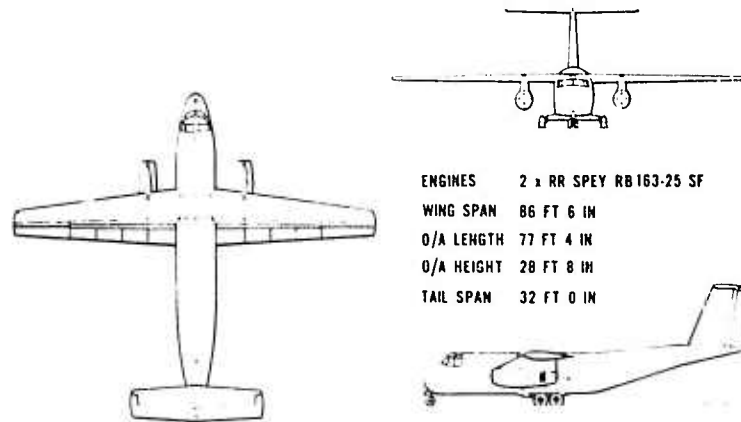

FIGURE 3

D.H.

BUFFALO/SPEY RESEARCH AIRCRAFT

INTERMEDIATE DESIGN (NAR) 1969

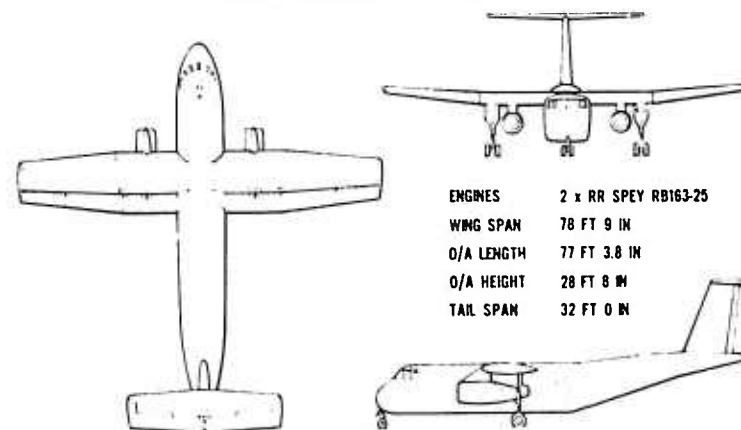

FIGURE 4

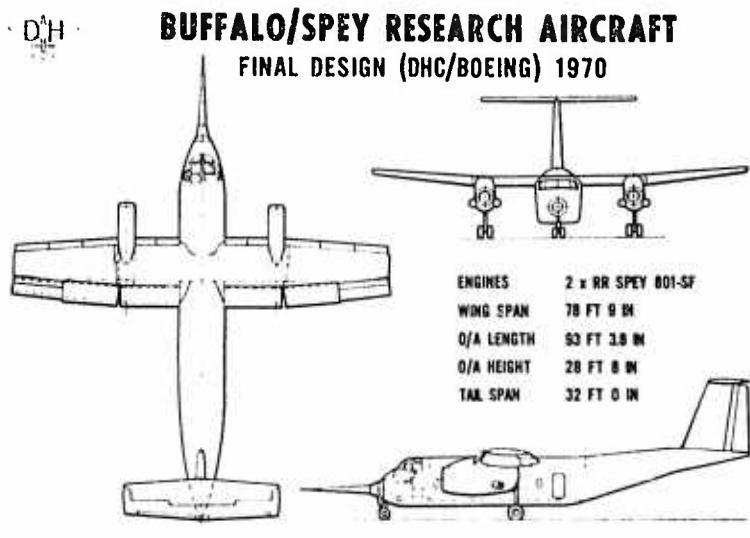

FIGURE 5

DH

ROLLS-ROYCE Mk.511 SPEY ENGINE

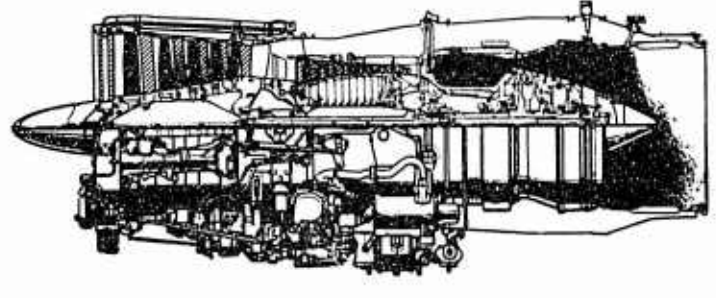

FIGURE 6

DH

ROLLS-ROYCE Mk.801 SF SPLIT FLOW SPEY ENGINE

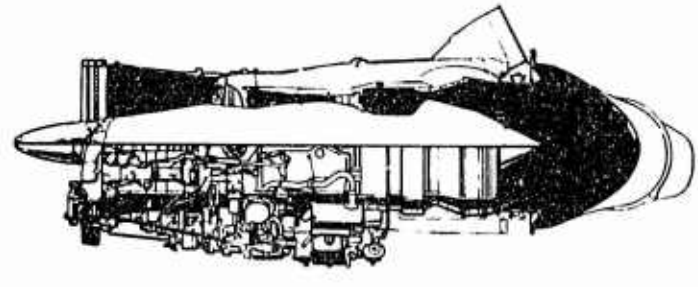

FIGURE 7

ROLLS-ROYCE Mk.801 SF SPLIT FLOW SPEY ENGINE

D.H.

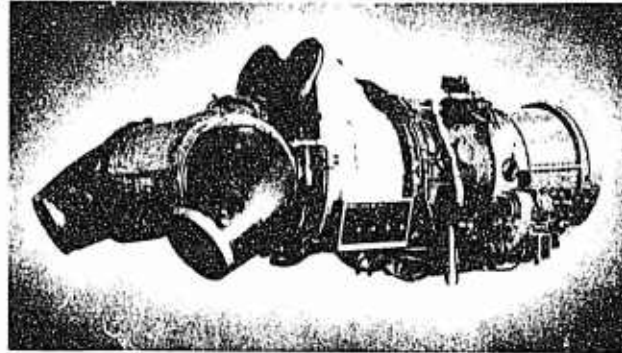

FIGURE 8

PEGASUS NOZZLE TRIMMING

D.H.

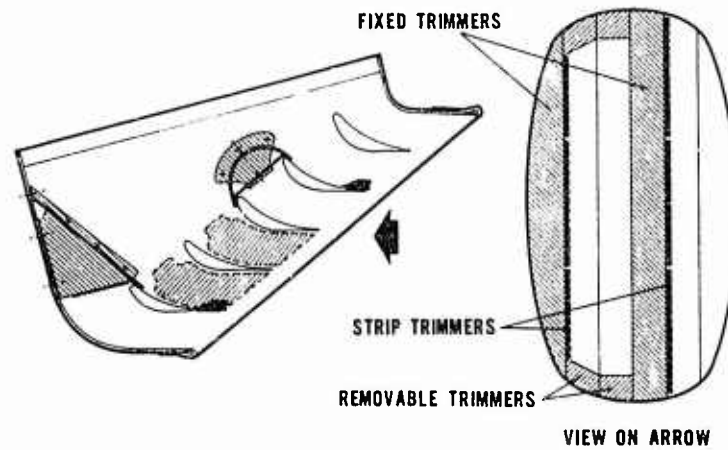

FIGURE 9

COLANDER PLATE BLANKING CONFIGURATION

D.H.

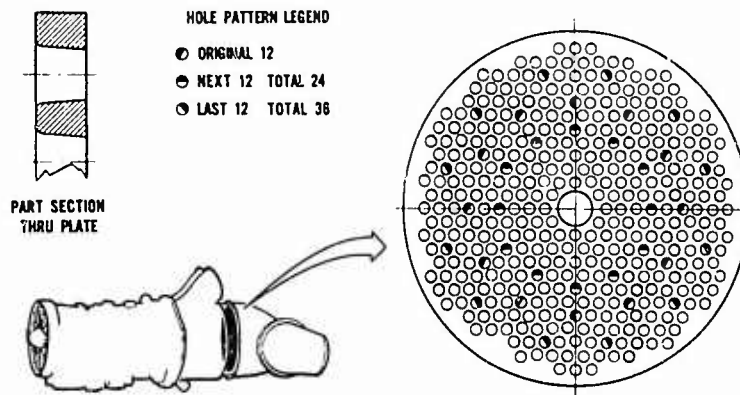

FIGURE 10

DH

BLOWING AIR DISTRIBUTION

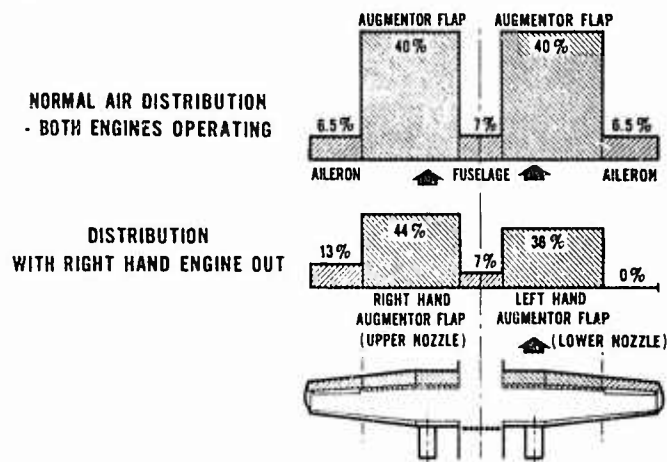

FIGURE 11

DH

AUGMENTOR-WING DUCT UNION

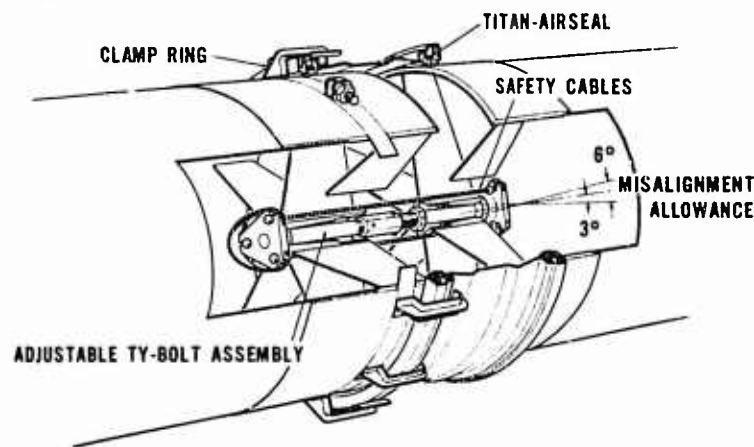

FIGURE 12

DH

SECTION OF WING DUCTING WITH SUPPORTS

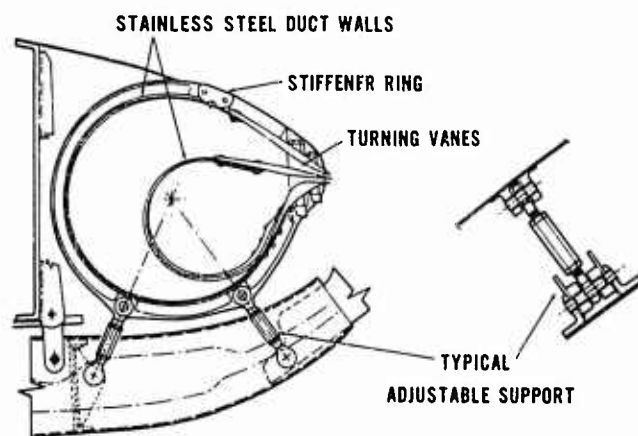

FIGURE 13

DH

NACELLE ARRANGEMENT FLIGHT RESEARCH AIRCRAFT

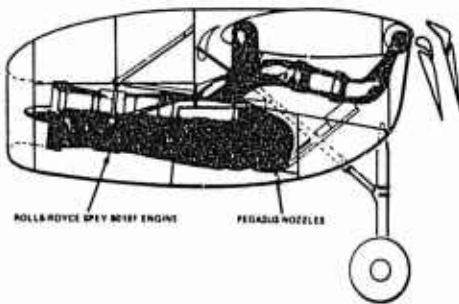

FIGURE 14

DH

AUGMENTOR-WING SECTION

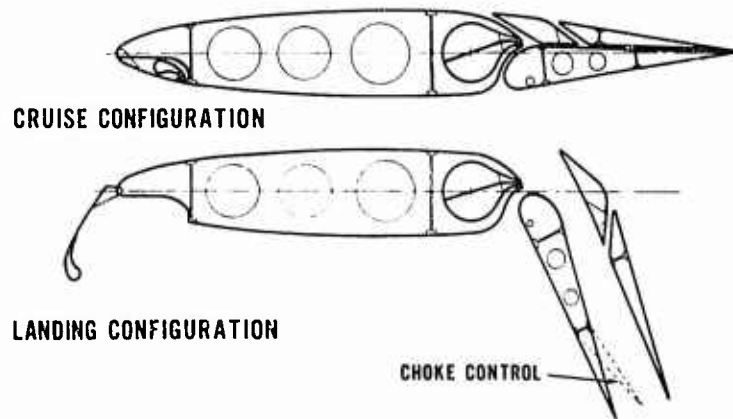

FIGURE 15

DH

ESTIMATED TAKEOFF PERFORMANCE

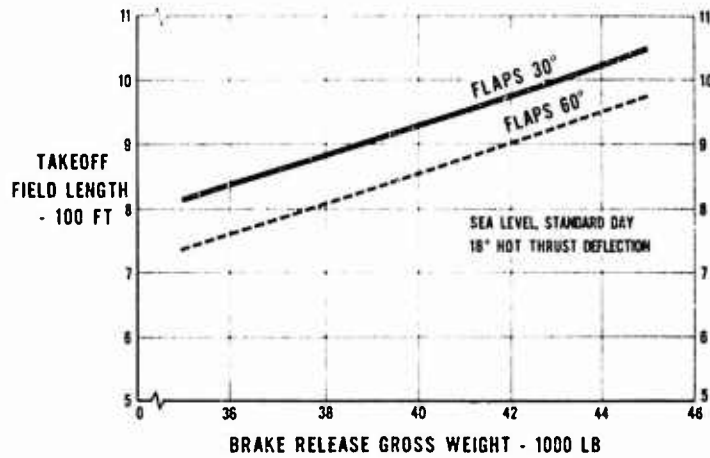

FIGURE 16

DH

**LATERAL CONTROL REQUIRED
WITH ASYMMETRIC POWER - (102%~IDLE)**

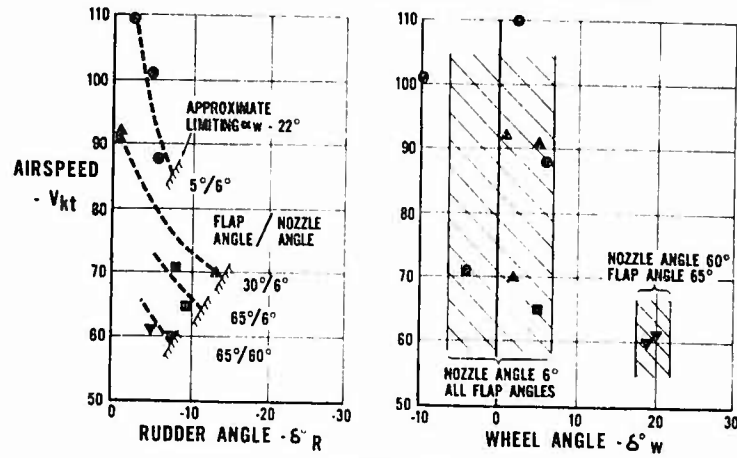

FIGURE 17

DH

SWEPT AUGMENTOR-WING MODEL

IN THE NASA AMES
40 ft x 80 ft WIND TUNNEL



FIGURE 10

DH

**AUGMENTOR-WING LMTT
LIGHT MILITARY JET-STOL TACTICAL TRANSPORT**

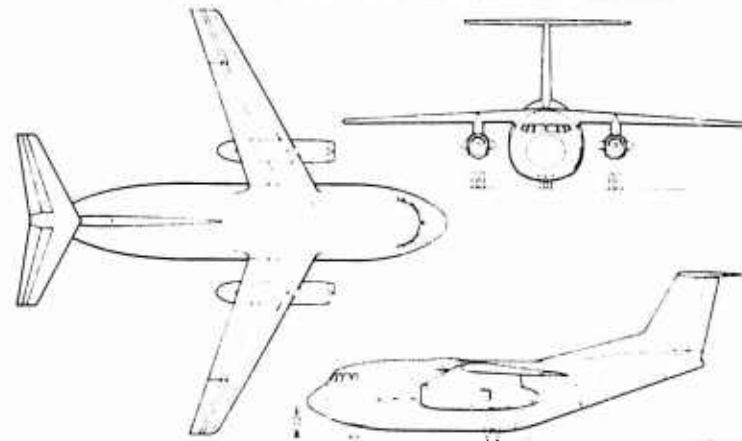

FIGURE 19

MILITARY ASPECTS OF CIVIL V/STOL AIRCRAFT

by

N. W. Boorer
 Executive Assistant to Sir George Edwards
 British Aircraft Corporation Limited
 Brooklands Road
 Weybridge
 Surrey KT13 ORN
 England

SUMMARY

The paper seeks to show that the development of a military tactical STOL transport in the present climate of financial restraint might more profitably follow an evolutionary pattern in parallel with current work on civil projects.

The basic requirements of short field operation and a large capacity airframe are common to both civil and military operators and should be developed in a joint programme.

The use of ultra-STOL or V/STOL fixed wing tactical transports is not considered to be a realistic or cost-effective requirement at this time because of the need to incorporate exotic high-lift systems, complex mechanical configurations and new untried materials, none of which would be readily acceptable in the civil market.

The author has attempted to interject a note of economic realism between promise and likely fulfilment by suggesting that project and development effort should be concentrated on those features and areas of concern which are common to both civil and military requirements.

INTRODUCTION

V/STOL as a transport aircraft operating requirement either for military or civil use, has probably, throughout recent history, been the most talked about, but least determinate of all aircraft developments. The ebb and flow of the tide toward vertical from conventional take-off and landing and then vice versa, passing all sorts of techniques such as STOL and RTOL on the way, has been almost as regular as the oceans themselves.

Forecasting the future is a notoriously dangerous, and frequently unprofitable activity in which to indulge. It is noticeable that the 'technical establishment' usually tends to be pessimistic about what will be technically feasible in the future, both in absolute terms and in terms of timescale. In this Aerospace business it is therefore necessary to cultivate, in the course of your work, what might seem a somewhat ambivalent attitude.

First you must retain a strictly practical approach to the problems with which you are faced, as they appear; remembering always that neither national armed forces, the commercial operating companies, nor the Aerospace Industries and Government Establishments which support them, exist by any God-given charter. They can only exist by virtue of the service they render to the body politic at large.

But there is the need to retain a long look forward, to retain the energies, driving force, and faith in the future of the visionary.

The most significant change of recent years has without doubt been an economic one. The cost of aerospace projects, particularly in the research and development field, of which V/STOL is a significant example, and the level of investment required for their production has led to a situation where markets must be extended by all possible means if these projects are to make economic sense. I believe that the tactical V/STOL, RTOL, or conventional field length aeroplane - which of these characteristics comes out in the wash - to be a classic example of a concept which will not get off the ground unless its horizons are wide. The successful concept, I think, will be the one which will service the military and civil customer alike.

THE OPERATIONAL ENVIRONMENT

Figure 1 establishes the special area of interest where military and civil requirements may be seen to overlap and consequently a common programme of research and development would be fruitful.

This paper is concerned, largely, with the Tactical Transport Aircraft required to service the forward supply bases from the main logistic support base and to serve in the airborne support roles of air supply and paratroop dropping.

In this context, the forward bases are considered to be relatively static supply and communications centres with access to at least one rudimentary airstrip to which vital supplies may be flown for onward transmission to the battle zone by surface transport or exceptionally, by helicopter.

In the civil scenario, the forward supply base becomes the regional airport and the main logistic supply base is, of course, the international air gateway.

By choosing to restrict the scope of my paper to the tactical transport, I shall be bypassing some of the controversial issues on the modus operandi of the tactical close-support combat aircraft. This is an arena of very great interest to the Military Division of my Company, who have been engaged in depth for many years in seeking solutions to improve the efficiency and performance of V/STOL combat aircraft.

This is referred to briefly, (Figures 10 and 11), but is more properly the subject for separate papers in other places.

Here I will be considering only the larger aircraft and its relationship to on-going civil programmes of research where, for reasons of restricted national budgets, I foresee a meeting of minds to the early benefit of both civil and military operators.

The success of any concept is dependent on the skill which is used in the matching and balance of the three prime ingredients shown in Figure 2. The customer need, technical feasibility, and economics.

It is no good the brilliant engineer providing some wonderful piece of machinery that nobody wants. On the other hand the individual customer cannot always be expected to know what could be made available to him more cheaply for both civil and military use. It is no good either customer or engineer wasting time if the cost of providing is prohibitive or of operating, uneconomic. The permutations and combinations of this lot are all too familiar for any further comment here.

Returning to the subject of this Symposium there is no need to dwell on technical feasibility of V/STOL operation.

During the last two decades there have been many experimental aircraft built and flown, demonstrating their ability to leap off the ground from little or no runway. The conclusion is that there is no real technical barrier to further progress in this direction if necessary.

The question which must be put then, is, that with all of this experience available why do we not see examples of these, or similar machines in service, militarily or in civil transport? The Harrier is the sole example of a V/STOL aircraft which has gone into real production.

It might be that either the customer does not need aircraft with these characteristics or that he is not quite sure how far in the direction of V/STOL he needs to go and its effect on performance costs.

A few of the main characteristics in this respect are now discussed.

MAIN CHARACTERISTICS REQUIRED OF MILITARY & CIVIL STOL AIRCRAFT

Figure 3 shows some of the principal characteristics required in military and civil applications which lean toward shorter than conventional airfields.

The military scenario is less predictable than that of the civil. For the military, the scene is dynamic; the task to be performed and from what bases, can change frequently.

With a main requirement being dispersion, the use of relatively unprepared airstrips and surfaces is a must. Forward bases with a reasonable life are likely to be the principal area of activity. I do not see direct support for the combat aircraft in the battle zone being carried out by the tactical transport aircraft; it appears to me that this is a job for the surface transport or in some circumstances, the helicopter.

Returning to Figure 3, these aircraft need to be rugged, quickly and easily maintainable, and therefore, must be free from complex engineering. A large cargo hold with good loading features is an essential, but aircraft noise, in military use, is not a primary design aim.

The civil counterpart is aimed at an improved service to the customer and a reduction of noise nuisance level in the environs of the airport. The improved service can come from relieving airport congestion, a greater frequency of service and large choice of terminal points.

These requirements demand, ideally, the ability to make greater use of the long runways at major airports and to be able to operate in and out of small regional fields.

A number of these military and civil requirements are complimentary, both need good airfield performance from unsophisticated surfaces, but determination of what is classed 'short' cannot be fixed arbitrarily and needs further thought and is referred to again later in the paper.

From the point of view of economics, reliability, ease of maintenance and quick turn round, it is desirable that the use of complex mechanisms be avoided or at worst, kept to an essential minimum.

Both aircraft need a large cross-section as shown in Figures 4 and 5 - the civil for quick turn round and passenger appeal of the wide body comfort. The military aircraft need a spacious, free access hold for the transport of military equipment and supply dropping.

The only significant difference in the characteristics between the two requirements is that of airport noise.

New civil aircraft have defined targets to meet. To achieve these, engine technology is developing via silencing kits associated with current engines to new engine cycles generally adopting the high by-pass ratio engine. However, as Figure 6 shows, the most powerful way to achieve the low noise targets is to get away from, and approach the landing strip in as short a horizontal distance as possible, viz., steep climb and approach paths. This, in turn, requires a relatively high thrust to weight ratio.

It is more likely then that the degree of the Short or Reduced in STOL or RTOL will be determined as a result of meeting noise regulations rather than from any other reason. But the installed power to provide the steep climb gradient and to meet civil airworthiness requirements, in the engine out case, will be of great value in reducing the take-off field length for the military tactical transport.

AIRSTRIP REQUIREMENT

The manner in which RTOL or V/STOL aircraft will be used in civil transport systems, is a subject which is currently being debated all around the industry. Some see the increase of frequency and service to the customer being achieved by double use of the long runways at major airports; that is a take-off strip at one end and a landing strip at the other. There are others who see the system being extended to use many of the smaller regional airfields which already exist, coupled with a separate short strip in or adjacent to major airports. To meet these a balanced field performance around 1,250 metres would appear to be adequate.

A recent survey of airfield lengths in the Western European environment, (Figure 7), shows that of 1,032 cases, 80% lay below 4,500 ft. (approx. 1,400 metres). Albeit the majority are unpaved. A survey of the distribution in the United States shows a similar trend, but the numbers are about nine times as great.

In looking at their requirements for the next ten years or so, the airlines do not appear to have a particularly short field requirement. In the course of recent studies BAC engineers have visited many of these airlines to establish the market for QTOL; the aircraft concerned offered a balanced field length capability of 1,000 metres. Of thirteen airlines visited all but two thought this performance to be about right, or unnecessarily short. Two airlines, Eastern and American, thought that 1,000 metres was too long; but these are the two most to the fore in promoting city centre operations with downtown airport platforms.

It appears from this that for civil operations a field capability much shorter than 1,000 metres is not likely to be bought, using the word 'bought' in its broader sense.

To determine the requirement for military activity is not so straightforward, the system and the environment within which it has to work is much more fluid. The permutations of battle games are numerous.

The very nature of the deployment tasks envisaged, as shown earlier by Figure 1, demand that the aircraft should operate from bases in friendly territory to at least a secure base at a destination significantly behind the forward battle area, or in the case of the para-dropping and battle support operation, from the forward base into the battle area and return.

As the task is to supply material to the troops, mechanised equipment and combat aircraft, at and around the battle front, ideally such places should be at or near surface communication focal points. This implies that forward base air communication and supply centres will be in localities where reasonably firm airstrips already exist or could be provided.

Airstrips of 800-1000 metres would seem to be a realistic requirement in this respect, but aircraft able to use rough, unpaved surfaces will always be of advantage to the tactical commander. The provision of 'instant airfields', by using membranes of neoprene-coated nylon fabric laid on semi-prepared ground, further increases the operational flexibility of the combat and tactical transport aircraft by reducing the hazard of mud - the common enemy of all battlefield commanders in Europe.

What emerges is that the customer for either civil or military transport has no unarguable need for V/STOL, but if this level of performance could be provided for at no extra charge then the inherent flexibility which would be gained is undeniable.

COST OF AIRFIELD PERFORMANCE

The fact that improving airfield performance from STOL further into V/STOL and V/TOL must cost something is difficult to argue with. The level and variation of cost with airfield distance will always be the source of debate.

Figure 8 shows the result of a study of civil transport aircraft using the BAC 1-11 400 Series as its datum. The aircraft to the right of centre in the figure are direct derivatives, those to the left are new aircraft. All do the same job, only the field lengths differ. The diagram shows the trend of increase in operating cost with reducing airfield length. Down to about 1,000 metres existing airworthiness requirements and 30° glide slopes are used but below this new regulations are assumed

with 6° glide slopes.

Developments of the aircraft within its present configuration and within known technology are possible down to the break point where the field length to civil requirements is about 1,000 metres. The first step in operating cost, shown on the diagram at about 2,000 metres, arises from assuming that ground manoeuvre times would be reduced for this type of operation. Thereafter the improvement is gained from developments of the wing and its high lift systems, the undercarriage and braking systems, air brakes and a booster engine.

To achieve a field capability significantly below 1,000 metres under civil rules configuration changes must be made, particularly in the wing, higher T/W ratios used and in the ultimate, lift engines installed.

The penalty for doing all this, in terms of operating costs, is clear. If operations can be limited to the use of 800-1,000 metres the penalty is relatively low. But to put our sights around the 300 metre mark suggests a penalty relative to the existing aircraft of 50-60%.

It must be made clear that this is a particular study based on a particular aircraft. The cost of the datum aircraft is known and the variation of cost down to the break point is likely to be quite near the mark as the changes are relatively small. In the real V/STOL area only the trend is right, the level is arguable. Similar studies, with no doubt similar conclusions, could be produced for a number of existing jet-powered civil aircraft.

Another series of V/STOL studies were done in the U.K. which involved both Hawker Siddeley Aviation Ltd., and British Aircraft Corporation Ltd. In order to arrive at data where like could be compared with like, a set of assumptions and rules were drawn up by a team of technicians drawn from both companies.

Relative direct operating cost measured against field length for a series of aircraft, each specifically designed for its chosen field length, and using these rules, is shown in Figure 9. The apparent cost penalty for field length is less than the earlier BAC 1-11 example but is still significant.

BACKGROUND OF V/STOL WORK IN B.A.C.

So far this short paper has dealt briefly with the main characteristics affecting the choice of civil and military transport V/STOL aircraft, and expanded a little on airfield performance and the costs which go with it. In order to come to any real conclusions for the direction of future work, much more detail needs to be worked out and discussed. But what emerges is, that within known technology, we have the ingredients to produce aircraft which suit both the military and civil customer.

BAC's current thinking has evolved from many years of work on military and civil V/STOL studies and a few words about this background follow.

We reviewed our work up to 1964 in an AGARD report (Ref.1), which discussed the choice and merits of many different transport and combat aircraft arrangements. These, including variable wing sweep, were discussed in some detail in respect of overall performance, engineering problems, ground and forward effects on jet lift, etc. All aspects were supported by V/STOL tunnel and simulator data. The refinement process has continued ever since.

The design by Grumman, shown in Figure 10, for small ship or Marines operations, is of the type we call "2 in 1" because, by removing the lift engines, etc., it can be returned to the simplest and cheapest form of aircraft for given CTOL performance. The economy of such designs is apparent when operation from larger airfields or ships is also possible. BAC have carried out over 10 years research into such design for a variety of operations.

It is of interest that American studies, Figure 11, show this to be the most economical V/STOL configuration for combat aircraft, leaving aside the tail-sitter.

Although not the main subject of this paper, I refer to the combat aircraft work, because of the value from cross fertilisation of ideas and data between project teams of different disciplines.

Returning to the tactical transport aircraft, BAC project teams have examined the relative merits and made design studies of aircraft with airfield capabilities down to pure 'V'.

However, it is our current opinion that what the customer needs can be supplied without resort to the complexities which are inherent for the capability of providing vertical, or very short, take-off and landing.

BAC 1-11 TYPE 475 UNSEALED RUNWAY AIRCRAFT

BAC with its BAC 1-11 475 aircraft, have made a start towards this end. The aircraft has been developed from the well-established 500 Series, combining the short fuselage of the 400 Series with the advanced engineering, aerodynamic improvements and higher engine power of the 500 Series. It features a new low pressure tyre system, characteristics which combine to make it an ideal aircraft for use in the less developed airfields of the world.

The aircraft is now in operation in one of the most testing areas of the world, that of the South American mountain regions. In ISA +20°C., sea level conditions and at a typical T.O. weight, the factored balanced field length is about 1,900 metres; used in a military environment with all engines operating this would be reduced to about 1,500 metres.

In order to meet these difficult conditions, considerable development work was carried out which culminated in the aircraft being fitted with a rough airfield protection kit as shown in Figure 12.

This kit protects the fuselage and underwing by the use of abrasion resistant teflon polyurethane paint, with glass cloth protection on the nose and underside of the inner flaps. There are gravel deflectors consisting of rubber flaps fitted between the main wheels and nose wheels. Stone catchers in the form of debris collection boxes are fitted between the ram air intakes and the secondary heat exchangers in the air conditioning system. The aircraft empty weight was increased by only 108 lb., as a result of these changes, but the kit has been certified by the Civil Airworthiness Authority for unsealed runway operations.

TACTICAL TRANSPORT AIRCRAFT DESIGN STUDIES

Further development in this direction and carrying this philosophy and experience into new designs would provide both military authorities and the civil air transport system with the breed of aircraft it needs. This can be had by squeezing all that can be got from more or less known technology and by avoiding complex mechanical arrangements and the safety, reliability, cost and servicing problems that go with them.

It must be made clear that these remarks apply only to the military transport aircraft and it is very important to differentiate quite clearly between this and the combat aircraft. Quite a strong case has been made for combat V/STOL - for a variety of different reasons.

Some of the advantages come from the reaction time for close support missions being reduced, the close co-operation achieved with ground forces in the forward area, and the greater need for guaranteeing combat aircraft operation with short term support more from stores and ground transport, rather than air transport.

Among the BAC current studies of civil and military transports is a twin-engined project using 2 - RB.211.22 engines; as well as being quiet, choice of this engine avoids the technically undesirable and expensive programme of developing an advanced airframe and advanced engine at the same time.

In the civil role, Figure 13, the aircraft carries about 180 passengers.

In the military role, Figure 14, it has a maximum payload of 70,000 lb., which it can carry over a distance of 1,300 nautical miles or a capability of 45,000 lb., over 2,500 nautical miles. In a typical 200-300 nautical mile battlefield support operation its STOL all engines performance to 35 ft. is about 850 metres. This is derived from a factored balanced field Q/TOL performance in ISA + 20°C. of 1,000 metres. In the battle support action the ground roll would be a little over 650 metres.

The cargo hold is 67' 8" long, 10' 5" high, allowing a rectangular envelope of 11 ft. x 10 ft.

Provision is also made for a side loading freight door which is particularly of importance in considering its civil potential.

This aircraft is only one example of work in this area.

Several of the advanced high lift systems shown in Figure 15 were considered, but because of the broad scope of the work at this stage, the initial comparisons procedures were kept relatively simple and the aircraft recently referred to was based on the use of the mechanical flap.

Critical consideration of the influence of configuration changes, e.g. engine arrangements for noise shielding, the use of more advanced aerodynamics, such as supercritical wing design, will be made in greater depth as the task and design requirements crystallise.

CONCLUSIONS

The purpose of this paper is to try to draw a few threads together which will point to a cost effective approach (Figure 16) to the tactical transport aircraft and suggest some lines of study for the future.

I conclude, therefore:

- that vertical or very short take-off and landing is not an absolute must, if it had been one or other of the many solutions would already have been developed for production;

- that the requirement of the military and civil operator is close enough to make it desirable that their aircraft may be developed jointly. It may even be essential in the economic environment to do this, if either party is going to be able to afford to buy this equipment;

- that the airfield performance of the Q/TOL airliner, with its steeper gradients, when converted into military operations provides an attractive STOL aircraft capable of using fields of about 800 metres;

- that real V/STOL performance becomes increasingly costly and for the tactical transport, appears unnecessary, especially in the light of the number of heavy lift helicopters which are in existence and whose development bills have already been paid;

- that we should develop our tactical transport aircraft progressively from existing knowledge, introducing advanced technology such as exotic high lift systems, reinforced fibre composite materials, etc., only when sufficient development work shows that all of their peculiarities, when seen in the total aircraft operation, are understood; thus minimising very expensive disappointments;

- that we should continue to research in these fields with a joint military/civil programme in mind;

- that we resist resorting to the use of aircraft with complex mechanical configurations.

Finally, in repetition, these remarks apply to the military tactical transport aircraft. The military combat aircraft is an entirely different matter, where V/STOL or even pure 'V' outside of, and as well as, helicopters, could offer some unique operational features.

ACKNOWLEDGEMENTS

The Author wishes to acknowledge the assistance given by senior colleagues from the Divisions of the Corporation in the preparation of this Paper.

The views and opinions expressed are, however, those of the writer and should not be taken as necessarily representing the policies of British Aircraft Corporation Limited.

REFERENCE

AGARDograph 89, September 1964,
R.F.Creasey, N.W.Boorer, and R.Dickson,
Effects of Airframe and Powerplant Configuration on V/STOL Performance,
Pages 185-221.

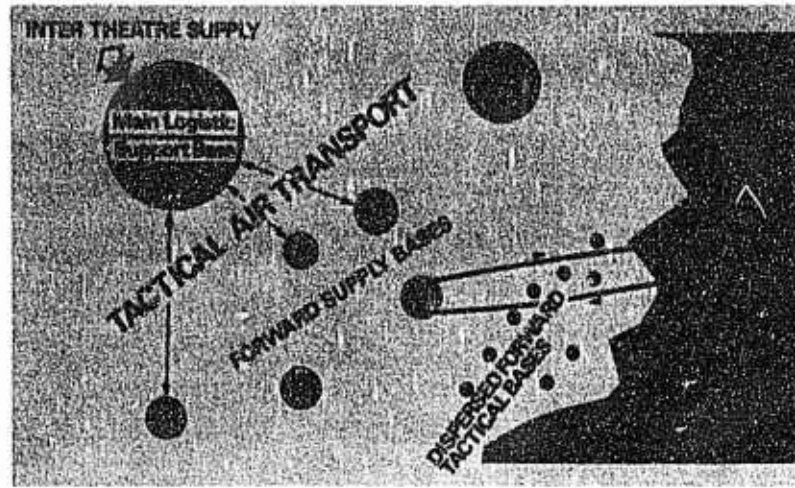

Fig. 1. Operational Environment.

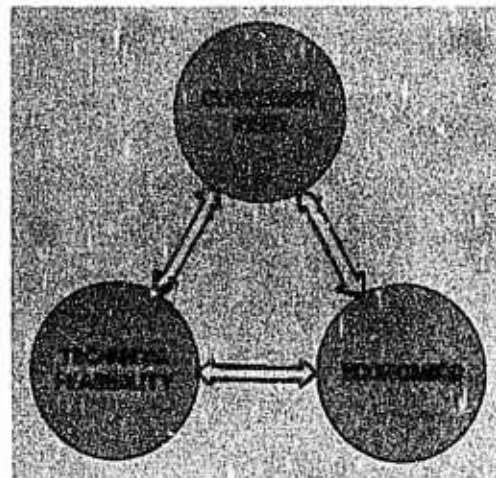

Fig. 2. Prime Ingredients.

Requirement		Influence on Design characteristics
Military	Civil	
BASE DISPERSION. MINIMUM AIRFIELDS. UNPREPARED SURFACE.	UTILISATION OF A WIDE VARIETY OF AIRFIELDS AND SURFACES.	IMPROVED AIRFIELD PERFORMANCE. HIGH T/W. STEEP CLIMB AND APPROACH.
PAYLOAD FLEXIBILITY. LARGE HOLD WITH GOOD ACCESS. QUICK TURNROUND	WIDE BODY, TWIN AISLE AND/OR CONTAINERS. QUICK TURNROUND.	LARGE FUSELAGE, HIGH WING, LOW DOOR SILL. ON-BOARD POWER SERVICES.
HIGH RELIABILITY. EASILY MAINTAINED.	MAX. REVENUE HOURS PER YEAR.	NOVEL AND COMPLEX ENGINEERING AVOIDED.
AIRFIELD AGILITY PLUS USEFUL PAYLOAD/RANGE.	LOW NOISE WITH ACCEPTABLE ECONOMICS.	HIGH BPR TURBO-FANS.

Fig. 3. Compatibility of Requirements.

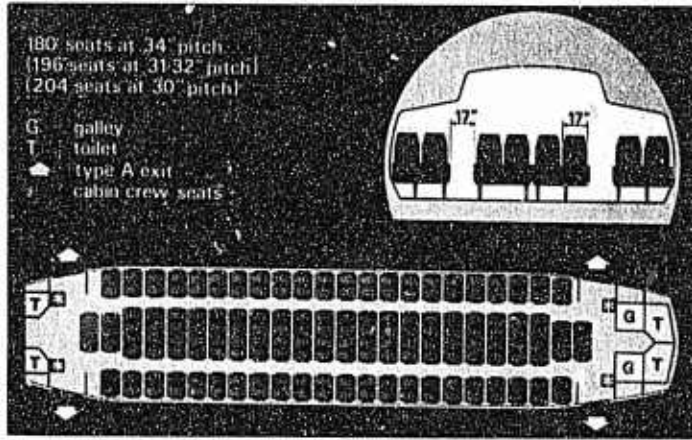

Fig. 4 Accommodation Layout.

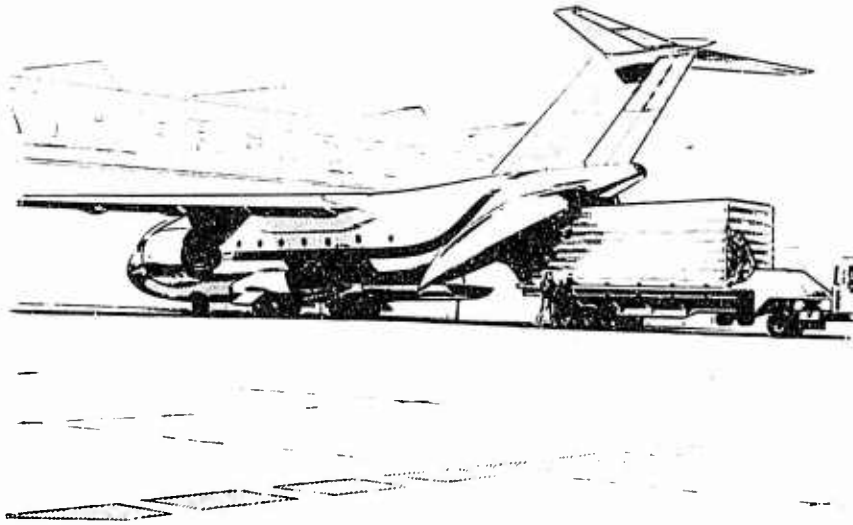

Fig. 5. Military Transport.

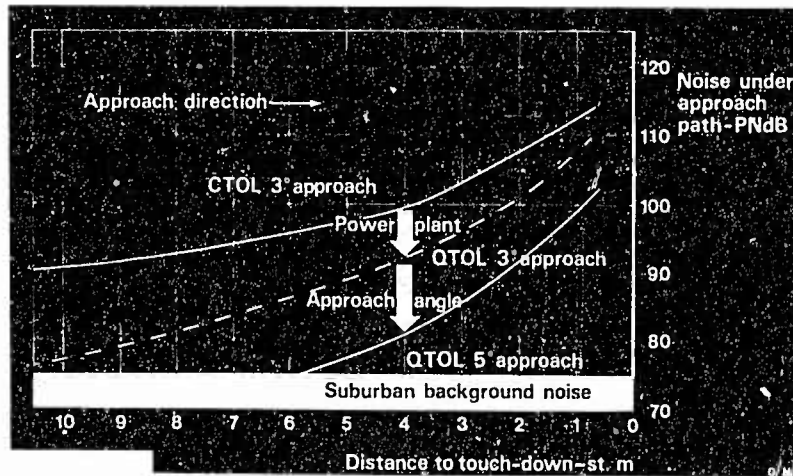

Fig. 6. Effect of Steeper Approaches.

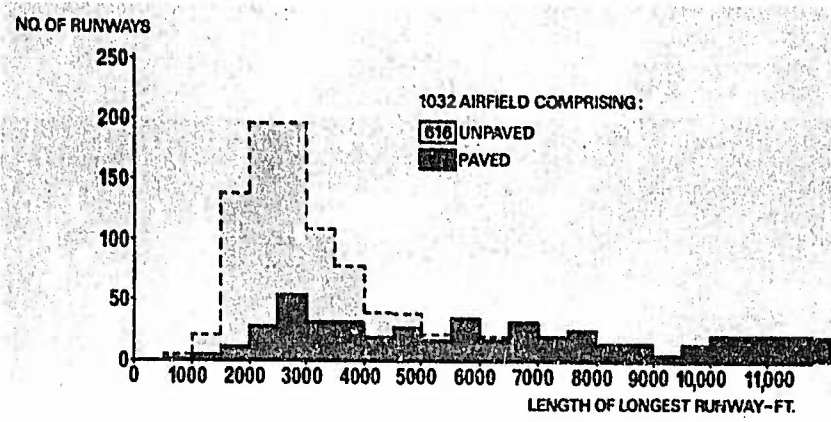

Fig. 7. Distribution of Runway Lengths in Western Europe.

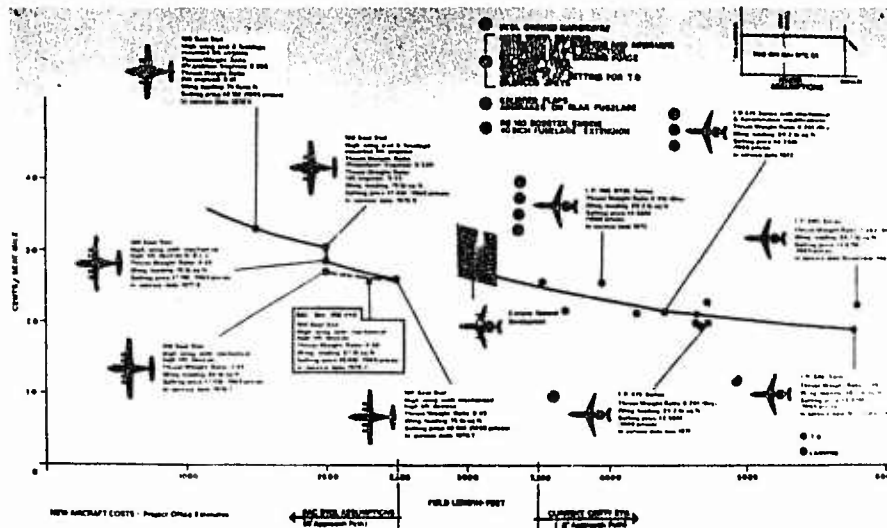

Fig. 8. Operating Costs vs Field Length (BAC 1-11 Developments).

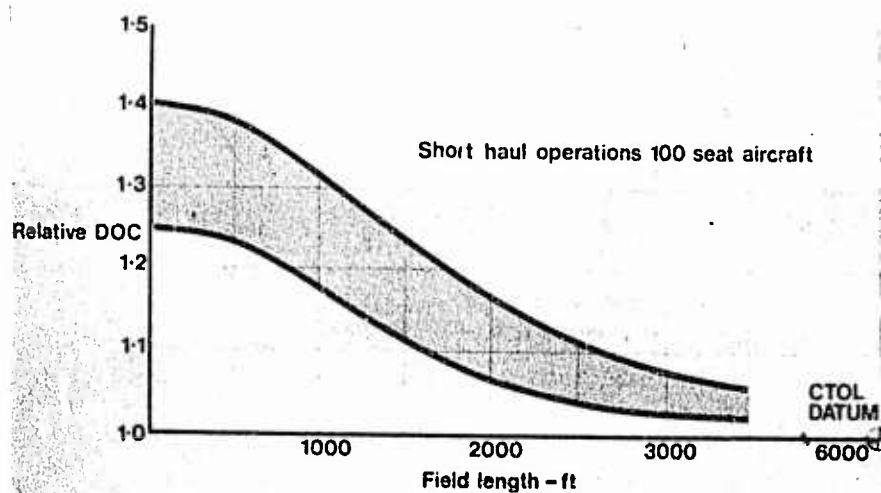

Fig. 9. Variation of Relative Direct Operating Costs with Field Length.

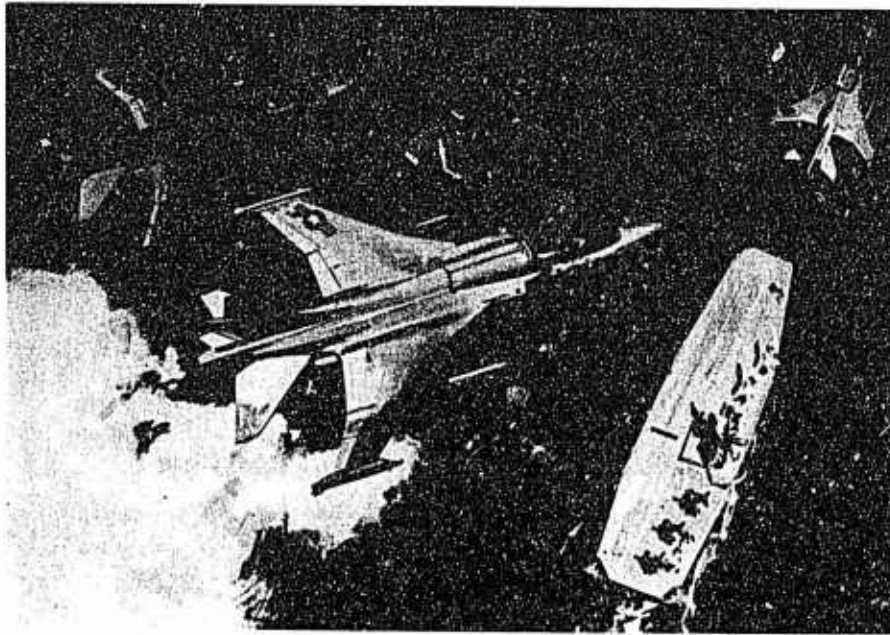

Fig. 10. A Recent Grumman V/STOL Design.

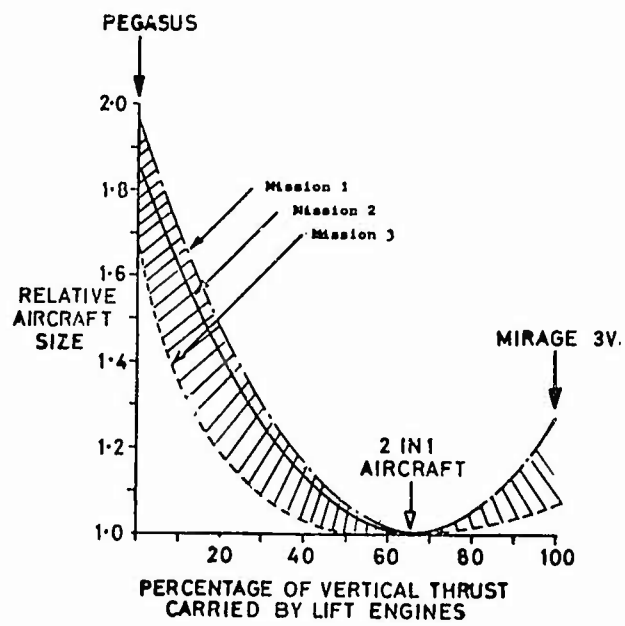

Fig. 11. V/STOL Concept Comparisons.

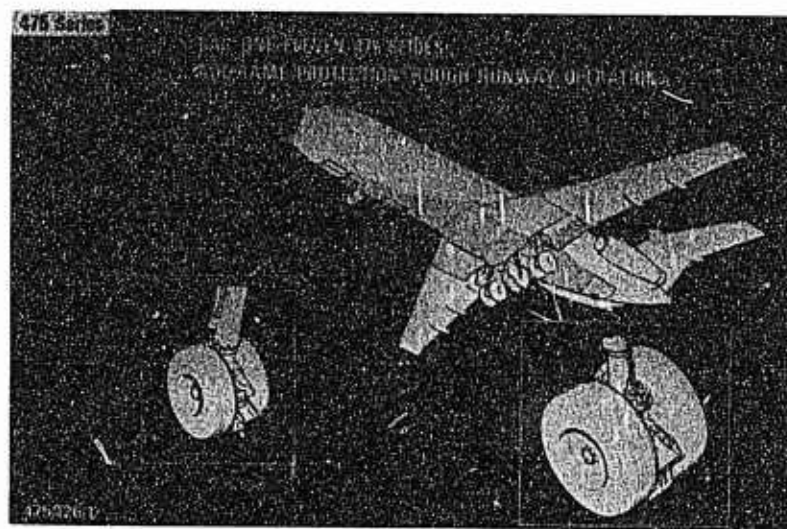

Fig. 12. BAC One-Eleven - Rough Runway Kit.



Fig. 13. Q/STOL Airliner.

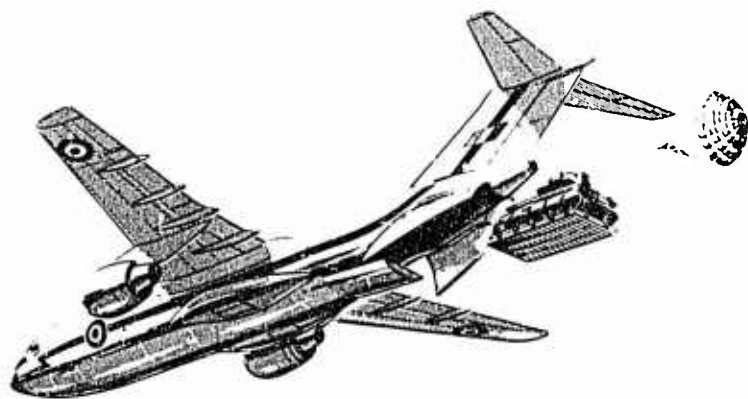

Fig. 14. Military Transport.

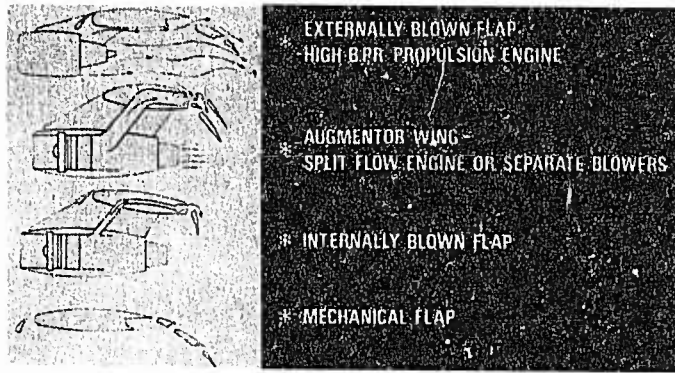

Fig. 15. Lift Systems.

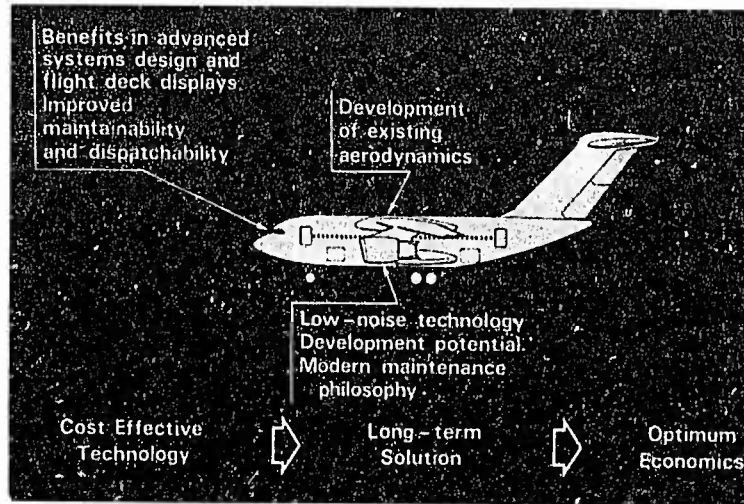

Fig. 16. Technology - Cost Effective Evolution.

SELECTING A STOL TRANSPORT

FRED D. ORAZIO, SR.
 Aeronautical Systems Division
 Air Force Systems Command
 United States Air Force
 Wright-Patterson AFB, Ohio 45433

ABSTRACT

The increasing demand for mobile ground forces in intratheater tactical operations emphasizes a greater need for extensive flexible and responsive airlift capability to provide rapid movement of personnel and equipment. The tactical airlift problem and its needs are recognized in United States Air Force planning. Further, to provide maximum flexibility, the tactical airlift equipment must interface with the strategic equipment and yet be capable of servicing forward austere operating locations. The flexibility can be realized through use of *short takeoff-and-landing (STOL) aircraft*.

The STOL transport also has commercial implications. The United States Department of Transportation is keenly aware of the necessity to improve our domestic short-haul air transportation system. Limitations on space for airports and environmental requirements for steep angle arrivals and departures suggest the need for STOL characteristics in short-haul aircraft.

In attempting to identify the proper characteristics of a STOL transport, we need to investigate current and past development efforts in the field and apply the most practical technology to form the basis for development decisions. These areas include feasible designs incorporating powered/lift systems, advanced structures (including composite structures), high flotation landing gears (air cushion landing system), vulnerability protection, etc. Also, the operational feasibility of a STOL transport system must carefully consider STOL operating margins and criteria, aircraft handling qualities, operating constraints (such as noise) and cost. Cost must be taken into consideration during the advance design stage for a determination of the Research, Development, Test, and Evaluation (RDTE) and Operations and Maintenance (O&M), (total life cycle cost). Through design studies and tradeoff analyses, cost sensitivities to various design parameters and performance goals must be investigated. These studies may not provide the desired confidence in all areas, and hardware flight test may be a desirable complement. The United States Air Force and National Aeronautics and Space Administration (NASA) have planned such hardware demonstration programs.

SUMMARY

The trend toward increased mobility of military ground forces dictates a growing airlift requirement to enhance that mobility. The United States Air Force is responsible for providing air transport for all of the Armed Forces, and specifically for furnishing logistical air support to the Army. These Air Force missions require an extensive, flexible, and responsive airlift capability to provide rapid movement of personnel and equipment. Both *long-range or strategic airlift* and *short-haul or tactical airlift* are recognized in United States Air Force planning.

Tactical airlift forces provide the military commander with a responsive and flexible *air line of communication (ALOC)* optimized for intratheater distribution of personnel and material. The ALOC extends from interface points with strategic air and surface modes to the ultimate consumer or to interface points with the consumer's organic transport resources. The airlift equipment used in the intratheater distribution role must be compatible with the large strategic airlift equipment and yet capable of servicing forward austere operating locations. Equipment compatibility means that the cargo loads must be readily transferable between the strategic and tactical equipment with little or no repackaging. Cargo handling and repackaging should be minimized at interface points. To support this concept, the cargo bay should be large enough to be compatible with standard shipping containers and pallets while simultaneously transporting passengers and providing for a safety aisle and adequate structural clearance.

The *ALOC flexibility* can be enhanced through use of short takeoff-and-landing (STOL) aircraft. For example, the capability to operate into 2,000 foot airfields would permit delivery of large quantities of personnel and equipment to within 75 nautical miles of a random point on a worldwide basis 90% of the time. More specifically, in the central European area there are more than 650 runways that are unsuitable for the United States Air Force C-130 aircraft but are usable by a STOL transport capable of operating into a 2,000 foot field. This degree of short field capability would greatly enhance logistics support at dispersed fields in an operational situation. Therefore, the tactical airlift aircraft which is developed to replace today's C-130 force should incorporate a large cargo bay and have substantial STOL capability. That aircraft will provide a strong link between strategic lift and the ground forces' organic ground transportation system.

Not unlike the United States Air Force to improve the theater of operation airlift system, the United States commercial airlines are keenly aware of the necessity to improve our domestic short-haul air transportation system. In an era of very rapid

transcontinental and intercontinental transportation there exists a very real need for more efficient center-city to center-city transportation. Limitations on space for airports and environmental requirements for steep angle arrivals and departures suggest the need for STOL characteristics in the short-haul aircraft planned to meet this need.

The United States airlines look at STOL operations as an inherent part of a total air transportation system. In the eastern part of the United States our airlines operate over the most congested air transportation network in the world. The airlines estimate the weekly costs of nonproductive flying due to air traffic congestion in the millions of dollars. Consequently, the commercial sector is anxious to minimize the nonproductive flying by employing STOL aircraft. Much can be accomplished towards this goal by employing STOL aircraft together with improvement in low altitude air traffic control, low level navigation,¹ improved terminal weather and turbulence detection methods, etc.

The value of the STOL concept has been partially obscured by the emphasis on vertical capability for transport aircraft. However, there is renewed interest in a flexible aircraft which can operate from short runways with substantial payloads and still transit several hundred miles rapidly. The STOL concept is not limited to terminal area operations, but encompasses the total task of transporting payloads between short fields. There is inherent flexibility associated with an aircraft designed for STOL operations when it is operated in a more conventional mode.

The payload overload capability is significant when the runway length constraint is relaxed and the aircraft is operated at a lower than design-point limit load factor. Figure 1 is based on an in-house study of a *typical STOL transport* designed to carry a 28,000 pound payload out of a 2,000 foot airfield and have an unrefueled radius of 400 nautical miles. As shown, the overload capabilities are large for lower limit load factors and larger critical field lengths demonstrating some of the operational flexibility mentioned above. However, one does not get anything for nothing. This overload capability does not just fall out -- *it must be designed into the aircraft.*

Numerous STOL system studies have attempted to identify the characteristics necessary for a STOL transport. While the characteristics of military and commercial STOL aircraft differ somewhat due to mission peculiarities, there is a general agreement on aircraft size, cruise speed, short field capability, and range. Our analyses indicate that the aircraft for the United States needs should be in a weight class to accommodate payloads in the 20,000 to 30,000 pound range with overload capabilities of 50,000 to 60,000 pounds. Such an aircraft would be useful in military tactical airlift operations and a comparable commercial aircraft would carry 100 to 150 passengers. Cruise speed is not a function of short field capability, but must be considered in developing a useful aircraft. Both military and commercial requirements for efficient and rapid mission segments drive the design toward turbofan engines. The turboprop STOL aircraft offers propulsion capabilities for excellent short takeoff and landing standpoint, but does not compare favorably with the jet STOL machine on the longer high-speed route segments. Air Force experience indicates that the jet transport is more acceptable than the turboprop transport from reliability and maintainability standpoints. The public sector views commercial propeller aircraft as obsolete. As indicated earlier in this paper, the United States Air Force is interested in operating from 2,000 foot field lengths. This goal appears to be acceptable to the commercial sector. The military mission radius and commercial range requirements are compatible. For a commercial STOL transport to be economically competitive it must capture the short route segments of 400 to 600 nautical miles.² United States Air Force mission requirements indicate that a 400 to 500 nautical mile mission radius is a suitable performance goal for a STOL tactical transport when combined with a cruise speed of Mach = 0.7 in order to achieve faster turnaround times for transporting troops and litter patients.

Turbofan STOL concepts involve the use of powered lift and introduce the complexities associated with the interaction of airframe and propulsion systems. *Powered lift* offers a solution for reducing takeoff distance. As shown in Figure 2, one possible concept utilizes vectoring nozzles on the turbofan engine and mechanical flaps. Thus the *aerodynamic lift* is supplemented by *propulsive lift*. Other promising approaches to powered lift exploit the use of blown aerodynamic surfaces to induce lift. As shown in Figure 3, in the *internally-blown flap concept*, engine bleed air is directed through the wing and over the trailing edge flaps. The internally-blown flap uses the Coanda effect to turn the jet stream over the upper surface of the flap. As shown in Figure 4, the *externally-blown flap concept* uses engine exhaust air and fan air directed externally through slotted flaps to augment lift. The blown flap concepts generate extra aerodynamic lift through supercirculation and also benefit from the vectored thrust. Thus the lift increment supplied by the engines through this means is greater than the direct contribution of engine thrust. The United States Air Force and the National Aeronautics and Space Administration (NASA) continue to support system design studies and test programs to investigate critical technology areas in support of development of powered lift concepts.

While past programs have indicated the feasibility of powered lift concepts, there has been insufficient attention devoted to those areas in which information is needed to form the basis for decisions in developing STOL transports on a broad scale. These areas include lift systems performance, STOL operating margins and criteria, aircraft handling qualities, operating constraints, and a very important factor in the decision equation--cost.

Lift system design and performance must be predictable with reasonable accuracy before detailed design can be accomplished. In order to predict performance, we must fully

understand the effects of powered lift. Effects such as wing/engine placement and wing and flap geometry must be included in investigations. Engine effects of temperature and structural loads on flaps must also be determined. Ground effect assumes a reversed role with powered lift aircraft in that it produces a suck-down effect in some configurations. Analytical techniques are being developed to assist in the understanding and prediction of this phenomenon. Simulation and wind tunnel tests of models are two useful techniques. Aircraft design concepts should be analyzed and performance predictions verified, then designs can be tailored and optimized for particular applications. The United States Air Force and NASA are quite active in the use of simulators to study lift system performance, airplane response and handling qualities.

Firm engineering design data are required in order to select configurations for detailed design. To develop design data, STOL operating margins and criteria must be established. STOL transports will not operate in the same fashion as present day jet transport aircraft, nor should they be required to meet the same criteria and suffer consequent design penalties. Current criteria does not recognize powered lift systems. New criteria must be compatible with the mode of operation, just as unique operating criteria apply to helicopters as compared to fixed-wing aircraft.

In establishing meaningful criteria, it is necessary to understand the effect of each requirement on the system design and operation safety. The United States Air Force conducted a study last year to determine how variations in criteria affect STOL transport design and the results showed that STOL performance criteria have significant effects.³ For example, both military and commercial conventional criteria base takeoff and landing stall speed margins on power-off operation, which penalize powered lift aircraft. Therefore, useful STOL criteria should possibly specify the margins in terms of power-on operation. Current criteria take no credit for thrust reversal in stopping the aircraft, but consider thrust reversers as a backup deceleration system in case of brake system failure or poor runway braking conditions.

Knowing the effects of STOL operating criteria, the designer is better able to identify the sensitivity of various design parameters. Additionally, he should participate in the process of establishing criteria. The Federal Aviation Agency is now embarked upon a program with the United States Air Force and NASA to develop the necessary criteria for certification of commercial STOL transports. Initially the program will study the flight characteristics and handling qualities of proposed STOL aircraft through the use of a moving base simulator. Then criteria will be developed which are applicable to powered lift STOL aircraft. Ultimately the proposed criteria will need to be verified in actual flight tests of STOL transports.

STOL operation creates some problem in *aircraft handling*. Low dynamic pressure at typical takeoff and landing speeds does not provide the control power experienced in conventional aircraft. The slow speeds reduce aerodynamic effectiveness, thus crosswinds, gusts, and engine failure severely impact the aircraft operating conditions. The very nature of STOL operation requires precision maneuvering of the aircraft to a landing spot through precise glide path control and then positive control throughout rapid deceleration. These problems are intensified by changed relationships between aircraft power and control. Powered lift aircraft behave differently from conventional aircraft.

Fairly sophisticated aerodynamic and propulsion forces for control and stability augmentation systems will be required to handle the controllability and handling quality problems. Through these systems the aircraft can be made to handle similar to a conventional aircraft, so that the pilot's power and control relationships remain familiar to him. Much of the stability and control functions will have to be automated in order to keep the pilot workload at a manageable level. Although approach speeds will be relatively slow, sink rates will be high, reaction to system failures must be rapid and glide path perturbations will have large effects on stopping distances.

Operating constraints on STOL transports naturally vary between military and commercial operations. Military constraints will vary because of variable tactical requirements. Austere operating locations may present undesirable terrain, unpaved runways, sparse navigation and landing aids, and a lack of maintenance and servicing facilities. The commercial operating environment, on the other hand, can be expected to provide fixed airfields with paved runways, advanced navigation and approach aids, and adequate maintenance and servicing facilities. The austere operating location characteristics translate into different design considerations for the military STOL transport. Unpaved runways dictate high flotation landing gear which cause increased aircraft weight. Also, engine thrust reversers must be improved to prevent reingestion of exhaust gases and ingestion of runway debris at low speeds during deceleration.

Aircraft noise is a growing concern throughout the world. The United States is no exception. The Congress has enacted legislation (Public Law 90-411) to require the control and abatement of aircraft noise. The Federal Aviation Agency has proposed STOL commercial noise criteria which establish a goal of 95EPNdB along a 500 foot sideline at 70 knots forward speed after liftoff with takeoff power setting.⁴ It is clear that such criteria will have significant impacts on the planning and selection of STOL ports as well as on STOL transport design. The military mission objectives and operating philosophy are different from those of the commercial airlines. The military emphasis is on maximum performance capacity, while commercial operations emphasize passenger comfort and harmonious community relations with reasonable performance. However, military STOL transports of the future will probably be subjected to constraints similar to commercial aircraft when operating near populated areas.

System cost is a major consideration in any decision to develop STOL transports. The aerospace community is well aware of the numerous proposed designs of STOL transports and their estimated costs. It is beyond the scope of this paper to investigate the many designs and associated cost estimates. However, there are some interesting findings emerging from our system studies. One very significant one is that turbofan STOL transports will not cost disproportionately in comparison to conventional jet transports of similar operation weight. It appears that we will experience additional costs for the higher aircraft thrust-to-weight ratios necessary in powered lift STOL transports. The sophisticated stability and control augmentation systems will induce additional costs over current basic systems. The wing flap system will be no more complicated than the Boeing 727, a tried and proven design. Stability and control augmentation systems will be similar to that of the Boeing 747, so there are no dramatic cost increases due to system design.

Through design studies and tradeoff analyses, cost sensitivities to various design parameters and performance goals must be investigated. Then, performance increments can be compared with associated system cost increments to assist in the development decision. These studies, however, do not render the desired confidence in all the areas requiring solutions. Some questions can only be answered through hardware demonstration and evaluation. Flight tests can validate study findings, identify areas requiring further investigation, as well as offer visibility on system costs. The United States Air Force and NASA have plans for such hardware demonstration programs.

The United States Air Force plans to fabricate and test a small number of STOL transport prototypes to evaluate the military operational feasibility and utility of a medium sized jet STOL transport. A major goal of the program is to identify a low-cost development option for modernization of the United States tactical airlift force. The prototype will provide a means of validating proposed STOL operating criteria under actual flight conditions.

NASA is concentrating on a program to evaluate some STOL transport designs that would lead to a quiet commercial STOL transport. Both programs should produce flying prototypes within three years.

I have briefly described the United States Air Force's concept of operations for tactical airlift to show our motivations for examining STOL aircraft. Similarly the United States commercial airlines are interested in STOL operations as a means of developing a short-haul system to service a growing market.

The motivations for developing STOL transports are clear and the hardware demonstration programs are underway. Inside three years, we will be gaining answers to our questions regarding STOL operations, either military or civil, to comply with existing procedures and methods of operations. We must not stifle innovation in the very beginning of a new segment of our air transportation system. New thinking is needed to enhance STOL concepts and their potential.

Military airlift operations are always subject to austere environment, dictating a great deal of self-sufficiency in aircraft design. Some form of integral cargo handling equipment is a virtual necessity. Our intratheater tactical airlift experience shows that ground-based cargo handling equipment is often lacking in forward operating locations. It is difficult to keep equipment operational in forward locations and frequently the off-loading equipment turns out to be a military truck and a small group of soldiers. Efficient military STOL operations depend on short turnaround times; thus the necessity for on-board cargo handling equipment.

Hastily prepared landing zones are common in tactical situations, so off-runway operations should be strongly considered for future airlift operations. As shown in Figure 5, an *air cushion landing system concept* offers great potential flexibility for intratheater airlift. We should strive to be as innovative as possible in carrying out military tactical airlift operations without large, paved runways.

It may be that new thinking requires equipment designers to concentrate on smaller vehicles and equipment rather than larger ones. If ground force mobility is to improve, the ground forces and their equipment must be light and compact. The United States Army planners have made marked progress in this regard, and the helicopter played a major role in the process. The "air mobile" concept, wherein troops and equipment are injected into combat in helicopters, has emphasized lightweight equipment.

Commercial STOL operations will introduce new considerations for the operators and users. The traveler must have access to reliable ground transportation systems. If the airline passenger must suffer surface transportation delays or pay expensive ground transportation fees, the advantages of the short-haul STOL operation are reduced.

In summarizing this discussion, I would like to offer the benefit of our experience in investigating STOL intratheater transports. It is obvious that there are a number of tradeoffs which must be conducted to integrate a complete STOL system from the standpoint of configuration, propulsion, performance, handling qualities, takeoff and landing, ground operations, etc. These major factors have to be considered from a total system design point of view in order to describe an operationally acceptable aircraft which will be practical and reasonable in cost. As I discuss some of the major STOL aircraft design considerations listed in Figure 6, you will notice that advanced technology can play an important role in achieving the desired performance and cost.

One of the important design aspects for STOL aircraft is *the structural fraction*. This parameter for STOL aircraft is in the order of 4% higher than that for a conventional aircraft. The higher structures weight is caused by increased weight for high lift devices, requirements for handling qualities and landing gear equipment for flotation improvements and high sink rates. The application of advanced metallic structures and composites wherever possible in the airframe design can help to alleviate this situation. Application of the latest technology in *the integration of the powered/lift system* in the aircraft is required if very short distances are to be achieved. The selection of the appropriate powered/lift system is very dependent on the absolute values of the design requirements such as takeoff distance, climb out angle, rolling coefficient used (unprepared or prepared fields) etc. These values considered together will determine the aircraft parameters such as thrust-to-weight and wing loading. Also, when these are related to various powered/lift combinations they will determine minimum weight/minimum cost systems. *Ferry range* necessary for military operations will influence the size of the wing for mission fuel volume and can compromise the aircraft designed for the basic mission. A serious consideration for the design of a STOL aircraft is *the loss of an engine at takeoff and landing speeds*. Loss of an engine not only reduces thrust but there is also a loss of lift usually on one side of the aircraft. This creates a rolling movement difficult to counter at slow speeds where control effectiveness is low. Consideration of the necessary control power and response time is a major design factor.

Vulnerability protection for military STOL aircraft is particularly important for the return to base fuel. In addition to protecting crew members and vital flight control components, the return to base fuel must receive more than ordinary attention. As already indicated *climb out and approach angles* are driving factors and deserve serious consideration in the design. High climb out angles increase thrust-to-weight and steep approach angles result in high sink rates and a heavier landing gear. For STOL systems, operational capability improvements in *landing gear and flotation* could be made by the application of replaceable tread tires/folding-sidewall (expandable) tires and ground mobility systems (auxiliary-power driven wheels for taxiing the aircraft). The problem of *designing for troop carrying and litter patients* could present additional weight by incorporating equipment and furnishings in addition to that needed for cargo operations. These furnishings can cause equipment weight to be as high as 10,000 pounds. *Designing for noise reduction* over current levels is a costly item in terms of weight. There are two primary noise sources - the engines and airframe. For STOL operations, the airframe noise is primarily caused by flap interaction noise particularly in the externally-blown flap design. Reduction of noise levels are important tradeoff considerations. Attenuation in engine noise to meet strict criteria causes installation thrust losses and specific-fuel-consumption (SFC) increases. This results in increase in aircraft gross weight to keep constant performance.

When all design considerations are applied to meet the mission requirements the choice of a "lifting concept" for the aircraft becomes a very important issue. As shown in Figure 7, there are several tradeoffs of performance parameters which impact on the takeoff distance and climb out angle and these in turn determine the thrust-to-weight. If one considers the *mechanical flap/vectored thrust design approach versus the externally blown flap*, it can be seen on this Figure that climb out angle is a very important consideration. For lower climb out angles and shorter takeoff distances the *externally-blown flap* is preferred; while for higher climb out angles the *mechanical flap/vectored thrust* becomes the choice. For STOL aircraft sized for the same mission and having the same takeoff wing loading, there exists a series of design points where externally blown flaps and mechanical flaps/vectored thrust would have equal capabilities. It is interesting to note, however, that the *mechanical flap/vectored thrust design* data shows a high and low climb out angle for the same takeoff distance depending on the amount of vectored thrust angle used.

I have covered but a few of the areas for consideration in selecting a STOL aircraft design and its operational concept. All considerations must be addressed and solutions developed where needed, if STOL aircraft are to provide maximum benefit in both military and civil operations.

REFERENCES

1. Crossfield, A. S., "Short-Haul STOL Concepts in Perspective," *Astronautics and Aeronautics*, December 1970, Vol. 8, No. 12, p. 46.
2. Cook, W. L., "Effects of Advanced Technology on STOL Transport Aircraft," *NASA SP-292*, November 1971.
3. Anon.: "The Effect of Short Takeoff and Landing Performance Criteria on Tactical Transport Aircraft Design," *Final Technical Report, ASD/XR 71-31*, Contract No. F33615-71-C-1880, The Boeing Company, January 1972.
4. "Conference on STOL Transport Aircraft Noise Certification," *FAA-NO-69-1*, January 1969.

ACKNOWLEDGEMENT: Special appreciation and acknowledgement is extended to Lt Colonel William H. Clarke, Aircraft Division, DCS/Development Plans, Air Force Systems Command, Andrews AFB, Maryland for his significant contribution in the preparation of this paper.

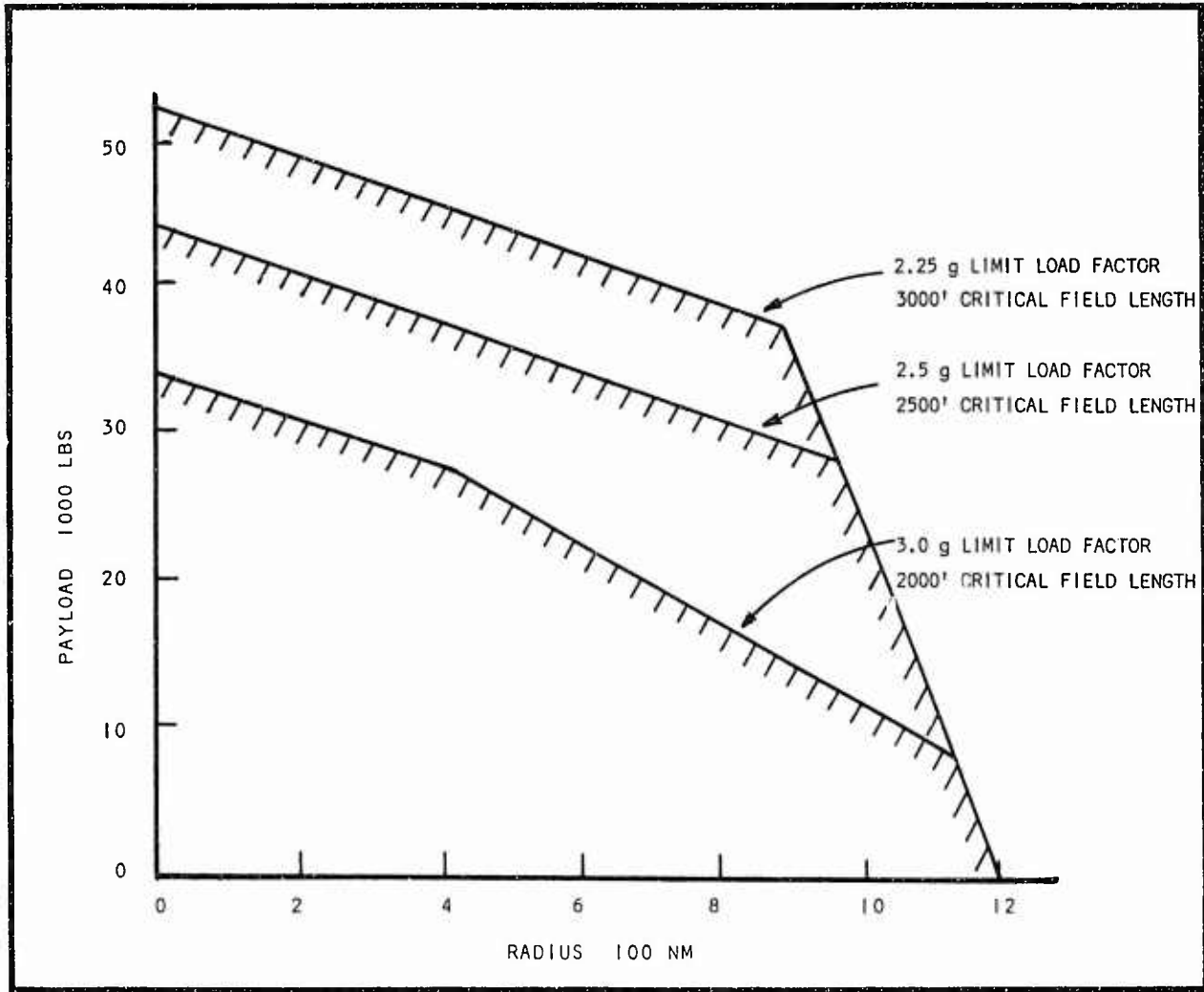

Figure 1. Payload versus Radius (Typical STOL Transport)

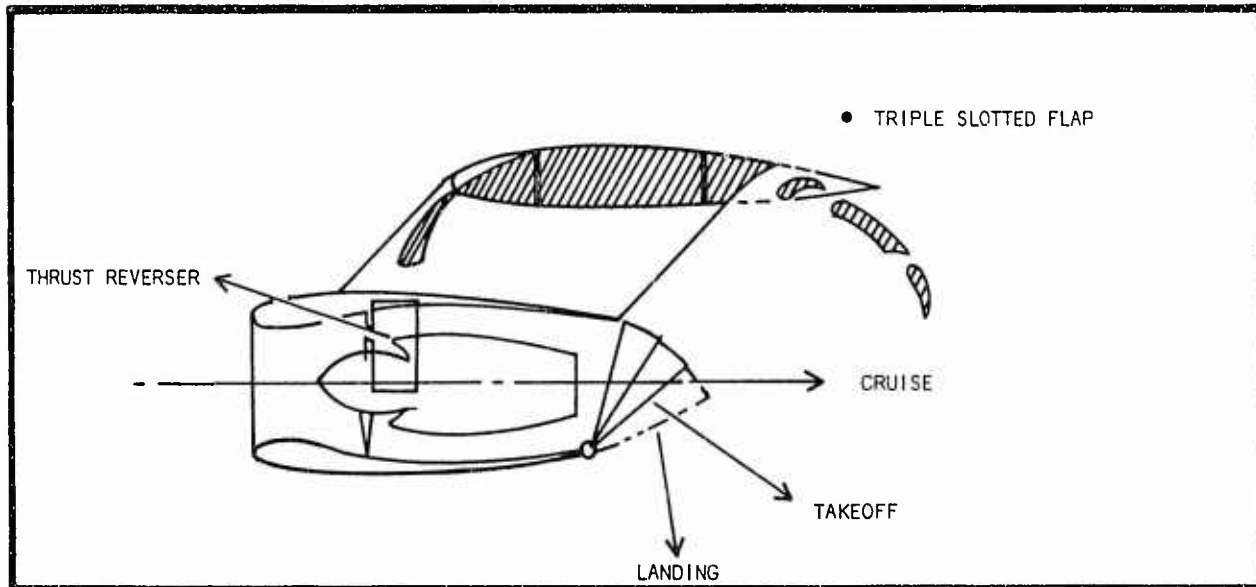

Figure 2. Mechanical Flaps - Vectored Thrust

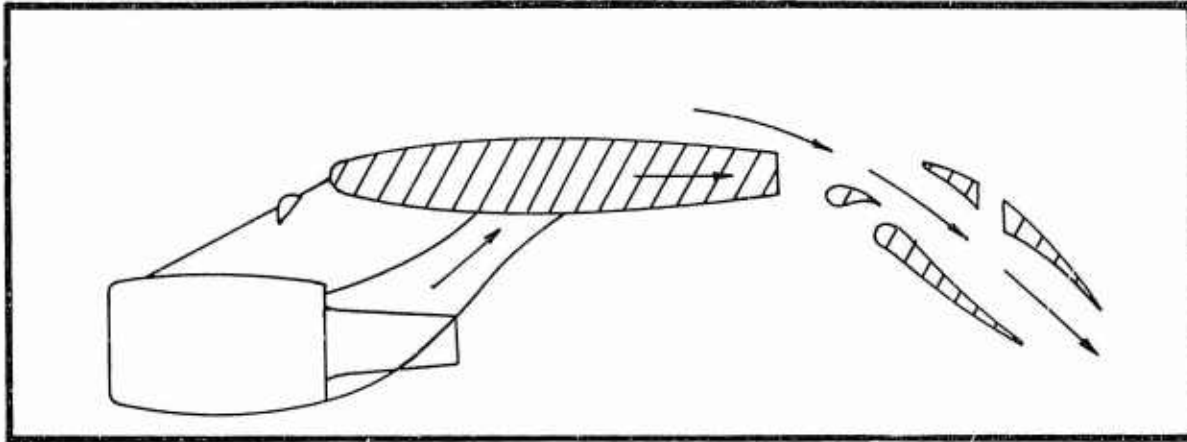

Figure 3. Internally Blown Flaps

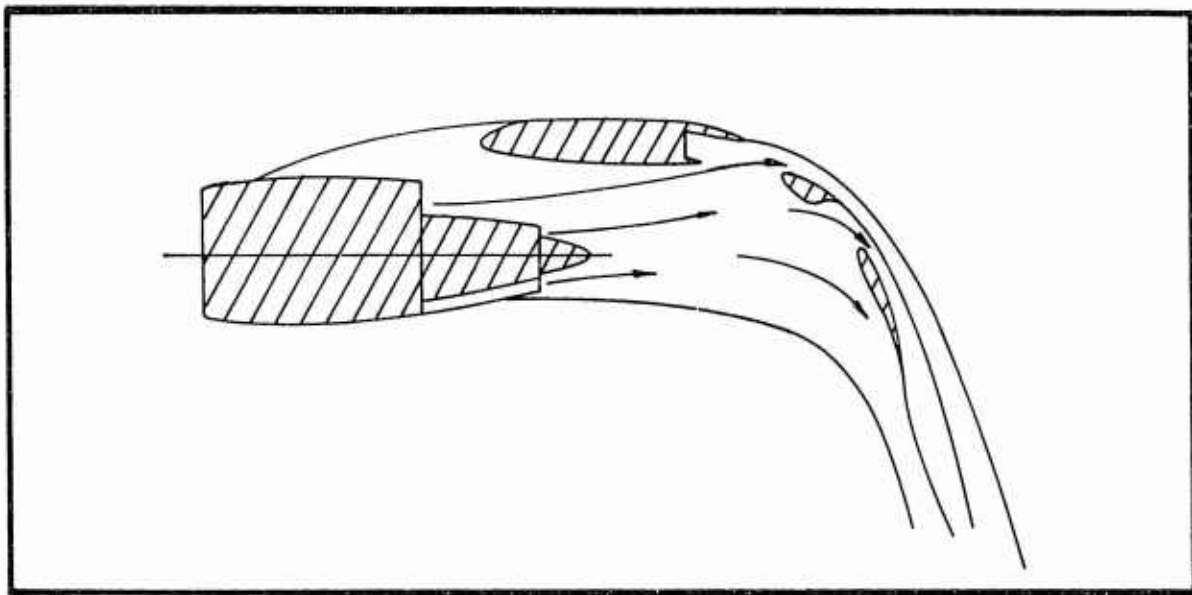

Figure 4. Externally Blown Flaps (Static Flow Pattern)

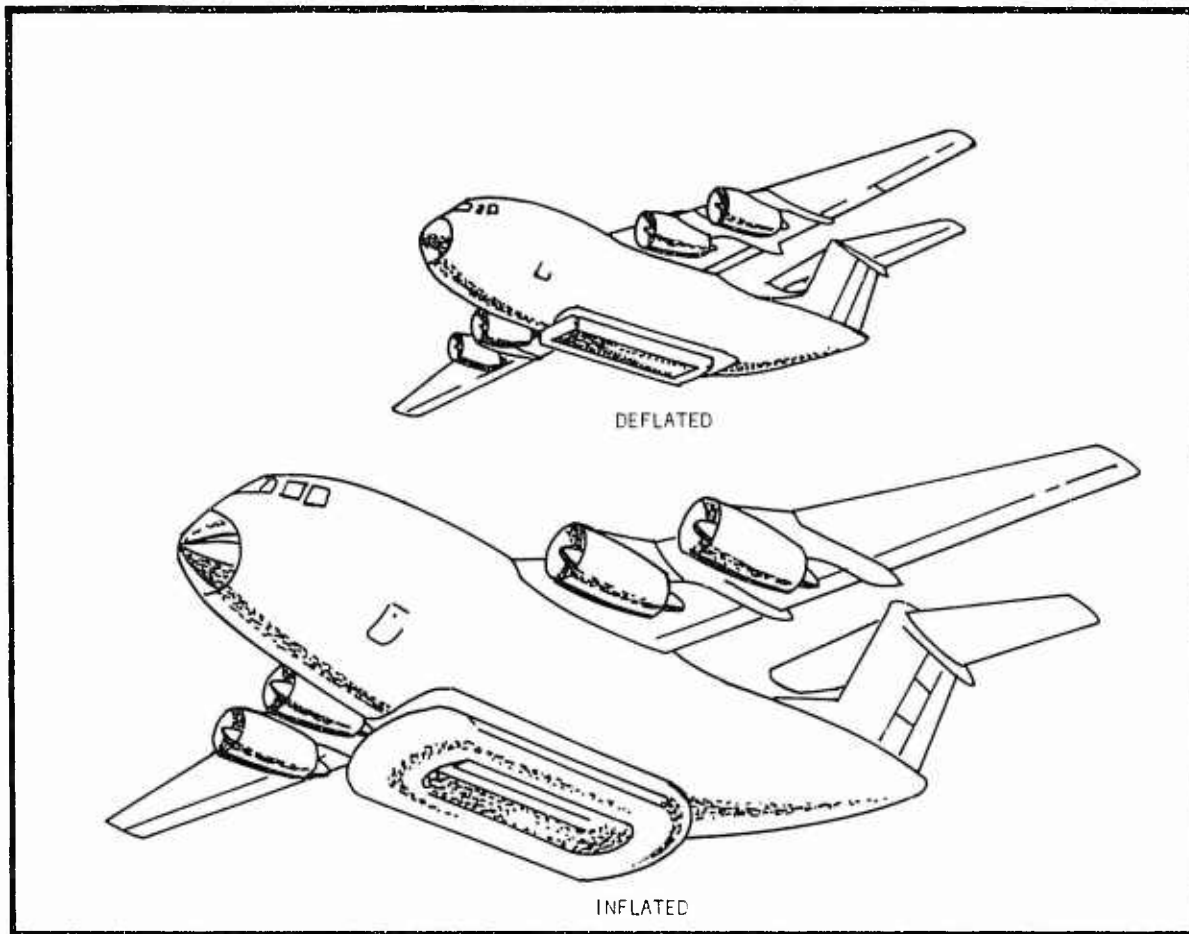

Figure 5. Air Cushion Landing System

- * STRUCTURAL FRACTION
- * PROPULSION SYSTEM/LIFT SYSTEM
- * FERRY RANGE
 - * VOLUME FOR MISSION FUEL
- * ENGINE OUT PROBLEM
 - * HANDLING QUALITIES
- * VULNERABILITY PROTECTION
 - * GO HOME FUEL
- * CLIMB OUT ANGLE/APPROACH ANGLE
- * LANDING GEAR AND FLOTATION
 - * RECAPPABLE TIRES
 - * FOLDING-SIDEWALL TIRES
 - * POWERED WHEELS
- * DESIGN FOR OTHER THAN CARGO
- * NOISE

Figure 6. STOL Aircraft - Important Design Considerations

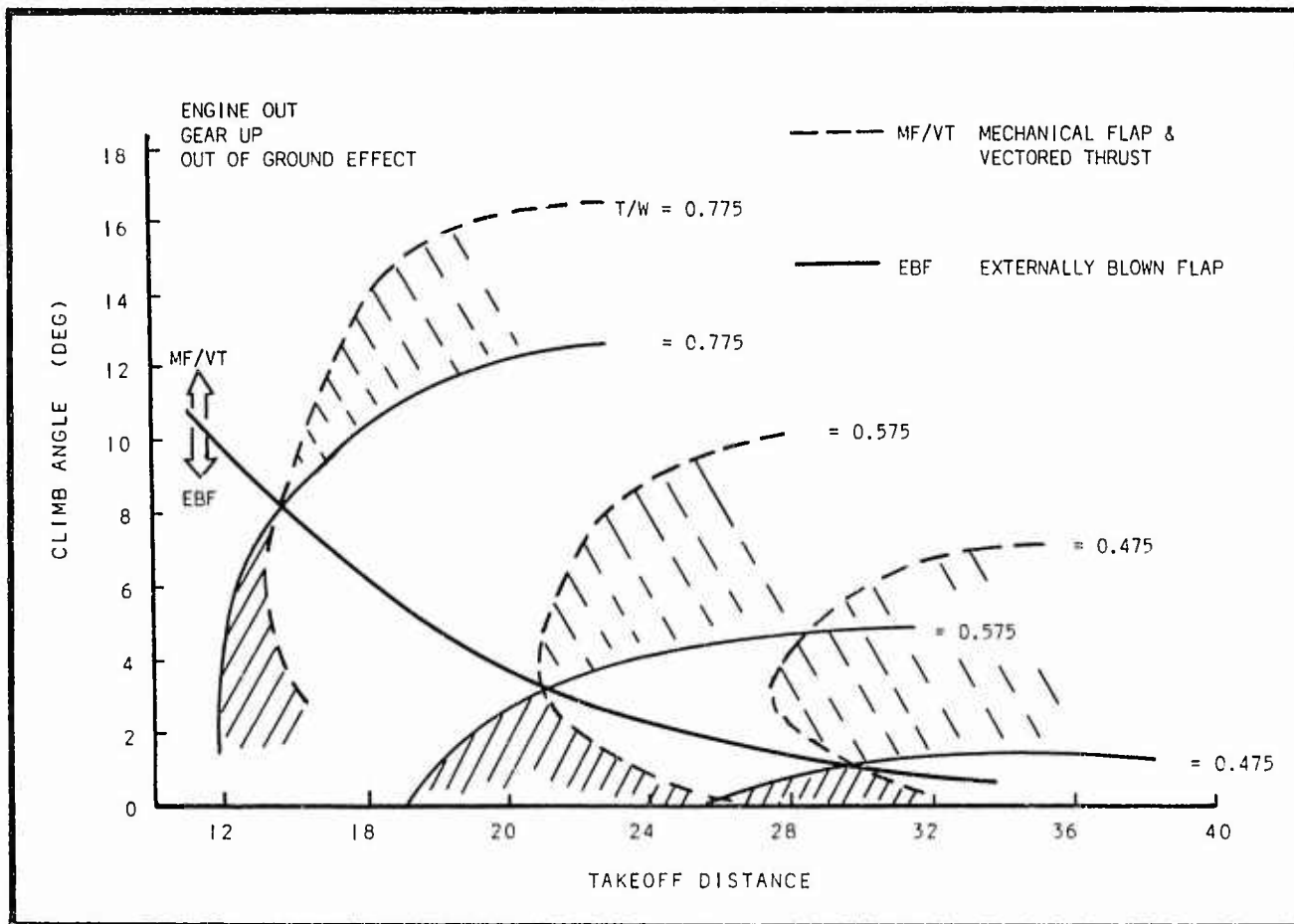

Figure 7. Choosing a Lifting Concept

GERMAN COMMENTS ON FUTURE V/STOL REQUIREMENTS

by

Brigadegeneral Uwe Köster
Bundesministerium der Verteidigung
5300 Bonn 1, Postfach 161
Germany

Mr Chairman, Gentlemen,

I have been invited to comment on the papers delivered by Captain O'Rourke, Mr Newby and Mr Orazio from the tactical/operational point of view of the German Air Force.

I shall do so with particular pleasure before this audience, and I should like to begin by giving you a brief survey of the V/STOL weapon system developments undertaken in Germany or with German participation.

I assume you all know that the German Air Force has decided to favor short rather than vertical takeoff and landing in its current programs although it was in Germany, in particular, that many VTOL projects were developed, flight hardware built, and a great deal of technological know-how generated.

What were the reasons for this decision?

Under the influence of the strategy of massive retaliation, requirements for an interceptor fighter having a vertical takeoff capability were formulated as early as in the late 1950's. They led to the development and prototype production of the VJ-101-C.

Concurrently therewith, a deployment concept -- although at first only a vaguely defined one -- was prepared which generated a need for a V/STOL transport. In the absence of specific military requirements, the DO 31 was developed as an experimental aircraft.

In addition, the Federal Ministry of Defense gave financial support to the development and testing of the P-1127 "Kestrel" from which ultimately the Harrier was developed.

The Kestrel could not meet the German requirement at the time; the aircraft envisioned to do that was the VAK-191B. Its design was oriented on the NBMR-3 and in keeping with the ideas of AC-169 b (Light Weight Panel). The requirements overemphasized the TVTO design mission, no longer permitted an adaptation of the aircraft to changed operational roles and thus had to be rescinded in 1966. However, this did not yet mean that the V/STOL concept had been abandoned.

For in the meantime efforts to find partners willing to cooperate in the development of an F-104 successor with a vertical and short takeoff and landing capability had been successful. Although no joint European program could be set up there were first discussions with the USAF in 1964 which eventually led to the US-FRG Advanced V/STOL Program. In 1968 it was jointly agreed that the project should not be pursued beyond the definition phase. Budgetary, operational and technological considerations were the reasons for this decision.

At that time, the German Air Force decided to content itself with a short takeoff and landing capability for an F-104 successor aircraft and to reduce the vulnerability of its tactical airfields by hardening. On the basis of the experience gained with the AVS program key requirements were established for a new combat aircraft (NKF) which later were incorporated in the requirements for the MRCA.

Extensive operations research studies conducted both jointly and nationally and with special emphasis on cost effectiveness in non-nuclear conflict situations materially influenced this decision.

The result of the overall analysis was that in terms of cost effectiveness STOL combat aircraft were equal to V/STOL aircraft but clearly superior to conventional takeoff and landing aircraft and that they could be realized with an acceptable technological risk and within the time frame envisaged.

It should be noted however, that while these studies answered a great deal of questions they raised perhaps even more others, especially since the outcome depended very materially on the assumed threat, overt and covert, and the distribution of operational roles, but also on the fact that neither the need for highly dispersed deployment nor the high cost resulting therefrom could be determined precisely.

Of the many problems that such a widely dispersed deployment would entail let me mention only those of logistics, including maintenance, repair and supply support of the weapon systems, and above all the security and manpower problems involved. Further, the problem of command and mission control via the necessary lines of communication, and the question of navigation aids on the ground.

The list could be continued.

We found that when there are so many open questions, theoretical studies can no longer provide the answers. Regarding the operation of conventional aircraft, enough knowledge is available to permit an operational concept to be established. In Germany V/STOL aircraft, however, have never advanced to the point where an operational concept could be tested in practice.

By contrast, the development of the British Harrier took a different course. The Harrier, designed for a single operational role in Europe with an already proven deployment concept, and conceived as a true V/STOL aircraft can rightly be regarded as representing the one extreme on the scale of potential applications of V/STOL technology. On the other hand, conventional combat aircraft have not stopped short in their development. Having installed thrusts hardly inferior to those of V/STOL aircraft and -- as a result of the requirement for maneuverability takeoff performance characteristics which place them in a category almost on a par with STOL aircraft, they can hardly be termed conventional any more in the sense of the F-104 or F-4.

The future requirements of the German Air Force will be oriented on the experience gained with already existing operational V/STOL combat aircraft. In order to reduce the variety of aircraft types it will continue to be necessary to combine several operational roles in one weapon system. In view of V/STOL technology it might be appropriate, however, to seek combinations different from those customary today. At any rate, there will be a requirement for an extremely short takeoff and landing capability.

The Air Force considers that it is neither necessary nor appropriate to begin to formulate concrete military requirements at this early stage. The reasons in support of this position are:

- the present, closed procurement programs of the German Air Force which extend into the 1980's,
- the medium- and long-term budgetary plans which practically leave no room for any new development projects; and
- the fact that there are a number of unsolved technological questions of which I would like to mention only the following:
 - utilization of the thrust-to-weight ratio of nearly unity that is available in advanced combat aircraft, for short or vertical takeoff and landing by thrust vectoring, but also for improved maneuverability in flight;
 - the need to improve existing landing gears to take greater sink rates and to permit a greater number of passes on soft-surfaced airfields for extremely short takeoff and landing operations;
 - the situation in the area of weapons developments which is currently in flux and which tends in two general directions: one is toward wide-dispersion weapons requiring a high payload capacity, and the other toward improved hit accuracy and stand-off capability which permit smaller payloads. But as VTOL aircraft go, they react to changes in payload much more sensitively than for instance STOL or CTOL aircraft;
 - the question of controllability and safety in extreme STOL, but also in the hover and transition phases of VTOL flight.

The list could be extended. But it may suffice to show that particularly in the area of extremely short takeoff and landing there are still a number of possibilities which need to be investigated and tested before we can determine the operational roles in which STOL weapon systems meet the military requirements, and in which they retain a greater flexibility.

This, Mr Chairman, concludes my brief comments.

Should any of the conferees have any further questions regarding the tactical/operational complex I shall try to answer them. Where questions are of a more technical nature they will be taken by General Birkenbeil.