

AMRL-TR-71-120

AD0446667
01/15/71



**PROCEEDINGS
OF THE
2nd ANNUAL CONFERENCE
ON
ENVIRONMENTAL TOXICOLOGY**

31 AUGUST, 1 AND 2 SEPTEMBER 1971

DECEMBER 1971

20060707032

Approved for public release; distribution unlimited.

STINFO COPY

AEROSPACE MEDICAL RESEARCH LABORATORY
AEROSPACE MEDICAL DIVISION
AIR FORCE SYSTEMS COMMAND
WRIGHT-PATTERSON AIR FORCE BASE, OHIO

NOTICES

When US Government drawings, specifications, or other data are used for any purpose other than a definitely related Government procurement operation, the Government thereby incurs no responsibility nor any obligation whatsoever, and the fact that the Government may have formulated, furnished, or in any way supplied the said drawings, specifications, or other data, is not to be regarded by implication or otherwise, as in any manner licensing the holder or any other person or corporation, or conveying any rights or permission to manufacture, use, or sell any patented invention that may in any way be related thereto.

Organizations and individuals receiving announcements or reports via the Aerospace Medical Research Laboratory automatic mailing lists should submit the addressograph plate stamp on the report envelope or refer to the code number when corresponding about change of address or cancellation.

Do not return this copy. Retain or destroy.

Please do not request copies of this report from Aerospace Medical Research Laboratory. Additional copies may be purchased from:

National Technical Information Service
5285 Port Royal Road
Springfield, Virginia 22151

The experiments reported herein were conducted according to the "Guide for Laboratory Animal Facilities and Care," 1965 prepared by the Committee on the Guide for Laboratory Animal Resources, National Academy of Sciences—National Research Council.

DOCUMENT CONTROL DATA - R & D

(Security classification of title, body of abstract and indexing annotation must be entered when the overall report is classified)

1. ORIGINATING ACTIVITY (Corporate author) Aerospace Medical Research Laboratory, Aerospace Division, Air Force Systems Command, Wright-Patterson Air Force Base, Ohio 45433		2a. REPORT SECURITY CLASSIFICATION UNCLASSIFIED	
		2b. GROUP N/A	
3. REPORT TITLE PROCEEDINGS OF THE 2ND ANNUAL CONFERENCE ON ENVIRONMENTAL TOXICOLOGY, 31 AUGUST, 1 AND 2 SEPTEMBER 1971			
4. DESCRIPTIVE NOTES (Type of report and inclusive dates)			
5. AUTHOR(S) (First name, middle initial, last name)			
6. REPORT DATE		7a. TOTAL NO. OF PAGES 322	7b. NO. OF REFS
8a. CONTRACT OR GRANT NO. F33615-70-C-1046*		8b. ORIGINATOR'S REPORT NUMBER(S) AMRL-TR-71-120	
b. PROJECT NO. 6302			
c.		9b. OTHER REPORT NO(S) (Any other numbers that may be assigned this report)	
d.			
10. DISTRIBUTION STATEMENT Approved for public release; distribution unlimited			
11. SUPPLEMENTARY NOTES *Conference was arranged by the Toxic Hazards Research Unit of Systemed Corporation		12. SPONSORING MILITARY ACTIVITY Aerospace Medical Research Laboratory, Aerospace Medical Div., Air Force Systems Command, W-PAFB, Ohio 45433	
13. ABSTRACT This report is a compilation of the papers presented and the Proceedings of the 2nd Annual Conference on Environmental Toxicology, sponsored by the Systemed Corporation and held in Fairborn, Ohio on 31 August, 1 and 2 September 1971. Major technical areas discussed included toxicological evaluation of volatile halogenated compounds, protection of the public against air pollution and toxicological problems with aircraft, missiles, and space vehicles. Key words: Continuous exposure Pathology Toxicological screening Gas chromatography Electron microscopy Propellant toxicity			

FOREWORD

The Second Conference on Environmental Toxicology was held in Fairborn, Ohio on 31 August, 1 and 2 September 1971. Sponsor was Systemed Corporation under the terms of Contract F33615-70-C-1046 with the Aerospace Medical Research Laboratory, Aerospace Medical Division, Air Force Systems Command, Wright-Patterson Air Force Base, Ohio. Arrangements were made by the Toxic Hazards Research Unit of Systemed Corporation, and the papers presented at this Conference by personnel of Systemed Corporation represent research conducted under the cited contract. Edmond H. Vernot, Assistant Laboratory Director, Systemed Corporation, served as Conference Chairman, and Mrs. Lois Doncaster, Systemed Corporation, served as Conference Coordinator.

TABLE OF CONTENTS

	Page
WELCOMING REMARKS	1
INTRODUCTORY REMARKS	3
SESSION I - TOXICOLOGY OF VOLATILE HALOGENATED ORGANIC COMPOUNDS	7
1 - NOMENCLATURE AND CHEMISTRY OF FLUOROCARBON COMPOUNDS Frank A. Bower	9
2 - PRESENT AND FUTURE APPLICATIONS OF FLUOROCARBONS. John J. Drysdale	17
3 - CARDIAC TOXICITY OF AEROSOL PROPELLANTS Willard S. Harris	23
4 - CARDIOPULMONARY EFFECTS OF FLUOROCARBON COMPOUNDS Domingo M. Aviado	31
5 - CARDIOVASCULAR EFFECTS OF FLUOROCARBON EXPOSURE. Alex Azar	41
6 - HALOGENATED HYDROCARBONS AND DRUG METABOLISM: THE EFFECT OF FLUOROCARBONS ON HEXOBARBITAL SLEEPING AND ZOXAZOLAMINE PARALYSIS TIMES IN MICE Ethard W. Van Stee	71
7 - THE TOXICOLOGY OF SOME COMMERCIAL FLUOROCARBONS Richard S. Waritz	85
8 - FLUORIDE-CONTAINING METABOLITES AFTER METHOXYFLURANE ANESTHESIA Bill W. Fry	101
9 - HALOTHANE METABOLISM-ANALYSIS AND TOXICOLOGICAL IMPLICATIONS. James R. Trudell	109

TABLE OF CONTENTS (CONT'D)

	Page
10 - CONTINUOUS ANIMAL EXPOSURE TO METHYLENE CHLORIDE Charles C. Haun	125
11 - A STUDY OF LIVER MICROSOMAL CYTOCHROMES FOLLOWING CHRONIC EXPOSURE TO DICHLOROMETHANE Francis J. Bullock	137
12 - DICHLOROMETHANE HEPATOTOXICITY IN MICE WITH CONTINUOUS AND INTERMITTENT INHALATION EXPOSURES Ronald S. Weinstein	147
13 - EFFECTS OF METHYLENE CHLORIDE EXPOSURE ON THE SPONTANEOUS ACTIVITY OF MICE Anthony A. Thomas	185
14 - THE TOXICITY OF PYROLYSIS PRODUCTS FROM A CHLOROTRI- FLUOROETHYLENE-ETHYLENE COPOLYMER (HALAR RESIN). Lester D. Scheel	191
SESSION II - NEW CONCEPTS ON ENVIRONMENTAL LIMITS FOR PROTECTION OF THE PUBLIC AGAINST AIR POLLUTANTS	217
15 - BASIS FOR ESTABLISHING GUIDES FOR SHORT-TERM EXPOSURES OF THE PUBLIC TO AIR POLLUTANTS Ralph C. Wands	219
16 - GUIDES FOR SHORT-TERM EXPOSURES OF THE PUBLIC TO AIR POLLUTANTS Frank G. Favorite	225
17 - NEW FEDERAL AIR QUALITY STANDARDS Orin W. Stopinski	231
SESSION III - TOXICOLOGICAL PROBLEMS WITH AIRCRAFT, MISSILES, AND SPACE VEHICLES	253
18 - CHRONIC EXPOSURE STUDIES WITH MONOMETHYLHYDRAZINE James D. MacEwen	255

TABLE OF CONTENTS (CONT'D)

	Page
19 - ANIMAL PATHOLOGY RESULTING FROM LONG-TERM EXPOSURE TO LOW LEVELS OF MONOMETHYLHYDRAZINE Donald J. Kroe	271
20 - THE ACUTE TOXICITY OF BRIEF EXPOSURES TO HYDROGEN FLUORIDE, HYDROGEN CHLORIDE, NITROGEN DIOXIDE, AND HYDROGEN CYANIDE SINGLY AND IN COMBINATION WITH CARBON MONOXIDE Louis C. DiPasquale	279
21 - THE ACUTE TOXICITY OF CHLORINE PENTAFLUORIDE, Kenneth I. Darmer, Jr.	291
22 - CONTINUOUS EXPOSURE OF ANIMALS TO METHYLISOBUTYL-KETONE Edmond H. Vernot	301
23 - PATHOLOGICAL LESIONS CAUSED BY METHYLISOBUTYLKETONE . . . William F. MacKenzie	311

PRINCIPAL SPEAKERS AND PARTICIPANTS

AVIADO, Domingo M., M. D.
Professor of Pharmacology
School of Medicine
University of Pennsylvania
Philadelphia, Pennsylvania

DRYSDALE, John J., Ph. D.
Director of Freon Research and
Development, Jackson Laboratory
E. I. du Pont de Nemours & Co., Inc.
Deepwater, New Jersey

AZAR, Alex, M. D.
Haskell Laboratory for Toxicology
and Industrial Medicine
E. I. du Pont de Nemours & Co., Inc.
Wilmington, Delaware

FAVORITE, Frank G., Ph. D.
Advisory Center on Toxicology
National Research Council
National Academy of Sciences
Washington, D. C.

BACK, Kenneth C., Ph. D.
Chief, Toxicology Branch
Toxic Hazards Division
Aerospace Medical Research Laboratory
Wright-Patterson Air Force Base, Ohio

FRIESS, Seymour L., Ph. D.
Director, Environmental Biosciences
Department
Naval Medical Research Institute
National Naval Medical Center
Bethesda, Maryland

BOWER, Frank A., Ph. D.
Freon Products Laboratory
Chestnut Run Location
E. I. du Pont de Nemours & Co., Inc.
Wilmington, Delaware

FRY, Bill W., Ph. D.
School of Dentistry
Medical College of Georgia
Augusta, Georgia

BULLOCK, Francis J., Ph. D.
Arthur D. Little, Inc.
Acorn Park
Cambridge, Massachusetts

HARRIS, Willard S., M. D.
Associate Professor of Medicine
Section of Cardiology
University of Illinois Hospital
and College of Medicine
Chicago, Illinois

DARMER, Kenneth I., Jr.
Toxic Hazards Research Unit
SysteMed Corporation
Wright-Patterson Air Force Base, Ohio

HAUN, Charles C.
Toxic Hazards Research Unit
SysteMed Corporation
Wright-Patterson Air Force Base, Ohio

DI PASQUALE, Louis C.
Toxic Hazards Research Unit
SysteMed Corporation
Wright-Patterson Air Force Base, Ohio

PRINCIPAL SPEAKERS AND PARTICIPANTS, Continued

HODGE, Harold C., Ph. D.
University of California
San Francisco Medical Center
Department of Pharmacology
San Francisco, California

SCHAFER, George E., Brig. General
USAF, MC
Commander
Aerospace Medical Division
Brooks Air Force Base, Texas

JACOBSON, Keith H., Ph. D.
Laboratory of Environmental Medicine
Tulane University School of Medicine
New Orleans, Louisiana

SCHEEL, Lester D., Ph. D.
Assistant Chief
Laboratory of Toxicology and Pathology
Department of Health, Education, and
Welfare, U. S. Public Health Service
Health Services and Mental Health
Administration, National Institute
for Occupational Safety and Health
Cincinnati, Ohio

KROE, Donald J., M. D.
Laboratory for Experimental Biology
St. Louis, Missouri

MAC EWEN, James D., Ph. D.
Laboratory Director
Toxic Hazards Research Unit
SysteMed Corporation
Wright-Patterson Air Force Base, Ohio

STOPINSKI, Orin W.
Chief, Office of Special Studies
Bureau of Air Pollution Sciences
Environmental Protection Agency
Research Triangle Park, North Carolina

MAC KENZIE, William F., Lt. Colonel
USAF, MC
School of Aerospace Medicine
Brooks Air Force Base, Texas

THOMAS, Anthony A., M. D.
Director, Toxic Hazards Division
Aerospace Medical Research Laboratory
Wright-Patterson Air Force Base, Ohio

ROBERTSON, A. B., Ph. D.
Plastics Division
Allied Chemical Corporation
Morristown, New Jersey

TRUDELL, James R., Ph. D.
Department of Anesthesia
Stanford University School of Medicine
Stanford University Medical Center
Stanford, California

ROWE, Verald K., D. Sc.
Biochemical Research Laboratory
The Dow Chemical Company
Midland, Michigan

VAN STEE, Ethard W., Major
USAF, VC
Toxic Hazards Division
Aerospace Medical Research Laboratory
Wright-Patterson Air Force Base, Ohio

PRINCIPAL SPEAKERS AND PARTICIPANTS, Continued

VERNOT, Edmond H.
Assistant Laboratory Director
Toxic Hazards Research Unit
Systemed Corporation
Wright-Patterson Air Force Base, Ohio

WANDS, Ralph C.
Director
Advisory Center on Toxicology
National Research Council
National Academy of Sciences
Washington, D. C.

WARITZ, Richard S., Ph. D.
Research Manager - Biosciences
Haskell Laboratory for Toxicology and
Industrial Medicine
E. I. du Pont de Nemours & Co., Inc.
Wilmington, Delaware

WEINSTEIN, Ronald S., Major
USAF, MC
Toxic Hazards Division
Aerospace Medical Research Laboratory
Wright-Patterson Air Force Base, Ohio

WELCOMING REMARKS

Edmond H. Vernot

SysteMed Corporation
Wright-Patterson Air Force Base, Ohio

Good morning, ladies and gentlemen, I'm chairman for this year's Conference on Environmental Toxicology, and I'd like to welcome you here on behalf of SysteMed Corporation and the Aerospace Medical Research Laboratory. We believe that this year's conference will meet the standards of interest and relevance set by those of previous years and that the information disseminated here will serve the needs of the Air Force and the nation, in addition to expanding the horizons of knowledge. A distinguished group of scientists has gathered here, some to present papers and some to engage in friendly but spirited discussion during the open forum segments of the program. It is my privilege now to present one of that distinguished group, Brigadier General George E. Schafer, Commander of the Air Force Systems Command's Aerospace Medical Division.

General Schafer has garnered many military honors in his service career. Of particular interest to participants of this conference is the scientific and medical recognition he has received from his professional peers. He is a member of the American Medical Association; American College of Preventive Medicine; New York Academy of Sciences; Society of USAF Flight Surgeons; and the Air Force Association. General Schafer is a Fellow in Aviation Medicine of the Aerospace Medical Association, is board certified in Aerospace Medicine by the American Board of Preventive Medicine, and is a National Consultant to the Surgeon General for Aerospace Medicine. General Schafer is no newcomer to our conference, having addressed it in 1966 and 1967 when he was Vice Commander of AMD. In 1968 and 1969, he served as Commander of the School of Aerospace Medicine. Appointed to his command position of the Aerospace Medical Division in March 1971, he is responsible for biotechnology research and development programs in support of Air Force Systems development, assigned research programs in support of the Air Force personnel system, and aerospace and clinical medicine programs; all of which makes him uniquely qualified to deliver the keynote address of the 2nd Conference on Environmental Toxicology. Will you please welcome General Schafer.

INTRODUCTORY REMARKS

George E. Schafer, Brigadier General, USAF, MC

Commander
Aerospace Medical Division
Brooks Air Force Base, Texas

It is an honor to be with you during the Second Conference on Environmental Toxicology, for it is environmental toxicology that is the cornerstone of a cleaner environment - one of the three major issues facing our great nation.

The Aerospace Medical Division's role in environmental protection is a natural extension of its traditional role - the role of protection and prevention. Questions of environmental protection tend to grow out of problems involving hazards to man. These hazards to man evolve into considerations of local environment, then eventually to worldwide considerations. The broader considerations are invariably built upon the data accumulated from the more immediate effects on man, animals, and plants.

Basically, the Air Force's environmental protection program is an extension from the protection of the environment inside an Air Force weapons system or inside a conglomerate of systems - an Air Force Base - to that outside an Air Force Base. However, outside the fence of the Air Force installation is an area where we must interact with other jurisdictions, primarily non-DOD agencies. Standards are primarily established by these other jurisdictions. The Air Force must be sure, however, that the standards established for peculiar Air Force pollutants are based upon well-founded data.

In its daily operation, the Air Force uses large quantities of materials whose release into the environment could result in significant deleterious effects to the local ecology. Such release could include pollution of soil, air, and water, and could affect plants, aquatic organisms, soil microflora, or any member of the ecological community exposed to the contaminant. Of particular significance is the disposal of toxic materials such as missile propellants which are used in very large quantities. The consequences of addition of inadequately treated Air Force chemicals and propellants such as hydrazines, nitrogen oxides, and fluorine-based oxidizers to the environment may be extremely destructive. The phasing-out of particular missile systems using liquid propellants will require that techniques be available that are designed to produce an effluent having insignificant ecological implications.

The Present Situation

Present Air Force policy requires that chemicals, insecticides, herbicides, and other preparations in common use in the Air Force be stored until disposal techniques can be developed. R&D is required to develop criteria for these chemicals and chemical formulations so as to ensure that appropriate disposal techniques are utilized. The first step will be to evaluate them for their pollution potential. The need is urgent since every Air Force base is beginning to stockpile these materials; and once collected into large quantities, it may become an almost impossible disposal problem.

The National Environmental Policy Act (NEPA) of 1969, Public Law 91-190, required all agencies of the Federal Government to include in every recommendation on proposals a detailed statement of the environmental effects the proposed action will encompass. Responsible officials will submit detailed statements including the environmental impact of the proposed action.

If a standard and method of measuring the concentration of a pollutant is available, then an environmental impact evaluation can theoretically be made. In practice, establishing the environmental impact is no easy matter. Ecology evaluation techniques are just beginning to be developed and no clear-cut guidance is available as to what should be included in impact statements. There is no doubt that environmental impact statements will play an increasing role in the future of advanced systems development. Consideration of the environmental aspect will be an early and continual consideration in systems development. The lesson of the SST should not be forgotten.

The proper evaluation of environmental impact requires expert judgment and knowledge and will remain an art for some time - expert judgment because present knowledge will have to be extrapolated to the future and all possibilities considered and evaluated. This requires review and considerable action by a number of people, both systems oriented and pollution-control oriented. There is also no doubt that ultimately the impact must be in terms of biological systems and the effect on their interrelationships. The R&D community must involve itself in this process not only for emerging systems, but also for those present changes involving primarily operational commands. The environmental impact statements will be excellent generators of R&D needs. Doing an environmental impact evaluation quickly reveals where knowledge is weak or lacking. Within the Air Force the environmental impact statement should be an excellent two-way street whereby the R&D community helps the operational commands and gets R&D requirements in return.

The Future

On a purely dollar basis, the majority of monies spent by the Air Force in environmental problems will be put toward control, disposal, and abatement systems.

We cannot afford the luxury of "white elephant" control systems that do not meet their intended purposes for environmental protection. The Air Force must develop not only new control and abatement technology but must adapt, apply, and improve existing technology and systems.

Control, abatement, and disposal technology for environmental protection encompasses many technical areas of direct interest to the civil engineer and surgeon. What originally started as sanitary urgency (water supply and waste water disposal) has grown in concept to a broader look at total environment control. In its broadest sense the objective is the control and abatement of those substances present in the environment in such quantities and duration as to be injurious to human, plant, or animal life. Therein lie the mission and goals of the Air Force Environmental Toxicology Program.

These conferences can become the most important means of communication with scientists of other organizations involved in environmental toxicology research across the United States in exchanging information between their respective agencies.

The success of the previous five conferences entitled "Atmospheric Contamination in Confined Spaces" and the "First Conference on Environmental Toxicology" held last September, indicates that through the medium of free discussion during the "open forum" periods, your goals will be achieved in an outstanding manner.

I had the privilege three years ago to represent the former Commander of AMD, General Roadman, and have addressed this illustrious group previously. It is a great pleasure for me to be back with you again and I wish you the best success for a stimulating scientific exchange.

TOXICOLOGY OF VOLATILE HALOGENATED ORGANIC COMPOUNDS

Co-Chairmen

Dr. Kenneth C. Back
Chief, Toxicology Branch
Toxic Hazards Division
Aerospace Medical Research Laboratory
Wright-Patterson Air Force Base, Ohio

Dr. Harold C. Hodge
Department of Pharmacology
San Francisco Medical Center
University of California
San Francisco, California

Dr. Verald K. Rowe
Biochemical Research Laboratory
The Dow Chemical Company
Midland, Michigan

NOMENCLATURE AND CHEMISTRY OF FLUOROCARBON COMPOUNDS

Frank A. Bower, Ph. D.

E. I. du Pont de Nemours & Company, Inc.
Wilmington, Delaware

For the purpose of this discussion, the term fluorocarbon will be used in its popular sense, as a generic term denoting fluorinated organic compounds in general commercial use. Chlorofluorocarbons, chlorofluorohydrocarbons, bromofluorocarbons, and perfluorocarbons will be considered as illustrative of the properties of this important group of chemicals.

NOMENCLATURE

Precise chemical nomenclature of the commercially important chlorofluorocarbons has proved to be cumbersome. To avoid this difficulty, two shorthand numbering systems have been devised. One system consists of a 4-digit number, preceded by a generic term describing the product's application - for example, Refrigerant ABCD. In this system, D is the number of fluorine atoms in the molecule, C is 1 plus the number of hydrogen atoms in the molecule, B is equal to the number of carbon atoms minus 1, and A equals the number of double bonds in the molecule. Whenever A or A and B equal zero, the digits are omitted from the number. Thus, Refrigerant 12 is the shorthand name for dichlorodifluoromethane.

A second system, called the "Halon" system has been devised by the fire extinguishing industry to better handle the naming of fluorobromo compounds. In this system, the compounds are designated Halon ABCD where D is the number of bromine atoms, C is the number of chlorine atoms, B is the number of fluorine atoms, and A is the number of carbon atoms. Thus, Halon 1301 is the shorthand name for bromotrifluoromethane.

SYNTHESIS

Chlorofluoromethanes are usually produced from carbon tetrachloride or chloroform and anhydrous hydrogen fluoride in the presence of a catalyst such as $SbCl_5$ or AlF_3 .



Ethane derivatives are usually prepared from perchloroethylene, chlorine and anhydrous hydrogen fluoride in the same manner.



Synthesis of these common chlorofluorocarbons is generally carried out in liquid or vapor phase at moderate temperatures and pressures.

Fluorocarbon 114 can be further fluorinated using more vigorous conditions to give Fluorocarbon 115 and Fluorocarbon 116.

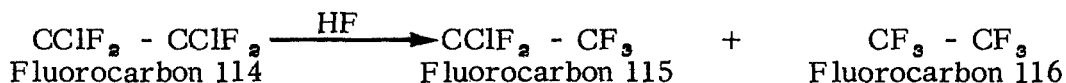

These more difficult fluorinations are usually conducted in the vapor phase at higher temperatures over appropriate catalysts.

High boiling perfluorinated compounds are most often prepared by electrolytic fluorination of organic liquids. Electrolysis is usually carried out in hydrogen fluoride using starting materials which are soluble in the molten salt. Organic acids produce perfluorinated organic acids;

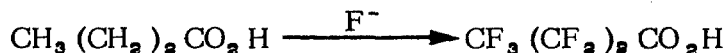

amines produce the expected perfluorinated alkyl amines;

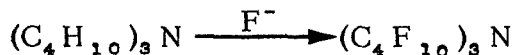

while heterocyclic compounds such as N-methyl morpholine produce mixtures of the expected perfluorinated compound and fluorinated compounds resulting from cleavage at the hetero atom.

Brominated compounds are prepared by direct bromination of hydrogen-containing molecules,



or by addition of bromine to unsaturated molecules.

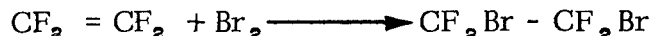

In all fluorocarbon syntheses, starting materials and by-products are separated by fractional distillation. The product is further purified by washing and drying over a suitable desiccant. The several purification steps are carefully performed with the result that the chlorofluorocarbons rank among the highest purity organic materials sold in this country.

Typical Analysis of R-12

R-12	99.96 ⁺ vol. %
R-13	0.010
R-11	0.002
R-21	0.003
R-22	0.017
 H ₂ O	 4.5 ppm
Non-volatile	<0.01 vol. %

PHYSICAL CHARACTERISTICS

Commercially important compounds - which are usually completely halogenated - are characterized by high vapor pressure (low boiling point), high density, low viscosity, low surface tension, and low solubility parameter. Some comparative values for fluorocarbon 113 and perchloroethylene, two solvents having comparable molecular weights are:

Properties of Fluorocarbon 113 vs. Perchloroethylene

	<u>Fluorocarbon 113</u>	<u>Perchloroethylene</u>
Boiling Point (C)	47.6	121
Density (g/cc)	1.565	1.610
Viscosity (cps)	0.66	0.88
Surface Tension (dyne/cm)	19	32
Solubility Parameter	7.2	9.7

Because of the low solubility parameter of most chlorofluorohydrocarbons, they are only slightly soluble in water, and are not capable of dissolving polymers. Low molecular weight, non-polar substances such as hydrocarbons are readily dissolved. As the proportion of fluorine in the compound increases, even this capability is diminished; perfluorocarbons are generally considered to be both hydrophobic and oleophobic. Most commercial uses capitalize on the selective solvent properties, high vapor pressures, and chemical stability of the entire family of compounds.

THERMAL STABILITY

Thermal stability of partially fluorinated halocarbon compounds is frequently compared to the stability of the closely related chlorocarbons. For example, fluorocarbon 11 is frequently considered to be relatively unstable by analogy with the well-known instability of carbon tetrachloride. This comparison is deceptive in that the substitution of fluorine for chlorine in the molecule results in a large increase in the stability. Increased stability results from the decreased bond lengths of the carbon-chlorine bonds and the corresponding increase in the energy required to rupture the carbon-chlorine bond. For example, the carbon-chlorine bond energy in carbon tetrachloride is 69 Kcal, while the energy of the carbon-chlorine bond in fluorocarbon 11 is 74 Kcal. Each subsequent substitution of fluorine for chlorine increases the stability of the molecule still further. In the homologous series CCl_4 , CCl_3F , CCl_2F_2 , CClF_3 , and CF_4 , stability increases as the number of fluorine atoms increases.

Bond Energies of Chlorofluoromethane Kcal

<u>Compound</u>	<u>C-Cl</u>	<u>C-F</u>
CCl_4	69	-
CCl_3F	74	99
CCl_2F_2	81	107
CClF_3	85	114
CF_4	-	122

In the ethane series, similar stabilization results when fluorine is substituted for chlorine in the hexachloroethane molecule. In this case, when all chlorine is replaced by fluorine, giving hexafluoroethane, the carbon-carbon bond becomes the weakest bond in the molecule and stability is governed by the carbon-carbon bond energy.

Bond Energies of Chlorofluoroethanes

<u>Compound</u>	<u>C-C</u>	<u>C-Cl</u>	<u>C-F</u>
C_2Cl_6	63	68	-
C_2Cl_5F	67	69 73	97
$C_2Cl_4F_2$	72	74	99
$C_2Cl_3F_3$	77	75 79	106
$C_2Cl_2F_4$	83	80	100 108
C_2ClF_5	88	81	109 115
C_2F_6	94	-	116

Hydrolytic stability closely parallels thermal stability, and hydrolysis rates decrease as fluorine is substituted in the chlorinated molecule.

It has also been observed that chemical reactivity tends to correlate with physiological effect. In the case of saturated fluorocarbons, increased fluorine content results in lowered toxicity of the compound in question. In the series CCl_4 through CF_4 , we proceed from a toxic chlorinated compound to a non-toxic perfluorocarbon. In general, saturated perfluorocarbons are physiologically inert for all practical purposes.

CHEMISTRY

The most prominent feature of the chemistry of saturated chlorofluorocarbons is their lack of conventional chemistry. The carbon-fluorine bond is resistant to almost all chemical reagents, and only the most vigorous treatments can bring about chemical reactions.

REDUCTION

For example, perfluorocyclohexane is inert to hydrogen at 830 C. More rigorous treatment results in cleavage of the carbon-carbon bonds.

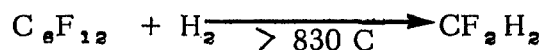

Molecules containing both chlorine and fluorine may be attacked at the chlorine atom to give straightforward reduction products. Dichlorohexafluorocyclobutane can be reduced with lithium aluminum hydride to form hexafluorocyclobutane.

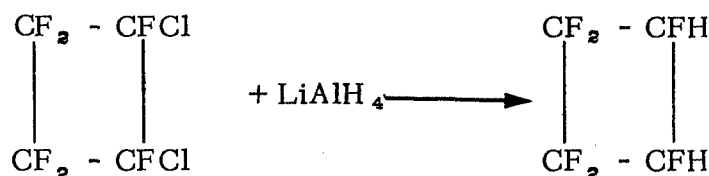

Trifluoromethyl iodide undergoes a free radical type reduction in the presence of hydrogen donors. For example, CF_3I is reduced by hexane to give CF_3H .

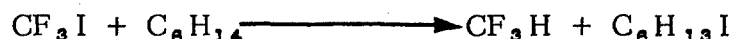

OXIDATION

Carbon-fluorine bonds are not normally attacked by conventional oxidizing agents. Fluorinated molecules containing carbon-carbon bonds, however, may be attacked at the carbon-carbon linkage by the usual oxidizing agents. Chlorotrifluoroethylene, for example, is oxidized to chlorotrifluoroethylene oxide with relative ease.



1, 1, 1-trifluoropropane can be oxidized to fluoral, while the trifluoromethyl group remains intact.

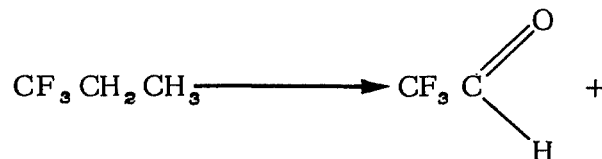

HALOGENATION

Saturated chlorofluoromethanes are inert to halogens. Unsaturated fluorocarbons will add halogen smoothly,



while compounds containing hydrogen react with halogens to give the expected substitution compounds.

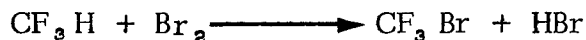

HYDROLYSIS

Hydrolysis of the carbon-fluorine bond proceeds at a much lower rate than does hydrolysis of the carbon-chlorine bond. Experiments performed with 1-chloro 3-fluoropropane indicate that the rate of hydrolysis of the carbon-chlorine bond is approximately 100 times greater than that of the carbon-fluorine bond.

Attempts to measure the homogeneous hydrolysis rates of fluorocarbon 11 in dioxane solution showed that the rate is unmeasurably small at the boiling point of dioxane. When metals are present, fluorocarbon 11 is decomposed, probably by a reductive process.

ANALYSIS

Because of extraordinarily low reactivity of the fluorinated compounds, traditional wet chemical methods are entirely unsuitable for characterization and assay. Instrumental methods are much more useful. Infrared spectroscopy and mass spectroscopy are effective tools for identification. Gas-liquid chromatography has proved to be invaluable for assay and separation of minor components.

PHYSIOLOGY

The usual physiological effect of chlorofluorocarbons is a mild anesthesia at fairly high concentrations, but anesthetic activity of the commercially important chlorofluorocarbons is so low that they are not considered to be useful anesthetics. Prolonged exposure to chlorofluorocarbons causes pulmonary edemas and other conditions arising from local irritation. The fluorinated compounds show essentially no effect on the liver whereas the simple chlorocarbons have a pronounced toxic effect. The several physiological effects reconfirm the biological activity of this class of compounds. Here, again, the biological activity of the compound is reduced as the amount of fluorine in the molecule is increased.

FLUORINATED OLEFINS

Fluorinated olefins are generally considered to be reactive compounds. The double bonds are active and may add the usual reagents under conditions of acid or base catalysis. Chemical reactivity of fluoro-olefins is reflected by their physiological activity. Certain low molecular weight compounds, vinyl fluoride and vinylidene fluoride, are relatively nontoxic and they are, in fact, comparable to the saturated chlorofluorocarbons. Perhalogenated ethylenes are much more toxic than the partially halogenated members, while the perfluoropropylenes and perfluorobutylenes are known to be highly toxic. Any applications involving elevated temperatures should be considered carefully so that any conditions which might cause rearrangement of the compound to the highly toxic perfluoro-olefins may be avoided. Strong heating of the fluoropropanes and butanes in the absence of air and water should be particularly avoided.

SUMMARY

The simple saturated fluorocarbons are an unusually stable, unreactive group of chemicals. Their industrial and commercial uses generally depend on their lack of deleterious effect on materials of construction. Past toxicological work and years of experience have established that the materials are not hazardous when used as intended.

PRESENT AND FUTURE APPLICATIONS OF FLUOROCARBONS

John J. Drysdale, Ph. D.

E. I. du Pont de Nemours & Company, Inc.
Deepwater, New Jersey

The objective of my paper this morning is to give you an overall view of the fluorocarbon industry. I hope that by briefly describing its size, principal products, and their uses, to provide a modest basis for the specific questions of toxicology and ecology which we will be discussing.

As shown in table I, the fluorocarbon business represents about 1/2% of the synthetic organic chemicals manufactured in the United States, and fluoropolymers represent about 1/10% of the synthetic polymers manufactured.

TABLE I

	<u>Lbs. , Millions</u>
Synthetic Organic Chemicals	120,000
Synthetic Organic Polymers	20,000
Fluorocarbons	800
Fluoropolymers	25

The five fluorinated methanes and ethanes shown in table II are the backbone of the fluorocarbon industry and constitute between 80 and 90% of the pounds of fluorocarbons manufactured today. These compounds were first manufactured in the early 1930's for use as refrigerants. Their use as aerosol propellants began in the 1940's with use as solvents for cleaning, drying and degreasing electronic equipment following in the 1950's, and use as blowing agents for foaming plastics in the 1960's (table III).

TABLE II

<u>Primary Fluorocarbons</u>	
	<u>B. P. °C.</u>
CCl_3F	23.8
CCl_2F_2	-29.8
CHClF_2	-40.8
$\text{CCl}_2\text{FCClF}_2$	47.6
$\text{CClF}_2\text{CClF}_2$	3.6

TABLE III

<u>Primary Fluorocarbon Markets</u>	
	<u>Lbs., Millions</u>
Refrigerants	250
Aerosol Propellants	375
Solvents	50
Blowing Agents	25

I believe that these fluorinated methanes and ethanes will continue to dominate the fluorocarbon business for some time to come. The manufacture of compounds containing fluorine is expensive and requires substantial R&D expenditures to develop processes for making new products. The natural tendency will be to expand markets for products we have.

Two such markets where we expect substantial growth in the next few years are the use of difluorodichloromethane for freezing food and of 1, 1, 2-trichloro-1, 2, 2-trifluoroethane as a solvent for dry cleaning clothes (table IV).

TABLE IV

Growth Markets

CCl_2F_2	Food Freezing
$\text{CCl}_2\text{FCClF}_2$	Clothes - Dry Cleaning

Two brominated fluorocarbons closely related to the chlorofluorocarbons have shown utility in strikingly different areas. 1-Bromo-1-chloro-2,2,2-trifluoroethane or Fluothane[®] is an anesthetic used worldwide. Bromotrifluoromethane or FE-1301 is an excellent fire extinguishant with attractive toxicological properties.

TABLE V

CF_3CHBrCl	Anesthetic
CF_3Br	Fire Extinguishant

Shifting from the fluorinated methanes and ethanes to fluoropolymers, we see as previously noted that the market for fluoropolymers is approximately 25 million pounds.

Major markets for fluoropolymers have been in industrial and military applications as bearings, seals, electrical insulation, and other uses where their outstanding thermal and chemical resistance are required. An exception to the above uses is the major entry that Teflon[®] made into the consumer market in the early 1960's with the advent of Teflon[®]-coated cookware. I believe that the current trend toward building things to last will favor the use of fluoropolymers in consumer devices. As a do-it-yourselfer, I specifically hope that fluoropolymers will in the near future be used extensively as exterior finishes because of their outstanding durability.

From a chemical viewpoint, five fluoromonomers are used in the manufacture of fluoropolymers (table VI). Future fluoropolymers will continue to use these monomers as building blocks using hydrocarbon olefins to reduce cost and exotic fluorocarbons for specialty effects.

TABLE VI

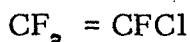
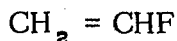
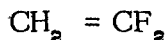
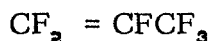
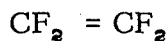
Fluoromonomers

Long chain fluoroalkyl molecules $\text{CF}_3(\text{CF}_2)_n\text{X}$ have outstanding surface activity, reducing the surface tension of water to 15 to 20 dynes/cm. A number of specialty applications have been found for these surfactants such as antimisting agents for chrome plating baths, and most recently in "Light Water" which is used for extinguishing petroleum fires.

The major use for surface active fluorochemicals is in giving textiles, paper and leather oil and water repellency. In the case of textiles, a fluoroalcohol such as $\text{C}_7\text{F}_{15}\text{CH}_2\text{OH}$ is converted to an acrylate monomer and polymerized to the polymer shown in figure 1. The polymer adheres to the fabric and is high enough in molecular weight to be durable to dry cleaning and laundering.

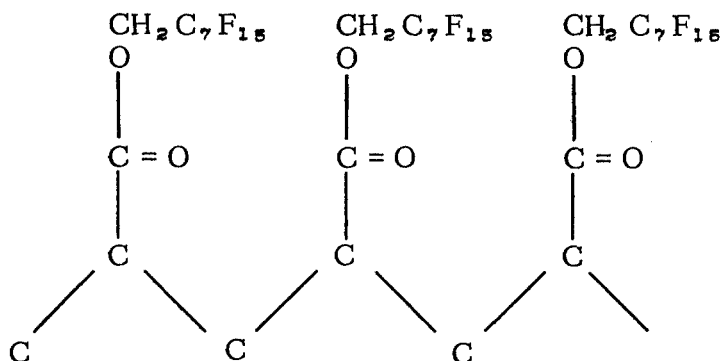

Figure 1. OIL AND WATER REPELLENTS

In summary, although the volume of fluorocarbons is small they touch our lives in many ways. We all use aerosol propellants, refrigerants, clothes treated with fluorocarbon oil and water repellents, and cookware coated with Teflon®. Before long we will all be eating food frozen with difluorodichloromethane, using fluorocarbon paints, and when needed putting out fires with bromotrifluoromethane.

REFERENCES

1. Klaus, C. G. ; "Fluorochemical Properties and Applications"; Chemical Engineering Progress, Vol. 62, No. 1, p. 98-101, 1966.
2. Hamilton, J. M. , Jr. ; "The Organic Fluorochemicals Industry"; Advances in Fluorine Chemistry, Vol. 3, 1962.
3. Materials in Design Engineering, Vol. 59, No. 2, p. 93-104, 1964.
4. Sharts, C. M. ; "Organic Fluorine Chemistry"; Journal of Chemical Education, Vol. 45, No. 3, p. 185-189, 1968.

DISCUSSION

MAJOR VAN STEE (Aerospace Medical Research Laboratory): I'd like to direct a question to Dr. Bower concerning the bond energies of fluorocarbons in the table which he displayed up there. The carbon-chlorine bond energies were indicated to be about three-quarters those carbon-fluorine bonds. Could you tell me where carbon-bromine lies in this scheme? Is it in the same range of the carbon-chlorine bond energies?

DR. BOWER (E. I. du Pont de Nemours and Company): It is substantially less.

MAJOR VAN STEE: Oh, less than carbon-chlorine. I see. Thank you very much.

DR. AVIADO (University of Pennsylvania School of Medicine): Those two numbering systems, Frank. You described an old one and a new one. I understand that the second one is simpler than the first. Can we just dispose of the first numbering system, and just remember the second one?

DR. BOWER: I sympathize with your problem. The only difficulty you run into is that the second system does not provide for specifying the number of chlorine or hydrogen atoms, and this gets you into difficulty with all of the standard commercial materials. It just won't cope with them, I'm afraid. There have been two or three proposals over the past ten to fifteen years, to simplify the numbering system, but the old system has been so ingrained now that everybody thinks in terms of 11, 12, 13, 14, and changing it would be very difficult. Sorry!

DR. CARHART (U. S. Naval Research Laboratory): I should like to propose a question for discussion this afternoon, but forewarn Dr. Bower so he may be thinking about it. You mentioned several of the large classes of chemical reactivities of the fluorocarbons. You missed one! Pyrolysis! Would you prepare yourself for some discussion of that this afternoon, please?

CARDIAC TOXICITY OF AEROSOL PROPELLANTS*

Willard S. Harris, M. D.

University of Illinois College of Medicine and Hospital
Chicago, Illinois

INTRODUCTION

Healthy youngsters who deliberately inhale aerosol propellant gases to "turn on" may, within minutes, die unexpectedly. Sudden death and negative autopsies suggest that a cardiac mechanism might be responsible. Possibly of related interest are reports from the United Kingdom (Speizer, Doll, Heaf, 1968; Speizer et al., 1968; Inman and Adelstein, 1969) of a striking increase there during the past decade in the incidence of sudden unexpected death among people with asthma. The British investigators have presented epidemiological and clinical evidence relating this mounting mortality in asthma to the increasing use of pressurized aerosol bronchodilators, which first became available in the late 1950's.

Our experimental results show, beyond doubt, that the fluoroalkane gases used to propel aerosols are toxic to the heart. Their cardiovascular toxicity takes several different forms.

METHODS, RESULTS, AND DISCUSSION

Let me first describe a simple and inexpensive way, using mice (Taylor and Harris, 1970a, 1970b), to show the cardiac toxicity of aerosol propellants. In these early studies, done with Mr. George Taylor, who was a fourth-year medical student, mice took 3 breaths of the fluoroalkane gas released by a single discharge of a pressurized bronchodilator nebulizer. Subsequent challenge with partial asphyxia, either immediately or 15 minutes later, was accompanied by the early appearance of asphyxia-induced sinus bradycardia, atrioventricular (AV) block and ventricular T-wave depression (Taylor and Harris, 1970a).

The essence of this approach is, of course, to apply a degree of partial asphyxia that otherwise untreated mice will tolerate for 4 minutes without developing bradyarrhythmia (Taylor and Harris, 1970a). Indeed, in mice unexposed to Freon, the degree

* This investigation was supported in part by an American Heart Association grant, Public Health Service research grants HE 14412-01 and 1T12-HE 05879 and a Public Health Service general research support grant.

of partial asphyxia that we apply causes tachycardia, not bradycardia. In striking contrast, after mice inhale 3 breaths of Freon, which takes about 2 seconds, application of exactly the same partial asphyxic challenge now causes the early appearance of lethal, asphyxia-induced AV block and profound sinus bradycardia (defined as a slowing of 200 or more beats per minute).

I emphasize that one need not apply the asphyxic challenge immediately but may start it, for the first time, as late as 15 minutes after the brief exposure to Freon.

If mice are studied with a degree of asphyxic challenge different from that we have described, care must be taken that its intensity is neither too great nor too mild. If complete asphyxia is applied, otherwise untreated mice will not have tachycardia but, instead, may develop sinoatrial bradycardia and atrioventricular block in a minute or less. As a result, too little time would be left to allow a demonstration that the onset of these asphyxia-induced bradyarrhythmias has been markedly accelerated by previous exposure to Freon. Such a "test", or pseudotest, would automatically abolish the chance of showing that the Freons are toxic. Its results would be meaningless, or worse. Because of false and misleading conclusions that might erroneously be drawn if the fallacy in such a pseudotest were not recognized, the mechanism of this fallacy will be restated slightly differently. Both Freon and asphyxia disturb sinoatrial pacemaking and atrioventricular conducting function. If asphyxia is made complete or nearly so, its depression of these functions may be too great for an additional effect (additive, synergistic, or sensitizing) of Freon to be demonstrated. To modify our test, which clearly and reproducibly shows Freon toxicity to the mouse heart, by using, instead, complete asphyxia, which could not possibly show Freon toxicity, would be wrong. Not only would such a procedure differ irrevocably from ours, but it would not be a "test" for Freon toxicity.

To test the reproducibility of our technique of partial asphyxia, a technician, unseen by Taylor, exposed 10 mice at random either to the 3 breaths of Freon or to a placebo. Five mice happened to receive Freon and five received none. Taylor then entered the room and applied his usual asphyxic challenge. 2:1 AV block or profound sinoatrial bradycardia appeared in less than a minute in each of the 5 Freon-sensitized mice but did not appear by 4 minutes of asphyxia in any of the 5 mice who had not received Freon, each of whom had, in contrast, sinoatrial tachycardia. Thus, the degree of partial asphyxic challenge produced by this technique is reproducible enough to differentiate easily the Freon-treated mouse from one not exposed to Freon.

We have also done extensive studies like this in over 200 mice, using, in place of the bronchodilator nebulizer, 8 different commonly used household and cosmetic aerosols and pure, commercially available Freon 12 (dichlorodifluoromethane), Freon 11 (trichloromonofluoromethane), and Freon 114 (dichlorotetrafluoroethane), singly and in combination. The results have been exactly the same in each instance. It has made no difference whether we applied the asphyxic challenge for the first time immediately after Freon or 15 minutes later. Atropine has failed to block these results, suggesting they are not reflex.

When we published our first mouse data in the October 5, 1970 issue of the Journal of the American Medical Association, we also predicted that the fluoroalkane propellant gases would be found toxic to the cardiovascular system in several different ways, dependent, in part, on the species studied (Taylor and Harris, 1970a). Since then, our experiments have shown exactly this. The remaining studies I shall tell you about will show that Freon is toxic to the heart despite adequate oxygenation. Moreover, its toxic effects differ, in many ways, from those of anoxia produced by 100% nitrogen.

Fourteen awake or anesthetized monkeys inhaled a mixture of 30% Freon 12 - 9% Freon 114 - 61% O₂ (Taylor, Harris, and Bogdonoff, 1971). All 14 monkeys, whether awake or anesthetized, quickly developed ventricular premature beats, bigeminy, or tachycardia, which began at an average of 39 (S. E. \pm 4.2) seconds. At this time, the concentration of Freon in arterial blood, measured in 3 monkeys by gas chromatography, averaged 8.2 mg/100 ml.

We measured arterial blood pH, PCO₂, and PO₂ in 7 of the monkeys and intra-arterial pressure in 5. Freon caused these ventricular arrhythmias without lowering the arterial PO₂ or pH or raising the arterial carbon dioxide tension and while reducing arterial blood pressure only slightly. For comparison, 7 of the monkeys inhaled 100% nitrogen without Freon for 3 minutes, which lowered arterial blood PO₂, on the average, to 30 \pm 3.2 mm Hg. Except in one monkey, whose arterial oxygen tension fell to 16 mm Hg, 3 minutes of anoxia failed to cause arrhythmias.

All 14 monkeys exposed to 39% Freon in oxygen developed ventricular premature beats, which occurred at an average of 39 \pm 4.2 seconds. After 11 of these monkeys received propranolol, the same Freon-O₂ mixture, given for 2 minutes, now caused no ventricular arrhythmias. The ventricular arrhythmias caused by aerosol fluoroalkane propellant gases may be mediated through beta adrenergic receptors, since these arrhythmias were abolished by pretreatment with propranolol, or may result from a nonadrenergic, direct, toxic effect of the gases on the heart. Our results in monkeys would suggest that some human deaths after propellant inhalation may be caused by ventricular tachycardia or fibrillation.

We recently learned of the excellent studies of the fire extinguishant, bromotrifluoromethane, or Halon 1301, or Freon 1301, published in 1969 by Van Stee and Back (Van Stee and Back, 1969). In addition to other interesting results, Van Stee and Back found that 20-80% Halon 1301 quickly caused ventricular arrhythmias in all monkeys studied. Our results, obtained in monkeys breathing the aerosol propellants, Freon 12 and 114, are concordant with the earlier work on Halon 1301 by Van Stee and Back.

Our next studies, done with Dr. Signe Kilen (Harris and Kilen, 1971) show that the aerosol propellant, dichlorodifluoromethane, or Freon 12, directly, rapidly, and profoundly depresses myocardial contractility. Papillary muscles excised from the left ventricles of 28 rats were studied in a well-oxygenated muscle bath. While the

papillary muscles were stimulated 9 times/minute and aeration with 99% O₂ - 1% CO₂ was continued throughout, Freon 12 was bubbled at 43 ml/minute into the bath. Developed force was depressed by the third beat after Freon was introduced and rapidly fell further to less than 35% of its control level. When Freon administration was stopped, contractility gradually returned to normal.

Thus, in a group of 14 rat papillary muscles contracting isometrically, developed force and the rate of force development (dF/dt) fell rapidly to 35% of control when Freon was given together with O₂ and CO₂. In contrast, substituting nitrogen in place of Freon, while O₂ - CO₂ aeration was continued, had virtually no effect. Without Freon, hypoxia induced by giving 100% nitrogen was much less depressant than was Freon given together with adequate O₂ and CO₂. Moreover, after 15 minutes hypoxia, the reintroduction of Freon depressed force development much further, almost abolishing it. Since Freon directly depresses myocardial contractility whether the muscle bath is well-oxygenated or deoxygenated, this action cannot be ascribed to hypoxia in the bath medium.

Freon with adequate oxygenation shifted the force-velocity curves downward and to the left far more than did hypoxia produced by 100% nitrogen, again demonstrating that Freon markedly depresses contractility.

Dose-response studies were done in 10 isolated rat papillary muscles. In a well-oxygenated bath, Freon 12 clearly depressed the myocardial contractility of these 10 muscles in a linearly dose-related manner.

At the highest flow rate, the bath concentration of Freon 12 was the same as we have found in the arterial blood of anesthetized cats and dogs breathing 25% Freon for 2 minutes, while, at the lowest flow rate studied, which depressed developed force 20%, the bath concentration of Freon approximated, on the average, 1 mg/100 ml, the same concentration we have found in the arterial blood of anesthetized animals breathing 2½% Freon for 2 minutes.

We have also found a similar depression of contractility by Freon 12 in 4 human papillary muscles, which were studied after they had been surgically excised from patients at the time of mitral valve replacement. Freon also depressed the myocardial contractility of human papillary muscle in a linearly dose-related manner.

Mr. Taylor and I determined the in vivo effects of Freon inhalation on the left ventricular contractility of anesthetized cats (Taylor and Harris, 1971). We obtained high-fidelity recordings of left ventricular pressure through a 19-gauge needle inserted directly into the left ventricle through the chest wall. Breathing a mixture of 20% Freon 12 - 80% oxygen for 1 minute caused a marked reduction in the rate of rise of left ventricular pressure, or dP/dt, relative to simultaneous left ventricular pressure during the isovolumic phase of contraction in all 11 cats studied.

Using the formula, instantaneous left ventricular dP/dt divided by the product of 32 times isovolumic left ventricular pressure, we determined the velocity of contractile element shortening, or V_{CE} . Plotting velocity of contractile element shortening on the vertical axis against isovolumic left ventricular pressure on the horizontal axis gives *in vivo* pressure-velocity curves analogous to the force-velocity curves obtained, *in vitro*, from isolated papillary muscles. In the 11 anesthetized cats studied, a 30-second inhalation of 25% Freon 12 in oxygen markedly depressed the curve, while a 1-minute inhalation depressed it even further.

In 6 cats, each exposed to 5 different concentrations of Freon 12 (1% to 25%) in oxygen for 1 minute, the arterial blood concentration of Freon was linearly related to its percent concentration in inspired air, and myocardial contractility, whether expressed as extrapolated V_{max} or peak measured V_{CE} , was clearly depressed in a dose-related manner by inhaled Freon. We have obtained similar findings with the inhalation of graded concentrations of Freon 12 mixed with 21% O_2 in intact, anesthetized dogs (Harris, 1972).

CONCLUSION

In conclusion, we have found that the fluoroalkane gases used to propel aerosols sensitize the hearts of mice to asphyxia-induced sinus bradycardia, atrioventricular block and T-wave depression, quickly enter the blood of monkeys, cats and dogs after inhalation and, despite adequate oxygenation, have a spectrum of cardiovascular toxic effects; for example, directly depressing contractility in rat, cat, dog and human myocardium and rapidly inducing ventricular arrhythmias in awake or anesthetized monkeys. The relevance of these findings to sudden unexpected death in young people who deliberately inhale these gases, to the widespread use of household and cosmetic aerosols, which most commonly discharge as propellants, Freons 12, 11 and 114, and perhaps, to the increasing uses of other Freons (e. g., the solvent, Freon 113), makes deeper study of this toxicity mandatory.

REFERENCES

1. Harris, W. S.; "Toxic Effects of Aerosol Propellants on the Heart"; Arch. Int. Med., in press.
2. Harris, W. S. and S. M. Kilen; "Aerosol Propellants Depress Myocardial Contractility"; Clin. Res., 19:319, 1971.
3. Inman, W. H. W. and A. M. Adelstein; "Rise and Fall of Asthma Mortality in England and Wales in Relation to Use of Pressurized Aerosols"; Lancet, 2:279-285, 1969.

REFERENCES (Cont'd)

4. Speizer, F. E., R. Doll and P. Heaf; "Observations on Recent Increase in Mortality from Asthma"; Brit. Med. J., 1:335-339, 1968.
5. Speizer, F. E., R. Doll, P. J. Heaf and L. B. Strang; "Investigation into Use of Drugs Preceding Death from Asthma"; Brit. Med. J., 1:339-342, 1968.
6. Taylor, G. J. and W. S. Harris; "Cardiac Toxicity of Aerosol Propellants"; JAMA, 214:81-85, 1970.
7. Taylor, G. J. and W. S. Harris; "Glue Sniffing Causes Heart Block in Mice"; Science, 170:866-868, 1970.
8. Taylor, G. J. and W. S. Harris; "Depression of Myocardial Contractility in the Intact Mammal by Aerosol Propellant Inhalation"; Clin. Res., 19:342, 1971.
9. Taylor, G. J., W. S. Harris and M. D. Bogdonoff; "Ventricular Arrhythmias Induced in Monkeys by the Inhalation of Aerosol Propellants"; J. Clin. Invest., 50:1546-1550, 1971.
10. Van Stee, E. W. and K. C. Back; "Short-term Inhalation Exposure to Bromotrifluoromethane"; Toxic. Appl. Pharm., 15:164-174, 1969.

DISCUSSION

DR. SCHEEL (U. S. Public Health Service): I would like to ask if you have approached the question of replacing the asphyxia with adrenaline or noradrenaline?

DR. HARRIS (University of Illinois Hospital and College of Medicine): You probably refer, if I am correct, to the question of sensitization of the myocardium to arrhythmias produced by these catecholamines. I doubt in the mice that the catecholamines would be responsible for the bradyarrhythmias, the AV blocks, or the profound sinoatrial slowing, and we have not administered catecholamines for this purpose to the mice.

DR. FRIESS (National Naval Medical Center): In your in vitro studies, is there any evidence that fibrils have membranes depolarized in the course of saturation of the Freons?

DR. HARRIS: That of course, is a very fine question. That is, what is the mechanism of the toxicity? I must say that it is extraordinarily fast - the muscle beating nine times per minute, and by the third beat there is a rather considerable depression already. This would suggest to us that it is probably acting on the membrane or at least exerting its effects on the contractile protein in an indirect manner through acting on some enzyme in one of the membranes, either around the cell or inside the cell. We have not done electrophysiological studies of action potential, to answer you specifically.

DR. SILVERGLADE (Riker Laboratories): Dr. Harris alluded to the fact that there was a statistical correlation between the sales of pressurized bronchodilator aerosols in England and Wales and an increase in death rate from asthma during the early part of the decade from 1960 to 1967. It is of interest that in the United States during the very same time, the death rate from asthma decreased from a rate of 3 per hundred thousand population to 1.3, and during that time the use of the bronchodilator aerosols really soared. The earliest statistics for the sales of the bronchodilator aerosols in this country were for the year 1964, when more than 3 million units were sold in drug stores. This increased progressively until 1968 when more than 5 million units were sold. In 1969, there was a slight drop to under 5 million, and in 1970, again over 5 million. Now, I maintain that one cannot have it both ways. If one is going to correlate death rate and the use of the bronchodilators, and attribute the cause of this rise in mortality to the use of the bronchodilators, then one must at the same time say that the use of the bronchodilators helped to cause a decrease in mortality in the United States. Now similar statistics on the sales of bronchodilators and mortality rates are available for Germany. I know of none in any other country. In Germany, the death rate also came down markedly at a time when the use of the bronchodilators increased. Now, during this time, death rate from asthma increased

in England and Wales, and in Sweden. Elsewhere in the world, the death rate from asthma decreased. This was true for Japan, Germany, Italy, France, and the United States. So it would seem to me that the use of this kind of data is inadmissible in drawing a definite conclusion in attributing the increased mortality in England and Wales to these products. It is of interest also that other investigators have been unable to reproduce the control findings of Taylor and Harris. When the paper was published, we immediately got to work. I am a clinician and not a laboratory worker, and what I have to say is derived from the work of other people and not my own. Dr. McClure, a pharmacologist of ten years industrial experience, attempted to reproduce the Taylor-Harris findings. He found at first that if the cuff placed over the head, in front of the ears, of the mouse was loose, he got no results; that is, he got no cardiovascular changes. If we made the cuff very, very tight, then we got the effects of asphyxia. And, we got the same results in controls that had received no propellants as those that had received propellants. Now, similar findings have been obtained, not only in our laboratory, but by Dr. Azar who is on this program and will speak later; by Dr. Frank Rosenberg of the Sterling-Winthrop Research Institute; and the group of workers in the laboratories of Allen-Hanbury in England. So as of the present time, the score stands four to one in favor of no changes with the controls. Now, one cannot apply a score to scientific validity as one does in asthma. But, I would say that the burden of proof still remains with Dr. Harris.

CARDIOPULMONARY EFFECTS OF FLUOROCARBON COMPOUNDS

Domingo M. Aviado, M. D.

University of Pennsylvania School of Medicine
Philadelphia, Pennsylvania

INTRODUCTION

The present investigation was designed to examine the hypothesis that the cardiopulmonary toxicity of the propellants is related to the irritation of sensory receptors in the respiratory passages. The anesthetized dog was used to allow measurement of pulmonary resistance and compliance, when propellants were confined to the upper respiratory tract or were administered intratracheally, bypassing the upper respiratory tract. Additional procedures to determine whether propellants influence the bronchial smooth muscle, pulmonary blood vessels and the heart are reported. Three propellants commonly used in aerosol units containing bronchodilators were investigated. They are trichlorofluoromethane (propellant 11), dichlorodifluoromethane (propellant 12), and 1, 2-dichloro-1, 1, 2, 2-tetrafluoroethane (propellant 114) [figure 1].

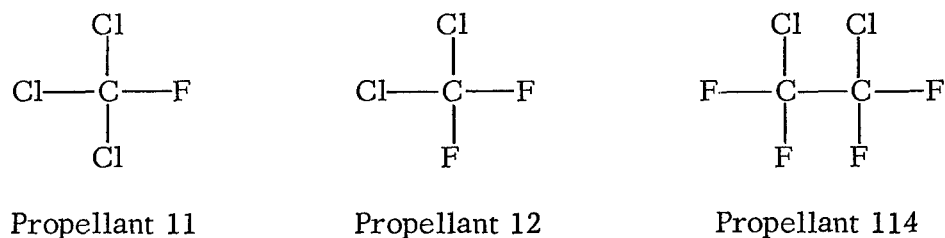

Figure 1. CHEMICAL STRUCTURES OF THREE FLUOROCARBON PROPELLANTS.

METHODS

Separation of Upper and Lower Respiratory Tract

Ten dogs, weighing from 14 to 20 kg, were anesthetized with a combination of morphine sulfate (2 mg/kg sc) and choralose (70 mg/kg iv). Two cannulas were inserted into the trachea, one directed towards the lungs and the other towards the nose. By means of these, it was possible to administer the propellant either to the lower respiratory tract (i. e., the lungs), bypassing the nose, pharynx and larynx, or to the upper respiratory tract separated from the lower. Lead II electrocardiogram and femoral arterial blood pressure were recorded. Pulmonary resistance and compliance were estimated from measurements of tracheal air flow and trans-pulmonary pressure. The cannula directed towards the lung was connected to a mesh screen Fleisch pneumotachograph with a heating unit to maintain inspired air at a constant temperature, and the pressure transducer. The signal from the transducer corresponded to air flow and was in turn integrated and recorded as tidal volume. The pressure difference between the trachea and the intrapleural space was measured by a second differential transducer. To measure pulmonary resistance, the flow and pressure signals were displayed simultaneously on both axes of the oscilloscope screen to show a P-V loop. Subsequently, an amount of pressure proportional to volume was subtracted, so that the loop was closed at zero flow. The slope of the line thus obtained corresponded to pulmonary resistance. The values for compliance were obtained similarly by displaying the P-V signals and subtracting pressure due to resistance, or by calculation from the subtracted pressure when closing the resistance, or by calculation from the subtracted pressure when closing the resistance loop (Klide and Aviado, 1967).

The following experimental procedures were performed on each animal: (a) exposure of upper respiratory tract to 200 ml of 50% of the propellant administered through the nasal orifices and with suction applied to the upper tracheal cannula; (b) administration of propellant via lower tracheal cannula containing a valve for actuation of the aerosol unit; and (c) repeated intravenous injection of epinephrine hydrochloride (1 μ g/kg). In four of the 10 dogs, procedure (b) preceded (a) with no noticeable difference in response compared to the dogs exposed in the usual sequence.

Cardiopulmonary Effects of Propellants and their Mechanism of Action

The second group of eight dogs was prepared in a manner similar to the first group. The differences included the following: (a) The propellants were administered via the tracheal cannula only. (b) In three of the eight dogs the chest was opened by a midline incision and the ventilation was controlled by a Starling Ideal pump. (c) In addition to measurement of pulmonary resistance, pulmonary arterial pressure was determined via a catheter in the artery to the left lower lobe and myocardial contractility by means of a Walton strain gauge. (d) The propellants were tested before and after the following forms of denervation: bilateral

cervical vagotomy (2 dogs), bilateral thoracic sympathectomy (2 dogs), intravenous injection of 0.1 mg/kg atropine sulfate (2 dogs), and intravenous injection of 10 mg/kg sotalol (2 dogs), a drug previously demonstrated to cause blocking of beta adrenergic receptors associated with inhalation of halothane.

RESULTS

Upper Respiratory Reflex

The greatest number of experimental procedures were performed on the first group of dogs. It was possible to expose the upper respiratory tract to the propellant without allowing its entrance into the lungs. The response to administration of propellant 11 in one dog is depicted in figure 2. Initially apnea, bradycardia and a fall in aortic blood pressure occurred. This was followed by a rise in aortic blood pressure which persisted for about 2 minutes. After the resumption of breathing, there was no important change in pulmonary resistance and compliance.

The immediate onset of respiratory and cardiovascular changes suggests that the response is a reflex one originating from irritation of sensory receptors in the mucosa and nasal passages. Absorption of the propellant by the blood followed by a direct effect on the medullary centers for respiration and circulation would take at least a minute. Propellant 11 caused the most intense bradycardia (-55%), propellant 114 ranked next in intensity, and propellant 12 did not influence respiration or circulation.

Administration of Individual Propellants to the Lower Respiratory Tract

The dogs used to elicit the upper respiratory reflex were also used to test the effects of tracheal administration of propellants. The aerosol unit containing a propellant was attached to the lower tracheal cannula and was actuated at each inspiration. Each propellant was tested in four doses: 5, 10, 15, and 20 actuations.

Propellant 11

Propellant 11, administered directly into the lower tracheal cannula, initiated some alterations in parameters relating to the respiratory and circulatory systems. There was a reduction in pulmonary resistance, which reached a peak effect of -20% following 10 puffs. A coincidental increase occurred in pulmonary compliance, which was maximal (+27%) after 15 puffs, and a fall in aortic blood pressure, maximal (-8%) after 15 puffs (figures 3 and 4).

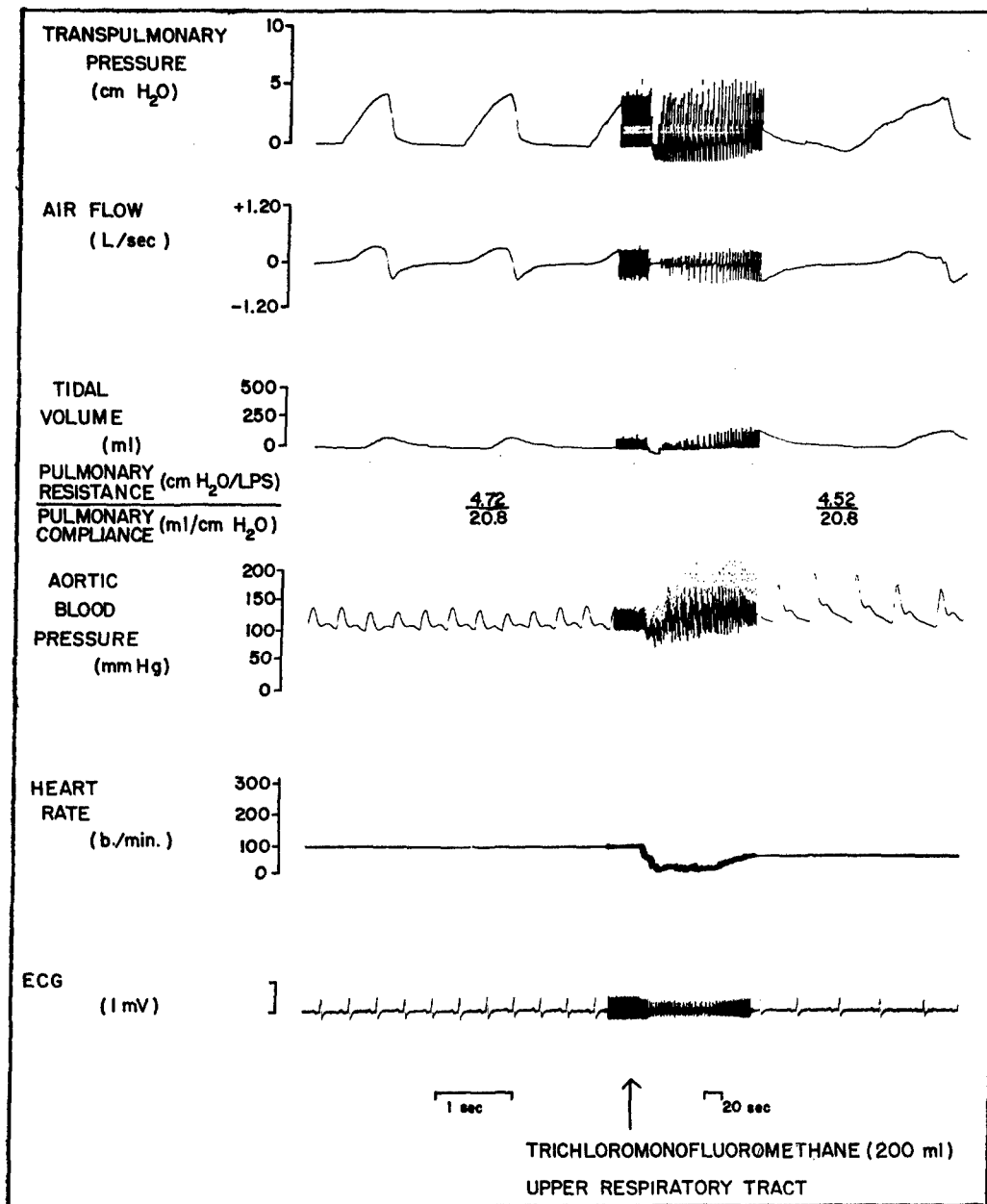

Figure 2. EXPOSURE OF UPPER RESPIRATORY TRACT TO PROPELLANT 11. The speed of the recording system was changed twice, so that the middle portion at a slow speed is between fast recordings. Note the apnea, bradycardia and biphasic fall and rise in aortic blood pressure. Dog No. 7, 13 kg.

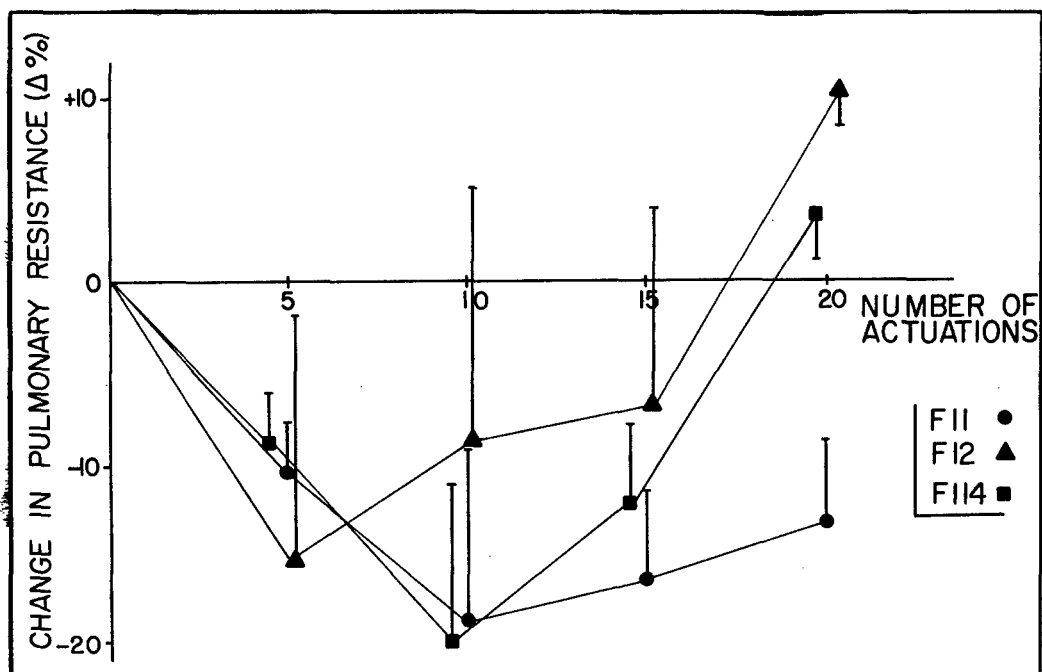

Figure 3. PERCENTAGE CHANGES IN PULMONARY RESISTANCE FOLLOWING TRACHEAL INHALATION OF PROPELLANTS. Note that all three propellants caused a fall in pulmonary resistance. However, 20 actuations of propellants 12 and 114 caused an increase in resistance.

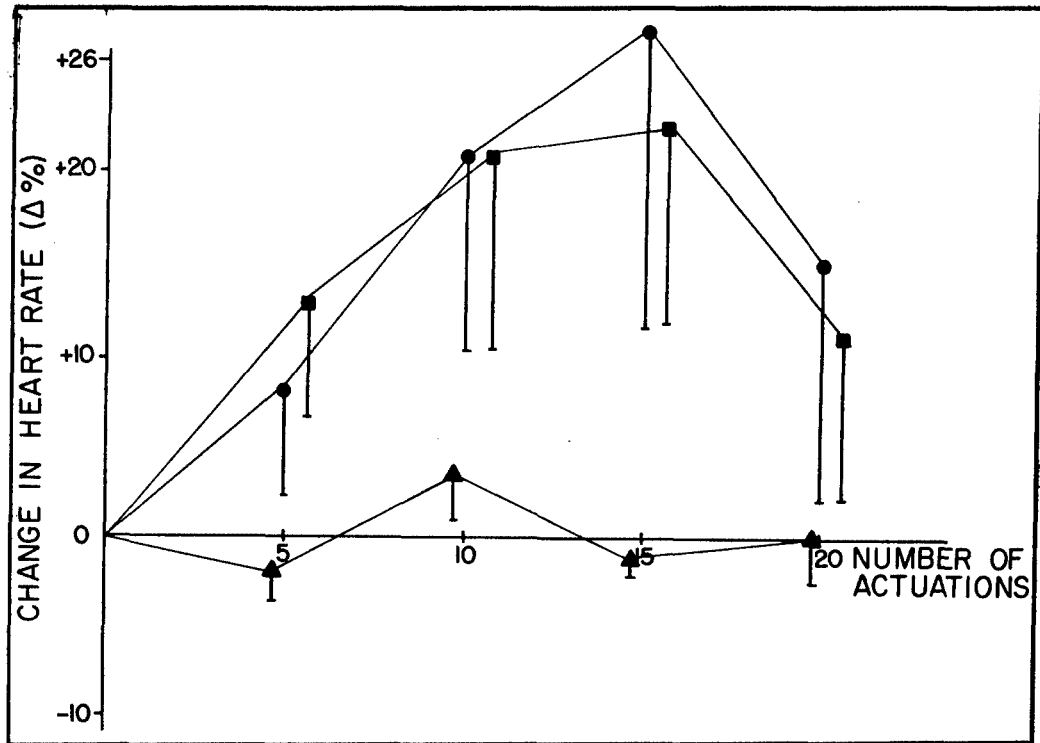

Figure 4. PERCENTAGE CHANGES IN HEART RATE FOLLOWING TRACHEAL ADMINISTRATION OF PROPELLANTS. Note that propellant 12 does not induce tachycardia, whereas propellant 11 and 114 caused acceleration of heart rate. Symbols are the same as used in figure 3.

Propellant 12

Propellant 12 was administered to another group of dogs. The inhalation of 5 to 15 puffs did not influence heart rate and pulmonary resistance. However, with 20 puffs, there was an increase in pulmonary resistance of 12% (figures 3 and 4).

Propellant 114

Propellant 114 influenced heart rate in the same manner as propellant 11; five to 20 puffs caused acceleration of heart rate. Ten and 15 puffs of propellant 114, like propellant 11, caused a reduction in pulmonary resistance (figures 3 and 4). The difference between both was that 20 puffs caused a slight increase in resistance. The biphasic pattern of response in airway resistance of propellant 114 was a combination of a fall characteristic of propellant 11, and of a rise characteristic of propellant 12.

Mechanism for Tachycardia of Large Doses of Propellants

The last group of dogs was used to investigate the mechanism of tachycardia induced by tracheal inhalation of propellant 11 and propellant 114. The single procedure that eliminated the tachycardia was thoracic sympathectomy. Since administration of sotalol, a drug known to block beta adrenergic receptors, did not obstruct the response, the sympathetic efferents are not important. By exclusion, the loss of sympathetic afferent fibers is responsible for the elimination of the response following sympathectomy.

The vagus nerve is involved in mediating the tachycardia following tracheal inhalation of a propellant. The vagal efferents, interrupted by either cervical vagotomy or administration of atropine, are involved in the tachycardia. However, their importance can be demonstrated only after prior blockade of sympathetic efferents, followed by interruption of vagal efferents. When both components are eliminated tachycardia is prevented.

DISCUSSION

The mechanisms responsible for the cardiopulmonary effects of fluorocarbon compounds are important in the defense against inhalation of noxious chemicals. The mechanisms described here as well as those reported in another publication (Aviado and Samanek, 1965) can be divided into four lines of defense, namely (1) respiratory, (2) bronchomotor and bronchovascular, (3) pulmonary vascular, and (4) cardiac and systemic. The details of each group are discussed below.

Respiratory Defense Mechanisms

The immediate response to the administration of a propellant into the upper respiratory tract is as follows: bradycardia, apnea and biphasic fall and rise in blood pressure. This response is similar to that elicited in the rabbit by the administration of vapors of chloroform, acetic acid, and acetone reported in 1870 by Kratschmer. Allen (1928-1929 a to d) reported a similar response in several animal species and in human subjects. He also demonstrated that the olfactory and trigeminal nerves were the sensory arm for the reflex response. The respiratory effect is regarded as a protective reflex that would prevent the entrance of an irritant vapor and its absorption by the lungs. The stimulation of a series of expirations from irritation of the lower respiratory tract stimulate coughing and would serve to expel the irritating vapor from the bronchiolar passages.

Bronchomotor and Bronchovascular Mechanisms

The most consistent effect of inhalation of propellants is a reduction in pulmonary resistance. This was encountered when 5 to 15 actuations of propellants 11, 12 and 114 were effected by inhalation via the tracheal cannula. However, with 20 actuations, propellants 12 and 114 exerted bronchoconstriction whereas propellant 11 continued to induce bronchodilatation. The mechanism for the bronchodilatation has not been elucidated. It is probable that these fluorinated hydrocarbon propellants have the same modes of action as halothane which stimulates directly the adrenergic receptor in the bronchial muscle (Klide and Aviado, 1967).

The bronchospasm seen with large doses of propellants 12 and 114 has been encountered in recently completed experiments in cats. There is also congestion of bronchial mucosa similar to the phenomenon reported previously in the dog lung induced by sulfur dioxide inhalation (Aviado, 1962). The combination of bronchospasm and bronchial congestion would serve to reduce absorption of the inhaled fluorocarbon via the bronchial mucosa and impede its distribution to the alveolar spaces. This would serve as the second line of defense.

Pulmonary Vascular Mechanisms

The third line of defense involves the pulmonary blood vessels. Experiments in rats indicate that inhalation of some fluorocarbons causes pulmonary edema (unpublished). The edema is similar to that reported previously in dogs following inhalation of sulfur dioxide resulting in constriction of the pulmonary veins (Salem and Aviado, 1961). The end-result is edema which would interfere with the absorption of the noxious inhalant.

Cardiac and Systemic Mechanism

The fourth and last line of defense involves the heart and systemic circulation. The fluorocarbon compounds can cause depression of ventricular function. This may in turn reduce pulmonary blood flow and the absorption of noxious inhalant. On the other hand, this depression of the heart may contribute to death which is a sign that all four lines of defense have failed.

REFERENCES

1. Allen, W. F. ; "Effect on Respiration, Blood Pressure and Carotid Pulse of Various Inhaled and Insufflated Vapors when Stimulating One Cranial Nerve and Various Combinations of Cranial Nerves. I. Branches of the Trigeminus Affected by these Stimulants"; Amer. J. Physiol. , 87:319-325, 1928-1929a.
2. Allen, W. F. ; "Effect on Respiration, Blood Pressure and Carotid Pulse of Various Inhaled and Insufflated Vapors when Stimulating One Cranial Nerve and Various Combinations of Cranial Nerves. II. Vagus and Vagotomy Experiments"; Amer. J. Physiol. , 87:558-565, 1928-1929b.
3. Allen, W. F. ; "Effect on Respiration, Blood Pressure and Carotid Pulse of Various Inhaled and Insufflated Vapors when Stimulating One Cranial Nerve and Various Combinations of Cranial Nerves. III. Olfactory and Trigeminals Stimulated"; Amer. J. Physiol. , 88:117-129, 1928-1929c.
4. Allen, W. F. ; "Effect of Various Inhaled Vapors on Respiration and Blood Pressure in Anesthetized, Unanesthetized, Sleeping and Anosmic Subjects"; Amer. J. Physiol. , 88:620-632, 1928-1929d.
5. Aviado, D. M. ; "Pharmacology of the Bronchial Circulation. With Special Reference to a New Homeostatic Mechanism for Bronchomotor Tone"; Proceedings First International Pharmacological Meeting, 9:125-149, 1962.
6. Aviado, D. M. and M. Samanek; "Bronchopulmonary Effects of Tobacco and Related Substances"; I-IV, Arch. Environ. Health, 11:141-176, 1965.
7. Klide, A. M. and D. M. Aviado; "Mechanism for the Reduction in Pulmonary Resistance Induced by Halothane"; J. Pharmacol. Exptl. Ther. , 158:28-35, 1967.
8. Kratschmer, F. ; "Uber Reflexe von der Nasenschleimhaut auf Athmung und Kreislauf"; Sitzungsb. Akad der Wissen, 62:147-170, 1870.
9. Salem, H. and D. M. Aviado; "Inhalation of Sulfur Dioxide"; Arch. Environ. Health, 2:656-662, 1961.

CARDIOVASCULAR EFFECTS OF FLUOROCARBON EXPOSURE

Alex Azar, M. D.

Haskell Laboratory for Toxicology and Industrial Medicine
E. I. du Pont de Nemours & Company, Inc.
Wilmington, Delaware

INTRODUCTION

I would like to review some of the studies carried out at Haskell Laboratory which have shown that certain fluorinated hydrocarbon compounds are capable of sensitizing the mammalian heart to epinephrine resulting in serious cardiac arrhythmias. This phenomenon is referred to as cardiac sensitization.

Cardiac sensitization is not a new phenomenon. The introduction of the electrocardiogram in the early 1900's permitted Levy and Lewis (1911) to study the mechanism of sudden death during chloroform anesthesia and on the basis of these investigations they concluded that chloroform anesthesia could sensitize the cat's heart to epinephrine, resulting in ventricular fibrillation and death. Since that time over forty compounds have been found which sensitize the heart to epinephrine, resulting in the production of ventricular arrhythmias (Reinhardt et al., 1971).

Table I lists some of the chemicals which have been reported in the literature as being capable, experimentally, of producing cardiac sensitization. The breakdown of the cardiac sensitization potential of the compounds was difficult because the majority of the reports had merely rated the chemicals as being capable of causing or not causing sensitization and the method of investigation varied considerably from study to study.

TABLE I		
COMPOUNDS TESTED FOR CARDIAC SENSITIZATION PROPERTIES*		
A. <u>Those Considered Most Active</u>		
Benzene		
Heptane		
Chloroform		
Trichloroethylene		
B. <u>Those Considered Intermediate in Potency</u>		
Carbon tetrachloride		
Halothane (or Fluothane)		
C. <u>Those Considered Weak Sensitizing Agents or Where Data Make Classification Difficult</u>		
Methyl chloride	Isopropyl chloride	Methyl bromide
Methylene chloride	Primary butyl chloride	Ethyl bromide
Ethyl chloride	Secondary butyl chloride	Methyl iodide
Ethylene chloride	Isobutyl chloride	Ethyl iodide
Propyl chloride	Tertiary butyl chloride	
Ethane	Isobutane	Cyclopentane
Propane	<u>cis- or trans-butene-2</u>	Isopentane
Propylene	Cyclobutene	2, 2-dimethyl-butane
n-Butane	Cyclobutane	
Acetylene	Vinyl chloride	Methyl cyclobutane
Spiropentane	Isopropenyl chloride	
Trifluorochloro-ethylene	Trichloromonofluoroethylene	<u>trans</u> -dichloroethylene
Monochlorodifluoroethylene	<u>cis</u> -dichloroethylene	
D. <u>Compounds Which Did Not Cause Sensitization</u>		
Ethylene	Difluoroethylene	
Tetrafluoroethylene	Propylene oxide	
Ethylene oxide	Acetone	
Alcohol		

* Adapted from Reinhardt et al., (1971)

The exact mechanism of cardiac sensitization is unclear; however, according to Price (1967), both exposure to compound and a high level of adrenergic agent (either exogenous or endogenous) is necessary for the reaction to occur. It has been suggested that epinephrine modifies impulse conduction through areas of the conduction system which have been depressed by exposure to the agent, thus permitting re-entry of impulses to unaffected areas of the conduction system (Innes et al., 1970).

Perhaps a simple analogy might help clarify the situation. The human heart is a pump which responds to epinephrine by increasing its rate of pumping. This is similar to an automobile where depression of the gas pedal usually results in a smooth acceleration of the car; however, sometimes when the gas pedal is rapidly depressed the car responds by coughing, sputtering and finally dying. The latter could be due to a host of factors - poor timing, dirty carburetor, etc. For some unknown reason the human heart, in the presence of high levels of epinephrine and exposure to a sensitizing agent, sometimes responds to the demand for speeding up by quivering and dying.

TABLE II	
<u>STANDARD EXPOSURE</u>	
CONTROL PERIOD	AIR
<p>0 MIN: START</p> <p>2 MIN: ADMINISTER EPINEPHRINE INTRAVENOUSLY; THE TOTAL DOSE (0.008 mg/kg) IS CONTAINED IN 1 ml OF NORMAL SALINE AND IS INJECTED IN 9 SEC. BY AN AUTOMATIC INFUSION PUMP.</p> <p>7 MIN: ADMINISTER COMPOUND</p>	
VAPOR ADMINISTRATION PERIOD	AIR AND COMPOUND
<p>12 MIN: ADMINISTER EPINEPHRINE (CHALLENGE INJECTION)</p> <p>17 MIN: STOP COMPOUND ADMINISTRATION; END EXPERIMENT</p>	
<u>SHORT-TERM EXPOSURE</u>	
CONTROL PERIOD	AIR
<p>0 MIN: START</p> <p>2 MIN: ADMINISTER EPINEPHRINE INTRAVENOUSLY; THE TOTAL DOSE (0.008 mg/kg) IS CONTAINED IN 1 ml OF NORMAL SALINE AND IS INJECTED IN 9 SEC. BY AN AUTOMATIC INFUSION PUMP.</p>	
VAP*	AIR
<p>12 MIN: ADMINISTER COMPOUND; ADMINISTER EPINEPHRINE (CHALLENGE INJECTION)</p> <p>12.5 MIN: DISCONTINUE VAPOR EXPOSURE</p> <p>15 MIN: END EXPERIMENT</p>	
* VAPOR ADMINISTRATION PERIOD, AIR AND COMPOUND.	

Our laboratory became interested in this phenomenon in the late 1960's because of a new fad which began to make the scene among the teenagers of the United States. That fad was the "sniffing" of aerosol products and aerosol propellants in order to achieve a "high" or for "kicks". The term "sniffing" is really a misnomer, since the practice involves the deliberate deep inhalation of highly concentrated vapors. When the first deaths attributed to "sniffing" a fluorocarbon propellant occurred in 1967, they came as a surprise since these compounds were known for their low order of toxicity.

The clinical picture plus the general lack of conclusive autopsy findings suggested that an acute cardiac arrest such as would occur in ventricular fibrillation may be a frequent cause of death. This could occur if the inhalation of high concentrations of these propellants was sensitizing the heart to epinephrine. In February 1970, prior to the publication of Bass (1970), Haskell Laboratory (Reinhardt et al., 1971) presented evidence that the propellants used in these aerosols are capable of sensitizing the dog's heart to epinephrine.

METHODS AND RESULTS

The protocol followed in these studies is shown in table II and basically consisted of exposing unanesthetized dogs to known concentrations of the compound under investigation for five minutes and injecting them with an intravenous dose of epinephrine which, by itself, would not result in ventricular tachycardia or fibrillation, but in the presence of a cardiac sensitizing agent might result in these arrhythmias.

Figure 1 shows typical electrocardiographic changes. Injection of epinephrine alone resulted in ventricular ectopic beats and ventricular complexes with absent or dissociated p waves. Marked responses which indicated cardiac sensitization consisted of a run of multiple ventricular beats or ventricular fibrillation.

Figure 2 shows that all of the propellant compounds tested were capable of sensitizing the heart to epinephrine; however, they differed in the exposure concentration required to produce this effect. Of this group of compounds, fluorocarbon 11 had the greatest cardiac sensitization potential since it produced this phenomenon in 8% and 41% of the dogs at concentrations of 0.5% (5000 ppm) and 1.0% (10,000 ppm) respectively. At the other end of the spectrum was fluorocarbon C-318 which produced the effect in 16% and 83% of the animals at concentrations of 25.0% and 50.0%. Most of the remaining compounds caused sensitization at concentrations in the range of 5.0% and 20.0%.

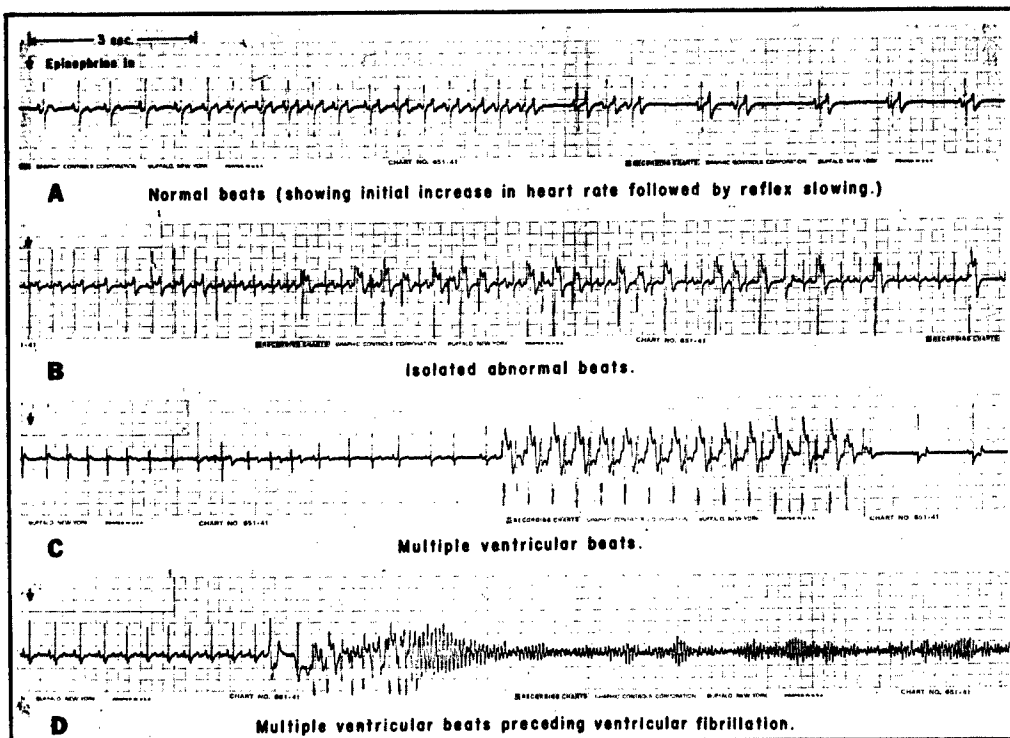

Figure 1. EXAMPLES OF ELECTROCARDIOGRAPHIC PATTERNS FOLLOWING THE CHALLENGE INJECTION OF EPINEPHRINE.

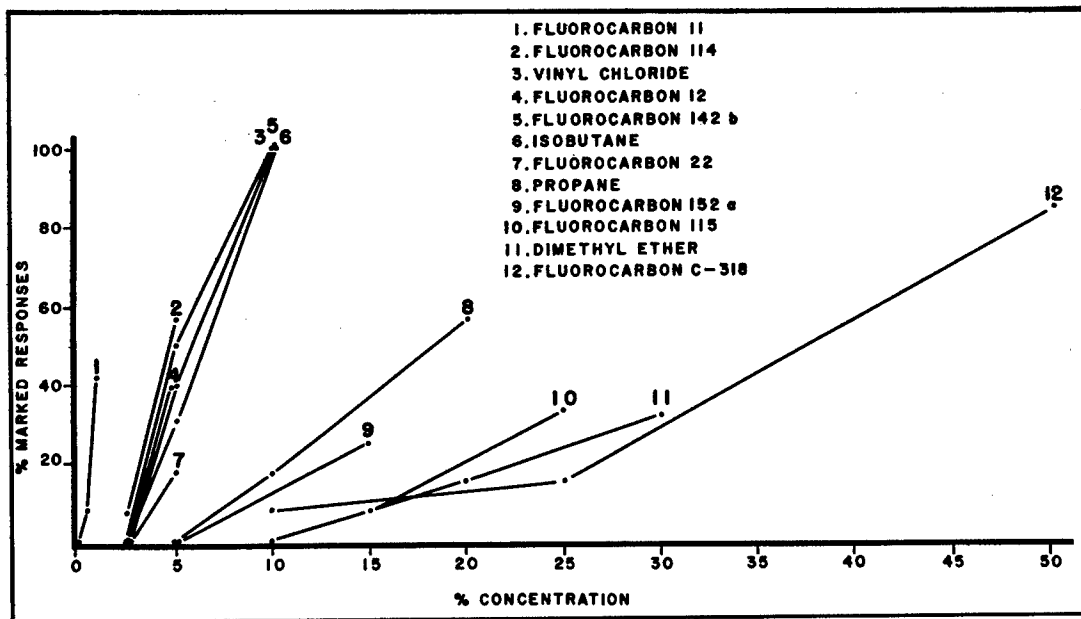

Figure 2.

The sensitization potential of a compound apparently depends partly on the degree and type of halogenation. Those compounds containing chlorine atoms produced the greatest degree of sensitization while those containing only fluorine atoms were among the weaker sensitizers. However, halogenation is not necessary since propane and isobutane produced a similar measure of sensitization as compared to many of the halogenated compounds (figure 2).

In order to study the effect of varying the duration of exposure, dogs were exposed to different concentrations of fluorocarbon 12 for varying periods of time prior to injection with epinephrine. Table III shows that an exposure of only 30 seconds was sufficient to cause cardiac sensitization; however, the concentration of compound had to be higher than that required to produce the same effect as that observed after the 5-minute exposure. On the other hand, increasing the duration of exposure to six hours a day for five consecutive days did not produce a sensitization effect at a concentration of 2.5%. These results suggest that there is a threshold concentration, independent of the duration of exposure which must be reached before an effect will be produced.

In an attempt to study the effect of endogenous epinephrine, dogs were exposed to 80% agent and 20% oxygen for 30 seconds and frightened. The fright consisted of a loud noise provided by an amplified sound-effects tape recording, having the sounds of sirens, gongs, jet takeoffs, etc. The results are shown in table IV. Fluorocarbon 142b (1-chloro-1,1-difluoroethane) which is not a widely used commercial propellant, was the most potent of the compounds tested, resulting in 41.7% marked responses. Of the three compounds most frequently used as aerosol propellants, fluorocarbon 11 resulted in two cases of marked responses and fluorocarbon 114 in one. No marked responses were seen with fluorocarbon 12. A tachycardia was seen in the dogs exposed to fluorocarbons 12 and 114 and a bradycardia was observed in the dogs exposed to fluorocarbon 11 and 142b. Although no deaths occurred, the animals did not tolerate these exposures. They would struggle violently, hold their breath, and frequently have tremors and convulsions. It is probable that the combination of fright, struggling, and convulsions resulted in an increased level of endogenous epinephrine.

In another series of experiments by Mullin et al. (1971) designed to stimulate endogenous epinephrine, dogs were trained to run on a treadmill. While running, they were exposed to different concentrations of fluorocarbon 11, 12, and 114 for 16 minutes. During the exposures, their electrocardiograms were recorded.

TABLE III

CARDIAC SENSITIZATION. RESULTS OF VARIABLE DURATION OF EXPOSURE TO FLUOROCARBON 12

Concentration (v/v) Percent	Duration of Exposure	Number of Dog Exposures	Number of Marked Responses	Percent of Marked Responses
13.5	30 sec.	7	2	28.6
5.0	5 min.	12	5	41.7
2.5	6 hr/day for 5 days	6	0	0
1.0	6 hr/day for 5 days	6	0	0

TABLE IV

RESULTS OF ENDOGENOUS EPINEPHRINE EXPERIMENT*

Compound	Number of Dog Exposures	Number of Mild Responses	Number of Marked Responses	Percent Responses	
				Mild	Marked
Fluorocarbon 11	12	9	2	75.0	16.7
Fluorocarbon 114	12	1	1	8.3	8.3
Fluorocarbon 12	12	2	0	16.7	0.0
Fluorocarbon 142b					
compound + noise	12	4	5	33.3	41.7
compound alone	12	3	1	25.0	8.3
noise alone	6	1	0	16.7	0.0

* 80% compound and 20% oxygen for 30 seconds with noise

The results of these tests are shown in table V. Of the six to eight dogs tested with each compound, only one particular dog developed a marked response consisting of multiple ventricular beats (figure 3). This occurred during exposure to 10% fluorocarbon 12 and during exposure to 5% fluorocarbon 114. These concentrations are approximately twice the concentration of compound required to produce cardiac sensitization using injected epinephrine. It was impossible to expose the dogs to higher concentrations of compound because many of the dogs became partially anesthetized and unable to run before the desired exposure concentrations were achieved.

TABLE V
RESULTS OF CARDIAC SENSITIZATION AND ENDOGENOUS EPINEPHRINE
EXPERIMENT IN DOGS ON TREADMILL

Test Compound	Concentration (v/v) Percent	Number of Dog Exposures	Number of Marked Responses	Percent Marked Responses
Air	-	8	0	0
Fluorocarbon 12	5.0	6	0	0
	7.5*	6	0	0
	10.0*	6	1	16.7
	10.0	6	0	0
Fluorocarbon 114	2.5	6	0	0
	5.0	7	1	14.3
	10.0	7	1	14.3
Fluorocarbon 11	0.5	8	0	0
	0.75	8	0	0
	1.0	7	0	0

* Nominal concentrations (the concentrations given the dogs were probably higher than 7.5% and 10.0%).

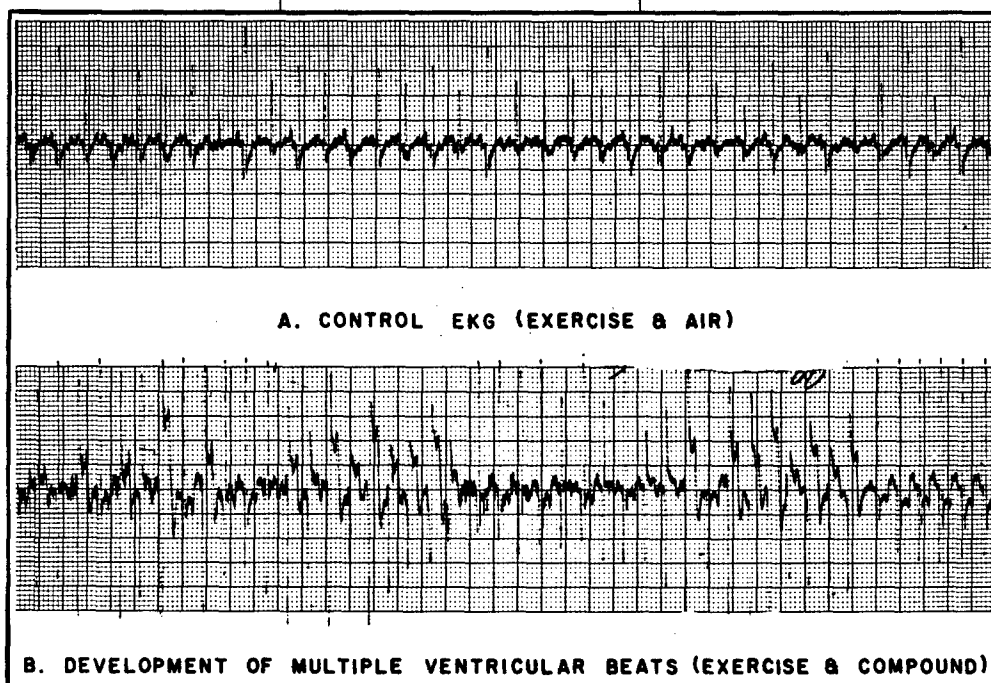

Figure 3.

Table VI shows the propellant concentrations measured six to eight inches in front of the nose of a live model, using a common hair spray and antiperspirant in a small bathroom (231.2 cubic feet). The measurements were made during routine use and following the complete emptying of the container in both a ventilated (door open, exhaust fan on) and non-ventilated (door closed, exhaust fan off) room. The time allotted for the routine use is considerably longer than that which most individuals would use. For comparison, the Threshold Limit Value (TLV) for each of the propellants recommended by the American Conference of Governmental Industrial Hygienists for an average eight-hour exposure is listed (1000 ppm or 0.1%). It is evident that the values obtained during routine use are well below the recommended TLV, and that this held true both in the ventilated and non-ventilated room. The values obtained when the containers were deliberately and completely emptied in a non-ventilated room did exceed the recommended TLV. It is important to note that it required 4 to 11 minutes to completely empty a container and the resulting mist was so great that the investigators reported that visibility was nil.

PROPELLANT CONCENTRATIONS					
FACE LEVEL : AFTER END OF SPRAYING SMALL BATH ROOM (231.2 FT ³)					
ROOM	CONDITION OF USE	SPRAYING TIME	PROPELLANT CONCENTRATIONS: % (BY VOL.)		
			P-12	P-11	ISOBUTANE
THRESHOLD LIMIT VALUE = 0.1%					
<u>HAIR SPRAY</u>					
VENTILATED	ROUTINE	14 SEC.	.038	.046	.016
	CAN EMPTIED	11 MINS.	.036	.044	.014
NOT VENTILATED	ROUTINE	14 SEC.	.018	.026	.008
	CAN EMPTIED	10.5 MINS.	.194	.245	.079
<u>ANTI PERSPIRANT</u>					
VENTILATED	ROUTINE	10 SEC.	.012	.021	
	CAN EMPTIED	4.5 MINS.	.050	.102	
NOT VENTILATED	ROUTINE	10 SEC.	< .002	.008	
	CAN EMPTIED	4.25 MINS.	.198	.391	
VENTILATED : DOOR OPEN, EXHAUST FAN ON.					
NOT VENTILATED : DOOR CLOSED, EXHAUST FAN OFF.					

COMMENTS

Before closing I should like to comment on some additional evidence which supports the view that some of the fluorocarbon compounds are capable of sensitizing the mammalian heart to epinephrine resulting in ventricular fibrillation and death.

Bass (1970) has vividly described the increased activity of the aerosol "sniffing" victims prior to their death. This increased activity would probably increase their endogenous epinephrine levels. The technique used by the sniffers of breathing in and out of a bag would result in an elevated carbon dioxide level which is known to potentiate the cardiac sensitization potential of compounds (Price, 1958).

Clark and Tinston (1971) in England, using a method very much like ours, have reported similar findings. In addition, they gave their dogs an injection of epinephrine 10 minutes following exposure to a known sensitizing concentration of fluorocarbon and never saw sensitization develop, thus demonstrating that exposure to the fluorocarbon compounds does not permanently sensitize the heart to epinephrine.

Professor Kehoe (1943) at the University of Cincinnati has experimentally exposed two human subjects to fluorocarbon 12. As the concentration of fluorocarbon 12 was increased from 4% to 11%, there was a progressive increase in central nervous system depression. At a concentration of 11%, a ventricular bigeminy was seen on the electrocardiogram of one subject. We (Azar et al., 1971) have experimentally exposed two human subjects to 0.1% and 1.0% fluorocarbon 12 for two and one-half hours without seeing any change in their electrocardiograms.

Spontaneous and epinephrine-induced arrhythmias have been reported by Van Stee et al. (1969) in dogs and monkeys exposed to high concentrations of fluorocarbon 1301. Clark (1970) has seen ventricular tachycardia develop in a human experimentally exposed to a high concentration of bromochlorodifluoromethane, a compound which closely resembles fluorocarbon 1301.

Before ending this presentation, I should like to comment on the reason why Haskell Laboratory chose to use unanesthetized dogs in preference to anesthetized animals. Priano et al. (1969), at the University of Texas, have reported that pentobarbital anesthesia, by itself, has a marked response on the cardiovascular system of dogs resulting in a 30% and 42% decrease in myocardial contractibility, a significant fall in cardiac output, a significant decrease in systolic blood pressure, and many other significant cardiovascular effects. It is also known that morphine premedication of subjects subsequently receiving cyclopropane anesthesia results in bradycardia (Price, 1967). The point of mentioning these influences is to emphasize the complexity of the problem and the difficulty of interpretation when data relating to these influences are not given. This is particularly important when one realizes that the principal toxic effect of exposure to high concentrations of the fluorocarbon propellants is that of central nervous system depression or anesthesia. It is possible that a potentiation of fluorocarbon propellant toxicity occurs when they are tested on anesthetized animals.

In summary, the epidemiologic evidence of the aerosol "sniffing" deaths plus that seen in animal and human experiments support the hypothesis that the inhalation of high concentrations of fluorocarbon compounds may sensitize the heart to epinephrine resulting in serious cardiac arrhythmias. I believe that the statement made by Paracelsus many years before the introduction of the fluorocarbon compounds is appropriate. He said, "Dosis sola facit venenum," or "The dose alone makes a poison." In other words, practically every substance is toxic if the dose is sufficient.

REFERENCES

1. Azar, A., C.F. Reinhardt, M.E. Maxfield, P.E. Smith, Jr., and L.S. Mullin; "Experimental Human Exposures to Fluorocarbon 12 (Dichlorodifluoromethane)"; Presented at the 1971 American Industrial Hygiene Association Conference, Toronto, Canada, May, 1971. (To be published)
2. Bass, M.; "Sudden Sniffing Death"; J. A. M. A., 212:(12), 2075-2079, June 22, 1970.
3. Clark, D.G.; "The Toxicity of Bromochlorodifluoromethane (BCF) to Animals and Man"; Imperial Chemical Industries Limited, Industrial Hygiene Research Laboratories, Alderley Park, Macclesfield, Cheshire, England, February, 1970. (Unpublished)
4. Clark, D.G. and D.J. Tinston; "The Influence of Fluorocarbon Propellants on the Arrhythmogenic Activities of Adrenaline and Isoprenaline in Conscious Dogs"; Imperial Chemical Industries Limited, Industrial Hygiene Research Laboratories, Alderley Park, Macclesfield, Cheshire, England, May, 1971. (Unpublished)
5. Innes, I.R. and M. Nickerson; "Drugs Acting on Post-ganglionic Adrenergic Nerve Endings and Structures Innervated by Them (Sympathomimetic Drugs)"; The Pharmacologic Basis of Therapeutics, Chapter 24, edited by L.S. Goodman and A. Gilman, 4th Edition, The Macmillan Company, New York, N.Y., 1970.
6. Kehoe, R.A.; "Report on Human Exposure to Dichlorodifluoromethane in Air"; The Kettering Laboratory, University of Cincinnati, July 15, 1943. (Unpublished)
7. Levy, A.G. and T. Lewis; "Heart Irregularities, Resulting From the Inhalation of Low Percentages of Chloroform Vapour, and Their Relationship to Ventricular Fibrillation"; Heart, 3:99-111, 1911-1912.
8. Mullin, L.S., A. Azar, C.F. Reinhardt, P.E. Smith, Jr., and E.F. Fabryka; "Cardiac Sensitization and Endogenous Epinephrine"; Presented at the 1971 American Industrial Hygiene Association Conference, Toronto, Canada, May, 1971. (To be published)
9. Priano, L.L., D.L. Traber, and R.D. Wilson; "Barbiturate Anesthesia: An Abnormal Physiologic Situation"; Journal of Pharmacology and Experimental Therapeutics, 165:126-135, 1969.
10. Price, H.L.; Circulation During Anesthesia and Operation, Charles C. Thomas Co., Springfield, Illinois, p. 3-27, 1967.

11. Price, H. L., A. A. Lurie, R. E. Jones, et al.; "Cyclopropane Anesthesia. II. Epinephrine in Initiation of Ventricular Arrhythmias by Carbon Dioxide Inhalation"; Anesthesiology, 19:619-630, 1958.
12. Reinhardt, C. F., A. Azar, M. E. Maxfield, P. E. Smith, Jr. and L. S. Mullin; "Cardiac Arrhythmias and Aerosol 'Sniffing'"; Arch. Environ. Health, 22:265-279, February, 1971.
13. Van Stee, E. W. and K. C. Back; "Short-Term Inhalation Exposure to Bromotrifluoromethane"; Toxicology and Applied Pharmacology, 15:164-174, 1969.

DISCUSSION

DR. SCHEEL (U. S. Public Health Service): Did you try phenacetin as an adjuvant for sensitization?

DR. AZAR (E. I. du Pont de Nemours and Company): No, we did not.

DR. SILVERGLADE (Riker Laboratories): What were the percentages, again, that were used of Freon 12 for two hours in humans?

DR. AZAR: One-tenth of a percent or 1000 ppm and one percent or 10,000 ppm.

DR. SILVERGLADE: In connection with the use of bronchodilator aerosols, let me point out that with the delivery of one aerosol (one puff), 12.5 ml of Freon are delivered. This is supposed to be taken in with a deep breath. The complementary air in humans is somewhere between 2000 and 3000 ml. If you then calculate the percentage concentration of one breath of an aerosol in complementary air, with complementary air of 2000 ml, one gets six-tenths of one percent, with 3000, four-tenths of one percent.

DR. AVIADO (University of Pennsylvania): Can I just mention something else on the opposite side of what Dr. Silverglade mentioned? He's talking about the amount, calculated concentration, that might be inspired in a patient using an aerosol. But the figures that Alex is referring to, I think, are not asthmatic patients. Is that right? These are normal volunteers inhaling one-tenth of a percent?

DR. AZAR: Yes, these were two normal volunteers, and they were in a chamber with the concentration maintained.

DR. AVIADO: I think one cannot compare the tolerance studies of a normal individual with the tolerance studies of an asthmatic individual. This is all that I wanted to mention.

DR. SILVERGLADE: To that I would like to reply on the experimental studies at Riker Laboratories. With dogs in which the asthmatic state was attempted (of course one cannot produce asthma in dogs) by getting them to breathe an atmosphere of reduced oxygen, increased carbon dioxide, and producing bronchospasms by the administration of histamine phosphate, we get about as close as we can in the animal. Using these animals, Dr. McClure found that the results were no different in normal dogs than these dogs breathing increased amounts of carbon dioxide, decreased amounts of oxygen.

DR. AZAR: I'd like to comment here. I've been alluded to earlier, so I thought I had better talk about this. When the mouse studies of Dr. Harris originally came out, naturally we attempted to asphyxiate mice. And, when we tried to do this we found that even our control mice were developing bradycardia and heart block; these were mice exposed to Freon 12 for five seconds and then asphyxiated (that was 100% Freon 12, 100% nitrogen, and then a single discharge of a nice promistimeter) - they were permitted to breathe this for five seconds and then asphyxiated. The reason I show this is that we saw a very marked bradycardia develop, and we began to wonder what was going on. I am certain that Dr. Harris saw what he saw, so why were we seeing what we saw? This is an EKG on a mouse - this was the EKG prior to exposure to nitrogen. Here we see 12 seconds after the application of asphyxia a 2-1 heart block develop in the animal's EKG. If the asphyxia was maintained for 160 seconds we see the variable or complete heart block. So we began to ask ourselves why this was occurring. Is there some physiological reason we're seeing different results. And, if you remember the picture of the exposures that Dr. Harris had, his control mice had their snout placed within the asthma inhaler and the animal's lung had a normal oxygen concentration. That's with the exposure; the nebulizer is not discharged. Then at the beginning of the asphyxia, the lung still has normal oxygen concentration. At the end of asphyxia the lung has a decreased oxygen concentration, but still not real bad, and you see a tachycardia. My training at Ohio State was also in aviation medicine, and I remembered that aviators, when they get up real high and their oxygen gets less than nine percent, suddenly develop a very severe, rapid onset of bradycardia. When you look at the system where you discharge the asthma inhaler and it displaces the available air, during the exposure the animal has a decreased oxygen concentration in the lung. Then you apply the asphyxia, and he's starting off with a decreased oxygen tension in the lung. At the end of asphyxia there is very little oxygen left in the lung. I just finished telling you about our studies on cardiac sensitization, so I don't disagree with Dr. Harris there. But I'm just puzzled that a mouse exposed to three breaths of an asthma inhaler would develop this severe bradycardia. I think there may be a physiologic reason for this. We also found, like other investigators, that depending on how tightly the mask fits, you can get varying results. I honestly don't think that the mouse is a good experimental animal to study this effect.

DR. BACK (Aerospace Medical Research Laboratory): Before we get out of context, I want to remind all of us that we are not just studying Freon 12. Freon 12 to us is just one more compound that has interesting properties which are sometimes the same as Freon 1301 which we are highly interested in, and all of these compounds seem to go in the same direction. Dose does seem to be worthwhile looking at, for one parameter to study. The other thing is the number of carbon atoms, the number of chlorine atoms, and the number of fluorine atoms involved. There seems to be a real difference between some of the effects of the compounds in a dog and some of the effects of the compounds in monkeys, depending upon the compound again. If you're talking about CBrF_3 , in the dog you get convulsions when you give anything over 50% concentration. In the monkey, you can give 80%, the rest being oxygen, and no convulsions ensue. So, there are physiological differences between animals, and with that in context, I'll let Dr. Harris rebut this.

DR. HARRIS (University of Illinois Hospital): I think I would just like to echo Dr. Back's comment that species variability is extremely important. I don't think one could say, on the face of it, that one animal is closer to man than another, and this is one of the reasons we have ranged through the animal kingdom. I have to disagree with Dr. Azar's statement that the mouse was not a good subject. As a matter of fact, I think it was an excellent subject since it opened up our eyes, and perhaps those of others, to the toxicity to the heart of the aerosol propellants, about a year or so ago. I'm not too sure why we have to dwell so long on the mice. We're positive of our results, and I'll explain in a moment how we can be that way. But, actually I really think the material presented on the arrhythmias in monkeys and the reduction of contractility, at least to a cardiologist, is much more interesting. The use of the larger animals is nice in that we can do much more with them than you can do with the mouse who has so little blood and is so difficult to study in many ways, except for electrocardiograms. At any rate, the four investigators that Dr. Silverglade lined up against us don't really count, if you will, in that they were doing a quite different study than we did, so I wouldn't expect them to get the same results. As I emphasized, we applied a partial asphyxia which operationally resulted not even in any bradycardia after four minutes, but actually produced a tachycardia. So, if you recall the next to last slide of Dr. Azar, you'll see that the line for the control would have actually shown a rise in heart rate, quite different from the effects observed with the Freon present. So, if they're going to go about completely choking off any air supply to the animal, of course they're going to get AV block or profound slowing of the heart rate in less than a minute. We did not do that, so they're really doing a different study. The reason I spent so long on that particular study in my presentation was that frankly this technique serves so beautifully for a fourth-year medical student and myself, novices in toxicology, to show this toxicity effect. I think it is a very nice technique for showing cardiac toxicity and it's very inexpensive. We tested several compounds, not propellants, and found them not to produce this. I think it's an excellent technique that I would suggest other people use, but I would ask them to do it by the Taylor-Harris technique and not by these others. Now, in regard to the explanation that Dr. Azar gave in that very beautiful last slide, I compliment Dr. Azar who is a very fine investigator, as a matter of fact. I think his work and that of his coauthors on the sensitization to epinephrine is very fine. But his explanation for his findings here, is really that which I have just given you. Perhaps it is stored away in some compartment like the AV node where it is still working its effect and it takes as long as 15 minutes for this effect to wear off. Either way, I don't think it looks too good for Freon because if the stuff is going to lie around in the lung for 15 minutes, which I very much doubt, that's not too good. So, I really don't think that explanation would suffice, and I've no reason to think that our results with the mouse are any more wrong now than they were then, because they were produced very easily and I would suggest those of you who have laboratories available, try it.

OPEN FORUM

MR. TOLIVER (Aerospace Medical Research Laboratory): Dr. Bower, about nomenclature -- it seems that your fluorocarbons nomenclature is not only numeric but also alphanumeric, and you didn't go into the alphanumeric nomenclature. Would you do so now?

DR. BOWER (E. I. du Pont de Nemours and Company): The system that I described this morning was originally invented for the methane series, and later extended to the ethane series, as I described in the 113-114 nomenclature, but as all you chemists will recognize very promptly, as soon as you move into the 2-carbon and more complex series, you open up the option for isomers. I'll use 114 to illustrate the point. (Blackboard Illustration) That compound is 114 and is symmetrical. There is another isomer possible. (Blackboard Illustration) Now, we have another isomer. If you follow the rule directly, both these compounds should be called 114, and utter confusion arises. So, the system was modified to include a lowercase alphabetical designation which is simply tacked on to the end to indicate the next less symmetrical isomer. If there are two isomers, the most symmetrical isomer gets the base number of 114, the next symmetrical isomer gets the a-designation, the third most symmetrical isomer gets the b-designation, and when you get to 3-carbon compounds, it gets very tricky to decide which is more symmetrical than the other, and the system is horrendous. I'm not sure that I should even call it a system at that point, but that is the logic of it.

LT. COL. STEINBERG (Army Environmental Hygiene Agency): I've seen designation 1301 referred to in some of the old literature as 13B1. Would you explain that?

DR. BOWER: That again is a modification of the original system to accommodate compounds that were not originally intended to fit. (Blackboard Illustration) This compound is 13. When compounds having bromine in them were first synthesized, the technique of naming them was to write down the original number as though the compound were only fluorine, chlorine, and hydrogen if it were there, and then to attach a suffix, B for bromine, followed by a number designating how many of the chlorines had been replaced by bromine. This then (Blackboard Illustration) became fluorocarbon 13 with one bromine substituted for one of the chlorines. (Blackboard Illustration) This compound is 12 and (Blackboard Illustration) this compound is 12B1; it is 12 with one bromine substituted for one chlorine - again, twisting the system out of shape to the point where the fire extinguishant people got tired and invented a new one.

DR. CARHART (U. S. Naval Research Laboratory): You mentioned the fact that these things will decompose at various temperatures, etc. Will you indicate roughly the effect of structure on the ease of decomposition of these by heat, and particularly in the presence of things like metal?

DR. BOWER: That is a very comprehensive question. We could easily spend the afternoon on this alone. If you refer to the listing that I gave of bond energies which ranked the compounds in the order of 11, 12, 13 and 14, the rate of pyrolysis will parallel the bond energy of the weakest bond in the molecule, because that will be the phenomenon which first occurs. If you heat #12, for example, the first thing that occurs is the formation of those two species, (Blackboard Illustration) and therefore, the rate of pyrolysis, or the extent of pyrolysis measured at any fixed temperature, is rather straightforwardly a function of that bond energy. The presence of metals unfortunately puts a skew into the reaction. There are two or three materials of construction that are essentially inert, as near as we are able to measure. They are platinum, nickel, and aluminum. Then there are other materials that do seem to lower the temperature at which pyrolysis occurs - things like aluminum, iron, and copper. So, this is how the metal effect shows up in the pyrolysis reaction. That is a very general kind of answer.

DR. CARHART: How about the brominated compounds? We are talking about fire extinguishers which are believed to be thermally stressed rather severely. What happens to these compounds? Do we get the fluorinated phosgenes and things of this type?

DR. BOWER: Now, you're bringing in another factor. In ordinary pyrolysis, homogeneous pyrolysis; you cannot get phosgene because you do not have any oxygen. Chemically, you must have oxygen if you're to get phosgene. So in a straightforward homogeneous pyrolysis, you don't get phosgene. However, if you're going to run the pyrolysis in the presence of air, you may. Then all bets are off as far as this kind of argument is concerned. If you stress 1301 in the same manner, you get essentially the same kind of reaction. You'll open up the weakest bond in the molecule, which is the carbon-bromine bond, and then further reactions take place from here. If you happen to be thinking of a fire environment, where you may have oxygen, water, hydroxyl radicals, hydrogen radicals, hydrocarbon fragments, carbon monoxide - these are very reactive species and they will combine with all those things. You may get ultimate end reaction products which are terribly difficult to identify. We've tried hard but we've not been able to find any carbonyl halide in the reaction products from fire extinguishers. We find hydrogen halides, but not carbonyl halides. Whether they are not formed because of the difficulty of the reaction sequence, or whether they are so unstable after they are formed that they are decomposed by the other elements from the fire, I do not know. I only know that they do not show up in the end products.

DR. PAUL SMITH (Federal Aviation Administration): How would you interpret the first breakdown of 1301 in terms of temperature in an inert atmosphere - the $CF_3 + Br$?

DR. BOWER: This carbon-chlorine bond (Blackboard Illustration) has an energy of about 80 kcal and we have made the estimate that this reaction proceeds to the extent of, I think it is 1% per year at about 900 degrees. Now, the energy here of carbon-bromine is 70 kcal, and I don't know just whether I'd have the courage to go out on a limb and predict at what temperature I might get this same reaction rate, certainly lower than 900 degrees, 700 maybe, I don't know. Jack, would you help me?

DR. DRYSDALE (E. I. du Pont de Nemours and Company): Yes, between 600 and 700 degrees - that's Fahrenheit obviously.

DR. BOWER: Does that help?

DR. CARHART: In the presence of oxygen, is this true?

DR. BOWER: I think so. I don't think that the oxygen has any way of attacking this basic molecule. I think that the first thing that happens is that enough thermal energy is put into it to open this bond, and after that you get reactions with oxygen or oxygen containing fragments.

DR. DRYSDALE: In the presence of a fire that would not necessarily be true. If you have hydrocarbon radicals - methyl radical, ethyl radical - they could attack the CF_3Br at a much lower temperature. In other words, if you were not right in the heart of the flame but had radicals outside it, it certainly would react with the CF_3Br , form an alkylbromine, and give you the CF_3 radical.

DR. BOWER: Good point, thank you!

DR. JOHN PARKER (National Aeronautics and Space Administration): I'd like to comment on the metals reactions that you went over very lightly here, and I'd like to do that by describing a very simple set of experiments that we performed with the totally perfluorinated teflon with aluminum. There is an enormous difference I think in the relative stability of these compounds depending upon the metal environment. It might come as a surprise to you to recognize that you can ignite with a match an equal weight of aluminum and tetrafluoroethylene and it will burn with the explosiveness of a rocket motor.

DR. BOWER: Oh, that is well known!

DR. JOHN PARKER: Secondly, iron and copper do not perform this abstraction reaction - they require oxygen to do so. So, when you encounter Teflon and a metal aluminum structure in the presence of oxygen, these bond energies and these inertnesses have no significance whatsoever. That is point number one. Point number two, in terms of these oxidation reactions, they are very difficult to study in this form, that is mixing oxygen. What I have done is take a small wafer of Teflon and heat it with hot air, and long before the 500 degrees centigrade ignition, I'm getting copious quantities of COF_2 and HF, because I've got some moisture present, and other unsaturated oxygen-fluorine compounds coming off such a system. So my only objection to using bond energies for characterizing these materials for a group which in the end has a systems approach to the matter, is that the presence of small amounts of metals, the presence of moisture, the presence of air, tends to influence these results so drastically as to make these bond energies not so significant in interpreting the stabilities of the compounds.

DR. BOWER: I'd like to respond a little to that. We were talking when we started, of course, of the simple chloro-fluoro molecules, rather than polymers, and I think what you've been describing is the oxidation reactions which are initially taking place at the carbon-carbon bonds, rather than at carbon-fluorine bonds, and the question as originally posed concerned the pyrolytic stability. I think we've mixed up several questions here.

DR. JOHN PARKER: No, I don't think we have. I disagree that the reaction at the moment on this question of oxidation of the carbon-carbon bond. It is the abstraction of, it begins at very low temperature by abstracting fluorines from the carbon skeleton and the first product is an AlF which then spontaneously causes the whole system to become participative in the reaction.

DR. DRYSDALE: I think in the case of aluminum, you're dealing basically with a thermite type of reaction, you are dealing with abstraction, and I'm sure that if you took the two under conditions where temperature-wise nothing occurred, but put them into a shearing situation, that you get the reaction at even a lower temperature. In other words, when you generate a fresh metal surface of aluminum, I'll guarantee it is going to go fast. That would be true of literally all of these fluorocarbons.

DR. JOHN PARKER: The only reason that I bring it up is that we in the aerospace business are concerned with aircraft and aluminum structures and the uses of these classes of compounds in contact with such surfaces, and when we encounter a fire, we are dealing with hot-hot fresh surface aluminum in contact with these classes of compounds which becomes difficult, I might add, to extinguish.

DR. DRYSDALE: If you look, for example, at the alkali metals in the fluoro-carbons, this is a more straightforward example of what you're talking about. If you take sodium metal or potassium metal and any halogen compound, you know that you've got your hands full in terms of an explosive situation. Aluminum is really just another example of that type of reaction.

DR. JOHN PARKER: Yes, but aluminum, unlike potassium and sodium, I systems-wise reiterate, is a material of construction of aerospace vehicles, and for that reason is of concern. Copper and iron, on the other hand, do not behave in this fashion at all. You mentioned these. These are relatively inert. One has to virtually pyrolyze the polymer by removing fluorine at a very high temperature to get these processes. So I'm just saying, the only thing I am primarily concerned with is focusing the information on quite the intent of the audience.

DR. LESTER SCHEEL (U. S. Public Health Service): I think that Dr. Bower is quite right, that you cannot talk about oxidation of a single carbon-fluorine or halogen compound in the same terms that you talk about the oxidation of a multiple carbon chain halogen compound, because you have the -diene generation and the peroxy generation in the chain compound which is not possible in the single carbon compound, so that these two are not comparable, and bond energies in these two are not comparable. Now, on

the other side of the thing, burning in air or burning with a fire is essentially a temperature phenomenon taking place with a limited supply, and we will talk a little tomorrow about the effect of hydrogen. The mechanism of generation on a perfluoro compound is a primary peroxy mechanism on a polymer chain. The mechanism on a hydrogen-containing halogen is a competition reaction, and we'll talk about that tomorrow. There is no use talking about it now.

DR. JOHN PARKER: It seems to me that the peroxy reaction which you speak of is really on a perfluoro monomer and has nothing to do with the chain. I cannot get into the details now, and will help you with it later. But fundamentally it looks to me as though the polymer itself depolymerizes very rapidly once the process is begun to produce tetrafluoroethylene, and that most of the oxidation reactions that we see in the oxidation of teflon go right back to your original statement that you made today about temperature, that we have Teflon monomer, in fact even at room temperature, equilibrium lying very, very far to the left in terms of the polymer. But you always have a small concentration of monomer. It is my opinion that all oxidations of Teflon begin literally with the tetrafluoroethylene. That is why I've felt so secure in relating it to your halogen compounds here.

DR. LESTER SCHEEL: In the Journal of Mass Spectrometry, we published a paper about four or five years ago wherein we burned Teflon in air and identified every single isomer from carbon-1 to carbon-11 as a breakdown of the chain. Now, this cannot occur in any other way except by primary attack of oxygen on the chain.

DR. DRYSDALE: I think you can explain the products in other ways without actually having the data in front of me. Once you break a chain and get a radical you can get ring closure reactions, abstractions, rearrangements, and things of this nature.

DR. LESTER SCHEEL: I think it is a complex reaction, I think that primary oxidation of the chain does occur.

DR. DRYSDALE: Well you can always argue that all you need is one weak spot in the chain and that is the one that breaks and then away you go, so things get a little subtle without data.

DR. CALDERWOOD (University of Florida): I'll direct this question to Dr. Drysdale. It's really not a question. I just wanted to bring the attention of the group to another possible future use of the perfluorocarbons. Dr. Modell and our group at the University of Florida have been investigating the use of liquid perfluorocarbons as an oxygenating medium and using it as a liquid ventilation in animals.

DR. DRYSDALE: That is an interesting application, and obviously we're looking at it closely to see what evolves out of this.

CAPT. GEORGE FRAME (Aerospace Medical Research Laboratory): I'd like to address this to Dr. Bower or Dr. Drysdale. When Dr. Drysdale spoke of the various uses for the fluorocarbon compounds, I was impressed by the large tonnages of the volatile compounds, and I was wondering what is the ultimate fate of these compounds. I assume most of them are not reclaimed and therefore these many hundreds of millions of tons are put into the atmosphere every year. Do we have any idea what the sinks of these compounds ultimately are?

DR. DRYSDALE: I don't think we have any acceptable answer, and that is something we are actively pursuing. I think in most instances we can write speculative mechanisms that will in due course decompose them, and that you would then go through the normal cycle of winding up with ultimately halogen acid which would go back and recombine with metals to give you the insoluble fluorides. That is obviously unacceptable because we don't know the time of these events or where they are most likely to occur, and I think we have to find out. While the tonnage is large, the concentration is small; however, I think we should begin getting an answer to that before we run into a situation where the total concentration conceivably might not be so small.

DR. ANTHONY THOMAS (Aerospace Medical Research Laboratory): This is going to be a philosophical question. We don't know what the fate of the compound in the environment is. We also know that any one of us who goes back to his own bathroom can probably come up with fifteen cans of pressurized materials. There used to be real nice things in life which were uncomplicated; like, you still can buy Windex with a plunger to dispense it. I mean, are we after the profit aspect or do we know what we do to our environment by using these Freons just for the sake of convenience? Any one want to tackle this one?

DR. LESTER SCHEEL: I'll tackle it only in one aspect. That is, that without the Freons, mining of minerals at hot temperature depths of wall temperatures of around 100 degrees wouldn't be possible. This is one aspect. It doesn't necessarily get into the atmosphere. The spray can operation, as a matter of convenience, is something which I think if we gave it to a Washington FTC man, he would go to the newspapers and we would have another propaganda battle as to whether we need it or not. I think that society itself, and this is philosophical, is geared to one aspect, and that is that man in his environment is part of his environment, and should, I think, have the opportunity to make himself as happy and as comfortable as possible. As long as he does this for himself, without interfering with others, then I think it is acceptable. If it is done in such a way as to interfere with the health, longevity, or the ability of others to accomplish a normal lifetime of work, then he has voluntarily to limit himself. So that within this framework, I think, my wife looks better after her hair is sprayed than before, so the hairspray is all right.

DR. CARHART: I'd like to comment on this because I think of an example of the very point we are talking about and the question you're raising. That is the case of a nuclear submarine where we button up a large number of people in a volume of about 250,000 cubic feet, and if you do a simple arithmetic problem and assume that everybody takes in two cans of underarm deodorant and aftershave lotion, this amounts to

something like 30 pounds of materials you're going to release into this rather small volume. Therefore, in the Navy we have rediscovered soap and water! (Laughter)

MR. JAMES CONKLE (School of Aerospace Medicine): In a recent geological journal, the results of an analysis of the vent gas of a Mexican volcano indicated the presence of chlorinated hydrocarbons as well as tetrafluoroethylene. Does anyone want to comment on maybe the natural occurrence of these compounds?

DR. DRYSDALE: Unbelievable!

DR. BACK (Aerospace Medical Research Laboratory): I have a question that I would like to present to anyone who has done a series of more than one compound. What is the relationship of the chlorine and fluorine to cardiac arrhythmias? The more chlorine, the more arrhythmias? Or, if you don't have a chlorinated compound, what is the relationship of those in a series containing fluorine or fluorine and bromine?

DR. AZAR (E. I. du Pont de Nemours and Company): I guess I have been volunteered. I alluded to that in my talk. There are always exceptions to things, but in general the more chlorine molecules on a compound, the more potent a cardiac sensitizer it was. We placed these by fluorine, the less potent of cardiac sensitization potential. I think bromine also increases the cardiac sensitization potential. Now, this is a general statement, but there are some exceptions.

DR. BACK: This brings up another point and gets around to the chemistry involved again, because Dr. Harris indicated that he was getting sensitization that was persisting some 15 minutes after exposure. You have to figure out how it is staying there for any given time, because Freon 1301 does not last any 15 minutes anywhere. Even if you have exposed for 15 minutes, or if you have exposed for half an hour, in five minutes or less the great bulk of it is gone. How do we handle this situation? I don't quite understand how you got sensitization lasting for that period of time. It must have something to do with the fat solubility of the compound, which is chemically dependent, which is again dependent upon how many chlorines, or fluorines, or bromines are involved. So, what about time sequence on these groups of compounds? Do we have any feel for this?

DR. JOHN PARKER: I think the rules are already here and I think they're pretty obvious. As one substitutes the chlorines with fluorines you get less and less fat solubility. So what you see is this mid-range of fat solubility giving you the most activity, and this would very definitely suggest fat storage for that interval; that is, as equilibrium concentration is high, and this would also suggest possibly the mechanism for action of the compound at the membrane where it was perturbing, through fat solubility, the normal arrangement of the phospholipids at the membrane surface which could be restored after the compound equilibrium-wise had been removed. So everything seems to go together. I think the suggestion is quite valid.

DR. BACK: The suggestion is there, but the data are not.

MR. RALPH WANDS (National Academy of Sciences): I'd like to follow up on your idea a little bit, Dr. Back. How about the nonvolatile polychlorinated compounds with which we are all cursed these days - some of our pesticides, some of our heat exchange materials, things like that? Are they also cardiac sensitizers?

DR. DOMINGO AVIADO (University of Pennsylvania): I don't have any information on this. I haven't worked with pesticides before. I'm sorry.

DR. BACK: Dr. Paul Smith, have you heard of any sensitizations with any of the insecticides?

DR. PAUL SMITH: Yes, I think I have. As a matter of fact, I went through one personal experience when we were working with arrhythmias in animals and when a colony of about 12 rather valuable ones were sprayed with chlordane, they became unuseful for this kind of research. Lindane has been accused of being a cardiac sensitizer, but there is another factor in all this. Most, if not all of them, are rather potent catecholamine releasers, and so unless all other chlorinated compounds to which we compare them are also catecholamine releasers, then the comparison is not quite across the board.

DR. BACK: In other words, the mechanism is different?

DR. PAUL SMITH: Yes, the mechanism could be different.

DR. VAN STEE (Aerospace Medical Research Laboratory): Then why do we have straight hydrocarbons also sensitizing?

MR. RALPH WANDS: Why do we have hydrocarbons such as toluene, benzene, propane, also sensitizers? There are some strange mechanisms here and I don't think we know enough. I don't think we have enough data on which to generalize even on the number of chlorines or lack of chlorines or bromines, or anything else. I think we just have an unknown mechanism or phenomenon here.

DR. BACK: That is one of the things I wanted to bring out. I don't think anyone can generalize. We have been generalizing, calling these 'Freons' and we have got to get away from calling them Freons, because Freon 12 is not the same compound as 1301. It may have some of the same properties, but not necessarily all of them. But I did want to see if there was any correlation and some data did indicate that there was probably an increase with the chlorinated ones rather than fluorinated ones.

DR. AZAR: I'd like to comment on this. You brought up this point about cardiac sensitization lasting for 15 minutes and I would like to mention the fact that Imperial Chemical Industries in England have described studies very much like ours. They give three doses of epinephrine, they give a control injection, then expose the animals for five minutes, and then give an injection and they will see the MVB develop and they always follow up their experiment 10 minutes later by giving another challenge dose of

the epinephrine. They have never seen cardiac sensitization develop on that third dose of epinephrine after the animal is taken away from the exposure. On our human studies with Freon 12, we found that it is rapidly excreted from the lungs. In about 20 minutes, the concentration which was initially 1000 ppm had fallen about 80%. Now with the asthma inhalers, Pola in France has administered this to humans and also to dogs, and he had a half-time in the pulmonary excretion of about three to four minutes. Now, I have some data here that I just got on some arterial levels where we exposed dogs to fluorocarbon 11 in the same way we did in our cardiac sensitization and got AV samples and at five minutes the concentration at one-half of a percent of fluorocarbon exposure was 28 micrograms per milliliter. At 10 minutes, the concentration is about 29 - it seems to come up and tends to level off. When you stop the exposure, at 10 minutes, and you keep taking arterial samples, the average concentration 15 minutes later is down to 2.2 micrograms per milliliter. These things are rapidly cleared. And, I honestly don't know why we're still seeing this effect 15 minutes later. I can't explain it.

DR. SILVERGLADE (Riker Laboratories): Very simply, the effect is from asphyxia, and if he did it 15 hours later he would still get the same results. Asphyxia alone is capable of producing these cardiovascular effects, and for anyone who doubts it, I can give you a long list of references in the literature, going back to the work of Sherrington in 1910. This is the same Sherrington who won the Nobel Prize in 1932. Sir Thomas Lewis and his associates and others who have worked in this field have shown that asphyxia alone is capable of producing the most profound effects on cardiac induction system, including 2-1 AV block, complete block, ventricular fibrillation, and death, and these effects can be obtained in dogs and cats within four minutes and in some animals even a little longer. Now I do not wish to belabor the Taylor-Harris study beyond unnecessary limits, but I think it is important for us to understand why we do this. The significance of the Taylor-Harris study is quite great. When it appeared in the Journal of the American Medical Association, within a day or two of publication the newspapers throughout the country published excerpts from it, or interpretations would probably be better, and where Taylor and Harris quite properly speculated on the possible relevance of their findings with the increased death rate attributed to the pressurized aerosols, in England and Wales the newspapers and magazines interpreted it as fact - it was no longer speculation. Articles appeared in Time magazine and The Wall Street Journal, and a rather pathetic situation developed. Patients who had used these products for years in complete safety and with considerable relief of their symptoms, were cutting out the article in Time and The Wall Street Journal and sending them to me and asking me to explain. Are they in danger? Will their hearts be irreparably damaged? One gentleman said "I intend to continue using them just the same, but would like to know what my chances are." And a man with emphysema in Idaho wrote me that the two doctors in his community, on the basis of the Taylor-Harris study, refused to prescribe the pressurized aerosols for him. He needed them, he had used them for years in complete safety, and now was deprived of them, how could he get some? Now, it is for this reason that this study is of such great importance. Beyond that, the Food and Drug Administration has intruded itself into the situation and has demanded all kinds of studies from industry, primarily from

our company. In reply to the statement that Dr. Harris made this morning, that because he got his 2-1 AV block in 15 minutes, that was proof that the Freons or fluorocarbons remained in the lung for that time; that is post hoc, ergo propter hoc type of reasoning. He does not know how long the propellant remained in the lung. On the basis of some blood and tissue studies done by other investigators, I have some slides to show that it doesn't remain very long. It shows that the concentration in the heart declines in a matter of minutes. The concentration in the fat - by the way the fat takes up the largest amount next to the adrenals - the adrenals take up the most (the significance of that I do not know), but the fat takes it up the most and releases it rather rapidly. The half-life of the propellants is of the order of three minutes, and it is important in doing this to determine whether or not the investigator determined the half-life from the very beginning of the curve or from a point in the curve where the precipitous drop in the blood level flattens out. I am told by my associates (I am not a pharmacologist and make no pretense at expertise in this area) that the Freons occupy a two-compartment system in the body, the blood and tissues; that there is a very rapid drop in the blood level in a matter of seconds. In our laboratory the alpha half-life, that is the blood half-life precipitous drop, was somewhere in the order of 30 seconds - 35 seconds. When he took the beta half-life it was more on the order of three minutes. The work in England also states that it is something like three minutes, and also the work at I. C. I. states that the half-life is three minutes. So, we see that there is no great retention of Freon in the body; it is lost very very rapidly, and if time permits I would like the opportunity to show the slides of the work that has been done elsewhere.

DR. BACK: We found a relatively quick dropoff after certain lengths of time of exposure. Of course it is the amount you're going to find in the blood or adrenal (and we found the same thing), that he describes with another compound, Freon 113 that it is picked up in blood and it is probably picked up in adrenal more than other tissue. But let's not lose sight of what we're trying to prove here. We are not trying to defend the use of propellant 12 or any one of them, but rather look at mechanisms, and I think the mechanism is there regardless (no one disputes the fact that the compound is a heart sensitizer). It is a matter of dosage, and it is a matter of how much gets there at the time. I don't think you would disagree with that?

DR. HARRIS (University of Illinois Hospital): No, but I think that I would add some important viewpoint here. I think we have come a long way since a year or so ago in showing that the Freons are not inert physiologically, but actually are toxic - at least to the heart if not to other organs. The fact that they are not known to be toxic to other organs may simply at this point reflect the lack of studies in that direction. The major point I'd like to get across is that I think we have demonstrated that the Freons have several different kinds of actions of a toxic nature on the cardiovascular system, and to keep referring to them as sensitization of the heart with any implication that it requires catecholamines present in order to produce the toxic manifestations, is in my mind wrong. I know that nobody here has said that, but it sounds from the discussion like words have been used loosely in that way. I would prefer to talk about toxic actions of Freon on the heart rather than sensitization of the heart. Now, what are these actions? I certainly agree that Dr. Azar has very beautifully shown sensitization of the myocardium to the arrhythmic effects of epinephrine.

Whether or not this is the cause of death when teenagers and others deliberately inhale large quantities, I don't know. We have shown a marked depression of contractility which is not mediated through the autonomic nerves; it is a direct effect and quite a marked one. We have shown slowing of the sino-atrial nodes of AV conduction, and a number of other actions, and I think there are probably more actions than we have already described here. Now the time constants for these various actions may differ. They may not in certain cases and certain species even depend upon the quantity present in the blood at that time. Tissue compartmentalization may be involved, for example, an actual effect that takes a while for reparation to occur, such as might have occurred in the mice. It might be present in the mice but not for sensitization of the myocardium to the effects of epinephrine. I really don't think at this point that enough data are available to relate all of these effects to the blood concentration. By the way, in answer to Dr. Silverglade's question, while in the original paper in the JAMA we did find that repeated exposure of the mice once exposed to the freon would repetitively produce this arrhythmia up until the last one which died at two hours, since then we have done many more studies and in these studies have actually not given any asphyxia for 15 minutes, and we then find that after the 15 minutes exposure to free breaths of Freon that this kind of sensitization, the production of AV block, asphyxia, the early production of it, will occur. But, if instead of that you wait 30 minutes it does not occur. So I can tell you that at 30 minutes, one hour, two hours later, they are no longer showing the effects of the Freon, but at 15 minutes after they are.

DR. ANTHONY THOMAS: I would like to ask a question. As a medical man I question the reason for using a certain type of propellant for dispensing medication. Can you achieve the same effect by simply using the old nebulizer, or can you go to nitrogen, or is it uneconomical? When we start talking about pills, and food and drug regulations, the drug is one thing, but the vehicle which dispenses it is very very closely scrutinized. I am not familiar with what the reasons are for dispensing this with a Freon. Is there no better way to do it?

DR. BACK: Well, as a user I can tell you that there is a reason for using it. One of the things is that when using a nebulizer, it is very difficult not to get an overdose, with isoproterenol especially. It is a very potent drug, as you well know. I have been using Riker's products for many years and I don't apologize for it. It is a good drug and you don't get overdosed, you don't get hypersensitive, you don't get cardiac palpitation, you get the dose that you need where it belongs, in the lung and not in the heart, for the most part. You get some obvious systemic effects, but if you're very judicious in the way you use it, and if you have been using it for twenty years like I have, you know how. I doubt very much that the amount of propellant that I'm getting is very much. As a matter of fact, I jog every morning two miles, and I occasionally need it then. Well, if you see me lying along the road one of these days, you'll know why.

DR. ANTHONY THOMAS: Is there any other propellant gas that you can use?

DR. BACK: I suppose there are others, but they are not very good. We're finding this in fire extinguishants too, as you know. As a matter of fact, this brings up other questions, and one of the other reasons that we're here. Some of the combined use of Freons, two or more Freons, may be as extinguishants at the same time. One of them is 2402 which is a very potent fire extinguishing agent, and they are using as the propellant 1301 or CBrF_3 , because of its chemical properties, being a pretty volatile compound, and they add some more cuties to it to make it foam, and when it hits a fire you get a two-fold effect; first, the effect of the propellant as it hits and then the effect of the foam as it hits. So you get an overkill, so to speak, of the fire.

MR. TOLIVER: Dr. Azar, I noticed in the woman's bathroom experiment that as a function of ventilation, the concentration was increased, and of nonventilation that the concentration decreased. Is that correct?

DR. AZAR: I'd like to elaborate on that, because we didn't do the study; Frank Bowers group did. And, when I first saw it I thought they were paying too much attention to the model and not enough to the gas chromatograph. Then they elaborated on this and explained that the ventilation was a fan in the ceiling, and if you discharge a propellant which is heavier than air, and have ventilation suspending it, it is going to stay up around the nose longer, whereas, if you turn off the ventilation and close the door, it's going to go down to the floor. Does that explain it?

DR. BERNARD MC NAMARA (Edgewood Arsenal): This is for whomever can answer it. Is there any evidence that, after these compounds, there is anoxia at the cellular level in the heart?

DR. HARRIS: No, there is no evidence. It hasn't been sought yet. This is the whole point that the mechanism of any of these actions is completely unknown, really. However, I would say that the fact of lowering the oxygen in the papillary muscle bath fluid to 50 mm Hg (which is essentially none) and there is a certain depression of contractility, and if at that point you introduce the Freon, there is a marked drop, almost a virtual abolition of activity. It is just a very weakly contracting muscle and this would happen after about three beats or so. So I really don't think that this particular action is acting fast enough to make an oxygen mechanism. The mode with which it is operating, however, may in addition have effects on oxygen which just haven't been looked for yet.

DR. BACK: I think part of the answer is that regardless of PO_2 , you still get the effect. In other words, if you have hyperoxygenation involved, if you use 10% of the compound and the rest all oxygen, you still get the effect, regardless of oxygen at the tissue level.

DR. HARRIS: But still, the studies haven't been done, so that in addition to the effects which we showed, it may also affect the oxygen; that is the point that I want to make.

DR. BACK: In dogs or monkeys that we study, if we use 90% oxygen and 10% compound, we still get an effect, and the PO_2 is up to 360 mm Hg or some such thing: we still get an effect.

DR. HARRIS: No, I don't doubt that, but I'm just saying that if you did various polarographic studies, for example, we might, to our surprise, find that there are effects on the oxygen transport that just aren't demonstrable by the mode of testing that we are employing. We've only scratched the surface of this toxicity.

DR. BERNARD MC NAMARA: The reason that I say this is because if you do make a dog anoxic to the point where it is cyanotic, and you inject epinephrine, you can fibrillate him every time.

MAJ. ETHARD VAN STEE (Aerospace Medical Research Laboratory): I would like to add to this that we have exposed a large number of animals of various species to various fluorocarbons, particularly $CBrF_3$ or 1301. We have sampled arterial blood during practically all phases of exposure, postexposure, all intervening activity, and we have never been able to associate any change in arterial blood oxygen tension with any of the effects that we have seen. Now, I grant that the arterial blood PO_2 is not necessarily a reflection of the intracellular activity; however, this has been investigated quite thoroughly in the case of halothane which, as has been pointed out before, bears a number of resemblances to the fluorocarbons which we are interested in here, and in no case were they able to attribute any alteration in the oxidative metabolism of the cells to any of the effects they were seeing. I just don't believe that this contributes to the mechanism of the genesis of these arrhythmias.

DR. HARRIS: Dr. Van Stee, there are several different mechanisms we are talking about. I have admired your work very much. If, for example, one were to give cyanide, you might alter the oxygen content of arterial blood at will and have no effect on the observed toxicity, because you don't know what is happening to the oxygen mechanism by so doing. So, really it boils down to guess work. And I think yours would be particularly intelligent in this regard. But the studies still have to be done, or we don't really know what is going where. Of course, halothane is in many ways similar in its toxicity to that of the various Freons that we have studied, but yet it may differ in certain respects.

DR. HODGE (University of California): I'd like to ask what fraction of the total propellant used for the purposes we have been talking about, is fluorocarbon? I mean across-the-board, industry-wide, and in all uses?

DR. BOWER: In terms of pounds, probably 2/3 to 3/4. We don't have good numbers for the hydrocarbon and compressed gas contribution, but it is in that neighborhood, I would guess.

HALOGENATED HYDROCARBONS AND DRUG METABOLISM:
THE EFFECT OF FLUOROCARBONS ON HEXOBARBITAL SLEEPING
AND ZOXAZOLAMINE PARALYSIS TIMES IN MICE

Ethard W. Van Stee, Major, USAF, VC
James P. F. Murphy
and
Kenneth C. Back, Ph. D.

Aerospace Medical Research Laboratory
Wright-Patterson Air Force Base, Ohio

A screening program has been initiated for the purpose of exploring the possibility that the inhalation exposure of rodents to selected halogenated hydrocarbons may affect enzymes of the hepatic smooth endoplasmic reticulum, the so-called microsomal drug-metabolizing enzymes. The materials of interest to the Air Force which have come under investigation are shown in figure 1 and include bromotrifluoromethane, trichlorotrifluoroethane, and dibromotetrafluoroethane. Some work with halothane has also been done for comparative purposes.

<u>STRUCTURAL FORMULA</u>	<u>NOMENCLATURE</u>	<u>COMMENTS</u>
$\begin{array}{c} \text{F} \\ \\ \text{F}-\text{C}-\text{Br} \\ \\ \text{F} \end{array}$	BROMOTRIFLUORO- METHANE FREON 1301 F1301, F13B1	B.P. -57.8 C USES: FIRE EXTINGUISH- ING AGENT PROPELLANT
$\begin{array}{cc} \text{F} & \text{F} \\ & \\ \text{Cl}-\text{C}-\text{C}-\text{F} \\ & \\ \text{Cl} & \text{Cl} \end{array}$	1,1,2-TRICHLORO- 1,2,2-TRIFLUORO- ETHANE FREON 113, F113 FREON TF SOLVENT FREON PRECISION CLEANING AGENT	B.P. +47.6 C USES: SOLVENT AND DEGREAS- ER REFRIGER- ANT
$\begin{array}{cc} \text{Br} & \text{Br} \\ & \\ \text{F}-\text{C}-\text{C}-\text{F} \\ & \\ \text{F} & \text{F} \end{array}$	1,2-DIBROMO-1,1, 2,2-TETRAFLUORO- ETHANE FREON 114B2, F114B2 HALON 2402, H2402	B.P. +47.3 C USE: FIRE EXTINGUISH- ING AGENT
$\begin{array}{cc} \text{F} & \text{Br} \\ & \\ \text{F}-\text{C}-\text{C}-\text{H} \\ & \\ \text{F} & \text{Cl} \end{array}$	1-BROMO-1-CHLORO- 2,2,2-TRIFLUORO- ETHANE HALOTHANE	B.P. +50.2 C USE: GENERAL ANESTHETIC

Figure 1.

CBrF_3 is a fluorocarbon which boils at about -58°C . It is a gas under standard conditions that is stored as a liquid under pressure. CBrF_3 is an effective fire-extinguishing agent that, although pharmacologically quite active, is tolerated by most species in comparatively high concentration by inhalation exposure. The most likely routes of exposure would be pulmonary or cutaneous. The gas is readily absorbed following inhalation and would be expected to be absorbed percutaneously to a certain extent because of its solubility in nonpolar materials. The discharge of CBrF_3 in the vicinity of a fire would be expected to produce rather high local concentrations of the material for brief periods in terrestrial environments. In extraterrestrial environments, longer potential exposure periods might be expected because of the problems involved in the purging and recharging of the life support system atmosphere.

Trichlorotrifluoroethane boils at about 48°C and is thus a liquid under standard conditions. Because of its relatively high vapor pressure under the usual conditions of its use, the material evaporates readily and relatively high concentrations of the gas phase could be expected in the vicinity when it is being used in its primary role as a solvent and degreaser. Brief cutaneous exposures to the liquid and pulmonary and cutaneous exposures to the gas of varying durations might be anticipated in practice.

H2402 is a candidate fire-extinguishing agent with physical properties similar to those of F113. The primary application by the USAF is expected to be in hand-held fire extinguishers for use aboard aircraft and in other closed and semi-closed environments. Because of the nature of its use, brief exposures to liquid and gas might be anticipated during its application to a fire. Since systems using this agent are now in the developmental phase, the possibility of repeated short-term or even chronic exposures exists for the personnel engaged in design and testing.

The anesthetic agent halothane bears a structural relationship to the other fluorocarbons mentioned and it is not surprising that it also shares some pharmacological-toxicological properties. Since its introduction in 1956, an enormous amount of research on its properties has been performed throughout the world. Because so much is known about halothane and because of its similarities to the fluorocarbons of interest to the Air Force, we have, in our laboratory, often included it in our studies for comparative purposes.

A rational approach to the evaluation of the effect of a drug or chemical on drug metabolism in an organism requires that a logical sequence of steps be performed as shown in figure 2. This process has only begun in our laboratory in our study of fluorocarbons, but we intend to pursue this line of study as long as we continue to remain reasonably confident of fruitful results. Our general approach to the problem of the effect of fluorocarbons on hepatic microsomal enzymes has been that which was outlined by Fouts (1971) in *Methods in Pharmacology*, edited by Schwartz. The first step in the program was the determination of the effects of exposure of male mice to the respective fluorocarbons on the duration of hexobarbital sleep and zoxazolamine

paralysis. The pharmacological basis of this test is the assumption that the duration of sleep or paralysis is largely an inverse function of the rate of biochemical inactivation of the barbiturate or muscle relaxant as shown in figures 3 and 4. In these cases, the conversion of most of the hexobarbital to 2 isomers of the oxidation product, ketohexobarbital, or the conversion of zoxazolamine to 6-OH-zoxazolamine is known to be mediated by enzymes of the hepatic smooth endoplasmic reticulum. The activity of these enzymes has been observed to be increased in a large number of species of animals following their exposure to a wide variety of organic compounds. By increasing the activity of the drug-metabolizing enzymes, the rate of inactivation of the compounds is increased and the duration of their pharmacologic effects decreased (figure 5). This test for induction is quite imprecise and is used only as a screening tool for selecting agents for further study which might be expected to elicit a marked alteration of enzyme activity in the test animals.

Once the determination has been made that exposure to the agent in question significantly alters the sleep and/or paralysis times, the next step in the investigation is undertaken (figure 6). Although the most likely reason that exposure to a fluorocarbon leads to a change in sleep or paralysis time is that the fluorocarbon led to a change in the rate of metabolic degradation of the hexobarbital or zoxazolamine, it is possible that a change in the agonist-receptor interaction could be induced which could in turn result in an altered sensitivity of the organism to any given concentration or dose of hexobarbital or zoxazolamine. In order to either eliminate from consideration or identify this phenomenon for further investigation, control and induced animals are given the standard doses of hexobarbital or zoxazolamine. The animals are killed by cervical dislocation at the appropriate pharmacological endpoint and the brain levels of the respective materials determined. If there is no significant difference in the waking brain levels of the hexobarbital or zoxazolamine between the control and treated groups, it may be safely assumed that no alteration in the animals' sensitivity to these drugs occurred, thereby strengthening the case for the alteration of the rate of metabolic degradation as the principal cause of the alteration of the sleep or paralysis time.

**STEPS IN THE DETERMINATION OF THE EFFECTS
OF XENOBIOTICS ON THE ENZYMES OF THE
HEPATIC SMOOTH ENDOPLASMIC RETICULUM**

A. IN VIVO STUDIES

1. HEXOBARBITAL SLEEPING AND ZOXAZOLAMINE PARALYSIS TIMES.
2. WAKING BRAIN LEVELS OF HEXOBARBITAL OR ZOXAZOLAMINE.
3. DECLINE OF WHOLE BODY CONCENTRATIONS OF HEXOBARBITAL OR ZOXAZOLAMINE.

**B. IN VITRO STUDIES - RATE OF SUBSTRATE DIS-
APPEARANCE OR PRODUCT FORMATION**

1. LIVER HOMOGENATES.
2. LIVER SUBFRACTIONS.

Figure 2.

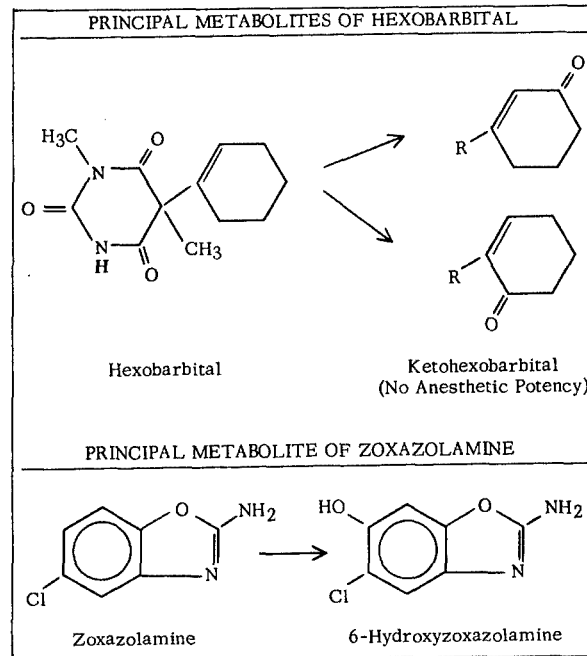

Figure 3.

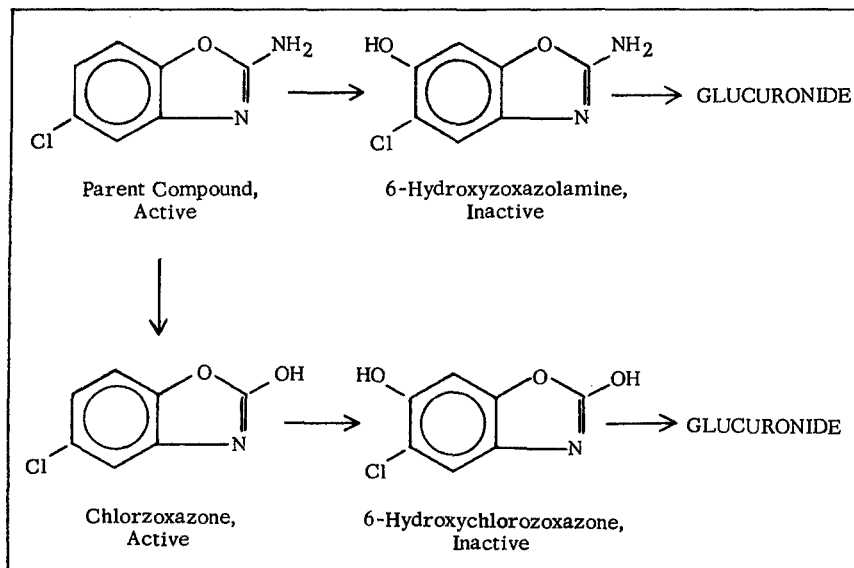

Figure 4. METABOLISM OF ZOXAZOLAMINE

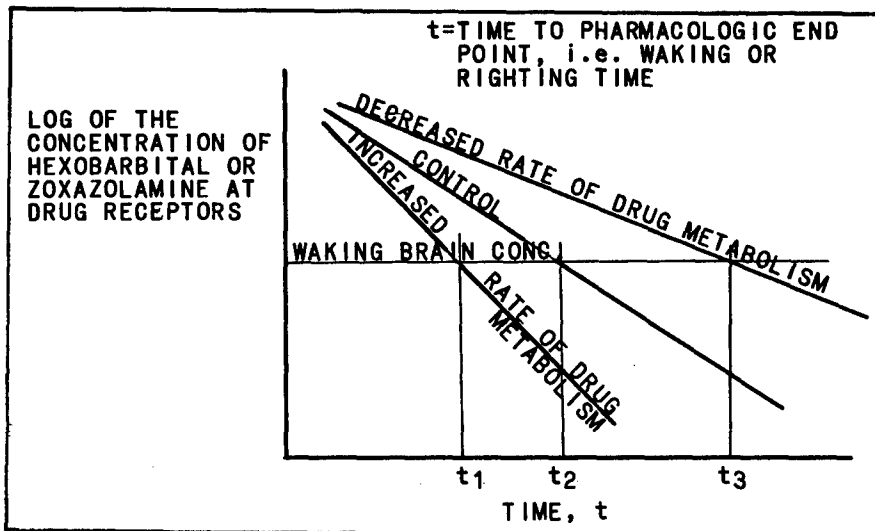

Figure 5. THE EFFECT OF CHANGING THE RATE OF DRUG METABOLISM ON PHARMACOLOGICAL ENDPOINT AND ITS RELATIONSHIP TO BRAIN LEVEL

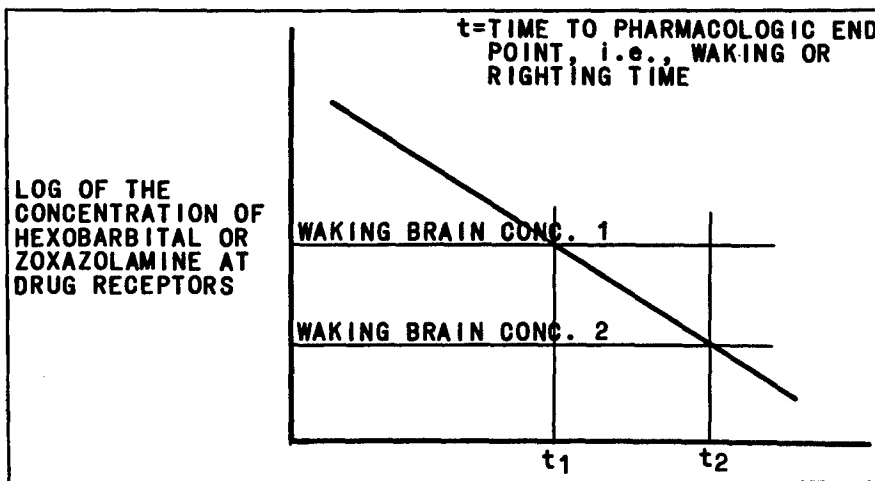

Figure 6. THE EFFECT OF CHANGING AN ORGANISM'S SENSITIVITY TO A DRUG ON PHARMACOLOGICAL ENDPOINT AND ITS RELATIONSHIP TO BRAIN LEVEL

The next step (figure 7) in the analysis of the effect of exposure to fluorocarbons on the hepatic microsomal enzyme system is the final *in vivo* step. The rate of decline of whole body levels of hexobarbital, zoxazolamine, or other test material (commonly compounds such as antipyrine, aminopyrine, ethylmorphine etc.) is determined as a reasonable estimate of the rate of metabolic degradation of the compound. Groups of test animals, control or induced, are injected with the drug whose rate of metabolism is to be followed. The animals are killed serially in groups of 3-5 and the whole body concentrations of the parent compound determined. These values may be plotted versus time and the time required for the whole body concentration to be reduced by one-half calculated. This is the so-called biological half-time and represents a commonly determined index of the rate of metabolic degradation of xenobiotics.

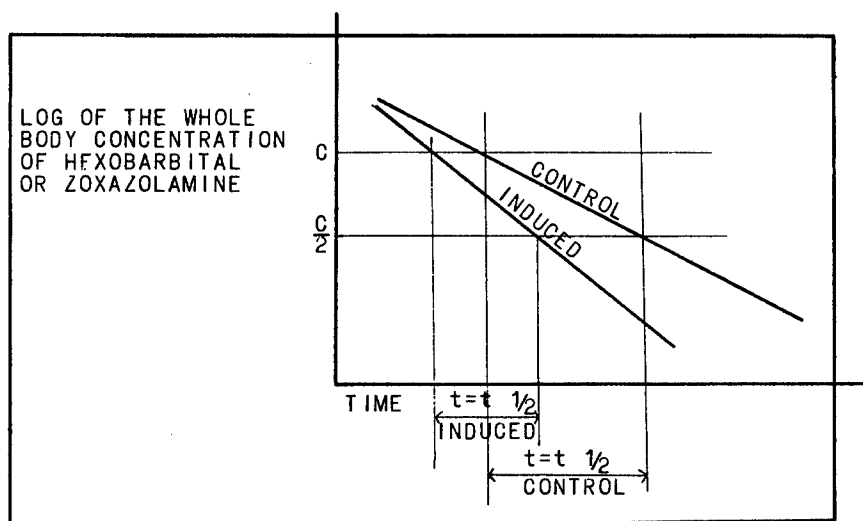

Figure 7. DETERMINATION OF THE TIME REQUIRED FOR THE WHOLE BODY CONCENTRATION OF HEXO-BARBITAL OR ZOXA ZOLAMINE TO DECLINE BY ONE-HALF, $t_{\frac{1}{2}}$.

In vitro studies logically follow the *in vivo* studies (figure 2). The rate of disappearance of substrate in homogenates and various liver subfractions may be used to characterize more precisely the nature of the changes induced in the hepatic smooth endoplasmic reticulum. In our studies of fluorocarbons, we are still weeks from the *in vitro* work and we will not consider it in any more detail at this time.

Dr. E. S. Vesell (1968) of the NIH published a report in 1968 which discussed factors altering the responsiveness of mice to hexobarbital. If I may be permitted to quote from his paper, "The pharmacologic responsiveness of mice to hexobarbital is altered by both genetic and environmental factors including age, sex, litter, strain, bedding, painful stimuli, ambient temperature, grouping, and hour of administration." These factors were borne in mind in the course of the determination of the sleep and paralysis times. Male mice were obtained from the same supplier which we hope has resulted in some degree of strain uniformity. All mice were 28-32 days old on the first day of exposure. Environmental factors were kept as nearly constant as possible and all necessary interventions performed as nearly uniformly as possible. The same operator performed all of the sleep studies and his subjectively-determined criteria for time of loss and time of regaining righting capability were applied uniformly to all animals.

To the list of reasons for differences in responsiveness to hexobarbital we may add variations of the mechanics of injection and the properties of the hexobarbital and zoxazolamine solutions (figure 8). The zoxazolamine was prepared for injection by first dissolving it in polyethylene glycol. The hexobarbital was dissolved in physiological saline adjusted to a high pH with sodium hydroxide. The final solutions were then injected intraperitoneally on the basis of weight. Injections were made with a 25 gage needle into the lower right quadrant. Occasionally, a mouse would not lose its righting capability at all. This can result from the injection of the bolus into the lumen of the intestine or bladder. Occasionally, others would die in a few minutes or sleep for exceedingly long times with or without ultimate survival. Because the mouse response can be so variable, it is necessary when evaluating sleep and righting times to establish criteria for rejecting outliers (figure 9). To begin with, all mice that failed to go down at all and those that slept for inordinate periods were eliminated. The remaining values for sleeping or paralysis time which lay beyond the mean plus or minus two times the standard deviation were eliminated from the group of animals which remained down from one to 400 minutes. The final means, standard deviations, and n-values are from the samples corrected according to these criteria.

<u>DRUG</u>	<u>PREPARATION</u>	<u>INJECTION</u>
ZOXAZOLAMINE	INITIALLY DISSOLVED IN PEG 200 - THEN DILUTED 1:1 WITH DISTILLED WATER FINAL CONCENTRATION: 10 mg/ml	100 mg/kg IP
HEXOBARBITAL	DISSOLVED IN NaOH SOLN, TITRATED BACK TO pH 9-10 WITH HCl, DILUTED TO FINAL CONCENTRATION OF 12 mg/ml WITH 0.9% NaCl	120 mg/kg IP

Figure 8.

SLEEP TIME EXCLUSION CRITERIA

1. EXCLUDE 0-MIN, > 400 MIN
2. REMAINDER: $0 < X < 400$ MIN
CALCULATE MEAN, STD DEV
3. EXCLUDE VALUES WHICH LIE OUTSIDE
 $X \pm 2.0$ S.D.
4. RECALCULATE FROM CORRECTED SAMPLE:
MEAN, STD DEV, N

Figure 9.

The next six figures illustrate the results of the determination of hexobarbital sleeping and zoxazolamine paralysis times in mice treated with four different fluorocarbons. All of the exposures were carried out on groups of 30 mice in a plexiglas exposure chamber of our design. The concentrations of fluorocarbons were checked as necessary using a gas chromatograph. All exposures were for 5 hours and were repeated for three consecutive days. The hexobarbital and zoxazolamine times were determined 24 hours following the third and final exposure session.

As illustrated in figure 10, exposure to 80% $CBrF_3$ had no effect on either hexobarbital sleeping or zoxazolamine paralysis time. Further exposures to $CBrF_3$ have not been performed in this study because 80% represents an extremely high concentration. It is understood that some compounds are known that have a delayed effect on the drug-metabolizing enzymes and that any compound cannot be classified as not an inducer with any degree of certainty until animals have been continuously exposed for 3 weeks or so without altering the sleep times. Nevertheless, our initial screening program has been limited to 3-day intermittent exposures for the purpose of detecting possible potent inducers which might be expected to produce an early effect.

The next two figures (11, 12) illustrate the results of the exposure of mice to F113. Exposure to 2% did not result in a significant alteration of the sleep times; however, exposure to 3% resulted in a significant decrease in the duration of both the hexobarbital and zoxazolamine times.

Exposure to 0.75% halothane yielded inconclusive results (figure 13). Although the hexobarbital sleeping times yielded a significant value of "t" at the 95% level, zoxazolamine paralysis time was unaffected. Repeating the experiment with 1% halothane did

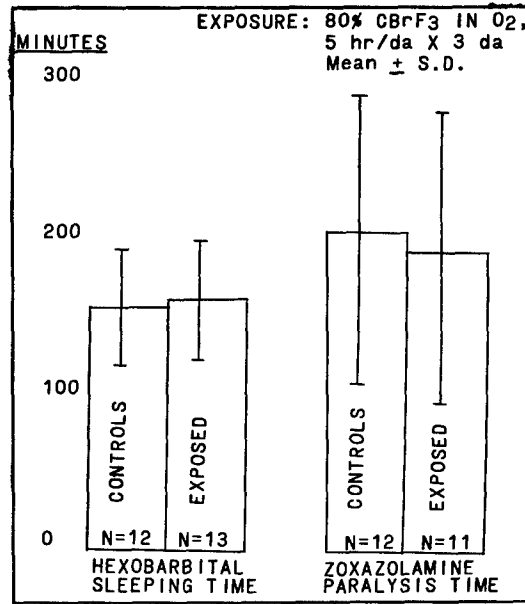

Figure 10.

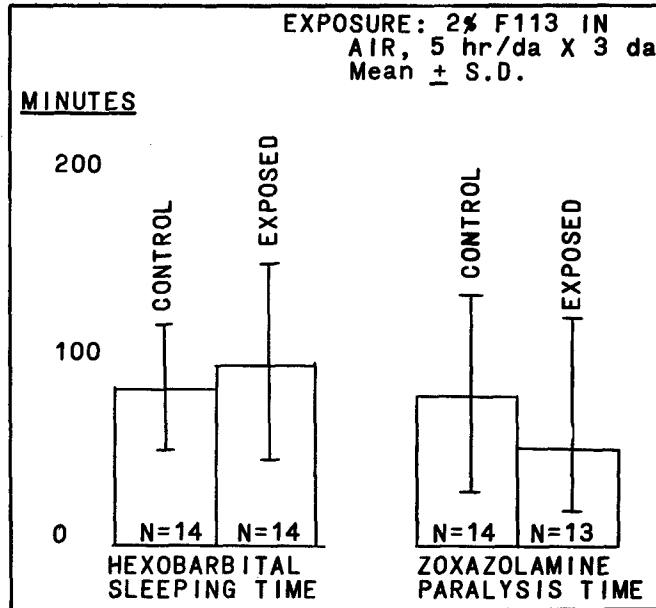

Figure 11.

not result in a significant alteration in either time (figure 14). Other workers have had similar experience with halothane and the only consistency seems to be the equivocal nature of the results.

Soon after beginning an evaluation of H2402 it became apparent that this compound was a likely candidate as a potent inducer of drug-metabolizing enzymes. Several experiments were performed in which groups of mice were exposed to concentrations from .25% to 2.5% with the results which are illustrated in figure 15. The duration of hexobarbital sleeping times and zoxazolamine paralysis times are expressed as percentage of control in order to pack as much information as possible into figure 15. It may be seen that the duration of both times follow a similar course. They decline from 0.25% and reach a plateau which extends from about 0.5% through 1.0%. Above 1.0% they begin to rise again. The statistical significance can be appreciated if an imaginary line parallel to the abscissa is drawn at about 75% of control. All values below that line represented statistically significant differences using Student's t-test.

Based on the results of the sleep studies which have been described we have concluded that any effect which CBrF_3 might have on the metabolizing enzymes of the hepatic smooth endoplasmic reticulum would be likely to be minimal within the context of its application as a fire-extinguishing agent. Our opinion is that the evidence does not warrant our further consideration of it at this time as a possibly significant enzyme inducer.

Freon[®] 113 and 114B2, in contrast to 1301, may be suspected to possess the potential to alter the microsomal enzyme systems. The evidence is not as clear-cut in the case of 113 as it appears to be with 114B2. In both cases, however, the evidence would seem to be substantial enough to justify proceeding to the next in vivo steps which are listed in figure 2; namely, determination of the waking brain levels and whole-body half-life of hexobarbital and/or zoxzolamine.

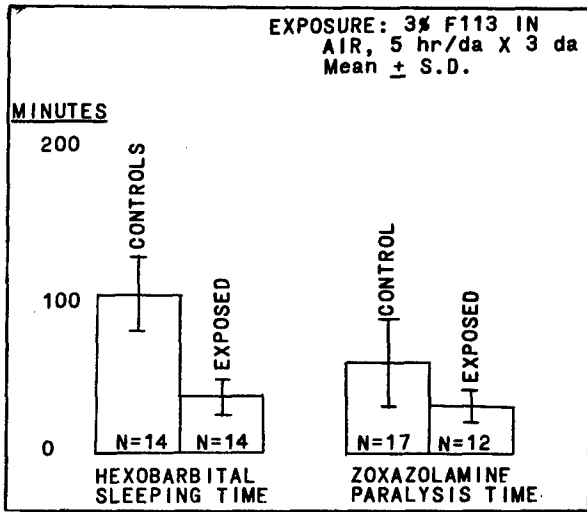

Figure 12.

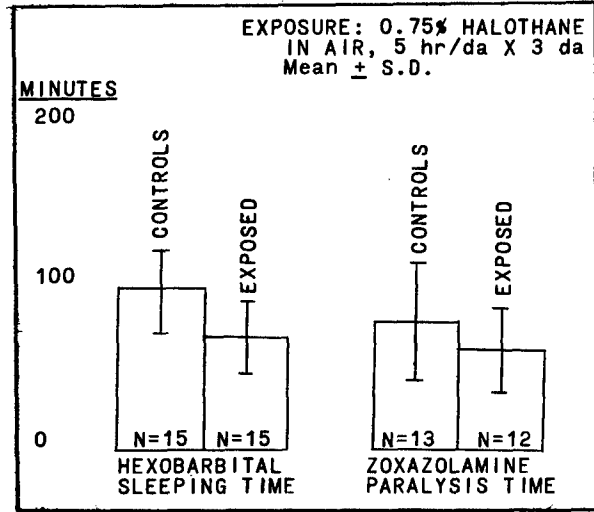

Figure 13.

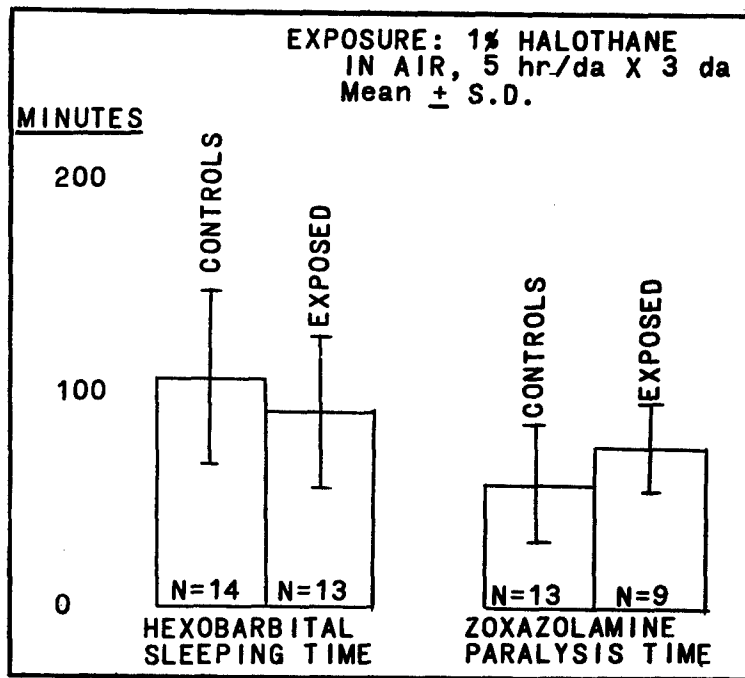

Figure 14.

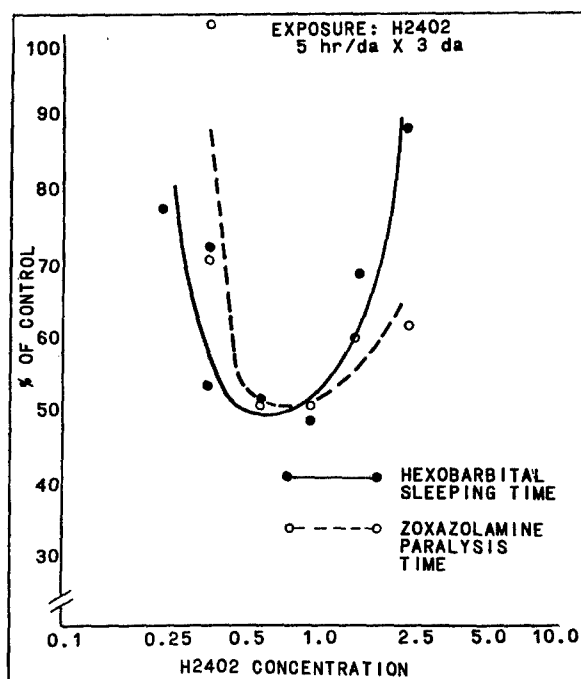

Figure 15.

REFERENCES

1. Conney, A. H. ; "Pharmacological Implications of Microsomal Enzyme Induction;" Pharmacol. Rev., 19(3):317-366, 1967.
2. Fouts, J. R. ; "Liver Smooth Endoplasmic Reticulum 'Microsomal' Drug-Metabolizing Enzyme System"; Methods in Pharmacology, Vol. I, A. Schwartz, Editor, Appleton-Century-Crofts, New York, 1971.
3. Rainaldi, N. ; "Advance Report on Halon 2402;" Montecatini Edison S. p. A. Laboratorio Applicazioni Tecnologiche, Stabilimento Petrochemico, Porto Marghera (Venice), Italy, 1969.
4. Vesell, E. S. ; "Factors Altering the Responsiveness of Mice to Hexobarbital"; Pharmacology (Basel), 1:81-97, 1968.

DISCUSSION

DR. CALDERWOOD (University of Florida): I just want to bring to your attention a paper recently published in the Journal of Anesthesiology by Sawyer, who is also a veterinarian, working with the metabolism of halothane in miniature pigs. If memory serves me correctly, part of the conclusion was that at very low levels of halothane in the blood, the amount of metabolizing enzyme produced by the liver was decreased. I suggest you read the paper and get it more accurately than I can remember it, but it might have some application here in other areas, in that with the low level of halothane decreasing the rate of metabolism of halothane, you get a prolonged period of halothane in the blood.

MAJOR VAN STEE (Aerospace Medical Research Laboratory): Don Sawyer is a friend of mine and I should have all of his papers. I think I may have it back in my office, but honestly I don't recall specifics at the moment.

DR. SMITH (Federal Aviation Administration): On exposure to the inducing agent itself, it did have a profound pharmacological or toxicological effect?

MAJOR VAN STEE: If you are referring to the behavioral effects on the mice in the exposure chamber, yes, there most certainly were, and these were most obviously dose-dependent because they ranged from no response to death and we had various de-arrangement of locomotion. This began at some of the lower concentrations and progressed as we approached lethal concentrations at about 5%. Of course, there was lethargy and inactivity at the higher concentrations also.

LT. COL. STEINBERG (Army Environmental Hygiene Agency): Your results help explain what we thought were some screwy results because about three years ago, we were looking at Freon 113 and its use in a solvent system. We took levels up to 5000 ppm for thirty days, and up to six weeks, and found that in running tests as the concentration increased the running would decrease (this is an activity measurement). We did a battery of chemistries and were unable to demonstrate any hepatotoxicity at all. Fortunately, the problem was dissipated before we had to pursue it.

DR. BACK (Aerospace Medical Research Laboratory): One of the things that Dr. Smith was wondering about was that these animals actually convulsed in lower dose ranges. I don't know if you call it a convulsion or not, anyway they pop like popcorn. This was at about 2%. They do pop like popcorn and then they become lethargic after the initial induction of whatever you want to call it - whether they're convulsions or not. Of course, I would guess that we had marked adrenal discharge, but we never lost any animals under these conditions - showing one thing, that endogenous epinephrine was not sufficient to kill the animals during the convulsive state.

MAJOR VAN STEE: I'd like to make one brief comment on that. We must consider the species of animal involved here, if we're making even indirect references to cardiac arrhythmias, particularly ventricular fibrillation. It is reasonably well known that very small hearts are most difficult to fibrillate, and I don't know that it is possible to fibrillate a mouse heart and thereby cause death. I do know that it is very difficult to cause an irreversible ventricular fibrillation in an animal such as a monkey, whereas in a dog it is very easy to bring about. Perhaps other people here would care to comment on that, but I doubt that cardiac arrest following ventricular fibrillation would be significant in the mouse.

THE TOXICOLOGY OF SOME COMMERCIAL FLUOROCARBONS

Richard S. Waritz, Ph. D.

Haskell Laboratory for Toxicology and Industrial Medicine
 E. I. du Pont de Nemours & Company, Inc.
 Wilmington, Delaware

INTRODUCTION

The field of fluorocarbon toxicology is, for me and many others who have worked in it, a very fascinating toxicological area. Except for the field of natural products such as amino acids and carbohydrates, it contains some of the best examples of extreme variations of biological activity accompanying seemingly minor structural variations. Tables I, II and III give a few examples of this.

TABLE I

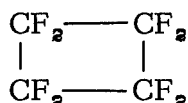
Inhalation Toxicity of Two Fluorocarbon Isologs

Octafluorocyclobutane



ALC >800,000 ppm
(4 hrs.)

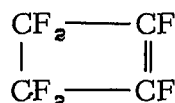

Hexafluorocyclobutene



ALC = 200 ppm
(3 min.)

TABLE II

Inhalation Toxicity of Two Fluorocarbon Structural Isomers

$\text{CF}_3\text{---CF}_2\text{---CF=CF}_2$	$\begin{array}{c} \text{CF}_2 \\ \\ \text{FC}_3\text{---C---CF}_3 \end{array}$
Octafluorobutene	Octafluoroisobutene
C_4F_8	C_4F_8
ALC = 6100 ppm	ALC = 0.5 ppm

TABLE III

Oral Toxicity of Some Acetic Acids

$\text{CH}_3\text{---COOH}$	$\text{CH}_2\text{F---COOH}$	$\text{CF}_3\text{---COOH}$
Acetic Acid	Monofluoroacetic Acid	Trifluoroacetic Acid
$\text{pK}_A - 4.75$	$\text{pK}_A - 2.66$	$\text{pK}_A - 0.23$
$\text{ALD}_0 - 3500 \text{ mg/kg}$	$\text{ALD}_0 - 0.28 \text{ mg/kg}$	$\text{ALD}_0 - 200 \text{ mg/kg}$

Octafluorocyclobutane (OFCB; table I) has a four-hour approximate lethal concentration (ALC) for rats of >800,000 ppm (v/v) (Clayton, et al., 1960). In other words, all of the nitrogen in the air which these rats breathed for four hours had been replaced with OFCB and it caused no toxic or even any anesthetic effects. Its isolog, hexafluorocyclobutene, was lethal to rats after a three-minute exposure at only 200 ppm (Stump, 1967). To my knowledge, there is no comparison in the hydrocarbon field. A better known example is the comparison of the two structural isomers of octafluorocyclobutane-octafluorobutene and octafluoroisobutene (table II). The four-hour ALC of the normal butene is 6100 ppm (Waritz, 1967), while that of the branched isomer is 0.5 ppm (Clayton, 1962). Again, there is no corresponding example of similar toxicity variations in the hydrocarbon field.

Perhaps the best known example is shown in table III. Acetic acid has the acute oral toxicity of an aliphatic carboxylic acid. It is roughly as toxic as table salt. Trifluoroacetic acid is 20,000 times as strong an acid as acetic acid, but only 17 times more toxic orally. The lesser fluorinated monofluoroacetic acid is 100 times as strong an acid as acetic acid, but 10,000 times more toxic. The toxic mechanism of

monofluoroacetic acid, inhibition of the tricarboxylic acid cycle, is well known. It is likely that perfluoroisobutene and hexafluorocyclobutene also interfere with specific biochemical reactions probably directly involved in energy production or transmission.

The fluorocarbon manufacturers have no arbitrary toxicological criteria for deciding which fluorocarbons will be manufactured and sold and which will not. In general, the fluorocarbons sold are characterized by low acute "conventional" toxicity and no indication of cumulative toxicity.

Although the title of my paper is toxicology of commercial fluorocarbons, I will not discuss the toxicology of the fire extinguishants and the anesthetics. These are the subjects of other papers in this series and their toxicology will be discussed there. Cardiac sensitization, another toxicological aspect of some fluorocarbons, also will be discussed in a later paper. The fluorocarbons I will discuss are shown in table IV.

TABLE IV

Fluorocarbon Structures, Boiling Points and Uses

<u>Fluorocarbon</u>		<u>B. Pt.</u> <u>(°C)</u>	<u>Use</u>		
<u>No.</u>	<u>Structure</u>		<u>Refrigerant</u>	<u>Propellant</u>	<u>Solvent</u>
11	CCl_3F	23.8	X	X	
12	CCl_2F_2	-29.8	X	X	
22	CHClF_2	-40.8	X		
113	$\text{CClF}_2-\text{CClF}_2$	47.6	X		X
114	$\text{CClF}_2-\text{CClF}_2$	3.8	X	X	
115	$\text{CClF}_2-\text{CF}_3$	-38.7	X	X	
116	CF_3-CF_3	-78.2	Dielectric Gas		
152a	CH_3-CHF_2	-25.0	X	X	

These materials are sold under various tradenames (e. g., Freon[®], Genetron[®], Ucon[®], Isotron[®], Arcton[®]), but all use the numerical suffix. I will refer to them as fluorocarbon or FC-11, 12, etc.

I have included their boiling points and some principal uses, even though they have been covered elsewhere, because the uses, as is usually the case, dictate much of the toxicological work that must be carried out. The boiling points also point immediately to the fact that the principal hazard at room temperature is inhalation.

The first important use of these fluorocarbons was as refrigerants, replacing the much more toxic ammonia and sulfur dioxide. The principal exposure with this use is by inhalation of the vapors arising from leaks in a refrigeration system.

However, many of these fluorocarbons are useful as propellants for many commodities, as indicated. A large market and human exposure potential exists in the pressure packaging area. Since many of the pressure packaged items are cosmetics which will be sprayed on humans, skin and eye toxicity evaluations also are important for these fluorocarbons. Some are suitable for propelling certain foodstuffs. In this application they become food additives, and toxicity tests for FDA clearance become necessary.

In the short time available, I will not be able to discuss all of the toxicity studies that have been carried out on all of these fluorocarbons. Since we have more information available on rats than any other animal species, I will discuss rat data principally. More complete discussions of fluorocarbon toxicity can be found in a series of reviews by Clayton (Clayton 1962, 1966, 1967).

ACUTE INHALATION STUDIES - ANIMALS

Most of the early inhalation toxicity work on these fluorocarbons was done by the Underwriters' Laboratories, using a standard test design they developed. Their work started in the early thirties and continued through the early sixties. In their tests, groups of 12 guinea pigs were exposed to various set concentrations of the fluorocarbon ranging from 0.5 - 20.0 volume percent for periods up to two hours. This is why some of the acute lethal concentrations shown below are indicated as >20 percent (v/v) for two hours. In the Underwriters' Laboratories exposures, groups of three guinea pigs were removed from the chambers after 5, 30, 60 and 120 minutes.

Registered Trademarks: Freon[®], E. I. du Pont de Nemours & Company; Genetron[®], Allied Chemical Corp.; Isotron[®], Pennsalt Chemicals Corp.; Arcton[®], Imperial Chemicals Industries, Ltd.; Ucon[®], Union Carbide Corp.

The details of the Underwriters' Laboratories protocol and toxicity classes are shown in table V. As can be seen, the toxicity varies inversely with the class number and Class 5b utilizes data that are not generated by Underwriters' Laboratories (Nuckolls, 1933). Except FC-113, all of the commercial fluorocarbons are in Class 5 or 6. To date, Class 6 contains only fluorocarbons.

TABLE V
Underwriters' Laboratories Criteria and Classification

<u>Group</u>	<u>Criteria</u>	<u>Fluorocarbons In This Class</u>	<u>Other Chemicals In This Class</u>
1	$\frac{1}{2}$ -1% for \leq 5 minutes causes injury or death		SO ₂
2	$\frac{1}{2}$ -1% for \leq 30 minutes causes injury or death		NH ₃
3	2-2 $\frac{1}{2}$ % for \leq 60 minutes causes injury or death		CHCl ₃
4	2-2 $\frac{1}{2}$ % for \leq 120 minutes causes injury or death		CH ₃ Cl
Between 4 & 5	Apparently less toxic than 4	113	CH ₂ Cl ₂
5a	Less toxic than 4; more toxic than 6	11, 12	CO ₂
5b	Available (Non-Underwriters') data indicate either 5a or 6		Ethane
6	20% for 120 minutes causes no injury	12, 114, 115, (116)	-

The actual acute lethal concentrations for these fluorocarbons are shown in table VI. As can be seen, there is over a ten-fold variation in lethal concentrations for these fluorocarbons. As indicated in Column 3, the hazard also varies over ten-fold. The only one that appears to be out of line, relative to the Underwriters' classification, is FC-22. The data suggest it might belong in Class 5b. All of the data are for rats except the ALC of FC-22, which is on guinea pigs.

TABLE VI

Acute Inhalation Toxicity

<u>Fluorocarbon</u>	<u>Approximate Lethal Concentration</u> <u>(ppm; v/v)</u>	<u>% of Saturation Conc.</u> <u>at Room Temperature</u>	<u>Exposure</u> <u>Duration</u> <u>(Hrs.)</u>	<u>Reference</u>
11	66,000	7	4	Morrison, 1961
12	>800,000	>80	4	Lester & Greenberg, 1950
22	>200,000	>20	2	Nuckolls, 1940
113	55,000 110,000	14 28	4 2	Hornberger, 1969 Desoille, 1968
114	>600,000	>60	2	Scholz, 1962
115	>800,000	>80	4	Clayton, 1966a
116	>800,000	>80	4	Morrison, 1962
152a	>200,000	>20	2	Lester & Greenberg, 1950

CLINICAL SIGNS

In general, these commercial fluorocarbons have an effect on the central nervous system. The ultimate effect is usually depressant, but excitability may be seen transiently at lower concentrations. The atmospheric concentrations at which central nervous system signs appear for these various fluorocarbons are shown in table VII as a fraction of their 4-hr. lethal concentration wherever possible. Fluorocarbons 115 and 116 are the only ones that do not appear to affect the central nervous system. Again, all data are for rats except the data for FC-22, which is for guinea pigs.

TABLE VII

Clinical Signs from Inhalation

<u>Fluoro-carbon</u>	<u>Concentration</u>	<u>Animal Species</u>	<u>Central Nervous System Signs</u>	<u>Reference</u>
11	1/2 ALC	Rat	Tremors, incoordination	Morrison, 1961
12	80%	Rat	Loss of postural, righting corneal reflexes. Anesthetized	Lester & Greenberg, 1950
22	~10% (2 hrs.)	Guinea Pig	Loss of equilibrium, tremors	Nuckolls, 1940
113	1/3 ALC	Rat	Incoordination	Pittman, 1952
114	60% (2 hrs.)	Rat	Deep narcosis	Scholz, 1962
115	80%	Rat	None	Morrison, 1962
116	80%	Rat	None	Morrison, 1962
152a	1/2 ALC	Rat	Loss of postural and righting reflexes	Lester & Greenberg, 1950

ACUTE ORAL STUDIES

The number of fluorocarbons that are of interest for food contact uses was very small until very recently. This fact, coupled with the difficulty of administering a gas orally, explains the lack of oral toxicity data on the fluorocarbons. FDA clearance for food contact use for FC-115 was based on a chronic inhalation only. With the recent development of the use of FC-12 as a food freezant and FC-11 and 114 as blowing agents for materials to be used for food packaging, oral studies became necessary for these materials. For these studies, solutions of the fluorocarbon in peanut oil or corn oil were used.

The acute oral toxicities determined for the various commercial fluorocarbons are shown in table VIII. It can be seen that an ALD could not be determined for some. This is due to their low solubility in corn oil and the fact that you can't give a rat an unlimited amount of corn oil. The data are for rats for 10-14 day survival.

TABLE VIII

Acute Oral Toxicity of Various Fluorocarbons

<u>Fluorocarbon</u>	<u>ALD (mg/kg)</u>	<u>Reference</u>
12	>1,000*	Hood, 1955
113	43,000	Odou, 1963 Michaelson, 1964
114	>2,250*	Hood, 1955

*Maximum feasible dose dissolved in corn oil.

Interestingly, although the chlorinated hydrocarbons such as carbon tetrachloride, chloroform, chlorobenzene and the chlorinated biphenyls characteristically cause liver damage, no such effect has been observed in any of the acute or chronic studies on rats with these chlorofluorocarbons.

ACUTE SKIN AND EYE STUDIES

Skin and eye toxicity of the fluorocarbons boiling below room temperature is not a serious problem in the conventional toxicological sense. The principal problem is chilling or freezing of tissue from rapid evaporation if any of the liquid is dropped on the skin or in the eye. The ALD of FC-113 is greater than the maximum feasible dose of 11,000 mg/kg for rabbits even when evaporation is prevented by occlusion (Hood, 1955). Temporary local irritation was the only effect observed under these conditions. When FC-114 was sprayed directly on shaved guinea pigs' backs, not even irritation was observed (Hood, 1967).

Eye toxicity tests have been carried out in rabbits with several of the fluorocarbons as shown in table IX. As shown, mild conjunctivitis lasting <48 hours was the usual clinical sign seen.

TABLE IX

Acute Eye Toxicity of Several Fluorocarbons

<u>Fluorocarbon</u>	<u>Dosage Form</u>	<u>Effect</u>	<u>Reference</u>
11	Aerosol	Mild conjunctivitis, lacrimation	Quevauviller, 1964
12	Mineral oil aerosol	Mild conjunctivitis, <24 hrs.	Downing, 1960
113	Neat liquid	Mild conjunctivitis, corneal dullness, <48 hrs.	Reinke, 1962
114	Mineral oil solution	Mild conjunctivitis, <48 hrs.	Hood, 1955

CHRONIC INHALATION STUDIES

Studies of the effect of repeated inhalation have been reported for all of these fluorocarbons except FC-116. The minimum number and time of exposures was 20, 3½-hour exposures. Repeated inhalation studies have been carried out on several rodent and non-rodent mammalian species. In table X, I have summarized some of the studies carried out in male rats. Except for mild pulmonary irritation seen with FC-152a, repeated inhalation of these compounds at levels up to, in some cases, 100 times the Threshold Limit Value (TLV) did not cause any tissue damage in rats. This illustrates a very important aspect of the TLV's with regard to these fluorocarbons. For these compounds, the TLV does not represent a value set on the basis of conventional toxicity, but rather a value that should not be exceeded for philosophical reasons, i. e., the TLV committee does not believe that workmen should be exposed chronically to atmospheres containing more than 1000 ppm of any organic compound. Recent studies on cardiac sensitization by fluorocarbons, which will be discussed later, indicate that 1000 ppm is a good choice from this standpoint also.

TABLE X

Chronic Inhalation Toxicity of Various Fluorocarbons

<u>Fluorocarbon</u>	<u>Concentration</u>		<u>Duration</u> (Exposure x Hrs.)	<u>Pathologic Effects</u>	<u>1970</u> <u>TLV</u>	<u>Reference</u>
	<u>ppm</u>	<u>Fraction ALC</u>				
11	4,000	1/10	28 x 6	None	1000	Lester & Greenberg, 1950 Jenkins, 1970
	1,000	?	90 x 24	None		
12	100,000	<1/8	20 x 3½	None	1000	Scholz, 1962 Prendergast, 1967
	810	?	90 x 24	None		
22	2,000	?	300 x 6	None	-	Karpov, 1963
113	25,000	2/5	20 x 3½	None	1000	Scholz, 1962 Desoille, 1968
	12,000	1/10	24 x 2	None		
114	100,000	?	20 x 3½	None	1000	Scholz, 1962
115	100,000	<1/8	90 x 6	None	-	Clayton, 1966a
152a	100,000	?	60 x 16	Mild irritation (lungs)	-	Lester & Greenberg, 1950

CHRONIC ORAL STUDIES

Chronic feeding studies have been carried out on only a few of the commercial fluorocarbons as mentioned earlier. Dosing was accomplished by intubating rats daily with a vegetable oil solution of the fluorocarbon. Dogs were dosed by freezing Gainesburgers® in the fluorocarbon, and allowing the burger to stand at room temperature until the desired residual fluorocarbon concentration was achieved.

A 90-day feeding study has been carried out on FC-12 in dogs and rats and 90-day feeding studies are in progress on rats and dogs with FC-11 and 114. A two-year study on rats and dogs with FC-12 is also in progress. In addition, a metabolic study in rats using ¹⁴C labeled FC-12 has been carried out.

In the 90-day study with FC-12, the rats received 160-380 mg/kg/day and the dogs received 90 mg/kg/day. The daily dosages are 50 and 250 mg/kg in the FC-11 and FC-114 studies. In the two-year FC-12 study, the rats are receiving 35 and 350 mg/kg/day and the dogs are receiving 10 and 100 mg/kg/day.

No clinical or histopathologic signs of toxicity were observed in rats or dogs in the 90-day feeding study with FC-12. Urinary fluoride levels and plasma alkaline phosphatase levels were higher in the test rats than in the controls at 30, 60 and 90 days. The values were within the normal range, however. All blood and urine analytical results in the test dogs were comparable to their controls (Sherman, 1966).

The radio-labeled study of FC-12 indicated that the rats metabolized about two percent of orally administered FC-12 to CO_2 . Approximately 0.5 percent of the dose was excreted in the urine. FC-12 and its metabolites were eliminated within 30 hours (Eddy, 1971).

Quevauviller (1964) reported that a daily dose of 2000 mg/kg of FC-114 was tolerated by rats for a period of 23-33 days.

Intragastric intubation of FC-115 in cottonseed oil to rats at a daily FC-115 level of 140-172 mg/kg for 10 days caused no clinical or histopathologic changes attributable to the fluorocarbon (Sherman, 1964).

CHRONIC SKIN AND EYE TOXICITY

Scholz (1962) sprayed 40 percent solutions of FC-11, FC-12, FC-113 or FC-114 in sesame oil onto shaved rabbit skin daily for 12 applications. He found no effect on the skin. Desoille (1968) applied an unspecified amount of FC-113 to rabbit skin five times a week for 20 weeks and did not detect any skin changes. However, 5000 mg/kg FC-113 applied daily for five days to shaved rabbit skin and kept occluded for two hours post-application caused severe local irritation (Hood, 1965).

Scholz (1962) applied 0.1 ml of FC-11 and FC-113 daily to the conjunctival sac of rabbits' eyes for nine applications. No toxic effects were observed.

HUMAN STUDIES

Human exposures to FC-12 by inhalation have been reported by Kehoe (1943) and Azar (1971). The results are summarized in table XI. Exposure for $2\frac{1}{2}$ hours at 1000 ppm (the TLV) had no effect on the subjects in Azar's (1971) study. Decreased psychomotor performance appeared at ten times the TLV or 10,000 ppm in this study. Kehoe found that at 40,000 ppm extra effort was required in his psychological tests and that 10 minutes at 110,000 ppm caused unconsciousness preceded by confusion and apprehension.

TABLE XI

Human Exposures to Various Fluorocarbons

<u>Fluoro-carbon</u>	<u>Concentration (ppm)</u>	<u>Time (hrs.)</u>	<u>Subject Response</u>	<u>Reference</u>
12	4×10^4	1-1/3	Elevated blood pressure Psychological tests required undue effort	Kehoe, 1943
	11×10^4	1/6	Confusion, apprehension Unconscious in 10 minutes	Kehoe, 1943
12	0.1×10^4	$2\frac{1}{2}$	No effect	Azar, 1971
	1×10^4	$2\frac{1}{2}$	Decreased psychomotor performance	
112	0.1×10^4	2 x 3 x 5 days	No effect	Reinhardt, 1971
	0.25×10^4	2-3/4	Difficulty concentrating	Stopps, 1967
	0.45×10^4	2-3/4	Decreased psychomotor performance	

Studies of repeated daily inhalation exposure to FC-113 vapors have been reported by Reinhardt (1970). He found that five daily exposures to the TLV caused no effect in his subjects as judged by routine physical examinations and blood tests which included liver function studies. Single exposures by Stopps (1967) to levels of FC-113 up to 4500 ppm also caused no tissue effects as judged by routine urinalyses, hematology, and liver function studies. This level, however, did decrease performance on psychomotor tests.

Thus, the human studies confirm the indications from the animal studies that these fluorocarbons affect the central nervous system.

Odou (1963) reported that a patient undergoing cryoscopic treatment for a stomach ulcer accidentally received approximately one liter of cold FC-113 in his stomach when the container broke. It caused immediate, transient cyanosis. The patient survived but reported severe rectal irritation and diarrhea for three days afterward.

SUMMARY

Extensive conventional toxicological studies have been carried out on the commercial fluorocarbons 11, 12, 22, 113, 114, 115, 116 and 152a. These studies include acute and repeated inhalation, oral, dermal and eye tests on many of these materials. Acute and repeated inhalation studies have been carried out in humans with two of them. The studies indicate that these commercial fluorocarbons have varying, but low, toxicity by the usual criteria.

REFERENCES

1. Azar, A., C. F. Reinhardt, M. E. Maxfield, P. E. Smith, Jr., and L. S. Mullin; "Human Exposures to Fluorocarbon 12"; Presented at the 1971 American Industrial Hygiene Association Conference, Toronto, Canada, May, 1971.
2. Clayton, J. W., Jr., M. A. Delaplane and D. B. Hood; "Toxicity Studies with Octofluorocyclobutane"; Am. Ind. Hyg. Assn. J., 21:382-388, 1960.
3. Clayton, J. W., Jr.; "The Toxicity of Fluorocarbons with Special Reference to Chemical Constitution"; J. Occ. Med., 4:262-273, 1962.
4. Clayton, J. W., Jr.; "The Mammalian Toxicology of Organic Compounds Containing Fluorine"; Chapter 9 in Handbuch der Experimentellen Pharmakologie, New Series, edited by Eichler, O., Farah, A., Herken, H., and Welch, A. D., Vol. XX/1, Springer-Verlag, New York, 1966.
5. Clayton, J. W., Jr., D. B. Hood, M. S. Nick, and R. S. Waritz; "Inhalation Studies on Chloropentafluoroethane"; Am. Ind. Hyg. Assn. J., 27:May-June, 1966a.
6. Clayton, J. W., Jr.; "Fluorocarbon Toxicity: Past, Present, Future"; J. Soc. Cosmetic Chemists, 18:333-350, 1967.
7. Desoille, H., L. Truffert, A. Bourguignon, P. Delavierre, M. Philbert and C. Girard-Wallon; "Experimental Study on the Toxicity of Trichlorotrifluoroethane (Freon® 113) (1)"; Arch. Maladies Profess. Trav. Securite Sociale, 29:(7-8) 381-388, 1968. (Translation)
8. Downing, R. C. and D. Madinabeitia; "The Toxicity of Fluorinated Hydrocarbon Aerosol Propellants"; Aerosol Age, 5:25, 1960.
9. Eddy, C. W. and F. D. Griffith; "Metabolism of Dichlorodifluoromethane C¹⁴ (Freon® 12 C¹⁴) by Rats"; Presented at the 1971 American Industrial Hygiene Association Conference, Toronto, Canada, May, 1971.

REFERENCES (Cont'd)

10. Hood, D. B. and M. Ward; E. I. du Pont de Nemours & Company, Haskell Laboratory Project MR-312-7, 1955. (Unpublished)
11. Hood, D. B.; E. I. du Pont de Nemours & Company, Haskell Laboratory Report 110-67, 1967. (Unpublished)
12. Hornberger, C. S.; E. I. du Pont de Nemours & Company, 1969. (Unpublished)
13. Jenkins, L. J., Jr., R. A. Jones, R. A. Coon and J. Siegel; "Repeated and Continuous Exposures of Laboratory Animals to Trichlorofluoromethane"; Toxicol. Appl. Pharm., 16:133-142, 1970.
14. Karpov, B. D.; "The Chronic Toxicity of Freon[®] -22"; Tr. Leningr. Sanit. Gigen. Med. Inst., 75:231-240, 1963.
15. Kehoe, R. A.; 1943. (Unpublished)
16. Lester, D. and L. A. Greenberg; "Acute and Chronic Toxicity of Some Halogenated Derivatives of Methane and Ethane"; Arch. Ind. Hyg. & Occ. Med., 2, 1950.
17. Michaelson, J. B. and D. J. Huntsman; "Oral Toxicity of 1, 2, 2-Trichloro-1, 1, 2-Trifluoroethane"; J. Med. Chem., 7:378-379, 1964.
18. Morrison, S. D.; E. I. du Pont de Nemours & Company, Haskell Laboratory Report No. 53-61, 1961. (Unpublished)
19. Morrison, S. D.; E. I. du Pont de Nemours & Company, Haskell Laboratory Report No. 41-62, 1962. (Unpublished)
20. Nuckolls, A. H.; "The Comparative Life, Fire, and Explosion Hazards of Difluoromonochloromethane (Freon[®] -22)"; Underwriters' Laboratories, Inc., Miscellaneous Hazard No. 3134, September 26, 1940.
21. Nuckolls, A. H.; "The Comparative Life, Fire, and Explosion Hazards of Trifluorotrichloroethane (Freon[®] -113)"; Underwriters' Laboratories, Inc., Miscellaneous Hazard No. 3072, April 7, 1941.
22. Odou, B. L.; Personal Communication to J. W. Clayton, Jr., 1963. (Reported in Clayton, 1966)
23. Pittman, W. E.; "Non-inflammable Solvent Cleaner for Insulated Electrical Motor Parts"; Toxicity Tests of (ITL Test No. 23335), U. S. Navy Report NS-041-001, Philadelphia, 1952.

REFERENCES (Cont'd)

24. Prendergast, J. A., R. A. Jones, L. J. Jenkins, Jr., and J. Siegel; "Effects on Experimental Animals of Long-Term Inhalation of Trichloroethylene, Carbon Tetrachloride, 1, 1, 1-Trichloroethane, Dichlorodifluoromethane, and 1, 1-Dichloroethylene"; Toxicol. Appl. Pharm., 10:270-289, 1967.
25. Quevauviller, A., M. Schrenzel, and Vu Ngoc Huyen; "Local Tolerance of Skin, Mucous Membranes, Sores, and Burns of Animals to Chlorofluorinated Hydrocarbons"; Therapie, 19:247-263, 1964.
26. Reinhardt, C. F., M. McLaughlin, M. E. Maxfield, L. S. Mullin and P. E. Smith, Jr.; "Human Exposures to Fluorocarbon 113"; Am. Ind. Hyg. Assn. J., 32, March, 1971.
27. Reinke, R. E.; E. I. du Pont de Nemours & Company, Haskell Laboratory Report No. 39-62, 1962. (Unpublished)
28. Scholz, J.; "New Toxicologic Investigations of Freons Used as Propellants for Aerosols and Sprays"; Fortschr. Biol. Aerosol-Forsch. 1957-1961, Ber. Aerosol-Kongr., 4:420-429, 1962.
29. Sherman, H. S.; E. I. du Pont de Nemours & Company, Haskell Laboratory Report No. 146-64, 1964. (Unpublished)
30. Sherman, H. S. and J. R. Barnes; E. I. du Pont de Nemours & Company, Haskell Laboratory Report No. 12-66, 1966. (Unpublished)
31. Stopps, G. J. and M. McLaughlin; "Psychophysiological Testing of Human Subjects Exposed to Solvent Vapors"; Am. Ind. Hyg. Assn. J., 28:43-50, January-February, 1967.
32. Stump, C. E.; Chem. Eng. News, p. 44, October 16, 1967.
33. Waritz, R. S.; E. I. du Pont de Nemours & Company, Haskell Laboratory Report No. 128-67, 1967. (Unpublished)

FLUORIDE-CONTAINING METABOLITES AFTER METHOXYFLURANE ANESTHESIA*

Bill W. Fry

School of Dentistry, Medical College of Georgia
Augusta, Georgia

and

Donald R. Taves

University of Rochester School of Medicine and Dentistry
Rochester, New York

INTRODUCTION

Methoxyflurane (2, 2-dichloro-1, 1-difluoroethyl methyl ether) has been used for about 12 years for analgesia and anesthesia in surgery and obstetrics. Our interest in methoxyflurane fluorometabolites arose when markedly elevated serum fluoride concentrations in a nephrotoxic patient were traced to the use of methoxyflurane anesthesia for surgery. These high fluoride levels were peculiar in that the ion-selective fluoride electrode did not detect a substantial part of the fluoride until after its separation from the sample by the hexamethyldisiloxane-acid diffusion method of Taves (1968). This finding suggested that inorganic fluoride (F) was not the only form present in the samples and that an organic acid-labile fluorometabolite (OALF) was also present.

We were interested in finding out whether there were in fact two discrete fluorometabolites, what their concentrations usually were in patients without renal failure, and whether they bore a constant relationship with each other. These and other aspects of our studies on the metabolism of methoxyflurane are reported in greater detail elsewhere (Fry, 1971).

*This study was supported in part by U. S. Public Health Service Grants 1 T1-DE-175-04 and 1-P11-GM-15190 and has been assigned technical report No. UR-49-1497.

METHODS

Inorganic fluoride (F) was analyzed with the ion-selective fluoride electrode after the addition of a buffer prepared by mixing equal volumes of 10 M acetic acid and 5 N sodium hydroxide (Fry and Taves, 1970). In the analysis of serum we usually took 0.5 ml serum and 1 drop (about 0.03 ml) of buffer. When only a small amount of serum was available, we mixed 25 μ l of serum with 1.3 μ l of buffer on the flat crystal surface of an inverted fluoride electrode and dipped the tip of the reference electrode into the drop of solution.

Total acid-labile fluoride (ALF) was analyzed by the method of Taves (1968) modified as follows: Diffusion times of at least 16 hours were required to allow for the conversion of OALF to F. Sera and urine dilutions were acidified to about 1.5 N with H_2SO_4 previously cleaned of fluoride contamination and saturated with hexamethyl-disiloxane for rapid diffusion of acid-labile fluoride. The trapping solution was 0.05 to 0.15 N aqueous NaOH. The diffused fluoride, inorganic fluoride plus that released from organic acid-labile fluorocompounds (OALF), in the trapping solution was measured with the fluoride electrode after the addition of two equivalents of acetic acid for each equivalent of base in the trap.

Blood samples were obtained from surgical and obstetric patients before, during, and after methoxyflurane anesthesia.

The electrophoretic mobility of fluorometabolites in serum and urine was determined by means of curtain electrophoresis, using 0.12% $(NH_4)_2CO_3$ as buffer and sample diluent.

RESULTS

Figures 1 and 2 show the previously published electrophoretic patterns of serum and urine obtained from a nephrotoxic patient 19 days after surgery and methoxyflurane anesthesia. This serum contained 120 μ M F and 870 μ M ALF, and the two peaks account for more than 95% of the ALF (Taves et al., 1970). The fluoride electrode sensed only the more electromobile substance; this peak contained identical quantities of F and ALF. The other peak is OALF.

Figure 3 shows two examples of both the rapid increase in serum F during and after brief obstetric administration of methoxyflurane and the delayed elevation of serum OALF.

Shown in figure 4 are two examples of serum F and OALF concentrations after administrations of methoxyflurane for surgery. The considerably longer periods of administration during surgery did not generally result in much higher serum F levels, but OALF levels were higher than after obstetric administration. The maximum concentrations were nearly always reached within 16 to 24 hours in both obstetrical and surgical patients. Table I shows the ranges and means of serum F and OALF concentrations for surgical and obstetric patients, none of whom became nephrotoxic.

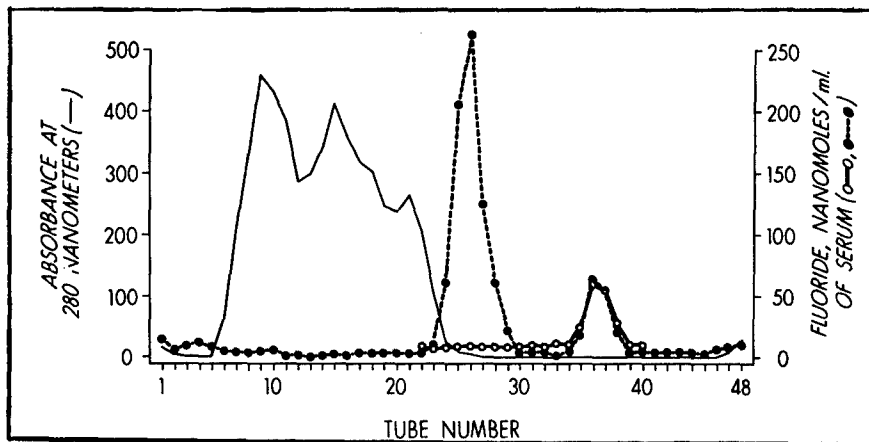

Figure 1. ELECTROPHORETIC PATTERN OF SERUM OBTAINED 19 DAYS AFTER METHOXYFLURANE ANESTHESIA FROM A NEPHROTOXIC PATIENT, SHOWING PROTEIN AND AROMATIC AMINO ACID (—), INORGANIC FLUORIDE (○—○), AND ACID-LABILE FLUORIDE (●---●) DISTRIBUTION IN COLLECTED FRACTIONS

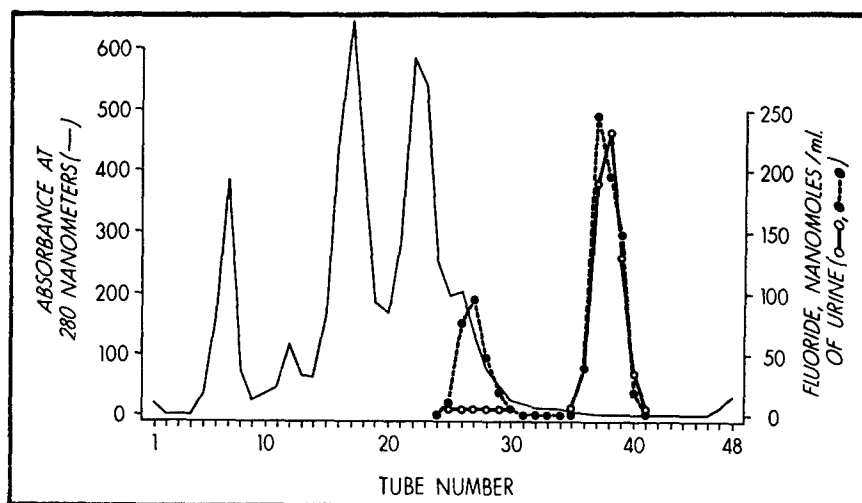

Figure 2. ELECTROPHORETIC PATTERN OF URINE EXCRETED 19 DAYS AFTER METHOXYFLURANE ANESTHESIA BY A NEPHROTOXIC PATIENT, SHOWING PROTEIN AND AROMATIC AMINO ACID (—), INORGANIC FLUORIDE (○—○), AND ACID-LABILE FLUORIDE (●---●) DISTRIBUTION IN COLLECTED FRACTIONS

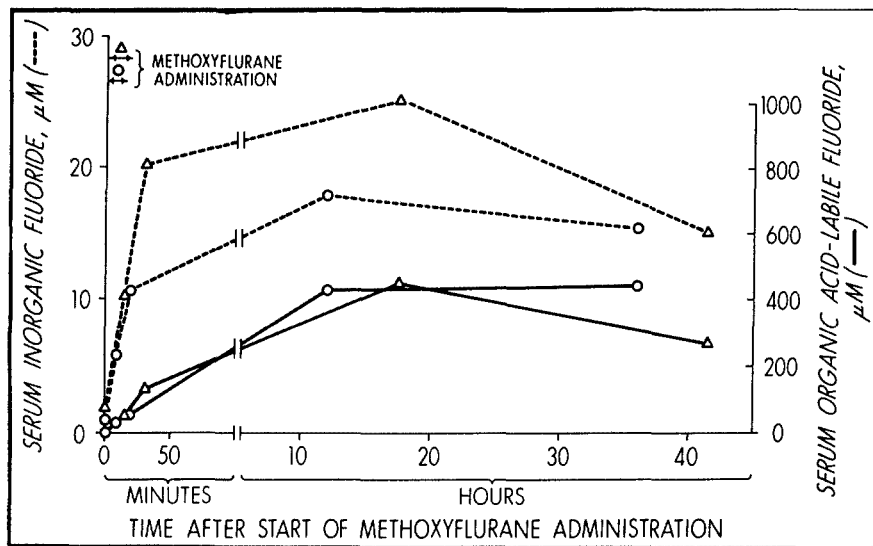

Figure 3. FLUOROMETABOLITE LEVELS IN SERA OF TWO OBSTETRIC PATIENTS.

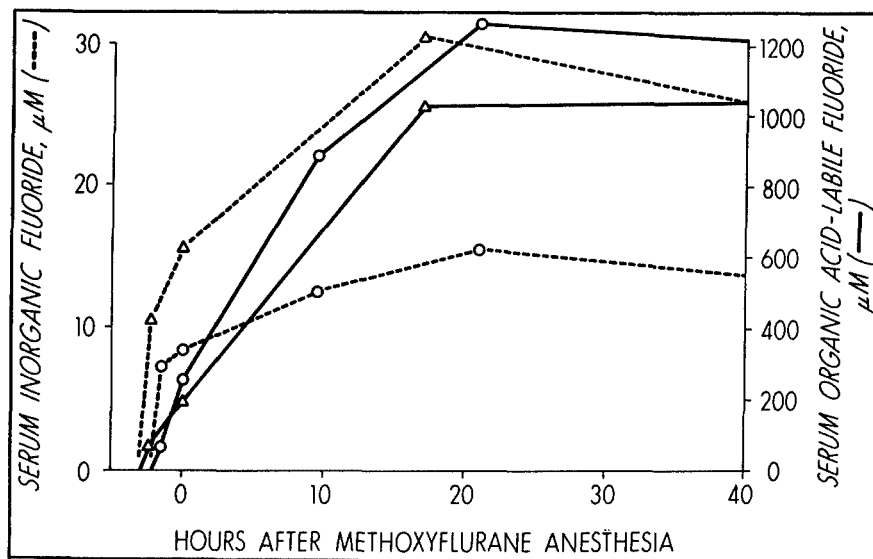

Figure 4. FLUOROMETABOLITE LEVELS IN SERA OF TWO SURGICAL PATIENTS.

The average F concentration increased less than 2-fold from the end of surgery to the following day. In contrast, the OALF values increased about 5-fold and are statistically significant despite the large standard errors of the means. The variability is not surprising in view of the wide ranges of age, weight, and anesthetic exposure of the patients.

Shown in table II are the averages and standard errors of OALF/F ratios in serum at various times during and after methoxyflurane administration to surgical and obstetric patients. The ratios are much less in samples obtained during and at the end of anesthesia than in samples obtained later. The ratios for the obstetric patients are also statistically significantly less than those for all surgical patients at all three time intervals. The post-anesthesia ratios for surgical patients under 20 years of age are significantly less than for older patients.

TABLE I

SERUM F AND OALF CONCENTRATION RANGES AND MEANS AT THE END OF METHOXYFLURANE ANESTHESIA AND 16 TO 24 HOURS LATER

Patients	No.	F (μM)		OALF (μM)	
		Range	Mean \pm SE	Range	Mean \pm SE
<u>At End of Anesthesia</u>					
Surgical	15	8.5-33.2	20.3 \pm 7.2	67-410	212.1 \pm 65.0
Obstetric	5	10.7-20.2	15.4 \pm 3.5	56-167	87.2 \pm 31.8
<u>16-24 Hours After Anesthesia</u>					
Surgical	13	15.5-81.5	35.5 \pm 22.6	678-1608	1108 \pm 274
Obstetric	4	12.2-25.2	18.8 \pm 5.2	306- 445	403 \pm 65

TABLE II

RATIOS OF OALF TO F IN SERUM OF PATIENTS DURING AND AFTER METHOXYFLURANE ANESTHESIA

Patients	Hours After Anesthesia								
	≤ 0			12-24			24-80		
	No.	\bar{x}	SE	No.	\bar{x}	SE	No.	\bar{x}	SE
<u>Surgical</u>									
< 20 years	5	16.8	± 4.0	4	56	± 8.4	3	65	± 13.7
> 20 years	12	9.0	± 0.8	9	27.4**	± 1.3	8	30.5*	± 2.3
Obstetric	10	5.4**	± 0.22	4	23.0*	± 1.8	5	23.8*	± 2.1

Statistical significance (comparisons are between value with asterisk and the combined values above it): *P < 0.05 **P < 0.01

DISCUSSION

Two distinct fluorometabolites, F and OALF, are shown to be present after the start of methoxyflurane anesthesia. This was demonstrated most clearly after separation of the fluorometabolites by curtain electrophoresis, when it was shown that only one of the peaks was detected as fluoride ion by the fluoride electrode until after acidification. The same peaks have been seen in a non-toxic patient (Taves et al., 1970), and the presence of two fluorometabolites has also been confirmed by Holaday et al. (1970) from urine samples, with the acid-labile fraction being identified as methoxydifluoroacetic acid.

The concentrations of fluoride found in the non-toxic patients were considerably lower than those observed in the toxic patient but were at least 10 times the normal serum fluoride concentration, $0.8 \mu\text{M}$ (Taves, 1966), and concentrations in the pre-anesthetic samples (Fry, 1971). The maximum F and OALF concentrations in the serum occurred the day after anesthesia and averaged 32 and $940 \mu\text{M}$, respectively.

The relationship between the F and OALF concentrations, expressed as the OALF/F ratios for each sample, showed distinct differences between groups of patients and as a function of time, suggesting that there can be differences either in the metabolism of methoxyflurane or in the clearance of these metabolites from the body. The most striking difference, seen in all patients, was the increase in OALF/F ratio the day after anesthesia as compared to that at the end of the anesthetic period. The mean increases were 3- to 5-fold, which were highly statistically significant. The most likely reason for this change can be seen from an abbreviated outline (figure 5) of the metabolic pathways proposed by Mazze (1971) for the metabolism of methoxyflurane. There are two pathways for the metabolism of methoxyflurane to the presumed end product, oxalic acid. The known intermediates along each path are methoxydifluoroacetic acid (OALF) and dichloroacetic acid. F is seen to arise along either pathway, and its relationship to OALF would then be expected to change if the concentration of methoxyflurane changes relative to the OALF. The concentration of methoxyflurane in the blood has been reported to drop to less than one tenth of its value by the day following the end of anesthesia (Holaday, 1970). In contrast, as our study shows, the concentration of OALF increases 5-fold in the same period. The explanation is probably that F arises predominantly from methoxyflurane at first, and then as the methoxyflurane is rapidly lost via the lungs, a greater amount arises from OALF, which is slowly cleared from the blood by renal and metabolic mechanisms. Alternatively, it can be postulated that there are changes in the rates of clearance of F or OALF; however, this does not seem likely. The clearance of F is known to occur predominantly by kidney and bone (Hodge and Smith, 1965). If the bone clearance were to increase or the renal clearance increase relative to OALF renal clearance, the observed change in ratio might occur; but the bone clearance decreases with time on a given dose since it fills up with fluoride and the ratio of the renal clearance of OALF to F appears to remain constant (Fry, 1971). A decrease in the rate of metabolism of OALF might also account for the change, but this would require a large, consistent decrease in enzyme activity, which seems less likely.

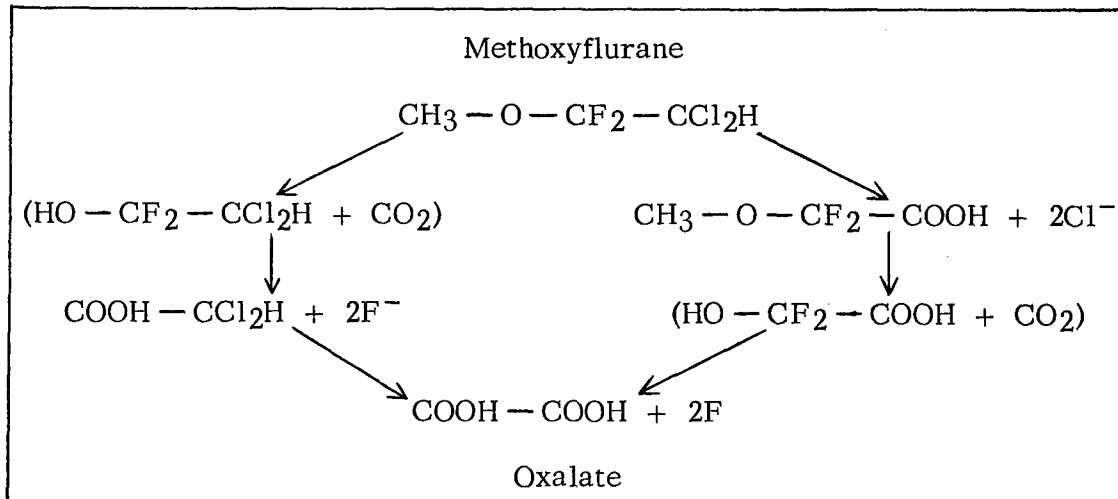

Figure 5. METABOLISM OF METHOXYFLURANE

The smaller differences in the ratios of OALF/F seen between adolescent and adult surgical patients and the obstetrical patients may involve differences in metabolism or clearance of fluoride by the bone. The amount of fluoride in adolescent bone is expected to be less than in adult bone (Hodge and Smith, 1965) and the rate of bone formation is much greater, which could explain the higher OALF/F ratios observed in the adolescent patients. The lower OALF/F ratio in obstetrical patients probably represents a difference in the primary rates of metabolism in the two pathways, since it seems unlikely that obstetrical patients would have reduced bone fluoride clearance. However, there are no data to demonstrate that the relative renal clearance of the two species of fluoride is the same in obstetrical and surgical patients, and hence a renal mechanism cannot be ruled out.

The reason for the large build-up in OALF after cessation of the anesthetic is not clear. From other data it is known that the renal clearance of OALF is about 10 ml/min, and the half-time of excretion varies from several hours to a day depending on the volume of distribution in the body. Thus, for a constant rate of production of OALF the concentrations would continue to rise for some time. However, with a sharply falling methoxyflurane concentration this seems to be an insufficient explanation. Holaday et al. (1970) noted a delay in the peak urinary excretion of these metabolites and postulated that the metabolic enzymes were depressed during the period of high concentration of methoxyflurane, but the evidence they give for this is not convincing. Thus this marked post-anesthetic build-up of OALF has not been well explained.

The implications of the increase in OALF and F following anesthesia with methoxyflurane are being actively pursued by a number of investigators. Methoxyflurane anesthetic has been administered 12 to 15 million times during the past 12 years, usually with no serious sequelae (NAS-NRC Committee on Anesthesia, 1971). There are, however, a few reports of cases of a highly variable incidence of renal dysfunction characterized by polyuria, loss of renal concentrating ability, and elevated levels of serum sodium and blood urea nitrogen. This syndrome appears to be caused by high concentrations of inorganic fluoride (NAS-NRC Committee on Anesthesia, 1971).

The concentration of F necessary to cause polyuria in man has been estimated to be about 60 μ M (Taves et al., 1970). This level has been shown to cause an 80% increase in urine flow rate in anesthetized rats. Preliminary evidence in the rat indicates that the sodium gradient from the cortex to the medulla which is required for making concentrated urine is markedly depressed by this concentration of fluoride in the serum (Whitford and Taves, 1971).

The role of metabolites other than F has received no attention as yet. It is possible that oxalic acid plays at least some part in the cases of nephrotoxicity that have led to death. It is obvious that we need considerably more information before the story is complete on this interesting and useful anesthetic.

REFERENCES

1. Fry, B. W.; Fluorometabolites of Methoxyflurane in Humans and Rats; Ph. D. thesis, University of Rochester (New York), 1971.
2. Fry, B. W. and D. R. Taves; "Serum Fluoride Analysis with the Fluoride Electrode;" J. Lab. Clin. Med., 75(6):1020-1025, 1970.
3. Hodge, H. C. and F. A. Smith; Fluorine Chemistry, Vol. IV, edited by J. H. Simons, Academic Press, New York, 1965.
4. Holaday, D. A., S. Rudofsky, P. S. Treuhart; "The Metabolic Degradation of Methoxyflurane in Man;" Anesthesiology, 33(6):579-593, 1970.
5. Mazze, R. I., J. R. Trudell, and M. J. Cousins (as cited by E. N. Cohen); "Metabolism of the Volatile Anesthetics;" Anesthesiology, 35(2):198, 1971.
6. NAS-NRC Committee on Anesthesia; "Statement Regarding the Role of Methoxyflurane in the Production of Renal Dysfunction;" Anesthesiology, 34(6):505-509, 1971.
7. Taves, D. R.; "Determination of Submicromolar Concentrations of Fluoride in Biological Samples;" Talanta, 15:1015-1023, 1968.
8. Taves, D. R.; "Normal Serum Fluoride Concentrations;" Nature, 211(5045):192-193, 1966.
9. Taves, D. R., B. W. Fry, R. B. Freeman and A. J. Gillies; "Toxicity Following Methoxyflurane Anesthesia: II. Fluoride Concentrations in Nephrotoxicity;" JAMA, 214(1):91-95, 1970.
10. Whitford, G. and D. R. Taves; "Fluoride Induced Diuresis: Plasma Concentrations in the Rat;" Proc. Soc. Exp. Biol. Med., 137(2):458-460, 1971.

HALOTHANE METABOLISM-ANALYSIS AND TOXICOLOGICAL IMPLICATIONS

James R. Trudell, Ph.D.

Stanford University
Stanford, California

Until recently all volatile anesthetics, with the known exception of trichloroethylene, were considered to be inert substances, eliminated from the body without alteration. This concept is no longer acceptable, and evidence is now available to indicate that most inhalation anesthetics of hydrocarbon structure are metabolized in the body.

Biodegradation of the clinically used volatile anesthetics has become an area of concern to both the anesthesiologist and the clinical pharmacologist. A number of recent investigations and developments have stimulated our interest in the implications of anesthetic metabolism. Among the significant questions to be answered are the possible toxic effects produced by anesthetic metabolites on vital organ systems such as the liver and kidney. Another serious question is the development of a sensitization response to certain anesthetics in susceptible individuals. Although the responsible factors at present remain unidentified, it is conceivable that sensitization results from the combination of small molecules with large protein fractions to form antigenic molecules. Of further concern is our knowledge that certain commonly administered drugs stimulate the metabolism of anesthetics, and that the anesthetics themselves may stimulate the metabolism of other inhalation anesthetics, as well as that of simultaneously administered drugs.

In vitro studies suggest that these effects result either from a physical alteration in enzyme structure, alteration of the microsomal membrane, or by a competition for "activated oxygen" (Korten, 1970). Of practical importance, certain preservatives, such as butylated hydroxytoluene, or n-phenyl-1-naphthylamine, which are added to the liquid anesthetics, will by themselves stimulate microsomal enzyme systems (Berman, 1970). Finally, of particular interest is a recent study indicating that anesthesiologists as a group metabolize halothane more efficiently than a control group of pharmacists. The implication of this study is that repeated exposure of anesthesiologists to this or other anesthetic gases in the operating room markedly stimulates enzyme induction systems (Cascorbi, 1970). Although enzyme induction in the above situation is slow and may involve weeks or months of exposure, induction of enzymes may be shown under other circumstances to begin within six hours and reach maximum levels within 24-48 hours (Van Dyke, In Press).

Inhibition of anesthetic metabolism may also occur, and has been demonstrated *in vivo* following treatment with various anti-metabolites such as SKF 525-A (Berman, 1970) or Disulfiram (tetraethylthiuram disulphide) (Scholler, 1970). Pretreatment with the latter drug actually serves to prevent the hepatotoxic effects of chloroform in rats, indicating that the damaging effects of this anesthetic may be due to "toxic metabolites." The suggestion has been made that the damaging effects following chloroform anesthesia may be related to a binding of free radical intermediates to cellular constituents within the liver (Van Dyke, 1969). Of further interest, chloroform hepatotoxicity cannot be produced in newborn animals, probably due to lack of development of drug metabolizing enzyme systems (Fouts, 1965).

It has also been shown that the rate of metabolism of an anesthetic may be influenced by the concentration being inhaled. When higher concentrations of halothane, methoxyflurane, or fluroxene were inhaled, their own biotransformation was inhibited, while in trace concentrations these anesthetics are extensively metabolized (Blake, 1967; Cascorbi, 1970; Sawyer, 1971; Van Dyke, 1964). High concentrations of anesthetic also reduce the metabolism of a variety of other drugs in a dose-dependent manner, suggesting an inhibition of the enzyme system by the anesthetic (Backeland, 1958; Brown, *In Press*).

Although halothane (2-bromo-2-chloro-1,1,1-trichloroethane) was originally introduced as one of the most stable of the hydrocarbon anesthetics, a significant degree of metabolism was soon demonstrated both *in vitro* and *in vivo* (Rehder, 1967; Stier, 1964; Van Dyke, 1964). As expected, the carbon to fluorine bond was not easily broken, and less than one percent $^{14}\text{CO}_2$ formed from 1- ^{14}C -halothane. The carbon to chlorine, and the carbon to bromine bonds, however, were more readily broken by liver microsomal enzymes which required the presence of reduced nicotinamide adenine dinucleotide phosphate (NADPH) and oxygen (Van Dyke, 1965). By measuring the amount of halothane taken into the body during an inhalation anesthetic, it was shown that 12-20 percent of the halothane could be accounted for in terms of nonvolatile urinary metabolites recovered over a 13-day period (Rehder, 1967). The major urinary metabolites have been suggested as bromide ion (Rehder, 1967; Stier, 1964) and trifluoroacetic acid (Rehder, 1967; Stier, 1966; Stier, 1967). Fluoride present in the urine is organically bound, with less than half of one percent as inorganic fluoride (Rehder, 1967). An evaluation of possible genetic and environmental influences on halothane metabolism has been studied recently in a small series of identical and fraternal twins. Intra-pair percent differences in the amounts of nonvolatile urinary metabolites were less in the identical than in the fraternal twins, suggesting the greater influence of genetic rather than environmental factors (Cascorbi, 1971).

A number of current studies have added to our information on the metabolism of halothane. Low temperature whole-body autoradiographic experiments in mice have demonstrated the accumulation of large amounts of nonvolatile metabolites in the liver following the injection of 1- ^{14}C -halothane (Cohen, 1969). These metabolites accumulate rapidly (9.2 percent present in the body within two hours), but leave the liver only slowly. Residual concentrations are present for at least 12 days. These nonvolatile

liver metabolites have been shown to be fluorine containing molecules in which the ratio of fluorine to ^{14}C remains unchanged from the parent ^{14}C -labeled halothane molecule. Thin layer radiochromatography indicates the presence of multiple metabolites in a liver extract which contains only 65 percent of the total radioactivity. The remainder of the radioactivity in the liver has thus far proven difficult to extract.

Although early investigators found trifluoroacetic acid as the only urinary metabolite of halothane, higher resolution techniques have revealed several others. Figure 1 shows the molecular weight distribution of urinary metabolites in swiss white mice, spider monkey, and man. Note the absence of high molecular weight fractions in man. This study along with other chromatographic evidence indicated that these mouse and monkey strains were poor models for the study of halothane metabolism in man. For this reason, our laboratory has discontinued animal studies with halothane.

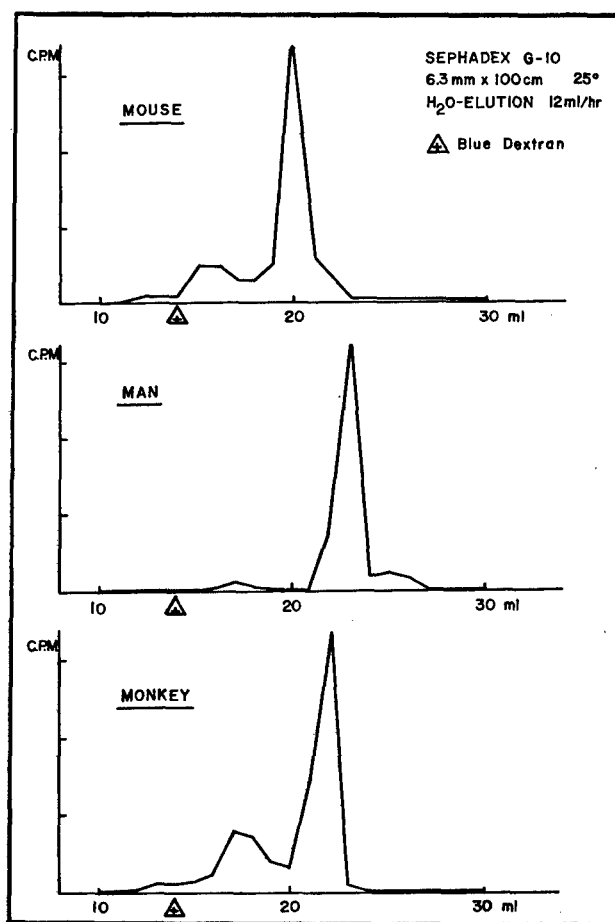

Figure 1

We have been studying the metabolism of 1-¹⁴C-halothane in man by administering 1-2 millicurie injections of anesthetic to human heart donors five hours prior to the heart transplant operation. Urine is collected continuously after the injection and the donor's liver, bile, and other organ samples are obtained after the heart excision.

The next figure (figure 2) shows the human urine run on an AG-50 cation exchange resin. In addition to the expected trifluoroacetic acid peak in the water elution, there is a significant positively charged component in the ammonia fraction (figure 3). Analysis on an AG-1 anion exchange resin reveals three peaks. The first has recently been identified in our laboratory as the trifluoroacetyl amide of ethanolamine. The third is trifluoroacetic acid and the components of the second peak are currently being investigated.

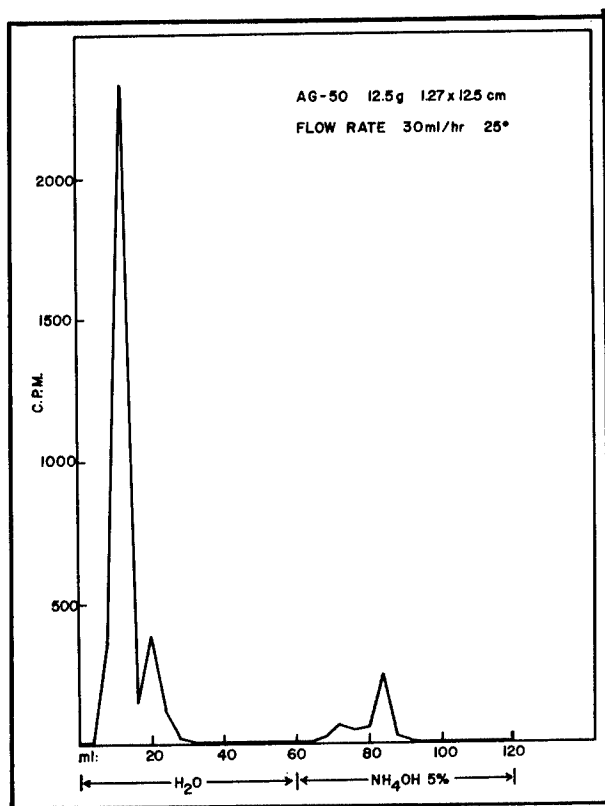

Figure 2

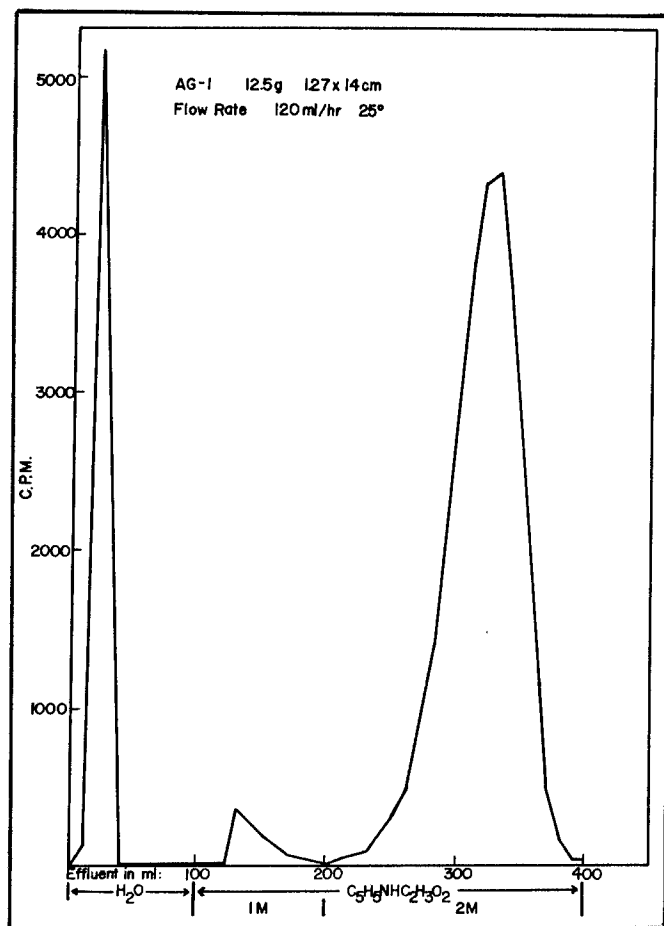

Figure 3

Figure 4 is a block diagram of the combined gas chromatography, electron capture, radio gas chromatography, and mass spectroscopy apparatus used to establish the structure of these metabolites.

Figure 5 is a radio gas chromatogram and flame ionization detector chromatogram of a derivatized preparation of the third and largest peak shown on the first AG-1 anion exchange resin. The next figure (figure 6) shows the mass spectrum of the component of the aforementioned peak after derivative formation. The molecular ion and fragmentation pattern show it to be methyl trifluoroacetate.

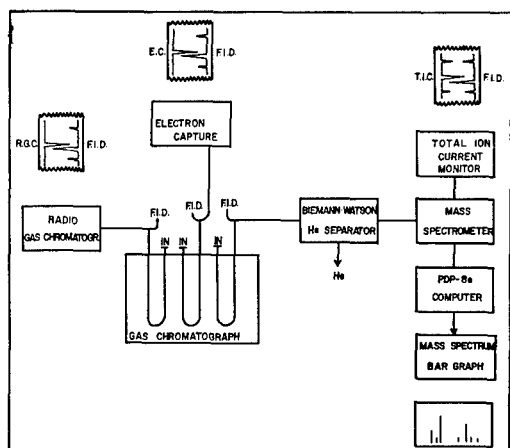

Figure 4

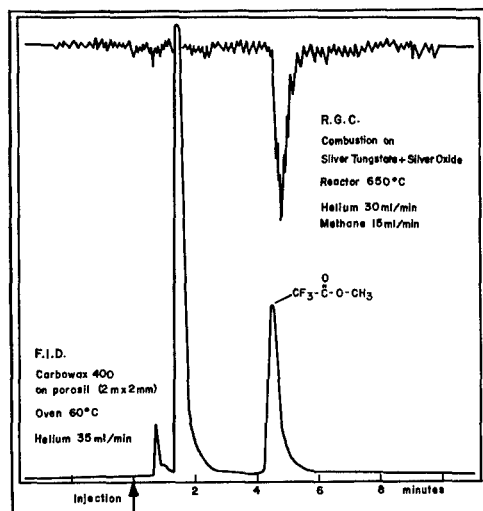

Figure 5

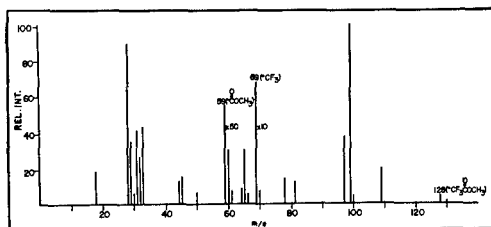

Figure 6

Figure 7 is a combined flame and radio gas chromatogram of the first peak off the AG-1 anion exchange column. Please note how the radio gas chromatograph allows one to decide which of the flame ionization detector peaks is a metabolite of interest. The peak which contains the radioactivity was introduced into the mass spectrometer and the spectrum in the next figure resulted (figure 8). The fragmentation pattern shows it to be a trifluoroacetyl amide of ethanolamine even though no molecular ion is seen.

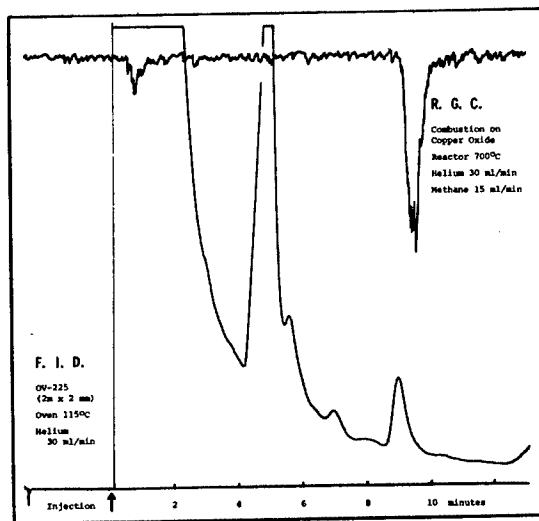

Figure 7

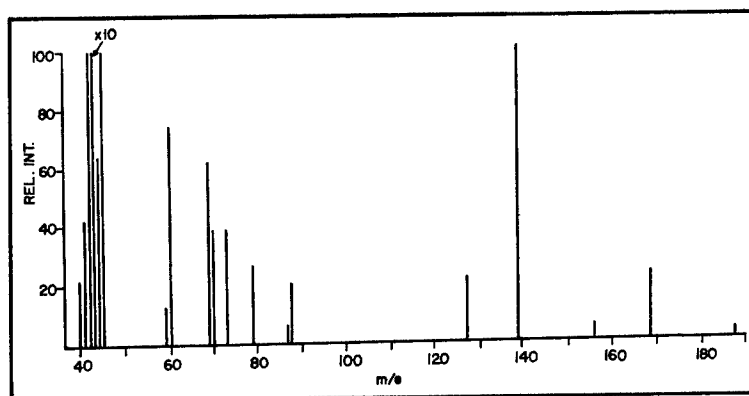

Figure 8

In summary, we have found that in order to be clinically useful, we had to do our study in man. Species differences made any conclusions drawn from animal studies about liver damage unreliable when applied to man. We believe we have made the first use of a heart donor for administration of a high activity dose of a drug. It is hoped that this will become a useful technique for other metabolism studies. We have found and partially identified three metabolites in urine in addition to confirming trifluoroacetic acid as the major metabolite. When the urinary metabolites are known, we hope this knowledge will lead us to elucidation of the metabolites which are bound to the liver and in turn to the mechanism of liver damage. Finally we plan to look at the antigenic, toxic, and enzyme altering effects of each of these metabolites.

REFERENCES

1. Backeland, F. and N. M. Greene; "Effect of Diethyl Ether on Tissue Distribution and Metabolism of Pentobarbital in Rats;" Anesthesiology, 19:724, 1958.
2. Berman, L. M. and B. S. Bochantin; "Evidence of Enzyme Induction by Preservatives in Volatile Anesthetics;" Conference on Cellular Toxicity of Anesthetics, Seattle, 1970 (In Press).
3. Berman, L. M. and J. F. Bochantin; "Non-Specific Stimulation of Drug Metabolism in Rats by Methoxyflurane;" Anesthesiology, 32:500, 1970.
4. Blake, D. A., R. S. Rozman, H. F. Cascorbi, et al.; "Anesthesia LXXIV: Biotransformation of Fluoxene-I. Metabolism in Mice and Dogs In Vivo;" Biochem. Pharmacol., 16:1237, 1967.
5. Brown, B. B. and L. D. Vandam; "A Review of Current Advances in Metabolism of Inhalation Anesthetics;" Proc. N. Y. Acad. Sci. (In Press).
6. Cascorbi, H. F., D. A. Blake, and M. Helrich; "Differences in Biotransformation of Halothane in Man;" Anesthesiology, 32:119, 1970.
7. Cascorbi, H. F., E. S. Vesell, D. A. Blake, et al.; "Genetic and Environmental Influence on Halothane Metabolism in Twins;" Clin. Pharm. and Therap., 12:50, 1971.
8. Cohen, E. N. and N. Hood; "Application of Low-Temperature Autoradiography to Studies of the Uptake and Metabolism of Volatile Anesthetics in the Mouse: III. Halothane;" Anesthesiology, 31:553, 1969.
9. Fouts, J. R. and L. G. Hart; "Hepatic Drug Metabolism During the Perinatal Period;" Ann. N. Y. Acad. Sci., 123, 124, 1965.

REFERENCES, Continued

10. Korten, K. and R. A. Van Dyke; "The Acute Effects of Volatile Anesthetics on the Biotransformation of Drugs;" Abstract, Annual Meeting A. S. A., New York, 1970, p. 34.
11. Rehder, K., J. Forbes, H. Alter, et al.; "Halothane Biotransformation in Man: A Quantitative Study;" Anesthesiology, 28:711, 1967.
12. Sawyer, D. C., E. I. Eger, S. H. Bahlman, et al.; "Concentration Dependence of Hepatic Halothane Metabolism;" Anesthesiology, 34:230-235, 1971.
13. Scholler, K. L.; "Modification of the Effects of Chloroform on the Rat Liver;" Brit. J. Anaesth., 42:603, 1970.
14. Stier, A.; "Trifluoroacetic Acid as Metabolite of Halothane;" Biochem. Pharmacol., 13:544, 1964.
15. Stier, A., H. Alter, O. Hessler, et al.; "Urinary Excretion of Bromide in Halothane Anesthesia;" Anesth. Analg., 43:723, 1964.
16. Stier, A. and H. Alter; "Stoffwechselprodukte des Halothan Im Urin;" Der Anaesthetis, 15:154, 1966.
17. Stier, A.; "The Biotransformation of Halothane;" Anesthesiology, 29:388, 1967.
18. Van Dyke, R. A., M. B. Chenoweth, and A. Van Poznak; "Metabolism of Volatile Anesthetics: I. Conversion In Vivo of Several Anesthetics to $^{14}\text{CO}_2$ and Chloride;" Biochem. Pharmacol., 13:1239, 1964.
19. Van Dyke, R. A. and M. B. Chenoweth; "The Metabolism of Volatile Anesthetics: II. In Vitro Metabolism of Methoxyflurane and Halothane in Rat Liver Slices and Cell Fractions;" Biochem. Pharmacol., 14:603, 1965.
20. Van Dyke, R. A.; "On the Fate of Chloroform;" Anesthesiology, 30:257, 1969.
21. Van Dyke, R. A.; "Biotransformation;" Section 5.2, Handbuch der Exp. Pharmakologie, Band XXX, Springer Verlag, Heidelberg (In Press).

OPEN FORUM

DR. HODGE (University of California Medical Center): I would like to ask Dr. Fry a question. Would you go through enough of the experimental procedure so that I understand exactly how you determined inorganic fluoride and the organic acid-labile fluoride?

DR. FRY (Medical College of Georgia): Inorganic fluoride in the serum was determined with a fluoride electrode by a method published by Dr. Taves and me last year. We had to buffer serum with a concentrated acetate buffer in order to get reproducible reliable readings. This procedure has been developed to the extent where an inverted fluoride electrode has been set up, and I can analyze as little as 25 microliters of serum. I used this technique to analyze infant serum and serum collected in microhematocrit capillary tubes from rat tails. When we get the inorganic fluoride in the serum, we then analyze it by the method described by Dr. Taves in 1968; this involves the acidification of a sample of biological fluid (serum or urine). His procedure was modified by me, so that I could use the fluoride electrode to measure the diffused fluoride. I made the serum about 1.5 N by adding sulphuric acid and put it in micro-diffusion dishes. In order to get all the organic acid-labile fluoride over, it is necessary to diffuse for 16 hours in contrast to the 2 or 3 hours that Dr. Taves found inorganic fluoride diffused over. There is the need to make this difference in the hexamethyldisiloxane acid diffusion of fluoride. All of the inorganic fluoride and the organic acid-labile fluoride, the two peaks that we showed, can be accounted for by doing an acid diffusion of the sample. The one other change that we made was that Dr. Taves used a sodium carbonate buffer, or trapping solution, to trap the fluoride diffusing out of the sample, and in order to use a fluoride electrode, I used sodium hydroxide and added two equivalents of acetic acid for every equivalent of base in order to neutralize and buffer the solution, in order to take a direct reading with the fluoride electrode. If you're in a hurry and don't want to wait overnight for diffusion, you can diffuse at elevated temperatures if you seal those dishes with silicone grease rather than vaseline. I can do a complete analysis of serum for fluoride and organic acid-labile fluoride in about two and one-half hours. If you're only going after inorganic fluoride, you can do it in about five minutes.

DR. HODGE: One additional question. Normally human blood has also some fluoride that travels with the albumin fraction in an electrophoretic field. The two that you have mentioned - are neither of them connected, equivalent to, or disturbed this other, whatever it is, fluoride. Is that true?

DR. FRY: That is correct. When you ash a sample of normal human serum you get between five and eight micromolar fluoride. When you analyze with the fluoride electrode you get a reading of less than one. Dr. Taves' method of hexamethyldisiloxane diffusion gives a fluoride of about one, so this protein-associated fluoride is not diffusible; it is not an acid-labile fluoride.

DR. ROWE (The Dow Chemical Company): Along that same line, I'd like to ask Dr. Fry if he's made any efforts to identify those organic fluorides?

DR. FRY: I did not mention it. We thought about trying to isolate a large amount of it and identify it, but about this time Dr. Holaday's report came out indicating the presence of methoxydifluoroacetic acid, and he identified it. We were satisfied that we were looking at the same thing. This is based on his observation and ours which shows that this material breaks down in stored serum. If you collect serum from a patient and store it in a refrigerator or freezer, the inorganic fluoride gradually increases. Dr. Holaday noted that this happened to his samples and we have noted it in our samples. I did manipulate about 20 liters of urine collected from patients who received methoxyflurane, and I had what I thought were several hundred millimoles of this material. It was very difficult to handle and it kept breaking down. I lost 20% on an overnight lyophilization, for example. It broke down into inorganic fluoride, so we realized it was a very labile material and would be very hard to get hold of.

DR. CARHART (U. S. Naval Research Laboratory): I would like to ask Dr. Waritz if he could expound a little bit on the Haskell Laboratory experience on the toxicity of Freons 1301 and 2402. We heard a little bit about it from Dr. Van Stee, but you avoided these and I don't know if you did this on purpose or not.

DR. WARITZ (E. I. du Pont de Nemours and Company): No, I didn't avoid them on purpose. I thought they would be covered later. I was not involved in that work at Haskell. The only work I was involved in was the acute exposure to rats with 80% 1301 and 20% oxygen for four hours, and I am not familiar with the details of the rest of that work.

DR. SCHEEL (U. S. Public Health Service): I'd like to ask a question about the fluorocarbons that contain hydrogen. We have talked a lot today about fluorocarbons without hydrogen, but there are fluorocarbons that do contain hydrogen. What is the stability of these compared to the ones we have been talking about?

DR. WARITZ: I don't know that I can give you a direct or exact answer to these. I just can't recall, for instance, with vinylidene fluoride or vinyl fluoride, what the lethal concentrations of these are. As to the stability, I am not involved in stability studies. I'm sorry I missed a part of that.

DR. SCHEEL: The part that we haven't talked about today are plastics like vinylidene fluoride which contain hydrogen. The vinyl fluorides, everyone knows, dehalogenate in a single specific reaction, and this occurs at a temperature separate from the carbon-carbon oxidation reaction. Now, the question is, when talking about vinylidene fluorides or hydrogen-containing polymers, are we talking about the same sort of thing that we're talking about in terms of these small molecular weight fluorocarbons? This is, I think, essential to understanding the difference between plastic polymers and what we have been talking about and calling Freons, as a generic name.

MR. VERNOT (Systemed Corporation): This is addressed to Dr. Trudell. It appeared to me that you were using the radiocarbon-14 as a tag to identify those peaks in your separatory procedures which you wanted to identify by mass spectrometric procedures. Aren't you a little concerned that you might have missed some of the metabolic products from which that particular carbon had been removed, and yet which might be metabolically or toxicologically active?

DR. TRUDELL (Stanford School of Medicine): Yes, it is a concern. I think the only way around that concern is to make the other tag. It is already extremely expensive to buy halothane labeled with that carbon; it would be about twice as much as the other carbon. Another thing holding me back from doing that so far is my feeling that what's happening to halothane is that the fluorines are remaining intact to it, and depending on the enzyme we're speaking of, and that is difficult to define, I'm losing either hydrogen, bromine or chlorine. I would presume either hydrogen or bromine as an initial step, and that this ethane, which is then a very reactive intermediate, is being added to either a protein fraction or a phospholipid. I think as a first guess there is not very much of the simile of one carbon bearing the chlorine and the bromine being stuck on as though it were formaldehyde. For instance, we did cite the fact that using the carbon-14 label at the fluorine end, we see a very little bit of carbon-14 dioxide, and if the opposite end of the molecule were being tagged, you'd expect to see carbon dioxide with the label in the expired air. I might add that you do see perhaps as much as one percent. This does mean that your suggestion is correct to that extent. Certainly, if you're getting that much carbon dioxide, you have that degree of the other carbon floating around.

DR. BACK (Aerospace Medical Research Laboratory): How much bromine do you find in the blood after halothane?

DR. TRUDELL: I can't give you a number.

DR. BACK: Do you find any?

DR. TRUDELL: You certainly must see it. I can say that it is extensively excreted in the urine, and it's almost surely broken off in the liver, and I think that means it must go from the liver into the blood and to the kidney. I have not measured that, but it has been done by Stier and Rehder who accounted for between 12% and 20% halothane intake in terms of excreted bromide ion; that's how those numbers were first arrived at. So you do see that level of bromine in the urine and so it must at one point be in the blood.

DR. BACK: The reason I ask is that Mr. Vernot and others did work exposing rats to monochloromonobromomethane for five hours a day for six months and we didn't postulate any breakdown. After awhile, we were getting breakdown to the point where the rats were probably under the influence of bromine; that is, the animals were getting sleepy. I wondered if this kind of an effect was taking place with halothane over any period of time, or were these all acute studies?

DR. TRUDELL: No, these were not acute. This occurs over about 13 days to clear the body of 95% of the injected anesthetic. That means that a whole lot of it has been stored probably not as intact halothane in the fat but as a metabolite to parts of the body. We have given it to mice and after 10 minutes, 1, 2 and 4 hours, dropped them into liquid nitrogen, sliced them in half while frozen, laid them on film, and radiographically we have gotten a very good idea of how the distribution looks in the various organs. A very large amount goes immediately to the brown fat, and a lot to the liver. But, after 4 hours, then after 12 hours and at 2 days, there is a great deal left in the liver and almost none in the rest of the animal. One can then take a thin slice of this frozen mouse, pump it under vacuum, and still see the same picture of radioactivity in the liver.

DR. ROWE: I'd like to address a question to Dr. Waritz. Did you do any fluoride analyses on your specimens that had received prolonged and repeated exposures to the various materials?

DR. WARITZ: The only ones that we have done for prolonged exposures were C318 and 115 where urinary and bone fluorides were done. I don't recall that any of them were outside the normal limits.

DR. ROWE: I think that is very pertinent because with some pretty stable compounds containing fluoride, you'll find an accumulation of fluoride even when they are metabolized.

DR. FRY: May I make a comment about fluoride? In some of my work, I used intraperitoneal injections of halothane in rats to compare it with the methoxyflurane, and I collected daily urines. I found an increase, almost a doubling, of the fluoride output in the urine of the halothane-dosed rat.

DR. ROWE: That is not surprising.

DR. FRY: Well, where did the fluoride come from, that is the question?

DR. ROWE: Well, I think there's probably some metabolism. There has to be.

DR. TRUDELL: I'd like to comment on the fluoride ion. We've been also working on metabolism of methoxyflurane at Stanford, and we've been wondering what happens to the body - why, in this case, not the liver but the kidneys fail. We have been giving intravenous and intraperitoneal fluoride ion as sodium fluoride to mice, and we can duplicate the renal shutdown, the polyuria, by just shooting in intraperitoneal sodium fluoride at about the same level as occurs after a normal methoxyflurane anesthesia, suggesting that this might be the culprit. I had first thought that, as was shown on Dr. Fry's slide, the oxalic acid, the final metabolic product, was causing calcium oxalate to accumulate in the distal tubules, shutting down the kidney. But now we are doing so very well in duplicating the entire syndrome by injecting fluoride that I now think once you start worrying if the compound is putting out fluoride, start worrying about the kidneys.

DR. ROWE: I don't know how often these anesthetics are given repeatedly, so there is some saving grace there, but in other materials where we may have repeated exposures this becomes another matter, because of possible accumulation over a period of time. That is why I asked the other question.

FROM THE FLOOR: I have a question I'd like to ask Dr. Van Stee. Did you do any exposures longer than three days in the effort to induce metabolic stimulation?

MAJOR VAN STEE: No, we did not. We selected three days, five hours per day, as the method which we thought would reveal which of these compounds we could call potent inducers, or which we would suspect to be likely potent inducers. And so, we limited all of our exposures to this five hours per day times three. I agree that many inducers do require much longer than this, but this test would reveal the very potent ones such as 2402.

DR. CAMPBELL (Environmental Protection Agency): Dr. Waritz, your terminology for the lethal concentrations, I believe, was ALC, and this somehow or other is strange to me. I wonder if you would explain just which lethal concentration that is.

DR. WARITZ: This is an abbreviation for the term Approximate Lethal Concentration.

DR. CAMPBELL: Then I'll ask you further how you define that?

DR. WARITZ: This is done much the same way as the approximate lethal dose for oral administration in which you have a set schedule of dosing, each level being 50% greater than the preceding one, and the first level at which you get deaths is called the Approximate Lethal Concentration.

DR. CAMPBELL: I'm sorry, I didn't mean to lead you down that path either, but does it come close to a minimal, median or maximum lethal concentration? In that kind of spectrum, does your value fit?

DR. WARITZ: It can fit anywhere in that. I don't like the term, and in studies that I run we use the LC_{50} wherever possible. In the case of these fluorocarbons which are easily analyzed, it is easy to determine the LC_{50} . There was one study carried out that originally proposed this concept and which indicated, at least in the case of oral dosing, that approximately half the time the ALD would be greater than the LD_{50} , and about half the time it would be less than the LD_{50} .

DR. CAMPBELL: Anything between 10% and 90%? This is a wide range in terms of lethal concentration.

DR. WARITZ: Right, and if you want to compare things, I feel it is useless. If you want to compare toxicities, you can't get dose response curves; you have no confidence limits. It's something that grew up with inhalation toxicity because in the early studies the analytical part was really horrendous. Now, with the gas chromatograph, it is very simple.

DR. CAMPBELL: So that by today's standards, we wouldn't be using that terminology any more, would we?

DR. WARITZ: We still do on some studies, but if it is something we're going to publish, it's sure to have the LC_{50} on it. But, if a department wants you to run a study on a compound on which they are doing a little bit of bench work, and just wants a ball park idea of what the toxicity is, you can get a rough idea pretty quickly with a few exposures this way. Whereas, if you really want to do the LC_{50} and really define it, you're going to have to spend quite a bit of money on it.

DR. ROWE: Dr. Hodge, correct me, but I think that was Dr. Deichman's original proposal, the ALD.

DR. LEE (Environmental Protection Agency): I have a question for Dr. Azar. You mentioned an increase of endogenous epinephrine level due to exposure. How was this measured?

DR. AZAR: We did not measure the actual epinephrine levels. The analytical technology available for measuring blood levels of epinephrine is quite difficult. In addition, we have been interested in the peak or burst level, and this is very difficult to obtain. We did not measure the epinephrine levels. By endogenous epinephrine, I mean that if you have a dog running on a treadmill, there are some studies that have been done measuring urine endogenous epinephrine. The Japanese have reported approximate doubling of the endogenous epinephrine levels in dogs. But we did not measure the epinephrine levels in our dogs.

DR. LEE: In your bathroom experiment, have you done any chamber chemistry to say that you found different concentrations at different height levels?

DR. AZAR: Yes. I didn't do the study, but they did do this and they looked at the floor, corners and various areas of the room.

MR. MOBERG (Analytical Research Laboratories, Inc.): I'd like to make an observation or two that I think are pertinent to the work reported this morning, and this afternoon as well. In some recent studies for a NASA program, we were evaluating Freons on activated materials and trying to determine if they were found in situ or if they were actually collected and measured from the closed ecological systems that we were concerned with. I think the observations are interesting, because first of all when adsorbants were used, we found a very large number of compounds that were apparently degradation products of the Freons. We backed up a step and found

quite a bit of inter-Freon contamination. I recognize that the Freons were supposedly quite pure to start with, but Freon 12 might have some Freon 11, and so forth, and Freon 113 have some Freon 12 dissolved in it. Starting from that point, we tried to see if other compounds were developed and apparently they were. Just about every compound that could be designed on paper was found actually from desorbance of these active materials. Now, the materials we were looking at were surface areas of more than 300 square meters per gram, and I propose an interesting thought here. Possibly the lung surface would resemble an adsorbance surface and you might have catalysis then occurring on this surface, because we did find that catalysis occurred on the surface of these adsorbants. Whether it was related to the micropores or transitional pores or macropores, we are not too sure. Some of this was related to the adsorption coefficients and would suggest that they were micropore catalysis, but apparently free radicals formed and all types of recombinations occurred where we would have halogens going on to aromatic structures that were not previously there. So, I would say that we have much work to do on the analysis of the actual surface of the lung, or the fluid that is on the surface to see if some of the toxicological observations made today were related to the actual Freon that was used or whether it was related to a catalytic product or some other byproduct that was apparently unrelated from normal chemical conjecture. I think when you consider you have carbon monoxide, carbon dioxide and oxygen on the lung surface, in addition to metal ions and chelated metal ions, you have an ideal situation for free radical forms, recombinations and catalysis. The bond energies from the adsorption studies that we made could go as high as 20 to 30 kcal, and now we're getting awfully close to the bond structures of some of the materials that actually are present and observed in the various fluorinated hydrocarbons.

DR. TRUDELL: I'd like to share a similar observation. When buying labeled hydrocarbons for my research, I have received compounds specified as being 95-98% pure, but which were in fact only 80% pure, the impurities being extremely reactive in some cases of butenes which were supposed to be halothane. Had I not found out and purified it, these studies would be truly worthless because the very reactive small contaminants would have swamped out the small amount, that is, less than one percent, which normally occurs in halothane. I would caution everyone buying labeled materials to do your own radio gas chromatography, radio thin layer, and check the chromatogram given by the company.

DR. ROWE: Very, very important point.

DR. ELLIOTT HARRIS (National Aeronautics and Space Administration): With all the discussions we've had today, have the people who have been involved checked the purity of the material they were giving? I guess that is directed to all of you.

CONTINUOUS ANIMAL EXPOSURE TO METHYLENE CHLORIDE

Charles C. Haun

SysteMed Corporation
Wright-Patterson Air Force Base, Ohio

Elliott S. Harris, Ph.D.

National Aeronautics and Space Administration
Houston, Texas

and

Kenneth I. Darmer, Jr.

SysteMed Corporation
Wright-Patterson Air Force Base, Ohio

INTRODUCTION

Dichloromethane, also known as methylene chloride, is used extensively as a solvent in many of the space cabin construction materials. The provisional space cabin limit has been set at 25 millimoles/25 M³ (25 ppm) for 90-day flights, and 5 millimoles/25 M³ (5 ppm) for 1000-day flights (Space Science Board, NAS-NRC, 1968). To properly assess the inhalation hazard to astronauts, 2 high levels, 1000 and 5000 ppm, were intentionally selected and 4 animal species were exposed continuously to these concentrations for periods of not more than 14 weeks. In a previous study Heppel et al. (1944) exposed dogs, rabbits, guinea pigs and rats to 5000 ppm intermittently for 7 hours per day, 5 days per week for periods up to 6 months. They found subnormal weight gains, decreased food intake and death of 3 of the 8 guinea pigs after 35, 90 and 96 exposures, respectively. Examination of the animals that died showed pneumonia and centrilobular fatty degeneration of the liver. However, none of the other species showed any evidence of toxicity during the course of exposure. CNS effects, varying in degree, were produced in the four species previously mentioned, and in monkeys exposed to 10,000 ppm on a 5 day per week, 4 hour per day schedule. Dogs were removed after 6 exposures because of injuries from hyperactivity while all other species finished 36-38 exposures. Lehmann and Schmidt-Kehl (1936) observed only drowsiness and slight reduction in body temperature in cats and rabbits exposed 8 hours a day, 6 days a week to concentrations of 1728-2036 ppm for 4 weeks. Little other work has been reported on the chronic toxicity of dichloromethane.

Acute LC_{50} values for mice have been reported as 14,500 ppm for a 2-hour exposure (Browning, 1965) and 16,188 ppm for an 8-hour exposure (Svirbely et al., 1947). Human exposure includes the fatality of one of four men accidentally exposed to undetermined concentrations (Moskowitz and Shapiro, 1952) and the nonfatal exposure of 33 workers to levels of approximately 29-5000 ppm (Kuzalova, 1966).

In the study reported here, both exposed groups and the control groups consisted initially of 8 female dogs, 4 female rhesus monkeys, 20 male Sprague-Dawley rats and 380 female ICR mice. An additional 20 mice were used in the 5000 ppm exposure to measure spontaneous activity.

Each group of animals was housed in separate Thomas Domes operated at 725 mm Hg pressure to avoid leakage of the gas. Nominal airflows of 40 cfm were used in all cases.

The dichloromethane used in this study was a technical grade and was analyzed by the mass spectrometer to be approximately 99% pure. During exposure, continuous analysis of concentration level in each dome was performed by using a Beckman flame ionization hydrocarbon analyzer (Archibald, 1971).

A large number of parameters were selected to measure the chronic toxicity of this compound. Signs of toxic stress were noted as well as numbers that died and times to death. Body weights of rats, dogs and monkeys were measured on biweekly schedules throughout the duration of the study. Organ weights were taken on rats that were sacrificed after one month of exposure and at the conclusion of the experiment. Gross and histopathologic examinations were made on animals that died or were sacrificed during the study, and on animals that were killed at termination of the study.

Table I shows the various clinical chemistry tests performed on blood samples taken from dogs and monkeys at the beginning and, when available, at the conclusion of the study. Table II shows the hematology measurements. It also shows serum enzymes, glutamic pyruvic transaminase (SGPT) and isocitric dehydrogenase (ICDH), and a liver function test using bromsulfalein that were of particular interest in the experiment. The tests shown in this table were performed at 4, 8 and at 13 or 14 weeks.

Additional tests included the measurement of dichloromethane in blood and urine of dogs at both exposure levels; spontaneous activity of mice for various time periods; and cytochrome B_5 and P450 analysis of mouse livers. These last two studies are the subjects of subsequent papers by Drs. Thomas and Bullock and need no further mention at this time.

TABLE I

CLINICAL CHEMISTRY TESTS PERFORMED ON
DICHLOROMETHANE-EXPOSED AND CONTROL
DOGS AND MONKEYS

Sodium	Total Bilirubin
Potassium	Uric Acid
Calcium	BUN
Albumin	Glucose
Total Protein	LDH
Cholesterol	Alkaline Phosphatase
Inorganic Phosphorus	Creatinine
SGOT	Chloride

TABLE II

OTHER CLINICAL TESTS PERFORMED ON
DICHLOROMETHANE-EXPOSED AND CONTROL
DOGS AND MONKEYS

<u>Hematology</u>	<u>Serum Enzymes</u>
Hematocrit	SGPT
Hemoglobin	ICDH
Red Blood Cell	<u>Liver Function</u>
White Blood Cell	BSP
Reticulocyte	

RESULTS

Toxic Signs

In regard to signs of toxicity, the narcotic effects were very noticeable in dogs and to a lesser extent in monkeys and mice during the first day of exposure to 5000 ppm. The rats appeared normal. By the second day of exposure, dogs and monkeys regained coordination; however, they as well as the mice were very lethargic and remained so until death due to exposure or sacrifice. Food consumption was noticeably reduced in all species. Emaciation in dogs and monkeys became progressively worse as exposure continued. In fact, in dogs it was so advanced in many cases that blood sampling was difficult and often unsuccessful. Animals exposed to 1000 ppm dichloromethane showed similar signs of toxicity, but to a far lesser degree, except for dogs. Appetite suppression was evident in about 80% of the large animals, while the rodents showed little visible evidence of toxicity.

Body Weights

The growth rates of the 3 rat groups are shown in figure 1. The weight measurements, made every 2 weeks, show dose and time dependent effects of chronic exposure to dichloromethane. Immediately noticeable is the 15 gram mean weight loss of the 5000 ppm exposed rats by 2 weeks. Compensatory increase occurred by 4 weeks and from that point steady but obviously subnormal weight gains continued until termination of the study. In the case of the 1000 ppm exposed rats, it can be seen that weight response is delayed until after 6 weeks of exposure. From 6 weeks until the study was concluded, their mean weight is certainly subnormal compared to control. At 14 weeks, the mean weight of 1000 ppm exposed group is 35 grams less than control,

and the 5000 ppm exposed group is 80 grams less than control. Statistical comparisons confirm these weight differences, at the 0.01 level, in all cases.

Monkeys exposed to 1000 ppm survived the entire 14 weeks. They showed small weight losses at 2 weeks, gains at 4 weeks equal to their original weights then maintained these weights for the duration of the study. However, dogs and monkeys exposed to 5000 ppm and dogs exposed to 1000 ppm showed severe weight losses until they died or were sacrificed. For example, dogs exposed to 5000 ppm showed a mean loss of 32% as early as 2 weeks. By 3 and 4 weeks, losses were as high as 45% of the original weights. Three of 4 monkeys exposed to 5000 ppm for 4 weeks showed a mean loss of 21%. A 48% loss was recorded for one monkey that died at 2 weeks. Although dogs exposed to 1000 ppm lost only an average of 9% after 2 weeks of exposure, losses continued, and at 6 weeks the mean loss from original weight was 38%.

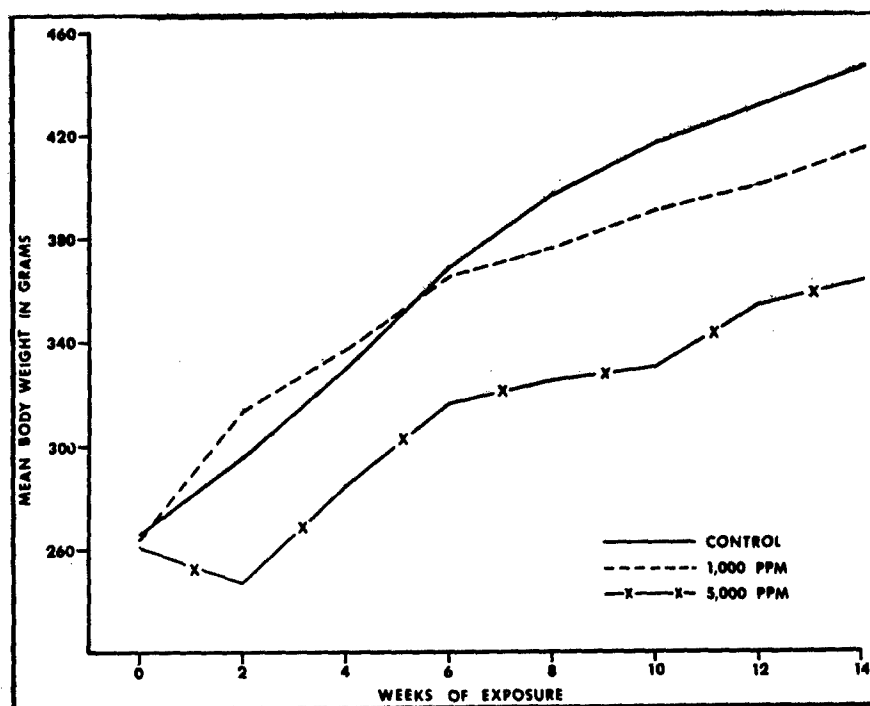

Figure 1. EFFECT OF CHRONIC DICHLOROMETHANE EXPOSURE ON RAT GROWTH.

The numbers of animals that died during the course of the experiment are shown in table III. Mortality in control animals was limited to 3 mice, one during the first month and 2 during the second month of exposure to air only. No exposed rats died and all 4 monkeys survived the 3-month exposure to 1000 ppm. Death was more immediate in animals exposed to the 5000 ppm dose level. By 4 days, 23 mice had died from exposure to 5000 ppm. An additional 100 were dead after one month. The first death of a large animal, a monkey in this same experiment, occurred at approximately 2 weeks. This was followed by the death of 4 of 8 dogs during the third and fourth weeks of exposure to 5000 ppm.

Due to the rather severe effect of one month continuous exposure to 5000 ppm and the obviously poor condition of large animals, we decided to sacrifice all surviving dogs, monkeys, mice and 10 of the 20 rats for pathology and to obtain rat organ weights. Five control rats were also sacrificed at this time for comparison with the ten 5000 ppm exposed rats.

Although one mouse did die during the first month of exposure, it can be seen in table III that the onset of mortality in animals exposed to 1000 ppm was delayed until the second month. Six more mice died and 6 of 8 dogs succumbed by the seventh week of exposure. Since death was imminent in the 2 remaining dogs, they were sacrificed at this time. During the third month, as the table shows, no other mortality occurred in any animal group, except in the case of 3 mice exposed to 1000 ppm.

TABLE III
MONTHLY MORTALITY IN ANIMALS EXPOSED TO DICHLOROMETHANE AND CONTROL

Species	1 Month			2 Months			3 Months		
	Control	1000 ppm	5000 ppm*	Control	1000 ppm	5000 ppm	Control	1000 ppm	5000 ppm
Mice	1	1	123	2	6	--	0	3	--
Dogs	0	0	4	0	6**	--	0	--	--
Monkeys	0	0	1	0	0	--	0	0	--
Rats	0	0	0	0	0	0	0	0	0

* 5000 ppm exposure terminated at 1 month except for 10 rats that completed 3 months of exposure.
** Two surviving dogs were sacrificed.

Table IV summarizes the total mortality produced in this study. The mortality figures for the 5000 ppm exposed animals represent only one month of exposure, except for 10 rats that completed 14 weeks of exposure.

Species	Control	1000 ppm	5000 ppm
Mice	3	10	123
Dogs	0	6	4
Monkeys	0	0	1
Rats	0	0	0

Clinical Results

As mentioned previously, significant numbers of exposed dogs and monkeys either died or were sacrificed during the first one third to one half of this study. This, or the very poor condition of the animals available, prevented blood sampling on a regular schedule. However, one of the first changes we noticed was in hematology results from samples taken at 4 and 8 weeks. At 4 weeks, there were significant elevations in hematocrit, hemoglobin and red blood cell values in dogs exposed to 1000 ppm. For example, the mean HCT value for controls was 42% compared to 56% for the exposed dogs. Monkeys at this same concentration level also showed increased HCT and RBC values. Hemoconcentration was attributed to starvation (little intake of food and water particularly in the case of dogs) due to the debilitating effect of dichloromethane exposure.

A minimal number of results of serum enzyme measurements, glutamic pyruvic transaminase, isocitric dehydrogenase, and a liver function test using bromsulfalein provide some evidence of deleterious liver changes in exposed dogs and monkeys.

Table V reveals that at 4 and 7 weeks, SGPT values for 1000 ppm exposed dogs were significantly elevated above control and their own preexposure levels. At 4 weeks, the value for the exposed dogs was about 3.5 times greater than control (102 versus approximately 29). At 7 weeks, for 2 dogs only, the value was approximately twice that of the control (76 versus 35). In the case of the monkeys exposed to 1000 ppm, there were no significant differences.

The results of the ICDH measurements are shown in table VI. At 4 weeks, the ICDH levels in 1000 ppm exposed dogs were nearly twice as great as the control (353 versus 193). At 7 weeks, the control value had risen but the mean value for 2 exposed dogs still appeared to be elevated. In light of the range of values shown for exposed and control monkeys, the difference at 4 weeks (351 for exposed versus 262 for control) is of questionable significance.

Time	Dogs		Monkeys	
	Control	1000 ppm	Control	1000 ppm
Preexposure	24.4	19.7	30.2	29.2
4 Weeks	28.8	102.2	25.5	29.2
7 Weeks	34.5	76.0**		
8 Weeks			31.0	25.7
14 Weeks			13.2	8.5

* Levels are mean values expressed as Reitman-Frankel units/ml.
** Two dogs.

Time	Dogs		Monkeys	
	Control	1000 ppm	Control	1000 ppm
Preexposure	210	157	392	379
4 Weeks	193	353	262	351
7 Weeks	263	304**		
8 Weeks			344	275
14 Weeks			394	388

* Levels are mean values expressed as Sigma units/ml.
** Two dogs.

Table VII shows the values obtained from the liver function test (BSP). The number of animals showing above 10% retention is indicated in parenthesis on the right side of the table. Significant elevations for 1000 ppm exposed dogs occurred at 7 weeks. Dye retention in 1000 ppm exposed monkeys is certainly abnormal at 4 and 8 weeks, and at 13 weeks although the mean value is slightly below the significant level. One of the 4 monkeys as indicated in parentheses gave a value of more than 10%. Although not shown in table VII, the value was 18% retention.

TABLE VII
RESULTS OF BROMSULFALEIN LIVER FUNCTION TEST IN CONTROL
AND DICHLOROMETHANE-EXPOSED DOGS AND MONKEYS*

Time	Dogs		Monkeys	
	Control	1000 ppm	Control	1000 ppm
Preexposure	5.5	6.0	3.4	5.0
4 Weeks	3.3	6.5	2.8	20.2 (3) [†]
7 Weeks	5.0	32.2 ^{**} (2) [†]		
8 Weeks			8.0	15.3 (2) [†]
13 Weeks			5.0	9.0 (1) [†]

* Results are mean values expressed as percent retention of dye.
** Two dogs.
† The number of animals showing above 10% retention is in parentheses.

The results of all other clinical chemistry determinations made at the conclusion of the study on the 1000 ppm exposed monkeys showed no significant differences when compared with control information. Preliminary data suggest that clinical abnormalities were present during the period of acute debilitation. The acute response will be discussed by Dr. Weinstein.

Dichloromethane in Dog Blood and Urine

Analysis of dichloromethane in the blood of dogs after 16 days of exposure to 5000 and 1000 ppm gave the results seen in table VIII. The mean value for eight 1000 ppm exposed dogs was 36 mg/liter of blood while approximately 5 times that amount, 183 mg/liter, was found in the blood of five 5000 ppm exposed dogs.

In order to determine whether significant amounts of dichloromethane were excreted unchanged through the kidneys of dogs exposed to 5000 ppm, urine samples from 2 dogs were collected after 6 hours and after 2 days. Analysis revealed 51 mg/liter in the first and 33 mg/liter in the second sample.

5000 ppm Exposure		1000 ppm Exposure	
Dog No.	CH ₂ Cl ₂ in blood (mg/l)	Dog No.	CH ₂ Cl ₂ in blood (mg/l)
M-89	175	N-05	35
N-23	130	N-07	30
N-29	200	N-09	34
N-31	160	N-11	36
N-33	250	N-13	41
		N-15	32
		N-19	57
		N-21	25
Mean	183	Mean	36

* Individual dog and mean values are given.

The results of the blood and urine tests simply demonstrate the fact that significant amounts of dichloromethane are absorbed into the blood and are eliminated unchanged.

Another test of interest was urine analysis for formic acid. One paper reported that this metabolite was found in the urine of several workers exposed to 0.1 to 17 mg/liter dichloromethane (Kuzelova, 1966). Therefore, urine samples were collected from the same 2 dogs mentioned previously every 6 hours over a 5-day period. Samples were also taken from 2 control dogs exposed to air only. Comparison of results showed no significant differences in the amounts of formic acid found in the 5000 ppm exposed, and the control dogs.

To study pathologic changes in mice, 14, 22 and 26 mice were removed serially during the first month from the control, the 1000 and the 5000 ppm groups respectively. A number of short-term exposures involving mostly mice were also conducted at various times during or after the original study for the same purpose. Dr. Weinstein will discuss some aspects of early hepatic lesions in detail in a subsequent presentation.

All surviving animals were sacrificed and submitted for gross and histopathology at the end of the study - 14 weeks.

A careful examination of all rat organ weight data revealed no biologically significant differences when mean organ weights and ratios of exposed rats were compared with those of the control.

Histopathology results are not available at this time since the study was only recently completed. However, gross findings can be summarized. Of the dogs that died during exposure to 5000 and 1000 ppm, or were sacrificed, gross pathology showed yellow, fatty livers and jaundice in all cases, edema of the brain, and extreme emaciation. Edema of the brain was limited to 3 dogs that died during exposure to 5000 ppm. There were borderline liver changes in 3 monkeys exposed to 5000 ppm. No gross lesions were seen in the monkeys that survived exposure to 1000 ppm. Rat pathology was unspectacular, the only findings which may be related to toxicity of dichloromethane were mottled livers in 40% of the rats that completed 14 weeks of exposure to 5000 ppm.

Complete evaluation of the toxicity at the tissue level must certainly await the results of histopathologic examination of all animal species used in this study.

In summary, the following observed changes were most significant:

1. Severe weight losses were observed in all species, most profound in dogs.
2. Dogs and monkeys continued to lose weight throughout the exposure or until death, and rats showed dose related subnormal growth rates when compared with controls.
3. At 5000 ppm dichloromethane, there were considerable deaths during the first 3 weeks; 50% in dogs, 25% in monkeys and 35% in mice. No rats died.

At 1000 ppm exposure level, significant deaths occurred only in dogs when 6 died during the 6th and 7th weeks and the remaining 2 dogs became moribund.

4. Monkeys exposed to dichloromethane at 1000 ppm level for 14 weeks showed clinical signs of liver injury.

5. Rats showed no response at either exposure level other than growth depression.

6. Dogs that died exhibited gross lesions associated with hepatic failure. The cause of death in the monkey that died as a result of exposure to 5000 ppm dichloromethane is not clear; histopathology results may reveal the answer.

The results of this study suggest the need for additional chronic exposures using lower dose levels of dichloromethane.

REFERENCES

1. Archibald, J. H.; "Methylene Chloride Analysis;" SysteMed Corporation Memorandum, 20 September 1971.
2. Browning, E.; Toxicity and Metabolism of Industrial Solvents; Elsevier Publishing Company, Amsterdam-New York-London, 1965, p 243.
3. Heppel, L. A., P. A. Neal, T. L. Perrin, M. L. Orr, and V. T. Poterfield; "Toxicology of Dichloromethane (Methylene Chloride). I. Studies on Effects of Daily Inhalation;" J. Ind. Hyg. Toxicol., 26:8, 1944.
4. Kuzelova, M., and R. Vlasak; "The Effect of Dichloromethane on the Health of Workers Engaged in the Manufacture of Plastic Film and the Determination of Formic Acid as a Metabolite of Dichloromethane;" Pracovni lekarstvi, Prague, Czechoslovakia, 18:167, 1966. Abstracted in Occup. Safety and Health Abst., 5:167, 1966.
5. Lehmann, K. B., and L. Schmidt-Kehl; "The Thirteen Most Important Chlorinated Aliphatic Hydrocarbons from the Standpoint of Industrial Hygiene;" Arch. Hyg. u. Bakteriol., 16:131, 1936.
6. Moskowitz, S., and H. Shapiro; "Fatal Exposure to Methylene Chloride Vapor;" A. M. A. Arch. Ind. Hyg. Occupational Med., 6:116, 1952.
7. Space Science Board; "Atmospheric Contaminants in Spacecraft. Report on Air Standards for Manned Space Flight;" National Academy of Sciences, National Research Council, June 1968.
8. Svirbely, J. L., B. Highman, W. C. Alford, and W. F. von Oettingen; "The Toxicity and Narcotic Action of Monochloro-monobromomethane with Special Reference to Inorganic and Volatile Bromide in Blood, Urine, and Brain;" J. Ind. Hyg. Toxicol., 29:382, 1947.

A STUDY OF LIVER MICROSOMAL CYTOCHROMES FOLLOWING
CHRONIC EXPOSURE TO DICHLOROMETHANE

F. J. Bullock
M. Callahan

Arthur D. Little, Inc.
Cambridge, Massachusetts

and

E. S. Harris

National Aeronautics and Space Administration
Houston, Texas

INTRODUCTION

Before presenting our results it seems appropriate to review briefly relevant aspects of microsomal enzymic oxidations, including some properties of these systems. The enzymes are located in the endoplasmic reticulum, which is a complex intracytoplasmic system of membrane-bound channels. The structural integrity of this membrane structure is important to its function. Some of this structure is preserved on rupture of the cell and is isolated in the microsomal fraction. The microsomal fraction is obtained by centrifugation of organ homogenates at 100,000 x g as described in figure 1 and is associated with the cellular functions indicated there.

Associated with the microsomal fraction is an electron transport function, although the metabolic significance of this function is incompletely understood. Several cytochromes and reductases are associated with liver microsomal electron transport and one in particular, cytochrome P-450, appears to play an important role in hydroxylation, not only of endogenous materials such as steroids (Sih, 1969) but of exogenous materials, such as drugs (Conney, 1967), and environmental contaminants (Fouts, 1965). The interrelationship between cytochrome P-450 and other NADPH-dependent functions in microsomes is shown schematically in figure 2. The exact position of cytochrome b_5 in the electron transport chain is unknown.

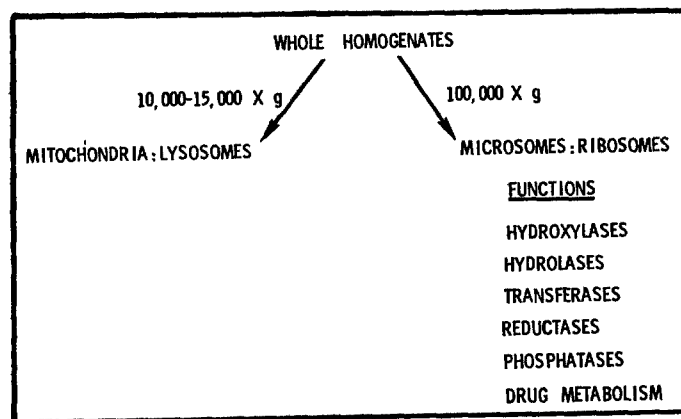

Figure 1. PREPARATION AND FUNCTION ASSOCIATED WITH MICROSOMAL FRACTION FROM ORGAN HOMOGENATES

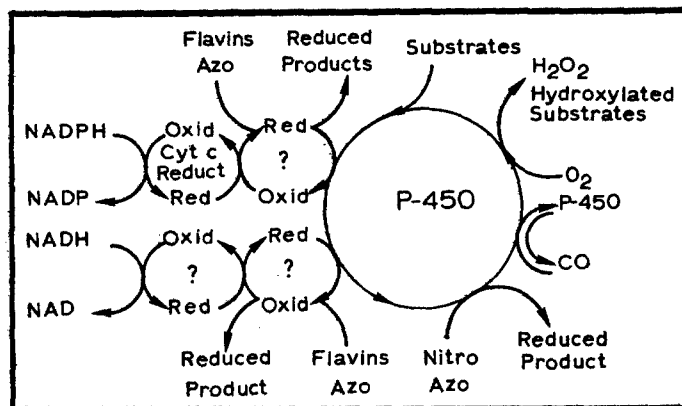

Figure 2. ELECTRON TRANSPORT IN LIVER MICROSOMES

Determination of microsomal DPNH-cytochrome c reductase, DPNH-cytochrome b₅ reductase, and a wide variety of other oxidases, reductases, and demethylases as well as of the cytochromes themselves can provide one means of studying functional changes in liver following exposure to exogenous materials. Chronic exposure to chlorinated pesticides or carcinogenic hydrocarbons, and use of many drugs result in induction of liver microsomal enzyme and cytochrome synthesis (Sher, 1971) although each substance may show a different specificity in induction of particular microsomal enzymes. This stimulation is associated with greatly increased levels

of enzymes and cytochromes in liver and is accompanied by increases in rates of hepatic metabolism of exogenous materials. Increase in cytochrome P-450 content of liver microsomes commonly parallels increasing rates of drug metabolism (Ernster, 1965). Changes in rates of metabolism can, in turn, influence toxicity of many substances (Burns, 1965). A relevant example is that induction of liver microsomal enzymes by pretreatment with phenobarbital greatly increased the toxicity of carbon tetrachloride in the rat (Garner, 1969). On the other hand, low protein diets decrease carbon tetrachloride toxicity in rats (McLean, 1966). Starvation is known to depress microsomal drug metabolizing enzymes (Dixon, 1960). It is with this background in mind that studies of the microsomal cytochromes b_5 and P-450 were included in the study of effects of chronic exposure to dichloromethane in the mouse.

METHODS

Continuous exposure of mice to levels of 5000 and 1000 ppm dichloromethane were carried out as described previously for periods of up to 90 days. After 30 days exposure, animals exposed at both levels of chlorocarbon were sacrificed with a control group by cervical dislocation, exsanguinated, and the livers were excised. Whole livers were frozen in 0.05M pH 7.5 Tris buffer containing 0.25M sucrose and preserved for analysis. Each group consisted of ten livers which were pooled into five groups of two livers each for analysis.

Livers were homogenized in buffer and the homogenate centrifuged at 9000 x g for 30 minutes. The supernatant was poured through a double layer of gauze, then centrifuged for 90 minutes in a refrigerated Beckman Model L ultracentrifuge at 100,000 x g maximum field. The microsomal pellet was resuspended in 0.5M phosphate pH 7.6 (10^{-3} M EDTA) buffer, and protein determinations carried out by the Folin phenol procedure (Lowry, 1951). Cytochromes P-450 and P-420 were determined by the method of Omura and Sato (1964); cytochrome b_5 by the method of Strittmatter and Velick (1956).

RESULTS

A preliminary study revealed relatively minor changes in content of cytochrome P-450 and b_5 as a result of freezing and storage of tissue. The major effect appears to be the conversion of some cytochrome P-450 to an inactive form which has been described as P-420 (Omura, 1964). In an atmosphere of CO, the absorption maximum of this new pigment is at 420 nm, rather than at the usual 450 nm. The in vitro conversion of P-450 to P-420 is well known to be catalyzed by a variety of agents which include: ureas, amides, ketones, nitriles, alcohols, cholate, digitonin, dodecyl sulfate, and phospholipase (Omura, 1964; Mason, 1965; Imai, 1967). Cytochrome P-420 is reported to be converted back to P-450 by treatment with polyols such as

glycerol or reduced glutathione (Ichikawa, 1967), but the enzymatic activity of P-450 is only partially restored (Ichikawa, 1969). The chemical basis of the interconversion of P-450 and P-420 is unknown but may be associated with a change in microsomal membrane structure or a conformational change. In particular, the conversion of P-450 to P-420 by phospholipase and digitonin support this interpretation.

As examples of what was observed in our study, the difference spectra for cytochrome P-450 in a nonfrozen test sample, in a frozen sample from the control groups, and in a dichloromethane-exposed group (1000 ppm for 60 days) are given in figure 3.

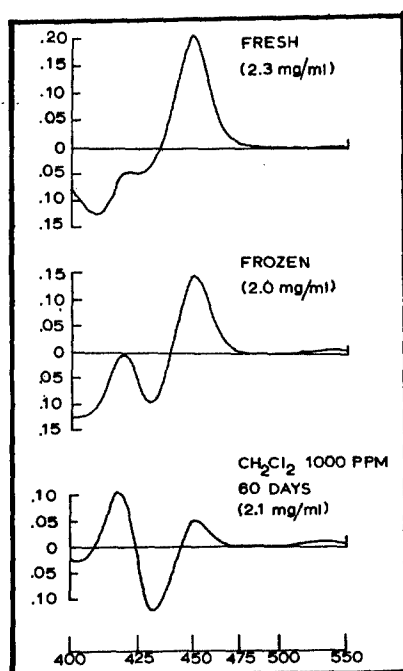

Figure 3. DIFFERENCE SPECTRA OF CYTOCHROME P-450 FROM FRESH LIVER, FROZEN LIVER, AND LIVER OBTAINED FROM MICE EXPOSED TO DICHLOROMETHANE AT 1000 PPM FOR 60 DAYS

We found typically that liver cytochrome P-450 levels were decreased in dichloromethane-exposed groups and that levels of cytochrome P-420 were increased. Detailed results are presented diagrammatically in figure 4. The results are expressed as millimicromoles cytochrome/mg microsomal protein \pm one standard deviation. For P-450 and P-420, the molar extinction coefficients given by Omura and Sato (1964) were used. These are $91 \text{ cm}^{-1}\text{mM}^{-1}$ and $111 \text{ cm}^{-1}\text{mM}^{-1}$, respectively.

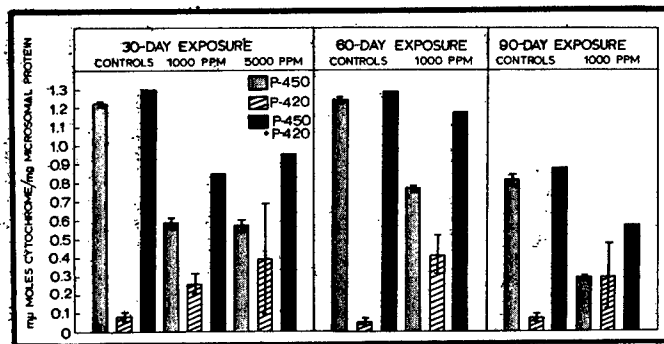

Figure 4. EFFECT OF DICHLOROMETHANE ON CYTOCHROME P-450 and P-420 CONTENT IN MOUSE LIVER MICROSOMES

Results obtained for cytochrome b_5 are given \pm one standard deviation in figure 5. The molar extinction coefficient of $171 \text{ cm}^{-1} \text{ mM}^{-1}$ given by Strittmatter and Velick (1956) was used. In figure 6 are presented our data on liver sizes and yields of microsomal protein for control and dichloromethane-exposed groups. As before, values are \pm one standard deviation. Data on liver weights and yields of microsomal protein were not obtained for 30-day-exposed groups.

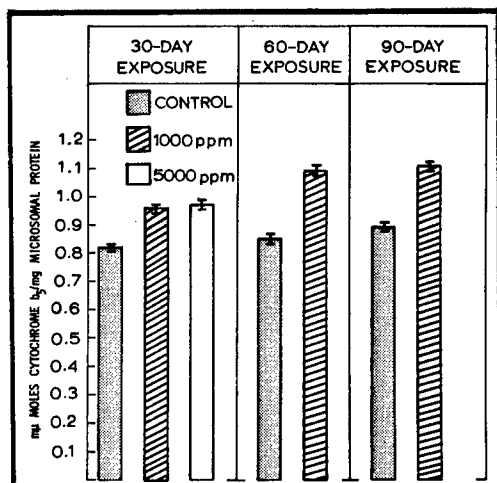

Figure 5. EFFECT OF DICHLOROMETHANE ON CYTOCHROME b_5 CONTENT IN MOUSE LIVER MICROSOMES

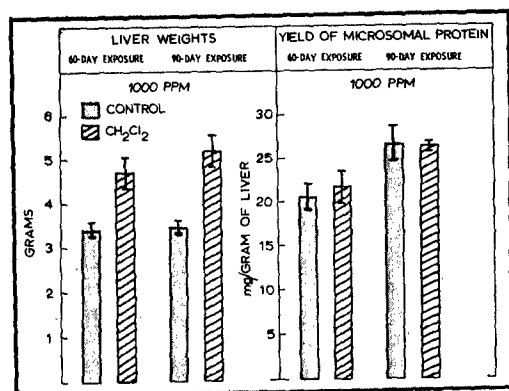

Figure 6. LIVER WEIGHTS AND YIELD OF MICROSOMAL PROTEIN IN CONTROL AND DICHLOROMETHANE EXPOSED GROUPS

DISCUSSION

The absence of information on body weights prevents reliable comparison of liver sizes on the basis of the ratio liver weight/body weight. Nevertheless, the increased sizes of livers of animals exposed to dichloromethane for 60 and 90 days does suggest this as one result of exposure to the chlorocarbon. It should also be noted that CCl_4 has been reported to increase liver size in the rat (Dingell, 1968). Yields of microsomal protein per unit of liver weight are unchanged by dichloromethane exposure for 60 or 90 days but because of greater liver weights in exposed groups the total amount of microsomal protein is greater in livers from exposed groups. Recognition of this fact leads to an interesting tentative conclusion regarding the effects of dichloromethane on cytochrome P-450. It becomes clear when the total amounts of cytochromes P-450 and P-420 per liver are compared as in figure 7. This comparison shows that the total amount of cytochromes P-450 and P-420 are actually similar or greater in exposed than in control groups. This suggests a major effect of dichloromethane may be the conversion of cytochrome P-450 to the catalytically inactive cytochrome P-420. Observation of decreased P-450 content is consistent with the observed increases in hexobarbital-induced sleeping times. However, these sleeping time experiments also suggest that what we are identifying spectroscopically as cytochrome P-450 may not be functionally normal P-450. This possibility follows from the fact that total apparent P-450 levels are found to be similar in control and treated groups.

Of interest, our results for dichloromethane are reminiscent of those Greene, Stripp and Gillette (1969) found after carbon tetrachloride administration to the rat. Twenty-four hours after a single oral dose of 2.5 ml CCl_4 /kg (p. o.) to the rat showed a sharp decrease in b_5 , they found a marked decrease in liver cytochrome P-450 and a sharp increase in liver P-420 content. They observed no change in cytochrome b_5 following this single dose of CCl_4 after twelve hours but a sharp decrease after

twenty-four hours. A comparable single oral dose of chloroform or dichloromethane produced effects on neither cytochrome P-450 nor cytochrome b_5 in Gillette's study. Therefore, long-term administration of dichloromethane by inhalation has revealed some liver effects, similar to those produced by CCl_4 , not previously detected.

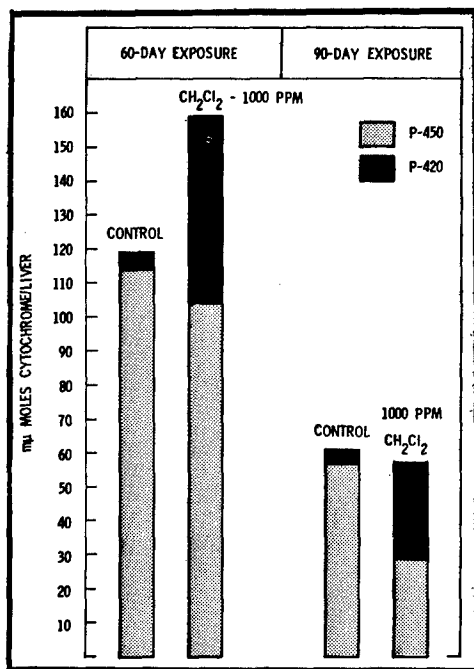

Figure 7. ESTIMATED TOTAL CYTOCHROME P-450 AND P-420 IN MOUSE LIVER. Calculated from $m\mu$ moles cytochrome/mg microsomal protein \times mg microsomal protein/g liver \times liver weight.

The induction of liver cytochrome b_5 by dichloromethane is marked in these experiments and also has not been detected previously, even with the more toxic carbon tetrachloride. On this point we can note only that cytochrome b_5 has never been studied after long-term exposure to CCl_4 and that we have no information on the time course for manifestation of cytochrome b_5 induction. Conceivably, no effects on cytochrome b_5 would be seen after one day or a few days' exposure to dichloromethane at the levels studied here.

The admittedly speculative idea that production of an impaired lipoprotein membrane is involved in the hepatic effects of dichloromethane is consistent with our experimental results. Induction of microsomal cytochrome b_5 is seen perhaps as part of the process of tissue repair, and its spectral properties are unaffected by

changes in microsomal membrane structure. Even if induction of P-450 synthesis occurred simultaneously, alteration of newly produced microsomal membranes by continuous exposure to dichloromethane could result in no apparent increase in P-450. The precise relationship between rates of P-450 synthesis and its conversion to P-420 from membrane changes might result in total apparent P-450 remaining constant.

Finally, to emphasize the subtleties of effects of related chlorocarbons on the liver, we note that CCl_2CH_2 has been reported to result in an increase of cytochrome P-450 as well as NADPH-cytochrome c reductase in rat liver. The chlorocarbon was administered by inhalation at 2500-3000 ppm for 24 hours (Fuller, 1970).

REFERENCES

1. Burns, J. J., S. A. Cucinell, R. Koster and A. H. Conney; "Application of Drug Metabolism to Drug Toxicity Studies"; Ann. N. Y. Acad. Sci., 123:273-286, 1965.
2. Cf. Conney, A. H.; "Pharmacological Implications of Microsomal Enzyme Induction"; Pharmacol. Revs., 19:317-366, 1967.
3. Dingell, J. V. and M. Heimberg; "The Effects of Aliphatic Halogenated Hydrocarbons on Hepatic Drug Metabolism"; Biochem. Pharmacol., 17:1269-1278, 1968.
4. Ernster, L. and S. Orrenius; "Substrate-Induced Synthesis of the Hydroxylating Enzyme System of Liver Microsomes"; Fed. Proc., 24:1190-1199, 1965.
5. Cf. Fouts, J. R. and L. A. Rogers; "Morphological Changes in the Liver Accompanying Stimulation of Microsomal Drug Metabolizing Enzyme Activity by Phenobarbital, Chlordane, Benzpyrene or Methylcholanthrene in Rats"; J. Pharmacol. Exptl. Therap., 147:112-119, 1965.
6. Fuller, G. C., A. Olshan, S. K. Puri, and H. Lal; "Induction of Hepatic Drug Metabolism in Rats by Methylchloroform Inhalation"; J. Pharmacol. Exptl. Therap., 175:311-317, 1970.
7. Cf. Garner, R. C. and A. E. M. McLean; "Increased Susceptibility to Carbon Tetrachloride Poisoning in the Rat after Treatment with Oral Phenobarbitone"; Biochem. Pharmacol., 18:645-650, 1969.
8. Greene, F. E., B. Stripp and J. R. Gillette; "The Effect of Carbon Tetrachloride on Heme Components and Ethylmorphine Metabolism in Rat Liver Microsomes"; Biochem. Pharmacol., 18:1531-1533, 1969.

REFERENCES (Cont'd)

9. Ichikawa, Y. and T. Yamano; "Reconversion of Detergent- and Sulfhydryl Reagent- Produced P-420 to P-450 by Polyols and Glutathione"; Biochim. Biophys. Acta, 131:490-497, 1967.
10. Ichikawa, Y., T. Yamano and H. Fujishima; "Relationship Between the Interconversion of Cytochrome P-450 and P-420 and its Activities in Hydroxylations and Demethylations by P-450 Oxidase Systems"; Biochim. Biophys. Acta, 171:32-46, 1969.
11. Imai, Y. and R. Sato; "Conversion of P-450 and P-420 by Neutral Salts and Some Other Reagents"; European J. Biochem., 1:419-426, 1967.
12. Lowry, O. H., N. J. Rosebrough, A. L. Farr and J. J. Randall; "Protein Measurement with the Folin Phenol Reagent"; J. Biol. Chem., 193:265-275, 1951.
13. Mason, H. S., J. C. North and M. Vanneste; "Microsomal Mixed-Function Oxidations: The Metabolism of Xenobiotics"; Fed. Proc., 24:1172-1180, 1965.
14. Omura, T. and R. Sato; "The Carbon Monoxide-Binding Pigment of Liver Microsomes. I. Evidence for Its Hemoprotein Nature"; J. Biol. Chem., 239:2370-2378, 1964.
15. Omura, T. and R. Sato; "The Carbon Monoxide-Binding Pigment of Liver Microsomes. II. Solubilization, Purification, and Properties"; J. Biol. Chem., 239:2379-2385, 1964.
16. Sher, S. S.; "Drug Enzyme Induction and Drug Interactions: Literature Tabulation"; Toxicol. Appl. Pharmacol., 18:780-834, 1971.
17. Cf. Sih, C. J.; "Enzymatic Mechanism of Steroid Hydroxylation"; Science, 163:1297-1300, 1969.
18. Strittmatter, P. and S. F. Velick; "The Isolation and Properties of Microsomal Cytochrome"; J. Biol. Chem., 221:253-264, 1956.

DICHLOROMETHANE HEPATOTOXICITY IN MICE WITH CONTINUOUS
AND INTERMITTENT INHALATION EXPOSURES*

Ronald S. Weinstein, Major, USAF, MC

Dale D. Boyd, Lt. Colonel, USAF, VC

and

Kenneth C. Back, Ph. D.

Aerospace Medical Research Laboratory
Wright-Patterson Air Force Base, Ohio

INTRODUCTION

Dichloromethane (CH_2Cl_2) is widely used as an industrial solvent and is considered to be of relatively low toxicity compared to other halogenated hydrocarbon solvents. Acute toxicity is manifested by symptoms related to the central nervous system. Ulanova (1961) reported that the threshold concentration for detecting an effect on conditioned reflexes in animals is 9 to 58 ppm. Exposure to five thousand ppm of CH_2Cl_2 for 30 minutes practically abolishes normal running activity in rats (Heppel and Neal, 1944) while 10,000 ppm for 30 minutes causes light to moderate narcosis in monkeys, rabbits, rats and dogs (Heppel et al., 1944). Deep narcosis can be produced in man by exposure to 20,000 ppm of CH_2Cl_2 for 30 minutes (Henderson and Haggard, 1943). Species differences have been observed with respect to lethality. Single inhalation exposures of CH_2Cl_2 to levels of 14,500 ppm are lethal to mice in two hours (Flury and Zernik, 1931 - cited by Browning, 1965). CH_2Cl_2 exposures to levels of 50,000 to 54,000 ppm for 1 to 1-1/2 hours cause progressive narcosis and death in guinea pigs (Nuckolls, 1933 - cited by Browning, 1965). Necropsies of these animals showed pulmonary edemas, "cloudy swelling" of the kidneys and early yellow atrophy of the liver. Several human deaths have been reported resulting from the use of CH_2Cl_2 as an anesthetic agent (Browning, 1965) and as the result of accidental exposures (Moskowitz and Shapiro, 1952).

Several studies of the effects of repeated exposures to CH_2Cl_2 have been reported. Rabbits and cats exposed 8 hours a day, 6 days a week for 4 weeks to concentrations of 6-7 mg/liter (1700-2000 ppm) experience a reduction in body temperature and slight depression of activity (Lehman et al., 1936). No deaths were reported in this study and autopsy data were not recorded. In another study, rats were subjected to repeated

*This work was partially supported by the National Aeronautics and Space Administration/Manned Spacecraft Center under Project Order T-80498 with the 6570 Aerospace Medical Research Laboratory, Toxic Hazards Division, Wright-Patterson AFB, Ohio.

8-hour exposures at 4-6 mg/liter (1300 ppm) and sacrificed at intervals of 25 days (Gross - cited by Heppel et al., 1944). No definite lesions were found in the tissues of animals sacrificed during the first 75 days of the study. Slight hepatic atrophy and central fatty degeneration were changes noted later. Similar changes were present in rabbits with inhalation exposures at a level of 10 mg/liter (2900 ppm) for 50 and 75 days (Gross - cited by Heppel et al., 1944). Flury et al. exposed cats from 4 to 8 hours a day, for 4 weeks, to 25 mg/liter CH_2Cl_2 (7200 ppm). Cats were sacrificed 1, 3 and 9 weeks after exposure and had marked fatty infiltration of the liver and kidneys (Flury et al., 1938 - cited by Heppel et al., 1944).

The most thoroughly documented reports of the effects of intermittent exposure to CH_2Cl_2 are by Heppel and his associates (Heppel et al., 1944; Heppel and Neal, 1944). Several species of animals were exposed to 17 mg/liter (5000 ppm) CH_2Cl_2 for 7 hours a day, 5 days a week, for periods up to 6 months. As judged by clinical data and microscopic examination of tissues, no toxic reactions occurred in rats, dogs or rabbits. Guinea pigs under these exposure conditions were adversely affected as evidenced by a decreased growth rate. However, no lesions attributable to the exposures were demonstrated by light microscopy. Other groups of animals including monkeys were exposed to 34 mg/liter (10,000 ppm) CH_2Cl_2 for 4 hours a day, 5 days a week for up to 8 weeks. At this level, livers from two of 4 dogs had moderate centrilobular congestion with narrowing of cell cords and slight to moderate fatty degeneration. Livers of the two other dogs appeared normal by light microscopy. Two monkeys and two of four rabbits were without lesions. Pulmonary congestion and edema were present in the two other rabbits that died. Four of 6 exposed guinea pigs had slight to moderate hepatic fatty degeneration at an exposure level of 10,000 ppm. One of 4 control guinea pigs also showed moderate fatty change of the liver; however, fatty involvement was diffuse throughout the parenchyma. Exposed rats had pulmonary edema and congestion but their livers appeared normal. On the basis of the apparent low toxicity of CH_2Cl_2 with intermittent exposures, Heppel et al. suggested a maximum allowable concentration of 500 ppm for 8-hour daily exposures (Heppel et al., 1944).

All reports to date on the toxicology of CH_2Cl_2 have dealt with the effects of single or multiple intermittent exposures. Few guidelines exist for establishing acceptable exposure levels for continuous exposures to toxic substances on the basis of data obtained from single or intermittent exposure experiments. In this study, the effects of continuous inhalation of CH_2Cl_2 on mice were examined in detail with respect to liver changes. The effects of continuous CH_2Cl_2 exposures are of particular interest since CH_2Cl_2 is present in space cabin construction materials and may be present in trace amounts in the atmosphere of space cabins. A comparison of the effects produced by continuous exposure with those of intermittent exposures should help in extrapolating and predicting effects and results of continuous exposures from data on intermittent exposures.

MATERIALS AND METHODS

Animals

ICR strain female mice (A. R. Schmidt Co., Madison, Wisconsin) weighing 20 to 32 g were used for all exposures. (Male and female rodents react similarly to haloalkanes (Srinivasan and Recknagel, 1971). Mice were fed ad libitum on Purina Laboratory Chow (Ralston Purina Co., St. Louis, Missouri) and were offered an unlimited supply of water. For all experiments, mice were randomized and separated into groups. Animals were sacrificed by cervical dislocation.

Chemicals

Technical grade dichloromethane (Dow Chemical Company, Midland, Michigan) was used for most of the exposures. The compound was analyzed by mass spectroscopy by the Systemed Corporation and was 99% pure. Most of the results described in this report were confirmed by a duplicate experiment using chemical grade dichloromethane (Matheson, Coleman & Bell, Norwood, Ohio).

Exposure Chambers

Thomas Domes, described elsewhere (McNerney and MacEwen, 1965; Thomas, 1968), were used for all exposures. Two domes were used, one serving as a control chamber (called "control dome"). Both domes were operated at 725 mm Hg pressure to avoid leakage of gas. An airflow of 40 cfm was used in all cases. Dome temperatures were 24 ± 2 C, relative humidities were $50\% \pm 10\%$ and the CO_2 level never exceeded 0.2%. The level of CH_2Cl_2 in the CH_2Cl_2 dome was 5000 ppm and was continuously monitored with a Beckman Model 109A hydrocarbon analyzer. The atmosphere from the dome was fed directly into the flame ionization chamber and the CH_2Cl_2 levels were recorded 6 times per hour throughout the exposures. The standard deviation from 5000 ppm during the exposure was ± 170 ppm. The readout of the hydrocarbon analyzer was checked daily with standard CH_2Cl_2 samples. The 5000 ppm standard was prepared by injecting 1.91 ml of CH_2Cl_2 into a bag containing 147 liters of air.

The level of CH_2Cl_2 in the exposure dome was maintained by an air pressure activated induction system. A pressure regulator controlled and limited the pressure applied to a 55 gallon drum of CH_2Cl_2 and the liquid CH_2Cl_2 then passed through a flowmeter to the evaporator. The flowmeter was set to permit 15 ml/min of liquid CH_2Cl_2 to flow to the evaporator. From the evaporator, the CH_2Cl_2 vapor was blown into the dome.

Continuous and Intermittent Exposures

The CH_2Cl_2 dome was equilibrated at 5000 ppm before test animals were introduced into the experimental environment. For continuous exposures, groups of animals were maintained in the control dome and CH_2Cl_2 dome for appropriate time intervals and sacrificed within five minutes of removal from the domes. Intermittent exposures were accomplished by placing groups of animals in control and CH_2Cl_2 domes for six hour periods on each of 4 successive days. The cages of mice were removed from the control and CH_2Cl_2 domes and placed in an animal room for the 18 hour non-exposure intervals. The mice in the control and CH_2Cl_2 exposed groups were sacrificed within 5 minutes after the fourth dome exposure.

Liver and Body Weights

Liver and body weights were obtained from measurements on the same mice used for the tissue triglyceride determinations described below.

Liver Triglycerides

Mice were drawn from a randomized, sequentially numbered population. Groups consisting of 20 sequentially numbered mice were caged separately and exposed to control or CH_2Cl_2 dome atmosphere for 1, 2, 3, 4, 6 and 7 days. At the termination of each exposure, mice bearing the first 16 numbers were divided into four subgroups containing four mice each. Where deaths occurred, survivors were substituted sequentially in order to fill the subgroup. Animals in each subgroup were sacrificed by cervical dislocation and their livers weighed and pooled, frozen in liquid nitrogen (-196 C) and stored at -20 C. Pooled livers were thawed and tissue triglycerides were determined in duplicate according to the method of Butler (Butler et al., 1961).

Light and Electron Microscopy

Four to 10 mice were sacrificed at each exposure period and their livers were prepared for conventional light and electron microscopy. Other organs, including heart, lung, spleen, pancreas, intestine, kidney and brain were processed for routine light microscopy. (Their appearances will be reported elsewhere). Groups of mice were sacrificed after 1, 4, 8 and 12 hours and 1, 2, 3, 4, 6 and 7 days of continuous inhalation exposure in the control or CH_2Cl_2 domes. Sections of neutral formalin-fixed paraffin embedded liver were routinely stained with hematoxylin and eosin and examined by light microscopy. Selected sections were stained with Periodic-acid Schiff (PAS), with sections incubated with diastase prior to PAS staining serving as controls. One micron sections of toluidine blue stained Epon embedded liver (Trump et al., 1961) were also examined in the light microscope. Cryostat sections of liver were stained for fat with Oil-red-O.

For electron microscopy, 1 mm³ blocks of liver were fixed by immersion in phosphate buffered 1% osmic acid at pH 7.2 at 4 C. The fixative osmolarity was adjusted to 320-330 milliosmols with distilled water. Some tissue blocks were fixed in 2.5% glutaraldehyde buffered to pH 7.4 with phosphate buffer and post-fixed with 1% osmic acid in phosphate buffer. All samples for electron microscopy were dehydrated by serial passage through graded ethanol solutions and embedded in Epon 812. Thin sections were cut on diamond knives, stained with uranyl acetate and lead citrate (Venable and Coggeshall, 1965) and photographed in an RCA EMU-4B electron microscope.

Autoradiography

Amino acid incorporation in liver cells was examined in mice continuously exposed to either 5000 ppm CH₂Cl₂ or the control dome environment. Two control mice and two exposed mice were used for each exposure interval. At exposure intervals of 4 and 12 hours and 1 and 2 days, solutions of L-leucine-4,5-³H (New England Nuclear Corporation, Boston, Massachusetts) containing 5.0 mCi/5.0 ml 0.01 N HCl, specific activity 5.0 Ci/mM were lyophilized and redissolved in sterile buffered saline to give a final activity of 20 μCi/0.01 ml. Mice were weighed in the exposure chamber and immediately given 20 μCi/gram body weight of L-leucine-4,5-³H via the tail vein. Forty-five minutes later, animals were sacrificed by cervical dislocation. Tissue blocks of liver were fixed in 10% neutral formalin, embedded in paraffin and 3 micron thick sections were cut and mounted on clean slides. The sections were deparaffinized and stained with eosin. The sections were then coated with Kodak NTB-2 nuclear track emulsion which had previously been diluted with an equal volume of ion free water. The coated slides were air dried for six hours and placed in black plastic boxes containing a small amount of desiccant. The boxes were sealed with black electrical tape and stored in a refrigerator at 6 C for 1, 2 and 4 weeks. Sets of the slides were developed in Kodak Dektol diluted 1:2 with water at 18-20 C for 2 minutes. The slides were fixed in Kodak acid fixer (18-20 C) for 10 minutes, washed in running water, dried, counter-stained with hematoxylin and coverslipped with permount. The developed stained preparations were examined by light microscopy and photographed with a Leitz Orthoplan photomicroscope using Kodak Panatomic-X film.

RESULTS

Clinical Observations

During the first few hours of exposure to 5000 ppm CH₂Cl₂, the principal clinical signs were increased activity and decreased food and water intake. At 24 hours of continuous exposure, spontaneous activity had decreased dramatically and the mice appeared very lethargic, somewhat dehydrated, and had a "hunched" posture and roughened hair coat. During the next 48 hours, the appearance of the mice became progressively worse with the apparent dehydration, hunched posture and rough hair

coat becoming more pronounced. In addition, the hair had yellowed, greasy appearance. Some of these changes appeared reversible since at 96 hours of continuous exposure, many mice had resumed some of their normal activity and were spending more time eating and drinking. Dehydration continued to be severe, but the degree of postural and hair coat changes began to lessen. At the end of one week of exposure, the mice were emaciated and dehydrated but were nearly as active as animals in the control dome. The hair coat lost the oily, yellowed appearance but retained the roughened character.

Liver and Body Weights

Figure 1 compares the liver weights for groups of animals in the control and the CH_2Cl_2 domes at 1, 2, 3, 4 and 7 days. The liver weights shown for day 1 in the control dome were essentially the same as observed for another group of mice (not illustrated) that were sacrificed without any dome exposure. The livers of CH_2Cl_2 exposed mice showed a significant increase in weight at 24 hours ($P < .01$, Students t-Test). The difference in the control and CH_2Cl_2 exposed groups remains significant only until day 4.

Figure 2 compares body weights for groups of mice in the control and CH_2Cl_2 dome at 1, 2, 3, 4 and 7 days. Both control and CH_2Cl_2 exposed mice show a significant decrease in weight ($P < .05$) during the first 24 hours. However, the difference between the two groups at 24 hours was not significant. After 24 hours, control dome mice gained weight and approached their initial weight by day 3. CH_2Cl_2 exposed mice continued to lose weight. After 2 days of exposure the difference between body weights of control and CH_2Cl_2 exposed mice was significant ($P < .01$) and remained so throughout the remainder of the exposure period. Under the conditions of this study, CH_2Cl_2 exposed mice never gained weight.

Figure 3 shows liver weight/body weight ratios of control versus exposed mice. They were significantly different ($P < .02$) from day 1 through day 7.

Liver Triglycerides

Liver triglycerides increased in a near linear fashion over the initial 3 days of exposure to 5000 ppm CH_2Cl_2 (figure 4). The peak concentration occurred at 3 days and reached a level 12-fold above the control value. Triglyceride levels then rapidly decreased until the sixth day of exposure at which time they plateaued at a concentration 2 times normal. Liver triglyceride levels were constant for mice in the control dome and identical with the levels in livers of mice with no dome exposure.

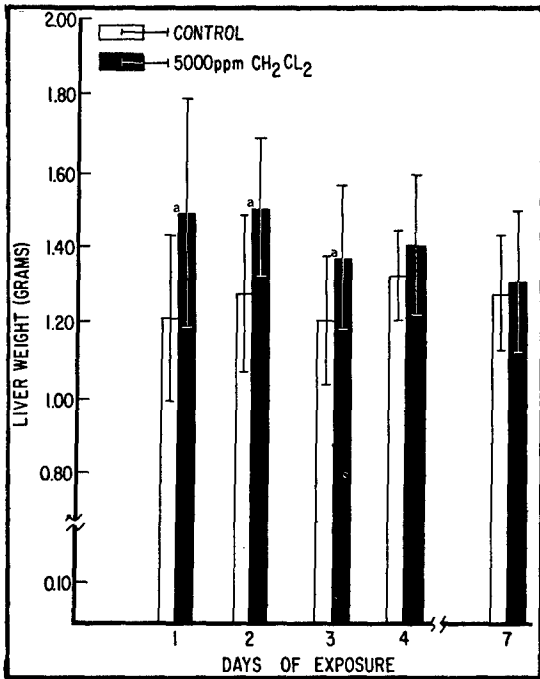

Figure 1. LIVER WEIGHTS OF CONTROL AND CH₂Cl₂ EXPOSED MICE. The ranges indicate the standard deviation from the mean. (a) Indicates statistically significant difference (P<0.01 at one and two days; P<0.02 at three days) from the control value.

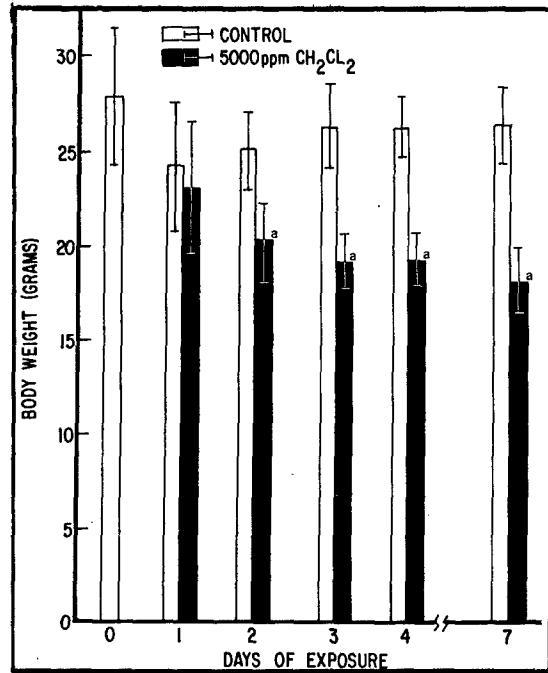

Figure 2. BODY WEIGHTS OF CONTROL AND CH₂Cl₂ EXPOSED MICE. The ranges indicate the standard deviation from the mean. (a) Indicates statistically significant difference (P<0.01) from control value for animals in the control dome for the same day.

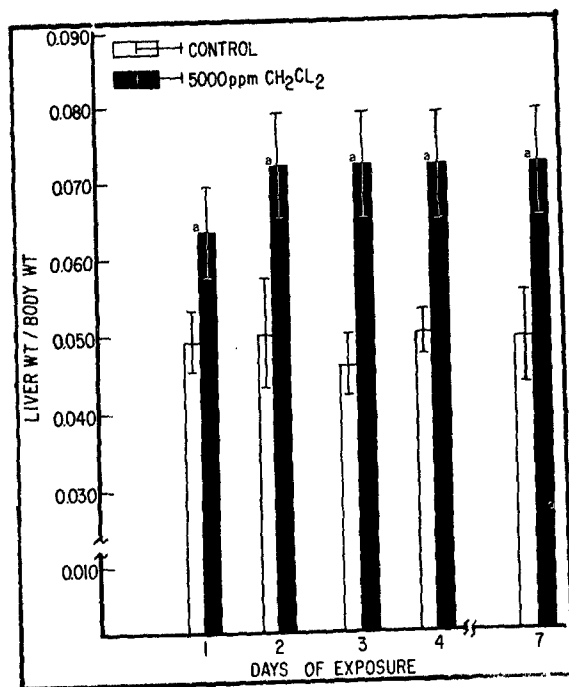

Figure 3. LIVER WEIGHT/BODY WEIGHT RATIOS FOR CONTROL AND CH₂Cl₂ EXPOSED MICE. The ranges indicate the standard deviation from the mean. (a) Indicates statistically significant difference ($P < 0.02$ at one day and $P < 0.01$ thereafter) from the control value.

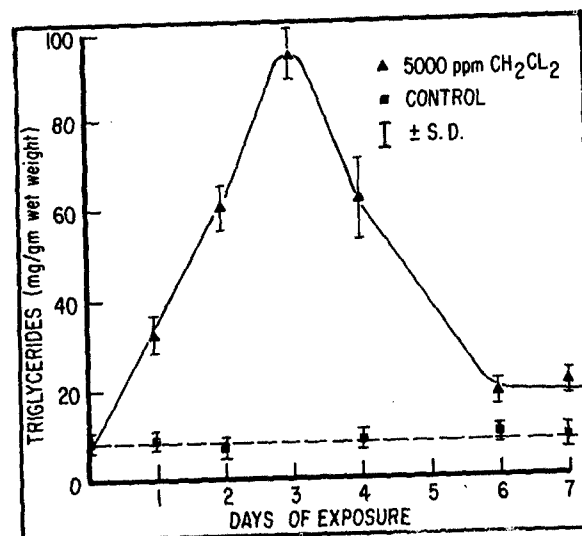

Figure 4. LIVER TRIGLYCERIDE LEVELS FOR CONTROL AND CH₂Cl₂ EXPOSED MICE. Continuous inhalation of 5000 ppm CH₂Cl₂ results in a rapid increase in liver triglyceride that peaks at three days of exposure. Triglyceride levels then decline but remain elevated at seven days. Differences between control mice and CH₂Cl₂ exposed mice are statistically significant for all days of exposure ($P < 0.01$).

Light Microscopy

For purposes of description, changes observed in this study can be considered in terms of changes in two zones, centrilobular and periportal. Traditionally the liver is described in terms of three zones: centrilobular, midzonal and periportal. In this report, the inner half of the midzone is included with the centrilobular zone and the outer half of the midzone is included as part of the periportal zone.

Fat stains of frozen sections showed the progression and regression of fatty change observed during one week of continuous inhalation exposure to 5000 ppm CH_2Cl_2 . Fatty infiltration at 24 hours (figure 5, B) involved the entire hepatic lobule; hepatocytes in the central half of each lobule contained one or several large lipid droplets while periportal hepatocytes contained many small droplets. At 2 days (figure 5, C) centrilobular cells showed severe balloon degeneration but had cleared some of their lipid and periportal lipid began to disappear. At 3 days, centrilobular cells began to reaccumulate lipid (figure 5, D). Each cell contained many droplets which varied greatly in size. Much lipid remained in periportal hepatocytes although total lipid continued to decrease. At 4 days, most of the periportal lipid had disappeared (figure 5, E) although the centrilobular cells continued to stain strongly positive with Oil-red-O. At one week (figure 5, F) centrilobular fatty change was less pronounced but still apparent. Control animals had small numbers of lipid droplets in both hepatocytes and Kupffer cells (figure 5, A).

In addition to changes in fat quantity and distribution, other significant alterations were observed in hepatocyte nuclei and cytoplasm. At 24 hours, nuclei of centrilobular hepatocytes were increased in density and decreased in size. Nuclear condensation peaked at 2 days (figure 6, B) and then gradually reversed. Except for condensation, nuclear structure was otherwise unremarkable. The most striking change observed by light microscopy in paraffin and plastic embedded liver was centrilobular balloon degeneration. Hepatocytes extending from the central vein to the periportal zone began to show ballooning at 1 day. The first change observed in the light microscope was the appearance of many minute empty-appearing vacuoles throughout the cytoplasm of all centrilobular hepatocytes (figure 6, B). At 2 days, the vacuoles began to coalesce (figure 6, C). The hepatocytes appeared swollen and were packed with many vacuoles ranging in size from minute to large which distorted the cell and compressed the nucleus. The severity of nuclear shrinkage paralleled the extent of cytoplasmic balloon degeneration. Ballooning regressed nonuniformly so that at 4 days centrilobular cells were pleomorphic. Some cells had a single large empty-appearing vacuole, others had many small vacuoles, and still others had no discernible vacuoles. At 1 week, still fewer cells showed balloon degeneration. However, single cells undergoing balloon degeneration were now scattered through the parenchyma including periportal areas. Other findings at 4 and 7 days included the presence of a few necrotic hepatocytes and mild accumulations of lipid in Kupffer cells. Focal inflammatory cell infiltrates were in lobules and in portal areas.

Figure 5. PHOTOMICROGRAPHS OF FROZEN SECTIONS STAINED FOR FAT OF LIVERS OF CONTROL AND CH₂Cl₂-EXPOSED MICE. A central vein is in the center of each field. (A) Control, no dome exposure. (B) 5000 ppm CH₂Cl₂, one day of exposure. (C) 5000 ppm CH₂Cl₂, two days of exposure. (D) 5000 ppm CH₂Cl₂, three days of exposure. (E) 5000 ppm CH₂Cl₂, four days of exposure. (F) 5000 ppm CH₂Cl₂, seven days of exposure. See text for description. Oil-red-O stain, hematoxylin counterstain. x125

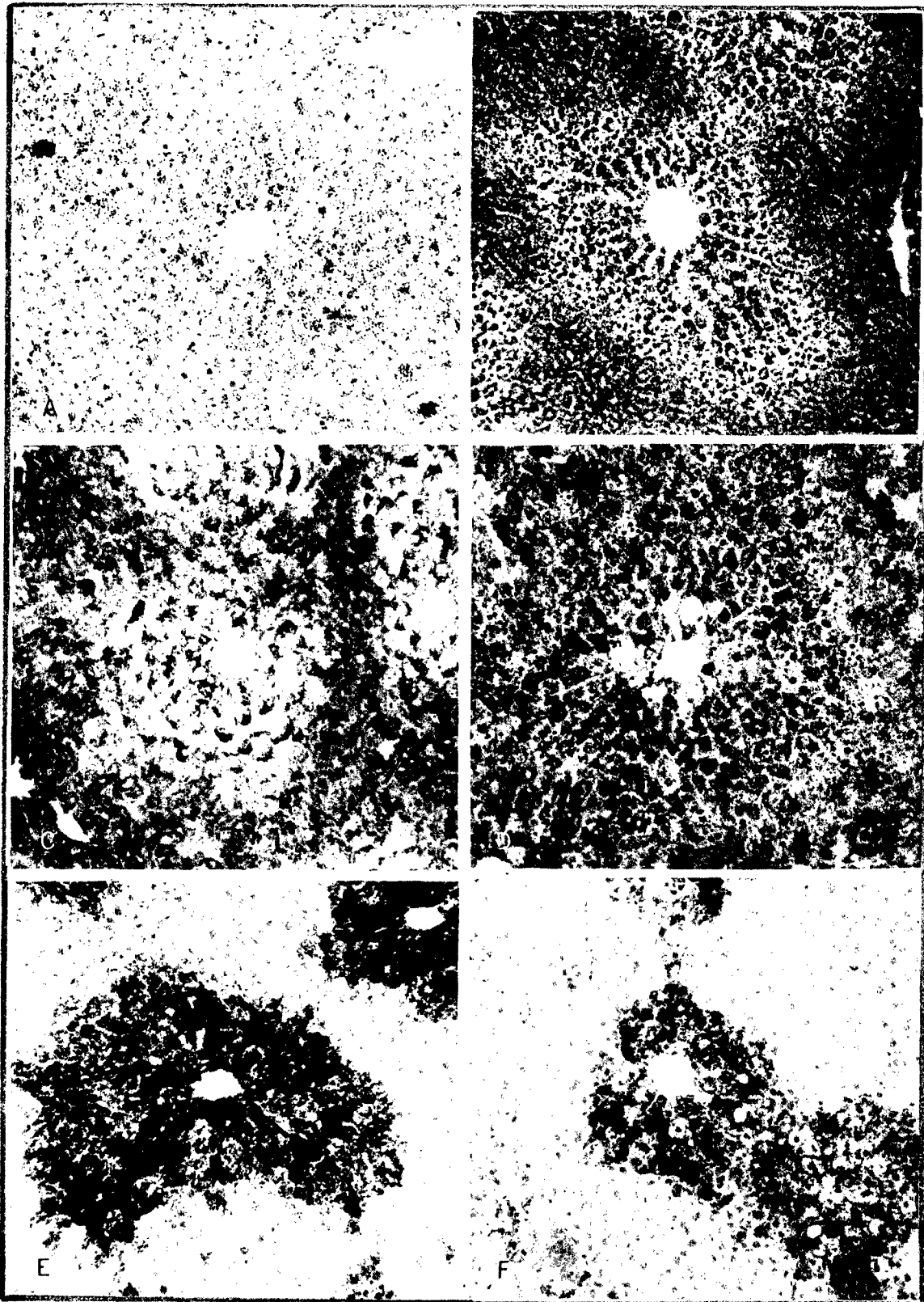

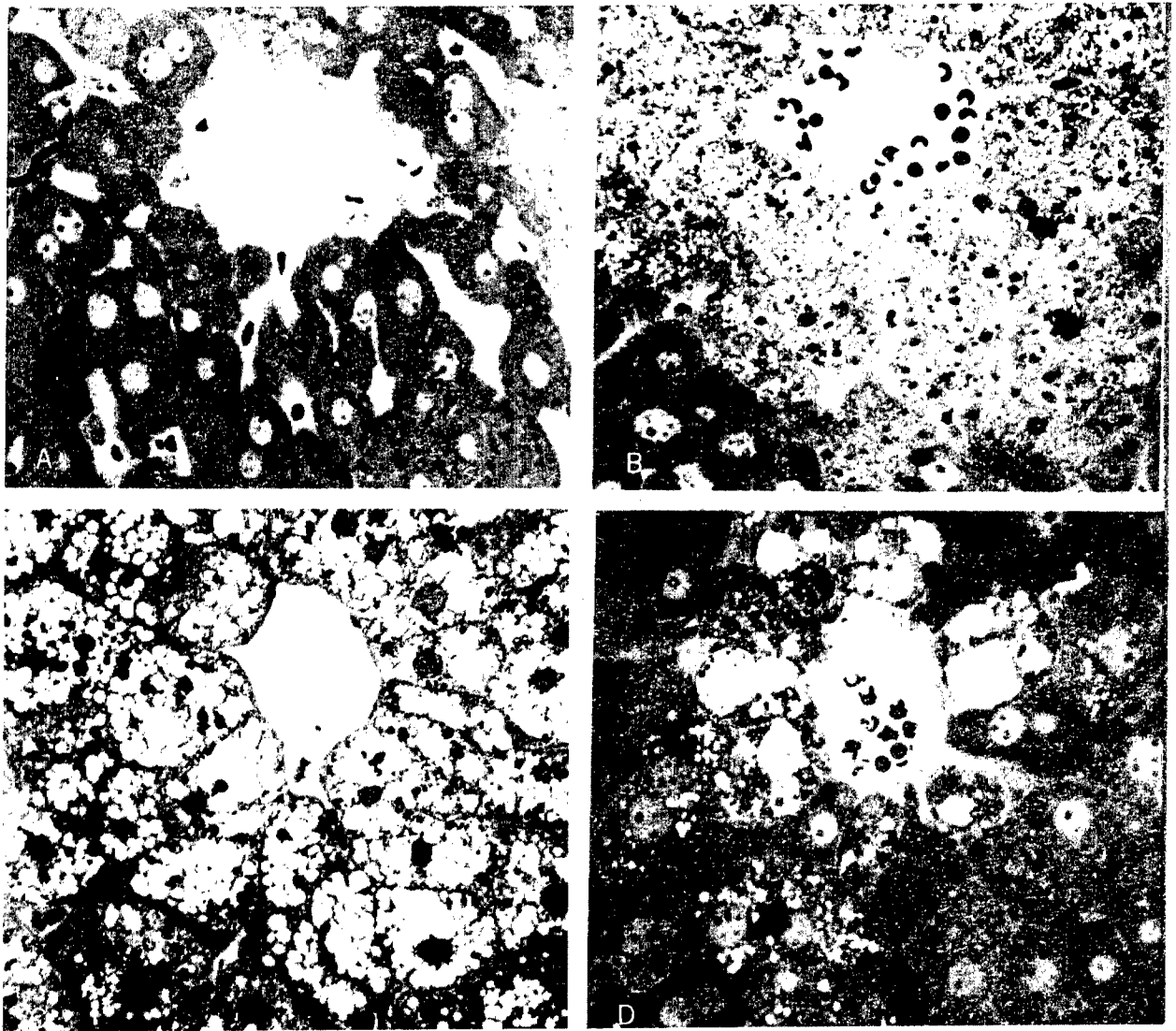

Figure 6. PHOTOMICROGRAPHS OF ONE MICRON SECTIONS OF CENTRILOBULAR HEPATOCYTES IN EPON-EMBEDDED LIVER. (A) Control dome, four days of exposure. (B) 5000 ppm CH₂Cl₂, one day of exposure. (C) 5000 ppm CH₂Cl₂, two days of exposure. (D) 5000 ppm CH₂Cl₂, seven days of exposure. See text for description. Toluidine blue stain. x950

PAS stains showed an initial decrease in liver glycogen in the first day for mice in both the control dome and the CH_2Cl_2 dome. Control animals then reaccumulated glycogen after the first day of exposure to the control dome environment. Hepatic glycogen continued to decrease in the CH_2Cl_2 exposed mice until day 3 when glycogen began to reaccumulate in the periportal zone. Glycogen remained decreased in centrilobular areas of livers of CH_2Cl_2 exposed mice throughout the 7 day exposure period.

Electron Microscopy

Livers of mice exposed for up to one week in the control dome appeared essentially normal except for mild glycogen depletion at day 1 and mild swelling of some mitochondria on day 4 and thereafter (figure 7).

Livers of animals exposed to 5000 ppm CH_2Cl_2 for 1, 4 and 8 hours showed loss of glycogen but were otherwise unremarkable at the electron microscopic level. Definite structural changes were present in centrilobular hepatocytes at 12 hours. There were prominent changes in the rough endoplasmic reticulum (rough ER) of hepatocytes. In control livers, rough ER of centrilobular cells consisted of flattened membrane-limited cisternae that bore clusters of polyribosomes (polysomes) in the form of spirals and rosettes. Polysomes were also free in the cytoplasm. After 12 hours of exposure to CH_2Cl_2 , there was a breakdown of polysomes and early detachment of ribosomal particles from the rough ER membranes in centrilobular liver cells (figure 8). Rough ER membranes fragmented into vesicles. In addition, the perinuclear cisterna was dilated and lipid droplets were increased in number. The smooth endoplasmic reticulum (smooth ER) and mitochondria appeared normal. Subtle changes were noted in a few periportal hepatocytes. The rough ER cisternae of periportal hepatocytes retained their normal elongate configuration; however, focally some polysomes appeared to fall off rough ER membranes and to disintegrate (figure 9).

At 1 day of exposure to CH_2Cl_2 , rough ER cisternae of centrilobular cells showed increased dilatation and the rough ER membranes were nearly denuded of ribosomal particles. Periportal cells showed definite changes (figure 10). Many rough ER and smooth ER membrane profiles were attenuated and, in many hepatocytes, the rough ER is decreased as are numbers of polysomes. Also, many profiles of endoplasmic reticulum disappeared and glycogen decreased, leaving a relatively empty appearing cytoplasm. Free ribosomes were present in the cytoplasm. Elements of smooth ER were widely separated. Lipid droplets were prominent but mitochondria appeared normal.

At 2 days, balloon degeneration, represented at the ultrastructural level as massively dilated cisternae of rough ER, reached its severest extent (figures 6C, 11 and 12). The cell nucleus, mitochondria, and the cytoplasm surrounding elements of dilated ER were condensed. The perinuclear cisterna was enlarged, massively distorted and communicated with cystically dilated elements of the rough ER.

Figure 7. ELECTRON MICROGRAPH OF CENTRILOBULAR HEPATOCYTES IN A CONTROL MOUSE. The mouse was in the control dome for seven days. A hepatocyte nucleus is round and rimmed by a flattened perinuclear cisterna (arrows). The smooth endoplasmic reticulum (SER) consists of a close-meshed network of tubules. The rough endoplasmic reticulum (RER) occurs as loose aggregations of cisternae that are arranged in more or less parallel arrays. RER membrane-associated ribosomes are in chains and rosettes. Particles of glycogen (Gly) form large aggregates. These cells appear normal except for mild swelling of mitochondria (Mit). The bar in the lower right corner of each electron micrograph indicates one micron, except where other calibrations are specifically noted. x16,000

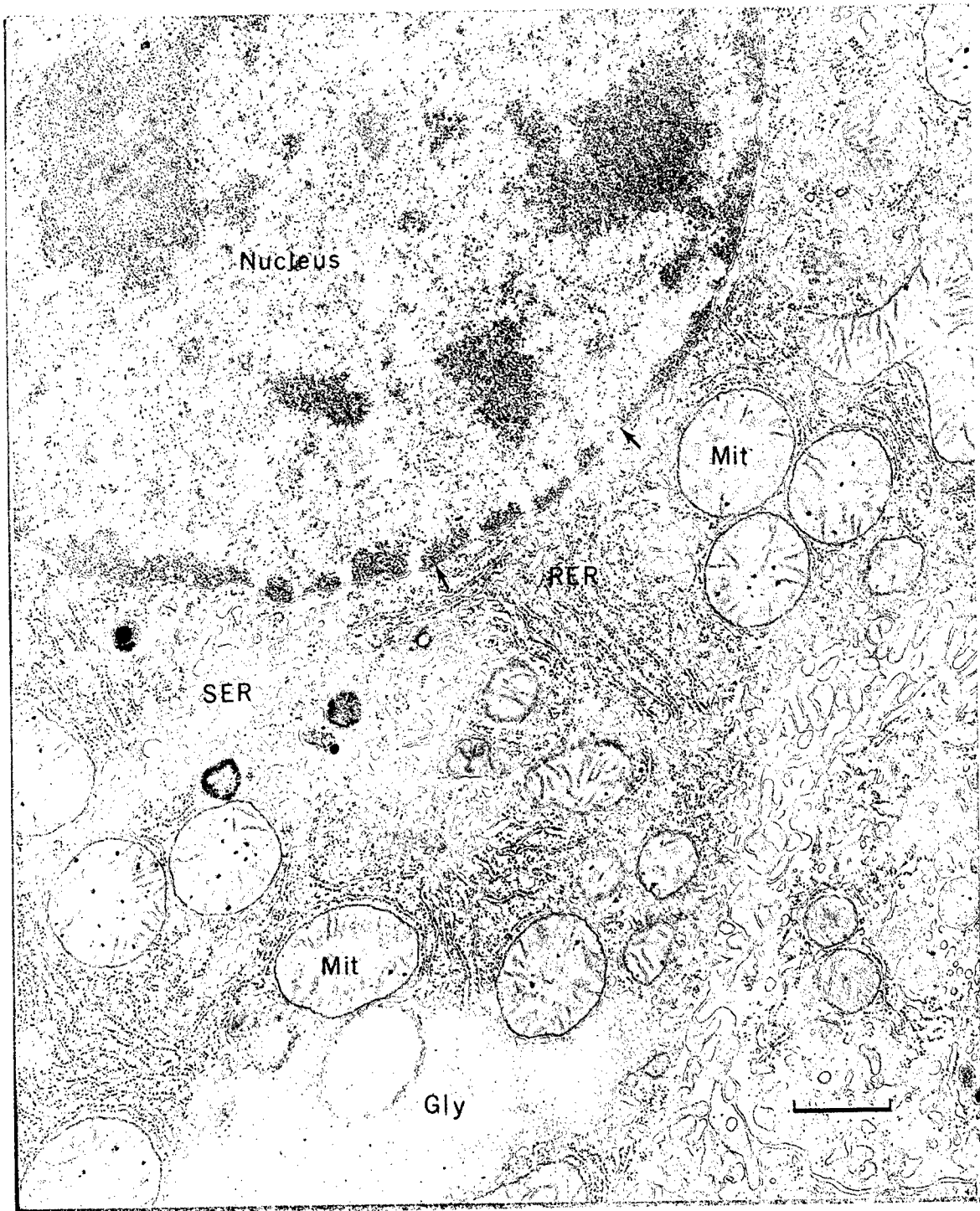

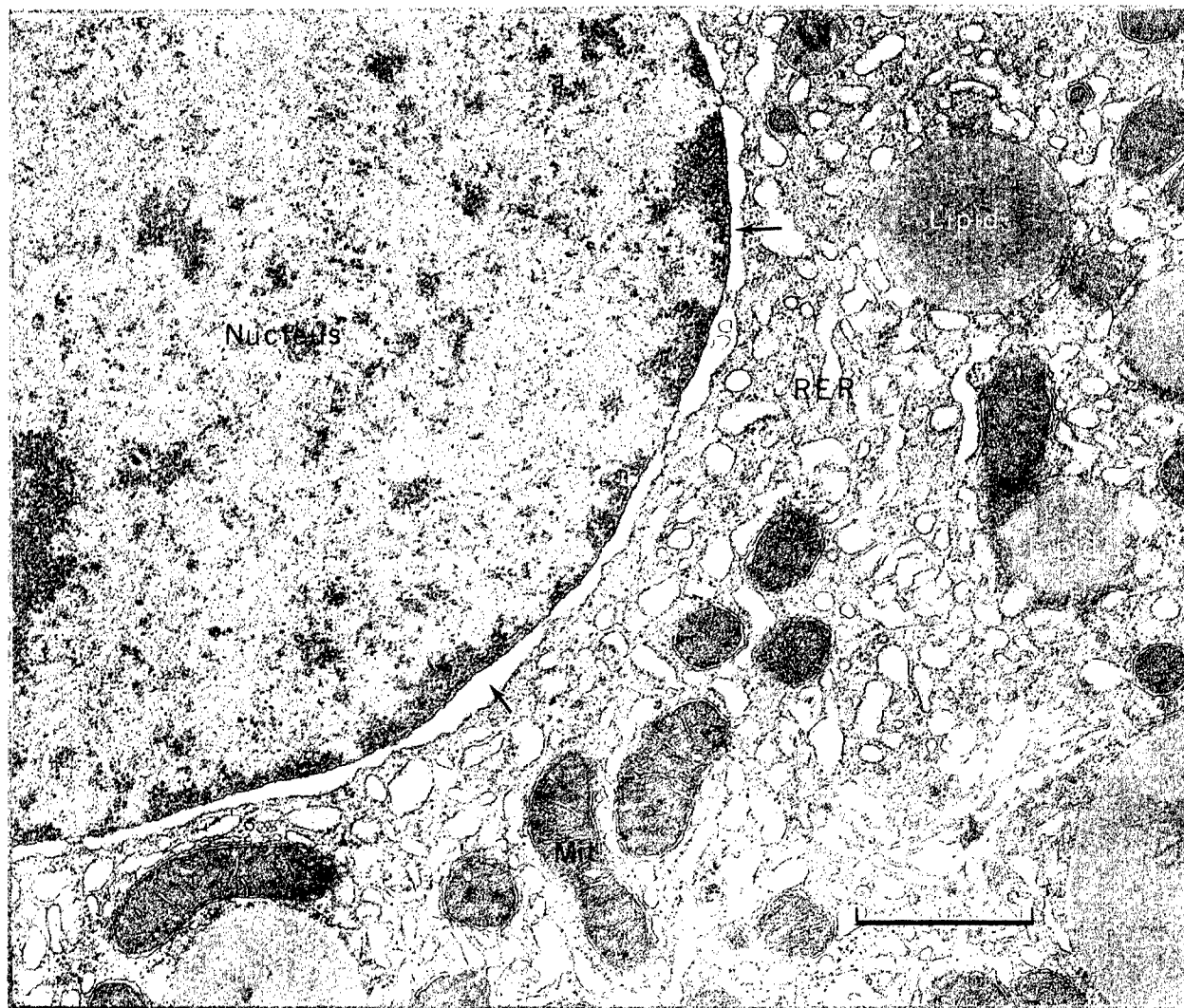

Figure 8. ELECTRON MICROGRAPH OF A CENTRILOBULAR HEPATOCYTE AFTER 12 HOURS OF EXPOSURE TO 5000 ppm CH_2Cl_2 . RER cisternae are fragmented and transformed into vesicles. Ribosomes are detached from RER membranes. The perinuclear cisterna is dilated (arrows). Mitochondria appear normal but lipid droplets are increased in number. x 27,000



Figure 9. ELECTRON MICROGRAPH OF A PERIportal HEPATOCYTE AFTER 12 HOURS OF EXPOSURE TO 5000 ppm CH_2Cl_2 . Membrane-limited cisternae of RER maintain a normal configuration and in some areas polysomes (single arrows) are intact. In other areas, polysomes appear to be disintegrating and fall off of RER membranes (double arrows). x 44,000. Insert - RER of a control mouse. A grazing section of RER shows the normal configuration of polysomes. x 44,000

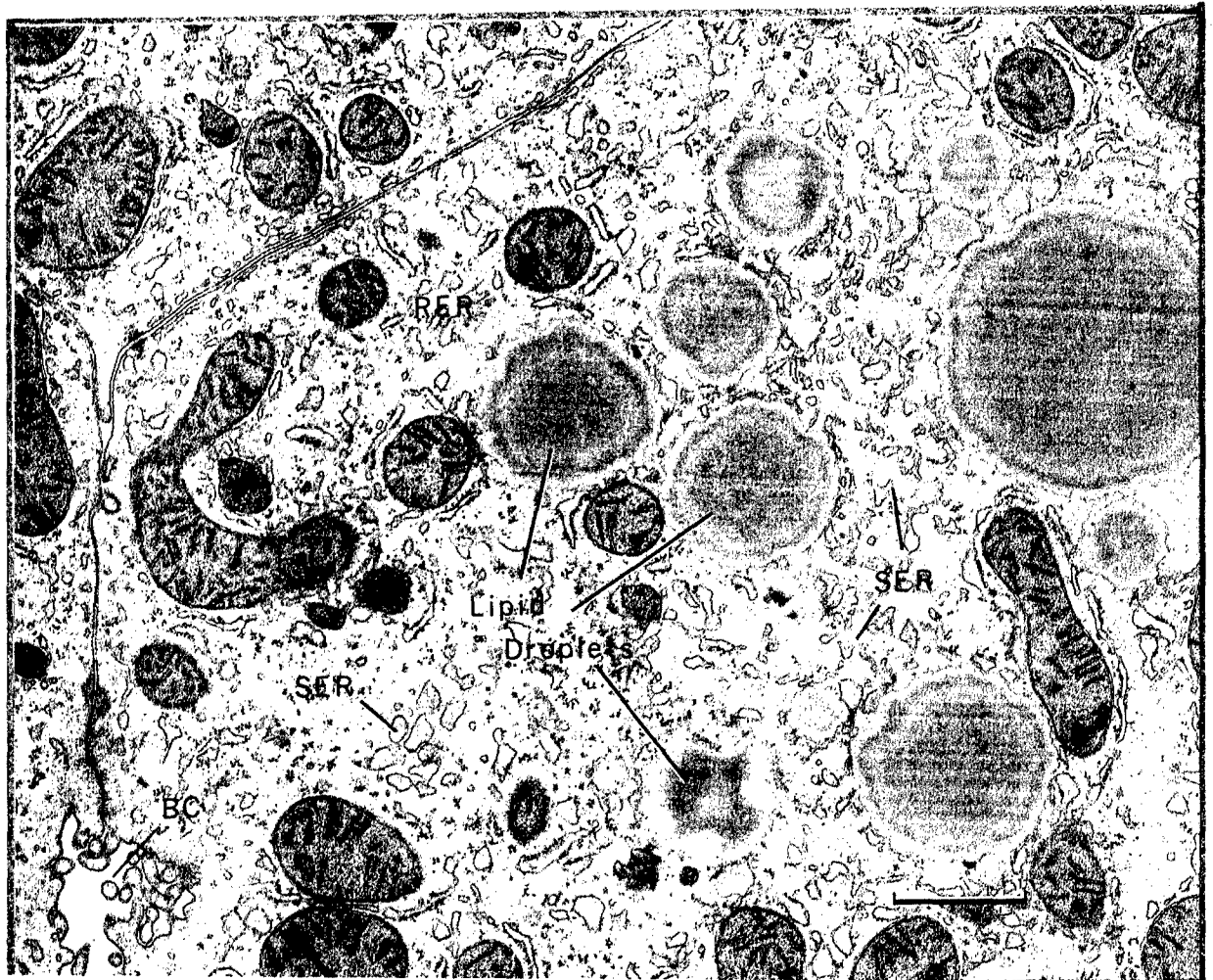

Figure 10. ELECTRON MICROGRAPH OF PERIPORTAL HEPATOCYTES AFTER ONE DAY OF INHALATION EXPOSURE TO 5000 ppm CH_2Cl_2 . The SER and RER are attenuated. Lipid droplets are prominent. Mitochondria and a bile canaliculus (BC) appear normal. x18,700



Figure 11. ELECTRON MICROGRAPH OF CENTRILOBULAR HEPATOCYTE AFTER TWO DAYS OF CONTINUOUS EXPOSURE TO 5000 ppm CH_2Cl_2 . Cisternae of RER vary greatly in size and some cisternae are nearly as large as the hepatocyte nucleus. Mitochondria are decreased in size and their matrix has increased density. The nucleus is contracted and contains lipid droplets. A few myelin figures (MF) are noted. x13,500

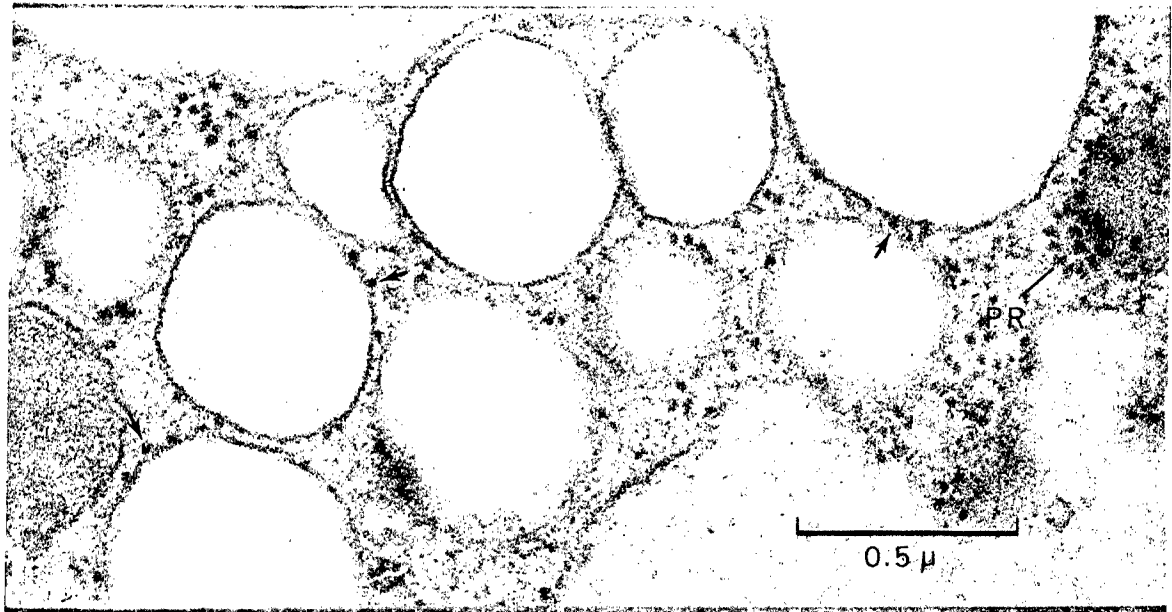

Figure 12. ELECTRON MICROGRAPH OF RER OF A CENTRILOBULAR HEPATOCYTE AFTER TWO DAYS OF CONTINUOUS EXPOSURE TO 5000 ppm CH_2Cl_2 . RER cisternae are dilated and nearly denuded of ribosomes. Only a few ribosomal particles remain attached to RER membranes (arrows). Polyribosomes (PR) are infrequently encountered. x75,000

Intranuclear lipid droplets and large numbers of cytoplasmic lipid droplets were present in centrilobular cells. The ultrastructure of periportal cells remained fairly constant from day 2 through day 4 except that the amount of smooth ER and glycogen increased, the number of lipid droplets decreased, and a few large mitochondria appeared. Some of the larger lipid droplets appeared to fragment and were transformed into smaller droplets. Concomitantly osmiophilic droplets appeared in the cisternae of ER and in elements of the Golgi apparatus.

After 4 days of continuous exposure, centrilobular cells were highly pleomorphic. Some cells showed small round to oval profiles of rough ER to which numbers of ribosomes were attached. Other centrilobular hepatocytes contained either many cystically dilated cisternae of rough ER or a single large empty-appearing vacuole lined with a membrane that probably represented coalesced elements of dilated ER. In the latter cells, the nucleus sometimes projected into this large vacuole which appeared as an extension of the perinuclear cisterna (figure 13). Smooth ER was prominent in a few centrilobular hepatocytes after 4 days of exposure. Some mitochondria were mildly swollen and a few large bizarre mitochondria were observed (figure 14). A few necrotic hepatocytes were present. Many cells contained autophagic vacuoles which are membrane-bound structures containing cytoplasmic organelles in various stages of digestion (deDuve and Wattiaux, 1966). The autophagic vacuoles observed in this study contained distorted elements of ER, abnormal mitochondria, dense cytoplasm and lipid droplets (figure 15). Autophagic vacuoles varied greatly in size, and some were as large as a hepatocyte nucleus.

After one week, centrilobular hepatocytes remained pleomorphic and resembled cells described in the mixed population of hepatocytes at 4 days (figure 6D and 16). However, balloon cells were less frequent and, in many areas, smooth ER was now prominent (figure 17). Smooth ER profiles were dilated (or hypertrophied) and tightly packed together, and glycogen particles were entrapped between neighboring membranous profiles. Peroxisomes were increased in number. Periportal cells showed increased amounts of both smooth and rough ER compared to analogous cells at 4 days although these elements were still decreased compared with controls. All hepatocytes were abnormal to some extent.

Livers of mice exposed intermittently 6 hours a day for four days to 5000 ppm CH_2Cl_2 were also examined by light and electron microscopy. Animals were sacrificed at the termination of the final exposure period. Oil-red-O stains of frozen sections showed a slight increase in fat as compared to sections of livers of the appropriate control animals. Light and electron microscopy showed decreased glycogen and a mild increase in hepatocyte fat. At the ultrastructural level, polysomes were intact and cisternae of rough ER maintained their normal configuration with no evidence of swelling. Endoplasmic reticulum in some hepatocytes appeared to be present in normal amounts and in other hepatocytes might have been slightly decreased. The livers of control mice appeared normal, except for mild glycogen depletion.

Figure 13. ELECTRON MICROGRAPH OF A CENTRILOBULAR HEPATOCYTE AFTER FOUR DAYS EXPOSURE TO 5000 ppm CH_2Cl_2 . Many dilated elements of RER have coalesced into a single large vesicle which communicates with collapsing cisternae of RER (arrow #1) and the perinuclear cisterna (arrow #2). The nucleus projects into the large vesicle. Nuclear pores facing into the vesicle are covered with membrane-bound tags of residual cytoplasm (double arrows). Nuclear and mitochondrial (Mit) condensation are less severe than at two days of exposure (compare with figure 11). The perinuclear cisterna away from the large cytoplasmic vesicle is regaining its normal flattened configuration. x 20,000



Figure 14. ELECTRON MICROGRAPH OF AREAS OF FOUR PERIportal HEPATOCYTES AFTER FOUR DAYS OF CONTINUOUS EXPOSURE TO 5000 ppm CH_2Cl_2 . In some hepatocytes, mitochondria appear normal (Mit_1). In some they are slightly swollen (Mit_2) and in others, mitochondria occasionally assume bizarre configurations (Mit_3). At four days, SER and RER (arrows) remain decreased. Bile canaliculi (BC) appear normal and lipid is mildly increased. Microbodies (MB) are prominent. x14,700

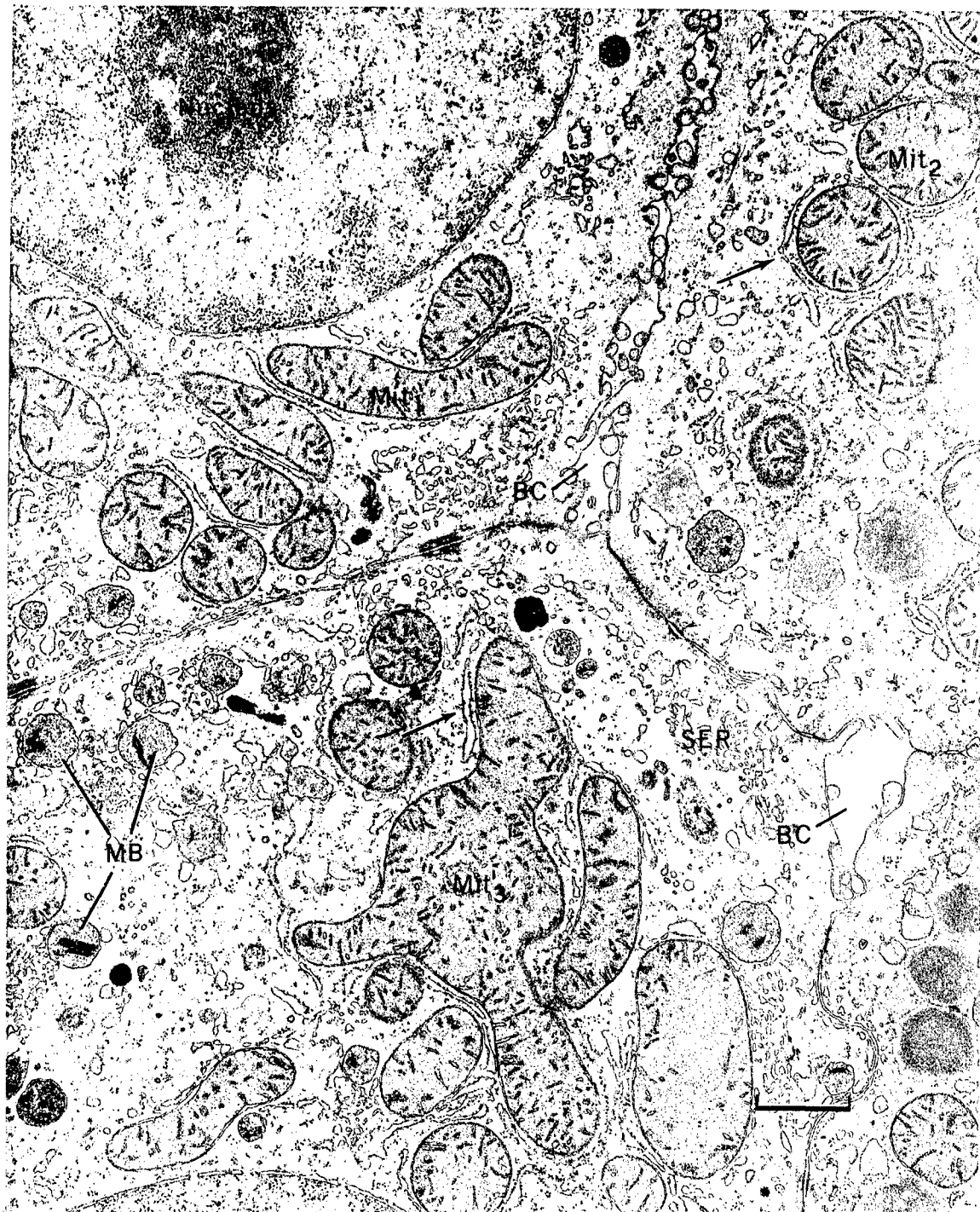
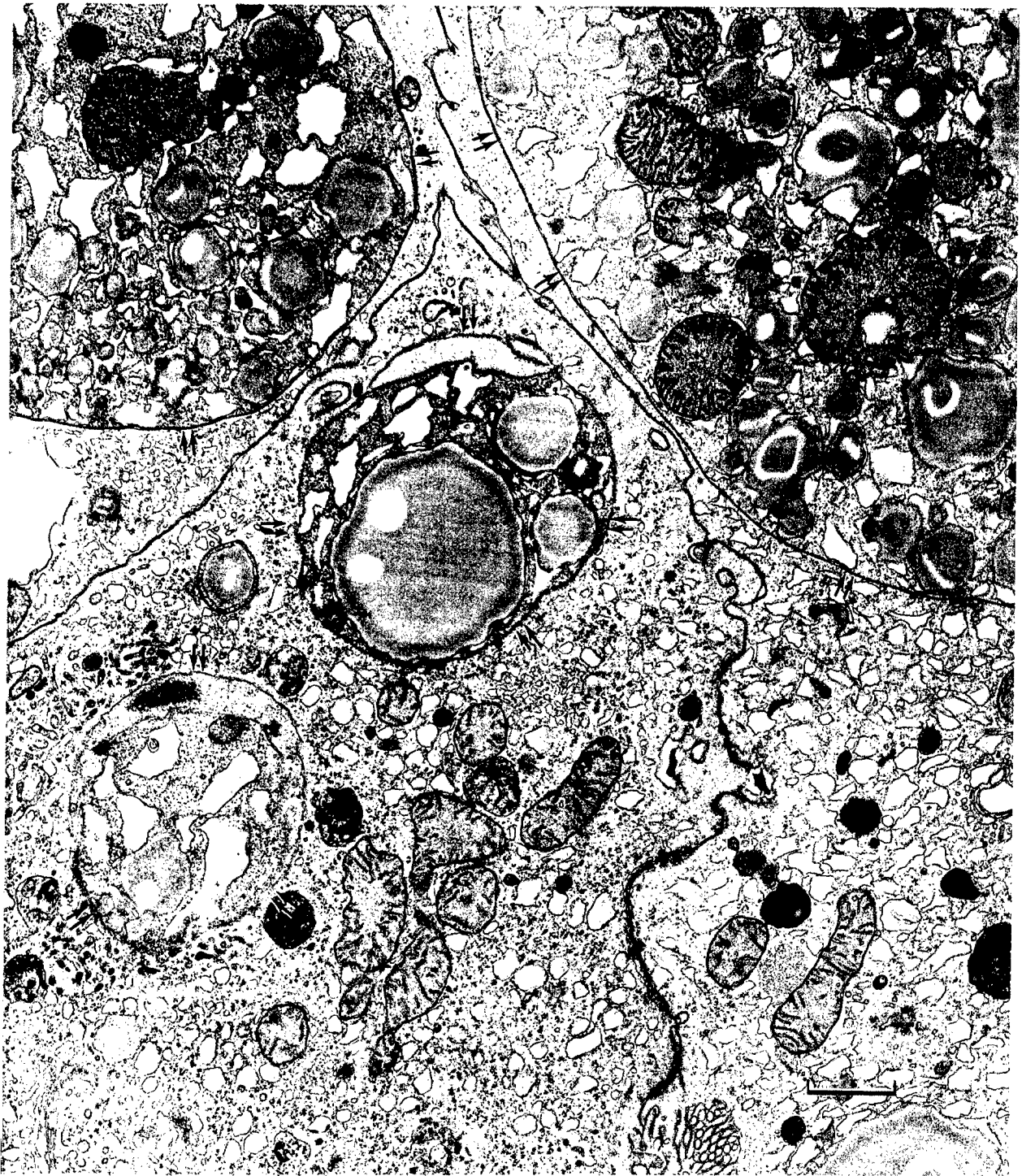

Figure 15. ELECTRON MICROGRAPH OF THE CYTOPLASM OF THREE CENTRILOBULAR HEPATOCYTES AFTER FOUR DAYS OF CONTINUOUS EXPOSURE TO 5000 ppm CH_2Cl_2 . Autophagic vacuoles are limited by membranes (double arrows) and contain degenerating mitochondria, RER, SER, lipid droplet, and dense cytoplasm. x14,000



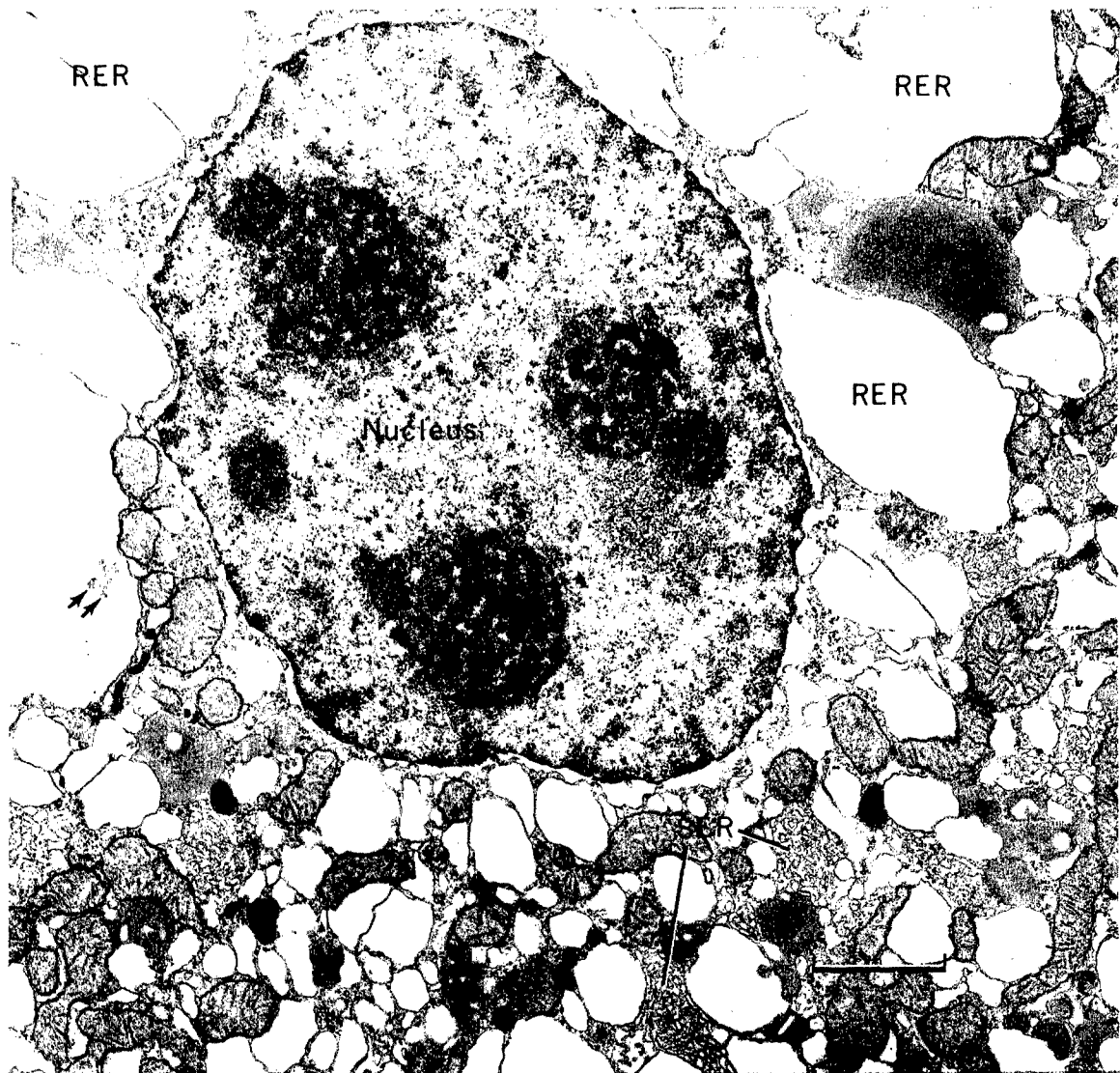

Figure 16. ELECTRON MICROGRAPH OF A CENTRILOBULAR HEPATOCYTE AFTER SEVEN DAYS OF CONTINUOUS EXPOSURE TO 5000 ppm CH_2Cl_2 . The hepatocyte is undergoing "ballooning degeneration." Small lipid droplets (arrows) are present in distended cisternae of RER. x18,000



Figure 17. ELECTRON MICROGRAPH OF THE SER OF A CENTRILOBULAR HEPATOCYTE AFTER SEVEN DAYS OF CONTINUOUS EXPOSURE TO 5000 ppm CH_2Cl_2 . SER tubules are dilated (? hypertrophied) and branch extensively. Entrapped between membranous elements are particles of glycogen. x50,000

Autoradiography

The livers of control mice (figure 18A) at all time intervals, and of mice exposed continuously to CH_2Cl_2 for 4 and 12 hours showed uniform labelling of hepatocytes throughout the lobules. Some grains were present over Kupffer cells and over cells in portal tracts. Very few grains were present over blood spaces, e. g., sinusoids and central veins. Livers of mice exposed to CH_2Cl_2 for 1 day showed a reduction in labelling of centrilobular hepatocytes although many grains were still present (figure 18B). Periportal hepatocytes showed a discernible reduction in grains, albeit less pronounced than in cells in the center of lobules. The transition between periportal and centrilobular cells was gradual. Kupffer cells appeared unaffected and had grain densities comparable to those over Kupffer cells in the control livers. With 2 days of exposure, there was a further decrease in grains over centrilobular hepatocytes (figure 18C). A gradient was still obvious with grains more concentrated over peripheral hepatocytes. Kupffer cells remained uninvolved.

DISCUSSION

Several of the observations in this study may be related to the experimental manipulation of test animals rather than to exposure to CH_2Cl_2 . In this regard, it is noteworthy that animal weights decreased in the first 2 days of exposure in both control and CH_2Cl_2 domes (figure 2). Control animals began to gain weight after day 1 and approached their initial weight by day 3; they never completely regained their initial weight by the end of a week. This weight loss and slow recovery may reflect incomplete adaptation to the control dome environment. Mice in the CH_2Cl_2 dome continued to lose weight after the first day. Part of the weight loss in mice in the CH_2Cl_2 dome appears to be related to the CH_2Cl_2 exposure. Decreased food intake, as reflected in weight loss, may account for some of the early changes seen in mice from both the control and CH_2Cl_2 domes. For example, a decrease in tissue glycogen and mitochondrial swelling can occur on a nutritional basis (Krishnan and Stenger, 1966). Some changes observed in CH_2Cl_2 exposed mice but not in control mice may also be on a nutritional basis since mice in the CH_2Cl_2 dome, although fed in the same manner as control animals, showed a profound and persistent weight loss throughout the exposure period. The appearance of autophagic vacuoles on the fourth day of exposure in the CH_2Cl_2 could be related, in part, to poor nutrition since autophagic vacuoles are frequently seen with tissue atrophy and in other pathologic states (see Cole et al., 1971 for references).

The endoplasmic reticulum of liver cells can also be sensitive to experimental manipulation of animals. Fasting, starvation and feeding of protein-free diets are all associated with loss of the common parallel arrangement of elements of the rough ER and the development of a more random appearance of the rough ER cisternae. Polysomes remain attached to rough ER membranes (Smuckler and Arcasoy, 1969).

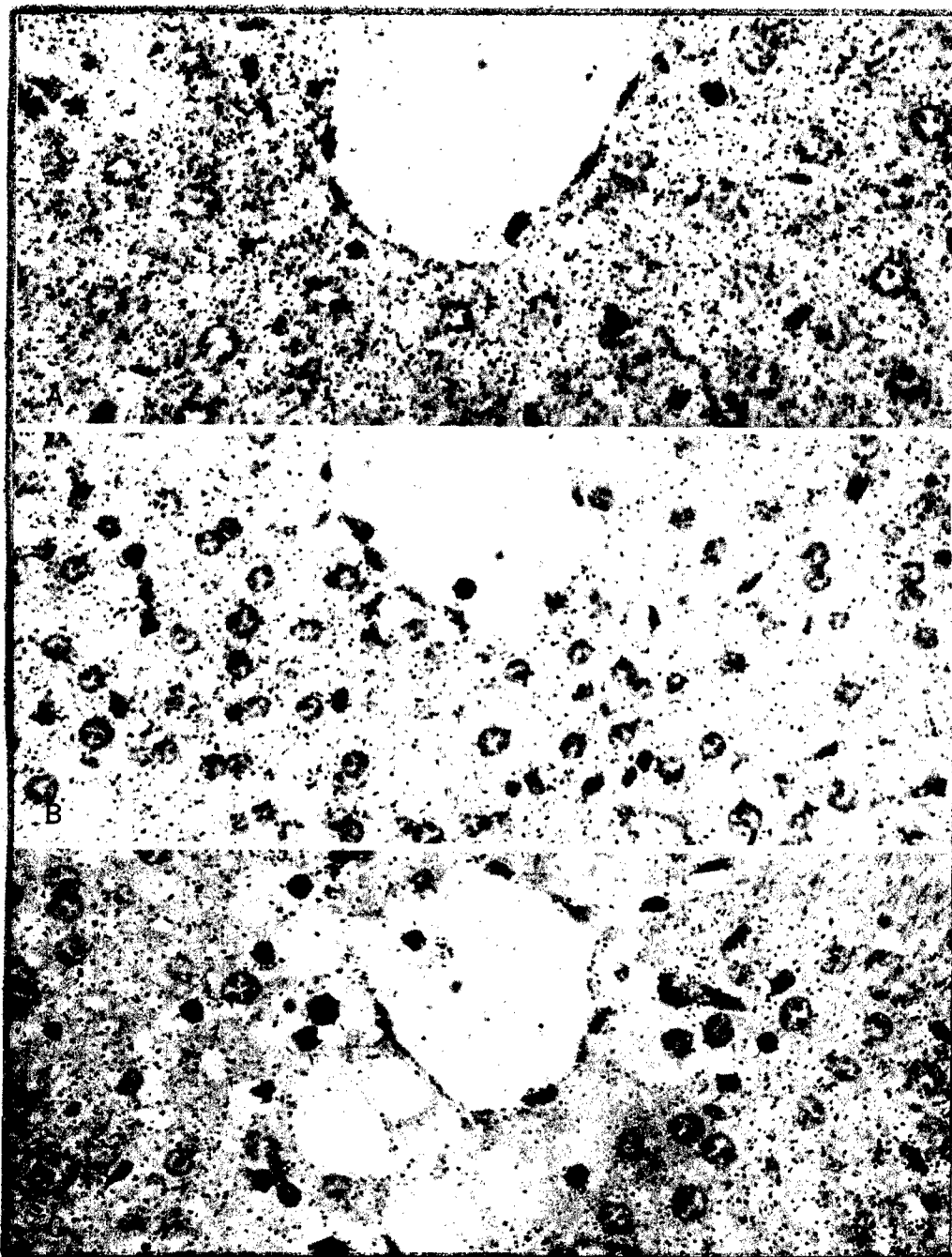

Figure 18. AUTORADIOGRAMS OF LIVER CONTAINING L-LEUCINE-4,5-³H. (A) Control dome, two days of exposure. (B) 5000 ppm CH₂Cl₂, one day of exposure. (C) 5000 ppm CH₂Cl₂, two days of exposure. See text for description. Hematoxylin and eosin staining. x 700

In young rats, low protein diets cause cisternae of rough ER to become markedly dilated (Svoboda and Higginson, 1964). The change is less pronounced in older rats and usually takes longer to induce than the total exposure time in this study. Ribosomal detachment, as observed with CH_2Cl_2 exposures, is not seen in either starvation or protein deficiency.

Intermittent exposures of mice to 5000 ppm CH_2Cl_2 results in a mild increase in the lipid content and a decrease in glycogen content of hepatocytes. These changes are not apparent in hematoxylin and eosin stained sections of paraffin embedded liver but are seen with special stains and in electron micrographs. At the electron microscopic level, minor changes are noted in the ER of some liver cells of mice exposed intermittently to CH_2Cl_2 . These are observed after four daily exposures of 6 hours each and are marginal. They are less apparent than changes observed in hepatocytes after a single 8-hour exposure to the same level of CH_2Cl_2 and are far less severe than alterations after a single 12-hour exposure. Early changes are reversible over the 18-hour nonexposure intervals which are sandwiched between the 6-hour exposure periods. Our observations indicate that multiple intermittent 6-hour exposures (i.e. 4 exposures) are no more toxic to liver cells than a single 6-hour exposure.

Continuous exposure to 5000 ppm CH_2Cl_2 produces lesions in hepatocytes that are first detected at 8 hours of exposure and are probably related to CH_2Cl_2 inhalation. The earliest and most striking change is in the hepatocyte ER. The changes consist of disruption of rough ER membranes and coalescence of ER membranes into large vacuoles (so-called balloon degeneration). The rough ER are more sensitive to CH_2Cl_2 injury than the smooth ER. Other early changes include nuclear condensation, related to movement of water out of the nucleus, and lipid droplet accumulation. An early change that may be unrelated to CH_2Cl_2 exposure is glycogen depletion. Mitochondrial changes are minor and consist of the development of enlarged, bizarre mitochondria and mild mitochondrial swelling. Balloon degeneration peaks at 2 days of exposure and then subsides. Fatty changes peak at 3 days and are also partially reversible. After three days of exposure, free and membrane-bound polysomes are present in increased numbers. The rough ER remains mildly swollen, although frank ballooning is confined to progressively fewer cells. Autophagic vacuoles are present in many centrilobular cells on day 4 but necrosis is seen in a very small percentage of hepatocytes.

The breakdown of polysomes into ribosomes and the detachment of ribosomes from rough ER membranes are common early events seen after lethal and sublethal exposures to a variety of toxic substances (Smuckler and Arcasoy, 1969). These changes have been studied particularly well by electron microscopy in the livers of animals exposed to carbon tetrachloride (CCl_4), an analog of dichloromethane (see reviews by Smuckler and Arcasoy, 1969; Farber, 1971). Within 30-60 minutes after a single intragastric dose of CCl_4 , a breakdown of polysomes and detachment of ribosomal particles from rough ER membranes is apparent in a few liver cells. Within the first 2 hours, aggregates of smooth-surfaced membranes are prominent. At 3 hours, 75% of liver cells show loss of ribosomal aggregates. Some ER membranes

show narrowing of cisternae and other ER profiles are dilated. At 6 hours, centrilobular hepatocytes show alterations consistent with irreversible change including karyolysis, cell membrane disruption, and severe intramitochondrial calcium salt accretion (Smuckler and Arcasoy, 1969; Reynolds et al., 1962). Livers examined 10 to 20 hours after ingestion have large accumulations of tangled smooth membrane vesicles. Lipid droplets are prominent and considerable numbers of hepatic cells are necrotic. The polysome-ribosome dynamics with CCl_4 injury has been documented biochemically (see review by Farber et al., 1971) as well as morphologically.

A shift from polysomes to single ribosomes (monosomes) is observed with continuous inhalation of 5000 ppm CH_2Cl_2 in mice but the onset of change is many hours later than is observed with intragastric or intraperitoneal CCl_4 in rats or mice at the standard experimental dose level (0.25 ml CCl_4 /100 grams body weight). There are also other significant differences in the ultrastructure of livers of mice exposed by inhalation to CH_2Cl_2 as compared to CCl_4 exposed animals. The appearance and configuration of cytomembranes differ significantly. Whereas intragastric CCl_4 produces collapse of rough ER membranes, widening of the individual membranes, and the accumulation of osmiophilic densities (flecks) between membrane-bound spaces (Arstila et al., 1970; Shinozuka, 1971), on inhalation of CH_2Cl_2 the rough ER membranes show extensive ballooning without significant focal collapse or the accumulation of electron-dense flecks. These differences in membrane configuration and appearance may reflect differences in the severity of membrane injury and/or in the mechanism of injury. Dilatation of rough ER cisternae (balloon degeneration), as is seen with CH_2Cl_2 , results from mild non-lethal injury to membranes causing impairment of normal transport of water and ions across membranes (Ginn et al., 1968). The membranes remain semi-permeable and the alterations are largely reversible. Collapse of rough ER membranes widening of the "unit membrane" and the accumulation of dense osmiophilic flecks, as seen with CCl_4 poisoning, probably represent a more severe form of injury that is irreversible (Arstila et al., 1970; Shinozuka, 1971). These later changes have been associated with membrane injury resulting from peroxidative decomposition of structural lipids in membranes and can be reproduced experimentally when ER membranes are peroxidized in vitro (Arstila et al., 1970).

Our observation that incorporation of tritiated leucine into hepatic proteins is depressed but not abolished with continuous inhalation of 5000 ppm CH_2Cl_2 is further evidence that the hepatotoxicity of CH_2Cl_2 is mild, relative to the standard experimental dose of CCl_4 administered via the oral route. In an autoradiographic study of protein synthesis in CCl_4 exposed mice, Monlux and Smuckler (1969) found that leucine incorporation into the proteins of centrilobular hepatocytes in mouse livers was almost entirely eliminated 1-3/4 hours after oral administration of CCl_4 . In contrast, we find that 24 hours of continuous exposure to CH_2Cl_2 mildly depresses amino acid incorporation into hepatic proteins and that even 48 hours of continuous exposure fail to inhibit incorporation completely.

Triglyceride metabolism is another measure of liver function. The accumulation of lipid in the hepatocyte cytoplasm is a common sublethal reaction to injury and is usually reversible. Fatty liver can result from impairment of one or a combination of metabolic processes which may result in an imbalance between supply, utilization and secretion of lipid by the liver cell. For example, with CCl_4 injury the supply of fatty acids and triglycerides to the liver is normal as is synthesis of triglycerides from fatty acids in the liver (Recknagel, 1967). However, triglyceride secretion from the liver is impaired, which may account for the accumulation of fat in CCl_4 hepatotoxicity (Seakins and Robinson, 1963). Since triglycerides are secreted from liver cells in the form of low density lipoproteins, triglyceride accumulation following CCl_4 poisoning may result from a depression of protein synthesis and, more specifically, depressed synthesis of the protein moiety for the lipoprotein complex responsible for carrying triglycerides from the liver (Seakins and Robinson, 1964; Robinson, 1964). This hypothesis has been critically reviewed by Recknagel (1967). Although definite conclusions cannot be drawn about the mechanism of fatty change with CH_2Cl_2 poisoning on the basis of our limited studies, the data to date suggest that the mechanism may be the same for CH_2Cl_2 and CCl_4 .

If inhibition of protein synthesis accounts for the fatty change observed in these studies, it might be anticipated that the rate of accumulation of lipid would be less than that induced by CCl_4 which profoundly inhibits protein synthesis (Smuckler and Benditt, 1965; Monlux and Smuckler, 1969). To test this possibility, the accumulation rate of lipid was compared for CH_2Cl_2 and CCl_4 exposed mice. Carbon tetrachloride was given to ICR strain female mice by gastric tube at a dose level of 0.25 ml/100 grams body weight. Over the first 24 hours, the rate of liver triglyceride accumulation per 100 grams of body weight was 0.20 mg/min (Weinstein and Boyd, unpublished data). This is comparable to the rate of liver triglyceride accumulation with CCl_4 poisoning reported in rodents by other investigators (Schotz et al., 1964; see Recknagel, 1967 for other references). This rate of accumulation is considerably greater than the rate of liver triglyceride accumulation in mice exposed continuously to 5000 ppm CH_2Cl_2 over 24 hours of continuous exposure. These animals accumulate triglycerides at a rate of 0.07 mg/min 100 grams body weight, as calculated from the data in figures 2 and 4.

It is widely speculated that a mechanism involving free radical formation and subsequent peroxidation of membrane lipids may account for at least part of the hepatotoxicity of CCl_4 (for reviews, see Recknagel, 1967 and Farber, 1971; Farber et al., 1971). A number of observations support this hypothesis including the early appearance of abnormal conjugated dienes in lipids extracted from liver microsomes (Rao and Recknagel, 1968), and the protective action of antioxidants in CCl_4 injury (Gallagher, 1962). The role of free radicals in the pathogenesis of the lesions in CH_2Cl_2 hepatotoxicity is unknown and cannot be reasonably discussed since data are unavailable on the formation of free radicals from CH_2Cl_2 either in vitro or in vivo. Several comments in the literature do suggest that CH_2Cl_2 is more stable than CCl_4 or CHCl_3 . In vitro studies by von Oettingen et al. (cited by Browning, 1965) show a lower rate of

production of inorganic chloride from hydrolysis of CH_2Cl_2 by alcoholic NaOH than from CCl_4 or CHCl_3 . It has also been mentioned that CH_2Cl_2 is relatively stable in the body and produces less chloride in the body than CCl_4 (Browning, 1965). The results of exposures reported by Dambrauskas and Cornish (1970) indicate that hepatocyte damage in rodents is far more severe with inhalation of 4000 to 7000 ppm CCl_4 than we observed in our inhalation experiments with CH_2Cl_2 . This could be related to the stability of CH_2Cl_2 and a lack of damaging intermediate metabolites.

A particularly interesting aspect of this study is the abrupt reversal of the fatty change in the liver. Continuous exposure of animals to substances that produce fatty liver more typically produce a relatively constant and persistent elevation in hepatic triglycerides. The rapid mobilization of triglycerides from mouse liver on the third day of exposure suggests that mice have adapted to the CH_2Cl_2 dome environment and may have developed a tolerance to CH_2Cl_2 to an extent that allows for near normal turnover of triglycerides. The development of tolerance in CH_2Cl_2 exposed animals in the face of continuous exposure to the agent should be considered when determining acceptable levels for continuous human exposures. The mechanisms involved in tolerance development merit further investigation.

ACKNOWLEDGEMENTS

The authors gratefully acknowledge Dr. Anthony A. Thomas for many valuable suggestions, MSgt William D. Leonard, TSgt Fred Morris and SSgt Joseph Lebida, Jr., for technical assistance, and Lida C. Voehringer for assistance in preparing the manuscript.

REFERENCES

1. Arstila, A. U., M. A. Smith and B. Trump; "Characterization of Peroxidation Lesion in the Endoplasmic Reticulum of the Rat Kidney and Liver In Vivo and In Vitro;" (Abstract) Lab. Invest., 22:490, 1970.
2. Browning, E.; Toxicity and Metabolism of Industrial Solvents; Elsevier Publishing Co., Amsterdam, 1965.
3. Butler, W. M., Jr., H. M. Maling, M. G. Horning, and B. B. Brodie; "The Direct Determination of Liver Triglycerides;" J. Lipid Res., 2:95, 1961.
4. Cole, S., A. Matter, and M. J. Karnovsky; "Autophagic Vacuoles in Experimental Atrophy;" Exp. Mol. Pathol., 14:158, 1971.
5. Dambrauskas, T., and H. H. Cornish; "Effect of Pretreatment of Rats with Carbon Tetrachloride on Tolerance Development;" Toxicol. App. Pharmacol., 17:83, 1970.

6. deDuve, C., and R. Wattiaux; "Function of Lysosomes;" Ann. Rev. Physiol., 28:435, 1966.
7. Farber, E.; "Biochemical Pathology;" Ann. Rev. Pharmacol., 11:71, 1971.
8. Farber, E., H. Liang, and H. Shinozuka; "Dissociation of Effects on Protein Synthesis and Ribosomes from Membrane Changes Induced by Carbon Tetrachloride;" Am. J. Path., 64:601, 1971.
9. Flury, F., and F. Zernik, 1931. Cited by Browning, E.; Toxicity and Metabolism of Industrial Solvents; Elsevier Publishing Co., Amsterdam, 1965, p. 244.
10. Gallagher, C. H.; "The Effect of Antioxidants on Poisoning by Carbon Tetrachloride;" Australian J. Exptl. Biol. Med. Sci., 40:241, 1962.
11. Ginn, F. L., J. D. Shelburne, and B. F. Trump; "Disorders of Cell Volume Regulation. I. Effects of Inhibition of Plasma Membrane Adenosine Triphosphatase With Ouabain;" Am. J. Path., 53:1041, 1968.
12. Gross, 1944. Cited by Heppel, L. A., P. A. Neal, T. L. Perrin, M. L. Orr, and V. T. Porterfield; "Toxicology of Dichloromethane (Methylene Chloride). I. Studies on Effects of Daily Inhalation;" J. Indust. Hyg. Toxicol., 26:8, 1944.
13. Hellwig, A., 1922. Cited by Browning, E.; Toxicity and Metabolism of Industrial Solvents;" Elsevier Publishing Co., Amsterdam, 1965, p. 245.
14. Henderson, Y., and H. W. Haggard; Noxious Gases and the Principles of Respiration Influencing their Action; Reinhold, New York, 1943, pp. 201, 205.
15. Heppel, L. A., P. A. Neal, T. L. Perrin, M. L. Orr, and V. T. Porterfield; "Toxicology of Dichloromethane (Methylene Chloride). I. Studies on Effects of Daily Inhalation;" J. Indust. Hyg. Toxicol., 26:8, 1944.
16. Heppel, L. A., and P. A. Neal; "Toxicology of Dichloromethane (Methylene Chloride). II. Its Effect upon Running Activity in the Male Rat;" J. Indust. Hyg. Toxicol., 26:17, 1944.
17. Krishnan, N., and R. J. Stenger; "Effects of Starvation on the Hepatotoxicity of Carbon Tetrachloride;" Am. J. Path., 49:239, 1966.
18. Lehmann, K. B., and L. Schmidt-Kehl; "The Thirteen Most Important Chlorinated Aliphatic Hydrocarbons from the Standpoint of Industrial Hygiene;" Arch. F. Hyg., 116:131, 1936.

19. McNerney, J. M., and J. D. MacEwen; "Comparative Toxicity Studies at Reduced and Ambient Pressures. I. Acute Response;" Am. Indust. Hyg. Assoc. J., 26:568, 1965.
20. Monlux, G., and E. A. Smuckler; "An Autoradiographic Study of Protein Synthesis in Mouse Liver Parenchymal Cells During CCl₄ Intoxication;" Am. J. Path., 54:73, 1969.
21. Moskowitz, S., and H. Shapiro; "Fatal Exposure to Methylene Chloride Vapor;" Arch. Ind. Hyg., 6:116, 1952.
22. Nuckolls, A. H., 1933. Cited by Browning, E.; Toxicity and Metabolism of Industrial Solvents; Elsevier Publishing Co., Amsterdam, 1965, p. 244.
23. Rao, K. S., and R. O. Recknagel; "Early Onset of Lipoperoxidation in Rat Liver after Carbon Tetrachloride Administration;" Exp. Mol. Pathol., 9:271, 1968.
24. Recknagel, R. O.; "Carbon Tetrachloride Hepatotoxicity;" Pharmacological Reviews, 19:145, 1967.
25. Reynolds, E. S., R. E. Thiers, and B. L. Vallee; "Mitochondrial Function and Metal Content in Carbon Tetrachloride Poisoning;" J. Biol. Chem., 237:3546, 1962.
26. Robinson, D. S.; "The Uptake and Release of Lipids by the Liver;" In: Lipid Transport, H. C. Meng, Editor. C. C. Thomas, Springfield, Ill., 1964, pp. 194-201.
27. Schotz, M. C., N. Baker, and M. N. Chavez; "Effect of Carbon Tetrachloride Ingestion on Liver and Plasma Triglyceride Turnover Rates;" J. Lipid Res., 5:569, 1964.
28. Seakins, A., and D. S. Robinson; "The Effect of the Administration of Carbon Tetrachloride on the Formation of Plasma Lipoproteins in the Rat;" Biochem. J., 86:401-407, 1963.
29. Shinozuka, H.; "Unusual Membrane Alterations in the Rough Endoplasmic Reticulum of Liver Cells after Carbon Tetrachloride Injury;" Exp. Cell Res. 64:380, 1971.
30. Smuckler, E. A., and M. A. Arcasoy; "Structural and Functional Changes in the Endoplasmic Reticulum of Hepatic Parenchymal Cells;" Int. Rev. Exp. Path., 7:305, 1969.

31. Smuckler, E. A., and E. P. Benditt; "Studies on Carbon Tetrachloride Intoxication. III. A Subcellular Defect in Protein Synthesis;" Biochemistry, 4:671, 1965.
32. Smuckler, E. A., O. A. Iseri, and E. P. Benditt; "An Intracellular Defect in Protein Synthesis Induced by Carbon Tetrachloride;" J. Exp. Med., 116:55, 1962.
33. Srinivasan, S., and R. O. Recknagel; "Carbon Tetrachloride Hepatotoxicity in Female Rats;" Exper. Mol. Path., 15:268, 1971.
34. Stern, P. H., T. Furukawa, and T. M. Brody; "Rat Liver and Plasma Lipids after Carbon Tetrachloride Administration;" J. Lipid Res., 6:278, 1965.
35. Svoboda, D., and J. Higginson; "Ultrastructural Changes Produced by Protein and Related Deficiencies in the Rat Liver;" Am. J. Path., 45:353, 1964.
36. Thomas, A. A.; "Low Ambient Pressure Environments and Toxicity;" Arch. Environ. Health, 11:316, 1965.
37. Trump, B. F., E. A. Smuckler, and E. P. Benditt; "A Method for Staining Epoxy Sections for Light Microscopy;" J. Ultrastructure Res., 5:343, 1961.
38. Ulanova, I. P.; "Toxikol. Novykh. Prom. Khim. Veschchest;" No. 1, 96, 1961. Abstracted in: Chem. Abst., 58:6120c, 1963.
39. Venable, J. H., and R. Coggeshall; "A Simplified Lead Citrate Stain for Use in Electron Microscopy;" J. Cell Biol., 25:407, 1965.

EFFECTS OF METHYLENE CHLORIDE EXPOSURE ON THE
SPONTANEOUS ACTIVITY OF MICE

Anthony A. Thomas, M. D.
Mildred K. Pinkerton

Aerospace Medical Research Laboratory
Wright-Patterson Air Force Base, Ohio

and

James A. Warden

SysteMed Corporation
Dayton, Ohio

INTRODUCTION

At last year's Conference on Environmental Toxicology we described a fully automated system for the evaluation of spontaneous activity in unrestricted animals (Thomas, 1970). In that paper the analyzer was used in one of its operating modes to evaluate time-lapse photography data collected on four dogs with 16 mm movie film. One of the main disadvantages of using light sensitive photographic emulsion material is the cost involved in storing the data. Equally important as a disadvantage is the fact that development of the silver halide picture must be scrupulously controlled to assure day-to-day reproducibility of the tonal quality (gamma) of the developed image. To overcome these disadvantages, the analyzer was used in a different mode by recording through a closed circuit TV system in real-time, thus eliminating photographic material and the associated lead time necessary to develop the pictures. The experiments described here were conducted during continuous exposure of mice to methylene chloride (dichloromethane), and the conditions of exposure and other pertinent findings have been adequately described in the three preceding papers (C. C. Haun, F. J. Bullock, and R. S. Weinstein).

METHODS

Specially fabricated cages for accommodating 10 mice were used in this study. Each cage had a sloped front matching the angle of the plate glass in the dome. The cages were anodized to present a black mat surface and interior in order to enhance

contrast between the white fur of the mice and the background. The top of the cage was covered with a glass plate lid and the inside of the cage was illuminated by a 40-watt tubular incandescent light during activity recording. The opening on the front of the cage was smaller than the total front area of the cage and the angle of vision of the TV camera, equipped with variable focus lens, was adjusted so that the opening on the cage front completely filled the entire monitor screen. Food and water were available ad libitum and the feeding and watering areas, on opposite sides of the cage, were obscured from view by the picture frame corners of the opening. Consequently, spontaneous activity associated with feeding or drinking was not recorded. In order to be recorded the mice had to move within the field of viewing. This setup therefore consisted of an activity area only, with no reference area in the display. To substitute for such a reference area a light bulb was used and its intensity was controlled by a rheostat. The light from this bulb was directed to the reference optical sensor and the light intensity was calibrated to read 0.7 volts on the instrument meter panel. This condition was unchanged throughout the entire experiment.

The closed circuit TV display was calibrated by properly aligning the video circuits of the cameras, by using a maximum contrast setting on the monitor, and by balancing the brightness between cameras (through measuring the light level equivalent to the brightness of a standard white 3" x 5" filing card) at 5.0 volts on the front panel meter.

Two groups of mice were recorded in this experiment. Each group consisted of 10 mice purchased from the same vendor at the same time. All mice used were female. One group was exposed to 5000 ppm methylene chloride; another group was exposed to 1000 ppm. Before exposure each group was recorded for baseline activity for one week in the dome without the contaminant.

Recording sessions were conducted for three hours per day, the 5000 ppm group from 0830 to 1130, and the 1000 ppm group from 1300 to 1600, in order to eliminate cyclic variations due to time of day. It should be noted, therefore, that each group must be treated as a separate entity and activity changes must be evaluated in terms of each group baseline. No recordings were made on weekends or holidays.

The pertinent characteristics of the recording process and the arbitrary units used in this study are found in table I.

RESULTS

The group exposed to 5000 ppm methylene chloride was severely affected and by the seventh day 50% of the mice died. Consequently, spontaneous activity fell off dramatically and recordings were discontinued for this group since there seemed to be no valid way to correct for loss of 50% of the animals.

TABLE I
 RECORDING SPONTANEOUS ACTIVITY OF MICE
 THROUGH CLOSED CIRCUIT TV

	<u>UNITS</u>
Number of Mice	Hourly Average Per Day
Rate of Observation	Hourly Weighted Average Per Day
Length of Observation	Weekly Arithmetic Mean of Hourly Averages
Total Samples	Weekly Arithmetic Mean of Weighted Averages
Baseline Data	
Exposure Data	

: 10/Cage
 : 1/Sec.
 : 3 Hrs./Day (1000-1300)
 : 10, 800/Day
 : 1 Week (5 Days = 54, 000 Samples)
 : 4 Weeks (20 Days = 216, 000 Samples)

The 1000 ppm exposed group survived the entire four weeks and the spontaneous activity findings are presented in figure 1. The hourly average activity per day is depicted by the striped bars and the weighted average is the dark portion of each bar at the bottom. It can be seen when compared to the baseline period that there is a definite trend toward lower activity during exposure, and when one compares the first two-week exposure period with the second two-week exposure period, activity seems to be stabilized at a considerably lower level. The weekly average values for total hourly activity and weighted average are printed above each one-week group of bar graphs.

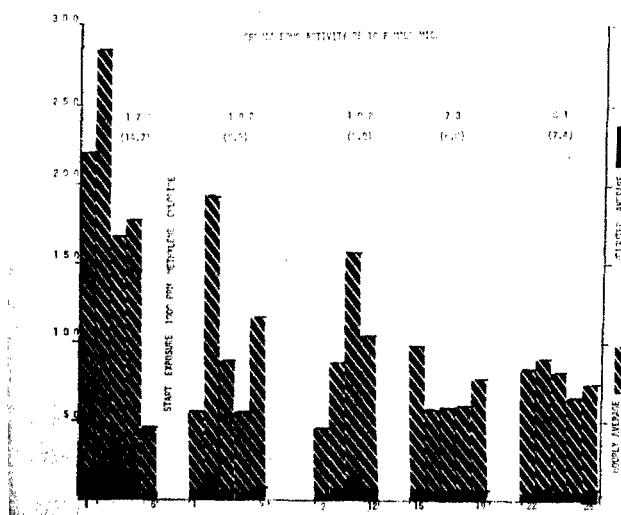

Figure 1. SPONTANEOUS ACTIVITY OF 10 FEMALE MICE.
(Exposure to 1000 ppm CH_2Cl_2 for four weeks.)

DISCUSSION

In contrast to previous studies which have analyzed the spontaneous activity from time-lapse films, the present study is characterized by a number of significant differences. The time-lapse photographic technique employed a sampling rate of two frames per minute for a 24-hour period, or a total of 2880 observations per day. The closed circuit TV technique collects 10,800 observations per day compressed into a three-hour recording session. By using a more frequent sampling interval, transient changes in spontaneous activity can be better resolved. Aside from the convenience aspect, the closed circuit TV monitoring method is real-time and results in considerable savings in photographic material, developing costs, and direct

labor. If new light intensification techniques become economical, it may become feasible to substitute a camera obscura system for the closed circuit TV and to further increase economy by reducing maintenance costs.

REFERENCES

1. Thomas, A. A. ; "Quantitative Analysis of Spontaneous Activity: Effects of Long-Term Continuous Exposure to Space Cabin Atmospheres"; AMRL-TR-67-200, 311-319, December 1967.

THE TOXICITY OF PYROLYSIS PRODUCTS FROM A
CHLOROTRIFLUOROETHYLENE-ETHYLENE COPOLYMER
(HALAR RESIN)

Lester D. Scheel

U. S. Public Health Service
Cincinnati, Ohio

A. B. Robertson

Allied Chemical Corporation
Morristown, New Jersey

Richard E. Kupel
Donald E. Richards
Charles V. Cooper
William P. Tolos
and
Louis Vignati

U. S. Public Health Service
Cincinnati, Ohio

INTRODUCTION

Halar*, a new copolymer of chlorotrifluoroethylene (CTFE) and ethylene having a 50/50 mole ratio and a high degree of one-to-one alternation, offers an attractive combination of properties including excellent chemical resistance, nonignitability, good electrical properties, and a good balance of mechanical properties. Variations in molecular weight, additives, and cross linking give slightly different characteristics to the copolymer (poly CTFE-E). The thermoplastic resin can be extruded, injection molded, or powder coated. Poly CTFE-E is thus suitable for a wide variety of applications.

* Trademark of the Allied Chemical Corporation.

Mention of commercial products or concerns does not constitute endorsement by the U. S. Public Health Service.

The structure elucidation of poly CTFE-E was reported by Sibia et al. (1971) and is also described in this paper. The products formed when poly CTFE-E undergoes thermal decomposition and the acute toxic action in experimental rats following the inhalation of those pyrolysis products have been studied at the National Institute for Occupational Safety and Health in cooperation with the Plastics Division of the Allied Chemical Corporation, Morristown, New Jersey.

STRUCTURE ELUCIDATION

The structures of CTFE-E copolymers have been shown by nuclear magnetic resonance and infrared measurements to contain a high percentage of one-to-one alternating units (Sibia et al., 1971).

The nuclear magnetic resonance spectra of CTFE-E copolymers (figure 1) show five distinct bands which are assigned to methylene protons in different structural environments. Band assignments were made by analysis of the spectra of a series of ethylene-chlorotrifluoroethylene polymers of different comonomer content. The upfield peak (1.3 ppm) in the nuclear magnetic resonance spectra is assigned to methylene protons in ethylene sequences and the downfield peak (2.6 ppm) to methylene protons in CTFE-E-CTFE sequences. The peaks centered at 1.8 and 2.3 ppm are assigned to methylene protons in E-E-CTFE sequences. The mole fraction of one-to-one alternating units in poly CTFE-E may be calculated from the relative area of the peak at 2.6 ppm and the total ethylene content. The degree of alternation in commercial Halar resin averages 82%. Ethylene content as measured by elemental analysis averages 49%.

Precise measurements of the chlorotrifluoroethylene and ethylene sequence distribution in Halar were obtained from infrared spectra. Infrared spectra of a series of poly CTFE-E copolymers varying in ethylene composition from 80 to 50 mole percent are shown in figure 2. Analysis of these spectra showed that the bands at 1471 cm^{-1} , 1450 cm^{-1} , 1435 cm^{-1} , 1398 cm^{-1} , and 1385 cm^{-1} are associated with vibrations of methylene groups in different structural environments. The absorbance at 1471 cm^{-1} is sensitive to ethylene block content, and that at 1450 cm^{-1} is sensitive to alternating structure.

Mole fractions of various sequences in the copolymer were calculated from infrared measurements. Typical commercial Halar resin contains 82% alternating structure, 8% ethylene blocks, and 10% chlorotrifluoroethylene blocks.

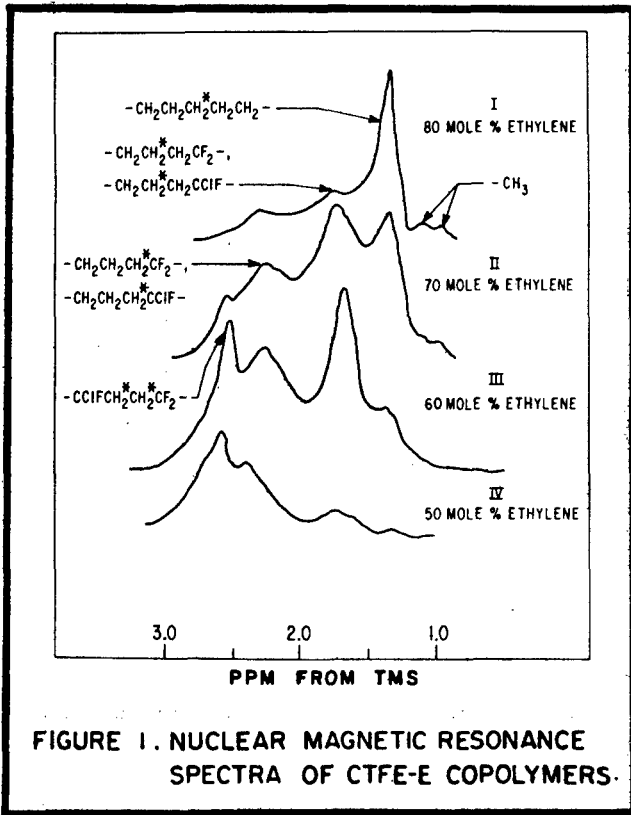

FIGURE 1. NUCLEAR MAGNETIC RESONANCE SPECTRA OF CTFE-E COPOLYMERS.

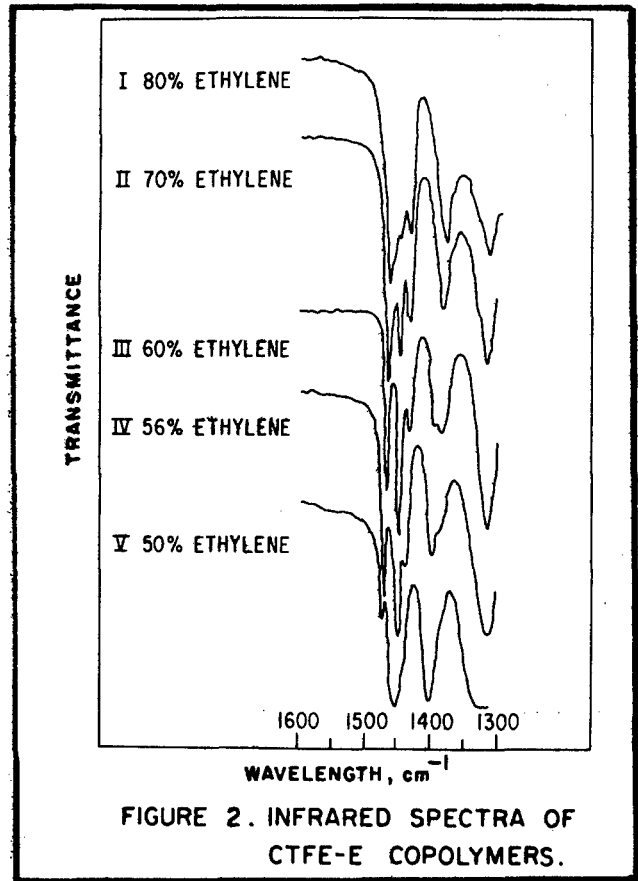

FIGURE 2. INFRARED SPECTRA OF CTFE-E COPOLYMERS.

PHYSICAL PROPERTIES

Poly CTFE-E exhibits certain extraordinary physical properties which make this copolymer potentially useful in various commercial applications.

The resin is insoluble in all common solvents below 140 C and is resistant to oxidation by concentrated nitric acid and 50% chromic acid at temperatures up to 100 C. No solvent has been found which will stress crack the resin.

Poly CTFE-E has been rated as either nonflammable or self-extinguishing in various flammability tests. When placed in a flame, the copolymer chars but does not melt or drip. On removal from the flame, poly CTFE-E immediately extinguishes and exhibits no afterburn. Its oxygen index is 64, and its UL vertically rating is SE-O.

In comparison to available fluorocarbon polymers, poly CTFE-E has a good balance of mechanical properties (table I). Its tensile strength is significantly higher than the prefluorinated polymers, polytetrafluoroethylene (PTFE) and fluorinated ethylene-propylene (FEP), and approximates that of polyvinylidene fluoride (PVF₂). Its flex modulus is nearly as high as that of PVF₂, and its impact strength is equal to or greater than that of FEP, depending upon the temperature at which the measurements are made.

As also shown in table I, poly CTFE-E is an excellent electrical insulation material. The dielectric strength is greater than 2000 V/mil in 10 mil thicknesses. Its dielectric constant is low and unaffected by temperature up to 200 C. The dissipation factor varies between 0.0005 and 0.015 depending on frequency and temperature. The electrical properties of poly CTFE-E are superior to those of PVF₂ and approaches those of PTFE and FEP.

The resin is melt processable and can be extruded, injection molded, and powder coated. It melts at 265 C and has good processing characteristics in the temperature range of 245-290 C. Suggested uses for the copolymer include wire and cable insulation, coatings, molded parts, tubing and film.

TABLE I
PROPERTIES OF POLY CTFE-E
AND OTHER FLUOROCARBON POLYMERS

PROPERTIES	POLY CTFE-E	PTFE	FEP	PVF ₂
MELTING POINT, °C	241.0	327.0	285.0	171.0
SPECIFIC GRAVITY	1.69	2.18	2.15	1.77
OXYGEN INDEX	64.0	100.0	100.0	43.0
TENSILE STRENGTH, psi	6000-8000	3000-4000	2000-3000	5000-7000
YIELD STRENGTH, psi	5000	3000	2000	6600
ELONGATION AT BREAK, %	200-250	250-350	250-350	50-200
FLEX MODULUS, psi	240,000	95,000	85,000	260,000
DROP WEIGHT IMPACT AT 23 °C, lbs	160	160	160	160
DROP WEIGHT IMPACT AT 80 °C, lbs	160	---	30	10
DIELECTRIC CONSTANT AT 60 Hz	2.5	2.1	2.1	8.0
DISSIPATION FACTOR AT 60 Hz	<0.0005	<0.0002	<0.0003	<0.018
VOLUME RESISTIVITY, ohm/cm ³	>10 ¹⁵	>10 ¹⁸	>10 ¹⁸	>2×10 ¹⁴

IDENTIFICATION OF PYROLYSIS PRODUCTS

The pyrolysis products of five poly CTFE-E samples having different properties were investigated using thermogravimetric (TGA) and mass spectrometric techniques supplemented by chemical analyses. The samples studied are described as: (1) low molecular weight copolymer, (2) high molecular weight copolymer, (3) high molecular weight copolymer cross-linked by electron-beam irradiation, (4) high molecular weight copolymer, which contained 0.25% CaO as a filler, cross-linked by electron-beam irradiation, and (5) high molecular weight copolymer, which contained 0.25% CaO as a filler, cross-linked by irradiation with cobalt-60.

Thermograms of the samples were obtained using a du Pont 600 TGA instrument programmed for a temperature increase of 15 C/min with an air flow of 40 cc/min. The thermogram of the electron-beam irradiated CTFE-E sample, which is typical of those obtained for all five copolymers, shows that this material decomposes in two major steps, the first taking place in the temperature range of 350 C to 450 C and the second occurring at temperatures greater than 450 C (figure 3).

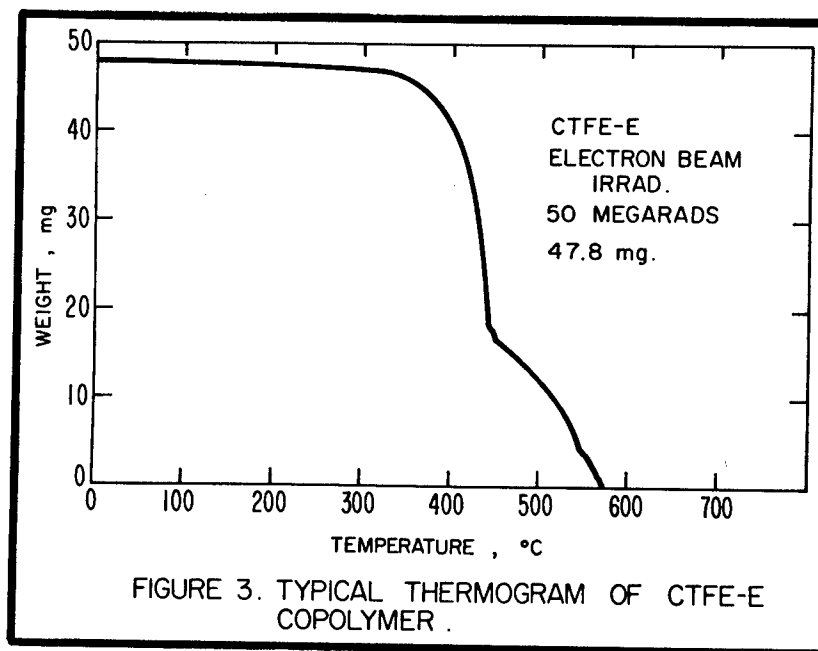

The effluent gases from the TGA furnace were passed through appropriate solutions and assayed for hydrolyzable fluoride and chloride with specific ion electrodes. These gases were also analyzed for carbon dioxide and carbon monoxide with Kitagawa detector tubes. Formaldehyde was indicated as a pyrolysis product by its characteristic odor and was confirmed by reaction with a chromotropic acid-sulfuric acid solution as described in P. H. S. No. 999-AP-11 (1965).

Fluoride and chloride ions and carbon dioxide were found only during the first stage of decomposition, whereas carbon monoxide was detected as a pyrolysis product in both temperature ranges.

Pyrolysis products of the CTFE-E copolymers were examined with a Bendix Time-of-Flight mass spectrometer, Model 12-107. These products were formed by introducing pellets of the plastic material into a platinum-lined Monel tube heated by a small electric furnace as described previously by Kupel and Scheel (1968). The decompositions were carried out in an air atmosphere under a controlled air flow of 22 cc/min and at a temperature of 600 C. The products of decomposition were passed into the ion source of the mass spectrometer. The ions shown in table II were found in the mass spectra of pyrolysis products originating from all poly CTFE-E samples. Mass 20 was attributed to hydrogen fluoride, and mass 36 was ascribed to hydrogen chloride. These compounds accounted for nearly all the hydrolyzable fluoride and chloride found in the effluent gases from the TGA furnace. A small amount of carbonyl fluoride, indicated by its major peak at mass 47, also made a slight contribution to the hydrolyzable fluoride content. Mass 44 confirmed the results of detector tubes that carbon dioxide was a major pyrolysis product. Carbon monoxide was identified by the comparison of the measured 14 to 28 mass peak ratio with that of nitrogen.

TABLE II
MASS SPECTRUM OF PYROLYSIS PRODUCTS
OF POLY CTFE-E

MASS NO.	ION	MASS NO.	ION
19	F ⁺	51	C ₂ F ₂ H ⁺
20	HF ⁺	63	C ₂ F ₂ H ⁺
28	CO ⁺	64	C ₂ F ₂ H ₂ ⁺
31	CF ⁺	65	C ₂ F ₂ H ₃ ⁺
35	³⁵ Cl ⁺	69	CF ₃ ⁺
36	H ³⁵ Cl ⁺	75	C ₃ F ₂ H ⁺
37	³⁷ Cl ⁺	77	C ₃ F ₂ H ₃ ⁺
38	H ³⁷ Cl ⁺	81	C ₂ F ₃ ⁺
44	CO ₂ ⁺	85	C ₂ F ₂ Cl ⁺
47	COF ⁺	95	C ₃ F ₃ H ₂ ⁺

TOXICITY STUDIES

A toxicity study of pyrolyzed low and high molecular weight poly CTFE-E was conducted in a manner similar to that described in previous publications on the pyrolysis of polytetrafluoroethylene by Coleman et al. (1968) and Scheel et al. (1968) and of chlorotrifluoroethylene by Birnbaum et al. (1968).

A quarter-inch rod of poly CTFE-E was fed into a 1½-inch Monel pipe heated with an electric furnace at 550 C to provide continuous pyrolysis of the polymer. The pyrolysis products were passed into an animal exposure chamber.

Male Carworth strain rats, weighing 220-250 grams each, were used in the exposure studies. All individual exposure groups consisted of 10 animals. In each exposure, two rats were first placed in each of five cages which were attached to a chamber airlock door. After the chamber had achieved an equilibrium concentration of poly CTFE-E pyrolysis products the airlock door was rotated to position the caged animals in the chamber atmosphere. After a two-hour exposure the animals were removed from the chamber and immediately returned to their housing cages.

During the exposures the chamber atmospheres were assayed for hydrolyzable fluoride, hydrolyzable chloride, formaldehyde, and carbon monoxide. Samples of the atmosphere to be analyzed for hydrolyzable fluoride and chloride were collected with a midjet impinger containing 10 ml of a solution that was 0.05 M in sodium acetate, 1.0 M in potassium nitrate, and adjusted to pH 5 with acetic acid. The sampling, which was conducted at a rate of 1.13 liters per minute, was continued for 15 to 30 minutes. The solutions were then analyzed with specific ion electrodes. The chamber atmospheres were also sampled for formaldehyde with midjet impingers containing a 1% sodium bisulfite solution for 45 minutes at a rate of 1.13 liters per minute. These solutions were analyzed for formaldehyde by the ACGIH Bisulfite Method (American Conference of Governmental Industrial Hygienists, 1958). The carbon monoxide concentrations, measured with an MSA portable carbon monoxide detector, were in the range of 225-400 ppm.

As shown in table III, appreciable hydrolyzable fluoride concentrations, expressed as hydrogen fluoride, were found in the chamber atmospheres along with lesser quantities of hydrolyzable chloride, expressed as hydrogen chloride and traces of formaldehyde.

The mortality data given in table III show a direct correlation with the level of hydrogen fluoride found in the exposure chamber. By plotting the mortality probit against the hydrogen fluoride concentration according to the method of Miller and Tainter (1944), the LC₅₀ for hydrogen fluoride is shown to be about 42.5 ppm (figure 4). This level of hydrogen fluoride was attained by the thermal decomposition in air of approximately 18 grams of the copolymer per hour and the introduction of the resulting pyrolysis products into the chamber in an airstream of 40 liters per minute.

TABLE III
TOXIC PRODUCTS OF CTFE-E
COPOLYMER PYROLYSIS

g/hr	HF, ppm	HCl, ppm	HCHO, ppm	Mortality
15.79	19	8	0.6	1/10
17.48	48	15	—	6/10
12.72	52	11	0.4	7/10
17.85	73	47	0.6	10/10
19.20*	33	19	0.7	3/10
19.46*	23	12	0.3	2/10

* HIGH MOLECULAR WEIGHT CTFE-E COPOLYMER.

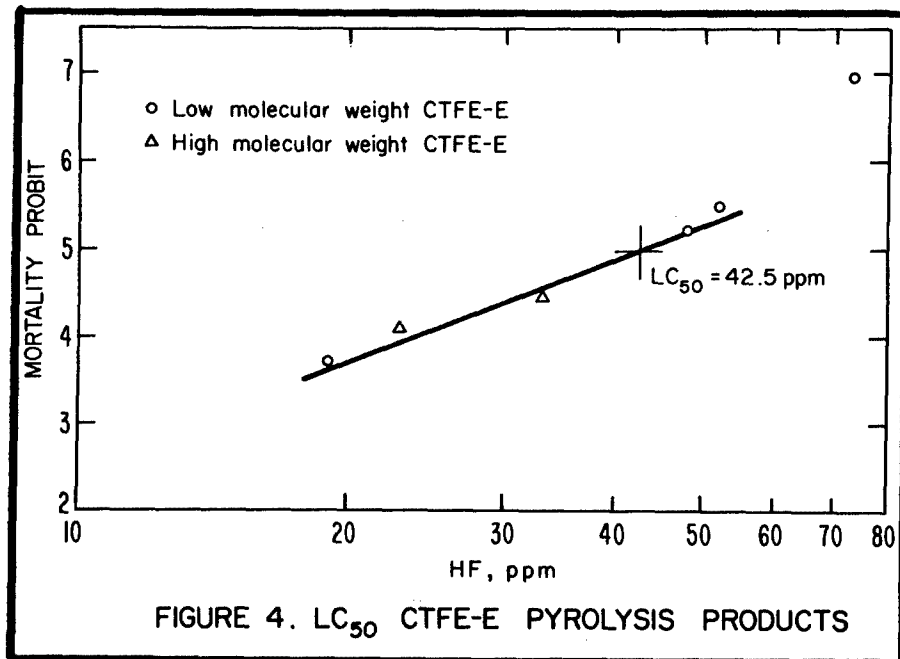

PATHOLOGY

Four rats that died during or immediately after a two-hour exposure to poly CTFE-E pyrolysis products were necropsied within 30 minutes of death. Gross inspection of the lungs showed areas of hemorrhage. The cut surfaces of the lungs were edematous, and a frothy fluid could be expressed from the tracheae. The hearts, livers, and kidneys appeared normal. Microscopic examinations were made of hematoxylin-eosin stained sections of pulmonary lobes, tracheae, livers, and kidneys. The lungs exhibited diffuse capillary hemorrhage, engorgement of perivascular lymphatics, and disruption of alveolar septa. Sloughing of respiratory epithelia occurred in the tracheae and bronchi. The livers showed vascular congestion and early vacuolation of hepatic cells. In the kidneys, moderate tubular necrosis was observed, and a pink-stained proteinaceous material was present in the tubular lumens.

SUMMARY

Thermal decomposition of a one-to-one alternating copolymer of chlorotrifluoroethylene and ethylene (poly CTFE-E), produced commercially as Halar, begins at 350 C and is complete at 600 C. The principal gaseous products formed by pyrolysis of poly CTFE-E at 600 C in air have been identified as hydrogen fluoride, carbon dioxide, carbon monoxide, hydrogen chloride and formaldehyde. Acute toxic inhalation studies using experimental rats have been conducted on the pyrolysis products formed at 550 C in air. A correlation of exposed animal fatalities could be made only with the hydrogen fluoride concentration in the exposure chamber. The LC_{50} for hydrogen fluoride was determined to be about 42.5 ppm for a single two-hour exposure. The toxic effects on the exposed animals were characterized by primary irritation of the respiratory tract and pulmonary edema and hemorrhage.

REFERENCES

1. American Conference of Governmental Industrial Hygienists; Manual of Analytical Methods, Cincinnati, Ohio, 1958.
2. Birnbaum, H. A., L. D. Scheel and W. E. Coleman; "The Toxicology of the Pyrolysis Products of Polychlorotrifluoroethylene"; Am. Ind. Hyg. Assoc. J., 29:61-65, 1968.
3. Coleman, W. E., L. D. Scheel, R. E. Kupel and R. L. Larkin; "The Identification of Toxic Compounds in the Pyrolysis Products of Polytetrafluoroethylene (PTFE)"; Am. Ind. Hyg. J., 29:33-40, 1968.

REFERENCES (Cont'd)

4. Kupel, R. E. and L. D. Scheel; "Experimental Method for Evaluating the Decomposition of Fluorocarbon Plastics by Heat"; Am. Ind. Hyg. Assoc. J., 29:27-32, 1968.
5. Public Health Service; Selected Methods for the Measurement of Air Pollutants, Publication No. 999-AP-11, Washington, D. C., May, 1965.
6. Scheel, L. D., W. C. Lane and W. E. Coleman; "The Toxicity of Polytetrafluoroethylene Pyrolysis Products - Including Carbonyl Fluoride and a Reaction Product, Silicon Tetrafluoride"; Am. Ind. Hyg. J., 29:41-48, 1968.
7. Sabilia, J. P., L. G. Roldan and S. Chandrasekaran; "Structure of Ethylene-Chlorotrifluoroethylene Copolymers"; American Chemical Society Preprint, March, 1971.

OPEN FORUM

MAJOR CARTER (NASA, Manned Spacecraft Center): This question is directed to both Doctors Weinstein and Bullock. I'd like to hear both of them comment on it. Would either one of you care to comment on the possible differences in free radical formation between carbon tetrachloride and the dichloromethane, and how it possibly relates to differences you have presented today, both biochemically and pathologically?

DR. BULLOCK (Arthur D. Little, Inc.): On that point, I wonder if you were listening when I was giving my views to someone during coffee break. I would be pleased to expand on that. I think that as far as carbon tetrachloride is concerned there is some very good evidence that free radicals are indeed involved in the hepatotoxicity of carbon tetrachloride. I think that is as far as published literature goes but I think that one can speculate further, and I would be pleased to do so, with the aid of the blackboard and some simple textbook diagrams. If we're talking about the formation of radicals from carbon tetrachloride in liver, we presumably are talking about CCl_4 going to a trichloromethyl radical plus a chlorine radical. If we're talking about the same kind of transformation with things like dichloromethane or chloroform, we ought to be talking about CH_2Cl_2 to Cl_2CH plus a chlorine radical, and for chloroform we ought to be talking about HCCl_3 going to HCCl_2 plus a chlorine radical. We ought to be able to correlate the relative toxicities with the ease of formation of these radicals, and in simple textbook terms, the ease of formation of radicals can be described as breaking the carbon-chlorine bond. This goes in two steps, the first of which is associated with a stretching - it is a simple transition state theory in the terms of a chemist to this (blackboard illustration). And, if we plot the energetics involved for this transformation, on this ordinate reaction coordinate (again simple physical chemical textbook term) and energy. The energy course for this transformation is from starting material through the transition state which is energy rich and the bond breaking comes down to products. The rate is determined by the so-called free energy of activation and goes in a way proportional to or equal to an expression of this sort where we have a preexponential factor to the $e^{-\frac{\Delta F}{RT}}$ where ΔF is the free energy of formation. Now, these rates, therefore, should vary with the free energy of activation for the bond breakage which in turn should vary with the thermodynamic properties of these bonds; that is, it would be nice if in this picture you anticipate a correlation between relative toxicity of these three chlorocarbons and the ease of formation of radicals, which in turn is proportional to or related to the bond energy of the carbon-chlorine bond for the rate of formation, and these numbers are measurable free energy of activation, you ought to be able to get from this so-called appearance potential for ions, which a mass spectroscopist has, and this is what one would predict from some simple arguments, that the toxicity should be correlated with these energies. I am not aware that anyone has looked at this problem in these terms, but I think it would perhaps be interesting to do so.

DR. PARKER (NASA, Ames Research Center): If you assume that this ΔF has about one-third the energy required, let's say from the heats of formation, you'd say this is between 35 and 40 kcal per mole. I'm just curious as to where that energy is going to come from. I can see that certainly in a normal situation for photochemical induced reactions which you have set up here, where you pump 50 to 60 kcal per mole into a bond, as a chemist I am not familiar with the biological source of that much energy to accommodate that; it has to site fit; it has to do all the good things; and I don't see how that would happen with classes.

DR. BULLOCK: I can't answer that question in detail, but I will say that it is known to happen. These chlorocarbons are metabolized by liver microsomes.

DR. PARKER: But not necessarily by a free radical mechanism.

DR. BULLOCK: No, not necessarily by a free radical mechanism.

DR. PARKER: I think that because you can write, sir, a free radical process for these does not in any sense mean that these systems would necessarily proceed by a radical mechanism in a biological system. That's the only point I want to make.

DR. BULLOCK: But a bond cleavage process, whatever you might postulate, should be correlated with an energetic diagram of that sort in some way, so if you don't say radicals, it will be some chemical transformation correlatable in those terms, terms like that.

DR. PARKER: There seems to be a lot of interest at this conference on the role of free radicals at surfaces, and I was wondering if anyone has planned or can carry out Electron Spin Resonance (ESR) type of experiments where you basically could allow the enzyme or whatever to come in contact with this and then follow the appearance of the ESR signal with the unpairing that would be associated?

DR. BULLOCK: I think you might have difficulty in finding it.

DR. PARKER: Because of the speed of the reactions?

DR. BULLOCK: No, not at all. The microsomes themselves give an ESR signal; there is copper in there which gives you an ESR signal and also the iron in the porphyrins of the cytochromes appears to be high spin and does give a signal. It might be interesting, however, to watch changes in that signal during the course of these.

DR. PARKER: You would think if this were going on okay one step further, it's possible that these compounds that you've postulated, the radical intermediates, would quench those spins by recombination reactions with them, because there would be available pairs of free electrons. I'm willing to bet that where these compounds would reside as a result of being formed, if you could give me enough energy, they would be sitting on those unbonded sites, and you might see a depression in the ESR signal.

DR. BULLOCK: That is possible. You incidentally do see a depression of the ESR signal when we put in things like aniline. The signal shifts and they are changed. Aniline, of course, is not a radical by itself. Whether or not you would see evidence for radical intermediates, you might see a change in the presence of carbon tetrachloride, just because it goes into the lipid-rich membrane and sits there, resulting perhaps in conformational changes which in turn manifest themselves in changes of the ESR signal for the iron porphyrin.

DR. PARKER: I prefer to believe that the way these compounds work is by tripping the phospholipid arrangements that exist in the membrane cells rather than a specific chemistry.

DR. BULLOCK: May I clarify one thing? This is an expansion on a theory expressed at great length in Pharmacological Reviews (1967) for mechanisms of toxicity of carbon tetrachloride. I do not want to be put in the place of assuming this theory is correct, but I merely wish to expand on the implications of that general theory for the other chlorocarbons.

DR. SCHEEL (U. S. Public Health Service): My only comment is that I don't think we should at the moment, from the evidence we have now, base our conclusions on tentative hypotheses. I think that what we need is to take a look at the hydrolysis reactions and the basic ion formation reactions because there are real good pieces of evidence that would indicate that in the body mechanism you don't necessarily have to add the activation energy all in one piece - you can add it in several pieces, and that this is why mechanism discussion at this stage may be a little bit premature. It is good to have a hypothesis, but it argues ad infinitum.

MR. DARMER (SysteMed Corporation): I have a couple of questions to ask of Dr. Scheel, relating to the mortality data which you described. What was the species?

DR. SCHEEL: The rat.

MR. DARMER: How were these exposures accomplished?

DR. SCHEEL: By inhalation exposure.

MR. DARMER: Inhalation in a chamber?

DR. SCHEEL: Yes.

MR. DARMER: And, for what length of time were these?

DR. SCHEEL: This was a two-hour exposure.

MR. DARMER: The LC_{50} value which you showed on your slides was for the combination of all gas-off products?

DR. SCHEEL: That is right.

MR. DARMER: What was the approximate temperature of this gas?

DR. SCHEEL: The temperature at which we pyrolyzed it was 550 C in the furnace.

MR. DARMER: Was this cooled in any fashion?

DR. SCHEEL: It was cooled before going into the chamber, in a dilution air stream.

DR. HODGE (University of California Medical Center): I'd like to follow this up. Aren't those values rather low to get such high kills?

DR. SCHEEL: You mean in terms of quantity?

DR. HODGE: Yes, the total ppm of HF, HCl, and formaldehyde, and what else, wasn't mentioned.

DR. SCHEEL: In the work at Rochester that was done on a four-hour exposure, the LC₅₀ was about 33 ppm, and so this is about in line with what we would expect from fluoride exposure. Now the pathology is a typical fluoride picture of lung edema and kidney nephritis with protein going into the tubules. So it looks to me like on a gross basis at the moment that we're talking about fluoride toxicity primarily.

MR. WANDS (National Academy of Sciences): I have two or three very short questions I'd like to ask. First of all, Dr. Scheel, were there any particulates such as you have seen in some of your other plastic pyrolysis studies?

DR. SCHEEL: Yes, in this kind of pyrolysis the generation of particulates is always there because the breakdown products rearrange and this takes a matter of a few minutes in terms of the rearrangement and they are still rearranging in the chamber. The density of particulates in this particular case is less than we had with Teflon. The particulate generation in this pyrolysis was smaller than in the case of Teflon.

MR. WANDS: Dr. Bullock, were your exposures of 1000 ppm for 30, 60, and 90 days continuous or five hours a day, something like that?

DR. BULLOCK: These exposures were continuous. These were the exposures carried out here at Wright-Patterson Air Force Base.

MR. WANDS: Dr. Weinstein, you used the Thomas domes for these exposures. Were they at altitude or at ambient atmospheric pressure?

MAJOR WEINSTEIN (Aerospace Medical Research Laboratory): Ambient atmospheric pressure.

DR. THOMAS (Aerospace Medical Research Laboratory): The reason for this was saving money. Oxygen costs quite a bit.

MAJOR VAN STEE (Aerospace Medical Research Laboratory): I would like to present some observations to supplement those provided by Dr. Bullock in his paper. If one accepts the proposition that the availability of cytochrome P-450 in some way limits the rate of metabolic degradation of hexobarbital, our observations of the effect of exposure of mice to dichloromethane on hexobarbital sleeping time are consistent with the changes in P-450 seen by Dr. Bullock. Our methods for the determination of the duration of hexobarbital sleeping times in this experiment were identical to those described earlier in this conference for our work with fluorocarbons. The results are illustrated in figure 1. Exposure to 5000 ppm CH_2Cl_2 for 30 days significantly prolonged the duration of hexobarbital sleeping times. Exposure to 1000 ppm for 30 days significantly prolonged sleeping time but these values were significantly lower than those obtained from the animals exposed to 5000 ppm. The sleeping times in the group exposed to 1000 ppm remained prolonged throughout the 90 day exposure and no significant differences were observed among the samples obtained from the dome at 30, 60, and 90 days.

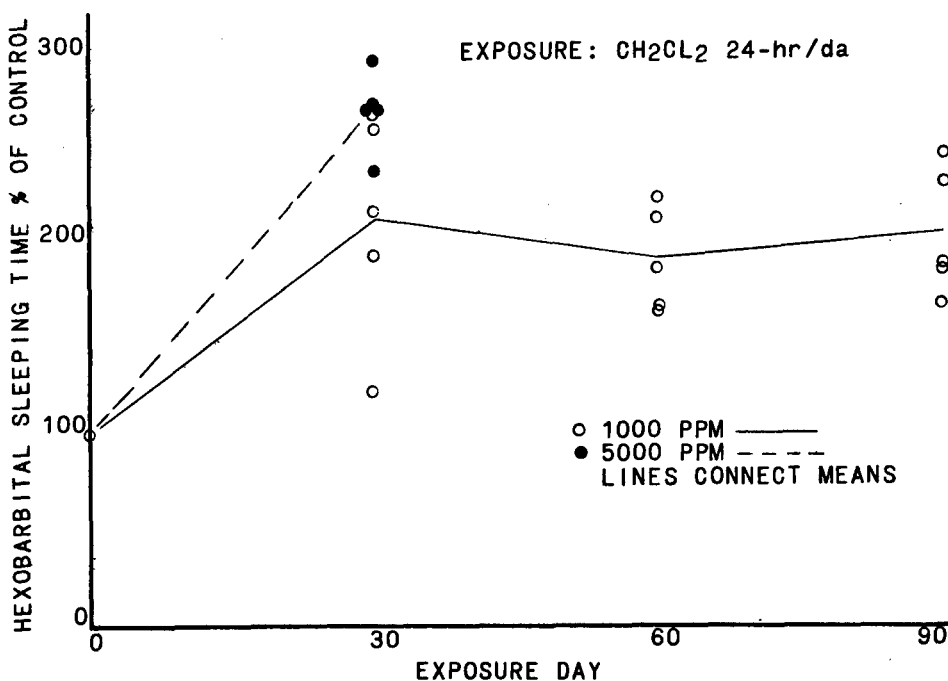

Figure 1.

DR. PARKER: I have a couple of comments I'd like to make. I'm sorry I didn't get in on the early part of Dr. Scheel's talk. Did you notice any difference in the mass spectroscopic distribution of products depending upon the size of the sample when you carried this experiment out, if you did your pyrolysis in oxygen? Was this geometry-dependent?

DR. SCHEEL: The mass spectrometry system is a small furnace system where we can either bring it up slowly or we can preset the temperature and dump it in rapidly.

DR. PARKER: These were done in air?

DR. SCHEEL: These that I have shown here were done in air. Now, we used oxygen atmospheres at a temperature around 450, and we were looking for an increase in carbonyl fluoride but it didn't happen. It still dehalogenates even in an oxygen-rich atmosphere. Now, if you do a nitrogen decomposition, the dehalogenation reaction still goes on and you get the breakdown products, but the carbon monoxide, etc. doesn't appear and you get what is essentially left in the furnace - a char of just plain carbon.

DR. PARKER: The reason I brought it up is this. These fluorocarbons can decompose and do decompose by chain scission or they decompose by scissioning processes, and when they do, they form a boundary layer which surrounds the polymer with monomer. Now, this is very true in the case of Teflon. We carry out the experiment by using a flat plate of polymer, heated from below with a stream of gas passing above the polymer. We begin to observe reactions only in the gas phase at temperatures of around 300 C, where that unzipping monomer in equilibrium is at the surface, and is being attacked by the gas phase. It's my contention that a polymer that produces any one of these monomeric or rearrangement products does not allow the oxygen to come in contact with the polymer and it forms a transpiring sheath around the polymer. And so if you have a polymer which is very stable to oxygen, and very stable to unzipping, what happens is that you get up to a very high temperature, as in the case of Teflon, the reaction is between the monomer and the gas, and not the polymer. I think the same things apply here; for example, you can form an awful lot of carbonyl fluoride from Teflon at 300 C, but you don't see this because it rearranges itself into CF_4 . But, if you admit moisture to the system, just a slight amount, you capture the COF_2 as it comes off the surface. The second point about your heat treating - do you believe that your heat treating induces instabilities in your polymer system; that is to say, cage free radical sites which then tend to make the polymer unzip the hydrohalogenate or suffer internal chain reactions more readily than if you had not heat-treated it?

DR. SCHEEL: The heat treating process as far as I can explain it would be simply a disproportionation reaction in which some hydrochloric acid cracks out.

DR. PARKER: But this would have to come from a fluorine cleavage which would form a free radical which would then find another free radical.

DR. SCHEEL: Well, you go ahead and talk free radical. I talk chemistry.

DR. PARKER: Well, that is the way it was reported in the Journal of Polymers since 1962. This is an important point.

DR. SCHEEL: I think I would disagree with your premise that you have to have a monomer to get COF_2 .

DR. PARKER: No, I didn't say you have to have, but what I'm simply saying is that direct action of the oxygen on a polymer backbone, that is giving off gas fraction, prevents the oxygen from getting at the surface, almost completely.

DR. SCHEEL: I think that I would totally disagree with this on the basis of the work on Teflon that we did, because here you're getting a recombination of oxygen-containing fragments to form a particle which has totally different properties than Teflon.

DR. PARKER: I don't agree with your publication necessarily. Basically, how come when we heat the Teflon specimen from below, and we collect with a mass spectrometric probe right at the top of the specimen, the gases that come off - we see COF_2 , we see HF and we recover the Teflon polymer that is the residual polymer on the plate unchanged?

DR. SCHEEL: What you're seeing in a thermal degradation, which is what you're doing, is carbon to carbon fragmentation as a result of thermal degradation, and you're measuring what is happening in the gas phase reactions as a result of the introduction of double bonds in a carbon-carbon fluorine molecule, and you're getting the ethylene reactivity which is very, very high. You've changed your reactivity from the single bond carbon chain reactivity to a carbon-carbon double bond reactivity.

DR. PARKER: I agree. I don't think you can attack a chain of Teflon oxidatively.

DR. ROBERTSON (Allied Chemical Corporation): I would like to respond and make a point which seems to be lost here somehow. Perhaps you're familiar with the concept of ceiling temperature in polymer science. That is the temperature above which the equilibrium between monomer and polymer shifts back to monomer, and above the ceiling temperature you cannot polymerize the material, or if you heat a material above the ceiling temperature, it will depolymerize. In the case of TFE, this apparently happens; it depolymerizes, generating monomer. This is not the case with Halar. It dehydrohalogenates and leaves an almost graphite-like residue. It does not degrade back to monomer, to any significant extent.

DR. PARKER: Just for the record, just how much of char residue does one get with the decomposition of the polymer?

DR. ROBERTSON: You lose about 64 percent of the weight when you burn it, and if you were to calculate the total content of halogen, it would be very close to that.

DR. SCHEEL: Take a look at our charred samples up here. This is a real good illustration in terms of the way in which this thing goes at different temperatures.

FROM THE FLOOR: How, Dr. Scheel, does the toxicity of TFE compare with Halar?

DR. SCHEEL: Basically I think it compares about one-third in terms of quantity; in terms of speed of reaction, it is a little faster simply because the fluoride is there as the reactive component and you don't have to wait for the carbonyl fluoride to hydrolyze. The carbonyl fluoride is almost exclusively a deep lung irritant, it doesn't irritate the upper respiratory tract appreciably at all. This is just simply a manifestation that the hydrolysis reaction is so slow that it is inhaled and in the deep lung before it begins to hydrolyze, and so, the upper respiratory irritation doesn't appear. In the case of a mixture of hydrochloric and hydrofluoric acid, we're talking about hydrochloric acid as a very severe upper respiratory irritant. It is so severe that I don't think anyone could ever stay in an atmosphere where this stuff was coming apart; it is very irritating, and so we get both upper respiratory and lower respiratory irritation here.

DR. HODGE: I take it, Dr. Scheel, that you are comparing the toxicity of the pyrolysis products at comparable levels of temperatures?

DR. SCHEEL: Yes, fairly comparable because the Teflon breakdown was done at 525° and the breakdown here was at 550°, so we're talking about the same general temperatures. We had to continue for two hours in order to kill anything, whereas the Teflon data was for one-hour exposures, so when I say that this was about half as toxic or less than half as toxic, this is based upon a time-weighted judgment, rather than any hard and fast data.

DR. ROBERTSON: I'd like to make one other point. In fires where escape is possible, a person might breathe carbonyl fluoride because it is not a potent irritant, but it is a potent toxicant. He would be more likely to hold his breath if he were in a room filled with HCl and perhaps wouldn't die if he could escape.

DR. PARKER: I'd like to comment on this relative toxicity. I mean it is a little confusing because you have time and you have temperature. We continually seek a means of comparing the relative toxicity of one polymer versus another. There is a treatment by Hecklen and Epstein which is very interesting and I offer it to the audience for what it is worth. What they basically do is a thermogravimetric analysis of a polymer and from that they numerically deduce the rate constants for decomposition. They then isolate the compounds of the principal pyrolysis reactions which have

occurred. They determine by mass spectrometry the relative weight fraction of each of these components in the gas phase. Then they plot the log of the rate constant times the summation of the individual components in the gas phase divided by LC_{50} against $1/T$, and it is remarkable for those of you who haven't seen this, that Teflon and others all fall on very straight lines. I think it's only one of the Vitons which comes along and makes a break and you know that if you compare, for example Fluoril, which you must have heard about in NASA, with Teflon, there are seven orders of magnitude of difference in the relative toxicity calculated and displayed relativistically in this way.

DR. HODGE: May I ask again the names of these two authors?

DR. PARKER: They are Heicklen and Epstein, and it is in an Aerospace Corporation report, and it goes back about two years. Now, many of my people regard this as a gem of an idea. Obviously there are synergistic effects which occur in here, and there are hydrolytic effects which occur, and there are oxygen reactions in the gas phase. This is the Aerospace Corporation report, done for the Air Force. I think there is a lot of refinement in this that has to come. It is not the absolute answer, but gives us one heck of a good handle, and it does permit the combination of temperature and time and reasonable kinetics.

DR. BACK (Aerospace Medical Research Laboratory): I caution you against putting too much credence in this particular document, because the basis upon which the toxicity was "guesstimated" put apples and pears in the same box, and you can't compare apples and pears. So, the straight lines extrapolated were figments of their imagination, I'm afraid. Although it is an Air Force publication, it shouldn't have been published.

DR. THOMAS: In other words, it is a lousy report.

DR. PARKER: Do you disagree with the principle?

DR. BACK: The principle is nice, but there are no data.

DR. PARKER: You're not arguing with my evaluation of the principle, you're arguing about your contractor's ability to perform the assigned research function.

DR. BACK: I'm arguing about the data that compare Viton, and the whole four or five other compounds. With the lack of data, they were comparing one-hour toxicities with four-hour toxicities, with two-week toxicities, with mice data, rat data, monkey data, and none of it correlated.

DR. PARKER: The equation as it is written only requires that you have a knowledge for the relative comparison of the LC_{50} , a knowledge of what the species are, what comes off each of the principal reactions, and the rate constants and their temperature dependence for each one of the reactions. I can't tell if they had good data or not because the report doesn't say, but I do think it is a gem of a very good idea in terms of ways, going back to the original question, of comparing time, temperature, compared with fundamental thermochemical processes which are releasing the toxins from the surface. Now, the fact that they didn't have good data, I apologize for.

DR. THOMAS: I would like to call your attention to a better publication and it is not specifically about these compounds, but it's been published by the National Academy of Sciences Committee on Toxicology, "Guidelines for Short-Term Exposure Limits." You're talking in this case about the short-term exposure, very brief, and it laid down the ground rules that you just don't take apples and oranges and you don't go through mathematical gyrations and predict toxicity. You have got to do the exposures.

DR. ROWE (Dow Chemical Corporation): I'd like to change the subject, if I may. I would like to address a question to Mr. Haun with regard to the methylene chloride exposures. One of the principal observations that was made was a tremendous change in weight. I was wondering what state of nutrition these animals were in and whether or not these animals were fed while in the chamber.

MR. HAUN (Systemed Corporation): Food was available to them at all times.

DR. ROWE: That tells me also then that there could have been a considerable amount of absorption and adsorption of those high concentrations of material on the food, so there was a considerable amount of ingestion going along at the same time. At least I've seen this happen. And the other one is, were they eating? Were there records of food consumption so we have an idea of whether or not they were in a horrible state of inanition?

MR. HAUN: In answer to that, we didn't maintain absolute data on food consumptions, merely observations on our part. But, this was very noticeable and one didn't really have to measure it, particularly in the case of the large animals. They got so bad and in such poor condition they simply couldn't get to the food many times. There was definitely malnutrition operating here.

DR. ROWE: The question is one of separating out the effect of malnutrition from the effect of the compound.

DR. SCHEEL: I would like to make a comment with regard to the same point. In order to have inanition in a short-term experiment which lasts the length of time he talks about, I think we're going to have to have some kind of central nervous system blockage for appetite. This is very unusual in my judgment as to the behavior of the animals, because a dog when he is hungry will take your arm off.

MR. HAUN: In this case, as far as the dogs were concerned, particularly those exposed to the highest dose level of 5000 ppm, they couldn't take anybody's arm off; they were really in bad shape. Certainly, this is true a little later on when we had six of the eight dogs die in the 1000 ppm exposure level; they were in extremely bad shape there too. In regard to actual appetite suppression from the effects of this compound, I think certainly that was operable too, but we have no evidence to support that. It's my opinion in the case of the rats that the only real effect on the rats was an appetite suppression from the compound itself. Interestingly enough, from a curiosity point, I'm wondering why no rats died in this study. In retrospect, it would have been interesting to have done some metabolic studies on the rats. Apparently they are able to blow off this compound, one way or another, metabolize it or what have you, and get away with it, whereas the other species can't do this at all.

DR. ROWE: One other question. Did you do any analysis of the food to see how much methylene chloride may have been adsorbed and consumed orally?

MR. HAUN: I think that was done, but I'll have to call on some aid from somebody else. Dr. MacEwen can answer that, perhaps.

DR. MAC EWEN (SysteMed Corporation): I'd like to back up just a little bit on this whole question. The food consumption wasn't measured because these dogs are group-housed, that is four to a pen within the chamber itself, so that it's not feasible to measure each individual animal's food consumption. Secondly, the food was completely replaced each day. That means there is some adsorption during the day in a continuous exposure. We didn't measure this adsorption but we did remove the excess food. The animals did not stop eating completely; all the animals ate to a certain degree.

DR. ROWE: The principal reason for bringing up the subject was that in some experiments done several years ago, I ran into a similar situation of attempting to feed animals and expose them 24 hours a day to high concentrations of materials that were readily adsorbed on food. We found that by giving 23.5 hours of exposure and allowing the animals to perhaps ventilate a lot of the material absorbed (and I suspect this may happen because I don't know exactly the degradation curve, but I would expect it to be fast), they would eat very well, rapidly in a half hour, and have changed the pattern completely.

DR. MAC EWEN: These animals in these facilities when they are fed, if they're not in seminarcotic states, normally do that; they go right to the pan and the dog food pan is emptied within an hour or so after introduction of food on a daily basis. The equilibrium blood levels of methylene chloride measured in each of the domes would indicate an equilibrium that was uniform in both of them; it would not have been a five to one ratio if they had been getting a significant dose from their food intake of more methylene chloride. The muscle mass loss in these animals was greater than you would normally expect to see in simple starvation and the response was somewhat different than you would expect to see in starvation. Does that clarify it a little bit?

DR. LEE (Environmental Protection Agency): I have a question for Dr. Bullock. I think I noticed considerable differences among the control groups in that experiment. Would you elaborate on that?

DR. BULLOCK: I can't, other than to say it is generally known that levels of the cytochromes b and b₅ will change somewhat with age; this is well known for rats. I don't know the situation for mice; it is not impossible that these variations in control level are due to the fact that after 90 days these animals obviously are 90 days older than the first group. Other than that, I cannot offer an explanation.

DR. LEE: In conjunction with your cytochrome electron transport system, have you looked at the mitochondrial electron transport system?

DR. BULLOCK: We did no work with mitochondria.

DR. CAMPBELL (Environmental Protection Agency): I wonder if you would elaborate, Dr. Thomas, on your recommendation for the continuous exposure versus, let's say, interrupted exposures to help compress the toxic potential of your experiment, and in particular what effect brief interruptions such as an hour might have for servicing animals, and gassing off through exhalation, and so on, in relation to 24 hours as is possible in your Thomas domes.

DR. THOMAS: I'll take your last question first. Theoretically, there must be a concentration during continuous exposure to a toxic chemical where the intake and excretion is in a perfect balance and that compound can be handled without any physiological injury. Let us assume 500 ppm of something, okay? Continuously for 24 hours, all right? If you have to open up the chamber and interrupt the exposure, that value might look more than 600 ppm. We are playing here with the idea of a summation of interest type of damage in chronic toxicity, and Dr. Harris and Dr. Back and I have been toying for a long time with the idea of getting good biological, mathematical models established on continuous exposures. With a number of compounds which we have used, we have found that as the exposure progresses the organism tries harder and harder to cope with it. Now, as I mentioned before, we will have to set valid 1000-day limits one of these days. There is no way to do all the exposure work at three dose levels for 1000 days, so our ideas are not clear yet on this subject - how you can do a good biological mathematical model on this. But, by accelerating the chronic toxic effect with continuous exposure, I think we might put a handle on this. Does that answer it?

DR. CAMPBELL: Yes, very good for now. I am interested in this modeling of yours for similar reasons.

DR. THOMAS: Well, let's get together.

DR. CAMPBELL: Wonderful! The second point I have is a comment on your disappearance of the phasic activity which you assert may be due to the estrus cycle.

It has been my experience that when you depress activity, via some toxic or CNS suppressive manner, you also compress the range of variability, so that activity is disappearing in that way. Also suggested, of course, is the possibility that these things may be having an actual reproductive effect.

DR. THOMAS: We missed the boat by not doing vaginal smears, and we found it out too late.

DR. CAMPBELL: Of course, there are other studies, and laboratories have used reproductive effects as an index of toxicity and this might be included in some of your regimens.

DR. THOMAS: We will be looking into this thoroughly and we will be using injection techniques and go through "typical drugs," tranquilizers, hydrocarbons and everything else by injection rather than by inhalation techniques.

DR. PROCTOR (The Boeing Company): I'd like to suggest there may be some behavioral factors compounding the experiment when you use a half hour or hour cessation of exposure for feeding. For one thing, if animals have not been fed for 23 hours, there is a hunger factor and the act of feeding to stimulate continued feeding when food is made available to them. Another thing, and I suspect that most of these compounds they're being exposed to are objectionably odorous, especially in pyrolysis. If the upper respiratory tract has a chance to clear out these odors, the odor of feed can come through loud and strong for the stimulation of hunger. There can be a great many factors which can make a change in an experiment, and repercussions can often be very great, so that the difficulty of comparing experiments can be as complex as when we change exposure times.

DR. FRIESS (National Naval Medical Center): May I pursue just one notch further the point raised about 1000-day limits for spacecraft application? We are being driven rather mercilessly by NASA at this point to make some estimations of permissible limits for 1000-day application, and therefore the point finally settled on that you and we are thinking about the matter has to be pushed one more notch up the wall. I'd like to ask at this stage in history if you have a feel for what factor of compression in time, and therefore what factor elevation and concentration, one can now at this point design his experiments with animals to get the first approximation toward rough data so the engineers can proceed on design?

DR. THOMAS: Have you ever heard a loaded question like that?

DR. FRIESS: You brought it on yourself by raising the issue twice, and it is terribly important to us.

DR. THOMAS: I'll tell you one thing, it is very hard at this stage of the game to give an estimate, but you're giving at least 4.5 times the dose per day, so if we're lucky we can just reduce the actual exposure run to one-third of 1000 days. I think

that figure is within reach. What is not within reach is that it's very hard for all of us to get a program going in the biological modeling area, because most of this research is not sponsored by people who are interested in long-term effects. I have the same problem in the Air Force. This is systems related, and if the system is Skylab, funds are unavailable for anything longer than a Skylab mission.

DR. FRIESS: Can I push one more notch? You gave me a factor of three, and I'd like to see if I can push one more notch to a factor of five because this would permit us to have the same experimental models running for the 180-200 day exposures that we are going to talk about for 1000. Now, does your gut feeling say that the 1000-day is not going to be much different from the 180-day situation?

DR. THOMAS: Not at this stage! Without having a model and cranking in all these data, and you remember we must have been looking at 80 different compounds with continuous exposure in the past seven or eight years. But, you know somebody has to write a program first, you've got to test the case and feed in all the old data, and it is available, and only by experimenting with this program will you really find out whether it works or not. My nose tells me it will work, but I have no proof of this.

DR. FRIESS: Will the program give you an extrapolation factor of five, from 200 to 1000?

DR. BACK: Since we have to struggle with this together, I think there is one saving grace in most of the long-term experiments that we have been doing, and this seems to be the fact that for almost all of our long-term experiments the animals seem to come to equilibrium, and the variation around the mean gets smaller and smaller. The animals become more and more alike, and if we can use this as a first indication that long-term experiments of three years or more may not be necessary, maybe we're on the right track. In other words, if we can get through a year's experiment at a given level, I think our chances for extrapolating to three years are getting better and better, and the more work we do, the more it indicates that we are on the right track.

DR. FRIESS: Is there some stage in history that 350-day exposures might be the best practical solution at the moment for recommendations bearing on the total mission over the next 10 years?

DR. BACK: We are going to have to use six-month data because that's all there is, and at this moment in time we're going to have to guess with six-month data. It seems the longer the animals go the more they are able to compensate for whatever deficit they started out with, and they get better and better as they go along. We're going to have to work with the data right now.

DR. ROWE: I know what Dr. Friess is talking about, and I know what Dr. Thomas' problems are in getting this sort of system outlined. But remember that these people who are going to be in this situation are going to have uncontaminated food and they're

going to have an adequate amount of good water and this factor I feel is so important in evaluating these long-term studies that we do keep our animals in a state of proper water balance and food nutrition balance. And, that could complicate this whole business of extrapolation.

AMRL-TR-71-120

SESSION II

NEW CONCEPTS ON ENVIRONMENTAL LIMITS FOR PROTECTION OF THE
PUBLIC AGAINST AIR POLLUTANTS

Chairman

Seymour L. Friess, Ph.D.
Director
Environmental Biosciences Department
Naval Medical Research Institute
National Naval Medical Center
Bethesda, Maryland

BASIS FOR ESTABLISHING GUIDES FOR SHORT-TERM EXPOSURES
OF THE PUBLIC TO AIR POLLUTANTS*

Ralph C. Wands

Frank G. Favorite

and

Lawrence M. Roslinski

National Academy of Sciences
Washington, D. C.

This paper and the one by Dr. Favorite are being presented on behalf of the Committee on Toxicology of the National Academy of Sciences - National Research Council. The chairman of the Committee, Dr. Herbert E. Stokinger, was unable to attend this year's conference and has asked us to provide a summary of recent and current work of the Committee on short-term exposures of the public to air pollutants.

Before proceeding with the discussion a quick history and orientation will be helpful for your understanding and perspective on the subject. One of the primary functions of the National Academy of Sciences is to serve as an independent source of scientific and technical consultation to the federal government. The National Research Council is the organizational unit providing most of these services. It does so through a series of committees whose membership is drawn from the entire scientific community of the U.S. These members serve out of a sense of professional and patriotic duty. They receive no fees for their services, but are reimbursed for their travel and other out-of-pocket expenses. One of these committees is the Committee on Toxicology whose membership is shown on table I.

*Prepared under Contract No. CPA 70-57 between the National Academy of Sciences, Advisory Center on Toxicology and the Air Pollution Control Office of the Environmental Protection Agency.

The Advisory Center on Toxicology is a full-time, paid-staff unit in the National Research Council whose task is to provide technical and logistic service to the Committee on Toxicology and to maintain liaison with the nine supporting federal agencies. Our technical support of the Committee consists primarily of a toxicology information storage and retrieval program.

TABLE I COMMITTEE ON TOXICOLOGY OF THE NATIONAL ACADEMY OF SCIENCES - NATIONAL RESEARCH COUNCIL 1971 - 1972	
HERBERT E. STOKINGER, CHAIRMAN	
ARTHUR B. DUBOIS, VICE-CHAIRMAN	
Bertram D. Dinman	C. Boyd Shaffer
Seymour L. Friess	Frank G. Standaert
Harold M. Peck	James E. Sterner
V. K. Rowe	Richard D. Stewart

The passage of the first Clean Air Act a few years ago enabled the health oriented staff of the sponsoring agencies to expand their concerns for the occupational environment to the public environment. This led to requests for acceptable levels corresponding to the occupational TLV's and EEL's that could be applied to exposures of the public to air contaminants. In order to respond to these requests, Dr. John Middleton as head of the National Air Pollution Control Administration invited the Committee on Toxicology to recommend, where possible, air quality standards for short-term exposures. This led to a contract with what is now the Air Programs Office of the Environmental Protection Agency and it is a pleasure to acknowledge their financial support under contract No. CPA 70-57.

Under the terms of this contract the Committee was to develop four documents. One of these was to be a set of specifications, or procedures, or definitions of what should be considered when recommending short-term air quality standards. This document is titled "Basis for Establishing Guides for Short-Term Exposures of the Public to Air Pollutants." The other three documents are identified as "Guides for Short-Term Exposures of the Public to Air Pollutants" and they deal with oxides of nitrogen, hydrogen chloride, and hydrogen fluoride. The present paper will describe the "Basis" document and Dr. Favorite's paper will describe the "Guides."

Short-term exposures are a separate and distinctly different health problem from that of chronic ambient air pollution. The effects of brief exposures to relatively high concentrations of air pollutants may be qualitatively and quantitatively different from those of chronic or frequently repeated exposures.

A short-term exposure to an air pollutant is defined as exposure experienced by an individual to a pollutant released from a single source for a brief time. The duration of such an exposure may be as much as 60 minutes under favorable atmospheric conditions. Under stagnant atmospheric conditions the short-term exposure may last up to 24 hours. There is little practical significance in considering exposures for less than 10 minutes, since variations in the dynamic processes of air movement and mixing lead to considerable uncertainty in predicting the amount of pollutant that might be inhaled. Short-term Guides are thus directed at relatively brief exposures to relatively high concentrations. They will be in addition to ambient levels of pollution existing at the time. They will involve a discrete downwind area and will affect only limited portions of the population in the vicinity of the source.

The Committee considered two categories of short-term exposures: those predictable as to time and place of occurrence; and those that are unpredictable. For predictable exposures the Committee endeavors to recommend Short-Term Public Limits (STPL's) which are concentrations whose effect upon public health and welfare will be no greater than is acceptable under prevailing criteria and standards for ambient air quality. For unpredictable exposures the Committee will try to recommend Public Emergency Limits (PEL's) which will be expected to produce minor but fully reversible injury among those exposed.

The Committee recognizes that while its attention must be primarily on human health there must also be secondary consideration to the effects of the short-term pollution episodes on plants, animals, and materials. In some cases these targets may be more sensitive than humans and thus require different criteria or standards.

Undesirable esthetic effects such as unpleasant odors or reduced scenic visibility, and associated economic losses, should be considered in connection with predictable exposures. They are not deemed to be important factors in standards to be applied to short-term unpredictable exposures.

The maintenance and monitoring of air-quality standards requires that suitable methods be available for sampling and analyzing air for the pollutant in question. If adequate procedures are not available the immediate need for research and development should be emphasized. Recommendations for "zero" levels are technically meaningless. If it is desirable to control a material to the lowest possible level, a phrase should be used such as "nondetectable by the most sensitive method of analysis available."

The physical form of a pollutant, i.e., gas, vapor, dust, or mist, may have a pronounced effect upon the route and extent of its attack. Particles up to 10 micra in diameter can be inhaled into the lungs, whereas larger particles are filtered out in the upper respiratory passages. Such properties as solubility and chemical composition will also alter the nature and degree of the effect of a pollutant. Consequently, it is essential that the pollutant be well characterized.

Exposure of the public to atmospheric pollutants is seldom, if ever, to a single compound. The effects of any pollutant involved in a short-term episode may be modified by interaction with one or more ambient pollutants. The interaction may be physical, as in the case of adsorption of gases on solid particulates; it may be chemical, as in photochemical smog; it may be biological, where the toxic effects are modified either in degree or in nature, as in thickening of the alveolar barrier by NO_2 . It is, therefore, important that information be obtained on the composition of the ambient air at the anticipated site of the short-term exposure.

As far as is known, all living systems have some ability to withstand injury from toxic materials. This resistance may be due to mechanisms that prevent absorption of the toxicant, rapidly excrete it, metabolize and detoxify it, or increase the rate of repair of injured tissues. These mechanisms are sometimes inherent in the organism and are sometimes enhanced or acquired in response to toxic stress. Whenever the capacity of these protective mechanisms is exceeded by the applied toxic stress the effect will become observable. Beyond this point of no biologically significant effect from a finite dose, the extent of the effect, i.e., the degree of injury, will increase with an increasing dosage of toxicant, with death of the organism as the upper limit. The relationship between causative dosage and resultant effect is not necessarily a constant proportionality over the entire range. This lack of proportionality in dose-effect relationships makes extrapolations much beyond the range of available data unreliable.

Most of the reliable data on the toxicity of any material are the results of carefully controlled experiments on animals. Occasionally, data may be available on controlled exposures of human volunteers. Comprehensive epidemiological data can only rarely be found.

The use of data from animal testing for predicting the effects of a substance on humans carries with it several sources of uncertainty which include:

1. differences between individuals of the same animal species
2. differences between animal species
3. extrapolation of the data from animals to humans
4. differences between humans
5. nonuniformity of the contaminated air mass
6. deviations from the predicted movement of the contaminated air mass.

The Committee has spelled out in some detail the kinds of data it would like to have as a basis for its recommendations of short-term limits. These needs may be summarized as follows:

1. the most sensitive target organ(s) or body system(s) to be affected by the short-term air contaminant
2. a full characterization of the nature of the effect upon the target(s)
3. the range of the time-concentration relationship for the target(s) from no effect to severe effects

4. the rate of recovery from reversible effects
5. the nature and severity of injury at which the effect ceases to be reversible
6. identification of cumulative effects, if any
7. the combined effects, if any, of the toxicant with other air pollutants and the concentrations at which the combined effects occur.
8. identification of types of functional abnormalities and pathological states among the potentially exposed population which may render such individuals more susceptible to the pollutant.

Even with these kinds of data, interpretation requires mature, experienced, scientific judgment from a variety of professional disciplines. The evaluation should consider the conditions under which the data were obtained and, in particular, their relevance to the conditions of human exposure. How closely do the test species and the target organ compare in morphology, sensitivity of response, and metabolism with that of man? Were the observed animal responses the consequences of exposure conditions to which the public may be subjected?

Having resolved these questions to the best of its ability the Committee must then develop its recommended limits. Looking at the situation realistically there will be many remaining valid sources of doubt or uncertainty so that resort must be made to the incorporation of safety factors. These safety factors should be of a magnitude commensurate with (1) the severity of the response; (2) degree of hypersusceptibility related to (a) preexisting disease, such as respiratory disease, (b) heredity, (c) nutritional state, or (d) age; (3) extent of physical exertion; and (4) uniqueness of man's response, e. g., hypersensitivity of the respiratory tract.

At this point the recommendations for STPL's and PEL's have been reached and the Committee has gone as far as it can. However, before these can be promulgated as standards it is my opinion that the Administrator of EPA and his staff must consider the impact of these limits on all aspects of the public interest. Selecting an upper limit for the concentration of an air pollutant for a short-term exposure of the public entails a choice of the least risk to the public health of all the risks to the public associated with the operation releasing the pollutant. It thus involves a study not only of the effects such as those already described but also an equally careful review of the source of the pollutant and the reasons for its presence. For example, consider the testing of a new firefighting technique or the training of firemen. The extent of public exposure to smoke, the firefighting agent, and its pyrolysis products are predictable. Among the risks to be evaluated and balanced would be the health and other effects that are the subject of these Guides, and the risk to the public of being deprived of adequate fire protection. There is no justification, in the view of the Committee, for subjecting the public to any appreciable health risk for a predictable exposure. Appropriate controls and safeguards must be developed.

The risks associated with unpredictable exposures require for their full evaluation a consideration of the probability of an accident. Such risks can never be reduced absolutely to zero but, by proper planning of operations and equipment design, they can be minimized. Exposure to an accidental release of an air pollutant should be a rare event in the lifetime of any individual. In some instances activities may be sufficiently important to justify accepting some probability of an accident associated with some degree of risk of reversible effects from exposure to a pollutant. There should be no acceptance of any possibility of irreversible injury from accidental exposure to a pollutant.

GUIDES FOR SHORT-TERM EXPOSURES OF THE PUBLIC
TO AIR POLLUTANTS*

Frank G. Favorite
Lawrence M. Roslinski
and
Ralph C. Wands

National Academy of Sciences
Washington, D. C.

The National Academy of Sciences-National Research Council commitment to the Environmental Protection Agency in the area of atmospheric pollutants takes several forms. One form is expressed through the Medical Sciences Division of the Academy-Research Council where a Committee on the Biologic Effects of Air Pollutants does a comprehensive study of a chemical family such as fluoride, lead, nickel, chromium, asbestos, or polycyclic organic matter. These documents, originally conceived as the basis for EPA criteria documents, now serve as scientific reviews of the state-of-knowledge about the chemicals and their compounds. EPA may use the documents in formulating legislative standards but they will not be issued by EPA as criteria documents. Since this administrative change, it has been decided that the Academy should publish the documents in order to make the data available to the scientific community.

Concurrent with the EPA-Medical Sciences Division activity, the Advisory Center on Toxicology has been asked by EPA to provide guidance for short-term exposure of the public to air pollutants. The rationale of this effort lies in the fact that there are both planned and unplanned (accidental) releases of pollutants to the atmosphere to which the public may be exposed. We have come to define the levels applicable to these two situations as Short Term Public Limits (STPL) and Public Emergency Limits (PEL), respectively.

The STPL are designed to recognize a planned, relatively brief, emission of a pollutant to the atmosphere. The public should be able to tolerate relatively high levels of a pollutant if the duration is sufficiently brief and if the frequency of

*Prepared under Contract No. CPA 70-57 between the National Academy of Sciences, Advisory Center on Toxicology, and the Air Pollution Control Office of the Environmental Protection Agency.

exposure and nature of the pollutant are such that no additive or sensitizing effect results. In keeping with previous philosophy on short-term limits, which are based on response time of instrumentation and atmospheric mixing, 10 minutes is considered the shortest time period for which a limit can reasonably be assigned. Other critical time periods for which levels have been set are 30 minutes, 1 hour, and 5 hours per day, 3 to 4 days a month.

PEL's apply to the unplanned or accidental releases of pollutants to the atmosphere. The levels recommended are believed by the Committee to be realistic so as to apply to a true emergency situation yet not so high that any irreversible or residual injury would accrue to the most probable sensitive segment of the exposed population, that is those with respiratory problems such as asthmatics and bronchitics.

We have made available to the EPA the Committee's recommendation for short-term exposures of the public to NO_x , HCl, and HF. The development of each guide has followed the same pattern. The initial task of determining the pertinent literature has been the responsibility of the professional staff of the Advisory Center on Toxicology. The literature is reviewed, evaluated, and used as a basis for the development of a draft guide. The draft guide is submitted to a specially constituted subcommittee of the Committee on Toxicology whose membership includes scientists who have performed toxicological research with the chemical. (The NO_x document was a product of the Committee on Toxicology.) This subcommittee then assumes responsibility for the document which in turn is submitted to the Committee on Toxicology for approval. Outside reviewers also comment on the document before it is released to EPA.

This rather lengthy and detailed technical-administrative process attending the development of a short-term guide may seem to some as overdoing it a bit, yet in the final analysis there may be those who feel it might not be enough. There seems never to be the right kind of data that will allow a direct extrapolation to a contamination level known to be safe for the more sensitive segments of the population. Thus in each of the three guides that have been written, NO_x , HCl, HF, the committees have found it necessary to urge additional research to lend greater support to the levels they have recommended or to provide data on which to base a modification of the limits.

Oxides of Nitrogen

In terms of air pollution, three oxides of nitrogen are of significance: NO, NO_2 , N_2O_5 . NO is of minimal concern since it is not an irritant gas and is only about one-fifth as acutely toxic as NO_2 , to which it is eventually converted in the presence of oxygen. N_2O_5 , if it exists in significant quantities in the atmosphere at all, does so only briefly. It is generally agreed that the ultimate fate of N_2O_5 is conversion to NO_2 . It has been calculated that in 1968 the total nationwide emission

of nitrogen oxides was about 20.6×10^6 tons, with all forms of transportation contributing approximately 40%, and stationary fuel combustion sources approximately 50% (Lagarias and Herrick, 1971).

NO₂ as a freely diffusible gas has the capability of causing adverse health effects as a deep lung irritant at high concentrations - several hundred ppm for a few minutes - that might lead to pulmonary edema. Many variations in toxicity patterns occur with NO₂: toxicity is enhanced in the presence of O₃, SO₂, aldehydes, and a high density of respirable particles. The ambient temperature and the age of the exposed person also markedly influence individual response. The Committee on Toxicology, having evaluated all of the influences on NO₂ toxicity, recommended the following short-term limits:

STPL

10 min.	1 ppm
30 min.	1 ppm
60 min.	1 ppm
5 hrs. /day, 3-4 days/mo.	

PEL

10 min.	5 ppm
30 min.	3 ppm
60 min.	2 ppm

Hydrogen Chloride

SUBCOMMITTEE ON HYDROGEN CHLORIDE

V. K. Rowe, Chairman
 Kenneth C. Back
 David W. Fassett

The major sources of atmospheric HCl are HCl synthesis plants, plastics manufacturing, and incineration, but more than half is related to the use of HCl in the synthesis of other organic chemicals. Anhydrous HCl may cause more severe injury to tissues than the hydrated form because of its dehydrating action. Except in unusually dry atmospheres, HCl would react quickly with moisture in the air to form an aqueous acid aerosol. Both the gas and the acid aerosol act as contact irritants with the epithelium and mucous membranes of the respiratory tract and conjunctivae of the eyes as the more sensitive sites of action due to absorption.

Several studies have been done on odor thresholds with results ranging from less than 1 ppm to about 5 ppm. Inhalation of 1000 ppm for one hour is dangerous to life and levels as low as 50 to 100 ppm have been shown to interfere with work.

Depending on the severity of exposure, the physiological responses to the inhalation of irritating levels of HCl are coughing, pain, inflammation, edema, and desquamation in the upper respiratory tract. If concentrations are high enough, acute irritation may bring about constriction of the larynx and bronchi, closure of the glottis, and breath holding. Fatal inhalation of HCl would be expected only when the victim is unable to escape from the contaminated atmosphere.

The Committee believes that the following levels which they recommended do not present any health hazard although the odor might be detectable and minimal irritation could occur:

STPL

10 min.	4 ppm
30 and 60 min.	2 ppm
5 hrs. /day, 3-4 days/mo.	0.67 ppm

PEL

10 min.	6.7 ppm
30 and 60 min.	3.4 ppm

Hydrogen Fluoride

SUBCOMMITTEE ON HYDROGEN FLUORIDE

Arthur B. DuBois, Chairman
 Moreno L. Keplinger
 Charles F. Reinhardt
 David L. Stoddard

Active volcanoes are the only known natural source of HF. It is a major constituent of effluents from fumaroles. It is this source that contributes background levels that have been detected in remote areas. Other sources include aluminum reduction plants, phosphate fertilizer plants, petroleum refineries, fluorocarbon manufacturing, welding, burning of coal, and ignition of rocket propellants.

Gaseous HF rarely exists in monomolecular form; rather, it tends to associate in molecules up to H_6F_6 . This association may lead to some equivocation in experimental results since the investigator may not in fact know whether he is measuring

the effects of HF, or H_6F_6 , or an association somewhere in between. The relative toxicities of the different associations are known to be different, but precision is lacking.

HF, like HCl, readily combines with moisture in the atmosphere to form an almost colorless fog, which in effect is an aqueous acid aerosol. In this form, it is corrosive to almost all forms of organic and inorganic materials.

The primary effect of acute exposure to gaseous HF in concentrations above a few ppm is irritation to the skin, eyes, and respiratory passages. Localized tissue damage may result on exposure to concentrations above recommended limits. At 12 ppm the mucosa are irritated, at 30 ppm for about 3 minutes the gas is detectable by taste, at 60 ppm the severity of irritation is noticeably increased, and at 120 ppm a stinging sensation of the skin is added, and the other irritations become so intense that man is unable to withstand the exposure for more than one minute.

Fluorides are also injurious to plants through systemic absorption of the gas and the accumulation of fluorides on the leaves. Plants show a wide range of tolerance to fluorides; some plants, gladiolus for example, suffer major damage when tissue accumulation reaches 20 ppm from atmospheric levels as low as a few $\mu g/M^3$. Yet other plants, camelia for example, can tolerate tissue accumulation to 1500 ppm.

Fluorides also cause an illness of cattle called fluorosis, resulting from the ingestion of contaminated grasses and forage in areas near sources of HF effluents. Inhaled HF plays an insignificant role in fluorosis because of dilution.

The Committee, recognizing the extreme hazard to health of HF, leaned conservatively in making the following recommendations:

STPL

10, 30, and 60 min.	4 ppm
5 hrs. /day, 3-4 days/mo.	1 ppm

PEL

10 min.	10 ppm
30 and 60 min.	5 ppm

REFERENCES

1. Lagarias, J. S., and R. A. Herrick; "Impact of Energy Consumption on the Environment"; A. J. P. H., 61, July 1971.

NEW FEDERAL AIR QUALITY STANDARDS

Orin W. Stopinski

Environmental Protection Agency
Research Triangle Park, North Carolina

Prior to the enactment of the Clean Air Amendments of 1970, signed into law on December 31, 1970, the responsibility for setting ambient air quality standards rested with the various states. Under the provisions of the Clean Air Act, as amended in 1967, specific actions were directed by the Act. These actions included:

- A. Designation of Air Quality Control Regions by the Federal Government, with this responsibility resting with the Administrator of the Environmental Protection Agency by the Administrator;
- B. Issuance, by the Administrator, of Air Quality Criteria for various pollutants;
- C. Adoption, by the states, of ambient air quality standards, based on the Air Quality Criteria issued by the Administrator with such standards to apply to the entire Air Quality Control Region, if intrastate, or to a portion of the region, if interstate;
- D. Review of the adopted standards by the Administrator and approval if, in his judgment, they were protective of the public health.

The Clean Air Amendments of 1970 specified certain changes in the standard setting process. These changes included the following:

- A. The Administrator of the Environmental Protection Agency was charged with the responsibility for setting air quality standards;
- B. Air Quality Standards were to be national in scope, applying to all Air Quality Control Regions;
- C. The National Air Quality Standards would be dual in nature with primary standards to protect human health and secondary standards to protect human welfare;

- D. For pollutants for which Air Quality Criteria had been previously issued, national standards would be proposed within thirty days following enactment of the Clean Air Amendments of 1970;
- E. For other pollutants for which Air Quality Criteria were published by the Administrator, national standards would be proposed simultaneously with publication of the criteria;
- F. National Primary and Secondary Ambient Air Quality Standards would be promulgated by the Administrator within ninety days after their proposal.

In the direct standard setting process the major changes were directed toward standards applicable throughout the nation and the acceleration of the process.

Other changes in the Clean Air Act included in the 1970 amendments were directed toward acceleration of attainment of the standards. Following promulgation of standards by the Administrator, the states are allowed nine months to submit implementation plans, the Administrator is allowed four months to approve such plans, and a maximum time limit of three years is allowed for the states to attain the National Primary Ambient Air Quality Standards. The three-year period for attainment begins with the date of approval, by the Administrator, of the State Implementation Plan.

Basic to ambient air quality standards are the air quality criteria. It is therefore appropriate to discuss these criteria before turning to those ambient air quality standards which have been promulgated by the Administrator.

Air quality criteria are an expression of the scientific knowledge of the relationship between various concentrations of pollutants in the air and their adverse effects on man and his environment. Air quality criteria are descriptive; that is, they describe the effects that have been observed when the ambient air concentration of a pollutant has reached or exceeded a specific figure for a specific time period. In developing criteria, many factors have to be considered -- the chemical and physical characteristics of the pollutants, the techniques available for measuring these characteristics, along with exposure time, relative humidity, and other conditions of the environment. In developing criteria, one must consider the contribution of all such variables to the effects of air pollution on human health, agriculture, materials, visibility, and climate. Further, the individual characteristics of the receptor must be taken into account.

Air quality criteria are statements of dose and response of a given pollutant at various concentrations acting for various time periods on various receptors. In their most refined form, criteria could provide a check list for those at any governmental level faced with the responsibility of establishing Air Quality Standards. Ideally one could scan the list of effects and identify those of concern in the jurisdiction for which standards are being promulgated.

Under the provisions of the Air Quality Act of 1967 and now under the Clean Air Act as amended in 1970, the Federal air pollution control program has prepared and issued Air Quality Criteria documents for various air pollutants.

These documents are compilations of the latest available scientific information on the sources, prevalence, and manifestations of recognized air pollutants. Their most important function is to describe effects associated with, or expected from, air pollutant concentrations in excess of specific concentrations for specific time periods. These effects generally include visibility reduction, material and vegetation damage, economic costs, nuisances, and adverse effects on the health and well-being of man and animals.

Air quality criteria documents are planned to provide comprehensive information in several major areas, whenever pertinent. An environmental appraisal section includes: origin (natural and man-made) and fate; physical and chemical properties; spatial and temporal distribution in the atmosphere; and atmospheric alterations which include chemical transformations and meteorological influences on the pollutant. Measurement technology is included so that a reference basis for quantitating the pollutant will be available.

The criteria present data on the effects of the pollutant on human health, including laboratory animal data where human inferences exist. Toxicologic criteria covering behavioral, sensory, biochemical, and physiological mechanisms and responses as well as epidemiological and clinical criteria based on field and clinical studies are included. Criteria on biological and physical effects on natural and cultivated plant life, domestic and wild animal life, and materials are included. Social and aesthetic effects criteria are included when information exists on these parameters. Economic impact, including that resulting from all other effects listed above plus effects on specific economic parameters, such as real property values, are also included in the criteria document. The search for air quality criteria usually highlights gaps in knowledge. Therefore, a section on research needs appears.

There are shortcomings in some of the data which are the bases for criteria. These shortcomings include:

1. Effects relating exposures to ambient air do not take into account the presence of all of the pollutants causing the net result; some of the pollutants may be intermediate or unstable products of known substances, while the presence of others may be unsuspected, thus not even monitored.
2. Laboratory experiments using simulated polluted atmospheres often cannot replicate the actual ambient air in composition, temperature, and humidity simultaneously. The presence of other pollutants (some not routinely measured) may also contribute to the observed effects.

3. It is extremely difficult, if at all possible, to state minimum or threshold levels for a particular pollutant with reference to a particular effect. Long-term exposures allow many variables to exert an additional influence on the outcome; short-term exposures often do not yield measurable effects when done at realistic ambient concentrations.
4. Many studies of effects are not directly comparable with each other because of nonparallel exposure times or conditions, and because of variations in measurement techniques and averaging times.
5. Air quality data are gathered at selected monitoring sites and may not reflect the actual exposures of the subjects being studied. In addition, with certain pollutants, the ambient air concentrations are not the concentrations that actually reach the sensitive tissues.

Even though the accuracy and precision of health and welfare effects data often leave something to be desired, we maintain that until better measurements are possible our actions must be based upon the best knowledge we have, and be guided by the principle of enhancing the quality of the air environment and, thus -- human life.

Air Quality Criteria documents, as initially issued under the provisions of the Clean Air Act, as amended in 1967, were published to serve as guides to the states in setting ambient air quality standards. The state-adopted standards were then reviewed by the Federal Air Pollution Control Office.

Today the Air Quality Criteria serve the same function -- a basis for the establishment of ambient air quality standards -- the only difference is that now the Administrator of the EPA establishes the standards, which must apply throughout the country. At the same time the states may develop their own air quality standards. Such state-adopted standards must be at least as stringent as the national standards.

Ambient Air Quality Standards, as defined in the Act, are of two types:

1. Primary Ambient Air Quality Standards are those ". . . which in the judgment of the Administrator, based on such criteria and allowing an adequate margin of safety, are requisite to protect the public health."
2. Secondary Ambient Air Quality Standards ". . . shall specify a level of air quality the attainment and maintenance of which in the judgment of the Administrator, based on criteria, is requisite to protect the public welfare from any known or anticipated adverse effects associated with the presence of such air pollutant in the ambient air."

Following the legal enactment of the Clean Air Amendments, several actions have been taken by the Administrator of the EPA in accordance with various provisions of the Act:

1. On January 30, 1971, a list of pollutants for which the Administrator planned to issue Air Quality Criteria was published. The list consisted of a single pollutant category -- Nitrogen Oxides.
2. At the same time, notice of issuance of the document, Air Quality Criteria for Nitrogen Oxides, was announced.
3. Simultaneously announcement was made by the Administrator of proposed National Primary and Secondary Ambient Air Quality Standards for six pollutants. Criteria documents for five of these pollutants had been previously issued under provisions of the Clean Air Act, as amended in 1967. Accordingly, standards were proposed for:
 - a. Sulfur Oxides
 - b. Particulate Matter
 - c. Carbon Monoxide
 - d. Photochemical Oxidants
 - e. Hydrocarbons
 - f. Nitrogen Dioxide

The proposed National Primary and Secondary Ambient Air Quality Standards were:

Sulfur Oxides as Sulfur Dioxide

Primary Standards

80 $\mu\text{g}/\text{m}^3$ annual arithmetic mean.

365 $\mu\text{g}/\text{m}^3$ maximum 24-hour concentration not to be exceeded more than once per year.

Secondary Standards

60 $\mu\text{g}/\text{m}^3$ annual arithmetic mean.

260 $\mu\text{g}/\text{m}^3$ maximum 24-hour concentration not to be exceeded more than once per year.

1300 $\mu\text{g}/\text{m}^3$ maximum 3-hour concentration not to be exceeded more than once per year.

Particulate Matter

Primary Standards

75 $\mu\text{g}/\text{m}^3$ annual geometric mean.

260 $\mu\text{g}/\text{m}^3$ maximum 24-hour concentration not to be exceeded more than once per year.

Secondary Standards

60 $\mu\text{g}/\text{m}^3$ annual geometric mean.

150 $\mu\text{g}/\text{m}^3$ maximum 24-hour concentration not to be exceeded more than once per year.

Carbon Monoxide

Primary and Secondary Standards

10 mg/m^3 maximum 8-hour concentration not to be exceeded more than once per year.

15 mg/m^3 maximum 1-hour concentration not to be exceeded more than once per year.

Photochemical Oxidants

Primary and Secondary Standards

125 $\mu\text{g}/\text{m}^3$ maximum 1-hour concentration not to be exceeded more than once per year.

Hydrocarbons*

Primary and Secondary Standards

125 $\mu\text{g}/\text{m}^3$ maximum 3-hour concentration (6 to 9 a. m.) not to be exceeded more than once per year.

Nitrogen Dioxide

Primary and Secondary Standards

100 $\mu\text{g}/\text{m}^3$ annual arithmetic mean.

250 $\mu\text{g}/\text{m}^3$ 24-hour concentration not to be exceeded more than once per year.

*To be implemented only if oxidant standard is exceeded.

Following publication of the proposed National Primary and Secondary Ambient Air Quality Standards written comments were received from nearly 400 sources. These comments were reviewed and each of the proposed standards was carefully reviewed in light of submitted comments. On April 30, 1971, the Administrator promulgated the National Primary and Secondary Ambient Air Quality Standards. As promulgated these standards are:

Sulfur Oxides as Sulfur Dioxide

Primary Standards

80 $\mu\text{g}/\text{m}^3$ (0.03 ppm) annual arithmetic mean.

365 $\mu\text{g}/\text{m}^3$ (0.14 ppm) maximum 24-hour concentration not to be exceeded more than once per year.

Secondary Standards

60 $\mu\text{g}/\text{m}^3$ (0.02 ppm) annual arithmetic mean.

260 $\mu\text{g}/\text{m}^3$ (0.1 ppm) maximum 24-hour concentration not to be exceeded more than once per year.

1300 $\mu\text{g}/\text{m}^3$ (0.5 ppm) maximum 3-hour concentration not to be exceeded more than once per year.

Particulate Matter

Primary Standards

75 $\mu\text{g}/\text{m}^3$ annual geometric mean.

260 $\mu\text{g}/\text{m}^3$ maximum 24-hour concentration not to be exceeded more than once per year.

Secondary Standards

60 $\mu\text{g}/\text{m}^3$ annual geometric mean.

150 $\mu\text{g}/\text{m}^3$ maximum 24-hour concentration not to be exceeded more than once per year.

Carbon Monoxide

Primary and Secondary Standards

10 mg/m^3 (9 ppm) maximum 8-hour concentration not to be exceeded more than once per year.

40 mg/m³ (35 ppm) maximum 1-hour concentration not to be exceeded more than once per year.

Photochemical Oxidants

Primary and Secondary Standards

160 µg/m³ (0.08 ppm) maximum 1-hour concentration not to be exceeded more than once per year.

Hydrocarbons* (excluding methane)

Primary and Secondary Standards

160 µg/m³ (0.24 ppm) maximum 3-hour concentration (6 to 9 a. m.) not to be exceeded more than once per year.

Nitrogen Dioxide

Primary and Secondary Standards

100 µg/m³ (0.05 ppm) annual arithmetic mean.

This presentation has discussed the current procedures for establishing air quality standards, the bases for standards, and, finally, proposed and final National Primary and Secondary Ambient Air Quality Standards for sulfur dioxide, particulate matter, carbon monoxide, nonmethane hydrocarbons, photochemical oxidants, and nitrogen dioxide.

*The hydrocarbons standard is for use as a guide in devising implementation plans to achieve oxidant standards.

OPEN FORUM

DR. MC NAMARA (Edgewood Arsenal): This question would be to Mr. Stopinski or Ralph Wands. Do you think that some time along the way it will be possible to set criteria for toxicological evaluations depending upon variations in the type of exposure and the degree of hazard? What I'm getting at is, in my own work people come to me every day saying, "We're going to shoot off a smoke grenade - it's going to get up into the air." What toxicology do I need on that? Now if you want to carry this thing to a conscientious conclusion, you would say that you have to make sure there will be absolutely no toxicological effect on any of the people in that community or on their offspring. And there is enough information that says right now that you can have one exposure to a chemical that sometime later in your life can be promoted to carcinogenicity or some bad effect, or it may be promoted second or third generation from now. This may happen with any chemical. We know it of a few. But any of the things that any of us are putting into the atmosphere may be a culprit in this regard. So, if we did all of the toxicology on everything that came along, there wouldn't be enough toxicologists or laboratories in the country to do this. So, do you think there is ever going to be a possibility that we will settle for inhalation LCT_{50} and damage to eyes and skin, or will we want all the entire picture on everything?

MR. WANDS (National Academy of Sciences): There are several aspects, Dr. McNamara, to your question, which are not at all unfamiliar to us. The Advisory Center and the Committee on Toxicology have dealt with this question of mixed exposures which is part of the example you raised of the testing of a smoke grenade or a colored smoke marker, or something like that. One of the things which we have asked in the way of data in the past on such problems has been first of all to identify just exactly what the problem is, in terms of what are the constituents that are going to be blown downstream - what does this smoke cloud consist of - and we ask for this information in both a qualitative and quantitative sense. Usually, in the case of pyrotechnics such as you're speaking of, one finds there is a fair amount of oxides of nitrogen; there is usually some carbon dioxide; there usually is a high level of particulates which may include such nice little things as freshly formed lead oxides; there may well be a fair amount of cyanides present, and also a large amount of carbon monoxide. Given a fairly good chemical characterization of the smoke, the Committee can then take a look at each of these things, separately and in combination, and say that the dominant acute inhalation exposure threat rests not with the cyanide but more probably with the carbon monoxide; and one can then say that if the concentrations of carbon monoxide are kept under control for the public exposures, then the rest of the things will fall in line. If, on the other hand, we find that there are other materials beside carbon monoxide there that are going to interfere with the transport of oxygen, such as the methemoglobin formers or the cyanides themselves, then we would want to cut down a little bit on the acceptable level of carbon monoxide. But it might still be possible to monitor this cloud merely by measuring its carbon

monoxide concentration and keeping that under control. In that case, if the material can be well characterized and shown to consist of materials upon which there are a fair amount of reliable data available, as with CO and oxides of nitrogen, then it may not be necessary to do any toxicology at all, but merely some good analytical work. Mr. Stopinski, do you have anything to add to that?

MR. STOPINSKI (Environmental Protection Agency): In recognition of the fact that actually there will exist at various places and at various times concentrations which will exceed the national standards, and I'm speaking of only those pollutants for which standards have been published, there was a concept of a definition of ambient air included in the standards which in essence incorporated the concept of the fence line. Now, remember that the Administrator of EPA is directed to protect the public health, and if one looks at a military installation, for example, and the general public does not have general access to your area, so long as you meet the standards at and beyond the fence line, you're all right.

DR. MC NAMARA: I take it from what was said that we would make our judgments on existing knowledge, and we could say based on existing knowledge that here is the degree of hazard and that we would need to go no further than that. Is that written any place in the laws?

MR. STOPINSKI: For the pollutants for which standards are set, the judgment has been made for you. Those standards must be met - at the places where the public has general access - at and beyond the fence line they must be met.

LT. COL. STEINBERG (Edgewood Arsenal): Just to pick a point - the definition of public - a good deal of the people that live on the other side of that fence line work on the installation. Are we then to say that these people are not part of the public, and where does our responsibility end in terms of a law suit later on?

MR. WANDS: Before he answers that, I would like to throw in another complication that is parallel to it. There are many military bases which have on-base housing.

LT. COL. STEINBERG: Again, not to muddy the water - for it is muddy enough already - where the installation was built years before, and the town, as has happened in many cases, has grown up around the installation, it becomes almost impossible because there is in fact no "fence" (though I know what you mean is the property line). The civilian community is indeed living cheek by jowl with the military installation. There again is no physical fence, if you will. But the more important is the first part of the question.

MR. STOPINSKI: On many military installations certainly your dependents are part of the general public. I don't think there is any question about that, and you want to protect them as much as the Administrator does. I think really the

point we're homing in on here is that if you indulge in an activity on a military installation, it will become your problem to see that no person is allowed to be exposed to levels which might be questioned at some later time. Now here I'm talking not about the people who are in uniform or who are working directly with the operation - this is an occupational problem - but about those who are not directly working with them, and there is quite a bit of precedence for this on many installations such as some of the AEC installations, in which people were flatly forbidden to go to work when experiments were carried on, to insure that they were not unduly exposed. I think this is the thing that will have to be done by the operating agency to insure that those people within the fence line are not exposed.

DR. SCHEEL (U. S. Public Health Service) : Apropos of this comment, could I turn this thing back to the audience again and ask Gen. Schafer whether there has been established some mechanism whereby the Armed Forces can deal with the Administrator in a meaningful way to establish STPL limits for the fence line, prior to his promulgation of an absolute law? Do we have a way of interacting with him?

GEN. SCHAFER (Aerospace Medical Division) : I don't believe we do at the present time. If we do I am not aware of it. However, I should hope on the question of whether you have standards within the fence line or outside that the military would not be denigrated any more than they have been in the past, and that we would also be considered human beings and equally applicable to the standards set for the public at large. I think most of us, indeed, are very aware of this, and the Federal Government has insisted you know that Federal agencies comply with many of these things, and we are perhaps in some instances the first to comply with some of these standards. This has been true of normal industrial contaminants that might occur from any base; some of the changes that have gone into effect on some of our bases have been required by a certain time period. They've either already been accomplished, and I think in most instances for normal industrial hazards at the average base installation (not a research and development organization) this is true, or must be accomplished by the end of fiscal 1972.

DR. FAIRCHILD (U. S. Public Health Service) : I am going to throw out a little bit on the philosophy of this thing. As you know, the Department of Labor is very shortly coming out with the adoption of all of the TLV standards into their standard package, which will be an enforcement of safe exposure for the eight-hour working day in the work environment. Has the Committee taken into consideration the fact that you're going to have one set of values, say carbon monoxide at 50 ppm for the working environment, or asbestos at 12 fibers (and it'll soon be 5 fibers) per milliliter - that the people in the work environment for eight hours a day are getting, and then they go to the outside environment and they are then catching the rest of it, whereas part of the population is not given the kind of work exposure that others have had. So you've got a combination. Have they really looked at all of these factors in coming up with these finals?

MR. WANDS: Dr. Fairchild, the Committee on Toxicology, in its relationship to the short-term guides, has certainly not considered this kind of situation. The

question has been posed to the so-called BEAP Committee (Biological Effects of Atmospheric Pollutants) of the Medical Sciences Division of the Academy who are preparing these major state-of-the-art documents for the EPA. I think the concept you're suggesting here will certainly be incorporated in future reports from that BEAP Committee. In light of the comment Mr. Stopinski made about changing the name of the BEAP Committee to environmental analysis or environmental evaluations, wherein the total insult to an individual would be taken into account - the insult from inhalation, from ingestion by both food and water - so that there will then be truly an environmental appraisal (and to me it is inconceivable that we can do a true environmental appraisal without incorporating the occupational exposure), I think that there must be some very close interrelationships - at least a lot of close communication between your new institute and the almost as new administration of EPA, and certainly it is at least as new in terms of its latest reorganization. I think these things do have to be meshed together. What mechanism is going to be set up for it I don't think anyone has the slightest idea yet.

DR. FRIESS (National Naval Medical Center): There was a point addressed to the Committee on Toxicology, and at that level the Committee has addressed itself to the question of occupational exposures, short-term emergency exposure limits as one discrete set of items, and then short-term public limits as another discrete set of items applying to a different population with no interaction between the two.

MR. WANDS: That is quite right, there is no relationship between the EEL's of the Committee, which are aimed at mostly the military and space community employees, and the PEL's for the general public. I think the difference here may well lie in that the PEL focuses on the most susceptible population unit - the aged and infirmed, the muling and puking, etc. - to quote Shakespeare - the first and last stages of man - are the limiting groups within the population for whom the PEL's are established. This then does not normally include the working population. We assume that all of us who are employed are in reasonably good shape.

DR. FAIRCHILD: What you're really saying is that there is a completely sufficient safety factor for the total population, so that even for the individual who's getting an insult all day long and then goes back to his home, there is no problem. Is this what we're really saying?

MR. WANDS: I think what I'm also saying is that the standards which will be established under the occupational safety and health act will carry a sufficient safety factor - that there will be no great hazard to the working population as well.

DR. FAIRCHILD: I've posed this question quite often. You know, it seems like we're coming up with a lot of different standards, and I'm just trying to see if they are going to really mesh together. I realize the tremendous complexity in this type of thing for extrapolation.

MR. WANDS: We're right back to the need for a lot of coordination and a tremendous amount of cooperation.

DR. FAIRCHILD: Very much so, and this is why I hope that Labor comes up with all of these standards, that somehow EPA, Labor, NIOSH, and other people eventually get together on these.

MR. DARMER (Systemed Corporation): I am curious as to why the subcommittee recommendations for these exposure limits are not made a matter of public record. Is there some reason for this?

DR. FRIESS: Well, I think this is just procedural legalistic. The Committee operated on a contract from an agency to do a job for that agency. What happens then becomes the property of EPA, and they will release it in conjunction with executing their legal responsibility. We did the job for them.

MR. WANDS: I might add that our presentation here this afternoon does constitute a public disclosure. The proceedings will be printed, publicly available. This was done with the blessing of EPA - they had no objections to our presenting these papers this afternoon. So, from that standpoint, the responsibility for public disclosure has been met, but it is a tentative disclosure in that there has been no formal action taken by the Administrator, Mr. Ruckelshouse.

DR. THOMAS (Aerospace Medical Research Laboratory): In following up on Dr. Fairchild's comment on coordination, I would like to address this question to Mr. Wands. I believe my good friend, Dr. McNamara, had a very bright idea about a year and a half ago which he submitted through official channels as a suggestion. And you know it is hard enough to coordinate with DOD, but we did that (Dr. Friess remembers that we spent a very pleasant time down in Texas writing technical coordination papers in all areas of medical research within DOD). What I'm really leading up to is that Dr. McNamara's suggestion was that perhaps we could utilize the Advisory Center on Toxicology a lot better than we are doing now by acting as a clearinghouse for DOD toxicology research programs, and then the Advisory Center, knowing the capabilities existing in DOD, would look at the available DOD facilities and laboratories and then just assign certain research problem areas based on best staffing, best equipment for the particular problem, and so on. I don't know what really happened to Bernie's proposal, but going one step further than that, there won't even be enough toxicology laboratory space in this United States, or enough scientists for that matter, to come up with all the criteria and the needed data which it will take to really clean up this environment. So maybe this approach should be reconsidered on a national basis for the best utilization of talent. Ralph, have you anything to say on that?

MR. WANDS: What was that remark you made yesterday when you got hit with a question like that? Loaded, yes. I honestly don't know whatever happened to Dr. McNamara's suggestion - it probably went the way of all things in suggestion boxes. A very good idea but there are no funds and no capabilities to carry it through, or something of that sort, I suspect is the official position. Certainly it is clear to all of us that there are limitations on the physical capabilities of the

existing toxicology laboratories or those which are on the drawing board, such as the new national center for toxicology down at Pine Bluff, Arkansas. There are limits to the number of existing professionals and associated technicians to do the toxicology. The universities cannot begin to turn them out fast enough. There is certainly a shortage today and there is going to be a continuing shortage of people who are capable of working in this area. We've got to do all we can to train more people. I think it also behooves us in terms of just good common sense and simple economics to make the best use that we can of the facilities we have and the people we have - total utilization of our national resources in this area. I think this means that there certainly must be coordination of some sort among the existing facilities and those responsible not only for their direction but for their ultimate end use in terms of regulation, standards setting, etc. I'm sorry to say that I do not see, from our particular vantage point anyway, the level of spontaneous coordination and cooperation that one might like to see. This is Utopia I guess I'm talking about. In terms of the Advisory Center on Toxicology acting as a focal point for this kind of coordination, the memorandum of agreement which exists between the nine Federal agencies who pay our bills does call for us to alert these agencies to duplication of efforts whenever we become aware of them - and on some occasions we have done so. This assumes that we know everything that is going on in everybody's shop, which is, of course, a falacious thing to begin with; and, secondly, that even if we do call attention to an overlap, that something gets done about it. You must remember one thing, that the Academy and all of its functions, including the Committee on Toxicology and the Advisory Center on Toxicology, are purely advisory. We make recommendations. The decision to act does not rest with us. We could not accept the responsibility for assigning the job of doing this LD_{50} to one laboratory and that LC_{50} to another laboratory, or any such thing. We could make recommendations; we could list priorities; we could evaluate laboratories; we could tie ourselves up with business like that for the next three generations. Whether this is a feasible thing to do, I am not really sure. This would open up some tremendous problems of interdepartmental diplomacy.

DR. THOMAS: I think the point is that if the Center can make recommendations for areas of research concerning various branches of DOD and problems, it would help a great deal, at least for us in the military, to stop this constant fighting over what is relevant research. Because it always helps to have a scientific body endorsing things which really have to be done. Really, Ralph, I'm talking about pure paper pushing exercises, justifying why you're doing what you are doing. So, I think just recommendations help us. I don't mean that you have to say this LC_{50} is going to be done here or there. Here is the problem and here is what should be done about it.

DR. FRIESS: There is a political point to be made. At the time the suggestion was made, I think three of us went back to our respective services and checked through medical commands, in my case the Research Division of the Bureau of Medicine and Surgery of the Navy, and found an attitude that probably can be expressed by the fact that we know our priority needs in the Navy - we really don't

need some supernational agency or sacred authority trying to issue priorities with respect to what we do in our laboratories to meet our operational requirements. That's the way it came out, more or less.

DR. MC NAMARA: I'd like to say a word about what the suggestion was.

DR. FRIESS: I thought Anton defined it.

DR. MC NAMARA: Well, he did. But to make it clearer to the people here, the suggestion was that each of the present agencies maintain its present mission - the present mission was not to be negated or interfered with. However, toxicological problems of national interest could be judged at a higher level, and not necessarily the National Academy of Sciences - some overall level that could see the whole national problem and could assign problems to the laboratories where there was a capability - and that the higher authority would then have to decide what was first priority and, perhaps, even if the national interest priority was above their regular mission priority that this would be decided at a much higher level, but it should not necessarily influence the day to day running of anybody's laboratory. The point was that, inasmuch as we all work for the Government, if there is a problem of national interest, it is the obligation of all of us to get it settled, to get it straightened out if we can, and if the capability is there, we should use it.

MR. WANDS: I think there are one or two other things that might be worth bringing out here. There are some facilities already within the national administrative structure for such coordination - the Council on Environmental Quality of the President's office, the Office of Science and Technology, again of the President's office - do have some of these coordinating and priority setting responsibilities. The other feature that I would like to mention here is that one of the advantages that accrues from the Academy structure is that it is independent, and I think we'd have to look awfully close at any of our involvement in recommending, or becoming involved in administrative priority establishment and things like that, because this might well jeopardize the independence which the Academy brings to bear on such problems. We might then have to end up being a proponent, rather than a non-biased uninvolved group. I think we would have to look very closely at our particular involvement in this thing. That is not to say though, that the basic idea of some overall coordination, over and above the kinds we are getting now from the President's office, might not be a very desirable thing.

LT. COL. STEINBERG: I'd like to change the subject, but may I make just two comments before that. One, right now with the cutbacks in the service, if you're willing to admit that you have someone free enough to work on somebody else's problem, you're going to lose them. The second point is, for someone to come in from outside the Command structure and try to tell the Commander, as was alluded to by Dr. Friess, these are the priorities you should put your research

efforts into, particularly if he is not within the medical structure, but let's say he is a four star infantry general - I wish you lots of luck. But, I'd like to change the subject and follow up on Dr. McNamara's point that he brought up earlier - although it was pushed to the side a little. I'd like to bring it back. We have a real problem - let me use a real life example. We're looking at a pyrethroid right now, for adoption by the World Health Organization and by the Department of Defense. The guidelines on what one should look at when something comes out in an aerosol can are very, very limited, and if you go to one regulatory agency they tell you that, well, this now belongs to another regulatory agency. And if you go to that regulatory agency they say no, no, no, that belongs to that other regulatory agency. What I am trying to get to is, what are the possibilities, because we feel it's very real that we're going to have to meet the criteria of two separate regulatory agencies sometime in the future. As a matter of fact, on both occasions when we asked what you thought we should do, the answer was what do you think you should do. And I'm not trying to be facetious. The other, as you say, is that you say you should use good analytical methods. In some instances, on the pursuit of good analytical methods what you are looking at may exist at x-time after let's say ignition, and then at x-times two it's different, and you may have two different problems. I think you know what I am alluding to, and that is, let's say a study of a propellant using a shoulder-fired weapon versus a crew-served weapon where really analytical means are of questionable value. So, I've got two questions really. What do we do, and are there going to be any guidelines? Is there any provision for someone establishing guidelines as to what we're going to need to say you have a relative degree of safety, and if, not, why not?

MR. WANDS: Let me first of all react to your problem with the pyrethroids. It should be no surprise to an Army man to get the buck passed from one agency to the next! I can't really go very far beyond that. I'll let Dr. Friess take a crack at your problem of interagency coordination.

DR. FRIESS: I think I am a better bureaucrat on this point than Ralph and I'd like to approach it by saying that within each of the Armed Forces one would assume that you have a trigger man picked in occupational health, engineering perhaps, who knows the mechanism whereby to get you a unique ruling on exposure to the unique military chemical you're talking about. In the case of the Navy, there is a man in Code-73. If we have an operational problem arising which involves exposure to x-milligrams per cubic meter of compound y, we turn to him and demand that he put the mechanism into operation to generate a unique ruling that we can live with operationally. He, in turn, has numerous techniques at his disposal, one of which is making a referral to the Advisory Center on Toxicology for information retrieval, potentially a recommendation from a committee, and then he has authority really to legislate within the Bureau of Medicine and Surgery of the Navy the number with which they will live in the fleet.

LT. COL. STEINBERG: We do have such a means of coming up with a number that you can live with - provided you wear suits, or a mask, or what have you. This is with standards. But, what I'm referring to is when you say that I've done a 21-day

wear, a 21-day exposure, and then somebody comes back and says no, you should have done a 90-day. And next year you have the same condition existing, and you get different guidance.

DR. FRIESS: But you must frame your question to the responsible official in terms of the body of information which presently exists and request a ruling for the time constraint of interest to you. He's got to give you a ruling within the time constraint that you specify.

MR. WANDS: I think, Col. Steinberg, that part of what you're experiencing is nothing at all new to our industrial friends who keep coming to Washington for similar rulings. This is exactly your problem, I know, and particularly as it goes beyond the confines of the Army and its personnel to the public and places like the World Health Organization, as you mentioned. Many of these regulatory agencies, and particularly the staffs of these regulatory agencies at the working level, are concerned about the multiplication of standards, multiplication of requirements for testing. They are trying honestly, I believe, to coordinate their own mission, their own requirements, in such a way that there will be some standardization. We see this, particularly now, in terms of coordinating the old interpretation 18 of the pesticides people, along with the requirements of the Department of Transportation, Office of Hazardous Materials, for labeling purposes along with the labeling requirements of the FDA hazardous substances group. All three of these people are setting up acute toxicology standards upon which to base a label, and they are hoping to coordinate their interests well enough that there will not need to be three sets of studies done and three sets of labels on each tiny little can. There is an honest effort being done to simplify and coordinate these kinds of testing requirements.

DR. FRIESS: Col. Steinberg, was there a second part of your question which bore on the need for matching the speed of the analytical method to the speed with which the phenomenon occurs - did you have that in there?

LT. COL. STEINBERG: No, I was alluding to Mr. Wands' statement that the ability to measure these things can be a very real problem - almost an impossible problem - particularly with free radicals and what have you.

DR. FRIESS: This touches on a question which was of prime interest to the Committee at one point, and that is the periods of time within which you worry about people being exposed, and then your ability to gain meaningful measurements of time mean concentration during that interval as against instantaneous point by point measurements. This is a very real problem.

MR. WANDS: We have been through one situation like that with the Army in conjunction with the Chinook Gunships, where they were able to get some very rapid response analytical measures, that gave both qualitative and good quantitative measure of what the instantaneous exposure almost was of the crew. We were at that time able to set one-minute levels for that particular operation.

DR. BACK (Aerospace Medical Research Laboratory): I have two questions involving that particular point. You gave 10-, 30-, and 60-minute limits for STPL's and none of the slides showed the longer duration, five hours a day, three to four times a month data, nor was it explained as to whether these were time-weighted averages, or are we in a new ballpark? Because, as you recognize, there were three different committees, subcommittees involved to begin with, and we were playing under different ground rules. What has been the final determination on these time-weighted averages? Are these peaks not to be exceeded?

MR. WANDS: Let me first of all ask Dr. Favorite to respond to the five hour, three to four days per month figures, and I'd also like to have Orin Stopinski get in on this business of the analytical procedures, and then I'm going to ask V. K. Rowe to finish off with the discussion of ceiling versus time-weighted average values.

DR. FAVORITE (National Academy of Sciences): On the five hour per day business, three or four days per month, they were not put on the slides to save the confusion of your seeing too many numbers. These numbers are available. If you want them, I'll give them to you. I don't think they are terribly significant. They are of a lower range, of course, than any of the others that were given for the STPL's and they will be in the printed version.

MR. WANDS: Orin, do you want to comment on this business of suitable analytical procedures - what it means to you people?

MR. STOPINSKI: Whenever the Administrator of EPA sets any time of standard, along with that standard he will publish a measurement analytical technique. This was done with the national standards; the standards of performance specified the measurement techniques which are to be followed. It is the plan within EPA for each standard set by EPA to specify a particular sampling and analytical technique with provision for substitution of equivalent measurement or analytical technique.

DR. BACK: Equivalent precision or equivalent what?

MR. STOPINSKI: The equivalents were defined for three pollutants, and we are in the process at the present time of modifying that table for the Federal Register. Two pollutants were omitted - the hydrocarbons and the nitrogen dioxide. That is being rectified. We know of no way other than the high volume sampler at the present time of measuring particulate matter, so we will not give a list of specifications. The instrument manufacturers are highly interested in this. They want to know what direction to go for development of instrumentation.

DR. BACK: I'm thinking of a cloud, like 500 feet up you know, and you're not going to get any instruments tracking up in a cloud. Is there any provision for differences from that supplied by the Administrator? Could we use long path infrared or something else that will give us an answer?

MR. STOPINSKI: I will have to give you a personal opinion here, not the Administrator's position. That is, we are interested in where people live, and most of us live within a couple meters of the surface.

DR. BACK: That's true, but we don't know where some of these clouds are coming down, so we have to monitor them.

MR. STOPINSKI: If you're putting a pollutant into the atmosphere for the average time for which standards are specified, and EPA comes along and measures it, no matter how it gets there, points the finger at you and tells you you have been a bad boy, the measurements must be taken by the techniques specified by the Administrator, and will be ground level measurements. This is my interpretation of what has been published and the thinking that has gone into specifications of measurement techniques.

DR. FRIESS: Ken, we promised you a brief run from V. K. on the surges or peaks versus the time-weighted average.

DR. ROWE (The Dow Chemical Company): I'd like to start by asking a colleague here what time interval is likely to be described in the official method?

MR. STOPINSKI: A time period will be specified. For NO_2 , for example, it is a 24-hour average, and you'll measure for a 24-hour period. Particulates you'll sample for 24 hours, and it is a 24-hour average that you're looking at. For photochemical oxidants it is a one-hour average time period, for hydrocarbon it is a three-hour average period, and for CO it is a one-hour and an eight-hour average period.

DR. ROWE: The problem, though, was the short-term limits for which you're sampling, and you haven't set a limit for 10 minutes. Now if this is considered to be at any interval, however short a time within that 10-minute period, we have a different concept than if we are permitted to time weight that average over that 10-minute period, and there is no standard that has any real meaning, in my opinion, unless it describes the method and the duration of time over which that concentration or exposure is integrated. If you set a 10-minute period that is a time-weighted average - if you set a five-minute period that is a time-weighted average - what happens during that particular period of time is of extreme importance when we're talking about short-term limits, and particularly when we start talking about irritant gases and that sort of compound where the total body burden and systemic toxicity is not nearly as important as with HCl, for example. Within 10 minutes, it usually is conceivable that you could have concentrations that would average less than the figure and yet the person might die of asphyxiation simply because he could not breathe. That's one of our problems in deliberating the significance of these figures. I don't see how we can consider it any way other than a time-weighted average over the period. But then again, I think we have to consider the reasonable fluctuations that are likely to occur within that interval of

time and still maintain our CT value - not exceeding the CT value for that time-weighted average. If the probability is that you're going to have a level ten times the accepted standard for a given period of time within a very short interval, then that's going to be bad news, and then that standard is not very meaningful. The Committee, at least our Committee, of which Dr. Back was a member, in considering this, considered the reasonable fluctuations that might be expected within a ten-minute interval, because most all the methodology that is reasonably available at the present time could hardly be expected to produce an answer in smaller sampling time periods. Specialized equipment, yes, but very little field equipment can do this. So we constructed a few graph charts just to plot what we thought might be reasonable, and came to the conclusion that two to three times these levels might well be expected within a 10-minute interval. But, as a wave of gas came by, if it weren't at the point of the source the fluctuations might be two to threefold, and yet stay within the 10-minute time-weighted average. Whether or not we are right in this I don't know, but I am convinced that we have to integrate and look at the possible exposures within any particular time limit. Now, in the longer periods of 30 minutes and 60 minutes, the guide standard specifies that in no 10-minute period during that interval would the concentration be above the 10-minute level, so that we have, in fact, put a ceiling on it, limited by the interval of time in which we could make measurements. Have I answered your question or created more?

DR. BACK: Yes, if all the committees were setting the limits on the same basis. HCl for instance, we set a 10-minute limit at 4 ppm, realizing full well that a peak might go by at 12 to 14 ppm for a relatively short period of time, but the total integrated dose would be less than 4 ppm over 10 minutes. This would allow a high flush going past in a short period of time. We guesstimated, and I think rightfully so, on human data that 16 ppm for a few minutes out of that 10 wouldn't incapacitate anybody; therefore, we could allow that kind of peak as long as the total integrated dose didn't go over 4. So, we took that into consideration and I wonder if the other committees took it into consideration with HF and NO_x.

DR. FAVORITE: It was not part of the original deliberations of the HF group; however, when the concept as Dr. Rowe has presented it here did come to light, and the activities of the HCl subcommittee were thoroughly discussed, this then was presented to the full committee on toxicology and they did decide to accept the same philosophy and apply the same measurements to the HF document as to the HCl. With respect to NO_x, so far as I know it has not changed.

DR. TRUDELL (Stanford School of Medicine): I have some comments on Mr. Wands' talk about the philosophy of setting limits and species variations. After our picking numbers out of a hat, in many ways, talking about acute human irritation, I think we'll all agree in this room that if we took a drug and tested it on six mouse strains, new world monkeys, old world monkeys, beagle dogs, chimps, and humans, we would get that many different answers and that many different limits. I think we are talking about humans, so I wanted to make the point that

we should perhaps standardize on some animal - hopefully on the human. And then I wanted to interject my comments that when you talk about volunteers to do these studies, perhaps the only really good volunteer who can give informed consent to volunteer for a study of breathing HF is either a person with an M. D. or Ph. D. in biochemistry or toxicology. I feel rather strongly that you can't really alert a person to the dangers of your volunteer study without scaring them off, often. I guess finally I'd like to point out that, as in my studies, people every day across this country are lying in hospitals in a coma - they won't live - at some point they will be declared legally dead; and yet their heart is fine, they're young, their blood is circulating well, they maintain temperature, and they have very good lung tissue. If this whole study is that important, that we should have these committees to set these limits, it's probably important enough that we can approach these people or their guardians and ask them to, when they are declared dead, accept what we would call an acute toxic dose and see what happens to a human.

DR. FRIESS: Interesting comment. Does anyone on the panel want to make a rejoinder?

MR. DI PASQUALE (SysteMed Corporation): I would like to direct a question to Dr. Favorite. Why are your short-term exposure limits higher for hydrogen fluoride than hydrogen chloride? Is this based on animal experimentation, or does it simply represent the different committees, or is there a hazard difference between the two compounds?

DR. FAVORITE: They certainly don't represent differences of opinion of the committees. Not having the full document here, I can't go to the references that were used by the committee in developing the levels that have been established. The HF levels, as well as the HCl levels, have their basis in experimental data, either with animals or with human use experience.

DR. CARHART (U. S. Naval Research Laboratory): I'm going to be speaking not so much as a Navy man, but as a member of another committee of the Academy of Sciences, and I think it is only fair that people should recognize that there are other activities in the Academy that are also concerned with some of these problems. This committee happens to deal with hazardous materials. The question or situation I propose may be out of the purview of discussion this afternoon, but I think it is a very real one, and ought to be considered. We have, as Ralph has pointed out, two situations - one in which we can more or less expect a certain thing to happen; and, under those conditions, hopefully we can reach Utopia and control the concentrations so the public will not be exposed to levels above these levels set by the committee. But, he also posed the situation of the unexpected event. Let's consider the situation of a barge going down the river near a city. The barge contains 600 tons of chlorine liquid, and another barge comes along and they run into each other. This is common, and we spill something on the order of 600 tons of chlorine. And just downwind of this situation there happens to be a city, and the chlorine unfortunately has not heard about the limits on toxicology and so on, and it evaporates at

its own rate - it doesn't stay within the limits of 5 ppm, or whatever is required. This becomes an event which requires some immediate and very fast action in terms of, among other things, establishing what the concentrations are going to be.

MR. WANDS: Dr. Carhart, this situation you described is exactly the sort of thing to which PEL's are directed. They are intended primarily for planning purposes; for example, to limit the size of the individual compartment on that barge, so that if a corner of it gets damaged in an accident, only 100 tons instead of 600 tons gets dumped - or maybe 100 pounds, depending upon how well you want to limit the potential disaster. This is the very purpose of the PEL. Let's be realistic, when an accident happens in an unpredictable time and place, you're never going to be out there taking air samples and then telling people they have been overexposed. What you have to be able to do is to say, given a chlorine barge on the bottom of the river at Natchez, if this thing does spring a leak and liberate its cargo, how far downwind must we be prepared to evacuate this community to stay within the 5 ppm, or whatever figure may be established? And then what administrative mechanisms are necessary to accomplish that evacuation? Let's not have four administrative bodies all claiming first priority, as was done after a hurricane when one of the chlorine barges went down in Baton Rouge. It is for these kinds of things that the PEL's have been requested by a lot of the agencies, including the Coast Guard, who have that responsibility, and they've ended up here in the lap of the committee. They're intended almost entirely for planning purposes, emergency planning purposes, whereas the STPL's are really intended for a monitorable situation where one does know the location - that you're going to fire at Cape Kennedy - that you know you can pick the weather patterns and everything else, and you can set up field sampling stations to monitor this - so that you can point the finger at NASA if they have overexceeded the limits and fix responsibility for it. This is the difference between these two kinds of levels, really. That is a very good point you brought out, and of course your committee that you operate on in the Academy, advisory to the Coast Guard on transport of these hazardous materials, is really looking at this concept, among other things, of how large a cargo should be permitted in any single container.

AMRL-TR-71-120

SESSION III

TOXICOLOGICAL PROBLEMS WITH AIRCRAFT, MISSILES, AND SPACE VEHICLES

Chairman

Keith H. Jacobson, Ph. D.
Laboratory of Environmental Medicine
Tulane University School of Medicine
New Orleans, Louisiana

CHRONIC EXPOSURE STUDIES WITH MONOMETHYLHYDRAZINE

J. D. MacEwen, Ph. D.
and
C. C. Haun

Systemed Corporation
Wright-Patterson Air Force Base, Ohio

The manufacture and use of monomethylhydrazine (MMH) as a rocket fuel has increased over the past 10 years. The acute health hazards from handling this highly reactive compound were well defined, but although its usage was increasing little was known about its chronic exposure effects. The current industrial threshold limit value (TLV) of 0.2 ppm was established by analogy with hydrazine and unsymmetrical dimethylhydrazine. Jacobson et al. (1955) had shown that the acute CNS effects from MMH exposure were intermediate to its two analogs. Additional acute exposure studies (Haun et al., 1971) revealed that the CNS effects and resulting death were dose-related with MMH following Haber's Law of $CT = K$.

A series of 6-month MMH chronic exposures to four animal species was undertaken to evaluate the safety factor and appropriateness of the current TLV for health of workmen. Exposures were conducted on a 6-hour/day, 5-day/week basis at air concentrations of 0.2, 1, 2, and 5 ppm MMH in four experiments. Another experiment was conducted which provided a continuous exposure of 0.2 ppm to animals for consideration of exposure limits for use in missile silos, spacecraft, or other confined spaces. The weekly dose of MMH in ppm-hours for each experiment is shown in table I. The 2 and 5 ppm MMH exposure experiments were made first and the results were reported by Haun (1970) at this conference last year.

Each of the experimental animal groups, as well as their controls, consisted of 8 beagle dogs, 4 rhesus monkeys, 50 Wistar strain rats, and 40 ICR mice. All animals were female except for male rats. The exposures were conducted in the Thomas Domes which were operated at 725 mm Hg pressure to avoid leakage of MMH into the laboratory environment. The exposure chamber effluent air was passed through a high volume water cooled vacuum pump which prevented discharge of the residual MMH to outdoor air by reaction with the water. The chamber MMH concentrations were continuously monitored and controlled using a colorimetric method with an AutoAnalyzer (Geiger, 1967).

The experimental animals were weighed biweekly during the studies and a series of 15 clinical chemistry and eight hematology tests was conducted on the same schedule. On conclusion of the experiments, the animals were killed for gross and histopathologic examination. Bone marrow studies on dogs were also performed at this time. At the end of the first series of experiments, half of the exposed and control dogs were held for 30 days postexposure observation to determine reversibility of the noted effects. The second series of experiments was extended four weeks to permit additional blood sampling because two sampling periods near the end of the experiment were unavoidably omitted.

TABLE I
MMH WEEKLY DOSE EQUIVALENTS

<u>Chamber Concentration (ppm)</u>	<u>Type of Exposure</u>	<u>Dose ppm-Hours</u>
0.2	Intermittent*	6
0.2	Continuous	33.6
1.0	Intermittent*	30
2.0	Intermittent*	60
5.0	Intermittent*	150

*6 hours/day - 5 days/week

EXPERIMENTAL RESULTS

Consistent dose-related effects were seen at all exposure levels, including the 0.2 ppm MMH continuous exposure. Deaths occurred only in mice at the two highest MMH concentrations. The mortality percentages were 27% at 5 ppm and 15% for the 2 ppm MMH exposure group. Mortality in mice at lower MMH exposure concentrations was comparable to that of the control groups.

Rat growth was significantly depressed in the 2 and 5 ppm MMH exposures as shown in figure 1. Body weight data for the lower MMH exposure concentrations also showed evidence of dose-dependent effects at 1 ppm intermittent exposure and at 0.2 ppm MMH continuous exposure. At no time interval were the mean weights of the rats exposed at the lowest dose level (0.2 ppm intermittent) statistically different from those of the control group. Differences, significant at the 0.01 level, were seen from the first to ninth week for the 1.0 ppm MMH intermittently exposed group and at weeks seven, nine, and 13 in the case of the 0.2 ppm continuous exposure rats, as seen in figure 2. High room temperatures caused by heating

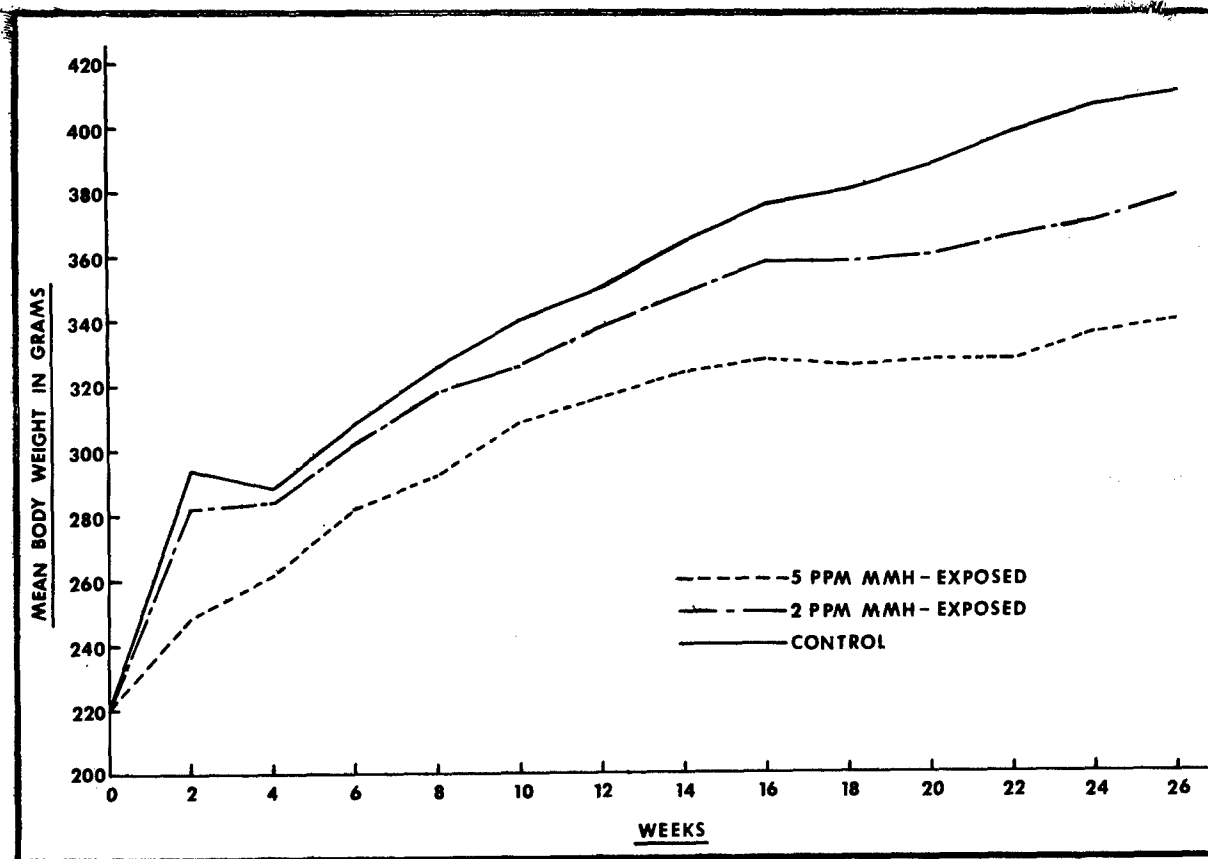

Figure 1. EFFECT OF CHRONIC MONOMETHYLHYDRAZINE EXPOSURE ON RAT GROWTH - GROUP I.

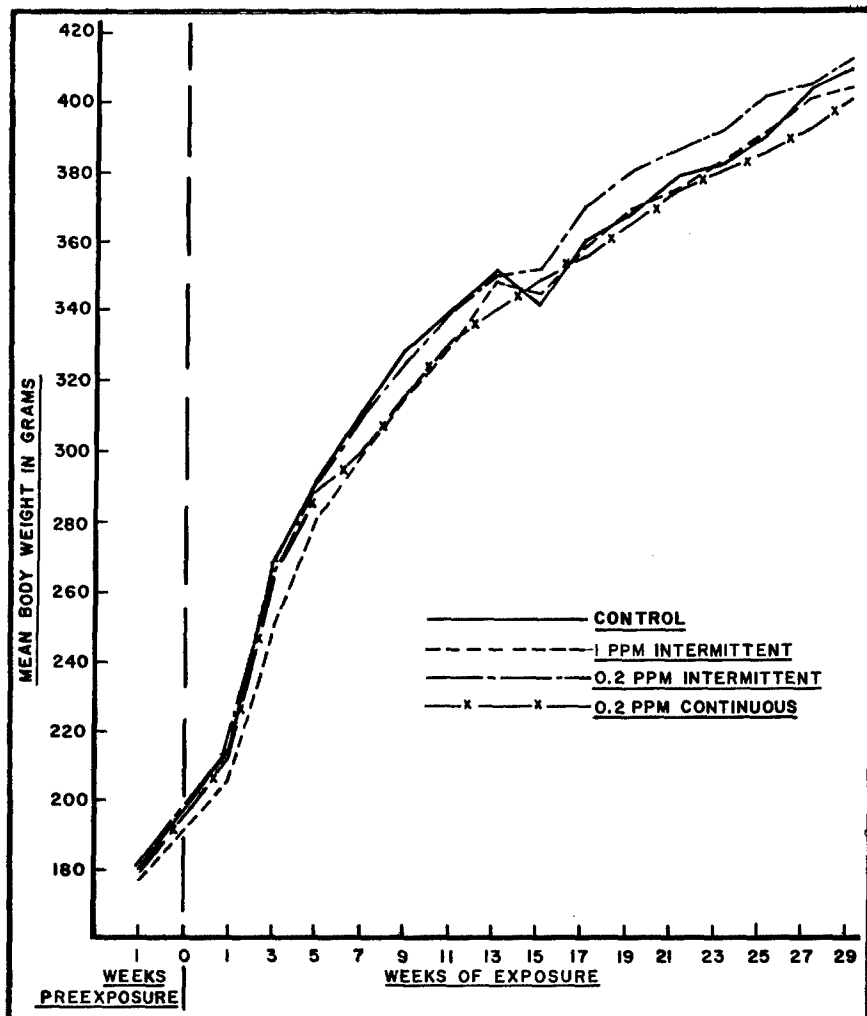

Figure 2. EFFECT OF CHRONIC MONOMETHYLHYDRAZINE EXPOSURE ON RAT GROWTH - GROUP II.

equipment malfunction occurred in the laboratory area containing the control animal chamber. Unfortunately, the control rats experienced actual weight loss resulting from the heat stress and comparisons between the low level MMH exposed rats and controls are valueless after the thirteenth week.

The majority of induced chronic effects on the animals were related to reaction of MMH with circulatory red blood cells. The effects were greatest in dogs but also occurred in monkeys. Hematology studies were not conducted on the rodents. Monomethylhydrazine produced a dose-related increase in methemoglobin, as shown in figure 3, for the two highest exposure levels. The methemoglobin increase, although not plotted, was also statistically significant at lower doses.

Figure 4 shows the effect of MMH exposure on dog red blood cell counts at 2 and 5 ppm, and figure 5 shows this effect at lower doses. The top unbroken line represents the mean red blood cell count of the group of eight control dogs in each figure during the six-month exposure period. The dose-response relation is clearly seen in figure 6 where the mean red blood cell values for each of the five exposure groups are shown at the six-month sampling point. The weekly MMH dose given to the animals in the 1 ppm intermittent exposure group is 30 ppm-hours and for the 0.2 ppm continuous exposure group the dose is 33.6 ppm-hours. Thus, the animals in these two exposure groups received essentially the same weekly dose of MMH and are very comparable in their response to exposure as shown in this figure. Therefore, in this and all other dose comparison curves, the 0.2 ppm continuous exposure results are plotted at the 1 ppm point. The effect of MMH on monkey red blood cell counts is shown in figure 7 for the first series of experiments.

Biweekly mean values for dog hematocrits are shown in figure 8 for the second series of six-month exposures. Again the solid line represents the control group, showing a small but significant effect at 0.2 ppm intermittent MMH exposure and a comparable effect at 0.2 ppm continuous and 1 ppm intermittent exposure. The dose response for hematocrit values of dogs is shown in figure 9. This relationship follows the plotted curve even better than the red blood cell counts. Mean biweekly hemoglobin values and the dose response are shown in figures 10 and 11, respectively. Again the various exposure groups exhibit a clear dose effect relationship with no apparent threshold effect level.

The effect of MMH exposure on red blood cell fragility is seen in figures 12 and 13, which are composite fragilograms for the exposed and control dogs. Values plotted for each curve on these graphs represent the mean values of five monthly determinations for each group. There was very little variation among animals in each group during the entire experimental period. There is a very definite shift toward increased initial hemolysis with increasing MMH dosage as shown in figure 14 which presents the percent hemolysis of RBC's in a 0.60% salt solution.

Blood samples taken from all dogs and monkeys at three, four, five, and seven months were examined microscopically for the presence of Heinz bodies. Group mean values from all sampling periods were always relatively low, but positive for

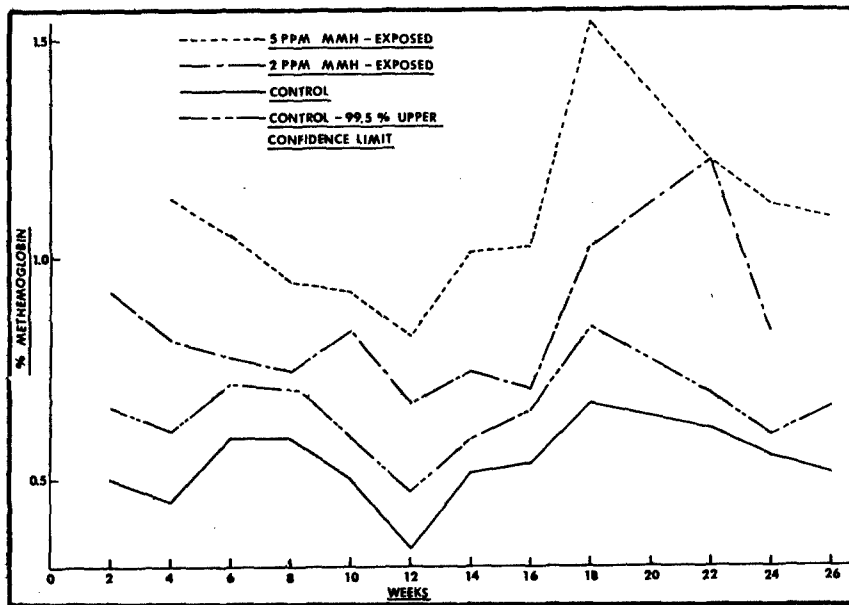

Figure 3. EFFECT OF CHRONIC MONOMETHYLHYDRAZINE EXPOSURE ON METHEMOGLOBIN FORMATION IN DOGS.

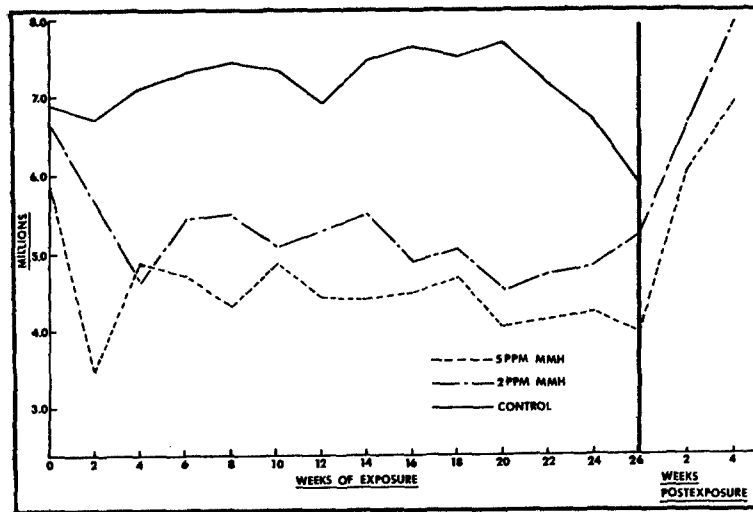

Figure 4. EFFECT OF CHRONIC MONOMETHYLHYDRAZINE EXPOSURE ON DOG RED BLOOD CELL COUNTS - GROUP I.

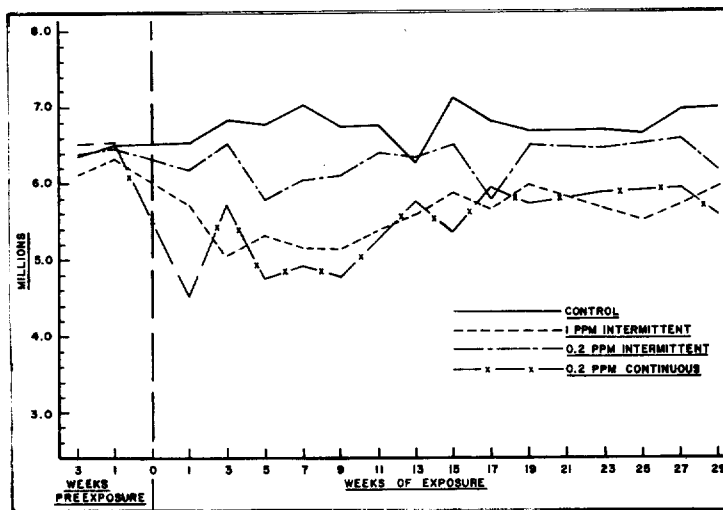

Figure 5. EFFECT OF CHRONIC MONOMETHYLHYDRAZINE EXPOSURE ON DOG RED BLOOD CELL COUNTS - GROUP II.

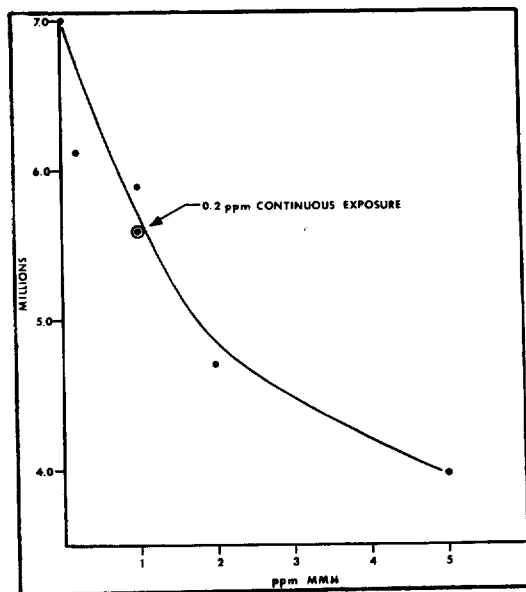

Figure 6. MEAN RED BLOOD CELL COUNTS IN DOGS EXPOSED TO VARIOUS CONCENTRATIONS OF MONOMETHYLHYDRAZINE FOR SIX MONTHS.

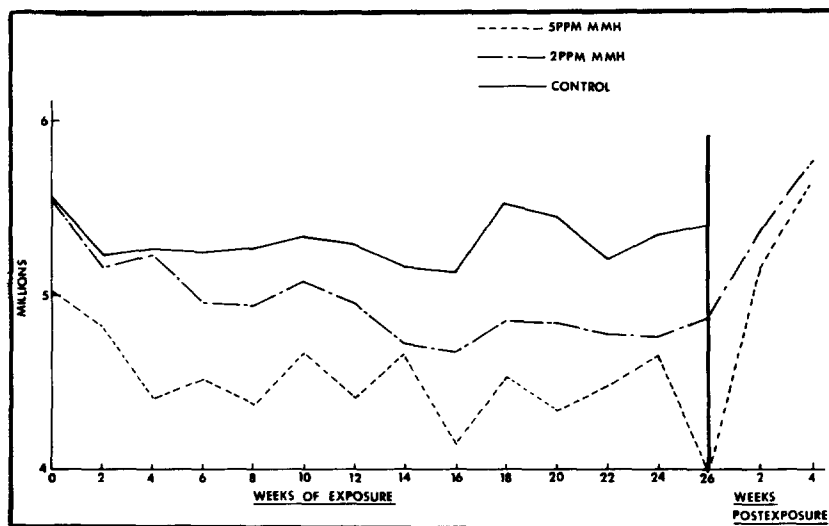

Figure 7. EFFECT OF CHRONIC MONOMETHYLHYDRAZINE EXPOSURE ON MONKEY RED BLOOD CELL COUNTS - GROUP I.

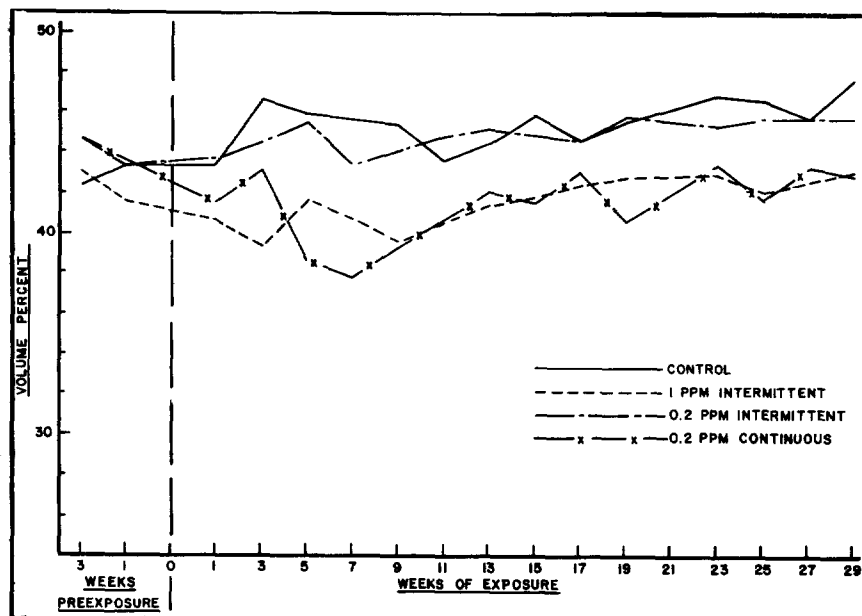

Figure 8. EFFECT OF CHRONIC MONOMETHYLHYDRAZINE EXPOSURE ON DOG HEMATOCRIT LEVELS - GROUP I.

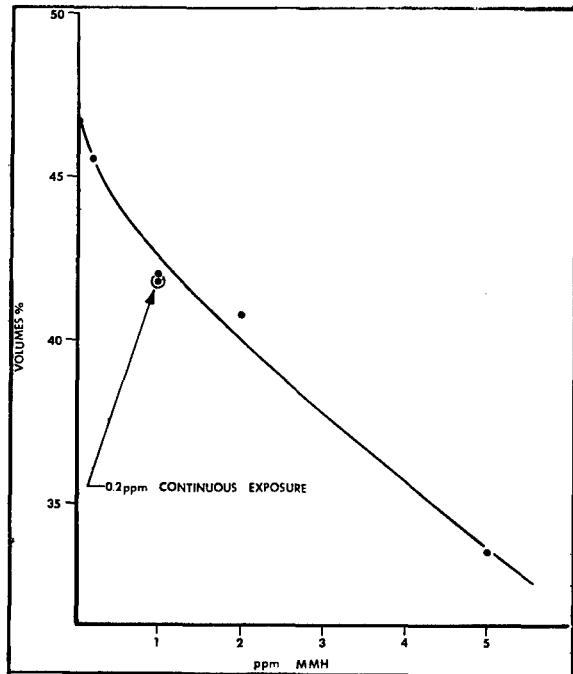

Figure 9. MEAN HEMATOCRIT VALUES IN DOGS EXPOSED TO VARIOUS CONCENTRATIONS OF MONOMETHYLHYDRAZINE FOR SIX MONTHS.

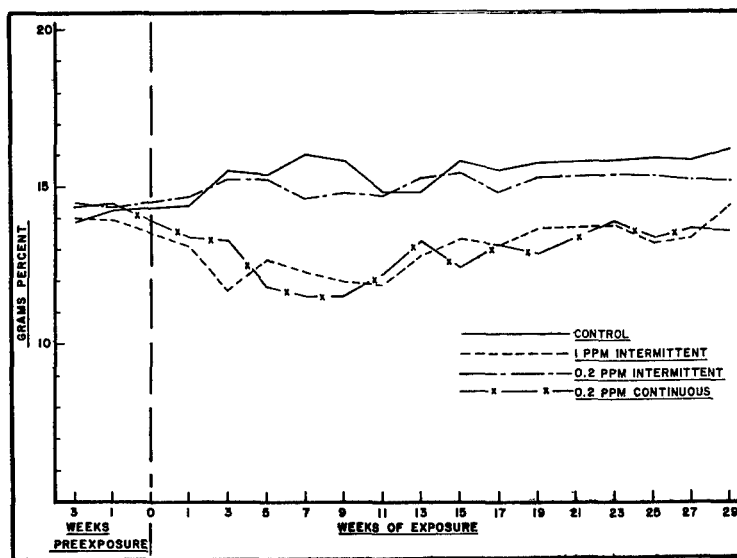

Figure 10. EFFECT OF CHRONIC MONOMETHYLHYDRAZINE EXPOSURE ON DOG HEMOGLOBIN VALUES - GROUP II.

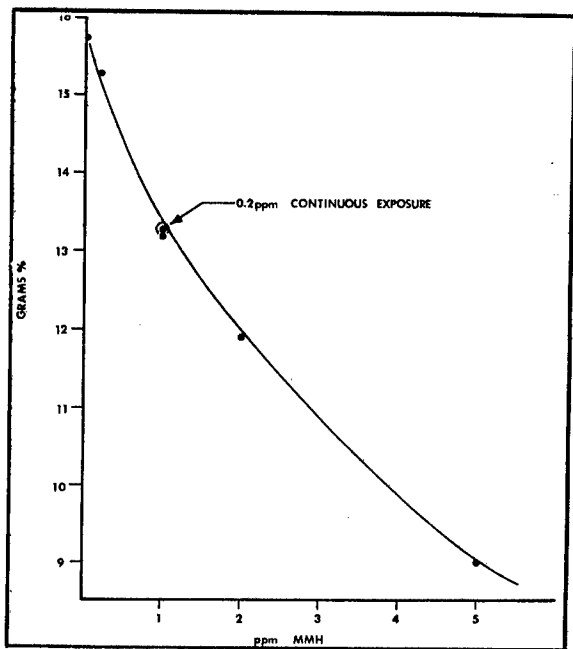

Figure 11. MEAN HEMOGLOBIN VALUES IN DOGS EXPOSED TO VARIOUS CONCENTRATIONS OF MONOMETHYLHYDRAZINE FOR SIX MONTHS.

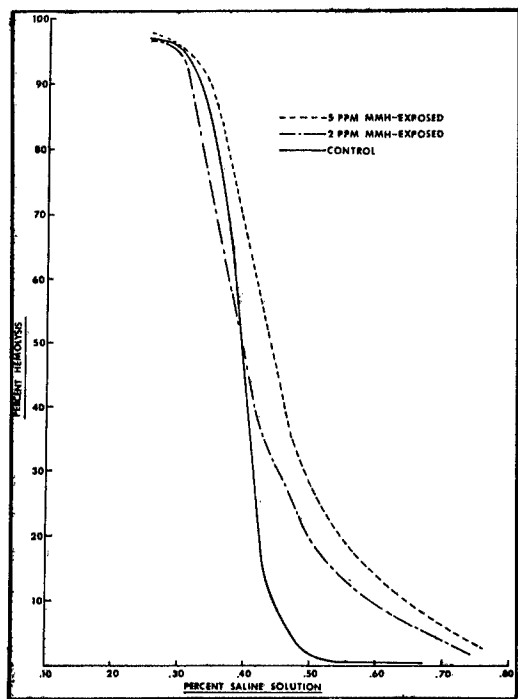

Figure 12. EFFECT OF CHRONIC MONO - METHYLHYDRAZINE EXPOSURE ON RED BLOOD CELL FRAGILITY IN GROUP I DOGS.

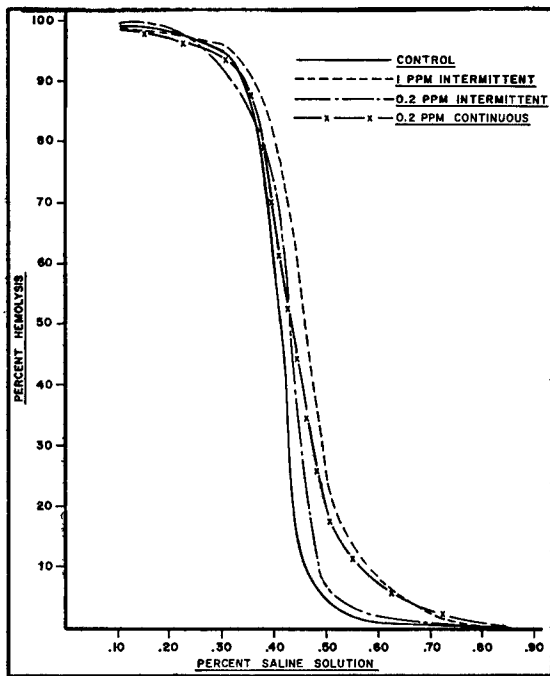

Figure 13. EFFECT OF CHRONIC MONOMETHYLHYDRAZINE EXPOSURE ON RED BLOOD CELL FRAGILITY IN GROUP II DOGS.

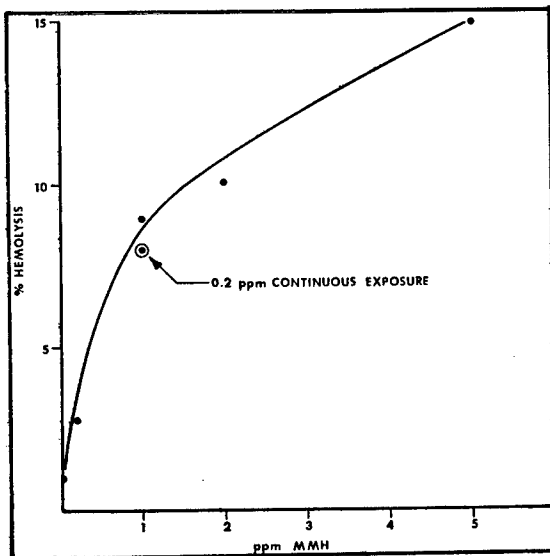

Figure 14. EFFECT OF MONOMETHYLHYDRAZINE EXPOSURE ON THE FRAGILITY OF DOG RED BLOOD CELLS IN A 0.6% SALT SOLUTION.

all exposed groups. Mean values of from one to five Heinz bodies in 100 red blood cells were found in each sample from MMH exposed animals. No dose- or species-related effects were evident. Overall assessment of the results of this test suggests, however, that minimal hemolytic effects were induced in monkeys as well as dogs as a result of low level exposures to MMH.

The dose effect of MMH on hematologic values in monkeys is shown in figure 15. Although the MMH induced effects are not as great as those seen in dogs, they are significant in terms of stress on the hemopoietic system.

Examination of clinical chemistry data, consisting of 15 separate determinations collected on a regular biweekly schedule for dogs and monkeys during the course of the study, revealed that mean bilirubin, alkaline phosphatase, and total inorganic phosphorus values for all exposed dog groups were, for the most part, statistically higher than control values.

Serum bilirubin and alkaline phosphatase levels were significantly elevated in all dog exposure groups at all sampling periods from three weeks to the conclusion of the study. Figures 16 and 17 present group mean values for each of these determinations. Dose-dependent effects are noticeable in both figures. Values for dogs exposed to the two highest MMH concentration levels were consistently higher than those recorded for the lowest MMH concentration exposure group. To a lesser extent, the latter values were repeatedly higher than control. Total inorganic phosphorus results, figure 18, were less pronounced, particularly for dogs exposed to the lowest concentration level, but are indicative, as are the abnormally high bilirubin and alkaline phosphatase levels, of the intrahepatic cholestasis produced in dog livers as a result of chronic exposure to MMH.

All exposed and control animals were sacrificed at the conclusion of the study and submitted for gross necropsy. Major organs from all dogs, monkeys, 10 rats, and 10 mice from each group were saved for histopathologic examination. The results of these examinations are reported by Dr. Kroe.

Bone marrow samples taken from MMH exposed dogs in each experiment were examined for their myeloid and erythroid elements. Figure 19 shows the dose-related decrease in M/E ratio with increasing erythropoietic activity. Although there was greater variation in the response of the dogs continuously exposed to MMH at 0.2 ppm, the mean M/E ratio is almost identical with that of the dogs given a comparable dose of 1 ppm MMH on an intermittent schedule.

It may well be asked where man fits in the spectrum of species responses seen with MMH chronic exposure. In a study of the *in vitro* formation of methemoglobin by MMH (Leahy, 1970), blood samples from four species were compared to determine their equilibrium conversion rates for oxyhemoglobin. In this study, man was found to rank next to the dog in susceptibility with a higher conversion equilibrium than the rat and monkey.

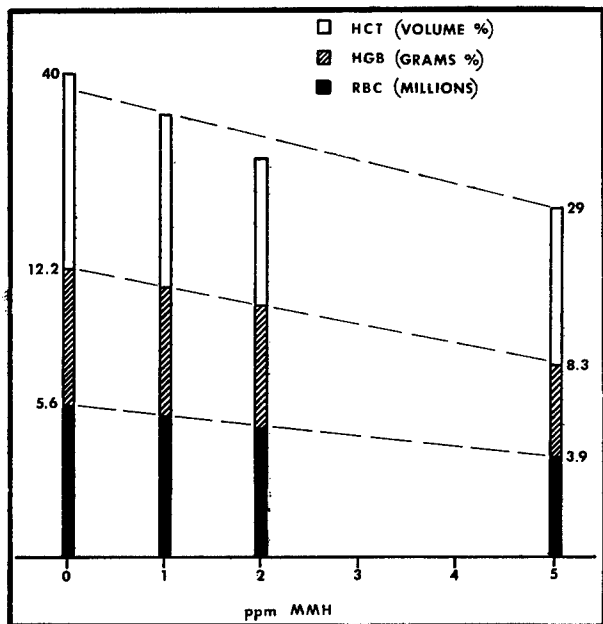

Figure 15. EFFECT OF SIX MONTH EXPOSURE TO MONOMETHYLHYDRAZINE ON HEMATOLOGIC VALUES IN MONKEYS.

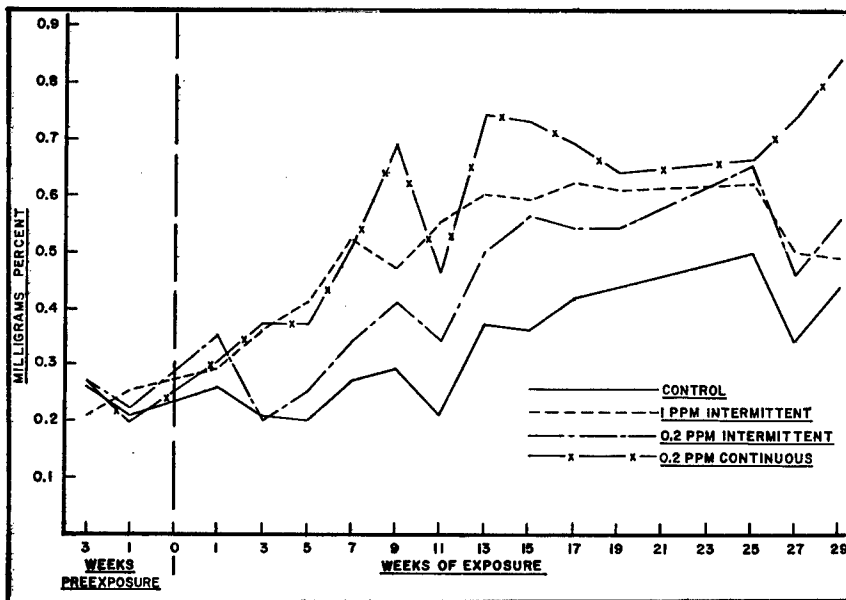

Figure 16. EFFECT OF CHRONIC MONOMETHYLHYDRAZINE EXPOSURE ON SERUM BILIRUBIN LEVELS IN DOGS.

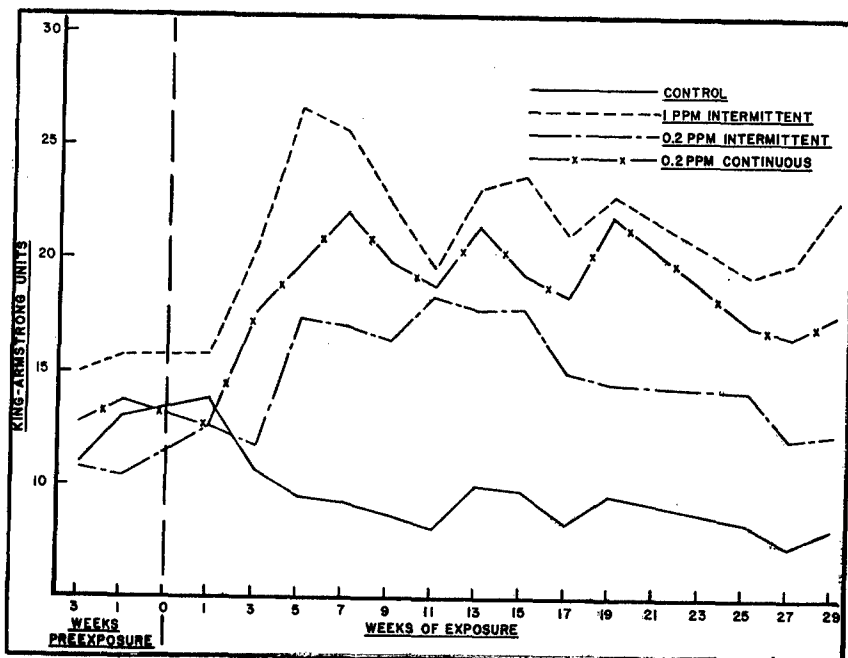

Figure 17. EFFECT OF CHRONIC MONOMETHYLHYDRAZINE EXPOSURE ON SERUM ALKALINE PHOSPHATASE LEVELS IN DOGS.

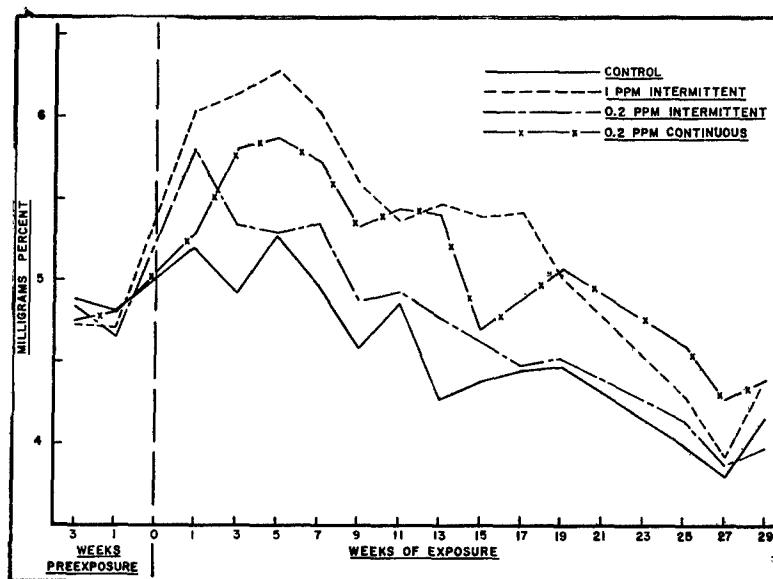

Figure 18. EFFECT OF CHRONIC MONOMETHYLHYDRAZINE EXPOSURE ON SERUM PHOSPHORUS LEVELS IN DOGS.

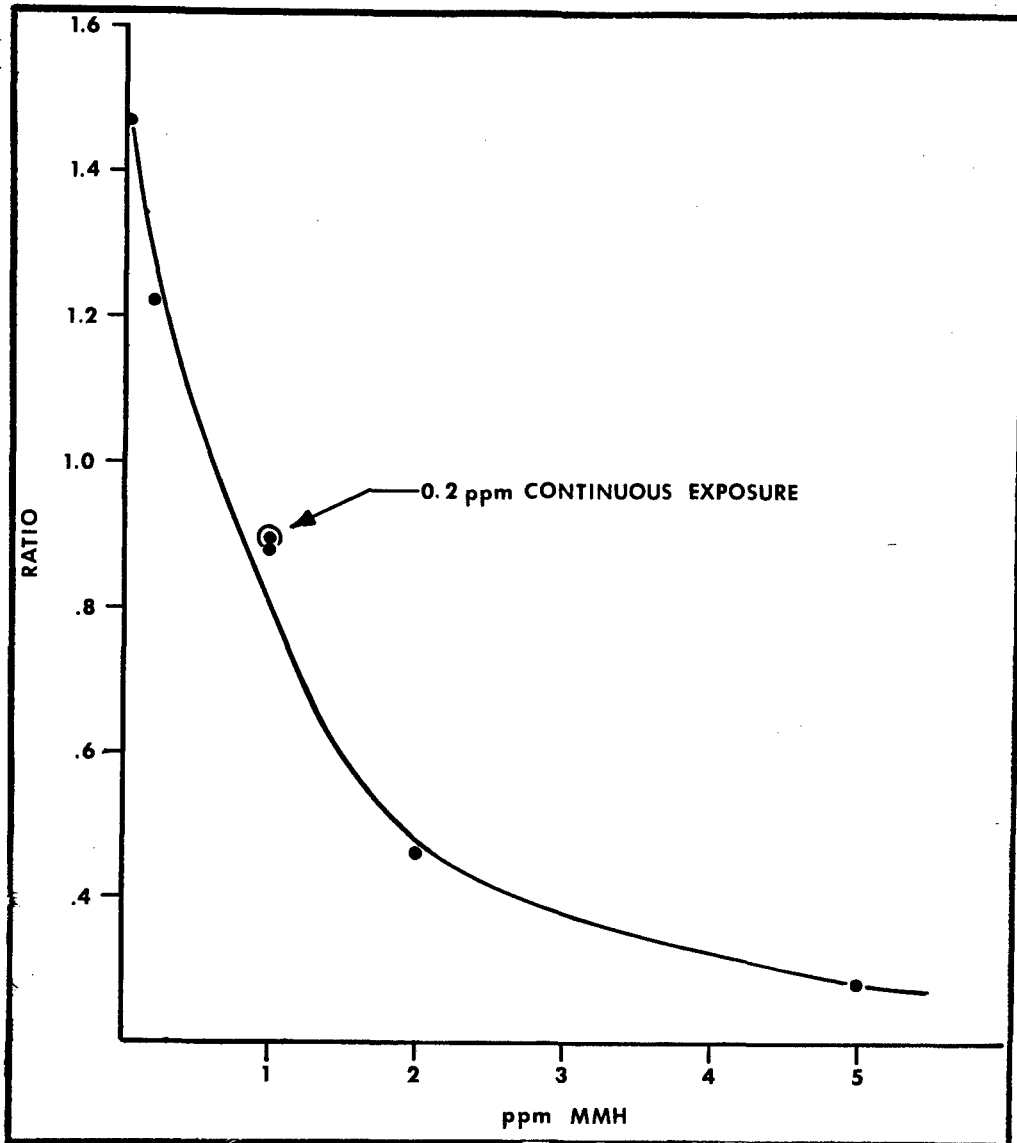

Figure 19. MEAN MYELOID/ERYTHROID RATIOS IN BONE MARROW OF DOGS AFTER SIX MONTHS EXPOSURE TO MONOMETHYLHYDRAZINE.

The results of these experiments have shown that MMH produces a dose-related hemolytic anemia with Heinz body formation for which there appears to be no threshold effect level. The anemia is reversible with removal from further exposure at least up to a level of 5 ppm intermittent exposure. These studies were performed on a 30-hour week basis but can be factored for interpretation of 40-hour weekly exposures because of the established dose-effect relationship. For use in establishing continuous exposure limits for confined spaces such as missile silos, consideration should be given to variations in concentration which could considerably shift the exposed people down the effect curve. Consideration should also be given to the effect of MMH on people with preexisting blood dyscrasias or hemolytic traits. In view of this risk, we believe the industrial TLV should be reexamined and consideration given to a safety factor for hemolytic effects.

REFERENCES

1. Geiger, D. L. ; "Approaches to Continuous Analysis of Exposure Chamber Atmospheres"; Proceedings of the 3rd Annual Conference on Atmospheric Contamination in Confined Spaces, AMRL-TR-67-200, Aerospace Medical Research Laboratory, Wright-Patterson Air Force Base, Ohio, December 1967.
2. Haun, C. C. ; "Chronic Exposure to Low Concentrations of Monomethylhydrazine"; Proceedings of the 1st Annual Conference on Environmental Toxicology, AMRL-TR-70-102, Aerospace Medical Research Laboratory, Wright-Patterson Air Force Base, Ohio, December 1970.
3. Haun, C. C. , J. D. MacEwen, E. H. Vernet, and G. F. Egan; "The Acute Inhalation Toxicity of Monomethylhydrazine Vapor"; Am. Ind. Hyg. Assoc. J. , 31:667, 1971.
4. Jacobson, K. H. , J. H. Klem, H. J. Wheelwright, Jr. , W. E. Rinehart, and N. Mayes; "The Vapor Toxicity of Methylated Hydrazine Derivatives"; AMA Arch. Ind. Health, 12:609, 1955.
5. Leahy, H. F. ; "Monomethylhydrazine Effects on Blood, In Vitro"; Proceedings of the 1st Annual Conference on Environmental Toxicology, AMRL-TR-70-102, Aerospace Medical Research Laboratory, Wright-Patterson Air Force Base, Ohio, December 1970.

ANIMAL PATHOLOGY RESULTING FROM LONG-TERM EXPOSURE
TO LOW LEVELS OF MONOMETHYLHYDRAZINE

D. J. Kroe, M. D.

Laboratory for Experimental Biology
St. Louis, Missouri

INTRODUCTION

Experiments have demonstrated that exposure of monkeys, dogs, rats, and mice to an ambient environment containing monomethylhydrazine (MMH) results in definite dose-related toxic effects (Geiger, 1967; Haun et al., 1968; Haun, 1970; Sopher et al., 1969).

The present experiments were designed to pursue investigation of the toxic effects of intermittent or continuous chronic exposure of monkeys, dogs, rats, and mice to lower levels of environmental MMH.

METHODS

The general experimental procedures and chamber operation techniques are detailed elsewhere in the conference proceedings and in previous publications (Geiger, 1967; Haun et al., 1968; Haun, 1970; Sopher et al., 1969). Briefly, the experimental design involved control animals which were maintained in an ambient environment of atmospheric air for similar periods of time as the experimental animals which were maintained in ambient environments containing various concentrations of MMH either intermittently or continuously for the duration of the exposure period. All animals which received intermittent exposure to MMH were exposed six hours per day and five days per week for the exposure period. At the end of the exposure period, the animals were sacrificed and tissue samples were taken at Wright-Patterson Air Force Base and submitted for pathological examination. Pathological alterations were graded by the degree and distribution of the lesions for each animal and animal group. All exposed animals were compared to appropriate non-exposed control animals. Incidental pathology, not specifically related to the experimental design, was noted; however, the overall occurrence was low and it is not discussed in this presentation.

RESULTS - I

Experiments 273, 274, and 275 were designed to assess toxic effects resulting from intermittent exposure of monkeys, dogs, rats, and mice to 5 ppm MMH or 2 ppm MMH for a six-month period. Microsections of lungs, hearts, livers, spleens, and kidneys were examined from all large animals and from 10 rats and 10 mice from each experimental group. Microsections of brains and endocrine glands were examined from monkeys and dogs (table I).

TABLE I
ANIMALS EXAMINED FOR PATHOLOGIC CHANGES (SET I)

<u>Species</u>	<u>Sex</u>	<u>Number of Animals</u>	<u>MMH Exposure Level</u>
Monkey	Female	4	5.0 ppm
Monkey	Female	4	2.0 ppm
Monkey	Female	4	none
Dog	Female	8	5.0 ppm
Dog	Female	8	2.0 ppm
Dog	Female	8	none
Rat	Male	10	5.0 ppm
Rat	Male	10	2.0 ppm
Rat	Male	10	none
Mouse	Male	10	5.0 ppm
Mouse	Male	10	2.0 ppm
Mouse	Male	10	none

Monkeys and Rats

Examination of microsections of tissues from control monkeys and rats, and monkeys and rats exposed to 5 ppm MMH or 2 ppm MMH intermittently for six months reveals that these levels and duration of exposure do not result in experimentally induced histopathological lesions in monkeys and rats at the light microscopic level of examination.

Dogs

Examination of tissues from the exposed dogs reveals that no experimentally induced pathological lesions are produced in lungs, hearts, spleens, brains, or endocrine glands. Uniformly, the dogs exposed to 5 ppm MMH do show periportal hepatic hemosiderosis and cholestasis. Microsections of kidneys from these dogs reveal proximal tubular hemosiderosis. Microsections from dogs exposed to 2 ppm MMH show a similar degree of bile stasis and hepatic and renal tubular hemosiderosis. Morphologically a difference in the degree of toxicity between the 5 ppm MMH and 2 ppm MMH exposure levels, as manifested by bile stasis and hepatic and renal hemosiderosis, cannot be determined by light microscopy.

Mice

Microsections of lungs and hearts of the mice exposed to 5 ppm MMH show no experimentally induced pathological lesions. Microsections of livers of the exposed mice show centrilobular cholestasis, bile duct proliferation, and centrilobular hemosiderosis. Microsections of kidneys and spleens from these animals reveal splenic and renal tubular hemosiderosis of proximal convoluted tubules.

Microsections of lungs and hearts from mice exposed to 2 ppm MMH show no experimentally induced changes. Livers show periportal cholestasis, bile duct proliferation, and hemosiderosis. Microsections of kidneys and spleens from these animals show renal tubular and splenic hemosiderosis but to a lesser degree than was noted in the animals exposed to 5 ppm MMH.

In contrast to dogs at these exposure levels, mice exposed to 2 ppm MMH can be distinguished from mice exposed to 5 ppm MMH by the decreased degree of renal tubular and splenic hemosiderosis induced by the 2 ppm MMH exposure level. The mice also differ from the dogs in that both exposure levels showed bile duct proliferation while this change was not observed in dogs.

RESULTS - II

The second series of experiments were designed to evaluate pathological changes induced by exposure of monkeys, dogs, rats, and mice to lower levels of MMH either continuously or intermittently for six months. Animals submitted for pathologic evaluation from each species were divided into four groups (table II), one of which was a nonexposed control group maintained in a similar chamber for periods of time equal to the exposed periods of experimental groups.

Each species consisted of three exposure groups: (1) exposure to 0.2 ppm MMH continuously for six months; (2) exposure to 1.0 ppm MMH intermittently for a total exposure duration of 144 days; (3) exposure to 0.2 ppm MMH intermittently for a period of 145 days.

TABLE II
ANIMALS EXAMINED FOR PATHOLOGIC CHANGES (SET 2)

<u>Species</u>	<u>Sex</u>	<u>Number of Animals</u>	<u>MMH Exposure Level (ppm)</u>
Monkey	Male	4	none
Monkey	Male	4	0.2 (continuous)
Monkey	Male	4	1.0 (intermittent)*
Monkey	Male	4	0.2 (intermittent)*
Dog	Male	8	none
Dog	Male	8	0.2 (continuous)
Dog	Male	8	1.0 (intermittent)*
Dog	Male	8	0.2 (intermittent)*
Rat	Male	10	none
Rat	Male	10	0.2 (continuous)
Rat	Male	10	1.0 (intermittent)*
Rat	Male	10	0.2 (intermittent)*
Mouse	Female	10	none
Mouse	Female	10	0.2 (continuous)
Mouse	Female	10	1.0 (intermittent)*
Mouse	Female	10	0.2 (intermittent)*

*Exposed for six hours per day for five days per week

Monkeys and Rats

Examination of microsections of tissues from exposed monkeys and rats does not reveal experimentally induced histopathological lesions at either level of exposure whether continuous or intermittent.

Dogs

Examination of lungs, hearts, spleens, kidneys, brains, and endocrine glands of dogs exposed to the three exposure conditions does not reveal experimentally induced changes as compared to nonexposed controls. Examination of livers from dogs exposed, whether continuous or intermittent, shows similar degrees of periportal intracanalicular cholestasis. Hepatic and renal tubular hemosiderosis is not

noted in these animals. Although not available on all animals, lymph nodes show moderate lymphoid hyperplasia of equal degree from the three exposure conditions. Lymphoid hyperplasia is not noted in nonexposed control animals.

Mice

Microsections of lungs and hearts of mice from the three exposure conditions do not show experimentally induced pathological changes. Microsections of livers, spleens, and kidneys of exposed mice show hepatic, splenic, and renal tubular hemosiderosis which is most severe in the animals exposed to 0.2 ppm MMH continuously for a total exposure period of six months and a similar though somewhat less degree of hemosiderosis in animals exposed to 1.0 ppm MMH intermittently over an exposure period of 144 days. Animals exposed to 0.2 ppm MMH intermittently for a total exposure period of 145 days show significantly less hemosiderosis than in the other two exposed groups but significantly more than nonexposed controls. Cholestasis and bile duct proliferation was not noted in mice under these conditions of exposure.

DISCUSSION

These experiments demonstrate that continuous exposure of monkeys or rats at a concentration of 0.2 ppm MMH does not induce histopathological lesions at the light microscopic level. Intermittent exposure of monkeys or rats to MMH concentrations of 5.0 ppm, 2.0 ppm, 1.0 ppm, or 0.2 ppm for the exposure periods of these experiments does not result in experimentally induced pathological lesions.

The same exposure levels and exposure periods do induce pathological lesions in livers and kidneys of dogs and livers, kidneys, and spleens of mice. Under the conditions of these experiments, whether exposed continuously or intermittently, all levels of exposure to MMH (5.0, 2.0, 1.0, and 0.2 ppm) induce periportal hepatic cholestasis in dogs. Intermittent exposure of dogs at the 5.0 ppm MMH and 2.0 ppm MMH levels induces periportal hepatic hemosiderosis and renal proximal tubular hemosiderosis; however, the lower level of exposure (i. e., 0.2 ppm MMH, whether continuous or intermittent) does not induce hepatic and renal tubular hemosiderosis.

Mice show hepatic, splenic, and renal tubular hemosiderosis under all conditions of exposure to MMH; however, the degree of hemosiderosis shows a dose-related pattern. Cholestasis and bile duct proliferation are also dose-related changes and they are not induced by the 1.0 ppm MMH intermittent exposure or by the 0.2 ppm MMH exposure, whether continuous or intermittent.

The fact that the MMH exposure conditions of these experiments induce histopathological changes in dogs and mice but not in monkeys and rats is most probably

explained by species susceptibility to MMH induced hemolysis and species capability for clearing the products of hemolysis. This is confirmed by the differences in histopathological changes induced in dogs and mice by graded decreases in MMH exposure. In dogs, the earliest change appears to be cholestasis, with subsequent hepatic and renal tubular hemosiderosis; whereas in the mice, the initial change appears to be hepatic, splenic, and renal tubular hemosiderosis, with subsequent cholestasis and bile duct proliferation. The changes noted in dogs and mice appear reversible.

Lymphoid hyperplasia was noted in some exposed dogs; however, the limited sampling precludes definitive interpretation of this observation.

The present experiments do not indicate a zero-toxicity MMH exposure level for dogs and mice. The experiments do demonstrate a striking difference in species susceptibility to MMH toxicity, and indicate tissue zero-toxicity levels for monkeys and rats as evaluated by light microscopy.

REFERENCES

1. Geiger, D. L.; "Approaches to Continuous Analysis of Exposure Chamber Atmospheres"; AMRL-TR-67-200, Aerospace Medical Research Laboratory, Wright-Patterson Air Force Base, Ohio, December 1967.
2. Haun, C. C., J. D. MacEwen, E. H. Vernet, and G. F. Egan; "The Acute Inhalation Toxicity of Monomethylhydrazine Vapor"; AMRL-TR-68-169, Aerospace Medical Research Laboratory, Wright-Patterson Air Force Base, Ohio, 1968.
3. Haun, C. C.; "Chronic Exposure to Low Concentrations of Monomethylhydrazine"; First Annual Conference on Environmental Toxicology, AMRL-TR-70-102, Aerospace Medical Research Laboratory, Wright-Patterson Air Force Base, Ohio, 1970.
4. Sopher, R. L., A. R. Esparza, and F. R. Robinson; "Renal Pathology of Acute Methylhydrazine Intoxication in Dogs"; Aerospace Medicine, 40:55-61, 1969.

DISCUSSION

DR. CARHART (U. S. Naval Research Laboratory) : I'd like to ask both the speakers how the concentrations of monomethylhydrazine were monitored.

DR. MAC EWEN (SysteMed Corporation) : Perhaps I should let one of our chemists answer that for you. As I indicated, it is a colorimetric method using an AutoAnalyzer on a continuous sampling basis.

MR. VERNOT (SysteMed Corporation) : It was an iodometric technique. The monomethylhydrazine reduced the iodine, and the absorbance of the iodine was measured at some wavelength close to the UV. This increased the sensitivity.

DR. DOST (Oregon State University) : I would just like to add to Doug's concern about limit values for MMH. We have done some subacute experiments where we intravenously or intraperitoneally infused MMH, and we find that at dose rates of around two thousandths of a micromole or two nanomoles per hour over a 60- to 72-hour period, we can detect a substantial decrease in the capability of rats to oxidize labeled methylamine. If you convert this to inhaled dosage situation, I think, if my calculations are correct, this amounts to something like one microgram per cubic meter, making some assumptions about the ventilation rate of the rat - which makes this a compound of considerable concern in terms of low level, long-term exposure.

LT. COL. MAC KENZIE (USAF School of Aerospace Medicine) : I have a loaded question for Dr. Kroe, concerning the bile duct stasis. Do you see this in humans with hemolytic anemias, and do you consider this a part of the hemolytic syndrome?

DR. KROE (Laboratory for Experimental Biology) : One can see it in humans with hemolytic anemias, but it would take a pretty severe degree. In addition, we don't that frequently biopsy livers of patients who have intravascular hemolysis. This would tend to be more frequently seen in cases of drug-induced hepatic damage and other forms of direct toxins which would affect the liver directly. I don't know offhand of any direct parallel where humans have been exposed to this type of hemolysis. In the animals (I go back to the comment I made in the presentation), everything we're seeing in the kidneys and livers, and also the spleen of mice, are secondary effects. The target organism is the red blood cell, and the differences we're seeing under the microscope between dogs, rats, mice, and monkeys are very marked differences in species susceptibility to being able to clear the products of hemolysis as well as being susceptible to the hemolytic property of MMH. Certainly from the previous paper it was very well documented that monkeys, for example, showed the effects of MMH, if you're evaluating serum enzymes and the red cells. But, on the other hand, when one looks at the livers, the interpretation that

you must come to is that they're capable of getting rid of the products of hemolysis much more easily. Specifically relating to your question, I can't think of a situation which would be strictly analogous.

DR. BACK (Aerospace Medical Research Laboratory): I have a comment. I'm being deluged with telephone calls from certain cancer research institutes who are interested in monomethylhydrazine, evidently for use therapeutically. I wonder if any of our pathologists have read anything about this on an experimental basis. These are extremely small doses, and I'm wondering if people are beginning to show these kinds of changes. Is anybody familiar with the newer literature on this?

DR. DOST: Part of the interest relates to the hydrazine derivatives, procarbazine particularly, and this is a subject of acute interest in the cancer institute. There have been quite a few studies in the past on carcinogenic and carcinostatic capability of MMH itself and it is still, I think, of questionable effect as a carcinostat, but the derivatives are highly effective in certain types of cancer. Unfortunately, it is a question of curing one shooting with another, you know, because the carcinogenic activity of those derivatives is very high.

THE ACUTE TOXICITY OF BRIEF EXPOSURES TO HYDROGEN FLUORIDE,
HYDROGEN CHLORIDE, NITROGEN DIOXIDE, AND HYDROGEN CYANIDE
SINGLY AND IN COMBINATION WITH CARBON MONOXIDE

L. C. DiPasquale

SysteMed Corporation
Wright-Patterson Air Force Base, Ohio

and

H. V. Davis, Ph. D.

Standard Oil of Illinois
Chicago, Illinois

INTRODUCTION

Many of the common plastic and rubber formulations in widespread use as aircraft cabin materials represent potential hazards in the event of fire aboard an aircraft. For example, polyurethane foams contain diisocyanate, fluorinated and chlorinated hydrocarbons, in addition to various aliphatic amines (Gleason et al., 1969). When subjected to the high temperatures of combustion, the pyro-decomposition products formed would include hydrogen chloride (HCl), hydrogen fluoride (HF), hydrogen cyanide (HCN), and nitrogen dioxide (NO₂) gases. Because of the inadequacy of available information regarding toxicity of these gases under very brief exposure conditions, animal experiments were conducted using these compounds, both singly and in combination with carbon monoxide (CO), to determine five-minute LC₅₀ values. Joint exposures with CO were performed since in all probability incomplete combustion during an aircraft fire would produce measurable concentrations of atmospheric CO. We wanted to see just what, if any, effect the CO would have on the toxicity of these several compounds. Since both civilian and military aircraft fires produce the same variety of pyro-decomposition products, this research was co-sponsored by the Federal Aviation Agency and the United States Air Force.

MATERIALS AND METHODS

Exposure groups for five-minute LC₅₀ determinations of the four test materials were comprised of male Wistar rats, 10 per group, ranging in weight from 250-275

grams, and male ICR mice, 15 per group, ranging from 30-35 grams. Exposed animals were observed for seven days postexposure to allow sufficient time for any delayed deaths resulting from pulmonary edema. LC_{50} values were calculated by the method of Litchfield and Wilcoxon (1949) using computer program techniques. This method results in a slope calculated by the method of least squares, providing the lowest Chi square values possible.

The tests consisted of dynamic five-minute exposures using a Rochester Chamber (Leach et al., 1959), modified with sliding cage drawers to facilitate rapid insertion and withdrawal of the test animals. This modification is shown in figure 1. The chamber concentration was equilibrated at the desired level and the caged animals were inserted through the opening, thus commencing the exposure.

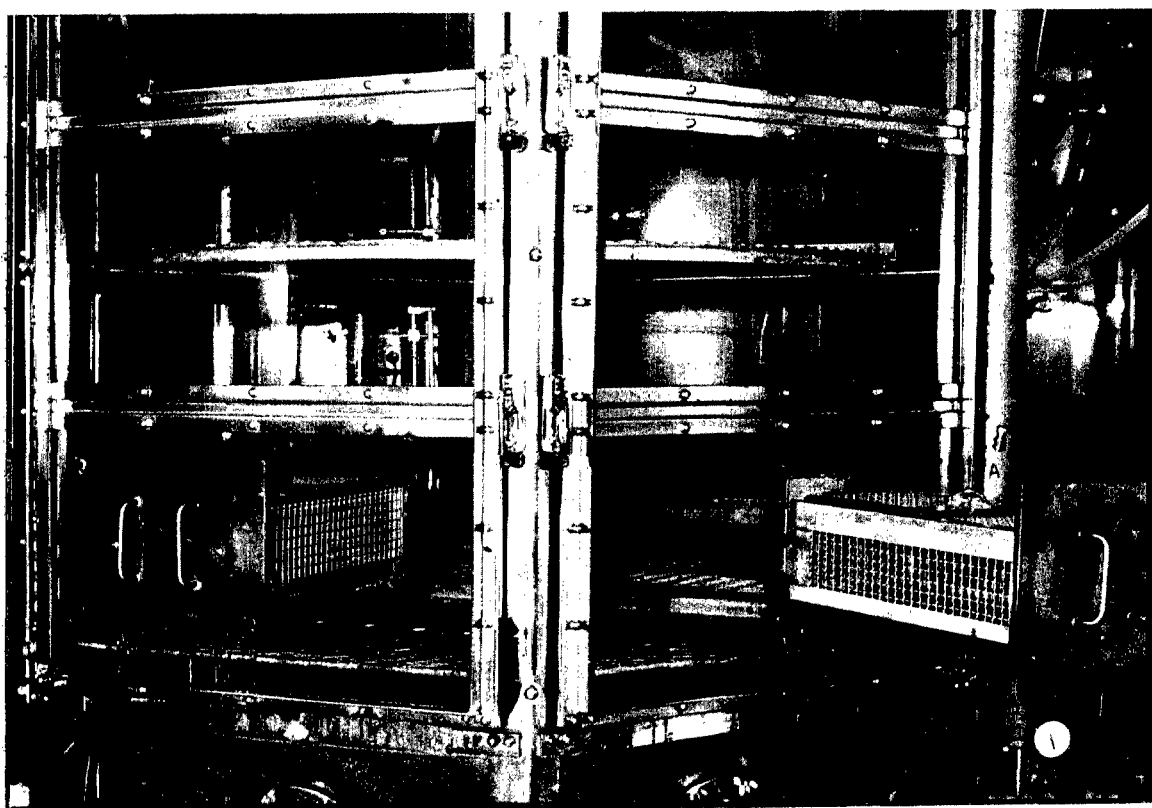

Figure 1. ROCHESTER CHAMBER MODIFIED TO ACCEPT SLIDING CAGE DRAWERS

Generation of HCl, HF, and CO consisted of metering the desired quantities from a standard gas cylinder into the exposure chamber. Hydrocyanic acid was metered as a liquid into a glass evaporator. The vapors were then transferred to the exposure chamber. The NO₂ gas cylinder was immersed in a constant temperature water bath in order to prevent condensation in the generation system. Vapors from this cylinder were then metered as desired to the exposure chamber.

Continuous analysis was provided for each of the compounds tested. Chamber concentrations of HCl, HF, and HCN were absorbed in aqueous reagent solution then measured using Coleman specific ion electrodes. Calibration curves were prepared by sampling known concentrations of the specific ion made from the primary standards NaCl, NaF, or NaCN. Chamber concentrations of NO₂ were absorbed in Saltzman Reagent (Saltzman, 1960) and analyzed spectrophotometrically using a Technicon AutoAnalyzer. NO₂ calibration curves were prepared by both vapor bag and permeation tube standardization (O'Keeffe and Ortman, 1966).

Determination of CO Concentration

A preliminary series of five-minute exposures was conducted to determine the atmospheric concentration of CO required to produce 25% carboxyhemoglobin (COHb) blood levels in rats and mice. This COHb concentration was chosen because, although not lethal in man, it is sufficient to produce minor CNS effects (Swinyard, 1970). Rats and mice were exposed to various CO concentrations for five minutes, at which time blood samples were drawn immediately. These samples were then analyzed for COHb content by a gas chromatographic technique which measures the CO moiety of COHb (Goldbaum et al., 1963). Our analyses indicated that 2100 ppm CO was sufficient to produce 25% COHb in rats exposed for five minutes, while 1500 ppm CO produced the same effects in mice. These respective CO concentrations were then used in combination with the test materials (HCl, HF, NO₂, or HCN) for the series of joint action experiments.

HYDROGEN FLUORIDE AND HYDROGEN CHLORIDE RESULTS

Symptomatology

There were a number of toxic signs noted both during and after exposure to HF and HCl vapors. Included among these were brittling and discoloration of fur, respiratory distress, corneal opacities, rhinorrhitis, and severe burns on exposed surface areas of the skin. Delayed deaths were normally seen with both of these compounds in concentrations below the LC₅₀ level. Peak mortality usually occurred by 24 hours postexposure, although some deaths were noted three to four days later. The time-to-death pattern did not appear to be influenced by the presence of CO for either the HF or the HCl exposures.

Mortality Response

Figure 2 shows the LC_{50} slopes for five-minute exposures of rats to HF, both singly and in combination with the predetermined 2100 ppm CO. The five-minute LC_{50} for HF alone was determined to be 18,200 ppm, while for the HF-CO combination this value was 18,208 ppm. There is no significant difference between these two values.

Figure 3 shows the LC_{50} slopes for five-minute exposures of mice to HF vapors singly and in combination with CO. Here again, there is no significant difference between the two LC_{50} values. For mice, the five-minute HF LC_{50} is 6,247 ppm in contrast to the 6,670 ppm LC_{50} for the HF-CO combination.

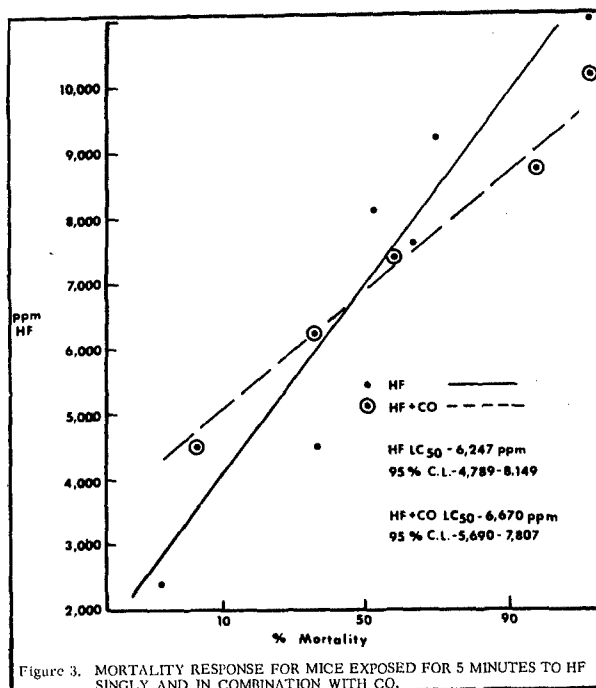
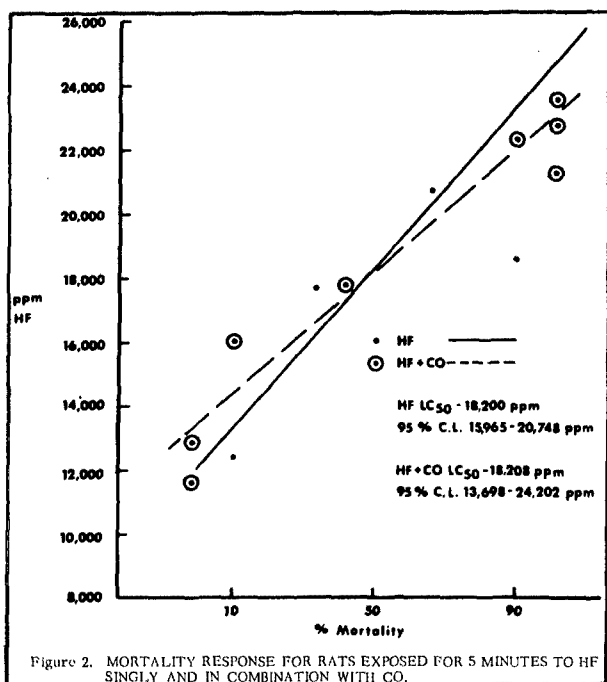
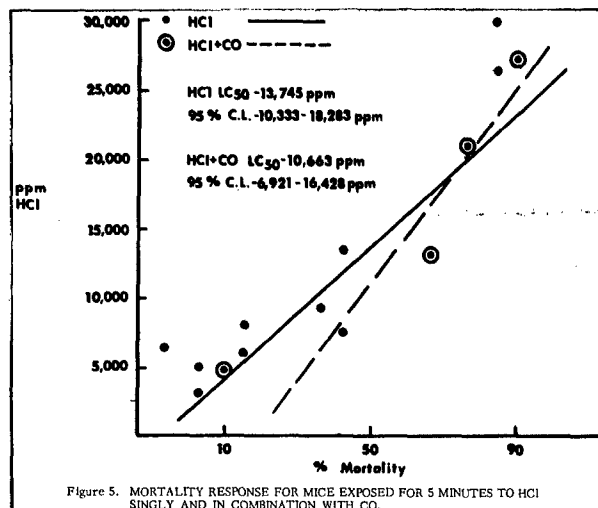
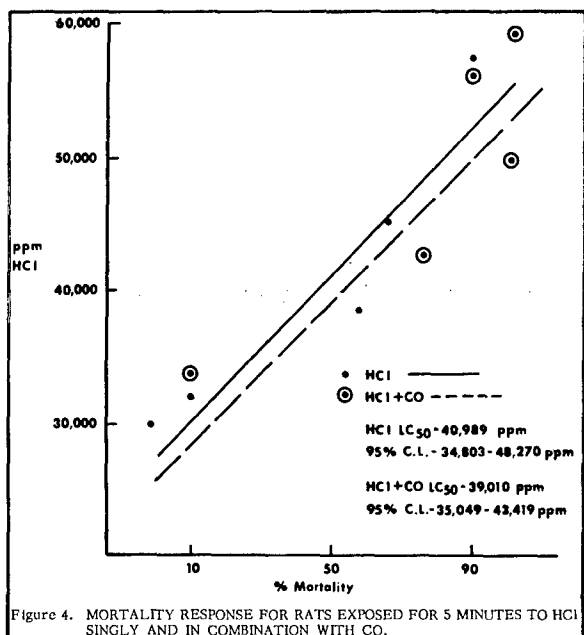

Figure 4 shows the mortality response of rats for five-minute exposures to HCl vapors and the HCl-CO combination. Once again, there is no statistically significant difference between the LC_{50} determinations of the two tests. It can be seen that the five-minute HCl vapor LC_{50} for rats is 40,989 ppm, while for the HCl-CO combination the LC_{50} is 39,010 ppm.

Figure 5 shows the mortality response of mice for five-minute exposures to HCl and the HCl-CO combination. The mouse LC_{50} for HCl alone was determined to be 13,745 ppm. The joint exposures with CO produced an LC_{50} of 10,633 ppm. Once again, there is no statistically significant difference between these two values.



Pathology

Gross pathology findings from both HF and HCl exposures included pulmonary edema of varying degrees of severity in both rats and mice. In animals that died during or shortly postexposure, pulmonary hemorrhage was a common finding.

NITROGEN DIOXIDE RESULTS

Symptomatology

Severe respiratory distress was the only toxic sign noted during five-minute rat and mouse exposures to lethal concentrations of NO_2 and the NO_2 -CO combination. Most animal deaths were seen within 24 hours postexposure with any remainder dead by 48 hours postexposure. Again, as with HCl and HF, we saw no alteration in the time-to-death pattern due to the presence of the 25% COHb levels.

Mortality Response

Figure 6 shows the five-minute rat mortality response to various concentrations of NO_2 and the NO_2 -CO combination. Although there appears to be a difference in the two LC_{50} values, this difference is not statistically significant at the 95% confidence levels. Here we found the LC_{50} for NO_2 vapors to be 831 ppm and for the NO_2 -CO combination, 1,140 ppm. This NO_2 LC_{50} is in good agreement with that of 833 ppm as found by another investigator (Gray et al., 1954).

Figure 7 shows the mouse response for the five-minute NO_2 and NO_2 -CO exposures. Here again, there is no significant difference between the two LC_{50} 's. For NO_2 singly this value is 1,880 ppm, and for NO_2 in combination with CO the LC_{50} is 1,644 ppm.

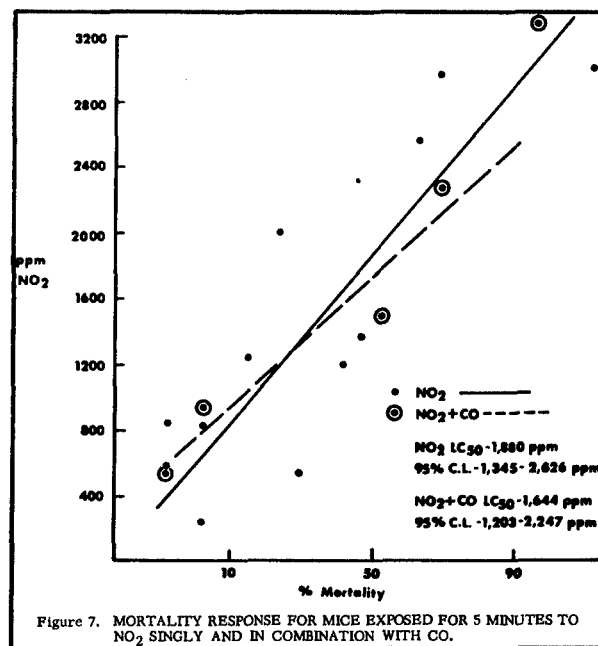
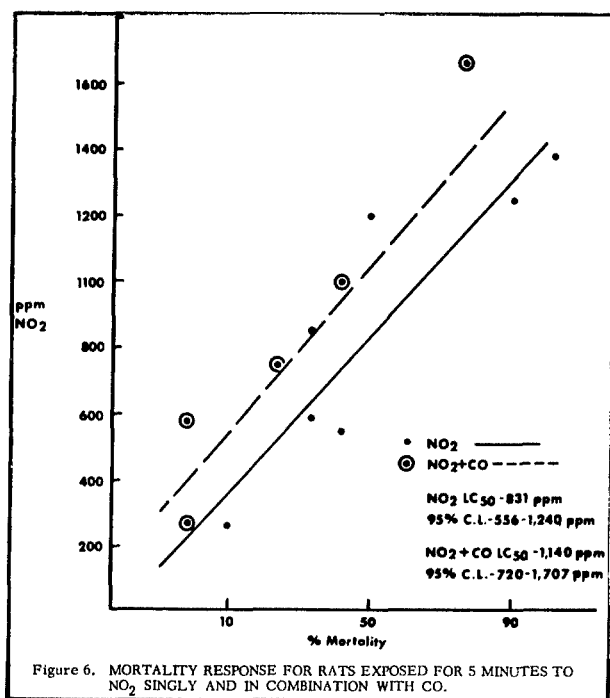

Pathology

Gross pathology indicated that NO_2 induced animal deaths resulted from pulmonary edema with a few animals exhibiting pulmonary hemorrhage.

HYDROGEN CYANIDE RESULTS

Symptomatology

With regard to toxic signs, hyperactivity and asphyxial convulsions were common to both species of rodents tested. All deaths from HCN, singly or in combination with CO, occurred either during the exposure or within 20 minutes postexposure. Again, there was no alteration in the time-to-death pattern due to the presence of CO.

Mortality Response

Figure 8 illustrates the five-minute rat mortality response to various concentrations of HCN vapors singly and in combination with CO. The LC_{50} for HCN was found to be 503 ppm while the HCN-CO combination produced an LC_{50} value of 467 ppm. Again, there is no significant difference in the two LC_{50} values.

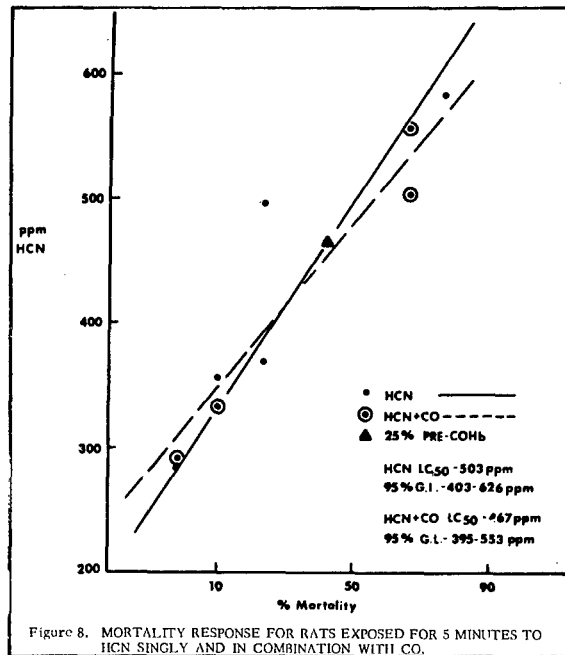

We know that the primary effect of HCN intoxication is the blocking of intracellular oxygen transport through the cytochrome system, specifically through the action of the cyanide ion reacting readily with the trivalent ferric ion of cytochrome oxidase, resulting in inhibition of cellular respiration. Based on the proximity of

the rat LC_{50} values for HCN singly and in combination with CO, it did not appear that the slightly decreased extracellular oxygen transport, due to the 25% COHb level, had any effect in potentiating the toxicity of HCN. We were concerned, however, that a response might not have been seen because of the short fraction of the five-minute exposure that the animals were at the 25% COHb level. Remember, these animals had achieved 25% COHb levels only after five minutes of exposure; they did not have these levels before exposure to the various materials. To resolve this question, we exposed an additional group of rats to HCN alone, immediately following a CO exposure resulting in 25% COHb. The mortality response from this exposure is also shown in figure 8 and is represented by the triangle. It can be seen that the results of this exposure are no different from those in which the HCN and CO were administered simultaneously.

Figure 9 shows the five-minute mortality response of mice to HCN and the HCN-CO combination; and again there is no significant difference between the two LC_{50} values. The five-minute mouse LC_{50} for HCN alone was shown to be 323 ppm and in combination with CO, 289 ppm.

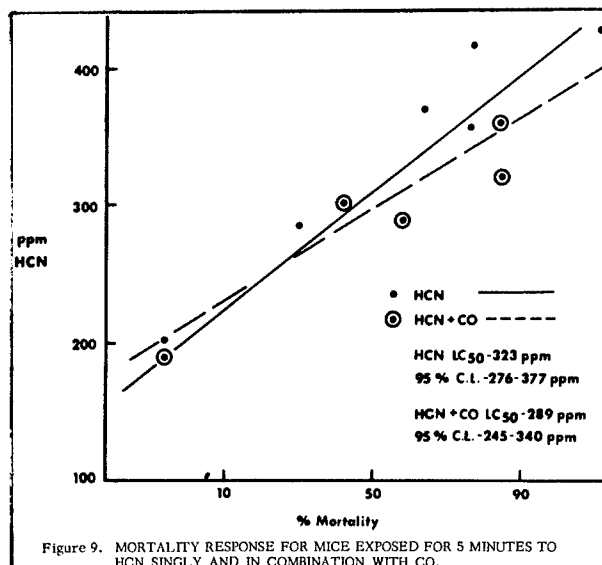

Pathology

Gross pathological findings from exposure to HCN showed widespread pulmonary hemorrhage accompanied by hepatic and renal congestion.

SUMMARY

Table I is a summary of the five-minute LC_{50} results for rats, ranking the four compounds tested from top to bottom in order of decreasing toxicity. The LC_{50} values are shown for each compound, with the value in parentheses being the LC_{50} for concurrent exposure with CO. Also listed are the 95% confidence limits with the values for joint exposure to CO being in parentheses. It can be seen that HCN is the most toxic to the rats, followed by NO_2 , HF, and HCl.

TABLE I

FIVE-MINUTE LC_{50} RESPONSE FOR RATS EXPOSED TO HCN, NO_2 , HF, AND HCl SINGLY AND IN COMBINATION WITH CO (25% COHb)

COMPOUND	LC_{50} CONCENTRATION (ppm)	95% CONFIDENCE LIMITS (ppm)
HCN (+CO)	503 (467)	403- 626 (395- 553)
NO_2 (+CO)	831 (1,140)	556- 1,240 (720- 1,707)
HF (+CO)	18,200 (18,208)	15,965-20,748 (13,698-24,202)
HCl (+CO)	40,989 (39,010)	34,803-48,270 (35,049-43,419)

() = Material + CO

Table II shows the same information for the mouse exposures. Again, the compounds are listed in order of decreasing toxicity, with LC_{50} and 95% confidence limits included for both single and joint exposure with CO. Once again, HCN is the most toxic, followed by NO_2 , HF, and then HCl. Notice that for all the compounds tested, except NO_2 , the mouse was more sensitive than the rat. For NO_2 , however, the rat was more susceptible than the mouse.

TABLE II

FIVE-MINUTE LC₅₀ RESPONSE FOR MICE EXPOSED TO HCN,
NO₂, HF, AND HCl SINGLY AND IN COMBINATION WITH CO
(25% COHb)

<u>COMPOUND</u>	<u>LC₅₀ CONCENTRATION (ppm)</u>	<u>95% CONFIDENCE LIMITS (ppm)</u>
HCN (+CO)	323 (289)	276- 377 (245- 340)
NO ₂ (+CO)	1,880 (1,644)	1,345- 2,626 (1,203- 2,247)
HF (+CO)	6,274 (6,670)	4,789- 8,149 (5,690- 7,807)
HCl (+CO)	13,745 (10,663)	10,333-18,283 (6,921-16,428)

() = Material + CO

CONCLUSION

As a result of these experiments, it has been shown that in terms of giving a hazard rating to various aircraft cabin materials, it must first be experimentally determined what the pyro-decomposition products are and, secondly, what their relative amounts are per unit mass of the specific material in question. For example, 100 pounds of a plastic which upon combustion yields a cabin concentration of 50,000 ppm HCl vapor would present a greater hazard than the combustion of 100 pounds of a plastic which would produce an aircraft cabin concentration of 200 ppm HCN.

These experiments also indicate that CO concentrations which are not hazardous to life do not enhance the toxicity of the four compounds as tested. In addition, the times to death for animals from both the singly exposed and the CO joint action exposures were comparable. This precludes the possibility that, although not resulting in greater mortalities at a given concentration, the addition of CO increases the hazard by decreasing the time to death.

REFERENCES

1. Gleason, M. N., R. E. Gosselin, H. C. Hodge, and R. P. Smith; "Section III General Formulations"; Clinical Toxicology of Commercial Products, The Williams and Wilkins Co., Baltimore, 93, 1969.
2. Goldbaum, L. R., E. L. Schloegel, and A. M. Dominguez; "Application of Gas Chromatography to Toxicology"; Progress in Chemical Toxicology, 1, A. Stolman, Ed., Academic Press, N. Y., 26, 1963.
3. Gray, E. LeB., F. M. Patton, S. B. Goldberg, and E. Kaplan; "Toxicity of the Oxides of Nitrogen: II. Acute Inhalation Toxicity of Nitrogen Dioxide, Red Fuming Nitric Acid and White Fuming Nitric Acid"; A. M. A. Arch. Indust. Hyg., 10: 418, 1954.
4. Leach, L. J., C. J. Spiegl, R. H. Wilson, G. E. Sylvester, and K. E. Lauterbach; "A Multiple Chamber Exposure Unit Designed for Chronic Inhalation Studies"; Amer. Ind. Hyg. Assoc. J., 20: 13, 1959.
5. Litchfield, J. T., Jr., and F. Wilcoxon; "A Simplified Method of Evaluating Dose-Effect Experiments"; J. Pharmacol. Exptl. Therap., 96: 99, 1949.
6. O'Keeffe, A. E., and G. C. Ortman; "Primary Standards for Trace Gas Analysis"; Anal. Chem., 38: 760, 1966.
7. Saltzman, B. E.; "Modified Nitrogen Dioxide Reagent for Recording Air Analyzers"; Anal. Chem., 32: 135, 1960.
8. Swinyard, E. A.; "Noxious Gases and Vapors"; The Pharmacological Basis of Therapeutics, R. S. Goodman and A. Gilman, Ed., The MacMillan Co., N. Y., 932, 1970.

DISCUSSION

MR. WANDS (National Academy of Sciences): Did you observe in your animals any excessive amount of preening, either during the exposure, immediately after, or during the observation period?

MR. DI PASQUALE (SysteMed Corporation): Yes, we did. This was a common occurrence in both the hydrogen chloride and hydrogen fluoride experiments. Previous to this, we have done experiments with these compounds, and we're doing experiments now, and we are noticing the excessive preening.

MR. WANDS: You, of course, will be getting a significant ingestion of fluoride ion?

MR. DI PASQUALE: I would imagine so - also chloride.

LT. COL. STEINBERG (Edgewood Arsenal): One question on the HF - did you note any excessive loss of HF to the delivery system prior to entry into the chamber?

MR. DI PASQUALE: We did some preliminary exposures before we started this work, and the entire system was well passivated by the time we did the LC₅₀'s. For each individual exposure we did not notice much of a loss. The entire system was prepassivated with the gases before we started the series of exposures. I don't know if that answers your question. We usually found that with many of the compounds we tested when we started out with a new system, we did lose considerable amounts of the compound to passivation of the system.

DR. MC NAMARA (Edgewood Arsenal): Although there was no statistical difference when you compared carbon monoxide alone and carbon monoxide plus any of the other four compounds, in all four cases it seemed that the combination had a lower LC₅₀ than the agent alone.

MR. DI PASQUALE: That is true in all cases but the nitrogen dioxide in the rat where we saw a reversal of this. It looked as though, if we can say there was a difference (which according to the confidence limits we saw there wasn't), the carbon monoxide actually protected the rat. There is a reversal of what you're referring to, with nitrogen dioxide in the rat.

THE ACUTE TOXICITY OF CHLORINE PENTAFLUORIDE

Kenneth I. Darmer, Jr.

SysteMed Corporation
Wright-Patterson Air Force Base, Ohio

INTRODUCTION

Chlorine pentafluoride (ClF_5) is one of a series of reactive fluorinated oxidizing agents of interest to the Air Force as a potential oxidizing propellant for missiles. As you might suspect from its very name, this is an unusual chemical species, and it may only be formed under extreme conditions of temperature and pressure. Its existence was first reported only eight years ago by Smith (1963) who described the molecule as having a square pyramidal structure as shown in figure 1. The chlorine atom lies almost in the same plane as the four fluorine atoms which comprise the base of this pyramid. The figure shows the outline of the shape of the molecule, and the bonds go directly from the chlorine atom to each of the fluorine atoms at the extremities of the molecule.

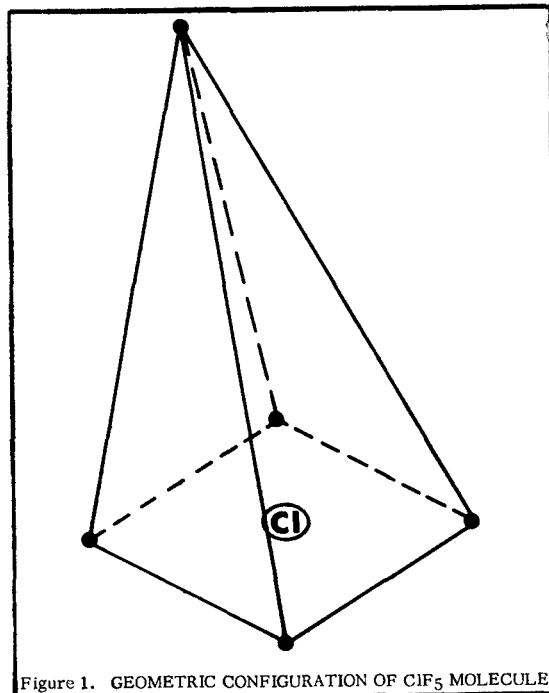

Little is known about its physical chemical properties, such as exactly which reactions it will enter into, how quickly it reacts, and exactly what products result from its reaction with different compounds. As an example, the proposed reaction for ClF_5 with water is this:



Smith (1963), who first made the molecule, claims that this reaction occurs slowly if at all. Dost and Wang (1970) reported that the reaction did occur, and that it was a slow reaction. Pilipovich et al. (1967), however, reported that ClF_5 reacts violently with water in any form.

Very little investigation of the acute inhalation toxicity of ClF_5 has been reported. Weinberg and Goldhamer (1967) described two 10-minute exposures of rats:

400 ppm	10 minutes	6/6 dead
200 ppm	10 minutes	1/10 dead

A periodic sacrifice of the nine survivors from the 200 ppm exposure over the 24 hours following exposure showed evidence of a reversible alveolar destruction.

The present study was undertaken to obtain symptomatic and pathological information resulting from acute exposure to ClF_5 gas, and to determine the LC_{50} values for exposure of rats, mice, dogs, and monkeys for 15, 30, and 60 minutes.

METHODS

To reduce the hazard associated with use of full-strength ClF_5 , concentrated ClF_5 was diluted in dry nitrogen and supplied in dilution tanks having a concentration of about 1.5%. These dilutions were carried out at our oxidizer dilution facility, which was described at last year's conference by Mr. Erk (Erk and Kaczmarek, 1970). The ClF_5 was introduced into the exposure chamber by metering it through a corrosion resistant gas regulator and a Fischer-Porter flow meter.

All exposures were made in a modified Rochester chamber under ambient conditions (Haun et al., 1969). Exposures were routinely conducted at a chamber flow rate of 70 cfm at a slight negative pressure, with relative humidity of about 50%, although this was somewhat variable depending upon ambient relative humidity conditions. Exposure groups consisted of 10 rats, 10 mice, 4 dogs, or 4 monkeys. Male Sprague-Dawley rats, male ICR mice, male and female beagle dogs, and male and female rhesus monkeys were the experimental animals used in this study.

Contaminant concentrations within the chamber were monitored continuously during all exposures. Analytical determinations were made with a fluoride ion specific electrode which was calibrated with bag samples having known concentrations of ClF_5 in air. The analysis was capable of detecting 10 to 1000 ppm ClF_5 .

The animals were observed for visible symptoms and mortality both during exposure and for a 14-day postexposure observation period. Gross and histopathological examinations of a representative sample of each of the four species for each exposure time were made.

RESULTS

There are no accounts in the literature of the symptomatology of ClF_5 exposure, but, as might be expected, symptoms appear to be similar to those caused by HF, OF_2 , and ClF_3 . Rodents showed lacrimation, rhinorrhea, salivation, and respiratory distress during exposure. This generally led to anoxic hyperactivity just prior to death, a state which very closely resembled CNS stimulation.

Dogs and monkeys showed unmistakable signs of irritation almost immediately after onset of the exposure. This was evidenced by marked salivation, lacrimation, and sneezing, which progressed to nausea, dyspnea, and, in some cases, unconsciousness prior to the end of the exposure, with both dogs and monkeys. Cyanosis was usually evident by the end of the exposure with both dogs and monkeys. The severity and progression of these symptoms was in general directly related to increasing concentration and duration of exposure. Corneal opacity was a common occurrence with all species, but was less pronounced in the monkeys, possibly due to the fact that their eyes were kept closed during exposure to a greater extent than the other species.

The death pattern appeared similar to that of OF_2 , HF, and ClF_3 , with delayed deaths being found in all four species. Dogs and monkeys generally died within 48 hours following exposure, and rodent deaths tended to occur throughout the entire 14-day postexposure period. There were more delayed deaths with mice than with rats.

Gross pathological examination of animals that died either during or after exposure showed that the lungs and respiratory passages were the primary targets for ClF_5 damage. Animals of all four species that died during exposure exhibited similar pathology. The lungs failed to collapse upon opening the chest cavity, and were found to contain edema fluid and blood, indicating alveolar destruction. Nasal and bronchial passages generally contained large amounts of mucus and other fluids, and, in some cases, blood. There were no other apparent systemic effects.

Tissue samples have been taken for histopathological examination, but these have not yet been processed. Examination of animals surviving the full 14-day postexposure observation period showed that the effects on the respiratory system were almost completely reversible within this period of time.

The mortality data and LC_{50} values with their 95% confidence limits are presented in the next four tables. Also included in these tables is a record of times to death for all species tested. You will notice that the 15-minute rat data (table I) is very similar to the 10-minute data reported by Weinberg and Goldhamer (1967).

TABLE I
 CIF₅ ACUTE TOXICITY RESULTS

RATS

Duration (minutes)	Average Conc. (ppm)	Conc. Range (ppm)	Mortality Response	Postexposure Time to Death	
				Hours (no. dead)	Days (no. dead)
15	175	145-194	1/10		6 (1)
15	235	195-249	4/10	3.5 (1), 17.5 (2)	12 (1)
15	258	210-317	6/10 1*	12 (2), 14 (2)	13 (1)
15	300	251-318	7/10 1*	24 (2)	7 (1), 8 (1), 9 (1), 11 (1)
15	325	300-349	9/10 3*	24 (3)	6 (1), 8 (2)
15	373	339-384	6/10 3*	24 (3)	
15	432	400-442	9/10 8*	24 (1)	

15 min. LC₅₀: 257 (210-314)

30	120	95-125	0/10		
30	163	140-175	0/10		
30	185	162-200	3/10 3*		
30	190	138-213	6/10 3*	48 (1)	7 (1), 9 (1)
30	233	201-253	9/10 5*	24 (1)	5 (1), 12 (1), 14 (1)
30	250	200-270	10/10 10*		

30 min. LC₅₀: 194 (135-278)

60	80	55- 86	0/10		
60	100	77-107	1/10 1*		
60	120	102-128	4/10 3*	2 (1)	
60	136	112-156	8/10 6*	8 (2)	

60 min. LC₅₀: 122 (108-139)

*Deaths occurred during exposure

TABLE II
 CIF₅ ACUTE TOXICITY RESULTS

Duration (minutes)	Average Conc. (ppm)	Conc. Range (ppm)	Mortality Response	MICE		Postexposure Time to Death	
				Hours (no. dead)	Days (no. dead)		
15	100	81-112	2/10			8 (1), 12 (1)	
15	130	100-145	4/10			8 (1), 9 (1), 10 (1), 11 (1)	
15	166	128-181	7/10			7 (2), 9 (5)	
15	174	150-188	7/10	1*		9 (1), 11 (2), 12 (2), 14 (1)	
15	195	175-203	6/10		2.5 (1)	7 (2), 8 (2), 12 (1)	
15	212	165-230	9/10	3*	8 (1)	5 (1), 7 (1), 8 (1), 9 (1), 12 (1)	
15	231	175-246	8/10	1*	.5 (1), 17 (1)	6 (2), 7 (1), 8 (1), 10 (1)	
15	305	260-320	9/10	6*	1 (2), 19 (1)		
15	360	315-387	15/15	15*			

15 min. LC₅₀ : 144 (112-186)

30	70	83- 50	2/10		5 (1), 48 (1)	
30	90	73-124	3/10		20 min. (3)	
30	117	90-138	6/10	3*	5 min. (2), 14 (1)	
30	120	102-141	5/10	3*	1.5 (1), 4.5 (1)	
30	140	93-163	8/10		5 min. (2), 5 (1), 6 (1), 7 (1), 10 (1), 24 (1)	7 (1)
30	145	116-163	8/10	4*	4.5 (1), 8 (1)	9 (1), 11 (1)
30	166	112-180	9/10		5 min. (5), 1 (1), 14 (1)	8 (1), 11 (1)
30	175	152-183	10/10	7*	15 (1)	6 (1), 12 (1)

30 min. LC₅₀ : 105 (93-119)

60	35	22- 40	1/10		6 (1)	
60	47	35- 73	2/10	2*		
60	62	30- 68	5/10	1*	5 min. (1), 2 (1), 9 (2)	
60	75	45- 82	9/10	5*	6 (1), 9 (1), 10 (1), 12 (1)	

60 min. LC₅₀ : 57 (47-70)

*Deaths occurred during exposure

TABLE III
 CIF₅ ACUTE TOXICITY RESULTS

Duration (minutes)	Average Conc. (ppm)	Conc. Range (ppm)	Mortality Response	Postexposure Time to Death	
				Hours (no. dead)	Days (no. dead)
15	168	130-185	0/4		
15	202	130-327	1/4	18 (1)	
15	300	206-352	2/4	5 (1), 21.5 (1)	
15	360	332-402	2/4	10 (1), 17 (1)	
15	443	403-460	4/4	17 (1), 21 (1), 30 (2)	
15 min. LC ₅₀ : 298 (238-374)					

30	102	89-113	1/4	29 (1)	
30	150	110-187	1/4	16.5 (1), 26 (1)	
30	190	138-213	2/4	20.5 (1), 29.5 (1)	
30	223	185-275	3/4	1 (1), 17 (1), 19 (1)	
30	252	155-307	3/4	10 (1), 21 (1), 39 (1)	
30	274	209-345	4/4	2.5 (1), 10 (1), 12 (1), 13 (1)	
30 min. LC ₅₀ : 156 (113-215)					

60	63	57-75	0/4		
60	110	61-125	1/4	23 (1)	
60	128	65-182	2/4	15 (1), 35 (1)	
60	143	110-154	4/4	22 (1), 37 (1)	6 (1), 10 (1)
60	170	130-175	4/4	75 (1), 14 (1), 15 (1), 24 (1)	
60 min. LC ₅₀ : 122 (111-134)					

TABLE IV
 CIF₅ ACUTE TOXICITY RESULTS

MONKEYS

Duration (minutes)	Average Conc. (ppm)	Conc. Range (ppm)	Mortality Response	Postexposure Time to Death	
				Hours (no. dead)	Days (no. dead)
15	165	152-175	0/4		
15	193	160-210	1/4	16 (1)	
15	225	185-265	3/4	12 (1), 24 (1)	3 (1)
15	335	300-355	3/4	2 (1), 4 (1), 6 (1)	
15	395	285-490	3/4	3 min. (1), 2 (1), 4 (1)	

15 min. LC₅₀ : 249 (191-326)

30	198	127-225	0/4		
30	218	168-262	2/4	1*	30 min. (1)
30	236	195-255	4/4		5 min. (1), 1 (2), 2.5 (1)

30 min. ALC₅₀ : 218

60	116	68-135	0/4		
60	122	102-140	1/4		9 (1)
60	140	87-155	1/4		3 (1)
60	189	112-212	2/4	2*	
60	215	160-230	2/4		5 min. (1), 15 min. (1)
60	223	166-252	4/4	1*	5 min. (2), 35 (1)

60 min. LC₅₀ : 173 (148-204)

*Deaths occurred during exposure

Table V is a summary of the LC_{50} data for each of the four species that were studied, and for each of the three exposure time limits used.

TABLE V
SUMMARY OF ACUTE ClF_5 TOXICITY LC_{50} VALUES

<u>Species</u>	LC_{50} Values in ppm		
	<u>15 min.</u>	<u>30 min.</u>	<u>60 min.</u>
Rats	257	194	122
Mice	144	105	57
Dogs	298	156	122
Monkeys	249	218	173

The CT (concentration x time) values for each of the ClF_5 LC_{50} values are presented in table VI.

TABLE VI
CT VALUES FOR ClF_5 ACUTE TOXICITY

<u>Species</u>	<u>Exposure Time</u>		
	<u>15 min.</u>	<u>30 min.</u>	<u>60 min.</u>
Rats	3855	5820	7320
Mice	2160	3150	3420
Dogs	4470	4680	7320
Monkeys	3750	6540	10380

As you may have noticed in looking at the individual data, the theoretical CT relationship does not exist for ClF_5 . For some of the data, the 30- and 60-minute mouse data and the 15- and 30-minute dog data, it holds very well; but it does not hold true for any single species, or for any particular time limits. The reason for this probably lies in the nature of the ClF_5 itself. As I stressed earlier, very little is known about how this compound reacts, and it is quite probable that different reactions and

different reaction rates occur under different conditions of temperature, relative humidity, and at either high or low concentrations of ClF_5 . The absence of a CT relationship is probably due to the presence of varying amounts of ClF_5 breakdown products in the chamber, with each of them having some effect on the overall toxicity that we observed. Since our analysis could only measure total concentration of fluoride ions in the chamber, it was impossible to determine what specific fluorine-containing compounds were present, and in what amounts they existed.

In summary, I would like to compare the results of the 60-minute ClF_5 exposures to 60-minute data for OF_2 , ClF_3 , and HF. The data from these compounds were also obtained in our laboratory, so the methods involved in gathering all of these comparative data were essentially identical. These data are presented in table VII.

TABLE VII
COMPARATIVE 60-MINUTE TOXICITY DATA
FOR FLUORINATED OXIDIZERS AND HF
(in ppm)

<u>Species</u>	OF_2	ClF_5	ClF_3	HF
Rats	2.6	122	299	1276
Mice	1.5	57	178	501
Dogs	26.0	122	---	---
Monkeys	26.0	173	230	1774

Probably the most obvious and the most interesting comparison is that of ClF_5 with HF. In every case in which the two compounds may be compared, the ClF_5 was almost exactly 10 times more toxic than HF. ClF_5 was also two to three times more toxic than ClF_3 , but was far less potent than OF_2 . Another interesting point is that, with the exception of monkeys, ClF_3 is about three times more toxic than HF, but ClF_5 is about 10 times more toxic than HF, so the toxicity of ClF_5 cannot be directly explained by a simple breakdown of ClF_5 to HF.

SUMMARY

The acute toxicity of exposure of rats, mice, dogs, and monkeys to the fluorinated oxidizer chlorine pentafluoride (ClF_5) for 15, 30, and 60 minutes has been studied. The LC_{50} values, with 95% confidence limits, for each species and each chosen time were presented. Associated pathology resulting from these exposures

was discussed. The toxicity data for ClF_5 were compared to two other fluorinated oxidizers (ClF_3 and OF_2) and to HF. ClF_5 was found to be far less toxic than OF_2 , about two to three times more toxic than ClF_3 , and almost exactly 10 times more toxic than HF.

REFERENCES

1. Dost, F. N., and C. H. Wang; "Studies on Environmental Pollution by Missile Propellants"; AMRL-TR-69-116, Aerospace Medical Research Laboratory, Wright-Patterson Air Force Base, Ohio, January 1970.
2. Erk, S. D., and L. W. Kaczmarek; "A System for Dilution of Rocket Oxidizers"; AMRL-TR-70-102, Aerospace Medical Research Laboratory, Wright-Patterson Air Force Base, Ohio, 127-133, December 1970.
3. Haun, C. C., J. D. MacEwen, E. H. Vernet, and G. F. Egan; "The Acute Inhalation Toxicity of Monomethylhydrazine Vapor"; AMRL-TR-68-169, Aerospace Medical Research Laboratory, Wright-Patterson Air Force Base, Ohio, April 1969.
4. Pilipovich, D., W. Maya, E. A. Lawton, H. F. Bauer, D. F. Sheehan, N. N. Ogimachi, R. D. Wilson, F. C. Gunderloy, Jr., and V. E. Bedwell; "Chlorine Pentafluoride, Preparation and Properties"; Inorganic Chem., 6: 1918-1919, 1967.
5. Smith, D. F.; "Chlorine Pentafluoride"; Science, 141: 1039-1040, 1963.
6. Weinberg, M. S., and R. E. Goldhamer; "Pharmacology and Metabolism of Compound A"; AMRL-TR-66-238, Aerospace Medical Research Laboratory, Wright-Patterson Air Force Base, Ohio, December 1967.

CONTINUOUS EXPOSURE OF ANIMALS TO
METHYLISOBUTYLKETONE

Edmond H. Vernot
James D. MacEwen, Ph. D.

Systemed Corporation
Wright-Patterson Air Force Base, Ohio

and

Elliott S. Harris, Ph. D.

National Aeronautics and Space Administration
Houston, Texas

INTRODUCTION

Methylisobutylketone (MIBK), also known as isopropylacetone, is a common solvent and vehicle for lacquers, oils, fats, waxes, gums, and resins. Its excellent solvent properties make it useful in fire resistant plastic materials currently under test by NASA for possible use in space cabins. The manufactured products contain, entrapped in the plastic, some residual MIBK which will outgas under reduced pressure conditions and may appear as a contaminant in the spacecraft environment.

Methylisobutylketone has a relatively low order of acute toxicity with mice surviving 30-minute exposure to 19,500 ppm (Shell Chemical Corporation, 1957), rats surviving 4-hour exposure to 2,000 ppm (Smyth, 1956), and guinea pigs surviving after exposure to 1,000 ppm for 6 hours (Specht, 1938).

The American Conference of Government Industrial Hygienists (1970) has recommended a threshold limit value (TLV) of 100 ppm for this compound.

Industrial experience with MIBK has not shown any adverse physiological effects on man other than headache or nausea at or around the TLV of 100 ppm. Elkins (1959) reported that exposed workers developed some tolerance to MIBK during the working week but lost this tolerance over the weekend. Silverman et al. (1946) found that a 100-ppm exposure to MIBK was acceptable to 12 human volunteers for a 15-minute period, but that 200 ppm was objectionable due to odor intensity. Because high air concentrations of MIBK have a narcotic action which would affect human

performance, further information about prolonged or continuous exposure to this chemical was desired. A 90-day continuous exposure was selected as being best able to determine toxicological effects under space cabin conditions. In order to determine the MIBK concentrations to be used in this exposure, two-week range-finding experiments were conducted at 820 and 410 mg/m³ MIBK under ambient conditions. Based on the results of the range-finding exposures, a concentration of 410 mg/m³, equivalent to 100 ppm at ambient pressure, was chosen as the MIBK concentration in the 90-day experiment.

METHODS

Animal exposure facilities (MacEwen, 1965; Thomas, 1968) of the Aerospace Medical Research Laboratory were used for both the two-week and the 90-day continuous experiments. Atmosphere flow was maintained at 40 cfm and chamber temperature at 72 F in both exposures. The ambient experiments were carried out in air, and the pressure maintained at 725 torr to seal the chamber and prevent contamination of the surrounding laboratory environment with MIBK vapor. The 90-day study was performed at 260 torr using a 68% O₂ - 32% N₂ atmosphere.

Liquid MIBK, highest purity, was introduced into an all glass vaporizing unit by means of a dual syringe pump from a large reservoir. Dry air flowing through the heated vaporizer carried the MIBK vapor through a flowmeter and metering valve system into the chamber air supply duct. The stainless steel tubing between the vaporizer and metering valve was heated to prevent recondensation of the MIBK. Heating was not necessary after dilution in the chamber air supply duct.

A gas chromatographic procedure was developed for contaminant monitoring on a semi-continuous basis. Air samples were taken from a position in the chamber just above the breathing zone of the dogs and continuously pumped to the analyzer system where an automatic sampling valve took samples every five minutes. The samples were introduced directly into the gas chromatograph sample inlet.

The MIBK in the gas sample was separated on a 10-inch column of Porapak Q operated at 190 C and detected with a flame ionization detector. The retention time of MIBK in this system was 1.5 minutes, which allowed convenient sampling at five-minute intervals. MIBK vapor calibration standards made up in Mylar[®] bags were used daily and a variation in detector response of $\pm 5\%$ was found. The variation from one bag to another when run the same day was approximately 2%.

RESULTS AND DISCUSSION

Range-Finding Experiments

Test animals for each exposure included four rhesus monkeys, eight beagle dogs, 40 ICR mice, and 50 Wistar rats. As controls, three monkeys, four dogs, 20 mice,

and 25 rats were placed in another Thomas Dome under the same conditions, with the exception of contaminant. One monkey in each group had cortical electrodes implanted for evaluation of CNS effects.

Test programs were designed to evaluate the inhalation effects of the MIBK exposure as shown in table I.

TABLE I
TESTS FOR DETERMINATION OF MIBK EFFECTS

Preexposure Tests

Body Weight - monkeys, dogs, rats
Clinical Serum Chemistry - monkeys, dogs
Hematology - monkeys, dogs
EEG - monkeys

During Exposure Tests

Spontaneous Activity Measurement - dogs
Symptomatology - all animals
Mortality Response - all animals

Postexposure Tests

Body Weight - monkeys, dogs, rats
Organ to Body Weight Ratios - rats
EEG - monkeys
Clinical Serum Chemistry - monkeys, dogs
Hematology - monkeys, dogs
Pathology - all animals
Blood pH and Gases - dogs

Table II details the individual tests performed in the hematological and clinical serum chemistry examinations.

TABLE II

HEMATOLOGY AND CLINICAL SERUM CHEMISTRY TESTS
PERFORMED TO DETERMINE MIBK EFFECTS

<u>Hematology</u>	<u>Serum (continued)</u>
Hematocrit	Calcium
Hemoglobin	Total Phosphorus
Red Blood Cell Count	Total Bilirubin
White Blood Cell Count	Albumin
	Total Protein
<u>Serum</u>	Uric Acid
Sodium	Blood Urea Nitrogen
Potassium	Glucose
Cholesterol	Alkaline Phosphatase
	Creatinine
	Chloride

There were no signs of toxic response during exposure to 820 mg/m³. At the end of the two-week exposure period, there was no difference in cortical activity between the exposed and control monkeys nor were any significant differences observed in hematologic or clinical serum chemistry measurements for either dogs or monkeys. Gross pathologic examination of tissues from both exposed and control animals failed to reveal any apparent differences except for the case of rat kidneys, which appeared slightly mottled. Blood gas measurements made on dogs did not show any effects attributable to MIBK exposure.

Organ weight and organ to body weight ratios were evaluated and the kidneys and livers were found to be significantly heavier in the rats exposed to MIBK, as shown in table III.

The animals exposed to 410 mg/m³ MIBK showed no outward toxic effects that could be attributed to the two-week exposure. Again, the only effect observed was on rats in which kidneys were significantly enlarged when compared to those in the control group. This is demonstrated in table IV.

From the data obtained in the range-finding experiments, the kidney appeared to be the organ primarily affected by exposure to MIBK. Histopathological examination of rat kidneys revealed some changes which are discussed by Col. MacKenzie in his presentation at this conference (MacKenzie, 1971).

TABLE III

EFFECT OF TWO-WEEK EXPOSURE TO 820 mg/m³ MIBK
ON ORGAN WEIGHTS OF ALBINO RATS

	Mean Organ Weight (grams)		Mean Organ/Body Weight Ratio (grams/100 grams body weight)	
	<u>Test</u> N = 50	<u>Control</u> N = 50	<u>Test</u> N = 50	<u>Control</u> N = 50
Heart	0.9	0.9	0.357*	0.343
Lung	1.3	1.3	0.499	0.510
Liver	9.0**	8.2	3.445**	3.198
Spleen	0.8	0.8	0.291	0.303
Kidney	1.8**	1.5	0.694**	0.582

*Different from control mean at the 0.05 significance level.

**Different from control mean at the 0.01 significance level.

TABLE IV

EFFECT OF TWO-WEEK AMBIENT EXPOSURE TO 410 mg/m³ MIBK
ON ORGAN WEIGHTS OF ALBINO RATS

	Mean Organ Weight (grams)		Mean Organ/Body Weight Ratio (grams/100 grams body weight)	
	<u>Test</u> N = 50	<u>Control</u> N = 25	<u>Test</u> N = 50	<u>Control</u> N = 25
Heart	1.0	0.9	0.416	0.417
Lung	1.2	1.3	0.547	0.569
Liver	8.6	8.4	3.756	3.753
Spleen	0.8	0.8	0.353	0.346
Kidney	1.7*	1.5	0.729*	0.670

*Different from control mean at the 0.01 significance level.

90-Day Continuous Exposure

Based on the range-finding results, the 410 mg/m³ MIBK exposure level was selected for the continuous 90-day study under simulated space cabin conditions.

The animal species selected for exposure to MIBK for 90 days were: 100 albino rats (Wistar strain); 8 beagle dogs; 2 rhesus monkeys.

As noted previously, test animals were exposed to 410 mg/m³ MIBK vapor for a period of 90 days in an altitude chamber operated at 260 torr pressure using a 68% O₂ - 32% N₂ atmosphere. The control group of animals was maintained in a separate altitude chamber under identical environmental conditions, except that no MIBK was present.

All dogs were examined biweekly, including the month prior to initiation of the experiment. At the time of each examination, the dogs were weighed and blood samples were taken for hematology and the battery of clinical serum chemistry tests previously detailed in table II.

Liver function tests (bromsulphalein [BSP] dye retention) were performed pre-exposure and immediately postexposure. Serum acid phosphatase and serum glucuronidase determinations were done preexposure and at 30 and 60 days.

At termination, two dogs from each group were transferred to the postexposure holding room for 60 days to determine reversibility of effects should any lesions be found. The remaining six dogs in each group were sacrificed, examined grossly, and samples of liver, brain, kidney, heart, lung, spleen, and endocrine glands were taken for histological evaluation.

Rats were weighed preexposure and biweekly during the exposure period to determine growth rate. Two rats from each group were necropsied at weekly intervals for three weeks and then at biweekly intervals thereafter. After two weeks of exposure, 10 rats were removed from each chamber and necropsied in groups of two at biweekly intervals to determine reversibility of the kidney lesions seen in the preliminary experiments. At termination of the experiment, 10 rats from each group were removed and saved for serial sacrifice for reversibility studies, 10 were submitted to histopathology, and the remaining rats were necropsied and the visceral organs weighed for determination of organ to body weight ratios.

Clinical serum chemistry, hematology, enzyme, and bromsulphalein tests on dogs and monkeys did not reveal any biologically significant differences between the exposed animals and their controls.

The growth rate (measured biweekly) of both the exposed and control groups of rats are shown in figure 1. There was no effect upon the growth rate as a result of continuous exposure to MIBK for 90 days.

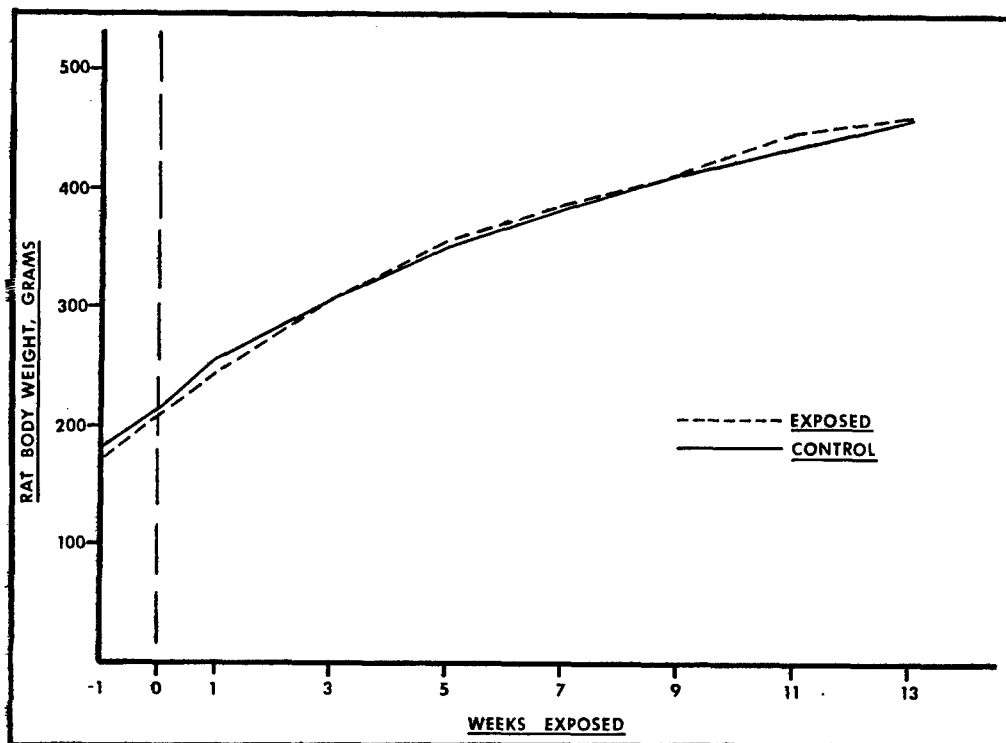

Figure 1. MEAN GROWTH RATE OF RATS EXPOSED CONTINUOUSLY TO 410 mg/m³ MIBK AND CONTROLS.

The effect of 90-day exposure to MIBK on albino rat organ weights and organ to body weight ratios is shown in table V. There is a statistically significant difference between exposed and control liver and kidney weight means with a corresponding increase in organ to body weight ratios for the samples from exposed animals.

Some significant histopathological changes were seen in the kidneys of exposed rats and these are discussed by Col. MacKenzie in his review of the pathological effects of MIBK exposures.

TABLE V

EFFECT OF 90-DAY ALTITUDE EXPOSURE TO 410 mg/m³ MIBK
ON ORGAN WEIGHTS OF ALBINO RATS

	Mean Organ Weight (grams)		Mean Organ/Body Weight Ratio (grams/100 grams body weight)	
	<u>Test</u>	<u>Control</u>	<u>Test</u>	<u>Control</u>
	N = 56	N = 55	N = 56	N = 56
Heart	1.3	1.3	0.302	0.306
Lung	1.5	1.5	0.352	0.359
Liver	10.8*	9.9	2.477*	2.305
Spleen	0.7	0.7	0.159	0.160
Kidney	3.1*	2.6	0.713*	0.604

*Different from control mean at the 0.01 significance level.

SUMMARY

Continuous exposure of dogs, monkeys, mice, and rats to MIBK for two weeks and all animals except mice for 90 days resulted in measurable adverse effects only in the case of rats. Rat kidney weights and kidney to body weight ratios were significantly elevated after exposure to 410 mg/m³ for two weeks, and kidney and liver organ weights and organ to body weight ratios were elevated after exposure to 820 mg/m³ for two weeks and to 410 mg/m³ for 90 days.

REFERENCES

1. American Conference of Government Industrial Hygienists; "Threshold Limit Values of Airborne Contaminants", 1970.
2. Elkins, H. B. ; The Chemistry of Industrial Toxicology, 2nd ed. , Wiley, New York, 1959.
3. MacEwen, J. D. ; "Toxic Hazards Research Unit Design and Construction Phase"; AMRL-TR-65-125, Aerospace Medical Research Laboratory, Wright-Patterson Air Force Base, Ohio, 1965.
4. MacKenzie, W. F. ; "Pathological Lesions Caused by Methylisobutylketone"; in the Proceedings of the 2nd Annual Conference on Environmental Toxicology, AMRL-TR-71-120, Aerospace Medical Research Laboratory, Wright-Patterson Air Force Base, Ohio, 1971.
5. Shell Chemical Corporation; Ind. Hyg. Bull. Toxicity Data Sheet, Methyl Isobutyl Ketone, SC57-113, 1957.
6. Silverman, L. , H. Schulte, and M. First; "Further Studies on Sensory Response to Certain Industrial Solvent Vapors"; J. Ind. Hyg. Toxicol. , 28: 262, 1946.
7. Smyth, H. F. ; "Improved Communication - Hygienic Standards for Daily Inhalation"; Am. Ind. Hyg. Assoc. Quart. , 17: 129-185, 1956.
8. Specht, H. ; "Acute Response of Guinea Pigs to Inhalation of Methyl Isobutyl Ketone"; Pub. Health Repts. , 53: 292-300, 1938.

DISCUSSION

FROM THE FLOOR: This was not at altitude, was it?

MR. VERNOT (SysteMed Corporation): The range-finding experiments were not at altitude, but the 90-day experiment was at altitude and under space cabin conditions - enriched oxygen, etc.

DR. THOMAS (Aerospace Medical Research Laboratory): I want to point out again that the Air Force is not in the man-in-space business. This study was sponsored and funded by NASA. And the reason why I'm so particular is that last year I lost almost \$200,000 due to the fact that some Congressman picking up our program documentation said, "What the hell is Anton doing in man-in-space?" So when you come here and hear about man-in-space, please keep in mind that all these studies are sponsored by NASA, and the Air Force is not doing these on its own.

MR. VERNOT: That is certainly true. It is also true that they have to come to Dr. Thomas' facility because there is no other place in the world that they can get this kind of work if they want it done.

PATHOLOGICAL LESIONS CAUSED BY METHYLISOBUTYLKETONE

William F. MacKenzie, Lt. Colonel, USAF, MC

USAF School of Aerospace Medicine
Brooks Air Force Base, Texas

The methods and results of the experimental exposure to methylisobutylketone (MIBK) were given in the preceding paper by Mr. Vernot.

The lesions caused by MIBK were interesting in that they were found only in one species, the rat, and in that species were limited to a specific part of one organ - the first and second sections of the proximal convoluted tubule of the nephron of the kidney. We designated this lesion hyaline droplet toxic tubular nephrosis, although in some respects it differed from the classic concept of hyaline droplet formation. The lesion was present at 14 days of exposure and continued with a variable decrease in severity throughout the exposure. In those rats removed for serial sacrifice at weekly intervals from the second week to the end of the exposure, the lesion completely reversed between the third and fourth weeks postexposure.

A knowledge of the anatomy and physiology of the kidney is necessary to understand the pathogenesis of the lesions. The basic working unit of the kidney is the nephron which consists of a tuft of capillaries - the glomerulus; a surrounding membrane - Bowman's capsule; and a tubule divided into proximal convoluted, loop of Henle, and distal convoluted sections. Blood enters the glomerulus where fluids, salts, and other compounds filter through the capillary walls into Bowman's space. This filtrate then flows through the renal tubules where it is transformed into urine by a complex process of absorption and excretion. In the rat and certain other mammals, blood proteins normally pass through this glomerular filter and are reabsorbed in the first two of the three subdivisions of the proximal convoluted tubule (Eliasch et al., 1955; Oliver et al., 1954). In the adult rat, approximately 5 mg of protein an hour pass the glomerular filter to be absorbed, catabolized, and returned to the bloodstream as polypeptides and amino acids (Eliasch et al., 1955; Oliver et al., 1954). In the normally functioning mammalian kidney, this process is completely inapparent by light microscopy. The process at a cellular level has been delineated in detail for the digestion of homologous hemoglobin (Oliver et al., 1954; Ericsson, 1965; Ericsson, 1965); and, briefly, is as follows: the protein is absorbed into the cell by pinocytosis at the base of the microvilli which form the brush border of the tubular cell. These absorption vacuoles then coalesce to form larger vacuoles and combine with organelles containing proteolytic enzymes. The vacuoles proceed toward the base of the cell decreasing in size along the way until

only the indigestible iron remains. These vacuoles are complex in that they contain degenerating cell organelles; thus, they are also autophagic vacuoles. When the ability of the cell to digest protein has been exceeded, there is a depletion of cellular organelles, changing the staining characteristics of the cytoplasm from granular to homogeneous. The protein-containing absorption vacuoles coalesce to become larger and become visible at the light microscopic level as hyaline droplets. When the cell has utilized its available cell membrane to form absorption vacuoles, the brush border disappears and no more protein can be absorbed. When hyaline droplets are produced experimentally by the injection of homologous or even mammalian protein, the droplets disappear within a few hours (Oliver et al., 1954; Ericsson, 1965); however, when nonmammalian proteins such as egg white are injected, the droplets persist as long as 33 days (Oliver et al., 1954).

The effect of MIBK on the kidney was seen as a distinct speckling of the surface of the kidney with white dots (figure 1). Each of these dots represents a proximal tubule as it loops under the surface and can be interpreted as swelling of the tubule. Microscopically the droplets were easily seen but very difficult to color differentially with those stains commonly used in pathology, probably because they were chemically similar to cytoplasm. The droplets varied in size and shape. Most droplets were round and one to two microns in diameter, but some were angular, suggesting crystal formation. Some were large enough to completely fill the cytoplasm and distort the cell. Rarely, a droplet was seen in the lumen of the tubule.

Histochemically, the droplets stained from light pink to deep red on hematoxylin-eosin stained sections, often very similar to hemoglobin (figure 2). The benzidine reaction for hemoglobin was negative. The droplets were also negative for the periodic acid-Schiff reaction, 24-hour oil red O, and frozen oil red O, but were strongly positive to the ninhydrin reaction for beta amino groups indicating the presence of protein. The droplets stained variably with Giemsa stain (figure 3). On tissue fixed in buffered formalin, postfixed in osmium tetroxide, embedded in epon and stained with toluidine blue, the droplets were distinctly visible (figures 4 and 5).

More questions are elicited by these findings than can be answered by this preliminary study, but some hypotheses can be formulated. The presence of protein droplets in proximal tubules can be explained either by an increase in protein passed through the glomerular filter or by the inability of the tubular cell to metabolize the protein absorbed. In this experiment, either or both processes could have caused the lesion, but since no detectable change occurred in the glomerulus, the latter is the most likely. The tubular cell could accumulate these deposits either because the cellular mechanisms of digestion were being interfered with by MIBK or the protein being absorbed was abnormal and difficult to digest. There is some evidence that the latter is the case because normal blood proteins are PAS positive and the droplets were negative. The persistence of the droplets for three weeks postexposure also supports this possibility. If the protein is abnormal, it is possibly produced in an organ other than the kidney and passed through the glomerular filter, since the lesion is limited to only those cells that reabsorb protein in the nephron. The livers of exposed rats were heavier than controls and, since the liver is a major organ of



Figure 1. WHITE SPOTTED KIDNEY OF RAT EXPOSED TO 100 PPM MIBK. Each white spot is a swollen proximal tubule beneath the capsule.

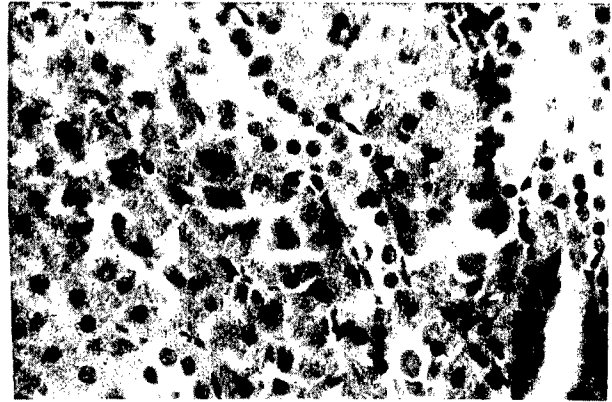

Figure 2. HEMATOXYLIN-EOSIN STAINED PARAFFIN SECTION OF CORTEX OF KIDNEY OF EXPOSED RAT. Acidophilic droplets in proximal tubules. X 400.

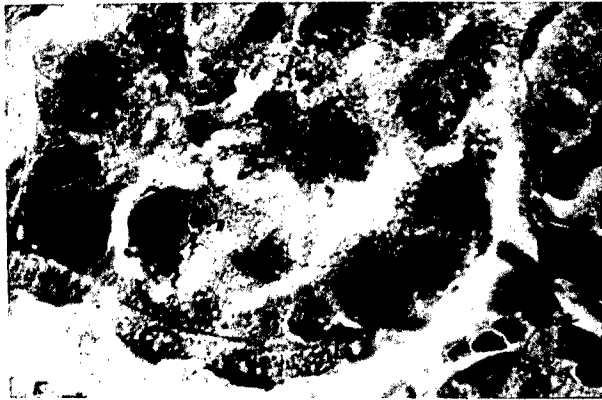

Figure 3. GIEMSA STAINED PARAFFIN SECTION OF PROXIMAL TUBULE OF EXPOSED RAT. Large amphiphilic droplets in cytoplasm. X 1000.

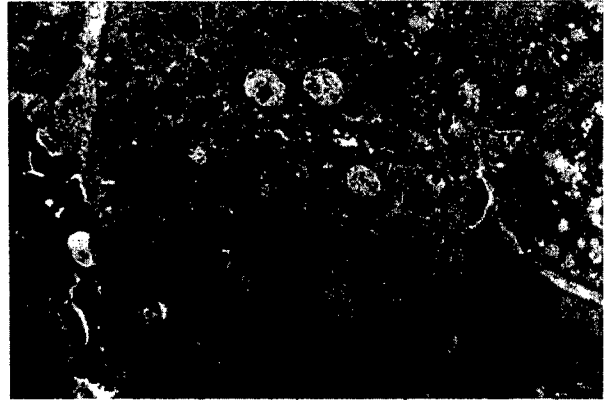

Figure 4. TOLUIDINE BLUE STAINED EPON SECTION OF PROXIMAL TUBULE OF EXPOSED RAT. Numerous droplets in cytoplasm. Several large droplets are irregular with angular corners suggesting crystal formation. X 1000.

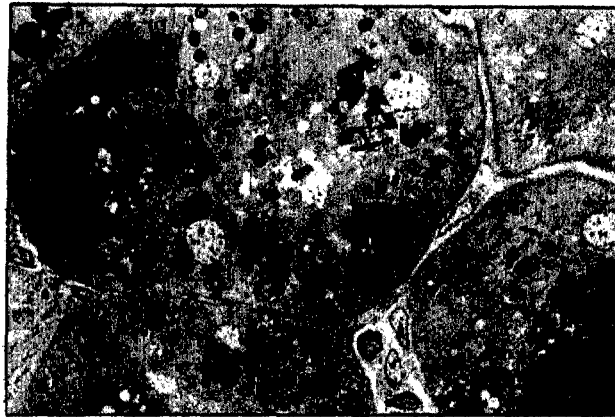

Figure 5. TOLUIDINE BLUE STAINED EPON SECTION OF PROXIMAL TUBULE OF EXPOSED RAT KIDNEY. Droplets and irregular crystal-like inclusions in cytoplasm. Large areas of cytoplasm are free of organelles. X 1000.

protein synthesis, it could be the target organ rather than the kidney. Abnormal protein could also be produced from abnormal digestion of normal serum proteins catabolized in the proximal tubular cells. However, since no PAS positive droplets were found, this possibility seems remote.

These questions must be answered before the mechanism of toxicity of MIBK can be understood. Although a light microscopic investigation of the pathogenesis of the lesions in the first few days of exposure would be helpful, the light microscope cannot answer these questions. The more refined methods of biochemistry and electron microscopy are needed.

REFERENCES

1. Eliasch, H., A. L. Sellers, S. Rosenfeld, and J. Marmoraton; "Protein Metabolism in the Mammalian Kidney"; J. Exp. Med., 101: 120-134, 1955.
2. Oliver, J., M. Muriel, and Y. C. Lee; "Cellular Mechanisms of Protein Metabolism in the Nephron. I. The Structural Aspects of Proteinuria; Tubular Absorption, Droplet Formation, and the Disposal of Proteins"; J. Exp. Med., 99: 589-604, 1954.
3. Oliver, J., M. J. Moses, M. C. MacDowell, and Y. C. Lee; "Cellular Mechanisms of Protein Metabolism in the Nephron. II. The Histochemical Characteristics of Protein Absorption Droplets"; J. Exp. Med., 99: 605-620, 1954.
4. Ericsson, J. L. E.; "Transport and Digestion of Hemoglobin in the Proximal Tubule. I. Light Microscopy and Cytochemistry of Acid Phosphatase"; Lab. Invest., 14: 1-15, 1965.
5. Ericsson, J. L. E.; "Transport and Digestion of Hemoglobin in the Proximal Tubule. II. Electron Microscopy"; Lab. Invest., 14: 16-39, 1965.

OPEN FORUM

DR. JACOBSON (Tulane University School of Medicine): It's very refreshing, I think, that somebody has stopped to consider that these analogies are inadequate and the data on which some of these analogies are based are inadequate, and has started all over again and done the work on monomethylhydrazine that needs to be done. I'm delighted that this work has been done. From the work that Dr. MacEwen reported this morning, I would say that the threshold limit value of monomethylhydrazine is not low enough, and I gather that nobody here is in disagreement with that.

DR. THOMAS (Aerospace Medical Research Laboratory): I would like to go on record. I think you misunderstood my comment. I would be the last person to throw stones at anybody who did the original hydrazine work. I didn't mean my comments in an offensive way. What I'm saying is that we've been good guys and bad guys, and if you look at our track record, we usually manage to raise limits higher and higher, especially in these short-term emergency exposure limits. But, we are also very conscientious and when we see something funny, we're willing to lower limits. But I think our track record is too bad for that purpose. We are always the ones who want to expand the tolerance you know. When we see something as toxicologists which scares us, we run scared. In the same vein, within the whole EPA concept of a varying population, I don't know what happens to a Negro with a sickle cell trait if he is exposed to monomethylhydrazine. And it looks like it doesn't make any difference how much you give - just a little bit and you see Heinz body formation. And so you see, you have a target organ here - the hemopoietic system, which isn't true with the other hydrazines. And so what are we doing? We are chasing the old chemical roulette - methylation, demethylation, double methylation, symmetrical, asymmetrical. Do you recall a published paper in which symmetrical dimethylhydrazine was declared practically nontoxic? The problem is that if you observe the animals for only seven days, you'll never find out that they die just as dead in 14 days! - which is the case with symmetrical dimethylhydrazine. I think this whole family of hydrazines is one of the most fascinating subjects in toxicology today, and I wish again to say that I was not trying to criticize previous work.

DR. JACOBSON: Well, I think that twenty years from now the work that is going on in the best laboratories today will need reexamination too. Methods are improving all the time.

MR. HAUN (Systemed Corporation): This is concerned with the renal toxicity in the MIBK exposures, specifically in rats. The first question is for Col. MacKenzie. What are the similarities or dissimilarities in kidney structure for rat versus man? My second question is open to anybody. If there are differences, or no differences, what does this mean in regard to MIBK exposure to astronauts under operating conditions? How significant is rat renal pathology in this experiment?

LT. COL. MAC KENZIE (USAF School of Aerospace Medicine): I think, in order to answer that question, the mechanism of action of MIBK in the specific enzyme systems involved with the rats would have to be elucidated, and until that is done, everything is a guesstimate. As far as relationships between man's kidney and rat's kidney, there are differences. What these are, I don't feel really competent to expound on. There is a difference in the amount of protein that escapes from the glomerulus of man and the rat, and in the constituents of this protein. Again, I don't want to comment. And there is some disagreement in the literature. Perhaps Dr. Kroe would like to comment on hyalin droplet degeneration in man. This is such a nonspecific term and it's seen in most proteinuria where you have a functioning tubular cell.

DR. KROE (Laboratory for Experimental Biology): It tends to be seen in man in massive proteinuria - also in toxins that enter the body in various ways - but whose primary way of excretion is through the kidney as opposed to through the liver or through the gastrointestinal tract. With the MIBK this might be the situation. With tagged MIBK, one could find out the pathway of excretion which could explain the difference in singling out the kidney as opposed to the liver. On the other hand, with more refined ways of looking into the liver and kidney, for example electron microscopy, the fact that the livers and the kidneys both had weight increases which were different from the controls would suggest that, at a higher resolution, one could find differences in the liver that are not discernible with light microscopy. With light microscopy, applying immunofluorescent techniques, we might be able to resolve whether this material, which appears proteinaceous, derives from serum protein or from endogenous individual renal cells - from the proteins there. If it did come from within the cells, one might expect it to be something along the line of autophagic vacuoles which were discussed yesterday. Simple immunofluorescence could help to resolve this.

LT. COL. MAC KENZIE: I'd like to add to that a little bit, since you brought up autophagic vacuoles. These droplets are not simple phagic droplets where a protein is gobbled up and then catabolized. In the hemoglobin work I was quoting when I drew the picture on the board, these droplets contained cell organelles, such as mitochondria, and, therefore, can be defined as an autophagic vacuole. So, the process is not simple; it is very complex. And I hope that I made the point clear that all we have done is point to where the lesion is - that we can see with the light microscope. But, to define this lesion is beyond the powers of light microscopy.

DR. KROE: I think also in answer to that question, rather than singling out individual differences between the kidney of the rat and the kidney of man, or the kidneys of the other species which were investigated with MIBK, one might possibly more appropriately ask about species differences in susceptibility to the toxic properties of MIBK, which appears to be the case in the MMH experiments. And, in this setting, it really depends upon the parameters that you're looking at. At the tissue level, we can single out mice and dogs, and separate them from monkeys and rats. But, if we're looking at more than tissues, such as the SMA battery and

peripheral blood picture, we see that all of them are affected, so it's a very subtle difference here. We're not seeing true zero toxicity, but it depends upon which parameter you're using to assess this. Maybe that is the situation with the MIBK.

MR. WANDS (National Academy of Sciences): I'd like to direct my question to Mr. Vernot. You had one of the monkeys wired for light and sound. Did you see any changes in the EEG?

MR. VERNOT (SysteMed Corporation): No, but I can't say that absolutely. I can say, however, that these things were done before and after exposure, and there were no differences between the control and exposed monkeys.

CAPT. FRAME (Aerospace Medical Research Laboratory): I'd like to ask Mr. Darmer if he would elaborate a little more on the use of the Orion electrode to measure ClF_5 concentrations. What actually was measured and how did it relate to the ClF_5 concentration?

MR. DARMER (SysteMed Corporation): I was expecting this. The analysis which we used was, as I said, a fluoride-specific electrode. Perhaps Mr. Vernot can elaborate more fully on this. Not being a chemist, I'm not that familiar with the chemistry involved in this. However, it did involve an absorber solution to which a buffer was added to allow the absorption of the fluoride ion, and this was measured by the electrode. Perhaps you can elaborate on this, Ed.

MR. VERNOT: The ClF_5 was absorbed directly into an almost normal buffered solution which one would use with a fluoride electrode. We assumed that we would get 100% hydrolysis, and then could account directly for all of the ClF_5 by measuring the fluoride. Unfortunately, we lost some - we don't know where or how - but we had to use calibration standards of ClF_5 rather than to work from theoretical calculation from the fluoride concentration.

DR. SCHEEL (U. S. Public Health Service): I would like to ask this of Mr. Vernot, Mr. Darmer, and Dr. MacEwen, since they have probably done more work on fluorides. The 1,272 LC_{50} for HF given, and the 850 LC_{50} for HF given in the carbon monoxide study, and the 40 ppm on a two-hour exposure as opposed to a one-hour exposure which I gave yesterday, in combination with HCl, leads me to feel that we can't with any real assured confidence say that we know what's happening in fluoride toxicity. This morning, on a five-minute exposure, the carbon monoxide effect may have been completely masked by a sudden acidosis or something of this sort which kills the animal off. We did one-hour exposures with the breakdown products in which we detected limits about twice to three times the level I expressed as killing animals in two hours. It seems to me that time of exposure to fluoride is one parameter and metabolic death is one thing, whereas edema, asphyxiation, or something of this sort is another thing. I'd like to have some comments. Perhaps we could get Dr. Hodge to summarize his feelings on this, because he's been in the business longer than all of us, with regard to this particular material.

LT. COL. MAC KENZIE: Having done many necropsies on the animals exposed in our studies, I would only want to say that the lung damage was adequate to explain the death of the animals. These are animals that die not only acutely, but also within the following couple of days.

DR. MAC EWEN (SysteMed Corporation): I might comment that the carbon monoxide introduction was stopped at the end of five minutes, along with the HF or HCl in the combined exposures. It would only be during that period, while the carboxyhemoglobin levels are still relatively high, that any anoxia might be seen at the cellular level, particularly the lung. The lung damage doesn't occur too rapidly, except at extremely high levels where the hemorrhage occurred, and that was more than adequate to cause death. In the delayed deaths, there was no hemorrhage, or relatively little. It was primarily an edematous type of death. I don't believe we've seen the renal failure associated with fluorosis in these particular experiments. Is that correct, Col. MacKenzie?

LT. COL. MAC KENZIE: I have not done histopathology of the kidney, but I'd have to point out that in a respiratory failure, this is an abnormal state which produces disease in all other tissues which are oxygen dependent, and some of those that aren't; and to separate minimal changes, or even rather large changes, in organs such as the kidney in a hypoxic animal that is slowly dying, would be very difficult.

MR. DI PASQUALE (SysteMed Corporation): I would like to comment, Dr. Scheel, that you mentioned that the five-minute rat LC_{50} was 800. That value was 18,200 ppm for the five-minute rat LC_{50} for hydrogen fluoride.

DR. SCHEEL: I think the one I was referring to was in the chloropentafluoride where they did the 60-minute exposure, and this was something like 800 for the fluoride that he was giving here.

DR. HODGE (University of California Medical Center): I doubt that I can add much. It seems to me that for the kinds of intense irritating exposures with severe upper respiratory damage and severe alveolar damage, this overwhelming insult is a matter primarily of concentration rather than time. The kinds of times that Dr. Scheel was mentioning (two hours, etc.) represent quite a different kind of biological insult. What the late death is due to with fluoride I've never been quite sure. There is a curious thing though - Dr. Scheel, you perhaps have seen it as some of the rest of us have. The highly poisoned animal is going to die, let's say in six to 24 hours, and frequently develops a falling blood pressure that simply cannot be reversed. It just goes down and down and down, and after a while the animal quietly expires. This possibly has a kidney factor in it, but I think we just don't know enough about fluoride yet to pinpoint where these things are. Coming back to the acute experiments, such as we have seen, where the intense lung damage that you got for HCl, or NO_2 , or whatever, these are all the same kind of insult, I feel. As long as I have this thing in my hand, I'd like to make a comment about the cyanide exposures. It

happens that I saw one or two of those, and I was struck by the fact that these rats, after a five-minute exposure which will kill a substantial fraction of them (half or more of a group of 10) after about two and a half minutes, a rat at one end of that sliding cage that we saw pictured would suddenly explode and just go over and bang himself against the other end. I wonder if this is the same popcorn phenomenon that we heard described yesterday or the day before, and whether there is anything useful in making this kind of comparison.

MR. DI PASQUALE: I'll make an attempt at this. As I mentioned in the paper, I believe this was more of an asphyxial convulsion rather than CNS response. I don't know if anyone can bear me out on this. This is my interpretation of the thing. The mice, more so than the rats, appeared very much like the popcorn phenomenon we saw with monomethylhydrazine. My interpretation of this is that it is an asphyxial convulsion due to the tissue hypoxia rather than CNS effect.

DR. MAC EWEN: This doesn't seem to be induced by sudden noise or anything like that. Usually the one that does that is about to die and will die after he hits the other wall.

MR. DARMER: I might mention that in our ClF_5 exposures, we did observe this particular effect with the rats to a certain degree, but it was more pronounced in the mice - this anoxic hyperactivity just prior to death.

DR. DOST (Oregon State University): I would like to comment on two considerations. Dr. Scheel mentioned the question of acidosis. We did some work with ClF_3 , which in terms of its irritant properties probably behaves somewhat like ClF_5 , and we found that the capability of the rat to clear labeled carbon dioxide after introduction of labeled bicarbonate was markedly reduced. Also, the blood pH dropped very sharply in a time period corresponding to the failure of bicarbonate clearance, which suggested to us that the primary damage was one of respiratory transport. Many of the animals which were affected in this way did survive, but there was a reasonable correspondence between the amount of deficiency that we observed and the death of the animal. The other thing I'd like to elaborate on a little bit is the chemistry of the two chlorine fluorides that we've been talking about, particularly in view of their differences in toxicity. The reactivity of ClF_5 is substantially less in liquid water than is the reactivity of ClF_3 . They both do react, however. In water vapor, it's an entirely different story. The two papers you've quoted on the reactivity of ClF_5 were apparently both in the vapor phase, but they didn't describe their procedures adequately. We have done some work with vapor phase ClF_5 and found that it does not react with water vapor, saturated nitrogen, or saturated air stream. ClF_3 is an entirely different proposition, however, because it will react on a mole for mole basis with water, and if there is insufficient water or a molar equivalent of water, the product will ultimately be ClO_2F ; this goes through an intermediate of ClOF which then disproportionates. If there is more than enough water, there will be formation of ClO_2 , and if we're dealing with liquid water, the products are ClO_2 and the various ClO_x anions, except for ClO_4 . The degree, or

the amount of products in general terms, is simply a function of the relative concentration. In other words, we can deal with a modest change in the ratio, particularly in the vapor state, and vary the ratio of the various products we're dealing with. If there is enough water vapor, we will get some of the ClO_x anions. The point is that in a vapor phase exposure with ClF_5 , much of the reaction is almost certainly at the pulmonary surface, whereas with ClF_3 , by the time it gets there, we have a big mess, depending upon the original concentration, of ClF_3 , ClO , HF , and Lord knows what all else, all of which are strongly irritant at the pulmonary surface.

FROM THE FLOOR: One comment you might make here - I don't know how ClF_3 affects the cornea, but the opacity of the cornea in the ClF_5 could be attributed to keratinization of the cornea. This membrane has the capacity to turn into keratin just like the surface of the skin, and in various conditions where you have mucosal surfaces, such as the bronchus in a chronic smoker or in the cervical mucosa of the female who has prolapse of the uterus, as these normally moist surfaces dry out, they tend to keratinize, and this is probably what's happening in the cornea. By analogy with what Dr. Dost just said, as this process happened in the terminal bronchi and on the alveolar surfaces of the animals exposed to ClF_5 , then they're just simply not going to be able to exchange oxygen and other gases, and could turn into a type of asphyxial death.

DR. THOMAS: I would like to point out one thing, and it's not really a question, but I'd like Dr. MacEwen to field it. Before anybody leaves from here having any doubt that there is a discrepancy in HF or fluorine data, there isn't. Doug, you can second me on that, but we got a beautiful dose response relationship. When we go to other compounds, especially OF_2 , we're talking about a different breed of cat. With the things which break down either into HF or plain fluorine, the dose responses are beautiful.

DR. MAC EWEN: Yes, very much so. I might like to add to Dr. Dost's comment that the ClF_3 is very reactive with water vapor, and I'm personally convinced that ClF_3 cannot be seen at the surface of the lung - that going through that saturated vapor of the interior of the lung, it's completely reacted by the time it hits the cell. If you noticed the data that was presented, the ratio of acute LC_{50} for HF and ClF_3 is almost exactly three to one, equimolar, with respect to their fluoride concentration. I'm sure that there is some intermediate ClOF_2 , but I don't think it's there when it hits the lung surface.

DR. SCHEEL: My comment was one which is related to the popping syndrome in mice. This is also present in ozone exposure and is the terminal sequence in ozone exposure just routinely. And here you're talking about an edematous asphyxiation which has really no effect on any other organ.

MR. WANDS: If my memory is correct, in previous years at this meeting, we have discussed the theoretical need for mixed exposures to irritant gases. I think the data that have been presented this week, not only the ones we have seen this

morning, but some of Dr. Scheel's work for example, emphasized that we must begin to look not only at mixtures of HF with CO, but more especially mixtures of HF and HCl, and of all these other irritant gases. We still do not know if irritation is an additive phenomenon. Dr. Hodge alluded to the possibility that the response for these short-term exposures is one of concentration rather than time dependence. If so, then are we talking of a total acidic insult, if you will? Are these irritant gases then additive? I hope that you people here at Systemed are going to pursue this as part of looking at the mixed gas situation for fire control, etc.

DR. MAC EWEN: I also hope that you didn't want an answer to that right now.

DR. THOMAS: I'd like to have the FAA recognized for a minute.

DR. SMITH (Federal Aviation Administration): I'd like to point out that NASA is not the only organization that comes to Dr. Thomas for help when they're in trouble. The FAA does it too. We intend to go ahead with whatever resources we can muster with some of this mixed gas toxicology. There are two reasons why we come here. Really, it's the only place I know of that has the sophisticated technology. It's the only place I know of, too, that possesses a curve polisher which gives those beautiful graphs and we like that aspect too.

DR. JACOBSON: I'd like to make one comment, if I may, on the MIBK. Am I correct that you found no change in serum glucuronidase? It would be interesting, if you have any tissue left, to look at kidney glucuronidase.

MR. VERNOT: Well, I don't know what we have preserved. I would imagine the preservation techniques would be rather drastic. I suspect we don't have any left.

DR. DOST: I hope you didn't misunderstand me, Doug. I don't expect that there would be any ClO_2F surviving to the surface of the lung. We made a calculation that in order to get intact ClF_3 all the way down to the surface of the lung, it would require exposures to around 20,000 ppm ClF_3 , which would probably very nearly consume the animal, the target organism.

MR. VERNOT: Frank, on that score, we were not only certain there was no ClF_3 left by the time it got down to the lung, but we suspected there wasn't any ClF_3 once it got into the chamber!