

PROJECT STORMFURY

OPERATION ORDER NO. 1-70

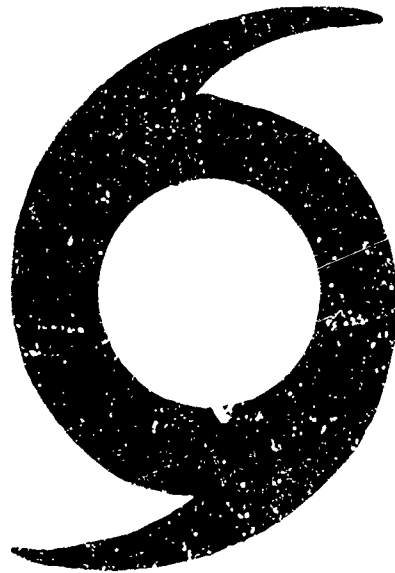

AD722671



DDC
RECEIVED
MAY 7 1971
RECEIVED

Handwritten initials 'C' and a signature.



As provided by
NATIONAL TECHNICAL
INFORMATION SERVICE

U. S. FLEET WEATHER FACILITY • NAVAL AIR STATION • JACKSONVILLE, FLA., 32212

JUNE 1970

Handwritten number '155'.

PROJECT STORMFURY
FLEET WEATHER FACILITY
NAVAL AIR STATION
JACKSONVILLE, FLORIDA 32212
JUNE 1970

UNCLASSIFIED

From: Navy Project STORMFURY Coordinator
To: Distribution List

Subj: Project STORMFURY Operation Order No. 1-70; promulgation of

Ref: (a) Project STORMFURY Operation Plan No. 1-69

1. Project STORMFURY Operation Order No. 1-70 supersedes Project STORMFURY Operation Plan 1-69, reference (a).
2. This Operation Order remains in effect for the 1970 STORMFURY Season, which is designated from 20 July 1970 through 31 October 1970. It includes the flight track and data gathering requirements of the National Hurricane Research Laboratory and Federal Aviation Administration agreements for airspace reservations. In combination with directives of higher authority, it provides basic guidance for all units and commands who will be under the operational command and/or control of Commanding Officer, Weather Reconnaissance Squadron FOUR during in-flight portions of the project.
3. Assignment of forces has been coordinated with Navy, Air Force and ESSA project representatives.
4. Changes to this Operation Order will be issued and annotated in serial order.



J. UNDERWOOD
Commander, U. S. Navy
Navy Project STORMFURY Coordinator/
Commanding Officer
Fleet Weather Facility, Jacksonville

Distribution List:

(See Annex G)

PROJECT STORMFURY
FLEET WEATHER FACILITY
NAVAL AIR STATION
JACKSONVILLE, FLORIDA 32212
JUNE 1970

OPERATION ORDER
FWF JAX NO. 1-70

Reference: (a) Navy Project STORMFURY Coordinator ltr with enclosures

Time Zone: ZULU Time Zone will be used for all operations.

Task Organization:

- | | |
|--|--|
| a. Project Director | Director, National Hurricane Research Laboratory, Miami |
| b. Assistant Project Director | Commanding Officer, Fleet Weather Facility, Jacksonville, Florida |
| c. Navy Project Coordinator | Commanding Officer, Fleet Weather Facility, Jacksonville, Florida |
| d. Alternate Project Director | Assistant Director, NHRL Miami |
| e. Alternate Assistant Project Director/Navy Project Coordinator | Executive Officer, Fleet Weather Facility, Jacksonville, Florida |
| f. WEARECONRON FOUR (VW-4) | Commanding Officer, Weather Reconnaissance Squadron FOUR |
| g. Naval Weapons Center (NWC) | Project Officer |
| h. Navy Weather Research Facility | Scientific Advisor |
| i. Marine Air Group FOURTEEN (MAG-14) | Group Commander |
| j. NAVSTA Roosevelt Roads | Officer in Charge, Naval Weather Service Environmental Detachment, Roosevelt Roads |
| k. ESSA/Research Flight Facility | Chief, ESSA/RFF Miami |
| l. 53rd WRS | Commander, 53rd Weather Reconnaissance Squadron |
| m. CARCAH (Chief, Aerial Reconnaissance Coordination, Atlantic Hurricanes) | Mr. R. E. Hairston |

OPERATION ORDER
FWF JAX NO. 1-70

- n. CHINFO (Chief of Information) Mr. A. E. Eastman
o. ESSA Public Affairs Officer Mr. H. Lieb

Forces:

- a. Navy/Marine Personnel as Assigned
(1) WEARECONRON FOUR 4 WC-121N Aircraft
(2) Naval Air Test Center 1 P-3 Aircraft (as available)
(3) MAG-14 4 A-6 Aircraft
- b. ESSA Personnel as Assigned
(1) Research Flight Facility 2 DC-6 Aircraft
1 C-130 Aircraft
1 WB-57 Aircraft
- c. Air Force Personnel as Assigned
(1) 58th WRS 1 RB-57F Aircraft
(2) 53rd WRS 2 WC-130 Aircraft

1. Situation. An interdepartmental agreement, executed in 1962, between the Department of Commerce (ESSA) and the Defense Department (U. S. Navy) provided for joint sponsorship of an experimental program of weather modification in hurricanes. The most recent renewal of this agreement was for a three-year period beginning in 1969. The Chief of Naval Operations provides direction and authority for the deployment of Naval personnel and equipment involved and also requires that airborne operational control be exercised by the Navy. The Chief of Naval Operations has also directed the Commander, Naval Weather Service Command to appoint the Commanding Officer, Fleet Weather Facility, Jacksonville, Florida as Navy Project Coordinator.

2. Mission Conduct experimental seeding and data collecting operations toward the goal of modifying and/or better understanding the hurricane processes.

a. Conduct a "dry run" exercise for (b), (c) and (d) during the period 20-23 July.

b. Conduct a cloudline experiment following the "dry run" with required forces (Annex D) remaining for this event.

OPERATION ORDER
FWF JAX NO. 1-70

c. Conduct experimental seeding of a hurricane eyewall over an eight-hour period.

d. Conduct a Rainsector experiment outside the eyewall.

e. Conduct a rainband seeding experiment in a tropical cyclone rainband.

3. Execution.

a. Conduct dry run exercise in accordance with Annex D, Appendix I.

b. Conduct experimental seeding of one or more hurricane eyewalls in accordance with Annex D, Appendix II.

c. Conduct a control data gathering eyewall experiment exercise in accordance with Annex D, Appendix II with seeding deleted.

d. Conduct a rainsector experiment in accordance with Appendix III of this annex.

e. Conduct rainband experiment, seeding one or more tropical cyclone/hurricane rainbands in accordance with Annex D, Appendix IV.

f. Conduct cloudline or fallback research missions in accordance with Annex D, Appendix V.

4. Logistics. Logistic requirements are listed in Annex B.

5. Command and Signal.

a. Communications procedures will be followed in accordance with Annex C.

b. Operational control of participating aircraft for the "at sea" portion of the project will be exercised by the Commanding Officer, Weather Reconnaissance Squadron FOUR (VW-4).

THIS OPERATION ORDER HAS BEEN REVIEWED AND APPROVED IN ACCORDANCE WITH THE PROVISIONS OF OPNAVINST 3120.25.



A. "F" MARSH
Commander, U. S. Navy
Commanding Officer
Weather Reconnaissance
Squadron FOUR



L. J. UNDERWOOD
Commander, U. S. Navy
Navy Project Coordinator/
Commanding Officer, Fleet
Weather Facility, Jacksonville

OPERATION ORDEE
FWF JAX NO. 1-70

ANNEXES

- A. Concept of Operations
- B. Administration and Logistics
- C. Communications
- D. STORMFURY Force Operations
 - I. Dry Run Exercise
 - II. Hurricane Eyewall Seeding Experiment
 - III. Hurricane Rainsector Experiment
 - IV. Hurricane/Rainband Seeding Experiment
 - V. Cloudline and Fallback Missions
 - VI. Data Logging System
 - VII. Kadar Operations and Photography
 - VIII. Airspace Reservation Agreement
- E. Reports
- F. Public Affairs
- G. Distribution

OPERATION ORDER
FWF JAX NO. 1-70

Project STORMFURY
Fleet Weather Facility
Naval Air Station
Jacksonville, Florida
June 1970

ANNEX A

CONCEPT OF OPERATIONS

1. General. This is the basic directive for the conduct of several types of hurricane/weather modification experiments, utilizing aircraft from the Navy, Air Force and ESSA for STORMFURY operations. These research operations will be initiated, following a dry run training exercise, when a hurricane meets specific scientific and operational criteria. This operation order represents the coordinated results of several technical and operational planning conferences by Navy, Air Force, FAA, and ESSA representatives. In addition, an advisory panel of five nationally prominent scientists has reviewed and validated the experiments as planned.

a. Dry Run Exercise. The dry run exercise is required for training of forces assigned in Annex D, Appendix I prior to seeding of an actual hurricane. A deployment to Naval Station, Roosevelt Roads will be initiated for this purpose.

b. Eyewall Experiment. The eyewall experiment involves the seeding of the wall cloud surrounding the eye of a well-developed hurricane and the associated multi-level monitoring by aircraft of the structures and circulation before, during, and after the seeding. See Annex D, Appendix II.

c. Rainsector Experiment. The rainsector experiment requires the seeding of an area outside the wall cloud combined with a multi-level monitoring system similar to that of the eyewall experiment. See Annex D, Appendix III.

d. Rainband Experiment. The objective of this experiment is to determine if the seeding of a rainband extending from a hurricane or tropical storm can change the basic structure and behavior of the total circulation.

e. Cloudline and Fallback Research Mission. These experiments will be implemented for modification research when deployed forces are unable to complete the eyewall, rainsector, or rainband experiments. See Annex D, Appendix V.

2. Operating Areas. As depicted in Appendix I to this annex. Primary bases of operation will be Naval Station, Roosevelt Roads and Naval Air Station, Jacksonville. Although not used as primary staging bases, the possibility exists of using other facilities, such as Bermuda, Corpus Christi or Norfolk for refueling/rearming.

OPERATION ORDER
FWF JAX NO. 1-70

3. Aircraft. Participating aircraft will be assigned as follows:

	<u>Eyewall</u>	<u>Rainsector</u>	<u>Rainband</u>	<u>Cloudline/Fallback</u>
SEEDERS	4 A-6 (USMC)	4 A-6	4 A-6	2 A-6
COMMAND/CONTROL	1 WC-121N (USN)	1 WC-121N	1 WC-121N	1 WC-121N
DATA MONITORS	3 WC-121N (USN) 2 DC-6 (ESSA) 1 WB-57 (ESSA) 1 C-130 (ESSA) 2 WC-120 (USAF) 1 RB-57F (USAF)	3 WC-121N 2 DC-6 1 WB-57 1 C-130 2 WC-130 1 RB-57F	3 WC-121N 2 DC-6 1 WB-57 1 C-130 2 WC-120	1 WC-121N 2 DC-6 1 WB-57 1 C-130 2 WC-130

4. Command Relation. The Aircraft Commander of the Command Control Aircraft shall assume the duties of On-Scene Commander for all in-flight operations. In this capacity, he shall have SAR responsibility for all aircraft under his control.

5. Sequence of Events.

a. Prior to 15 July, all pyrotechnic canisters and racks will be prepositioned at staging bases, as directed by the Navy Coordinator.

b. In July, a dry run/cloudline training exercise will be conducted for a period of approximately 10 days.

c. From 20 July through 31 October, all participating units will be on a 48-hour standby to conduct eyewall, rainsector, and rainband experiments.

6. Air Operations. As described in Annex D.

7. Safety.

a. Safety of flight is paramount. Due regard will be given to crew and aircraft capabilities. Scheduling of flight and crew rest will be in accordance with directives pertinent to the agency or service involved. Aircraft standard operating procedures will be observed.

b. Only pyrotechnic canisters approved by Naval Air Systems Command will be carried and used by Navy aircraft.

OPERATION ORDER
FWF JAX NO. 1-70

8. Times. All times noted in the Operation Order are GMT, Time Zone ZULU. All reports, records, clocks, voice communications and other references to time will likewise be expressed in ZULU time.



L. J. UNDERWOOD
Commanding Officer
Navy Project STORMFURY Coordinator

Appendix:

I - Operating Area

OPERATION ORDER
FWF JAX NO. 1-70

Project STORMFURY
Fleet Weather Facility
Naval Air Station
Jacksonville, Florida
June 1970

ANNEX B

LOGISTICS

1. Logistics.

a. General. Transportation of men and material will be implemented upon receipt of the T-48 deployment message from the Navy Project Coordinator. An alert message will precede the actual deployment message at the earliest time practicable. Maintenance of aircraft system will be the responsibility of the agencies or services participating. Ground support equipment and fuel requirements are listed in Appendix I to this annex and will be provided by the host station, as available. Billeting requirements and magazine stowage requirements are also listed in Appendix I.

b. Implementing Messages.

(1) Pre-Deployment Alert. At the earliest possible time, usually 48-72 hours, in advance of a STORMFURY exercise, the Assistant Project Director/Naval Project Coordinator will originate a message alerting and directing deployment of forces to the staging base. Telephone calls may precede message traffic. See Appendix II.

(2) Deployment Message. The deployment message at approximately T-48 hours assigns staging base, tango time, etc.. See Appendix II.

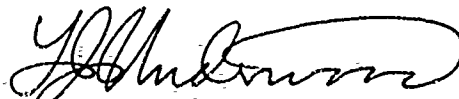

E. J. UNDERWOOD
Commander, U. S. Navy
Navy Project STORMFURY Coordinator

Appendices:

- I - Logistic Requirements
- II - Implementing Messages
- III - Address Indicator Group (AIG) 7753

OPERATION ORDER
FWF JAX NO. 1-70

APPENDIX I TO ANNEX B
LOGISTIC REQUIREMENTS

1. NAVSTA Roosevelt Roads. The following services and equipment are required:

a. General.

(1) Reproduction Machine. Recommend Bruning or Ozalid capable of reproducing to a width of 30 inches.

(2) Office Copier. Recommend dry copier such as Xerox.

(3) Briefing space for approximately 40 people to be used for general briefing approximately 24 hours before each operation.

(4) Limited briefing area to be used just prior to each flight. Recommend some area close to flight line, preferably in the Operations Building.

(5) Telephone in BOQ rooms for Project Director, Navy Project Coordinator and alternates, Data Quality Control Coordinator, Commanding Officer of WEARECONRON FOUR, Chief of Research Flight Facility and Navy Scientific Advisor.

(6) Three office spaces with three desks in each; a total of two telephones required. Project Director and Navy Project Coordinator will assign.

(7) Debriefing area required.

b. Specific.

(1) WEARECONRON FOUR (VW-4). Requirements below include the 10 officers and 33 enlisted comprising the Detachment deployed during the Hurricane Season.

(a) BOQ billeting for 30 officers.

(b) Billeting for 85 enlisted men, including 12 CPO's, 5 mess cooks and 2 stewards.

OPERATION ORDER
FWF JAX NO. 1-70

(c) Ground Support Equipment:

- | | |
|--|---|
| <u>1.</u> Workstands, B4 | 4 |
| <u>2.</u> Workstands, B5 | 4 |
| <u>3.</u> Compressor, Air (3,000 psi capacity) | 1 |
| <u>4.</u> Cart, Oxygen (aviators breathing) | 1 |
| <u>5.</u> Ground Power Unit, RY-400 or NC-12C | 3 |

(2) Naval Weapons Center (NWC) China Lake

(a) BOQ billeting for two officers and six civilians, GS-9 through GS-16.

(b) Billeting for four enlisted men.

(c) Stowage.

1. Magazine stowage for approximately 3,000 MK-112 photo-flash canisters (pyrotechnic devices) from about 15 July to approximately 1 November 1970. Space required is approximately 10'x12'x14'.

(d) Transportation.

1. One pick-up or bomb truck for transporting pyrotechnics and personnel.
2. Two GSA, Navy or rental station wagons.

(3) ESSA/Research Flight Facility (ESSA/RFF)

(a) BOQ billeting for 36 civilians (10 for Dry Run), GS-9 through GS-15.

(b) Ground Support Equipment:

1. Three power units, Type MD-3 (28V DC 400 cycle three phase 115V)
2. Routine aircraft support.

(c) Fuel/Oil - DC-6's:

1. AVGAS-115/145, 100,000 gallons
2. Oil-AD-1120 grade, 960 gallons
3. ADI-300 gallons

(d) Fuel/Oil - W-57:

1. JP-4 - RFF will provide.
2. Oil - RFF will provide.

OPERATION ORDER
FWF JAX NO. 1-70

(e) Fuel/Oil - C-130:

1. JP-4 - 40,000 gallons
2. Oil - MIL-L-7808, 100 gallons

(f) Fuel/Oil - B-57:

1. JP-4 - 18,000 gallons
2. Oil - RFF will provide.

(g) Transportation

1. One half-ton pick-up truck.
2. One station wagon.

(4) Navy Weather Research Facility (WEARESCHFAC)

- (a) BOQ billeting for four civilians, GS-9 through GS-13
- (b) Billeting for one enlisted.

(5) Fleet Weather Facility, Jacksonville (FWF JAX)

- (a) BOQ billeting for the Navy Project Coordinator
- (b) Billeting for one CPO.
- (c) Transportation.

1. One rental (Navy) sedan.

(6) National Hurricane Research Laboratory (NHRL)

- (a) BOQ billeting for eight civilians, GS-9 through GS-16.

(7) CHINFO

- (a) Billeting for two enlisted men.

(8) MAG-14

- (a) BOQ billeting for 11 officers.
- (b) Billeting for one Staff NCO and 19 enlisted men.

OPERATION ORDER
FWF JAX NO. 1-70

(c) Ground Support Equipment:

1. Pre-oiler PONG
2. LOX cart
3. Air compressor
4. Tow tractor
5. Aircraft jacks:
 - a. Three (3) Tripod jacks
 - b. One (1) 10-ton wheel jack
6. Four (4) NR2 Air conditioners or 2 NR10's
7. Hydraulic test stand (3,000 psi, 6-25 gal/min) 3 micron filter
8. Flood light unit
9. GTC-85 (or equivalent)
10. NB-2 electrical power unit (or equivalent). A-6A electrical power requirements are very critical as to frequency, phase rotation and voltage fluctuations. 115/200 V 400 cps AC 23 (CVA).
11. Air conditioner (35° to 50°F) NR-2A/B (2B preferred)
12. Nitrogen cart (3,000 psi)
13. Single Point JP refueler
14. Mil-L-23699 oil
15. Pick-up truck

c. Pooling of Resources. It is realized that NAVSTA Roosevelt Roads may not have the capability to provide all of the equipment requested by each separate activity. In this eventuality, pooling of equipment compatible to each type aircraft may be necessary. The Project Officer, NAVSTA Roosevelt Roads, will determine what equipment is available and forward this information to the Navy Project Coordinator.

OPERATION ORDER
FWF JAX NO. 1-70

APPENDIX II TO ANNEX B
IMPLEMENTING MESSAGES

1. T-72 HOUR ALERT

PR
FM FLEWEAFAC JAX
TO AIG 7753

BT
UNCLAS //NO3930//
STORMFURY ALERT OF FORCES

A. PROJECT STORMFURY OF ORDER 1-70

1. DUE TO THE POSSIBILITY OF OPERATIONS ON (NAME OF STORM OR HURRICANE) ON (DATE AND MONTH), ALL ACTION ADDEES ARE REQUESTED TO READY NECESSARY FORCES FOR DEPLOYMENT TO (OPERATING BASE) OR APPROPRIATE STAGING BASE ON (DATE AND MONTH) IN ACCORDANCE WITH REFERENCE A.
2. TENTATIVE TANGO TIME IS (DATE-TIME GROUP)Z. DEPLOYMENT OR CANCELLATION MESSAGE TO FOLLOW.

NAVY PROJECT STORMFURY COORDINATOR SENDS.

2. T-48 HOUR DEPLOYMENT

PR
FM FLEWEAFAC JAX
TO AIG 7753

BT
UNCLAS //NO3930//
STORMFURY DEPLOYMENT OF FORCES

1. ALL FORCES DEPLOY TO (ROOSEVELT ROADS/JACKSONVILLE) OR APPROPRIATE STAGING BASES TO ARRIVE IN TIME FOR STORMFURY/ _____ (NAME OF STORM OR HURRICANE) OPERATING ON _____ (DATE AND MONTH). TENTATIVE TANGO TIME IS _____ (DATE-TIME GROUP)Z.
2. BRIEFING FOR KEY PERSONNEL PLANNED FOR _____ (DATE-TIME GROUP)Z AT ROOSEVELT ROADS/JACKSONVILLE.

NAVY PROJECT STORMFURY COORDINATOR SENDS.

OPERATION ORDER
FWF JAX NO. 1-70

APPENDIX III TO ANNEX B

ADDRESS INDICATOR GROUP (AIG) 7753

FM NAVY PROJECT STORMFURY COORDINATOR AT FLEWEAFAC JAX/NWSED ROOS RDS

TO ESSA USWB SILVER SPRINGS MD
COMNAVWEASERV
CHINFO
WEARSCHFAC NORVA
9TH WRWG
53RD WRS RAMEY AFB
58TH WRS KIRTLAND AFB
PROJECT DIRECTOR, PROJECT STORMFURY
RFF MIAMI
WEARECONRON FOUR
NAVWPCEN CHINA LAKE
CARCAH HOMESTEAD AFB
MAG 14

INFO CNO FLEWEAFAC SUITLAND
CMC FLEWEAFAC LONDON
CGFMFLANT FLEWEAFAC JAX
CG 2ND MAW NATC PATUXENT RIVER
CINCLANTFLT NAS BERMUDA
COMNAVAILRANT JAX ARTCC
COMNAVIAIRSYSOM AWS SCOTT AFB
SECNAV ASN (R&D) COM ATL MSL RANGE PATRICK AFB
OSD (DDR&E) NAS JAX
COMCARIBSEAFRON AFWR NAVSTA ROOS RDS
COMSIX NHC MIAMI
COMTEN
COMFAIRJAX
COMFAIRCARIB
NAVSTA ROOS RDS
NWSED ROOS RDS
WEARECONRON FOUR DET SIX
NALCOLANT
SAN JUAN ARTCC
HOUSTON ARTCC
COMNAVBASE GTMO
NEW YORK ARTCC
MIAMI ARTCC

(Includes modification 7753/1 of 28 May 1970)

OPERATION ORDER
RWF JAX NO. 1-70

Project STORMFURY
Fleet Weather Facility
Naval Air Station
Jacksonville, Florida
June 1970

ANNEX C

COMMUNICATIONS PLAN

1. Effectiveness. Communications will be in accordance with NWP 16 and appropriate Joint Allied and Navy Department publications. NWP 16 is effective throughout as applicable to the existing situation unless modified or amplified by this annex.
2. General. This annex provides communications instructions and procedures for aircraft operations during Project STORMFURY.
3. Call Signs. Aircraft call signs are as follows: "STORMFURY" followed by phonetic letter of assigned flight; i.e., STORMFURY ALPHA, STORMFURY BRAVO, etc.
4. Frequency Plan.
 - a. Frequencies are contained in Appendix I to this annex.
 - b. All aircraft will contact the command control aircraft (STORMFURY E, F or G) on UHF (STORMFURY Common) or SSB when prepared to submit OPS Normal Report.
5. Communications with ARTCC.
 - a. Command Control Aircraft. The On-Scene Commander will be responsible for maintaining a continuous communication watch with the appropriate ARTCC and making consolidated, hourly OPS Normal Reports for all participating aircraft, updating the geographical coordinates of the center of the airspace, projected track and rate of movement of reservation area, and notifying the ARTCC when use of the airspace reservation has been terminated. The frequencies are:

(1) San Juan Radio	SSB 6724.5 KHZ, 4712.5 KHZ HF 6567 KHZ
(2) Jacksonville/Miami ARTCC	(1) Day SSB 6724.5 (2) Night SSB 4712.5
 - b. Other Aircraft. Standard air traffic control procedures will be utilized enroute to and from the reservation area. Participating aircraft shall advise ATC when entering the airspace reservation and shall obtain ATC clearance through STORMFURY Command Aircraft prior to departing the area, or remain in VFR flight conditions. Communications with aircraft, including hourly OPS Normal Reports, shall be conducted through STORMFURY Command Control Aircraft, on station.

OPERATION ORDER
FWF JAX NO. 1-70

6. IFF Plan. IFF Plan will be assigned at pre-flight briefing in accordance with FAA criteria. If available, separate squawking modes will be assigned for aircraft departing operating area.
7. Lost Communication Plan. Should an aircraft develop transmitter malfunctions and be unable to transmit, the aircraft shall squawk MODE 3 CODE 01 and "IDENT". Should an aircraft develop receiver difficulties and be unable to receive, or should the aircraft experience both transmitter and receiver difficulties, the aircraft shall squawk MODE 3 CODE 02 and "IDENT".
8. Emission Control Plan (EMCON). EMCON will be directed by the command control aircraft for all experiments.
9. Distress and SAR Communications. Aircraft shall inform the command control aircraft of intentions on assigned frequency. If no contact, aircraft shall attempt communications with ground stations on VHF, UHF or HURRECO frequencies in Appendices I and II to this annex. If unable to contact any station on these frequencies, utilize 243.0 MHZ (AERONAUTICAL EMERGENCY) or 121.5 MHZ (INTERNATIONAL AERONAUTICAL EMERGENCY).



L. J. UNDERWOOD
Commander, U. S. Navy
Navy Project STORMFURY Coordinator

Appendices:

- I - Project STORMFURY Communications Plan

OPERATION ORDER
FWF JAX NO. 1-70

APPENDIX I TO ANNEX C
PROJECT STORMFURY COMMUNICATION PLAN

UHF	SSB	VHF
COMMON 377.1	PRI 15082.5	PRI 141.96
AIR CTL 282.3	SEC 18000.5	SEC 142.68
AIR CTL 371.9	SEC 23228.5	JAX ARTCC 135.05
AIR CTL 387.9	TER 4701.5	JAX ARTCC 123.05
JAX ARTCC 327.0	TER 9011.5	
	TER 13222.5	
	SAN JUAN ARTCC 6724.5	

BLANK PAGE

OPERATION ORDER
FWF JAX NO. 1-70

Project STORMFURY
Fleet Weather Facility
Naval Air Station
Jacksonville, Florida
June 1970

ANNEX D

STORMFURY FORCE OPERATIONS

1. General. STORMFURY operations are authorized and directed by the Chief of Naval Operations under the scientific guidance of the Director, National Hurricane Research Laboratory, with the operational control for the "at sea" portion of the project being exercised by the Commanding Officer, Weather Reconnaissance Squadron FOUR. Research Flight Facility and Air Force forces will participate, as available. Detailed information pertaining to the various experiments are listed in appendices to this annex.

2. Safety. Nothing in this Operation Order or such amplifying instructions as may be issued is intended to prevent the On-Scene Commander from taking whatever action is necessary to ensure safe flight operations, especially as to fuel and weather. Plane Commanders must take prudent and timely action to avoid, insofar as practicable, subjecting aircraft to storm damage. Modifications to flight tracks should be made when required.

3. Coordination Relationships.

a. Direct liaison is authorized between all commands and activities who are directly concerned with the support of STORMFURY operations, keeping the Navy Project Coordinator informed.

b. For all STORMFURY operations, deployment transits or other group operations, the Navy Project Coordinator is the scheduling authority.

c. Prior to 1600Z each day of STORMFURY operations, the Navy Project Coordinator will forward recommendations to CARCAH, Miami, for meeting operational (POD) reconnaissance requirements.

4. STORMFURY Common Instructions.

a. General Briefing.

(1) Time. The Navy Project Coordinator, in conjunction with the Project Director, will notify all activities/units of the specific dates and times for conducting STORMFURY operational briefings.

(2) Place. Designated in message above.

(3) Attendees. Key STORMFURY personnel.

OPERATION ORDER
FWF JAX NO. 1-70

(4) Agenda

- (a) Opening Remarks and Operation Objectives - Director, Project STORMFURY
- (b) Operation Plan Review - Navy Project Coordinator
- (c) Flight Operations and Safety - Commanding Officer, VW-4
- (d) Data Collection and Reporting - Data Quality Control Coordinator
- (e) Aircraft and Equipment Status Reports - Senior Representative Present from Each Activity
- (f) Flight Assignment of Key Personnel - Project Director will assign at or before briefing for each mission.

b. Air Operations.

(1) Filing a Flight Plan. Aircraft will file VFR/IFR flight plans at the staging base to a geographical position to be decided at the pre-flight briefing. Aircraft departing from other bases file flight plans, as appropriate, in order to be on station at scheduled times. Coordination of takeoff and on-station times should be accomplished through STORMFURY Project Officers at the staging base or Fleet Weather Facility, Jacksonville.

(2) Communications, IFF/SIF Procedures. See Annex C. Procedures for aircraft entering and departing STORMFURY operating area will be promulgated at the briefing.

(3) Initial Report. After takeoff, report to ARTCC as required.

(4) Reporting for Control. As soon as practical after reporting to ARTCC, each flight will contact the Command Control Aircraft via UHF/SSB communications and submit an "OPS Normal" report, verify altitude, and standby to be assigned an air controller and air control frequency. Each aircraft will report "OPS Normal", or appropriate condition, to the Command Control Aircraft every hour while under his positive control.

(5) Air Control. Upon assignment of an air controller and air control frequency, each flight will then establish communications on the assigned UHF frequency. Upon establishing UHF communications, the Command Control Aircraft, a Navy WC-121N, will assume air control responsibility for the reporting aircraft by notifying the appropriate ARTCC of the exercise voice call, FAA radio call, altitude and time of assuming control. The Command Control Aircraft will retain this

OPERATION ORDER
FWF JAX NO. 1-70

responsibility until either the controlled aircraft or the Command Control Aircraft departs the operating area, in which case another WC-121N will assume control function. In the event that a shift in mission is required, all aircraft will maintain original voice call. Ensure compliance with air control procedures set forth by FAA in Appendix VIII to this annex.

(6) Communications with ARTCC. Command Control Aircraft responsibilities. See Annex C.

(7) Departing STORMFURY Operating Area. Thirty minutes prior to departing from the STORMFURY operating area, each flight will advise the appropriate Oceanic Control of such plans, obtain clearance, and return independently to the staging base or other operating base. Advise Command Control when departing area.

c. Radarscope Photography. Radarscope photography will be conducted in accordance with Appendix VII of Annex D and the schedule provided by Modus Operandi appendix applicable to each flight. Radarscope Photography Log, as shown in Appendix VII and Annex E, will be completed for each radarscope photographed.

d. Doppler Calibration. All aircraft equipped with doppler navigation equipment will fly a wind calibration box on the outbound and inbound legs of each flight for doppler calibration. Commence wind calibration box pattern using 2½ minute legs. Data will be entered on forms furnished by the Data Quality Control Coordinator as in Annex E.

e. Data Collection Forms. See Annex E.

f. Aircraft Employment. Aircraft will be employed in accordance with the time table, mission and altitude assignments, as described in the appendices of this annex.

g. Altitude Assignments. All flights fly pressure altitude (altimeter set 29.92), except those flights at 1,000 feet, which fly absolute altitude.

h. Abort Contingency.

(1) Decision to abort the mission is an inherent responsibility of the Plane Commander for each aircraft. However, the decision to abort for reason of data measuring instruments failure only should be made after due coordination with the Project Director aboard the Command Control Aircraft.

OPERATION ORDER
FWF JAX NO. 1-70

i. Post-Flight Scientific Debriefing. Selected key crew members attend post-flight debriefing. Deliver flight reports, film, and other material collected.

j. Post-Flight Operational Debriefing. To be announced.



J. UNDERWOOD
Commander, U. S. Navy
Navy Project STORMFURY Coordinator

Appendices:

- I Dry Run Exercises - Eyewall/Rainband
- II Eyewall Experiment
- III Rainsector Experiment
- IV Rainband Experiment
- V Cloudline/Fallback Experiments
- VI Data Logging System
- VII Radar
- VIII Airspace Reservation Agreement

OPERATION ORDER
FWF JAX NO. 1-70

APPENDIX I TO ANNEX D

DRY RUN EXERCISES

1. General. Dry Run Exercises for the Eyewall, Rainsector, and Rainband Experiments will be conducted prior to actual seeding experiments.

a. Dry runs will be conducted from Naval Station, Roosevelt Roads, Puerto Rico on 21 and 23 July 1970. First event is a flight crew briefing at 1400 local, 20 July, at Roosevelt Roads.

b. Center and movement of the eye for these experiments will be simulated. Position and movement will be announced at the briefing.

c. Aircraft missions and mission priorities, flight tracks, voice calls, altitudes, communications procedures and data collection requirements will correspond to those for the Eyewall (Appendix II), Rainsector (Appendix III), and Rainband (Appendix IV) Experiments, as appropriate.

d. On station times for aircraft will be in accordance with Tabs A and B of this annex.

2. Dry Run - Eyewall Experiment. See Appendix II and Tabs A and B of this annex.

3. Dry Run - Rainsector/Rainband. See Appendices III & IV and Tabs C and D of this annex.

TAB A - Time Table for Dry Run, Eyewall Experiment

TAB B - On Station Summary for Dry Run, Eyewall Experiment

TAB C - Time Table for Dry Run, Rainsector/Rainband Experiment

TAB D - On Station Summary for Dry Run, Rainsector/Rainband Experiment

OPERATION ORDER
 FWF JAX NO. 1-70

TAB A TO APPENDIX I TO ANNEX D
 TIME TABLE FOR DRY RUN - EYEWALL EXPERIMENT

49,000	-----	FLT K / RB-57							
37,000	-----	FLT C / WB-57							
33,000	-----	FLT L/A-6	FLT M/A-6	FLT N/A-6	FLT O/A-6	FLT P/A-6			
29,000	-----	FLT I / WC-130	FLT J / WC-130						
10,000	-----	FLT H / WC-121N							
7,000	-----	FLT E / WC-121N							
5,000	-----	FLT A / DC-6	FLT B / DC-6						
1,000	-----	FLT F / WC-121N	/WC-121N / FLT G						
	1300Z	1400Z	1500Z	1600Z	1700Z	1800Z	1900Z	2000Z	
	T-2	T-1	Tango	T+1	T+2	T+3	T+4	T+5	

D-I-A-1

OPERATION ORDER
FWF JAX NO. 1-70

TAB B TO APPENDIX I TO ANNEX D
CHRONOLOGICAL SUMMARY OF ON-STATION TIMES
DRY RUN - EYEWALL EXPERIMENT

<u>Aircraft</u>	<u>Voice Call</u>	<u>On Station</u>	<u>Altitude (MSL)</u>
WC-121	STORMFURY F	1300-1630Z	1,000 ABS
DC-6	STORMFURY A	1330-1630Z	5,000
RB-57	STORMFURY K	1400-1600Z	49,000
WC-121	STORMFURY H	1400-1830Z	10,000
WC-121	STORMFURY E	1400-1900Z	7,000
A-6	STORMFURY L-P	1430 + 1 Hr Intervals	33,000 Out 35,000 Back
WC-130	STORMFURY I	1445-1700Z	29,000
WB-57	STORMFURY C	1500-1630Z	37,000
WC-121	STORMFURY G	1630-1930Z	1,000
WC-130	STORMFURY J	1700-1915Z	29,000
DC-6	STORMFURY B	1630-1930Z	5,000
DC-6	STORMFURY A2	NR	
WB-57	STORMFURY C2	NR	

OPERATION ORDER
FWF JAX NO. 1-70

TAB C TO APPENDIX I TO ANNEX D
 TIME TABLE FOR DRY RUN - RAINSECTOR/RAINBAND EXPERIMENTS

49,000	-----	FLT K/RB-57						
37,000	-----	FLT C / WB-57						
29,000	-----	FLT I / WC-130	FLT J / WC-130					
26,000	-----	FLTS L, M / A-6	FLTS N, O / A-6					
18,000	-----	FLT A / DC-6	Rainband only					
10,000	-----	FLT H / WC-121						
8,000	-----	FLT E / WC-121N						
5,000	-----	FLT B / DC-6						
1,000	-----	FLT F / WC-121N	FLT G / WC-121N					
	1300Z	1400Z	1500Z	1600Z	1700Z	1800Z	1900Z	
	T-2	T-1	Tango	T+1	T+2	T+3	T+4	

D-I-C-1

OPERATION ORDER
FWF JAX NO. 1-70

TAB D TO APPENDIX I TO ANNEX D
CHRONOLOGICAL SUMMARY OF ON-STATION TIMES
DRY RUN - RAINSECTOR/RAINBAND EXPERIMENTS

<u>Aircraft</u>	<u>Voice Call</u>	<u>On Station</u>	<u>Altitude (MSL)</u>
WC-121N	STORMFURY F	1300-1600Z	1,000 ABS
DC-6	STORMFURY B	1330-1800Z	5,000
WC-121N	STORMFURY H	1345-1800Z	10,000
WC-121N	STORMFURY E	1400-1800Z	8,000
DC-6	STORMFURY A	1400-1800Z	18,000 (Rainband only)
WC-130	STORMFURY I	1400-1600Z	29,000
RB-57	STORMFURY K	1430-1600Z	49,000 or Up
WB-57	STORMFURY C	1430-1630Z	37,000
A-6	STORMFURY L & M	1430-1615Z	26,000
WC-130	STORMFURY J	1600-1800Z	29,000
WC-121	STORMFURY G	1600-1830Z	1,000 ABS

BLANK PAGE

OPERATION ORDER
FWF JAX NO. 1-70

APPENDIX II TO ANNEX D

EYEWALL EXPERIMENT

Flight Procedures

1. General. Detailed flight procedures for STORMFURY aircraft are listed in alphabetical flight order as follows:

- a. FLIGHTS A, B, A2: DC-6 (ESSA)
- b. FLIGHTS C, C2: WB-57 (ESSA)
- c. FLIGHT D: C-130 (ESSA)
- d. FLIGHT E: WC-121N (USN)
- e. FLIGHT F: WC-121N (USN)
- f. FLIGHT G: WC-121N (USN)
- g. FLIGHT H: WC-121N (USN)
- h. FLIGHT I, J: WC-130 (USAF)
- i. FLIGHT K, K2: RB-57 (USAF)
- j. FLIGHTS L, M, N, O, P, Q: A-6 (USMC)
- k. FLIGHT U: WC-135 (USAF)

2. DC-6, FLIGHTS A, B, A2

a. Mission. Mid-Level Cloud Physics Monitor.

(1) Mission Priorities:

- (a) Meteorological data
- (b) Radarscope photography, IFF video
- (c) Cloud physics measurements

(2) Modus Operandi

(a) Takeoff in time to arrive on station at 5,000 feet by T-2:30, T+3:30 and T+9:30, FLIGHTS A, B, A2, respectively. Conduct operations in accordance with Tab A/B of this appendix.

b. General Communications. See Annex C.

(1) Initial Report. See Annex D, item 4.b(3).

(2) Reporting for Control. See Annex D, item 4.b(4).

(3) Operations Normal Report. See Annex D, item 4.b(4).

(4) Departing Area Report. See Annex D, item 4.b(7).

OPERATION ORDER
 FWF JAX NO. 1-70

c. Data Collection. Data will be collected in accordance with Annex E.

(1) Meteorological

<u>Interval</u>	<u>Data Recorded</u>	<u>Digital Tape</u>	<u>Photo Panel</u>
Every 5 seconds for Photo Panel	Time	X	X
	Latitude	X	X
Every second for Digital Tape	Longitude	X	X
	Magnetic heading	X	
	Magnetic variation	X	
	D.T.C.	X	
	True airspeed	X	
	Radar altitude	X	X
	Pressure altitude		X
	Differential pressure	X	
	Absolute pressure	X	
	Temp (vortex)	X	X
	Temp (Rosemont)	X	
	Drift angle	X	
	Wind direction	X	X
	Wind speed	X	X
	Pitch angle	X	
	Roll angle	X	
	Absolute humidity	X	
	Liquid water (J.W.)	X	
	CSI Dew Pt Hygro	X	
	Engine power (BMEP)		X
Icing-detector	X		
Interval timer		X	
Flight ID	X		
Monitor switches	X		
Every 15 minutes	Observations and navigation fixes as required to update automatic systems		
Every hour	WWV time check		
Continuous when within 100 mi. of eye, but particularly in eyewall and major rainband.	Visicorder: Levine liquid water instrumentation. Cambridge system total plus water and Rosemont (39C).		

OPERATION ORDER
FWF JAX NO. 1-70

Data Collection (continued)

<u>Interval</u>	<u>Data Recorded</u>
At special positions relative to the eye	Cold Box samples at following positions: (a) <u>Approaching hurricane first time</u> ; just before moving under cirrostratus shield. (b) <u>Approaching eye first pass</u> ; at first evidence of gale force winds. (c) <u>In eyewall</u> ; all passes in which time permits. Where there is insufficient time for samples in eyewall on both sides of center, select samples from the wall nearest radial of seeding. (d) At least one sample <u>in eye</u> before and two after seeding.
d. <u>Radar</u> . Operate radars in accordance with Appendix VII.	
e. <u>Dropsonde</u> . Be prepared to make operational drops, as required by the Plan of the Day (POD).	
f. <u>Center Fixes</u> . Be prepared to make operational fixes of the eye, as required by the POD.	
g. <u>Cloud Photography</u> . Standard operating procedures.	
h. <u>Cancelling of Reserved Airspace</u> . As soon as FLIGHT A2 is outside the reserved airspace, contact ARTCC to report all STORMFURY aircraft are clear of the area, operations terminated for the day.	
i. <u>Post-Flight Debriefing</u> . Selected crew members attend debriefing(s). Deliver flight records, including radar film, to the DOCC.	

TAB A - Flight Track for FLIGHTS A, B and A2

TAB A TO APPENDIX II TO ANNEX D

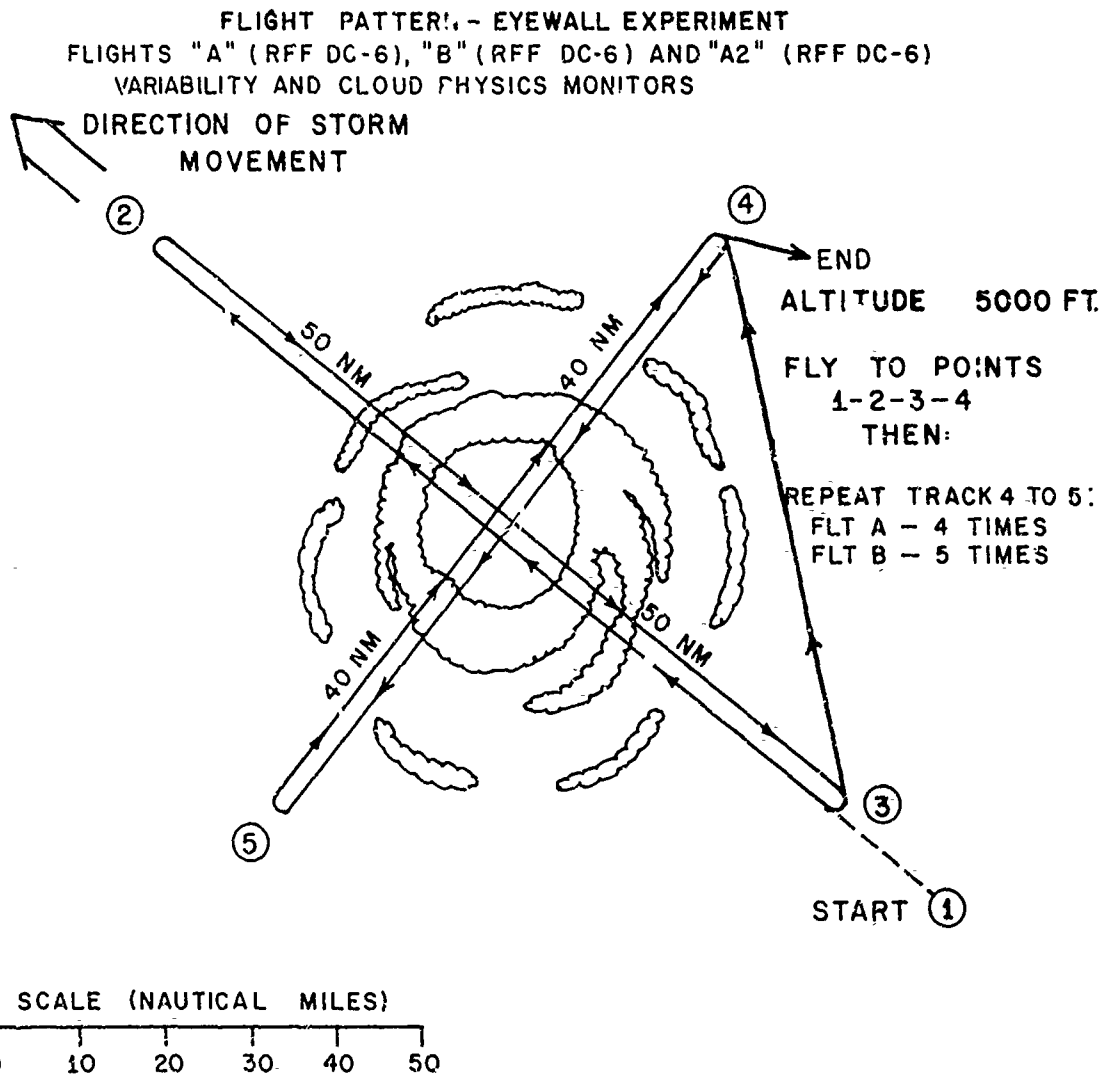

OPERATION ORDER
FWF JAX NO. 1-70

3. WB-57, FLIGHTS C, C2

a. Mission. Outflow Monitor.

(1) Mission Priorities:

- (a) Meteorological data
- (b) Radarscope photography, radar video

(2) Modus Operandi

(a) Takeoff in time to arrive on station at 37,000 feet by T-(2:30) and T+7:00, FLIGHTS C and C2 respectively, as prescribed at the briefing. Conduct operations in accordance with Tab C of this appendix.

b. General Communications. See Annex C.

(1) Initial Report. See Annex D, item 4.b(3).

(2) Reporting for Control. See Annex D, item 4.b(4).

(3) Operations Normal Report. See Annex D, item 4.b(4).

(4) Departing Area Report. See Annex D, item 4.b(7).

c. Cloud Cameras. All nose camera cloud photographs.

d. Meteorological Data Collection. Record data in accordance with Annex E.

<u>Interval</u>	<u>Data Recorded</u>
Every second	Time, latitude, longitude, magnetic heading, magnetic variation, ETC, TAS, radar altitude, differential pressure, absolute pressure, temp (vortex), drift angle, wind direction and speed, pitch angle, roll angle
Every 5 minutes	Manually recorded data for back-up: Absolute altitude, pressure altitude, pressure, temperature, wind direction and speed (or raw navigation to compute same)
Every hour	WWV time check

OPERATION ORDER
FWF JAX NO. 1-70

e. Radar and Radarscope Photography. Unless otherwise directed by command control, operate RDR-1 radar, radarscope and camera systems in accordance with Appendix VII of this annex.

f. Post-Flight Debriefing. Selected crew members attend debriefing(s) and turn in all records of data collected, including radar film, to the DQCC.

TAB C - Flight Pattern for FLIGHTS C and C2

TAB C TO APPENDIX II TO ANNEX D

FLIGHT PATTERN - EYEWALL EXPERIMENT
FLIGHTS "C" AND "C2" (RFF WB-57) ALTITUDE — 37,000 ft.
OUTFLOW MONITOR

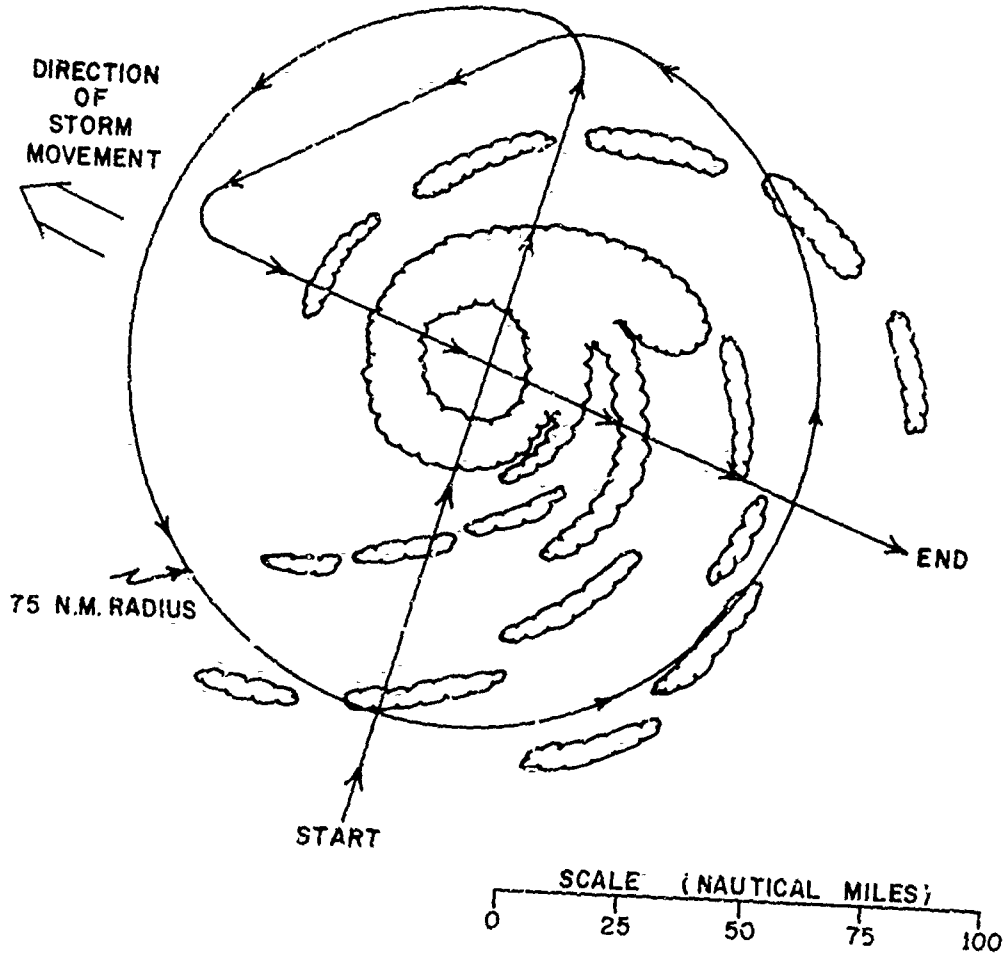

D-IT-C-1

OPERATION ORDER
FWF JAX NO. 1-70

4. C-130, FLIGHT D

a. Mission. Cloud Physics Monitor.

(1) Mission Priorities:

- (a) Meteorological cloud physics data
- (b) Radarscope photography

(2) Modus Operandi

(a) Takeoff in time to arrive on station at 22-25,000 feet at T-1. Conduct operations in accordance with Tab D of this appendix.

b. General Communications. See Annex C.

- (1) Initial Report. See Annex D, item 4.b(3).
- (2) Reporting for Control. See Annex D, item 4.b(4).
- (3) Operations Normal Report. See Annex D, item 4.b(4).
- (4) Departing Area Report. See Annex D, item 4.b(7).

c. Data Collection. Record data in accordance with Annex E.

<u>Interval</u>	<u>Data Recorded</u>
Every 10 seconds	Time, latitude/longitude, magnetic heading, indicated airspeed, radar altitude, pressure altitude, temp (vortex), wind speed and direction, absolute humidity, flight identification
Every 1 minute if AMQ-17 operative; every 5 minutes if AMQ-17 inoperative.	Doppler wind direction/speed. (Visual wind when doppler inoperative)
Every 10 minutes	Visual wind for doppler check
Every 15 minutes routinely and at every significant change of course	Aircraft position (range/bearing from eye)
Every hour	WWV time check

OPERATION ORDER
FWF JAX NO. 1-70

- d. Radar. Operate in accordance with Appendix VII or as briefed.
- e. Post-Flight Debriefing. Selected crew members attend debrief, turn in all records of data collected, including radar film, to the DQCC.

TAB D - Flight Pattern for FLIGHT D

D-11-7

TAB D TO APPENDIX II TO ANNEX D

FLIGHT PATTERN-EYEWALL EXPERIMENT
FLIGHT "D" (RFF WC-130) ALTITUDES 22-25,000 FT.
CLOUD PHYSICS MONITOR

DIRECTION
OF
STORM
MOVEMENT

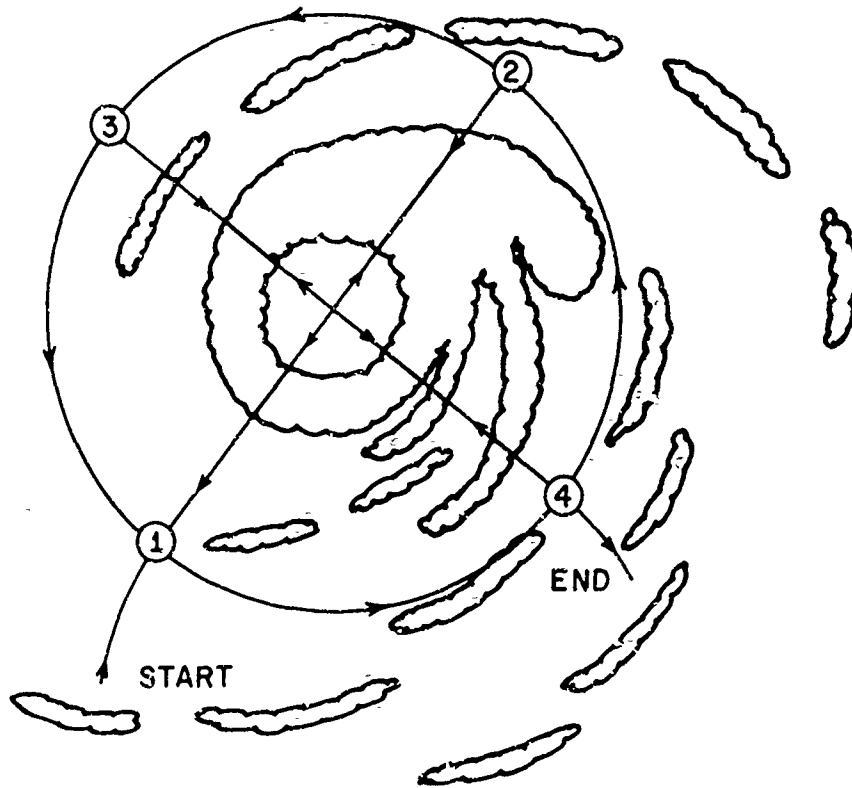

ORDER OF FLIGHT PATTERN BY POINTS
(1-2-1) 25,000 FT. DESCEND
(1-4-3-4-2-1-2-3-4-3-1-2-1) 22,000 FT.
(1-4) CLIMB
(4-3-4) 25,000 FT.

SCALE (NAUTICAL MILES)

0 25 50 75 100

D-II-D-1

OPERATION ORDER
FWF JAX NO. 1-70

5. WC-121, FLIGHT E

a. Mission. Command Control Aircraft.

(1) Mission Priorities:

- (a) Aircraft control and command
- (b) Radarscope photography, radar and IFF video

(2) Modus Operandi

(a) Takeoff in time to arrive on station at 7,000 feet at T-1 and conduct flight operations in accordance with Tab E of this appendix.

b. General Communications. See Annex C.

(1) Initial Report. See Annex D, item 4.b(3).

(2) Reporting for Control. As soon as FLIGHTS A, C, F and H are held independently on radar, contact FLIGHT F on UHF/SSB and copy air control frequencies assigned to each flight. As soon as each flight is contacted on these respective frequencies, notify FLIGHT F that he is relieved of on-scene command for these flights. Determine the axis and area for the initial seeding run. Notify ARTCC when air control responsibilities for these flights have been assumed by reporting the flight identification, aircraft type and altitude.

(3) Operations Normal Report. See Annex D, item 4.b(4).

c. Assignment of Air Control Frequency and Air Controller. As each flight checks in on UHF/SSB, it is to report OPS Normal and verify altitude and flight identification. Air Controller will then assign an air control frequency and air controller for each aircraft, except the seeding aircraft. All seeding aircraft will be assigned to the same air control frequency and air controller.

d. Vector Control. Air Controller will vector seeding aircraft to perform assigned missions along applicable flight tracks; other aircraft will be under surveillance only. Tab A of Appendix I to Annex D is the time table for STORMFURY aircraft employment. Tab B of Appendix I to Annex D is a chronological summary of aircraft employed in the STORMFURY experiments.

e. Communications with ARTCC. Command control responsibilities. See Annex C.

f. Shift of Command Control. At time T+8:30, contact FLIGHT G. After verification that the APS-20 is in "up" status, FLIGHT G will exercise surveillance control for FLIGHTS B, C2, J and A2.

OPERATION ORDER
FWF JAX NO. 1-70

g. Data Collection. Record data in accordance with Annex E. Channelization for the DLS as in Appendix VI

(1) Meteorological Parameters

<u>Interval</u>	<u>Data Required</u>
DLS operative, 1 minute.	All available channels
Every 5 minutes	Time, pressure, relative humidity, absolute altitude, pressure altitude, range/bearing from eye. Wind direction/speed (or raw navigation data to obtain same)
Every 10 minutes	Latitude, longitude
Every hour	WWV time check

(2) Radar. Operate radars as required for airborne air control of all aircraft under air control. Photograph IFF and weather video as prescribed in Appendix VII of this annex.

h. Post-Flight Debriefing. Selected crew members attend debriefing(s). Deliver flight records and film to the DQCC.

TAB E - Flight Pattern for FLIGHT E

TAB E TO APPENDIX II TO ANNEX D

FLIGHT PATTERN - EYEWALL EXPERIMENT
FLIGHT "E" (NAVY WC-121N) ALTITUDE 7,000 ft.
COMMAND AND CONTROL

DIRECTION
OF
STORM
MOVEMENT

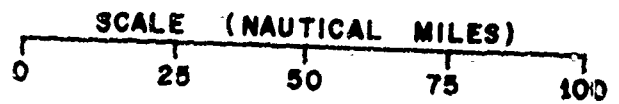
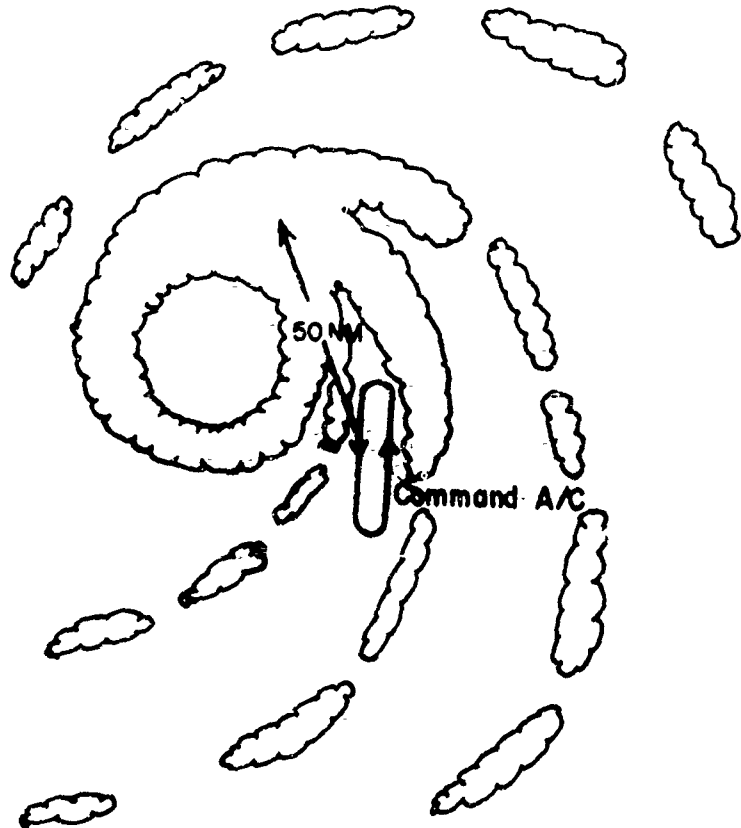

D-II-E-1

OPERATION ORDER
FWF JAX NO. 1-70

6. WC-121, FLIGHT F

a. Mission. Radar and Inflow Monitor.

(1) Mission Priorities.

- (a) Back-up for FLIGHT H.
- (b) Meteorological and oceanographic data.
- (c) Radarscope photography, radar video.

(2) Modus Operandi

(a) Takeoff in time to arrive at a point 50 nautical miles from the hurricane eye center at 1,000 feet absolute at T-2:20. Make circumnavigations of eye center with eye penetrations as depicted in pattern, Tab F.

b. General Communications. See Annex C.

(1) Initial Report. See Annex D, item 4.b(3).

(2) Command Control. FLIGHT F will assume command of FLIGHTS A, C and H until relieved of these duties at T-1 by FLIGHT E.

(3) Communications with ARTCC. Command control responsibilities. See Annex C.

c. Data Collection Requirements (within 100 nautical miles of eye). Record data in accordance with Annex E; channelization will be in accordance with Appendix VI.

Interval

Data Collected

(Same as FLIGHT E, Eyewall Experiment)

d. Radars and Radarscope Photography. Operate in accordance with Appendix VII of this annex.

e. Post-Flight Debriefing. Turn in all records of data collected, including radar film, to the DQCC.

TAB F - Flight Pattern for FLIGHT F

OPERATION ORDER
FWF JAX NO. 1-70

7. WC-121, FLIGHT G

a. Mission. Radar and Inflow Monitor.

(1) Mission Priorities:

- (a) Meteorological and oceanographic data
- (b) Radarscope photography, radar and IFF video.

(2) Modus Operandi.

(a) Takeoff in time to arrive at the nearest point 50 nautical miles from the hurricane eye center at an absolute altitude of 1,000 feet at T+5:30. Make circumnavigations of the eye center with eye penetrations as depicted in pattern, Tab G.

b. General Communications. See Annex C.

(1) Initial Report. See Annex D, item 4.b(3).

(2) Command Control. FLIGHT G will assume command control of FLIGHT A2.

(3) Communications with ARTCC. Command control responsibilities. See Annex C.

c. Data Collection Requirements (within 100 nautical miles of eye). Record data in accordance with Annex F, channelization to be in accordance with Appendix VI.

Interval

Data Collected

(Same as FLIGHT E, Eyewall Experiment)

d. Departing Area. At T+13:30, FLIGHT G will proceed independently to staging base, advising FLIGHT A2 of departure.

e. Radars and Radarscope Photography. Operate in accordance with Appendix VII to this annex.

f. Post-Flight Debriefing. Turn in all records of data collected, including film, to the DQCC.

TAB F - Flight Pattern for FLIGHT G

TAB F TO APPENDIX II TO ANNEX D

FLIGHT PATTERN - EYEWALL EXPERIMENT
FLIGHTS "F" AND "G" (NAVY WC-121N) ALTITUDE 1,000 FT
RADAR AND INFLOW MONITOR
COMPLETE PATTERN FOUR TIMES EACH FLIGHT

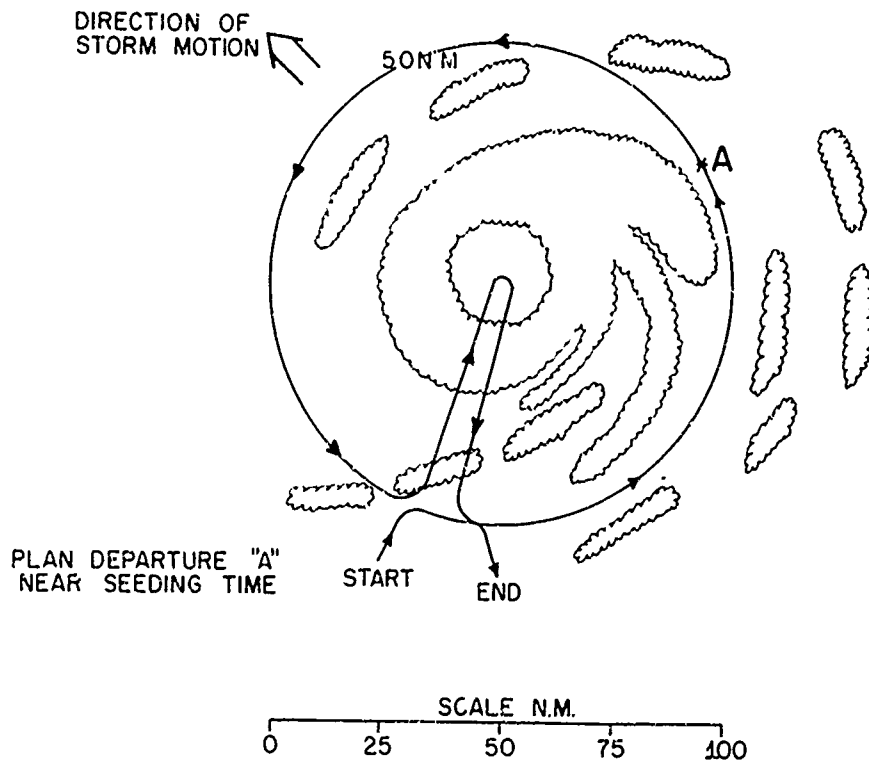

OPERATION ORDER
FWF JAX NO. 1-70

8. WC-121, FLIGHT H

a. Mission. Radar Monitor and Back-up Command Control

(1) Mission Priorities:

- (a) Radarscope photography, radar and IFF video
- (b) Back-up command control aircraft
- (c) Meteorological data, mid-level
- (d) Dropsonde

(2) Modus Operandi

(a) Takeoff in time to arrive on station at T-1:30 and conduct flight operations in accordance with Tab H of this appendix.

b. General Communications. See Annex C.

(1) Initial Report. See Annex D, item 4.b(3).

(2) Reporting for Control. See Annex D, item 4.b(4).

(3) Operations Normal Report. See Annex D, item 4.b(4).

c. Data Collection Requirements (within 100 nautical miles of the eye). Record data in accordance with Annex E.

Interval

Data Collected

(Same as FLIGHT E, Eyewall Experiment)

d. Radar and Radarscope Photography. Operate in accordance with Appendix VII to this annex.

e. Post-Flight Debriefing. Turn in all records of data collected, including film, to the DQCC.

TAB H - Flight Pattern for FLIGHT H

TAB H TO APPENDIX II TO ANNEX D

FLIGHT PATTERN - EYEWALL EXPERIMENT
FLIGHT "H" (NAVY WC-121N) ALTITUDE 10,000 ft.
RADAR MONITOR

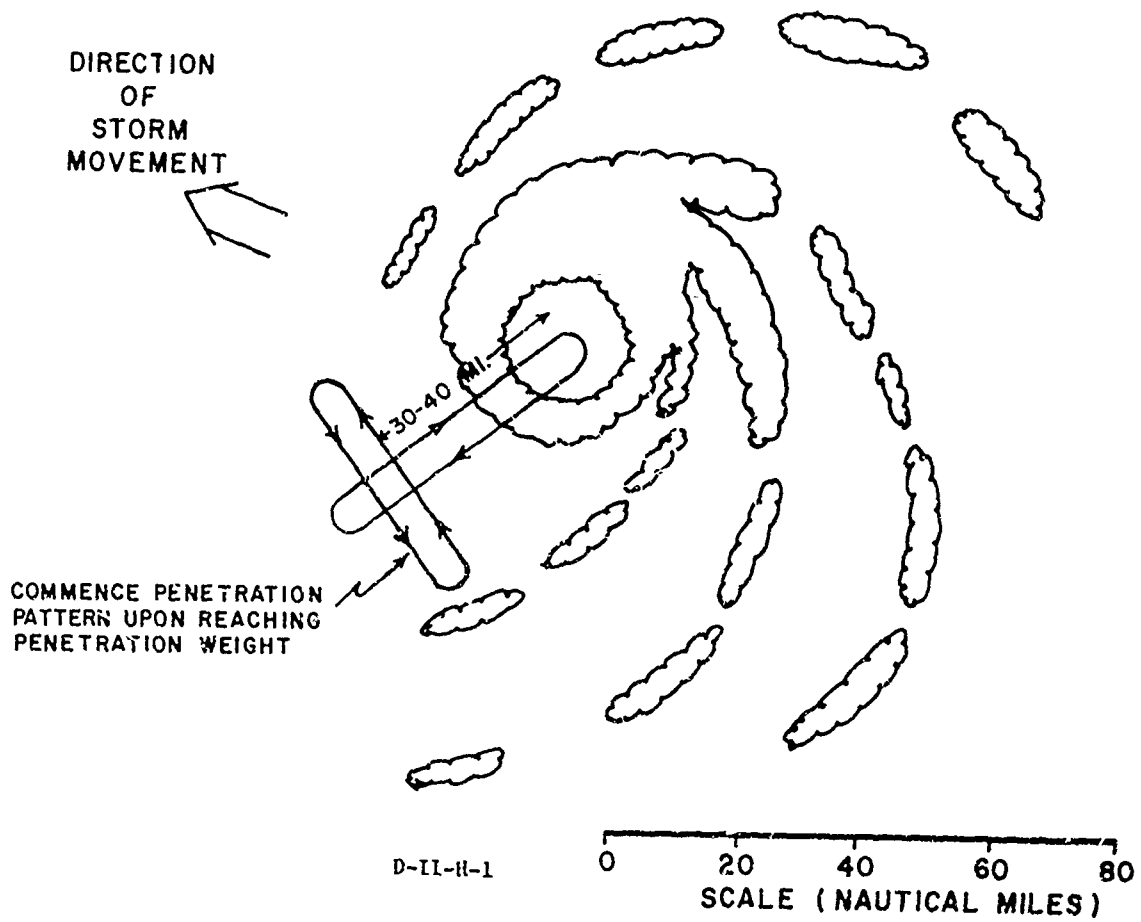

OPERATION ORDER
FWF JAX NO. 1-70

9. WC-130, FLIGHTS I and J

a. Mission. Outflow Monitor and Dropsonde

(1) Mission Priorities:

- (a) Meteorological data (dropsondes)
- (b) Radarscope photography, radar video

(2) Modus Operandi

(a) Takeoff in time to arrive on station at 29,000 feet by T-3:30 and T+4:30 respectively. Conduct operations in accordance with Tab I of this appendix.

b. General Communications. See Annex C.

- (1) Initial Report. See Annex D, item 4.b(3).
- (2) Reporting for Control. See Annex D, item 4.b(4).
- (3) Operations Normal Report. See Annex D, item 4.b(4).
- (4) Departing Area Report. See Annex D, item 4.b(7).

c. Data Collection Requirements. Record data in accordance with Annex E.

(1) Meteorological:

<u>Interval</u>	<u>Data Recorded</u>
Every 5 minutes	Time, wind direction and speed, ambient temperature, pressure, altitude and radar altitude. A/C position (lat/long)
Every 10 minutes	Range and bearing of eye center.
Every 15 minutes	Observations as required for updating doppler and automatic recording equipment.
Every hour	WWV time check

(2) Radar. Operate in accordance with Appendix VII of this annex.

d. Post-Flight Debriefing. Attend post-flight debriefing. If not feasible, retain all copies of all data collected, including film, at base of flight origin to be hand-delivered to the DOCC. Under no circumstances will records or film be mailed.

TAB I - Flight Pattern for D-II-13
FLIGHTS I and J

TAB I TO APPENDIX II TO ANNEX D

FLIGHT PATTERN - EYEWALL EXPERIMENT
FLIGHT "I" & "J" (AF WC-130) ALTITUDE 29,000 ft.
OUTFLOW MONITOR
AND DROPSONDES (D)

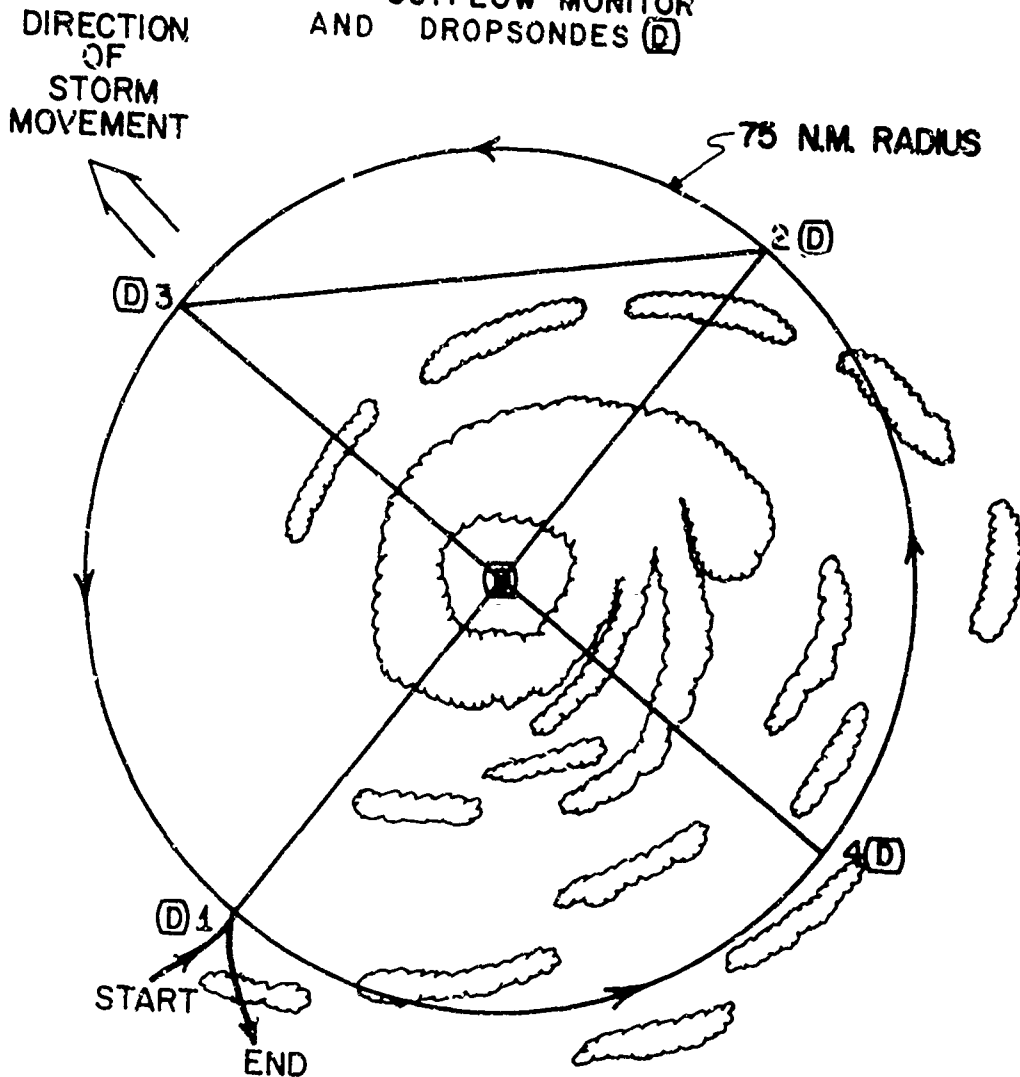

START AT "1" TO "2" CIRCUMNAVIGATE TO "2" DIRECT
TO "3" THEN TO "4" CIRCUMNAVIGATE TO "4" DIRECT
TO "3" DIRECT TO "2" AND THEN TO "1" (REPEAT
AS TIME PERMITS)

SCALE (NAUTICAL MILES)

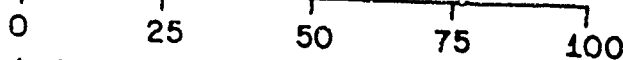

NOTE: Permission to DROP must be obtained from Command Control

OPERATION ORDER
FWF JAX NO. 1-70

10. RB-57, FLIGHTS K and K2

a. Mission. High Level Cloud Photography.

(1) Takeoff in time for first sortie to arrive on station "I" at 49,000 feet at T-0:20. Conduct operations in accordance with Tab K of this appendix. A total of two sorties will be flown to provide maximum coverage until sunset, as briefed prior to the K2 mission.

b. General Communications. See Annex C.

(1) Initial Report. See Annex D, item 4.b(3).

(2) Reporting for Control. See Annex D, item 4.b(4).

(3) Operations Normal Report. See Annex D, item 4.b(4).

(4) Departing Area Report. See Annex D, item 4.b(7).

c. Data Collection Requirements. Record data in accordance with Annex E.

(1) Meteorological Data. Record following every five minutes:

- | | |
|-----------------|-----------------------|
| (a) Time | (f) CAS |
| (b) Position | (g) Absolute altitude |
| (c) TAS | (h) Ground speed |
| (d) Altitude | (i) Drift angle |
| (e) Temperature | |

(2) Cloud Photography. Camera is to be operated to provide full coverage of hurricane clouds on each pass.

TAB K - Flight Pattern for FLIGHTS K and K2

TAB K TO APPENDIX II TO ANNEX D

FLIGHT PATTERN - EYEWALL EXPERIMENT
FLTS "K"8"K2"(AF RB-57F) ALTITUDE 49,000ft. or above
REPEAT 3-2-3 PATTERN AS LONG AS POSSIBLE
CLOUD MAPPING

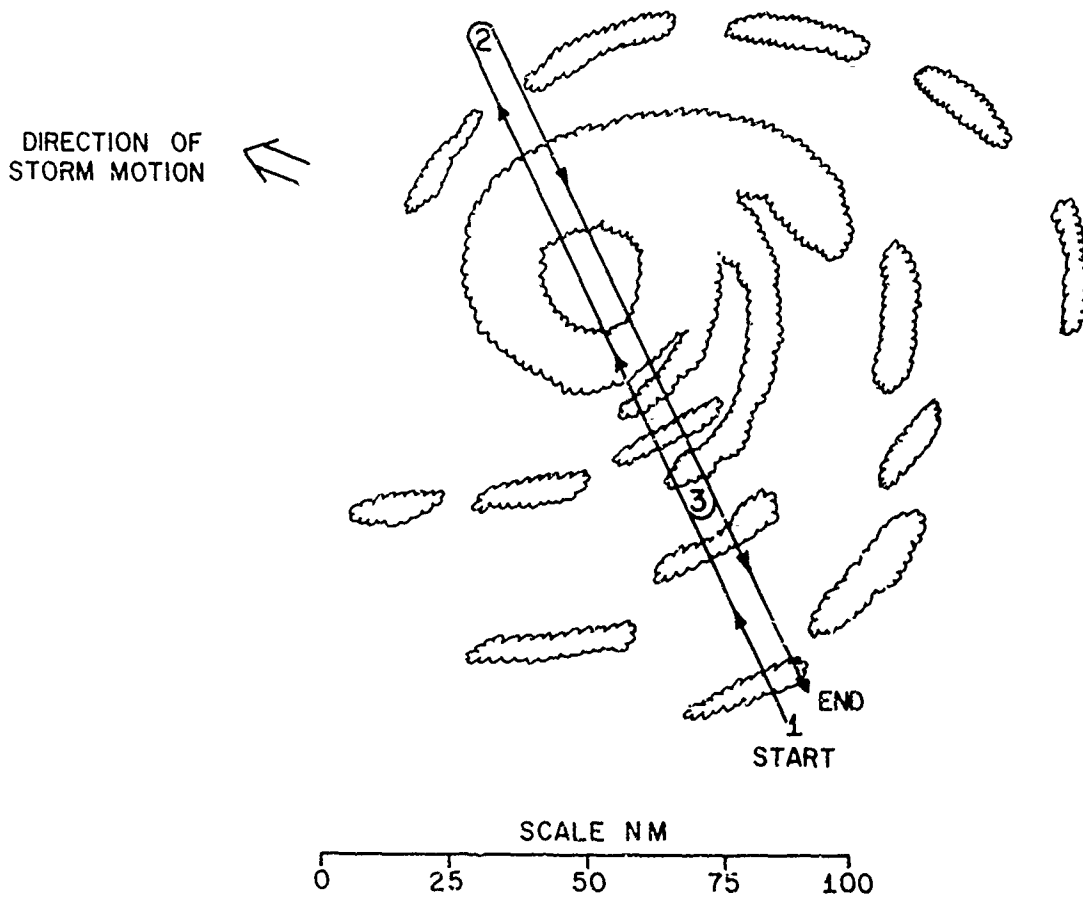

D-II-K-1

OPERATION ORDER
FWF JAX NO. 1-70

11. A-6, FLIGHTS L, M, N, O, P, Q

a. Mission. Seeder Aircraft

(1) Mission Priorities:

- (a) Pyrotechnic devices delivery
- (b) Meteorological data, high level
- (c) Radarscope photography, if available
- (d) Random photography, if available

(2) Modus Operandi

(a) Seeder Aircraft. Takeoff in time to arrive on station at 33,000 feet at times shown in Tab L. Conduct flight operations in accordance with Tab M.

b. General Communications. See Annex C.

- (1) Initial Report. See Annex D, item 4.b(3).
- (2) Reporting for Control. See Annex D, item 4.b(4).
- (3) Operations Normal Report. See Annex D, item 4.b(4).
- (4) Departing Area Report. See Annex D, item 4.b(7).

c. Flight Operations. Track to be flown is shown in Tab L of this appendix.

(1) Pre-seeding. Prior to the actual seeding run, each seeding flight will be vectored around the hurricane, as practicable, and arrive in the seeding run area fifteen minutes prior to scheduled drop time.

(2) Seeding. The track to be flown during the seeding run will be determined by the Project Director and relayed to each flight by the assigned air controller. This track will take into account "hard core" areas, if any, which will be avoided by use of radar information. The air controller will notify each aircraft at the 25, 10, 5 and every mile thereafter to the drop point. Indicated air speed during the seeding run should be 240 knots \pm 10 knots. Pyrotechnic canister drop will commence 5 seconds after entering the wall cloud, outbound, or as briefed prior to flight. The seeding aircraft will commence the release of two hundred eight (208) pyrotechnic canisters at a rate of approximately twelve each mile (approximately one every $\frac{1}{2}$ second). Report commencement and completion of drops to command control. If unable to commence release of pyrotechnic canisters within 30 seconds after being so directed, cease seeding attempts and notify command control. Determination of a second seeding attempt will be discussed with command control before the seeder departs the STORMFURY airspace reservation.

OPERATION ORDER
FWF JAX NO. 1-70

(3) Post-seeding. After completion of drop or abort, activate return flight plan for 35,000 feet, check out with Command Control and proceed independently to the staging base. Upon return, determine the exact number of canisters dropped and include this information for debriefing purposes.

d. Data Collection Requirements. Record data in accordance with Annex E (Forms SF-3 and SF-4).

(1) Radarscope Photography. If possible, operate in accordance with Appendix VII to this annex.

(2) Cloud Photography. Operate hand-held camera to obtain vertical profiles of clouds, as briefed.

(3) Meteorological Data. Collect and correlate with time as much of the following information as possible:

- (a) CAS
- (b) Temperature
- (c) Absolute altitude
- (d) Pressure altitude
- (e) Ground Speed
- (f) Drift angle
- (g) Ambient pressure

e. Post-Flight. Attend debriefing and turn in all records and film to the DOCC.

TAB L - Seeding Aircraft Flight Schedule
TAB M - Flight Track for Seeding Aircraft

OPERATION ORDER
FWF JAX NO. 1-70

TAB L TO APPENDIX II TO ANNEX D
SEEDING AIRCRAFT FLIGHT SCHEDULE

(Based on hurricane center not more than 600 NM from staging base)

FLIGHT	AIRCRAFT	TANGO(T)	T+2	T+4	T+6	T+8
L	A-6	DROP				
		HOLDING	DROP			
M	A-6	STANDBY				
			HOLDING	DROP		
N	A-6		STANDBY			
				HOLDING	DROP	
O	A-6			STANDBY		
					HOLDING	DROP
P	A-6				STANDBY	
						HOLDING
Q	A-6					STANDBY

First seeding aircraft arrive on station at T-(0+10) at 33,000 feet. All subsequent seeding aircraft arrive on station 20 minutes prior to scheduled drop time, for the aircraft they are to back-up.

TAB M TO APPENDIX II TO ANNEX D

FLIGHT PATTERN-EYEWALL EXPERIMENT
FLIGHTS "L,M,N,O,P,Q" (M.C. A-6's) ALTITUDE 33,000 ft.
SEEDERS

FLIGHT TRACK FOR SEEDING AIRCRAFT

DIRECTION OF STORM
MOVEMENT

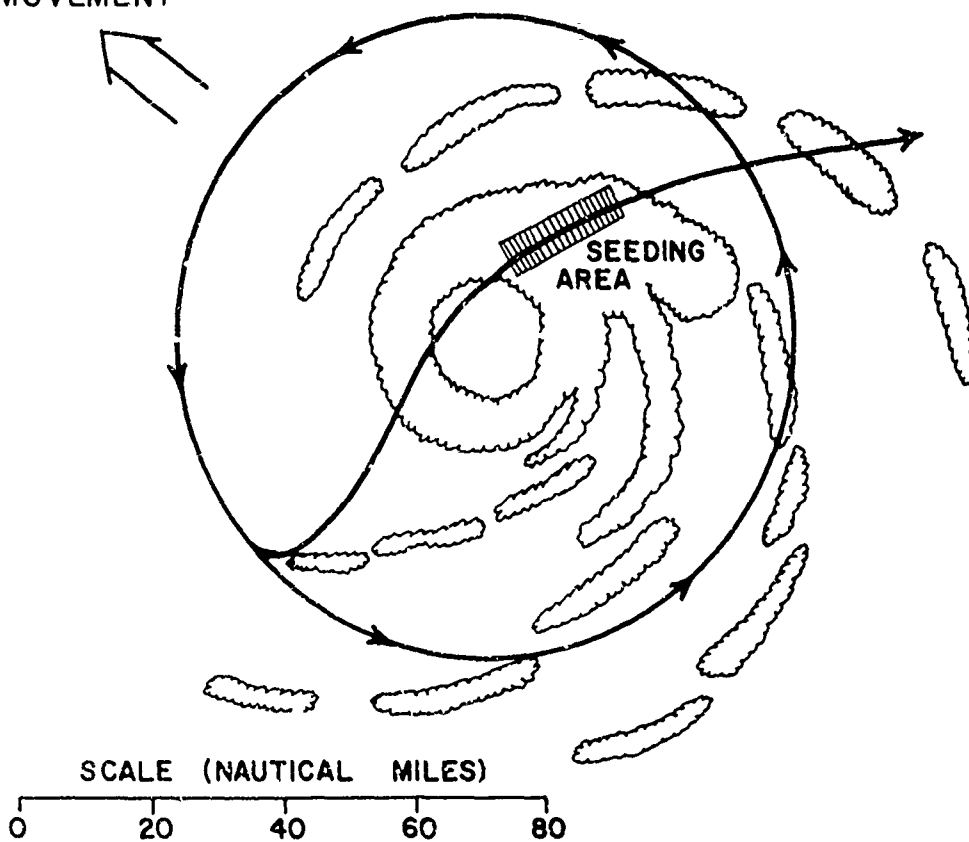

D-II-M-1

OPERATION ORDER
FWF JAX NO. 1-70

12. WC-135, FLIGHT U

a. Mission. Outflow Monitor

(1) Takeoff in time to arrive on station at 41,000 feet at Tango plus 1 hour. Conduct operations in accordance with Tab N of this appendix.

b. General Communications. See Annex C.

(1) Initial Report. See Annex L, item 4.b(3).

(2) Reporting for Control. See Annex D, item 4.b(4).

(3) Operations Normal Report. See Annex D, item 4.b(4).

(4) Departing Area Report. See Annex D, item 4.b(7).

c. Data Collection. Record data in accordance with Annex E or as briefed.

d. Post-Flight. Selected crew members attend debriefing, as feasible, and turn in all records of data collected.

TAB N - Flight Pattern for FLIGHT U
TAB O - Chronological Summary of Aircraft
TAB P - Time Table for Aircraft
TAB Q - Flight Track Summary

TAB N TO APPENDIX II TO ANNEX D

FLIGHT PATTERN--EYEWALL EXPERIMENT
FLIGHT "U" (AF WC-135). ALTITUDE 41,000 FT
OUTFLOW MONITOR

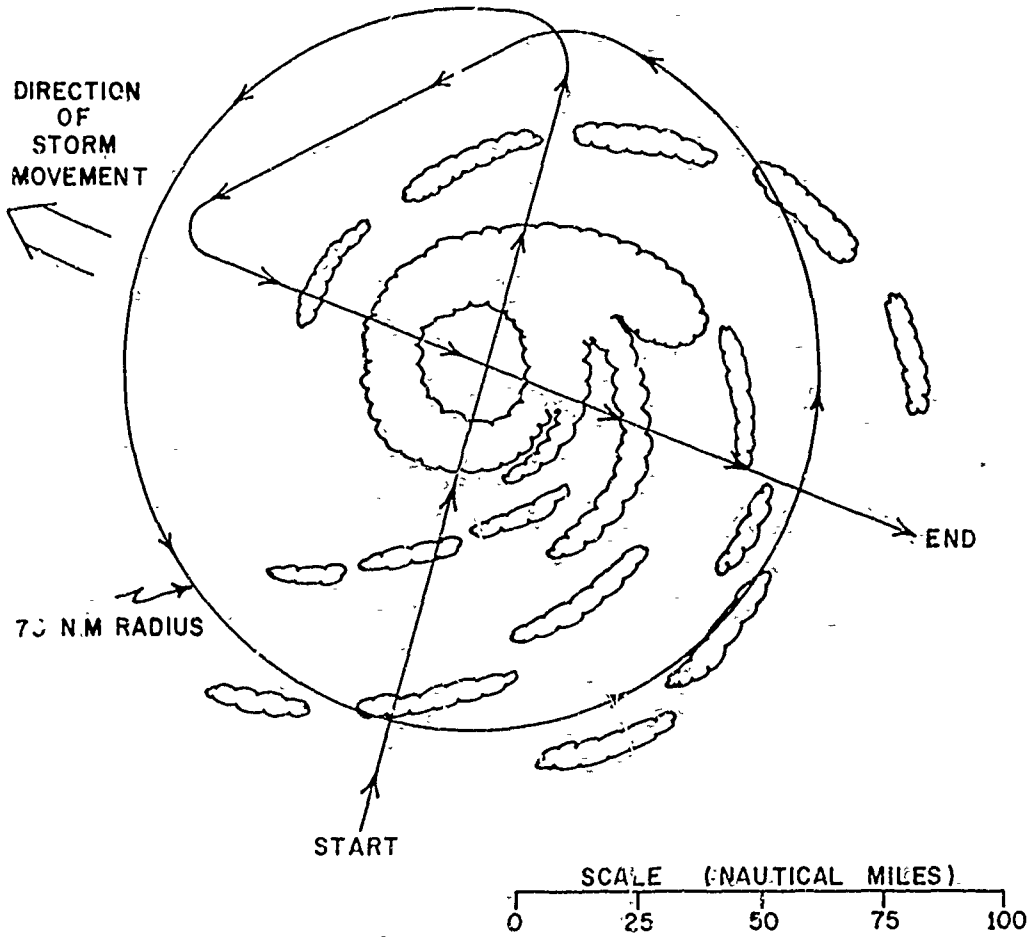

D-II-S-1

OPERATION ORDER
FWF JAX NO. 1-70

TAB O TO APPENDIX II TO ANNEX D
CHRONOLOGICAL SUMMARY OF ON-STATION TIMES
EYEWALL EXPERIMENT

<u>Aircraft</u>	<u>Voice Call</u>	<u>On Station</u>	<u>Altitude (MSL)</u>
WC-130	STORMFURY I	T-3:30 to T+2	29,000
DC-6	STORMFURY A	T-2:30 to T+2:30	5,000
WB-57	STORMFURY C	T-2:20 to T	37,000
WC-121	STORMFURY F	T-2:30 to T+4	1,000 ABS
WC-121	STORMFURY H	T-1:30 to T+7	10,000
WC-130	STORMFURY D	T-1 to T+4	22-25,000
WC-121	STORMFURY E	T-1 to T+9	7,000
RB-57	STORMFURY K	T-0:30 to T+2	49,000
A-6	STORMFURY L-Q	T-0:30 to T+8	33-35,000
WC-135	STORMFURY U	T+1 to T+8	41,000
DC-6	STORMFURY B	T+3:30 to T+9	5,000
WC-130	STORMFURY J	T+4:30 to T+10	29,000
RB-57	STORMFURY K2	T+6:30 to T+9	49,000
WC-121	STORMFURY G	T+7 to T+14	1,000
WB-57	STORMFURY C2	T+7 to T+9	37,000
DC-6	STORMFURY A2	T+9:30 to T+15	5,000

TAB P TO APPENDIX II TO ANNEX D
 TIME TABLE FOR STORMFURY AIRCRAFT EMPLOYMENT EYEWALL EXPERIMENT 1

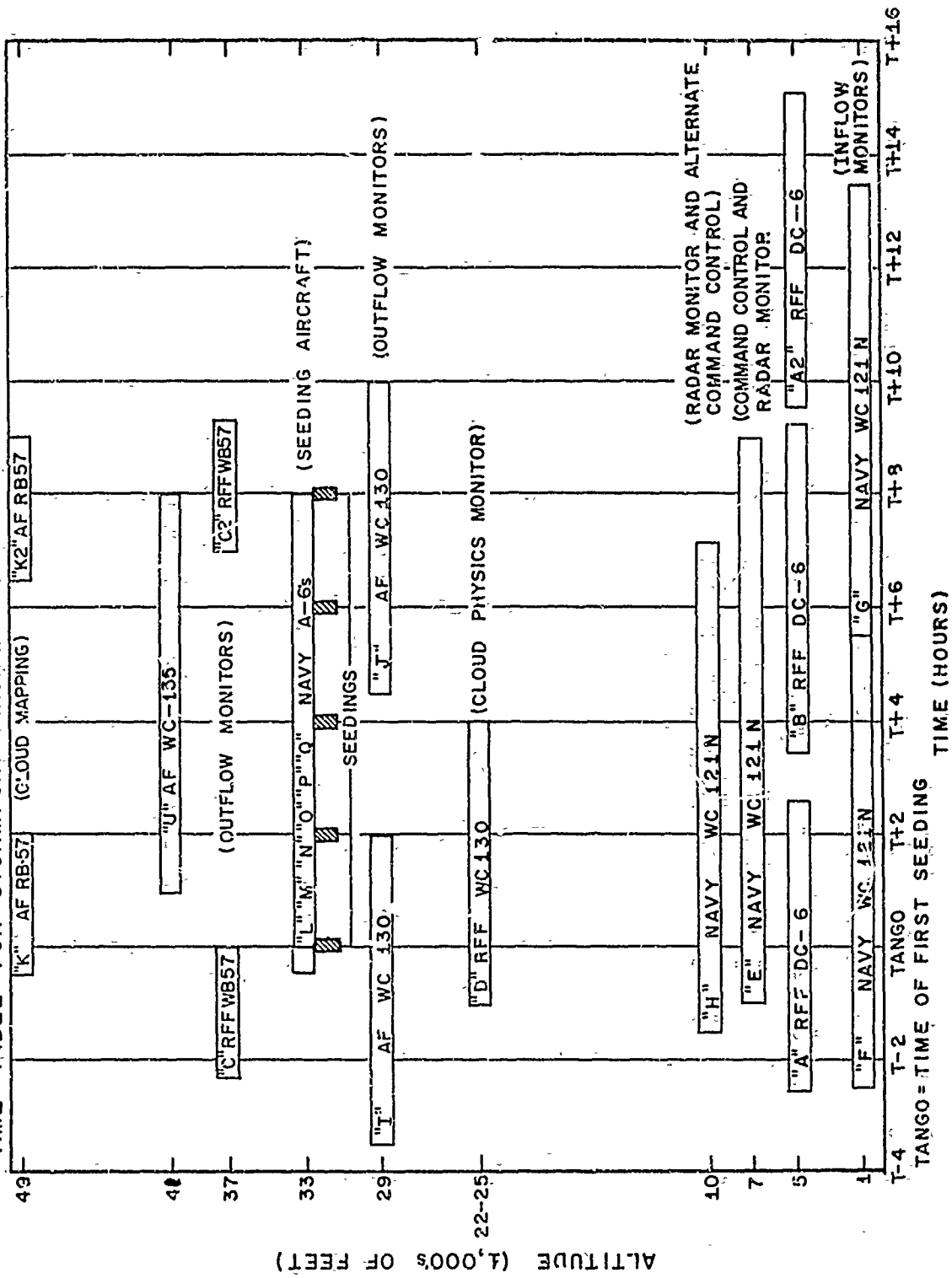

EYEWALL EXPERIMENT



49,000 FT.

TAB Q TO APPENDIX II TO ANNEX D

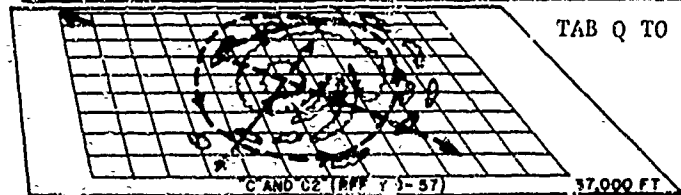

37,000 FT.

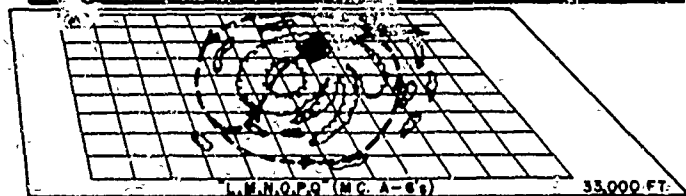

33,000 FT.



29,000 FT.

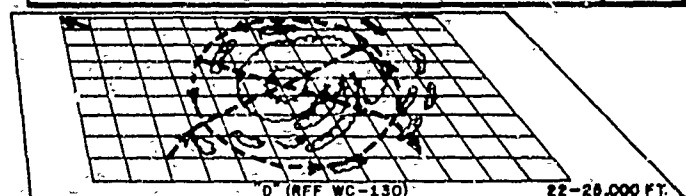

22-28,000 FT.

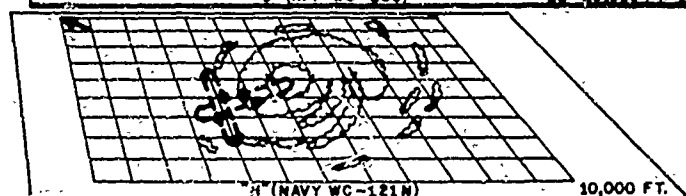

10,000 FT.

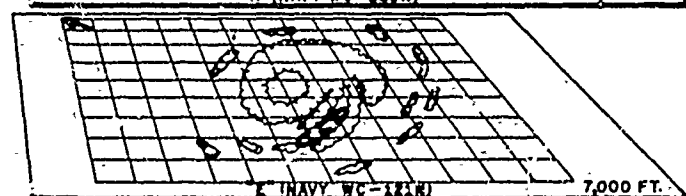

7,000 FT.

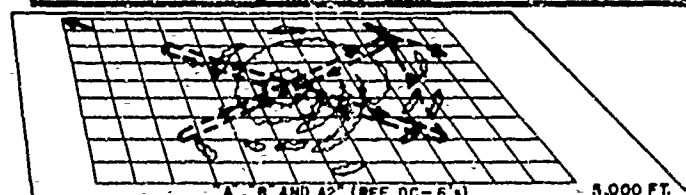

5,000 FT.



1,000 FT.

D-II-Q-1

BLANK PAGE

OPERATION ORDER
FWF JAX NO. 1-70

APPENDIX III TO ANNEX D

RAINSECTOR EXPERIMENT

Flight Procedures

1. General. Flight procedures for STORMFURY aircraft are listed in alphabetical order, as follows:

- a. FLIGHTS A, B, A2: DC-6 (ESSA)
- b. FLIGHT C: WB-57 (ESSA)
- c. FLIGHT D: WC-130 (ESSA)
- d. FLIGHT E: WC-121 (USN)
- e. FLIGHTS F, G: WC-121 (USN)
- f. FLIGHT H: WC-121 (USN)
- g. FLIGHTS I, J: WC-130 (USAF)
- h. FLIGHTS K, K2: RB-57 (USAF)
- i. FLIGHTS L, M, N, O, P: A-6 (USMC)
- j. FLIGHT S: WP-3 (USN)
- k. FLIGHT U: WC-135 (USAF)

2. DC-6, FLIGHTS A, B, A2

- a. Mission. Variability and Cloud Physics Monitor.

Take off in time to arrive on station at 5,000 at T-3:30, T+3, and T+9, respectively. Conduct operations in accordance with Tab A.

- *b. General Communications and Reports.

- *c. Data Collection.

- *d. Radar.

- *e. Dropsondes.

- *f. Cloud photography.

- *g. Post-flight.

*Same as Eyewall Experiment, FLIGHT A.

h. FLIGHT A2, when returning to base, will notify ARTCC that use of airspace reservation has been terminated for the day.

TAB A - Flight Pattern for FLIGHTS A, B, A2

TAB A TO APPENDIX III TO ANNEX D

FLIGHT PATTERN RAIN SECTOR EXPERIMENT
 FLIGHTS "A", "B", "A2" (RFF DC-6B) ALTITUDE 5,000 FT.
 T₀ = STARTING TIME OF FIRST SEEDING

FLIGHT	START	PATTERN SEQUENCE
"A"	T ₀ -2:45	1-2-3-4-3-4
"B"	T ₀ +3:00	-3-4-5
"A2"	T ₀ +9:00	

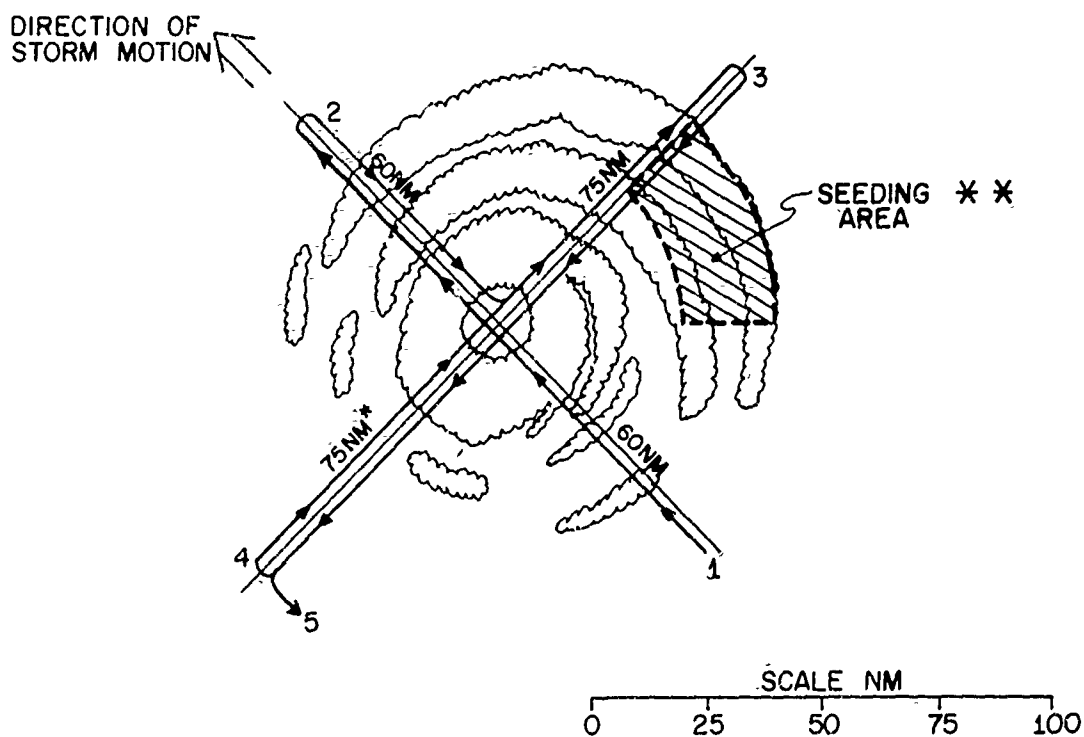

* Length of pattern adjustable to have the aircraft in the eye heading toward the seeding area 50 minutes after the beginning of each seeding. (Length must exceed radius of maximum winds)

** SEE SEEDER FLIGHT PLAN

OPERATION ORDER
FWF JAX NO. 1-70

3. WB-57, FLIGHTS C, C2

a. Mission. Outflow Monitor. Take off in time to arrive on station at 37,000 feet at T-2:20 and T+7, respectively. Conduct operations in accordance with Tab C.

- *b. General Communications and Reports.
- *c. Cloud Cameras.
- *d. Data Collection.
- *e. Radar and Radarscope Photography.
- *f. Post-Flight.

*Same as Eyewall Experiment, FLIGHT C.

4. WC-130, FLIGHT D

a. Mission. Cloud Physics Monitor. Take off in time to arrive on station at 18,000 feet by T-1. Conduct operations in accordance with Tab D.

- *b. General Communications and Reports.
- *c. Meteorological Data Collection.
- *d. Radar.
- *e. Post-Flight Debrief.

*Same as Eyewall Experiment, FLIGHT C.

5. WC-121, FLIGHT E

a. Mission. Command Control and Radar Monitor. Take off in time to arrive on station at 8,000 feet by T-0:30. Conduct operations in accordance with Tab D.

- *b. General Communications.
- *c. Data Collection.
- *d. Departing Area.
- *e. Post-Flight.

*Similar to Rainband Experiment, FLIGHT E.

TAB C - Flight Pattern for FLIGHT C
TAB D - Flight Pattern for FLIGHT D
TAB E - Flight Pattern for FLIGHT E

TAB C TO APPENDIX III TO ANNEX D

FLIGHT PATTERN RAIN SECTOR EXPERIMENT
FLIGHTS "C" AND "C2" (RFF WB-57) ALTITUDE—37,000 FT.
OUTFLOW MONITOR

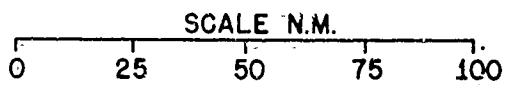
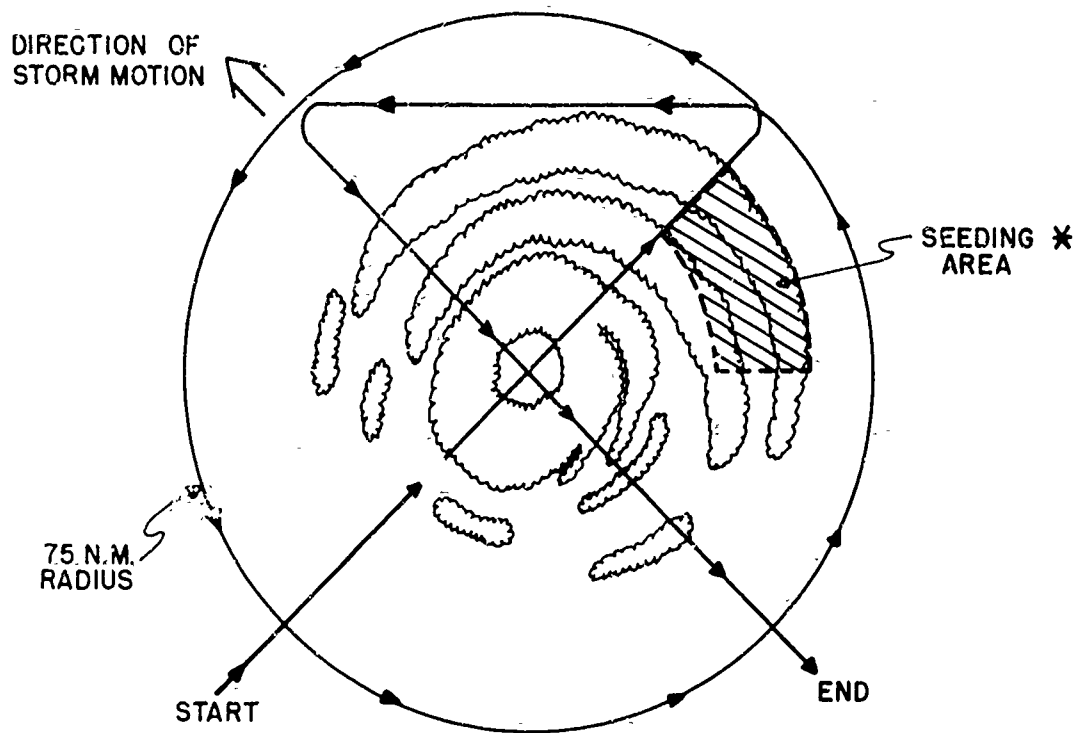

* SEE SEEDER FLIGHT PLAN

TAB D TO APPENDIX III TO ANNEX D

FLIGHT PATTERN RAIN SECTOR EXPERIMENT
FLIGHT "D" (REF WC-130) ALTITUDE — 18,000 FT
CLOUD PHYSICS MONITOR

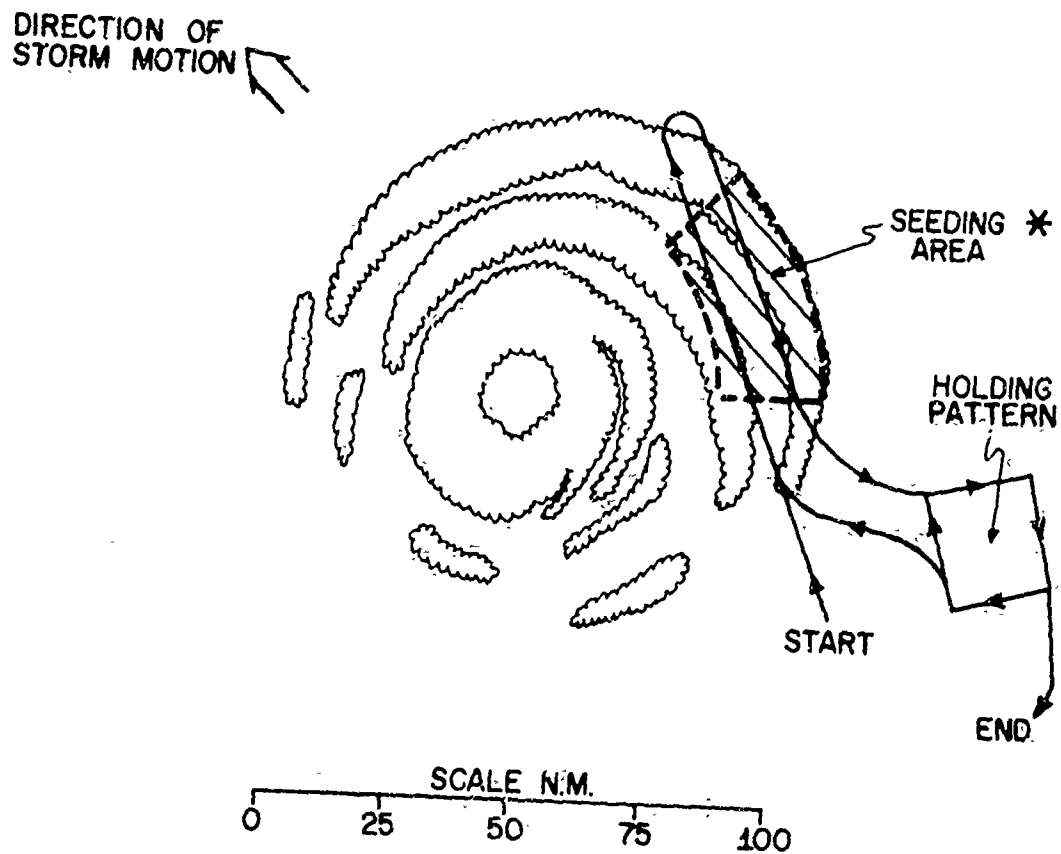

* SEE SEEDER FLIGHT PLAN

TAB E TO APPENDIX III TO ANNEX D

FLIGHT PATTERN RAIN SECTOR EXPERIMENT
FLIGHT "E" (NAVY WC-121N) ALTITUDE 8,000 FT.
COMMAND AND CONTROL AND RADAR MONITOR

DIRECTION OF
STORM MOTION ↙

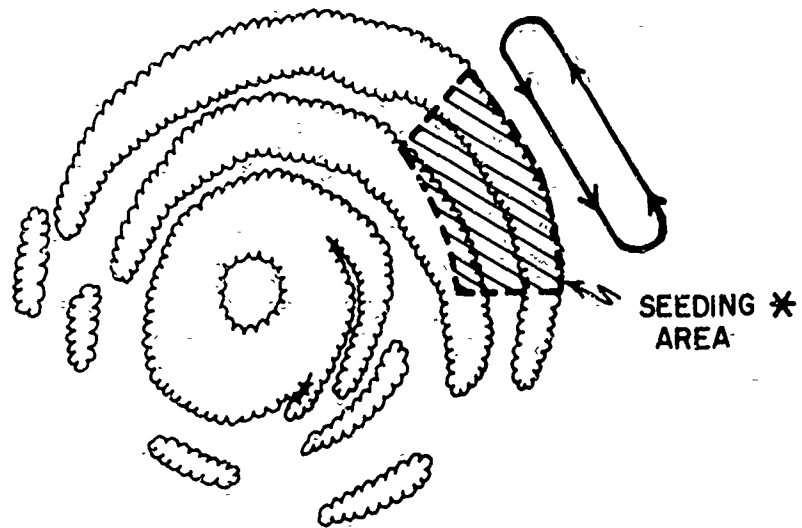

* SEE SEEDER FLIGHT PLAN

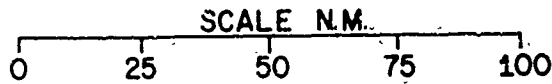

D-III-E-1

OPERATION ORDER
FWF JAX NO. 1-70

6. WC-121, FLIGHTS F, G

a. Mission. Inflow Monitor. Take off in time to arrive on station at 1,000 feet by T-3:30 and T+4, respectively. Conduct operations in accordance with Tab F.

- *b. General Communications.
- *c. In-flight Procedures.
- *d. Data Collection.
- *e. Cloud Photography.
- *f. Post-Flight.

*Same as Rainband Experiment, FLIGHTS F and G

7. WC-121, FLIGHT H

a. Mission. Radar Monitor and Back-up Command Control. Take off in time to arrive on station at 10,000 feet by T-1:30. Conduct operations in accordance with Tab H.

- *b. General Communications and Reports.
- *c. Data Collection.
- *d. Radar and Radarscope Photography.
- *e. Post-Flight.

*Same as Rainband Experiment, FLIGHT H

8. WC-130, FLIGHTS I, J

a. Mission. Outflow Monitor. Take off in time to arrive on station at 29,000 feet at T-3:30 and T+4, respectively. Conduct operations in accordance with Tab I.

- *b. General Communications.
- *c. Data Collection.
- *d. Post-Flight.

*Same as Eyewall Experiment, FLIGHTS I and J.

TAB G -- Flight Pattern for FLIGHTS F and G

TAB H -- Flight Pattern for FLIGHT H

TAB I -- Flight Pattern for FLIGHTS I and J

FLIGHT PATTERN RAIN SECTOR EXPERIMENT
FLIGHTS "F" AND "G" (NAVY WC-121N) ALTITUDE 1,000 FT.
DO COMPLETE PATTERN TWICE PER FLIGHT
INFLOW MONITOR

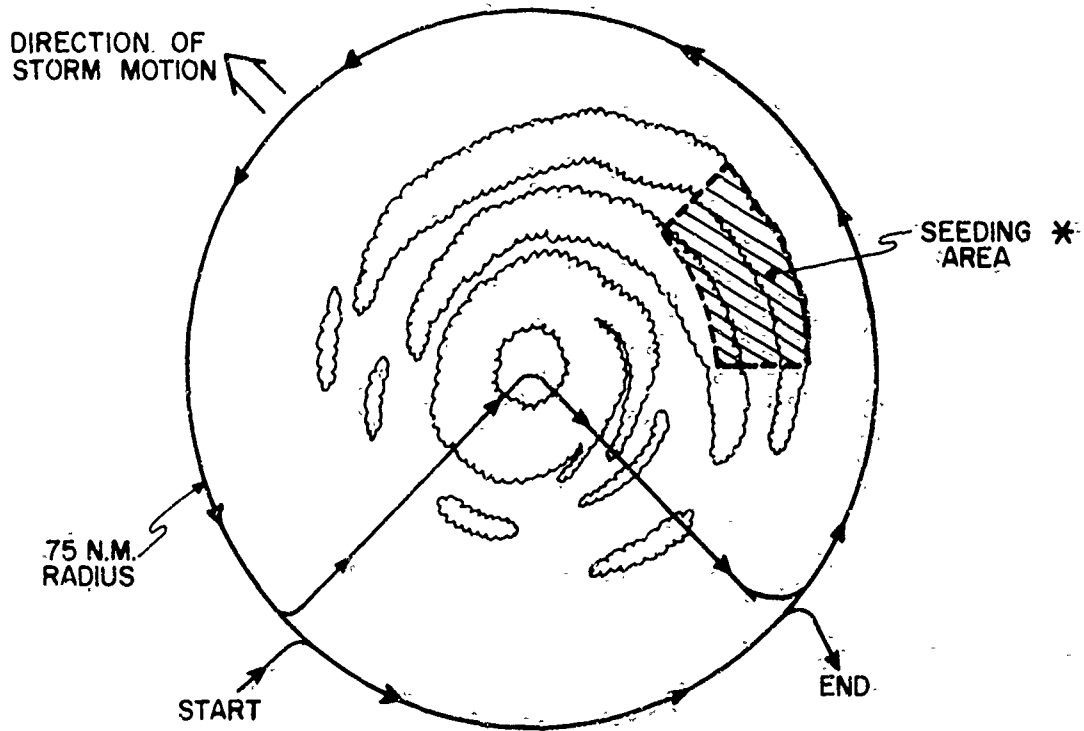

SCALE N.M.
0 25 50 75 100

* SEE SEEDER FLIGHT PLAN

TAB H TO APPENDIX III TO ANNEX D

FLIGHT PATTERN RAIN SECTOR EXPERIMENT
FLIGHT "H" (NAVY WC-121N) ALTITUDE 10,000 FT.
RADAR MONITOR AND BACKUP COMMAND AND CONTROL

DIRECTION OF
STORM MOTION ↖

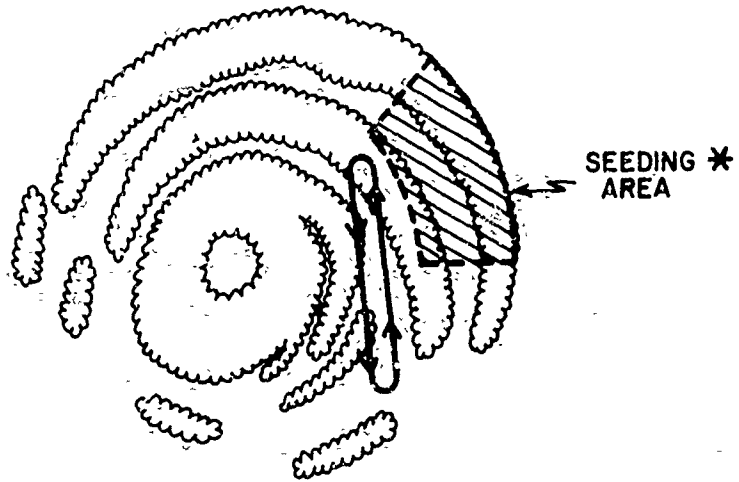

* SEE SEEDER FLIGHT PLAN

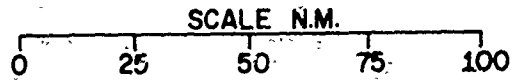

D-III-H-1

FLIGHT PATTERN RAIN SECTOR EXPERIMENT
FLIGHTS "I" AND "J" (AFWC-130) ALTITUDE 29,000 FT.
OUTFLOW MONITOR
TWO CIRCUMNAVIGATIONS
DROPSONDES (D)

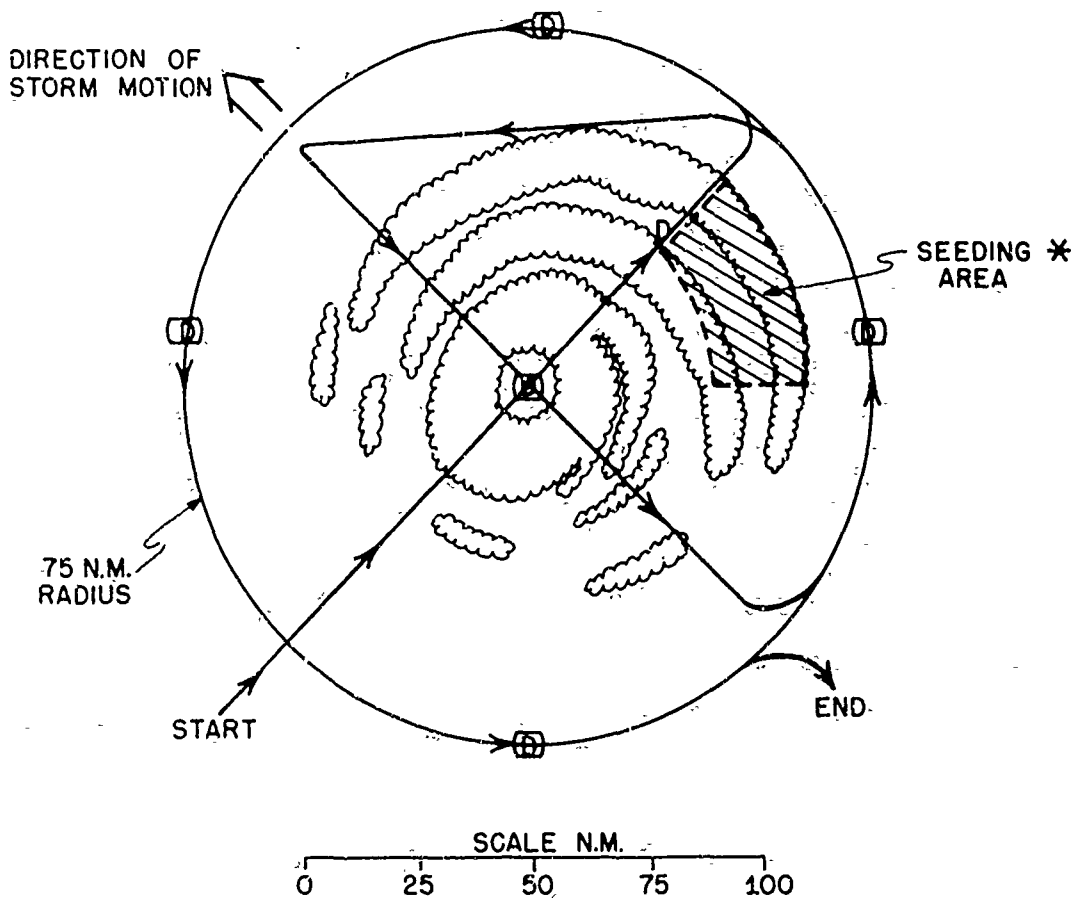

* SEE SEEDER FLIGHT PLAN

NOTE: Permission to DROP must be obtained from Command Control.

OPERATION ORDER
FWF-JAX NO. 1-70

9. RB-57, FLIGHTS K, K2

a. Mission. Cloud Mapping. Take off in time to arrive on station at 49,000 feet by T-0:30 and T+6:30, respectively. Conduct operations in accordance with Tab K.

- *b. General Communications and Reports.
- *c. Data Collection.
- *d. Post-Flight.

*Same as Eyewall Experiment, FLIGHT K

10. A-6, FLIGHTS L, M, N, O, P (WP-3, FLIGHT S)

a. Mission. Seeder Aircraft. Take off in time to arrive on station at 20-26,000 feet, as briefed, by T+0, T+1:40, T+3:20, T+5 and T+6:40, respectively. WP-3 is to arrive on station at T+0 and remain through seeding periods when available. Conduct operations in accordance with Tab L.

- *b. General Communications and Reports.
- *c. Flight Operations
- *d. Data Collection.
- *e. Post-Flight.

*Same as Rainband Experiment, FLIGHTS L, M, N, O, and S

11. RB-57, FLIGHT U

a. Mission. Outflow Monitor. Take off in time to arrive on station at 41,000 feet by T+0. Conduct operations in accordance with Tab M.

- *b. General Communications and Reports.
- *c. Data Collection.
- *d. Post-Flight.

*Same as Eyewall Experiment, FLIGHT U.

TAB K - Flight Pattern for FLIGHT K
TAB L - Flight Pattern for FLIGHTS L, M, N, O, P
TAB M - Flight Pattern for FLIGHT U
TAB N - Chronological Summary of On-Station Times
TAB O - Time Table for Aircraft Employment
TAB P - Flight Track Summary

TAR-K TO APPENDIX III TO ANNE' D

FLIGHT PATTERN RAIN SECTOR EXPERIMENT
FLIGHT "K" AND "K2" (AF RB-57F) ALTITUDE 49,000ft. or above
CLOUD MAPPING
REPEAT 1-2-1 — TRACK AS LONG AS POSSIBLE

DIRECTION OF
STORM MOTION ↙

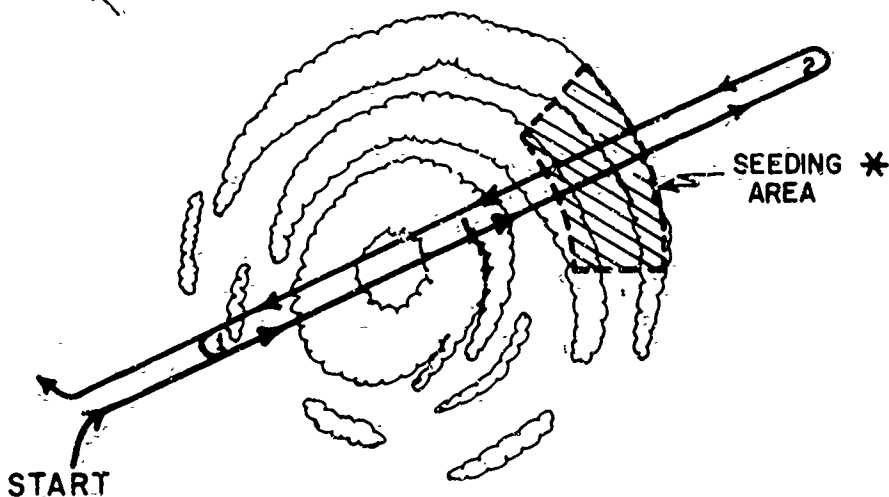

* SEE SEEDER FLIGHT PLAN

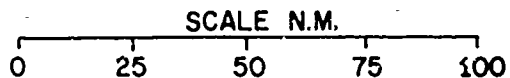

D-III-K-1

TAB L TO APPENDIX III TO ANNEX D

FLIGHT PATTERN RAIN SECTOR EXPERIMENT
FLIGHTS "S" OR "L", "M", "N", "O", "P" (NAVY P3 OR A6'S)
ALTITUDE 20-26,000 FT
SEEDER AIRCRAFT

DIRECTION OF
STORM MOTION ↙

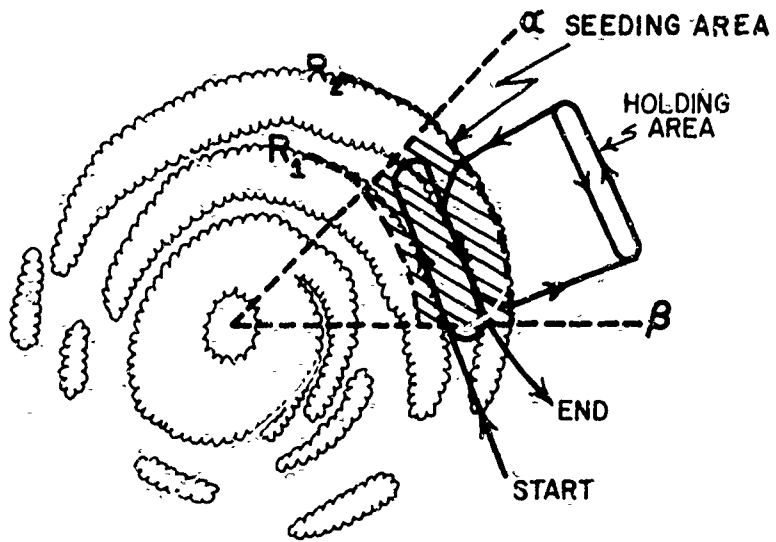

TRUE BT RINGS α AND β AND RADIAL DISTANCES R_1 AND R_2
ARE TO BE DESIGNATED PRIOR TO EACH OPERATION.

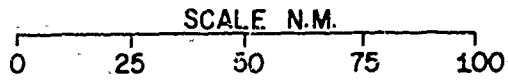

D-III-L-1

TAB M TO APPENDIX III TO ANNEX D

FLIGHT PATTERN RAIN SECTOR EXPERIMENT
FLIGHT "U" (AF WC-135) ALTITUDE 42,000 FT.
OUTFLOW MONITOR

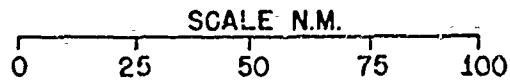
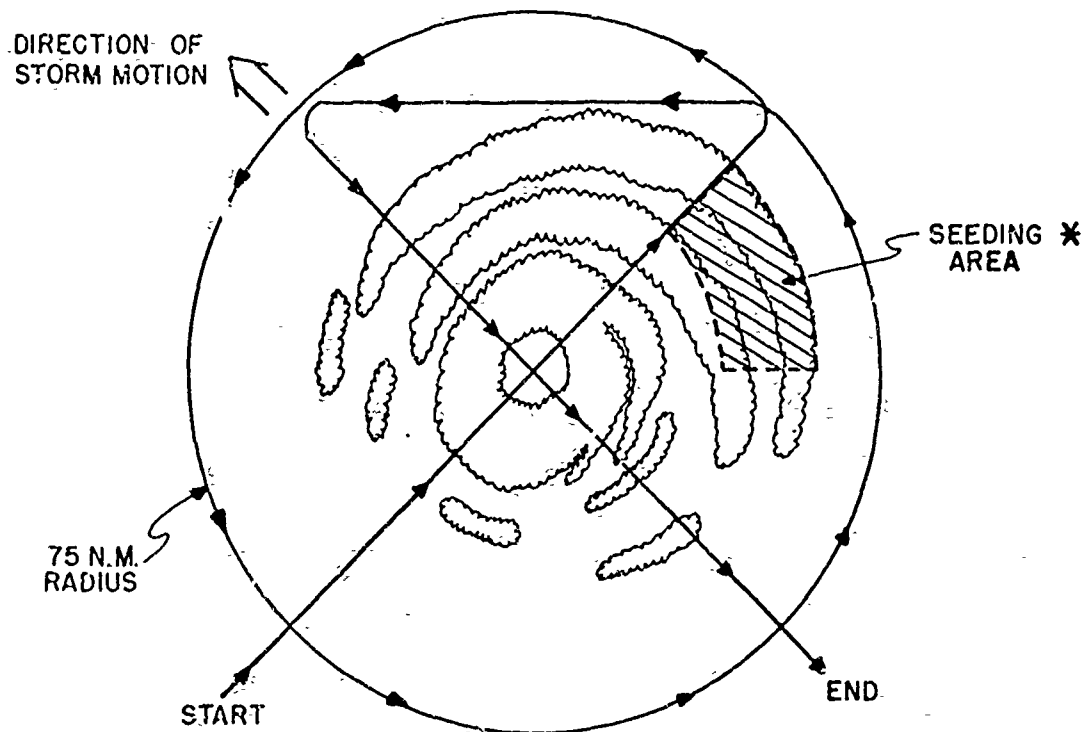

* SEE SEEDER FLIGHT PLAN

D-111-N-1

OPERATION ORDER
FWF JAX NO. 1-70

TAB N TO APPENDIX III TO ANNEX D
 CHRONOLOGICAL SUMMARY OF ON-STATION TIMES
 RAINSECTOR EXPERIMENT

<u>Aircraft</u>	<u>Voice Call</u>	<u>On-Station</u>	<u>Altitude (MSL)</u>
DC-6	STORMFURY A	T-3:30 to T+2	5,000
WC-121	STORMFURY F	T-3:30 to T+3:30	1,000 ABS
WC-130	STORMFURY I	T-3:30 to T+2	29,000
WB-57	STORMFURY C	T-2:20 to T	37,000
WC-130	STORMFURY D	T-1 to T+4	18,000
WC-121	STORMFURY H	T-1:30 to T+7	10,000
WC-121	STORMFURY E	T-0:30 to T+9:30	8,000
RB-57	STORMFURY U	T to T+7	41,000
WP-3	STORMFURY S	T to T+8	20-26,000
A-6	STORMFURY L-P	T to T+8	20-26,000
RB-57F	STORMFURY K	T+0:30 to T+2	49,000
DC-6	STORMFURY B	T+3 to T+7:30	5,000
WC-130	STORMFURY J	T+4 to T+9:30	29,000
WC-121	STORMFURY G	T+4 to T+11	1,000 ABS
RB-57F	STORMFURY K2	T+5:30 to T+9	49,000
WB-57	STORMFURY C2	T+7 to T+9:30	37,000
DC-6	STORMFURY A2	T+9 to T+14:30	5,000

} either/or

TAB. O TO APPENDIX I.II TO ANNEX
TIME TABLE FOR STORMFURY AIRCRAFT EMPLOYMENT "RAINSECTOR EXPERIMENT"

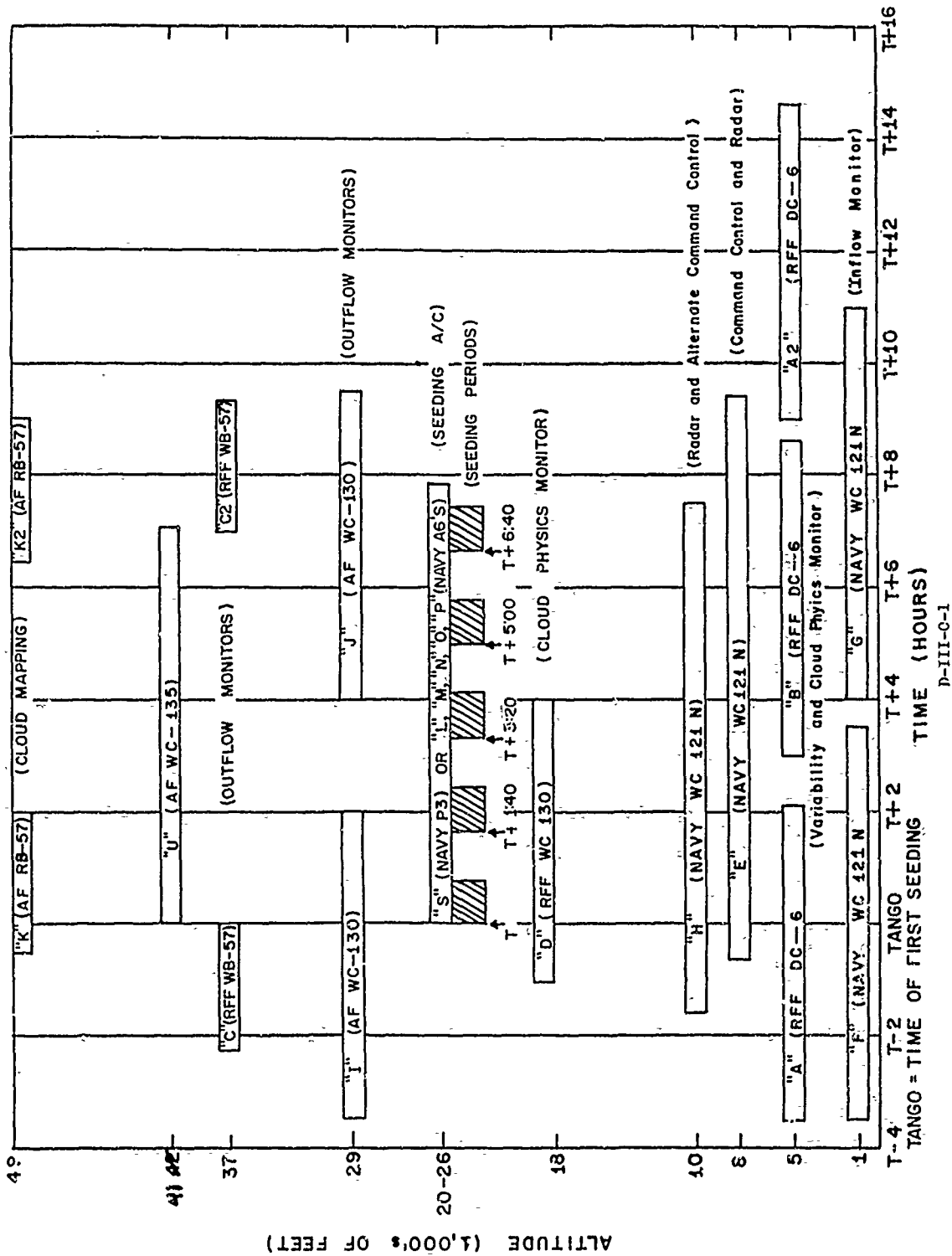

RAINSECTOR EXPERIMENT

TAB P TO APPENDIX III TO ANNEX D

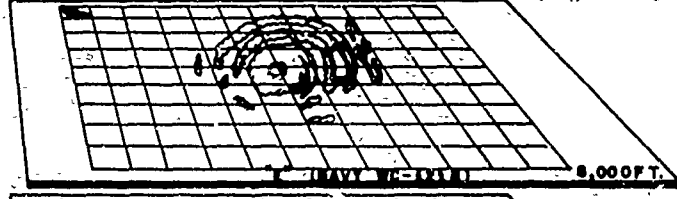
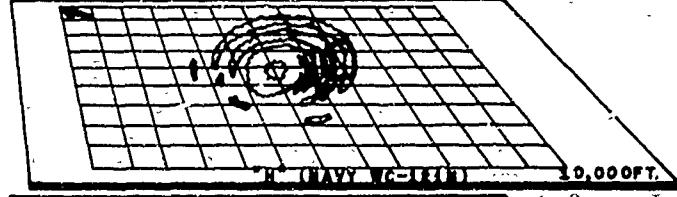
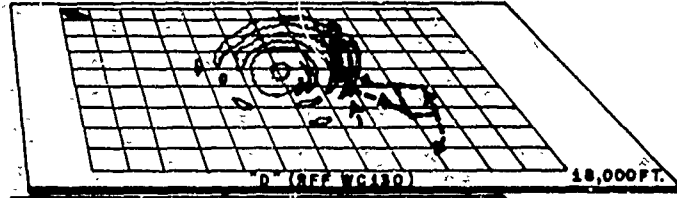
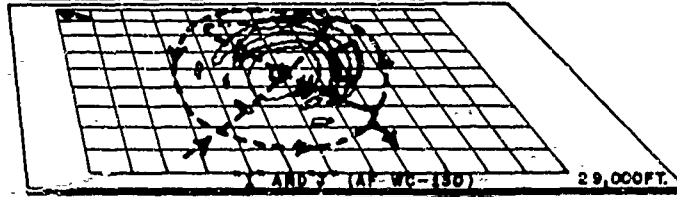
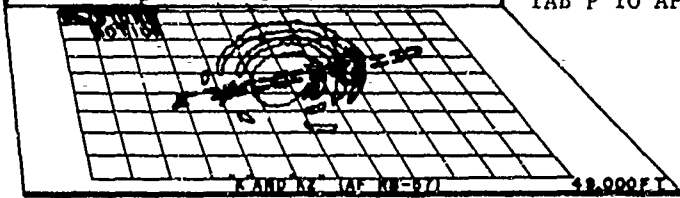

D-III-P-1

BLANK PAGE

OPERATION ORDER
FWF JAX NO. 1-70

APPENDIX IV TO ANNEX D

RAINBAND EXPERIMENT

Flight Procedures

1. General. Detailed flight procedures for STORMFURY aircraft are listed in alphabetical order as follows:

- a. FLIGHT A: DC-6 (ESSA)
- b. FLIGHT B: DC-6 (ESSA)
- c. FLIGHT C: WB-57 (ESSA)
- d. FLIGHT D: C-130 (ESSA)
- e. FLIGHT E: WC-121 (USN)
- f. FLIGHTS F & G: WC-121 (USN)
- g. FLIGHT H: WC-121 (USN)
- h. FLIGHTS I & J: WC-130 (USAF)
- i. FLIGHT K: RB-57 (USAF)
- j. FLIGHTS L, M, N, O: A-6 (USMC)
- k. FLIGHT P: WP-3 (USN)
- l. FLIGHT U: WC-135 (USAF)

2. DC-6, FLIGHT A

a. Mission. Cloud Physics and Variability Monitor. Take off in time to arrive on station at 18,000 feet by T-1. Conduct operations in accordance with Tab A. Complete flight track patterns will be flown before, during, and after seeding run.

- *b. General Communications and Reports.
- *c. Data Collection.
- *d. Radar.
- *e. Dropsondes.
- *f. Cloud Photography.
- *g. Post-Flight.

*Same as Eyewall Experiment, FLIGHT A.

TAB A - Flight Pattern for FLIGHT A

FLIGHT PATTERN - RAINBAND EXPERIMENT
FLIGHT "A" (RFF DC-6) ALTITUDE — 18,000 ft.
CLOUD PHYSICS MONITOR
COMPLETE PATTERN 1-2-3-4-1 SIX TIMES (DASHED
TRACK TO BE COMPLETED IMMEDIATELY AFTER SEEDING)

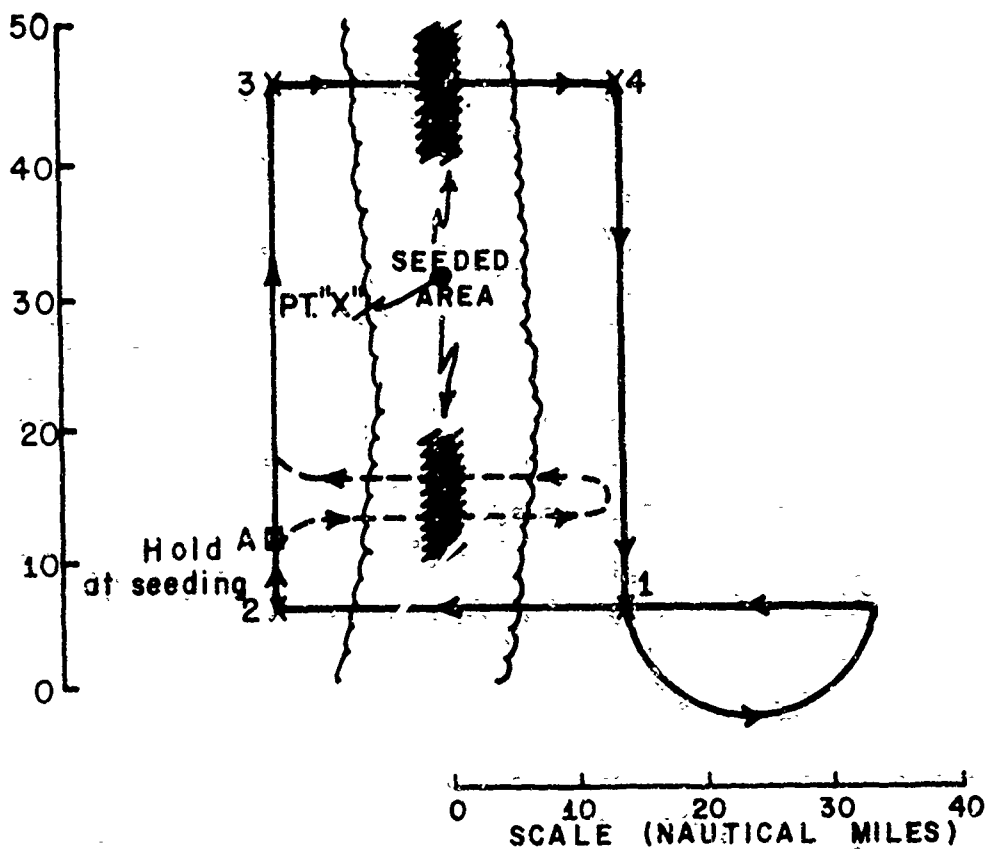

OPERATION ORDER
FWF JAX NO. 1-70

3. DC-6, FLIGHT B

a. Mission. Variability Monitor. Take off in time to arrive on station at 5,000 feet by T-1:30. Conduct operations in accordance with Tab B.

- *b. General Communications and Reports.
- *c. Data Collection.
- *d. Radar.
- *e. Dropsondes.
- *f. Cloud Photography.
- *g. Post-Flight.

*Same as Eyewall Experiment, FLIGHT B.

4. WB-57, FLIGHT C

a. Mission. Variability Monitor and Photo. Take off in time to arrive on station at 37,000 feet by T-0:30. Conduct operations in accordance with Tab C. Complete flight track patterns will be flown before, during, and after seeding run.

- *b. General Communications and Reports.
- *c. Cloud Cameras.
- *d. Data Collection.
- *e. Radar and Radarscope Photography.
- *f. Post-Flight.

*Same as Eyewall Experiment, FLIGHT C.

5. WC-130, FLIGHT D

a. Mission. Cloud Physics Monitor. Take off in time to arrive on station at 20,000 feet by T-0:30. Conduct operations in accordance with Tab D.

- *b. General Communications and Reports.
- *c. Meteorological Data Collection.
- *d. Radar.
- *e. Post-Flight Debrief.

*Same as Eyewall Experiment, FLIGHT D.

TAB B - Flight Pattern for FLIGHT B
TAB C - Flight Pattern for FLIGHT C
TAB D - Flight Pattern for FLIGHT D

FLIGHT PATTERN RAINBAND EXPERIMENT
FLIGHT "B" (RFF DC-6) ALTITUDE 5,000 FT. AND
FLIGHT "C" (RFF WB57) ALTITUDE 37,000 FT.
VARIABILITY MONITORS
REPEAT 1-2-3-1 TRIANGLE FOR DURATION OF FLIGHT

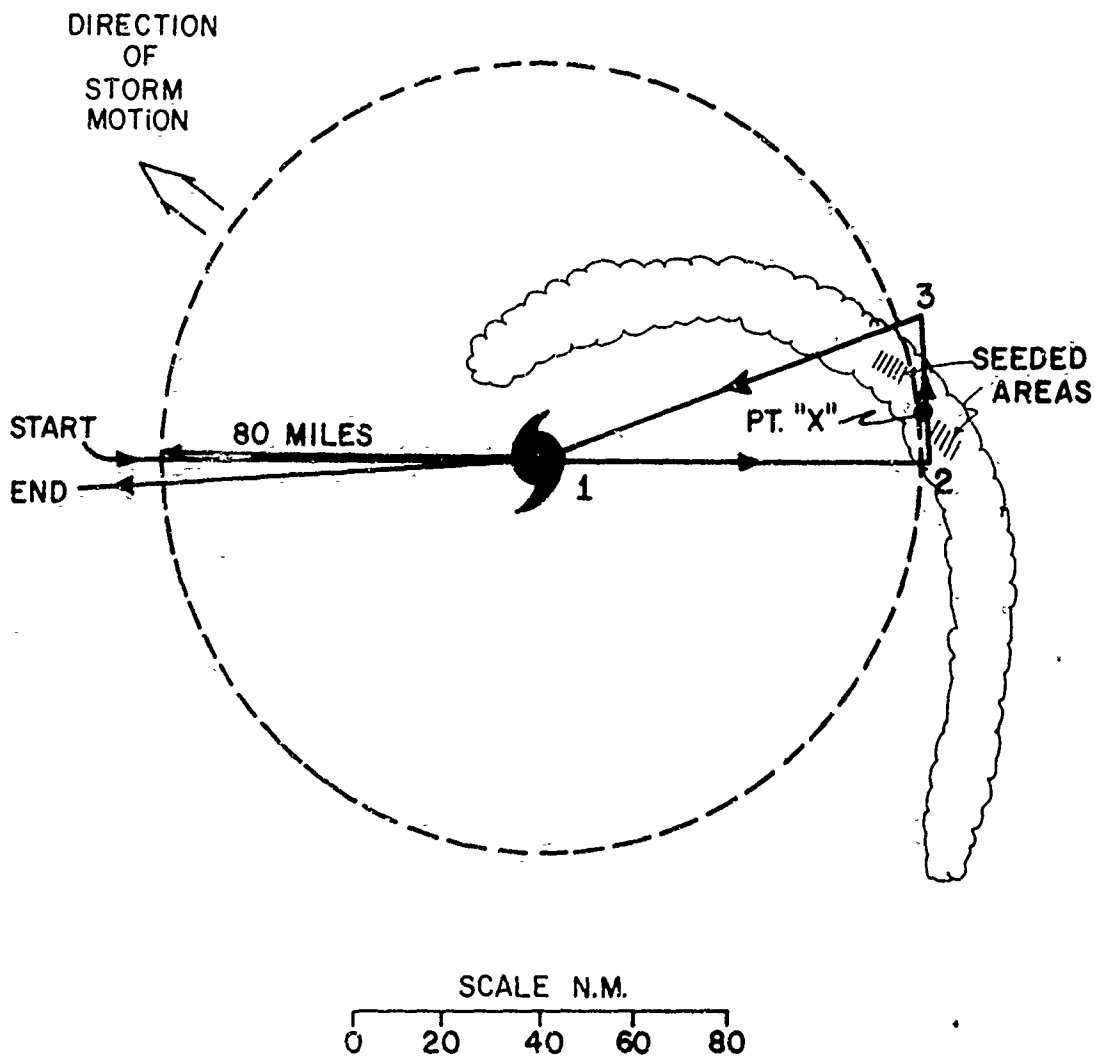

TAB D TO APPENDIX IV TO ANNEX D

FLIGHT PATTERN - RAINBAND EXPERIMENT
FLIGHT PATTERN "D" (RFF WC-130) ALTITUDE 20,000 ft.
CLOUD PHYSICS MONITOR
COMPLETE PATTERN 1-2-3-4-1 SIX TIMES (DASHED
TRACK TO BE COMPLETED IMMEDIATELY AFTER SEEDING)

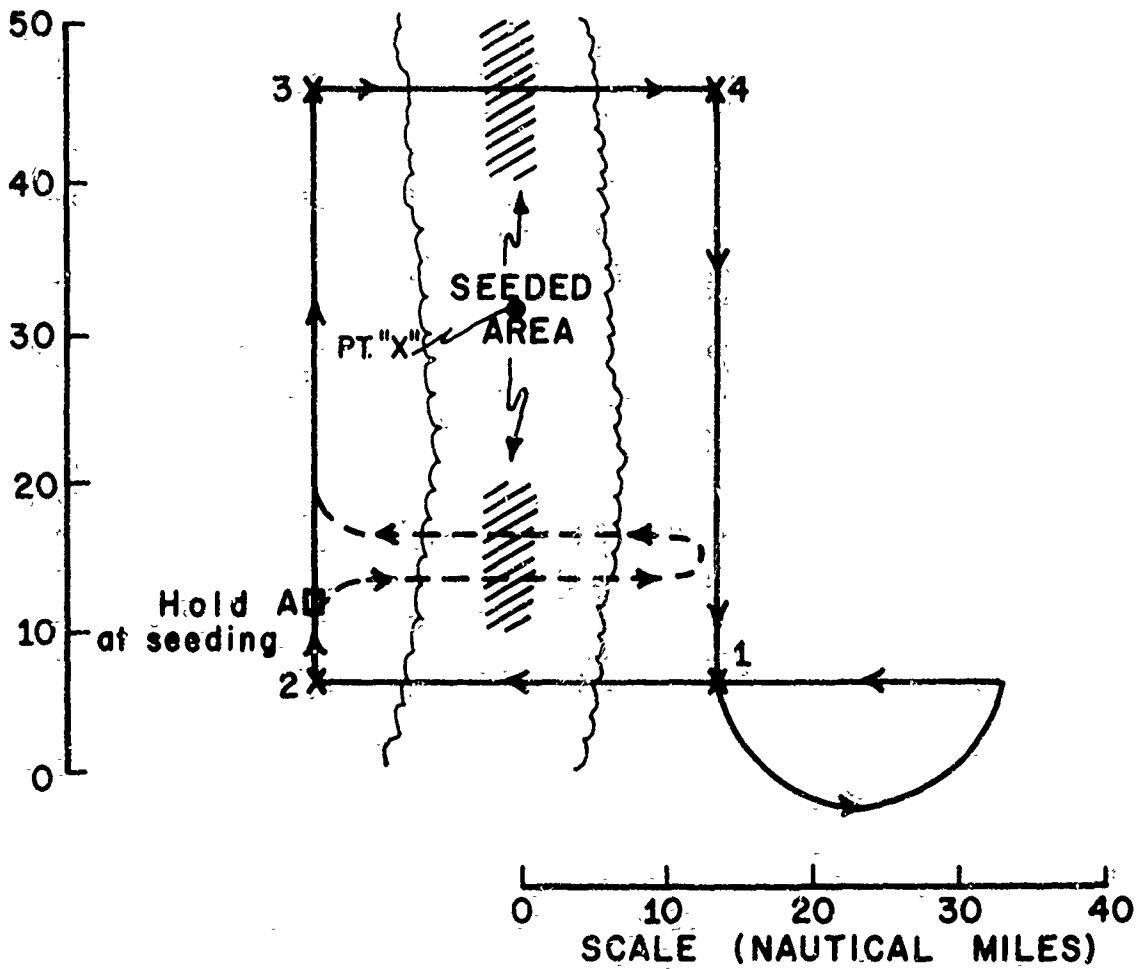

D-IV-D-1

OPERATION ORDER
FWF JAX NO. 1-70

6. WC-121, FLIGHT E

a. Mission. Command Control and Radar Monitor.

(1) Take off in time to arrive on station at 8,000 feet by T-1. Conduct operations in accordance with Tab E.

b. General Communications. See Annex C.

(1) Initial Report. See Annex D, item 4.b(3).

(2) Reporting on Station. See Annex D, item 4.b(4).

(3) Assignment of Air Control Frequency and Air Controller.

As flights report on station and UHF communications are established on STORMFURY Common, assign an air control frequency and air controller to each seeder flight. Other flights will be under surveillance only. For tracks to be flown by assigned aircraft, see composite flight tracks for Rainband Experiment, tabs for each flight.

(4) Communications with ARTCC. Command Control responsibilities. See Annex C.

c. Data Collection. Same as for Eyewall Experiment, FLIGHT E.

d. Photography. Photography as in Appendix VII.

e. Departing Area. Notify ARTCC when all aircraft except FLIGHTS G and J have departed the reserved airspace area, verifying flight identification and altitude of each aircraft previously under positive control of the Command Control Aircraft.

f. Post-Flight. Same as Eyewall Experiment, FLIGHT E.

TAB E - Flight Pattern for FLIGHT E

TAB E TO APPENDIX IV TO ANNEX D

FLIGHT PATTERN RAINBAND EXPERIMENT
FLIGHT "E" (NAVY WC-121N) ALTITUDE 8,000 FT
COMMAND CONTROL AND RADAR

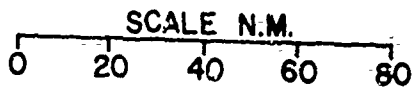
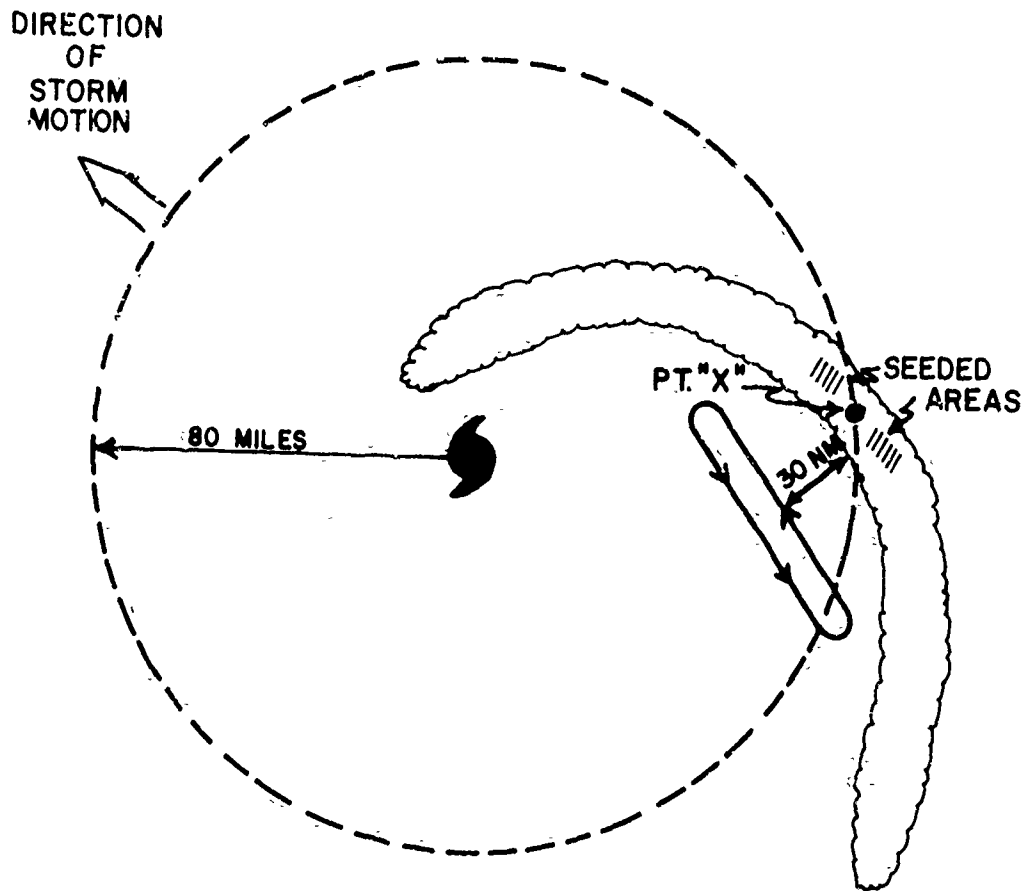

D-IV-E-1

OPERATION ORDER
FWF JAX NO. 1-70

7. WC-121, FLIGHTS F and G

a. Mission. Low Level Inflow Monitor.

(1) Take off in time to arrive on station at T-2:30 and T+6 respectively. Conduct operations in accordance with Tab F.

b. General Communications. See Annex C.

(1) Initial Report. See Annex D, item 4.b(3).

(2) Reporting for Air Control. As soon as possible after the arrival of FLIGHT E (WC-121N, STORMFURY ECHO) into the Project STORMFURY operating area (approximately T-1), FLIGHT F will establish UHF (STORMFURY Common)/SSB voice communications and standby for assignment of an air control frequency and air controller. After establishing UHF communications with the assigned air controller, all maneuvers will be under surveillance of the air controller. See Annex D, item 4.b(4).

(3) Operations Normal Report. See Annex D, item 4.b(4).

(4) Departing STORMFURY Operating Area. See Annex D, item 4.b(7). FLIGHT G will notify ARTCC that use of the airspace reservation has been terminated for the day.

c. In-Flight Procedures.

(1) Initial Rainband Description Report. As soon as practicable after the aircraft has acquired the center of the storm/hurricane on radar, FLIGHT F will initiate an initial rainband description report to the appropriate ARTCC via Single Sideband, precedence "Immediate". This report will contain the coordinates of the center of the storm/hurricane, and the distance to the inbound and outbound extremities of each rainband at 15 degree increments:

Example - (Text)

N 45929 STORMFURY "F" A/C Posit Time (Z) 360-None 030-40/60
045-40/60 90/120 060-50/80 90/130 075-60/90 80/130 etc.

d. Data Collection Requirements for FLIGHTS F and G. Record data in accordance with Annex E.

(1) Meteorological. Same as FLIGHTS F and G of Eyewall Experiment.

(2) Radar. Operate in accordance with Appendix VII.

OPERATION ORDER
FWF JAX NO. 1-70

e. Cloud Photography. While on station, the time lapse 35 MM camera system will be operated as follows:

Frame Rate	1 frame/5 seconds
Vertical Tilt	Zero degrees
Auxiliary Data	24-Hour clock (Total elapsed time in seconds) Flight identification

f. Post-Flight. Attend post-flight debriefing and turn in all records of data, including film, to the DQCC.

8. WC-121, FLIGHT H

a. Mission. Radar Monitor and Back-up Command Control. Take off in time to arrive on station at 10,000 feet by T-2. Conduct operations in accordance with Annex H.

- *b. General Communications and Reports.
- *c. Data Collection.
- *d. Radar and Radarscope Photography.
- *e. Post-Flight.

*Same as Eyewall Experiment, FLIGHT H.

9. WC-130, FLIGHTS I and J

a. Mission. Outflow Monitor and Dropsonde. Take off in time to arrive on station at 29,000 feet at T-3:30 and T+2 respectively. Conduct operations in accordance with Tab I.

- *b. General Communications and Reports.
- *c. Data Collection.
- *d. Post-Flight.

*Same as Eyewall Experiment, FLIGHTS I and J.

TAB F - Flight Pattern for FLIGHTS F and G
TAB H - Flight Pattern for FLIGHT H
TAB I - Flight Pattern for FLIGHTS I and J

T' b F TO APPENDIX IV TO ANNEX D

FLIGHT PATTERN -- RAINBAND EXPERIMENT
FLIGHTS "F", "G" (NAVY WC-121N) ALT. 1000 ft.
LOW-LEVEL MONITORS
COMPLETE PATTERN TWICE EACH FLIGHT

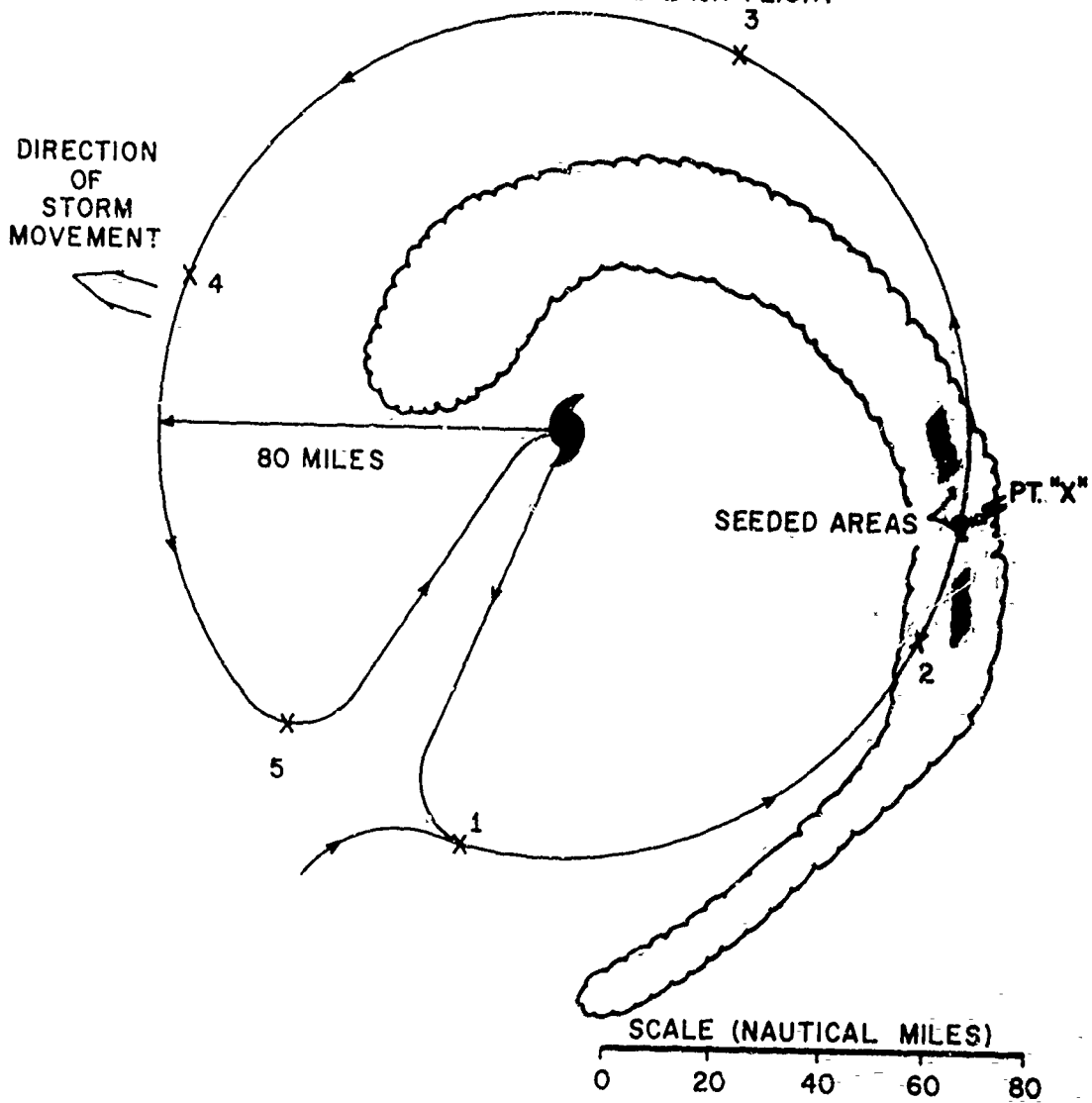

D-IV-F-1

**FLIGHT PATTERN RAINBAND EXPERIMENT
FLIGHT "H" (NAVY WC-121N) ALTITUDE 10,000 FT.
RADAR AND ALTERNATE COMMAND CONTROL**

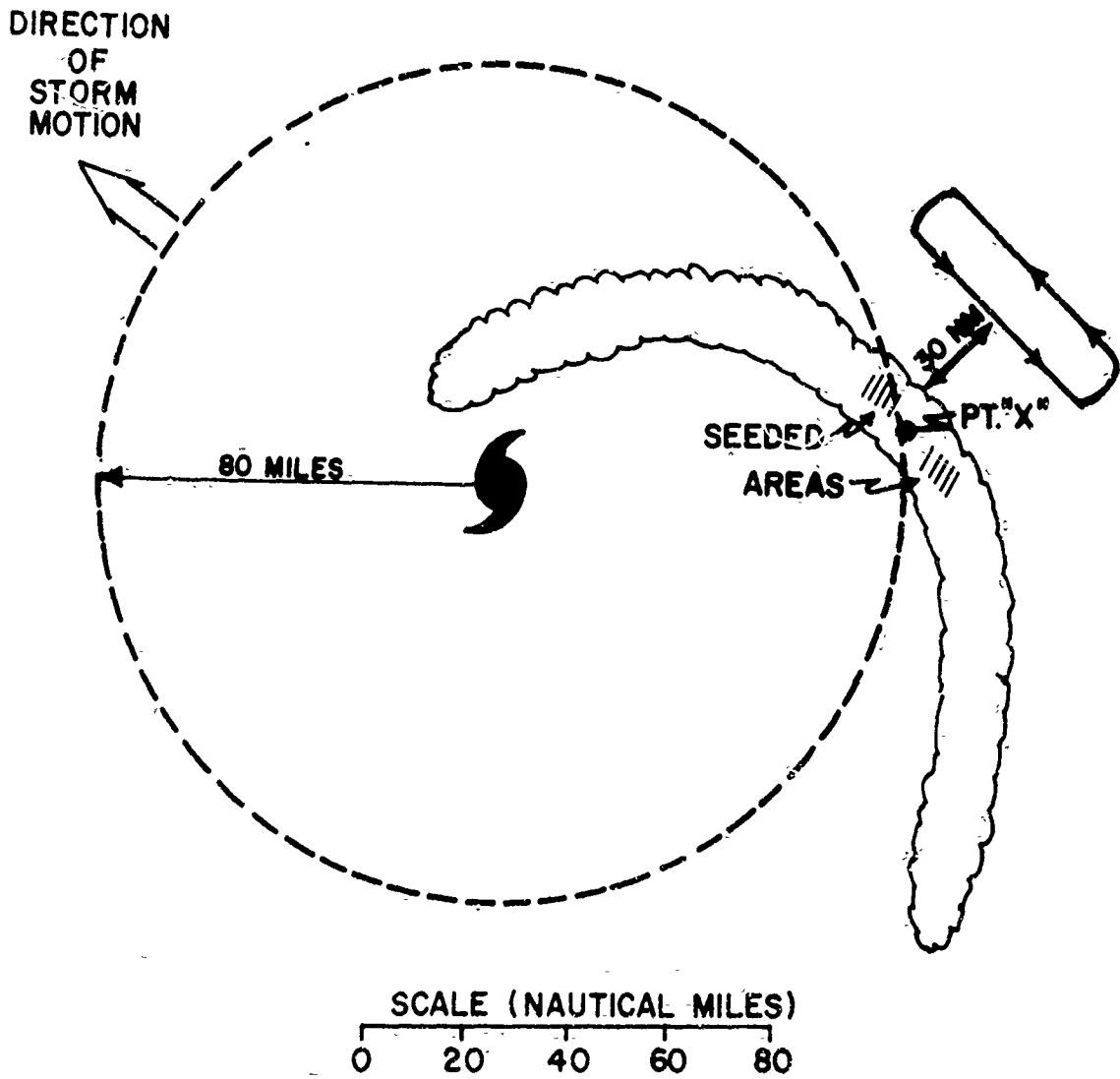

**FLIGHT PATTERN RAINBAND EXPERIMENT
FLIGHT "I" AND "J" (AF WC-130) ALTITUDE 29,000 FT.
TWO CIRCUMNAVIGATIONS
OUTFLOW MONITOR
AND DROPSONDES (D)**

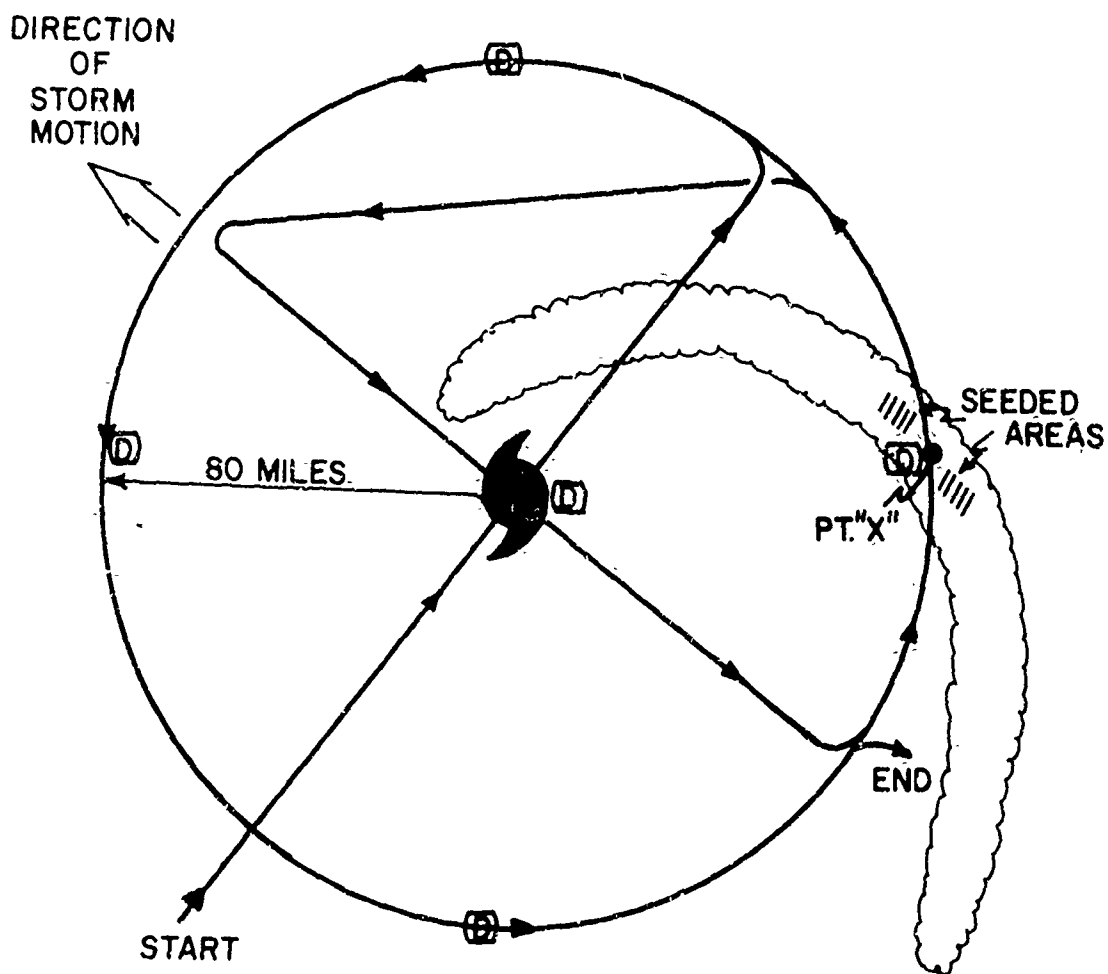

NOTE: Radius to be adjusted to radius of seeded area.

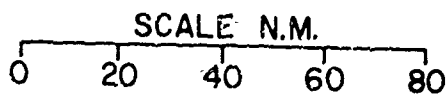

OPERATION ORDER
FWF JAX NO. 1-70

10. RB-57, FLIGHT K

a. Mission. Cloud Mapping. Take off in time to arrive on station as fuel permits. Conduct operations in accordance with Tab K.

*b. General Communications and Reports.

*c. Data Collection.

*d. Post-Flight.

*Same as Eyewall Experiment, FLIGHT K.

11. A-6, FLIGHTS L, M, N, O (WP-3, FLIGHT S)

a. Mission. Seeding and Photo. Take off in time to arrive on station at 22-26,000 feet, as briefed, by T-0:15. Conduct operations in accordance with Tab L.

b. General Communications. See Annex C.

(1) Initial Report. See Annex D, item 4.b(3).

(2) Reporting for Air Control. See Annex D, item 4.b(4).

(3) OPS Normal Report. See Annex D, item 4.b(4).

(4) Departing STORMFURY Operating Area. See Annex D, item 4.b(7).

c. Flight Operations

(1) Pre-Seeding. Prior to the actual seeding, flight will be vectored to arrive in the seeding area 15 minutes prior to scheduled drop time. Indicated airspeed during the seeding run should be 240 knots \pm 10 knots.

(2) Seeding. The track to be flown during the seeding run will be determined by the Project Director and relayed to the flight by the assigned air controller. This track will take into account "hard core" areas, if any, which will be avoided by use of radar information. Drop rate interval will be $\frac{1}{2}$ second for the number of canisters briefed by the Project Director. Report commencement and completion of each series of drops to Command Control.

TAB K - Flight Pattern for FLIGHT K

TAB K TO APPENDIX IV TO ANNEX D

FLIGHT PATTERN RAINBAND EXPERIMENT
FLIGHT "K" (AF RB-57F) ALTITUDE 49,000 FT. or above
CLOUD MAPPING
REPEAT 1-2-1 ——— TRACK AS LONG AS POSSIBLE

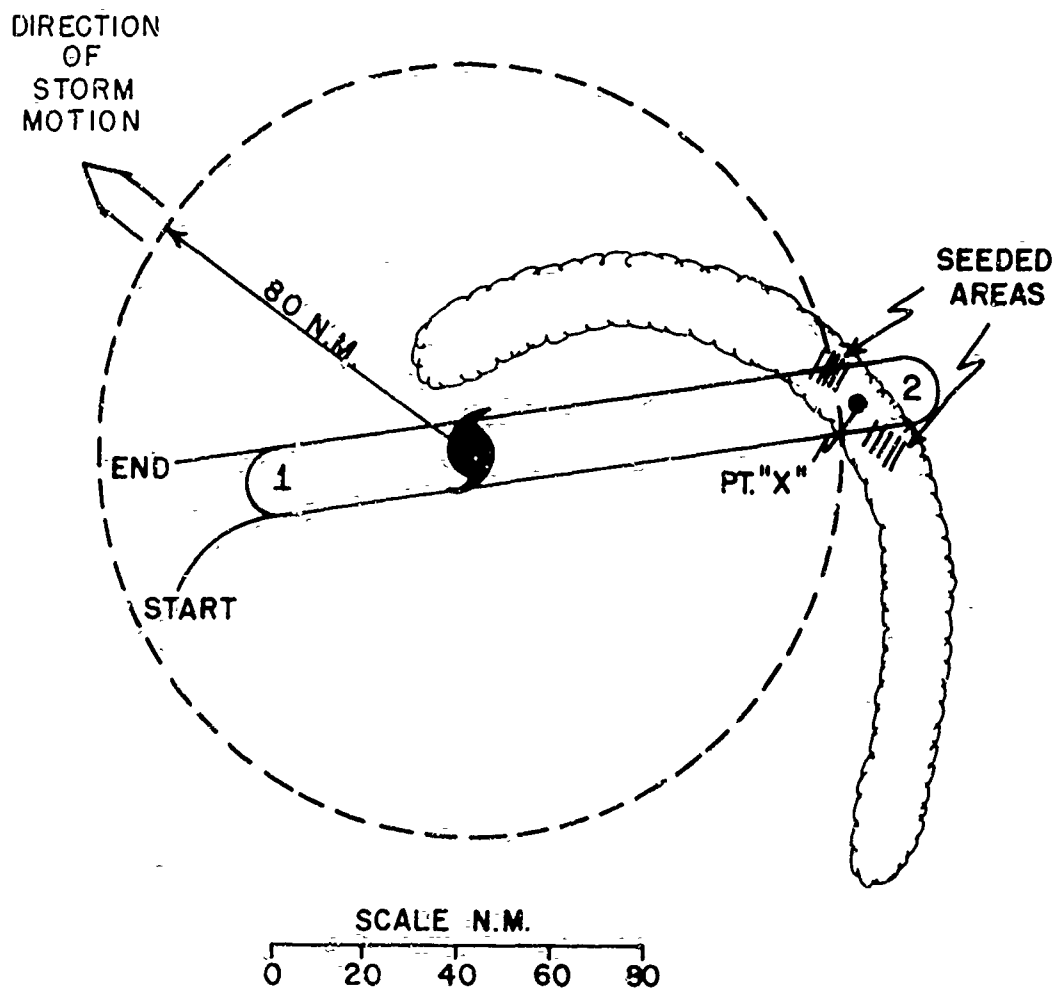

D-IV-K-1

OPERATION ORDER
FWF JAX NO. 1-70

(3) Post-Seeding. After completion of drops, activate return flight plan, check out with Command Control, and proceed independently to the staging base. Upon return, determine the exact number of pyrotechnic canisters dropped and include this information for debriefing purposes.

d. Data Collection. Record data in accordance with Annex E. (Forms SF-3 and 4)

(1) Radarscope Photography. If possible, operate in accordance with Appendix VII of this annex.

(2) Cloud Photography. Operate hand-held cameras, if available, to obtain vertical profiles of clouds, as briefed.

(3) Meteorological Data. A-6's will collect and correlate with time as much of the following information as possible:

- | | |
|-----------------------|----------------------|
| (a) CAS | (e) Ground Speed |
| (b) Temperature | (f) Drift angle |
| (c) Absolute altitude | (g) Ambient pressure |
| (d) Pressure altitude | |

WP-3 will collect and record data in accordance with Annex E or as briefed.

e. Post-Flight. Attend debriefing and turn in all records collected and film to the DOCC.

TAB L - Flight Pattern for FLIGHTS L, M, N, O and S

FLIGHT PATTERN RAINBAND EXPERIMENT
FLIGHT "S" (NAVY P3) ALTITUDE 22-26,000 ft. OR
FLIGHTS "L", "M", AND "O" (M.C. - A6'S) ALTITUDE 22-26,000 FT
SEEDER AND PHOTO AIRCRAFT

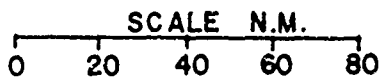
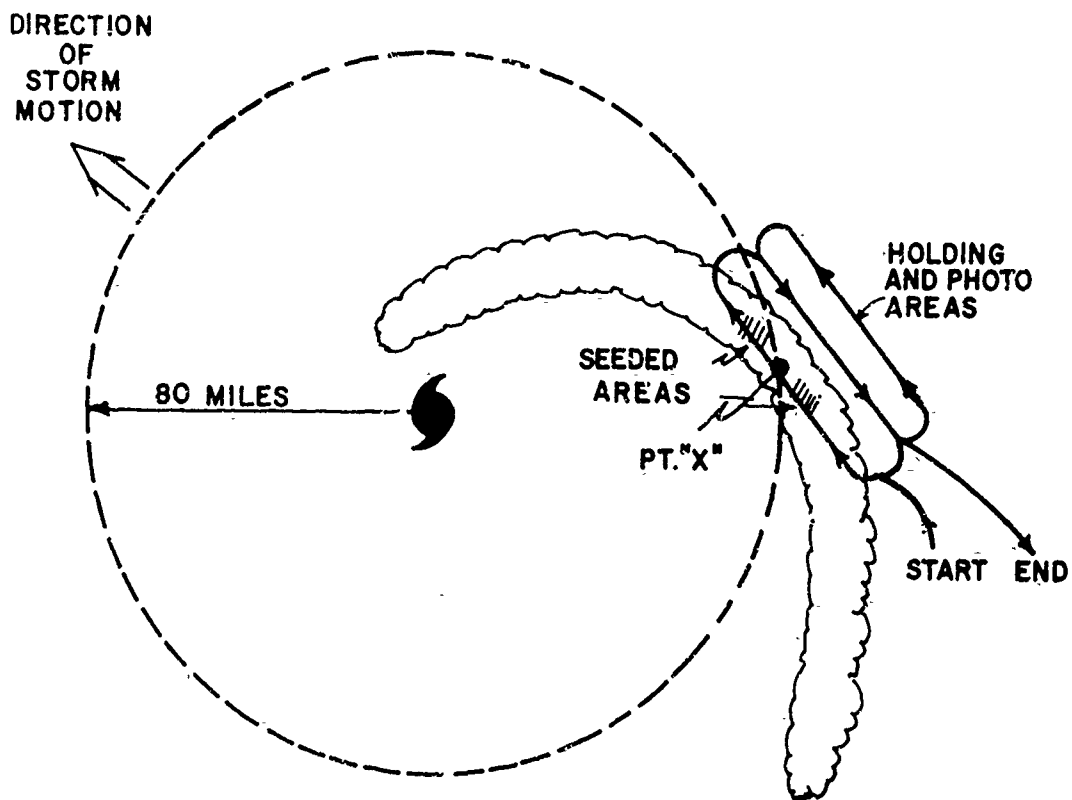

OPERATION ORDER
FWF JAX NO. 1-70

12. WC-135, FLIGHT U

a. Mission. Outflow Monitor. Take off in time to arrive on station at 41,000 feet at T-1. Conduct operations in accordance with Tab M of this appendix.

*b. General Communications and Reports.

*c. Data Collection.

*d. Post-Flight.

*Same as Eyewall Experiment, FLIGHT U.

TAB M - Flight Pattern for FLIGHT U
TAB N - Chronological Summary of On-Station Times
TAB O - Time Table of Aircraft Employment
TAB P - Flight Track Summary

FLIGHT PATTERN RAINBAND EXPERIMENT
FLIGHT "U" (AF WC-135) ALTITUDE 40,000 FT.
REPEAT 1-2-3-1 TRIANGLE FOR DURATION OF FLIGHT
VARIABILITY MONITORS

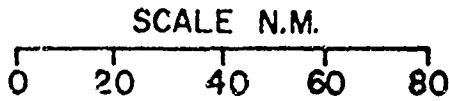
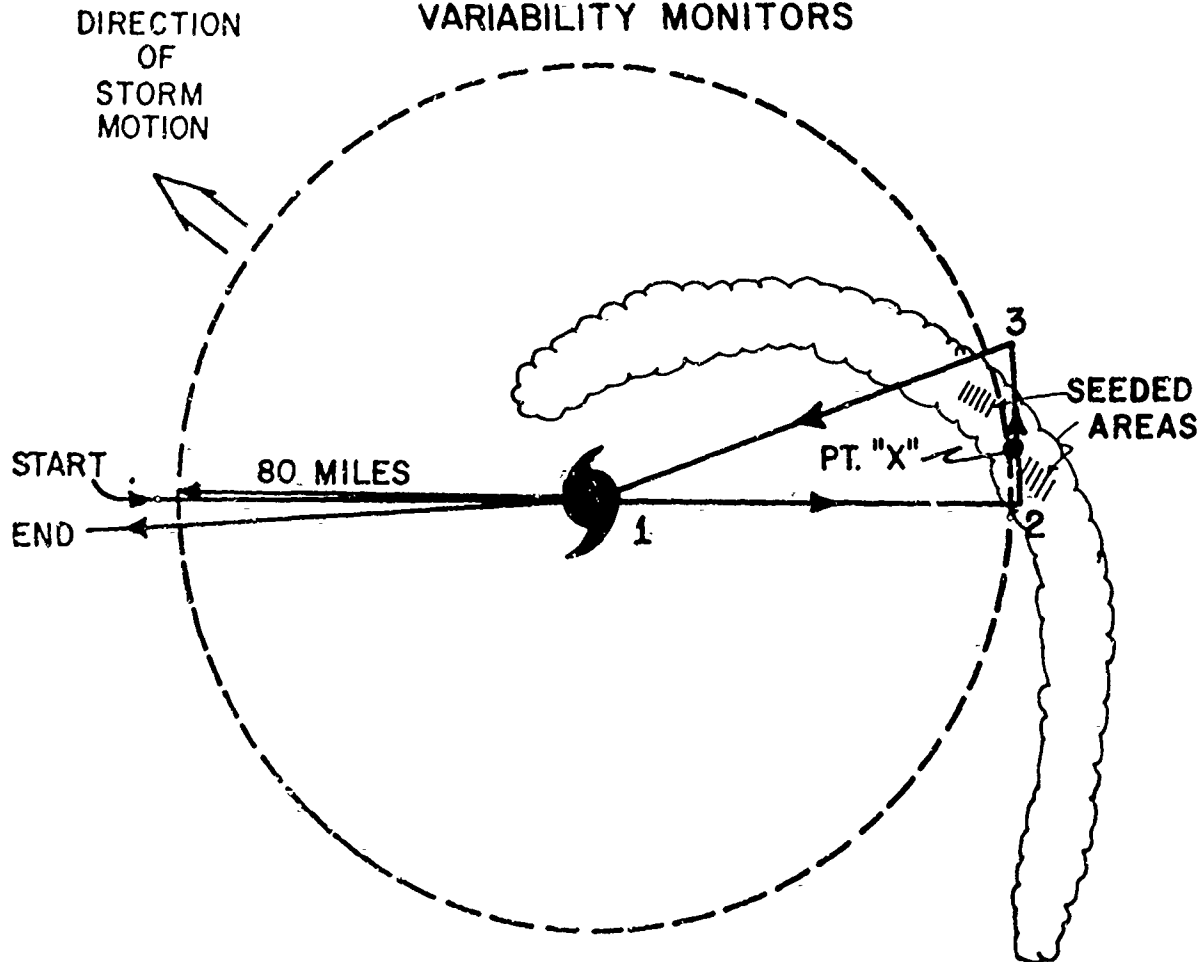

OPERATION ORDER
FWF JAX NO. 1-70

TAB N OF APPENDIX IV OF ANNEX D
CHRONOLOGICAL SUMMARY OF ON-STATION TIMES
RAINBAND EXPERIMENT

<u>Aircraft</u>	<u>Voice Call</u>	<u>On Station</u>	<u>Altitude (MSL)</u>
WC-130	STORMFURY I	T-3:30 to T+1	29,000
WC-121	STORMFURY F	T-2:30 to T+5	1,000 ABS
WC-121	STORMFURY H	T-2 to T+5	10,000
DC-6	STORMFURY B	T-1:30 to T+4	5,000
WC-135	STORMFURY U	T-1 to T+6	41,000
DC-6	STORMFURY A	T-1 to T+4	18,000
WC-121	STORMFURY E	T-1 to T+6	8,000
WB-57	STORMFURY C	T-0:30 to T+3	37,000
RB-57	STORMFURY K	T-0:30 to T+2:30	49,000
WC-130	STORMFURY D	T-0:30 to T+4	20,000
WP-3	STORMFURY S	T-0:15 to T+4	22-26,000
A-6	STORMFURY L-0	T-0:15 to T+4	22-26,000
WC-130	STORMFURY J	T+2 to T+7	29,000
WC-121	STORMFURY G	T+6 to T+13:30	1,000 ABS

TAB 1 TO APPENDIX IV TO ANNEX D
TIME TABLE FOR STORMFURY AIRCRAFT EMPLOYMENT — RAINBAND EXPERIMENT

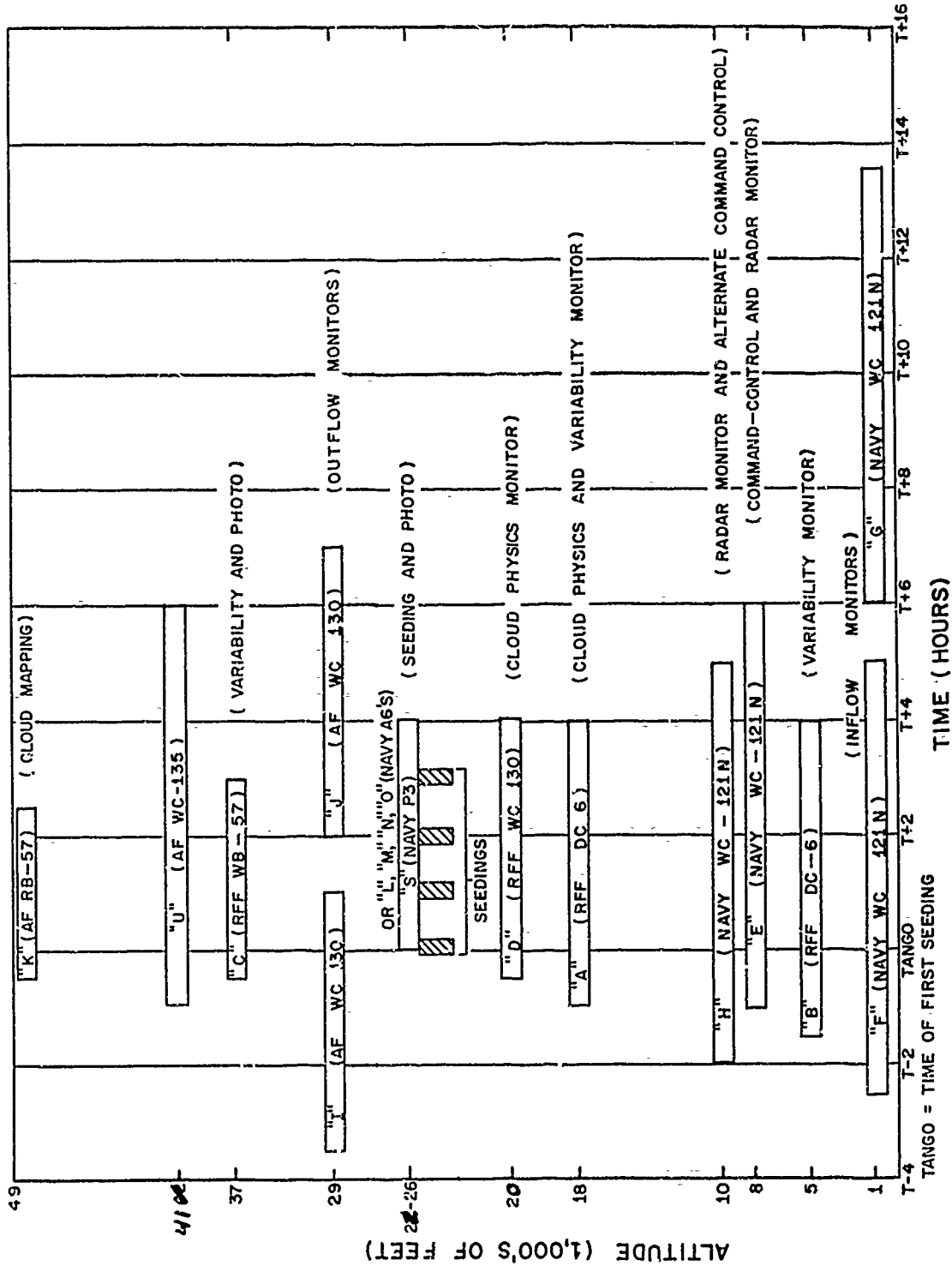

D-IV-0-1

RAINBAND EXPERIMENT

TAB P TO APPENDIX IV TO ANNEX D

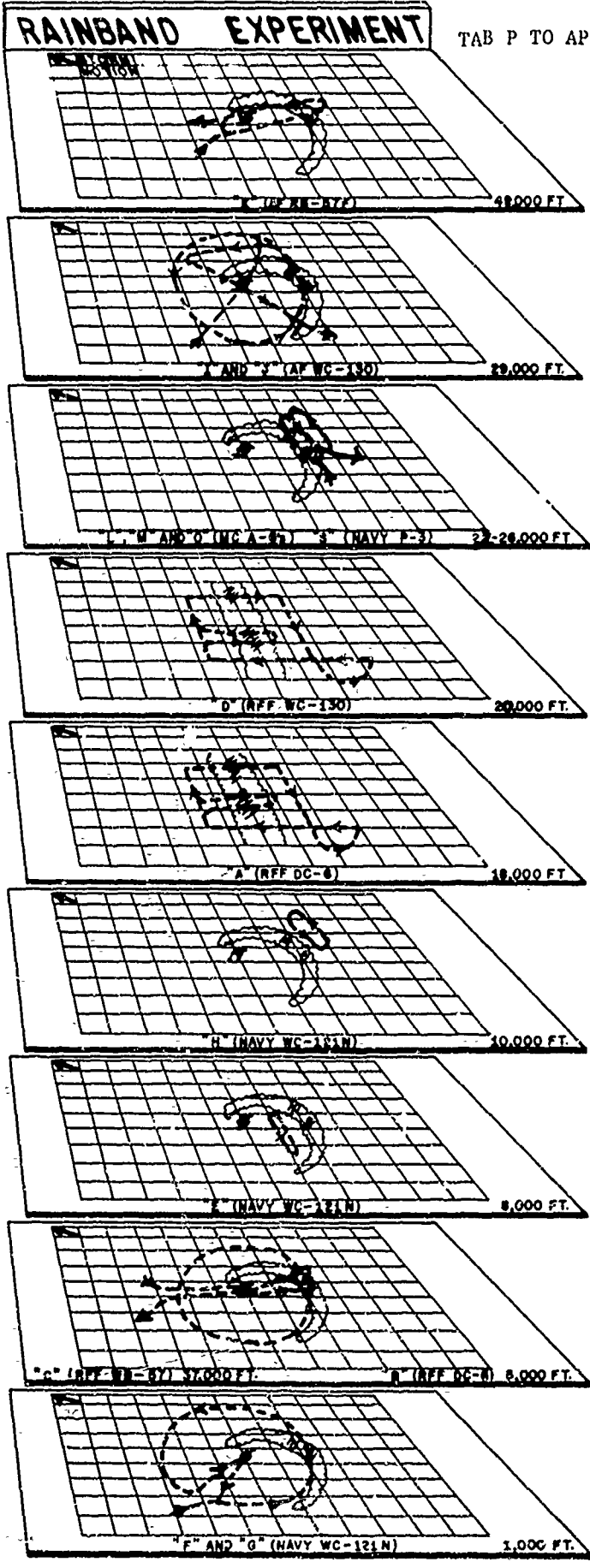

D-IV-P-1

BLANK PAGE

OPERATION ORDER
FWF JAX NO. 1-70

APPENDIX V TO ANNEX D

CLOUDLINE AND FALL-BACK RESEARCH MISSIONS

1. Situation. In the event that aircraft and personnel are deployed to the staging base to accomplish the primary mission of Project STORMFURY (to conduct either an Eyewall or a Rainband Experiment) and this mission cannot be completed, a fall-back research mission will be conducted. This mission is a data collection program, utilizing the deployed USN, ESSA and USAF aircraft and personnel to collect hurricane, tropical storm, or easterly wave meteorological/oceanographic data. A cloudline experiment has been scheduled for approximately an 8-day period at Naval Station, Roosevelt Roads, following the dry run.

2. Mission.

- a. Conduct FALLBACK ONE on a tropical cyclone.
- b. Conduct FALLBACK TWO on a tropical cyclone.
- c. Conduct FALLBACK THREE on an easterly wave.
- d. Conduct CLOUDLINE EXPERIMENT #1.
- e. Conduct CLOUDLINE EXPERIMENT #2.

3. Execution. When it appears that it will not be possible to conduct the primary mission of Project STORMFURY, the Navy Project Coordinator will direct execution of one of the following:

- a. Conduct FALLBACK ONE in accordance with Tab A.
- b. Conduct FALLBACK TWO in accordance with Tab B.
- c. Conduct FALLBACK THREE in accordance with Tab C.
- d. Conduct CLOUDLINE EXPERIMENT #1 in accordance with Tab D.
- e. Conduct CLOUDLINE EXPERIMENT #2 in accordance with Tab E.

4. Flight Procedures.

- a. STORMFURY Common instructions apply, pages D-1 through D-4.
- b. Mission. Data collection will be conducted as briefed prior to the experiment. FLIGHT E retains command control throughout. Back-up command control, if necessary, will be determined on scene.
- c. Flight Tracks and Altitudes. Conduct operations in accordance with the appropriate tab.
- d. Post-Flight Debriefing. As directed.

FALLBACK ONE

Altitude Assignments

41,000'	RFF-B-57 (STORMFURY C)
29,000'	AF-C-130 (STORMFURY I)
26,000'	RFF-C-130 (STORMFURY D)
18,000'	RFF-DC-6 (STORMFURY A)
11,000'	N-WC-121 (STORMFURY E & G)
6,000'	RFF-DC-6 (STORMFURY B)
1,000'	N-WC-121 (STORMFURY F & H)

FLIGHT TRACKS

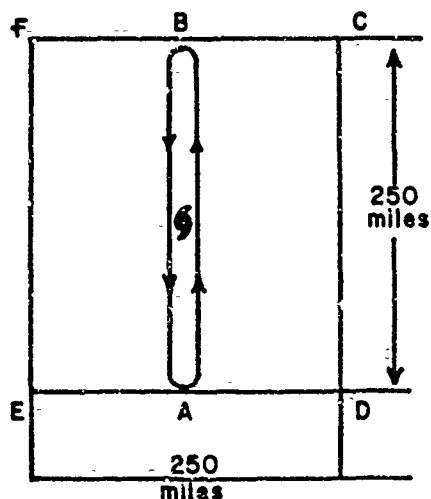

1. Point A is 125 miles from the tropical cyclone center along a radial from the tropical cyclone center to the staging base.
2. STORMFURY A, B, C, D, E, F, and I will fly the penetration pattern (A-B-A) and will take off at such time as required to arrive at Point A at 1245Z or at a time to be announced.
3. STORMFURY G and H will fly the box pattern (A-D-C-B-F-E-A) and will take off at such time as required to reach Point A at 1200Z or at a time to be announced.
4. Data collection same as in eyewall experiment.

FALLBACK TWO

Altitude Assignments

41,000'	RFF-WB-57 (STORMFURY C)
29,000'	AF-C-130 (STORMFURY I)
25,000'	RFF-C-130 (STORMFURY D)
18,000'	RFF-DC-6 (STORMFURY A)
12,000'	N-WC-121 (STORMFURY F)
7,000'	N-WC-121 (STORMFURY E)
2,000'	RFF-DC-6 (STORMFURY B)

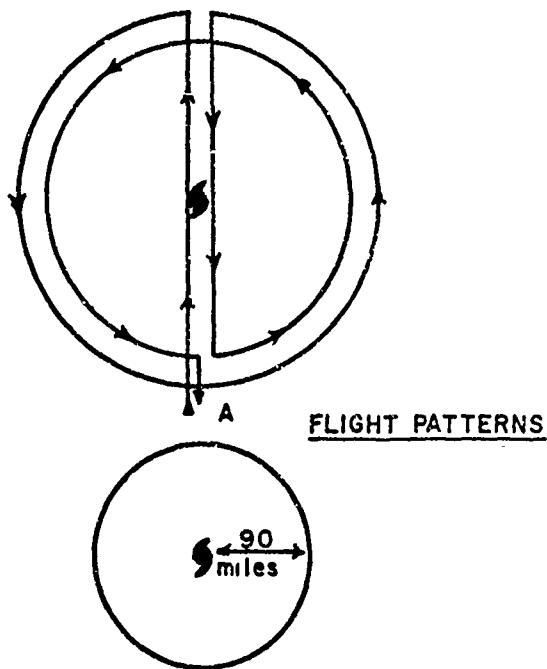

1. Point A is 90 miles from the tropical cyclone center along a radial from the center of the tropical cyclone to the staging base.
2. Each aircraft will make two circular patterns around and into the tropical cyclone as indicated. Takeoffs will be at such time as required to arrive at Point A at 1200Z or at a time to be announced.
3. Two options for FALLBACK TWO are as follows:
 - a. One WC-121 on a 150-mile orbit or 60 miles further out.
 - b. Two WC-121's with 2,000 feet separation and 10 minutes apart.
4. Data collected will be as in Annexes E and F, or as appropriate. Drops will be made by STORMFURY F and STORMFURY A every 30 minutes, keeping baseline checks while on radial legs. Drops will be copied, but not worked up until the aircraft has landed.

FALLBACK THREE

FLIGHT PATTERNS

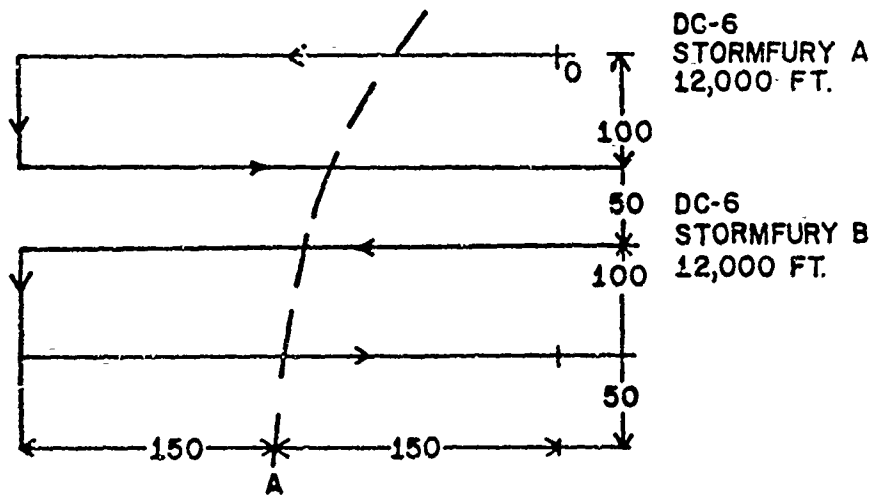
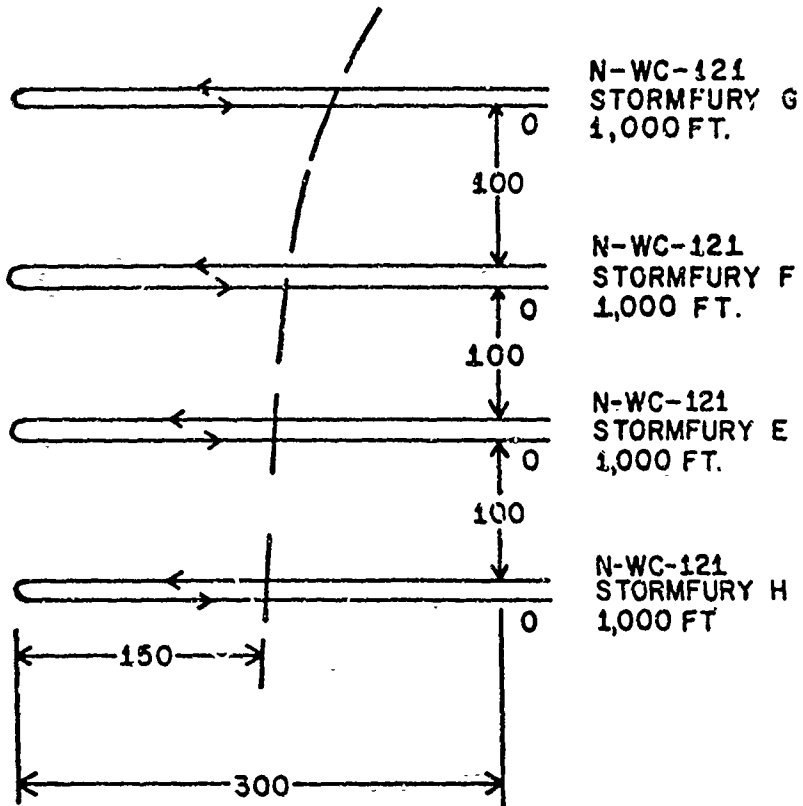

FALLBACK THREE FLIGHT PATTERN

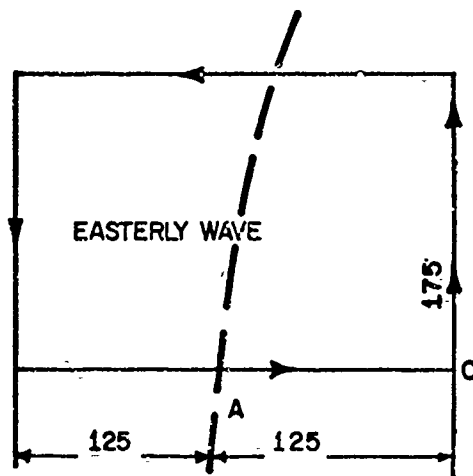

RFF-B-57
STORMFURY "C"
41,000'

1. Point A in all FALLBACK THREE flight pattern is a point on an easterly wave determined by the Navy Project Coordinator. Point O in all flight patterns is the origin of the track to be flown. All distances are in nautical miles.
2. Takeoffs will be at such time as required to arrive at the respective point O's at 1200Z, or at a time to be announced.
3. Data collected will be as in eyewall experiment or as appropriate. Drops will be made by STORMFURY A and B every 30 minutes. Drops will be copied, but not worked up until the aircraft has landed.

FLIGHT PATTERN CLOUD LINE EXPERIMENT NO. 1
 FLIGHTS "A" (RFF DC-6) Altitude 18-20,000 FT.
 FLIGHTS "B" (RFF DC-6) Altitude 1500 FT.

VARIABILITY AND CLOUD PHYSICS MONITORS

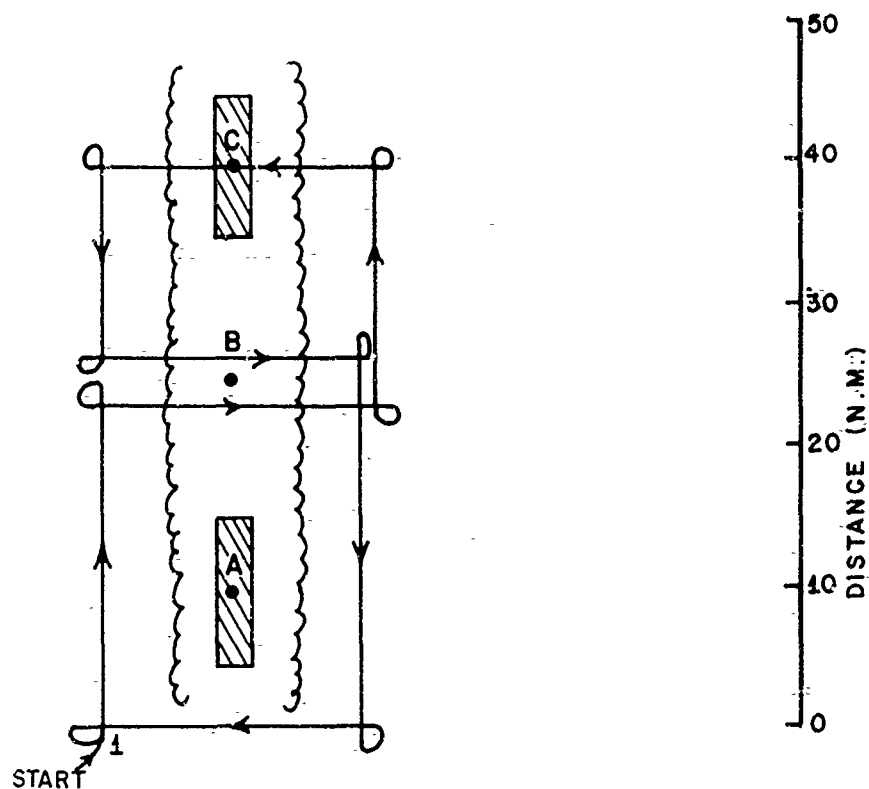

COMPLETE THE PATTERN PRIOR TO THE FIRST SEEDING AND REPEAT THE PATTERN UNTIL RELEASED BY THE PROJECT DIRECTOR. MULTIPLE SEEDINGS ARE ANTICIPATED AND AREAS A and C WILL BE REDESIGNATED AT THE TIME OF EACH SEEDING.

FLIGHT PATTERN - CLOUD LINE EXPERIMENT NO. 1

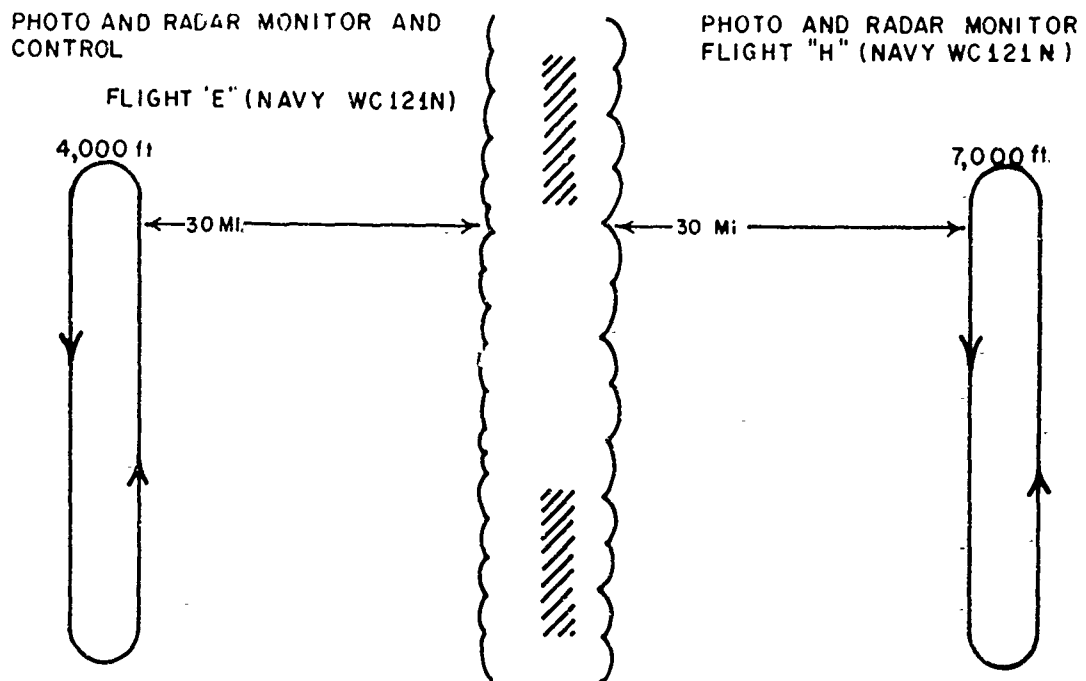

BOTH AIRCRAFT WILL FLY PATTERNS AS DEPICTED ORIENTED ON THE CLOUD LINE SELECTED BY THE PROJECT DIRECTOR. CONTROL OF SEEDER AIRCRAFT MAY BE REDELEGATED AT BRIEFING.

FLIGHT PATTERN CLOUDLINE EXPERIMENT NO. 1
FLIGHT "I" (AF WC 130) ALTITUDE 29,000 FT.
COMPLETE TWO CIRCUMNAVIGATIONS OF SEEDING AREA
DROPSONDE AND LARGE SCALE MONITOR

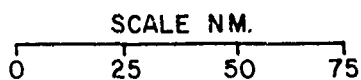
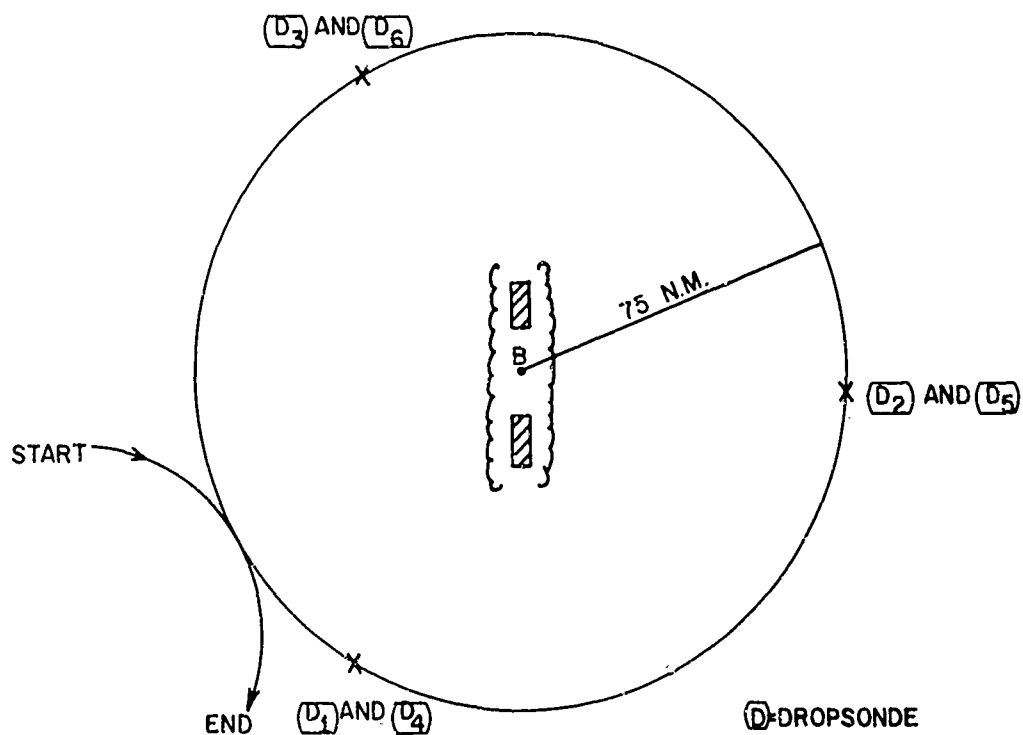

FLIGHT PATTERN - CLOUD LINE EXPERIMENT NO. 1
FLIGHT "K" (AF RB-57) Altitude 49,000 FT.
CLOUD MAPPING AND ABOVE

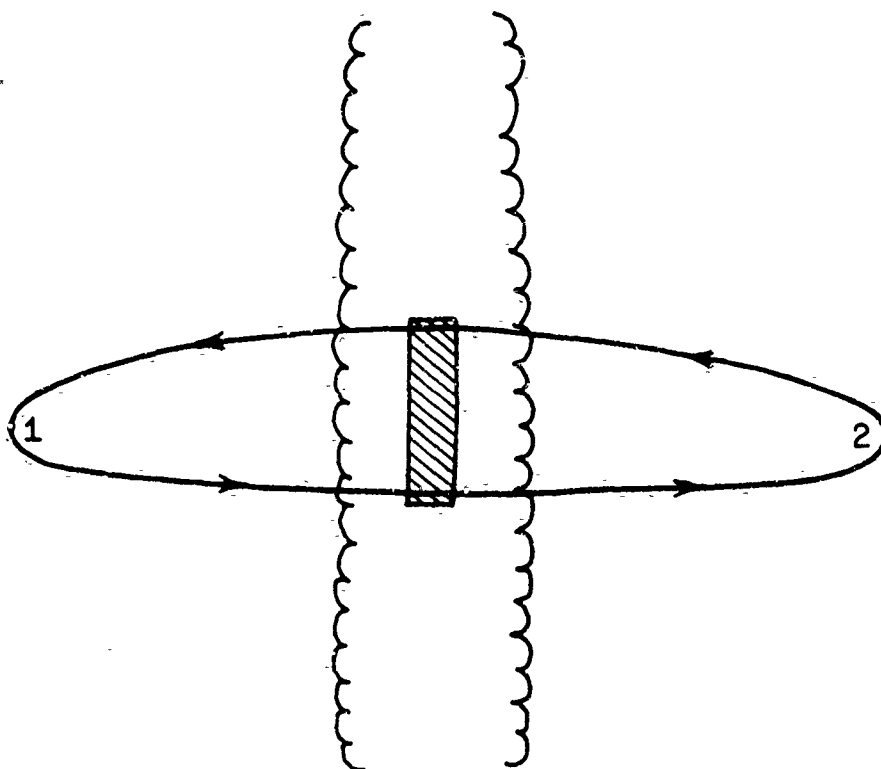

REPEAT PATTERN UNTIL RELEASED BY THE PROJECT DIRECTOR

FLIGHT PATTERN CLOUDLINE EXPERIMENT NO. 1
 FLIGHTS "S" (NAVY P-3) ALTITUDE 22-27,000FT.
 OR "A" (RFF DC-6) ALTITUDE 18-22,000FT.
 OR "L" and "M" (NAVY A-6b) ALTITUDE 22-27,000FT.
 SEEDER AIRCRAFT AND PHOTO MONITORS

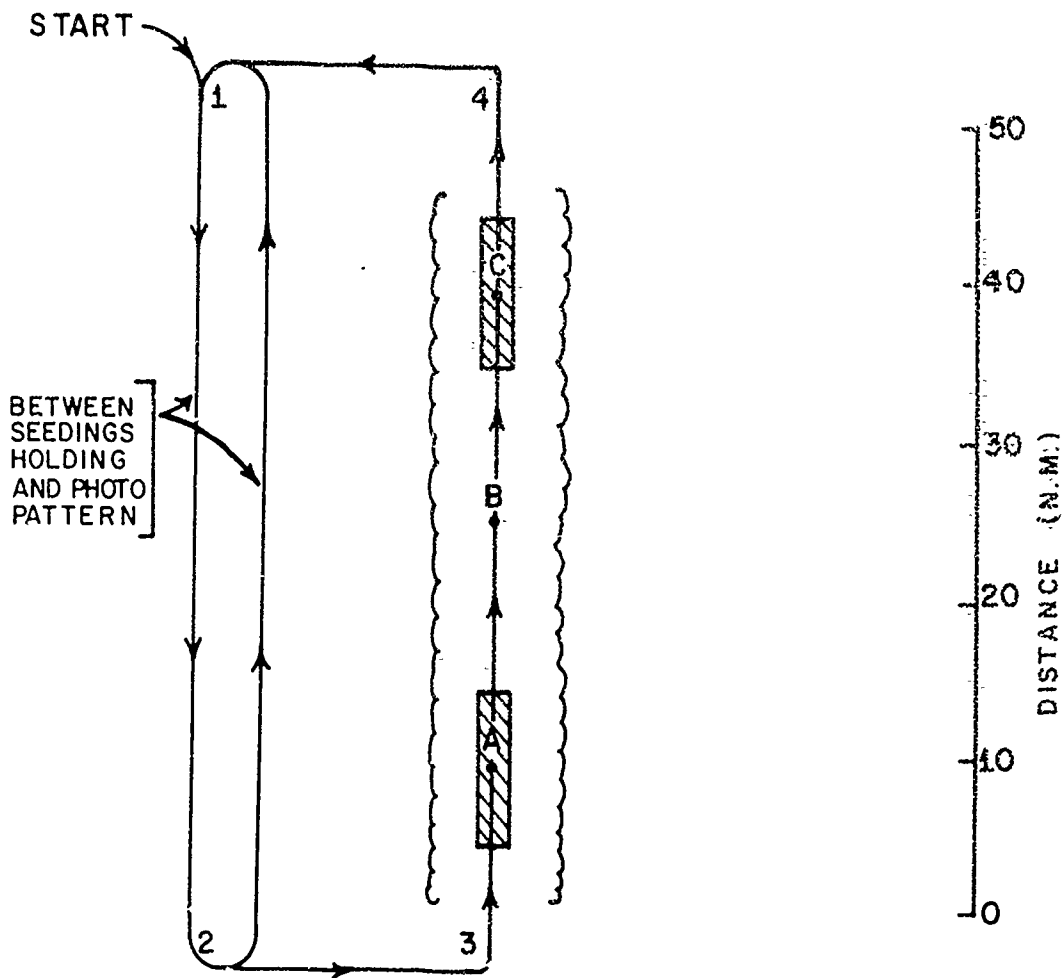

PHOTOGRAPHS TO BE OBTAINED BETWEEN POINTS 1 and 2

FLIGHT PATTERN CLOUDLINE EXPERIMENT NO. 2
FLIGHTS "A" (RFF DC-6) ALTITUDE 18-20,000 FT.
AND "B" (RFF DC-6) ALTITUDE 1500 FT.

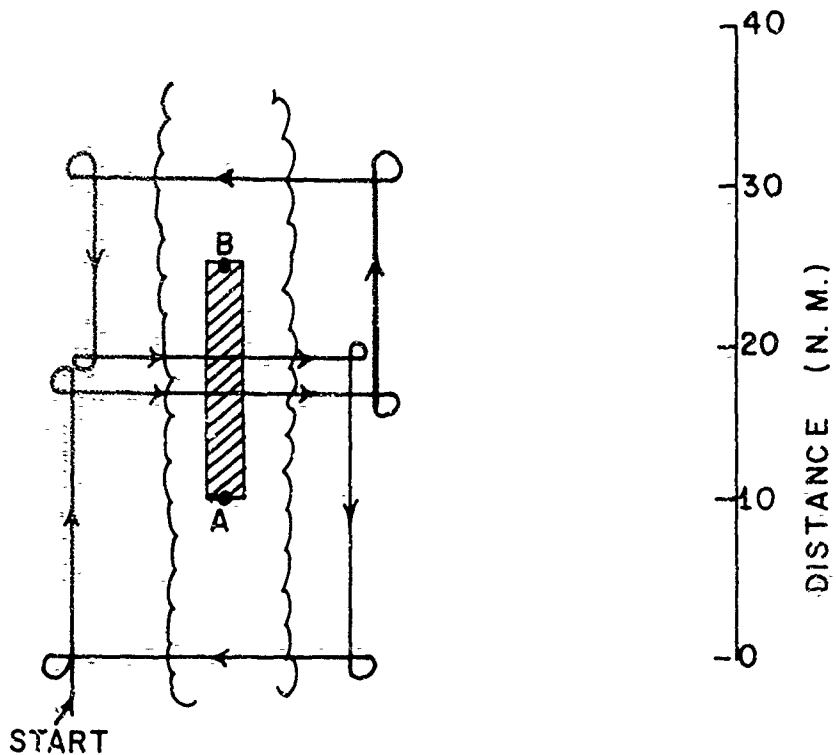

COMPLETE THE PATTERN PRIOR TO THE FIRST SEEDING AND REPEAT THE PATTERN UNTIL RELEASED BY THE PROJECT DIRECTOR. MULTIPLE SEEDINGS ARE ANTICIPATED AND AREAS A and B WILL BE REDESIGNATED AT THE TIME OF EACH SEEDING.

FLIGHT PATTERN — CLOUD LINE EXPERIMENT NO.2

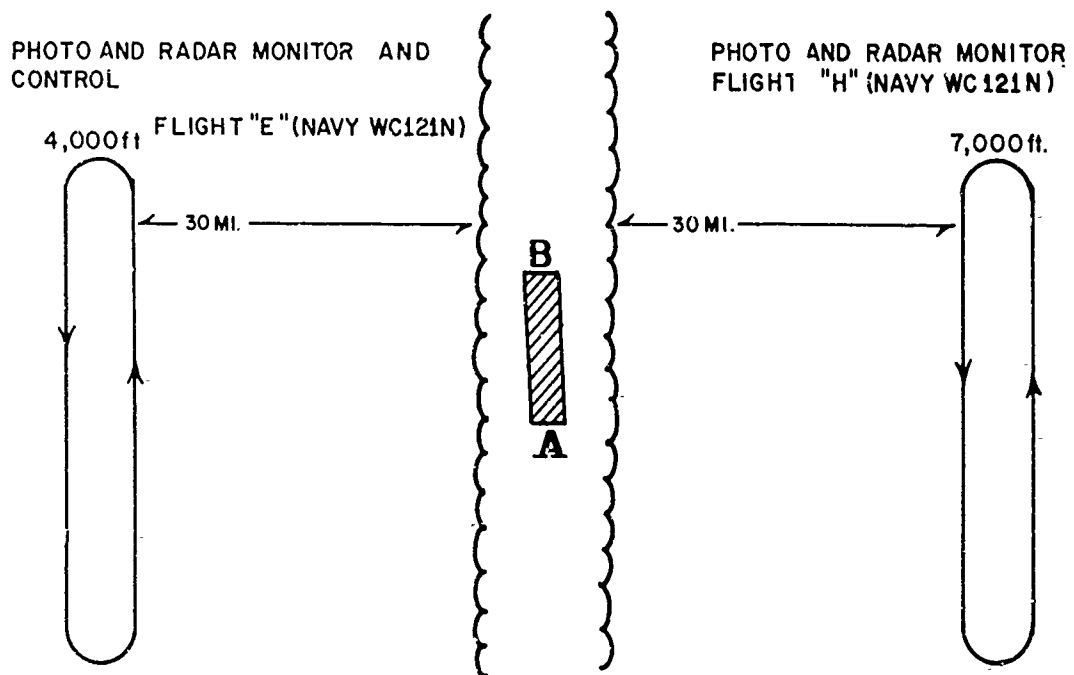

BOTH AIRCRAFT WILL FLY PATTERNS AS DEPICTED ORIENTED ON THE CLOUD LINE SELECTED BY THE PROJECT DIRECTOR. CONTROL OF SEEDER AIRCRAFT MAY BE REDELEGATED AT BRIEFING.

FLIGHT PATTERN — CLOUDLINE EXPERIMENT NO.2
FLIGHT "I" (AF WC-130) ALTITUDE — 29,000 FT.
COMPLETE TWO CIRCUMNAVIGATIONS OF SEEDING AREA
DROPSONDE AND LARGE SCALE MONITOR

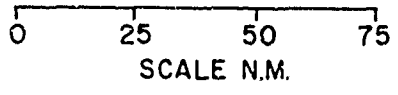
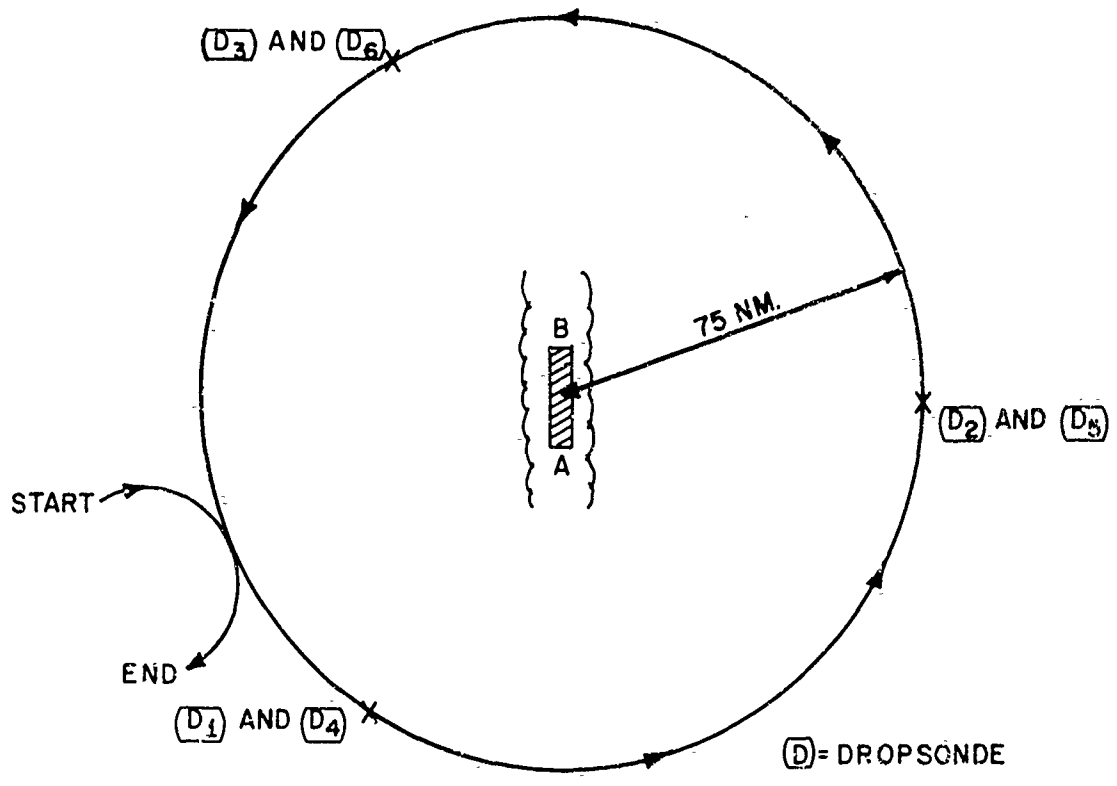

FLIGHT PATTERN CLOUDLINE EXPERIMENT NO. 2
 FLIGHTS "S" (NAVY P3) ALTITUDE 22-27,000 FT.
 OR "A" (RFF DC6) ALTITUDE 18-22,000 FT.
 OR "L" AND "M" (NAVY A6'S) ALTITUDE 22-27,000 FT.
 SEEDER AIRCRAFT AND PHOTO MONITORS

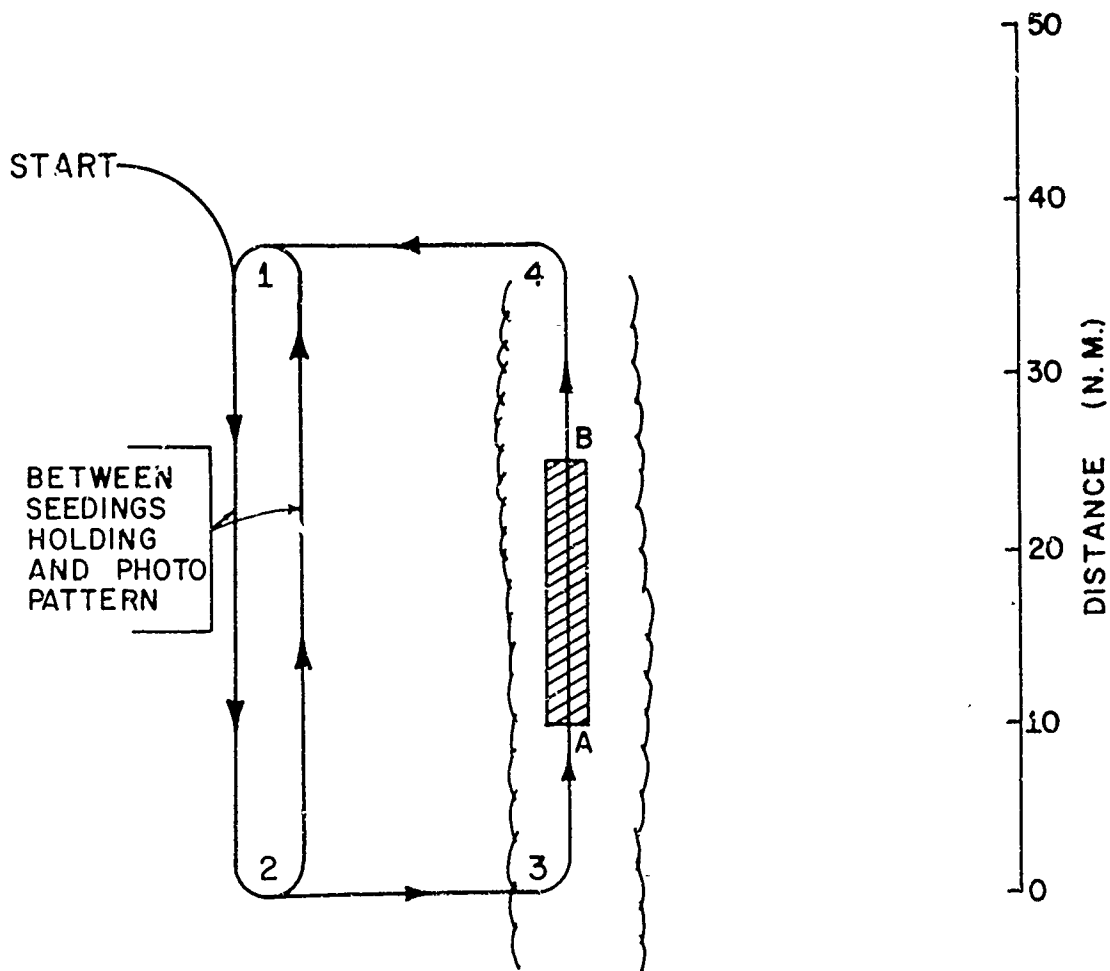

PHOTOGRAPHS TO BE OBTAINED BETWEEN POINTS 1 AND 2

FLIGHT PATTERN CLOUD LINE EXPERIMENT NO. 2
FLIGHT "K"(AF RB-57) ALTITUDE 49,000 FT.
CLOUD MAPPING AND ABOVE

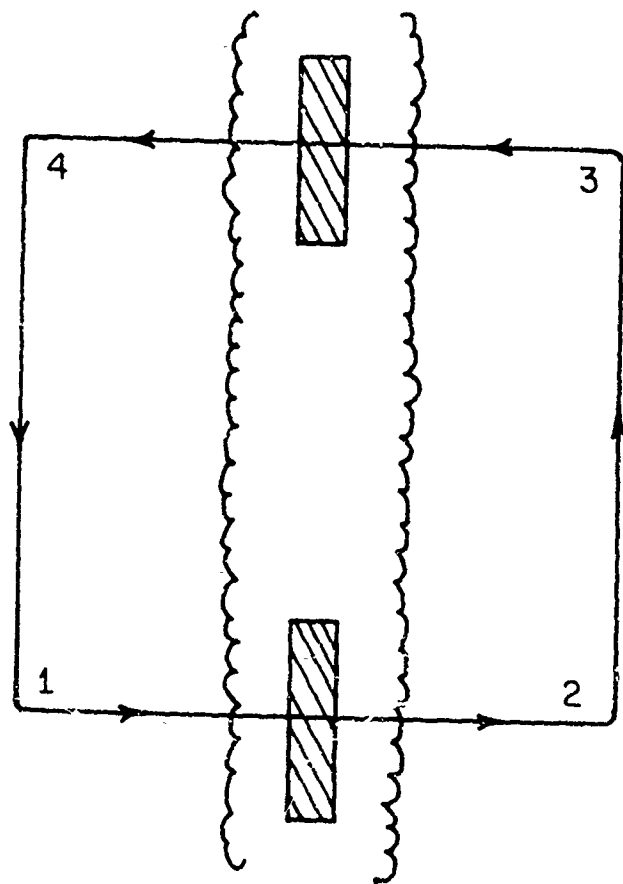

REPEAT PATTERN UNTIL RELEASED BY THE PROJECT DIRECTOR

OPERATION ORDER
FWF JAX NO. 1-70

APPENDIX VI TO ANNEX D

DATA LOGGING SYSTEM

1. General. The following information is provided on the channelization of the Navy WC-121N Data Logging System:

Channel	Parameter	Recorded Increments	Limits	Source
00	Date	Month, Day, Year	0 to 12319	Metro
01	Time	Hrs., Min., 10 Secs.	0 to 23:59:5	Clock
02	Lat. & Quadrant	Degrees, Min., Quad.	0 to 90:00:3	ASN-41
03	Longitude	Degrees, Min.	0 to 180:00	ASN-41
04	Absolute Altitude	10 Feet	0 to 29990	APN-159
05	Pressure Altitude	10 Feet	0 to 20000	XDucer
06	Ambient Pressure	Tenths of Millibars	500.0 to 1050.0	XDucer
07	Ambient Temp.	Tenths of Deg Cen	-40.0 to +99:99	DY 2801A
08	Dew Point	Tenths of Deg Cen	-50.0 to +50.0	Dew Ptr
09	Wind Direction	1 Degree	0 to 359	ASN-41
10	Wind Velocity	1 Knot	0 to 359	ASN-41
11	Sea Surface Temp.	Tenths of Deg Cen	-10 to +40	ART-4A
*12	Wave Height	Nearest Foot	0 to 99	APN-159
*13	Wave Period	Nearest Second	0 to 999	APN-159
14	True Air Speed	1 Knot	0 to 359	AX-606
15	True Heading	1 Degree	0 to 359	ASN-41
16	Ground Speed	1 Knot	0 to 359	APN-153
17	Drift Angle	1 Degree	+60	APN-153
*18	Ice Rate	1 Degree	0 to 250	XDucer
19	Cloud Group	RECCO Code	0 to 99999	Metro
20	Cloud Group	RECCO Code	0 to 99999	Metro
21	Cloud Group	RECCO Code	0 to 99999	Metro
22	Cloud Group	RECCO Code	0 to 99999	Metro
23	Cloud Group	RECCO Code	0 to 99999	Metro
24	Surface Winds	RECCO Code	0 to 99999	Metro
25	Sea Condition Group	RECCO Code	0 to 99999	Metro
26	Icing Group	RECCO Code	0 to 99999	Metro
27				
*28	Rocketsonde			
29	Bathythermograph	10 Ft Tenths of Deg F	0025.0 - 9995.0	ARR-51

*Not Operational

OPERATION ORDER
FWF JAX NO. 1-70

Project STORMFURY
Fleet Weather Facility
Naval Air Station
Jacksonville, Florida
June 1970

APPENDIX VII TO ANNEX D

RADAR EQUIPMENTS, OPERATIONS AND PHOTOGRAPHY

1. General.

a. Radarscope photography, by presenting three-dimensional displays of the precipitation patterns, as well as prevision IFF aircraft positional data, is one of the most important contributions to the success of the Project STORMFURY experiments. Radars and radarscope photographic facilities on such aircraft should therefore be maintained, tuned and calibrated to the highest standards in order to obtain research-grade data as well as contributing to flight control and safety.

b. Radar Data Advisors, designated by the Project Director, will be aboard each WC-121N aircraft to assist APS-45 operators and Photo Officers in the operations involved in obtaining optimum radar data for each experiment.

2. Radar Equipment and Operations.

a. All aircraft containing radars will operate within the guidelines specified for their flight designation in Tab A through Tab B of this annex and/or as modified by Command or Radar aircraft with Project Director exercising Emission Control for the experiment.

b. All radar antennas will be aligned on true north where possible. Aircraft configured with two or more radar systems will ensure that all radar antennas are in agreement before takeoff. Where possible, they will simultaneously photograph ground patterns after takeoff to document such alignment and make an appropriate entry in the Radarscope Photography Log (see Annex E, Form SF-8).

c. All radarscope picture tubes which are photographed will be scribed with a narrow opaque line originating at the center of the tube face and extending to the outer edge of the glass surface to continuously and precisely indicate true north on all photographs.

d. All cameras aboard WC-121N aircraft will have ID code numbers affixed in the camera data chamber, separate from the clock and data card, such that the number appears on each radar photograph. (A typed number on white paper stuck on the right edge of the frame counter or other suitable location would accomplish this.) This camera number along with the film magazine will be entered in the Radarscope Photography Log, Form SF-8.

OPERATION ORDER
FWF JAX NO. 1-70

e. Minimum Discernible Signal (MDS) and Peak Power transmitted (P_T) will be determined for each radar and entered in the Radarscope Photography Log (Form SF-8 , Annex E) under "Remarks" for all radars.

3. Radarscope Photography Instructions.

a. Pre-Flight Checks, All Cameras.

(1) Darkroom load all film. Use Plus X film. If possible, carry at least one spare magazine in addition to that required for radarscope photography while within 200 miles of the storm center and/or seeded area.

(2) Wind and set clocks only once per flight, noting clock error thereafter in seconds fast (F) or slow (S) on data card, as shown on data card sample below. Clock face will be conspicuously annotated with a (Z). This will be done by typing a capital Z on a small piece of paper, and attaching the paper to the clock crystal with glue. The paper must be small to minimize obscuration of clock hands.

(3) All radar data cards will be completed before takeoff as follows:

A/C voice call sign/BuNo. .
Date (Z).....
Type radar/scope nomenclature
Altitude/time error (in sec).
Range/range marks.....
RHI stroke ht, K ft, APS-45..
or APS-20 MDS test: DBM.

STORMFURY H/1323
3 Oct 1969
APS-20 IP-230
6,000 ft/8S
100/50 mi. RM

	STORMFURY G/ 1232 4 Aug 1970

Keep aircraft altitude and data correct and up-to-date on all data cards as changes occur in flight.

(4) Without magazine in place, check shutter operation for visible sweep through lens aperture.

(5) Check solenoid for single film advancement each shutter operation.

(6) Set f , stop (f , 5.6 all APS-20 and APS-45 cameras).

(7) Check clock and data section illumination lights for proper operation, loose wires, smooth operation and proper orientation of azimuth wheel on APS-45 camera, etc..

OPERATION ORDER
FWF JAX NO. 1-70

(8) Check internal and external frame counter on camera for agreement; and film "backing plate" pressure all magazines.

(9) Never put magazine on camera without first turning camera off.

(10) After installing magazine first time and before removing last time, click off 20 frames; other intermediate times of magazine removal, click off 5 frames.

b. In-Flight Checks and Operations.

(1) Set up all scopes after reaching assigned altitude. First, set intensity so sweep is visible with video OFF; then set video until "noise" is visible on scope; then add proper range mark intensity. Except as prescribed later, leave all scope settings alone for entire flight (to facilitate data reduction and minimize data card changes, which are frequently overlooked).

(2) APS-20 Range Mark Documentation. As soon as possible after takeoff, take three frames of film on each different range setting specified for flight with intensity, video and range marks set for normal photography. This series is necessary in order to document N-line and island targets on each scope range before beginning normal radarscope operations. Document each properly by standard data card entry.

(3) A Radarscope Photography Log (Form SF-8) shall be maintained each hour for each radarscope while it is photographed in order to ensure for continuous optimum operation and accuracy of time clocks being photographed to within one second each hour, reference WWV.

(4) At each hourly time check, as camera operates normally, check external film advancement (star wheels on side of magazine); note internal and external frame counters (log differences); check for clock and data section illumination; check data card for proper mode of radar operation and possible aircraft height or date changes; check APS-45 azimuth documentation wheel against console; check film footage for possible magazine replacement. Do NOT run out of film!

(5) Unless scope intensity, range marks, focus, etc., change appreciably, do not adjust at each time check.

(6) Short Test Film. In the event a special in-flight film test is necessary, use spare magazine to take about 20 frames of radar data (at assigned altitude and after setting all permanent modes of radar and camera operation for that flight). Do NOT include APS-20 radar calibration, APS-45 height line checks, etc., described elsewhere, which are necessary on each piece of operational film. Develop test film in dark bag. Show film to Radar Data Advisor and retain for inclusion with permanent radar data.

OPERATION ORDER
FWF JAX NO. 1-70

(7) APS-45 Range and Height Line Documentation. After setting up radar operation modes and clicking off 20 frames of film to clear magazine and check normal operation, take series of PPI north line and ground pattern orientation photography. Run photo height line film documentation by manually taking one picture with the height cursor line set at each 5,000 foot level from the surface to 40,000 feet on 60 mile range. Range marks should be prominent on these photos. All subsequent RHI pictures are taken with the height line at 20,000 feet above the surface. Origin of sweep should remain constant for entire flight. If changes do become necessary, redocument height lines. Documentation enroute to and from area are minimum requirements.

(8) APS-45 Console Azimuth, Camera Data Chamber Azimuth and PPI Sweep Azimuth Documentation. At any time early and late in the flight (altitude is not important, but radar and camera operation modes should be as set for entire flight), adjust console azimuth manually to North or East (depending on alignment aid provided in camera for pointer on camera syncro), carefully twist camera syncro to bring data chamber pointer (long stripped end) to exact agreement with console azimuth indicator and document on film as follows: Install clock and data card in camera (write "AZ test" on card), place scope in PPI mode, antenna fixed in azimuth (not rotating), but rocking 16° vertically, "EMERGENCY SCAN" on, camera control box: lights "ON", set for "EVERY OTHER" scan, "JOHN'S BOX" on "RHI MANUAL". Take one picture normally each 10°, starting at North and ending at North, changing azimuth manually between frames. This documentation is necessary for later film analyses.

(9) General APS-45 Camera Operation. Set C3-R camera control box to lights "ON"; voltage on RHI to maximum, PPI to 16V; "EVERY OTHER" scan and leave for entire flight. Operate camera entirely with "JOHN'S BOX", turning camera off by going to "PPI" - or "RHI MAN" modes, not by using C3-R control box. Operating modes are covered in Radarscope Photography requirements.

4. Radar Logs, Film Processing and Distribution.

a. MDS, Radarscope Photography, and Radar Advisor's Logs will be disseminated before experiments and collected after flights by the Data Quality Control Coordinator (DOCC).

b. Copies of all logs and film will be made and sent by DOCC to NHRL Miami, WEARESCHFAC Norfolk, and the generating agency, as required.

OPERATION ORDER
FWF JAX NO. 1-70

TAB A

ALL VW-4 WC-121N FLIGHTS

1. Radarscope Photographic Requirements:

<u>Radar</u>	<u>Scope</u>	<u>Range</u>	<u>RM</u>	<u>Presentation</u>
APS-20	IP-230	200	50	Radar video only when over 100 NM from storm center.
		100	50	Radar video only when over 100 NM from storm center.
	APA-81	100	40	Radar video and IFF, off center or GPI, best presentation.
		50	40	When within 50 miles of eye of experimental area.
APS-45	PPI	60	20	Every 2 minutes. Series of PPI-2°, 0°, +2° tilt for flights above 5,000 ft; 0°, +2°, +4° for flights below 5,000 ft; 360° RHI survey of significant weather every half hour.
	RHI	60	20	Concentrate on eye (eyewall) or seeded and surrounding areas. Use manual azimuth control constantly on "E" and "H"; when in eye or within range of experimental area on "F" and "G"; otherwise, use RHI Auto on 1 RPM for "F" and "G".

a. APS-20 photo every scan, APS-45 PPI and RHI every other scan as above when within 200 miles of eye and/or center of seeded area.

b. Operate APS-20 with moderate STC as necessary, FTC off, IAGC N, receiver gain at 20-30% "grass" for best weather video presentation. GPI may be used on "radar" (H) and/or "command" (E) scopes at discretion of Project Director. Log permanent antenna elevation +1° to +3° for best weather video depending on flight altitude. Log changes if necessary.

c. On all APS-20's where radar weather video and IFF data are gathered simultaneously, the weather video should be slightly visible above "noise" on the scope with the IFF appearing as a much stronger, but not "blooming", signal such that IFF data are best displayed on these scopes.

OPERATION ORDER
FWF JAX NO. 1-70

d. On "radar" (H) and/or "command" (E) aircraft, the APS-20 radar data program may be modified slightly by the Radar Data Advisor with consent of the Project Director in order to suit changing conditions of track, flight safety, control of aircraft, etc.. However, the basic intent on both aircraft is to obtain the highest quality of radar weather video on one scope and mixed video - IFF on the other for accurate aircraft positioning, both scopes on optimum range settings for maximum detail. Consequently, radarscope range settings might be changed for short periods on these aircraft, then returned for basic operation.

e. On fallback and cloudline experiments, rely on flexibility provided in paragraph (d) above to modify APS-20 IP-230 ranges to 50/10 mile range marks when within 50 miles of experimental area, leaving APS-81 and APS-45 programs basically as specified. On cloudline missions when within 50 miles of experimental area, operate APS-45 RHI survey series at plus or minus 45 degrees azimuth, centered on seeded areas; then survey three hundred sixty degrees (360°) RHI every half hour; PPI series every five minutes. On fallback and cloudline missions, when beyond 50 miles of experimental area, take PPI series at 5 minute intervals, RHI Auto on 1 RPM if significant weather; if not, specified cloud only.

OPERATION ORDER
FWF JAX NO. 1-70

TAB B

ALL DC-6 FLIGHTS

1. Radarscope Photographic Requirements:

<u>Radarscope</u>	<u>Range</u>	<u>RM</u>	<u>IEC</u>	<u>STC</u>	<u>Presentation</u>
APS-20 Eyewall	100	20	-	On	IFF, no radar video.
APS-20 Rainband & Fallback	100	20	-	On	IFF and radar video, tilt antenna up for best weather.
APS-20 Cloudline	50	10	-	On	IFF and weather.
WP-101 (All Missions)	50	10	On	On	Permanent antenna tilt best presentation.
RDR-1 (All Missions)	20	5	On	On	Antenna: rotating vertical.

a. Photograph every scan (or at least once every 10 seconds, whichever occurs last) when within 200 miles of eye and/or center of seeded area.

b. Note proper documentation necessary on all data cards, paragraph 3 in this appendix.

c. Note hourly time checks necessary for equipment, cameras, radarscope clocks, etc., and maintain Radarscope Photography Log, Annex E, Form SF-8.

d. Operate APS-20 with moderate STC as necessary, FTC off, IAGS on, receiver gain at 20-30% "grass" for best weather video presentation.

e. On all APS-20's where radar weather video and IFF data are gathered simultaneously, the weather video should be slightly visible above "noise" on the scope, with the IFF appearing as a much stronger, but not "blooming" signal, such that IFF data are best displayed on these scopes.

OPERATION ORDER
FWF JAX NO. 1-70

TAB C

C-130, WB-57, WB-47 AND SEEDERS

1. Radar Photographic Requirements:

<u>Radar</u>	<u>Range</u>	<u>RM</u>	<u>IEC</u> <u>STC</u>	<u>Presentation</u>
Nose Radar	Intermediate- about 50 miles	10/20 mi. visible	On On	Weather video only - antenna tilt for best weather presenta- tion- <u>log antenna tilt.</u>

a. Photograph at least every other scan consistent with capability to record all radarscope data within 200 miles of eye and/or center of seeded area, except 30 to 50 mile radius for seeders.

b. Note proper documentation necessary all data cards (paragraph 3 of this appendix).

c. Note hourly time checks necessary for equipment, cameras, radarscope clocks, etc., on Radar Photography Log, Form SF-8.

d. Seeder aircraft and others with "turn around" missions, install freshly-loaded film magazine in radarscope cameras when refueling. Others carry necessary spare magazines consistent with paragraph (a) above.

OPERATION ORDR
FWF JAX NO. 1-77

APPENDIX VIII TO ANNEX D

AIRSPACE RESERVATION AGREEMENT

1. Airspace reservations will be requested and utilized as outlined in Tabs A through D inclusive.

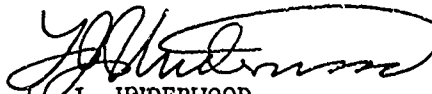

L. J. UNDERWOOD
Commander, U. S. Navy
Navy Project STORMFURY Coordinator

Tabs:

- A - Project STORMFURY Letter of Agreement with FAA
- B - International NOTAMS, AIM Publication
- C - 24-Hour NOTAM
- D - 3-Hour NOTAM

OPERATION ORDER
FWF JAX NO. 1-70

APPENDIX VIII TO ANNEX D
AIRSPACE RESERVATION AGREEMENT

1. Airspace reservations will be requested and utilized as outlined in Tabs A through D inclusive.



L. J. UNDERWOOD
Commander, U. S. Navy
Navy Project STORMFURY Coordinator

Tabs:

- A - Project STORMFURY Letter of Agreement with FAA
- B - International NOTAMS, AIM Publication
- C - 24-Hour NOTAM
- D - 3-Hour NOTAM

OPERATION ORDER
FWF JAX NO. 1-70

3. Request for Airspace. A request for a specific airspace reservation will be made to the appropriate Center 48 hours before "T" time by the Navy Project Coordinator. The coordinates of the designated center point of the requested airspace reservation will be validated or revised at T minus 24 hours, T minus 12 hours, and T minus 6 hours. Concurrent with the 12-hour notification, the Navy Project Coordinator will advise the type mission, either Rainband, Rainsector, Eyewall or Cloudline Experiment.

The Navy Project Coordinator is responsible for obtaining approval for operations within Warning/Restricted Areas.

4. Air Traffic Control Procedures. Standard air traffic control procedures will be utilized enroute to and from the reservation area. Participating aircraft shall flight plan to/from a point(s) on the perimeter of the reservation and advise ATC when entering the airspace reservation, and shall obtain ATC clearance through the STORMFURY Command Aircraft prior to departing the area or remain in VFR flight conditions. Should any deviation from the assigned protected airspace be necessary, it will be requested by the aircraft concerned on an individual basis through the STORMFURY Command Aircraft.

The Commanding Officer, VW-4, will ensure that operational control and separation of participating aircraft in the STORMFURY airspace reservation, including all military and BSSA aircraft, will be exercised and maintained by the STORMFURY Command Aircraft. This MARSAs concept shall become effective upon activation of the STORMFURY airspace reservation and remain in effect until the reservation is terminated.

Search and Rescue action, if necessary, shall be initiated by action of the Commanding Officer, VW-4. Notification of emergencies shall be given to the ARTCC concerned.

In the event radio failure should occur, the aircraft is to depart the reservation at the point filed in the flight plan. The flight is to proceed in VFR conditions or maintain the altitude/flight level assigned in STORMFURY Operation Order No. 1-70, as appropriate, or the minimum enroute altitude/flight level, whichever is higher. The STORMFURY Command Aircraft shall immediately advise ATC of known or suspected radio failure.

In the event a non-participating aircraft should enter the airspace reservation due to communication failure or other circumstances, all available information will be forwarded to the STORMFURY Command Aircraft.

OPERATION ORDER
FWF JAX NO. 1-70

The decision for continuing pyrotechnic drops or reassigning altitudes within the reservation remains with the Commanding Officer, VW-4. Complete coordination will be effected in such an instance.

5. Communications. Communications with aircraft operating within the reservation shall be conducted through the STORMFURY Command Aircraft on station. The reservation center point location, projected track, and rate of movement are to be forwarded to the ARTCC(s) concerned on an hourly basis by the STORMFURY Command Aircraft in order that an accurate reference point is available at all times. This information shall be relayed by the receiving Center to other Centers concerned.

6. Notification of Aeronautical Interests. NOTAM's are to be issued by the appropriate Center, except that the Miami Center shall issue the AIM Publication NOTAM. The NOTAM's to be issued are included as tabs to this agreement.

NOTE: The appropriate Center is the facility within whose control area of responsibility the storm eye is located.

Navy Project Coordinator/
Commanding Officer
Fleet Weather Facility
Jacksonville, Florida

Commanding Officer
Weather Reconnaissance Squadron FOUR

Chief, New York ARTC Center

Chief, San Juan ARTC Center

Chief, Miami ARTC Center

Chief, Houston ARTC Center

Chief, Jacksonville ARTC Center

Chief, Research Flight Facility
Environmental Science Services
Administration

OPERATION ORDER
FWF JAX NO. 1-70

TAB B

INTERNATIONAL NOTAM'S
AIM PUBLICATION

NOTAM

"OPERATION STORMFURY" IDENTIFIES A GROUP OF LARGE-SCALE EXPERIMENTS TO BE CONDUCTED ON HURRICANES AND TROPICAL STORMS BY THE U. S. ENVIRONMENTAL SCIENCE SERVICES ADMINISTRATION AND DEPARTMENT OF DEFENSE DURING THE PERIOD 15 JULY - 31 OCTOBER 1970.

THE EXPERIMENTS WILL BE PERFORMED ON STORMS MOVING SEAWARD 50 OR MORE MILES FROM ANY LAND MASS IN THE WESTERN PORTION OF THE ATLANTIC, CARIBBEAN SEA AND GULF OF MEXICO. WITHIN THIS AREA, A MOVING AIRSPACE RESERVATION EXTENDING FROM THE SURFACE UPWARD WILL BE ESTABLISHED IN CLOSE PROXIMITY TO THE CENTER OF A NAMED TROPICAL STORM. THE RESERVATION AIRSPACE WILL TRAVEL IN A DIRECTION AND AT A RATE CONSISTENT WITH THE TROPICAL STORM'S MOVEMENT.

DETAILED NOTAM INFORMATION ON LOCATION, RATE AND DIRECTION OF MOVEMENT WITHIN U. S. CTA/FIR WILL BE ISSUED 24 HOURS IN ADVANCE OF OPERATION STORMFURY. INFORMATION RELATIVE TO DEVIATION OF THE RESERVATION FROM PROJECTED TRACK WILL BE ISSUED BY NOTAM AS IT BECOMES NECESSARY. AERONAUTICAL INTERESTS ARE URGED TO KEEP ALERT FOR NOTAMS REFERRING TO "OPERATION STORMFURY".

D-VIII-B-1

OPERATION ORDER
FWF JAX NO 1-70

TAB C

24-HOUR NOTAM

INTERNATIONAL NOTAM _____ OPERATION STORMFURY HURRICANE
RESEARCH PROJECT OF THE U. S. ENVIRONMENTAL SCIENCE SERVICES ADMINIS-
TRATION AND DEPARTMENT OF DEFENSE WILL BE CONDUCTED (JULY, AUGUST,
SEPTEMBER, OCTOBER) _____ Z TO (JULY, AUGUST, SEPTEMBER, OCTOBER)
_____ Z WITHIN AN AIRSPACE RESERVATION 75NM RADIUS FROM COORDINATES
_____ N _____ W. THE RESERVATION WILL MOVE (DIRECTION) _____ ON A
TRACK OF _____ DEGREES FROM INITIAL POINT AT (KNOTS) _____.
DEVIATIONS IN SPEED AND/OR DIRECTION OF MOVEMENT CAUSED BY VARIATION
OF HURRICANE (NAME) _____. TRACK WILL BE ISSUED BY NOTAM AS NECESSARY,
OR AT THREE HOURLY INTERVALS. ALL AIRCRAFT ARE ADVISED TO REMAIN CLEAR
OF DEFINED AREAS DURING THE PERIOD AND TO MAINTAIN CONTACT WITH
APPROPRIATE AIR TRAFFIC CONTROL CENTERS FOR LATEST INFORMATION.

D-VIII-C-1

OPERATION ORDER
FWF JAX NO. 1-70

TAB D

3-HOUR NOTAM

INTERNATIONAL NOTAM _____ OPERATION STORMFURY.
CENTER OF AIRSPACE RESERVATION ESTABLISHED AT _____ N _____ W AT
_____ Z. BLOCK ALL ALTITUDES WITHIN _____ NM RADIUS.
MOVEMENT WILL BE (DIRECTION) _____ ON A TRACK OF _____ DEGREES
AT _____ KNOTS.

D-VIII-D-1

BLANK PAGE

OPERATION ORDER
TWF JAX NO. 1-70

Project STORMFURY
Fleet Weather Facility
Naval Air Station
Jacksonville, Florida
June 1970

ANNEX E

REPORTS

1. General. Proper data reporting is essential to the scientific success of each mission. Appendices I and II of this annex tabulate flight reporting requirements for the Eyewall and Rainsector/Rainband experiments. Each unit/activity will use STORMFURY forms (see Appendices III through IX) provided prior to takeoff by the Data Quality Control Coordinator (DOCC) or forms standard to its routine operational requirements.
2. Annual Report. An annual report will be prepared covering the experiments conducted during the year. The Project Director will be responsible for the organization and scientific content of the report, drawing upon the scientific staffs of the ESSA and the Navy for assistance.
3. Data Quality Control Coordinator (DOCC). This position of responsibility will be filled by a person appointed by the Project Director. The duties of this representative will include, but not necessarily be limited to, the following:
 - a. Chair the Committee of Data Quality Coordinators, composed of one representative each from VW-4, Seeder Squadron, RFF, NWC, 53rd WRS and NHRL.
 - b. Coordinate the design and content of all records and/or forms used.
 - c. Provide sufficient copies of all STORMFURY recording forms to units/activities participating in the experiment prior to the Dry Run exercises.
 - d. Be on the scene at the staging base during all STORMFURY operations.
 - e. Receive, inventory, and catalog all data collected, including film and personal notes, at the termination of each day's operations.
 - f. Report daily to the Project Director any discrepancies noted concerning data missing from an experiment.
 - g. Hand deliver all dropsonde data to the VW-4 Data Quality Coordinator for evaluation and duplication of coded messages.
 - h. Hand deliver to the WEARESCHEFAC Data Quality Coordinator a duplicate copy of data, except film and dropsondes.

OPERATION ORDER
FWF JAX NO. 1-70

i Hand deliver to the designated Photo Lab all radar and time lapse film data for printing of one positive and sufficient negative copies of all film to meet project requirements.

j. As soon as possible after the completion of the processing of the film, an evaluation report will be forwarded to the generating agency. This report should comment on the quality of the photography, areas requiring improvement, and other pertinent remarks.

k. Make distribution of the processed film as follows: (1) Master positive to Naval Weather Records Center, Asheville; (2) Original and one duplicate negative to National Hurricane Research Lab, Miami; (3) One duplicate negative to Navy Weather Research Facility, Norfolk; and (4) One duplicate negative to the generating agency.

4. Assistant Data Quality Control Coordinator. This position will be filled by an appointee of the Project Director. The Assistant DQCC will assist the DQCC Officer, as requested.

5. STORMFURY Coordinated Forms. All data collected on STORMFURY forms, Appendices III through IX, will be recorded in triplicate. The original and copies will be distributed as follows:

a. Turn in original and first carbon to Data Quality Control Coordinator (DQCC) at post-flight debriefing.

b. DQCC will provide the first carbon of such data to Navy Weather Research Facility, Norfolk.

c. Retain second copy for squadron/unit utilization.

6. Unit/Activity Forms. If unit/activity forms standard to routine operational requirements are used, the minimum additional information necessary is as follows:

- a. Date (Z)
- b. Flight Identification (STORMFURY letter)
- c. Takeoff and landing time (Z)
- d. Aircraft type
- e. Time of obtaining each parameter recorded
- f. Hourly WWV time checks with error noted



J. UNDERWOOD
Commander, U. S. Navy
Navy Project STORMFURY Coordinator

OPERATION ORDER
FWF JAX NO. 1-70

Appendices:

- I - STORMFURY Data Inventory - Eyewall Experiment
- II - STORMFURY Data Inventory - Rainsector/Rainband Experiment
- III - Meteorology Data Form (SF-1)
- IV - RB57F Report Form (SF-2)
- V - Seeder Report Form (SF-3)
- VI - Seeding Aircraft Run Report (SF-4)
- VII- Wind Calibration Tabulation Sheet (SF-6)
- VIII- Radar Data Advisor's Meteorological Log (SF-7)
- IX - Radarscope Photography Log (SF-8)

STORMFURY
DATA INVENTORY
EYEWALL EXPERIMENT

TYPE AIRCRAFT	DC-6	B-57	C-130	WC-121N	WC-130	RB57F	26
FLIGHT	A/A2/B	C/C2	D	E/F/G/H	I/J	K/K2	L/N/X/O/P
SF-1 MET. LOG				X	X		
SF-2 RB-57F LOG						X	
SF-3 SEEDER MET.							X
SF-4 RUN REPORT							X
SF-6 WIND CALIB.	X		X	X	X	X	
SF-11 RADARSCOPE LOGS				X	X		X
SF-12 RADAR ADV. LOG				X			
AMC 17 TAPE				X			
NAV LOG	X		X	X	X		
TRUE TRACK RECORD					X		
DIGITAL TAPE	X	X		X			
PHOTO PANEL FILM	X	X					
RADAR FILM			X		X	X	X
APS-20 FILM (230)	X			X			
APS-20 FILM (81)				X			
APS-45 FILM				X			
WF-101 FILM	X						
RDR-1 FILM	X	X					
CLOUD CAMERA FILM	X	X					
DROPSONDES	X				X		
COLD BOX LOG	X						
MET LOG (RFF)	X		X				
RADAR LOG (RFF-5)	X	X	X				
FLIGHT PROG (RFF-1)	X	X	X				
FLIGHT INFO. (RFF-2)	X	X	X				
FLIGHT DATA (RFF-3)	X	X	X				
DIGITAL STA. (RFF-4)	X	X	X				
DPT. (RFF)	X		X				
ELECT. STATUS (RFF)	X		X				
MET. SYSTEMS (RFF)	X		X				
CLOUD PHOTOS	X	X	X	X	X	X	X
PERSONAL NOTES	X	X	X	X	X	X	X
FWV TIME CHECKS	X	X	X	X	X	X	X
FLIGHT DESIG.	A/A2/B	C/C2	D	E/F/G/H	I/J	K/K2	L-P

Voice Call is STORMFURY plus Flight Letter (STORMFURY Echo).
(Each flight turn in the data collected to DQCC as soon as possible after landing.)

STORMFURY
DATA INVENTORY
RAINSECTOR/RAINBAND EXPERIMENT

TYPE AIRCRAFT	DC-6	B57	C-130	WC-121N	C-130	RB57F	A6
FLIGHT	A/B	C	D	E/F/G/H	I/J	K/R2	L/M
SF-1 MET. LOG				X	X		
SF-2 LOG RB57F						X	
SF-3 SEEDER MET.							X
SF-4 RUN REPORT							X
SF-6 WIND CALIB.	X	X	X	X	X	X	
SF-11 RADARSCOPE LOGS				X	X		X
SF-12 RADAR ADVISOR LOGS				X			
AMQ 17 TAPE				X			
NAV LOG	X		X	X	X		
TRUE TRACK RECORD					X	X	
DIGITAL TAPE	X	X	X	X			
PHOTO PANEL FILM	X	X					
RADAR FILM			X		X		X
APS-20 FILM (230)	X			X			
APS-20 FILM (81)				X			
APS-45 FILM				X			
WP-101 FILM	X						
RDR-1 FILM	X	X					
CLOUD CAMERA FILM	X	X	X			X	
DROPSONDES					X		
COLD BOX LOG	X		X				
MET. LOG (RFF)	X		X				
RADAR LOG (RFF-5)	X	X	X				
FLIGHT PROG. (RFF-1)	X	X	X				
FLIGHT INFO. (RFF-2)	X	X	X				
FLIGHT DATA (RFF-3)	X	X	X				
DIGITAL STA. (RFF-4)	X	X	X				
DRT. (RFF)	X		X				
ELECT. STATUS (RFF)	X		X				
MET. SYSTEMS (RFF)	X		X				
CLOUD PHOTOS (RANDOM)	X	X	X	X	X		X
PERSONAL NOTES	X	X	X	X	X	X	X
WWV TIME CHECKS	X	X	X	X	X	X	X
FLIGHT DESIG.	A/B	C	D	E/F/G/H	I/J	K/R2	L/M
TYPE AIRCRAFT	DC-6	B57	C-130	121	130	RB57F	A6

Voice Call is STORMFURY plus Flight Letter (STORMFURY Echo).
(Each flight turn in the data collected to DQCC as soon as possible after landing.)

STORMBURY
SEEDING AIRCRAFT
RUN REPORT

SET ALTIMETER AT 29.92 INCHES

DATE _____ FLIGHT _____

ON STATION _____ Z OFF STATION _____ Z

SEEDING RUN (RELEASE) BEGAN _____ Z ENDED _____ Z

HEADING (TRUE) _____ DEGREES AIRSPEED _____ TAS

PRESSURE ALT. _____ FT

LOCATION START RUN _____ LOCATION END RUN _____

NUMBER OF UNITS RELEASED _____ NUMBER HUNG OR NOT RELEASED _____

EST. NO. OF UNITS ENTERING
CLOUD _____

EST. CLOUD TOPS ON
SEEDING RUN _____

REMARKS: (Please describe or sketch before and after appearance of clouds,
turbulence, radar echoes, etc.)

STORMFURY
WIND CALIBRATION TABULATION SHEET

FLIGHT _____		VOICE CALL _____				DATE _____						
TIME		1	2	3	4	5	6	7	8	9	10	11
(Every 30 sec.)	H	MAG HEAD	DRIPT	GROUND SPEED	WIND DIR	WIND SPEED	ALT.	TAS	IAS	TEMP		
	D											
	G											
00	T											
30	O											
00												
30	S											
00	O											
30	U											
00	T											
30	H											
00	T											
30	O											
00												
30	E											
00	A											
30	S											
00	T											
30												
00	T											
30	O											
00	N											
30	O											
00	R											
30	T											
00	H											
30												
00	T											
30	O											
00	W											
30	E											
00	S											
30	T											
00												
30												

- NOTES: 1. Box consists of four 2½-minute, straight and level legs on cardinal headings. Standard rate turns (3°/sec). If necessary, extend leg to obtain a minimum of two minutes of readings each heading after memory cycle ends.
2. Take readings every 30 seconds. Note beginning and ending of periods of memory.

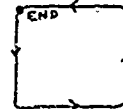

STORMFURY
RADAR SCOPE PHOTOGRAPHY LOG

(SF-8)

DATE _____ MISSION _____ RADAR/SCOPE _____ / _____

CAMERA SER. NO. _____ CREW _____ FLIGHT/BuNo _____ / _____

MAGAZINE SIDE NO. _____

PREFLIGHT AND HOURLY CHECK

1. DATA CHAMBER LIGHTS.
2. RANGE MARKER FUNCTIONING.
3. F STOP SET AT 5.6.
4. CLOCK TIME CHECKED & FUNCTIONING.
5. CAMERA MAGAZINE FILM ADVANCE FUNCTIONING.
6. FOCUS, VIDEO & INTENSITY CONTROLS FUNCTIONING.

PREFLIGHT COMPLETED BY _____

TIME CHECK	CLOCK ERROR FAST/SLOW (SECONDS)	FRAME NO.	START (ZULU)	STC (%)	ANT. ELEV.	RANGE (MI.)	RANGE MARKS (MI.)	ALT. (FT.)	STOP (ZULU)	FRAME NO.	OBSV. INIT.
Example: 1300	10/S	27	1301	0	+2 1/2	100	20	5000	1401	28	CS

- NOTE: 1. Return this sheet to DQCC after each flight.
2. Use at least one new sheet per flight.
3. Log any malfunctions or gaps in photography below, new mag. #, time, etc.

REMARKS:

OPERATION ORDER
FWF FAX NO. 1-70

Project STORMFURY
Fleet Weather Facility
Naval Air Station
Jacksonville, Florida
June 1970

ANNEX F

PUBLIC AFFAIRS

1. General.

a. In order to make accurate information available to the public, ESSA-Navy Public Affairs Teams located at the staging base, Miami, and Washington, will handle all public information relative to Project STORMFURY operations.

b. As in previous years, a coordinated press release on plans for Project STORMFURY will be distributed before the beginning of the season's operations. The Commander, Naval Weather Service Command will be responsible for all approvals and coordination within the Department of Defense. ESSA will exercise the same responsibility within the Department of Commerce. The release should carry both DOD and DOC mastheads and should be printed at the Department of Commerce. Initial release will be made simultaneously by DOD and DOC facilities in Washington, San Juan, Miami and Jacksonville.

c. Releases on a continuing basis during Project STORMFURY operations will be prepared at the staging base by the Public Affairs Team working directly with the Project Director or Assistant Project Director. Upon approval of the Project Director or Assistant Project Director, the release will be simultaneously transmitted to on-the-scene news media and, by the most expeditious means, to the National Hurricane Center, Miami. From there, it will be relayed to national news media, as well as all ESSA and Navy facilities, utilizing the Hurricane Circuit and other means of dissemination. A Public Affairs Team assigned to the Hurricane Center at Miami during STORMFURY operations will be responsible for disseminating the releases and handling news media inquiries. Releases and news media may also be handled by the Navy and ESSA in Washington, D. C.

d. All releases will reflect proper credit to participating components and personnel. Copies of all releases will be distributed as widely as possible, and in particular to the Commander, Naval Weather Service Command and Headquarters, Air Weather Service (Attention: DI).

e. Four aircraft seats will be made available on each day's operation for news media representatives on a pool basis. Two seats will be provided for representatives of the printed news media and two seats for cameramen representing TV networks. Prior to the beginning of the STORMFURY operational period, a letter will be forwarded to the major news and television outlets explaining the intent of this plan and

OPERATION ORDER
FWF JAX NO. 1-70

requesting the selection of four pool representatives. Subject to DOD approval, transportation will be provided these four pool representatives and their equipment, on a space-available basis, to the staging base aboard VW-4 aircraft from Jacksonville. The pool representatives will be alerted at the same time as STORMFURY personnel are put on alert. All local requests for media participation will be referred to the ESSA and Navy Public Affairs Offices in Washington for coordination. During Dry Run operations, professional photographers may be contracted to make film footage and still photography of Project STORMFURY operations. The resultant film and photographs will be released by DOD/DOC to the media before actual operations.

f. All arrangements for press conferences and interviews with Project STORMFURY officials will be made by the Public Affairs Teams.

2. Releasable Information.

a. Releases prepared during Project STORMFURY operations will consist of background information, plans for the next day's operations and an operational summary of the day's operations.

b. In no case will release of information include unpublished experimental results or personal speculations about the experiment. However, this should in no way prohibit project officials from freely participating in news conferences or interviews which have been previously arranged through the Public Affairs Team.

c. Joint ESSA Navy Press Kits will be prepared by ESSA and Navy CHINFO offices prior to the start of the Project season. These kits should contain basic fact sheets, dry run and hurricane photography and feature material on Project personnel and programs.



J UNDERWOOD
Commander, U. S. Navy
Navy Project STORMFURY Coordinator

OPERATION ORDER
FWF JAX NO. 1-70

Project STORMFURY
Fleet Weather Facility
Naval Air Station
Jacksonville, Florida
June 1970

ANNEX G

DISTRIBUTION

CNG	(1)	CARCAH	(2)
CMC	(1)	FLEWEAFAC BERMUDA	(1)
NAVAIRSYSCOM	(1)	FAA HQS AT-40 DC	(1)
COMNAVWEASERV	(2)	HOUSTON ARTCC	(1)
AWS SCOTT AFB	(1)	SAN JUAN ARTCC	(2)
ASST SECNAV (R&D)	(1)	NEW YORK ARTCC	(2)
CHINFO	(1)	MIAMI ARTCC	(2)
ONR	(1)	JACKSONVILLE ARTCC	(1)
COMOPTEVFOR	(1)	AFWR NAVSTA ROOS RDS	(1)
COMTEN	(1)	COM ATL MSL RG PATRICK AFB	(1)
COMSIX	(1)	NHC	(1)
ESSA WB WASH DC	(1)	NHRL	(15)
CINCLANTFLT	(1)	H.V. SENN, UNIV. MIAMI	(2)
COMNAVAIRLANT	(1)	WEARESCHFAC	(2)
COMCARIBSEAFRON	(1)	NRL	(1)
MAG-14	(3)	NAS JACKSONVILLE	(1)
CG FMFLANT	(1)	NAS BERMUDA	(1)
CG 2ND MAW	(1)	NAVSTA ROOS RDS	(4)
FLEWEAFAC SUITLAND	(1)	ADVISORY PANEL	(5)
FLEWEAFAC JAX	(10)	PATRICK AFB	(1)
FLEWEACEN ROTA	(1)	FAA ATLANTA (SO. REGION)	(1)
WEARECONRON FOUR	(10)	FAA FT WORTH (SW REGION)	(1)
ESSA/RFF MIAMI	(10)	ESSA RSCH LAB, BOULDER	(2)
NAVWPCEN CHINA LAKE (602)	(3)	ESSA ADMINISTRATOR, WASH DC	(2)
FLENUMWEACEN MONTEREY	(1)	COMFAIRJAX PHOTO LAB	(1)
FLEWEACEN NORVA	(1)	FILE	(9)
9TH WEARECONWING	(2)	NAS CORPUS CHRISTI	(1)
NWSED ROOS RDS	(1)	NAS NEW ORLEANS	(1)
COMFAIRCARI	(1)	NAS PENSACOLA	(1)
COMFAIRJAX	(1)	NAS NORFOLK	(1)
53RD WRSQ	(6)	NAS OCEANA	(1)
58TH WRSQ	(3)	NS GTMO	(1)



J. UNDERWOOD
Commander, U. S. Navy
Navy Project STORMFURY Coordinator