

ORC 68-11
MAY 1968

5307.34-07

OPTIMUM OPEN PIT MINE PRODUCTION SCHEDULING

by
THYS B. JOHNSON

AD 672094

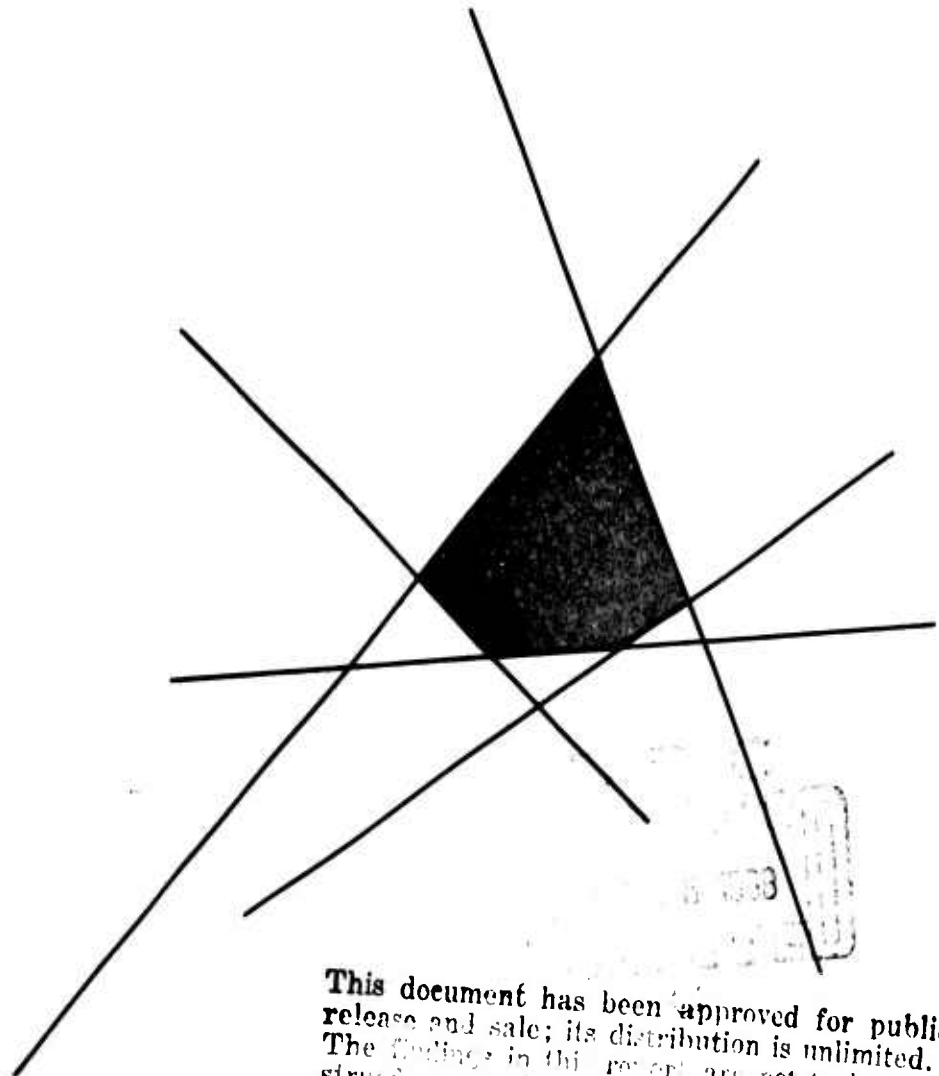

This document has been approved for public release and sale; its distribution is unlimited. The findings in this report are not to be construed as an official Department of the Army position, unless so designated by other authorized documents.

OPERATIONS
RESEARCH
CENTER

UNIVERSITY OF CALIFORNIA • BERKELEY

OPTIMUM OPEN PIT MINE PRODUCTION SCHEDULING

by

Thys B. Johnson[†]
Operations Research Center
University of California, Berkeley

May 1968

ORC 68-11

This research has been partially supported by the U.S. Army Research Office-Durham, Contract DA-31-124-ARO-D-331, and the National Science Foundation under Grant GK-1684 with the University of California. Reproduction in whole or in part is permitted for any purpose of the United States Government.

[†]This research has been supported also by the U.S. Bureau of Mines, Denver, Colorado.

ACKNOWLEDGEMENTS

I wish to express my appreciation to the members of my committee, Professors William S. Jewell, Charles R. Glassey and Charles Meyer. Special gratitude is due to Professor Jewell for his suggestions and careful reading of the manuscript.

Grateful acknowledgement is also due to the U.S. Bureau of Mines whose support made this work possible, and especially, Mr. Scott W. Hazen, Jr., Mine Systems Engineering Group, Denver, Colorado, for his encouragement. Also, I wish to thank the various people who contributed to the typing of this manuscript, especially Noreen Comotto for the effort in organizing the final draft.

Finally, I am eternally grateful to my wife, [REDACTED] and family for their encouragement, patience and understanding.

ABSTRACT

The multi-period open pit mine production scheduling problem is formulated as a large scale linear programming problem using the block concept. A solution procedure is developed through decomposition and partitioning of the subproblem into elementary profit routing problems for which an algorithm is presented. Many of the traditional mine planning concepts are discussed and suggestions for improvement through use of the techniques developed in this thesis are given.

In the development of the solution procedure, those constraints which govern the mining system are considered as the master problem. The constraints which dictate the sequence of extraction are used as the subproblem. The properties of the single period subproblem and its dual are discussed, and the dual problem is shown to be equivalent to a bipartite maximum flow problem for which an algorithm is given. The multi-period subproblem algorithm is developed by partitioning by stages and using the properties of the single period subproblem.

This treatment allows optimization of the complete mining-concentrating-refining system over the entire planning horizon and permits the system to dictate how and when to process a block of material.

TABLE OF CONTENTS

	PAGE
CHAPTER 1: INTRODUCTION	1
1.1 Mine Planning	1
1.2 Traditional Approach to Mine Planning	4
1.3 General Description of Problem	5
1.3.1 Problem Area	5
1.3.2 The Block Concept	6
1.3.3 Preliminary Block Development	8
1.4 The Cut-Off Concept	11
1.5 Previous and Related Work	17
1.6 The Grossman-Lerchs Algorithm	21
CHAPTER 2: FORMULATION OF GENERAL MATHEMATICAL MODEL	22
2.1 Introduction	22
2.2 Assumptions of Model	23
2.2.1 Statement of Assumptions	23
2.2.2 Discussion of Assumptions	24
2.3 Mathematical Formulation	41
CHAPTER 3: THE SINGLE PERIOD PROBLEM	50
3.1 Introduction	50
3.2 Analysis of the Problem	52
3.2.1 Decomposition of Problem	52
3.2.2 The Subproblem	54
3.2.3 Properties of Primal and Dual Subproblem	56
3.3 Equivalent Formulations of Subproblem	65
3.4 Proposed Method of Solution	73
3.5 Summary of Subproblem Algorithm	76
3.6 Numerical Example of Subproblem	79
3.7 Modification of Procedure when Assumption 2 is Relaxed	83
CHAPTER 4: GENERAL T-PERIOD PROBLEM	85
4.1 Introduction	85
4.2 Decomposition of General Problem	86
4.3 Subproblem Solution	89
4.4 Numerical Example of 2-Period Subproblem	96
4.5 General Comments and Procedural Summary	100

TABLE OF CONTENTS

	PAGE
CHAPTER 5: MINE PLANNING AND SYSTEM MANAGEMENT	103
5.1 Introduction	103
5.2 Numerical Examples	104
5.2.1 Model Setting	104
5.2.2 Example 1	104
5.2.3 Example 2	109
5.3 Management Considerations	115
REFERENCES	119
APPENDIX A: NETWORK DEFINITIONS	A.1

CHAPTER 1

INTRODUCTION

1.1 MINE PLANNING

The mining of mineral deposits in such a manner that at depletion the maximum possible profit is realized has been an unsolved problem since man's discovery of the usable elements buried beneath the earth's surface. In the days when high grade reserves were adequate to supply our needs the attention given this problem was negligible. The philosophy at that time was to extract the material in an orderly fashion, keeping in the high grade until depletion. Right or wrong, profits were high, so no question of optimum profitability confronted the operators. Since World War II and the depletion of the most accessible of the world's high grade reserves, the mining industry has been forced into working with lower grade material. The sequence of extraction has now become more important; and, in many cases, has become a problem whose solution is vital to the existence of a profitable operation.

The planning of an extraction sequence over a particular time horizon, typically the life of the mineral deposit, is commonly referred to as *mine planning*. Mine planning is usually divided into three categories; *long range*, *short range*, and *operational* [8].

A *long range plan* defines the ultimate economic limit, or optimum pit limit, i.e., defines the size and shape of an open pit at the end of its life [8], [10], [16], [20]. The long range plan serves as an aid in the evaluation of the economic potential of a mineral deposit and delineates the economic ore body. This analysis is essential in the planning for surface facilities such as treatment plants, waste dump, tailing ponds and

other elements complementary to the mining operation. In some instances the long range plan also serves as a guide for short range plans.

Short range plans are a sequence of depletion schedules leading from the initial condition of the deposit to the ultimate pit limit [8], [1]. These plans are developed subject to physical, geological, operating, legal, and other policy constraints. Each plan usually varies in duration from one to ten years and provides information necessary for forecasting future production and capital expenditures.

Operational or actual production planning is concerned with the present operating state within the confines of the most recent short range plan. It is the operator's guide for orderly mining to gain the objectives of the present as well as the short range plans under the constraints of present conditions and policies. The planning period is usually a year with stages of months, weeks, or days.

The division of *mine planning* into the categories described above closely follows the stages of evaluation, data refinement and development of an ore deposit. For example, in the initial stages of an evaluation, only sufficient data is obtained from drilling, geological studies and other sources, to determine the economic feasibility of the deposit and hence whether or not it seems profitable to continue to invest time and money in a particular deposit. If such an investment is deemed profitable, more data is obtained through additional expenditures. With this additional information the long range plans are refined, and the evaluation extends to the short range planning stage.

Operational planning is the final stage of planning and is based on the best possible information available; that is, information from exploration, development and production drilling, extensive geological studies, production

records, economic studies and forecasts and other sources.

Since the characteristics of the material to be mined are based primarily on a sampling program and also since the mining process typically extends over a considerable number of years, there exists a great deal of uncertainty in the physical, economic and technological factors upon which planning is based. Also, management's objectives may vary over time due to changes in economics and technological conditions. There is considerable interaction between the categories of mine planning each of which may have a different objective. Clearly as we progress from long range to operational planning, the degree of uncertainty decreases.

For the reasons of uncertainty, changing objectives, and the increasing availability of more and better information as the operation progresses discussed in the previous paragraph, the necessity of the different categories of mine planning and their continual revision is quite evident.

As additional data becomes available and objectives change each category of planning is updated so as to reflect the refined information or changing conditions of the times.

The primary problem to be considered in this investigation is open pit mine planning in the short range and operational stages. This is what we will call open pit mine production scheduling. As will become clear to the reader, as he progresses through the development of the approach to this problem given in this study, the effect of uncertainty will be lessened; changes in economic and technological conditions and the integration of the planning stages may be accomplished with relative ease with our method.

1.2 TRADITIONAL APPROACH TO MINE PLANNING

The traditional method of mine planning is the trial-and-error, hand-calculated, cross-section approach. This method consists of tracing a trial pit limit on vertical and/or horizontal sections, taking into consideration wall slopes, geology and plan objective. The material within the trial pit is divided into ore and waste on the basis of geological interpretations and an economic or grade cut-off.[†] Volumes of material are determined by planimetry on the sections and multiplying by a proper factor based on the distance between sections and geological interpretations.

Grade analyses are assigned to the various types of material based on drill-hole data by various method of assigning drill-hole sample influence to a certain volume of material. The trial pits are expanded or contracted to meet desired requirements by considering the profitability of small increments surrounding the trial pit.

The profitability of the increments and trial pit is determined by a ratio of cubic yards of waste to tons of ore. This ratio is usually referred to as the break-even stripping ratio [20], or bottom stripping ratio [10]. This stripping ratio indicates the point where it is uneconomical to remove ore considering the amount of waste this necessitates in removing. The basis for this ratio is usually purely economic or empirical.

Obviously, there are many faults in this method, and also in the basic foundations on which the many judgements involved are made, in particular, cut-off grade and stripping ratio. These shortcomings are discussed in [1], [10], [19], and [20]. The advent of computers improved mine planning methods considerably as discussed in the following section.

[†]Cut-off grade: the criterion, with an economic motive, normally employed in mining to discriminate between ore and waste in a mineral deposit [14], [22]. (Section 1.4).

1.3 GENERAL DESCRIPTION OF PROBLEM

1.3.1 Problem Area

Many of the shortcomings of the traditional long and short range mine planning methods have been overcome in the past few years. Much of the improvement can be attributed solely to the speed of data manipulation and calculation with computers, since many of the methods, as reported in the literature [1], [20], are patterned after the conventional methods. Elimination of the emphasis on the stripping ratio is one of the improvements made. The "block concept," which will be discussed in more detail later, is a key to the improvements in the planning methods [1]. Very little has been accomplished in the area of operational planning.

The operational mining system may be considered as a combination of three subsystems; mining, concentrating, and refining. The mine or group of mines is the area in which the material is extracted from its position in the earth and this subsystem also usually includes the transportation to the concentrator or waste dump. The concentrator is a plant or group of plants where the crude ore is upgraded by various processes, depending on the type of ore, to a concentrate which is amenable for refining. The refinery contains the finishing process which produces the product ready for the manufacturing market. Not all operations include all three subsystems and some may even include more, such as the marketing phase. The model discussed in this work is general enough so that it conforms to any particular operation.

The goal of management is usually to maximize some form of profit subject to the particular constraints of their operation. The form of profits is usually total profits, present value, or immediate profit.

The purpose of our research is to develop an approach to production scheduling which improves on the trial-and-error concept still prevalent in present techniques, and does away with the present concept of cut-off grade or economic cut-off based on purely marginal analysis. This cut-off concept will be discussed in Section 1.4 of this chapter.

The objective of production scheduling is to determine a feasible extraction schedule which maximizes profits over the planning period. (The term profits here may be actually revenue minus costs, or present value; differentiation of these values is not necessary for purposes of this investigation.) A feasible schedule is one which satisfies a number of constraints on factors such as: orderly extraction, mining equipment capacity, milling capacity, refining or market capacity, grades of mill feed and concentrates, labor, and other physical, operating, legal, and policy limitations.

To develop a model to investigate this problem, we need to expand on a key factor, the *block concept*.

1.3.2 The Block Concept

First of all, consider the actual methodology of open pit mining. Due to the type of equipment available and its capabilities, open pit mining usually proceeds along a series of benches as shown in Figure 1.1. The mining sequence usually consists of blasting a certain volume of material in a bench, loading this material into a haulage unit, and transporting it to a waste dump or concentrator. The blasting patterns usually are rectangular and material from the entire height of the bank is loaded into a unit. Thus a very accurate description of a mining operation can be given in terms of

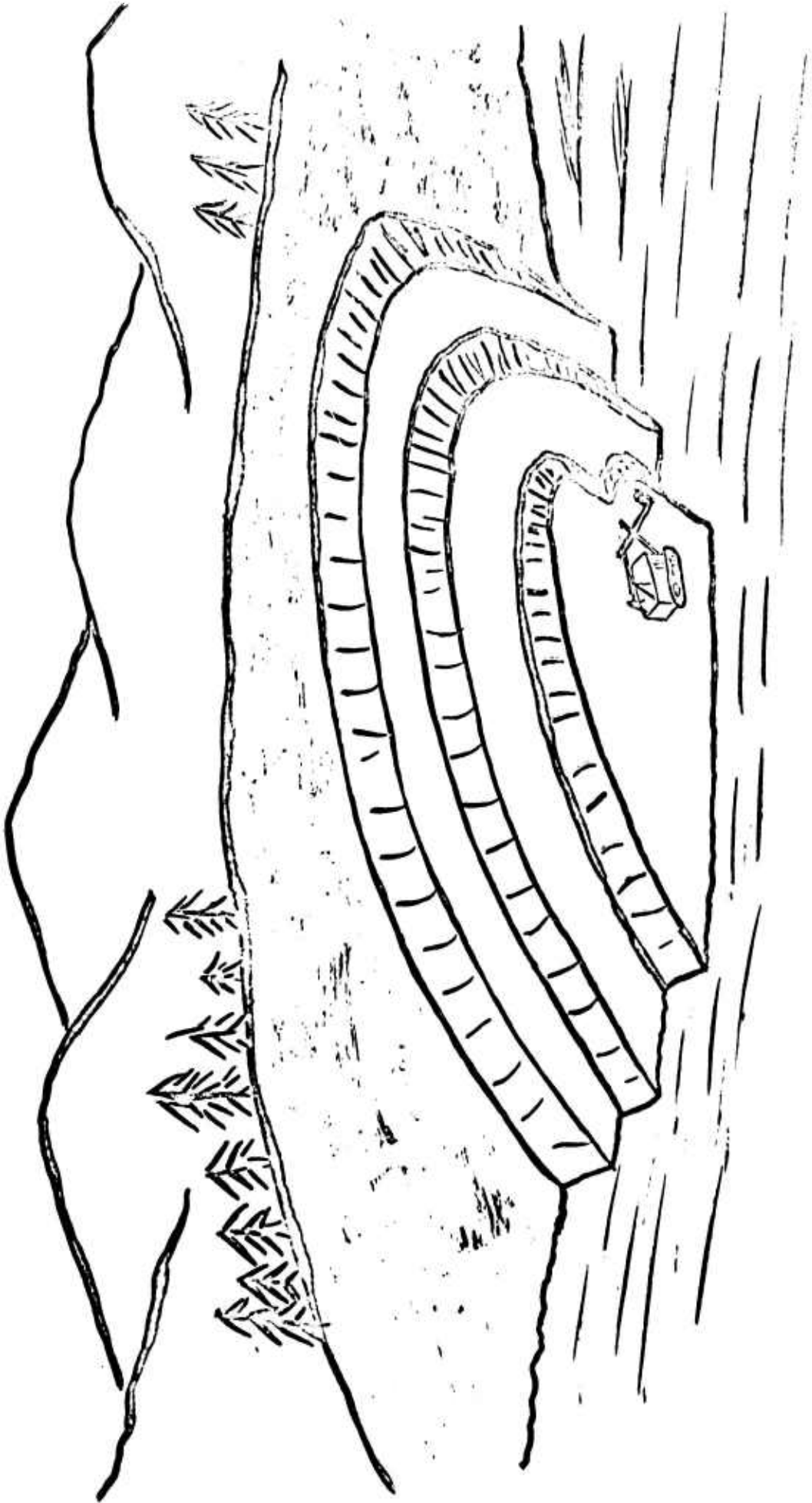

FIGURE 1.1: OPEN PIT MINING OPERATION

mine-able units or "blocks"--remove a block of material from the deposit and transport it to its destination. One of the earliest reports on the "block concept" is given in [1]. Since the actual mining is accomplished by blocks, it follows that the concentrating and refining can be similarly described as a treatment of blocks. This idea is illustrated in Figure 1.2. Note the reduction in block size after concentrator, illustrating the removal of some waste material from the block.

Since the process can be so accurately described in terms of blocks, it seems clear that the block concept should provide a very good estimate of the input and output to the system. The "block" then becomes the logical unit to which production scheduling can be applied.

The block size is influenced by equipment capabilities, geological structure, allowable wall slopes, accuracy of sample data, manner of mining, desired use of block, and capability of manipulating a huge number of blocks [1], [11]. The smaller the block size, the more flexibility in planning is available and also more refinement possible, but the number of blocks increases. Actually, very small blocks are not very realistic, since the economic and assay data upon which scheduling is dependent are based on samples from drill-holes which may range in separation from 40 to 1000 feet. The height of a block should usually be taken as the bench height since this is the way it is mined. Examples of block dimensions that have been used in previous studies are: 100' x 100' x 40', 40' x 40' x 40' and 100' x 50' x 50 [1], [10], [20].

1.3.3 Preliminary Block Development

The manner in which a deposit is divided into blocks is a function of criteria similar to the block size. One could accomplish this by hand and

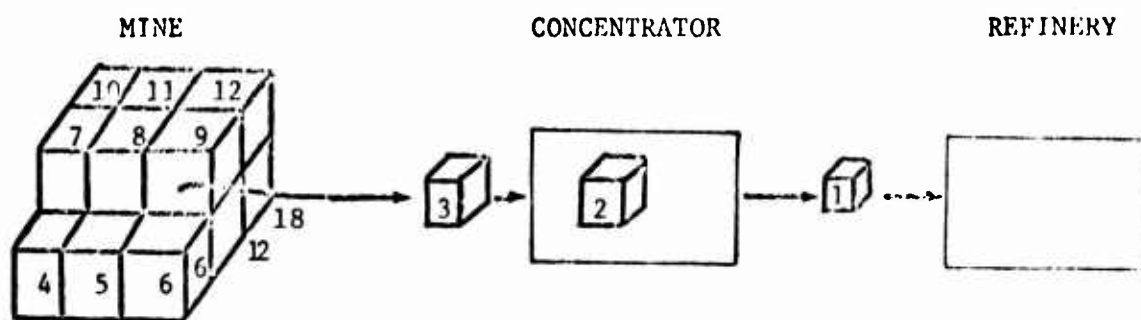

FIGURE 1.2

BLOCK CONCEPT ILLUSTRATION OF MINING, CONCENTRATING, AND REFINING PROCESS

thus consider a great deal of geological detail, but the more realistic way is to do the job with a computer. The reduction in labor usually far outweighs any refinement gained in the manual technique.

Once the deposit has been divided into blocks, the geological, physical, and economic characteristics of each block must be obtained before production scheduling can be undertaken. That is, a mineralized block inventory providing the following data must be developed:

1. Block Identification
2. Volumes (crude, concentrate, etc.)
3. Analysis
4. Material Classification
5. Mining Equipment Hours
6. Treatment Plant Hours
7. Economics

The development of this data is based on drill-hole samples, metallurgical test data, and economic and technological features of present or proposed mining systems. It is not the purpose of this work to go into the development of this data since the methods are peculiar to each operation and examples of such methods are given in [1], [8], [19], and [20].

Given this block inventory which provides the necessary economic, technological, and geological data, we are ready for evaluation studies and production scheduling.

1.4 THE CUT-OFF CONCEPT

The cut-off concept is an economically-based criterion which is normally used in mining to discriminate between waste and ore in a mineral deposit [8], [14], [19]. As presently employed, it is usually a static cut-off as compared to a dynamic economic cut-off which will be proposed in this discussion. The essential difference is that the dynamic cut-off is a function of the state of the mining system at the time a decision is to be made as well as the future effects of this decision. This difference will be made clear in what follows. The profits of a mining operation can be appreciably affected by the choice of a cut-off and hence this is an important consideration.

The traditional cut-off grade is a product of static or semi-dynamic marginal analysis. An extremely simple example of this is shown graphically in Figure 1.3. In this figure, λ could be any parameter with which one wants to judge profits such as cut-off grade, volume, depth, etc.! If λ represents cut-off grade, then λ_0 would be the optimum cut-off grade. Note λ_0 is the point where marginal revenue equals marginal cost.

This analysis is usually made without regard to the state of the mining system. Thus the cut-off grade is essentially determined independent of the mining sequence, capabilities of the mining system, and other operational constraints. K. F. Lane recognized the fallacy of this approach and proposed in [14] that the capacities of the various subsystems should be considered as well as economics when determining a cut-off grade. He assumed the mining sequence to be known, even though the sequence may be influenced by the cut-off choice, since the tools were not available for him to discuss the more complex problem.

The economic cut-off which may be attributed to the block concept has replaced the grade cut-off in some operations [1], [8], [10]. It is an

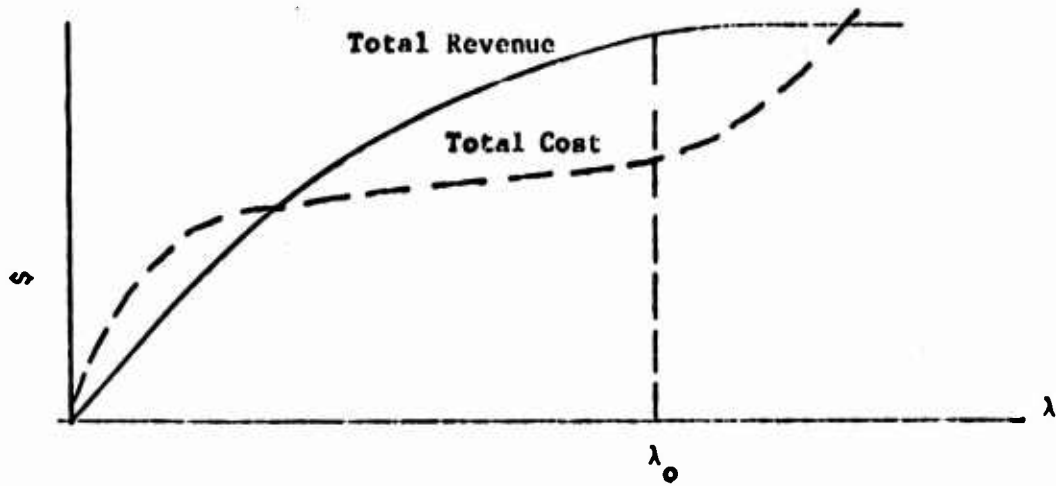

(a) Total Cost and Revenue Versus Parameter λ

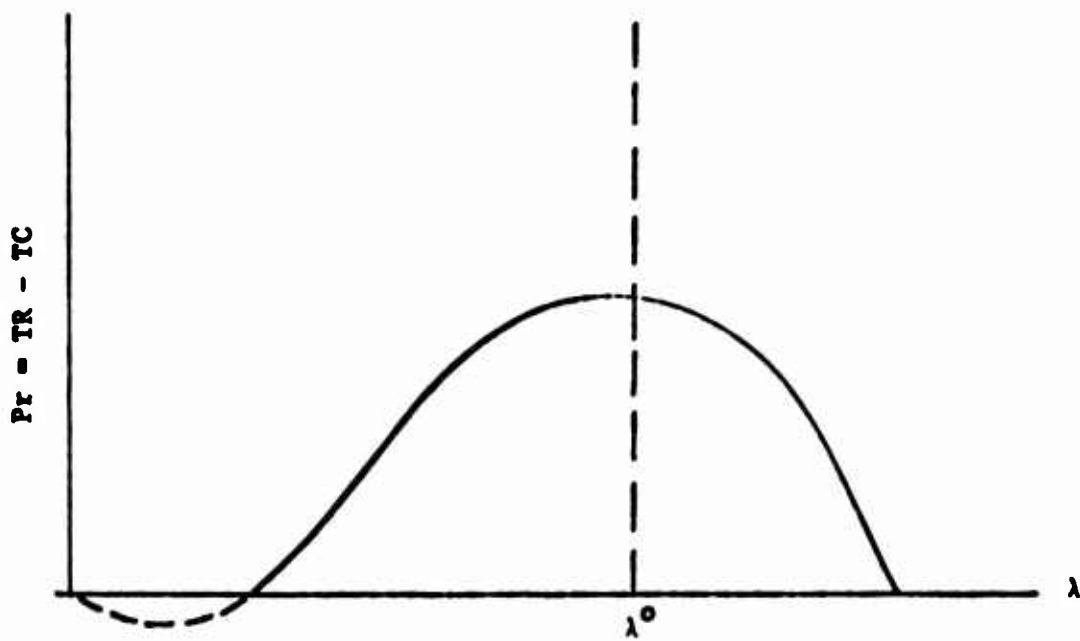

(b) Total Profit Versus λ (cut-off grade)

FIGURE 1.3: GRAPHIC MARGINAL ANALYSIS

improvement over the traditional cut-off grade in that it gives weight to factors such as location, material characteristics which affect operations, and other factors which are not easily taken care of with the grade approach. The main objection to its use is that it is normally a prejudgement. That is, it is not based on the influencing factors of the mining system. Usually a volume of material (block) is classified as ore or waste on the economics or characteristics of the single block itself without considering the system or the interaction of other blocks. At times this practice may be justified, but in general it is in error.

As a simple example of where the static economic cut-off breaks down, consider the situation illustrated in Figure 1.4. The value of the blocks as both an ore and a waste is shown. To obtain the bottom block, all of the top blocks must be removed. Obviously, if it is desirable from a system standpoint to have the bottom block, it is also more profitable to treat the top layer as ore if the system constraints permit. Using the static economic cut-off, the top level would always go as a waste.

ore	waste	ore	waste	ore	waste
-1	-3	-1	-3	-1	-3
			ore		
			4		

FIGURE 1.4: TYPICAL CONDITION OF STATIC ECONOMIC CUT-OFF FAILURE

Also, if the system capacity was limited to only one more block and the constraints of the system were satisfied by any one of the four, the most profitable selection would be one of the top three.

As represented in [1], there has been some attempt to incorporate the system influence into the classifying process, but none that considers all the influencing factors.

The real question to be answered in cut-off analysis is what material to mine and what to do with it once it is extracted, so as to maximize profits subject to the constraints of the mining system. It is readily seen, as pointed out in [14], that the answer to this problem is greatly influenced by the state of the mining system, which varies over time. Thus any classification decision is influenced by economics, capabilities of the system, assay values of the material, mining sequence, desired products, and other operational constraints. These factors may interact in complex ways over time and hence cause a variation in the optimum economic or grade cut-off. Under the constraints of a mining system, the mining plan or sequence of mining may be influenced by the choice of cut-off, and hence there is an interaction between these two elements.

The objections mentioned in the preceding paragraphs are eliminated by the linear programming model to be discussed in the following chapters. This model provides for alternate methods of classifying blocks and considers the system state in its decision process. Thus, linear programming in this sense is dynamic marginal analysis.

To obtain a better understanding of why the model provides a more optimum cut-off decision, let us examine the cut-off problem from the viewpoint of a linear programming model:

$$\begin{array}{ll}
 \text{Maximize} & cx = z \\
 \text{(1.4.1)} & \text{Subject to } Ax = b \\
 & x \geq 0
 \end{array}$$

The dual to this problem becomes;

$$\begin{aligned}
 & \text{Minimize } \pi b = v \\
 (1.4.2) \quad & \pi A \geq c \\
 & \pi \text{ unrestricted.}
 \end{aligned}$$

The linear programming approach may be thought of as decomposing a system into a number of elementary components, (activities), describing the interrelationships of the activities which may be used to meet the requirements (b), and to determine the level of activities $\{x_j\}$, such that the requirements are satisfied at the maximum payoff. In this sense, the columns, A^j , of A represent the input-output coefficients for activity j per unit of activity level. For example a_{ij} could represent the amount of requirement b_i produced by activity j per unit of activity level. The $\{c_j\}$ can be considered as profits per level of activity j .

In reference to the primal problem (1.4.1) the dual variables are called multipliers or prices. The interpretation of the dual variables as prices comes from the following economic interpretation of the dual problem.

"Given a unit profit c_j for each activity j and a requirement b_i for each resource i , what must be the unit price π_i , of each resource such that the total value of the resources produced or consumed by j is greater than or equal to the profit c_j , and such that total value of the requirements, πb , is minimal?" [21].

The condition $\max z = \min v$ is a consequence of the duality theorem, [6], [21]. It is also shown in [6] that if $\pi A^j < c_j$, it is profitable to increase the level of activity j . In an economic sense, what is occurring is that an activity whose marginal return is greater than its marginal cost

is being substituted for an activity whose marginal return equals marginal profit. When this is not possible with present prices, the optimal solution has been reached.

In the production scheduling model, formulated in Chapter 2, each activity with its corresponding level X_j^q represents a possible method of handling block (j) in the mining system over a particular time period. Thus we have a set of alternatives Q_j for each block (j) from which a convex combination of alternatives is to be selected and combined with other convex combinations from other Q_k to meet the requirements in such a way that maximum profits are obtained.

Using a static cut-off grade or economic cut-off selects one element from Q_j without considering its true marginal worth to the system. In selecting an element of Q_j in this manner, one is never quite positive that there doesn't exist another element $A^j \in Q_j$ such that $\pi A^j < c_j$ and hence profits could be increased. Let \bar{Z} be the maximum profit when the Q_j are restricted to one element and Z maximum profit with unrestricted Q_j . The preceding argument shows that $\bar{Z} \leq Z$. For details on linear programming the unfamiliar reader is referred to [6] or [21].

It is now clear that the static cut-offs presently used in mine planning do not provide for maximum profits and do not yield the best possible mining plan. Yet all is not lost since, as will be shown, the model to be discussed in this paper utilizes a dynamic cut-off which fluctuates with the system and this yields a mining plan which is as close as presently possible to the optimal mining plan with maximum profits.

1.5 PREVIOUS AND RELATED WORK

The use and potential of all the published and known work in mine planning has been limited to the long and short range stages. This is, however, closely related to production scheduling. All the previous approaches utilize the block concept except the work by Meyer [16], [17]. The static cut-off is inherent in all approaches to one degree or another.

Meyer uses a pillar approach. He formulates the problem of determining the ultimate pit limits subject to wall slope constraints as a mathematical programming problem with a nonlinear objective function. Meyer's formulation concentrates on the geometric problems induced by the slope constraints. He uses the principles of separable programming to obtain a solution. The pillar approach reduces the number of restrictions and variables required, compared to the block concept, and hence may be an attractive method of determining the ultimate pit limits when accuracy may not be too important.

However, the pillar approach does not allow for any extreme variability, with depth, of costs, revenue, or geology, and thus loses accuracy. When allowance for variability is introduced the formulation converges to the block concept.

Meyer's attempt to extend the pillar concept to short range planning is not very successful. The lack of variability with the pillars method limits its use in this area. His proposal is to maximize profits considering only the geometric and mining capacity constraints, ignoring completely the flow and form of products in the mining, concentrating, and refining process. Another objective is the prejudgement of what is ore and what is waste, (a static cut-off).

Mine planning at the Kennecott Copper Corporation as reported in [8], [19], and [20] is based on the block concept with simulated extraction by cones and is patterned after the traditional methods. Similar to most block concept systems, Kennecott's begins with a preparation of a mineralized block inventory and an economic evaluation of the blocks. The ore-waste evaluation is based on the net value of a block (a static economic cut-off).

The Kennecott open pit design system proceeds toward the ultimate pit limit by selecting an initial trial pit (truncated cone) which conforms to the desired wall slopes, and expanding the initial cone by adding conical increments [20]. The pit limit is reached when no additional increment can be found which increases the total net value of the material with an outline. The value of a cone or increment is obtained by summing the values of the blocks within the cones or increments. One of their special problems is the variable pit slopes that must be maintained in some of their operations. This system can be essentially described as an economic evaluation subject to wall slope constraints.

Kennecott's short range mine planning system is similar to its long range system, as it is patterned after the traditional manual method and subject to constraints related to operating slopes, boundaries, mine system capacities, and operating capabilities. It is a trial-and-error method utilizing a trial start with incremental stages. Each increment or combination of increments represents a stage in the development of the ore body. A number of trial plans are developed, and those which provide the highest dollar value with desired ore volumes, satisfactory metal grades, and best stripping ratios, are selected. This method does not guarantee optimality, although it recognizes most of the necessary constraints

required in short range mining planning and is practical, thus gaining acceptance by the mine operators.

Another trial-and-error block concept system is that of Minnesota Ore Operations, U. S. Steel Corporation as reported in [1]. This work is probably one of the earliest uses of the block concept for mine planning. Here the preparation of a block inventory is similar to what has already been described, but the method of economic evaluation of the blocks recognizes the fallacy of a pure grade or economic cut-off based on the net value of a block. The Minnesota Ore method takes cognizance of the fact that once a block of material is removed from the earth, there is a possibility that it is better to treat this material and recover some of the cost rather than completely dispose of it at additional cost. The objection to their scheme arises from the fact that this classification is done on a block basis and the influence of the entire mining-refining process is not taken into account. This method also considers the possibility of treating an ore block in a number of ways. (This may not be possible at some operations.) Thus, in a sense this approach uses a dynamic cut-off on a single block basis. For mine planning and scheduling, a number of blocks are combined into feasible mining increments called shovel units. The development of the shovel units is accomplished through the judgement of the mining engineer with full knowledge of the material classification by blocks, equipment requirements of blocks, grades and profit values. The shovel units are the entities of scheduling and are selected on a profit basis and combined into a plan or schedule subject to mining system constraints. Alternate schedules are developed to meet metallic requirements and management policies on a trial-and-error basis.

The work of H. Lerchs and I. Grossman, [15], is the first known nontrivial and error approach to the problem of determining the ultimate pit limits. This work utilized the block concept and their assumptions included equality of block size and predetermination of what was ore and what was waste. The Grossman-Lerchs algorithm is a directed graph algorithm which divides the set of blocks into mineable and nonmineable subsets, positive and nonpositive subsets on the basis of profitability of each block. Their algorithm was implemented for use and is discussed further in [10].

Although their primary objective was to determine the ultimate pit contour, they did recognize that there are many ways by which this may be reached. To accomplish this scheduling they suggested the use of an arbitrary penalty parameter, by which the profitability of each block could be adjusted to determine the various stages of development towards the ultimate pit plan. This penalty parameter could be thought of as the assignment of Lagrange multipliers to the constraint set.

While the penalty parameter is the "germ" of a good idea, it is sometimes a difficult task to arbitrarily subset the proper penalty, especially when numerous constraints are present. Also, unless some method of combining plans is available, the method does not always converge to the optimum plan since the optimum may not consist of entirely whole blocks.

There are other proposals such as [7] and some unpublished work at the U. S. Bureau of Mines which has contributed to the area of mine planning. However, discussion of this work will not add greatly to what has already been given.

1.6 THE GROSSMAN-LERCHS ALGORITHM [10], [15]

Because the problem to which the Grossman-Lerchs algorithm is intended to be applied and the sub-problem to be discussed in Chapter 3 are equivalent, the G-L algorithm will be presented here as paraphrased by Gilbert [10].

Positivity and negativity in the following refers to positive and negative profits of a subset of blocks.

Algorithm:

- Step 1. Initialize: each block of the whole set becomes a distinct subset of one element.
- Step 2. If a positive subset A exists which is constrained by a negative subset B , combine both to form a new subset $C = A \cup B$. If no such subset A exists, go to Step 4, otherwise go to Step 3.
- Step 3. Examine only subset C formed in Step 2 to determine if an advantageous split can be made. A split will be advantageous if any negative subset D exists which does not constraint its complement in C . If such a D exists, remove it from C and return to Step 2.
- Step 4. Stop. The optimal pit is identified by all positive subsets.

For the original presentation, which is considerably more mathematical in content the reader is referred to [15].

There are many interesting characteristics of this algorithm and the problem it solves, although they seemingly were not recognized by Lerchs and Grossman. The characteristics of the problem are treated extensively in Chapter 3. It is felt that the method to be proposed in Chapter 3 is more efficient, more readily implemented and more adaptable to unequal blocks than the Grossman-Lerchs approach.

CHAPTER 2

FORMULATION OF GENERAL MATHEMATICAL MODEL

2.1 INTRODUCTION

The problem to be investigated in this paper as defined in Chapter 1 is to determine an "optimal" production schedule for an open-pit mining operation for a planning horizon of T time periods (years, months, weeks, etc.). The term "optimal" refers here to that schedule which will result in the maximum total profit over the planning horizon. The term profit may be interpreted to be discounted or undiscounted as the reader desires.

The T time periods could vary in length depending on the range and purpose of the scheduling plan. For example, one could view the problem as: to determine a yearly schedule for the next ten to twenty years for the purpose of future economic planning. Another possibility is to find a monthly schedule for one to five years for the purpose of actual production planning.

As will be shown later, the techniques to be presented are also applicable to the problem of determining the so-called *optimal pit limits* used in mine evaluation. Used for this purpose, the method would provide an optimal ultimate pit limit on the basis of present technology and forecasted economic conditions. In using the proposed method for determining the long range pit limit, consideration can be given to factors other than economic (mining costs and revenue) and the geometry of development, such as the form and flow of products in the mining-refining system and other factors, which cannot be given an exact numerical value.

2.2 ASSUMPTIONS OF MODEL

2.2.1 Statement of Assumptions

In order to obtain a workable mathematical model, a number of assumptions must be made as follows:

1. The mineral deposit can be divided into a finite number of mineable units called blocks, such that the flow and form of the products in the mining, concentrating, and refining process can be described in terms of these units.
2. All blocks are the same size. (Not truly essential, but makes development of procedures easier.)
3. There is a one-to-one relationship between the removal of a block which is restricted and its restricting blocks.
4. It is possible to describe the allowable mining sequence, consistent with required pit geometry, in such a manner that it is known precisely at any time what blocks must be removed before a particular block may be removed. Also this sequencing should be uniform throughout most of the probable mining area.
5. The restrictions for mining capacity, milling, capacity, required volumes of products at certain stages of the process, required grades of mill feed and concentrate and other operating, legal, and management conditions may be expressed as linear relationships of crude volume.
6. One is able to assign representative values to each block for costs, revenue, volumes, assays, equipment requirements and other data necessary for the relationships in 5.

2.2.2 Discussion of Assumptions

Assumption 1:

As discussed in Section 1.3.2, rectangular blocks provide an excellent means of describing the flow and form of products in the almost continuous mining, concentrating and refining process. Actually, open pit mining is essentially accomplished in terms of blocks, hence this is not a very restrictive assumption for our model. The block concept has been used successfully for ore estimation in a number of cases as reported in [1, 8, 10, 15, 19, 20].

Assumption 2:

Uniformity of block size yields some niceties in formulation, however, it is not a necessity for the treatment of the problem by the method to be proposed as will be seen in Chapter 3. In the interior of the mineral deposit, this assumption does not limit the description of the mining process except possibly for the wall slope requirements. This exception may be overcome by varying the configuration of blocks describing the allowable mining sequence. Another objection which may arise is that it may be more advantageous for planning purposes especially where selective mining is employed to vary the block size so as to conform more closely to geological breaks. However, the block is usually quite small relative to the entire amount of material to be removed in a planning period and also the geological breaks are not precisely defined (only estimates from drill hole data). Therefore, the inclusion or exclusion of a small amount of undesirable material in a block will not be detrimental to the overall optimal schedule. It would seem to balance out in the final plan.

On the surface boundary, the situation is somewhat different. Here the

dimensions of the top blocks is definitely restricted by the topography.

For example, see Figure 2.1.

Level 1	1,1	1,2	1,3	1,4	1,5	1,6	1,7	1,8
Level 2	2,1	2,2	2,3	2,4	2,5			
Level 3	3,1	3,2						

FIGURE 2.1: X-SECTION SHOWING BLOCK CONFIGURATION

As shown, blocks (1,1) through (1,8) vary in heights due to the variation in the surface. This variation can easily be overcome by a simple change in variable. Let

X_{ij} = actual volume of block (i,j) mined

\bar{X}_{ij} = adjusted block volume mined.

Since block volumes are assumed equal to K and the actual is V_{ij} if we know \bar{X}_{ij} we can find X_{ij} by the relation

$$X_{ij} = \bar{X}_{ij} \frac{V_{ij}}{K} .$$

Hence, for any irregular block, the above transformation can be used and all blocks can be regarded as having equal size. This would be overwhelming if we had to do it on all blocks but with only surface blocks it isn't too bad. Of course, the coefficients of the various constraints which include these transformed variables will have to be adjusted also.

A reasonable dimension for the block height is the height of the mining bench of the operation being studied. This allows block representation of

the actual material being mined. Bench heights in present mining practice are in the range of 40-50 feet.

The other two dimensions of a block are influenced by equipment capacities, geological structure, wall slopes, manner of mining, accuracy of sample data, desired use of block, and the inconvenience and incapability of manipulating a large number of blocks. It is geometrically desirable, due to the conical shape of the configuration of blocks used to represent the allowable mining sequence to make the other two dimensions equal. The value of this dimension will be called w in all further discussion. The value of w can usually be selected within the following limits:

equipment or mining method bounds $\leq w \leq$ geological bounds.

Some of the geometrical conditions on w will be discussed in relation to the block configurations representing an allowable mining sequence since the problems are related.

Assumption 3:

A one-to-one relationship here is interpreted to mean that for every unit volume which is mined from a block that is restricted (overlaid) by a number of other blocks at least an equal volume must be removed from each of the restricting blocks. For example, in Figure 2.1, assume that to remove block (2,4) we must first of all have mined blocks (1,3), (1,4), and (1,5). The one-to-one assumption states that for every unit volume of block (2,4) mined at least one unit must be removed from each of the blocks (1,3), (1,4), (1,5). It is conceivable, therefore, that a plan would result in only taking $1/4$ of each block (1,3), (1,4), and (1,5), and $1/8$ of block (2,4). The question will arise to the "operator" how to get $1/8$ of block (2,4). If these blocks occurred on a boundary of a mining cut other than the surface,

it is entirely possible to get such answers and it would be a mineable plan. For example, a fractional block plan on a wall slope is shown in Figure 2.2.

Although the possibility of an unmineable situation exists, it is thought that in most practical problems its occurrence will be negligible. The rationale for such an opinion is based upon the relatively large volumes that will be removed, the occurrence of assay value trends in a deposit, and that in general, all else remaining relatively fixed costs tend to increase with the depth of mining.

Assumption 4:

The allowable mining sequence is primarily a problem of geometry. In an actual mining operation, the material is removed in such a way that the *safe wall slope* is never exceeded in any direction. The safe wall slope is defined as the angle between the sides of a mining cut and a horizontal plane at which the material will stand without support (angle of repose). The practice of benching gives the open pit mine a step-like structure. (See Figure 1.1.) These conditions justify the representation of the outline of a mining plan or the volume of the material to be removed, consistent with the wall slope constraints and mining practices, by a series of *cone-frustration-cones* (see Figure 2.3a). Considering the vertical sides induced by the block concept, a better configuration to work with is the *disk-cone* shown in Figure 2.3b.

The relationship between the radii of the respective disks is given by

$$r^2 = \frac{r_1^2 + r_1 r_2 + r_2^2}{3}$$

where

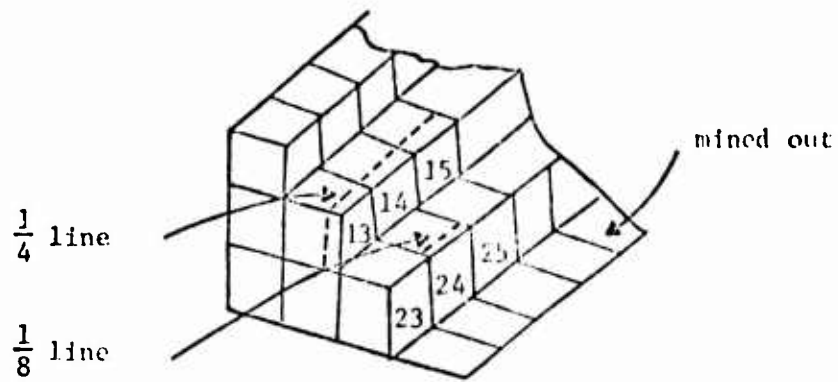
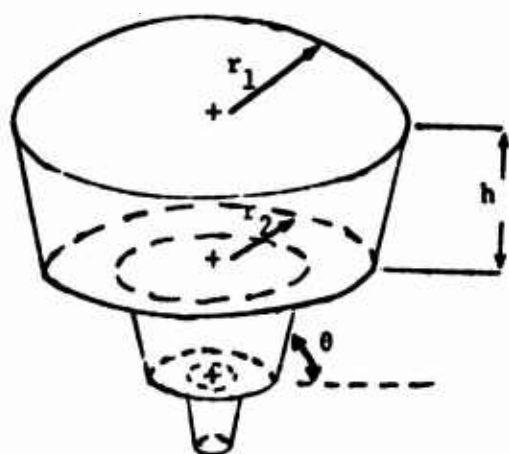

FIGURE 2.2: POSSIBLE FRACTIONAL BLOCK PLAN

a. Cone-Frustum-Cone



b. Disk-Cone

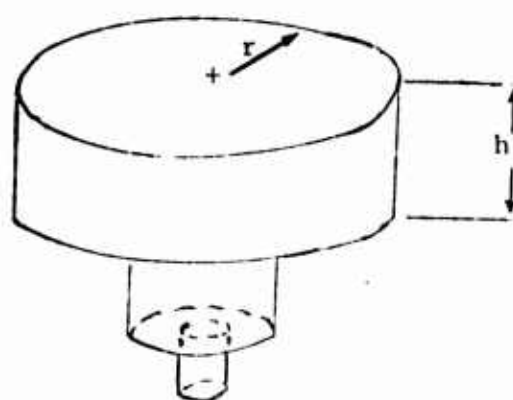

FIGURE 2.3: UNITS FOR REPRESENTATION OF PIT GEOMETRY

r = radius of disk (cylinder) which has equal volume and height
as frustrum of regular cone with radii r_1 and r_2 .

Other authors dealing with related problems [10, 15] have proposed a conical representation, but when the block concept is used, the representations are topologically invariant. That is, one ends up using the disk-cone eventually in both approaches.

At this point, the problem is to determine a block configuration that closely approximates the shape and volume of the disk-cone. A desirable configuration should be symmetrical and center on a bottom block. The block configuration is a function of the wall slope, θ , the block dimension, w , and the height h . Attempting to determine a block configuration and a dimension w , which satisfy the geometric constraints of the problem and minimize the volume difference as well as the penalty for having a large number of blocks gets to be a very messy problem and it is not the function of this investigation to go into its solution.

As we have bounds on w (Assumption 2), it may be well to consider w fixed and determine a block configuration that satisfies the desired conditions. This can be accomplished graphically by drawing concentric circles, representing the disks, on a uniform grid of w by w squares and comparing the volumes generated by the disks and various patterns of blocks. Due to the symmetry and uniform grid considerations, the patterns will consist of combinations of a 9:1 configuration and a 5:1 configuration [10]. These configurations are shown in Figure 2.4.

Two of the possible surface patterns generated by a cubic block configuration scheme of 1:5:9:5 for an overall $\theta = 45^\circ$ are shown in Figure 2.5. The configurations and volumes generated differ due to the starting conditions (1:9:5:9:5 or 1:5:9:5:9). This is important since in the

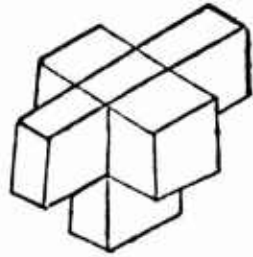

5:1

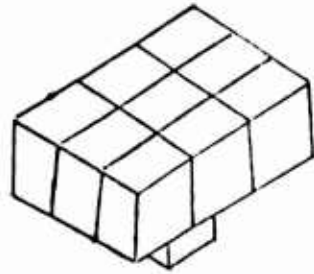

9:1

FIGURE 2.4: UNIT BLOCK CONFIGURATIONS

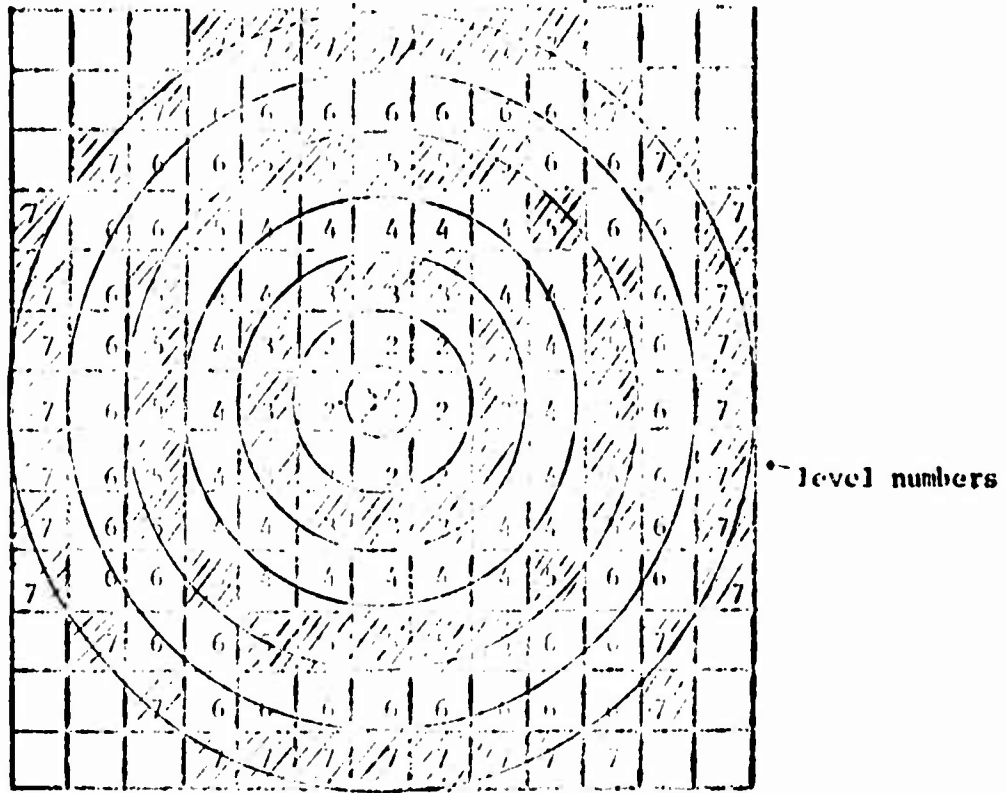

1/1:9/1:5/1:9/1:5

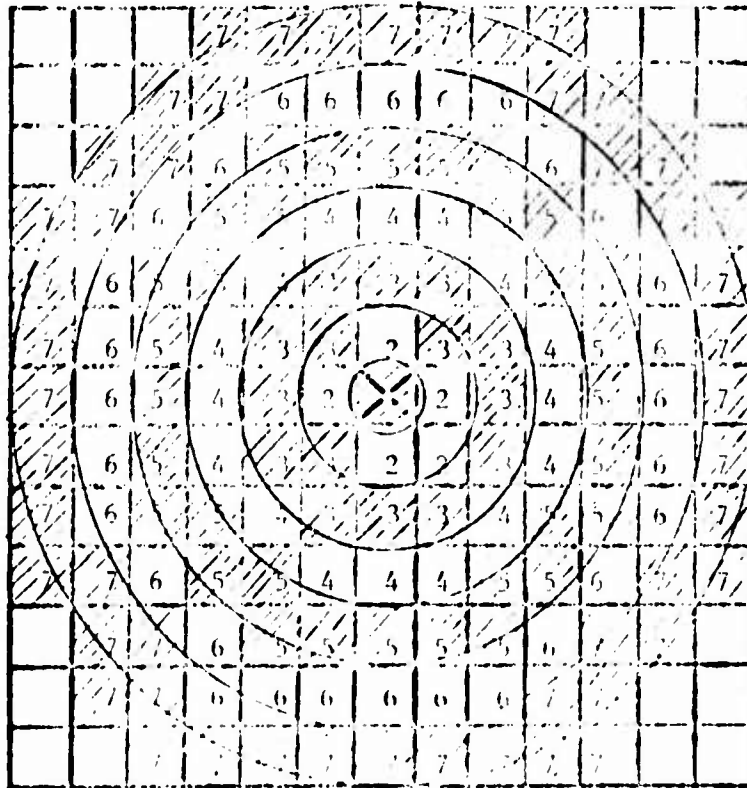

1/1:5/1:9/1:5/1:9

FIGURE 2.5: SURFACE PATTERNS FOR 1:5/1:9 CONFIGURATION

formulation of the problem we will want to assign the block configuration representing the allowable mining sequence a priori and hence may enter the configuration at any level. It was reported in [10] and confirmed by the author that a 1:5:9 configuration gives an excellent approximation for the volume and shape of a diskical cone generated by a regular cone with a side slope of 45° .

The allowable mining sequence varies from operation to operation due to the differences in permissible wall slopes and operating practices. Usually, the wall slope is constant in any one operation but there are cases where the wall slope varies in a single open pit. As has been discussed, the allowable mining sequence for any open pit mining operation can be closely approximated by selecting the proper configuration and block size. In the cases where a number of slopes are used in a single pit, it would be advantageous to vary the configuration rather than the block size. In the case of single value slopes, it appears a change in block dimensions would be the best thing to do. For example, with 45° slopes, $w = h$ appears to be a good choice, whereas with 30° slopes, $w = 1.3 h$ is a good choice.

Assumption 5:

When developing a model for open pit mine production scheduling, consideration must be given to factors other than the geometric conditions discussed under Assumption 3. These factors provide further constraints for the model and may be classified into the following general categories:

1. Form of the material within a block and the method of treatment it will receive in the mining, concentrating, and refining system.
2. Equipment availability and capacity.

3. Availability and capacities of plants.
4. Manpower availability.
5. Orderly mining of the pit.
6. Legal and physical boundaries.
7. Desired limits on assays of plant feed.
8. Desired form, quantity, and assays of final or intermediate products of the system.

As will be illustrated in the following discussion, most of the constraints in the above categories can be expressed as linear relationships of crude volume.

The type and method of treatment of the material in a block is a very important consideration. All too often, the decision as to whether a block is ore or waste, and if either, exactly what treatment it should receive in the system, is made without considering the influence of the entire system and other blocks in the system. That is, the material is ore if its profit value exceeds a certain economic cut-off, and its treatment is determined on the basis of metallurgical tests, which are valid only when this particular material is in the system by itself. A priori decisions such as these do not always lead to the best mining schedule. The proposal here is to let these decisions be based on a block's effect on the profitability of the entire system operation as discussed in Chapter 1.

This proposal can be included in the model by letting:

x_h^{rpt} = amount of material mined from block h ,
used in the system as material of type
 r and treated by method (process), p ,
during period t .

$$\sum_{r,p,t} x_h^{rpt} \leq l_h = \text{total volume of block.}$$

Consideration of equipment availability and capacity leads to constraints on the amount of material that can be taken from the pit or certain areas of the pit. These constraints can be expressed in terms of equipment hours per ton or yard of material. Equipment used in an open pit mine which has an influence on the mining operation capability are shovels, haulage units, drills, and other auxiliary mining equipment. Mining capacity may be limited in a certain area of the pit, say Q_g , since not all the equipment can be concentrated in one particular area. This can be expressed for a single period as follows:

$$\sum_{h \in Q_g} a_h^d x_h^{rpt} \leq \text{hours available in } Q_g \text{ for each type of equipment}$$

where a_h^d = hours of equipment d required per unit volume of block (h) .

Q_g , $g = 1, 2, 3, \dots$ could represent a number of small areas of the pit or it could be the entire pit operation, in which case the above constraint would be a limit on the total capacity for equipment type d . Also, the mining capacity may be limited by the capacity of a certain sub-system of the mining operation to handle a certain amount of material type r , for example, $r = \text{waste}$. This would yield:

$$\sum_{r=\text{waste}} \sum_h x_h^{rpt} \leq \text{waste handling capacity in tons or yards.}$$

If an operation had the option of stockpiling, there would be similar constraints for this.

The capacity of plants such as the concentrator, refinery, and even the maintenance facilities, have an influence on the capability of the entire system. Examples of such constraints are as follows:

Concentrator capacity

$$\sum_{r,h,p} x_h^{rpt} \leq \text{total plant capacity}$$

Concentrator capacity for material r

$$\sum_{h,p} x_h^{rpt} \leq \text{material r plant capacity}$$

Concentrator capacity for treatment p

$$\sum_{h,r} x_h^{rpt} \leq \text{treatment p capacity}$$

Refinery capacity

$$\sum_{r,h,p} r_h x_h^{rpt} \leq \text{refinery capacity}$$

where r_h = tons refinery feed per unit volume of block (h)

Maintenance facilities

$$\sum_{r,p,h,d} m_h^{dw} a_h^d x_h^{rpt} \leq \text{capacity of maintenance function}$$

where

m_h^{dw} = hours maintenance function w required for equipment type d per hour d works in block (h)

a_h^d = hours of equipment d required per unit volume of block (h) .

Manpower is a very important element in a mining operation. The availability of manpower may restrict the capabilities of the system, or due to union pressures or other labor relations, uniformity of operation may

have to be considered. There are a number of operations in open pit mining which can be expressed as functions of manpower availability. For example, blasting limitations could be expressed as:

$$\sum_h p_h x_h^{rpt} \leq \text{available blasting man-hours}$$

where p_h = blasting man-hours required per unit volume of block (h) .

Although not directly expressed in terms of man-hours, lower bounds may have to be considered for plant and equipment availability in order to insure a stable environment for the labor force. For example,

$$\sum_{r,p,h} f_h^d x_h^{rpt} \geq \text{lower bound for equipment } d \text{ in hours in period } t$$

where f_h^d = hours of equipment d required per unit volume of block (h)

$$\sum_h b_h^{rp} x_h^{rpt} \geq \text{lower bound for sub-system handling material } r \text{ with method } p \text{ in period } t$$

where

b_h^{rp} = hours of sub-system per unit volume of block (h) treated in process p as material r .

Conditions other than the geometric factors discussed under Assumption 3 may influence the orderly mining of the open pit. These conditions may arise due to operating procedures such as access for transportation units or management operating policies. Reasonable expressions for constraints of this type can be in terms of ratios of material on different levels or areas or just bounds on volume from particular areas.

Legal and physical boundaries are similar to the orderly mining constraints. These conditions may impose limits on mining volumes and on final and intermediate products. They may be due to legal contracts such as those for royalties and other property agreements. Boundary constraints may also arise from management policies and locations of the physical plants.

Desired limits on assays of plant feed and desired form, quantity, and assays of final or intermediate products are essentially one class. They were separated in listing for the sake of emphasizing the importance of control of plant input. Constraints in this category may be due to design characteristics of the concentrator and refinery. Also, they may arise from desired products as influenced by marketability. Design characteristics give rise to concentrator feed restrictions expressed as:

Lower bounds on feed

$$\sum_{p,h,rcore} q_h^s x_h^{rpt} \geq 0$$

where q_h^s = (crude analysis-lower assay limit) per unit volume of block (h) for element s , (s could be iron, silica, copper, etc., depending on a particular operation), or lower bound on the assays for a particular treatment of type r material.

$$\sum_h q_h^{sp} x_h^{rpt} \geq 0,$$

where q_h^{sp} = [crude analysis-lower assay limit] per unit volume of block (h) used as type r material in process p .

Upper bounds on feed

$$\sum_{p,h,rcore} \bar{q}_h^s x_h^{rpt} \leq 0$$

where \bar{q}_h^s = (crude analysis-upper assay limit) per unit volume of block (h) .
 It may be desirable to have bounds on the form of concentrator input, which
 can be expressed as ratios of different materials.

$$\sum_{p,h} x_h^{rpt} - \sum_{p,h} v_{rs} x_h^{spt} \geq 0$$

where v_{rs} expresses the desired volumetric ratio of materials r and s .

Assay bounds on the concentrator product may be expressed as:

$$\sum_{p,h,r} n_h^{sp} x_h^{rpt} \leq 0$$

and

$$\sum_{p,h,r} \bar{n}_h^{sp} x_h^{rpt} \geq 0$$

where

n^{sp} = [crude assay-(upper concentrator assay limit) recovery]
 per unit volume of block (h) in process p for
 element s .

\bar{n}^{sp} = [crude assay-(lower concentrator assay limit) recovery]
 per unit volume of block (h) in process p for
 element s .

Similar constraints can be expressed for other products as desired.

It is the opinion of the author that the constraint areas discussed in
 the preceding paragraphs cover most of the important conditions that
 influence the scheduling plan. Of course, there may exist some unusual
 conditions which are not adaptable to a linear expression, but it is felt
 that they would be of minor importance in determining the final plan. Many

of the management objection which arise from the exclusion of such unusual conditions may be answered by sensitivity analysis. Part of the discussion in Chapter 5 will cover this topic.

One condition which is considered important by the operators in some cases and has not been mentioned in any discussion so far is minimum pit bottom. Some operators and authors have expressed the opinion that the constraint structure must provide for a minimum pit bottom area in order to allow working space for equipment. Even though it can be implemented quite easily in the proposed method of solution, the author believes that it is unnecessary for two reasons: (1) because of geologic trends, it is felt relatively few blocks in a plan would violate this constraint, and (2) in actual mining practice, the expansion to the minimum full working bottom is done essentially one block at a time. Thus, a plan which bottoms out in only one block can be thought of as the initial stage or cut into the lowermost level.

Assumption 6:

Assignment of the representative values to each block required for expressing the constraints discussed under Assumption 5 has been discussed in 1.3.3. As stated there, a number of assignment procedures have been reported in [1, 8, 19, 20]. The methods are dependent on the particular operation involved, and also on the basic data available. Great care should be given this phase, and also to the collection of the basic data since the solution of the scheduling problem is only as good as the data on which it is based.

2.3 MATHEMATICAL FORMULATION

Based on the preceding assumptions, the problem of determining an extraction schedule for an open pit mine over a duration of T time periods which will yield the maximum profit may be formulated as a large scale linear programming problem with the following structure;

$$\begin{aligned}
 \text{Maximize} \quad & c^1 X^1 + c^2 X^2 + \dots + c^T X^T \\
 \text{Subject to} \quad & D_1 X^1 + D_2 X^2 + \dots + D^T X^T = d \\
 & A_1 X^1 = b_1 \\
 & \quad \quad \quad A_2 X^2 = b_2 \\
 & \quad \quad \quad \cdot \\
 & \quad \quad \quad \cdot \\
 & \quad \quad \quad A_N X^N = b_N \\
 & B_{11} X^1 \leq \underline{0} \\
 & B_{21} X^1 + B_{22} X^2 \leq \underline{0} \\
 & B_{11} X^1 + B_{T2} X^2 + \dots + B_{TT} X^T \leq \underline{0} \\
 & \sum_{r,p} X_h^{rpl} + \sum_{np} X_h^{rp2} + \dots + \sum_{r,p} X_h^{rpT} \leq \ell_h \quad \forall h \\
 & X^{rpt} \geq 0
 \end{aligned}
 \tag{2.3.1}$$

where

X_h^{rpt} = amount of material mined from block (h) used in the processing of material of type r and treated by method p during time period t .

$X^t = X_h^{rpt}$ RPH x 1 component vector for each period $t = 1, \dots, T$.

R = number of material types.

P = number of possible methods of treatment.

H = IJK = number of blocks.

I = maximum level dimension.

J = maximum column dimension.

K = maximum section dimension.

$A_i = m_i \times n$ matrix corresponding to the coefficients of the constraints discussed under Assumption 5 for period i . $n = RPIJK$

$b_i = m_i \times 1$ vector corresponding to the right-hand side of these constraints.

$\underline{0} = w \times 1$ zero vector

$D_i = m_0 \times n$ matrix corresponding to the period i portion of coefficients of constraints discussed under Assumption 5 which relate to the entire planning duration.

$d = m_0 \times 1$ vector corresponding to the right-hand side of these constraints.

$c^p = 1 \times n$ vector of cost or profit coefficients for period p .

$l_h =$ volume of block (h).

$B_{it} = w \times n$ matrix of coefficients for the constraints which describe the allowable mining sequence as discussed under Assumption 4.

For the purpose of explaining the detailed structure of the matrices B_{it} it is convenient to change from the single subscript notation $h = 1, 2, \dots, H$ for each block, to a more natural 3-dimensional notation $i = 1, 2, \dots, I$, $j = 1, 2, \dots, J$ and $k = 1, 2, \dots, K$, as shown in

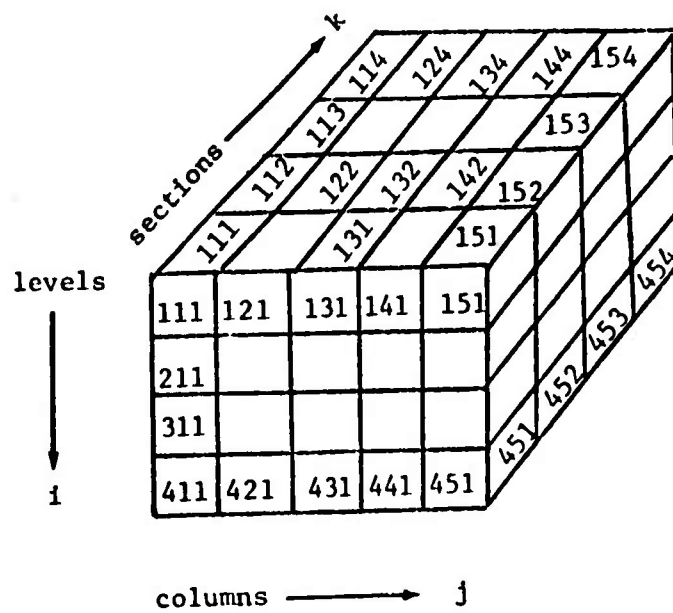

FIGURE 2.6: BLOCK STRUCTURE

Figure 2.6. Our block volume variables X_h^{rpt} now are designated by X_{ijk}^{rpt} .

Consider the sequence extraction constraints for block (232) (directly below block (132)) assuming we must remove the five blocks restricting it as discussed under Assumption 4. Also assume the schedule duration to be two periods, blocks to be classifiable as ore or waste, and that it is possible to treat the ore by two different methods. Then we have, in accordance with Assumptions 3, 4, and 5, the following constraints which illustrate the structural form of the B_{ip} matrices:

$$\begin{array}{l}
 -x_{131}^{111} \quad -x_{131}^{211} \quad -x_{131}^{121} \quad -x_{131}^{221} \quad + \sum_{r=1}^2 \sum_{p=1}^2 x_{232}^{rp1} \quad \leq 0 \\
 -x_{122}^{111} \quad -x_{122}^{211} \quad -x_{122}^{121} \quad -x_{122}^{221} \quad + \sum_{r=1}^2 \sum_{p=1}^2 x_{232}^{rp1} \quad \leq 0 \\
 -x_{132}^{111} \quad -x_{132}^{211} \quad -x_{132}^{121} \quad -x_{132}^{221} \quad + \sum_{r=1}^2 \sum_{p=1}^2 x_{232}^{rp1} \quad \leq 0 \\
 -x_{142}^{111} \quad -x_{142}^{211} \quad -x_{142}^{121} \quad -x_{142}^{221} \quad + \sum_{r=1}^2 \sum_{p=1}^2 x_{232}^{rp1} \quad \leq 0 \\
 -x_{133}^{111} \quad -x_{133}^{211} \quad -x_{133}^{121} \quad -x_{133}^{221} \quad + \sum_{r=1}^2 \sum_{p=1}^2 x_{232}^{rp1} \quad \leq 0
 \end{array}$$

$$\begin{array}{l}
 -x_{131}^{112} \quad -x_{131}^{212} \quad -x_{131}^{122} \quad -x_{131}^{222} \quad + \sum_{r,p} x_{232}^{rp2} \leq 0 \\
 -x_{122}^{112} \quad -x_{122}^{212} \quad -x_{122}^{122} \quad -x_{122}^{222} \quad + \sum_{r,p} x_{232}^{rp2} \leq 0 \\
 -x_{132}^{112} \quad -x_{132}^{212} \quad -x_{132}^{122} \quad -x_{132}^{222} \quad + \sum_{r,p} x_{232}^{rp2} \leq 0 \\
 -x_{142}^{112} \quad -x_{142}^{212} \quad -x_{142}^{122} \quad -x_{142}^{222} \quad + \sum_{r,p} x_{232}^{rp2} \leq 0 \\
 -x_{133}^{112} \quad -x_{133}^{212} \quad -x_{133}^{122} \quad -x_{133}^{222} \quad + \sum_{r,p} x_{232}^{rp2} \leq 0
 \end{array}$$

(2.3.2)

PERIOD 1

PERIOD 2

These relationships express the fact that to get at block (232) in Period 1, blocks (122), (131), (132), (133), and (142) must be removed in Period 1 irrespective of what is done with the material after it is mined. To obtain block (232) in Period 2, the sequence of blocks (122) - (142) can be removed in Period 1 or Period 2.

It is easily seen from the coefficient matrix of (2.3.2) that each B_{ip} can be expressed as:

$$B_{ip} = [E \ E \ E \ E]$$

by re-arrangement of the columns, where each E is a matrix with exactly one -1 and one $+1$ in each row, and all other elements are zero. Thus E is the *transpose* of the node arc incidence matrix of a network-flow problem. [see Appendix or [2], [21]]

Before giving a theorem which will demonstrate an important advantage of this structure, consider the constraints:

$$\sum_{r,p} x_{ijk}^{rp1} + \sum_{r,p} x_{ijk}^{rp2} + \dots + \sum_{r,p} x_{ijk}^{rpt} \leq l_{ijk} .$$

Dividing each of these constraints by l_{ijk} gives

$$\sum_{r,p} \bar{x}_{ijk}^{rp1} + \sum_{r,p} \bar{x}_{ijk}^{rp2} + \dots + \sum_{r,p} \bar{x}_{ijk}^{rpt} \leq 1$$

where

$$\bar{x}_{ijk}^{rpt} = \frac{x_{ijk}^{rpt}}{l_{ijk}}$$

This same transformation can be carried out for each constraint of 2.3.1 and is possible because of Assumption 2, ($l_{ijk} = K$). Note the matrices D_i , A_i , and B_{it} remain unchanged, but the b_i and d are transformed to $\bar{b}_i = \frac{b_i}{l_{ijk}}$ and $\bar{d} = \frac{d}{l_{ijk}}$. In all further discussion, problem (2.3.1) will be considered in this transformed form unless stated otherwise.

Theorem 2.1:

If the Dantzig-Wolfe Decomposition technique is used to solve (2.3.1) with

$$\begin{aligned}
 & B_{11}X^1 && \leq 0 \\
 & B_{21}X^1 + B_{22}X^2 && \leq 0 \\
 (2.3.3) \quad & B_{T1}X^1 + B_{T2}X^2 + \dots + B_{TT}X^T && \leq 0 \\
 & \sum_{r,p} X_h^{rpl} + \sum_{r,p} X_h^{rpt} + \dots + \sum_{r,p} X_h^{rpt} && \leq 1 \quad \text{for all } ijk \\
 & X_h^{rpt} && \geq 0
 \end{aligned}$$

as the sub-problem constraints, then the actual sub-problem to be solved can be reduced to:

$$\begin{aligned}
 & \text{Maximize} && \bar{d}^1 Y_h^1 + \bar{d}^2 Y_h^2 + \dots + \bar{d}^T Y_h^T \\
 & \text{Subject to} && EY^1 \leq 0 \\
 & && EY^1 + EY^2 \leq 0 \\
 (2.3.4) & && EY^1 + EY^2 + \dots + EY^T \leq 0 \\
 & && Y_h^1 + Y_h^2 + \dots + Y_h^T \leq 1 \\
 & && Y_h^p \geq 0
 \end{aligned}$$

where

$$Y_h^t = X_h^{\text{sut}} / \bar{c}_h^{\text{sut}} = \max_{r,p} \bar{c}_h^{\text{rpt}}$$

and

$$\bar{d}_h^t = \bar{c}_h^{\text{sut}} = c_h^{\text{sut}} - \sum_{t=1}^T \pi_t^{\text{hsut}} - \pi_t^{\text{Ahsut}}$$

Proof:

From the structure of each $B_{ip} = (E, E, \dots, E)$, it is seen that only one of the rp variables X_h^{rpt} can appear in the basis solution of (2.3.3), otherwise the basic columns would be dependent, contradicting the independence of a basis. If some X_h^{sut} does occur in the basic optimal solution at a positive level, it must correspond to $\bar{c}_h^{\text{sut}} = \max_{r,p} \bar{c}_h^{\text{rpt}}$. This is true since the columns corresponding to the set of variables $X_h^{\text{rpt}}, r = 1, \dots, R$, $p = 1, \dots, p$, are all the same and at optimality

$$0 \geq \bar{c}_h^{\text{sut}} = \bar{c}_h^{\text{sut}} - \sum_{\ell=t}^T \bar{\pi}_\ell B_{\ell t}^{\text{hsut}} \geq \bar{c}_h^{\text{rpt}} - \sum_{\ell} \bar{\pi}_\ell B_{\ell t}^{\text{hrp}} \quad \text{for all } r, p.$$

Hence, to solve problem of (2.3.3), we need only consider those columns corresponding to:

$$Y_h^t = X_h^{\text{sut}} / \bar{c}_h^{\text{sut}} = \max_{r, j} \bar{c}_r^{\text{rpt}}$$

Doing this we get (2.3.4).

Q.E.D.

Theorem 2.1 will be used to great advantage in the chapters to follow since it provides considerable simplification to problems in the form of (2.3.3).

CHAPTER 3
THE SINGLE PERIOD PROBLEM

3.1 INTRODUCTION

In order to investigate the properties of the scheduling problem as formulated in Chapter 2 and to simplify the development of a solution technique for a T-period problem, the single period problem will first be considered.

The one-period problem has the following form:

$$\begin{array}{rcl}
 \text{Maximize} & cX & \\
 \text{Subject to} & AX & = b \\
 & BX & \leq 0 \\
 (3.1.1) & \left. \begin{array}{l} \sum_{r,p} X_{ijk}^{rp} \leq 1 \\ X_{ijk}^{rp} \geq 0 \end{array} \right\} & \text{for all } ijk
 \end{array}$$

The single-period problem is similar to the ultimate pit limit problem of which a number of reports have appeared in the literature as indicated in Chapter 1; [1, 5, 10, 16, 17, 18]. The problem as considered by these authors excludes the constraint set $AX = b$ and considers only an a priori classification of the material which is essentially setting $B = E$. ($E =$ transpose of node arc incidence matrix, see Appendix). This type of an approach yields a rough idea of the mineable reserves and is valuable in a preliminary evaluation study of a deposit. However, it is the opinion of the author that it is more desirable to study the "reserve picture" under the influence of the constraints which limit the form and flow of products in the entire system.

The approach presented in this paper is applicable to the ultimate pit

limit problem as well as many extensions which may be valuable in the evaluation and design of a mining, concentrating and refining system. For example, it may be important to know the ultimate pit limits, or reserve tonnage for a particular time horizon when volume restrictions are imposed on various components of the system and/or when the average assay of mill feed or concentrates are limited to a particular range. Markets for the system products may also impose constraints which will influence the total reserves. There are many other problems which may be investigated by the methods of this paper but those presented seem sufficient to point out the versatility of the approach.

The linear programming problem (3.1.1) will in most practical situations, exceed the capabilities of presently available linear programming codes and computing facilities, due to the dimension of the B matrix. (Recall from the discussion in Chapter 2 that there are approximately seven constraints in $BX = b$ per block. The A constraints will be relatively few in number (less than 40).) Because of these limitations, it seems desirable, even necessary, to seek other, more compact, methods of solution.

3.2 ANALYSIS OF THE PROBLEM

3.2.1 Decomposition of Problem

Due to the structure of problem (3.1.1), the relatively small size of the A matrix and the simplified structure of the B matrix which can be reduced by virtue of Theorem 2.1, it appears attractive to examine the application of the Dantzig-Wolfe decomposition principle [6] to this problem.

Applying the decomposition principle to problem (3.1.1) using

$$\left\{ \begin{array}{l} BX \leq b \\ \sum_{r,p} x_{ijk}^{rp} \leq 1 \\ x_{ijk}^{rp} \geq 0 \end{array} \right\} \text{ as the constraint set}$$

of the subproblem yields the following full master problem:

$$(3.2.1.1) \quad \begin{array}{l} \text{Maximize} \quad \sum_{i=1}^L \lambda_i cX^i \\ \text{Subject to} \quad \sum_{i=1}^L \lambda_i AX^i = b \\ \quad \quad \quad \sum_{i=1}^L \lambda_i = 1 \\ \quad \quad \quad \lambda_i \geq 0, \end{array}$$

where X^i is an extreme point solution of the subproblem. For optimality it is required that $cX^i - \pi AX^i - s \leq 0$ for all i . Here π is the $1 \times m$ vector of multipliers for the equations $\sum_{i=1}^L \lambda_i AX^i = b$ and s is the scalar multiplier corresponding to the equation $\sum_{i=1}^L \lambda_i = 1$ [6].

Therefore, the subproblem becomes

$$\begin{array}{r}
 \text{Maximum} \quad (c - \pi A)X \\
 \text{Subject to} \quad BX \leq 0 \\
 \left. \begin{array}{l}
 \sum_{r,p} X_{ijk}^{rp} \leq 1 \\
 X_{ijk}^{rp} \geq 0
 \end{array} \right\} \quad \forall ijk
 \end{array}
 \tag{3.2.1.2}$$

The general procedure (as given in [5, 6]) assuming we have at hand an initial feasible solution to the restricted master (3.2.1.3)

$$\begin{array}{r}
 \text{Maximum} \quad \sum_{i=1}^q \lambda_i cX^i \\
 \sum_{i=1}^q \lambda_i AX^i = b \\
 \sum_{i=1}^q \lambda_i = 1 \\
 \lambda_i \geq 0 \quad i=1, \dots, q
 \end{array}
 \tag{3.2.1.3}$$

is to determine π , s by solving

$$\pi AX^i + s = cX^i \quad \text{for } i = 1, \dots, q$$

Then solve the subproblem (3.2.1.2) to determine if maximum $cX - \pi AX \leq s$.

If this holds, then the optimal solution to problem (3.2.1.1) has been obtained and hence to problem (3.1.1) through

$$X = \sum_{i=1}^q \lambda_i X^i$$

If maximum $cX - \pi AX > s$ then it is profitable to introduce the new vector, $\begin{pmatrix} AX \\ 1 \end{pmatrix}$ with cost coefficient cX , into the basis.

After introducing the new vector, new π , s are determined and the process is repeated.

Once the subproblem has been solved, introducing a new vector into the master problem and solving it is relatively simple, since the master is rather a small (less than 40 constraints) linear programming problem.

3.2.2 The Subproblem

The problem remains how to solve the subproblem (3.2.1.2) since as it appears it is a large linear programming problem. Fortunately, it can be reduced by employing Theorem 2.1. By virtue of this theorem the new subproblem becomes

$$\begin{array}{ll}
 \text{Maximize} & (c - \pi A)^* Y = \bar{c}Y = Z & \text{(a)} \\
 \text{(3.2.2.1)} & \text{Subject to} & EY \leq 0 & \text{(b)} \\
 & & 0 \leq Y \leq 1 & \text{(c)}
 \end{array}$$

where $\bar{c} = (c - \pi A)^* = (c_{ijk}^{su} - \pi A^{ijk su})$ such that

$$\bar{c}_{ijk} = c_{ijk}^{su} - \pi A^{ijk su} = \max_{r,p} (c_{ijk}^{rp} - \pi A^{ijk rp})$$

and $Y = \{Y_{ijk}\}$ such that $Y_{ijk} = X_{ijk}^{su}$ which corresponds to \bar{c}_{ijk} .

Lemma 3.2.2.1:

There always exists an optimal solution to the problem (3.2.2.1).

Proof:

A feasible solution $Y = 0$ always exists and any feasible solution is bounded ($Z \neq \infty$). Therefore as a consequence of the Duality Theorems of linear programming (see [5, 21]), it is known that the dual of this problem always has a feasible solution, and an optimal solution to both problems

exists such that $\max Z = \min$ (the value of the dual problem).

Q.E.D.

Due to Lemma 3.2.2.1 there need be no concern for any $\lambda_i \geq 0$ other than those which satisfy $\sum_i \lambda_i = 1$ in the master problem.

The dual to problem (3.2.2.1) is:

$$\text{Minimize } P = \sum_{ijk} p_{ijk} \quad (\text{a})$$

$$\text{Subject to } uE + pI \geq \bar{c} \quad (\text{b})$$

$$u, p \geq 0 \quad (\text{c})$$

It is immediately clear that a feasible solution to problem (3.2.2.2) is:

$$u = 0, p_{ijk} = \max(0, \bar{c}_{ijk}) \quad \text{for all } ijk.$$

Lemma 3.2.2.2:

The following bounds exist for $\max Z$ of problem (3.2.2.1):

$$\max Z \begin{cases} \geq 0 & (\text{a}) \\ \leq \sum_{h/\bar{c}_h > 0} \bar{c}_h & (\text{b}) \end{cases}$$

Proof:

Part (a) is obvious since $\max Z \geq \bar{c}Y$ for any feasible Y and $Y = 0$ is feasible for (3.2.2.1) hence $\max Z \geq 0$.

To show (b), the weak duality theorem, [5, 21], states that:

$$P = \sum_h p_h \geq \bar{c}Y = Z \quad \text{for any feasible } p, Y, \text{ and } u. \text{ Hence setting:}$$

$$u = 0$$

$$p_h = 0 \text{ if } \bar{c}_h \leq 0$$

and

$$p_h = \bar{c}_h \text{ if } \bar{c}_h > 0$$

results in

$$\sum p_h = \sum_{h/\bar{c}_h > 0} \bar{c}_h \geq \bar{c}Y$$

for all feasible Y and hence for an optimal Y corresponding to $\max Z$.

Q.E.D.

The necessary and sufficient optimality conditions for problems (3.2.2.1) and (3.2.2.2) are:

$$\left. \begin{array}{l} EY \leq 0 \\ 0 \leq Y \leq 1 \end{array} \right\} \text{Primal Feasibility}$$

$$\left. \begin{array}{l} uE + pI \geq \bar{c} \\ u \geq 0, p \geq 0 \end{array} \right\} \text{Dual Feasibility}$$

$$\left. \begin{array}{l} u(EY) = 0 \\ p(I - Y) = 0 \end{array} \right\} \text{Complimentary Slackness}$$

$$(\bar{c} - uE + pI)Y = 0$$

3.2.3 Properties of Primal and Dual Subproblems

An investigation of the properties of the subproblem will lead to a better understanding of the problem and aid in stating an efficient method of solution.

As was pointed out in Chapter 2, the structure of the matrix E in problems (3.2.2.1) and (3.2.2.2) has the characteristics of the transpose of a node-arc incidence matrix of a network or graph, at most two nonzero elements per row.

Examining the dual problem (3.2.2.2), it is seen that each block (ijk) corresponds to a node in the network. The arcs corresponding to the variables, p , are incident out from the set $Y = \{(ijk)\}$. The arcs corresponding to the variables, u , are:

incident into node (ijk) if the coefficient of u_q in the E matrix is -1

and

incident out from node (ijk) if the coefficient of u_q in the E is $+1$.

The variables p and u can be thought of as flow variables on their respective arcs. Taking the dual constraint set and adding nonnegative slack variables yields:

$$uE + pI - vI = \bar{c},$$

the conservation equations of the network corresponding to the dual problem. The variables $v = \{v_{ijk}\}$ correspond to flow on arcs leading into each node. Each component \bar{c}_{ijk} of \bar{c} corresponds to a given quantity of flow into or out of each node depending on the sign of \bar{c}_{ijk} .

This assignment is as follows:

if $\bar{c}_{ijk} > 0 \Rightarrow$ flow into node (ijk) - a demand of \bar{c}_{ijk}
 if $\bar{c}_{ijk} \leq 0 \Rightarrow$ flow out of node (ijk) - a supply of \bar{c}_{ijk} .

To clarify these relations, consider the small two dimensional system of blocks shown in Figure 3.1. The block number appears in the upper left corner and \bar{c}_{ijk} at the bottom of each block. Assume the allowable mining sequence is such that for any block (ij) or partial block removed from a level (other than level 0) the block directly above it $(i-1,j)$ and its neighboring blocks $(i-1,j-1)$ and $(i-1,j+1)$ must also be removed.

The network corresponding to the dual problem for this system of blocks is shown in Figure 3.2.

The first thing one notes when looking at the network is that there are no arcs corresponding to the variables $\{p_{ij}, i \neq 0\}$ and $\{v_{ij}, j=3\}$. In other words, these variables have been set equal to zero and their corresponding arcs ignored. This is a general characteristic of the networks represented by the dual problem and is the result of the following lemma.

Lemma 3.2.3.1:

The problem

$$\begin{aligned} &\text{Minimize} && \sum_{ijk} p_{ijk} \\ &\text{Subject to} && uE + pI - vI = \bar{c} \\ &&& u, p, v \geq 0 \end{aligned}$$

has an optimal solution that

$$p_{ijk} = 0 \text{ for all } p_{ijk}, i \neq 0 \text{ and}$$

$$v_{ijk} = 0 \text{ for all } v_{ijk}, i \neq \max i \text{ if there exists}$$

LEVEL 0	0,1 -3.2	0,2 12.0	0,3 -3.2	0,4 7.0	0,5 -3.4	0,6 6.5	0,7 11.5	0,8 10.0
LEVEL 1	1,1 5.0	1,2 6.3	1,3 -3.1	1,4 4.8	1,5 4.0	1,6 4.5	1,7 6.0	1,8 13.0
LEVEL 2	2,1 -3.2	2,2 6.2	2,3 -3.2	2,4 10.6	2,5 6.4	2,6 -4.8	2,7 5.0	2,8 5.2
LEVEL 3	3,1 12.1	3,2 12.2	3,3 12.1	3,4 11.8	3,5 10.4	3,6 -8.0	3,7 8.5	3,8 9.4

FIGURE 3.1: EXAMPLE TWO-DIMENSION BLOCK SYSTEM

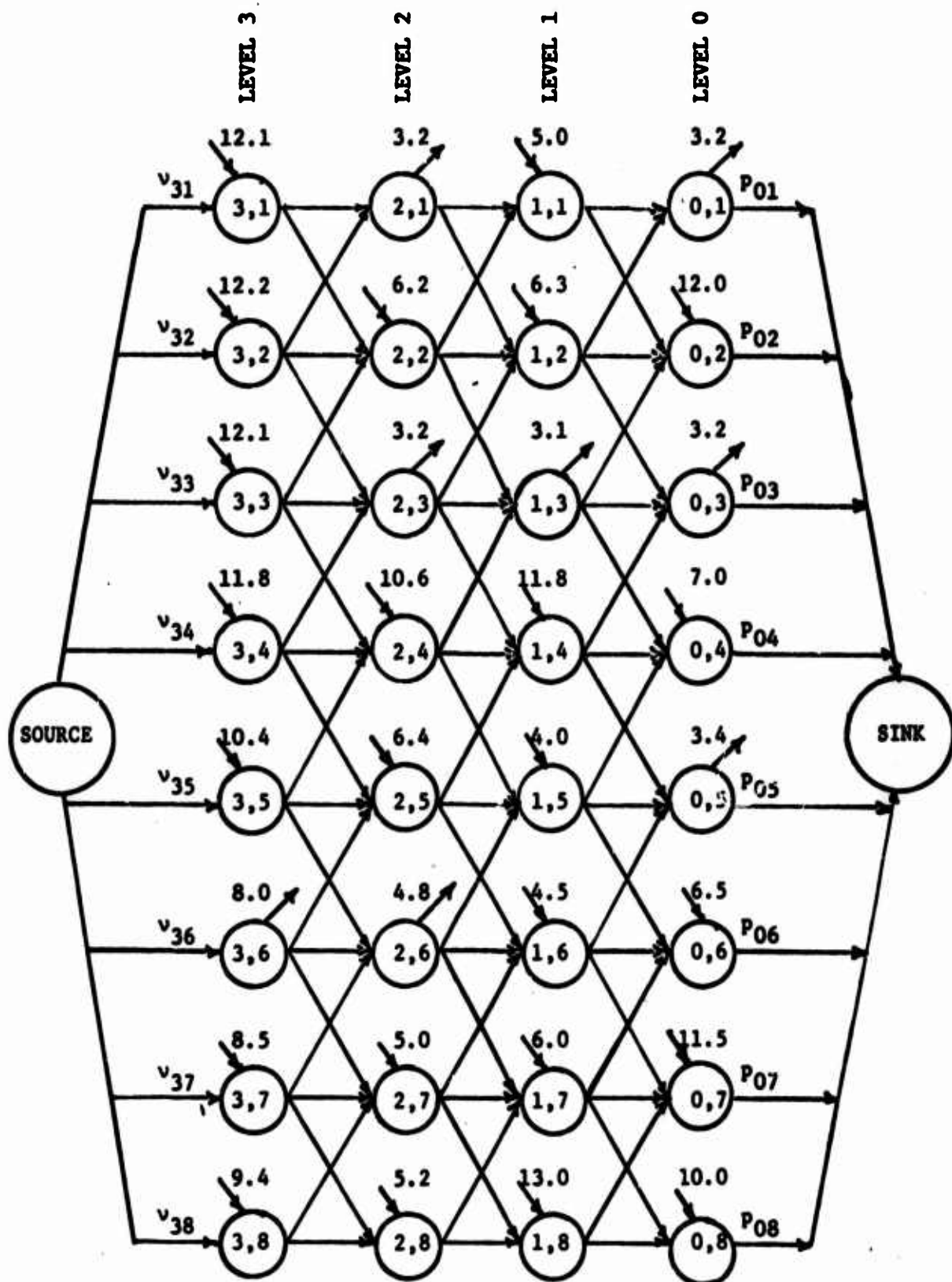

FIGURE 3.2: NETWORK REPRESENTATION OF BLOCK SYSTEM IN FIGURE 3.1

a "free path" from node (ijk) to node $(i-1, j, k)$. A "free path" is defined as a path for which there is no associated cost.

Proof:

From Lemma 3.2.2.1, it is known that the above problem always has an optimal solution. Assume that there exists an optimal solution with $P = \{ijk/p_{ijk} > 0, i \neq 0\}$ and $P^0 = \{0jk\}$ and $V^+ = \{ijk/v_{ijk} > 1 \neq \max i\}$ and $V^n = \{\max i, j, k\}$.

From the statement of the lemma, all nodes are accessible¹ from the set V^n by a free path. Hence for some $pqr \in V^+$ so that $v_{pqr} = \epsilon$. Set $v_{pqr} = 0$ and for some $(stv) \in V^n$ such that $(stv) > (pqr) \in V^+$. Set $v_{stu} = \delta_{stv} + \epsilon$ and change the flow along the path from (stv) to (pqr) by $+\epsilon$ in each arc. Also it is clear that there exists a free path from all $(ijk) \in P^+$ to P^0 . Hence setting $p_{ijk} = 0$ for $(ijk) \in P^+$ and $p_{0pr} = \delta_{0pr} + \epsilon_{ijk}$ for $(ijh) > (0pr)$ and increasing flow by ϵ_{ijk} along this path gives the desired result.

Q.E.D.

It should be noted that this problem could be treated as a minimum cost flow problem and solved by use of the out-of-kilter algorithm. This does not seem particularly attractive with the present form of the problem,

¹Accessability: If n_i and n_j are nodes such that there is a path from n_i to n_j then n_j is "accessible" from n_i written as $n_i > n_j$. The accessible set $D(n_i)$ is the set of all nodes accessible from n_i , ($n_j \in D(n_i)$). Define $\underline{D}(n_i) = D(n_i) + n_i$. The word "path" used in the above explanation is: a sequence of arcs $\{a_1, \dots, a_i, a_{i+1}, \dots, a_n\}$ such that the terminal node of each arc coincides with the initial node of the succeeding arc; i.e., all arcs in the path have a similar orientation.

however, due to the large number of arcs one would have to consider.

The primal variables, Y_{ijk} are called node numbers or node potentials in their relationship to the network formulation of the dual problem.

$Y_{ijk} = 1$ means a block is to be mined while $Y_{ijk} = 0$ means the block (ijk) will be left. As will be shown later (Theorem 3.3), the solution to the subproblem is in terms of blocks to be mined ($Y_{ijk} = 1$) or left ($Y_{ijk} = 0$). It will be clear that the subproblem provides a system of blocks to the master problem which selects and combines the systems into the optimal mining plan.

The theorems to follow characterize the solutions to the primal and dual subproblems, (3.2.2.1) and (3.2.2.2) and hence aid in presenting a method of solution.

Theorem 3.1:

If for any node corresponding to a block which is not restricted by any other block, the condition $\bar{c}_h > 0$ holds, then $p_h > 0$ and $Y_h = 1$ in the optimal solution of problem 3.2.2.1.

Proof:

Looking at the dual equations for any node, h , which is not restricted by other nodes (such as the nodes on level "0" in Figure 3.2) it is seen that the arcs incident on h , excluding the arcs corresponding to p_h and \bar{c}_h are all incident into node h . Now if $\bar{c}_h > 0$ (incident into h) the p_h is the only possible flow leaving h . Hence from the dual inequality for node h ,

$$-\sum_i u_{ih} + p_h \geq \bar{c}_h$$

it is clear that $p_h \geq \bar{c}_h > 0$. From the complimentary slackness condition $p_h(1 - Y_h) = 0$ it is clear that $p_h > 0 \Rightarrow Y_h = 1$.

Q.E.D.

Theorem 3.1 provides a means of classifying unrestricted blocks by immediate inspection of \bar{c}_h . There may be blocks in level "0" that are to be selected ($Y_h = 1$) for other reasons which will be brought out by the theorems to follow.

Theorem 3.2:

If some $Y_h = 1$, then every Y_k corresponding to $(k) \in D(h)$ is 1 in the optimal solution.

Proof:

Let $D_1(p) = \{q / (p, q) \in A_p^+\}$. Where A_p^+ = set of arcs incident out from node p . From the primal equations: $EY \leq 0$ we have that if $Y_h = 1$ then $Y_k = 1$ for $k \in D_1(h)$. Then consider $i \in D_1[D_1(h)]$, again from the primal relationships $Y_i = 1$. Continue in this manner until the nodes on level "0" are reached for which the accessible set is empty and the theorem is proven.

Q.E.D.

The next theorem is important in that it shows that we need only concern ourselves with potentials $\{Y_{ijk}\}$ of 0 or 1. Thus the primal subproblem solutions are sets of zeros and ones as indicated previously.

Before giving the next important theorem, we must discuss briefly the unimodular property of matrices. A matrix A is called *unimodular* if the determinant of every square submatrix of A equals 0, +1 or -1.

The following lemma is given by Hoffman and Kuhn in [13].

Lemma (Hoffman and Kuhn):

If in a system of linear inequalities with integral coefficients and constant terms, every nonsingular submatrix of the coefficient matrix has determinant ± 1 , then every extreme solution is integral.

Since it is well known that every matrix $[E^T I]$ is unimodular if E is, the next theorem follows immediately.

Theorem 3.3:

$y_h = 1$ or 0 in the optimal solution of the subproblem:

Maximize $\bar{c}Y$

Subject to $EY \leq 0$

$0 \leq Y \leq 1$

3.3 EQUIVALENT FORMULATIONS OF SUBPROBLEM

The subproblems, (3.2.2.1) and (3.2.2.2), analyzed in Section 3.2 were stated as follows:

Primal:		Maximize $\bar{c}Y = Z$	(a)
(3.3.1)		Subject to $EY \leq 0$	(b)
		$0 \leq Y \leq 1$	(c)
Dual:		Minimize $P = \sum_{h=1}^H p_h$	(a)
(3.3.2)		Subject to $uE + pI \geq \bar{c}$	(b)
		$u, p \geq 0$	(c)

From a network-flow point of view the objective in solving the dual problem (3.3.2) is to induce flow into the network in such a way that the requirements of the \bar{c}_h are satisfied and as little as possible goes through the arcs corresponding to the p_h variables. As indicated in Section 3.2.3, flow is forced into the network by the positive \bar{c}_h and taken from the system by the negative \bar{c}_h . For any node (h) there are only two ways for flow that is forced in (condition when $\bar{c}_h + \sum_{i/h \in D_1(i)} u_{ih} > 0$) to get out,

one way is to route flow along an arc corresponding to u_{hk} , i.e., to another node k , or remove flow via a p_h arc. Therefore, flow leaves the system (or reaches the sink) only through the p_h arcs or through the arcs corresponding to $\bar{c}_h < 0$. This indicates we may replace all paths from a node (h) such that $\bar{c}_h > 0$ to a node (k) with $\bar{c}_k \leq 0$ by a single arc (h,k). Considering all nodes (h) with $\bar{c}_h > 0$ and connecting them to all k such $k \in D(h)$ and $\bar{c}_k \leq 0$ we have constructed a bipartite

graph² with the nodes corresponding to positive \bar{c}_h as one set of nodes and the nodes with nonpositive \bar{c}_h as the other set. Note that all arcs lead from the positive set to the nonpositive set. Figure 3.3 illustrates the original network and its bipartite equivalent.

The structure of the equivalent bipartite graph of the network corresponding to the dual problem (3.3.2) resembles that of a simple transportation problem. The problem could be solved as a transportation problem but in doing so by the primal-dual method of Ford and Fulkerson [9] one essentially only need solve a maximum flow problem which by itself seems the most attractive method of solution.

Consider the following maximum flow problem and its dual where we assume $\bar{c}_1 > 0$ and $-\bar{c}_j \geq 0$.

$$\begin{aligned}
 & \text{Maximize} && \sum_i f_{s1} \\
 & \text{Subject to} && -f_{s1} + \sum_j f_{1j} = 0 && \forall i \\
 & && -\sum_i f_{1j} + f_{jT} = 0 && \forall j \\
 (3.3.3) & && f_{s1} \leq \bar{c}_1 && \forall i/\bar{c}_1 > 0 \\
 & && f_{jT} \leq -\bar{c}_j && \forall j/\bar{c}_1 > 0 \\
 & && f_{s1} \geq 0, f_{jT} \geq 0, f_{1j} \geq 0
 \end{aligned}$$

²Bipartite graph: A graph $G = (N, A)$ in which the node set N decomposes into two disjoint sets $V = \{n_i^1\}$ and $\bar{V} = \{n_j^2\}$ such that each edge $(n_i^1, n_j^2) \in A$ joins a node $n_i^1 \in V$ and a node $n_j^2 \in \bar{V}$.

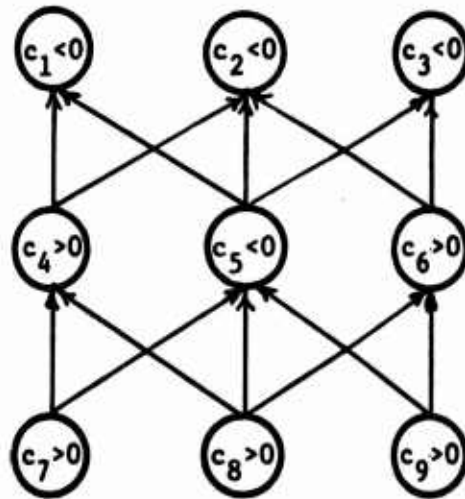

(a) Original

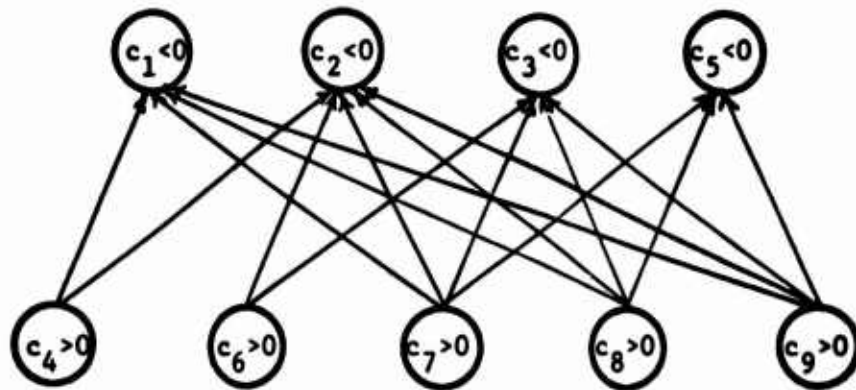

(b) Equivalent Bipartite

FIGURE 3.3: EXAMPLE OF ORIGINAL AND EQUIVALENT BIPARTITE GRAPHS

The dual to this problem is:

$$\begin{aligned}
 & \text{Minimize} && \sum_i s_i \bar{c}_i - \sum_j h_j \bar{c}_j \\
 & \text{Subject to} && -x_i + s_i \geq 1 \quad \forall i \\
 (3.3.4) & && x_i - x_j \geq 0 \\
 & && x_j + h_j \geq 0 \quad \forall j \\
 & && s_i \geq 0, h_j \geq 0
 \end{aligned}$$

The complimentary slackness conditions for this set of problems are for all i and j :

$$\begin{aligned}
 & s_i (\bar{c}_i - f_{si}) = 0 && (a) \\
 & h_j (-\bar{c}_j - f_{jT}) = 0 && (b) \\
 (3.3.5) & (s_i - x_i - 1) f_{si} = 0 && (c) \\
 & (x_i - x_j) f_{ij} = 0 && (d) \\
 & (x_j + h_j) f_{jT} = 0 && (e)
 \end{aligned}$$

It is well known that the coefficient matrix of problems (3.3.3) and (3.3.4) is unimodular [2, 13].

The unimodular property insures that the optimal values of the dual variables are integers but not that they are only "0" or ± 1 which is required to relate problem (3.3.4) and (3.3.1). The following theorem will aid in establishing the zero-one property of problem (3.3.4).

Theorem 3.3.1:

If (\bar{x}_i) , (\bar{x}_j) , (\bar{s}_i) and (\bar{h}_j) are the optimal variables for problem (3.3.4), then:

$$\bar{g}_i = 0 \text{ or } 1 ; \bar{x}_i = 0 \text{ or } -1$$

and

$$\bar{h}_j = 0 \text{ or } 1 ; \bar{x}_j = 0 \text{ or } -1$$

Proof:

For feasibility $\bar{g}_i \geq 0$ so assume $\bar{g}_i = \delta > 1$. From the complimentary slackness conditions (3.3.5a) and (3.3.5c), this implies $f_{si} = \bar{c}_i > 0$ and hence $x_i = \bar{g}_{si} - 1 = \alpha > 0$. By the primal feasibility conditions, we must have some $f_{ij} > 0$ and by condition (3.3.5d) $x_i = x_j = \alpha > 0$. Since $f_{ij} > 0$, it must be that $f_{jT} > 0$ which makes $-h_j = x_j = \alpha > 0$ by (3.3.5e) so that $h_j < 0$ which contradicts the feasibility constraint $h_j \geq 0$. Thus, $0 \leq g_i \leq 1$ must hold. Since $-\bar{c}_j = 0$ has no effect on the problem we can safely assume that all $-\bar{c}_j > 0$ and then a similar argument goes through for h_j showing that, $0 \leq h_j \leq 1$. By the unimodular property, the Kuhn-Hoffman Lemma given in Section 3.2.3 and the bounds just shown for g_i and h_j we have that in the optimal solution of (3.3.4):

$$\bar{g}_i = 0 \text{ or } 1$$

and

$$\bar{h}_j = 0 \text{ or } 1.$$

Also we have that

$$-x_i \geq 1 - g_{si} \geq 0 \text{ or } x_j \leq 0,$$

$$x_j \geq -h_{jT} \geq -1$$

and

$$0 \geq x_i \geq x_j \geq -1.$$

Hence $-1 \leq x_i \leq 0$ and $-1 \leq x_j \leq 0$. Then similarly to \bar{g}_i and \bar{h}_j ,
 $\bar{x}_i = 0$ or -1 and $\bar{x}_j = 0$ or -1 .

Q.E.D.

Theorem 3.3.2:

The optimal solution to the subproblem (3.3.1) may be obtained from the optimal solution of (3.3.4) by letting:

$$Y_i = 1 - g_i$$

$$Y_j = h_j$$

Proof:

Making the substitution as given above for g_i and h_j in (3.3.4) and using the bounds established in Theorem 3.3.1 yields:

$$\begin{aligned} \text{Minimize} \quad & \sum_{i/\bar{c}_i > 0} \bar{c}_i - \sum_{i/\bar{c}_i > 0} \bar{c}_i Y_i - \sum_{j/\bar{c}_j \leq 0} \bar{c}_j Y_j = v & (a) \\ \text{Subject to} \quad & -x_i & \geq 0 & (b) \\ (3.3.6) \quad & x_i - x_j & \geq 0 & (c) \\ & x_j & + Y_j \geq 0 & (d) \\ & 0 \leq Y_i \leq 1 & (e) \\ & 0 \leq Y_j \leq 1 & (f) \end{aligned}$$

Since the objective functions of (3.3.6) and (3.3.1) are equivalent, we need only establish the equivalent feasibility of the respective optimum solutions. Because (3.3.1c) and (3.3.6e,f) are the same, only the equivalent feasibility of (3.3.1b) and (3.3.6b,c,d) need be considered.

Let $D(h) = D^-(h) \cup D^+(h)$ with respect to the dual network of (3.3.1).

Where:

$$D^-(h) = \{j/h > j \text{ and } \bar{c}_j \leq 0\}$$

and

$$D^+(h) = \{i/h > i \text{ and } \bar{c}_i > 0\} .$$

Every feasible solution, hence every optimum solution, of (3.3.1) is feasible for (3.3.6) since (3.3.1b) requires that if $Y_h = 1$ then $Y_k = 1$ for all $k \in D(h)$ and all that (3.3.6b,c,d) requires is $Y_j = 1$ for all $j \in D^+(h) \subset D(h)$.

To show every optimum solution of (3.3.6) is feasible for 3.3.1, we observe that the conditions (3.3.6b,c,d) imply that:

$$Y_i = 1 \Rightarrow x_i = -1 \Rightarrow x_j = -1 \Rightarrow Y_j = 1 \quad \forall j \in D^-(i)$$

This leaves only to establish that if $Y_k = 1$ then $Y_k = 1$ for $k \in D^+(h)$. If this condition were not true, then the value of the objective function (3.3.6a) could be decreased, since $\bar{c}_k > 0$, contradicting the optimality assumption.

Q.E.D.

It has now been established that solving the maximum flow problem (3.3.3) and using the dual variables thus generated will provide a solution to the subproblem (3.3.1). An efficient method for solving problem (3.3.3) is essentially the labeling procedure developed by Ford and Fulkerson [9, 21].

From the complimentary slackness conditions (3.3.5), for problems (3.3.3) and (3.3.4), we know that if it is impossible to saturate any arc (s,i) , that is when $f_{si} < \bar{c}_i$ in the optimal solution, then $g_i = 0$ and hence $Y_i = 1$ from Theorem 3.3.2. Also if some $f_{jT} < -\bar{c}_j$ then $h_j = 0$ and $Y_j = 0$. From Theorem 3.2, we know that if $Y_i = 1$, then $Y_k = 1$ for all

$k \in D(i)$. It also follows that if $f_{jT} < -\bar{c}_j$ implying that $Y_j = 0$ then $Y_h = 0$ for all h such that $j \in D(h)$. These conditions are key factors in the algorithm to be discussed and presented in the following sections.

3.4 PROPOSED METHOD OF SOLUTION

The proposed method for solving the original subproblem (3.2.1.2) is to transform it into problem (3.3.1); transform this into problem (3.3.3) and solve (3.3.3) as a maximum flow problem. Since the network corresponding to (3.3.3) is bipartite, actual labeling of the nodes is unnecessary and a flow equal to $\min(\bar{c}_k; -\bar{c}_j)$ for $k > j$ can be allocated at each iteration. If it is impossible to route all flow away from a node when $\bar{c}_k > 0$ then $Y_k = 1$ and from Theorem 3.2 all $Y_p = 1$ for $p \in D(k)$. Once a set $\bar{Y} = \{k/Y_k = 1\}$ with $f_{ik} = 0$ for $k \in \bar{Y}$, $i \notin \bar{Y}$ has been determined it may be removed from all further consideration. The values of f_{ij} must be recorded since re-routing of flow may be required. Re-routing may be necessary if for some \bar{c}_k the following conditions hold:

$$\bar{c}_k > \sum_{j \in D(k) \cap S^-} \left(-\bar{c}_j - \sum_i f_{ij} \right)$$

and $f_{ij} > 0$ for $i \notin D(k)$, $j \in D(i) \cap D(k)$ where $S^- = \{j/\bar{c}_j \leq 0\}$.

The transformation from (3.3.1) to (3.3.3) is depicted in a network sense in Figure 3.4. Although the network for (3.3.3) looks like a maze, hence making the problem difficult to deal with in this form, this is not the case, since given any node number and the allowable mining sequence, we know exactly which nodes to look at. In this sense, the solution procedure deals with the network in Figure 3.4a in a node-path manner.

The dual problem (3.3.2) variables $\{p_j\}$ are just $p_j = 0$ for $\bar{c}_j \leq 0$ and $p_j = \bar{c}_j - f_{sj}$ otherwise. In effect, we have solved problem (3.3.2) neglecting the $\{p_j\}$ variables and determined them from the slack in the equations corresponding to $\bar{c}_j > 0$.

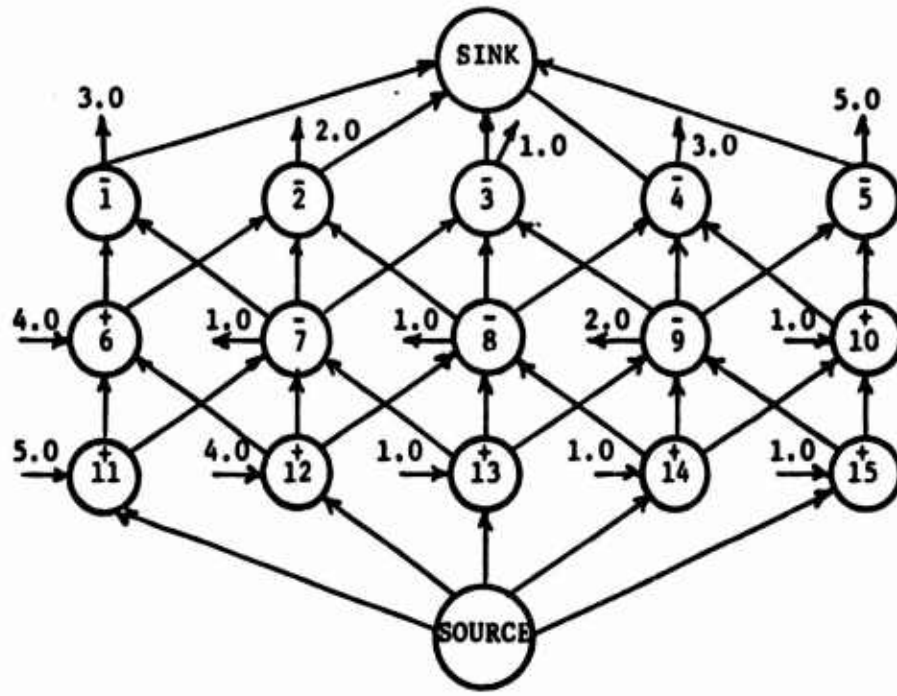

(a) Example (3.3.1) Network (All Unattached Arcs Leading Out, Go to Sink; Pointing into a Node Are From Source)

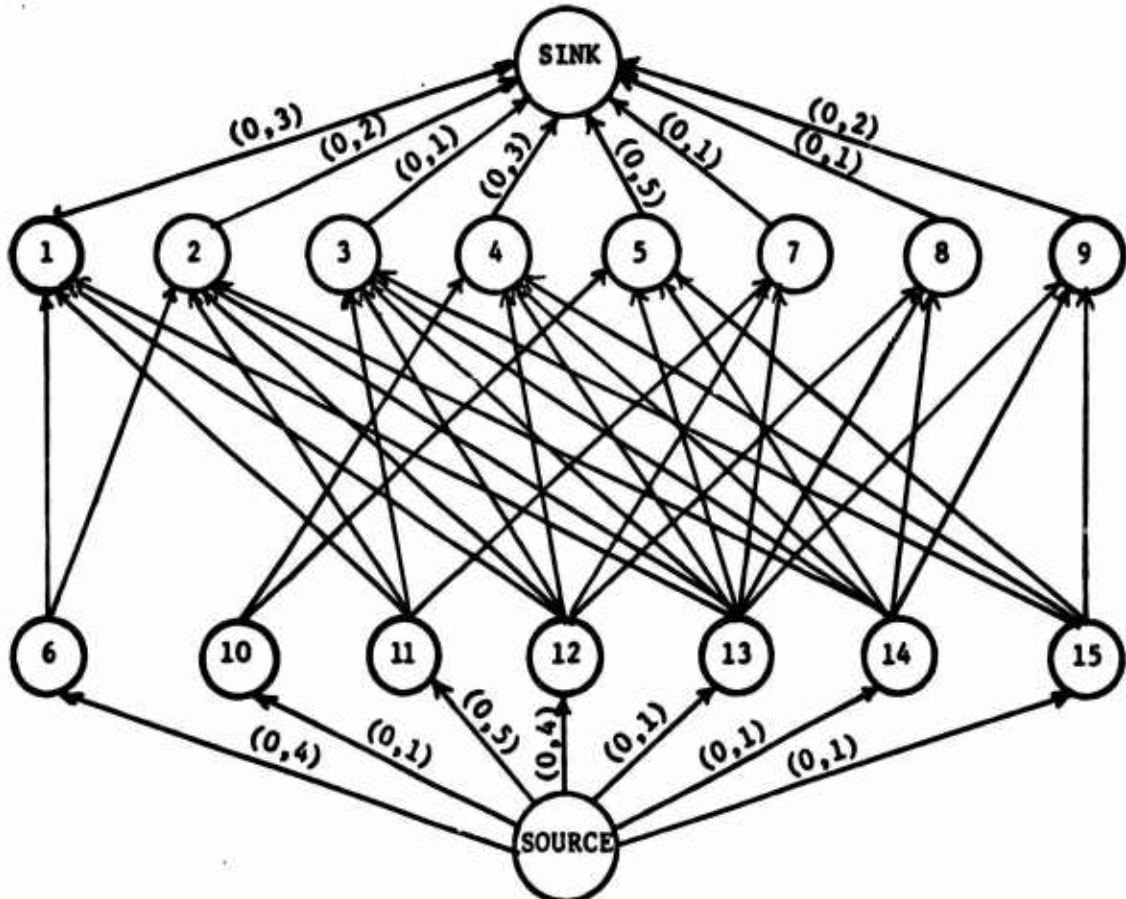

(b) Example (3.3.3) Network [The $(0, k_{ij})$ on the Arcs Indicate the Lower and Upper Flow Bounds]

FIGURE 3.4: EXAMPLE NETWORK FORMS FOR PROBLEMS (3.3.1) AND (3.3.3)

The other dual variables $\{\mu_{ij}\}$ may be obtained from the flow variables $\{f_{ij}\}$ in problem (3.2.2) as follows:

f_{ij} = flow in path from i to j in both networks.

Consider any arc (p,q) in a path from i to j . Set $\mu_{pq} = f_{ij}$ if (p,q) is not in any previously considered path; $\mu_{pq} = \mu_{pq} + f_{ij}$ if (p,q) is in a previously considered path.

An outline of the subproblem algorithm developed in the above discussion follows.

3.5 SUMMARY OF SUBPROBLEM ALGORITHM

Step 1. Initialize:

$$\text{Let } S^+ = \{i/\bar{c}_i > 0\}$$

$$S^- = \{j/\bar{c}_j \leq 0\}$$

$$Y = \{Y_k\} = 0$$

Step 2. Scan Node $\text{Min } k \in S^+$:

If $S^+ = \emptyset$, go to Step 5.

If $\bar{c}_k \leq \sum_{j \in D(k) \cap S^-} -\bar{c}_j = V(k)$, go to Step 3.

Otherwise, Step 4.

Step 3. Allocate \bar{c}_k :

$$(a) \text{ Let } \bar{c}_1 = \max_{j \in D(k) \cap S^-} -\bar{c}_j$$

$$(b) \text{ Set } f_{k1} = \min(\bar{c}_k, \bar{c}_1)$$

$$\bar{c}_1 = \bar{c}_1 - f_{k1} \text{ and delete } 1 \text{ from } D(k)$$

$$\bar{c}_k = \bar{c}_k - f_{k1}$$

(c) When $\bar{c}_k = 0$ delete (k) from S^+ and go to Step 2.

Otherwise, 3(a).

Step 4. Determine Profitable Blocks:

$$(a) \text{ If } \bar{c}_k > V(k) + \sum_{\substack{i \notin D(k) \\ j \in D(i) \cap D(k)}} f_{ij} = \bar{V}(k)$$

Set $Y_p = 1$ for $p \in \underline{D}(k)$ and delete $\underline{D}(k)$ from $S^+ \cup S^-$

$$\bar{c}_i = \bar{c}_i + f_{ij} \text{ for } i \notin D(k), j \notin D(k) \text{ and repeat}$$

Steps 2-4 for such i when $f_{ij} > 0$. Then go to

Step 2.

(b) If $\bar{c}_k \leq \bar{V}(k)$, let $Q = \{i/i \notin D(k), f_{ij} > 0, j \in D(i) \cap D(k)\}$.

For each $i \in Q$ and all $j \in D(i) \cap D(k)$ with $f_{ij} > 0$, let

$$\Delta f_{ij} = \min(\bar{c}_k, f_{ij}), \Delta f_{kj} = \min(\bar{c}_k, -(\bar{c}_j - \Delta f_{ij})),$$

$$f_{kj} = f_{kj} + \Delta f_{kj} \text{ and } \bar{c}_k = \bar{c}_k - \Delta f_{kj}. \text{ Then with } f_{ij} = f_{ij} -$$

Δf_{ij} and $\bar{c}_i = \Delta f_{ij}$ repeat Step 2. Terminate examination of Q

if $\bar{c}_k = 0$ and go to 3(c). If $Q = \emptyset$ and $\bar{c}_k > 0$ go to

Step 4(a).

Step 5. Terminate:

$Y = \{Y_k\}$ solves the subproblem with value $\sum_k \frac{0}{c_k} Y_k = \sum_{k \in S^+} \bar{c}_k = Z$,
 where $\frac{0}{c_k}$ = original \bar{c}_k , and \bar{c}_k = modified $\bar{c}_k = \bar{c}_k - \sum_j f_{kj}$ for
 $k \in S^+ = \{k/\bar{c}_k > 0\}$.

It is quite obvious the algorithm terminates in a finite number of steps since S^+ is finite and each iteration through Steps 1-4 eliminates at least one element from S^+ and the procedure is stopped when $S^+ = \emptyset$.

Now that a rather simple method of solving the subproblem has been developed the entire problem (3.1.1) can be solved by the decomposition principle as described in Section 3.2.1. In actual computational scheme, it may be wise to terminate the subproblem algorithm once $Z > S$ and introduce the corresponding $\{Y\}$ into the master basis even though the subproblem is not optimal. If the set S^+ is large, this is especially recommended.

A general flow chart of the subproblem algorithm follows.

GENERAL FLOW CHART OF SUB-PROBLEM ALGORITHM

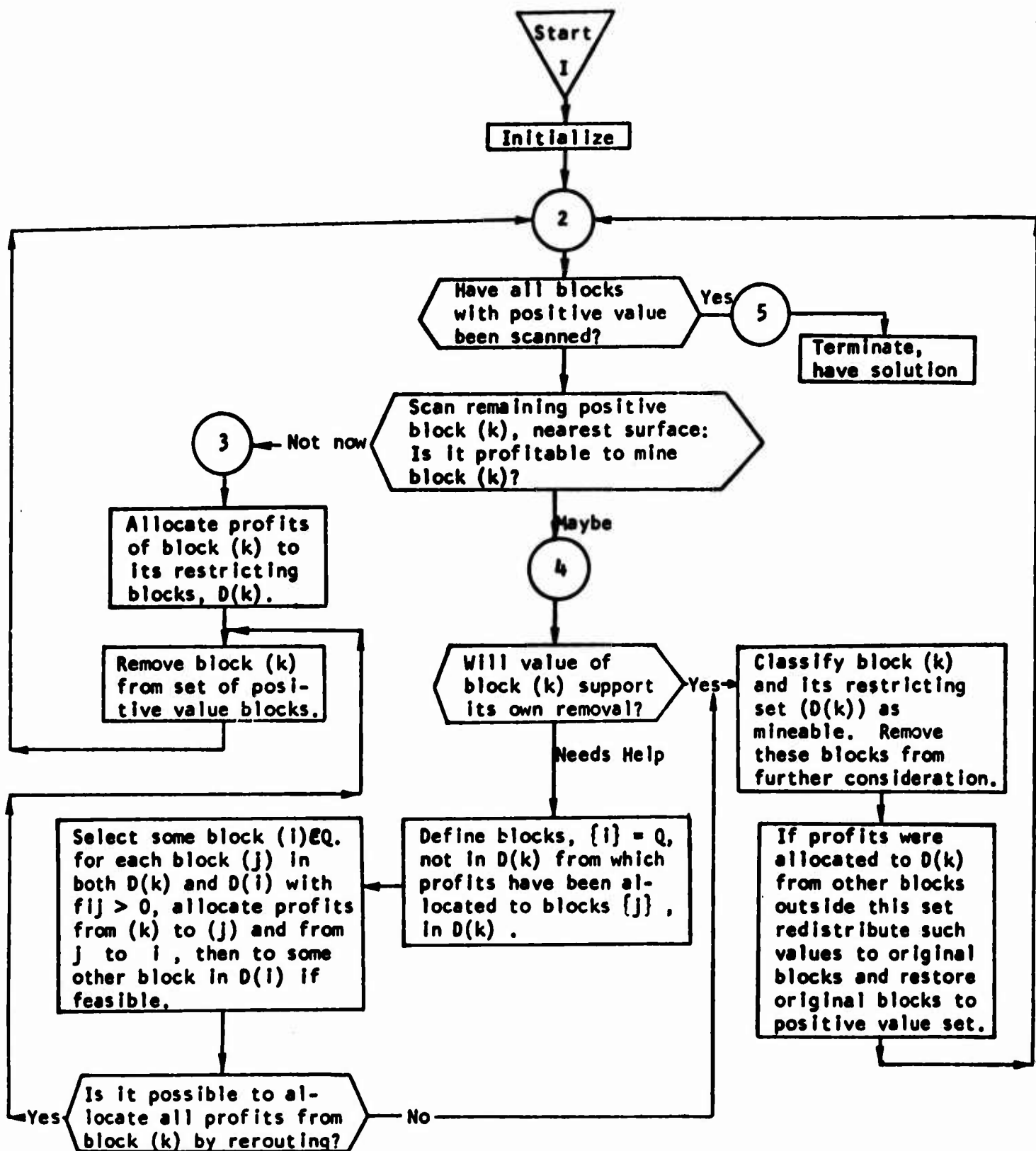

3.6 NUMERICAL EXAMPLE OF SUBPROBLEM

As an example to demonstrate the algorithm, consider the problem in Figure 3.4.

Step 1:

s^+	\bar{c}_i	s^-	$-\bar{c}_i$
6	4	1	3
10	1	2	2
11	5	3	1
12	4	4	3
13	1	5	5
14	1	7	1
15	1	8	1
		9	2

Step 2:

$$\bar{c}_6 = 4 \leq -\bar{c}_1 - \bar{c}_2 = 5. \text{ Therefore, go to Step 3.}$$

Step 3:

$$f_{61} = 3, f_{62} = 1, \bar{c}_6 = 0, -\bar{c}_1 = 0, -\bar{c}_2 = 1. \text{ Since } D(k) = \emptyset, \text{ go to Step 2.}$$

Step 2:

$$\bar{c}_{10} = 1 \leq \bar{c}_4 - \bar{c}_5 = 8, \text{ therefore, go to Step 3.}$$

Step 3:

$$f_{10,5} = 1, f_{10,4} = 0, \bar{c}_{10} = 0. -\bar{c}_5 = 4, -\bar{c}_4 = 3. \text{ Since } D(k) = \emptyset, \text{ go to Step 2.}$$

Step 2:

$$\bar{c}_{11} = 5 > -\bar{c}_1 + (-\bar{c}_2) + (-\bar{c}_3) + (-\bar{c}_7) = 0 + 1 + 1 + 1 = 3.$$

Therefore, go to Step 4.

Step 4a:

$\bar{c}_{11} = 5 > 3 + 0$. The last term is zero since all $f_{1j} = 0$ for all $j \in D(11)$ and $1 \notin D(11)$. Hence, $Y_{11} = 1$, $Y_1 = Y_2 = Y_3 = Y_6 = Y_7 = 1$ and these nodes can be deleted from S^+ and S^- . At this point, the problem has been reduced to:

S^+	\bar{c}_1	S^-	$-\bar{c}_1$
12	4	4	3
13	1	5	4
14	1	8	1
15	1	9	2

 $= -\bar{c}_5 - f_{10,5}$

Since S^+ is not empty, return to Step 2 and scan node 12.

Step 2:

$\bar{c}_{12} = 4 \leq -\bar{c}_4 + (-\bar{c}_8) = 4$. Therefore, go to Step 3.

Step 3:

$f_{12,4} = 3$, $f_{12,8} = 1$, $\bar{c}_{12} = 0$, $-\bar{c}_4 = 0$, $-\bar{c}_8 = 0$.

Step 2:

$\bar{c}_{13} = 1 \leq -\bar{c}_4 + (-\bar{c}_5) + (-\bar{c}_8) + (-\bar{c}_9) = 5$; go to Step 3.

Step 3:

$f_{13,5} = 1$, $-\bar{c}_5 = 3$, $\bar{c}_{13} = 0$; others unchanged.

Step 2:

$\bar{c}_{14} = 1 \leq -\bar{c}_4 + (-\bar{c}_5) + (-\bar{c}_8) + (-\bar{c}_9) = 5$; go to Step 3.

Step 3:

$$f_{14,5} = 1, \quad -\bar{c}_5 = 2, \quad \bar{c}_{14} = 0.$$

Step 2:

$$\bar{c}_{15} = 1 \leq -\bar{c}_4 + (-\bar{c}_5) + (-\bar{c}_9) = 4; \text{ go to Step 3.}$$

Step 3:

$f_{15,5} = 1, \quad -\bar{c}_5 = 1, \quad \bar{c}_{15} = 0$. Now all nodes of S^+ have been examined so that S^+ is considered empty so go to Step 5.

Step 5. Terminate:

The following $\{Y_j\}$ give the optimal solution with value $\max Z = 2$:

S^+	original		final		S^-	original		final	
	\bar{c}_1	Y_1	\bar{c}_1			$-\bar{c}_1$	Y_1	$-\bar{c}_2$	
6	4	1	0		1	3	1	0	
10	1	0	0		2	2	1	0	
11	5	1	2		3	1	1	0	
12	4	0	0		4	3	0	0	
13	1	0	0		5	5	0	1	
14	1	0	0		7	1	1	0	
15	1	0	0		8	1	0	0	
					9	2	0	2	

$$\text{NOTE: } \sum \bar{c}_i Y_i + \sum \bar{c}_j Y_j = \sum_{i \in S^+} \bar{c}_i (\text{final}) = \max Z.$$

The values of the flow variables are:

$$f_{61} = 3, \quad f_{62} = 1, \quad f_{10,5} = 1, \quad f_{11,2} = 1, \quad f_{11,3} = 1, \quad f_{11,7} = 1,$$

$$f_{12,4} = 3, \quad f_{12,8} = 1, \quad f_{13,5} = 1, \quad f_{14,5} = 1 \text{ and } f_{15,5} = 1.$$

Hence, the u_{ij} are:

$$u_{61} = 3, u_{62} = 2, u_{73} = 1, u_{84} = 3, u_{95} = 2, u_{10,5} = 2$$

$$u_{11,6} = 1, u_{11,7} = 2, u_{12,8} = 4, u_{13,9} = 1, u_{14,9} = 1,$$

$$u_{15,10} = 1,$$

and all others zero.

3.7 MODIFICATION OF PROCEDURE WHEN ASSUMPTION 2 IS RELAXED

Assumption 2, as discussed in Chapter 2, constrained the blocks of the problem to be all of equal size. The result of this was that the coefficients of the dual subproblem variables $\{p_j\}$ (see problem 3.2.2.2) were all ones.

The method of solution proposed in that last section actually neglected the set of variables $\{p_j\}$. This indicates that a similar procedure will work when the block size differs in certain areas of the deposit. It may be desirable to have different block sizes in various zones of a pit due to physical elements such as varying pit slopes.

Consider, for example, the case with two block sizes B_1 and B_2 (volumes). In this situation, the coefficients of the variables $\{p_j\}$ would be B_1 and B_2 . From a network viewpoint, we then have two sets of nodes defined as:

$$N_1 = \{j/\text{block } (j) \text{ has volume } B_1\}$$

$$N_2 = \{j/\text{block } (j) \text{ has volume } B_2\}.$$

The maximum flow algorithm of Section 3.4 can now be used to solve the problem. First apply the algorithm to the set

$$N_1 \cup \{k/k \in N_2, D(k) \cap N_1 \neq \emptyset\} \text{ (assume } B_1 < B_2\text{)}. \text{ This yields}$$

$$Y_1 = Y_1^1 \cup Y_2^1. \text{ Where}$$

$$Y_1^1 = \{Y_j/Y_j = 1, \underline{D}(j) \cap N_2 = \emptyset\}$$

and

$$Y_2^1 = \{Y_j/Y_j = 1, \underline{D}(j) \cap N_2 \neq \emptyset\}.$$

Now apply the algorithm to the set of nodes $N_2 \cup \{j/Y_j \in Y_2^1\}$. The solution here gives $Y_1^2 = \{Y_j/Y_j = 1\}$. The solution to the subproblem is then provided by $Y_1^1 \cup Y_1^2$ setting

$$Y_j = B_1 Y_j \quad j \in N_1$$

and

$$Y_j = B_2 Y_j \quad j \in N_2 .$$

CHAPTER 4
GENERAL T-PERIOD PROBLEM

4.1 INTRODUCTION

Open pit mine production scheduling as defined in Chapter 1 is a very real problem that concerns most mine operating management. The best schedule for the entire planning horizon of T-periods is usually not attainable by repetitive single-period scheduling because of the dependence of the future on the past and present. Thus, the effect of any single-period schedule on future period schedules must be considered in a multi-period scheduling problem. The following formulation, developed in Chapter 2, illustrates this dependence.

$$\begin{aligned}
 & \text{Maximize} && c_1 X^1 + c_2 X^2 + \dots + c_T X^T \\
 & \text{Subject to} && D_1 X^1 + D_2 X^2 + \dots + D_T X^T &= d \\
 & && A_1 X^1 &= b_1 \\
 & && & A_2 X^2 &= b_2 \\
 & && & & \vdots \\
 & && & & A_T X^T &= b_T \\
 & && BX^1 &= 0 \\
 & && BX^1 + BX^2 &= 0 \\
 & && BX^1 + BX^2 + BX^3 + \dots + BX^T &= 0 \\
 & && \sum_q X_h^{q1} + \sum_q X_h^{q2} + \dots + \sum_q X_h^{qT} &= 1 \quad \forall h \\
 & && X_h^q &\geq 0
 \end{aligned}
 \tag{4.1.1}$$

Most of the concepts in this chapter will be examined in the context of a two-period problem. General extensions will be presented only when they do not follow directly. Thus the problem to be considered has the form:

$$\begin{aligned}
 & \text{Maximize} && c_1 X^1 + c_2 X^2 && \text{(a)} \\
 & \text{Subject to} && D_1 X^1 + D_2 X^2 &= d && \text{(b)} \\
 & && A_1 X^1 &= b_1 && \text{(c)} \\
 & && && A_2 X^2 &= b_2 && \text{(d)} \\
 (4.1.2) & && B X^1 &\leq 0 && \text{(e)} \\
 & && B X^1 + B X^2 &\leq 0 && \text{(f)} \\
 & && \sum_q X_h^{q1} + \sum_q X_h^{q2} &\leq 1 && \text{(g)} \\
 & && X_h^{qt} &\geq 0 && \text{(h)}
 \end{aligned}$$

In any practical situation this problem, as in the case of the problem discussed in Chapter 3, rapidly exceeds the capabilities of available linear programming codes, even with the most modern computing facilities, and a more compact method of solution is necessary. Because of the special structure of the dynamic constraints (4.1.2), and especially of the B matrices, some form of decomposition seems promising.

4.2 DECOMPOSITION OF GENERAL PROBLEM

There are many ways to decompose (4.1.2). The problem as formulated has essentially two parts: (1) the blending and allocation portion corresponding to the $\{D_h\}$ and $\{A_h\}$, and (2) the allowable mining sequence

portion characterized by the B matrices. The most attractive decomposition approaches to the problem appear to be those which permit the reduction of the B -structure by virtue of Theorem 2.1, and allow isolation of the $EY^h \cong 0$ as sub-problems, hence using their simplified structure to advantage. It is reasonable to expect that the blending and allocation part of the problem [4.1.2 (b) - (d)], will be of such a dimension that it can easily be solved as a linear program, either as a master or sub-master.

This rationale leads to the following master problem:

$$\begin{aligned}
 & \text{Maximize} && \sum_{i=1}^L \lambda_i \left[c_1 x^{1i} + c_2 x^{2i} \right] \\
 (4.2.1) \quad & \text{Subject to} && \sum_{i=1}^L \lambda_i \begin{bmatrix} D_1 & D_2 \\ A_1 & 0 \\ 0 & A_2 \end{bmatrix} \begin{bmatrix} x^{1i} \\ x^{2i} \end{bmatrix} = \begin{bmatrix} d \\ b_1 \\ b_2 \end{bmatrix} \\
 & && \sum_{i=1}^L \lambda_i = 1 \\
 & && \lambda_i \geq 0
 \end{aligned}$$

Where the $\{x^i = x^{1i}, x^{2i}\}$ is the set of extreme points of the convex polyhedron defined by:

$$BX^1 \cong 0$$

$$BX^1 + BX^2 \cong 0$$

$$\sum_q x_h^{q1} + \sum_q x_h^{q2} \cong 1$$

$$x_h^{qt} \cong 0$$

so that the sub-problem becomes:

$$\begin{aligned}
 & \text{Maximize} && \bar{c}_1 X^1 + \bar{c}_2 X^2 \\
 & \text{Subject to} && BX^1 \leq 0 \\
 & && BX^1 + BX^2 \leq 0 \\
 (4.2.2) & && \sum_q X_h^{q1} + \sum_q X_h^{q2} \leq 1 \quad \forall h \\
 & && X_h^{qt} \geq 0
 \end{aligned}$$

By virtue of Theorem 2.1 this can be reduced to

$$\begin{aligned}
 & \text{Maximize} && \hat{c}_1 Y^1 + \hat{c}_2 Y^2 && (a) \\
 & \text{Subject to} && EY^1 \leq 0 && (b) \\
 & && EY^1 + EY^2 \leq 0 && (c) \\
 (4.2.3) & && IY^1 + IY^2 \leq 1 && (d) \\
 & && Y_h^t \geq 0 && (e)
 \end{aligned}$$

Where $\hat{c}^t = \{\hat{c}_{st}^h\}$ such that $\hat{c}_{st}^h = \max_q \bar{c}_{qt}^h$ and $Y^t = \{Y_h^t\}$ such that $Y_h^t = X_h^{st}$ which corresponds to \hat{c}_{st}^h .

The problem as given in (4.2.3) has many less variables than (4.2.2) and has a structure that is much easier to deal with. This reduction step amounts to a classification and selection of the method of treatment of a block if it is to be mined. It reduces the sub-problem strictly to a scheduling problem in which the remaining decisions are if and when to select a block for mining.

4.3 SUB-PROBLEM SOLUTION

The sub-problem (4.2.3), is still a rather large problem and not easily solved in a straightforward manner. The triangular structure could be employed to some advantage but is somewhat cumbersome due to the dimension of the problem.

By making the proper substitution of variables (4.2.3) can be transformed into a more workable form. Let $w^1 = \sum_{k=1}^i y^k$. Then (4.2.3) becomes:

$$\begin{array}{llll}
 \text{Maximize} & (\hat{c}_1 - \hat{c}_2)w^1 + \hat{c}_2w^2 & & \text{(a)} \\
 \text{Subject to} & Ew^1 & \cong & 0 & \text{(b)} \\
 & & & & \\
 & & & & \text{(c)} \\
 (4.3.1) & & & & \\
 & & & & \text{(d)} \\
 & & & & \text{(e)} \\
 & & & & \text{(f)}
 \end{array}$$

In (4.3.1), (e) and (f) replace (4.2.3)(e). Thus the transformation has increased the constraint set, but the problem now has a more computational efficient structure.

In Chapter 3 an efficient method was proposed to solve a problem of the form

$$\begin{array}{ll}
 \text{Maximize} & cY \\
 \text{Subject to} & EY \cong 0 \\
 (4.3.2) & IY \cong 1 \\
 & Y \cong 0
 \end{array}$$

which used the structure of the matrix E to advantage. It seems attractive to again isolate problems of the form (4.3.2) and thus use the method developed in Chapter 3. It is clear from the structure of problem (4.3.1) that the decomposition principle could be applied again in a straightforward manner with the constraints (4.3.1e) as the master problem with P sub-problems each with a form corresponding to (4.3.2). In such a scheme the master problem would be relatively large and even though the constraints are simple it would require sufficient calculations to introduce the sub-problem solutions into the master basis to make this suggestion unattractive.

It is known from the Theorem of Heller-Thompkins-Gale given in [13] that the coefficient matrix for problem (4.3.1) is unimodular and hence from the Hoffman-Kuhn Lemma, [13], stated in section 3.2.3 that the optimal $\{w_h^t\}$ are zeros and ones. This fact and the implications of the constraint set (4.3.1e) lead to an efficient method of solution through decomposing by both rows and columns. The constraint set (4.3.1e) implies that problem (4.3.1) may be solved by considering a sequence of problems in the form of (4.3.2) but need only consider those w_h^k in the k^{th} stage problem which correspond to $w_h^{k+1} = 1$. To solve problem (4.3.1), first consider:

$$\begin{aligned}
 & \text{Maximize} && \hat{c}_2 w^2 \\
 & \text{Subject to} && Ew^2 \cong 0 \\
 (4.3.3) & && Iw^2 \cong 0 \\
 & && w^2 \cong 0
 \end{aligned}$$

Solving this problem yields an optimal solution $\bar{w}^2 = W_+^2 \cup W_-^2$

where

$$W_+^2 = \left\{ \begin{array}{l} -2 \\ w_h \end{array} / \begin{array}{l} -2 \\ w_h \end{array} = 1 \right\}$$

and

$$W_-^2 = \left\{ \begin{array}{l} -2 \\ w_h \end{array} / \begin{array}{l} -2 \\ w_h \end{array} = 0 \right\}$$

Next, consider

$$\begin{array}{ll} \text{Maximize } (\hat{c}_1 - \hat{c}_2)\hat{w}^1 & \\ & \\ & E\hat{w}^1 \quad \equiv 0 \\ (4.3.4) \quad & I\hat{w}^1 \quad \equiv 1 \\ & \hat{w}^1 \quad \equiv 0 \end{array}$$

where

$$\hat{w}^1 = \left\{ \begin{array}{l} w_h^1 \\ w_h^1 \end{array} / \begin{array}{l} -2 \\ w_h^1 \end{array} = 1 \right\}$$

The optimal solution of this yields $\bar{w}^1 = W_+^1 \cup W_-^1$, with $W_+^1 \subseteq W_+^2$.

In the terms of a mining schedule, problem 4.3.3) determines those blocks which are profitable for mining in periods 1 and 2; then solving problem (4.3.4) selects from this group those which are best taken in period 1.

Next we must consider blocks which were not profitable for mining in period 2 but whose value in period 1 may be such that they can be profitably taken in period 1. This may also force blocks, which have already been selected for period 2, to be rescheduled into period 1.

To determine such blocks consider only the set W_-^1 and adjust the cost coefficients of these variables as follows:

$$\hat{c}_1^h \begin{cases} \hat{c}_1^h - \hat{c}_2^h & \text{if } h \in W_-^1 \cap W_-^2 \\ \hat{c}_1^h & \text{if } h \in W_+^1 \cap W_+^2 \end{cases}$$

Solve

$$\text{Maximize } \hat{c}_1^h w^1$$

$$\text{Subject to } Ew^1 \leq 0$$

$$Iw^1 \leq 1$$

$$w^1 \geq 0$$

giving the optimal solution \bar{w}^1 . Then alter the sets W_+^1 , W_-^1 , W_+^2 and W_-^2 as follows:

$$W_+^1 = \left\{ w_h^1 / \bar{w}_h^1 = 1, \bar{w}_h^1 = 1 \right\}$$

$$W_-^1 = \left\{ w_h^1 / \bar{w}_h^1 = 0 \right\}$$

$$W_+^2 = \left\{ w_h^2 / \bar{w}_h^2 = 1, \bar{w}_h^1 = 1 \right\}$$

$$W_-^2 = \left\{ w_h^2 / \bar{w}_h^1 = 0 \right\}$$

These sets provide the optimal solution to problem (4.3.1).

The steps of the algorithm will now be presented in terms of the general T-period sub-problem (4.3.5) where $\bar{c}_k = \hat{c}_k - \hat{c}_{k+1}$.

Maximize $\bar{c}_1 w^1 + \bar{c}_2 w^2 + \dots + \bar{c}_T w^T$

Subject to $Ew^1 \leq 0$

$Ew^2 \leq 0$

$Ew^T \leq 0$

(4.3.5)

$Iw^T \leq 1$

$Iw^1 - Iw^2 \leq 0$

$Iw^2 - Iw^3 \leq 0$

$Iw^{T-1} - Iw^T \leq 0$

$w^t \geq 0$

OUTLINE OF SUB-PROBLEM ALGORITHM

STEP 1. INITIALIZE:

$$\text{Set, } V^k = \left\{ \text{all } w_h^T \right\}$$

$$\bar{T} = T$$

$$Y^k = \emptyset, \bar{Y}^k = \left\{ \text{all } w_h^k \right\} \text{ for all } k.$$

STEP 2. SOLVE STAGE k PROBLEM:

$$\text{Maximize } \bar{c}_k w^k \\ \text{over } V^k$$

$$\text{Subject to } Ew^k \cong 0$$

$$Iw^k \cong 1$$

$$w^k \cong 0$$

Let \bar{w}^k be the optimal solution and define;

$$w^k = \left\{ w_h^k / \bar{w}_h^k = 1 \right\}$$

$$V^{k-1} = \left\{ w_h^{k-1} - 1 / \bar{w}_h^k = 1 \right\}$$

Add w^k to Y^k and delete from \bar{Y}^k and if $k = \bar{T}$ add w^k to $Y^{\bar{T}}$ and delete from \bar{Y}^t for $t = k + 1, \dots, T$.

STEP 3.

If $\bar{T} = 1$, terminate. The sets Y^k and \bar{Y}^k for $k = 1, 2, \dots, T$ solve the sub-problem. If $k = 1$, set $k = \bar{T}$ and go to STEP 4. If $V^{k-1} \neq \emptyset$, set $k = k - 1$ and go to STEP 2. Otherwise go to STEP 4.

STEP 4. ADJUST $\bar{c}_{\bar{T}-1}$

Set

$$\bar{c}_{\bar{T}-1}^h = \bar{c}_{\bar{T}-1}^h + \bar{c}_{\bar{T}}^h \quad \text{for } h \in \bar{Y}^{\bar{T}}$$

Set

$$k = k - 1$$

$$V^k = \bar{Y}^{\bar{T}-1}$$

$$\bar{T} = \bar{T} - 1 \quad \text{and go to STEP 2.}$$

THEOREM 4.1: *The sub-problem algorithm terminates in a finite number of steps with the optimal solution of problem (4.3.5).*

Proof: Since the algorithm starts with period T ($\bar{T} = T, k = T$) and proceeds step by step through period 1 ($\bar{T} = 1$) it indeed terminates in a finite number of steps.

Because the conditions of the algorithm always insure feasibility of problem (4.3.5), to demonstrate optimality it must be shown that there does not exist a node (h) such that

$$(a) \quad w_h^k = 0, \quad k = \text{maximum } t / w_h^t = 0 \quad \text{and} \quad \bar{c}_k^h + \sum_{i \in D(h)} \bar{c}_k^i > 0$$

or

$$(b) \quad w_h^z = 1, \quad z = \text{minimum } t / w_h^t = 1 \quad \text{and} \quad h \in D(i) / \bar{c}_z^i + \sum_{q \in D(i)} c^q < 0.$$

Clearly the algorithm does not allow all these conditions to hold. For example, consider the case where $T = 2$. When $w_h^k = 0$ and $k = 2$ then the initial pass through STEP 2 prohibits condition (a) by insuring $w_h^2 = 1$ if $\sum_{i \in D(h)} \bar{c}_2^i > 0$. If $w_h^k = 0$ and $k = 1$, then by the algorithm $\bar{c}_1^h + \sum_{i \in D(h)} \bar{c}_1^i < 0$, thus condition (a) cannot hold. When $w_h^z = 1$ and $z = 2$, then as before the initial STEP 2 assures $h \in D(i)$ such that $\bar{c}_h^i + \sum_{q \in D(i)} \bar{c}_2^q > 0$. If $w_h^z = 1$ and $z = 1$, then either both $\bar{c}_t^i + \sum_{q \in D(i)} \bar{c}_t^q > 0$ for $t = 1$ and 2 or for $(i) \in \bar{Y}_2$ such that $h \in D(i)$, $\bar{c}_2^i + \sum_{q \in D(i) \cup \bar{Y}_2} \bar{c}_2^q \cong 0$ and (i) for period 1 is such that $\bar{c}_1^i + \sum_{q \in D(i)} \bar{c}_1^q = \bar{c}_1^i > 0$ so that $\bar{c}_1^i - \bar{c}_2^i - \sum_{q \in D(i) \cup \bar{Y}_2} \bar{c}_2^q \cong \bar{c}_1^i > 0$.

Hence condition (b) cannot hold and Theorem is proven. QED

4.4 NUMERICAL EXAMPLE OF 2-PERIOD SUB-PROBLEM

Consider the following networks corresponding to a 2-period sub-problem in the form of (4.2.3). The number in the lower half of the circle represents the $\{\hat{c}_t^h\}$ while the node number is shown in the upper half.

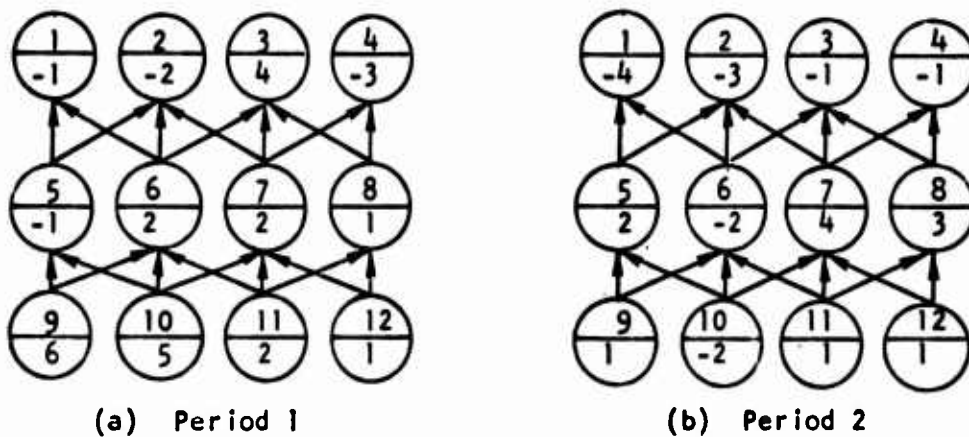

FIGURE 4.4.1: EXAMPLE NETWORKS FOR TWO-PERIOD PROBLEM

Using $w^i = \sum_{k=1}^i \gamma^k$ and transforming the problem to the form of (4.3.1) gives the corresponding networks shown in Figure 4.4.2.

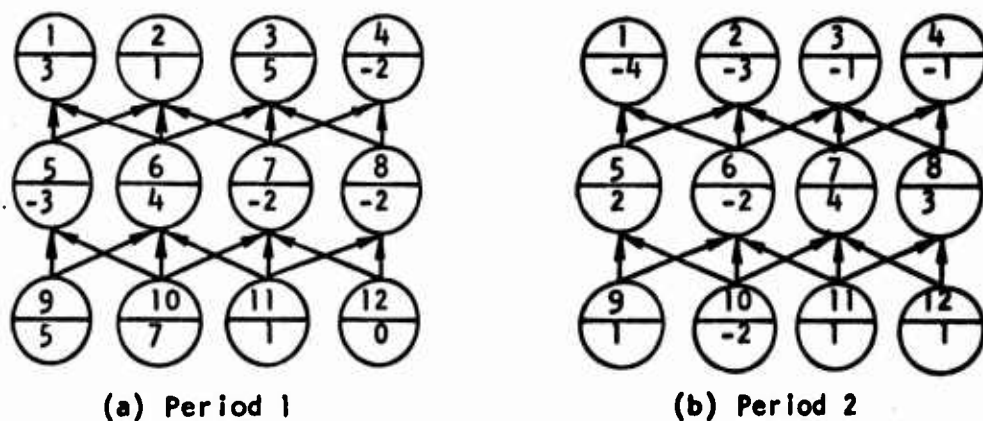

FIGURE 4.4.2: EXAMPLE NETWORK FOR TRANSFORMED TWO-PERIOD PROBLEM

Applying the algorithm to the problem represented in Figure 4.4.2 for $\bar{T} = 2$ gives

$$W^2 = \left\{ w_2^2, w_3^2, w_4^2, w_7^2, w_8^2, w_{12}^2 \right\}$$

after STEP 2

$$V^1 = \left\{ w_2^1, w_3^1, w_4^1, w_7^1, w_8^1, w_{12}^1 \right\}$$

$$\gamma^2 = W^2.$$

Since $V^1 \neq \emptyset$, set $k = 1$, return to STEP 2 and solve the problem represented by the network in Figure 4.4.3.

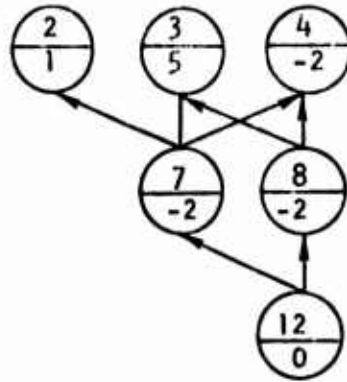

FIGURE 4.4.3: NETWORK FOR PROBLEM IN FIGURE 4.4.2
WHEN $\bar{T} = 2$ AND $k = 1$

On this pass STEP 2 yields

$$W^1 = \{w_2^1, w_3^1\}$$

and

$$Y^1 = W^1$$

Since $k = 1$ in STEP 3 proceed to STEP 4 which yields the network shown in Figure 4.4.4 with $\bar{T} = 1$ and $k = 1$.

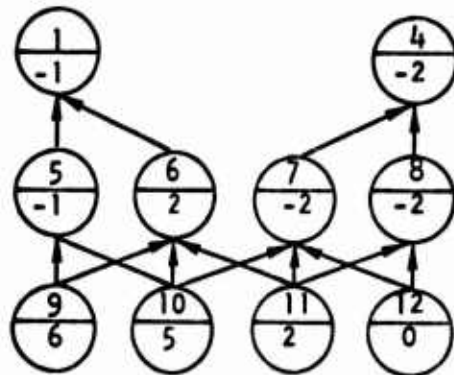

FIGURE 4.4.4: EXAMPLE NETWORK FOR $\bar{T} = 1$ AND $k = 1$

Another STEP 2 provides

$$w^1 = \{w_1^1, w_4^1, w_5^1, w_6^1, w_7^1, w_9^1, w_{10}^1\}$$

and since $\bar{T} = 1$, termination is reached in STEP 3 with

$$y^1 = \{w_1^1, w_2^1, w_3^1, w_4^1, w_5^1, w_6^1, w_7^1, w_9^1, w_{10}^1\}$$

$$\bar{y}^1 = \{w_8^1, w_{11}^1, w_{12}^1\}$$

$$y^2 = \{\text{all } w_2^2\}$$

$$\bar{y} = \emptyset$$

In other words the optimum mining plan for this sub-problem is to take blocks 1-7, 9, 10 in period 1 and blocks 8, 11, 12 in period 2.

4.5 GENERAL COMMENTS AND PROCEDURAL SUMMARY

The type of decomposition utilized in the algorithm presented in section 4.3 reduces the size of the problems with the form (4.3.2) which need to be solved at any one time by the methods of Chapter 3. In this sense it reduces the average number of paths incident out from any positive node and hence should decrease computation time considerable. Even though computational experience is not available at present to verify this assertion, there seems to be a strong indication that this is true. In [10], Gilbert deals with a comparable scheme and his conclusion is (from the viewpoint of this paper) that the ability to partition the problem (4.3.2) into separate parts would be computationally efficient. Even though he is not actually dealing with the same form of the problem, his conclusions seem applicable here.

The extension of the methods described in section 4.3 to the case of unequal block size can be accomplished with ease in a manner similar to that discussed in Chapter 3.

With the developments of Chapters 3 and 4, the T-period open pit mine production scheduling problem can now be handles quite nicely by employing the decomposition principle of Datzig and Wolfe, thus taking full advantage of efficient network techniques permitted by the simple structure of the sub-problems.

The procedures and the algorithms developed in this present investigation may be used for all phases of mine planning; optimum long range planning and optimum short range planning as well as optimum operational or actual production scheduling.

In order to utilize the methods of this study, one must first of all formulate the scheduling problem as a large scale linear programming problem

considering the constraints which govern the system as discussed in Chapter 2. Next, the decomposition principle is used to decompose the problem into a rather simple linear programming problem, called the master problem, and a sub-problem which can be easily solved by the methods developed in Chapters 3 and 4. The master problem is first solved to obtain the *prices*, π and s , from which the profit coefficients for the sub-problem are determined. After the subproblem is solved for a mining plan based on the profit coefficients, the value of this plan, $\hat{c}Y$, (see problem 4.2.3) is compared to the price, s , for optimability. If $\hat{c}Y > s$ it is profitable to include the present plan in the master problem. This procedure is repeated until the optimality condition, $\hat{c}Y \leq s$, is realized. The master program selects a convex combination of the sub-problem plans which satisfies the given constraints and maximizes total profits. To initiate the master problem an initial feasible mining plan is required. Such a plan is readily available since any mining scheme which satisfies the allowable mining sequence constraints will do.

To aid the presentation of the complete procedure the following flow chart is given.

In the next chapter the flexibility and general utilization of the proposed methods will be discussed and illustrated through numerical examples.

GENERAL FLOW CHART OF COMPLETE PROCEDURE

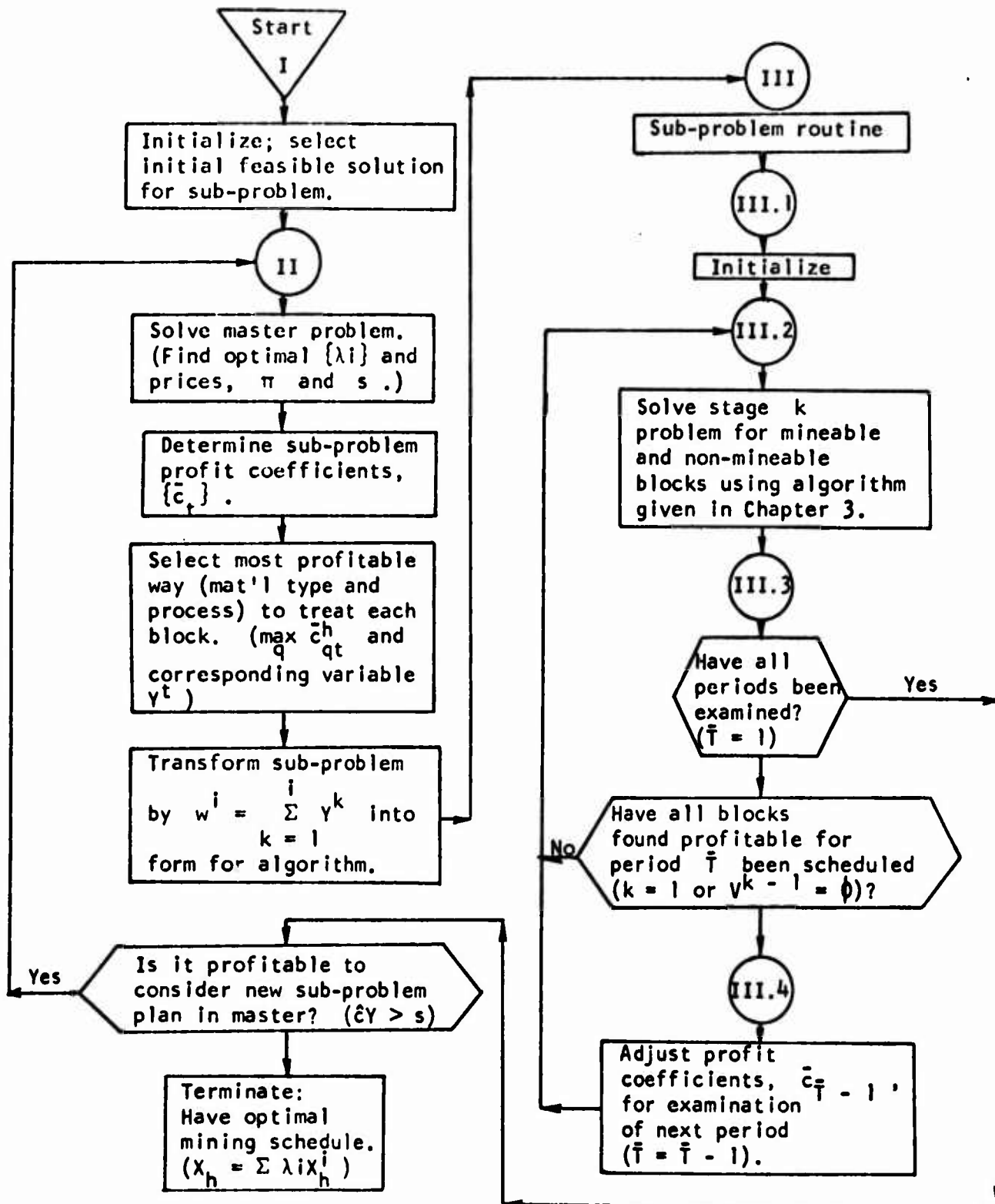

CHAPTER 5
MINE PLANNING AND SYSTEM MANAGEMENT

5.1 INTRODUCTION

Mine planning and system management contribute greatly to converting a mineral deposit into an economically feasible mining operation. If management's goal of maximum profit is ever to be attained, scientific decision tools similar to those developed in this investigation must be substituted for present mine planning practices.

Besides providing that open pit mining schedule which maximizes profit, the model and the method of solution discussed in previous chapters yields other benefits as well. The techniques of sensitivity analysis by parametric variation of costs or constraints, provides much valuable information to aid management in evaluating their policies, mining techniques, system design, and technological changes. In a sense, solving the model is a "lab experiment," in which many different possible plans resulting from various policies, practices and technologies may be rapidly expanded to evaluate the ensuing patterns of development. The procedures presented in this study may also affect some of the traditional concepts used in mine planning such as cut-off grade or economic cut-off in the sense they are presently known to be applied as discussed in Chapter 1. Also one can view the entire planning horizon through the model and thus consider the interaction of demands of period schedules. This insures the attainment of the maximum total profit goal if a feasible plan exists. This goal of maximum total profit may not be attainable by sequential sub-optimization: maximizing profits for each period in succession subject to only the constraints of that period.

In order to illustrate some of these concepts some simple numerical examples will be presented.

5.2 NUMERICAL EXAMPLES

5.2.1 Model Setting

A two dimensional model based on the data in Table 5.1 will serve to illustrate how mining programs (schedules) may vary with management objectives and the constraints induced by the system or management policies.

The system considered here is a mine and a concentrator. It is assumed that the concentrating process is not varied to change output but that it is operating within its' most efficient range. The valuable constituent within the ore will not be designated, but if the reader desires he may think of the ore as an iron-bearing material. The assay values are then per-cent iron.

5.2.2 Example 1

The ultimate pit limit obtained by using the method of Chapter 3 (without constraints) is shown in Figure 5.1. The *total minable reserve* as indicated by the ultimate contour has a value of \$232,320 (96.8×2400) (profit before taxes). This *reserve* includes 9600 cubic yards waste and 110,400 tons crude ore yielding 42,219 tons concentrate with an average grade of 66.05.

Note that within the ultimate limit there are blocks, for example (1,4) and (0,12), which are designated as ore even when their profit values are negative. These blocks are such that their value as an ore is greater than their value as waste. Such ore blocks with negative values will only be mined if the underlying blocks cover the loss of the negative ore. For example if block (1,4) had been designated waste, it would have been uneconomical to recover block (2,5), and hence total profits would have been reduced to 96.0 instead of 96.8. (These values are the profit index values. The true

TABLE 5.1: BASIC DATA FOR NUMERICAL EXAMPLE

Blk.	Volume* cu. yds.	% Crude Analysis	% Rec Tons Conc/ Ton Crd.	Conc Tons	% Conc Analysis	Pit Hrs per yd.	Profit Factor/yd.	
							Conc	Waste
0,1	2400 ↑	0.0	—	—	—	—	—	-4.0
0,2		0.0	—	—	—	—	—	-4.0
0,3		30.0	44.8	2150	67.0	.015	9.3	-4.0
0,4		20.0	30.4	1460	66.0	.015	3.2	-4.0
0,5		15.0	23.8	1140	63.0	.020	- .1	-4.0
0,6		10.0	19.8	930	52.0	.020	-4.2	-4.0
0,7		25.0	39.2	1880	64.0	.020	5.0	-4.0
0,8		40.0	58.1	2790	69.0	.025	14.1	-4.0
0,9		35.0	51.8	2480	68.0	.015	10.8	-4.0
0,10		35.0	51.8	2480	68.0	.015	11.2	-4.0
0,11		10.0	16.7	800	60.0	.012	-4.2	-4.0
0,12		15.0	24.2	1160	62.0	.018	-1.7	-4.0
0,13		0.0	—	—	—	—	—	-4.0
0,14		0.0	—	—	—	—	—	-4.0
1,2		0.0	—	—	—	—	—	-4.2
1,3		20.0	32.3	1550	62.0	.020	2.9	-4.2
1,4		15.0	23.5	1130	64.0	.020	-1.7	-4.2
1,5		10.0	15.9	763	63.0	.020	-4.3	-4.3
1,6		5.0	12.5	600	40.0	.020	-7.5	-4.3
1,7		15.0	25.0	1200	60.0	.020	-1.2	-4.3
1,8		20.0	31.8	1520	63.0	.020	1.7	-4.3
1,9		20.0	31.8	1520	63.0	.020	1.2	-4.2
1,10		25.0	40.5	1940	62.0	.020	4.6	-4.2
1,11		20.0	30.4	1455	66.0	.020	2.1	-4.2
1,12		15.0	22.7	1009	66.0	.020	-1.2	-4.1
1,13		0.0	—	—	—	—	—	-4.1
2,3	2400 ↓	20.0	31.7	1500	64.0	.012	.8	-4.1
2,4		22.0	33.9	1625	65.0	.012	1.0	-4.1
2,5		20.0	24.4	1412	68.0	.015	2.5	-4.2
2,6		35.0	51.5	2470	68.0	.010	9.6	-4.2
2,7		40.0	58.9	2820	68.0	.015	12.9	-4.2
2,8		40.0	58.0	2880	69.0	.015	13.3	-4.3
2,9		35.0	52.4	2510	67.0	.015	9.2	-4.2
2,10		25.0	37.9	1830	66.0	.015	4.3	-4.2
2,11		30.0	46.1	2220	65.0	.012	8.3	-4.2
2,12		30.0	46.1	2220	65.0	.012	8.0	-4.2

*Yards to tons conversion factor = 2 tons/yard.

Ultimate limit (double line)

0,1 -4.0	0,2 -4.0	0,3 ore 9.3	0,4 ore 3.2	0,5 ore -.1	0,6 waste -4.0	0,7 ore 5.0	0,8 ore 14.1	0,9 ore 10.8	0,10 ore 11.2	0,11 waste -4.0	0,12 ore -1.7	0,13 waste -4.0	0,14 -4.0
	1,2 -4.2	1,3 2.9	1,4 ore -1.7	1,5 ore -4.3	1,6 waste -4.3	1,7 ore -1.2	1,8 ore 1.7	1,9 ore 1.2	1,10 ore 4.6	1,11 ore 2.1	1,12 ore -1.2	1,13 -4.1	
		2,3 .8	2,4 1.0	2,5 ore 2.5	2,6 ore 9.6	2,7 ore 12.9	2,8 ore 13.3	2,9 ore 9.2	2,10 ore 4.3	2,11 ore 8.3	2,12 8.0		

NOTE: Numbers in blocks represent; Block No.
How Used
Profit

Total Value = 96.8 x 2400 = \$232,320
 Total Tons Crude = 110,400 tons
 Total Tons Conc = 42,219
 Avg Grade Conc = 66.05
 Total Cubic Yards Waste = 9600 cubic yards

FIGURE 5.1: BLOCK REPRESENTATION OF EXAMPLE MINERAL DEPOSIT
 SHOWING ULTIMATE UNRESTRICTED PIT LIMIT

profit may be obtained by multiplying by 2400.) In all further discussion the index profit values will be used.

Now let us assume that we are going to mine this deposit over a time horizon of three periods. Also assume that the restrictions on the system are only on mining capacity per period. These restrictions are that not more than 8 block units may be taken in period 1 and not more than 10 in each of the remaining periods.

The problem now is to plan the operation such that the restrictions are not violated, but so that we maximize total profit. It is known from the unrestricted ultimate plan that the maximum profit realizable from this deposit is 96.8. If this can be obtained by a mining program that satisfies the capacity restrictions, such a program is optimal.

From Figure 5.2 it is seen that there are at least three different schedules which meet these criteria. Any of these plans is optimal with respect to our assumed model and could be obtained by the methods proposed in this study. The optimal solution in this case is not unique and a post-optimal analysis of the model would provide all the possible variations of the optimal solution.

In plan 1, Figure 5.2a, the profit values for periods 1 and 2 are more nearly equal than in the other plans. In plan 2 the concentrate tonnages for periods 1 and 2 are approximately the same. The cumulative schedules for periods 1 and 2 are identical for plan 2 and the plan shown in Figure 5.2c, yet for the individual periods the mining plans differ.

Figure 5.2c shows the mining schedule which maximizes the profit in period 1 subject to the mining capacity constraints and then from what remains, provides the maximum profit in period 2, again subject to the capacity constraints. The remaining material within the ultimate contour is recovered in period 3 and also satisfies the capacity constraints. This last plan

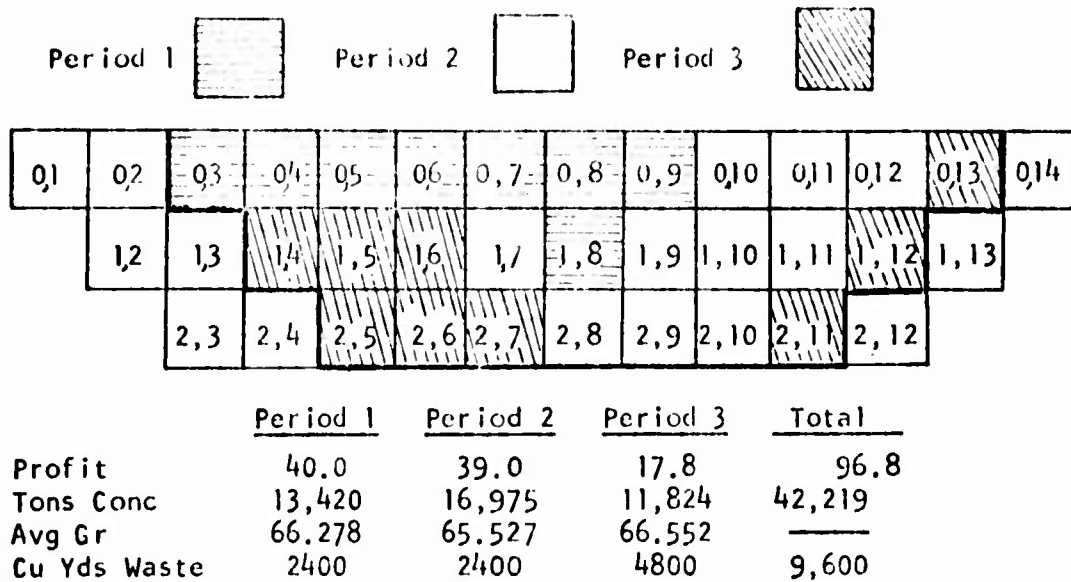

(a) Feasible Mining Plan 1

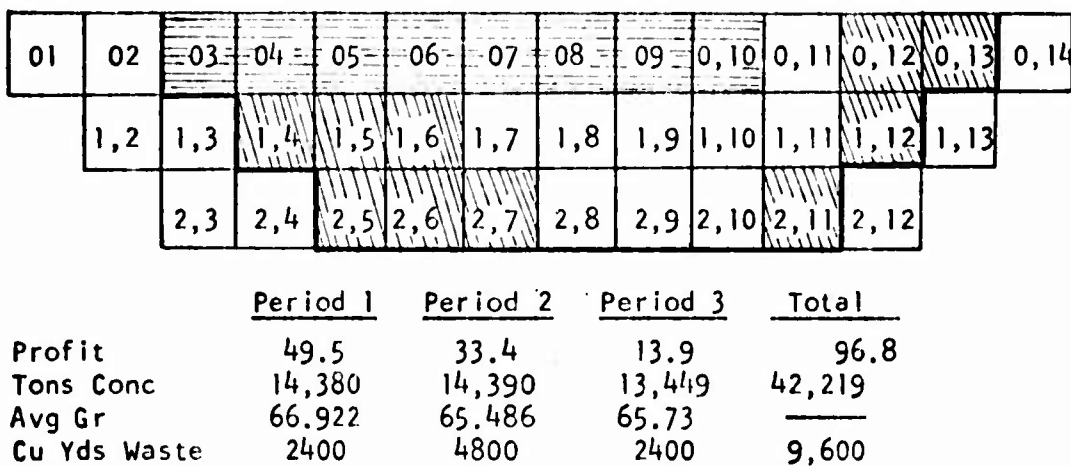

(b) Feasible Mining Plan 2

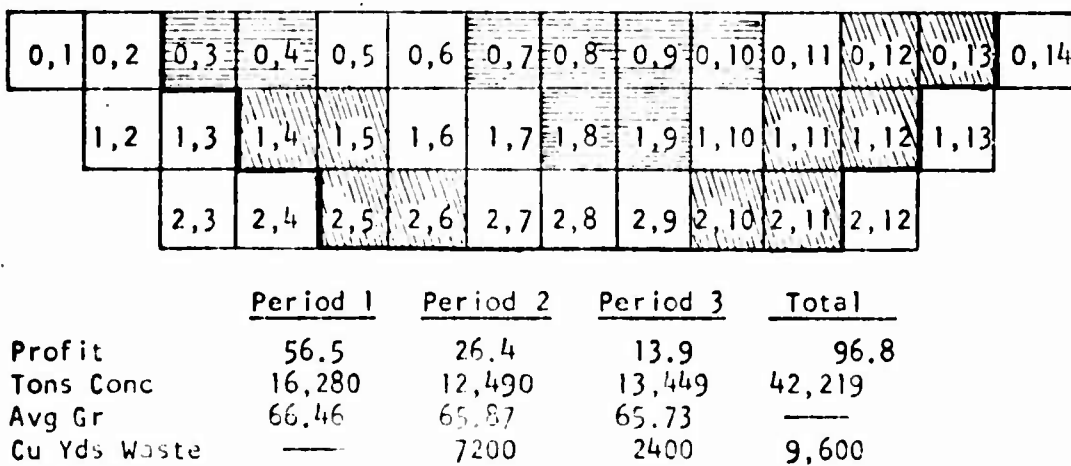

(c) Maximum Profit in Successive Periods

FIGURE 5.2: VARIOUS MINING SCHEDULES LEADING TO ULTIMATE LIMIT

illustrates sequential sub-optimization which in this case also maximizes total profit. This situation is not always true as will be indicated in the next section.

The mining programs shown in Figure 5.2, thus illustrate that there may be a number of feasible plans which satisfy the overall objective of maximum profit. However, as also is shown, there may be other objectives or considerations such as to equalize production among periods or even to maximize profits in a particular period. Many times these considerations may be due to what is termed the *intuitive mining approach* or the *art of mining*. With the techniques developed in this investigation many of these practices may be studied and evaluated.

5.2.3 Example 2

In order to illustrate, to a greater extent, the effect and cost of system constraints and management policy let us now impose further restrictions on the example model. Assume together with the mining capacity constraints of the previous example we have the following restrictions on the concentrator and concentrator product:

1. Available concentrator hours for period 1 ≤ 240 .
2. Available concentrator hours for periods 2 and 3 ≤ 480 .
3. Average grade of concentrate be between 64.0 and 66.0 in each period.

The objectives will be to maximize total profit.

As was indicated in the discussion of the ultimate contour, the average grade of the total ultimate reserve was 66.05, hence the last restriction may be somewhat unrealistic. But for the sake of illustration we will assume this is the result of some management policy. Because of this grade

restriction as well as the others we know that our total profit may be less than 96.8 and one of the following or both are going to occur. First in order to meet the grade restriction of 66.0 it may be necessary to blend in some waste material with the ore. Another way to possibly achieve this limit is to extend the mining operation beyond the optimum ultimate contour. Using the methods developed in the present investigation the best way to meet the given restrictions will be selected from these alternatives.

Shown in Figure 5.3 are two mining plans for our three period problem which satisfy the constraints on mining capacity, concentrator capacity and management's grade restrictions. These plans were obtained by using the procedures developed in Chapters 3 and 4. To start, one of the plans given in Figure 5.2, was used as an initial feasible subproblem solution, which even though infeasible for the master problem provided initial prices. After a few iterations of the master problem and the subproblem routine, plan 1 was obtained.

In plan 1 the period schedules remain within the ultimate limit but some of the material, blocks (0,6) and (0,11), which was previously designated as waste has been utilized as ore. The total profit at this stage of the master problem is 96.715.

Plan 2, Figure 5.3b, is the result of another iteration through the subproblem routine and the master problem. The pricing mechanism of the master problem has indicated that profits may be increased to 96.756 by remaining with the waste designation of blocks (0,6) and (0,11), except for a small amount of block (0,6), but extending the mining operation beyond the optimum ultimate limit.

Figure 5.4 illustrates the optimum mining schedule for the three period problem which was obtained after one more iteration. The average grade in each period is 66.0. This plan is similar to plan 2, but note now that all

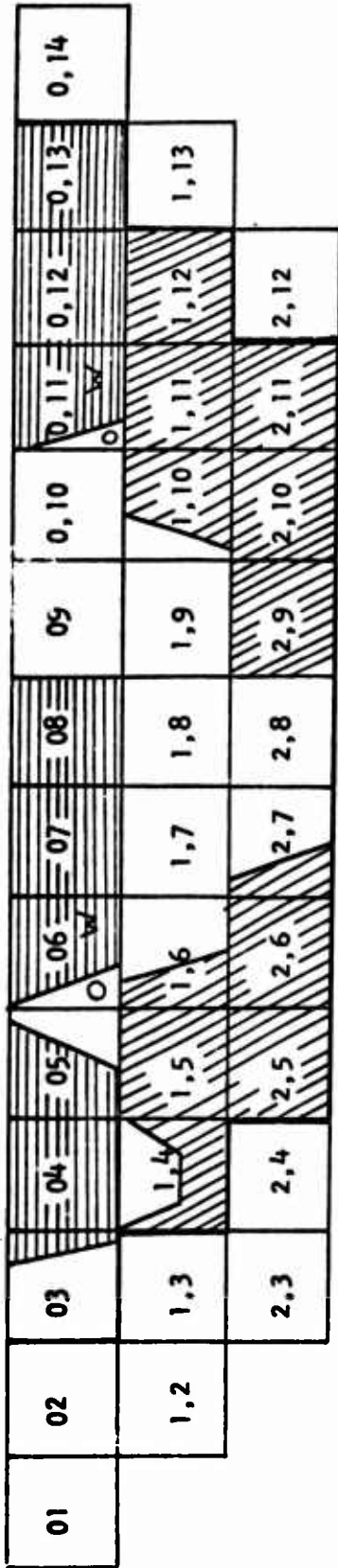

(a) Plan 1: Total Profit = 96.715

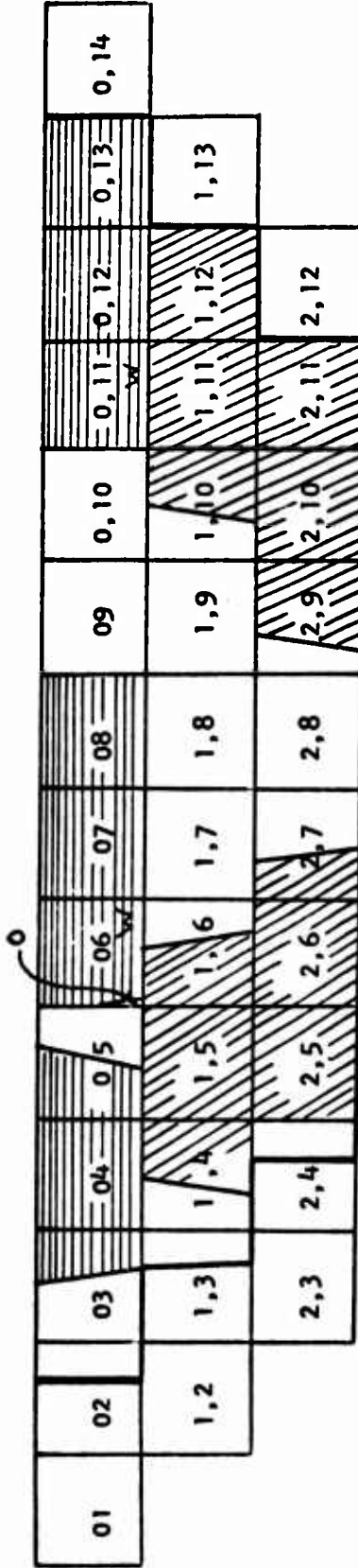

(b) Plan 2: Total Profit = 96.756

FIGURE 5.3: FEASIBLE NON-OPTIMAL MINING PLANS FOR RESTRICTED MODEL

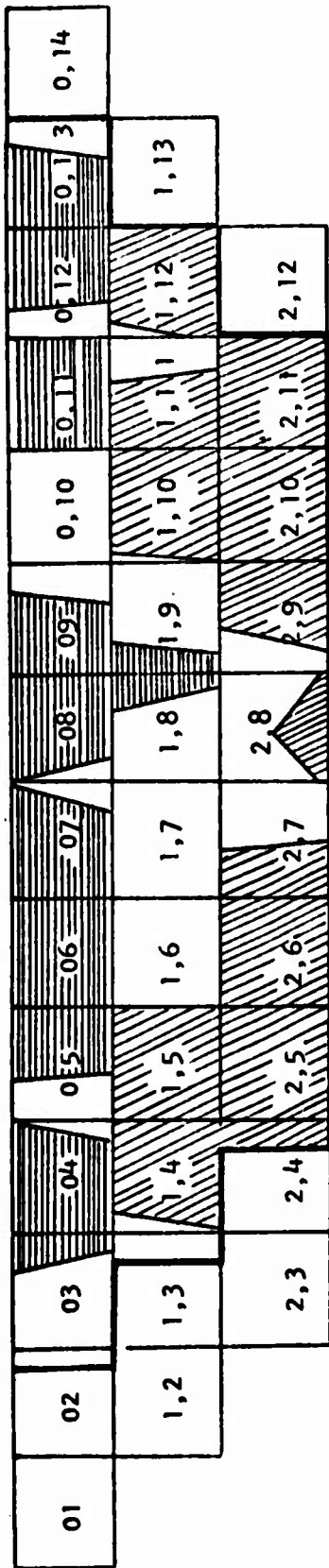

Profit 15.967 Period 1 Period 2 Period 3 Total
 41.6187 39.195 96.781

FIGURE 5.4: MAXIMUM TOTAL PROFIT PLAN WITH RESTRICTIONS

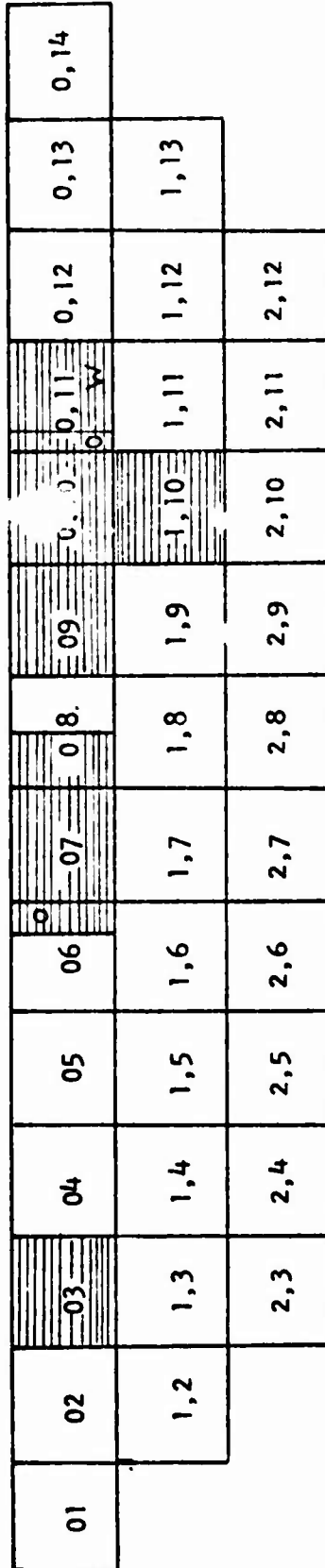

Profit 41.4266 Tons Conc: 11,282 Avg Gr: 66.0 Pit Hr: 240 Blocks 6.65

FIGURE 5.5: PERIOD 1 SCHEDULE WHICH YIELDS MAXIMUM PROFIT WITH RESTRICTIONS ON MINING CAPACITY, PLANT CAPACITY AND GRADE

of both blocks (0,6) and (0,11) are designated as waste and the extension beyond the ultimate limit is slightly less than in plan 2. The total maximum profit is 96.781 and thus some restriction has caused a decrease in profit from that of the ultimate limit. Since as is shown in Table 5.2 there still is concentrator (plant) capacity remaining for each period, the conclusion is that the decrease in profit is mainly due to the grade restriction.

The previous example has demonstrated how the cost and effect of system constraints and management policies may be evaluated. Even though the given grade restriction may not have been realistic considering the average grade of the entire deposit, it still brings out the value of such an analysis. Many of the system constraints and policies are unavoidable, but knowing their cost and effect may be a tremendous aid to management.

Figure 5.5 shows the mining plan for period 1 which yields the maximum profit subject to the mining capacity, concentrator capacity and grade constraints of the previous problem. This is the initial phase of determining a mining plan by sequential sub-optimization in that the constraints for the other periods were ignored. This plan for period 1 differs considerably from that of the period 1 plan within the maximum total profit plan. (Compare Figures 5.4 and 5.5) Note that in the plan of Figure 5.5 it is more profitable to treat some waste blocks (0,6) and (0,11) as ore rather than extend the mining beyond the ultimate contour.

The period 1 profit in the sequential sub-optimization plan (Figure 5.5) is 41.427 which is nearly triple that of the period 1 plan given in Figure 5.4. This looks quite good until we consider the mining system over the entire planning horizon of three periods and the objective of total maximum profit.

First of all we must recall that any deviation from the optimum ultimate contour plan costs money. Since the average grade of the remaining material

TABLE 5.2: FRACTIONAL BLOCKS FOR MAX. TOTAL PROFIT & MAX. PERIOD 1 PROFIT PLANS (RESTRICTED CASE)

Blk.	Max. Total Profit Plan			Max. Profit Period 1 Plan
	Fraction of Block			
	Period 1	Period 2	Period 3	
0,2	—	.1875		—
0,3	.2348	.7652		1.000
0,4	.7936	.2064		
0,5	.5588	.4412		
0,6	1.0000	—		.2512(ore)
0,7	.7936	.2064		1.000
0,8	.8320	.1680		.3990
0,9	.6224	.3776		1.0000
0,10		1.0000		1.0000
0,11	1.000	—		1.0000
0,12	.6523	.3478		
0,13	.6733	.3267		
1,3	—	.1875	—	
1,4	—	.0919	.9081	
1,5			1.000	
1,6		1.000		
1,7		1.000		
1,8	.2348	.7652		
1,9	.2348	.7652		
1,10		.0750	1.000	1.0000
1,11		.3267	.6733	
1,12		.0919	.9081	
2,4	—	—	.1875	
2,5			1.0000	
2,6			1.0000	
2,7		.6285	.3715	
2,8		.6507	.3493	
2,9		.3267	.6733	
2,10		—	1.000	
2,11		—	1.000	
Total	6.7304	9.9430	9.9967	6.650
Plt Hrs	225.17	403.92	417.60	240.0

{ .1478 ore
.8522 waste }

in the sequential plan is 65.94 we would expect that the grade restrictions could be met. We would also expect to stay within the concentrator capacity limitations. However, consider the mining capacity constraints. As indicated in Figure 5.5, a total of 6.65 blocks were taken in period 1. This leaves 20.35 blocks to be mined in the remaining two periods if we are to adhere to the optimum ultimate plan. The condition could be relieved by taking some waste blocks in period 1. This would of course decrease period 1 profit. No further ore material could be treated in period 1 since the concentrator is at maximum capacity. By shifting waste blocks we would not effect the value of possible total profits.

Next consider the value of the remaining material within the ultimate contour. This is found to be 55.279 and together with the maximum profit of 41.427 from period 1 gives a possible maximum profit of 96.706. This is less than the 96.781 profit value achieved in the maximum total profit plan. Since 96.706 is an upper bound on the total maximum profit for the sequential suboptimization schedule it is clear that in this case such an approach would be costly.

The last example has illustrated the possible profit effect of sequential sub-optimization. Even when discounting we cannot be certain of attaining the goal of maximum total profit unless consideration is given the mining system over the entire planning horizon.

5.3 MANAGEMENT CONSIDERATIONS

The model and techniques developed in this thesis provide management with a new decision tool. Besides yielding the optimal production schedule and an evaluation of the mineral deposit, policies, technological changes and system design features may be evaluated as demonstrated by the numerical examples of the previous section.

The cost and effect of policies can be readily obtained by inserting constraints describing such policies. Sensitivity analysis or parametric analysis will aid the determination of the effect of constraints on profit. For example, assume for one reason or another a limit has been imposed on capital expenditures of a certain type, say electric shovels, thus limiting available shovel hours per period. By examining the multiplier or price corresponding to this restriction, the increase or decrease in profit related to a variation of such a constraint could be indicated.

Such an analysis could be helpful in determining a capital investment plan. If policy constraints are not tight, they are not effectual in governing the plan and hence need not concern management or operators until the conditions change. Among the many management considerations which may be studied are orderly depletion policies, equipment relocation, marketing and labor agreements which effect the operation.

Technological changes such as those which affect the method and results of mining, concentrating or refining can be evaluated by considering them as a new activity or possibly only effecting the profit coefficients of present activities. For example, if a new method of concentrating is developed, this could be considered as adding a new element to each Q_j as discussed in Chapter 1. Thus using the present prices, the economic value of the new technology could be evaluated.

System design features such as mining methods, concentrator design, haulage systems and location of surface facilities may be evaluated through use of the proposed model. The design variations could be incorporated into the original model by introducing new activities or evaluated as separate systems. The location of surface facilities such as waste dumps, concentrator and other shops can be studied by employing the model. Problems of relocating existing facilities, which may for some reason be

within the area of the possible mineable reserve, can be solved by using a dummy block with a cost equal to the relocating cost [10]. The best time for relocating would also be a product of the model with this technique.

Since the coefficients of the model are based on drill hole samples, their estimates may not always be precisely accurate. This fact makes sensitivity analysis [5, 21] extremely important [12]. Many of the coefficients may be the result of a statistical analysis, thus using sensitivity analysis in conjunction with the confidence intervals for these coefficients could aid in determining where expenditures should be made to obtain better estimates. Also, sensitivity analysis is important due to the variability that occurs in a mining operation. Some of this is controllable while in other cases uncontrollable circumstances may cause disruptions in the optimal plan. Knowing the effects of variability through sensitivity analysis could aid greatly once a disruption occurs in the plan of operation.

The great effect mine planning has on corporate profits certainly justifies a scientific approach to the problem. The cost associated with a poor mining plan may far exceed the cost of development and utilization of new scientific decision techniques which greatly improve mine planning and production scheduling. Even though the trial and error techniques which have been developed recently have improved mine planning, they still contain many of the inherent erroneous concepts of the traditional methods as has been pointed out in this work. Often with the trial and error methods, many of the important factors influencing profit are neglected and there is always that element of doubt concerning how the chosen plan rates with regard to the "best possible."

As a readily adaptable suggestion to those who are presently utilizing

extensive trial and error methods we present the following. Formulate the system constraints as a linear programming master problem and use present techniques of selecting a plan to solve the subproblems. The master problem will select and combine the trial plans into a feasible schedule and the pricing mechanism will guide the trial plan selection towards the optimal. Although not as desirable as the methods developed in this study, such a scheme should improve the trial and error method with very little additional work.

The model and the method of solution developed through this research have great potential application. Their flexibility greatly improves present methods of mine planning. The profit derived from the system approach to the cut-off alone may pay for the cost of practical implementation. It is hoped that the tools provided by these techniques will be a benefit to engineers, operators, mine and corporate management through increased efficiency and effectiveness in planning, scheduling, evaluating and managing their operations.

REFERENCES

- [1] Axelson, A. H., "A Practical Approach to Computer Utilization in Mine Planning," presented at the International Symposium - Applications of Statistics, Operations Research and Computers in the Mineral Industry, Colorado School of Mines, (October 1964).
- [2] Berge, Claude, THE THEORY OF GRAPHS AND ITS APPLICATIONS, translated by Alison Doig, Methuen and Company, Ltd., London, (1966).
- [3] Berge, Claude and A. Ghouila-Houri, PROGRAMMING, GAMES, AND TRANSPORTATION NETWORKS.
- [4] Busacker and Saaty, FINITE GRAPHS AND NETWORKS: AN INTRODUCTION WITH APPLICATIONS, McGraw-Hill, (1965).
- [5] Dantzig, G. B., LINEAR PROGRAMMING AND EXTENSIONS, Princeton University Press, Princeton, New Jersey, (1963).
- [6] Dantzig, G. B. and P. Wolfe, "Decomposition Principle for Linear Programs," Operations Research, Vol. 8, No. 1, (January 1960).
- [7] Duer, B. C., "Optimization of the Design of Open Pit Mining Systems," Thesis (Doctor of Engineering, Industrial Engineering), University of California, Berkeley, (June 1962).
- [8] Erickson, J. D. and M. T. Pana, "Preparation of Short-Range Mining Plans by Computer at the Utah Mine of Kennecott Copper Corporation," Scientific and Engineering Computer Center Report, Kennecott Copper Corporation, Salt Lake City, Utah, (1966).
- [9] Ford, L. R. and D. R. Fulkerson, FLOWS IN NETWORKS, Princeton University Press, Princeton, New Jersey, (1962).
- [10] Gilbert, James W., "A Mathematical Model for the Optimal Design of Open Pit Mines," M.S. Thesis, Department of Industrial Engineering, University of Toronto, (September 1966).
- [11] Hartmen, R. J., "The Design of a Mining Engineering System for Computer Applications," presented at the University of Minnesota Mining Symposium, (January 1967).
- [12] Johnson, Thys B., "Maximizing Returns from Mine Products through Use of Operations Research Techniques," to be published as U.S. Bureau of Mines Report of Investigations.
- [13] Kuhn, H. W. and A. W. Tucker, LINEAR INEQUALITIES AND RELATED SYSTEMS, Annals of Mathematical Studies, No. 38, Princeton University Press, Princeton, New Jersey, (1956).
- [14] Lane, K. F., "Choosing the Optimum Cut-Off Grade," International Symposium - Applications of Statistics, Operations Research and Computers in the Mineral Industry, Colorado School of Mines Quarterly, Vol. 59, No. 4, (October 1964).

- [15] Lerch, Helmut and I. F. Grossman, "Optimum Design of Open-Pit Mines," Canadian Mining and Metallurgical Bulletin, Vol. 58, No. 633, pp. 47-54, (January 1965).
- [16] Meyer, Manfred, "A Mathematical Programming Model for Optimum Design of Open Pit Ore Mines," Management Sciences Research Group Report No. 93, Carnegie Institute of Technology, Graduate School of Industrial Administration, Pittsburgh, Pennsylvania, (December 1966).
- [17] Meyer, Manfred, "Some Computational Experiences with a Mathematical Programming Model for Optimum Design of Open Pit Ore Mines," Management Sciences Research Group Report No. 99, Graduate School of Industrial Administration, Carnegie Institute of Technology, Pittsburgh, Pennsylvania, (March 1967).
- [18] Ore, Oystein, THEORY OF GRAPHS, American Mathematical Society Colloquium Publications, Vol. XXXVIII, Providence, Rhode Island, (1962).
- [19] Pana, M. T., "The Simulation Approach to Open-Pit Design," presented at the Fifth Annual Symposium on Computer Applications in the Mineral Industry, Tucson, Arizona, (March 1965).
- [20] Pana, M. T., Carlson, O'Brian and Erickson, "A Description of Computer Techniques Used in Mine Planning at the Utah Mine of Kennecott Copper Corporation," presented at the Sixth Annual Symposium on Computers and Operations Research, Pennsylvania State University, (April 1966).
- [21] Simonnard, Michel, LINEAR PROGRAMMING, translated by William S. Jewell, Prentice-Hall, Inc., Englewood Cliffs, New Jersey, (1966).
- [22] Vickers, Edward L., "The Application of Marginal Analysis in the Determination of Cut-Off Grade," presented at the Annual Meeting of A.I.M.E., St. Louis, Missouri, (February 1961).

APPENDIX A
NETWORK DEFINITIONS

The following definitions of network or graph terminology are an aid to the interpretation of the development in the main text.

1. Graph or Network (Directed) the system, $E = (x, A)$ formed by a set of elements $x_i \in x$ called nodes, and a set of ordered pairs $(x_i, x_j) \in A$ called arcs.
2. Sub graph of (x, A) - a graph (Y, A) where $Y \subset x$ and $A_y = \{(x_i, x_j) / (x_i, x_j) \in A, x_i, x_j \in Y\}$ in other words it consists of a subset, Y of x and all the arcs in A which connect the nodes in Y .
3. Partial graph of (x, A) - a graph (x, A_p) formed by the set x and the set of arcs $A_p \subset A$; i.e., a partial graph contains all the nodes of the original graph and a partial set of arcs.
4. Partial subgraph of (x, A) - a partial graph of a subgraph of the form (Y, A_{yp}) , where $Y \subset x$ and $A_{yp} \subset A_y \subset A$.

Remark:

An arc (x_i, x_j) or (i, j) will always be assumed to be directed from x_i or i to x_j or j .

5. Edge $[x_i, x_j]$ of the graph (x, A) - a pair of nodes $[x_i, x_j]$ is an edge if $(x_i, x_j) \in A$ or $(x_j, x_i) \in A$.
6. Adjacent nodes - two distinct nodes joined by an arc.
7. Adjacent arcs (edges) - two arcs (edges) with a common node.
8. Path - a sequence of arcs $\{a, a_1, a_{1+1}, a_n\}$ such that the terminal node of each arc coincides with the initial node of the

succeeding arc; i.e., all arcs in the path have a similar orientation.

A path is compound if it uses the same arc more than once.

A path is elementary if it does not pass through the same node more than once.

9. Circuit - a path $\{a_1, \dots, a_n\}$ such that the initial node of a_1 and the terminal node of a_n coincide.
10. Strongly connected graph - a graph in which for any two nodes x_i and x_j , $x_i \neq x_j$ there exists a path connecting x_i with x_j .
11. Accessible sets - when x_i and x_j are nodes such that there is a path from x_i to x_j , then x_j is accessible from x_i written as $x_i > x_j$. The accessible set $D(x_i)$ is the set of all nodes accessible from x_i .

Note:

By definition $x_i \notin D(x_i)$ also define $\underline{D}(x_i) = D(x_i) \cup x_i$

12. Chain - a sequence of edges $(l_1, l_2, l_3, \dots, l_n)$ such that each of the intermediate edges l_i is attached to l_{i+1} at one of its extremities and to l_{i-1} at the other.
13. Cycle - a chain beginning and ending at the same node.
14. Connected graph - a graph in which for any pair of nodes x_i and x_j there exists a chain connecting them.
15. Antisymmetric graph - a graph (x, A) such that

$$(x_i, x_j) \in A \Rightarrow (x_j, x_i) \notin A.$$
16. Incidence - an arc whose initial node is x is said to be "incident out from" x - an arc whose terminal node is x is said

to be "incident into" x .

given the set of nodes \bar{x} , then the arc $a_1 = (x,y)$.

is incident into \bar{x} if $y \in \bar{x}$, and $x \notin \bar{x}$.

and incident out from \bar{x} if $x \in \bar{x}$ and $y \notin \bar{x}$.

The set of arcs incident into \bar{x} is denoted as $A(\bar{x})$ and

the set incident out from \bar{x} as $A^+(\bar{x})$.

17. Co-boundary - the nonempty set of arcs $A(\bar{x}) \cup A^+(\bar{x})$.
18. Co-circuit - a co-boundary in which all arcs are in the same set, either in $A(\bar{x})$ or all in $A^+(\bar{x})$.
19. Tree - a connected graph which contains no cycles; it is connected and has n -nodes and $n - 1$ arcs.
20. Node-arc incidence matrix (E) - given a graph or network (x,A) the node-arc incidence matrix is formed by:

1. Listing all nodes vertically = row index

2. Listing all arc horizontally = column index

3. The elements e_i^j of E are formed by

$$e_i^j = \begin{cases} +1 & \text{if arc } j \text{ is incident out of node } i \\ -1 & \text{if arc } j \text{ is incident into node } i \\ 0 & \text{otherwise} \end{cases}$$

For example the node-arc incidence matrix for the network in

Figure A.1 is

A.4

$$E = \begin{array}{c} x_1 \\ x_2 \\ x_3 \\ x_4 \end{array} \begin{array}{cccccc} (x_1x_2) & (x_1x_3) & (x_2x_3) & (x_4x_4) & (x_3x_2) & (x_3x_4) \\ \left[\begin{array}{cccccc} 1 & 1 & 0 & 0 & 0 & 0 \\ -1 & 0 & 1 & 1 & -1 & 0 \\ 0 & -1 & -1 & 0 & 1 & 1 \\ 0 & 0 & 0 & -1 & 0 & -1 \end{array} \right] \end{array}$$

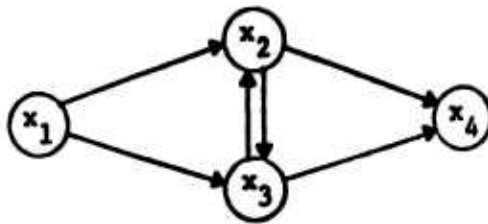

FIGURE A.1: EXAMPLE NETWORK

Unclassified
Security Classification

DOCUMENT CONTROL DATA - R&D		
<i>(Security classification of title, body of abstract and indexing annotation must be entered when the overall report is classified)</i>		
1. ORIGINATING ACTIVITY (Corporate author)		2a. REPORT SECURITY CLASSIFICATION
University of California, Berkeley		Unclassified
		2b. GROUP
		NA
3. REPORT TITLE		
OPTIMUM OPEN PIT MINE PRODUCTION SCHEDULING		
4. DESCRIPTIVE NOTES (Type of report and inclusive dates)		
Technical Report		
5. AUTHOR(S) (Last name, first name, initial)		
Johnson, Thys B.		
6. REPORT DATE	7a. TOTAL NO. OF PAGES	7b. NO. OF REFS
May 1968	120	22
8a. CONTRACT OR GRANT NO.	9a. ORIGINATOR'S REPORT NUMBER(S)	
DA-31-124-ARO-D-331	ORC 68-11	
b. PROJECT NO.	9b. OTHER REPORT NO(S) (Any other numbers that may be assigned this report)	
20014501B14C	5307.34-M	
c.		
d.		
10. AVAILABILITY/LIMITATION NOTICES		
This document has been approved for public release and sale; its distribution is unlimited.		
11. SUPPLEMENTARY NOTES	12. SPONSORING MILITARY ACTIVITY	
None	U.S. Army Research Office-Durham Box CM, Duke Station Durham, North Carolina 27706	
13. ABSTRACT The multi-period open pit mine production scheduling problem is formulated as a large scale linear programming problem using the block concept. A solution procedure is developed through decomposition and partitioning of the subproblem into elementary profit routing problems for which an algorithm is presented. Many of the traditional mine planning concepts are discussed and suggestions for improvement through use of the techniques developed in this thesis are given. In the development of the solution procedure, those constraints which govern the mining system are considered as the master problem. The constraints which dictate the sequence of extraction are used as the subproblem. The properties of the single period subproblem and its dual are discussed, and the dual problem is shown to be equivalent to a bipartite maximum flow problem for which an algorithm is given. The Multi-period subproblem algorithm is developed by partitioning by stages and using the properties of the single period subproblem. This treatment allows optimization of the complete mining-concentrating-refining system over the entire planning horizon and permits the system to dictate how and when to process a block of material.		
14. KEY WORDS		
block concept algorithm mine planning concepts mining system multi-period subproblem algorithm		

DD FORM 1473
1 JAN 64

Unclassified
Security Classification