

7767-62677  
AD657258

FTD-TT-66-22

FOREIGN TECHNOLOGY DIVISION



(PART II)

ENCYCLOPEDIA OF CONTEMPORARY ENGINEERING.  
STRUCTURAL MATERIALS.

heat and sound insulating loose fiber materials  
thru nichrome

Reproduced From  
Best Available Copy

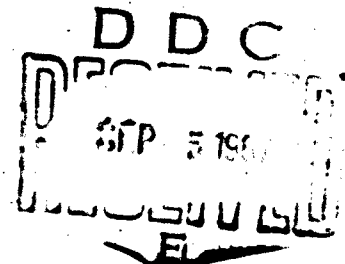
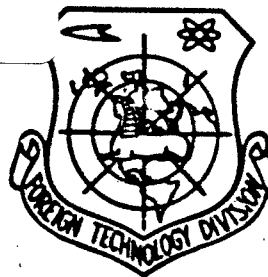

2002115110

Distribution of this document  
is unlimited. It may be  
released to the Clearinghouse,  
Department of Commerce, for  
sale to the general public.

Reproduced by the  
**CLEARINGHOUSE**  
for Federal Scientific & Technical  
Information Springfield Va. 22151

898

**UNEDITED ROUGH DRAFT TRANSLATION**

(PART THREE OF FIVE PARTS),

**ENCYCLOPEDIA OF CONTEMPORARY ENGINEERING.  
STRUCTURAL MATERIALS.**

English pages: 1823 - 2716

**SOURCE:** Entsiklopediya Sovremennoy Tekhniki. Kon-  
struktsionnyye Materialy. Volumes I, II, III,  
Gosudarstvennoye Nauchno Izdatel'stvo "Sovetskaya  
Entsiklopediya", Moskva, 1965, Vol. I, pp. 1-416,  
Vol. II, pp. 1-408, and Vol. III, pp. 1-527.

Translated under: Contract AF 33(657)-14184, SA2

TM7500368

THIS TRANSLATION IS A RENDITION OF THE ORIGINAL FOREIGN TEXT WITHOUT ANY ANALYTICAL OR EDITORIAL COMMENT. STATEMENTS OR THEORIES ADVOCATED OR IMPLIED ARE THOSE OF THE SOURCE AND DO NOT NECESSARILY REFLECT THE POSITION OR OPINION OF THE FOREIGN TECHNOLOGY DIVISION.

PREPARED BY:

TRANSLATION DIVISION  
FOREIGN TECHNOLOGY DIVISION  
WP-APL, OMS.

## **REPRODUCTION QUALITY NOTICE**

**This document is the best quality available. The copy furnished to DTIC contained pages that may have the following quality problems:**

- **Pages smaller or larger than normal.**
- **Pages with background color or light colored printing.**
- **Pages with small type or poor printing; and or**
- **Pages with continuous tone material or color photographs.**

**Due to various output media available these conditions may or may not cause poor legibility in the microfiche or hardcopy output you receive.**

**If this block is checked, the copy furnished to DTIC contained pages with color printing, that when reproduced in Black and White, may change detail of the original copy.**

HEAT AND SOUND INSULATING LOOSE FIBER MATERIALS - materials used for reducing the heat transfer between the insulated object and the surrounding medium and for sound insulation from it. By their structure a distinction is made between fibrous, cellular, grain-type and laminar heat and sound insulating loose fiber materials. Compositions from various materials are also frequently used in insulation designs.

The following fibers are used as the starting raw material for loose fiber materials: a) organic, i.e., natural (cotton, wool), artificial and synthetic (viscose, capron, nitron, coal, graphite); b) inorganic, (asbestos, glass, kaolin, quartz, silica, from slag, etc.). Magnesium carbonate, perlite, silica-gel, colloidal silica, carbon black, diatomite crumbs, refractory oxides, etc., are used for powder heat and sound insulating loose fiber materials.

The temperature range in which heat and sound insulating loose fiber materials can be used depends on their chemical composition and properties. The majority of the materials has a porous structure, which imparts to them high heat protection properties with a relatively low specific weight. Fibrous materials, powders and vacuum designs are the most effective insulators.

The thermal conductivity of heat and sound insulating loose fiber materials depends on the temperature, specific weight, moisture content, fiber diameter (particle size) and a number of other factors.

Heat and sound insulating loose fiber materials with communicating pores have good sound absorption properties and are used in designs simultaneously as heat insulating and sound insulating materials. An

increase in the sound absorption at low frequencies is obtained by making the absorbing layer thicker and providing an air gap (space) between it and the retaining wall. The greatest absorption is obtained with the air gap width equal to a half-wave, since then the absorber is located in the zone of greatest vibrations and friction losses.

The following kinds of heat and sound insulating loose fiber materials are most efficient.

I. Materials from organic fibers (maximum working temperature up to +120°).

Quilted

1. VT4 (TU MPTShP 340-55) - quilted mats from the waste of drawn or nondrawn capron staple fiber. The material burns and melts weakly, after the flame source is removed, the burning ceases. The presence of admixtures of other fibers, including glass fiber, is not permitted, since it increases the combustibility.

VT4 is used for heat and sound insulation of ships, cutters, aircraft, service premises, ventilating installations, pipelines; when faced by capron fiber it is fungus resistant and suitable for use in a humid atmosphere. The thermal conductivity coefficient for a specific weight of 50 kg/m<sup>3</sup> is expressed by the equation  $\lambda = 0.032 (1 + 0.0056 t_{sr})$ . The temperature range of application is -60-+120°.

2. ATIMKh (MLP TU 1845-52) - quilted mats from antipyrine-treated (with fire-proofing impregnation) cotton (loose cotton), faced on both sides by antipyrine-treated cotton gauze. After the source of fire is removed, ATIMKh does not burn or smolder. The thermal conductivity coefficient at an average temperature of -20° is 0.03 kcal/m-hour-°C, it is highly sensitive to moisture and may rot. ATIMKh is used in the form of blanks or panels faced by decorative fabrics, materials, rigid retaining walls; its high sound absorption characteris-

tics and low cost make it possible to use this material in ventilating installations of dry premises. The blanks and panels can be glued by glues 88 (up to 90°) and PU-2M, thumb tacks or by lathing. The temperature range of application is -60-+120°.

With an Organic Binder Base

1. VT4S (VTU STU35-115-61) - covers from drawn and nondrawn capron staple fiber with polyamide binders, i.e., varnish (FTU MKhP M319-53) or glue PEF2/10 (VTU GKHPK P38-56); is produced in thicknesses of 15, 20, 25 and 30 mm and is correspondingly marked as VT4S-15, VT4S-20, VT4S-25 and VT4S-30; burns and melts weakly, after the source of flame is removed the burning ceases. Admixtures increase the combustibility and are not permitted. The thermal conductivity coefficient for a specific weight of 25 kg/m<sup>3</sup> and an average temperature of 20° is 0.032 kcal/m-hour-°C. VT4S is used in the form of blanks or panels, faced with decorative fabrics and materials, as heat and sound insulation of ships, cutters and aircraft. The blanks and panels are fastened in the same manner as ATIMKh. The material is easily deformed under load upon installation and use; it is suitable for operation in a moist atmosphere. The temperature range of application is -60-+120°.

II. Materials from inorganic fibers (maximum operating temperature from 100° to 700°).

With an Organic Binder Base

1. Heat and sound insulating plates (Tables 1 and 2) are made from staple glass fiber obtained by vertical blowing and a binder, i.e., brand MF-17, SP-2, B, etc., synthetic resins.

The hygroscopicity of the plates after they are held for 5 days at a relative air humidity of 65% does not exceed 6%. Brand "A" plates are faced on one side by a dense glass fabric from nonalkaline glass.

The plates are used as heat and sound insulating materials aboard

1825

ships, river boats, refrigerators, autobuses, railroad cars, the temperature of the insulated surfaces being -60-+100°.

The rolled glass fiber material (VTU-13-59) is made from staple glass fibers, which are obtained by blowing and are bound by synthetic resins (MF-19, B, and SP-2). The dimensions of the rolled material

TABLE 1  
Indicators of Heat and Sound Insulating Plates

| 1<br>Марки плит и ТУ    | 2<br>Объемный вес (кг/м³, не более) | 3<br>Размеры |             |                | 4<br>Средний диаметр волокна (мк, не более) | 5<br>Содержание неволокнистых включений (% не более) | 6<br>Содержание смолы (% не более) | 7<br>Упругость (коэф. восстановления, %) не менее |
|-------------------------|-------------------------------------|--------------|-------------|----------------|---|--|------------------------------------|---|
|                         |                                     | 8<br>длина   | 9<br>ширина | 10<br>толщина  |   |  |                                    |   |
|                         |                                     | 11<br>(см)   |             |                |   |  |                                    |   |
| 12<br>Марка А ВТУ 12-58 | 20-80                               | 100          | 100, 50     | 20, 30, 40     | 15  | 5  | 15                                 | 85  |
| Марка В ВТУ 12-58       | 20-80                               | 100          | 100, 50     | 20, 30, 40     | 15  | 5  | 15                                 | 85  |
| Марка А ВТУ 965-352-58  | 30-80                               | 100          | 100, 50     | 30, 40, 50     | 11  | 5  | 25                                 | 90  |
| 14<br>Марка В, то же    | 40-80                               | 100          | 100, 50     | 30, 40, 50     | 11  | 5  | 15                                 | 90  |
| 15<br>ВТУ 13-59         | 40-80                               | 100, 90, 50  | 100         | 30, 40, 50, 60 | 15  | 5  | 15                                 | 85  |

1) Plate brands and TU; 2) specific weight (kg/m<sup>3</sup>, not more than); 3) dimensions; 4) average fiber diameter (microns, not more than); 5) content of nonfibrous inclusions (% not more than); 6) resin content (% not more than); 7) resilience (restoration coefficient, %); 8) length; 9) width; 10) thickness (mm); 11) cm; 12) brand A VTU 12-58; 13) brand B VTU 12-58; 14) brand A VTU 965-352-58; 15) brand B, same as above; 16) VTU 13-59.

TABLE 2  
Heat and Sound Absorption Characteristics of Plates

| 1<br>Средняя температура изоляции (°C)      | 0                 | 20    | 40    | 60    | 100   | 120   |
|---|-------------------|-------|-------|-------|-------|-------|
| 2<br>Коэф. теплопроводности (ккал/м·час·°C) | 0.031             | 0.032 | 0.034 | 0.037 | 0.046 | 0.053 |
| 3<br>Звукопоглощение:                       | 4<br>частота (гц) |       |       |       |       |       |
|   | 200               | 400   | 800   | 1000  | 2000  | 8000  |
| 5<br>коэфф. звукопоглощения                 | 0.50              | 0.45  | 0.50  | 0.52  | 0.60  | 0.65  |

1) Average temperature of the insulation (°C); 2) thermal conductivity coefficient (kcal/m-hour-°C); 3) sound absorption; 4) frequency (cps); 5) sound absorption coefficient.

are: thickness (mm) 20, 30, 40, 50, 60, width 100 (cm), roll diameter up to 80 cm, fiber diameter not more than 15 microns. Specific weight 30-65 kg/m<sup>3</sup>. Binder content from 1.5 to 16%. The rolled material from nonimpregnated staple fiber with 2.5% of lubricant, specific weight of 35 kg/m<sup>3</sup>, average fiber diameter of 12 microns and temperature of 20°

has a thermal conductivity coefficient of 0.036 kcal/m-hour-°C. The sound absorption for a 45 mm thickness of material is characterized by indicators given in Table 3.

TABLE 3  
Sound Absorption Characteristics of Rolled Material

| 1 Частота (гц)                    | 300  | 300  | 400  | 500  | 1000 | 1200 | 2000 | 3000 |
|-----------------------------------|------|------|------|------|------|------|------|------|
| 2 Коэф. звукопоглощения . . . . . | 0.92 | 0.82 | 0.60 | 0.62 | 0.45 | 0.82 | 0.88 | 0.97 |

1) Frequency (cps); 2) sound absorption coefficient.

The material is used as sound insulation in residential and industrial construction, cooling equipment and pipeline insulation and in petroleum refining apparatus. The temperature range of application is -60-100°.

3. Mineral wool products FMV-Kh (VTU 965-2183-52 MSPTI and MSP) — lumpy heat insulating material consisting of 52% mineral wool, 17% grade IV asbestos, 18% calcined vermiculite, 4% bentonite clay and 9% brand Sh bitumen. The specific weight of the products is not higher than 300 kg/m<sup>3</sup>. The thermal conductivity coefficient at a temperature of 20° is not higher than 0.055 kcal/m-hour-°C. The ultimate flexural strength is not less than 1.6 kg/cm<sup>2</sup>. The moisture content does not exceed 5%. They are used for heat insulation of pipelines and ship systems. The temperature range of application is up to +100°.

4. Mineral wool mats with a bitumen binder base (VTU 42-47 MSPTI), specific weight 225 kg/m<sup>3</sup>, thermal conductivity coefficient at 20-30° not higher than 0.052 kcal/m-hour-°C; are used for heat insulation of industrial installations and equipment, and also for enclosing structures of buildings. The temperature range of application is up to +100°.

5. Mineral felt with a bitumen binder as a base (GOST 6125-61) is made with specific weights of 150, 200 and 250 kg/m<sup>3</sup>, at 30° the ther-



mal conductivity coefficient is, respectively, 0.05, 0.055 and 0.060 kcal/m-hour-°C. The ultimate tensile strength along the layers, depending on the brand, is not lower than 0.08-0.14 kg/cm<sup>2</sup>; it is used for heat insulation of industrial installations, pipelines and equipment, as well as for enclosing structures of buildings with a temperature of +60° (inside the buildings).

6. ATIMSS (TU MLP 1520-57) - porous covers from staple glass fiber 5-7 microns in diameter with an alcohol solution of the IF or B bakelite varnish as the binder. Aluminum-borosilicate glass which is used for making ATIMSS should contain not more than 2% alkaline metal oxides. ATIMSS does not burn or smolder. For characteristics of ATIMSS see Table 4.

ATIMSS is used for heat insulation of aircraft and other communications facilities in a temperature range of -60-+150°. At higher operating temperatures the binder (varnish) burns out and the material becomes more dense; it is used in the form of panels and blanks faced by the AZT or ANZM materials. The blanks and panels are fastened in the same manner as ATIMKh. The thermal conductivity coefficient for a specific weight of 25 kg/m<sup>3</sup> is determined from the equation  $\lambda = 0.03 (1 + 0.0093 \cdot t_{sr})$ . The temperature range of application is -60-+150°.

7. ATM-1 (MRTU 6-11-11-64) - porous covers (mats) from ultrasuper-thin staple glass fiber with a diameter up to 2.5 microns and with the VR-1 phenolformaldehyde resin as a binder. On one side the covers are faced by a layer of aluminum foil 20 microns thick (GOST 618-62) or by a synthetic film. The material without the film does not burn or smolder. The thermal conductivity coefficient for a specific weight of 10 kg/m<sup>3</sup> and an average temperature of 20° is 0.027 kcal/m-hour-°C. ATM-1 is used for heat and sound insulation of aircraft, in the temperature range from -60 to +150°.

The ATM-1 material is produced with a thickness of 20, 25, 30, 35 and 40 mm and, depending on the facing it is marked as: a) ATM-1-20-F when faced on one side with aluminum foil; b) ATM-1-20-P, ATM-1-25-P, ATM-1-30-P, ATM-1-35-P and ATM-1-40-P when faced on one side with a synthetic film; c) ATM-1-20-PP, ATM-1-25-PP, ATM-1-30-PP, ATM-1-35-PP and ATM-1-40-PP when faced on both sides with a synthetic film; d) ATM-1-20, ATM-1-25, ATM-1-30, ATM-1-35, ATM-1-40 when no facing is applied. Indicators of ATM-1 are given in Table 5.

TABLE 4  
Dimensional and Weight Characteristics of ATIMSS

| Марка<br>1 | 2 Размеры полотна |         |          | 3 Вес 1 м <sup>2</sup> | 4 Объемный вес (кг/м <sup>3</sup> ) |
|------------|-------------------|---------|----------|------------------------|-------------------------------------|
|            | 5 Толщина (мм)    | 6 Длина | 7 Ширина |                        |                                     |
|            |                   | 8 (см)  |          |                        |                                     |
| АТИМСС-10  | 15-2              | 130±5   | 95±5     | 425                    | 25                                  |
| АТИМСС-20  | 20-2              | 130±5   | 95±5     | 550                    | 25                                  |
| АТИМСС-25  | 25-2              | 130±5   | 95±5     | 675                    | 25                                  |
| АТИМСС-30  | 30-2              | 130±5   | 95±5     | 800                    | 25                                  |
| АТИМСС-40  | 40-2              | 130±5   | 95±5     | 925                    | 25                                  |

- 1) Brand; 2) cover dimensions; 3) weight of a m<sup>2</sup> (g, not more than);  
 4) specific weight (kg/m<sup>3</sup>, not more than); 5) thickness (mm); 6) length;  
 7) width; 8) cm; 9) ATIMSS.

TABLE 5  
Dimensional and Weight Characteristics of ATM-1

| Толщина при давлении 1 г/см <sup>2</sup> (мм) | 2 Длина (см) | 3 Ширина, см              |             |                           | 4 Вес 1 м <sup>2</sup> , г |                        |                |
|---|--------------|---------------------------|-------------|---------------------------|----------------------------|------------------------|----------------|
|   |              | 5 неоклеенный и с пленкой | 6 с фольгой | 7 фольга с одной стороной | 8 пленка с одной стороной  | 9 пленка с двух сторон | 10 неоклеенный |
|   |              |                           |             |                           |                            |                        |                |
| 20+4  | 550-600      | 55-60                     | 48-54       | 220-260                   | 190-230                    | 220-260                | 180-200        |
| 25+4  | 550-600      | 55-60                     | 48-54       | 240-310                   | 230-280                    | 240-310                | 200-250        |
| 30+4  | 550-600      | 55-60                     | 48-54       | 300-360                   | 270-330                    | 300-360                | 240-300        |
| 35+4  | 550-600      | 55-60                     | 48-54       | 340-410                   | 310-380                    | 340-410                | 240-350        |
| 40+4  | 550-600      | 55-60                     | 48-54       | 380-460                   | 350-430                    | 380-460                | 320-400        |

The specific weight of ATM-1 without the facing should be within the limits of 8-10 kg/m<sup>3</sup>.

- 1) Thickness under a pressure of 1 g/cm<sup>2</sup> (mm); 2) length (cm); 3) width (cm); 4) weight of a m<sup>2</sup>, g; 5) unfaced and with a film; 6) with the foil; 7) foil-faced on one side; 8) film applied to one side; 9) film applied to both sides; 10) unfaced.

8. Mineral felt with synthetic resin bases is made in the form of rolled material or mats; specific weight not higher than  $100 \text{ kg/m}^3$ . The thermal conductivity coefficient at  $30^\circ$  is  $0.037 \text{ kcal/m-hour-}^\circ\text{C}$ . Hygroscopicity - the amount of moisture after 15 days comprises 3-4%. The felt can be used at  $150^\circ$  and higher temperatures, depending on the binder properties.

9. Mineral wool mats with synthetic resin bases (VTU 104-53 of the Building Ministry) are made of two brands, i.e., S-100 and S-125, the specific weight, respectively, is 100 and  $125 \text{ kg/m}^3$ . The thermal conductivity coefficient at  $30^\circ$  is  $0.09-0.045 \text{ kcal/m-hour-}^\circ\text{C}$ . The ultimate tensile strength of S-100 is not lower than 0.05 and of S-125 is not lower than  $0.10 \text{ kg/cm}^2$ . The organic binder content is not higher than 8%, moisture content not above 1%. The mats are used for heat insulation of industrial installations and equipment, and also for the enclosing structures of buildings at temperatures up to  $+130^\circ$ .

10. Mineral wool-asbestos plates KCh (TU 95-52 MSPTI). Specific weight 350 and  $400 \text{ kg/m}^3$  with the corresponding branding as "350" and "400." The plates consist of 62% mineral wool, 21% grade V asbestos, 12% bentonite clay and 5% brand V bitumen. The thermal conductivity coefficient at  $50^\circ$  is not higher than  $0.068-0.073 \text{ kcal/m-hour-}^\circ\text{C}$ , the ultimate strength in flexure is  $2.5-3.0 \text{ kg/cm}^2$  the moisture content is not above 5%. The plate dimensions are  $1000 \times 500 \text{ mm}$  with thicknesses of 25 and 30 mm. They are used for insulating refrigerators, industrial installations and equipment. The limiting temperatures for building-installed objects is up to  $+150^\circ$ .

With an Organosilicon Binder Base

ATIMSSK (STU 35-116-61) - covers from staple glass fiber 5-7 microns in diameter with organosilicon resin as the binder. The glass fiber is made from aluminum borosilicate glass containing not more

than 2% of alkaline metal oxides. The binder used is a toluene solution of the M-1 or K-47 organosilicon resins. The thickness of the material is 15, 20, 25 and 30 mm and the brands are named, respectively, ATIMSSK-15, ATIMSSK-20, ATIMSSK-25 and ATIMSSK-30. The dimensions of the covers are: length  $130 \pm 5$  cm and the width  $95 \pm 5$  cm. Specific weight  $25 \text{ kg/m}^3$ . Binder content 15-30%. The thermal conductivity coefficient is expressed by the equation  $\lambda = 0.03(1 + 0.0093 \cdot t_{gr})$ . It is used in the form of panels for heat insulation of aircraft in the temperature range from  $-60^\circ$  to  $+350^\circ$ . The ANTM-1 material, which is suitable for operation at temperatures up to  $+200^\circ$ , is used as the facing material.

#### Quilted (without a binder)

1. ATM-3 (VTU 35 ShP-1-62) - quilted mats from ultrasuperthin staple glass fiber with a diameter up to 2.5 microns, is the lightest quilted material (Table 6).

TABLE 6

Dimensional and Weight Characteristics of ATM-3

| Марка    | Размер маты                       |                     |                      |                     |                      | 6<br>Средн.<br>плотность<br>по ГОСТ | 7<br>Вес 1 м <sup>2</sup><br>по ГОСТ |
|----------|-----------------------------------|---------------------|----------------------|---------------------|----------------------|-------------------------------------|--------------------------------------|
|          | 3<br>Толщина,<br>не менее<br>(мм) | 4<br>Длина,<br>(см) | 5<br>Ширина,<br>(см) | 2<br>Длина,<br>(см) | 2<br>Ширина,<br>(см) |                                     |                                      |
| ATM-3-5  | 5                                 | 110-5               | 60-5                 | 50                  | 50                   | 300                                 |                                      |
| ATM-3-10 | 10                                | 110-5               | 60-5                 | 50                  | 50                   | 400                                 |                                      |
| ATM-3-15 | 15                                | 110-5               | 60-5                 | 50                  | 50                   | 400                                 |                                      |
| ATM-3-20 | 20                                | 110-5               | 60-5                 | 50                  | 50                   | 700                                 |                                      |

1) Brand; 2) mat dimensions; 3) thickness, not less than (mm); 4) length (cm); 5) width (cm); 6) specific weight ( $\text{kg/m}^3$ ) not more than; 7) weight of  $1 \text{ m}^2$  not more than.

The standard moisture content of the material is not higher than 2%, and the chlorine ion content in water drawing should not exceed 0.03%. Leaching out in terms of  $\text{Na}_2\text{O}$  not more than 5 mg. For a standard specific weight of  $40 \text{ kg/m}^3$  the thermal conductivity coefficient is  $0.041 \text{ kcal/m-hour-}^\circ\text{C}$  at a temperature of  $160^\circ$  and  $0.06 \text{ kcal/m-hour-}^\circ\text{C}$

at a temperature of 260°.

2. Mats and strips for heat insulation (GOST 2245-43) from drawn and blown glass fiber are made in the form of quilted products of various sizes. The mats are used for heat insulation of flat and cylindrical surfaces with a large radius of curvature, while the strips are used for insulating cylindrical surfaces of pipelines with a small radius of curvature. The temperature range of application is -60-+500°.

3. ATIMS (VTU LP S-1-57) - quilted mats from nonalkaline staple glass fiber with a diameter of 5-7 microns are produced of the following brands: ATIM S-5, ATIMS-10 and ATIMS-15. The material does not burn or smolder. The thermal conductivity coefficient for a specific weight of 100 kg/m<sup>3</sup> is determined by the equation  $\lambda = 0.026(1 + 0.009 \cdot t_{sr})$ . ATIMS is used for insulating pipelines and units operating at temperatures from -60 to +450° or for short periods of time up to +600°.

4. ASIM (TU MPSM 182-53) - quilted mats from glass fiber of alkaline composition (fiber diameter 14 microns), faced by glass fabric and sawn through with glass threads. ASIM brands are ASIM-5 and ASIM-9. ASIM does not burn or smolder. The thermal conductivity coefficient is determined by the equation  $\lambda = 0.023(1 + 0.056 \cdot t_{sr})$ . ASIM is used for insulating pipelines and other components and units operating at temperatures from -60 to +400° or for short periods of time up to +500°.

The ZhST (TU 1135-51) and ZhST-15 (TU 660-51) glass heat insulating packing cord consist of a core made from glass fiber 19 microns in diameter and a mesh braiding, formed by interweaving of 12, 16 and 24 twisted glass fibers along a spiral; they are used as heat insulation of pipelines and other units with a complex geometric shape. Temperature range of application -60-+500°.

III. High temperature resistant from quartz, silica and ceramic

fibers (maximum operating temperature up to 1200° and above).

1. Materials from silica fiber (VTU 13-52) (fabrics), contain 98% silicon dioxide and are obtained by treating aluminum borosilicate glass fiber and products made from it with acids. As a result of heat treatment at temperatures of 800-1000° the silica materials shrink and upon secondary heating become stabilized and retain their geometric dimensions. The sintering temperature of silica materials is 1450-1500°. The specific heat of the material is 0.2 kcal/kg-°C at 20° and 0.25 kcal/kg-C° at 1000°. Materials from silica fiber are used for heat insulation of various pieces of equipment at temperatures up to 1200°, they are also used as gas filters and sound absorbing materials.

2. Materials from graphite and coal fibers with a limiting application temperature up to 2500° (for short periods of time) are made by thermochemical treatment of fabrics mats and felts from organic fibers, have a sufficient resilience, chemical inertness (resistance) to the effect of alkalis and acids (except for strong oxidizers) and high heat resistance. At low temperatures (-196°) and in the region of above-zero temperatures up to +400° the graphite and coal materials do not oxidize. At higher temperatures they increase their mechanical strength and are not oxidizable in a reducing medium. Coal materials have higher heat protection properties than graphite materials, but contain several percents of volatile substances.

Graphite and coal fibrous materials can be used for heat insulation of various objects, in the making of vessels for corrosion-aggressive fluids, filters, heat resistant gaskets, etc. The temperature range of application is up to +400° in air, at higher temperatures they can be used in protective atmosphere.

IV. Heat insulating materials for deep freezing. Deep freezing equipment makes extensive use of liquefied gases which are stored and

transported in the presence of materials and designs which make it possible to reduce to a minimum the evaporation losses, i.e., with highly-effective insulation from fine-dispersion powders, fine fibers and other materials, the thermal conductivity of which decreases substantially with the temperature (see Table 7).

The insulating efficiency of powdered and fibrous heat insulating materials under standard atmospheric pressure is insufficiently high if, in addition, it is taken into account that they can become moist, thus impairing their heat insulating properties. Insulation obtained by using a high vacuum produced between two highly reflecting surfaces is also not entirely satisfactory. Use is made of vacuum-powder insulation which makes it possible, under a vacuum of the order of 0.010-0.10 mm of Hg, to obtain a thermal conductivity coefficient of 0.005-0.015.

TABLE 7  
Thermal Conductivity of Heat  
Insulating Materials

| 1<br>Материалы                          | 2<br>Объемный<br>вес (г/см <sup>3</sup> ) | 3<br>Коэффициент теплопроводности (ккал/м·ч·°С) при средней температуре (°С) |        |        |       |
|---|---|--|--------|--------|-------|
|   |   | -200   | -100   | -50    | 0     |
| 4<br>Измельченная пробка (зерно - 3 мм) | 37  | 0.008  | 0.0175 | 0.22   | 0.028 |
| 5<br>Диатомовая земля (порошок)         | 54  | 0.0105   | 0.019  | 0.0245 | 0.030 |
| 6<br>Углекислая магнезитовая пыль       | 131                                       | 0.018  | 0.025  | 0.029  | 0.033 |
| 7<br>Хлопчатобумажное волокно           | 81  | 0.028  | 0.038  | 0.043  | 0.048 |
| 8<br>Шлаковая вата                      | 95  | 0.009  | 0.017  | 0.022  | 0.027 |
| 9<br>Асбестовое волокно                 | 470                                       | 0.072  | 0.117  | 0.127  | 0.132 |
| 10<br>Пробка                            | 107                                       | -  | -      | 0.026  | 0.032 |

1) Materials; 2) specific weight (kg/m<sup>3</sup>); 3) thermal conductivity coefficient (kcal/m-hour-°C) at an average temperature (°C); 4) crushed cork (grain size 3 mm); 5) diatomaceous earth (powder); 6) magnesium carbonate; 7) cotton fiber; 8) slag wool; 9) asbestos fiber; 10) cork.

To reduce radiant heat transfer use is made of screening additions of aluminum powder to the aerogel. However, vacuum screening insulation, the use of which substantially reduces the thermal conductivity, parti-

cularly when the reflecting layer is alternated with thin interlayers from glass fibers, is most efficient.

Heat insulating and sound absorbing materials are used in ship-building, motor vehicle building, in railroad transportation facilities, in aircraft and rocket construction, in satellites, space vehicles, heat, electric and atomic stations, etc.

References: Voprosy glubogo okhlazhdeniya [Deep Freezing Problems], Collection of [translated] articles, edited by M.P. Malkov, Moscow, 1961; Kaganer, M.G. and Glebova, L.I., Teploprovodnost' izolatsionnykh materialov pod vakuomom [Thermal Conductivity of Insulating Materials Under a Vacuum], "Kislород" [Oxygen], No. 1, 1959; Kitaytsev, V.A., Tekhnologiya teploizolyatsionnykh materialov [Technology of Heat Insulating Materials], 2nd Edition, Moscow, 1964; Faktorovich, L.M., Teploizolyatsionnyye materialy i konstruktsii [Heat Insulating Materials and Designs], Leningrad, 1957; Izdeliya iz steklyannogo volokna [Glass Fiber Products], Collection of technical specifications, Moscow, 1960.

Y.G. Nabatov

Manu-  
script  
Page  
No.

[Transliterated Symbols]

|      |   |
|------|---|
| 1824 | cp = sr = sredniy = average   |
| 1824 | TV = TU = tekhnicheskaya usloviya = technical specifications                                |
| 1824 | MJII = MLP = Ministerstvo legkoy promyshlennosti = Ministry of Light Industry               |
| 1825 | BTY = VTU = Vsesoyuznoye tekhnicheskoye usloviye = All-Union technical specification        |
| 1825 | MXII = MKhP = Ministerstvo khimicheskoy promyshlennosti = Ministry of the Chemical Industry |
| 1827 | MCH = MSP = Ministerstvo sredney promyshlennosti = Ministry of Medium Industry              |



III-23t13

- 1827 ГОСТ = GOST = Gosudarstvennyy obshchesoyuznyy standard = All-  
Union State Standard
- 1832 ЛП = LP = legkaya promyshlennost' = light industry
- 1832 ХСТ = zhst = zhguty steklyannyye teploizolyatsionnyye =  
glass heat-insulating packing cord

1836

HEAT CONDUCTION — process of heat transfer in a nonuniformly heated body, which is produced by the carrying of energy directly through the substance by the motion of individual molecules, atoms and electrons. (The macroscopic parts of the body remain here stationary.) The capacity of a substance to conduct heat by heat conduction is characterized by the thermal conductivity coefficient  $\lambda$  [kcal/m-hour-degree], which is the coefficient of proportionality between the thermal flux density vector  $\vec{q}$  [kcal/hour-m<sup>2</sup>] at any point and the temperature gradient  $\nabla t$  at the same point of the body:

$$\vec{q} = -\lambda \nabla t.$$

The term thermal flux density denotes the quantity of heat [kcal], carried per unit time [hour] through unit surface area [m<sup>2</sup>] perpendicular to the direction of  $\nabla t$ . The minus sign takes into account the fact that the thermal flux is always directed in the direction of decreasing temperatures. The relationship between  $\vec{q}$  and  $\nabla t$  expresses the experimental Fourier law, which comprises one of the fundamentals for description of thermal processes.

References: Livshits, B.G., Fizicheskiye svoystva metallov is splavov [Physical Properties of Metals and Alloys], Moscow, 1959; Mikryukov, V.Ye., Teploprovodnost' i elektroprovodnost' metallov is splavov [Thermal and Electric Conductivity of Metals and Alloys], Moscow, 1959; Rink, Teploprovodnost' [Heat Conduction], In the collection Tekhnika vysokikh temperatur [High-Temperature Techniques], under the general editorship of I.E. Campbell. Translated from English, Moscow, 1959; Kudryavtse, Ye.V., Chakalev, K.N. and Shumakov, N.V., Nestats-

III-25t1

ionarnyy teploobmen [Unsteady Heat Transfer], Moscow, 1961; Kutateladze, S.S., Osnovy teorii teploobmena [Fundamentals of the Heat Transfer Theory], Moscow-Leningrad, 1957; Teplotekhnicheskiy spravochnik [Heat Engineering Handbook], Vol. 1, Moscow-Leningrad, 1957.

B.G. Livshits, A.A. Yudin

HEAT INSULATION CERAMICS - are ceramic refractory materials destined for heat insulation at normal, elevated (to 1300-1500°), and high (to 1750-1800°) temperatures depending on the used raw material and the refractoriness. Heat insulation ceramics are characterized by an artificially increased porosity and by a low coefficient of the heat conductivity. Heat insulation ceramics are used in building and in refrigeration engineering; they are produced either by firing of natural low-melting clays to the state of swelling (ceramsite), or by artificial swelling and subsequent firing (foamed keralit). The weight by volume of heat insulation ceramics is 0.27-1.3 g/cm<sup>3</sup>, the ultimate compression strength is from 77 to 140 kg/cm<sup>2</sup>, the heat conductivity from 0.08 to 0.8 kcal/m·hr·°C. Porous refractories are used for the heat insulation of heat-engine assemblies. According to the production method, they are subdivided into foamed light-weight refractories and light-weight refractories with combustible admixtures. The designation (fireclay, kaolin, dinas, etc., refractories) depends on the raw material, and the porosity on the production method. Foamed light-weight refractories have a honeycomb structure with closed pores, a low gas-permeability and a high porosity. The physicomachanical properties of the main types of light-weight refractories are quoted in Table 1.

Porous light-weight products from pure oxides, carbides and other materials are used for insulation at high temperatures (the properties of these materials are listed in Table 2).

TABLE 1

Physicomechanical Properties of Light-Weight Refractories

| 1 Материал                                    | Объемный вес<br>2 (г/см <sup>3</sup> ) | Прочность<br>3 при сжатии<br>(кг/см <sup>2</sup> ) | Окислитель-<br>ная прочность<br>4 (°C) | Усадка при<br>1300° (°C)<br>5 | Термостабильность<br>6 (гемморфность)<br>см/мм | 7 Коэффициент температурного расширения (мм/м.град.°C) |       |       |       | 8 Температура<br>размягчения<br>(°C) |
|---|--|--|--|-------------------------------|--|--|-------|-------|-------|--------------------------------------|
|   |  |  |  |                               |  | 20°  | 200°  | 400°  | 800°  |                                      |
| Шпинель ультралегкая                          | 0.27-0.32                              | 7-10   | 1610-1730                              | 0.1-1.0                       | 1-2  | 0.088  | 0.121 | 0.179 | 0.218 | 1700                                 |
| Шпинель легкая                                | 0.34-0.41                              | 25-35  | 1610-1730                              | 0.1-1.5                       | 1-2  | 0.080  | 0.140 | 0.185 | 0.188 | 1700                                 |
| Шпинель сверхлегкая                           | 0.38-0.52                              | 24-31  | 1630-1710                              | 0.3-1.0                       | 2-12   | —  | 0.148 | 0.185 | 0.218 | 1700                                 |
| Ультралегкая шпинель                          | 0.43-1.05                              | 20-30  | 1670-1730                              | 0.3-1.0                       | 10-12  | —  | 0.187 | 0.274 | 0.358 | 1550                                 |
| Ультралегкая шпинель с<br>высокой пористостью | 0.93-1.05                              | 1673-1730  | 1673-1730                              | 0.7-1.2                       | 14-17  | 0.28-0.34  | —     | —     | —     | 1400                                 |
| Делювий                                       | 0.4-1.3                                | 25-140   | 1680-1700                              | 0.1-0.2<br>13 пункт           | 18   | 0.2-0.5  | —     | —     | —     | 1500-1550                            |

\* Heating up to 1300° and cooling in air to 20° up to a loss in weight of 20%.

1) Material; 2) weight by volume (g/cm<sup>3</sup>); 3) compression strength (kg/cm<sup>2</sup>); 4) refractoriness (°C); 5) additional shrinkage at 1300° (°C); 6) heat endurance\* (thermal shocks); 7) coefficient of the heat conductivity (kcal/m.hr.°C) at a temperature of; 8) temperature of operation (°C); 9) ultra light-weight fireclay; 10) foamed light-weight (argillaceous); 11) "chemical" light-weight materials; 12) foamed light-weight (fireclay); 13) light-weight refractories with combustible admixtures; 14) dinas; 15) increase; 16) low.

TABLE 2

Physicomechanical Properties of Light-Weight Refractories for High Temperatures

| 1 Свойства | Al <sub>2</sub> O <sub>3</sub>    |                                 | B <sub>2</sub> O                  |                                 | ZrO <sub>2</sub>                  |                                 |
|------------|-----------------------------------|---------------------------------|-----------------------------------|---------------------------------|-----------------------------------|---------------------------------|
|            | Объемный вес (г/см <sup>3</sup> ) | Пористость (г/см <sup>3</sup> ) | Объемный вес (г/см <sup>3</sup> ) | Пористость (г/см <sup>3</sup> ) | Объемный вес (г/см <sup>3</sup> ) | Пористость (г/см <sup>3</sup> ) |
| 2          | 0.70                              | 1.25                            | 1.6                               | 1.10                            | 1.6                               | 2.0                             |
| 3          | 80                                | 70                              | 40                                | 250                             | 50                                | 2.0                             |
| 4          | 120-156                           | 300-350                         | 350-400                           | 175-200                         | 300-350                           | 300                             |
| 5          | 40.0                              | 6.0                             | 2.0                               | 12                              | 16                                | 400                             |
| 6          | 245-0.83                          | 260-1.56                        | 246-3.35                          | 300-6.5                         | 250-0.4                           | 265-0.38                        |
| 7          | 500-0.75                          | 520-1.32                        | 570-2.57                          | 575-4.0                         | 200-0.43                          | 220-1.12                        |
| 8          | 945-0.65                          | 900-1.06                        | 870-1.87                          | 945-2.3                         | 232-0.44                          | 255-0.62                        |
| 9          | 1570                              | 1690                            | 1750                              | 1800                            | 1470                              | 1550                            |
| 10         | 5                                 | 15                              | 40                                | 40                              | 1-5                               | 1-3                             |
| 11         | 0.3                               | 0.1                             | 0.1                               | 0.5                             | 0.3                               | 0.3                             |

1) Properties; 2) weight by volume (g/cm<sup>3</sup>); 3) total porosity (%); 4) compression strength (kg/cm<sup>2</sup>); 5) gas-permeability (liter/m<sup>2</sup>.hr.mm water column); 6) heat conductivity (kcal/m.hr.°C); 7) softening temperature (°C); 8) heat endurance at 1000° (number of thermal shocks); 9) additional shrinkage at 1750° (%).

V. L. Balkevich

HEAT RESISTANCE (resistance to heating) - resistance of a material to the effect of heat. Usually the heat resistance of a material is evaluated on the basis of the temperature at which it undergoes various chemical and physical transformations (formation of gaseous and liquid products, change in color, etc.). Heat resistance determines the upper temperature limit of the service capabilities of the material. The heat resistance of polymers is evaluated on the basis of the temperature at which they begin to perceptibly decompose, on the basis of the decomposition products and the kinetics of the process.

HEAT RESISTANCE — the ability of a material to resist creep and destruction at high temperatures. Heat resistant materials must have a high long-life strength and resistance to creep; in many cases they must strongly resist mechanical fatigue, and, when used at changing temperatures, thermal fatigue also. The heat resistance may be combined with high values of internal friction of the material when resonance conditions are present. Resistance to oxidation, to corrosion and to wear are in many cases very significant factors characterizing the operating reliability at high temperatures. The temperature level of the heat resistance is mainly defined by the strength of the interatomic cohesion and the melting point of the material. Within a selected system, the structure of the alloy plays a decisive part.

S. I. Kishkina-Ratner

HEAT RESISTANCE OF ALLOYS - is the increased resistance of metal alloys to chemical reaction with air and other gases at high temperatures. The heat resistance is caused by the formation of a tight film of oxides (or other compounds) on the surface of the alloy, which adheres well to the metal and manifests a high resistance to the diffusion of active gases into the metal. Besides the basic metal, the components of the alloy can take part in the formation of the protective film, improving or impairing its protecting properties. The composition of the film and its structure may change depending on the temperature and the holding time at a given temperature.

The mechanical density of the oxide film is defined by the proportion of the molecular volume of the oxide to the volume of the equivalent quantity of metal atoms; the proportion must be equal to or greater than unit:  $\frac{M}{mD}$ , where  $M$  and  $D$  are the molecular weight and the density of the oxide, and  $m$  and  $d$  that of the metal. The resistance to diffusion through the oxide depends directly on its high-melting characteristic and also on the perfection of its crystal structure (the presence of defects facilitates the diffusion).

The rate of the oxidation through a tight film depends on the diffusion of the reacting components and decreases with increasing thickness of the oxide following a parabolic law:  $P = K_p t$ , where  $P$  is the degree of oxidation which can be characterized by the depth of the oxidation, the quantity of absorbed oxygen, or the quantity of formed oxides; it is determined by the increase or the loss in weight after the cinder has been removed, and is expressed in  $g/cm^2$  or  $g/m^2$ ;  $K_p$  is



I-3ZH1

the constant of the oxidation rate, depending on material and temperature;  $t$  is the time; the exponent  $n$  is greater than unit and depends on the diffusion penetrability of the oxide. In reality, this function has a more complex nature owing to the scaling of the cinder, which occurs from time to time due to the difference in the specific volume of the metal and oxide, being favorized also by the temperature changes inevitable during operation. Hence, for safety,  $n$  is often taken as equal to unit, and the mean oxidation rate is expressed in  $g/m^2 \cdot hr$ .

Practice has shown that materials with high heat resistance are characterized by an increase in weight of not more than  $0.5 g/m^2 \cdot hr$  within a test of 100 hours (e.g., Nichrome 80-20 at a temperature of  $1100^\circ$ ). Materials with a sufficient heat resistance are characterized by an increase in weight of  $0.1-1.0 g/m^2 \cdot hr$  (e.g., 1Kh18N9T stainless steel at  $950^\circ$ ). An increase in weight of more than  $1 g/m^2 \cdot hr$  indicates generally a low heat resistance.

The cindering process may be accelerated by the destruction of the low-plastic protective film when stresses causing deformation occur. In Table 1, the dependence of the degree of oxidation on the extent of the deformation and on the temperature in a 100 hours test is given for Nichrome 80-20 as an example.

TABLE 1  
Function of the Degree of  
Oxidation of Nichrome

| Темп-ра<br>испытания<br>(°C) | 2 Удлинение (%), вызывающее<br>ускоренное окисление |         |
|------------------------------|---|---------|
|                              | 1<br>3  | 4       |
| 1000                         | 5 Не менее 50                                       | 150-200 |
| 1100                         | • 15  | 70-100  |
| 1200                         | • 4   | 20-40   |

- 1) Test temperature ( $^\circ C$ );
- 2) elongation (in %) causing an accelerate oxidation;
- 3) first symptoms of oxidation; 4) through oxidation

of a 1.5 mm thick specimen; 5) not less than.

A classification of the principal heat resistant alloys is given in Table 2.

TABLE 2

Classification of the Principal Heat Resistant Alloys, Tensile Strength and Characteristic Grades

| 1  | 2 Легирование        |   | 3  | 4                 | 5  | 6  | 7 $\sigma_b$ (кг/мм <sup>2</sup> ) |         | 8   |
|----|----------------------|---|----|-------------------|--|----|------------------------------------|---------|---|
|    | элементы             | эффект                                  |    |                   |  |    | 900°                               | 1100°   |   |
| Fe | Cr                   | Повышение жаростойкости                 | 9  | 10 ОЦМ (феррит)   | Высокая до темп-ры 900-1100° жаростойкость от количества хрома | 11 | 1.0-2.7                            | 0.8-1.4 | 12 Kh17, Kh25, Kh28, Kh28AN**                             |
|    | Cr+Al<br>Cr+Al+Si    | То же                                   | 13 | 13 То же          | Высокая до темп-ры 1150-1250° жаростойкость от легирования     | 14 | 4.8                                | 1       | 15 Kh18Yu4, Kh17Yu5, Kh18Cu, OKh17Yu5, Kh25Yu5, OKh25Cu6  |
|    | Cr+Ni                | Повышение жаростойкости и жаропрочности | 16 | 17 ГЦМ (аустенит) | Высокая до темп-ры 900-1050° жаростойкость от легирования      | 18 | 7-9                                | 3.0     | 18 Kh18N9, Kh18N9T, Kh18N12T, Kh23N18, Kh23N13, Kh21N5T** |
|    | Cr+Ni+Si             | То же                                   | 13 | 13 То же          | 1100°  |    | 10                                 | 8       | 20 Kh20N14S2**, Kh25N20S2, Kh18N25S2                      |
| Ni | Cr+Ni+Mo, W и т. д.) | •                                       | •  | •                 | 1100°  |    | 10-10                              | 6-7     | 21 Kh25N16G7AR, Kh138VT, EP126                            |
|    | Cr                   | Повышение жаростойкости                 | 9  | ГЦМ 22            | 1100°  |    | 11                                 | 4-6     | 23 Kh170T, Kh170  |
|    | Cr+Al                | Повышение жаростойкости и жаропрочности | 16 | То же 13          | 1200°  |    | 10                                 | 6       | 24 Kh170D, Kh160D   |
|    | Cr+(W, Mo и т. д.)   | То же                                   | 13 | •                 | 1100°  |    | 10-13                              | 6-6     | 26 Kh175N5TD, Kh160D                                      |

\* OTsK = body-centered cube; GTSK = face-centered cube.  
\*\* Austenite + ferrite structure.

1) Base metal; 2) alloying; 3) elements; 4) effect; 5) crystalline structure; 6) heat resistance [temperature at which the oxidation rate is less than 1 g/m<sup>2</sup>·hr (determined by increase in weight)]; 7)  $\sigma_b$  (kg/mm<sup>2</sup>); 8) characteristic grades of steels and alloys; 9) increase in heat resistance; 10) OTsK (ferrite); 11) high up to a temperature of 900-1100°, depending on the chromium content; 12) Kh17, Kh25, Kh28, Kh28AN\*\*; 13) the same; 14) high up to a temperature of 1150-1250°, depending on the alloying; 15) Kh13Yu4, Kh17Yu5, Kh18Syu, OKh17Yu5, lKh17Yu5, lKh25Yu5, OKh25Yu5; 16) increase in heat resistance and heat proofness; 17) GTSK (austenite); 18) high up to a temperature of 900-1050°, depending on the alloying; 19) Kh18N9, Kh18N9T, Kh18N12T, Kh23N18, Kh23N13, lKh21N5T\*\*; 20) Kh20N14S2\*\*, Kh25N20S2, Kh18N25S2; 21) Kh25N16G7AR, KhN38VT, EP126; 22) GtsK

I-3ZH3

23) KhN78T, KhN70; 24) KhN70Yu, KhN60Yu; 25) etc.

M. Ya. L'vovskiy -

HEAT RESISTANCE OF PLASTICS ACCORDING TO SCHRAMM - is the ability of a plastic specimen to resist for 3 minutes the contact of a Silit rod heated to 950°. The dimensions (in mm) of the specimen are: length 120±0.2; width 15±0.2; thickness 3±0.2, and those of the Silit rod are: length 170±2, and diameter 7.7±0.1. The heat resistance of the specimen is characterized by the product of the burnt length of the specimen (in cm) and the loss in weight (in mg) and is expressed by the heat resistance number (see Table).

| 1 | Продукция мг<br>на см    | 2 | Число<br>устойчивости |
|---|--------------------------|---|-----------------------|
| 3 | Больше 100 000 . . . . . | 0 |                       |
|   | 100 000-10 000 . . . . . | 1 |                       |
|   | 10 000-1 000 . . . . .   | 2 |                       |
|   | 1 000-100 . . . . .      | 3 |                       |
|   | 100-10 . . . . .         | 4 |                       |
| 4 | Меньше 10 . . . . .      | 5 |                       |

1) Product of mg and cm; 2) heat resistance number; 3) more than; 4) less than.

M.S. Krol'

HEAT-RESISTANT ALUMINUM SHAPING ALLOYS - alloys distinguished by high strength characteristics, particularly fatigue strength and creep, at elevated temperatures. The heat-resistant aluminum shaping alloys include D16, D19, M40, VAD1, and VD17 in the Al-Cu-Mg system; AK2, AK4 and AK4-1 in the Al-Cu-Mg-Fe-Ni system; alloys D20 and VAD23 in the Al-Cu-Mn system; SAP-1 and SAP-2 in the Al-Al<sub>2</sub>O<sub>3</sub> system. For alloys D16, M40, D19 and VAD1, see Medium-strength aluminum shaping alloys; for alloys M40 and D20, see Welding aluminum shaping alloys; concerning alloys AK2, AK4, AK4-1 and VD17, see Aluminum forging alloys; for SAP-1 and SAP-2, see Sintered aluminum powder.

Alloy VAD23 possesses the highest strength characteristics at room and elevated (to 160-180°) temperatures, as well as in high-temperature holding for thousands of hours. However, it requires certain structural and technological measures because of its notch sensitivity under alternating load and its lower plasticity in the artificially aged state. At room temperature, alloy V95 has strength characteristics approaching those of VAD23, but it weakens rapidly above 100-120°.

Alloy D20 has relatively high strength characteristics at 200-300° and during long-term soaking. Below 160-180°, alloys D16, VD17, D19, M40 and VAD1 have lower strength characteristics than alloy VAD23, but they are less sensitive to notching under alternating load and more adaptable to production. Alloys D20, M40 and VAD1 are welded by argon-shielded arc. Alloys AK2, AK4 and AK4-1 are characterized by property isotropy and good hardenability; these alloys have high hot plasticity and high fatigue strength up to 200°.

Of all the heat-resistant aluminum shaping alloys, SAP-1 and SAP-2 have the highest strength characteristics at 300-500°, even when held at those temperatures for tens of thousands of hours. High corrosion resistance is characteristic for these alloys. The comparative mechanical properties, from tensile tests on sheets of several aluminum shaping alloys at elevated temperatures, together with comparative data on the fatigue strengths, are presented in Tables 1 and 2.

Alloys D20 and VAD23 differ from the other heat-resistant aluminum shaping alloys in that they do not contain as an alloying element. This gives them certain specific properties. They have a high hardening effect in tempering, undergo virtually no property changes during storage at room temperature (there is no natural aging effect), and alloy VAD23 is strengthened sharply as a result of artificial aging. As a result, alloys D20 and VAD23 are conveniently used in structures in the artificially aged state. In this state, however, these alloys, and VAD23 in particular, have low plasticity. Artificially aged VAD23 alloy can be subjected to only a few technological operations. In the tempered (naturally aged state), irrespective of time after tempering, and even more so in the annealed state, alloys D20 and VAD23 admit of complex technological deformation. Units must be riveted up from alloy VAD23 in the tempered (naturally aged) state of the VAD23 wire. Then the entire unit is given artificial aging. Alloys D20 and VAD23 may also be tempered in hot (boiling) water without loss of properties. Tempering in hot water makes it possible to deduce the internal stresses in the pieces and eliminate warpage during machining. Neither of the alloys has a tendency to corrode under stress in any of the semifinished forms or any of the heat-treatment states. In this respect they differ from alloy V95 (and other zinc-containing alloys) and from alloys D16 and AK8, which are sensitive to corrosion under stress in cer-

tain semifinished forms and certain heat-treatment states (see High-strength aluminum shaping alloys). However, alloys D20 and VAD23 have somewhat lower general corrosion resistance (as a result of their comparatively high copper contents). Bath and etching conditions for alloys D20 and VAD23 are selected to ensure a rapid process and a good surface state after precision etching.

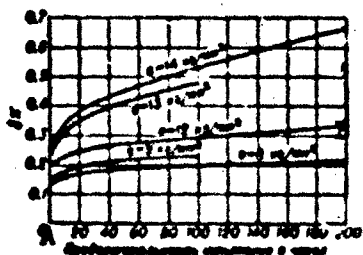

Fig. 1. Creep curves of D20 alloy at 200°. A) Test time in hours; B)  $\sigma = 8 \text{ kg/mm}^2$ .

Alloys D20 and VAD23 show high property stability at elevated temperatures and during prolonged holding at these temperatures; this accounts for their importance as heat-resistant aluminum shaping alloys. At room temperature, the strength characteristics of VAD23 semifinished products are higher than those of alloy V95 but somewhat lower than those of alloy V36. The strength of VAD23 alloy at 175° after 100 hours of holding is somewhat lower than the strength of D1 at room temperature. The specific gravity of VAD23 alloy is 6% lower than that of alloy V96, while its elastic modulus is markedly (6-7%) higher than those of all other aluminum alloys. All of these characteristics of alloy VAD23 render it a promising material. Large, hollow and flat ingots of practically any dimensions are cast from it, and semifinished products of the standard dimensions are extruded, rolled and forged from it. The strength under repeated static loading at room and elevated temperatures is higher for VAD23 than for V95 and somewhat than for D16 alloy. The same measures (structural and technological) should be taken in using VAD23 alloy to eliminate stress concentrators as in the case of V95 alloy. The properties of alloys D20 and VAD23 are given in Tables 3-9 and Figs. 1-7.

The corrosion resistance of D20 and VAD23 semifinished products is

TABLE 1

Elevated-temperature Tensile Properties of Sheets of Certain Shaping Alloys

| Temp. (°C) | A    | C D16T     |           |           | E D16T     |           |           | F D19T     |           |           | G VAD23    |           |           | H AK4-1    |           |           | I D20      |           |           | J SAP-1    |           |           |    |    |   |
|------------|------|------------|-----------|-----------|------------|-----------|-----------|------------|-----------|-----------|------------|-----------|-----------|------------|-----------|-----------|------------|-----------|-----------|------------|-----------|-----------|----|----|---|
|            |      | Temp. (°C) | Time (hr) | Yield (%) | Temp. (°C) | Time (hr) | Yield (%) | Temp. (°C) | Time (hr) | Yield (%) | Temp. (°C) | Time (hr) | Yield (%) | Temp. (°C) | Time (hr) | Yield (%) | Temp. (°C) | Time (hr) | Yield (%) | Temp. (°C) | Time (hr) | Yield (%) |    |    |   |
| 30         | -    | 32         | 44        | 14        | 44         | 30        | 10        | 44         | 30        | 10        | 44         | 30        | 0         | 44         | 30        | 14        | 44         | 30        | 14        | 30         | 10        | 20        | 21 | 1  |   |
| 100        | 0.5  | 48         | 41        | 14        | 41         | 20        | 14        | 41         | 20        | 14        | 41         | 20        | 0         | 41         | 20        | 14        | 41         | 20        | 14        | 30         | 10        | 20        | 21 | 1  |   |
|            | 10   | 48         | 42        | 14        | 42         | 20        | 14        | 42         | 20        | 14        | 42         | 20        | 0         | 42         | 20        | 14        | 42         | 20        | 14        | 30         | 10        | 20        | 21 | 1  |   |
|            | 1000 | 48         | 42        | 14        | 42         | 20        | 14        | 42         | 20        | 14        | 42         | 20        | 0         | 42         | 20        | 14        | 42         | 20        | 14        | 30         | 10        | 20        | 21 | 1  |   |
| 150        | 0.5  | 41         | 35        | 13        | 35         | 27        | 17        | 35         | 27        | 17        | 35         | 27        | 0         | 35         | 27        | 13        | 35         | 27        | 13        | 30         | 10        | 20        | 21 | 1  |   |
|            | 10   | 41         | 36        | 13        | 36         | 27        | 17        | 36         | 27        | 17        | 36         | 27        | 0         | 36         | 27        | 13        | 36         | 27        | 13        | 30         | 10        | 20        | 21 | 1  |   |
|            | 1000 | 41         | 36        | 13        | 36         | 27        | 17        | 36         | 27        | 17        | 36         | 27        | 0         | 36         | 27        | 13        | 36         | 27        | 13        | 30         | 10        | 20        | 21 | 1  |   |
| 175        | 0.5  | 37         | 32        | 12        | 32         | 25        | 17        | 32         | 25        | 17        | 32         | 25        | 0         | 32         | 25        | 12        | 32         | 25        | 12        | 30         | 10        | 20        | 21 | 1  |   |
|            | 10   | 37         | 33        | 12        | 33         | 25        | 17        | 33         | 25        | 17        | 33         | 25        | 0         | 33         | 25        | 12        | 33         | 25        | 12        | 30         | 10        | 20        | 21 | 1  |   |
|            | 1000 | 37         | 33        | 12        | 33         | 25        | 17        | 33         | 25        | 17        | 33         | 25        | 0         | 33         | 25        | 12        | 33         | 25        | 12        | 30         | 10        | 20        | 21 | 1  |   |
| 200        | 0.5  | 29         | 25        | 11        | 25         | 20        | 15        | 25         | 20        | 15        | 25         | 20        | 0         | 25         | 20        | 11        | 25         | 20        | 11        | 30         | 10        | 20        | 21 | 1  |   |
|            | 10   | 29         | 26        | 11        | 26         | 20        | 15        | 26         | 20        | 15        | 26         | 20        | 0         | 26         | 20        | 11        | 26         | 20        | 11        | 30         | 10        | 20        | 21 | 1  |   |
|            | 1000 | 29         | 26        | 11        | 26         | 20        | 15        | 26         | 20        | 15        | 26         | 20        | 0         | 26         | 20        | 11        | 26         | 20        | 11        | 30         | 10        | 20        | 21 | 1  |   |
| 250        | 0.5  | 18         | 12        | 10        | 12         | 10        | 11        | 12         | 10        | 11        | 12         | 10        | 0         | 12         | 10        | 10        | 12         | 10        | 10        | 30         | 10        | 20        | 21 | 1  |   |
|            | 10   | 18         | 12        | 10        | 12         | 10        | 11        | 12         | 10        | 11        | 12         | 10        | 0         | 12         | 10        | 10        | 12         | 10        | 10        | 30         | 10        | 20        | 21 | 1  |   |
|            | 1000 | 18         | 12        | 10        | 12         | 10        | 11        | 12         | 10        | 11        | 12         | 10        | 0         | 12         | 10        | 10        | 12         | 10        | 10        | 30         | 10        | 20        | 21 | 1  |   |
| 300        | 0.5  | 0.5        | 7         | 30        | 17         | 14        | 18        | 19         | 10        | 13        | 13         | 11        | 18        | 17         | 18        | 13        | 18         | 13        | 18        | 13         | 30        | 10        | 20 | 21 | 1 |
|            | 10   | 0.5        | 7         | 30        | 17         | 14        | 18        | 19         | 10        | 13        | 13         | 11        | 18        | 17         | 18        | 13        | 18         | 13        | 18        | 13         | 30        | 10        | 20 | 21 | 1 |
|            | 1000 | 0.5        | 7         | 30        | 17         | 14        | 18        | 19         | 10        | 13        | 13         | 11        | 18        | 17         | 18        | 13        | 18         | 13        | 18        | 13         | 30        | 10        | 20 | 21 | 1 |

A) Temperature (°C); B) holding time, (hours); C) V95T; D) kg/mm<sup>2</sup>; E) D16T; F) D19T; G) VAD23; H) AK4-1; I) D20; J) SAP-1; K) at.

TABLE 2

Fatigue Limit of Sheets of Certain Aluminum Alloys (kg/mm<sup>2</sup>)

| Temp. (°C) | A    | B          |           | C Alloy |      |       |       |     |       |       |  |
|------------|------|------------|-----------|---------|------|-------|-------|-----|-------|-------|--|
|            |      | Temp. (°C) | Time (hr) | D16T    | D19T | VAD23 | AK4-1 | D20 | SAP-1 | at    |  |
| 100        | 10   | 10         | 40        | 43      | -    | -     | -     | -   | -     | 0.11  |  |
|            | 100  | 10         | 30        | 39      | -    | -     | -     | -   | -     | 0.11  |  |
|            | 1000 | 10         | 30        | 34      | -    | -     | -     | -   | -     | 0.11  |  |
| 150        | 10   | 10         | 35        | 31      | 33   | -     | -     | -   | -     | 0.021 |  |
|            | 100  | 10         | 32        | 32      | 30   | -     | -     | -   | -     | 0.021 |  |
|            | 1000 | 10         | 31        | 31      | 28   | -     | -     | -   | -     | 0.021 |  |
| 200        | 10   | 10         | 30        | 18      | 24   | 19    | 18    | 18  | 14    | -     |  |
|            | 100  | 10         | 18        | 18      | 17   | 18    | 18    | 18  | 14    | -     |  |
|            | 1000 | 10         | 18        | 18      | 18   | 18    | 18    | 18  | 14    | -     |  |

\*The fatigue limit of SAP-1 is given for rods at temperatures of 350° (1) and 500° (2).

A) Test temperature (°C); B) test time (hours); C) alloy; D) D16T; E) V95T; F) D19T; G) D20; H) VAD23; I) SAP-1.



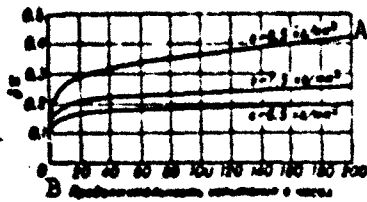

Fig. 2. Creep curves of D20 alloy at 250°. A) kg/mm<sup>2</sup>; B) test time in hours.

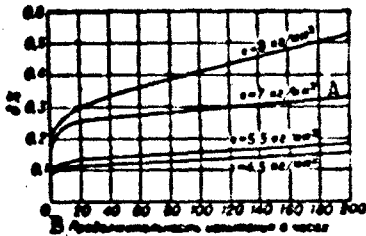

Fig. 3. Creep curves of D20 alloy at 300°. A) kg/mm<sup>2</sup>; B) test time in hours.

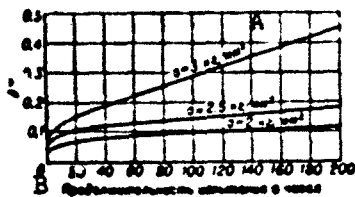

Fig. 4. Creep curves of D20 alloy at 350°. A) kg/mm<sup>2</sup>; B) test time in hours.

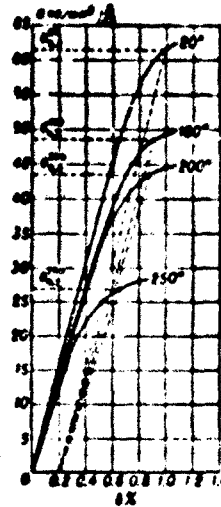

Fig. 5. Stress-strain diagrams to yield-point of VAD23 alloy at room and elevated temperatures. A) kg/mm<sup>2</sup>.

satisfactory. Alloy D20 exhibits high plasticity in the hot state. The forging and stamping temperature is 400-460°. Heat-treatment conditions: heating temperature for quenching 535 ± 5°; artificial aging at 165-175° for 10-16 hours (for parts working short-term) and for 12 hours at 200-220° (for parts working long-term). Alloy D20 may be used to fabricate forgings and stampings of complex shape, rolled sheets and extruded semi-finished products. It is used in loaded and welded-up structures operating at 200-

300°. Alloy VAD23 is quenched from 525° ± 5° and artificially aged at 170-180° for 16-12 hours. It is used to fabricate all forms of semi-finished products - sheets, plates, forgings, stampings, extruded products and wire. Alloy VAD23 is used for heavily stressed structures

TABLE 3  
Mechanical Properties of D20 and VAD23  
Alloys According to TU (no less than)

| Связь<br>A | Вид полуфабриката<br>B                                    | Состояние материала<br>C              | D (кг/мм <sup>2</sup> ) |                  | δ<br>(%) |
|------------|---|---------------------------------------|-------------------------|------------------|----------|
|            |   |                                       | σ <sub>в</sub>          | σ <sub>0.2</sub> |          |
| D20<br>E   | Листы плакированные всех толщин                           | Заваленные и искусственно состаренные | 28                      | 28               | 8        |
|            | Листы плакированные всех толщин                           | Заваленные<br>Отожженные              | 28<br>24                | —                | 12<br>15 |
| J          | Прессованные бруски                                       | Заваленные и искусственно состаренные | 28                      | 24               | 8        |
| K          | Прессованные профили (продольное направление)             | Заваленные и искусственно состаренные | 35                      | 24               | 8        |
| L          | Прессованные панели (продольное и поперечное направления) | Заваленные и искусственно состаренные | 38                      | 28               | 8        |
| VAD23<br>M | Прессованные полуфабрикаты N                              | Заваленные и искусственно состаренные | 55-58                   | 50-54            | 6        |
| O          | Листы плакированные                                       | Заваленные и искусственно состаренные | 54-58                   | 48-50            | 6        |

A) Alloy; B) form of semifinished product; C) state of material; D) kg/mm<sup>2</sup>; E) D20; F) clad sheets, all thicknesses; G) tempered and artificially aged; H) tempered; I) annealed; J) extruded rods; K) extruded shapes (longitudinal direction); L) extruded panels (longitudinal and transverse directions; M) VAD23; N) extruded semifinished products; O) clad sheets.

TABLE 4  
Typical Mechanical Properties of D20 and VAD23  
Alloys at 20°

| Связь<br>A | Вид полуфабриката<br>B        | Состояние<br>C                        | E G                |      |      | σ <sub>в</sub> σ <sub>0.2</sub> |     | σ <sub>0.1</sub> σ <sub>0.01</sub> |    | τ <sub>sp</sub> | σ <sub>-1</sub> |       |    |
|------------|-------------------------------|---------------------------------------|--------------------|------|------|---------------------------------|-----|------------------------------------|----|-----------------|-----------------|-------|----|
|            |                               |                                       | kg/mm <sup>2</sup> | D    | D    | D (кг/мм <sup>2</sup> )         | (%) | D (кг/мм <sup>2</sup> )            |    |                 |                 |       |    |
| D20<br>G   | Прессованные полуфабрикаты    | Заваленные и искусственно состаренные | I                  | 7200 | 2700 | 0.33                            | 48  | 25                                 | 40 | 12              | 35              | 30    | 7* |
|            | Поковки J                     | То же                                 | K                  | —    | —    | —                               | —   | —                                  | 43 | 17              | —               | —     | —  |
|            | Листы L                       | То же                                 | K                  | 6800 | —    | —                               | —   | —                                  | 30 | 40              | 18              | —     | —  |
| VAD23<br>M | Прессованные полуфабрикаты N  | То же                                 | 7800               | 2900 | 0.35 | 46                              | 34  | 60                                 | 5  | 14              | 30              | 8.5** |    |
|            | Листы толщиной от 0,8 до 5 мм | То же                                 | —                  | —    | —    | —                               | 50  | 35                                 | 5  | —               | —               | —     |    |
| O          |                               |                                       |                    |      |      |                                 |     |                                    |    |                 |                 |       |    |

\*Semicircular notch; α<sub>K</sub> = 2.0.

\*\*Semicircular notch; α<sub>K</sub> = 2.2.

A) Alloy; B) form of semifinished product; C) state; D) kg/mm<sup>2</sup>; E) σ<sub>pts</sub>; F) τ<sub>sp</sub>; G) D20; H) extruded semifinished products; I) tempering and artificial aging; J) forgings; K) same; L) sheets; M) VAD23; N) extruded semifinished products; O) sheets from 0.8 to 5 mm thick.

TABLE 5

Mechanical Properties of Semifinished Products Extruded from D20 Alloy at Low and Elevated Temperatures

| Температура<br>испытания<br>(°C) | B                       | b <sub>0.2</sub> | σ <sub>0.2</sub> | σ <sub>0.1</sub> | σ <sub>0.01</sub> | σ  |
|----------------------------------|-------------------------|------------------|------------------|------------------|-------------------|----|
|                                  | C (кг/мм <sup>2</sup> ) |                  |                  |                  | %                 |    |
| -70                              | —                       | —                | —                | 41               | 12                | 60 |
| 20                               | 8900                    | 19               | 25               | 40               | 12                | 25 |
| 150                              | 8950                    | 18               | 27               | 39               | 11                | 34 |
| 200                              | 8700                    | 16               | 21               | 38               | 12                | 34 |
| 250                              | 8700                    | 11               | 16               | 24               | 11                | 67 |
| 270                              | —                       | 9                | 15               | 22               | 10                | 70 |
| 300                              | 8000                    | 7                | 13               | 18               | 10                | 70 |
| 350                              | —                       | 6                | 9                | 12               | 10                | 68 |
| 400                              | —                       | 3                | 4                | 8                | 20                | 68 |

A) Test temperature (°C); B) σ<sub>pts</sub>; C) kg/mm<sup>2</sup>.

TABLE 6

Fatigue and Creep Limits for Extruded D20 Alloy Strips\*

| Температура<br>испытания<br>(°C) A | σ <sub>100</sub> | σ <sub>50</sub> | σ <sub>10</sub> | σ <sub>5</sub> | σ <sub>1</sub> | σ <sub>0.1</sub> | B По остаточной деформации |                      |
|------------------------------------|------------------|-----------------|-----------------|----------------|----------------|------------------|----------------------------|----------------------|
|                                    |                  |                 |                 |                |                |                  | σ <sub>0.2/100</sub>       | σ <sub>0.2/500</sub> |
| 200                                | 19.5             | 19.0            | 18.0            | 17.2           | 17.0           | —                | 12                         | 11.5                 |
| 250                                | 13.5             | 13.0            | 12.5            | 11.5           | 11.0           | 11.0             | 8                          | 7.5                  |
| 270                                | 11.0             | 10.5            | 10.0            | 10.0           | 9.9            | 9.9              | 7                          | 6.5                  |
| 300                                | 8.8              | 8.5             | 8.0             | 7.8            | 7.5            | 7.4              | 6.5                        | 6.0                  |
| 320                                | 7.8              | 7.2             | 6.0             | 5.6            | 5.5            | 5.7              | 5.0                        | 4.0                  |
| 350                                | 6.5              | 6.2             | 4.0             | 3.3            | 3.0            | 2.8              | 3.0                        | 2.7                  |

\*In kg/mm<sup>2</sup>.

A) Test temperature (°C); B) from residual deformation.

TABLE 7

Endurance and Creep Limits of Extruded VAD23 Alloy Rods

| Состояние материала<br>1                           | 2<br>Температура<br>испытания<br>(°C) | 3 (кг/мм <sup>2</sup> ) |                      |
|--|---------------------------------------|-------------------------|----------------------|
|  |                                       | σ <sub>100</sub>        | σ <sub>0.2/100</sub> |
| Залуженный и<br>использованный<br>состаренный<br>4 | 180                                   | 33                      | 22                   |
|  | 200                                   | 25                      | 18                   |
|  | 250                                   | 12.5                    | 9                    |

1) State of Material; 2) test temperature (°C); 3) (kg/mm<sup>2</sup>); 4) tempered and artificially aged.

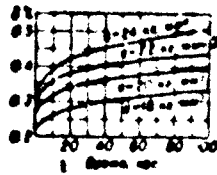

Fig. 6. Creep curves of VAD23 alloy at 180° (extruded rod). 1) Time, hours; 2) kg/mm<sup>2</sup>.

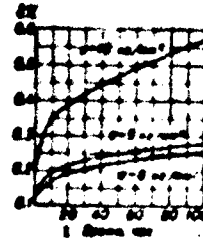

Fig. 7. Creep curves of VAD23 alloy at 250° (extruded rod). 1) Time, hours; 2) kg/mm<sup>2</sup>.

TABLE 8

Physical Properties of D20 and VAD23 Alloys

| №№№№ 1  | γ (g/cm <sup>3</sup> ) | λ (cal/cm·sec·°C) | ρ (ohm·mm <sup>2</sup> /m) | c (cal/g·°C) |
|---------|------------------------|-------------------|----------------------------|--------------|
| D20*    | 22.6 (20-100°)         | 0.23 (25°)        | 0.0010                     | —            |
|         | 24.7 (100-200°)        | 0.24 (100°)       |                            | —            |
|         | 27.3 (200-300°)        | 0.25 (200°)       |                            | —            |
|         | 29.2 (300-400°)        | 0.27 (300°)       |                            | —            |
|         |                        | 0.28 (400°)       |                            | —            |
| VAD23** | 24 (20-100°)           | 0.23 (100°)       | 0.0012 (25°)               | 0.23 (100°)  |
|         | 24.9 (20-200°)         | 0.25 (200°)       |                            | 0.25 (200°)  |
|         | 26 (100-200°)          | 0.27 (300°)       |                            | 0.26 (300°)  |
|         | 28.2 (200-300°)        | 0.28 (400°)       |                            | 0.28 (300°)  |
|         | 29.9 (300-400°)        |                   |                            | 0.31 (400°)  |

\*γ = 2.84 g/cm<sup>3</sup>.

\*\*γ = 2.72 g/cm<sup>3</sup>.

1) Alloy; 2) λ (cal/cm·sec·°C); 3) ρ (ohms·mm<sup>2</sup>/m);  
4) c (cal/g·°C); 5) D20\*; 6) VAD23\*\*.

working short- or long-term at temperatures up to 160-180°. VAD23-alloy rivets are used. When artificially aged material is being riveted, rivets made from D19 alloy are recommended.

Alloy D16 is recommended for stressed structures working below 180-200°, and alloys D19, VAD1 and M40 for loaded structures, including welded-up types, operating at elevated temperatures up to 250°. Alloys AK2, AK4 and AK4-1 are used for forged and stamped parts to work at elevated temperatures up to 250°. AK4-1 alloy sheet can be used efficiently with prolonged holding times up to 200°. SAP-1 and SAP-2 are used in structures working at 300-500°.

TABLE 9  
Mechanical Properties  
of Extruded VAD23 Al-  
loy Rods at Elevated  
Temperatures\*

| Test Temperature<br>(°C) | Heating time<br>(hours) | $\sigma_b$              | $\sigma_{0.2}$ | $\delta$<br>(%) |
|--------------------------|-------------------------|-------------------------|----------------|-----------------|
|                          |                         | C (kg/mm <sup>2</sup> ) |                |                 |
| 180                      | 0.5                     | 52                      | 48             | 6               |
|                          | 100                     | 47                      | 44             |                 |
|                          | 1000                    | 39                      | 34             |                 |
| 200                      | 0.5                     | 48                      | 44             | 4               |
|                          | 100                     | 40                      | 39             |                 |
|                          | 1000                    | 31                      | 27             |                 |
| 220                      | 0.5                     | 36                      | 27             | 4               |
|                          | 100                     | 22                      | 18             |                 |

\*At 20°:  $\sigma_b = 65$  kg/  
/mm<sup>2</sup>;  $\sigma_{0.2} = 61$  kg/mm<sup>2</sup>;  
 $\delta = 4\%$ .

A) Test temperature (°C);  
B) heating time (hours);  
C) (kg/mm<sup>2</sup>).

References: Romanova, O.A. Novyyzharoprochnyy deformiruyemyy al-  
yuminiyevyy splav D20 [The New D20 Heat-Resistant Aluminum Shaping Al-  
loy], Moscow, 1958; Archakova, Z.N., Romanova, O.A., Fridlyander, I.N.,  
Issledovaniye splavov sistemy Al-Cu-Li-Cd-Mn pri komnatnoy i povyshenn-  
ykh temperaturakh [Investigation of Alloys of the Al-Cu-Li-Cd-Mn System  
at Room and Elevated Temperatures], "IAN SSSR. OTN. Metallurgiya i top-  
livo," [Bulletin of the USSR Academy of Sciences, Technical Sciences  
Section, Metallurgy and Fuel], 1960, No. 4; — Mekhanicheskiye svo-  
stva teploprochnykh alyuminiyevykh splavov s litiyem i kadmiyem [Mech-  
anical Properties of Heat-Resistant Aluminum Alloys with Lithium and  
Cadmium], Ibid., 1962. No. 4.

I.N. Fridlyander, T.K. Ponar'ina

I-40a9

Manu-  
script  
Page  
No.

[Transliterated Symbols]

1853

nn = pts = proportsional'nost' proportionality

1853

cp = sr = srez = shear

1857

**HEAT-RESISTANT CAST IRON** - is a cast iron, the strength of which decreases only insignificantly at rising temperatures, thus allowing a long service of the cast iron at higher temperatures and, due to its sufficient chemical stability, also under the conditions of operation at high temperatures and aggressive media (oxidizing gases, etc.). Liftings and other objects working at higher temperatures are made of heat-resistant cast iron.

The strength of cast iron at higher temperatures is characterized not only by the results of creeping and endurance tests, similar to those of steel and nonferrous metals, but also by the results of bending and bending tests at elevated temperatures; the bending strength at an angle of deflection of  $10^\circ$  is defined as a characteristic of the heat resistance of cast iron. The tensile strength of gray iron increases insignificantly at temperatures up to  $400^\circ$ , it changes significantly, however, above  $500^\circ$  (Fig. 1). The high-strength iron with spheroidal graphite (see Magnesium-alloy cast iron) possesses a higher tensile and creeping strength than gray iron and malleable iron.

High-alloy iron grades with lamellar graphite in the structure, a. Ni-Resists, Silals, and Microsilals (see Corrosion-resistant cast iron, Alloyed cast iron) possess a higher heat-resistance, i.e., a higher bending strength (Fig. 2) and a higher creeping strength (Fig. 3) than the nonalloyed and low-alloy cast iron grades. Treatment of these cast irons with magnesium in order to form spheroidal graphite in their structure, further increases their heat resistance; this heat resistance can also be increased by addition of 1% Mo. The mechanical pro-

properties of heat resistant cast iron are quoted in the Tables 1-4.

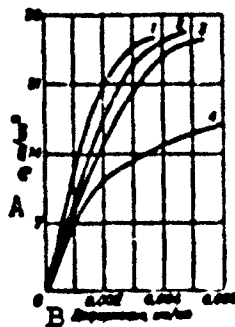

Fig. 1. Deformation vs. tensile strength curves of the short-time tensile tests of gray iron containing 2.9% C, 1.75% Si, and 1.15% Ni: 1) Test at 20°, fracture at 29.2 kg/mm<sup>2</sup>; 2) test at 230°, fracture at 27.2 kg/mm<sup>2</sup>; 3) test at 400°, fracture at 28.8 kg/mm<sup>2</sup>; 4) test at 540°, fracture at 18.6 kg/mm<sup>2</sup>. A)  $\sigma_b$ , kg/mm<sup>2</sup>; B) deformation, mm/mm.

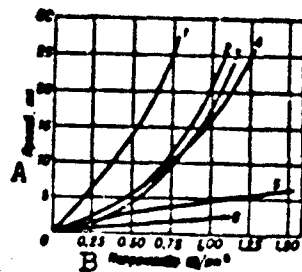

Fig. 2. Bending of cast iron and steel at 850°: 1) Steel; 2) gray iron; 3) high-phosphorus cast iron; 4) silicon cast iron, Silal (6.62% Si); 5) austenitic cast iron, Ni-Resist; 6) high-silicon cast iron (13.77% Si). A) Deflection, mm; B) stress, kg/mm<sup>2</sup>.

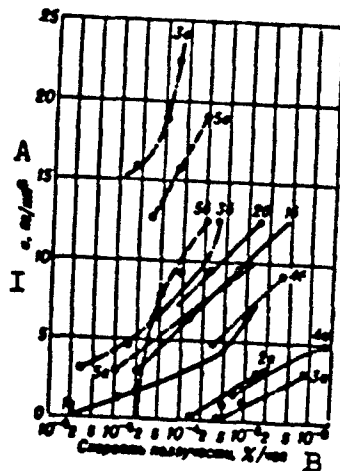

Fig. 3. Creeping strength of cast irons of different chemical composition: 1) Black cast iron; 2) low-alloy chrome-nickel iron; 3) Silal (6% Si); 4) Microsilal; 5) Ni-Resist: a) at 538°; b) at 450°; c) at 370°. I)  $\sigma$ , kg/mm<sup>2</sup>; II) creeping rate, % per hour.



**TABLE 1**  
**Strength of Different Cast Iron Grades at Short-Time and Long-Time (4000 hours) Tensile Tests**

| Чугун                       | 1 | 2) при кратковременных испытаниях (кг/мм <sup>2</sup> ) |      | 3) при длительных испытаниях (кг/мм <sup>2</sup> ) |      |
|-----------------------------|---|---|------|--|------|
|                             |   | 425°  | 500° | 425°   | 500° |
| Серый модифицированный      | 4 | 22.9  | 18.3 | 13.9   | 7.4  |
| Ковкий перлитно-ферритный   | 6 | 40.6  | 21.6 | 20.8   | 9.1  |
| Ферритный                   | 7 | 20.3  | 12.8 | 11.7   | 7.5  |
| Высокопрочный (магнелиевый) | 8 | 52.8  | 37.9 | 26.5   | 11.5 |
| перлитный                   |   | 35.4  | 22.4 | 22.2   | 8.8  |
| ферритный                   |   |   |      |  |      |

1) Cast iron; 2)  $\sigma_b$  at short-time tests (kg/mm<sup>2</sup>); 3)  $\sigma_b$  at long-time tests (kg/mm<sup>2</sup>); 4) gray, modified; 5) malleable; 6) pearlite-ferritic; 7) ferritic; 8) high-strength (magnesium-alloy).

**TABLE 2**  
**Creeping Strength of Gray and High-Strength (Magnesium-Alloy) Iron at 400°**

| Чугун                       | 1 | Время (час.) | 3) Напряжение, при котором достигается деформация (кг/мм <sup>2</sup> ) |      |      |
|-----------------------------|---|--------------|---|------|------|
|                             |   |              | 0.1%  | 0.2% | 3%   |
| Серый                       | 4 | 1000         | 7.7   | 9.7  | —    |
|                             |   | 5000         | 5.8   | 8.2  | —    |
| Высокопрочный (магнелиевый) | 5 | 1000         | 13.3  | 16.4 | 21.9 |
|                             |   | 5000         | 9.7   | 12.6 | 17.5 |

1) Cast iron; 2) time (hr); 3) stress (kg/mm<sup>2</sup>) at which the following deformation was obtained; 4) gray; 5) high-strength (magnesium-alloy).

TABLE 3

Comparison of the Creeping Rates and Creeping Strength of Malleable and High-Strength Cast Irons at 425°

| Чугун 1                                 | 2<br>Напряжение<br>(кг/мм <sup>2</sup> ) | 3<br>Скорость ползучести<br>(0.00001% в час) | 4<br>Предел ползучести<br>для скорости деформации<br>0.00001% в час (кг/мм <sup>2</sup> ) |
|---|--|--|---|
| Ковкий перлитно-ферритный 5             | 8.0<br>6.5                               | 4.62<br>1.39                                 | 0.1   |
| Ковкий ферритный 6                      | 8.0<br>6.5                               | 8.7<br>2.61                                  | 3.6   |
| Высокопрочный (магний-алло) перлитный 7 | 8.0<br>6.5                               | 1.17<br>0.36                                 | 7.8   |
| Высокопрочный (магний-алло) ферритный 8 | 8.0<br>6.5                               | 1.43<br>0.34                                 | 7.8   |

1) Cast iron; 2) stress (kg/mm<sup>2</sup>); 3) creeping rate (0.00001% per hr);  
 4) creeping strength at a deformation rate of 0.00001% per hr (kg/mm<sup>2</sup>);  
 5) malleable, pearlite-ferritic; 6) malleable ferritic; 7) high-strength (magnesium-alloy) pearlitic; 8) high-strength (magnesium-alloy) ferritic.

TABLE 4

Heat Resistance of High-Alloy Iron Grades (Ni-Resists) with Spheroidal Graphite

| 1<br>Хим. сост.<br>сплав<br>(%) | 2<br>Температура<br>Тестирования (°C) | 3<br>Экспериментальная прочность |                     | 4<br>Время до разрушения (1000 ч) | 5<br>Предел ползучести (кг/мм <sup>2</sup> ) |
|---------------------------------|---------------------------------------|----------------------------------|---------------------|-----------------------------------|--|
|                                 |                                       | σ <sub>0.2</sub>                 | σ <sub>0.0001</sub> |                                   |  |
| 6 (кг/мм <sup>2</sup> )         |                                       |                                  |                     |                                   |  |
| 20 Ni.<br>3 Cr                  | 20                                    | 42.0                             | 24.5                | —                                 | —  |
|                                 | 125                                   | 38.2                             | 19.5                | —                                 | —  |
|                                 | 510                                   | 33.5                             | 19.5                | 19.5                              | 6.5  |
|                                 | 650                                   | 25.0                             | 17.5                | 8.5                               | 2.5  |
|                                 | 705                                   | —                                | —                   | 6.0                               | 1.5  |
| 760                             | 16.0                                  | 12.6                             | 1.0                 | —                                 |  |
| 20 Ni.<br>3 Cr.<br>1 Mo         | 20                                    | 43.5                             | 26.5                | —                                 | —  |
|                                 | 510                                   | 26.0                             | 20.5                | —                                 | 12.5   |
|                                 | 650                                   | 27.0                             | 14.5                | 11.0                              | 4.5  |
|                                 | 705                                   | —                                | —                   | 7.5                               | 2.5  |
|                                 | 760                                   | 17.5                             | 12.0                | 6.5                               | —  |
| 30 Ni.<br>3 Cr                  | 20                                    | 41.5                             | 24.0                | —                                 | —  |
|                                 | 510                                   | 34.0                             | 20.0                | —                                 | —  |
|                                 | 650                                   | 29.5                             | 19.5                | 10.5                              | —  |
|                                 | 705                                   | —                                | —                   | 7.0                               | —  |
|                                 | 760                                   | 18.5                             | 11.0                | 4.5                               | —  |
| 30 Ni.<br>3 Cr.<br>1 Mo         | 20                                    | 43.0                             | 28.5                | —                                 | —  |
|                                 | 510                                   | 38.0                             | 20.0                | —                                 | 15.0   |
|                                 | 650                                   | 31.0                             | 20.5                | 12.5                              | 5.5  |
|                                 | 705                                   | —                                | —                   | 7.5                               | 3.5  |
|                                 | 760                                   | 20.5                             | 15.5                | 5.0                               | —  |
| 30 Ni.<br>3 Cr.<br>3 Si         | 20                                    | 45.0                             | 31.5                | —                                 | —  |
|                                 | 510                                   | 43.0                             | 29.5                | —                                 | —  |
|                                 | 650                                   | 36.0                             | 24.0                | 6.5                               | —  |
|                                 | 705                                   | —                                | —                   | 4.5                               | —  |
|                                 | 760                                   | 19.5                             | 13.0                | 2.0                               | —  |

1) Chemical composition of the cast iron (%); 2) test temperature (°C); 3) short-time tests; 4) endurance (1000 hours); 5) creeping strength (at 0.00001% per hour); 6) kg/mm<sup>2</sup>.

References: Hall, A.M., *Nikel' v chugune i stali* [Nickel in Cast Iron and Steel], translated from English, Moscow, 1959; Girshovich, N.G., *Sostav, i svoystva chugna* [Composition and Properties of Cast Iron], in the book: *Spravochnik po chugunному lit'yu* [Handbook on Iron Casting], 2nd Edition, Moscow-Leningrad, 1960; Dovgalevskiy, Ya.M., *Otlivki iz chugunov s osobymi fizicheskimi svoystvami* [Iron Castings with Special Physical Properties], in the book: *Spravochnik po mashinostroitel'nym materialam* [Handbook on Machine-Building Materials], Vol. 3, Moscow, 1959; Everest, A.B., *Nickel, O.*, "Foundry Trade J.," 1960,

III-iOch5

Vol. 108, No. 2264, pages 515-522; Grilliat, J. and Poirot, R., "Fonderie" [Casting], 1960, No. 178, pages 449-461; Towers, I.A., "BCJRA Journal," 1960, Vol. 8, No. 3, pages 422-424.

A.A. Simkin

HEAT RESISTANT LACQUER AND PAINT COATINGS are coatings which are capable of withstanding the action of temperature above 100° for a definite time without noticeable deterioration of the physical-mechanical and anticorrosion properties or of the external appearance. The heat resistance of the coating depends on the nature of the film-forming agent, the pigments and the fillers. The majority of the polymers, with heating in the presence of atmospheric oxygen, are subject to thermo-oxidative destruction, as a result of which two processes occur: decomposition of the polymer molecules with the formation of molecules of smaller size (products of oxidation and splitting of the polymer) and structuring - the formation of molecules of three-dimensional structure. These processes cause deterioration of the properties of the heat-resistant coatings. Depending on the nature of the film-forming agent the coatings may stand up for long periods under the following conditions (approximately): nitrocellulosic and perchlorvinyl coatings at 80-90°, ethyl cellulosic at 100°, alkyd using drying oils at 120-150°, alkyd using semidrying oils at 200°, phenol-butyric, polyacrylic and polystyrene at 200°, epoxy at 230-250°, polyvinyl butyralic at 250-280°, bitumen-butyric-resinous at 200°, polysilicone, depending on the resin type, at 350-400-550°. As pigments in the heat resistant enamels, use is made of carbon black (to 350°), titanium white, green chromium oxide, strontium chrome, cadmium and cobalt compounds, zinc dust, aluminum powder and stainless steel powder. The fillers are mica, talc and asbestos. The preparation of the surface of the metal to be painted has a considerable effect on the heat resistance of the coatings. The

II-55k1

roughness, the presence of oxide, oxide-phosphate, oxide-chromate films provides for better adhesion of the coating, which is particularly important for the use of the siloxane enamels. The following are used for the preparation of the surface: dry sand blast cleaning (average roughness 14 microns), and hydro sand blast cleaning (roughness 9-10 microns) in combination with subsequent phosphatization or passivation. The method of preparation of the surface is determined by the form of the metal, the construction or type of detail being painted, the operating temperature and the form of the lacquer/paint material. For example, steel details fabricated from the low-alloy steels of the S-10, S-45, ZOKhGSA types and others which are used at temperatures to 400° are subjected to hydro sandblasting cleaning with subsequent treatment in a zinc phosphate bath. Good results are obtained by treating with iron grit or by oxide phosphatization. Steels of the SN-2, EI-65<sup>4</sup>, 1Kh18NGT and other types are subjected to hydro sandblast treatment with subsequent passivation or etching with passivation. Steel articles which are heated during operation above 400° are subjected to hydro sandblast treatment with subsequent passivation. The aluminum alloys are usually anodized in a sulfuric acid bath (thickness of the oxide film is 5-8 microns). The magnesium alloys are chemically oxidized (thickness of the oxide film 2-3 microns) or anodized in an alkaline bath (thickness of film 10-15 microns).

The heat resistant lacquer/paint coatings are applied in 2-3 layers. The priming coat must contain a passivating pigment, particularly for the aluminum and magnesium alloys. The following coatings are used: alkyd, epoxy, bitumen-butyric-resinous, polyvinyl butyralic and polysiloxane.

Satisfactory protection of articles from the action of temperatures above 200° over long periods is provided by the heat-resistant

II-55k2

coatings based on pentone, the polycarbonates, the fluorine-containing and silicone polymers modified by certain other polymers.

References: Drinberg A.Ya., Gurevich Ye.S., Tikhomirov A.V., Tekhnologiya nemetallicheskih pokrytiy [Technology of Nonmetallic Coatings], L., 1957; Lyubimov B.V., Spetsial'nyye lakokrasochnyye pokrytiya v mashinostroyeni [Special Lacquer and Paint Coatings in Machine Construction], M.-L., 1959; Organic Protective Coatings, coll. of articles transl. from Eng., M.-L., 1959.

V.V. Chebotarevskiy

HEAT RESISTANT TITANIUM SHAPING ALLOYS - alloys with an ultimate strength of not less than  $75-80 \text{ kg/mm}^2$  at a temperature of  $400^\circ$ , which are subjected to hot shaping, i.e., forging, stamping, pressureworking, etc. Are distinguished by an elevated ultimate and satisfactory creep strength at temperatures up to  $450-550^\circ$  and also by their high corrosion resistance. Among heat resistant titanium shaping alloys are the VT3-1, VT8 and VT9 alloys. For the chemical composition see the article Titanium alloys. Heat resistant titanium shaping alloys are used for making semifinished products, i.e., forgings, stampings, bar stock, etc. Square and round cross section forgings and stampings are produced (AMTU 368-62) with a side (diameter) from 30 to 250 mm, as well as pressed bar stock (AMTU 487-62) with a square side (diameter) from 15 to 200 mm and rolled bar stock (AMTU 451-59) with a square side (diameter) from 10 to 60 mm. The mechanical properties of the forgings and stampings in the annealed state are given in Table 1.

TABLE 1

Mechanical Properties of Forgings and Stampings from Heat Resistant Titanium Shaping Alloys

| Case  | 1 | 2              | TV | 3       | 6, 1, 9 |    | 4 | 5       |
|-------|---|----------------|----|---------|---------|----|---|---------|
|       |   |                |    |         | (%)     |    |   |         |
|       |   |                |    | 3       | 6       |    | 5 |         |
| VT3-1 | 7 | AMTY 368-11-62 |    | 105-125 | 9       | 30 | 3 | 3.3-3.5 |
| VT8   | 8 | AMTY 368-1-62  |    | 100-120 | 10      | 25 | 3 | 3.3-3.7 |

1) Alloy; 2) TU; 3) ( $\text{kg/mm}^2$ ); 4) ( $\text{kgm/cm}^2$ ); 5) ( $d_{\text{otp}}$ , mm); 6) not more than; 7) VT; 8) AMTU.

The mechanical properties of rolled and pressed bar stock in the annealed state are the same as for forgings and stampings. Typical



mechanical properties of heat resistant titanium shaping alloys at various temperatures are given in Tables 2 and 3.

TABLE 2

Mechanical Properties of VT3-1, VT8 and VT9 Alloys (Bar Stock, Forgings, Stampings) at Various Temperatures

| Temper (°C) | $\sigma_b$ (kg/mm <sup>2</sup> ) 1 |     |     | $\sigma_{0.2}$ (kg/mm <sup>2</sup> ) 2 |     |     | $\delta_5$ (%) |     |     | $\beta$ (kg/mm <sup>2</sup> ) |     |     | $H_{0.2}$ (kg/mm <sup>2</sup> ) |     |     | $\sigma_{-1}$ (kg/mm <sup>2</sup> ) |     |     |    |    |
|-------------|------------------------------------|-----|-----|--|-----|-----|----------------|-----|-----|-------------------------------|-----|-----|---------------------------------|-----|-----|-------------------------------------|-----|-----|----|----|
|             | VT3-1                              | VT8 | VT9 | VT3-1                                  | VT8 | VT9 | VT3-1          | VT8 | VT9 | VT3-1                         | VT8 | VT9 | VT3-1                           | VT8 | VT9 | VT3-1                               | VT8 | VT9 |    |    |
| -196        | 183                                | 175 | —   | —                                      | —   | —   | 5              | 2   | —   | —                             | —   | —   | —                               | —   | —   | —                                   | —   | —   |    |    |
| -70         | 123                                | 148 | —   | —                                      | —   | —   | —              | —   | —   | —                             | —   | —   | —                               | —   | —   | —                                   | —   | —   |    |    |
| 20          | 107                                | 115 | 100 | 92                                     | 103 | 93  | 10             | 8   | 12  | —                             | —   | 7   | 6                               | 3.6 | 3.5 | 5                                   | 50  | 56  | 68 |    |
| 100         | 96                                 | 106 | —   | 84                                     | —   | —   | —              | —   | —   | —                             | —   | —   | —                               | —   | —   | —                                   | —   | —   | —  |    |
| 200         | 86                                 | 95  | 91  | 71                                     | —   | —   | —              | —   | —   | —                             | —   | —   | —                               | —   | —   | —                                   | —   | —   | —  |    |
| 300         | 83                                 | 92  | 84  | 69                                     | 74  | 66  | —              | —   | —   | —                             | —   | —   | —                               | —   | —   | —                                   | —   | —   | —  |    |
| 400         | 77                                 | 85  | 78  | 63                                     | 72  | 63  | —              | —   | —   | —                             | —   | —   | —                               | —   | —   | —                                   | —   | 51  | 43 | 39 |
| 500         | 72                                 | 80  | 70  | 57                                     | 66  | 56  | —              | —   | —   | —                             | —   | —   | —                               | —   | —   | —                                   | —   | 41  | 44 | 37 |
| 550         | 68                                 | 78  | —   | 51                                     | —   | —   | —              | —   | —   | —                             | —   | —   | —                               | —   | —   | —                                   | —   | —   | —  | —  |
| 600         | 60                                 | 72  | 53  | 41                                     | 55  | 23  | —              | —   | —   | —                             | —   | —   | —                               | —   | —   | —                                   | —   | —   | —  | —  |

\*The endurance limit was determined in uniform flexure of a rotating specimen for  $2 \cdot 10^7$  cycles.

1) Temperature (°C); 2) (kg/mm<sup>2</sup>); 3)  $\tau_{sr}$  (kg/mm<sup>2</sup>); 4) (kg/cm<sup>2</sup>).

TABLE 3

Creep Resistance (on the Basis of 0.2% Residual Deformation) and Creep Strength\* of the VT3-1, VT8 and VT9 Alloys (Bar Stock, Stampings and Forgings)

| Temper (°C) | $\sigma_{0.2, 1000}$ |     |       |     |     |       | $\sigma_{cr}$ |     |       |    |
|-------------|----------------------|-----|-------|-----|-----|-------|---------------|-----|-------|----|
|             | VT8                  | VT9 | VT3-1 | VT8 | VT9 | VT3-1 | VT8           | VT9 | VT3-1 |    |
| 400         | —                    | —   | 31    | 37  | —   | 30    | —             | 73  | —     | 65 |
| 450         | —                    | —   | 17    | 23  | —   | 16    | —             | 65  | —     | 55 |
| 500         | —                    | 24  | 31    | 17  | 12  | 28    | 5             | 60  | 45    | 43 |
| 550         | —                    | —   | 13    | —   | —   | —     | —             | 41  | 38    | 45 |
| 600         | —                    | —   | —     | —   | —   | —     | —             | —   | 23    | —  |

\*The 1000 hour creep strength for the VT3-1 alloy comprises 70 kg/mm<sup>2</sup> at 200°, 65 kg/mm<sup>2</sup> at 300°, 55 kg/mm<sup>2</sup> at 400°, 50 kg/mm<sup>2</sup> at 450° and 27 kg/mm<sup>2</sup> at 500°.

1) Temperature (°C); 2) VT; 3) (kg/mm<sup>2</sup>).

TABLE 4  
Change in the Ultimate Strength of VT3-1 and VT8 Alloys under Load

| 1<br>Case | 2<br>Temp-ре<br>(°C) | 3<br>Время под нагрузкой<br>(сек.)    |     |     |
|-----------|----------------------|---------------------------------------|-----|-----|
|           |                      | 10                                    | 100 | 300 |
|           |                      | 4<br>$\sigma_1$ (кг/мм <sup>2</sup> ) |     |     |
| VT3-1     | 0°                   | 55                                    | 47  | 42  |
|           | 700                  | 35                                    | 25  | 20  |
|           | 800                  | 17                                    | 10  | 7   |
| VT8       | 0°                   | 72                                    | 62  | 57  |
|           | 700                  | 47                                    | 36  | 25  |
|           | 800                  | 25                                    | 17  | 12  |

1) Alloy; 2) temperature (°C); 3) time held under load (seconds); 4) (kg/mm<sup>2</sup>); 5) VT.

TABLE 5  
Physical Properties of the VT3-1 Alloy

| Temp-ре (°C)               | 1 | 20     | 100     | 200     | 300     | 400     | 500     | 600   | 700   | 800   | 900   |
|----------------------------|---|--------|---------|---------|---------|---------|---------|-------|-------|-------|-------|
| $\lambda$ (кал/см·сек·°C)  | 2 | 0.018  | 0.020   | 0.023   | 0.027   | 0.030   | 0.033   | 0.027 | 0.040 | 0.044 | 0.047 |
| $\epsilon$ (кал/г·°C)      | 3 | —      | 0.12    | 0.13    | 0.14    | 0.14    | 0.15    | 0.16  | —     | —     | —     |
| Интервал темп-ре (°C)      | 4 | 20-100 | 100-200 | 200-300 | 300-400 | 400-500 | 500-600 |       |       |       |       |
| $\alpha \cdot 10^6$ (1/°C) |   | 9.9    | 9.8     | 10.2    | 10.6    | 11.3    | 12.7    |       |       |       |       |

1) Temperature (°C); 2)  $\lambda$  (cal/cm·sec·°C); 3)  $\epsilon$  (cal/g·°C); 4) temperature interval (°C).

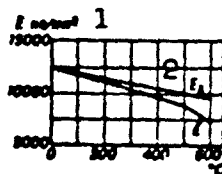

The moduli of elasticity of heat resistant titanium shaping alloys as a function of the test temperature. 1) Kg/mm<sup>2</sup>; 2) E<sub>d</sub>.

Heat resistant titanium shaping alloys are not sensitive to stress concentration in tension in the presence of a sharp notch ( $\alpha_K = 4.5$ ). At room temperature  $\sigma_{-1} \approx 0.5 \sigma_b$ . When the temperature is raised to 500°,  $\sigma_{-1}$  is reduced by approximately 20%. The figure shows the temperature dependence of the dynamic and static moduli of elasticity of heat resistant titanium shaping alloys. The Poisson's ratio for these alloys

comprises 0.33-0.34. The change in the ultimate strength under short duration loads is given in Table 4.

Heat resistant titanium shaping alloys have a satisfactory heat resistance. Prolonged holding (100 and more hours) at 450-500° results in a certain reduction in the plasticity characteristics. Thus, after the VT8 alloy is held at 500° for 100 hours,  $\psi$  is decreased from 40 to 20%,  $a_n$  is reduced from 4 to 3 kgm/cm<sup>2</sup>, while  $\sigma_b$  and  $\delta$  practically do not change.

Heat resistant titanium alloys have the following specific gravities:

| Alloy    | VT8  | VT9  | VT3-1 |
|----------|------|------|-------|
| $\gamma$ | 4.47 | 4.51 | 4.50  |

The physical properties of the VT3-1 alloy are given in Table 5.

The thermal conductivity, specific heat and linear expansion coefficient of the VT8 and VT9 alloys are close to the corresponding properties of the VT3-1 alloy. The specific electrical resistivity (at 20°) of the VT8 and VT9 alloys comprises 1.61, for the VT3-1 alloy it is 1.58 ohm·mm<sup>2</sup>/m.

All the three alloys have a high corrosion resistance in the majority of aggressive media (see Titanium). The production process for making semifinished products, i.e., forgings, stampings, bar stock, from these alloys is as follows: heating of ingots or billets is performed in ordinary electric furnaces with an air atmosphere or in muffle furnaces, heated by gas, petroleum or diesel oil in a slightly oxidized atmosphere (to avoid hydrogenation of the metal). The temperature range for pressureworking is 1100-850° for the VT8 alloy; 1150-900° for the VT9 alloy and 1050-850° for the VT3-1 alloy.

The time during which ingots or billets are kept in the furnace when heated for forging must be limited. Billets with a diameter from

10 to 60 mm should be kept in the furnace for not more than 50-60 min, those with a diameter from 60 to 150 mm should be kept for 60-90 min, while those with diameters from 150 to 400 mm should be held not more than 90-240 min. Ingots and billets with a diameter higher than 350 mm are first heated at 800-850° to prevent the formation of cracks and failure due to high thermal stresses. Ingots and billets with a smaller diameter (or thickness) can also be preheated at 800-850°.

Cast billets are first forged by weak impacts until the degree of deformation reaches 20-30% and then by stronger impacts. To obtain forged and stamped semifinished products use is made of preshaped blanks. Intermediate heating is permitted in the forging and stamping processes. The optimum degree of deformation between heatings and intermediate heatings is 50-70%. If the production of the semifinished products requires a smaller degree of deformation (20-25%), then the heating (or intermediate heating) temperature must be reduced by 50-100°. For small degrees of deformation (finishing of bar stock, insignificant finish stamping, straightening) the intermediate heating temperature should be reduced by another 100-150°.

The regimes and technology for machining (turning, milling, drilling, etc.) of titanium alloys of a given group are similar to those used in machining stainless steels.

Heat resistant titanium shaping alloys are satisfactorily welded by resistance welding methods, and also by molten slag arcless electric welding and submerged arc welding. Welding must be followed by heat treatment to restore the plasticity of the welded joint.

The alloys of this group are heat treated (annealed) in order to increase their post-shaping plasticity and improve the thermal stability, i.e., the ability to retain unchanged mechanical properties under the action of working stresses and temperatures. Double annealing: at

920° and then at 590° for 1 hour is recommended for the VT8 alloy. Double annealing: at 950° and at 530° for 6 hours is also recommended for the VT9 alloy. The VT3-1 alloy is annealed at 870° and then at 650° for 2 hours. The heating time when annealing the alloys depends on the component or semifinished product dimensions. In addition, the VT3-1, VT8 and VT9 alloys can be subjected to hardening heat treatment, i.e., quench hardening and aging which, however, has not yet come into industrial use (see Heat treatment of titanium alloys).

Semifinished products from the VT8, VT9 and VT3-1 alloys are used for making components operating at temperatures up to 450° (the VT3-1 alloy), up to 500° (the VT8 alloy) or up to 550° (the VT9 alloy), for example, rotors and blades of engine compressors.

References: see at the end of article Titanium alloys.

S.G. Glazunov, V.N. Moiseyev and Yu.S. Danilov

Manu-  
script  
Page  
No.

[Transliterated Symbols]

|      |  |
|------|--|
| 1867 | TY = TU = tekhnicheskiye usloviya = technical specifications |
| 1867 | otn = otp = otpechatka = impression                          |
| 1868 | cp = sr = srez = shear                                       |
| 1869 | d = d = dinamicheskiy = dynamic                              |

HEAT-TREATABLE SPRING STEEL -- steel hardenable by quenching and tempering and having high elasticity and durability; it is used in the manufacture of elastic elements, spring components, and springs. Steels of this type can be classified as carbon steels, which contain 0.6-1.05% carbon, or alloy steels, which contain 0.46-0.74% carbon. Heat-treatable spring steel is alloyed with silicon, manganese, and chromium; these elements raise its elastic limit and improve its temperability. Steel alloyed with tungsten, vanadium, and nickel is used in the manufacture of springs for especially critical applications. Silicon, silicon-tungsten, and chromium-nickel steels withstand impact loads well. Carbon and particularly chromium-vanadium steels have the highest fatigue strength.

TABLE 1  
Mechanical Characteristics of  
Strips (according to GOST  
2614-55)

| 1 группа прочности | 2 $\sigma_s$<br>(кг/мм <sup>2</sup> ) | 3 $\delta$ на базе<br>200 мм<br>(%, не менее) | 4 HV<br>(кг/мм <sup>2</sup> ) |
|--------------------|---------------------------------------|---|-------------------------------|
| 4 1П               | 130-160                               | 4   | 375-485                       |
| 5 2П               | 161-190                               | 2.5   | 480-600                       |
| 6 3П               | >190                                  | 2   | >600                          |

1) Strength group; 2) kg/mm<sup>2</sup>; 3)  $\delta$  based on 200 mm (%; no less than);  
4) 1P; 5) 2F; 6) 3P.

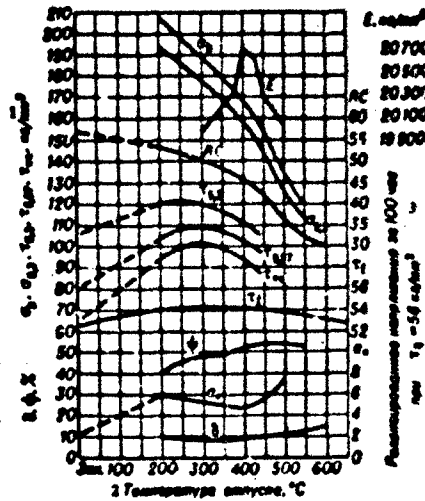

Fig. 1. Physicommechanical characteristics of 50KhFA steel as a function of tempering temperature. 1) kg/mm<sup>2</sup>; 2) tempering temperature, °C; 3) stress relaxed over 100 hr at  $\tau_0 = 56$  kg/mm<sup>2</sup>.

TABLE 2  
Durability of Certain  
Types of Heat-Treatable  
Spring Steel

| 1<br>Сталь | 2 $\sigma_b$<br>(кг/мм <sup>2</sup> ) | 3 Состояние<br>поверхности<br>образца   | $\sigma_{-1}$ | $\tau_{-1}$ |
|------------|---------------------------------------|---|---------------|-------------|
| 45СГ       | 146                                   | 12 Полированная   | 61,5          | —           |
| 55ХГ       | 131                                   | 12 То же  | 64            | —           |
| 60С2ВА     | 219                                   | 13 Зачищена наждач-<br>ной бумагой  | —             | 31,2        |
| 76СГ       | —                                     | 12 Полированная (НН =<br>420 кг/мм <sup>2</sup> )   | 66            | —           |
| 85С2       | 130                                   | 13 Зачищена наждач-<br>ной бумагой  | 50            | 30          |
| 98С2       | 140                                   | 12 То же  | 50            | 30          |
| 1050ХФА    | 180                                   | 14 Неполірованная<br>(НН = 471 кг/мм <sup>2</sup> )<br>Полированная<br>(НН = 677 кг/мм <sup>2</sup> ) | 50            | 30          |
|            |                                       |   | 67            | —           |

1) Steel; 2) kg/mm<sup>2</sup>; 3) surface condition of specimen; 4) 55SG; 5) 50KhG; 6) 60S2VA; 7) 65G; 8) 55S2; 9) 60S2; 10) 50KhFA; 11) polished; 12) the same; 13) cleaned with emery paper; 14) unpolished.

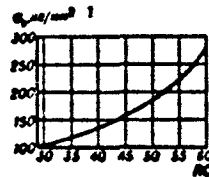

Fig. 2. Ultimate tensile strength of steel as a function of hardness. 1) kg/mm<sup>2</sup>.

Heat-treatable spring steel is produced in the hot-rolled and annealed states, in the form of bars, strips, bands, and wire. The standards provide for a bar diameter of 5-50 mm (0.2-25 mm for silver steel), a strip thickness of 0.08-3 mm, a round-wire diameter of 0.5-14 mm, and a square- and rectangular-wire thickness of 0.6-6 mm.

Strips are produced in accordance with GOST 2283-57 and GOST 2614-55 from steel of types U7A, U8A, U9A, U10A, 85, 65G, 60S2, 60S2A, 50KhFA, and 65S2VA; Table 1 shows the mechanical characteristics of strips as a function of strength group.

The chemical composition of heat-treatable spring steel of types U7A, U8A, U9A, and U10A is given by GOST 1435-54, that of types 65, 70, 75, 85 and 65G is given by GOST 1050-60, and that of types 55GS, 55S2, 60S2A, 70S3A, 50KhGA, 50KhFA, 60S2KhFA, 60S2KhA, 60S2VA, 65S2VA, and 60S2N2A is given by GOST 2052-53. The mechanical characteristics of all these heat-treatable spring steels are given by GOST 2052-53.

Figure 1 shows the character of the variation in the physicomechanical characteristics of heat-treatable spring steel as a function of tempering temperature, using 50KhFA steel as an example.

Carbon and low-alloy heat-treatable spring steels are characterized by a monotonic decrease in hardness as tempering temperature rises.

Different types of heat-treatable spring steel with the same hardness after tempering have almost the same ultimate tensile strength (Fig. 2). As their hardness increases ( $RC > 50$ ) the tendency of high-strength heat-treatable spring steels to undergo delayed fracture under the action of a constant applied stress becomes stronger. In the majority of cases delayed fracture of springs is caused by fine superficial or internal cracks. Cracking occurs during manufacture of the wire or quenching of the springs and as a result of etching and hydro-



gen absorption during cadmium-plating, zinc-plating, or application of other coatings. High requirements must consequently be imposed on the quality of the wire and of the surface of the working turns of the spring.

TABLE 3

Heat-Treatment Regimes for Coiled and Flat Springs

| 1 Сталь            | 2 Режим-ре (°C)      |           | RC    | 3<br>(кг/мм <sup>2</sup> ) | 4<br>H <sub>В</sub><br>H <sub>С</sub> | 5<br>H <sub>В</sub><br>H <sub>С</sub> |
|--------------------|----------------------|-----------|-------|----------------------------|---------------------------------------|---------------------------------------|
|                    | 3 закалка<br>в масле | 4 отпуски |       |                            |                                       |                                       |
| 6У7А               | 770-820              | 350-420   | 42-46 | —                          | —                                     | —                                     |
| 7У8А, У9А,<br>У10А | 770-790              | 350-420   | 44-48 | —                          | —                                     | —                                     |
| 8С5П               | 800-820              | 340-380   | 44-48 | —                          | —                                     | —                                     |
| 960С2А, 60С2       | 830-860              | 430-480   | 48-50 | 160-185                    | 0,41                                  | 0,44                                  |
| 1070С3А, 70С3      | 830-870              | 430-500   | 48-50 | 160-175                    | 0,42                                  | 0,44                                  |
| 1150С1А            | 830-860              | 430-480   | 48-50 | 160-175                    | 0,43                                  | 0,45                                  |
| 1260С1А            | 830-860              | 430-500   | 48-50 | 160-180                    | 0,44                                  | 0,46                                  |
| 1380С2А            | 830-860              | 430-500   | 48-50 | 160-180                    | 0,44                                  | 0,46                                  |
| 1480С2Н2А          | 830-860              | 390-425   | 48-50 | 160-180                    | 0,44                                  | 0,46                                  |

1) Steel; 2) temperature (°C); 3) quenching in oil; 4) tempering; 5) kg/mm<sup>2</sup>; 6) У7А; 7) У8А, У9А, У10А; 8) 60С; 9) 60С2А, 60С2; 10) 70С3А, 70С3; 11) 50ХНФА; 12) 60С2ВА; 13) 60С2ВА; 14) 60С2Н2А.

It is wise to quench and temper helical and flat springs to a hardness of 46-50 RC.

The principal methods for hardening springs and increasing their resistance to cyclic loads are hydroabrasive treatment, shot-blasting, and oriented cold-working, the latter being carried out by loading coiled springs under stresses exceeding the elastic (proportional) limit of the steel. The cyclic strength of the steel can be considerably increased by nitriding.

The permissible calculated stresses for springs should be selected in accordance with the type of steel, loading conditions (static or dynamic), service life, design, and type of spring.

Depending on operating conditions, springs are cadmium- and zinc-plated or oxidized in order to provide corrosion protection.

References: Sergiyevskaya, T.V., Ressorno-pruzhinnyye stali [Spring Steels], in book: Spravochnik po mashinostroitel'nyim materialam

III-123p4

[Handbook of Machine-Building Materials], Vol. 1, Moscow, 1959; Avtomobil'nyye konstruktsionnyye stali. Spravochnik [Automobile Structural Steels. A Handbook], Moscow, 1951; Metallovedeniye i termicheskaya obrabotka stali i chuguna [Metalworking and Heat Treatment of Steel and Pig Iron], Handbook, Moscow, 1956; Spravochnik metallista [Metalworker's Handbook], Vol. 2, Moscow, 1958; Shmykov. A.A., Spravochnik termista [Handbook for Heat-Treatment Workers], 2nd Edition, Moscow, 1961.

A.L. Selyavo

HEAT TREATMENT HARDENABLE TITANIUM ALLOYS - alloys whose strength can be substantially increased by heat treatment (as a rule, quench hardening and artificial aging). The strength increase is obtained by retaining metastable phases by quenching with subsequent decomposition of these phases in the aging process. Several types of heat treatment hardenable titanium alloys with the  $\alpha + \beta$  structure exist; basically two of them have come into industrial use: 1) "martensite" type alloys, which are hardened due to the decomposition of the metastable  $\beta$  and  $\alpha'$  ( $\alpha''$ ) phases (titanium martensite). This group includes, for example, the VT14 and VT16 alloys; 2) alloys with a metastable  $\beta$  phase, for example, VT15, which is quenched to the  $\beta$  phase both by rapid cooling (in water) and by slow cooling, for example, in air. Isothermal heating at the aging temperature results in the decomposition of the  $\beta$  phase with a precipitation of the disperse  $\alpha$  phase, which is accompanied by a sharp increase in strength (see Titanium alloys).

The majority of industrial titanium alloys with the  $\alpha + \beta$  structure: VT3, VT3-1, VT6, VT6S, VT8 have their strength increased to one or another degree by heat treatment. However, heat treatment of the VT14, VT15 and VT16 high-alloy alloys is most effective; these alloys are used primarily for making sheet metal semifinished products (sheets, ribbons, strips), and also forgings, stampings, bar stock, etc.

Sheets, ribbons and strips from the VT15 and VT16 alloys are clad by the VT1-0 or VT1-1 commercial titanium for protection from selective oxidation in the process of heating attendant to hot pressureworking and heat treatment, as well as from hydrogenation when the sheets

are etched in an acid bath. The cladding layer from soft titanium promotes increasing the plasticity and improve the surface finish of the sheets. Components from clad metal operate reliably in designs. Cladding is performed by hermetic welding of a titanium sheet to the slab (along the perimeter) and subsequent rolling by the ordinary production process methods. The thickness of the cladding layer (after rolling) comprises 3-5% of the thickness of the nonclad sheet per side.

TABLE 1

Properties of Heat-Treatment-Hardenable Titanium Alloys at Various Temperatures

| Температура (°C)               | $\sigma_b$              | $\sigma_{0.2}$ | $\sigma_{пл}$ 2 | $\delta$ | $\delta$ (%) | $\alpha_H$ ° (кг/см <sup>2</sup> ) |
|--------------------------------|-------------------------|----------------|-----------------|----------|--------------|------------------------------------|
|                                | 4 (кг/мм <sup>2</sup> ) |                |                 |          |              |                                    |
| 5 Сплав ВТ14 (лист 1,5-5,0 мм) |                         |                |                 |          |              |                                    |
| -70                            | 130-150                 | 120-135        | —               | —        | 2,0-3,5      | 1,8-2,5                            |
| 20                             | 115-140                 | 108-130        | 85-108          | 11000    | 8-10         | 2,5-3,5                            |
| 350                            | 85-100                  | 73-80          | 53-60           | 8900     | 3,5-6,0      | —                                  |
| 400                            | 80-95                   | 68-75          | 45-55           | 8700     | 4-6          | —                                  |
| 450                            | 75-90                   | 60-70          | 40-50           | 8500     | 4-6          | —                                  |
| 500                            | 70-78                   | 50-60          | 30-40           | 8700     | 6-10         | —                                  |
| 6 Сплав ВТ15 (лист 1,5-2,0 мм) |                         |                |                 |          |              |                                    |
| -70                            | 150-165                 | —              | —               | —        | —            | 1,5-2,0                            |
| 20                             | 130-150                 | 118-140        | 100-120         | 11000    | 3,0-4,5      | 2,8-3,8                            |
| 300                            | 120-130                 | 105-120        | 80-100          | 10000    | 4-5          | —                                  |
| 400                            | 110-120                 | 100-115        | 84-90           | 9500     | 4-5          | —                                  |
| 500                            | 100-110                 | 80-80          | 45-55           | 7500     | 4-6          | —                                  |
| 7 Сплав ВТ16 (лист 1,5-2,0 мм) |                         |                |                 |          |              |                                    |
| -70                            | 135-150                 | —              | —               | —        | 4-6          | 4-6                                |
| 20                             | 125-145                 | 110-125        | 85-100          | 10000    | 4-6          | 4-6                                |
| 300                            | 91-98                   | 81-80          | 50-67           | 9000     | 3-6          | —                                  |
| 350                            | 90-95                   | 79-85          | 50-60           | 8700     | 4-6          | —                                  |
| 400                            | 89-94                   | 77-82          | 50-54           | 8200     | 4-6          | —                                  |
| 450                            | 80-87                   | 63-68          | 38-40           | 8000     | 5-6          | —                                  |
| 500                            | 78-80                   | 52-57          | 25-28           | —        | 6-8          | —                                  |

\*For bar stock.

1) Temperature (°C); 2) pts; 3) (kgm/cm<sup>2</sup>); 4) (kg/mm<sup>2</sup>); 5) VT14 alloy (sheet 1.5-5.0 mm); 6) VT15 alloy (sheet 1.5-2.0 mm); 7) VT16 alloy (sheet 1.5-2.0 mm).

The VT14, VT15 and VT16 alloys are recommended for components subjected to high loads made from sheets, forgings and stampings. The VT14 and VT16 alloys can be used for fasteners subjected to shear and also for welded designs.

The properties of heat-treatment hardenable VT14, VT15 and VT16 alloys are given in Table 1.

Sheets from the VT14 and VT16 alloys have, correspondingly, the

following properties in the annealed state:  $\sigma_b = 80-95$  kg/mm<sup>2</sup> and 80-95 kg/mm<sup>2</sup>,  $\sigma_{0.2} = 65-76$  kg/mm<sup>2</sup> and 35-50 kg/mm<sup>2</sup>,  $\sigma_{11.2} = 7-14\%$  and 12-17%,  $a_p = 6-12$  kg/cm<sup>2</sup> and 10-15 kg/cm<sup>2</sup>. The higher plasticity of the VT16 alloy in the annealed state is also characterized by the greater bending angle: when  $r = 1.5 \delta$  ( $\delta$  is the thickness) sheets from the VT16 alloy ( $\delta = 10$  mm) have a bending angle of 80°, while sheets from the VT14 alloy ( $\delta = 3.5$  mm) have a bending angle of 40°, and for  $\delta = 4-5$  mm their bending angle is 30°. In the annealed state and for close values of the ultimate strength of the three alloys ( $\sigma_b = 80-95$  kg/mm<sup>2</sup> for VT16, 90-100 kg/mm<sup>2</sup> for VT15, 95-105 kg/mm<sup>2</sup> for VT14) the VT14 and VT16 alloys are distinguished by a low yield point ( $\sigma_{0.2} = 65-76$  kg/mm<sup>2</sup> for VT14 and  $\sigma_{0.2} = 35-50$  kg/mm<sup>2</sup> for VT16), which is due to the martensitic decomposition of the  $\beta$  phase of the quench hardened VT15 alloy is stable under load and such a phenomenon is not observed. The VT16 and VT15 alloys in the form of bar stock have endurance limits (based on  $2 \cdot 10^7$  cycles) of 52 and 50 kg/mm<sup>2</sup>, respectively. Sheets from these alloys have a substantially lower fatigue strength ( $\sigma_{-1} = 36$  kg/mm<sup>2</sup> for VT16, 44 kg/mm<sup>2</sup> for VT14) which, apparently, is due to the surface finish.

The heat resistant characteristics of heat-treatment-hardenable titanium alloys are given in Tables 2 and 3.

The VT14 and VT16 alloys can in certain cases be used for making of bolts instead of the 30KhGSA steel. Bolts from the VT14 and VT16 alloys are by 40% lighter than steel bolts. Heat treated to  $\sigma_b \geq 110$  kg/mm<sup>2</sup>, they have the same tensile properties as steel bolts and are somewhat superior to them with respect to shear strength (Table 4).

Bolts made from the VT14 and VT16 alloys are not liable to cross-thread and do not show tendencies toward retarded brittle failure.

TABLE 2  
Creep Strength, Creep Resistance and Endurance of Heat-Treatment Hardenable Titanium Alloys

| Температура (°C) 1             | 2 (кг/мм <sup>2</sup> ) |                |                |
|--------------------------------|-------------------------|----------------|----------------|
|                                | $\sigma_{0.01}$         | $\sigma_{0.1}$ | $\sigma_{0.5}$ |
| 3 Сплав ВТ14 (лист 1.5-5.0 мм) |                         |                |                |
| 350                            | —                       | 53             | —              |
| 400                            | 68                      | 35             | 38             |
| 450                            | 54                      | —              | —              |
| 4 Сплав ВТ15 (лист 1.5-2.0 мм) |                         |                |                |
| 350                            | 95                      | 53             | 50**           |
| 400                            | 74                      | —              | —              |
| 500                            | 35                      | —              | 48**           |
| 5 Сплав ВТ16 (лист 1.0-5.0 мм) |                         |                |                |
| 300                            | 80                      | 70             | 38             |
| 350                            | 80                      | 60             | 38             |
| 400                            | 57                      | 27             | 39**           |

\*On the basis of  $2 \cdot 10^7$  cycles.

\*\*Bar stock.

1) Temperature (°C); 2)  $\text{kg/mm}^2$ ; 3) VT14 alloy (sheet 1.5-5.0 mm) 4) VT15 alloy (sheet 1.5-2.0 mm); 5) VT16 (sheet 1.0-5.0 mm).

TABLE 3  
Change in the Ultimate Strength Under Load of Heat-Treatment-Hardenable Titanium Alloys

| Температура (°C) 1             | 2 Время нагружения (сек.) |     |     |     |     | 3   |
|--------------------------------|---------------------------|-----|-----|-----|-----|-----|
|                                | 30                        | 60  | 90  | 150 | 300 |     |
| 4 Сплав ВТ14 (лист 1.5-5.0 мм) |                           |     |     |     |     |     |
| 300                            | —                         | —   | —   | —   | —   | 110 |
| 400                            | 102                       | —   | —   | —   | —   | 100 |
| 500                            | 78                        | —   | 70  | 68  | —   | 84  |
| 600                            | 48                        | 44  | 40  | 34  | —   | 30  |
| 700                            | 23                        | 18  | 14  | 12  | —   | 10  |
| 5 Сплав ВТ15 (лист 1.5-2.0 мм) |                           |     |     |     |     |     |
| 300                            | —                         | —   | —   | —   | —   | 125 |
| 400                            | —                         | —   | —   | —   | —   | 130 |
| 500                            | —                         | 105 | 103 | 100 | —   | 98  |
| 600                            | —                         | 48  | 43  | 38  | —   | 33  |
| 700                            | —                         | 15  | 12  | 12  | —   | 12  |
| 6 Сплав ВТ16 (лист 1.0-2.0 мм) |                           |     |     |     |     |     |
| 300                            | 92                        | —   | 81  | —   | —   | 89  |
| 600                            | 63                        | —   | 56  | —   | —   | 51  |
| 700                            | 33                        | —   | 27  | —   | —   | 22  |
| 800                            | 17                        | —   | 13  | —   | —   | 10  |

1) Temperature (°C); 2) load application time (sec); 3)  $\text{kg/mm}^2$ ; 4) VT14 alloy (sheet 1.5-5.0 mm); 5) VT15 alloy (sheet 1.5-2.0 mm); 6) VT16 alloy (sheet 1.0-2.0 mm).

TABLE 4

Properties of Bolts from Titanium Alloys as Compared with Steel Bolts

| 1<br>Резьба   | 2<br>Разрушающая нагрузка при растяжении (кг) |      |        | 3<br>Разрушающая нагрузка при сдвиге (кг) |           |             |
|---------------|---|------|--------|---|-----------|-------------|
|               | VT14  | VT16 | 30X1CA | 4<br>VT14                                 | 5<br>VT16 | 6<br>30X1CA |
| M6 . . . . .  | 2110  | 2140 | 2110   | 2020                                      | 2130      | 1970        |
| M8 . . . . .  | 3800  | 3850 | 3800   | 3620                                      | 3800      | 3500        |
| M10 . . . . . | 6000  | 6100 | 6000   | 5650                                      | 5900      | 5490        |

1) Thread; 2) tensile breaking load (kg); 3) shearing breaking load (kg); 4) VT14; 5) VT16; 6) 30KhGSA.

Following are the properties of VT14, VT15 and VT16 alloys in the heat-treatment hardened state:

| Alloy                           | VT14 | VT15 | VT16 |
|---------------------------------|------|------|------|
| $\gamma$                        | 4.52 | 4.89 | 4.68 |
| $\rho$ (ohm-mm <sup>2</sup> /m) | -    | 1.55 | 1.11 |

The thermal conductivity, specific heat and linear expansion coefficients are given in Table 5.

The VT14, VT15 and VT16 have a high corrosion resistance to a majority of aggressive media (see Titanium). The VT14 and VT16 have a good and the VT15 has a satisfactory plasticity in the hot state. The technology of hot pressureworking and the heating regimes for ingots or billets are the same as for other titanium alloys (see Heat resistant titanium shaping alloys).

It is recommended that the VT15 be heated in furnaces with a protective atmosphere. The forging temperature range is 1150-850°, the hot rolling temperature is 1000°, the warm rolling temperature is 850-700°. The alloy can be cold rolled and cold sheet pressworked with a degree of deformation of 50-80%.

The VT14 alloy is sensitive to overheating, for which reason the

temperature range for its pressureworking must be strictly kept. The temperature range for forging or hot rolling of ingots is 1050-850°, the temperature for forging components from blanks is 930-750° (the  $\alpha + \beta$  range) with a degree of deformation of not less than 40-60%. The VT14 alloy is warm rolled at 750-550°. Cold stamping and rolling in several passes with a total degree of deformation of 40-60% is permitted.

TABLE 5  
Physical Properties of Heat-Treatment-Hardenable Titanium Alloys

| Class 1 | 2 Temp-ра исслывания (°C)   |       |       |       |       |       |       |       |       |       |
|---------|-----------------------------|-------|-------|-------|-------|-------|-------|-------|-------|-------|
|         | 25                          | 100   | 200   | 300   | 400   | 500   | 600   | 700   | 800   | 900   |
|         | 3 $\lambda$ (кал/см·сек·°C) |       |       |       |       |       |       |       |       |       |
| BT14 4  | 0.020                       | 0.022 | 0.025 | 0.028 | 0.031 | 0.033 | 0.037 | 0.040 | 0.044 | 0.048 |
| BT15    | -                           | 0.019 | 0.023 | 0.027 | 0.031 | 0.035 | 0.039 | 0.048 | 0.048 | 0.052 |
| BT16    | 0.025                       | 0.026 | 0.029 | 0.032 | 0.035 | 0.038 | 0.040 | 0.043 | 0.047 | 0.051 |
|         | 5 $c$ (кал/г·°C)            |       |       |       |       |       |       |       |       |       |
| BT14    | -                           | 0.12  | 0.13  | 0.14  | 0.15  | 0.16  | 0.17  | 0.20  | 0.24  | -     |
| BT15    | -                           | 0.12  | 0.13  | 0.14  | 0.15  | 0.16  | 0.17  | 0.18  | 0.19  | -     |
| BT16    | -                           | 0.11  | 0.12  | 0.13  | 0.14  | 0.16  | 0.17  | 0.19  | 0.20  | -     |
|         | $\alpha \cdot 10^4$ (1/°C)* |       |       |       |       |       |       |       |       |       |
| BT14    | -                           | 8.0   | 8.2   | 8.5   | 8.8   | 8.9   | 8.6   | 8.8   | 9.1   | 8.8   |
| BT15    | -                           | 9.1   | 9.3   | 9.5   | 9.7   | 9.2   | 8.0   | 8.4   | 8.6   | 8.8   |
| BT16    | -                           | 9.1   | 9.4   | 9.7   | 9.9   | 10.0  | 9.6   | 9.7   | 10.1  | -     |

\*When heated from 20° to the specified temperature.

1) Alloy; 2) test temperature (°C); 3)  $\lambda$  (cal/cm·sec·°C); 4) VT; 5)  $c$  (cal/g·°C).

The VT16, as the VT14, alloy is sensitive to overheating and a strict adherence to the temperature regime in pressureworking is necessary. The ingots should be forged and hot rolled in the temperature range of 1000-800°, components should be forged in the range of 850-700° ( $\alpha + \beta$  range) with a degree of deformation of not less than 40-60%. The warm rolling temperature is 700-500°. Cold sheet stamping and rolling in several passes with a total degree of deformation of not less than 40-60%. The warm rolling temperature is 700-500°. Cold sheet



stamping and rolling in several passes with a total degree of deformation of 50-70% is permitted.

TABLE 6

Properties of Welded Joints of Heat-Treatment-Hardenable Titanium Alloys\*

| Силав<br>1 | Состояние сварного соединения<br>2                                  | Угол загиба (град.)<br>3 |                            | σ <sub>b</sub> (кг/мм <sup>2</sup> )<br>4 |                       |
|------------|---|--------------------------|----------------------------|---|-----------------------|
|            |   | ОСНОВНОЙ<br>МЕТАЛЛ<br>5  | СВАРНОЕ<br>СОЕДИНЕНИЕ<br>6 | ОСНОВНОЙ<br>МЕТАЛЛ                        | СВАРНОЕ<br>СОЕДИНЕНИЕ |
| BT14<br>8  | После сварки без термич. обработки 7                                | 50-60                    | 25-40                      | 94-102                                    | 95-100                |
|            | Отжиг при 800-850° в течение 15 мин.; охлаждение на воздухе 9       | 55-65                    | 45-60                      | 92-100                                    | 94-101                |
|            | Закалка с 870±10° в воде; старение при 520±10° в течение 16 час. 10 | 25-30                    | 20-27                      | 120-130                                   | 110-130               |
| BT15       | После сварки без термич. обработки                                  | 70-120                   | 40-150                     | 90-94                                     | 91-97                 |
| BT16       | После сварки без термич. обработки                                  | 60-100                   | 70-120                     | 85-95                                     | 87-95                 |
|            | Закалка с 780±10° в воде; старение при 520±10° в течение 12 час. 11 | 35-45                    | 30-40                      | 125-135                                   | 107-120               |

\*Sheet 1-3 mm thick.

1) Alloy; 2) state of the welded joint; 3) bending angle (degrees); 4) (kg/mm<sup>2</sup>); 5) base metal; 6) welded joint; 7) after welding without heat treatment; 8) VT; 9) annealing at 800-850° for 15 min, air cooling; 10) quenching from 870 ± 10° in water, aging at 520 ± 10° for 16 hours; 11) water quenching from 780 ± 10°, aging at 520 ± 10° for 12 hours.

With respect to machining (turning, milling, drilling, etc.) heat-treatment hardenable titanium alloys are close to stainless steel. The VT15 machines poorer than the other heat-treatment-hardenable titanium alloys.

The VT14, VT15 and VT16 alloys weld satisfactory by all welding methods used for titanium. Welded joints made by argon-shielded arc welding do not differ by their strength and plasticity from the base metal. To increase the plasticity of the welded joint in VT14 alloys it must be heat treated. Heat treatment (quench hardening and artificial aging) can be used to strengthen welded joints of VT14 and VT16 alloys; the welded joints from the VT15 alloy tend to become brittle after hardening heat treatment. Typical properties of welded joints of

the VT14, VT15 and VT16 alloys (sheet thickness 1.5-3.0 mm) made by argon-shielded arc welding are presented in Table 6.

Wire from a titanium alloy with 2-3% aluminum is recommended for a filler when welding the VT14 alloy (if the alloy is annealed, then a filler from the VT1-1 alloy should be used), while wire from the VT17 alloy (10% Mo, 2% Al) is recommended for the VT15 and VT16 alloys.

The VT14, VT15 and VT16 alloys are subjected to annealing and to hardening heat treatment, i.e., quench hardening in water and to artificial aging. (See Heat treatment of titanium alloys). If components or semifinished products from the VT14, VT15 and VT16 alloys have an elevated hydrogen content, then it is recommended that it be removed by annealing at 800-850° in a vacuum of not less than  $10^{-3}$  mm of Hg for 1-2 hours.

Heat-treatment-hardenable titanium alloys are recommended for use at room as well as at elevated temperatures. The VT14 alloy is used for making components and articles operating for prolonged periods of time at temperatures of up to 400° and for short periods of time at temperatures up to 500°; the VT15 alloy is recommended for extended operation at temperatures up to 300° and for short-duration work at up to 500°; the VT16 alloy can be used for long periods of time at temperatures up to 350° and for short periods of time at up to 700°.

References: see at the end of article Titanium alloys.

V.N. Moiseyev and S.G. Glazunov

Manu-  
script  
Page  
No.

[Transliterated Symbols]

1879

ππ = pts = proportsional'nost' = proportionality

HEAT TREATMENT OF ALUMINUM ALLOYS. Three kinds of heat treatment are used for aluminum shaping alloys: hardening, aging and annealing. The alloys are made stronger by hardening and aging while their strength is reduced by annealing. Only alloys in which the solubility of alloying elements in the base metal increases with a forced air circulation or in saltpeter baths. Heating of components in a molten mixture of salts ensures rapid and uniform heating. Air furnaces are more economical and safe than saltpeter baths, but the heating of metal in an air medium is much slower. The minimum necessary rate of cooling on quenching is determined by the nature of the alloy, dimensions of components and the level of the required corrosion and other properties. For example, in order that pipes from the D16 alloy, intended for critical service, should possess high corrosion resistance properties, they must be pre-quench heated in vertical air furnaces with a forced air circulation and submerged in water at a rate of not less than 0.8 m/sec. The temperature of the pre-quench heating is determined by the nature of the alloys (Table 1), it is higher than the solubility limit of the alloying elements, but does not exceed the solidus temperature. The duration of heating depends on the kind and thickness of the semifinished product (Table 2).

Incubating period - time interval from the instant of quenching to the beginning of perceptible strengthening of the quenched alloy by natural aging (see Aging of Aluminum Alloys). The duration of the incubation period depends on the nature of the alloy after quenching. It is desirable that pressureworking in this state be performed in a single

TABLE 1

Temperature of Pre-Quench Heating of Semifinished Products from Aluminum Alloys

| 1<br>Сплав | 2<br>Вид полуфабриката             | 3<br>Температура нагрева при полимеризации металла (°C) | 4<br>Допустимый интервал температуры закалки (°C) |
|------------|------------------------------------|---|---|
| Д18 } 5    | Листы 6                            | 490   | 495-505   |
| Д19 } 5    |                                    | 495   | 500-515   |
| Д18 } 7    | Прессов. полуфабрикаты и плиты     | 490   | 495-505   |
| Д19 } 7    |                                    | 495   | 495-505   |
| Д1         | 7                                  | 490   | 495-510   |
| Д6         | 7                                  | 495   | 497-503   |
| Д20        | 7                                  | 525   | 530-540   |
| ВД17, 8    | 8                                  | 490   | 495-505   |
| М40        | 8                                  | 515   | 520-530   |
| Д21        | 8                                  | 500   | 505-510   |
| ВАД1       | Листы 6<br>Все виды полуфабрикатов | 505   | 510-530   |
| АД31       |                                    | 505   | 510-530   |
| АД33       |                                    | 505   | 510-530   |
| АД31, 10   |                                    | 505   | 510-530   |
| АН12       | Все виды полуфабрикатов            | 500   | 505-525   |
| АН6-1      |                                    | 490   | 495-505   |
| АН4        |                                    | 520   | 525-540   |
| АН4-1      | 11                                 | 505   | 510-520   |
| АН2        | 11                                 | 480   | 485-475   |
| В95, В96   | 13                                 | 515   | 520-528   |
| БАД23      | 9                                  | 515   | 520-528   |

1) Alloy; 2) kind of semifinished product; 3) temperature from which the heating duration is reckoned (°C); 4) allowable interval of hardening temperature; 5) D; 6) sheets; 7) pressed semifinished products and plates; 8) VD-17; 9) VAD; 10) AD; 11) all kinds of semifinished products; 12) AV; 13) V.

operation, since plastic deformation produces a perceptible strengthening of the alloy as a result of decomposition of the hardened, supersaturated solid solution. This property is used in the industry, where in order to retain the high plasticity of the alloy during the incubating period (freshly quenched state) the components (rivets) are held in special refrigerators.

The high plasticity of the material in the freshly quenched state is used for straightening of products after quenching. Stretch

TABLE 2

Holding Time when Pre-Quench Heating of Semifinished Products and Components in Air Furnaces and in Saltpeter Baths

| 1 | Вид полуфабриката  | Толщина материала (мм) | 3 Продолжительность выдержки (мин.) |                      |
|---|--|------------------------|-------------------------------------|----------------------|
|   |  |                        | 4 в воздушных печах                 | 5 в сернистых ваннах |
| 6 | Листы плакированные отожженные   | до 1,4                 | 10-12                               | 5                    |
|   |  | 1,5-1,9                | 15-20                               | 7                    |
| 8 | Листы неплакированные отожженные, трубы холоднодеформированные отожженные, плиты горячекатаные, профили, прутки, полосы и ступки горячекатаные | 2-4                    | 20-25                               | 10                   |
|   |  | 4,1-10                 | 35-40                               | 20                   |
|   |  | до 1,2                 | 10-20                               | 5                    |
|   |  | 1,3-3                  | 15-30                               | 10                   |
|   |  | 3,1-5                  | 20-45                               | 15                   |
|   |  | 5,1-10                 | 30-60                               | 20                   |
|   |  | 11-20                  | 35-75                               | 25                   |
|   |  | 21-30                  | 45-90                               | 30                   |
|   |  | 31-50                  | 60-120                              | 40                   |
|   |  | 51-75                  | 100-150                             | 50                   |
|   |  | 76-100                 | 120-180                             | 70                   |
|   |  | 101-150                | 150-210                             | 80                   |
| 9 | Штамповки и поковки  | до 2,5                 | 15-30                               | 10                   |
|   |  | 2,6-5                  | 20-45                               | 15                   |
|   |  | 5,1-15                 | 30-50                               | 25                   |
|   |  | 16-30                  | 40-60                               | 40                   |
|   |  | 31-50                  | 60-150                              | 50                   |
|   |  | 51-75                  | 150-210                             | 60                   |
|   |  | 76-100                 | 180-240                             | 90-140               |
|   |  | 101-150                | 210-260                             | 120-240              |

1) Kind of semifinished product; 2) material thickness (mm); 3) holding time (min); 4) in air furnaces; 5) in saltpeter baths; 6) clad, annealed sheets; 7) up to; 8) unclad annealed sheets, cold pressureworked annealed pipes, hot rolled plates, shapes, bar stock, hot pressureworked strips and sleeves; 9) stampings and forgings.

straightening aids in the redistribution of internal stresses, perceptibly increases the yield strength and is mandatory operation for certain kinds of semifinished products (pressed products, plates).

Age hardening. Age hardening regimes for components and semifinished products from aluminum alloys are presented in Table 3. It should be taken into account that plastic deformation (by 2-4%) in the freshly-quenched state can reduce the ultimate strength of components from the V95 alloy in the artificially age hardened state by 1.5-3 kg/mm<sup>2</sup>. The absence of a moderate plastic deformation (straightening) in the freshly quenched state in semifinished products from the annealed state, can result in reducing  $\sigma_b$  by 1-2 kg/mm<sup>2</sup> and of  $\sigma_{0.2}$  by 3-5 kg/mm<sup>2</sup> in the aged state.

TABLE 3

Age Hardening Regimes for Components and Semifinished Products from Aluminum Alloys

| 1   | 2  | 3   | 4   | 5   |
|---|--|---|---|---|
| Сплав   | Вид полуфабриката  | Старение  | Температура старения (°C)   | Продолжительность старения (час.)                             |
| Д1, Д6, Д18<br>Д19  | 6 Все виды полуфабрикатов  | 8 Естественное<br>То же   | Комнатная<br>То же  | 88<br>120-240   |
| Д18   | 7 Листы  | 12 Искусственное<br>То же   | 185-195<br>185-195  | 12<br>0   |
| Д20   | 13 Прессованные полуфабрикаты  | 15 Искусственное<br>I режим<br>II режим   | 180-170<br>200-220<br>180-190   | 10-10<br>12<br>15   |
| Д21<br>ВД17<br>АН, АН4<br>АК8<br>АН<br>АН6, АК6-1<br>АК8<br>АК4<br>АН4-1<br>М40 | 17 То же<br>.<br>.<br>.<br>.<br>.<br>.<br>.<br>.<br>.<br>Листы<br>Поковки и прессованные полуфабрикаты | 15 Искусственное<br>То же<br>Естественное<br>Искусственное<br>То же<br>Искусственное<br>То же | 185-175<br>Комнатная<br>150-165<br>130-165<br>150-165<br>185-180<br>185-195<br>150-180<br>185-175 | 16<br>98<br>8-15<br>6-15<br>4-15<br>10-10<br>8-12<br>10<br>16 |
| В95<br>В95-1  | 18 Листы<br>Прессованные полуфабрикаты и штамповки   | 18 .<br>.   | 120-125<br>135-165  | 24<br>18  |
| В96   | 18 Все виды полуфабрикатов   | 20 Искусств.<br>Ступенчатое:<br>I ступень<br>II ступень                                       | 135-145<br>85-105<br>155-180  | 16<br>4-5<br>8-9  |
| В93   | 10 То же   | 23 Ступенчатое:<br>I ступень<br>II ступень  | 115-125<br>160-170  | 3<br>6  |

\*If the semifinished products from the V95 alloy have a strength and elongation highly in excess of the technical specifications, then gradual age hardening can be used as follows: stage I - heating at 115-125° for 3 hours; stage II - heating at 157-163° for 3 hours.

1) Alloy; 2) kind of semifinished product; 3) age hardening; 4) age hardening temperature (°C); 5) age hardening duration (hours); 6) D; 7) all kinds of semifinished products; 8) natural; 9) room; 10) same as above; 11) sheets; 12) artificial; 13) pressworked semifinished products; 14) regime I; 15) regime II; 16) VD; 17) AV; 18) forgings and pressworked semifinished products; 19) V; 20) gradual; 21) state I; 22) stage II.

Annealing. As a result of processes of recrystallization, polygonization and recovery, annealing reduces or completely eliminates the strength increase produced by the cold hardening of the material. In alloys which are being strengthened by heat treatment, annealing also produces decomposition of the solid solution and coagulation of the decomposition products, which is accompanied by reducing the strength of the alloy and increasing its plasticity. The annealing regimes are

recommended on the basis of the nature of the alloy and the intended service of the material. Semifinished products and components from brand A00, A0, A1, A2, A3, AD, AD1, AMts, AMg, AMg3, AMg5, AMg5V and AMg6 alloys, for which strengthening heat treatment is not used, should be annealed.

High annealing — it is a heat treatment consisting of heating the metal to a temperature of 300-500°, at which, as a result of intensive recrystallization, the greatest reduction in strength of alloys of this group is achieved (Table 4). To prevent increasing the grain size, the holding time should be minimum. The grains grow particularly intensively in size upon slow heating. Hence the heating for high annealing should take place at the maximum rate. Flaws in the form of blow holes which result from the generation of hydrogen can appear on sheets from brand A00, A0, AD1 and AD at high annealing temperatures. Therefore temperatures above 450° should be avoided.

Hot rolled sheets and hot pressed pipes from AMg5, AMg5V and AMg6 alloys should be annealed at 325-350° before cold rolling. All the semifinished products from these alloys should be subjected to final

TABLE 4  
High Annealing Regimes\*

| 1<br>Сплав   | 2<br>Температура<br>отжига<br>(°C) | 3<br>Время выдержки<br>(мин.)            |  |
|--|------------------------------------|--|--|
|  |                                    | 4<br>при<br>толщине<br>надежи<br>до 6 мм | 5<br>при<br>толщине<br>надежи<br>более<br>6 мм |
| A00, A0, A1,<br>A2, A3, AD1,<br>6 AD, AMg<br>AMt, AMg3 | 350-500<br>350-420                 | 1-10<br>(до про-<br>грева)               | 10-30  |
| 9<br>AMg5,<br>AMg5B,<br>AMg6                           | 310-335                            | 60-180                                   | 120-180  |

\*Air is the cooling medium.

1) Alloy; 2) annealing temperature (°C); 3) holding time (min); 4) for a product thickness up to 6 mm; 5) for a product thickness in excess of 6 mm; 6) AD; 7) AMts; 8) AMg; 9) AMg5V.

annealing at 310-335°. In this case they acquire the required corrosion resistance.

Low annealing - is a heat treatment consisting of heating the material to a temperature of 150-300°, at which the recrystallization takes place slowly, and partial reduction in strength of the hardened metal is obtained by recovery or relaxation, i.e., a semi-hardened state of the material is obtained.

TABLE 5  
Low Annealing Regimes\*

| 1<br>Сплав                            | 2<br>Температура<br>отжига<br>(°C) | 3<br>Время вы-<br>держки при<br>отжиге<br>(час) |
|---------------------------------------|------------------------------------|---|
| AMg, AMg1, AM2, AM3,<br>AM4, AM5, AM6 | 150-200                            | 2-3   |
| AMg                                   | 200-250                            | 1-2, 5  |
| AMg1                                  | 150-180                            | 1-2   |
| AMg2                                  | 170-200                            | 1-2   |

\*Air is the cooling medium.

1) Alloy; 2) annealing temperature (°C); 3) holding time for all material thicknesses (hours); 4) AD; 5) AMts; 6) AMg.

The temperature for low annealing of aluminum within the limits shown in Table 5, is selected depending on its admixture content. A higher annealing temperature is used for a higher admixture content. For the AMg3 alloy the annealing regime shown in Table 5 ensures mechanical properties corresponding to the annealed state.

Full annealing - is a heat treatment consisting of heating the metal to a temperature at which the saturated solid solution is least stable and subsequent slow cooling, which ensures that processes of decomposition of the solid solution and of coagulation of the decomposition products take place. It is used for removing the strength increase which was obtained as a result of quenching and age hardening or hardening (cold deformation), and also for complete removal of internal stresses. After full annealing the semifinished products have



the maximum production process plasticity for the given alloy (Table 6).

Foreshortened annealing - is a heat treatment consisting of heating to a temperature at which the saturated solid solution decomposes at a high rate, holding at this temperature, which is sufficient for maximum precipitation of intermediate phases from the solid solution and subsequent air cooling.

TABLE 6  
Full Annealing Regime

| 1 | Сплав              | 2                             | Темп-ра отжига (°C) | 3             | Время выдержки для материала всех толщ (мин.) | 4                | Скорость охлаждения |
|---|--------------------|-------------------------------|---------------------|---------------|---|------------------|---------------------|
| 5 | Д1, Д16, ВД17      | 390-450                       | 10-60               | 30°/ч до 260° | 7   | затем на воздухе |                     |
| 6 | Д16, Д20, Д21, М40 | 380-430<br>390-460<br>400-420 | 10-60               | 30°/ч до 150° |   |                  |                     |
| 8 | В95, В98           | 390-430                       | 10-60               | 30°/ч до 150° | 9   | затем на воздухе |                     |

1) Alloy; 2) annealing temperature (°C); 3) holding time for all material thicknesses (min); 4) cooling rate; 5) D; 6) VD; 7) 30°/hour up to 260°, then in air; 8) V; 9) 30°/hour up to 150°, then in air.

TABLE 7  
Foreshortened Annealing Regimes\*

| 1 | Сплав                        | 2       | Темп-ра отжига (°C) | 3 | Время выдержки для всех толщин материала (час.)** |
|---|------------------------------|---------|---------------------|---|---|
| 4 | Д1, Д16, ВД17, Д19, Д20, Д21 | 350-370 | 2-4                 |   |   |
| 5 | В95, В98                     | 290-320 |                     |   |   |
| 6 | АВ                           | 350-420 |                     |   |   |
| 7 | АК8                          | 350-400 |                     |   |   |
| 8 | АК8                          | 390-410 |                     |   |   |

\*The cooling medium is air or water.

\*\*When annealing clad sheets it is recommended to reduce the holding time to 20 minutes.

1) Alloy; 2) annealing temperature (°C); 3) holding time for all material thicknesses (hours)\*\*; 4) D; 5) VD; 6) V; 7) AV.

After foreshortened annealing (Table 7) the semifinished products products can be cold pressureworked with medium degrees of deformation

since they become less plastic than after full annealing.

Since natural aging of the V95 and V96 alloys may take place following foreshortened annealing at the above temperatures, the material should not be held between the annealing and strengthening heat treatment for longer than 10 days.

Heat treatment of cast alloys differs from heat treatment of shaping alloys. For example, the T1 regime (artificial age hardening without pre-quenching) is used extensively for increasing the hardness of components cast from alloys to improve their machinability; and also the T2 regime (high-temperature tempering) which is used for removing casting stresses and the T9 regime (repeated cyclical heating with subsequent cooling) which is used for stabilizing the component dimensions (Table 8).

The pre-quench heating time for cast components is many-fold greater than that for shaping semifinished products. This is due to the fact that the cast metal has a rougher and more heterogenous structure.

Depending on the nature of the alloys, casting methods and the intended use of the components, one or another heat treatment regime may be used. Varying the heating rate, time of holding at the appropriate temperature and the cooling rate, it is possible to obtain components with various properties. For example, components can usually be hardened by quench hardening or quench hardening with subsequent aging. In the first case the increase in the strength and plasticity indicators is produced by dissolving strengthening phases in the solid solution. In the second case the highest decomposition of the supersaturated solid solution. When establishing the main parameters of heat treatment (temperature, holding time, cooling rate, etc.) it is necessary to take into account the structure of the components, i.e.,

TABLE 8

Typical Heat Treatment Regimes for the Most Extensively Used Cast Aluminum Alloys

| Сплав           | Режим терм. обра-ботки | 3 Закалка                                      |                        |                                       | 4 Старение             |                        |                        | 5 Условия работы деталей   |
|-----------------|------------------------|--|------------------------|---------------------------------------|------------------------|------------------------|------------------------|--|
|                 |                        | 6 темп-ра нагрева (°C)                         | 7 время выдержки (час) | 8 охлажд- лаящая среда и темп-ра (°C) | 6 темп-ра нагрева (°C) | 7 время выдержки (час) | 8 охлажд- лаящая среда |  |
| АЛ3-10          | T1                     | -  | -                      | -                                     | 175±5                  | 3-5                    | Воздух                 | 1 Детали малой нагруженности   |
|                 | T2                     | -  | -                      | -                                     | 300±10                 | 2-4                    | Воздух                 | 2 Детали, требующие постоянства размеров и снятия остаточных напряжений  |
|                 | T5                     | 515±5  | 3-8                    | 4 Вода 20-100                         | 175±5                  | 3-5                    | -                      | 3 Крупные детали большой нагруженности, работающие до 175°   |
| АЛ4             | T1                     | -  | -                      | 15 Вода 20-100                        | 230±5                  | 3-5                    | Воздух                 | 4 Детали, длительно работающие до 175-275°   |
|                 | T6                     | 535±5  | 2-8                    | Вода 20-100                           | 175±5                  | 5-17                   | Воздух                 | 5 Детали средней нагруженности   |
| АЛ5             | T1                     | -  | -                      | -                                     | 175±5                  | 5-10                   | -                      | 6 Крупные детали большой нагруженности   |
|                 | T6                     | 525±5  | 3-5                    | Вода 20-100                           | 175±5                  | 5-10                   | -                      | 7 Детали средней нагруженности   |
| АЛ8             | T4                     | 430±5  | 15-20                  | 19 Вода 20-100 или масло              | -                      | -                      | -                      | 8 Крупные детали большой нагруженности. Меньшее время выдержки при нагреве рекомендуется применять для тонкостенных деталей. Детали, отлитые с резкими переходами в сечениях, рекомендуется закалять в масле |
|                 | T6                     | 535±5  | 2-8                    | 20 Вода 20-100                        | -                      | -                      | -                      | 9 Детали, требующие повышенной пластичности  |
| АЛ9             | T4                     | 535±5  | 2-8                    | 21 Кипящая вода                       | -                      | -                      | -                      | 10 Детали, имеющие миним. внутр. напряжения  |
|                 | T6                     | 535±5  | 2-8                    | 22 То же                              | 150±5                  | 1-3                    | Воздух                 | 11 Детали, требующие повышенной твердости  |
|                 | T5                     | 535±5  | 2-8                    | 23 То же                              | -                      | -                      | -                      | 12 Детали, требующие повышенной пластичности   |
| АЛ19            | T4                     | Ступенчатый нагрев: 370±5, 540±5               | 3-8, 3-8               | 24 Вода 20-100                        | -                      | -                      | -                      | 13 Детали, требующие повышенной прочности  |
|                 | T5                     | Ступенчатый нагрев: 370±5, 540±5, 500±5, 515±5 | 3-8, 3-8, 2-3, 2-3     | 25 То же                              | 175±5                  | 3                      | Воздух                 | 14 Детали, требующие повышенной предела текучести  |
| 28 АЛ20 (В14А)  | T5                     | 500±5, 515±5                                   | 2-3, 2-3               | 26 Вода 20-100 или масло              | 175±5                  | 5                      | Воздух                 | 15 Детали с макс. прочностью, работающие до 200°   |
|                 | T7                     | 500±5, 515±5                                   | 2-3, 2-3               | 27 То же                              | 250±5                  | 3-5                    | 11                     | 16 Детали, длительно работающие при 250-275°   |
| 31 АЛ21 В300    | T2                     | -  | 1-3                    | -                                     | 300±5                  | 3-10                   | -                      | 17 Детали, требующие постоянства размеров и снятия остаточных напряжений   |
|                 | T6                     | Ступенчатый нагрев: 500±5, 525±5               | 2-5, 2-3               | 28 Вода 20-100 или масло              | 175±5                  | 5                      | -                      | 18 Детали с макс. прочностью, работающие при 150-200°  |
|                 | T7                     | Ступенчатый нагрев: 500±5, 525±5, 425±5        | 2-5, 2-3, 13-24        | 29 То же                              | 300±5                  | 3-10                   | -                      | 19 Детали, длительно работающие при 275-350°   |
| 35 АЛ22 (ВН1-3) | T4                     | 425±5  | 13-24                  | 30 Вода 20-100 или масло              | -                      | -                      | -                      | 20 Меньшее время выдержки рекомендуется применять для тонкостенных деталей. Детали, отлитые с резкими переходами в сечениях, рекомендуется закалять в масле  |

1) Alloy; 2) heat treatment regime; 3) quench hardening; 4) age hardening; 5) operational conditions of the components; 6) heating temperature (°C); 7) holding time (hours); 8) cooling medium and temperature (°C); 9) cooling medium; 10) AL; 11) air; 12) components subjected to low loads; 13) components requiring dimensional stability and removal of residual stresses; 14) water; 15) large components subjected to high loads, operating up to 175°; 16) components operating for long periods of time to 175-275°; 17) components subjected to medium loads; 18) large components subjected to high loads; 19) water 20-100 or oil;

20) it is recommended that the holding time during heating be reduced for thin-walled components. It is recommended that components cast with sharp changes in cross sections be quenched in oil; 21) components requiring elevated plasticity; 22) boiling water; 23) same as above; 24) components with minimum internal stresses; 25) components requiring an elevated yield strength and elevated hardness; 26) heating in stages; 27) components requiring an elevated yield strength; 28) AL20 (V14A); 29) maximum strength components, operating at up to 200°; 30) components operating for long periods of time at 250-275°; 31) AL 21 V300; 32) components requiring dimensional stability or removal of residual stresses; 33) maximum strength components operating at 150-200°; 34) components operating for long periods of time at 275-350°; 35) AL22 (VI 11-3); 36) the use of a shorter holding time is recommended for thin-walled components; 37) it is recommended that components cast with sharp changes in cross sections be quenched in oil.

by partial decomposition of the supersaturated solid solution. When establishing the main parameters of heat treatment (temperature, holding time, cooling rate, etc.) it is necessary to take into account the structure of the components, i.e., the multiplicity of phases, particle size for secondary phases, the character of their distribution, as well as the liquation nonhomogeneity.

The coarser the structure of castings (for example, components cast in sand molds), the longer holding period in pre-quench heating is required, in order to ensure maximum solubility of the alloying elements in the solid aluminum. Castings in metal molds (for example, chill-mold castings) usually have a fine-grained structure. This ensures a more rapid dissolution of the strengthening phases at the pre-quench heating temperature. Hence the time of pre-quench heating of castings with a fine-grained structure is several-fold shorter.

The higher the quench cooling rate, the higher the mechanical properties of the components. However, as the cooling rate is increased the danger of formation of residual stresses, which can serve as the cause of crack formation, particularly for intricately shaped castings, is increased.

Many components used in instruments require dimensional stability.

This is achieved by cold working with subsequent heating to the operating temperature. Aluminum alloys have no tendency to embrittlement at low temperatures, but a certain increase in the strength and reduction in the plasticity of alloys is observed with a reduction in the temperature.

Repeated heating (200-400°) and cooling (from -50° to -1,6°) aids in improving the dimensional stability of components.

References: Bochvar, A.A., Metallovedeniye [Metal Science], 5th Edition, Moscow, 1956; by the same author, Osnovy termicheskoy obrabotki splavov [Fundamentals of Heat Treatment of Alloys], 5th Edition, Moscow-Leningrad, 1940; Petrov, D.A., Voprosy teorii splavov alyuminiya [Problems of the Theory of Aluminum Alloys], Moscow, 1951; Fridlyander, I.N., Vysokoprochnyye deformiruyemye alyuminiyevyye splavy [High-Strength Shaping Aluminum Alloys], Moscow, 1960; Kolobnev, I.F., Termicheskaya obrabotka alyuminiyevykh splavov [Heat Treatment of Aluminum Alloys], Moscow, 1961.

Ye.D. Zakharov, I.F. Kolobnev.

HEAT TREATMENT OF BERYLLIUM. Internal stresses which are produced by pressureworking and machining are relieved by annealing in the range of 450-760°. To prevent oxidization it is recommended that annealing above 650° be performed in vacuum or in an inert gas atmosphere.

The recrystallization temperature depends on the process by which the products are made (cast or metal ceramics), degree of deformation and the holding time. The figure shows the temperature dependence of the recrystallization time.

Annealing at 850° is sufficient for complete softening of vacuum-cast deformed beryllium and for partial grain growth; an exclusively coarse grain is formed at a temperature of 1000° and very short holding times. No apparent structural changes are observed in powdered beryllium at up to 800° and moderate holding times. Recovery takes place at temperatures substantially lower than the recrystallization temperature. Data on the effect of annealing on properties of beryllium are given in Beryllium.

Data on the presence of the hardening effect are available. It is very difficult to discover the admixtures which are responsible for this phenomenon, since the majority of elements has a limited solubility in beryllium at low temperatures. It is assumed that Fe, Cr, Mn and Al participate in the aging process. The aging effect is also substantiated by the fact that no reduction in plasticity was observed during tests at 600°, while the plasticity of beryllium which was not heat treated is reduced with time. It was proven that this process is

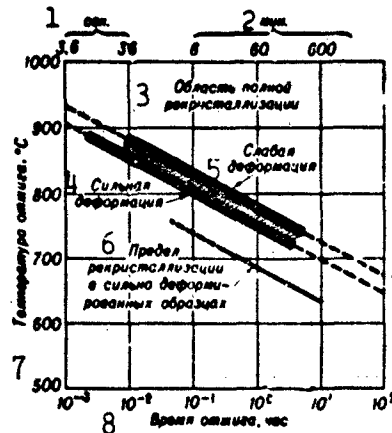

Temperature dependence of the recrystallization time. 1) Sec; 2) min; 3) complete recrystallization region; 4) intensive recrystallization; 5) weak deformation; 6) recrystallization boundary in highly deformed specimens; 7) annealing temperature ( $^{\circ}\text{C}$ ); 8) annealing time (hours).

reversible.

References: Berilliy [Beryllium], edited by D. White and G. Berk, translated from English, Moscow, 1960; Darwin, G. and Baddery, G., Berilliy [Beryllium], translated from English, Moscow, 1962; Reactor Handbook, 2nd Edition, Vol. 1, Materials, New York-London, Chapter 44, 1960; Conference on the metallurgy of beryllium, London, 1961.

I.A. Akopov, N.M. Bogorad, K.P. Yatsenko

HEAT TREATMENT OF CAST IRON. By its physical principles the heat treatment of cast iron is in many respects similar to the heat treatment of steel, however, in heat treatment of cast iron it is possible to use carburization of its metal base by dissolving a part of the free-graphite which is present in the structure of gray and malleable cast irons (on heat treatment of white cast iron for obtaining malleable cast iron from it, see Malleable Cast Iron).

Heat treatment of cast iron is divided into volume and surface treatments. Volume heat treatment of cast iron is subdivided into annealing (low-temperature, softening, graphitizing), normalization, quench hardening with tempering, isothermal quench hardening. Surface heat treatment of cast iron is subdivided into gas flame and induction quench hardening and into case-hardening (nitriding, aluminizing, sulfonizing and diffusion chromizing).

Low-temperature annealing is designed for relieving casting stresses in castings. Castings from gray and chilled cast iron are subjected to low-temperature annealing at 500-600°, castings from high-alloy cast irons of the Ni-Resist type (see High-Temperature Corrosion Resistant Cast Iron) are annealed at 620-680°. The holding duration in low-temperature annealing comprises one hour per 25 mm of casting cross section, with subsequent furnace cooling to 400-330° and then in air.

Softening annealing (ferritizing) is performed in order to decompose the cementite of the pearlite and to obtain a ferritic structure. It is achieved by slow cooling the castings at 760-700° of prolonged



holding at temperatures lower than the lower critical point (680-700°). Softening annealing is used for improving the machinability of the cast iron and for improving the plasticity and impact ductility of the castings, and also to improve the ferromagnetic properties of gray cast iron castings (see Ferritic Cast Iron).

Graphitizing annealing has as its purpose decomposition of the lattice-free carbides and partial decomposition of the cementite of pearlite; the latter is achieved by slow (furnace) cooling of the castings. The heating temperature and the holding time which are needed for decomposition of lattice-free carbides depends on the chemical composition of the cast iron, the quantity of the carbide phase and the casting cross section; it varies within the limits of 850-1050°. Graphitizing annealing is used for improving the machinability, reducing the hardness and increasing the plasticity of metal in castings.

Normalizing (pearlitzing) is performed in order to completely transform the ferritic or ferrite-pearlitic structure of the base into a pearlitic structure in gray iron castings, as well as for partial decomposition, of cementite in chilled iron castings. Normalizing consists in heating the castings at 850-900° with subsequent air cooling. When the structure is transformed into pure pearlite, the hardness, strength and wear resistance of gray iron castings are improved; partial decomposition of cementite improves the machinability and the mechanical properties of chilled iron castings.

Normalizing Ni-Resist type austenitic cast irons (see Corrosion Resistant Cast Iron), which is performed at 950-1100°, improves the mechanical properties of the castings and their machinability.

Quench hardening with tempering is performed in order to obtain structures of martensite, troostite and other products of decomposition of supercooled austenite. This improves the strength, hardness

and wear resistance of castings. The hardening is performed at heating temperatures above  $A_{c1}$  (up to 950°). Oil is overwhelmingly used as the quenching medium. The tempering temperature is 200-600°.

Isothermal quench hardening is performed in order to obtain acicular troostite (bainite), troostite and other products of isothermal decomposition of austenite. Isothermal quench hardening imparts to the castings increased hardness, strength and wear resistance, without producing quenching cracks which usually arise in ordinary quenching. Castings subjected to isothermal quench hardening are heated to 830-900° and are cooled in liquid media heated to 250-600°, with air cooling following the holding in these media. Isothermal quench hardening is most frequently used for castings from pig iron, alloyed with nickel and molybdenum, to obtain the acicular (bainite) structure.

Temper hardening is performed at 300-600° (for unquenched castings from gray and white cast iron) in order to increase the strength, ductility (of white cast iron), wear resistance and to improve the machinability (Table 1).

TABLE 1  
Effect of Temper Hardening on the Mechanical Properties of Castings

| 1<br>Исходная структура | 2<br>Содержание элементов (%) |         |         |         |         | 3<br>Температура отжига (°C) | 4<br>Механич. свойства  |     |                   |     |
|-------------------------|-------------------------------|---------|---------|---------|---------|------------------------------|-------------------------|-----|-------------------|-----|
|                         | Mn                            | Ni      | Cr      | Mo      | B       |                              | 5<br>до отжига          |     | 6<br>после отжига |     |
|                         |                               |         |         |         |         |                              | $\sigma_b$              | HB  | $\sigma_b$        | HB  |
|                         |                               |         |         |         |         |                              | 7 (кг/мм <sup>2</sup> ) |     |                   |     |
| Иглообразный троостит 8 | 0.4-0.8                       | 1.0-4.0 | -       | 0.8-1.0 | -       | 300-350                      | -                       | -   | 36                | -   |
| Аустенит 9              | 2.75                          | 0.50    | -       | -       | -       | 600                          | 20                      | 100 | 32                | 418 |
| Белый чугун 10          | -                             | 4.0-5.0 | 1.5-2.5 | -       | -       | 275                          | 11 Повыш. вязкость      |     |                   |     |
| То же 12                | -                             | -       | -       | -       | 0.7-1.0 | 300                          | 11 Повыш. вязкость 13   |     |                   |     |

1) Starting structure; 2) element content (%); 3) tempering temperature; 4) mechanical properties; 5) before tempering; 6) after tempering; 7) (kg/mm<sup>2</sup>); 8) bainite; 9) austenite; 10) white cast iron; 11) increased ductility; 12) same as above; 13) increased wear resistance.

TABLE 2  
Effect of Alloying on the Depth of the Hardened Zone

| 1 Чугун                   | 2 Твердость (RC) |                                   |     |       |       |       |       |       |
|---------------------------|------------------|-----------------------------------|-----|-------|-------|-------|-------|-------|
|                           | На поверхности   | На расстоянии от поверхности (мм) |     |       |       |       |       |       |
|                           |                  | 0.8                               | 1.6 | 2.4   | 3.2   | 4.0   | 5.5   | 7.0   |
| 5 Неаллоированный         | 45               | 48                                | 47  | 40    | 20-39 | 20    | 18    | 16    |
| 6 Молибденовый            | 55-56            | 55                                | 54  | 54    | 32-50 | 30-48 | 16-18 | 16-18 |
| 7 Никельмолибденовый      | 52               | 51                                | 50  | 44    | 40    | 19    | 19    | 19    |
| 8 Хромомолибденовый       | 53               | 52                                | 52  | 12-49 | 18-32 | 18    | 18    | 18    |
| 9 Хромоникельмолибденовый | 52               | 52                                | 52  | 54    | 53    | 52    | 31    | 17    |

1) Cast iron; 2) hardness (RC); 3) at the surface; 4) at the distance from the surface (mm); 5) unalloyed; 6) molybdenum; 7) nickel-molybdenum; 8) chromium-molybdenum; 9) chromium-nickel-molybdenum.

Gas flame or induction surface quench hardening is obtained by heating the surface of a product by a gas flame or high frequency current to above the critical temperature (850-1000°) and rapid cooling by the lower-lying layers, a water jet and other media. Stresses which arise on quenching are relieved by tempering at 175-200°. Surface quench hardening is used for castings with a ductile pearlitic core for increasing the wear resistance. The depth of the quench hardened zone is increased with an increase in the number of alloying elements (Table 2).

Nitriding is performed in a medium of dissociated ammonium for 50-70 hours at 560-580°. Short-duration nitriding (0.5-1.0 hours at 500-700°) is used for increasing the corrosion resistance of the castings in a steam and water medium. Nitriding is used for castings which are alloyed with additives capable of nitride formation, i.e., Al, Cr and Mo. Before nitriding, the gray cast iron castings are subjected to quench hardening with tempering or to normalizing, in order to obtain a sorbitic structure, which is most favorable for nitriding. Castings from white or chilled cast iron are, before nitriding, annealed to obtain partial decomposition of the carbide and formation of a ferritic-graphitic structure. Then they are quench hardened at 800-850°

III-38t4

and subjected to short-duration tempering at 600°. The thickness of the nitrided case is = 0.25-0.4 mm, the hardness = 600-800 HB.

Aluminizing, which increases the high-temperature heat resistance of the castings, is performed in liquid, solid and gaseous media which contain aluminum, as well as by the metallization process, i.e., by atomizing the aluminum with subsequent annealing for formation of a diffusion layer. The following are used for aluminizing: an aluminum melt (aluminizing) in a liquid medium, a mixture of aluminum powders  $Al_2O_3$  and  $NH_4Cl$  in a solid medium, and  $AlCl_3$  vapor mixed with other gases, in a gaseous medium.

Aluminizing in the liquid medium is performed at 700-720° for 1 hour, in a solid medium it is performed at 900-1050° for 6 hours and in the gaseous medium it is performed at 1050° for 2 hours. The depth of the aluminized layer = 0.1-0.4 mm.

Sulfidizing - saturating the component surfaced by sulfur to improve their finish machining. It is performed in sulfur salt baths. Extensive use is made of a low temperature (125-250°) bath with the composition: 40%  $Na_2S$  and 60% of  $Na_2S_2O_3$ .

Diffusion chromizing - saturating the component surfaces by chromium - is performed in chromium containing liquid, solid and gaseous media. Diffusion chromizing improves the wear resistance, high-temperature corrosion resistance and corrosion resistance of the castings.

References: Hall, A.M., *Nikel' v chugune i stali* [Nickel in Cast Iron and in Steel]. Translated from English, Moscow, 1959; Grechin, V.P., *Legirovannoye chugunnoye lit'ye* [Alloyed Cast Iron Castings], Moscow, 1962; Ushakov, A.D., *Termicheskaya obrabotka chuguna* [Heat Treatment of Cast Iron], in the book: *Spravochnik po mashinostroitel'nyim materialam* [Handbook of Machine-Building Materials], Vol. 3, Moscow, 1959; Everest, A.B. and Nickel, O., "Foundry Trade J.," Vol. 108,

III-38t5

No. 2264, pages 515-522, 1960; Barton, R., "B.C.J.R.A.J," Vol. 8, No. 6, pages 857-82, 1960; Borchers, H. and Haberl, G., "Giesserei" [The Foundry], No. 30, pages 1679-93, 1960.

A.A. Simkin

III-37t

HEAT TREATMENT OF CHROMIUM - see Chromium.

HEAT TREATMENT OF MAGNESIUM ALLOYS - heating, holding at specified temperature and cooling at the specified rate of casting and shaped semifinished products in order to change their mechanical properties and structure, i.e., to increase the strength characteristics ( $\sigma_b$ ,  $\sigma_{0.2}$ ), plasticity ( $\delta$ ,  $\psi$ ,  $a_H$ ), to relieve internal stresses and workhardening.

The capacity of alloys to be strengthened is determined by changing the solubility of alloying components in the solid magnesium as a function of the temperature. A peculiar feature of magnesium alloys is the low rate of diffusion processes attendant to phase transformations, which requires prolonged holding when pre-quench heating or aging. For the same reasons it is possible to quench magnesium alloys in air, they take on partial quenching attendant to cooling after hot pressureworking and casting and can be artificially age hardened without first being quenched. Retarded air cooling on quench hardening is accompanied by partial decomposition of the solid solution of certain magnesium alloys (ML4, ML6, MA5), which results in reducing their plasticity. Alloys alloyed with zinc with addition of zirconium and zirconium together with lanthanum (ML12, ML15, VM65-1), have their strength increased by artificial aging directly after casting or hot pressureworking. The strengthening effects on heat treatment of shaping semifinished products from magnesium alloys is lower than that for products from aluminum alloys. The increase in  $\sigma_b$  usually comprises 10-20%. The highest strength increase is imparted to the MA10 alloy the  $\sigma_b$  and  $\sigma_{0.2}$  of which are increased by 30%, with a reduction in  $\delta$  by 40-50%. Heat

TABLE 1  
Heat Treatment Regimes for Shaping Magnesium Alloys

| 1<br>Система сплава                                    | 2<br>Марка | 3<br>Старение *     |                               | 4<br>Гомогенизация<br>и закалка |                               | 5<br>Отжиг          |                               | 8<br>Вид<br>полуфабриката      |
|--|------------|---------------------|-------------------------------|---------------------------------|-------------------------------|---------------------|-------------------------------|--------------------------------|
|  |            | 6<br>тем-ра<br>(°C) | 7<br>вы-дер-<br>жка<br>(час.) | 6<br>тем-ра<br>(°C)             | 7<br>вы-дер-<br>жка<br>(час.) | 6<br>тем-ра<br>(°C) | 7<br>вы-дер-<br>жка<br>(час.) |                                |
| Mg - Mn  | MA1        | -                   | -                             | -                               | -                             | 320-350             | 0.5                           | Листы 10<br>То же 11           |
|  | MA8        | -                   | -                             | -                               | -                             | 320-350             | 0.5                           |                                |
|  | MA9        | -                   | -                             | -                               | -                             | 300-350             | 0.5                           |                                |
| Mg - Al -<br>- Zn - Mn                                 | MA2 и 9    | -                   | -                             | -                               | -                             | 250-280             | 0.5                           | Прессованные ва-<br>готовки 12 |
|  | MA3        | -                   | -                             | -                               | -                             | 320-350             | 0.5                           |                                |
| Mg - Zn - Zr   | MA8        | 175-200             | 18-8                          | 410-425                         | 8-2                           | -                   | -                             | Прессованные ва-<br>готовки 12 |
| UM68-1   | 180-180    | 24-10               | -                             | -                               | -                             | -                   | -                             |                                |
| 14<br>Mg - Mn - 13<br>- P3M<br>Mg - Th<br>Mg - Al - Ag | MA11       | 175                 | 24-18                         | 485-500                         | 4-8                           | -                   | -                             | -                              |
|  | MA13 **    | 200                 | 18-12                         | 550-580                         | 2-4                           | -                   | -                             | -                              |
|  | MA10       | 170-180             | 24-12                         | 190-410                         | 8-8                           | -                   | -                             | -                              |
|  | MA10       | 170-180             | 24-12                         | 190-410                         | 8-8                           | -                   | -                             | -                              |

\*Air cooled.

\*\*RZM means rare earth metals.

\*\*\*Cold rolling with a compression of 5-10% is per-  
formed between quenching and aging.

1) Alloy system; 2) brand; 3) aging\*; 4) homogenization and quenching\*;  
5) annealing; 6) temperature (°C); 7) holding (hours); 8) kind of semi-  
finished product; 9) and; 10) sheets; 11) same as above; 12) pressure-  
worked blanks; 13) VM; 14) RZM.

TABLE 2  
Heat Treatment Regimes for Cast Magnesium Alloys\*

| 1<br>Система сплава | 2<br>Марка | 3<br>Старение из литого<br>состояния (T1)** |                         | 4<br>Гомогенизация<br>с закалкой (T4) |                         | 5<br>Гомогенизация с за-<br>калкой и старением<br>(T6) |                            |
|---------------------|------------|---|-------------------------|---------------------------------------|-------------------------|--|----------------------------|
|                     |            | 6<br>тем-ра<br>(°C)                         | 7<br>выдержка<br>(час.) | 6<br>тем-ра<br>(°C)                   | 7<br>выдержка<br>(час.) | 6<br>тем-ра<br>(°C)                                    | 7<br>выдержка<br>(час.)    |
| Mg - Al - Zn - Mn   | 8 ML4 -    | -   | -                       | 380                                   | 8-18                    | 380  | 8-18                       |
|                     | ML5        | -   | -                       | 420                                   | 8-24                    | +175<br>420<br>+175 или<br>200                         | 8-18<br>18<br>8-18<br>16-8 |
|                     | ML6        | -   | -                       | 410                                   | 24-32                   | 410<br>+190  | 24-32<br>4-8               |
| Mg - Zn - Zr        | ML12       | 300   | 4-8                     | -                                     | -                       | 400-500<br>+180  | 2-3<br>24                  |
|                     | ML9 и 10   | 200   | 8-18                    | 330                                   | 8-12                    | -  | -                          |
| Mg - Zr - P3M 11    | ML11       | -   | -                       | 570                                   | 4                       | -  | -                          |
|                     | ML15       | 300   | 2-8                     | -                                     | -                       | -  | -                          |
| Mg - Th             | ML14       | 315   | 18                      | -                                     | -                       | -  | -                          |
|                     | VM11       | -   | -                       | -                                     | -                       | +370<br>200  | 2<br>18                    |

\*Air cooling after all heating operations.

\*\*T1, T4 and T6 are conventional designations of  
treatment regimes.

1) Alloy system; 2) brand; 3) aging from the cast state (T1)\*\*; 4)  
homogenization with quench hardening (T4); 5) homogenization with  
quench hardening and aging (T6); 6) temperature (°C); 7) holding time  
(hours); 8) ML; 9) or; 10) end; 11) RZM; 12) VML1.



treatment of sheets from the MA13 alloy (quench hardening and artificial aging after intermediate cold rolling with a compression of 8-10%) perceptibly increases the creep resistance at temperatures in excess of 250°.

The strength increase effect due to heat treatment of magnesium alloys is higher for cast than for shaping alloys. The ultimate strength is increased by 35-60% due to quench hardening and aging. The heat treatment regimes for shaping and cast magnesium alloys are presented in Tables 1 and 2.

In those cases when magnesium alloy castings are to be used for making high-precision instruments, which requires dimensional stability, use is made of special regimes of stabilizing heat treatment. The most extensively used ML5 cast alloys, after being quench hardened according to the regime given in Table 2, is subjected to stabilizing tempering at 300-320° for 10-25 hours, with air cooling and then to cyclical stabilizing heat treatment (cooling to -70- -80° for one hour, heating to 230-250° during 4-6 hours and final air cooling. Depending on the dimensions and configuration of the component, from 2 to 8 cycles are used. After the cyclical stabilizing heat treatment the casting is aged at 130-150° for 10-20 hours

When heat treating magnesium alloys they are heated in shaft-type or box furnaces of the hotblast type with induced air circulation, in a protective or neutral medium. Furnaces with a temperature adjustment accuracy of  $\pm 5^\circ$ . Sulfur dioxide, in amounts of 0.7-1.0% of the total air volume in the furnace space, can be used as the protective atmosphere.

References: see at the end of the article Magnesium Alloys.

A.A. Kazakov, A.A. Lebedev

III-33t3

Manu-  
script  
Page  
No.

[Transliterated Symbols]

1907 P3M = RZM = redkozemel'nyye metally = rare-earth metals

**HEAT TREATMENT OF METALS** - ensemble of heating, holding and cooling operations, as a result of which the internal structure and, correspondingly, the properties of metals and metallic alloys are changed. Heat treatment of metals and alloys is usually\* performed in those cases when polymorphic transformations, limited and variable (increasing with the temperature) solubility of one components in the other in the solid state, change in the structure of the metal due to cold deformation, take place.

Processes of heat treatment of the majority of metals and alloys (including steel and pig iron) are based on the phenomenon of polymorphism. The first result of polymorphism is recrystallization, which represents a change in the crystal structure of the metal or metallic alloy, which takes place on heating or cooling to a specified temperature, i.e., to a critical point. Recrystallization is related to the appearance of new crystal grains and determines the meaning of such processes of heat treatment of metals as, for example, annealing and normalization.

Annealing. Annealing creates conditions for the most complete progress of diffusion processes and for obtaining a relatively equilibrium structure (see Normalization of Steel).

These metals heat treatment processes are most frequently used in treating semifinished products, i.e., commercial grade rolled stock, stampings, forgings or castings.

Quench hardening. Heating above the critical point, holding and subsequent rapid cooling, as a result of which a stressed and nonequil-

ilibrium structure is produced (see Quench Hardening of Steel).

Tempering. As the tempering temperature is increased, the rate of diffusion processes is increased, which results in gradual changing of the nonequilibrium (metastable) quench hardened structure into an equilibrium structure (see Tempering of Steel).

The aforementioned main processes of heat treatment of metals which have polymorphous transformations, can be depicted graphically by diagrams in the "temperature-time" coordinates (Fig. 1).

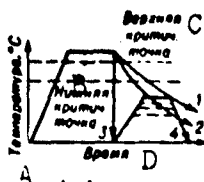

Fig. 1. Schematic graphs of the main heat treatment operations. 1) Annealing; 2) normalization; 3) quench hardening; 4) tempering to various temperatures. A) Temperature, ( $^{\circ}\text{C}$ ); B) lower critical point; C) upper critical point; 4) time.

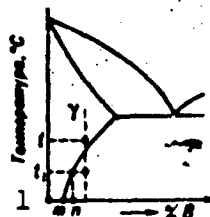

Fig. 2. Construction diagram of a system of components A-B, which form aging alloys. 1) Temperature,  $^{\circ}\text{C}$ .

Metallic alloys which do not undergo polymorphic transformations can be subjected to effective heat treatment provided that they are capable of aging. In the general case, aging is observed in those metallic alloys which, as a result of previous treatment, have acquired an unstable, the so-called metastable structure, which is related primarily to distortion of the crystal lattice. The metastable structure is responsible for free energy level of the alloy which is higher than for the stable structure for which reason, according to laws of thermodynamics, transition of the alloy from the metastable to the stable state is highly probable. This transition is related to atomic displacements and takes place with difficulty at room temperature, for which

reason natural aging proceeds over a long period of time, and sometimes does not come about at all. When the temperature is increased, atomic displacements are facilitated, for which reason artificial aging is completed more rapidly and depends on the heating temperature.

Technology makes use of aging which is related either to reducing the internal stresses (which can bring about warping or cracks), or to decomposition of supersaturated solid solutions (Fig. 2). After heating to the quench-hardening temperature and rapid cooling to the room temperature (quenching operation) the solid solution ( $\gamma$ ) will have a metastable structure, the quantity of component B dissolved in its crystal lattice will not be that ( $m$ ) which corresponds to the limiting solubility at room temperature, but a larger quantity ( $n$ ), which has dissolved when heating to the temperature  $t_1$ . Usually pre-quench heating is performed up to the temperature  $t_1$ , dissolving in the solid solution the entire amount of component B present in the solution. The following mechanism can be suggested for this process: first diffusion of atoms of component B takes place in the lattice of the supersaturated solid solution and then they accumulate in specific sections of the crystal lattice. The second stage of the process is the formation of a new crystal lattice in the B component enriched sections; however, this new lattice remains crystallographically close to the original mother lattice of the solid solution (the so-called coherent relationship of lattices is observed). The third stage is the breaking away of lattices from one another and formation of independent, quite disperse particles of component B. The fourth stage is the enlarging (coagulation) of component B particles. In natural aging the decomposition of supersaturated solid solutions usually ends at the first, and less frequently at the second stage; the higher the heating temperature in artificial aging, the shorter should be the holding time for obtaining

the fourth, final stage. A superposition of individual stages is sometimes observed. An indirect indicator which determines the progress of the aging process upon decomposition of supersaturated solid solutions is the hardness; the coherent relationship of two different lattices, as well as the precipitation of very disperse particles of the second component, results in a sharp increase in the resistance to plastic deformation, in an increase in hardness. However, if the first three stages results in increasing the hardness of the alloy, the fourth stage - coagulation of disperse particles, is related to a drop in hardness. Consequently, the change in the hardness of the supersaturated solid solution in the process of its aging will be characterized by a curve with a maximum; here the extremum shape of the curve will prevail in the process of aging at constant temperature and increasing holding time, (Fig. 3a), as well as at a constant holding time and in-

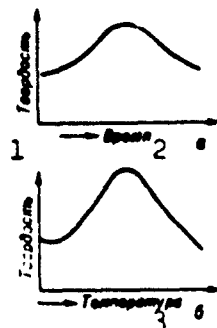

Fig. 3. Change in the hardness of a quench hardened alloy. a) In the aging process at constant temperature; b) at various temperatures, but with the same holding time. 1) Hardness, 2) time; 3) temperature.

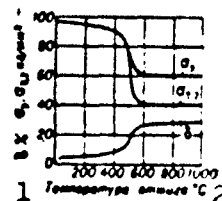

Fig. 4. Change in  $\sigma_b$  and  $\sigma_{0.2}$  as well as in  $\delta$  of workhardened iron, as a function of the heating temperature. 1)  $\text{kg/cm}^2$ ; 2) annealing temperature.

creasing temperature (Fig. 3b).

Heat treatment of workhardened (cold worked) metal is considered separately. The crystal lattice energy level as well as the strength increase after workhardening, but the plasticity is reduced. However,

such a state after cold working is dynamically unstable. This results in the fact that phenomena related to the removal of those distortions of intracrystalline structure which have produced the energy increase will spontaneously take place in the metal in the aging process. In the beginning, for an insignificant temperature increase (by 200-300° for low-carbon steel) an insignificant increase in plasticity, which is sometimes accompanied by a reduction in the strength of the cold worked metal, takes place. These processes characterize the state of recovery (or recovery) of the workhardened metal. When the temperature is increased further, a high-rate process of reconstruction of grains elongated in the direction of deformation into equiaxial, coarser grains, starts. This phenomenon, which is called recrystallization, is accompanied by a substantial strength reduction and increase in the metal's plasticity (Fig. 4).

The development of the technology of heat treatment of metals involves the adaption by the industry of various methods for increasing the surface hardness and strength of components, simultaneously retaining high ductility and plasticity of the core. Such a combination of properties ensures high operational stability of many components subjected to rubbing under dynamic loads (engine shafts, gears, cams, etc.).

Heat treatment of metals which provides for surface hardening can be divided into two varieties: casehardening, which involves heating the metallic components in an active medium, whose character ensures the required change in the composition of the metal's surface layers; surface quence hardening, when the core of the component remains cold, while the surface layer is heated to the hardening temperature either by direct passing of electric current or by inducing high frequency currents in the component, or by heating in a gas flame or

in an electrolyte attendant to the passing of direct current.

A variety of metal heat treatments are performed at machine-building plants: annealing or normalizing of castings, forgings and stampings; b) heat treatment, which consists in quench hardening and high tempering (500-650°), which ensures obtaining a sorbite structure. A special case is the heat treatment of standard and coil springs, which provides for quench hardening and medium tempering (300-450°) to obtain a troostite structure, which determines the high elastic properties of the products; c) quench hardening and low tempering (100-250°) to a high hardness (obtaining a martensite structure), which are performed in heat treating tool steel. These operations are usually performed before finish grinding. Cooling to about -80° after annealing is sometimes used when heat treating tools or carburized products; d) case-hardening: carburization (one or two quenches and low tempering), cyaniding (quenching and low tempering), and nitriding (quenching and high tempering). These operations are performed either successively, one after the other (before finish grinding), or the surface saturation processes and the heat treatment operations are separated; e) annealing of white cast iron for obtaining malleable iron; f) treatment for dispersion hardening of aluminum and heat resistant alloys, and also of some other alloys (high-temperature quench hardening and aging.

Components with special physical properties are subjected to complex metal heat treatment processes, for example, in combination with workhardening or the action of the magnetic field. Straightening, which destroys warping, is performed after heat treatment.

If the heat treatment of metal involves high-temperature heating, as a result of which the component's surface can oxidize appreciably, then the furnace atmosphere is made neutral or protective.

Machine-building plants make checks of hardness and mechanical



properties (usually in tension). In a number of cases the tests are performed not only at room but also at elevated and reduced temperatures. Finish heat treated components have their surface thoroughly cleaned by washing, etching or sandblast with subsequent checking of the surface for the presence of flaws.

References: Metallovedeniye i termicheskaya obrabotka stali [Metal Science and Heat Treatment of Steel], Handbook, edited by M.L. Bernshteyn and A.G. Rakhshadt, 2nd Edition, Vol. 1, Moscow, 1961; Gulyayev, A.B., Termicheskaya obrabotka stali [Heat Treatment of Steel], 2nd Edition, Moscow, 1960; Livshits, B.G., Metallografiya [Metallography], Moscow, 1963; Blanter, M.E., Metallovedeniye i termicheskaya obrabotka [Metal Science and Heat Treatment], Moscow, 1963.

M.L. Bernshteyn

Manu-  
script  
Page  
No.

[Footnotes]

1910

An exception is a special case of heat treatment which provides for special growing of large grains under high-temperature heating (for example, heat treatment of transformer and dynamo steel).

III-35t

HEAT TREATMENT OF MOLYBDENUM - see Molybdenum.

HEAT TREATMENT OF TITANIUM ALLOYS - hardening of titanium alloys which contain elements of the  $\beta$ -stabilizer group (see Beta Stabilizers of Titanium). Quenching retains in them unstable martensitic phases and the  $\beta$ -phase (solid solutions), which decompose upon subsequent aging, forming particles of more disperse phases. This results in a substantial (in certain cases two-fold) increase in the strength with attendant retention of the required plasticity minimum.

TABLE 1  
Regimes of Hardening Heat Treatment of Titanium Alloys (water cooling is used in quench hardening and air cooling is used in aging)

| 1<br>Сплав 1 | 2<br>Темп-ра закалки<br>( $\pm 10^\circ$ )<br>( $^\circ\text{C}$ ) | 3 Старение   |                             |
|--------------|--|--|-----------------------------|
|              |  | 4<br>темп-ра<br>( $\pm 10^\circ$ )<br>( $^\circ\text{C}$ ) | 5<br>длительность<br>(час.) |
| 6 BT3-1      | 880  | 550  | 3-10                        |
| BT6          | 950  | 450-500  | 2                           |
| 7 BT6C       | 850-920  | 450-500  | 2                           |
| BT8          | 950  | 500-600  | 1-6                         |
| BT9          | 900  | 500-600  | 1-6                         |
| BT14         | 870  | 500  | 8-16                        |
| BT14*        | 880  | 540  | 8-12                        |
| BT15**       | 800  | 1) 480-500   | 1) 15-25                    |
|              |  | 2) 560   | 2) 15 мин. 8                |
| BT16         | 790  | .00  | 16                          |

\*For components from semi-finished products with cross section in excess of 100 mm.

\*\*Two-stage aging without intermediate cooling.

1) Alloys; 2) temperature from which quenched ( $\pm 10^\circ$ ) ( $^\circ\text{C}$ ); 3) aging; 4) temperature ( $\pm 10^\circ$ ) ( $^\circ\text{C}$ ); 5) duration (hours; 6) VT; 7) VT6S; 8) min.

Following are the holding time at the quench hardening temperature:

| Толщина<br>листа<br>(мм) | До<br>1,5 | 1,6-2 | 2,1-4 | 4,1 -<br>10 | Более<br>10 |
|--------------------------|-----------|-------|-------|-------------|-------------|
| 2                        |           |       |       |             |             |
| 3                        |           |       |       |             |             |
| 4                        |           |       |       |             |             |
| 5                        |           |       |       |             |             |
| 7                        |           |       |       |             |             |
| 10                       |           |       |       |             |             |
| 25                       |           |       |       |             |             |
| 60                       |           |       |       |             |             |

1) Sheet thickness (mm); 2) up to; 3) more than; 4) holding time (min).

Both the mother solution and the hardening phases are varieties of titanium-base solid solutions, which is true of all the currently heat treated alloys used in the industry. Titanium alloys with intermetalloid type hardening also exist.

The VT3-1, VT6, VT6S, VT8, VT9, VT14, VT15 and VT16 titanium alloys may be heat treatment hardened (quench hardening and aging). The hardenability of titanium alloys varies: the VT3-1, VT6, VT6S, VT8 and VT9 alloys are hardened through when the sheet thickness is up to 45 mm, the VT14 and VT16 alloys are hardened to a sheet thickness of 60 mm, and the VT15 alloys is hardened to any thickness.

In addition to hardening heat treatment, titanium alloys are annealed to equalize the structure and mechanical properties [heating to a temperature above the recrystallization point, but lower than the temperature of the  $(\alpha + \beta)$ - $\beta$  phase transformation and air cooling]. The annealing regimes for industrial alloys are presented in Table 2.

TABLE 2

Annealing Regimes for Industrial Titanium Alloys

| A<br>Сплав                                   | Температура отжига ( $\pm 10^\circ$ )<br>B (°C) |   | A<br>Сплав                             | Температура отжига ( $\pm 10^\circ$ )<br>B' (°C) |   |
|--|---|---|--|--|---|
|  | E<br>Листы и детали из них                      | D<br>Прутки,ковки,штамповки,трубы,профили и детали из них |  | C<br>Листы и детали из них                       | D<br>Прутки,ковки,штамповки,трубы,профили и детали из них |
|  |   |   |  |  |   |
| BT1-00,<br>BT1-0,<br>BT1-1,<br>BT1-2,<br>OT4 | 530   | 880   | BT3<br>BT5-1<br>BT6<br>BT6C*)<br>BT8*) | —<br>750<br>—<br>800<br>—                        | 800<br>800<br>800<br>—<br>—                               |
| OT4-1  | 670   | 750   | BT9*)                                  | —  | —   |
| OT4-2  | 650   | 750   | BT14*)                                 | 750  | 520,<br>500,<br>450,<br>570                               |
| BT3-1*)                                      | 700   | 850   | BT15                                   | 800  | 750<br>800  |
| BT3-1*)                                      | —   | 870   |  |  |   |
| BT3-1*)                                      | —   | 850   |  |  |   |
| BT4  | 700   | 800   | BT16*)                                 | 780  | 780   |
|  |   | 750   | 5                                      |  |   |

1) Isothermal annealing: heating to  $870 \pm 15^\circ$ , holding, cooling with the furnace (or transfer to a furnace) with a temperature of  $650 \pm 15^\circ$ , holding for 2 hours, air cooling; 2) for short duration operations at elevated temperatures; 3) to increase the plasticity it is permitted to perform annealing at  $850^\circ$ , holding; furnace cooling to  $750^\circ$ , holding for 30 minutes, air cooling; 4) double annealing; holding at  $590^\circ$  for 1 hour and holding at  $530^\circ$  for 6 hours; 5) to increase the plasticity it is permitted to perform isothermal annealing at  $845^\circ$ , holding, furnace cooling (or transfer to another furnace) to  $650^\circ$ , holding for 30 min; air cooling; 6) furnace cooling at a rate of  $2-3^\circ$  per minute to  $400^\circ$ , then air cooling. A) Alloy; B) annealing temperature ( $\pm 10^\circ$ )(°C); C) sheets and components made from them; D) bar stock, forgings, stampings, pipes, shapes and components made from them; E) VT; 6) VT6S.

The holding times at the annealing temperature are as follows:

| Толщина листа<br>1) (мм) | До<br>2 | 1.6-2.1 |     | Более<br>3 |
|--------------------------|---------|---------|-----|------------|
|                          |         | 1.5     | 2.0 |            |
| Выдержка (мин.)          | 15      | 20      | 25  | 60         |

1) Sheet thickness (mm); 2) up to; 3) more than; 4) holding time (min).

Annealing can be performed in stages, with intermediate air cooling, or it can be isothermal, when the product is transferred to another furnace without intermediate cooling. The temperature of the upper stage is by  $30-80^\circ$  and of the lower stage by  $300-400^\circ$  lower than the

phase transition temperature; cooling is to room temperature in air.

TABLE 3

Temperatures of the  $[(\alpha + \beta) \rightarrow \beta]$  Phase Transformation of Titanium Alloys

| 1 Сплав         | 2 Темп-ра (°C) | 3 Сплав         | 2 Темп-ра (°C) |
|-----------------|----------------|-----------------|----------------|
| Технич. титан   | 880-900        | BT3, . . .      | 840-880        |
| BT3-1 . . . . . | 870-880        | BT5-1 . . . . . | 850-1000       |
| OT4-1 . . . . . | 880-990        | BT8, BT9        | 870-1000       |
| OT4 . . . . .   | 920-1000       | BT14 . . . . .  | 820-880        |
| BT4 . . . . .   | 960-1100       | BT15 . . . . .  | 750-800        |

1) Alloy; 2) temperature (°C); 3) industrial titanium; 4) VT.

Due to the sensitivity of titanium alloys to contamination by atmospheric gases at high temperatures, heat treatment and heating for pressureworking must be performed upon conformance with the following recommendations. The components and semifinished products should be

TABLE 4

Incomplete Annealing Temperatures for Titanium Alloys

| Сплав                       | 1 Темп-ра ор. жара ( $\pm 20^\circ$ ) (°C) | 1 Сплав             | 2 Темп-ра ор. жара ( $\pm 20^\circ$ ) (°C) |
|-----------------------------|--|---------------------|--|
| BT1-00, BT1-0, BT1-1, BT1-2 | 465  | BT4, BT6, BT6C, BT8 | 600  |
| BT3-1, BT9                  | 525  | BT5-1, BT5          | 620  |
| OT4-1                       | 540  | BT14                | 700  |
| OT4                         | 585  |                     |  |

1) Alloy; 2) annealing temperature ( $\pm 20^\circ$ )(°C); 3) VT.

heated only in electric furnaces with automatic adjustment and recording of the temperature. Heating in saltpeter baths and diesel oil fired furnaces is not permissible. To prevent scale formation, it is recommended that finished components and sheets be heated in furnaces with a protective atmosphere of neutral gases. Sometimes annealing is

III-36t4

used for relieving internal stresses which formed as a result of machining, sheet pressworking, welding, etc. The incomplete annealing temperatures are given in Table 4 (the holding time comprises 30-60 minutes).

References: see at the end of article Titanium Alloys.

S.G. Glazunov

HELIODOR - see Beryl.



HEMATITE - an extensively prevailing iron mineral, one of the major iron ores, contains up to 70% of iron, up to 13%  $\text{SiO}_2$ , sometimes  $\text{TiO}_2$ ,  $\text{MgO}$ ,  $\text{FeO}$ ,  $\text{MnO}$  and  $\text{H}_2\text{O}$ . Widely known in the USSR are hematite ore deposits of the Krivoy Rog (Ukrainian SSR), Kursk magnetic anomaly, and also deposits on the Urals and in Siberia. Hematite is brittle, not cleavagable, has subconchoidal fracture. The color of hematite is iron-black to dark-steel and cherry red, frequently with mottled iridescence; the thinnest (0.1 microns) hematite flakes are yellow colored in passing light; as the thickness is increased the color changes from reddish brown to deep cinnamon red and then to blood red. Several varieties of hematite are encountered in nature: iron glance, micaceous hematite, red iron ore. When heated from 650 to 1000° all the varieties of hematite become brown or dark-violet, and above 1000° they become black and grayish-black. Mohs hardness 5-6.5, specific gravity varies from 4.914 to 5.247, depending on the temperature, specific magnetic permeability  $70 \cdot 10^{-6} \text{ cm}^3/\text{g}$ , electrical conductivity  $3 \cdot 10^{-4} \text{ ohm}^{-1}\text{-cm}^{-1}$ , relative conductivity 2.23, dielectric permeability 81.0, dielectric constant 25.0, specific electric resistivity  $10^6\text{-}10^8 \text{ ohm-cm}$ ; electrical resistivity 1430-6500 ohms. Thermal expansion of hematite: 7.61 parallel to the c-axis, 7.71 perpendicular to the c-axis, specific heat: at -180°-0.171, at 0°-0.61, at 200°-0.79, at 800°-1.08 joule/gram, thermal conductivity coefficient at 30° parallel to the c-axis-121, parallel to the c-axis-147 watt/cm·degree· $10^{-3}$ , specific thermal conductivity of compressed hematite powder at 200°-0.00411, at 400°-0.00189, at 800°-0.00294 cal/sec· $\text{cm}^2$ ·degree. Formation heat of hematite 192.-194.4 kcal, decomposi-

I-15G1

tion temperature 1350-1360°. Hematite is a detector and it is polymorphous:  $\alpha\text{-Fe}_2\text{O}_3$  is paramagnetic,  $\gamma\text{-Fe}_2\text{O}_3$  is ferromagnetic. Hematite is capable of emitting infrared rays (in the 800-1200° interval), does not fluoresce or luminesce. It resists ammonia, bromine, fluoride (in the cold), water solutions of iodine, water, oil, alcohol, alkalis, sunlight and atmospheric factors. It decomposes in HCl, HF, HBr,  $\text{H}_2\text{SO}_4$ ,  $\text{HNO}_3$  (very weakly), in warm solutions of bromine, ammonium acetate, when heated with F, Cl, S (red heat),  $\text{H}_2\text{S}$  (white heat). Hematite has catalytic properties. It has been obtained artificially. Pig iron is smelted from hematite iron ores. Hematite is used: in the lacquers and paint industry as mineral pigments (Prussian red, red ochre), for the making of wallpaper and oil paints, and as a mineral filler to impart strength to the paint film; in the production of oil cloth, leatherette, linoleum, red pencils, art type characters, fast colored enamels; as a natural abrasive for polishing of sheet glass and mirrors, as a finishing stone, as a crystal detector in radio engineering.

References: Betekhtin, A.G. Mineralogiya [Mineralogy]. Moscow, 1950; Trebovaniya promyshlennosti k kachestvu mineral'nogo syr'ya [Industrial Requirements Put to the Quality of Mineral Raw Materials]. 2nd edition, Issue 48; Vaynshteyn, E.S., Prirodnoye krasochnoye syr'ye [Natural Raw Materials for Paints]. Moscow, 1961.

V. I. Magidovich

HERBERT'S PENDULUM - an instrument for determination of metal hardness by the oscillation method. It consists of a massive (4 kg) arch-

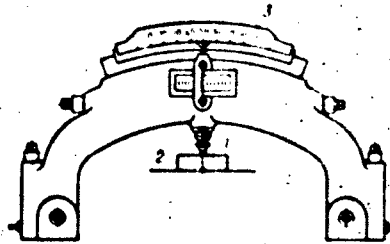

Fig. Herbert's pendulum.  
1) Tip; 2) test specimen;  
3) scale.

sahped pendulum (Fig.), which is supported on a steel or diamond ball 1 mm in diameter, which is placed on a strictly horizontal surface of the specimen to be tested. The Herbert hardness number is measured by the time (in secs.) of ten complete oscillations of the pendulum ( $H_z$ ) or by the amplitude of the first deflection of the pendulum ( $H_{sk}$ ), which was raised through a specified angle which is recorded on the instrument's scale. The Herbert hardness is approximately related to the Brinell hardness number by the empirical formulas:

$$H_z = 0.08 \text{ HB} + 7.6 \text{ (for a steel ball)}$$

$$\text{HB} = 13.5 H_z \text{ (for a diamond ball).}$$

References: Avdeyev, B.A., *Ispytatel'nyye mashiny i pribory* [Testing Machines and Instruments]. Moscow, 1957.

I.V. Kudryatsev, D.M. Shur

I-51a

HERMETIC ALUMINUM CASTING ALLOYS - see High- and medium-strength  
aluminum casting alloys.

**HERMETIZERS** - polymeric compounds (cements, pastes, viscous fluids), which are applied to riveted, bolted, and other joints of metal structures, instruments and units to ensure their impermeability. Hermetizers work primarily under the action of tensile forces attendant to periodic loads of relatively short duration. The following requirements are put to hermetizers: elasticity, high adhesion to metals and other materials, heat and frost resistance, resistance to the effect of working media. Hermetizers should not bring about corrosion of metals, be easily applicable to the surfaces which are hermetized, not require prolonged drying or the use of high temperatures and pressures for solidification, etc. By their external appearance, physical and mechanical properties hermetizers are subdivided into cements (nondrying and drying), self-vulcanizing pastes and film hermetizers. Usually a combination of various types of hermetizers is used.

Cements - highly viscous plastic materials, consisting of polymers with linear structures (Thiocol, polyisobutylene, etc.) and mineral fillers. As an example we can cite the U20A cements (TU MKhP 3572-54) and the Thiocol packing cement (TU MKhP 1391-51), which has the following properties: softness 10-25 secs., strength of bound with metals (shear strength)  $0.15 \text{ kg/cm}^2$ , swelling after 24 hours in water 2.0%, in a mixture of gasoline with benzol 3.0%, interval of working temperatures  $\pm 50^\circ$ . In hermetizing riveted or bolted joints cements are used together with a packing strip, which is a strip of cloth covered from both sides by a thin cement layer. The strip is placed between the components which are joined, then they are assembled, the joint thus formed is

additionally hermetized by the cement, which is applied in the form of packing cord and is packed by a roll. The advantage of this group of cements is the simplicity of hermetization and the absence of delays in the production process. Shortcomings of cements are: unstable hermetization of joints in the process of operation and limited thermal stability, which is to a large extent eliminated by the use of drying or vulcanizable cements. Heat-resistant-polymer based cements which, after vulcanization, can withstand the prolonged effect of temperatures of 250-300° are known. The production process which uses cements is substantially complicated by the need of heating for their vulcanization.

Self-vulcanizing pastes - liquid or viscous fluid compositions consisting of liquid polymers and mineral fillers, which are capable, under the effect of vulcanizing agents, to be transformed into elastic rubber-like materials at room temperature. Ensure stable hermeticity of structures in a wide temperature range and do not require heating. Depending on the consistency, they are applied to sections to be hermetized by a spatula, sprayer or brush. Unlike cements, pastes are capable of providing reliable hermetization even without a hermetizing strip between components (so-called "surface hermetization"), which appreciably simplifies the assembly process. Self-vulcanizing, liquid thiocol-based hermetizers, which vulcanize without shrinkage, have a high adhesion to metals, elasticity, resistance to the effect of gasoline, kerosene, oils, resistance to light and ozone, water resistance, which do not bring about corrosion of metals, have come into extensive use. These are the properties of the following hermetizers: U-30M (VTU UT 949-52), UT-32 (VMU UT 1066-60); UZO MES-5 (VTU STU 55-302-61), etc. Following are the properties of the U-30 and MES-5 hermetizers: consistency-paste, dry residue 100%, service life 3-10 years, vulcanization duration at 20° 24-48 hours, color black, specific gravity 1.4,

I-17G2

ultimate tensile strength  $20 \text{ kg/cm}^2$ , relative elongation 250%, adhesion (separation force) 2-4 kg/cm, working temperatures range from  $-60^\circ$  to  $+150^\circ$ .

Of considerable interest are liquid polysiloxane-based self-fulcanizing hermetizers, which by their mechanical and production process properties and the methods of utilization are close to liquid Thiocol based hermetizers, but differ from them by their high thermal resistance. They can operate for long periods of time in an air medium at  $250^\circ$ , do not have the necessary resistance to gasoline and kerosene. Self-vulcanizing paste-like hermetizers are used extensively in the aircraft, rocket, shipbuilding, automotive and other branches of technology. Self-vulcanizing hermetizers (particularly polysiloxane), due to their elasticity, softness, water resistance and high dielectric properties, which are combined with the ability to vulcanize in the cold, are extensively used in radio engineering to protect various electronic circuits from moisture and external effects.

Film hermetizers are used either in the form of polymeric films which are placed between components to be joined and which ensure their hermeticity by their adhesive property and plasticity, or in the form of solutions of polymers in organic solvents, which are applied by a brush to sections to be hermetized. In the first case hermeticity is achieved by precise finishing of components and small gaps, in the second case after the evaporation of solvents a film is formed which has a good adhesion to the metal, strength and elasticity. Hermetizers of this type are such as: VGK-18 (VTU-30-54), TEI (VTU MKhP 3284-52), RA-6 (TU MKhP 4082-56), which have the following properties: viscosity according to VZ-1 40-80 secs, dry residue 14-18%, ultimate tensile strength  $100-200 \text{ kg/cm}^2$ , relative elongation 150-250%, adhesion (break-away strength)  $15-20 \text{ kg/cm}^2$ , swelling (after 24 hours) in a mixture of

I-17G3

gasoline with benzol 0.5-1.0%, in kerosene 0.1%, in water 12-14%, working temperatures interval  $\pm 60^\circ$ . Usually hermetizers are applied to structural elements by a brush in several layers, in certain cases it is convenient to apply hermetizers by pouring (for example, when hermetizing vessels with a large number of riveted joints), which creates a uniform continuous "facing" of the entire internal surface of the structure and ensures its impermeability. Film hermetizers are usually used in combination with other kinds of hermetizers.

N. B. Baranovskaya



**HETERO-CHAIN SYNTHETIC FIBER** - fiber from synthetic polymers, the macromolecular chain of which, in addition to carbon atoms, also contains atoms of oxygen, nitrogen, sulfur, silicon and other elements. The most widely used fibers of this class are polyamide and polyester fibers, polyurethane and polyaminotriazole fibers being less widely used. The starting polymers for hetero-chain synthetic fibers are obtained by condensation polymerization of bifunctional chemical compounds (aminocarboxylic and hydroxycarboxylic acids and dicarboxylic acids with diamines and diatomic alcohols, etc.) or by converting rings (lactams) into linear polymers. Hetero-chain synthetic fibers have a high strength and, as a rule, a circular cross section. They are produced in the form of standard and high-strength filament thread, staple fiber, monofiber and bristle. Unlike carbon-chain synthetic fibers, hetero-chain synthetic fibers melt at elevated temperatures without decomposition, are more heat resistant, absorb more moisture, are easier to dye, have a higher resistance to the action of organic solvents (with the exception of certain phenol-type compounds), but are less resistant to concentrated solutions of acids and alkalis.

For properties and utilization of individual hetero-chain synthetic fibers see Polyamide Fiber, Polyester Fiber, Polyurethane Fiber and Polyaminotriazolic Fiber.

References: Rogovin, Z.A. Osnovy khimii i tekhnologii proizvodstva khimicheskikh volokon [Fundamentals of the Chemistry and Technology of Chemical Fibers Production]. 2nd edition, Moscow, 1957; Korshak, V.V. and Vinogradova S.V. Geterotsepnyye poliefiry [Hetero-Chain Polyesters], Moscow, 1958. E.M. Ayzenshteyn

HIGH-ALLOY HEAT-TREATABLE STRUCTURAL STEEL - steel which can be hardened by heat treatment and contains more than 3% alloying elements. It is used in the manufacture of extremely critical machine components subject to considerable static and dynamic loads. In addition to high mechanical characteristics, this type of steel has good hardenability, which makes it possible to strengthen components with large cross-sectional areas by heat treatment. As a rule, these steels anneal comparatively poorly and are more difficult to cut than other structural steels. Table 1 shows the chemical composition of high-alloy heat-treatable structural steels, while Table 2 shows their mechanical characteristics.

TABLE 1  
Chemical Composition of High-Alloy Heat-Treatable Structural Steels (GOST 4543-61)

| Сталь 1                | 2 Содержание элементов * (%) |           |           |           |  |
|------------------------|------------------------------|-----------|-----------|-----------|--|
|                        | C                            | Mn        | Cr        | Ni        | 3 другие элементы                        |
| 20Kh3A 4               | 0.17-0.24                    | 0.3-0.6   | 0.6-0.9   | 2.6-3.2   | -  |
| 5 30Kh3A 6             | 0.27-0.34                    | 0.3-0.6   | 0.6-0.9   | 2.8-3.2   | -  |
| 7 37Kh3A               | 0.31-0.41                    | 0.25-0.55 | 1.2-1.6   | 3.0-3.5   | -  |
| 8 33Kh3MA**            | 0.29-0.37                    | 0.3-0.6   | 0.8-1.1   | 2.5-3.0   | 0.2-0.3 Mo                               |
| 9 20Kh4FA              | 0.17-0.24                    | 0.25-0.55 | 0.7-1.1   | 3.75-4.25 | 0.15-0.30 V                              |
| 10 20Kh2N4A            | 0.14-0.22                    | 0.3-0.6   | 1.25-1.65 | 3.3-3.7   | -  |
| 11 18KhNVA (18Kh2N4VA) | 0.14-0.21                    | 0.25-0.55 | 1.35-1.65 | 4.0-4.5   | 0.8-1.2 W                                |
| 12 25KhNVA (25Kh2N4VA) | 0.21-0.28                    | 0.25-0.55 | 1.35-1.65 | 4.0-4.5   | 0.8-1.2 W                                |
| 13 30Kh2MFA            | 0.26-0.33                    | 0.3-0.6   | 0.6-0.9   | 2.0-2.5   | 0.15-0.30 V,<br>0.2-0.3 Mo,<br>0.5-0.8 W |
| 14 45KhNMFA**          | 0.42-0.50                    | 0.5-0.8   | 0.8-1.1   | 1.3-1.8   | 0.1-0.2 V,<br>0.2-0.3 Mo                 |

\*The S and P contents should not be more than 0.025% each; the Si content ranges from 0.17 to 0.37% in each type of steel.

\*\*This steel is not provided for in GOST 4543-61.

- 1) Steel; 2) content of elements (%); 3) other elements; 4) 20KhN3A; 5) 30KhN3A; 6) 37KhN3A; 7) 33KhN3MA; 8) 20KhN4FA; 9) 20Kh2N4A; 10) 18KhNVA (18Kh2N4VA); 11) 25KhNVA (25Kh2N4VA); 12) 30KhN2MFA; 13) 30KhN2VFA; 14) 45KhNMFA.

TABLE 2

Mechanical Characteristics of High-Alloy Heat-Treatable Structural Steels (GOST 4543-61)

| Сталь 1                | Термич. обработка 2   | $\sigma_b$              | $\sigma_{0.2}$ | $\delta_5$ | $\psi$ | $\alpha_n$<br>(кг/см <sup>2</sup> ) | $\rho_{11100}$<br>(кг/мм <sup>3</sup> ) |
|------------------------|---|-------------------------|----------------|------------|--------|-------------------------------------|---|
|                        |   | (кг/мм <sup>2</sup> ) 3 | (%)            |            |        |                                     |   |
| 20KhN3A 6              | Закалка с 820° в масле; отпуск при 500° 17  | 95                      | 75             | 12         | 55     | 10                                  | 229                                     |
| 8 30KhN3A 7            | Закалка с 820° в масле; отпуск при 530° 18  | 110                     | 80             | 10         | 50     | 8                                   | 241                                     |
| 9 37KhN3A*             | Закалка с 820° в масле; отпуск при 510° 19  | 115                     | 100            | 10         | 50     | 6                                   | 269                                     |
| 20KhN3MA*              | Закалка с 850° в масле; отпуск при 600-650° 20                                    | 105                     | 90             | 12         | 50     | 10                                  | -                                       |
| 20Kh2N4A 10            | 1-я закалка с 860° в масле; 2-я закалка с 780°; отпуск при 180° 21                | 120                     | 110            | 9          | 45     | 8                                   | 269                                     |
| 11 20Kh4FA             | Закалка с 850° в масле; отпуск при 630° 22  | 90                      | 70             | 12         | 50     | 10                                  | 269                                     |
| 18KhNVA (18X2H4BA)     | 1-я закалка с 950° в масле; 2-я закалка с 850° на воздухе; отпуск при 180° 23     | 115                     | 85             | 12         | 50     | 10                                  | 269                                     |
| 12                     | 1-я закалка с 850° на воздухе; 2-я закалка с 860° в масле; отпуск при 525-575° 24 | 105                     | 80             | 12         | 50     | 12                                  | -                                       |
| 25KhNVA 13 (25X2H4BA)  | Закалка с 850° в масле; отпуск при 560° 25  | 110                     | 95             | 11         | 45     | 9                                   | 269                                     |
| 30KhN2MFA 14 (30X2MFA) | Закалка с 860° в масле; отпуск при 680° 26  | 90                      | 80             | 10         | 40     | 9                                   | 241                                     |
| 15 30KhN2VFA           | Закалка с 860° в масле; отпуск при 460°   | 150                     | 135            | 7          | 35     | 6                                   | 269                                     |
| 16 45KhNMFA            |   |                         |                |            |        |                                     |   |

\*This steel is not provided for in GOST 4543-61.

\*\*After annealing or high tempering.

1) Steel; 2) heat treatment; 3) kg/mm<sup>2</sup>; 4)  $\alpha_n$  (kg-m/cm<sup>2</sup>); 5) Hb (kg/mm<sup>2</sup>); 6) 20KhN3A; 7) 30KhN3A; 8) 37KhN3A; 9) 33KhN3MA; 10) 20Kh2N4A; 11) 20KhN4FA; 12) 18KhNVA (18Kh2N4VA); 13) 25KhNVA (25Kh2N4VA); 14) 30KhN-2MFA; 15) 30KhN2VFA; 16) 45KhNMFA; 17) quenching from 820° in oil, tempering at 500°; 18) quenching from 820° in oil, tempering at 530°; 19) quenching from 850° in oil, tempering at 600-650°; 20) 1st quenching from 860° in oil, 2nd quenching from 780°, tempering at 180°; 21) quenching from 850° in oil, tempering at 630°; 22) 1st quenching from 950° in oil, 2nd quenching from 850° in air, tempering at 180°; 23) 1st quenching from 950° in air, 2nd quenching from 860° in oil, tempering at 525-575°; 24) quenching from 850° in oil, tempering at 560°; 25) quenching from 860° in oil, tempering at 680°; 26) quenching from 860° in oil, tempering at 460°.

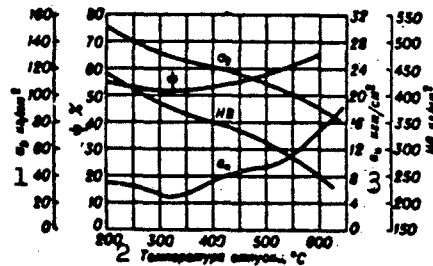

Fig. 1. Influence of tempering temperature on the mechanical characteristics of 20KhN3A steel. 1) kg/mm<sup>2</sup>; 2) tempering temperature, °C; 3) kg-m/cm<sup>2</sup>.

Figures 1-5 show the mechanical characteristics of high-alloy heat-treatable structural steel of various types as a function of tem-

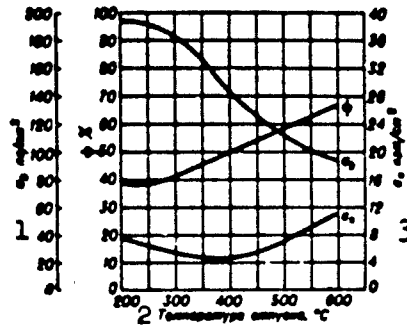

Fig. 2. Influence of tempering temperature on the mechanical characteristics of 37KhN3A steel. 1)  $\text{kg}/\text{mm}^2$ ; 2) tempering temperature,  $^{\circ}\text{C}$ ; 3)  $\text{kg}\cdot\text{m}/\text{cm}^2$ .

pering temperature. The Ni content increases the viscosity of the steel and improves its plasticity across the grain. Addition of Mo and W reduces the sensitivity of the steel to temper brittleness and improves the characteristics of large forgings. Addition of Ti and V promotes production of a fine-grained structure. Steels of this type containing an increased quantity of Cr and additions of Mo, W, and V have an elevated heat resistance. The presence of Mo permits prolonged operation of such steels at temperatures of up to  $400\text{--}450^{\circ}$  with minimal loss of plasticity and viscosity. The weldability of high-alloy heat-treatable structural steels is determined principally by their C content; it must be kept in mind that, as a result of their high hardenability, a harder zone with a tendency toward formation of cold welding cracks is formed parallel to the weld. Despite certain difficulties, all these steels except type 45KhNMFA can be welded when preliminary and subsequent heating is employed; it is best to use argon-arc and arc welding. Gas welding, which produces a large heating zone, is not recommended. High-alloy heat-treatable structural steels have a relatively low cold-shortness temperature; components fabricated from these alloys function completely satisfactorily at temperatures of down to  $-70^{\circ}$ . During manufacture of thick-walled forgings or large-diameter bars steel generally displays

III-97s3

a tendency to form floccules, this being an uncorrectable defect; when floccules are detected in even one forging all the forgings produced from the melt in question are usually rejected. This defect can be prevented by slow cooling after hot deformation or by special annealing to remove H, which is the principal cause of floccule formation.

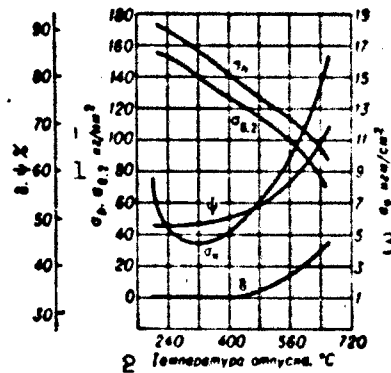

Fig. 3. Influence of tempering temperature on the mechanical characteristics of 33KhN3MA steel. 1) kg/mm<sup>2</sup>; 2) tempering temperature, °C; 3) kg-m/cm<sup>2</sup>.

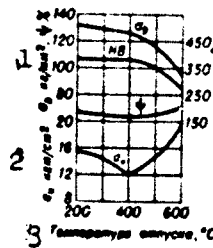

Fig. 4. Influence of tempering temperature on the mechanical characteristics of 18KhNVA steel. 1) kg/mm<sup>2</sup>; 2) kg-m/cm<sup>2</sup>; 3) tempering temperature, °C.

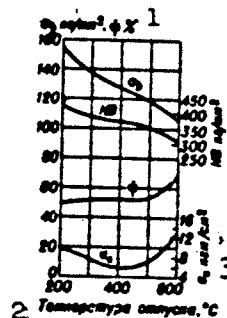

Fig. 5. Influence of tempering temperature on the mechanical characteristics of 25KhNVA steel. 1) kg/mm<sup>2</sup>; 2) tempering temperature, °C; 3) kg-m/cm<sup>3</sup>.

TABLE 3

Ultimate Strength and Durability of High-Alloy Heat-Treatable Structural Steels

| Сталь 1   | $\sigma_b$   $\sigma_{-20}^*$ |      | Сталь      | $\sigma_b$   $\sigma_{-20}^*$ |      |      |
|-----------|-------------------------------|------|------------|-------------------------------|------|------|
|           | 2 (кг/мм <sup>2</sup> )       |      |            | (кг/мм <sup>2</sup> )         |      |      |
| 20KhN3A 3 | 97.9                          | 79   | 17KhN3A 5  | 104                           | 67.5 |      |
|           | 98                            | 63   |            | 111                           | 51.6 |      |
|           | 74.5                          | 74.5 |            | 128                           | 57   |      |
| 30KhN3A 4 | 90                            | 65   | 33KhN3MA 6 | 94                            | 64   |      |
|           | 94.2                          | 60.9 |            | 18KhNVA 7                     | 95   | 64.5 |
|           | 106                           | 71   |            |                               | 126  | 54   |

\*Tests conducted by bending rotating specimen (according to data of various researchers).

- 1) Steel; 2) kg/mm<sup>2</sup>; 3) 20KhN3A; 4) 30KhN3A; 5) 37KhN3A; 6) 33KhN3MA; 7) 18KhNVA.

TABLE 4

Mechanical Characteristics of Certain Types of High-Alloy Heat-Treatable Structural Steel at Elevated Temperatures

| Сталь 1                              | Термич. обработка 2                        | 3 Свойства                              | 4 Темп-ра (°C) |     |     |      |     |      |     |     |
|--------------------------------------|--|---|----------------|-----|-----|------|-----|------|-----|-----|
|                                      |  |   | 20             | 200 | 300 | 400  | 450 | 500  | 550 | 600 |
| 37KhN3A 5                            | Закалка с 840°; отпуск при 535° 8          | $\sigma_b$ (кг/мм <sup>2</sup> )        | 116            | 2   | 108 | 88   | -   | -    | -   | 53  |
|                                      |  | $\sigma_{0.2}$ (кг/мм <sup>2</sup> ) 11 | 108            | -   | 93  | 70   | -   | -    | -   | 28  |
| 33KhN3MA 6                           | Закалка с 860°; отпуск при 640° 9          | $\sigma_b$ (кг/мм <sup>2</sup> )        | 97             | 92  | 93  | 89   | -   | 82   | -   | 49  |
|                                      |  | $\sigma_{0.2}$ (кг/мм <sup>2</sup> )    | 87             | 78  | 73  | 71   | -   | 55   | -   | 48  |
|                                      |  | $\delta_5$ (%)                          | 19             | 16  | 17  | 21   | -   | 18   | -   | 25  |
|                                      |  | $\psi$ (%)                              | 49             | 80  | 86  | 70   | -   | 73   | -   | 89  |
| 18KhNVA 7                            | Закалка с 880° в масле; отпуск при 560° 10 | $\sigma_b$ (кг/мм <sup>2</sup> )        | 126            | -   | 122 | 108  | 103 | 93   | 77  | -   |
|                                      |  | $\sigma_{0.2}$ (кг/мм <sup>2</sup> )    | 111            | -   | 107 | 98   | 94  | 83   | 72  | -   |
|                                      |  | $\delta_5$ (%)                          | 14             | -   | 16  | 14   | 14  | 14   | 16  | -   |
|                                      |  | $\delta_{10}$ (%)                       | 13             | -   | 12  | 11   | 10  | 10   | 11  | -   |
|                                      |  | $\sigma_{0.2}$ (кг/мм <sup>2</sup> )    | -              | -   | -   | 86   | 71  | 61   | 22  | -   |
|                                      |  | $\sigma_{0.2}$ (кг/мм <sup>2</sup> )    | -              | -   | 77  | 26   | 21  | 12.6 | 3.4 | -   |
| $\sigma_{0.2}$ (кг/мм <sup>2</sup> ) | -  | -                                       | -              | 23  | 20  | 11.6 | 3.4 | -    |     |     |

- 1) Steel; 2) heat treatment; 3) characteristics; 4) temperature (°C); 5) 37KhN3A; 6) 33KhN3MA; 7) 18KhNVA; 8) quenching from 840°, annealing at 535°; 9) quenching from 860°, tempering at 640°; 10) quenching from 880° in oil, tempering at 560°; 11) kg/mm<sup>2</sup>; 12) kg-m/cm<sup>2</sup>.

The most widely used of these steels are 20KhN3A, 30KhN3A, 37KhN3A, 33KhN3MA, and 18KhNVA; type 18KhNVA is also employed as a cementable steel (see Cementable structural steel). Table 3 shows the ultimate strength and durability of these steels at 20°.

The mechanical characteristics of high-alloy heat-treatable struc-

III-9785

tural steels at elevated temperatures are shown in Table 4.

Steel of type 33KhN3MA is widely used for extremely critical components, including large components operating at temperatures of up to 450°; such components are quenched and high-tempered before use. Table 5 shows the mechanical characteristics of 33KhN3MA steel at elevated temperatures (the specimens were quenched and tempered to a hardness HB of 293-311 kg/mm<sup>2</sup>).

TABLE 5  
Mechanical Characteristics of 33KhN3MA Steel at Elevated Temperatures\*

| Coeff. 1                                       | 2) Temperature (°C) |      |     |      |     |     |           |     |     |     |
|--|---------------------|------|-----|------|-----|-----|-----------|-----|-----|-----|
|  | 20                  | 100  | 200 | 300  | 400 | 450 | 500       | 550 | 575 | 600 |
| $\sigma_b$ (kg/mm <sup>2</sup> ) 3             | 103                 | 90   | 81  | 81   | 74  | 77  | 70        | 59  | —   | 40  |
| $\sigma_{0.2}$ (kg/mm <sup>2</sup> )           | 87                  | 75   | 78  | 77   | 71  | 66  | 61        | 55  | —   | 37  |
| $\sigma_{0.01}$ (kg/mm <sup>2</sup> )          | 15                  | 14   | 18  | 9    | 15  | 15  | 15        | 19  | —   | 14  |
| $\phi$ (%)                                     | 31                  | 48   | 42  | 38   | 54  | 64  | 68        | 77  | —   | 79  |
| $\phi_{10}$ (kg/cm <sup>2</sup> ) 4            | 9                   | 10   | 10  | 10   | 10  | 8   | 7         | 7   | —   | 15  |
| $\sigma_{\text{center}}$ (kg/mm <sup>2</sup> ) | —                   | —    | —   | —    | —   | 37  | 11.5-15.5 | 7   | 5.5 | —   |
| $\sigma_{\text{edge}}$ (kg/mm <sup>2</sup> )   | —                   | —    | —   | —    | —   | 23  | 6.0-7.8   | 4   | 3.2 | —   |
| $\sigma_{\text{center}}$ (kg/mm <sup>2</sup> ) | —                   | —    | —   | —    | —   | 30  | 10        | 3.2 | —   | —   |
| $\sigma_{\text{edge}}$ (kg/mm <sup>2</sup> )   | —                   | —    | —   | —    | —   | 16  | 3.5       | 1.2 | —   | —   |
| $\sigma_{\text{center}}$ (kg/mm <sup>2</sup> ) | 2.11                | 2.07 | —   | 1.96 | —   | —   | 1.78      | —   | —   | —   |
| $\sigma_{\text{edge}}$ (kg/mm <sup>2</sup> )   | —                   | —    | —   | —    | —   | —   | —         | —   | —   | —   |

\*Specimens cut in the tangential direction from a disk 1106 mm in diameter and 50 mm thick.

- 1) Characteristic; 2) temperature (°C); 3) kg/mm<sup>2</sup>; 4) kg-m/cm<sup>2</sup>.

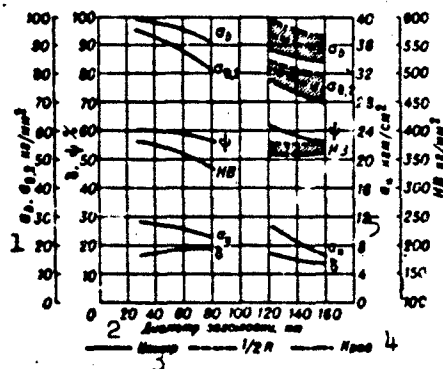

Fig. 6. Influence of blank diameter on the mechanical characteristics of 30KhN3A steel after quenching in oil (left) and in water (right) and tempering at 580-600°. 1) kg/mm<sup>2</sup>; 2) blank diameter, mm; 3) center; 4) edge; 5) kg-m/cm<sup>2</sup>.

Table 6 and Figs. 6 and 7 show the mechanical characteristics of high-alloy heat-treatable structural steels as a function of the thick-

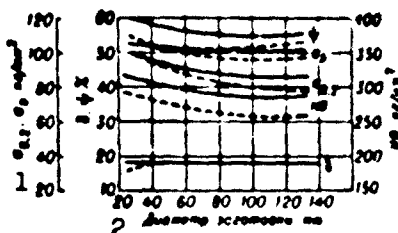

Fig. 7. Influence of blank diameter on the mechanical characteristics of 37KhN3A steel after quenching in water and in oil and tempering at 540°. The dash line represents quenching in oil and the solid line quenching in water. 1) kg/mm<sup>2</sup>; 2) blank diameter, mm.

TABLE 6

Mechanical Characteristics of Quenched Thick-Walled Components Fabricated from High-Alloy Heat-Treatable Structural Steel

| 1<br>Сталь   | 2<br>Термич. обработка  | 3<br>Место вырезки образцов по сечению детали | 4<br>Толщина сечений детали (мм) | 5   |   | σ <sub>b</sub><br>(%) | σ <sub>0,2</sub><br>(кгс/см <sup>2</sup> ) |
|--------------|---|---|----------------------------------|---|---|-----------------------|--|
|              |   |   |                                  | σ <sub>0,2</sub><br>(кг/мм <sup>2</sup> ) | σ <sub>в</sub><br>(кг/мм <sup>2</sup> ) |                       |  |
| 25ХНВА<br>7  | Закалка с 860° на воздухе, отпуск при 660°<br>Закалка с 860° в масле, отпуск при 600°                 | 18 Центр                                      | 30                               | 105                                       | 95                                      | 12                    | 10   |
|              |   | 19 То же                                      | 50                               | 105                                       | 95                                      | 12                    | 10   |
|              |   | " "   | 280                              | 105                                       | 90                                      | 12                    | 10   |
|              |   | " "   | 200                              | 100                                       | 80                                      | 10                    | 6  |
| 20ХНЗА<br>8  | Закалка с 820° в масле, отпуск при 400-500°<br>Закалка с 820° в масле, отпуск при 540°                | 17 1/2 радиуса                                | 60                               | 100                                       | 80                                      | 9                     | 9  |
|              |   | Центр   | 12                               | 103                                       | 87                                      | 20                    | -  |
|              |   | 1/2 радиуса                                   | 25                               | 103                                       | 84                                      | 21                    | -  |
|              |   | То же   | 50                               | 95  | 79                                      | 22                    | -  |
|              |   | " "   | 75                               | 91  | 74                                      | 23                    | -  |
|              |   | " "   | 100                              | 87  | 71                                      | 22                    | -  |
| 33ХНЗМА<br>9 | Нормализация при 850°, закалка с 850° в масле, отпуск при 580-600° на воздухе                         | 15 Центр                                      | 30                               | 108                                       | 96                                      | 12                    | 10   |
|              |   | 1/2 радиуса                                   | 50                               | 108                                       | 94                                      | -                     | -  |
|              |   | Центр   | 50                               | 106                                       | 92                                      | 12                    | 10   |
|              |   | Поверхность                                   | 120                              | 106                                       | 92                                      | -                     | -  |
|              |   | Центр   | 120                              | 104                                       | 88                                      | 12                    | 8  |
|              |   | Поверхность                                   | 200                              | 104                                       | 88                                      | -                     | -  |
| 18ХНВА<br>10 | Закалка с 860-870° на воздухе, отпуск при 150-170°<br>Закалка с 860-870° в масле, отпуск при 150-170° | 21 1/2 радиуса                                | 150                              | 115                                       | 85                                      | 11                    | 12   |
|              |   | 1/2 радиуса                                   | 150                              | 115                                       | 80                                      | 12                    | 12   |
|              |   | " "   | " "                              | " "                                       | " "                                     | " "                   | " "  |
|              |   | " "   | " "                              | " "                                       | " "                                     | " "                   | " "  |

1) Steel; 2) heat treatment; 3) area of component cross-section from which specimens were cut; 4) component thickness (mm); 5) kg/mm<sup>2</sup>; 6) kg-m/cm<sup>2</sup>; 7) 25KhNVA; 8) 20KhN3A; 9) 33KhN3MA; 10) 18KhNVA; 11) quenching from 860° in air, tempering at 660°; 12) quenching from 860° in oil, tempering at 600°; 13) quenching from 820° in oil, tempering at 400-500°; 14) quenching from 820° in oil, tempering at 540°; 15) normalization at 850°, quenching from 850° in oil, and tempering at 580-600° in air; 16) quenching from 860-870° in oil, and tempering at 150-170° in air; 17) center; 18) the same; 19) 1/2 radius; 21) surface.

ness of the heat-treated component.

Table 7 shows the physical characteristics of high-alloy heat-treatable structural steels.



TABLE 7

## Physical Characteristics of High-Alloy Heat-Treatable Structural Steels

| Сталь<br>1 | Критич. точки<br>(°C) 2 |                 | $\frac{\sigma}{\sigma_{0.2}}$<br>3 | $\lambda$ (кал/см.сек.°C)<br>3 |
|------------|-------------------------|-----------------|------------------------------------|--------------------------------|
|            | A <sub>s1</sub>         | A <sub>c2</sub> |                                    |                                |
| 4 20XН3А   | 700                     | 760             | 11.5                               | —                              |
| 5 30XН3А   | 715                     | 775             | 11.6                               | 0.09 (200°)                    |
| 6 37XН3А   | 710                     | 770             | 11.6                               | 0.10 (100°)                    |
| 7 33XН3МА  | 720                     | 790             | 10.8                               | 0.098 (100°)                   |
| 8 18XНВА   | 700                     | 810             | 11.5                               | 0.057 (100°)                   |
| 9 25XНВА   | 700                     | 720             | 10.7                               | 0.065 (40°)                    |

1) Steel; 2) critical points (°C); 3)  $\lambda$ (cal/cm.sec.°C); 4) 20KhN3A; 5) 30KhN3A; 6) 37-KhN3A; 7) 33KhN3MA; 8) 18KhN-VA; 9) 25KhNVA.

As a result of the need to conserve Ni many types of high-alloy heat-treatable structural steel are being replaced by nickel-free or low-nickel steels (see Low-nickel structural replacement steel). For thin and moderately thick components almost all types of high-alloy heat-treatable structural steel can be replaced by medium-alloy steel (see Medium-alloy heat-treatable structural steel).

References: Spravochnik po mashinostroitel'nym materialam [Handbook of Machine-Building Materials], Vol. 1, Moscow, 1959; Avtomobil'nyye konstruktsionnyye stali [Automobile Structural Steels], Handbook, Moscow, 1951; Liberman, L.Ya., Peysikhis, M.I., Spravochnik po svoystvam staley, primenyayemykh v kotlotrubostroyenii [Handbook of Characteristics of Steels Used in Boiler and Pipe Fabrication], 2nd Edition, Moscow-Leningrad, 1958; Metallovedeniye i termicheskaya obrabotka stali [Metalworking and Heat Treatment of Steel], Handbook, edited by M.L. Bernshteyn and A.G. Rakshtadt, 2nd Edition, Vols. 1-2, Moscow, 1961-62; Mes'kin, V.S., Osnovy legirovaniya stali [Principles of the Alloying of Steel], Moscow, 1959.

HIGH- AND MEDIUM-STRENGTH ALUMINUM CASTING ALLOYS - the Al-Si alloys AL2, AL4, and AL9. These alloys, as well as AL11, are used in the modified state (see Silumin).

The silicon forms an  $\alpha$ -Si eutectic (where  $\alpha$  is a solid solution of

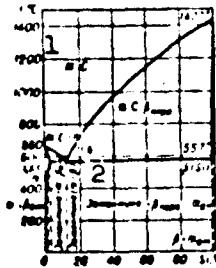

Phase diagram of Al-Si system. 1) ZHS; 2) eutectic.

TABLE 1

Casting Characteristics of AL2, AL4, and AL9 Alloys

| Class | 1                | 2                | 3                | 4                    | 5                    | 6 |
|-------|------------------|------------------|------------------|----------------------|----------------------|---|
|       | Temperature (°C) | Contraction (°C) | Flowability (mm) | Volume shrinkage (%) | Linear shrinkage (%) |   |
| 7     | 577              | 577              | 420              | 3.3                  | 1.6                  |   |
| 8     | 601              | 569              | 359              | 3.3                  | 1.6                  |   |
| 9     | 620              | 567              | 361              | 3.3                  | 1.6                  |   |

1) Alloy; 2) liquidous; 3) solidus; 4) flowability; 5) volumetric shrinkage; 6) linear shrinkage; 7) AL2; 8) AL4; 9) AL9.

silicon in aluminum) containing 11.7% Si (Figure). As can be seen from the phase diagram, Al-Si alloys are similar in composition to eutectic alloys and consequently have good casting properties. Binary aluminum-silicon alloys, however, do not provide the requisite strength, since silicon does not form hardening compounds with aluminum. Magnesium is consequently added to Al-Si alloys, forming  $Mg_2Si$  with the silicon and making it the alloys hardenable by heat treatment. Manganese is also added to reduce the detrimental influence of iron, forming a stable compound with the aluminum, iron, and silicon; this compound crystallizes in compact round grains and does not embrittle the alloy.

AL2 alloy has distinctive casting properties. Just as other Al-Si

TABLE 2

Change in Mechanical Properties of AL2, AL4, and AL9 Alloys as a function of Casting Diameter

| Сплав 1                           | Диаметр отливки (мм) 2 | $\sigma_b$ (кг/мм <sup>2</sup> ) 3 | $\delta$ (%) 4 |
|-----------------------------------|------------------------|------------------------------------|----------------|
| AL2 (немодифицированный, литой) 4 | 15                     | 13.5                               | 5.5            |
|                                   | 30                     | 13.0                               | 2.4            |
|                                   | 45                     | 12.1                               | 1.7            |
|                                   | 60                     | 11.2                               | 1.5            |
| AL4 (термически обработанный) 5   | 15                     | 26.1                               | 5.0            |
|                                   | 30                     | 22.2                               | 4.0            |
|                                   | 45                     | 19.2                               | 2.2            |
|                                   | 60                     | 17.4                               | 2.0            |
| AL9 (термически обработанный) 6   | 15                     | 20.3                               | 5.5            |
|                                   | 30                     | 17.1                               | 2.5            |
|                                   | 45                     | 15.3                               | 1.7            |
|                                   | 60                     | 14.7                               | 1.4            |

1) Alloy; 2) casting diameter; 3) kg/mm<sup>2</sup>; 4) AL2 (unmodified, cast); 5) AL4 (heat-treated); 6) AL9 (heat-treated).

TABLE 3

Typical Mechanical Properties (individually cast Samples)

| Сплав 1 | Состояние материала 2   | $\sigma_b$ (кг/мм <sup>2</sup> ) 3 | $\sigma_{0.2}$ (кг/мм <sup>2</sup> ) 4 | $\delta_{10}$ (%) 5 | НВ 6 | E (кг/мм <sup>2</sup> ) 7 | G 8  | $\nu$ 9 | $\sigma_{-1}$ (кг/мм <sup>2</sup> ) 10 |
|---------|---|------------------------------------|--|---------------------|------|---------------------------|------|---------|--|
| AL2 4   | Литой в песчаную форму, модифицированный  | 18                                 | 8                                      | 6                   | 55   | 7000                      | 2700 | 0.33    | 4                                      |
|         | Литой под давлением   | 22                                 | 12                                     | 2                   | —    | —                         | —    | —       | —                                      |
| AL4 5   | Модифицированный, литой в песчаную форму, закаленный и состаренный по режиму T6 | 26                                 | 20                                     | 4                   | 70   | 7000                      | 2700 | 0.33    | 7                                      |
|         | Литой под давлением   | 29                                 | —                                      | 2                   | 80   | 7000                      | 2800 | 0.33    | —                                      |
| AL9 6   | Модифицированный, литой в песчаную форму, закаленный по режиму T4               | 20                                 | 11                                     | 4                   | 60   | 7000                      | 2700 | 0.31    | 4                                      |

\*Sample rotated during cantilever bending; N =  $5 \cdot 10^8$  cycles.

1) Alloy; 2) state of material; 3) kg/mm<sup>2</sup>; 4) AL2; 5) AL4; 6) AL9; 7) cast in sand mold, modified; 8) pressure cast; 9) modified, cast in sand mold, quenched, and aged under regime T6; 10) modified, cast in sand mold, and quenched under regime T4.

I-50a2

alloys, it has a tendency toward formation of gas pores. Its mechanical characteristics are moderately high and it has satisfactory corrosion resistance in moist air and salt water (see Corrosion of aluminum alloys) and high hermeticity. This alloy cannot be hardened by heat treatment. It is satisfactory for gas and argon-arc welding. AL2 is intended for casting geometrically complex components which will not bear large loads.

AL4 alloy is distinguished by good casting properties, comparatively high mechanical characteristics, satisfactory corrosion resistance in moist air and salt water, and good cuttability and is satisfactory for gas and argon-arc welding. It yields high hermeticity. The principal drawback of AL4 is its greater tendency toward formation of gas pores. The heat-treatment regime involves prequenching heating at  $535 \pm 5^\circ$  for 2-5 hr, water-cooling ( $50-100^\circ$ ), and aging at  $175 \pm 5^\circ$  for 15 hr. AL4 is generally used for fabrication of large- and medium-size components which are subject to substantial stresses and must function under pressure.

TABLE 4  
Mechanical Properties of AL2 and AL4 Alloys at Low Temperatures

| Сплав<br>1 | Вид полу-<br>фабриката<br>2         | Состояние<br>материала<br>3                        | Темп-ра<br>испытания<br>4 (°C) | $\sigma$<br>(кг/мм <sup>2</sup> )<br>5 | $\delta$ (%)<br>6 | $\sigma_{0.2}$<br>(кг/мм <sup>2</sup> )<br>7 |
|------------|-------------------------------------|--|--------------------------------|--|-------------------|--|
| AL2<br>6   | Отдельно<br>отлитые<br>образцы<br>8 | Модифици-<br>рованный<br>10                        | -40                            | 19                                     | 9                 | 0.6  |
|            |                                     |  | -70                            | 20                                     | 8                 | 0.5  |
| AL4<br>7   | То же<br>9                          | Термически<br>обработанный по ре-<br>жиму Т6<br>11 | -40                            | 28                                     | 3.2               | 0.25   |
|            |                                     |  | -70                            | 29                                     | 2.4               | 0.25   |
|            |                                     |  | -196                           | 33                                     | 2.8               | 0.25   |

1) Alloy; 2) type of semifinished product; 3) state of material; 4) test temperature (°C); 5) kg/mm<sup>2</sup>; 6) AL2; 7) AL4; 8) individually cast samples; 9) the same; 10) modified; 11) heat-treatment under regime T6.

AL9 alloy has good casting properties and moderate mechanical properties. It has a tendency toward natural aging, so that after one

TABLE 5

## Mechanical Properties of AL4 Alloy at Elevated Temperatures

| Сплав<br>1 | Вид полуфабриката<br>2                 | Состояние материала<br>3                                 | Температура испытания<br>4 (°C) | $\sigma_b$<br>5 (кг/мм <sup>2</sup> ) | $\epsilon$ (%) |
|------------|--|--|---------------------------------|---------------------------------------|----------------|
| AL4<br>6   | Отдельно отлитые образцы, d 10 мм<br>7 | Литой в песок, термически обработанный по режиму Т6<br>8 | 20                              | 24                                    | 3.4            |
|            |  |  | 100                             | 22                                    | 2.9            |
|            |  |  | 150                             | 19                                    | 3.5            |
|            |  |  | 175                             | 18                                    | 3.6            |
|            |  |  | 200                             | 16                                    | 4.0            |
|            |  | 250  | 11                              | 5.4                                   |                |

1) Alloy; 2) type of semifinished product; 3) state of material; 4) test temperature (°C); 5) kg/mm<sup>2</sup>; 6) AL4; 7) individually cast samples, d = 10 mm; 8) sand-cast, heat-treated under regime T6.

TABLE 6

## Mechanical Properties of AL4 Alloy at Elevated Temperatures After Stabilization\*

| Вид полуфабриката<br>1                 | Состояние материала<br>2  | Температура испытания<br>3 (°C) | $\sigma_b$<br>4 (кг/мм <sup>2</sup> ) | $\epsilon$ (%) |
|--|---|---------------------------------|---------------------------------------|----------------|
| Отдельно отлитые образцы, d 10 мм<br>5 | Литой в песок, термически обработанный по режиму Т6, стабилизированный<br>6 | 20                              | 24                                    | 3.0            |
|  |   | 100                             | 23                                    | 2.6            |
|  |   | 150                             | 20                                    | 3.2            |
|  |   | 175                             | 14                                    | 5.4            |

\*Stabilization: preliminary holding at test temperature for 100 hr.

1) Type of semifinished product; 2) state of material; 3) test temperature (°C); 4) kg/mm<sup>2</sup>; 5) individually cast samples, d = 10 mm; 6) sand-cast, heat-treated under regime T6, stabilized.

TABLE 7

## Physical Properties of AL2, AL4, and AL9 Alloys

| Сплав<br>1 | γ (г/см <sup>3</sup> )<br>2 | α · 10 <sup>4</sup> (1/°C)<br>3 при темп-ре |         |         | κ (кал/см · сек · °C)<br>4 | Электропроводность в % и электропроводности меди<br>5 | c при 100° (кал/г · °C)<br>6 |
|------------|-----------------------------|---|---------|---------|----------------------------|---|------------------------------|
|            |                             | 20-100°                                     | 20-200° | 20-300° |                            |   |                              |
| AL2<br>7   | 2.65                        | 21.1  | 22.1    | 23.3    | 0.42                       | 40.0  | —                            |
| AL4<br>8   | 2.65                        | 21.7  | 22.3    | 23.5    | 0.38                       | 37.0  | 0.23                         |
| AL9<br>9   | 2.66                        | 23.0  | 24.0    | 24.5    | 0.36                       | 36.0  | 0.23                         |

1) Alloy; 2) g/cm<sup>3</sup>; 3) at temperature of; 4) cal/cm · sec · °C; 5) electrical conductivity in % of conductivity of copper; 6) c at 100° (cal/g · °C); 7) AL2; 8) AL4; 9) AL9.

I-50a4

or two months the mechanical characteristics of the quenched alloy approximate those of the quenched and artificially aged alloy. Its salt-water corrosion resistance and cuttability are satisfactory and it yields high hermeticity. This alloy is suitable for gas and argon-arc welding. Two heat-treatment regimes, T4 and T5, are used, depending on the mechanical properties required.

AL9 alloy is usually employed for geometrically complex components which will bear moderate loads and must function under pressure.

The creep strength and long-term strength of AL4 alloy which has been sand-cast, modified, and heat-treated under regime T6 (individually cast samples,  $d = 10$  mm) are as follows:  $\sigma_{100} = 2.5$  kg/mm<sup>2</sup>;  $\sigma_{0.2/100} = 1.0$  kg/mm<sup>2</sup> (from total deformation) at 300°.

As has already been noted, the alloys of this group are characterized by high hermeticity, i.e., an ability to withstand hydraulic pressures of the order of 150-250 atm without flowing, depending on the thickness of the casting walls. The hermeticity of castings can be increased by thickening the walls, by casting in chill molds, by permitting the castings to crystallize under elevated pressure (see Crystallization of aluminum alloys in an autoclave), or by vacuum evaporation of the liquid metal before casting (see Vacuum evaporation of aluminum alloys). The good casting properties of AL2, AL4, and AL9 make it possible to use them for producing castings of virtually all sizes and shapes by any current casting method.

References: Al'tman, M.B., et al., *Plavka i lit'ye legkikh splavov* [Melting and Casting of Light Alloys], Moscow, 1956; Kolobnev, I.F., Krymov, V.V., and Polyanskiy, A.P., *Spravochnik liteyshchika. Fasonnoye lit'ye iz alyuminiyevykh i magniyevykh splavov* [Handbook of Foundry Work. Die Casting of Aluminum and Magnesium Alloys], Moscow, 1957.

M.B. Al'tman and T.K. Ponar'ina

1945

HIGH CORROSION RESISTANT CAST MAGNESIUM ALLOYS are magnesium alloys which surpass the magnesium alloy ML5 in corrosion resistance. They include: the type ML4pch (pch - high purity) and type ML5pch alloys (AMTU 488-63) of the Mg - Al - Zn system; all alloys of the Mg - Zr system of types ML10, ML12 (AMTU 488-63); type ML2 alloy (GOST 2856-55) and others of the Mg - Mn system. The ML4pch and ML5pch alloys differ from the ML4 and ML5 alloys in lower content of undesirable impurities. The most widely used ML5pch alloy permits 0.001% Ni in place of 0.01%, 0.007% Fe in place of 0.08%, 0.05% Cu in place of 0.1%, 0.08% Si in place of 0.25%. (For chemical composition of the alloys see Magnesium Alloys). The high corrosion resistance of details made from the ML4pch and ML5pch alloys is achieved not only by means of limiting the content of the injurious impurities, but also by use during casting of the chloride-free fluxes (FL1) in place of the chloride fluxes (VL2 or VL3). As a result, castings are obtained which are practically free of inclusions of the chloride fluxes which form, with moisture, concentrated solutions of the chloride salts which destroy the magnesium alloys.

The corrosion resistance, determined from the amount of hydrogen released during 48-hour soak of specimens in a 3% NaCl solution, is on the average  $30 \text{ cm}^3/\text{cm}^2$  for the ML5 alloy, while for the ML5 alloy prepared with the use of a chloride-free flux it is no more than  $12 \text{ cm}^3/\text{cm}^2$ , and for the ML5pch alloy it is no more than  $6 \text{ cm}^3/\text{cm}^2$ . The corrosion resistance of the alloys based on the Mg - Zr system as determined by the amount of hydrogen released during a 48-hour soak in a 0.5% NaCl solution is typically  $0.3-1.3 \text{ cm}^2/\text{cm}^2$ , in particular the ML12

II-13M1

alloy figure is about  $0.9 \text{ cm}^3/\text{cm}^2$ , the ML10 alloy is about  $1.1 \text{ cm}^3/\text{cm}^2$ , the VML2 alloy is about  $0.3-0.5 \text{ cm}^3/\text{cm}^2$ , while the ML5 alloy figure is  $2.5 \text{ cm}^3/\text{cm}^2$ .

The ML2 alloy, which is used relatively little because of low mechanical and processing properties, is capable of resisting the action of concentrated solutions of caustic soda at temperatures to  $120^\circ$  and soda solutions. Unslaked lime, lime solutions and concrete destroy castings made from the ML2 alloy very slowly. The mechanical and physical properties of the ML4pch and ML5pch alloys are similar to the properties of the commercially pure ML4 and ML5 alloys (see High-Strength Cast Magnesium Alloys). For the mechanical, physical and processing properties of the alloys of the Mg - Zr system see High-Strength Cast Magnesium Alloys and High-Temperature Cast Magnesium Alloys. Typical mechanical properties of the ML2 alloy are presented in tables 1-2. The minimal mechanical properties guaranteed by GOST 2856-55 for the ML2 alloy are lower than the typical properties by  $1 \text{ kg}/\text{mm}^2$  in ultimate strength and by 1% in elongation.

TABLE 1

Mechanical Properties of the ML2 Alloy at Various Temperatures (12-mm-diam specimens separately cast in sand mod, without heat treatment)

| 1<br>Темп-ра<br>(°C) | $\sigma_{0.2}$          | $\sigma_b$ | $\delta_{10}$ | $\psi$ | HB | $\sigma_{0.2 \text{ 100}}$ (по<br>постоянной<br>деформации) 2 |
|----------------------|-------------------------|------------|---------------|--------|----|---|
|                      | (кг/мм <sup>2</sup> ) 3 |            | %             |        |    |   |
| 20                   | 3                       | 10         | 4             | 6      | 35 | —   |
| 100                  | 3                       | 9.5        | 10            | 12     | 35 | 1.8   |
| 150                  | 3                       | 8          | 11            | 14     | 30 | 1.6   |
| 200                  | 3                       | 7          | 12.5          | 17     | 20 | 1.3   |

1) Temperature; 2) (permanent deformation); 3) ( $\text{kg}/\text{mm}^2$ ).



II-13M2

TALBE 2

Typical Mechanical Properties of ML2 alloy at 20° (specimens cut from details cast in sand mold, without heat treatment)

| 1<br>Толщина стенок<br>отливки (мм) | 2<br>$\sigma_b$<br>(кг/мм <sup>2</sup> ) | 3 (%) |
|-------------------------------------|--|-------|
| 3 До 10                             | 10                                       | 3     |
| 3 До 20                             | 9  | 2.5   |
| 4 Более 20                          | 7  | 1.5   |

1) Casting wall thickness (mm); 2) (kg/mm<sup>2</sup>); 3) to ; 4) over.

The properties of the ML2 alloy in compression at 20°:  $\sigma_b = 16$  kg/mm<sup>2</sup>,  $\Delta = 25\%$ . Shear resistance  $\tau_{sr} = 7$  kg/mm<sup>2</sup>, impact strength  $\alpha_n = 0.5$  kgm/cm<sup>2</sup>. Physical and processing properties of the ML2 alloy:  $\gamma = 1.8$ ;  $\alpha = 26.6 \cdot 10^{-6}$  (20 - 100°),  $27.3 \cdot 10^{-6}$  (20 - 200°),  $27.7 \cdot 10^{-6}$  (20 - 300°) 1/°C;  $\lambda = 0.32$  (20°) cal/cm-sec-°C;  $\rho = 6.88 \cdot 10^{-6}$  (20°),  $8.3 \cdot 10^{-6}$  (100°)  $9.7 \cdot 10^{-5}$  (200°) ohm-cm;  $c = 0.25$  (20 - 100°) cal/g-°C;  $E = 4200$  kg/mm<sup>2</sup>; linear shrinkage 1.7-1.9%; liquidus temperature 650°; solidus temperature 645°. In casting the ML4pch and ML5pch alloys observation of the following conditions is recommended: 1) melting crucibles and tools are coated to prevent enrichment of the alloys with iron impurities; 2) to obtain casting free from inclusions of chloride fluxes the last 2-3 minutes of refining and settling of the molten metal and pouring into the forms is performed under the FL1 chloride-free flux; 3) as charge materials, use may be made of finished MGS4pch and MGS5pch alloys prepared in accordance with TU 47-59, preliminary alloys prepared by the fabricating plants, and also MGS4 and MGS5 alloys selected on the basis of chemical composition. In the latter case manganese additives must be used to remove the iron impurities.

The casting properties of the ML4pch and ML5pch alloys are the same as those of the alloys of commercial purity, while those of the ML2 alloy are low; the minimal wall thickness in casting details from the ML2

II-1883

alloy is equal to 6-8 mm depending on the cast size. Casting density is good. The alloy has a tendency to formation of hot cracks (in testing for hot brittleness the first crack is formed with a ring width of 50 mm), therefore, only casting of details of simple configuration is possible. The alloy is not strengthened by heat treatment. It welds well with gas-acetylene welding under the VF156 flux, and with electric spct welding and argon-arc welding.

The details made from the high corrosion resistant cast magnesium alloys, just as those made from the alloys of commercial purity, are protected from corrosion by oxidation and paint/varnish coatings (see Corrosion of Magnesium Alloys).

The ML4pch and ML5pch alloys are used for highly loaded details operating for long periods in severe conditions, for example, under atmospheric conditions of high humidity. For areas of application of the alloys of the Mg - Zr system of types ML10, ML12, and others, see High-Strength Cast Magnesium Alloys and High-Temperature Cast Magnesium Alloys. The ML2 alloy is used for production of lowly loaded details of simple configuration (various gasoline and oil fittings, tanks). The alloy may find application in the chemical industry for details operating in an alkaline medium.

References: see article Cast Magnesium Alloys.

N.M. Tikhova

HIGH-ELASTIC EQUILIBRIUM MODULUS characterizes the equilibrium deformation of lattice polymers (rubbers) and is determined from the relation  $E_{\infty} = \sigma/\epsilon$ , where  $E_{\infty}$  is the high-elastic equilibrium modulus,  $\sigma$  is true stress (equilibrium),  $\epsilon$  is the specified tensile (compressive) deformation. The equilibrium stress is determined after complete relaxation of the stress in the specimen. The high-elastic equilibrium modulus is associated in a definite way with the structure of the lattice polymer. The formula  $N = C(E_{\infty}/T)^3$  is used to compute the number of bonds  $N$  of the three-dimensional lattice in unit volume; here  $T$  is the absolute temperature ( $^{\circ}\text{K}$ ),  $E_{\infty}$  is in  $\text{kg}/\text{cm}^2$ , and  $C$  is a constant which for rubbers varies from  $1 \cdot 10^{22}$  to  $3 \cdot 10^{22}$ .

References: Bartenev G. M., Zhurnal tekhn. fiz. (Journal of Tech. Physics), 1950, No. 4, page 461; 1952, No. 7, page 1154; in book: Vulkanizatsiya rezin (Vulcanization of Rubber), Leningrad, 1954, page 196; Vishnitskaya L.A., KZh, 1959, Vol. 21, No. 3, pages 370-73; Tr. N.-i. in-ta rezinovoy prom-sti (Transaction of the Sci. Res. Institute of the Rubber Industry), 1954, coll. 1.

G.M. Bartenev

I-45K

HIGH-FREQUENCY CERAMICS - see Ceramic Materials for Radio Engineer-  
ing.

HIGH-GRADE CHROMIUM — is a chromium which contains impurities in a quantity of not more than 0.015%; it possesses plastic properties at low temperatures. This peculiarity of pure chromium combined with its thermal endurance, its resistance to aggressive media and the relatively low specific gravity makes it possible to use chromium as a structural material for a number of special-purpose parts. High-grade chromium may also be used for alloys with special properties: precision, refractory, corrosion-resistant and other alloys, in which it is present either as the basic metal or as an alloying component. High-grade chromium is obtained by removing the impurities of commercial chromium by refining (Table 1). The total of Pb, Sb, Bi, Cd, Sn, and Cu amounts

TABLE 1

Percentage of Impurities in Electrolytic Chromium (according to the data of the TsNIICrM)

| Примеси 1                 | O       | N         | H         | S         | C         | Fe      |
|---------------------------|---------|-----------|-----------|-----------|-----------|---------|
| Содержание (всвое %)<br>2 | 0,3-0,8 | 0,05-0,15 | 0,05-0,12 | 0,02-0,03 | 0,02-0,03 | до 0,01 |

1) Impurities; 2) content (in % by weight).

to about 0.003%. The electrolysis of aqueous solutions of chromic anhydride is the most thoroughly developed but not the best method to obtain commercial chromium suitable for a subsequent refining. The electrolysis is carried out in lead tanks which serve as an anode; the cathode is made from stainless steel. The electrolyte is composed of chromic anhydride (300-350 g/liter), sulfuric acid (3-7 g/liter), and distilled water as a solvent. The chromium is precipitated on the

cathode in the form of 0.2-0.3 mm thick scales.

Chromium obtained by electrolysis of molten media using soluble electrodes may also be used as a commercial metal. Various chromium alloys (ferrochrome, for example) and also other chromium-containing material with n-type conductivity are used as soluble electrodes. A melt of sodium chloride containing a small quantity of chromium chloride serves as an electrolyte. The quality of such a chromium is somewhat higher than that of a chromium obtained from aqueous chromic anhydride solutions, and the former chromium is considerably cheaper than the latter.

Electrolytic chromium serves as a raw material for the preparation of high-grade chromium. A number of methods are known to refine chromium; a general method, however, which removes all impurities with an equal completeness, does not exist. Each method is suitable to remove only certain impurities, and the expedient choice of the method depends on the requirements of the purity of the chromium with respect to specific impurities.

Refining of electrolytic chromium in a stream of pure hydrogen at high temperatures is the most thoroughly developed and efficient method for the preparation of high-grade chromium. This method is suitable for purifying chromium from O, H, N, C, S, P, Cu, Sb, Bi, Cd, Pb, and Sn. Metals with a low vapor pressure (Al, Si, Fe, Ni, etc.) are removed from the chromium to a lower degree. The refining is carried out in special furnaces with a molybdenum heater. The furnace is made completely from metal in order to prevent a contamination of the chromium. Scales of electrolytic chromium are put into a molybdenum container placed in the furnace and heated in a dry hydrogen stream. The temperature of the process, the holding time, the purity and the specific consumption of hydrogen (i.e., the ratio of the quantity of hydrogen con-

sumed for the refining of the chromium to the weight of the chromium) are the main factors which determine the completeness of the refining of chromium by hydrogen. Raising the temperature facilitates a more complete removal of the impurities and shortens the treatment time. A residual oxygen content 0.001% is obtainable within 15 hrs at 1700°, within 23 hrs at 1500° and after more than 50 hrs at 1300°. A residual carbon content of 0.001% is attained within 5 hrs at 1700°, and within 30 hrs at 1500°; at 1300°, however, the minimum carbon content amounts to 0.004%. An increase in the specific consumption of hydrogen shortens the time of the refining process. The degree of purity of the hydrogen has a great influence on the purity of the chromium (especially with respect to the oxygen and nitrogen content). The percentage of impurities in refined chromium is quoted in Table 2.

TABLE 2

Percentage of Impurities  
in Refined Chromium (accord-  
ing to the data of the  
TsNIChM)

| Примеси                                     | 2 Рафинированный<br>в водороде |                     | 4 Рафиниро-<br>ванный<br>иодидным<br>методом |
|---|--------------------------------|---------------------|--|
|   | 3 при 1300°                    | 3 при 1700°         |  |
| 5 Газовый анализ (весовые %)                |                                |                     |  |
| O   | 0,003-0,005                    | 0,001-0,002         | 0,001-0,002                                  |
| H   | 0,0004                         | 0,0004              | 0,0004                                       |
| N   | 0,01-0,02                      | 0,001-0,002         | 0,001  |
| 6 Химический анализ (весовые %)             |                                |                     |  |
| C   | 0,004-0,008                    | 0,001-0,002         | 0,001-0,002                                  |
| S   | —                              | <0,001              | <0,001                                       |
| P   | 0,001                          | <0,001              | <0,001                                       |
| 7 Химико-спектральный анализ<br>(весовые %) |                                |                     |  |
| Fe  | 0,05                           | 0,003-0,005         | 0,003  |
| Ni  | —                              | 0,003-0,005         | —  |
| Al  | 0,01                           | 0,001-0,005         | <0,005                                       |
| Cu  | —                              | <0,001              | <0,001                                       |
| Pb  | 0,001                          | <5·10 <sup>-4</sup> | <5·10 <sup>-4</sup>                          |
| Bi  | 1·10 <sup>-4</sup>             | <1·10 <sup>-4</sup> | <1·10 <sup>-4</sup>                          |
| Cd  | 1·10 <sup>-4</sup>             | <5·10 <sup>-4</sup> | <5·10 <sup>-4</sup>                          |
| Sn  | 1·10 <sup>-4</sup>             | <1·10 <sup>-4</sup> | <1·10 <sup>-4</sup>                          |
| Sb  | 1·10 <sup>-4</sup>             | <1·10 <sup>-4</sup> | <1·10 <sup>-4</sup>                          |

1) Impurities; 2) refined in hydrogen; 3) at ...; 4) refined by the iodide method; 5) gas analysis (% by weight); 6) chemical analysis (% by weight); 7) spectrochemical analysis (% by weight).

High-grade chromium may be prepared by thermal dissociation of its iodides (iodide method) (Table 2). The refining of chromium may also be carried out by the method of zone melting. This method, however, has certain disadvantages in the case of chromium, caused mainly by the design of the apparatus for zone melting.

From the mentioned methods of production of high-grade chromium, only the refining of electrolytic chromium in hydrogen at high temperatures is utilized on a semiindustrial scale. The other methods have not surpassed the level of laboratory investigations.

References: Greenaway, H.T., The Electrodeposition and Refining of High-grade Chromium, "J. Inst. Metals," 1954, Vo. 83, Part 4, pages 121-125; Marvin, J.U., Chromium, Vol. 2, N.Y., 1956, page 148; Smith, W.H., Seybolt, A.U., Ductile Chromium, "J. Electrochem. Soc.," 1956, Vol. 103, No. 6, page 347; Karsanov, G.V., Lyakhin, B.P., Ponomarev, Yu.N., Polucheniye elektroliticheskogo rafinirovannogo khroma [Preparation of Electrolytically Refined Chromium], "Tsent. in-t informatsii chernoy metallurgii" [Central Information Institute for Ferrous Metallurgy], Information No. 40 (562), Moscow, 1959, pages 99-103; Yemel'yanov, V.S. [et al.], Uovershenstvovannyy metod polucheniya iodidnogo khroma i yego svoystva [Improved Method of the Preparation of Chromium, and the Properties of the Latter], in the Collection: Metallurgiya i metallovedeniye chistykh metallov [Metallurgy and Metal Science of Pure Metals], No. 1, Moscow, 1959; Ageyev, N.V., Trapeznikov, V.A., Polucheniye iodidnogo khroma i yego svoystva [Preparation of Iodide Chromium and Its Properties], in the book: Issledovaniya po zharoprochnym splavam [Investigations on Thermally Endurable Alloys], edited by V.S. Yemel'yanov and A.I. Yevstyukhin, M., 1957; Pfann, J., Zonnaya plavka [Zone Melting], translated from English, Moscow, 1960.

B.P. Lyakhin



III-14kh4

Manu-  
script  
Page  
No.

[Transliterated Symbols]

1952 ЦИИИЧМ = TsNIICHM = Tsentral'nyy nauchno-issledovatel'skiy  
institut chernoy metallurgii = Central  
Scientific Research Institute for Fer-  
rous Metallurgy

HIGH-HOT-STRENGTH ALUMINUM CASTING ALLOYS - high-hot-strength alloys intended to function at elevated temperatures. The hot strength of an alloy characterizes its resistance to stress and temperature. The changes in the strength and other properties of aluminum alloys during prolonged exposure to high temperature and stress depend on the following factors: 1) the energy of the interatomic bonds of the alloying elements, which is roughly characterized by their heat of sublimation and the activation energy of their diffusion in aluminum; 2) the degree of supersaturation and the character of the aluminum solid solution; 3) the structure of the alloy (i.e., the size, shape, quantity, and distribution of the secondary-phase particles). Hence it follows that the higher the working temperature and the longer the exposure, the higher should be the melting temperature of the alloying elements and the lower should be the diffusion coefficient. For example, for prolonged functioning at 350° or more high-hot-strength aluminum casting alloys should not contain lithium, zinc, calcium, or magnesium, which have interatomic bonds of lower energy than the aluminum atoms and high diffusion coefficients; the higher the temperature, the more complex should be the chemical composition of the solid solution and the lower should be its supersaturation. The decomposition products of the aluminum solid solution should be ultradispersed solid particles of stable complex phases with little tendency to coagulate at the working temperature. In this case a microheterogeneous structure is formed within the grains of the solid solution, inhibiting the displacement of dislocations and atomic layers along the slip planes. This is the principal factor in

I-52a1

obtaining increased hot strength; in order to retard decomposition of the aluminum solid solution and recrystallization high-hot-strength aluminum casting alloys should contain stable phases (e.g.,  $\text{Al}_6\text{Cu}_3\text{Ni}$ ,  $\text{Al}_3(\text{CuNi})_2$ ,  $\text{Al}_8\text{Mn}_4\text{Ce}$ , etc.), which crystallize in slender ramified structures that completely block the grains of the aluminum solid solution. In selecting alloying elements for high-hot-strength aluminum casting alloys it is necessary to take into account the possibility of forming more than 20% of eutectic, a condition necessary for obtaining good casting properties (increased flowability, reduced tendency toward hot cracking, etc.).

Alloys of the silumin type have the lowest hot strength of the high-hot-strength aluminum casting alloys. Al-Cu-Ni-Mg and Al-Cu-Ni-Mn alloys have high hot strengths as a result of the presence of complex stable phases (S, T, etc.). VAL1 and ATsR1 alloys have the highest hot strength. The following alloys are usually employed for cast components which must function at elevated temperatures for prolonged periods: AL1, AL3-1, AL4, AL5, AL10V, AL25 (ZhLS1), AL26 (VKZhLS), AL19, AL20 (V14A), AL21 (V300), VAL1 and ATsR1. For example, the cylinder heads of liquid-cooled engines are usually fabricated from AL4 alloy, which has high casting characteristics, good hermeticity, and the requisite strength characteristics for prolonged functioning at temperatures of up to 200°. AL3-1 alloy has a higher hot strength than AL5, but has very similar technological properties. AL3-1 and AL5 alloys have higher hot strengths than AL4 and are used for the cylinder heads of air-cooled engines.

AL1, AL25 (ZhLS1), AL26 (VKZhLS - hypereutectic silumin), AL10V, and VAL1 alloys are employed for cast pistons. These alloys can be arranged in the following order of increasing hot strength: AL10V, AL26 (VKZhLS), AL25 (ZhLS1), AL1, and VAL1. The order with respect to in-

I-52a2

creasing technological characteristics is AL1, VAL1, AL10V, AL26 (VKZhLS), and AL25 (ZhLS1). The latter two alloys have the lowest coefficient of linear expansion and their use makes it possible to employ small clearances between piston and cylinder in piston engines. It must be noted that AL25 and AL26 alloys, which contain neither nickel nor cobalt, have lower hot strengths than AL10V. All the alloys used for casting pistons have a low relative elongation (0.5-2%) and a low impact strength (0.3-0.5 kg-m/cm<sup>2</sup>). Practical experience has shown that the reduced plasticity of piston alloys has no marked influence on piston service life.

AL19 alloy has the highest mechanical properties at room temperature ( $\sigma_b = 34-45$  kg/mm<sup>2</sup>;  $\delta = 4-8\%$ ) and a high hot strength. Its principal drawback is the fact that components cast from it have a low hermeticity.

AL21 (V300), ATsR1 and VAL1 alloys have the highest hot strength and high hermeticity. AL20 (V14A) alloy has almost the same hot strength as AL1, but has substantially better technological properties. AL21 alloy contains 1.5% iron as an alloying element and can consequently be produced from secondary alloys and various aluminum-production wastes. High-strength alloy (of the AL8 type) can be employed for brief operation at elevated temperatures, since they do not undergo any substantial softening over short periods. Heating-system units require an aluminum casting alloy with the following characteristics: high long-term strength at 350-425°, hermeticity (the components should be able to withstand high gas and liquid pressures), and satisfactory weldability and cuttability. ATsR1 alloy satisfies these requirements; it has a higher hot strength when cast (without quenching) than when heat-treated.

In contrast to ATsR1, VAL1 alloy is used in the heat-treated state.

TABLE 1  
Minimum Mechanical Properties (according  
to GOST 2685-53 or STU)

| Сила <sup>1</sup>  | Состояние материала **                | 3  | $\sigma_{0.2}$<br>(кг/мм <sup>2</sup> ) | $\delta_{10}$ (%) | ТВ<br>(кг/мм <sup>2</sup> ) |
|--------------------|---------------------------------------|----|---|-------------------|-----------------------------|
| 4                  | АЛ1 Термически обработанный по режиму | T5 | 20                                      | 0.5               | 95                          |
| АЛ3-1              | Термически обработанный по режиму     | T5 | 21                                      | 0.5               | 75                          |
| 5                  | То же                                 | T7 | 20                                      | 1.0               | 70                          |
| АЛ5                | Термически обработанный по режиму     | T1 | 16                                      | 0.5               | 85                          |
| 6                  | То же                                 | T5 | 20                                      | 0.5               | 70                          |
|                    |                                       | T7 | 18                                      | 1.0               | 65                          |
| АЛ7                | Термически обработанный по режиму     | T4 | 20                                      | 4                 | 60                          |
| 7                  | То же                                 | T5 | 22                                      | 3                 | 70                          |
| АЛ10В              | Термически обработанный по режиму     | T1 | 17                                      | 0.5               | 90                          |
| 8                  | То же                                 | T6 | 20                                      | 0.5               | 100                         |
| АЛ19               | Термически обработанный по режиму     | T4 | 30                                      | 8                 | 80                          |
| 9                  | То же                                 | T5 | 34                                      | 3                 | 100                         |
| АЛ20<br>(V14A)     | Отжиг из литого состояния по режиму   | T2 | 16                                      | 0.8               | 65                          |
| 10                 | Термически обработанный по режиму     | T7 | 21                                      | 0.8               | 65                          |
| АЛ21<br>(V300)     | Отжиг из литого состояния по режиму   | T2 | 18                                      | 0.8               | 65                          |
| 11                 | Термически обработанный по режиму     | T7 | 21                                      | 0.8               | 75                          |
| 12 АЦР1            | Отпуск из литого состояния по режиму  | T1 | 20                                      | 1.0               | 70                          |
| 13 АЛ25<br>(VKLS1) | Отпуск из литого состояния по режиму  | T1 | 20*                                     | 0.2               | 90*                         |
| АЛ26<br>(VKZhLS)   | Отпуск из литого состояния по режиму  | T1 | 20*                                     | 0.2               | 90*                         |
| 14                 |                                       |    |   |                   |                             |

\*These characteristics are for samples cast in chill molds.

\*\*For the heat-treatment regime see Heat treatment of aluminum alloys.

1) Alloy; 2) state of material; 3) kg/mm<sup>2</sup>; 4) AL1; 5) AL3-1; 6) AL5; 7) AL7; 8) AL10V; 9) AL19; 10) AL20 (V14A); 11) AL21 (V300); 12) ATsR1; 13) AL25 (ZhLS1); 14) AL26 (VKZhLS); 15) heat-treated under regime; 16) the same; 17) annealed from cast state under regime.

TABLE 2

Influence of 100-hr Heating at Test Temperature on Mechanical Properties\*

| Сплав<br>1     | Состояние<br>материала<br>2                   | Темп-ра<br>испытания<br>(°C)<br>3 | 4 Нагрев 30 мин.                      |                        | 6 Нагрев 100 час.                     |                        |
|----------------|---|-----------------------------------|---------------------------------------|------------------------|---------------------------------------|------------------------|
|                |   |                                   | $\sigma_s$ (кг/мм <sup>2</sup> )<br>5 | $\delta_{10}$ (%)<br>7 | $\sigma_s$ (кг/мм <sup>2</sup> )<br>8 | $\delta_{10}$ (%)<br>9 |
| АЛ1            | Термически<br>обработанный<br>по режиму<br>Т5 | 20                                | 25                                    | 0.5                    | 25                                    | 0.5                    |
|                |   | 250                               | 22                                    | 1.0                    | 20                                    | 1.5                    |
|                |   | 300                               | 18                                    | 1.5                    | 16                                    | 2.0                    |
|                |   | 350                               | 14                                    | 2.0                    | 13                                    | 2.5                    |
|                |   | 400                               | 9                                     | 2.0                    | 8                                     | 3.0                    |
| АЛ3-1          | Термически<br>обработанный<br>по режиму<br>Т6 | 20                                | 27                                    | 1.0                    | 27                                    | 1.0                    |
|                |   | 250                               | 20                                    | 1.5                    | 18                                    | 2.0                    |
|                |   | 300                               | 18                                    | 2.0                    | 16                                    | 2.5                    |
|                |   | 350                               | 13                                    | 2.0                    | 11                                    | 3.0                    |
|                |   | 400                               | 9                                     | 2.0                    | 7                                     | 3.5                    |
| АЛ4            | Термически<br>обработанный<br>по режиму<br>Т4 | 20                                | 26                                    | 1.0                    | 26                                    | 1.0                    |
|                |   | 250                               | 16                                    | 1.0                    | 12                                    | 1.0                    |
|                |   | 300                               | 12                                    | 1.0                    | 9                                     | 1.0                    |
|                |   | 350                               | 9                                     | 1.0                    | 7                                     | 1.0                    |
|                |   | 400                               | 6                                     | 1.0                    | 5                                     | 1.0                    |
| АЛ5            | Термически<br>обработанный<br>по режиму<br>Т6 | 20                                | 26                                    | 0.8                    | 26                                    | 0.8                    |
|                |   | 250                               | 22                                    | 1.5                    | 18                                    | 1.7                    |
|                |   | 300                               | 18                                    | 2.0                    | 15                                    | 2.0                    |
|                |   | 350                               | 12                                    | 2.0                    | 10                                    | 2.5                    |
|                |   | 400                               | 7                                     | 2.0                    | 5                                     | 3.0                    |
| АЛ9            | Термически<br>обработанный<br>по режиму<br>Т4 | 20                                | 20                                    | 3.0                    | 20                                    | 3.0                    |
|                |   | 250                               | 15                                    | 12                     | 14                                    | 15                     |
|                |   | 300                               | 11                                    | 18                     | 10                                    | 25                     |
|                |   | 350                               | 8                                     | 26                     | 6                                     | 35                     |
|                |   | 400                               | 5                                     | 36                     | 4                                     | 45                     |
| АЛ19           | Термически<br>обработанный<br>по режиму<br>Т5 | 20                                | 36                                    | 4.0                    | 36                                    | 4.0                    |
|                |   | 250                               | 26                                    | 8.0                    | 25                                    | 8.0                    |
|                |   | 300                               | 19                                    | 7.0                    | 17                                    | 7.0                    |
|                |   | 350                               | 14                                    | 8.0                    | 13                                    | 8.0                    |
|                |   | 400                               | 9                                     | 10.0                   | 7                                     | 15                     |
| АЛ20<br>(В14А) | Термически<br>обработанный<br>по режиму<br>Т7 | 20                                | 22                                    | 0.8                    | 22                                    | 0.8                    |
|                |   | 250                               | 18                                    | 1.5                    | 16                                    | 2.0                    |
|                |   | 300                               | 16                                    | 2.5                    | 15                                    | 2.0                    |
|                |   | 350                               | 14                                    | 2.0                    | 12                                    | 3.0                    |
|                |   | 400                               | 10                                    | 2.0                    | 8                                     | 4.0                    |
| АЛ21<br>(В300) | Термически<br>обработанный<br>по режиму<br>Т7 | 20                                | 24                                    | 1.0                    | 24                                    | 1.0                    |
|                |   | 250                               | 21                                    | 1.0                    | 20                                    | 1.5                    |
|                |   | 300                               | 17                                    | 1.5                    | 17                                    | 2.5                    |
|                |   | 350                               | 16                                    | 2.0                    | 15                                    | 3.0                    |
|                |   | 400                               | 12                                    | 4.0                    | 10                                    | 4.0                    |
| ВАЛ1           | Термически<br>обработанный<br>по режиму<br>Т5 | 20                                | 28                                    | 1.0                    | 28                                    | 1.0                    |
|                |   | 250                               | 24                                    | 1.2                    | 22                                    | 1.5                    |
|                |   | 300                               | 21                                    | 1.5                    | 19                                    | 2.5                    |
|                |   | 350                               | 18                                    | 2.5                    | 14                                    | 3.8                    |
|                |   | 400                               | 10                                    | 3.0                    | 8                                     | 6.0                    |
| АЦР1           | Термически<br>обработанный<br>по режиму<br>Т1 | 20                                | 20                                    | 1.5                    | 20                                    | 1.5                    |
|                |   | 250                               | 18                                    | 1.5                    | 18                                    | 1.5                    |
|                |   | 300                               | 16                                    | 1.5                    | 15                                    | 1.8                    |
|                |   | 350                               | 12                                    | 2.5                    | 10                                    | 3.0                    |
|                |   | 400                               | 8                                     | 4.0                    | 8                                     | 5.0                    |

\*Individually cast (in sand molds) specimens.

1) Alloy; 2) state of material; 3) test temperature (°C); 4) heating for 30 min; 5) kg/mm<sup>2</sup>; 6) heating for 100 hr; 7) AL1; 8) AL3-1; 9) AL4; 10) AL5; 11) AL9; 12) AL19; 13) AL20 (V14A); 14) AL21 (V300); 15) VAL1; 16) ATsR1; 17) heat-treated under regime.

TABLE 3  
Typical Mechanical Properties

| Сплав<br>1 | Режим<br>термич.<br>обработ-<br>ки **2 | E                       | $\sigma_{0.2}$ | $\sigma_b$ | $\delta_{100}$<br>(%) | HВ  | $\alpha_{-1}$<br>° | $\sigma_{-1}$<br>(кг/мм <sup>2</sup> ) |
|------------|--|-------------------------|----------------|------------|-----------------------|-----|--------------------|--|
|            |  | (кг/мм <sup>2</sup> ) 3 |                |            |                       |     |                    |  |
| 4 AL1      | T5                                     | 7000                    | 22             | 26         | 0.7                   | 100 | 5.6                | 0.3                                    |
| 5 AL3-1    | T6                                     | 7000                    | 21             | 27         | 0.8                   | 85  | 6.0                | 0.3                                    |
| 6 AL4      | T6                                     | 7000                    | 20             | 26         | 4.0                   | 70  | 7.5                | 0.4                                    |
| 7 AL5      | T5                                     | 7000                    | 21             | 26         | 1.0                   | 80  | 6.5                | 0.3                                    |
| 8 AL10V    | T6                                     | 7000                    | 22             | 28         | 0.5                   | 100 | 5.0                | 0.2                                    |
| 9 AL19     | T5                                     | 7000                    | 24             | 30         | 5.0                   | 85  | 7.0                | 0.4                                    |
| 10 AL20    | T7                                     | 7100                    | 18             | 22         | 1.2                   | 70  | 7.5                | 0.3                                    |
| 11 AL21    | T7                                     | 7000                    | 21             | 24         | 1.2                   | 85  | 7.5                | 0.3                                    |
| 12 VAL1    | T5                                     | 7000                    | 18             | 26         | 2.0                   | 85  | 7.5                | 0.5                                    |
| 13 ATsR1   | T1                                     | 7200                    | 15             | 20         | 1.5                   | 75  | 7.0                | 0.3                                    |
| 14 ZhLS1   | T1                                     | 7000                    | 18             | 20         | 0.5                   | 75  | 9.0                | 0.4                                    |
| 15 VKZhLS  | T1                                     | 7200                    | 18             | 21         | 0.4                   | 95  | 9.0                | 0.3                                    |

\*Cantilever bending of rotating specimen;  $N = 5 \cdot 10^8$  cycles.

\*\*See Heat treatment of aluminum alloys.

1) Alloy; 2) heat-treatment regime; 3) kg/mm<sup>2</sup>; 4) AL1; 5) AL3-1; 6) AL4; 7) AL5; 8) AL10V; 9) AL19; 10) AL20; 11) AL21; 12) VAL1; 13) ATsR1; 14) ZhLS1; 15) VKZhLS.

TABLE 4  
Mechanical Properties at Low Temperatures

| Сплав<br>1          | Состояние материала*<br>2   | Темп-ра<br>испытания<br>(°C)<br>3 | $\sigma_b$<br>(кг/мм <sup>2</sup> )<br>4 | $\delta_{10}$ (%)<br>5   |
|---------------------|---|-----------------------------------|--|--------------------------|
| AL3-1<br>5          | Литой в песчаную форму, термически обработанный по режиму T1<br>12  | -40<br>-70                        | 19<br>20                                 | 1.0<br>0.8               |
| AL4<br>6            | Литой в песчаную форму, термически обработанный по режиму T6  | -40<br>-70<br>-196                | 28<br>29<br>33                           | 3.5<br>2.8<br>2.5        |
| AL19<br>7           | Литой в песчаную форму, термически обработанный по режиму T4<br>То же, термически обработанный по режиму T5<br>13 | -40<br>-70<br>-40<br>-70          | 28<br>28<br>30<br>30                     | 6.5<br>6.5<br>5.0<br>5.0 |
| AL20<br>(V14A)<br>8 | Литой в песчаную форму, термически обработанный по режиму T7<br>Литой в песчаную форму, отожженный<br>14          | -40<br>-70<br>-40<br>-70          | 19<br>20<br>17<br>18                     | 0.5<br>0.5<br>0.5<br>0.5 |
| AL21<br>(V300)<br>9 | Литой в песчаную форму, термически обработанный по режиму T7<br>Литой в песчаную форму, отожженный<br>14          | -40<br>-70<br>-40<br>-70          | 21.0<br>21.5<br>20.0<br>21.0             | 0.8<br>0.8<br>0.8<br>0.8 |
| VAL1<br>10          | Литой в песчаную форму, термически обработанный по режиму T5  | -40<br>-70                        | 26<br>26                                 | 2.0<br>1.5               |
| ATsR1<br>--         | Литой в песчаную форму, термически обработанный по режиму T1  | -40<br>-70                        | 21<br>22                                 | 1.5<br>1.2               |

\*For heat-treatment regime see Heat treatment of aluminum alloys.

1) Alloy; 2) state of material; 3) test temperature (°C); 4) kg/mm<sup>2</sup>; 5) AL3-1; 6) AL4; 7) AL19; 8) AL20 (V14A); 9) AL21 (V300); 10) VAL1; 11) ATsR1; 12) cast in sand mold, heat-treated under regime; 13) the same, heat-treated under regime; 14) cast in sand mold, annealed.

TABLE 5  
Physical Properties

| Сплав        | 1                    | 2                                | 3                              | 4                       |
|--------------|----------------------|----------------------------------|--------------------------------|-------------------------|
|              | (г/см <sup>3</sup> ) | · 10 <sup>3</sup> (1°С)          | (милл. см/см <sup>2</sup> ·°С) | (ом·мм <sup>2</sup> /м) |
| А-11         | 2.75                 | 22.3 (20-100°)<br>24.4 (20-300°) | 0.31 (25°)<br>0.37 (300°)      | 0.0528 (20°)            |
| АЛ3-1        | 2.7                  | 22 (20-100°)<br>24 (20-300°)     | 0.39 (25°)<br>0.38 (300°)      | 0.0449 (20°)            |
| АЛ5          | 2.68                 | 23.1 (20-100°)<br>21 (20-300°)   | 0.38 (25°)<br>0.42 (300°)      | 0.0462 (20°)            |
| АЛ10В        | 2.78                 | 22.3 (20-100°)<br>24.4 (20-300°) | 0.49 (25°)<br>0.42 (300°)      | 0.046 (25°)             |
| АЛ19         | 2.78                 | 19.5 (20-100°)<br>25.8 (20-300°) | 0.25 (25°)<br>0.34 (300°)      | 0.0595 (20°)            |
| АЛ20 (В14А)  | 2.74                 | 18.1 (20-100°)<br>23.8 (20-300°) | 0.31 (30°)<br>0.35 (300°)      | 0.0518 (20°)            |
| АЛ21 (В300)  | 2.83                 | 22.9 (20-100°)<br>27.8 (20-300°) | 0.27 (30°)<br>0.3 (300°)       | 0.0572 (20°)            |
| ВАЛ1         | 2.89                 | 23.8 (20-100°)<br>28.7 (20-300°) | 0.32 (100°)<br>0.37 (300°)     | 0.0545 (20°)            |
| АТ8Р1        | 2.8                  | 23.8 (20-100°)<br>28.7 (20-300°) | 0.23 (25°)<br>0.27 (300°)      | 0.053 (20°)             |
| АЛ25 (ЖЛС1)  | 2.72                 | 19 (20-100°)<br>20.5 (20-300°)   | 0.38 (25°)<br>0.38 (300°)      | 0.051 (25°)             |
| АЛ26 (ВКЖЛС) | 2.68                 | 17.5 (20-100°)<br>18.5 (20-300°) | 0.49 (25°)<br>0.42 (300°)      | 0.056 (25°)             |

1) Alloy; 2) g/cm<sup>3</sup>; 3) cal/cm·sec·°C; 4) ohm·mm<sup>2</sup>/m; 5) AL1; 6) AL3-1; 7) AL5; 8) AL10V; 9) AL19; 10) AL20 (V14A); 11) AL21 (V300); 12) VAL1; 13) AT8R1; 14) AL25 (ZhLS1; 15) AL26 (VKZhLS).

TABLE 6  
Technological Properties and Areas of Application

| Сплав    | 2                          | 3                      | 4                   | 5  | 6  | 7             | 8                  | 9                      |
|----------|----------------------------|------------------------|---------------------|--|--|---------------|--------------------|------------------------|
|          | Температура плавления (°С) | Температура литья (°С) | Линейная усадка (%) | Жидкотекучесть при 700° (прутковая проба) (мм) | Склонность к образованию горячих трещин (ширина кольца в мм) | Герметичность | Сваряемость        | Обрабатываемость резан |
| 13 АЛ1   | 535                        | 740                    | 1.35                | 260  | 27.5   | 26            | 31                 | Хорошо                 |
| 14 АЛ3-1 | 530                        | 750                    | 1.15                | 340  | 13   | Средняя       | Удовлетворительная | Удовлетворительная     |

1) Данные по испытанию на растяжение при 100 °С и при 20 °С.  
2) В зависимости от состава сплава.  
3) В зависимости от состава сплава.  
4) В зависимости от состава сплава.  
5) В зависимости от состава сплава.  
6) В зависимости от состава сплава.  
7) В зависимости от состава сплава.  
8) В зависимости от состава сплава.  
9) В зависимости от состава сплава.

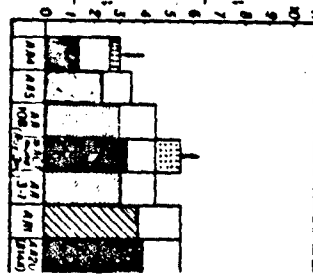

В зависимости от состава сплава.  
1) В зависимости от состава сплава.  
2) В зависимости от состава сплава.  
3) В зависимости от состава сплава.  
4) В зависимости от состава сплава.  
5) В зависимости от состава сплава.  
6) В зависимости от состава сплава.  
7) В зависимости от состава сплава.  
8) В зависимости от состава сплава.  
9) В зависимости от состава сплава.

\*The linear shrinkage may amount to 2-2.5% in casting large components in tube form.

\*\*Corrosion protection is covered in Special Instructions No. 265-54 issued by the MAP.

1) Alloy; 2) melting point (°C); 3) casting temperature (°C); 4) linear shrinkage (%); 5) flowability at 700° (rod test) (mm); 6) tendency toward hot cracking (ring width in mm); 7) hermeticity; 8) weldability; 9) cuttability; 10) tendency to adsorb gases; 11) corrosion resistance and corrosion protection of components; 12) recommended areas of prolonged



application; 13) AL1; 14) AL3-1; 15) AL4; 16) AL5; 17) AL10V; 18) AL19; 19) AL20 (V14A); 20) AL21 (V300); 21) VAL1; 22) ATsR1; 23) AL25 (ZhLS1); 24) AL26 (VKZhLS); 25) none; 26) low; 27) moderate; 28) good; 29) elevated; 30) high; 31) satisfactory; 32) low; 33) higher than for AL1 alloy; 34) pistons to operate at temperatures of up to 275°; 35) cylinder heads and other components which must have elevated hermeticity and sufficient strength at temperatures of up to 275°; 36) the same, for components which must function at temperatures of up to 225°; 37) the same for components which must function at temperatures of up to 250°; 38) pistons for tractor engines, which must function at temperatures of up to 200°; 39) high-stress components which will function at 20° and other components which must operate at temperatures of up to 300°; 40) components operating at up to 275° which must have high hermeticity; 41) pistons and jet-engine components which must function at up to 325°; 42) pistons and jet-engine components which must function at up to 350°; 43) hermetic components of heating systems and gas-flow regulators which must operate at up to 400°; 44) pistons and cylinder heads which must function at up to 275°; 45) the same.

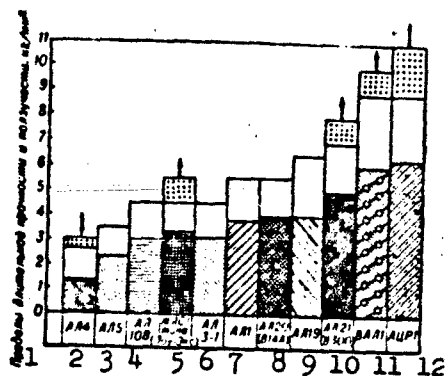

Creep strength (shaded columns) and long-term strength (shaded and unshaded columns) of aluminum casting alloys heated at 300° for 100 hr. The dotted portions of the columns represent the increase produced in the long-term strength by the optimum chemical composition (arrows pointing upward) or the decrease produced by modification (arrows pointing downward). 1) Long-term strength and creep strength, kg/mm<sup>2</sup>; 2) AL4; 3) AL5; 4) AL10V; 5) ZhLS1 type (Lou-Eks); 6) AL3-1; 7) AL1; 8) AL20 (V14A); 9) AL19; 10) AL21 (V300); 11) VAL1; 12) ATsR1.

It consequently has a higher strength at room temperature than ATsR1. VAL1 has the highest hot strength of any aluminum casting alloy at 300°. However, at higher temperatures ATsR1 has a higher hot strength. All the other indices (hermeticity, weldability, casting characteristics) of VAL1 are virtually the same as those of AL21. Its hermeticity

I-52a8

is higher than that of AL19, but lower than that of ATsR1.

It should be noted that the high-hot-strength aluminum casting alloys developed in the USSR (VAL1 and ATsR1) have substantially better properties than the high-hot-strength aluminum alloys produced abroad. For example, X140F, MI. (similar to AL1, but containing Cr and Mn), and RR-57 alloys are intended for operation at temperatures of up to 300-320°, while VAL1 can function for extended periods at temperatures of up to 350° and has a 25% higher hot strength. The American alloy SAM has substantially lower strength characteristics than ATsR1 at temperatures of 20-400°. It has been established that the majority of eutectic alloys and of those with high eutectic contents (35% or more) have a higher hot strength when cast than when heat-treated. Moreover, alloys of the silumin type have a higher hot strength when unmodified than when modified.

Table 1 shows the minimum and Table 3 the typical mechanical properties of individually cast (in sand molds) specimens (d = 12 mm) of high-hot-strength aluminum casting alloys.

Tables 2 and 4 show the change in the mechanical properties of these alloys as a function of test temperature. Table 5 shows their physical properties and Table 6 their technological characteristics. The figure presents comparative data on the hot strength and creep strength of these alloys at 300° (after 100 hr).

References: Bochvar, A.A., Metallovedeniye [Metalworking], 5th edition, Moscow, 1956; Kolobnev, I.F., Termicheskaya obrabotka alyumin-iyevykh splavov [Heat Treatment of Aluminum Alloys], Moscow, 1961; Kolobnev, I.F., Krymov, V.V., and Polyanskiy, A.P., Spravochnik liteyshch-ika. Fasonnoye lit'ye iz alyuminiyevykh i magniyevykh splavov [Handbook of Foundry Work. Die Casting of Aluminum and Magnesium Alloys], Moscow,

I-52a9

1957; Kolobnev, I.F., Zharoprochnost' alyuminiyevykh liteynykh splavov  
[Hot Strength of Aluminum Casting Alloys], Moscow, 1963.

I.F. Kolobnev

HIGH-HOT-STRENGTH SHAPING BRONZE - a bronze with high strength at elevated temperatures, a property achieved by raising the melting point (with nickel, which is infinitely soluble in copper) or by creation of a highly dispersed phase mixture on quenching and annealing. In the latter case the high-melting phases which precipitate (metals or intermetallic compounds) hinder flow on loading at high temperatures, blocking the grain boundaries. Chromium, iron, and cobalt, which have an extremely low solubility in solid copper, and a whole series of intermetallic compounds ( $Cr_2Zr$ ,  $Ni_3Al$ ,  $CoBe$ ,  $NiBe$ ,  $Ni_2Si$ , etc.), which form pseudobinary alloys with copper, have

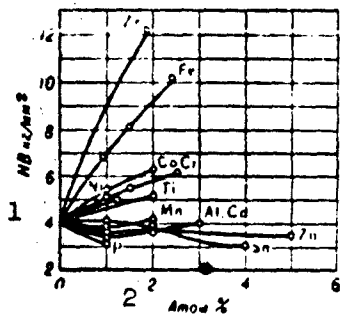

Fig. 1. Influence of different elements on the long-term hardness of copper at 800°. 1) HB,  $kg/mm^2$ ; 2) atom-%.

tallic compounds) hinder flow on loading at high temperatures, blocking the grain boundaries. Chromium, iron, and cobalt, which have an extremely low solubility in solid copper, and a whole series of intermetallic compounds ( $Cr_2Zr$ ,  $Ni_3Al$ ,  $CoBe$ ,  $NiBe$ ,  $Ni_2Si$ , etc.), which form pseudobinary alloys with copper, have this type of effect (Fig. 1). Of the Structural shaping bronzes alloys containing copper,

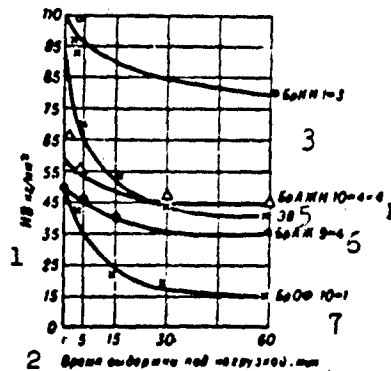

Fig. 2. Hardness of high-hot-strength shaping bronzes at 450° as a function of holding time in comparison with BrOF10-1 bronze. 1) HB,  $kg/mm^2$ ; 2) loading time, min; 3) BrKN1-3; 4) BrAZhN10-4-4; 5) EV; 6) BrAZh9-4; 7) BrOF10-1.

TABLE 1

Content of Principal Elements in High-Hot-Strength Shaping Bronzes with High Thermal and Electrical Conductivity

| Сплав<br>1         | Cr (%)    | Др. элементы<br>(%)<br>2                 | ГОСТ, ТУ<br>3         |
|--------------------|-----------|--|-----------------------|
| 4 Кадмиевая бронза | —         | 0.9-1.2 Cd                               | ГОСТ 4134-48 13       |
| 5 ВрKh0.5          | 0.4-0.6   | —  | ТМТУ 3299-53 14       |
| 6 МЦ5Б             | 0.2-0.4   | 0.2-0.35 Cd                              | Спец. технич. условия |
| 7 МЦ5А             | 0.15-0.25 | 0.2-0.35 Zr                              | " " " "               |
| 8 МЦ5              | 0.4-0.6   | 0.2-0.35 Zr                              | " " " " 15            |
| 9 ЭВ               | 0.5-0.8   | 0.4-0.6 Zn                               | " " " "               |
| 10 МЦ4             | 0.4-0.7   | 0.1-0.25 Mg<br>0.1-0.25 Al               | " " " "               |
| 11 МЦ3             | —         | 0.1-0.2 Mg<br>0.9-1.1 Ni<br>0.15-0.25 Be | " " " "               |
| 12 МЦ2             | —         | 0.15-0.3 Mg<br>0.4-0.8 Si<br>1.5-1.7 Ni  | " " " "               |

1) Alloy; 2) other elements; 3) GOST, TU; 4) cadmium bronze; 5) BrKh0.5; 6) MTS5B; 7) MTS5A; 8) MTS5; 9) EV; 10) MTS4; 11) MTS3; 12) MTS2; 13) GOST 4134-48; 14) TsMTU 3299-53; 15) special technical specifications.

TABLE 2

Physical and Mechanical Properties of High-Hot-Strength Shaping Bronzes with High Thermal and Electrical Conductivity

| Сплав<br>1          | Электропроводность (% от электропроводности чистой меди)<br>2 | $\rho$ при 20° (ом·мм <sup>2</sup> /м)<br>3 | Темп-ра испытания (°C)<br>4 | HB после термич. обра-ботки (кг/мм <sup>2</sup> )<br>5 | 6 Длит. твердость стабилизиров. сплава (кг/мм <sup>2</sup> ) при: |      |      | 7 Длит. прочность при 500°       |                              |
|---------------------|---|---|-----------------------------|--|---|------|------|----------------------------------|------------------------------|
|                     |   |   |                             |  | 400°  | 500° | 600° | 8 $\sigma$ (кг/мм <sup>2</sup> ) | 9 время до разрушения (часы) |
| 10 Кадмиевая бронза | 85-90   | 0.0219                                      | 350                         | 110-120  | 30  | 16   | 8    | —                                | —                            |
| 11 ВрKh0.5          | 80-85   | 0.0219                                      | —                           | 110-136  | 34  | 42   | 20   | 7                                | 105                          |
| 12 МЦ5Б             | 87-90   | 0.0219                                      | 380                         | 85-95  | 32  | 28   | 19   | —                                | —                            |
| 13 МЦ5А             | 85-87   | —   | 510                         | 95-100   | 40  | 35   | 28   | —                                | —                            |
| 14 МЦ5              | 80-85   | —   | 520                         | 110-120  | 56  | 52   | —    | 11                               | 140                          |
| 15 МЦ4              | 75-78   | 0.0230                                      | 510                         | 110-130  | 58  | 50   | 27   | 9                                | 180                          |
| 16 ВВр1             | 65  | 0.0300                                      | 550                         | 150-180  | —   | 110  | 40   | —                                | —                            |
| 17 МЦ3              | 55-60   | —   | 550                         | 160-180  | 148   | 100  | 45   | 14                               | 190                          |
| 18 МЦ2              | 45-50   | 0.0383                                      | 540                         | 140-170  | 114   | 70   | 32   | 12                               | 145                          |
| 19 ЭВ               | 75-80   | —   | 440                         | 100-110  | 50  | 32   | 16   | 8                                | 154                          |

1) Alloy; 2) electrical conductivity (% of conductivity of pure copper); 3)  $\rho$  at 20° (ohm·mm<sup>2</sup>/m); 4) test temperature (°C); 5) HB after heat treatment (kg/mm<sup>2</sup>); 6) long-term hardness of stabilized alloy (kg/mm<sup>2</sup>) at; 7) long-term strength at 500°; 8)  $\sigma$  (kg/mm<sup>2</sup>); 9) time to fracture (hr); 10) cadmium bronze; 11) BrKh0.5; 12) MTS5B; 13) MTS5A; 14) MTS5; 15) MTS4; 16) VBr1; 17) MTS3; 18) MTS2; 19) EV.

nickel, and aluminum have high hot strengths; these include kunials containing 6 and 13% Ni (MNA6-1.5 and MNA13-3), the silicon-nickel bronze BrKN1-3 (see Silicon bronze), which is strengthened by precipi-

TABLE 3

Technological Pressing Regimes for High-Hot-Strength Shaping Bronzes with High Thermal and Electrical Conductivity

| Сплав<br>1         | 2 Температура (°C) |         | 5 Закалка      |                        | 8 Отпуск          |                      |
|--------------------|--------------------|---------|----------------|------------------------|-------------------|----------------------|
|                    | 3 литье            | 4 ковка | 6 темп-ра (°C) | 7 время нагрева (часы) | темп-ра (°C)      | время нагрева (часы) |
| 9 Кадмиевая бронза | 1150-1170          | 780-760 | 780-740        | 2-3                    | Закалка на 50-70% |                      |
| 10 BrKh0.5         | 1200-1250          | 800-700 | 980-1000       | 1.5                    | 450-480           | 5                    |
| 11 M15             | 1140-1170          | 930-700 | 1000-1020      | 1.0-1.5                | 470-490           | 4                    |
| 12 M14             | 1140-1200          | 900-850 | 1000-1020      | 1.0-1.5                | 470-490           | 4                    |
| 13 VBr1            | 1140-1160          | 950-700 | 950-980        | 0.5-1.0                | 440-300           | 4                    |
| 14 M13             | 1180-1220          | 900-850 | 900-850        | 1.0-1.5                | 310-320           | 5                    |
| 15 M12             | 1180-1220          | 900-850 | 850-900        | 1.0-1.5                | 310-320           | 5                    |

1) Alloy; 2) temperature (°C); 3) casting; 4) forging; 5) quenching; 6) temperature (°C); 7) heating time (hr); 8) annealing; 9) cadmium bronze; 10) BrKh0.5; 11) M15; 12) M14; 13) VBr1; 14) M13; 15) M12; 16) cold working to 50-70%.

TABLE 4

Physical and Mechanical Properties of Certain High-Hot-Strength Shaping Bronzes in Comparison with Collector Copper

| Свойства<br>1  | Медь коллекторная твердая<br>2 | Кадмиевая бронза закалочная<br>3 | Хромистая бронза BrX 0,5<br>4 | Многокомпонентная бронза VBr1<br>5 |
|--|--------------------------------|----------------------------------|-------------------------------|------------------------------------|
| 6 $\gamma$ (г/см <sup>3</sup> )                            | 8.9                            | 8.9                              | 8.9                           | 8.9                                |
| 7 $\rho$ (ом·мм <sup>2</sup> /м; при 20°)                  | 0.0179                         | 0.0219                           | 0.0219                        | 0.0300                             |
| 8 Температурный коэффициент электросопротивления (20-100°) | 0.0043                         | 0.0031                           | 0.0025                        | —                                  |
| 9 $\lambda$ (кал/см·сек·°C; при 20°)                       | 0.90                           | 0.82                             | 0.80                          | 0.60                               |
| 10 E (кг/мм <sup>2</sup> )                                 | 11200                          | 12000                            | 12000                         | 12500                              |
| $\sigma_b$ (кг/мм <sup>2</sup> )                           | 27                             | 50                               | 50                            | 54                                 |
| $\sigma_{0.2}$ (кг/мм <sup>2</sup> )                       | —                              | 40                               | 40                            | 40                                 |
| $\delta$ (%)   | 6                              | 1.8                              | 11                            | 20                                 |
| НВ (кг/мм <sup>2</sup> )                                   | 75                             | 110                              | 110                           | 130                                |

1) Property; 2) solid collector copper; 3) cold-worked cadmium bronze; 4) BrKh0.5 chromium bronze; 5) VBr1 multicomponent bronze; 6)  $\gamma$  (g/cm<sup>3</sup>); 7)  $\rho$  (ohm·mm<sup>2</sup>/m, at 20°); 8) temperature coefficient of electrical conductivity (20-100°); 9)  $\lambda$  (cal/cm·sec·°C, at 20°); 10) kg/mm<sup>2</sup>.

tation of nickel silicides (Ni<sub>2</sub>Si), and the aluminum bronze BrAZhN10-4-4, which contains 4% Fe and 4% Ni (Fig. 2). Aluminum bronzes containing iron and manganese (BrAZh9-4 and BrAZhMts10-3-1.5) and silicon-manganese bronzes (BrKMts3-1) have lower hot strengths. The high-hot-strength shaping bronzes include a special group of alloys which combine an elevated recrystallization temperature with high thermal and electrical conductivity. This combination of properties is provided by a minimal

I-38b3

alloying-element content in the copper solid solution, which raises the thermal and electrical conductivity of the alloy. Moreover, the heat-resistant constituents which precipitate from the solid solution during tempering reinforce the grain boundaries. These alloys include the chromium bronze BrKh0.5 and chromium-zirconium (MTs5, MTs5A), chromium-cadmium (MTs5B), chromium-zinc (EV), and other bronzes (Table 1) containing very small quantities of other components (Ni, Be, Al, Mg, Si, etc.). Alloys with high thermal and electrical conductivity usually contain no less than 98.5-99.0% Cu, the total alloying-element content not exceeding 1-1.5%. The properties of these alloys and their production and processing regimes are shown in Tables 2-4. High-hot-strength shaping bronzes are widely used for welder electrodes, the commutators of electric motors, and other components which must function at elevated temperatures. Cadmium bronze, an alloy of copper with 0.9-1.2% cadmium, is an exception; quenching and annealing have no material effect on this alloy and increased hardness can be obtained only by cold working.

References: Zakharov, M.V., DAN SSSR [Proceedings of the Academy of Sciences USSR], Vol. 65, No. 3, Ibid, in book: Issledovaniye splavov tsvetnykh metallov [Investigation of Alloys of Nonferrous Metals], Collection 1, Moscow, 1955; Ibid, Metallovedeniye i obrabotka metallov [Metalworking and Processing of Metals], 1956, No. 5; Ibid, Sb. nauch. tr. Mosk. in-ta tsvetn. met. i zolota [Collection of Scientific Works of the Moscow Institute of Nonferrous Metals and Gold], 1955, No. 25.

O.Ye. Kestner

HIGH-HOT-STRENGTH SPRING STEEL - steel used in the manufacture of springs and elastic sensing elements intended to operate at high temperatures. Such steel should have a high elastic (proportional) limit and durability, sufficient viscosity and plasticity, and high resistance to Relaxation (attenuation) of stresses. Table 1 shows the chemical composition of high-hot-strength spring steel. Steel of this type is produced in strips 0.05-3.0 mm thick and in wire 0.1-14 mm in diameter.

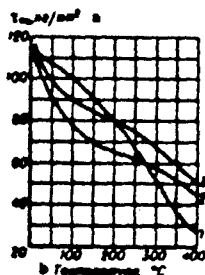

Fig. 1. Proportional limit of types 70 (class IIA), 50KhFA, and 65S2VA steel on torsion as a function of temperature: 1) 70 (class IIA) steel ( $d = 2$  mm); tempering at  $280^\circ$ ; 2) 50KhFA steel; quenching from  $850^\circ$  in oil, tempering at  $400^\circ$ ; 3) 65S2VA steel; quenching from  $850^\circ$ , tempering at  $450^\circ$ . a)  $\text{kg}/\text{mm}^2$ ; b) temperature,  $^\circ\text{C}$ .

The high-hot-strength spring steels whose mechanical characteristics are shown in Table 2 are used in the manufacture of flat springs for boiler and pipe fabrication. High-hot-strength spring steels of the perlitic, martensitic, and transition classes (for working temperatures above  $400^\circ$ ) are employed in other branches of industry; the mechanical characteristics and heat-treatment regimes of these steels are shown in Table 3.



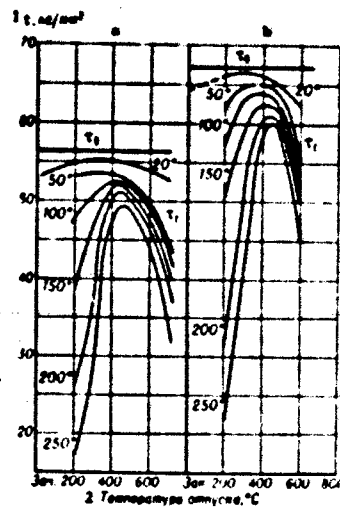

Fig. 2. Relaxation resistance of 50KhFA and 65S2VA steels over 100 hr (initial stress  $E_0 = 56 \text{ kg/mm}^2$  for 50KhFA steel and  $E_0 = 67 \text{ kg/mm}^2$  for 65S2VA steel) as a function of tempering temperature at various relaxation temperatures: a) 50KhFA steel; b) 65S2VA steel. 1)  $\text{kg/mm}^2$ ; 2) tempering temperature,  $^\circ\text{C}$ .

TABLE 1  
Chemical Composition of High-Hot-Strength Steels

| 1                           | 2   | 3     | 4         | 5                                     | 6  | 7 |
|-----------------------------|---|-------|-----------|---------------------------------------|--|---|
| Сталь                       | данные на воздухе   |       |           | 400                                   | ~0.75  |   |
| 670 (класс IIA)             |   |       |           |                                       |  |   |
| 750ХФА                      |   |       |           |                                       |  |   |
| 865С2ВА                     |   |       |           |                                       |  |   |
| 9ЭИ723                      |   |       |           |                                       |  |   |
| 103Х13 (ЭЖЗ)                |   |       |           |                                       |  |   |
| 114Х13 (ЭЖ4)                |   |       |           |                                       |  |   |
| 121Х12Н2ВМФ (ЭИ961)         |   |       |           |                                       |  |   |
| 13Х15Н9Ю (ЭИ904, СН-2)      |   |       |           |                                       |  |   |
| 140Х17Н7ГТ (ЭИ814)          |   |       |           |                                       |  |   |
| 150Х17Н13ГТ (ЭИ816)         |   |       |           |                                       |  |   |
| 1636НХТЮ (Н36ХТЮ, ЭИ702)    |   |       |           |                                       |  |   |
| 1736НХТЮМ (Н36ХТЮМ5, ЭИ702) |   |       |           |                                       |  |   |
| 18Н36ХТЮМ8 (ЭП52)           |   |       |           |                                       |  |   |
| 19Х12Н22Т3МР (ЭП33, ЭИ696М) |   |       |           |                                       |  |   |
| 20ХН35ВТЮ (ЭИ787)           |   |       |           |                                       |  |   |
| 21ХН35РТ (ЭИ612)            |   |       |           |                                       |  |   |
| 2240КХНМ (К40НХМ)           |   |       |           |                                       |  |   |
| 2344НХТЮ (Н43ХТ)            |   |       |           |                                       |  |   |
| Х15Н9Ю (СН-2, ЭИ904)        | Закалка с 1050° на воздухе, нагартовка на 50-60%, старение при 650-680° в течение 1 час., охлаждение на воздухе               | >4М   | ~7700     | 20<br>100<br>200<br>300<br>400        | 1.0<br>~0.97<br>~0.93<br>~0.88<br>~0.75                              |   |
| Н36ХТЮ (ЭИ702)              | Закалка с 920-950° в воде, нагартовка на 50-60%, старение при 650-670° в течение 2 час., охлаждение на воздухе                | >3М   | 7800-8000 | 20<br>100<br>200<br>300<br>400        | -1.0<br>-0.98<br>-0.90<br>-0.85<br>-0.77                             |   |
| Х12Н22Т3МР (ЭИ633, ЭИ696М)  | Закалка с 1130° на воздухе или в воде, нагартовка на 20 или 40%, старение при 700+20° в течение 5 час., охлаждение на воздухе | 35-45 | 7100-7600 | 20<br>400<br>500<br>600<br>650<br>700 | 1.0<br>0.74-0.88<br>0.79-0.82<br>0.75-0.77<br>0.72-0.75<br>0.68-0.71 |   |
| ХН35РТЮ (ЭИ787)             | Закалка с 1150° на воздухе или в воде, нагартовка на 30%, старение при 700-20° в течение 5 час., охлаждение на воздухе        | -     | 7000-7800 | 20<br>400<br>500<br>600<br>700        | 1.0<br>0.88-0.89<br>0.83-0.84<br>0.78-0.79<br>0.67-0.73              |   |

\* $G_m$  — модуль сдвига при тем-ре испытания,  $G_m$  — модуль сдвига при 20°; \* условные рабочие напряжения ( $\sigma_r$ ) в даны для цилиндрич. винтовых пружин (сжатие) без учета релаксации напряжений при рабочей тем-ре.

1) Steel; 2) content of elements (%); 3) no more than; 4) other elements; 5) GOST or TU; 6) 70 (class IIA); 7) 50KHFA; 8) 65S2VA; 9) EI723; 10) 3Kh13 (EZh3); 11) 4Kh13 (EZh4); 12) 1Kh12N2VMF (EI961); 13) Kh15N9Yu (EI904, SN-2); 14) Okh17N7GT (EI814); 15) Okh17N13GT (EI816); 16) 36NKhTYu (N36KhTYu, EI702); 17) 36NKhTYuM (N36KhTYuM5, EP51); 18) N36KhTYuM8 (EP52); 19) Kh12N22T3MR (EP33, EI696M); 20) KhN35VTYu (EI787); 21) KhN35VT (EI 612); 22) 40KKhNM (K40NKhM); 23) 44NKhTYu (N43KhT); 24) GOST; 25) Spravochnik po svoystvam staley, primenyayemykh

v kotlotrubostroyenii [Handbook of Characteristics of Steels Used in Boiler and Pipe Fabrication], Moscow, 1958; 26) the same; 27) ChMTU/ /TsNIICM; 28) design standard; 29) ChMTU.

TABLE 2

Mechanical Characteristics of High-Strength Spring Steels for Flat Springs used in Boiler and Pipe Fabrication

| 1<br>Сталь | 2. Закалка            |                        | 3. Отпуск             |                | 8<br>Температура испытания (°C) | 9<br>$\sigma_{0.2}$ | $\sigma_s$ | 10<br>$\delta$ | 11<br>$\psi$ | 12<br>K<br>(кг/мм <sup>2</sup> ) | 13<br>RC | 14<br>Макс. рабочий температур (°C) |
|------------|-----------------------|------------------------|-----------------------|----------------|---------------------------------|---------------------|------------|----------------|--------------|----------------------------------|----------|-------------------------------------|
|            | 3<br>Температура (°C) | 4<br>Охлаждающая среда | 5<br>Температура (°C) | 6<br>Время (ч) |                                 |                     |            |                |              |                                  |          |                                     |
| 114X13     | 1030-1050             | 19 Масло               | 550                   | 10             | 20                              | 98                  | 118        | 13             | 47           | 21700                            | 34-35    | 470                                 |
| 12 918     | 16                    | 20 Воздух              | 23                    | 1              | 20                              | 80                  | 95         | 12             | 15           | 23300                            | 59-61    | 470                                 |
|            | 18                    |                        |                       |                |                                 |                     |            |                |              |                                  |          |                                     |
| 13ЭИ723    | 17                    | 21                     | 650-680               | 6              | 20                              | 78                  | 89         | 17             | 67           | 22100                            | —        | 550                                 |
|            | 18                    |                        |                       |                |                                 |                     |            |                |              |                                  |          |                                     |
| 14ЭИ612    | 19                    | 22                     | 780-800               | 10-10          | 20                              | 44-55               | 80-87      | 18-30          | 30-50        | 20200                            | 22       | 460                                 |
|            | 19                    |                        |                       |                |                                 |                     |            |                |              |                                  |          |                                     |
| 15ЭИ765    | 1150                  | 20                     | 800                   | 20             | 20                              | 87                  | 113        | 32             | 32           | —                                | 30       | 640                                 |
|            |                       |                        |                       |                |                                 |                     |            |                |              |                                  |          |                                     |

1) Steel; 2) quenching; 3) temperature (°C); 4) cooling medium; 5) tempering; 6) temperature (°C); 7) holding time (hr); 8) test temperature (°C); 9)  $\sigma_{0.2}$  kg/mm<sup>2</sup>; 10) maximum working temperature (°C); 11) 4Kh13; 12) R18; 13) EI723; 14) EI612; 15) EI765; 16) step-wise heating; 17) first; 18) second; 19) oil; 20) air; 21) the same; 22) water; 23) triple; 24) double.

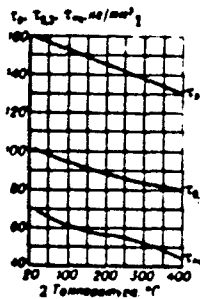

Fig. 3. Mechanical characteristics of 3Kh13 steel under torsion as a function of temperature. Quenching from 1050° in oil, tempering at 450°. 1) kg/mm<sup>2</sup>; 2) temperature, °C.

**TABLE 3**  
**Mechanical Characteristics of High-Hot-Strength Steel**  
**for Cylindrical Helical Springs Used in Machine Building**

| 1<br>Сталь                | 2<br>Термич. обработка  | RC    | 3<br>σ (кг/мм²) | 4<br>Генерация на растяжение (°C) | 5<br>σ <sub>0.2</sub> / σ <sub>0.01</sub> | 6<br>σ <sub>0.2</sub> / σ <sub>0.01</sub> | 7<br>σ <sub>0.2</sub> / σ <sub>0.01</sub> | 8<br>σ <sub>0.2</sub> / σ <sub>0.01</sub> |
|---------------------------|---|-------|-----------------|-----------------------------------|---|---|---|---|
| 670 (класс 11A)           | Отпуск при 250-320°, выдержка 1 час., охлаждение на воздухе<br>17   | 46-50 | 7700-8000       | 20                                | 1.0                                       | —   | До 150                                    | 28  |
|                           |   |       |                 | 100                               | 0.96-0.94                                 | —   |   |   |
|                           |   |       |                 | 150                               | 0.94-0.92                                 | —   |   |   |
|                           |   |       |                 | 200                               | 0.90-0.88                                 | —   |   |   |
| 7 50XΦА                   | Закалка с 850° в масле, отпуск при 370-470°, выдержка в течение 1 часа, охлаждение в горячей воде, масле, на воздухе<br>18          | 42-44 | 7000-8200       | 20                                | 1.0                                       | 75-80                                     | До 200                                    | —   |
|                           |   |       |                 | 100                               | 0.96-0.94                                 | 62  |   |   |
|                           |   |       |                 | 150                               | 0.94-0.92                                 | 60  |   |   |
|                           |   |       |                 | 200                               | 0.90-0.88                                 | 50  |   |   |
|                           |   |       |                 | 300                               | 0.82-0.81                                 | —   |   |   |
| 8 65C2BA                  | Закалка с 850° в масле, отпуск при 450-540°, выдержка не менее 1 часа, охлаждение на воздухе<br>19                                  | 44-50 | 7600-7850       | 20                                | 1.0                                       | 80-85                                     | До 250                                    | —   |
|                           |   |       |                 | 100                               | 0.96-0.94                                 | 73  |   |   |
|                           |   |       |                 | 150                               | 0.93-0.92                                 | 72  |   |   |
|                           |   |       |                 | 200                               | 0.90-0.88                                 | 70  |   |   |
|                           |   |       |                 | 300                               | 0.87-0.86                                 | 60  |   |   |
| 9 3X13                    | Закалка с 1000-1050° в масле, отпуск при 400-450° в течение 1 часа, охлаждение на воздухе<br>20                                     | 44-50 | 7600-8000       | 20                                | 1.0                                       | 50  | До 300                                    | —   |
|                           |   |       |                 | 100                               | 0.96-0.97                                 | 49  |   |   |
|                           |   |       |                 | 200                               | 0.90-0.93                                 | 47  |   |   |
|                           |   |       |                 | 300                               | 0.83-0.90                                 | 45  |   |   |
|                           |   |       |                 | 400                               | 0.78-0.86                                 | —   |   |   |
| 10 1X12H2PMΦ (ЭИ961)      | Закалка с 1000-1020° в масле, отпуск при 500±10° в течение 1 часа, охлаждение на воздухе<br>21                                      | 40-45 | 7600-7800       | 20                                | 1.0                                       | 62  | До 350                                    | —   |
|                           |   |       |                 | 100                               | 0.96-0.97                                 | 59  |   |   |
|                           |   |       |                 | 200                               | 0.91-0.93                                 | 56  |   |   |
|                           |   |       |                 | 300                               | 0.84-0.90                                 | 52  |   |   |
|                           |   |       |                 | 400                               | 0.81-0.88                                 | 50  |   |   |
| 11 ЭИ816                  | Закалка с 950-1050° в воде, нагартовка на 40-45°, старение при 450-470° в течение 2-4 час., охлаждение на воздухе<br>22             | >48   | 7500-8200       | 20                                | 1.0                                       | —   | До 300                                    | —   |
|                           |   |       |                 | 100                               | ~0.98                                     | —   |   |   |
|                           |   |       |                 | 200                               | ~0.92                                     | 60  |   |   |
|                           |   |       |                 | 300                               | ~0.87                                     | 50  |   |   |
|                           |   |       |                 | 400                               | ~0.80                                     | —   |   |   |
| 12 ЭИ814                  | Закалка с 950-1000° в воде, нагартовка на 35-50%, старение при 450-480° в течение 1-3 час., охлаждение на воздухе<br>23             | >46   | ~8100           | 20                                | 1.0                                       | —   | До 300                                    | —   |
|                           |   |       |                 | 100                               | ~0.98                                     | —   |   |   |
|                           |   |       |                 | 200                               | ~0.95                                     | 60  |   |   |
|                           |   |       |                 | 300                               | ~0.88                                     | 56  |   |   |
|                           |   |       |                 | 400                               | ~0.75                                     | —   |   |   |
| 13 X15H9Ю (ЭИ904)         | Закалка с 1050° на воздухе, нагартовка на 50-60%, старение при 450-480° в течение 1 час., охлаждение на воздухе<br>24               | >44   | ~7700           | 20                                | 1.0                                       | 65-70                                     | До 300                                    | —   |
|                           |   |       |                 | 100                               | ~0.97                                     | 63  |   |   |
|                           |   |       |                 | 200                               | ~0.93                                     | 60  |   |   |
|                           |   |       |                 | 300                               | ~0.88                                     | 50  |   |   |
|                           |   |       |                 | 400                               | ~0.75                                     | —   |   |   |
| N36KH7У (ЭИ702)           | Закалка с 920-950° в воде, нагартовка на 50-80%, старение при 650-670° в течение 2 час., охлаждение на воздухе<br>25                | >38   | 7800-6000       | 20                                | ~1.0                                      | —   | До 300                                    | —   |
|                           |   |       |                 | 100                               | ~0.96                                     | —   |   |   |
|                           |   |       |                 | 200                               | ~0.90                                     | 60  |   |   |
|                           |   |       |                 | 300                               | ~0.84                                     | 50  |   |   |
|                           |   |       |                 | 400                               | ~0.77                                     | —   |   |   |
| KH12M22T3M (EP33, ЭИ906M) | Закалка с 1130° на воздухе или в воде, нагартовка на 20 или 40%, старение при 700±20° в течение 3 час., охлаждение на воздухе<br>26 | 35-45 | 7100-7800       | 20                                | 1.0                                       | 60  | 400-500                                   | —   |
|                           |   |       |                 | 400                               | 0.84-0.86                                 | 51  |   |   |
|                           |   |       |                 | 500                               | 0.79-0.82                                 | 45  |   |   |
|                           |   |       |                 | 600                               | 0.75-0.77                                 | 37  |   |   |
|                           |   |       |                 | 650                               | 0.72-0.75                                 | 30  |   |   |
|                           |   |       |                 | 700                               | 0.68-0.71                                 | 22  |   |   |
| KH133VTУ (ЭИ787)          | Закалка с 1150° на воздухе или в воде, нагартовка на 30%, старение при 700±20° в течение 3 час., охлаждение на воздухе<br>27        | —     | 7000-7800       | 20                                | 1.0                                       | 60  | 400-600                                   | —   |
|                           |   |       |                 | 400                               | 0.88-0.89                                 | 53  |   |   |
|                           |   |       |                 | 500                               | 0.83-0.84                                 | 45  |   |   |
|                           |   |       |                 | 600                               | 0.78-0.79                                 | —   |   |   |
|                           |   |       |                 | 700                               | 0.67-0.73                                 | —   |   |   |

\* $G$  is the shear modulus at the test temperature and  $G_{20}$  is the shear modulus at 20°.

\*\*The maximum permissible working stresses ( $\tau_{dop}$ ) are given for compression (static loading) of cylindrical helical springs, without taking into account the relaxation of stresses at the working temperature.

1) Steel; 2) heat treatment; 3)  $\text{kg}/\text{mm}^2$ ; 4) test temperature (°C); 5) working temperature (°C); 6) 70 (class IIA); 7) 50KhFA; 8) 65S2VA; 9) 3Kh13; 10) 1Kh12N2VMF (EI961); 11) EI816; 12) EI814; 13) KhisN9Yu (SN-2, EI904); 17) tempering at 250-320°, holding for 1 hr, cooling in air; 18) quenching from 850° in oil, tempering at 370-470°, holding for 1 hr, cooling in hot water, oil, or air; 19) quenching from 850° in oil, tempering at 450-540° in oil, tempering at 400-450° for 1 hr, cooling in air; 20) quenching from 1000-1050° in oil, tempering at 400-500° for 1 hr, cooling in air; 21) quenching from 1000-1020° in oil, tempering at  $500 \pm 10^\circ$  for 1 hr, cooling in air; 22) quenching from 950-1050° in water, cold-working to 80-85%; aging at 450-470° for 2-4 hr, cooling in air; 23) quenching from 950-1000° in water, cold-working to 35-50%, aging at 450-480°, for 1-3 hr, cooling in air; 24) quenching from 1050° in air, cold-working to 50-60%, aging at 450-480° for 1 hr, cooling in air; 25) quenching from 920-950° in water, cold-working to 50-60%, aging at 650-670° for 2 hr, cooling in air; 26) quenching from 1130° in air or water, cold-working to 20 or 40%, aging at  $700 \pm 20^\circ$  for 5 hr, cooling in air; 27) quenching from 1150° in air or water, cold-working 30%, aging at  $700 + 20^\circ$  for 5 hours, cooling in air; 28) up to.

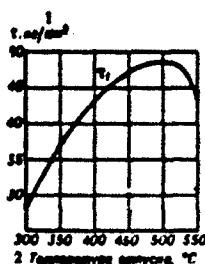

Fig. 4. Relaxation rate of 3Kh13 steel over 300 hr at 350° (initial stress  $\tau_0 = 55 \text{ kg/mm}^2$ ) as a function of tempering temperature. Quenching from 1050° in oil, tempering for 1 hr. 1)  $\text{kg/mm}^2$ ; 2) tempering temperature, °C.

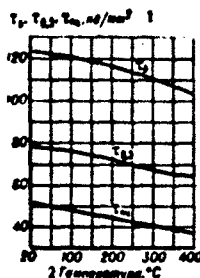

Fig. 5. Mechanical characteristics of 1Kh12N2VMF (EI961) steel under torsion as a function of temperature. Quenching from 1000-1020° in oil, tempering at 500°. 1)  $\text{kg/mm}^2$ ; 2) temperature, °C.

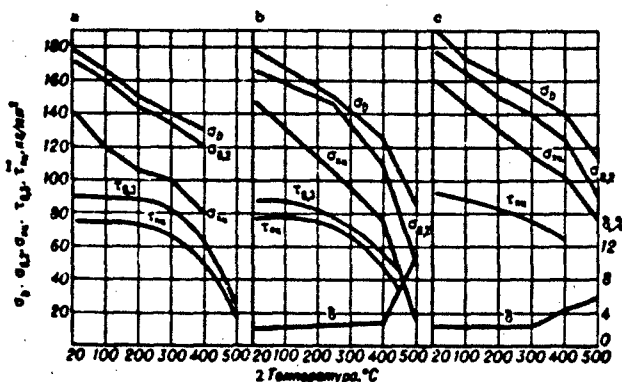

Fig. 6. Mechanical characteristics of EI816, EI814, and Kh15N9Yu (SN-2) steels as a function of temperature: a) EI816 steel; quenching from 1000-1050° in water, cold-working to 75%, aging at 450°; b) EI814 steel; quenching from 1000-1050° in water, cold-working to 35-50%, aging at 470°; c) Kh15N9Yu (SN-2) steel; quenching from 1050° in air, cold-working to 60%, aging at 450-480°. 1)  $\text{kg/mm}^2$ ; 2) temperature, °C.



Fig. 7. Mechanical characteristics of N36KhTYu and N36KhTYuM alloys as a function of temperature: a) 1 - N36KhTYu, 2 - N36KhTYuM5, 3 - N36KhTYuM8; quenching from 1150°, aging at 650-700°; b) N36KhTYu; quenching from 970° in water; 1 - cold-working to 35%, 2 - cold-working to 70%; aging at 650°. A) kg/mm<sup>2</sup>; B) test temperature, °C.



Fig. 8. Ultimate strength and modulus of elasticity of K4ONKhM alloy as a function of temperature: 1) Cold-working to 30%; 2) cold-working to 50%; 3) cold-working to 70%. Aging at 500°. a) kg/mm<sup>2</sup>; b) test temperature, °C.

Figures 1-8 show the change in the mechanical characteristics of certain high-hot-strength spring steels as the ambient temperature rises and as a function of tempering temperature (the technical limit of proportionality  $\tau_{pts}$  is defined as the stress corresponding to an increase of 50% in the slope of the torsion curve in comparison with its linear segment).

Wire of EI696M steel cold-worked to 40% is recommended for the manufacture of springs to operate at temperatures of up to 550°, while wire of this type cold-worked to 20% is recommended for working temperatures above 550°. Type EI696M steel does not provide complete stabilization at temperatures above 600°; on loading for 300 hr it undergoes relaxation by 4% at 650° and 11% at 700°. The stabilization regime for

each individual type of standardized spring has now been established experimentally. Electropolishing is employed to increase the corrosion resistance of high-hot-strength spring steels of the martensitic and transition classes containing less than 18% chromium. Springs fabricated from 50KhFA and 65S2VA steel are cadmium-plated for the same purpose. The temperature to which the springs are heated should not exceed the melting temperature of the plating (cadmium melts at 321°). Brittle fracture readily occurs if this condition is not observed. In order to protect springs fabricated from EI696M steel against gaseous corrosion they must be plated with a 10-15  $\mu$  layer of nickel matte immediately after winding. High-carbon spring wire cannot be subjected to superficial degreasing, since this reduces the relaxation resistance of high-hot-strength spring steel.

Steel of this type is used in the manufacture of elastic elements, including various kinds of springs, membranes, and spring components.

References: Gintsburg, Ya.S., *Relaksatsiya napryazheniy v metalakh* [Relaxation of Stresses in Metals], Moscow-Leningrad, 1957; Volkova, T.I., in collection: *Voprosy metallovedeniya kotlotrubinnykh materialov* [Problems of the Metalworking of Boiler and Pipe Materials], Moscow, 1955 (TsNIIIMash [Central Scientific Research Institute of Technology and Machine Building], Book 71); Idem, *Metallovedeniye i obrabotka metallov* [Metallography and Metalworking], 1958, No. 6; Selyavo, A.L., *ZL*, 1960, Vol. 26, No. 2; Selyavo, A.L. et al., *Metallovedeniye i termicheskaya obrabotka metallov* [Metalworking and Heat Treatment of Metals], 1961, No. 11; Sol'ts, V.A., in book: *Spravochnik po mashinostroitel'nykh materialam* [Handbook of Machine-Building Materials], Vol. 1, Moscow, 1959; Idem, in collection: *Perspektivy razvitiya uprugikh chuvstvitel'nykh elementov* [Prospects for the Development of Elastic Sensing Elements], Moscow, 1961; Shpitsberg, A.L., in collection: *Elek-*

III-121p8

tropromyshlennost' i priborostroyeniye [The Electrical Industry and  
Instrument Building], No. 21, Moscow, 1960.

A.L. Selyavo



III-95s

HIGH-HOT-STRENGTH STEEL - see High-hot-strength stainless shaping steel, High-hot-strength stainless casting steel, High-hot-strength structural shaping steel, and High-hot-strength structural casting steel.

HIGH-HOT-STRENGTH STRUCTURAL CASTING STEEL - alloy steel for cast machine components to operate at elevated temperatures (up to 550-600°). For a description of steels which will ensure components functioning at higher temperatures see the article entitled High-hot-strength stainless casting steel. The high-temperature strength and creep resistance of these steels is increased by additions of Mo, Cr, W, and V. The most widely employed high-hot-strength structural casting steels are 20ML, 25ML, 20KhML, 30KhML and Kh5ML; type Kh6N2MVF is used in the manufacture of aircraft-engine components. Table 1 shows the chemical composition of these fields.

TABLE 1  
Chemical Composition of High-hot-Strength Structural Casting Steels

| Сталь               | Химический состав (%) |           |           |       |            |         |         |           |                    |                 |
|---------------------|-----------------------|-----------|-----------|-------|------------|---------|---------|-----------|--------------------|-----------------|
|                     | 1                     | C         | Si        | Mn    | S          | P       | Cr      | Ni        | Mo                 | Другие элементы |
|                     |                       |           |           |       | не более 3 |         |         |           |                    |                 |
| 20ML ... 5 ...      | 0.15-0.25             | 0.20-0.45 | 0.5-0.8   | 0.04  | 0.04       | -       | <0.3    | 0.4-0.8   | -                  |                 |
| 25ML ... 6 ...      | 0.20-0.30             | 0.20-0.40 | 0.5-0.8   | 0.04  | 0.04       | <0.3    | -       | 0.4-0.8   | 0.3Cu              |                 |
| 20KhML ... 7 ...    | 0.15-0.25             | 0.17-0.37 | 0.5-0.8   | 0.04  | 0.04       | 0.4-0.7 | <0.3    | 0.4-0.6   | -                  |                 |
| 20KhMFL ... 8 ...   | 0.18-0.25             | 0.20-0.35 | 0.4-0.6   | 0.03  | 0.03       | 0.9-1.2 | <0.3    | 0.5-0.7   | 0.2-0.3V           |                 |
| 30KhML ... 9 ...    | 0.25-0.35             | <0.5      | 0.4-0.7   | 0.05  | 0.05       | 0.8-1.1 | <0.4    | 0.15-0.25 | -                  |                 |
| Kh5ML ... 10 ...    | 0.15-0.30             | 0.35-0.70 | 0.4-0.6   | 0.045 | 0.040      | 4.0-6.5 | 0.5     | 0.45-0.65 | -                  |                 |
| Kh6N2MVF ... 11 ... | 0.18-0.28             | 0.15-0.60 | 0.15-0.60 | 0.045 | 0.045      | 6.5-8.5 | 1.5-2.3 | 0.45-0.90 | 0.8-1.3V, 0.8-1.4W |                 |

1) Steel; 2) chemical composition (%); 3) no more than; 4) other elements; 5) 20ML; 6) 25ML; 7) 20KhML; 8) 20KhMFL; 9) 30KhML; 10) Kh5ML; 11) Kh6N2MVF.

Prolonged exposure to elevated temperatures (above 400°) causes hot shortness (a decrease in viscosity) in steels of the perlite class. Chromium-nickel and copper steels are also subject to hot shortness.

TABLE 2

Minimum Mechanical Characteristics of High-Hot-Strength Structural Casting Steels

| Сталь 1    | Термич. обработка контрольных образцов 2 | $\sigma_b$ 3          | $\sigma_{0.2}$ 3      | $\delta$ 4 | $\psi$ 4 | $\alpha_H$ 4          |
|------------|--|-----------------------|-----------------------|------------|----------|-----------------------|
|            |  | (кг/мм <sup>2</sup> ) | (кг/мм <sup>2</sup> ) | (%)        | (%)      | (кг/мм <sup>2</sup> ) |
| 20ML 5     | 12                                       | 45                    | 24                    | 16         | 28       | 5.0                   |
| 25ML 6     | 13                                       | 50                    | 27                    | 20         | 40       | 4.5                   |
| 20KhML 7   | 14                                       | 45                    | 25                    | 18         | 30       | 3.0                   |
| 20KhMFL 8  | 15                                       | 50                    | 32                    | 20         | 15       | 3.5                   |
| 30KhML 9   | 16                                       | 65                    | 40                    | 16         | 40       | 6.0                   |
| X5ML 10    | 16                                       | 70                    | 45                    | 18         | 30       | 6.0                   |
| X6H2MnФ 11 | 17                                       | 75                    | -                     | 10         | 20       | -                     |

1) Steel; 2) heat treatment of control specimens; 3) kg/mm<sup>2</sup>; 4) kg-m/cm<sup>2</sup>; 5) 20ML; 6) 25ML; 7) 20KhML; 8) 20KhMFL; 9) 30KhML; 10) Kh5ML; 11) Kh6N2MnV; 12) normalization and tempering; 13) normalization at 900-920° and tempering at 650-670°; 14) normalization at 880-900° and tempering at 600-650°; 15) normalization at 930° and tempering at 700°; 16) the same; 17) quenching from 1050° and tempering at 720°.

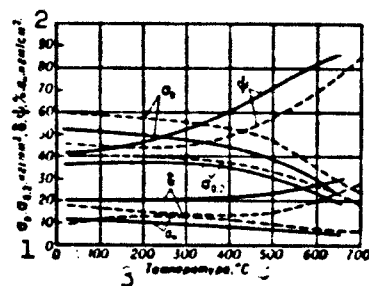

Fig. 1. Mechanical characteristics of 20KhML steel (solid line) and 20KhMFL steel (dash line) at elevated temperatures. 1) kg/mm<sup>2</sup>; 2) kg-m/cm<sup>2</sup>; 3) temperature, °C.

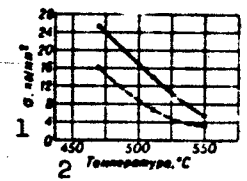

Fig. 2. Long-term strength of 20KhML steel over 100,000 hr (solid line) and creep strength (dash line) of same steel over 100,000 hr at elevated temperatures in the presence of 1% residual deformation. 1) kg/mm<sup>2</sup>; 2) temperature, °C.

Chromium-molybdenum, chromium-molybdenum-vanadium, and chromium-molybdenum-tungsten-vanadium steels have a high resistance to hot shortness.

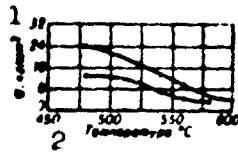

Fig. 3. Long-term strength of 20KhMFL steel over 100,000 hr (solid line) and creep strength (dash line) of same steel in the presence of residual deformation (1% over 100,000 hr) at elevated temperatures. 1)  $\text{kg/mm}^2$ ; 2) temperature,  $^{\circ}\text{C}$ .

The majority of high-hot-strength structural casting steels are used with a perlitic or sorbitic structure after annealing or normalization and high tempering. The mechanical characteristics of these alloys are shown in Table 2.

The mechanical characteristics of castings are checked on specimens cut from separately cast test bars, which are heat-treated together with the castings. Figures 1-3 show the mechanical characteristics at elevated temperatures, creep strength, and long-term strength over 100,000 hr for 20KhML and 20KhMFL steels. Figure 4 shows the mechanical characteristics of Kh5ML steel as a function of tempering temperature. The mechanical characteristics of this steel at low temperatures are shown in Fig. 5. Figure 6 represents the mechanical characteristics of Kh6N2MVF steel at elevated temperatures. The long-term strength of this steel over 100 hr at  $600^{\circ}$  amounts to  $16 \text{ kg/mm}^2$ .

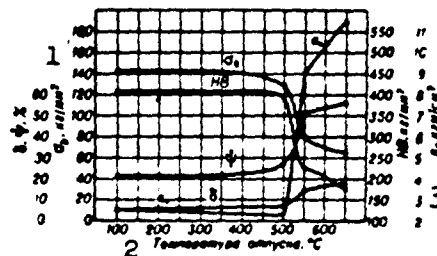

Fig. 4. Mechanical characteristics of Kh5ML steel as a factor of tempering temperature (quenching in oil from  $875^{\circ}$ ). 1)  $\text{kg/mm}^2$ ; 2) tempering temperature,  $^{\circ}\text{C}$ ; 3)  $\text{kg-m/cm}^2$ .

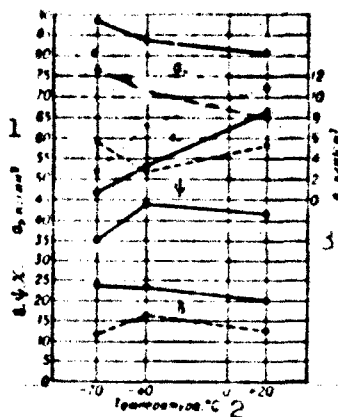

Fig. 5. Mechanical characteristics of Kh5ML steel at low temperatures after quenching and tempering at 550° (solid line) and 650° (dash line). 1) kg/mm<sup>2</sup>; 2) temperature, °C; 3) kg-m/cm<sup>2</sup>.

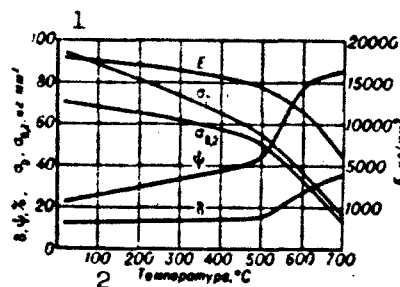

Fig. 6. Mechanical characteristics of Kh6N2MVF steel at elevated temperatures (quenching from 1050° and tempering at 720°). 1) kg/mm<sup>2</sup>; 2) temperature, °C.

The physical characteristics of 20KhMFL steel include:  $\gamma = 7.8$ ,  $\alpha \cdot 10^6$  (1/°C) = 11.0 (25-100°), 11.9 (25-200°), 12.9 (25-300°), 13.1 (25-400°), 13.5 (25-500°), 13.8 (25-600°), and 14.1 (25-700°), and  $\lambda$ (cal/cm·sec·°C) = 0.117 (100°), 0.102 (200°), 0.088 (300°), 0.075 (400°), 0.066 (500°), 0.060 (600°). Its critical points are  $A_{c1} = 777^\circ$ ,  $A_{c3} = 868^\circ$ ,  $A_{r1} = 683^\circ$ ,  $A_{r3} = 800^\circ$ . The physical characteristics of Kh6N2MVF steel include:  $\gamma = 7.88$  and  $\alpha \cdot 10^6$  (1/°C) = 11.1 (20-100°), 11.9 (100-200°), 12.7 (200-300°), 12.7 (300-400°), and 13.4 (400-500°).

Steels of this type are used in boiler and pipe fabrication for steam-turbine components (valve housings, cylinders), boiler installations, and high-pressure (up to 100 atm) piping to operate at tempera-

III-100s4

tures of up to 500-550°, as well as in the shipbuilding industry for naval-equipment components to operate at temperatures of up to 500-550° and in the petroleum industry for cracking-unit components and fittings to operate at temperatures of up to 500-550° and pressures of up to 40 atm. Type Kh6N2MVF steel is used for gas-turbine housings to operate at temperatures of no more than 700°.

References: Nekhendzi, Yu.A., Stal'noye lit'ye [Steel Casting], Moscow, 1948; Liberman, L.Ya., Peysikhis, M.I., Spravochnik po svoystvam staley, primenyayemykh v kotlotrubostroyeni [Handbook of Characteristics of Steels Used in Boiler and Pipe Fabrication], 2nd Edition, Moscow-Leningrad, 1958; Kershenbaum, Ya.M., Markhasin, E.L., Yaroshevskiy, F.M., Tekhnologiya proizvodstvo neftepromyslovogo oborudovaniya [Production Technology of Petroleum-Refining Equipment], Moscow-Leningrad, 1948; Steel Castings Handbook, Cleveland, 1950.

N.M. Turevich

**HIGH-HOT-STRENGTH STRUCTURAL SHAPING STEEL** – steel used in the manufacture of components to operate at temperatures of up to 500–550° for prolonged periods and up to 700° for brief periods.

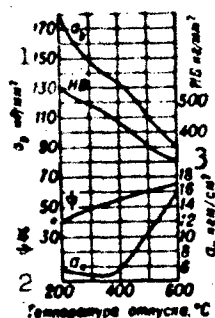

Fig. 1. Influence of tempering temperature on the mechanical characteristics of 38KhA steel (quenched from 850° in oil). 1) kg/mm<sup>2</sup>; 2) tempering temperature, °C; 3) kg-m/cm<sup>2</sup>.

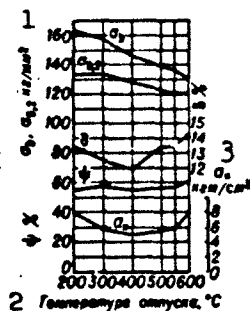

Fig. 2. Mechanical characteristics of 23Kh2NVFA (EI659) steel after quenching and tempering at various temperatures. 1) kg/mm<sup>2</sup>; 2) tempering temperature, °C; 3) kg-m/cm<sup>2</sup>.

The characteristics of this material include a capacity to withstand working stresses for prolonged periods, high fatigue strength, satisfactory hot strength, and low susceptibility to temper and thermal brittleness. They include steels of the perlite, martensite, austenite, and transition (austenite-martensite) classes. High-hot-strength struc-

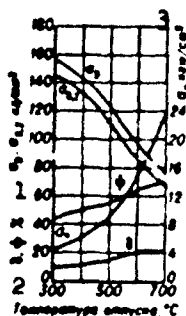

Fig. 3. Mechanical characteristics of 40KhNVA steel as a function of tempering temperature (quenching from 850° in oil). 1) kg/mm<sup>2</sup>; 2) tempering temperature, °C; 3) kg-m/cm<sup>2</sup>.

TABLE 1  
Chemical Composition of Perlitic High-Hot-Strength Structural Shaping Steel

| Сталь 1                   | 2 Содержание элементов (%) |           |           |           |           |           |           |           | S     | P     |
|---------------------------|----------------------------|-----------|-----------|-----------|-----------|-----------|-----------|-----------|-------|-------|
|                           | C                          | Si        | Mn        | Cr        | Ni        | W         | V         | Mo        |       |       |
| 5 38XA 4                  | 0.34-0.42                  | 0.17-0.37 | 0.50-0.80 | 0.80-1.10 | <0.40     | -         | -         | -         | 0.020 | 0.010 |
| 5 30X1CA 5                | 0.28-0.35                  | 0.90-1.20 | 0.80-1.10 | 0.80-1.10 | <1.40     | -         | -         | -         | 0.020 | 0.010 |
| 6 30X1CHA 6               | 0.34-0.37                  | 0.90-1.20 | 1.00-1.30 | 0.80-1.20 | 1.40-1.80 | -         | -         | -         | 0.020 | 0.010 |
| 7 30XMA 7                 | 0.25-0.33                  | 0.17-0.37 | 0.40-0.70 | 0.80-1.10 | <0.40     | -         | -         | 0.15-0.25 | 0.020 | 0.010 |
| 8 30X3PA 8                | 0.27-0.35                  | 0.17-0.37 | 0.30-0.60 | 2.80-3.20 | <0.30     | 0.80-1.20 | -         | -         | 0.020 | 0.010 |
| 9 20X3MΦΦ (20X3MΦΦ) 9     | 0.16-0.24                  | <0.4      | 0.25-0.60 | 2.4-3.3   | <0.30     | 0.30-0.50 | 0.60-0.85 | 0.35-0.55 | 0.020 | 0.015 |
| 10 23X2HΦΦA (23X2HΦΦA) 10 | 0.19-0.28                  | 0.17-0.37 | 0.30-0.60 | 1.90-2.40 | 0.80-1.20 | 1.00-1.40 | 0.18-0.28 | -         | 0.020 | 0.010 |
| 11 30X2H2BΦΦA 11          | 0.27-0.34                  | 0.17-0.37 | 0.30-0.60 | 1.60-2.00 | 1.40-1.80 | 1.20-1.60 | 0.18-0.28 | -         | 0.020 | 0.010 |
| 12 30X2H2BΦΦMA 12         | 0.27-0.34                  | 0.17-0.37 | 0.30-0.60 | 1.60-2.00 | 1.40-1.80 | 1.20-1.60 | 0.18-0.28 | 0.20-0.30 | 0.020 | 0.010 |
| 13 40XNVA 13              | 0.37-0.44                  | 0.17-0.37 | 0.40-0.80 | 0.80-0.90 | 1.25-1.75 | 0.80-1.20 | -         | -         | 0.020 | 0.010 |
| 14 33XN3MA (OKHN3MA) 14   | 0.28-0.37                  | 0.17-0.37 | 0.30-0.80 | 0.80-1.10 | 2.50-3.0  | -         | -         | 0.20-0.30 | 0.020 | 0.010 |

1) Steel; 2) content of elements (%); 3) no more than; 4) 38KhA; 5) 30KhGSA; 6) 30KhGSNA; 7) 30KhMA; 8) 30Kh3VA; 9) 20Kh3MVF (EI415); 10) 23Kh2NVFA (EI659); 11) 30Kh2N2VFA; 12) 30Kh2N2VFMA; 13) 40KhNVA; 14) 33KhN3MA (OKHN3MA).

tural shaping steels of the perlite class utilize Mo, W, V, and Nb as solid-solution hardeners. A relatively small amount of these elements, especially Mo or W, greatly increases the resistance of the steel to plastic deformation at elevated temperatures. The hot strength of these perlitic steels is also favorably affected by Mn and Nb, as well as small quantities of Cr; it must, however, be kept in mind that Mn makes steel hot-short. Perlitic alloys of this type achieve their greatest hot strength by complex alloying of the solid solution with Mo and W



TABLE 2

Mechanical Characteristics of High-Hot-Strength Structural Shaping Steel (perlite) at Elevated Temperatures (no less than)\*

| Сталь<br>1            | Термич. обработка<br>2   | Темп-ра (°C)<br>3 | $\sigma_b$ , $\sigma_{0.2}$<br>(кг/мм <sup>2</sup> )<br>4 |                | $\delta$ , $\psi$<br>(%)<br>5 |        | $\sigma_{-1}$ (кг/мм <sup>2</sup> )<br>образец без над-рза<br>образец с над-рзом<br>6 |               | $\sigma_{10}$ (кг/мм <sup>2</sup> )<br>7 | $\sigma_{11}$ (кг/мм <sup>2</sup> )<br>8 | HR<br>(отв. мм)<br>9 |
|-----------------------|--|-------------------|---|----------------|-------------------------------|--------|---|---------------|--|--|----------------------|
|                       |  |                   | $\sigma_b$  | $\sigma_{0.2}$ | $\delta$                      | $\psi$ | $\sigma_{-1}$   | $\sigma_{-1}$ |  |  |                      |
| 38ХА 18<br>8          | Закалка с 860° в масле, отпуск при 520° в воде или масле 19                        | 20                | 105   | 95             | —                             | 64     | 50  | 33            | —  | 9  | 3.3-3.6              |
|                       |  | 200               | 101   | 86             | 13                            | 54     | —   | —             | 30                                       | 9  | —                    |
|                       |  | 400               | 81  | 72             | 17                            | 69     | —   | —             | —  | 4  | —                    |
| 30ХГСА 9              | Закалка с 880° в масле, отпуск при 560° в масле 20                                 | 20                | 110   | 95             | 14                            | 55     | 72  | 46            | —  | 8  | 3.2-3.6              |
|                       |  | 200               | —   | —              | —                             | —      | —   | —             | —  | 11                                       | —                    |
|                       |  | 400               | 92  | 80             | 16                            | 69     | —   | —             | —  | 10                                       | —                    |
| 30ХГСНА 10            | Закалка с 930° в масле, отпуск при 200° 21   | 20                | 140   | 135            | 9                             | 45     | —   | —             | —  | 6  | 42.9                 |
|                       |  | 200               | 160   | 135            | 9                             | 40     | —   | —             | —  | 6  | —                    |
|                       |  | 400               | 150   | 125            | 11                            | 50     | —   | —             | —  | 5  | —                    |
| 30ХМА 10 11           | Закалка с 870° в воде, отпуск при 600° 22  | 20                | 95  | 75             | 12                            | 50     | 42  | 26            | —  | 9  | 3.3-3.6              |
|                       |  | 200               | 80  | 65             | 20                            | 65     | 34  | 22            | —  | 20                                       | —                    |
|                       |  | 400               | 74  | 60             | 19                            | 75     | 37  | 19            | —  | 18                                       | —                    |
| 30Х3ВА 12             | Закалка с 880° в масле, отпуск при 600° 23   | 20                | 106   | 93             | —                             | 64     | —   | —             | —  | 14                                       | 3.2-3.6              |
|                       |  | 400               | 91  | 77             | 16                            | 62     | —   | —             | 75                                       | 16                                       | —                    |
|                       |  | 500               | 79  | 72             | 20                            | 71     | —   | —             | 40                                       | —  | —                    |
| 20Kh3MVF (EI415) 13   | Закалка с 1020-1050° в масле, отпуск при 680° в течение 7 час 24                   | 20                | 92  | 87             | 13                            | 61     | 53  | 20            | —  | 4  | 3.3-3.6              |
|                       |  | 400               | 74  | 68             | 15                            | 53     | 48  | —             | —  | 9  | —                    |
|                       |  | 500               | 67  | 58             | 17                            | 63     | 44  | —             | 45                                       | 8  | —                    |
| 23Kh2NVFA (EI659) 14  | Закалка с 890° в масле, отпуск при 500° 25   | 20                | 135   | 118            | 13                            | 55     | —   | —             | —  | 8  | 3.0-3.3              |
|                       |  | 400               | 125   | 100            | 9                             | 53     | —   | —             | 115                                      | —  | —                    |
|                       |  | 500               | 105   | 75             | 7                             | 53     | —   | —             | 80                                       | —  | —                    |
| 30Kh2N2VFA 15         | Закалка с 940° в масле, отпуск при 640° 26   | 20                | 118   | 109            | 15                            | 57     | 56  | 36            | —  | 8  | 3.3-3.6              |
|                       |  | 400               | 105   | 93             | 12                            | 50     | 52  | 37            | 80                                       | —  | —                    |
|                       |  | 500               | 92  | 86             | 12                            | 56     | 50  | 29            | 54                                       | —  | —                    |
| 40KhNVA 16            | Закалка с 860°, отпуск при 580° 27   | 20                | 105   | 95             | 16                            | 62     | —   | —             | —  | 10                                       | 3.3-3.55             |
|                       |  | 200               | 101   | 85             | 14                            | 58     | —   | —             | —  | 11                                       | —                    |
|                       |  | 400               | 91  | 78             | 15                            | 64     | 50  | —             | —  | 9  | —                    |
| 33KhN3MA (oKhN3MA) 17 | Закалка с 860° в масле, отпуск при 680°; вторая закалка с 860°, отпуск при 650° 27 | 20                | 97  | 87             | 10                            | 50     | —   | —             | —  | 13                                       | 3.6                  |
|                       |  | 200               | 92  | 78             | 16                            | 60     | —   | —             | —  | 15                                       | —                    |
|                       |  | 400               | 88  | 71             | 21                            | 70     | —   | —             | —  | 15                                       | —                    |
|                       |  | 500               | 62  | 55             | 18                            | 75     | —   | —             | —  | 10                                       | —                    |

\*Modulus of elasticity E = 19,000-20,000 kg/mm<sup>2</sup>.

1) Steel; 2) heat treatment; 3) temperature (°C); 4) kg/mm<sup>2</sup>; 5) un-notched specimen; 6) notched specimen; 7) kg-m/cm<sup>2</sup>; 8) 38KhA; 9) 30Kh-GSA; 10) 30KhGSNA; 11) 30KhMA; 12) 30Kh3VA; 13) 20Kh3MVF (EI415); 14) 23Kh2NVFA (EI659); 15) 30Kh2N2VFA; 16) 40KhNVA; 17) 33KhN3MA (oKhN3MA); 18) quenching from 860° in oil, tempering at 520° in water or oil; 19) quenching from 880° in oil, tempering at 560° in oil; 20) quenching from 930° in oil, tempering at 200°; 21) quenching from 870° in water, tempering at 600°; 22) quenching from 880° in oil, tempering at 600°; 23) quenching from 1020-1050° in oil, tempering at 680° for 7 hr; 24) quenching from 890° in oil, tempering at 500°; 25) quenching from 940° in oil, tempering at 640°; 26) quenching from 860°, tempering at 580°; 27) quenching from 860° in oil, tempering at 680°, second quenching from 860°, tempering at 650°.

or Mo, W, and V.

Table 1 shows the chemical composition of the most common high-hot-strength structural shaping steels of the perlite class. These ma-

**TABLE 3**  
Physical Characteristics of Certain Types of High-Hot-Strength Structural Shaping Steel

| 1<br>Сталь   | в.10° (1.°C) |          | λ (кал/см·сек·°C) |       |
|--------------|--------------|----------|-------------------|-------|
|              | 20-100°      | 500-600° | 100°              | 500°  |
| 38ХА 3       | 13.6         | 14.8     | 0.12              | 0.089 |
| 30ХМА 4      | 12.3         | -        | 0.31              | 0.092 |
| 30ХГСА 5     | 11.0         | -        | 0.094             | 0.083 |
| 33ХНЗМА 6    | 10.8         | -        | 0.094             | -     |
| 23Х2НВФА 7   | 11.7         | 14.6     | 0.083             | 0.077 |
| 40ХНВА 8     | 11.6         | -        | 0.085             | 0.081 |
| 30ХГСНА 9    | -            | -        | 0.070             | 0.074 |
| 20Х3МВФ 10   | 9.4          | 11.22    | 0.026             | 0.046 |
| 30Х2Н2ВФА 11 | 11.73        | 14.01    | 0.092             | 0.081 |

- 1) Steel; 2) cal/cm·sec·°C; 3) 38KhA; 4) 30KhMA; 5) 30KhGSA; 6) 33KhN3MA; 7) 23Kh2NVFA; 8) 40KhNVA; 9) 30KhGSNA; 10) 20Kh3MVF; 11) 30Kh2N2VFA

**TABLE 4**  
Forging Regimes, Heat-Treatment Regimes, and Applications of High-Hot-Strength Structural Shaping Steels

| 1<br>Сталь          | 2<br>Интервал ковки, штамповки (°C)  | 3<br>Термич обработка   | 4<br>Хритич. точки (°C)  | 5<br>Применение   |
|---------------------|--|---|--|---|
| 38ХА 6              | 1180-850   | Предварит. нормализация при 450°, отпуск при 680°. Окончат. закалка с 860° в масле, отпуск при 580°   | A <sub>1</sub> 740<br>A <sub>2</sub> 780<br>A <sub>3</sub> 693<br>A <sub>γ</sub> 730<br>M <sub>n</sub> 250 | Болты, шпильки, шестерни, мало-нагруж. детали, работающие до 350°                     |
| 30ХГСА 7            | 1200-850   | 17<br>Предварит. обработка: неслыный отжиг при 780°, высокий отжиг при 900° с охлаждением в печи до 650°, окончат. отжиг. Закалка с 890° в масле, отпуск при 510°, охлаждение в масле | A <sub>1</sub> 780<br>A <sub>2</sub> 830   | Силовые детали, работающие до 400°  |
| 30ХГСНА 8           | 1200-850   | 18<br>Предварит. нормализация с 900°, ускоренный отжиг при 780°, охлаждение с печью до 650°, низкий отжиг при 680-700°. Окончат. закалка с 890° в масле, отпуск при 200-300°          | A <sub>1</sub> 750-780<br>A <sub>2</sub> 805-830   | 26<br>27<br>28<br>Детали самолета   |
| 30ХМА 9             | 1150-850   | 19<br>Предварит. нормализация при 880-880°, отпуск при 580-650°. Окончат. закалка с 870-880° в масле или в воде, отпуск при 550-650°  | A <sub>1</sub> 758<br>A <sub>2</sub> 808<br>A <sub>3</sub> 678<br>A <sub>γ</sub> 768                       | 29<br>Силовые детали, работающие до 450°  |
| 20Х3МВФ (ЭН415) 10  | Посадка в печь при темп-рах не выше 900°. Ковка при 1140±20°. ковки ковки не выше 900° | 20<br>Предварит. нормализация с 950°. Окончат. закалка с 1030-1080° в масле или на воздухе, отпуск на воздухе, отпуск при 640-700°  | 20   | 21<br>22<br>23<br>24<br>25<br>Диски, бабблжн, колеса и др. детали, работающие до 300° |
| 33Х2НВФА (ЭН659) 11 | 1150-850°  | 22<br>Нормализация при 890±10°, отпуск при 500°. Закалка с 890±10° в масле, отпуск при 500°   | A <sub>1</sub> 760<br>A <sub>2</sub> 805<br>A <sub>3</sub> 378<br>A <sub>γ</sub> 425                       | 30<br>31<br>Детали сварные и несварные, работающие до 500°                            |
| 30Х2Н2ВФА 12        | 1180-850   | 23<br>Нормализация с 930-980°, отпуск при 650-840°. Закалка с 890-940°, отпуск при 560-600°   | A <sub>1</sub> 770<br>A <sub>2</sub> 840   | 32<br>33<br>34<br>Высоконагруж. детали - диски, валы, лопатки, работающие до 660°     |
| 40ХНВА 13           | 1150-850   | 24<br>Нормализация при 950°, высокий отпуск при 650°. Закалка с 860° в масле, отпуск при 580°   | A <sub>1</sub> 730<br>A <sub>2</sub> 770<br>A <sub>3</sub> 380   | 38<br>Нагруженные детали работающие до 500°   |
| 33ХНЗМА (ОХНЗМА) 14 | 1150-850   | 25<br>Нормализация при 950°, отпуск при 650°. Закалка с 850-870 в масле, отпуск при 690°. Вторая закалка с 860°, отпуск при 650°  | -  | 34<br>Нагруженные детали, работающие до 450°  |

1) Steel; 2) forging and stamping range ( $^{\circ}\text{C}$ ); 3) heat treatment; 4) critical points ( $^{\circ}\text{C}$ ); 5) application; 6) 38KhA; 7) 30KhGSA; 8) 30KhGSNA; 9) 30KhMA; 10) 20Kh3MVF (EI415); 11) 23Kh2NVFA (EI659); 12) 30Kh2N2VFA; 13) 40KhNVA; 14) 33KhN3MA (OKhN3MA); 15) holding in furnace at temperatures not above  $900^{\circ}$ , forging at  $1140 + 20^{\circ}$ , final forging temperature not below  $900^{\circ}$ ; 16) preliminary normalization at  $850^{\circ}$ , tempering at  $660^{\circ}$ , final quenching from  $860^{\circ}$  in oil, tempering at  $590^{\circ}$ ; 17) preliminary treatment: incomplete annealing at  $780^{\circ}$ , high annealing at  $900^{\circ}$  with furnace cooling to  $650^{\circ}$ , final annealing, quenching from  $890^{\circ}$  in oil, tempering at  $510^{\circ}$ , cooling in oil; 18) preliminary normalization at  $900^{\circ}$ , accelerated annealing at  $780^{\circ}$ , furnace cooling to  $650^{\circ}$ , low annealing at  $680-700^{\circ}$ . Final quenching from  $890^{\circ}$  in oil, tempering at  $200-300^{\circ}$ ; 19) preliminary normalization at  $860-880^{\circ}$ , tempering at  $580-650^{\circ}$ , final quenching from  $870-880^{\circ}$  in oil or water, tempering at  $550-650^{\circ}$ ; 20) preliminary normalization at  $950^{\circ}$ , final quenching from  $1030-1080^{\circ}$  in oil or air, tempering in air, tempering at  $660-700^{\circ}$ ; 21) normalization at  $890 + 10^{\circ}$ , tempering at  $500^{\circ}$ , quenching from  $890 + 10^{\circ}$  in oil, tempering at  $500^{\circ}$ ; 22) normalization at  $930-980^{\circ}$ , tempering at  $650-840^{\circ}$ , quenching from  $890-940^{\circ}$ , tempering at  $560-600^{\circ}$ ; 23) normalization at  $950^{\circ}$ , high tempering at  $650^{\circ}$ ; 24) quenching from  $860^{\circ}$  in oil, tempering at  $580^{\circ}$ ; 25) normalization at  $950^{\circ}$ , tempering at  $650^{\circ}$ , quenching from  $850-870^{\circ}$  in oil, tempering at  $690^{\circ}$ , second quenching from  $860^{\circ}$ , tempering at  $650^{\circ}$ ; 26) bolts, pins, gears, low-stress components operating at up to  $350^{\circ}$ ; 27) load-bearing components operating at up to  $400^{\circ}$ ; 28) aircraft components; 29) load-bearing components operating at up to  $450^{\circ}$ ; 30) disks, facings, rings, and other components operating at up to  $500^{\circ}$ ; 31) welded and unwelded components operating at up to  $500^{\circ}$ ; 32) high-stress components (disks, shafts, blades) operating at up to  $560^{\circ}$ ; 33) stressed components operating at up to  $500^{\circ}$ ; 34) stressed components operating at up to  $450^{\circ}$ .

materials are produced in bars and forgings; types 38KhA, 30KhGSA, and 30KhGSNA are also produced in seamless tubing up to 133 mm in diameter.

All these steels have a hardness  $\text{HB}(d_{\text{отн}}) = 3.9-4.0$  mm after annealing or normalization and tempering. Table 2 shows the mechanical characteristics of high-hot-strength structural shaping steels of the perlite class at elevated temperatures.

Figures 1-3 show the influence of tempering on the mechanical characteristics of 38KhA, 23Kh2NVFA, and 40KhNVA steels.

The change in modulus of elasticity as the temperature rises is similar to that for carbon steel. The physical characteristics of these alloys (Table 3) are also similar to those of carbon steels.

The forging regime, preliminary heat-treatment regime (at the pro-

ducer plant), and final heat-treatment regime (at the consumer plant) for high-hot-strength structural shaping steels and their fields of application are shown in Table 4.

High-hot-strength structural shaping steels can be welded, although special restrictions are necessary for certain types. Thus, 30KhGSNA steel can be joined by arc (manual or automatic) or atomic-hydrogen welding, but not by gas welding. Both quenched and low-tempered steels of this type can be welded (see High-strength structural steel). Type 20Kh3MVF (EI415) steel is readily welded by the arc (manual or automatic) or argon-arc resistant method and satisfactorily welded by the atomic-hydrogen or gas method (see High-hot-strength structural casting steel).

References: Alekseyenko, M.F. *Struktura i svoystva teplostoykikh konstruktsionnykh i nevrzhaveyushchikh staley* [Structure and Properties of Heat-Resistant Structural and Stainless Steels], Moscow, 1962; Liberman, L.Ya. Peysikhis, M.I. *Spravochnik po svoystvam staley, primenyemykh v kotlotrubostroyeni* [Handbook of Characteristics of Steels Used in Boiler and Pipe Fabrication], 2nd Edition, Moscow-Leningrad, 1958; Pridantsev, M.V., Lanskaya, K.A. *Stali dlya kotlostroyeniya* [Steels for Boiler Fabrication], Moscow, 1959.

M.F. Alekseyenko

HIGHLY PLASTIC STAINLESS STEEL is a structurally stable austenitic steel with high deformability in the cold condition which is used for fabricating detail parts which require deep drawing (watch and clock cases, dental crowns, etc.). The type 12-12 chrome-nickel steel with carbon content not over 0.1% (Fig. 1) has the highest plastic properties with satisfactory corrosion resistance under everyday conditions (wristwatch cases).

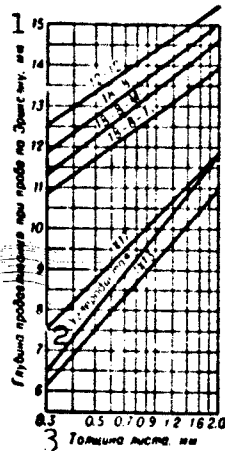

Fig. 1. Variation of penetration depth in Erichsen test as a function of sheet thickness for various steel types. 1) Erichsen test penetration depth, mm; 2) carbon; 3) sheet thickness, mm.

Steels of the chrome-nickel grades OKh18N9 and OKh18N11 per GOST 5632-61 (see Austenitic Stainless Steel) are used to fabricate other detail parts which have higher corrosion resistance. The 12-12 type steel is produced on special order.

The effect of nickel content on the variation of the hardness of 18% chrome steel as a function of the degree of reduction during cold deformation is shown in Fig. 2. Figure 3 shows the effect of nickel

Mechanical Properties of Highly Plastic Stainless Steel

| Сталь            | $\delta_{111}$          | $\sigma_b$ | $\sigma_{0.2}$ | $\delta$ | $\psi$ |
|------------------|-------------------------|------------|----------------|----------|--------|
|                  | 2 (кг/мм <sup>2</sup> ) |            |                | 1 (%)    |        |
| 12-12 *          | 115-150                 | 50-65      | >20            | >55      | -      |
| OKh18N11 (ЭИ684) | 125-160                 | 50-65      | >20            | >50      | -      |
| OKh18N9 (ЭИ10)   | 135-170                 | >54        | >19            | >50      | >50    |

\*Used in Germany as grade Kh8CrNi-12-12.

- 1) Steel; 2) (kg/mm<sup>2</sup>); 3) OKh18N11  
4) OKh18N9 (EYaO).

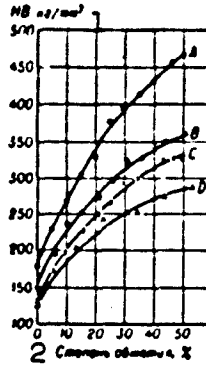

Fig. 2. Effect of nickel content on variation of hardness of 18% chrome steel (quench from 1150°) as a function of degree of reduction prior to rolling: A) Type 18-8 steel with 0.09% C; B) 18-12 type steel with 0.08% C; C) 18-15 type steel with 0.09% C (Jones). 1) HB kg/mm<sup>2</sup>; 2) degree of reduction, %.

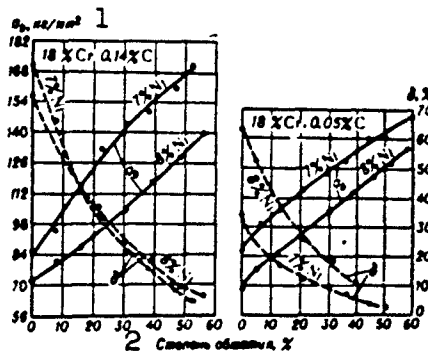

Fig. 3. Effect of nickel content in 18% chrome steel with 0.05% C and 0.14% C on mechanical properties as a function of degree of reduction during cold rolling. 1)  $\sigma_b$ , kg/mm<sup>2</sup>; 2) degree of reduction, %.

II-28N2

content on the capability of chrome-nickel steel for strengthening during cold rolling. The highly plastic stainless steel welds well using various techniques, but just as the steel with high carbon content (more than 0.06%) it must be subjected to heat treatment after welding to avoid intercrystalline corrosion. Heat treatment of detail parts after spot and seam welding is not mandatory. Steel with 12% Cr is corrosion resistant under atmospheric and household conditions. Steel with 18% Cr content is resistant in more aggressive media (foodstuffs) and in nitric acid.

References: Gudremon E., Special Steels, translated from German, Vol. 1-2, Moscow, 1959-60; Khimushin, F.F., Nerzhaveyushchiye stali (Stainless Steels), Moscow, 1963.

F.F. Khimushin

HIGH-PERMEABILITY SOFT MAGNETIC ALLOY is an alloy having high initial ( $\mu_0$ ) and maximal ( $\mu_{\max}$ ) permeability in weak fields and low coercive force  $H_c$ . The most important of the high permeability soft magnetic alloys are the alloys based on Fe - Ni (40 - 80% Ni) of the Permalloy type (see table). The alloying additives (Mo, Cr, Mn, Cu) are introduced to increase the electric resistivity  $\rho$ , the magnetic properties and to simplify the heat treatment. The low-nickel Permalloys 45N, 50N and 50KhNS (figure) have high saturation magnetic induction  $B_s$ , high resistivity  $\rho$  and therefore are used in equipment with magnetic biasing (cores of low-power transformers and chokes in communications equipment, the automation, in instrumentation). The grain-oriented alloys 50NP and 65NP have a rectangular hysteresis loop (close to unity ratio of the residual induction  $B_r$  to the saturation induction  $B_s$ ) and are used for cores of magnetic amplifiers, switching chokes, computer elements. The high-nickel Permalloys (79NM, 80NKhS) have particularly high  $\mu_0$  and  $\mu_{\max}$ . The alloys 50NP and 65NP are delivered in the form of cold rolled strip of thickness 0.02-0.1 and 0.02-0.5 mm respectively, the remaining alloys are delivered in the form of cold rolled strip and sheet of thickness 0.02-2.5 mm, hot rolled 3-22 mm sheet and rods of diameter 8-100 mm. Supermalloy (79% Ni, 16% Fe, 5% Mo) has the highest permeability ( $\mu_{\max}$  to  $1.5 \cdot 10^6$ ). Heat treatment of the Permalloys amounts to annealing in a vacuum or in hydrogen with subsequent controlled graduated or slow cooling.



Magnetic Properties of Permalloy Type Alloys

| 1. Cases | 2. $\mu_0$ (cc, no more) | 3. $\mu_{max}$ (cc, no more) | 4. $H_c$ (cc, no more) | 5. $B_s$ (cc, no more) | 6. $B_s/B_s$ (no more) |
|----------|--------------------------|------------------------------|------------------------|------------------------|------------------------|
| 7 45N    | 1700-2800                | 18000-21000                  | 0.4-0.2                | 15000                  | -                      |
| 8 45H    | 1800-3000                | 20000-21000                  | 0.2-0.12               | 15000                  | -                      |
| 9 50NP   | 500-1000                 | 35000-50000                  | 0.2-0.18               | 15000                  | 0.85                   |
| 10 65NP  | 300-2000                 | 70000-80000                  | 0.8-0.03               | 17000                  | 0.9                    |
| 11 70NXC | 1500-3200                | 15000-30000                  | 0.25-0.1               | 19000                  | -                      |
| 12 79NM  | 18000-25000              | 70000-130000                 | 0.05-0.02              | 7500                   | -                      |
| 13 80NXC | 18000-35000              | 70000-170000                 | 0.05-0.01              | 7000                   | -                      |

1) Alloy; 2)  $\mu_0$  (gauss/oe, no less than); 3)  $\mu_{max}$  (gauss/oe, no less than); 4)  $H_c$  (oe, no more than); 5)  $B_s$  (gauss, no less than); 6)  $B_s/B_s$  with  $H = 10^6$  (no less than); 7) 45N; 8) 50N; 9) 50NP; 10) 65NP; 11) NKhs; 12) 79NM 13) 80NKhS.

Magnetic saturation ( $B_s$ ),  $4\pi I_s$ , and electric resistivity of the Fe-Ni alloys

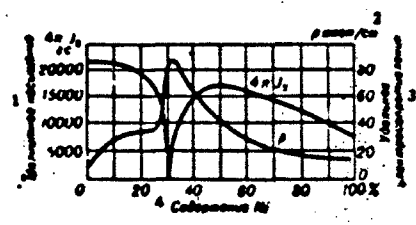

1) Magnetic saturation; 2)  $\rho$ , microhms/cm; 3) electrical resistivity; 4) Ni content.

Promising alloys are Fe-Al with 16% Al (Alfenol,  $\mu_0$  to 2870,  $\mu_{max}$  to 115,000) and Fe-Al-Mo with 15-16% Al and 3.3% Mo (Termenol,  $\mu_0$  to 7750,  $\mu_{max}$  to 145,000). In these alloys the high magnetic properties are combined with high electrical resistivity (150-160 microhm-cm), low density (about 6.5 g/cm<sup>3</sup>), corrosion resistance and strength at high temperature.

A high permeability alloy is the nondeformable alloy Alsifer (Sendust), containing 9.6% Si, 5.4% Al, balance Fe ( $\mu_0 = 35100$ ,  $\mu_{max} = 11700$ ,  $H_c = 0,022$ ). It is used in the form of shape castings for parts of magnetic circuits with constant magnetic flux and in the form of powder for the fabrication of magneto-dielectrics.

References: Gabrielyan D.I., Klevitskaya G.Z., Puzey I.M., Stand-

II-27M2

artizatsiy (Standardization), 1960, No. 10, page 48; Smolyarenko D. A. Kaplan A.S., *ibid*, 1959, No. 3, page 13; Zaymovskiy A.S., Chudnovskaya L.A., *Magnitnyye materialy (Magnetic Materials)*, 3rd edition, M.-L., 1957 ( *Metally i splavy v elektrotekhnike (Metals and Alloys in Electrical Engineering)*, Vol. 1); Bozort R., *Ferromagnetism*, translated from English, M., 1956.

B.G. Livshits, A.A. Yudin

I-59a

HIGH-PURITY ALUMINUM - see Types of aluminum.

HIGH-PURITY NIOBIUM is obtained by electron beam melting and also by vacuum sintering, vacuum induction melting in the suspended state, zone melting without crucible, and by the iodide method. The table shows the impurity content in high-purity niobium (weight %) obtained

Impurity Content in High Purity Niobium Obtained by Various Methods

| 1<br>Элемент (примесь) | 2<br>Ниобий электродуговой плавки*           | 3<br>Ниобий, спеченный в вакууме** | 4<br>Ниобий электродуговой плавки в вакууме |
|------------------------|--|------------------------------------|---|
| 5 Содержание примесей  |  |                                    |   |
| O                      | 1.3·10 <sup>-2</sup><br>1.5·10 <sup>-2</sup> | (2.5-10)·10 <sup>-3</sup>          | 7·10 <sup>-3</sup>                          |
| N                      | 1·10 <sup>-2</sup> -3·10 <sup>-2</sup>       | <1·10 <sup>-2</sup>                | 2.5·10 <sup>-2</sup>                        |
| H                      | 1·10 <sup>-2</sup>                           | <1·10 <sup>-2</sup>                | -   |
| C                      | 1·10 <sup>-2</sup> -2·10 <sup>-2</sup>       | (3-10)·10 <sup>-3</sup>            | 3.3·10 <sup>-2</sup>                        |
| Al                     | <2·10 <sup>-2</sup>                          | -                                  | -   |
| B                      | <1·10 <sup>-2</sup>                          | -                                  | -   |
| Ca                     | <1·10 <sup>-2</sup>                          | <1·10 <sup>-2</sup>                | -   |
| Fe                     | <2·10 <sup>-2</sup>                          | <2·10 <sup>-2</sup>                | <1·10 <sup>-2</sup>                         |
| Pb                     | 4.5·10 <sup>-2</sup>                         | <1·10 <sup>-2</sup>                | -   |
| Si                     | <1·10 <sup>-2</sup>                          | <1·10 <sup>-2</sup>                | -   |
| Sn                     | <5·10 <sup>-2</sup>                          | -                                  | -   |
| Ta                     | <2·10 <sup>-2</sup>                          | 4·10 <sup>-2</sup>                 | -   |
|                        | 9.8·10 <sup>-2</sup>                         | -                                  | -   |
| Ti                     | <1.5·10 <sup>-2</sup>                        | <3·10 <sup>-2</sup>                | <5·10 <sup>-2</sup>                         |
|                        | 4·10 <sup>-2</sup>                           | -                                  | -   |
| W                      | <2·10 <sup>-2</sup>                          | -                                  | -   |
| Zr                     | <3·10 <sup>-2</sup>                          | -                                  | 1·10 <sup>-2</sup>                          |
|                        | <5·10 <sup>-2</sup>                          | -                                  | -   |

\*First number applies to industrial metal reduced by the carbothermic method from a mixture of niobium oxide and carbide and remelted twice; the second numbers are minimal values (literature data).  
 \*\*For metal obtained by laboratory methods (literature data).

1) Element (impurity); 2) niobium produced by electron beam melting\*; 3) niobium produced by vacuum sintering\*\*; 4) niobium produced by electron beam zone melting; 5) impurity content.

by electron beam melting, zonal electron beam melting, and by the powder metallurgy methods - sintering niobium which has been reduced by the carbothermic method at 2300° (see Carbothermic Niobium). The properties of high-purity niobium differ markedly from the properties of

II-62n1

the technical metal. For example, its Brinell hardness is 45-55 in place of 70-120 kg/mm<sup>2</sup> for the technical metal (see Niobium),  $t_{pl}^{\circ}$  is close to 2500° in place of 2415°, and so on. Monocrystals of specially pure niobium are obtained with a length of about 0.5 meters. The high-purity niobium is produced on an industrial scale. High-purity niobium finds its primary application abroad in nuclear power production, production of high-temperature alloys, and in radioelectronics.

References: Kolchin, O. P., Sumarokova, N. V., and Chuveleva, N. P., Poluchenlye plastichnogo niobiya [Obtaining Plastic Niobium], "Atomnaya energiya" [Atomic Energy], 1957, Vol. 3, No. 12, pages 515-24; Rare Metals Handbook, 2nd Edition, London, 1961; Proceeding of the Fourty Symposium on Electron Beam Technology, 29-30 March, Boston, 1962; Miller, G. L., "Ind. Chemist," 1962, Vol. 38, No. 451, pages 455-60.

O. P. Kolchin

HIGH-PURITY TANTALUM - metallic tantalum obtained by smelting in an electron beam furnace. Tantalum is an extremely refractory metal, which is easily oxidized at elevated temperatures, for which reason it is smelted in electric arc vacuum furnaces or in smelting installations with electron beam heating. A water-cooled copper crystallization pan is used as the crucible. Due to the high rate of evacuation of harmful gaseous impurities, ease in adjusting the smelting process, possibility of using wastes and the lower cost of the process proper, smelting of tantalum by the use of electron beam heating is the most expedient method. It is so much more modern that it has already partially replaced the existing method for obtaining concentrated tantalum by sintering it in a vacuum. Below is presented the change in the admixture content (atoms per million) in cast tantalum, smelted in a vacuum electric arc furnace after it has been remelted in an electron beam smelting installation. The results of metal analysis after purification are given in parentheses.

|          |     |        |            |     |        |
|----------|-----|--------|------------|-----|--------|
| aluminum | 220 | (< 50) | titanium   | 45  | (< 10) |
| iron     | 89  | (< 10) | molybdenum | 92  | (20)   |
| carbon   | 40  | (18)   | oxygen     | 83  | (< 6)  |
| nickel   | 80  | (8)    | hydrogen   | 115 | (< 1)  |
| silicon  | 230 | (25)   | nitrogen   | 35  | (10)   |

The reduction in the admixture and gas content sharply reduces the metals's hardness. The hardness of the original tantalum smelted in an arc vacuum installation is 150-350 kg/mm<sup>2</sup> (HBO, after 1st resmelting in the electron beam furnace the hardness is reduced to 70 kg/mm<sup>2</sup>, after a 2nd resmelting it is reduced to 45-55 kg/mm<sup>2</sup>. As the purity of cast tantalum is increased, the specific pressure which is needed for

III-3t1

deforming it can be substantially reduced. In electric arc furnaces it is possible to obtain a shaping tantalum alloy with the tungsten content not exceeding 10%. An excess tungsten content highly embrittles the metal. The use of an electron beam smelting installation has made it possible to increase the tungsten content to 15-20% retaining at the same time the alloy's plasticity.

References: "Metall," Year of Publication 14, No. 5, 1960; Year of publication 15, No. 1, 1961; "J. of the Less-Common Metals," Vol. 2, No. 2-4, 1960.

O.Z. Budzinskiy

HIGH-SPEED STEEL - high-alloy steel used primarily in the manufacture of cutting tools which must function at speeds higher than those employed for ordinary carbon-steel tools. Cutting-tool materials should be harder than the material to be cut, but the hardness of a tool does not determine its quality. In cutting metals the cutting edges of the tool heat up and the hard steel of which they are made is tempered and softened. Heating carbon tool steel to 200° greatly reduces its hardness; high-speed steel is softened by tempering only when heated to temperatures above 550°-600°, although it is equally hard at room temperature (Fig. 1). It has been established that those cutting speeds which heat carbon-steel tools to above 200-300°, high-speed-steel tools to above 600°, or hard-alloy tools to above 1000° are impermissible, since they cause instantaneous softening of the tool. If the cutting speed of carbon-steel tools is assumed to be 1, the corresponding speed for high-speed steel is 3-5 and that for hard alloys is 10-15 or more. Thus, in many cases high-speed steel cannot satisfy the requirements imposed on tool materials under contemporary production conditions. However, hard alloys cannot replace high-speed steel in all instances, since they are quite brittle. The ability of a steel to undergo only slight softening or none at all on rather long exposure to high temperatures (red-heat temperature, 600-650°) is called red hardness. In order for a steel to have high red hardness it should contain alloying elements which form special carbides that are soluble in steel on heating but have difficulty precipitating from solution. The rate at which the carbon and alloying elements precipitate from the solution



I-60b1

(martensite) is determined by the chemical stability of these carbides, which in turn depends on the position of the carbide-forming alloying element in the periodic table. The further from iron the alloying element lies, the more stable are the carbides it forms. On the other hand, elements which lie far from iron (titanium, zirconium, niobium, tantalum) have carbides so stable that they do not dissolve in austenite and consequently do not participate in imparting high hardness and red hardness to the martensite. In order to obtain high red hardness it is best to alloy high-speed steel with tungsten, molybdenum, chromium, and vanadium, which form carbides with the requisite stability. The content of these scarce elements in high-speed steel explains its high cost. Contemporary scientists have developed methods which permit a reduction in the content of alloying elements.

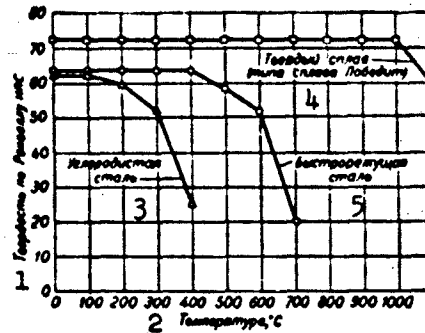

Fig. 1. Hardness of tool materials at different temperatures. 1) Rockwell hardness, HRC; 2) temperature, °C; 3) carbon steel; 4) hard alloy (Pobedit type); 5) high-speed steel.

TABLE 1

| Сталь 1 | C         | W         | Cr      | V       |
|---------|-----------|-----------|---------|---------|
| P18 2   | 0.7-0.8   | 17.5-19.0 | 3.8-4.6 | 1.0-1.4 |
| P9 3    | 0.85-0.95 | 8.5-10.0  | 4.0-4.6 | 2.0-2.6 |

1) Steel; 2) R18; 3) R9.

At present, types R18 and R9 high-speed steel are predominant in the USSR (Table 1).

TABLE 2

| Сталь <sup>1</sup>  | C         | W        | Cr      | V       | Co       |
|---------------------|-----------|----------|---------|---------|----------|
| 2 P9Ф5 . . . . .    | 1.4-1.5   | 9.0-10.5 | 3.8-4.4 | 4.9-5.1 | —        |
| 3 P10K5Ф5 . . . . . | 1.45-1.55 | 10-11.5  | 4.0-4.6 | 4.3-5.1 | 5.0-6.0  |
| 4 P9K10 . . . . .   | 0.8-1.0   | 9.0-10.5 | 3.8-4.4 | 2.0-2.6 | 8.5-10.5 |
| 5 P14Ф4 . . . . .   | 1.2-1.3   | 13-14.5  | 4.0-4.6 | 3.4-4.1 | —        |
| 6 P18Ф2 . . . . .   | 0.85-0.95 | 17.5-19  | 3.8-4.4 | 1.8-2.4 | —        |
| 7 P18K5Ф2 . . . . . | 0.85-0.95 | 17.5-19  | 3.8-4.4 | 1.8-2.4 | 5.0-6.0  |

- 1) Steel; 2) R9F5; 3) R10K5F5; 4) R9K10;  
5) R14F4; 6) R18F2; 7) R18K5F2.

Despite the considerably lower tungsten content of R9 steel, its properties (particularly its cutting characteristics) are similar to those of R18 steel. This is due to the fact that only that part of the carbon and alloying elements which has gone into solution is responsi-

TABLE 3

Red Hardness of Steels

| Сталь <sup>1</sup>   | Красноот-<br>кость (°C) |
|----------------------|-------------------------|
| 3 P18 . . . . .      | 625                     |
| 4 P9 . . . . .       | 625                     |
| 5 P9Ф5 . . . . .     | 648                     |
| 6 P10K5Ф5 . . . . .  | 650                     |
| 7 P9K10 . . . . .    | 645                     |
| 8 P14Ф4 . . . . .    | 650                     |
| 9 P18Ф2 . . . . .    | 650                     |
| 10 P18K5Ф2 . . . . . | 650                     |

- 1) Steel; 2) red hardness (°C); 3) R18; 4) R9; 5) R9F5; 6) R10K5F5; 7) R9K10; 8) R14F4; 9) R18F2; 10) R18K5F2.

ble for red hardness. Experiments have shown that the solubility of tungsten in austenite does not exceed 7-8% (at 1% C), this being the amount present in R18 and R9 steels; these two steels consequently have the same dissolved-tungsten content. The old view that the quality of high-speed steel is determined by its total tungsten content was not confirmed. Experience has shown that, in the overwhelming majority of cases, R9 steel is in no way inferior to R18 steel.

Standard high-performance high-speed steels, which have a higher vanadium content than R9 and R18 steels or contain cobalt, have been developed and approved. Table 2 shows the composition of these alloys.

Vanadium, which forms the very hard carbide VC, gives these steels high durability, while cobalt gives them high red hardness. The latter is usually measured by determining the temperature at which the initial high hardness (RC > 62) drops to RC = 58.

The structure of high-speed steels is governed by that of the carbide component and the metallic base. The carbides in tungsten high-speed steels are compounds of the  $Fe_3W_3C$  type. Vanadium carbide, VC, is present in steels containing more than 1.5-2% vanadium. In cast high-speed steels the primary carbides (those precipitated from the melt) form a eutectic, ledeburite (Fig. 2). In this case the structure of the metallic base is determined by the cooling conditions and may be martensitic-austenitic (rapid cooling) or perlitic-sorbitic (slow cooling). Forging breaks the carbide eutectic into small individual carbide grains (Fig. 3), thus improving the quality of the steel. It is therefore recommended that forging be carried out to improve the structure of the metal even when no change in shape is required.



Fig. 2. Cast high-speed steel. Eutectic (ledeburite) and austenite (white spots). Magnified 500 times.



Fig. 3. Annealed high-speed steel (magnified 1000 times).

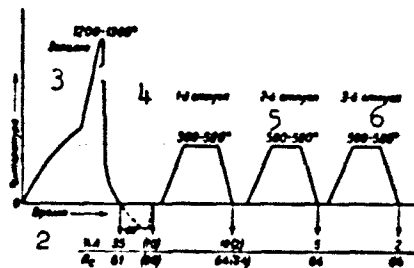

Fig. 4. Graph of heat treatment of high-speed steel. 1) Temperature; 2) time; 3) quenching; 4) 1st annealing; 5) 2nd annealing; 6) 3rd annealing.

TABLE 4

| Grade    | C       | W       | Cr      | V       |
|----------|---------|---------|---------|---------|
| 1) EI347 | 0.7-0.8 | 0.5-1.0 | 4.0-6.0 | 1.0-1.7 |

1) Steel; 2) EI347.

The procedure for heat treating high-speed steel differs radically from that for other steels (Fig. 4). The works of a number of contemporary researchers give exhaustive descriptions of the complex structural transformations which occur in high-speed steels during heat treatment. New methods for heat treating these steels (isothermal annealing, gradual quenching, multiple annealing, cyanation, cold working) were developed and put into practice in the USSR before their introduction abroad. High-speed steels are heated to high temperatures before quenching (1280-1300° for R18, 1220-1240° for P9) in order to permit more complete dissolution of the carbides, which improves the cutting characteristics and red hardness of the steel. After quenching, the structure of high-speed steel consists of 30-40% residual austenite, the increased content of this phase being responsible for the relatively low quality of the steel; the job of the subsequent treatment is consequently to convert the residual austenite to martensite, which is done by annealing at 560-580°. A single annealing does not completely convert the residual austenite and it is consequently recommended that this procedure be repeated two or 3 times (so-called multiple annealing). Cold working can also be carried out after quenching to convert the austenite to martensite. A single annealing suffices in this case. The surface of a high-speed steel tool is often saturated to a shallow depth (20-50  $\mu$ ) with nitrogen and carbon by cyanation in order to improve its cutting properties.

High-speed steel was formerly used solely as a tool material, but

I-60b5

the development of certain branches of engineering has resulted in a demand for high-speed and similar steels with high hardness at elevated temperatures.

Thus, R9, R18, and other high-speed steels are used for components subject to friction and heating to up to 500-650°. If their hardness and red hardness can be somewhat lower than the figures indicated above, high-speed-steel components are quenched from lower-than-usual temperatures (e.g., from 1150-1200° instead of 1200-1240°), which produces a slight increase in viscosity. All other high-speed-steel components are treated under tool regimes. High-speed steels have found a special application in so-called thermostable bearings and ball bearings, which are subject to operational heating to 500-600°. In addition to hardness and annealability, purity (reduction of nonmetallic inclusions and carbide liquation to a minimum) and absence of metallurgical defects are very important. High-speed steels with as low a carbon, tungsten, and vanadium content as possible (in order to maintain red hardness) are used for these purposes, (Table 4).

EI347 steel substantially surpasses ordinary high-speed steels with respect to carbide liquation. It was formerly used in conjunction with R18 and R9 steels, but, since it has a lower red hardness, it has found a special application in the manufacture of ball bearings. The foreign literature contains reports that high-speed steels with a low (approximately 0.3%) carbon content, which are subject to cementation, can be used in such cases. High red hardness can be obtained by adding up to 30% cobalt to steels of this type (with both normal and reduced carbon contents). Partial replacement of the tungsten by molybdenum is also effective.

References: Gulyayev, A.P., Nizkolegirovannyye vol'framom i molib-

I-60b6

denom bystrorezhushchiye stali [Low-Alloy High-Speed Tungsten and Molybdenum Steels], Moscow-Leningrad, 1941; Ibid, Svoystva i termicheskaya obrabotka bystrorezhushchey stali [Properties and Heat Treatment of High-Speed Steels], Moscow-Leningrad, 1939; Lebedev, T.A., Revis, I.A., Struktura i svoystva litogo instrumenta iz bystrorezhushchey stali [Structure and Properties of a Cast High-Speed-Steel Tool], Moscow-Leningrad, 1949; Geller, Yu.A. and Babayev, V.S., Instrumental'naya stal' [Tool Steel], Moscow, 1945; Minkevich, N.A., Malolegirovannyye bystrorezhushchiye stali [Low-Alloy High-Speed Steels], Moscow, 1944.

A.P. Gulyayev

HIGH-STRENGTH ALUMINUM SHAPING ALLOYS - alloys that have an ultimate strength over  $45-50 \text{ kg/mm}^2$  in the direction of the fibers. They include the alloys V93, V95 and V96 of the Al-Zn-Mg-Cu system; alloy VAD23 of the Al-Cu-Mn-Li-Cd system and, to some extent depending on the heat treatment and the form of the semifinished products, alloys D16, D19 and M40 of the Al-Cu-Mg system; also, alloy AK8 of the Al-Cu-Mg-Si system.

In rolled products made from alloys D16, D19 and M40, the strength is increased to the level of the high-strength class by cold-hardening, artificial aging and removal of cladding. Adequately high strength values can be obtained in alloy AK8 only for extruded semifinished products of a certain cross section, and in alloy D16 for extruded semifinished products in a broad range of sections as a result of some modification of the chemical composition (within the standards) and use of certain extrusion conditions.

The following points must be remembered in use of all high-strength aluminum shaping alloys: 1) the increased sensitivity to notching, particularly for repeated and vibrational loading; 2) the lower-than-usual corrosion stability; 3) certain production peculiarities. Thus, for example, in using alloy VAD23 and artificially aged alloy D16, all deformations of the semifinished products (bending, beveling, fullering, and the like) and riveting up of assemblies must be completed before the artificial aging operation. The finished riveted units are subjected to artificial aging; 4) the possibility of fabricating semifinished products of the necessary shapes and dimensions and

I-38a1

the degree to which the properties deteriorate when the sections and dimensions of the semifinished product are enlarged.

Alloys V93, V95, V96 and VAD23 possess the highest strength at room temperature. Alloys V96, V95 and V93 soften as a result of prolonged residence at temperatures of the order of 100° or higher. Alloy VAD23 retains relatively high strength characteristics after prolonged heatings to 160-180°. Alloys D16, D19 and M40 have lower strength values at room temperature than alloys V95, V96 and V93, but they are less sensitive to notches under repeated loading. They also show higher hot strength than alloys of the V95-V93 type. As for general corrosion resistance, all high-strength aluminum shaping alloys with high copper concentrations (alloys VAD23, D16 and the like) are substantially inferior to alloys with lower copper contents (V95 and similar alloys).

High-strength aluminum shaping alloys are selected for specific structures on the basis of the characteristics noted above. For stress-bearing structures operating below 100°, for example, when it is necessary to raise the general corrosion resistance, alloys V96, V95 and V93 should be used. Here the shapes of the structure and the process by which it is built must minimize stress concentrations situated in the plane perpendicular to the action of the forces. For load-bearing structures operating above 100°, as well as those operating at room temperature but subject to very long-term application of vibration loads, and in those cases where there are no special requirements as to general corrosion resistance, Alloys D16, D19 and M40 should be employed. On the other hand, for structures working in compression under these conditions, it would be more efficient to use a V95-type high-strength aluminum shaping alloy. With little stress concentration and thin sections, the expediency of choosing alloy V95 or D16 should be decided by preliminary tests. Alloy VAD23 may be used for the most



**BLANK PAGE**

heavily loaded riveted or bonded structures intended for long-term operation at 160-180°.

TABLE 1  
Mechanical Properties According to TU or GOST

| Сварка<br>1  | Вид полу-<br>фабриката<br>2   | 3 Состояние материала   | 4 Направление<br>вырезки<br>образцов          | 5 (кг/мм <sup>2</sup> ) |                  | 6, σ <sub>0.2</sub> (%)          |
|--------------|---|---|---|-------------------------|------------------|----------------------------------|
|              |   |   |   | σ <sub>b</sub>          | σ <sub>0.2</sub> |                                  |
| V03          | 6 Поковки и штам-<br>повки весом до<br>30, 200 и 2000 кг                              | 8 Закаленные и искусст-<br>венно состаренные                                    | 8 Продольное                                  | 49-48                   | 44-40            | 6                                |
| VAD23        | 9<br>10 Листы<br>Профили  | 11 То же  | 12<br>9 Поперечное<br>Продольное              | 54-55<br>55-54          | 49-50<br>50-54   | 6<br>6                           |
| D 18<br>D 19 | 13 Листы плакиро-<br>ванные и не-<br>плакированные                                    | 14 Нагартованные на 6-7%<br>и на 20%; естественно<br>и искусственно состаренные | 12 Поперечное                                 | 45-54                   | 29,5-44          | 14-8                             |
| D 18         | 15 Профили повышенной<br>прочности и<br>профили с тол-<br>щиной стенки<br>более 20 мм | 15 Закаленные и естест-<br>венно состаренные                                    | 9 Продольное                                  | 45-49                   | 32-36            | 10-7                             |
| M40          | 17 Листы плакиро-<br>ванные   | 18 Закаленные, нагарто-<br>ванные на 25% и 50%<br>и искусственно состаренные    | 12 Поперечное                                 | 45-52                   | 38-47            | 9-5                              |
| AK8          | 19 Прутья диамет-<br>ром до 22 мм и<br>до 160 мм                                      | 16 Закаленные и естест-<br>венно состаренные                                    | 9 Продольное                                  | 45-46                   | -                | 10                               |
| V 25         | 20 Листы<br>21  | 8 Закаленные и искусст-<br>венно состаренные,<br>в т. ч. нагартованные          | 9 Поперечное                                  | 49-53                   | 41-46            | 7-6                              |
|              | 22 Профили, прут-<br>ки, панели<br>прессованные                                       | 8 Закаленные и искусст-<br>венно состаренные                                    | 9 Продольное<br>23 По ширине<br>24 По толщине | 50-58<br>50-54<br>48    | 38-50<br>-       | 7-5<br>5-4<br>5                  |
|              | 25 Поковки, штам-<br>повки  | 8 Закаленные и искусст-<br>венно состаренные                                    | 9 Продольное<br>24 По ширине<br>24 По толщине | 50-54<br>45-48<br>40-42 | 42-44<br>-       | 5-7 (5d)<br>3-6 (5d)<br>2-3 (5d) |

- 1) Alloy
- 2) Form of semifinished product
- 3) State of material
- 4) Specimen cutting direction
- 5) (kg/mm<sup>2</sup>)
- 6) Forgings and stampings weighing up to 30, 200 and 2000 kg
- 7) Tempered and artificially aged
- 8) Longitudinal
- 9) Sheets
- 10) Shapes
- 11) Same
- 12) Transverse
- 13) Cladded and uncladded sheets
- 14) Cold-hardened by 6-7% and by 20%; naturally and artificially aged
- 15) High-strength profiles and profiles with wall thickness over 20 mm
- 16) Tempered and naturally aged
- 17) Cladded sheets
- 18) Tempered, cold-hardened by 25% and 50% and artificially aged
- 19) Rods up to 22 mm and up to 160 mm in diameter
- 20) Sheets
- 21) Tempered and artificially aged, including cold-hardening

- 22) Extruded shapes, rods and panels
- 23) Across width
- 24) Across thickness
- 25) Forgings, stampings

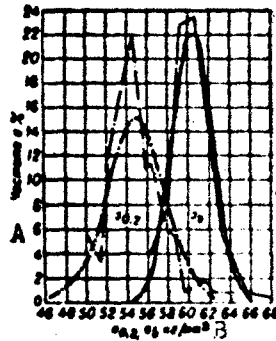

Fig. 1. Normal distribution curves of ultimate strength and yield point values in the transverse direction for flat extruded panels up to 520 mm wide with a sheet thickness of 4 mm, made from V95T alloy (total number of panels 246). A) Frequency in %; B) kg/mm<sup>2</sup>.

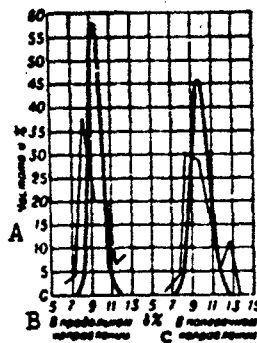

Fig. 2. Normal distribution curves of elongation for flat extruded panels up to 520 mm wide with a sheet thickness of 4 mm, made from V95T alloy (total number of panels 246). A) Frequency in %; B) in longitudinal direction; C) in transverse direction.

The present paper is concerned chiefly with the properties of alloys V95 and V96. For more detailed data on alloys V93 and AK8, see Forging aluminum alloys; for alloys D16, D19 and M40, see Medium-strength aluminum shaping alloys; for alloy VAD23, see Heat-resistant aluminum shaping alloys. Alloys V95 and V96 are characterized by high ultimate strength and yield point values, and by good plasticity in the hot state. As regards general corrosion resistance, alloy V95 is super-

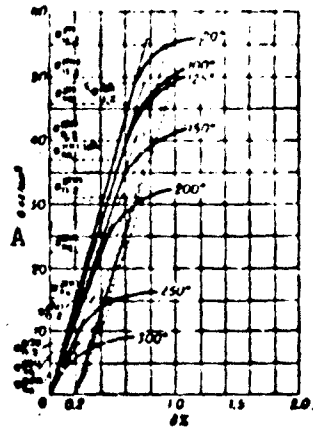

Fig. 3. Tension diagram to yield point for alloy V95T at room and elevated temperatures; solid extruded shapes. A)  $\sigma$ ,  $\text{kg}/\text{mm}^2$ .  $\epsilon\%$  = pts.

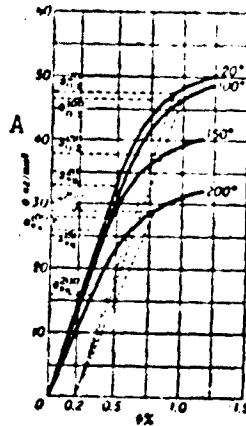

Fig. 4. Compression diagram to yield point at room and elevated temperatures for V95AT alloy (sheet 2 mm thick,  $\sigma_b = 52 \text{ kg}/\text{mm}^2$ ,  $\delta_{10} = 14\%$ ). A)  $\text{kg}/\text{mm}^2$ .  $\epsilon\%$  = pts.

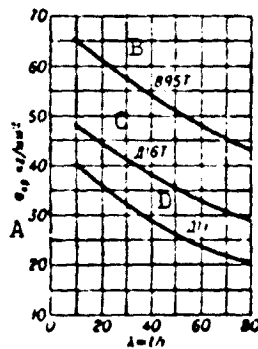

Fig. 5. Curves of longitudinal stability for P-section profiles, 35 x 35 x 4-mm section, made from alloys V95T, D16T and D1T; supported at faces. A)  $\sigma_{kr}$ ,  $\text{kg}/\text{mm}^2$ ; B) V95T; C) D16T; D) D1T.

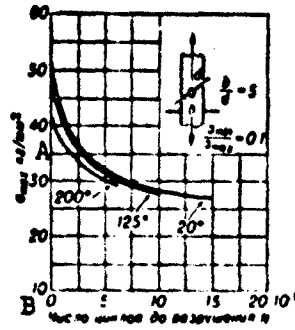

Fig. 6. Influence of test temperature on static endurance of V95T alloy specimens under uniaxial tension (sheet thickness up to 3 mm). A)  $\text{kg}/\text{mm}^2$ ; B) number of cycles to failure, N.

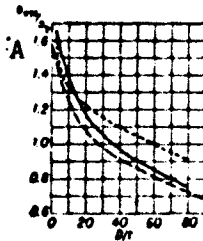

Fig. 7. Bending strength of round tubing made from aluminum alloys AV, AK8, V95T and D16T. Upper broken curve represents alloy AV, the solid curve alloys AK8 and V95T, and the lower dashed curve alloy D16T; D is the tubing diameter (mm) and  $t$  is the wall thickness (mm). A)  $\sigma_{1zg}/\sigma_b$ .

TABLE 2

| A Толщина листа (мм) | $\sigma_b$              | $\sigma_{0.2}$ | $\epsilon_{0.2}$ (%) |
|----------------------|-------------------------|----------------|----------------------|
|                      | B (кг/мм <sup>2</sup> ) |                |                      |
| 0.3-2.5              | 48.0                    | 40.0           | 7                    |
| 2.6-10.0             | 49.0                    | 41.0           | 7                    |

- A) Sheet thickness (mm)
- B) (kg/mm<sup>2</sup>)

ior to alloys D16 and AK8. Alloys V95 and particularly alloy V96 are distinguished by low plasticity in the artificially aged state; only limited production operations can be performed on them in this state. If the necessary precautions are adhered to, alloy V95 performs successfully in structural zones under tension and compression. Alloy V96 is recommended preferentially for compressed zones in the structure or for smooth parts with a minimum of stress concentrators. The properties of semifinished products made from alloys V95 and V96 are given by Tables 2-12 and Figs. 1-8. In the annealed state, V95 and V96 semifinished products have low strength and high plasticity and can be deformed in production as necessary. They also shape well (bending, fullering and beveling of

I-38a6

profiles, straightening, etc.) in the freshly tempered state.

With the purpose of protecting them from corrosion, sheets of V95 alloy are clad with an aluminum alloy containing 0.9-1.3% of zinc, no more than 0.16% Fe, 0.16% Si, 0.26% (Fe + Si) and 0.01% Cu. The cladding layer represents 4% for sheets up to 2.5 mm thick and 2% for sheets 2.6-10.0 mm thick. If the relative thickness of the cladding layer is reduced, the guaranteed ultimate-strength and yield-point values rise accordingly (from 49 to 50 kg/mm<sup>2</sup> and from 41 to 42 kg/mm<sup>2</sup>).

Especially strong sheets ( $\sigma_b = 53.0$  kg/mm<sup>2</sup>,  $\sigma_{0.2} = 46$  kg/mm<sup>2</sup>,  $\delta = 6\%$ ) are obtained either by holding the chemical composition of the alloy near the upper limit or by rolling the sheets in the tempered and artificially-aged state (degree of deformation up to 3%). Cold-hardened sheets are made for use in compressed zones of the structures. In cases in which the sheets are tempered and artificially aged at the user plants (without traction straightening after tempering) or when previously annealed sheets are tempered, the guaranteed mechanical properties are those given in Table 2.

Extruded plates are produced by cross-rolling extruded strips; this ensures high strength properties, but the process is unproductive and may be used only in rare cases. The basic method for producing plates is to roll flat ingots. The properties of extruded shapes depend heavily on wall thickness (see Press effect of aluminum alloys). The differences in  $\sigma_b$  and  $\sigma_{0.2}$  between thin and massive shapes reach 6-7 kg/mm<sup>2</sup> according to the TU. The actual strength characteristics of profiles (particularly thin ones) are considerably in excess of the TU requirements. For extruded products, and panels in particular, traction straightening after tempering is important. Traction straightening redistributes the tempering stresses and reduces warpage substantially during machining. The panels should be stretched by at least 1.5%.

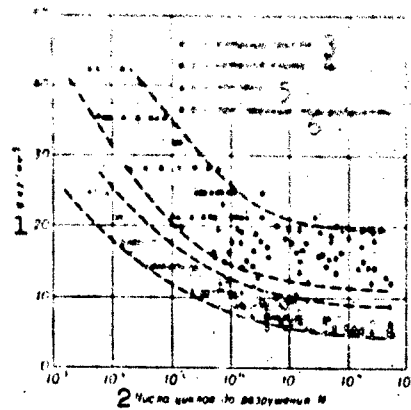

Fig. 8. Data on endurance of V95T-alloy semifinished products, obtained in bending tests on a rotating specimen: dark circles represent specimens without notch ( $d = 7.6$  mm); open circles are specimens with a V-shaped notch ( $d_N = 8.4$  mm,  $z_N = 0.025$  mm). 1)  $\sigma$ , kg/mm<sup>2</sup>; 2) number of cycles to failure, M; 3) rolled bar; 4) rolled plate; 5) forging; 6) extruded semifinished product.

It is advisable to make forgings and stampings from alloy V93 rather than V95. In sheet form, alloy V96 has no particular advantages over V95. Extruded and forged V96 products show substantially increased strength characteristics.

The corrosion resistance of V95 and V96 alloy semifinished products in the artificially aged state is satisfactory. To guarantee satisfactory corrosion resistance in clad semifinished products, they should be aged at least 16 hours at a temperature no lower than 135-145° (or stepwise). The corrosion resistance in the naturally aged state is unsatisfactory; semifinished products may be stored in this state only for a limited time, and they may not be sent to the fabricator. The corrosion resistance of massive semifinished products may drop considerably. In manufacturing the first few consignments, it is necessary to check their corrosion resistance. It can be improved considerably by the use of forged or rough-extruded blanks for solid workpieces. Anodizing and painting provide dependable corrosion protection.

Technological data. Round and flat ingots are cast with water and

air cooling. For fabricating rolls, forgings, stampings, shapes, plates and rods, only ingots that have been water-cooled should be used. Alloy V95 rolls, extrudes, forges and stamps satisfactorily. It is used to fabricate sheets, plates, forgings, stampings, shapes and extruded panels. V96 alloy is used for extruded and forged products. Alloy V95 is tempered at 465-480°, and V96 at 460-465°; the products should be cooled quickly during the tempering process; the time lapse between removal of the workpieces or semifinished products from the bath and immersion in the tempering water should not exceed 15 sec. If transfer of the pieces is delayed, their mechanical properties drop sharply. To improve the hardenability of massive pieces, it is necessary to have a tempering vat of sufficient capacity with vigorous circulation of the water. Solid pieces must be tempered after rough machining and their mechanical properties must be checked across the section of the piece.

TABLE 3  
Typical Mechanical Properties of Alloy V95 at 20°

| Вид полуфабриката               | E   G                 |                       | ν    | σ <sub>0.2</sub>        | σ <sub>b</sub>          | σ <sub>0.01</sub>       | σ <sub>0.001</sub>      | σ <sub>0.0001</sub>     | σ <sub>0.00001</sub>    | σ <sub>0.000001</sub>   | σ <sub>0.0000001</sub>  | σ <sub>ср</sub> <sup>d</sup> | σ <sub>н</sub> <sup>d</sup> | III                     |                         |
|---------------------------------|-----------------------|-----------------------|------|-------------------------|-------------------------|-------------------------|-------------------------|-------------------------|-------------------------|-------------------------|-------------------------|------------------------------|-----------------------------|-------------------------|-------------------------|
|                                 | (кг/мм <sup>2</sup> ) | (кг/мм <sup>2</sup> ) |      | σ (кг/мм <sup>2</sup> ) | σ (кг/мм <sup>2</sup> ) | σ (кг/мм <sup>2</sup> ) | σ (кг/мм <sup>2</sup> ) | σ (кг/мм <sup>2</sup> ) | σ (кг/мм <sup>2</sup> ) | σ (кг/мм <sup>2</sup> ) | σ (кг/мм <sup>2</sup> ) |                              |                             | σ (кг/мм <sup>2</sup> ) | σ (кг/мм <sup>2</sup> ) |
| e Профиль толщиной до 20 мм     | 7100                  | 27000                 | 0.30 | 53-55                   | 56-60                   | 8                       | 12                      | 100                     | 30                      | 53                      | 33                      | 1.0                          | 150                         | 15.5                    |                         |
| f Листы плоскокванные до 2.5 мм | 6700                  | -                     | -    | 44                      | 52                      | 14                      | -                       | -                       | -                       | -                       | -                       | -                            | -                           | -                       | -                       |

\*The endurance limit  $\sigma_{0.1}$  was determined in alternating bending,  $N = 5 \cdot 10^8$ .  
 a) Form of semifinished product; b) kg/mm<sup>2</sup>; c)  $\tau_{sr}$ ; d)  $a_{\sigma}$  (kg-m/cm<sup>2</sup>); e) profile less than 20 mm thick; f) rolled sheets up to 2.5 mm.

Application and quality control. Alloy V95 is used for stress-bearing structures that will work for prolonged periods at temperatures no higher than 100-120°. Uses include the skin, stringers, bulkheads and spars of airframes, stressed frameworks of certain riveted struc-



TABLE 4

Mechanical Properties of Forged and Extruded Semi-Finished Products of V95 Alloy at 20°\*

| a | Форма полуфабриката                                    | $\sigma_b$            |           | $\sigma_{0.2}$ ** | $\delta$   | $\psi$     |
|---|--|-----------------------|-----------|-------------------|------------|------------|
|   |  | (кг/мм <sup>2</sup> ) |           |                   |            |            |
| b | Массивный профиль                                      |                       |           |                   |            |            |
| c | Тонкая полка   | 55 48                 | 64 51     | —                 | 11 8       | 11 7       |
| d | Периферия толстой полки                                | 52 51 51              | 60 57 58  | —                 | 12 7 5,7   | 19 0 6     |
| e | Середина толстой полки                                 | 53 48 47              | 59 50 51  | —                 | 11 3 5 2 5 | 15         |
| f | Панель   | 57,5 54,5             | 60,5 61,5 | —                 | 7,5 9,5    | —          |
| g | Поклонки сечением 1000 × 300 × 120 мм                  |                       |           |                   |            |            |
| h | Периферия  | 49 48 47              | 55 53 53  | 72 81 87          | 9,5 8,5 4  | 23 18 10   |
| i | Середина   | 50 47 48              | 56 53 52  | 74 82 81          | 10,5 5,5 3 | 21,5 12 5  |
| j | Штамповки  | 55 44 44              | 61 49 47  | 73 55 55          | 10 3,5 3   | 16 8,5 8,5 |
| k | Каченовые поклонки сечением 1 700 × 900 × 250 (300) мм | 51 51 44              | 54 51 44  | 68 65             | 8 5 2      | —          |

\*The property figures are indicated by the shilling fraction for the length, width and height of the specimen.

\*\* $\sigma_{0.2}$  is for a specimen with a round notch having a radius of 0.75 mm.

a) Form of semifinished product; b) solid profile; c) thin flange; d) periphery of thick flange; e) center of thick flange; f) extruded panels; g) forgings, 1000 × 300 × 120-mm section; h) periphery; i) center; j) stampings. k) tapered forgings, 1700 × 900 × 250 (300)-mm section.

TABLE 5

Mechanical Properties of V95-Alloy Profiles at Low Temperatures

| Темп-ра испытания<br>A (°C) | $\sigma_b$<br>B (кг/мм <sup>2</sup> ) | $\delta$ | $\psi$ |
|-----------------------------|---------------------------------------|----------|--------|
|                             |                                       |          |        |
| + 20                        | 63                                    | 10       | 15     |
| - 40                        | 66                                    | 8        | 13     |
| - 70                        | 66                                    | 8        | 14     |
| - 196                       | 80                                    | 7        | 9      |

A) Test temperature (°C); B)  $\sigma_b$  (kg/mm<sup>2</sup>)

tures, etc. In quality control of structures

that have been built with V95 alloy, care

should be taken to eliminate sharp stress

concentration perpendicular to the action of

the forces. Massive structures are conven-

iently made from alloy V93, which has super-

ior casting properties and hardenability and

higher property uniformity. Alloy V96 is

used in particular for stressed structures

that will operate for long periods at temperatures no higher than 100°.

Alloy VAD23 may be used for heavily loaded structures, including those

intended for long-term work at temperatures up to 160-180°. Alloy D16

is used for structures under medium loads for long-term operation at

temperatures below 150°. It is used to fabricate skin panels, stringers,

bulkheads and spars for aircraft, structural frameworks, truck cabs,

TABLE 2  
Mechanical Tensile Properties of V95AT1 Alloy at Elevated Temperatures\*

| Температура испытания (°C) | σ <sub>b</sub> (кг/мм <sup>2</sup> ) | δ <sub>5</sub> (%) |     | σ <sub>0.2</sub> (кг/мм <sup>2</sup> ) |     | σ <sub>0.01</sub> (кг/мм <sup>2</sup> ) |     |
|----------------------------|--------------------------------------|--------------------|-----|--|-----|---|-----|
|                            |                                      | min                | typ | min                                    | typ | min                                     | typ |
| 20                         | 6700                                 | 41                 | 44  | 49                                     | 52  | 7                                       | 14  |
| 100                        | 6200                                 | 38                 | 41  | 44                                     | 48  | —                                       | 14  |
| 125                        | 5900                                 | 37                 | 40  | 43                                     | 47  | —                                       | 14  |
| 150                        | 5600                                 | 34                 | 35  | 39                                     | 41  | —                                       | 15  |
| 175                        | 5400                                 | 30                 | 32  | 35                                     | 37  | —                                       | 16  |
| 200                        | 5100                                 | 22.5               | 24  | 26                                     | 28  | —                                       | 17  |
| 250                        | 4700                                 | 11                 | 12  | 14                                     | 15  | —                                       | 16  |
| 300                        | —                                    | 6.5                | 7.0 | 7.5                                    | 8.5 | —                                       | 11  |

\*Sheet up to 2.5 mm thick.

a) Test temperature (°C); b) kg/mm<sup>2</sup>; c) minimum; d) typical.

TABLE 3  
Mechanical Compressive Properties of V95AT1-Alloy Sheets at Elevated Temperatures

| Температура испытания (°C) | E <sub>szh</sub> (кг/мм <sup>2</sup> ) |      | σ <sub>-pts</sub> (кг/мм <sup>2</sup> ) |    |
|----------------------------|--|------|---|----|
|                            | A                                      | B    | C                                       | D  |
| 20                         | 6700                                   | 50.0 | 47.5                                    | 33 |
| 100                        | 6350                                   | 48.5 | 47.5                                    | 28 |
| 150                        | 5900                                   | 47.0 | 47.5                                    | 26 |
| 200                        | 5400                                   | 32.0 | 29.0                                    | 18 |

A) Test temperature (°C);  
B) E<sub>szh</sub>; C) σ<sub>-pts</sub>; D) kg/mm<sup>2</sup>.

TABLE 4  
Influence of Heating time to 150° on Mechanical Properties of V95T Alloy Profiles\*

| Направление и место выреза образца | A | Механические свойства после нагрева в течение |                    |                                      |                    |
|------------------------------------|---|---|--------------------|--------------------------------------|--------------------|
|                                    |   | 100 час.                                      |                    | 200 час.                             |                    |
|                                    |   | σ <sub>b</sub> (кг/мм <sup>2</sup> )          | δ <sub>5</sub> (%) | σ <sub>b</sub> (кг/мм <sup>2</sup> ) | δ <sub>5</sub> (%) |
| Профильная часть вдоль волокон     | E | 51.5  | 10.0               | 47.0                                 | 10.5               |
|                                    |   |   |                    |                                      |                    |
| Законочка поперек волокон          | G | 52.0  | 3.5                | 49.0                                 | 4.5                |

\*Properties of V95T alloy in the initial state: profiled part along fiber (σ<sub>b</sub> = 62 kg/mm<sup>2</sup>, δ<sub>5</sub> = 7.3%); butt, with fiber (σ<sub>b</sub> = 56.5 kg/mm<sup>2</sup>, δ<sub>5</sub> = 8.5%); butt, across fiber (σ<sub>b</sub> = 53.0 kg/mm<sup>2</sup>, δ<sub>5</sub> = 3.5%). After heating at 100 and 125° for 100 and 200 hours, the properties of the profiles show little change; σ<sub>b</sub> has a tendency to rise slightly (by 1-3 kg/mm<sup>2</sup>).

A) Direction and location of specimen cutout; B) mechanical properties after heating for; C) hours; D) kg/mm<sup>2</sup>; E) profiled part, with fiber; F) butt, with fiber; G) butt, across fiber.

TABLE 9

Influence of Heating Time on Mechanical Properties of V95T Alloy Profiles at Elevated Temperatures

| Темп-ра<br>испытания<br>(°C) | Направление вырезки<br>образца | Механические свойства после нагрева и выдержки |                      |                                     |                      |                                     |                      |      |
|------------------------------|--------------------------------|--|----------------------|-------------------------------------|----------------------|-------------------------------------|----------------------|------|
|                              |                                | 30 мин. D                                      |                      | 100 час. E                          |                      | 200 час                             |                      |      |
|                              |                                | $\sigma_b$<br>(кг/мм <sup>2</sup> )            | $\delta_{10}$<br>(%) | $\sigma_b$<br>(кг/мм <sup>2</sup> ) | $\delta_{10}$<br>(%) | $\sigma_b$<br>(кг/мм <sup>2</sup> ) | $\delta_{10}$<br>(%) |      |
| A                            | B                              | F  |                      |                                     |                      |                                     |                      |      |
| 100                          | G                              | Профильная часть вдоль волокна                 | 57,5                 | 9,0                                 | 59,0                 | 9,5                                 | 59,0                 | 10,5 |
|                              | H                              | Законцовка вдоль волокна                       | 57,5                 | 12,0                                | 58,0                 | 12,0                                | 58,0                 | 11,5 |
|                              | I                              | Законцовка поперек волокна                     | 53,0                 | 8,0                                 | 54,0                 | 5,0                                 | 54,0                 | 9,0  |
| 125                          | G                              | Профильная часть вдоль волокна                 | 55,0                 | 9,0                                 | 53,0                 | 10,5                                | 50,0                 | 11,0 |
|                              | H                              | Законцовка вдоль волокна                       | 54,0                 | 14,5                                | 53,0                 | 14,0                                | 52,0                 | 13,0 |
|                              | I                              | Законцовка поперек волокна                     | 51,0                 | 9,0                                 | 48,5                 | 5,5                                 | 47,5                 | 7,0  |
| 150                          | G                              | Профильная часть вдоль волокна                 | 49,0                 | 11,0                                | 40,0                 | 11,5                                | 35,0                 | 13,0 |
|                              | H                              | Законцовка вдоль волокна                       | 50,0                 | 13,0                                | 44,0                 | 15,0                                | 38,5                 | 16,5 |
|                              | I                              | Законцовка поперек волокна                     | 48,0                 | 10,0                                | 40,0                 | 7,0                                 | 35,5                 | 9,5  |

A) Test temperature (°C); B) direction of specimen cutout; C) mechanical properties after heating for; D) 30 minutes; E) 100 hours; F) kg/mm<sup>2</sup>; G) profiled part, with fiber; H) butt, with fiber; I) butt, across fiber.

TABLE 10

Typical Mechanical Properties of Alloy V96 at 20°

| Вид полуфабриката<br>А                 | В Направление вырезки образца  | E                     |            |                |            | $\delta_{10}$<br>(%) | НВ<br>(кг/мм <sup>2</sup> ) |
|--|--------------------------------|-----------------------|------------|----------------|------------|----------------------|-----------------------------|
|  |                                | $\sigma_{0,2}$        | $\sigma_b$ | $\sigma_{0,2}$ | $\sigma_b$ |                      |                             |
|  |                                | (кг/мм <sup>2</sup> ) |            |                |            |                      |                             |
| Прессованные профили с законцовкой E   | Профильная часть вдоль волокна | 7000                  | 52,0       | 64,0           | 68,0       | 7,0                  | 190                         |
|  | Законцовка вдоль волокна G     | 6800                  | 50,0       | 63,0           | 66,0       | 7,0                  | 190                         |
| Прессованные панели толщиной 8-16 мм H | Вдоль волокна I                | -                     | -          | 63,0           | 66,0       | 8,0                  | -                           |
|  | По ширине J                    | -                     | -          | 58,0           | 63,0       | 6,0                  | -                           |

A) Form of semifinished product; B) direction of specimen cutout; C)  $\sigma_{pts}$ ; D) kg/mm<sup>2</sup>; E) extruded profiles with butt flare; F) profiled part, with fiber; G) butt, with fiber; H) extruded panels 8-16 mm thick; I) with fiber; J) crosswise.

etc. Alloys M40, D19 and VAD1 are used for structures that will come under moderate loads, including welded-up designs to operate at temperatures up to 250°.

Alloy AK8 is used for stressed constructions operating long-term

TABLE 11

Mechanical Properties of V96 Alloy at  
-70°

| Вид полуфабриката    | A | σ <sub>0.2</sub>        |      | σ <sub>0.1</sub> | σ <sub>0.01</sub> |
|----------------------|---|-------------------------|------|------------------|-------------------|
|                      |   | B (кг/мм <sup>2</sup> ) |      |                  |                   |
| Профили прессованные | C | 33.0                    | 25.0 | 10.0             | 4.0               |

A) Form of semifinished product; B) kg/  
/mm<sup>2</sup>; C) extruded profiles.

TABLE 12

Physical Properties of High-Strength  
Aluminum Shaping Alloys

| Сплав | A | B<br>(г/см <sup>3</sup> ) | C<br>(ом·мм/м) | D<br>(кал/см·сек·°C) |                     |
|-------|---|---------------------------|----------------|----------------------|---------------------|
|       |   |                           |                | (25°)                | (100°)              |
| V95   |   | 2.85                      | 0.042 (V95T)   | 0.37 (25°)           | 22 (от -50 до +20°) |
| E     |   | -                         | F -            | 0.38 (300°)          | 26.2 (20-300°) G    |
| V96   |   | 2.89                      | 0.0570 (V96T)  | 0.27 (25°)           | 22.84 (20-100°)     |
| H     |   | -                         | I -            | 0.39 (300°)          | 24.68 (100-200°)    |

A) Alloy; B) g/cm<sup>3</sup>; C) ohms·mm<sup>2</sup>/m; D)  
cal/cm·sec·°C; E) V95; F) V95T; G) from  
-50° to +20°; H) V96; I) V96T.

at temperatures below 100°; in fabrication of large forgings and stampings, the pieces lose considerable strength and a tendency to overheat makes its appearance. Engine subframes, railroad-car tires, and helicopter rotor blades are made from AK8 alloy. Attempts have been made to use this alloy (and certain other aluminum alloys) for coal-mine supporting pillars, but it was found that sparking occurred when these metals were struck against steel - an inadmissible hazard for mines, where the atmosphere may contain inflammable mixtures.

All large, solid and complex-shaped semifinished products made from the high-strength alloys must be given UZ [ultrasonic] inspection in order to detect internal flaws (cracks and separation); the surface layers must be eddy-current tested and given careful visual inspection with a magnifier, particularly after the finished pieces have been

I-38a13

anodized.

References: Mikheyeva, V.I., *Khimicheskaya priroda vysokoprochnykh splavov alyuminiya s magniyem i tsinkom* [Chemical Nature of High-Strength Alloys of Aluminum with Magnesium and Zinc], Moscow-Leningrad, 1947; *Legkiye splavy. Metallovedeniye, termicheskaya obrabotka, lit'ye i obrabotka davleniyem* [Light Alloys. Physical Metallurgy, Heat Treatment, Casting and Mechanical Working], collection of articles, Moscow, 1958; Fridlyander, I.N., *Vysokoprochnyye deformiruyemye alyuminiyevyye splavy* [High-strength Aluminum Shaping Alloys], Moscow, 1960; *Deformiruyemye alyuminiyevyye splavy* [Aluminum Shaping Alloys], collection of articles edited by I.N. Fridlyander [et al.], Moscow, 1961; *Stroitel'nyye konstruktsii iz alyuminiyevykh splavov* [Aluminum Alloy Structures], [collection of articles], edited by S.V. Taranovskiy, Moscow, 1962; *Mekhanicheskiye svoystva nekotorykh konstruktsionnykh staley i splavov pri komnatnoy i povyshennykh temperaturakh* [Mechanical Properties of Certain Structural Steels and Alloys at Room and Elevated Temperatures], Moscow, 1957.

I.N. Fridlyander, T.K. Ponar'ina

Manu-  
script  
Page  
No.

[Transliterated Symbols]

|      |   |
|------|---|
| 2011 | ТУ = TU = tekhnicheskiye usloviya = technical specifications                      |
| 2011 | ГОСТ = GOST = Gosudarstvennyy obshchesoyuznyy standard = State All-Union Standard |
| 2013 | пц = pts = proporsional'nost' = proportionality                                   |
| 2013 | кр kr = kriticheskiy = critical   |
| 2017 | н = n = nadrez = notch  |
| 2017 | сп = sr = srez = shear  |

:-58a14

2019 cx = szh = szhatiye = compression

2021 y3 UZ = ul'trazvukovoy = ultrasonic

III-7ch

HIGH-STRENGTH CAST IRON - see Magnesium cast iron.

HIGH-STRENGTH CAST MAGNESIUM ALLOYS are magnesium alloys with ultimate of no less than 21 kg/mm<sup>2</sup>, intended for mold casting of details. These alloys include the types ML4, ML5, ML6 (GOST 2856-55, AMTU 488-63) ML4 pch, ML5 pch (AMTU 488-63, see High Corrosion Resistant Cast Magnesium Alloys) of the Mg - Al - Zn system and the type ML12 and ML15 (AMTU 488-63) alloys based on the Mg - Zn - Zr system. For the chemical composition of these alloys see Magnesium Alloys. The mechanical properties of the alloys are given in Tables 1-5, the physical properties in Table 6, information on the precessing properties in Tables 7-8.

TABLE 1

Mechanical Properties of High-Strength Cast Magnesium Alloys at Room Temperature\*

| 1<br>Сплав | 2<br>Режим термич. обработки | E                     | σ    | 3 σ <sub>пс</sub> |                 | σ <sub>ср</sub> | σ <sub>в</sub> | δ               |                 | ψ     | σ <sub>ср</sub> |                 |                 |   | σ <sub>ср</sub><br>(кг/мм <sup>2</sup> ) | НВ<br>(кг/мм <sup>2</sup> ) | σ <sub>ср</sub> (кг/мм <sup>2</sup> ) |                 |
|------------|------------------------------|-----------------------|------|-------------------|-----------------|-----------------|----------------|-----------------|-----------------|-------|-----------------|-----------------|-----------------|---|--|-----------------------------|---------------------------------------|-----------------|
|            |                              |                       |      | σ <sub>пс</sub>   | σ <sub>ср</sub> |                 |                | σ <sub>ср</sub> | σ <sub>ср</sub> |       | σ <sub>ср</sub> | σ <sub>ср</sub> | σ <sub>ср</sub> | σ <sub>ср</sub>                         |  |                             | σ <sub>ср</sub>                       | σ <sub>ср</sub> |
|            |                              | (кг/мм <sup>2</sup> ) |      |                   |                 |                 |                |                 |                 |       |                 |                 |                 | образцы образцы с<br>7 гладкие надрезки |  |                             |                                       |                 |
| ML4        | 10 Литов                     | —                     | 1600 | —                 | 9.5             | 16-18           | 3-5            | 6               | —               | —     | —               | 13              | 13              | 0.2                                     | 50                                       | 8                           | 6.5                                   |                 |
|            | T4                           | 4200                  | 1600 | 1.8               | 8.5             | 22-25           | 5-9            | 15              | 37              | —     | —               | 4.5             | 16.5            | 13.5                                    | 0.4                                      | 40-45                       | 8                                     | 5               |
|            | T8                           | 4200                  | 1600 | 4.5               | 11.5            | 21-25.5         | 2-6            | 4-8             | 39              | —     | —               | 6               | 18              | 14.5                                    | 0.2                                      | 60-75                       | 8                                     | 7               |
| ML5        | 10 Литов                     | 4200                  | 1600 | —                 | 9.5             | 15-16           | 2-3            | 4               | —               | —     | —               | 12              | —               | —                                       | 50-65                                    | 8.5                         | 7                                     |                 |
|            | T4                           | 4200                  | 1600 | 3                 | 8.5             | 23-25           | 5-9            | 15              | 36.5            | 7-8.5 | 4               | 15.5            | 13.5            | 0.5                                     | 50-65                                    | 10                          | 8                                     |                 |
|            | T8                           | 4200                  | 1600 | 4.5               | 12              | 23-25.5         | 2-4            | 4-6             | 34              | —     | 6               | 17              | 14              | 0.3                                     | 65-75                                    | 8.5                         | 7                                     |                 |
| ML6        | 10 Литов                     | 4200                  | 1600 | —                 | 11              | 15-16           | 1-1.5          | 2-3             | —               | —     | —               | —               | —               | —                                       | 55-65                                    | 8.5                         | 7                                     |                 |
|            | T4                           | 4200                  | 1600 | 3.5               | 10              | 22-25           | 4-5            | 12              | —               | —     | —               | —               | —               | —                                       | 55-65                                    | 9.5                         | 7.5                                   |                 |
|            | T8                           | 4200                  | 1600 | 5.5               | 14              | 22-26           | 1              | 3               | —               | —     | —               | —               | —               | —                                       | 65-75                                    | 8.5                         | 7                                     |                 |
| ML12       | 10 Литов                     | 4400                  | 1650 | 7-8               | 9-12            | 20-22           | 6-12           | 8               | —               | —     | —               | —               | 15.5            | 0.6                                     | 50-60                                    | 5                           | 5                                     |                 |
|            | T1                           | 4400                  | 1650 | 8-9               | 12-14           | 22-24           | 5-10           | 7               | 34-36           | 12-14 | 0.5             | 18              | 15.5            | 0.4                                     | 50-60                                    | 7.5                         | 7                                     |                 |
|            | T8                           | 4400                  | 1650 | 8-9               | 14-18           | 25              | 5-8            | 7               | 34-39           | 12-14 | 8               | 18              | 15.5            | 0.4                                     | 65-70                                    | 8                           | —                                     |                 |
| ML15       | T1                           | 4300                  | 1650 | 8                 | 13-15           | 21-22           | 3-4            | 5               | 34              | 13-15 | 9               | 17              | 15              | 0.2                                     | 50-60                                    | 9                           | 7                                     |                 |

\*Lower limit of properties is minimal, upper limit is typical.

1) Alloy; 2) temper; 3) σ<sub>пс</sub> pts; 4) τ sr; 5) (кгс/см<sup>2</sup>); 6) (кг/мм<sup>2</sup>); 7) smooth specimens; 8) notched specimens; 9) ML ; 10, as cast.



II-11M1

TABLE 2

Mechanical Properties of High-Strength Cast Magnesium Alloys at High Temperatures

| 1<br>Сплав | 2<br>Режим термич. обработки | 100°                        |          | 150°                        |                |                             |          | 200°                        |                |                             |          | 250°                        |                |                             |          | 300°       |                |                |          |
|------------|------------------------------|-----------------------------|----------|-----------------------------|----------------|-----------------------------|----------|-----------------------------|----------------|-----------------------------|----------|-----------------------------|----------------|-----------------------------|----------|------------|----------------|----------------|----------|
|            |                              | $\sigma_b$                  | $\delta$ | $\sigma_b$                  | $\sigma_{0.2}$ | $\sigma_{0.1}$              | $\delta$ | $\sigma_b$                  | $\sigma_{0.2}$ | $\sigma_{0.1}$              | $\delta$ | $\sigma_b$                  | $\sigma_{0.2}$ | $\sigma_{0.1}$              | $\delta$ | $\sigma_b$ | $\sigma_{0.2}$ | $\sigma_{0.1}$ | $\delta$ |
|            |                              | 3 (кг/мм <sup>2</sup> ) (%) |          | 3 (кг/мм <sup>2</sup> ) (%) |                | 3 (кг/мм <sup>2</sup> ) (%) |          | 3 (кг/мм <sup>2</sup> ) (%) |                | 3 (кг/мм <sup>2</sup> ) (%) |          | 3 (кг/мм <sup>2</sup> ) (%) |                | 3 (кг/мм <sup>2</sup> ) (%) |          |            |                |                |          |
| МЛ5        | T4                           | 23                          | 10       | 18.5                        | 6              | —                           | 12       | 15.5                        | 5              | —                           | 15       | 12                          | 4              | —                           | 15       | —          | —              | —              | —        |
|            | T6                           | 23                          | 6        | 18.5                        | —              | —                           | 10       | 15.5                        | —              | —                           | 15       | —                           | —              | —                           | —        | —          | —              | —              | —        |
| МЛ6        | T4                           | 23                          | 5        | 21                          | —              | —                           | 12       | 15.5                        | —              | —                           | 15       | —                           | —              | —                           | —        | —          | —              | —              | —        |
|            | T6                           | 23                          | 5        | 21                          | —              | —                           | 8        | 15.5                        | —              | —                           | 15       | —                           | —              | —                           | —        | —          | —              | —              | —        |
| МЛ12       | T1                           | —                           | —        | 16                          | 11             | 10                          | 5        | 14                          | 8.5            | 8.5                         | 5        | 10                          | 6              | 6                           | 6        | 5.5        | 4.5            | —              | 5        |
|            | T6                           | —                           | —        | 16                          | 10             | 10                          | 4        | 12.5                        | 7.5            | 7.5                         | 10       | 8.5                         | 5              | 5                           | 12       | 5.5        | 4.5            | —              | 15       |
| МЛ15*      | T1                           | —                           | —        | 14.5                        | 10.5           | 11.5                        | 5        | 12.5                        | 8.5            | 9.5                         | 13       | 10                          | 6.5            | 7.5                         | 16       | 7.5        | 5              | 5.5            | 16       |

\*Properties of ML15 alloy at 350°:  $\sigma_b = 5.5 \text{ kg/mm}^2$ ;  $\sigma_{0.2} = 3.7 \text{ kg/mm}^2$ ;  $\delta = 16\%$ .

1) Alloy; 2) temper; 3) (kg/mm<sup>2</sup>); 4) ML.

TABLE 3

Creep Limits (permanent deformation 0.2%) Stress to Rupture of High-Strength Cast Magnesium Alloys after 100 Hours at Elevated Temperatures\*

| 1<br>Сплав | 2<br>Режим терм. обра-ботки | 100°                    |     | 150°                    |     | 200°                    |     | 250°                    |   | 300°                    |   | 350°                    |   |
|------------|-----------------------------|-------------------------|-----|-------------------------|-----|-------------------------|-----|-------------------------|---|-------------------------|---|-------------------------|---|
|            |                             | 3 (кг/мм <sup>2</sup> ) |     | 3 (кг/мм <sup>2</sup> ) |     | 3 (кг/мм <sup>2</sup> ) |     | 3 (кг/мм <sup>2</sup> ) |   | 3 (кг/мм <sup>2</sup> ) |   | 3 (кг/мм <sup>2</sup> ) |   |
| МЛ4        | Исходное состояние          | 6                       | 2.7 | 1.6                     | —   | —                       | —   | —                       | — | —                       | — | —                       | — |
|            |                             | 6.6                     | 2.9 | 1.2                     | —   | —                       | —   | —                       | — | —                       | — | —                       | — |
|            |                             | 6.3                     | 2.7 | 1.4                     | —   | —                       | —   | —                       | — | —                       | — | —                       | — |
| МЛ5        | T4                          | 7.1                     | 2.5 | 0.8                     | 8.5 | 5                       | 2.5 | —                       | — | —                       | — | —                       |   |
|            | T6                          | 7.4                     | 2.4 | 1.1                     | —   | —                       | —   | —                       | — | —                       | — | —                       |   |
| МЛ6        | T4                          | 7.2                     | 2.4 | 0.7                     | —   | —                       | —   | —                       | — | —                       | — | —                       |   |
|            | T6                          | 7.5                     | 2.6 | 1                       | —   | —                       | —   | —                       | — | —                       | — | —                       |   |
| МЛ12       | T1, T6                      | —                       | 4   | 2.5                     | 8   | 4                       | 2   | —                       | — | —                       | — | —                       |   |
| МЛ15       | T1                          | —                       | —   | 4                       | —   | 6.5                     | —   | —                       | — | —                       | — | —                       |   |

\*Figures for specimens individually cast in sand mold.

1) Alloy; 2) temper; 3) (kg/mm<sup>2</sup>); 4) ML ; 5) as cast.

Most widely used in Soviet industry is the ML5 alloy (8% Al, 0.5% Zn, 0.2% Mn), which has a favorable combination of high mechanical and processing properties. The ML4 alloy (6% Al, 3% Zn, 0.2% Mn), which exceeds the ML5 alloy in corrosion resistance, finds limited application because of the high tendency to formation of hot cracks and microporosity in castings (see Defects of Magnesium Castings). The ML6 alloy (9.6% Al, 0.9% Zn, 0.15% Mn) has the highest yield point of the high-strength magnesium alloys of the Mg - Al - Zn system, the drawback of this alloy is the low plasticity at 20°.

The ML12 alloy (45% Zn, 0.6% Zr) and the ML15 alloy (4.5% Zn, 0.9% La,

II-11M2

0.7% Zr) exceed the ML5 alloy in yield strength and are equal to the ML6 alloy. A typical value of the ratio  $\frac{\sigma_{0.2}}{\sigma_b}$  for the ML5 alloy is 0.45, for the ML12 alloy it is 0.55, and for the ML15 alloy 0.65. In comparison with the ML5 and ML6 alloys, the ML12 alloy combines a high yield point with high plasticity, which permits using it under conditions of high static and alternating loads. With regard to plasticity at 20°, the ML15 alloy occupies an intermediate position between the ML12 and ML6 alloys (minimal values of  $\delta$  equal to 5, 3, and 1% respectively).

TABLE 4

Mechanical Properties of High-Strength Cast Magnesium Alloys at Low Temperatures

| 1<br>Сплав | 2<br>Режим термич. обработки | 3<br>Темп-ра испытания (°C) | E                           |                  |                | δ   | ψ   | 4<br>σ <sub>0.2</sub><br>(кгс/см <sup>2</sup> ) |
|------------|------------------------------|-----------------------------|-----------------------------|------------------|----------------|-----|-----|---|
|            |                              |                             | 5<br>(кгс/мм <sup>2</sup> ) | σ <sub>0.2</sub> | σ <sub>b</sub> |     |     |   |
| ML5<br>6   | T6                           | -40                         | —                           | —                | 23             | 4   | 6   | 0.3   |
|            |                              | -70                         | —                           | 14               | 25             | 4   | 6   | 0.3   |
|            | T4                           | -196                        | —                           | 17               | 25             | 2   | 4   | 0.3   |
|            |                              | -196                        | —                           | —                | —              | —   | —   | 0.4   |
| ML6        | T4                           | -70                         | —                           | —                | 27             | 5   | 8.5 | 0.3   |
|            | T6                           | -70                         | —                           | —                | 27.5           | 1   | 2.5 | 0.1   |
| ML12<br>7  | Без термич. обработки        | -70                         | —                           | 16               | 23             | 2.5 | —   | 0.4   |
|            | T1                           | -70                         | —                           | 20               | 25             | 2   | —   | 0.4   |
|            | T6                           | -70                         | —                           | 20               | 26             | 1.5 | —   | 0.4   |
| ML15       | T1                           | -70                         | 4500                        | 14.5             | 21             | 1   | —   | 0.18  |
|            |                              | -196                        | 5000                        | 16               | 22             | <1  | 3   | 0.15  |

1) Alloy; 2) temper; 3) test temperature (°C); 4) (kgm/cm<sup>2</sup>); 5) (kg/mm<sup>2</sup>); 6) ML ; 7) without heat treatment.

TABLE 5

Moduli of Elasticity of ML12 and ML15 Alloys at High Temperatures

| 1<br>Сплав | 2<br>Режим термич. обработки | 3<br>Темп-ра. испытания (°C) | E                   |                       |                             |
|------------|------------------------------|------------------------------|---------------------|-----------------------|-----------------------------|
|            |                              |                              | 4<br>E <sub>d</sub> | 5<br>E <sub>szh</sub> | 6<br>(кгс/мм <sup>2</sup> ) |
| ML12<br>7  | T1                           | 150                          | 3400                | —                     | 3500                        |
|            |                              | 200                          | 3000                | —                     | 3100                        |
|            |                              | 250                          | 2300                | —                     | 2600                        |
|            | T6                           | 150                          | —                   | —                     | 3500                        |
|            |                              | 200                          | —                   | —                     | 3100                        |
|            |                              | 250                          | —                   | —                     | 2600                        |
| ML15<br>7  | T1                           | 150                          | 3600                | 4300                  | 3900                        |
|            |                              | 200                          | 3200                | 4200                  | 3900                        |
|            |                              | 250                          | 3000                | 4100                  | 3300                        |
|            |                              | 300                          | —                   | 3950                  | —                           |
|            |                              | 350                          | —                   | 3800                  | —                           |
|            |                              | 400                          | —                   | 3700                  | —                           |

1) Alloy; 2) temper; 3) test temperature (°C); 4) E<sub>d</sub>; 5) E<sub>szh</sub>; 6) (kg/mm<sup>2</sup>); 7) ML .

II-11M3

TABLE 6

Physical Properties of High-Strength Cast Magnesium Alloys

| 1 Свойства                                      | 2 Сплавы |         |         |         |         |
|---|----------|---------|---------|---------|---------|
|   | МЛ14-Т4  | МЛ15-Т4 | МЛ16-Т6 | МЛ12-Т1 | МЛ15-Т1 |
| 3) $\gamma$ , в . . . . .                       | 1.83     | 1.81    | 1.81    | 1.81    | 1.83    |
| 4) $\rho$ , г/см <sup>3</sup> в интервале: 5    |          |         |         |         |         |
| 20-100° . . . . .                               | 26.4     | 26.8    | 26.1    | 26.2    | 25.9    |
| 20-200° . . . . .                               | 27.6     | 28.1    | 27.5    | —       | 27.9    |
| 20-300° . . . . .                               | 28.3     | 28.7    | 27.7    | —       | 27.9    |
| 20-400° . . . . .                               | —        | —       | —       | —       | 28.8    |
| 6) $\lambda$ (кал/см-сек-°C) при 25° . . . . .  | 0.19     | 0.185   | 0.185   | 0.32    | 0.33    |
| 7) $c$ (кал/г-°C) в интервале 20-100° . . . . . | 0.25     | 0.25    | 0.25    | —       | 0.22    |
| 8) $\rho$ (ом-мм <sup>2</sup> /м) . . . . .     | 0.115    | 0.17    | 0.16    | —       | —       |

1) Properties; 2) alloys; 3) ML ; 4) specific weight; 5) in range; 6)  $\lambda$  (cal/cm-sec-°C) at 25°; 7)  $c$  (cal/g-°C) in range 20-100°; 8)  $\rho$  (ohm-mm<sup>2</sup>/m).

The ultimate strength at room temperature of the ML5-T4 and ML12-T1 alloys on individually cast specimens is practically the same (23-26 and 22-26 kg/mm<sup>2</sup>) while that of the ML15-T1 alloy is 21-23 kg/mm<sup>2</sup>. The small variation of the mechanical properties of the ML12 and ML15 alloys as a function of the section thickness permits obtaining castings made from them with small scatter of the mechanical properties. Details made from the ML12 and ML15 alloys have higher strength than those made from ML5. Long-term heating of the ML5-T4 alloy for 200 hours at 100 and 125° causes practically no change of  $\sigma_b$  and  $\delta$  at 20°; heating at 150° somewhat increases  $\sigma_b$  (by 1-2 kg/mm<sup>2</sup>) and reduces  $\delta$  (from 10 to 5%).

With regard to ultimate strength at elevated temperatures, all the high-strength cast magnesium alloys are practically equivalent. Heating specimens of the ML5 alloy at temperatures from 100° to 175° for 200 hours has no effect on the values of the ultimate strength and elongation at these temperatures. The yield point of the ML12 and ML15 alloys at temperatures from 150° to 250° is 30-40% higher than that of the ML5 alloy, the ratio  $\frac{\sigma_{0.2}}{\sigma_b}$  is about 0.32 for the ML5 alloy, for the ML12 and ML15 alloys it is 0.6 on the average. The yield points of the alloys in tension and compression are practically the same (see Table 1). The

## II-11M4

ML15 alloy, alloyed with lanthanum, exceeds the ML12 alloy in ultimate strength and stress-rupture strength and has the best strength at high temperature of the high-strength cast magnesium alloys (see Table 3). The ML15 and ML12 alloys have high creep resistance in comparison with the alloys of the Mg - Al - Zn system (see Table 3) and are recommended for long-term use to 200°, the ML4, ML5, ML6 alloys are recommended to 150°.

The endurance limit of the alloys at 20° is in the range of 7.5-10 kg/mm<sup>2</sup> (see Table 1). The alloys ML12 (as cast and in the T1 temper) and ML4-T4 have the lowest notch sensitivity in endurance tests - the effective concentration coefficient  $\beta_k$  is equal to 1, 1.07 and 1.1 respectively; for the ML15-T1 alloy  $\beta_k$  is equal to about 1.3. With increases of the test temperature to 200° and 250°  $\beta_k$  for this alloy is not reduced ( $\sigma_{-1} = 5$  and  $4$  kg/mm<sup>2</sup>,  $\sigma_{-1}^n = 3.5$  and  $3$  kg/mm<sup>2</sup> at 200° and 250° respectively).

For short-term operation the high-strength cast magnesium alloys are used to temperatures of the order of 250°. For loadings of duration up to 5 minutes the ML15 alloy may be used to 300-350°.

The high-strength cast magnesium alloys have satisfactory corrosion resistance. The ML4 pch, ML5 pch (high purity), ML12 and ML15 alloys have high corrosion resistance. Details made from the high-strength cast magnesium alloys are used with surface coatings (inorganic films and paint coatings). Locations of contact of magnesium details with other alloys are subjected to protective treatment (see Corrosion of Magnesium Alloys).

The ML4 and ML12 alloys are used without heat treatment and in the heat treated condition. Of the high-strength cast magnesium alloys, ML12 has the highest mechanical properties in the cast condition ( $\sigma_b = 20 - 23$  kg/mm<sup>2</sup>,  $\sigma_{0.2} = 9 - 12$  kg/mm<sup>2</sup>;  $\delta = 6 - 12\%$ ). The heat treatment re-

II-11M5

gimes which are most often used are: for the ML4, ML5 alloys, solution treatment after casting (T4); for the ML6 alloy, solution treatment and aging (T6); for the ML12 and ML15 alloys, aging after casting (T1) (for heat treatment regimes see Table 7).

The ML4 alloy has the widest crystallization interval ( $210^{\circ}$ ) and is characterized by high tendency to formation of microporosity and hot cracks in castings, lowered hermeticity and fluidity in comparison with the other high-strength cast magnesium alloys. It is used for casting into sand forms; casting into chill molds and pressure casting are not recommended.

The ML5 and ML6 alloys are used for casting into sand forms, into chill molds and for pressure casting. They have good casting properties which make it possible to produce complex and large castings (see Cast Magnesium Alloys). The ML12 alloy has satisfactory casting properties. In comparison with the ML5 alloy it has high tendency to formation of hot cracks during casting of thin-wall details. Alloy ML15 exceeds the ML12 alloy in casting properties, castings made from it are characterized by high density and hermeticity. The ML12 and ML15 alloys are recommended for casting into sand forms and into chill forms (Table 8). The processing properties of these alloys depend on the zirconium content (grain refining agent). The best mechanical and processing properties are obtained with a zirconium content of 0.8%. Thanks to the small grain size the variation of section thickness has less effect on the mechanical properties of castings made from the ML12 and ML15 alloys than on those made from the ML5 alloy. Details made from these alloys have higher and more uniform mechanical properties.

According to AMTU 488-63 the average value of the ultimate strength of specimens cut from castings of the ML12-T1 and ML15-T1 alloys must be no less than 85% of the ultimate strength of individually cast

II-11M6

specimens, i.e., 18.5 and 17.5 kg/mm<sup>2</sup> respectively, regardless of the wall thickness. On specimens cut from castings of the ML5-T4 alloy with wall thickness more than 20 mm,  $\sigma_b$  must be  $\geq 15.5$  kg/mm<sup>2</sup> (i.e., about 70%). On specimens cut from thin-wall (up to 10-20 mm) castings the average value of the ultimate strength is about the same for the ML5-T4 and ML15-T1 alloys, i.e., 17-17.5 kg/mm<sup>2</sup>. The average values of the yield point of the high-strength cast magnesium alloys are different on individually cast specimens and on specimens cut from details. The average value of the elongation of specimens cut from details must be no less than 60-65% of the minimal values of the elongation of individually cast specimens. In casting details from the ML12 and ML15 alloys account must be taken of their greater shrinkage and increased thermal conductivity; therefore, increased riser sections must be used in comparison with the ML5 alloy. The casting temperature for details made from the ML12 and ML15 alloys must be 10-20° higher than for the ML5 alloy.

Taking account of the high hot brittleness and oxidizability of the ML12 alloy, use is recommended of core mixtures with maximal pliability and high gas permeability, uniform supply of metal to the form and nonturbulent filling.

The weldability of the ML4 and ML12 alloys is limited; only small defects can be welded over. Argon-arc welding is used for the ML15 alloy, the ML5 and ML6 alloys are quite satisfactorily argon-arc and oxyacetylene welded. In oxyacetylene welding use is made of the chloride-free VF-156 flux. Depending on the size of the defect being welded over, heating (either local or of the entire detail) is used prior to welding - to 300-370° for ML5, ML6 and to 300-390° for ML12 and ML15. The filler material is extruded wire made from the alloy being welded, except that for the ML12 alloy use is made of wire made from the alloy of the Mg-Zn-rare-earth metal-Zr system.

II-11M7

TABLE 7

Heat Treatment Regimes for the High-Strength Cast Magnesium Alloys

| 1     | 2                                 | 3  | 4 Залудка   |                       |                   | 5 Старение          |                       |                   | 6 Отпуск            |                       |                   |        |   |
|-------|-----------------------------------|--|---|-----------------------|-------------------|---------------------|-----------------------|-------------------|---------------------|-----------------------|-------------------|--------|---|
|       |                                   |  | 7   | 8                     | 9                 | 7                   | 8                     | 9                 | 7                   | 8                     | 9                 |        |   |
| Сплав | Вид литья                         | Условное обозначение режима  | тем-ра нагрева (°C)   | время выдержки (часы) | охлаждающая среда | тем-ра нагрева (°C) | время выдержки (часы) | охлаждающая среда | тем-ра нагрева (°C) | время выдержки (часы) | охлаждающая среда |        |   |
| МЛ4   | Литье в песчаную форму            | 11   | T4  | 380±5                 | 8-16              | Воздух              | -                     | -                 | -                   | -                     | -                 |        |   |
|       |                                   |  | T6  | 380±5                 | 8-16              | Воздух              | 175±5                 | 16                | Воздух              | -                     | -                 | -      |   |
| МЛ5   | 13                                | 1. Литье в песчаную форму и в кокиль. Отливки с толщиной стенки более 12 мм, отлитые в песчаную форму и имеющие массивные части толщиной или диаметром более 25 мм | T2  | -                     | -                 | -                   | -                     | -                 | -                   | 350±5                 | 2-3               | Воздух |   |
|       |                                   |  | T4  | 360±5                 | 3                 | Воздух              | -                     | -                 | -                   | -                     | -                 | -      |   |
|       |                                   |  | T6  | 420±5                 | 13-21             | Воздух              | 175±5                 | 16                | Воздух              | -                     | -                 | -      |   |
|       |                                   | 15   | 2. Отливки в кокиль; отливки с толщиной стенки до 12 мм, отлитые в песчаные формы и имеющие массивные части до 25 мм, охлаждаемые установкой холодильников (если массивные части не переохлаждены, то их следует относить к 1-й группе) | T4                    | 415±5             | 8-16                | Воздух                | -                 | -                   | -                     | -                 | -      | - |
|       |                                   |  |   | T6                    | 415±5             | 8-16                | Воздух                | 175±5             | 16                  | Воздух                | -                 | -      | - |
|       |                                   |  |   | T6                    | 415±5             | 8-16                | Воздух                | 175±5             | 8                   | Воздух                | -                 | -      | - |
| МЛ6   | Литье в песчаную форму и в кокиль | 16   | T4  | 360±5                 | 3                 | Воздух              | -                     | -                 | -                   | -                     | -                 |        |   |
|       |                                   |  | T6  | 410±5                 | 21-29             | Воздух              | 190±5                 | 4-8               | Воздух              | -                     | -                 | -      |   |
|       |                                   |  | T6-1  | 410±5                 | 21-29             | Вода горячая (90°)  | 190±5                 | 4-8               | Воздух              | -                     | -                 | -      |   |
| МЛ12  | 18 То же                          |  | T1  | -                     | -                 | -                   | 300±5                 | 4-8               | Воздух              | -                     | -                 | -      |   |
|       |                                   |  | T6  | 400±5                 | 2                 | Воздух              | 150±5                 | 50                | Воздух              | -                     | -                 | -      |   |
| МЛ15  |                                   |  | T1  | -                     | -                 | -                   | 300±5                 | 6                 | Воздух              | -                     | -                 | -      |   |

1) Alloy; 2) form of casting; 3) temper designation; 4) solution treatment; 5) aging; 6) annealing; 7) heating temperature; 8) soak time (hours); 9) cooling medium; 10) ML; 11) sand mold; 12) air; 13) 1. Sand and chill mold casting. Castings with wall thickness more than 12 mm cast into sand forms and having massive portions of thickness or diameter more than 25 mm; 14) or; 15) 2. Chill mold castings; castings with wall thickness to 12 mm, castings in sand forms having massive sections of thickness to 25 mm, cooled by installation of coolers (if the massive sections are not over-cooled they may be considered in group 1.); 16) sand and chill mold casting; 17) hot water; 18) same.

II-11M8

TABLE 8

Processing Properties and Solidification Temperature of the High-Strength Cast Magnesium Alloys

| 1 Свойства  | 2 Сплавы            |  |  |                               |                               |
|---|---------------------|--|--|-------------------------------|-------------------------------|
|   | 3 ML4               | ML5  | ML6  | ML12                          | ML15                          |
| 4 Темп-ра начала кристаллизации (°C)  | 610                 | 600  | 600  | 630                           | 650                           |
| 5 Темп-ра конца кристаллизации (°C)   | 400                 | 430  | 440  | 450                           | 539                           |
| 6 Интервал кристаллизации (°C)  | 210                 | 170  | 160  | 180                           | 91                            |
| 7 Линейная усадка (%)   | 1.2-1.4             | 1.1-1.3                                      | 1.1-1.2                                      | 1.3-1.4                       | 1.3-1.6                       |
| 8 Жидкотекучесть, определяемая по длине отлитого прутка (мм)  | 245                 | 290-300                                      | 330  | 290                           | 320                           |
| 9 Склонность к образованию горячих трещин, определяемая по ширине вставки в мм, при которой появляется первая трещина | 37.5                | 30-35  | 27.5   | 32.5-35                       | 27.5-30                       |
| 10 микрорыхлоты (средний балл микрорыхлоты при содержании водорода 20 см <sup>3</sup> в 100 г)                        | 70.0 11 (высокая)   | 40.0 12 (средняя)                            | 24.1 (средняя) 12                            | 30.0 (средняя) 12             | —                             |
| 13 Герметичность  | 14 Пониженная       | Средняя 12                                   | Средняя 12                                   | —                             | 15 Повышенная                 |
| 16 Темп-ра литья деталей (°C)   | 700-800             | 700-800                                      | 700-800                                      | 740-800                       | 740-800                       |
| 17 Рекомендуемые виды литья   | 18 В песчаную форму | В песчаную форму, в кокиль, под давлением 19 | В песчаную форму, в кокиль, под давлением 19 | В песчаную форму, в кокиль 20 | В песчаную форму, в кокиль 20 |

1) Properties; 2) alloys; 3) ML ; 4) temperature of crystallization initiation (°C); 5) temperature of crystallization termination (°C); 6) crystallization interval (°C); 7) liner shrinkage (%); 8) fluidity, determined from length of cast rod (mm); 9) tendency to formation of hot cracks, determined from width of ring in mm for which the first crack appears; 10) tendency to formation of microporosity (average microporosity number with hydrogen content of 20 cm<sup>3</sup> per 100 grams); 11) (high); 12)(average); 13) hermeticity; 14) low; 15) high; 16) detail casting temperature (°C); 17) recommended form of casting; 18) sand form; 19) sand form, chill mold, pressure; 20) sand form, chill mold.

In the melting of the alloys, use is made of the V13, V13 chloride fluxes, special fluxes (for the Mg-Zn alloys), the chloride-free FL1 flux which refine the molten metal of nonmetallic inclusions and prevent it from buring. A fluoride flux is used in the final stage of the refining and as a covering for the pouring of the alloys of the Mg-Al-Zn system into the forms.

To refine the grain of the ML4, ML5, ML6 alloys use is made of modification - heating the liquid metal to 850-900° or the introduction of substances containing carbon (magnesite, chalk, etc.), see Modification of Magnesium Alloys. Introduction of zirconium into the ML12 and



II-11M9

ML15 alloys is accomplished with the aid of a ligature of magnesium with 20-50% zirconium obtained by smelting magnesium with potassium fluozirconate ( $K_2ZrF_6$ ) in the presence of salts which reduce the temperature of the reaction - carnalite or a mixture consisting of lithium chloride and potassium fluoride; triple ligatures of Mg - Zn - Zr are also used.

In the melting of alloys containing zirconium (ML12 and ML15) alloys containing aluminum must not be allowed to enter the charge. Aluminum and silicon impurities (hundredths of a percent) lead to the separation of the zirconium from the molten metal.

The high-strength cast magnesium alloys are widely used in various branches of industry. The ML4 alloy is used primarily for protectors in shipbuilding; the ML5 alloy is used for details of flight vehicles (wheel parts, control details and airplane wings), accessory details ( housings, oil pumps, and many others); in the auto industry for engine crankcase castings, transmissions, motor vehicle wheel parts; in the tractor industry for transmission cases and in many other branches of the national economy (see Cast Magnesium Alloys). The ML12 and ML15 alloys are used for casting details of flight vehicles. Thus, for example, the ML12 alloy is widely used for casting airplane wheel parts. The ML15 alloy is used to cast details of housings, accessory cases, etc.

References: see article Cast Magnesium Alloys.

N.M. Tikhova

HIGH-STRENGTH STAINLESS STEEL is steel which has high strength and is resistant to oxidation in a gaseous medium at temperatures to 600°. In many cases the fabrication of detail parts from high-strength stainless steel permits considerable reduction of the weight and size of machinery, which is of particular importance for aviation and other transport equipment. The EP65 and VNS-6 high-strength stainless steels belong to the martensitic class; their high strength is achieved by the use of quench with subsequent low temper. Using this heat treatment the ultimate strength of the steel depends primarily on the carbon content. With regard to temperature resistance, the high-strength stainless steels are not inferior to the pearlitic class high-strength steels which are widely used in industry (30KhGSA, 30KhGSNA, 30KhGSNMA, EI643, 30Kh2GSN2VM) and at 450-500° are superior.

The EP65 and VNS-6 grades of high-strength stainless steel are 12% chrome steel of the EI961 type (see Martensitic Stainless Steel) with high vanadium content (EP65 steel) and molybdenum content increased to 2% (VNS-6 steel); the carbon content is also increased in both steel grades. High-strength stainless steel is produced in the form of rod, forging blanks, and sheet.

The effect of tempering temperature on the mechanical properties of quenched EP65 steel is shown in Fig. 1.

The fatigue limit is determined on the basis of  $1 \cdot 10^7$  cycles; the specimen notch radius is 0.75 mm. The modulus of elasticity of the EP65 steel is 19,00 kg/mm<sup>2</sup>.

The effect of tempering temperature and quench temperature on the

II-29N1

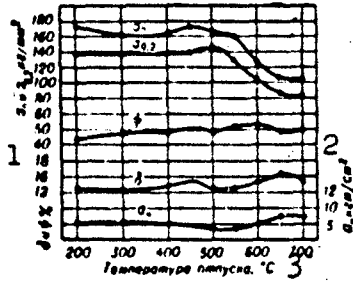

Fig. 1. Effect of tempering temperature on mechanical properties of EP65 steel (oil quench from 1050-1070°). 1)  $\sigma_n$  and  $\sigma_{0.2}$ , kg/mm<sup>2</sup>; 2)  $a_n$ , kgm/cm; 3) tempering temperature, °C; 4)  $a_n$ .

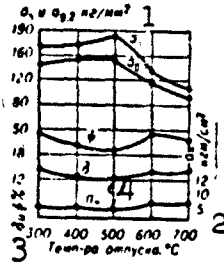

Fig. 2. Effect of tempering temperature on mechanical properties of VNS-6 steel (oil quench from 1050°). 1)  $\sigma_n$  and  $\sigma_{0.2}$ , kg/mm<sup>2</sup>; 2)  $a_n$ , kgm/cm<sup>2</sup>; 3) tempering temperature, °C; 4)  $a_n$ .

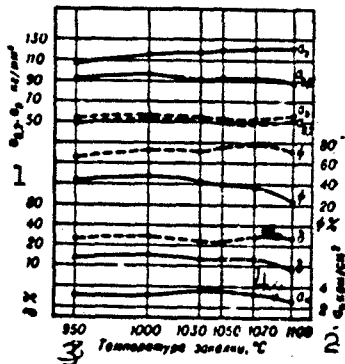

Fig. 3. Effect of quench temperature on mechanical properties of VNS-6 steel (tempered at 650°): -----) air quench; —) oil quench. 1)  $\sigma_{0.2}$ ,  $\sigma_b$ , kg/mm<sup>2</sup>; 2)  $a_n$ , kgm/cm<sup>2</sup>; 3) quench temperature, °C; 4)  $a_n$ .

TABLE 1

Mechanical Properties of High-Strength Stainless Steel (No Less Than)

| Сталь 1                | Термич. обработки 2  | $\sigma_b$              | $\sigma_{0.2}$ | $\delta$ | $\psi$ | 4 $a_{11}$<br>(кг/мм <sup>2</sup> ) | 5 HB<br>(d <sub>отп.</sub> , мм) |
|------------------------|--|-------------------------|----------------|----------|--------|-------------------------------------|----------------------------------|
|                        |  | 3 (кг/мм <sup>2</sup> ) |                | (%)      |        |                                     |                                  |
| 23X13HBMFA<br>(ЭП65) 6 | Нормализация 7 при 1050°, замалка с 1050-1070°, охлаждение в масле или на воздухе, отпуск при 300-350° | 155                     | 110            | 10       | 40     | 4                                   | 2.7-3.2                          |
|                        |  | 185                     | 130            | 11       | 48     | 4                                   | 2.7-3.06                         |

1) Steel; 2) heat treatment; 3) (kg/mm<sup>2</sup>); 4)  $a_n$  (kgm/cm<sup>2</sup>); 5) HB (d<sub>отп.</sub>, mm); 6) 23Kh13NVMFA (EP65); 7) normalize at 1050°, quench from 1050-1070°, oil or air cooling, temper at 300-350°; 8) VNS-6 (EP311); 9) normalize at 1050°, oil quench from 1050°, temper at 300°.

TABLE 2

Stress-Rupture, Creep, and Fatigue Limits of EP65 Steel

| Термич. обработки 1 | 2<br>Темп-ра испытания (°C) | $\sigma_{100}$        | $\sigma_{0.1/100}$ | 3 $\sigma_{-1}$<br>(кг/мм <sup>2</sup> ) |                          |
|---------------------|-----------------------------|-----------------------|--------------------|--|--------------------------|
|                     |                             | (кг/мм <sup>2</sup> ) |                    | 4<br>образцы без над-резов               | 5<br>образцы с над-резов |
| 6                   | 20                          | —                     | —                  | 60                                       | 45                       |
|                     | 400                         | 140                   | 87                 | —  | —                        |
|                     | 450                         | 100                   | 62                 | 50                                       | 30                       |
|                     | 500                         | 70                    | 21                 | 50                                       | 30                       |
|                     | 550                         | —                     | —                  | 50                                       | 30                       |

1) Heat treatment, 2) test temperature (°C); 3)  $\sigma_{-1}$  (kg/mm<sup>2</sup>); 4) smooth specimens; 5) notched specimens; 6) quench<sup>1</sup> from 1050°, oil cooled, temper at 550°.

TABLE 3

Variation of Elastic Modulus of EP65 Steel With Temperature Increase

| Термич. обработка 1 | 2<br>Темп-ра испытания (°C) | 3<br>E<br>(кг/мм <sup>2</sup> ) |
|---------------------|-----------------------------|---------------------------------|
| 4                   | 300                         | 17 300                          |
|                     | 400                         | 16 200                          |
|                     | 450                         | 15 700                          |
|                     | 500                         | 15 800                          |
|                     | 550                         | 15 200                          |

1) Heat treatment; 2) test temperature (°C); 3) E (kg/mm<sup>2</sup>); 4) quench from 1020-1050°, oil cooled temper at 530-550°.

TABLE 4  
Stress-Rupture, Creep, and Fatigue Limits of VNS-6 Steel

| Термич. обработка<br>1                                 | Темп. закалки (°C)<br>2 | $\sigma_{100}$ | $\sigma_{0.1/100}$ | $\sigma_{-1}$         |                      |
|--|-------------------------|----------------|--------------------|-----------------------|----------------------|
|  |                         |                |                    | образцы без надреза 3 | образцы с надрезом 4 |
| (кг/мм <sup>2</sup> ) 5                                |                         |                |                    |                       |                      |
| Закалка 6 с 1050°, охлаждение в масле, отпуск при 580° | 20                      | —              | —                  | 63                    | 36                   |
|  | 450                     | 80             | 58                 | —                     | —                    |
|  | 500                     | 88             | 32                 | —                     | —                    |
| Закалка 7 с 1050°, охлаждение в масле, отпуск при 650° | 550                     | 50             | 23                 | 50                    | 28                   |
|  | 600                     | 35             | —                  | —                     | —                    |
|  | 20                      | —              | —                  | —                     | —                    |
| 7  | 450                     | 80             | —                  | —                     | —                    |
|  | 500                     | 54             | 27                 | —                     | —                    |
|  | 550                     | 44             | 19                 | —                     | —                    |
|  | 600                     | 35             | 15                 | —                     | —                    |

\*On the basis of  $1 \cdot 10^7$  cycles;  
radius of specimen notch 0.75 mm.

1) Heat treatment; 2) test temperature (°C); 3) smooth specimens; 4) notched specimens; 5) (kg/mm<sup>2</sup>); 6) quench from 1050°, oil cooled, temper at 580°; 7) quench from 1050°, oil cooled, temper at 650°.

TABLE 5  
Physical Properties of High-Strength Stainless Steel ( $\gamma = 7.84 \text{ g/cm}^3$ )

| Сталь 1             | $\alpha \cdot 10^4$ (1/°C) |          |          | $\lambda$ (кал/см·сек·°C) 2 |       |       |       |       |       |
|---------------------|----------------------------|----------|----------|-----------------------------|-------|-------|-------|-------|-------|
|                     | 20-100°                    | 100-200° | 400-500° | 100°                        | 200°  | 300°  | 400°  | 500°  | 600°  |
| 23X13HVMFA (ЭП65) 3 | 10.4                       | 11.2     | 13.2     | 0.048                       | 0.051 | 0.054 | 0.057 | 0.061 | 0.064 |
| VNS-6 (ЭП311) 4     | 8.7                        | 9.4      | 11.6     | 0.048                       | 0.051 | 0.054 | 0.056 | 0.055 | 0.061 |

Note: Steels 23Kh13NVMFA and VNS-6 are oxidation resistant in a gaseous medium at 600-650°.

1) Steel; 2)  $\lambda$  (cal/cm-sec-°C; 3) 23Kh13NVMFA (EP65)  
4) VNS-6 (EP11).

TABLE 6

Hot Pressure Working Regime, Heat Treatment Regime, and Field of Application of High-Strength Stainless Steel

| Сталь<br>1             | Режим горячей обработки давлением<br>2  | Режим предварит. термич. обработки на в де-постав-шке<br>3  | Режим окончат. термич. обработки на в де-потреби-теле<br>4   | Применение<br>5  |
|------------------------|---|---|--|--|
| 23X13HVMFA (ЭП65)<br>6 | Медленный нагрев до 600°, затем ускоренный до 1150°, горячая деформация в интервале 1150-900°, охлаждение в золе или горячем песке<br>7 | После ковки, прокатки, штамповки для смягчения - нормализация с 1000-1050° и отпуск при 750-780°<br>8 | 1) Закалка с 1050°, охлаждение в масле или на воздухе, отпуск при 530-550°<br>2) Закалка с 1050°, охлаждение в масле или на воздухе, отпуск при 300-350°<br>10   | Силовые детали, работающие до 500° во влажном воздухе с повышенной прочностью:<br>$\sigma_b$ 150 кг/мм <sup>2</sup> при 400°,<br>$\sigma_b$ 135 кг/мм <sup>2</sup> при 450°,<br>$\sigma_b$ 115 кг/мм <sup>2</sup> при 500°<br>11 |
| VNS-6 (ЭП311)<br>13    | То же<br>14   | То же<br>14   | 1) Закалка с 1050°, охлаждение в масле или на воздухе, отпуск при 580°<br>2) Закалка с 1050°, охлаждение в масле или на воздухе, отпуск при 650°<br>3) Закалка с 1050°, охлаждение в масле или на воздухе, отпуск при 300-350°<br>15 | Силовые детали, работающие при 600° во влажном воздухе<br>12<br>16<br>19   |

1) Steel; 2) hot pressure working regime; 3) preliminary heat treatment regime at producing plant; 4) final heat treatment regime at using plant; 5) application; 6) 23Kh13NVMFA (EP65) 7) slow heating to 600°, then accelerated heating to 1150°, hot deformation in the range 1150-900°, cooling in ashes or hot sand; 8) for softening after forging, rolling, or stamping - normalizing from 1000-1050° and tempering at 750-780°; 9) 1) oil or air quench from 1050°, temper at 530-550°; 10, 2) oil or air quench from 1050°, temper at 300-350°; 11) structural parts operating up to 500° in moist air with strength characteristics; 12)  $\sigma_b$ , kg/mm<sup>2</sup> at; 13) VNS-6 (EP311); 14) same; 15, 1) oil or air quench from 1050°, temper at 580°; 16) structural parts operating at 600° in moist air; 17, 2) oil or air quench from 1050°, temper at 650°; 18, 3) oil or air quench from 1050°, temper at 300-350°; 19) structural parts operating at 350°.

mechanical properties of tempered VNS-6 steel is shown in Figs. 2 and 3.

The high-strength stainless steel has satisfactory corrosion resistance in conditions of a humid atmosphere and fresh water with a surface finish of  $\Delta 7$ ; passivation is used to improve the corrosion resistance.

M.F. Alekseyenko

**HIGH-STRENGTH STRUCTURAL STEEL** - noncorrosion-resistant alloy steel heat-treatable to a high ultimate strength ( $\sigma_b = 130-210 \text{ kg/mm}^2$ ). The maximum  $\sigma_b$  of a heat-treated steel is governed principally by its C content. The C content should be ~0.40% in order to obtain a  $\sigma_b \approx 200 \text{ kg/mm}^2$  after quenching and low tempering, 0.35% to obtain a  $\sigma_b \approx 190 \text{ kg/mm}^2$ , 0.28% to obtain a  $\sigma_b \approx 170 \text{ kg/mm}^2$ , 0.25% to obtain a  $\sigma_b \approx 160 \text{ kg/mm}^2$ , and 0.23% to obtain a  $\sigma_b \approx 150 \text{ kg/mm}^2$ . Steel containing 0.45% C can reach a  $\sigma_b \approx 220 \text{ kg/mm}^2$  after quenching and low tempering, but has a low plasticity and viscosity. Any further increase in the C content of quenched low-temper steel causes a simultaneous decrease in strength, viscosity, and plasticity. High-strength structural steel is given the necessary viscosity, plasticity, and hardenability by alloying with Cr, Ni, Mn, Si, Mo, W, and certain other elements. The highest-quality steels of this type usually contain Cr, Ni, and Mo; almost all types of high-strength structural steel are now also alloyed with Si. Less expensive high-strength structural steels cannot contain Ni or Mo. The content of detrimental impurities, S and P, should be minimal. Table 1 shows the alloy steels which can be used as high-strength structural steels.

Steel of types 30KhGSNA, 30KhGSNMA, VL1, and EI643, and less frequently 30KhGSA and 35KhGSA is used in the manufacture of machine components heat-treated to high strength; type 30KhGSNA is most widely used as a high-strength structural steel. Tables 2 and 3 show the chemical composition of these alloys and their mechanical characteristics after various types of heat treatment.

TABLE 1

Ultimate Strength of High-Strength Alloy Structural Steel

| Сталь     | 1 | $\sigma_b$<br>(кг/мм <sup>2</sup> ) | 2         | Сталь | $\sigma_b$<br>(кг/мм <sup>2</sup> ) | 3       | Сталь | $\sigma_b$<br>(кг/мм <sup>2</sup> ) |
|-----------|---|-------------------------------------|-----------|-------|-------------------------------------|---------|-------|-------------------------------------|
| 30X1ГCНА  | 4 | 160-180                             | 30XН3А    | 8     | 150-180                             | 35X1ГCА | 13    | 170-200                             |
| 30X1ГCНМА | 4 | 160-180                             | 33XН3МА   | 9     | 170-190                             | 33XС    | 14    | 170-190                             |
| ЭИ643     | 5 | 190-210                             | 30X2Н2ВФА | 10    | 160-180                             | 37XС    | 15    | 180-200                             |
| 40XНМА    | 6 | 190-205                             | 25X1ГCА   | 11    | 160-180                             | ВЛ1     | 16    | 160-180                             |
| 25K2ГНТА  | 7 | 150-170                             | 25X1ГCА   | 12    | 160-170                             |         |       |                                     |

1) Steel; 2)  $\sigma_b$  (kg/mm<sup>2</sup>); 3) 30KhGSNA; 4) 30KhGSNMA; 5) EI643; 6) 40KhNMA; 7) 25K2GNTA; 8) 30KhN3A; 9) 33KhN3MA; 10) 30Kh2N2VFA; 11) 30KhGSA; 12) 25KhGSA; 13) 35KhGSA; 14) 33KhS; 15) 37KhS; 16) VL1.

TABLE 2

Chemical Composition of the Most Widely Used High-Strength Alloy Structural Steels

| Сталь       | 2                        |         |         |         |         |         |         |       | 3        |  |
|-------------|--------------------------|---------|---------|---------|---------|---------|---------|-------|----------|--|
|             | Содержание элементов (%) |         |         |         |         |         |         |       | не более |  |
| 1           | C                        | Si      | Mn      | Cr      | Ni      | Mo      | W       | S     | P        |  |
| 4 30X1ГCНА  | 0.27-0.34                | 0.9-1.2 | 1.0-1.3 | 0.9-1.2 | 1.4-1.8 | -       | -       | 0.025 | 0.025    |  |
| 5 30X1ГCНМА | 0.27-0.34                | 0.9-1.2 | 1.0-1.3 | 0.9-1.2 | 1.4-1.8 | 0.4-0.5 | -       | 0.030 | 0.030    |  |
| 6 ЭИ643     | 0.36-0.43                | 0.7-1.0 | 0.5-0.8 | 0.8-1.1 | 2.5-3.0 | -       | 0.8-1.2 | 0.025 | 0.025    |  |
| 7 ВЛ1       | 0.24-0.31                | 0.9-1.2 | 1.0-1.3 | 1.5-2.0 | 2.0-2.5 | 0.4-0.5 | 0.8-1.3 | 0.030 | 0.030    |  |

1) Steel; 2) content of elements (%); 3) no more than; 4) 30KhGSNA; 5) 30KhGSNMA; 6) EI643; 7) VL1.

Type 30KhGSNA steel is supplied in accordance with GOST 4543-61, 30KhGSNMA steel in accordance with TU, EI643 steel in accordance with ChMTU/TsNIICM 584-61, and VL1 steel in accordance with ChMTU/TsNIICM 213-59.

The principal special feature of VL1 steel is the hardenability in air of products with large cross-sectional areas (d = 80 mm). Quenching in air ensures minimal warping and, in many cases, makes it possible to use clamping devices, which completely eliminate the need to straighten the component. Bar, forgings (including large components), hot-rolled tubing, strips, and sheets are produced from 30KhGSNA steel, large forgings from 30KhGSNMA steel, bars, forgings, and hot-rolled



tubing from EI643 steel, and bars and forgings from VL1 steel.

TABLE 3

Mechanical Characteristics of the Most Widely Used High-Strength Structural Steels (typical characteristics)

| Сталь 1    | 2 Термич. обработка   | 3                                       |   | 4, 5                  |          | 4 σ <sub>н</sub><br>(мм/см <sup>2</sup> ) |
|------------|---|---|---|-----------------------|----------|---|
|            |   | σ <sub>b</sub><br>(кг/мм <sup>2</sup> ) | σ <sub>0.2</sub><br>(кг/мм <sup>2</sup> ) | δ <sub>5</sub><br>(%) | ψ<br>(%) |   |
| 30XГСНА 5  | Закалка с отпуском при 250° 10  | 175                                     | 135                                       | 10                    | 45       | 6-7                                       |
| 30XГСНМА 6 | Изотермич. закалка в солях или масле при 250° 11<br>То же, но при 300° 12 | 165                                     | 125                                       | 11                    | 50       | 7   |
|            |   | 150                                     | 120                                       | 13                    | 55       | 7-8                                       |
| ВЛ1 7      | Закалка на воздухе с отпуском при 250° 13                                 | 175                                     | 135                                       | 10                    | 45       | 6-7                                       |
| ЭИ643 8    | Закалка с отпуском при 220° 14<br>Изотермическая закалка 15               | 200                                     | 150                                       | 10                    | 40       | 5.5-6                                     |
|            |   | 190                                     | 140                                       | 11                    | 50       | 6   |
| 30XГСА 9   | Закалка с отпуском при 220° 14  | 175                                     | 135                                       | 9                     | 40       | 5-6                                       |

1) Steel; 2) heat treatment; 3) kg/mm<sup>2</sup>; 4) kg-m/cm<sup>2</sup>; 5) 30KhGSNA; 6) 30KhGSNMA; 7) VL1; 8) EI643; 9) 30KhGSA; 10) quenching and tempering at 250°; 11) isothermal quenching in potassium nitrate or alkali at 250°; 12) the same, but at 300°; 13) quenching in air and tempering at 250°; 14) quenching and tempering at 220°; 15) isothermal quenching.

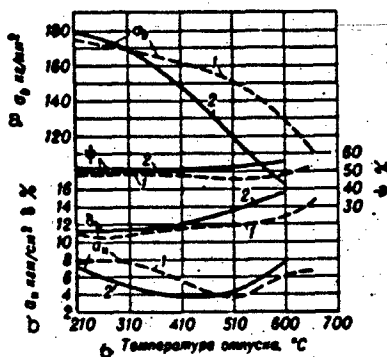

Fig. 1. Influence of tempering temperature on the mechanical characteristics of 30KhGSNA and VL1 steels: 1) VL1 (quenched in air); 2) 30KhGSNA (quenched in oil). a) kg/mm<sup>2</sup>; b) kg-m/cm<sup>2</sup>; c) tempering temperature, °C.

Figures 1 and 2 show the variation in the mechanical characteristics of 30KhGSNA, VL1, and EI643 steels as a function of tempering temperature. This steel is ensured maximum strength ( $\sigma_b = 160-180 \text{ kg/mm}^2$ ) and satisfactory viscosity by low tempering. Heat treatment of 30KhGSNA steel to a  $\sigma_b$  of less than  $160 \text{ kg/mm}^2$  is carried out by isothermal quenching, which can produce a  $\sigma_b = 160-180, 150-170, \text{ or } 140-160 \text{ kg/mm}^2$ ;

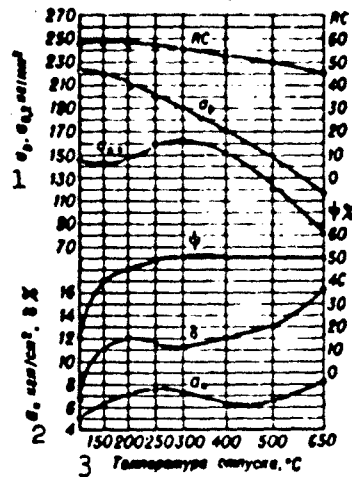

Fig. 2. Influence of tempering temperature on the mechanical characteristics of EI643 steel. 1) kg/mm<sup>2</sup>; 2) kg-m/cm<sup>2</sup>; 3) tempering temperature, °C.

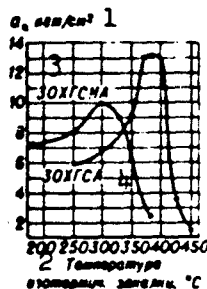

Fig. 3. Influence of isothermal quenching temperature on the impact strength of 30KhGSNA and 30KhGSA steels. 1) kg-m/cm<sup>2</sup>; 2) isothermal quenching temperature, °C; 3) 30KhGSNA; 4) 30KhGSA.

use of isothermal quenching in a hot medium at temperatures above 300° to obtain a  $\sigma_b$  of less than 140 kg/mm<sup>2</sup> is not recommended because of the danger of a sharp increase in brittleness. Figure 3 shows the influence of the isothermal quenching temperature on the impact strength of 30KhGSNA and 30KhGSA steels.

For heavy forgings (200-300 mm or more thick) it is best to use 30KhGSNMA steel with the same range of ultimate strengths and heat-treatment regimes as for 30KhGSNA steel. High-strength structural steels also have a high durability, even for notched specimens. Table 4 shows the durability of high-strength structural steel on alternate bending

III-98s4

of rotating specimens 8 mm in diameter (the durability of structural steel treated to moderate strength is also given for purposes of comparison).

For many mechanisms and machines the strength of components and units is determined from their ability to withstand comparatively infrequent large loads. It has been established that, just as high-strength aluminum alloys, in the presence of stress concentrators high-strength structural steels have a lower resistance to repeated static loads than steel treated to moderate strength. Components of high-strength steel with sizable stress concentrators may prove to be weaker than medium-strength steel. High-strength steel components with small stress concentrators have a high resistance to repeated static loads. If a high-strength steel component cannot be designed without severe stress concentrators or they cannot be shifted to a less highly stressed area, it is necessary to use medium-strength steel. Figure 4 shows the strength of 40KhNMA steel specimens under fatigue loads as a function of tensile strength and stress concentration.

TABLE 4  
Durability of Structural Steel Treated to High Strength

| Сталь<br>1  | $\sigma_b$              | $\sigma_{-1}$ | $\sigma_{-1}^{H**}$ | $\sigma_{-1}^H / \sigma_b$ | $\sigma_{-1}^{H**} / \sigma_b$ |
|-------------|-------------------------|---------------|---------------------|----------------------------|--------------------------------|
|             | 2 (кг/мм <sup>2</sup> ) |               |                     |                            |                                |
| 3 EI643     | 200                     | 43            | 55                  | 0.41                       | 0.275                          |
| 4 30XГСА    | 174                     | 73            | —                   | 0.42                       | —                              |
| 5 30XГСА*   | 164                     | 70            | 49                  | 0.425                      | 0.30                           |
| 6 30XГСА    | 180                     | 72            | 46                  | 0.40                       | 0.255                          |
| 7 30XMA     | 180                     | 72            | —                   | 0.39                       | —                              |
| 8 25X2ГНТА* | 152                     | 70            | 44                  | 0.44                       | 0.275                          |
| 9 25X2ГНТА* | 152                     | 61            | 36                  | 0.40                       | 0.24                           |
| 37X2НВФА    | 137                     | 64.5          | 38                  | 0.47                       | 0.28                           |
| 37XН3А      | 126.5                   | 56            | 31                  | 0.44                       | 0.245                          |

\*Isothermal quenching.  
\*\*Semicircular notch,  $r = 0.75$  mm.

1) Steel; 2) kg/mm<sup>2</sup>; 3) EI643; 4) 30KhGSNA; 5) 30KhGSA; 6) 30KhMA; 7) 25Kh2GNТА; 8) 23Kh2NVFA; 9) 37KhN3A.

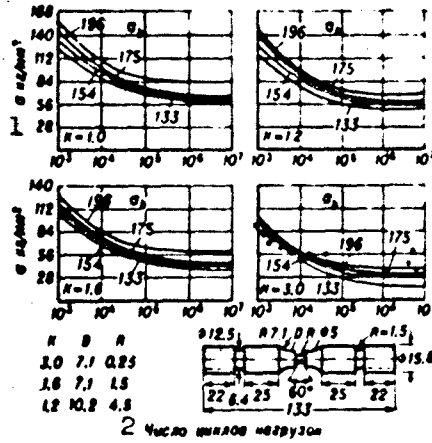

Fig. 4. Strength of 40KhNMA steel specimens under repeated loads as a function of tensile strength and stress concentration (K). (Symmetric extension-compression cycle). 1) kg/mm<sup>2</sup>; 2) number of loading cycles.

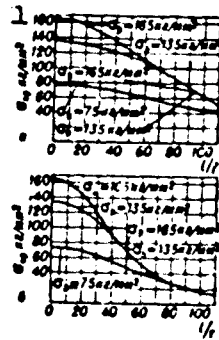

Fig. 5. Longitudinal stability of 30KhGSA steel pipe as a function of rigidity and ultimate strength: a) Pipe with flat supports; b) pipe with spherical supports; 1) length of pipe; 1) radius of inertia of pipe cross-section;  $\sigma_{kr}$ ) critical compressive stress. 1) kg/mm<sup>2</sup>.

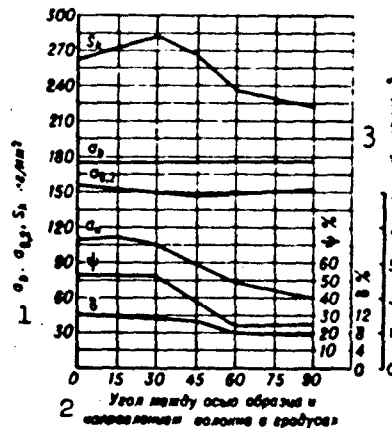

Fig. 6. Mechanical characteristics of 30KhGSNA steel treated for high strength as a function of specimen-cutting direction with respect to grain of metal. 1) kg/mm<sup>2</sup>; 2) angle between specimen axis and grain direction, degrees; 3) kg-m/cm<sup>2</sup>.

III-98s6

It is expedient to use high-strength structural steel for structural elements which must function under compression and have increased rigidity (Fig. 5). Such elements have a substantially higher longitudinal stability than elements fabricated from medium-strength or low-strength steel. When a structural element is of low rigidity its longitudinal stability is determined principally by its modulus of elasticity and does not depend on its ultimate strength.

The mechanical characteristics of high-strength structural steel depend to a considerable extent on the grain direction. Viscosity, true fracture strength, and plasticity are materially reduced across the grain. Ultimate strength, yield strength, and proportionality limit are virtually independent of grain direction. Figure 6 shows the variation in the mechanical characteristics of 30KhGSNA steel treated to high strength as a function of the angle between the specimen axis and the grain direction. It is necessary to take into account the fact that various metallurgical defects (hairline cracks, nonmetallic inclusions, etc.) are always oriented along the grain and consequently only affect the strength of those components in which the normal stresses are directed across or at an acute angle to the grain. High-strength structural steel is considerably sensitive to metallurgical defects, hairline cracks, and ordinary cracks than medium-strength steel (Fig. 7); in a number of cases it is consequently unwise to employ it for components which function principally across the grain. Such components require high-strength steel of high metallurgical quality (with a minimal number of nonmetallic inclusions) and a careful check must be made for metallurgical defects.

High-strength structural steels are usually not cold-short at temperatures of down to  $-60^{\circ}$  to  $-70^{\circ}$  and have a rather low viscosity at

III-98s7

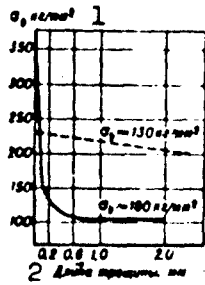

Fig. 7. Comparative influence of cracks on the strength of high-strength and medium-strength 30KhGSA steel on bending. 1)  $\text{kg/mm}^2$ ; 2) crack length, mm.

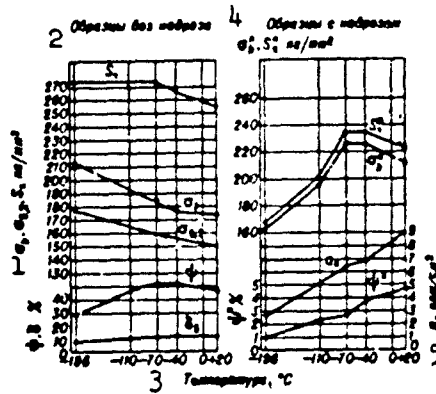

Fig. 8. Mechanical characteristics of 30KhGSNA steel (quenched and tempered at  $200^\circ$ ) at low temperatures. Notched specimens:  $d_0 = 10 \text{ mm}$ ,  $d_n = 7 \text{ mm}$ , notch angle  $- 60^\circ$ , and notch radius  $- 0.1 \text{ mm}$ . 1)  $\text{kg/mm}^2$ ; 2) non-notched specimens; 3) temperature,  $^\circ\text{C}$ ; 4) notched specimens; 5)  $\text{kg-m/cm}^2$ .

TABLE 5

Mechanical Characteristics of 30KhGSNA Steel at Elevated Temperatures

| 1<br>Термич. обработка   | 2<br>Температура<br>( $^\circ\text{C}$ ) | 3<br>$\sigma_s$<br>( $\text{kg/mm}^2$ ) | 4        |        | 5<br>$\sigma_{0.2}$<br>( $\text{kg/mm}^2$ ) |
|--|--|---|----------|--------|---|
|  |  |   | $\delta$ | $\psi$ |   |
| 5<br>Закалка в масле;<br>отпуск при $310^\circ$                              | 20                                       | 170                                     | 10       | 48     | 7   |
|  | 250                                      | 170                                     | 10       | 49     | 6.5   |
|  | 300                                      | 160                                     | 14       | 52     | 5   |
| 6<br>Закалка в масле;<br>отпуск при $280^\circ$                              | 20                                       | 155                                     | 9        | 52     | 6   |
|  | 250                                      | 155                                     | 9        | 52     | 6   |
|  | 300                                      | 155                                     | 10       | 53     | 5.8   |
|  | 350                                      | 150                                     | 10       | 54     | 5.2   |
| 7<br>Изотермич. закалка<br>в масле с $270^\circ$ ;<br>отпуск при $310^\circ$ | 20                                       | 160                                     | 10       | 48     | 7.7   |
|  | 250                                      | 160                                     | 10       | 50     | 6.5   |
|  | 300                                      | 160                                     | 14       | 52     | 6   |
| 8<br>Изотермич. закалка<br>в масле с $320^\circ$<br>(без отпуска)            | 20                                       | 150                                     | 10       | 54     | 8.2   |
|  | 250                                      | 150                                     | 11       | 55     | 8   |
|  | 300                                      | 150                                     | 12       | 56     | 8   |

1) Heat treatment; 2) temperature ( $^\circ\text{C}$ ); 3)  $\text{kg/mm}^2$ ; 4)  $\text{kg-m/cm}^2$ ; 5) quenching in oil, tempering at  $310^\circ$ ; 6) quenching in oil, tempering at

III-98s8

360°; 7) isothermal quenching in potassium nitrate from 270°, tempering at 310°; 8) isothermal quenching in potassium nitrate from 320° (without tempering).

TABLE 6  
Mechanical Characteristics of EI643 Steel at Elevated Temperatures

| Термич. обработка 1              | 2<br>t (°C) | 3<br>σ <sub>b</sub><br>(кг/мм <sup>2</sup> ) | δ, ψ  |       |
|----------------------------------|-------------|--|-------|-------|
|                                  |             |  | δ (%) | ψ (%) |
| Закалка в масле; отпуск при 210° | 20          | 200  | 10    | 40    |
|                                  | 200         | 200  | 10    | 40    |
| Закалка в масле; отпуск при 310° | 20          | 190  | 8     | 40    |
|                                  | 300         | 175  | 12    | 55    |
| Закалка в масле; отпуск при 360° | 20          | 180  | 9     | 40    |
|                                  | 350         | 165  | 12    | 55    |
| Закалка в масле; отпуск при 410° | 20          | 175  | 10    | 40    |
|                                  | 400         | 155  | 12    | 55    |

1) Heat treatment; 2) temperature (°C); 3) kg/mm<sup>2</sup>; 4) quenching in oil, tempering at.

TABLE 7  
Mechanical Characteristics of VL1 Steel at Elevated Temperatures

| Термич. обработка 1                        | 2<br>t (°C) | 3<br>σ <sub>b</sub><br>(кг/мм <sup>2</sup> ) | E     |
|--|-------------|--|-------|
|  |             |  |       |
| Закалка с 930° на воздухе; отпуск при 210° | 20          | 175  | 19500 |
|  | 200         | 165  | —     |
| То же, отпуск при 310°                     | 20          | 170  | —     |
|  | 300         | 170  | —     |
| То же, отпуск при 360°                     | 20          | 165  | —     |
|  | 350         | 160  | —     |
| То же, отпуск при 410°                     | 20          | 160  | —     |
|  | 400         | 155  | 17000 |
| То же, отпуск при 460°                     | 20          | 155  | —     |
|  | 450         | 135  | 16300 |
| То же, отпуск при 510°                     | 20          | 150  | —     |
|  | 500         | 120  | 15700 |

1) Heat treatment; 2) temperature (°C); 3) kg/mm<sup>2</sup>; 4) quenching from 930° in air, tempering at 210°; 5) the same, tempering at.

TABLE 8  
Calculated Ultimate Strength (kg/mm<sup>2</sup>) of Welds in High-Strength Structural Steel

| Толщина шва без усиления (мм) 1 | Сварка дуговая с электродом из стали 18ХМА 2 | Сварка дуговая с электродом из аустенитной стали 3 |
|---------------------------------|--|--|
|                                 |  |  |
| До 10                           | 120  | 85   |
| 10-15                           | 100  | 85   |
| 15-25                           | 80 (90 для EI 643)                           | 85   |

1) Weld thickness without reinforcement (mm); 2) arc welding with 18KhMA steel electrode; 3) arc welding with austenitic-steel electrode. 4) up to; 5) 90 for EI 643 steel.

III-98s9

temperatures of from  $-123^{\circ}$  to  $-196^{\circ}$ ; Fig. 8 shows the mechanical characteristics of 30KhGSNA steel at low temperatures. The mechanical characteristics of steels of this type usually drop rather rapidly at elevated temperatures, although the rate of decrease is for the most part determined by the alloying elements. Tables 5, 6, and 7 show the mechanical characteristics of 30KhGSNA, EI643, and VLI steels at elevated temperatures.

Welded joints in high-strength steel components can be planned from the weld-strength data given in Table 8.

Wire electrodes of 08KhMA steel or some other low-carbon steel are recommended for welding EI643 steel and other types of high-strength steel containing more than 0.35% C.

It is permissible to introduce a plasticity factor of 1.25 into calculations for the bending of welds. The physical characteristics of 30KhGSNA, VLI, and EI643 steels include:  $\gamma = 7.8$  (for VLI) or 7.9 (for the other types),  $\lambda = 0.068$  ( $25^{\circ}$ ), 0.070 ( $100^{\circ}$ ), 0.073 ( $200^{\circ}$ ), 0.075 ( $300^{\circ}$ ), and 0.078 ( $400^{\circ}$ ) cal/cm $\cdot$ sec $\cdot^{\circ}$ C (for 30KhGSNA), and  $\alpha = 11.2 \times 10^{-6}$  ( $20-100^{\circ}$ ),  $12.65 \cdot 10^{-6}$  ( $100-200^{\circ}$ ),  $13.45 \cdot 10^{-6}$  ( $200-300^{\circ}$ ), and  $14.2 \cdot 10^{-6}$  ( $300-400^{\circ}$ )  $1/^{\circ}$ C (for all three steels).

The critical points for 30KhGSNA steel are  $Ac_1 = 750-760^{\circ}$  and  $Ac_3 = 805-830^{\circ}$ , while for EI643  $Ac_1 = 700^{\circ}$  and  $Ac_3 = 750-770^{\circ}$  and for VLI  $Ac_1 = 760^{\circ}$  and  $Ac_3 = 830^{\circ}$ . The following types of preliminary heat treatment are employed to improve the machinability of high-strength structural steel: full annealing at  $900-930^{\circ}$  with subsequent slow furnace cooling (this type of annealing is not used for VLI and EI643 steels); prolonged low annealing at  $680-700^{\circ}$  ( $660-670^{\circ}$  for EI643); accelerated annealing at  $780-800^{\circ}$ , furnace cooling to  $650^{\circ}$  (to  $600^{\circ}$  for EI643 steel), holding at this temperature for several hours, and cooling in air. Accelerated annealing most effectively reduces the hardness



III-98s10

and improves the machinability of high-alloy high-strength steels. Temper brittleness of steel may develop during slow postannealing cooling over the range 650-400° and leads to brittle fracture of the annealed components during straightening or shipment. This type of brittleness is completely eliminated by prequenching heating and consequently presents no danger to completely heat-treated specimens.

TABLE 9

Table for Determination of Strength from Hardness for High-Strength Structural Steel

| Твердость 1 |                     | 2   | Твердость |                     |                                     |
|-------------|---------------------|-----|-----------|---------------------|-------------------------------------|
| RC          | HH<br>(допн.<br>мм) |     | RC        | HH<br>(допн.<br>мм) | $\sigma_b$<br>(кг/мм <sup>2</sup> ) |
| 54          | —                   | 215 | 49.5      | 2.74                | 180                                 |
| 53.5        | —                   | 210 | 47.5      | 2.61                | 170                                 |
| 53          | —                   | 205 | 45.5      | 2.50                | 160                                 |
| 52.5        | 2.6                 | 200 | 42.5      | 2.39                | 150                                 |
| 52          | 2.63                | 195 | 40        | 3.09                | 140                                 |
| 51.5        | 2.66                | 190 | 38        | 3.21                | 130                                 |
| 50.5        | 2.7                 | 185 |           |                     |                                     |

1) Hardness; 2)  $\sigma_b$  (kg/mm<sup>2</sup>).

Three types of final heat treatment are employed for high-strength structural steel: quenching in oil and subsequent tempering at 200-250° for 3-4 hr; isothermal quenching in molten potassium nitrate or alkali at temperatures of from 220 to 300-380°, with or without subsequent tempering (the strength of high-strength structural steel decreases as the isothermal quenching temperature is raised); quenching in air and subsequent tempering at 200-250° (used only for V11 high-alloy steel).

Isothermal quenching of high-strength structural ensures greater viscosity than quenching in oil and also results in lesser (by a factor of 3) Warping of the component. In addition, use of isothermal quenching makes it possible to regulate the ultimate strength of the steel by varying the temperature of the quenching medium; this is impossible in quenching and low tempering. In order to avoid cracking quenched

III-98s11

high-strength steel components should not be pickled. Scale is removed by wet sandblasting. The final heat treatment is usually checked by measuring the hardness of the steel, utilizing the data presented in Table 9.

Heat-treated high-strength steel components are straightened by static loading in a press or by hammering through a pad (without denting the metal); additional annealing of the component after straightening is not obligatory. High-strength structural steel has satisfactory machinability after annealing and can be machined in the quenched state if a hard-alloy cutting tool is used. Threads can be produced only with cutters. It is generally necessary to temper the steel at 200-250° after polishing in order to relieve the internal stresses. In reaming holes it is very important that the surface fineness after machining be no less than  $\nabla 6$ . The surface fineness of high-strength steel components should be no less than  $\nabla 4$ - $\nabla 5$  and sites of stress concentration should be machined to a fineness of  $\nabla 6$ - $\nabla 7$ . High-strength structural steel is welded by the arc (manual and automatic), atomic-hydrogen, and argon-arc methods. Steels of this type are usually welded in the annealed state, but welding of previously quenched elements is permissible in individual cases. Electrodes of EI334 alloy and other alloys of the nichrome type are used as the rod material in this case. In order to avoid development of "cold" welding cracks high-strength steel components must be heated to 200-300° before welding and to no less than 200° immediately after welding. High-strength steel components are generally not soldered, since contact between molten solder and steel with internal or external stresses may cause cracking during soldering.

In order to ensure maximum strength under repeated static loads it is recommended that the protruding portion of the weld be machined down flush with the surface of the component and that the root of the weld

III-98s12

be ground down in single-sided welding. Where such grinding is impossible the weld should pass smoothly into the base metal, without forming notches or sharp angles.

High-strength structural steel can be welded to itself and to low-carbon unalloyed or alloy steel. Welding to stainless-steel components should be carried out either with a low-alloy rod of the nichrome type or through transition elements fabricated from low-carbon steel. High-strength structural steel is very susceptible to hydrogen embrittlement (see Hydrogen embrittlement of steel) and consequently cannot be galvanized in the hardened state. Chromium-plating of smooth surfaces to provide corrosion protection for the friction surfaces of components is an exception; the plating process must be followed by tempering to eliminate hydrogen embrittlement. The components should be subjected to minimum straightening after quenching in order to avoid cracking during plating.

High-strength structural steel is protected against corrosion by painting, metallization, or phosphating. Eluig provides poor corrosion protection and may cause the component to crack when substantial internal stresses are present.

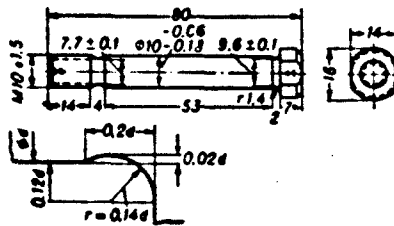

Fig. 9. Drawing of bolt fabricated from high-strength structural steel ( $\sigma_b > 180 \text{ kg/mm}^2$ ).

Definite restrictions must be imposed on the design of high-strength steel components, since this material is highly susceptible to stress concentrators. All cross-sectional transitions must be planned

III-98s13

to have the maximum possible radius of curvature; this is especially important in areas where there is a sharp change in the direction of the forces. Threaded components must have a clear space in front of the thread and, in the case of very high-strength steel ( $\sigma_b = 180-210 \text{ kg/mm}^2$ ), beneath the head as well (Fig. 9). These clear spaces reduce the stress concentration in the most heavily loaded areas of the bolt. Threads on bolts and other components should be made with a standard minimum radius measured across the thread trough.

High-strength steel bolts must usually function under shear. The permissible short-term tensile stress (maximum) is generally no more than  $100 \text{ kg/mm}^2$ , while the permissible long-term tensile stress is no more than  $40 \text{ kg/mm}^2$ . Bolts should be installed with no curvature under the nut or the bolt head. Fabrication of welded tanks subject to gas pressure for prolonged periods from high-strength structural steel is not recommended. Tanks subject to brief pressure are best welded by the argon-arc method with a nonfusible electrode and no rod.

High-strength structural steel is employed for various machined and welded components not having sizable stress concentrators in the areas of greatest stress; the higher the strength of the steel, the more rigid are the requirements that must be imposed on the permissible stress concentrators.

References: *Primeneniye staley vysokoy i sverkhvysokoy prochnosti dlya detaley mashin* [Use of High- and Ultrahigh-Strength Steels for Machine Components], Moscow, 1958 (Filial VINITI. Perevodoy nauchno-tekhn. i proiz. oput [Branch of the All-Union Institute of Scientific and Technical Information. Advanced Scientific and Technical Experience], Report 19, No. M-58-474/19).

Ya.M. Potak

HIGH-STRENGTH TITANIUM SHAPING ALLOYS — alloys with an ultimate strength not less than  $100 \text{ kg/mm}^2$ , which are subjected to hot shaping, i.e., forging, stamping, rolling, etc. These include alloy brands VT8, VT9, VT14, VT15, VT16. The VT3 and VT3-1 alloys occupy an intermediate position, having a strength of  $95\text{-}120 \text{ kg/mm}^2$ . High-strength titanium shaping alloys are distinguished by their high specific strength (not less than  $22 \cdot 10^5 \text{ cm}$ ) and high corrosion resistance. See Medium-strength titanium shaping alloys, Heat resistant titanium shaping alloys, Heat treatment hardening titanium alloys.

References: see at end of the article Titanium alloys.

S.G. Glazunov and V.N. Moiseyev

HIGH-STRENGTH WROUGHT MAGNESIUM ALLOYS are magnesium alloys with an ultimate strength of 26-40 kg/cm<sup>2</sup>. This group includes the MA2-1, MA3, MA5, VM65-1 and MA10 alloys. The MA2-1 alloy is the most plastic, therefore, it can be subjected to rolling for the production of plate and sheet. It welds better than the other alloys of this group and is suitable for fabrication of welded structures. The MA3 alloy differs little in mechanical properties from the MA2-1 alloy but is less plastic, has lower weldability and is more prone to stress corrosion. The MA5 alloy has the highest strength of the wrought alloy of the Mg - Al - Zn - Mn system, but is less plastic, less suitable for welding and has greater tendency to stress corrosion. The VM65-1 alloy has high mechanical properties, high plasticity in forging and stamping, is not prone to stress corrosion, but is not amenable to welding. The MA10 alloy has the highest mechanical properties of all the wrought magnesium alloys, can be welded, but is more expensive because of the alloying with silver and is most prone to stress corrosion, therefore, it has limited application. For chemical composition of the alloys see Magnesium Alloys.

The MA2-1 alloy is used for the production of all forms of wrought mill products, including rolled plate and sheet; the other alloys are used for the production of extruded items and stampings. For the mechanical properties of the High-Strength Wrought Magnesium Alloys see Tables 1-7. The minimal mechanical properties of these alloys guaranteed by the specifications are lower than the typical values by 3.5-7% with regard to ultimate, 10-15% with regard to yield; the elongation is less by a factor of 1.3-2 times.

II-5M1

The wear resistance of these alloys is characterized by the following figures: for the MA3 and MA5 alloys in the annealed condition, with dry friction, sliding rate 1.15 m/sec and a pressure of 4 kg/cm<sup>2</sup>, the wear depth is 0.13-0.14 mm, and with a pressure of 16 kg/cm<sup>2</sup> the wear depth is 0.31-0.34 mm per km of friction path.

TABLE 1

Typical Mechanical Properties of Mill Products from the High-Strength Wrought Magnesium Alloys at 20°

| 1<br>Сплав        | 2<br>Вид полуфабриката | 3<br>Состояние материала | E<br>(кг./мм <sup>2</sup> ) | μ    | 5 σ <sub>тп</sub>        |      |      | δ <sub>тп</sub> | ψ  |
|-------------------|------------------------|--------------------------|-----------------------------|------|--------------------------|------|------|-----------------|----|
|                   |                        |                          |                             |      | 4 (кг./мм <sup>2</sup> ) |      |      |                 |    |
| MA2-1             | Листы толщ. 6          | Отожженные 7             | 4200                        | 0.31 | —                        | 18   | 28   | 16              | —  |
|                   | ной 0.8-3 мм           |                          |                             |      |                          |      |      |                 |    |
|                   | Плиты толщ. 6          | Горячекатаные 9          | 4200                        | 0.31 | 10                       | 16   | 27   | 14              | 20 |
|                   | ной 30 мм              |                          |                             |      |                          |      |      |                 |    |
|                   | Прутки 10              | Прессованные 11          | 4200                        | 0.31 | —                        | 18   | 28   | 12              | —  |
| MA3               | Профили 12             | То же 13                 | 4200                        | 0.31 | —                        | 18   | 28   | 14              | —  |
|                   | Поковки и 14           | Без термич. 15           | 4200                        | 0.31 | —                        | 16   | 27   | 10              | —  |
|                   | штамповки              | обработанные 11          | 4300                        | 0.34 | —                        | 22   | 28   | 12              | —  |
|                   | Прутки 10              | Прессованные 11          | 4300                        | 0.34 | 10                       | 17   | 27   | 14              | 23 |
|                   | Прутки и по- 16        | То же 13                 | 4300                        | 0.34 | —                        | —    | —    | —               | —  |
| MA5               | лосы                   | Отожженные 7             | 4300                        | 0.34 | —                        | 22   | 28   | 12              | —  |
|                   | Поковки и 14           |                          |                             |      |                          |      |      |                 |    |
|                   | штамповки              |                          |                             |      |                          |      |      |                 |    |
| MA5               | Прутки 10              | Закаленные 17            | 4300                        | 0.34 | 13                       | 22   | 32   | 14              | 20 |
|                   | Поковки и 14           | То же 13                 | 4300                        | 0.34 | —                        | 22   | 31   | 12              | —  |
|                   | штамповки              |                          |                             |      |                          |      |      |                 |    |
| BM65-1            | Прутки 10              | Искусственно 18          | 4300                        | 0.34 | 14.5                     | 28   | 33.5 | 9               | 24 |
|                   |                        | состаренные              |                             |      |                          |      |      |                 |    |
|                   | Полосы 19              | То же 13                 | 4300                        | 0.34 | 13                       | 27   | 32.5 | 10              | 25 |
|                   | Профили 12             | "                        | 4300                        | 0.34 | —                        | 29   | 34.5 | 10              | —  |
|                   | Поковки 20             | "                        | 4300                        | 0.34 | —                        | 25   | 31   | 12              | —  |
| MA10              | Штамповки 21           | "                        | 4300                        | 0.34 | —                        | 26   | 32   | 14              | —  |
|                   | Прутки 10              | Термически 22            | 4300                        | 0.33 | 13                       | 30   | 43   | 6               | 8  |
|                   |                        | обработанные             |                             |      |                          |      |      |                 |    |
|                   | Полоса сечением 23     | То же 13                 | 4300                        | 0.33 | —                        | 29   | 39   | 4.5             | —  |
|                   | 32x410 мм              | "                        | 4300                        | 0.33 | —                        | 21.5 | 36   | 6               | —  |
| Поковка из прутка | "                      |                          |                             |      |                          |      |      |                 |    |
| Ø 200 мм 24       |                        |                          |                             |      |                          |      |      |                 |    |

1) Alloy; 2) form of mill product; 3) material condition; 4) (kg/mm<sup>2</sup>); 5) σ<sub>тп</sub>; 6) sheets of thickness 0.8-3 mm; 7) annealed; 8) plate of thickness 30 mm; 9) hot rolled; 10) rods; 11) extruded; 12) profiles; 13) same; 14) forgings and stampings; 15) without heat treatment; 16) rods and strip; 17) solution treated; 18) artificially aged; 19) strip; 20) forgings; 21) stampings; 22) heat treated; 23) strip of section 32 x 410 mm; 24) forging from 200-mm-diam rod.

II-5M2

TABLE 2

Mechanical Properties of High-Strength Wrought Magnesium Alloys in Various Forms of Testing at 20°

| 1 Сплав   | 2 Вид полуфабриката | 3 Состояние материала       | 4 Сжатие                 |                  |                  | 5 Кручение       |                  |                  | 6 $\sigma_{\tau}$ (кг/мм <sup>2</sup> ) | 7 $\sigma_{\tau}$ (кг/мм <sup>2</sup> ) | 8 $\sigma_{\tau}$ (кг/мм <sup>2</sup> ) |
|-----------|---------------------|-----------------------------|--------------------------|------------------|------------------|------------------|------------------|------------------|---|---|---|
|           |                     |                             | σ                        | σ <sub>0.2</sub> | σ <sub>0.1</sub> | τ <sub>0.2</sub> | τ <sub>0.1</sub> | τ <sub>0.1</sub> |   |   |   |
|           |                     |                             | 11 (кг/мм <sup>2</sup> ) |                  |                  |                  |                  |                  |   |   |   |
| MA2-1     | 11 Плиты            | 12 Горячекатаные            | 1600                     | 39               | 8.5              | 4                | 8                | 17.5             | 14                                      | 0.8                                     | 10.5                                    |
| MA3       | 13 Полосы           | 14 Прессованные             | 1600                     | 42               | —                | 5                | 8.5              | 19               | 14                                      | 1                                       | 11                                      |
| MA3       | 15 Прутки           | 16 Закаленные               | 1600                     | 46               | 14               | 3.5              | 8.5              | 21               | 18                                      | —                                       | 14                                      |
| 17 VM65-1 | 15 Прутки           | 18 Искусственно состаренный | 1600                     | 47               | —                | 7.5              | 12.5             | 23               | 16                                      | 0.9                                     | 15                                      |
| MA10      | 13 Полосы           | 19 То же                    | 1600                     | 46               | 16               | —                | —                | —                | 14                                      | 0.7                                     | 11                                      |
|           | 15 Прутки           | 20 Закаленные и состаренный | —                        | 54               | 24               | —                | 10               | 28               | —                                       | 0.25                                    | 12.5                                    |

1) Alloy; 2) form of mill product; 3) material condition; 4) compression; 5) torsion; 6) shear; 7) τ pts; 8) τ sr; 9) (kg/cm<sup>2</sup>); 10) (kg/mm<sup>2</sup>) on basis of 5.10<sup>7</sup> cycles; 11) plate; 12) hot rolled; 13) strip; 14) extruded; 15) rod; 16) solution treated; 17) VM65-1; 18) artificially aged; 19) same; 20) solution treated and aged.

TABLE 3

Typical Mechanical Properties of Mill Products of the High-Strength Wrought Magnesium Alloys in Longitudinal and Lateral Directions

| 1 Сплав   | 2 Вид полуфабриката          | 3 Состояние материала                    | 4 Продольное            |                  |    | 5 Поперечное     |                  |    |
|-----------|------------------------------|--|-------------------------|------------------|----|------------------|------------------|----|
|           |                              |  | σ <sub>0.2</sub>        | σ <sub>0.1</sub> | δ  | σ <sub>0.2</sub> | σ <sub>0.1</sub> | δ  |
|           |                              |  | 6 (кг/мм <sup>2</sup> ) |                  |    |                  |                  |    |
|           |                              |  | 7 (%)                   |                  |    |                  |                  |    |
| MA2-1     | 7 Плиты толщиной 30 мм       | 8 Горячекатаные                          | 26                      | 15               | 12 | 27               | 17               | 12 |
|           | 7 Листы толщиной 0.8-3 мм    | 9 Отожженные                             | 27.5                    | 17               | 14 | 28.5             | 19               | 14 |
| MA3       | 10 Прутки прессованные       | 11 То же                                 | 28                      | 18               | 10 | 20               | 12               | 3  |
| MA3       | 12 Поковки типа допустя      | 13 Закаленные                            | 28                      | 20               | 7  | 22               | 12               | 3  |
| 14 VM65-1 | 15 Прутки Ø 112 мм           | 16 Состаренные                           | 31                      | 28               | 12 | 27               | 12.5             | 14 |
|           | 17 Полоса сечением 34x455 мм | 11 То же                                 | 33                      | 28               | 10 | 28               | 20               | 14 |
| MA10      | 15 Прутки Ø 120 мм           | 16 Закаленные и искусственно состаренные | 44                      | 32               | 4  | 28               | 25               | 4  |
|           | 17 Полоса сечением 32x410 мм | 11 То же                                 | 39                      | 28               | 4  | 31               | 22               | 4  |

1) Alloy; 2) form of mill product; 3) material condition; 4) longitudinal; 5) lateral; 6) (kg/mm<sup>2</sup>); 7) plate - mm thick; 8) hot rolled; 9) annealed; 10) extruded rods; 11) same; 12) forgings of balde type; 13) solution treated; 14) VM65-1; 15) rods - mm in diameter; 16) aged; 17) strip of section - mm.



II-5M3

TABLE 4

Mechanical Properties of High-Strength Wrought Magnesium Alloys at Various Temperatures

| Temp-<br>ra<br>(°C)     | 2  |                |                         | 3                          |                |                         | 4  |                |                         | 5   |                |                         | 6   |                |          |
|-------------------------|--|----------------|-------------------------|----------------------------|----------------|-------------------------|--|----------------|-------------------------|---|----------------|-------------------------|---|----------------|----------|
|                         | МАС-1 - ПЛИТА<br>ГОРИЗОНТАЛЬНАЯ<br>Толщина 50 мм |                |                         | МА3 - иголка<br>отожженная |                |                         | МА5 - прутки на-<br>каленные и состаренные |                |                         | ВМ65-1 - полоса<br>80 x 140 мм<br>состаренная |                |                         | МА10 - прутки<br>25 мм диаметра<br>накаленные и состаренные |                |          |
|                         | $\sigma_b$                                       | $\sigma_{0.2}$ | $\delta$                | $\sigma_b$                 | $\sigma_{0.2}$ | $\delta$                | $\sigma_b$                                 | $\sigma_{0.2}$ | $\delta$                | $\sigma_b$                                    | $\sigma_{0.2}$ | $\delta$                | $\sigma_b$  | $\sigma_{0.2}$ | $\delta$ |
| 7 (кг/мм <sup>2</sup> ) |  |                | 7 (кг/мм <sup>2</sup> ) |                            |                | 7 (кг/мм <sup>2</sup> ) |  |                | 7 (кг/мм <sup>2</sup> ) |   |                | 7 (кг/мм <sup>2</sup> ) |   |                |          |
| -70                     | 29   | -              | 6.5                     | -                          | -              | -                       | -  | -              | -                       | 41  | 36             | 8                       | 67  | 31             | 2.5      |
| -140                    | -  | -              | -                       | 35                         | 28             | 12                      | -  | -              | -                       | 39  | 34             | 9                       | -   | -              | -        |
| 100                     | 23   | 12             | 20                      | 28.5                       | 18             | 21                      | 32   | 22             | 20                      | 26  | -              | 20                      | 17  | 21             | 9        |
| 150                     | 19.5   | 10             | 29                      | 19                         | 10.5           | 35                      | 23   | 15             | 41                      | 21  | -              | 28                      | 26  | 17             | 16       |
| 200                     | 14   | 7.5            | 30                      | 15                         | 8              | 45                      | 13   | 10             | 49                      | 14  | -              | 50                      | 29  | 14             | 17       |
| 250                     | 9  | 5              | 32                      | 11.5                       | 4.5            | 70                      | 10   | 6              | 83                      | 10  | -              | 60                      | 15  | 9.5            | 18       |
| 300                     | 7  | 4              | 40                      | -                          | -              | -                       | 6.5  | 3.5            | 120                     | 7   | -              | 65                      | 11  | 6.5            | 20       |

1) Temperature; 2) MA2-1 hot rolled plate 30-mm thick; 3) MA3 annealed strip; 4) MA5 rod, solution treated and aged; 5) VM65-1 strip 80 x 140 mm, aged; 6) MA10 rod 25-mm diameter, solution treated and aged; 7) (kg/mm<sup>2</sup>).

TABLE 5

Sensitivity of High-Strength Wrought Magnesium Alloys to Notching at 20° \*

| 1<br>Сплав          | 2 Статические<br>испытания |              |                         | 3 Вибрационные<br>испытания |                 |                               |
|---------------------|----------------------------|--------------|-------------------------|-----------------------------|-----------------|-------------------------------|
|                     | $\sigma_b$                 | $\sigma_b^n$ | $\sigma_b^n / \sigma_b$ | $\sigma_{-1}$               | $\sigma_{-1}^n$ | $\sigma_{-1}^n / \sigma_{-1}$ |
|                     | 4 (кг/мм <sup>2</sup> )    |              |                         | 4 (кг/мм <sup>2</sup> )     |                 |                               |
| МА2-1               | 27                         | 29           | 1.1                     | 10.5                        | 7               | 1.5                           |
| МА3                 | 28                         | 28           | 1                       | 11.5                        | 9.5             | 1.2                           |
| МА5                 | 32                         | 32           | 1                       | 14                          | 11              | 1.3                           |
| ВМ65-1 <sup>5</sup> | 34                         | 40           | 1.2                     | 12                          | 8               | 1.5                           |
| МА10                | 43                         | 38           | 0.9                     | 12.5                        | 8               | 1.55                          |

\* At a temperature of 70° for the alloy MA2-1  $\sigma_b^n / \sigma_b = 1$  and for the alloy VM65-1  $\sigma_b^n / \sigma_b = 1.1$ .

1) Alloy; 2) static testing; 3) vibrational testing; 4) (kg/mm<sup>2</sup>); 5) VM65-1.

II-5M4

TABLE 6

Creep Limits of Some High-Strength Wrought Magnesium Alloys

| Temp-<br>pa<br>1 (°C) | MA2-1                   | MA3               |                   |                   |                   | MA5               |      |
|-----------------------|-------------------------|-------------------|-------------------|-------------------|-------------------|-------------------|------|
|                       | $\sigma_{0.0001}$       | $\sigma_{0.0100}$ | $\sigma_{0.1000}$ | $\sigma_{0.2000}$ | $\sigma_{0.1000}$ | $\sigma_{0.0100}$ |      |
|                       | 2 (kg/mm <sup>2</sup> ) |                   |                   |                   |                   |                   |      |
| 30                    | -                       | -                 | -                 | -                 | -                 | 18.1              | 16.2 |
| 100                   | 7                       | 11.2              | 9                 | 8.2               | 6.5               | 8.6               | 6.6  |
| 150                   | 2                       | 4.5               | 3.3               | 1.2               | 0.7               | 1.3               | 0.7  |
| 200                   | -                       | -                 | 0.5               | -                 | -                 | -                 | -    |

1) Temperature; 2) (kg/mm<sup>2</sup>).

TABLE 7

Long Time Ultimate Strengths of Some High-Strength Wrought Magnesium Alloys

| Temp-<br>pa<br>1 (°C) | MA2-1                                      | 2 VM65-1                                 |
|-----------------------|--|--|
|                       | 3 ( $\sigma_{0.0001}$ kg/mm <sup>2</sup> ) | 3 ( $\sigma_{1000}$ kg/mm <sup>2</sup> ) |
| 100                   | 13   | -  |
| 150                   | 8  | -  |
| 200                   | 4  | 2.5                                      |

1) Temperature; 2) VM65-1; 3) (kg/mm<sup>2</sup>).

Physical properties of the high-strength wrought magnesium alloys. Alloy MA2-1:  $\gamma = 1.79$ ;  $\alpha = 26 \cdot 10^{-6}$  (20 - 100°) 1/°C;  $\rho = 0.12$  (20°) ohm-mm<sup>2</sup>/m;  $\lambda = 0.23$  (20°) cal/cm-sec-°C;  $c = 0.26$  (100°), 0.27 (200°), 0.29 (300°) cal/g-°C. Alloy MA3:  $\gamma = 1.8$ ;  $\alpha = 26.1 \cdot 10^{-6}$  (20 - 100°),  $27.1 \cdot 10^{-6}$  (100 - 200°),  $31.2 \cdot 10^{-6}$  (200 - 300°) 1/°C;  $\rho = 0.153$  (20°) ohm-mm<sup>2</sup>/m;  $\lambda = 0.16$  (20°), 0.19 (200°), 0.20 (300°) cal/cm-sec-°C;  $c = 0.27$  (100°), 0.29 (200°), 0.30 (300°) cal/g-°C; recrystallization temperature (deformation 20%, anneal for one hour) is 285°. Alloy MA5:  $\lambda = 1.82$ ;  $\alpha = 26.1 \cdot 10^{-6}$  (20 - 100°),  $27.7 \cdot 10^{-6}$  (100 - 200°),  $28.5 \cdot 10^{-6}$  (200 - 300°) 1/°C;  $\rho = 0.162$  (20°) ohm-mm<sup>2</sup>/m;  $\lambda = 0.14$  (20°) cal/cm-sec-°C;  $c = 0.27$  (100°), 0.29 (200°), 0.30 (300°) cal/g-°C; recrystallization temperature (deformation 20%, anneal for one hour) is 345°. Alloy VM65-1:

## II-5M5

$\lambda = 1.8$ ;  $\alpha = 20.9 \cdot 10^{-6}$  (20 - 100°),  $22.6 \cdot 10^{-6}$  (100 - 200°)  $1/^\circ\text{C}$ ;  $\rho = 0.0565$  (20°)  $\text{ohm-mm}^2/\text{m}$ ;  $\lambda = 0.28$  (20°),  $0.30$  (200°),  $0.30$  (300°)  $\text{cal/cm-sec-}^\circ\text{C}$ ;  $c = 0.25$  (100°)  $\text{cal/g-}^\circ\text{C}$ . Alloy MA10:  $\gamma = 1.99$ ;  $\alpha = 27.9 \cdot 10^{-6}$  (20 - 100°),  $27.8 \cdot 10^{-6}$  (100 - 200°),  $30.2 \cdot 10^{-6}$  (200 - 300°)  $1/^\circ\text{C}$ ;  $\rho = 0.162$  (20°)  $\text{ohm-mm}^2/\text{m}$ ;  $\lambda = 0.13$  (20°),  $0.17$  (200°),  $0.18$  (300°)  $\text{cal/cm-sec-}^\circ\text{C}$ .

The high-strength wrought magnesium alloys have satisfactory general corrosion resistance, but in usage details must be protected by inorganic films and paint coatings. The tendency to stress corrosion of the alloys MA2-1, MA3, MA5 and MA10 increases from the MA2-1 alloy to the MA10 alloy. The MA3 and MA5 alloys can be used with long-term tensile stresses which do not exceed 60% of the tensile yield limit ( $\sigma_{0.2}$ ). With stresses equal to 90% of  $\sigma_{0.2}$  in the natural atmosphere in the unprotected condition cracks will appear on the surface of the MA10 alloy specimens after 6-8 days; therefore, this alloy can be used only in products intended for short service life. The tensile processing stresses must not exceed 0.4 times  $\sigma_{0.2}$ ; the compressive stresses are not limited (see Corrosion of the Magnesium Alloys, Protection of the Magnesium Alloys).

The MA2-1 and MA3 alloys are not strengthened by heat treatment. MA2-1 sheet and MA3 stampings are subjected to annealing, extruded mill products and plates made from the MA2-1 alloy are delivered without annealing. The VM65-1 and MA5 alloys are subjected to heat treatment - solution treatment in air or hot water and artificial aging. Solution treatment alone without aging is usually used for the MA5 alloy. Only aging is used for the VM65-1 alloy. The MA10 alloy is subjected to solution treatment and artificial aging (Table 8).

II-5M6

TABLE 8

Processing and Heat Treatment Conditions for High-Strength Wrought Magnesium Alloys

| 1<br>Сплав | 2<br>Литье | 3<br>Обработка давлением | 4<br>Отпуск           |                   | 5<br>Нагрев |             | 6<br>Старение |             |
|------------|------------|--------------------------|-----------------------|-------------------|-------------|-------------|---------------|-------------|
|            |            |                          | 7<br>температура (°C) | 8<br>время (часы) | 7<br>°C     | 8<br>(часы) | 7<br>(°C)     | 8<br>(часы) |
| MA2-1      | 700-740    | 230-470                  | 250-350               | 0,5-2,0           | -           | -           | -             | -           |
| MA3        | 680-730    | 240-400                  | 320-380               | 2-6               | -           | -           | -             | -           |
| MA5        | 680-750    | 280-385                  | 350-380               | 2-8               | 410-425     | 2-4         | 170-180       | 16-24       |
| VM65-1     | 680-720    | 250-420                  | 300-350               | 2-4               | -           | -           | 160-180       | 10-16       |
| MA10       | 700-750    | 300-425                  | 280-380               | -                 | 390-410     | 6-8         | 170-180       | 12-24       |

1) Alloy; 2) casting; 3) pressure working; 4) anneal; 5) solution treatment; 6) aging; 7) temperature; 8) time (hours); 9) VM65-1.

The MA2-1 alloy has the highest processing plasticity. It can be used for the production of all forms of wrought mill products. In the hot condition it is subjected to the various operations of sheet stamping. Three-dimensional stamping can be used for the production of details of complex form; free forging is used to a limited extent. The alloy welds well using argon-arc welding, the strength of the weld joints is 90-100% of the strength of the parent material. The MA3 alloy has medium plasticity and sheet rolling is not recommended. Three-dimensional stamping can be used to fabricate details of medium complexity in shape, free forging is not recommended. This alloy welds satisfactorily. The MA5 alloy has low plasticity and is not worked by free forging; stamping is used to fabricate details of simple form. Limited welding is used. The VM65-1 alloy has satisfactory plasticity in extruding and stamping. It is suitable for the production of profiles and stampings of complex form, simple free forging operations can be used. This alloy is not weldable. The plasticity of the MA10 alloy is the same as that of the MA5 alloy. Pressing and stamping of details of complex form from this alloy cause no difficulty. This alloy is welded using argon-arc and resistance welding. Forging and stamping of the high-

II-5M7

strength wrought magnesium alloys must be done on hydraulic presses, the use of mechanical presses is less favorable, and drop hammers should be used only in extreme cases. The use of double action hammers is not recommended. All these alloys machine well.

Among the high-strength wrought magnesium alloys, the VM65-1 and MA2-1 alloys have found the widest use. The high-strength alloys are used for the production of details for hoisting machines, hitches for trucks and buses, power saw frames, moving parts of knitting and weaving looms, railway and hand cars, details of portable instruments, various instruments and equipment. The MA2-1 alloy is used for paneling, partitions and frames, in the form of profiles and tubes for weldments and other details fabricated by three-dimensional stamping. The MA2-1 alloy can be used for the production of bodies, gas tanks, instrument panels, and other details of sports cars. The VM65-1 alloy is used for unwelded large loaded details, panels, etc. The MA3 and MA5 alloys are used for loaded details which do not have thin sections ( $< 4-7$  mm). The MA10 alloy can be used for the fabrication of details which are subject to high short-term loadings. The high-strength wrought magnesium alloys are also used in aircraft and rocket engineering.

References: see article on Wrought Magnesium Alloys.

A.A. Kazakov

HIGH-TEMPERATURE CAST MAGNESIUM ALLOYS are magnesium alloys which are intended for casting details operating at temperatures to 250-350° (long-term) and to 350-400° (short-term). The high-temperature cast magnesium alloys include the type ML9 (AMTU 447-59), ML10 (AMTU 488-63), ML11 (AMTU 488-63) alloys based on the magnesium-rare earth metal - zirconium system, the type ML14 (AMTU 436-59) and VML1 alloys based on the Mg - Th - Zr system and the VML2 alloy. For the chemical composition of these alloys see Magnesium Alloys. The recommended temperature limits for the use of these alloys are shown in Table 1, the mechanical properties in Tables 2-8 and in Figs. 1-7. At room temperature these alloys have relatively high mechanical properties with the exception of the ML11 alloy (Figs. 1-3), which is weaker than the rest. The ML10 and VML2 alloys, having the most favorable combination of high strength and good plasticity, have the best properties at 20°. The ML9 alloy surpasses the ML10 and VML2 alloys in yield strength (Tables 2,3,4). On the average the guaranteed yield strengths of the ML9 and ML10 alloys surpass the yield strengths of the most widely used casting alloy ML5 and are on the same level with those of the alloys ML12 and ML15. Castings with massive sections made from the ML9, ML10 and VML2 alloys have more castings from the ML5 alloy, and surpass them in both yield strength and ultimate strength.

The high-temperature cast magnesium alloys ML9, ML10, VML1 and VML2 differ from the high-strength magnesium and aluminum casting alloys in a comparatively slight reduction of the yield point with temperature increase (Table 5, see Figs. 2,4). At 200° the yield strength of these al-

II-12M1

TABLE 1

Recommended Temperature Limits for Use of High-Temperature Cast Magnesium Alloys

| 1<br>Сплав | 2<br>Предельные рабочие температуры (°C) |                                   |
|------------|--|-----------------------------------|
|            | 3<br>длительная эксплуатация             | 4<br>кратковременная эксплуатация |
| 5 МЛ10     | 250                                      | 350                               |
| МЛ10       | 250                                      | 350                               |
| МЛ11       | 250                                      | 350                               |
| 6 ВМЛ12    | 300                                      | 350-400                           |
| 6 ВМЛ11    | 300                                      | 400-450                           |
| МЛ14       | 350-370                                  | 400-450                           |

- 1) Alloy; 2) limiting working temperature (°C); 3) long-term operation; 4) short-term operation; 5) ML ; 6) VML.

TABLE 2

Typical Mechanical Properties of High-Temperature Cast Magnesium Alloys at 20° (12-mm-diameter specimens cast in sand form)

| 1<br>Сплав и его состояние | B                       |                         | μ    | 2 σ <sub>0.2</sub> σ <sub>0.1</sub> σ <sub>b</sub> |      |     | δ | ψ   | σ <sub>-1</sub> σ <sub>-0.1</sub> σ <sub>-2</sub> |      |      | Δ  | 3 τ <sub>ср</sub> | σ <sub>-1</sub> | НВ |
|----------------------------|-------------------------|-------------------------|------|--|------|-----|---|-----|---|------|------|----|-------------------|-----------------|----|
|                            | 4 (кг/мм <sup>2</sup> ) | 4 (кг/мм <sup>2</sup> ) |      | (кг/мм <sup>2</sup> )                              | 4    | (%) |   |     | (кг/мм <sup>2</sup> )                             | 4    | (%)  |    |                   |                 |    |
| 5 МЛ10-Т6                  | 4300                    | 1650                    | 0.33 | 7.5  | 14.5 | 26  | 3 | 6   | 7   | 14   | 35   | 16 | 17                | 8               | 65 |
| МЛ10 Т6                    | 4300                    | 1650                    | 0.33 | 7  | 12   | 24  | 5 | 7.5 | 5   | 10   | 33   | 13 | 17                | 7               | 65 |
| МЛ11 без термич. обработки | 4200                    | 1600                    | 0.31 | 4  | 10   | 13  | 3 | 3.5 | 4   | 10   | 31   | 13 | —                 | —               | 60 |
| МЛ11-Т4                    | 4200                    | 1600                    | 0.31 | 4  | 9    | 15  | 5 | 7   | 4   | 9    | 31.5 | 26 | 12                | 7               | 60 |
| МЛ11-Т6                    | 4200                    | 1600                    | 0.31 | 4.5  | 10.5 | 18  | 3 | 5   | 4.5   | 10.5 | 32   | 25 | 12                | 7               | 65 |
| 7 МЛ14                     | 3900                    | —                       | —    | 5  | 9.5  | 20  | 8 | —   | —   | —    | —    | —  | —                 | 5               | 60 |
| ВМЛ1                       | 3900                    | —                       | —    | 5  | 9.5  | 20  | 6 | —   | —   | —    | —    | —  | —                 | —               | —  |
| ВМЛ2                       | 4300                    | 1600                    | 0.33 | 6  | 12   | 26  | 6 | 6   | 6   | 12   | —    | —  | 17                | 6               | 65 |

\*Endurance limit determined in cantilever bending of rotating specimen, N = 2 · 10<sup>7</sup> cycles.

- 1) Alloy and temper; 2) σ pts; 3) τ sr; 4) (kg/mm<sup>2</sup>); 5) ML ; 6) without heat treatment; 7) VML.

TABLE 3

Mechanical properties of Certain Alloys at 20° (5-mm-diameter specimens cut from details)

| 1<br>Сплав и его состояние | 2 Типичные                             |         | 3 Минимальные                          |         |
|----------------------------|--|---------|--|---------|
|                            | 4 σ <sub>b</sub> (кг/мм <sup>2</sup> ) | 4 δ (%) | 4 σ <sub>b</sub> (кг/мм <sup>2</sup> ) | 4 δ (%) |
| 5 МЛ10-Т6                  | 22-24                                  | 5       | 17.5                                   | 2.5     |
| МЛ11 без термич. обработки | 12-14                                  | 2.5     | 10.5                                   | 1.5     |
| МЛ11-Т4                    | 13.5-15                                | 3.5     | 12                                     | 2       |
| 7 ВМЛ2                     | 22-26                                  | 6       | 17.5                                   | 2.5     |

11-12M2

1) Alloy and temper; 2) typical; 3) minimal; 4) (kg/mm<sup>2</sup>); 5) ML ; 6) without heat treatment; 7) VML.

TABLE 4

Mechanical Properties of Certain Alloys in Torsion and Impact Loading Strength at 20°

| Сплав и его состояние<br>1 | σ <sub>0.2</sub><br>2<br>(kg/mm <sup>2</sup> ) | T <sub>0</sub> | K <sub>IC</sub><br>(kg/cm <sup>3/2</sup> )<br>3 | σ <sub>0.2</sub><br>(kg/cm <sup>2</sup> )<br>4 |
|----------------------------|--|----------------|---|--|
|                            |  |                |   |  |
| ML11-T4                    | 5.3  | 13.8           | 270   | 0.3  |
| ML11-T6                    | 6.5  | 14             | 250   | 0.25   |
| 6 DM12-T6                  | 7.5  | 19             | -   | 0.45-0.75                                      |

\*Impact strength of ML10 alloy at 20° is 0.4 kgm/cm<sup>2</sup>.

1) Alloy and temper; 2) (kg/mm<sup>2</sup>); 3) bend angle (degrees); 4) (kgm/cm<sup>2</sup>); 5) ML ; 6) VML.

TABLE 5

Typical Mechanical Properties of Alloys at Elevated Temperatures (10-mm diameter specimens cast in sand form)

| Сплав и его состояние<br>1      | Temp (°C)<br>2 | E    | σ <sub>0.2</sub> | σ <sub>b</sub> | δ <sub>5</sub> | ψ  |
|---------------------------------|----------------|------|------------------|----------------|----------------|----|
|                                 |                |      |                  |                |                |    |
| ML10-T6<br>4                    | 200            | 3850 | 14               | 21             | 5              | 8  |
|                                 | 250            | 3600 | 13               | 19             | 10             | 20 |
|                                 | 300            | 3300 | 10.5             | 13             | 20             | 40 |
|                                 | 350            | -    | 8                | 10             | 25             | 60 |
|                                 | 400            | -    | -                | 6              | 35             | -  |
| ML10-T6                         | 200            | 3500 | 11               | 18             | 10             | 20 |
|                                 | 250            | 3400 | 10.5             | 15             | 15             | 30 |
|                                 | 300            | -    | 8.5              | 11             | 25             | 45 |
|                                 | 350            | -    | 4.5              | 8.5            | 35             | 65 |
|                                 | 400            | -    | -                | 6              | 55             | -  |
| ML11 без термич. обработки<br>5 | 200            | 3900 | 7                | 13             | 9              | 10 |
|                                 | 250            | 3400 | 6                | 12.5           | 13             | 15 |
|                                 | 300            | -    | 4                | 11             | 17             | -  |
| ML11-T4                         | 250            | 3400 | 3                | 13             | 13             | 20 |
|                                 | 300            | -    | 4.5              | 10.5           | 18             | 60 |
|                                 | 350            | -    | 3.5              | 7              | 40             | 80 |
| ML11-T6                         | 250            | 3400 | 7.5              | 13             | 8.5            | 14 |
|                                 | 300            | -    | 6                | 10.5           | 30             | 60 |
|                                 | 350            | -    | 4.5              | 7.5            | 30             | 75 |
| ML14-T1                         | 300            | 3200 | 4.5              | 8              | 25             | -  |
|                                 | 350            | 3100 | 4.2              | 7              | 30             | -  |
|                                 | 400            | -    | 3.4              | 6.8            | 35             | -  |
| VM11-T6<br>6                    | 300            | 3200 | 7.5              | 14.5           | 10             | -  |
|                                 | 350            | 3100 | 5.5              | 11.2           | 20             | -  |
|                                 | 400            | -    | 3.5              | 8.7            | 25             | -  |
| VM12                            | 250            | 3850 | 11               | 18             | 15             | -  |
|                                 | 300            | 3350 | 10               | 15             | 20             | -  |
|                                 | 350            | 3000 | 7                | 10             | 30             | -  |
|                                 | 400            | -    | 3.5              | 6              | 40             | -  |



II-12M3

1) Alloy and temper; 2) temperature (°C); 3) (kg/mm<sup>2</sup>); 4) ML ; 5) without heat treatment; 6) VML.

TABLE 6

Creep\* Limits and Stress-Rupture of Alloys

| Сплав и его состояние<br>1 | Длительность испытаний<br>2 (часы) | 3 Температура испытаний (°C)                  |     |     |     |  |     |     |
|----------------------------|------------------------------------|---|-----|-----|-----|--|-----|-----|
|                            |                                    | 200   | 250 | 300 | 350 | 200  | 250 | 300 |
|                            |                                    | пределы ползучести<br>4 (кг/мм <sup>2</sup> ) |     |     |     | пределы длительной прочности (кг/мм <sup>2</sup> ) 5 |     |     |
| 6 МЛ9-Т6                   | 30                                 | —   | 5   | —   | —   | —  | —   | 5.5 |
|                            | 100                                | —   | —   | —   | —   | —  | —   | —   |
| МЛ10-Т6                    | 100                                | 9   | 3.5 | —   | —   | 11.5   | 6   | 2.5 |
|                            | 1000                               | 6   | 2   | —   | —   | —  | 7   | —   |
| МЛ11-Т6                    | 100                                | 6.5   | 3   | 1   | —   | 10   | 5.5 | 2.5 |
|                            | 1000                               | 4.5   | 1.8 | 0.7 | —   | —  | —   | —   |
| 7 ВМЛ2                     | 100                                | 9.5   | 4.5 | 1.8 | —   | 14   | 7   | 4   |
| ВМЛ1                       | 100                                | —   | —   | 2.5 | 0.9 | —  | —   | —   |
|                            | 1000                               | —   | —   | —   | 0.5 | —  | —   | —   |
| МЛ14                       | 100                                | —   | —   | 3.7 | 1.8 | —  | —   | 8.5 |
|                            | 1000                               | —   | —   | 2   | 1   | —  | —   | —   |

\*Permanent deformation 0.2%.

1) Alloy and temper; 2) test duration (hours); 3) test temperature (°C); 4) creep limits (kg/mm<sup>2</sup>); 5) stress-to-rupture (kg/mm<sup>2</sup>); 6) ML ; 7) VML.

TABLE 7

Notch Sensitivity of Alloys at Various Temperatures

| Сплав и его состояние<br>1     | 2<br>Темп-ра (°C) | Статические испытания 3<br>$\sigma^H / \sigma^B$ | Вибрационные испытания 4<br>$\sigma^H / \sigma^B$ |
|--------------------------------|-------------------|--|---|
| МЛ9-Т6<br>5                    | 20                | 0.85   | 0.75  |
|                                | 200               | 1.0  | —   |
|                                | 250               | 1.1  | —   |
|                                | 300               | 1.4  | —   |
| МЛ10-Т6                        | 20                | 0.95   | 0.9   |
|                                | 200               | 1.25   | —   |
|                                | 250               | 1.4  | —   |
| МЛ11 — без термич. обработки 6 | 20                | 1.0  | —   |
| МЛ11-Т6                        | 20                | 1.0  | 0.9   |

1) Alloy and temper; 2) temperature (°C); 3) static tests; 4) vibratory tests; 5) ML ; 6) without heat treatment.

II-12M4

TABLE 8

Mechanical Properties of Alloys at Low Temperatures

| Сплав и его состояние<br>1 | Темп-ра<br>(°C)<br>2 | $\sigma_{0.2}$<br>(kg/mm <sup>2</sup> )<br>3 | $\sigma$<br>(%)<br>4 | $\sigma_{0.2}$<br>(kg/cm <sup>2</sup> )<br>5 |
|----------------------------|----------------------|--|----------------------|--|
| МЛ9-Т8 3                   | -40                  | 24   | 3                    | 0.75-0.3                                     |
|                            | -70                  | 26   | 2                    |  |
| МЛ10-Т8                    | -40                  | 27   | 5                    | 0.4  |
|                            | -70                  | 27   | 4.5                  |  |
|                            | -196                 | 24   | 3.5                  |  |
| МЛ11-Т4                    | -40                  | 15   | 3                    | 0.2-0.3                                      |
|                            | -196                 | 16   | 2                    |  |
| ВМЛ2-Т6 6                  | -196                 | 32   | 4.5                  | 0.65-0.75                                    |

1) Alloy and temper; 2) temperature (°C); 3) (kg/mm<sup>2</sup>); 4) kgm/cm<sup>2</sup>; 5) ML ; 6) VML.

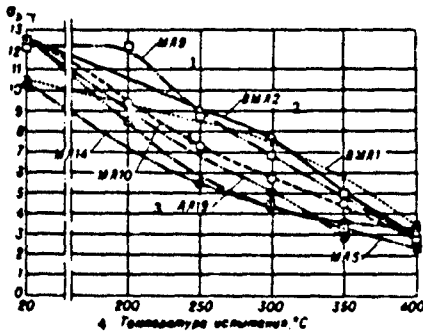

Fig. 1. Ultimate specific strengths of cast magnesium and AL19 aluminum alloys. 1) ML ; 2) VML ; 3) AL19.

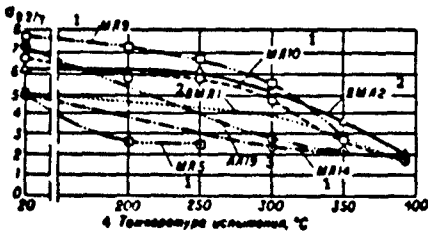

Fig. 2. Yield specific strengths of cast magnesium and AL19 aluminum

loys remains practically the same as at 20°, at 250° it is lower by 10-15% on the average, at 300° it is 20-30% lower, at 350° it is 35% lower for the VML2 alloy and 50-60% lower for the other alloys. In terms of decreasing yield strength characteristics, the high-temperature cast magnesium alloys are arranged in the following order: ML9, ML10, VML2, VML1, ML14, ML11, ML15 and ML5. The creep limits of the alloys are practically equal to one another in tension and compression.

The Ultimate strength of the alloys diminishes with increase of the test temperature more rapidly than the yield strength (Fig. 3 and 4). The ratio of yield strength to ultimate for the ML9, ML10, VML2 alloys increases with increase

II-12M5

alloys. 1) ML ; 2) VML ;  
3) AL19; 4) test tempera-  
ture, °C.

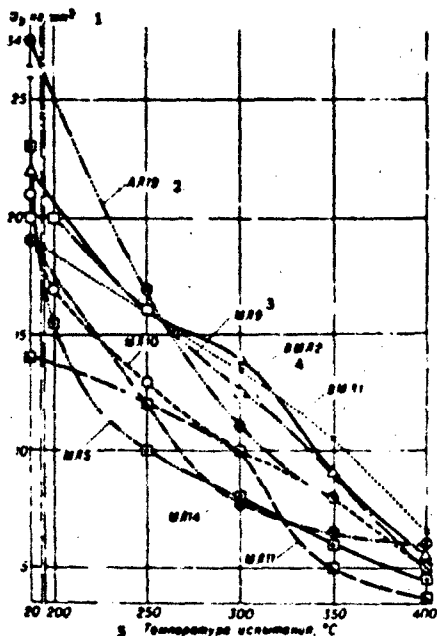

Fig. 3. Ultimate strength of cast magnesium alloys and AL19 aluminum alloy at room and elevated temperatures. 1) kg/mm<sup>2</sup>; 2) AL19; 3) ML ; 4) VML; 5) test temperature, °C.

of the temperature to 250-300° (for example, for ML10, from 0.5-0.55 to 0.8 at 250° and 0.85 at 300°), and at 350° again becomes close to the ratio which is characteristic for 20°.

Under conditions of long-term loading at elevated temperatures the magnesium alloys are subject to creep. The ML9, ML10, ML11 alloys are characterized by high creep resistance at 200-250° (see Table 6, Fig. 7). The VML2, VML1 and ML14 alloys have the highest creep resistance at 300°, the ML14 alloy is best at 350°.

The proportional limit ( $\sigma_{pts}$  kg/mm<sup>2</sup>) of some of the high-temperature cast magnesium alloys are: 6.5 for ML9-T6 at 200°, 5 at 250° and 3 at 300°; for ML10-T6 it is 5.5 at 200° and 5 at 250°. The endurance limit ( $\sigma_{-1}$ , kg/mm<sup>2</sup>) of some of the high-temperature cast magnesium alloys

(on the basis of  $2 \cdot 10^7$  cycles) is: for ML9-T6, 6 at 250°, 3.5 at 300°; for ML10-T6, 6 at 250°; for ML11-T4 at 250°, 6 and ML11-T6, 5.5; for VML2 at 300°, 5.

Physical properties of the high-temperature cast magnesium alloys. Alloy ML9:  $\gamma = 1.8$ ;  $\alpha = 25.6 \cdot 10^{-6}$  (20 - 100°),  $27.8 \cdot 10^{-6}$  (20 - 200°),  $30.8 \cdot 10^{-6}$  (20 - 300°),  $34.6 \cdot 10^{-6}$  (20 - 400°) 1/°C;  $\rho = 0.069$  (20°) ohm-mm<sup>2</sup>/m;  $\lambda = 0.26$  (25°), 0.27 (100°), 0.28 (200°), 0.29 (300°), 0.29 (350°) cal/cm-sec-°C. Alloy ML10  $\gamma = 1.77$ ;  $\alpha = 25.02 \cdot 10^{-6}$  (20 - 100°),  $26.07 \cdot 10^{-6}$  (20 - 200°),  $26.71 \cdot 10^{-6}$  (20 - 300°) 1/°C;  $\rho = 0.069$  (20°)

II-12M6

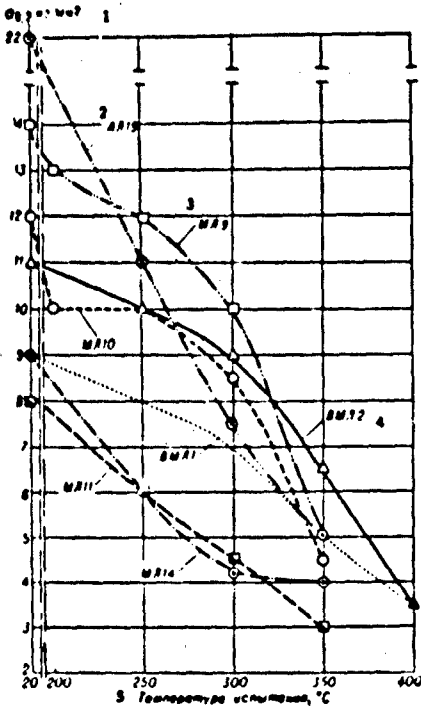

Fig. 4. Yield strength of cast magnesium alloys and AL19 aluminum alloy at room and elevated temperatures. 1) kg/mm<sup>2</sup>; 2) AL19; 3) ML; 4) VML; 5) test temperature.

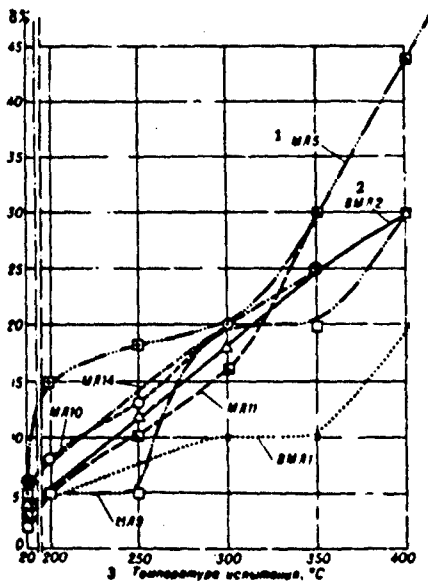

Fig. 5. Elongation of cast magnesium alloys at room and elevated temperatures.

ohm-mm<sup>2</sup>/m;  $\lambda = 0.26$  (25°), 0.27 (100°), 0.28 (200°), 0.29 (300°) cal/cm-sec-°C. Alloy ML11:  $\gamma = 1.8$ ;  $\alpha = 21.9 \cdot 10^{-6}$  (20 - 100°),  $22.7 \cdot 10^{-6}$  (20 - 200°),  $24.8 \cdot 10^{-6}$  (20 - 300°) 1/°C;  $\rho = 0.059$  (20°) ohm-mm<sup>2</sup>/m;  $\lambda = 0.25$  (25°), 0.26 (100°), 0.27 (200°), 0.27 (300°) cal/cm-sec-°C. Alloy ML14:  $\gamma = 1.84$ ;  $\alpha = 25.2 \cdot 10^{-6}$  (20 - 100°)  $26.7 \cdot 10^{-6}$  (20 - 200°),  $27.6 \cdot 10^{-6}$  (20 - 300°),  $28.2 \cdot 10^{-6}$  (20 - 400°) 1/°C;  $\rho = 0.066$  (20°) ohm-mm<sup>2</sup>/m;  $\lambda = 0.26$  (25°), 0.29 (400°) cal/cm-sec-°C. Alloy VML1:  $\gamma = 1.79$ ;  $\alpha = 27.3 \cdot 10^{-6}$  (20 - 100°),  $28.0 \cdot 10^{-6}$  (20 - 200°),  $29.3 \cdot 10^{-6}$  (20 - 300°)  $30.2 \cdot 10^{-6}$  (20 - 400°) 1/°C;  $\rho = 0.072$  (20°) ohm-mm<sup>2</sup>/m;  $\lambda = 0.26$  (25°), 0.29 (400°) cal/cm-sec-°C. Alloy VML2:  $\gamma = 1.79$ ;  $\alpha = 23.4 \cdot 10^{-6}$  (20 - 100°),  $27.1 \cdot 10^{-6}$  (20 - 200°),  $28.9 \cdot 10^{-6}$  (20 - 300°),  $30.6 \cdot 10^{-6}$  (20 - 400°) 1/°C;  $\rho = 0.0726$  (20°) ohm-mm<sup>2</sup>/m;  $\lambda = 0.28$  (25 - 200°), 0.29 (300°) cal/cm-sec-°C.

The high-temperature cast magnesium alloys, just as all the alloys based on the Mg-Zr system, differ from the ML5 alloy in having higher corrosion resistance, particularly the VML2 alloy (see Corrosion of Magnesium Alloys, Protection of Magnesium Alloys). Details made

## II-12M7

and elevated temperatures.  
1) ML ; 2) VML ; 3) test temperature, °C.

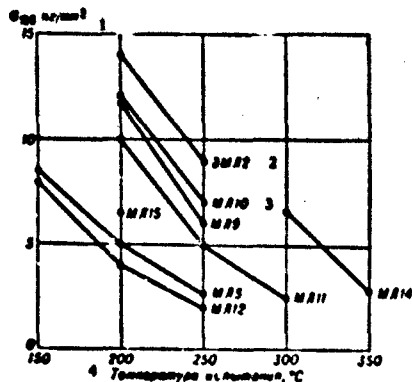

Fig. 6. Stress-to-rupture limits of cast magnesium alloys (after 100 hours). 1) kg/mm<sup>2</sup>; 2) VML; 3) ML ; 4) test temperature, °C.

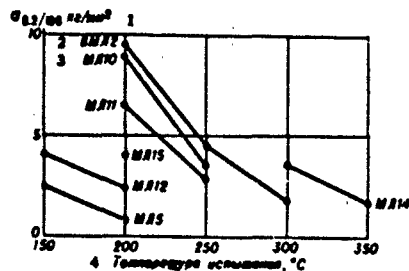

Fig. 7. Creep limits of cast magnesium alloys (after 100 hours). 1) kg/mm<sup>2</sup>; 2) VML ; 3) ML ; 4) test temperature, °C.

from the high-temperature cast magnesium alloys are used after anti-corrosion treatment of the surface: application of inorganic films and paint coatings. The processing properties of the high-temperature cast magnesium alloys in comparison with the properties of the ML5 alloy are presented in Table 9. These alloys are used for the production of large cast details. Thanks to the presence of zirconium, which effectively refines the grain, they have more uniform (in comparison with details made from the ML5 alloy) mechanical properties across various sections, close to the properties of individually cast specimens. These alloys are less prone to the formation of microporosity in castings and have high hermeticity. In the design of spruce systems account must be taken of the high shrinkage on solidification of the high-temperature cast magnesium al-

loys in comparison with the ML5 alloy. To prevent combustion of the metal in the forms, the same protective additives as are used for the ML5 alloy (see Magnesium Alloys) are added to the molding and core mixtures and to the paint for chill molds.

Casting of the high-temperature cast magnesium alloys is performed at temperatures 10-20° higher than used for the ML5 alloy. The casting temperature varies in the range of 720-800°. All these alloys are easily

II-12M8

TABLE 9

Processing Properties and Solidification Temperature of the Alloys

| 1 Свойства  | 2 Сплавы                    |                   |                 |                  |         |                             |                               |
|---|-----------------------------|-------------------|-----------------|------------------|---------|-----------------------------|-------------------------------|
|   | 3 М.19                      | М.110             | М.111           | М.114            | 4 ММ.11 | ММ.12                       | М.15                          |
| 5 Темп-ра начала кристаллизации (°C)  | 648                         | 650               | 645             | 648              | 645     | 651                         | 660                           |
| 6 Темп-ра конца кристаллизации (°C)   | 555                         | 555               | 580             | 560              | 582     | 558                         | 470                           |
| 7 Интервал кристаллизации (°C)  | 93                          | 95                | 55              | 88               | 63      | 93                          | 170                           |
| 8 Линейная усадка (%)   | 1.2-1.4                     | 1.2-1.4           | 1.2-1.5         | 1.3-1.4          | 1.3-1.5 | 1.3-1.5                     | 1.1-1.3                       |
| 9 Жидкотекучесть (по длине отлитого прутка, мм)   | 250-270                     | 250               | 270-290         | -                | -       | 270-290                     | 290-300                       |
| 10 Склонность к образованию горячих трещин (по ширине кольца в мм, при которой появляется первая трещина)                     | 27.5                        | 30                | 20-25           | -                | 25      | 30                          | 30-35                         |
| 11 Склонность к образованию микропористости (средний балл микропористости при содержании водорода 20 см <sup>3</sup> в 100 г) | -                           | 12 10<br>(низкая) | 9.6<br>(низкая) | 13 0<br>(нижняя) | -       | -                           | 40<br>(средняя) <sup>14</sup> |
| 15 Герметичность  | Повышенный                  | Повышенный        | Высокая         | Низкая           | Высокая | Повышенный                  | Средняя <sup>14</sup>         |
| 18 Темп-ра литья (°C)   | 720-800                     | 720-800           | 720-800         | 720-800          | 720-800 | 720-800                     | 700-800                       |
| 19 Рекомендуемые виды литья   | В песчаную форму и в кокиль |                   |                 | В песчаную форму |         | В песчаную форму и в кокиль | Все виды литья                |
|   | 20                          |                   |                 | 21               |         | 22                          |                               |

1) Properties; 2) alloys; 3) ML ; 4) VML ; 5) temperature of beginning of crystallization; 6) temperature of end of crystallization; 7) crystallization interval; 8) linear shrinkage; 9) fluidity (in terms of length of cast rod, mm); 10) tendency to formation of hot cracks (in terms of width of ring in mm for which the first crack appears); 11) tendency to formation of microporosity (average microporosity number with hydrogen content of 20 cm<sup>3</sup> per 100 grams); 12) low; 13) very low; 14) average; 15) hermeticity; 16) higher; 17) high; 18) casting temperature; 19) recommended forms of casting; 20) sand and chill mold; 21) sand; 22) all forms of casting.

argon-arc welded using wire made of the basic alloy as the filler material. The mechanical properties of the alloys on specimens cut across the weld seam, as a rule, are no less than 80-85% of the properties of the parent material. Details are heated to 350-425° before welding, and are subjected to heat treatment after welding using the conditions shown in Table 10.

The following charges are used for the production of the alloys: grade Mg1 magnesium (GOST 804-62), metallic zinc of grade no lower than Ts2 (GOST 3640-47), mischmetal (mixture of rare-earth metals with cerium content about 50%), ligature of magnesium with 15-80% neodymium (or

II-12M9

metallic neodymium), ligature of magnesium with 10-30% thorium (or metallic thorium in the form of chips), ligature of magnesium with 20-50% zirconium obtained by smelting potassium fluozirconate ( $K_2ZrF_6$ ) with magnesium in the presence of haloid salts of the alkali and alkaline-earth metals. Melting and casting, mechanical working, etching of the magnesium-thorium alloys are performed observing special rules for safety engineering because of the natural radioactivity of thorium.

TABLE 10

Heat Treatment Regimes for the High-Temperature Cast Magnesium Alloys (cast in sand and chill molds)

| Сплав и его<br>1 состояние | 2 Замачка             |                               | 3 Старение            |                               |
|----------------------------|-----------------------|-------------------------------|-----------------------|-------------------------------|
|                            | температура<br>4 (°C) | время<br>выдержки<br>5 (часы) | температура<br>4 (°C) | время<br>выдержки<br>5 (часы) |
|                            | 6 ML9-T8 . . .        | 530                           | 12-16                 | 200                           |
| ML10-T8 . . .              | 530                   | 12-16                         | 200                   | 12-16                         |
| ML11-T8 . . .              | 570                   | 4-6                           | -                     | -                             |
| ML11-T8 . . .              | 570                   | 4-6                           | 200                   | 16                            |
| ML14-T1 . . .              | -                     | -                             | 315                   | 16                            |
| 7 VML1-T8 . . .            | 570                   | 2                             | 200                   | 16                            |

Remarks. Casting of the alloys and cooling after aging are performed in air. Heating for tempering must be performed in a reducing or protective atmosphere, usually sulfur dioxide (iron pyrites at a ratio of 0.5-1.0 kg per m<sup>3</sup> of furnace are added to the furnace charge). Details are unloaded onto a metal plate to increase the cooling rate.

1) Alloy and temper; 2) solution treatment; 3) aging; 4) temperature; 5) soak time (hours); 6) ML ; 7) VML.

Mold casting must be performed in a separate, specially equipped facility. Working operations associated with the formation of dust, aerosols, gaseous decomposition products must be performed either in separate facilities or on equipment which is covered and has local exhaust ventilation. The ML9, ML10, ML11 and VML2 alloys do not contain radioactive additive and therefore, details made from them are fabricated in conventional shops. The high-temperature cast magnesium alloys are used for casting details of various flight vehicles which are subject to

II-12M10

heating during operation. The ML11 alloy (cheapest) is used to produce details requiring high hermeticity, operating at both elevated and room temperature, for example, pump cases, fittings, etc.; damping details, since the damping capability of the alloy is the same as that of iron while the thermal conductivity is higher by a factor of two.

References: see Cast Magnesium Alloys.

N.M. Tikhova



HIGH-TEMPERATURE LUBRICANTS - plastic lubricating materials used to ensure normal operation of friction units at temperatures of 120-400°.

NK-50 lubricant (GOST 5573-50), which is used principally in the bearings of aircraft wheels, is obtained by thickening MK-22 high-viscosity oil with sodium soaps of hydrogenated and nonhydrogenated fats and contains 0.5% colloidal graphite; it is capable of prolonged operation at 120-130° and brief operation at 15-180°. Its shortcomings include its solubility in water and its poor operational characteristics at low temperatures.

TsIATIM-221 lubricant (GOST 9433-60), ethylpolysiloxane thickened with a complex calcium soap, is recommended for use at temperatures of from -60 to 150°; it can be employed for rather long periods at high temperatures, ensuring normal operation of rolling-contact bearings for 30-50 hr at 180° and 10,000 rpm. The modifications of this lubricant are TsIATIM-221s (VTU NP 18-58), VNIINP-214 (VTU NP 37-59), and VNIINP-220 (containing 3% molybdenum disulfide, VTU NP 17-58), which are based on more heat-resistant methylphenylpolysiloxanes and are used at temperatures of up to 180-200°. VNIINP-235 lubricant (VTU NP 78-60), which is produced by thickening methylphenylpolysiloxane with a pigment of the indanthrene series, can be employed at temperatures of up to 250°; it is not recommended for use in bearings operating at high speeds. This lubricant has low evaporability, good water resistance, and high mechanical stability. DNIINP-211 lubricant (TU NP 33-59), which is produced by thickening phenylmethylpolysiloxane with graphite

III-52sl

and 1% indanthrene, can be used at temperatures of up to 250°; it ensures normal operation of ball bearings at speeds of up to 10-15 thousand rpm.

VNIINP-210 (TU 72-60) and PFMS-4S lubricants, which are highly concentrated pastes consisting of graphite and liquid phenylmethylpolysiloxanes, are intended for operation at 300-400°. The former contains additions of indanthrene and molybdenum disulfide and is generally employed in low-speed or pendulum-type sliding and rolling-contact bearings; it can also be used to prevent "freezing" of threaded joints and has a service life of up to 10 hr at its maximum temperature. VNIINP-225 lubricant (VTU 12-61), which consists of polysiloxane thickened with molybdenum disulfide, is employed at temperatures of from -50° to 350°. It is used principally to prevent sticking of threaded components at high temperatures and, in some cases, to lubricate friction units.

V.V. Sinitsyn

HIGH-TEMPERATURE TEST, mechanical - is the determination of the mechanical properties of predominantly heat resistant alloys and non-metallic materials at temperatures higher than the room temperature. The most simple high-temperature test methods are the so-called short-time tests of specimens for static elongation at constant temperature determining the same strength and plastic properties of the material as in static tests at room temperature (see Tensile Test). Short-time tests are carried out, as a rule, on usual tensile-test or universal testing machines with constant motion of the active clamp (the IM-4R machine designed by TsNIIITMASH is mostly used for this purpose), provided with heating systems and thermocontrollers. In addition to the static short-time tensile tests, compression, torsional, hardness and impact-bending tests with determination of the impact strength are carried out on heated specimens. For short-time tests, the specimen is usually heated for 20-30 minutes and then destroyed within 1-3 min. The results of strength and creep tests in which the loading and heating times continue seconds only, for arrangements whose life is measured by seconds or minutes acquire an especial importance. The determination of the "secondary" strength and creep has obtained a wide spread. In contrast to tests at room temperature, the results of short-time (static) high-temperature tests depend strongly on the deformation rate and the total test time. This dependence is caused by the creep phenomenon (GOST 3248-60) observable in all structural materials and consisting in continuous increase of the plastic deformation in time under a constant load and at high temperatures; the active stress may be in this case

I-4411

considerably lower than the yield limit of the material (at the same temperature). In practice, the creep phenomenon may cause inadmissible large deformations or destruction of machine parts at a relatively small load which acts for a long time, however. Creeping and endurance tests (see Creeping Test, Endurance Test) are widely used for the investigation of material properties at high temperatures and under long-time acting constant loads. The creep phenomenon of materials at high temperatures may also take effect in the relaxation of stresses, i.e., in a spontaneous decrease in time of stresses in machine parts which operate at the condition of constant deformation. Stress-relaxation tests at a given (fixed) deformation of the specimen and measurement of the relaxation of the load (stress) in time under the action of a high temperature are carried out to investigate the so-called relaxation stability of materials.

The results of short-time and long-time tests at high temperatures were found to be insufficient for the evaluation of the operating reliability of responsible machine parts working at high temperatures and under a repeatedly changing load causing fatigue phenomena in the material. In this case, the investigation of the fatigue properties of the material at high temperatures (drawing of the endurance curves, determination of the endurance limit and ascertainment of its dependence on the test temperature) is necessary. Program tests at high temperatures permit the investigation of the physicomechanical properties of materials in unsteady loading and heating conditions, reproducing the character of change in load and temperature in the working process of real machine parts (gas-turbine blades, for example). The operating reliability of many parts and units of modern machines depends not only on the temperature and the load but also on the properties of the working medium (the corrosive, cavitation, and erosion effect of fluids

I-44I2

and gases, for example, which are in a lasting or short contact with the part). This caused the development of test methods under simultaneous action of high temperature and load in a given working medium (gas, steam, fluid, molten metals and alloys, etc.). The mentioned methods are used, for example, on materials which are destined for the production of nozzles of jet engines (erosion effect of hot gases at a high outflow velocity), pipelines (danger of cavitation effects), etc. Certain technological trials, the test for stamping in hot state, for example, and others, belong also to the high-temperature tests.

References: Borzdyka A.M., *Metody goryachikh mechanicheskikh ispytaniy metallov* [Methods of Hot Mechanical Tests of Metals], Moscow, 1955; Gintsburg Ya.S., *Ispytaniye metallov pri povyshennykh temperaturakh* [Testing of Metals at Elevated Temperatures], Moscow-Leningrad, 1954; Sichikov M.F., *Metally v turbostroyeni* [Metals in the Construction of Turbines], Moscow, 1954.

I.V. Kudryavtsev, D.M. Shur

## II-6M

HIGH-TEMPERATURE WROUGHT MAGNESIUM ALLOYS are magnesium alloys which lose their strength slowly at high temperatures ( $> 200^{\circ}$ ). With regard to degree of strength at high temperature, the wrought magnesium alloys are arbitrarily divided into three groups: 1) the alloys suitable for long time ( $\geq 100$  hours) operation at temperatures to  $150^{\circ}$ . This group includes the MA1 alloy of the Mg-Mn system and also the alloys with high aluminum and zinc content - MA2, MA2-1, MA3, MA5, VM65-1 and VMD2 (see Low-Strength Wrought Magnesium Alloys, Medium-Strength Wrought Magnesium Alloys); 2) alloys suitable for long time operation at temperatures to  $200^{\circ}$ . This group includes alloys of magnesium with manganese and small additions of mischmetal or aluminum and calcium (MA8 and MA9) and those with high mischmetal content (VM17) (see High-Strength Wrought Magnesium Alloys); 3) the alloys suitable for long time operation at temperatures to  $250-350^{\circ}$ . This group includes the alloys with the rare-earth metals-neodymium or yttrium - and the alloys with thorium (MA11, MA13 and VMD1). The alloys of the third group have high strength at high temperature. The MA11 alloy of the Mg-Nd-Mn-Ni system has adequately high stress-rupture and creep limits at temperatures to  $250^{\circ}$  and also has high ultimate strength to  $300^{\circ}$ . It is used for long-term operation to  $250^{\circ}$  and for short-term operation to  $300^{\circ}$ . It is basically used for the production of extrudings and stampings, sheet and plate may also be rolled. The alloys MA13 and VMD1 of the Mg-Th-Mn system have the highest creep and stress-rupture limits at temperatures of  $300-350^{\circ}$ . They can operate at temperatures to  $350^{\circ}$  for long periods and briefly to  $400^{\circ}$ . The primary use of the MA13 alloy is the production of sheet and

II-6M1

plate, the VMD1 alloy is used primarily for extruded mill products and stampings. The chemical composition of the high-temperature wrought magnesium alloys is presented in Table 1, the mechanical properties are given in Tables 2-9.

TABLE 1  
Chemical Composition of High-Temperature Wrought Magnesium Alloys

| 1<br>Сплав | 2 Содержание основных компонентов (%) |         |          |         |        | 3 Содержание примесей, не более (%) |      |       |     |      |      |      |                  |  |
|------------|---------------------------------------|---------|----------|---------|--------|-------------------------------------|------|-------|-----|------|------|------|------------------|--|
|            | Mg                                    | Nd      | Ni       | Th      | Mg     | Al                                  | Cu   | Ni    | Zn  | Si   | Be   | Fe   | Прочие примеси 4 |  |
| MA11       | 1.5-2.5                               | 2.5-4.0 | 0.1-0.25 | —       | 5 ост. | 0.2                                 | 0.03 | —     | 0.2 | 0.15 | 0.02 | 0.03 | 0.3              |  |
| MA13       | 0.4-0.8                               | —       | —        | 1.7-2.5 | То же  | 0.2                                 | 0.05 | 0.005 | 0.2 | 0.15 | 0.02 | 0.05 | 0.3              |  |
| ВМД1       | 1.5-2.0                               | —       | —        | 2.5-3.5 | •      | 0.2                                 | 0.05 | 0.005 | 0.2 | 0.15 | 0.02 | 0.05 | 0.3              |  |

1) Alloy; 2) content of basic components (%); 3) impurity content, not more than (%); 4) other impurities; 5) balance; 6) same; 7) VMD1.

TABLE 2  
Typical Mechanical Properties of Mill Products at 20°

| 1<br>Сплав | 2<br>Вид полуфабриката                    | 3<br>Состояние материала | 4 (кг/мм <sup>2</sup> ) |                |                |            | 5 (%)    |        |
|------------|---|--------------------------|-------------------------|----------------|----------------|------------|----------|--------|
|            |   |                          | E                       | $\sigma_{0.2}$ | $\sigma_{0.1}$ | $\sigma_b$ | $\delta$ | $\psi$ |
| MA11       | Прессованный пруток $\varnothing$ 25 мм 6 | T6                       | 4250                    | 8              | 14             | 28         | 10       | 12     |
|            | Лист толщиной 0.8-3.0 мм 7                | T6                       | 4250                    | 8              | 13             | 26         | 10       | —      |
| ВМД1       | Прессованный пруток 9                     | Горячепрессованным 10    | 4250                    | 17             | 25             | 30         | 5        | 10     |
| MA13       | Лист 11                                   | T8                       | 4250                    | 8              | 18             | 24         | 6        | —      |

1) Alloy; 2) form of mill product; 3) material condition; 4) (kg/mm<sup>2</sup>); 6) extruded rod, diameter 25 mm; 7) sheet of thickness 0.8-3.0 mm; 8) VMD1; 9) extruded rod; 10) hot extruded; 11) sheet.

II-6M2

TABLE 3

Mechanical Properties of High-Temperature Wrought Magnesium Alloys at 20° as a Function of the Type of Test

| 1<br>Сплав              | 2<br>Вид полу-<br>фабриката | 3<br>Состояние<br>материала | 4 Сжатие |                 |                 | 5 Кручение   |              |          | 6 (раз)            |                    | 7<br>$\sigma_{0.2}$<br>(кг/мм <sup>2</sup> ) | 8<br>$\sigma_{0.2}$<br>(кг/мм <sup>2</sup> ) |
|-------------------------|-----------------------------|-----------------------------|----------|-----------------|-----------------|--------------|--------------|----------|--------------------|--------------------|--|--|
|                         |                             |                             | $\sigma$ | $\sigma_{-0.2}$ | $\sigma_{-0.1}$ | $\tau_{0.2}$ | $\tau_{0.1}$ | $\tau_0$ | 10<br>$\tau, \rho$ | 11<br>$\tau, \rho$ |  |  |
| (кг/мм <sup>2</sup> ) 8 |                             |                             |          |                 |                 |              |              |          |                    |                    |  |  |
| МА11                    | 11 Прессованный пруток      | Т6                          | 1600     | 38              | 12              | —            | 9            | 22       | 17                 | 0.35               | 4.5  |  |
| МА13                    | 12 Лист 12                  | Т6                          | 1600     | —               | —               | —            | —            | —        | 2.3                | —                  | 7  |  |
| 13ВМД1                  | 14 Прессованный пруток      | Горячепрессованный          | 1600     | —               | 16              | 11           | —            | —        | 16                 | 0.65               | 7  |  |

\*Determined with cantilever bending of rotating specimen on basis of  $2 \cdot 10^7$  cycles.

1) Alloy; 2) form of mill product; 3) material condition; 4) compression; 5) torsion; 6) shear; 7) (kg/cm<sup>2</sup>); 8) (kg/mm<sup>2</sup>); 9)  $\tau$  pts; 10)  $\tau$  sr; 11) extruded rod; 12) sheet; 13) VMD1; 14) extruded rod; 15) hot extruded.

TABLE 4

Notch Sensitivity of High-Temperature Wrought Magnesium Alloys at Various Temperatures

| 1<br>Сплав | 20°                                      | -70° | 20°   |
|------------|--|------|---|
|            | 2<br>Статическая<br>( $\alpha_0 = 2.2$ ) |      | 3<br>Вибрацион-<br>ная<br>$\sigma_{-1}$<br>$\sigma_{-1}^H$<br>$\sigma_{-1}^L$ |
| 4ВМД1      | 1.2                                      | 1.1  | 1.4   |
| МА11       | 0.9                                      | 0.93 | 1.7   |

1) Alloy; 2) static; 3) oscillatory; 4) VMD 1.

TABLE 5

Mechanical Properties of High-Temperature Wrought Magnesium Alloys at Low Temperatures

| 1<br>Сплав              | 2<br>Вид полу-<br>фабриката | 3<br>Состояние<br>материала | -70°       |                |                 | -196°      |                |                 |
|-------------------------|-----------------------------|-----------------------------|------------|----------------|-----------------|------------|----------------|-----------------|
|                         |                             |                             | $\sigma_b$ | $\sigma_{0.2}$ | $\delta$<br>(%) | $\sigma_b$ | $\sigma_{0.2}$ | $\delta$<br>(%) |
| 4 (кг/мм <sup>2</sup> ) |                             |                             |            |                |                 |            |                |                 |
| 5 ВМД1                  | 6 Пруток                    | Горячепрессованный          | 36         | —              | 4               | —          | —              | —               |
| МА11                    | 8 Лист 8                    | Т6                          | 30         | 13             | 9               | 31         | 13             | 6               |



II-6M3

1) Alloy; 2) form of mill product; 3) material condition; 4) ( $\text{kg}/\text{mm}^2$ );  
5) VMD1; 6) rod; 7) hot extruded; 8) sheet.

TABLE 6

Mechanical Properties of Extruded Rods at High Temperatures\*

| 1<br>Tempe-<br>rature<br>(°C) | MA11                    |                               |                  |                |          |  | BM11                    |                               |                  |                |          |  |
|-------------------------------|-------------------------|-------------------------------|------------------|----------------|----------|--|-------------------------|-------------------------------|------------------|----------------|----------|--|
|                               | E                       | <sup>2</sup> σ <sub>0.2</sub> | σ <sub>0.1</sub> | σ <sub>b</sub> | δ<br>(%) | σ <sub>0.2</sub><br>(kg/cm <sup>2</sup> )<br>3 | E                       | <sup>2</sup> σ <sub>0.2</sub> | σ <sub>0.1</sub> | σ <sub>b</sub> | δ<br>(%) | σ <sub>0.2</sub><br>(kg/cm <sup>2</sup> )<br>3 |
|                               | (kg/mm <sup>2</sup> ) 4 |                               |                  |                |          |  | (kg/mm <sup>2</sup> ) 4 |                               |                  |                |          |  |
| 200                           | 3700                    | 7                             | 12               | 22             | 14       | —  | 4000                    | 11                            | 15               | 18             | 12       | —  |
| 250                           | 3400                    | 6                             | 10               | 15             | 17       | 0.6  | 3800                    | 9                             | 14               | 17             | 12       | —  |
| 300                           | 3100                    | 5                             | 9                | 15             | 22       | 0.7  | 3600                    | 8                             | 11               | 13.5           | 13       | 1.2  |
| 350                           | —                       | —                             | 8                | 10             | 50       | 0.6  | 3200                    | 4.5                           | 9.5              | 11.5           | 20       | 1.6  |
| 400                           | —                       | —                             | —                | 7.5            | 55       | —  | 2000                    | 2.5                           | 5.5              | 8              | 24       | >2   |

\* Material condition: MA11-T6, VMD1 - hot extruded

1) Temperature; 2) σ pts; 3) ( $\text{kg}/\text{cm}^2$ ); 4) ( $\text{kg}/\text{mm}^2$ ).

TABLE 7

Mechanical Properties of Sheet at High Temperatures\*

| 1<br>Temp-er<br>(°C) | MA11**                  |                               |                  |                |          | MA13***                 |                               |                  |                |          |
|----------------------|-------------------------|-------------------------------|------------------|----------------|----------|-------------------------|-------------------------------|------------------|----------------|----------|
|                      | E                       | <sup>2</sup> σ <sub>0.2</sub> | σ <sub>0.1</sub> | σ <sub>b</sub> | δ<br>(%) | E                       | <sup>2</sup> σ <sub>0.2</sub> | σ <sub>0.1</sub> | σ <sub>b</sub> | δ<br>(%) |
|                      | (kg/mm <sup>2</sup> ) 3 |                               |                  |                |          | (kg/mm <sup>2</sup> ) 3 |                               |                  |                |          |
| 200                  | 3650                    | 7.5                           | 11               | 20             | 18       | —                       | 5.5                           | 12.5             | 14.5           | 5        |
| 250                  | 3400                    | 6.5                           | 10               | 18.5           | 18       | 3800                    | 5                             | 12               | 14             | 5        |
| 300                  | —                       | —                             | 8.5              | 14             | 28       | 3600                    | 4                             | 12               | 13.5           | 7        |
| 350                  | —                       | —                             | —                | 8.5            | 75       | 3100                    | 3.5                           | 9                | 10.5           | 8        |
| 400                  | —                       | —                             | —                | —              | —        | 2000                    | 3                             | 6.5              | 8              | 15       |

\* Sheet thickness 0.8-3.0 mm; material condition: MA11-T6, MA13-T8

\*\* Endurance limit at 250° for rods is 7  $\text{kg}/\text{mm}^2$ , for sheet 5  $\text{kg}/\text{mm}^2$ .

\*\*\* Endurance limit at 350° for sheet is 3.5  $\text{kg}/\text{mm}^2$ .

1) Temperature; 2) σ pts; 3) ( $\text{kg}/\text{mm}^2$ ).

TABLE 8

Stress-Rupture Limits of High-Temperature Wrought Magnesium Alloys\*

| 1<br>Сплав              | 2<br>Вид полуфабриката | 200°           |                | 250°           |                | 300°           |                | 350°           |                |
|-------------------------|------------------------|----------------|----------------|----------------|----------------|----------------|----------------|----------------|----------------|
|                         |                        | $\sigma_{0.2}$ | $\sigma_{1.0}$ | $\sigma_{0.2}$ | $\sigma_{1.0}$ | $\sigma_{0.2}$ | $\sigma_{1.0}$ | $\sigma_{0.2}$ | $\sigma_{1.0}$ |
| 3 (кг/мм <sup>2</sup> ) |                        |                |                |                |                |                |                |                |                |
| МА11                    | 4 Прутки<br>3 Листы    | 18             | 13             | 10             | 8              | 6              | 5              | 2              |                |
| МА13                    | 5 Листы                | -              | -              | -              | -              | -              | 7              |                | 3.5            |
| ВМД1                    | 4 Прутки               | -              | -              | -              | 11.5           | -              | 9              | -              | 5              |

\*Material condition: МА11-Т6, МА13-Т8, ВМД1 - hot extruded

1) Alloy; 2) form of mill product; 3) (kg/mm<sup>2</sup>); 4) rods, 5) sheet; 6) ВМД1.

TABLE 9  
Creep Limits of High-Temperature Wrought Magnesium Alloys\*

| 1<br>Сплав              | 2<br>Вид полуфабриката | 200°           |                | 250°           |                | 300°           |                | 350°           |                |
|-------------------------|------------------------|----------------|----------------|----------------|----------------|----------------|----------------|----------------|----------------|
|                         |                        | $\sigma_{0.2}$ | $\sigma_{1.0}$ | $\sigma_{0.2}$ | $\sigma_{1.0}$ | $\sigma_{0.2}$ | $\sigma_{1.0}$ | $\sigma_{0.2}$ | $\sigma_{1.0}$ |
| 3 (кг/мм <sup>2</sup> ) |                        |                |                |                |                |                |                |                |                |
| МА11                    | 4 Прутки<br>3 Листы    | 18             | 13             | 10             | 8              | 6              | 5              | 2              |                |
| МА13                    | 5 Листы                | -              | -              | -              | -              | -              | 7              |                | 3.5            |
| ВМД1                    | 4 Прутки               | -              | -              | -              | 11.5           | -              | 9              | -              | 5              |

\*Material condition:  
МА11-Т6, МА13-Т8,  
ВМД1 - hot extruded

1) Alloy; 2) form of mill product; 3) (kg/mm<sup>2</sup>); 4) rods; 5) sheet; 6) ВМД1.

Physical properties of the high-temperature wrought magnesium alloys.

Alloy МА11:  $\gamma = 1.8 \text{ g/cm}^3$ ;  $\alpha = 25.7 \cdot 10^{-6}$  (20 - 100°),  $28.7 \cdot 10^{-6}$  (20 - 200°),  $30.4 \cdot 10^{-6}$  (20 - 300°),  $29.3 \cdot 10^{-6}$  (100 - 200°);  $30.1 \cdot 10^{-6}$  (200 - 300°),  $1/^\circ\text{C}$ ;  $\lambda = 0.26$  (25°),  $0.27$  (100°),  $0.28$  (300°),  $0.28$  (400°) cal/cm-sec-°C;  $\rho = 0.0621 \text{ ohm-mm}^2$ /m. Alloy МА13:  $\gamma = 1.78 \text{ g/cm}^3$ ;  $\alpha = 25.6 \cdot 10^{-6}$  (20 - 100°),  $26.6 \cdot 10^{-6}$  (20 - 200°),  $27.7 \cdot 10^{-6}$  (20 - 300°),  $28.7 \cdot 10^{-6}$  (20 - 400°),  $27.7 \cdot 10^{-6}$  (100 - 200°),  $29.8 \cdot 10^{-6}$  (200 - 300°),  $31.6 \cdot 10^{-6}$  (300 - 400°),

$32.3 \cdot 10^{-6}$  (400 - 500°)  $1/^\circ\text{C}$ ;  $\lambda = 0.29$  (25°),  $0.30$  (100°),  $0.31$  (200°)  $0.32$  (450°) cal/cm-sec-°C;  $\rho = 0.061 \text{ ohm-mm}^2$ /m;  $c = 0.25$  (100°),  $0.26$  (200°),  $0.28$  (300°),  $0.29$  (400°) cal/g-°C. Alloy ВМД1:  $\gamma = 1.81 \text{ g/cm}^3$ ;  $\alpha = 26.9 \cdot 10^{-6}$  (20 - 100°),  $27.9 \cdot 10^{-6}$  (20 - 200°),  $28.9 \cdot 10^{-6}$  (20 - 300°)  $30.2 \cdot 10^{-6}$  (20 - 400°),  $30.6 \cdot 10^{-6}$  (20 - 500°)  $1/^\circ\text{C}$ ;  $\lambda = 0.295$  (25°),  $0.30$  (100°),  $0.31$  (300°),  $0.33$  (400°) cal/cm-sec-°C;  $c = 0.25$  (100°),  $0.26$  (200°),  $0.275$  (300°),  $0.29$  (400°),  $0.30$  (450°) cal/g-°C;  $\rho = 0.0582$

II-6M5

ohm-mm<sup>2</sup>/m.

Alloys MA13 and VMD1 have satisfactory (same as the MA8 alloy) corrosion resistance and the MA11 alloy has somewhat low corrosion resistance. None of the high-temperature wrought magnesium alloys are subject to stress corrosion cracking. Protection from corrosion is provided by paint/lacquer coatings applied over the oxidized surface (see Corrosion of the Magnesium Alloys). For long-term storage, parts are protected by the Irvinylpercho enamels, and for operation at high temperatures they are protected by the siloxane enamels.

The VMD1 alloy is not strengthened by heat treatment and can be used in the hot-deformed or annealed condition. In order to improve creep resistance the MA11 and MA13 alloys are subjected to heat treatment: the MA11 alloy is solution treated and artificially aged (T6 condition), and the MA13 alloy is subjected to solution treatment, intermediate cold rolling and artificial aging (T8 condition). The thermal regimes for casting, pressure working and heat treatment of the high-temperature wrought magnesium alloys are presented in Table 10.

TABLE 10

Thermal Regimes for Working the High-Temperature Wrought Magnesium Alloys

| 1<br>Сплав | 2 Литье        |         | 3 Обработка давлением |   | 4 Отжиг        |   | 5 Закалка      |    | 6 Старение     |  |
|------------|----------------|---------|-----------------------|---|----------------|---|----------------|----|----------------|--|
|            | 7 темп-ра (°C) |         | 7 темп-ра (°C)        |   | время в (часы) |   | 7 темп-ра (°C) |    | время в (часы) |  |
| MA11       | 710-730        | 350-480 | 350                   | 1 | 480-500        | 4 | 175            | 24 |                |  |
| MA13       | 710-730        | 300-480 | 400                   | 1 | 550-570        | 1 | 200            | 16 |                |  |
| VMD1       | 710-730        | 380-480 | 400                   | 1 | -              | - | -              | -  |                |  |

1) Alloy; 2) casting; 3) pressure working; 4) anneal; 5) solution treatment; 6) aging; 7) temperature; 8) time (hours); 9) VMD1.

The processing plasticity of the MA11 alloy for extrusion and stamping-forging on presses in the temperature range 425-480° is satisfactory, but the plasticity is low for rolling. The permissible degree

## II-6M6

of deformation per heat in stamping-forging is 50-60%. Sheet stamping can be performed at temperatures of 350-400°. The limiting coefficient for the first draw is 2, the minimal permissible bend radius is 3S (S is the material thickness). The processing plasticity of the VMD1 alloy for extrusion and forging-stamping in the temperature interval 380-480° is satisfactory. The MA13 alloy has the highest processing plasticity in all forms of pressure working. Sheet stamping of the MA13 alloy is performed at temperatures of 300-400°. For sheets 1.6 mm thick the permissible bend radius is: (5.5 - 6)S at a temperature of 20°, (3.5 - 4)S at 300°, (2.5 - 3)S at 370°, 1.2S at 425°, where S is the material thickness. The limiting coefficient of the first draw is 3 - 3.2. Extruded mill products made from the MA11 alloy are welded satisfactorily using argon-arc welding with wall thickness to 5 mm. Argon-arc welding of sheet is difficult in view of the high tendency of the alloy to formation of cracks during welding of thin sections. Resistance welding causes no difficulty. The MA13 and VMD1 alloys are satisfactorily argon-arc welded. When welding using a filler of the parent material the strength of the weld joints at room temperature is 70% of the strength of the parent material for the MA13 alloy and 60% for the VMD1 alloy, and at elevated temperatures (300-400°) the strengths are 80-90% of that of the parent material. When using as the filler material an alloy with 2.7% Zn, 0.7% Zr and 3.8% Th, the strength of the weld joints is increased at room temperature, amounting to 90% of the strength of the parent material, but at higher temperatures the percentage will be lower. The strength of weld joints of the MA13 alloy at room temperature without removal of the weld bead is on the average 70% of the strength of the parent material, for the VMD1 alloy this figure is 60%. The strength of the weld spot for sheet of the alloy MA11 as a function of temperature is shown in Table 11.

II-007

TABLE 11  
Mechanical Properties of  
Weld Joints for Spot Weld-  
ing of MA11 Alloy Sheet

| 1 Температу-<br>ра испытания (°C)              | 20  | 200 | 250 | 300 | 350 | 400 |
|--|-----|-----|-----|-----|-----|-----|
| 2 Разрывная<br>нагрузка P при<br>справке (кг)  | 430 | 410 | 400 | 385 | 420 | 380 |
| 3 Разрывная<br>нагрузка P при от-<br>рыве (кг) | 255 | 270 | 290 | 310 | 300 | 325 |

1) Test Temperature; 2)  
shear failure load P (kg);  
3) tensile failure load P  
(kg).

The alloys MA13 and MA21 contain radioactive thorium in their composition therefore, all forms of working must be performed in accordance with special regulations. For application of the high temperature wrought magnesium alloys Magnesium Alloys, Wrought Magnesium Alloys.

References: see article on Wrought Magnesium Alloys.

HIPERCO - see Magnetic Materials with a High Magnetic Saturatio

HOMOGENIZATION OF STEEL - diffusion annealing to improve the macrostructure and equalize the liquation inhomogeneity of steel which was produced upon solidification of the ingot or cast component. Homogenization of steel consists in heating to a high temperature (1000-1250°) and prolonged holding (10-30 hours) which is needed for diffusion equalization of the chemical composition. Shaped steel can also be homogenized. Homogenization improves the plasticity and ductility of steel and in shaped steel it improves the impact ductility, primarily across the fiber direction. It was established that homogenization of ingots (at 1200-1270° for 2 hours) results in reducing the tendency of alloyed structural steels to the formation of welding cracks. Homogenization of finished semifinished products results in an excess increase in the grain size. To remove this disadvantage, homogenization of steel should be followed by normalization of steel or annealing of steel. After homogenization of ingots or rolled blanks which are subsequently subjected to hot shaping, heat treatment should not be used to reduce the grain size, since the grain size will be reduced by the hot shaping. In certain cases homogenization of steel is performed to facilitate hot shaping (primarily the shaping of stainless and heat resistant steel). Due to the high cost of homogenization, it is only used for high-quality alloyed steel utilized for particularly critical components.

Ya.M. Potak

HOMOLOGOUS (corresponding) TEMPERATURE – ratio of a given temperature expressed in degrees Kelvin to the melting temperature of the material expressed in the same degrees. It is expressed in percent or in dimensionless units. The homologous temperature evaluates the degree

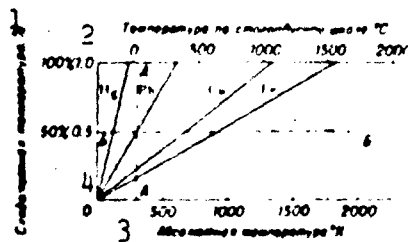

Diagram showing the interrelationship between homologous temperatures in percent or in relative units (along the vertical axis), degrees on the 100 degree centigrade scale (upper horizontal scale) and absolute temperatures (lower horizontal scale) for metals with different melting temperatures. 1) Homologous temperature, %; 2) temperature on the 100 degree scale, °C; 3) absolute temperature, °K; 4) B.

of nearness of the given temperature state of a material to the melting point. Many quantitative laws can be discovered only when they are expressed in terms of the homologous temperature. For example, according to the rule due to A.A. Bochvar, the recrystallization of metals takes place at a constant homologous temperature (0.35). The study and comparison of quantitative laws governing the effect of temperature on the properties of metals with sharply differing melting temperatures is facilitated by the use of the homologous temperature. Thus, comparing at 20° the properties of, for example, lead and iron, these metals are studied at different physical states: lead at 20° is quite close to its melting temperature (its homologous temperature is then about 50%), while the homologous temperature of iron at 20° is only 16.5%. The



III-2011

lead is thus in the region of hot and the iron in the region of cold deformation. It is more correct to compare the properties of these metals at equal homologous temperatures, for example, at 50%, which corresponds to 20° for lead and 630° for iron (figure).

Ya.P. Fridman

HOSE FABRIC — commercial unfinished fabrics which are used in the production of rubber hose; ensure strength and retention of dimension under pressure. Hoses are made from hose fabrics which are produced on ordinary looms and from sheathing made on seamless-weave looms. Rubberized hose fabrics should have the warp and weft of the same strength and with similar elongations.

Hose fabrics are made from cotton, flax, asbestos and chemical fibers; hose fabrics from glass fiber and Khlorin are used for hoses which carry aggressive fluids. The physicomechanical indicators of various hose fabrics are given in Tables 1-4.

TABLE 1  
Physicomechanical Indicators of Cotton Fabrics for Hoses

| 1<br>Наименование<br>ткани | 2<br>Вес 1 м <sup>2</sup><br>(г) | 3<br>Разрывная по-<br>дольная нагрузка<br>50 × 200 мм<br>(кг, не менее) |           | 4<br>Номер пряжи |       | 5<br>Удлинение<br>при разрыве<br>(%) |        | 6<br>Толщина<br>ткани (мм) | 7<br>Ширина<br>ткани<br>(см) |
|----------------------------|----------------------------------|---|-----------|------------------|-------|--------------------------------------|--------|----------------------------|------------------------------|
|                            |                                  | 8<br>основа   | 9<br>уток | основа           | уток  | основа                               | уток   |                            |                              |
| 11 Автомобильная           | 590 ± 30                         | 180   | 190       | 20/6             | 20/6  | 32 ± 3                               | 16 ± 2 | 1.25 ± 0.05                | 103, 188                     |
| 11 Кордовая                | 710 ± 35                         | 215   | 235       | 37/13            | 37/13 | 34 ± 3                               | 15 ± 2 | 1.3 ± 0.05                 | 103, 107                     |
| 12 Ручкавая P-1            | 260 ± 12                         | 80  | 70        | 37/2             | 21/2  | 24 ± 3                               | 12 ± 3 | 0.7 ± 0.05                 | 107                          |
| 12 Ручкавая P-2            | 350 ± 18                         | 94  | 94        | 20/3             | 20/3  | 24 ± 3                               | 14 ± 3 | 0.95 ± 0.05                | 107, 148                     |
| 12 Ручкавая P-3            | 515 ± 25                         | 125   | 140       | 12/3             | 12/3  | 24 ± 3                               | 13 ± 3 | 1.1 ± 0.05                 | 107, 146                     |
| 12 Ручкавая P-4            | 620 ± 30                         | 155   | 175       | 12/4             | 12/4  | 29 ± 3                               | 15 ± 3 | 1.2 ± 0.1                  | 153, 146                     |
| 13 Бреннерная              | 230 ± 12                         | 87  | 87        | 17/4             | 17/4  | 12 ± 4                               | 12 ± 4 | 1.1 ± 0.1                  | 110                          |

1) Fabric designation; 2) weight of 1 m<sup>2</sup> (g); 3) rupture load of a 50 × 200 mm fabric strip (kg, not less than); 4) yarn number; 5) elongation at break (%); 6) fabric thickness (mm); 7) fabric width (cm); 8) warp; 9) weft; 10) automobile pneumatic; 11) pneumatic cord; 12) hose R; 13) breaker.

TABLE 2

Physicomechanical Indicators of Flax Fabrics for Aircraft Rubber Canvass Hose

| Наименование ткани<br>1      | Артикул<br>2 | Ширина ткани (см)<br>3 | Вес 1 м <sup>2</sup> ткани (г)<br>4 | № пряди     |           | Сопротивление разрыву полоски 50 x 200 мм (кг) |           | Вид переплетения<br>7 |
|------------------------------|--------------|------------------------|-------------------------------------|-------------|-----------|--|-----------|-----------------------|
|                              |              |                        |                                     | основа<br>8 | уток<br>9 | основа<br>6                                    | уток<br>6 |                       |
| 10 Полотно из вареной пряжи  | 355          | 90±1                   | 455±30                              | 5           | 5         | 118-12   | 126-13    | 11 Подотканное        |
| 12 Полотно из отварной пряжи | 356          | 106±1.5                | 280±18                              | 11          | 11        | 90-9   | 90-9      | .                     |

1) Fabric designation; 2) type; 3) fabric width (cm); 4) weight of 1 m<sup>2</sup> of fabric (g); 5) yarn No.; 6) tensile strength of a 50 x 200 mm strip (kg); 7) weave type; 8) warp; 9) weft; 10) boiled yarn linen; 11) plain; 12) scoured yarn linen.

TABLE 3

Physicomechanical Indicators of Glass Fabrics Used in Making of Hoses

| Марка          | Толщина ткани (мм)<br>2 | Вес 1 м <sup>2</sup> ткани (г)<br>3 | Сопротивление разрыву полоски 25 x 100 мм (кг, не менее)<br>4 |           | Вид переплетения<br>5 | Ширина ткани (мм)<br>6                                   |
|----------------|-------------------------|-------------------------------------|---|-----------|-----------------------|--|
|                |                         |                                     | основа<br>7   | уток<br>8 |                       |  |
| T <sub>1</sub> | 0.27                    | 285±15                              | 170   | 105       | Гарнитурное           | 800-<br>700±10<br>800, 900:<br>1000;<br>1100;<br>1170±15 |
| T <sub>2</sub> | 0.27                    | 285±15                              | 180   | 85        |                       |  |

1) Brand; 2) fabric thickness (mm); 3) weight of 1 m<sup>2</sup> of fabric (g); 4) tensile strength of a 25 x 100 mm strip (kg, not less than); 5) kind of weave; 6) fabric width (mm); 7) warp; 8) weft; 9) card weave.

TABLE 4

Physicomechanical Indicators of Type 2088 Khlirin Hose Fabrics

| Ширина ткани (см)<br>1 | № пряди<br>2 |           | Толщина (мм)<br>3 | Вес 1 м <sup>2</sup> (г)<br>4 | 5 Сопротивление разрыву полоски 50 x 200 мм (кг, не менее) |           | 6 Вид переплетения |
|------------------------|--------------|-----------|-------------------|-------------------------------|--|-----------|--------------------|
|                        | основа<br>7  | уток<br>8 |                   |                               | основа<br>7  | уток<br>8 |                    |
| 105±2                  | 20/2         | 20/2      | 0.85±0.2          | 350±30                        | 80±5   | 32±5      | 9 Саржевое         |

1) Fabric width; 2) yarn No.; 3) thickness (mm); 4) weight of 1 m<sup>2</sup> (g); 5) tensile strength of a 50 x 200 mm strip (kg, not less than); 6) kind of weave; 7) warp; 8) weft; 9) serge.

For long (up to 7 m) hose with a diameter of 25-125 mm and a high axial load (up to 25 tons) the woven capron or anide sheathing is loomed directly onto the rubber inner tube.

To remove static electricity which is generated during the hose operation several strands of 34, 5/6/3 cord threads in the sheathing warp are replaced by several threads of the 34, 5/6/2 + 1 copper strands (Table 5).

TABLE 5

Physicomechanical Indicators of Cord Ropes from Polyamide Fibers

| Структура шнура<br>1                     | Толщина<br>(мм)<br>2 | Средне-<br>ная разрыв<br>нагрузка<br>(кг)<br>3 | Удлинение<br>при разрыве<br>(%)<br>4 |
|--|----------------------|--|--------------------------------------|
| 34,5 16/3                                | 1,4 ± 0,1            | 70   | 14                                   |
| 34,5 16/1                                | 1,9 ± 0,1            | 135  | 10/20                                |
| 34,5 16/2 + 1 мед-<br>ная проволока<br>5 | 1,3 ± 0,1            | 45   | 18                                   |

1) Rope structure; 2) thickness (mm); 3) tensile strength (kg); 4) elongation for the given strength (%); 5) copper strand.

All the cotton hose fabrics are made by plain weave.

Breaker fabric has a moderate density, due to which, when it is processed, the rubber penetrates freely cells which are formed by mutually perpendicular threads of the fiber, thus interlinking the rubber layers. Breaker fabric imparts to the hose a high transverse stiffness and is used extensively in making boring, steam pipeline and certain other kinds of rubberized hoses. In assembling the hoses the rubberized breaker fabric is placed either between the inner tube and the first lining or inside the layer of the external rubber sheathing of the hose.

Sheathing for fire hoses from cotton, flax and chemical fiber yarn are made on seamless weave looms (TKP-125) as well as on standard plane looms.

**HOT HARDNESS** - hardness which is determined at elevated temperatures by the indentation method. Hardness at temperatures up to 500° is measured by using ordinary steel balls, while at higher temperatures (up to 900°) use is made of Pobedit balls which are subjected to special casehardening. The hardness which is determined at elevated temperatures by short duration (of the order of 30 seconds) indenting and the ultimate strength at the same temperatures are related, and the character of their changes as a function of the chemical composition, processing regimes, etc., is similar. The creep hardness method suggested by A. Bochvar gives a comparative estimate of the heat resistance of various materials, primarily light alloys. The creep hardness is usually determined after indenting for an hour, when, as is shown by experience, the rate of hardness reduction becomes practically constant. Numerous experiments have confirmed the fact that a satisfactory relationship exists between the creep hardness and creep strength characteristics.

References: Bochvar, A.A., "IAN SSSR OTN," No. 10, page 1369, 1947; Ob ispytanii na dlitel'nuyu tverdnost' [On Creep Hardness Testing], "ZL," Vol. 16, No. 1, page 78, 1950; Mirkin, I.L., and Livshits, D.E., *ibid*, Vol. 15, No. 9, page 1080, 1949.

N.V. Kadobnova

II-19k

HOT SHORTNESS OF STEEL is steel brittleness which appears at a relatively high temperature in the process of forging, hot rolling and other forms of plastic deformation. The brittle fractures associated with hot shortness of steel are explained either by the weakening of the grain boundaries with increase of the temperature or by the presence in the steel of a quite large quantity of a second phase which differs markedly in resistance to plastic deformation from the basic structure. In the carbon and alloyed constructional steel, the hot shortness is primarily due to the high sulfur content or high content of other low-melting impurities (copper and lead, for example). In the alloyed stainless steel with high chromium content, hot shortness is indicated by the appearance of the delta-ferrite structure at the deformation temperature. Reduction of the hot shortness along with the elimination of its causes can be achieved in many cases by lowering the hot deformation temperature.

For technically pure iron the hot shortness temperature is in the 850-1150° range, therefore hot deformation should be initiated at 850° or carried out at 1250-1300°, interrupting the working as the iron cools through the 850-1150° range. The detrimental effect of sulfur on the hot shortness of steel is explained by the formation of low-melting eutectics. To reduce the effect of sulfur, manganese is introduced into the composition of the perlitic steel, and molybdenum into the composition of the austenitic steel. Also effective are aluminum, titanium, zirconium, calcium, magnesium and the rare elements which aid in the formation of high-melting sulfides which are arranged in the steel

II-19kl

structure in the form of chains or individual inclusions. We must keep in mind that the low-melting sulfides, as a rule, are arranged along the grain boundaries, thus causing hot shortness of the steel.

References: Mes'kin V.S., Osnovy legirovaniya stali [Fundamental of Steel Alloying], M., 1959.

Ya.M. Pot

HUGENBERGER'S TENSOMETER - is a lever device for the measurement of linear deformations of specimens and constructions. Hugenberger's tensometer (Fig.) is pressed with the two knife edges against the surface of the specimen by means of a screw clamp. The one knife edge is immobile, the other, due to the deformation moves around the axis by



Diagram of Hugenberger's tensometer.

means of a hinge-joint; the deviation of the arrow on the scale permits one to judge the magnitude of the deformation. The distance between the two knife edges (the basis of the device) is usually equal to 20 mm, certain models are made with distances from 10 to 1000 mm. The magnification factor of the device is about 1000.

References: Avdeyev, B.A., *Tekhnika opredeleniya mekhanicheskikh svoystv materialov* [The Techniques for the Determination of Mechanical Properties of Materials], 3rd Edition, Moscow, 1958.

N.V. Kadobnov



I-22G

HYDROBIOTITE - see Vermiculite.

HYDROGEN EMBRITTLEMENT OF STEEL - brittleness which appears as a result saturation of steel by hydrogen. It occurs most frequently on electroplating or etching of steel, can also appear when steel is held at a high temperature and pressure in a gaseous hydrogen medium. In the process of electroplating the positively charged hydrogen ions are adsorbed on the component; the largest part of the hydrogen escapes to the atmosphere, while a certain part of it diffuses into the metal, giving rise to the hydrogen embrittlement. Two hypotheses exist which interpret the hydrogen embrittlement of steel. According to the first, hydrogen embrittlement of steel is a result of penetration of atomic hydrogen into individual voids, pores or other defects of the crystal lattice and its transformation into a molecular gas which creates a tremendous pressure. According to the second hypothesis hydrogen embrittlement of steel is due to adsorption of atomic hydrogen at surfaces of the component and internal voids, pores and other metal discontinuities, with the result that the surface energy of the steel decreases, which reduces its resistance to embrittlement failure. Hydrogen embrittlement of steel demonstrates itself in reducing its plasticity and when extensively developed it is demonstrated in loss of strength; the hardness and physical properties practically do not change here. In many cases hydrogen embrittlement of steel results, under repeated loading, in reducing the number of loading cycles which the steel can withstand before failure, in certain cases the endurance limit is reduced, the strength of high-carbon hardened steel is decreased. Hydrogen embrittlement of steel usually demonstrates itself

I-34v1

most fully at room temperature and at a relatively low rate of load application. Under a higher rate of loading (impact loads) or at very low temperatures ( $-183^{\circ}$  and lower) hydrogen embrittlement of steel demonstrates itself only in the case of extensive hydrogenation, and also in retarded failure of steel components (for example, bolts). In this case failure ensues some time after the application of a constant static load which is considerably smaller than the ultimate strength. Hydrogen embrittlement of steel is most dangerous for components with sharp notches, small radii of cross-sectional transition, and other stress raisers and also for vessels operating under a high internal pressure. The sensitivity of steel to hydrogen embrittlement increases as the ultimate strength increases. In order to avoid the harmful effects of hydrogen embrittlement it is not recommended to subject high-strength ( $\sigma_b \geq 130-140 \text{ kg/mm}^2$ ) and highly hard steel to any electroplating with the exception of chrome plating (see High-strength Structural Steel). Different metallurgical heats of the same steel brand have different hydrogen embrittlement sensitivities. Most appreciable hydrogen embrittlement of steel arises on cyanide zinc galvanization, it is less significant in acidic galvanization, copper and cadmium plating. To reduce hydrogen embrittlement of steel after electroplating the components are heated at  $180-200^{\circ}$  for two hours and in certain cases for 24 hours. Electroplating interferes to a substantial extent with dehydrogenation. Hydrogen removal is most substantially retarded by the zinc and to a lesser extent by the cadmium layer. For components with an ultimate limit less than  $130 \text{ kg/mm}^2$  dehydrogenation eliminates the hydrogen embrittlement and restores, as a rule, the initial mechanical properties; high-strength steel in certain cases does not recover fully its mechanical properties even after dehydrogenation. Cracks which are not eliminated by subsequent dehydrogenation can form in the process of electro-

I-34v2

plating of components with stresses (internal or due to an external load). Sometimes these cracks arise in electroplating of components which have impressions, dents and other local defects, which are made in the steel in the hardened state. Formation of cracks attendant to electroplating of highly-hardened wire as a result of the action of hydrogen on the stressed steel is also observed. Hydrogen embrittlement appears on both low-alloy and high-alloy heat-hardened perlitic and martensitic steels, including stainless steels. Austenitic steel is almost unaffected by hydrogen embrittlement, which is due to a certain extent to the weak diffusion of hydrogen through the austenitic structure. Substantial hydrogen embrittlement, which is called hydrogen corrosion arises in carbon and alloyed steel when they are held at temperatures above 300-400° in a hydrogen atmosphere under pressures of the order of hundreds of atmospheres; hydrogen embrittlement of steel was discovered at room temperature when the hydrogen pressure was 9000 atmospheres. Hydrogen corrosion is produced by the penetration of atomic hydrogen to the grain boundaries, decomposition of carbides and decarburization. Steels containing a substantial quantity of chrome, molybdenum, tungsten and other elements which form stable carbides resist this kind of hydrogen embrittlement.

References: Mes'kin, V.S., Osnovy legirovaniya stali [Fundamentals of Steel Alloying], Moscow, 1959; Potak, YaM., Khrupkiye razrusheniya stali i stal'nykh detaley [Brittle Failure of Steel and Steel Components], Moscow, 1959; Moroz, L.S. and Mingin, T.E., O mekhanizme vodorodnoi khrupkosti stali [Concerning the Mechanism of Hydrogen Embrittlement of Steel], in the book: Metallovedeniye [Metal Science], collection 3, [Leningrad], 1959.

Ya.M. Potak

HYDROGEN EMBRITTLEMENT OF TITANIUM ALLOYS - reduction in rupture strength and plasticity of material subjected to mechanical effects as a result of the precipitation of the titanium hydride or microsegregation of hydrogen in defective spots of the crystal lattice. In titanium and its alloys it is possible to have two kinds of hydrogen embrittlement, the character of manifestation of which is determined by the deformation rate. Both kinds are peculiar of both  $\alpha$ - and ( $\alpha + \beta$ ) titanium alloys. Depending on specific conditions, one or the other variety of brittleness can predominate.

Hydrogen embrittlement of titanium alloys of the 1st kind arises in the case when the hydrogen content is higher than the limiting solubility and the metal's structure contains particles of titanium hydride. These particles can be regarded as notches of a kind which produce local stress concentrations and softening of titanium alloys. The harmful effect of the hydrides is amplified by the local tensile stresses in the close-lying section of the metal which are produced attendant to the precipitation of the former due to the large specific volume of the hydridic phase. The most probable point of initiation and development of cracks is the interface between the titanium hydride particles and the metallic base. This is attested to by the color difference in the surface of failure which is light in the absence and dark in the presence of titanium hydrides in the structure. All the factors which interfere with shaping (reduction in temperature, increasing the rate of shaping deformation, notching) amplify hydrogen embrittlement of titanium alloys of the 1st kind.

I-35v1

Hydrogen embrittlement of titanium alloys of the 2nd kind arises when the hydrogen content is below the limiting solubility; here the quantity of hydrogen which brings it about is the smaller, the slower the shaping deformation or the longer the metal is held in the stress state. The causes and the mechanism of hydrogen embrittlement of titanium alloys of the 2nd kind are not as yet entirely clear, but it can be claimed that they are based on diffusion processes, which produce a substantial microsegregation of hydrogen at specific spots of the crystalline structure, which is accompanied by an increase in brittleness. All the factors which promote the diffusion of hydrogen (raising of the temperature within known limits, distortion of the crystal lattice, plastic deformation, etc.) amplify the embrittlement of the metal. Deformation aging, formation of the so-called Cottrell atmospheres and absorption hypotheses have been put forward as an explanation of the mechanism of hydrogen embrittlement of titanium alloys of the 2nd kind. According to the deformation aging hypothesis, when a material is held in a stressed state or is deformed at a sufficiently low rate (such as provides sufficient time for diffusion of hydrogen which is needed for the formation of titanium hydride) very fine hydridic precipitates, which produce embrittlement, are formed in the structure. The formation of Cottrell atmospheres results in embrittlement as a result of increasing the resistance to the displacement of dislocations. In accordance with the last hypothesis, a layer of hydrogen atoms, being adsorbed at the surface of the defective spots in the crystalline structure, reduces the magnitude of the surface energy and thus promotes the opening and enlargement of cracks.

Hydrogen absorption by titanium alloys can take place both at a high temperature (at any stage of fabrication and processing) and also at room temperature (during etching, corrosion, chemical and electric

1-35V2

treatment). Hydrogen can be absorbed also attendant to the use of titanium products, particularly when subjected to aggressive media, high temperatures and pressures.

Titanium is a good absorber of hydrogen starting with room temperature. As the hydrogen pressure increases, the quantity of atoms which are adsorbed increases. Titanium belongs to a group of metals which actively absorb large amounts of hydrogen. One gram of titanium can absorb up to 0.4 liters of hydrogen. As the temperature is increased, the quantity of hydrogen which is occluded is reduced. The rate of hydrogen absorption by titanium increases as the temperature and the partial pressure of hydrogen are increased. It also depends on the chemical

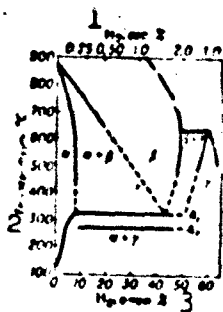

Fig. 1. Constitutional diagram of the Ti-H system.  
1) H<sub>2</sub>, % by weight;  
2) temperature, °C;  
3) H<sub>2</sub>, atomic %.

composition and microstructure of the alloys and is highly reduced at the surface of an oxidized layer. The limiting solubility of hydrogen in  $\alpha$ -titanium is substantially lower than in  $\beta$ -titanium (Fig. 1). As the temperature is raised to 300° the limiting solubility of hydrogen in the  $\alpha$  phase of titanium increases. Alloying of titanium is accompanied by changes in the limiting solubility. If the hydrogen content is higher than the limiting content,

then in the  $\alpha$ -phase at temperatures below 300° a titanium hydride ( $\gamma$ -phase) is precipitated, the latter having a face-centered cubic lattice with a period which varies from 4.395 to 4.450 Å as the quantity of hydrogen in the homogeneous region of the  $\gamma$  phase is increased from 48 atomic %, to the limiting amount of 63.3 atomic %. The density of the titanium hydride (3.84 g/cm<sup>3</sup>) is by 15% lower than the density of pure titanium. Depending on the specific conditions, hydridic precipitations may situate themselves along the planes of slip or twinning, the inter-

I-35v3

faces of the  $\alpha$  and  $\beta$  phases, along the boundaries of grains (Fig. 2a and b).

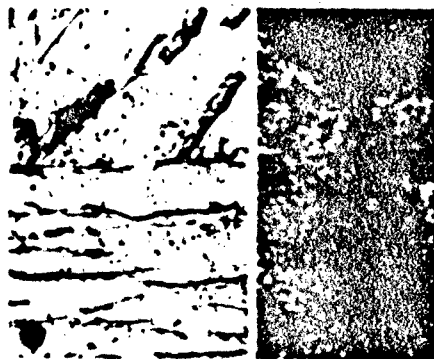

Fig. 2. Character of the precipitation of the hydridic phase of titanium. a) Titanium alloyed with 3% of Fe (slow cooling from 700° after thermal diffusion saturation with hydrogen up to 0.03%); b) titanium alloyed with 5% Fe (hardening from 700°, aging at 300° for 100 hours, hydrogen content 0.03%). Magnification factor 400.

The hydrogen has no significant effect on changes in the parameters of the crystal lattice, electric resistance and magnetic properties of titanium. Up to a known "critical" level (Table 1) which depends on the test conditions, chemical composition and structure of the alloy, hydrogen has no substantial effect even on the mechanical properties. Above

TABLE 1

Highest Hydrogen Content.  
(at Which it Practically  
Does Not Effect the Pro-  
perties) in Titanium and  
its Alloys Under Differ-  
ent Test Conditions

| 1             | 2 Условия испытания |                                       |       |                   |
|---------------|---------------------|---------------------------------------|-------|-------------------|
|               | Удар 3              | Растяжение<br>до скорости<br>4 мм/мин |       | Длит.<br>напряж 5 |
|               |                     | 6                                     |       |                   |
| Сплав 7       | от -196°<br>до +20° | +20°                                  | -40°  | +20°              |
|               | 8 Содержание H, (%) |                                       |       |                   |
| BT1-1         | 0.003               | 0.030                                 | 0.015 | 0.030             |
| BT1-2         | 0.005               | —                                     | —     | 0.003             |
| TiAl3         | 0.010               | 0.030                                 | 0.010 | —                 |
| BT3           | 0.020               | 0.020                                 | 0.015 | 0.003             |
| BT3-1         | 0.030               | 0.030                                 | 0.020 | 0.003             |
| TiAl3 Sn11    | 0.030               | 0.030                                 | 0.020 | 0.003             |
| TiAl4 Sn8 Cu2 | 0.040               | 0.030                                 | —     | 0.003             |
| OT4           | 0.010               | 0.030                                 | 0.010 | 0.003             |
| BT4, BT14     | —                   | —                                     | —     | 0.010             |
| BT6           | —                   | —                                     | —     | 0.030             |

1) Alloy; 2) test conditions;  
3) impact; 4) elongation at



I-35v4

the rate of 1 mm/min; 5)  
prolonged flexure; 6) from;  
7) to; 8) H<sub>2</sub> content, %.

this level, as the hydrogen content is increased, a lowering of mechanical properties ( $S_k$ ,  $\delta$ ,  $\psi$ ,  $a_H$ ) is observed up to transition of the metal to the brittle state. When titanium hydride is present in the structure (hydrogen embrittlement of the titanium alloys of the 1st kind) the hydrogen has the strongest effect on impact ductility (Fig. 3). In the absence of hydridic precipitations (hydrogen embrittlement of titanium alloys of the 2nd kind) the effect of hydrogen is most clearly manifested in changes of plasticity when testing at a slow rate and in the metal's resistance to retarded failure. The character of plasticity change is shown schematically in Fig. 4., in which is seen that, as the hydrogen content is increased in a known temperature region (from  $-100^\circ$  to  $+100^\circ$ ) the drop in plasticity is amplified (curves 1, 2, 3 and 4 in Fig. 4). Curves of changes in plasticity in the presence of the hydridic phase in the metal (curves 5, 6, 7, and 8 in Fig. 4) are shown for comparison; in the latter case, the higher the hydrogen content, the higher the critical embrittlement. The rupture strength of titanium alloys creep strength, resistance to the formation of cold cracks, etc.) decreases substantially if their hydrogen content is increased above the critical value. Hydrogen in amounts of up to 0.1% and more does not produce substantial changes in the hardness, ultimate strength (attendant to plastic failure) and the yield point of titanium alloys (Table 2).

Titanium alloys with below-critical hydrogen content can be obtained by production process operations which ensure minimum hydrogenation of material in its fabrication and processing, and by strict control of the execution of these operations. In those cases when the hydrogen content of the metal exceeds the allowable percentage use must be made of vacuum annealing. Degassing annealing is more expedient for

I-35v5

semifinished products and component blanks. Here the oxide layer must be removed from their surface. The annealing regime is as follows.

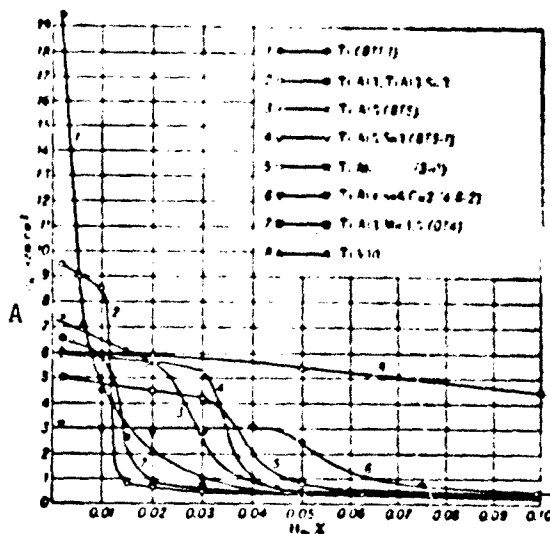

Fig. 3. Change in the impact ductility of titanium alloys at 20° as a function of the hydrogen content. A)  $a_H$ ,  $\text{kgm/cm}^2$ .

heating to 700-800°, holding for 4-2 hours, the vacuum not less than  $1 \cdot 10^{-3}$  mm of Hg, cooling in the vacuum. For more complete removal of hydrogen from the metal, the holding time should be increased to 10-6



Fig. 4. Effect of the hydrogen content and test temperature on the plasticity of titanium alloys. The dashed line shows the plasticity level of a metal which contains less than 0.002% of  $\text{H}_2$ ; the numbers denote curves which characterize the change in the plasticity of the metal at a higher, arbitrarily specified hydrogen content, which increases gradually from 1 to 8. A) Plasticity; 2) temperature, °C.

hours, and the vacuum should be increased to  $1 \cdot 10^{-4}$ - $1 \cdot 10^{-5}$  mm of Hg.

The degassing rate depends on many factors and, primarily, on the temperature, degree of vacuum, the hydrogen content of the metal, state of the surface of specimens, chemical composition, etc. Degassing is highly retarded at temperatures below 650° and also in the presence of an oxide layer or surface coatings. The following methods of analysis are

I-35v6

used to determine the hydrogen content of titanium alloys: melting under a vacuum, heating under a vacuum, spectral, spectral-isotopic and gravimetric.

TABLE 2

Effect of Hydrogen on the Mechanical Properties of Titanium Alloys at 20°

| Alloy    | Concentration of hydrogen (%)    |                                  |                                      |              |                                |                                  |                                  |                                      |              |                                |                                  |                                  |                                      |              |                                |                                  |                                  |                                      |              |                                |  |
|----------|----------------------------------|----------------------------------|--------------------------------------|--------------|--------------------------------|----------------------------------|----------------------------------|--------------------------------------|--------------|--------------------------------|----------------------------------|----------------------------------|--------------------------------------|--------------|--------------------------------|----------------------------------|----------------------------------|--------------------------------------|--------------|--------------------------------|--|
|          | 0.002                            |                                  | 0.015                                |              | 0.050                          |                                  | 0.002                            |                                      | 0.015        |                                | 0.050                            |                                  | 0.002                                |              | 0.015                          |                                  | 0.050                            |                                      |              |                                |  |
|          | $\sigma_c$ (kg/mm <sup>2</sup> ) | $\sigma_b$ (kg/mm <sup>2</sup> ) | $\sigma_{0.2}$ (kg/mm <sup>2</sup> ) | $\delta$ (%) | $H_{10}$ (kg/mm <sup>2</sup> ) | $\sigma_c$ (kg/mm <sup>2</sup> ) | $\sigma_b$ (kg/mm <sup>2</sup> ) | $\sigma_{0.2}$ (kg/mm <sup>2</sup> ) | $\delta$ (%) | $H_{10}$ (kg/mm <sup>2</sup> ) | $\sigma_c$ (kg/mm <sup>2</sup> ) | $\sigma_b$ (kg/mm <sup>2</sup> ) | $\sigma_{0.2}$ (kg/mm <sup>2</sup> ) | $\delta$ (%) | $H_{10}$ (kg/mm <sup>2</sup> ) | $\sigma_c$ (kg/mm <sup>2</sup> ) | $\sigma_b$ (kg/mm <sup>2</sup> ) | $\sigma_{0.2}$ (kg/mm <sup>2</sup> ) | $\delta$ (%) | $H_{10}$ (kg/mm <sup>2</sup> ) |  |
| BTI-1    | 102                              | 85                               | 83                                   | 43           | 44                             | 45                               | 36                               | 36                                   | 38           | 34                             | 71                               | 24                               | 158                                  | 140          | 143                            |                                  |                                  |                                      |              |                                |  |
| TIA18    | 94                               | 93                               | 75                                   | 45           | 67                             | 69                               | 59                               | 43                                   | 61           | 21                             | 7                                | 5                                | 218                                  | 218          | 229                            |                                  |                                  |                                      |              |                                |  |
| OT4      | 112                              | 115                              | 92                                   | 80           | 86                             | 83                               | 71                               | 79                                   | 75           | 16                             | 4                                | 7                                | 255                                  | 26           | 262                            |                                  |                                  |                                      |              |                                |  |
| BT8      | 105                              | 108                              | 89                                   | 80           | 83                             | 82                               | 75                               | 78                                   | 77           | 16                             | 18                               | 6                                | 262                                  | 262          | 269                            |                                  |                                  |                                      |              |                                |  |
| BT8-1    | 115                              | 113                              | 100                                  | 89           | 93                             | 91                               | 87                               | 84                                   | 85           | 18                             | 19                               | 9                                | 265                                  | 262          | 269                            |                                  |                                  |                                      |              |                                |  |
| TIA18S11 | 124                              | 124                              | 108                                  | 91           | 93                             | 93                               | 87                               | 87                                   | 88           | 18                             | 18                               | 9                                | 269                                  | 263          | 277                            |                                  |                                  |                                      |              |                                |  |

1) Alloy; 2) hydrogen content, %; 3) (kg/mm<sup>2</sup>).

References: MacQuillen, A.D. and MacQuillen, M.K., Titanium, translated from English, Moscow, 1958; Galaktionova, N.A., Vodorod v metalakh [Hydrogen in Metals], Moscow, 1959; Titan i yego splavy [Titanium and its Alloys], Vol. 1, edited by L.S. Moroz, Leningrad, 1960; Livano V.A., Bukhanova, A.A. and Kolachev, B.A., Vodorod v titane [Hydrogen in Titanium], Moscow, 1962.

B.S. Krylov, M.A. Nikanorov

HYDRONALIUM - an obsolete name (in Germany) of an aluminum-magnesium alloy (see Magnalium) and of an aluminum-zinc alloy (see High-Strength Aluminum Shaping Alloys).

References: Fridlyander, I.N., *Vysokoprochnyye deformiruyemye aluminievyye splavy* [High-Strength Aluminum Shaping Alloys]. Moscow 1960.

O.S. Bochvar, K.S. Pokhoda;

HYDROPHILY OF FIBERS - the ability of fibers to absorb water. Hydrophily of fibers affects the chemical, physical and mechanical properties of fibers, for example, when the moisture content of cellulose hydrate fiber changes from 1-2% to 15-18%, the fiber strength is reduced by 30-40%, and the elongation is increased by a factor of 1.5-2. The hydrophily of fibers is determined in a chamber with a constant temperature (20°) and relative humidity (65%). The specimen is held for about 24 hours and the hydrophily of fibers is determined by the difference in weight of the held material which is dried at 100±5° referred to the weight of the dry material. The hydrophily of fibers is determined more precisely by the isotherm of water sorption by the fiber. The hydrophily of fibers can be varied by treating by various compounds (for example, surface-active substances).

V.A. Berestne

I-27G

HYDROPHLOGOPITE - see Vermiculite.

I-290

HYDROPHOBY OF FIBERS - inability of fibers to sorb water.

I-25G

HYDROPLASTICS - see Polyvinyl Chloride Plastics.



HYDROTUBRINE STAINLESS STEEL is steel with improved resistance to corrosion, cavitation and the abrasive action of solid particles suspended in the water, and is used for parts of the flow portions of hydroturbines. The hydroturbine stainless steel also has good plasticity and polishing properties.

Most widely used are the chrome, chrome-nickel, and chrome-nickel-manganese stainless hydroturbine steels. The chrome-nickel stainless steel is also used as a protective coating applied over less expensive carbon steel to protect parts from cavitation and corrosive destruction by the water. The protective coating is applied using the electrometallic atomization method or the electro-arc weld-plating method, and also by the method of facing the part with thin sheets or lamina of stainless steel. The last method does not cause internal stresses, therefore there is no deformation of the parts and the production process is accelerated. These advantages are particularly marked in the facing of large surfaces, for example the blades of large radial-axial and axial hydroturbines. The following grades of stainless steels are used most frequently in hydroturbine construction (for chemical composition and physico-mechanical properties see Table 1 and 2).

OKh13 (EI496) steel is produced in the form of thin and thick sheet. Hot working is performed in the 1150-900° range, and weldability is satisfactory. Wire of the same steel with a coating of ENTU-3 is used as filler material; in this case the seam has properties close to the parent metal.

Prior to welding, the sheet edges must be heated to 200-300°.

TABLE 1

Chemical Composition of Stainless Steels for Hydro-turbine Construction

| Марка стали 1                           | 2 Элементы (%) |             |       |               |             |                                 | Др. элементы 3 | S      | P      |
|---|----------------|-------------|-------|---------------|-------------|---------------------------------|----------------|--------|--------|
|   | C              | Si          | Mn    | Cr            | Ni          |                                 |                |        |        |
| 4<br>0X13 (ЭИ496)<br>(ГОСТ 5632-61)     | <0.08          | <0.8        | <0.8  | 11-13         | -           | -                               | -              | <0.025 | <0.03  |
| 5<br>2X13 (ЭИ2)<br>(ГОСТ 5632-61)       | 0.10-<br>0.24  | <0.8        | <0.8  | 12-14         | -           | -                               | -              | <0.025 | <0.03  |
| 6<br>2X13L<br>(ГОСТ 2176-57)            | 0.10-<br>0.24  | <0.7        | <0.8  | 12-14         | <0.8        | -                               | -              | <0.03  | <0.028 |
| 7<br>20X13NL<br>(ТУ621-52НKM3)          | 0.17-<br>0.23  | <0.7        | <0.8  | 12-14         | 0.8-1       | -                               | -              | <0.03  | <0.035 |
| 8<br>1X18N9TL<br>(ГОСТ 2176-57)         | <0.14          | <1          | 1-2   | 17-20         | 8-11        | Ti (%C=0.03)5, но не более 0.8% | -              | <0.03  | <0.028 |
| 10<br>1X21N5T (ЭИ811)<br>(ГОСТ 5632-61) | 0.09-<br>0.14  | <0.8        | <0.8  | 20-22         | 4.8-<br>5.8 | Ti (%C=0.02)5, но не более 0.8% | -              | <0.035 | <0.035 |
| 11<br>1X20N3G3D2L<br>(ЦНИИТМАШ)         | <0.1           | 0.3-<br>0.5 | 2.5-3 | 18.5-<br>20.5 | 3-3.5       | См 1.9-2.3                      | -              | <0.03  | <0.03  |

1) Steel grade; 2) elements (%); 3) other elements; 4) 0Kh13 (EI496) (GOST 5632-61); 5) 2Kh13 (Zh2) (GOST 5632-61); 6) 2Kh13L (GOST 2176-57); 7) 20Kh13NL (TU621-52NKM3); 8) Kh18N9TL (GOST 2176-57); 9) but no more than; 10) 1Kh21N5T (EI811) (GOST 5632-61); 11) 1Kh20N3G3D2L (Central Scientific Research Institute for Technology and Machine Design).

After welding the parts are heat treated using the following regime: heat to 950-1000°, air cool and subsequent temper at 680-720°. In those cases when this regime cannot be followed, the weld joint alone must be subjected to short-term tempering. Applications are: welded spiral chambers (scrolls), facing (jacketing), cowling.

2Kh13 (Zh2) steel is produced in the form of thin and thick sheet, rod, wire. In the annealed condition this steel has high plasticity and may be welded (with preheating). High tempering or annealing must be performed after welding. This steel is subject to temper brittleness; to obtain high impact strength the tempering after quenching must be accompanied by accelerated cooling. The highest corrosion resistance is achieved after quenching with high tempering and polishing. Applications are: detail parts operating under conditions of water corrosion, cavitation, and erosion (bolts, screws, nuts, shafts, sleeves).

The 2Kh13L and 20Kh13NL steels are produced in the form of shaped castings. The casting properties are satisfactory, though a tendency to

TABLE 2

Physical and Mechanical Properties of Stainless Steels for Hydroturbine Construction

| Марка, сорт, лист                                    | Режим термич. обработки   | σ <sub>0.2</sub> (кг/мм <sup>2</sup> ) (%) |     |      |    | λ        | R <sub>m</sub> (кг/мм <sup>2</sup> ) | K <sub>IC</sub> (кг/мм <sup>3/2</sup> ) | α (1/°C)       |
|--|---|--|-----|------|----|----------|--------------------------------------|---|----------------|
|  |   | 6  | 7   | 8    | 9  |          |                                      |   |                |
| 8 OKh13 (EI496)<br>Тонкий лист (ЧМТУ 2117-49)        | 9<br>Отжиг при 740-780°, охлаждение на воздухе или в печи   | 40   | 20  | 20   | 20 | 24,5     | 21000                                | 0,07                                    | 10,5 (20-100°) |
| 10 Тонкий лист (ЧМТУ/ЦНИИЧМ 225-59)                  | 10<br>Отжиг при 740-780°, охлаждение на воздухе или в печи  | 6,5  | 7,5 | 24,5 | 12 | RC-20-39 |                                      |   |                |
| 13 2Xh13 (EZh2)<br>Роды (ГОСТ 5949-61)               | 11<br>Закалка с 1000-1050° в масле или воде, отпуск при 680-770° с охлаждением в масле, в воде или на воздухе | 60   | 45  | 18   | 55 | 8        | 21000                                | 0,05                                    | 10,1 (20-100°) |
| 15 2Xh13L (ГОСТ 2176-57)                             | 14<br>Отжиг при 950°, закалка с 1050° в масле, отпуск при 750°, охлаждение на воздухе                         | 63   | 43  | 16   | 40 | 6        |                                      |   |                |
| 17 20Xh13NL (ТУ 621-52НKM3)                          | 16<br>Термически обработанные отливки   | 55   | 30  | 14   | 30 | 3        | 120-235                              |   |                |
| 19 Xh18N9T (EYalt)                                   | 18<br>Температура 1050-1100°, охлаждение на воздухе, в масле или в воде                                       | 55   | 20  | 40   | 55 |          | 20300                                | 0,039                                   | 16,6           |
| 20 ГОСТ 5949-61                                      | 21  |  |     |      |    |          |                                      |   |                |
| 22 Тонкий лист (ГОСТ 7350-55)                        | 22<br>Закалка с 1080-1120°, охлаждение в воде   | 55   | 38  |      |    |          |                                      |   |                |
| 24 Тонкий лист (ГОСТ 5582-50)                        | 23<br>Закалка с 1050-1120°, охлаждение в воде или на воздухе  | 54   | 40  |      |    |          |                                      |   |                |
| 26 Xh18N9TL (ГОСТ 2176-57)                           | 25<br>Закалка с 1100°, охлаждение в воде  | 45   | 20  | 25   | 32 | 10       |                                      | 0,039                                   | 14,8 (20-100°) |
| 28 (ТУ 255-52) (Невский завод им. Ленина, Ленинград) | 27<br>Термически обработанные отливки   | 35   | 18  | 20   | 25 | 4        |                                      |   |                |
| 30 Xh21N13T (EYalt)                                  | 29  |  |     |      |    |          |                                      |   |                |
| 31 Тонкий лист (ЧМТУ/ЦНИИЧМ 220-60)                  | 30<br>Закалка с 1050°, охлаждение в воде или на воздухе   | 70   | 45  | 18   | 6  | 6        |                                      |   |                |
| 33 Тонкий лист (ЧМТУ/ЦНИИЧМ 62-58)                   | 31<br>Закалка с 1050°, охлаждение в воде  | 70   | 45  | 25   | 6  | 6        |                                      |   |                |
| 35 Сортовая сталь (ГОСТ 5949-61)                     | 32<br>Закалка с 950-1050°, охлаждение на воздухе  | 60   | 35  | 20   | 6  | 6        |                                      |   |                |
| 37 1X20H13Г3Д2                                       | 33<br>Отжиг при 880-920°, нормализация с 1080-1120° и отпуск при 980-820°                                     | 55   | 30  |      | 2  | 2        | 210-250                              |   |                |

1) Grades, forms; 2) heat treatment regime; 3) (kg/mm<sup>2</sup>); 4) (a<sub>n</sub>, kgm/cm<sup>2</sup>); 5) λ (cal/cm/sec-°C); 6) no less than; 7) OKh13 (EI496); 8) thin sheet (ChMTU 2117-49); 9) anneal at 740-780°, air or furnace cool; 10) thick sheet (ChMTU/TsNIICHM 225-59); 11) high temper at 680-780°, air or furnace cool; 12) RC = 20 - 39 depending on the tempering temperature in the range 680-500°; 13) 2Kh13 (EZh2) rods (GOST 5949-61); 14) oil or water quench from 1000-1050°, temper at 660-770° with oil, water or air cooling; 15) 2Kh13L (GOST 2176-57); 16) anneal at 950°, oil quench from 1050°, temper at 750°, air cool; 17) 20Kh13NL (TU 621-52NKM3); 18) heat treated castings; 19) Kh18N9T (EYalt); 20) rods (GOST 5949-61); 21) air, oil, or water quench from 1050-1100°; 22) thick sheet (GOST 7350-55); 23) water quench from 1080-1120°; 24) thin sheet (GOST 5582-50); 25) water or air quench from 1050-1120°; 26) Kh18N9TL (GOST 2176-57); 27) water quench from 1100°; 28) (TU 255-52) (Lenin Neva Plant,

## II-30N3

Leningrad); 29) heat treated casting; 30) 1Kh21N5T (EI811); 31) thin sheet (ChMTU/TsNIICHM 290-60); 32) water or air quench from 1050°; 33) thick sheet (ChMTU/TsNIICHM); 34) water quench from 950-1050°; 35) section steel (GOST 5949-61) 36) air quench from 950-1050°; 37) 1Kh20N3G3D2L; 38) anneal at 880-920°, normalize from 1080-1120°, and temper at 980-820.

formation of hot cracks during casting is observed. Welding is difficult, since the steel is prone to local hardening and the formation of cracks in the heat affected zone; this limits the use of electric welding to correction of casting defects prior to their final heat treatment. Applications are: impellers and other cast parts of the flow sections of radial-axial and axial turbines which are subject to simultaneous action of both cavitation and erosion; wheels of bucket turbines for high pressures; wheels of bucket turbines subject to corrosive action.

The Kh18N9T (EYalt) steel is produced in the form of thin and thick sheet, rod and tubing (see Austenitic Stainless Steel). Applications are: welded designs of protective and sealing rings, protective jacketing for turbine covers and bases, facings for impellers of axial and radial-axial turbines, facings for shaft journals in locations operating in stuffing boxes and rubber bearings.

The Kh18N9TL steel is produced in the form of shaped castings. The casting properties are good and it welds well in the cold condition. Applications: impellers and other cast parts of the flow sections of radial-axial, axial and bucket turbines which are subject to cavitation, erosion and corrosion.

The 1Kh21N5T (EI811) steel is produced in the form of thin and thick sheet, rod, wire, tubing, castings. Hot pressure working is performed in the range 1050-800°, subsequent heat treatment includes quench from 950-1050° into water or in the air (depending on the form of the product). The steel is welded using all forms of welding; wire

II-30N4

of the same steel is used as the filler material, in this case the weld seam has properties close to those of the parent material. This steel has good resistance to intercrystalline corrosion and corrosion cracking. It is a replacement for the Kh18N9T steel.

The lKh20N3GD2L steel is produced in the form of shaped castings per factory specifications. Applications are: cast and welded-cast detail parts for the flow sections of hydroturbines operating using water with a large amount of silt (sand).

References, German, A.L., et al., Tekhnologiya proizvodstva malykh i srednikh gidroturbin (Technology of Production of Small and Medium Hydroturbines), Moscow-Sverdlovsk, 1954; Korsakov, V.S., Tekhnologiya gidromashinostroyeniya (Technology of Hydromachine Construction), Moscow, 1948; Gamze, Z.M. and Gol'dsher, A.Ya., Tekhnologiya proizvodstva krupnykh gidroturbin (Technology of Large Hydroturbine Production), Moscow-Leningrad, 1950; Orakhelashvili, M.M., Iznosostoykost' reaktivnykh gidroturbin (Wear Resistance of Reaction Hydroturbines), Moscow-Leningrad, 1960; Kermabon, R. and Tuvenin, G., Restoration of Hydro-turbine Impellers at French Hydrostations), translated from German, Moscow-Leningrad, 1957; Hydroturbine Construction in the USA, translated from English, edited by A. Artemov, Moscow-Leningrad, 1957; Mikhaylov-Mikheyev, P.B., Spravochnik po metallicheskim materialam tubino- i motorostroyeniya (Handbook on Metallic Materials for Turbine and Engine Construction), Moscow-Leningrad, 1961; Stali s ponizhennym sodержaniyem nikelya (Steels with Reduced Nickel Content), Handbook, edited by M.V. Prindantsev and G.L. Livshits, Moscow, 1961.

I.Ye. Gerasimov

I-210

HYGROSCOPIC NATURE - see Moisture Absorption Capacity.

III-kh

HYPALON - see Chlorosulfonated polyethylene.

HYPERELASTIC DEFORMATION - a form of high-elastic deformation which is peculiar of various amorphous polymers within specific temperature intervals, where the flexibility of chain molecules is exhibited. Hyperelastic deformation is characterized by a low modulus of elasticity ( $1-10 \text{ kg/cm}^2$ ) and large mechanical reversible deformations, which many-fold exceed the initial dimensions of the specimen. Raw and processed rubbers are typical hyperelastic materials in the temperature range from  $-70^\circ$  to  $+100^\circ$ . The application of an external force to them changes the conformation of chain molecules which are usually coiled into a tangle as a result of intensive thermal movement. The main difference between hyperelastic and ordinary elastic deformation consists in the fact that elastic deformation of polymers in the vitreous state involves changes in the mean distances between particles, while hyperelastic deformation is related to regrouping links of chain molecules without changing the mean distance between them. The displacement of polymeric molecules with respect to one another is made difficult due to the large dimensions of the molecules proper, and for reticular polymers (rubbers) it is made difficult by the presence of strong transverse bonds between them. Hyperelastic deformation does not develop immediately but rather requires time, and proceeds the slower, the lower the temperature. Below the vitrification temperature the rate at which the hyperelastic deformation develops is negligible and the polymer undergoes ordinary elastic deformation. When the stress is removed, the initial state is reached with time. Since hyperelastic materials are capable of restoring their shape after the load is removed in the same



I-86G1

manner as solid bodies, from the point of view of mechanics they are solid bodies. However, with respect to other physical properties hyperelastic materials (rubber) are similar to a liquid and even to a gas. Liquids and rubber are amorphous substances, their thermal expansion and compressibility coefficients are close and are much lower than those for solid bodies. At the same time, the nature of hyperelastic deformation differs from the nature of deformation in solid bodies and simple liquids. Hyperelastic stresses in deformed rubber, as the pressure of a compressed gas, are proportional to the absolute temperature, since the deformation of gases and rubbers has a molecular-kinetic (entropic) nature. Such a combination of characteristics of a solid body, liquid and gas in hyperelastic materials is due to their polymeric structure. The relaxation properties of these materials and molecular-kinetic concepts on the thermal motion of molecules are fundamental for the understanding of the mechanics of rubber and a key to the explanation of various physical states. For example, the value of stress in rubber with a specified deformed state (tension, compression, torsion) drops with time. Hence, unlike other bodies which are characterized by moduli of elasticity, hyperelasticity moduli cannot be regarded as being time-independent quantities. If a constant load or a periodic load of constant amplitude is applied to rubber, then the value of the deformation will increase with time. In the first case static and in the second case dynamic creep (elastic aftereffect) is observed. As in the process of stress relaxation, the hyperelastic modulus of elasticity  $E$  decreases in the process of the aftereffect, approaching the equilibrium modulus  $E_{\infty}$  (hyperelastic equilibrium modulus). The molecular nature of relaxation properties of fluids and amorphous polymers is the same. As atoms in simple liquids pass from one equilibrium state to the neighboring one under the effect of thermal motion, so do section of linear

I-8602

macromolecules (segments) move from one position to another. Here the frequency of transition of segments from one equilibrium state to the neighboring one depends on the magnitude of potential barriers and the temperature, and also on the stress, i.e., the higher the stress, the easier the movement of segments in the direction of the force and the more difficult in the opposite direction. Deformation of the chain takes place by successive displacement of segments, that is, with time. Hence, the hyperelastic deformation always lags behind the externally applied stress. As a result of this, when the stress varies periodically, mechanical losses which are depicted on the diagram by a hysteresis loop, take place at each deformation cycle.

At high temperatures the time of "settled down life" of each segment of rubber raw materials is so small that the chain molecules are deformed almost instantaneously upon load application. However, as the temperature is reduced, this time can be regarded as being sufficiently large so that the chain molecules do not change their shape during the observation time. Mechanical vitrification takes place, i.e., transition from the hyperelastic to elastic deformation, which is characteristic of glass.

Change in the dimension and shape (for example, elongation by a factor of 2-3) of a body which is in the vitreous state, due to stresses exceeding the forced elasticity limit is called induced hyperelastic deformation. This property is peculiar only to polymeric materials. The high induced hyperelastic deformation which develops in the vitreous state is highly-elastic by nature, since it is related not to changes in the mean distances between particles, and to displacements of chain molecules as a whole, but to changes in the conformation of flexible chain molecules. Transition of chain molecules from one conformal state to another below the vitrification temperature becomes possible only on

I-8603

attendant forcing action of externally applied stresses. Without these stresses the insignificant thermal motion in polymeric glass is not capable of perceptibly changing the conformal state of chain molecules which are held in their positions by intermolecular interaction. Hence, induced hyperelastic deformation does not disappear after the load is removed and the material remains in the directed state for an infinite time. Single-axis and two-axis extrusions are used in practice (polymeric fibers, films and directed organic glass). When these materials are heated they spontaneously contract to their initial dimensions (before extrusion).

References: Kobeko, P.P., *Amorfnyye veshchestva* [Amorphous Substances], Moscow-Leningrad, 1952; Treloar, L., *Fizika uprugosti kauchuka* [Rubber Elasticity Physics], Moscow, 1953; Kargin, V.A. and Slonimskiy, G.L. *Kratkiye ocherki po fiziko-khimii polimerov* [Brief Outlines on the Physical Chemistry of Polymers], Moscow, 1960; Lazurkin, Yu.S. and Fogel'son, R.L., "Zhurnal tekhn. fiz." [Journal of Technical Physics], Issue 3, pages 267-86, 1951.

G.M. Bartenev

HYSTERESIS - irreversible changes which are expressed in different progress of direct and reverse processes. A distinction is made between magnetic hysteresis, sorption, mechanical, etc., hystereses. In the latter case of hysteresis mismatch exists between branches on the stress-strain diagram which correspond to loading and unloading as a result of irreversible processes (local plastic deformations, distortion of structure, etc.). This mismatch is usually exhibited as early as in the macroelastic region; for which reason this hysteresis is called elastic, which is inaccurate, since mechanical hysteresis is based on inelastic processes. As the load increases, "elastic" hysteresis becomes plastic, since macroscopic residual deformation appears. As the structure becomes increasingly less homogeneous, hysteresis usually is increased. The area of the hysteresis loop characterizes the magnitude of the dissipated energy and is related to the capacity to damp vibrations. An attempt is made in the case of flexible elements of instruments (membranes, etc.) to reduce the divergence between loading and unloading readings, for which reason it is desirable to reduce the hysteresis. In certain cases, for example, when it is difficult to avoid resonance phenomena in a structure, the high damping capacity of the material can be found to be useful.

Ya. B. Fridman

**IMPACT DUCTILITY** - ability of a material to absorb mechanical energy upon being deformed to failure under the action of an impact load. It is estimated by the breaking energy of a notched specimen (see Menager Specimen) when testing in impact flexure on a Charpy impact machine. By convention it is referred to the specimen cross section at the base of the notch, and has the dimensions of  $\text{kgm/cm}^2$ . Impact ductility is one of the major characteristics used for evaluating the quality of metals, it is frequently specified in technical specifications for delivery. In many cases the tendency of metals and alloys to brittle failure under rigorous load conditions is reliably estimated. A sharp drop in impact ductility with a reduction in the test temperature (in the so-called serial tests) determines the threshold of cold brittleness of the material (see Low-Temperature Mechanical Properties).

S.I. Kishkina-Ratner.

IMPEDANCE-TYPE OF THE ACOUSTIC METHOD OF FLAW DETECTION - is based on the evaluation of the mechanical impedance (the total mechanical resistance) of the tested product when elastic oscillations are excited in it. This method is used for the detection of glued, soldered and other joints in multilayer constructions from metallic and nonmetallic materials (see Acoustic Flaw Detection).

Yu.G. Lange

IMPREGNATED CERMETS - are metallic products obtained by impregnating compressed metal-powder blanks with molten metals. The necessary uniform compression of the powders in the blanks is achieved by pressing, extrusion, spraying, compacting by vibration, molding of slip in plaster molds, etc. The specific pressure during the compacting amounts to 2-10 kg/cm<sup>2</sup> and may in certain cases rise to values usual in the production of cermets. Organic binders: solutions of paraffin and rubber in gasoline, of resins in alcohol, etc., are added to the metallic powders before the molding in order to make the blanks stable. The molding of the blanks is carried out into fireproof containers, into high-melting powder-refractories, as alumina and magnesia. The containers are fired in furnaces filled with a protective gas atmosphere; the impregnation of the powder-blanks is carried out by a pouring system, the liquid metal is supplied overheated by 100-200° (see Infiltration). The surface of the blanks molded in a refractory which is non-wettable by the liquid metal retains after the impregnation all the finest details even of very intricate contours. The linear shrinkage of the impregnated blanks amounts 1-2% at room temperature, therefore, in contrast to sintered cermets, no stresses of the 1st order arise when the impregnated products are cooled, and distortions and cracks are almost absent.

Impregnated cermets are widely used for the production of objects from fireproof alloys and copper-iron compositions and are experimentally applied for the production of art objects and typographic clichés.

A.A. Abinder

IMPREGNATED WOOD - wood material treated by chemical substances to improve its properties. Integrated methods of treatment which at the same time improve a number of properties of wood are known. Most extensively used is impregnation of wood by antiseptics, i.e., by substances which are toxic to fungi and mold, which cause wood to rot. Use is also made of impregnation of wood by fireproofing substances, i.e., antipyrenes, and hydrophobic substances, which aid in reducing the hygroscopicity.

The physicomechanical properties of wood are improved when it is impregnated by organic and inorganic substances, for example, aromatic amines or alloys of sulfur with 10% chlorinated naphthalene (Table 1).

TABLE 1

Physicomechanical Properties of Birch, Impregnated by Sulfur with 10% Chlorinated Naphthalene

| 1<br>Виды           | 2<br>Объемный вес<br>(г/см <sup>3</sup> ) | 3<br>Влагопоглощение<br>(%) | 4<br>Предел прочности<br>(кг/см <sup>2</sup> ) |                                |                                  |                  | 5<br>Удельная работа<br>при изгибе (кг·см/см <sup>3</sup> ) |
|---------------------|---|-----------------------------|--|--------------------------------|----------------------------------|------------------|---|
|                     |   |                             | 6<br>при сжатии<br>вдоль волокон               | 7<br>при статическом<br>изгибе | 8<br>при сдвиге<br>вдоль волокон | 9<br>при разрыве |   |
| Непропитанная . . 9 | 0.65                                      | 22                          | 600  | 1150                           | 110                              | 0.332            |   |
| Проштанная . . 10   | 1.20                                      | 18                          | 1030   | 1385                           | 165                              | 0.450            |   |

1) Birch; 2) specific weight (g/cm<sup>3</sup>); 3) moisture absorption (%); 4) ultimate strength (kg/cm<sup>2</sup>); 5) modulus of resilience in bending (kg-m/cm<sup>3</sup>); 6) in compression along the fibers; 7) in static bending; 8) in cleaving along the fibers; 9) not impregnated; 10) impregnated.

The first place with respect to the production and use of impregnated wood is occupied by railroad maintenance (cross-ties, transfer



TABLE 2

## Physicomechanical Properties of Bakelite-Impregnated Wood

|  |           |
|--|-----------|
| Specific weight ( $\text{g}/\text{cm}^3$ )                     | 0.46-0.96 |
| Ultimate strength ( $\text{kg}/\text{cm}^2$ )                  |           |
| in comparison  | 1300-1500 |
| in static bending  | 1100-1300 |
| in tension   | 800-1500  |
| in cleaving  | 200- 250  |
| Modulus of resilience in bending ( $\text{kg-m}/\text{cm}^3$ ) | 3-8       |
| Martens specific heat (cal)                                    | 0.20-0.50 |
| Moisture absorption in 24 hours (%)                            | 8-20      |
| Swelling in 24 hours (%)                                       | 5-18      |

bars, bridge and car components); the second place is occupied by power facilities and the communications service (poles, masts). In shipbuilding and hydraulic engineering impregnation is used for parts of ships, wooden barges, wharf piles, components of dams, sluices, water pressure towers, etc. Mine supports are impregnated in the ore and coal mining industries.

Wood which is used for constructing chemical apparatus (cylindrical vessels, montejus for work under pressure, etching vats, connecting pipes, taps, mixers, exhausters, and other chemical machine building components, as well as components of pipelines and wood structures which are subjected to the effect of gases and aggressive media, etc.), are impregnated by synthetic resins, in particular phenolformaldehydes, which in practice are called bakelite resins (Table 2).

Impregnated wood is used extensively also in other branches of the national economy.

References: Berlin, A.A., Issledovaniya v oblasti khimii i tekhnologii oblagorozhennoy drevesiny i drevesnykh plasticheskikh mass [Studies in the Field of Chemistry and Technology of Improved Wood and Wood Plastics], Moscow - Leningrad, 1950; Lektorskiy, D.N., Zashchitnaya

I-11602

obrabotka drevesiny [Protective Treatment of Wood], part 1, Moscow-Leningrad, 1951; Romanov, N.T., Kompleksnyy metod fiziko-khimicheskoy obrabotki drevesiny [An Integrated Method for Physicochemical Treatment of Wood], Moscow-Leningrad, 1957; Novitskiy, G.I. and Stogov, V.V., Derevopropitochnyye zavody [Wood-Impregnating Plants], Moscow, 1959.

N.T. Romanov

IMPRESSION HARDNESS - property of materials to resist local plastic deformation which is produced by forced penetration, i.e., impression into the surface of a specimen or product a body (indenter, tip) spherical, pyramidal or conical in shape from hardened steel, diamond or hard alloy. In the most extensively used methods of impression hardness determination (Brinell, Rockwell, Vickers) the tip is made to penetrate by instruments, i.e., hardness testers, with a smoothly (statically) applied load. The magnitude and rate of load application, time of holding under the load, the geometric shape of the tip are specified by the appropriate All-Union standards. The impression hardness is determined quantitatively by the so-called hardness number, which represents either the mean specific pressure at the surface of the impression left after the tip is removed (Brinell Hardness, Vickers Hardness), or an arbitrary quantity, which depends on the depth of the tip's penetration (Rockwell hardness). In certain nonstandard methods of impression hardness determination (for example, Meier, Ludwig) the hardness number is determined by the ratio of the load to the area of projection of the impression on a surface perpendicular to the direction of tip penetration. Methods in which the hardness is determined by dynamic impressing of ball or tapered tips with subsequent approximate recalculation of the data thus obtained into generally used hardness numbers (HB, HV, HR) or with calculation of the so-called dynamic hardness by multiplying the energy used up for making the impression by its volume are used much more infrequently. Impression hardness is an important and convenient characteristic of a material, since it is determined quite

simply and rapidly, does not require destruction of the specimen or component, unlike other methods of mechanical testing, and can serve for indirect approximate estimating the strength properties of a material (for example, the Brinell hardness of many materials is linearly related to the ultimate strength). Scratch methods of hardness determination as well as the oscillation methods (Herbert) and elastic rebound method (Shore) are at present used very infrequently, so that impression hardness determination methods are basic in the modern techniques of mechanical materials testing.

References: O'Neil, H., Tverdost' metallov i yeye izmereniye [Hardness of Metals and Its Measurement], Translated from English, Moscow-Leningrad, 1940; Shaposhnikov, N.A., Mekhanicheskiye ispytaniya metallov [Mechanical Testing of Metals], 2nd Edition, Moscow-Leningrad, 1954.

I.V. Kudryatsev and D.M. Shur

INCONEL - is a scale-resistant heatproof nickel alloy produced in U. S.

TABLE

## The Chemical Composition of Inconel Alloys

| 1 Alloy     | 2 Composition Elements (%) |      |      |      |               |     |     |     | 3 Other Elements   |
|-------------|----------------------------|------|------|------|---------------|-----|-----|-----|--------------------|
|             | C                          | Mn   | Si   | Cr   | Ni            | Ti  | Al  | Fe  |                    |
| 4 Inconel X | 0.04                       | 0.05 | 0.20 | 15.5 | 76            | -   | -   | 7   | -                  |
| X 750       | 0.04                       | 0.05 | 0.3  | 15   | 73            | 2.5 | 0.9 | 7   | 0.9 Nb             |
| 700         | 0.13                       | 0.05 | 0.25 | 15   | 66            | 2.2 | 3.2 | 0.8 | 29 Co,<br>3.0 Mo   |
| 702         | 0.04                       | 0.10 | 0.25 | 15.5 | 79            | -   | 3.0 | 0.5 | -                  |
| 713         | 0.12                       | 0.15 | 0.4  | 13   | Octane<br>500 | 0.8 | 6.0 | 1.0 | 4.5 Mo,<br>2.25 Nb |

1) Alloy; 2) content of elements (%);  
3) other elements; 4) Inconel; 5) the rest.

Inconel is used for the production of heatproof parts for diverse units of gas-turbine engines (fire tubes, exhaust pipes, parts of the gas collector, combustion chambers) working at high temperatures of the 800-1100° range at low stresses. The parts are joined by welding. The Inconel grades X, X500, and 700 are aging alloys with intermetallic hardening. They are used for the production of parts of gas-turbine engines which operate at high temperatures under higher loads. The X grade Inconel is used as a construction and covering material for rockets, supersonic aircrafts and apparatuses for the flight into the ionosphere. The alloy is characterized by a good strength at 480-760°, a high toughness and is insensitive to notches at low temperatures up to -78°. It proves a good weldability especially by the resistance-welding method in the state after austenite hardening. The welded units are subject to heat treatment with subsequent pickling in alkali and passi-

I-1612

vation in nitric acid when high strength is required. Soviet scientists had developed alloys whose properties are not inferior to that of the Inconel alloys.

Inconel 700 is used for the production of the working blades of gas-turbine engines operating at temperatures about 900°. Inconel 713 is a super-heatproof cast alloy. It is intended for the production of guide- and rotor-blades of gas turbines. The alloy grades EI617 and EI826 and certain cast alloys are used in USSR. The change in long-life strength of Inconel is shown in Figs. 1 and 2.

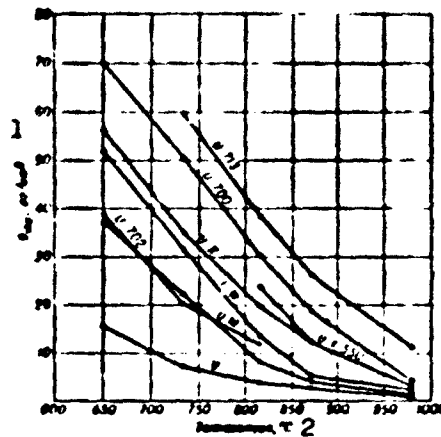

Fig. 1. Change in the 100-hour long-life strength of Inconel at rising temperature. 1)  $\text{kg}/\text{mm}^2$ ; 2) temperature, °C.

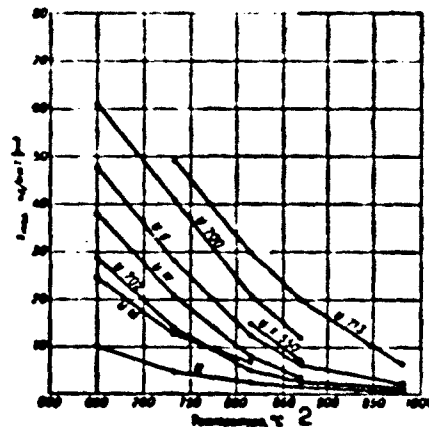

Fig. 2. Change in the 1000-hour long-life strength of Inconel at rising temperature. 1)  $\text{kg}/\text{mm}^2$ ; 2) temperature, °C.

I-1613

References: Woldman N. E., "Mater. and Methods," 1946, Vol. 4, No. 6, page 1475-90; Simmons W. F., Krivobock V. H., "ASTM Special Technical Publ.," 1958, No. 179A; "Metal Progr.," 1954, Vol. 66, No. 1A, page 293; "Aircraft Prod.," 1959, Vol. 21, No. 4, page 122-26; "Mater. and Methods," 1956, Vol. 44, No. 2, page 151; "Metal Ind.," Vol. 88, No. 12, page 225.

F. F. Khimushin

INDEX OF REFRACTION - the ratio of the speed of light in a vacuum to the speed of light in a given material (absolute index of refraction). The relative refractive index of two media is the ratio of the speed of light in the medium from which the light is incident on the surface of separation to the speed of light in the second medium, in which the light rays are refracted. The refractive index is numerically equal to the ratio of the sine of the angle of ray incidence to the sine of the angle of refraction. It depends on the wavelength, or color, of the light (see Coefficient of dispersion) and precise refractive indices are consequently generally accompanied by an indication of the wavelength at which they were determined. For example,  $n_D$  is the refractive index corresponding to the D line of sodium (the yellow doublet  $\lambda_D = 5893 \text{ \AA}$ ). Devices for measuring refractive indices are called refractometers.

L.S. Priss



I-15I

INDIGOLITE - see Tourmaline.

INDUSTRIAL TESTING - simplified method for determining the homogeneity, plasticity and ability of metals to deform under conditions similar to those to which they are subjected on machining or in service.

Unlike mechanical tests, industrial tests are not accompanied by determination of stresses arising in the material or of loads applied to them. The rapidity with which industrial testing is performed and the feasibility of using simple instruments make it possible to use them for mass control in the industry. The results of industrial tests are evaluated either by the external appearance of the specimens (presence of cracks, peeling, cleavage, etc.) or by measuring the deformation obtained after applying a load (number of bends, twists, angle of twist, etc.). The majority of industrial tests is standardized. Bending (see Bending Test), folding, unfolding (OST 1694), double roofing joint (OST 1697), extrusion (pressing through), flattening (GOST 8818-58) tests are used for sheet, strip and shaped (shapes) materials. Bending, shrinkage (GOST 8817-58), flattening (GOST 8818-58) tests are used for bar stock, while twisting (GOST 1545-42) folding, winding (OST 1695), flattening (GOST 8818-58) tests are used for wire. Bending (GOST 3728-47), flanging (GOST 8693-58), compressing (GOST 8695-58) and flaring (GOST 8694-58) tests are used for pipes.

The unfolding test consists in the unfolding by a small, sledge or large hammer of an angle in a shaped material into a flat shape with subsequent bending the plate thus straightened in accordance with the technical specifications for the material.

The double roofing joint test consists in joining two pieces of

111-5311

sheet material tightly by a double joint with subsequent bending along a line perpendicular to the line of the joint over a specified angle and unfolding to the initial state.

The extrusion (pressing through) test is performed for sheet material and strips. It consists in extruding a hole in a specimen by a semispherical punch and die of specified dimensions. An estimate of the plasticity is the depth of extrusion which is obtained before the material fails. The test is performed on the PTL-10 device, which is produced by the ZIP plant (city of Ivanovo).

The flattening test is performed under a press or by a hammer. Specimens from strip or sheet materials are flattened until the width of a standard specimen is increased to a value specified in the technical specifications for the material. When testing wire the flattening is performed on specimens of specified height until a head of specified size is obtained.

The shrinkage test is used for materials from which fasteners (bolts, rivets) are made by hot or cold upsetting and by end forging. The specimens are tested under a press or by a hammer to a specified deformation the magnitude of which is given in technical specifications.

The twisting test is used for wire not more than 10 mm in diameter. The number of 360° twists in a specimen of a specified length serves as an estimate of the materials capacity for plastic deformation. The tests are performed in a special instrument and can be achieved with a constant and variable direction of twist, twisting of one or two specimens clamped alongside one another, without and with preliminary stretching.

The winding test is used for wire 6 mm and less in diameter. It consists in winding the wire (5-10) coils in tightly wound coils along

III-54t1

a spiral line on a cylinder of specified diameter or onto the wire proper.

The flanging test consists in smooth flanging of the end of the pipe by using a mandrel until a flange of a specified diameter is formed.

The compressing test consists in smooth compressing of the end or section of a pipe between parallel planes until the specified size between the planes is reached.

The flaring test consists in smooth flaring the end of a pipe into a taper, using a special mandrel, until a specified diameter is produced at the end.

References: Shaposhnikov, N.A., Mekhanicheskiye ispytaniya metallov [Mechanical Testing of Materials], 2nd Edition, Moscow-Leningrad, 1954.

Yu.S. Danilov

Manu-  
script  
Page  
No.

[Transliterated Symbols]

|      |   |
|------|---|
| 2139 | OCT = OST = Obshchesoyuznyy standart = All-Union State Standard                   |
| 2139 | ГОСТ = GOST = Gosudarstvennyy obshchesoyuznyy standart = All-Union State Standard |
| 2140 | ЗИП = ZIP = zavod izmeritel'nykh priborov = Measuring Instruments Plant           |

INFILTRATION - is the penetration of a fluid or gas into a porous solid. The infiltration process of liquid metals and alloys into porous metallic blanks has found application in practice for the production of impregnated Cermets. Impregnation takes place when a porous solid is wet by a fluid, i.e., on condition that the contact angle  $\theta$  is lower than  $90^\circ$ .

The surface tension of the fluid and the wetting effect cause the origin of a capillary pressure termed Laplace's pressure. The magnitude of this pressure is determined by the formula

$$P = \frac{2\sigma}{r} \cos \theta \frac{g}{cm^2}.$$

where  $P$  is the capillary pressure in  $g/cm^2$ ;  $\sigma$  is the surface tension in dyne/cm;  $r$  is the radius of the capillary tube in cm;  $\theta$  is the contact angle.

The presence of a liquid slag film (impregnation using a fusing agent) on the surface of the melted metal changes significantly the surface tension on the slag - metal interface. The calculation of the additional Laplace's pressure is carried out in this case according to the formula

$$P = P_1 + P_2 \frac{g}{cm^2}.$$

where  $P_1$  is the Laplace pressure in the metal caused by the effect of the gas - slag interface, in  $g/cm^2$ ;  $P_2$  is the Laplace pressure of the meniscus formed by the slag - metal interface in  $g/cm^2$ .

The work consumed for overcoming the friction of the fluid flowing in the capillary must be taken into account for the impregnation of

I-1911

porous metal blanks with melted metals. The coefficient of the internal friction of fluids is reduced at rising temperature, therefore, fusing agents (borax, phosphites, etc.) and overheating of the liquid metal by 100-200° are used.

A.A. Abinder

INFUSORIAL EARTH - is a loose rock composed mainly of fine particles, the residual shells of diatoms. With regard to its composition, properties and utilization, it is identical with Diatomite.

INORGANIC ADHESIVE - is a compound based on sodium silicate and other mineral salts, and also on oxides of certain metals. The heat resistance of the inorganic adhesives is their primary advantage compared with adhesives based on organic substances, at the same time, however, they possess a high brittleness, a fact which considerably limits their field of utilization. Inorganic adhesives and cements on silicate basis are used for bonding aluminum foil on paper, for joining glass, wood, paper, board, etc. Inorganic cements (hydraulic, magnesia, iron, sulfur and other cements) are used in industry. Cements for joining metals and other materials in stressed structures operating at very high temperatures have been recently developed.

A well-known adhesive is an aqueous suspension of a frit composed of feldspar, borax, calcined soda, saltpeter, barium carbonate and other components. The bonding process consists in the application of the compound on the metal, drying in air and heat treatment of the joint surfaces at  $955^{\circ}$  for 20 minutes under a pressure of  $3.5 \text{ kg/cm}^2$ . The shearing strength of the adhesive joint is  $70 \text{ kg/cm}^2$  within  $20-500^{\circ}$ . Investigations are in progress to find heat resistant ceramic adhesives. It is to be hoped that such adhesives may replace solders, especially in the production of three-layer all-metal construction from stainless steel with a honeycomb filler.

References: Adgeziya, klei, tsamenty, pripoi [Adhesion, Adhesives, Cements, and Solders], [A collection of papers], translated from English, Moscow, 1954; "J. Amer. Ceram. Soc.," 1958, Vol. 41, No. 4.

D.A. Kardashev



INSTALLATIONS FOR GAMMA-RAY FLAW DETECTION - devices which are used for irradiating by gamma rays to obtain a channeled radiation beam and for protection of the servicing personnel from the harmful effect of radiation. When idle, the installations serve as protective crating (container) of the gamma ray source (radioactive isotope), which ensures safe transportation. When the radiation sources are highly active the installations usually have two containers, i.e., a transportation and working container which is located on the support. The radiation source in this case is moved by an electromechanical manipulator equipped with remote control.

ISOCYANATE ADHESIVE - is a solution of diisocyanates and triisocyanates (leuconates) in dichloroethane (20:80%); it is used to bond rubbers on metals, and to improve the joint between rubbers and fabrics made from synthetic fibers. The leuconate (triphenylmethane p-,p'-,p"-triisocyanate), the most universal isocyanate adhesive, is used to adhere all kinds of commercial rubbers on Duralumin, stainless steel, brass, bronze and other alloys. The bonding of rubber on metal by means of leuconate must be carried out in a room with not more than 60-65% relative moisture content; before the adhesion, the metal pieces are treated with steel or cast-iron shot in an apparatus. The surfaces of the metal pieces are covered with the adhesive and dried at 18-30° for 30-40 minutes, or at 30-45° for 10-30 min. After being cooled, the pieces are again covered with a double layer of adhesive and dried in the same way as before. The vulcanized adhesive film resists kerosene, gasoline and mineral oils. The peel strength of the joint between rubber and metals is not lower than 40 kg/cm<sup>2</sup>. The glue may be stored for 1.5 years in tightly closed containers at 0-20°.

References: Zhrebkov S.K., Krepleniye reziny k metallam [Fastening of Rubber on Metals], Moscow, 1956.

D.A. Kardashev

ISO RUBBER HARDNESS. The determination of ISO rubber hardness consists in measuring the difference in the depth of penetration of a ball with  $d = 2.5$  mm into the rubber under an initial load of 30 g for 5 secs., and under a final load of 580 for 30 secs. The results in international hardness units are found either from a table, or from the instrument's scale, which is graduated directly in these units.

The scale of international hardness units is selected so that hardness of 0 is assigned to a material with the Young modulus  $E = 0$ , while the number 100 is assigned to a material with  $E = \infty$ .

The readings in international hardness units for rubber correspond to the Shore scleroscope (type A). The relationship between the depth of penetration of the rubber and the hardness in international units is based on the relationship of the depth of penetration of the ball and Young's modulus, which is valid for elastic isotropic materials.

$$F/E = 0.00017r^{0.65}h^{1.33}$$

where  $F$  is the pressing-in force (kg),  $E$  is Young's modulus ( $\text{kg}/\text{cm}^2$ ),  $h$  is the depth of penetration of the ball (hundredths of mm) and  $r$  is the radius of the ball (cm).

Specimens which are hardness tested are at least 6 mm thick which have plane parallel sections. The measurements are taken in 4 points and the arithmetic mean is taken as the result. At the time of testing the instrument is lightly vibrated in order to eliminate friction when the ball penetrates the rubber specimen.

References: ISO, Technical Committee 45, documents No. 219, 250,

III-14t1

448, 452, 557.

V.V. Ovchinnikov

Manu-  
script  
Page  
No.

[Transliterated Symbols]

2148

WCO = ISO = Internatsyonal'naya organizatsiya standartizatsii  
= International Standardization Organization

INTEGRAL RADIATION - total radiation - is the thermal radiation in the whole range of the wavelength of the spectrum from  $\gamma = 0$  to  $\gamma = \infty$ . The energy transfer takes place mainly in the visible ( $\gamma = 0.4-0.76$  microns) and the infrared ( $\gamma = 0.76-750$  microns) spectral ranges. At the temperatures occurring in technology, the main part of the radiation energy falls in the infrared range of the spectrum with wavelengths from 0.76 to 15 microns. The radiation in the visible (luminous) spectral range becomes important only at very high temperatures. A thermal radiation in a narrow wavelength interval  $d\gamma$  is termed monochromatic. The integral radiation is studied in thermal calculations, the monochromatic radiation in pyrometry, in spectral and other investigations.

G.A. Zhorov

INTERMEDIATE CLASS STAINLESS STEEL is steel which with respect to chemical composition is on the boundary between the austenitic and martensitic classes and, depending on the heat treatment, may have struc-

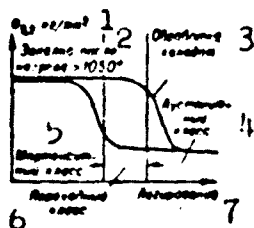

Diagram of position of the intermediate class stainless steel between the austenitic and martensitic classes (cold treatment is performed at  $-70^{\circ}$ ). 1)  $\sigma_{0.2}$ ,  $\text{kg}/\text{mm}^2$ ; 2) quench after heating  $\geq 1050^{\circ}$ ; 3) cold treatment; 4) austenitic class; 5) martensitic class; 6) intermediate class; 7) alloying.

ture and properties close to the steel of either class. The positioning of the intermediate class stainless steel between the austenitic and martensitic classes is shown in the figure. In some cases, in addition to the basic structure of austenite and martensite the intermediate class stainless steel has a definite amount of  $\delta$ -ferrite. After quench from the austenitizing temperature which is sufficient to dissolve the carbides, the structure of the intermediate class stainless steel becomes basically austenitic. One of the salient features of the intermediate class stainless steel is the ability of the austenite to convert intensively into martensite under the influence of plastic deformation at room temperature. The relatively high values of the ultimate strength of the intermediate class stainless steel in the austenitic condition is explained by the fact that during tensile testing a considerable amount of martensite is formed in the steel at the instant

**TABLE 1**  
**Chemical Composition of Intermediate Class Stainless Steel**

| Сталь                 | 2 Содержание элементов (%) |          |     |           |         |       |         |          |       |
|-----------------------|----------------------------|----------|-----|-----------|---------|-------|---------|----------|-------|
|                       | C                          | Mn       |     | Cr        | Ni      | Mo    | Al      | S, P     |       |
|                       |                            | не более |     |           |         |       |         | не более |       |
| X15N9YU (CH-2, EI904) | 0.05-0.09                  | 0.7      | 0.7 | 14.8-16.5 | 7-9.4   | -     | 0.9-1.4 | 0.02     | 0.03  |
| X17N5M3 (CH-3, EI925) | 0.06-0.10                  | 0.7      | 0.7 | 16-17.5   | 4.5-5.5 | 3-3.5 | -       | 0.02     | 0.035 |
| X17N7YU (EI973)       | <0.09                      | 0.8      | 0.8 | 16-18     | 6.5-7.3 | -     | 0.8-1.3 | 0.025    | 0.035 |

1) Steel; 2) element content (%); 3) no more than; 4) Kh15N9Yu (SN-2, EI904); 5) Kh17N5M3 (SN-3, EI925); 6) Kh17N7Yu (EI973).

**TABLE 2**  
**Mechanical Properties of Intermediate Class Stainless Steels (no less than)**

| Сталь 1                  | 2 Состояние  | $\sigma_s$              | $\sigma_{0.2}$ | $\delta_5$ (%) | $\psi_n$ (кал/см <sup>2</sup> ) |
|--------------------------|--|-------------------------|----------------|----------------|---------------------------------|
|                          |  | 3 (кг/мм <sup>2</sup> ) |                |                |                                 |
| X15N9YU (CH-2, EI904) 5  | 6 Мягкая (после закалки на воздухе с 1020-1050°)   | 85                      | 18             | 20             | 12                              |
|                          | 7 Упрочненная (после закалки на воздухе с 975°, обработки холодом при темп-ре от -50 до -75° в течение 2-4 час. и старения при 425-500°) | 120                     | 95             | 10             | 4                               |
|                          | 8 Полунагартованная и состаренная (старение при 480° в течение 1 часа)   | 110                     | 90             | 14             | -                               |
|                          | 9 Нагартованная и состаренная (старение при 480° в течение 1 часа)   | 140                     | 110            | 6              | -                               |
|                          | 10 Упрочненная (после закалки на воздухе с 950-930°, обработки холодом при темп-ре от -50 до -70° в течение 2-4 час. и отпуска при 450°) | 119                     | 25             | 20             | 12                              |
| X17N5M3 (CH-3, EI925) 10 | 11 Мягкая (после закалки на воздухе с 1050°)   | 120                     | 90             | 10             | 5                               |
|                          | 12 Упрочненная (после закалки на воздухе с 950-930°, обработки холодом при темп-ре от -50 до -70° в течение 2-4 час. и отпуска при 450°) | 120                     | 100            | 5              | -                               |
| X17N7YU (EI973) 14       | 13 Нагартованная и отпущенная  | 120                     | 100            | 5              | -                               |
|                          | 15 Упрочненная (после закалки на воздухе с 1030-1070°, отпуска при 740-760° с охлаждением на воздухе, старения при 550-600°)             | 85                      | 70             | 10             | 5                               |

1) Steel; 2) condition; 3) (kg/mm<sup>2</sup>); 4)  $a_n$  (kgm/cm<sup>2</sup>); 5) Kh15N9Yu (SN-2, EI904); 6) soft (after air quench from 1020-1050°); 7) strengthened (after air quench from 975°, cold treatment at temperatures from -50 to -75° for 2-4 hours and aging at 425-500°); 8) half work-hardened and aged (aging at 480° for 1 hour); 9) work-hardened and aged (aging at 480° for 1 hour); 10) Kh17N5M3 (SN-3, EI925); 11) soft (after air quench from 1050°); 12) strengthened (after air quench from 950-930°, cold treatment at a temperature from -50 to -70° for 2-4 hours, and tempering at 450°); 13) work-hardened and tempered; 14) Kh17N7Yu (EI-973); 15) strengthened (after air quench from 1030-1070°, tempering at 740-760° with air cooling, aging at 550-600°).

**TABLE 3**  
**Mechanical Properties of Some Intermediate Class**  
**Stainless Steels (no less than)\***

| Temp. (°C)<br>1 | 2 Kh15N9Yu                          |   |          |   | 3 Kh17N5M3                          |   |          |   |
|-----------------|-------------------------------------|---|----------|---|-------------------------------------|---|----------|---|
|                 | $\sigma_y$<br>(kg/mm <sup>2</sup> ) | $\sigma_{0.2}$<br>(kg/mm <sup>2</sup> ) | A<br>(%) | $\sigma_{100}$<br>(kg/mm <sup>2</sup> ) | $\sigma_y$<br>(kg/mm <sup>2</sup> ) | $\sigma_{0.2}$<br>(kg/mm <sup>2</sup> ) | A<br>(%) | 5 $\sigma_{100}$<br>(kg/mm <sup>2</sup> ) |
| 200             | 113                                 | 90                                      | 9        | 113                                     | -                                   | -                                       | -        | -   |
| 300             | 105                                 | 85                                      | 8        | 105                                     | -                                   | -                                       | -        | 6 $\sigma_{100}$                          |
| 400             | 100                                 | 80                                      | 8        | 85                                      | 110                                 | 85                                      | -        | (100-150°)                                |
| 500             | 75                                  | 50                                      | 10       | -                                       | 95                                  | 80                                      | -        | 85  |
| 550             | -                                   | -                                       | -        | -                                       | 75                                  | 50                                      | 10       | 80  |

\*Properties of steel in strengthened condition.

1) Temperature (°C); 2) Kh15N9Yu; 3) Kh17N5M3; 4)  $(kg/mm^2)$ ; 5)  $\sigma_{100}$   $(kg/mm^2)$ ; 6) at.

of reaching the maximal load under the influence of the preceding plastic deformation. As a result of this, in the soft condition (after quench from a sufficiently high temperature) the intermediate class stainless steel has an unusual combination of mechanical properties: a low yield point, a relatively high ultimate strength, high plasticity and toughness. With increase of the test temperature (to 100-150°) the strength of the intermediate class stainless steel in the soft quenched condition decreases sharply, since with even a slight temperature increase there is a reduction of the rate of decomposition of the austenite into martensite during plastic deformation in the test process.

Strengthening of the intermediate class stainless steel is achieved by three methods. The first method consists of quenching from a temperature, as a rule, which is lower than necessary for full solution of the carbides (950-1050°), as a result of which the steel acquires a structure of unstable austenite with a slight amount of martensite; then cold treatment at a temperature from -50 to -70° for several hours and tempering at 400-600°. During the cold treatment period there is conversion of austenite into martensite, which is accompanied by a significant increase of the steel strength. If the intermediate class stainless steel is an aging steel, then during tempering there is



II-45n3

further increase of its strength, the maximal strengthening effect of the aging shows up in the temperature range 450-550° depending on the steel alloying. In all probability, the aging is associated with the precipitation, or the preparation of the crystalline lattice for precipitation, of the dispersed intermetallides. Strengthening by the first method provides the intermediate class stainless steel with a combination of high values of the yield point and the ultimate strength along with satisfactory impact toughness and plasticity. The second method of strengthening the intermediate class stainless steel consists in quenching after prolonged soak at 700-800°, during the soak time at this temperature there is intensive precipitation of the chromium-containing carbides, in this case the austenite is depleted of carbon and the alloying elements, the martensitic point is raised, and with cooling to room temperature the steel structure becomes martensitic. The final operation is tempering or aging, in the latter case further strengthening of the steel takes place. After treatment by this method the intermediate class stainless steel acquires lower strength and lower toughness, and also has lower corrosion resistance. The third method of strengthening consists in work hardening the previously austenitic-quenched steel by means of rolling or wire drawing, in this case the steel structure also becomes to a considerable degree martensitic. Further strengthening of the work-hardened steel is achieved by aging at 450-480°. The intensity of the strengthening of the work-hardened steel depends primarily on the cold deformation temperature, with increase of the deformation temperature the rate of strengthening is reduced significantly. As a rule, in the strengthened condition the intermediate class stainless steel has good thermal stability.

The properties of the intermediate class stainless steels of the same grade depend on the chemical composition: the higher the content

II-45n4

of the alloying elements which lower the martensitic point (nickel, chromium, molybdenum, manganese, etc.), the lower its strength, and the greater the content of the elements which raise the martensitic point (aluminum), the closer the steel becomes to the martensitic class and the higher its strength. Carbon and nitrogen have a dual influence on the intermediate class stainless steels. On the one hand, increase of the content of these elements lowers the martensitic point and facilitates obtaining a more stable austenite in the soft quenched condition and less intensive strengthening during cold treatment. On the other hand, carbon and nitrogen increase the strength of the martensite which is formed both during deformation of the austenite and during the cold treatment of the steel. The effect of titanium and the other elements which form nitrides and carbides which are difficult to dissolve must be considered primarily from the point of view of the reduction of the carbon and nitrogen content in the solid solution. The chemical composition of the intermediate class stainless steels is shown in Table 1 and the mechanical properties are given in Table 2.

After heating to 1050° and air quench, the structure of the Kh15N9Yu steel is austenitic, and the Kh17N5M3 and Kh17N7Yu steels are austenitic plus 10-25%  $\delta$ -ferritic. The mechanical properties of the Kh15N9Yu and Kh17N5M3 steels at high temperatures are presented in Table 3.

The physical properties of the Kh15N9Yu steel are:  $\gamma$  in the strengthened condition is 7.66, in the soft condition it is 7.75,  $\alpha$  in the strengthened condition is:  $11.2 \cdot 10^{-6}$  (20-100°),  $11.9 \cdot 10^{-6}$  (20-200°),  $12.2 \cdot 10^{-6}$  (20-300°),  $12.5 \cdot 10^{-6}$  (20-450°) 1/°C; the figures for the Kh17N5M3 steel in the strengthened condition are:  $\gamma = 7.88$ ,  $\alpha = 10.4 \cdot 10^{-6}$  (20-100°) 1/°C.

The intermediate class stainless steel has the highest plasticity after quench from 1050°, it can be deep drawn and stamped easily in

this condition. The martensitic transformation during cold treatment of the steel may be inhibited as a result of preliminary stabilization of the austenite, achieved by heating at temperatures of 200-550°, soak at a temperature slightly below zero, and also by plastic deformation. For most complete strengthening in the cold treatment, this treatment should be performed as quickly as possible after the preliminary quench. The parts should be loaded into a bath or chamber which has been precooled to a temperature in the range of -50° to -70°.

Improvement of the machinability of the intermediate class stainless steel is achieved by the use of the following anneal: heat to 760°, hold for no less than 1.5 hours, air or furnace cool to room temperature, subsequent tempering at 650° with air or furnace cooling. After this treatment the steel structure is basically martensitic. In fabricating parts from soft quenched mill products, account must be taken for the fact that as a result of the final strengthening during the martensitic transformation during the cold treatment there is an increase of all dimensions by 4 mm per meter.

In fabricating parts from mill products in the annealed condition, there is a reduction of the dimensions by 0.4% at the time of the subsequent quenching, and an increase of 0.4% during cold treatment, i. e., in this case there is little change of the dimensions of the parts in the final strengthened condition in practice.

The weldability of the intermediate class stainless steel is very good in both the soft and the strengthened condition; no heating prior to or after welding is required. Directly after welding, the weld seams have basically an austenitic structure and therefore they have high plasticity and toughness along with relatively high strength, close to the strength of the basic metal in the soft quenched condition (kg/mm<sup>2</sup>). Having high plasticity directly after welding, the weld seams of

II-45nc

the intermediate class stainless steels are considerably less sensitive in this condition to nonpenetration, pores, and other stress concentrators than weld seams of martensitic or pearlitic steel which has been treated to the same strength. Taking account of the good weldability of the intermediate class stainless steel in the fully strengthened condition, in many cases it is of advantage to fabricate large-scale welded structures from elements which have been prequenched. Forging of the Kh15N9Yu steel is performed in the temperature range 1200-850°, and for the Kh17N5M3 and Kh17N7Yu steels in the range 1050-850°. With regard to corrosion resistance, the intermediate class stainless steel surpasses the 13% chrome martensitic steel and is somewhat inferior to the type 18-8 austenitic steel. The Kh17N7Yu steel is resistant to corrosion in sea water. The intermediate class stainless steel is delivered in the form of rod, sheet and strip.

References: Potak, Ya.M., Sachkov, V.V., Popova, L.S., Vysokoprochnyye nerzhavayushchiye stali perekhodnogo austenitnomartensitnogo klassa [High Strength Stainless Steels of the Intermediate Austenitic-Martensitic Class], Metallovedeniye i termicheskaya obrabotka metallov [Metal Science and Heat Treatment of Metals], 1960, No. 5.

Ya.M. Potak

## [Transliterated Symbols]

пл = pl = plavleniye = melting

макс = maks = maksimalnyy = maximum

ГОСТ \* GOST = Gosudarstvennyy obshchesoyuznyy standart = All-Union State Standard

ТУ = TU = Tekhnicheskiye usloviya = Specifications

ЦМТУ = TsMTU = Tsvetnoy metallurgii tekhnicheskiye usloviya =  
= Nonferrous Metals Specification

отп = otp = otpetchatka = imprint

ЧМТУ = ChMTU = Chernoy metallurgii tekhnicheskiye usloviya =  
= Ferrous Metals Specification

ЦНИИЧМ = TsNIICHM = Tsentral'nyy nauchno-issledovatel'skiy  
institut chernoy metallurgii = Central  
Scientific Research Institute for Ferrous  
Metallurgy

н = n = nadrez = notch

ЦНИИТМАШ = TsNIITMASH = Tsentral'nyy nauchno-issledovatel'-  
skiy institut tekhnologii i mashino-  
stroyeniya = Central Scientific Re-  
search Institute for Technology and  
Machinery

пц = pts = proporsional'nost' = proportionality

отп = otp = otpushchennaya = tempered

зак = zak = zakalennaya = quenched

НИИПРОДМАШ = NIIPRODMASH = Nauchno-issledovatel'skiy institut  
produktsionnykh mashin = Scienti-  
fic Research Institute of Produc-  
tion Machinery

НИИХИММАШ = NIIXHIMMASH = Nauchno-issledovatel'skiy institut  
khimicheskogo mashinostroyeniya =  
= All-Union Scientific Research and  
Design Institute for Chemical Ma-  
chinery Construction

INTERNAL FRICTION - property of materials to dissipate (convert into heat) the mechanical energy which is imparted to a body in the process of deformation. Internal friction is a typically nonelastic property which characterizes the degree of deviation from the behavior of perfectly elastic bodies. Hence the theory of elasticity does not at all take internal friction into account. The internal friction mechanism can be different: 1) flow of material (analogous to a viscous fluid), which can be observed in both crystalline and amorphous bodies; 2) local or general plastic creep (primarily in the case of crystalline bodies); 3) unlike the two above mechanisms of internal friction, in which the thermodynamic irreversibility is combined with geometric irreversibility due to the formation of residual (irreversible) macro- or microscopic deformations, it is possible to have dissipation processes also without the appearance of residual deformations. Reference is had here, for example, to diffusion displacements of atoms through distances of the order of interatomic distances, disturbance of the temperature and concentration equilibrium, etc. For example, elastic flexure of a rod initially held at a constant temperature gives rise to a temperature gradient, since the elongated fibers are cooled and the compressed fibers are heated up. Disturbance of the thermal equilibrium results in relaxation and equalization of temperatures with attendant conversion of a part of the elastic into mechanical energy. A second example is the elastic deformation of an alloy with an initially random distribution of the component atoms which is nonuniform with respect to zones. Large atoms in the elastically deformed lattice of the alloy tend to

diffuse into expanded zones, while smaller atoms tend to diffuse into compressed zones. This elastic deformation gives rise to a relaxation process, that is, diffusion, which brings the elastically deformed body closer to the equilibrium state. The demonstrations of internal friction in these case (hysteresis, damping, aftereffect, etc.) can take place independently of the presence of general and local plastic deformation and also when the latter do not exist. The group of phenomena which is related to the 2nd and 3rd of the enumerated internal friction mechanisms is frequently called incompleteness of elasticity.

The following differentiation can be made between kinds of internal friction on the basis of the extent to which they are local: 1) Submicroscopic, for example, by diffusion, thermal conductivity, etc. At moderate temperatures an important role is played by the distance mechanism of internal friction, under which the energy dissipation take place due to vibrations, breakaway, and other modes of dislocation displacements. These processes may take place both in elastic and in plastic deformations and they can interact with them. 2) In the form of plastic microdeformation, when the entire body is, on the average, still in the elastic region. 3) Macroscopic, when viscous flow or plastic deformation of the entire body takes place. Thus, in the all-encompassing sense of the word, we can refer to internal friction nonelastic processes of varying nature, including diffusion, heat, electric and magnetic, damagability and initial failure, etc. However, it is conventional to refer to internal friction primarily local processes: relaxation of stresses, damping of vibrations, hysteresis, aftereffect, and other phenomena which accompany the deformation of an elastic body as a whole. Demonstrations of internal friction are accompanied by changes in a number of physical (temperature, changes in magnetic and electric fields, appearance of internal stresses) and physio-chemical (structur-

al changes which are closely related to diffusion) factors. Hence the material can approach equilibrium through relaxation due to the simultaneous effect of various processes. The ensemble of relaxation times (or their reciprocals) forms the relaxation spectrum of the given material.

The following can serve as a measure of internal friction: 1) the absolute amount of energy which was converted into heat (attendant to repeated loadings referred to one cycle); 2) ratio of the amount of energy converted into heat (dissipated) per cycle  $\Delta W$ , to the maximum potential energy of the cycle  $W$ , that is, the quantity  $W$ ; 3) changes in the area, width or height of the hysteresis loop in single or multiple loadings; 4) damping of free vibrations which is evaluated, for example, by  $\delta$ , the logarithmic damping decrement; 5) the width of the resonance curve of  $\Delta\omega/\omega$ , where  $\Delta\omega$  is the deviation from the resonance frequency  $\delta$ , at which the amplitude of the induced vibrations is reduced by a factor of two; 6) the quality factor  $Q$  which shows by what factor does the amplitude of stationary induced vibrations on resonance exceeds the amplitude of these vibrations away from resonance, or its reciprocal,  $Q^{-1}$ . All these quantities are interrelated:

$$Q^{-1} = \frac{\Delta W}{2\pi W} = \frac{\delta}{\pi} \approx \frac{\Delta\omega}{\omega} \cdot \sqrt{3}.$$

The methods of measurement of internal friction can be based: 1) On static measurements. Here a comparison is made of loading and unloading curves attendant to static deformation with an accuracy sufficient for finding divergence between the loading and unloading branches of the diagram. The comparison can be performed either with respect to the relative width  $\gamma$  of the hysteresis loop (referred to the greatest strain), or with respect to the relative area  $\psi$  of the hysteresis loop (referred to the highest energy of the cycle). 2) On measurements at-



tendant to stationary undamped (induced) vibrations, for example, for a given amplitude of induced vibrations a measurement is taken of the quantity of dissipated energy, or for a specified vibration force a measurement is made of the amplitude, etc. 3) On measurements attendant to longitudinal, transverse, flexural or torsional damped vibrations, where the extent of damping measured under specified conditions serves as the characteristic of internal friction.

Study of internal friction is important: 1) As a sensitive method for discovering and studying structural changes. In this case of primary importance is not the absolute value of internal friction, but its variation as a factor of the value and character of the load, temperature, composition, structure and other factors. The method of internal friction can be used to study many phase transformations, in particular, the kinetics of the disintegration of supersaturated solid solutions, diffusion parameters, solubility limits of solid solutions, displacement of boundaries of spontaneous magnetization in ferromagnetic materials, dissipation of oscillation of the crystal lattice of metals, etc. 2) For characterization of the material's capacity to reduce (equalize) the maximum vibration stresses. In these cases an attempt is made to achieve, all other conditions remaining equal, highest internal friction. For example, when the internal friction is reduced by a factor of two and the vibrations are damped, the vibration-induced stress peaks increase in service and result in fatigue failure of steam-turbine buckets. However, frequently the "structural damping," for example, in couplings, joints and hinges plays the major role, since its amplitude exceeds appreciably the damping of material by internal friction. 3) To characterize the materials of precision instruments such as manometers, altimeters, flowmeters, barometers, etc. It is desirable that the materials of the elastic elements of these instruments should have the small-

est deviation between the loading and unloading branches, since the indications of the instrument should not depend on whether the measurement was taken in the process of loading the elastic element ("from the bottom") or unloading it ("from the top"). In these cases an estimate on the basis of the size of the hysteresis loop is most suitable.

References: Finkel'shtein, B.N. Relaksatsionnyye yavleniya v tverdykh telakh [Relaxation Phenomena in Solid Bodies], in the collection: Relaksatsionnyye yavleniya v metallakh i splavakh [Relaxation Phenomena in Metals and Alloys], Moscow, 1960; Vnutrenneye treniye [Internal Friction], in the book: Fizicheskiy Entsiklopedicheskiy slovar' [Encyclopedical Dictionary of Physics], Vol. 1, Moscow, 1960, page 284; Uprugost' i neuprugost' metallov [Elasticity and Inelasticity of Metals], Collection of translations, Moscow, 1954.

Ya. B. Fridman

INTERNAL STRESS is the stress existing within the limits of a body (sometimes a system of connected bodies or a portion of a body) which is in equilibrium with nonuniform deformation within the body without the application of external forces to the body. From the condition of equilibrium it follows that the sum of the internal loads (forces, bending and torsional moments) from the internal stresses is equal to zero. Therefore, for example, tensile stress in one zone corresponds to compressive stress in another zone. The smaller the section in one of the zones, the higher the stresses in this zone. The internal stresses are divided into residual stresses and transient stresses, which disappear after removal of their cause. An example of the latter might be the thermoelastic stresses in an elastic body (with occurrence of a nonlinear temperature gradient in the body) or in the thermal bimetal, in which metals with sharply differing coefficients of thermal expansion are in intimate contact.

Ya.B. Fridman

I-1.1

INVAR -- is an Fe alloy with 36% Ni (N36), characterized by a very low linear expansion coefficient ( $\alpha \leq 1.5 \cdot 10^{-6}$  in the temperature range from  $-80^\circ$  to  $+100^\circ$ ). It is utilized for the production of tape measures, rules, geodesic wire, and parts of measuring instruments whose dimension must be constant within the range of climatic temperature changes. It is delivered in the form of tapes with a thickness of 0.2-2.0 mm, in sheets with a thickness of 3-11 mm, as wire with a thickness of 0.1-3.0 mm, and as forged rods with different diameters. Fe-Ni-Co alloys with 30-31% Ni and 4-6% Co (Superinvar) possess a particularly low linear expansion coefficient. The N30K4D (EI63CA) alloy ( $\alpha < 1 \cdot 10^{-6}$  within  $-60^\circ$  and  $+60^\circ$ ) is delivered in experimental lots for parts of measuring instruments with a very high accuracy. The corrosion-resistant Fe-Co-Cr alloy with 37% Co and 9% Cr (stainless Invar) shows also a low linear expansion coefficient.

References: Livshits B.G., Fizicheskiye svoystva metallov i splavov [The Physical Properties of Metals and Alloys], Moscow, 1956; Smolyarenko D.A., and Kaplan A.S., "Standardizatsiya" [Standardization], 1959, No. 3, page 13.

B.G. Livshits, A.A. Yudin

IOFFE'S EFFECT - is the increase in strength and plasticity of rock salt effected by water. This phenomenon was first ascertained by A.F. Ioffe and M.A. Levitskaya. Rock-salt crystals proved a high strength and plasticity when broken in hot water. The true ultimate strength of individual samples reached 30-160 kg/mm<sup>2</sup> approaching, therefore, to the values of the theoretical strength. Rock-salt crystals have a low strength (up to 0.5 kg/mm<sup>2</sup>) and plasticity ( $\delta$  less than 0.1%) in dry state. Other researchers had subsequently also observed a significant increase in strength (up to 5-10 kg/mm<sup>2</sup>) and elongation (up to 20-30%) in numerous experiments of stretching diverse varieties of rock salt in water. Experiments had shown that water has an analogic effect also on the crystals of other metal halides (KCl, for example). The Ioffe effect is explained by dissolution of surface defects and cracks which are removed and smoothed by the action of water. Owing to this fact, not only the breaking strength of rock salt is increased, but the rock salt becomes capable of plastic deformation; the strengthening occurring in this way increases in turn the ultimate strength of the rock salt. Water does not only render harmless the surface defects which are present in the initial state, but also the defects which appear on the surface of the sample at the plastic deformation. Therefore, the strength and plasticity of dry-rock-salt increase also, although in a lower degree than when stretched in water, after a previous dissolution of the surface layer in water (without load).

References: Ioffe A.F., Kirpicheva M.V., Levitskaya M.A., "Zhurnal rus. fiz.-khim. ob-va" [Journal of the Russian Society of Physical

I-2211

Chemistry], 1924, Vol. 56, No. 5-6; Kuznetsov V. D., Fizika tverdogo tela [Solid State Physics], Vol. 2, Tomsk, 1941 (in collaboration with M. A. Bol'shanina).

S. I. Kishkina-Ratner

IONIZATION METHOD OF X-RAY AND GAMMA-RAY FLAW DETECTION - is the control of the quality of materials and objects by trans-illumination and measuring the intensity of the radiation, which has passed the object to be checked, by means of detectors transforming the radiation intensity into an electric signal. The degree of weakening of the radiation on the controlled section, and therefore, the presence of flaws involving an interruption of the continuity of the material (blisters, accumulation of pores, etc.) or local changes in the thickness of the checked object can be judged by the magnitude of the electric signal. The procedure of checking a large number of monotypic objects can be automatized. The main units of an ionization flaw detector (Fig.) are: the radiation source (X-ray tube, Radioactive Isotope or Betatron) with a collimator isolating a small radiation beam; the radiation detector (usually a scintillation counter when operating with current); the amplifier, and the recording or signalling output-device. A small section of the object, corresponding to the cross section of the operating radiation beam is radiated in each instant of time; the total object is checked successively by moving of the object relatively to the source - detector system. The limit thickness of the radioscopy is determined by the penetrating capacity of the used radiation and can approach 500-600 mm for steel and cast iron when betatrons are used. The sensitivity of this method is of the same order as the photographic control, but the efficiency is significantly higher especially when very thick objects must be checked.

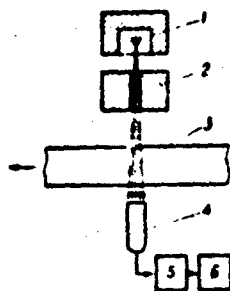

Fig. Scheme of the ionization flaw detector: 1) Radiation source; 2) collimator; 3) object to be checked; 4) radiation detector; 5) amplifier; 6) output device.

L. K. Tatochenko



IRIDIUM, Ir - is a chemical element of the VIII<sup>th</sup> group of Mendeleev's Periodic System, atomic number 77, atomic weight 192.2 Ir<sup>191</sup> (38.5%) and Ir<sup>193</sup> (61.5%) are the stable isotopes. The metal belongs to the platinum family; its occurrence in the earth's crust is equal to  $1 \cdot 10^{-7}\%$  by weight. Its density is  $22.4 \text{ g/cm}^3$ ,  $t_{\text{pl}}^{\circ}$  is  $2410^{\circ}$ . It is a very hard and brittle metal. It is mined together with platinum. The high-melting characteristic, the inoxidability at high temperatures, and the hardness are its most valuable features for technical purposes. The price of iridium is higher than that of platinum due to the rarity of the former. See Noble Metals.

O.Ye. Zvyagintsev

IRON, Fe — is a chemical element of the VIII Group of Mendeleev's Periodic System; atomic number 26, atomic weight 56.85. It consists of 4 stable isotopes: Fe<sup>54</sup> (5.84%), Fe<sup>56</sup> (91.68%), Fe<sup>57</sup> (2.17%), and Fe<sup>58</sup> (0.31%). The degree of purity attained is 99.98%; it melts at 1539°; it exists in solid state in two allotropic modifications. Up to 910°, iron exists in the  $\alpha$  modification characterized by a body-centered cubic lattice. The  $\alpha$  modification turns above 910° into the  $\gamma$  modification with a closely packed face-centered cubic lattice (Fig.); this modification is stable up to 1400°. Above 1400°, the body-centered cubic lattice, termed as  $\delta$  modification (although it is analogous to the  $\alpha$  modification), becomes stable anew. Commercially, pure iron is used mainly in electrical engineering for the production of cores of electromagnets, rotors of electric motors, etc. Iron powder is widely used for the production of machine parts by means of powder metallurgy, and also as a base for steel production.

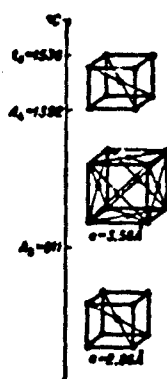

Fig. Scheme of the change of the crystalline structure of iron on heating (the value of the lattice constant is given for 20°).

TABLE 1  
Mechanical Properties of Iron of  
Different Purity

| 1<br>Свойства                        | 2<br>Чистей-<br>шее же-<br>лезо | 3<br>Электро-<br>литич.<br>железо<br>(итонк-<br>ментное) | 4<br>Карбо-<br>нильное<br>железо | 5<br>Технич.<br>мягкий сталь.<br>(отжиганный) |
|--------------------------------------|---------------------------------|--|----------------------------------|---|
| 6 $HV$ (кг/мм <sup>2</sup> )         | 6: —                            | 45-55  | 55-80                            | 80-90   |
| $\sigma_{0.2}$ (кг/мм <sup>2</sup> ) | 6: 17.65                        | 10-14  | 9-17                             | 9-25  |
| $\sigma_b$ (кг/мм <sup>2</sup> )     | 6: 29.15                        | 18-25  | 20-28                            | 18-32   |
| $\delta_{10}$ (%)                    | 6: 50                           | 50-40  | 40-30                            | 40-30   |
| $\psi$ (%)                           | 6: 93                           | 80-70  | 80-70                            | 80-70   |
| $K$ (кг/мм <sup>3/2</sup> )          | 6: —                            | 21 000   | 20 700                           | 20 000-21 000                                 |
| $G$ (кг/мм)                          | 6: —                            | 8 200  | —                                | —   |

1) Properties; 2) purest iron; 3) electrolytic iron (annealed); 4) carbonyl iron; 5) commercial soft steel (annealed); 6) kg/mm<sup>2</sup>.

TABLE 2  
Physical Properties of Iron

| 1<br>Свойства  | 2<br>Технически<br>чистое железо<br>массового<br>производства | 3<br>Переплавлен-<br>ное электро-<br>литич. железо<br>и спеченное<br>карбонильное<br>железо | 4<br>Чистейшее<br>железо   |
|--|---|---|--|
| $\gamma$ (г/см <sup>3</sup> )                        | 7.876   | —   | —  |
| $\alpha \cdot 10^6$ (0-100°)                         | 12.5  | 11.9  | —  |
| $\lambda$ (0 и 100°; ккал/см·сек·°C)                 | 0.133   | 0.177   | —  |
| $\epsilon$ (0-100°; ккал/г·°C)                       | 0.111   | —   | —  |
| Теплоемкость<br>(0-100°; ккал/г)                     | 11.3  | —   | —  |
| $\rho$ (20°; ом·мм <sup>2</sup> /м)                  | 0.99  | —   | —  |
| Кoeff. самодиффузии<br>(см <sup>2</sup> /сек)        | 9   | —   | $\alpha$ -Fe $2.3 \cdot 10^{-11}$<br>$\gamma$ -Fe $5.8 \cdot 10^{-11}$ |
| Энергия активации са-<br>модиффузии<br>(ккал/г·атом) | 10  | —   | $\alpha$ -Fe 73.2<br>$\gamma$ -Fe 74.2                                 |
| Остаточная магнитная<br>индукция (кс)                | 11  | —   | —  |
| 12 Коэрцитивная сила (о)                             | 8000-11 000   | 8000-11 000   | 8000-11 000  |
| Магнитное насыщение<br>(кс)                          | 13  | —   | —  |
| 14 Макс. магнитная про-<br>ницаемость                | 14  | —   | —  |
|  | 5000-10 000   | 10 000-20 000   | 15 -<br>до 680 000   |

1) Properties; 2) commercial pure iron of large-scale production; 3) remelted electrolytic iron and sintered carbonyl iron; 4) purest iron; 5) cal/cm·sec·°C; 6) cal/g·°C; 7) heat capacity (0-100°, cal/g); 8) ohm·mm<sup>2</sup>/m; 9) self-diffusion (kcal/g·atom); 11) residual magnetic induction (gauss); 12) coercive force (oersted); 13) magnetic saturation (gauss); 14) maximum magnetic permeability; 15) up to.

M. L. Bernshteyn

I-9I

ISOPERM - see Magnetic Material with Increased Permeability.

ISOTROPIC MATERIALS - are homogeneous materials whose properties, in contrast to anisotropic materials, do not depend on the direction of the measurement. All "structureless materials - glasses, certain polymers (rubber, polystyrene, etc.), gases and fluids, free from the effect of force fields, are isotropic. Many polycrystalline materials are macroscopically isotropic if a texture is absent, i.e., if the crystal lattices in the different grains are chaotically disorientated. These materials are more strictly termed quasiisotropic because they are anisotropic within each grain (in the microvolumes). Spatially directed external effects, mechanical and thermal stresses, etc., displace conforming to a rule the particles of bodies and transform the latter from the isotropic into the anisotropic state (fluids running in pipes, stretched polymers, etc.). This effect is utilized particularly in the optical method of the investigation of stresses.

Sh. Ya. Korovskiy

I-81

ISOVIL - see Polyvinylchloride fiber.

JET - a variety of bituminous, dense, tenacious, low ash-content coal which is easily machined. The composition is not constant, it is characterized by a high content of volatile fractions (above 50%) and hydrogen (up to 9%). On the average jet contains (in %): C 70-80, H 6-8, O 14-19, N up to 1; when burned the residue contains less than 0.5% ash, 40-45% of coke and 55-60% of volatile fractions. The specific weight 1.2-1.4, Mohs hardness 3-4, pendulum hardness (in secs.) 29-40, the porosity does not exceed 0.25%. The color is black-brown or black. Young's modulus  $300 \text{ kg/cm}^2$ , ultimate compressive strength up to 1000, ultimate flexural strength 300, ultimate tensile strength  $350 \text{ kg/cm}^2$ . Jet has good dielectric properties: dielectric coefficient 7-12, specific volume resistivity  $2.6 \cdot 10^8 - 1.9 \cdot 10^{10}$  ohm-cm, the dielectric losses angle tangent is 0.4-0.9. Jet is easily cut by a knife, drilled, sawed, planed, takes threading, is beautifully polished. In thin plates it is elastic at room temperature, at  $100^\circ$  it can be twisted and forge rolled retaining the shape thus imparted on cooling. When heated to  $250-275^\circ$ , jet generates gases and at  $400^\circ$  it burns. It resists cold hydrochloric and particularly phosphorus acids and alkalis. It decomposes in sulfuric and nitric acids.

The use of jet is based on its dielectric properties, chemical stability, attractive, lustrous, deep black color, the feasibility of machining by simple tools. It is used for components of radio and telephone apparatus, noncritical components of textile and other machines, in chemical machine building as an acid and alkali resistant material, for the production of art articles. Jet can be used as a filler of

I-2G1

plastics and rubbers. It is machined by metal-cutting and woodworking machine tools (circular saws, lathes, etc.), frequently upon heating to 120-150°.

References: Rybin, A.A., Gagat, yego mestorozhdeniya, obrabotka i primeneniye [Jet, Its Deposits, Machining and Utilization], "Byul. Tsentral'noy n.-i. labor. kamney-samotsvetov" [Bull. of the Central Scientific Research Laboratory for Gems], Issue 5, No. 2, pages 11-26, 1953.

V.I. Fin'ko



KALAKUTSKIY'S METHOD - is a method to measure the radial and circular residual stresses in discs. The disc is marked on its face with a number of concentric rings, in each the initial diameter is measured by drawing graduation lines. Then the disc is cut into rings, the diameter of the rings are measured anew, and the radial and circular residual stresses are calculated based on the changes in the diameter values. The magnitude of the radial stresses which relax when the ring is cut, and which cause partially its deformation, is neglected in a simplified variation of the Kalakutskiy's method. Further Kalakutskiy's method was simplified by McRee and Klein. The residual stresses are determined by the formula  $\sigma_r = \sigma_t \pm \mu \sigma_t = -E \frac{\Delta D}{D}$ , where  $\sigma_t$  are the normal circular stresses,  $\sigma_r$  are the radial stresses,  $\mu$  is the Poisson's ratio,  $E$  is the normal modulus of elasticity, and  $\Delta D$  is the change of the diameter  $D$  caused by cutting out the ring. The minus sign in the right part of the formula indicates the appearance of stretching residual stresses when the diameter decreases ( $\Delta D < 0$ ), and of compressing ones when the diameter increases ( $\Delta D > 0$ ). In the case of a great stress gradient along the thickness of the rings, the rings are in addition cut radially, and the not-detected part of the residual circular stresses  $\sigma_t$  in the outer fibers of the ring is determined by the formulae  $\sigma_r = \pm \frac{E \delta}{D^2} \Delta D$ , or  $\sigma_r = \pm \frac{E \delta}{3 D^2} \Delta a$ , where  $\delta$  is the thickness of the ring;  $\Delta D$  is the mean change in the ring diameter  $D$  after it is cut along the radius,  $\Delta a$  is the change in the distance between the marks on both sides of the gap which arises when the ring is cut along the radius. The exactness of the last two formulae is sufficient if the ratio of the radius to the thickness is not

I-1K1

less than 10.

Literature, see Residual Stress.

Ya. B. Fridman

KAOLIN - is a loose rock with white color, consisting of the argillaceous minerals kaolinite, halloysite, hydromicas and greater or fewer impurities as quartz, feldspars, micas, rutile, iron oxides, and other minerals. Primary and secondary (redeposited) kaolins are distinguished. Kaolin concentrates obtained by enrichment of natural, mainly of primary kaolins, consisting essentially of the mineral kaolinite, are used in the industry. Kaolinite is the main argillaceous mineral of kaolin (nacrite and dickite, differing from kaolinite in structure, occur considerably more rarely in nature). Kaolinite is a schistous aluminosilicate hydrate with the composition:  $\text{Al}_2\text{O}_3 \cdot 2\text{SiO}_2 \cdot 2\text{H}_2\text{O}$  (46.54%  $\text{SiO}_2$ ; 39.50%  $\text{Al}_2\text{O}_3$ ; 13.96%  $\text{H}_2\text{O}$ ); it is triclinic, and is one of the most widespread in nature polymorphous modifications of this substance. It occurs in the form of segregations of white-colored lamellae with a pseudo-hexagonal shape and a size of some microns, very perfectly cleavable along (001). The Mohs hardness is 1-2, the specific gravity is 2.58-2.60; the weight by volume is 1.8-2.2 g/cm<sup>3</sup>; the refraction indices are:  $n_g = 1.566$ ;  $n_p = 1.560$ . The heat of wetting is 1-2 cal/g; the specific heat (in joules/g) is 0.99 at 0°; 1.17 at 200°, and 1.35 at 400°. Kaolinite loses water and transforms into metakaolinite when heated to 550-600°. The dehydration of kaolinite is accompanied by a heat absorption of 95-100 cal/g. When heated further, metakaolinite transforms at 925-950° into aluminosilica spinel (giving off 16.5 cal/g), which at 1050° is transformed into mullite contaminated by cristobalite. Kaolin is hydrophilic, it forms with water a suspension or a plastic body; the coherence of kaolin is considerably lower than that of other plastic refrac-

I-8kl

tory clays and does not exceed  $7-10 \text{ kg/cm}^2$ , the cementing power is low, the sintering temperature is  $1300-1350^\circ$ . The refractoriness is  $1750-1800^\circ$ . Hydrochloric and nitric acid have almost no effect on kaolin, sulfuric acid decomposes it easily, especially when heated. Kaolin has found a very varied and wide utilization in industry, which is based on its diverse physicochemical and physical properties: hydrophilic nature, high dispersity, white color in natural and fired state, high refractoriness and high content in alumina, plasticity, chemical inertness, high electric properties in fired state, etc. Kaolin is used: 1) as an active filler for paper (250-300 kg kaolin are consumed for 1 ton of paper), for rubbers (10-12% by volume), for plastics, for composition materials, etc.; 2) in the production of glue-colors and oil-paints as a white pigment (in fired state) instead of titanium white; 3) in ceramics for the production of China clay and faience; 4) for the production of refractories; 5) in the chemical industry for the production of aluminum sulfate, alumina, ultramarine, as a catalyst for the cracking of hydrocarbons, as a carrier and filler for insecticides and fertilizers; 6) in the production of oilcloths, pencils, perfumeries and cosmetics, and in other industrial branches.

References: Nemetallicheskiye iskopayemyye SSSR [Nonmetallic Mineral Resources of the USSR]. (Collection of Papers), Vol. 4, Moscow-Leningrad; Otsenka mestorozhdeniy pri poiskakh i razvedkakh [Evaluation of Deposits in Prospecting and Exploration], No. 11; Samoylov V.F., Mel'nikov I.I., Kaolin, Moscow, 1951; Betekhtin A.G., Mineralogiya [Mineralogy], Moscow, 1950.

V.I. Fin'ko

KEROSENE-CHALK METHOD OF FLAW DETECTION - consists in putting kerosene on the surface of the piece to be checked, which fills the hollows of the flaws. Thereupon, the excess of kerosene is removed from the surface of the piece and a chalk cover is applied. After some time, the kerosene issuing from the flaws impregnates the chalk cover. The presence of flaws can be detected on basis of a darkening (getting yellow) of the chalk cover which reproduces the features of the flaw. The kerosene-chalk method of flaw detection has a low sensibility, it is therefore used only for the detection of flaws on objects with a lower responsibility (see Capillar Detection of Flaws).

S. I. Kalashnikov

KERSEY - is a tight multilayer combined-weave cotton fabric used for technical purposes. Kersey is manufactured in a raw and in a smooth-dyed form. The main characteristics of kersey are listed in the Table. In the printing trade kersey is used as a technical fabric to cover the drums of lithographic machines. It must have a uniform thickness, a smooth surface, and a strong resistance to stretching.

TABLE  
The Main Characteristics of Kersey

| 1<br>Артикул | 2<br>Характеристика   | 3<br>Вес<br>1 м<br>(г) | 4<br>Ширина<br>(см)      | 5<br>Разрывная<br>нагрузка<br>(кг, не менее)<br>полоска<br>20 x 200 мм |              | 6<br>Удлинение<br>(%, не менее) |              |
|--------------|---|------------------------|--------------------------|--|--------------|---------------------------------|--------------|
|              |   |                        |                          | 7 по<br>основе   | 8 по<br>утку | 7 по<br>основе                  | 8 по<br>утку |
| 4108 9       | двухслойная<br>Отбельная 10<br>красящая   | 385 ± 15               | 99 ± 2                   | 130  | 118          | 22                              | 19           |
| 4111 9       | двухслойная<br>То же 11   | 340 ± 15               | 98 ± 2                   | 120  | 90           | 13                              | 13           |
| 4112 9       | двухслойная<br>Гладнокрасящая 12  | 365 ± 20               | 101 ± 2                  | 125  | 93           | 18                              | 12           |
| 131          | трехслойная, обрабо-<br>танная каучуковы-<br>ми пленками или<br>пленками на основе<br>полиэтилена | 610 ± 20               | 91,5 ± 1,3<br>89,5 ± 1,3 | 108  | 85           | 25                              | 19           |
|              | Гладнокрасящая 12   | 810 ± 20               | 87,0 ± 1,3<br>84 ± 1,5   | 100  | 80           | 19                              | 12           |

1) Fabric; 2) characteristics; 3) weight per 1 m (g); 4) width (cm); 5) breaking load (kg, not less than), for a 20 x 200 mm strip; 6) elongation (% , not less than), 7) along the warp; 8) along the woof; 9) double layer; 10) bleached, dyed; 11) the same; 12) dyed; 13) three-layer, with application of rubber- or polychlorovinyl films; 14) crude.

S. Ye. Strusevich

I\_62K

KIESELGUHR - is a loose or compact mineral composed mainly from hydrated silica particles. With regard to the composition, the properties and the application, it is identical with tripoli earth. Variants of tripoli earth, used as adsorbents, are named kieselguhr.

P.P. Smolin

I-91K

KNOFITE - see Perovskite.



KOL'CHUG ALUMINUM - is the first Soviet alloy of the Duralumin type produced in the Kol'chugino Plant in 1922. The chemical composition (in %) is: 4-5 copper; 0.5-0.6 magnesium; 0.3-0.5 manganese; 0.2-0.6 nickel; 0.3-1 iron; 0.2-0.4 silicon, the rest is aluminum. The physical properties are: density  $2.9 \text{ g/cm}^3$ , modulus of elasticity  $7300 \text{ kg/mm}^2$ . The alloy is hardened by heat treatment and, dependent upon the type of the intermediate product, produces the following properties:  $\sigma_b = 36-42 \text{ kg/mm}^2$ ;  $\sigma_{0.2} = 19-23 \text{ kg/mm}^2$ ;  $\delta = 15-22\%$ ; HB = 90-100  $\text{kg/mm}^2$ . It is no longer used.

References: Butalov V., "Kol'chugalyumin" [Kol'chug Aluminum], "Vestnik metallopromyshlennosti," 1924, No. 1-3.

O.S. Pochvar, K.S. Pokhodayev

II- 38k

KURALON is a synthetic fiber produced in Japan in the form of film and staple fiber (see Polyvinyl Alcohol Fiber).

II-39k

KURPLETA is a triacetate fiber (staple and filamentary) produced in England (see Triacetate Fiber).

KURTEL' is a synthetic carbo-chain, polyacrylonitrile modified fiber used in the textile and knitwear industries. It is produced in the form of staple fiber ( $N_M$  el. 6000, 4500 and 3000, fiber length from 36 to 150 mm) with circular cross-section. The fiber is resistant to sunlight and microorganisms. The specific weight of the fiber is 1.17, moisture content at standard conditions is 2 percent, swelling in water is 20 percent by weight. Softening temperature is 160°, burning temperature is 230°. Shrinkage in boiling water is 1 percent (fiber is also produced with 19 percent shrinkage for fabrication of high-volume yarn).

For other physical and chemical properties see Modified Polyacrylonitrile Fiber.

Breaking length in the dry condition is 27-31.5 km; in the wet condition it is 22.5-27 km; elongation in the wet condition is 30 percent. Kurtel' is colored using the dispersion and basic dyes which give the fiber colors which are resistant to sunlight and washing. Kurtel' is used in the pure form and in combination with wool (to give products stability of form and dimensions). Products made from Kurtel' are notably wrinkle-free.

L.M. Musichenko-Vasil'yeva

KYANITE (disthene) - is a mineral of the class of silicates ( $\text{Al}_2\text{SiO}_5$ ); it is similar to sillimanite and andalusite with regard to the composition and application, and differ from them in the structure of the crystal lattice and in some physical properties; it has usually up to 1-2% (sometimes up to 7%)  $\text{Fe}_2\text{O}_3$  as an isomorphous impurity. Its color is azure or blue, green, yellow, or grayish-brown; it is rarely colorless or black. The hardness is unequal in the different directions: 4.5 along the crystal, and 6-7 across the crystal (according to the Mohs scale). It is brittle. The specific gravity is 3.56-3.68. It decomposes at 1000-1380° (according to the diverse sources) and forms mullite and alumina glass, the volume increases at the same time by 20%. Products with a porosity of 25-10% and a weight by volume of 2.6-2.7  $\text{g/cm}^3$  may be obtained in the production of mullite refractories depending on the binder and the preheating. The products from kyanite have, in contrast to sillimanite products, a somewhat higher mechanical strength; the resistance to abrasion, determined in Richter's device (in mm) is: 0.4 at 1000 m wavelength, and 0.6 at 3000 m. The coefficient of the thermal expansion is 0.43-0.5 at 1000°. The heat endurance (according to different sources) is equal to 15-50 cycles (with a temperature drop from 850±5°). Objects from kyanite dissolve more readily in strong acids than sillimanite products; 68-78% remain insoluble in hydrofluoric acid. Kyanite is better extractable by flotation than sillimanite and andalusite. Kyanite is the most widely used mineral of the sillimanite group.

P. P. Smolin

LACQUER AND PAINT COATINGS are coatings which are widely used for protection of metallic products from corrosion, nonmetallic materials from moistening and rotting, and also to give the products and materials special properties and a decorative appearance. The lacquer and paint coatings are liquid or paste-like solutions of resins (polymers) in organic solvents or vegetable oils with additions to them of finely dispersed mineral or organic pigments, fillers, drying agents and certain special substances. After application to the surface of the product to a thickness of 100-150 microns, the lacquer and paint coatings dry with the formation of a film which has valuable technical and decorative properties. The film properties are determined by the properties of the film-forming substance and the pigment. We differentiate two groups of lacquer and paint coatings. Those of the first group form nonconversion or conversion films as a result of the physical process of the evaporation of the solvents. The film-forming substances are: low-molecular natural resins (shellac, resins, bitumens); various simple and complex cellulose esters; synthetic resins: low-molecular (iditol) and high-molecular (perchlorvinyl, polystyrene, polyvinylacetate and others). Those of the second group form conversion or nonconversion films as a result of the complex physico-chemical processes of oxidation, polymerization, condensation or simultaneous polymerization and condensation. The film-forming substances are: low-molecular vegetable oils; low-molecular synthetic resins (polyurethane, alkyd, epoxy, urea- and melamine-formaldehyde, phenolic and others); high-molecular (rubbers and others).

The lacquer and paint coatings are used for painting: exterior (aircraft, automobiles, railway cars, motorcycles, heavy machine construction equipment, etc.); interior (instruments, interior surfaces of railway cars, etc.); special (labeling of rubber, leather, etc.); temporary (protection of metal during transport and temporary storage); chemical resistant (protection against moisture, acids, alkalis, combustibles, aggressive gases, organic solvents); heat resistant, supporting temperatures from 100 to 1000° with retention of protective properties and exterior appearance; waterproof (protection of underwater portions of ocean and river vessels, hydrotechnical installations, etc.), which retain their properties under water for long periods and prevent the formation of surface fouling by microorganisms and algae; illumination (screens, light reflectors, etc.), which have a high light reflection coefficient; bactericidal, which prevent the growth of infectious microorganisms on the painted surfaces; and also for the electric insulation protection of various electric machines, radio equipment, artistic paintings, etc. A unified nomenclature and designation for lacquers (TU-KU-471) and for enamels (TU-KU-472) is used in the USSR. The designation for the lacquers and enamel paints is composed from the name of the basic resin appearing in the composition of the material, a nomenclature symbol (field of application), and the designation of the external form of the coating. The protective lacquer and paint coatings for various surfaces are different: for the metals they usually consist of a primer layer, having anticorrosion properties, and an outer layer of enamel paint which prevents penetration of moisture and aggressive ions to the metal surface; for wood they consist of a primer layer which has pore-filling and sealing properties and an outer waterproof layer (lacquer or paint). Puttying materials are used to smooth the surface prior to painting. The outer paint layers must cor-

respond to the specified operating conditions: atmospheric resistant, water resistant, resistant to microorganisms, chemical resistance, etc. The production of the lacquer and paint coatings consist of the following technological operations: preparation of the surface, application of the lacquer or paint material, drying of the coating film. The preparation of the surface prior to painting determines the quality of the coating. A rough surface, oxide, phosphate and other films improve the paint adhesion, which improves its protective effect. The lacquer and paint coatings are applied by brush, spatula, dipping, pouring, pulverization, spraying, compressorless spraying or spraying in an electrostatic field. Stamp or roller application is also used. The lacquer and paint coatings are dried at 15-35° (cold method) or at 80-180° (hot method). Most of the conversion lacquer and paint coatings based on the thermoreactive resins give high quality coatings only with hot drying. The use of hot drying depends on the size and material from which the product is made. High temperatures accelerate the drying by several fold and improve the film quality. Hot drying on conveyor lines is particularly effective. The existing drying devices are divided into three types on the basis of the method of thermal action: convection (heating with hot air), thermoradiation (heating by thermal rays), and induction (heating by induction currents). In some cases the painted article is subjected to grinding and polishing using special pastes. With time, the lacquer and paint coatings deteriorate. Periodic treatment of the painted surface with special prophylactic pastes is recommended in order to improve service life under atmospheric conditions.

References: Drinberg A.Ya., Gurevich Ye.S., Tikhomirov A.V., *Tekhnologiya nemetallicheskih pokrytiy* [Technology of Nonmetallic Coatings], L., 1957; Drinberg A.Ya., *Tekhnologiya plenkoobrazuyushchikh veshchestv* [Technology of Film-Forming Substances], 2nd ed., L., 1955;



II-46k3

Organic Protective Coatings, coll. of articles transl. from Eng., M.-L., 1959; Lyubimov B.V., Spetsial'nyye lakokrasochnyye pokrytiya v mashinostroyeni [Special Lacquer and Paint Coatings in Machine Construction], M.-L., 1959.

V.V. Chebotarevskiy

LACQUER AND PAINT COATINGS FOR THE ALUMINUM ALLOYS. Depending on the type of alloy, the construction of the part, the purpose of the item, the operational conditions and other factors, the protection of the aluminum alloys and parts made from them from corrosion is accomplished by chemical or electrochemical oxidation, by oxidation and painting (see Corrosion of the Aluminum Alloys). The most reliable method of protection is electrochemical oxidation in combination with painting, the latter often serving as a decorative coating as well. The lacquer and paint coatings consist of a passivating primer, a passivating primer and finishing coatings, the lacquer coatings. The selection of a particular lacquer or paint coating is determined by the type of alloy, the oxidation method, the thickness of the oxide film and the method of sealing of the film (in water or in chromate solution), the usage of the item and the operational conditions. Complete isolation of the protected surface of the metal can be achieved only in the case when the coating is fully impenetrable to gas and water. Obtaining such coatings is quite difficult, frequently it is necessary to apply a large number of layers to achieve this. But this weakens the adhesion, makes painting expensive and increases the weight. The most reliable protection of aluminum and other metals from corrosion is provided by coatings consisting of primers with passivating pigments and outer insulating layers. The insulating layer serves simultaneously for decoration. For aluminum and its alloys the passivating pigments are zinc and strontium chrome pigments, and also zinc tetraoxochromate. In addition to the methods of painting and the nature of the lacquer and paint ma-

materials, the form and the quality of preparation of the surface effect the protective quality of the coating, other conditions being equal. Obtaining strong coatings on aluminum is made difficult by the weak adhesion of many lacquer and paint materials to the aluminum. As a result of this, the coatings applied to the metal without preliminary preparation can easily delaminate under the influence of atmospheric or other factors. Improvement of the adhesion of the coatings to the metal is achieved primarily by chemical or electrochemical oxidation. The oxide film obtained by the chemical method has weaker protective properties and provides less improvement of the bond with the metal than the oxide film obtained by the electrochemical method. Sealing of the oxide films in a bichromate solution improves their protective properties and aids in strengthening the adhesion of the coatings.

All forms of coatings intended for the protection of the products made from the ferrous and other metals are also suitable for the protection of aluminum and its alloys, with the single difference that only the zinc chromate primer can be used for priming aluminum and, in addition, usually fewer layers of coats are applied to aluminum and its alloys with the exception of the cases of protection against the action of various aggressive media.

For products operating in atmospheric conditions, use is made of the aluminum alloys which are most resistant to corrosion. Depending on the method of preparation of the surface, the following coating variants can be used.

1st variant. The details of the products are anodized either by the sulfuric acid method with the formation of an oxide film no less than 8 microns thick, or by the chromic acid method with an anodic film no less than 3-5 microns thick with subsequent sealing in water or a potassium bichromate solution. Thanks to the relatively high corrosion

II-47k2

resistance of the anodic film, we can limit ourselves for external surfaces to only lacquering with two layers of 170-A lacquer or the 9-32f and AS-82 lacquers. In contrast with enamel painting, which gives the product a definite color, the lacquer coating permits retaining the metal color. An adequately atmospheric-resistant coating based on the 170-A lacquer (two coats) is formed after drying each coat at 70-80° for 4-5 hours. Drying at normal temperature reduces the atmospheric resistance of the coating considerably. The lacquer is applied by dipping, brushing or spraying. The working viscosity of the lacquer applied by dipping is 12-16 seconds, while that applied by spraying is 20-30 seconds, measured by the VZ-4 viscosimeter. Thinning of the lacquer to working viscosity is accomplished using xylene or a mixture of xylene with white spirit at a ratio of 1:1. The 9-32f lacquer is quick drying. It has good adhesion with oxidized dural. The adhesion and the gasoline resistance of its coating increase significantly with drying at 80° for no less than 4 hours or at 120° for 1.5-2 hours. To obtain better protection, two coats of fast-drying AS-82 lacquer, cold-dried, are applied on top of the 9-32f lacquer. The coating based on the 9-32f and AS-82 lacquers has high atmospheric resistance but limited gasoline and kerosene resistance. The lacquers are applied using paint sprayers. The lacquer is thinned to working viscosity (12-14 sec) with R-5. If the product is to be color coated, use can be made of atmospheric-resistant enamels. The internal surfaces of products fabricated from clad dural or the AMg and AMts alloys and anodized using the sulfuric acid method with oxide film thickness of 8-10 microns, or by the chromic acid method with films of 3-5 microns in thickness, can be coated either by the indicated lacquers or by the enamels and can be primed by the following zinc chromate primers: ALG-1, FL-03Zh, ALG-14 or AT-3a. Details fabricated from unclad dural and used inside the product are oxidized

II-47k3

and covered with zinc chromate primer, while products which require a decorative finish are coated with two layers of glyptal or other enamel after priming.

2nd variant. The parts are anodized in a sulfuric acid solution or are chemically oxidized with the formation of a film 3-5 microns thick. The protective properties of the 3-5 micron anodic film are considerably less than the 8-10 micron thick film.

To obtain reliable protection on the exterior surface, there is applied a hot-dried coat of ALG-1 primer or AG-3a, or ALG-14 or FL-03Zh and then two coats are applied of the same enamels as used in the 1st variant. The interior surfaces are protected just as in the 1st variant with the exception of the lacquering. In this case a single lacquer coat is not sufficient for protection.

3rd variant. The details are not anodized nor chemically oxidized. Protection is provided by means of application of one or two coats of zinc chromate primer and two or three layers of enamel. If a decorative finish of the internal surfaces is not required it is possible to limit ourselves to two primer coats. This variant of the protection is weaker than the first and second variants.

In order to give parts and instruments made from the aluminum alloys an attractive external appearance, use is made of various decorative coatings, for example, the "crackle" lacquers, "frosted" lacquer, "moiré" enamels, hammered finishes, etc. To obtain the "frosted" coating use is made of the oil-base lacquer 331 (TU MKhP 1045-43), and to obtain the "moiré" coating use is made of the so-called moiré enamels of various colors. Prior to the application of the 331 lacquer the surface is painted with one or two coats of oil-base or glyptal enamel and dried at 75-80° for 4 hours. Then the surface is polished with a fine abrasive cloth after which the lacquer is applied. To form a pattern

the lacquered part is placed for 25 minutes in a drying chamber at a temperature of 55-65° in which there is created an atmosphere saturated with the products of incomplete combustion of kerosene or illuminating gas. The nature of the pattern obtained depends on the lacquer viscosity, the thickness of the coating applied, the drying regime, etc. After the appearance of the pattern, the lacquer coating is maintained at 15-25° for 24-30 hours. Prior to finishing with the "moire" enamel, an oil-base or glyptal zinc chromate primer is applied. The dimension of the pattern (texture) depends on the enamel viscosity and the thickness of the layer applied. Drying of the coating is performed in two stages: first the pattern is "developed" by heating for 25-40 minutes at 75-80°, then the film is given a final drying and fixing with exposure for 2 hours at 150-160° for enamels of dark-gray color and black color and with exposure of no less than 4 hours at a temperature of 75-80° for the clear enamels and at 90-100° for the brown, blue and red. The "moire" coating covers small surface defects quite well.

The hammered-finish coatings of various colors find wide application for decorative finishing (see Hammered Lacquer and Paint Coatings).

The protection of the aluminum alloys from attack by chemical reagents is accomplished by chemically resistant coatings (see Chemically Resistant Lacquer and Paint Coatings), and protection from attack by various forms of fuels and oils is provided by the gas-kerosen-oil resistant coatings (see Gas and Oil Resistant Lacquer and Paint Coatings).

Cast details made from the aluminum alloys are impregnated with lacquers under pressure in order to fill the pores. For this purpose use is made of the bakelite lacquer (GOST 901-56) and the 101/19 primer-enamel (TU MKhP 1573-47). Prior to impregnation the details are degreased, heated to 70-80°, loaded into a basket and placed in a tank in which they are held for 10 minutes at a vacuum of 580-600 mm Hg. Af-

II-47k5

ter this the impregnating lacquer or enamel which has been preheated to 50-65° is admitted to the tank, air is pumped into the tank to create a pressure of up to 4 atm. which is maintained for 10 minutes, after which the pressure is reduced to normal, the basket with the details is removed from the tank and the excess lacquer or enamel is allowed to drain out. Drying of the 101/19 primer-enamel is allowed to drain out. Drying of the 101/19 primer-enamel is performed at 175° for 2.5 hours. The bakelite lacquer is subjected to multistep drying with initial exposure to 12-20° for 1.5 hours, 20-100° for 2.5 hours, 100-130° for 2 hours, and finally 130-150° for 2 hours.

I.I. Denker

LACQUER AND PAINT COATINGS FOR THE MAGNESIUM ALLOYS. The most common method for the protection of the magnesium alloys from corrosion (see Corrosion of the Magnesium Alloys) is that of painting. Protection presents considerable difficulty; with penetration of moisture under the lacquer and paint coatings there are formed on the surface of the metal hydroxide compounds of an alkaline nature which, acting on the film, hydrolyze and destroy it, which leads to loss of adhesion. Reduction of the chemical activity of the magnesium alloys is achieved by oxidation and the use of primers. The oxide film prevents direct contact of the lacquer/paint coating films with the metal surface and simultaneously improves their adhesion to the metal surface. The protection provided by the lacquer and paint coatings for the magnesium alloys amounts to the following: the priming coating must have passivating properties, good adhesion and resistance to the alkaline corrosion products. The outer enamel coats must have minimal water penetrability and suitable physical and mechanical properties. As pigments in the primers, use is made of the zinc or strontium chromes and zinc tetraoxochromate, which dissociate when moistened, with the formation of the chromic acid ion, which is a strong oxidizer capable of passivating the metal. Such pigments as red lead, zinc dust, aluminum powder, chrome yellow and others accelerate the corrosion process. The lower the water penetrance of the outer enamel coat, the better the anticorrosion protection. The surface to be painted must be clean and smooth. Fluxes are removed by sand blasting, boiling in a soda solution, washing in cold water, processing in a solution of chromic anhydride, rinse in hot wa-



II-5Cki

ter, and drying. Oxidation is performed after the final mechanical working. For details of 1st and 2d accuracy classes, use is made of special solutions which do not alter the dimensions of the details. Priming is performed no more than 24 hours after oxidation. The following primers are used: alkyd ALG-7 and epoxy EPO9T with baking at 100-150°; acrylic primer AG-10s with cold drying which has good protective properties also on the non-oxidized magnesium alloys, which permits its use for repair of coatings under field conditions. The thickness of the film when using a two-coat covering of the alkyd and epoxy primers is 30-40 microns, when using the acrylic primer it is 14-20 microns. The first two primers are combined with the alkyd, phenol-melamine, polyurethane and perchlorvinyl enamels. The acrylic primer gives very effective protection in combination with the perchlorvinyl or epoxy enamels. The thickness of the coating consisting of two coats of primer and one-two coats of enamel is 50-60 microns. This coating is suitable for use in tropical conditions. Details made from the magnesium alloys which are subjected to long-term exposure to gasoline, kerosene and moisture are protected over the oxide film by polyvinyl butyral lacquer of the VL-725 type. The thickness of the three-coat covering is 25-30 microns. The heat resistance of the listed coatings are: perchlorvinyl system to 100°, others to 200-250°. The high-temperature magnesium alloys are protected using the type K-3 silicone enamels. The system consists of two coats of enamel containing a chromate pigment and two coats of green color enamel. With a thickness of 60-80 microns, the coating withstands long-term heating to 350° and periodic cooling to minus 50°. Most vulnerable with regard to corrosion are the places of joining the magnesium alloy with other metals which have a more positive potential than the magnesium alloy (aluminum, copper and iron alloys, nickel, lead, silver, etc.). Contact corrosion is prevented by

the creation of a continuous layer of the lacquer/paint coating which prevents direct contact of the unlike metals. Parts which have a tight fit (bearing races, inserts, etc.) are processed as follows: steel parts are cadmium plated and passivated, bronze parts are zinc plated and passivated, aluminum parts are anodized, brass parts are tin plated, etc., and are installed on a fresh, undried coat of chromate primer. Various gaps and spaces where dust and moisture can collect, sharp edges on which the film of the lacquer/paint coating is subjected to accelerated wear are also danger spots. To provide the maximal possible insulation from moisture, bolts, nuts, grounding terminals, etc., are covered with a dense layer of a waterproof coating (epoxy or polyurethane primer with subsequent painting with a suitable enamel). Welded parts which are fabricated by electric spot welding from sheet magnesium alloy, thanks to the absence of an oxide film, require specially careful protection in the region of the weld spots. Welding is performed using fresh chromate primer. The primer is distributed as a thin uniform layer in the weld seam and protects the inner side. The outer side of the seam is mechanically cleaned of the oxide traces in the region of the weld spots, is primed with two coats of acrylic primer and is painted with perchlorvinyl or epoxy enamels. Parts made from the magnesium alloys and protected by oxide and lacquer/paint coatings are used for 5-7 years without corrosion damage.

Reference: Drinberg A.Ya., Gurevich Ye.S, Tikhomirov A.V., Tekhnologiya nemetallicheskih pokrytiy [Technology of Nonmetallic Coatings], L., 1957.

V.V. Chebotarevskiy

LACQUER AND PAINT COATINGS FOR THE TITANIUM ALLOYS. The usual lacquer/paint coatings have poor adhesion to the surfaces of the titanium alloys, therefore prior to decorative painting the surface is first subjected to hydro sandblast cleaning or etching in nitric, hydrochloric acids or in a solution of chromium anhydride. On the prepared surface there is applied the VL-02 polyvinyl butyralic mordant etch or primer or the acrylic AG-10s primer; painting is done with the type PKhV or KhV perchlorvinyl enamel, type FL-76 phenol-butyric enamel or the type E-5 epoxy enamel. See Corrosion of the Titanium Alloys.

V.V. Chebotarevskiy

LACQUER AND PAINT COATINGS FOR STEEL. For the protection of steel from corrosion, use is made of the lacquer and paint coatings (see Corrosion of Stainless Steels) whose properties and decorative appearance are determined by the quality of the preparation of the surface. It is particularly important to provide good bonding (adhesion) of the coatings with the surface, which is achieved primarily by the application of the coatings on rough and carefully degreased surfaces. The surface roughness is provided by hydrojet, shot blasting, sand blasting treatment of the surface or by metal-pellet blasting. The selection of the coating, the primer and the filler is determined by the purpose of the parts and articles and by their operation conditions. If the coating is required to have high decorative qualities, then the technological process of painting includes priming, local and overall filling, grinding, application of the outer coating layers and polishing. For protective coatings it is sufficient to apply 2-3 coats of paint of suitable quality. Priming of the steel surfaces is accomplished using primers intended for the ferrous and nonferrous metals. The lacquer and paint coatings find widest application for the protection of steel articles or structures from atmospheric attack. The following types of coatings are used for steel articles and structures: atmospheric resistant (see Atmospheric Resistant Lacquer and Paint Coatings); chemically resistant (see Chemically Resistant Lacquer and Paint Coatings); gasoline and oil resistant (see Gasoline and Oil Resistant Coatings Lacquer and Paint); heat resistant (see Heat Resistant Lacquer and Paint Coatings); water resistant and moisture resistant. The water and moisture resist-

II-54k1

ant coatings are used for the protection of structures and articles used in the water and under conditions of high humidity. For protection from hot water, use is made of the epoxy primer-filler (type E-4021) and the epoxy enamels, for protection from cold water use is made of the bakelite and bituminous enamels and red lead over natural linseed oil, for protection against high humidity use is made of the KhV, PKhV and KhSE perchlorvinyl enamels, the VKhE enamels, the phenol-formaldehyde enamels and others.

References: Drinberg A.Ya., Gurevich Ye.S., Tikhomirov A.V., Tekhnologiya nemetallicheskih pokrytiy [Technology of Nonmetallic Coatings], L., 1957; Lyubimov B.V., Spetsial'nyye lakokrasochnyye pokrytiya v mashinostroyeni [Special Lacquer/Paint Coatings in Machine Construction], M.-L., 1959; Stochik G.F., Tekhnologiya lakokrasochnykh pokrytiy v mashinostroyeni [Technology of Lacquer-Paint Coatings in Machine Construction], M., 1950; Korzin N.V., Gurevich Yu.M., Ioshpe M.L., LM 1 IP, 1961, No. 5, p. 67-68.

I.I. Denker

LAMINATED STEEL refers to mill products and articles made from steel in the form of two or more layers differing in composition and properties. We must differentiate laminated steel from the steel mill products and articles with layers differing in composition and properties which are obtained in an initially homogeneous stock by thermodiffusional methods (cementation, nitriding, decarbonization, etc.) or by special heat treatment (surface quench and tempering, differential tempering, etc.). Laminated steel finds application in the form of two-layer, less often three-layer, sheet and profiled rolled stock; in certain, generally experimental, operations use is made of five-layer rolled stock or even more layers.

Laminated steel makes it possible to economize on the alloy steels. In many cases, when special properties are demanded of portions of the volume of an article, for example corrosion resistance of the surface layers, high hardness of the surface, wear resistance and other special properties which are provided by complex alloying, it is advisable to make use of laminated steel with a relatively thin layer of the complex-alloy steel and the rest of the volume made up of general-purpose steel. Other problems which cannot be resolved with the use of uniform metal can be solved with the use of laminated steel, for example, provide high structural strength of an article (which cannot be accomplished by making it from brittle steel of high hardness) by combining a hard surface layer and high-strength, ductile basic metal; it is also possible to increase the specific strength of stainless steel by combining it with high strength steel which is not corrosion resistant, and

so on.

There are various methods of producing laminated steel. The methods most widely used are casting, surfacing and rolling. In casting, an ingot with two or more layers is formed which is later rolled out into plate, sheet or strip. The layered ingot is prepared by casting into a mold in which there have been placed blanks of steel of a different grade which bonds with the liquid metal used to fill the mold. The layered ingot may also be prepared by simultaneous or sequential pouring of steels of two grades into a mold which is divided into two sections by a partition (temporary or soluble) made from soft steel sheet. Various arrangements are known for casting the laminated ingot, the most typical of these are shown in Fig. 1.

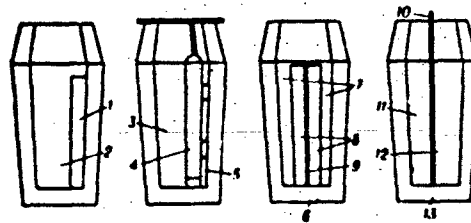

Fig. 1. Typical arrangements for casting laminated ingot: 1) soft steel plate; 2) filler of hard steel (hard layer); 3) filler of hard steel; 4) soft steel plate; 5) layer to improve thermal regime (removed later); 6) double casting of two two-layer ingots; 7) filler of hard steel (hard layer); 8) soft steel plate; 9) ceramic interlayer preventing welding of ingots; 10) soft sheet-steel barrier; 11) pouring of first layer; 12) pouring of second layer; 13) sequential layer-by-layer casting.

The common characteristic of these methods is the provision on the boundary of the liquid and solid metals of a thermal regime adequate for uniform welding, but eliminating cold welds, premature melting of the barrier, nonuniform or excessive fusion of the stock introduced into the mold, and other bonding defects of the ingot layers. A promising method is that of continuous casting of two-layer steel. It is also possible to use centrifugal layer-by-layer casting.

In surfacing a rolled substrate with surface which has been prepared by mechanical working, the electric arc method is used to apply a layer of steel of a different grade. The most promising method for forming this layer is that of electrosag welding.

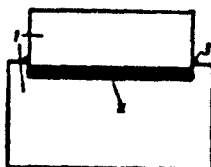

Fig. 2. Schematic of joining blanks using soft iron powder: 1) Blanks being laminated; 2) interlayer of iron powder; 3) fillet weld after forging.

To obtain laminated steel by rolling, use is made of the method of packet rolling with an interlayer of braze or flux in some cases. The thermal regime and the degree of deformation are specified as a function of the steel composition and the required strength of the bond. A very effective method of joining blanks with panel rolling is that of placing between the blanks of layer of iron powder whose thickness is 5-10% of the thickness of the blanks (Fig. 2). After forging, a fillet weld of the edges of the blanks is made and then rolling is performed using the usual regime for the steels being joined. During the rolling process the powder particles are sintered with one another and the surfaces of the steel blanks are bonded with formation of a layer of soft steel between them. Use of lamina rolling with the powder method permits (as a result of the presence of the internal plastic layer) improving the plasticity and impact strength of the high strength steels ( $\sigma_b = 180 \text{ kg/mm}^2$  and higher), reducing their sensitivity to stress concentration, and also reducing the loss of plasticity and impact strength with transition to low temperatures.

N.M. Sklyarov



LAMINATED WOOD PLASTICS (delta-wood, balinit) - materials made from veneer sheets of wood, impregnated by a resol-type resin, which are obtained by hotpressing in multi-storied hydraulic presses under a high specific pressure. In Germany these laminated wood plastics are known under the name lignofol, in England they are called hydulignum and in the USA they are called compreg. The lamination of the structure and the regular position of thin veneer sheet layers substantially reduce the effect of local defects of the wood and the anisotropic character of its properties, ensuring the obtaining of laminated wood plastics with the specified high physicomechanical properties. The industry produces laminated wood plastics in the form of short and long sheets and plates, the former from 1 to 8 mm thick, the latter from 10 to 60 mm thick and of multifaceted blanks 15-60 mm thick. In addition, products of intricate shape are produced from "crumbs" of pulverized, resin impregnated veneer sheets and veneer sheet strips by hot pressing. The mechanical, electrical insulation and physical properties of laminated wood plastics depend on the thickness, moisture content and structure (direction of fibers in adjoining layers) of the veneer sheets, the moisture content of the impregnated veneer sheets and the final moisture content of the wood plastic material, the nature and content of the resin, quality of impregnation, pressing regime (temperature, pressure, holding duration), on the nature of the wood, density of structure and the presence of preliminary chemical treatment of the veneer sheets, the degree of fiber cutting on shelling, etc. The highest qualities of laminated wood plastics are ensured by birch veneer

sheets. For certain brands of laminated wood plastics, of which particularly high mechanical properties are not required, use is made of beech, pine, and in individual cases also of linden. The final strength and the degree of anisotropy of mechanical properties depend substantially on the thickness of the veneer sheet and on its position in the stack before pressing. The use of thinner veneer sheets substantially improves the mechanical properties of laminated wood plastics. The highest specific strength in tension and static bending is obtained by using 0.4-0.5 mm thick sheets, and in compression it is achieved by using sheets 0.35-0.4 mm thick. A reduction in the wear of laminated wood plastics in friction across the veneer layers is also achieved by these means. Thus, when the veneer sheet thickness is increased from 0.3 to 1.2 mm, the volume wear in the friction nodes increases by approximately a factor of 30 (from  $20 \cdot 10^{-3}$  to  $600 \cdot 10^{-3} \text{ mm}^3$ ).

Laminated wood plastics used for structural purposes are made from veneer sheets with a thickness of 0.55 and  $0.75 \pm 0.05$  mm. Alongside with the veneer sheet thickness and its microstructure, the properties of laminated wood plastics are substantially influenced by the nature of the resin and its content in the material. When the resin content is increased to approximately 20%, the compression and tensile strength increase; the cleaving resistance is also improved and the volume swelling and water absorption are substantially reduced. An increased (38-43%) resin content reduces the tensile and static bending strengths, the modulus of elasticity and the impact ductility. When the specific pressing pressure is increased to approximately  $100-125 \text{ kg/cm}^2$ , the specific weight of the material changes and the mechanical and physical properties of laminated wood plastics are improved. Usually the specific pressure used in producing laminated wood plastics is  $100-125 \text{ kg/cm}^2$ , the temperature is  $150 \pm 5^\circ$  (for laminated wood plastics with

water soluble resins it is  $145 \pm 5^\circ$ ) the duration of holding under the press is 4-5 minutes per mm of thickness. The veneer sheet, as a result of chemical treatment is condensed by 30-35% and its strength is substantially increased.

Shaped and formed-in-a-single-piece laminated wood plastics are made in form of products of intricate or simply shaped form from pressed crumbs by pressing in heated molds at an elevated or high specific pressure. Components pressed in a single piece, for example, weaving equipment components, are made from a combination of the above pressed materials. The resin content in the veneer sheet depends on its thickness, intended use and the complexity of the product shape and usually varies between the limits of 18-25% and 25-30%, and the specific pressure in pressing varies between the limits of 110-125 kg/cm<sup>2</sup> for the simple and 400-800 kg/cm<sup>2</sup> and more for the more complex product shapes. The pressed crumbs are usually preformed. Shaped products are made with a variable specific weight and strength, on the basis of the magnitude of stresses and the design features of the products, for example, blanks for propeller blades. This is achieved by placing a different number of veneer sheet layers in the given cross sections and pressing the articles in hot molds to the necessary thickness and required shape. Laminated wood plastics have sufficiently highly physicomachanical properties, which is precisely the reason why they are extensively used in the aircraft, electrical equipment, machine-tool building and textile industries. The mechanical properties of laminated wood plastics depend on the moisture and temperature. The greatest effect is exerted by moisture on the compressive and static bending strength, and on the impact ductility, while it has a lesser effect on the tensile and on cleaving along the glued surfaces. To prevent from moisture absorption, the ends of the material after cutting and the open ends of

I-117G3

structural elements made from laminated wood plastics are protected by a 45-50% alcohol solution of bakelite lacquer or by another water resistant coating. This ensures an operating moisture content of ~5.5-7.0%. The effect of temperature on the mechanical properties of laminated wood plastics is characterized by data presented in Table 1.

TABLE 1

Effect of Temperature on the Mechanical Properties of Laminated Wood Plastics

| Свойства 1   | 2 Температура (°C) |     |     |     |    |    |     |
|--|--------------------|-----|-----|-----|----|----|-----|
|  | -80                | -40 | 0   | 20  | 40 | 60 | 100 |
| 3 Растяжение вдоль волокон (кг/см <sup>2</sup> ) . . .               | 117                | 113 | 109 | 100 | 91 | 81 | 60  |
| 4 Сжатие вдоль волокон (кг/см <sup>2</sup> ) . . .                   | 135                | 124 | 110 | 100 | 76 | 58 | 47  |
| 5 Склеивание по склеиванию по склеиванию (кг/см <sup>2</sup> ) . . . | 33                 | 33  | 30  | 100 | 69 | 63 | 54  |
| 6 Склеивание по материалу (кг/см <sup>2</sup> ) . . .                | 119                | 112 | 105 | 100 | 93 | 85 | 69  |
| 7 Уд. ударная вязкость при изгибе (кг-см/см <sup>2</sup> ) . . . . . | 117                | 117 | 109 | 100 | 74 | 61 | 48  |

1) Properties; 2) temperature (°C); 3) tension along the fibers (kg/cm<sup>2</sup>); 4) compression along the fibers (kg/cm<sup>2</sup>); 5) cleaving along the glued surfaces (kg/cm<sup>2</sup>); 6) cleaving in the material (kg/cm<sup>2</sup>); 7) specific impact ductility in bending (kg-cm/cm<sup>2</sup>).

Holding for 100 hours at a temperature of up to 140° after the perfectly dry weight is achieved practically does not reduce the tensile and compressive strength of laminated wood plastics.

The effect of variable temperature and moisture on the various properties of laminated wood plastics varies and depends on the nature of the binder and its quantitative content in the plastic material. Laminated wood plastics with alcohol-soluble resins as a base have a sufficiently high resistance to the effect of variable temperature (from -55° to +60°) and moisture. Prolonged (for a year) holding of laminated wood plastics in water results in reducing the impact ductility and ductility and ultimate static bending strength in the wet state by 50%. Gradual drying restores to a substantial degree the mechanical properties of the material. A shortcoming of laminated wood plastics is swelling, since it brings about changes in the shape of structural elements. The oil and gasoline resistance of laminated wood plastics is quite high. The limiting oil absorption does not exceed 2% and the attendant swelling reaches 0.4%. Oil absorption by the materials is used for creating

The effect of variable temperature and moisture on the various properties of laminated wood plastics varies and depends on the nature of the binder and its quantitative content in the plastic material. Laminated wood plastics with alcohol-soluble resins as a base have a sufficiently high resistance to the effect of variable temperature (from -55° to +60°) and moisture. Prolonged (for a year) holding of laminated wood plastics in water results in reducing the impact ductility and ductility and ultimate static bending strength in the wet state by 50%. Gradual drying restores to a substantial degree the mechanical properties of the material. A shortcoming of laminated wood plastics is swelling, since it brings about changes in the shape of structural elements. The oil and gasoline resistance of laminated wood plastics is quite high. The limiting oil absorption does not exceed 2% and the attendant swelling reaches 0.4%. Oil absorption by the materials is used for creating

The limiting oil absorption does not exceed 2% and the attendant swelling reaches 0.4%. Oil absorption by the materials is used for creating

I-117G4

self-lubricant bearings which operate more efficiently than with water lubrication. Laminated wood plastics practically do not absorb gasoline, kerosene or diesel oil. The thermophysical properties of laminated wood plastics vary depending on the structure, the material's density, the resin content and other factors. The thermal conductivity varies between the limits of 0.21-0.26 kcal/m·hour·°C, the specific heat varies from 0.37 to 0.57 kcal/kg·°C. The temperature resistance of laminated wood plastics is insufficient; being submerged in heated transformer oil they practically cannot withstand temperatures in excess of 100-115°, at higher temperatures small cracks form in the ends and the material increases in thickness to 0.5%; low temperatures also affect laminated wood plastics, e.g., after moistened articles are held for 30-70 days temperatures up to -50°, the dimensions change by 0.5-1.0%. The chemical resistance of laminated wood plastics and their stability when acted upon by aggressive media depend on the nature of the binder, its content in the plastic, depth of impregnation, completeness of the resin's polymerization, density of the structure and design of the structure and design of the laminated wood plastics, as well on the preliminary treatment of the veneer sheets. The chemical resistance of laminated wood plastics after being held for 1000 hours at 10° in 100% acetic aldehyde and at 20° in 100% oleic acid, transformer oil, butyl alcohol, styrene, is good; in 10% solution of calcined soda, methyl alcohol and sodium silicate it is satisfactory. The material cannot resist higher alcohols (at the boiling temperature for 500 hours) and solutions of a 5% concentration of potassium persulfate and ferrous sulfate. Laminated wood plastics are weakly resistant to hydrochloric acid and even more subjected to swelling and failure in a caustic soda solution. The chemical resistance of laminated wood plastics becomes substantially lower as the temperature is increased in conjunction with

I-11705

which temperature limits have been established for the use of products, such as: in hydrochloric acid up to 16°, in glacial acetic acid up to 60°, in diluted formic acid up to 20°, in mineral oil up to 80°, in ethyl and butylacetates (with an acid admixture) up to 30°, in methyl alcohol (with an acid admixture) up to 20°. To improve the chemical resistance of laminated wood plastics they are made (for example, DSP-F) from pine veneer sheets 0.4 - 0.5 mm thick, impregnated under pressure so that it contains up to 50 - 60% of phenolformaldehyde resin. In individual cases the chemical resistance of laminated wood plastics is improved by preliminary impregnation of the veneer sheets by chemically resistant substances with subsequent gluing it together by another binders. The wear resistance of laminated wood plastics depends on the properties of the material with which it is mated and the specific pressure. Thus, together with low-tin bronze (BrOTsS 5-5-5) the wear is less than, for example, with BrOTs 10-2 bronze and it is at minimum on contact with stainless steel. The wear resistance of laminated wood plastics in comparison with bronze is lower by a factor of 6 - 15. Under a specific pressure of 75 kg/cm<sup>2</sup>, water lubrication, peripheral sliding speed of 2.5 m/sec and a path equal to 25,000 m, the wear comprises 0.05 - 0.1 mm. Bearings from laminated wood plastics do not form scratches on the rubbing surfaces of shafts and even polish them, reducing the friction coefficient with time. Laminated wood plastics have high antifriction properties, which depend on the design of the material, specific pressure, flow rate and type of lubricant (water, oil), sliding rate, type of rubbing pair, etc. When the coefficient of friction of the material is 0.002, the specific pressure is 250 kg/cm<sup>2</sup> and the sliding velocity is 4.55 m/sec, the water flow rate comprises 0.08 m<sup>3</sup>/min per 1 cm<sup>2</sup> of sliding surface. The friction coefficient in dry rubbing over steel for sliding bearings made from laminated wood plas-

tics is higher than with water lubrication. The friction coefficient of laminated wood plastics without lubrication is equal to 0.2 - 0.26, when lubricated with lubricant grease it is 0.02 - 0.05, liquid oil it is 0.1 - 0.06 and with water it is 0.008 - 0.004. As the specific pressure and sliding speed increase, the friction coefficient first decreases and then slowly increases; here as the specific pressure is increased the reduction in the friction coefficient is first rapid and then slows down. The start-up torque and the start-up friction coefficient in the case when bearings from laminated wood plastics are used are substantially higher than for bearings from antifriction alloys and increases on water lubrication. Of substantial importance is the location of the laminated wood plastic in the bearing lining relative to the shaft journal. The highest results with respect to the friction coefficient and wear are obtained when the material is located at the end, not flat. The dielectric properties of laminated wood plastics depend on the material's resin content, its moisture content, veneer sheet thickness, the surrounding temperature, density of the laminated wood plastic's structure, etc. Of substantial importance also is the direction of the electric field intensity vector. Thus, in the case when it coincides with the pressing direction (across the layers), the indicators of surface and volume resistivity practically are not inferior to textolite and are within the limits of  $10^{11}$ - $10^{12}$  ohm·cm and after the material is moistened for 48 hours they are only slightly reduced. The average breakdown voltage of the electric field of laminated wood plastics across the layers (perpendicular to the pressing plane) is by approximately a factor of ten greater than the breakdown voltage along the wood fibers. The dielectric losses of various brands of laminated wood plastics are practically independent of the direction of the electric field intensity vector relative to the material's fibers. The die-

I-11707

lectric permittivity ( $\epsilon$ ) of laminated wood plastics is usually within the limits of 6.7-7.9, and the tangent of the dielectric losses angle ( $\arctan \delta$ ) varies between the limits 0.038-0.068.

Table 2 (page ) gives the nominal dimensions, intended service and fields of application of laminated wood plastics. The physiomechanical indicators of laminated wood plastics can be found in GOST 8698-58 and 8697-58.

References: Sheydn, I. A., Smirnov, A. V. and Demidova, L. A., *Tekhnologiya drevesnykh plastikov (Wood Plastic Technology)*, Moscow - Leningrad, 1956; *Plasticheskiye massy v mashinostroyeni. Sbornik trudov Ural'skogo soveshchaniya po plastmassam (Plastic Materials in Machine Building. Collection of Transactions of the Ural Conference on Plastic Materials, Moscow, 1955; Genel', S. V., Drevesnyye plastiki v tekhnike (Wood Plastics in Technology)*, Moscow, 1959; Rabinovich, A. L. and Avrasin, Ya. D., *O mekhanicheskikh kharakteristikakh nekotorykh sloisttykh plast-kov v svyazi s prochnost'yu boltovykh i zaklepochnykh soyedineniy (On the Mechanical Characteristics of Certain Laminated Plastic Materials in Connection with the Strength of Bolted and Riveted Joints)*. In the collection: *Steklotekstolity i drugiye konstruktsyonnyye plastiki (Glass Textolites and Other Plastics Used as Materials of Construction)*, Moscow, 1960; *Spravochnik po mashinostroitel'nyim materialam (Handbook of Machine-Building Materials)*, edited by G. I. Pogodina-Alekseyeva, vol. 4, pages 148-56, 1960:

Ya. D Avrasin



TABLE 2

Nominal Dimensions of Laminated Wood Plastics, their Intended Service and Main Fields of Application \*

| 1<br>Марка                                    | 2<br>Длина<br>(мм)  | 3<br>Ширина<br>(мм)     | 4<br>Толщина<br>(мм)  | 5<br>Тип<br>восталь-<br>емого<br>материала | 6<br>Назначение и основные области<br>применения  |  |   |                   |                                      |  |
|---|---|-------------------------|---|--|---|--|---|-------------------|--------------------------------------|--|
| 7 DSP-V<br>8 DSP-V-e<br>11                    | 700, 1100<br>и 1500<br>700, 1100,<br>1500 и<br>2300,<br>4800,<br>8800     | 800-1200                | 1.0-2.5   | Короткие<br>9 листы                        | 10<br>Листы, как конструкционный обшивочный материал, а также для изготовления различных деталей конструкций, оборудования, как заменитель текстолита ПТ, ПТК, гетинакса В, а также различных прокладок, в чашках и болтовых соединениях деревянных конструкций и др.<br>14<br>Листы для деталей конструкционного назначения 14 |  |   |                   |                                      |  |
|   | 3.0-8.0   |                         | Короткие<br>и длинные<br>12 листы   |  |   |  |   |                   |                                      |  |
|   | 15-60   |                         | Короткие<br>и длинные<br>плиты 13   |  |   |  |   |                   |                                      |  |
| 15 DSP-A<br>18 DSP-B-m<br>19 DSP-B-m          | 700, 1100,<br>1500  | 800-1200                | 15-60   | Короткие<br>плиты 16                       | 17<br>Для изделий конструкционного антифрикционного назначения (соединительные втулки в судостроении, вкладыши подшипников)<br>20<br>Как самосмазывающиеся материалы в различных отраслях машиностроения, где требуется трудоемкая (ползуны лесопильных рам, подшипники, направляющие углов трения) 20                          |  |   |                   |                                      |  |
| 21 DSP-B,<br>22 DSP-B-a<br>(дельта-древесина) |   |                         |   |  |   | 700, 1100,<br>1500 и<br>2300,<br>4800,<br>8800 | 800-1200<br>(с градацией<br>в 100 мм)<br>23 | 16 и 18<br>и<br>8 | Короткие<br>и длинные<br>плиты<br>13 | 24<br>Как конструкционный материал для силовых авиационных деталей (лопасты комбинированных с древесиной воздушных винтов, усиленные планеры, консоли крыла, детали торной леминги и т. п.) и изделий силового назначения в других отраслях машиностроения   |
| 25 DSP-E-9<br>26 DSP-B-t                      |   |                         |   |  |   | То же<br>24                                    | То же<br>24                                 | 15-60             | То же<br>24а                         | 25<br>Для деталей конструкционного и изоляционного назначения (стали аппаратов, турбин и электрич. машин, трансформаторов, масляных выключателей и т. п.), работающих в масле или в воздухе при невысоких напряжениях и температуре от -40° до +105°<br>27<br>Для деталей машин в текстильной промышленности (ваднов тяжных стенок и т. п.) 27 |
| 29 DSP-G<br>33 DSP-G-m                        | Многогранный диаметром<br>внешней окружности<br>от 800 до 1000 ± 50<br>29 | Много-<br>гранный<br>30 | Для зубчатых колес и в качестве антифрикционного материала для вкладышей подшипников 31<br>Самосмазывающийся антифрикционный материал (ползуны лесопильных рам и аналогичные детали машин) 33 |  |   |  |   |                   |                                      |  |

\* The letter designations point to the field of application of the material: a) aviation; e) electrical equipment; m) machine building; t) the textile industry.

1) Brand; 2) length (mm); 3) width (mm); 4) thickness (mm); 5) form in which the material is supplied; 6) intended service and the main fields of application; 7) DSP-V; 8) and; 9) short sheets; 10) sheets, as a structural skin material, as well as for the making of various structural components, equipment, as a replacement of PT and PTK textolites, V Getinaks, in shock absorber liners, in nodal and bolted joints of wooden structures, etc.; 11) DSP-V-e; 12) short and long sheets; 13) short and long plates; 14) plates for structural components; 15) DSP-A; 16) short plates; 17) for products to be used in atifrication designs (deadwood sleeves in shipbuilding, bearing liners); 18) DSP-B-m 19) DSP-V-m; 20) as self-lubricating materials in various machine building branches where lubrication is difficult (sliders of timber-sawing frames, guides of friction subassemblies); 21) DSP-B, 22) DSP-B-a (delta-wood); 23) (with a calibration each 100 mm); 24) as a material for the construction of aircraft power components (blades of wood-composite propellers, reinforced bulkheads, wing cantilevers of light-engine aircraft, etc.) and power products in other machine-building branches; 24a) the same as above; 25) for components of designs or for components used as insulation (components of apparatus and electrical machinery,

I-117G9

transformers, oil switches, etc.), which work in oil or air under moderate stresses and at temperatures from  $-40^{\circ}$  to  $+105^{\circ}$ ; 26) DSP-B-t; 27) for machine components in the textile industry (for loom shafts, etc.); 28) DSP-G; 29) multifaceted blanks with an inscribed circle diameter from 600 to  $1000+50$ ; 30) multifaceted blanks; 31) for gears and as an antifriction material for bearing liners; 32) DSP-G-m; 33) self-lubricating antifriction material (sliders of wood sawing frames and similar machine components).

II-61k

.LANON is a synthetic hetero-chain fiber made from polyethylene terephthalate. It is produced in the GDR in the form of ordinary and high-strength filamentary thread and staple fiber (matte finish or painted). For properties and application see Polyester Fiber.

E.M. Ayzenshteyn

II-111k

LAPIS-LAZURE - see Lazurite.

LASER MATERIALS are materials used in quantum optical generators (lasers) as the active medium in which the generation of the light is performed directly. Solids, gases and liquids are used as laser materials. An external source of energy is used to transform the atoms of the active medium into the excited state in order to obtain generation; if we provide the conditions under which all the excited atoms are simultaneously returned to the normal state, then the energy thus released will be radiated in the form of a powerful monochromatic beam of visible or infrared light. To provide for generation it is necessary that the optical spectrum of the active medium have certain quantum-mechanical properties, since the generation of the light is possible only as a result of the transitions from the excited metastable state into a state with a very short lifetime. The active medium can be solid, liquid or gaseous.

The gaseous active medium is a mixture of two gases; under the action of an external electrical high-frequency discharge the atoms of one of the components of this mixture are excited and by means of thermal collisions increase the energy of the atoms of the second component; the latter, returning to the normal state, radiate light with the linear spectrum characteristic for the atoms of the second component. Thus, one of the components of the mixture participates in the "pumping" of the external energy, while the other is used directly for the generation. Therefore, in the selection of the mixture it is necessary, in addition to other conditions, to provide the conditions for effective "pumping" (for this the utilized excited states of the atoms

II-42k1

of both components must be characterized by similar energy values). Widest application has been made of a mixture of helium and neon with partial pressures of 1 and 0.1 mm Hg respectively; use is also made of a mixture of mercury and krypton vapors.

The solid active medium consists of a crystalline or amorphous substance in which there are "dissolved" in small concentrations (of the order of fractions of a percent) paramagnetic ions of a doping substance; light generation is obtained by exciting these ions. Presence of other impurities hinders the generation, and, therefore, the material is subjected to careful purification. As solvents use is made of: corundum, potassium tungstate, rutile, and from among the amorphous substances - barium crown glass; the role of dopant ions can be performed by  $\text{Cr}^{3+}$  ions, the ions of many of the rare earth elements, for example, neodymium  $\text{Nd}^{3+}$ , samarium  $\text{Sm}^{2+}$ , praseodymium  $\text{Pr}^{3+}$ , holmium  $\text{Ho}^{3+}$ , dysprosium  $\text{Dy}^{2+}$ . Of all the materials, widest use has been made of ruby ( $\text{Al}_2\text{O}_3 \cdot \text{Cr}^{3+}$ ). Use is also made of  $\text{CaWO}_4 \cdot \text{Nd}^{3+}$ ,  $\text{CaWO}_4 \cdot \text{Pr}^{3+}$ , barium crown-glass with the addition of neodymium.

As the active medium use is made of the monocrystalline semiconductors, and in this case the radiation is generated with recombination of the carriers (injected through the p-n junction) through the forbidden zone. The principal requirement on these materials is a high probability of radiative recombination of the carriers (i.e., a small lifetime in relation to the radiative transitions). Such a material is the compound GaAs, which has been used as the basis for the design of a laser with exceptionally effective transformation of electrical energy into light energy.

In the case of a liquid active medium, use can be made of the organic liquids (nitrobenzene, cyclohexane, etc.).

References: Shavlov A., Fogel S, Dalberdger L., Optical Quantum

II-42k2

Generators [Lasers], transl. from Eng., M., 1962; Electronics [Russ. transl.], 1962, Vol. 35, No. 7, p. 37; No. 11, p. 41; "Phys. Rev. Letters", 1962, v. 8, No. 1, p. 18, 19; No. 10, p. 404.

M.M. Gorshkov

LATENT DEFORMATION ENERGY - is the excess potential energy of the atoms displaced by the deformation from their equilibrium positions. Under a load, a part of the strain on plastic deformation of the solid is transformed into heat, and a part (about 10-20%) is consumed for the increase of the lattice potential. The latent deformation energy increases with the increasing degree of imperfection of the deformed crystal lattice; it depends on the degree of the plastic deformation and on the type of the external load (static, alternating). The latent deformation energy is measured in cal/g (it lies in the range of 1 cal/g for cadmium, and 0.5 cal/g for lead).

Ya.B. Fridman



LATICES are aqueous colloidal dispersions of rubber-like polymers which are the raw material for the production of rubber and other articles with more or less elasticity. Natural latex, the milky sap of the rubber tree, is a dispersion of natural rubber. By analogy with natural latex, the synthetic latices are aqueous dispersions of elastomers obtained by emulsion polymerization or copolymerization of various organic unsaturated compounds; the synthetic latices are sometimes considered to include the dispersions of polymers obtained by polycondensation (for example, the dispersions of the thiokols) and by dispersion in water of the prepared polymers (for example, butyl rubber) and also the dispersions of the plastics obtained by emulsion polymerization (for example, the dispersions of polyvinyl acetate, polystyrene, etc.). Natural latex is a liquid which is superficially similar to milk. The particles (globules) of rubber in the latex have a spherical or pear-shaped form; about 90% of the globules have dimensions less than 0.5 microns, the largest particles reach 6 microns in diameter. The proteins, salts of the fatty acids and other constituent parts of the latex which are located on the surface of the rubber particles give them a negative electrical charge and prevent spontaneous coagulation, which ensures stability of the freshly obtained latex as a colloidal system. About 0.5% ammonia is added to the latex to provide further stabilization during storage, transport and processing. Acidification of the latex and the introduction into it of soluble salts of the multivalent metals leads to coagulation, i.e., to the separation of the rubber.

Natural latex is used almost exclusively in the concentrated

form. Articles made from natural latex are frost resistant (brittle temperature of rubber is  $-67^{\circ}$ ) and have high physical and mechanical properties (even without reinforcing fillers). The strength of vulcanized films made from this latex is  $200-350 \text{ kg/cm}^2$ , the relative elongation is 500-1000%.

The synthetic latices differ in composition and properties depending on the recipe and the conditions of their production. Their synthesis is accomplished by polymerization of various monomers in an aqueous emulsion containing emulsifiers, a polymerization initiator, and also, as a rule, a regulator of the rubber plasticity, a stabilizer, an activator and certain other substances. The latices are formed as intermediate products and in the production of a whole series of synthetic ("emulsion") rubbers. Depending on their end usage, the synthetic latices will contain from 20 to 60-69% rubber. With low concentrations of the polymer (usually up to 20-40%) the viscosity of the latices obeys Newton's law and differs little from the viscosity of water. This is one of the basic advantages of the latices over the highly viscous solutions of the corresponding rubbers which are widely used for the impregnation of various materials.

Among the polymer materials, the latices occupy one of the first places with regard to the number of possible areas of application and this is increasing with each year. The production of various latex-based articles reduces to the preparation of the latex mixtures and to the separation of the dispersed phase from them by some method. The following stages of the process are the drying of the articles and in the majority of cases vulcanization. The methods of separation of the dispersed phase from the latex are based on: evaporation of the water, absorption of the water by porous materials, coagulation, gelatination. The methods based on the evaporation of the water are characterized by

II-52k3

the fact that all the ingredients of the latex mixture (except the volatile ingredients and those which are capable of decomposing) completely enter into the composition of the finished article. In this case use is made primarily of the concentrated latices whose viscosity is increased as a result of the introduction of special additives. This group of processes includes the fabrication of thin-wall articles by repeated dipping of the forms into the latex mixture, the application of anticorrosion coatings on metallic surfaces, the insulation of wires, the application of waterproof coatings on fabrics, paper and other materials, and also the painting of structural objects using the latex paints. Separation of the rubber from the latex preferentially as a result of the evaporation of the water also takes place in the use of latex-cement and latex-bitumen mixtures and in the bonding of various materials with the use of latex glues, although in these cases some role is also played by the absorption of the water, and sometimes by coagulation as well. Among the processes in which the separation of the rubber is accomplished basically as a result of the absorption of the water into a porous material, we can mention the preparation of rubber and plastic articles in collapsible gypsum forms, the impregnation of textile materials, paper, etc. In the latter case the separated water is usually squeezed out under the press, on rollers, or is removed by some other method. Coagulation is used in the production of thin-wall rubber articles by the method of alternate dipping in latex and in a coagulant solution, and also in the sizing of various fibers. Jellification is used in the production of sponge rubber, microporous ebonite, rubber articles by use of gelatinization and ion deposition.

The latices are almost never used in the pure form in the fabrication of various articles, there are first added a series of ingredients to provide the required technological properties of the mixture

II-62k4

and the technical properties of the resulting article. The ingredients are usually introduced into the latices in the form of aqueous solutions or dispersions prepared on ball, colloidal or vibrational mills, paint grinders ultrasonic installations, etc. The basic ingredients of the latex mixtures are: a) surface-active substances to provide the wetting and foaming properties of the mixture and the stability of the mixture as well: these are the salts of oleic and other natural and synthetic fatty acids, Nekal, nonionogenic emulsifiers (type OP-7 or OP-10), resin salts, and others; b) thickening agents to increase the viscosity of the latices, which are usually high-molecular substances which are soluble in water: caseinates, alginates, starch, cellulose derivatives, polyacrylates, etc.; c) fillers introduced to improve the stiffness, increase the wear resistance and reduce the cost of the articles, and also used in certain cases as thickening agents to increase the viscosity: chalk, caolin, carbon black, lithopone, etc.; d) softeners such as mineral oils, paraffin and others, added to reduce the stiffness and increase the frost resistance of the product; e) synthetic resins such as phenol-formaldehyde, resorcin-formaldehyde, urea-formaldehyde and others, used to improve the processability and the adhesive properties of the mixtures, and also to increase the stiffness and strength of the products; f) vulcanizing agents, which are used in nearly all the latex mixtures: sulfur (in the form of a dispersion or solution of polysulfides), zinc oxide, and also the organic vulcanization accelerators and ultra-accelerators - Captax, its zinc salt, thiuram, sodium diethyldithiocarbamate, dimethylammonium dimethyldithiocarbamate and others; g) antioxidants, which prevent the article from oxidizing in the process of long-time storage and usage - darkening Neozone D., non-darkening P-23 and others; h) antifoamants - silicone oils, turpentine, fatty and cyclic spirits and others; i) pigments; j) gela-

II-62k5

tinizing and thermosensitizing agents - sodium fluosilicate, formaldehyde, boric acid, zinc oxide and ammonium salts, polyvinyl methyl ester, nitroparaffin and others.

One of the most important areas of application of the latices is the creation of adhesives which can provide a strong bond between elements of rubberized fabric articles - tires, drive belts, transporter belts, etc. Impregnation of tire cord with latex-based compositions considerably increases the service life of the treads. Latex is widely used in the production of sponge or foam rubber - used as a shock absorbing material for automobile and other seats, mattresses, pillows, furniture, etc. Latex sponge with low volumetric weight ( $0.1-0.2 \text{ g/cm}^3$ ) has adequate resistance to compression which increases uniformly with deformation, which in combination with the rapid recovery of the shape after removal of the load provides seat comfort. Wide use has been made of water-soluble latex paints based on the copolymer of styrene and butadiene, polyvinyl acetate, etc., which are used primarily in building for the painting of interior and exterior finishing of structures. They have practically no odor, dry rapidly and give coatings with a pleasant surface appearance. The painted surfaces can be washed with soap and brush. The production of the latex paints is accomplished using the conventional equipment of the paint factories. A whole series of leather substitutes is produced with the use of the latices. These include the bonded fibrous materials obtained by combined deposition of the latex rubber and vegetable or animal fibers from a dilute aqueous dispersion, and the fabrics with latex coating (with or without preliminary impregnation). Many seamless rubber products with comparatively thin walls are fabricated from the latices - surgical, industrial, household and other gloves, pilot-balloon and sounding-balloon envelopes, footwear, etc. Latices are used in the form of cement-latex

coatings mixtures to obtain polymer-cement coatings with improved elasticity, water resistance and adhesion to various materials. Particularly effective is the use of these mixtures for the covering of floors in public buildings, decks of vessels, walls of reservoirs for combustible liquids, reinforcing of hydrotechnical structures, and also for the bonding of glass, porcelain, tile with stone, brick, metallic, wooden and other materials. The latices are also used in other branches of industry: as a print pigment in the textile industry and for the production of nonwoven textile materials; as bonding agents in the footwear, polygraphic, chemical and other industries; for the production of frictional components in the asbestos-technical industry; for impregnating and coating paper in the paper industry; for leather finishing; for sealing containers in the foodstuffs industry; for insulating wires and cables in electrical work; as an additive to the bitumens in highway construction; for fire extinguishing in mines and for a whole series of other fields.

References: Noble R.J., *Latex in Engineering*, transl. from Eng., L., 1962; Gauzer E., *Tekhnologiya reziny [Rubber Technology]*, Vol. 2, M., 1937; Litvin O.B., *Sinteticheskiye lateksy [Synthetic Latices]*, L.-M., 1953; *Synthetic Rubber*, ed. by G.S. Whitby, transl. from Eng., L., 1957; Lebedev A.V., Fermor N.A., *KhNIP*, 1957, Vol. 2, No. 3, p. 339-47; Voyutskiy S.S., Shtarkh B.V., *Fiziko-khimiya protsessov obrazovaniya plenok iz dispersiy vysokopolimerov [Physico-Chemistry of Processes of Formation of Films from Dispersions of High Polymers]*, M., 1954; *Proizvodstvo i primeneniye sinteticheskikh lateksov [Production and Application of Synthetic Latices]*, [Data], L.-M., 1953; *Sintez lateksov i ikh primeneniye [Synthesis of Latices and Their Application]*, coll. of articles, L., 1961.

A.I. Yezriyev. A.V. Lebedev

II-78k

LAUTAL is an alloy of aluminum with 4% Cu, 1-2% Si, about 1% Mn, up to 0.4% Fe, balance aluminum. The alloy forges well, rolls well, is heat-treatable. After quenching and artificial aging  $\sigma_b = 32-40 \text{ kg/mm}^2$ ,  $\sigma_{0.2} = 20-26 \text{ kg/mm}^2$ ,  $\delta = 18-23\%$ .

O.S. Bochvar, K.S. Pokhodadayev

LAVSAN is a synthetic hetero-chain fiber made from polyethylene terephthalate (PETF). It is produced in the form of ordinary and strengthened filamentary thread and in the form of staple fiber in the USSR, England (under the name Terylene), US (Dacron), GDR (Lanon). The specific weight of the fiber is 1.38. The moisture content at standard conditions is 0.4-0.5 percent, at 20° and 95 percent relative humidity it is 0.5-0.7 percent. The breaking length of the ordinary filamentary thread is 34-40 km (45-55; 35-45). (Numbers in parentheses refer respectively to the strengthened filamentary thread and to the staple fiber). Loss of strength in the wet condition is very slight, in a loop it amounts to 7-12% (6-17; 10-28). The ultimate breaking strength is 46-55 kg/mm<sup>2</sup> (63-77; 47-63). Breaking elongation in the dry condition is 14-17% (9-12; 40-50), in the wet condition it is 15-18% (10-13; 41-52). The degree of elasticity of the ordinary thread (with 4 percent elongation) is 100% (100;-), with an elongation of 10 percent it is 57-59% (71-72;-). The strain recovery of a fibrous mass of the staple fiber after removal of compressive load is 72 percent after 1 minute, increasing to 83 percent after 30 minutes. Lavsan has a high elastic modulus (990-1060 kg/mm<sup>2</sup> for the ordinary fiber and 1120-1200 kg/mm<sup>2</sup> for the strengthened fiber); the shear modulus in torsion is 8700-10,800 kg/cm<sup>2</sup> (13,000-14,000). The resistance to repeated deformation (on the DN-15 tester with 110 flexures per minute) with a stress of 5 kg/mm<sup>2</sup> is 9300-12,200 flexures for the ordinary thread; for the strengthened thread it is 9000-15,000 flexures; with a stress of 10 kg/mm<sup>2</sup> (on the "Sinus" tester) the value for the staple fiber is 21,000-30,000 flexures. Abra-



II-41k1

sion resistance of the ordinary fiber is greater by a factor of two than that of the strengthened fiber.

For detailed information on the physical and chemical and other properties see Polyester Fiber.

References: Petukhov B.V., Poliefirnoye volokno. [Terilen, lavsan] [Polyester Fiber] [Terylene, Lavsan], M., 1960; Demina N.V., et al. KhV, 1960, No. 5.

E.M. Ayzenshteyn

LAW OF SIMILARITY - constancy of relative deformation and specific work of deformation (per unit volume) in geometrically and mechanically similar stressed specimens of the same material in identical stressed states. Hence, at a given relative-deformation amplitude and rate the forces are proportional to the square of the similar dimensions of the bodies, while the work of deformation is proportional to the cube of these dimensions. The law of similarity often breaks down (see Scale effect) because of disruptions of other types of similarity (temperature, structural, kinetic, etc.), which are not taken into account by this law and are often associated with differences in the structure and characteristics of large and small specimens, these being due to variations in temperability, casting, pressure-working, and cutting conditions, etc.

References: Davidenkov, N.N., Nekotoryye problemy mekhaniki materialov [Certain Problems in the Mechanics of Materials], Leningrad, 1943.

Ya.B. Fridman

LAZURITE (lapis-lazure) is a mineral of the silicate class  $(\text{Na}, \text{Ca})_4 - 8 [\text{AlSiO}_4]_6 [\text{SO}_4, \text{Cl}, \text{S}]_1 - 2$ . It is usually encountered in solid dense masses; crystals in the form of cubes are extremely rare. The specific weight is 2.38-2.42, hardness 5.5, brittle. The color may be azure-blue, dark-blue, violet, sky-blue and greenish-blue; in thin sections it is blue. The index of light refraction is 1.5. After calcining the color is not lost, at times it is amplified. It dissolves in HCl, releasing  $\text{H}_2\text{S}$ . Lazurite is used as a rare and beautiful ornamental stone. Lazurite is used for the production of decorative vases, jewel cases, statuettes, etc. In the form of thin plates it is used for inlaying in artistic mosaic work, and also for facing of columns, fireplaces, etc.

References: Betekhtin A.G., Mineralogiya (Mineralogy) M., 1950; Fersman A.Ye., Ocherki po istorii kamnya [Notes on the History of Stone], Vols. 1-2, M., 1954-61.

Yu. L. Orlov

LEAD ARGENTAN - argentan alloyed with lead. Addition of lead improves the cuttability of Cu-Ni-Cn alloys of the argentan type. The USSR produces lead argentan of type MNTsS17-18-1.8 (16.5-18.0% Ni, 1.6-2.0% Pb, 61-64.9% Cu, and the remainder zinc), which is used principally for watch components. Lead argentan combines high corrosion resistance and strength with good cuttability. On drilling, milling, or turning lead argentan forms fine, friable chips. Its cuttability amounts to 50% of that of LS63-3 brass. Lead argentan is pressure-worked only when cold. According to TsMTU 4589-55, lead argentan is produced in soft, semihard, and hard strips. For the principal properties of lead argentan see the article entitled Copper-Nickel alloys.

Ye.S. Shpichinetskiy

**LEAD BABBITT** - a lead-based alloy intended for casting bearings. The principal alloying element in lead-based babbitts are tin, antimony, and copper (Table 1). Cadmium, nickel, arsenic, and tellurium are also found in certain types. The tin content of lead-tin babbitts produced to Soviet standards does not exceed 7%.

**TABLE 1**  
Chemical Composition of Lead-Tin Babbitts\* (GOST 1320-55)

| 1 Alloy | 2 Содержание элементов (%) |       |         |           |           |         |           |     |    |          |      | 3    |      |     |
|---------|----------------------------|-------|---------|-----------|-----------|---------|-----------|-----|----|----------|------|------|------|-----|
|         | Sn                         | Sb    | Cu      | Ni        | Cd        | As      | Fe        | Pb  | Fe | As       | Zn   |      | Bi   |     |
| 4 B16   | 15-17                      | 15-17 | 1,5-2,0 | -         | -         | -       | -         | -   | 8  | Не более |      |      |      | 0,6 |
| 5 EN    | 9-11                       | 13-15 | 1,5-2,0 | 0,75-1,25 | 1,25-1,75 | 0,5-0,9 | -         | 0,1 |    | -        | 0,15 | 0,1  | 0,35 |     |
| 6 ET    | 9-11                       | 14-16 | 0,7-1,1 | -         | -         | -       | 0,05-0,20 | -   |    | -        | 0,3  | 0,15 | 0,1  | 0,6 |
| 7 B6    | 5-8                        | 14-16 | 2,5-3,0 | -         | 1,75-2,25 | 0,8-1,0 | -         | 0,1 |    | -        | 0,15 | 0,1  | 0,4  |     |

\*The tin content of B16 should not exceed its antimony content. ET may contain impurities of up to 0.1% Cd and 0.2% Ni, while B16 may contain up to 0.1% Cd and 0.5% Ni.

1) Alloy; 2) content of elements (%); 3) total impurities; 4) B16; 5) EN; 6) ET; 7) B6; 8) remainder; 9) no more than.

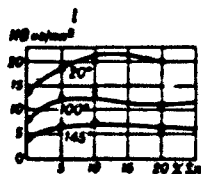

Fig. 1. Influence of temperature on the hardness of lead-tin babbitts with different tin contents. 1) kg/mm<sup>2</sup>.

The strength and hardness of lead babbitt increases with its antimony and tin content, but its plasticity decreases. EN and B6 alloys, which contain arsenic, are distinguished by a fine-grained structure.

TABLE 2

## Mechanical Characteristics of Lead-Tin Babbitts

| Сплав | Растяжение                          |                 |   | Сжатие                              |               | ИИ<br>(кг/мм <sup>2</sup> ) | УС<br>(кг/мм <sup>2</sup> ) |
|-------|-------------------------------------|-----------------|---|-------------------------------------|---------------|-----------------------------|-----------------------------|
|       | $\sigma_b$<br>(кг/мм <sup>2</sup> ) | $\delta$<br>(%) | $\sigma_{0.2}$<br>(кг/мм <sup>2</sup> ) | $\sigma_c$<br>(кг/мм <sup>2</sup> ) | Усадка<br>(%) |                             |                             |
| Б16   | 7,8                                 | 0,2             | 7,6                                     | 12,3                                | 14,7          | 36                          | 0,16                        |
| БН    | 7,8                                 | 1,1             | 7,1                                     | 10,7                                | 21            | 29                          | 0,1                         |
| БТ    | 8,7                                 | 11,7            | 2,4                                     | 10,1                                | —             | 21                          | 0,5                         |
| Б6    | 8,8                                 | 0,2             | —                                       | 12                                  | 21            | 28                          | 0,18                        |

1) Alloy; 2) extension; 3) kg/mm<sup>2</sup>; 4) compression; 5) shrinkage (%);  
6) kg-m/cm<sup>2</sup>; 7) Б16; 8) БН; 9) БТ; 10) Б6.

TABLE 3

## Physical Characteristics of Lead-Tin Babbitts

| Сплав | $\gamma$ (г/см <sup>3</sup> ) | Температура затвердевания (°C) |        | $\lambda$ (кал/см·сек·°C) | $\mu$ (коэф. трения) | Износ<br>Баббитов<br>(мм/см <sup>2</sup> ·кг) |
|-------|-------------------------------|--------------------------------|--------|---------------------------|----------------------|---|
|       |                               | начало                         | оконч. |                           |                      |   |
| Б16   | 9,29                          | 610                            | 240    | 25                        | 0,06                 | 0,008   |
| БН    | 9,33                          | 400                            | 240    | 26                        | 0,055                | 0,008   |
| БТ    | 9,53                          | 410                            | 240    | 26                        | 0,055                | 0,007   |
| Б6    | 9,6                           | 410                            | 232    | 27                        | 0,05                 | 0,007   |

1) Alloy; 2)  $\gamma$ (g/cm<sup>3</sup>); 3) solidification temperature (°C); 4) initiation; 5) termination; 6)  $\lambda$ (cal/cm·sec·°C); 7) coefficient of friction with lubrication; 8) wear (mg/cm<sup>2</sup>·kg); 9) Б16; 10) БН; 11) БТ; 12) Б6.

TABLE 4

## Technological Characteristics of Lead-Tin Babbitts

| Технологические характеристики | Сплав |      |      |      |
|--------------------------------|-------|------|------|------|
|                                | Б16   | БН   | БТ   | Б6   |
| Плывучесть (см) ..             | 51    | 67   | 53   | —    |
| Линейная усадка (%) ..         | 0,30  | 0,30 | 0,30 | 0,33 |

1) Technological characteristics; 2) alloy; 3) Б16; 4) БН; 5) БТ; 6) Б6;  
7) flowability (cm); 8) linear shrinkage (%).

Addition of nickel, cadmium, or arsenic to lead babbitt increases its hardness and strength and makes it possible to reduce the tin content to 9-11%. When added to lead babbitt copper forms a chemical compound with the antimony present; this compound exhibits acicular crystalliza-

TABLE 5

Applications of Lead-Tin Babbitts

| 1 Alloy  | 2 Основные области применения  |
|----------|--|
| EN<br>3  | Для литья шатуны и коренные подшипников двигателей внутр. сгорания (автомобильных, тракторных и др.), верхние половины опорных подшипников паровых турбин, судовых и стационарных паровых машин мощностью до 1200 л. с., гидротурбин, электродвигателей, электродвигателей мощностью 250-750 квт, компрессоров и генераторов мощностью до 500 квт, центробежных насосов мощностью до 2000 л. с. и др.<br>7 |
| BT<br>4  | Для литья шатуны и коренные подшипников тракторных и автомобильных двигателей<br>8   |
| B16<br>5 | Для литья верхних подшипников опорных подшипников паровых турбин, судовых и стационарных паровых машин мощностью до 1200 л. с., лесопильных рам, гидротурбин, электродвигателей, электродвигателей, генераторов, компрессоров, центробежных насосов, вакуум-насосов, редукторов и востеренных клетей прокатных станков, долговых машин мощностью до 1800 л. с., дробилок<br>9                              |
| B6<br>6  | Для литья подшипников нефтяных двигателей, выносных подшипников компрессоров, подшипников металлообрабатывающих станков, трансмиссий, вентиляторов, выносных, электродвигателей мощностью от 100 до 250 квт, паровых машин, газовых и бензиновых двигателей, востеренных клетей малосортных станков<br>10  |

1) Alloy; 2) principal fields of application; 3) EN; 4) BT; 5) B16; 6) B6; 7) for casting rocker and crankshaft bearings for internal-combustion engines (automobile, tractor, etc.), the upper halves of thrust bearings for steam turbines, marine and stationary steam engines of up to 1200 hp, hydroelectric turbines, electric drives, electric motors of up to 250-750 kw, compressors and generators of up to 500 kw, centrifugal pumps of up to 2000 hp, etc.; 8) for casting rocker and crankshaft bearings for tractor and automobile engines; 9) for casting the upper halves of thrust bearings for steam turbines, marine and stationary steam engines of up to 1200 hp, saw frames, hydroelectric turbines, electric drives, electric motors, generators, compressors, centrifugal pumps, vacuum pumps, reduction gears and pinion stands for rolling mills, hoists of up to 1800 hp, and crushers; 10) for casting bearings for gasoline engines, outboard bearings for compressors, bearings for metal working machinery, transmissions, fans, exhaust fans, electric motors of from 100 to 250 kw, ball mills, and gas and gasoline engines, and pinion stands for light-weight machine tools.

tion and prevents liquation of the lighter crystals of the  $\beta$ -antimony and tin solid solution. BT babbitt, which contains a small quantity of tellurium, has a considerably higher plasticity than other alloys. Babbitts rapidly lose their hardness as the temperature rises (Fig. 1)

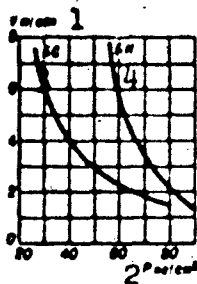

Fig. 2. Sliding speed employed as a function of specific pressure for EN and B6 babbitts. 1) m/sec; 2) kg/cm<sup>2</sup>; 3) B6; 4) EN.

and the working temperatures of cast-babbitt bearings consequently should not exceed 80°.

Tables 2-3 show the mechanical, physical, and technological characteristics of lead-tin babbitts and their fields of application.

The long-term strength of BT6 babbitt is 2.0 kg/mm<sup>2</sup>.

Figure 2 shows the operating conditions for EN and B6 babbitts at different specific pressures and sliding speeds.

The principal differences in the characteristics of tin and lead-tin babbitts lie in the greater brittleness and somewhat lower durability of the latter, which are associated with their microstructure (the presence of substantial amounts of an antimony-lead eutectic). In tin babbitts the brittle metal, antimony, forms a solid solution in the tin ( $\alpha$ - and  $\beta$ -crystals).

Good adhesion of lead-tin babbitts to the steel bearing housing is made possible by careful preparation of the surface of the component to be lined and observation of the proper technological regime.

The lead babbitts also include calcium babbitts, in which the principal alloying components are alkali-earth metals - calcium and sodium (Table 6).

The soft lead in BK babbitt is strengthened by dissolution of sodium in it or by formation of solid crystals of a calcium-lead compound



TABLE 6

Chemical Composition of Calcium Babbitts (according to GOST 1209-59)\*

| Сплав 1 | 2 Содержание элементов (%) |           |         |           |              |      |     |      |      | 3 прочие примеси |
|---------|----------------------------|-----------|---------|-----------|--------------|------|-----|------|------|------------------|
|         | Ca                         | Na        | Sa      | Mg        | Pb           | Cu   | Ni  | Sb   | Mg   |                  |
| БК 4    | 0.85-1.15                  | 0.0-0.9   | -       | -         | Остаточное 7 | -    | 0.1 | 0.25 | 0.02 | 0.3              |
| БК2 5   | 0.35-0.55                  | 0.25-0.50 | 1.5-2.5 | 0.01-0.09 |              | 0.15 |     |      |      |                  |

\*Addition of up to 0.08% AL to BK2 is permissible when requested by the consumer.

1) Alloy; 2) content of elements (%); 3) other impurities; 4) BK; 5) BK2; 6) remainder; 7) no more than.

TABLE 7

Mechanical Characteristics of Calcium Babbitts

| Сплав 1 | 2 Растяжение                           |       |  | 4 Сжатие                             |              | НН (кг/мм <sup>2</sup> ) | σ <sub>н</sub> (кг/мм <sup>2</sup> ) | σ <sub>-1</sub> (кг/мм <sup>2</sup> ) |
|---------|--|-------|--|--------------------------------------|--------------|--------------------------|--------------------------------------|---------------------------------------|
|         | σ <sub>в</sub> 3 (кг/мм <sup>2</sup> ) | δ (%) | σ <sub>0.2</sub> (кг/мм <sup>2</sup> ) | σ <sub>с</sub> (кг/мм <sup>2</sup> ) | Осадка (%) 5 |                          |                                      |                                       |
| 7 БК    | 10                                     | 2.5   | 11.8                                   | 10                                   | 10           | 32                       | 0.4                                  | 2.6                                   |
| 8 БК2   | 9.5                                    | 8     | 8                                      | -                                    | -            | 20                       | 1.2                                  | -                                     |

1) Alloy; 2) extension; 3) kg/mm<sup>2</sup>; 4) compression; 5) shrinkage (%); 6) kg-m/cm<sup>2</sup>; 7) BK; 8) BK2.

TABLE 8

Physical Characteristics of Calcium Babbitts

| Сплав 1 | 2 γ (г/см <sup>3</sup> ) | 3 Температура затвердевания (°C) |         | 6 λ (кал/см·сек·°C) | 7 Коэф. трения со смазкой | 8 Иллюс. (мг/см <sup>2</sup> ·км) |
|---------|--------------------------|----------------------------------|---------|---------------------|---------------------------|-----------------------------------|
|         |                          | начало 4                         | конец 5 |                     |                           |                                   |
| 9 БК    | 10.3                     | 440                              | 320     | 38                  | 0.05                      | 0.004                             |
| 10 БК2  | 10.3                     | 440                              | 320     | 35                  | 0.05                      | 0.004                             |

1) Alloy; 2) γ(g/cm<sup>3</sup>); 3) solidification temperature (°C); 4) beginning; 5) end; 6) λ(cal/cm·sec·°C); 7) coefficient of friction with lubrication; 8) wear (mg/cm<sup>2</sup>·km); 9) BK; 10) BK2.

(Pb<sub>3</sub>Ca). In BK and BK2 babbitt these crystals are a solid structural constituent similar to the solid solution of β-antimony and tin in tin and lead babbitts. BK2 babbitt is a solid solution of tin and magnesium

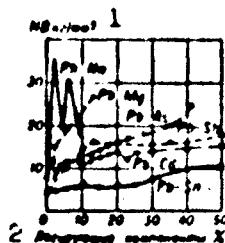

Fig. 3. Hardness of lead alloyed with various metals used in babbitts. 1)  $\text{kg/mm}^2$ ; 2) alloying elements, %.

in lead. Calcium babbitts have a harder base than other lead babbitts since the strengthening effect of sodium and magnesium is substantially greater than that of the other metals added to lead babbitts (Fig. 3). Calcium babbitts are distinguished by high mechanical characteristics, good durability, and a low coefficient of friction (Tables 7-8), but their usefulness is limited, since they are unable to adhere well to steel bushings, as tin and lead-tin babbitts do. In order to obtain a strong joint between the babbitt layer and the bushing it is necessary to employ various types of mechanical fastening ("dovetailing," etc.).

BK2 babbitt has a considerably higher plasticity and impact strength than BK, which contains more calcium and sodium. The linear shrinkage of BK babbitt amounts to 0.75%. Calcium babbitts have come into wide use as bearings for railway and subway rolling stock, mining equipment, briquette presses, and other machinery.

References: Spravochnik mashinostroitelya [Handbook of Machine Building], 2nd Edition, Vol. 2, Moscow, 1956; Spravochnik metallista [Metalworker's Handbook], Vol. 3, Books 1-2, Moscow, 1959; Tselikov, I.A., Vazinger, V.N., Alloys of Lead with Alkali and Alkaline-Earth Metals, Kal'tsiyevyye babbity [Calcium Babbitts], Scientific-Technical Committee of NKPS [National Commissariat of Communications], No. 65, Moscow, 1927; Shpagin, A.I., Antifriktsionnyye splavy [Antifriction Alloys], Moscow, 1956.

O.Ye. Kestner

**LEAD BRASS** (free-cutting brass) - brass containing 57-75% Cu whose principal alloying element is lead. Addition of lead, which is virtually insoluble in the brass solid solution, makes the metal more cuttable and increases its antifriction characteristics. The cuttability of type LS63-3 lead brass is assumed to be 100%. Lead brass is easily deformed when cold. GOST 1019-47 shows 7 types of lead brass, 3 of which are Muntz metal. Sheets, strips, bands, bars, shapes, and wire are produced from lead brass.

**TABLE 1**

Chemical Composition and Mechanical Characteristics of Lead Brasses

| 1 Сплав      | 2 Содержание осн. элементов (%) по ГОСТ 1019-47 |                      |    | 3 Механич. свойства в состоянии    |              |                          |                                  |              |                          |
|--------------|---|----------------------|----|------------------------------------|--------------|--------------------------|----------------------------------|--------------|--------------------------|
|              | Cu  | Pb                   | Zn | 4 твердый                          |              |                          | 6 мягкий                         |              |                          |
|              |   |                      |    | 5 $\sigma_b$ (кг/мм <sup>2</sup> ) | $\delta$ (%) | НВ (кг/мм <sup>2</sup> ) | $\sigma_b$ (кг/мм <sup>2</sup> ) | $\delta$ (%) | НВ (кг/мм <sup>2</sup> ) |
| 7 ЛС74-3     | 72-75   | 2.4-3.0              | 11 | 60-70                              | 2-5          | 100-120                  | 30-40                            | 40-55        | 50-60                    |
| 8 ЛС64-2     | 63-66   | 1.5-2.0              | 12 | 58-67                              | 4-6          | 100-120                  | 32-40                            | 55-65        | 40-60                    |
| 9 ЛС63-3     | 63-65   | 2.4-3.0              | •  | 55-65                              | 4-6          | 105-125                  | 30-40                            | 40-50        | 50-70                    |
| 10 ЛЖС58-1-1 | 58-58   | 0.7-1.3<br>0.7-1.3Fe | •  | -                                  | -            | -                        | -                                | -            | -                        |

1) Alloy; 2) content of basic elements (%) according to GOST 1019-47; 3) mechanical characteristics in following state: 4) hard; 5) kg/mm<sup>2</sup>; 6) soft; 7) LS74-3; 8) LS64-2; 9) LS63-3; 10) LZhs58-1-1; 11) remainder; 12) the same.

**TABLE 2**

Physical and Technical Characteristics of Lead Brasses

| 1 Сплав | 2 $\gamma$ (г/см <sup>3</sup> ) | 3 $\lambda$ (кал/см <sup>2</sup> ·сек·°C) | 4 $\rho$ (ом·мм <sup>2</sup> /м) | 5 E (кг/мм <sup>2</sup> ) | 6 Обработ. резанием по отношению к Латунь ЛС63-3 (%) | 7 Темп-ра (°C) |           |     |
|---------|---------------------------------|---|----------------------------------|---------------------------|--|----------------|-----------|-----|
|         |                                 |   |                                  |                           |  | 8 отжига       | 9 закалки |     |
| ЛС74-3  | 8.7                             | 19.8                                      | 0.20                             | 0.078                     | 10500  | 80             | 450-650   | 985 |
| ЛС64-2  | 8.5                             | 20.3                                      | 0.23                             | 0.088                     | 10500  | 90             | 450-650   | 910 |
| ЛС63-3  | 8.5                             | 20.5                                      | 0.28                             | 0.088                     | 10500  | 100            | 650-850   | 905 |

1) Alloy; 2)  $\gamma$ (g/cm<sup>3</sup>); 3)  $\lambda$ (cal/cm<sup>2</sup>·sec·°C); 4)  $\rho$ (ohm·mm<sup>2</sup>/m); 5) E(kg/mm<sup>2</sup>); 6) cuttability with respect to LS63-3 brass (%); 7) temperature

(°C); 8) annealing; 9) melting; 10) LS74-3; 11) LS64-2; 12) LS63-3.

Lead brasses are supplied in hard (cold-worked), semihard, and soft (annealed) variants. The harder a lead brass, the finer are the chips produced during cutting. Lead brasses are used in the manufacture of watch parts, polygraph matrices, friction clutches, nuts, bolts, and other cut components which must have high corrosion resistance. Lead brasses of types LS59-1 and LS63 and Muntz metal are the most widely employed. LS59-1 brass is used to produce soft and hard wire from 2.0 to 12.0 mm in diameter, in accordance with GOST 1066-58, and cold-rolled sheets and strips from 0.4 to 10 mm thick and hot-rolled sheets from 5 to 22 mm thick, in accordance with GOST 931-52.

Soft ( $\sigma_b > 30 \text{ kg/mm}^2$ ,  $\delta > 40\%$ ), semihard ( $\sigma_b > 35-44 \text{ kg/mm}^2$ ), hard ( $\sigma_b > 44-54 \text{ kg/mm}^2$ ,  $\delta > 6\%$ ), and especially hard ( $\sigma_b > 64 \text{ kg/mm}^2$ ,  $\delta > 5\%$ ) bands from 0.55 to 1.4 mm thick and strips from 1.5 to 8.0 mm thick are produced for the watch industry from LS63-3 brass, in accordance with GOST 4442-48. Pressed and drawn rods with round, rectangular, and hexagonal cross-sections and varying dimensions are produced from LS59-1, LS63-3, and LZhs58-1-1 (GOST 2060-60). Semifinished products of other types of lead brasses are manufactured in accordance with technical specifications. Tables 1 and 2 show the chemical composition and principal characteristics of lead brasses.

References: Smiryagin, A.P., Promyshlennyye tsvetnyye metally i splavy [Commercial Nonferrous Metals and Alloys], 2nd Edition, Moscow, 1956; Spravochnik po mashinostroitel'nyim materialam [Handbook of Machine-Building Materials], Vol. 2, Moscow, 1959; Metals Handbook, Cleveland, 1948 (ASM).

Ye.S. Shpichinetskiy

LEAD BRONZE — a copper alloy whose principal alloying element is lead (Table 1). It is used in heavily loaded bearings subject to impact and alternating stresses. Structurally, lead bronze consists of comparatively hard copper crystals with inclusions of soft lead. The structure of lead bronze remains unchanged when small quantities of tin, nickel, or silver are added. The mechanical characteristics of copper-lead alloys decrease and their antifriction characteristics increase as their lead content rises. Addition of tin increases the mechanical characteristics of the alloy, especially its fatigue resistance (Table 2). Nickel and silver have little influence on the mechanical properties of the alloy when present in concentrations of less than 2%. Lead bronze has a considerably higher heat resistance than other bearing alloys. A slight decrease in hardness sets in only at temperatures above 150°. The thermal conductivity of these alloys is several times that of tin and lead babbitts (Table 3). Lead bronze is used in the form of a steel-bronze bimetal.

TABLE 1  
Chemical Composition of Lead Bronzes

| 1<br>Сплав        | 2<br>Содержание элементов (%) |     |         |           |     |      |      |      |       |     |         | 4<br>Сумма примесей |     |                     |
|-------------------|-------------------------------|-----|---------|-----------|-----|------|------|------|-------|-----|---------|---------------------|-----|---------------------|
|                   | Pb                            | Sn  | P       | Cu        | Sb  | Fe   | Al   | Si   | Bi    | As  | 3<br>Sn |                     | Ni  | Zn                  |
| 5<br>BrC30        | 29,5±2                        | —   | До 0,15 | Остальное | 0,3 | 0,25 | 0,01 | 0,02 | 0,005 | 0,1 | 0,2     | 0,3                 | 0,1 | 0,6 (кроме Sn и Ni) |
| 6<br>BrOC<br>1-22 | 2±2                           | 1-2 | До 0,1  | •         | 0,3 | 0,25 | 0,01 | 0,02 | 0,005 | 0,1 | —       | 0,3                 | 0,1 | 0,6 (кроме Ni) 10   |

1) Alloy; 2) content of elements (%); 3) no more than; 4) total impurities; 5) BrS30; 6) BrOS1-22; 7) up to; 8) remainder; 9) in addition to Sn and Ni; 10) in addition to Ni.

TABLE 2  
Mechanical Characteristics  
of Lead Bronzes

| 1<br>Class  | $\sigma_{0.2}$             | $\sigma_b$ | $\sigma_{-b}$ | $\sigma_H$ | HRC | $\sigma_{-1}$ | $\sigma_{-1}^H$ |                            |
|-------------|----------------------------|------------|---------------|------------|-----|---------------|-----------------|----------------------------|
|             | 2<br>(kg/mm <sup>2</sup> ) |            |               |            |     |               |                 | 3<br>(kg/mm <sup>2</sup> ) |
| 4) Br30     | 3.5                        | 8          | 6             | 21         | 0.4 | 30            | 3               | 2.2                        |
| 5) BrOC1-22 | 5                          | 12         | 8             | 35         | 0.6 | 38            | 4.5             | 4.2                        |

\*Based on 20 million cycles.

1) Alloy; 2) kg/mm<sup>2</sup>; 3) kg-m/cm<sup>2</sup>; 4) Br30; 5) BrOS1-22.

TABLE 3  
Physical Characteristics  
of Lead Bronzes

| 1 Class     | 2<br>$\gamma$ (g/cm <sup>3</sup> ) | 3<br>$\alpha \cdot 10^3$ (1/°C)<br>80-260° | 4<br>$\lambda$ (kcal/cm sec °C) |
|-------------|------------------------------------|--|---------------------------------|
| 4) Br30     | 8.4                                | 18.3                                       | 0.34                            |
| 5) BrOC1-22 | 8.2                                | 18.2                                       | 0.30                            |

1) Alloy; 2)  $\gamma$ (g/cm<sup>3</sup>); 3)  $\lambda$ (cal/cm·sec·°C); 4) Br30; 5) BrOS1-22.

Bimetallic bearings are manufactured by casting individual bushings, which are heated to high temperatures (1050°) under a protective flux, or by casting a strip from which the bushings are subsequently stamped. One special feature of lead bronze is its tendency toward liquation. Special measures, such as especially rapid cooling by spraying with water, are employed to prevent liquation. Shafts intended to function in conjunction with lead-bronze bearings should be heat-treated to a hardness RC  $\geq$  45 and their surfaces should be thoroughly cleaned. Such bearings are machined with a diamond drill, making shallow cups at high speed. In order to accelerate running-in the final bearing surface is galvanically coated with a thin layer (30-50  $\mu$ ) of lead and indium or lead and tin, which permits compensation for any noncorrespondence in the geometry of the friction pair and ensures the requisite

III-18s1

conditions for hydrodynamic lubrication of the bearing. This applied layer of soft metal functions almost without wear for hundreds of hours.

References: Shpagin, A.I., Antifriktsionnyye splavy [Antifriction Alloys], Moscow, 1956; Spravochnik mashinostroitelya [Handbook of Machine Building], 2nd Edition, Vol. 2., Moscow, 1956; Spravochnik metallista [Metalworker's Handbook], Vol. 3, Books 1-2, Moscow, 1959; Spravochnik po mashinostroitel'nym materialam [Handbook of Machine-Building Materials], Vol. 2, Moscow, 1959.

I-516

LEATHERETTE - see Leather Substitutes.



II-91k

LEATHEROID is a variety of thin sheet fiber used in electric machinery construction.

LEATHER SUBSTITUTE MATERIALS are textile fabrics which are coated on one side, less frequently on both sides, with films based on vegetable oils (oilcloth), nitrocellulose (leatherette), polyvinyl chloride (testovinite and pavinol), and polyamides. The film composition contains pigments, fillers, plasticizers, antipyrenes (to provide noncombustibility). Waterproofing of the fabrics is achieved by special impregnation. The basic data and the mechanical properties of the leather substitute materials are given in the table.

Oilcloth. Low combustibility; stable to 60°; must not pass water; resistance of color to abrasion in wet condition no less than number 4. Film adhesiveness 0.4-0.5 kg/cm<sup>2</sup>. Resistance of film on TsNIIKZ tester no less than 60-160 cycles in abrasion and 60-90 cycles in bending.

Leatherettes. Combustible. Smooth hose leatherette is resistant to gasoline, kerosene, oil; embossed automobile leatherette is stable in the range from +60 to -50°. In waterproof testing, films of all grades of leatherette must not soften after two hours, must not become sticky and the pigment must not wash out (water resistance is determined by pouring 0.5 liters of water at room temperature into a bag made from the material with an area of 15 x 15 cm<sup>2</sup>. Adhesion of the film to the fabric must be no less than one kg. Film on moleskin substrate must not crack prior to failure of the fabric.

Aircraft materials (thin leatherettes). Noncombustible; stable to 90-100°; stiffness (bump test method) no more than 71 mm for ANAM, ANZM and ANKM, no more than 90 mm for AZT. For the physical and mechanical properties and water resistance of ANAM, ANZM, ANKM, AVZM, AZT see art-

Basic Data on Leather Substitute Materials

| 1  | 2                                      | 3  |  |                      | 4   | 5   |  | 6                                |      | 7     |   |   |
|----|--|--|--|----------------------|-----|---|--|----------------------------------|------|-------|---|---|
|    |  | 8  | 9  | 10                   |     | 11  | 12                                     | 13                               | 14   | 15    | 16  |   |
| 13 | Кожина заменитель (ТУ 1-59)            | Кожина, серая 04   | 120-140<br>120-120<br>100-120<br>85-100                    | 15-20                | -   | 000   | 25-30                                  | 24-29                            | 6    | 12    | -   | - |
| 14 | Гладкий заменитель (ТУ 9236-59)        | Молескин 17  | 100, 100, 110,<br>110 (1, 2)                               | -                    | 0,0 | 600±50  | 75                                     | 75                               | 10±3 | 22±10 | -   | - |
| 15 | Упругий заменитель (ТУ 9236-59)        | Тяжелый 10   | 100, 110, 110,<br>120 (1, 2)                               | -                    | -   | 550±50<br>500±50  | 81                                     | 81                               | 8±3  | 22±10 | -   | - |
| 16 | Молескин (ТУ 9236-59)                  | Молескин, серый 21   | 90, 90, 100, 100<br>110, 110, 120,<br>120 (1, 2)           | -                    | -   | 600±50<br>550±50  | 100                                    | 100                              | 10±0 | 24±10 | -   | - |
| 17 | Молескин (ТУ 9236-59)                  | Молескин 22  | 80, 80, 80,<br>70, 70, 80,<br>80, 80, 80,<br>100 (1, 2)    | -                    | -   | 400±50<br>300±25  | 81                                     | 81                               | 8±3  | 22±10 | -   | - |
| 18 | Молескин                               | Канва, грубая 25   | 100, 100, 110,<br>110 (1, 2)                               | 15, 20, 20<br>или 50 | -   | 310±10<br>400±10  | 65                                     | 65                               | 12±0 | 22±10 | -   | - |
| 19 | Молескин                               | Тяжелый 10   | 80, 90 (1, 2)  | 20                   | -   | 200±30<br>200±30  | 65                                     | 71                               | 8±3  | 22±10 | -   | - |
| 20 | Молескин заменитель № 1-4 (ТУ 6603-53) | 1-2 Молескин 30<br>3 AST-100<br>4 Канва  | 700±50±2;<br>75±3  | -                    | -   | 600±100<br>310±50<br>400±50<br>470±50   | 20, 12<br>20, 12                       | 20, 22<br>20, 12                 | -    | -     | -   | - |
| 21 | Молескин заменитель № 5-7              | 5 Канва<br>6 Молескин<br>7 Канва   | 670±50±2;<br>72±3  | -                    | -   | 800±70<br>500±50<br>500±70  | 30<br>16<br>16                         | 20<br>20<br>16                   | -    | -     | -   | - |
| 22 | Молескин № 8-14                        | 8-10 - Молескин 34<br>11-12 - Канва<br>13 - Канва<br>14 - AST-100<br>15 - Молескин<br>16 - Канва | 700±50±2;<br>60±3, 81±3,<br>81±3, 75±3,<br>60, 67±1, 72±0. | -                    | -   | 600±100<br>500±100<br>700±100<br>600±100<br>520±50<br>300±100<br>300±100<br>600±100 | 20<br>16<br>14<br>12<br>18<br>20<br>20 | 20<br>20<br>12<br>12<br>11<br>22 | -    | -     | 4, 2, 2, 6<br>10, 10, 10, 10<br>2, 0, 1, 0<br>1, 0, 2, 0, 7, 20<br>20, 0, 0, 0, 2<br>0, 0, 0, 0, 10, 20 |   |
| 23 | Молескин заменитель № А (ТУ 1-59)      | Канва, грубая 25   | 110, 100 03  | -                    | -   | 370±50 (мал.<br>или по размерам)<br>400±50 (крупн.<br>или по размерам)              | 20<br>25×100<br>мм                     | 42                               | -    | -     | -   | - |

1) Leather substitute materials (GOST or TU); 2) substrate fabric; 3) dimensions; 4) weight per m<sup>2</sup> (g); 5) breaking load (kg, no less than); 6) elongation (%); 7) tear strength (kg); 8) width (cm); 9) roll length (m); 10) thickness (mm); 11) warp; 12) fill; 13) strip oilcloth (GOST 8270-57); 14) cambric, serge; 15) leatherettes; 16) smooth hose (GOST 9236-59); 17) moleskin; 18) embossed automobile (GOST 9236-59); 19) same; 20) furniture (GOST 9236-59); 21) shoe fabric, moleskin; 22) book-binding (GOST 8705-58); 23) cambric; 24) phonograph; 25) serge, moleskin; 26) or; 27) curtain; 28) textovinites; 29) porous upholstery No. 1-4 (GOST 6603-53); 30) 1-2 moleskin, 3 AST-100, 4 coarse calico; 31) porous clothing No. 5-7; 32) 5 canvas, 6 moleskin, 7 satin; 33) nonporous No. 8-16; 34) 8-10 moleskin, 11-12 canvas, 13 coarse calico, 14 AST-100, 15 canvas, 16 satin; 35) for and ; 36) no less than 2; 37) pavinol; 38) pavinol aircraft P.A. (TU 1-59); 39) glass fiber; 40) no less than 85; 41) 370 ± 50 (small patterns), 400 ± 50 (large pattern); 42) strip.

icle Nonflammable Materials.

Testovinites. Low combustibility; stable at temperatures from +70 to -25°. Vapor permeability of porous upholstery textovinite is no less

II-57M2

than  $0.8 \text{ mg/cm}^2\text{-hr}$ ; resistance to gasoline 10 minutes, to kerosene 4 minutes, oil 1.5 hours. Water permeability of porous clothing textolite is  $0.1 \text{ cm}^3/\text{cm}^2\text{-hr}$ . In testing for waterproofing, the film must not soften nor become sticky after two hours and the pigment must not wash out. After soak for three minutes in concentrated nitric acid the strength loss of porous textolite must not exceed 45%. Adhesion of film with fabric is no less than 3 kg/50 mm. Wear of the porous textolites (after 10,000 cycles) is  $130 \text{ g/m}^2$ , corresponding figure for nonporous materials is  $50 \text{ g/m}^2$ . Nonporous textolite has high resistance to gasoline (two hours) and kerosene (two hours) in comparison with porous textolite. The water resistance is the same for both.

Pavinol. Does not burn or smolder after removal of flame. Pavinol must not crack at temperatures above  $-25^\circ$  (see Pavinol).

The nonflammable and waterproof materials are used for facing thermal insulating materials; ANKM, leatherettes, textovinites and pavinol are used as coverings for ceilings, walls, doors, furniture, railway car, aircraft, and automobile seats, etc. Porous textovinite (vapor permeable) is used for the fabrication of special sanitary clothing and also for footwear.

I. Yu. Sheydeman

LEDEBURITE is a eutectic mixture of austenite and cementite which forms at the point C (1130°) of the state diagram of iron-carbon. With cooling below the point A (723° for the pure iron-carbon alloys), the austenite which appears in the composition of the ledeburite is converted into perlite, consequently at normal temperature ledeburite consists of perlite and cementite.

In the pure iron-carbon alloys ledeburite is formed with a carbon content of more than 2%, i.e., only in the pig irons. In the highly alloyed steels with a carbon content of 0.7-1% and with the presence of the carbide-forming alloying elements (Cr, W, Mo, V), ledeburite is a component part of the structure in the cast condition; the carbides of the alloying elements enter into this structure in place of the cementite. Such a steel (for example, the high-speed Cr-W-V steel R18 and R9) belongs to the ledeburite class. The name ledeburite is used in honor of the German scientist-metallurgist A. Ledebur.

A.F. Golovin

LIGHT ALLOYS are structural alloys based on the metals with low specific weight (see Aluminum Alloys, Manganese Alloys, Titanium Alloys, Beryllium Alloys). The index of the structural strength of the light alloy is not its absolute value, but the specific strength (see Specific Strength). The light alloys are widely used in transport machine construction, particularly in aviation, and in domestic articles.

O.S. Eechvar, K.S. Fokhodayev

**LIGHT- AND OZONE-RESISTANT RUBBER** - rubber which retains its properties under atmospheric conditions and under conditions associated with generation of ozone. The majority of rubbers crack and lose their usefulness when deformed (by extension, torsion, or bending, but not by pure compression) in the presence of gaseous ozone. The maximum ozone concentration is  $2-4 \cdot 10^{-6}\%$  at the earth's surface,  $\sim 20 \cdot 10^{-6}\%$  at an altitude of 20-25 km, and  $50 \cdot 10^{-6}\%$  at the summits of high mountains. Ozone in high concentrations may be formed in the presence of spark discharges (high-voltage installations) or ultraviolet, x-ray,  $\gamma$ , and other types of radiation produced during the operation of nuclear reactors, electronic instruments and equipment, etc.

Rubbers can be divided into three groups in accordance with their resistance to ozone cracking:

Especially stable rubbers are based on saturated polymers (fluorine-containing polymers, chlorosulphated polyethylene, ethylene-propylene, polyisobutylene, and, to a lesser extent, siloxane gums lacking double bonds) remain intact for prolonged periods (years) on exposure to ozone in atmospheric concentrations or concentrations of the order of 0.1-1%.

TABLE 1

| 1 Ребрики на основе каучуков |   |                                |   |
|------------------------------|---|--------------------------------|---|
|                              | 2 натураль-ного                           | 3 СКС-30                       | 4 полихлорпропено-вого                      |
| 5 u, cal/mole                | 0.35<br>0.6-1.0<br>2000-3000              | 0.30<br>0.5-0.8<br>2000-3000   | 0.70<br>0.5-1<br>8000                       |
| 6 $\tau_0$ , min.            | $1.2 \cdot 10^{-1}$<br>$-7 \cdot 10^{-1}$ | $1.9 \cdot 10^{-1}$<br>$-0.11$ | $2.5 \cdot 10^{-1}$<br>$-1.6 \cdot 10^{-1}$ |

1) Rubbers based on the following gums; 2) natural; 3) SKS-30; 4) polychloroprene; 5) u, cal/mole; 6)  $\tau_0$ , min.

TABLE 2

| 1 | Назва  | b.   | A    |
|---|--------|------|------|
| 2 | NK     | 17.8 | 4.38 |
| 3 | SKS-30 | 14.5 | 2.93 |
| 4 | SKN-26 | 9.3  | 2.47 |
| 5 | SKB    | 4.3  | 1.16 |
| 6 | SKN-40 | 12   | 2.16 |

1) Gum; 2) NK; 3) SKS-30; 4) SKN-26; 5) SKB; 6) SKN-40.

Moderately stable rubbers are based on butyl rubber, brombutyl rubber, and chloroprene. These rubbers crack within a few months at atmospheric ozone concentrations; at ozone concentrations of the order of  $10^{-2}$ - $10^{-1}\%$  they crack within several tens of minutes at room temperature.

Unstable rubbers are based on unsaturated gums (natural, isoprene, divinylstyrene, divinylnitrite, and divinyl) and break down within a few days under the action of atmospheric ozone concentrations.

Addition of active or inactive fillers or of softeners reduces the time required for appearance of ozone cracks and the time to fracture under test (or operational) conditions, the degree of deformation remaining constant. In tests involving identical stresses addition of fillers, especially active fillers, increases the time to fracture in the low-stress region to approximately  $\text{kg/cm}^2$ . All three types of rubber are used commercially. Unstable rubbers require special protection against ozone and proper selection of working conditions.

Under constant deformation the time required for cracks to appear ( $\tau_u$ ) decreases monotonically as the deformation increases. The time to fracture ( $\tau_p$ ), which, together with  $\tau_u$ , is the principal quantitative index of the resistance of a rubber to ozone cracking, describes a curve with a minimum (the region of most dangerous critical deformation  $\epsilon_{kr}$ ) and a maximum as the deformation increases. For the majority of rubbers  $\epsilon_{kr}$  lies in the region of 15-20% tensile deforma-



For NK rubbers  $\epsilon_{kr}$  may shift to 5%, depending on the type of gum. For polychloroprene rubbers  $\epsilon_{kr}$  shifts to the region of deformation by more than 60%, while for butyl rubbers it lies in the region of deformation by more than 80%. Addition of active fillers to rubbers based on nonpolar gums shifts  $\epsilon_{kr}$  toward larger deformations, while addition of softeners to polar gums shifts  $\epsilon_{kr}$  toward smaller deformations.

A constant stress for load displaces  $\epsilon_{kr}$  toward smaller deformations than when  $\epsilon = \text{const}$ ; two-dimensional extension shifts  $\epsilon_{kr}$  greatly toward larger deformations. Distension of the surface layer causes displacement of  $\epsilon_{kr}$  toward larger deformations and increases the resistance of the rubber to ozone cracking. In particular, superficial distension with water or a mospheric water vapor, which is espeically important in tropical climates, somewhat increases the resistance of NK rubbers and polychloroprene. A rize in temperature usually leads to a drop in  $\tau_u$  and  $\tau_p$ , as well as to displacement of  $\epsilon_{kr}$  toward smaller deformations, so that  $\tau_p$  may exhibit an anomalous temperature function. There is a sharp increase in the  $\tau_p$  of rubbers functioning at  $\epsilon = \text{const}$  when the temperature drops (to below 0°), especially during crystallization or vitrification. The ozone resistance of rubbers under constant stress is increased to a lesser extent and even vitrified rubbers crack. The  $\tau_p$  of a rubber under tension can be evaluated as a function of the stress ( $\sigma$ ), ozone concentration (C), and temperature (T) only when it does not contain ozone-protective substances, when its deformation is less than  $\epsilon_{kr}$ , and over the temperature range 20-50°. The empirical formula  $\tau_v = \tau_0 \sigma^{-b} C^{-a} e^{u/RT}$  is valid in this case. Table 1 shows the orders of magnitude of a, b, u, and  $\tau_0$  for certain unfilled rubbers, with  $\tau_p$  expressed in min,  $\sigma$  in kg/cm<sup>2</sup>, C in % by volume, and u in cal/mole.

The formula for b as a function of the volumetric caoutchouc con-

tent ( $v_1$ ) takes the form  $b = b_0 e^{-kv_1}$ , where  $v_1 = v - v^1/v$ ,  $v$  is the volume of rubber, and  $v^1$  is the volume of nongum ingredients in an equal amount of rubber. Table 2 shows the values of  $b_0$  and  $k$  for rubbers based on different gums.

Sunlight usually accelerates the ozone cracking of rubbers, especially those which are unstable. The resistance of rubbers to ozone can be increased by adding waxy substances (which migrate to the surface) or anti-ozone-aging agents, by reducing the tensile stresses, or by creating compressive stresses in the surface layer of the article. It is sometimes possible to increase the resistance to ozone cracking of components functioning under static deformation to 2-3 years with waxes. A more common technique for protecting rubbers which must function under static and dynamic deformations is addition of anti-ozone-aging agents, the most effective of which is 4010 NA (phenol-isopropyl paraphenylene diamine). It has been suggested in England that rubbers be protected by superficial application of concentrated solutions or aqueous suspensions of antiozonants. Chloroprene is most widely used in the USSR for producing light- and ozone-resistant rubbers, while butyl rubber and chlorosulphated polyethylene are used abroad. Unstable rubbers are commonly protected with anti-ozone-aging agents and waxes, as well as by combinations of these substances with chlorosulphated polyethylene and polychloroprene. Unstressed rubber articles functioning in the open air are essentially subject only to light and light-heat aging, which alters their color and rigidity. Thin-walled products (rubber and rubber-cloth membranes, protective clothing, covers, etc.) are especially affected. The resistance of rubbers to light is greatly enhanced by addition of soot, coating with powdered aluminum, or addition of anti-light-aging agents (nickel dibutyldithiocarbamate, 2,6-di-tributyl-1-methylphenol, 2,2-methylene-

III-31r4

bis-4-methyl-6-tributylphenol, etc.); the latter do not alter the color of the rubber in light. Butyl rubber, chlorosulphated polyethylene, polychloroprene, and NK are used with the appropriate protective substances in the manufacture of light-resistant rubbers.

References: Kuz'minskiy, A.S., Lezhnev, N.N., Zuyev, Yu.S., *Okisleniye kauchukov i rezin* [Oxidation of Gums and Rubbers], Moscow, 1957; Zuyev, Yu.S., Borshchevskaya, A.Z., *Metody zashchity rezinovykh izdeliy ot ozonnogo rastreskivaniya* [Methods of Protecting Rubber Articles from Ozone Cracking], Moscow, 1957; Zuyev, Yu.S., Pravednikova, S.I., Kotel'nikova, G.V., *I i R*, 1961, No. 11; Zuyev, Yu.S., Pravednikova, S.I., Kotel'nikova, G.V., *K i R*, 1962, No. 3; Zuyev, Yu.S., Malofeyevskaya, V.F., *K i R*, 1961, No. 6; Smirnova, L.A., in collection: *Khimiya i tekhnologiya polimerov* [Chemistry and Technology of Polymers], collection of translations from the foreign periodical literature, 1960, No. 11; *Stareniye i zashchita rezin* [Aging and Protection of Rubbers], collection of articles, Moscow, 1960, pages 3, 27; Zuyev, Yu.S. et al., *VS*, 1961, Vol. 3, No. 2, page 164; Zuyev, Yu.S., Postovskaya, A.F., *Svetovoye stareniye, zashchita i retseptura izdeleniy iz tsvetnykh rezin* [Light Aging, Protection, and Compounding of Colored-Rubber Articles], Moscow, 1959.

Yu.S. Zuyev

III-54p

LIMITING CYCLE AMPLITUDE - the stress amplitude corresponding to the limit of durability (or the limit of restricted durability).

III-55p

**LIMITING CYCLIC STRESS** - the maximum and minimum cyclic stress corresponding to the limit of durability (or the limit of restricted durability).

LIMIT OF FORCED ELASTICITY - the stress at the instant of necking at the weakest point on extinction of a polymer (Fig.). The limit of

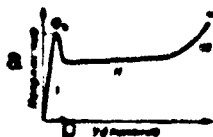

Curve for extension of an amorphous solid polymer: I) Segment of elastic deformation; II) gradual transition of entire specimen to neck; III) extension of oriented specimen to fracture. a) Stress; b) elongation.

forced elasticity is designated as  $\sigma_b$ . In crystalline polymers (see Strength of polymers) necking is associated with a first-order phase transition from the initial to the oriented phase, with the chain lying along the axis of extension. Forced deformation of an amorphous polymer (see Highly elastic deformation) is not associated with a phase transition. The limit of forced elasticity increases as the temperature decreases. At low temperatures the extension curve does not reach a maximum, since brittle fracture occurs.

B.M. Bartenev

LIMIT OF PROPORTIONALITY - the maximum stress at which deformation still increases in proportion to the applied load. In engineering the arbitrary proportionality limit is defined as the stress at which the deviation of the increase in deformation (elongation, shrinkage, shear) from the law of proportionality reaches a definite stipulated value: 50% (sometimes 10 or 30%) for elongation on extension or bending and shrinkage on compression and 75, 15, and 45% for shear on torsion. The proportionality limits for extension, compression warping, bending, and torsion are designated as  $\sigma_{pts}$ ,  $\sigma_{-pts}$ ,  $\sigma_{pts\ sm}$ ,  $\sigma_{pts\ izg}$ , and  $\tau_{pts}$  respectively. The proportionality limit is calculated from the following formulas:  $\sigma_{pts} = P_{pts}/F_0$ ,  $\sigma_{-pts} = P_{pts}/F_0$ ,  $\sigma_{pts\ sm} = P_{pts}/da$ ,  $\sigma_{pts\ izg} = 6M_{izg\ pts}/bh^2$  (for a rectangular specimen with a width  $b$  and a height  $h$ ),  $\tau_{pts} = M_{kr\ pts}/\pi d^3$  (for a round specimen with a diameter  $d$ ). In these equations  $P_{pts}$  is the axial load at the proportionality limit in kg,  $M_{izg\ pts}$  is the bending moment at the limit of proportionality in kg-cm or kg-mm,  $M_{kr\ pts}$  is the torsional moment at the proportionality limit in kg-cm or kg-mm,  $F_0$  is the initial cross-sectional area of the specimen in  $mm^2$  or  $cm^2$ ,  $d$  is the aperture diameter in mm or cm, and  $a$  is the width of the plate in mm or cm in warping tests. The tensile and compressive proportionality limits of low- and medium-strength structural steels (after annealing, normalization, and high tempering) and aluminum and titanium alloys are generally very low. The compressive proportionality limit is usually 10-15% than the tensile proportionality limit in high-strength steels and 10-20% lower than the tensile limit in magnesium alloys. The tensile and compressive

III-48pl

proportionality limits of cold-worked materials may differ materially; this is due principally to the Bauschinger effect. In very soft materials with a low yield strength (e.g., copper) the value of the proportionality limit is greatly affected by surface hardening during machining; in such cases the finished specimen to be used for determination of the proportionality limit must be preliminarily annealed in order to eliminate cold hardening.

S.I. Kishkina-Ratner



**LIMIT OF RESTRICTED DURABILITY** - a characteristic of the durability of a material in the descending segment of the Fatigue curve. In tests with a constant coefficient of cycle asymmetry the limit of restricted durability is defined as the greatest maximum (with respect to amplitude) cyclic stress at which the specimen withstands fracture for a definite (predetermined) number of cycles. In tests with a constant mean-stress the limit of restricted durability is defined as the greatest cyclic-stress amplitude at which the specimen withstands fracture for a definite (predetermined) number of cycles. In testing a large number of specimens and subjecting the test results to statistical processing the value of the limit of restricted durability can be defined as a function of the probability  $P$  that the specimen will fracture, as the greatest maximum cyclic stress (with respect to amplitude) or as the greatest cyclic-stress amplitude at which the specimen does not undergo fatigue fracture (with a probability  $P$ ) during a definite (predetermined) number of cycles.

G.T. Ivanov

LINEAR DEFORMATION - elementary deformation, which arises under the action of normal stresses; is expressed by the increase in the displacement of points in a body in the direction of one of the coordinate axes; is characterized by elongation or contraction.

N. V. Kadobnova

**LINEAR THERMAL EXPANSION COEFFICIENT** is a measure of the linear expansion coefficient ( $\alpha$ ) is determined from the expression  $\alpha = \frac{1}{l} \frac{dl}{dT}$ , where  $l$  is the body length at  $0^\circ$ , and the variation of the length  $dl$  with variation of the temperature  $dT$  is taken with a constant external pressure. For the determination of  $\alpha$  it is necessary to measure accurately the length of the test rod, its elongation, and also the initial and final temperatures. The measurement of  $\alpha$  is carried out on dynamometers of various designs. For solid bodies of complex composition (metal alloys or glasses) it is computed from the Mattisen formula:

$$\alpha = \frac{1}{V} \sum_{i=1}^n \alpha_i v_i$$

where  $v_i$  is the volume of the  $i$ -th material present in the alloy composition,  $V$  is the body volume; in some materials  $\alpha$  is subject to several anomalies. Thus, for example, amorphous quartz expands on cooling from  $-58^\circ$  to  $-250^\circ$ , while rubber which is stretched by a constant load shrinks with heating. The linear thermal expansion coefficient of the plastics and rubbers is several times larger than for the metals, which must be taken into account in the design of reinforced plastic products and rubber fillers, since the thermal shrinkage of these materials leads either to cracking or to the loss of pressure tightness. With nonuniform cooling and heating of materials there arise thermoelastic stresses whose magnitude depends on the linear thermal expansion coefficient. The linear thermal expansion coefficient of the engineering plastics varies over wide limits from  $0.3 \cdot 10^5$  to  $36 \cdot 10^5 \text{ deg}^{-1}$ . The pure resins have the highest values of  $\alpha$  (for example, for formaldehyde re-

II-93k1

$\sin \alpha = 12 \cdot 10^5$ ). Fillers, as a rule, reduce this value.

G.M. Bartenev

1-1040

LIQUID DIELECTRICS - see Dielectrics.

LKT AND LL STRIPS are woven textile products made from kapron (LKT strip) or lavsan (LL strip) threads which have high strength in the filling direction and are used for the soft retention of transparent components made from plexiglass in metal frames. This retention permits quite free movement of the plexiglass relative to the frame, permits uniform transmission of operational loading along the entire perimetry of the retention and eliminates local stress concentrations in the plexiglass at points of restraint. The LKT strip is fabricated by garniture interweaving from thrown kapron silk of  $N_m$  34 and 12 strands in the warp and  $N_m$  34 and 16 strands in the fill directions, while the LL strip is fabricated by repp weaving from twisted lavsan silk 34/4/3 in the warp and 34/8/4 in the filling directions. The strip width is from 70 to 110 mm with retention of all the material properties with exception of weight per running meter, which depends on the strip width.

The LKT kapron stripping is recommended for the retention of trans-details operating for long periods at temperatures no higher than 80°, while the lavsan stripping is recommended for operating temperatures to 150°. In order to provide for dimensional stability of the LL strip at elevated temperatures, it must be subjected to heat treatment at 155-160° for one hour; during the heat treatment the width and length of the strip will be reduced by 10-13% while the strength will increase by 10-13%. Thereafter the initial condition of the LL strip is considered to be its condition after the thermal treatment. The LKT strip, recommended for usage at lower temperatures, does not require heat treatment.

## II-90k1

The basic physical and mechanical properties of the LKT and LL strip-  
ping are presented in the Table.

| Лента<br>1                                     | 2<br>Ширина<br>(мм)                | 3<br>Вес<br>1 м по л<br>(г, не<br>более) | 4<br>Толщина<br>(мм)  | 5<br>Разрывная нагрузка<br>каждой из двух лент<br>(кг, не менее) |                                  | 6<br>Разрывное удлине-<br>ние (%) |               |
|--|------------------------------------|--|-----------------------|--|----------------------------------|-----------------------------------|---------------|
|  |                                    |  |                       | 7<br>по утку,<br>ширина<br>50 мм                                 | 8<br>по утку,<br>ширина<br>25 мм | 9<br>по утку                      | 10<br>по утку |
|  |                                    |  |                       |  |                                  |                                   |               |
| ЛКТ<br>(ТУ 1268-55)<br>11                      | 90 ± 2.0<br>100 ± 2.5<br>112 ± 3.0 | 80<br>70<br>80                           | 1.0 ± 0.1             | 650  | 320                              | 29-35                             | 24-48         |
| ЛЛ до термообработ-<br>ки (ВТУ Т-227-59)<br>12 | 100 ± 2.5                          | 100                                      | Не более<br>1.9<br>13 | 200  | 420                              | 18-20                             | 13-20         |
| ЛЛ после термообра-<br>ботки<br>14             | 90 ± 2                             | 110                                      | Не более<br>2.0       | 220  | 500                              | 32-50                             | 24-48         |

1) Strip; 2) width (mm); 3) weight per running meter (g, no more than); 4) thickness (mm); 5) breaking load of each band of the strip (kg, no less than); 6) breaking elongation (%); 7) along the warp, band 50 mm wide; 8) along the fill, band 25 mm wide, 9) along warp; 10) along fill; 11) LKT (TU 1268-55); 12) LL prior to thermal treatment (VTU T-227-59); 13) no more than; 14) LL after thermal treatment.

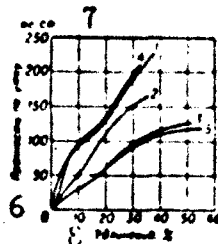

Tensile curves for the LL and LKT strip-ping in warp direction: 1) LL at 20-25°; 2) LKT at 20-25°; 3) LL at 150° (prior to long-time exposure to a temperature of 150°); 4) LL at 20-25° after exposure to temperature of 150° for 300 hours; 5) LL at 150° after exposure to a temperature of 150° for 300 hours; 6) strength in warp direction; 7) kg/cm; 8) elongation, %.

Long-time (for 300 hours) exposure to elevated temperature (up to 150°) reduces the strength of the LL strip to 50% of the initial value; the strength of strip tested after this at 20-25° amounted to 94% of the initial value. The elongations in the warp direction at failure were equal to 34 and 59%, respectively. The figure presents the tensile curves for the LL lavsan strip in the warp direction at 20-25° and 150° and for the LKT kapron strip at 20-25°, from which we can judge the magnitudes of the strip deformations which can take place with opera-

II-90k2

tion of the retention members for window elements. These deformations must be taken into account in the impregnation of the retention member with the sealing materials. We must also take into account the intense aging of the LL and LKT stripping under the action of direct solar rays. Therefore, during the storage and use of these strippings in structures they must be protected from direct exposure to solar radiation.

A.S. Konstantinov



LONGITUDINAL STABILITY - the ability of a rod loaded parallel to its axis with compressive forces to resist passing into a state of unstable equilibrium. The force corresponding to this transition point is referred to as the critical force. Longitudinal stability is one of many cases of stability (plates, hollow tubes under external pressure, etc.). Assurance of stability, particularly longitudinal stability, is one of the principal conditions for structural reliability, especially in thin-walled structures. Both local and general loss of longitudinal stability may occur.

Ya.B. Fridman

**LONG-LIFE STRENGTH TEST** - is the checking preponderance of heat-proof metals and alloys at high temperatures, resulting in the determination of the constant stress which causes the destruction of the specimen (as a rule, at monoaxial stretching) for a given time interval  $\tau$  and a constant temperature  $t$ . The long-life strength is determined based on the results of the test of a series of equal specimens at a given temperature, each specimen being brought to rupture. An empirically ascertained exponential relationship is valid between the long-life strength  $\sigma$  and the rupture time  $\tau$ :  $\tau = Be^{-\beta\sigma}$ , (at  $t = \text{const}$ ), where  $B$  and  $\beta$  are constants depending for the given material only on the temperature  $t$ . For many materials, heat-resistant steels, for example, this relationship is linear in the coordinates  $(\log \tau, \sigma)$  (Fig.), and this fact permits one to determine approximately the long-life strength  $\sigma$  for a useful life of some ten thousand hours by means of extrapolation. This is, however, not always just, a linear relationship between  $\sigma$  and  $\tau$  in the coordinates system  $(\log \tau, \sigma)$  was not observed for the aluminum alloys D16 and V95, for example.



Fig. Graph of the long-life strength as a function of the time.

The relative elongation and the necking of the cross section of the specimen in the moment of rupture can also be determined in the long-life strength test (by direct measuring the specimens before and after rupture). The same equipment and device are used for the long-life test as for the creeping test (see GOST 3248-60).

References: Borzdyka A.M., Metody goryachikh mechanicheskikh ispy-

I-2711

taniy metallov [Methods of Hot Mechanical Tests of Metals], Moscow, 1955; Teoriya polzuchesti i dlitel'noy prochnosti metallov [Theory of the Creeping and Long-life Strength of Metals], edited by I.A. Odintsov, Moscow, 1959.

I.V. Kudryavtsev, D.M. Shur

III-45p

LONG-TERM ULTIMATE STRENGTH - see Long-term strength.

**LOW-ALLOY HEAT-TREATABLE STRUCTURAL STEEL** — steel that can be hardened by heat treatment and contains up to 2% of a single alloying element. This group includes manganese and chromium steels widely used in industry. Table 1 shows the chemical composition of these steels, while Table 2 shows their mechanical characteristics.

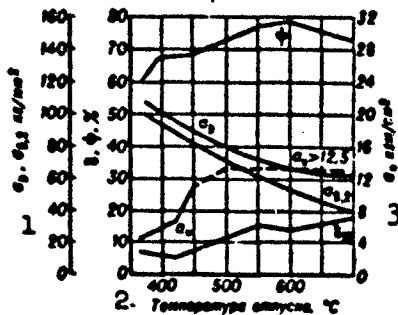

Fig. 1. Influence of tempering temperature on the mechanical characteristics of 20G steel (0.19% C, 0.96% Mn). Quenching from 890° in water and cooling in oil after tempering (blank diameter — 20 mm). 1) kg/mm<sup>2</sup>; 2) tempering temperature, °C; 3) kg-m/cm<sup>2</sup>.

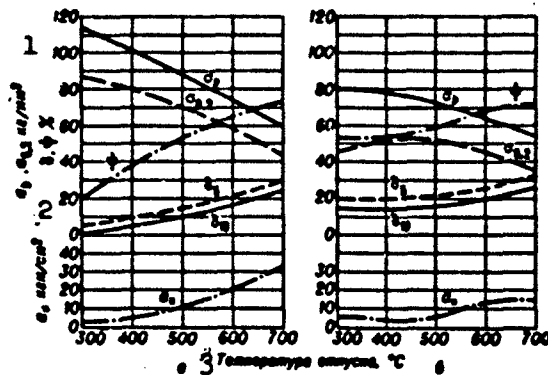

Fig. 2. Influence of tempering temperature on the mechanical characteristics of 30G steel (0.32% C, 1.18% Mn): a) Quenching from 820° in water; b) quenching from 840° in oil (Charpy impact specimens). 1) kg/mm<sup>2</sup>; 2) kg-m/cm<sup>2</sup>; 3) tempering temperature, °C.

**TABLE 1**  
**Chemical Composition of Low-Alloy Heat-Treatable Structural Steels\* (GOST 1050-60 and 4543-61)**

| Сталь<br>1 | Содержание основных элементов<br>2 (%) |         |         |
|------------|--|---------|---------|
|            | C                                      | Mn      | Cr      |
| 3 15Г      | 0.12-0.19                              | 0.7-1.0 | <0.25   |
| 4 20Г      | 0.17-0.24                              | 0.7-1.0 | <0.25   |
| 5 25Г      | 0.22-0.30                              | 0.7-1.0 | <0.25   |
| 6 30Г      | 0.27-0.35                              | 0.7-1.0 | <0.25   |
| 7 35Г      | 0.32-0.40                              | 0.7-1.0 | <0.25   |
| 8 40Г      | 0.37-0.45                              | 0.7-1.0 | <0.25   |
| 9 45Г      | 0.42-0.50                              | 0.7-1.0 | <0.25   |
| 10 50Г     | 0.47-0.55                              | 0.7-1.0 | <0.25   |
| 11 60Г     | 0.52-0.60                              | 0.7-1.0 | <0.25   |
| 12 65Г     | 0.57-0.65                              | 0.7-1.0 | <0.25   |
| 13 70Г     | 0.62-0.70                              | 0.9-1.2 | <0.25   |
| 14 10Г2    | 0.07-0.15                              | 1.2-1.8 | <0.25   |
| 15 35Г2    | 0.31-0.39                              | 1.4-1.8 | <0.25   |
| 16 40Г2    | 0.36-0.44                              | 1.4-1.8 | <0.25   |
| 17 45Г2    | 0.41-0.49                              | 1.4-1.8 | <0.25   |
| 18 50Г2    | 0.46-0.54                              | 1.4-1.8 | <0.25   |
| 19 30Х     | 0.25-0.33                              | 0.5-0.8 | 0.8-1.1 |
| 20 35Х     | 0.31-0.39                              | 0.5-0.8 | 0.8-1.1 |
| 21 35ХРА   | 0.25-0.40                              | 0.5-0.8 | 0.8-1.1 |
| 22 38ХА    | 0.35-0.42                              | 0.5-0.8 | 0.8-1.1 |
| 23 40Х     | 0.36-0.44                              | 0.5-0.8 | 0.8-1.1 |
| 24 40ХР    | 0.37-0.45                              | 0.5-0.8 | 0.8-1.1 |
| 25 45Х     | 0.41-0.49                              | 0.5-0.8 | 0.8-1.1 |
| 26 50Х     | 0.46-0.54                              | 0.5-0.8 | 0.8-1.1 |

\*All steels contain 0.17-0.37% Si, while types 35KhRA and 40KhR contain 0.002-0.005% B.

1) Steel; 2) content of basic elements (%); 3) 15G; 4) 20G; 5) 25G; 6) 30G; 7) 35G; 8) 40G; 9) 45G; 10) 50G; 11) 60G; 12) 65G; 13) 70G; 14) 10G2; 15) 35G2; 16) 40G2; 17) 45G2; 18) 50G2; 19) 30Kh; 20) 35Kh; 21) 35KhRA; 22) 38KhA; 23) 40Kh; 24) 40KhR; 25) 45Kh; 26) 50Kh.

Figures 1-9 show the mechanical characteristics of certain types of low-alloy heat-treatable structural steel after quenching and heat treatment under various regimes, while Table 3 shows these characteristics at elevated temperatures.

As a result of the comparatively low hardenability of steels of this type, their mechanical characteristics depend to a considerable extent on the cross-sectional area of the component to be hardened. Their critical points are shown in Table 4.

Forging and other hot deformation of low-alloy heat-treatable structural steels presents no difficulty and is usually conducted over

**TABLE 2**  
**Mechanical Characteristics of Low-Alloy Heat-Treatable Structural Steels (GOST 1050-60 and 4543-61)**

| Сталь | Термич. обработка | σ <sub>b</sub>     |                     | σ <sub>0.2</sub> | δ <sub>5</sub> | ψ | K <sub>II</sub> |    |
|-------|-------------------|--------------------|---------------------|------------------|----------------|---|-----------------|----|
|       |                   | кг/мм <sup>2</sup> | кгс/мм <sup>2</sup> |                  |                |   | мм              | мм |
| 1     | 2                 | 3                  | 4                   | 5                | 6              | 7 | 8               | 9  |
| 15Г   | 5                 | 42                 | 25                  | 28               | 55             | — | —               | —  |
| 20Г   | 5                 | 48                 | 28                  | 28               | 50             | — | —               | —  |
| 25Г   | 5                 | 50                 | 30                  | 22               | 50             | — | —               | —  |
| 30Г   | 29                | 55                 | 32                  | 20               | 48             | — | —               | —  |
| 35Г   | 9                 | 57                 | 34                  | 18               | 45             | — | —               | —  |
| 40Г   | 10                | 60                 | 36                  | 17               | 45             | — | —               | —  |
| 45Г   | 10                | 63                 | 38                  | 15               | 40             | — | —               | —  |
| 50Г   | 12                | 66                 | 40                  | 13               | 40             | — | —               | —  |
| 55Г   | 12                | 71                 | 42                  | 11               | 35             | — | —               | —  |
| 60Г   | 14                | 75                 | 44                  | 9                | 30             | — | —               | —  |
| 70Г   | 16                | 80                 | 46                  | 8                | 25             | — | —               | —  |
| 80Г   | 16                | 83                 | 47                  | 22               | 50             | — | —               | —  |
| 90Г   | 18                | 87                 | 49                  | 12               | 40             | — | —               | —  |
| 100Г  | 18                | 90                 | 51                  | 11               | 40             | — | —               | —  |
| 110Г  | 20                | 93                 | 53                  | 11               | 35             | — | —               | —  |
| 120Г  | 20                | 95                 | 55                  | 11               | 35             | — | —               | —  |
| 30Х   | 30                | 90                 | 70                  | 12               | 45             | 7 | <187            | —  |
| 35Х   | 21                | 95                 | 75                  | 11               | 45             | 7 | <187            | —  |
| 35ХРА | 22                | 95                 | 80                  | 12               | 50             | 9 | <217            | —  |
| 38ХА  | 23                | 95                 | 80                  | 12               | 50             | 9 | <207            | —  |
| 40Х   | 24                | 100                | 80                  | 10               | 45             | 8 | <217            | —  |
| 40ХР  | 25                | 100                | 80                  | 12               | 50             | 9 | <229            | —  |
| 45Х   | 26                | 105                | 85                  | 9                | 45             | 5 | <229            | —  |
| 50Х   | 27                | 110                | 90                  | 9                | 40             | 5 | <229            | —  |
| 50Х   | 28                | 110                | 90                  | 9                | 40             | 5 | <229            | —  |

\*Hardness after annealing or high tempering.

- 1) Steel; 2) heat treatment; 3) kg/mm<sup>2</sup>; 4) kg-m/cm<sup>2</sup>; 5) 15G; 6) 20G; 7) 25G; 8) 30G; 9) 35G; 10) 40G; 11) 45G; 12) 50G; 13) 60G; 14) 65G; 15) 70G; 16) 10G2; 17) 35G2; 18) 40G2; 19) 45G2; 20) 50G2; 21) 30Kh; 22) 35Kh; 23) 35KhRA; 24) 38KhA25) 40Kh; 26) 40KhR; 27) 45Kh; 28) 50Kh; 29) normalization; 30) quenching from 860° in oil, tempering at 500°; 31) quenching from 860° in oil, tempering at 560°; 32) quenching from 860° in oil, tempering at 550°; 33) quenching from 850° in oil, tempering at 500°; 34) quenching from 860° in oil, tempering at 540°; 35) quenching from 840° in oil, tempering at 520°; 36) quenching from 830° in oil, tempering at 520°.

the range 1200-800°. The most favorable structure for machinability (ferrite + lamellar perlite) is obtained by high annealing at a temperature 30-50° above the critical point Ac<sub>3</sub>; such steel is readily cut.

The weldability of low-alloy heat-treatable structural steels is governed principally by their carbon content. At 0.30% C or more it is recommended that the components be annealed or tempered after welding to prevent welding cracks. Steel with a C content of 0.40% or more is

TABLE 3

Ultimate Strength of Certain Types of Low-Alloy Heat-Treatable Structural Steel at Elevated Temperatures

| Сталь<br>1 | Термич. обработка<br>2              | 3 Температура (°C)                 |              |     |     |      |      |     |     |
|------------|-------------------------------------|------------------------------------|--------------|-----|-----|------|------|-----|-----|
|            |                                     | 20                                 | 200          | 300 | 350 | 400  | 450  | 500 | 600 |
|            |                                     | 4 $\sigma_b$ (кг/мм <sup>2</sup> ) |              |     |     |      |      |     |     |
| 5 20Г      | 10 Нормализация                     | —                                  | 90<br>(230°) | 89  | 87  | 86   | —    | —   | —   |
| 6 40Г      | То же 11                            | —                                  | —            | —   | —   | —    | 30   | —   | —   |
| 7 50Г      | То же 11                            | —                                  | —            | 76  | —   | 60   | —    | 53  | —   |
| 8 30Х      | 12 Закалка в масле, отпуск при 500° | 83                                 | 78           | 81  | 80  | 66   | 61   | 51  | —   |
| 9 38ХА     | 13 Закалка в масле, отпуск при 550° | 93                                 | 90           | 89  | —   | 78   | 60   | 50  | —   |
| 10 40ХА    | 14 То же, отпуск при 680°           | 71                                 | 66           | —   | —   | 60,5 | 44,5 | 43  | 29  |
| 11 40ХА    | 15 То же, отпуск при 720°           | 66                                 | —            | 57  | —   | 62   | 22   | 25  | 21  |

1) Steel; 2) heat treatment; 3) temperature (°C); 4)  $\sigma_b$  (kg/mm<sup>2</sup>); 5) 20G; 6) 40G; 7) 50G; 8) 30Kh; 9) 38KhA and 40Kh; 10) normalization; 11) the same; 12) quenching in oil, tempering at 500°; 13) quenching in oil, tempering at 550°; 14) the same, tempering at 680°; 15) the same, tempering at 720°.

TABLE 4

Critical Points of Low-Alloy Heat-Treatable Structural Steels

| Критические точки<br>1         | Сталь    |          |          |          |          |           |          |                  |           |           |  |
|--------------------------------|----------|----------|----------|----------|----------|-----------|----------|------------------|-----------|-----------|--|
|                                | 20Г<br>3 | 30Г<br>4 | 40Г<br>5 | 50Г<br>6 | 60Г<br>7 | 45Г2<br>8 | 30Х<br>9 | 40Х и 38ХА<br>10 | 45Х<br>11 | 50Х<br>12 |  |
| A <sub>c1</sub> (°C) . . . . . | 725      | 725      | 725      | 725      | 725      | 715       | 730      | 730              | 730       | 730       |  |
| A <sub>c2</sub> (°C) . . . . . | —        | 812      | 790      | 776      | 765      | 725       | 815      | 785              | 775       | 765       |  |

1) Critical points; 2) steel; 3) 20G; 4) 30G; 5) 40G; 6) 50G; 7) 60G; 8) 45G2; 9) 30Kh; 10) 40Kh and 38KhA; 11) 45Kh; 12) 50Kh

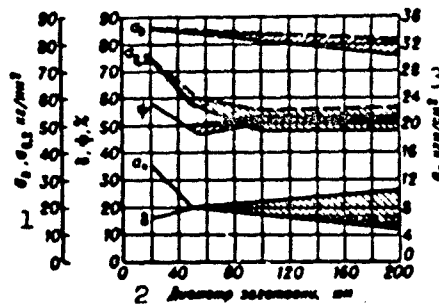

Fig. 3. Influence of diameter of quenched articles on mechanical characteristics of heat-treated 40G steel (0.43% C, 0.70% Mn). Quenching from 840° in water, tempering at 550°. (Dashed curves - characteristics near edge of blank, solid curves - characteristics at center of blank). 1) kg/mm<sup>2</sup>; 2) blank diameter, mm; 3) kg-m/cm<sup>2</sup>.



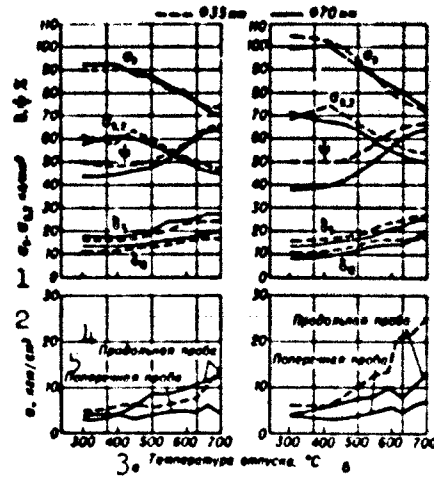

Fig. 4. Influence of tempering temperature on the mechanical characteristics of 50G steel (0.46% C, 0.80% Mn): a) Quenching from 850° in oil; b) quenching from 800° in water. 1) kg/mm<sup>2</sup>; 2) kg-m/cm<sup>2</sup>; 3) tempering temperature, °C; 4) longitudinal test; 5) transverse test.

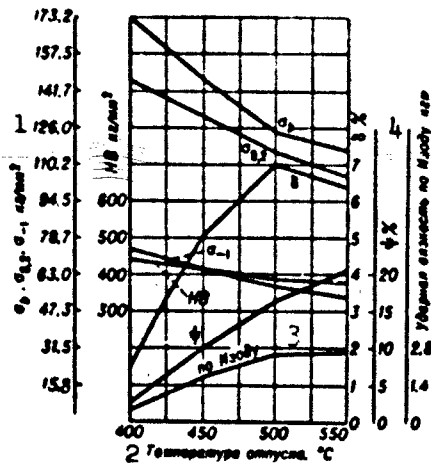

Fig. 5. Influence of tempering temperature on the mechanical characteristics of 60G steel (0.60% C, 0.77% Mn). Quenching from 950° in oil. 1) kg/mm<sup>2</sup>; 2) tempering temperature, °C; 3) Izod test; 4) Izod impact strength, kg-m.

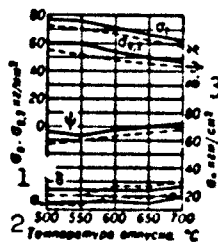

Fig. 6. Influence of tempering temperature on the mechanical characteristics of steel containing 0.28% C and 1.43% Mn. Quenching from 850° in water (blank diameter - 60 mm). The dashed curves represent character-

istics at the center of the blank and the solid curves characteristics near its edge. 1)  $\text{kg/mm}^2$ ; 2) tempering temperature,  $^{\circ}\text{C}$ ; 3)  $\text{kg-m/cm}^2$ .

TABLE 5

Heat Treatment, Mechanical Characteristics, and Applications of 40Kh and 38KhA Steels

| Термич. обработка   | Свойства   | Применение |
|---|--|------------|
| 4) Закалка с $830-850^{\circ}$ в масле, отпуск при $500^{\circ}$  | $\sigma_b = 100 \text{ кг/мм}^2$<br>$\sigma_{0.2} = 40 \text{ кг/мм}^2$<br>$\psi > 10 \text{ кг/мм}^2$ | 12         |
| 5) То же, отпуск при $540-580^{\circ}$  |  | 13         |
| 6) Закалка с $830-850^{\circ}$ в масле, отпуск при $180-200^{\circ}$  | $\sigma_b = 140 \text{ кг/мм}^2$<br>RC - 45-50<br>RC - 44-51   | 13         |
| 7) Поверхностная закалка с нагревом токами высокой частоты, отпуск при $180-200^{\circ}$ (перед поверхностной закалкой детали иногда подвергается закалке с последующим высоким отпуском) |  | 13         |
| 8) Жидкостная цементация (цианирование), закалка в масле, отпуск при $200^{\circ}$  | RC = 55 в боках<br>11  | 14         |

1) Heat treatment; 2) characteristics; 3) applications; 4) quenching from  $830-850^{\circ}$  in oil, tempering at  $500^{\circ}$ ; 5) the same, tempering at  $540-580^{\circ}$ ; 6) quenching from  $830-850^{\circ}$  in oil, tempering at  $180-200^{\circ}$ ; 7) surface quenching with high-frequency electric heating, tempering at  $180-200^{\circ}$  (the component is sometimes quenched and high tempered before surface quenching); 8) liquid cementation (cyaniding), quenching in oil, tempering at  $200^{\circ}$ ; 9)  $\text{kg/mm}^2$ ; 10)  $\text{kg-m/cm}^2$ ; 11) or more; 12) components to operate under moderate pressures, gears, spindles, shafts for rolling-contact bearings, worm shafts, splined shafts, axles, etc.; 13) components to operate at high pressures, gears, spindles, racks, water-pump rotors (these components should not have sharp notches or other stress concentrators); 14) components to operate at high pressures.

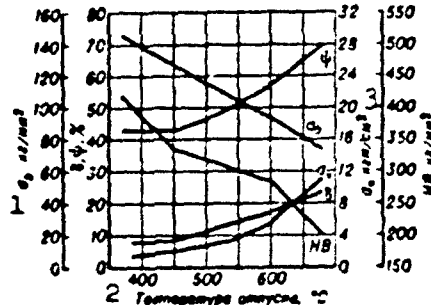

Fig. 7. Influence of tempering temperature on the mechanical characteristics of 45G2 steel (0.45% C, 1.46% Mn). Quenching from  $810^{\circ}$  in oil (blank diameter - 25 mm; Charpy impact specimens. 1)  $\text{kg/mm}^2$ ; 2) tempering temperature,  $^{\circ}\text{C}$ ; 3)  $\text{kg-m/cm}^2$ .

difficult to weld, while a C content of 0.50% or more makes steel unsuitable for welded components. The best combination of mechanical characteristics is obtained in steels of this type by quenching and subsequent tempering. Water is used as the quenching medium at C con-

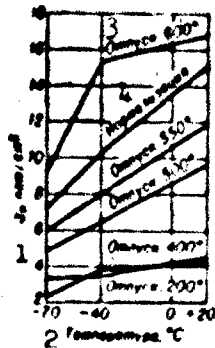

Fig. 8. Influence of low temperatures on the impact strength of 40Kh and 38KhA steels. Quenching from 860° in oil. 1) kg-m/cm<sup>2</sup>; 2) temperature, °C; 3) tempering; 4) normalization.

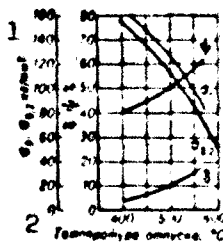

Fig. 9. Influence of tempering temperature on the mechanical characteristics of 50Kh steel (0.47% C, 1.25% Cr). Quenching from 820° in oil (blank diameter - 50 mm). 1) kg-m/cm<sup>2</sup>; 2) tempering temperature, °C.

tents of up to 0.30%, while oil is used at higher C contents. Large components are an exception, being quenched in water to ensure the necessary hardenability. Cooling in an aqueous emulsion is employed in surface quenching with high-frequency electric heating. When quenching in water is used tempering must be carried out as soon as possible, in order to avoid development of quenching cracks. Components of low-alloy heat-treatable steel are usually subjected to high tempering. Components intended to under cementation or cyaniding are an exception, being tempered at 160-180°. Tempering after surface quenching is conducted at ~200°.

The most widely used steels of this type are 40Kh and 38KhA; Table 5 shows the applications of these steels and the heat-treatment regimes employed.

III-102s7

References: Spravochnik po mashinostroitel'nym materialam [Handbook of Machine-Building Materials], Vol. Moscos, 1959; Avtomobil'nyye stali [Automobile Structural Sheels], Handbook, Moscow, 1951; Davydova, L.N., Pshechenkova, G.V., Konstruktsionnyye stali [Structural Steels], Vol. 1, Moscow, 1947

Ya.M. Potak

LOW-ALLOY STRUCTURAL STEEL - high-strength steel with a total alloying-element content of no more than 4-4.5%. Figures 1 and 2 show the influence of individual alloying elements on the characteristics of these steels.

TABLE 1  
Chemical Composition of Low-Alloy Structural Steels According to GOST 5058-57

| Steel               | Chemical composition, % |           |             |             |           |             |             |
|---------------------|-------------------------|-----------|-------------|-------------|-----------|-------------|-------------|
|                     | C                       | Mn        | P           | S           | Si        | Al          | Ni          |
| 1) 15GS             | 0.12-0.18               | 0.20-0.30 | 0.015-0.025 | 0.005-0.010 | 0.10-0.20 | 0.005-0.010 | 0.005-0.010 |
| 2) 18G2S            | 0.14-0.22               | 0.20-0.30 | 0.015-0.025 | 0.005-0.010 | 0.10-0.20 | 0.005-0.010 | 0.005-0.010 |
| 3) 25G2S (25GS)     | 0.20-0.28               | 0.20-0.30 | 0.015-0.025 | 0.005-0.010 | 0.10-0.20 | 0.005-0.010 | 0.005-0.010 |
| 4) 10G2SD (MK)      | 0.12-0.18               | 0.20-0.30 | 0.015-0.025 | 0.005-0.010 | 0.10-0.20 | 0.005-0.010 | 0.005-0.010 |
| 5) 14KhGS           | 0.11-0.17               | 0.10-0.18 | 0.015-0.025 | 0.005-0.010 | 0.10-0.20 | 0.005-0.010 | 0.005-0.010 |
| 6) 10KhSND (SKhL-4) | 0.12-0.18               | 0.10-0.18 | 0.015-0.025 | 0.005-0.010 | 0.10-0.20 | 0.005-0.010 | 0.005-0.010 |
| 7) 15KhSND (SKhL-1) | 0.12-0.18               | 0.10-0.18 | 0.015-0.025 | 0.005-0.010 | 0.10-0.20 | 0.005-0.010 | 0.005-0.010 |
| 8) 12KhG (ENL-2)    | 0.14                    | 0.20-0.30 | 0.015-0.025 | 0.005-0.010 | 0.10-0.20 | 0.005-0.010 | 0.005-0.010 |
| 9) 15KhGN           | 0.12-0.18               | 0.20-0.30 | 0.015-0.025 | 0.005-0.010 | 0.10-0.20 | 0.005-0.010 | 0.005-0.010 |
| 10) 19G             | 0.16-0.22               | 0.20-0.30 | 0.015-0.025 | 0.005-0.010 | 0.10-0.20 | 0.005-0.010 | 0.005-0.010 |
| 11) 09G2            | 0.17                    | 0.20-0.30 | 0.015-0.025 | 0.005-0.010 | 0.10-0.20 | 0.005-0.010 | 0.005-0.010 |
| 12) 14Q2            | 0.17-0.18               | 0.20-0.30 | 0.015-0.025 | 0.005-0.010 | 0.10-0.20 | 0.005-0.010 | 0.005-0.010 |
| 13) 35GS            | 0.20-0.28               | 0.20-0.30 | 0.015-0.025 | 0.005-0.010 | 0.10-0.20 | 0.005-0.010 | 0.005-0.010 |

1) Steel; 2) content of elements (%); 3) no more than; 4) 15GS; 5) 18G2S; 6) 25G2S (25GS); 7) 10G2SD (MK); 8) 14KhGS; 9) 10KhSND (SKhL-4); 10) 15KhSND (SKhL-1); 11) 12KhG (ENL-2); 12) 15KhGN; 13) 19G; 14) 09G2; 15) 14Q2; 16) 35GS.

Low-alloy structural steels are used in riveted and welded structures. Their advantages over St. 3 low-carbon steel (for which they are used as a substitute) include a higher  $\sigma_b$  and  $\sigma_{0.2}$  combined with satisfactory plasticity, a lesser tendency toward aging, and less cold shortness; in addition, the modulus of elasticity of low-alloy structural steels is no higher than that of low-carbon steel.

Low-alloy steel is more sensitive to stress concentrators (holes, welds, etc.), so that the fatigue strength of a number of typical welded

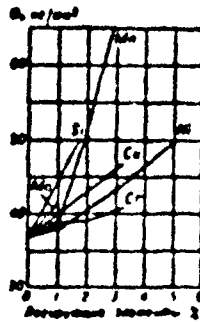

Fig. 1. Influence of alloying elements on the ultimate strength of low-carbon steel. 1)  $\text{kg/mm}^2$ ; 2) alloying elements, %.

TABLE 2  
Mechanical Characteristics of Low-Alloy Structural Steels According to GOST 5058-57 (no less than)

| Сталь                   | Толщина проката (мм) | по длине   |                                      |              | Темп в изгибе в соответствии * |
|-------------------------|----------------------|------------|--------------------------------------|--------------|--------------------------------|
|                         |                      | $\sigma_b$ | $\sigma_{0.2}$ (кг/мм <sup>2</sup> ) | $\delta$ (%) |                                |
| 15ГС .6 . . . .         | 4-10                 | 50         | 35                                   | 18           | 180°, с=2a                     |
|                         | 11-20                | 48         | 34                                   | 18           |                                |
| 18ГС .7 . . . .         | 4-10                 | 50         | 30                                   | 14           | 180°, с=2d                     |
|                         | 10-20                | 50         | 30                                   | 14           |                                |
| 25Г2С (25ГС) .8 . . . . | 4-10                 | 60         | 40                                   | 14           | 90°, с=3/4                     |
|                         | 10-20                | 60         | 40                                   | 14           |                                |
| 9 10Г2СД (МК) . . . .   | 4-10                 | 50         | 35                                   | 18           | 180°, с=2a                     |
|                         | 10-20                | 50         | 35                                   | 18           |                                |
| 14ХГС .10 . . . .       | 4-10                 | 50         | 35                                   | 18           | 180°, с=2a                     |
|                         | 11-20                | 50         | 34                                   | 18           |                                |
| 10ХСНД .11 . . . .      | 4-10                 | 54         | 40                                   | 16           | 180°, с=2a                     |
|                         | 11-20                | 51         | 37                                   | 15           |                                |
| 15ХСНД .12 . . . .      | 4-10                 | 52         | 35                                   | 18           | 180°, с=2a                     |
|                         | 11-20                | 46         | 32                                   | 15           |                                |
| 13 12ХГ (ЕНЛ-2) . . . . | 4-10                 | 52         | 36                                   | 18           | —                              |
|                         | 11-20                | 49         | 35                                   | 18           |                                |
| 15ХГН .14 . . . .       | 4-10                 | 47         | 30                                   | 18           | 180°, с=2a                     |
| 19Г .15 . . . .         | 4-10                 | 46         | 31                                   | 18           | 180°, с=2a                     |
| 09Г2 .16 . . . .        | 4-10                 | 45         | 30                                   | 18           | 180°, с=2a                     |
|                         | 11-20                | 44         | 29                                   | 18           |                                |
| 14Г2 .17 . . . .        | 4-10                 | 48         | 34                                   | 18           | 180°, с=2a                     |
|                         | 11-20                | 47         | 33                                   | 18           |                                |
| 35ГС .18 . . . .        | 4-10                 | 60         | 40                                   | 14           | 90°, с=3d                      |
|                         | 11-20                | 60         | 40                                   | 14           |                                |

\*See - straightening thickness, a - rolled-sheet thickness, d - rod diameter.

1) Steel; 2) rolled-sheet thickness; 3)  $\text{kg/mm}^2$ ; 4) no less than; 5) cold bending; 6) 15GS; 7) 18G2S; 8) 25G2S (25GS); 9) 10G2SD (MK); 10) 14KhGS; 11) 10KhSND (SKhL-4); 12) 15KhSND (SKhL-1); 13) 12KhG (ENL-2); 14) 15KhGN; 15) 19G; 16) 09G2; 17) 14G2; 18) 35GS.

joints is no higher than that of identical welds in St. 3 low-carbon steel. For more effective utilization of low-alloy structural steels in welded structures it is necessary to make smooth structural seams, to machine welds in dangerous areas, to harden the joints by cold working,

TABLE 3

Chemical Composition of Low-Alloy Structural Steels, as Set by Special Technical Specifications

| Grade 1     | 2 Содержание элементов (%) |         |         |       |           |      |      |      |      |
|-------------|----------------------------|---------|---------|-------|-----------|------|------|------|------|
|             | C                          | Mn      | Si      | Cu    | Ti        | Cr   | Ni   | S    | P    |
| 4 09G2T (M) | <0.12                      | 1.3-1.7 | 0.3-0.8 | <0.30 | 0.01-0.03 | 0.30 | 0.30 | 0.04 | 0.04 |
| 5 16GT (3N) | 0.14-0.18                  | 0.9-1.2 | 0.4-0.7 | <0.30 | 0.01-0.03 | 0.30 | 0.30 | 0.04 | 0.04 |

1) Steel; 2) content of elements (%); 3) no more than; 4) 09G2T (M); 5) 16GT (3N).

TABLE 4

Mechanical Characteristics of Low-Alloy Structural Steels, as Set by Special Technical Specifications (no less than)

| 1<br>Сталь       | 2<br>Толщина (мм)   | 3<br>σ <sub>b</sub> (кг/мм <sup>2</sup> ) |                  | σ <sub>0.2</sub> (%) | 4<br>α <sub>n</sub> (кг-м/см <sup>2</sup> ) при темп-ре |      |      |  |  |  |  |
|------------------|---------------------|---|------------------|----------------------|---|------|------|--|--|--|--|
|                  |                     | σ <sub>b</sub>                            | σ <sub>0.2</sub> |                      | 20°   | -40° | -70° |  |  |  |  |
| 5 Листовая сталь |                     |   |                  |                      |   |      |      |  |  |  |  |
| 7                | 4-10                | 50.0                                      | 35.0             | 18                   | 6   | 3.5  | 3.0  |  |  |  |  |
|                  | 12-18               | 48.0                                      | 33.0             |                      |   |      |      |  |  |  |  |
|                  | 20-24               | 48.0                                      | 32.0             |                      |   |      |      |  |  |  |  |
|                  | 26-30               | 47.0                                      | 31.0             |                      |   |      |      |  |  |  |  |
|                  | 32-48               | 46.0                                      | 30.0             |                      |   |      |      |  |  |  |  |
|                  | 50-80               | 45.0                                      | 29.0             |                      |   |      |      |  |  |  |  |
| 82-100           | 44.0                | 27.0                                      |                  |                      |   |      |      |  |  |  |  |
| 8                | 4-10                | 50.0                                      | 33.0             | 18                   | 6   | 3.0  | 2.5  |  |  |  |  |
|                  | 12-18               | 50.0                                      | 32.0             |                      |   |      |      |  |  |  |  |
|                  | 18-30               | 48.0                                      | 30.0             |                      |   |      |      |  |  |  |  |
|                  | 32-60               | 47.0                                      | 29.0             |                      |   |      |      |  |  |  |  |
|                  | 62-100              | 46.0                                      | 28.0             |                      |   |      |      |  |  |  |  |
|                  | 6 Профильный прокат |   |                  |                      |   |      |      |  |  |  |  |
| 09G2T (M)        | 20-10               | 50.0                                      | 35.0             | 18.0                 | 6   | -    | -    |  |  |  |  |
| 16GT (3N)        | 20-10               | 50.0                                      | 33.0             | 18.0                 | 6   | -    | -    |  |  |  |  |

1) Steel; 2) thickness (mm); 3) kg/mm<sup>2</sup>; 4) α<sub>n</sub> (kg-m/cm<sup>2</sup>) at temperature of; 5) sheet steel; 6) roller shapes; 7) 09G2T (M); 8) 16GT (3N).

etc. Many types of low-alloy structural steel have an increased resistance to atmospheric corrosion. Nickel, copper, chromium, and phosphorous are elements that enhance corrosion resistance; simultaneous addition of copper, phosphorous, and nickel to the steel has an especially favorable effect.

The minimum value of α<sub>n</sub> at -40° or after cold working and aging at 20° is no less than 3 kg-m/cm<sup>2</sup> for rolled sheets up to 20 mm thick. The

III-103s3

$\alpha_n$  of 10KhSND (SKhL-4) steel should be no less than 4 kg-m/cm<sup>2</sup> for rolled sheets 10-15 mm thick and no less than 5 kg-m/cm<sup>2</sup> for sheets 16-32 mm thick. Figures 4 and 5 show the impact strength of certain types of as-delivered cold-worked and aged low-alloy structural steel at different temperatures in comparison with that of rimmed and killed St. 3 low-carbon steel.

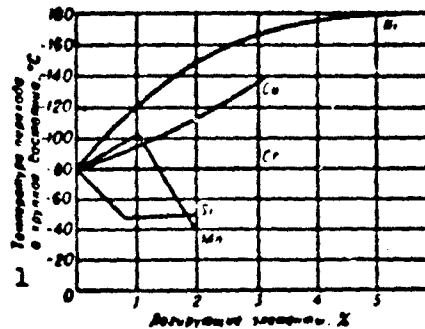

Fig. 2. Influence of alloying elements on the transition temperature of embrittled low-carbon steel. 1) Transition temperature in embrittled state, °C; 2) alloying elements, %.

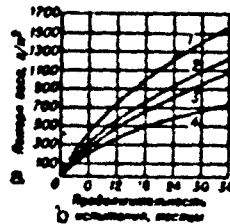

Fig. 3. Loss in weight of specimens of low-alloy structural steel under the atmospheric conditions of an industrial city (Moscow): 1) St. 3; 2) 15GS; 3) 10G2SD (MK); 4) 15KhSND. a) Loss in weight, g/m<sup>2</sup>; b) test time, months.

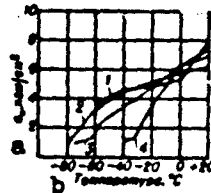

Fig. 4. Variation in the impact strength of low-alloy structural steels as a function of temperature: 1) 15KhSND; 2) 10G2SD (MK); 3) killed St. 3; 4) rimmed St. 3. a) kg-m/cm<sup>2</sup>; b) temperature, °C.



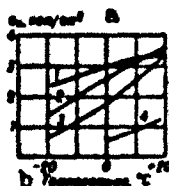

Fig. 5. Variation in the impact strength of low-alloy structural steel cold worked by 10% under tension and aged at 250° for 1 hr as a function of temperature: 1) 15KhSND; 2) 10G2SD (MK); 3) killed St. 3; 4) rimmed St. 3. a) kg-m/cm<sup>2</sup>; b) temperature, °C.

Rolled sheet steel more than 25 mm thick intended for welded structures is supplied only in the heat-treated state. Rolled sheets of 10KhSND (SKhL-4) steel more than 15 mm thick are supplied heat-treated. Steel for welded structures is supplementally deoxidized with aluminum and titanium.

Types 09G2, 14G2, and 15GS steel are used in the construction industry. Types 09G2 and 10G2SD are employed in railroad-car building, types 10G2SD and 10KhSND in shipbuilding, types 15KhSND and 10G2SD in bridge building and for extremely critical structures, types 18G2S, 25G2S, and 35GS for concrete-reinforcement rods, types 19G and 14KhGS for gas and petroleum pipelines, and type 12KhG for sheet piles.

A number of types of low-alloy structural steel are produced in accordance with special technical specifications: specifically, 09G2T (M) and 16GT (3N) steels are used for especially critical welded structures. Tables 3 and 4 show the chemical composition and mechanical characteristics of these types of steel.

References: Delle, V.A., Legirovannaya konstruktsionnaya stal' [Alloy Structural Steel], Moscow, 1953; Issledovaniya stroitel'noy stali [Investigation of Structural Steel], collection of articles, edited by N.P. Shchapov, Moscow, 1960; Leykin, I.M. Chernashkin, V.G., Nizkolegirovannyye stroitel'nyye stali [Low-Alloy Structural Steels],

III-103s5

Moscow, 1952; Kanfor, S.S., Korpusnaya stal' [Framing Steel], Leningrad, 1960; Gudremon, E., Spetsial'nyye stali [Special Steels], translated from German, Vol. 1, Moscow, 1959.

E.Sh. Volkhovyanskaya

**LOW-CARBON HEAT-TREATABLE STEEL** - steel containing 0.1-0.4% carbon; it is subjected to quenching and tempering or to self-tempering. Steels of this type are characterized by high strength combined with high plasticity and impact strength and a low threshold of cold-shortness.

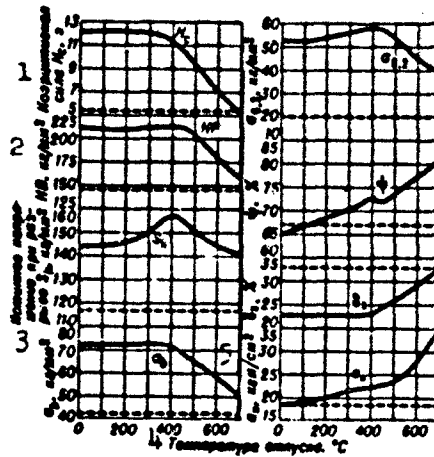

Fig. 1. Variation in the characteristics of type 20 steel bars ( $d = 20$  mm) as a function of tempering temperature after quenching in water from  $900^\circ$  (specimens cut along blank axis). 1) Coercive force  $H_c$ , oersteds; 2)  $\text{kg/mm}^2$ ; 3) true fracture stress  $S_k$ ; 4) tempering temperature,  $^\circ\text{C}$ ; 5)  $\text{kg-m/cm}^2$ .

The following types of steel are subjected to heat treatment: MSt.3-MSt.5 open-hearth steel, BSt.3-BSt.6 Bessemer steel (GOST 380-60), KSt.3-KSt.5 converter steel (GOST 9543-60), 15-35 and 15G-35G high-quality structural steel (GOST 1050-60), and low-alloy structural steel (GOST 5058-57). Killed and semikilled steels are recommended for thermal hardening. As experience has shown, it is possible to replace a number of types of low-alloy steel with heat-treated carbon steels. Figures 1-2 show the variation in the characteristics of steel bars 20 and 55 mm

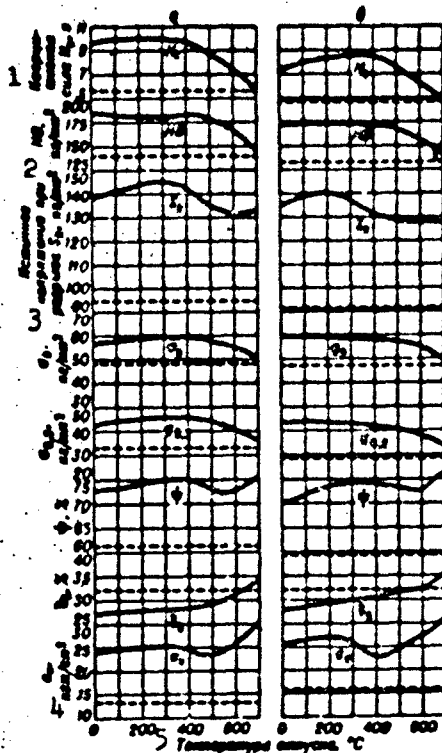

Fig. 2. Variation in the characteristics of type 20 steel bars ( $d = 55$  mm) as a function of tempering temperature after quenching in water from  $900^\circ$  (specimens cut: a) at a distance equal to half blank radius from blank axis; b) along blank axis). 1) Coercive force  $H_c$ , oersteds; 2)  $\text{kg}/\text{mm}^2$ ; 3) true fracture stress  $S_k$ ; 4)  $\text{kg}\cdot\text{m}/\text{cm}^2$ ; 5) tempering temperature,  $^\circ\text{C}$ .

in diameter containing 0.19% C, 0.56% Mn, 0.27% Si, 0.017% P, and 0.017% S (type 20 steel according to GOST 1050-60) after quenching from  $900^\circ$  in water and tempering for 1 hr. The characteristics of killed St.3 steel (0.18% C, 0.55% Mn, 0.16% Si, 0.014% P, and 0.042% S) sheets  $400 \times 135 \times 11$  mm in size after quenching from  $900^\circ$  in water and tempering for 1 hr are shown in Fig. 3. Figure 4 illustrates the characteristics of low-alloy 19G steel (0.14% C, 1.12% Mn, 0.22% Si, 0.020% P, and 0.040% S) sheets  $400 \times 300 \times 12$  mm in size after quenching from  $870^\circ$ , tempering for 1 hr, and subsequent cooling in air. In all these figures the horizontal dash line represents the characteristics of the steel in the hot-rolled state. Research indicates that the characteristics of

III-109s2

steel hardened by prerolling heating are similar to those of steel hardened by separate heating. Thermal hardening reduces the cold shortness of the steel. The weldability of thermally hardened carbon steel is essentially the same as that of hot-rolled carbon steel.

Low-carbon heat-treatable steels are presently used in the manufacture of concrete-reinforcement rods, thick sheets, broad strips for bridge building, and petroleum pipelines. Experimental batches of rolled shapes have been produced, some experience has been amassed in the manufacture of high-pressure vessels, etc.

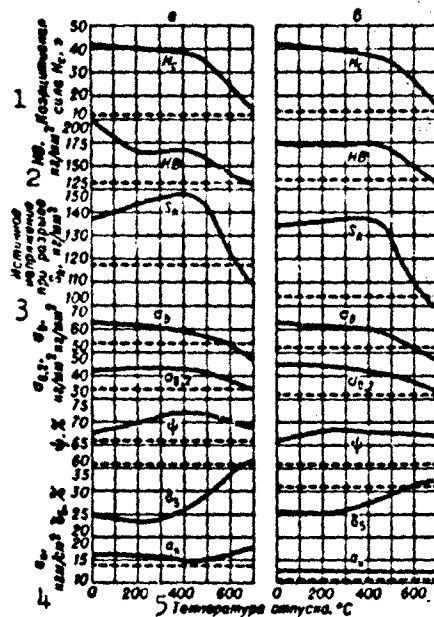

Fig. 3. Variation in the characteristics of type St.3 (killed) steel quenched in sheets 12 mm thick as a function of tempering temperature: a) Along rolled product; b) across rolled product. 1) Coercive force  $H_c$ , oersteds; 2)  $kg/mm^2$ ; 3) true fracture stress  $S_k$ ; 4)  $kg-m/cm^2$ ; 5) tempering temperature, °C.

Low-carbon heat-treatable steel reinforcement rods for prestressed concrete structures are produced in round and periodic shapes with  $d = 10-40$  mm. They can be divided into four classes in accordance with their mechanical characteristics: At-IV, At-V, At-VI, and At-VII (GOST 5781-61).

Mechanical Characteristics of Heat-Treated Armature Steel\*

| Класс термически упрочнённого арматурного стального стержня | $\sigma_{0.2}$<br>(миним. значение) | $\sigma_{0.2}$<br>(миним. значение) | 1<br>2<br>3<br>4<br>5 | Испытание на изгиб в холодном состоянии (C - диаметр стержня) |
|---|-------------------------------------|-------------------------------------|-----------------------|---|
|   | 3 (кг/мм <sup>2</sup> )             |                                     |                       |   |
| AT-IV   | 90                                  | 80                                  | 8                     | 45° (C = 5 d)   |
| AT-V  | 110                                 | 80                                  | 7                     | 45° (C = 5 d)   |
| AT-VI   | 120                                 | 100                                 | 6                     | 45° (C = 5 d)   |
| AT-VII  | 140                                 | 120                                 | 5                     | 45° (C = 5 d)   |

\*Rod d = 10-40 mm.

1) Class of thermally hardened armature steel; 2) minimum; 3) kg/mm<sup>2</sup>; 4) no less than; 5) bend testing in cold state (C - straightening diameter).

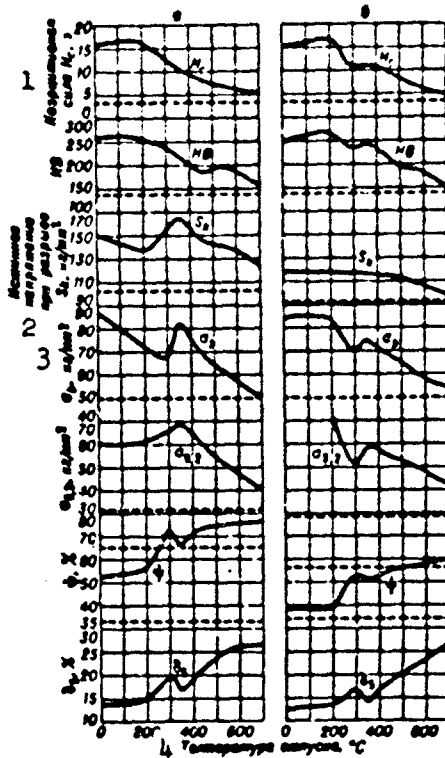

Fig. 4. Variation in the characteristics of 19G steel after quenching and tempering: a) Along rolled product; b) across rolled product (for steel containing 0.14% C). 1) Coercive force  $H_c$ , oersteds; 2) true fracture stress  $S_k$ ; 3) kg/mm<sup>2</sup>; 4) tempering temperature, °C.

Such rods should be supplied with guaranteed  $\sigma_{0.2}$ ,  $\sigma_b$ , and  $\delta_5$  and should be able to withstand cold bending.

III-10324

Broad-strip hot-rolled (general-purpose) steel for bridge building is supplied in accordance with GOST 5781-53. Heat treatment is carried out to ensure the mechanical characteristics required by the GOST.

References: Starodubov, Ye.F., Borkovskiy, Yu.Z., in collection: *Sovremennyye problemy metallurgii* [Contemporary Problems of Metallurgy], Moscow, 1958; Idem, *Metallovedeniye i termicheskaya obrabotka metallov* [Metalworking and Heat Treatment of Metals], 1961, No. 5; Idem, in collection: *Metallovedeniye i termicheskaya obrabotka stali i chuguna* [Metalworking and Heat Treatment of Steel and Pig Iron], Kiev, 1960-62 (Tr. In-ta chernoy metallurgii [Transactions of the Institute of Ferrous Metallurgy], Vol. 13-14, 18); Krasil'shchikov, Z.N. et al., *Termicheskoye uprochneniye nezakalivayushchey ughlerodistoy stali* [Thermal Hardening of Unquenched Carbon Steel], Leningrad, 1960; Pridantsev, M.V. et al., *Stal'* [Steel], 1958, No. 5; Pridantsev, M.V., Levinzon, Kh.Sh., *Ibid*, 1956, No. 11; Starodubov, K.F. et al., *Izv. Vysshikh ucheb. zavedeniy. Chernaya metallurgiya* [Bulletin of Higher Educational Institutions. Ferrous Metallurgy], 1961, No. 1, 2; Aborn, R.H., *Trans. Amer. Soc. Metals*, 1956, Vol. 48, pages 51-85.

K.F. Starodubov

III-110s

LOW-CARBON THIN-SHEET ELECTRICAL STEEL - see Electrical iron.



LOW-MELTING ALLOYS are alloys with melting point below about 200°. The low-melting alloys consist of bismuth, tin, cadmium, lead, indium and other metals (see Table). They are used in those cases when easy

Chemical Composition and Melting Point of Low-Melting Alloys

| Сплав 1                              | 2 Химический состав (%) |      |      |      | Температура плавления (°C) 3 |
|--------------------------------------|-------------------------|------|------|------|------------------------------|
|                                      | Bi                      | Sn   | Pb   | Cd   |                              |
| Сплав Вуда 4                         | 50                      | 12.5 | —    | 12.5 | 68                           |
| 5 Четверная эвтектика                | 49.5                    | 13   | —    | 10.5 | 70                           |
| 6 Легкоплавкий сплав                 | 27.5                    | 10   | 27.5 | 34.5 | 75                           |
| То же 7                              | 50                      | —    | 42.9 | 7.1  | 82                           |
| 8 Тройная эвтектика                  | 52.5                    | 15.5 | 32   | —    | 98                           |
| 9 Легкоплавкий сплав                 | 40                      | 40   | 20   | —    | 100                          |
| То же 10                             | 50                      | 10   | 40   | —    | 100                          |
| Сплав Розе 10                        | 50                      | 22   | 28   | —    | 100                          |
| 11 Тройная эвтектика                 | 54                      | 26   | —    | 20   | 103                          |
| Сплав для матрицы                    | 48                      | 14.5 | 28.5 | 9    | 105                          |
| 12 Висмутовый припой                 | 40                      | 20   | 40   | —    | 113                          |
| Тройная эвтектика                    | —                       | 51.4 | 30.4 | 18.2 | 142                          |
| 13 Сплав для точного литья           | 40                      | 60   | —    | —    | 139                          |
| 14 Сплав с низкой темп-рой плавления | 23.5                    | 29.5 | 47   | —    | 152                          |

1) Alloy; 2) chemical composition (%); 3) melting point (°C); 4) Wood's alloy; 5) quaternary eutectic; 6) low-melting alloy; 7) same; 8) ternary eutectic; 9) low-melting alloy; 10) Rose alloy; 11) matrix alloy; 12) bismuth solder; 13) alloy for precision casting; 14) alloy with low melting point.

fusibility is required. The metals which have low melting points alloy with the formation of eutectic binary, ternary and quaternary mixtures, thanks to which the melting points of such alloys reach very low values. The lowest melting point (47°) is that of the alloy with the composition 44.7% Bi; 22.6% Pb; 19.1% In; 8.3% Sn; 5.3% Cd. The following alloy composition containing mercury is used for taking anatomical casts: 53.5% Bi; 19% Sn; 17% Pb; 10.5% Hg. Its melting point is 60°. Bismuth is the basic component of the majority of the low-melting alloys. Low shrinkage of the alloys, and at times its complete absence, is provided

II-8001

by the presence of the bismuth, and in some cases antimony. These metals have the property of expanding strongly during solidification. The low-melting alloys which do not shrink are used in precision casting for the preparation of models, and other low-melting alloys are used in electrical engineering (fusible breakers, sprinkler heads, etc.), in the bending of thin-wall tubes and, for fusible bars used in the fabrication of hollow bodies by the method of electrodeposition

Reference: Spravochnik metallista [Metal Worker's Handbook], Vol. 3, books 1-2, M., 1959.

O.Ye. Kestner

LOW-MELTING SOLDERS - lead and zinc alloys, as well as tin, cadmium, and their alloys. Four- and five-component alloys of indium, bismuth, tin, cadmium, lead, and gallium are the lowest-melting (see Especially low-melting solders).

The most commonly used low-melting solders are those consisting of tin and lead, which are usually hardened with antimony (Tables 1 and 2). These solders are employed for copper and copper alloys, steel, and iron, but use of antimony-containing solders for zinc and galvanized iron is not recommended, because of the increased brittleness of the joints. Tin-lead solders have high technological characteristics and are employed with various fluxes (Table 3). Joints soldered with tin-lead solders can function at temperatures of from near absolute zero to +100°. They are weakened at higher temperatures. Soldered joints subject to impact loads for considerable deformation during operation can function only at temperatures above the cold-shortness temperature of the solder. For example, the cold-shortness temperature of POS40 solder is approximately -30°. Lead (<250°) and cadmium (up to 250-300°) solders alloyed with silver are used for soldering copper components to operate at temperatures above 120°. Lead solders have a low wetting power and spread poorly over the material to be soldered. Addition of tin improves these characteristics (PSr2.5 solder). Cadmium solders tend to oxidize when molten. Magnesium, zinc and nickel are added to reduce their oxidizability. Cadmium solders intensively dissolve copper and form chemical compounds with it; layers of these compounds in a joint reduces the mechanical characteristics of the soldered article.

Rapid controlled heating with sufficiently powerful soldering guns or by the electrical-resistance method is recommended when soldering with cadmium solders; copper can be soldered in baths with PSr8KTsN cadmium solder. When soldering with lead and cadmium solders and employing sufficiently rapid heating ( $\geq 200^\circ/\text{min}$ ) it is possible to use LK2, LTI120, or VTS flux. Tin-zinc and zinc solders are used principally for soldering aluminum (see Solder for soldering aluminum alloys)

TABLE 1

Chemical Composition and Physicomechanical Characteristics of Low-Melting Solders

| 1<br>Применение<br>(ГОСТ<br>8190-56) | 2 ХИМИЧ. СОСТАВ (%) |                |              |              |       |    | 3<br>Температура<br>полного<br>расплава<br>сплава (°C) | 4<br>Плотность<br>(г/см <sup>3</sup> ) | 5<br>Электро-<br>проводность,<br>% от меди<br>от меди | 6<br>$\sigma_b$ (кг/мм <sup>2</sup> ) |      |      |      | 7<br>A<br>(%) |
|--------------------------------------|---------------------|----------------|--------------|--------------|-------|----|--|--|---|---------------------------------------|------|------|------|---------------|
|                                      | Pb                  | Cd             | Sn           | Ag           | Zn    | Ni |  |  |   | -60°                                  | 20°  | 200° | 250° |               |
| 7 ПСр2                               | 83±1.5              | 5±0.5          | 30±0.1       | 2±0.3        | —     | —  | 235  | 9.6                                    | —   | —                                     | —    | —    | —    | —             |
| 8 ПСр2.5                             | 92±1                | —              | 5.5±<br>±0.5 | 2.5±<br>±0.3 | —     | —  | 305  | 11                                     | —   | —                                     | —    | —    | —    | —             |
| 9 ПСр3                               | 97±1                | 14             | —            | 3±0.3        | —     | —  | 305  | 11.3                                   | —   | —                                     | 1.1  | 1.2  | 0.6  | 15            |
| 10 ПСр3Кд                            | —                   | Осталь-<br>ное | —            | 3±0.5        | 1±0.5 | —  | 325  | —                                      | —   | —                                     | —    | —    | —    | —             |
| 11 ПСр1.5                            | 83.5±<br>±1.5       | —              | 15±1         | 1.5±<br>±0.8 | —     | —  | —  | 10.6                                   | —   | —                                     | —    | —    | —    | —             |
| 12 ПСр5КТИН<br>(нестан-<br>дартный)  | —                   | Осталь-<br>ное | —            | 5            | 2     | 2  | 315—<br>355  | 8.83                                   | 18.1  | 25                                    | 15.5 | 6.5  | 6    | 1.5           |
| 13 ПСр8КТИН<br>(нестан-<br>дартный)  | —                   | Осталь-<br>ное | —            | 8            | 6     | 2  | 330—<br>380  | 8                                      | 21.2  | 10                                    | 15   | 6    | —    | 1             |

1) Solder (ГОСТ 8190-56); 2) chemical composition (%); 3) fusion-termination temperature (°C); 4) density (g/cm<sup>3</sup>); 5) electrical conductivity, % of that of copper; 6)  $\sigma_b$  (kg/mm<sup>2</sup>); 7) PSr2; 8) PSr2.5; 9) PSr3; 10) PSr3Kd; 11) PSr1.5; 12) PSr5KTsN (nonstandard); 13) PSr8KTsN (nonstandard); 14) remainder.

TABLE 2

Chemical Composition, Physicochemical Characteristics, and Applications of Tin-Lead Solders

| 1<br>Примой | 2<br>Химич. состав (%)<br>(ГОСТ 1499-54) |      |       | 3<br>Температура плавления (°C) |     | 4<br>Начало плавления | 5<br>Конец плавления | 6<br>Плотность (г/см <sup>3</sup> ) | 7<br>Удлинение (%)<br>в зависимости от температуры |       |       | 8<br>σ <sub>b</sub> (кг/мм <sup>2</sup> ) | 9<br>σ <sub>0.2</sub> (кг/мм <sup>2</sup> ) | 10<br>σ <sub>0.01</sub> (кг/мм <sup>2</sup> )  | 11<br>Применение  |
|-------------|--|------|-------|---------------------------------|-----|-----------------------|----------------------|-------------------------------------|--|-------|-------|---|---|--|---|
|             | Sn                                       | Pb   | Sb    | 4                               | 5   |                       |                      |                                     | 100°C  | 150°C | 200°C |   |   |  |   |
| 12 ПОС61    | 59-61                                    | Ост. | 0,08  | 183                             | 183 | -                     | -                    | -                                   | -  | -     | -     | -   | -   | -  | Пайка точных приборов, радиоаппаратуры, для особо прочных паяных соединений |
| 13 ПОС50    | 49-50                                    | •    | 0,08  | 183                             | 200 | 8,83                  | 11                   | 3,6                                 | 3,54   | 32    | -     | -   | -   | Для особо прочных паяных соединений и радиотехники; пайка авиа-радиотехники  |   |
| 14 ПОС90    | 89-90                                    | •    | 0,15  | 183                             | 222 | 7,57                  | -                    | 4,3                                 | 2,7  | 25    | -     | -   | -   | Пайка паяемых паяных и медносплавных инструментов в изделиях, где пайка после погружения в электролитический раствор |   |
| 15 ПОС40    | 39-40                                    | •    | 1,5-2 | 183                             | 235 | 9,31                  | 10,2                 | 3,2                                 | 3,4  | 63    | -     | -   | -   | Пайка радиаторов, электротехнического оборудования, холодильных компрессоров   |   |
| 16 ПОС30    | 29-30                                    | •    | 1,5-2 | 183                             | 256 | 9,53                  | 9,5                  | 3,3                                 | 2,9  | 5,8   | -     | -   | -   | Пайка неответственного химического и электротехнического оборудования  |   |
| 17 ПОСС4-6  | 4-6                                      | •    | 5-6   | 215                             | 265 | 10,7                  | -                    | 5,2                                 | 3,6  | 23,7  | -     | -   | -   | Вспомогательное применение   |   |
| 18 ПОС18    | 17-18                                    | •    | 2-2,5 | 215                             | 277 | 10,28                 | 8,6                  | 2,8                                 | 2,52   | 67    | -     | -   | -   | То же  |   |
| 19 Олово    | 100                                      | -    | -     | 232                             | 232 | 7,31                  | 11,9                 | 19                                  | 2  | 53    | -     | -   | -   | То же  |   |

1) Solder; 2) chemical composition (%) (GOST 1499-54); 3) melting temperature (°C); 4) initiation; 5) termination; 6) density (g/cm<sup>3</sup>); 7) electrical conductivity, % of that of copper; 8) σ<sub>b</sub>(kg/mm<sup>2</sup>); 9) on extension; 10) on shear; 11) application; 12) POS61; 13) POS50; 14) POS90; 15) POS40; 16) POS30; 17) POSS4-6; 18) POS18; 19) tin; 20) soldering precision instruments, radio assembly, for especially tight joints; 21) for especially compact vacuum-tight joints, soldering aircraft radiators; 22) soldering food containers and medical instruments, in articles where the soldered joints are to be galvanized; 23) soldering radiators, electrical equipment and refrigerator compressors; 24) soldering noncritical chemical and electronic equipment; 25) auxiliary applications; 26) the same.

TABLE 3

## Certain Fluxes Used in Soldering with Low-Melting Solders

| 1 Флюс                   | 2 Состав   | Температура активного действия 3 (°C) | 4 Применение  |
|--------------------------|--|---------------------------------------|---|
| 5 Канифольно-спиртовой * | Канифоль 30 г <sup>13</sup><br>Спирт этиловый (ректификат) 70 см <sup>3</sup>  | 150-300                               | Пайка меди; для латуни и бронзы менее эффективна 21   |
| 6 ЛК2 *                  | Хлорид аммония 1 г <sup>14</sup><br>Хлорид цинка 3 г<br>Канифоль 30 г<br>Спирт этиловый (ректификат) 66 см <sup>3</sup>                          | 150-300                               | Пайка меди, латуни и оцинкованного железа 22  |
| 7 Стеарино-парафиновый * | Стеарин 30 г <sup>15</sup><br>Парафин 68 г<br>Триэтаноламин 2 г  | 150-300                               | Пайка меди и латуни с оловянно-свинцовыми и оловянно-цинковыми припоями паяльником, в струе припоя, в ваннах 23 |
| 8 ЛТИ120 *               | Спирт этиловый 70% <sup>16</sup><br>Канифоль 24%<br>Диэтиламин сульфат 4%<br>Триэтаноламин 2%  | 230-400                               | Пайка меди и ее сплавов, углеродистой стали и никеля 24   |
| 9 ЛМ1 *                  | Ортофосфорная к-та (уд. вес 1,6-1,7) 100 см <sup>3</sup> <sup>17</sup><br>Этиленгликоль или спирт метиловый 400 см <sup>3</sup><br>Канифоль 30 г | 240-350                               | Пайка хромоникелевых нержавеющей сталей оловянно-цинковыми припоями, содержащими более 30% Sn 25                |
| 10 38N *                 | Этиленгликоль (глицерин или их смесь 1:1) 50% <sup>18</sup><br>Диэтиламин сульфат 25%<br>Ортофосфорная к-та 25%                                  | 200-480                               | Пайка никрома, вольфрамовой и бериллиевой бронзы, нержавеющей сталей 26   |
| 11 Паста НИСО *          | Вазелин (медицинский) 80% <sup>19</sup><br>Хлорид цинка 15%<br>Глицерин (дистиллированный) 5%  | До 350                                | Пайка меди свинцовыми припоями 27   |
| 12 ФК50 **               | Хлорид натрия 51,2% <sup>20</sup><br>Хлорид кадмия 27,3%<br>Хлорид аммония 2,5%<br>Хлорид цинка 19%  | 320-500                               | Пайка меди в ваннах с кадмиевыми припоями и для раскисления ванны припоя 28                                     |

\*Residues of this flux are removed with cotton wetted in alcohol.

\*\*Residues of this flux are thoroughly removed by rinsing in cold and hot running water.

1) Flux; 2) composition; 3) active temperature (°C); 4) application; 5) rosin-alcohol; 6) ЛК2; 7) stearin-paraffin; 8) ЛТИ120; 9) ЛМ1; 10) 38N; 11) NICO paste; 12) ФК50; 13) rosin - 30g, ethyl alcohol (redistilled) - 70 cm<sup>3</sup>; 14) ammonium chloride - 1 g, zinc chloride - 3 g, rosin - 30 g, ethyl alcohol (redistilled) - 66 cm<sup>3</sup>; 15) stearin - 30 g, paraffin - 68 g, triethanolamine - 2 g; 16) ethyl alcohol - 70%, rosin - 24%, diethylamine sulfate - 4%, triethanolamine - 2%; 17) orthophosphoric acid (specific gravity - 1.6-1.7) - 100 cm<sup>3</sup>, ethylene glycol or methyl alcohol - 400 cm<sup>3</sup>, rosin - 30 g; 18) ethylene glycol (glycerin or a 1:1 mixture of the two) - 50%, diethylamine sulfate - 25%, orthophosphoric acid - 25%; 19) vasoline (medical) - 80%, zinc chloride - 15%, glycerin (distilled) - 5%; 20) sodium chloride - 51.2%, cadmium chloride - 27.3%, ammonium chloride - 2.5%, zinc chloride - 19%; 21) soldering copper, less effective for brass and bronze; 22) soldering copper, brass, and galvanized iron; 23) soldering copper and brass with tin-lead and tin-cadmium solders, using soldering guns, flowing solder, or baths; 24) soldering copper and its alloys, carbon steel, and zinc; 25) soldering chromium-nickel stainless steels with tin-lead solders

containing more than 20% Sn; 26) soldering nichrome, aluminum and beryllium bronzes, and stainless steel; 27) soldering copper with lead solders; 28) soldering copper in baths with cadmium solders and for deoxidizing solder baths.

References: Apukhtin, G.I., Tekhnologiya payki montazhnykh soyedineniy v priborostroyenii [Techniques for Soldering Fitting Joints in Instrument Building], Moscow-Leningrad, 1957; Artsmovich, A.N., Spetsial'nyye tekhnologicheskiye protsessy v priborostroyenii [Special Technological Processes in Instrument Building], Leningrad, 1957.

N.F. Lashko and S.V. Lashko

LOW-MOLECULAR SILOXANE RUBBER - is the product of the polycondensation of dimethyl dichlorosilane; it is capable of solidifying at room temperature. Low-molecular siloxane rubber is delivered in diverse grades which differ in their viscosity and molecular weight. The low-molecular siloxane rubber is used for sealing compounds. The properties of vulcanized low-molecular siloxane rubbers depend on the dosage of the curing agent, the chemical nature and dispersity of the used filler, and also on the methods of its addition. Powdered silica gel is the most active filler. The curing of the sealing compounds is carried out by addition of acyloxy derivatives of dialkyls.

Dielectric properties: the tangent of the loss angle at 20° and 50°,  $10^3$  and  $10^6$  cps, is equal to 0.0037; 0.0025, and 0.0075, respectively; it is equal to 0.0052 at 20° and 50 cps after aging at 200° for 3000 hours, and 0.0317 and 0.0775, respectively, at 50 cps, 150 and 200°. The specific volume resistivity (ohm·cm) is  $1 \cdot 10^{14}$  at 20° and  $1 \cdot 10^{11}$  at 200°, these values are equal to  $9.4 \cdot 10^{14}$ ;  $2.6 \cdot 10^{14}$ , and  $7.5 \cdot 10^{13}$ , at 20°, 150° and 200°, respectively, after aging at 200° for 3000 hrs. The breakdown voltage (kv/mm) at 20° is equal to 18-22, and equal to 24 at 20° after aging at 200° for 2000 hrs.

The shrinkage in thickness of the vulcanized product after heating at 350° for 4 days amounts to 15%. Zinc oxide and magnesia are used to reduce this shrinkage to 5-10%. In contrast to other polysiloxane rubbers, the sealing compounds from low-molecular siloxane rubber may be molded within a time from some minutes to several hours also after the curing agents are added, obtaining solid vulcanized products which are



I-32K1

equivalent to such from dimethyl siloxane rubber. The property of the low-molecular siloxane rubber to vulcanize at room temperature makes it unnecessary to use mixing rolls, extruders and vulcanization presses, and permits one to apply this heat resistant and waterproof material, resistant to weathering, and with good dielectric properties, in many branches of the industry. Low-molecular siloxane rubber is widely used in the electric industry for the insulation of electric devices, and in aircraft industry for the tightening of diverse joints in aircraft.

TABLE

Properties of Vulcanized  
Low-Molecular Siloxane  
Rubber

| 1 | Условия испытания  | 2<br>Прочность<br>на разрыв<br>(кг/см <sup>2</sup> ) | Относи-<br>тельное<br>удлинение<br>(%) 3 |
|---|--|--|--|
| 4 | До старения . . . . .  | 26   | 100                                      |
| 5 | После старения в течен-<br>ие 10 суток при 200°                        | 22   | 160                                      |
| 6 | в течение 100 суток<br>при 200° . . . . .                              | 23   | 150                                      |
| 7 | в течение 10 суток при<br>250° . . . . .                               | 18   | 160                                      |
| 8 | в течение 100 суток<br>при 250° . . . . .                              | 21   | 150                                      |
| 9 | с теплоустойчивой добавкой<br>в течение 100 час.<br>при 300° . . . . . | 11   | 100                                      |
|   | при 350° . . . . .   | 7  | 70                                       |

1) Test conditions; 2) ten-  
sile strength (kg/cm<sup>2</sup>); 3)  
relative elongation (%); 4)  
before aging; 5) after aging  
for 10 days at 200°; 6) for  
100 days at 200°; 7) for 10  
days at 250°; 8) for 100 days  
at 250°; 9) with a heat-resist-  
ant addition, for 100 days;  
10) at.

F.A. Galil-ogly

LOW-NICKEL STRUCTURAL STEEL SUBSTITUTE is steel used as a substitute for structural steel with highnickel content. It has good hardenability and is used for fabricating parts subject to chemical and thermal treatment. Nickel is usually introduced into steel to improve the hardenability, and it simultaneously improves the plasticity of the steel. Improvement of the hardenability may also be accomplished by introducing other elements which aid in retaining the stability of the austenite and thereby increase the hardenability of the steel. Among the most active elements are chromium, manganese, silicon (Fig. 1); molybdenum and tungsten increase the steel hardening depth sharply.

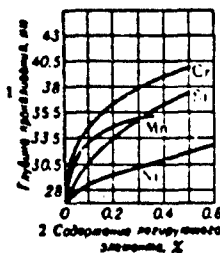

Fig. 1. Effect of alloying elements on steel hardenability. 1) Hardening depth, mm; 2) alloying element content, %.

The alloying elements which form stable carbides, VC, TiC and so on, remain outside the solid solution during the usual heating of the steel for tempering, which leads to conversion of the austenite into perlite on cooling and reduces the hardenability of the steel. But with high temperature tempering ( $1200^{\circ}$ ), which provides for dissolution of the carbides, these alloying elements have a stronger effect on the increase of the hardenability than chromium, manganese, silicon, nickel. Addition of boron also has a favorable influence on steel hardenability; introduction of boron in the amount of 0.001 – 0.005% is equivalent to the introduction of 1 – 1.25% nickel, 0.15% molybdenum, 0.3 – 0.35% chromium, 0.5 – 0.6% manganese or 0.12% vanadium. However, boron increases the sensitivity of steel to overheating. Before introducing boron into steel in the form

6

II-43M1

of ferroboreon, it is necessary to first add 1-1.5 kg of ferrotitanium per ton to bind the nitrogen, otherwise the boron will form nitrides with the nitrogen dissolved in the steel and will not have any effective influence on the steel hardenability.

For chemical composition and properties of the most widely used alloy structural steel with high nickel content, see High Alloy Heat-Treatable Structural Steel.

To economize scarce nickel it is of great national economic importance to make use of low-nickel (economical) structural steel which has properties, including hardenability, as good as the high alloy steel with high nickel content. Basically, the reduction of the nickel content in the low-nickel structural steel substitute is achieved by the use of such alloying elements as boron, tungsten, molybdenum, zirconium, vanadium, and increase of the manganese and chromium content (Table 1).

TABLE 1  
Chemical Composition of Low-Nickel Structural Steel Substitutes

| Grade              | TU     | C    | Mn   | Si   | Alloying Elements, % |        |        |        | Ni     | B      | W      | Mo     | V      | Zr     |
|--------------------|--------|------|------|------|----------------------|--------|--------|--------|--------|--------|--------|--------|--------|--------|
|                    |        |      |      |      | Ni                   | B      | W      | Mo     |        |        |        |        |        |        |
| 5 15KhPA           | 0.0015 | 0.15 | 0.40 | 0.03 | 0.0015               | 0.0015 | 0.0015 | 0.0015 | 0.0015 | 0.0015 | 0.0015 | 0.0015 | 0.0015 | 0.0015 |
| 7 20KhP            | 0.0020 | 0.20 | 0.50 | 0.03 | 0.0020               | 0.0020 | 0.0020 | 0.0020 | 0.0020 | 0.0020 | 0.0020 | 0.0020 | 0.0020 | 0.0020 |
| 8 20KhP            | 0.0020 | 0.20 | 0.50 | 0.03 | 0.0020               | 0.0020 | 0.0020 | 0.0020 | 0.0020 | 0.0020 | 0.0020 | 0.0020 | 0.0020 | 0.0020 |
| 9 15Kh2NPA (E100)  | 0.0015 | 0.15 | 0.40 | 0.03 | 0.0015               | 0.0015 | 0.0015 | 0.0015 | 0.0015 | 0.0015 | 0.0015 | 0.0015 | 0.0015 | 0.0015 |
| 10 20Kh2PA         | 0.0020 | 0.20 | 0.50 | 0.03 | 0.0020               | 0.0020 | 0.0020 | 0.0020 | 0.0020 | 0.0020 | 0.0020 | 0.0020 | 0.0020 | 0.0020 |
| 11 30Kh2N2VA       | 0.0030 | 0.30 | 0.60 | 0.03 | 0.0030               | 0.0030 | 0.0030 | 0.0030 | 0.0030 | 0.0030 | 0.0030 | 0.0030 | 0.0030 | 0.0030 |
| 12 30Kh2GN2        | 0.0030 | 0.30 | 0.60 | 0.03 | 0.0030               | 0.0030 | 0.0030 | 0.0030 | 0.0030 | 0.0030 | 0.0030 | 0.0030 | 0.0030 | 0.0030 |
| 13 20Kh3VVF (E1.1) | 0.0020 | 0.20 | 0.50 | 0.03 | 0.0020               | 0.0020 | 0.0020 | 0.0020 | 0.0020 | 0.0020 | 0.0020 | 0.0020 | 0.0020 | 0.0020 |
| 14 30Kh2N2VFA      | 0.0030 | 0.30 | 0.60 | 0.03 | 0.0030               | 0.0030 | 0.0030 | 0.0030 | 0.0030 | 0.0030 | 0.0030 | 0.0030 | 0.0030 | 0.0030 |
| 15 35KhR           | 0.0035 | 0.35 | 0.65 | 0.03 | 0.0035               | 0.0035 | 0.0035 | 0.0035 | 0.0035 | 0.0035 | 0.0035 | 0.0035 | 0.0035 | 0.0035 |
| 16 40KhR           | 0.0040 | 0.40 | 0.70 | 0.03 | 0.0040               | 0.0040 | 0.0040 | 0.0040 | 0.0040 | 0.0040 | 0.0040 | 0.0040 | 0.0040 | 0.0040 |

1) Steel; 2) TU; 3) content of elements (%); 4) not more than; 5) 1Kh RA; 6) ChMTU; 7) 20KhNR; 8) 20KhGR; 9) 15KhENRA (E100); 10) 30Kh2VA; 11) 30Kh2N2VA; 12) 30Kh2GN2; 13) 20Kh3VVF (E1.1); 14) 30Kh2N2VFA; 15) 35KhR; 16) 40KhR.

For properties of the low-nickel structural steel substitutes applicable for case hardening, grades 15Kh2GTA, 15Kh2GN2TRA, 15Kh2GTA, 20KhGNR, 20KhNR, 15Kh2GN2VFA, 15Kh2GN2VFA, see Case Hardenable Structural Steel.

II-43M2

TABLE 2

Mechanical Properties of Low-Nickel Structural Steel Substitutes

| 1<br>Сталь       | 2<br>Термич. обра-<br>ботка                                  | 3<br>Темп-ра<br>°C | $\sigma_b$              | $\sigma_{0.2}$ | $\delta$ | $\psi$ | 5<br>$\sigma_{0.2}$<br>(мм/см <sup>2</sup> ) |
|------------------|--|--------------------|-------------------------|----------------|----------|--------|--|
|                  |  |                    | σ (кг/мм <sup>2</sup> ) |                | δ (%)    |        |  |
| 30X3BA ...<br>6  | Заналка с 880° в<br>масле, отпуски<br>при 800°               | 350                | 96                      | 81             | 15       | 61     | 15   |
|                  |  | 400                | 91                      | 77             | 16       | 62     | 16   |
|                  |  | 500                | 79                      | 72             | 20       | 71     | —  |
| 30X2N2VA...<br>8 | Заналка с 860°<br>в масле, отпуски<br>при 800°               | 300                | 102                     | 86             | 14       | 58     | 14   |
|                  |  | 400                | 92                      | 82             | 17       | 64     | 13   |
|                  |  | 500                | 83                      | 74             | 19.5     | 71     | 9  |
|                  |  | 600                | 54                      | 50             | 24       | 86     | 17   |
| 20X3MVF...<br>9  | Заналка с 1030—<br>1030° в масле,<br>отпуски при<br>660—700° | 300                | 83                      | 74             | 13       | 61     | 9  |
|                  |  | 400                | 75                      | 68             | 15       | 53     | 9  |
|                  |  | 500                | 67                      | 56             | 17       | 63     | 8  |
|                  |  | 600                | 53                      | 37             | 21.6     | 68     | 6  |
|                  |  | 700                | 31                      | 24             | 21       | 66     | —  |
| 30X2N2VFA<br>10  | Заналка с 840° в<br>масле, отпуски<br>при 840°               | 300                | 108                     | 89             | —        | —      | —  |
|                  |  | 400                | 105                     | 83             | 12       | 52     | —  |
|                  |  | 500                | 92                      | 86             | 12       | 56     | —  |
|                  |  | 600                | 80                      | 70             | 12       | 56     | —  |

1) Steel; 2) heat treatment; 3) temperature, °C; 4) (kg/mm<sup>2</sup>); 5) (kgm/cm<sup>2</sup>); 6) 30Kh3VA; 7) oil quench from ; anneal at ; 8) 30Kh2N2VA; 9) 20Kh3MVF; 10) 30Kh2N2VFA.

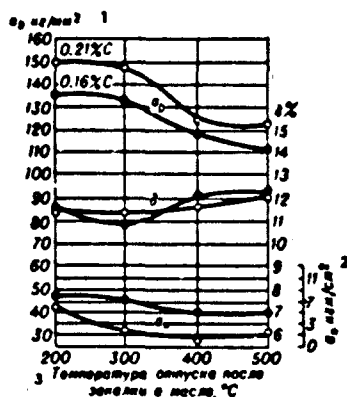

Fig. 2. Effect of annealing temperature on mechanical properties of 18KhSNRA steel with varying carbon content. 1)  $\sigma_b$ , kg/mm<sup>2</sup>; 2) kgm/cm<sup>2</sup>; 3) annealing temperature after oil quench, °C.

After annealing or normalization with tempering, the Brinnell hardness of the low-nickel structural steel substitute ( $d_{отп}$ ) is 4 mm. The effect of tempering temperature on the mechanical properties of hardened 18KhSNRA steel is shown in Fig. 2. The mechanical properties of the 30Kh3VA, 30Kh2N2VA, 20Kh3MVF steels at high temperatures are shown in Table 2. The impact strength of the low-nickel structural steel substitute varies little with reduction of the temperature to minus 60°. The

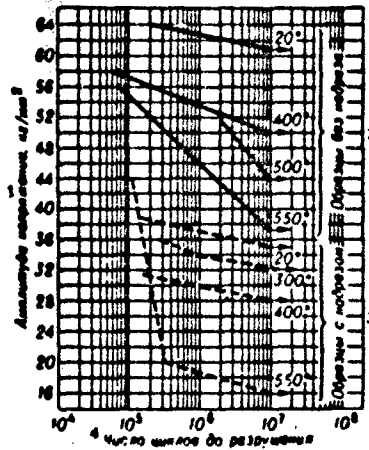

Fig. 3. Endurance of 30Kh3VA steel at various temperatures (oil quench from 880°, anneal at 580° for 2 hours, air cool). 1) Stress level, kg/mm<sup>2</sup>; 2) Unnotched specimens; 3) notched specimens; 4) number of cycles to failure.

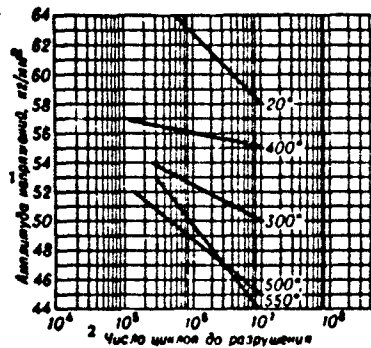

Fig. 4. Endurance of 30Kh2N2VA steel at various temperatures (oil quench from 860°, anneal at 580° for 3 hours, air cool). 1) Stress level, kg/mm<sup>2</sup>; 2) number of cycles to failure.

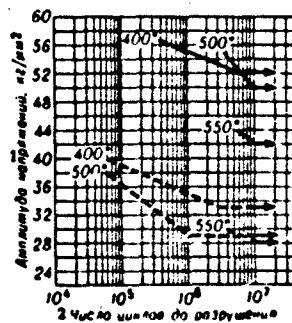

Fig. 5. Endurance of 30Kh2N2VFA steel at various temperatures. Broken line is for notched specimens. 1) Stress level, kg/mm<sup>2</sup>; 2) number of cycles to failure.

II-43M4

ultimate strength of the 30Kh3VA, 30Kh2N2VA, 30Kh2N2VFA steels after quenching and high tempering is shown in Figs. 3-5. The modulus of elasticity of the low-nickel structural steel substitute  $E = 20,000 \text{ kg/mm}^2$ , the variation of the modulus of elasticity with increase of temperature is the same as for carbon steel (see Wrought Carbon Structural Steel).

The physical properties of certain widely used grades of low-nickel structural steel substitute are shown in Table 3.

TABLE 3

Physical Properties of Some Grades of Low-Nickel Structural Steel Substitutes

| 1 Сталь        | 2 $\gamma$<br>(g/cm <sup>3</sup> ) | 3 $\alpha \cdot 10^6$ (1/°C) | 4 $\lambda$<br>(kcal/cm <sup>2</sup> × sec °C) |
|----------------|------------------------------------|------------------------------|--|
| 4 15XPA . . .  | 7.74                               | 11 (20-100°)                 | 0.12(100°)                                     |
|                |                                    | 14.5 (20-600°)               | 0.09(500°)                                     |
| 5 18XCHPA . .  | 7.72                               | 12.2 (20-100°)               | 0.1 (100°)                                     |
|                |                                    | 14 (300-400°)                | 0.091(400°)                                    |
| 6 30X3VA . . . | 7.85                               | 12.1 (20-100°)               | 0.092(100°)                                    |
|                |                                    | 14.4 (400-500°)              | 0.087(300°)                                    |
| 7 30X2H2BA     | 7.8                                | 11.8 (20-100°)               | 0.085(100°)                                    |
|                |                                    | 14.9 (400-500°)              | 0.084(400°)                                    |
| 8 20X3MВФ . .  | 7.79                               | 9.4 (20-100°)                | 0.098(100°)                                    |
|                |                                    | 14.62(500-800°)              | 0.081(200°)                                    |
| 9 30X2H2BΦA    | 7.8                                | 11.73 (20-100°)              | 0.094(20°)                                     |
|                |                                    | 14.04(500-800°)              | 0.083(500°)                                    |

1) Steel; 2) (g/cm<sup>3</sup>); 3) (cal/cm-sec-°C); 4) 15KhRA; 5) 18KhSNRA; 6) 30-Kh3VA; 7) 30Kh2N2VA; 8) 20Kh3MVF; 9) 30Kh2N2VFA.

TABLE 4

Critical Points (°C) of Some Grades of Low-Nickel Structural Steel Substitutes

| 1 Сталь         | Ac <sub>1</sub> | Ac <sub>3</sub> | Ar <sub>1</sub> | Ar <sub>3</sub> |
|-----------------|-----------------|-----------------|-----------------|-----------------|
| 2 18XCHPA . . . | 725             | 790             | 560             | 620             |
| 3 30X3VA . . .  | 730             | 780             | 350             | 420             |
| 4 30X2H2BA . .  | 740             | 800             | 380             | 430             |
| 5 15XPA . . .   | 735             | 870             | 720             | —               |
| 6 30X3M2BΦA . . | 760             | 810             | 575             | 635             |

1) Steel; 2) 18KhSNRA; 3) 30Kh3VA; 4) 30Kh2N2VA; 5) 15KhRA; 6) 30Kh2N2-VFA.

II-43M5

TABLE 5

Forging Conditions for Low-Nickel Structural Steel Substitutes

| 1<br>Сталь         | Температурный интервал 2<br>ковки (°C) | Заменяемая конструкт- рунц. сталь с боль- шим содержанием никеля 3 |
|--------------------|--|--|
| 4 15XPA . . .      | 1150-800                               | 13H2A  |
| 6 20XHP . . .      | 1150-850                               | 20XH3A, 12XH3A   |
| 8 20XGP . . .      | 1150-850                               | 20XH3A, 12XH3A   |
| 9 18XSNPA . . .    | 1100-850                               | 13H5A, 12X2H4A, 12XH3A, 20XH3A                                     |
| 10 30X3BA . . .    | 1180-850                               | 20X2H4A, 37XH3A, 18XHBA, 21H5A                                     |
| 11 30X2H2BA . . .  | 1180-850                               | 20XH3A, 20X2H4A, 18XHBA, 33XH3MA, 25X2H4HA                         |
| 12 35XP . . .      | 1150-850                               | 20X2H4A, 20XH3A  |
| 13 40XHP . . .     | 1150-850                               | 37XH3H, 20X2H4   |
| 14 30X2H2BFA . . . | 1180-850                               | 33XH3MA, 18XHBA, 25X2H4BA, 20XH3A                                  |
| 15 20X3MΦ . . .    | 1140-900                               | 18XHBA, 25X2H4BA, 33XH3MA, 20X2H4A, 20XH3A, 21H5A, 13H5A           |
| 16 30X2GH2 . . .   | 1150-850                               | 37XH3A, 20X2H4A, 21H5A   |

1) Steel; 2) forging temperature range (°C); 3) high-nickel structural steel which is replaced; 4) 15KhRA; 5) 13N2A; 6) 20KhNR; 7) 12KhN3A; 8) 20KhGR; 9) 18KhSNRA; 10) 30Kh3VA; 11) 30Kh2N2VA; 12) 35KhR; 13) 40KhNR; 14) 30Kh2N2VFA; 15) 20Kh2MVF; 16) 30Kh2GN2.

Of no less national economic importance is the use of low-nickel (economical) stainless steel substitute.

Of the large number of grades of stainless steel, the most widely used in the various branches of industry is the Kh18N9T (EYalT) steel, produced in the form of rod, sheet, tube and forgings. This wide usage is explained by the fact that Kh18N9T is insensitive to intercrystalline corrosion, welds well and has satisfactory strength at temperatures to 600°.

Usually the Kh18N9T steel contains 8-9.5% Ni (see Austenitic Stainless Steel), in the initial condition it may have some amount of ferrite in the structure, which affects the high-temperature strength. Moreover, as a result of long time action of high temperatures (600 - 700°) the Kh18N9T steel acquires a tendency to marked brittleness because of the formation of the σ phase. To eliminate these deficiencies the nickel content in the Kh18N9T steel is increased to 11-13% and the carbon con-

II-43M6

tent is reduced to 0.08%. This steel (OKh18N12T) has application in boiler construction, the chemical industry, etc. However, with all its merits Kh18N9T does not provide in the strain hardened condition adequate plasticity of the sheet material to permit bending and stamping operations. Several grades of austenitic stainless steel have been developed in which part of the nickel is replaced by manganese and nitrogen; under certain conditions these grades of steel may serve as reliable replacements for the Kh18N9T steel. The chemical composition of the most widely used stainless low-nickel structural steel substitutes are presented in Table 6.

TABLE 6

Chemical Composition of Stainless Low-Nickel Structural Steel Substitutes

| 1<br>Сталь                 | 2<br>ГОСТ       | 3<br>Содержание элементов (%) |       |            |       |             |        |               |               |               |
|----------------------------|-----------------|-------------------------------|-------|------------|-------|-------------|--------|---------------|---------------|---------------|
|                            |                 | C                             | Si    | Mn         | Cr    | Ni          | Ti     | N             | S<br>не более | P<br>не более |
| 5<br>OK17T<br>(EI645)      | ГОСТ<br>5632-61 | <0.08                         | <0.08 | <0.7       | 16-18 | -           | 5C-0.8 | -             | 0.025         | 0.03          |
| 6<br>Kh28T<br>(EI457)      | -               | <0.15                         | <1    | <1.5       | 25-28 | -           | 5C-0.8 | -             | 0.025         | 0.03          |
| 7<br>Kh28AN<br>(EI657)     | ГОСТ<br>5632-61 | <0.15                         | <1    | <1.5       | 25-28 | 1-1.7       | -      | 0.18-<br>0.25 | 0.025         | 0.035         |
| 8<br>Kh14G14N3T<br>(EI711) | ГОСТ<br>5632-61 | <0.1                          | <0.8  | 13-<br>15  | 13-15 | 2.5-<br>3.5 | До 0.6 | -             | -             | -             |
| 10<br>Kh17N4AG9<br>(EI878) | ГОСТ<br>5632-61 | <0.12                         | <0.8  | 8-<br>10.5 | 16-18 | 8.5-<br>6.5 | -      | 0.15-<br>0.25 | 0.02          | 0.035         |

1) Steel; 2) GOST; 3) content of elements (%); 4) not more than; 5) OKh-17T (EI645); 6) Kh28T (EI457); 7) Kh28AN (EI657); 8) Kh14G14N3T (EI711); 9) to; 10) Kh17N4AG9 (EI878).

The low-nickel structural steel substitutes accept all forms of welding, however during fusion welding of the OKh17T and Kh28T steels there is observed a sharp growth of the ferritic grains of the parent metal. The Kh14G14N3T and Kh17N4AG9 steels weld similarly to the Kh18N9T steel, filler material from the OKh18N9 or Kh18N9T steels is used; in this case the strength of the weld joints in the soft condition is the same as that of the parent metal. The strength of weld joints of the strain hardened metal when using argon arc welding of the Kh17N4AG9



II-43M7

steel is practically the same as the strength of the steel in the soft condition, while with seam and spot welding it is higher by 20 - 30%. Welding of the stainless low-nickel structural steel substitutes with austenitic and austenitic-ferritic stainless steel of all grades is permissible.

The OKh17T steel is corrosion resistant in sea water, industrial atmospheres, and is not subject to intercrystalline corrosion. The Kh-28T steel has high corrosion resistance in atmospheric conditions, in aggressive media and in sea water. The corrosion rate of the Kh28T steel is very slow in a mixture of 1.5% lactic acid and 2% phosphoric acid (at 25° no more than 0.001 mm/year), in 9% acetic acid, 3% lactic acid and in a mixture of 10% sodium chloride and 3% acetic acid (at 40°) it is no more than 0.0005-0.002 mm/year.

TABLE 7

Mecahnical Properties of Stainless Low-Nickel Structural Steel Substitutes (no less than)

| 1<br>Сталь          | $\sigma_b$                 | $\sigma_{0.2}$ | $\delta$<br>(%) | 3<br>Состояние                 |
|---------------------|----------------------------|----------------|-----------------|--------------------------------|
|                     | 2<br>(кг/мм <sup>2</sup> ) |                |                 |                                |
| 4 OK17T (ЭИ645)     | 51                         | 29             | 33              | В состоянии поставки 5         |
| 6 X28T (ЭИ457)      | 62                         | —              | 28              | "                              |
| 7 X28AN (ЭИ657)     | 67                         | 54             | 25              | Нормализация с 900° 8          |
| 9 X14G14N3T (ЭИ711) | 70                         | 25             | 40              | Закалка с 10 1050°             |
| 11 X17N4AG9 (ЭИ878) | 70                         | 35             | 45              | Закалка с 12 1075-1100° в воде |
| 13 То же            | 100                        | 75             | 20              | После нагартовки 14            |

1) Steel; 2) (kg/mm<sup>2</sup>); 3) temper; 4) OKh17T (EI645); 5) as delivered; 6) Kh28T (EI457); 7) Kh28AN (EI657); 8) normalized from 900°; 9) Kh14-G14N3T (EI711); 10) quench from 1050°; 11) Kh17N4AG9 (EI878); 12) water quench from 1075-1100°; 13) same; 14) after strain hardening.

Along with this the Kh28T steel is not prone to intercrystalline corrosion and is highly refractory (weight gain from gaseous corrosion does not exceed 1 g/m<sup>2</sup>/hr). The Kh28AN steel containing nitrogen is not

II-43M8

TABLE 8

Physical Properties of Stainless Low-Nickel Structural Steel Substitutes

| Сталь<br>1             | Температурный интервал<br>2 (°C) | $\alpha_{10^4}$<br>(1/°C) | Темп-ра<br>3 (°C) | $\lambda$<br>4 (кал/см <sup>2</sup> ·сек·°C) |
|------------------------|----------------------------------|---------------------------|-------------------|--|
| 5 X28T                 | 100-200                          | 10.4-15.95                | 200               | 0.956  |
|                        | 700-800                          | 18.11-25.53               | 900               | 0.8726                                       |
| 6 X28AN<br>(ЭИ657)     | 100-200                          | 9.63                      | 300               | 0.962  |
|                        | 700-800                          | 15.88                     | 900               | 0.888  |
| 7 X14G14N3T<br>(ЭИ711) | 100-200                          | 17.4                      | 100               | 0.943  |
|                        | 700-800                          | 24.3                      | -                 | -  |
| 8 X17N4AG9<br>(ЭИ878)  | 100-200                          | 15.9                      | -                 | -  |
|                        | 300-600                          | 21.2                      | -                 | -  |

1) Steel; 2) temperature range (°C); 3) temperature (°C); 4) (cal/cm<sup>2</sup>-sec-°C); 5) Kh28T; 6) Kh28AN (EI657); 7) Kh14G14N3T (EI711) 8) Kh17-N4AG9 (EI878).

TABLE 9

Pressure Working, Heat Treatment and Application Conditions for Stainless Low-Nickel Structural Steel Substitutes

| Сталь<br>1                 | Обработка давлением<br>2  | Термич. обработка<br>3   | Темп-ра начала интенсивного окисления<br>4 во время | Применение<br>5  |
|----------------------------|---|--|---|--|
| 6<br>8X17T                 | Холодная деформация. Хорошо прокатывается в горячем и холодном состоянии с обжатием до 80%  | Отжиг при 780°<br>8  | 900°  | Несварные узлы или конструкции, в к-рых не требуется применения сварки давлением   |
| 10<br>X28T                 | •   | •  | 1100-1150°  | 11<br>Заместитель стали X18N9T   |
| 12<br>X28AN<br>(ЭИ657)     | Глубокая вытяжка без промежуточной термич. обработки. Штампуются с удлинения более 20% производится в мес. приемки с промежуточной термич. обработкой<br>13 | Нормализация при 900° (для снятия внутренних напряжений)<br>14 | 1100-1150°  | Сварные соединения. Заместитель стали X18N9T для работы в агрессивных средах (азотной, органич. и неорганич. кислотах)<br>15 |
| 16<br>X14G14N3T<br>(ЭИ711) | Горячая обработка давлением при 1200-820°. Допускается глубокая вытяжка и др. виды холодной штамповки<br>17   | Закалка с 181050°, охлаждение в воде или на воздухе            | 700°  | Детали, работающие до 400° в нагружающихся условиях азотсодержащей среды. Заместитель стали X18N9T<br>19                     |
| 20<br>X17N4AG9<br>(ЭИ878)  | •   | Закалка с 211075°, охлаждение на воздухе или в воде            | 900°  | Детали, работающие в агрессивных условиях до 800°. Заместитель стали X18N9T<br>22  |

1) Alloy; 2) pressure working; 3) heat treatment; 4) temperature of beginning of intensive scale formation; 5) application; 6) OKh17T; 7) cold deformation. Rolls well in hot and cold conditions with reduction to 80%; 8) anneal at 780°; 9) unwelded components or structures in which the use of fusion welding is not required; 10) Kh28T; 11) replacement for Kh18N9T steel; 12) Kh28AN (EI657); 13) deep drawing without intermediate heat treatment. Stamping with elongation no more than 20% performed in several steps with intermediate heat treatment; 14) normalization at 900° (to relieve internal stresses); 15) weld joints. Replace-

ment for Kh18N9T steel for operation in aggressive media of nitric, organic and inorganic acids; 16) Kh14G14N3T (EI711); 17) hot pressure working at 1200-820°. Deep drawing and other forms of cold stamping are permitted; 18) quench from 1050°, cooling in water or air; 19) parts operating to 400° and subject to the action of atmospheric corrosion. Replacement for Kh18N9T steel; 20) Kh17N4AG9 (EI878); 21) quench from 1075°, cooling in water or air; 22) parts operating in atmospheric conditions to 800°. Replacement for Kh18N9T steel.

prone to intercrystalline corrosion.

The Kh14G14N3T steel has high corrosion resistance in atmospheric conditions, but somewhat lower than the Kh18N9T steel.

With regard to corrosion resistance in atmospheric conditions and in contact with liquid fuel, the Kh17N4AG9 steel is similar to the 18-8 type chrome-nickel steel. The steel is not prone to intercrystalline corrosion in the soft or strain hardened conditions, weld joints in thin sheet material made using argon-arc and resistance welding also do not show any tendency to intercrystalline corrosion. After an inducing tempering the Kh17N4AG9 steel acquires a tendency to intercrystalline corrosion.

References: Akimov G.V., Akimov K.I., Yedinaya spetsifikatsiy metallicheskih materialov mashinostroyeniya Soyuza SSR, ch. 3 (Unified Specification for Metallic Materials for Machine Design, USSR, Part 3), M., 1948; Spravochnik po mashinostroitel'nyim materialam (Handbook on Materials for Machine Design), Vol. 1., M., 1959; Alekseyenko M.F., Orekhov G.N., Boristaya stal' 15Kh2GN2TRA - zamenitel' staley 12KhN3A, 12Kh2N4A, i 18KhNVA (Boron Steel 15Kh2GN2TRA - replacement for the 12KhN3A, 12Kh2N4A and 18KhNVA Steels), Stal' (Steel), 1960, No. 6; Alekseyenko M.F., Korobkov A.V., Orekhov G.N., Malolegirovannaya konstruktsionnaya stal' 15Kh2GN2A (Low-Alloy Structural Steel 15Kh2GN2A), ibid, 1954, No. 4; Odesskiy D.A., Alekseyenko M.F., Vysokokhromistyye stali s titanom i azotom - zameniteli staley 1Kh18N9 i 1Kh18N9T (High-Chrome

II-43M10

Steels with Titanium and Nitrogen - Replacements for the 1Kh18N9 and 1Kh-18N9T Steels), *ibid*, 1961, No. 3; Alekseyenko M.F., *Struktura i svoystva teplostoykikh konstruktsionnykh i nezhaveyushchikh staley* (Structure and Properties of Heat Resistant Structural and Stainless Steels), M., 1962.

M. F. Alekseyenko

I-44a

LOW-STRENGTH ALUMINUM SHAPING ALLOYS - see Corrosion-resistant  
aluminum shaping alloys.

LOW-STRENGTH WROUGHT MAGNESIUM ALLOYS are magnesium alloys with ultimate strength of 17-23 kg/mm<sup>2</sup>. One typical alloy is MA1, which contains 1.5-2.5% Mn in addition to magnesium.

For chemical composition see Magnesium Alloys. The MA1 alloy is used for the production of all forms of wrought mill products. Their mechanical properties are shown in Tables 1-5.

TABLE 1  
Mechanical Properties of Mill Products Guaranteed by Specifications\*

| 1 Вид полуфабриката  | 2 Технич. условия        | 3 Состояние материала                       | 4 (кг/мм <sup>2</sup> ) |                  | 5 δ <sub>5</sub> (%) |
|--|--------------------------|---|-------------------------|------------------|----------------------|
|  |                          |   | σ <sub>b</sub>          | σ <sub>0.2</sub> |                      |
| 9 Листы толщиной:<br>0,8-3 мм . . . . .<br>3,1-10 мм . . . . . | 6 АМТУ 228-81<br>8 То же | 7 Отожженные при 300-350° в течение 30 мин. | 19                      | 11               | 5                    |
|  |                          |   | 17                      | 9                | 3                    |
| 9 Прутки прессованные Ø до 130 мм . . . . .                    | 6 АМТУ 227-49            | 10 Без термич. обработки                    | 18                      | -                | 2                    |
| 11 Профили прессованные . . .                                  | 6 АМТУ 226-49            | То же 8                                     | 22                      | -                | 4                    |
| 12 Поковки и штамповки . . .                                   | 6 АМТУ 226-45            | 9   | 18                      | -                | 2                    |

\*Specimens cut along fiber direction.

1) Form of mill product; 2) specification; 3) material condition; 4) (kg/mm<sup>2</sup>); 5) sheet thickness; 6) АМТУ ; 7) annealed at 300-350° for 30 minutes; 8) same; 9) extruded rods of diameter to 130 mm; 10) without heat treatment; 11) extruded profiles; 12) forgings and stampings.

TABLE 2  
Typical Mechanical Properties of Extruded Rods with Different Forms of Testing

| 1 Состояние материала                               | 2 Растяжение            |      |                         |                  |                         | 3 Сжатие        |                   | 4 Кручение |                | 5 Срез          |                                      | 6 НН, σ <sub>-1</sub> (кг/мм <sup>2</sup> ) |   |    |
|---|-------------------------|------|-------------------------|------------------|-------------------------|-----------------|-------------------|------------|----------------|-----------------|--------------------------------------|---|---|----|
|   | E (кг/мм <sup>2</sup> ) | μ    | σ <sub>b</sub>          | σ <sub>0.2</sub> | δ <sub>10</sub>         | σ <sub>-b</sub> | σ <sub>-0.2</sub> | G          | T <sub>b</sub> | τ <sub>ср</sub> | σ <sub>н</sub> (кг/мм <sup>2</sup> ) |   |   |    |
|   |                         |      | 6 (кг/мм <sup>2</sup> ) |                  | 6 (кг/мм <sup>2</sup> ) |                 |                   |            |                |                 |                                      |   | 7 |    |
| 8 Отожженный при 300-350° в течение 30 мин. . . . . | 4000                    | 0,34 | 24                      | 14               | 4                       | 6               | 33                | 8,5        | 1800           | 19              | 13                                   | 0,6   |   | 48 |

1) Material condition; 2) tension; 3) compression; 4) torsion; 5) shear; 6) (kg/mm<sup>2</sup>); 7) (kg-m/cm<sup>2</sup>); 8) annealed at 300-350° for 30 minutes.

II-7M1

TABLE 3

Typical Mechanical Properties of Sheet at Room Temperature

| 1 Состояние материала                         | $\sigma_b$ |                | $\delta$ (%) | 2 HB (кг/мм <sup>2</sup> ) | 3 $\sigma_{0.2}$ (кг/мм <sup>2</sup> ) | 4 $\sigma_{0.2}$ (кг/мм <sup>2</sup> ) |
|---|------------|----------------|--------------|----------------------------|--|--|
|   | $\sigma_b$ | $\sigma_{0.2}$ |              |                            |  |  |
| Отжиганный при 300° в течение 30 мин. . . . . | 21         | 12             | 8            | 45                         | 0.5                                    | 7.5                                    |

\*Determined with cantilever bending of rotating specimens on the basis of  $5 \cdot 10^7$  cycles

- 1) Material condition; 2) (kg/mm<sup>2</sup>); 3) (kg-m/cm<sup>2</sup>); 4) annealed at 300° for 30 minutes.

TABLE 4

Mechanical Properties of Mill Products at Elevated Temperatures

| 1 Темп-ра испытания (°C) | 2 Листы полунагартованные |                |              | 3 Прессованные прутки   |                |              |
|--------------------------|---------------------------|----------------|--------------|-------------------------|----------------|--------------|
|                          | $\sigma_b$                | $\sigma_{0.2}$ | $\delta$ (%) | $\sigma_b$              | $\sigma_{0.2}$ | $\delta$ (%) |
|                          | 4 (кг/мм <sup>2</sup> )   |                |              | 4 (кг/мм <sup>2</sup> ) |                |              |
| 100                      | 18                        | 13             | 5            | 18                      | 15             | 15           |
| 150                      | 13                        | 8              | 10           | 14                      | 11             | 18           |
| 200                      | 8                         | 5              | 20           | 13                      | 8              | 25           |
| 250                      | 6                         | 4              | 32           | 9                       | 5              | 60           |
| 300                      | 4.5                       | 2.5            | 35           | 6                       | 3.5            | 90           |

- 1) Test temperature; 2) half-hard sheet; 3) extruded rod; 4) (kg/mm<sup>2</sup>).

TABLE 5

Creep Limits After 200 Hours with Residual Deformations of 0.1 and 0.2%

| 1 Вид полуфабриката           | Остаточная деформация 2 (%) | Предел ползучести (кг/мм <sup>2</sup> ) при темп-рах 3 |      |      |      |
|-------------------------------|-----------------------------|--|------|------|------|
|                               |                             | 100°   | 150° | 200° | 250° |
| Пруток прессованный . . . . . | 0.1                         | 3.7  | 2.8  | 1.5  | 0.9  |
|                               | 0.2                         | 4.3  | 2.8  | 1.8  | 1.1  |

- 1) Form of mill products; 2) residual deformation; 3) creep limit (kg/mm<sup>2</sup>) at temperatures; 4) extruded rod.

The wear resistance of the MA1 alloy in the annealed condition is characterized by the following figures: in testing without lubrication with sliding velocity 1.15 meters/second, the wear number v (indicating the depth of wear in mm for a friction path of one kilometer) is 0.18 and 0.35 mm/km with specific pressure of 4 and 16 kg/mm<sup>2</sup> respectively.

Physical properties of the alloy MA1:  $\gamma = 1.76$ ;  $\alpha = 22.3 \cdot 10^{-6}$  (20 -

II-7M2

- 100°),  $25.7 \cdot 10^{-6}$  (100 - 200°),  $32.0 \cdot 10^{-6}$  (200 - 300°) 1/°C;  $\lambda = 0.30$  (20°), 0.32 (200°), 0.32 (300°) cal/cm-sec-°C;  $c = 0.24$  (100°), 0.25 (200°), 0.27 (300°) cal/g-°C;  $\rho = 0.0612$  (20°) ohm-mm<sup>2</sup>/m; the latent heat of fusion is about 70 cal/g. The MA1 alloy, in comparison with the other magnesium alloys, has higher general corrosion resistance and is not prone to stress corrosion. Product surfaces are protected with inorganic films and paint/lacquer coatings (see Paint-Lacquer Coatings for the Magnesium Alloys, Corrosion of Magnesium Alloys). The MA1 alloy is not strengthened by heat treatment. Sheet is delivered in the annealed condition, other mill products are delivered without annealing.

The basic regimes for working of the alloy are: ingot casting temperature 675-750°, pressure working temperature 250-450°, annealing temperature 340-400°. In the temperature range for pressure working the plasticity of the alloy is high, at room temperature it is low. The alloy is welded well by the gas, argon-arc and resistance methods. It machines well. The basic process parameters for stamping of sheet are: minimal diameter of holes which can be punched at room temperature is 0.75S, at 260 - 320° - (0.25 - 0.50)S (S is the material thickness). Table 6 presents the ratio of the minimal bend radius to the sheet thickness as a function of temperature and bend angle ( $r_{min}/S$ ).

TABLE 6

| 1<br>Темп-ра (°C)       | 2 Угол загиба (градусы) |         |      |
|-------------------------|-------------------------|---------|------|
|                         | 60                      | 120     | 180  |
| 3 Отношение $r_{min}/S$ |                         |         |      |
| 20                      | 7-9                     | 5-7     | 3-11 |
| 100                     | 6-7                     | 4-5     | 2-9  |
| 200                     | 4-5                     | 2.5-3.5 | 1-7  |
| 300                     | 2-3                     | 1-2     | 1-5  |

1) Temperature; 2) bend angle (degrees); 3) ratio  $r_{min}/S$ .

The limiting degree of draw of annealed sheet is: 3.0-3.2 for the 1st draw, 2.0-2.2 for the second draw, pressing pressure at the optimal stamping temperature is 3.0-4.5 kg/cm<sup>2</sup>. Sheet made from the MA1 alloy is used for various reservoirs in the chemical and other branches of industry, for gas and oil tanks which are fabricated by stamping and welding. Rods and stampings



II-7M3

are used to fabricate details of tank and pipeline fittings and also other lightly-loaded details. In connection with the introduction into industry of argon-arc welding, the alloy MA1 in the majority of cases is replaced with the stronger and more plastic alloy MA8.

References: see Wrought Magnesium Alloys.

A.A. Kazakov

LOW-TEMPERATURE LUBRICANTS - plastic lubricating materials used in mechanisms which must operate at temperatures down to  $-50^{\circ}$  and occasionally down to  $-80^{\circ}$ . The lowest temperature at which a given lubricant can be employed depends on the design of the mechanism to be lubricated and the conditions under which it must operate. The viscosity of low-temperature lubricants at their minimum temperature usually does not exceed 5-20 thousand poises. These lubricants are prepared from low-viscosity petroleum or synthetic products thickened with small quantities of lithium, calcium, or other soaps, ceresin, etc.

The general-purpose lubricant TsIATIM-201 (GOST 6267-59) has come into wide use in the friction units of radio direction finders, computers, and other precision mechanisms; it is produced by thickening MVP oil with lithium stearate (10%) and adding 0.3% of an antioxidant (divinylamine). In addition to its positive properties (usability at low temperatures, satisfactory resistance to oxidation and water), this lubricant also has shortcomings (poor protective properties and high evaporability) which limit its usefulness at temperatures above  $80^{\circ}$  and under unfavorable operational conditions. It has a service life of a year or more and retains its properties for three years or more when stored in containers. It is recommended as a substitute for absolute low-quality lubricants, such as KV, NK-30, No. 21, GOI-54, No. 12, etc.

TsIATIM-203 lubricant (GOST 8773-58) is prepared from the more viscous MK-8 oil thickened with the lithium soap of stearin and spermaceti oil and contains viscous and antiwear additives. It is somewhat

111-7481

less useful than TsIATIM-201 at low temperatures, but has better anti-wear characteristics, a lower evaporability, and greater stability during storage; it is used in cases where a lubricant must be usable at low temperatures and have good antisiezing characteristics. TsITIM-221 can be used as a low-temperature lubricant (see High-temperature lubricants), as can OKB-122-7-5, 122-7, 122-8, and 122-12 instrument greases, which are produced by thickening a mixture of mineral oils and synthetic products with ceresin and lithium and sodium soaps. They are usable down to  $-70^{\circ}$  and can be employed at elevated temperatures (up to  $120^{\circ}$ ).

V.V. Sinitsyn

LOW-TEMPERATURE TREATMENT OF STEEL - is a thermal treatment consisting in cooling of the hardened steel to a temperature lower than zero and a subsequent heating in air. The transformation of a considerable part of the residual austenite into martensite, a fact which results in a supplementary hardening of the steel, is realizable by cooling to  $-40^{\circ}$  and below. The low-temperature treatment of steel is applied to increase the stability of cutting tools, to improve the abrasion resistance of parts, especially after cementation, and to stabilize the dimensions of hardened parts. Steel whose end point of the martensite transformation lines below the room temperature is submitted to the low-temperature treatment.

References: Petrosyan, P.P., Termicheskaya obrabotka stali kholodom [Thermal Treatment of Steel by Cold], Kiev-Moscow, 1957.

M.L. Bernshteyn and I.N. Kidin

**LUBRICANTS RESISTANT TO AGGRESSIVE MEDIA** - lubricants used primarily as sealers in pump packing glands, stop cocks, and threaded joints and less frequently as antifriction lubricants in friction units exposed to chemically active products (acids, alkalies, strong oxidizing agents, etc.). These lubricants consist of purified petroleum oils or mixtures of liquid fluorocarbons and fluoroparaffins thickened with special types of ceresin. The lubricant most suitable for the type of aggressive medium involved is selected in each specific case. The lubricant should have no detrimental influence on the chemical substance in contact with it. The most inexpensive and convenient lubricant resistant to oxidizing agents is the hydrocarbon lubricant TsIATIM-205 (GOST 8551-57), which is obtained by thickening a mixture of vasoline and perfume oils (85:15) with white ceresin (45%). It is used chiefly in packing glands, threaded joints, and motor armatures and less frequently for lubricating bearings exposed to aggressive substances. It is difficult to use this lubricant at low temperatures; its melting point is 65°. The new lubricant germetol (TU 10-61) is now being produced; this material is as resistant to aggressive media as TsIATIM-205, but is serviceable at -50° or -60°. TsIATIM-205 is considerably less resistant to very aggressive media than the fluorocarbon lubricants 5A (STU 12-10, 15-61), No. 8 (BU 60-60), No. 11A (BU 17-59), 3F, and 10 OKF (VTU YeU 159-57), which are obtained by thickening liquid perfluorochlorocarbons or trifluorochlorocarbons with solid fluoroparaffins or fluoroplasts 3 and 4. These lubricants are resistant to fuming nitric acid, chloric, hydrochloric, and sulfuric

acids, concentrated hydrogen peroxide, liquid and gaseous hydrogen chloride, liquid oxygen, etc. They are less resistant to amines than TsIATIM-205 or the high-temperature lubricant TsIATIM-221. The specific gravity of fluorocarbon lubricants is approximately 2; their viscosity depends to a large extent on the temperature. Type 5A lubricant is distinguished by high viscosity and density, but has unsatisfactory operational characteristics at low temperatures. Its evaporability is very high at 120-150°. Lubricants Nos. 8 and 11A are recommended for use during the winter, but not at elevated temperatures (this being particularly true of 11A), since they have high evaporability even at 80-100°. Lubricants 3F and 10 OKF have comparatively low evaporability at temperatures of up to 150° and can be used at temperatures of up to 80-120°. Because of their poor frost resistance most fluorocarbon lubricants are rarely employed as winter antifriction lubricants, but they can successfully be used under these conditions in packing glands and similar lubrication points. In addition to plastic (consistent) lubricating materials, liquid fluorocarbon oils of types 4F, 12F, 13F, and UPI, manometric and balance fluids, etc., can be used as lubricants resistant to aggressive media. These oils are used for lubricating friction units and mechanisms and as separatory and sealing fluids for filling manometers and other instruments exposed to aggressive gases (chlorine, nitrogen oxides, etc.).

References: Nikolayeva, T.N. and Kryzhko, Ye.P., KhP [Chem. Ind.], 1959, No. 5, pages 18-20.

V.V. Sinitsyn

**LUBRICATING MATERIALS** - substances and mixtures of substances employed principally for reducing the frictional forces which develop when moving bodies come into contact and protecting metal articles against corrosion. Such materials reduce the wear and heating of the friction components, since the friction of one metallic surface against another is replaced by friction between the layers of lubricant separating the contact surfaces. Certain lubricating materials (industrial oils) are used for cooling cutting tools, for quenching metals, in hydraulic systems and shock absorbers for protecting mechanisms and metal articles, and as heat-transfer agents, electrical insulating materials (e.g., transformer oil), and sealers (in packing glands, etc.).

Depending on their aggregate state, lubricating materials can be subdivided into four basic groups: liquid, plastic (consistent), solid, and gaseous. Liquid lubricants, which account for more than 90% of the total consumption, are petroleum products (petroleum oils) or synthetics (diesters, polysiloxanes, etc.). The viscosity of these lubricants varies within wide limits, depending on their type and the operational temperature; they are used in internal-combustion engines, steam, water, and gas turbines, various types of friction units, transmission mechanisms, etc. Plastic lubricants are grease-like materials in their initial state and during operation, having a consistency similar to that of vasoline. The wide use of these lubricants is due to the fact that they are employed in various types of friction units (rolling-contact and sliding bearings, etc.), as well as for prolonged preservation of mechanisms and as sealers (see Plastic lubricants). Solid lub-

ricants (graphite, molybdenum disulfide, polytetrafluorethylene, etc.) are used in pure form, mixed with other lubricating materials (oils, plastic lubricants), or with fillers. Gaseous lubricants are pure gases, mixtures of gases, or the vapors of certain compounds in which the friction and wear of unlubricated surfaces are less than in air or in a vacuum. Depending on their purpose, lubricating materials can be classified as general-purpose, high-temperature, low-temperature, protective, or sealing lubricants and lubricants resistant to aggressive media.

V.V. Sinitsyn



II-107k

LUDERS-CHERNOV LINES are systems of lines (slippage traces) which appear on the surface of metals (and other materials) as a result of plastic deformation. The Luders-Chernov lines are most clearly seen on a pre-polished surface. Usually these lines are inclined to the direction of the normal stresses, which is associated with the orientation of the surfaces of the plastic shears and the tangential stresses which cause them. The occurrence, density and extent of the Luders-Chernov lines give valuable information on the nature of the initial plastic deformation (see Flow Figures).

Ya.B. Fridman

II-109k

LUMINESCENT DEFECTOSCOPE is an apparatus for the detection of surface defects of materials and parts using the luminescent method. The luminescent defectoscope is a stationary installation in which there are mounted devices for electric power supply and control, equipment for coating the part with the luminescent composition, washing, drying, and irradiation of the part with ultraviolet light with the aid of a special lamp. Certain defectoscopes, for example, the LD-4 defectoscope using the DRSh-250 lamp are equipped with a portable radiating unit with the DRSh-250 mercury-quartz lamp which is used for the inspection of large surfaces a section at a time. The supply for this type of luminescent defectoscope is 3-phase alternating current at 380 volts with power consumption of 2 kw; the equipment dimensions are: 1015x12040x766 mm, weight 240 kg.

S.I. Kalashnikov

LUMINESCENT DEFECTOSCOPY is the inspection of the quality of materials and products by means of magnifying the visibility of defects by irradiating them with ultraviolet rays; here use is made of the effect of luminescence of certain irradiated fluids (mineral oils, certain salts, etc.). During luminescent defectoscopy there is applied to the surface of the part being examined the fluorescent fluid with high capacity for penetration into the cavity of the defects. The excess fluid is removed, then the surface is powdered with a finely dispersed powder which has high absorptive capacity (magnesium oxide, talc, silica gel). The powder attracts the fluorescent fluid from the cavity of the defects and the excess powder is removed by an air blast. The defects are detected from the luminescence of the powder moistened with the fluid when it is irradiated with ultraviolet light. To improve the sensitivity and reduce the time of contact of the part with the fluorescent fluid use is made of the vacuum method. The essence of this method is that the part with the fluorescent fluid applied to its surface is placed in a chamber which is then evacuated. There is simultaneous removal of the air which was in the cavities of the defects, which results in facilitating the filling of these cavities with the fluorescent fluid. The ultrasonic method of luminescent defectoscopy is based on the action of intense ultrasonic vibrations on the test part immersed in the fluorescent fluid, which results in improvement of the filling of the defect cavities by the fluid and the sensitivity of the luminescent method is increased.

II-108k1

Reference: Polyak E.V., Lyuminescentnyy metod defektoskopii i opyt primeneniya yego v mashinostroyeni [Luminescent Method of Defectoscopy and Experience of its Use in Machine Design], in collection "Defektoskopiya metallov" [Defectoscopy of Metals], M., 1959, p. 139.

S.I. Kalashnikov

LUMINOPHORES are synthetic luminescent substances. With respect to chemical composition the luminophores are divided into the inorganic, most of which belong to the crystallo-phosphors, and the organic.

The organic luminophores produced under the name of lumogens (for example, light-yellow lumogen, orange-red lumogen) are usually quite complex organic substances of varied structure having bright luminescence under the action of ultraviolet and frequently also the short-wave portion of visible light. They are used as decorative paints, in polygraphy, for luminescent fabric finishes, in hydrology for luminescent marking of sand, in luminescent microscopy. Paints made from the organic luminophores have greater brightness and purity of color than the conventional paints. The inorganic luminophores are divided into the following basic types:

1. The luminophores which are excited by light (photo-luminophores). Initially, for low-pressure luminescent lamps use was made of a mixture of  $MgWO_4$  (blue light) and  $(Zn, Be)_2SiO_4-Mn$  (yellow-red light). These luminophores were replaced by the single-component luminophore - calcium halophosphate, activated with Sb and  $Mn[3Ca_3(PO_4)_2 \cdot Ca(F, Cl)_2 - Sb, Mn]$ , having a radiation defect in the red part of the spectrum. To improve the color index, there can be added  $CaSiO_3-Pb, Mn$  (red light) and  $Zn_2SiO_4-Mn$  (green emission). For lamps with improved light color transmission, there can also be used the additives  $6MgO \cdot As_2O_5-Mn$ ,  $(Sr, Mg)_3(PO_4)_2-Sn$  which radiate in the red region of the spectrum. For lamps with emission in the ultraviolet, use is made of  $BaSiO_3-Pb$ ;  $(Sr, Ca)_3(PO_4)_2-Tl(\gamma=250-360 \text{ m}\mu)$ ;  $(Ca, Zn)_3(PO_4)_2-Tl$ ;  $(Ca, Mg)_3(PO_4)_2-Tl$

II-110k1

( $\lambda = 290-300$  millimicrons, the so-called erythematous lamps). To correct the color index of the high and super-high pressure mercury lamps, use is made of luminophores which under the action of ultraviolet light give red emission and are not extinguished under the influence of the high temperature created by the high-pressure lamps:  $[6\text{MgO} \cdot \text{As}_2\text{O}_5 \cdot 0.01 \text{Mn}; 3.5 \text{MgO} \cdot 0.5 \text{MgF}_2 \cdot \text{GeO}_2 \cdot 0.01 \text{Mn}; \text{BaO} \cdot \text{SrO} \cdot \text{Li}_2\text{O} \cdot 2.2\text{SiO}_2 \cdot 0.3\text{Ce} \cdot 0.07 \text{Mn}; (\text{Sr}, \text{Zn})_3(\text{PO}_4)_2\text{-Sn}]$ .

The luminophores with extended after-emission find varied use, for example, for emergency illumination, luminous paints, marking signs. The luminous paints, marking signs. The longest after-emission is shown by the luminophores based on the sulfides of the alkali-earth metals (CaS, SrS), activated with Cu, Bi, Pb, the rare earths and others (for example, SrS-Bi, Cu). However, these luminophores are unstable in the air and are difficult to seal. More practical use is made of the luminophores based on ZnS. The brightest after-emission is that (in the yellow-green portion of the spectrum) of ZnS-Cu (FKP-OZK) whose brightness an hour after excitation by a daylight lamp is 0.005 apostilb. ZnS-Cu, Co (FKP-04, FKP-05) has a lower initial brightness but still longer emission duration.

2. Luminophores for electron-ray tubes and electron-optical converters (cathodoluminophores). A tremendous number of luminophores with differing emission spectra and differing duration of the after-emission have been developed. The brightest are the luminophores with blue emission - ZnS-Ag (K-10) (energetic output of the cathodoluminescence up to 20%); to obtain white screens it is mixed with ZnS-CdS-Ag (yellow emission). Use is also made of the silicate and tungstate luminophores and certain oxides, for example, ZnO, CaO-Ce. For electron beam tubes with after-emission use made of the luminophores 73% ZnS-27% CdS-0.004%Cu (inner layer) and ZnS-0.015% Ag (outer layer).

3. Luminophores which are excited by x-rays (x-ray luminophores). For x-ray screens for visual observation use is made of luminophores made from 58% ZnS and 42% CdS-Ag ( $10^4$  g Ag/g of the base) with yellow-green emission corresponding to the region most sensitive for the eye; for roentgenography use is made of the luminophores with blue emission  $\text{CaWO}_4$  and also 90%  $\text{BaSO}_4 \cdot 10\% \text{PbSO}_4$ .

4. Luminophores excited by nuclear radiation. For luminous paints and as weak sources of light, use is made of the so-called permanent action phosphors (PAP) - luminophores with an admixture of a small quantity of radioactive substance. Originally to the ZnS-Cu luminophores there were added the natural  $\alpha$ -radioactive substances (Ra or Th). The service life of such PAP is limited by radiation damage to the luminophores. This deficiency is not present in the PAP using  $\beta$ -radiators, for which use is made of certain isotopes with small energies of the  $\beta$  particles, for example,  $\text{H}^3$ ,  $\text{C}^{14}$ . The use of gaseous  $\text{Kr}^{85}$  in tanks coated internally with luminophores is being developed. Luminophores for the recording of nuclear radiation in scintillation counters are used in the form of large inorganic or organic monocrystals, and also plastics and liquid solutions termed scintillators.

Electroluminophores. ZnS-Cu is the primary one of practical importance. In contrast with the conventional luminophores, in the electroluminophores the Cu content is elevated (to  $10^{-3}$  g Cu/g ZnS). Coactivators Mn, Ag, Pb, Sb, Ga, Al, Cl are introduced into the luminophores to vary their properties (increase the brightness, variation of the spectrum). In addition to ZnS, (Zn, Cd)S, Zn(S, Se) and others can be used as bases for the electro-luminophores.

References: Moskvina A.V., Katodolyuminestsentsiya [Cathode Luminescence], Pt. 2, M.-L., 1949; O nekotorykh primeneniyyakh lyuminestsentsii [Some Uses of Luminescence], Tallin, 1960; Khimiya i tekhnologiya

II-110k3

lyuminoforov [Chemistry and Technology of Luminophores], L., 1960  
[coll. of works of the State Institute of Applied Chemistry].

Yu.S. Leonov



LUMINOUS COATINGS - coatings containing luminous powders (luminophores) as pigments. They are used to illuminate instrument scales, indicator needles, emergency instruments, fire-fighting equipment in public buildings, warning signs in passageways, etc. Both temporary and permanent luminous coatings are manufactured. The former include coatings containing luminophores (zinc and cadmium sulfides, mixtures of calcium and strontium sulfides, and sulfides of other metals). The sulfides themselves are not phosphorescent, the luminous agents being selective impurities or activators (Bi, Cu, Mn, Ag, and other metals), introduced into the sulphite crystals. A luminophore fluoresces as a result of exposure to light, ultraviolet rays, electron beams, and other types of energy. Luminous coatings are obtained by mixing a dry fluorescent substance with a lacquer. A total of 6-8 parts by weight of light-colored lacquer (dammar varnish, TU MKhP VSh-91-47, or methacrylic lacquer, TU MKhP 1072-47, etc.) are added to four parts by weight of the luminescent substance. Luminescent coatings are prepared in glass or porcelain vessels shortly before they are to be used. In order to obtain maximum brightness several layers of luminescent coating are applied to a surface preliminarily covered with a white paint containing no lead. After the luminous coating has been applied it is protected with several additional layers of light-colored lacquer. The service life of temporary luminous coatings is up to 1 year in dry rooms and 3-5 months in damp or exposed areas. Permanent luminous coatings (which last several years) are obtained by introducing radioactive impurities into the luminescent substance (radium, thorium, etc. salts).

Commercial dammar varnish is used as a binder. A total of 1 part by weight of varnish is used for each 1.8-2 parts by weight of luminescent substance. Such paints are applied to surfaces preliminarily covered with zinc oxide suspended in dammer varnish. Strict observation of the safety requirements established for working with radioactive substances is necessary in storing and using permanent luminous coatings.

References: Lazarev, D.N., Svetyashchiesya kraski [Luminous Paints], Leningrad, 1944.

I.I. Denker

LUSTER - the ability of solids to scatter light in rather selective directions, so that the apparent brightness of the object or individual portions of its surface is sharply altered when the position of the object or observer is slightly shifted. The character of the luster depends on the nature of the surface and the extent to which it is treated. We can distinguish metallic, metalline, and nonmetallic lusters. The term metalline refers to the luster of tarnished surfaces. Nonmetallic lusters are classified as adamantine (diamond, cuprite, etc.), vitreous (quartz, glass, gypsum, etc.), oily, and silky.

L.S. Priss

MACHINING OF PLASTICS - removal of burrs, poring marks, and other nonuniformities and roughnesses from finished products, milling, drilling, and cutting of semifinished products with cutting or abrasive tools, etc. Plastics are machined by hand or on specialized metal-working machine tools. The optimum machining regimes and cutting-tool geometries for different types of plastics vary, depending on the properties of the binder and the character of the filler and differing from those for metals. As a result of the special characteristics of plastics (low thermal conductivity, relative softness, and high abrasive characteristics), a large portion of the heat is absorbed by the cutting tool, which wears considerably more rapidly than during the machining of metals. The cutting tool should consequently be made of high-speed steel faced with hard alloys or ceramic plates. At low cutting speeds the machined plastic surface is of low quality, while at very high speeds the material burns; the optimum machining regime must consequently be selected for each type of plastic.

Plastics are turned on lathes with cutting, sinking, and other types of tools. The cutting regime for lathing depends on the type of cutter, the type of hard alloy, the resistance of the tool, the depth of the cut, etc. There are cutting-speed correction factors for various conditions.

The table shows the optimum cutting regimes and cutting-tool characteristics.

Laminated plastics (including glass plastics) and thermal-plastic sheets and shapes are cut with band saws, circular saws, disc millers

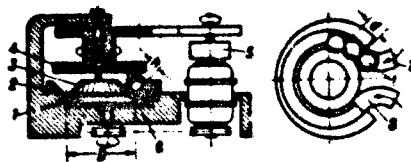

Fig. 1. Diagram of general-purpose semiautomatic machine tool with continuous circular displacement of workpiece: 1) Abrasive wheel; 2 and 3) tapers forming annular slit and positioning workpiece; 4) feed disc rolling workpiece along slit; 5) reduction gear transmitting motion of motor to feed disc; 6) workpiece; 7) loading trough; 8) discharge trough.

of the NIIPM type, millers with alternately inclined teeth and an oval cutting edge, etc. It is recommended that tubes and other shaped products of thermoreactive plastics be cut and faced with abrasive wheels having a thickness of 1-4 mm, a hardness of from SML to ST1, and a vulcanite or bakelite binder of type KCh-36. Sheets of vinyl plastic up to 4 mm thick are easily cut with various types of shears, especially mechanical shears consisting of two sharp-edged discs rotating in opposite directions. This process is carried out at a temperature of no less than 20-25°, since vinyl plastic cracks when cut at lower temperatures. Thermoreactive plastics are machined without cooling, but it is recommended that thermal plastics be cooled with 5% emulsol or compressed air.

Deburring of holes and drilling are carried out with cylindrical, spiral, and flat bits. The latter are employed only for deburring or for drilling shallow holes. In order to increase the resistance of the bits they are faced with hard-alloy plates. In drilling through holes it is recommended that a soft, smooth material (e.g., wood) be placed beneath the plastic to eliminate burrs on the lower edge of the hole. Drilled surfaces of the highest quality are obtained by using high speeds and low feed rates and raising the drill frequently. Machining of polyformaldehyde at high speeds requires cooling or lubrication, but

II-65P-3

cooling is not obligatory at low speeds.

Drilling and turning of plastics require rigid clamping of the workpiece in order to avoid wobbling and vibration; the play of the working end of the drill should not exceed 0.05 mm. A powerful exhaust system is needed to remove the dust produced in drilling plastics, especially thermoreactive plastics (phenolic plastics, ATM-1, textolite, and glass plastics).

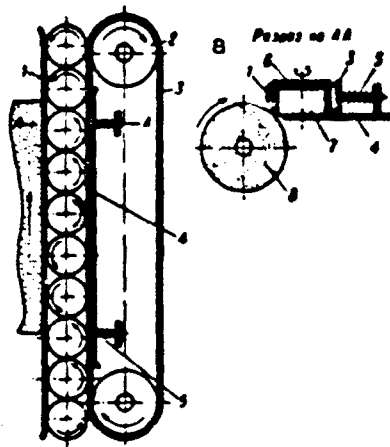

Fig. 2. Diagram of general-purpose semiautomatic machine tool with continuous gradual displacement of workpiece: 1) vertical stand; 2) drive pulley; 3) belt that rotates and gradually advances workpiece; 4) clamp; 5) pressure springs; 6) workpiece; 7) bench; 8) abrasive cylinder. a) Section through AA.

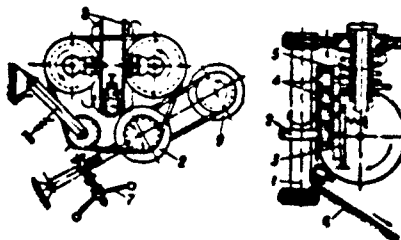

Fig. 3. Diagram of semiautomatic machine tool for machining cylindrical components: 1) Shaft of abrasive wheel; 2) abrasive wheel; 3) special spring-loaded file-like tool; 4) workpiece; 5) guide-channel intake; 6) discharge hopper; 7) flywheel; 8) coaxial discs that rotate workpiece; 9) electric motor.

II-65P-4

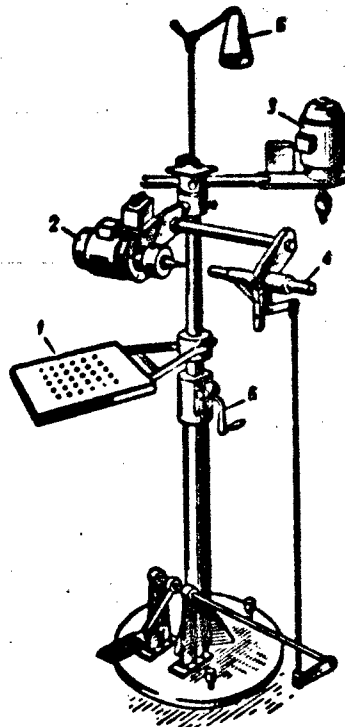

Fig. 4. General-purpose machine tool for machining various plastic components: 1) Bench; 2) electric motor; 3) electric motor with chuck for drilling; 4) pressure roller; 5) lamp; 6) foot pedal.

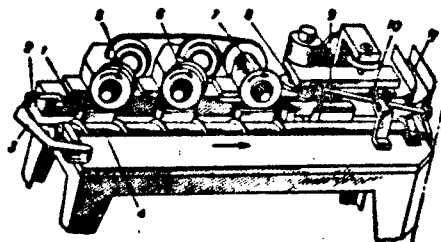

Fig. 5. Semiautomatic machine tool for complex machining of rectangular workpieces: 1) Workpiece; 2) loading aperture; 3) loading lever; 4) screw conveyor to transport workpiece along bench; 5 and 6) abrasive (grinding) wheels for facing; 7) abrasive wheel for cutting grooves; 8) miller for punching films and milling holes; 9 and 10) brushes for cleaning dust from finished product; 11) trough for moving finished products to packing bench.

# Optimum Cutting Regime and Cutting-Tool Characteristics

| 1                       | 2                                     | 3 Характеристики режущего инструмента |                     |                     |                            |                            |                            |                            | 17                         |                            |                            |                            | 16                         |                      |                          |                          |                                  |
|-------------------------|---------------------------------------|---------------------------------------|---------------------|---------------------|----------------------------|----------------------------|----------------------------|----------------------------|----------------------------|----------------------------|----------------------------|----------------------------|----------------------------|----------------------|--------------------------|--------------------------|----------------------------------|
|                         |                                       | А) формы                              |                     | Б) резцы            |                            | В) сверла                  |                            |                            | скорость резания           |                            | 20                         |                            |                            | 21                   |                          |                          |                                  |
| Обработываемый материал | Материал режущей части инструмента    | 5                                     | 6                   | 7                   | 8                          | 9                          | 10                         | 11                         | 12                         | 13                         | 14                         | 15                         | 18                         |                      | 19                       | 20                       | 22                               |
|                         |                                       | Классификация (мм)                    | Число зубьев (штук) | Число зубьев (штук) | Угол при вершине (градусы) | Угол при вершине (градусы) | Угол при вершине (градусы) | Угол при вершине (градусы) | Угол при вершине (градусы) | Угол при вершине (градусы) | Угол при вершине (градусы) | Угол при вершине (градусы) | Угол при вершине (градусы) | Длина сверления (мм) | Скорость резания (м/мин) | Скорость резания (м/мин) |                                  |
| 24                      | Сталь Р-18                            | -                                     | -                   | 12                  | 20                         | 45                         | -                          | -                          | -                          | -                          | 1.0                        | 36                         | 47                         | 180-400              | -                        | -                        | При грубом режиме резания 1,8 мм |
|                         | Твердый сплав ВК-8                    | -                                     | -                   | 10                  | 20                         | 45                         | -                          | -                          | -                          | -                          | 1.0                        | 60                         | Тот же                     | 250-700              | 0.1-0.6                  | -                        |                                  |
|                         | Твердый сплав ВК-6М                   | -                                     | -                   | 10                  | 20                         | 45                         | -                          | -                          | -                          | -                          | 0.5-0.7                    | 60                         | 49                         | 457-1177             | -                        | -                        |                                  |
|                         | То же ВК-8, ВК-6М                     | 200-400                               | 24-60               | -                   | -                          | -                          | -                          | -                          | -                          | -                          | 0.3                        | 180                        | 50                         | 600-1000             | 0.07-0.3                 | -                        |                                  |
|                         | Высокоскоростная сталь                | 100-200                               | 32-40               | -                   | -                          | -                          | -                          | -                          | -                          | -                          | -                          | -                          | -                          | 150-400              | 0.03-0.3                 | -                        |                                  |
|                         | То же Р-18                            | 275-410                               | 50-72               | -                   | -                          | -                          | -                          | -                          | -                          | -                          | 0.4                        | 120                        | -                          | 150-400              | 0.2-0.5                  | -                        |                                  |
|                         | • 85ХФ                                | 315-400                               | 50-56               | -                   | -                          | -                          | -                          | -                          | -                          | -                          | 0.6                        | 120                        | -                          | 1500-2000            | 0.0-0.6                  | -                        |                                  |
|                         | Твердый сплав ВК-6, ВК-6М             | -                                     | -                   | -                   | -                          | -                          | -                          | 65-95                      | -                          | -                          | -                          | -                          | -                          | 90-150               | 0.2-0.4                  | -                        |                                  |
|                         | Высокоскоростная сталь (разная марка) | -                                     | -                   | -                   | -                          | -                          | -                          | 60-75                      | -                          | -                          | -                          | -                          | -                          | 25-40                | 0.2-0.4                  | -                        |                                  |
|                         | То же ВК-8                            | -                                     | -                   | 15                  | 20                         | 45                         | -                          | -                          | -                          | -                          | 0.15-0.3                   | 12-16                      | 200                        | 0.1                  | -                        | -                        |                                  |
| 23                      | То же ВК-6М                           | -                                     | -                   | 10                  | 20                         | 45                         | -                          | -                          | -                          | -                          | 0.7-0.5                    | 60                         | 100-140                    | 0.0                  | -                        | -                        |                                  |
|                         | То же                                 | -                                     | -                   | 20                  | 30                         | 45                         | -                          | -                          | -                          | -                          | 1.0                        | 20                         | 100-140                    | 0.5                  | -                        | -                        |                                  |
|                         | То же                                 | -                                     | -                   | 20                  | 30                         | 45                         | -                          | -                          | -                          | -                          | -                          | -                          | -                          | -                    | -                        | -                        |                                  |
| 33                      | Фемальт К-18-С                        | -                                     | -                   | -                   | -                          | -                          | -                          | -                          | -                          | -                          | -                          | -                          | -                          | -                    | -                        | -                        |                                  |
|                         | Фемальт                               | -                                     | -                   | -                   | -                          | -                          | -                          | -                          | -                          | -                          | -                          | -                          | -                          | -                    | -                        | -                        |                                  |





| Обработка-<br>вспомогательный<br>материал | Материал<br>режущей части<br>инструмента | Характеристика режущего инструмента |                      |                  |                 |                 |                                    |                                  |                |                  |       | Режимы резания |        |               |   | Примечание |
|---|--|-------------------------------------|----------------------|------------------|-----------------|-----------------|------------------------------------|----------------------------------|----------------|------------------|-------|----------------|--------|---------------|---|------------|
|   |  | Формы                               |                      | Размеры          |                 |                 | Секция                             |                                  | Скорость (мм.) | Скорость резания |       | Позиция        |        |               |   |            |
|   |  | диаметр (мм)                        | число зубьев (штуки) | гребень (градус) | радиус (градус) | радиус (градус) | тип                                | угол для свер-<br>ления (градус) |                | глубина (мм)     | назад | назад          | назад  | назад         |   |            |
| Чугуны                                    | Быстрорежущая<br>сталь P18               | 100-<br>200                         | 45-90                | -                | -               | -               | -                                  | -                                | 0.3            | 180              | м/мин | 90-300         | мм/об  | 0.03-0.3      |   |            |
|   | Твердые сплавы<br>BK-6, BK-8             | 200-<br>400                         | 24-60                | -                | -               | -               | -                                  | -                                | 0.3            | 180              | •     | 600-800        | мм/об  | 0.3-0.4       | При глубине<br>резания<br>5130-60 мм          |            |
|   | Сталь 85XΦ                               | 315-<br>400                         | 112-<br>180          | -                | -               | -               | -                                  | -                                | 0.4            | 120              | •     | 1500-<br>2000  | мм/мин | 0.0-0.0       | При глубине<br>резания 15 мм<br>лучшей подачи |            |
|   | Быстрорежущая<br>сталь (разная<br>марка) | -                                   | -                    | -                | -               | -               | Цилиндри-<br>ческие<br>инструменты | 85-78                            | -              | -                | -     | •              | 23-40  | мм/об         | 0.2-0.4                                       |            |
| 61<br>Сталь                               | Твердые сплавы<br>BK-6, BK-8             | -                                   | -                    | -                | -               | -               | -                                  | -                                | -              | -                | -     | 80-150         | •      | 0.2-0.4       |   |            |
|   | Твердые сплавы<br>BK-6M                  | -                                   | -                    | 18-20            | 18              | 45              | -                                  | -                                | 0.5-0.7        | 60               | м/мин | 157-360        | мм/об  | 0.1-0.3       | При глубине<br>резания<br>0.5-2.5 мм          |            |
|   | То же                                    | -                                   | -                    | 18-20            | 18              | 45              | -                                  | -                                | 0.5-0.7        | 60               | •     | 85-302         | •      | 0.15-<br>0.6  | При глубине<br>резания 3-8 мм                 |            |
|   | Твердые сплавы<br>BK-6M                  | 250-<br>400                         | 36-30                | -                | -               | -               | -                                  | -                                | 0.3            | 240              | м/мин | 240-600        | мм/об  | 0.15-<br>0.07 | То же, 30-60 мм                               |            |
| 63<br>Углеродистая<br>сталь типа<br>АГ-1Б | То же                                    | 200-<br>400                         | 36-60                | -                | -               | -               | -                                  | -                                | 0.3            | 140              | •     | 240-600        | •      | 0.15-<br>0.07 | При глубине<br>резания<br>0.5-1.5 мм          |            |
|   | •  | -                                   | -                    | 20               | 15              | 45              | -                                  | -                                | 0.3-0.7        | 60               | •     | 72-197         | мм/об  | 0.1-0.6       |   |            |
|   | •  | -                                   | -                    | 20               | 15              | 45              | -                                  | -                                | 0.3-0.7        | 60               | •     | 47-131         | •      | 0.1-0.6       | То же, 2-6 мм                                 |            |

|                           |  |             |             |       |    |       |   |               |    |    |                       |               |                                  |
|---------------------------|--|-------------|-------------|-------|----|-------|---|---------------|----|----|-----------------------|---------------|----------------------------------|
| Древесная<br>прессованная | Твердая сталь<br>ВК-6М                       | -           | -           | -     | -  | -     | - | 0.5-0.7       | 60 | -  | 180, 212,<br>230, 250 | 0.1-0.25      | При габарите<br>размера 6, 25 мм |
|                           | То же  | -           | -           | -     | -  | -     | - | 0.5-0.7       | 60 | -  | 132-302               | 0.1-0.4       | То же<br>0.5-1.5 мм              |
| 64                        | С пластинами<br>из титанового сплава<br>ВК-6 | -           | -           | -     | -  | -     | - | 0.5-0.8       | 60 | -  | 130-161               | 0.255         | То же 0.15 мм                    |
|                           | То же  | -           | -           | -     | -  | -     | - | 0.1-0.15      | 40 | -  | 750                   | 0.03-<br>0.02 |                                  |
| 66                        | Высокопрочная<br>сталь                       | 160-<br>250 | 63-50       | -     | -  | -     | - | 0.1-0.12      | 30 | -  | 1000-<br>2000         | 0.1-0.5       | При разрезе<br>стершей           |
|                           | Твердые сплавы<br>ВК-6, ВК-8                 | -           | -           | 15-20 | 15 | 60-65 | - | -             | -  | 70 | 700                   | 0.03-<br>0.02 |                                  |
| 67                        | Высокопрочная<br>сталь Р-18                  | 200-<br>250 | 125-<br>112 | -     | -  | -     | - | 0.1-0.12      | 30 | -  | 590-750               | 0.04-<br>0.01 | Для листов тол-<br>щины до 8 мм  |
|                           | То же  | 100-<br>200 | 24-36       | -     | -  | -     | - | 0.1-0.12      | 30 | -  | 470                   | 0.03-<br>0.02 | То же толщин<br>от 8 до 20 мм    |
| 68                        | Высокопрочная<br>сталь                       | 100-<br>125 | 40-42       | -     | -  | -     | - | 0.1-0.12      | 40 | -  | 750                   | 0.04-<br>0.02 |                                  |
|                           | То же  | 160-<br>250 | 63-50       | -     | -  | -     | - | 0.1-0.12      | 40 | -  | 30-50                 | 0.4           | Отливки стале-<br>вых изделий    |
| 68                        | Высокопрочная<br>сталь Р-18                  | 200-<br>250 | 125-<br>112 | -     | -  | -     | - | 0.15-0.2      | 60 | -  | 780                   | 0.03-<br>0.02 | Для листов<br>толщины до 8 мм    |
|                           | То же  | 100-<br>200 | 24-36       | -     | -  | -     | - | 0.15-<br>0.20 | 60 | -  | 550-750               | 0.04-<br>0.01 | То же тол-<br>щины от 6 до 57 мм |
| 69                        | Высокопрочная<br>сталь                       | 100-<br>250 | 40-63       | -     | -  | -     | - | 0.15-<br>0.20 | 80 | -  | 470-750               | 0.04-<br>0.01 |                                  |
|                           | То же  | -           | -           | -     | -  | -     | - | -             | -  | -  | 47                    | 0.03          | Отливки<br>медно-тitan           |
| Полнугроз                 | Высокопрочная<br>сталь                       | 160-<br>250 | 63-50       | -     | -  | -     | - | 0.1-0.12      | -  | -  | 100-300               | 0.03-<br>0.01 |                                  |
|                           | Высокопрочная<br>сталь Р-9                   | -           | -           | -     | -  | -     | - | -             | -  | -  | 5-25                  | 0.03-<br>0.01 | Отливки<br>изделия               |

KEY TO TABLE:

\* When the machined finish must satisfy more stringent requirements the permissible bluntness is reduced to 0.3-0.4 mm.

1) Material to be machined; 2) material of working portion of cutting tool; 3) characteristics of cutting tool; 4) millers; 5) diameter (mm); 6) number of teeth; 7) cutters; 8) anterior angle (degrees); 9) posterior angle (degrees); 10) principal angle in plane of (degrees); 11) drills; 12) type; 13) apical angle (degrees); 14) permissible dullness or wear (mm); 15) resistance (min); 16) cutting regime; 17) cutting speed; 18) unit of measurement; 19) speed; 20) feed; 21) feed rate; 22) notes; 23) textolite; 24) R-18 steel; 25) VK-8 hard alloy; 26) VK-6M hard alloy; 27) VK-8 and VK-6M hard alloys; 28) high-speed steel; 29) the same, R-18; 30) 85KhF; 31) VK-6 and VK-8 hard alloys; 32) high-speed steel (various types; 33) K-18-2 phenolic plastic, amino plastics; 34) type KCh-36 abrasive wheel; 35) R-9 high-speed steel; 36) the same, with hard-alloy facing plates; 37) ATM-1 press-material (antegmit); 38) voloknit; 39) R-9 and R-18 high-speed steels; 40) high-speed steel and VK-6 hard alloy; 41) Getinaks; 42) R-18 high-speed steel; 43) cylindrical; 44) spiral; 45) cylindrical and spiral; 46) flat; 47) m/min; 48) m/sec; 49) mm/rev; 50) mm/tooth; 51) at cutting depth of; 52) for sheets with thicknesses of up to; 53) with manual feed for sheets with thicknesses of up to; 54) for amino plastics; 55) for nonthrough holes; 56) for through holes; 57) for deep nonthrough holes; 58) for through and non-through holes; 59) with manual feed and a cutting depth of; 60) 85KhF steel; 61) glass plastics of the AG-4V type; 62) VK-8 and VK-6M hard alloys; 63) glass of VK-8 hard alloy; 66) faolite; 67) hard polyvinyl chloride (vinyl plastic); 68) organic glass; 69) polystyrene; 70) rpm; 71) with cutting depth of 45 mm and manual feed; 72) for cutting rods; 73) the same, with thicknesses of from 6 to 30 mm; 74) the same, with thicknesses of from 6 to 20 mm; 75) cooling with compressed air; 76) the same, with thicknesses of from 6 to 50 mm; 77) cooling with liquid.

Pressed components of thermoreactive plastics are generally deburred and finished with abrasive tools, corundum and carborundum grinding wheels and belts. The structure of grinding wheels is specified by GOST 3647-59, while that of belts is determined by GOST 5009-62 and 6456-62. Phenolic and amino plastics are rough-machined with carborundum grinding wheels having a highly porous open structure, a granularity  $m = 20, 24, \text{ or } 36$ , and a hardness of S1, S11, or M2. In order to obtain a good surface the cutting depth or transverse feed should not exceed 0.07-0.2 mm for rough machining and 0.01-0.05 mm for finish machining. After deburring with a cutting or abrasive tool the machined surface must be polished. This is done with soft cotton-flannel or byz pads coated with a thin layer of polishing paste and then with clean pads. A typical buffing pad has a diameter of 150-300 mm and operates at 1400-2200 rpm. Sharp edges or corners of the component should not be pressed against the buffing pad counter to its rotation, since this may lead to breakdowns and accidents. Certain types of plastic (particularly organic glass) can be polished in a hydrogen flame, which gives the material a very smooth, lustrous surface. A very efficient process for finishing small press-powder components with burrs no more than 0.25-0.3 mm thick is tumbling in drums containing abrasive materials (wood chips, sawdust, ground fresh peach, apricot, and other pits, etc.), which provides more rapid and cleaner machining.

Pressed components are machined with specialized and general-purpose automatic and semiautomatic machine tools; these include semiautomatic tools with continuous circular displacement of workpieces having the shape of bodies of rotation (Fig. 1), semiautomatic tools with continuous gradual displacement of the workpiece (Fig. 2), semiautomatic tools for machining cylindrical components (Fig. 3), tools for machining various plastic products (Fig. 4), semiautomatic tools

II-65P-11

for complex machining of rectangular workpieces (Fig. 5), etc. See Structural plastics.

References: Yegorov, S.V., Obrabotka rezaniyem konstruktsionnykh plastmass [Cutting of Structural Plastics], Moscow, 1955; Larin, M.N. and Ignatov, B.A., Frezovaniye plastmass - tekstolita i getinaksa [Milling of Plastics - textolite and getinaks], in collection: Novyye issledovaniya v oblasti obrabotka rezaniyem metallov i plastmass [New Investigations in the Cutting of Metals and Plastics], Moscow, 1952; Shapiro, G.I., Mekhanizatsiya i avtomatizatsiya mekhanicheskoy obrabotki plastmassovykh izdeliy [Mechanization and Automation of the Machining of Plastic Products], in collection: Plastmassy v mashinostroyeni [Plastics in Machine Building], Moscow, 1959; Shrader, V., Obrabotka i svarka plasticheskikh mass [Machining and Welding of Plastics], translated from German, Moscow, 1960; Konovalov, P.G., Plasticheskiye massy, ikh svoystva i primeneniye v promyshlennosti [Plastics, Their Properties and Industrial Applications], Moscow, 1961; Normali mashinostroyeniya [Machine-Building Norms]: MN 3638-62, MN 3646-62, RTM 59-62, RTM 60-62. Instrument rezhushchiy dlya obrabotka termoreaktivnykh plastmass. Frezy otreznyye [Cutting Tools for Machining Thermoreactive Plastics. Milling Cutters], Moscow, 1963; Bernhardt, E., Pererabotka termoplastichnykh materialov [Machining of Thermoplastic Materials], translated from English, Moscow, 1962.

Ye.A. Kuks

MACROCRYSTALLINE SHELL OF ALUMINUM ALLOYS (recrystallization shell) is the macrocrystalline structure on the periphery of the cross section of extruded aluminum alloys. The structure and the properties of the metal in the shell differ significantly from the structure and the properties of the fine grained core. The shell is formed during heating of the extruded semifabricates as a result of the marked agglomerative recrystallization of the strongly deformed metal of the surface layers. In the shell there is observed a reduction of the strength in comparison with the core as a result of the partial or complete relief of the press effect (see Press Effect of the Aluminum Alloys). It can reach  $10 \text{ kg/mm}^2$  and more. The thickness of the shell increases from the leading end (emerging end) of the extruded semifabricate. Therefore, the measurement of the thickness of the shell is made at the end opposite the emerging end. The thickness of the shell may vary around the periphery of a particular cross-section of the semifabricate. On profiles which are not to be subjected to mechanical working, and also on rods of the alloys AV, AK6 and AK8, the thickness of the macrocrystalline shell must not exceed 5 mm; on rods from the alloys D1, D16 and V95 it must not exceed 3 mm. It is possible that cracks will appear in the shell zone during hardening of massive extruded semifabricates. To avoid this, the heating of such products for hardening should be carried out at a temperature corresponding to the lower limit of the recommended temperature range and cooling should be done in warm water (30-50°). During stretch straightening in the as-hardened condition, there may arise in the extruded semifabricates with a macrocrystalline shell

II-31k1

internal stresses which are associated with the nonhomogeneity of the properties across the section. The magnitude of the stresses is proportional to the thickness of the shell and the difference of the values of the proportional limits of the shell and the core. The formation of the macrocrystalline shell can be prevented or reduced if the temperature of the initiation of recrystallization of the alloy is increased. This is achieved by correction of the chemical composition of the alloy (in particular, by increase of the manganese content to 0.6% and higher), by increase of the extruding temperature and reduction of the hardening temperature.

Ye.D. Zakharov



## II-M

MAGNALIUMS are alloys of aluminum with up to 10% magnesium and other elements. Depending on the Mg content, the magnaliums are divided into wrought (to 7% Mg) and casting (5-10% Mg). The magnaliums weld well, have high corrosion resistance and ductility and the highest fatigue limit of all the aluminum alloys. The wrought alloys are further strengthened by strain hardenings, the cast alloys with Mg content of more than 8% are further strengthened by heat treatment. The properties of the magnaliums vary depending on the composition:  $\sigma_b = 17 - 36 \text{ kg/mm}^2$ ,  $\sigma_{0.2}$  to 16  $\text{kg/mm}^2$ ,  $\delta = 16 - 20\%$  (see Weldable Wrought Aluminum Alloys). The magnaliums have found wide application in connection with the development of the technology for their fusion welding (see Welding of the Aluminum Alloys).

O.S. Bochvar, K.S. Pokhodayev

## II-1M

MAGNESITE is a mineral, magnesium carbonate ( $MgCO_3$ ), also an ore consisting primarily of mineral magnesite. In industry the names caustic magnesite and deadburned magnesite are given to the industrial products consisting primarily of Mg oxide, regardless of the original material (magnesite, dolomite, brucite, magnesium salts, sea water or strong natural brines). Admixtures are most often Fe, less often Mn and Ca; in nature the most common variable admixtures are of carbonaceous matter, silica (in the form of quartz and talc), lime (in the form of dolomite). Magnesite dissolves slowly in cold acids. The solubility in water at  $25^\circ$  is 9.0 mmol/liter. The color is white, yellowish, gray; in cathode rays it has a crimson color. Its specific weight is 2.9-3.1, volumetric weight is 2.10-2.35. Magnesite is brittle, has perfect hexagonal cleavage, the hardness of pure  $MgCO_3$  is 3.75-4.25, the hardness of magnesite rock is 4.0-4.5. The compressive strength of fresh magnesite rock is about  $900 \text{ kg/cm}^2$ . Thermal conductivity is about 11 cal/sec-cm. The equilibrium dissociation temperature at  $PCO_2 = 1 \text{ atm}$  is  $373^\circ$ , under conditions of rapid heating in an air atmosphere it is  $520-690^\circ$ . Heat of formation:  $MgO + CO_2 = MgCO_3 + 27240 \text{ cal}$ . Chemically active caustic magnesite is obtained with a calcining temperature of  $750-1000^\circ$ , highly refractory deadburned magnesite is obtained at  $1500-1650^\circ$ . Specially pure molten periclase is obtained with elevated calcining temperature in electric furnaces. Magnesite is used primarily as a refractory and binding material; in metallurgy deadburned magnesite in the form of metallurgical powder is used for building up the bottoms and walls of open-hearth furnaces (it is sometimes replaced by dolomite powder); in

## II-1M1

the form of magnesite brick it is used for the lining of the front and rear walls and the floors of open-hearth furnaces, in electric steel smelting, heating and rotating furnaces, mixers, converters, etc. Caustic magnesite is used in other branches of industry. The construction industry uses magnesite cements for the production of heat and sound insulating materials: fibrolite (with wood chips), xylolite tiles (with wood shavings), terrazzo tiles (with marble grit), magnesite foam (structural cellular concrete), magnesite plaster. Magnesite also finds wide application in the chemical industry (in the form of magnesium compounds), in the sugar industry (for refining), in the ceramic industry (fluxing additives to porcelain, earthenware, sanitary ceramics which reduce the coefficient of thermal expansion of the products and the deformation during firing), in the paper industry (sulfite production of cellulose), in the rubber industry, in the cable industry (filler for electric insulation materials), in the paint industry (filler for fire-resistant paints), in the metallurgy of light metals (production of metallic magnesium by means of charcoal recovery from a mixture of magnesite and a charge of the magnesian cement type).

The requirements for magnesite are defined by GOST 1216-41 which applies to magnesite caustic powder.

References: Trebovaniya promyshlennosti k kachestvu mineral'nogo syr'ya (Industry Requirements on Quality of Mineral Raw Material), Handbook for geologists, No. 40, Kileso S.I., Magnesite, M.-L., 1947; Minerals yearbook 1958, Vol. 1, Wash., 1959.

P.P. Stolin

MAGNESIUM. Mg is a chemical element of group II of the Mendeleev periodic system, atomic number 12, atomic weight 24.312; it has three stable isotopes:  $Mg^{24}$  (78.60%),  $Mg^{25}$  (10.11%) and  $Mg^{26}$  (11.29%). Magnesium is one of the most abundant elements, its content in the earth's crust is 2.10 wt. %. The raw material resources of magnesium are practically unlimited, in nature it is encountered primarily in minerals; dolomite ( $CaCO_3 \cdot MgCO_3$ ), magnesite ( $MgCO_3$ ), carnallite  $KCl \cdot MgCl_2 \cdot 6H_2O$ , in sea water (0.14% Mg) and others. Magnesium is a light, silvery-white metal with bright luster. The chemical composition and mechanical properties of the magnesium produced industrially are shown in Tables 1 and 2. Magnesium crystallizes in a hexagonal close-packed lattice:  $a = 3.2028$  A,  $c = 5.1998$  A, atomic radius 1.60 A.

TABLE 1

Chemical Composition of Grade Mg Magnesium (GOST 804-62)

| Mg<br>1 (% , не<br>менее) | 2 Присеси (% , не более) |       |      |      |      |       |      |       |       |                     |
|---------------------------|--------------------------|-------|------|------|------|-------|------|-------|-------|---------------------|
|                           | Al                       | Ni    | Si   | Mn   | Fe   | Cu    | Na   | K     | Cl    | сумма<br>присесей 3 |
| 99.9                      | 0.02                     | 0.001 | 0.01 | 0.04 | 0.04 | 0.005 | 0.01 | 0.005 | 0.005 | 0.1                 |

1) Mg (% , not less than); 2) impurities (% , not more than); 3) total impurities.

The specific weight of wrought magnesium is 1.739, for cast magnesium it is 1.737,  $t_{pl}$  is  $651^\circ$ ,  $t_{kip}$  is  $1107^\circ$ , heats of fusion and evaporation (at  $t_{kip}$ ) in cal/g-atom are respectively 2100 and 30,500. Thermal conductivity is 0.37 cal/cm-sec- $^\circ C$ , specific heat in cal/g- $^\circ C$ : 0.241 ( $0^\circ$ ); 0.248 ( $20^\circ$ ); 0.254 ( $100^\circ$ ); 0.312 ( $650^\circ$ ). Thermal coefficient

II-16M1

TABLE 2

Mechanical Properties of Magnesium at 20°

| 1 Состояние материала  | R                       |      | σ    | σ <sub>0.2</sub>        |      | δ   |    | ψ  | HB (кг/мм <sup>2</sup> ) |
|------------------------|-------------------------|------|------|-------------------------|------|-----|----|----|--------------------------|
|                        | 2 (кг/мм <sup>2</sup> ) |      |      | 2 (кг/мм <sup>2</sup> ) |      | (%) |    |    |                          |
| Литье в песчаную форму | 4700                    | 1600 | 0.35 | 2.5                     | 11.5 | 8   | 9  | 38 |                          |
| Прутки прессованные    | 4700                    | 1600 | 0.35 | 9                       | 20   | 11  | 12 | 40 |                          |
| Полки                  | 4700                    | 1600 | 0.35 | —                       | 19   | 9   | —  | 40 |                          |
| Листы отожженные       | 4300                    | 1600 | 0.35 | 9.5                     | 19   | 16  | —  | 40 |                          |

1) Material condition; 2) (kg/mm<sup>2</sup>); 3) cast in sand mold; 4) extruded rods; 5) forgings; 6) annealed sheet.

of linear expansion  $25.0 \cdot 10^{-6} + 0.0188 t$  (in the interval 0-550°). Electrical resistivity is  $4.5 \cdot 10^{-6}$  ohm-cm at 20°. Pressure of saturated magnesium vapor in mm Hg: 1.66 (627°); 8.71 (727°); 407.4 (1027°); 760 (1107°).

Magnesium is the most electronegative of the constructional metals thus, for example, its electrode potential in a 3% NaCl solution is equal to - 1.45 v. Magnesium has satisfactory corrosion resistance in atmosphere conditions, is stable in many anhydrous organic liquids (oils, petroleums, gasoline, kerosene), in solutions of the fluorides, chromates and bichromates, in the alkalis. Magnesium corrodes actively in the organic and mineral acids and their salts (other than the fluorides) in aqueous and alcohol solutions of the acids. Among the most harmful impurities which reduce the corrosion resistance of magnesium are nickel (thousandths of a %), iron (hundredths of a %). Products made from magnesium are protected against corrosion by inorganic films. Unprotected magnesium interacts with moist air and is covered with a hydroxide film which does not protect the metal from further corrosion. For long time storage pig magnesium is coated with gum oil and wrapped with paraffined paper. Magnesium is melted under fluxes to prevent combustion. The casting temperature is 680-710°. Pressure working is performed in the range

II-16M2

of 230-480°. Extruding temperature is 400-440°, rolling is initiated at 470-480°. Magnesium machines very well, welds well using oxyacetylene, argon-arc and electric spot welding (see Welding of Magnesium Alloys). The primary field of application of magnesium is the production of magnesium alloys (see Magnesium Alloys). Magnesium is used in metallurgy as a reducing agent in the production of several metals (beryllium, titanium, chromium, and others), and also as a deoxidizer. Magnesium is used as an alloying element with aluminum, zinc and other bases. The ability of magnesium to ignite in the powdery condition with the release of a large quantity of heat and white light is used in pyrotechnics - - for the production of signal rockets, incendiary bombs, etc. There are indications of the possibility of the use of magnesium as a coolant in reactors (see Formed Magnesium, Technical Magnesium, Electrolytic Magnesium).

References: Portnoy K.I., Lebedev A.A., Magniyevyye splavy (Magnesium Alloys), Handbook, M., 1952; Kolobnev I.F., Krymov V.V., Polyanskiy A.P., Spravochnik liteyshchika. Faconnoye lit'ye iz alyuminiyevkh i magniyevykh splavov (Founder's Handbook. Shape Casting from Aluminum and Magnesium Alloys), M., 1957; Raynor G.V., The physical metallurgy of magnesium and its alloys, L., 1959.

N.M. Tikhova

MAGNESIUM-ALLOY CAST IRON (high-strength cast iron) - is a variety of the gray iron, in the structure of which the graphite coagulations have a spheroidal size, brought about by modifying the molten iron with additions of magnesium or its alloys (Table 1). The spheroidal graphite coagulations, having a minimum surface at a given volume and a smooth profile, weaken the metal base of the cast iron to a much lesser degree than the precipitations of lamellar graphite. In contrast with the latter, the spheroidal coagulations have a lower stress-concentration effect, and therefore impart to the magnesium-alloy iron a high strength and a considerable plasticity, properties which are not at all peculiar to gray iron with lamellar graphite. Moreover, magnesium-alloy cast iron possesses a considerable impact toughness. Thus, given the same structure of the metal base, magnesium-alloy cast iron possesses better mechanical properties than gray iron with lamellar graphite; thus magnesium-alloy cast iron is used in machine building for parts working under high loads. Many parts with a chilled surface layer are also made of magnesium-alloy cast iron (see Chilled iron).

Magnesium-alloy cast iron is not inferior to cast carbon steel with regard to several mechanical properties, and retains at the same time the specific properties of cast iron with lamellar graphite: a high toughness under alternating loads, a good workability by cutting, a high wear-resistance, etc.

There exist nonadditionally alloyed magnesium-bearing cast irons with pearlitic, pearlite-ferritic, or ferritic structure; alloyed magnesium-bearing cast irons, including low-alloy irons with sorbitic or

III-16chl

acicular (bainitic) structure; medium-alloy magnesium-bearing cast irons with martensitic structure, and high-alloy magnesium-bearing cast irons with austenitic structure (see Corrosion-resistant cast iron).

TABLE 1

Chemical Composition of Nonadditionally Alloyed Magnesium-Bearing Cast Iron (GOST 7293-54)

| Чугун<br>1        | Толщина стержня отливки (мм)<br>2     | 3 Содержание элементов (%) |                               |                       |              |              |              |
|-------------------|---------------------------------------|----------------------------|-------------------------------|-----------------------|--------------|--------------|--------------|
|                   |                                       | С. не менее<br>4           | Si                            | Mn                    | 5 не более   |              |              |
| P                 | S                                     |                            |                               |                       | Cr           |              |              |
| ВЧ40-0<br>6       | до 30<br>30-50<br>50-100<br>свыше 100 | 3.0                        | 2.6-3.1                       | 0.3-0.8               | 0.2          | 0.03         | 0.2          |
|                   |                                       |                            | 2.0-2.5<br>1.5-2.0<br>1.3-1.8 |                       |              |              |              |
| ВЧ50-1.5          | до 10<br>10-30                        | 3.2                        | 2.8-3.2<br>2.6-3.0            | 0.3-0.8               | 0.12         | 0.02         | 0.15         |
| ВЧ60-2            | 30-50<br>50-100<br>свыше 100          | 3.2                        | 2.8-3.2                       | 0.3-0.8               | 0.12         | 0.02         | 0.10         |
|                   |                                       |                            | 1.8-1.8                       |                       |              |              |              |
|                   |                                       |                            | 2.9<br>1.0-1.6                |                       |              |              |              |
| ВЧ45-8<br>ВЧ40-10 | 7 =                                   | 3.2<br>3.2                 | 2.3-3.2                       | 8<br>до 0.8<br>до 0.8 | 0.10<br>0.08 | 0.02<br>0.01 | 0.10<br>0.08 |
|                   |                                       |                            | 2.3-3.0                       |                       |              |              |              |

\*The Mg content is equal to 0.04-0.08% in all magnesium-bearing cast iron grades.

- 1) Cast iron; 2) wall-thickness of the casting (mm); 3) percentage of elements; 4) not less than; 5) not more than; 6) VCh...; 7) more than; 8) up to.

Modifying by magnesium causes in almost all cast iron grades a spheroidal shape of the graphite coagulations, excepting cast iron which contains Ti, Pb, Sb, As, Sn, Al, and more than 2% Cu. Addition of cerium somewhat neutralizes the harmful effect of these impurities. A spheroidal graphite may be also obtained by the joint addition of calcium and chlorides of magnesium, calcium and cerium to the molten iron. In order to prevent chilling caused by magnesium, the cast iron is subsequently modified by magnesium or magnesium alloys and graphitizing additions, mainly high-silicon ferrosilicon.

The modulus of elasticity of the magnesium-alloy cast iron with a ferritic base is 13,000-17,000 kg/mm<sup>2</sup>; that of the iron with pearlitic base is equal to 14,000-18,000 kg/mm<sup>2</sup>; the toughness under alternating loads is, independently of the structure, equal to 5-8% at a



111-10cn2

load of  $1/3 \sigma_p$ .

Heat treatment of magnesium-alloy cast iron, in order to obtain castings with the required properties, is carried out under the following conditions: 1) low-temperature annealing at 550-650° to remove the casting stresses; 2) graphitizing tempering at 900-980° (first graphitizing stage) and at 700-760° (second graphitizing stage) for castings with an initial pearlite-cementitic structure in order to obtain a ferritic or a pearlite-ferritic base; 3) graphitizing tempering at 700-760° (ferritization) of castings with an initial pearlitic base to obtain a ferritic or pearlite-ferritic base; 4) graphitizing tempering at 900-980° with subsequent furnace cooling or, in the case of castings having a pearlite-cementitic structure, cooling in air in order to obtain a pearlitic base; 5) spheroidizing tempering at 720-740° with subsequent cooling in air of castings having an increased content of manganese and chromium (0.8-1.5 Mn and 0.15-0.25% Cr) in order to obtain a base with a grained pearlitic structure; 6) normalizing at 900-950° and annealing at 200-350° to increase the wear resistance, or annealing at 350-450° to improve generally the mechanical properties; 7) surface hardening (by firing or by high-frequency) with subsequent tempering at 150-200° to increase the wear resistance while at the same time maintaining the toughness of the core.

The alloying of magnesium-alloy cast iron is carried out with the following quantities: 1.5-2.5% Ni, 0.4-0.7% Cr without molybdenum or with 0.25-0.25% Mo to obtain a sorbitic base; 1.5-4.5% Ni, up to 0.5% Cr (depending on the wall-thickness of the casting) and 0.8-1.0% Mo to obtain a base with an acicular structure; 3.5-5.5% Ni, 0.8-2% Mn, and 0.5-1% Mo to obtain a martensitic base. Magnesium-alloy cast iron with a martensitic base is annealed at 650° or normalized at 850-900° and annealed at 200-600°, depending on the required hardness, before ma-

chining.

Nonadditionally alloyed magnesium-bearing cast iron in raw or in heat-treated state is used in the manufacture of a large number of parts, especially in automobile construction: coupling forks, gearcases, differential-gear housings, housings of the rear-axle; brake drums, brake shoes, segments, cylinders, crankshafts (after spheroidizing tempering), etc.; alloyed magnesium-bearing cast iron is used for parts working under high loads or exposed to wear. The properties of magnesium-alloy cast iron are quoted in the Tables 2-8.

TABLE 2  
Mechanical Properties of Magnesium-Alloy Cast Iron (GOST 7293-54)

| Марка<br>1                        | Структура<br>основы<br>2 | $\sigma_b$ / $\sigma_{0.2}$<br>(кг/мм <sup>2</sup> ),<br>не менее |                | $\delta$ (%) | $\sigma_{0.2}$<br>(мм/мм <sup>2</sup> ) | Состояние<br>3  |
|-----------------------------------|--------------------------|---|----------------|--------------|---|---|
|                                   |                          | $\sigma_b$  | $\sigma_{0.2}$ |              |   |   |
| 6 ВЧ 45-0<br>ВЧ 50-1.5<br>ВЧ 60-2 | Перлитная                | 45  | 38             | —            | —                                       | Литой<br>То же<br>Термиче-<br>ский обра-<br>ботанный<br>То же<br>11 |
|                                   | То же                    | 50  | 38             | 1.5          | 1.5                                     |   |
|                                   | То же                    | 60  | 42             | 2.0          | 1.5                                     |   |
| ВЧ 45-5<br>ВЧ 40-10               | Ферритная                | 45  | 35             | 5.0          | 2.0                                     | То же<br>То же  |
|                                   | То же                    | 40  | 35             | 4.0          | 3.0                                     |   |

1) Grade; 2) structure of the base; 3) (kg/mm<sup>2</sup>) not less than; 4) kgm/cm<sup>2</sup>; 5) state; 6) VCh...; 7) pearlitic; 8) the same; 9) ferritic; 10) cast; 11) heat-treated.

TABLE 3  
Relationship of the Effective Mechanical Properties of Magnesium-Alloy Cast Iron at Different Types of Load

| Марка<br>1 | $\frac{\sigma_{0.2}}{\sigma_b}$ | $\frac{\sigma_{уст}}{\sigma_b}$ | $\frac{\sigma_{-2}}{\sigma_b}$ | $\frac{\tau_b}{\sigma_b}$ | $\frac{\sigma_{-1}}{\sigma_b}$ | $\frac{\sigma_b}{HV}$ |
|------------|---------------------------------|---------------------------------|--------------------------------|---------------------------|--------------------------------|-----------------------|
|            | ВЧ45-0                          | 0.72                            | 1.5                            | 3.5                       | 1.1                            | 0.36                  |
| ВЧ50-1.5   | 0.72                            | 1.8                             | 3.2                            | 1.0                       | 0.33                           | 0.23                  |
| ВЧ60-2     | 0.72                            | 1.6                             | 2.8                            | 1.0                       | 0.35                           | 0.28                  |
| ВЧ45-5     | 0.80                            | —                               | —                              | 1.0                       | 0.27                           | 0.23                  |
| ВЧ40-10    | 0.84                            | —                               | —                              | —                         | —                              | 0.28                  |

1) Grade; 2) VCh... .

TABLE 4  
Fatigue Strength of Magnesium-Alloy Cast Iron

| Структура основы<br>1 | $\sigma_b$              | $\sigma_{-1}$ | $\sigma_{-2}$ | $\frac{\sigma_{-1}}{\sigma_b}$ | $\frac{\sigma_{-2}}{\sigma_b}$ | $\frac{\sigma_{-3}}{\sigma_{-1}}$ |
|-----------------------|-------------------------|---------------|---------------|--------------------------------|--------------------------------|-----------------------------------|
|                       | 2 (кг/мм <sup>2</sup> ) |               |               |                                |                                |                                   |
| Ферритная 3           | 42-44                   | 15-17         | -             | 0.36-0.38                      | -                              | -                                 |
| Перлитная 4           | 58-64                   | 23-25         | 18-20         | 0.41-0.58                      | 0.33-0.31                      | 0.8-0.79                          |

1) Structure of the base; 2) kg/mm<sup>2</sup>; 3) ferritic; 4) pearlitic.

TABLE 5  
Mechanical Properties of Magnesium-Alloy Cast Irons (British Standard BS 2789/1956)

| Структура осевым<br>1 | $\sigma_b$                        | $\sigma_{0.2}$ | $\delta$ (%) | $\sigma_{0.2}$ 3                   | 4                       |
|-----------------------|-----------------------------------|----------------|--------------|------------------------------------|-------------------------|
|                       | 2 (кг/мм <sup>2</sup> ), не менее |                |              | (кг/см <sup>2</sup> ) <sup>*</sup> | Состояние               |
| Перлитная 5           | 55                                | -              | 2            | -                                  | Литой 8                 |
| Ферритная 6           | 42.5                              | 28             | 12           | 0.65 9                             | Термически обработанный |
| То же 7               | 38                                | 27             | 17           | 1.5                                | То же 7                 |

\*On notched Charpy specimens.

1) Structure of the base; 2) (kg/mm<sup>2</sup>) not less than; 3) kgm/cm<sup>2</sup>\*; 4) state; 5) pearlitic; 6) ferritic; 7) the same; 8) cast; 9) heat-treated.

TABLE 6  
Mechanical Properties of Magnesium-Alloy Cast Iron (Standard of the German Federal Republic DIN 17006)

| Марка 1          | Структура осн-ым (термич. обработка)<br>2          | $\sigma_b$                        | $\sigma_{0.2}$ | $\delta$ (%) | $\sigma_{0.2}$ 4 | III (кг/мм <sup>2</sup> )<br>5 | $\sigma_{-1}$           | $\frac{\sigma_{-1}}{\sigma_{0.2}}$ 6 |
|------------------|--|-----------------------------------|----------------|--------------|------------------|--------------------------------|-------------------------|--------------------------------------|
|                  |  | 3 (кг/мм <sup>2</sup> ), не менее |                |              |                  |                                | 5 (кг/мм <sup>2</sup> ) |                                      |
| 666-38<br>666-42 | Ферритная 7<br>То же 8                             | 38<br>42                          | 25<br>28       | 20<br>15     | 10-20<br>8-16    | 140-170<br>150-190             | 24                      | 14.5                                 |
| 666-50<br>666-60 | Феррито-перлитная 9<br>Перлитно-ферритная 10<br>11 | 50<br>60                          | 35<br>42       | 12<br>7      | 7-14<br>5-10     | 170-210<br>200-250             | -                       | -                                    |
| 666-70<br>666-80 | Перлитная<br>То же                                 | 70<br>80                          | 48<br>55       | 4<br>2       | 4-8<br>3-6       | 220-270<br>240-300             | 34                      | 18                                   |
| 666-9L           | Игольчатая троостит 12                             | 90                                | 64             | 2            | 2-4              | 260-340                        | 36                      | 17.5                                 |
| 666-100V         | Закалка и отпуск 13                                | 100                               | 70             | 2            | 2-4              | 290-380                        | 39.5                    | -                                    |

1) Grade; 2) structure of the base (heat treatment); 3) (kg/mm<sup>2</sup>) not less than; 4) kgm/cm<sup>2</sup>; 5) kg/mm<sup>2</sup>; 6) notched; 7) ferritic; 8) the same; 9) ferrite-pearlitic; 10) pearlitic; 10) pearlite-ferritic; 11) pearlitic; 12) acicular trocstite; 13) hardening and tempering.

TABLE 7

## Physical Properties of Magnesium-Alloy Cast Iron

| Свойства 1                        | Размерность 2   | Показатели 3 |
|-----------------------------------|---|--------------|
| 5                                 | $\frac{\text{г}}{\text{см}^3}$ 4                                  | 7.1-7.4      |
| Линейная усадка<br>в 10° или 100° | $\frac{1}{\%}$ 5  | 1.1-1.4      |
| А                                 | $\frac{\text{кал}}{\text{см} \cdot \text{сек} \cdot \text{°C}}$ 8 | 10-12        |
| В                                 | $\frac{\text{микроhm} \cdot \text{см}}$ 9                         | 0.08-0.10    |
| С                                 | $\frac{\text{милл. га}}$ 10                                       | 50-65        |
| Минус 7                           |   | 600-1400     |

1) Properties; 2) dimension; 3) characteristics; 4)  $\text{g}/\text{cm}^3$ ; 5) linear shrinkage; 6) at; 7)  $\mu_{\text{maks}}$ ; 8)  $\text{cal}/\text{cm} \cdot \text{sec} \cdot \text{°C}$ ; 9)  $\text{microhm} \cdot \text{cm}$ ; 10) gauss/oersted.

TABLE 8

## Mechanical Properties of Alloyed Magnesium-Baring Cast Iron

| Структура 1  | $\sigma_b$                    | $\sigma_{0.2}$ | $\delta$ (%) | НН<br>( $\text{кг}/\text{мм}^2$ ) 2 |
|--|-------------------------------|----------------|--------------|-------------------------------------|
|  | 2 ( $\text{кг}/\text{мм}^2$ ) |                |              |                                     |
| Иглообразная<br>Мартенситная<br>(3% Ni)<br>0.5% Mn): 4 | 75-100                        | 55-75          | 1-3          | 280-330                             |
| отпуск 350°  | 136                           | -              | -            | 300                                 |
| отпуск 380° 5  | 100                           | -              | -            | 325                                 |

1) Structure; 2)  $\text{kg}/\text{mm}^2$ ; 3) acicular; 4) martensitic; 5) tempering at.

References: Girshovich, N.G., Sostav i svoystva chuguna [Composition and Properties of Cast Iron], in the book: Spravochnik po chugunному lit'yu [Handbook on Iron Casting], 2nd Edition, Moscow-Leningrad, 1960; the same, Termicheskaya obrabotka chugunnykh otlivok [Heat Treatment of Iron Castings], ibid.; Kudryavtsev, I.V. and Zhukov, A.A., Konstruktsionnaya prochnost' chuguna [Structural Strength of Cast Iron], in the book: Spravochnik po stroitel'nykh materialam [Handbook on Structural Materials], Vol. 3, Moscow, 1959; Muhlberger, H., "Giesserei" [Foundry], 1960, Vol. 47, No. 22, pages 614-622; Grilliat, J. and Poirot, R., "Fonderie," 1960, No. 178, pages 449-461.

A.A. Simkin

III-1600

Manu-  
script  
Page  
No.

[Transliterated Symbols]

2361 B4 = VCh = vysokoprochnyy chugun = high-strength cast iron

MAGNESIUM ALLOYS are alloys based on magnesium; they are divided into cast and wrought. Cast details are fabricated from the casting alloys; pressed and rolled mill products, forgings and stampings are produced from the wrought alloys. The cast and wrought magnesium alloys are suited for use at cryogenic, normal and elevated temperatures, the most refractory ones being usable to 350-400°. Tables 1 and 2 present the chemical compositions of the cast and wrought magnesium alloys. Table 3 lists the types and compositions of the magnesium alloys produced in pigs and intended for the production of structural castings and ingots. The magnesium alloys are alloyed with aluminum, zinc, manganese, zirconium, the rare-earth elements, thorium and other metals. A large group of alloys has been developed on the basis of the Mg - Al - Zn system with manganese additions. They include the widely used high-strength alloys: the casting alloy ML5 ( $\sigma_b = 23 - 26 \text{ kg/mm}^2$ ,  $\delta = 5 - 10\%$ ); the wrought alloys MA2-1 for sheet and plate ( $\sigma_b = 25 - 28 \text{ kg/mm}^2$ ,  $\delta = 8 - 16\%$ ), MA5 for pressed products ( $\sigma_b = 28 - 32 \text{ kg/mm}^2$ ,  $\delta = 4 - 12\%$ ).

The high strength alloys based on the system Mg - Zn - Zr of types ML12 and ML15 are intended for casting ( $\sigma_b = 22$  and  $21 \text{ kg/mm}^2$ ,  $\sigma_{0.2} = 12$  and  $13 \text{ kg/mm}^2$ ,  $\delta = 5$  and  $3\%$  respectively), while VM65-1 is intended for extruded mill products and stampings ( $\sigma_b = 30 - 32 \text{ kg/mm}^2$ ,  $\sigma_{0.2} = 20 - 28 \text{ kg/mm}^2$ ,  $\delta = 8 - 12\%$ ). Castings from the alloys with zirconium have more uniform mechanical properties than those from the alloys with aluminum, which are close to the properties of the individually cast specimens (alloys ML9, ML10, ML11, ML12, ML14, VML1, VML2, ML15). The rare-earth metals and thorium considerably increase the strength of the mag-

II-2M1

TABLE 1  
Chemical Composition of Cast Magnesium Alloys

| 1 Alloy   | 2 TECHN. SPECIFICATION | 3 Basic elements (%) |         |            |                   | 4 Impurities (%) |      |       |      |       |       |       |       |                   |                     |
|-----------|------------------------|----------------------|---------|------------|-------------------|------------------|------|-------|------|-------|-------|-------|-------|-------------------|---------------------|
|           |                        | Al                   | Zn      | Mn         | 5. OTHER ELEMENTS | Mg               | Al   | Cu    | Ni   | Sn    | Pb    | Fe    | Ca    | 6. OTHER ELEMENTS | 7. TOTAL IMPURITIES |
| 3M.12     | 9 OCT 2506-53          | —                    | —       | 1.0-2.0 Mn | —                 | ML               | 0.1  | 0.01  | 0.1  | 0.08  | 0.002 | 0.002 | 0.002 | 0.002             | 0.002               |
| M.11      | To spec 11             | 2.5-7.0              | 0.5-1.5 | 0.1-0.5 Mn | —                 | *                | 0.1  | 0.01  | 0.25 | 0.08  | 0.002 | 0.002 | 0.002 | 0.002             | 0.002               |
| 1) M.108  | AMTY 488-63            | 5.0-7.0              | 2.0-4.0 | 0.1-0.5 Mn | —                 | *                | 0.05 | 0.002 | 0.08 | 0.002 | 0.002 | 0.002 | 0.002 | 0.002             | 0.002               |
| M.109     | DMT 2506-53            | 2.5-7.0              | 0.2-0.4 | 0.1-0.5 Mn | —                 | *                | 0.1  | 0.01  | 0.25 | 0.08  | 0.002 | 0.002 | 0.002 | 0.002             | 0.002               |
| M.109*    | AMTY 488-63            | 2.5-7.0              | 0.2-0.4 | 0.1-0.5 Mn | —                 | *                | 0.05 | 0.002 | 0.08 | 0.002 | 0.002 | 0.002 | 0.002 | 0.002             | 0.002               |
| M.10      | DMT 2506-53            | 2.0-10.2             | 0.6-1.2 | 0.1-0.5 Mn | —                 | *                | 0.1  | 0.01  | 0.25 | 0.08  | 0.002 | 0.002 | 0.002 | 0.002             | 0.002               |
| M.17      | AMTY 488-63            | 5.0-6.5              | 0.4-0.7 | 0.1-0.5 Mn | —                 | *                | 0.1  | —     | 0.25 | 0.1   | —     | —     | —     | —                 | —                   |
| M.10      | AMTY 488-63            | —                    | —       | 0.2-0.5 Ca | 0.2-0.8           | *                | 0.1  | 0.01  | 0.01 | 0.01  | —     | —     | —     | 0.02 Al           | 0.002               |
| M.110     | AMTY 488-63            | —                    | —       | 1.0-1.8 Nd | 0.4-1.0           | *                | 0.01 | 0.01  | 0.01 | 0.01  | —     | —     | —     | 0.02 Al           | 0.002               |
| M.111     | AMTY 488-63            | —                    | —       | 1.0-2.0 Nd | 0.4-1.0           | *                | 0.01 | 0.01  | 0.01 | 0.01  | —     | —     | —     | 0.02 Al           | 0.002               |
| M.112     | AMTY 488-63            | —                    | —       | 0.2-0.7    | 0.4-1.0***        | *                | 0.01 | 0.01  | 0.01 | 0.01  | —     | —     | —     | 0.02 Al           | 0.002               |
| M.112     | AMTY 488-63            | —                    | —       | 4.0-5.0    | 0.5-1.1           | *                | 0.01 | 0.01  | 0.01 | 0.01  | —     | —     | —     | 0.02 Al           | 0.002               |
| M.114     | AMTY 488-63            | —                    | —       | 1.7-2.3    | 2.6-3.8 Th        | *                | 0.01 | 0.01  | 0.01 | 0.01  | —     | —     | —     | 0.02 Al           | 0.002               |
| 15) M.114 | AMTY 488-63            | —                    | —       | 2.0-2.8 Th | 0.2-0.4           | *                | 0.01 | 0.01  | 0.01 | 0.01  | —     | —     | —     | 0.02 Al           | 0.002               |
| M.115     | AMTY 488-63            | —                    | —       | 4.0-5.0    | 0.7-1.1 La        | *                | 0.01 | 0.01  | 0.01 | 0.01  | —     | —     | —     | 0.02 Al           | 0.002               |

\*pch - high purity. \*\*Rare-earth metals. \*\*\*Cerium-bearing mischmetal (Ce > 45%, balance other rare-earth elements).

1) Alloy; 2) GOST or specifications; 3) basic elements (%); 4) impurities, not more than (%); 5) other elements; 6) other impurities; 7) total impurities; 8) ML ; 9) GOST ; 10) balance; 11) same; 12) ML/pch\*; 13) AMTU ; 14) other; 15) VML1.

TABLE 2  
Chemical Composition of Wrought Magnesium Alloys

| 1 Alloy  | 2 TECHN. SPECIFICATION | 3 Basic elements (%) |         |         |                   | 4 Impurities (%) |      |      |        |       |     |       |       |       |                   |                     |
|----------|------------------------|----------------------|---------|---------|-------------------|------------------|------|------|--------|-------|-----|-------|-------|-------|-------------------|---------------------|
|          |                        | Al                   | Zn      | Mn      | 5. OTHER ELEMENTS | Mg               | Al   | Cu   | Zn     | Ni    | Sn  | Pb    | Fe    | Ca    | 6. OTHER ELEMENTS | 7. TOTAL IMPURITIES |
| M.11     | 7 AMTY 476-51          | —                    | —       | 1.7-2.5 | —                 | —                | 0.1  | 0.05 | 0.1    | 0.01  | 0.1 | 0.002 | 0.002 | 0.002 | 0.002             | 0.002               |
| M.12     | 8 To spec              | 3.0-5.0              | 0.2-0.8 | 0.1-0.5 | —                 | *                | —    | 0.05 | —      | 0.002 | 0.1 | 0.002 | 0.002 | 0.002 | 0.002             | 0.002               |
| M.13     | "                      | 4.8-8.0              | 0.5-1.5 | 0.1-0.5 | —                 | *                | —    | 0.05 | —      | 0.002 | 0.1 | 0.002 | 0.002 | 0.002 | 0.002             | 0.002               |
| M.14     | "                      | 5.5-7.0              | 0.5-1.0 | 0.1-0.5 | —                 | *                | —    | 0.05 | —      | 0.002 | 0.1 | 0.002 | 0.002 | 0.002 | 0.002             | 0.002               |
| M.15     | "                      | 7.8-9.2              | 0.2-0.8 | 0.1-0.5 | —                 | *                | —    | 0.05 | —      | 0.002 | 0.1 | 0.002 | 0.002 | 0.002 | 0.002             | 0.002               |
| 9) M.16  | "                      | —                    | —       | 1.5-2.5 | 0.15-0.35*        | *                | 0.1  | 0.05 | 0.1    | 0.01  | 0.1 | 0.002 | 0.002 | 0.002 | 0.002             | 0.002               |
| M.17     | "                      | —                    | 5.0-6.0 | —       | 0.3-0.9 Zr        | *                | 0.01 | 0.05 | 0.1 Mn | 0.002 | 0.1 | 0.002 | 0.002 | 0.002 | 0.002             | 0.002               |
| M.18     | "                      | 0.4-0.8              | —       | 1.0-1.8 | 0.08-0.3 Ca       | *                | —    | 0.05 | 0.1    | 0.01  | 0.1 | 0.002 | 0.002 | 0.002 | 0.002             | 0.002               |
| M.19     | "                      | 7.8-9.8              | —       | 0.2-0.6 | 7.0-8.0 Cd        | *                | —    | 0.01 | 0.1    | 0.005 | 0.1 | 0.002 | 0.002 | 0.002 | 0.002             | 0.002               |
| M.11     | "                      | —                    | —       | 1.5-2.5 | 2.0-2.5 Ag        | *                | 0.2  | 0.03 | 0.2    | —     | 0.1 | 0.002 | 0.002 | 0.002 | 0.002             | 0.002               |
| M.11     | "                      | —                    | —       | 1.5-2.5 | 0.1-0.25 Nd       | *                | 0.2  | 0.03 | 0.2    | —     | 0.1 | 0.002 | 0.002 | 0.002 | 0.002             | 0.002               |
| 10) M.11 | "                      | —                    | —       | 0.4-0.8 | 1.7-2.5 Th        | *                | 0.2  | 0.05 | 0.2    | 0.005 | 0.1 | 0.002 | 0.002 | 0.002 | 0.002             | 0.002               |
| M.11     | "                      | —                    | —       | 1.2-2.0 | 2.5-3.5 Th        | *                | 0.2  | 0.05 | 0.2    | 0.005 | 0.1 | 0.002 | 0.002 | 0.002 | 0.002             | 0.002               |
| 11) M.17 | "                      | —                    | —       | 1.5-2.2 | 2.5-3.5*          | *                | 0.2  | 0.05 | 0.1    | 0.005 | 0.1 | 0.002 | 0.002 | 0.002 | 0.002             | 0.002               |

\*Cerium-bearing mischmetal.

1) Alloy; 2) specification; 3) basic elements (%); 4) impurities, not more than (%); 5) other elements; 6) other impurities; 7) AMTU ; 8) same; 9) VM65-1; 10) VMD1; 11) VML7.

II-2M2

TABLE 3

Chemical Composition of Magnesium Alloys in Pigs

| 1 Класс | 2 ГОСТ или<br>технич. усл. | 3 Основные элементы (%) |         |         |    | 4 Примеси, не более (%) |       |       |                   |                   | 6 |
|---------|----------------------------|-------------------------|---------|---------|----|-------------------------|-------|-------|-------------------|-------------------|---|
|         |                            | Al                      | Zn      | Mn      | Mg | Ni                      | Fe    | Cu    | Сумма<br>примесей | Сумма<br>примесей |   |
| 7 МГС1  | 8 ГОСТ<br>251-55           | -                       | -       | 1.8-2.5 | 4  | 0.005                   | 0.05  | 0.04  | 0.07 Si           | 0.2               |   |
| МГС2    | 10 То же                   | 3-4                     | 0.3-0.7 | 0.2-0.5 | •  | 0.005                   | 0.04  | 0.07  | 0.1 Si            | 0.19              |   |
| МГС3    | •                          | 7.5-8.7                 | 0.3-0.7 | 0.2-0.5 | •  | 0.005                   | 0.04  | 0.07  | 0.1 Si            | 0.20              |   |
| МГС5    | •                          | •                       | •       | •       | •  | •                       | •     | •     | •                 | •                 |   |
| 11 МЧ*  | 12 ГОСТ<br>47-50           | 7.5-8.7                 | 0.3-0.7 | 0.2-0.5 | •  | 0.0004                  | 0.005 | 0.015 | 0.04 Si           | 0.1               |   |

\*pch - high purity

1) Alloy; 2) GOST or specification; 3) basic elements (%); 4) impurities, not more than (%); 5) other impurities; 6) total impurities; 7) MGS ; 8) GOST ; 9) balance; 10) same; 11) pch\*; 12) TU

nesium alloys at elevated temperatures. The casting magnesium alloys with neodymium at room temperature have mechanical properties at the level of the high strength magnesium alloys. Alloys with additions of a mixture of the rare-earth elements (ML11 for casting, VM17 for wrought mill products) and of neodymium (ML9, ML10 for casting and MA11 for the wrought mill products) are suitable for long time ( $\geq 100$ -hour) operation with temperatures to  $250^{\circ}$  and short time operation ( $\geq 5$  hours) to  $350^{\circ}$ .

Magnesium alloys with high strength at thigh temperature have been developed on the basis of the Mg-Th system - casting ML14, VML1 and wrought MA13 (for sheet, pressed and stamped mill products) and VMD1 (pressed products, stampings) which can be used for long times at  $300 - 370^{\circ}$  and for short times at  $400 - 450^{\circ}$ .

Among themore harmful impurities which enter the magnesium alloys from the charge and in the smelting process are nickel, iron, silicon and copper, which reduce the corrosion resistance. In exceptional cases, in the presence of neodymium and mangarèse a small addition of nickel (to 0.25%) is made to increase the high-temperature strength (alloy MA11).



## II-2M3

The aluminum impurity content is also limited in the magnesium alloys with zirconium since zirconium does not dissolve in liquid magnesium in the presence of small quantities of this element, forming with it a high-melting compound which is insoluble in magnesium. The solubility of zirconium in magnesium is also reduced by the presence of iron, silicon, manganese and hydrogen. In the alloys based on the Mg-Th system the content of the impurities of the rare-earth elements is limited since they reduce the creep resistance.

Beryllium and calcium are usually present in magnesium in very slight quantities (Be < 0,0001%, Ca ~ 0,0015%). As alloying elements, calcium (to 0.5%) is introduced into certain alloys (ML7-1, MA9) to increase the high-temperature strength, and beryllium is introduced (to 0.05%) into the alloys used for casing for nuclear fuel in order to improve the oxidation resistance. They are also used as process additives to reduce the oxidation of the alloys in the molten condition, in this case the content is limited. Beryllium coarsens the grain and can therefore cause reduction of the mechanical and technological properties with a content of more than 0.002% in the casting alloys and more than 0.02% in the wrought alloys. Up to 0.1% Ca is sometimes introduced into the type ML5 alloys to reduce the microporosity, since Ca increases the solubility of hydrogen in solid magnesium.

The magnesium alloys are the lightest structural metallic material. Depending on the composition, their specific weight is in the range of 1.76-2.0 g/cm<sup>3</sup>, approximately 4 times less than steel and 1.5 times less than aluminum and its alloys. The use of the magnesium alloys permits weight reduction and a considerable increase of the stiffness of structures. The relative stiffness in bending of I-beams of equal weight and the same width for steel is equal to 1, for aluminum 8.9, and for magnesium 18.9. In specific strength at room temperature, the casting

II-2M4

magnesium alloys exceed the aluminum casting alloys, the high strength irons and certain grades of steels. The comparative properties of magnesium alloys, aluminum alloys, steels and iron are presented in tables 4-10.

With regard to specific static strength, the magnesium alloys are somewhat inferior to the aluminum alloys. For example, rods extruded from the MA2 alloy and the D16AT aluminum alloy have specific static strengths under identical test conditions of 0.67 and 0.78 respectively. With respect to sensitivity to concentrated stresses in static tensile test of smooth and notched specimens, the magnesium alloys hardly differ from the aluminum alloys. For both, the notch effect coefficient ( $\sigma_b^n/\sigma_b$ ) is in the range of 0.92-1.2. With respect to sensitivity to concentration of vibratory stresses, the magnesium alloys have considerable advantage over the aluminum alloys. For the same test conditions the notch effect factor for the magnesium alloys ( $\sigma_{-1}^n/\sigma_{-1}$ ) is from 0.67 to 0.83, while for the aluminum alloys it is from 0.54 to 0.59.

TABLE 4  
Comparative Mechanical Properties of Magnesium Alloys with Steel, Iron and Aluminum Alloys

| 1                       | Сплав       | 2 Марка сплава | 3 ГОСТ или ТУ   | 4 Вид полу-фабриката  | 5 Состояние материала              | 6 $\sigma_b$ (кг/мм <sup>2</sup> ) | 7 $\gamma$ (г/см <sup>3</sup> ) | 8 Уд. прочность |
|-------------------------|-------------|----------------|-----------------|-----------------------|------------------------------------|------------------------------------|---------------------------------|-----------------|
| Литейные сплавы 40      |             |                |                 |                       |                                    |                                    |                                 |                 |
| 9                       | Чугун       | 10 МН          | 11 АМУ          | 12 Литье в землю      | 13 Отожжен. после литья            | 50                                 | 7.25                            | 6.9             |
| 14                      | Сталь       | 15 35ХГСЛ      | 16 ГОСТ 294-58  | 17 То же              | 18 Термич. обработан               | 80                                 | 7.8                             | 10.2            |
| 19                      | Алюминиевые | 20 АЛ4         | 16 ГОСТ 7832-55 | "                     | 18 Термич. обработан (Т6)          | 23                                 | 2.8                             | 8.2             |
| 21                      | Магнелиевые | 20А.Т19        | 16 ГОСТ 2685-53 | "                     | 17 То же (Т6)                      | 34                                 | 2.8                             | 12.2            |
|                         |             | 22 М.15        | 16 ГОСТ 2856-62 | "                     | 18 Термич. обработан (Т6)          | 23                                 | 1.8                             | 12.8            |
| Деформируемые сплавы 41 |             |                |                 |                       |                                    |                                    |                                 |                 |
| 23                      | Сталь       | 10             | 16 ГОСТ 914-56  | 24 Листы              | 25 Нормализованные                 | 38                                 | 7.8                             | 4.9             |
|                         |             | 26 30ХМА       | 16 ГОСТ 4543-48 | 27 Прутки             | 25 Термич. обработанные            | 95                                 | 7.8                             | 12.2            |
| 28                      | Алюминиевые | 29 Д16         | 16 ГОСТ 4977-52 | 30 Листы (плакировка) | 31 Закален. и естествен. состарен. | 43.5                               | 2.8                             | 15.5            |
|                         |             | 32 В95         | 16 ГОСТ 4783-49 | 33 Прутки (прессов.)  | 31 Закален. и искусств. состарен.  | 54                                 | 2.8                             | 19.3            |
| 35                      | Магнелиевые | МА2-1          | 36 СТУ          | 24 Листы              | 37 Отожжен. Искусств. состарен.    | 27                                 | 1.8                             | 15              |
|                         |             | ВМ65-1         | 36 АМУ          | 27 Прутки             | 37 Отожжен. Искусств. состарен.    | 22                                 | 1.8                             | 17.8            |

1) Alloy; 2) alloy type; 3) GOST or TU; 4) form of mill product; 5) material condition; 6) (kg/mm<sup>2</sup>); 7) (g/cm<sup>3</sup>); 8) specific strength; 9) iron; 10) MN; 11) АМУ; 12) cast in earth; 13) annealed after castings;

II-2M5

14) steel; 15) 35KhGSL; 16) GOST; 17) same; 18) heat treatment; 19) aluminum; 20) AL ; 21) magnesium; 22) ML ; 23) steel; 24) sheet; 25) normalized; 26) ZOKhMA; 27) rods; 28) aluminum; 29) D ; 30) sheet (clad); 31) quenched and naturally aged; 32) V ; 33) rods (extruded); 34) quenched and artificially aged; 35) magnesium; 36) STU; 37) annealed; 38) VM ; 39) artificially aged; 40) cast alloys; 41) wrought alloys

TABLE 5

Comparative Specific Strength ( $\frac{\sigma_b}{\gamma}$ ) of High Strength Magnesium and Aluminum Alloys at Elevated Temperatures

| Сплав<br>1              | Марка сплава<br>2 | 200°                                  |                   | 250°                                  |                   | 300°                                  |                   | 350°                                  |                   | 400°                                  |                   |
|-------------------------|-------------------|---------------------------------------|-------------------|---------------------------------------|-------------------|---------------------------------------|-------------------|---------------------------------------|-------------------|---------------------------------------|-------------------|
|                         |                   | 3 $\sigma_b$<br>(кг/мм <sup>2</sup> ) | $\sigma_b/\gamma$ | 3 $\sigma_b$<br>(кг/мм <sup>2</sup> ) | $\sigma_b/\gamma$ | 3 $\sigma_b$<br>(кг/мм <sup>2</sup> ) | $\sigma_b/\gamma$ | 3 $\sigma_b$<br>(кг/мм <sup>2</sup> ) | $\sigma_b/\gamma$ | 3 $\sigma_b$<br>(кг/мм <sup>2</sup> ) | $\sigma_b/\gamma$ |
| 4 Литейные сплавы       |                   |                                       |                   |                                       |                   |                                       |                   |                                       |                   |                                       |                   |
| 6 Магнелиевые           | 8 ВМ.71           | —                                     | —                 | —                                     | —                 | 13.5                                  | 7.4               | 10.5                                  | 5.8               | 6.5                                   | 3.5               |
|                         | 8 ВМ.72           | —                                     | —                 | 16                                    | 9                 | 14                                    | 7.8               | 9                                     | 5                 | —                                     | —                 |
| 7 Алюминиевые           | 9 АЛ19            | 26                                    | 14.4              | 17                                    | 6.1               | 12                                    | 4.2               | 8                                     | 2.9               | —                                     | —                 |
|                         | 9 ВАЛ1            | —                                     | —                 | 20                                    | 7.1               | 15                                    | 5.3               | 10                                    | 3.5               | —                                     | —                 |
| 10 Деформируемые сплавы |                   |                                       |                   |                                       |                   |                                       |                   |                                       |                   |                                       |                   |
| 6 Магнелиевые           | 11 ВМД1           | 17                                    | 9.4               | 15                                    | 8.3               | 13                                    | 7.2               | 11                                    | 6.1               | 7                                     | 3.9               |
|                         | 11 МА11           | 21                                    | 11.6              | 18                                    | 10                | 14                                    | 7.8               | 10                                    | 5.5               | —                                     | —                 |
| 7 Алюминиевые           | 12 Д20            | 28                                    | 10                | 23                                    | 8.2               | 17                                    | 6.1               | 11                                    | 3.9               | 5                                     | 1.9               |

1) Alloy; 2) alloy type; 3) (kg/mm<sup>2</sup>); 4) cast alloys; 5) magnesium; 6) VML ; 7) aluminum; 8) AL ; 9) VAL ; 10) wrought alloys; 11) VMD ; 12) D

TABLE 6

Comparative Specific Long-Time Strength and Creep (in 100 hours) of High Temperature Magnesium and Aluminum Alloys

| Сплав<br>1                             | Марка сплава<br>2 | 250°                                      |                       | 300°                                      |                       | 350°                                      |                       | 250°  |                           | 300°  |                           | 350°  |                           |
|--|-------------------|---|-----------------------|---|-----------------------|---|-----------------------|---|---------------------------|---|---------------------------|---|---------------------------|
|  |                   | 3 $\sigma_{100}$<br>(кг/мм <sup>2</sup> ) | $\sigma_{100}/\gamma$ | 3 $\sigma_{100}$<br>(кг/мм <sup>2</sup> ) | $\sigma_{100}/\gamma$ | 3 $\sigma_{100}$<br>(кг/мм <sup>2</sup> ) | $\sigma_{100}/\gamma$ | 3 $\sigma_{0.2/100}$<br>(кг/мм <sup>2</sup> ) | $\sigma_{0.2/100}/\gamma$ | 3 $\sigma_{0.2/100}$<br>(кг/мм <sup>2</sup> ) | $\sigma_{0.2/100}/\gamma$ | 3 $\sigma_{0.2/100}$<br>(кг/мм <sup>2</sup> ) | $\sigma_{0.2/100}/\gamma$ |
| 4 Длительная прочность Литейные сплавы |                   |   |                       |   |                       |   |                       |   |                           |   |                           |   |                           |
| 6 Магнелиевые                          | 7 М.714           | —   | —                     | 6.5                                       | 3.6                   | 2.8                                       | 1.5                   | —   | —                         | 3.7   | 2.0                       | 1.8   | 1.0                       |
| 8 Алюминиевые                          | 9 АЛ19            | —   | —                     | 7.0                                       | 2.5                   | 3.5                                       | 1.2                   | —   | —                         | 0.0   | 2.0                       | —   | —                         |
|  | 10 ВАЛ1           | —   | —                     | 9.0                                       | 3.2                   | 4.5                                       | 1.6                   | —   | —                         | —   | —                         | —   | —                         |
| 11 Деформируемые сплавы                |                   |   |                       |   |                       |   |                       |   |                           |   |                           |   |                           |
| 6 Магнелиевые                          | 12 ВМД1           | 11  | 6.1                   | 9   | 5                     | 5   | 2.8                   | 8   | 4.4                       | 0   | 3.3                       | 2.5   | 1.4                       |
| 8 Алюминиевые                          | 13 Д20            | 12.5                                      | 5                     | 8   | 2.9                   | 4   | 1.4                   | 7   | 2.5                       | 0.5   | 2.3                       | 2.5   | 0.9                       |
| 11 Деформируемые сплавы                |                   |   |                       |   |                       |   |                       |   |                           |   |                           |   |                           |

1) Alloy; 2) alloy type; 3) (kg/mm<sup>2</sup>); 4) long time strength; casting alloys; 5) creep; casting alloys; 6) magnesium; 7) ML ; 8) aluminum; 9) AL ; 10) VAL ; 11) wrought alloys; 12) VMD ; 13) D

TABLE 7

Comparative Specific Fatigue Strength (Endurance) of the Magnesium and Aluminum Alloys at Room Temperature (bending test of rotating specimen with number of cycles  $N = 2-5 \cdot 10^7$ )

| 1 Сплав  | 2 Марка сплава | 3 $\sigma_{-1}$ (кг/мм <sup>2</sup> ) | 4 $\gamma$ (г/см <sup>3</sup> ) | 5 $\sigma_{-1} \gamma$ |
|--|----------------|---------------------------------------|---------------------------------|------------------------|
| 7 Литые сплавы                                   |                |                                       |                                 |                        |
| 6 Магнелиевые                                    | M.L15          | 10                                    | 0.45                            | 1.81                   |
|  | M.L12          | 7.5                                   | 0.34                            | 1.81                   |
|  | M.L15          | 9                                     | 0.42                            | 1.83                   |
| 8 Алюминиевые                                    | А.П19          | 7                                     | 0.20                            | 2.8                    |
| 9 Деформируемые сплавы (прессовые полуфабрикаты) |                |                                       |                                 |                        |
| 10 Сплавы (прессовые полуфабрикаты)              |                |                                       |                                 |                        |
| 8 Алюминиевые                                    | Д1             | 12.5                                  | 0.3                             | 2.8                    |
|  | Д14Т           | 14.0                                  | 0.27                            | 2.8                    |
|  | В95            | 15.5                                  | 0.26                            | 2.8                    |
| 6 Магнелиевые                                    | МА2            | 10                                    | 0.35                            | 1.8                    |
|  | МА2-1          | 10.5                                  | 0.40                            | 1.8                    |
|  | ВМ65-1         | 15                                    | 0.47                            | 1.8                    |

1) Alloy; 2) alloy type; 3) (kg/mm<sup>2</sup>); 4) (g/cm<sup>3</sup>); 5) cast alloys; 6) magnesium; 7) ML ; 8) aluminum; 9) AL ; 10) wrought alloys (extruded semimanufactures); 11) D ; 12) V ; 13) VM

TABLE 8

Modulus of Elasticity of Magnesium Alloys in Comparison with Aluminum Alloys and Steel

| 1 Сплав       | 2 E (кг/мм <sup>2</sup> ) | 3 $\gamma$ (г/см <sup>3</sup> ) | 4 E $\gamma$ |
|---------------|---------------------------|---------------------------------|--------------|
| 4 Магнелиевые | 4200-4500                 | 1.8                             | 2.3-2.17     |
| 5 Алюминиевые | 7000-7200                 | 2.8                             | 2.5-2.57     |
| 6 Сталь       | 20 000-22 000             | 7.8                             | 2.7-2.8      |

1) Alloy; 2) (kg/mm<sup>2</sup>); 3) (g/cm<sup>3</sup>); 4) magnesium; 5) aluminum; 6) steel

TABLE 9

Relationships of Yield and Ultimate Strengths of Magnesium and Aluminum Alloys at Room Temperature

| 1 Сплав                | 2 Марка сплава и состояние | 3 $\sigma_{0.2}$ $\sigma_b$ (кг/мм <sup>2</sup> ) |            | 4 $\sigma_{0.2} \sigma_b$ |
|------------------------|----------------------------|---|------------|---------------------------|
|                        |                            | $\sigma_{0.2}$                                    | $\sigma_b$ |                           |
| 4 Литые сплавы         |                            |   |            |                           |
| 5 Магнелиевые          | М.Л15-Т4                   | 9   | 23         | 0.39                      |
|                        | М.Л12-Т1                   | 12  | 22         | 0.54                      |
|                        | М.Л15-Т1                   | 13  | 21         | 0.62                      |
| 7 Алюминиевые          | А.Л14                      | 18  | 24         | 0.75                      |
|                        | А.Л19-Т5                   | 22  | 34         | 0.65                      |
| 9 Деформируемые сплавы |                            |   |            |                           |
| 5 Магнелиевые          | МА2-1                      | 15  | 26         | 0.57                      |
|                        | ВМ65-1                     | 20  | 33.5       | 0.83                      |
| 7 Алюминиевые          | Д14Т                       | 28  | 43.5       | 0.64                      |
|                        | В95Т                       | 38  | 50         | 0.78                      |

1) Alloy; 2) alloy type and conditon; 3) (kg/mm<sup>2</sup>); 4) cast alloys; 5) magnesium; 6) ML ; 7) aluminum; 8) AL ; 9) wrought alloys; 10) VM ; 11) D ; 12) V

TABLE 10

Relationships of Yield and Ultimate Strengths of Magnesium and Aluminum Alloys at Elevated Temperatures

| 1 Сплав                 | 2 Марка | 3 Температура испытаний (°C) |            |                         |            |                |            |                         |            |                |  |
|-------------------------|---------|------------------------------|------------|-------------------------|------------|----------------|------------|-------------------------|------------|----------------|--|
|                         |         | 250                          |            |                         | 300        |                |            | 350                     |            |                |  |
|                         |         | $\sigma_{0.2}$               | $\sigma_b$ | $\sigma_{0.2}$          | $\sigma_b$ | $\sigma_{0.2}$ | $\sigma_b$ | $\sigma_{0.2}$          | $\sigma_b$ | $\sigma_{0.2}$ |  |
| 4 (кг/мм <sup>2</sup> ) |         | 5                            |            | 4 (кг/мм <sup>2</sup> ) |            | 5              |            | 4 (кг/мм <sup>2</sup> ) |            | 5              |  |
| 5 Литейные сплавы       |         |                              |            |                         |            |                |            |                         |            |                |  |
| 6 Магнийевые            | 7 МЛ10  | 10                           | 12.5       | 0.8                     | 8.5        | 10             | 0.85       | 4.5                     | 8          | 0.56           |  |
|                         | 8 ВМЛ12 | 10                           | 16         | 0.6                     | 9          | 14             | 0.64       | 6.5                     | 9          | 0.7            |  |
| 9 Алюминиевые           | 10 АЛ19 | 11                           | 17         | 0.6                     | 7.5        | 12             | 0.6        | 5                       | 8          | 0.6            |  |
|                         | 11 ВАЛ1 | 15                           | 20         | 0.75                    | 10         | 15             | 0.67       | 7                       | 10         | 0.7            |  |
| 12 Деформируемые сплавы |         |                              |            |                         |            |                |            |                         |            |                |  |
| 6 Магнийевые            | 13 МЛ1  | 9                            | 18         | 0.5                     | 8          | 14             | 0.57       | 5.5                     | 10         | 0.55           |  |
|                         | 13 ВМЛ1 | 13                           | 15         | 0.86                    | 10.5       | 13             | 0.81       | 9                       | 11         | 0.82           |  |
| 9 Алюминиевые           | 14 АЛ20 | 16                           | 24         | 0.66                    | 12.5       | 18             | 0.69       | 8.5                     | 12         | 0.71           |  |
|                         | 14 ВАЛ4 | 25                           | 28         | 0.89                    | 14.5       | 16.5           | 0.88       | 5                       | 7.5        | 0.66           |  |

1) Alloy; 2) type; 3) test temperature (°C); 4) (kg/mm<sup>2</sup>); 5) cast alloys; 6) magnesium; 7) ML ; 8) VML ; 9) aluminum; 10) AL ; 11) VAL ; 12) wrought alloys; 13) VMD ; 14) D

The magnesium alloys have good damping capability. A favorable property of the magnesium alloys is the high specific thermal capacity. The surface temperature of a detail made from the magnesium alloys, for the same quantity of absorbed heat, will be half that of the surface temperature of a detail made from low-carbon steel and 15-20% lower than that of a detail made from aluminum alloy.

The magnesium alloys machine easily, twice as fast as aluminum and ten times faster than the carbon steels. However, in working with the magnesium alloys it is necessary to observe the rules for fire prevention safety. A drawback of the magnesium alloys is the lower corrosion resistance in comparison with the aluminum alloys (see Corrosion of Magnesium Alloys). With suitable chemical and paint protection, the structures made from the magnesium alloys can operate reliably under atmospheric conditions, in alkaline media, mineral oils, kerosene and gasoline (see Anodizing of Magnesium Alloys, Oxidizing of Magnesium Alloys, Paint/Lacquer Coatings for the Magnesium Alloys). The magnesium alloys

are not acceptable for operation in direct contact with sea water, in salt solutions, in acids and acidic vapors. Contact corrosion is possible with combinations of details made from magnesium alloys with details made from other metals and alloys, therefore, it is necessary to make use of the recommended methods for prevention of contact. Among the deficiencies of the magnesium alloys we must also include the high coefficient of expansion, which is higher by 10-15% than for the aluminum alloys. Characteristic of the wrought mill products made from the magnesium alloys is some anisotropy of the mechanical properties which must be taken into account in design (see Wrought Magnesium Alloys).

As a result of the great affinity for oxygen and nitrogen, in the melting of magnesium and its alloys in an air atmosphere the surface of the molten metal is protected by a layer of flux. As fluxes, use is made of various mixtures of the fluoride and chloride salts of the alkaline and alkaline-earth metals. In order to avoid combustion of the metal during casting, protective additives are introduced into the composition of the molding loam (see Cast Magnesium Alloys).

During pressure working, account is taken of the large variation of the plasticity of the magnesium alloys with temperature. At room temperature magnesium and its alloys have low plasticity, which is explained by the hexagonal structure of the crystal lattice in which slippage takes place only along one base plane. At temperatures above 200-225° slippage is also possible along other planes (planes of the pyramid of first kind of first order), which is accompanied by a sharp increase of the metal plasticity. Therefore, all forms of pressure working of the magnesium alloys, including rolling of sheet and sheet stamping, is performed in the hot condition.

For joining details use is made of various forms of welding, as well as riveting, brazing and soldering, bonding. Welding is also used

II-2M9

to correct defects of cast details. Welding of the magnesium alloys is associated with certain difficulties as a result of the high affinity for oxygen, the formation of oxides, slags, and the tendency to hot shortness. The high coefficient of linear expansion and high thermal capacity lead to the warping of welded structures. For these reasons gas welding is possible only for certain low-alloy alloys (MA1). Arc welding in a medium of inert gases can be widely used for the magnesium alloys. Only the alloys with high zinc content (VM65-1, ML12) are not amenable to welding. The remaining alloys are welded satisfactorily with both argon-arc and spot and resistance welding.

In view of the release of dangerous gases (fluorine, chlorine, sulfur dioxide), the melting and casting of the magnesium alloys is performed with local ventilation of the working areas and general ventilation of the smelting shop. In working with the magnesium-thorium alloys, in addition to the general rules for industrial safety, special rules are observed as a result of the presence of radioactive thorium in the alloys. Mold and blank casting is performed in separate specially equipped areas. All the operations of working the magnesium-thorium alloys which are associated with the formation of dust, aerosols and gaseous products are performed either in individual areas or on equipment having special covering and local exhaust ventilation.

The magnesium alloys are widely used in the automobile and tractor industries, in the production of engine crankcases, oil sumps, transmission cases, wheel discs and other details; they are used in electrical engineering and radio engineering for instrument cases, television chassis, details of electric motors; they are used in the optical industry for binocular cases, camera cases; in the textile industry for the production of bobbins, spools, coils, etc.; in the polygraphic industry for matrices, engraving plates, rollers and other details; in ship con-

II-2M10

struction (for protectors), in aviation and rocket design, and in many other areas of the national economy.

Reference: see articles Wrought Magnesium Alloys, Cast Magnesium Alloys.

N.M. Tikhova, A.A. Kazahov



MAGNESIUM BARS - semifinished products with simple cross-sectional shapes (round, square, hexagonal) produced by hot pressing. Bars pressed from MA1, MA2, MA3, MA5 and MA8 alloys conform to AMTU227-49, those pressed from VM65-1 alloy conform to AMTU288-50, and those pressed from other alloys are produced in accordance with special TU. Bars of MA3 alloy are supplied in the annealed state, those of MA5 alloy are supplied in the quenched state, those of VM65-1 alloy are artificially aged, those of MA10 and MA11 alloys are quenched and artificially aged, and those of other alloys are hot-pressed without heat treatment. The variety of magnesium bars and their tolerances with respect to diameter, length, curvature, and degree of ovalness are set by GOST 7857-55, as are those for aluminum-alloy bars. Magnesium bars are produced in diameters of 5-300 mm. The permissible deviations in diameter are set by the 7th and 8th precision classes for bars 5-10 mm in diameter by the 7th, 8th, and 9th precision classes for bars 10.5-80 mm in diameter, by the 8th and 9th precision classes for bars 85-120 mm in diameter, and by the 9th precision class for bars 130-300 mm in diameter. Such bars are fabricated in: a) measured and short lengths as ordered, with a permissible deviation of +10 mm; b) nonstandard lengths: 1-6 m for bars 5-100 mm in diameter, 1-5 m for bars 10-50 mm in diameter, 0.5-4 m for bars 50-150 mm in diameter, and 0.5-3 m for bars more than 150 mm in diameter. The permissible local curvature per running meter of length is 3 mm for bars up to 100 mm in diameter and 6 mm for bars more than 100 mm in diameter. Bars are supplied with oxidized surfaces, being preserved and packed as indicated in ANTU 227-49.

111-1201

References: See article entitled Magnesium shaping alloys.

A.A. Kazakov

III-3P

MAGNESIUM FORGINGS - see Magnesium Stampings and Forgings.

MAGNESIUM PANELS - semifinished products in the form of thin-walled plates and strips with stiffening ribs; they are intended for monolithic structural elements. Magnesium panels can be fabricated by the following methods: milling of pressed strips or rolled plates, stamping from plates or strips in powerful vertical hydraulic presses, pressing from ingots in horizontal hydraulic presses, and rolling between plates with grooves for formation of the stiffening elements.

Pressed strips of MA1, MA2, MA2-1, MA8, and VM65-1 alloys are supplied with cross-sectional areas of up to  $130 \text{ cm}^2$ , in accordance with AMTU478-61. The tolerances for strip thickness and width are taken as twice those given by AMTU-258, being equivalent to those for shapes of normal precision. Strips of large cross-section or of other types of alloys are supplied in accordance with special TU. Strips of VM65-1 alloy are delivered in the artificially aged state, while those of other types of alloys are hot-pressed without heat treatment. Rolled plates of MA8 and MA2-1 alloys for plates are produced in accordance with AMTU474-61. Such plates are supplied in thicknesses of from 12 to 20 mm with a tolerance of  $\pm 0,5 \text{ mm}$ , in thicknesses of 22 and 25 mm with a tolerance of  $\pm 0.75 \text{ mm}$ , and in thicknesses of 27 and 30 mm with a tolerance of  $\pm 1 \text{ mm}$ . The standard plate widths are 500, 600, 800, and 1000 mm. Depending on their thickness and width, plates are supplied in lengths of 2000, 2500, and 3000 mm; the tolerance for plate width is  $\pm 15 \text{ mm}$ , while that for plate length is  $\pm 30 \text{ mm}$ . Plates are delivered in the hot-rolled state, without heat treatment. Plates of other sizes and of other types of alloys are produced in accordance with special TU. Strips and plates

II-17P-2

are subjected to surface oxidation, preserved, and packed in accordance with AMTU478-61 and AMTU474-61. Pressed and stamped panels are manufactured in accordance with special TU and specifications agreed to by the producing plant.

References: See the article entitled Magnesium shaping alloys.

A.A. Kazakov

MAGNESIUM PIPES - are made from the MA8 and MA2-1 alloys (AMTU 299-61) by hot extrusion with subsequent sizing. The pipe dimensions on the basis of the outside diameter are 16-38 mm (all even dimensions), as well as 25 and 35 mm. The permissible deviation for the outside diameter comprise:  $\pm 0.2$  mm for pipes 16-28 mm in diameter and  $\pm 0.25$  mm for pipes 30-38 mm in diameter. Magnesium pipes are made with wall thickness of 1.2, 2.0 and 2.5 mm with permissible deviations of  $\pm 0.25$ ,  $\pm 0.4$  and  $\pm 0.45$ , respectively. Magnesium pipes of other dimensions are made in accordance with special technical specifications. Example of designating a pipe with an outside diameter of 20 mm, wall thickness 2 mm and length of 3000 mm from the MA8 alloy - pipe 20 x 2 x 3000 MA8. Magnesium pipes are supplied in the annealed and hot extruded states. The pipe surfaces are subjected to oxidation; preservation, packing and transporting are performed in accordance with AMTU 299-61. For the use of magnesium pipes see Magnesium Alloys.

A.A. Kazakov

Manu-  
script  
Page  
No.

[Transliterated Symbols]

2383

AMTY - AMTU - aviatsionnyye metallurgicheskiye tekhnicheskkiye  
usloviya - Aviation Metallurgical Technical  
Specifications

MAGNESIUM SHAPES - semifinished products with various cross-sectional configurations (angles, T-beams, channels, etc.) and a large length-to-cross-section ratio. Magnesium shapes are manufactured by hot pressing in hydraulic presses. Pressed shapes of MA1 and MA8 alloys in the annealed state are produced in accordance with AMTU286-49, from VM65-1 alloy in the artificially aged state in accordance with AMTU289-50, and from other alloys in accordance with special TU. The variety of shapes and permissible size deviations should correspond to the norms set by AN-1089 and to the specifications agreed upon by the consumer and producer. Shapes of measured length are manufactured with longitudinal tolerances of +20 mm. The permissible waviness (local warping of the flange from true planularity) is no more than 1 mm per 2 running meters. A gap of  $\pm 1$  mm between the flange and a straight edge placed against it is permissible in the transverse direction. The warping of the shape about its longitudinal axis should not exceed  $3^\circ$  per running meter. Shapes are subjected to surface oxidation, preserved, and packed in the manner indicated in AMTU289-50.

A.A. Kasakov

MAGNESIUM SHEET is produced by rolling a flat ingot, a forged slab or a pressed bar on smooth cylindrical rollers. Sheets made from the MA1 and MA8 alloys are produced in accordance with the requirements of AMFU 228-61, sheets made from the MA2-1 and MA9 alloys and from the high-temperature MA11 and MA13 alloys are produced in accordance with special Specifications. Sheets are delivered in the annealed condition from the alloys MA1, MA2-1 and MA9; MA8 sheets annealed (designation MA8M) and in the half-strain-hardened condition (designation MA8N); in the heat-treated state (designations MA11-T6 and MA13-T8) from the MA11 and MA13 alloys (see Wrought Magnesium Alloys). The sheet dimensions are: thickness 0.6-1.2 mm with intervals of 0.2 mm, with tolerance from -8 to -20% of the thickness; 1.5-4.0 mm with intervals of 0.5 mm with tolerance from -6 to -17% of the thickness; 5-10 mm with intervals of 1 mm with tolerance from -4 to -9% of the thickness; width: 500, 1000, 1200, 1500 and 2000 mm, length: 1000, 1500, 2000, 2500, 3000 and 5000 mm.

The tolerances on the sheet thickness are established as a function of the width and thickness of the sheet. The permissible tolerances are:  $\pm 10$  mm in width,  $\pm 15$  mm in length. Sheets which are longer and wider than those indicated, and also with smaller tolerances on thickness, can be produced in accordance with a special agreement with the producing plant. The quality of the flatness of the sheets is established as a function of their dimensions. When placed freely on a surface plate the gap between each side of the sheet and the surface must not exceed the following values:



| Толщина листа (мм)<br>1 | Ширина листа (мм)<br>2     | Длина листа (мм)<br>3     | Отстояние листа каждой стороны при свободной укладке от поверхности плиты 4 |  |
|-------------------------|----------------------------|---------------------------|---|--|
|                         |                            |                           | по всей поверхности листа, включая длинные стороны (мм, не более)<br>5      | по коротким сторонам, включая длинные стороны до 300 мм от углов (мм, не более)<br>6 |
| До 2 включительно<br>7  | До 1500 включительно<br>8  | До 5000 включительно<br>9 | 16  | 25   |
| Более 2<br>8            | До 1500 включительно<br>10 | До 3000 включительно<br>9 | 20  | 30   |

1) Sheet thickness (mm); 2) sheet width (mm); 3) sheet length (mm); 4) gap of each side of sheet when placed freely on surface plate; 5) over entire sheet surface, including the long sides (mm, not more than); 6) along the short sides, including the long sides to 300 mm from the corners (mm, not more than); 7) to 2 inclusive; 8) to 1500 inclusive; 9) to 5000 inclusive; 10) more than 2.

Delivery of sheets with higher flatness tolerance is performed in accordance with special agreement with the producing plant. Sheets are delivered with oxidized surface protected in accordance with the requirements of AMTU 228-61.

A.A. Kazakov

MAGNETIC DEFECTOSCOPE is an apparatus for detecting surface and subsurface discontinuities of steel products by the magnetic powder method (see Magnetic Defectoscopy). The basic elements of the magnetic defectoscope are the devices for magnetization, for application of the magnetic suspension, and for demagnetization of the parts being inspected. All the devices are mounted in a single apparatus, but in some cases are fabricated in the form of individual units. The modern versions of the magnetic defectoscope are equipped with ultraviolet lamps and the shading shutters required for magnetic luminescent defectoscopy (figure). Depending on purpose, the magnetic defectoscopes are divided into universal and specialized, while in construction they may be stationary or portable.

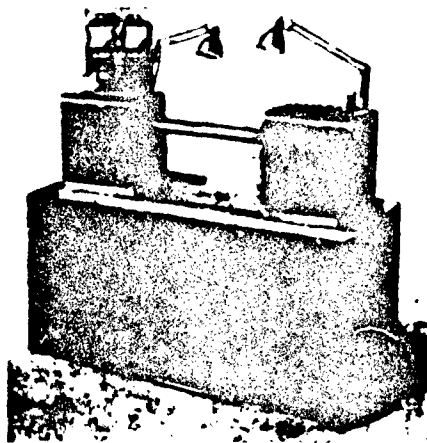

Universal magnetic defectoscope UMDE-2500 with electronic control.

The size of the magnetic defectoscope is determined by the dimensions of the parts being inspected, thus, for example, the length of some magnetic defectoscopes reaches 5-10 meters. The magnetizing device of

## II-33M1

the magnetic defectoscope provides for longitudinal, circular and combined magnetization. Circular magnetization is accomplished by passing through the part, and for hollow parts through a rod placed inside, a high intensity current (up to several thousand amps) from a source of low (up to 36 volts) voltage (step-down transformer, storage battery, etc.). For longitudinal magnetization use is made of electromagnets or solenoids in the magnetic defectoscope. Combined magnetization is accomplished by simultaneous action on the part being inspected of two or three mutually-perpendicular alternating magnetic fields shifted in phase by 90 or 60 degrees. Sometimes a constant field is used in place of one of the alternating fields. The magnetic powder is applied by immersion of the magnetized part in a bath with the suspension, sometimes the suspension is poured over the part from a hose; a mixing device is provided in the magnetic defectoscope to prevent settling of the magnetic powder on the bottom of the bath. Demagnetization of the part which has been inspected is most often done by passing the part through a solenoid. Large parts are demagnetized with the aid of the magnetizing device by smooth reduction of the supply current from the maximal value to zero. Most efficient are the magnetic defectoscopes of the universal type: UMDE-10,000 (for inspection of large and medium sized parts) and UMDE-2500 (for inspection of parts of small and medium size). These magnetic defectoscopes are equipped with electronic control to provide smooth regulation of the magnetizing current and also complete stability of the residual magnetization of the parts being inspected.

S.M. Rozhdestvenskiy

MAGNETIC DEFECTOSCOPY. This technique is used for the detection of discontinuities (cracks, nonmagnetic inclusions and other defects) in the surface layers of parts made from the ferromagnetic materials and the detection of ferromagnetic inclusions in parts made from the non-ferromagnetic materials, for monitoring the thickness of nonmagnetic coatings on parts made from the ferromagnetic materials and the wall thickness of thin-wall parts, and also for monitoring the quality of the thermal or chemico-thermal treatment of metal parts. For the detection of discontinuities of the material of ferromagnetic (primarily steel) parts, use is made of the methods based on the study of the stray magnetic fields about these parts after they are magnetized. At the locations of discontinuities there takes place a redistribution of the magnetic flux and a sharp variation of the nature of the stray magnetic field. The nature of the stray magnetic field is determined by the size and shape of the defect, its depth below the surface, and also by its orientation relative to the direction of the magnetic flux. Surface defects of the type of cracks oriented perpendicular to the magnetic flux cause the appearance of the most sharply defined stray magnetic fields; defects oriented along the magnetic flux cause very little stray magnetic field.

The most wide widely used method of magnetic defectoscopy is that of magnetic powder. In this method a magnetic powder is sprinkled over the part (dry method) or a magnetic suspension is poured over the part (wet method). The powder particles enter the stray magnetic field zone and deposit on the surface of the part near the location of the defects.

## II-22M1

The width of the strip on which the powder is deposited is considerably greater than the width of the defect "opening," therefore, previously invisible defects are located even with the unaided eye from the powder deposited near them. The magnetic powder method is very simple and makes it possible to determine the location and the contours of material discontinuities located on the surface of the parts and also at depths of up to 2-3 mm below the surface. The magnetization of the parts, their treatment with the powder (more often with suspension) and also the subsequent demagnetization are performed with the aid of magnetic defectoscopes. When differing orientation of the defects is possible in the parts being inspected, it is necessary to make a dual inspection with longitudinal and circular magnetization. Magnetic powder inspection with the use of combined magnetization is more productive.

Circular magnetization is basic for magnetic defectoscopy, longitudinal magnetization is used only in those cases when there are assumed to be strictly transverse defects in the part being inspected or when the use of circular magnetization is difficult or is associated with damage to the part (for example, because of dangerous overheating of the part at the points of contact with the electrodes of the defectoscope). The sensitivity of the magnetic powder method depends significantly on the degree of magnetization of the part during the time of treatment with the magnetic suspension (or powder). In the majority of the cases, for the conduct of the magnetic inspection the residual magnetization of the material of the parts being inspected after their magnetization in suitable magnetic fields is sufficient. However, in the inspection of parts made from materials with low coercive force (low-carbon steel or steel in the annealed condition) the residual magnetization may be insufficient even if the magnetization was performed in magnetic fields close to saturation. In these cases the treatment of

II-22M2

the parts with the suspension or powder must be performed during the time of action on the part of a magnetic field required to create the necessary magnetization of the material. This form of inspection, in contrast with inspection using residual magnetization, is termed inspection in an applied magnetic field. Detectability of defects also depends on their geometric parameters. Defects having greater depth, higher ratio of depth to width and located closer to the surface are detected more easily. The magnetization conditions are selected so that in each particular case clear-cut detection is provided of those material defects which are hazardous for operation of the part and the defects which are nonhazardous for the given part are not detected. Thus, for the inspection of highly loaded parts which have undergone surface finishing treatment a magnetization field of about 100 oe is created on the surface when using residual magnetization and about 30 oe when inspecting in the applied field. In this case detection is provided of defects with a height of more than 0.05 mm which extend to the surface and detection provided for about half the defects of the same height located at a depth of up to 0.5 mm. For detecting small defects (hairline cracks, grinding cracks, etc.) use is made of the so-called "high intensity" regime in which magnetic fields of about 180 and 60 oe respectively are created on the surface of the part. In control in the "low intensity" regime, use is usually made of the residual magnetization after magnetization in a field on the surface of the part of about 50 oe; in this case detection is provided for cracks extending to the surface, hairline cracks extending into the depth of the metal and a portion of the smaller surface and subsurface defects. The nature of the defect is judged on the basis of the deposition of the magnetic powder. Thus, quenching, forging and other cracks cause a dense deposition of powder in the form of sharp broken lines. Flakes show up in the

## II-22M3

form of individual curved figures arranged individually or in groups, in this case the layer of deposited powder is also quite dense. Hair-line cracks are detected from deposition of powder in the form of straight or slightly curved (along the fiber) thin traces, in this case the intensity of the powder deposition is less than in the case of cracks. Figures 1 and 2 show powder deposition on certain characteristic defects and microphotographs of the cross sections of these defects.

To improve the powder visibility, it is colored to contrast with the color of the parts being inspected. Along with the usual reddish brown and dark gray powders used in the inspection of parts with a light surface, use is made of light gray, yellow or green powders for the inspection of parts having a dark surface. Defects show up considerably brighter with the use of magnetic powders whose particles are covered with a layer of a luminophore (see Magnetic Luminescent Defectoscopy).

The magnetic powder method of magnetic defectoscopy is used not only in the process of the production of parts, but also during their operation, for example, for the detection of cracks of fatigue origin. Portable defectoscopes permit the use of the magnetic powder method for the inspection of parts, components and assemblies without disassembling them.

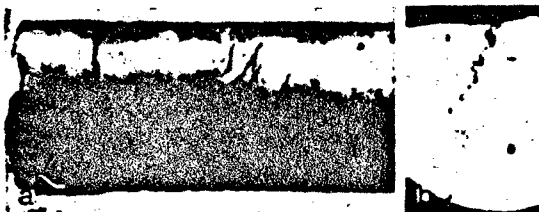

Fig. 1. a) Powder deposition on quenching cracks; b) cross section of one of the quenching cracks. Magnified 100 times.

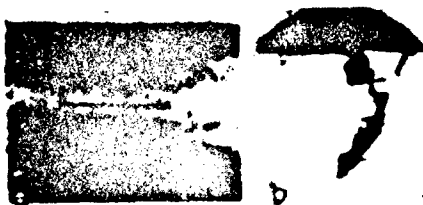

Fig. 2. a) Powder deposition on a hairline crack; b) cross section of hairline crack. Magnified 120 times.

A very promising method of magnetic defectoscopy is that based on the use of stray field ferro-probe indicators (see Ferro-Probe Method of Defectoscopy).

In the inspection of tubing weld quality, wide use is made of the magnetographic method of defectoscopy.

The magnetic defectoscopy methods used for monitoring the quality of heat treatment, and sometimes also for sorting of metal by grade, are based on connection between some magnetic characteristic and the structural-mechanical properties or the chemical composition of the material of the parts being inspected; this group of methods is known under the name structurescopic. Most often, in magnetic structurescopy use is made of the following magnetic characteristics: the coercive force ( $H_c$ ), the residual induction ( $B_r$ ), the saturation magnetization ( $I_{max}$ ), the maximal magnetic permeability ( $\mu_{max}$ ). In this connection the magnetic structurescopic methods are divided into ferrometric (measurement of  $I_{max}$ ), permeametric (measurement of  $\mu_{max}$ ), coercimetric (measurement of  $H_c$ ), remanancescopic (measurement of  $B_r$ ).

An important advantage of the widely used coercimetric methods is that the accuracy of measurement of the coercive force is practically independent of the shape and dimensions of the parts being inspected. In the coercimetric instruments (coercimeters) the part being inspected is magnetized to technical saturation, after which it is subjected to



11-22M5

the action of a gradually increasing magnetic field of opposite sense; in this case a determination is made of the magnitude of the magnetic field (or the current feeding the demagnetizing device) at which the magnetization of the part becomes equal to zero. In the remanenscopic instruments an evaluation is usually made of the magnitude of the apparent residual induction. This is accomplished either by the ballistic method - rapid passage of the part through a coil connected with a measuring instrument, or by the magnetometric method - measurement of the intensity of the magnetic field created by the part being inspected at a definite distance from this part. Wide usage has been made of very simple permeametric instruments in which the sensor is a system consisting of primary and secondary coils located either on the part being inspected or on a  $\pi$ -shaped coil core whose ends are closed by the part. Usually commercial frequency current is passed through the primary coil and a measuring instrument is connected in the secondary coil circuit. To improve the resolving capability of the permeametric method, use is made of various compensation circuits which permit the use of measuring equipment of greater sensitivity.

The ferrometric methods of magnetic structurescopy, used for the determination of the amount of the ferromagnetic phase in steel, are based on the measurement of the saturation magnetization; the measurement accuracy is higher the closer to magnetic saturation the magnetization of the parts in the inspection process. Only with complete saturation is there a one-to-one relationship between the magnetization intensity and the amount of the ferromagnetic phase. Other interfering factors also have an effect on the intensity of the material magnetization in smaller magnetic fields (for example, the particle shape and the nature of the distribution of the ferromagnetic field phase). In practice, use is normally made of inspection in weaker fields; in many

II-22M6

cases quite simple permeametric instruments are used for the purpose of ferrometry.

One of the important applications of magnetic defectoscopy is the measurement of the thickness of coatings by magnetic methods. These methods are used in those cases when the materials of the base and the coating differ sharply in their magnetic properties. They are used, for example, for the measurement of nonmagnetic metal, nonmetal, and also weakly magnetic (nickel) coatings on steel parts. Two groups of magnetic thickness meters are in common use. The instruments of the first group meters are based on the measurement of the force of attraction of a permanent magnet or of the core of an electromagnet to the part being inspected. This force diminishes with increase of the thickness of the layer of nonmagnetic (or weakly magnetic) coating. The force of attraction is usually determined from the force required to separate the magnet (or the core of the electromagnet) from the part being inspected, therefore, the instruments included in this group are termed "separating" instruments. The instruments of the second group determine the resistance of the magnetic circuit composed of the portion of the part being inspected and the core of the electromagnet (or permanent magnet). The magnitude of this resistance depends on the thickness of the coating; the thicker the coating, which forms a nonmagnetic or weakly magnetic gap between the sensor core and the part being checked, the higher the circuit resistance.

One of the instruments of the "separating" type is the MT2-54 thickness meter, which is a force-measuring mechanism which determines the magnitude of the force of attraction of a permanent magnet to the part being checked. The instrument permits making measurements in the range from 0 to 600 microns with an error not exceeding 5% of the measured thickness. The operation of the other magnetic thickness meter MT-

## II-22M7

-DA3 is based on the measurement of the force of attraction of the movable core of an electromagnet to the part being inspected. The thickness of the coating is determined from the indication of a galvanometer connected in the solenoid circuit at the moment of separation of the core; the galvanometer scale is calibrated in microns. If as a result of the action of interfering factors the instrument indication on an uncoated part is not equal to zero, then it is necessary to make use of a conversion graph with sliding rule similar to the graph of the MT2-54 instrument. The magnetic methods are used successfully for the measurement of the wall thickness of parts made from the ferromagnetic materials. These methods are particularly effective with access to the part from only one side. The methods used in these cases are directly or indirectly associated with the measurement of the magnetic flux in the controlled section of the part being inspected when it is magnetized to technical saturation.

In the Forster instrument (FRG) the sensor is a permanent horseshoe magnet with a measuring winding in the middle part. With contact of the sensor with the part being checked, as a result of the reduction of the demagnetizing field the intensity of the magnetization of the magnet is increased and in the winding circuit there appears a current pulse whose magnitude is proportional to the part wall thickness. In this case a fluxmeter is used as the measuring instrument. The range of thicknesses which can be measured with this instrument is from 0 to 3 mm. In certain magnetic thickness meters the sensor is a horseshoe electromagnet supplied with alternating current of commercial frequency. The indications of the galvanometer connected in the circuit of the secondary (measuring) winding of the sensor depend on the wall thickness of the part being checked. In connection with the strong influence of the skin effect, the instruments of this type are used for checking wall thick-

nesses not exceeding 1-1.5 mm. To increase the range of the thicknesses measured, either the supply current frequency is reduced (which considerably complicates the instrument), or use is made of additional magnetic biasing of the section being inspected with a constant magnetic field.

The magnetic method with the use of ferro-probes is also applied for the measurement of the wall thickness of parts made from nonferromagnetic materials, however in this case it is necessary to have access to both sides of these walls.

As a result of inspection using the magnetic defectoscopic methods, parts made from the ferromagnetic materials take on residual magnetization, which in many cases may lead to disruption of normal operation of the product in which the magnetized parts are located. Thus, for example, magnetization of parts may lead to increase of the deviation of the compass in an airplane or to increased wear in friction components as a result of the attraction of iron particles. Therefore, after magnetic inspection it is necessary to perform demagnetization of the parts.

Most often, demagnetization is accomplished by means of passing the magnetized items through demagnetization chambers (solenoids) which are fed by alternating current of commercial frequency. In cases when it is necessary to demagnetize large parts (particularly those magnetized by a constant magnetic field) use is made of a lower-frequency demagnetization field. In some defectoscopes (UMDE-10,000, for example) the demagnetization of large parts is accomplished by means of commutation of direct current passed through the part with gradual reduction of the current to zero.

References: Sovremennyye metody kontrolya materialov bez razrusheniya (Modern Methods of Nondestructive Material Inspection), collection of articles, M., 1961; Priborostroyeniye i sredstva avtomatizatsii

II-22M9

kontrolya (Instrument Design and Means for Automating Inspection), ed. by S.I. Freyberg, book 1, M., 1961 (VINITI); Defektoskopiya metallov (Defectoscopy of Metals), collection of articles ed. by D.A. Shrayber, M., 1959.

S.M. Rozhdestvenskiy

MAGNETIC HYSTERESIS - dependence of a magnetized ferromagnetic material not only on the magnitude of the magnetizing field at the given instant, but also on the fact whether it is magnetization, demagnetization or magnetic polarity reversal which is taking place. The curve which expresses this dependence forms the so-called hysteresis loop (Fig.). The magnetic field intensity  $I_r$  with  $H = 0$  is obtained in the process of demagnetization of a specimen which is first saturation mag-

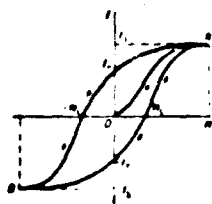

Fig. Dependence of the magnetic field intensity  $I$  on the external field  $H$  in magnetic hysteresis. Branch  $OA$  forms on magnetization of a demagnetized specimen to saturation (the main magnetization curve), the upper branch  $AB$  forms on reduction of the external field and further reversal of the magnetic polarity of the specimen by an increasing field which is opposite in direction, the lower branch  $BA$  forms on reverse magnetic polarity reversal,  $A$  and  $B$  are saturation points.

netized (to  $I_s$ ), is called residual magnetization, and the magnetic field intensity  $H_c$ , at which the magnetization in the process of magnetic polarity reversal becomes zero, is called the coercive force. Upon magnetic polarity reversal of a substance with magnetic hysteresis, a part of the magnetic field energy is converted into heat, which is proportional to the area of the hysteresis loop. This phenomenon is frequently harmful (for example, in transformers).

A small hysteresis loop area corresponds to magnetically soft materials, such as pure iron, iron alloyed with 0.5% Si (electrical

I3301

steel), Permalloy-type iron-nickel alloys. A large hysteresis loop area is characteristic of magnetically hard materials, which are used as permanent magnets, such as carbon, tungsten, chromium and cobalt steels. Alnico or Alni type alloys. Ferrites, which are extensively used in electronics and automatic equipment, have a characteristic, almost rectangular, hysteresis loop.

Magnetic hysteresis is brought about by three basic phenomena which take place on demagnetization and magnetic polarity reversal of the ferromagnetic material, which are: the irreversible processes of rotation of the spontaneous domain magnetization vector, retardation in the generation of magnetic polarity reversal nuclei and retardation of interdomain boundary displacement.

A.A. Ivanov

MAGNETIC MATERIALS WITH HIGH MAGNETIC SATURATION are Fe-Co alloys with 30-50% Co which have the highest magnetic saturation  $4\pi I_s$  (23,500 -24,000 gauss), higher than that of Fe (figure). Industrial use is made of the alloys Permendur K50F2 (50% Co, 2% V) and Hiperco (35% Co, 0.5% Cr).

Magnetic saturation  $4\pi I_s$  of Fe-Co alloys at room temperature in a magnetic field H equal to 1500 and 17,000 gauss.

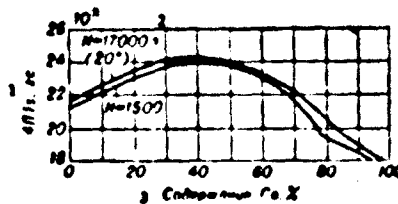

1)  $4\pi I_s$ , gauss; 2) oersted; 3) Co content, %.

Both alloys also have high permeability (on the order of 1500-2000 gauss/oe) in the region of high inductions. Permendur is the more widely used. Soviet industry produces it in the form of cold rolled sheet of 0.1-0.7 mm thickness. The properties of Permendur are shown in Tables 1,2.

TABLE 1  
Magnetic Properties of K50F2\* Alloy (forged rods, forgings)

| 1 Магнитное поле (e)     | 11    | 16    | 25    | 36    | 67    | 93    |
|--------------------------|-------|-------|-------|-------|-------|-------|
| 2 Индукция (г. не менее) | 18000 | 19000 | 20000 | 20500 | 21000 | 22000 |

\*Coercive force for all values equal to no more than 2 gauss.

1) Magnetic field (oe); 2) induction (gauss, no less than).



II-30M1

TABLE 2

Magnetic Properties of K50F2 Alloy (cold rolled sheet)

| 1 Начальная проницаемость ( $\mu_0$ ) | 2 Индукция в поле 150 э (гс) | 3 Коэрцитивная сила (э) |
|---------------------------------------|------------------------------|-------------------------|
| 4 Не менее 700                        | 4 Не менее 22000             | 5 Не более 2            |

- 1) Initial permeability (gauss/oe); 2) induction in 150 oe field (gauss)  
3) coercive force (oe); 4) no less than; 5) no more than.

These alloys are used for magnetic circuit parts (where high concentration of the magnetic flux is required), telephone membranes, magnetostriction transformer cores (K50F2), cores for small electrical machines (K35Kh).

References: Gabrielyan D. I., Klevitskaya G. Z., Puzey I. M., Standartizatsiya (Standardization), 1960, No. 10, page 48; Smolyarenko D. A., Kaplan A. S., *ibid*, 1959, No. 3, page 13; Zaymovskiy A. S., Chudnovskaya L. A., *Magnitnyye materialy* (Magnetic Materials), 3rd edition, M.-L., 1957 (*Metally i splavy v elektrotekhnike*) (Metals and Alloys in Electrical Engineering Vol. 1); Bozort R., *Ferromagnetizm* (Ferromagnetism), translated from Eng., M., 1956.

B. G. Livshits, A. A. Yudin

MAGNETIC MATERIALS WITH HIGH PERMEABILITY CONSTANT are materials characterized by practically constant magnetic permeability  $\mu$  in the region of weak fields and absence of losses during demagnetization from these fields. They are used in telephony, radio and instrumentation (cores for coils and transformers). With regard to both properties and processing technology the best materials of this type are the magnetodielectrics produced by pressing of finely dispersed ferromagnetic powder with an insulating resin; their magnetic permeability, amounting to 6-150 gauss/oe, is constant in fields up to several oersted.

The permeability of Permalloy ( $\mu$  about 2000 gauss/oe) and of transformer steel ( $\mu$  about 800 gauss/oe) which have been subjected to cold rolling or partial annealing is approximately constant up to fields of 0.1-0.2 oe. Alloys of the Perminvar type have constant magnetic permeability to fields of 1-3 oe. Their deficiency is a sharp irreversible change of magnetic permeability under the random influence of a magnetic field exceeding the region of constant magnetic permeability. Alloys of the Isoperm type do not have this deficiency. Not all of these alloys have found wide application, since with respect to processing technology and in most cases with respect to properties they cannot compete with the magnetodielectrics.

References: Rabkin L. I., Shol'ts N. N., *Magnitodielektriki i ferrokatushki* (Magnetodielectrics and Ferrocoils), M.-L., 1948; Zaymovskiy A. S., Chudnovskaya L. A., *Magnitnyye materialy* (Magnetic Materials), 3rd edition, M.-L., 1957 (*Metally i splavy v elektrotekhnike, t. 1*) (Metals and Alloys in Electrical Engineering, Vol. 1); Bozort R., *Ferromagne-*

II-31M1

tism, translated from Eng., M., 1956.

B.G. Livshits, A.A. Yudin

**MAGNETIC POWDER** is a powder used for detecting defects of ferromagnetic parts by the method of magnetic powder defectoscopy. Widest use is made of magnetic powders from finely-ground mixed iron oxide ( $\text{Fe}_3\text{O}_4$ ) of dark brown or black color. Use is also made of powders prepared from iron cinder, magnetites, ferrites, etc. For inspection of parts having a dark surface, use is made of light magnetic powders of yellow, red or light gray colors. The particle size of the magnetic powders used to detect surface defects is no greater than 50 microns. For detecting subsurface defects preference is given to the magnetic powders with larger particles of elongated acicular form.

S.M. Rozhdestvenskiy

MAGNETIC PROPERTIES (magnetism) are the totality of the properties which are manifested during the interaction of a material with a magnetic field. The most important macroscopic manifestation of the magnetic properties is the ability of the material to create a self-magnetic field.

The ability of a material to interact with an external magnetic field depends on the magnetic properties, more exactly, on the magnetic moments of the free atoms or molecules of this material, which are determined primarily by their electron structure. The magnetic moment of an atom consists basically of the magnetic moment due to electron spin (electron spin is the self-mechanical moment of momentum of the electron) and of the magnetic moment due to the orbital motion of the electron around the nucleus of the atom. The magnetic moment of the atomic nucleus is about a thousand times less than the magnetic moment of the electron shell of the atom and in the consideration of the conventional magnetic properties it may be neglected. Nuclear magnetism manifests itself in nuclear magnetic resonance and in the superfine structure of the spectral lines.

The Magnetic moment due to the electron spin is equal to where

$$M_s = g_s \sqrt{s(s+1)} \mu_B$$

$s = \frac{1}{2}$  - is the spin quantum number;  $g_s$  is the so-called gyromagnetic ratio, equal to 2 for spin;  $\mu_B$  is the Bohr magneton, equal to  $eh/4\pi mc$  -  $0.9273 \cdot 10^{-20}$  erg/gauss (e is the electron charge, m is the electron rest mass, c is the speed of light in a vacuum, h is the Planck constant). The projections of this moment on the direction of the external magne-

II-32M1

tic field can have only two values, equal in absolute magnitude to the Bohr magneton.

The magnetic moment due to the electron is equal to:

$$M_l = g_l \sqrt{l(l+1)} \mu_B,$$

where  $g_l$  is the gyromagnetic ratio of the orbital motion of the electron around the nucleus, equal to unity;  $l$  is the orbital quantum number which takes the values 0, 1, 2, ...,  $n - 1$ , where  $n$  is the principal quantum number. The projection of the magnetic moment on the direction of the external magnetic field is determined by the magnetic quantum number  $m_l$  and is equal to  $M_l \mu_B$ , where  $m_l$  can take  $(2l + 1)$  values from  $+l$  to  $-l$ .

In an atom with several electrons, their orbital ( $\vec{l}$ ) and spin ( $\vec{s}$ ) moments of momentum add to one another and form the total moment of momentum of all the electrons of the atom. Addition of these moments, according to the scheme of Russell-Saunders, amounts to the fact that the  $\vec{l}_1$  - vectors of the individual electrons form the resultant orbital moment of momentum  $\vec{L}$ , and the  $\vec{s}_1$  - vectors form the resultant spin moment  $\vec{S}$ . The total moment of momentum of the atomic electrons  $\vec{J}$  is the vector sum of the resultant  $\vec{L}$ - and  $\vec{S}$ - moments, i.e.,  $\vec{J} = \vec{L} + \vec{S}$ . Corresponding to this there takes place the formation of the resultant magnetic moment of all the atomic electrons, whose magnitude is determined by the relation

$$M_J = g_J \sqrt{J(J+1)} \mu_B,$$

where  $g_J = 1 + \frac{S(S+1) + J(J+1) - L(L+1)}{2J(J+1)}$  is the Landé factor.

The values of the resultant  $\vec{S}$ -,  $\vec{L}$ -,  $\vec{J}$ - moments depend on the distribution of the atomic electrons with respect to the energetic states, usually termed the electron shells or orbits. The distribution of the electrons with respect to these states is subject to the quantum mechanical governing laws, the most important of which is the Pauli princi-

ple. According to this principle, in the atom there cannot be more than a single electron in each state determined by the set of all (four) quantum numbers. The number of electrons on the shells with the principle quantum number  $n$  does not exceed  $2n^2$ , and on shells with the same value of  $n$  and  $l$  there can be no more than  $2(2l + 1)$  electrons. As the electron shells of the atom are filled, there takes place mutual compensation of the magnetic moments of the individual electrons and the filled shell as a whole is devoid of magnetic moment; therefore, the self-magnetic moment of the atom is due only to the electrons of the incomplete shells. However, if the atoms form complex molecules or crystals, then the magnetic moments of the interacting atoms may undergo considerable alterations. Thus, the valence electrons of the outer shells, whose magnetic moments may not be compensated in the free atom, mutually compensate their magnetic moments with interactions of the atom with the surrounding neighbors. Therefore, the atoms in the majority of the nontransition metals, molecules with even number of electrons, covalent crystals and so on are devoid of self-magnetic moments. In contrast with this, the electrons of the inner incomplete orbits in the atoms of the rare earth metals are to a considerable degree shielded from interactions, and their magnetic moments are scarcely subject to significant alterations. In atoms of the transition elements of the iron, platinum, palladium group the incomplete electron shells are insufficiently completely shielded by the outer electrons, therefore, their magnetic moments are subject to significant alterations. Frequently, in crystals of the compounds of the elements of the iron group the interatomic forces "freeze" the orbital component of the magnetic moment, while the spin component remains. With complete "freezing" the magnetic moment becomes equal to  $M_s = 2\sqrt{S(S+1)} \mu_B$ , where  $S$  is the total spin of all the electrons. The "freezing" mechanism is due to the

influence of the crystal electric field on the motion of the electrons of the inner incomplete shells. The orbital moment is sort of oriented by this strong field, and its orientation cannot be altered by the weaker external magnetic field; in this case the spin moments remain more free.

The majority of the molecules occurring in the composition of the chemical compounds have an even number of electrons and thus, as a rule, are devoid of magnetic moment. A comparatively small number of molecules with an odd number of electrons have a magnetic moment, however the orbital component of this moment is either small or completely missing. The magnetic moment of such molecules is determined only by the total spin.

The basic macroscopic magnetic characteristic of a substance is its magnetization or resultant magnetic moment. Magnetization of a substance is manifested in the variation of the intensity and configuration of the magnetic field inside and outside of this substance. Magnetization arises as a result of the interaction of the elementary magnetic moments of the particles of the substance with the magnetizing field and is the resultant projection of these moments on the field direction. Between the magnetization of a substance  $\vec{I}$  and the intensity of the magnetic field in it  $\vec{H}$  there exists the relation  $\vec{I} = \vec{I}(\vec{H})$  which does not depend on the shape of the body and is characteristic for its electron structure. For the majority of substances the magnetization in the first approximation is proportional to the intensity of the magnetic field. The coefficient of proportionality  $\chi$  between the magnetization of a substance and the intensity of the field in it is termed the magnetic susceptibility of the substance, i. e.,  $\chi = \vec{I}/\vec{H}$ . Depending on whether the magnetization is referred to unit volume or mass, gram-atom or gram-molecule, the susceptibility is divided respectively into volumetric  $\kappa$ , mass or specific  $\chi$ , atomic  $\chi_a$  and molar  $\chi_m$ .



The resultant magnetic field in a substance is characterized by the magnetic induction  $\vec{B}$ , where  $\vec{B} = \vec{H} + 4\pi\vec{I}$  or  $\vec{B} = \vec{H} (1 + 4\pi\kappa)$ , or  $\vec{B} = \mu\vec{H}$ , where the quantity  $\mu = 1 + 4\pi\kappa$  is termed the magnetic permeability. The magnetization  $\vec{I}$  and the induction  $\vec{B}$  are, just as the intensity of the magnetic field, vector quantities.

With regard to magnetic properties, all substances may be basically divided into diamagnetic ( $\chi < 0$ ) and paramagnetic ( $\chi > 0$ ). The magnitude of the specific magnetic permeability of the majority of the paramagnetics and diamagnetics is small and in order of magnitude amounts to  $10^{-5} - 10^{-6}$ , however among the paramagnetics we can identify a special class of ferromagnetics whose susceptibility in weak fields exceeds unity by several orders (see Ferromagnetism).

The atoms or molecules of a paramagnetic substance have a self-magnetic moment due to the uncompensated moments of the electrons; the atoms or molecules of a diamagnetic substance do not have such a moment. Magnetization of the paramagnetics involves the preferential orientation of the self-magnetic moments of the atoms in the direction of the magnetizing field; magnetization of the diamagnetics is connected with the fact that the magnetic field induces in atoms magnetic moments whose resultant component is directed in opposition to this field. All substances possess diamagnetic susceptibility, however in the paramagnetic substances this susceptibility is overshadowed by the stronger paramagnetic effect. The magnetic properties of the ferromagnetics are due to the fact that the magnetic moments of their atoms in considerable regions, termed domains, have parallel orientation, due primarily to the exchange quantum mechanical interaction between these atoms. Magnetization of the ferromagnetic substances involves the orientation of the resultant magnetic moments of the domains in the direction of the magnetizing field, and this orientation is possible in relatively weak

II-32M5

fields.

References: Vonsovskiy S.V., *Sovremennoye ucheniye o magnetizme* (Present Knowledge of Magnetism), M., 1953; Dorfman Ya.G., *Magnitnyye svoystva i stroyeniye veshchestva* (Magnetic Properties and Structure of Matter), M., 1955; Livshits B.G., *Fizicheskiye svoystva metallov i spavov* (Physical Properties of Metals and Alloys), M., 1959.

A.A. Ivanov

II-23M

MAGNETIC SUSPENSION is a suspension of particles of magnetic powder in a liquid, used for the detection of surface and subsurface defects of products by the method of magnetic powder defectoscopy (see Magnetic Defectoscopy). As liquids for the magnetic suspensions, use is made of transformer oil, kerosene and their mixtures, and also water with surface-active and anticorrosion additives.

S.M. Rozhdestvenskiy

II-36M

MAGNETODIELECTRICS - see Magnetic Materials with High Permeability  
Constant.

MAGNETOGRAPHIC DEFECTOSCOPY METHOD is one of the methods of magnetic defectoscopy, whose salient feature is the that the recording of the stray magnetic field is accomplished with the aid of magnetic tape which is normally used for sound recording. The magnetic tape is pressed to the surface of the part being magnetized (or which has already been magnetized), as a result of which there is "written" on the tape the distribution of the magnetic fields at the tape location. The recorded magnetic fields are reproduced with the aid of a special magnetographic defectoscope. The defectoscope sensitive element (head of tape recorder type) performs a sawtooth movement relative to the magnetic tape, and the electric signals in the winding of this element which appear with intersection of a nonuniformly magnetized portion of the tape, after suitable amplification, are applied to an oscilloscope. From the shape and magnitude of the signal image on the screen a judgement is made on the nature and size of the defects which gave rise to these signals. The MD-9 and MD-11 magnetographic defectoscopes are the most effective. The magnetographic method of defectoscopy is widely used for the inspection of the quality of weld seams of trunk pipelines. With pipe wall thickness from 5 to 12 mm, cracks, non-penetrations of depth more than 10% of the wall thickness, chains of gaseous pores and large slag inclusions show up sharply. Fine longitudinal cracks and narrow non-penetrations are particularly clearly seen. Sharp ledges, excrescences and "seam beads" of height more than 5 mm on the surface of the weld seam may give rise to false signals, therefore, the magnetographic method of defectoscopy is most successfully used to inspect seams made by automatic

II-35M1

welding under a flux which have a more even surface. Magnetographic defectoscopy may also find application in the detection of defects of other products made from the ferromagnetic mater'als.

S.M. Rozhdestvenskiy

MAGNETO-LUMINESCENT DEFECTOSCOPY is one of the forms of the magnetic powder defectoscopy method (see Magnetid Defectoscopy). The salient feature of the method is that the magnetic powder particles contain a luminophor which fluoresces when the parts being inspected are irradiated with ultraviolet light, as a result of which the defects stand out more clearly. To bond the luminophor with the ferromagnetid particles, use is made of ethylcellulose or low-melting resins. Magnetro-luminescent defectoscopy is particularly effective in inspection of parts with a dark surface. The use of magneto-luminescent defectoscopy in combination with photocells makes it possible to automate the inspection process.

References: *Sovremennyye metody kontrolya materialov bez rezhneniya* (Modern Methods of Nondestructive Material Inspection), collection of articles, M., 1961; Karyakin A.V., *Lyuminestsentnaya defektoskopiya* (Luminescent Defectoscopy), M., 1959.

S.M. Rozhdestvenskiy

MAGNETOSTRICTIVE MATERIALS are soft magnetic materials which have magnetostrictive properties (i.e., dependence of deformations and stresses on the magnetic field and inductances and vice versa) and which are used for the fabrication of magnetostrictive transformers. The magnetostrictive materials are evaluated on the basis of the magnitude of their properties which determine the basic properties of the transformers: sensitivity in the radiation and reception regimes, efficiency, etc. The most important characteristic of the magnetostrictive materials relate the mechanical and magnetic parameters of the state of the material: 1) magneto-mechanical coupling coefficient  $k$  - the ratio of the transformed mechanical energy to the magnetic energy with operation of the magnetostrictive radiator at low frequency without account for the losses (or correspondingly the ratio of the transformed magnetic energy to the mechanical energy with operation of a receiver under the same conditions); 2) the magnetostrictive constant  $\alpha = \left(\frac{\partial \sigma}{\partial H}\right)_\epsilon$ ; 3) the magnetostrictive sensitivity constant  $\lambda = \left(\frac{\partial H}{\partial \sigma}\right)_\epsilon$ ; here  $\sigma$  is the mechanical stress,  $B$  is the magnetic induct subscript  $\epsilon$  and  $H$  denote the invariability of the deformation and magnetic field intensity. The quantity  $\alpha$  determines the transformer sensitivity in the radiation regime,  $\lambda$  is the sensitivity in the reception regime. The efficiency is determined by the quantity  $k$  and the losses in the magnetostrictive material. The mechanical losses are characterized by the mechanical figure of merit, the Foucault current losses are characterized by the electrical resistivity  $\rho$ , the hysteresis losses are characterized indirectly by the coercive force  $H_c$ . The density of the magnetostrictive material  $d$



and Young's modulus  $E$  determine the resonant frequency of the transformer for a given core form. The limiting intensity power of magnetostrictive radiators depends on the mechanical strength, the magnetostrictive saturation  $\lambda_s$ , the saturation induction  $B_s$ . Another important characteristic of a magnetostrictive material is the inverse magnetic permeability  $\mu$ . The quantities  $k$ ,  $a$ ,  $\mu$ ,  $E$ ,  $\lambda$  are connected by the relations:  $k^2 = \frac{a^2 \mu}{E \lambda}$ ,  $A = \frac{a \mu}{E \lambda}$  and depend significantly on the magnitude of the constant magnetization field  $H_0$  and consequently on the induction  $B_0$ . The value of  $H_0$  corresponding to the maximum of  $k$  is usually termed optimal -  $H_{opt}$ . The basic characteristics of the most important magnetostrictive materials are presented in the table. Two values are given for the quantity  $\mu$ : the initial value  $\mu_0$  and the value for residual magnetization  $\mu_r$ ; the values of  $k$  and  $a$  are for optimal magnetization and  $A_r = 10$  given for residual magnetization.

Basic Characteristics of Magnetostrictive Materials

| 1  | 2    | 3   | 4   | 5   | 6   | 7   | 8   | 9   | 10  | 11  | 12  | 13  | 14  | 15  | 16  | 17  | 18  | 19  | 20  | 21  |
|----|------|-----|-----|-----|-----|-----|-----|-----|-----|-----|-----|-----|-----|-----|-----|-----|-----|-----|-----|-----|
| 12 | 100% | 7.8 | 1.8 | 1.8 | 1.8 | 1.8 | 1.8 | 1.8 | 1.8 | 1.8 | 1.8 | 1.8 | 1.8 | 1.8 | 1.8 | 1.8 | 1.8 | 1.8 | 1.8 | 1.8 |
| 13 | 99%  | 7.8 | 1.8 | 1.8 | 1.8 | 1.8 | 1.8 | 1.8 | 1.8 | 1.8 | 1.8 | 1.8 | 1.8 | 1.8 | 1.8 | 1.8 | 1.8 | 1.8 | 1.8 | 1.8 |
| 14 | 99%  | 7.8 | 1.8 | 1.8 | 1.8 | 1.8 | 1.8 | 1.8 | 1.8 | 1.8 | 1.8 | 1.8 | 1.8 | 1.8 | 1.8 | 1.8 | 1.8 | 1.8 | 1.8 | 1.8 |
| 15 | 99%  | 7.8 | 1.8 | 1.8 | 1.8 | 1.8 | 1.8 | 1.8 | 1.8 | 1.8 | 1.8 | 1.8 | 1.8 | 1.8 | 1.8 | 1.8 | 1.8 | 1.8 | 1.8 | 1.8 |
| 16 | 99%  | 7.8 | 1.8 | 1.8 | 1.8 | 1.8 | 1.8 | 1.8 | 1.8 | 1.8 | 1.8 | 1.8 | 1.8 | 1.8 | 1.8 | 1.8 | 1.8 | 1.8 | 1.8 | 1.8 |
| 17 | 99%  | 7.8 | 1.8 | 1.8 | 1.8 | 1.8 | 1.8 | 1.8 | 1.8 | 1.8 | 1.8 | 1.8 | 1.8 | 1.8 | 1.8 | 1.8 | 1.8 | 1.8 | 1.8 | 1.8 |
| 18 | 99%  | 7.8 | 1.8 | 1.8 | 1.8 | 1.8 | 1.8 | 1.8 | 1.8 | 1.8 | 1.8 | 1.8 | 1.8 | 1.8 | 1.8 | 1.8 | 1.8 | 1.8 | 1.8 | 1.8 |
| 19 | 99%  | 7.8 | 1.8 | 1.8 | 1.8 | 1.8 | 1.8 | 1.8 | 1.8 | 1.8 | 1.8 | 1.8 | 1.8 | 1.8 | 1.8 | 1.8 | 1.8 | 1.8 | 1.8 | 1.8 |
| 20 | 99%  | 7.8 | 1.8 | 1.8 | 1.8 | 1.8 | 1.8 | 1.8 | 1.8 | 1.8 | 1.8 | 1.8 | 1.8 | 1.8 | 1.8 | 1.8 | 1.8 | 1.8 | 1.8 | 1.8 |
| 21 | 99%  | 7.8 | 1.8 | 1.8 | 1.8 | 1.8 | 1.8 | 1.8 | 1.8 | 1.8 | 1.8 | 1.8 | 1.8 | 1.8 | 1.8 | 1.8 | 1.8 | 1.8 | 1.8 | 1.8 |

1) Material; 2) chemical composition; 3) ( $g/cm^3$ ); 4) ( $dynes/cm^2$ ); 5) (gauss); 6) (oe); 7)  $H_{opt}$  (oe); 8)  $k_{opt}$ ; 9)  $a_{opt}$  ( $dynes/cm^2$ -gauss); 10) (gauss-cm<sup>2</sup>/dyne); 11) (ohm-cm); 12) nickel; 13) remainder; 14) permendur K-9F2; 15) permendur K65; 16) alfer Yu-14; 17) alfer Yu-12; 18) permalloy 40; 19) hiperco; 20) nickel ferrite; 21) nickel ferrite with cobalt additive.

The magnetostrictive materials may also be required to have corrosion resistance (for transformers used in water or in chemically active media), plasticity, permitting the production of thin sheet from the magnetostrictive material (necessary to reduce the eddy current

losses), small variation of the parameters with temperature, high Curie temperature for operation over a wide temperature interval, and, finally low cost, simplicity of technology, availability of source materials.

Of the magnetostrictive materials, the most widely used is nickel, which has good magnetostrictive, mechanical and anticorrosion properties. Its drawbacks are a comparatively low value of the electrical resistance, low saturation induction, which limits the limiting power of magnetostrictive ultrasonic radiators made from nickel, relatively low Curie temperature ( $360^{\circ}$ ). The Permendur alloy has high values of the magnetostriction constants, high saturation magnetostriction and induction, four times higher than for nickel, good dynamic properties in the residual magnetization state, high Curie temperature ( $960^{\circ}$ ). The deficiencies of the alloy are poor corrosion resistance and low plasticity. Permendur K-65 has better mechanical properties in comparison with the K49 F2 alloy, however its  $\rho$  value is lower by nearly a factor of three. The iron-aluminum alloys (Yu-14 and Yu-12) have high electrical resistance and good magnetostrictive properties, but corrode very strongly and are highly brittle. Their advantage is the abundance of the source materials. The magnetostriction constants of the ferrite magnetostrictive materials are quite high. The advantage of the ferrites is the high electrical resistance (practical absence of Foucault current losses) and high corrosion resistance; the Curie temperature for nickel ferrite is  $590^{\circ}$ . Their high mechanical strength is essential for fabrication of cores for magnetostrictive filters. The ferrites are markedly inferior to the metallic materials with regard to mechanical strength and their saturation induction is relatively low. The ferrites are the least scarce and the cheapest of the magnetostrictive materials.

References: Spravochnik po elektrotekhnicheskim materialam (Handbook on Electrical Materials), Vol. 2, M.-L., 1960; Gershgal D.A., Frid-

II-37M3

man V.M., Ul'trazvukovaya apparatura (Ultrasonic Equipment), M.-L., 1961; Shur Ya.S., et al., IAN SSSR, Physics Series, 1958, Vol. 22, No. 10; Golyamina I.P., AZh, 1960, Vol.6, No. 3, pages 311-20; Davis C. M., Fersbee S. F., J. Appl. Phys., 1959, Suppl. to v. 30, No. 4, p. 113; Sussman H., Ehrlich S. L., J. Acoust Soc., America, 1950, v. 22, No. 4, p. 499.

I.P. Golyamina

II-21M

MAGNICO - see Alni alloys.

MALACHITE is a mineral of carbonate class, anhydrous basic copper carbonate  $\text{Cu}_2 [\text{CO}_3] (\text{OH})_2$ , containing the hydroxyl group  $[\text{OH}]^{1-}$  as an additional anion. Malachite is encountered in zones of oxidation of copper sulfide deposits in the form of sintered forms, dense, with concentrically zonal or radial-fibrous structure, and also in the form of friable, powder-like masses; in the voids there are formed (very rarely) prismatic crystals of monoclinic syngony. Hardness is 3.5-4. Brittle. Perfect cleavage along  $\{201\}$  and good along  $\{010\}$ . Specific weight 3.9-4.1; reduces to 3.6 for the filamentary varieties. Color is bright green, dark green. Luster is glassy to diamond, silken in the fibrous varieties. Transparent in thin sections. Light refraction index  $n_g = 1.809$ ;  $n_m = 1.875$ ;  $n_p = 1.655$ ;  $n_g - n_p = 0.254$ .  $N_g N_p = (010)$ ;  $cN_p = 23^\circ$ . Loses water on heating to about  $315^\circ$ . Slightly soluble in water containing  $\text{CO}_2$ . Dense sintered varieties of malachite are used as ornamental stones.

References: Betekhtin A.G., Mineralogiya (Mineralogy), M., 1950; Fersman A.Ye., Dragotsennyye i tsvetnyye kamni Rossii (Precious and Colored Stones of Russia), Vols. 1-2, P.-L. 1920-25; Dana G.D., et al., System of Mineralogy, translated from English, Vol. 2, Part 1, M. 1953.

Yu.L. Orlov

MALLEABLE CAST IRON — is a plastic cast iron obtained by tempering white iron; it surpasses significantly the gray cast iron, which has a lamellar graphite in its structure, with regard to plasticity. The plasticity of the malleable iron is caused by the fact that the graphite precipitations in its structure, the so-called temper carbon have a floccular form and, therefore, loosen the metal-base of the iron to a lower degree than the lamellar graphite in the gray iron. The temper carbon is formed during the tempering of the white iron by the decomposition of the carbide component. With regard to the microstructure, the malleable iron is subdivided into the more plastic ferritic, and the less plastic but harder pearlitic or pearlite-ferritic types. The chemical composition of the malleable iron (Table 1) is characterized by a lower content of carbon and silicon, compared with the composition of gray iron. The lowered carbon content (i.e., the total decrease of the graphite quantity in the structure of the malleable iron) causes an increased plasticity, and the reduced silicon content causes a total chilling of the castings and averts the separation of laminar graphite in their structure.

For wear-resistant castings, the malleable iron is alloyed with copper, manganese or molybdenum (see Antifriction cast iron). Addition of sulfur favors the coagulation of the graphite in a more compact form, similar to that of the spheroidal graphite, and allows the silicon content of the iron to be increased in order to reduce the tempering time. In modern industry, the modifying of cast iron is widely used, i.e., the addition of modifying agents (Table 2) before pouring into the

III-13chl

molds (see Modifying of cast iron). The main purpose of modifying is to reduce the tempering time and to prevent the formation of lamellar graphite (to give the latter a spheroidal form).

TABLE 1  
Chemical Composition of Castings of Malleable Iron  
(GOST 1215-59)

| Чугун<br>1  | Основы<br>структуры<br>2         | 3 Содержание элементов (%) |         |         |      |      |      |
|---|----------------------------------|----------------------------|---------|---------|------|------|------|
|   |                                  | C                          | Si      | Mn      | P    | S    | Cr   |
| 5<br>KЧ30-6<br>KЧ33-8<br>KЧ35-10<br>KЧ37-12<br>KЧ45-6<br>KЧ40-4<br>KЧ34-4<br>KЧ30-3<br>KЧ33-2 | Ферритная 6                      | 2.7-3.1                    | 0.7-1.1 | 0.3-0.6 | 0.18 | 0.12 | 0.08 |
|   |                                  | 2.3-2.8                    | 0.8-1.2 | 0.3-0.6 |      |      |      |
|   |                                  | 2.4-2.8                    | 0.9-1.4 | 0.3-0.5 |      |      |      |
|   |                                  | 2.2-2.3                    | 1.0-1.5 | 0.3-0.5 |      |      |      |
|   | Перлитная и перлитно-ферритная 7 | 2.2-3.1                    | 0.7-1.5 | 0.3-1.0 | 0.18 | 0.12 | 0.20 |

1) Cast iron; 2) basic structure; 3) percentage of the elements; 4) not more than; 5) KCh.; 6) ferritic; 7) pearlitic or pearlite-ferritic.

TABLE 2  
Modifiers of Malleable Iron

| Модификаторы<br>1                                   | Назначение модификаторов<br>2   | Количество при-<br>савки (%)<br>3                | 4 Способ присавки   |
|---|---|--|---|
| Al  | 7 Сокращение длительности от-<br>жига                                     | 0.015-0.03                                       | В ковш 12   |
| Bi + B<br>Bi + Al<br>Bi + B + Al                    | 8 То же и предотвращение обра-<br>зования пластинчатого графита           | 0.002-0.01 Bi<br>0.002-0.03 B<br>0.015-0.03 Al   | В виде легитур или смеси в<br>ковш, или на жолоб, либо<br>Bi - на жолоб, B и Al - в<br>ковш |
| Sb + B<br>Sb + B + Al                               | 9 То же   | 0.004-0.007 Sb<br>0.003-0.004 B<br>0.015-0.02 Al | В ковш  |
| N в виде аммиака<br>или CaCN <sub>2</sub> + Al<br>5 | .   | 0.2-0.5 CaCN <sub>2</sub><br>0.03 Al             | То же   |
| S + Al  | 10 Сокращение длительности от-<br>жига и получение шаровидного<br>графита | 0.3-0.4 S<br>0.015-0.03 Al                       | S - в ковш или шпату, Al -<br>в ковш  |
| Mg или магниевые<br>легитур 6                       | 11 Получение шаровидного графита<br>11                                    | 0.2-0.3 Mg                                       | В ковш  |

1) Modifiers; 2) purpose of the modifier; 3) quantity of addition; 4) mode of addition; 5) N as ammonia or CaCN<sub>2</sub> + Al; 6) Mg or magnesium alloys; 7) reduction of the tempering time; 8) the same, and prevention of the formation of lamellar graphite; 9) the same; 10) reduction of the tempering time and formation of spheroidal graphite; 11) formation of spheroidal graphite; 12) into the ladle; 13) as an alloy or a mixture into the ladle or on the spout; or Bi on the spout, and Al into the ladle; 14) S into the ladle or the charge, Al into the ladle.

The mechanical properties of malleable iron according to the standards of the USSR and of the US are quoted in the Tables 3-5, and the

III-13ch2

physical properties in Table 6.

TABLE 3  
Mechanical Properties of  
Malleable Iron (GOST 1215-59)

| Чугун<br>1 | $\sigma_b$ (kg/mm <sup>2</sup> )<br>2 | $\delta_{10}$ (%)<br>3 | KCh (kg/mm <sup>2</sup> )<br>4 | Основная структура<br>5               |
|------------|---------------------------------------|------------------------|--------------------------------|---------------------------------------|
| КЧ10-6     | 30                                    | 6                      | 183                            | 6<br>Ферритная                        |
| КЧ13-8     | 33                                    | 8                      | 183                            |                                       |
| КЧ15-10    | 35                                    | 10                     | 183                            |                                       |
| КЧ17-12    | 37                                    | 12                     | 183                            |                                       |
| КЧ45-6     | 45                                    | 6                      | 261                            | 7<br>Перлитная или перлитно-ферритная |
| КЧ50-4     | 50                                    | 4                      | 261                            |                                       |
| КЧ55-4     | 55                                    | 4                      | 269                            |                                       |
| КЧ60-3     | 60                                    | 3                      | 269                            |                                       |
| КЧ63-2     | 63                                    | 2                      | 269                            |                                       |

1) Cast iron; 2) (kg/mm<sup>2</sup>), not less than; 3) (kg/mm<sup>2</sup>), not more than; 4) basic structure; 5) KCh...; 6) ferritic; 7) pearlitic or pearlite-ferritic.

TABLE 4  
Mechanical Properties of  
Pearlitic Malleable Iron  
(according to the ASTM  
A220-55T US Standard)

| Чугун<br>1 | $\sigma_b$                      | $\sigma_{0.2}$ | $\delta_{10}$ (%) |
|------------|---------------------------------|----------------|-------------------|
|            | (kg/mm <sup>2</sup> , не менее) |                |                   |
| 65013      | 45.7                            | 31.6           | 10                |
| 43007      | 47.8                            | 31.6           | 7                 |
| 48006      | 49.2                            | 33.7           | 6                 |
| 50007      | 52.7                            | 35.1           | 7                 |
| 53004      | 56.2                            | 37.3           | 6                 |
| 60003      | 58.2                            | 42.2           | 3                 |
| 80002      | 70.3                            | 56.2           | 3                 |

1) Cast iron; 2) (kg/mm<sup>2</sup>), not less than.



• TABLE 5  
Mechanical Properties of Malleable Iron

| 1. Показатели   | 2. Феррит-ный | 3. Перлит-ный |
|---|---------------|---------------|
| σ (кг/мм <sup>2</sup> ) 4   | 13000-17000   | 14000-18000   |
| σ <sub>н</sub> без надреза (кг/мм <sup>2</sup> ) 5                        | 8-16          | 16-24         |
| σ <sub>н</sub> с надрезом (кг/мм <sup>2</sup> ) 6                         | 8-12          | 12-17         |
| σ <sub>н</sub> без надреза (кгс/см <sup>2</sup> ) 7                       | 8-23          | 2-5           |
| σ <sub>н</sub> с надрезом (кгс/см <sup>2</sup> ) 8                        | 2-4           | 0.8-1.5       |
| Демпфирующая способ-ность при напряжении, равном 1/3 σ <sub>н</sub> (%) 9 | 5-8           | 5-8           |
| HB (кг/мм <sup>2</sup> )  | 90-160        | 170-250       |

1) Characteristics; 2) ferritic; 3) pearlitic; 4) (kg/mm<sup>2</sup>); 5) without notch (kg/mm<sup>2</sup>); 6) notched (kg/mm<sup>2</sup>); 7) without notch (kgm/cm<sup>2</sup>); 8) notched (kgm/cm<sup>2</sup>); 9) damping capacity at a stress equal to 1/3 σ<sub>p</sub> (in %).

TABLE 6  
Physical Properties of Malleable Iron

| Свойства                       | 1 | 2. Размерность      | 3. Показатели |
|--------------------------------|---|---------------------|---------------|
| γ 4                            |   |                     | 7.2-7.4       |
| α · 10 <sup>6</sup> при 100° 5 |   | г/см <sup>3</sup> 6 | 10-12         |
| λ при 20° 7                    |   | кал/см·сек·°C       | 0.12-0.15     |
| ρ при 20° 8                    |   | мкн·см              | 30-55         |
| μ макс 9                       |   | г/см <sup>3</sup>   | 60-1800       |

1) Properties; 2) dimension; 3) characteristics; 4) at; 5) maks; 6) g/cm<sup>3</sup>; 7) cal/cm·sec·°C; 8) microohms/cm; 9) gauss/oersted.

TABLE 7  
Tempering Conditions of the Ferritic Black-Core Malleable Iron

| Тип печи 1  | 2. Содержа-ние крем-ния (%) | 3. Продолжительность отжига (час.) |                             |                          |   |                            | 9. всего |       |
|---|-----------------------------|------------------------------------|-----------------------------|--------------------------|---|----------------------------|----------|-------|
|   |                             | 4. нагрев                          | 5. 1-я стадия при 950-1060° | 6. промежу-точная стадия | 7. 2-я стадия при 780-700° или при 720° | 8. оконч.-чат. охлажде-ние |          |       |
| Периодич. намерные, на разном топливе, в горнах с засыпкой 10                                     | 0.8-1.0                     | 10-24                              | 20-30                       | 15-25                    | 5-15                                    | 20-35                      | 3-20     | 43-60 |
|   | 1.0-1.2                     |                                    |                             |                          |   |                            |          |       |
| Туннельные непрерывного дей-ствия, на мазуте или на газе, в горнах без засыпки 11                 | 0.8-1.0                     | 10-24                              | 15-25                       | 10-20                    | 6-15                                    | 20-30                      | 0-8      | 30-60 |
|   | 1.0-1.2                     |                                    |                             |                          |   |                            |          |       |
| Аксцентрично периодич. или непрерывного действия, без горючего и без засыпки 12                   | 0.8-1.0                     | 3-15                               | 15-30                       | 10-20                    | 2-4                                     | 15-30                      | до 6     | 20-60 |
|   | 1.0-1.2                     |                                    |                             |                          |   |                            |          |       |
| Садильные ванны для тонкостен-ных отливок (ванны электро-стого натрия или электроного металла) 13 | 1.0-1.4                     | -                                  | 0.5-1.0                     | -                        | -                                       | 10-15 в намерной печи      | -        | 13-14 |

1) Furnace types; 2) silicon content; 3) tempering time; 4) heating; 5) first stage at 950-1060°; 6) intermediate stage; 7) second stage at 780-700° or at 720°; 8) final cooling; 9) item; 10) periodic box furnaces, fired with various fuels, in covered crucibles; 11) continuous

tunnel-type furnace fired with black oil or gas, in uncovered crucibles; 12) periodic or continuous electrical furnaces, without pots and without covering; 13) salt baths for thin-walled castings (sodium chloride or potassium chloride baths); 14) in a box furnace.

In order to obtain the so-called black-core ferritic malleable iron, the fracture of which having a black color, the white iron castings are submitted to a graphitizing tempering in a neutral medium; this process not only causes the decomposition of the carbide phase, but also the formation of the temper carbon during the first stage of tempering, as well as the decomposition of the cementite in the pearlite-base and formation of ferrite during the second stage of tempering (Table 7).

The rarely used tempering of white iron to obtain the so-called white-core malleable iron is carried out in an oxidizing medium: in a mixture of waste or fresh iron ore in a ratio from 4:1 to 10:1 or in an oxidizing gas atmosphere, 27-30% CO; 7-10% CO<sub>2</sub>; 24-60% H<sub>2</sub>; 16-19% H<sub>2</sub>O, the rest N<sub>2</sub>, for example. The high plasticity of the white-core malleable iron is caused by the burning-out of the carbon in the external layers of massive castings, and the formation of a ferritic layer with a small quantity of precipitated temper carbon; in thin-walled castings, however, an almost pure ferrite structure is formed in the whole cross section (see Roofing iron). The tempering of the white iron to obtain pearlitic or pearlite-ferritic malleable iron is similar to that used in obtaining ferritic black-core malleable iron, the second stage of graphitization being reduced or left out entirely. The spheroidizing tempering at 720-740° improves the mechanical properties of the pearlitic malleable iron with an increased manganese content (0.8-1.0%). Ferritic malleable iron is transformed into pearlitic iron by normalizing after annealing at 800-850° for 0.2-1.0 hour per each 25 mm

111-13ch5

of the casting thickness. Hardening and tempering of pearlitic malleable iron increase its wear-resistance. Hardening of the parts made of pearlitic malleable iron are case-hardened to obtain a high surface hardness.

The malleable iron is used in the manufacture of a great number of parts for tractors and agricultural machines, automobiles, textile machines, ships, boilers, cars, diesel engines, and electrical machines. Moreover, malleable iron is widely used in tool manufacture and in manufacture of medical equipment, and also of equipment for sanitary, fire-department and building purposes.

References: Girshovich, N.G., Sostav i svoystva chuguna [Composition and Properties of Cast Iron], in the book: Spravochnik po chugunomu lit'yu [Handbook on Iron Casting], 2nd Edition, Moscow-Leningrad, 1960; the same, Termicheskaya obrabotka chugunnykh otlivok [Heat Treatment of Iron Castings], ibid.; Ioffe, A.Ya., Modifitsirovaniye kovkogo i otbelennogo chuguna [Modifying of Malleable and Chilled Iron], ibid.; Landa, A.F., Sobolec, B.F. and Khrapkovskiy, E.Ya., Otlivki iz kovkogo chuguna [Malleable Iron Castings], in the book: Spravochnik po mashinostroitel'nyim materialam [Handbook on Machine-Building Materials], Vol. 3, Moscow, 1959; Joseph, C.F., "Brit. Foundryman," 1960, Vol. 53, Part 2, pages 58-67.

A.A. Simkin

MALLEABLE COBALT ALLOYS - are alloys based on cobalt and chromium which have a high heat resistance at 800-1000°, a high resistance to thermal fatigue and which are readily worked by pressing. They contain chromium (in certain cases nickel) which increases both scale and heat resistance. High-melting elements such as molybdenum, tungsten, niobium, carbon and small quantities of boron are also added to the cobalt - chromium-nickel alloys in order to increase the heat resistance (Table).

TABLE  
Chemical Composition (%) of Foreign Heatproof Malleable Alloys

| Сплав<br>1                            | C    | Mn   | Cr   | Ni   | Co          | Mo  | W   | Nb  | Другие<br>элементы<br>2 |
|---------------------------------------|------|------|------|------|-------------|-----|-----|-----|-------------------------|
| 3<br>В-816 деформированный<br>и литой | 0,38 | 1,20 | 20,0 | 20,0 | Основа<br>4 | 4,0 | 4,0 | 4,0 | -                       |
| G-32                                  | 0,27 | 0,80 | 19,0 | 10,0 | 46,0        | 2,2 | -   | 1,4 | 3,0 V                   |
| G-34                                  | 0,80 | -    | 19,0 | 12,0 | 45,0        | 2,0 | -   | 1,3 | 1,0 B                   |
| 5<br>E-844 опытный                    | 0,26 | 0,50 | 25,3 | 20,0 | Основа      | 2,0 | 2,0 | 2,0 | -                       |
| V-36                                  | 0,27 | 1,0  | 25   | 20   | Основа      | 4,0 | 2,0 | 2,0 | -                       |
| I-1570                                | 0,20 | -    | 20   | 28   | 38          | -   | 7   | -   | 4,0 Ti                  |
| M-203                                 | 0,07 | -    | 19,5 | 24,5 | 36,5        | -   | 12  | 1,5 | 2,15 Ti<br>0,75 Al      |
| M-205                                 | 0,07 | -    | 18,5 | 24,5 | 37,5        | -   | 12  | 1,2 | 2,75 Al<br>0,22 B       |
| Иллиум X . 6                          | 0,85 | 0,25 | 28,5 | 1,0  | 52          | -   | 15  | -   | -                       |

1) Alloy; 2) other elements; 3) malleable and cast;  
4) basis; 5) experimental; 6) ILLIUM.

The alloys of the cobalt - chromium system may have the following structural components: a) A solid solution of chromium in the  $\beta$  ( $\gamma$ ) cobalt modification, characterized by a polyhedral structure; b) an acicular structure due to the diffusionless  $\beta$ - $\epsilon$  transformation (in alloys

I-94K1

containing 13-17% chromium); c) a solid solution of chromium in the  $\epsilon$  cobalt modification; d) eutectoidal segregations due to the reduced solubility of the  $\delta$  phase in the initial solid solution (similar in its appearance to the pearlite structures, observable in specimens of a cobalt-chromium-molybdenum alloy of the 63-27-6 grade after an extended test at 800°).

Cobalt and nickel form continuous  $\beta$  ( $\gamma$ ) solid solutions within a wide range of proportions owing to their similar physicochemical properties, but some changes occur, however, due to the effect of the low-temperature  $\epsilon$  cobalt modification. The heatproofness of the cobalt - nickel alloys is nearly equal to that of the pure cobalt and nickel metals, and a certain increase is observable in the range of the cobalt-rich alloys. The heatproofness of alloys in which nickel is prevalent is somewhat lower than that of pure nickel; therefore, cobalt only insignificantly strengthens nickel both at low and high temperatures.

Alloys hardened from the  $\epsilon$  region are harder than alloys hardened from the  $\beta$  ( $\gamma$ ) region. The hardness of alloys hardened from the  $\epsilon$  region decreases significantly after tempering.

The investigation of the effect of alloying elements (W, Mo, Nb, Ti, and V) in the cobalt - nickel system without chromium has not resulted in alloys with a high heat-resistance. The effect of chromium on the mechanical properties of malleable cobalt alloys and of the cobalt - nickel alloy with a ratio  $Co/Ni = 1$  is shown in Fig. 1. A chromium percentage of more than 24% ensures the highest long-life strength of the malleable cobalt alloys. The formation of a two-phase structure and a loss in the heat resistance can be observed when the chromium content is further increased.

Apart from the EI416 (VK36A) alloy, malleable cobalt alloys were not widespread in the USSR; in their place were mainly heat-resistant

I-94K2

alloys on a nickel basis without Co (EI617, ZhS6) or with 5-13% Co (EI867, EI929) (Fig. 2). Malleable cobalt alloys are widely used in the

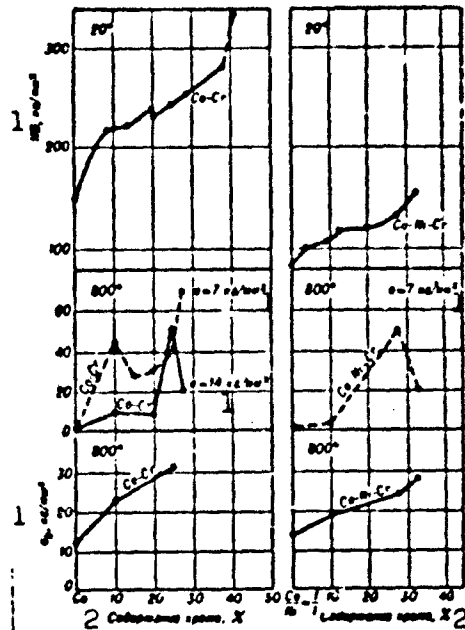

Fig. 1. Effect of chromium on the ultimate and long-life strength of malleable cobalt alloys and of the cobalt - nickel alloy. 1) kg/mm<sup>2</sup>; 2) chromium percentage.

U.S. The high mechanical and heat-resistant properties of the malleable cobalt alloys are attained by hardening at 1150-1200°, cooling in air, in oil, or in water, and a subsequent aging at 750-800°. The S-816 alloy hardened by carbide, was one of the most widespread, but it has gradually been replaced by alloys with a higher heat resistance (I-1570 and alloys of the M type). Malleable cobalt alloys (S-816; I-1570; G-32; G-34) are used in the production of the working blades of gas turbine engines, and of parts (valves) of the afterburner sections made from sheet and band metal (V-36).

References: Symposium on Materials for Gas Turbines, Phil., [1946]; Mikhaylov-Mikheyev P.B., Metall gazovoykh turbin (Metal for Gas Turbines),

I-94K3

Moscow-Leningrad, 1958; Zharoprochnyye splavy v usloviyakh poletov so sverkhzvukovymi skorostyami, [Heatproof Alloys Under the Conditions of Supersonic Flight], [Collection of papers], translated from English, Moscow, 1962; Simmons W.F., Krivobok V.N., Mochel N.L., Compilation of Chemical Compositions and Rupture Strengths of Super-Strength Alloys, Phil. [s.a.], 1958 (ASTM Special Technical Publ., No. 170); Khimushin F.F., Zharoprochnyye stali i splavy [Heat-resistant Steels and Alloys], Moscow, 1949.

F.F. Khimushin

MANGANESE BRASS is brass in which the basic alloying element is manganese. The manganese brasses have higher strength, hardness and corrosion resistance than the simple brasses. Alloying of brass with manganese increases the resistance to the action of sea water, superheated steam and chlorides. The favorable effect of manganese on the properties of the brasses is intensified in the presence of aluminum. Manganese brasses are produced in the standard grades LMts58-2 and LMts57-3-1. Widest application is of the LMts58-2 brass in the form of sheet, strip, rod and wire.

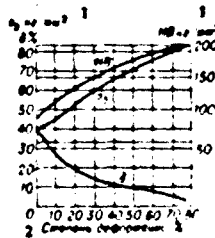

Fig. 1. Variation of mechanical properties of LMts58-2 brass as a function of degree of deformation. 1)  $\text{kg/mm}^2$ ; 2) degree of deformation, %.

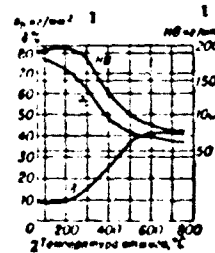

Fig. 2. Variation of mechanical properties of LMts58-2 brass as a function of annealing temperature. 1)  $\text{kg/mm}^2$ ; 2) annealing temperature, °C.



II-45M1

TABLE 1

Chemical Composition and Mechanical Properties of Manganese Brasses

| 1 Сплав<br>(марка<br>по ГОСТ<br>1019-47) | 2 Содержание основных элементов (%) |         |         |           | 3 Механич. свойства<br>(среднего химич.<br>состава) |                           |   | 4 Составные<br>материалы          |
|--|-------------------------------------|---------|---------|-----------|---|---------------------------|---|-----------------------------------|
|  | Сu                                  | Mn      | Al      | Zn        | 5 σ <sub>0.2</sub><br>(кг/мм <sup>2</sup> )         | 6 σ <sub>0.1</sub><br>(%) | 7 H <sub>118</sub><br>(кг/мм <sup>2</sup> ) |                                   |
| 07ЛМц58-2                                | 57.0-60.6                           | 1.0-2.0 | -       | Остальное | 40<br>70  | 38<br>19                  | 85<br>175                                   | Мягкий<br>Твердый<br>(никель 50%) |
| 10ЛМцА57-3-1                             | 55.0-58.5                           | 2.5-3.5 | 0.5-1.5 | *         | 45<br>75  | 30<br>5                   | 80<br>200                                   | Мягкий<br>Твердый<br>(никель 50%) |

1) Alloy (grade according to GOST 1019-47); 2) content of basic elements (%); 3) mechanical properties (average chemical composition); 4) material temper; 5) (kg/mm<sup>2</sup>); 6) LMTs58-2; 7) remainder; 8) soft; 9) hard (50% work hardening); 10) LMTsA57-3-1.

TABLE 2

Physical and Technological Properties of Manganese Brasses

| 1 Сплав      | 2 γ<br>(г/см <sup>3</sup> ) | 3 α · 10 <sup>4</sup><br>(1/°C) | 4 ρ <sub>30</sub><br>(ом·мм <sup>2</sup> /м) | 5 E<br>(кг/мм <sup>2</sup> ) | 6 Темп-ра<br>плавления<br>(°C) | 7 Темп-ра<br>горячей<br>обработки<br>(°C) | 8 Темп-ра<br>отжига<br>(°C) |
|--------------|-----------------------------|---------------------------------|--|------------------------------|--------------------------------|---|-----------------------------|
| 07ЛМц58-2    | 8.5                         | 21.2                            | 0.17   | 10 000                       | 880                            | 650-750                                   | 600-650                     |
| 10ЛМцА57-3-1 | -                           | -                               | -  | -                            | -                              | 650-750                                   | 600-700                     |

1) Alloy; 2) (g/cm<sup>3</sup>); 3) (cal/cm-sec-°C); 4) (ohm-mm<sup>2</sup>/m); 5) (kg/mm<sup>2</sup>); 6) melting point (°C); 7) hot working temperature (°C); 8) annealing temperature (°C); 9) LMTs58-2; 10) LMTsA57-3-1.

The LMTsA57-3-1 brass is delivered in the form of forging blanks. The manganese brasses are used primarily in ship construction. Tables 1, 2 present the chemical composition and basic properties of the manganese brasses, Figures 1, 2 show the variation of the mechanical properties with the degree of deformation and the annealing temperature of the manganese brasses.

References: Mal'tsev M.V., Barsukova T.A., Borin F.A., Metallografiya tsvetnykh metallov i splavov (Metallography of Nonferrous Metals and Alloys), M., 1960; Smiryagin A.P., Promyshlennyye tsvetnyye metally i splavy (Industrial Nonferrous Metals and Alloys), 2nd edition, M., 1956.

Ye.S. Shpichinetskiy

MANGANESE BRONZE is bronze in which the basic alloying element is manganese. Manganese has unlimited solubility in copper in both the liquid and solid states. The manganese bronzes containing up to 20% Mn have the structure of a homogeneous solid solution. With Mn content of 35%  $t_{pl}$  is 871°. In the presence of Mn, the copper recrystallization temperature increases by 150°. Alloys with manganese (to 15-20%), while retaining the plasticity of copper, have considerably higher hardness and strength at high temperature with a slight increase of strength at normal temperature. These alloys are easily pressure worked in the cold and hot conditions, permitting deformation to 80% with cold rolling. The manganese bronzes are corrosion resistant. The grade BrMts5 manganese bronze containing 4.5-5.5% Mn (GOST 493-54), produced in the form of forging blanks, is recommended for broad practical applications.

Physical, Mechanical and Processing Properties of BrMts5 Bronze

| 1 Свойства                       | Показатель 2 свойства | 3 Состояние материала | 4 Свойства   | Показатель 2 свойства  |
|----------------------------------|-----------------------|-----------------------|--|--|
| $\sigma_b$ (кг/мм <sup>2</sup> ) | 25<br>30<br>60<br>80  | 5 Литое               | 4 E (кг/мм <sup>2</sup> )<br>а 10° (1/°C)<br>в A (кал/см-сек-°C)<br>8 Температура литья (°C)<br>10 Температура горячей обработки (°C)<br>11 Температура отжига (°C)<br>12 Усадка (%)<br>13 Жидкотекучесть (см) | 10500<br>20.4<br>0.26<br>1110-1130<br>800-850<br>700-750<br>3<br>5 |
|                                  |                       | 6 Мягкое              |  |  |
|                                  |                       | 7 Твердое             |  |  |
| $\delta$ (%)                     | 40                    | 5 Литое               | 13 Жидкотекучесть (см)   | 3<br>5   |
|                                  |                       | 6 Мягкое              |  |  |
| HB (кг/мм <sup>2</sup> )         | 2<br>70<br>80<br>160  | 7 Твердое             | 13 Жидкотекучесть (см)   | 3<br>5   |
|                                  |                       | 5 Литое               |  |  |
|                                  |                       | 6 Мягкое              |  |  |
|                                  |                       | 7 Твердое             |  |  |

1) Properties; 2) property index; 3) material temper; 4) (kg/mm<sup>2</sup>); 5) cast; 6) soft; 7) hard; 8) (cal/cm-sec-°C); 9) casting temperature; 10) hot working temperature; 11) annealing temperature; 12) shrinkage; 13) fluidity (cm).

O. Ye. Kestner

MANGANESE COPPER is an alloy containing, in addition to copper, 0.8 - 1.2% Mn. A representative of this group is the MMts-1 alloy which has a uniform solid solution structure.

Manganese increases the corrosion resistance of copper and the recrystallization temperature. It is also introduced into copper for the purpose of deoxidation. Rods used in the electro-vacuum industry (see Pure Copper) are fabricated from manganese copper which is deoxidized by manganese and contains Mn in the amount of 0.1 - 0.3% (TsMTU-3204-52). The ultimate strength of parts made from products using manganese copper is 35-60 kg/mm<sup>2</sup>.

Chemical Composition of Manganese Copper

| 1<br>Сплав          | 2 Содержание элементов (%) |         |     |      |      |       |       |      |      |       |      |     | сумма<br>примесей<br>4 |
|---------------------|----------------------------|---------|-----|------|------|-------|-------|------|------|-------|------|-----|------------------------|
|                     | Cu                         | Mn      | Fe  | Pb   | Sn   | Sb    | Bi    | As   | S    | Ni+Cr | Al   | Si  |                        |
| 3 примеси, не более |                            |         |     |      |      |       |       |      |      |       |      |     |                        |
| MMts-1              | 98.5-99.2                  | 0.8-1.2 | 0.1 | 0.01 | 0.05 | 0.005 | 0.002 | 0.01 | 0.01 | 0.2   | 0.07 | 0.1 | 0.3                    |

1) Alloy; 2) content of elements (%); 3) impurities, not more than; 4) total impurities; 5) MMts-1.

Manganese copper is used in general machine construction (in particular, for radiators). Manganese copper is used for the production of hexagonal, round, pentahedral and flared tubing (GOST 529-41 and TsMTU-3086-52).

O. Ye. Kestner

MANGANESE GERMAN SILVER is a copper-base alloy in which the basic alloying elements are nickel and manganese. Dean (US) proposed the heat treatable alloy of composition 60% Cu + 20% Ni + 20% Mn as an equivalent replacement for beryllium bronze. In the USSR there has been developed a new alloy of higher quality containing 57.5% Cu, 25% Ni, 15% Mn, 1% Al, 1% Cr, 0.5% Si. The Soviet manganese German silver has good casting properties and may be produced by continuous casting. It has high plasticity at temperatures of 700-900°, can be hardened and has a considerable improvement of properties after tempering (Table 1). The heat treatment regime for manganese German silver is: solution treatment temperature 850°, tempering at 450-500°.

TABLE 1

Mechanical Properties of Manganese German Silver

| 1 Состояние материала       | 2 $H_{0.2}$ (кг/мм <sup>2</sup> ) | 3 $\sigma_{0.2}$ (кг/мм <sup>2</sup> ) | 4 $\delta$ (%) |
|-----------------------------|-----------------------------------|--|----------------|
| 3 Закаленный                | 153                               | 67                                     | 40             |
| 4 Отпущенный после закалки  | 321                               | 108                                    | 17             |
| 5 Холоднокатанный           | 280                               | 100                                    | 5              |
| 6 Отпущенный после прокатки | 324                               | 150                                    | 3              |

1) Material temper., 2) (kg/mm<sup>2</sup>); 3) solution treated; 4) annealed after solution treatment; 5) cold rolled; 6) annealed after rolling.

In the refined (after solution treatment) condition the modulus of elasticity of the alloy is equal to 14.700 kg/mm<sup>2</sup>, elastic limit is 63 kg/mm<sup>2</sup>, yield point is 85 kg/mm<sup>2</sup>, resistivity is 0.7 ohm-mm<sup>2</sup>/m. With regard to elastic hysteresis and cyclic resistance at room temperature, the alloy is equivalent to beryllium bronze, and at elevated temperature it surpasses the American spring alloy MNMts20-20 and beryllium

II-47M1

TABLE 2

Properties of P100 Instrument Membranes Made from Soviet Manganese German Silver in Comparison with Membrane from Beryllium Bronze and an American Alloy

| 1<br>Сплав                                | 2 При давлении<br>100 ат и 20° | 3<br>Максимальный гистерезис (%) при нагрузке<br>200 кг и темп-ра (°C) | 4                                |                                 |                        |
|---|--------------------------------|--|----------------------------------|---------------------------------|------------------------|
|   |                                |  | 5<br>Максимальный гистерезис (%) | 6<br>Число циклов до разрушения | 7<br>Темп-ра (°C)      |
| 8 Отечественный марганцовистый медь-бронз | 0.44                           | 15402  | 1.03                             | 0.89                            | 1.89<br>(3.6 при 350°) |
| 9 BrB2.5                                  | 0.55                           | 4734   | 1.12                             | 1.04                            | 2.89                   |
| 10 BrBNT1.9                               | 0.58                           | 17107  | 1.01                             | 0.98                            | 3.80                   |
| 11 MNMts20-20                             | 0.39                           | 6276   | 1.21                             | 1.27                            | 3.06                   |

\*Considerable creep is noted in the BrB2.5, BrBNT1.9 and MNMts 20-20 alloys at 350°.

1) Alloy; 2) at pressure of 100 atm and 20°; 3) maximal hysteresis (%) with load of 200 kg and temperatures (°C); 4) maximal hysteresis (%); 5) number of cycles to failure; 6) Soviet manganese German silver; 7) at; 8) BrB2.5; 9) BrBNT1.9; 10) MNMts20-20.

bronze (Table 2).

Manganese German silver is significantly cheaper than beryllium bronze. The alloy is nonmagnetic, welds and brazes well, is produced in the form of strip and ribbon with thickness from 0.08 mm. It is used for spring parts of precision instruments and other sensing elements.

References: Bobylev A.V., Margantsovy mel'khior - vysokoprochnyy mednyy splav (Manganese German Silver - A High Strength Copper Alloy), P, 1958, No. 3; — Mednyye splavy dlya uprugikh chuvstvitel'nykh elementov (Copper Alloys for Elastic Sensing Elements), in book Perspektivy razvitiya uprugikh chuvstvitel'nykh elementov (Prospects for Development of Elastic Sensing Elements), M., 1961; Dean R.S., [a.o.], Trans. Amer. Soc. Metals, 1945, v. 34, p. 481-504.

A.B. Bobylev

MARBLE - various carbonate rocks which differ in petrographic characteristics and which are to some degree decrystallized as a result of metamorphism, consisting basically of calcite or dolomite minerals; not infrequently containing admixtures of silicate minerals, serpentine for example. Common to all these rocks is a dense structure and the ability to take polishing. Marble colors are white, gray, yellow, pink, red, green, lilac; the colored regions often form a beautiful pattern. Harmful impurities which make working difficult are quartz and other hard minerals; the presence of sulfides, (pyrite and others) degrade the quality of marble - when these impurities oxidize, rust spots are formed on the surface of facing stone; the iron sulfides and oxides reduce the dielectric properties of marble (electric panels). Specific weight of marble is 2.69-2.88. Volumetric weight 2.59-2.86. Mohs hardness 3-3.5. Porosity of marble is usually low - in the range of 0.7-1.5%. Water absorption of marble is 0.12-1.5 weight percent. Electrical resistivity of marble varies from  $10^5$  to  $10^{13}$  ohm-cm; breakdown voltage varies from 10 to 45 kv/cm. The compression ultimate strength varies from 600 to 2200  $\text{kg/cm}^2$ , coarse crystalline marble has the lower strength and fine-grained has the higher strength. Tensile strength is 60-150  $\text{kg/cm}^2$ , bending strength is 80-295  $\text{kg/cm}^2$ . Marble is used in the electrical industry for fabrication of electrical distribution panels, switchboards, etc., and other articles for electrical insulation; it is used in sanitary engineering for facing walls, etc.

References: Trebovaniya promyshlennosti k kachestvu mineral'nogo

syr'ya (Industry Requirements on Quality of Mineral Raw Material), No. 4  
 Solov'yev D.V., Mramor (Marble, M.-L, 1946. Yu.A. Rozanov

MARSHALITE is powdery quartz (mountain meal, quartz melite, powdery silica) - a mealy mass of finely dispersed quartz, usually of a spotless white color. It consists of angular grains of quartz with admixture of chalcedony, opal, carbonates and clayey minerals. Calcining losses are 0.55-1.42%. Marshalite has a high degree of dispersion and low content of iron oxides. The predominant fraction (over 80%) are grains of less than 0.01 mm. Specific weight is 2.61-2.65, volumetric weight is 1.14, void volume in natural Marshalite reaches 60%. Specific surface is 1130-1500  $\text{cm}^2/\text{g}$ , refractoriness 1650-1710°, thermal conductivity at 20°  $1.67 \cdot 10^{-3}$ , with moisture of 21 weight %  $22 \cdot 10^{-3}$  w/cm-deg, and at 344° it is  $1.07 \cdot 10^{-4}$  cal/cm-sec-deg. Marshalite is easily refined by elutriation and air separation with the separation of monomineral fractions and simultaneous reduction of the  $\text{Fe}_2\text{O}_3$  content to 0.02%. The  $\text{Fe}_2\text{O}_3$  content may be reduced to 0.004% by chemical refinement. Marshalite is sometimes obtained artificially - by grinding quartz sand.

The use of Marshalite is based on its chemical composition, approximating that of quartz, and high degree of dispersion with low iron oxide content. Marshalite is of interest for all branches of industry where finely ground quartz raw material with low iron content is required: as filler for rubber (particularly that used for electrical insulation) and plastics; for production of colorless glass in the glass industry; as a forming compound or paint for casting forms; in place of quartz in the production of porcelain and faience; as an abrasive for grinding glass, marble, etc.; for the production of light-weight Dinas refractory brick and refractory pastes; for the production of sodium

II-5141

silicate (soluble glass), silicalcite, acid-resistant cement, autoclave structural materials; as a microfiller for concretes; as filler for special grades of paper, paints, glues, etc.

References: Zhilin A.I., Pylevidnyy kvartz, yego svoystva i primeneniye (Powdery quartz, its properties and use), in collection: Pylevidnyy kvartz (Powdery Quartz), Sverdlovsk-m., 1939, pages 32-55 (Transactions of the Ural Industrial Institute, collection 9); ----, Primeneniye pylevidnogo kvartsa v stekol'noy promyshlennosti (Use of powdery quartz in the glass industry), SiK, 1956, No. 9, pages 26-27; Mamurovskil A.A., Avisov B. P., Pylevidnyy kvartz kak promyshlennoye syr'ye (Powdery quartz as industrial raw material), Mineral'noye syr'ye (Mineral Raw Material), 1937, No. 10-11; Chernyshov I.A., Marshalit (Kvar-tsevaya muka) i yego primeneniye v liteynykh (Marshalite (quartz flour) and its application in casting shops), Liteynoye delo (Casting), 1934, No. 7.

V. I. Fin'ko



MARTENS HEAT RESISTANCE (GOST 9551-60) - an arbitrary indicator of the heat resistance of plastic materials; the temperature at which a cantilever specimen, subjected to a bending moment which produces a stress of  $50 \text{ kg/cm}^2$  in the specimen, deforms in a manner such that an arrow attached to it is lowered by 0 mm. The instrument with a specimen with  $120 \times 15 \times 10 \text{ mm}$  is placed in an air thermostat, which is heated at the constant rate of  $50^\circ$  per hour.

Manu-  
script  
Page  
No.

[Transliterated Symbols]

2442

ГОСТ = GOST = Gosudarstvennyy obshchesoyuznyy standart = All-  
Union State Standard

MARTENSITE is a structural component of steel which is formed with abrupt cooling after heating above the critical point. In each grain of the original austenite there is formed a large number of martensite crystals, which have a centered tetragonal lattice close to the lattice of  $\alpha$ -iron. As a rule, martensite has the form of elongated platelets (needles), its outstanding characteristic is high hardness. The martensitic structure is also found with quenching (rapid cooling) of several metals (cobalt, titanium, zirconium, lithium) from a temperature above the polymorphic transformation point. In the nonferrous alloys the martensitic structure has been found as a result of the transformation (quenching) of the  $\beta$ -phase of the eutectoid alloys Cu - Al, Cu - Sn and the  $\beta$ -phase of the Cu-Zn alloys, the  $\beta \rightarrow \alpha$  transformation in alloys based on titanium, zirconium and cobalt, in the Li-Mg alloys.

Common factors in the kinetics of the transformation in the solid state which lead to the formation of martensite are: absence of diffusional displacements of the atoms; development of the transformation primarily during the process of continuous cooling; formation of martensite crystals by a shear mechanism (similar to the formation of mechanical twinning) which leads to relief formation.

The high hardness and resistance to deformation of steel with martensitic structure is explained by the creation of a fine mosaic structure of the grains as a result of the austenite-martensite transformation and primarily by the high elastic limit of the martensite crystals themselves, associated with the presence of interstitial carbon in the crystals. Therefore, the higher the carbon content in the mart,

II-50M1

ensite, the higher the steel hardness after quenching.

M.L. Bernshteyn

MARTENSITIC STAINLESS STEEL is steel combining resistance to corrosion in the moist atmosphere with strength which is higher than that of austenitic stainless steel. As a result of the capability for tempering, the martensitic stainless steel has mechanical properties close to those of the usual structural steel. Figure 1 shows the effect of carbon content on the hardness of 12% chrome steel after tempering.

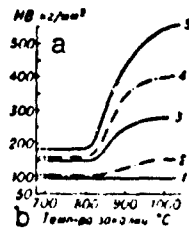

Fig. 1. Effect of tempering temperature and carbon content in 12% chrome steel on variation of the hardness: 1) 0.01% C and 13% Cr; 2) 0.01% C and 12% Cr; 3) 0.05% C and 12.4% Cr; 4) 0.12% C and 12% Cr; 5) 0.35% C and 13% Cr. a) HB, kg/mm<sup>2</sup>; b) tempering temperature, °C.

The martensitic stainless steels are divided into 5 groups on the basis of carbon and chrome content.

The first group includes the martensitic stainless steels containing less than 0.15% carbon and 12-14% chromium, which are characterized by a favorable combination of mechanical properties and corrosion resistance. The martensitic stainless steels of the second group have higher carbon content and greater hardness with adequate strength. The martensitic stainless steels of the third group have still greater carbon content and high chromium content, as a result of which they have high hardness with some reduction of plasticity. Characteristic of the martensitic stainless steels of the fourth group is the same chrome

II-35n1

content as that of the steels of the third group, but a lower carbon content, which gives them higher corrosion resistance in comparison with the steels of the other groups. The addition of nickel aids the improvement of the hardenability and the mechanical properties of these steels. The martensitic stainless steels of the fifth group contain alloying elements - nickel, molybdenum, tungsten, vanadium - and as a result of this are characterized by high mechanical properties up to 600°, good hardenability and almost complete absence of the ferritic phase in the structure.

The specific weight, coefficient of linear thermal expansion, specific heat, and elastic modulus of the OKh13 and lKh13 steels differ little from the analogous properties of unalloyed medium-carbon steels, while the coefficient of thermal conductivity is considerably lower (0.06 cal/cm-sec-°C at 100° and 0.069 cal/cm-sec-°C at 500°).

The basic physical properties of the steels of the first group are:  $\gamma = 7.7-7.75 \text{ g/cm}^3$ ;  $\alpha(1/^\circ\text{C})$ :  $11 \cdot 10^{-6}$  (20-100°),  $12 \cdot 10^{-6}$  (20-500°);  $\lambda$  (kal/cm-sec-°C): 0.060 (100°), 0.069 (500°);  $\rho$  (ohm-mm<sup>2</sup>/m): 0.5 (20°), 0.58 (100°), 0.93 (500°);  $E = 20,000 \text{ kg/mm}^2$ .

The martensitic stainless steels of this group, just as those of the other groups, are ferromagnetic and this property is retained after heat treatment. The transformation initiation point  $A_{c_1}$  is at 850°, the end point  $A_{c_3}$  is at 920°. Transformation to austenite takes place on heating above 920°. Heating the steel above 1050° leads to the separation of  $\delta$ -ferrite from the austenite. Tempering at 260-400° aids in relieving the stresses which arise after quenching, and also tends to reduce the hardness, which takes place more slowly than for carbon steel. With tempering at 450-550° there is observed a considerable decrease of the impact strength (Fig. 2) and deterioration of the corrosion resistance.

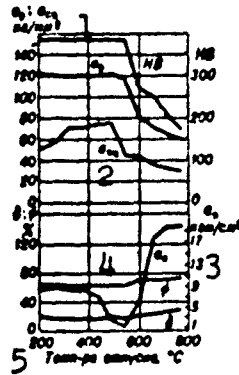

Fig. 2. Variation of mechanical properties of 1Kh13 steel with tempering temperature (oil quench from 980°). 1)  $\sigma_b$ ,  $\sigma_{pts}$ , kg/mm<sup>2</sup>; 3)  $a_n$ , kgm/cm<sup>2</sup>; 4)  $a_n$ ; 5) tempering temperature, °C.

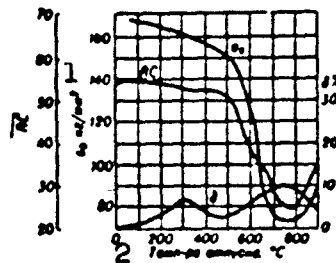

Fig. 3. Variation of mechanical properties of EI474 steel as a function of tempering temperature. 1)  $\sigma_b$ , kg/mm<sup>2</sup>; 2) tempering temperature, °C.

TABLE 1

Chemical Composition of Martensitic Stainless Steels of the First Group

| Сталь 1        | 2 Содержание элементов (%) |      |      |       |        |       | 3 ГОСТ         |
|----------------|----------------------------|------|------|-------|--------|-------|----------------|
|                | C                          | Si   | Mn   | Cr    | S      | P     |                |
| 4 0X13 (ЭИ496) | <0.08                      | <0.6 | <0.6 | 11-13 | <0.025 | <0.03 | } ГОСТ 5632-61 |
| 5 1X13 (Ж1)    | 0.09-0.15                  | <0.6 | <0.6 | 12-14 | <0.025 | <0.03 |                |

1) Steel; 2) element content (%); 3) GOST; 4) 0Kh13 (EI496); 5) 1Kh13 (Zh1).

To obtain better machinability of the martensitic stainless steels, it is recommended that high tempering be performed at 650-700° or complete annealing, consisting of heating to 870-900°, soak for 1-2 hours, slow furnace cooling to 450-650° at a rate of 15-25° per hour, and further cooling in air, oil or water.

TABLE 2

Mechanical Properties of Martensitic Stainless Steels of the First Group (no less than)

| Сталь 1  | 2 Термич. обработка   | $\sigma_b$            | $\sigma_{0.2}$ | $\delta$ | $\psi$ | 3 $a_n$<br>(кгм/см <sup>2</sup> ) |
|--|---|-----------------------|----------------|----------|--------|-----------------------------------|
|  |   | (кг/мм <sup>2</sup> ) | (%)            | (%)      | (%)    |                                   |
| 5<br>OKh13<br>(ЭИ496)<br>7<br>1Xh13 (Ж1)<br>Прутки | 6 Отпуск при 780°, охлаждение в печи или на воздухе                   | 43                    | —              | 23       | —      | —                                 |
|  | 8 Закалка с 1020°, охлаждение на воздухе или в масле, отпуск при 370° | 120                   | 114            | 18       | 60     | 7                                 |
| 9<br>Листы   | 10 Отпуск при 780°  | 40                    | —              | 21       | —      | —                                 |

1) Steel; 2) heat treatment; 3)  $a_n$ , kgm/cm<sup>2</sup>; 4) kg/mm<sup>2</sup>; 5) OKh13 (EI496); 6) temper at 780°, cool in furnace or in air; 7) lKh13 (Zh1), rods; 8) quench from 1020°, air or oil cool, temper at 370°; 9) sheets; 10) temper at 780°.

TABLE 3

Hot Work Regimes and Application of Martensitic Stainless Steel of the First Group

| Сталь 1                        | 2 Режимковки  | 3 Термич. обработка   | 4 Применение   |
|--------------------------------|---|---|--|
| OKh13 (ЭИ496), 1Xh13 (Ж1)<br>5 | 6 Медленный нагрев до 800°, затем быстрый до 1150°, температура концаковки 850°, охлаждение в воде или горячем песке. Для снятия внутр. напряжений и наклепа послековки необходимо отпуск при 730-780° в течение 1-3 час., охлаждение на воздухе или отжиг при 850-900° в течение 1-2 час., охлаждение в печи | 7 Отпуск при 680-780°, охлаждение в печи или на воздухе.<br>8 Закалка с 980-1020°, охлаждение на воздухе или в масле, отпуск при 230-370° в течение 1-3 час., охлаждение на воздухе. Для листов отпуск при 740-780° | 9 Сварные детали невысокой прочности. Детали с повышенной пластичностью, подвергающиеся ударным нагрузкам: турбинные лопатки, клапаны гидравлич. прессов, арматура крекинг-установок |

1) Steel; 2) forging regime; 3) heat treatment; 4) application; 5) OKh13 (EI496), lKh13 (Zh1); 6) slow heating to 800°, then fast heating to 1150°, temperature at end of forging 850°, cool in ashes or hot sand. To relieve internal stresses and strain hardening it is necessary after forging to temper at 730-780° for 1-3 hours, air cool, or anneal at 850-900° for 1-2 hours, furnace cool; 7) temper at 680-780°, furnace or air cool; 8) welded detail parts of low strength; 9) quench from 980-1020°, air or oil cool, temper at 230-370° for 1-3 hours, air cool. For sheets, temper at 740-780°; 10) detail parts with high elasticity which are subject to impact loading; turbine blades, hydraulic press valves, cracking plant fittings.

The martensitic stainless steels of the first group are resistant to oxidation to 750-800°, have high corrosion resistance under atmospheric conditions, in river and reservoir water, and satisfactory resistance in nitric acid at room temperature. The highest corrosion resistance is obtained after tempering and polishing.

With regard to physical properties, the martensitic stainless

II-35n4

steels of the second group hardly differ from those of the first group.

Rods, forgings and sheets are produced from the 2Kh13, 3Kh13, and 4Kh13 steels, only rods are made from the EI474 steel.

Weldability of the 2Kh13 and EI474 steels is satisfactory. Heat treatment is required after welding - tempering at 740-780° with air cooling. The 3Kh13 and 4Kh13 steels weld poorly, and during welding measures must be taken to prevent the occurrence of cracks: heating prior to welding to 200-300°, heat treatment immediately after welding using the same regime as for the 2Kh13 and EI474 steels. The stress-rupture, creep, and fatigue limits of the 2Kh13 steel after quench and tempering are shown in Figs. 4-6.

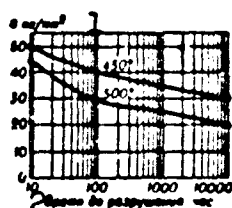

Fig. 4. Stress rupture strength of 2Kh13 steel at temperatures of 450 and 500° (air quench from 1020°, temper at 700°). 1)  $\sigma$ , kg/mm<sup>2</sup>; 2) time of failure, hours.

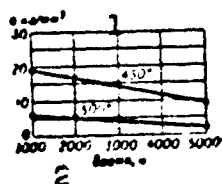

Fig. 5. Creep of 2Kh13 steel with respect to residual deformation at 450-500° (air quench from 1020°, temper at 700°). 1)  $\sigma$ , kg/mm<sup>2</sup>; 2) time, hours.

TABLE 4

Chemical Composition of Martensitic Stainless Steels of the Second Group

| Сталь<br>1                 | 2 Содержание элементов (%) |              |                 |                |            |                     |                    | ГОСТ или ТУ<br>3             |
|----------------------------|----------------------------|--------------|-----------------|----------------|------------|---------------------|--------------------|------------------------------|
|                            | C                          | Si           | Mn              | Cr             | Ni         | S                   | P                  |                              |
| 4 2X13 (ЖЗ)<br>ЭИ474       | 0.18-0.24<br>0.2-0.3       | <0.8<br><0.8 | <0.8<br>0.8-1.2 | 12-14<br>12-14 | -<br>1.5-2 | <0.025<br>0.15-0.25 | <0.03<br>0.08-0.15 | ГОСТ 5632-81<br>МНТУ 6157-83 |
| 8 2X13 (ЖЗ)<br>9 4X13 (Ж4) | 0.25-0.34<br>0.35-0.44     | <0.8<br><0.8 | <0.8<br><0.8    | 12-14<br>12-14 | -          | <0.025<br><0.025    | <0.03<br><0.03     | ГОСТ 5632-81<br>То же<br>10  |

1) Steel; 2) element content (%); 3) GOST or TU; 4) 2Kh13 (Zh2); 5) GO-



II-35n5

ST; 6) EI474; 7) MPTU; 8) 3Kh13 (Zh3); 9) 4Kh13 (Zh4); 10) same.

TABLE 5

Mechanical Properties of Martensitic Stainless Steels of the Second Group (no less than)

| Сталь     | ТУ                      | Термич. обработка * | $\sigma_b$   $\sigma_{0.2}$ |     | $\delta$ | $\psi$ | $a_n$ | НВ        |
|-----------|-------------------------|---------------------|-----------------------------|-----|----------|--------|-------|-----------|
|           |                         |                     | (кг/мм <sup>2</sup> )       | (%) |          |        |       |           |
| 3X13 (ЖЗ) | МПТУ 2362-49            | 9                   |                             |     |          |        |       |           |
| 7         | 8                       | 10                  | 85                          | 65  | 10       | 50     | 6     | 3.9-3.8   |
| 11        | Для листов ЧМТУ 3126-52 | 12                  | 125                         | —   | 7        | 45     | 5     | 3.2-3.6   |
| EI474**   | МПТУ 4157-53            | 15                  | 85                          | —   | 10       | —      | —     | 3.95-3.85 |
| 13        | 14                      | 16                  | 165                         | —   | 3        | —      | —     | 2.9-2.7   |
| 3X13 (ЖЗ) | МПТУ 2362-49            | 17                  |                             |     |          |        |       |           |
| 17        | 18                      | 19                  | 68                          | 42  | 25       | 60     | —     | 4.8       |
|           |                         | 20                  | 72                          | 55  | 22       | 55     | —     | 4.2-4     |
| 11        | Для листов ЧМТУ 3126-52 | 21                  | 175                         | 155 | 8        | 4      | —     | 2.9-2.6   |
| 4X13 (Ж4) | МПТУ 2362-49            | 22                  |                             |     |          |        |       |           |
| 22        | 14                      | 23                  | 168                         | 140 | 4        | 8      | —     | 2.7       |
| 11        | Для листов ЧМТУ 3126-52 | 24                  | 88                          | 42  | 25       | 60     | —     | 4.8-4.4   |
|           |                         | 12                  | 80                          | —   | 15       | —      | —     | —         |

\*After annealing HB (d<sub>отп</sub>) for all grades of the martensitic stainless steels is  $\geq 3.9$  mm.

\*\*Effect of tempering on mechanical properties of quenched EI474 steel is shown in Fig. 3.

- 1) Steel; 2) TU; 3) heat treatment\*; 4) (kg/mm<sup>2</sup>); 5) a<sub>n</sub> (kgm/cm<sup>2</sup>); 6) HB (d<sub>отп</sub>, mm); 7) 2Kh13 (Zh2); 8) MPTU; 9) quench from 1050°, air or oil cool, temper at 700°, oil cool; 10) quench from 1050°, air cool, temper at 500°; 11) for sheets ЧМТУ; 12) anneal at 780°; 13) EI474\*\*;
- 14) MPTU; 15) after annealing; 16) quench from 1030-1050°, air cool, temper at 180-240°; 17) 3Kh13 (Zh3); 18) MPTU; 19) full anneal for 1-2 hours at 870-900°, slow cooling to 600°; 20) intermediate anneal for 2-6 hours at 760°, air cool; 21) quench from 1000-1050°, air or oil cool, temper at 150-370°; 22) 4Kh13 (Zh4); 23) quench from 1000-1050°, air or oil cool, temper at 200°; 24) full anneal for 1-2 hours at 870-900°, cool to 600°.

The steels of the grades 2Kh13, 3Kh13, and 4Kh13 are widely used for decorative purposes and also to fabricate tableware. The blueish color of chrome steel is explained by its low reflectivity (reflects 62% of the incident light). The martensitic stainless steels polish well.

The martensitic stainless steels of the third class include Kh18

TABLE 6

Mechanical Properties of Some Grades of Martensitic Stainless Steels of the Second Group at High Temperatures

| Сталь 1       | Термич. обработка 2                                     | Темп ра 3 (°C) | σ <sub>b</sub> |                       | σ <sub>0.2</sub> |     | δ  |      | ψ | a <sub>n</sub> (мм/см <sup>2</sup> ) 5 |
|---------------|---|----------------|----------------|-----------------------|------------------|-----|----|------|---|--|
|               |   |                | 4              | (кг/мм <sup>2</sup> ) | (%)              | (%) |    |      |   |  |
| 2X13(Ж2)<br>6 | Закалка с 1050°, охлаждение на воздухе, отпуск при 700° | 300            | 20400          | 55                    | 40               | 18  | 66 | 20   |   |  |
|               |   | 400            | 19300          | 53                    | 40               | 16  | 58 | 20   |   |  |
|               |   | 500            | 18400          | 44                    | 36               | 26  | 68 | 25   |   |  |
| 2X13(Ж3)<br>8 | Нормализация 7 при 1000°, отпуск при 650°               | 300            | 20600          | 79                    | 64               | 13  | 59 | 12.5 |   |  |
|               |   | 400            | 20000          | 72                    | 58               | 12  | 52 | 16   |   |  |
|               |   | 500            | 18500          | 62                    | 54               | 14  | 54 | 18.5 |   |  |

1) Steel; 2) heat treatment; 3) temperature (°C); 4) (kg/mm<sup>2</sup>); 5) a<sub>n</sub> (kgm/cm<sup>2</sup>); 6) 2Kh13 (Zh2); 7) quench from 1050°, air cool, temper at 700°; 8) 3Kh13 (Zh3); 9) normalization at 1000°, temper at 650°.

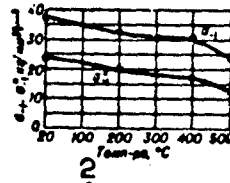

Fig. 6. Fatigue strength of the 2Kh13 steel (quench from 1050° in oil, temper at 700°). 1) σ<sub>-1</sub>, σ<sub>n-1</sub>, kg/mm<sup>2</sup>; 2) temperature, °C.

(EI229) with the following chemical composition: 0.9-1% C, 17-19% Cr, ≤ 0.8% Si, ≤ 0.7% Mn, ≤ 0.025 S, ≤ 0.03% P.

The Kh18 steel is used in those cases when high hardness is required regardless of the value of the impact strength, in particular for cutters, surgical instruments, bearings, pump components, etc. With

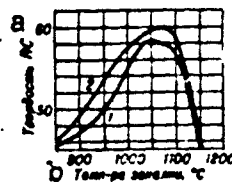

Fig. 7. Effect of quench temperature on hardness of the Kh18 (EI229) steel: 1) carbon content 0.7%; 2) carbon content 1.0%. A) Hardness, RC; b) quench temperature, °C.

regard to its physical properties, this steel is close to the martensitic stainless steels of the preceding groups, but as a result of the

TABLE 7

Hot Work Regime and Application of Martensitic Stainless Steels of the Second Group

| 1          | 2           | 3                 | 4          |
|------------|-------------|-------------------|------------|
| Сталь      | Режим ковки | Термич. обработка | Применение |
| 2X13 (Zh2) | 6           | 7                 | 8          |
| ЭИ474      | 10          | 11                | 12         |
| 3X13 (Zh3) | 14          | 15                | 16         |
| 4X13 (Zh4) | 18          | 19                | 20         |

1) Steel; 2) forging regime; 3) heat treatment; 4) application; 5) 2Kh-13 (Zh2); 6) slow heating to 800°, then fast heating to 1150°. Temperature at end of forging 850°, cool in ashes or hot sand; 7) after forging, anneal at 870-900°. Quench from 980-1050°, oil or air cool, temper (to required hardness) at 150-370°; 8) carburetor needles, sleeves and gears for aircraft instruments, detail parts of equipment for direct fuel injection, compressor blades; 9) EI474; 10) slow heating to 800°, then fast heating to 1150°. End of forging at 850°, cool in ashes or hot sand; 11) after forging, anneal at 870-900°. Quench from 1030-1050°, air or oil cool, temper at 180-240°. For parts with high elasticity, temper at 240-280°; 12) gears, jack shafts, trunnions, instrument components requiring good machinability and clean surface after machining; 13) 3Kh13 (Zh3); 14) slow heating to 800°. Begin forging at 1150°, end forging at 860°, cool in ashes or hot sand; 15) after forging, anneal at 870-900°. Quench from 1000-1050°, air or oil cool, temper (to required hardness) at 150-170°. It is recommended that intermediate heat treatment between operations be performed at 740-780°; 16) parts operating under high stresses, cutting, gauging, and surgical tools, carburetor needles, household articles; 17) 4Kh13 (Zh4); 18) slow heating from 500-540° to 790°. Begin forging at 1150°, end forging at 850°, cool in ashes or hot sand; 19) after forging, anneal at 870-900° and slow cooling with furnace to 540-650°. Quench from 1000-1050°, cool in hot oil or air. Tempering directly after quench: a) at 150-370° with air or water cooling (to relieve internal stresses); b) at 600-760° (to facilitate mechanical working); c) at 740-700° with air or water cooling (intermediate tempering); 20) cutting, gauging, and surgical in-

II-35n8

struments, carburetor needles, ball bearings, parts with high hardness operating in wear conditions with high mechanical loads. Bolts, fittings.

increased carbon and chrome content it has lower thermal conductivity. However the temperature of the heating prior to quenching must be higher than  $A_{C3}$  to obtain full solution of the chromium carbides. Figure 7 shows the variation of hardness as a function of quenching temperature for steel with varying carbon content: with quenching from a

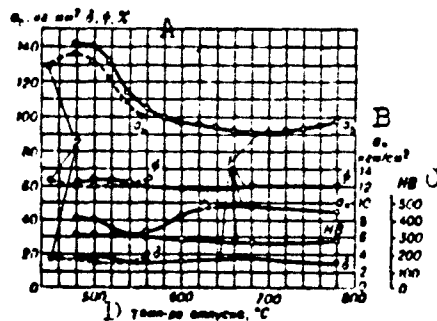

Fig. 8. Variation of mechanical properties of 1Kh17N2 steel with tempering temperature: 1) quench from 1030°; 2) quench from 975°. A)  $\sigma_b$ , kg/mm<sup>2</sup>; b)  $a_n$ , kgm/cm<sup>2</sup>; c)  $a_n$ ; d) tempering temperature, °C.

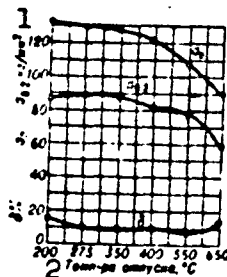

Fig. 9. Mechanical properties of 1Kh17N2 steel sheet after quench from 1040° into oil as a function of tempering temperature. 1)  $\sigma_{0.2}$ , kg/mm<sup>2</sup>; 2) tempering temperature, °C.

temperature above 1050° there takes place a reduction of the hardness as a result of the considerable amount of the residual austenite, which is retained during cooling even to -80°. The mechanical properties (no less than) of tempered Kh18 steel in accordance with MPTU 2362-49 are:  $\sigma_b = 200$  kg/mm<sup>2</sup>,  $\sigma_{0.2} \sim 190$  kg/mm<sup>2</sup>,  $\delta = 2\%$ ,  $\psi = 10\%$ , 55-60RC. The forging regime

II-35n9

for the Kh18 (EI229) steel is: slow heating from 550°, begin forging at 1130-1170°, end forging not below 950°, slow cooling after forging in a

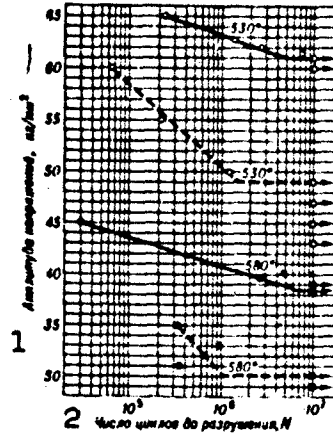

Fig. 10. Endurance of 1Kh17N2 steel after quench from 1050° in air and tempering at 530 and 580° (solid curve is for smooth specimens, dashed curve is for notched specimens). 1) Stress amplitude, kg/mm²; 2) number of cycles to failure, N.

TABLE 8

Mechanical Properties of Martensitic Stainless Steels of the Fourth Group (no less than)

| Сталь 1             | ТУ 2                                     | Термич. обработка 3   | $\sigma_b$    | $\sigma_{0.2}$ | $\delta$ | $\psi$ | $a_n$ 5<br>(кг/см²) | НВ 6<br>(d <sub>отп</sub> , мм) |
|---------------------|--|---|---------------|----------------|----------|--------|---------------------|---------------------------------|
|                     |  |   | 4<br>(кг/мм²) | (%)            | (%)      |        |                     |                                 |
| 1X17N2<br>(EI268) 7 | Для прутков<br>МПТУ 2362-49 8            | Закалка с 950-1040° в масле, отпуск при 275-350°                      | 110-130       | -              | 10       | -      | 5.5                 | -                               |
|                     |  |   | 120           | 90             | 8        | 62     | 12                  | 3.15-3.4                        |
|                     | Для листов<br>ЧМТУ 3126-52 9<br>То же 11 | Закалка с 950-1040° в масле, отпуск при 275-350°<br>Отжиг при 680° 12 | 110           | -              | 10       | -      | -                   | -                               |
|                     |  |   | 70            | 40             | 15       | -      | -                   | -                               |

1) Steel; 2) TU; 3) heat treatment; 4) (kg/mm²); 5)  $a_n$  (kgm/cm²); 6) HB (d<sub>отп</sub>, mm); 7) 1Kh17N2 (EI268); 8) for rods MPТУ -; 9) quench from - in oil, temper at -; 10) for sheets ChMTU -; 11) same; 12) temper at 680°.

TABLE 9

Mechanical Properties of 1Kh17N2 Steel at High Temperatures

| Термич. обработка 1                        | Темп-ра 2<br>(°C) | 3<br>(кг/мм²) |            |                | 4<br>(%) |        |
|--|-------------------|---------------|------------|----------------|----------|--------|
|  |                   | E             | $\sigma_b$ | $\sigma_{0.2}$ | $\delta$ | $\psi$ |
| Закалка с 1030° в масле, отпуск при 580° 4 | 300               | 18700         | 112        | 84             | 8        | 52     |
|  | 500               | 15150         | 95         | 87             | 16       | 84     |
|  | 600               | 13600         | 33         | -              | 31       | 87     |

1) Heat treatment; 2) temperature, °C; 3) (kg/mm²); 4) quench from 1030° in oil, temper at 580°.

TABLE 10

Hot Work Regimes and Application of 1Kh17N2 Steel

| 1 Режим ковки   | 2 Термич. обработка   | 3 Применение  |
|---|---|---|
| 4<br>Медленный нагрев до 800°, ин-тервал ковки 1175-825°, охлаждение после ковки мед-ленное | 5<br>Закалка с 1030-1070° в масле или на воздухе, отпуск при 230-370°<br>Закалка с 980-1020° в масле или на воздухе, отпуск при 540-650° на требуемую твердость<br>Отжиг при 680° | 6<br>Детали высокой прочности работающие до 400° во влажной среде. Детали компрессора |

1) Forging regime; 2) heat treatment; 3) application; 4) slow heating to 800°, forging range 1175-825°, slow cooling after forging; 5) quench from 1030-1070° in oil or air, temper at 230-370°; 6) high strength parts operating up to 400° in moist medium. Compressor parts: 7) quench from 980-1020° in oil or air, temper at 540-650° to required hardness; 8) anneal at 680°.

TABLE 11

Chemical Composition of Martensitic Stainless Steels of the Fifth Group

| Сталь 1              | 2 Содержание элементов (%) |      |      |         |         |           |         |                      |        |       |
|----------------------|----------------------------|------|------|---------|---------|-----------|---------|----------------------|--------|-------|
|                      | C                          | Si   | Mn   | Cr      | Ni      | V         | W       | Mo                   | S      | P     |
| 3 13X12HVMFA (ЭИ961) | 0.1-0.18                   | <0.6 | <0.6 | 10.5-12 | 1.5-1.8 | 0.18-0.3  | 1.8-2   | 0.38-0.5             | <0.025 | <0.03 |
| 4 10X12HVMFA (ЭИ962) | 0.09-0.13                  | <0.6 | <0.6 | 10.3-12 | 1.4-1.8 | 0.18-0.3  | 1.5-2   | 0.38-0.5<br>B <0.004 | <0.025 | <0.03 |
| 5 13X14HVFRA (ЭИ736) | 0.1-0.18                   | <0.6 | <0.6 | 13-15   | 2.8-3.4 | 0.18-0.38 | 1.8-2.2 | Ti <0.05             | <0.025 | <0.03 |

1) Steel; 2) element content (%); 3) 13Kh12NVMFA (EI961); 4) 10Kh12NVMFA (EI962); 5) 13Kh14NVFRA (EI736).

TABLE 12

Mechanical Properties of Martensitic Stainless Steels of the Fifth Group (no less than)

| 1 Сталь                       | ТУ 2         | Термич. обработка 3   | σ <sub>b</sub>         |          | δ        | ψ        | 5 σ <sub>n</sub> (кгс/мм <sup>2</sup> ) | НВ 6 (d <sub>отп</sub> , мм) |
|-------------------------------|--------------|---|------------------------|----------|----------|----------|---|------------------------------|
|                               |              |   | (кгс/мм <sup>2</sup> ) | (%)      |          |          |   |                              |
| 7 13X12HVMFA (ЭИ961)          | ЧМТУ 5948-57 | 9<br>Закалка с 1000°, охлаждение в масле или на воздухе, отпуск при 620-680°                    | 90                     | 75       | 15       | 55       | 10                                      | 3.7-3.8                      |
| 10 10X12HVMFA (ЭИ962) (листы) | ЧМТУ 5948-57 | 9<br>Закалка с 1000-1020°, отпуск при 550-600°  | 120                    | 100      | 12       | 50       | 7                                       | 3.4-3.1                      |
| 12 То же                      | То же        | 13<br>Высокий отпуск при 350-750°   | 85                     | 45       | 19       | -        | -                                       | -                            |
| 12 То же                      | То же        | 14<br>Нормализация при 1000°, отпуск при 620-680°   | 85                     | -        | 17       | -        | -                                       | -                            |
| 15 13X14HVFRA (ЭИ736)         | ЧМТУ 5067-57 | 16<br>Закалка с 1050±10°, охлаждение в масле или на воздухе, отпуск: при 620-680°, при 550-590° | 95<br>115              | 75<br>90 | 14<br>12 | 55<br>50 | 9<br>7                                  | 3.8-3.3<br>3.35-3.1          |

1) Steel; 2) TU; 3) heat treatment; 4) (kg/mm<sup>2</sup>); 5) σ<sub>n</sub> (kgm/cm<sup>2</sup>); 6) HB (d<sub>отп</sub>, mm); 7) 13Kh12N2VMF (EI961); 8) ЧМТУ -; 9) quench from 1000°, cool in oil or air, temper at -; 10) 10Kh12NVMFA (EI962) (sheets); 11) quench from -, temper at -; 12) same; 13) high temper at -; 14) normal-

II-35n11

ization at -; temper at -; 15) 13Kh14NVFRA (EI736); 16) quench from -, cool in oil or air, temper: at -, at -.

TABLE 13

Mechanical Properties of 10Kh12NVMFA Steel at Room and High Temperatures

| Вид полуфабриката<br>1       | 2 Состояние материала                                    | Темп-ра исп-т. (°C)<br>3 | $\sigma_b$   $\sigma_{0.2}$ |     | $\delta_{10}$ (%) |
|------------------------------|--|--------------------------|-----------------------------|-----|-------------------|
|                              |  |                          | 4 (кг/мм <sup>2</sup> )     |     |                   |
| Листы толщиной 0,8-4 мм<br>5 | После отпуска при 730-750°<br>6                          | 20                       | 45                          | 45  | 12                |
|                              |  | 300                      | 55                          | —   | 18                |
|                              |  | 600                      | 35                          | —   | 28                |
| Листы<br>7                   | После нормализации при 1000° и отпуска при 420-680°<br>8 | 20                       | 83                          | —   | 17                |
|                              |  | 300                      | 80                          | —   | 19                |
|                              |  | 600                      | 50                          | —   | 29                |
| То же<br>9                   | После нормализации при 1000° и отпуска при 530-580°<br>8 | 20                       | 120                         | 100 | 9                 |
|                              |  | 300                      | 115                         | —   | 10                |
|                              |  | 600                      | 65.5                        | —   | 16                |

1) Form of mill product; 2) material condition; 3) test temperature, °C; 4) (kg/mm<sup>2</sup>); 5) sheets of thickness 0.8-4 mm; 6) after temper at -; 7) sheets; 8) after normalization at 1000° and temper at -; 9) same.

TABLE 14

Stress-Rupture, Creep, and Fatigue Strengths of 1Kh-12N2VMF and 13Kh14NVFRA Steels at High Temperatures

| Сталь 1              | 2 Термич. обработка  | Темп-ра (°C)<br>3 | $\sigma_{100}$   $\sigma_{0.2/100}$   $\sigma_{-1}$   $\sigma_{-1}^H$ |    |    |    |
|----------------------|--|-------------------|---|----|----|----|
|                      |  |                   | 4 (кг/мм <sup>2</sup> )   |    |    |    |
| 5 1X12N2VMF (EI961)  | 6 Закалка с 1000°, охлаждение в масле, отпуск при 580-580° | 450               | 73  | 58 | 50 | 29 |
|                      |  | 550               | 44  | 20 | 43 | 28 |
|                      |  | 600               | 27  | 15 | 30 | —  |
| 7 13X14NVFRA (EI736) | Закалка с 1050°, охлаждение в масле, отпуск при 580°       | 300               | 85  | 78 | —  | —  |
|                      |  | 450               | 72  | 38 | —  | —  |
|                      |  | 550               | 30  | 15 | —  | —  |
| 7                    | Закалка с 1050°, охлаждение в масле, отпуск при 550°       | 400               | —   | —  | 51 | 33 |
|                      |  | 500               | —   | —  | 49 | 30 |

\*On the basis of 10<sup>7</sup> cycles.

1) Steel; 2) heat treatment; 3) temperature (°C); 4) (kg/mm<sup>2</sup>); 5) 1Kh-12N2VMF (EI961); 6) quench from -, oil cool, temper at -; 7) 13Kh14NVFRA (EI736).

furnace heated to 700-725°, hold for 3-6 hours, air cool. The heat treatment is: quench from 1010-1065°, cool in hot oil or air, temper to required hardness at 150-370°.

The martensitic stainless steels of the fourth group include the 1Kh17N2 (EI268) steel, GOST 5632-61, with the following chemical composition: 0.11-0.17% C, 16-18% Cr, 1.5-2.5% Ni, ≤ 0.8% Si, 0.3-0.8% Mn, ≤ 0.025% S, ≤ 0.03% P. As a result of the high chrome content, the 1Kh-17N2 chrome-nickel steel has higher corrosion resistance both under atmospheric conditions and in numerous chemical media and sea water. The

addition of up to 2.5% nickel increases the amount of austenite at high temperatures, which facilitates better tempering of the steel and reduces the  $\delta$ -ferrite structural component (the presence of  $\delta$ -ferrite causes difficulty in hot working the steel and leads to high anisotropy of the properties).

TABLE 15  
Hot Work Regimes and Application of Martensitic Stainless Steels of the Fifth Group

| Сталь 1                     | 2 Режимковки  | 3 Термич. обработка  | 4 Применение   |
|-----------------------------|---|--|--|
| 13X12HVMFA<br>(ЭИ961)<br>5  | 6 Медленный нагрев до 600°, затем быстрый до 1180°. Окончаниековки при 900°, охлаждение в воде или горячем песке        | 7 Предварит. термич. обработка прутков и поковки: отжиг при 730-750°, крупногабаритные поковки подвергнутся нормализации с 1000°<br>8 Окончат. термич. обработка: закалка с 1000-1020°, охлаждение на воздухе или в масле, отпуск при 550-680° | Высоко нагруженные детали, работающие при темп-ре до 600° в условиях повыш. влажности<br>8 |
| 10X12HVMFA<br>(ЭИ962)<br>10 | 11 Медленный нагрев до 600°. Прокатка и штамповка в интервале 1180-900°   | 9 Предварит. термич. обработка: низкий отжиг при 730-750°<br>10 Окончат. термич. обработка: закалка с 1000-1020°, отпуск при 580-650°  | 12 Сварные детали, работающие до 600° в условиях повыш. влажности                          |
| 13X14HVMFA<br>(ЭИ736)<br>15 | 16 Медленный нагрев до 600°, затем быстрый до 1150°. Ковка в интервале 1150-850°, охлаждение в воде или в горячем песке | 17 Предварит. термич. обработка: нормализация с 930-950°, отпуск при 680°. Окончат. термич. обработка: закалка с 1050°, охлаждение в масле или на воздухе, отпуск при 540-590°   | 18 Высоконагруженные детали, работающие до 550° (диски, валы, лопатки турбины и т. п.)     |

1) Steel; 2) forging regime; 3) heat treatment; 4) application; 5) 13-Kh12NVMFA (EI961); 6) slow heating to 600°, then fast heating to 1180°. End forging at 900°, cool in ashes or hot sand; 7) preliminary heat treatment of rods and forgings: anneal at -, very large forgings are subjected to normalization from -; 8) highly loaded parts operating at temperatures to 600° in conditions of high moisture content; 9) final heat treatment: quench from -, cool in air or oil, temper at -; 10) 10-Kh12NVMFA (EI962); 11) slow heating to -, rolling and stamping in the range -; 12) preliminary heat treatment: low anneal at -; 13) welded detail parts operating to - under conditions of high moisture content; 14) final heat treatment; quench from -, temper at -; 15) 13Kh14NVMFA (EI736); 16) slow heating to -, then fast heating to -. Forging in range -, cool in ashes or hot sand; 17) preliminary heat treatment: normalization from -, temper at -. Final heat treatment: quench from -, cool in oil or air, temper at -; 18) highly loaded parts operating to 550° (turbine disks, shafts, blades, etc.).

The effect of quenching on the mechanical properties of the 1Kh17-N2 steel is shown in Fig. 8.

Effect of tempering on mechanical properties of 1Kh17N2 steel sheet is shown in Fig. 9.

The endurance of 1Kh17N2 steel is shown in Fig. 10. The physical



## II-35n13

properties are:  $\gamma = 7.75 \text{ g/cm}^3$ ;  $\alpha \cdot 10^6 (1/^\circ\text{C})$ : 10.3 (20-100°), 11.8 (300-400°), 12.4 (400-500°);  $\lambda$  (cal/cm-sec-°C); 0.05 (20°), 0.06 (500°), 0.062 (600°).

The 1Kh17N2 steel welds well by all forms of welding; filler wire is made from the EN400 alloy with NZh1 coating.

The martensitic stainless steels of the fifth group combine high strength with good plasticity and corrosion resistance. There is almost complete absence of  $\delta$ -ferrite in the structure, which permits the use of this steel in the form of large forgings. The steel is quite amenable to hot working.

The stress-rupture, creep, and endurance limits of the EI961 and EI736 steels at high temperatures are shown in Table 14.

With regard to physical properties, the martensitic stainless steels of the fifth group do not differ from the 1Kh17N2 steel of the fourth group. They weld well using all forms of welding, nitriding is used to give the highest hardness and this somewhat reduces the corrosion resistance.

The martensitic stainless steels of the fifth group have found very wide application as a result of the corrosion resistance, excellent mechanical and processing properties.

References: Spravochnik po mashinostroitel'nym materialam [Handbook on Machine Design Materials], Vol. 1, Moscow, 1959; Colombie, L. and Gokhman, I., Stainless and High Temperature Steels, translated from French, Moscow, 1958; Khimushin, F.F., Zharoprochnyye stali dlya aviatsonnykh dvigateley [High Temperature Steels for Aircraft Engines], Moscow, 1942; Alekseyenko, M.F., Struktura i svoystva teplostoykikh konstruktsionnykh i nerzhavayushchikh staley [Structure and Properties of Thermally Stable Constructional and Stainless Steels], Moscow, 1962.

M.F. Alekseyenko

II-48M

MARTENS METHOD - see Scratch Test.

II-49M

MARTENS TENSOMETER is an optical gage for material deformation. It consists of a bar and a rhombic prism with a mirror. With deformation of the specimen the prism, clamped between the specimen and the bar, rotates through an angle proportional to the elongation (figure). At a distance of  $250d$  (where  $d$  is the longest diagonal of the prism rhombus) in the plane of displacement of the mirror there is mounted a rod with millimeter divisions. During deformation a telescope is used to observe the change of mirror position by means of the rod divisions reflected in the mirror. Accuracy of deformation measurement is two microns. Two tensometers are usually mounted symmetrically on the specimen to eliminate the misalignment effect and to increase reading accuracy. When testing under conditions of high or low temperatures, extensions are used to transmit the specimen deformation to the instrument so that the Martens tensometer may be mounted external to the furnace or cold chamber.

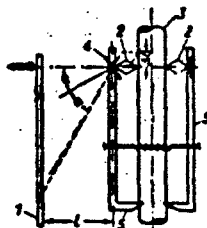

Schematic of Martens Tensometer; 1) rod; 2) prism; 3) specimen; 4) mirror; 5) bar.

Reference: Shaposhnikov N.A., Mekhanicheskiye ispytaniya metallov (Mechanical Tests of Metals), 2nd edition, M.-L., 1954.

N.V. Kadobnova

II-2N

MATERIAL RELIABILITY - see Problem of Material Reliability.

II-41M

MAXIMAL CYCLE STRESS is the cycle stress which is highest in algebraic magnitude (in material testing); equal to the algebraic sum of the average cycle stress and the amplitude:  $\sigma_{max} = \sigma_m + \sigma_a$ ,  $\tau_{max} = \tau_m + \tau_a$ .

See Fatigue.

G. T. Ivanov

III-89s

MEAN CYCLIC STRESS - the static component of the total stresses of a cycle (see Fatigue); it equals the algebraic mean of the maximum and minimum stresses of the cycle:

$$\sigma_m = \frac{\sigma_{MAX} + \sigma_{MIN}}{2} \quad \tau_m = \frac{\tau_{MAX} + \tau_{MIN}}{2}$$

G.T. Ivanov

**MECHANICAL PROPERTIES** are the parameters which characterize the behavior of bodies (primarily solid) under the action of mechanical forces. The mechanical properties are measured by the stresses (see Strength), the deformations (see Elongation, Contraction), the work of deformation, time to develop a definite deformation or to failure, etc. (see Mechanical Tests). We must differentiate subcritical mechanical properties occurring without any sharp disruption of equilibrium (hardness, for example), critical and postcritical characteristics after disruption of stable equilibrium, for example, the nature of the final portion of the deformation diagram (after reaching the maximal load); in the latter case it is proper to speak not of the properties of the material, but of the characteristics of the body which depend on the properties of the material, the properties of the loading system, the shape and dimensions of the body, and its restraint and loading conditions. Postcritical behavior is also evaluated by the structure of the final fracture zones (see Fractography). The environment may have a significant effect on all the mechanical properties (see Rebinder Effect, Corrosional Fatigue).

References: Shaposhnikov N.A., Mekhanicheskiye ispytaniya metallov (Metal Mechanical Tests), 2<sup>nd</sup> edition, M.-L., 1954; Fridman Ya.B., Mekhanicheskiye svoystva metallov (Mechanical Properties of Metals), 2<sup>nd</sup> edition, M., 1952.

Ya.B. Fridman

MECHANICAL PROPERTIES AT HIGH LOADING RATES are the mechanical properties which are obtained during loading with a rate higher by several orders than the rate used in standard testing, for example, following GOST 1497-61. In evaluating the mechanical properties at high loading rates we differentiate the variation of the material parameters due to its structure from the peculiarities of the material behavior at high loading rates which depend on the deformation and failure conditions (stress state, magnitude of the volume being deformed, etc.).

We differentiate loading rates at which their effects on the mechanical properties are limited to: 1) variation with rate of the behavior of the physical processes which comprise the plastic deformation and, as a result, variation of the resistance to deformation; 2) inclusion of the inertial component in the resistance to deformation. Elastic and plastic deformations are displacements of inert masses. At deformation rates typical for standard tests, the forces required to communicate the accelerations to the specimen masses which are displaced during deformation are negligibly small. At high rates they increase and may exceed the strength of the structural bonds of the material. At deformation speeds which arise, for example, during impact of meteor particles on a metallic barrier, the structural bonds become negligibly small and resistance to deformation is practically limited to the inertial component and the metal may be similar to a liquid; 3) appearance of elastic and elastoplastic waves. In this case the deformations, failure and their characteristics are basically determined not by the variation of the mechanical properties with the rate as ma-



II-84M1

terial parameters, but by the nature of the behavior and interference of the elastic and elastoplastic waves.

The first group includes the cases of loading with high constant or variable loading rates. The second group includes the cases in which along with the high loading rate there is high material deformation rate (as a rule, beyond the yield point). The third group includes the cases when with given dimensions of the specimen and a finite rate of propagation of elastic and plastic waves characteristic of the material the loading rate is sufficiently high so that it is necessary to take account of the nonsimultaneity of propagation of the load and the deformation through the entire volume of the specimen and it is necessary to examine their stepwise propagation by means of the formation of an elastic or elastoplastic wave.

First group. Variation of mechanical properties with loading rates for which we may neglect the effect of the inertial component and the nature of the behavior of the impact waves. The mechanical properties of the materials depend on the loading rate (stress rise):  $\dot{\sigma} = d\sigma/d\tau$  kg/mm<sup>2</sup>/sec, where  $\sigma$  is stress (engineering or true),  $\tau$  is time. For given dimensions, construction and specimen material, the rate of increase of the stresses corresponds to the rate of increase of the deformation — the deformation rate:  $\dot{\epsilon} = d\epsilon/d\tau$  1/sec or %/sec, where  $\epsilon$  is the deformation (engineering or true). The specification, regulation and monitoring of deformation velocity during material tests are performed experimentally more simply and more reliably than the specification of loading rate (determination of the loading at high loading speeds is complicated by the difficulty of avoiding the effect of the inertia of the loading elements of the machine). In this connection the variation of the mechanical properties at high loading rates is normally related with the deformation rate. It is difficult to define the

II-84M2

lower limit of the loading or deformation rates with which we should start to term them high, since the practice of testing the mechanical properties using the current GOST's gives for the metallic alloys used in machine construction a wide range of loading rates from  $10^{-1}$  to 50  $\text{kg/mm}^2/\text{sec}$  with deformation rates of  $5 \cdot 10^{-2} - 2) \text{ \%}/\text{sec}$ . Therefore it is advisable to term loading rates  $\dot{\sigma} > 50 \text{ kg/mm}^2/\text{sec}$  and deformation rates  $\dot{\epsilon} > 2\%/\text{sec}$  high. For many metallic alloys, for example those based on lead, tin and other alloys with low melting point at room temperature and for the majority of the constructional alloys at the corresponding temperature level (Fig. 1a, b), even within the limits of this band of rates there are observed considerable deviations of the mechanical properties which require regulation of the deformation rate. Under these conditions, we must term the lower limit of high loading rates those rates at which the mechanical properties deviate from those obtained in testing in accordance with the GOST by more than ten times the error of the test machine (5 percent for most cases). The upper limit of the loading rate does not lend itself to definition. The existing hypotheses on the critical velocity as the velocity at which plastic deformation can not take place and brittle fracture appears do not take account of the variation of the stress state, the magnitude of the volume being deformed, and other peculiarities of the high loading rates associated with the action of the inertial component and the behavior of the impact waves. Experience shows that completely brittle fractures are not observed for any loading rate which can be achieved by the present testing equipment, and that clear up to loading velocities appearing with impact at a velocity exceeding earth escape speed plastic deformation takes place. The variation of the mechanical properties, as parameters of the alloy structure, depends only on the degree to which the dislocational, diffusional, shearing, physical and physico-chemical

II-84M3

processes which comprise plastic deformation are able to take place. For the majority of the metallic alloys used in machine design this situation has been confirmed experimentally.

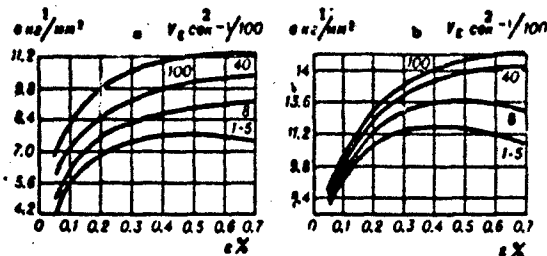

Fig. 1. Stress-strain relation for various loading rates: a) for low-carbon steel at test temperature 900°; b) for Cr18Ni9T stainless steel. 1)  $\sigma$  kg/mm<sup>2</sup>; 2) sec.

The absence of a limiting rate for plastic deformation does not mean that it is not advisable to use the term "critical rate" for rates at which there are observed significant variations in the magnitude of the resistance to deformation or other peculiarities of the deformation process. We encounter the use of the term "critical rate", for example to designate the rate at which the metal may be similar to a liquid, since at these rates the structural bonds become significantly smaller than the inertial component of the resistance to deformation rate there is a change of the time in the course of which the processes comprising plastic deformation take place, processes which are schematically combined into two complexes: strengthening and weakening.

The strengthening is basically determined by the degree and nature of the deformation, the weakening is associated only in part with the degree of deformation and is determined basically by the time during which a given degree of deformation is reached, i.e., by the deformation rate. Consequently, with a lower deformation rate the weakening process will be able to develop more strongly and with higher rate will develop less, and the higher rate of deformation will correspond to the

higher strength. In actuality the influence of deformation rate is more complex. The stress state and the degree of deformation affect the diffusional mobility and together with it affect the weakening process; in its turn, strengthening proceeds as a function of time and is determined not only by the degree of deformation, but also by those processes which are caused and activated by the deformation, for example, aging, dispersion hardening, etc. It is also necessary to consider that the work of plastic deformation, transformed into heat, causes heating of the material being deformed. As a result of the local nature of the plastic deformation, at high deformation rates the redistributing of the heat generated locally cannot take place throughout the entire volume of the metal, and the process proceeds adiabatically and leads to very considerable local increase of the temperature. During high-rate deformation of steel, for example, with impact of a shell on armor, the local heating reaches  $900^{\circ}$  and more, austenite is formed which with subsequent cooling (quite rapid into the surround metal) undergoes martensitic transformation.



Fig. 2. Martensitic formation (Krause-Tarnavskiy bands) occurring in shear regions at location of shell impact on armor.

Figure 2 shows martensite lamina (the so-called Krause-Tarnavskiy bands) formed in this way. Temperature change is a change of the initial conditions, therefore variation of the resistance to deformation in connection with the formation of spalling, etc. along the martensitic lamina cannot be related directly with the effect of rate on the

resistance to deformation as a material parameter. The thermal effect observed with high deformation rates finds application in high-velocity high-rate stamping and other forms of pressure working which are per-

II-84M5

formed with high deformation rates.

The increase of the strength of the metallic alloys with transition to high loading rates and high deformation rates is not large in the case of ordinary temperatures.

In generalized form it may be expressed by the relation:

$$\sigma = B + C \ln \dot{\sigma},$$

In the first approximation the constants B and C, according to Zhurkov, may be determined with the aid of the parameters A and  $\alpha$  from the expression  $\tau = Ae^{-\alpha\sigma}$  (dependence of lifetime - time to failure  $\tau$  - on the constant stress  $\sigma$ ).

At elevated temperatures there is observed a considerably greater influence of rate on the resistance to deformation than at 20°. This is explained by the more intense process of strengthening and weakening at higher temperature. For certain alloys there are temperature ranges in which increase of the loading rate by two orders, for example, from 1 to 100 kg/mm<sup>2</sup>/sec, leads to an increase of the ultimate strength by 100 percent or more. As a rule, the strength increase is not associated in a linear dependence on the rate. The superpositioning of the strengthening and weakening processes leads to a complex dependence of strength on loading rate; for the majority of the constructional alloys used in machine construction, the maximal strength increase at elevated temperatures is observed with a relatively small loading rate increase and this increase is less at the higher rates. On reaching a definite value of the loading rate, the further increase of strength becomes negligible (Fig. 3). For certain of the metallic alloys in which the aging, dispersion hardening, etc. processes take place in the temperature range in question, for example, the V95 aluminum alloy, there may be a deviation from the general rule and the strength may decrease with increase of the loading rate in some range. A similar deviation is also observed

II-84M6

in the nickel-base alloy El868 (Fig. 4), although this alloy is not one of the aging alloys and soaking at temperature alone without stressing does not lead to age strengthening. In this case we must take account of the activation of the processes of decomposition of the solid solution under the influence of stress and deformation.

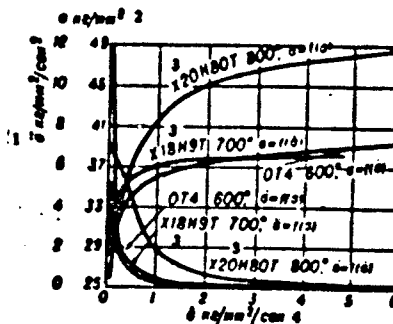

Fig. 3. Variation of breaking stress  $\sigma$  with loading rate  $\dot{\delta}$ , and loading rate rise  $\ddot{\delta}$  for the titanium alloy OT4, for Kh18N9T steel, for the nickel alloy Kh20N8OT (El435);  $\dot{\delta}$  (kg/mm<sup>2</sup>/sec) is the first derivative of the stress with respect to loading rate and characterizes the loading rate;  $\ddot{\delta}$  (kg/mm<sup>2</sup>/sec<sup>2</sup>) is the second derivative of the stress as a function of loading rate and characterizes the increase of the loading rate. 1) kg/mm<sup>2</sup>/sec<sup>2</sup>; 2) kg/mm<sup>2</sup>; 3) Kh - N - T; 4) kg/mm<sup>2</sup>/sec.

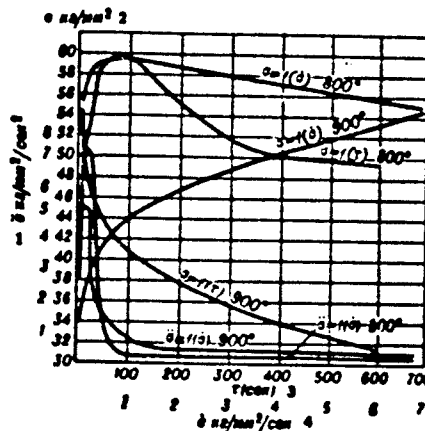

Fig. 4. Variation of breaking stress with loading time  $\tau$  (sec) and loading rate  $\dot{\delta}$  (kg/mm<sup>2</sup>/sec), and increase of loading rate  $\ddot{\delta}$  (kg/mm<sup>2</sup>/sec<sup>2</sup>) for alloy EI868 at temperatures of 800 and 900°. 1) kg/mm<sup>2</sup>/sec<sup>2</sup>; 2) kg/mm<sup>2</sup>; 3) (sec); 4) kg/mm<sup>2</sup>/sec.

Second group. Mechanical properties at loading rates for which the inertial component becomes commensurate with the resistance to deforma-

II-84M7

tion. The loading rate level at which it becomes necessary to take account of the inertial component is determined by the deformation rate and in this case it depends to a considerable degree on the deformation magnitude. At stresses below the elastic limit the effect of the inertial component may be neglected, even at the highest loading rates which are possible in machine design practice, for example,  $10^8$  kg/mm<sup>2</sup>/sec. As a rule, the inertial component shows up at stresses which lead to plastic deformation, and in these cases the loading conditions are given not by the loading rate, but by the rate of deformation as displacement, and the variation of the strength as a function of the rate has the form:  $\sigma_p = \sigma_{v_0}(\underline{v}/v_0)^n + K\rho v^2$ , here  $\underline{v}$  and  $v_0$  are the rates of deformation as displacements, for example, the rate of penetration of the indenter;  $\sigma_{v_0}$  is the strength at the rate  $v_0$ ;  $\sigma_v$  is the strength at the rate  $\underline{v}$ ;  $\rho$  is the mass density of the alloy;  $K$  is a coefficient characterizing the geometric conditions of the deformation, for example, the shape of the head portion of the indenter. For an indenter of conical shape  $K = \sin^2 \varphi/2$ , where  $\varphi$  is the cone vertex angle.

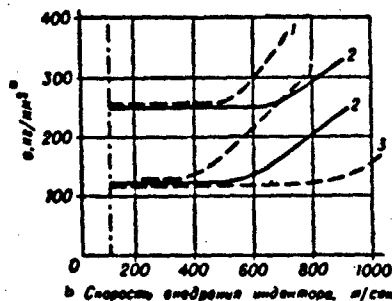

Fig. 5. Variation of strength (hardness HB) with indenter penetration rate: 1) 90° cone; 2) 60° cone; 3) 37° cone; a)  $\sigma$ , kg/mm<sup>2</sup>; b) indenter penetration rate, m/sec.

Figure 5 presents the variation of the strength (hardness) with penetration rate, and Fig. 6 shows the variation of the strength with deformation rate for typical metals. Two regions are clearly present: an

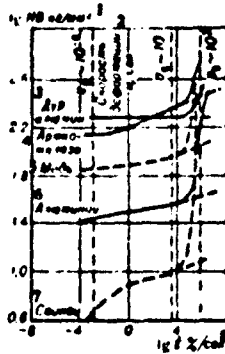

Fig. 6. Variation of strength (hardness HB) with deformation rate  $\dot{\epsilon}$ .  
 1)  $\lg HB \text{ kg/mm}^2$ ; 2) deformation rate,  $\text{m/sec}$ ; 3) dural; 4) armco iron;  
 5) copper; 6) aluminum; 7) lead; 8)  $\lg \dot{\epsilon} \text{ \%}/\text{sec}$ .

initial region with quite flat rise, hardly noticeable for the stronger metals, and a subsequent region with a steep rise of the curve, which characterizes a rapid increase of the resistance to deformation. The sharp boundary between these regions gives basis for some authors to term the rate which characterized the transition from one region to the other the critical rate. The considerably greater rise in the first region for lead is explained by the fact that in lead under the penetration conditions with an initial temperature of the metal of  $20^\circ$  recrystallization and other weakening processes may take place, in connection with which the importance of the deformation rate is emphasized and the exponent  $n$  increases. With increase of the test temperature, an analogous change of the initial region of the curves will be observed for the metals which are stronger than lead as well.

Third group. Mechanical properties with loading rates for which the deformation process is characterized by the propagation of elastic and elastoplastic waves. With explosive action or the impact of a shell with sufficiently high velocity, there is created a special form of loading involving the formation and propagation of an impact wave. When the wave reaches the section in question there is an instantaneous, i.e., in a time interval which cannot be accounted for as it is incom-



II-84M9

measurably small in comparison with the time for passage of the wave through the given section, increase of the stress and then a decrease following some particular law. Such a loading, as a rule lasting a very short time interval (microseconds), is termed impulsive. The passage of shock waves causes several specific effects. In Fig. 7 we see that on reaching a free boundary a reflection of the wave takes place, the wave changes sign.

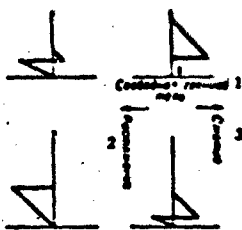

Fig. 7. Schematic of reflection of elastic wave from a free boundary of a body. 1) Free boundary of body; 2) tension; 3) compression.

If a compression wave arrives at a free boundary, a tension wave is reflected. The appearance of tensile stresses may lead to failure of the material. In those cases when, for example in a plate subjected to the action of an explosion, the fracture due to the reflected wave takes place from the normal stresses, it is of a brittle nature. This fracture may be multiple, since the cleavage surface becomes a new free boundary and in turn causes reflection and superposition of a new wave — tensile — on the continuing motion of the compression wave. Failure from impulsive stresses of the opposite sign from those communicated by the applied external impulsive loading is observed also with rapid removal of very high impulsive loads. Thus, a lead sphere subjected to hydrostatic compression by a pressure of about 100,000 atmospheres will begin to expand after rapid removal of the pressure (in the course of several microseconds), during expansion the elastic energy accumulated during the compression transitions into kinetic energy. At

the instant of return to the original dimensions a very high rate of displacement is developed, the inertia of the displacing particles is considerably greater than their structural bonds and the sphere fractures from normal tensile stresses. Impulsive loads also create very high stresses, reaching  $10^5$  kg/cm<sup>2</sup>. With normal stresses of  $10^5$  kg/cm<sup>2</sup> the deformation has significant peculiarities. A slight degree of deformation at these loads, for example characterized by a degree of reduction of 5 percent, may lead to strengthening which with static application of the load would correspond to a degree of deformation larger by an order of magnitude (50%). This is explained by the fact that with high impulsive loadings and small reductions the deformation is concentrated primarily within the limits of the individual grains, within which there are observed intensive shearing phenomena and also twinning (Fig. 8). Intergranular deformation is quite slight and hardly noticeable. Shearing and twin formation, beginning in one grain, continue into another as if the grain boundary did not exist (Fig. 9).



Fig. 8. Complex twinning system in grain of Hadfield steel with impulsive loading (pressure 250 kilobars, deformation about 5 percent).

We must differentiate between impulsive loads and impact loads, which rise, last and fall in the course of small time intervals (seconds and fractions of seconds) and which, as a rule, are insufficient for complete manifestation of the effect of the inertial component and the propagation of shock

waves. These loads include those which arise with rapid change of the velocity of motion of machine components which takes place with impact of one body on another. We must point out that not all the forces arising during rapid change of the velocity of motion of machine parts may be associated with the impact loads, In those cases when the rapid



Fig. 9. Twin formation in soft steel with impulsive loading. The twins propagate through the ferrite and pearlite grains as in an isotropic material, without noticeable deformation of the grains.

change of velocity of motion of the parts is the result of the kinematic scheme of the machines and does not depend on the quality of the material of the parts, but is determined by their mass and the velocity change, the loads are considered to be dynamic. The impact loads differ in that their magnitude is determined not only by the change of the momentum of the impacting bodies, but also the mechanical properties of the material (elastic and plastic moduli, elastic and yield limits, plasticity). For a given change of the momentum the magnitude of these properties determines the change of the kinetic energy of the impacting bodies, the time and the force of the impact. Impact loads, just as the impulsive loads, are a particular case of the dynamic loads, which include all the one-time and repeated loads arising as a result of various factors: during impact, rapid loading change, as a result of vibrations, etc. A typical example of impact loads is impact strength testing. From the definition of impact strength it follows that its parameters are the result of the change of the kinetic energy of the moving mass of the tester which is expended on breaking the specimen; as a rule, the force and the deformation occurring in this

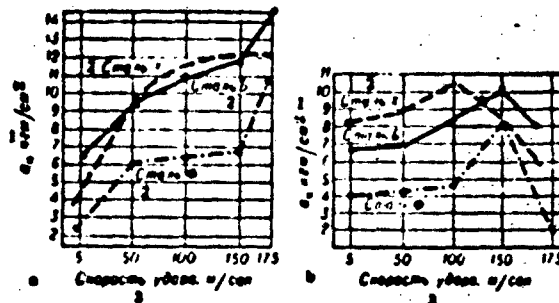

Fig. 10. Variation of impact strength as a function of the impact velocity: a) Steel after tempering at 200°; b) steel after tempering at 600°; 1) kgm/cm<sup>2</sup>; 2) steel; 3) impact velocity, m/sec.

case are not determined. The deformation arate may be accounted for indirectly from the impact velocity (the velocity of the impacting mass of the tester at the instant of encountering the specimen). With increase of the impact velocity there is a change of the impact material strength (impact strength in the present case). Depending on the nature of the alloy there may be observed either a steady increase of the impact strength, clear up to the very highest values of the impact velocity (200 m/sec), or the presence of a maximum. The first type of relation is observed, for example, for low-annealed quenched constructional steel, the second type is found in high-annealed steel (Fig. 10).

N.M. Sklyarov

MECHANICAL PROPERTIES AT HIGH TEMPERATURES. With increase of temperature the mechanical properties which characterize the material strength diminish while the plastic properties increase. At high temperatures many materials undergo physico-chemical transformations (precipitation of strengthening phases, coagulation and dissolution of phases, oxidation, particularly of grain boundaries, and so on). Depending on the nature of these transformations, there may be observed marked deviations in the shape of the strength and plasticity curves as a function of temperature, and also a change of the nature of fracture. Precipitation of the embrittling phases along the grain boundaries in a definite temperature interval may lead at these temperatures to transition from fracture through the grain body to intergranular fracture with marked reduction of plasticity. The phenomenon of overaging (see Aging of the Aluminum Alloys) in the aluminum alloys leads to a considerable reduction of elongation at various (depending on the alloy composition) temperatures in the 150-250° range. Reduction of plasticity at certain temperatures is also observed for many copper alloys, steels, titanium alloys, etc. Among the strength characteristics those depending most strongly on temperature are the static properties which characterize the resistance to plastic deformation - hardness, ultimate strength, yield strength. Depending on the peculiarities of the alloy, there may be observed both cases of sharper reduction of yield point than ultimate with temperature increase, and the opposite.

In low-alloy constructional steel, for example, the ultimate strength hardly changes up to a temperature of 300-350°, while the

II-85M1

yield strength diminishes by 15-20%. On the other hand, in material made from SAP-3 sintered aluminum powder, increase of temperature to 250° causes a marked (by 40%) reduction of  $\sigma_b$ , while the yield point is changed very little. Temperature has considerably less effect on the fracture resistance and the structurally-insensitive properties - normal elastic modulus and shear modulus (Table 1). The shear modulus diminishes somewhat more strongly than the normal elastic modulus with temperature increase, while the Poisson coefficient increases. For retention of strength at high temperatures, the greatest importance lies in such physical properties as the energy of the interatomic bond and the melting point of the metal. Therefore the alloys based on the refractory metals (W, Mo and others) weaken less with temperature increase than the alloys based on nickel and iron, which in turn surpass in this respect, for example, the magnesium alloys, since magnesium is the element having the lowest melting point and energy of the binding forces of all the metals which serve as bases for the constructional alloys. The mechanical properties of alloys made using the same basis may to a considerable degree be improved by alloying (see Wrought High Temperature Nickel Alloys), by variation of the alloy structure. The alloying elements which increase the strength of the interatomic bond and the diffusion activation energy have a favorable effect on the strength at high temperatures. In this case there is an increase of the stability of the solid solution and the diffusion processes are retarded.

The grain boundary properties and the grain size are of great importance. The nickel-base refractory alloys have the best resistance to fracture under long-term loading with grain size No. 2-3; the stress-rupture strength is reduced with a fine grain structure. However the fatigue resistance at high temperatures diminishes with increase of the grain size. The presence of a fine intermittent framework along the

TABLE 1

Normal Elastic Modulus, Shear Modulus\* (E, G, in kg/mm<sup>2</sup>) and Poisson Coefficient ( $\mu$ ) of Some Steels and Nonferrous Alloys as a Function of Test Temperature

| 1 Сплав и его состояние            | 2 Константа упругости | 3 Температура (°C) |       |       |       |       |       |       |       |
|------------------------------------|-----------------------|--------------------|-------|-------|-------|-------|-------|-------|-------|
|                                    |                       | 20                 | 200   | 300   | 400   | 500   | 600   | 800   | 900   |
| 4 Сталь 30XГСА                     | E                     | 21150              | 20100 | 19400 | 18750 | 17750 | 17000 | —     | —     |
|                                    | G                     | 8600               | 8100  | 7800  | 7550  | 7100  | 6700  | —     | —     |
|                                    | $\mu$                 | 0.23               | 0.24  | 0.24  | 0.24  | 0.25  | 0.27  | —     | —     |
| 5 Титановый сплав ВТ5-1            | E                     | 12800              | 12000 | 11600 | 11200 | 10700 | 10130 | 9180  | —     |
|                                    | G                     | 4800               | 4450  | 4200  | 3900  | 3750  | 3500  | 3000  | —     |
|                                    | $\mu$                 | 0.33               | 0.35  | 0.37  | 0.43  | 0.43  | 0.45  | 0.52  | —     |
| 6 Алюминиевый сплав Д16Т           | E                     | 7450               | 6800  | 6500  | —     | —     | —     | —     | —     |
|                                    | G                     | 2800               | 2450  | 2330  | —     | —     | —     | —     | —     |
|                                    | $\mu$                 | 0.33               | 0.39  | 0.40  | —     | —     | —     | —     | —     |
| 7 Магнийевый сплав МЛ10            | E                     | 4540               | 4200  | 3990  | —     | —     | —     | —     | —     |
|                                    | G                     | 2800               | 2450  | 2330  | —     | —     | —     | —     | —     |
|                                    | $\mu$                 | 0.33               | 0.39  | 0.40  | —     | —     | —     | —     | —     |
| 8 Никелевый сплав ХН70ВМТЮ (ЭЖ617) | E                     | 22000              | —     | —     | 20500 | —     | 19000 | 17700 | 17000 |
|                                    | G                     | 8800               | —     | —     | 8100  | —     | 7500  | 6850  | 6600  |
|                                    | $\mu$                 | 0.25               | —     | —     | 0.26  | —     | 0.27  | 0.29  | 0.30  |

\*Determined by electrodynamic method from resonant frequency.

1) Alloy and temper; 2) elastic constant; 3) temperature (°C); 4) 30XhGSA steel; 5) VT5-1 titanium alloy; 6) D16T aluminum alloy; 7) ML10 magnesium alloy; 8) KhN70VMTYu (E1617) nickel alloy.

grain boundaries improves the strength of the alloys at high temperatures.

For the designer the efficiency of application of a particular material for service at high temperatures is determined not only by the absolute values of its elastic modulus, ultimate and yield strengths; of decisive importance is the specific strength and the specific stiffness of the materials. With respect to specific strength under short-term loading, the optimal materials are: aluminum alloys at temperatures up to 150-175°, high strength steels at temperatures to 300-350°, steels of the intermediate class at temperatures of 500-550°, nickel-base alloys in the temperature range 600-1000°, alloys based on the refractory metals at temperatures of 1000° and above. The titanium and magnesium alloys are of particular interest in connection with their

high specific stiffness (Fig. 1).

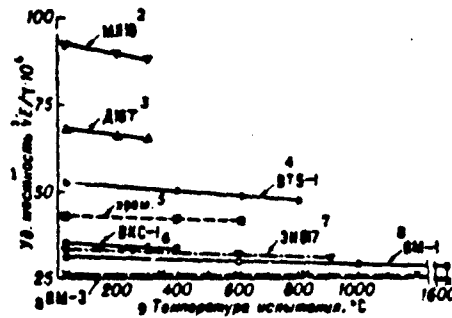

Fig. 1. Specific stiffness of constructional materials as a function of temperature. 1) Specific stiffness -; 2) ML10; 3) D16T; 4) VT5-1; 5) chrome; 6) VKS-1; 7) EI617; 8) VM-; 9) test temperature, °C.

Increase of time of application load at high temperatures leads to weakening of the metals and alloys, and in many cases to their loss of plasticity. For a given temperature the degree of weakening depends on the characteristics of the alloy, so that in some cases materials which have higher resistance to creep and fracture with comparatively short-term application of load will be inferior or equivalent to alloys which were previously weaker (Table 2).

TABLE 2  
Weakening With Time of Nickel-Base High Temperature Alloys

| Температура испытания (°C) | 2<br>Сплав        | 3<br>Пределы длительной прочности (кг/мм²) за время (часы) |     |     |      |      |      |
|----------------------------|-------------------|--|-----|-----|------|------|------|
|                            |                   | 10   | 100 | 500 | 1000 | 2000 | 3000 |
| 800                        | 4<br>Сплав ЭИ1867 | 55   | 43  | 35  | 31   | 29   | 25   |
|                            | 5<br>Сплав ЭИ1929 | 54   | 44  | 34  | 33   | —    | 31   |
| 900                        | 4<br>Сплав ЭИ1867 | 29   | 19  | 13  | 11   | 9    | 8    |
|                            | 5<br>Сплав ЭИ1109 | 34   | 24  | 14  | 12   | 10   | —    |

- 1) Test temperature (°C);
- 2) alloy; 3) stress-rupture limits (kg/mm²) after time (hours); 4) alloy;
- 5) EI.

A very important characteristic of the constructional materials is the ratio of the yield strength to the ultimate strength ( $\sigma_{0,2}/\sigma_b$ ), which establishes, in essence, the magnitude of the safety factor which the designer can assume in the design of statically loaded structures and thus determines the weight of these structures. As a rule, with increase of temperature the ratio  $\sigma_{0,2}/\sigma_b$  diminishes, although this ratio remains

nearly constant for certain alloys (for example, for the SN-3 steel) or



II-85M4

TABLE 3  
 Ratios  $\sigma_{0,2}/\sigma_b$  and  $\sigma_{0,2/100}/\sigma_{100}$  for Some Constructional Materials

| Temp-er-ature (°C) | 2 Д16АТ                         |   | 3 ВАД23                         |   | МА9                             |   | 4 ВТ14                          |   | 5 КН15N7M2 (SN-4)               |   | 6 WI437                         |   |
|--------------------|---------------------------------|---|---------------------------------|---|---------------------------------|---|---------------------------------|---|---------------------------------|---|---------------------------------|---|
|                    | $\frac{\sigma_{0,2}}{\sigma_b}$ | $\frac{\sigma_{0,2/100}}{\sigma_{100}}$ | $\frac{\sigma_{0,2}}{\sigma_b}$ | $\frac{\sigma_{0,2/100}}{\sigma_{100}}$ | $\frac{\sigma_{0,2}}{\sigma_b}$ | $\frac{\sigma_{0,2/100}}{\sigma_{100}}$ | $\frac{\sigma_{0,2}}{\sigma_b}$ | $\frac{\sigma_{0,2/100}}{\sigma_{100}}$ | $\frac{\sigma_{0,2}}{\sigma_b}$ | $\frac{\sigma_{0,2/100}}{\sigma_{100}}$ | $\frac{\sigma_{0,2}}{\sigma_b}$ | $\frac{\sigma_{0,2/100}}{\sigma_{100}}$ |
| 20                 | 0.86                            | —                                       | 0.93                            | —                                       | 0.77                            | —                                       | 0.84                            | —                                       | 0.87                            | —                                       | 0.84                            | —                                       |
| 150                | 0.7                             | 0.43                                    | 0.91                            | 0.84                                    | 0.79                            | 0.5                                     | —                               | —                                       | —                               | —                                       | —                               | —                                       |
| 200                | 0.77                            | 0.44                                    | 0.82                            | 0.78                                    | 0.5                             | 0.36                                    | —                               | —                                       | —                               | —                                       | —                               | —                                       |
| 300                | 0.77                            | —                                       | 0.84                            | —                                       | —                               | —                                       | —                               | —                                       | 0.85                            | —                                       | —                               | —                                       |
| 350                | —                               | —                                       | —                               | —                                       | —                               | —                                       | 0.86                            | 0.61                                    | —                               | —                                       | —                               | —                                       |
| 400                | —                               | —                                       | —                               | —                                       | —                               | —                                       | 0.85                            | 0.51                                    | 0.80                            | 0.68                                    | —                               | —                                       |
| 500                | —                               | —                                       | —                               | —                                       | —                               | —                                       | 0.79                            | 0.72                                    | 0.88                            | 0.84                                    | —                               | —                                       |
| 600                | —                               | —                                       | —                               | —                                       | —                               | —                                       | —                               | —                                       | —                               | —                                       | 0.65                            | 0.81                                    |
| 700                | —                               | —                                       | —                               | —                                       | —                               | —                                       | —                               | —                                       | —                               | —                                       | 0.7                             | 0.98                                    |
| 800                | —                               | —                                       | —                               | —                                       | —                               | —                                       | —                               | —                                       | —                               | —                                       | 0.82                            | 0.83                                    |

1) Test temperature (°C); 2) D16AT; 3) VAD23; 4) VT14; 5) Kh15N7M2 (SN-4); 6) WI437.

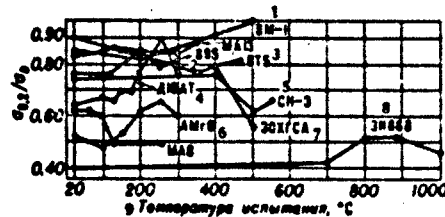

Fig. 2. Ratio  $\sigma_{0,2}/\sigma_b$  for various constructional materials as a function of temperature. 1) VM-1; 2) V95; 3) VT5; 4) D16AT; 5) SN-3; 6) AMg6; 7) 30KhGSA; 8) EI68; 9) test temperature, °C.

even increases (for example, for the MA13 magnesium-thorium alloy) is a definite temperature range (Fig. 2). At a given temperature the ratio of the creep strength to the stress-rupture strength (for the same test duration) may differ significantly from the ratio  $\sigma_{0,2}/\sigma_b$  (Table 3), and depending on the temperature and the duration of load application — the conditions establishing the strengthening and weakening processes in the alloys — this difference may be in favor of the ratio  $\sigma_{0,2}/\sigma_b$  or vice versa. This characteristic must be taken into account in the selection of the safety factor for statically loaded parts operating for long periods at high temperatures. In many cases, for example for structures with a high ratio of short-term loadings or for structures designed with large values of the safety factor, the heating duration

II-85M5

(without load or with low load) has an important effect on strength and plasticity. Under these conditions the weakening of the alloys is considerably less, which makes possible the use in these cases of alloys of a particular group for service at higher temperatures. The creep and fracture strengths depend on the form of the stress state. There are indications that the creep of the wrought metals is higher with compression than with tension, while for the cast metals this phenomenon is only slightly noted. At high temperatures and static loads the metallic alloys usually do not show notch sensitivity, or it is very slight (see Stress-Rupture Strength), which, apparently, is associated with reduction of the deformed volume in the presence of the notch.

Scale effect on the creep and stress-rupture strengths has received inadequate study. There are indications that with an increase of rod diameter the stress-rupture strength increases and the creep rate diminishes, while with increase of rod length, on the other hand, the lifetime is reduced. Reduction of the stress-rupture strength with reduction of rod diameter is related to the negative effect of work hardening of the surface layer of the specimens during their preparation and the stronger manifestation in this case of oxidation of grain boundaries. The influence of work hardening on creep and stress-rupture strength depends primarily on the operating temperature of the part: work hardening may be advantageous for comparatively low temperatures; at temperatures at which work hardening accelerates the diffusion processes and makes the alloy structure less stable, the creep rate is increased under the influence of work hardening, and the stress-rupture strength is reduced. Of particular importance for strength at high temperatures are the condition of the surface layer, surface purity, residual stress state, presence of work hardening, etc. Electropolishing and annealing to remove the residual tensile stresses have

II-85M6

a positive effect.

Usually the mechanical properties at high temperatures are determined in an air atmosphere. The creep and fracture (stress-rupture) strengths may be altered significantly in a vacuum, in a neutral gas atmosphere, in liquid metals, etc. It has been established that at high (for a given alloy) temperatures and low stresses the creep rate is less in an air atmosphere than in a vacuum as a result of metal evaporation. On the other hand, at low temperatures and high stresses the stress-rupture and creep strengths are higher in a vacuum, since the vacuum protects the metal from oxidation. Contact of materials with a liquid metallic medium, which reduces their surface energy, leads to a reduction of the breaking strength and, consequently, of the stress-rupture strength as well. A negative action of the liquid medium is manifested at those values of temperature, stress and duration of load application for which the breaking strength becomes lower than the resistance to plastic deformation. The creep and fracture strengths under static loading vary with the action of irradiation. The nature of these variations depends on the radiation sources, the test temperature and the level of the applied stresses. At temperatures which are not very high for a given material, the creep may be reduced as a result of the barriers to creep provided by the interstitial atoms; but with irradiation, on the other hand, there is an increase of the total number of vacancies and, as a result, there is an increase of the coefficient of diffusion, which for certain conditions may lead to intensification of creep. The breaking strength is reduced under the influence of irradiation; with a considerable reduction of the breaking strength there may occur premature fracture with long-term loads. It has been established experimentally that irradiation of a zinc monocrystal by  $\alpha$ -particles reduces the creep rate, while irradiation with neutrons

11-05M/

increases the creep rate. At 50° aluminum creep is not altered under the influence of neutron irradiation by a beam of  $1.3 \cdot 10^{12}$  n/cm<sup>2</sup>. The ultimate strength of the wrought high-temperature alloys - Inconel, Inconel X, Hastelloy C - increases by 40-50 percent under the influence of irradiation by a neutron flux of  $(4 - 5) \cdot 10^{19}$  n/cm<sup>2</sup> with comparatively slight reduction of elongation.

With increase of the temperature the fatigue resistance is reduced, although to a lesser degree than the stress-rupture strength, so that at some temperature the stress-rupture strength becomes lower than the fatigue strength. A slight reduction of the fatigue strength in a quite broad temperature interval is characteristic for many constructional materials - steels, high-temperature alloys, aluminum alloys, etc. (see Mechanical Properties With Repeated Loads).

S.I. Kishkina-Ratner

**MECHANICAL PROPERTIES AT LOW TEMPERATURES.** With reduction of temperature below room temperature the mechanical properties of the metals and their alloys change, and various types of change may be observed depending on the type of crystalline lattice, the structure and purity of the metal, the loading conditions, and other factors (Tables 1-2). As a rule, at low temperatures the resistance to plastic deformation (yield point, ultimate strength, hardness) increases; the yield point increases particularly sharply for the materials with body-centered-cubic (BCC) lattice (Fig. 1), for materials with face-centered-cubic lattice (FCC) the yield point usually increases less than the ultimate strength. Resistance to brittle fracture (Table 3), modulus of normal elasticity, and shear modulus (Table 4) change little at low temperatures. With temperature reduction the plasticity and viscosity usually diminish, which is seen particularly strongly in the metals with BCC lattice, while for the metals and alloys with FCC lattice the plasticity either diminishes slightly (nickel-base high-temperature alloys,

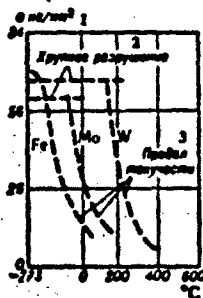

Fig. 1. Variation of yield strength and brittle fracture strength for certain metals with reduction of temperature.

1)  $\text{kg}/\text{mm}^2$ ; 2) brittle fracture; 3) yield strength.

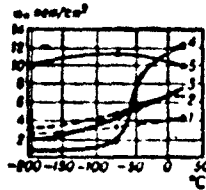

Fig. 2. Variation of impact strength of certain metals and alloys with temperature reduction: 1) Alloy VT6; 2) steel 30KhGSA ( $\sigma_b = 200 \text{ kg/mm}^2$ ); 3) steel 30KhGSA ( $\sigma_b = 120 \text{ kg/mm}^2$ ); 4) steel 45; 5) alloy AMg.  
a)  $\text{kg/cm}^2$ .

certain aluminum alloys), or increases (copper and its alloys). With temperature reduction the sharpest decrease is that of the impact strength (Fig. 2); in many of the structural steels, nickel and titanium alloys there is observed a smooth decrease of  $a_n$ , while for iron, carbon steel, molybdenum and certain other materials the decrease of the impact strength (or plasticity) takes place in a narrow temperature range, termed the critical brittleness temperature interval. In this interval there is a transition from ductile fractures to brittle crystalline fractures, with low values of plasticity and ductility. Sometimes this transition is manifested so sharply that we speak of the critical brittleness temperature. The formation of brittle fractures with reduction of the temperature is termed cold shortness. For certain materials the temperature for the transition to the brittle state may be considerably above room temperature (Fig. 3). The mechanical nature of cold shortness is explained by the well-known Ioffe diagram. With reduction of the temperature, for the cold short metals the yield point increases sharply (Fig. 4a) and, beginning at some temperature (critical brittleness temperature), when the yield strength becomes greater than the tensile strength, only brittle fractures can be observed, while for the noncold short materials the yield strength may be considerably below the tensile strength clear down to the very lowest

II-85M10

TABLE 1  
Mechanical Properties of Pure Metals at Low Temperatures

| Свойства<br>1                          | Температура<br>(°C)<br>2 | 3 Решетка ОЦК |    |      |     |     | 4 Решетка ГЦК |         |         |         |         | 5 Решетка гексагональная |         |         |         | 6 Итого для всех решеток |
|--|--------------------------|---------------|----|------|-----|-----|---------------|---------|---------|---------|---------|--------------------------|---------|---------|---------|--------------------------|
|  |                          | Fe            | Mo | Ta   | Nb  | Na  | Al            | Ag      | Cu      | Ni      | Pb      | Mg                       | Ti      | Zn      | Zr      | Σ                        |
|  |                          | (09.21%)      |    |      |     |     | (09.7%)       | (09.4%) | (09.6%) | (09.6%) | (09.7%) | (09.6%)                  | (09.6%) | (09.6%) | (09.6%) | (09.6%)                  |
| $\sigma_b$ (кг/мм <sup>2</sup> ) 7     | +20                      | 38            | 49 | 62   | 35  | 1.4 | 12            | 18      | 24      | 39      | 2.8     | 12                       | 75      | 39      | 28      | 3.6                      |
|  | -196                     | 83            | 54 | 103  | 108 | 1.9 | 21            | 29      | 34      | 66      | 4.5     | 18                       | 119     | 27      | 47      | 7.1                      |
|  | -253                     | 106*          | 56 | 115* | 112 | 4.0 | 25            | 38      | 46      | 75*     | 7       | 21                       | 134*    | 35      | 68*     | 11.3                     |
| $\sigma_{0.2}$ (кг/мм <sup>2</sup> ) 7 | +20                      | 28            | —  | 36   | —   | —   | —             | —       | —       | 12.5    | —       | —                        | 48      | 29      | 11      | —                        |
|  | -196                     | 78            | —  | 103  | —   | —   | —             | —       | —       | 14.5    | —       | —                        | 108     | 23      | 23      | —                        |
|  | -253                     | 106*          | —  | 115* | —   | —   | —             | —       | —       | 14.5*   | —       | —                        | 134*    | —       | 18*     | —                        |
| $\delta$ (%)                           | +20                      | 27            | 3  | 13   | 30  | 19  | 29            | 39      | 29      | 51      | 29      | 5                        | 18      | —       | 35      | —                        |
|  | -196                     | 4             | 0  | 0    | —   | 13  | 42            | 42      | 41      | 61      | 34      | 5                        | 12      | —       | 49      | —                        |
|  | -253                     | 0.15*         | 0  | 0.6* | 7   | 60  | 68            | 64      | 64      | 85*     | 36      | 5                        | 10      | —       | 69*     | —                        |
| $\psi$ (%)                             | +20                      | 88**          | 3  | 60   | —   | —   | 88            | 94      | 71      | 85      | —       | 16                       | 48      | —       | 52      | —                        |
|  | -196                     | 54**          | 3  | 74   | —   | —   | 75            | 88      | 72      | 81      | —       | 7                        | 18      | —       | 58      | —                        |
|  | -253                     | 73*           | 4  | 77*  | —   | —   | 66            | 79      | 74      | 75*     | —       | 8                        | 16**    | —       | 55*     | —                        |

\*At - 268.8°.

\*\*Total reduction; uniform reduction at - 196° and below is equal to zero.

1) Properties; 2) temperature (°C); 3) BCC lattice; 4) FCC lattice; 5) hexagonal lattice; 6) tetragonal lattice; 7) (kg/mm<sup>2</sup>).

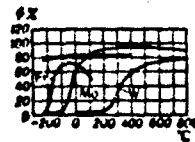

Fig. 3. Effect of temperature on plasticity of iron, molybdenum, tungsten and tantalum (tantalum is upper horizontal curve).

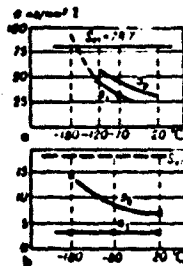

Fig. 4. Ioffe diagram in application to cold-short iron and to noncold short aluminum: a) iron; b) aluminum ( $\sigma_{ot}$  is resistance to tensile fracture). 1) kg/mm<sup>2</sup>.

II-85M11

TABLE 2

Mechanical Properties of Steels and Alloys at Low Temperatures

| 1 Сплав, состояние                               | σ <sub>0.2</sub> (кг/мм <sup>2</sup> ) 2 |      |       |       | σ <sub>b</sub> (кг/мм <sup>2</sup> ) 3 |      |       |       | δ (%) |      |       |       | ψ (%) |      |       |       | K <sub>И</sub> (кг/мм <sup>3/2</sup> ) 3 |      |       |
|--|--|------|-------|-------|--|------|-------|-------|-------|------|-------|-------|-------|------|-------|-------|--|------|-------|
|  | +20°                                     | -70° | -196° | -253° | +20°                                   | -70° | -196° | -253° | +20°  | -70° | -196° | -253° | +20°  | -70° | -196° | -253° | +20°                                     | -70° | -196° |
| * Конструкционные стали                          |  |      |       |       |  |      |       |       |       |      |       |       |       |      |       |       |  |      |       |
| 5 Сталь 35, прутки нормализованные               | 35                                       | 42   | 88    | —     | 58                                     | 65   | 98    | —     | 31    | 30   | 10    | —     | 80    | 58   | 14    | —     | 14                                       | 6    | 0.2   |
| 6 Сталь 45, прутки: закалка и отпуск при 550°    | 89                                       | 96   | 178   | —     | 100                                    | 105  | 132   | —     | 10    | 10   | 7     | —     | 57    | 54   | 11    | —     | 14                                       | 6    | 1     |
| 7 12KhN3A, прутки: закалка и отпуск при 560°     | —  | —    | —     | —     | 80                                     | 84   | 115   | —     | 18    | 20   | 20    | —     | 70    | 70   | 81    | —     | 20                                       | 17   | 1     |
| 8 18KhNVA, прутки: закалка и отпуск при 170°     | 92                                       | 86   | 120   | —     | 134                                    | 143  | 174   | —     | 13    | 12   | 13    | —     | 52    | 52   | 48    | —     | 12                                       | 9    | 4     |
| 9 EI519, прутки: закалка и отпуск при 200°       | 150                                      | 160  | 175   | —     | 170                                    | 175  | 200   | —     | 12    | 13   | 12    | —     | 50    | 51   | 53    | —     | 6.5                                      | 5.5  | 2     |
| 10 EI659, прутки: закалка и отпуск при 500°      | 125                                      | 135  | 180   | —     | 140                                    | 150  | 175   | —     | 13    | 13   | 6     | —     | 53    | 50   | 20    | —     | 6.5                                      | 5    | 1.5   |
| 11 40KhNMA, прутки: закалка и отпуск при 560°    | 98                                       | 105  | 140   | —     | 110                                    | 130  | 155   | —     | 17    | 12   | 12    | —     | 55    | 56   | 27    | —     | 11                                       | 6    | 4     |
| 12 30KhGSA, прутки: закалка и отпуск при 500°    | 110                                      | 118  | 148   | —     | 120                                    | 130  | 158   | —     | 14    | 14   | 7     | —     | 50    | 47   | 13    | —     | 7  | 4    | 1.5   |
| 13 30KhGSA, прутки: закалка и отпуск при 200°    | 145                                      | 155  | 185   | —     | 175                                    | 182  | 209   | —     | 11    | 11   | 5     | —     | 45    | 45   | 9     | —     | 6.5                                      | 5    | 3     |
| 14 30KhGSNA, прутки: закалка и отпуск при 200°   | 150                                      | 160  | 175   | —     | 175                                    | 188  | 210   | —     | 10    | 11   | 7     | —     | 46    | 50   | 29    | —     | 9  | 6.8  | 2.5   |
| 15 30KhGSNA, прутки: изотермич. закалка при 330° | 120                                      | 123  | 145   | —     | 160                                    | 170  | 190   | —     | 13    | 14   | 2.5   | —     | 52    | 53   | —     | —     | 9  | 4.5  | 1     |
| 16 EI643, прутки: закалка и отпуск при 225°      | 145                                      | 148  | 170   | —     | 210                                    | 220  | 240   | —     | 11    | 13   | 10    | —     | 47    | 45   | 16    | —     | 5.5                                      | 5.5  | 1.5   |
| 17 50KhFA, закалка и отпуск при 400°             | 152                                      | 167  | 200   | —     | 168                                    | 177  | 210   | —     | 9     | 8    | 2.5   | —     | 34    | 32   | 5     | —     | 2.5                                      | 2.0  | 0.5   |
| 18 35KhGSA, листы: закалка и отпуск при 650°     | —  | —    | —     | —     | 95                                     | 103  | 135   | —     | 15    | 15   | 6     | —     | 50    | 50   | 10    | —     | —  | —    | —     |
| 19 VLiD, листы: закалка и отпуск при 210°        | 138                                      | 151  | 172   | —     | 165                                    | 172  | 204   | —     | 7     | 7    | 7     | —     | —     | —    | —     | —     | —  | —    | —     |
| 20 25KhGSNA, прутки: отпуск при 500°             | 115                                      | 125  | 180   | —     | 130                                    | 140  | 160   | —     | 10    | 10   | 2.5   | —     | 45    | 40   | 5     | —     | 3.5                                      | 1.5  | —     |
| * Нержавеющие стали                              |  |      |       |       |  |      |       |       |       |      |       |       |       |      |       |       |  |      |       |
| 22 1Kh18N9, прутки: закалка с 1050°              | 22                                       | 24   | 25    | —     | 62                                     | 120  | 170   | —     | 62    | 50   | 42    | —     | 70    | 67   | 55    | —     | —  | —    | —     |
| 23 1Kh18N9T, прутки: закалка с 1050°             | 24                                       | 28   | 36    | 42    | 62                                     | 115  | 165   | 190   | 42    | 37   | 30    | —     | 63    | 55   | 45    | —     | —  | —    | —     |
| 24 1Kh18N11B (EI402), листы: закалка с 1050°     | 24                                       | 24   | 31    | 40    | 60                                     | 100  | 140   | 170   | 46    | 41   | 35    | 3     | 63    | 61   | 53    | —     | —  | —    | —     |
| 25 EI268, прутки: закалка и отпуск при 560°      | 93                                       | 98   | 123   | —     | 112                                    | 122  | 150   | —     | 10    | 11   | 4     | —     | 60    | 50   | 25    | —     | —  | —    | —     |
| 26 EI268, прутки: закалка и отпуск при 660°      | 72                                       | 81   | 106   | —     | 95                                     | 108  | 138   | —     | 15    | 20   | 13    | —     | 58    | 55   | 35    | —     | —  | —    | —     |

\*Bar.  
\*\*At - 183°.

1) Alloy, temper; 2) (kg/mm<sup>2</sup>); 3) (kg/cm<sup>2</sup>); 4) structural steels; 5) steel 35, normalized bar; 6) steel 45, bar, quench and temper at 550°; 7) 12KhN3A, bar, quench and temper at 560°; 8) 18KhNVA, bar quench and temper at 170°; 9) EI519, bar, quench and temper at 200°; 10) EI659, bar, quench and temper at 500°; 11) 40KhNMA, bar, quench and temper at 560°; 12) 30KhGSA, bar, quench and temper at 500°; 13) 30KhGSA, bar, quench and temper at 200°; 14) 30KhGSNA, bar, quench and temper at 200°; 15) 30KhGSNA, bar, isothermal quench at 330°; 16) EI643, bar, quench and temper at 225°; 17) 50KhFA, quench and temper at 400°; 18) 35KhGSA, cast, quench and temper at 650°; 19) VLiD, sheet, quench and temper at 210°; 20) 25KhGSNA, bar, temper at 500°; 21) stainless steels; 22) 1Kh18N9, bar, quench from 1050°; 23) 1Kh18N9T, bar, quench from 1050°; 24) Kh18N11B (EI402), sheet, quench from 1050°; 25) EI268, bar, quench and temper at 560°; 26) EI268, bar, quench and temper at 660°.



Table 2 Continued

| 1 Сплав, состояние   | σ <sub>0.2</sub> (кг/мм <sup>2</sup> ) 2 |      |       |       | σ <sub>0.1</sub> (кг/мм <sup>2</sup> ) 3 |      |       |       | δ (%) |      |       |       | ψ (%) |      |       |       | σ <sub>н</sub> (кг/мм <sup>2</sup> ) 3 |      |       |
|--|--|------|-------|-------|--|------|-------|-------|-------|------|-------|-------|-------|------|-------|-------|--|------|-------|
|  | +20°                                     | -70° | -196° | -253° | +20°                                     | -70° | -196° | -253° | +20°  | -70° | -196° | -253° | +20°  | -70° | -196° | -253° | +20°                                   | -70° | -196° |
| 4 SN-2) нормализация, обработка<br>SN-3) закалка, старение | 125                                      | 135  | 165   | 180   | 135                                      | 150  | 175   | 185   | 11    | 12   | 9     | 9.3   | —     | —    | —     | —     | —                                      | —    | —     |
| 5 VNS-2, пруток: нормализация                              | 115                                      | —    | 175   | —     | 135                                      | —    | 180   | —     | 15    | 14   | —     | 5     | —     | —    | —     | —     | —                                      | —    | —     |
| 6 EI878, пруток: старение<br>при 250° и отпуск при 250°    | 94                                       | —    | 130   | —     | 110                                      | —    | 150   | —     | 15    | —    | 15    | —     | 64    | —    | 51    | —     | 15                                     | —    | 9     |
| 9 EI878, закалка с 1075°                                   | 37                                       | 60   | 82    | —     | 75                                       | 110  | 130   | —     | 45    | 55   | 23    | —     | 68    | 66   | 21    | —     | 35                                     | 32   | 18    |
| 7 Жаропрочные сплавы на никелевой основе                   |  |      |       |       |  |      |       |       |       |      |       |       |       |      |       |       |  |      |       |
| 8 ВЖ101, лист  | 82                                       | —    | 93    | 106   | 112                                      | —    | 140   | 144   | 34    | 30   | —     | 21    | 42    | —    | 28    | 29    | —                                      | —    | —     |
| 9 EI437B, пруток: закалка и старение при 700°              | 69                                       | —    | 80    | —     | 130                                      | —    | 134   | —     | 25    | —    | 18    | —     | 20    | —    | 15    | —     | 5                                      | —    | 3.5   |
| 10 Титановые сплавы  |  |      |       |       |  |      |       |       |       |      |       |       |       |      |       |       |  |      |       |
| 11 VT5, пруток; отжиг                                      | —  | —    | —     | —     | 80                                       | 94   | 153   | —     | 12    | 12   | 9     | —     | 30    | —    | 15    | —     | 4                                      | 3    | 2     |
| 12 VT3-1, лист; отжиг                                      | 45                                       | 95   | 125   | —     | 75                                       | 95   | 135   | —     | 10    | 10   | 10    | —     | —     | —    | —     | —     | —                                      | —    | —     |
| 13 VT6, отжиг  | 94                                       | 115  | 155   | —     | 100                                      | 120  | 165   | —     | 15    | 16   | 16    | —     | 37    | 33   | 36    | —     | 4                                      | 3.5  | 2.7   |
| 14 VT3-1, пруток; отжиг                                    | —  | —    | —     | —     | 100                                      | 120  | 160   | —     | 12    | 12   | —     | —     | 35    | 30   | 25    | —     | 4                                      | 3    | 2.5   |
| 15 OT4, лист; отжиг  | 64                                       | 83   | 112   | —     | 81                                       | 87   | 122   | —     | 2.5   | 15   | 12    | —     | —     | —    | —     | —     | —                                      | —    | —     |
| 16 Алюминиевые сплавы                                      |  |      |       |       |  |      |       |       |       |      |       |       |       |      |       |       |  |      |       |
| 17 D1; закалка и старение                                  | —  | —    | —     | —     | 41                                       | —    | 52    | 68    | 15    | —    | 18    | —     | 25    | —    | 20    | 14    | —                                      | —    | —     |
| 18 D16; закалка и старение                                 | 34                                       | 36   | 45    | 52    | 44                                       | 55   | 68    | 72    | 14    | 17   | 16    | —     | 18    | 18   | 15    | —     | 2.4                                    | 2.4  | 2.4   |
| 19 V95; закалка и старение                                 | 54                                       | 54   | 66    | 73    | 64                                       | 67   | 74    | 85    | 10    | —    | 7     | —     | 13    | 15   | 9     | —     | 1                                      | 1    | 1     |
| 20 VAD23; закалка и старение                               | 54                                       | 54   | 63    | 66    | 61                                       | 63   | 70    | 77    | —     | —    | —     | —     | 17    | 8    | 6     | —     | —                                      | —    | —     |
| 21 AMg; отжиг  | 14                                       | 14   | 18    | —     | 18                                       | 19   | 31    | —     | 30    | 40   | 50    | —     | 61    | 63   | 57    | —     | 10                                     | 11   | 10    |
| 22 AMg6; отжиг   | 18                                       | 18   | 18.5  | 27    | 37                                       | 37   | 52    | 61    | 17    | 27   | 31    | 34    | 22    | 59   | 33    | —     | 27                                     | —    | —     |
| 23 AV; закалка и старение                                  | 28                                       | —    | 34    | 39    | 31                                       | —    | 43    | 53    | —     | —    | —     | —     | —     | —    | —     | —     | —                                      | —    | —     |
| 24 AJ2; литое  | —  | —    | —     | —     | 13                                       | —    | 13    | 23    | 1.2   | —    | —     | —     | 0.8   | 1.4  | 0.6   | —     | 0                                      | —    | —     |
| 25 Магниево-алюминиевые сплавы                             |  |      |       |       |  |      |       |       |       |      |       |       |       |      |       |       |  |      |       |
| 26 MA2; горячекатаный                                      | 14                                       | 18   | 21    | 23    | 25                                       | 30   | 37    | 43    | 25    | 23   | 10    | 8     | —     | —    | —     | —     | —                                      | —    | —     |
| 27 VM65-1; закалка и старение                              | 26                                       | 36   | 38    | 40    | 32                                       | 41   | 47    | 48    | 12    | —    | 8     | 10    | 11    | —    | —     | —     | —                                      | —    | —     |
| 28 VMD1; горячекатаный                                     | 23                                       | 33   | 34    | —     | 26                                       | 34   | 44    | 50    | —     | —    | —     | —     | —     | —    | —     | —     | —                                      | —    | —     |
| 29 ML4; закалка  | —  | —    | —     | —     | 20                                       | 20   | 22    | —     | 9     | 6    | 5     | —     | 12    | —    | —     | —     | —                                      | —    | —     |
| 30 ML5; закалка и старение                                 | —  | —    | —     | —     | 24                                       | 24   | 25    | —     | 5.5   | 4    | —     | —     | 7     | —    | 4     | —     | —                                      | —    | —     |
| 31 VML1; закалка и старение                                | 13                                       | 12   | 13    | 14    | 24                                       | 25   | 28    | 32    | 14    | 8    | 7     | —     | 5     | 4    | —     | —     | 0.35                                   | 0.25 | 0.2   |
| 32 Медные сплавы   |  |      |       |       |  |      |       |       |       |      |       |       |       |      |       |       |  |      |       |
| 33 Бериллиевый бронза                                      | —  | —    | —     | —     | 117                                      | 122  | 134   | —     | 4     | —    | 7     | —     | 9     | 10   | 11    | —     | 2.5                                    | 2.8  | 3.2   |
| 34 Латунь ТС58   | —  | —    | —     | —     | 45                                       | —    | 81    | 92    | 20    | —    | 34    | 40    | 64    | —    | 64    | —     | 64                                     | —    | —     |
| 35 Бронза БрОФ6.5-0.4 твердая                              | —  | —    | —     | —     | 45                                       | —    | 59    | 65    | 32    | —    | 37    | 34    | 35    | —    | 34    | —     | 35                                     | —    | —     |
| 36 Монель-металл НМЖМН                                     | —  | —    | —     | —     | 63                                       | —    | 84    | 95    | 12    | —    | 29    | 29    | 61    | —    | 54    | —     | 51                                     | —    | —     |
| 37 28-2.5-1.5  | 15                                       | 19   | 21**  | —     | 50                                       | 60   | 79**  | —     | 41    | 40   | 51**  | —     | 75    | 74   | 72**  | —     | —                                      | —    | —     |
| 37 Купроникель 90:10                                       | 27                                       | 24   | 32    | —     | 31                                       | 34   | 43    | —     | 64    | 67   | 50    | —     | —     | —    | —     | —     | —                                      | —    | —     |

1) Alloy, temper; 2) (kg/mm<sup>2</sup>); 3) (kgm/cm<sup>2</sup>); 4) SN-, normalized, cold worked, aged; 5) VNS-2, bar normalized from 950° and temper at 250°; 6) EI878, quench from 1075°; 7) nickel-base high-temperature alloys; 8) VZh101, sheet; 9) EI437B, bar, quench and age at 700°; 10) titanium alloys; 11) VT5, bar, anneal; 12) VT5-1, sheet, anneal; 13) VT6, anneal; 14) VT3-1, bar, quench and age; 15) AMg, anneal; 16) AV, quench and age; 17) VAD23, quench and age; 18) D16, quench and age; 19) V95, anneal; 20) VAD23, quench and age; 21) AMg, anneal; 22) AMg6, anneal; 23) AV, quench and age; 24) AJ2, cast; 25) magnesium alloys; 26) MA2, hot forged; 27) VM65-1, quench and age; 28) VMD1, hot forged; 29) ML4, quench; 30) ML5, quench and age; 31) VML1, quench and age; 32) copper alloys; 33) beryllium bronze; 34) LS59 soft brass; 35) BrOF6.5-0.4 hard bronze; 36) NMZMts 28-2.5-1.5 monel metal; 37) 90:10 cupronickel.

temperatures (Fig. 4b). Many hypotheses have been suggested to explain the physical nature of cold brittleness (twinning, impurities, and others). Many experimental data favor the impurity hypothesis, which relates the onset of brittleness at lower temperatures with the fact that the impurity atoms embedded in the lattice of the basic solid so-

TABLE 3

Resistance to Brittle Fracture in Tension of High Alloy Steels, Quenched and Tempered at 200°

| 1<br>Steel | +20°                                       |       | -196°                                      |       | Прирост<br>S <sub>от</sub> при<br>-196° (%) |
|------------|--|-------|--|-------|---|
|            | 2 S <sub>от</sub><br>(кг/мм <sup>2</sup> ) | ψ (%) | 2 S <sub>от</sub><br>(кг/мм <sup>2</sup> ) | ψ (%) |   |
| 4X7        | 220  | 1.7   | 245  | 0     | 11  |
| 4X9        | 190  | 1.3   | 210  | 0     | 10.5  |

1) Steel; 2) (kg/mm<sup>2</sup>); 3) increase of S<sub>от</sub> at -196° (%); 4) U.

TABLE 4

Elastic Moduli of Some Metals at Low Temperatures

| Модуль<br>упругости<br>(кг/мм <sup>2</sup> ) | Темп-ра<br>(°C) | Al   | Mg   | Ti    | Mo    | Be    | Алюминий-<br>сыйм<br>сплав В95 | Магний-<br>ыйм сплав<br>ВМ65-1 | Титановый<br>сплав ВТ6 |
|--|-----------------|------|------|-------|-------|-------|--------------------------------|--------------------------------|------------------------|
| E  | +20             | 7100 | 4400 | 10500 | 30000 | 31000 | 7000                           | 4200                           | 11200                  |
|  | -196            | 7700 | 4700 | 11500 | 30800 | 31000 | 8200                           | 5000                           | 12400                  |
|  | -253            | 7800 | 4800 | 12100 | 31100 | 33000 | —                              | 5000                           | 12450                  |
| G  | +20             | 2660 | 1880 | 4000  | 11550 | —     | —                              | —                              | 4250                   |
|  | -196            | 2940 | 1820 | 4550  | 11900 | —     | —                              | —                              | 4750                   |
|  | -253            | 3010 | 1890 | 4620  | 12040 | —     | —                              | —                              | 4850                   |

1) Elastic modulus (kg/mm<sup>2</sup>); 2) temperature (°C);  
3) aluminum alloy V95; 4) magnesium alloy VM65-1;  
5) titanium alloy VT6.

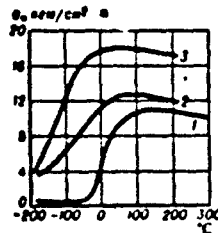

Fig. 5. Curves of impact strength of chrome-moly steel (0.31% C, 0.34% Mo, 1.05% Cr, 0.54% Mn) in annealed and improved condition: 1) annealed at 850°; 2) quench from 850° and tempered at 550°; 3) quench from 850° and tempered at 650°. a) a<sub>n</sub> kgm/cm<sup>2</sup>.

lution cause deformation of the lattice in the cold-short materials; for example, in the BCC lattice these atoms, located at the centers of the faces or edges of the cube, distort its cubic symmetry and give it a certain tetragonality. The lower the temperature, the more strongly the embedded atoms deform the lattice, which then leads to a sharp in-

II-85M14

crease of the yield strength with temperature reduction. In the noncold short metals with FCC lattice the embedded impurity atoms located in the center of the cube do not destroy its symmetry. The fact that many metals become brittle only in the presence of impurities is also in favor of the impurity hypothesis. Thus, with the presence in technical titanium of 0.05% H it retains high reduction (over 50%) at a temperature of  $-196^{\circ}$ , while with 1% of H there is observed a sharp reduction of  $\psi$  (from 55-60 to 20%) in the temperature interval from  $-40$  to  $-80^{\circ}$ . In chromium containing 0.02% N and 0.03% C there is noted a transition from ductile to brittle fracture at a temperature of  $600^{\circ}$ ; however chromium which is purified of the nitrogen and carbon impurities retains plasticity even at room temperature. Cold brittleness shows up only in the martensitic and pearlitic class steels and is not manifested in the austenitic class steels.

Certain alloying elements have a considerable effect on the cold brittleness of steel. Within certain limits chromium, manganese, and particularly nickel homogenize the solid solution of carbon in iron, which makes the steel less cold-brittle. With increase of the chromium and manganese content, when a tendency to carbide liquation manifests itself, the cold brittleness threshold is raised. The critical cold brittleness temperature interval increases in low-alloy normalized constructional steel with an increase of the carbon content; in the quenched and tempered condition with a medium carbon content its effect depends on the tempering temperature; for high-strength steel the optimal carbon content is apparently 0.3-0.4%, at this content this steel has the highest tensile strength. Nickel has a favorable effect on the low temperature properties of low-carbon normalized and medium-carbon improved steel. Up to 1% chromium has practically no effect on the critical brittleness temperature of the low-carbon normalized steel,

II-85M15

then higher content increases this temperature. In the improved temper the negative effect of chromium begins to show up with content above 2-3%. Manganese with content to 1.5% reduces the critical brittleness temperature of normalized low-carbon steel, however the presence of other alloying elements may reduce the favorable effect of this concentration of manganese. In medium carbon steel in the quenched and low-tempered condition, an increase of the manganese content leads to increase of the critical brittleness temperature. Phosphorus and silicon have a negative effect on the low temperature properties, shifting the critical brittleness interval in the direction higher temperatures. With an increase of the phosphorus content in low carbon steel from 0.11 to 0.41% the upper limit of the critical brittleness temperature interval increases from  $-145^{\circ}$  to  $0^{\circ}$ .

The quenched and tempered steels are less prone to cold brittleness than the annealed steels, and therefore in many cases they have higher impact strength at low temperatures (Fig. 5). The pearlite of normalized steel has a higher critical brittleness temperature than bainite or a mixture of bainite and tempered martensite.

Grain size has a large influence on the tendency to cold brittleness. It is known that with an increase of the grain size there is a reduction of the tensile strength and, consequently, in accordance with the Ioffe diagram there must be observed an earlier (with respect to temperature) transition to the brittle state (Fig. 6). The unfavorable effect of coarse grain is manifested in all the materials which are prone to cold brittleness. In molybdenum the change from No. 3-4 grains to No. 7-8 reduces the critical temperature by more than  $100^{\circ}$  (Fig. 7). Transition from ductile to brittle fracture with temperature reduction is also observed for niobium with a BCC lattice, however in comparison with iron it is less prone to cold brittleness, which is clearly mani-

**BLANK PAGE**

II-85M16

tested only with sufficiently large grain size (Fig. 8). In coarse-grained niobium at  $-235^{\circ}$  there is observed completely brittle fracture and twinning in the structure, while at this same temperature fine-grained niobium deforms plastically, there are slip lines and twinning in the structure, the fracture in the neck is of a mixed nature (tensile and shear). The properties of the noncold brittle materials in the work hardened condition vary with temperature reduction just the same as in the thermally treated condition (Fig. 9).

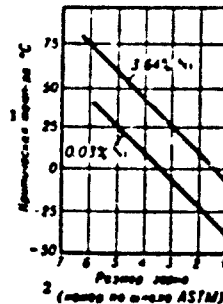

Fig. 6. Effect of ferrite grain size on critical brittleness temperature of iron (0.02% C) with varying nickel content. 1) Critical temperature,  $^{\circ}\text{C}$ ; 2) grain size (number on ASTM scale).

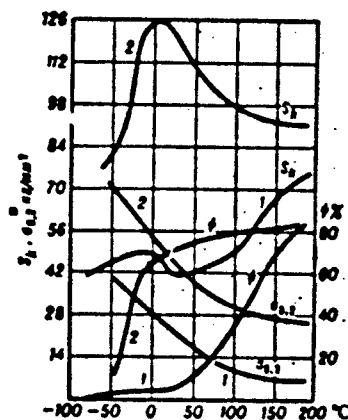

Fig. 7. Effect of grain size on cold shortness of molybdenum produced by powder metallurgy method: 1) Grain No. 3-4; 2) grain No. 7-8. a)  $\text{kg}/\text{mm}^2$ .

II-85M17

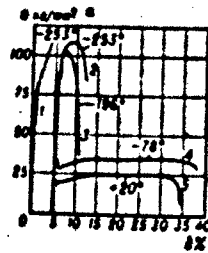

Fig. 8. Tensile diagrams for niobium with fine ( $2d = 0.00476$  mm) grain (curves 2-5) and with coarse ( $2d = 0.1414$  cm) grain (curve 1) for tension with rate of  $2.02 \cdot 10^{-4}$  sec. a)  $\text{kg}/\text{mm}^2$ .

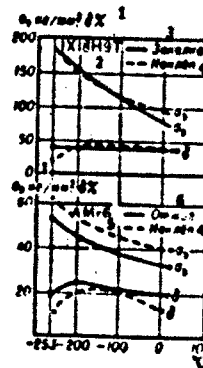

Fig. 9. Effect of low temperature on mechanical properties of LKh18N9T steel and AMg6 aluminum alloy as a function of treatment regime. 1)  $\text{kg}/\text{mm}^2$ ,  $\delta\%$ ; 2) LKh18N9T; 3) quench; 4) work hardened; 5) AMg6; 6) anneal.

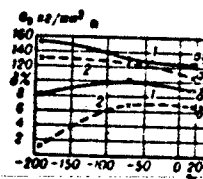

Fig. 10. Variation of ultimate strength and elongation of basic material and weld joint (electro-arc welding) of 30KhGSA steel, quenched and tempered at  $500^\circ$ ; 1) Parent metal; 2) weld joint. a)  $\text{kg}/\text{mm}^2$ .

Weld joints of low-alloy constructional steel show greater tendency to cold brittleness than the parent material (Fig. 10). Weld joints of the noncold-brittle metals behave at low temperatures qualitatively just as the parent metal (Table 5) if the welding weakening coefficient at room temperature is close to unity.

The tendency to cold brittleness is intensified under the influ-

II-85N18

TABLE 5  
Effect of Low Temperatures on Properties of Weld Joints (With Bead Removed) of Aluminum Alloy Sheets

| 1 Сплав   | +20°                                   |     | -183°                                  |      | +20°                                   |      | -183°                                  |  | +20°  |  | -183° |  |
|-----------|--|-----|--|------|--|------|--|--|-------|--|-------|--|
|           | σ <sub>0.2</sub> (кг/мм <sup>2</sup> ) |     | σ <sub>0.2</sub> (кг/мм <sup>2</sup> ) |      | σ <sub>0.2</sub> (кг/мм <sup>2</sup> ) |      | σ <sub>0.2</sub> (кг/мм <sup>2</sup> ) |  | δ (%) |  | δ (%) |  |
| Al(Mg5%)  | 19.1                                   | 14  | 20                                     | 24.9 | 5.4                                    | 6    |  |  |       |  |       |  |
| Al(99.5%) | 6.6                                    | 6.1 | 7.6                                    | 14.3 | 22.3                                   | 23.8 |  |  |       |  |       |  |

1) Alloy; 2) (kg/mm<sup>2</sup>).

ence of neutron irradiation (Table 6), and a metal which is not prone to cold brittleness in the unirradiated condition (copper, for example) becomes prone.

The manifestation of brittleness at low temperatures is to a considerable degree associated with the loading conditions (loading rate, magnitude of stress concentration, from of stress state) and with the dimensions of the specimen or part. With increase of the dimensions the critical brittleness temperature interval is shifted in the direction of higher temperatures (Fig. 11). Although cold brittleness is not directly associated with notch sensitivity (annealed low-carbon steel is not notch sensitive, but has marked cold brittleness), for the cold-brittle materials the loss of plasticity and ductility with stress concentrations present will be more marked for the lower test temperatures (Table 7).

The manifestation of brittleness

at low temperatures is to a considerable degree associated with the load-

TABLE 6  
Effect of Irradiation on Cold Brittleness in Tension of Titanium (Neutron Irradiation by Flux of 5.1·10<sup>19</sup> neutrons/cm<sup>2</sup>)

| 1 Состояние материала | σ <sub>0.2</sub> (кг/мм <sup>2</sup> ) 2 |      | σ <sub>0.2</sub> (кг/мм <sup>2</sup> ) 2 |      |       | δ (%) |      |
|-----------------------|--|------|--|------|-------|-------|------|
|                       | +20°                                     | -78° | +20°                                     | -78° | -196° | +20°  | -78° |
| 3 Необлученный        | 58                                       | 70   | 58                                       | 75   | 103.5 | 10.4  | 10.6 |
| 4 Облученный          | 62                                       | 78   | 64.5                                     | 75.5 | 115.8 | 8.3   | 6.8  |

1) Material condition; 2) (kg/mm<sup>2</sup>); 3) unirradiated; 4) irradiated.

Increase of the testing rate usually increases the critical brittleness temperature (Fig. 12), however, in titanium, whose cold brittleness is associated with the hydrogen impurity, the opposite variation is observed: static tests show titanium brittleness more strongly



TABLE 7  
Variation of Strength  $\frac{\sigma_b^n}{\sigma_b}$  and Deformational Sensitivity to Notch at Low Temperatures

| 1<br>Сплав, состояние                 | Предел прочности образца с надрезом $\sigma_b^n$ (кг/мм <sup>2</sup> ) 2 |      |       | $\frac{\sigma_b^n}{\sigma_b}$ |      |       | Сумма сдвига с надрезом $\psi_n$ (%) 3 |      |       | $\psi_n$ |      |       |
|---------------------------------------|--|------|-------|-------------------------------|------|-------|--|------|-------|----------|------|-------|
|                                       | +20°   | -70° | -196° | +20°                          | -70° | -196° | +20°                                   | -70° | -196° | +20°     | -70° | -196° |
|                                       | 4 Сталь 35, нормализованная  | 83   | 93    | 78                            | 1.48 | 1.42  | 0.8                                    | 14   | 8     | 0.5      | 0.25 | 0.14  |
| 5 12KhN3A, отпуск при 340°            | 115  | 120  | 170   | 1.44                          | 1.41 | 1.48  | 20                                     | 17   | 4     | 0.29     | 0.24 | 0.06  |
| 6 30KhGSA, закалка и отпуск при 300°  | 165  | 164  | 164   | 1.25                          | 1.46 | 1.05  | 2.0                                    | 1.8  | 0.2   | 0.05     | 0.04 | 0.01  |
| 7 30KhGSA, закалка и отпуск при 200°  | 215  | 185  | 140   | 1.22                          | 1.01 | 0.87  | 3                                      | 1.5  | 0     | 0.06     | 0.03 | 0     |
| 8 EI643, закалка и отпуск при 330°    | 210  | 200  | 145   | 1.31                          | 1.20 | 0.77  | 7                                      | 4    | 1     | 0.18     | 0.07 | 0.12  |
| 9 EI696, закалка и старение при 200°  | 230  | 240  | 153   | 1.1                           | 1.1  | 0.64  | 5                                      | 2.5  | 1.5   | 0.11     | 0.05 | 0.07  |
| 10 EI878, закалка и старение при 700° | 160  | 175  | 170   | 1.6                           | 1.55 | 1.37  | 3.5                                    | 3.5  | 3.0   | 0.11     | 0.18 | 0.18  |
| 11 VT6, закалка с 1200° в воде        | 105  | 160  | 155   | 1.3                           | 1.21 | 1.15  | 35                                     | 17   | 3     | 0.5      | 0.31 | 0.13  |
| 12 D16, закалка и старение            | 140  | 160  | 200   | 1.4                           | 1.33 | 1.21  | 4                                      | 4    | 3     | 0.08     | 0.08 | 0.1   |
| 13 V95, закалка и старение            | 55   | 58   | 74    | 1.15                          | 1.05 | 1.09  | 4                                      | 4    | 3     | 0.25     | 0.25 | 0.2   |
| 14 AMg, отпуск                        | 72   | 77   | 77    | 1.12                          | 1.15 | 1.0   | 5.5                                    | 3.5  | 3     | 0.27     | 0.23 | 0.33  |
| 15 ML4, закалка                       | 24   | 24   | 37    | 1.33                          | 1.3  | 1.19  | 27                                     | 29   | 20    | 0.44     | 0.46 | 0.35  |
| 16 ML5, закалка и старение            | 21   | 19   | 21    | 1.05                          | 0.95 | 0.95  | 5                                      | 2.5  | 1.5   | 0.41     | 0.28 | 0.37  |
|                                       | 21   | 20   | 21    | 0.88                          | 0.83 | 0.88  | 3                                      | 2    | 0     | 0.42     | 0.40 | 0     |

1) Alloy, temper; 2) ultimate strength of notched specimen,  $\sigma_b^n$  (kg/mm<sup>2</sup>); 3) reduction of notched specimen,  $\psi_n$  (%); 4) steel 35, normalized; 5) 12KhN3A, tempered at 560°; 6) 30KhGSA, quench and temper at °; 7) 30KhGSNA, isothermal quench at 330°; 8) EI643, quench and temper at 200°; 9) EI696, quench and age at 700°; 10) EI878, quench from 1200° into water; 11) VT6, anneal; 12) D16, quench and age; 13) V95, quench and age; 14) AMg, anneal; 15) ML4, quench; 16) ML5, quench and age.

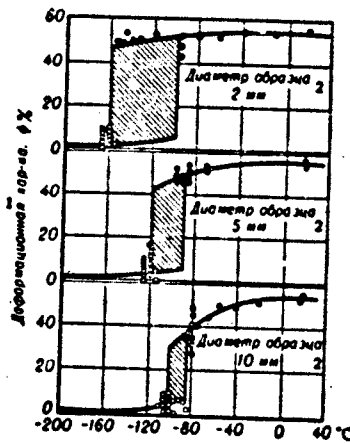

Fig. 11. Cold brittleness curves as a function of specimen diameter; 1) Deformation characteristic,  $\psi$ , percent; 2) specimen diameter — mm.

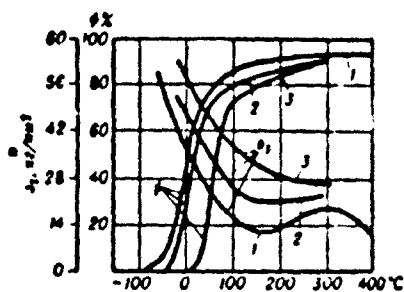

Fig. 12. Effect of deformation rate ( $v$ ) on critical brittleness temperature of annealed molybdenum; 1)  $v = 2.8 \cdot 10^{-4} \text{ sec}^{-1}$ ; 2)  $v = 4.10^{-3} \text{ sec}^{-1}$ ; 3)  $v = 0.17 \text{ sec}^{-1}$ . a)  $\text{kg}/\text{mm}^2$ .

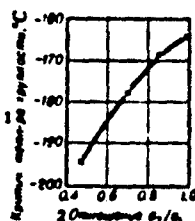

Fig. 13. Effect of biaxiality during plane tension on critical brittleness temperature of SAE1045 steel. 1) Critical brittleness temperature,  $^{\circ}\text{C}$ ; 2) ratio.

TABLE 8

Fatigue Limits of Certain Constructional Steels at Low Temperatures

| 1 Сплав                   | 2 Состояние                 | 3 $\sigma_{-1}$ ( $\text{kg}/\text{mm}^2$ ) при темп-рах: |       |        |       |       |
|---------------------------|-----------------------------|---|-------|--------|-------|-------|
|                           |                             | -20°  | -78°  | -193°  | -253° | -268° |
| 4 Алюминий *              | 5 Отожженный                | 4.5   | 5.0** | 12.5   | 23    | 25    |
| 6 Сталь (0,15% С)         | 7 Нормализованная           | 22.6  | —     | 50.5   | —     | —     |
| 8 Сталь 1Х18Н9            | 9 Нормализованная           | 76  | 88**  | 125*** | —     | —     |
| 10 Алюминиевый сплав Д16  | 11 Закаленный и состаренный | 16  | 17.5  | 28     | —     | —     |
| 12 Титановый сплав ВТ6    | 5 Отожженный                | 34  | 37    | 58***  | 53    | —     |
| 13 Титановый сплав RC130B | —                           | 38  | 68**  | 81***  | —     | —     |

\*With  $N = 10^6$ .  
 \*\*At  $-78^{\circ}$ .  
 \*\*\*At  $-196^{\circ}$ .

1) Alloy; 2) temper; 3)  $\sigma_{-1}$  ( $\text{kg}/\text{mm}^2$  at temperatures; 4) aluminum\*; 5) annealed; 6) steel (0.15% C); 7) normalized; 8) steel 1Kh18N9; 9) work hardened; 10) D16 aluminum alloy; 11) quenched and aged; 12) VT6 titanium alloy; 13) RC130B titanium alloy.

than impact testing. In some cases reduction of the temperature from +20 to  $-196^{\circ}$  led to a 10-fold decrease of the reduction in tension,

II-85M21

while the impact strength was reduced by only 25%. This is associated with the peculiarities of the hydrogen brittleness of the titanium alloys. The form of the stress state is particularly important. The brittleness critical temperature increases with increase of the triaxiality coefficient  $\sigma_1 + \sigma_2 + \sigma_3/3\sigma_1$  (Fig. 13).

The fatigue strength of the constructional materials usually improves at low temperatures (see Mechanical Properties with Repeated Loads). This observed not only with the noncold brittle materials, but also with the metals which are prone to cold brittleness (Table 8).

The metal properties at low temperatures are particularly important for the new technology associated with space exploration and the development of engines using liquid oxygen, hydrogen and other low-boiling media.

S.I. Kishkina-Ratner

MECHANICAL PROPERTIES WITH REPEATED LOADS. The resistance to repeated loads diminishes with increase of the number of load cycles. The rate and nature of the strength reduction depend on many factors in this case: peculiarities of the material (its composition, structure, heat treatment), loading conditions, magnitude of the stress concentration, dimensions of the part or specimen, surface condition, aggressivity of the surround medium (see Corrosion Fatigue), test temperature, etc. Some of these factors (for example, surface work hardening, reduction of grain size) affect the endurance in the region of a limited number of cycles and high levels of the repeated load (static endurance) in the same direction and just as effectively as they affect the fatigue strength for long lifetimes and comparatively low stress amplitude; other factors (for example, increase of test temperature, presence of soft cladding layer on the aluminum alloys) usually reduce the endurance limit to a greater degree than the resistance to low-cycle fatigue; in many cases, for example after chemical heat treatment of steel - cementation, nitriding - there is considerable increase of the fatigue strength and a reduction of the static endurance. Many of these effects may be explained by the basic laws governing the fatigue process which are examined in the article on Fatigue.

The mechanical properties with repeated loads are most frequently characterized by the endurance limit (fatigue limit) or by a limited endurance strength. The capability of materials to damp vibrations (cyclic strength, internal friction) is determined much less frequently. This property is important primarily in those cases when it is dif-

difficult to avoid resonant phenomena during operation of the part, in which case the greater capability of a material to damp vibrations may improve the reliability of the structure. Usually the damping capability is not related with the fatigue strength and in many cases materials with high cyclic strength have a low endurance limit.

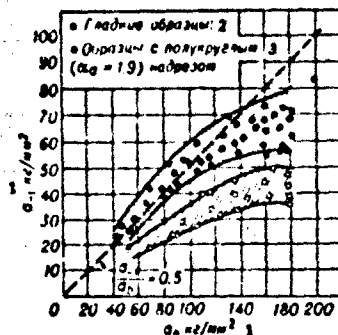

Fig. 1. Relation between endurance limits and strength limits for steel (from data of various authors); 1) kg/mm<sup>2</sup>; 2) smooth specimens; 3) specimens with semicircular ( $\alpha_\sigma = 1.9$ ) notch.

As a rule, with increase of the ultimate strength the endurance limit increases (Fig. 1), however for many materials increase of the static strength is not accompanied by a corresponding increase of the fatigue strength. For the low-alloy structural steels the ratio of the endurance strength limit to the ultimate strength normally varies from 0.45-0.55 for the low and medium-strength tempers to 0.35-0.45 for high strength steel. For the aluminum and magnesium alloys the limited endurance strength (on the basis of  $N = 2 \cdot 10^7$  cycles) is about 25-40% of the ultimate strength, for the most widely used titanium alloys this ratio is close to 0.45. The endurance of the nonmetallic materials has had little study. The following ratios have been obtained for some of these materials on the basis of  $N = 10^7$ :  $\sigma_{-1}/\sigma_b = 0.3$  (delta-plywood DSPBA),  $\sigma_{-1}/\sigma_b = 0.2$  (PTK textolite),  $\sigma_{-1}/\sigma_b = 0.2 - 0.3$  (organic glass).

In heat treating to a specified ultimate strength there may be a

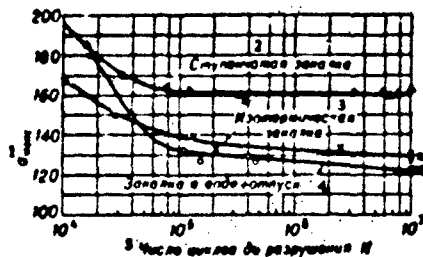

Fig. 2. Endurance of SAE1095 steel (type U9 carbon steel) as a function of the heat treatment regime at hardness RC 53  $\sigma_{max}$  in pounds per dm<sup>2</sup>). 1)  $\sigma_{max}$ ; 2) stepped quench; 3) isothermal quench; 4) water quench plus temper; 5) number of cycles to failure, N.

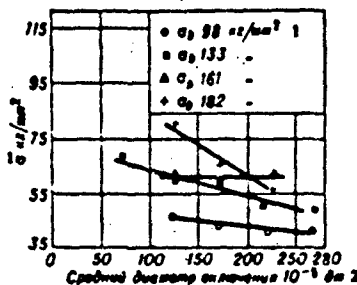

Fig. 3. Effect of nonmetallic inclusions on endurance strength of SAE4340 steel (similar in composition to 40KhNMA). 1) kg/mm<sup>2</sup>; 2) average inclusion diameter, 10<sup>-5</sup> dm.

considerable effect on the endurance strength as a result of the internal stresses caused by the heat treatment, grain size, metal purity with regard to contamination and nonmetallic inclusions. It has been shown that stepped quenching, during which the soak above the martensitic point in the zone of greatest austenitic stability leads to equalization of the temperatures in the center and on the surface of the specimen and thereby to simultaneous transformation through the entire volume, gives the steel greater endurance than water quench and low tempering, in which case for the same hardness the steel has higher internal tensile stresses (Fig. 2). For this same reason increase of tempering temperature of structural steel from 200 to 400°, accompanied by a considerable reduction of the ultimate strength, frequently not only does not lead to a marked reduction of the fatigue strength, but for

II-86M3

some grades of steel even gives rise to an increase of the endurance. The alloy melting technology is of great importance. Data have been presented showing that high strength steel melted in a vacuum has an endurance limit which is higher by 30-40 percent than that of steel melted in the atmosphere. The presence of nonmetallic inclusions in the steel structure leads to a reduction of the endurance limit which is greater the higher the level of the static strength (Fig. 3). For many alloys the fatigue strength improves with reduction of grain size, although the ultimate strength and hardness may remain practically constant in this case. For several grades of brass, bronze, magnesium alloys, austenitic chrome-nickel steel, high temperature Cr-Ni-base alloys, an increase of the fatigue strength with reduction of grain size has been obtained experimentally. For example, in the 70-30 brass increase of the average grain diameter from 25 to 100 microns reduces the fatigue strength by about 20%. For the cast magnesium alloys there is observed a linear dependence between the fatigue strength and the quantity  $1/D^2$ , where D is the average grain diameter. The influence of grain size on fatigue of the aluminum alloys has not yet been fully explained: along with experimental data obtained in the USA on increase of the endurance strength by 25-35 percent for alloys similar in composition to the Soviet alloys D1, AK2, and AK6, there are also results of tests in which no noticeable connection is noted between the grain size and the fatigue strength of the aluminum alloy. The fatigue strength of notched specimens decreases relatively little with increase of grain size. Therefore the effective stress concentration coefficient  $k_g$  for the alloys with coarse-grain structure is smaller than for the fine-grain materials. The notch sensitivity coefficient  $q_g$  varies similarly. With increase of the test temperature the nature of the effect of grain size on the endurance is apparently retained until the process of fatigue

failure develops through the grain body; at those temperatures for which fatigue fracture begins along the grain boundaries, heat treatment of the coarse grain gives the alloy better endurance.

The wrought alloys have a certain degree of anisotropy of the endurance limit. The available data show that for structural steel the fatigue strength across the fiber is lower by 15-35% than for specimens cut along the fiber, and, the higher the static strength level of the steel and the less uniform the structure for a given level of  $\sigma_b$ , normally the more marked the anisotropy of the fatigue strength. In many cases a slight anisotropy of the fatigue strengths obtained in testing smooth specimens is intensified markedly in the presence of stress concentrations (see Table 1). For steel, on the other hand, there are indications that with a considerable anisotropy of the fatigue strengths for smooth specimens this anisotropy is not manifested or shows up more weakly in the presence of stress concentrations.

TABLE 1

Effect of Fiber Direction in Aluminum Alloy Forging Blanks on Their Fatigue Strength with Alternating Bending Load  $N = 2 \cdot 10^7$ ).

| Сплав<br>1  | Направление<br>вырезки об-<br>2) разца | Гладкие<br>образцы<br>$\sigma_{-1}$<br>(кг/мм <sup>2</sup> )<br>3 | Образцы с<br>полукруг-<br>лым надрез-<br>ком $r_n =$<br>$= 0.75$ мм <sup>4</sup><br>$\sigma_{-1}^n$ , (кг/мм <sup>2</sup> ) |
|---|--|---|---|
| АК4<br>( $\sigma_b = 40$<br>кг/мм <sup>2</sup> )    | Вдоль<br>волокна 6                     | 13.5  | 7.5   |
|   | Поперек<br>волокна 7                   | 13  | 3.5   |
| 8 ВД17<br>( $\sigma_b = 52$<br>кг/мм <sup>2</sup> ) | Вдоль<br>волокна 6                     | 16.5  | 9.5   |
|   | Поперек<br>волокна 7                   | 15.5  | 5.5   |

1) Alloy; 2) direction of specimen cut; 3) smooth specimens,  $\sigma_{-1}$  (kg/mm<sup>2</sup>); 4) specimens with semicircular notch.  $r_n = 0.75$  mm,  $\sigma_{-1}^n$  (kg/mm<sup>2</sup>); 5) АК4 ( $\sigma_b = 40$  kg/mm<sup>2</sup>); 6) along fiber; 7) across fiber; 8) ВД17 ( $\sigma_b = 52$  kg/mm<sup>2</sup>).



Work hardening caused by plastic deformation (rolling, drawing, stretching, compression) increases the fatigue strength of carbon steel, chrome stainless steel (13% Cr) and 18-8 chrome-nickel steel, 70-30 brass by 10-50% depending on the degree and method of cold working. In regard to the aluminum alloys there are indications of unfavorable effect of work hardening on the endurance.

The fatigue indices are characterized by a large scatter of the individual values (see Scatter of Mechanical Properties). The more non-uniform the alloy structure, the greater the scatter with repeated loads. As a rule, the high strength materials show a greater scatter in fatigue and strength characteristics than the alloys of medium and low strength (Fig. 4). The scatter depends on the cycle asymmetry; for a given amplitude of stress the scatter with a symmetric cycle is usually lower than with an asymmetric cycle. The fatigue life scatter increases with reduction of stress amplitude.

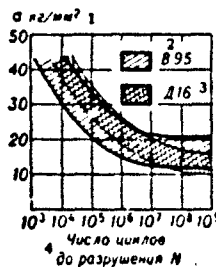

Fig. 4. Fatigue curves for symmetrical bending of smooth cylindrical specimens made from forged semifinished products of V95 ( $\sigma_b = 60-65 \text{ kg/mm}^2$ ) and D16 ( $\sigma_b = 50-55 \text{ kg/mm}^2$ ) aluminum alloys. 1)  $\sigma$ ,  $\text{kg/mm}^2$ ; 2) V95; 3) D16; 4) number of cycles to failure, N.

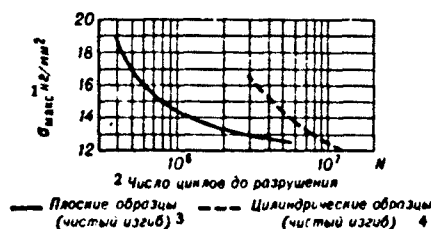

Fig. 5. Fatigue curves for Avial' alloy with failure probability  $P = 5$  percent obtained in testing specimens of various shape in pure bending.

11-212

1)  $\sigma_a$ , kg/mm<sup>2</sup>; 2) number of cycles to failure; 3) flat specimens (pure bending); 4) cylindrical specimens (pure bending).

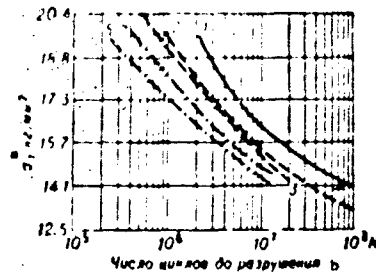

Fig. 6. Effect of frequency on fatigue curve of RR56 (type AK6) aluminum alloy: 1) 3835 cps; 2) 1550 cps; 3) 850 cps; 4) 370 cps; 5) 24 cps. a)  $\sigma_a$ , kg/mm<sup>2</sup>; b) number of cycles to failure.

In evaluating the fatigue strength of various semimanufactures (for example, sheets and stampings) we must keep in mind that the results obtained in testing specimens of different shape are usually not comparable (Fig. 5).

As a rule, the fatigue strengths are determined in tests with a loading frequency of 25-50 cps. Materials which have higher fatigue strengths under these conditions may be less strong under low-frequency loading. In particular, the high strength steels, which have a fatigue strength 20-40% higher than that of the medium strength steels, show reduced life under repeated static testing in comparison with the latter. The same is observed in comparing the high strength aluminum alloys V95, V93, VAD23 with the medium strength alloys D16, AK6 (see Static Fatigue). With a frequency increase by one-two orders the fatigue resistance, as a rule, increases markedly (Fig. 6), and the frequency effect is manifested more strongly the higher the stress level. A time dependence of the strength with repeated loadings is manifested in the frequency effect. For certain alloys this dependence is to a considerable degree associated with the fact that atmospheric air is a weakly corrosive medium for these alloys.

In connection with increase of the service life of modern engines,

various sorts of machines and structures, for the non-iron alloys, which do not have a real fatigue limit (see Fatigue), the limited fatigue strength determined for a large number of cycles is of particular importance. For some aluminum and titanium alloys the available data indicate that increase of the testing base beyond 10-100 million cycles does not lead to any significant reduction of the fatigue strength (Table 2).

TABLE 2  
Fatigue Strength of Smooth Specimens in Symmetric Bending

| 1<br>Сплав      | 2<br>$\sigma_{-1}$ (кг/мм <sup>2</sup> ) при числе циклов до разрушения |                 |                 |                 |                   |
|-----------------|---|-----------------|-----------------|-----------------|-------------------|
|                 | 10 <sup>7</sup>   | 10 <sup>8</sup> | 10 <sup>9</sup> | 10 <sup>8</sup> | 5-10 <sup>8</sup> |
| 3 В95Т . . .    | 27  | 19              | 16              | 14,5            | 14,5              |
| 4 ВАД23 . . .   | 22  | 18              | 15              | 13,8            | —                 |
| 5 Типа АВ . . . | 21  | 16              | 11,5            | 10,5            | 9,8               |
| 6 ВТ5-1 . . .   | 54  | 51,5            | 50              | 49,5            | —                 |

1) Alloy; 2)  $\sigma_{-1}$  (kg/mm<sup>2</sup>) with number of cycles to failure; 3) V95T; 4) VAD23; 5) type AB; 6) Vt5-1.

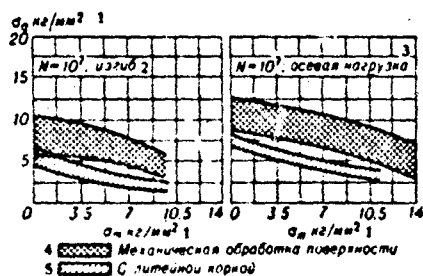

Fig. 7. Influence of average cycle stress on amplitude of safe stresses in Mg-Al-Zn alloys. 1) kg/mm<sup>2</sup>; 2) bending; 3) axial load; 4) surface machining; 5) with casting skin.

The low alloy structural steels of low and medium strength have little sensitivity to cycle asymmetry. For the brittle material (for example, irons, cast alloys) the amplitude of the safe stresses diminishes considerably with increase of the mean cycle stress (Fig. 7). Among the wrought alloys the effect of cycle asymmetry on fatigue strength has been studied most thoroughly for the aluminum alloys, for which the

TABLE 3  
Effect of Mean Stress  $\sigma_m$  of Cycle  
With Axial Loading for Wrought  
Aluminum Alloys\*

| 1. Alloy | 2. $\sigma_m$<br>(kg/mm <sup>2</sup> ) | 3. $\sigma_a$ (kg/mm <sup>2</sup> ) при N = 3 |                 |                 |                 |
|----------|--|---|-----------------|-----------------|-----------------|
|          |  | 10 <sup>5</sup>                               | 10 <sup>6</sup> | 10 <sup>7</sup> | 10 <sup>8</sup> |
| 75ST6**  | 0                                      | 27  | 19.5            | 16              | 14.5            |
|          | 10                                     | 24  | 17.5            | 14              | 13              |
|          | 20                                     | 20  | 15              | 12              | 11.5            |
|          | 30                                     | 18  | 11.5            | 10              | 10              |
| 26ST4*** | 0                                      | 24.5  | 19              | 14.5            | 12.5            |
|          | 10                                     | 22.5  | 17              | 13.5            | 11.5            |
|          | 20                                     | 19  | 14              | 11.5            | 10              |
|          | 30                                     | 14  | 12              | 8.5             | 8.5             |

\*Approximate values of  $\sigma_a$  obtained from graphs are presented.

\*\*Analogous to V95T1.

\*\*\*Analogous to D16T.

1) Alloy; 2) kg/mm<sup>2</sup>; 3)  $\sigma_a$  (kg/mm<sup>2</sup>) for N.

TABLE 4  
Stress Concentration Sensitivity in Bending of Rotating Specimen

| 1. Alloy                  | 2. $\frac{\sigma_a(\sigma^* - \sigma_m)}{(\sigma^* - \sigma_m)}$ |    | 3. $\sigma_a$ | 4. $k_\sigma$ | 5. $q_\sigma$ |      |
|---------------------------|--|----|---------------|---------------|---------------|------|
|                           | (kg/mm <sup>2</sup> )  | 2  |               |               |               |      |
| Сталь 3                   |  |    |               |               |               |      |
| 45                        | 95   | 53 | 28            | 2.05          | 1.9           |      |
| 30X13NA 4                 | 180  | 71 | 60            | 2             | 1.45          |      |
| ЭИ643 5                   | 200  | 82 | 54            | 2             | 1.33          |      |
| Алюминиевые сплавы 6      |  |    |               |               |               |      |
| 7 Дефор-<br>мируе-<br>мые | АК4-1*   | 50 | 13.5          | 8             | 2.2           | 1.7  |
|                           | ВД17*  | 50 | 18            | 10            | 2             | 1.6  |
| 9 Ли-<br>тои              | 355-Т6**   | -  | 6             | 6             | 2             | 1    |
| Магниеые сплавы 10        |  |    |               |               |               |      |
| 11 Ли-<br>тои             | МТ9-Т6*  | 24 | 8             | 6             | 2.05          | 1.33 |
|                           | 12   |    |               |               |               | 0.31 |

\*Fatigue strength on basis of N = 2·10<sup>7</sup> cycles.

\*\*Analogous to AL5 alloy.

1) Alloy; 2) (kg/mm<sup>2</sup>); 3) steels; 4) 30KhGSNA; 5) EI643; 6) Aluminum alloys; 7) wrought; 8) VD17\*; 9) cast; 10) magnesium alloys; 11) cast; 12) ML9-T6.

limiting amplitudes decrease sharply with increases of  $\sigma_m$  (Table 3).

The majority of the data on the fatigue strengths of the structural materials has been obtained from bending tests with symmetric cycle. For a preliminary estimate of the fatigue strength with differ-

ent forms of stress state, we must keep in mind the approximate relations between the fatigue strengths in tension-compression ( $\sigma_{-1}^D$ ), bending ( $\sigma_{-1}$ ) and torsion ( $\tau_{-1}$ ); for constructional steel  $\frac{\sigma_{-1}^D}{\sigma_{-1}} = 0.8-0.9$  and  $\tau_{-1}/\sigma_{-1} = 0.5-0.6$ ; for the aluminum alloys  $\sigma_{-1}^D/\sigma_{-1} = 0.85-0.95$  and  $\tau_{-1}/\sigma_{-1} = 0.55-0.65$ ; for irons  $\sigma_{-1}^D/\sigma_{-1} = 0.6-0.7$  and  $\frac{\tau_{-1}}{\sigma_{-1}} = 0.7-0.9$ .

The fatigue strength of the wrought alloys diminishes sharply in the presence of stress concentration. Sensitivity to stress concentration with repeated loading, characterized by the coefficient  $\eta_s = \frac{k_\sigma - 1}{\alpha_\sigma - 1}$ , where  $\alpha_\sigma$  is the theoretical stress concentration coefficient, and  $k_\sigma = \sigma_{-1}^D/\sigma_{-1}$ , is not associated directly with the material strength level. This sensitivity is usually less marked for the cast alloys in view of their greater nonhomogeneity than for the wrought alloys (Table 4). With increase of the theoretical concentration coefficient the notch sensitivity with repeated loading diminishes for many steels, however there are data for SAE4340 steel (type 40KhNMA), the VT5-1 titanium alloy and the AK4-1, VD17, 6061-T6 aluminum alloys on increase of  $q_\sigma$  with increase of  $\alpha_\sigma$ .

The strength under repeated loading depends on the dimensions of the specimen or part, decreasing with increase of the size. However, the greater the specimen diameter the less the scatter of the fatigue strength. Therefore the fatigue strengths determined for low failure probabilities on large and small specimens will approach one another (Fig. 8). The scale effect increases with increase of the test basis. Scale effect in fatigue is manifested more strongly the higher the carbon content in the steel, the higher the steel strength level, the poorer the surface finish, and the higher the stress concentration (Fig. 9). With increase of specimen diameter  $k_\sigma$  approaches  $\alpha_\sigma$  and from the available data for alloy steels with  $\sigma_b = 120 \text{ kg/mm}^2$  the effective concentration coefficient becomes equal to the theoretical value with

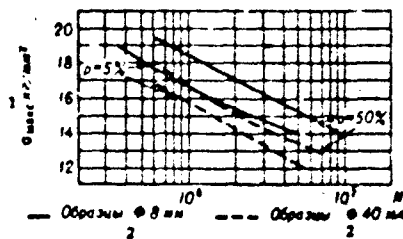

Fig. 8. Fatigue curves of specimens of various diameters made from the AV-T1 alloy with failure probability  $P = 50\%$  and  $P = 5\%$ . 1)  $\sigma_{max}$ ,  $kg/mm^2$ ; 2)  $\phi$  8-mm-diam specimens.

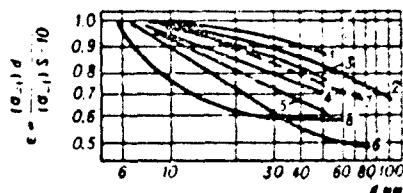

Fig. 9. Scale effect factor in bending and torsion for steels and light alloys: 1) Carbon steel without stress concentration (polished); 2) carbon steel without stress concentration (ground); 3) alloy steel without stress concentration (polished); 4) alloy steel without stress concentration (ground); 5) alloy steel with stress concentration; 6) steel with high stress concentration; 7) constructional steel in torsion; 8) light alloys in bending and torsion.

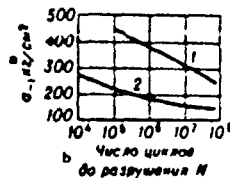

Fig. 10. Fatigue curves for bending in one plane for organic glass ( $\sigma_b = 625 \text{ kg/mm}^2$ ): 1) Specimen thickness 3.2 mm; 2) specimen thickness 6.4 mm. a)  $\sigma_{-1}$   $kg/cm^2$ ; b) number of cycles to failure,  $N$ .

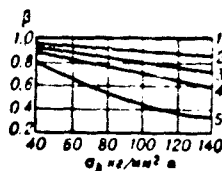

Fig. 11. Relative reduction of fatigue strength as a function of surface condition: 1) Polished; 2) ground; 3) fine turned; 4) rough turned; 5) with scale. a)  $kg/mm^2$ .

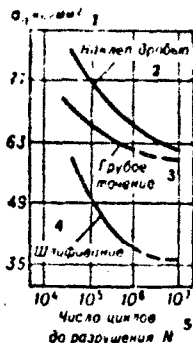

Fig. 12. Effect of surface treatment on fatigue strength of RC130B titanium alloy. 1)  $\sigma$ , kg/mm<sup>2</sup>; 2) shot peening; 3) rough turning; 4) grinding; 5) number of cycles to failure. N.

increase of the specimen diameter to 40-50 mm. The scale effect is also intensified with transition from carbon steels to alloy steels. It is manifested particularly strongly in the brittle material (Fig. 10). Scale effect has been studied primarily in bending and torsion, i.e., under conditions in which the reduction of specimen dimensions is accompanied by an increase of the stress gradient across the section.

The strength under repeated loading depends to a considerable degree on the surface condition — its microrelief, physical properties of the surface layer, residual stresses in the surface layer — and depending on the material properties and the service conditions, particular surface characteristics will be of decisive importance. The presence of machining and grinding marks reduces the fatigue strength more, the higher the steel strength level (Fig. 11). The aluminum alloys of low and medium strength are comparatively insensitive to the form of machining. The fatigue strength of the irons is almost independent of the surface microrelief after machining because of the structural non-uniformities (graphite inclusions, etc.), which are stronger stress concentrators. There are some indications that for certain titanium alloys the fatigue strength after grinding is lower than after machining (Fig. 12). The grinding operation, particularly in materials having low

II-86M12

thermal conductivity, may lead to the appearance of residual tensile stresses and grinding cracks in the surface layer, which causes a reduction of the fatigue strength. The sensitivity of a material to machining shows up more strongly the larger the specimen or part. Surface finish is particularly important in testing with symmetrical cycles.

Machining not only establishes the surface microrelief, but also causes work hardening of the surface layer, depending primarily on the feed, geometry and condition of the cutting tool. Work hardening after machining, if there is no deterioration of the surface microrelief, increases the fatigue strength.

Special methods of work hardening the surface - rolling, shot peening - can increase the fatigue strength of smooth specimens of many constructional materials by 20-40 percent (Table 5). Surface work hardening is particularly effective for materials in whose structure physico-chemical transformations take place during plastic deformation (high strength steels, stainless steels of the 1Kh18N9T type). In the presence of stress concentration, the work hardening effect increases so much that in many cases the fatigue strengths of work hardened notched specimens differ little from those of the smooth specimens. With increase of the lateral dimensions the strengthening from surface work hardening is scarcely reduced if the relative depth of the work hardened layer is maintained.

The fatigue strength is reduced in the presence of a soft surface layer - decarbonized for steel and of soft aluminum for the clad aluminum alloys (Table 6). The presence of casting skin reduces the fatigue strength of the cast alloys by 25-30 percent. The anodic films applied to protect aluminum alloys from corrosion affect the fatigue strength differently depending on coating thickness, electrolyte composition,



TABLE 5

Effect of Surface Work Hardening on Bending Fatigue Strength of Constructional Materials

| 1 Сплав  | 2 Состояние поверхности |    | 3 $\sigma_{-1}$ (кг/мм <sup>2</sup> ) |                      | $a_{\sigma}$ | $k_{\sigma}$ | $\rho_{\sigma}$ |
|--|-------------------------|----|---------------------------------------|----------------------|--------------|--------------|-----------------|
|  |                         |    | 4 образцы гладкие                     | 5 образцы с надрезом |              |              |                 |
| 6 Сталь 30ХГСА ( $\sigma_b = 180$ кг/мм <sup>2</sup> )           | Полированная            | 7  | 81                                    | 34,5                 | 1,9          | 1,75         | 0,83            |
|  | Наклепанная дробью      | 8  | 89                                    | 81                   | 1,9          | 1,31         | 0,34            |
| 9 Сталь 40ХНМА нормализованная                                   | Полированная            | 7  | 30,2                                  | 17,7                 | 3,0          | 1,71         | 0,36            |
|  | Наклепанная обкаткой    | 8  | 33,7                                  | 30,7                 | 3,0          | 1,09         | 0,04            |
| 11 Хромоникелевая сталь 18-8                                     | Неполированная          | 12 | 32,2*                                 | —                    | —            | —            | —               |
|  | Наклепанная дробью      | 8  | 62,4*                                 | —                    | —            | —            | —               |
| 13 Алюминиевый сплав АК4-1                                       | Полированная            | 7  | 13,5                                  | 8                    | 2,2          | 1,68         | 0,62            |
|  | Наклепанная дробью      | 8  | 17,5                                  | 17                   | 2,2          | 1,03         | 0,027           |
| 14 Алюминиевый сплав ВД17  | Полированная            | 7  | 16                                    | 10                   | 2,0          | 1,6          | 0,6             |
|  | Наклепанная дробью      | 8  | 19,5                                  | 17,5                 | 2,0          | 1,18         | 0,18            |
| 15 Магнийский сплав AZ-31 ( $\sigma_b = 29$ кг/мм <sup>2</sup> ) | Тонкая обточка          | 16 | 9,2                                   | —                    | —            | —            | —               |
|  | Наклепанная             | 17 | 12                                    | —                    | —            | —            | —               |
| 18 Титановый сплав ВТ2   | Полированная            | 7  | 42                                    | 27                   | 2,1          | 1,55         | 0,5             |
|  | Наклепанная дробью      | 8  | 49                                    | 34                   | 2,1          | 1,44         | 0,4             |

\*Pulsating torsion.

- 1) Alloy; 2) surface condition; 3)  $\sigma_{-1}$  (kg/mm<sup>2</sup>); 4) smooth specimen; 5) notched specimen; 6) 30KhGSA steel ( $\sigma_b = 180$  kg/mm<sup>2</sup>); 7) polished; 8) shot peened; 9) normalized 40KhNMA steel; 10) work hardened by rolling; 11) 18-8 chrome-nickel steel; 12) unpolished; 13) AK4-1 aluminum alloy; 14) VD17 aluminum alloy; 15) AZ-31 magnesium alloy ( $\sigma_b = 29$  kg/mm<sup>2</sup>); 16) Finely machined; 17) work hardened; 18) VT2 titanium alloy.

TABLE 6

Effect of Cladding on Fatigue Strength of Aluminum Alloy Sheet

| 1 Сплав | 2 Состояние поверхности | 3 Ограниченные пределы выносливости $\sigma_{-1}$ (кг/мм <sup>2</sup> ) на базе N циклов |    |    |    |    |
|---------|-------------------------|--|----|----|----|----|
|         |                         | 4  | 5  | 6  | 7  | 8  |
| 7074-T3 | Неплакированная         | 34   | 26 | 21 | 18 | 18 |
|         | Плакированная           | 31   | 23 | 18 | 17 | 17 |
| 7075-T6 | Неплакированная         | 37   | 26 | 21 | 20 | 20 |
|         | Плакированная           | 31   | 19 | 15 | 13 | 13 |

- 1) Alloy; 2) surface condition; 3) limited fatigue strength,  $\sigma_{-1}$  (kg/mm<sup>2</sup>) on the basis of N<sup>-1</sup> cycles; 4) unclad; 5) clad.

surface preparation, presence of stress concentrators, level of the effective repeated stresses.

The anodic films, brittle and containing internal stresses, obtained in solutions of H<sub>2</sub>SO<sub>4</sub>, with film thickness of 15 micros or more significantly reduce the fatigue strength of the wrought aluminum alloys. The greatest reduction is observed in the alloys of the Al-Mg-Cu-Zn system,

where the presence of a cladding layer diminishes the unfavorable effect of the anodic film. A thick anodic film either does not reduce the fatigue strength of the cast aluminum alloys or reduces it only

II-86M14

slightly. With regard to the effect of thin (5-8 microns) sulfate anodic films, there are data on reduction of the fatigue strength of the 7075 alloys (analogous to V95) and dural only in the area of high repeated stresses. It is noted that anodized specimens show considerably greater scatter of fatigue life than nonanodized specimens (Fig. 13). According to some data, anodizing in a chromate electrolyte with film thickness to 5 microns not only does not reduce the fatigue strength of the aluminum alloys, but even increases it somewhat. Chromate films of thickness 10-12 microns reduce the fatigue strength of smooth specimens of the V95 type alloys by 10-15 percent. According to some data, anodizing does not intensify the effect of sharp notches on the fatigue strength with  $N = 10^7 - 10^8$  cycles.

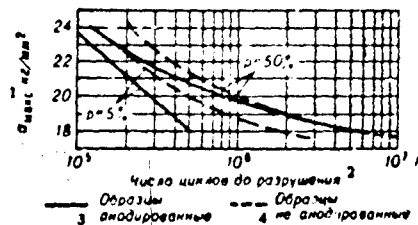

Fig. 13. Endurance curves for anodized and nonanodized specimens of the V91 alloy corresponding to fracture probability  $P = 50\%$  and  $P = 5\%$ . 1)  $\sigma_{max}$ ,  $\text{kg/mm}^2$ ; 2) number of cycles to failure; 3) anodized specimens; 4) nonanodized specimens.

Galvanic coating used to increase resistance to wear and corrosion generally reduce the fatigue strength. Depending on bath composition and layer thickness, nickel plating may reduce the fatigue strength of smooth specimens of carbon and low-alloy steel up to 40-50 percent. Chrome plating has a similar unfavorable effect. Electrolytic chrome plating reduces the fatigue strength of the AK4, AK6 aluminum alloys by 25-30 percent. In the presence of stress concentration the unfavorable effect of nickel and chrome plating shows up much less strongly (Fig. 14). Increase of test temperature to  $200^\circ$  does not eliminate the harm-

II-86M15

ful effect of anodizing and chrome plating on the endurance of the AK4, VD17, AK6 alloys. Tin and zinc coatings reduce the fatigue strength of steel, while cadmium plating has little effect on the shape of the fatigue curve (Fig. 15).

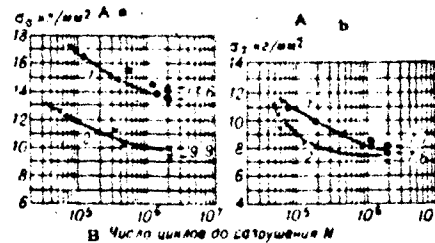

Fig. 14. Effect of electrolytic chrome plating on fatigue strength of smooth (a) and notched (b) specimens of AK4 alloy: 1) Polished; 2) chrome plated. A)  $\sigma_a$  kg/mm<sup>2</sup>; B) number of cycles to failure, N.

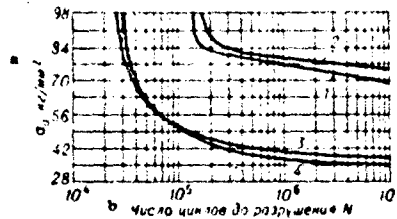

Fig. 15. Effect of surface coatings on fatigue strength of steel with 0.66 percent C and 0.71 percent Mn ( $\sigma_b = 148$  kg/mm<sup>2</sup>): 1) Normal treatment; 2) cadmium plated; 3) zinc plated; 4) tin plated. (Curves plotted from minimal values obtained in tests). a)  $\sigma_a$  kg/mm<sup>2</sup>; b) number of cycles to failure, N.

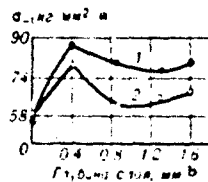

Fig. 16. Variation of fatigue strengths of 12KhN3A (1) and 18KhNMA (2) steels as a function of the depth of cemented layer. a)  $\sigma_{-1}$  kg/mm<sup>2</sup>; b) depth of layer, mm.

There are data on the favorable effect of films of certain polar organic compounds (dodecyl alcohol, dodecyl amine, and others) on the fatigue strength of the carbon and low-alloy steels, beryllium bronze, magnesium alloys. Some of these compounds have the same effect in tests

II-86M16

in water as in air. Oleophobic films have no effect on the fatigue strength of the titanium alloys and the age hardening 17-7 stainless steel.

The strength of constructional steel under repeated loading may be increased considerably (by 10-50% for smooth specimens) by chemico-thermal treatment of the surface - cementation, nitriding, cyanidation. In the absence of stress concentration. Cementation and cyanidation yield a greater increase of the fatigue strength, however nitriding performed at temperatures below the critical points of the steel leads to considerably less wrapping of the part. In addition, the fatigue strength of cemented or cyanided steel depends not only on the cementation regime, but also on the subsequent thermal and mechanical treatment, while the nitrided parts are subjected only to a final grinding and lapping, and their properties are determined primarily by the nitriding regime. The effectiveness of the strengthening with a given form of chemico-thermal treatment depends on the depth of the hardened layer (Fig. 16), magnitude of the stress concentration, loading conditions. The smaller the part size and the higher the stress concentration, the more marked the effect of the surface treatment (Table 7). There are indications that with small specimen diameters nitriding makes them notch sensitive even with very sharp notches, with large diameters insensitivity to notching as a result of nitriding is observed with low stress concentration.

When exposed to a corrosive medium, steel no longer demonstrates fatigue strength; the limited fatigue strength of both the iron alloys and many noniron alloys diminishes sharply (Table 8). The fatigue strength of the carbon and low alloy steels are lower by a factor of 2-3 times in fresh water than in air, and in sea water it is lower by a factor of 5-6 times. The fatigue strength of the martensitic class of

TABLE 7  
Effect of Nitriding on Bending Fatigue Strength of EI275 Steel

| Образец  | Диаметр образца (мм) | $\sigma_{-1}$         |     |
|--|----------------------|-----------------------|-----|
|  |                      | (кг/мм <sup>2</sup> ) | (%) |
| 4 Гладкий,<br>5 неазотированный<br>6 азотированный                 | 10                   | 48                    | 100 |
|  | 10                   | 63                    | 131 |
| 4 Гладкий,<br>5 неазотированный<br>6 азотированный                 | 40                   | 40                    | 100 |
|  | 40                   | 47                    | 117 |
| 7 С буртом (r=2,2 мм),<br>5 неазотированный<br>6 азотированный     | 40                   | 24                    | 100 |
|  | 40                   | 42                    | 175 |
| 7 С буртом (r=1,1 мм),<br>5 неазотированный<br>6 азотированный     | 40                   | 16                    | 100 |
|  | 40                   | 34                    | 210 |
| 8 С поперечным отверстием,<br>5 неазотированный<br>6 азотированный | 40                   | 14                    | 100 |
|  | 40                   | 29                    | 210 |

1) Specimen; 2) specimen diameter (mm); 3)  $\sigma_{-1}$  (kg/mm<sup>2</sup>); 4) smooth; 5) unnitrided; 6) nitrided; 7) with fillet (r = 2.2 mm); 8) with lateral hole.

TABLE 8  
Bending Corrosion Fatigue Strength of Some Constructional Materials

| Сплав                                | $\sigma_v$ (кг/мм <sup>2</sup> ) | $\sigma_{-1}$ (кг/мм <sup>2</sup> ) |      |       | Базисная долговечность (N циклов) |
|--------------------------------------|----------------------------------|-------------------------------------|------|-------|-----------------------------------|
|                                      |                                  | 3                                   | 4    | 5     |                                   |
| 8 Сталь (0,3% С)                     | 50                               | 25                                  | —    | 5,5   | 10*                               |
| 8 Сталь (0,36% С)                    | 54                               | 28                                  | 12   | 7     | 10*                               |
| 9 Сталь типа 38ХМЮА                  | 79                               | 40                                  | 18   | 7     | 5-10*                             |
| 8 Cr-Ni-Mo сталь                     | 181                              | 89                                  | —    | 12    | 10*                               |
| 105%-ная никелевая сталь             | 112                              | 50                                  | 19   | —     | То же 25                          |
| 11 Стальное литье (0,48% С)          | 84                               | 22                                  | 12   | 8     | "                                 |
| 12 Нержавеющие стали:                |                                  |                                     |      |       |                                   |
| 13 X13                               | 63                               | 39                                  | 27   | 19*   | 5-10*                             |
| 13 4X13                              | 125                              | 62                                  | 28   | 19*   | То же                             |
| 14 Чугун (3,4% С, 1,52% Si, 0,8% Mn) | 30                               | 13                                  | 9    | 8     | "                                 |
| 15 Никель                            | 54                               | 23                                  | 17   | 15,5* | "                                 |
| 16 Медь                              | 22                               | 7                                   | 7    | 7*    | "                                 |
| 17 Латунь Л62                        | 37,5                             | 14,7                                | 11,3 | 11,3* | "                                 |
| 18 Бронза (84,5% Cu, 5,4% Sn)        | 56                               | 16,2                                | 15,5 | 15,5* | "                                 |
| 19 Алюминий                          | 9,8                              | 6                                   | —    | 3     | 10*                               |
| 20 Дуралюмин                         | 40                               | 14                                  | —    | 7     | То же                             |
| 21 Алюминиевый сплав АД33            | 33                               | 14                                  | —    | 5,5** | 5-10*                             |
| 22 Алюминиевый сплав АВ-Т1           | 38                               | 9                                   | —    | 3**   | 2-10*                             |
| 23 Силумин, литье                    | 19,5                             | 6                                   | —    | 5     | 10*                               |
| 24 Магниевого сплава МА4             | 19                               | 5,8                                 | —    | 2**   | То же                             |

\*In salt water containing 1/6 salt from sea water.  
\*\*In 3% NaCl solution.

1) Alloy; 2)  $\sigma_v$  (kg/mm<sup>2</sup>); 3)  $\sigma_{-1}$  (kg/mm<sup>2</sup>) 4) in air; 5) in fresh water;

II-86M18

6) in sea water; 7) test basis (N cycles); 8) steel (C.3% C); 9) steel type 38KhMYuA; 10) 5% nickel steel; 11) cast steel (0.36% C); 12) stainless steels; 13) 4Kh13; 14) iron; 15) nickel; 16) copper; 17) L62 brass; 18) bronze; 19) aluminum; 20) dural; 21) AD33 aluminum alloy; 25) AV-T1 aluminum alloy; 23) cast silumin; 24) MA4 magnesium alloy; 23) same.

stainless steels is also reduced considerably under corrosive conditions (by a factor of 2-3 times when tested in sea water). The fatigue strengths in corrosive media are not related with the tensile strength and fatigue strength in air. With a large difference in the fatigue strengths when tested in an air atmosphere, under sea water conditions the fatigue strengths of the various constructional low and medium alloy steels usually have valued from 5 to 10 kg/mm<sup>2</sup>. The more aggressive the corrosive medium and the less corrosion resistant the material, the greater the reduction of the fatigue strength, and with increase of the number of test cycles the medium effect is intensified. The fatigue strength of the copper and titanium alloys is reduced little in fresh and sea water, which makes them particularly suitable for application in ship building. The corrosion fatigue strength is considerably reduced even with a comparatively small reduction of the frequency, which is not reflected in the fatigue strength in air testing. In the presence of stress concentration the fatigue strengths of the constructional low alloy steels and aluminum alloys are reduced to a lesser degree under the influence of a corrosive medium than in the case of smooth specimens, so that according to some data, with a large number of cycles (low stresses) the fatigue strength of a notched specimen in the corrosive medium may be higher than the strength of a smooth specimen. The scale effect with simultaneous action of a corrosive medium and fatigue loading has been inadequately studied, but the available data permit us to assume that the effect of the absolute dimensions of the specimen will depend on the level of the effective stresses. With com-

paratively low stress amplitudes (in the region of long fatigue life), in certain experiments there was observed a definite increase of the fatigue strength of low alloy steel with increase of specimen diameter (Fig. 17). For the corrosion resistant materials the fatigue strength is reduced in corrosive media with increase of the dimensions. A smaller but still significant decrease of the fatigue strength also is observed during fatigue tests under normal conditions of specimens which have been subjected to preliminary corrosion (Fig. 18). The corrosion fatigue strength may be increased considerably by the use of protective coatings and also methods of treatment which create residual compressive stresses in the surface layers (surface work hardening, nitriding, surface tempering) (Table 9). The most effective method of protecting steel is zinc plating using the hot or electrolytic methods with sufficiently thick coating. There are data on the effectiveness of aluminum anodizing with subsequent lacquer coating using bakelite, synthetic rubber, etc. lacquers. Nonmetallic coatings are less reliable since they are easily damaged mechanically.

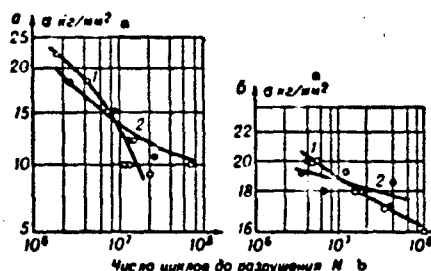

Fig. 17. Corrosion fatigue curves for steel 40 in 3% NaCl solution (a) and fresh water (b): 1) 9-mm-diam specimens; 2) 60-mm-diameter specimens. a)  $\sigma$ , kg/mm<sup>2</sup>; b) number of cycles of failure,  $N$ .

As a rule, with increase of the test temperature the fatigue strength diminishes, to lesser degree, however, than the static strength characteristic. For some materials the curve of the variation of the fatigue strength as a function of temperature has a maximum correspond-

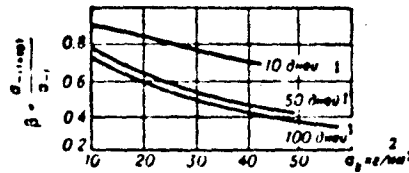

Fig. 18. Reduction of fatigue strengths of aluminum alloys as a result of corrosion taking place prior to fatigue testing. 1) Days; 2)  $\sigma_b$  kg/mm<sup>2</sup>.

TABLE 9

Effect of Surface Treatment on Corrosion Fatigue Strength of Steel

| 1 Сталь                      | 2 Обработка поверхности                       | Толщина покрытия 3 (мк) | 4 $\sigma_{-1}$ (кг/мм <sup>2</sup> ) |                        | Коррозионная среда 7   |
|------------------------------|---|-------------------------|---------------------------------------|------------------------|------------------------|
|                              |   |                         | 5 на воздухе                          | 6 в коррозионной среде |                        |
| 8 Сталь 50 (нормализованная) | 9 Без покрытия                                | —                       | 25.8                                  | 10.1                   | 15 3%-ный раствор NaCl |
|                              | 10 Горячее цинкование                         | 48                      | 25.3                                  | 26.4                   |                        |
|                              | 11 Электролитич. цинкование                   | 14                      | 25.3                                  | 23.6                   |                        |
|                              | 12 Кадмирование                               | 13                      | 25.3                                  | 23.3                   |                        |
|                              | 13 Фосфатирование и покрытие эмалевой краской | —                       | 28                                    | 21.7                   |                        |
| 16 Хромованадиевая сталь     | 14 Поверхностный наклеп (обкатка роликами)*   | —                       | 28.2                                  | 25.2                   | 18 Пресная вода        |
|                              | 17 Азотирование                               | 500                     | 73.5                                  | 59.5                   |                        |
| 19 Хромоникелевая сталь      | 9 Без покрытия                                | —                       | 47                                    | 10.5                   | 20 То же               |
|                              | 11 Электролитич. цинкование                   | 4                       | —                                     | 19.6                   |                        |
|                              | 21 Электролитич. кадмирование                 | 2.5                     | —                                     | 11.9                   |                        |

\*Steel 45.

1) Steel; 2) surface treatment; 3) coating thickness (microns); 4)  $\sigma_{-1}$  (kg/mm<sup>2</sup>); 5) in air; 6) in corrosive medium; 7) corrosive medium; 8) steel 50 (normalized); 9) without coating; 10) hot zinc plating; 11) electrolytic zinc plating; 12) cadmium plating; 13) parkerizing and coating with enamel paint; 14) surface work hardening (rolling); 15) nitriding; 16) chrome-vanadium steel; 17) nitriding; 18) fresh water; 19) chrome-nickel steel; 20) same; 21) electrolytic cadmium plating.

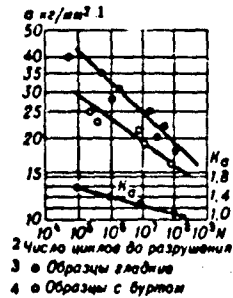

Fig. 19. Variation of stress concentration sensitivity of the nickel alloy EI598 as a function of test duration. 1)  $\sigma$  kg/mm<sup>2</sup>; 2) number of cycles to failure; 3) smooth specimens; 4) specimens with fillet.



TABLE 10

Effect of Low Temperature on Fatigue Strength of Constructional Materials

| 1 Сплав                           | 2 $\sigma_v$<br>(кг/мм <sup>2</sup> ) | 3 Образец                 | 4 $\sigma_{-1}$ (кг/мм <sup>2</sup> ) при темп-ре |       |        |       | 5 База<br>испытания<br>N |
|-----------------------------------|---------------------------------------|---------------------------|---|-------|--------|-------|--------------------------|
|                                   |                                       |                           | +20°  | -70°  | -196°  | -252° |                          |
| 6 Сталь Х4Н                       | 77,5<br>104,3                         | 7 Гладкий<br>8 С надрезом | 39,6  | 42,5* | 56**   | —     | 10°                      |
|                                   |                                       |                           | 24,6  | 25,3* | 23**   | —     |                          |
| 9 Сталь (0,15% С)                 | 44                                    | 7 Гладкий                 | 22,6  | —     | 50,5** | —     | 10°                      |
| 10 Сталь SAE4340<br>(типа 40ХНМА) | 160<br>—                              | 7 Гладкий<br>8 С надрезом | 66  | —     | 90     | —     | 10°                      |
|                                   |                                       |                           | 37  | —     | 24     | —     |                          |
| 11 Сталь SN-2                     | 135                                   | 7 Гладкий                 | 62  | 77    | 97     | 76    | 10°                      |
| 12 Сталь типа<br>ЭИ402            | 95                                    | 7 Гладкий                 | 12  | 22,5  | 34,5   | 33    | 10°                      |
| 13 Титановый сплав<br>BT6         | —                                     | 7 Гладкий                 | 34,5  | 37,5  | 56     | 53    | 10°                      |
| 14 Титановый сплав<br>150         | 107<br>130                            | 7 Гладкий<br>8 С надрезом | 77  | 84*   | 99     | —     | 10°                      |
|                                   |                                       |                           | 33  | 39*   | 47     | —     |                          |
| 15 Алюминиевый<br>сплав В95       | 60<br>—                               | 7 Гладкий<br>8 С надрезом | 22  | 25    | 41     | —     | 10°                      |
|                                   |                                       |                           | 12,5  | 15,5  | 18     | 18,5  |                          |
| 16 Алюминиевый<br>сплав D16       | —                                     | 8 С надрезом              | 12  | —     | 17,5   | 18,5  | 10°                      |
| 17 Латунь 70-30                   | 65                                    | 7 Гладкий                 | 25  | 37    | 50     | 7     | 10°                      |

\*Test temperature -78°.

\*\*Test temperature -183°.

1) Alloy; 2)  $\sigma_v$  (kg/mm<sup>2</sup>); 3) specimen; 4)  $\sigma_{-1}$  (kg/mm<sup>2</sup>) at temperature; 5) test basis, N; 6) steel Kh4N; 7) smooth; 8) notched; 9) steel (0.15% C); 10) steel SAE4340 (type 40KhNMA); 11) steel SN-2; 12) steel type EI402; 13) titanium alloy VT6; 14) titanium alloy 150; 15) aluminum alloy V95; 16) aluminum alloy D16; 17) 70-30 brass.

ing. for example, for soft steel to a temperature of 300-350°. The effective concentration coefficient usually diminishes with temperature increase, although for certain alloys in a definite temperature interval the notch sensitivity with repeated loading increases, which is apparently associated with the structural transformations taking place in the material at these temperatures. Sensitivity to stress concentration at a given temperature may vary as a function of the test duration (Fig. 19).

The effect of average cycle stress on the amplitude of safe :

II-86M22

stresses is intensified with increase of test temperature. Frequency variation also has more effect at the higher temperatures. Certain methods of surface hardening may be used to increase the fatigue strength at high temperatures. For example, there are indications that the effect of surface work hardening is retained to a considerable degree during fatigue testing of the AK4 and VD17 aluminum alloys at temperatures of 150-200°. With reduction of the test temperature below room temperature, the fatigue strengths of the constructional steels and alloys increase and only at the temperature of liquid hydrogen is a reduction of the fatigue strength noted for some of them (Table 10). Usually, the lower the temperature the less the reduction of the fatigue strength as a function of the number of test cycles. From the available data, the effective stress concentration coefficient at temperatures to -200° varies comparatively little for the titanium alloys and increases considerably for the constructional low and medium alloy steels.

References: Serensen S.V., Giatsintov Ye.V., Kogayev V.P., Stepanov N.N., Konstruktsionnaya prochnost' aviatsionnykh splavov (Structural Strength of Aircraft Alloys), M., 1962 (Transactions of Moscow Aviation Technical Institute, No 54); Odina A.I., Dopuskayemye napryazheniya v mashinostroyeni i tsiklicheskaya prochnost' metallov (Permissible Stresses in Machine Design and Cyclic Strength of Metals), 4th edition, M., 1962; Glikman L.A., Korrosionno-mekhanicheskaya prochnost' metallov (Corrosion-Mechanical Strength of Metals), M. 1955; Ryabchenkov A.V., Korrosionno-ustalostnaya prochnost' stali (Corrosion-Fatigue Strength of Steel), M., 1953; Ratner S.I., Razrusheniye pri povtornykh nagruzkakh (Fracutre with Repeated Loads), M., 1959; Fatigue and Endurance of Metals, collection articles translated from English, edited by G.V. Uzhik, M., 1963; Fatigue in Airplane Structures, collection of articles translated from English, edited by I.I. Eskin, M., 1961.

S.I. Kishkina-Ratner

II-81P-1

MECHANICAL SIMILARITY - constancy of the ratio of characteristics of identical mechanical systems or phenomena, particularly identity of the stressed and deformed states at similar points in deformed bodies exhibiting geometric similarity. During rapid deformation, where it is impossible to neglect inertial forces, mechanical similarity can be obtained only by changing the density of the material while retaining its mechanical characteristics, which is difficult to do. See Law of similarity.

Ya.B. Fridman

MECHANICAL TEST AT LOW TEMPERATURES - is the determination of the mechanical properties of a material at temperatures lower than the room temperature. The most used low-temperature tests are the impact-bending and tensile tests, rarely the hardness, bending, torsion, and endurance tests. In any method of mechanical tests at low temperatures, the specimens are cooled in a bath, a cryostat, ensuring to reach the required temperature within as short a time as possible. The design of the cryostat depends on the temperature and the method of the test. Simple double-walled copper or brass vessels with external felt heat insulation which is thicker the lower the test temperature, are used at temperatures to  $-196^{\circ}$ . At temperatures near to the absolute zero, the cryostat consists, as a rule, of two glass- or metal Dewar vessels inserted into each other. the space between them filled with liquid nitrogen in order to diminish the evaporation of the liquid hydrogen or helium. Cooling and testing of specimens at temperatures to  $-70^{\circ}$  is sometimes carried out in refrigerating chambers with circulating air. Temperatures to  $-120^{\circ}$  are measured by thermometers (alcohol, toluene, pentane thermometers), whereas thermocouples (platinum, copper-constantan) are used at lower temperatures. Compositions of freezing mixtures are listed in the Table.

Liquid hydrogen and helium are used to obtain low temperatures. Liquid hydrogen evaporates relatively slowly and is cheap, but the operation with it is only possible by observing strictly the rules of accident prevention. Liquid helium can be applied without danger, but it evaporates 10 times more rapidly than nitrogen and hydrogen and is rela-

tively expensive. Operating with liquid helium is economical in stationary units with closed cycle (Fig. 1): unit (for production of liquid helium) - testing machine - unit (for collecting the evaporated helium).

TABLE  
Freezing Mixtures

| 1 Температура испытания |      | 2 Охлаждающая смесь   |
|-------------------------|------|---|
| (°C)                    | (°K) |   |
| -40                     | 233  | Твердый углекислота (размеленный сухой лед) со спиртом или ацетоном |
| -70                     | 203  |   |
| -100                    | 173  | Жидкий азот со спиртом или бензином                                 |
| -120                    | 153  | Жидкий азот с петролеумным эфиром                                   |
| -160                    | 113  | Жидкий азот с изопентаном   |
| -183                    | 90   | Жидкий азот со спиртом  |
| -196                    | 78   | Жидкий азот   |
| -253                    | 21   | Жидкий водород  |
| -269                    | 4    | Жидкий гелий  |
| -271                    | 1.6  | Жидкий гелий (с откачкой)   |

1) Test temperature; 2) freezing mixture; 3) solid carbon dioxide (crushed dry ice) with alcohol or acetone; 4) liquid nitrogen with alcohol or gasoline; 5) liquid nitrogen with petroleum ether; 6) liquid nitrogen with isopentane; 7) liquid nitrogen with alcohol; 8) liquid nitrogen; 9) liquid hydrogen; 10) liquid helium; 11) liquid helium (with evacuation).

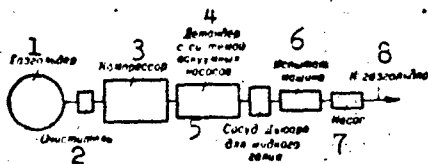

Fig. 1. Scheme of a stationary liquid-helium unit for low-temperature tests. 1) Gas holder; 2) purifier; 3) compressor; 4) engine driven by compressed gas, and a system of vacuum pumps; 5) Dewar's vessel for liquid helium; 6) testing machine; 7) pump; 8) to the gas holder.

The impact strength at temperatures to  $-196^{\circ}$  is determined according to GOST 9455-60 on specimens of the Mesnager type (see Mesnager Specimen). The specimens are previously cooled to a temperature by  $3-6^{\circ}$  lower than the test temperature, kept at this temperature for 5-15 minutes and then checked with an impact-bending machine. N. N. Davidenkov had proposed "serial impact tests" - a series of impact-bending tests on 30-60 specimens at a gradually lowered temperature for cold-brittle materials (see Mechanical Properties at Low Temperatures). The tempera-

ture rises significantly (by 20-30°) within the time the specimens, cooled at -253° and to be checked at this temperature, are set on the anvil of the impact machine. The impact test at -253° is carried out on a specimen put into a double-walled test tube with freely passing liquid hydrogen (Fig. 2); the specimen is then transferred into a great Dewar's vessel and destroyed on the anvil together with the test tube after being cooled and kept at standard temperature.

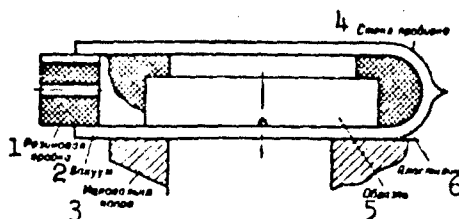

Fig. 2. Scheme of the device for the determination of impact strength at -253°. 1) Rubber plug; 2) vacuum; 3) anvil of the impact machine; 4) glass test tube; 5) specimen; 6) plasticine.

Low-temperature tensile tests of smooth or notched specimens are carried out with testing machines whose size permits one to set in a cryostat. A simplest cryostat is used up to -196°, having a stuffing box with felt soldered into the bottom, which permits a shift of the vessel along the lower rod (Fig. 3). The specimen is fixed by rods which are connected with the clamps of the machine, and is immersed into the cryostat filled with freezing mixture, after a preliminary, insignificant stress is put on. The device for tests at extremely low temperatures must be compact in order to avoid heat losses. As a rule, specimens of small size ( $d = 1-3$  mm) are tested at -253° and -269°, and special loading apparatuses and devices for recording the deformations are provided in these cases (Fig. 4). The checking of specimens with  $d = 5-10$  mm consumes more liquid hydrogen or helium. Usually, the tensile strength, elongation and constriction are determined in the low-temperature tensile tests. Strain gauges are attached in the working part of the specimen, transmitting the deformation of the specimen outside of

I-2613

the cryostat by means of extension arms to any recording system, to determine the modulus of elasticity, the proportional limit and the yield strength. The additional feed of heat through the extension arms makes it difficult to keep constant the temperature conditions. Tests with other methods of loading at low temperatures differ from tests at room temperature only in the use of cryostats.

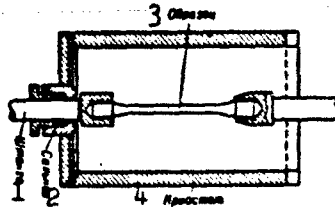

Fig. 3. Cryostat for the tensile test of smooth notched specimens at low temperatures. 1) Rod; 2) stuffing box; 3) specimen; 4) cryostat.

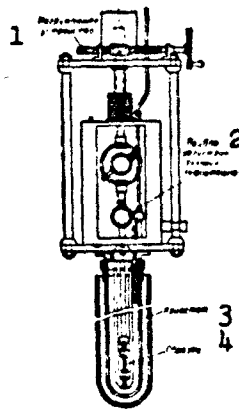

Fig. 4. Scheme of the device for the tensile test small specimens at  $-253$  and  $-269^{\circ}$ . 1) Loading system; 2) device for recording the deformation; 3) cryostat; 4) specimen.

A machine for alternating bending of the specimen without rotation is used in low-temperature endurance tests. The immobile specimen, which one end is clamped, is put into the cryostat, and, on the other end, a cross arm with an unbalanced weight is fixed which develops centrifugal force by rotation resulting in alternating bending of the specimen (Fig. 5). Low-temperature endurance tests require a significant consumption of freezing mixture owing to the long duration of the test process.

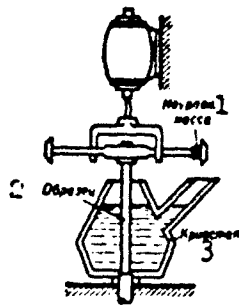

Fig. 5. Scheme of the device for low-temperature endurance test. 1) Unbalanced weight; 2) specimen; 3) cryostat.

References: Davidenkov N.N., Problema udara v metalovedenii [The Impact Problem in Metal Science], Moscow-Leningrad, 1938; Uzhik G.V., Prochnost' i plastichnost' metallov pri nizkikh temperaturakh [Strength and Plasticity of Metals at Low Temperatures], Moscow, 1957; Belyayev S. Ye., Mekhanicheskiye svoystva aviatsionnykh metallov pri nizkikh temperaturakh [Mechanical Properties of Aviation Metals at Low Temperatures], Moscow, 1940; Kostenets V.I., "Zhurnal tekhn. fiz." [Journal of Technical Physics], 1946, Vol. 16, No. 5; Kudryavtsev I.V., "Zavodskaya laboratoriya," 1946, Vol. 12, No. 9-10, page 843.

Yu.S. Danilov, N.V. Kadobnova



MECHANICAL TESTING OF CERMET MATERIALS\_ Cermets are tested for stretching, compression, fatigue, long-life strength, creeping, impact strength, hardness and heat resistance up to a temperature of 3000°. Most widespread is the mechanical testing of cermet materials for bending strength owing to the low resistance to breaking, low plasticity and high sensitivity to eccentricity of these materials. A device for bending test at high temperatures is shown in Fig. 1. The device can be installed on universal testing machines. The load is transmitted to the specimen to be checked by a water-cooled rod and a prism; prisms are used as supports. The loading and the supporting prisms are made from sintered tungsten. Graphite heaters, ceramic heat insulation and a metallic water-cooled jacket provide a uniform heating of the specimen. The test is carried out in an inert gas - argon - atmosphere, as a rule, on nonstandardized specimens whose shape and size depend on the method of production, the porosity and the chemical composition of the cermets (Fig. 2.).

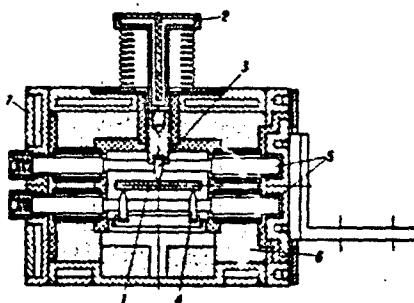

Fig. 1. Device for the bending test of cermets at high temperatures: 1) Specimen; 2) water-cooled rod; 3) prism; 4) supporting prism; 5) graphite heaters; 6) ceramic heat insulation; 7) water-cooled jacket.

The tensile test is carried out on standard breaking machines with a 100 and 500 kg dial. The specimens are fastened in special clamps with tilting bearings. Flat shaped specimens (Fig. 2) are mostly used. The

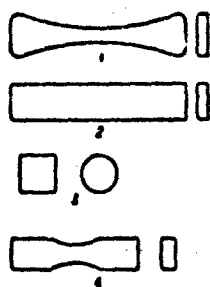

Fig. 2. Shape of specimens for testing of cermets: 1) For tensile test; 2) for bending test; 3) for compression test; 4) for fatigue test.

loading rate is 2 mm/min for brittle and highly hard cermets, and 5 mm/min for weak and porous ones.

The compression test is also carried out on standard breaking machines with reversing gear, or on hydraulic presses with a power from 100 kg to 100 tons. Such machines must have inserts from cardboard or graphite in order to compensate even the smallest roughness of the specimen. Brittle materials are tested as cube-shaped specimens with the dimensions  $15 \times 15 \times 15$  mm, weak and porous materials - as cylinders with 10 mm diameter and 15 mm height.

The fatigue test is carried out on non-standard low-power devices with alternating bending. The test of brittle materials is based on 1 million cycles, that of weak and porous materials on 10 million cycles. Flat specimens are usable for brittle materials, and cylindrical, short specimens for weak and porous ones. The impact strength is determined on impact machines with a margin of energy of less than 2 kgm on specimens with standard shape but without notch. Brittle materials are tested on impact machines with an energy margin of 0.2 kgm.

The heating of the specimens by electric resistance (the specimen itself being the heater); heating with acetylene or kerosene burners

(gas-flame heating); heating in special Silit, graphite or tungsten furnaces, are the most used methods. The electric-resistance heating is used only in short-time tests. Long-life tests at high temperatures are carried out on specimens heated in tungsten, molybdenum or graphite furnaces in neutral gas media (usually in argon). Gas-flame heating of specimens is mainly used in fatigue and heat resistance tests.

The inhomogeneity and porosity of the cermets cause a wide scattering of the test results. Not less than 8-10 specimens must be tested to evaluate the strength of cermets. The frequency curves of the strength of friction cermets are shown in Fig. 3.

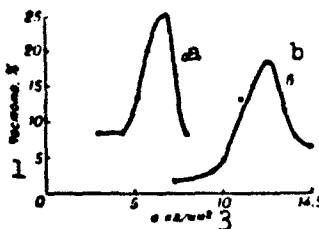

Fig. 3. Frequency curves of the strength of friction cermets: a) Tensile test; b) bending test. 1) Frequency, in %; 2)  $\sigma$ ,  $\text{kg}/\text{mm}^2$ .

References: Pisarenko G.S., K voprosu o prochnosti materialov, poluchayemykh metodami poroshkovoy metallurgii [On the Problem of the Strength of Materials obtained by Powder-Metallurgy Methods], "Poroshkovaya metallurgiya" [Powder Metallurgy], 1961, No. 1.

Ye.N. German

MECHANICAL TESTS are tests on machines and instruments (usually in mechanical laboratories) for evaluation of the mechanical properties. In view of their simplicity and speed, static mechanical tests are most widely used - most often the tests in tension, bending, torsion, compression, internal pressure, penetration (Brinell, Rockwell, Vickers hardness), and so on. The majority of the delivery and acceptance specifications for the constructional materials is based on the static mechanical tests which, although very arbitrarily, characterize the behavior of materials under conditions of real loading in service and during processing. Among the mechanical impact tests most widely used is the determination of the impact strength; the basic groups of mechanical tests also include fatigue (see Fatigue), creep and stress-rupture tests, wear tests; special tests, for example, to determine the internal friction, vibration damping, etc.; full-scale mechanical tests of finished parts and entire structures (bolts, crankshafts, gears, tanks, weld joints, etc.) under conditions as near operational as possible. Although the full-scale tests give a more direct feeling for the strength under actual conditions, in view of the complexity, duration and high cost these tests cannot replace the mechanical testing of laboratory specimens. The best solution is a combination of a large number of mechanical tests of specimens with subsequent full scale mechanical tests of the most favorable variants. See also Micromechanical Tests.

Ya.B. Fridman

**MEDICAL GLASS** - glass intended for the manufacture of special instruments, equipment, and containers (syringes, ampules, cells, vials, etc.) used in medicine. Medical glass has a high chemical and thermal stability. In view of the fact that articles of medical glass are subjected to heat treatment, they should have a reduced tendency toward crystallization. Specifically, such glass should not crystallize (become cloudy), in the flame of a glass-blowing burner.

| Марка стекла                     | 2 Состав (в %)   |                               |                                |     |     |                   |                  |                  |                  | 3 Аннилевая обработка на 100 г |  |                  | 4 Коэффициент линейного расширения в 1°С | 5 Термическая стойкость (°С) | 6 Обработка в автоклавах в г/ч при | 7 Темп. стеклов. перехода (°С) |
|----------------------------------|------------------|-------------------------------|--------------------------------|-----|-----|-------------------|------------------|------------------|------------------|--------------------------------|--|------------------|--|------------------------------|------------------------------------|--------------------------------|
|                                  | SiO <sub>2</sub> | B <sub>2</sub> O <sub>3</sub> | Al <sub>2</sub> O <sub>3</sub> | CaO | MgO | Na <sub>2</sub> O | K <sub>2</sub> O | N <sub>2</sub> O | H <sub>2</sub> O | в дистиллированной воде        | в 1N раств. H <sub>2</sub> SO <sub>4</sub> | в 2N раств. NaOH |  |                              |                                    |                                |
| 11) Безцветный                   | 72.0             | 1.0                           | 0.5                            | 0.5 | 0.5 | 12.0              | 0.5              | 0.5              | 0.5              | 0.10                           | 0.062                                      | 25.2             | 70.722                                   | 160                          | 21 Хорошо                          | 61                             |
| 12) NS-1                         | 72.0             | 1.0                           | 0.5                            | 0.5 | 0.5 | 12.0              | 0.5              | 0.5              | 0.5              | 0.10                           | 0.062                                      | 25.2             | 70.722                                   | 160                          | 21 Хорошо                          | 61                             |
| 13) NS-2                         | 72.0             | 1.0                           | 0.5                            | 0.5 | 0.5 | 12.0              | 0.5              | 0.5              | 0.5              | 0.10                           | 0.062                                      | 25.2             | 70.722                                   | 160                          | 21 Хорошо                          | 61                             |
| 14) AB-1                         | 72.0             | 1.0                           | 0.5                            | 0.5 | 0.5 | 12.0              | 0.5              | 0.5              | 0.5              | 0.10                           | 0.062                                      | 25.2             | 70.722                                   | 160                          | 21 Хорошо                          | 61                             |
| 15) MT                           | 72.0             | 1.0                           | 0.5                            | 0.5 | 0.5 | 12.0              | 0.5              | 0.5              | 0.5              | 0.10                           | 0.062                                      | 25.2             | 70.722                                   | 160                          | 21 Хорошо                          | 61                             |
| 16) OS                           | 72.0             | 1.0                           | 0.5                            | 0.5 | 0.5 | 12.0              | 0.5              | 0.5              | 0.5              | 0.10                           | 0.062                                      | 25.2             | 70.722                                   | 160                          | 21 Хорошо                          | 61                             |
| 17) Sh/1 (MKhTI)                 | 72.0             | 1.0                           | 0.5                            | 0.5 | 0.5 | 12.0              | 0.5              | 0.5              | 0.5              | 0.10                           | 0.062                                      | 25.2             | 70.722                                   | 160                          | 21 Хорошо                          | 61                             |
| 18) нейтральная ампульная        | 72.0             | 1.0                           | 0.5                            | 0.5 | 0.5 | 12.0              | 0.5              | 0.5              | 0.5              | 0.10                           | 0.062                                      | 25.2             | 70.722                                   | 160                          | 21 Хорошо                          | 61                             |
| 19) ампульная (высококремнистая) | 72.0             | 1.0                           | 0.5                            | 0.5 | 0.5 | 12.0              | 0.5              | 0.5              | 0.5              | 0.10                           | 0.062                                      | 25.2             | 70.722                                   | 160                          | 21 Хорошо                          | 61                             |
| 20) иностранная                  | 72.0             | 1.0                           | 0.5                            | 0.5 | 0.5 | 12.0              | 0.5              | 0.5              | 0.5              | 0.10                           | 0.062                                      | 25.2             | 70.722                                   | 160                          | 21 Хорошо                          | 61                             |
| 21) Jena vessel glass            | 72.0             | 1.0                           | 0.5                            | 0.5 | 0.5 | 12.0              | 0.5              | 0.5              | 0.5              | 0.10                           | 0.062                                      | 25.2             | 70.722                                   | 160                          | 21 Хорошо                          | 61                             |
| 22) Jena neutral glass           | 72.0             | 1.0                           | 0.5                            | 0.5 | 0.5 | 12.0              | 0.5              | 0.5              | 0.5              | 0.10                           | 0.062                                      | 25.2             | 70.722                                   | 160                          | 21 Хорошо                          | 61                             |
| 23) Polish neutral glass         | 72.0             | 1.0                           | 0.5                            | 0.5 | 0.5 | 12.0              | 0.5              | 0.5              | 0.5              | 0.10                           | 0.062                                      | 25.2             | 70.722                                   | 160                          | 21 Хорошо                          | 61                             |
| 24) Czechoslovak neutral glass   | 72.0             | 1.0                           | 0.5                            | 0.5 | 0.5 | 12.0              | 0.5              | 0.5              | 0.5              | 0.10                           | 0.062                                      | 25.2             | 70.722                                   | 160                          | 21 Хорошо                          | 61                             |
| 25) Hungarian neutral glass      | 72.0             | 1.0                           | 0.5                            | 0.5 | 0.5 | 12.0              | 0.5              | 0.5              | 0.5              | 0.10                           | 0.062                                      | 25.2             | 70.722                                   | 160                          | 21 Хорошо                          | 61                             |
| 26) USA R-6                      | 72.0             | 1.0                           | 0.5                            | 0.5 | 0.5 | 12.0              | 0.5              | 0.5              | 0.5              | 0.10                           | 0.062                                      | 25.2             | 70.722                                   | 160                          | 21 Хорошо                          | 61                             |
| 27) USA 51-A                     | 72.0             | 1.0                           | 0.5                            | 0.5 | 0.5 | 12.0              | 0.5              | 0.5              | 0.5              | 0.10                           | 0.062                                      | 25.2             | 70.722                                   | 160                          | 21 Хорошо                          | 61                             |
| 28) German "Ultra" syringe glass | 72.0             | 1.0                           | 0.5                            | 0.5 | 0.5 | 12.0              | 0.5              | 0.5              | 0.5              | 0.10                           | 0.062                                      | 25.2             | 70.722                                   | 160                          | 21 Хорошо                          | 61                             |
| 29) USA "Record" glass           | 72.0             | 1.0                           | 0.5                            | 0.5 | 0.5 | 12.0              | 0.5              | 0.5              | 0.5              | 0.10                           | 0.062                                      | 25.2             | 70.722                                   | 160                          | 21 Хорошо                          | 61                             |
| 30) English "Izi" syringe glass  | 72.0             | 1.0                           | 0.5                            | 0.5 | 0.5 | 12.0              | 0.5              | 0.5              | 0.5              | 0.10                           | 0.062                                      | 25.2             | 70.722                                   | 160                          | 21 Хорошо                          | 61                             |
| 31) good                         | 72.0             | 1.0                           | 0.5                            | 0.5 | 0.5 | 12.0              | 0.5              | 0.5              | 0.5              | 0.10                           | 0.062                                      | 25.2             | 70.722                                   | 160                          | 21 Хорошо                          | 61                             |
| 32) satisfactory                 | 72.0             | 1.0                           | 0.5                            | 0.5 | 0.5 | 12.0              | 0.5              | 0.5              | 0.5              | 0.10                           | 0.062                                      | 25.2             | 70.722                                   | 160                          | 21 Хорошо                          | 61                             |
| 33) very good                    | 72.0             | 1.0                           | 0.5                            | 0.5 | 0.5 | 12.0              | 0.5              | 0.5              | 0.5              | 0.10                           | 0.062                                      | 25.2             | 70.722                                   | 160                          | 21 Хорошо                          | 61                             |
| 34) the same                     | 72.0             | 1.0                           | 0.5                            | 0.5 | 0.5 | 12.0              | 0.5              | 0.5              | 0.5              | 0.10                           | 0.062                                      | 25.2             | 70.722                                   | 160                          | 21 Хорошо                          | 61                             |

Note: The figures in parentheses were obtained by computation and are of value only as guidelines.

1) Type of glass; 2) composition (% by weight); 3) chemical stability (mg per 100 cm<sup>2</sup>); 4) distilled water; 5) 1N H<sub>2</sub>SO<sub>4</sub>; 6) 2N NaOH; 7) coefficient of linear expansion α·10<sup>7</sup> (1/°C); 8) heat resistance (°C); 9) workability in glass-blowing burner; 10) softening initiation temperature (°C); 11) Soviet; 12) NS-1; 13) NS-2; 14) AB-1; 15) MT (medical container glass); 16) OS (orange glass); 17) Sh/1 (MKhTI); 18) neutral ampule glass; 19) ampule glass (high-silica); 20) foreign; 21) Jena vessel glass; 22) Jena neutral glass; 23) Polish neutral glass; 24) Czechoslovak neutral glass; 25) Hungarian neutral glass; 26) USA R-6; 27) USA 51-A; 28) German "Ultra" syringe glass; 29) USA "Record" glass; 30) English "Izi" syringe glass; 31) good; 32) satisfactory; 33) very good; 34) the same.

Articles fabricated from medical glass retain their original physi-

III-117s1

cochemical characteristics during steam sterilization at high temperatures under a pressure of 2 atm. This material is resistant to water, drug solutions, and acids; just as ordinary glasses, it is less resistant to the action of alkalies. Various types of medical glass are produced. Containers intended for brief storage of drugs are fabricated from the cheap sodium-calcium-silicate glass MT. Types NS-1, NS-2, etc., are used for prolonged storage of drugs, particularly aggressive bacteriological sera (pH = 8-8.5). The principal components of the majority of medical glasses are  $\text{SiO}_2$ ,  $\text{B}_2\text{O}_3$ ,  $\text{Al}_2\text{O}_3$ ,  $\text{CaO}$ ,  $\text{MgO}$ ,  $\text{BaO}$ ,  $\text{Na}_2\text{O}$ , and  $\text{K}_2\text{O}$ ; the two latter components are introduced in limited quantities. Ampule glasses produced abroad also contain  $\text{ZnO}$ . Arsenic and antimony oxides and fluorides cannot be used in medical glass, since the drug may be spoiled or the patient poisoned by the decomposition products of the glass.

Type AB-1 glass can be sterilized in an autoclave, this process not producing high alkalinity or flaky deposits. Containers of AB-1 glass are suitable for autoclaving of drugs under a pressure of 2 atm. Types MT and OS glass are generally not used under these conditions, since their chemical stability is lower (the solution becomes highly alkaline and a flaky deposit is formed); types NS-1 and NS-2 are neutral glasses and have a high resistance to autoclaving. The chemical stability of medical glass can be raised by superficial heat treatment or by addition of silicoorganic compounds.

The table shows the composition and principal physicochemical characteristics of medical glasses.

G.G. Sentyurin

MEDIUM-ALLOY HEAT-TREATABLE STRUCTURAL STEEL - steel hardenable by heat treatment and containing no less than two alloying elements to a total of no more than 3% (Table 1). These steels are widely used in all branches of the machine-building industry for load-bearing components of machinery and mechanisms.

TABLE 1  
Chemical Composition of Medium-Alloy Heat-Treatable Structural Steels (GOST 4543-61)

| 1  | Сталь  | 2 Содержание элементов (%) * |           |         |           |           | 3 Другие элементы        |
|----|--------|------------------------------|-----------|---------|-----------|-----------|--------------------------|
|    |        | C                            | Si        | Mn      | Cr        | Ni        |                          |
| 4  | 20XФ   | 0.17-0.23                    | 0.17-0.37 | 0.5-0.8 | 0.8-1.1   | 0.25      | 0.1-0.2 V                |
| 5  | 40XФА  | 0.37-0.44                    | 0.17-0.37 | 0.5-0.8 | 0.8-1.1   | 0.25      | 0.1-0.2 V                |
| 6  | 30XМ   | 0.28-0.34                    | 0.17-0.37 | 0.4-0.7 | 0.8-1.1   | 0.25      | 0.15-0.25 Mo             |
| 7  | 35XМ   | 0.32-0.40                    | 0.17-0.37 | 0.4-0.7 | 0.8-1.1   | 0.25      | 0.15-0.25 Mo             |
| 8  | 35XМФА | 0.30-0.38                    | 0.17-0.37 | 0.4-0.7 | 1.0-1.3   | 0.25      | 0.1-0.2 V,<br>0.2-0.3 Mo |
| 9  | 33XС   | 0.29-0.37                    | 1.0-1.3   | 0.3-0.6 | 1.3-1.6   | 0.25      | —                        |
| 10 | 38XС   | 0.34-0.42                    | 1.0-1.3   | 0.3-0.6 | 1.3-1.6   | 0.25      | —                        |
| 11 | 40XС   | 0.37-0.45                    | 1.2-1.6   | 0.3-0.6 | 1.3-1.6   | 0.25      | —                        |
| 12 | 20XГ   | 0.15-0.21                    | 0.17-0.37 | 0.9-1.2 | 0.9-1.2   | 0.25      | —                        |
| 13 | 20XГР  | 0.18-0.24                    | 0.17-0.37 | 0.7-1.0 | 0.8-1.1   | 0.25      | 0.002-0.005 B            |
| 14 | 40XГ   | 0.37-0.45                    | 0.17-0.37 | 0.9-1.2 | 0.9-1.2   | 0.25      | —                        |
| 15 | 40XГР  | 0.37-0.45                    | 0.17-0.37 | 0.7-1.0 | 0.8-1.1   | 0.25      | 0.002-0.005 B            |
| 16 | 30XГТ  | 0.24-0.32                    | 0.17-0.37 | 0.8-1.1 | 1.0-1.3   | 0.25      | 0.06-0.12 Ti             |
| 17 | 35XГТ  | 0.32-0.40                    | 0.17-0.37 | 0.8-1.1 | 1.0-1.3   | 0.25      | 0.06-0.12 Ti             |
| 18 | 40XГТ  | 0.37-0.45                    | 0.17-0.37 | 0.8-1.1 | 1.0-1.3   | 0.25      | 0.06-0.12 Ti             |
| 19 | 30XГНА | 0.28-0.35                    | 0.17-0.37 | 0.6-0.9 | 0.9-1.2   | 0.6       | —                        |
| 20 | 38XГН  | 0.35-0.43                    | 0.17-0.37 | 0.8-1.1 | 0.5-0.8   | 0.7-1.1   | —                        |
| 21 | 20XГСА | 0.17-0.23                    | 0.9-1.2   | 0.8-1.1 | 0.8-1.1   | 0.25      | —                        |
| 22 | 25XГСА | 0.22-0.28                    | 0.9-1.2   | 0.8-1.1 | 0.8-1.1   | 0.25      | —                        |
| 23 | 30XГС  | 0.28-0.35                    | 0.9-1.2   | 0.8-1.1 | 0.8-1.1   | 0.25      | —                        |
| 24 | 30XГСА | 0.28-0.34                    | 0.9-1.2   | 0.8-1.1 | 0.8-1.1   | 0.25      | —                        |
| 25 | 35XГСА | 0.32-0.39                    | 1.1-1.4   | 0.8-1.1 | 1.1-1.4   | 0.20      | —                        |
| 26 | 40XН   | 0.36-0.44                    | 0.17-0.37 | 0.3-0.6 | 0.45-0.75 | 1.0-1.4   | —                        |
| 27 | 45XН   | 0.41-0.49                    | 0.17-0.37 | 0.3-0.6 | 0.45-0.75 | 1.0-1.4   | —                        |
| 28 | 50XН   | 0.46-0.54                    | 0.17-0.37 | 0.3-0.6 | 0.45-0.75 | 1.0-1.4   | —                        |
| 29 | 40XНМА | 0.37-0.44                    | 0.17-0.37 | 0.3-0.6 | 0.8-0.9   | 1.25-1.65 | 0.15-0.25 Mo             |
| 30 | 40XНВА | 0.37-0.44                    | 0.17-0.37 | 0.3-0.6 | 0.8-0.9   | 1.25-1.65 | 0.8-1.2 W                |
| 31 | 16XСН  | 0.13-0.20                    | 0.6-0.9   | 0.3-0.6 | 0.8-1.1   | 0.8-0.9   | —                        |

\*Good-quality steel contains P ≤ 0.035%, S ≤ 0.035%, Cu ≤ 0.20%; high-quality steel contains P ≤ 0.025%, S ≤ 0.025%, and Cu ≤ 0.020%.

\*\*This type of steel is not provided for in GOST 4543-61.

- 1) Steel; 2) content of elements (%); 3) other elements; 4) 20KhF; 5) 40KhFA; 6) 30KhM; 7) 35KhM; 8) 35KhMFA; 9) 33KhS; 10) 38KhS; 11) 40KhS; 12) 20KhG; 13) 20KhGR; 14) 40KhG; 15) 40KhGR; 16) 30KhGT; 17) 35KhGT; 18) 40KhGT; 19) 30KhGNA; 20) 38KhGN; 21) 20KhGSA; 22) 25KhGSA; 23) 30KhGS; 24) 30KhGSA; 25) 35KhGSA; 26) 40KhN; 27) 45KhN; 28) 50KhN; 29) 40KhNMA; 30) 40KhNVA; 31) 16KhSN.

TABLE 2

Mechanical Characteristics of Chromium-Vanadium Steels According to GOST 4543-61 (no less than)

| Сталь<br>1 | Термич. обработка<br>2  | $\sigma_b$               | $\sigma_{0.2}$ | $\delta_5$ | $\psi$ | $\sigma_{\text{нп}}$<br>(кгс/мм <sup>2</sup> ) | НВ <sup>0</sup><br>(кгс/мм <sup>2</sup> ) |
|------------|---|--------------------------|----------------|------------|--------|--|---|
|            |   | 3 (кгс/мм <sup>2</sup> ) |                | %          |        |  |   |
| 20ХФ<br>5  | 1-я закалка с 880°;<br>2-я закалка с 770-820° в воде или масле; отпуск при 180° | 85                       | 70             | 13         | 50     | 8  | 197                                       |
| 40ХФА<br>6 | Закалка с 880° в масле; отпуск при 650°   | 90                       | 75             | 10         | 50     | 9  | 241                                       |

\*After annealing or high tempering.

1) Steel; 2) heat treatment; 3) kg/mm<sup>2</sup>; 4) kg-m/cm<sup>2</sup>; 5) 20KhF; 6) 40KhFA; 7) 1st quenching from 880°, 2nd quenching from 770-820° in water or oil, tempering at 180°; 8) quenching from 880° in oil, tempering at 650°.

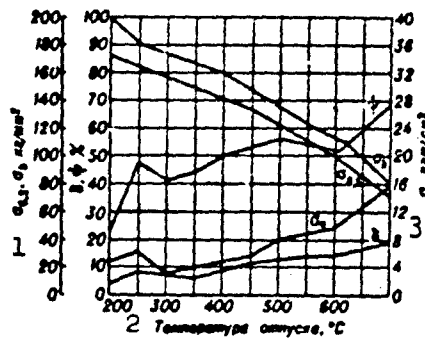

Fig. 1. Influence of tempering temperature on the mechanical characteristics of 40KhFA steel. 1) kg/mm<sup>2</sup>; 2) tempering temperature, °C; 3) kg-m/cm<sup>2</sup>.

TABLE 3

Mechanical Characteristics of 40KhFA Steel at Elevated Temperatures

| Термич. обработка<br>1                  | Температура (°C)<br>2 | $\sigma_b$               | $\sigma_{0.2}$ | $\delta_5$ | $\psi$ |
|---|-----------------------|--------------------------|----------------|------------|--------|
|   |                       | 3 (кгс/мм <sup>2</sup> ) |                | %          |        |
| Закалка с 850° в масле; отпуск при 640° | 20                    | 94.5                     | 86.1           | 26.6       | 63     |
|   | 200                   | 92.4                     | 82.4           | 22.4       | 60.8   |
|   | 300                   | 86.2                     | 78.2           | 18.7       | 35.5   |
|   | 400                   | 87.3                     | 72.2           | 28.8       | 50.6   |
|   | 500                   | 50.5                     | 41.8           | 30.4       | 65.8   |
|   | 600                   | 38.5                     | —              | 51         | 80     |
|   | 700                   | 18                       | —              | 48.8       | 88     |

1) Heat treatment; 2) temperature (°C); 3) kg/mm<sup>2</sup>; 4) quenching from 850° in oil, tempering at 640°.



TABLE 4  
Physical Characteristics of  
Chromium-Vanadium Steels

| Сталь<br>1 | Критич.<br>точки (°C)<br>2 |                 | λ 3<br>(кал/см·сек·°C) | α·10 <sup>6</sup><br>(1/°C) |
|------------|----------------------------|-----------------|------------------------|-----------------------------|
|            | A <sub>c1</sub>            | A <sub>c3</sub> |                        |                             |
| 4 20XΦ     | 788                        | 840             | 0.095 (20°)            | 11.5<br>(20-100°)           |
| 5 40XΦA    | 755                        | 790             | 0.095 (20°)            | 11.5<br>(20-100°)           |

1) Steel; 2) critical points (°C); 3) cal/cm·sec·°C; 4) 20KhF; 5) 40KhFA.

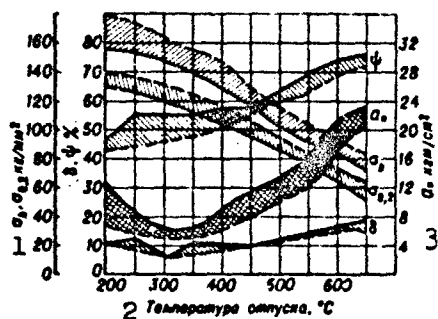

Fig. 2. Influence of tempering temperature on the mechanical characteristics of chromium-molybdenum steel: solid line - 0.25% C, 1.05% Cr, 0.21% Mo; dashed line - 0.35% C, 0.91% Cr, 0.16% Mo (blank diameter - 10 mm). 1) kg/mm<sup>2</sup>; 2) tempering temperature, °C; 3) kg-m/cm<sup>2</sup>.

Chromium-vanadium steel. Addition of V to chromium steel promotes a reduction in grain size and better deoxidation, thus increasing viscosity and plasticity. Moreover, addition of V prevents grain growth and ensures a low sensitivity to overheating. Table 2 shows the mechanical characteristics of chromium-vanadium steel, while Fig. 1 represents the influence of tempering temperature on these characteristics. The mechanical characteristics of 40KhFA at elevated temperatures are shown in Table 3 and the physical characteristics of chromium-vanadium steels in Table 4.

Hot deformation of these steels is carried out at 1250-800°; they are readily cuttable. The weldability of 20KhF steel is good, while

III-104s3

that of 40KhFA is poor. Type 20KhF is employed as a cementable steel, being subjected to cementation at 900-925°, a first quenching from 870-900°, a second quenching from 775-800°, and tempering at 150-220°, although a single quenching from 830-855° is sometimes used; oil serves as the quenching medium in the majority of cases. After such treatment the core has a hardness HB of 400, while the surface hardness RC  $\geq$  58. Type 40KhFA steel is susceptible to temper brittleness and should consequently be cooled after tempering. Both types of steel have a comparatively low hardenability and are therefore recommended only for the manufacture of thin-walled components. Type 40KhFA is also used in the production of nitridable components; in this case it is subjected to preliminary quenching and high tempering in order to improve the characteristics of the core of the component. The hardness of the nitrided layer is less than for steels containing Al.

Chromium-molybdenum steel. Addition of Mo to chromium steel increases its hardenability, improves its plasticity and viscosity, reduces its tendency toward grain growth, and prevents temper brittleness and the thermal embrittlement which occurs during operation at elevated temperatures. Table 5 shows the mechanical characteristics of chromium-molybdenum steels.

TABLE 5  
Mechanical Characteristics of  
Chromium-Molybdenum Steels Accord-  
ing to GOST 4543-61 (no less than)

| Сталь<br>1 | Термич.<br>обработка<br>2                        | $\sigma_b$                 | $\sigma_{0.2}$ | $\delta_5$ | $\psi$ | $\sigma_{0.1}$<br>(кг/мм <sup>2</sup> ) | HB<br>(кг/мм <sup>2</sup> ) |
|------------|--|----------------------------|----------------|------------|--------|---|-----------------------------|
|            |  | 3<br>(кг/мм <sup>2</sup> ) |                |            |        |   |                             |
| 5 30ХМ     | 8 Закалка с 880°<br>в масле; отпуск<br>при 540°  | 95                         | 75             | 11         | 45     | 8                                       | <228                        |
| 6 35ХМ     |  |                            |                |            |        |   |                             |
| 35ХМФА     | 10 Закалка с 850°<br>в масле; отпуск<br>при 560° | 100                        | 85             | 12         | 45     | 8                                       | <241                        |
|            | Закалка с 900°<br>в масле; отпуск<br>при 630°    |                            |                |            |        |   |                             |
| 7          |  | 110                        | 95             | 10         | 50     | 8                                       | <4<br>( $d_{0.1}$ )         |

\*After annealing or high tempering.

III-104s4

1) Steel; 2) heat treatment; 3)  $\text{kg/mm}^2$ ; 4)  $\text{kg-m/cm}^2$ ; 5) 30KhM; 6) 35KhM  
 7) 35KhMFA; 8) quenching from  $880^\circ$  in oil, tempering at  $540^\circ$ ; 9) quenching from  $850^\circ$  in oil, tempering at  $560^\circ$ ; 10) quenching from  $900^\circ$  in oil tempering at  $630^\circ$ .

TABLE 6

Ultimate Strength and Yield Strength ( $\text{kg/mm}^2$ ) of Chromium-Molybdenum Steels at Elevated Temperatures\*

| Сталь 1 | Термич. обработка 2   | 3 Темп-ра ( $^\circ\text{C}$ ) |      |      |      |      |      |     |      |
|---------|---|--------------------------------|------|------|------|------|------|-----|------|
|         |   | 20                             | 200  | 300  | 400  | 450  | 500  | 550 | 600  |
| 30KhM   | Закалка с $870-880^\circ$ в масле; отпуск при $650^\circ$ 6 | 74.5                           | 67.5 | 73.5 | 64.5 | 59   | 51   | 47  | 35.5 |
| 4       | Закалка с $870-880^\circ$ в масле; отпуск при $600^\circ$ 7 | 80                             | 50.7 | 53   | 49   | 46.5 | 43.5 | 43  | 33   |
| 35KhM   | Закалка с $880^\circ$ в масле; отпуск при $650^\circ$ 8     | 85                             | 80   | 80   | 74   | —    | 57   | —   | 40   |
| 5       | Закалка с $880^\circ$ в масле; отпуск при $650^\circ$ 8     | 75                             | 65   | 65   | 60   | —    | 50   | —   | —    |
|         |   | 89.5                           | —    | —    | 74.8 | 68.3 | 55.7 | —   | —    |
|         |   | 78.7                           | —    | —    | 58.7 | 56.6 | 49.7 | —   | —    |

\*The upper figure represents  $\sigma_b$  and the lower figure  $\sigma_{0.2}$ .

1) Steel; 2) heat treatment; 3) temperature ( $^\circ\text{C}$ ); 4) 30KhM; 5) 35KhM;  
 6) quenching from  $870-880^\circ$  in oil, tempering at  $650^\circ$ ; 7) quenching from  $870-880^\circ$  in oil, tempering at  $600^\circ$ ; 8) quenching from  $880^\circ$  in oil, tempering at  $650^\circ$ .

TABLE 7

Long-Term Strength and Creep Strength ( $\text{kg/mm}^2$ ) of 30KhM Steel\*

| 1 Темп-ра ( $^\circ\text{C}$ ) | 2 Длительная прочность за: |             |              | 3 Ползучесть (по остаточной деформации) за: |              |
|--------------------------------|----------------------------|-------------|--------------|---|--------------|
|                                | 4 200 час.                 | 10 000 час. | 100 000 час. | 10 000 час.                                 | 100 000 час. |
| 400                            | 74                         | —           | —            | —   | —            |
| 450                            | 58                         | 30          | 23           | —   | 11           |
| 500                            | 38                         | 19          | 13.5         | 14.2  | 7            |
| 550                            | 28                         | 11          | 7.7          | 5.8   | 3.5          |

\*After quenching from  $880^\circ$  and tempering at  $650^\circ$ .

\*\*Tempering at  $560^\circ$ .

1) Temperature ( $^\circ\text{C}$ ); 2) long-term strength over; 3) creep strength (from residual deformation) over; 4) hr.

The influence of tempering temperature on the mechanical characteristics of chromium-molybdenum steels is shown in Fig. 2, while the

TABLE 8  
Physical Characteristics of  
Chromium-Molybdenum Steels

| 1<br>Сталь | 2 Критич.<br>точки (°C) |           | 3<br>$\lambda$<br>(кал/см·сек·°C) | $\alpha \cdot 10^6$<br>(1/°C) |
|------------|-------------------------|-----------|-----------------------------------|-------------------------------|
|            | $A_c$                   | $A_{c_2}$ |                                   |                               |
| 4 30ХМ     | 755                     | 805       | 0.11 (100°)                       | 11.5<br>(20-100°)             |
| 5 35ХМ     | 757                     | 802       |                                   |                               |
| 6 35ХМФА   | 765                     | 845       | 0.1 (100°)                        | 11.8<br>(20-100°)             |

1) Steel; 2) critical points (°C); 3) cal/cm·sec·°C; 4) 30KhM; 5) 35KhM; 6) 35KhMFA.

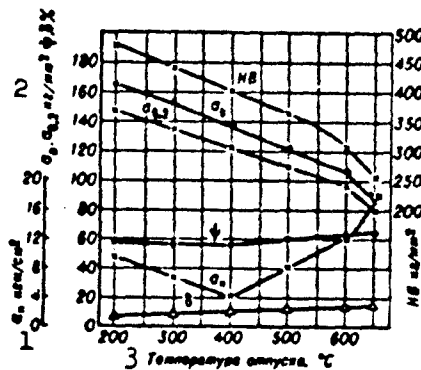

Fig. 3. Influence of tempering temperature on the mechanical characteristics of 35KhMFA steel. 1) kg-m/cm<sup>2</sup>; 2) kg/mm<sup>2</sup>; 3) tempering temperature, °C.

mechanical characteristics of these steels at elevated temperatures are presented in Tables 6 and 7.

Table 8 shows the physical characteristics of chromium-molybdenum steels.

Hot deformation of these steels is carried out at 1200 (1250)-850°. They have satisfactory machinability. The weldability of 30KhM steel is satisfactory, while that of 35KhM and 35KhMFA is low.

Types 30KhM and 35KhM steel are used for various components, including those which must operate at temperatures of up to 500° for extended periods; prolonged heating at 550 or 600° reduces their ultimate and yield strengths, but their plasticity and viscosity remain at a

sufficiently high level. Type 35KhMFA steel has a higher hot strength than type 35KhM. The higher Cr and Mo content of 35KhMFA steel ensures good hardenability and it is consequently used for relatively thick components; quenching first in water and then in oil is sometimes employed to enhance the hardenability of this steel.

Chromium-silicon and chromium-silicon-manganese steel. Steels of this type do not contain scarce, expensive elements and have rather high mechanical characteristics and satisfactory hardenability. Certain brands, especially 30KhGSA, are very widely used in the machine-building industry. Addition of Si to structural steel has a positive effect on its mechanical characteristics after quenching and low tempering, i.e., after treatment to high strength. Si retards the decrease in ultimate strength during tempering and silicon-containing steels can consequently be subjected to higher tempering during heat treatment to high strength. Alloying with Si materially improves the mechanical characteristics of steel after isothermal quenching, which ensures a better combination of strength and viscosity than ordinary quenching and tempering. The drop in the impact strength of silicon-containing steel is shifted toward higher tempering temperatures, so that components fabricated from such steel should be heat treated only to a given strength in order to avoid an undesirable loss of viscosity. Table 9 shows the mechanical characteristics of chromium-silicon and chromium-silicon-manganese steels.

Figures 4-6 show the influence of tempering temperature on the mechanical characteristics of various steels, while Fig. 7 shows the influence of the size of the quenched components on the ultimate strength of 30KhGSA steel. The most common ultimate strengths obtained by heat treatment are  $\sigma_b = 110-130$  and  $100-120$  kg/mm<sup>2</sup> for 25KhGSA steel and  $\sigma_b = 90-110$ ,  $100-120$ ,  $110-130$ , and  $120-140$  kg/mm<sup>2</sup> for 30KhGSA steel.

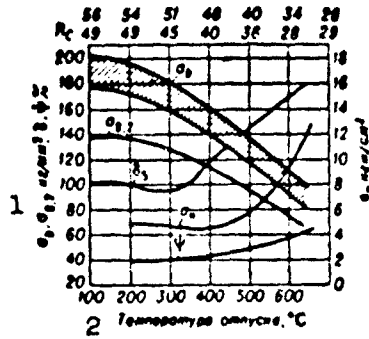

Fig. 4. Influence of tempering temperature on the mechanical characteristics of 30KhGSA steel. 1) kg/mm<sup>2</sup>; 2) tempering temperature, °C; 3) kg-m/cm<sup>2</sup>.

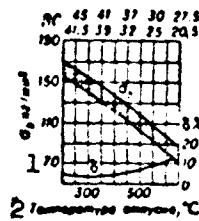

Fig. 5. Influence of tempering temperature on the mechanical characteristics of 25KhGSA steel (sheets, tubing). 1) kg/mm<sup>2</sup>; 2) tempering temperature, °C.

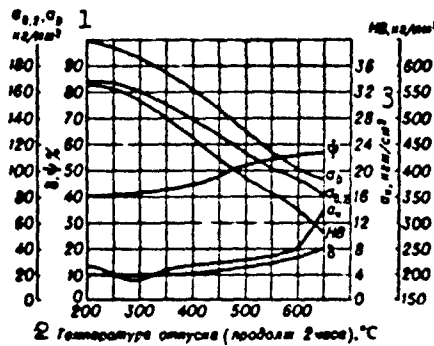

Fig. 6. Influence of tempering temperature on the mechanical characteristics of 38KhS steel. 1) kg/mm<sup>2</sup>; 2) tempering temperature (tempering time - 2 hr), °C; 3) kg-m/cm<sup>2</sup>.

These values are achieved by quenching and subsequent tempering. In some cases 30KhGSA steel is treated to  $\sigma_b = 160-190$  kg/mm<sup>2</sup> by quenching and low tempering (200-250°). Type 30KhGSA steel is often subjected to isothermal quenching to  $\sigma_n = 110-145$  or  $120-150$  kg/mm<sup>2</sup> and sometimes to  $\sigma_b = 130-160, 140-170, 150-170,$  or  $160-180$  kg/mm<sup>2</sup>. Isothermal

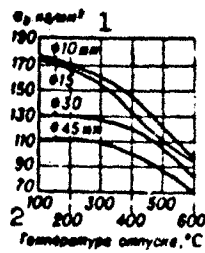

Fig. 7. Ultimate strength (minimum) of central portion of bars of 30KhGSA steel with different cross-sectional areas (quenching in oil). 1) kg/mm<sup>2</sup>; 2) tempering temperature, °C.

TABLE 9

Mechanical Characteristics of Chromium-Silicon and Chromium-Silicon-Manganese Steels According to GOST 4543-61 (no less than)

| Сталь     | 1 | 2 Термич. обработка  | σ <sub>B</sub>          | σ <sub>0.2</sub> | δ <sub>5</sub> | ψ  | α <sub>K</sub><br>(кг/см <sup>2</sup> ) | HB <sup>*</sup><br>(кг/мм <sup>2</sup> ) |
|-----------|---|--|-------------------------|------------------|----------------|----|---|--|
|           |   |  | 3 (кг/мм <sup>2</sup> ) |                  | 4 (%)          |    |   |  |
| 33ХС5     |   | Закалка с 920° в масле или воде, отпуск при 630°   | 90                      | 70               | 13             | 50 | 8                                       | <241                                     |
| 38ХС 6    |   | Закалка с 900° в масле, отпуск при 630°  | 95                      | 75               | 12             | 50 | 7                                       | <255                                     |
| 40ХС 7    |   | Изотермич. закалка с 900-910° в селитре при 330-350° или закалка с 900° в масле; отпуск при 540° | 125                     | 110              | 12             | 40 | 5                                       | <255                                     |
| 20ХГСА 8  |   | Закалка с 880° в масле; отпуск при 500°  | 80                      | 65               | 12             | 45 | 7                                       | <207                                     |
| 25ХГСА 9  |   | Закалка с 880° в масле; отпуск при 480°  | 110                     | 95               | 10             | 40 | 6                                       | <217                                     |
| 30ХГСА 10 |   | Закалка с 880° в масле; отпуск при 540°  | 110                     | 95               | 10             | 45 | 4,5                                     | <229                                     |
| 30ХГСА 11 |   | То же  | 110                     | 85               | 10             | 45 | 5                                       | -  |
| 35ХГСА 12 |   | Изотермич. закалка с 880° в селитре при 280-310° или закалка с 880°; отпуск при 230°             | 165                     | 130              | 9              | 40 | 4                                       | <239                                     |

\*After annealing or high tempering.

1) Steel; 2) heat treatment; 3) kg/mm<sup>2</sup>; 4) kg-m/cm<sup>2</sup>; 5) 33KhS; 6) 38KhS; 7) 40KhS; 8) 20KhGSA; 9) 25KhGSA; 10) 30KhGS; 11) 30KhGSA; 12) 35KhGSA; 13) quenching from 920° in oil or water, tempering at 630°; 14) quenching from 900° in oil, tempering at 630°; 15) isothermal quenching from 900-910° in potassium nitrate at 330-350° or quenching from 900° in oil, tempering at 540°; 16) quenching from 880° in oil, tempering at 500°; 17) quenching from 880° in oil, tempering at 480°; 18) quenching from 880° in oil, tempering at 540°; 19) the same; 20) isothermal quenching from 880° in potassium nitrate at 280-310° or quenching from 890°, tempering at 230°.

quenching yields a higher impact strength and a lower sensitivity to notching than ordinary quenching in oil and subsequent tempering. Type 30KhGSA steel cannot be subjected to isothermal quenching for treatment to an ultimate strength of less than 110-145 kg/mm<sup>2</sup>, since this process

III-104s9

causes a sharp drop in plasticity and viscosity. Type 35KhGSA is frequently used as a high-strength steel, employing quenching and low tempering or isothermal quenching. Types 33KhS and 38KhS can also be heat treated to high strength, the former to  $\sigma_b \geq 165$  and the latter to  $\sigma_b \geq 170 \text{ kg/mm}^2$ ; quenching in oil or isothermal quenching is used for this purpose. The durability of 30KhGSA steel is directly proportional to its ultimate strength (Table 10).

TABLE 10  
Ultimate Strength and Durability of 30KhGSA Steel\*

| Термич. обработка<br>1     | $\sigma_b$ | $\sigma_{-1}$         |                         |
|----------------------------|------------|-----------------------|-------------------------|
|                            |            | 2 образцы без надреза | 3 образцы с надрезом ** |
| 4 (кг/мм <sup>2</sup> )    |            |                       |                         |
| 5 Закалка; отпуск при 200° | 180        | 71.5                  | 48                      |
| 6 Закалка; отпуск при 400° | 154        | 35                    | 38                      |
| 7 Закалка; отпуск при 600° | 90         | 48                    | 22                      |

\*Tests involving bending of rotating specimen with working-area diameter of 8 mm.

\*\*Semicircular notch,  $d_n = 8 \text{ mm}$ ,  $r_n = 0.75 \text{ mm}$ .

1) Heat treatment; 2) unnotched specimen; 3) notched specimen; 4) kg/mm<sup>2</sup>; 5) quenching, tempering at 200°; 6) quenching, tempering at 400°; 7) quenching, tempering at 600°.

TABLE 11  
Mechanical Characteristics of 30KhGS Steel at Elevated Temperatures\*

| Свойства 1                               | 2 Темп-ра (°C) |      |      |     |      |      |      |     |
|--|----------------|------|------|-----|------|------|------|-----|
|  | 20             | 250  | 300  | 350 | 400  | 450  | 500  | 550 |
| $\sigma_b$ (кг/мм <sup>2</sup> ) 3       | 110            | 103  | 100  | 100 | 92   | 80   | 70   | 55  |
| $\sigma_{0.2}$ (кг/мм <sup>2</sup> )     | 95             | 86   | 84   | 83  | 80   | 70   | 63   | 50  |
| $\delta_5$ (%)                           | 13.5           | 13   | 11   | 16  | 16   | 19   | 21   | 27  |
| $\psi$ (%)                               | 35             | 50   | 50   | 57  | 69   | 77   | 84   | 84  |
| $\alpha_k$ (кг/см <sup>2</sup> ) 4       | 5.5            | 13   | 13   | 12  | 10   | 9    | 8    | 6.5 |
| $E \cdot 10^{-4}$ (кг/мм <sup>2</sup> )  | 1.98           | 1.77 | 1.72 | —   | 1.69 | —    | 1.59 | —   |
| $\sigma_{300}$ (кг/мм <sup>2</sup> )     | —              | —    | —    | —   | 60   | 46   | 26   | 12  |
| $\sigma_{0.2/300}$ (кг/мм <sup>2</sup> ) | —              | —    | —    | —   | 16.3 | 11.3 | 5.5  | 2.2 |

\*After quenching from 880° in oil and tempering at 560°.



1) Characteristic; 2) temperature (°C); 3) kg/mm<sup>2</sup>; 4) kg-m/cm<sup>2</sup>.

TABLE 12

Physical Characteristics of Chromium-Silicon and Chromium-Silicon-Manganese Steels

| Сталь<br>1 | Критич. точ-<br>ки (°C) 2 |                 | λ<br>(кал/см·сек·°C)<br>3 | α·10 <sup>6</sup><br>(1/°C) |
|------------|---------------------------|-----------------|---------------------------|-----------------------------|
|            | A <sub>c1</sub>           | A <sub>c2</sub> |                           |                             |
| 33XС 4     | 780                       | 880             | 0.088 (200°)              | 11.5                        |
| 38XС 5     | 783                       | 810             | 0.088 (200°)              | 11.5                        |
| 25XСГА 6   | 760                       | 850             | 0.09 (20°)                | 11.5                        |
| 30XСГ 7    | 760                       | 830             | 0.094 (100°)              | 11.5                        |

1) Steel; 2) critical points (°C); 3) cal/cm·sec·°C; 4) 33KhS; 5) 38KhS; 6) 25KhGSA; 7) 30KhGS.

The mechanical characteristics of 30KhGS steel at elevated temperatures are shown in Table 11.

Figure 8 shows the impact strength of 30KhGS steel at low temperatures as a function of tempering temperature. The physical characteristics of chromium-silicon and chromium-silicon-manganese steels are given in Table 12.

Chromium-silicon and chromium-silicon-manganese steels are easily annealed and readily cut. Hot deformation is carried out at 1250-850°. The weldability of 25KhGSA steel is completely satisfactory, that of 30KhGS is satisfactory, and that of 33KhS and 38KhS is low. All these types of steel are generally quenched in oil, rarely being transferred from oil to water or quenched in water and immediately tempered. The tempering temperature for 30KhGS steel is selected on the following basis:

| σ <sub>b</sub> (кг/мм <sup>2</sup> ) ... 1. .... | 70-90   | 80-100  | 90-110  | 100-120 | 110-130 | 120-140 |
|--|---------|---------|---------|---------|---------|---------|
| Темп-ра отпуски (°C) . 2 .                       | 660-680 | 620-640 | 580-600 | 540-560 | 520-540 | 480-500 |

1) σ<sub>b</sub> (kg/mm<sup>2</sup>); 2) tempering temperature (°C).

Depending on the strength required, isothermal quenching of 30KhGSA steel is carried out in quenching baths whose temperature is selected on the following basis:

|  |         |         |         |         |         |
|--|---------|---------|---------|---------|---------|
| $\sigma_b$ (kg/mm <sup>2</sup> ) . . . . . 1 . . . . . | 110-145 | 120-150 | 140-180 | 150-170 | 180-190 |
| Темп-ра выключной ванны (°C) . . . . . 2 . . . . .     | 370-400 | 380-390 | 340-360 | 270-310 | 180-200 |

1)  $\sigma_b$  (kg/mm<sup>2</sup>); 2) quenching-bath temperature (°C).

During isothermal quenching 30KhGSA steel is held in the quenching bath for 15 min. Isothermal quenching ensures less warping of the component than ordinary quenching. Steels of the cromansil type (30KhGS and 25KhGSA) are used for machine components to be machined and welded, type 25KhGSA steel in sheet form is used for welded structures, including tanks intended to function under pressure, and types 33KhS, 38KhS, and 35KhGSA are used in the manufacture of various medium- and high-strength components intended to be machined.

Chromium-manganese steel. Since they have an increased hardenability, steels of this type can be used in place of nickel-containing steels. Addition of titanium promotes a fine-grained structure and reduces the tendency of the steel to overheat. Table 13 shows the mechanical characteristics of chromium-manganese steels.

The influence of the tempering temperature on the mechanical characteristics of 30KhGT steel is represented in Fig. 9. Chromium-manganese steels are employed in various branches of machine building, including the automobile industry and machine-tool building. Type 30KhGT steel is used for components to be subjected to cementation (the high hardness of the core increases the static and dynamic strength of such components); type 40KhGT is used for components to be surface quenched with high-frequency electric heating and subsequent tempering at 180°,

TABLE 13

Mechanical Characteristics of Chromium-Manganese Steels According to GOST 4543-61 (no less than)

| Сталь 1            | 2 Термич. обработка   | $\sigma_b$   $\sigma_{0.2}$   $\delta_5$   $\psi$ |     |    |    | $\alpha^4$<br>(кг/см <sup>2</sup> ) | НН <sup>0</sup><br>(кг/мм <sup>2</sup> ) |
|--------------------|---|---|-----|----|----|-------------------------------------|--|
|                    |   | (кг/мм <sup>2</sup> ) 3                           |     |    |    |                                     |  |
| 5 20ХГ . . . 14    | Закалка с 880° в масле; отпуск при 180°                                 | 90  | 75  | 10 | 40 | —                                   | <187                                     |
| 6 20ХГР . . . . .  | 1-я закалка с 910° в масле; 2-я закалка с 870° в масле; отпуск при 200° | 100   | 80  | 9  | 50 | 8                                   | <197                                     |
| 7 40ХГ . . . 15    | Закалка с 840° в масле; отпуск при 320°                                 | 100   | 85  | 9  | 45 | 6                                   | <229                                     |
| 8 40ХГР . . . 16   | Закалка с 840° в масле; отпуск при 320°                                 | 100   | 80  | 11 | 45 | 8                                   | <241                                     |
| 9 30ХГТ . . . 17   | Закалка с 850° в масле; отпуск при 200°                                 | 150   | 130 | 9  | 40 | 6                                   | <229                                     |
| 10 35ХГТ . . . 18  | Закалка с 850° в масле; отпуск при 380°                                 | 115   | 95  | 10 | 50 | 8                                   | <229                                     |
| 11 40ХГТ . . . . . | Закалка с 850° в масле; отпуск при 380°                                 | 125   | 105 | 9  | 45 | 8                                   | <241                                     |
| 12 30ХГНА . . . 19 | Закалка с 880° в масле; отпуск при 300°                                 | 110   | 85  | 10 | 45 | 7                                   | <229                                     |
| 13 38ХГН . . . 20  | Закалка с 850° в масле; отпуск при 370°                                 | 90  | 70  | 12 | 45 | 10                                  | <229                                     |

\*After annealing or high tempering.

\*\*This type of steel is not provided for in GOST 4543-61.

- 1) Steel; 2) heat treatment; 3) kg/mm<sup>2</sup>; 4) kg-m/cm<sup>2</sup>; 5) 20KhG; 6) 20KhGR; 7) 40KhG; 8) 40KhGR; 9) 30KhGT; 10) 35KhGT; 11) 40KhGT; 12) 30KhGNA; 13) 38KhGN; 14) quenching from 880° in oil, tempering at 180°; 15) 1st quenching from 910° in oil, 2nd quenching from 870° in oil, tempering at 200°; 16) quenching from 840° in oil, tempering at 520°; 17) quenching from 850° in oil, tempering at 200°; 18) quenching from 850° in oil, tempering at 580°; 19) quenching from 880° in oil, tempering at 500°; 20) quenching from 850° in oil, tempering at 570°.

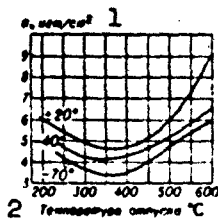

Fig. 8. Impact strength of 30KhGSA steel at low temperatures as a function of tempering temperature. 1) kg-m/cm<sup>2</sup>; 2) tempering temperature, °C.

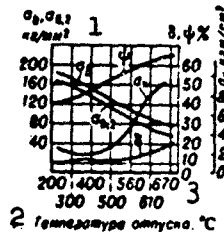

Fig. 9. Influence of tempering temperature on the mechanical characteristics of 35KhGS steel. 1) kg/mm<sup>2</sup>; 2) tempering temperature, °C; 3) kg-m/cm<sup>2</sup>.

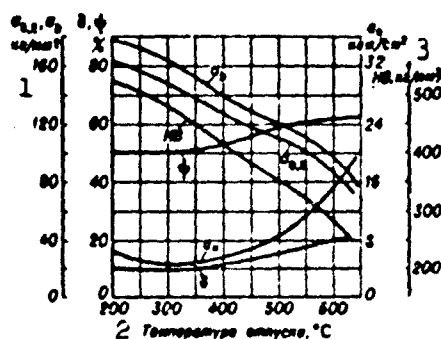

Fig. 10. Influence of tempering temperature on the mechanical characteristics of 40KhNMA steel. 1) kg/mm<sup>2</sup>; 2) tempering temperature, °C; 3) kg-m/cm<sup>2</sup>.

the surface hardness RC reaching  $\geq 52-56$  after such treatment. Gears with teeth treated to a hardness RC = 48-53 are also produced from 40KhGT steel. Its Ti content makes 40KhGT steel less susceptible to overheating during surface quenching with high-frequency electric heating. In individual cases components of this steel are quenched in oil and then tempered at 200°, which gives them the characteristics  $\sigma_b \geq 180$  kg/mm<sup>2</sup> and  $\alpha_n \geq 2.5$  kg-m/cm<sup>2</sup>. Components with such a high hardness can function only in the absence of sizeable stress concentrators.

Chromium-nickel steel. Steels of this type are among the highest-quality structural steels, having a good combination of strength, viscosity, and hardenability. Addition of Ni to chromium steel ensures a fine-grained structure, improves its characteristics across the grain, and increases its resistance to brittle fracture, the latter being very important for reliable functioning of machine components. Supplemental alloying of chromium-nickel steel with Mo enhances its hardenability and improves its macrostructure, especially in large semifinished products.

Type 16KhSN steel, which is alloyed with Cr and small amounts of Si and Ni, is intended for mass production of small components by up-

III-104sl4

setting. Table 14 shows the mechanical characteristics of chromium-nickel steels.

Figure 10 represents the mechanical characteristics of a chromium-nickel steel as a function of tempering temperature. Table 15 shows the characteristics of 40KhNMA steel at elevated temperatures, while Fig. 11 shows its characteristics at low temperatures.

TABLE 14

Mechanical Characteristics of Chromium-Nickel Steels According to GOST 4543-61 (no less than)

| Сталь 1    | 2 Термич. обработка                                 | $\sigma_b$   $\sigma_{0.2}$ |    | $\delta_5$   $\psi$ |    | $\sigma_H$<br>(кг/мм <sup>2</sup> ) | HВ <sup>0</sup><br>(кг/мм <sup>2</sup> ) |
|------------|---|-----------------------------|----|---------------------|----|-------------------------------------|--|
|            |   | 3 (кг/мм <sup>2</sup> )     |    | (%)                 |    |                                     |  |
| 40ХН 5     | Закалка с 820° в воде или масле; отпуск при 500° 11 | 100                         | 80 | 11                  | 45 | 7                                   | <207                                     |
| 45ХН 6     | То же, отпуск при 530° 12                           | 105                         | 85 | 10                  | 45 | 7                                   | <207                                     |
| 50ХН 7     | То же 13  | 110                         | 90 | 9                   | 40 | 5                                   | <207                                     |
| 40ХНМА 8   | Закалка с 840° в масле; отпуск при 620° 14          | 110                         | 95 | 12                  | 50 | 8                                   | <269                                     |
| 40ХНВА 9   | То же 14  | 110                         | 95 | 12                  | 50 | 8                                   | <269                                     |
| 16ХСН** 10 | Закалка с 925° в воде; отпуск при 400° 15           | 100                         | —  | —                   | —  | 8                                   | <197                                     |

\*After annealing or high tempering.

\*\*Mechanical characteristics not given by GOST.

1) Steel; 2) heat treatment; 3) kg/mm<sup>2</sup>; 4) kg-m/cm<sup>2</sup>; 5) 40KhN; 6) 45KhN; 7) 50KhN; 8) 40KhNMA; 9) 40KhNVA; 10) 16KhSN; 11) quenching from 820° in water or oil, tempering at 500°; 12) the same, tempering at 530°; 13) the same; 14) quenching from 850° in oil, tempering at 620°; 15) quenching from 925° in water, tempering at 400°.

TABLE 15

Mechanical Characteristics of 40KhNMA Steel at Elevated Temperatures\*

| Температура (°C) 1 | $\sigma_b$   $\sigma_{0.2}$ |    | $\delta_5$   $\psi$ |    | $\sigma_H$<br>(кг/мм <sup>2</sup> ) 3 |
|--------------------|-----------------------------|----|---------------------|----|---------------------------------------|
|                    | 2 (кг/мм <sup>2</sup> )     |    | (%)                 |    |                                       |
| 20                 | 109                         | 97 | 15                  | 58 | 8                                     |
| 250                | 103                         | 85 | 13                  | 47 | 10                                    |
| 350                | 103                         | 83 | 17                  | 53 | —                                     |
| 400                | 97                          | 79 | 17                  | 63 | 9                                     |
| 450                | 90                          | 78 | 17.5                | 74 | —                                     |
| 500                | 71                          | 69 | 18                  | 80 | 8                                     |

\*After quenching from 860° and tempering at 580°.

1) Temperature (°C); 2) kg/mm<sup>2</sup>; 3) kg-m/cm<sup>2</sup>.

TABLE 16  
Physical Characteristics of  
Chromium-Nickel Steels

| Сталь<br>1 | Критич. 2<br>Точки (°C) |                 | λ (кал/см·сек·°C)<br>при 100° 3 | α · 10 <sup>6</sup> (1/°C) при<br>20-100° 4 |
|------------|-------------------------|-----------------|---------------------------------|---|
|            | A <sub>c1</sub>         | A <sub>c2</sub> |                                 |   |
| 40XН 5     | 730                     | 770             | 0.105                           | 11.8  |
| 50XН 6     | 730                     | 755             | 0.107                           | 11.8  |
| 40XНМА 7   | 710                     | 790             | 0.11                            | 11.7  |
| 40XНВА 8   | 730                     | 790             | 0.085                           | 11.6  |

1) Steel; 2) critical points (°C); 3) λ (cal/cm·sec·°C) at 100°; 4) α · 10<sup>6</sup> (1/°C) at 20-100°; 5) 40KhN; 6) 50KhN; 7) 40KhNMA; 8) 40KhNVA.

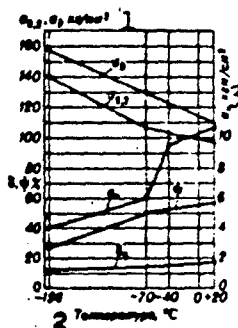

Fig. 11. Mechanical characteristics of 40KhNMA steel at low temperatures (quenching in oil, tempering at 560°). 1) kg/mm<sup>2</sup>; 2) temperature, °C; 3) kg-m/cm<sup>2</sup>.

The physical characteristics of chromium-nickel steels are shown in Table 16.

Steels of this type readily undergo hot machining, rolling and forging being carried out over the range 1200-850°. They have a tendency toward formation of floccules so that rolled and forged products are cooled slowly after hot deformation; large forgings are subjected to special annealing to remove the hydrogen present. These steels have satisfactory machinability in the annealed state. Types 40KhN, 50KhN, 40KhNMA, and 40KhNVA steel weld poorly, while type 16KhSN welds satisfactorily. When necessary, 40KhN and 40KhNMA steels can be welded if they are heated beforehand and tempered or annealed immediately after

III-104sl6

welding. Types 40KhN, 50KhN, and 40KhNMA are generally quenched in oil; in rare instances large components are quenched in water and transferred to oil or subjected to immediate tempering. Type 16KhSN steel supplied in the form of wire or wire rod, being intended for the manufacture of upset bolts heat treated to a  $\sigma_b = 110-130 \text{ kg/mm}^2$  or less. The distinctive feature of this steel is its exceptional ability to undergo cold upsetting in the annealed and mildly cold-worked states. Type 16KhSN has a good combination of strength and plasticity after quenching and tempering. Types 40KhN and 40KhNMA steel are used in the mass production of machinable machine components. Components of 40 KhN steel are often subjected to surface or through quenching with high-frequency electric heating and subsequent low tempering in order to produce a high surface hardness ( $RC = 52-56$ ). The maximum cross-sectional thickness of components fabricated from 40 KhN steel is 100-120 mm, while that of components fabricated from 40KhNMA steel is 150-200 mm. Type 40KhNMA is successfully employed in the production of components 100-120 mm thick to operate at temperatures of up to 450°.

References: Spravochnik po mashinostroitel'nym materialam [Handbook of Machine-building Materials], Vol. 1, Moscow, 1959; Davydova, L.N. Pshechenkova, G.V., Konstruktsionnyye stali [Structural Steels], Handbook, Vol. 1, Moscow, 1947; Avtomobil'nyye konstruktsionnyye stali [Automobile Structural Steels], Handbook, Moscow, 1951.

Ya.M. Potak

**MEDIUM-MELTING SOLDER** - aluminum, copper, silver, titanium, nickel, palladium and gold alloys with a melting temperature in the 200-1100° range. Base metals, such as silver and copper, are sometimes used as solders of this type. Aluminum solders are employed principally for soldering aluminum alloys (see Solder for soldering aluminum alloys).

**Medium-Melting Solders**

| 1<br>Designation | 2<br>GOST, TU | 3<br>Chemical composition, % |    |    |    |    |    |   |    |    |    | 4<br>Initiation, °C | 5<br>Termination, °C | 6<br>Density, g/cm <sup>3</sup> | 7<br>Application |   |   |
|------------------|---------------|------------------------------|----|----|----|----|----|---|----|----|----|---------------------|----------------------|---------------------------------|------------------|---|---|
|                  |               | Al                           | Cu | Ag | Ni | Ti | Co | P | Sn | Zn | Fe |                     |                      |                                 |                  |   |   |
| 101              | 101           | —                            | —  | —  | —  | —  | —  | — | —  | —  | —  | —                   | —                    | —                               | —                | — | — |
| 102              | 102           | —                            | —  | —  | —  | —  | —  | — | —  | —  | —  | —                   | —                    | —                               | —                | — | — |
| 103              | 103           | —                            | —  | —  | —  | —  | —  | — | —  | —  | —  | —                   | —                    | —                               | —                | — | — |
| 104              | 104           | —                            | —  | —  | —  | —  | —  | — | —  | —  | —  | —                   | —                    | —                               | —                | — | — |
| 105              | 105           | —                            | —  | —  | —  | —  | —  | — | —  | —  | —  | —                   | —                    | —                               | —                | — | — |
| 106              | 106           | —                            | —  | —  | —  | —  | —  | — | —  | —  | —  | —                   | —                    | —                               | —                | — | — |
| 107              | 107           | —                            | —  | —  | —  | —  | —  | — | —  | —  | —  | —                   | —                    | —                               | —                | — | — |
| 108              | 108           | —                            | —  | —  | —  | —  | —  | — | —  | —  | —  | —                   | —                    | —                               | —                | — | — |
| 109              | 109           | —                            | —  | —  | —  | —  | —  | — | —  | —  | —  | —                   | —                    | —                               | —                | — | — |
| 110              | 110           | —                            | —  | —  | —  | —  | —  | — | —  | —  | —  | —                   | —                    | —                               | —                | — | — |
| 111              | 111           | —                            | —  | —  | —  | —  | —  | — | —  | —  | —  | —                   | —                    | —                               | —                | — | — |
| 112              | 112           | —                            | —  | —  | —  | —  | —  | — | —  | —  | —  | —                   | —                    | —                               | —                | — | — |
| 113              | 113           | —                            | —  | —  | —  | —  | —  | — | —  | —  | —  | —                   | —                    | —                               | —                | — | — |
| 114              | 114           | —                            | —  | —  | —  | —  | —  | — | —  | —  | —  | —                   | —                    | —                               | —                | — | — |
| 115              | 115           | —                            | —  | —  | —  | —  | —  | — | —  | —  | —  | —                   | —                    | —                               | —                | — | — |
| 116              | 116           | —                            | —  | —  | —  | —  | —  | — | —  | —  | —  | —                   | —                    | —                               | —                | — | — |
| 117              | 117           | —                            | —  | —  | —  | —  | —  | — | —  | —  | —  | —                   | —                    | —                               | —                | — | — |
| 118              | 118           | —                            | —  | —  | —  | —  | —  | — | —  | —  | —  | —                   | —                    | —                               | —                | — | — |
| 119              | 119           | —                            | —  | —  | —  | —  | —  | — | —  | —  | —  | —                   | —                    | —                               | —                | — | — |
| 120              | 120           | —                            | —  | —  | —  | —  | —  | — | —  | —  | —  | —                   | —                    | —                               | —                | — | — |
| 121              | 121           | —                            | —  | —  | —  | —  | —  | — | —  | —  | —  | —                   | —                    | —                               | —                | — | — |
| 122              | 122           | —                            | —  | —  | —  | —  | —  | — | —  | —  | —  | —                   | —                    | —                               | —                | — | — |
| 123              | 123           | —                            | —  | —  | —  | —  | —  | — | —  | —  | —  | —                   | —                    | —                               | —                | — | — |
| 124              | 124           | —                            | —  | —  | —  | —  | —  | — | —  | —  | —  | —                   | —                    | —                               | —                | — | — |
| 125              | 125           | —                            | —  | —  | —  | —  | —  | — | —  | —  | —  | —                   | —                    | —                               | —                | — | — |
| 126              | 126           | —                            | —  | —  | —  | —  | —  | — | —  | —  | —  | —                   | —                    | —                               | —                | — | — |
| 127              | 127           | —                            | —  | —  | —  | —  | —  | — | —  | —  | —  | —                   | —                    | —                               | —                | — | — |
| 128              | 128           | —                            | —  | —  | —  | —  | —  | — | —  | —  | —  | —                   | —                    | —                               | —                | — | — |
| 129              | 129           | —                            | —  | —  | —  | —  | —  | — | —  | —  | —  | —                   | —                    | —                               | —                | — | — |
| 130              | 130           | —                            | —  | —  | —  | —  | —  | — | —  | —  | —  | —                   | —                    | —                               | —                | — | — |
| 131              | 131           | —                            | —  | —  | —  | —  | —  | — | —  | —  | —  | —                   | —                    | —                               | —                | — | — |
| 132              | 132           | —                            | —  | —  | —  | —  | —  | — | —  | —  | —  | —                   | —                    | —                               | —                | — | — |
| 133              | 133           | —                            | —  | —  | —  | —  | —  | — | —  | —  | —  | —                   | —                    | —                               | —                | — | — |
| 134              | 134           | —                            | —  | —  | —  | —  | —  | — | —  | —  | —  | —                   | —                    | —                               | —                | — | — |
| 135              | 135           | —                            | —  | —  | —  | —  | —  | — | —  | —  | —  | —                   | —                    | —                               | —                | — | — |
| 136              | 136           | —                            | —  | —  | —  | —  | —  | — | —  | —  | —  | —                   | —                    | —                               | —                | — | — |
| 137              | 137           | —                            | —  | —  | —  | —  | —  | — | —  | —  | —  | —                   | —                    | —                               | —                | — | — |
| 138              | 138           | —                            | —  | —  | —  | —  | —  | — | —  | —  | —  | —                   | —                    | —                               | —                | — | — |
| 139              | 139           | —                            | —  | —  | —  | —  | —  | — | —  | —  | —  | —                   | —                    | —                               | —                | — | — |
| 140              | 140           | —                            | —  | —  | —  | —  | —  | — | —  | —  | —  | —                   | —                    | —                               | —                | — | — |
| 141              | 141           | —                            | —  | —  | —  | —  | —  | — | —  | —  | —  | —                   | —                    | —                               | —                | — | — |
| 142              | 142           | —                            | —  | —  | —  | —  | —  | — | —  | —  | —  | —                   | —                    | —                               | —                | — | — |
| 143              | 143           | —                            | —  | —  | —  | —  | —  | — | —  | —  | —  | —                   | —                    | —                               | —                | — | — |
| 144              | 144           | —                            | —  | —  | —  | —  | —  | — | —  | —  | —  | —                   | —                    | —                               | —                | — | — |
| 145              | 145           | —                            | —  | —  | —  | —  | —  | — | —  | —  | —  | —                   | —                    | —                               | —                | — | — |
| 146              | 146           | —                            | —  | —  | —  | —  | —  | — | —  | —  | —  | —                   | —                    | —                               | —                | — | — |
| 147              | 147           | —                            | —  | —  | —  | —  | —  | — | —  | —  | —  | —                   | —                    | —                               | —                | — | — |
| 148              | 148           | —                            | —  | —  | —  | —  | —  | — | —  | —  | —  | —                   | —                    | —                               | —                | — | — |
| 149              | 149           | —                            | —  | —  | —  | —  | —  | — | —  | —  | —  | —                   | —                    | —                               | —                | — | — |
| 150              | 150           | —                            | —  | —  | —  | —  | —  | — | —  | —  | —  | —                   | —                    | —                               | —                | — | — |

1) Solder; 2) GOST, TU; 3) chemical composition; 4) —) melting temperature (°C); 5) initiation; 6) termination; 7) density (g/cm<sup>3</sup>); 8) application; 9) silver; 10) solder; 11) PSr70; 12) PSr75; 13) PSr72; 14) PSr71; 15) PSr73; 16) PSr71; 17) PSr77.5; 18) PSr77-15; 19) PSr77-Mn; 20) PSr77-PT-5; 21) PSr77-LMN; 22) copper; 23) L62; 24) LOK62-06-0.4;



25) LOK59-1-0.3; 26) MF3; 27) VPr2; 28) VPr1; 29) VPr4; 30) nonstandard; 31) the same; 32) GOST; 33) TU; 34) remainder; 35) soldering titanium and its alloys; 36) soldering copper components not subject to impact or vibration loads; 37) soldering copper and copper, nickel, and titanium alloys, as well as steel and cast iron. When soldering copper alloys, steel, and high-hot-strength alloys 209 flux is used; chemical nickel-plating is employed before soldering titanium alloys with PSr40 or PSr45 solder; 38) soldering steel and titanium alloys in an argon atmosphere; 39) soldering structural steel in a hydrogen atmosphere or stainless steel in dry hydrogen or with gaseous fluxes; 40) soldering stainless steel and high-hot-strength alloys in a flowing-argone atmosphere; 41) soldering copper and steel with 200 flux or borax; 42) soldering copper and copper alloys with 200 flux or borax; 43) soldering copper in air, using high-frequency heating, electrical-resistance heating, or a blowtorch; 44) furnace soldering of steel in an argon atmosphere; 45) soldering steel and nickel alloys in a vacuum ( $10^{-2}$ - $10^{-3}$  mm Hg) or argon atmosphere with 200 or 201 flux, employing high-frequency heating, a blowtorch, or an electric furnace.

Silver solders are the most widely used and are suitable for soldering copper, titanium, and nickel alloys, steel, and high-melting metals and alloys; they are technically the most efficient and have high electrical conductivity and strength. Silver is sometimes used in soldering titanium and its alloys. Among the elements which reduce the melting temperature of silver solders are copper, zinc, cadmium, antimony, phosphorus, tin, and indium. Alloys of the Ag-Cu type, which have good technological characteristics, are widely employed as solders. It is possible to reduce the complete-fusion temperature of Ag-Cu alloys to  $605^{\circ}$  (while retaining sufficient plasticity) by alloying them with cadmium and zinc. A further decrease in the melting point of silver solders can be achieved by increasing their cadmium content or by adding substantial quantities of antimony and phosphorus, which lead to intensive embrittlement of the solder. Such solders are suitable only for soldering copper components not subject to bending or impact loads. A solder has been proposed with the composition 41% Ag, 14% Cu, 16% Zn, and 24% Cd; this solder is alloyed with 5% Sn and has a melting point of  $550^{\circ}$ . Solders based on Ag-Mn (Ag and 15% Mn) solid solutions are

used in some cases; however, they have lower technical characteristics than solders based on Ag-Cu or Ag-Cu-Zn-Zd. Moreover, joints soldered in stainless steel with solder consisting of Ag and 15% Mn tend to corrode in alkalies. Addition of small amounts of lithium (0.2-0.8%) to silver solders improves their wetting power and makes them self-fluxing in a neutral-gas atmosphere when soldering stainless and structural steel and nickel alloys. However, addition of lithium to alloys containing less than 70% Ag sharply reduces their rollability. Addition of phosphorus in widely varying concentrations makes many silver solders self-fluxing when soldering copper in air. Copper is used as a solder principally for soldering structural and stainless steels. The principal elements that reduce the melting point of copper solders are zinc, silicon, tin, phosphorus and manganese. Binary copper alloys containing zinc, silicon, or tin crystallize to form peritectis. It is only with phosphorus that copper forms eutectic alloys with an especially high flowability and a high capacity for wetting the base material and filling capillary spaces. Copper and manganese form a continuous series of solid solutions, which serve as the basis for a number of solders. Of the copper solders, brass, copper-phosphorus bronze, and Cu-Mn-Ni solders are widely used. Among the alloying elements which give copper solders special characteristics are nickel, which reduces their oxidizability in the solid and liquid states, phosphorus, which makes them self-fluxing when soldering copper in air, lithium, which makes copper and Cu-Mn-Mi solders self-fluxing when soldering stainless steel in flowing argon, and titanium and zirconium, which activate lithium-containing self-fluxing silver solders.

Manganese and zinc are among the elements easily ignited during soldering and promote joint porosity, especially when welding with 200 and 201 fluxes in furnaces and gas-burner flames. Solders of the

III-86p3

Cu-Mn-Ni type containing >15% Mn (20-30% Mn) are used principally for soldering steel in an atmosphere of flowing argon (with lithium-containing solders) or gaseous fluxes. Small amounts of silicon are added to brass to prevent combustion of its zinc. Nickel solders are used for soldering high-hot-strength alloys and steels (see Solder for soldering high-hot-strength alloys). The table shows the compositions of certain copper and silver solders.

References: Kulikov, F.V. and Lekhtsiyer, I.R., Tverdaya payka [Solid Soldering], Moscow-Leningrad, 1959; Bruker, H.R. and Bitson, E.V., Payka v promyshlennosti [Soldering in Industry], translated from English, Moscow, 1957; Lueder, E., Handbuch der Loettechnik [Handbook of Soldering Technique], Berlin, 1952; Mikova Shenesaku, Nizkotemperaturnyy serebryanny pripoy [Low-Temperature Silver Solder], Japanese Patent No. 3303, 22-06-61. See also the References to the article entitled Soldering.

N.F. Lashko and S.V. Lashko

I-55a

MEDIUM-STRENGTH ALUMINUM CASTINGALLOYS - see High- and medium-  
strength aluminum casting alloys.

MEDIUM-STRENGTH ALUMINUM SHAPING ALLOYS -- widely used structural shaping alloys having a strength of 30-45 kg/mm<sup>2</sup>. They include the alloys designated as AV, AK6, AK8, AK2, AK4, AK4-1, VD17, D1, D16, D19, VAD1, M40, D20, AMg6, SAP-2. AK6, AK8, AK2, AK4, AK4-1 and VD17 are forging alloys (see Aluminum shaping alloys for forging); VAD1, M40, and D20 are high-hot-strength weldable alloys (see Weldable aluminum shaping alloys); AMg6 is a corrosion-resistant weldable alloy (see Corrosion-resistant aluminum shaping alloys); SAP-2 is a sintered alloy (see Sintered aluminum powder).

AV alloy is a Al-Mg-Si system containing a small admixture of copper; D1, D16, D19, VAD1 and M40 alloys are Al-Cu-Mg systems, all having a far higher copper content than AV alloy. The corrosion resistance of aluminum shaping alloys decreases with copper content, so that the resistance of AV alloy is far higher and its strength characteristics far lower than those of the other alloys under consideration. AV alloy is distinguished by high plasticity when hot and can be used for fabrication of geometrically complex forged, stamped, and extruded articles. It is the strongest of the Al-Mg-Si alloys. In order to improve its corrosion resistance the Cu and Zn contents should be limited to 0.1% each. Research has shown, however, that the Al-Mg-Si alloys AD31, AD33, and AD35 have a substantially higher corrosion resistance, although they are somewhat less strong than AV alloy. It is wise to substitute the corrosion-resistant alloys AD31, AD33, and AD35 for AV alloy in assemblies which will have long service lives. On the other hand, it is expedient to use AV alloy for geometrically complex forged and

I-48a1

stamped articles which must have high strength and a rather high corrosion resistance. This alloy is used after natural or artificial aging, predominantly the latter. Artificial aging of AV alloy leads to an increase of 50% in ultimate strength and more than doubles its yield strength.

Al-Cu-Mg alloys are arranged in the following order, in accordance with the copper-magnesium ratio:

| Сплав 1 | Отношение<br>2<br>Cu Mg |
|---------|-------------------------|
| D1 3    | 6.35                    |
| D16 4   | 2.76                    |
| D19 5   | 1.7                     |
| VD17 6  | 1.32                    |

1) Alloy; 2) Cu/Mg ratio; 3) D1; 4) D16; 5) D19; 6) VD17.

As this ratio decreases the corrosion resistance of the alloy improves, sensitivity to intercrystalline corrosion after heating to 100-170° being particularly reduced.

D1 alloy is used to produce all types of semifinished products, while D16 and D19 alloys are used for fabrication of rolled and extruded articles and wire.

In addition to quenched and naturally aged sheets, D16 alloy is used for cold-worked sheets (D16ATN). The sheets are cold-worked by cold rolling after quenching; the degree of cold working amounts to 6-7%. This increases the ultimate strength and especially the yield strength of the sheets and somewhat reduces their elongation. Cold-worked sheets are used when there should be no substantial deformation during the fabrication process. Sheets of D16 and D19 alloys are strongest when subjected to further cold working, of the order of 20% (D16AT1N1). Such cold working makes it possible to increase sheet strength by 6 kg/mm<sup>2</sup>. Subsequent artificial aging at 130° yields approximately the same elongation level as in D16ATN sheets. However, intensively cold-worked D16AT1N1 and D19AT1N1 sheets have an increased sensitivity to stress concentrators and the expediency of using them should be carefully checked in each individual case.

The sheets are aluminum-plated to provide corrosion protection

I-48a2

(AV alloy need not be plated). The thicker the sheets, the less is the relative thickness of the plating; the absolute thickness of the plating layer should never be less than  $40 \mu$ . In order to avoid diffusion of the copper through the plating layer (which causes a decrease in corrosion resistance and a deterioration of appearance) extremely thin sheets of D16 alloy carry a thicker plating.

AV, D1, D16, and D19 alloys exhibit a pronounced pressed effect (see Press effect in aluminum alloys), so that the strength characteristics of shapes depend on their cross-sectional area and are higher than for rolled sheets and plates. As a rule, the larger the cross-sectional area of the extruded products, the higher are the strength characteristics of the alloy. The difference between the ultimate strength and yield strength of shapes extruded from D16 alloy reaches  $6-9 \text{ kg/mm}^2$ , depending on cross-sectional area. By regulating the chemical composition of the D16 alloy and the technical restrictions on the extrusion process it is possible to obtain high strength characteristics over a broad range of cross-sectional areas (so-called high-strength shapes). Certain types of semifinished products extruded from D1 and D16 alloys can be regarded as high-strength products (having ultimate strengths of more than  $45 \text{ kg/mm}^2$ ). In some cases a zone of large grains appears at the periphery of forged and, particularly, extruded articles; this is the so-called large-crystal border. The strength of this border is far less than that of the remaining cross-section of the product.

After quenching sheets, shapes, and panels of aluminum shaping alloys with special properties are straightened, which affects both the geometric shape and properties of the semifinished products. Straightening redistributes the internal stresses and reduces the deformation during subsequent mechanical processing:  $\sigma_b$  and  $\sigma_{0.2}$  are raised by  $1-3 \text{ kg/mm}^2$  and the yield time is markedly increased. If sheets, shapes, or

panels are requenched at the consumer plant (when extension is not carried out) the strength characteristics and yield time are accordingly reduced.

Natural aging of D16 alloy after brief annealing at temperatures above 150° causes a marked decrease in corrosion resistance, so that it is better to use D19 alloy, which is less sensitive to intercrystalline corrosion, or artificially aged D16 alloy. The susceptibility of D16 alloy to notching under alternating stresses is virtually the same after natural and artificial aging. The plasticity of this alloy is markedly reduced after artificial aging: all technological operations must be carried out after natural aging, while riveted assemblies are subjected to artificial aging.

M40 alloy is of considerable interest. It can be forged, rolled, or extruded and is satisfactory for all types of welding. For plated sheets of M40 alloy  $\sigma_b = 39-43 \text{ kg/mm}^2$ ,  $\sigma_{0.2} = 25-35 \text{ kg/mm}^2$ ,  $\delta = 18-6\%$ . For extruded shapes  $\sigma_b = 43 \text{ kg/mm}^2$ ,  $\sigma_{0.2} = 32 \text{ kg/mm}^2$ , and  $\delta = 13\%$ . In contrast to D16 alloy, large shapes fabricated from M40 alloy do not tend to corrode under stress. The weldable variant of D19 alloy, VAD1, can be used for welded assemblies. Tables 1-11 and Figs. 1-10 give data on the mechanical and physical properties of a number of these alloys.

Corrosion resistance. AV alloy has a higher corrosion resistance when naturally aged. The artificially aged alloy has a tendency toward intercrystalline corrosion, which becomes stronger as the copper content increases.

Plated sheets of D1 and D16 alloys 1 mm or more thick have a high corrosion resistance. Sheets less than 1 mm thick have a lower corrosion resistance. Sheets less than 1 mm thick with a thicker plating layer have a high corrosion resistance. The resistance of D16ATN plated



TABLE 1

Mechanical Properties of Semifinished Products Fabricated from AV, D1, D16, D19, M40, VAD1 Alloys (at 20°)

| Связь 1        | Над полуфабриката 2                  | 3 Состояние материала  | σ <sub>0.2</sub>                          |                         |                         |                         |                         | δ                     |                        |                        |                        |                         |
|----------------|--------------------------------------|--|---|-------------------------|-------------------------|-------------------------|-------------------------|-----------------------|------------------------|------------------------|------------------------|-------------------------|
|                |                                      |  | σ <sub>0.2</sub><br>(кг/мм <sup>2</sup> ) | σ <sub>0.2</sub><br>(%) | σ <sub>0.2</sub><br>(%) | σ <sub>0.2</sub><br>(%) | σ <sub>0.2</sub><br>(%) | δ <sub>5</sub><br>(%) | δ <sub>10</sub><br>(%) | δ <sub>20</sub><br>(%) | δ <sub>50</sub><br>(%) | δ <sub>100</sub><br>(%) |
| AV<br>5        | Прутки, профили,ковки,штамповки<br>6 | Закаленные и искусственно состаренные (AVT1) 7                                     | —   | 28                      | 38                      | 18                      | 20                      | 21                    | —                      | —                      | 95                     | 9.8                     |
|                |                                      | Закаленные и естественно состаренные 8   | —   | 12                      | 22                      | 22                      | 50                      | 16.5                  | —                      | —                      | 65                     | 9.8                     |
|                |                                      | Отжигенные (AVM) 9   | —   | —                       | 12                      | 30                      | 65                      | 8                     | —                      | —                      | 30                     | 6.3                     |
| D1<br>10       | Штамповки,ковки<br>11                | Закаленные и естественно состаренные (σ <sub>N</sub> = 3 кг-м/см <sup>2</sup> ) 12 | 19  | 25                      | 41                      | 15                      | 30                      | 27                    | 18                     | 38                     | 115                    | 12.5                    |
| D16<br>13      | Крупногабаритные профили<br>14       | Закаленные и естественно состаренные 15  | 34  | 38                      | 52                      | 12                      | 15                      | 30                    | 20                     | 38                     | 131                    | 14                      |
|                |                                      | Отжигенные 16  | —   | 23                      | 47                      | 13                      | 15                      | —                     | —                      | —                      | —                      | —                       |
| D16<br>13      | Прутки, d 40 мм<br>17                | Закаленные и естественно состаренные 15  | 34  | 38                      | 52                      | 8.5                     | 15                      | 21                    | 18                     | 35                     | 131                    | 14                      |
|                |                                      | Отжигенные 16  | —   | 23                      | 47                      | 13                      | 15                      | —                     | —                      | —                      | —                      | —                       |
| D16, D19<br>18 | Листы плакированные<br>19            | Закаленные и естественно состаренные 20  | —   | 20                      | 44                      | 19                      | —                       | —                     | —                      | —                      | —                      |                         |
| M40<br>20      | Листы плакированные<br>21            | Закаленные и искусственно состаренные при 150° в течение 10 час. 22                | —   | 25                      | 39                      | 18                      | —                       | —                     | —                      | —                      | —                      |                         |
| M40<br>21      | Профили прессованные<br>22           | Закаленные и искусственно состаренные при 170° в течение 16 час. 23                | —   | 32                      | 43                      | 13                      | 18                      | —                     | —                      | —                      | —                      |                         |
| D16T1<br>23    | Листы плакированные<br>19            | Закаленные и искусственно состаренные 24   | —   | 41                      | 46                      | 8                       | —                       | —                     | —                      | —                      | —                      |                         |
| D16T1<br>24    | Профили<br>25                        | Закаленные и искусственно состаренные 24   | —   | 40-44                   | 42-50                   | 7                       | —                       | —                     | —                      | —                      | —                      |                         |
| VAD1<br>25     | Листы плакированные<br>19            | Закаленные и естественно состаренные 8   | —   | 28                      | 44                      | 18                      | —                       | —                     | —                      | —                      | —                      |                         |

\*On alternate bending; N = 5·10<sup>8</sup> cycles.

1) Alloy; 2) type of semifinished product; 3) state of material; 4) kg/mm<sup>2</sup>; 5) AV; 6) rods, shapes, forgings, stampings; 7) quenched and artificially aged (AVT1); 8) quenched and naturally aged; 9) annealed (AVM); 10) D1; 11) stampings, forgings; 12) quenched and naturally aged (σ<sub>N</sub> = 3 kg-m/cm<sup>2</sup>); 13) D16; 14) large-size shapes; 15) freshly quenched; 16) annealed; 17) rods 40 mm in diameter; 18) D16, D19; 19) plated sheets; 20) quenched and artificially aged at 150° for 10 hr; 21) extruded shapes; 22) quenched and artificially aged at 170° for 16 hr; 23) D16T1; 24) quenched and artificially aged; 25) shapes; 26) VAD1.

TABLE 2

Mechanical Properties of Sheets of D16T Alloy (naturally aged) at Elevated Temperatures\*

| Температура испытания (°C) 1 | Длительность выдержки (часы) 2 | Кратковременные испытания на растяжение 3 |            |                   | Длительная прочность $\sigma$ (кг/мм <sup>2</sup> ) 5 |
|------------------------------|--------------------------------|---|------------|-------------------|---|
|                              |                                | $\sigma_{0.2}$                            | $\sigma_b$ | $\delta_{11.3VF}$ |   |
|                              |                                |   |            |                   |   |
| 100                          | 0.5                            | 28.0                                      | 41.0       | 14                | —   |
|                              | 1                              | —   | —          | —                 | 40.0  |
|                              | 10                             | 29  | 40         | 14                | 40.0  |
|                              | 100                            | 39.0                                      | 42.0       | 14                | 39.0  |
| 150                          | 0.5                            | 27.0                                      | 40.0       | 17                | —   |
|                              | 1                              | —   | —          | —                 | 37.0  |
|                              | 10                             | 27.0                                      | 40         | 17                | 35.0  |
|                              | 100                            | 30.0                                      | 40         | 12                | 32.0  |
| 200                          | 0.5                            | 23.0                                      | 35.0       | 18                | —   |
|                              | 1                              | —   | —          | —                 | 31.0  |
|                              | 10                             | 27.0                                      | 32.0       | 12                | 25.0  |
|                              | 100                            | 25.0                                      | 37.0       | 9                 | 18.0  |
| 1000                         | —                              | 20.0                                      | 22.0       | 11                | 12.0  |

\*At 20°  $\sigma_b = 44 \text{ kg/mm}^2$ ;  $\sigma_{0.2} = 30.5 \text{ kg/mm}^2$ ;  $\delta = 16\%$ .

1) Test temperature (°C); 2) holding time (hr); 3) short-term tensile tests; 4) kg/mm<sup>2</sup>; 5) long-term strength  $\sigma$  (kg/mm<sup>2</sup>).

TABLE 3

Mechanical Properties of D16T1 Alloy (Artificially Aged) at Elevated Temperatures\*

| Температура испытания (°C) 1 | $\sigma_{0.2}$          | $\sigma_b$ | $\delta$ |
|------------------------------|-------------------------|------------|----------|
|                              | 2 (кг/мм <sup>2</sup> ) |            | (%)      |
| 150                          | 38                      | 45         | 11       |
| 175                          | 38                      | 43.0       | 10       |
| 200                          | 35                      | 40.5       | 10       |
| 250                          | 21                      | 28         | 12       |

\*At 20°  $\sigma_b = 46 \text{ kg/mm}^2$ ;  
 $\sigma_{0.2} = 41 \text{ kg/mm}^2$ ;  $\delta = 5\%$ .  
 1) Test temperature (°C);  
 2) holding time (hr); 3) kg/mm<sup>2</sup>.

TABLE 4

Mechanical Properties of Shapes Fabricated from D16T1PP Alloy at Elevated Temperatures\*

| Температура испытания (°C) 1 | $E_{сш}$                | $\sigma_{0.2}$ | $\sigma_b$ | $\delta_{-10}$ |
|------------------------------|-------------------------|----------------|------------|----------------|
|                              | 2 (кг/мм <sup>2</sup> ) |                |            |                |
| 20                           | 7150                    | 35.5           | 32         | 20.5           |
| 100                          | 6650                    | 35             | 32         | 19.5           |
| 150                          | 6400                    | 33             | 30         | 18.5           |
| 200                          | 6000                    | 32.5           | 29.5       | 14.5           |
| 250                          | 5450                    | 23             | 21         | 13.0           |

\*At 20°  $\sigma_b = 51 \text{ kg/mm}^2$ ;  
 $\sigma_{0.2} = 41 \text{ kg/mm}^2$ ;  $\delta = 10\%$ .  
 1) Test temperature (°C);  
 2) kg/mm<sup>2</sup>.

TABLE 5

Mechanical Properties of Sheets of D16AT Alloy Under Compression at Elevated Temperatures

| Темп-ра испытания (°C) 1 | Время выдержки (часы) 2 | $\sigma_{0.2}$ (кг/мм <sup>2</sup> ) 3 | $\sigma_b$ (кг/мм <sup>2</sup> ) | $\delta_{10}$ % |
|--------------------------|-------------------------|--|----------------------------------|-----------------|
| 175                      | 0.5                     | 34                                     | 38.5                             | 7               |
| 200                      | 0.5                     | 34                                     | 37.0                             | 6               |
| 225                      | 0.5                     | 30                                     | 33.0                             | 7               |
| 250                      | 0.5                     | 26                                     | 29.5                             | 8               |

1) Test temperature (°C); 2) kg/mm<sup>2</sup>.

TABLE 6

Mechanical Properties of Rods Fabricated from D16 Alloy Under Torsion and Shear at Elevated Temperatures

| Темп-ра испытания (°C) 1 | 2 (кг/мм <sup>2</sup> ) |          |              |            |             |
|--------------------------|-------------------------|----------|--------------|------------|-------------|
|                          | $\sigma$                | $\tau_b$ | $\tau_{0.2}$ | $\tau_{ш}$ | $\tau_{ср}$ |
| 20                       | 2470                    | 35       | 19           | 13         | 26          |
| 100                      | 2400                    | 33       | 18           | 13         | 25          |
| 150                      | 2300                    | 32       | 17.5         | 13         | 24.5        |
| 200                      | 2200                    | 28.5     | 17.5         | 13         | 27.5        |
| 250                      | 2080                    | 25       | 17.0         | 10         | 17          |
| 300                      | 1780                    | 19       | 14.0         | 8          | 12          |

1) Test temperature (°C); 2) kg/mm<sup>2</sup>.

TABLE 7

Influence of Heating Time at Elevated Temperatures on the Mechanical Properties of Large Shapes Fabricated from the D16T Alloy (at 20°, with grain:  $\sigma_b = 52$  kg/mm<sup>2</sup>,  $\sigma_{0.2} = 38$  kg/mm<sup>2</sup>,  $\delta_{10} = 16\%$ ; across grain:  $\sigma_b = 45$  kg/mm<sup>2</sup>,  $\sigma_{0.2} = 33$  kg/mm<sup>2</sup>,  $\delta_{10} = 15\%$ )

| Темп-ра испытания и нагрева (°C) 1 | 2 После нагрева при температуре испытания в течение * |                   |                                  |                   |                                  |                   |
|------------------------------------|---|-------------------|----------------------------------|-------------------|----------------------------------|-------------------|
|                                    | 0.5 час. 3  |                   | 100 час.                         |                   | 200 час.                         |                   |
|                                    | $\sigma_b$ (кг/мм <sup>2</sup> ) 4                    | $\delta_{10}$ (%) | $\sigma_b$ (кг/мм <sup>2</sup> ) | $\delta_{10}$ (%) | $\sigma_b$ (кг/мм <sup>2</sup> ) | $\delta_{10}$ (%) |
| 100                                | 07/04   | 11/10             | 07/10                            | 10/10             | 07/06                            | 10/10             |
| 125                                | 07/04   | 10/10             | 07/06                            | 10/10             | 07/06                            | 10/10             |
| 150                                | 07/10   | 10/10             | 07/06                            | 10/10             | 07/06                            | 10/10             |
| 175                                | 07/06   | 10/10             | 07/06                            | 10/10             | 07/06                            | 10/10             |
| 200                                | 07/06   | 10/10             | 07/06                            | 10/10             | 07/06                            | 10/10             |
| 250                                | 07/06   | 10/10             | 07/06                            | 10/10             | 07/06                            | 10/10             |
| 300                                | 07/10   | 10/10             | 07/06                            | 10/10             | 07/06                            | 10/10             |
| 350                                | 07/10   | 10/10             | 07/06                            | 10/10             | 07/06                            | 10/10             |

\*The numerator represents the figure with the grain and the denominator the figure against the grain.

1) Test temperature (°C); 2) after heating at test temperature for\*; 3) hr; 4) kg/mm<sup>2</sup>.

TABLE 8

Influence of Natural and Artificial Aging on the Mechanical Properties of Sheets of D16 Alloy

| Испытание при 20° 1       |                |                   |                            |                |                   | Испытание при 200° после выдержки при 200° в течение |                |                   |            |                |                   |      |    |
|---------------------------|----------------|-------------------|----------------------------|----------------|-------------------|--|----------------|-------------------|------------|----------------|-------------------|------|----|
| естественно состаренный 2 |                |                   | искусственно состаренный 3 |                |                   | 20 час.  |                |                   | 100 час.   |                |                   |      |    |
| $\sigma_b$                | $\sigma_{0.2}$ | $\delta_{10}$ (%) | $\sigma_b$                 | $\sigma_{0.2}$ | $\delta_{10}$ (%) | $\sigma_b$   | $\sigma_{0.2}$ | $\delta_{10}$ (%) | $\sigma_b$ | $\sigma_{0.2}$ | $\delta_{10}$ (%) |      |    |
| (кг/мм <sup>2</sup> ) 4   |                |                   | (кг/мм <sup>2</sup> )      |                |                   |  |                |                   |            |                |                   |      |    |
| 44.5                      | 30             | 18                | 47                         | 43.5           | 6                 | 32   | 10.5           | 31.5              | 10         | 30.5           | 12                | 29.8 | 12 |

- 1) Testing at 20°; 2) natural aging; 3) artificial agings; 4) kg/mm<sup>2</sup>;  
5) testing at 200° after holding at 200° for; 6) hr.

TABLE 9

Mechanical Properties of M40 Alloy at Elevated Temperatures as a Function of Holding Time

| Вид 1<br>полу-<br>фабриката            | Свойство 2                           | 175°     |          | 200°     |          | 225°     |          | 250°     |          | 300°     |          |
|--|--------------------------------------|----------|----------|----------|----------|----------|----------|----------|----------|----------|----------|
|  |                                      | 0.5 час. | 100 час. | 0.5 час. | 100 час. | 0.5 час. | 100 час. | 0.5 час. | 100 час. | 0.5 час. | 100 час. |
| Листы<br>плакиро-<br>ванные<br>(AI) 4  | $\sigma_b$ (кг/мм <sup>2</sup> )     | 31       | 34       | 30       | 28       | 26       | 26       | 25       | 20       | —        | —        |
|  | $\sigma_{0.2}$ (кг/мм <sup>2</sup> ) | 22       | 26       | 21       | 20       | 20       | 19       | 19       | 14       | —        | —        |
|  | $\delta_{10}$ (%)                    | 18       | 12       | 19       | 12       | 20       | 16       | 13       | 20       | —        | —        |
| Листы<br>плакиро-<br>ванные<br>(ATN) 5 | $\sigma_b$ (кг/мм <sup>2</sup> )     | 41       | 40       | 40       | 31       | 13       | 26       | 26       | 20       | —        | —        |
|  | $\sigma_{0.2}$ (кг/мм <sup>2</sup> ) | 34       | 30       | 30       | 22       | 19       | 18       | 16       | 10       | —        | —        |
|  | $\delta_{10}$ (%)                    | 10       | 8        | 9        | 9        | 7        | 12       | 7        | 12       | —        | —        |
| Профиля<br>прессов-<br>анные 6         | $\sigma_b$ (кг/мм <sup>2</sup> )     | 35       | 34       | 33       | 27       | 29       | —        | 27       | 20       | 15       | 15       |
|  | $\sigma_{0.2}$ (кг/мм <sup>2</sup> ) | 24       | 27       | 27       | 23       | 24       | —        | 21       | 15       | —        | —        |
|  | $\delta_{10}$ (%)                    | 11       | 12       | 11       | 11       | 12       | —        | 13       | 23       | 18       | 28       |

- 1) Type of semifinished product; 2) properties; 3) hr; 4) plated sheets (AI); 5) plated sheets (ATN); 6) extruded shapes; 7) kg/mm<sup>2</sup>.

TABLE 10

Mechanical Properties of Sheets of VAD1 Alloy at Elevated Temperatures\*

| Темп-ра<br>испытания<br>(°C) 1 | $\sigma_b$ (кг/мм <sup>2</sup> ) 2 |    | $\delta_{10}$ (%) |
|--------------------------------|------------------------------------|----|-------------------|
|                                | 200                                | 23 | 33                |
| 250                            | 21                                 | 27 | 16                |
| 300                            | 14                                 | 19 | 18                |

\*AE 20° E = 6800  
kg/mm<sup>2</sup>;  $\sigma_b = 44$  kg/mm<sup>2</sup>;  
mm<sup>2</sup>;  $\sigma_{0.2} = 28$  kg/mm<sup>2</sup>;  
 $\delta = 18\%$ ; 1) Test tem-  
perature (°C); 2) kg/  
/mm<sup>2</sup>.

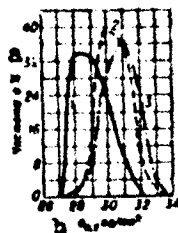

Fig. 1. Normal-distribution curves for ultimate strength of sheets of D16AT alloy: 1) Sheets 0.8-1.2 mm thick; 2) sheets up to 2.5 mm thick; 3) sheets up to 4 mm thick. a) Frequency, %; b)  $\sigma_b$ , kg/mm<sup>2</sup>.

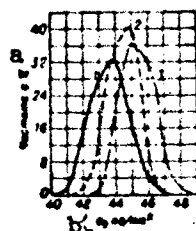

Fig. 2. Normal-distribution curves for yield strength of sheets of D16AT alloy: 1) Sheets 0.8-1.2 mm thick; 2) sheets up to 2.5 mm thick; 3) sheets up to 4 mm thick. a) Frequency, %; b)  $\sigma_{0.2}$ , kg/mm<sup>2</sup>.

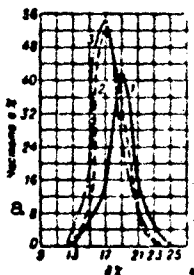

Fig. 3. Normal-distribution curves for elongation of sheets of D16AT alloy: 1) Sheets 0.8-1.2 mm thick; 2) sheets up to 2.5 mm thick; 3) sheets up to 4 mm thick. a) Frequency, %.

sheets (which are cold-worked and naturally aged) is satisfactory. Unplated extruded and forged semifinished products have a low corrosion resistance. Mass-extruded articles fabricated from D16 alloy exhibit a tendency toward intercrystalline corrosion when quenched and naturally aged. Heating naturally aged semifinished products to temperatures above 100° creates a tendency toward intercrystalline corrosion. The corrosion resistances of naturally and artificially aged semifinished

I-48a9

products fabricated from D16 alloy are virtually identical; however, subsequent technological and operational heating of the artificially aged alloy does not cause the decrease in corrosion resistance observed in naturally aged semifinished products. When the proper anodizing (oxidation) regimes are observed varnish coatings ensure reliable protection of plated and unplated semifinished products. Polished plated sheets can be used without anodizing (oxidation). The corrosion resistance of D19 alloy is the same as that of D16. Artificial aging does not reduce the corrosion resistance of M40 alloy. The latter can be protected against corrosion in the same manner as D16 alloy.

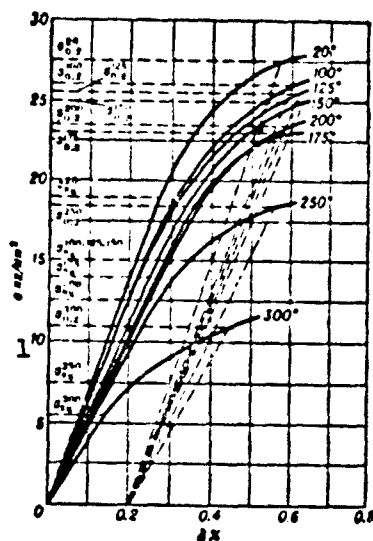

Fig. 4. Graphs showing extension of D16AT alloy to yield point at room and elevated temperatures (sheet 2 mm thick with minimal TU properties). 1)  $\sigma$ , kg/mm<sup>2</sup>.

Technological properties. AV alloy has a high plasticity when annealed and satisfactory plasticity after quenching and natural aging; its plasticity is reduced by artificial aging. It also has high plasticity when hot. This alloy can be used for fabrication of extruded and forged articles of complex geometric shape. The forging and stamping temperature is high, 470-475°. The heat-treatment regime involves

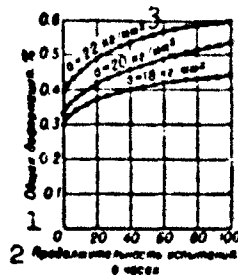

Fig. 5. Creep curves for D16T alloy at 150° (sheet 2 mm thick). 1) Total deformation, %; 2) test time, hr; 3) kg/mm<sup>2</sup>.

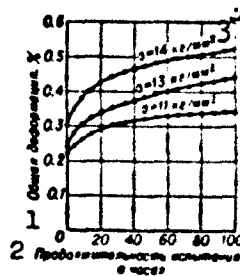

Fig. 6. Creep curves for D16T alloy at 175° (sheet 2 mm thick). 1) Total deformation, %; 2) test time, hr; 3) kg/mm<sup>2</sup>.

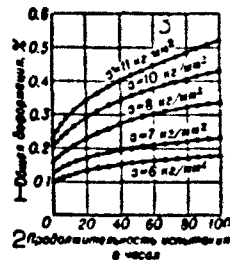

Fig. 7. Creep curves for D16T alloy at 200° (sheet 2 mm thick). 1) Total deformation, %; 2) test time, hr; 3) kg/mm<sup>2</sup>.

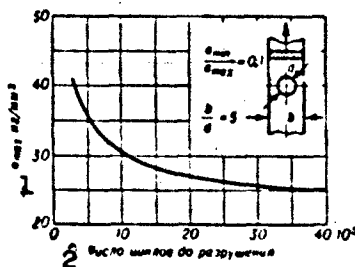

Fig. 8. Static endurance of D16T alloy (extruded shape) under repeated asymmetric ( $\sigma_{\min}/\sigma_{\max} = 0.1$ ) extension. 1)  $\sigma_{\max}$ , kg/mm<sup>2</sup>; 2) number of cycles to fracture.

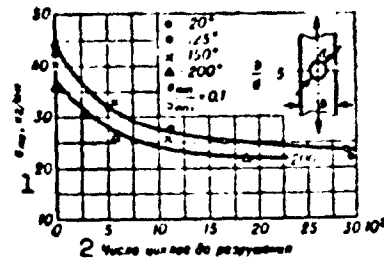

Fig. 9. Influence of test temperature on static endurance of D16AT alloy (sheet 3 mm thick) on repeated asymmetric ( $\sigma_{\min}/\sigma_{\max} = 0.1$ ) extension. 1)  $\sigma_{\max}$ , kg/mm<sup>2</sup>; 2) number of cycles to fracture.

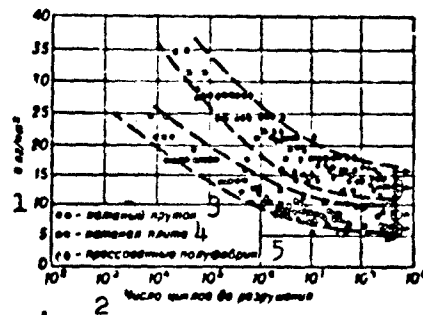

Fig. 10. Data on the endurance of semifinished products fabricated from D16 alloy after quenching and natural aging, obtained by bend-testing of rotating specimen: unnotched specimens - black dots ( $d = 7.6$  mm); v-notched specimens - white dots ( $d_N = 8.4$  mm,  $r_N = 0.025$  mm). 1)  $\sigma$ , kg/mm<sup>2</sup>; 2) number of cycles to fracture; 3) rolled rod; 4) rolled plate; 5) extruded semifinished products.

postquenching annealing at 515-525°, water-cooling, and natural (AVT) or artificial (AVT1) aging at 150° for 6 hr; the strength characteristics of artificially aged semifinished products fabricated from AV alloy decrease when the interval between quenching and aging is prolonged. Annealing is carried out at 350-370° and is followed by air-cooling.

D1 alloy has satisfactory plasticity when annealed, freshly quenched, or hot. The forging and stamping temperature is 450-475°. The heat-treatment regime involves postquenching annealing at 495-510°, water-cooling, and subsequent natural aging for no less than four days.



TABLE 11  
Physical Properties

| Сплав      | $\gamma$ (г/см <sup>3</sup> ) | $\alpha \cdot 10^3$<br>(1/°C)                        | $\lambda$ (кал/см·сек·°C)  | $\rho$<br>(ом·мм <sup>2</sup> /м)                    | $\epsilon$<br>(кал/г·°C)                  | Уд. электро-<br>проводность*<br>(%) |
|------------|-------------------------------|--|--|--|---|-------------------------------------|
| АВ<br>7    | 2.7                           | 21.8 (от -50<br>до +20°)<br>14<br>25.4<br>(200-300°) | 0.37 (25°) 15<br>АВТ и АВТ1<br>0.41 (25°) АВМ16<br>0.42 (25°) АВТ1<br>0.45 (300°) АВТ1<br>17 | 0.055 (АВТ<br>и АВТ1)<br>0.048 (АВМ)<br>0.037 (АВТ1) | 0.19 (100°)<br>0.23 (300°)                | 55 (АВМ)<br>45 (АВТ и<br>АВТ1)      |
| Д1<br>3    | 2.8                           | 21.8 (от -50<br>до +20°)<br>25 (20-300°)             | 0.28 (25°) } 18<br>0.42 (400°) } Д1Т<br>0.41 (25°) Д1М 19                                    | 0.054 (Д1Т)  | 0.22 (100°)<br>0.25 (400°)                | 30 (Д1Т)<br>45 (Д1М)                |
| Д16<br>9   | 2.78                          | 21.4 (от -50<br>до +20°)<br>24.7<br>(20-300°)        | 0.29 (25°) (Д16Т) 20<br>0.46 (25°) (Д16М)<br>21  | 0.073 (Д16Т)<br>0.044 (Д16М)                         | 0.22 (100°)<br>0.28 (350°)                | 30 (Д16Т)<br>50 (Д16М)              |
| Д19<br>10  | 2.78                          | 20.3<br>(20-100°)<br>25.2<br>(200-250°)              | 0.33 (100°) } Д19Т<br>0.41 (300°) } 22   | 0.0410<br>(Д19Т)                                     | 0.21 (100°)<br>0.25 (300°)<br>0.28 (400°) | -                                   |
| М40<br>11  | 2.75                          | 24.2<br>(20-100°)                                    | 0.29 (25°) } М40Т<br>0.34 (300°) }   | 0.0613<br>(М40Т)                                     | -   | -                                   |
| ВАД1<br>12 | 2.76                          | 24.6<br>(20-100°)<br>27.6<br>(20-400°)               | 0.28 (25°) } ВАД1Т<br>0.36 (300°) }  | 0.0594<br>(ВАД1Т)                                    | 0.21 (100°)<br>0.23 (300°)                | -                                   |

\*As % of the conductivity of copper.

1) Alloy; 2) g/cm<sup>3</sup>; 3) cal/cm·sec·°C; 4) ohm·mm<sup>2</sup>/m; 5) cal/g·°C; 6) specific conductivity\* (%); 7) АВ; 8) Д1; 9) Д16; 10) Д19; 11) М40; 12) ВАД1; 13) from; 14) to; 15) АВТ and АВТ1; 16) АВМ; 17) АВТ1; 18) Д1Т; 19) Д1М; 20) Д16Т; 21) Д16М; 22) Д19Т; 23) М40Т; 24) ВАД1Т.

Annealing can be carried out under two regimes: heating at 390-430°, cooling to 250-270° at no more than 30°/hr, and air-cooling. This regime ensures higher plasticity. The second regime involves heating at 350-370° and air-cooling.

Д16, Д19, ВАД1, and М40 alloys have satisfactory plasticity when annealed or freshly quenched. Д16 alloy has its highest hot plasticity at 350-450°. This alloy is subjected to postquenching annealing at 495-505°, water-cooling, natural aging for no less than 4 days, and artificial aging at 190° for 11-13 hr (for sheets) or 6-8 hr (for extruded articles). Sheets of Д16 and Д19 alloys cold-worked to 15-20% are artificially aged at 125-135° for 10-20 hr. The first annealing regime for

I-48a13

these alloys involves heating at 390-430°, cooling to 250-270° at no more than 30°/hr, and air-cooling; the second regime involves heating at 350-370° and air-cooling. The first annealing regime provides higher plasticity; before annealing cold-worked sheets they should be heated at 450-500°. It is recommended that semifinished products of D16 alloy which must function at 150° or which will undergo technological heating to this level be subjected to artificial aging. It is desirable that this operation be carried out at the consumer plant, so that all technological operations involving deformation of the material are executed before aging. When the semifinished products must not undergo deformation at the consumer plant artificial aging can be carried out at the producer plant. For quenching D19 alloy is heated to 500-515° (sheets), 495-505° (shapes) or 503-508° (wire), water-cooled, and naturally aged for no less than 5 days. Samples to be used for checking the mechanical properties of wire after quenching are aged at 100° for 3 hr.

M40 alloy has high plasticity when hot. This alloy is hot pressure-worked at 380-440°. The heat-treatment regime for semifinished products involves quenching from 500° and artificial aging at 150 ± 5° for 10 hr, at 175 ± 5° for 16-20 hr, or at 200-220° for 10-20 hr, depending on the type of product. Annealing to produce a soft material is carried out at 380-420°; the alloy is furnace-cooled to 270-280° and then air-cooled. The annealed alloy has satisfactory stampability, approximating that of D16 alloy. The quenched alloy is highly plastic, which permits cold-working of sheets to deformations of up to 50%. Natural aging does not strengthen the alloy, so that there is no limit on the interval between quenching and cold-working or artificial aging.

AV, D1, A16, D19, VAD1 and M40 alloys have satisfactory cuttability when naturally or artificially aged and reduced cuttability when annealed.

All these alloys can be satisfactorily cut by chemical means (regulated etching). If this process produces a rough surface the components must be subjected to additional surface treatment (e.g., cold hardening) to avoid a decrease in fatigue strength.

Applications. AV alloy is used for geometrically complex components of assemblages bearing moderate loads (aircraft-engine crankcases, geometrically complex tubes, helicopter rotors, framing, and doors). D1 alloy is used for medium-strength assemblages. The manufacture of semi-finished products from D1 alloy has been markedly reduced; D1 has been replaced by D16 for sheets and shapes, while AK6, V93, and corrosion-resistant alloys are used for forgings and stampings. D16 alloy is employed in tensile-stress zones in medium- and high-strength assemblages requiring a long service life under alternating stresses (replacing V95 alloy); D16 is also used for girders in structural assemblages not requiring high corrosion resistance, as well as for the skin, ribs, stringers, and longerons of aircraft. Massive round rods cannot be fabricated from D16 alloy; forging alloys of the appropriate strength are recommended for this purpose.

D16 (artificially aged), D19, VAD1, and M40 alloys are employed in assemblages which must function at temperatures of up to 250°.

References: Legkiye splavy. Metallovedeniye, termicheskaya obrabotka, lit'ye i obrabotka davleniyem [Light Alloys. Working, Heat Treatment, Casting, and Pressure Working], collection of articles, Moscow, 1958; Pavlov, S.Ye., Corroziya duralyumina [Corrosion of Duralumin], Moscow, 1949; Mekhanicheskiye svoystva nekotorykh konstruktsionnykh staley i splavoy pri komnatonoy i povyshennykh temperaturakh [Mechanical Properties of Certain Structural Steels and Alloys at Room and Elevated Temperatures], Moscow, 1957; Livanov, V.A., et al., Otzhig

I-48a15

listovogo al'kled [Annealing of Cast Alclad], Moscow, 1940; Voronov, S.M., Protsessy uprocheniya splavoy alyuminiy-magniy-kremniy i ikh novyye promyshlennyye kompozitsii [Hardening Processes for Aluminum-Magnesium-Silicon Alloys and the New Industrial Compositions of Such Alloys], Moscow, 1946; Stroitel'nyye konstruktsii iz alyuminiyevykh splavov [Structural Units of Aluminum Alloys], Collection of articles edited by S.V. Taranovskiy, Moscow, 1962.

I.N. Fridlyander and T.K. Ponar'ina

MEDIUM-STRENGTH CAST MAGNESIUM ALLOYS are magnesium alloys with ultimate strength  $\leq 16 \text{ kg/mm}^2$  which are intended for casting of shapes. These alloys include the high hermeticity ML3 alloy (GOST 2856-55) and the ML7-1 alloy (AMTU 488-63) which has high creep resistance at 150-200° (higher by 2-2.5 times in comparison with the ML5 alloy). Both alloys are based on the Mg - Al - Zn system and are not strengthened by heat treatment. Details of complex configuration are subjected to annealing at 325° for 5 hours to relieve internal stresses. According to the specifications the minimal guaranteed properties of the ML3 alloy are:  $\sigma_b = 16 \text{ kg/mm}^2$ ,  $\delta = 6\%$ ; for ML7-1  $\sigma_b = 16 \text{ kg/mm}^2$ ,  $\delta = 4\%$ . For chemical composition of the alloys see Magnesium Alloys, for the mechanical properties see Tables 1-3.

TABLE 1

Typical Mechanical Properties of Alloys at 20° (12-mm-diam specimens separately cast in sand mold, without heat treatment)

| № Сплав | E                     | G    | $\sigma_{0.2}$ | $\sigma_b$ | $\delta$ | $\psi$ | $\sigma_{-1}^2$         | $\tau_{cp}$ | $a_H$   | HB                    | $\sigma_{-1}^*$ |
|---------|-----------------------|------|----------------|------------|----------|--------|-------------------------|-------------|---|-----------------------|-----------------|
|         | (кг/мм <sup>2</sup> ) |      |                | 3          | (%)      |        | 3 (кг/мм <sup>2</sup> ) |             | $\left(\frac{\text{кг/мм}^2}{\text{см}^2}\right)$ | (кг/мм <sup>2</sup> ) | 3               |
| №.13    | 4200                  | 1800 | 5.5            | 18         | 8        | 12     | 25                      | 11          | 0.5   | 45                    | 5.5             |
| №.17-1  | 4000                  | 1550 | 7              | 18         | 6        | 8      | -                       | -           | 0.3   | 50                    | 5.5**           |

\*Determined in cantilever bending of rotating specimen on basis of  $2 \cdot 10^7$  cycles.

\*\*On notched specimens  $5 \text{ kg/mm}^2$ , notch radius 0.75 mm.

1) Alloy; 2)  $\tau_{sr}$ ; 3)  $(\text{kg/mm}^2)$ ; 4)  $(\text{kg/cm}^2)$ ; 5) ML .

II-14M1

TABLE 2

Typical Mechanical Properties of Alloys at Elevated Temperatures (10-mm-diam specimens separately cast in sand mold, without heat treatment)

| 1<br>Сплав | 2<br>Темп-ра (°C) | E    | $\sigma_{0.2}$ | $\sigma_b$ | $\delta_{10}$ | HВ | $\sigma_{0.2 \text{ 100 ч}}$<br>(по остаточной деформации) |
|------------|-------------------|------|----------------|------------|---------------|----|--|
|            |                   |      |                |            |               |    |  |
| МЛ3        | 100               | —    | 3              | 16.5       | 19            | 40 | 3.9  |
|            | 150               | —    | 4.5            | 14.5       | 11            | 35 | 3.5  |
|            | 200               | —    | 4              | 10.5       | 12            | 30 | 2.5  |
|            | 250               | —    | 3.7            | 7.5        | 12            | 24 | 1.8  |
| МЛ7-1      | 150               | 3300 | 8.5            | 15.5       | 6.5           | 30 | 5.5  |
|            | 200               | 3200 | 5              | 12.5       | 9             | 25 | 2.5  |
|            | 250               | 3000 | 5.5            | 10         | 12.5          | —  | —  |
|            | 300               | 3000 | 4              | 8          | 14            | —  | —  |

1) Alloy; 2) temperature; 3) (permanent deformation); 4) (kg/mm<sup>2</sup>); 5) ML.

TABLE 3

Mechanical Properties of ML7-1 Alloy at Low Temperatures (12-mm-diam specimens separately cast, without heat treatment)

| 1<br>Темп-ра (°C) | $\sigma_b$ | $S_b$ | $\delta_{10}$ | $\psi$ |
|-------------------|------------|-------|---------------|--------|
|                   |            |       |               |        |
| -40               | 19.5       | 21    | 6.5           | 7.5    |
| -70               | 19.5       | 20.5  | 5             | 5.5    |

1) Temperature; 2) (kg/mm<sup>2</sup>).

The stress-rupture limit of the ML7-1 alloy after 100 hours is 9 kg/mm<sup>2</sup> at 150° and 5.5 kg/mm<sup>2</sup> at 200°. The endurance limit at 200° is 3.5 kg/mm<sup>2</sup>.

Physical properties. Alloy ML3:  $\gamma = 1.78$ ;  $\alpha = 26.0 \cdot 10^{-6}$  (20 - 100°) 27.0 · 10<sup>-6</sup> (20 - 200°) 1/°C;  $c = 0.25$  (20 - 100°) cal/g-°C;  $\lambda = 0.25$  (20°) cal/cm-sec-°C; liquidus temperature 628°; solidus temperature 561°; linear shrinkage 1.6%. Alloy ML7-1  $\gamma = 1.76$ ;  $\alpha = 24.0 \cdot 10^{-6}$  (100 - 200°) 1/°C;  $c = 0.26$  (20 - 100°), 0.28 (200°), 0.30 (300°) cal/g-°C;  $\lambda = 0.19$  (20°), 0.21 (200°), 0.22 (300°), 0.23 (400°) cal/cm-sec-°C;  $\rho = 0.109$  (20°) ohm-mm<sup>2</sup>/m; liquidus temperature 645°; solidus temperature 505°.

II-1-M2

The ML3 and ML7-1 alloys have satisfactory corrosion resistance. For corrosion prevention the details are oxidized (see Oxidation of the Magnesium Alloys) and paint/lacquer coatings are applied (see Paint/Lacquer Coatings for the Magnesium Alloys). The ML3 alloy has low casting properties - high tendency to formation of hot cracks (in testing for hot brittleness the first crack is formed with a ring width of 42.5 mm, while for the ML5 alloy the width for the first crack is 30-35 mm), low fluidity (length of test rod for fluidity is 215 mm, while for the ML5 alloy it is 290-300 mm). Linear shrinkage is 1.4-1.6%. Casting density is good, the alloy has little tendency to formation of microporosity. The ML7-1 alloy has satisfactory casting properties: length of the fluidity test rod is 250 mm, the first crack is formed with a ring width of 32.5-37.5 mm in testing for hot brittleness. Linear shrinkage is 1.2-1.5%. Density and hermeticity of castings are somewhat higher than for the ML5 alloy. The ML3 and ML7-1 alloys are satisfactorily welded by argon-arc and oxyacetylene welding. The ML3 alloy is intended for casting details of simple configuration which require high hermeticity (pump housing parts, various gasoline and oil fittings, tanks etc.), it can also be used for casting details subject to impact loads. The maximal operating temperature of the ML3 alloy is not above 200°. The ML7-1 alloy is used for casting pump housings, details of oil accessories and engines operating for long periods in the temperature range from 150 to 200°.

References: see article Cast Magnesium Alloys.

N.M. Tikhova

III-01

MEDIUM STRENGTH TITANIUM SHAPING ALLOYS - alloys with an ultimate strength of not less than  $85 \text{ kg/mm}^2$ . Medium strength titanium shaping alloys have a specific strength of  $(18-19) \cdot 10^5 \text{ cm}$ , satisfactory creep strength at temperatures up to  $350-450^\circ$  and a high corrosion resistance. Medium strength titanium shaping alloys include the alloys: VT3, VT4, VT6, VT6S and OT4-2. These are  $\alpha$  titanium based alloys with a moderate amount of the  $\beta$  phase. The presence of  $\beta$  stabilizing elements substantially increases their strength at room and elevated temperatures without a perceptible drop in the plasticity. For the chemical composition see Titanium alloys.

Medium strength titanium shaping alloys are used for making forgings, stampings, bar stock, while the VT6, VT4, VT6S and OT4-2 alloys are used, in addition, for making sheets and strips.

For the assortment of forged and stamped semifinished products, as well as of pressed and rolled bar stock from medium strength titanium shaping alloys see Heat resistant titanium shaping alloys. The assortment of sheets from the VT6S, OT4-2, VT4 and VT6 alloys is determined by the AMTU 461-60, while the mechanical properties are specified in AMTu 476-61 (see Titanium sheet material).

The mechanical properties of forgings and stampings from medium strength titanium alloys are the same as for rolled and pressed bar stock. The mechanical properties of forgings and stampings in the annealed state are presented in Table 1.

Typical mechanical properties of alloys at various temperatures are given in Tables 2 and 3.



**TABLE 1**  
**Mechanical Properties of Forgings and Stampings from Medium Strength Titanium Shaping Alloys\***

| 1  | 2  |    | 3  |    | 4  |    | 5  |    | 6  |    |
|----|----|----|----|----|----|----|----|----|----|----|
|    | 7  | 8  | 9  | 10 | 11 | 12 | 13 | 14 | 15 | 16 |
| 1  | 10 | 10 | 10 | 10 | 10 | 10 | 10 | 10 | 10 | 10 |
| 2  | 10 | 10 | 10 | 10 | 10 | 10 | 10 | 10 | 10 | 10 |
| 3  | 10 | 10 | 10 | 10 | 10 | 10 | 10 | 10 | 10 | 10 |
| 4  | 10 | 10 | 10 | 10 | 10 | 10 | 10 | 10 | 10 | 10 |
| 5  | 10 | 10 | 10 | 10 | 10 | 10 | 10 | 10 | 10 | 10 |
| 6  | 10 | 10 | 10 | 10 | 10 | 10 | 10 | 10 | 10 | 10 |
| 7  | 10 | 10 | 10 | 10 | 10 | 10 | 10 | 10 | 10 | 10 |
| 8  | 10 | 10 | 10 | 10 | 10 | 10 | 10 | 10 | 10 | 10 |
| 9  | 10 | 10 | 10 | 10 | 10 | 10 | 10 | 10 | 10 | 10 |
| 10 | 10 | 10 | 10 | 10 | 10 | 10 | 10 | 10 | 10 | 10 |
| 11 | 10 | 10 | 10 | 10 | 10 | 10 | 10 | 10 | 10 | 10 |
| 12 | 10 | 10 | 10 | 10 | 10 | 10 | 10 | 10 | 10 | 10 |
| 13 | 10 | 10 | 10 | 10 | 10 | 10 | 10 | 10 | 10 | 10 |
| 14 | 10 | 10 | 10 | 10 | 10 | 10 | 10 | 10 | 10 | 10 |
| 15 | 10 | 10 | 10 | 10 | 10 | 10 | 10 | 10 | 10 | 10 |
| 16 | 10 | 10 | 10 | 10 | 10 | 10 | 10 | 10 | 10 | 10 |

\*As annealed.

1) Alloy; 2) TU; 3) (kg/mm<sup>2</sup>); 4) (% not less than); 5) (kg/cm<sup>2</sup>); 6) (d<sub>opt</sub>, mm); 7) VT; 8) AMTU; 9) VT6S; 10) STU.

**TABLE 2**  
**Mechanical Properties of Medium Strength Titanium Shaping Alloys at Various Temperatures**

| 1  | 2  |    | 3  |    | 4  |    | 5  |    | 6  |    | 7  |    | 8  |    | 9  |    | 10 |    | 11 |    |
|----|----|----|----|----|----|----|----|----|----|----|----|----|----|----|----|----|----|----|----|----|
|    | 12 | 13 | 14 | 15 | 16 | 17 | 18 | 19 | 20 | 21 | 22 | 23 | 24 | 25 | 26 | 27 | 28 | 29 | 30 | 31 |
| 1  | 10 | 10 | 10 | 10 | 10 | 10 | 10 | 10 | 10 | 10 | 10 | 10 | 10 | 10 | 10 | 10 | 10 | 10 | 10 | 10 |
| 2  | 10 | 10 | 10 | 10 | 10 | 10 | 10 | 10 | 10 | 10 | 10 | 10 | 10 | 10 | 10 | 10 | 10 | 10 | 10 | 10 |
| 3  | 10 | 10 | 10 | 10 | 10 | 10 | 10 | 10 | 10 | 10 | 10 | 10 | 10 | 10 | 10 | 10 | 10 | 10 | 10 | 10 |
| 4  | 10 | 10 | 10 | 10 | 10 | 10 | 10 | 10 | 10 | 10 | 10 | 10 | 10 | 10 | 10 | 10 | 10 | 10 | 10 | 10 |
| 5  | 10 | 10 | 10 | 10 | 10 | 10 | 10 | 10 | 10 | 10 | 10 | 10 | 10 | 10 | 10 | 10 | 10 | 10 | 10 | 10 |
| 6  | 10 | 10 | 10 | 10 | 10 | 10 | 10 | 10 | 10 | 10 | 10 | 10 | 10 | 10 | 10 | 10 | 10 | 10 | 10 | 10 |
| 7  | 10 | 10 | 10 | 10 | 10 | 10 | 10 | 10 | 10 | 10 | 10 | 10 | 10 | 10 | 10 | 10 | 10 | 10 | 10 | 10 |
| 8  | 10 | 10 | 10 | 10 | 10 | 10 | 10 | 10 | 10 | 10 | 10 | 10 | 10 | 10 | 10 | 10 | 10 | 10 | 10 | 10 |
| 9  | 10 | 10 | 10 | 10 | 10 | 10 | 10 | 10 | 10 | 10 | 10 | 10 | 10 | 10 | 10 | 10 | 10 | 10 | 10 | 10 |
| 10 | 10 | 10 | 10 | 10 | 10 | 10 | 10 | 10 | 10 | 10 | 10 | 10 | 10 | 10 | 10 | 10 | 10 | 10 | 10 | 10 |
| 11 | 10 | 10 | 10 | 10 | 10 | 10 | 10 | 10 | 10 | 10 | 10 | 10 | 10 | 10 | 10 | 10 | 10 | 10 | 10 | 10 |

\*For OT4-2 at 500° it comprises 34 kg/mm<sup>2</sup> when tested for 2·10<sup>7</sup> cycles.

1) Alloy; 2) (kg/mm<sup>2</sup>); 3) τ<sub>sr</sub> (kg/mm<sup>2</sup>); 4) α<sub>H</sub> (kg/cm<sup>2</sup>); 5) VT3 (bar stock, stampings); 6) VT4 (sheets); 7) VT6 (bar stock, forgings, stampings); 8) VT6 (sheets); 9) VT6S (sheets); 10) OT4-2 (bar stock, stampings, forgings); 11) OT4-2 (sheets).

**TABLE 3**  
**Creep Resistance (on the Basis of Residual Deformation of 0.2%) and Creep Strength of Medium Strength Titanium Shaping Alloys**

| 1  | 2  |    | 3  |    | 4  |    | 5  |    | 6  |    | 7  |    | 8  |    | 9  |    | 10 |    |
|----|----|----|----|----|----|----|----|----|----|----|----|----|----|----|----|----|----|----|
|    | 11 | 12 | 13 | 14 | 15 | 16 | 17 | 18 | 19 | 20 | 21 | 22 | 23 | 24 | 25 | 26 | 27 | 28 |
| 1  | 10 | 10 | 10 | 10 | 10 | 10 | 10 | 10 | 10 | 10 | 10 | 10 | 10 | 10 | 10 | 10 | 10 | 10 |
| 2  | 10 | 10 | 10 | 10 | 10 | 10 | 10 | 10 | 10 | 10 | 10 | 10 | 10 | 10 | 10 | 10 | 10 | 10 |
| 3  | 10 | 10 | 10 | 10 | 10 | 10 | 10 | 10 | 10 | 10 | 10 | 10 | 10 | 10 | 10 | 10 | 10 | 10 |
| 4  | 10 | 10 | 10 | 10 | 10 | 10 | 10 | 10 | 10 | 10 | 10 | 10 | 10 | 10 | 10 | 10 | 10 | 10 |
| 5  | 10 | 10 | 10 | 10 | 10 | 10 | 10 | 10 | 10 | 10 | 10 | 10 | 10 | 10 | 10 | 10 | 10 | 10 |
| 6  | 10 | 10 | 10 | 10 | 10 | 10 | 10 | 10 | 10 | 10 | 10 | 10 | 10 | 10 | 10 | 10 | 10 | 10 |
| 7  | 10 | 10 | 10 | 10 | 10 | 10 | 10 | 10 | 10 | 10 | 10 | 10 | 10 | 10 | 10 | 10 | 10 | 10 |
| 8  | 10 | 10 | 10 | 10 | 10 | 10 | 10 | 10 | 10 | 10 | 10 | 10 | 10 | 10 | 10 | 10 | 10 | 10 |
| 9  | 10 | 10 | 10 | 10 | 10 | 10 | 10 | 10 | 10 | 10 | 10 | 10 | 10 | 10 | 10 | 10 | 10 | 10 |
| 10 | 10 | 10 | 10 | 10 | 10 | 10 | 10 | 10 | 10 | 10 | 10 | 10 | 10 | 10 | 10 | 10 | 10 | 10 |

1) Alloy; 2) (kg/mm<sup>2</sup>); 3) VT3 (bar stock, stampings, strips); 4) VT4 (sheets); 5) VT6 (bar stock, forgings, stampings); 6) VT6 (sheets); 7) VT6S (sheets); 8) OT4-2 (sheets, bar stock, forgings, stampings).

The notch sensitivity in terms of  $\alpha_K$  for medium strength titanium shaping alloys does not become apparent for sufficiently high stress concentration factors ( $\alpha_K = 4.5-6.5$ ). The change in the dynamic and static moduli of elasticity is shown in the figure. The Poisson ratio

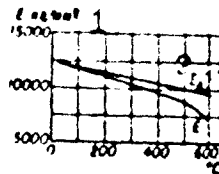

The moduli of elasticity of medium strength titanium shaping alloys as a function of the test temperature. 1) Kg/mm<sup>2</sup>; 2)  $\underline{d}$ .

for medium strength titanium shaping alloys comprises 0.32-0.34. The change in the ultimate strength of the alloys under momentary loads is presented in Table 4. Physical properties of medium-strength titanium shaping alloys. Specific gravity 4.46 (VT3), 4.43 (VT6), 4.60 (VT4), 4.45 (VT6S), 4.46 (OT4-2).  $\lambda$  for the VT6 alloy: 0.018(25°); 0.020(100°); 0.023 (200°); 0.027 (300°); 0.030 (400°); 0.033 (500°); 0.037(600°); 0.040 (700°); 0.044(800°) cal/cm·sec·°C; the thermal conductivity of the remaining medium strength titanium shaping alloys is close to the thermal conductivity of the VT6 alloy.  $\alpha \cdot 10^6$  for the VT6 alloy: 8.9 (20-100°); 9.6 (100-200°); 10.2 (200-300°); 10.8 (300-400°); 11.3 (400-500°); 12.7 (500-600°); 13.3 (600-700°) °C<sup>-1</sup>; the linear expansion coefficient of other titanium alloys of this group is close to that of the VT6 alloy;  $\underline{c}$  for the VT3 alloy: 0.11 (100°); 0.12 (200°); 0.13 (300°); 0.15 (400°); 0.16 (500°); 0.17 (600°); 0.19 (700°) cal/g·°C; the specific heat of the OT4-2 alloy is close to that of the VT3 alloy.  $\underline{c}$  for the VT6 alloy: 0.13 (100°); 0.14 (200°); 0.16 (300°); 0.17 (400°); 0.19 (500°); 0.21 (600°) cal/g·°C; the specific heat of the VT4 and VT6S alloys is close to that of the VT6 alloy.  $\rho$  at 20° for the VT3 alloy is 1.58 ohm·mm<sup>2</sup>/m, for the VT6 alloy it is 1.60, for the VT6S al-

loy is: is 1.42 ohm-cm/m. The emissivity of the VT6S alloy: 0.22 (100°); 0.22 (200°); 0.22 (300°); 0.23 (400°); 0.25 (500°); 0.30 (600°); 0.45 (700°); 0.53 (800°); 0.59 (900°).

TABLE 4

Change in the Ultimate Strength of Medium Strength Titanium Shaping Alloys under a Load

| Сплав<br>1 | Тем-па<br>(°C)<br>2 | Время под нагрузкой (сек.)<br>3           |     |      |
|------------|---------------------|---|-----|------|
|            |                     | 10  | 100 | 1000 |
|            |                     | σ <sub>в</sub> (кг/мм <sup>2</sup> )<br>4 |     |      |
| 5<br>VT4   | 600                 | 37  | 29  | 21   |
|            | 700                 | 30  | 20  | 17   |
|            | 800                 | 15  | 11  | 9    |
| 6<br>VT6S  | 600                 | 54  | 45  | 30   |
|            | 700                 | 31  | 26  | 20   |
|            | 800                 | 21  | 14  | 10   |
| OT4-2      | 600                 | 50  | 48  | 18   |
|            | 700                 | 38  | 22  | 15   |
|            | 800                 | 2*  | 10  | 6    |

1) Alloy; 2) temperature (°C); 3) time held under load (secs); 4) (kg/mm<sup>2</sup>); 5) VT4, 6) VT6S.

Medium strength titanium shaping alloys have a high corrosion resistance in the majority of aggressive media (see Titanium).

The VT3, VT4, VT6S and VT6 alloys have a good plasticity in the hot state, while the plasticity of the OT4-2 alloy is satisfactory.

For the processes of producing forgings, stampings, bar stock and other semifinished products from medium strength titanium shaping alloys see Heat resistant titanium shaping alloys. The temperature ranges for hot shaping of these alloys are: 1050-850° for VT3, 1100-850° for VT4, VT6, and VT6S, and 1150-900° for OT4-2.

Machining (turning, milling, drilling, etc.) of the VT3, VT6, VT4, VT6S and OT4-2 alloys is similar as that for stainless steels. The VT4, VT6S and OT4-2 alloys are satisfactorily welded by argon-shielded arc and resistance welding, as well as by molten slag arcless electric welding and by submerged arc welding. A filler from the VT1-1 alloy is

and is also recommended for welded joints. Arc-on-shielded arc welding must be followed by heat treatment to restore plasticity of the welded joint (annealing at 700-800°).

Heat treatment (annealing) of medium strength titanium shaping alloys is performed in order to increase the metal's plasticity after shaping and to improve the thermal stability, i.e., the capacity of an alloy to retain its mechanical properties after a prolonged effect of operating stresses and temperatures. The VT3, VT6 and VT6S alloys can be subjected to hardening heat treatment which consists of quench hardening and aging, however, it has not as yet come into extensive industrial use. For the heat treatment regimes for medium strength titanium shaping alloys see Heat treatment of titanium alloys.

The VT3 alloy is recommended for components and products operating at up to 350°, the VT6 and VT6S alloys are recommended up to 400°, while the VT4 and OT4-2 alloys can be used up to 450°. The VT3 and VT6 alloys are used for engine compressor blades and for other components, the OT4-2, VT4 and VT6S alloys are used for components and power elements of designs made by welding.

References: see at end of the article Titanium alloys.

S.G. Glazunov, V.N. Moiseyev and Yu.S. Danilov

Manu-  
script  
Page  
No.

[Transliterated Symbols]

2576 TV = TU = tekhnicheskiye usloviya = technical specifications  
2576 orn = otp = otpechatka = impression  
2576 cp = sr = srez = shear  
2577 n = d = dinamicheskiy = dynamic

MEDIUM-STRENGTH WROUGHT MAGNESIUM ALLOYS are magnesium alloys with ultimate strength of 23-26 kg/mm<sup>2</sup>. This group includes the low-alloy alloys of the Mg-Mn system: MA8 with small cerium addition, MA9 with small additions of aluminum and calcium, and the medium-alloy MA2 alloy of the Mg - Al - Zn - Mn system (for chemical composition see Magnesium Alloys).

Along with relatively high mechanical properties, these alloys have good processing plasticity which permits rolling sheet from them and production of all the other forms of wrought mill products. The MA8 alloy is used primarily for sheet, and the MA2 alloy is used primarily for stampings of complex shape. The MA9 alloy can be used for the production of sheet and extruded mill products. The mechanical properties of the medium-strength wrought magnesium alloys are presented in Tables 1-6.

TABLE 1

Typical Mechanical Properties of Mill Products Made From the Medium-Strength Wrought Magnesium Alloys at 20°

| 1    | 2                          | 3                    | σ <sub>0.2</sub>      | σ <sub>b</sub> | δ <sub>5</sub> |
|------|----------------------------|----------------------|-----------------------|----------------|----------------|
| Сила | Вид полуфабриката          | Состояние материала  | (кг/мм <sup>2</sup> ) | (%)            | (%)            |
| MA2  | 5 Прутки                   | 6 Горячепрессованные | 17                    | 27             | 10             |
|      | 7 Листы                    | 8 Листы штамповки    | 17                    | 26             | 12             |
|      | 9 Листы                    | 10 Отожженные        | 15                    | 25             | 18             |
| MA8  | 11 Листы (поперек волокон) | 10 Отожженные        | 18                    | 25             | 18             |
|      | 12 Листы (вдоль волокон)   | 13 То же             | 20                    | 27             | 11             |
|      | 11 Листы (поперек волокон) | 14 Полунагарто-      | 19                    | 27             | 15             |
|      | 12 Листы (вдоль волокон)   | 13 То же             | 21                    | 29             | 8              |
|      | 5 Прутки                   | 6 Горячепрессованные | 15                    | 26             | 7              |
| MA9  | 9 Листы                    | 10 Отожженные        | 18                    | 27             | 15             |
|      | 5 Прутки                   | 6 Горячепрессованные | 24                    | 27             | 10             |

1) Alloy; 2) from of mill product; 3) material condition; 4) (kg/mm<sup>2</sup>);

1) rods; 2) hot extruded; 3) forgings and stampings; 4) after stamping; 5) sheet; 6) annealed; 7) sheet (across the fiber); 8) sheet (along the fiber); 9) same; 10) half-strain-hardened.

The minimal mechanical properties guaranteed by the specifications are lower than the typical properties by 7-10% for the ultimate, by 10-15% for the yield and by 1.5-2 times for the elongation.

At 20° for the MA2 alloy (hot extruded rod):  $E = 4300 \text{ kg/mm}^2$ ,  $\mu = 0.34$  (for forgings and stampings as well),  $\sigma_{\text{pts}} = 8 \text{ kg/mm}^2$ ,  $S_k = 38 \text{ kg/mm}^2$ ,  $\psi = 30\%$ ; for the MA8 alloy (annealed sheet):  $E = 4100 \text{ kg/mm}^2$ ,  $\mu = 0.34$ ,  $S_k = 30 \text{ kg/mm}^2$ ,  $\psi = 28\%$ ; for the MA9 alloy (annealed sheet):  $E = 4200 \text{ kg/mm}^2$ ,  $\sigma_{\text{pts}} = 10 \text{ kg/mm}^2$  and  $\psi = 11\%$  (hot-extruded rods).

The mechanical properties of the wrought mill products made from the medium-strength wrought magnesium alloys depend on the direction of deformation. For example, in the MA2 and MA8 alloy sheet, depending on the direction of rolling, the ultimate strength may vary by 1-2  $\text{kg/mm}^2$  (3-5%), the yield point by 2-3  $\text{kg/mm}^2$  (10-20%) and the relative elongation by a factor of 1.5-2 times. The relationship of the mechanical properties depends on the rolling scheme. With rolling in one direction the highest properties will be in the cross direction of the sheet, while with rolling in different directions (turning of the sheet) the higher properties will be in the direction perpendicular to the rolling direction with the higher reduction.

The medium-strength wrought magnesium alloys are not notch sensitive in axial tension ( $\sigma_b^n / \sigma_b = 1$ , while with oblique tension their notch sensitivity is about the same as for the medium-strength aluminum alloys. Thus, for example, notched specimens from the MA2 alloy in tension tests with obliquity of 4° show a loss of ultimate of 10-15%, while with an obliquity of 8° the loss is 30-40%.

TABLE 2  
Mechanical Properties of Medium-Strength Wrought Magnesium Alloys for Different Forms of Testing at 20°\*

| 1<br>Сплав | 2<br>Вид полуфабриката | 3 Сжатие         |                  |                  | 4 Кручение       |                  | 5 Срез | 6<br>σ <sub>H</sub> (кг/мм <sup>2</sup> ) | 7<br>σ <sub>0.2</sub> на базе 5 · 10 <sup>7</sup> циклов (кг/мм <sup>2</sup> ) |
|------------|------------------------|------------------|------------------|------------------|------------------|------------------|--------|---|--|
|            |                        | σ <sub>0.2</sub> | σ <sub>0.1</sub> | σ <sub>1.2</sub> | τ <sub>0.2</sub> | τ <sub>0.1</sub> |        |   |  |
| MA2        | Прутки                 | 11               | 40               | 36               | 6                | 10               | 16     | 1.2                                       | 10   |
| MA8        | Полосы                 | —                | —                | —                | 6                | 10               | 15     | 1.0                                       | 8  |
| MA9        | Прутки                 | —                | 34               | —                | —                | —                | —      | 0.8                                       | —  |

\*Rods and strips in the hot-pressed condition

1) Alloy; 2) form of mill product; 3) compression; 4) torsion; 5) shear; 6) (kg-m/cm<sup>2</sup>); 7) on the basis of 5 · 10<sup>7</sup> cycles (kg/mm<sup>2</sup>); 8) (kg/mm<sup>2</sup>); 9) rods; 10) strips.

TABLE 3  
Mechanical Properties of MA2 and MA8 Alloys at Low Temperatures

| 1<br>Тем-ра (°C) | 2 MA2 (пруток диа-метр 80 мм) |                  |                  |                  |     |                | 3 MA8-M (лист толщиной 1,2 мм)            |                  |                  |                    |                  |  |
|------------------|-------------------------------|------------------|------------------|------------------|-----|----------------|---|------------------|------------------|--------------------|------------------|--|
|                  | σ <sub>к</sub>                |                  | σ <sub>л</sub>   |                  | φ   | δ <sub>к</sub> | 7<br>σ <sub>H</sub> (кг/мм <sup>2</sup> ) | 4 вдоль прокатки |                  | 5 поперек прокатки |                  |  |
|                  | σ <sub>0.2</sub>              | σ <sub>0.1</sub> | σ <sub>0.2</sub> | σ <sub>0.1</sub> |     |                |   | σ <sub>0.2</sub> | σ <sub>0.1</sub> | σ <sub>0.2</sub>   | σ <sub>0.1</sub> |  |
| -40              | 30                            | 37               | 20               | 14               | 0.9 | 32             | 10  | 29               | 15               |                    |                  |  |
| -70              | 31                            | 38               | 18               | 13               | 0.7 | 33             | 9   | 30               | 13               |                    |                  |  |

1) Temperature; 2) MA2 (80-mm-diam rods); 3) MA8-M (1.2-mm-thick sheet); 4) along direction of rolling; 5) across direction of rolling; 6) (kg/mm<sup>2</sup>); 7) (kg-m/cm<sup>2</sup>).

The creep limits of extruded rods for permanent deformation of 0.2% for the medium-strength wrought magnesium alloys are the following:

for the MA2 alloy at 100° σ<sub>0.2/200</sub> = 6.7 kg/mm<sup>2</sup>; at 150° σ<sub>0.2/200</sub> = 1.2 kg/mm<sup>2</sup>; for the MA9 alloy at 200° σ<sub>0.2/100</sub> = 2.5 kg/mm<sup>2</sup>, at 250° σ<sub>0.2/100</sub> = 1.3 kg/mm<sup>2</sup>.

Physical properties of the medium strength wrought magnesium alloys. Alloy MA2: γ = 1.78; α = 26 · 10<sup>-6</sup> (20 - 100°), 27.8 · 10<sup>-6</sup> (100 - 200°), 29.5 · 10<sup>-6</sup> (200 - 300°) 1/°C; λ = 0.23 (20°), 0.25 (200°), 0.26 (300°) cal/cm-sec-°C; ρ = 0.10 (20°) ohm-mm<sup>2</sup>/m; c = 0.27 (100°), 0.28 (200°), 0.29 (300°) cal/g-°C; latent heat of fusion is about 70 cal/g.

Alloy MA8: γ = 1.78; α = 23.7 · 10<sup>-6</sup> (20 - 100°), 26.1 · 10<sup>-6</sup> (100 - 200°), 32 · 10<sup>-6</sup> (200 - 300°) 1/°C; λ = 0.32 (200°) cal/cm-sec-°C; ρ = 0.051 (20°) ohm-mm<sup>2</sup>/m. Alloy MA9: γ = 1.77; α = 25.5 · 10<sup>-6</sup> (20 - 100°), 28.7 · 10<sup>-6</sup> (100 - 200°), 32.3 · 10<sup>-6</sup> (200 - 300°) 1/°C; λ = 0.35 (20°), 0.33 (200°), 0.32 (300°) cal/cm-sec-°C.

II-100

TABLE 4

Mechanical Properties of Rods Extruded from the Medium-Strength Magnesium Alloys at Elevated Temperatures

| 1<br>Temp-ra (°C) | MA2                          |   |   |                          | MA8   |   |                          | MA9   |                           |  |
|-------------------|------------------------------|---|---|--------------------------|---|---|--------------------------|---|---------------------------|--|
|                   | 2<br>E (kg/mm <sup>2</sup> ) | 3<br>σ <sub>0.2</sub> (kg/mm <sup>2</sup> ) | 4<br>σ <sub>0.1</sub> (kg/mm <sup>2</sup> ) | 5<br>δ <sub>10</sub> (%) | 6<br>σ <sub>0.2</sub> (kg/mm <sup>2</sup> ) | 7<br>σ <sub>0.1</sub> (kg/mm <sup>2</sup> ) | 8<br>δ <sub>10</sub> (%) | 9<br>σ <sub>0.2</sub> (kg/mm <sup>2</sup> ) | 10<br>δ <sub>10</sub> (%) |  |
|                   |                              |   |   |                          |   |   |                          |   |                           | 11<br>σ <sub>0.1</sub> (kg/mm <sup>2</sup> ) |
| 100               | 3600                         | 0.39  | 21  | 11.5                     | 25  | —   | —                        | 20  | 16                        | —  |
| 125               | 3300                         | 0.44  | 18.5  | 9.5                      | 33  | —   | —                        | 18  | 13                        | —  |
| 150               | —                            | —   | —   | —                        | —   | 15  | 8                        | 30  | 18                        | 7  |
| 200               | —                            | —   | —   | —                        | —   | 13  | 7                        | 31  | 15                        | 12   |
| 250               | —                            | —   | —   | —                        | —   | 11  | 6                        | 36  | 12                        | 5  |

1) Temperature; 2) kg/mm<sup>2</sup>.

TABLE 5

Mechanical Properties at Elevated Temperatures of Sheet Made From the Medium-Strength Magnesium Alloys, Annealed at 250° for 30 Minutes

| 1<br>Temp-ra (°C) | MA8   |   |                          | MA9   |   |                          |
|-------------------|---|---|--------------------------|---|---|--------------------------|
|                   | 2<br>поперек прокатки                       |   |                          | 3<br>вдоль прокатки                         |   |                          |
|                   | 4<br>σ <sub>0.2</sub> (kg/mm <sup>2</sup> ) | 5<br>σ <sub>0.1</sub> (kg/mm <sup>2</sup> ) | 6<br>δ <sub>10</sub> (%) | 7<br>σ <sub>0.2</sub> (kg/mm <sup>2</sup> ) | 8<br>σ <sub>0.1</sub> (kg/mm <sup>2</sup> ) | 9<br>δ <sub>10</sub> (%) |
| 100               | 20  | 11  | 28                       | 21  | 16  | 11                       |
| 150               | 16  | 8   | 32                       | 19  | 15  | 13                       |
| 200               | 14  | 7   | 34                       | 16  | 8   | 17                       |
| 250               | 12  | 6   | 36                       | 13  | 5   | 18                       |

1) Temperature; 2) across rolling direction; 3) along rolling direction; 4) (kg/mm<sup>2</sup>).

The medium-strength wrought magnesium alloys have satisfactory general corrosion resistance. The MA8 and MA9 alloys are not subject to stress corrosion, while the MA2 alloy has a slight tendency to stress corrosion cracking which does not limit its use. Protection from corrosion is provided by inorganic films and paint coatings (see Protection of Magnesium Alloys, Corrosion of Magnesium Alloys).

The medium-strength wrought magnesium alloys are not strengthened by heat treatment. Extruded mill products and stampings are delivered without annealing, while sheet made from the MA8 alloy is delivered annealed at 350 ± 10° for 30 minutes in the MA8-M designation or half-strain-hardened in the MA8-H temper. In the latter case the sheets are subjected to annealing at a temperature of 240 ± 10° for 30 minutes and partially retain the strengthening obtained as a result of rolling (Table 7).



II-9M4

TABLE 6

Stress-Rupture Limits (100 hours) for MA8 and MA9 Alloys

| Сплав<br>1 | 2 Вид полуфабриката                             | 3 Состояние материала   | 4 $\sigma_{100}$ (кг/мм <sup>2</sup> ) при темп-рах |      |      |      |
|------------|---|---|---|------|------|------|
|            |   |   | 100°  | 150° | 200° | 250° |
| MA8        | 5 Прутки Ø 25 мм                                | 6 Горячепрессованный<br>8 Отожженный при 350° в течение 30 мин. | 14  | 12   | 7.5  | 3.5  |
|            | 7 Лист толщиной 1.5 мм (поперечное направление) |   | 13  | 11   | 5    | 2    |
| MA9        | 5 Прутки Ø 25 мм                                | 6 Горячепрессованный  | —   | 10   | 7    | 5    |

1) Alloy; 2) form of mill product; 3) material condition; 4) (kg/mm<sup>2</sup>) at temperatures of: 5) 25-mm-diam rods; 6) hot extruded; 7) 1.5-mm-thick sheet (across rolling direction); 8) annealed at 350° for 30 minutes.

TABLE 7

Working Regimes for the Medium-Strength Wrought Magnesium Alloys

| Сплав<br>1 | 2 Темп-ра (°C)  |                    | 3 Режим отжига |                     |
|------------|-----------------|--------------------|----------------|---------------------|
|            | 4 Литье слитков | 5 обраб. давлением | темп-ра 2 (°C) | длительность (час.) |
| MA2        | 670-750         | 230-420            | 350-400        | 3-5                 |
| MA8        | 680-750         | 250-450            | 300-400        | 0.5-2               |
| MA9        | 680-750         | 250-450            | 300-400        | 0.5-2               |

1) Alloy; 2) temperature; 3) annealing condition; 4) ingot casting; 5) pressure working; 6) duration (hours).

The processing plasticity of the alloys in the pressure working temperature range is high, at room temperature it is low. Rolling of sheet and sheet stamping are performed in the hot condition. With certain limitations the MA2 alloy can be freely hammer forged and stamped. Sheets made from the MA8 alloy are amenable to the various stamping operations. The medium-strength wrought

magnesium alloys can be satisfactorily argon-arc and electric-resistant welded. In comparison with the alloys MA2 and MA8, the MA9 alloy has less satisfactory weldability because of the presence of calcium in its composition. The medium-strength wrought magnesium alloys machine well.

The minimal bend radii of sheet made from the MA8 alloy as a function of temperature with degree of bend 120° are: at 20° (4 - 5) S, at 100° (3.5 - 4) S, at 200° (2 - 2.5) S, and at 300° (1 - 2) S (S is the material thickness). The limiting draw coefficient of annealed sheet made from the MA 8 alloy is: first draw 3.2-3.4, second draw 2.2-2.4. For the half-strain-hardened sheets the first draw coefficient is 2.6-

II-9M5

-2.8 and the second draw coefficient is 2.3-2.5. The specific squeezing force with drawing under conditions of optimal temperature is from 3.5 to 5.5 kg/cm<sup>2</sup>. The limiting flanging coefficient for sheets of thickness from 1 to 3 mm is from 2.5 to 2.94 respectively.

The MA2 alloy is used for medium loaded details of complex form fabricated by forging and stamping; sheet made from the MA8 alloy is used for instrument cases, gasoline and oil tank trucks, diaphragms and reservoirs; stampings, profiles and tubing are used for details of fittings for gasoline and oil lines. The MA9 alloy is intended for the same purposes. Details made from the MA2 alloy can operate at temperatures up to 150°, those made from the MA8 and MA9 alloys can operate to 200-250°.

References: see article Wrought Magnesium Alloys.

A.A. Kazakov

MELAMINE MOLDING MATERIALS are molding compositions based on pure or modified melamine-formaldehyde resin and organic (cellulose sulfite cotton cellulose (linter)) or mineral (asbestos of various grades with addition of mica, quartz flour, talc, etc.) fillers. A combination of both fillers is possible. Melamine molding materials of various grades are produced for the manufacture of products for engineering and household applications.

Melalite (K-79-79) is a molding material based on melamine-formaldehyde resin with cellulose sulfite with additions of titanium dioxide, zinc stearate and dyes. Melalite is a fine powder which is formed into products by compression molding at  $155 \pm 5^\circ$ , with a specific pressure of  $105-420 \text{ kg/cm}^2$  for a time of no less than 1 minute per 1 mm thickness. Tableting and high-frequency heating prior to molding are recommended. Products made from melalite may be operated in the temperature range from  $-30^\circ$  to  $+100^\circ$ , they are resistant to detergents, hot water, weak acids. They withstand long-term operation. Melalite is used in products for the food industry, for electrical apparatus chassis (telephones, sockets), for consumer goods.

Melavoloknite is a molding material based on modified melamine-formaldehyde resin and linter with the additions of calcium stearate, lithopone and a dye. It is prepared by mixing the compounds in a blade mixer with subsequent drying. The external appearance of the finished mass is that of stiff tangled fibers. It is transformed into products by compression molding at  $155 \pm 5^\circ$ , with a specific pressure of  $300-600 \text{ kg/cm}^2$ , with time in the press of 1 minute/mm. Tableting is not recom-

II-68M1

mended for the processing, high frequency heating is recommended. Melavoloknite resists the action of weak acid solutions, boiling water, live steam. It is used for the production of items for engineering use operating in bending, torsion, tension, compression under conditions of temperatures of 110-130° and high humidity. In particular, melavoloknite is used in the textile industry for the production of reels for winding and steaming of Kapron, silk and other high quality fiber materials using live steam.

Arc Resistant Melamine Formaldehyde Molding Materials (MFK-20, K-78-51, VEI-11, VEI-12) are produced on the basis of modified melamine-formaldehyde resins and a mineral filler - fibrous asbestos with additions of talc, linter, lubricating substances (oleic acid) and a dye. In the production process there is one additional stage (in comparison with melalite and melavoloknite) - mixing on rollers after leaving the mixer. The finished material has the appearance of small scales. Tableting and preheating are not used. The MFK-20, VEI-12, K-78-51 melamine molding materials are transformed into products by hot molding at 130-180°, with a specific pressure of 250-600 kg/cm<sup>2</sup>, time in the press is 1-10 minutes/mm. Items made from VEI-11 are formed by cold molding at 20 ± 10°, specific pressure 600-1200 kg/cm<sup>2</sup>, time in press 2-3 minutes, after which solidification of the molded items proceeds using the following regime: four hours at 65 - 75° - 4 heat at 140 ± 5° for two hours and hold at this temperature for 4-5 hours. The molding material is used for the fabrication of arc extinguisher chambers (MFK-20), mining equipment and other items for engineering use which have high requirements with respect to mechanical and dielectric properties. The characteristics of the melamine molding compositions are given in the table.

V.N. Gorbunov, V.Z. Mayevskaya

II-68M2

Characteristics of Melamine Molding Materials

| 1 Понятия   | 2 Мелалит                          | 3 Мелаволокнит                     | 4 МФК-20, К-78-51, ВЭИ-11, ВЭИ-12 |
|---|------------------------------------|------------------------------------|-----------------------------------|
| 3 Уд. вес   | 1.45                               | 1.45                               | 1.6-1.9                           |
| 6 Уд. ударная вязкость (кг-см/см <sup>2</sup> , не менее) | 3.0                                | 9.0                                | 1.7-10                            |
| 7 Предел прочности (кг/см <sup>2</sup> ):                 |                                    |                                    |                                   |
| 8 при сжатии  | 2000-3000                          | 2000-3500                          | 1200-1500                         |
| 9 при растяжении  | 350-600                            | 400-650                            | 300-400                           |
| 10 при изгибе   | 600-700                            | 600-800                            | 200-300                           |
| 11 Модуль упругости при растяжении (кг/см <sup>2</sup> )  | 77300-75000                        | 70000-75000                        | -                                 |
| 12 Твердость по Бринеллю (кг/мм <sup>2</sup> )            | 35-40                              | 33-40                              | 20-25 14                          |
| 13 Теплостойкость по Мартенсу (°C)                        | 130-150                            | 140-160                            | Не менее 150                      |
| 15 Теплоемкость (ккал/кг-град)                            | 0.3-0.4                            | 0.3-0.4                            | -                                 |
| 16 Теплопроводность (ккал/час-м-град)                     | 0.23-0.30                          | 0.23-0.30                          | -                                 |
| 17 Влагопоглощение (г/дм <sup>3</sup> )                   | 0.10-0.50                          | 0.10-0.50                          | -                                 |
| 18 Уд. объемное сопротивление (ам-см, не менее)           | 10 <sup>11</sup> -10 <sup>10</sup> | 10 <sup>11</sup> -10 <sup>10</sup> | 10 <sup>11</sup>                  |
| 19 Электрич. прочность (кв/мм)                            | 12-18                              | 12-18                              | 2-12                              |
| 20 Содержание летучих (%)                                 | 2.8-3.0                            | 1.7-2.0                            | 1.5-4.0                           |
| 21 Текучесть по Рашигу (мм)                               | 90-180                             | 60-110                             | 60-160                            |

1) Characteristics; 2) melalite; 3) melavoloknite; 4) МФК-20, К-78-51, ВЭИ-11, ВЭИ-12; 5) specific weight; 6) specific impact strength (kg-cm/cm<sup>2</sup>, no less than); 7) Ultimate strength (kg/cm<sup>2</sup>); 8) in compression; 9) in tension; 10) in bending; 11) elastic modulus in tension (kg/cm<sup>2</sup>); 12) brinnell hardness (kg/mm<sup>2</sup>); 13) martens thermal stability (°C); 14) no less than; 15) heat content (kcal/kg-deg); 16) thermal conductivity (kcal/hr-m-deg); 17) water absorption (g/dm<sup>2</sup>); 18) volumetric resistivity (ohm-cm, no less than); 19) electrical strength (kv/mm<sup>2</sup>); 20) volatile content (%); 21) raschig viscosity (mm).

MELCHIOR are binary and more complex nickel alloys containing 18-30% Cu. Two grades of melchior are produced in accordance with GOST 492-52: MNZhMts 30-0.8-1.0 (29.0 - 30.0% Ni, 0.6 - 1.0% Fe, 0.8 - 1.3% Mn, remainder copper), and MN19 (18.0 - 20.0% Ni, remainder copper). The structure of the melchior-type alloys is a solid solution, therefore, they are easily worked in the cold and hot conditions. Melchior is marked by high corrosion resistance in fresh and sea water, dry gases, and also in atmospheric conditions. The corrosion resistance and the strength both increase with increase of the nickel content. Melchior of the MNZhMts 30-0.8-1.0 grade is very stable in a steam condensate medium and surpasses all known alloys in resistance to the action of impact (turbulent) corrosion, therefore, it is used for condenser tubes of marine vessels operating in particularly severe conditions. The melchior is stable in alkaline solutions of salts and organic compounds. Melchior of the MN19 type is used for production of coins, precision mechanical parts, medical tools, sieves, tableware and other products. Melchior of the MNZhMts 30-0.8-1.0 type is used for tubing (GOST 10092-62), MN19 is used to produce band (GOST 5063-49) and strip (GOST 5187-49 and GOST 1018-54).

Table 1 presents the physical, mechanical and technological properties of melchior, and Table 2 presents the mechanical properties of mill products made from melchior.

II-69M1

TABLE 1

Physical, Mechanical and Technological Properties of Melchiro

| 1 Сплав               | 2 $\gamma$ (g/cm <sup>3</sup> ) | 3 $\rho \cdot 10^3$ (1/°C) | 3 $\rho$ (ohm·mm <sup>2</sup> /m) | 4 Температурный коэфф. электро-сопротивл. при 20° | 5 c (кал/см·сек·°C) | 6 E (кг/мм <sup>2</sup> ) | 8 $\sigma_b$ / $\delta$ (%) |       | 7 Темпер (°C) |                  |         |
|-----------------------|---------------------------------|----------------------------|-----------------------------------|---|---------------------|---------------------------|-----------------------------|-------|---------------|------------------|---------|
|                       |                                 |                            |                                   |   |                     |                           | 8 мягкое состояние          | 8 (%) | 9 плавления   | 10 горяч. обраб. | 11 отж. |
| 12 MN19               | 8.8                             | 16                         | 0.287                             | 0.0003  | 0.092               | 14000                     | 38                          | 35    | 1190          | 800-1020         | 800-780 |
| 13 MNZnMts 30-0,8-1.0 | 8.8                             | 18                         | 0.42                              | 0.0012  | 0.089               | 14300                     | 40                          | 28    | 1230          | 850-860          | 730-810 |

1) Alloy; 2)  $\gamma$  (g/cm<sup>3</sup>); 3)  $\rho$  (ohm·mm<sup>2</sup>/m); 4) temperature coefficient of resistance at 20°; 5) c (cal/cm·sec·°C); 6) E (kg/mm<sup>2</sup>); 7) temperature (°C); 8) soft condition; 9) melting; 10) hot working; 11) annealing; 12) MN19; 13) MNZnMts.

TABLE 2

Mechanical Properties of Melchior Mill Products

| 1 Сплав               | 2 Полуфабрикаты                                  | 3 ГОСТ, тех. усл. | 4 $\sigma_b$ (кг/мм <sup>2</sup> ) | 5 $\delta$ (%) |
|-----------------------|--|-------------------|------------------------------------|----------------|
| 8 MN19                | Полосы 6 твердые 8 мягкие 9                      | ГОСТ 5053-49      | 40                                 | 3              |
|                       |  | 7                 | 30                                 | 30             |
|                       | Ленты 10 мягкие 8 твердые 9 мягкие 9             | ГОСТ 3187-49      | 30                                 | 25             |
|                       |  | 7                 | 40                                 | 2.5            |
| 11 MNZnMts 30-0,8-1.0 | Трубы 12 конденсаторные 82 мягкие 13 полутвердые | ГОСТ 1018-54      | 30-28                              | 32             |
|                       |  | 7                 |                                    |                |
|                       |  | ГОСТ 10082-54     | 38                                 | 25             |
|                       |  | 13                | 50                                 | 10             |

1) Alloy; 2) mill product; 3) GOST, specifications; 4)  $\sigma_b$  (kg/mm<sup>2</sup>); 5) MN19; 6) bands; 7) GOST; 8) hard; 9) soft; 10) strips; 11) MNZnMts; 12) condenser tubes; 13) half-hard.

Reference: Smiryagin A. P., Promyshlennyye tsvetnyye metally i splavy (Industrial Nonferrous Metals and Alloys), 2nd edition, M., 1956.

Ye. S. Shpichinetskiy

II-71M

MERINOVA - see Albumin Fiber.



MESNAGER SPECIMEN is a specimen used for impact strength testing of materials, having a square section ( $10 \times 10 \text{ mm}^2$ ) with a notch on one side (specimen shape in accordance with GOST 9454-60). Specimens of smaller section may be used for comparative tests:  $10 \times 5 \text{ mm}^2$  and  $5 \times 5 \text{ mm}^2$ . Impact strength is determined abroad using Charpy specimens, differing from the Mesnager specimen in section and sharpness of the notch.

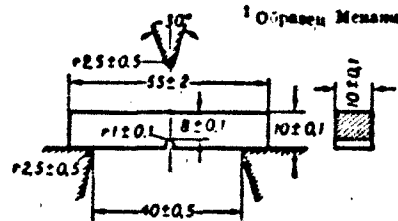

1) Mesnager Specimen

N. V. Kadobnov

I-61v

METALALGINATE FIBER - see Alginate Fiber.

METAL - CERAMIC MATERIALS (cermets) - is a class of sintered materials which are a homogeneous composition of metal and ceramic. The idea of fastening one material by combining it with another is realized in cermets in the same way as in reinforced concrete. A high chemical and thermomechanical stability is the characteristic feature of cermets. High-refractory oxides and compounds (carbides, borides, nitrides, silicides, etc.) being components of the cermet, impart to it a high inoxidability and strength at high temperatures, and the metals - a high heat endurance. The type of the interaction between the components of the cermet, depending for its part on the structure of the oxide films formed on the surfaces of the grains of the metal or the high-melting alloys, is one of the basic factors which determine the properties of the cermet. A solid solution is formed if the oxide films are isomorphous with the oxide, otherwise, this joint is a pure mechanical one and of less strength. Cermets are used in jet-propulsion engineering, in abrasion-resistant structural parts and in other fields where a combination of a high refractoriness with a high strength is required.

Cermets on basis of metals of the iron group (Fe, Co, Ni, Cr, etc.) and oxides ( $\text{Al}_2\text{O}_3$ ,  $\text{ZrO}_2$ ,  $\text{BeO}$ , etc.) are the most widespread.

4 types of metal-ceramics compositions are possible: 1)  $\text{Al}_2\text{O}_3$ -Cr; 2)  $\text{Al}_2\text{O}_3$ -Fe; 3) graphite-Cu; and 4) compositions with addition of a third component which serves as a binder.

The most stable compositions are obtained using metals whose oxides are related (with regard to the form and the lattice constants) with the oxides of the ceramic component, forming with the latter continuous

I-55K1

series of solid solutions.  $Al_2O_3$ -Cr;  $MgO$ -Ni;  $Al_2O_3$ -Ti, etc., are examples of such compositions. Apart from this, the coefficients of the thermal expansion of the components have a great influence on the formation of a strong joint between the components; their values must be similar together. Special high-temperature furnaces with a controlled gas atmosphere are necessary for the production of cermets. A reducing atmosphere is obtained in them by means of hydrogen, a neutral one by means of argon, nitrogen, or helium. Data, characterizing the thermomechanical properties of cermets composed from 50%  $MgO$ , 30% TiN, and 20% Ni are quoted in Table 1.

TABLE 1  
Thermomechanical Properties of Cermets

| 1<br>Темп-ра<br>(°C) | 2<br>Количество циклов нагрева и (охлаждения) при 1120° в течение 10 мин; охлаждения в течение 5 мин в струе воздуха под давлением | 3<br>Прочность при изгибе<br>(кг/см <sup>2</sup> ) |
|----------------------|--|--|
| 45                   | —  | 1670   |
| 430                  | —  | 1430   |
| 1000                 | —  | 1480   |
| 1120                 | —  | 2180   |
| 1310                 | —  | 2220   |
| 45                   | До испытания . . . . . 4   | 1670   |
| 45                   | После 2 циклов . . . . . 5   | 2070   |
| 45                   | После 8 циклов . . . . . 5   | 1800   |

1) Temperature (°C); 2) number of thermal-shock cycles (heating at 1120° for 10 min; cooling in a current of compressed air for 5 min); 3) ultimate bending strength (kg/cm<sup>2</sup>); 4) before the test; 5) after ... cycles.

The increased strength of cermets after heating is due to the disappearance of surface defects. The properties of cermets composed from 30% Cr and 70%  $Al_2O_3$ , and from 80% TiC and 20% Cr are quoted in Table 2.

Cermets with the composition 30% Cr and 70%  $Al_2O_3$  are excellently resistant to oxidation up to 1520° and well resistant to thermal shocks;

I-55K2

cermets with the composition 70% Cr and 30% Al<sub>2</sub>O<sub>3</sub> have a tensile strength of 1225 at 980°; 490 at 1200°, and 210 kg/cm<sup>2</sup> at 1315°; c with the composition of 72% Cr and 28% Al<sub>2</sub>O<sub>3</sub> stand 540-620 cycles of the thermal shock test at 1000°; cermets of the composition 85% chromium boride and 15% nickel prove a high mechanical strength within

TABLE 2  
Properties of Cermets Formed  
on Basis of Single Metals  
and Compounds

| 1 Показатели   | 2 Состав  |                          |
|--|---|--------------------------|
|  | 3<br>30% Cr и<br>70% Al <sub>2</sub> O <sub>3</sub> | 4<br>80% TiC и<br>20% Co |
| 4 Удельный вес   | 4.68-4.72   | 5.8                      |
| 5 Объемный вес (г/см <sup>3</sup> )                        | 4.60-4.65   | —                        |
| 6 Модуль упругости (кг/см <sup>2</sup> ):                  |   |                          |
| 7 при 20°  | —   | 6.02·10 <sup>8</sup>     |
| 7 при 40°  | 5.23·10 <sup>8</sup>                                | —                        |
| 8 Твердость по Роквеллу (шкала А)                          | —   | 59.5                     |
| 9 Коэфф. линейного расширения в интервале:                 |   |                          |
| 25-40°   | 86.5·10 <sup>-6</sup>                               | —                        |
| 25-1315°   | 94.5·10 <sup>-6</sup>                               | —                        |
| 40-850°  | —   | 81.10 <sup>-6</sup>      |
| 10 Теплопроводность (ккал·м·час <sup>-1</sup> ·°C) при 20° | 8.25 (±20%)   | 87.7                     |
| 11 Уд. электросопротивление при 20° (ом·см)                | —   | 6.9·10 <sup>8</sup>      |
| 12 Предел прочности при сжатии (кг/см <sup>2</sup> ):      |   |                          |
| при 20°  | —   | 31.5·10 <sup>8</sup>     |
| при 40°  | 23·10 <sup>8</sup>                                  | —                        |
| 13 Предел прочности при изгибе (кг/см <sup>2</sup> ):      |   |                          |
| 7 при 20°  | —   | 10.5·10 <sup>8</sup>     |
| 7 при 40°  | 3900  | —                        |
| 7 при 840°   | 3100  | —                        |
| 7 при 1110°  | 2300  | —                        |
| 7 при 1340°  | 1730  | —                        |
| 14 Предел прочности при растяжении (кг/см <sup>2</sup> ):  |   |                          |
| 7 при 40°  | 2520  | —                        |
| 7 при 820°   | 1500  | —                        |
| 7 при 1110°  | 1300  | —                        |
| 7 при 1340°  | 1040  | —                        |

1) Characteristics; 2) composition; 3) and; 4) specific gravity; 5) weight by volume (g/cm<sup>3</sup>); 6) modulus of elasticity (kg/cm<sup>2</sup>); 7) at; Rockwell hardness (scale A); 9) coefficient of linear expansion in temperature range; 10) heat conductivity (kcal/m·hr·°C) at 20°; 11) specific electric resistance at 20° (ohm·cm); 12) ultimate compressive strength (kg/cm<sup>2</sup>); 13) ultimate bending strength (kg/cm<sup>2</sup>); 14) ultimate tensile strength (kg/cm<sup>2</sup>).

a wide temperature interval (to 1000°). The strength of cermets does not depend on the strength of their components. The ultimate bending strength of a cermet, for example, with the composition TiC and Me at 982° surpasses significantly the bending strength of its components: 2170 kg/cm<sup>2</sup> for 80% TiC and 20% Co; 4220 for 90% TiC and 10% Fe; 5070

I-55K3

for 90% TiC and 10% NiAl.

The chemical stability of cermets depends on the chemical stability of their components and on the nature of the oxidized layer. A layer of boron-silicate glass formed on the surface of a cermet with the composition TiC, TiB<sub>2</sub>, and SiO<sub>2</sub>, for example, inhibits its oxidation. Vitreous films appearing on cermets protect them reliably to oxidation.

References: Tekhnika vysokikh temperatur [High-Temperature Engineering], edited by I.E. Campbell, translated from English, Moscow 1959; Kiefer R. and Schwarzkopf P., Tverdye splavy [Hard Alloys], [translated from German], Moscow, 1957.

N.M. Pavlush

I-62v

METALLIC FIBER - see Fibrous Metal Ceramics.

METALLIC POWDERS are metallic and alloy powders consisting of individual isolated particles, usually of a complex polycrystalline structure. The metallic powders differ in chemical composition and physical characteristics, in state of the particles as a result of preparatory treatment, and in the condition of their surface. The combination of chemical composition and physical characteristics determines the technological properties of the metallic powders, on which, in turn, depends the field of their application.

The chemical composition of the metallic powders differs somewhat from the composition of the cast metal. The impurity content in the powders (for example, carbon, sulfur, phosphorus) may be reduced to extremely small values, on the other hand they contain a large amount of oxygen in the form of oxide films on the particle surfaces. For the metals whose oxides are reduced by hydrogen, the oxygen content in the powder may be decreased by a preliminary reducing annealing in hydrogen. Certain methods of metallic powder production (for example, carbonyl, electrolytic) ensure thorough refining of the majority of the usual impurities (for example, copper, manganese and silicon) from the metal. The form of the metallic powder particles is determined by the method of production. We differentiate powders with spherical, dendritic, flaky and irregular (fragmentary) particle form. The dendritic powders press well, the spherical press less well. The flaky powders are most often used as pigments (aluminum and bronze powders). The particle sizes of the metallic powders may vary over quite wide limits depending on the method of production. For electronic purposes, use is made of iron car-



II-72M1

bonyl powder with particle size of 1-10 microns, for production of machine parts use is made of reduced iron powder with particle dimensions of 50-200 microns. As a rule, the metallic powders are a mixture of particles of differing dimensions; the weight relationships of the fractions of different dimensions is termed the granulometric composition of the powder, which is usually determined by sieve analysis, and for the very fine powders (with particle size of less than 40 microns) by microscopic analysis.

The shrinkage of products during sintering depends basically on the coarseness of the metallic powders. Highly dispersed powders with particle size of less than 5 microns give linear shrinkage to 20%, which permits obtaining sintered metal with a relative density to 99%. Coarse grained (with particle size 150-200 microns) metallic powders do not result in shrinkage during sintering and may even lead to increase of the volume of the sintered products. By combining powders of differing granulometric composition we obtain a charge which provides a specified shrinkage on sintering.

With preparation of the powder by the mechanical grinding method (for example, by grinding sponge), work hardening of the particles takes place, which degrades the pressability of the metallic powder and causes warping of the parts and crack formation during sintering; annealing to relieve strain hardening is required to improve the pressability. The condition of the particle surface (rough, smooth, oxidized) first of all affects the viscosity of the powder, and also affects its pressability. The bulk weight (volumetric weight with free pouring of the powder) is a most important characteristic of the metallic powders, depending on the chemical and granulometric composition of the powder, the form and condition of the particles. For example, iron powders have a bulk weight from 0.5 to 4.5 grams depending on the method of product-

II-72M2

ion. The constancy of the value of the bulk weight is of great importance in automatic compacting with volumetric dosage of the powder. When pressing to a given volume (to a stop), the magnitude of the bulk weight of the powder is directly related with the density of the product being pressed.

The powder flowability, expressed in g/sec or sec/100 g (time required for pouring a standard powder charge through a composite opening) depends on the nature of the metal (in particular, on its specific weight), the granulometric composition, the form and surface condition of the particles. The dendritic and very fine powders have poor flowability, are prone to caking and "hang-up". The flowability of the metallic powders determines the productivity of automatic compaction.

The compactability of the metallic powders is determined by the relative density of a briquet of definite shape and dimensions, compacted with a specified unit pressure or with that minimal unit pressure for which the briquet takes on sharp edges, without spalls and pitting. The description of the methods of preparation of the metallic powders presently used in industry is shown in Table 1.

Iron powder is produced in accordance with GOST 9849-61 (see Table 2). The GOST provides for five groups of powders depending on the chemical composition (PZh1, PZh2, PZh3, PZh4, PZh5), four groups depending on the granulometric composition (K - coarse, S - medium, M - fine, OM - very fine); for the powder of group M there are established three subgroups with respect to bulk weight (the designation PZh1M2 indicates that the given powder belongs to the 1st group with regard to chemical composition and is fine, belongs to the 2nd group with regard to bulk weight; PZh3K is a powder of the 3rd group with regard to chemical composition and is coarse).

TABLE 1

Description of Basic Methods of Production of Metallic Powders

| 1 Наименование метода                | 2 Сущность метода  | 3 Для каких металлов применяется   | 4 Характер полученного порошка   | 5 Назначение порошка   |
|--------------------------------------|--|--|--|--|
| 6 Восстановление газов или углеродом | Рудный концентрат, химически чистый оксид или оксид, окислы подвергается воздействию восстановителя (водород, диссоциированный аммиак, генераторный газ, природный газ, сланец, уголь и др.) при 700-1000°   | Железо, никель, кобальт, молибден, вольфрам и др.                                | Порошок имеет осколочную форму зерна, сохраняет примеси, содержащиеся в сырье                                      | Изделия машиностроения, твердые сплавы, детали из тугоплавких металлов |
| 11 Восстановление металлами          | Исходным сырьем служат окислы или соли (фтористые или хлористые), восстановителем — натрий или гидрид кальция  | Ниобий, титан, тантал, ниобий-сплав и др. 13                                     | То же 14   | Спец. сплавы, изделия из тугоплавких металлов и др.                    |
| 16 Электролиз                        | Порошок получается в виде осадка на катоде из водного раствора соли или расплава соли путем пропуска тока через электроды  | Железо, серебро, никель, кобальт, олово, тантал, ниобий, медь, титан             | Частицы имеют дендритную форму и высокую степень чистоты 19  | Детали ответственного машиностроения, электрические изделия, магниты   |
| 21 Механич. pulverization            | Измельчение исходной стружки или проволоки в шаровой, шаровой, вибрац. мельнице или в тололке 22   | Для крупных материалов — детали металлов при изготовлении порошков для красок 23 | Порошки имеют частички блюдцеобразной формы (вибрац. размола), плоской (размола в тололке) или осколочной формы 24 | Изделия машиностроения и др. 25  |
| 26 Распыление                        | Распылен. металла, вытекающей тонкой струей через отверстие тигля, подвергается воздействию струи газа или воды под давлением 5-7 атм 27   | Любые металлы и сплавы с температур плавления не выше 1700° 28                   | Порошки имеют частички сферич. формы. Хим. сост. близок к составу исход. материала 29                              | Изделия машиностроения   |
| 31 Карбонильный                      | Карбонильный, в 6 хим. соединенная форма $M_2(CO)_6$ подвергается нагреву до 200-400° под давлением в 200-400 атм, в результате чего происходит диссоциация карбонила с выпадением металла в виде порошка 32 | Железо, никель, кобальт и ниобий др. 33  | Порошки имеют частички сферич. формы и высокую чистоту 34  | Магниты и спец. изделия 35   |

1) Name of method; 2) essence of method; 3) applicable for following metals; 4) nature of resulting powder; 5) powder usage; 6) gas or hydrogen reduction; 7) ore concentrate, chemically pure oxide or technical scale are subjected to the action of a reducing agent (hydrogen, dissociated ammonia, generator gas, natural gas, lampblack, charcoal, etc.) at 700-1000°; 8) iron, nickel, cobalt, molybdenum, tungsten and other; 9) powder has fragmentary grain form, retains impurities present in the raw material; 10) machine design products, hard alloys, refractory metal products; 11) reduction by metals; 12) raw materials are oxides or salts (fluorides or chlorides), the reducing agent is sodium or calcium hydride; 13) niobium, titanium, tantalum, certain alloys, etc.; 14) same; 15) special alloys, products made from titanium, niobium, etc.; 16) electrolysis; 17) powder is obtained in the form of a deposit on a cathode from an aqueous solution of a salt or a molten salt by means of passage of direct current through the electrolyte; 18) iron, silver, nickel, cobalt, tin, tantalum, niobium, copper, titanium; 19) particles have dendritic form and high degree of purity; 20) details for critical applications, electrical products, magnets; 21) mechanical pulverization; 22) pulverization of chips or wire in vortex, ball, vibratory mills or in ore mills; 23) for brittle materials, nonferrous metals in preparation of powders for paints; 24) powders have particles of saucer-like form (vortex grain grinding), flat form (grinding in ore mills), or fragmentary form; 25) products for machine and instrument construction, metal pigments; 26) atomization; 27) molten metal flowing in a fine jet through crucible orifices is subjected to the action of a jet of gas or water under a pressure of 5-7 atmospheres; 28) any metals and alloys with melting point no higher than 1700°; 29) powders have particles of spherical form. Chemical composition is close to that of the original material; 30) machine construction details; 31) carbonyl;

32) carbonyls, i.e., chemical compounds of the type Me (CO)<sub>x</sub>, are subjected to heating to 200-400° under a pressure of 200-400 atmospheres, as a result of which there is dissociation of the carbonyl with deposition of the metal in powder form; 33) iron, nickel, cobalt and certain others; 34) powders have particles of spherical form and high chemical purity; 35) magnets and special details.

TABLE 2  
Technical Requirements on Iron Cermet Powder (GOST 9849-61)

| а) Химический состав        |                                       |                    |  |      |      |      |      |   |  |   |
|-----------------------------|---------------------------------------|--------------------|--|------|------|------|------|---|--|---|
| 1<br>Группа по хим. составу | 2<br>Группа по гранулометрич. составу | 3<br>Fe (не менее) | 3<br>Содержание элементов (% не более) |      |      |      |      | 4<br>Остаток, нерастворимый в соляной кислоте (%) | 5<br>Примечание  |   |
|                             |                                       |                    | C                                      | Si   | Mn   | S    | P    |   |  | O |
| 1<br>Крупный                | Все гр. 7                             | 98.5               | 0.08                                   | 0.2  | 0.5  | 0.02 | 0.02 | 0.5   | 1 По требованию потребителя в порошок может быть включено содержание элементов, а также влажность при содержании в порошке не должно превышать 0.2 % |   |
|                             | То же 8                               | 98                 | 0.12                                   | 0.25 | 0.5  | 0.03 | 0.03 | 1   |  |   |
|                             | 9                                     | 0.15               | 0.25                                   | 0.5  | 0.05 | 0.05 | —    | —   |  |   |
|                             | 10                                    | 0.25               | 0.45                                   | 0.5  | 0.05 | 0.05 | —    | —   |  |   |
|                             | 11                                    | 0.4                | 1.2                                    | 0.5  | 0.08 | 0.05 | —    | —   |  |   |

| б) Гранулометрический состав          |                             |                                  |   |  |   |  |
|---------------------------------------|-----------------------------|----------------------------------|---|--|---|--|
| 1<br>Группа по гранулометрич. составу | 2<br>Группа по хим. составу | 3<br>Подгруппы по массовому весу | 4<br>Номера сетки по ГОСТ 6613-53       | 5<br>Остаток порошка на сите (%)   | 6<br>Пропуск через сито (%)   | 7<br>Примечание  |
| 8<br>Крупный - К                      | Все группы 9                | —                                | 0.45<br>0.25                            | 10 Не более 10<br>30   | 11 Не менее 90<br>60  | 12 По требованию потребителя для изготовления деталей могут поставляться порошки др. гранулометрич. состава, влажность, влажность при содержании в порошке не должно превышать 0.2 % |
| 13<br>Средний - С                     | 1, 2, 3, 4                  | —                                | 0.18<br>0.45                            | 13 Не менее 30<br>0  | 14 Остаток 100  |  |
| 16<br>Мелкий - М                      | Все группы 9                | 1, 2, 3                          | 0.25<br>0.18                            | 10 Не более 10<br>13 Не менее 70   | 11 Не менее 90<br>100   |  |
| 17<br>Очень мелкий - ОМ               | Все группы 9                | —                                | 0.16<br>0.071<br>0.18<br>0.071<br>0.056 | 10 Не более 10<br>13 Не менее 33<br>0<br>10 Не более 5<br>10 Не более 23 | 11 Не менее 90<br>100<br>14 Остаток 100<br>11 Не менее 95<br>11 Не менее 70 |  |

a) Chemical Composition; 1) Group with respect to chemical composition; 2) group with respect to granulometric composition; 3) content of elements (% no more than); 4) residue which is insoluble in hydrochloric acid (%); 5) remarks; 6) Fe (no less than); 7) all groups; 8) same; 9) 1. On request of the user, content of individual elements may be altered, and also the chromium content may be standardized; 10) 2. Powder moisture content must not exceed 0.2%; b) Granulometric composition; 1) Group with respect to granulometric composition; 2) group with respect to chemical composition; 3) subgroups with respect to bulk weight; 4) sieve number from GOST 6613-53; 5) powder residue on sieve (%); 6) powder passing through sieve (%); 7) remarks; 8) coarse - K; 9) all groups; 10) no more than; 11) no less than; 12) on request of user, powder of differing granulometric composition and with standardized compactability may be delivered; 13) no less than; 14) remainder; 15) medium - S; 16) fine - M; 17) very fine - OM.

II-72M5

The production of powder steels and refractory alloys based on nickel has recently been initiated in the USSR and abroad. In the USSR production is under way of the powder stainless steels Kh17N2, Kh18N9T, Kh18N15; structural steels ShKh15, 40Kh, 1Kh13; nichrome Kh20N80 and others. The chemical composition with respect to the content of the basic and alloying metals and the permissible impurities are taken in accordance with standards for casting steels of the corresponding grades; the granulometric composition and the bulk weight are agreed upon with the user (see Powder Metallic Materials).

References: Borok B.A., Ol'khov I.I., Poroshkovaya metallurgiya chernykh i tsvetnykh metallov (Powder Metallurgy of Ferrous and Nonferrous Metals), M., 1948; Bal'shin M.Yu., Poroshkovoye metallovedeniye (Powder Metal Science), M., 1948; Ayzenkol'b F., Powder Metallurgy, translated from German, M., 1959; Samsonov G.V., Plotkin S.Ya., Proizvodstvo zheleznogo poroshka (Production of Iron Powder), M., 1957; Poroshkovaya metallurgiya (Powder Metallurgy) (Reports of Fourth All-Union Scientific-Engineering Conference on Questions of Powder Metallurgy), Yaroslavl', 1956.

B.A. Borok

METHYL VINYL PYRIDINE RUBBER - is the product of the polymerization of divinyl and 2-methyl-5-vinyl pyridine in an aqueous emulsion at an 85:15 or 75:25 ratio of the monomers. The rubber is resistant to the effect of oils, solvents, hydraulic fluids of the ester type, acids and alkalis. It is delivered in USSR in the SK MVP grade, in the U.S. as Filprene VP or Filprene VP-25. It maintains its elasticity in the temperature range from  $-55^{\circ}$  to  $180^{\circ}$ . The physicomechanical indices are: tensile strength 160-200 kg/cm<sup>2</sup>; relative elongation 250-350%. The relative elongation drops by not more than 25-30% if the rubber is kept some days in hot mineral oils esters of dicarboxylic and phosphoric acids at  $150-180^{\circ}$ ; the tensile strength even increases slightly. Methyl vinyl pyridine rubber surpasses the divinyl nitrile and other oilproof rubbers with regard to the resistance to hot esters. Besides, methyl vinyl pyridine rubber is characterized by a high resistance to the growth of cracks in alternating bending. The insufficient resistance to thermal aging in air at temperatures higher than  $100^{\circ}$  is a serious disadvantage of the methyl vinyl pyridine rubber which limits its field of application. The highest resistance to oils and esters, combined with high oilproofness, is achieved if organic halogen-containing compounds as methyl iodide, benzalchloride, chloranil, etc., are used as vulcanizers, which are able to form salts of quaternary bases during the process of vulcanization. They are used in a dosis of one mole per one mole, adding simultaneously sulfur and accelerants. Carbon blacks are used as fillers. Compounds with good physicomechanical properties are also obtained when kaolin is used as a filler. All kinds of packing and seal-

I-27K1

ing parts, working in oils and hydraulic fluids at both elevated and low temperatures (from 150-160° to -50, -60°) may be made from methyl vinyl pyridine rubbers owing to the complex of their valuable technical properties. Triple copolymers of divinyl, styrene, and methyl vinyl pyridine, used as rubber for general purposes, are also produced. The properties of the triple copolymers are similar to those of divinyl styrene rubbers, surpassing, however, the latter in regard to the resistance to abrasion.

References: Novyye kauchuki. Svoystva i primeneniye [New Rubbers. Properties and Application], Collection of Translations, Moscow, 1958.

I. V. Borodina

III-51s

MICA - see Muscovite and Phlogopite.



MICROHARDNESS is the resistance to plastic penetration (usually into a flat surface) of a hard tip, generally in the form of a diamond cone or pyramid. Microhardness testing is performed far less frequently by scratching. The difference between microhardness testing and the conventional measurements of hardness lies in the very small magnitudes of the penetrating loads (on the order of grams) and the correspondingly small depth and size of the imprint (imprint diagonal of the order of microns). Microhardness tests are performed either with the aid of table-top instruments using an arrangement with a vertical portable microscope with revolver head and direct loading with the aid of weights (PMT-2 and PMT-3 testers), or in the form of an adaptation to the horizontal metallurgical microscope with spring loading (Khaneman tester and others). Microhardness testing has found an important application where other methods cannot be used: 1) determining hardness of individual microstructural components; here microscopic study, permits evaluating the properties of the microregions since the microhardness varies with transition from the central zones of the micrograins to the periphery; 2) determining hardness of thin surface layers; conventional hardness tests determine the properties of comparatively thick surface layers (of the order of fractions of a mm), while measurement of the microhardness permits evaluating, for example, the effect of polishing work hardening, effect of finish machining, effect of saturation of a very thin layer by gases. Microhardness testing permits inspection of very small parts, for example, the testing and rejection of watch, instrument and like parts. Study of the microhardness of the rare and

II-91MI

noble metals is possible using quantities which are not sufficient for the preparation of specimens for conventional hardness testing. Brittleness of surface layers, coatings (for example, chrome plating) and very brittle materials may be evaluated on the basis of the number and nature of placement of cracks around the microhardness imprint.

References: Khrushchov M.M. and Berkovich Ye.S., Pribory PMT-2 and PMT-3 dlya ispytaniya na mikrotverdost' (PMT-2 and PMT-3 Instruments for Microhardness Testing), M., 1950.

Ya.B. Fridmar

MICROHARDNESS TEST - is the checking of the hardness mainly by indentation of a hard, usually a diamond tip or indenter at very low loads (units or hundreds of grams) effecting, therefore, very weak indents on the tested surface (with a size from units to hundreds of microns. The latter fact permits one to evaluate the hardness of the individual structural components of alloys, minerals, etc., by this test (in contrast to the usual macroscopic hardness which indicates the means properties of the grain conglomerate). Microhardness tests are applied to both very weak materials (hardness lower than  $1 \text{ kg/mm}^2$ ) and highly hard ones of the diamond type (hardness higher than  $10,000 \text{ kg/mm}^2$ ) and highly hard ones of the diamond type (hardness higher than  $10,000 \text{ kg/mm}^2$ ). Devices (PMT-2 and PMT-3 in USSR), in which the loading with small weights and the subsequent measuring of the indent are combined in the shall of a vertical microscope, serve for microhardness tests. The microhardness test has found a wide application: test of small parts of watches and devices, of foils, of thin wires, thin electroplatings and other coatings, of oxide films of the surface layers of decarbonized, carbonized and other steels, and of glasses and enamels which, due to their brittleness, are difficult to test by other methods, etc.

References: Khrushchov M.M., Berkovich Ye. S., Pribory PMT-2 i PMT-3 dlya ispytaniya na mikrotverdost' [The Devices PMT-2 and PMT-3 for the Microhardness Test], Moscow, 1950.

Ya.B. Fridman

MICROMECHANICAL TESTS are methods of determining the mechanical properties of very small specimens (microspecimens) whose gauge length amounts to several millimeters, and whose lateral dimension is about 1 mm. (For determination of hardness with low loads, see Microhardness). The structure, and therefore the properties as well, of real materials are generally nonuniform as a result of the difference in the conditions of crystallization, sintering, pressure working and machining, different cooling after tempering or welding of the surface and internal zones after tempering or welding. Therefore in the bounds of the sections of the conventional mechanical specimens (tens of  $\text{mm}^2$ ) there are measured only the average strength and deformation, in many cases the knowledge of these characteristics is not adequate. In comparison with conventional mechanical tests, the micromechanical tests permit evaluating the local properties in far smaller sections ( $1 \text{ mm}^2$  and less). The micromechanical tests are used and are often indispensable in the following conditions: a) with small dimensions of the body from which the microspecimens are prepared (for example, in testing rare and noble metals — uranium, plutonium, tantalum, rhenium and others), when necessary to cut the specimen from wire or from a small damaged part, etc.: b) with nonuniformity of properties over zones of surface layers subjected to the action of chemico-thermal processes, wear, corrosion (for example, for evaluating the properties of weld seams and transition zones); c) with anisotropy of the properties (for example, mechanical properties of thick sheets in the direction perpendicular to their largest surface, and the lateral properties of thin bars and profiles usually can be de-

II-90M1

terminated only by micromechanical testing). The following microtesters are used in the USSR for micromechanical tests: RF-2 for tension to 140 kg, for torsion to 40 kg/cm; G.A. Dubov tester with rigid photoelectric dynamometer for forces to 200 kg; MIFI with force to 200 kg for tensile testing at temperatures to 1500° in vacuum or inert medium. Low temperature and high temperature testing to 800-900° is also performed on modified machines of the RF type and on the Dubov micro tester. Micro-mechanical testing to 1500° is performed on the Konoplenko tester. Abroad, use is made of the MI-3<sup>4</sup> Shevenar tester with interchangeable elastic force-measuring element produced by the Amsler firm for axial loads of 350 kg (this tester is not intended for torsion tests), and others. With significant reduction of the test scales (magnitude of loads, specimen dimensions, etc.), difficulties arise both in providing accuracy and in preparation of the microspecimens. Machines for fracture testing of threads, textiles and leather, foil with loads from grams to several kilograms generally have low stiffness and therefore are not accurate with decreasing load (for example, after necking in tension). In view of the small absolute magnitude of the microspecimen deformation, to retain accuracy it is necessary to ensure still less displacement of the force-measuring device in the direction of deformation by means of designing microtesters which are sufficiently rigid. This is particularly important in the case of sharp transitions from loading to unloading with the development of cracks, tensile necking, loss of stability, fracture of individual filaments, etc. On the other hand, small displacements in the force-measuring mechanism reduce the accuracy of measurement of the loading and the deformation diagram. High accuracy of micromechanical tests is achieved in the RF micro-testers by means of a differential system with high gear ratios, and also by the use of a spring-action force-measuring device. In the Dubov

II-90M2

microtester the force measurement accuracy is 15 grams, rigidity of the glass sensor is 50 kg/micron. Completely acceptable for micromechanical testing are the particularly rigid testers for small loads of the Instron type with electronic recording devices (USA). These machines have very rigid, interchangeable elastic force-measuring devices (with loads to hundreds of kilograms the deformation of the force gauge is no more than 0.075 mm) using electric resistance strain gage sensors. Recording of the load is accomplished by a recorder with controllable servomotor. The microtesters have mechanical drive and usually use optical chart recording, since friction of a pencil or pen on paper creates considerable errors. A calibrated spring or lever-pendulum system serves as the force-measuring element. Reduction of the diameter of the working portion of the microspecimens to less than 0.5 mm is generally not advisable in view of the considerable difficulties of preparation (particularly for the soft or springy materials), marked increase of errors, and definite manifestations of structural nonuniformities in very small sections. The effect of surface work hardening during cutting, which is usually not noticeable for the standard specimens, becomes significant in the preparation of microspecimens. For soft materials such as copper, surface work hardening may increase the yield strength markedly, for the steels it may distort the yield area. Therefore the finishing operations are carried out with minimal depth of cut and a feed of no more than 0.01-0.02 mm or with the use of electric polishing. The effect of the scale factor in comparing results of tests of microspecimens and specimens with  $d = 5$  mm shows up in greater strength and plasticity of the smaller specimens. This effect increases with increase of the ultimate strength and the nonuniformity of the structure. For copper the effect of specimen size is quite small, for the D16 and V95 aluminum alloys the strength of the microspecimens is higher by 5-10%, for quenched

II-90M3

and low-tempered steels the fracture resistance of the microspecimens is higher by 30-50% than for specimens with  $d = 5$  mm. The plasticity of the microspecimens exceeds that of the  $d = 5$  mm specimens by a larger amount for the materials with low plasticity. Micromechanical testing of drawn rods show that the work hardening of the central and inner zones is different; in the latter, in contrast with the periphery of the rod, there is observed a considerable reduction of plasticity. Micromechanical tests of weld joints show a considerable variation of strength and plasticity, particularly in the transitional zones. These variations cannot be detected by conventional tests in which the fracture is determined by the properties of the weakest zones. Micromechanical testing of turbine blades after service shows considerable variation of properties of the surface layers as a result of combined mechanical and corrosional damage. Micromechanical tests are a reliable means of evaluating local variations of properties in service conditions.

References: Roytman I.M., Fridman Ya.B., ZhTF, 1949, Vol. 19, No. 3; Roytman I.M., ZL, 1956, No. 7; Konoplenko V.P., Vinogradov D.K., *ibid*, 1959, No. 1; Regel' V.R., Berezhkova G.V., Dubov G.A., *ibid*.

Ya.B. Fridman

MILLERITE (capillary pyrite, yellow nickel pyrite) is nickel sulfide NiS; contains 64.7% Ni; Fe, Co, Cu, are usually present in small quantities. Millerite is relatively rare. It forms fine hairlike or acicular crystals with perfect cleavage, appears in tangled-fibrous masses, radial-rayed aggregates. The color of millerite is brass-yellow to bronze-yellow. Mohs hardness is 3-3.5, specific weight 5.03-5.9, brittle, the hairlike crystals are somewhat elastic. Millerite is a good conductor of electricity, nonmagnetic, antiferromagnetic. Millerite has strong magnetic anisotropy; it dissolves in sulfur monochloride at 170° and on heating with Cu; with Fe the same reaction begins at 380° (with the release of 57 kcal); at 350° it transitions into the high-temperature  $\beta$ -modification. The melting point  $t_{pl} = 797^\circ$  for artificial variety); heat of formation is 20,000 cal; heat capacity at 0° is 0.565 joules/gram. Millerite is attacked by bromine vapors, is subject to weak attack by chlorine beginning at 150°. It is stable with respect to HCl, H<sub>2</sub>SO<sub>4</sub>, KOH, KCN, FeCl<sub>3</sub>, HNO<sub>3</sub> (1:1); dissolves in concentrated HNO<sub>3</sub> and aqua regia; solubility in water is  $39.87 \cdot 10^{-6}$  moles/liter.

Millerite is used in engineering as a result of its antiferromagnetic properties and the strong magnetic anisotropy; it is also used in radiotechnics as a crystal detector.

References: Betekhtin A.G., Mineralogiya (Mineralogy), M., 1950; Shadlun T.N., Millerite, in book: Minerals of the USSR, Vol. 2, M.-L., 1940.

V.I. Magidovich



II-93M

MINIMAL CYCLE STRESS is the cycle stress which is smallest in absolute magnitude; equal to the algebraic difference of the average cycle stress and amplitude  $\sigma_{\min} = \sigma_m - \sigma_a$ ,  $\tau_{\min} = \tau_m - \tau_a$ . See Fatigue.

G.T. Ivanov

MIPORA is a solidified foam based on urea formaldehyde resin. It is prepared by mixing the resin with other components and is a rigid porous plastic with volumetric weight  $0.01 \text{ g/cm}^3$  and up, and has the very lowest (in comparison with other similar material) coefficient of thermal conduction ( $0.022-0.026 \text{ kcal/m-hr-}^\circ\text{C}$ ). Mipora is characterized by a large quantity of open pores, ability to absorb a considerable amount of moisture and relatively low mechanical strength. Mipora has low flammability, high thermal stability (to  $95-100^\circ$ ), can be used for short time at temperatures to  $140-140^\circ$ . The properties of mipora are: moisture content 12 percent, with 20 percent compression the material must not fracture, at  $200^\circ$  the material may char but must not burn under the action of an open flame. Mipora is widely used as a thermal insulation material in refrigerators and in railway cars. To retain the thermal insulating properties, mipora is first packaged in waterproof film and placed in that form between the walls.

MODIFICATION OF ALLOYS is the artificial alteration of the structure of cast metal and alloy involving the refinement of the micrograin, alteration of the form, size and distribution of the structural components. Modification of alloys is accomplished by addition to the melt of small quantities of modifiers - substances which in small quantities influence the crystallization process and alter the structure. Refinement of metal grain and alloy structural components during crystallization may be achieved by creating a concentration gradient which retards crystal growth, and by artificial formation of difficultly soluble particles which, acting as nuclei, aid the beginning of crystallization throughout the entire volume of the liquid. Usually an additive which forms with the alloy components refractory compounds which crystallize first is selected as the modifier. This method of modification is used for the aluminum alloys (introduction of Ti, V, Zr, Mn), for the irons (treatment with Mg to alter the graphite form - see Modification of Iron), for steels (addition of aluminum). Modification of the structure of a casting alloy has an effect on the properties not only in the cast condition, but also during the entire subsequent processing of alloy. Modification improves the hot workability of the alloy, improves the mechanical properties and affects the transformation processes in the solid state. For example, in the aluminum alloys modification reduces the tendency to grain growth during recrystallization, in the steels it leads to obtaining the so-called naturally fine-grained alloys, i.e., steels with low tendency to austenitic grain growth during heating for thermal treatment. Another method of modifying the structure of the

II-99M1

casting alloys involves the creation of conditions which increase the supercooling of the melt, i.e., leading to reduction of the actual alloy recrystallization temperature. These conditions arise as a result of a considerable overheating of the liquid metal. A more effective method is the introduction of special modifiers. For example, for the casting aluminum alloys (silumins) more frequent use is made of treating the melt with sodium or its salts.

References: Bochvar A.A., Metallovedeniye (Metal Science), 5th edition, M., 1956; Mal'tsev M.V., Modifitsirovaniye struktury metallicheskih splavov (Structural Modification of Metallic Alloys), in Alyuminiyevyye splavy (Aluminum Alloys), M., 1955.

O.S. Bochvar, K.S. Pokhodayev

MODIFICATION OF IRON is the treatment of liquid iron before pouring it into forms by graphitizing and stabilizing modifiers to improve its structure and increase the mechanical properties as a result of a favorable influence on the crystallization process. The objectives of iron modification are varied: 1) favorable lamellar graphite precipitation distribution; 2) giving the iron a fine-grained structure by means of increasing the number of crystallization centers; 3) precipitation of the structure-free cementite; 4) giving the metallic matrix of the iron a purely pearlitic structure (in place of ferritic-pearlitic); 5) accelerating the process of annealing white iron into wrought; 6) improving the mechanical properties of refined iron.

Iron modification also includes its treatment with magnesium or its alloys in order to obtain high strength iron with graphite in spherical form (see Magnesium Iron). By treating iron with graphitizing modifiers we obtain a structure without precipitates of structure-free carbides, by using stabilizing modifiers we obtain a purely pearlitic iron matrix which is free of ferrite (stabilization of pearlitic carbides). Treatment of iron with modifiers of both types is accompanied by a general improvement of the mechanical properties as a result of the specific action of the modifiers mentioned above and also as a result of refinement of the iron grain and uniform distribution of the graphite.

As graphitizing modifiers, use is made of ferro-silicon grade SI75 (GOST 1415-49), calcium-silicon grades Kasi-0, Kasi-1 and Kasi-2 (GOST 4762-49) and graphite. For simultaneous alloying of the gray irons they

II-100M1

are modified with alloys containing: 1) 60-65% Si, 5-7% Mn and 5-7%Zr; 2) 50-55% Si, 5-7% Ca and 10% Ti; 3) 30% Si and 60% Ni. Ferro-silicon for modifying gray iron must contain about 1.5% Al and a small quantity of calcium.

TABLE 1  
Mechanical Properties of Gray Iron Modified with Ferro-Silicon With Differing Aluminum Content

| Aluminum content in ferro-silicon (%) | 1    | 2    | 3    | 4  | 5  |
|---------------------------------------|------|------|------|----|----|
| 0.3                                   | 28.1 | 27.8 | 22.2 | 27 | 17 |
| 0.4                                   | 25.1 | 27.2 | 22.0 | 27 | 17 |
| 1.4, 0.7 Ca                           | 28.1 | 27.2 | 21.9 | 27 | 17 |
|                                       | 28.1 | 27.2 | 22.4 | 27 | 17 |

\*Amount of modifier in terms of 0.5% Si.

1) Aluminum content in ferro-silicon modifier\* (%); 2) (kg/mm<sup>2</sup>); 3) a<sub>n</sub> (Izod) (kgm); 4) number of eutectic grains in 25 mm length.

Graphitizing modifiers are used to treat gray irons with carbon equivalent [%C + 1/3% (Si + P)] no greater than 3.8, which are prone to the formation of cementite surface or to the formation of interdendritic graphite precipitates. The amount of modifier is specified in terms of silicon or ferro-silicon.

In order to transform the ferritic-pearlitic structure into pearlitic, the gray irons are treated with stabilizing modifiers with high carbon equivalent (more than 3.8). Here use is made of alloys containing: 1) 17-19% Si, 40% Cr and 10% Mn; 2) 25-30% Si and 50% Cr. Alloys of silicon with 1% B, silicon with 2% Ce, silicon with 2% Mg, mischmetal (an alloy containing cerium), calcium, etc. are used experimentally as modifiers. A method is being developed for blowing through the iron a powder consisting of calcium carbide and fluorides of the rare metals

II-100M2

in a jet of nitrogen or argon, which permits obtaining high mechanical properties of irons with high carbon equivalent (4.2-4.7). The increase of the mechanical properties of the gray irons treated in the liquid state by modifier additives is shown in the figure as a function of the carbon equivalent.

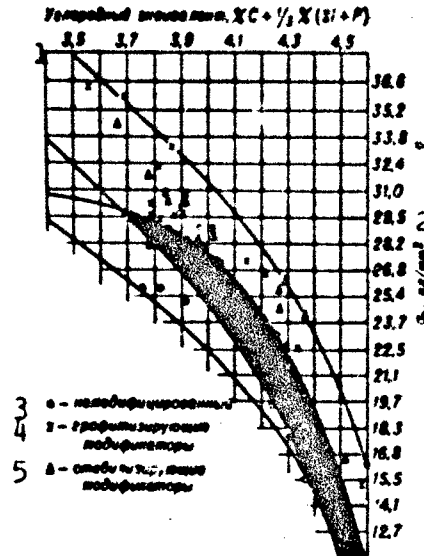

Relationship between carbon equivalent and strength in unmodified and modified irons. 1) Carbon equivalent,  $\%C + 1/3\%(Si + P)$ ; 2)  $\sigma_0$ ,  $kg/mm^2$ ; 3) unmodified; 4) graphitizing modifiers; 5) stabilizing modifiers.

TABLE 2

Mechanical Properties of Modified Alloyed Irons

| Углеродный эквивалент $\%C + 1/3\%(Si + P)$ | 2 Содержание леггирующих элементов |      |      | $\sigma_0$ | НВ      |
|---|------------------------------------|------|------|------------|---------|
|   | Ni                                 | Cr   | Mo   |            |         |
| 4.06  | -                                  | -    | -    | 26.1       | 202-212 |
| 3.84  | -                                  | -    | -    | 24.4       | 196-220 |
| 3.75  | -                                  | -    | -    | 34.3       | 202-212 |
| 3.61  | 0.73                               | -    | -    | 34.3       | 228     |
| 3.29  | 0.98                               | -    | -    | 34.1       | 228     |
| 3.57  | 2.44                               | -    | -    | 46.5       | 269     |
| 3.34  | 2.84                               | -    | -    | 47.8       | 269     |
| 3.73  | 1.63                               | 0.4  | -    | 39.6       | 240     |
| 3.58  | 2.74                               | 0.65 | -    | 45.6       | 306     |
| 4.15  | 1.55                               | 0.26 | 0.73 | 49.5       | 293     |
| 3.72  | 1.44                               | 0.23 | 0.74 | 53.8       | 302     |

1) Carbon equivalent  $\%C + 1/3\%(Si + P)$ ; 2) content of alloying elements; 3)  $kg/mm^2$ .

TABLE 3

Mechanical Properties of Magnesium Iron Modified With Ferro-Silicon

| Присадка кремния (%) | $\sigma_b$ (кг/мм <sup>2</sup> ) | НВ  | $\delta$ (%) | Число зерен на 1 см <sup>2</sup> |
|----------------------|----------------------------------|-----|--------------|----------------------------------|
| 1                    |                                  | 3   | 2            |                                  |
| -                    | 38.1                             | 285 | 0.4          | 27.8                             |
| 0.14                 | 37.3                             | 222 | 0.8          | 47.6                             |
| 0.28                 | 37.8                             | 224 | 0.7          | 38                               |
| 0.5                  | 35.5                             | 203 | 12.7         | 54                               |
| 0.7                  | 32.5                             | 208 | 12.8         | 71.0                             |

1) Silicon addition; 2) number of grains per 1 cm<sup>2</sup>; 3) (kg/mm<sup>2</sup>)

The effect of modification is more marked on the properties of the alloyed irons (Table 2).

Modification of magnesium iron with ferro-silicon improves its plasticity as a result of increasing the amount of ferrite in the matrix and refinement of the grain (Table 3). The presence of aluminum in the ferro-silicon is not of essential importance.

The modifiers are added in the ladle in crushed form, placing them on the bottom of the ladle prior to pouring the metal or using jet injection. In the latter case metering devices of varying construction are used. Risers must be installed for castings made from modified iron.

The modified irons are used for the production of critical castings of high strength in machine construction.

References: Spravochnik po chugunному lit'ur (Handbook on Iron Casting), ed. by N.G. Girshovich, 2nd edition, M.-L., 1960; Vasilenko A.A., Grigor'yev N.S., Instruktivnyye i metodicheskiye ukazaniya po tekhnologicheskomy protsessu polucheniya modifitsirovannogo chuguna (Instructive and Process Directions on the Technological Process of Producing Modified Iron), Kiev, 1950; Hall A.M., Nickel in Iron and Steel, translated from English, M., 1959; Wilder H.H., "Foundry," 1960 v. 88, No 6, p. 116-19.

A.A. Sitkin



MODIFICATION OF MAGNESIUM ALLOYS is the introduction into the liquid metal in very small quantities of modifying substances which aid in obtaining fine grain (crystals) which is uniform through the entire volume of a casting. Alloys of the Mg-Al-Zn-Mn, system are subjected to modification.

Alloys containing more than 0.5% zirconium are not modified since the grains in these alloys are sufficiently small and uniform. Grain refinement in the Mg - Al - Zn - Mn alloys is associated with the formation of components with relatively high melting points whose solubility in the liquid metal diminishes with temperature reduction. Precipitating in the form of very fine particles, these components serve as crystal nuclei. It is believed that the nuclei may be particles of aluminum carbide or the more complex compounds: Mg - Al - C; Mg - Al - Mn - C; the compounds of aluminum with iron: Al - Fe - Mn; Al - Mg - Fe - Mn.

Modification of the magnesium alloys is achieved by addition to the liquid metal of substances containing carbon - by blowing natural gas, acetylene, carbon dioxide through or by introducing aluminum and calcium carbides, graphite, carbonates (chalk, marble, magnesite), chlorides (carbon tetrachloride, hexachloroethane, hexachlorobenzene and others). Magnesite and chalk are widely used in industry to modify the magnesium alloys. Magnesite is introduced in lump form (10-25 mm size) in the amount of 0.3-0.4% of the alloy weight at a temperature of 720-730°, chalk is introduced in powder form in the amount of 0.5-0.6% at 760-780°; the modification operation lasts 7-10 minutes (to

II-97M1

termination of turbulence). Modification of the magnesium alloys may be accomplished by overheating the liquid metal, i.e., heating to 850-950°, and holding at this temperature for 10-20 minutes. The modification effect disappears with long-term soak of the liquid metal at a temperature of 680-700°, but heating to high temperature again leads to grain refinement. Modification of the magnesium alloys refines the grain from 0.2-0.3 to 0.01-0.02 mm. Modification permits producing casting alloys with high mechanical properties ( $\sigma_b$ ,  $\sigma_{0.2}$ ,  $\delta$ ,  $a_n$ ). The variation of the properties as a function of grain size corresponds to a straight line relation in the coordinates (properties - logarithm of number of grains per 1 mm<sup>2</sup>) (figure). Modification improves the al-

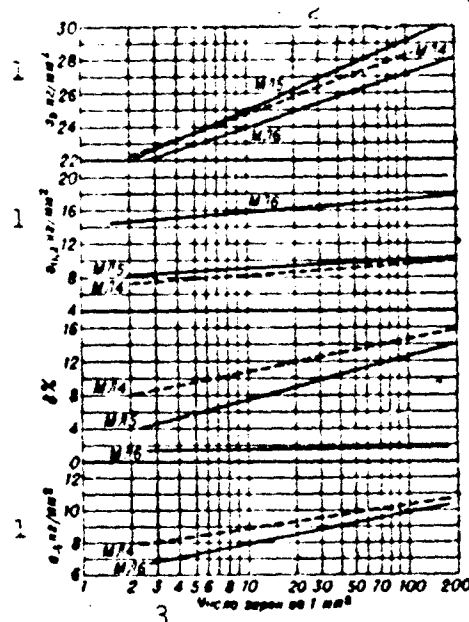

Variation of mechanical properties of cast magnesium alloys with grain size.  
1) kg/mm<sup>2</sup>; 2) ML; 3) number of grains per 1 mm<sup>2</sup>.

loy processing properties, reduces the probability of appearance of cracks and microporosity (see Modification of Alloys).

A.A. Lebedev

II-98M

MODIFICATION OF POLYMERS - see Molymer.

MODIFIED POLYACRYLONITRILE FIBER - synthetic carbon-chain fiber containing, in addition to the nitrile of acrylic acid, other components (vinylpyridine, vinyl chloride, acrylic acid, acrylamide, etc.). It is produced primarily in the form of staple fiber containing up to 15% of a modifier under the names: Orion-42 and Orlon-31, Acrilar, Creslan, Zefran, Dynel and Verel (USA), Saniv (USSR), Darvan (FRG), Tacryl (Sweden), Courtella (England), Kanekalon (Japan). Modified polyacrylonitrile fibers are dry and wet spun from solutions of the copolymer in dimethylformamide, sodium thiocyanide or acetone. The staple fiber is produced in the form of clusters (general  $N_m$  0.019, elementary  $N_m$  1500-4500) or pieces from 38 to 114 mm long in the twisted form with a rough surface. The properties of the modified fibers depend on the chemical nature and the quantity of the second added polymer and also on the modification method (copolymerization, inoculation or mixing of polymers). Modified polyacrylonitrile fibers are inferior to nonmodified polyacrylonitrile fibers with respect to strength, light and heat resistance and, to a smaller extent, with respect to chemical stability, but they are superior to the latter with respect to elastic restoration, moisture absorption (with the exception of Dynel), wear resistance, with respect to chemical affinity to dyes, with respect to solubility (fibers with a high content of the second monomer are soluble in acetone); are less inflammable.

The physicochemical and mechanical properties of modified polyacrylonitrile fibers are given in Tables 1 and 2.

With respect to other physicochemical properties modified polyacry-

I-64v1

lonitrile fibers are close to polyacrylonitrile fibers. Modified polyacrylonitrile fibers are dyeable by acid, dispersion, indigo, vat, basic or cation dyes; sometimes use is made of chromizing (for Acrilan) and mordant (for Verel), etc., dyes.

Modified polyacrylonitrilic fibers are used for engineering pur-

TABLE I  
Physicochemical Properties of Certain Modified Polyacrylonitrile Fibers

| Свойства 1  | 2 Орлон-42 | Зефран 3 | Такрил 4                               | Верел 5 | Дай-сел 6 |
|---|------------|----------|--|---------|-----------|
| Уд. вес . . . 7 . . . . .                                     | 1.14-1.17  | 1.19     | 1.18                                   | 1.37    | 1.31      |
| Влажосодержание при стандартных условиях . . . 8 . . .        | 1.5        | 2.5      | 1.1-1.4                                | 3.5-4   | 0.4       |
| Влажосодержание при 95% относительной влажности . . . 9 . . . | 2.5        | 3.0      | -                                      | -       | 1         |
| Горючесть . . . 10 . . . . .                                  | 11/ Горюча |          | 12 Не горюча и не поддерживает горение |         |           |

1) Properties; 2) Orlon-42; 3) Zefran; 4) Tacryl; 5) Verel; 6) Dynel; 7) specific weight; 8) moisture content under standard conditions; 9) moisture content at 95% relative humidity; 10) inflammability; 11) flammable; 12) nonflammable and do not support combustion.

TABLE 2  
Mechanical Properties of Certain Modified Polyacrylonitrilic Fibers

| Свойства 1  | 2 Орлон-42 | 3 Зефран | 4 Такрил  | 5 Верел   | 6 Дайсел  |
|---|------------|----------|-----------|-----------|-----------|
| Разрывная длина (км) сухого волокна . . . . . 7 . . .   | 19.8-23.4  | 31.5     | 22.5-45.0 | 22.5-25.2 | 22.5-31.5 |
| Временное сопротивление разрыву (кг/мм <sup>2</sup> ) . . . . . 8 . . .                       | 16.4-19.1  | 27.9     | 18-36     | 21.6-24.2 | 27.0      |
| Удлинение (%) . . . . . 11 10 . . . . .   | 22.5-27.1  | 37.3     | 26.6-33.1 | 29.2-35   | 29.3-40.2 |
| Властичность (упругое восстановление при удлинении от 2 до 5%) (%) . . . . . 12 . . . . .     | 20-28      | 33       | 20-45     | 30-35     | 30-42     |
| Начальный модуль упругости (при удлинении на 1%) (кг/мм <sup>2</sup> ) . . . . . 13 . . . . . | 26-34      | 33       | -         | 32-34     | 30-42     |
|   | 92 (2%)    | 92 (2%)  | 80 (3%)   | 88 (4%)   | 98 (5%)   |
|   | 3.5        | -        | -         | 4.93      | -         |

1) Properties; 2) Orlon-42; 3) Zefran; 4) Tacryl; 5) Verel; 6) Dynel; 7) rupture length (km); 8) of the dry fiber; 9) of the wet fiber; 10) ultimate tensile strength (kg/mm<sup>2</sup>); 11) elongation (%); 12) elasticity (elastic restoration upon from 2 to 5% elongation) (%); 13) initial modulus of elasticity (for an elongation of 1%) (kg/mm<sup>2</sup>).

I-64v2

poses (making of working clothing, filtering materials, diaphragms, etc.). Dynel and Verel, which contain 40-60% of a modifier are used for making draping materials and finishing fabrics for internal upholstery of aircraft, and also for obtaining (from fibers with 9-17% shrinkage) artificial fur. Modified polyacrylonitrile fibers with varying degree of shrinkage (1-28%) mixed with wool (80:20) are used for obtaining high-volume yarn. Addition of modified polyacrylonitrile fibers to viscose and acetate fibers improves the wear resistance of fabrics and improves their service properties.

References: Rogovin, Z.A., Osnovy khimii i tekhnologii proizvodstva khimicheskikh volokon [Fundamentals of the Chemistry and Technology of Chemical Fiber Production]. 2nd edition, Moscow, 1957; Pakshver, A. B. and Geller, B. E., Khimiya i tekhnologiya proizvodstva volokna nitron [The Chemistry and Technology of the Production of Nitron Fiber]. Moscow, 1960; Monkrieff, R. W. Khimicheskiye volokna [Chemical Fibers], translated from English, Moscow, 1961.

V.M. Bukhman

MODIFIED POLYAMIDE FIBER -- synthetic hetero-chain fiber from mixed or substituted polyamides. Processing of mixed polyamides, for example, products of condensation polymerization of caprolactam (10-40%) with the AG or TG salt, produces a fiber with an irregular structure with a high, in comparison with ordinary polyamide fibers, solubility and higher (in comparison with capron) melting temperature (see Vetrelon, Eftrelon). Processing of N- or C-substituted polyamides (most frequently by the  $\text{CH}_3$  group) substantially reduces the melting temperature; as the number of N- or C-substituted groups in the polyamide macromolecules increases, the ultimate tensile strength decreases and the relative elongation increases; the introduction of OH polar groups increases the hygroscopicity of the fiber and improves its dyeing ability. A modified polyamide fiber has been developed in the USSR with the product of condensation polymerization of hexamethylenediamine and thiodivaleric acid as a base. The specific weight of modified polyamide fibers is 1.14, moisture absorption under standard conditions 1.9%, at 95% relative humidity it is 3.2%;  $t_{pl}$  183°. Rupture length from 23 to 29 km; strength losses in the wet state 6-7%, in a loop 6-8%. Ultimate tensile strength 26-33  $\text{kg/mm}^2$ . Elongation in the dry state 13-18% in the wet state 15-19%. The modulus of elasticity of the fiber is 272-280  $\text{kg/mm}^2$ ; shear modulus in torsion is 6065  $\text{kg/mm}^2$ . The strength loss after irradiation by ultraviolet light for 20 hours comprise 72-84%.

Modified polyamide fibers, having a higher elasticity than other polyamide fibers are used primarily for the production of consumer goods.

I-66v1

References: Rogovin, Z.A., Osnovy khimii i tekhnologii proizvodstva khimicheskijg vlakn [Fundamentals of the Chemistry and Technology of Chemical Fibers Production]. 2<sup>nd</sup> edition, Moscow, 1957; Kudryatsev, G. I. and Konkin, A.A., "KhV" [Chemical Fibers], No. 12, pages 3-12, 1961; Shein, T. I., Chelnokova, G.N. and Vlasova, L.N., Ibid, No. 2, pages 19-20, 1959.

E.M. Ayzenshtevn



MODIFIED POLYESTER FIBER - synthetic hetero-chain fiber from chemically modified polyethyleneterephthalate (PETF). Modification is achieved by adding moderate quantities of other dicarboxylic acids or their dimethyl esters and glycols (copolyester fibers) or by block polymerization with other polymers. Copolyester fibers differ from polyester fibers (see Polyester Fiber) by greater elongations (30-60% softness, ability to be dyed without pressure and the use of "transfer agents," high shrinkage (20-25%) in boiling water, due to which they are used for obtaining high-volume yarn which is similar to wool, but they have a lower melting temperature and strength. Block copolymer fibers (for example, from block polymerizing PETF with polyethylene glycol) have the same strength but are more hygroscopic, better dyeability (by a factor of 3) and resistance to multiple flexure (by a factor of 10) than polyester fibers. A shortcoming of these fibers is the low resistance to atmospheric factors. The Kodel fiber (product of condensation polymerization of terephthalic acid or its dimethyl ester with hexahydroxyleneglycol) which is produced in the USA in the form of staple fiber, has a higher melting temperature (290-295°) and lower affinity to the peeling effect (coming of elementary fibers onto the surface of articles) than polyester fibers (Terylene, Dacron, Lavan), which makes it possible to use it together with cotton. The specific weight of the fibers 1.22, moisture content 0.4% (under standard conditions) and 0.8% (at 20° and 95% relative humidity), is soluble only in a phenol-tetrachloroethane mixture (1:1) upon heating, it swells in trichloroethylene and methyl chloride, it is easier dyed by standard dis-

I-79v1

persion and azo dyes than Terylene, resists the action of microorganisms, shrinkage in boiling water 1%, when held in air at 220°, its resistance to atmospheric factors and chemical reagents is the same as for Terylene, and the resistance to heat aging is higher, the product can be ironed at 205-215°, strength loss of the yarn after 1000 hours at 160° is 50% (it is 55-60% at 150° for Terylene), rupture length 22-32 km, at 260-265° it is 0.45 km, rupture elongation (under standard conditions and in the wet state) 24-30%, modulus of elasticity 275-385 k/mm<sup>2</sup>, elasticity 85-95% (on 2% elongation), 50-60% (on 5% elongation) and 30-40% (on 10% elongation). The Vycron fiber [product of condensation polymerization of terephthalic acid (90%) and isophthalic acid (10%) their esters, with ethylene glycol] is produced in the USA as a staple fiber. The specific weight is 1.36,  $t_{pl}^{\circ}$  237°, rupture length 50 km with an attendant elongation of 35%, elasticity 93% (in 2% elongation) 44% (in 5% elongation) and 33% (in 10% elongation). It is used widely for making wrinkle-proof fabrics, in special yarns for furniture, decorative and industrial fabrics, and also mixed with cotton, wool, viscose and polyamide fibers.

References: Petukhov, B.V., Poliefirnoye volokno. (Terilen, lavsan) [Polyester Fibers. (Terylene, Lavsan)]. Moscow, 1960; Bogdanov, M.N., Petukhov, B.V. and Kondrashova, S.M., "KhV," No. 6, 1959; Petukhov, B. and Kondrashova, S.M. "VS," Vol. 3, No. 5, 1961.

E.M. Ayzenshteyn

MODULUS OF ELASTICITY is the index which characterizes the resistance of a material to elastic deformation. We differentiate: 1) modulus of normal elasticity, or Young's modulus  $E$ , which is the coefficient of proportionality between the normal stress  $\sigma$  and the relative elongation  $\epsilon$ :  $\sigma = E\epsilon$ ; 2) the shearing modulus, or modulus of tangential elasticity  $G$ , which is the coefficient of proportionality between the tangential stress  $\tau$  and the relative shear  $\gamma$ :  $\tau = G\gamma$ ; 3) the modulus of bulk elasticity, or the modulus of hydrostatic compression,  $K$ , which is the coefficient relating the relative change of volume  $\Theta$  and the average hydrostatic stress  $(\sigma_1 + \sigma_2 + \sigma_3)/3$ :

$$\Theta = -\frac{1}{K} \frac{\sigma_1 + \sigma_2 + \sigma_3}{3}$$

The moduli of elasticity  $E$ ,  $G$ , and  $K$  have dimensions of a stress ( $\text{kg/mm}^2$  or  $\text{kg/cm}^2$ ). For an isotropic material  $G$  and  $K$  are related with  $E$  by the relations:  $G = E/2(1+\mu)$  and  $K = E/3(1-2\mu)$  where  $\mu$  is the poisson coefficient. The modulus of elasticity  $E$  is most frequently determined by tensile tests using the technique described in GOST 1497-61. The modulus of elasticity  $G$  is determined in torsion tests or may be calculated from the values of  $E$  and  $\mu$  determined in tension. The modulus of elasticity is a structurally insensitive property and therefore depends little on the heat treatment regime. The magnitude of the modulus of elasticity is determined by the alloy composition and primarily by the alloy base (Table 1). A marked increase (by 10-15%) of  $E$  in the direction of deformation may be obtained with considerable reduction or cold deformation. An anisotropy of the modulus of elasticity is usually noted in the metallic monocrystals (Table 2). Anisotropy

of the modulus of elasticity is also typical of the plastics, where it depends strongly on the degree of orientation of the filler fibers and their arrangement relative to one another. For the majority of the metallic alloys the values of the modulus of elasticity E in tension and compression are close, they may differ considerably in nonmetallic materials.

TABLE 1

Values of the Moduli of Elasticity E and G for Some Construction Materials

| Материал                       | 1  | 2 Состояние материала                            | 3 (кг/мм <sup>2</sup> ) |      |
|--------------------------------|----|--|-------------------------|------|
|                                |    |  | E                       | G    |
| 4 Железо                       |    | 5 Отожженное                                     | 20000                   | 7700 |
| 6 Сталь 30KhGSA                | 6  | 7 Закалка и отпуск при 510°                      | 20000                   | 7700 |
| 8 Хромо-никелевый сплав ЭИ437Б |    | 9 Закалка с 1080° + старение при 700°            | 19800                   | 7700 |
| 10 Медь                        | 10 | 11 Отожженная                                    | 11000                   | -    |
|                                |    | 12 Холодная                                      | 12000                   | 4400 |
|                                |    | 13 Мягкая после закалки                          | 12000                   | -    |
| 14 Бронза бериллиевая БрБ 2.5  | 14 | 15 Старенная после закалки и холодной деформации | 13800                   | -    |
| 16 Титановый сплав ВТ6         | 16 | 17 Отожженный                                    | 11200                   | 4350 |
| 18 Алюминий                    | 18 | 19 Отожженный                                    | 7100                    | 2700 |
| 19 Алюминиевый сплав Д16       | 19 | 20 Прессованный                                  | 7200                    | 2700 |
| 22 Магний                      | 22 | 21 Катаный лист                                  | 4900                    | -    |
| 23 Магний сплав МА8            | 23 | 22 Отожженный                                    | 4400                    | 1800 |
| 24 Дельта-древесина            | 24 | 23 Отожженный                                    | 4100                    | 1700 |
| 25 Стекло-текстолит ВТ-С       | 25 | -  | 3000                    | -    |
| 26 Стекло органическое СТ-1    | 26 | -  | 2170                    | -    |
| 27 Стекло силикатное ВВС       | 27 | -  | 280                     | -    |
|                                |    |  | 6800                    | -    |

1) Material; 2) material condition; 3) (kg/mm<sup>2</sup>); 4) iron; 5) annealed; 6) 30KhGSA steel; 7) quenched and tempered at 510°; 8) EI437B chrome-nickel alloy; 9) quench from 1080° plus aging at 700°; 10) copper; 11) annealed; 12) cold worked; 13) soft after tempering; 14) BrB 2.5 beryllium bronze; 15) aged after tempering and cold deformation; 16) VT6 titanium alloy; 17) annealed; 18) aluminum; 19) D16 aluminum alloy; 20) forged; 21) rolled sheet; 22) magnesium; 23) MA8 magnesium alloy; 24) delta-plywood; 25) VFT-S glass textolite; 26) ST-1 organic glass; 27) VVS silicate glass.

TABLE 2  
Moduli of Elasticity of Some Monocrystals

| Металл    | 1  | 2 Тип решетки                         | 3 E (кг/мм <sup>2</sup> ) |        | 3 G (кг/мм <sup>2</sup> ) |        |
|-----------|----|---------------------------------------|---------------------------|--------|---------------------------|--------|
|           |    |                                       | максим.                   | миним. | максим.                   | миним. |
| Алюминий  | 6  | Кубическая гранецентри-<br>рованная   | 7700                      | 6400   | 2900                      | 2500   |
| Медь      | 8  |                                       | 9 То же                   | 19400  | 6800                      | 7700   |
| Серебро   | 10 | 9                                     | 11700                     | 4400   | 4450                      | 1970   |
| Золото    |    |                                       | 11400                     | 6200   | 4100                      | 1800   |
| Железо    | 12 | Кубическая объемноцент-<br>рированная | 29000                     | 12500  | 11800                     | 6100   |
| 14 Магний | 15 |                                       | Гексагональная            | 5140   | 4370                      | 1840   |
| 16 Цинк   | 17 | 9                                     |                           | 12630  | 3650                      | 4970   |
| Кадмий    |    |                                       | 8300                      | 2880   | 2510                      | 1840   |

1) Metal; 2) lattice type; 3) E (kg/mm<sup>2</sup>); 4) maximal; 5) minimal; 6) aluminum; 7) face-centered-cubic; 8) copper; 9) same; 10) silver; 11) gold; 12) iron; 13) body-centered-cubic; 14) magnesium; 15) hexagonal; 16) zinc; 17) cadmium.

S.I. Kishkina-Ratne:

II-102M

MODULUS OF HYDROSTATIC COMPRESSION - see Modulus of Elasticity.

MODULUS OF INTERNAL FRICTION OF RUBBER is the index which characterizes the hysteresis properties of rubber under dynamic cyclic loading. The modulus of internal friction is designated by the letter  $K$  and is defined as double the mechanical losses in unit volume  $\Delta W$  in one dynamic loading cycle with unit value of the amplitude of the dynamic deformation  $\epsilon_0$ . In the linear approximation, satisfied more accurately the smaller  $\epsilon_0$ ,  $K = \frac{2\Delta W}{\epsilon_0^2}$ . The advantage of using  $K$  is the applicability in describing any cyclic loadings, including nonharmonic. With harmonic loading the connection between  $K$  and the other indices used to characterize the hysteresis properties of rubber is given by the relations:

$$K = 2\pi E \sin \psi = 2\pi E'' = \Gamma E'$$

in which:  $E$  is the complex dynamic modulus;  $E'$  and  $E''$  are its real and imaginary components;  $\Gamma$  is the relative hysteresis or the ratio of the mechanical losses to the total cycle energy;  $\psi$  is the phase shift angle between stress and deformation. See Internal Friction.

References: Reznikovskiy M.M., KhNIP, 1959, Vol. 4, No. 1, page 79; Priss L.S., VS, 1960, Vol. 2, No. 9, page 1309.

M.M. Reznikovskiy

II-106M

MODULUS OF PLASTICITY - see Secant Modulus.



MOISTURE - moisture (water) content of a solid body or gas. A distinction is made between absolute moisture (moisture content) which represents the quantity of water referred to a unit mass or volume of dry material ( $\text{kg/kg}$  or  $\text{kg/m}^3$ ), and relative moisture content which is the ratio of the quantity of water to unit mass of moist material, expressed in percent. Water absorbed by the material (see Moisture absorbing capacity), depending on its structure and composition, can be bound to the material by adsorption or osmosis, or can be free, being held mechanically in the pores (capillary moisture and wetting moisture and wetting moisture). The mode of the bound between the moisture and the material is classified by estimating the intensity of the binding energy. The moisture content of solid bodies is determined by drying under standard conditions until a constant weight is reached, measuring some physical properties of the body which are moisture-dependent (for example, electric conductivity, dielectric losses, etc.), hydrocarbon distillation or alcohol extraction. The moisture content of gases is measured by hygrometers and psychrometers. Moisture is of great importance in evaluating the quality of materials and in production processes. Air humidity is one of the main parameters in the evaluation of the weather and climate.

References: Lykov, A.V. Teoriya sushki [The Theory of Drying], Moscow-Leningrad, 1950; by the same author, Yavleniya perenosa v kapillyarno-poristyykh telakh [Transfer Phenomena in Capillary-Porous Bodies], Moscow, 1954.

S.A. Reytlinger

MOISTURE ABSORPTION CAPACITY (hygroscopicity) - capacity of materials to absorb moisture from the air. The moisture absorption mechanism depends on the structure and composition of the material; capillary-porous materials absorb moisture by capillary condensation, polymer materials do this by osmotic suction and dissolution, crystalline bodies and fluids do this by dissolving water in themselves. The moisture absorption capacity of porous materials increases with an increase in the air humidity, reaching a maximum at 100% relative humidity (hygroscopic moisture  $W_g$ ). The moisture absorption capacity is determined by keeping initially dried materials in moist air at 65% or 100% relative humidity until their weight reaches a constant value, or for a specified period of time. Certain hygroscopic substances [ $\text{CaCl}_2$ ,  $\text{Mg}(\text{ClO}_4)_2$ , concentrated  $\text{H}_2\text{SO}_4$ , etc.] are used for drying of solid bodies and gases.

S.A. Reytlinger

MOLYBDENIZING THE TITANIUM ALLOYS is the deposition of molybdenum on the surfaces of parts made from the titanium alloys. Molybdenizing of the titanium alloys takes place during decomposition of molybdenum hexacarbonyl vapors  $\text{Mo}(\text{CO})_6$  at temperatures above  $250^\circ$ . Application of the coating takes place after heating the parts using high frequency current or other methods in a vacuum chamber with the use of a gas carrier (argon) or without it at the carbonyl vaporization temperature of  $30-50^\circ$  and a working pressure in the chamber of 0.1-0.5 mm Hg. The deposition rate depends on the configuration and volume of the chamber, the carbonyl vaporization temperature, the intensity of the vacuum evaporation and other factors, and may amount to several tens of microns per hour. Nonuniform deposition of the coating is observed along the direction of motion of the gas flow (flow phenomenon). The coating consists of molybdenum and molybdenum carbide (to 4.0% C), whose relationship is determined basically by the application temperature and partially by the carbonyl evaporation temperature. At  $850^\circ$  and above, the coating consists almost entirely of pure molybdenum with hardness 300 HV, well bonded with the base metal. With reduction of the process temperature there is an increase of the amount of carbon in the coating and the bond with the titanium is weakened; at an application temperature of  $250^\circ$  almost pure molybdenum carbide with hardness about 2000 HV is deposited. The coating obtained in two steps - first at  $850^\circ$  and then at  $350-450^\circ$  - has good bonding with the base metal and high antifric-tion properties.

Reference: Tour S., Styka A., Fischer G., "J. Metals", 1955, v. 7, No. 2, p. 291. I.S. Anitov

MOLYBDEUM. Mo is a chemical element of group VI of the mendeleev periodic system, atomic number 42, atomic weight 95.94. The isotopic composition of natural Mo is: Mo<sup>92</sup> (15.86%); Mo<sup>94</sup> (9.12%); Mo<sup>95</sup> (15.7%); Mo<sup>96</sup> (16.5%); Mo<sup>97</sup> (9.45%); Mo<sup>98</sup> (23.75%); Mo<sup>100</sup> (9.62%). Molybdenum is a silvery gray metal, density 10.32 g/cm<sup>3</sup>,  $t_{pl}^{\circ}$  2622 ± 10°,  $t_{kip}^{\circ}$  about 4804°. Molybdenum is used in engineering as a refractory metal which retains considerable strength when heated to 2000°. Its content in the earth's crust is less than 0.001%. Deposits of molybdenum are encountered in many countries: USA, Norway, Mexico, Australia and others. The most abundant minerals containing molybdenum are: molybdenite MoS<sub>2</sub>, wulfenite PbMoO<sub>4</sub>, molybdenite MoO<sub>3</sub>, and others. The content of these minerals in the ores is low (in the richest ores there is no more than 1.5% Mo). In the USA, ores containing 0.6% Mo are worked. The molybdenum ores often accompany copper ores. These ores are subjected to a complex treatment with the separation of pure Mo. Ores containing molybdenite which contain 90-95% molybdenite after refining are of commercial importance. Technical molybdenum trioxide is obtained after roasting the concentrates. The volatility of MoO<sub>3</sub>, which vaporizes beginning at 600°, is used for purification. The pure product is collected in filters in the form of a fine powder containing about 99.97% pure MoO<sub>3</sub>. Reduction of MoO<sub>3</sub> to metallic molybdenum is performed in hydrogen at 600-1100°. In this case the oxygen content in the resulting powder is about 0.5%. The powder is ground, sized and then processed to obtain compact molybdenum. The powder metallurgy method is used to obtain the compact molybdenum (see Sintered Molyb-

II-113M1

denum) utilizing electric-arc vacuum melting and also electron beam melting. Molybdenum production is concentrated primarily in the USA (80% of world output, except from the USSR). The greatest amount of molybdenum was produced in 1943 (31,400 metric tons). In 1959 the capitalist countries produced 30,200 metric tons. Artificial radioactive isotopes of molybdenum exist. Atomic radius is 1.36 Å, ionic radius of tetravalent Mo is 0.68 Å, that of hexavalent Mo is 0.62 Å, atomic volume is 9.45 cm<sup>3</sup>/gram-atom. Crystal lattice is body-centered-cubic with period 3.1466 Å (allotropic modification is not observed up to the melting temperature), powder density (bulk weight) is 3 g/cm<sup>3</sup>, density of cold pressed briquet is 6 g/cm<sup>3</sup>, that of sintered briquet is 9.2-9.8 g/cm<sup>3</sup>, density of thin sheet or wire made from sintered briquet is 10.3 g/cm<sup>3</sup> cast and arc melted density is 10.2 g/cm<sup>3</sup>. Vapor pressure (at 10<sup>-3</sup> mm Hg): 0.01 (1954°); 0.1 (2125°); 1 (2324°); 10 (2568°) 15.7 (2622°). Heat of fusion is 70 cal/g. Heat of vaporization is 1625 cal/g, c (cal/g-°C) 0.004 (-257°); 0.030 (-181.5°); 0.058° (0°); 0.065 (100°); 0.075 (475°).  $\alpha$  (1/°C); 2.8·10<sup>-6</sup> (173°); 5·10<sup>-6</sup> (27°); 5.1·10<sup>-6</sup> (500°); 5.5·10<sup>-6</sup> (1000°); 6.2·10<sup>-6</sup> (1500°); 7.2·10<sup>-6</sup> (2000°).  $\lambda$  (cal/cm-sec-°C): 0.44 (-183°); 0.33 (-76°); 0.32 (0°); 0.26 (1473°); 0.17 (2173°)  $\rho$  ( $\mu$ ohm-cm): 5.17 (0°); 5.78 (27°); 23.9 (727°); 35.2 (1127°); 47.2 (1527°); 59.5 (1927°); 71.8 (2327°); 81.4 (2622°). Enthalpy change ( $H_T - H_{25}^{\circ}$ ) cal/mole: 5825 (927°); 8740 (1327°). Photoelectric threshold is = 3.22  $\pm$  0.16 volts; electron work function is 4.17 volts; work function of positive ion is 8.35 or 8.6 volts (from data of different investigators). Cross section for absorption of thermal neutrons is 2.4  $\pm$  0.2 barn. The metal is not thermally stable in an oxidizing medium at temperatures above 700° because of the volatility of the oxides (see Protective Coatings for Molybdenum).

About 3/4 of the molybdenum produced goes for alloying of the

II-113M2

steel and nickel alloys. Molybdenum improves the through-hardenability and surface-hardenability of steel, eliminates tempering brittleness, and increases the high-temperature stability. Metallic molybdenum is used in the electric light bulb and radiotechnical industries in the form of wire and bars. Molybdenum is used for the fabrication of sheet anodes, grids, cathode springs. Since the coefficient of expansion of molybdenum is nearly the same as that of glass, it is used for electrical contacts sealed to glass. Molybdenum oxide does not color glass, and therefore it is used for electrodes of glass vats in the founding of optical glass. Molybdenum is also used for the fabrication of heating elements of resistance furnaces operating in a vacuum or in a neutral medium (hydrogen, ammonia, inert gases) up to 1700°. Molybdenum is utilized for fabricating tools in the metal working industry: piercing punches, dies, stamps for hot stamping and equipment for pressure casting. The use of molybdenum for highly loaded parts of gas turbines and for parts of rockets which are heated to very high temperatures is quite promising.

TABLE 1  
Mechanical Properties at Room Temperature of Molybdenum Melted in Vacuum by the Arc Method

| Хар-на материала 1    | 2  | Режим  | $\sigma_{0.2}$          | $\sigma_b$ | $\delta$ | $\psi$ |
|-----------------------|----|--|-------------------------|------------|----------|--------|
|                       |    |  | 3 (kg/mm <sup>2</sup> ) |            | 4 (%)    |        |
| Прутки d=15-20 мм     | 6  | а) без отжига 5  | 65                      | 70         | 23       | 40     |
|                       |    | б) после отжига для снятия напряжений при 985° в течение 1 часа  | 54                      | 68         | 25       | 50     |
| 4                     | 7  | а) после рекристаллизационного отжига при 1175° в течение 1 часа | 39                      | 47         | 25       | 25     |
|                       |    | б) после отжига при 1000° вдоль направления прокатки             | 70                      | 75         | 20       | -      |
| Лист толщиной 1,25 мм | 9  | а) после отжига при 985° вдоль направления прокатки              | 80                      | 82         | 11       | -      |
|                       |    | б) после отжига перпендикулярно направлению прокатки             | 71                      | 80         | 14       | -      |
| Лист толщиной 0,33 мм | 10 | а) после отжига при 945° вдоль направления прокатки              | 80                      | 82         | 8        | -      |
|                       |    | б) после отжига перпендикулярно направлению прокатки             | 80                      | 82         | 8        | -      |

1) Nature of material; 2) temper; 3) (kg/mm<sup>2</sup>); 4) rod, d = 15-20 mm; 5) a) without annealing; 6b) after annealing to relieve stresses at 985° for 1 hour; 7c) after recrystallizing anneal at 1175° for 1 hour; 8) mm-thick sheet; 9a) after anneal at 985°, along direction of rolling; 10b) after annealing, across direction of rolling.

II-113M3

The mechanical properties of molybdenum depend on the degree of purity, the production technology, and the testing conditions. As a result of the absence of phase transformations, molybdenum is strengthened by half-hot strain hardening, and not by heat treatment. The only heat treatment used with molybdenum is annealing. The required combination of the mechanical properties of molybdenum mill products (bar, sheet, tube, foil, wire) is achieved by deformation and annealing. Typical mechanical properties of molybdenum sheet and rod are shown in Table 1. The effect of notching on short-term strength and fatigue of molybdenum is shown in Table 2. Molybdenum has a high fatigue life coefficient - from 0.65 to 0.80. Just as some other metals which crystallize in a body-centered-cubic lattice (Fe, Cr, W), molybdenum is cold brittle. The temperature threshold for cold brittleness of molybdenum depends on the degree of purity of the metal, the production method, the grain size, the testing conditions. Molybdenum of high purity, produced by repeated zonal refinement in vacuum, is plastic at  $-190^{\circ}$  (in tensile tests). When produced by arc melting in vacuum and by the powder metallurgy method, the temperature for the transition of molybdenum from the plastic to brittle condition varies in the range from  $-50$  to  $+700^{\circ}$ . Oxygen has a particularly large influence on raising the cold brittleness threshold of molybdenum. From tests in bending, with an increase of the oxygen content from 0.003 to 0.008 the transition temperature of the specimens increased from  $45$  to  $325^{\circ}$ . The transition temperature also increases with increase of the grain size. The effect of grain size on the transition temperature of molybdenum into the brittle state is shown in Fig. 1. The effect of test temperature on the mechanical properties of wrought molybdenum is shown in Fig. 2. With increase of the temperature from  $20$  to  $1800^{\circ}$ ,  $\sigma_b$  drops from  $68$  to  $4.5-5$   $\text{kg/mm}^2$ . The stress-rupture strength of wrought molyb-

II-113M4

denum at 1100° is 9 kg/mm<sup>2</sup> after 100 hours. The 100-hour strength of recrystallized molybdenum under these conditions is equal to about 6.3 kg/mm<sup>2</sup>. When wrought molybdenum is heated to a certain temperature the recrystallization process takes place, involving the formation and growth of new grains and accompanied by weakening of the metal. In physcial metallurgy practice the recrystallization temperature is generally taken to be the temperature at which after short-time heating (about 1 hour) 50% of the initial strengthening is retained. The crystallization temperature of molybdenum depends on the purity of the metal, the production method, and the initial degree of deformation. With increase of the degree of deformation from 70 to 99.7%, the recrystallization temperature of molybdenum drops from 1200 to 900°. At room temperature recrystallized molybdenum may be in the brittle or plastic states depending on the degree of purity and the grain size. The tensile strength of recrystallized molybdenum at room temperature is 40-48 kg/mm<sup>2</sup>. The difference of the strength of molybdenum in the recrystallized and strain hardened conditions decreases with increase of the temperature above 1000°.

TABLE 2  
Tensile and Fatigue Strengths of Molybdenum at 20°

| Свойства   | 1  | 2 Вид образца | 3 Метод изготовления металла |                          |
|--|----|---------------|------------------------------|--------------------------|
|  |    |               | 4 дуговая плавка             | 5 порошковая металлургия |
| $\sigma_b$ (кг/мм <sup>2</sup> )   | 6  | 7             | 68-76                        | 66-71.6                  |
| $\sigma_{-1}$ (при изгибе) за 5·10 <sup>7</sup> циклов                         |    | 8             | 88-104                       | 78-86                    |
| 9 (кг/мм <sup>2</sup> )  |    |               | 26.2                         | 52.7                     |
| Коэфф. чувствительности к надрезу  | 10 |               | 21.8                         | 38.7                     |
| 11 Коэфф. чувствительности к надрезу при испытаниях на устойчивость $K_f^{**}$ |    |               | 0.81                         | 0.74                     |
|  |    |               | 2.2                          | 1.36                     |

\*Fatigue life coefficient  $\sigma_{-1}/\sigma_b$ .

\*\* $K_f = \sigma_{-1}$  smooth specimens /  $\sigma_{-1}$  notched specimens.

1) Properties; 2) form of specimen; 3) metal production method; 4) arc melting; 5) powder metallurgy; 6)  $\sigma_b$  (kg/mm<sup>2</sup>); 7) smooth specimen; 8) notched specimens; 9)  $\sigma_{-1}$  (bending) after 5·10<sup>7</sup> cycles (kg/mm<sup>2</sup>); 10) fatigue life coefficient\*; 11) notch sensitivity coefficient in fatigue testing  $K_f^{**}$ .



II-113M5

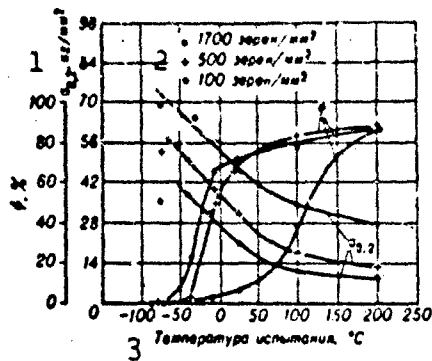

Fig. 1. Effect of grain size on molybdenum plasticity.

1)  $\text{kg/mm}^2$ ; 2) grains/ $\text{mm}^2$ ;  
3) test temperature,  $^{\circ}\text{C}$ .

Impurities (C, O, N, Si, Fe, Al, Ca, P, S and other elements) are present in technical molybdenum in amounts from hundredths to hundred thousandths of a percent by weight depending on the metal production technology and have a marked effect on its properties. The most harmful of these impurities is oxygen, which has limited solubility in Mo: at  $1700^{\circ}$  it dissolves in the

amount of 0.0065% by weight, with temperature reduction the oxygen solubility diminishes and at  $1100^{\circ}$  is 0.0045% by weight. With increase of the oxygen content low-melting Mo oxides are formed, which are arranged in the metal along the grain boundaries in the form of a thin

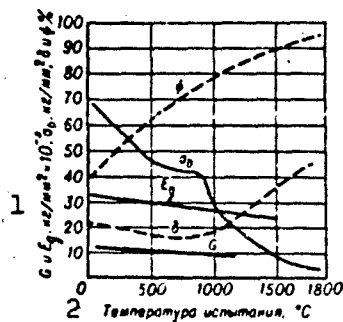

Fig. 2. Effect of test temperature on mechanical properties of wrought molybdenum produced by the arc method. 1)  $G$  and  $E_g$ ,  $\text{kg/mm}^2 \times 10^{-3}$ ,  $\sigma_b$ ,  $\text{kg/mm}^2$ ,  $\delta$  and  $\psi$ , %; 2) test temperature,  $^{\circ}\text{C}$ .

film, which leads to marked embrittlement of Mo at room and elevated temperatures. With an oxygen content over 0.004% by weight the capability of Mo for deformation is reduced, particularly in the presence of nitrogen and carbon. In the case of melting Mo with additions of Th, Zr, Hf, Ti the deleterious effect of the oxygen is reduced as a result of binding it into refractory oxides which precipitate out during

II-11346

crystallization of the metal in the form of globules within and along the boundaries of the grains. The effect of oxygen in the form of Mo oxides and oxides of the refractory metals, nitrogen and carbon on the temperature for the transition of Mo from the plastic to brittle state is shown in Fig. 3.

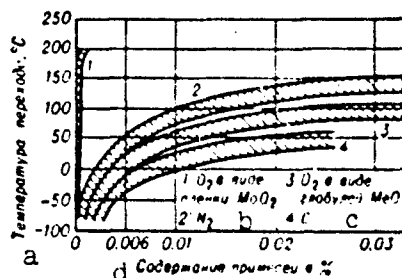

Fig. 3. Effect of impurities on transition temperature of cast molybdenum from plastic to brittle state (bending tests). a) Transition temperature, °C; b)  $O_2$  in the form of  $MoO_2$  film; c)  $O_2$  in the form of  $MeO$  globules; d) impurity content in %.

References: Molybdenum, collection edited by A.K. Natanson, translated from English, M., 1959; Nuclear Reactors, translated from English, Vol. 3, M., 1956 (Materials of the Atomic Energy Commission of the USA); Stroyev A.S., Ovsepyan Ye.S., Zakharova G.V., Tugoplavkiye metally: molibden, vol'fram, niobiy i tantal (Refractory Metals: Molybdenum, Tungsten, Niobium, and Tantalum), M., 1960; Zarubin N.M., Koptsik A.N., Proizvodstvo tugoplavkikh metallov (Production of Refractory Metals), M.-L., 1941; Problemy sovremennoy metallurgii (Problems of Modern Metallurgy), 1955, No. 4 (22); 1956, No. 2, (26); The metal molybdenum, Cleveland, 1958.

Ye.S. Ovsepyan, A.S. Stroyev

MOLYBDENUM ALLOYS are construction materials for the fabrication of parts operating at temperatures of 1100-1800°; for short periods (to 5 minutes) the molybdenum alloys may be used for operation in a stream of combustion products at 2300-2500°.

The high-temperature strength level of the molybdenum alloys depends on the degree of alloying, the nature of the interaction of the alloying elements with the base metal, and to some extent on the production technology. With regard to the alloy deformability conditions, the alloying limits of molybdenum are comparatively limited, and the selection of alloying elements for rational alloying is not extensive.

To obtain a marked increase of the high-temperature strength of molybdenum, tungsten must be added to an extent of more than 20%, which leads to unwanted increase of the specific weight of the alloy deterioration of its deformability. The overwhelming majority of alloying elements make molybdenum brittle. The only element which increases its plasticity is rhenium, whose introduction in the amount of 40-50% makes molybdenum deformable at room temperature. However rhenium is scarce and therefore not easily available for alloying production alloys. The best alloying elements from the viewpoint of effectiveness of increase of the high-temperature strength of molybdenum and retention of its deformability are Zr and Ti. The alloys containing these metals (to 0.5%) are single-phase and with regard to physico-chemical nature belong to the hard alloy group which are strengthened by half-hot strain hardening. A higher level of high-temperature strength is shown by the hetero-phase, heat-treatable, complex-alloyed molybdenum alloys containing Ti, Zr,

C and other elements. However the hetero-phase alloys are less plastic and their production is associated with considerable difficulties.

The low-alloy molybdenum alloys of grade VM-1, TsM-2, and VM-2 containing 0.1-0.4% Zr, to 0.4% Ti and to 0.02% C are produced in the USSR. The following low-alloy single-phase alloys are produced abroad: Mo + 0.3% Nb; Mo + 1% V; Mo + 2% W; Mo + 0.5% Ti and Mo + 0.08% Zr + 0.22% Ti, of which the last two alloys have the highest high-temperature strength. The VM-2 and Mo + 5% Ti alloys are used to produce mill products: rods, forging blanks, stampings, and the VM-1 and TsM-2 alloys are used to produce rods, sheet, tubing.

To obtain high quality mill products from these alloys it is necessary to use new technology for producing the metal with utilization of vacuum during melting and heat treatment, and protective media during deformation. The mechanical properties of the molybdenum alloys depends on their composition and temperature. Figure 1 shows the variation of the tensile strength of the molybdenum alloys with temperature in the 20-2000° range. The effect of temperature on  $\sigma_b$ ,  $E_d$ ,  $\delta$  and  $a_n$  of the VM-2 alloy is shown in Fig. 2. With temperature increase from 20 to 2000°, the alloy strength decreases consistently from 80 to 3-4 kg/mm<sup>2</sup>. At 1300° the hetero-phase alloy is stronger, and the VM-2 is the strongest of the single-phase alloys.

The modulus of elasticity ( $E_d$ ) of low alloy molybdenum alloys is equal to the elastic modulus of unalloyed molybdenum. With temperature increase from 20 to 1800°,  $E_d$  of the low alloys gradually decreases from 32,000-33,000 to 18,000-18,500 kg/mm<sup>2</sup>.

The molybdenum alloys, just as molybdenum, are cold brittle (see Molybdenum). From impact tests of standard notched specimens, the transition temperature from the plastic to brittle condition of the alloys VM-1, TsM-2 and VM-2 is in the 150-300° range. From static tensile

II-116M2

tests, not rolled sheets of the alloy VM-1 of 1-mm thickness with degree of deformation 90-95% are plastic at  $-70^{\circ}$ . Fatigue limits of low alloy alloys on the basis of  $10^7$  cycles at room temperature are: VM-2 52-54  $\text{kg/mm}^2$  (cylindrical specimens); VM-1, 46-48  $\text{kg/mm}^2$  (sheet specimens).

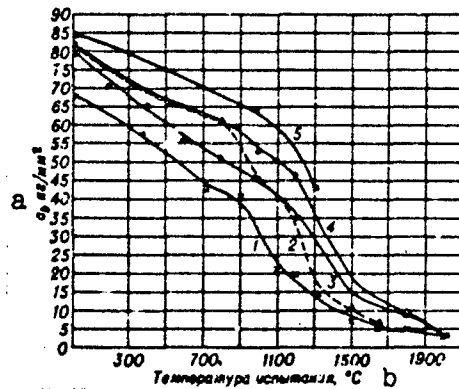

Fig. 1. Effect of temperature on mechanical properties of molybdenum alloys: 1- Unalloyed Mo; 2- Mo + 0.5% Ti; 3- alloys VM-1 and TsM-2; 4- alloy VM-2; 5- Mo + 1.27% Ti + 0.29% Zr + 0.3% C. a)  $\sigma_p$ ,  $\text{kg/mm}^2$ ; b) test temperature,  $^{\circ}\text{C}$ .

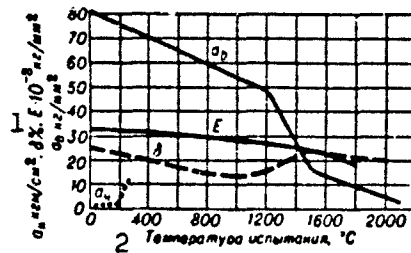

Fig. 2. Effect of temperature on mechanical properties of the VM-2 alloy. 1)  $\sigma_p$ ,  $\text{kg/cm}^2$ ,  $\delta\%$ ,  $E \cdot 10^{-3}$ ,  $\text{kg/mm}^2$ ; 2) test temperature,  $^{\circ}\text{C}$ .

The stress-rupture strength of the single-phase alloys after 100 hours (testing in neutral medium and in vacuum); Mo + 0.5% Ti at  $1100^{\circ}$  is 24  $\text{kg/mm}^2$ ; Mo + 0.08% Zr + 0.22% Ti at  $1100^{\circ}$  is 33  $\text{kg/mm}^2$ ; alloy VM-2 at  $1200^{\circ}$  is 23  $\text{kg/mm}^2$ ; alloys VM-1 and TsM-2 at  $1200^{\circ}$  is 8-10  $\text{kg/mm}^2$ . The 100-hour strength of the hetero-phase alloys alloyed with Ti, Zr, Nb, C and others is considerably higher than the strength of the single-phase alloys and at  $1300^{\circ}$  reaches 23  $\text{kg/mm}^2$ .

## II-116M3

The only form of heat treatment of the low-alloy alloys of the type VM-1, TsM-2, VM-2, is annealing: homogenizing anneal of ingots at 1800-2000°, in intermediate recrystallizing anneal of the deformed materials at 1300-1450° and annealing of the finished products to relieve stresses at 900-1100°. The alloys are also weakened as a result of recrystallization. After deformation by 75-95% the recrystallization temperature of alloys of the type VM-1, TsM-2, Mo + 0.5 Ti is about 1300-1350°, and for the VM-2 alloy it is about 1400°. The difference in strength of the molybdenum alloys in the strain hardened and recrystallized conditions reduces with increase of the test temperature. At temperature of 1500° and above, the short-term strength of the metal in the strain hardened and recrystallized conditions is the same.

Molybdenum alloys are not refractory because of the volatility and low melting point of the molybdenum oxides. The alloys are not used without coatings at temperatures above 700° for long-term operation in oxidizing media (see Protective Coatings for Molybdenum). Without protective coatings parts made from the molybdenum alloys can operate only in reducing and neutral media and in a vacuum.

The physical properties of the low-alloys of the type VM-1, TsM-2, VM-2 and others are the same:

$$\begin{aligned} \gamma &= 10.2 \text{ g/cm}^3 \\ \alpha &= (5.6 - 5.75) \cdot 10^{-4} \text{ at } 20 - 1000^\circ \\ \alpha &= (5.7 - 6.06) \cdot 10^{-4} \text{ at } 20 - 1000^\circ \\ \alpha &= (6.7 - 6.8) \cdot 10^{-4} \text{ at } 20 - 2000^\circ \end{aligned}$$

Alloys of the type VM-1, TsM-2, VM-2, Mo + 0.5% Ti are satisfactorily machined using a tool made from high speed steel.

To prevent spalling, the vibration of parts must be minimal during machining, they should be mounted on the machine tool with pads made from Al, Cu or soft iron.

Parts of complex configuration can be made from sheets of the type VM-1 and TsM-2 alloys by stamping at 300-600° (see Forging and Stamping

II-116M4

Thermal Conductivity and Heat Capacity of Molybdenum Alloys

| Хар-на 1                    | 2 При темп-ре |       |       |
|-----------------------------|---------------|-------|-------|
|                             | 20°           | 1500° | 1900° |
| $\lambda$ (кал/см-сек-°C) 3 | 0.31          | 0.23  | 0.21  |
| $c$ (кал/г-°C) 4            | 0.067         | 0.087 | 0.094 |

- 1) Characteristic; 2) at temperature; 3)  $\lambda$  (cal/cm-sec-°C); 4)  $c$  (cal/g-°C).

of Molybdenum).

Sheets of the type VM-1 and TsM-2 alloys are resistance welded and fusion welded using argon arc or electron beam in a vacuum. With high welding speeds and cooling, weld seams of sheets of thickness to 1 mm may be plastic, with a bend angle of no less than 20° (at room temperature) (see Welding of Refractory Metals).

The molybdenum alloys are used as materials for inserts of critical nozzle sections, skins for flight vehicles, parts for rockets and atomic reactors, die inserts for pressure casting steel, equipment and tooling in the metal working industry, parts for equipment in the petroleum and glass industries, parts for radio, electrotechnical and electronic engineering, etc.

References: Molybdenum, collection edited by A.K. Natanson, translated from English, M., 1956 (Materials of the Atomic Energy Commission of the USA): "Less - common metals"; 1960, v. 2, No 2-4; The metal molybdenum, Cleveland, 1958; "Metaux (Corros.-inds)" 1955, v. 30.

Ye.S. Ovsepyan

MOLYBDENUM BARS - semifinished products manufactured from sintered molybdenum obtained by powder metallurgy and from cast molybdenum and its alloys melted in vacuum arc furnaces.

In view of their low mechanical characteristics and recrystallization temperature, pure molybdenum bars are of limited application, being employed principally in the electronics industry, where they are converted to fine wire and foil. Use of molybdenum-alloy bars is more promising. Bars of VM-1, VM-2 and TsM-2A alloys are employed as structural materials and as blanks for the manufacture of tubing and sheets (VM-1 and TsM-2A alloys) and stampings (VM-2 alloy, etc.). Bars are produced by pressing, rolling, and forging. Bars are pressed from ingots of VM-1, VM-2, and other alloys at 1600-1700° with a minimum deformation of 70%. Blanks consisting of preliminarily deformed bars of VM-2 alloy are pressed at 1250-1450°, while blanks of VM-1 alloy are pressed at 900-1300°.

The temperature to which preliminary deformed blanks are heated before rolling is 1350° for VM-2 alloy and 1250° for VM-1 alloy. Rolling is completed at 800-900°. Prepressing or prerolling heating of the blanks is carried out in an atmosphere of purified hydrogen, argon, or helium. After reduction in area by 80-85% intermediate annealing is carried out at 1400° for VM-1 alloy and 145° for VM-2 alloy, employing a holding time of 5 hr in a vacuum ( $10^{-4}$  mm Hg). Large-diameter bars can be annealed in a neutral atmosphere. In order to achieve optimum mechanical characteristics the final degree of deformation should be 80-85°. In order to relieve internal stresses the finished bars are an-



III-129p1

nealed in a vacuum or neutral atmosphere at 1100-1000° for 2 hr; the surface oxide layer is removed before annealing.

Pressed bars can be produced in diameters of from 20 to 150 mm, while rolled bars have diameters of from 10 to 50 mm. The normal length of pressed bars ranges up to 2500 mm, while that of rolled bars ranges up to 800 mm.

For the mechanical characteristics of molybdenum and molybdenum-alloy bars see the articles entitled Molybdenum and Molybdenum alloys.

References: Obrabotka zharoprochnykh splavov [Processing of High-Hot-Strength Alloys], Moscow, 1960.

S.B. Pevzner

I-97G

MOLYBDENUM DISILICATE ( $\text{MoSi}_2$ ) - chemical compound of molybdenum with silicon (Si 36.9% by weight), which has a high high-temperature corrosion resistance at  $1700^\circ$ . Molybdenum disilicate is known for over 50 years, but it is only after the Second World War that a practical use has been found for it.

Properties of sintered molybdenum disilicate:

Tetragonal crystal structure. Lattice spacings (A):  $a = 3.197$ ,  $c = 7.871$ ,  $c/a = 2.463$ ;  $t_{p1} 2030 \pm 50^\circ$ ,  $\gamma = 5.9-6.3 \text{ g/cm}^3$ ; H for P = 100 g is  $1300 \text{ kg/mm}^2$ ,  $\rho 22 (25^\circ)$  microohms·cm, at  $1600^\circ$  it is 80 microohms·cm.  $\alpha = 8 \cdot 10^{-6} (20-1000^\circ) ^\circ\text{C}^{-1}$ , according to different data in the temperature range 27-1480 it is  $5.1 \cdot 10^{-6} ^\circ\text{C}^{-1}$ .

Creep strength after 100 hours at  $980^\circ$  is  $21 \text{ kg/mm}^2$ , at  $1040^\circ$  it is  $10.6 \text{ kg/mm}^2$ , at  $1090^\circ$  it is  $6 \text{ kg/mm}^2$ .  $\sigma_{1zg} = 25-40 \text{ kg/mm}^2$ .

Ultimate tensile strength at  $980^\circ$  is  $28.1 \text{ kg/mm}^2$ , at  $1200^\circ$  it is  $30 \text{ kg/mm}^2$ , at  $1315^\circ$  it is  $28.8 \text{ kg/mm}^2$ .  $\delta$  at  $127-1320^\circ$  is 0.5%,  $\sigma_b = 246 \text{ kg/mm}^2$ ,  $c = 0.092 \text{ cal/g} \cdot ^\circ\text{C}$ , enthalpy  $47.9 \text{ kcal/mole}$ .  $\gamma$  at  $150^\circ$  is  $0.129 \text{ cal/cm} \cdot \text{sec} \cdot ^\circ\text{C}$ , at  $540^\circ$  it is  $0.093 \text{ cal/cm} \cdot \text{sec} \cdot ^\circ\text{C}$ .  $E = 41,300 \text{ kg/mm}^2$ .

Radiation coefficient at  $1000-1600^\circ$  is 0.93. Thermal stability according to the regime: heating from 200 to 1200 in 12 sec, cooling to  $200^\circ$  in 15 secs. (10-20 cycles); according to the regime: heating from 100 to  $1500^\circ$  in 30 secs. cooling to  $100^\circ$  in 45 secs. (5-10) cycles). It is resistant to all nonorganic acids, to molten sodium, tin, lead, bismuth, mercury and other metals which do not form silicates, but dissolves in a mixture of hydrofluoric and nitric acids or in hydrofluoric

I-97G1

acid in the presence of some other oxidizers and in alkalis. High-temperature corrosion resistance, which is an important property of molybdenum disilicate, is due to the formation on its surface of a protective film consisting of silicon dioxide. Molybdenum disilicate is stable in air up to 1700°, i.e., to a temperature somewhat lower the melting temperature (1713°). The properties of molybdenum disilicate depend to a large extent on the manner in which it is prepared. The simplest method for obtaining molybdenum disilicate powder is combining directly  $\text{Mo} + 2\text{Si} = \text{MoSi}_2$  at 1000-1270°. Products from molybdenum disilicate are made by hot pressing of the  $\text{MoSi}_2$  powder at 1900°. Molybdenum disilicate is used for the production of refractory products, heat resistant alloys, creating of high-temperature corrosion resistant coatings on articles from molybdenum, niobium, iron, alloys with them as a base, etc. Molybdenum disilicate for oxidation protection of components can be applied by spraying (oxygen-acetylene, plasma and other burners), precipitation of silicon from the vapor phase at 1000-1800° from a mixture of hydrogen and silicon tetrachloride or by the thermodiffusion method from powders. In the last two cases, as a result of diffusion of the silicon in a molybdenum, a protective film is formed, as a rule, from  $\text{MoSi}_2$  (sometimes other phases, such as  $\text{Mo}_5\text{Si}_3$  and  $\text{Mo}_3\text{Si}$ , are present) (See Protective Coatings of Molybdenum).

References: Borisenko, A. I., Zashchita molibdena ot vysokotemperaturnoy gazovoy korrozii [Protecting Molybdenum from High-Temperature Gas Corrosion], Moscow-Leningrad, 1960; Samsonov, G. V. and Neshpor, V. S., Polucheniye, svoystva i tekhnicheskoye primeneniye disilitsida molibdena [Obtaining, Properties and Engineering Application of Molybdenum Disilicate], "Ogneupory" ["Refractory Materials"], No. 1, 1958; Samsonov, G. V. and Portnoy, K. I., Splavy na osnove tugoplavkikh soyedineniy [Refractory Compound-Based Alloys], Moscow, 1961; Bückle, H., Les alliages

I-97G2

de molybdene et leur protection contre l'oxidation [Molybdenum Alloys and Their Protection Against Oxidation], "Rech. aeronaut.," [Aeronautical Research], No. 61, page 47, 1957; "Metallurgia," Vol. 53, No. 318, page 175, 1956.

Ye.V. Sivakova

MOLYBDENUM FORGINGS AND STAMPINGS - forgings and stampings made from molybdenum and low-alloy molybdenum. Medium-size and small forgings and stampings (up to 200 mm) are made from previously extruded bar 150 mm in diameter or less or from other extruded blanks similar in shape to the forging. Blanks and ingots are heated in an atmosphere of hydrogen, argon, or helium. A low-alloy blank is heated to a temperature of 1400-1540° for stamping. Stampings in the form of blades and valves are best made by extrusion. An ingot 200 mm or more in diameter serves directly as the initial blank for large forgings and stampings (more than 250 mm). Under deformation, a low-alloy ingot will be heated to a temperature of 1800-1600°. In the manufacture of forgings, after several heatings, the second and subsequent heatings are carried out at 1400-1500°, and the last heating at 1350-1400°.

The permissible degree of deformation in one machine pass for forging and stamping is ≈50%, in extrusion, 70% or more. Forgings and stampings obtained from a bar that has first been extruded will work better, have more uniform structure, and improved mechanical properties. To relieve internal stresses, forgings and stampings are subjected to annealing in a vacuum of  $10^{-4}$  mm Hg at 1100° for 2 hr. Prior to annealing, the forgings and stampings are worked mechanically until oxides are removed completely from the surface. Large forgings may be annealed in a neutral atmosphere after stamping. In this case, after annealing an oxide layer about 1.5 mm thick is removed from each side.

Pure molybdenum may also be used for forgings and stampings (disks, blanks for gas-turbine blades, etc.), intended for the manufacture of

III-2p1

lightly loaded parts. The technology employed in manufacturing the stampings and forgings is similar to that used for lightly loaded alloys, but the pressure-working temperature is 400-300° lower.

Molybdenum and its alloys have a wide temperature range of plasticity, so that the forging and stamping processes may be concluded at 900-1000°.

The chief factor impairing the plasticity of molybdenum and molybdenum-based alloys during deformation is elevated content of oxygen and other impurities contained in the metal.

References: Obrabotka zharoprochnykh splavov [Processing of High-temperature Alloys]. [Reports to a Conference]. Moscow, 1960.

S.V. Pevzner

MOLYBDENUM PIPES - are made from sintered molybdenum, pure cast metal (smelted in electric arc vacuum furnaces) and from molybdenum-base low-alloy alloys.

Pipes from sintered molybdenum usually have a low density, reduced plasticity in the recrystallized state for which reason their utilization is limited. Pipes from pure cast molybdenum, due to the low recrystallization temperature, cannot be used in designs operating at temperatures above 800°.

The use of pipes from low-alloy alloys with molybdenum as a base, with a recrystallization temperature by 300-400° higher than that of pure molybdenum is most promising. Molybdenum pipes are also used in nuclear engineering (reactors, heat exchangers) and in radioengineering apparatus.

Pipes from the VM-1 alloy can operate successfully under substantial stresses at 1000-1200°, and at low loads up to 1700°. Extrusion of pipes with a wall thickness of 4-12 mm is performed at 900-1200°, rolling and drawing is done at 350-500°. The starting blank for pipe extrusion is a pressed hollow cartridge, while an extruded pipe is used for rolling of thin-walled pipes. Intermediate annealing for pipes is performed for each 60-70% total deformation at 1250-1450°. The final annealing takes place at 1100° or 1650°, depending on the intended use of the product. The medium in which the blanks are heated before extrusion: purified hydrogen, argon or helium.

Annealing is performed in a vacuum of  $10^{-4}$  mm of Hg. The product quality (particularly plasticity) depends on the purity of the starting

III-98t1

metal, heat treatment under vacuum, and also on the conditions under which the extrusion, rolling and drawing processes take place, which should desirably be done in a neutral medium.

The length of extruded pipes is up to 2 meters, of rolled up to 3 m, of drawn up to 1.5 m. Pipes in the hardened state are annealed at 1100° under a vacuum to relieve residual internal stresses.

Nominal Pipe Dimensions  
(mm)

| 1<br>Трубы<br>прессованные |                       | 2<br>Тонкостенные<br>трубы<br>катаные |                  | 3<br>Тонкостенные<br>трубы<br>тянутые |                  |
|----------------------------|-----------------------|---------------------------------------|------------------|---------------------------------------|------------------|
| 4<br>наружный<br>диаметр   | 5<br>толщина<br>стены | наружный<br>диаметр                   | толщина<br>стены | наружный<br>диаметр                   | толщина<br>стены |
| 30-40                      | 4-5                   | 8-15                                  | 0.2-0.5          | 1.5-3                                 | 0.1-0.25         |
| 45-60                      | 5-6                   | 21-40                                 | 1-2              | 4-6                                   | 0.2-0.5          |
| 65-80                      | 6-8                   | 41-56                                 | 1.5-3            | 6-12                                  | 0.2-1.0          |
| 85-100                     | 8-10                  | -                                     | -                | -                                     | -                |

1) Extruded pipes; 2) thin-walled rolled pipes; 3) thin-walled drawn pipes; 4) outside diameter; 5) wall thickness.

The mechanical properties of pipes at 20° should conform to the following norms:  $\sigma_b \geq 75 \text{ kg/mm}^2$ ,  $\delta \geq 10\%$  for extruded,  $\sigma_b \geq 85 \text{ kg/mm}^2$ ,  $\delta \geq 6\%$  for thin-walled rolled and drawn pipes.

Thin-walled pipes are tested for flaring and flattening at 350-500°. On request by the consumer, thin-walled pipes are tested for gas permeability and hydraulic pressure.

References: "Steel," No. 6, 1958; Yadernyye reaktory [Nuclear Reactors], translated from English, Vol. 3, 1956 (Materialy Komis. po atomonoy energii SShA [Materials of the Atomic Energy Commission of the USA]).

S.B. Pevzner



MOLYBDENUM SHEET is used for the fabrication of details operating for a long time (from several hours to several tens of hours) at 1200-2000° in a nonoxidizing medium and for a short time (from several seconds to several minutes) in an air atmosphere.

The sheets may be produced from the pure metal or from certain plastic alloys (see Molybdenum Alloys) which are obtained by smelting or by the powder metallurgy method. The production technologies are: forging or pressing of ingots at 1500-1800° (blank of rectangular section); hot rolling (into sheet in the range of 1250-1000°). Strip of thickness from several tenths to several hundredths of a millimeter is obtained by rolling on multi-roller mills.

For the mechanical properties of the molybdenum sheet see the articles on Molybdenum and Molybdenum Alloys.

Molybdenum sheet of 0.5 mm thickness is easily pressure worked at room temperature. Sheets 0.5 mm thick which have been rolled in two directions (with 90° rotation) can be bent through an angle of 180° in any direction with radius equal to the sheet thickness. To avoid the formation of cracks when forming material of thickness 0.5 and 1 mm (in sheet stamping), the sheets must be heated to 100-160°, sheets of thickness greater than 1 mm must be heated to 350-400°. This also applies to the case of trimming in dies and shearing. Heating of the dies is also recommended. Stamping must be performed with a minimal number of operations. Molybdenum sheet can also be subjected to end milling. This must be done in the longitudinal direction and the sheets must be clamped between steel sheets to avoid tearing the edges. Milling of

II-100k1

flat specimens for mechanical testing and the drilling of holes is performed similarly.

Molybdenum cladding is one of the methods of application of protective metal coatings on sheet and is used to protect the molybdenum from oxidation at high temperatures. As a cladding material we can make use of pure nickel and also the nickel- and iron-base refractory alloys. The cladding technology is the following: fabrication of a shell from the cladding material, welding of the molybdenum blank to the shell, hot rolling into sheet. The maximal operational temperature of clad molybdenum is determined by the heat resistance of the cladding material. Cladding improves the fabricability of molybdenum sheet in the operations of cutting, bending, blanking, drilling, etc.

Mechanical Properties of  
Clad Molybdenum in Short-  
Time Testing

| Механич.<br>свойства 1             | 2) Темп-ра испытания (°C) |           |
|------------------------------------|---------------------------|-----------|
|                                    | 1000                      | 1200      |
| $\sigma_b$ (кг/мм <sup>2</sup> ) 3 | 29-40.2                   | 29.5-30.6 |
| $\delta$ (%)                       | 3.5-5                     | 5.75-8.5  |

1) Mechanical properties;  
2) test temperature; 3)  
(kg/mm<sup>2</sup>).

Joining of molybdenum sheets (clad and unclad) can be accomplished by riveting (molybdenum rivets), welding (argon-arc, spot, electron beam), brazing. See Welding the Refractory Metals, Brazing Refractory Metals and Their Alloys.

References: Northcott L., Molybdenum, in volume Molybdenum, transl. from Eng., ed. by A.K. Natanson, M., 1959; "Less-common Metals", 1960, v. 2, No. 2-4.

A.I. Mikheyev

II-85k

MOLYBDENUM STRIP see Molybdenum Sheet.

MOLYBDENUM WIRE. The initial blanks for the manufacture of this wire are rolled rods or bars forged in a rotary-forging machine.

As a result of the low technological plasticity of molybdenum at room temperature, the wire is drawn at 500°. Heating is carried out in a hydrogen atmosphere in a special chamber. Preliminary heating ensures that deformation can be carried out at the desired temperature. After a total deformation of 85-98% the wire is annealed at 1250-1350° in a vacuum of  $10^{-4}$  mm Hg. The minimum finished-wire diameter is 20  $\mu$ .

Test methods are dictated by the purpose for which the wire is intended: the principal requirement imposed on wire to be used in heaters is long-term serviceability at high temperatures, that imposed on wire to be used in electronic equipment is high physical characteristics, and that imposed on wire to be employed in structural applications is high strength.

Molybdenum wire is produced in the cold-worked and annealed states. The  $\sigma_b$  of wire 100  $\mu$  in diameter is  $\approx 2.0$  kg/mm<sup>2</sup>; after annealing at 1000°  $\sigma_b \approx 100$  kg/mm<sup>2</sup>, while after after annealing at 1250°  $\sigma_b \approx 60$  kg/mm<sup>2</sup>.

Small-diameter molybdenum wire is used in the manufacture of vacuum tubes, instruments, etc. and in electronic devices; medium-diameter wire is used in heating elements for electric furnaces intended to function at temperatures of up to 1800°; thick wire is employed as a structural material.

References: Davis, G.L and Burdon, P.J., Metal Treatm. and Drop Forging, 1958, Vol. 25, No. 159.

II-117M

MONEL METAL is a nickel-base alloy which contains as the basic alloying element 27-37% Cu. In the USA the term monel metal is used for the alloy consisting of 2/3 nickel and 1/3 copper obtained by metallurgical processing of local natural ores. Monel metal of type NMZhMts 28-2.5-1.5 is produced in accordance with GOST 492-52 with the composition: 27-29% Cu; 2-3% Fe; 1.2-1.8% Mn, remainder nickel. This alloy has excellent corrosion resistance, high tensile strength and good plasticity in the cold and hot conditions. The NMZhMts 29-2.5-1.5 alloy is used to produce sheet (TsMTU 200-41), strip and band (GOST 5187-49 and GOST 492-52), wire (TsMTU 664-41), and rods (GOST 1525-53). Monel metal is used for many parts requiring high corrosion resistance and mechanical strength (in chemical, shipbuilding, medical, petroleum, textile and other branches of industry, machinery and equipment construction). Varieties monel metal are the improvable (strengthened by heat treatment) alloy monel-K and the high strength casting alloy monel-S. Monel-K contains 63-70% Ni, 2% Fe, 1% Mn, 1% Si, 2-4% Al, remainder copper. This alloy is used in those cases requiring higher strength than conventional monel metal.

Monel-S contains 62-68% Ni, 28-31% Cu, 3% Fe, 1.0% Mn and 3.0-5.0% Si. It is used for casting articles with high strength, hydraulic impermeability, high chemical stability and good resistance to wear. It is used to make valve seats and rubbing parts of gas turbines and other machinery. Monel metal does not corrode in dry air and distilled water, is resistant to the action of dilute sulfuric acid, strong alkalis, most organic acids, dry gases at ordinary temperatures and sea water.

II-117M1

Corrosion rate of monel metal in sea water and subsurface waters does not exceed 0.003 cm/year. The monel metals surpass the other copper and iron alloys in stress-rupture strength and refractoriness at temperatures of 250-500°. The mechanical properties of mill products made from monel metal are presented in the table and the figure.

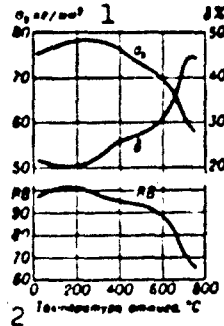

Variation of mechanical properties of monel metal with annealing temperature; cold rolled strip (20% strain hardened), annealed for 3 hours at indicated temperatures. 1)  $\text{kg/mm}^2$ ; 2) annealing temperature, °C.

Mechanical Properties of Mill Products of NMZhMts 28-2.5-1.5

| Полуфабрикаты                   | ГОСТ или ТУ  | 3                                |              |
|---------------------------------|--------------|----------------------------------|--------------|
|                                 |              | $\sigma_b$ (kg/mm <sup>2</sup> ) | $\delta$ (%) |
| 1                               | 2            | 4 не менее                       |              |
| Ленты и полосы: 5               | 7            |                                  |              |
| 6 мягкие                        | ГОСТ 5083-49 | 45                               | 25           |
| 6 полутвердые                   | ГОСТ 5187-49 | 58                               | 8.5          |
| 8 Листы мягкие                  | ЦМТУ 200-41  | 60                               | 25           |
| 11 Прутки:                      |              | 50                               |              |
| 12 тянутые твердые              | ГОСТ 1525-53 | 60                               | 10           |
| 13 тянутые мягкие               |              | 45                               | 25           |
| 14 горячекатаные                |              | 50                               | 18           |
| 15 Проволока:                   | ЦМТУ 684-41  |                                  |              |
| 16 мягкая, диаметр 0,5-4,00 мм  |              | 58                               | 25           |
| 16 5,0-10 мм                    |              | 45                               | 30           |
| 17 твердая, диаметр 0,5-4,00 мм |              | 70                               | 1            |
| 17 5,0-10 мм                    |              | 65                               | 1            |

1) Mill products; 2) GOST or TU; 3)  $\sigma_b$  ( $\text{kg/mm}^2$ ); 4) no less than; 5) strip and band; 6) soft; 7) GOST; 8) half-hard; 9) soft sheet; 10) TsMTU; 11) rods; 12) hard drawn; 13) soft drawn; 14) hot rolled; 15) wire; 16) soft, diameter; 17) hard, diameter.

Mechanical properties of monel metal type NMZhMts 28.2.5-1.5; in soft condition  $\sigma_b = 50 \text{ kg/mm}^2$ ,  $\delta = 40\%$ ; in hard condition (50% strain hardening)  $\sigma_b = 75 \text{ kg/mm}^2$ ;  $\delta = 20\%$ ;  $\sigma_{0,1/1000}$  at 315° is 24, at 425° is

II-117M2

17, and at 540° is 4 kg/mm<sup>2</sup>.

Physical and technological properties:  $\gamma = 8.8$ ;  $\lambda = 0.062$  kcal/cm-sec-°C;  $\rho = 0.48$  ohm-mm<sup>2</sup>/m;  $c = 0.127$  cal/g-°C;  $\alpha = 0.000014$  (0-100°C<sup>-1</sup>);  $E = 18,200$  kg/mm<sup>2</sup>; temperature coefficient of electrical resistance 0.001 (20-100°);  $t_{pl} 1350^\circ$ ; hot working temperature 926-1177°, annealing temperature 850-950°.

References: Spravochnik po mashinostroitel'nykh materialam (Handbook on Machine Construction Materials), Vol. 2, M., 1959; Smiryagin A.P., Promyshlennyye tsvetnyye metally i splavy (Industrial Nonferrous Metals and Alloys), 2nd edition, M., 1956; Espe W. Werkstoffkunde der Hochvakuumtechnik, Bd 1, V., 1959.

Ye.S. Shpichinetskiy

II-119M

MONOLITHS - see Phenol Molding Powders.



II-120M

MORGANITE - See Beryl.

II-112M

MOTHPROOFNESS - see Biological Stability.

**MOTTLED IRON** - is a cast iron in the structure of which the carbon is partially present in bound state (cementite, carbides) and partially in free state (graphite). Mottled iron is characterized by poor mechanical properties; it is difficult to cut, and it is, therefore, not used in practice, excepting the medium-hard chilled iron, the surface structure of which is similar to that of the mottled iron. The structure of the mottled iron is formed by a low silicon content in the iron, an increased content of carbide-forming constituents (Mn, Cr) and in the case of overheating of the molten iron. The graphite may precipitate in the lamellar or spheroidal form, depending on the technological melting conditions. Mottled iron is improved by tempering (see Heat treatment of cast iron). Mottled iron with a lamellar graphite is not used for tempering into malleable iron because the malleable iron obtained by this method possesses poor mechanical properties due to the precipitations of lamellar graphite is not used for tempering into malleable iron because the malleable iron obtained by this method possesses poor mechanical properties due to the precipitations of lamellar graphite. The formation of mottled iron in castings may be prevented by modifying (see Modifying of cast iron). Some pig iron grades for steel manufacture possess the structure of mottled iron.

A.A. Simkin

MOUNTAIN CORK (attapulgite) - an argillaceous mineral, a hydrated aluminum magnesia silicate with the composition  $(\text{OH}_2)_4 (\text{OH})_2 \text{Mg}_5 \text{Si}_8 \text{O}_{20} \cdot 4\text{H}_2\text{O}$ , where some of the Mg and Si atoms are replaced by Al. It crystallizes monoclinically. This mineral is white or gray with a yellowish or brownish tint. Under natural conditions (where it occurs in pockets and blanket deposits) it forms masses with a tangled fibrous structure ("mountain leather," "mountain cork," or "mountain wood"). It has a specific gravity of 2.1-2.4, a Moos hardness of 2-2.5, and an index of refraction of 1.53-1.54. Its fibers are 4-5  $\mu$  long, 50-100 A thick, and elongated along the  $c$  axis. Attapulgite has a ribbon-like structure of the amphibole type and is highly hydrophilic, its water absorption reaching 500-600%; the aggregate mineral can absorb more than 40% of its own weight in liquid without losing its initial strength and shape. Attapulgite is readily decomposed by hot acids, liberating  $\text{SiO}_2$ ; it is less soluble in alkalis. This mineral loses its adsorbed water when heated to  $100^\circ$ , its interstitial zeolitic water when heated to  $150-200^\circ$ , and its hydroxyl water when heated to  $375-425^\circ$ , the latter process being accompanied by conversion to enstatite. The melting temperature of mountain cork is  $1200-1300^\circ$ ; it has a low thermal conductivity and can to some extent be used as a substitute for asbestos. Attapulgite is employed in the preparation of salt-resistant solutions for marine drilling and in the counterboring of salt-bearing strata. It is used as a catalyst in cracking, for removing sulfur compounds from gasoline, in the manufacture of special types of paper, cleaning and polishing compounds, and dies, as a drying agent for various chemical products and

II-15P-2

gases, and as an adsorbant for purifying petroleum and animal oils, wines, and vitamins. It can also be employed for separating certain chemical products by molecular sifting.

References: Betekhtin, A.G., Mineralogiya [Mineralogy], Moscow, 1950; Grim, R.E., Applied Clay Mineralogy, N.Y., 1962.

V.I. Fin'ko

II-96M

MOVIL is a synthetic fiber produced in Italy (see Polyvinyl Chloride Fiber).

Z.A..Zazulina

II-125M

MULLITE is a mineral, aluminum silicate  $3Al_2O_3 \cdot 2SiO_2$ . Specific weight 3.03-3.16. Mohs hardness 6. Bending strength is  $4.2 \cdot 10^4$  kg/cm<sup>2</sup>, shearing resistance at high hydrostatic pressure (kg/cm<sup>2</sup>): at 10,000 -  $1.8 \cdot 10^3$ ; at 30,000 -  $9.0 \cdot 10^3$ ; at 50,000 -  $10.8 \cdot 10^3$ . Modulus of elasticity is  $3.5 \cdot 10^5$  kg/cm<sup>2</sup>. Does not dissolve in acids (even in HF).  $t_{pl}$  is 1810°. Heat capacity (joules/gram) at temperatures: 0°-0.77; 800°-1.09; 1200°-1.13. Mullite is formed on heating kaolinite at 950°, on heating andalusite, sillimanite (see), and kyanite (see) at 1300-1550°. Molten mullite is used to produce high-alumina refractories with excellent high-temperature strength (crucibles, plates, bricks). The fused articles usually consist of short-fiber marble (70-80%) with the addition of corundum (to 10-15%) and glass-like material.

References: Betekhtin A.G., Kurs mineralogii (Course in Mineralogy), 3rd edition, M., 1961; Budnikov P.P., et al., Tekhnologiya keramiki i ogneuporov (Ceramic and Refractory Technology), 3rd edition, M., 1962.

P.P. Stolin

MUNTZ METAL is a copper-zinc alloy (form of brass) suggested by Muntz (England) in 1832. Muntz metal contains 57-61% Cu, with and without additions of lead. The following grades of Muntz metal are produced in accordance with GOST: LS59-1 (57-60% Cu, 0.8-1.9 Pb, balance zinc), LS59-1V (57-51% Cu, 0.8-1.9 Pb, balance zinc) and LS60-1 (59-61% Cu, 0.6-1.0 Pb, balance zinc). This group of alloys are also termed lead brasses (see Special Brass). The most widely used alloy is LS59-1 which contains the lowest amount of copper and has the high plasticity in cold and hot conditions; it machines well (80% of the machinability of the LS63-3 lead brass). The LS59-1 alloy is used to produce strip and bends (GOST 931-52), rods (GOST 2060-60), tubing (GOST 494-52), wire (GOST 1066-58), and profiles (TsMTU 1317-46).

The basic properties of Muntz metal are given in Tables 1, 2 and Figures 1, 2.

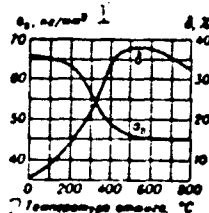

Fig. 1. Variation of mechanical properties of LS59-1 alloy with annealing temperature. 1)  $\text{kg}/\text{mm}^2$ ; 2) annealing temperature,  $^{\circ}\text{C}$ .



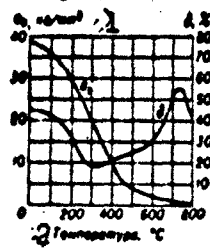

Fig. 2. Variation of mechanical properties of LS59-1 alloy with temperature. 1)  $\sigma_0$ , kg/mm<sup>2</sup>; 2) temperature, °C.

TABLE 1  
Mechanical Properties of Muntz Metal

| Сплав<br>1 | $\sigma_0$<br>(кг/мм <sup>2</sup> ) | $\delta$ (%) | НВ 2<br>(кг/мм <sup>2</sup> ) | 3 твердое состояние                   |              | 4 мягкое состояние            |  |
|------------|-------------------------------------|--------------|-------------------------------|---------------------------------------|--------------|-------------------------------|--|
|            |                                     |              |                               | $\sigma_0$ 2<br>(кг/мм <sup>2</sup> ) | $\delta$ (%) | 2 НВ<br>(кг/мм <sup>2</sup> ) |  |
| ЛС59-1     | 45-65                               | 4-6          | 140-160                       | 35-45                                 | 35-50        | 70-80                         |  |
| ЛС60-15    | 55-65                               | 4-6          | 100-120                       | 30-40                                 | 45-55        | 40-60                         |  |

1) Alloy; 2)  $\sigma_0$  kg/mm<sup>2</sup>; 3) hard condition; 4) soft condition; 5) LS.

TABLE 2.  
Physical and Technological Properties of Muntz Metal

| Сплав<br>1 | $\gamma$<br>(г/см <sup>3</sup> ) | $\alpha \cdot 10^6$<br>(1/°C) | $\lambda$<br>(кал/см·сек·°C) | $\rho$<br>(ом·мм <sup>2</sup> /м) | E<br>(кг/мм <sup>2</sup> ) | Обрабатываемость резанием по отношению к латуни ЛС 63-3 (%) 6 | Темп-ра отжига (°C) 7 |
|------------|----------------------------------|-------------------------------|------------------------------|-----------------------------------|----------------------------|---|-----------------------|
| ЛС59-1     | 8.5                              | 20.8                          | 0.25                         | 0.065                             | 10500                      | 80  | 450-650               |
| ЛС60-1     | 8.5                              | 20.8                          | 0.25                         | 0.064                             | 10500                      | 75  | 450-650               |

1) Alloy; 2)  $\gamma$  (g/cm<sup>3</sup>); 3)  $\lambda$  (cal/cm-sec-°C); 4)  $\rho$  (ohm-mm<sup>2</sup>/m); 5) E (kg/mm<sup>2</sup>); 6) machinability with respect to LS63-3 brass (%); 7) annealing temperature (°C); 8) LS.

References: see article Lead Brass.

Ye.S. Shpichinetskiy

MUSCOVITE is a mineral of the subgroup of the potassium-sodium micas of composition  $KAl_2(AlSi_3O_{10})(OH)_2$ . Bright green muscovite containing up to 4%  $Cr_2O_3$  is termed fuchsite. The crystal system of muscovite is easily split into flexible, elastic, thin (in practice to [100]) lamina. Just as phlogopite, it forms an impact figure and a pressure figure. In thin lamina it is colorless, in thicker lamina (0.3-0.5 mm) it has grayish, pinkish red, brownish, greenish and green colors; it does not give patterns. It has a glassy luster, on cleavage planes it is pearly, silken.  $N_g = 1.588-1.615$ ;  $N_m = 1.582-1.611$ ;  $N_p = 1.552-1.572$ . It is very clearly biaxial. Density 2.7-2.9; hardness 2.0-2.5;  $t_{p1}$  1260-1290°. Acids dissolve it with difficulty; alkalis do not attack it. Thermal conductivity (perpendicular to the cleavage plane) is 0.0010-0.0016 cal/cm-sec-deg. Temperature resistant to 500-600°. Compressive strength (4 × 4 cm plate) is 4200-5400 kg/cm<sup>2</sup>; tensile strength (thickness 0.02-0.05 mm) is 17-36 kg/mm<sup>2</sup>; flexibility index (maximal thickness in bending around a 4-mm-diameter cylinder) is 11-12 microns; wearability less than copper. Hygroscopicity (after 48 hours) is about 0.2%; water absorption is 1.4-4.5%. Frequently contains mineral and air inclusions. Muscovite has very high electrical characteristics. Volume resistivity: perpendicular to the cleavage planes is  $10^{14}-10^{15}$  ohm-cm; parallel to the cleavage planes is  $10^8-10^9$  ohm-cm, surface resistance  $10^{11}-10^{12}$  ohm. Electrical strength of muscovite in the direction perpendicular to the cleavage plane (with testing in oil, cylindrical electrodes) is: for lamina of thickness 0.025 mm, 2.9-3.3 kv, and for lamina of thickness 0.05 mm, 4.9 kv; in this case the

II-127M1

breakdown voltage varies respectively in the ranges of 109-132 and 85-98 kv/mm. Muscovite has very low dielectric losses: tangent of the dielectric loss angle ( $\tan \delta$  at a frequency of 50 Hz is 0.002-0.003, and at a frequency of 100-1000 kHz it is 0.0001-0.0004. All these electrical characteristics relate to muscovite which has no mineral or air inclusions, whose presence leads to considerable degradation of the electrical properties, particularly  $\tan \delta$ .

The combination of the electrical characteristics of muscovite with its technological properties, such as the excellent cleavage into thin and uniform-thickness lamina, high chemical stability, flexibility, mechanical strength, make it a high quality electrical insulation material, therefore up to 90% of the muscovite is used in electrical and radio engineering, the remainder is used for inspection. windows in boilers furnaces, kerosene stoves, etc. In the form of plucked mica it is used to produce molding and flexible lining micanites, mica foil and mica tape for insulation of high power turbogenerators and other high voltage machinery; for the production of sheared mica in the form of rectangular plates, for the production of capacitors (in radio transmitting and receiving stations, electrical filters for telephone equipment), rod and screen mica for ignition plugs in aircraft engines, plates for television transmitting tubes, electric insulation spacers; in the form of radio tube parts, thermal screens for electric bulbs, washers for aircraft spark plugs, washers for thermal and electrical insulation and so on; in the flake and powder forms for production of micalex, thermal insulation materials, dusting of rubberoid, production of flame-resistant paints, as a rubber filler, for the production of wallpapers. Waste from the processing of muscovite is used for the production of new forms of mica insulation: "slyudinite" - a mica paper - and "integrated mica."

II-127M2

Requirements for muscovite quality are standardized by GOST for plucke (3028-57), capacitor (7134-57), and ground (855-41) mica.

References: Betekhtin A.G. Kurs mineralogii (Course in Mineralogy), 3rd edition, 1961; Volkov K.I. and Zagibalov P.N., Tekhnologiya slyudy (Mica Technology), M., 1958; Trebovaniya promyshlennosti k kachestvy mineral/nogo syriya (Industry Requirements on Quality of Mineral Raw Material), No. 23 - Lashev Ye.K. Markov P.N., Suloyev A.I., Slyuda (muskovit i flogopit) (Mica (muscovite and phlogopite), M.-L., 1946.

N.N. Zubarev

II-88M

MYCOLOGICAL STABILITY - see Biological Stability.

NATURAL ACIDPROOF MATERIALS - are rocks and minerals which are highly resistant to the action of chemical reagents, especially acids and bases. Andesite, beschtaunite, felsite, volcanic rocks of the type of Artik-tuff, granite, quartzite, marshallite, and asbestos belong to the group of natural acidproof materials.

Andesite is a volcanic rock composed mainly of neutral plagioclase and a subordinate quantity of ferruginous magnesia minerals (pyroxene, hornblende, and biotite); it is characterized by a very compact aphanitic bulk. Fresh varieties of andesite are used as an acidproof material. The specific gravity is 2.2-2.7; the weight by volume is  $2.06 \text{ g/cm}^3$ ; the porosity is 4.9-12.9%; the water adsorption is 3.5-7.0; the hardness (according to Mohs) is 5; the temporary compression strength of the dry specimen is  $800-1250 \text{ kg/cm}^2$ , and that of the frozen specimen  $715-1175 \text{ kg/cm}^2$ ; the Young's modulus is  $2.74-4.5 \text{ dyne/cm}^2$ . The heat conduction at  $60^\circ$  is  $3.06 \text{ cal/cm}\cdot\text{sec}\cdot^\circ\text{C}\cdot 10^{-3}$ ; the melting point is  $1195^\circ$ ; the specific electric resistance is  $4\cdot 10^5 \text{ ohm}\cdot\text{cm}$ . The acid resistance is (in %): 95-97 in sulfuric acid (specific gravity 1.8), and 95-97 in nitric acid (specific gravity 1.4). The natural acidproof material andesite possesses acid resistance, heat endurance, fireproofness, mechanical strength, and viscosity. It is used in the lining of Glover and Gay Lussack towers in the nitrose and contact methods of the production of sulfuric acid, in drying and absorbing towers, and also in the lining of electric filters. Andesite rubble is used as an aggregate of acidproof concrete.

Beschtaunite is an eruptive rock. According to the petrographical

I-65K1

characteristics it may be defined as an alkaline pyroxene-amphibolic trachyl-liparite; in engineering it is known under the name granite-porphry. The specific gravity is 2.67; the weight by volume is 2.4-2.54 g/cm<sup>3</sup>; the porosity is 14.2; the hardness (according to Mohs) is 6-7; the ultimate compression strength is 1480 kg/cm<sup>2</sup>, 1450 kg/cm<sup>2</sup> when kept for a month in H<sub>2</sub>SO<sub>4</sub>, and 1260 kg/cm<sup>2</sup> after one month in HNO<sub>3</sub>. Beschtaunite is resistant to thermal shocks. The compression strength of specimens heated to 800° amounts to 1350 kg/cm<sup>2</sup> after 40 thermal shocks. The softening point is 1270°, the melting point 1330°. The dielectric constant is 8.0-9.0. The acid resistance (in %) is 97.36-98.48 in H<sub>2</sub>SO<sub>4</sub> (with a specific gravity of 1.84), and 98.22 in HNO<sub>3</sub> (with a specific gravity of 1.4). Beschtaunite belongs to the class of high-quality naturally acidproof materials and is used in the same industrial branches as andesite.

Felsite is a volcanic rock, composed from a fine- and cryptograin-ed aggregate of quartz, cristobalite and alkaline feldspar; it belongs to the liparite group. The specific weight is 2.2-2.4; the hardness (according to Mohs) is 5; the compression strength is 1800 kg/cm<sup>2</sup>; the heat conduction is 8 cal/cm·sec·°C·10<sup>-3</sup> at 25°; the melting point is 1470-1500°; the specific electric resistance is 10<sup>6</sup> ohm·cm. The acid resistance in sulfuric acid is 99.3%. Felsite is a first-class acidproof material; in the form of rubble it is used as a filling material in towers and filters, and as an aggregate for acidproof concretes, it is an ingredient of the charge of special cement grades. The applications of felsite are limited due to its difficult machinability.

Artik tuff (AT) or Artik tuff-lava is a porous volcanic rock mined in Armenia. Due to its petrographic peculiarities, it may be defined as a porous variety of semivitreous dacite. The specific gravity is 0.75-1.5; the hardness (according to Mohs) is 2-3; the ultimate compression

I-65K2

strength is 85-135 kg/cm<sup>2</sup>; the porosity is 57-60.3%; the melting point is 1200°. The acidproofness in sulfuric acid is 96-98%. Owing to its low weight by volume and its high acid resistance, AT is a good filling material for towers in the production of sulfuric and nitric acid.

Granite is an eruptive intrusive rock composed from quartz, alkaline feldspar, plagioclase, and mica. The weight by volume is 2.5-2.7 g/cm<sup>3</sup>. The water adsorption is 0.2-0.3%. The ultimate compression strength is 1527-1278 kg/cm<sup>2</sup>. The acid resistance (in %) is 96-98.2 in H<sub>2</sub>SO<sub>4</sub>, and 97.35 in HNO<sub>3</sub>; it is used in the construction of towers in the production of nitric and hydrochloric acid and also in the production of bromine, iodine and for other purposes.

Quartzite is a metamorphic rock composed of 95-98% quartz. The specific gravity is 2.4-2.65; the weight by volume is 2.65 g/cm<sup>3</sup>; the water adsorption is 3-5%; the porosity is 2-8%. The ultimate compression strength is 2676-3200 kg/cm<sup>2</sup>, the mean crushing strength is 2920 kg/cm<sup>2</sup>. The heat conductivity is 14.9 at 0°, and 12.5 cal/cm·sec·°C·10<sup>-3</sup> at 100°. The specific heat (joule/g) is 0.70 at 0°; 0.97 at 200°; 1.13 at 400°; 1.17 at 800°, and 1.33 at 1200°. The melting point is 1700°. The dielectric constant is 9.0-11.0. The acid resistance in sulfuric acid is 99.5%. It is used as filling material in absorption and reaction towers in the production of sulfuric, nitric, hydrochloric and other acids.

Asbestos, marshallite, melted basalt, and quartz belong also to the natural acidproof materials.

References: Burch F., Sherer D., and Spicer G., Spravochnik dlya geologov po fizicheskim konstantam [Handbook on the Physical Constants for Geologists], translation from English, Moscow, 1949. Zavaritskiy A.N., Izverzhennyye gornyye porody [Eruptive Rocks], Moscow, 1956; Trebovaniya promyshlennosti k kachestvu mineral'nogo syr'ya [Requirements



I-65K3

of the Industry for the Quality of Mineral Raw Materials], No. 58;  
Tumanskiy A.L., and Tukul'skaya E.M., Kisloutopornyye materialy [Acid-  
proof Materials], Moscow-Leningrad, 1948.

V. V. Nasedkin

NATURAL MODIFIED FIBER - fibers which have acquired new valuable properties as a result of chemical treatment (modification). The linear structure of the cellulose micromolecule is either retained on modification (esterification reactions of hydroxyl cellulose groups or conversion of hydroxyl groups into aldehyde, carboxyl, etc.), or branched or space structures are formed (for example, synthesis of graft polymers). Surface acetylation of the cotton fiber improves its resistance to heat and to the action of decay microorganisms, surface treatment of this fiber as well as of flax and hemp by ethylene cyanide, in addition, improves their resistance to diluted mineral acids and abrasion and improves the dyeability. Partial treatment of cotton fabrics with carboxyl methylene (treating it with monochloroacetic acid in the presence of an alkali), imparts to the fabric cation-exchange properties with the result that it swells readily in alkalis, which makes the surface esterification reaction easier. Treatment of fabrics with haloidal alkylamines and epoxideamines in an alkaline medium improves the dyeability of fabrics by acid dyes. Fibers which are thus modified can serve as anion exchanges. The fiber becomes fire resistant upon synthesis of phosphorus-containing cellulosic esters or by treatment with phosphorus-containing compounds (for example, triethylenimide of phosphoric acid), which form space polymers within the fiber and, probably, partially esterize the hydroxyl cellulosic groups. Selective oxidation of secondary hydroxylic cellulosic groups is used for obtaining dicarboxyl cellulose; fabrics made from it can be used as cation exchangers. Synthesis of graft copolymers of cellulose (copolymers with methyl vinylpyridine,

I-80v1

with acrylic and methacrylic acids) produces fabrics with ion-exchange properties. The copolymer with vinylidene chloride is incombustible. To increase the elasticity (reduce wrinkling) the fibers are treated by methylol derivatives of urea and by melamine, but the compounds which are thus obtained (space structures) form chloroamines when washed with chlorine-containing reagents, which reduces the strength of the fabric by destruction due to the action of HCl which is generated on ironing. This shortcoming is eliminated by using diepoxy compounds (for example, vinylcyclohexandiepoxyde). Fabric from cellulose fiber is made water-proof by alkalizing with onium compounds which contain hydrophobic radicals, or by epoxy compounds (for example, diglycidyle ester of penta-decylresorcyne).

References: Rogovin, Z.A., "UKh" [Advance in Chemistry], Vol. 28, Issue 7, page 850, 1959; Usmanov, Kh.U., "KhNIP" [Chemical Science and Industry], Vol. 4, No. 6, page 706, 1959; Fisher, C.H. and Perkerson, F.S., "Text. Res. J.," Vol. 28, No. 9, page 769, 1958.

L.S. Gal'braykh

NATURAL RUBBER (NK) - is a high elastic vegetable material used mainly for the production of rubber and rubber products. NK is present in the milky juice of rubber-yielding plants or in the form of singular inclusions in their bark and leaves. Commercial NK is obtained almost without exclusion from the milky juice of the Brazilian hevea. The milky juice, termed latex, is obtained by incising five year old trees. The rubber is present in the latex as spherical or pear-shaped particles, globuli, which are suspended in water. Formic or acetic acid are added to the latex on the place where it was extracted in order to coagulate it. The loose clot (coagulum) obtained is washed with water and rolled to sheets which are dried and, usually, smoked in chambers. The smoking makes the NK resistant to oxidation and inhibits the development of bacteria in it. The finished sheets of NK are more or less transparent and have an amber color; such an NK is termed smoked-sheet. The so-called pale crepe is less spread. Pure NK is in chemical view a high-molecular unsaturated hydrocarbon with the composition  $(C_5H_8)_n$  and represents a polymer of isoprene. NK is soluble in aliphatic and aromatic hydrocarbons and their derivatives, in gasoline, benzene, chloroform, carbon disulfide, etc., for example, forming viscous solutions which are used as an adhesive. NK swells before the dissolution increasing its volume up to 1000%. NK shows almost no tendency to swell and is insoluble in water, acetone, fatty acids, and other fluids with associated molecules. The product of the reaction of NK with chlorine has the composition  $(C_5H_6Cl_4)_n$ . This chlorinated rubber is used for the production of fireproof varnishes and also of adhesives for gluing rubber on me-

I-29K1

tals. Saturated hydorrubber is formed by a catalyzed action of hydrogen (platinum black being used as a catalyst); hydorrubber has the composition  $(C_5H_{10})_n$  and is used as a surrogate for guttapercha and as an addition to lubricating oils. Gaseous hydrogen chloride forms with NK the rubber hydrochloride with the composition  $(C_5H_9Cl)_n$ , used as a plastic and a raw material for the production of tight packings for foodstuffs. The halogen derivatives may further transform into more complex derivatives of the NK. NK may be transformed into a cyclic form under the effect of acids. The cyclic rubber is an excellent film-forming material. All reactions of the NK are generally accompanied by changes in the structure: disruption of the macromolecular chains and joining ("cross-linking") of them into complex network systems, resulting in an essential change in the physical and mechanical properties of the rubber - in the solubility, strength, elasticity, etc. Structural changes occur also by reaction of the NK with atmospheric oxygen and other oxidizers. Oxygen combines with NK even at room temperature, causing an oxidative degradation. The so-called aging of the gum and the rubber, causing a change in the properties of rubber products during storage and operation (decrease in strength and elasticity, appearance of stickiness, brittleness, etc.) is the result of this reaction. The salts of metals with variable valency (iron, manganese), and also some organic compounds (aldehydes, mercaptanes) accelerate the oxidation; amino-compounds, alcohols, and phenols inhibit it. The latter are used as antifatigue agents. Reacting with ozone, NK is transformed into the ozonide  $(C_5H_8O_3)_n$ , an unstable compound. The reaction of NK with the ozone present in air is one of the causes for the appearance of cracks on the surface of rubber products during storage and service. NK decomposes when heated higher than  $200^\circ$ , forming diverse low-molecular hydrocarbons, in which isoprene is always present. Irradiation with light with a wave-

I-29K2

length shorter than 4000 Å results in a degradation of the macromolecules of the NK and a generation of hydrogen gas. This process occurs also when rubber products age in light. The reaction of NK with sulfur, sulfur monochloride, organic peroxides and other substances causing vulcanization is of great importance in practice. The vulcanization results in the formation of network structures, in which the long macromolecules are joint ("cross-linked") together by sulfur atoms or the other vulcanizing agents. The high elasticity in a wide temperature range, including the usually occurring raised and reduced temperatures, is the technically most valuable property of NK and especially of its vulcanizates. Soft vulcanizates (gums) of the NK are able to a reversible elongation by more than 1000%, having a tensile strength of up to  $350 \text{ kg/cm}^2$  (related to the initial cross section). In contrast to crystalline substances, the deformation of NK within 100-200% elongation is not accompanied by a change in volume, and, therefore, by a change in internal energy. Being connected with the thermal motion of the flexible macromolecules of the NK, its high elasticity may appear in that temperature range where this motion is sufficiently intense. At a temperature of about  $-70^\circ$ , the NK loses its elasticity even at very slow actions and becomes brittle; NK becomes plastic at temperatures higher than  $80-100^\circ$ . The magnitude of the deformation of NK depends not only on the magnitude of the mechanical stress, but also on the time of its action. The elongation of NK, just so as that of all elastomers, is accompanied by generation of heat, and its contraction by absorption of heat. The irreversible part of the thermal effect is the cause of the heating of rubber products during their service in practice and affects strongly their strength and abrasion. Thus, the temperature of massive rubber tires may attain  $100-200^\circ$  at a high speed of the motorcar.

NK is usually present in an amorphous state. Crystallization, how-

I-29K3

ever, is possible during a long storage. The crystallization proceeds with the highest rate about  $-25^{\circ}$ , but even in this case, not more than 40% of the total bulk of the NK become crystallized. The stretching of NK also causes crystallization. The amount of the crystallization increases with increasing deformation and reaches a limit of 50-70% at an elongation of 700%. This phenomenon is reversible. The appearance of a crystalline phase during the elongation of the rubber increases essentially the strength of the NK and of its vulcanized products.

The electrical properties of the NK are also of great interest for engineering. Its dielectric constant (and that of its vulcanization products) is about 2.5. Soft vulcanizates and also ebonite are used as electrical insulating materials. The gas- and waterproofness of the NK is also widely used. Pure rubber is almost impervious by water, the diffusion coefficient for water vapor through an NK film is equal to  $8 \cdot 10^{-8}$  g/hr. The diffusion coefficient of air is  $1.21 \cdot 10^{-8}$  g/hr. The main physical constants of NK are given in the Table.

TABLE

| 1<br>Константы и единицы<br>измерения*                                       | 2<br>Чистый<br>каучук | 3<br>Технич.<br>каучук | 4<br>Мягкий<br>вулкани-<br>зат с 2%<br>серы | 5<br>Эбонит          |
|--|-----------------------|------------------------|---|----------------------|
| 6 Плотность ( $g/cm^3$ ) . . . . .   | 0.906                 | 0.911                  | 0.923                                       | 1.173                |
| 7 Теплопроводность<br>(кал/сек см град) . . . . .                            | —                     | $32 \cdot 10^{-8}$     | $34 \cdot 10^{-8}$                          | $39 \cdot 10^{-8}$   |
| 8 Теплоемкость $c_p$<br>(кал/град) . . . . .                                 | 0.419                 | —                      | 0.510                                       | 0.341                |
| 9 Сжимаемость ( $бар^{-1}$ ) . . . . .                                       | $53.7 \cdot 10^{-6}$  | —                      | $51.0 \cdot 10^{-6}$                        | $24.3 \cdot 10^{-6}$ |
| 10 Диэлектрич. проницае-<br>мость (при частоте<br>1000 гц) . . . . .         | 2.37                  | 2.45                   | 2.68  | 2.82                 |
| 11 Тангенс угла диэлек-<br>трич. потерь (при ча-<br>стоте 1000 гц) . . . . . | $1.6 \cdot 10^{-3}$   | $1.8 \cdot 10^{-3}$    | $1.8 \cdot 10^{-3}$                         | $5.1 \cdot 10^{-3}$  |
| 12 Электропроводность<br>( $ом^{-1} \cdot см^{-1}$ ) . . . . .               | $23 \cdot 10^{-11}$   | $420 \cdot 10^{-11}$   | $13 \cdot 10^{-11}$                         | $15 \cdot 10^{-11}$  |

\* At 1 atm and  $25^{\circ}$ .

- 1) Constants and units of measurement\*;
- 2) pure rubber; 3) commercial rubber;
- 4) softly vulcanized rubber with 2% sulfur; 5) ebonite; 6) density ( $g/cm^3$ );
- 7) heat conductivity (cal/sec·cm·degree);
- 8) specific heat,  $c_p$  (cal/g·degree); 9) compressibility ( $бар^{-1}$ ); 10) dielectric constant (at a frequency of 1000 cps); 11) tangent of the loss angle (at a frequency of 1000 cps); 12) electrical conductivity ( $ohm^{-1} \cdot cm^{-1}$ ).

I-29K4

The high elasticity of NK, the water- and gasproofness, the high electric insulating properties, the stability to a great number of aggressive media cause the extremely wide application of NK in all fields of engineering and life. The main part of NK is manufactured to rubber (vulcanized products). Not more than 1% of the extracted NK is used in the raw form (rubber adhesive, crepe soles). More than 60% of the NK are used for the production of motor car tires.

References: Dogadkin B.A., *Khimiya i fizika kauchuka* [The Chemistry and Physics of Rubber], Moscow-Leningrad, 1947; Byzov B.V., *Prirodnyy kauchuk* [Natural Rubber], Leningrad, 1932.

B.A. Dogadkin



NATURAL WOOD – the main part of the trunk of a tree, an ensemble of shells of plant cells. An anisotropic material. Natural wood contains

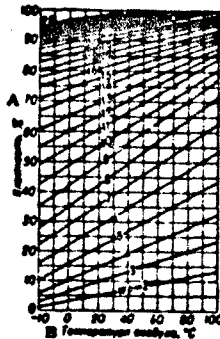

Fig. 1. Diagram of the equilibrium moisture content of wood. A) Moisture content, %; B) air temperature, °C.

free (capillary) moisture, which fills the voids of the cells, and bound (hygroscopic) moisture held in the cell shells. The moisture content of natural wood is calculated by the formula  $W = \frac{P_1 - P_0}{P_0} \cdot 100$ , where  $W$  is the moisture content in %,  $P_1$  is the initial weight of the specimen,  $P_0$  is the weight of the specimen in the perfectly dry state. The state in which natural wood contains the maximum amount of bound moisture and the cell voids are filled with air, is called the saturation point (TN) of the cell shells. The moisture at the saturation point and a temperature of 20° comprises on the average for natural wood 30%; the range of variation for individual species is 23-31%. The majority of properties of natural wood is affected by the bound moisture content, i.e., variation in the moisture content in the range of 0-30%, which depends on the air temperature and humidity. When held for a sufficiently long time, natural wood acquires an equilibrium moisture con-

tent, the value of which can be found from a diagram (Fig. 1). A reduction in the bound moisture content results in contraction of the linear dimensions and volume of natural wood, i. e., shrinkage on drying.

Shrinkage on drying is calculated by the formula  $Y = a_1 - a_0/Q_0 \times 100$ , where  $Y$  is the shrinkage on drying in %,  $a_1$  and  $a_0$  are the specimen's dimensions in the initial and perfectly dry state. Complete linear shrinkage on drying (when the moisture content is reduced from 30 to 0%) comprises 0.1-0.3% along the fibers; 3-5% across the fibers in the radial direction and 6-10% in the tangential direction. The total volume shrinkage on drying comprises on the average 12%. Shrinkage on drying which corresponds to a moisture reduction of 1% is calculated by the formula  $K = Y/w$ , where  $w$  is bound moisture in %. For values of  $K$  see Table 4. Natural wood is hygroscopic. When the bound moisture content is increased distention (swelling), i. e., a phenomenon which is the reverse of shrinkage on drying and is governed by the same laws, takes place. Absorption of other fluids by natural wood also results in swelling, but its value is the lower, the lower the dielectric constant of the fluid. As a result of the difference in the radial and tangential shrinkage on drying, transverse warping, i. e., change in the cross sectional shape of timber, wood blanks and products takes place when natural wood is dried or its moisture content increased. Sometimes longitudinal warping takes place, which is a result of nonuniform shrinkage on drying and natural wood defects. The shape imparted to components by machining can change as a result of residual stresses which formed in the material in the drying process. Klin-dried boards, if not subjected to final moistening heat treatment, have residual compressive stresses in the surface zones which are as high as  $45 \text{ kg/cm}^2$  for beech and  $16 \text{ kg/cm}^2$  for pine, with the tensile stresses in the middle zone of the cross section being  $22 \text{ kg/cm}^2$  and  $8 \text{ kg/cm}^2$ , respective-

ly. The water permeability of hardwood is higher than that of conifers. The specific gravity of wood substance is practically independent of the species and comprises on the average 1.54. The specific weight of natural wood is calculated by the formula  $\gamma = p/v \text{ g/cm}^3$ , where  $p$  and  $v$  are the weight and volume, respectively, of a natural wood specimen with the same moisture content. The specific weight depends on the species and increases with an increase in the moisture content. The specific weight of the natural wood of birch, beech, white beech and larch for other moisture contents should be calculated by the formula  $\gamma_w = \frac{\gamma_{15}}{1.075 - 0.005 w}$  and for the remaining species by the formula  $\gamma_w = \gamma_{15} / 1.075 - 0.005 w$ . In these formulas  $w$  is a moisture content below the saturation point. The conventional specific weight is determined by the formula  $\gamma_{usl} = p_0/v_{TN}$ , where  $p_0$  is the weight of the specimen in the perfectly dry state, and  $v_{TN}$  is the specimen's volume at the saturation point of the cell shells.

The specific heat of natural wood depends on its temperature and moisture and can be found independently of the species (see Fig. 2). The thermal conductivity coefficient  $\lambda$  of natural wood depends on the temperature, moisture content, species (specific weight) and the thermal flux direction. For practical calculations the values of  $\lambda$  upon consideration of the above factors can be determined by the formula  $\lambda = \lambda_{nom} \cdot K_\gamma \cdot K_x$ , where  $\lambda_{nom}$  is the nominal value of the thermal conductivity coefficient for wood with  $\gamma_{usl} = 0.36 \text{ g/cm}^3$  is found from Diagram 3,  $K_\gamma$  is a coefficient which is determined from Table 1 as a function of  $\gamma_{usl}$ , and  $K_x$  is a coefficient which is determined, depending on the thermal flux direction, from Table 2.

The linear expansion coefficient of pine along the fibers is  $3.7 \cdot 10^{-6}$ , across the fibers it is  $63.6 \cdot 10^{-6}$ , for oak it is  $4.9 \cdot 10^{-6}$  and  $54.4 \cdot 10^{-6}$ , respectively.

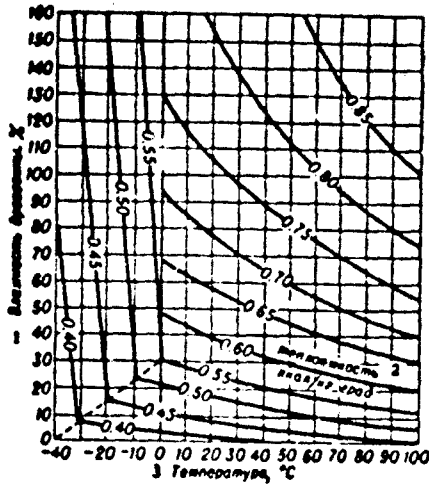

Fig. 2. Diagram of specific heat of wood. 1) Moisture content of the wood, %; 2) specific heat, kcal/kg-degree; 3) temperature, °C.

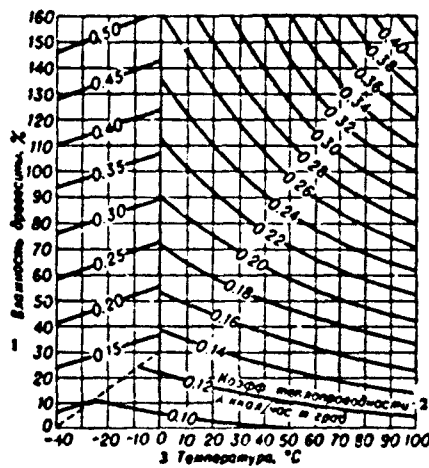

Fig. 3. Diagram of the nominal ( $\lambda_{nom}$ ) thermal conductivity coefficient for wood with  $\gamma_{usl} = 0.36 \text{ g/cm}^3$  in the tangential direction. 1) Moisture content of the wood, %; 2) thermal conductivity coefficient  $\lambda$  kcal/hour-m-degree; 3) temperature, °C.

TABLE 1

| $\gamma_{усл}$ 1 | $K_{\gamma}$ | $\gamma_{усл}$ 1 | $K_{\gamma}$ |
|------------------|--------------|------------------|--------------|
| 0.34             | 0.98         | 0.50             | 1.22         |
| 0.38             | 1.00         | 0.55             | 1.36         |
| 0.38             | 1.02         | 0.60             | 1.58         |
| 0.40             | 1.05         | 0.65             | 1.86         |
| 0.45             | 1.12         |                  |              |

1) usl.

TABLE 2

| 1<br>Направление | 2<br>Группа пород                                      | 3<br>Кoeffици-<br>ент $K_x$ |
|------------------|--|-----------------------------|
| Тангенциальное 4 | 5) все   | 1.00                        |
| Радиальное 6     | 5) все   | 1.15                        |
| 7) вдоль волокон | 8) Хвойные и рассеян-<br>но-сосудистые лист-<br>венные | 2.20                        |
| Вдоль волокон    | 9) Кольцевосудистые<br>лиственные                      | 1.60                        |

1) Direction; 2) group of species; 3) coefficient  $K_x$ ; 4) tangential; 5) all; 6) radial; 7) across the fibers; 8) conifers and diffuse-vascular hardwoods; 9) girdle-vascular hardwoods.

TABLE 3

| 1<br>Свойства древесины<br>различных пород   | 2<br>Размер-<br>ность                                 | 3<br>Вдоль<br>воло-<br>кон | 4<br>Поперек волокон<br>в направлении |                          |
|--|---|----------------------------|---------------------------------------|--------------------------|
|  |   |                            | 5<br>радиаль-<br>ным                  | 6<br>танген-<br>циальным |
| 7) Уд. объемное элект-<br>росопротивление<br>при влажности 8%:<br>лиственница 8<br>береза 10 | 9<br>10 <sup>10</sup> ом см<br>10 <sup>10</sup> ом см | 3.8<br>4.2                 | 19.0<br>8.6                           | 14.5<br>—                |
| 11) Пробивное напряже-<br>ние при W = 8-9%:<br>береза 10<br>бук 13                           | ке см<br>ке см  | 15.2<br>14.0               | 59.8<br>41.5                          | —<br>52.0                |
| 14) Диэлектрич. прои-<br>цаемость при W =<br>0% и частоте<br>10 <sup>3</sup> см:             | 12  |                            |                                       |                          |
| 15) ель  |   | 3.06                       | 1.98                                  | 1.91                     |
| 16) дуб  |   | 2.86                       | 2.30                                  | 2.48                     |
| 13) бук  |   | 3.18                       | 2.20                                  | 2.40                     |
| Скорость распрост-<br>ранения звука: 17  | 19  |                            |                                       |                          |
| 18) сосна  | м сек   | 5030                       | 1450                                  | 850                      |
| 16) дуб  | "   | 4175                       | 1685                                  | 1400                     |
| 10) береза   | "   | 3625                       | 1995                                  | 1535                     |

1) Property of wood of various species; 2) units; 3) along the fibers; 4) across the fibers in the direction; 5) radial; 6) tangential; 7) specific volume electrical resistivity at 8% moisture;; 8) larch; 9) ohm-cm; 10) birch; 11) breakdown voltage at W = 8-9%;; 12) kv/cm; 13) beech; 14) dielectric permittivity at W = 0% and frequency of 10<sup>3</sup> cps;; 15) spruce; 16) oak; 17) rate of sound propagation; 18) pine; 19) m/sec.

The indicators of certain electrical and acoustic properties of wood are presented in Table 3. The mechanical properties are determined by testing small clean (free of defects) natural wood specimens in accordance with GOST 6336-52. The highest mechanical properties indicators of wood are exhibited when the load is applied along the fibers, in the plane across the fibers these indicators are sharply reduced. Data

TABLE 4

| Порода             | Объемный вес<br>3 (г/см <sup>3</sup> ) |               | Коэф. усушки<br>3 (%) |                      | Предел прочности<br>4 (кг/см <sup>2</sup> ) при |                              |                                   |                             |                           |                | Уд. р.убота при изгибе<br>(кг/см <sup>2</sup> ) | Твердость<br>6 (кг/см <sup>2</sup> ) |  |
|--------------------|--|---------------|-----------------------|----------------------|---|------------------------------|-----------------------------------|-----------------------------|---------------------------|----------------|---|--------------------------------------|--|
|                    | 7<br>при 15%-ной<br>влажности          | 8<br>условные | 9<br>радиальных       | 10<br>тангенциальных | 11<br>сжатия вдоль<br>волокон                   | 12<br>статического<br>изгиба | 13<br>растяжения<br>вдоль волокон | сдвиг в<br>плоскостях<br>14 |                           | 17<br>торцевая |   | 18<br>боковая                        |  |
|                    |  |               |                       |                      |   |                              |                                   | 15<br>радиаль-<br>ной       | 16<br>танген-<br>циальной |                |   |                                      |  |
| 1) Лиственница     | 0.67                                   | 0.52          | 0.20                  | 0.30                 | 548   | 987                          | 1227                              | 91                          | 86                        | 0.25           | 307   | 246                                  |  |
| 2) Сосна           | 0.51                                   | 0.40          | 0.18                  | 0.31                 | 414   | 758                          | 1009                              | 69                          | 67                        | 0.20           | 282   | 220                                  |  |
| 3) Ель             | 0.45                                   | 0.36          | 0.17                  | 0.31                 | 350   | 703                          | 1003                              | 63                          | 62                        | 0.19           | 237   | 164                                  |  |
| 4) Кедр            | 0.44                                   | 0.35          | 0.12                  | 0.28                 | 358   | 648                          | 893                               | 60                          | 64                        | 0.15           | 292   | 115                                  |  |
| 5) Пихта сибирская | 0.38                                   | 0.30          | 0.11                  | 0.31                 | 344   | 603                          | 856                               | 58                          | 59                        | 0.14           | 257   | —                                    |  |
| 6) Граб            | 0.81                                   | 0.63          | 0.24                  | 0.35                 | 531   | 1211                         | 1347                              | 141                         | 177                       | 0.48           | 825   | 709                                  |  |
| 7) Дуб             | 0.70                                   | 0.55          | 0.19                  | 0.29                 | 508   | 944                          | —                                 | 93                          | 111                       | 0.37           | 613   | 477                                  |  |
| 8) Клен            | 0.70                                   | 0.55          | 0.20                  | 0.32                 | 520   | 1053                         | —                                 | 113                         | 129                       | 0.37           | 600   | 522                                  |  |
| 9) Ясень           | 0.69                                   | 0.53          | 0.19                  | 0.31                 | 499   | 1083                         | 1390                              | 126                         | 122                       | 0.43           | 732   | 572                                  |  |
| 10) Береза         | 0.64                                   | 0.50          | 0.28                  | 0.34                 | 467   | 967                          | 1610                              | 85                          | 102                       | 0.45           | 423   | 318                                  |  |
| 11) Липа           | 0.50                                   | 0.40          | 0.23                  | 0.33                 | 398   | 775                          | 1158                              | 78                          | 74                        | 0.28           | 314   | 160                                  |  |
| 12) Осина          | 0.50                                   | 0.40          | 0.15                  | 0.30                 | 374   | 666                          | 1201                              | 57                          | 78                        | 0.41           | 241   | 179                                  |  |

1) Species; 2) specific weight (g/cm<sup>3</sup>); 3) coefficient of shrinkage on drying; 4) ultimate strength (kg/cm<sup>2</sup>) in; 5) modulus of resilience in flexure (kg-m/cm<sup>3</sup>); 6) hardness (kg/cm<sup>2</sup>); 7) for 15% moisture content; 8) conventional; 9) radial; 10) tangential; 11) compression along the fibers; 12) static bending; 13) tension along the fibers; 14) cleaving along the fibers; 15) radial; 16) tangential; 17) end; 18) side; 19) larch; 20) pine; 21) spruce; 22) cedar; 23) Siberian fir; 24) white beech; 25) oak; 26) maple; 27) ash; 28) birch; 29) linden; 30) asp.

on the main physicommechanical properties of the most extensively prevalent species of natural wood, reduced to a 15% moisture content, are presented in Table 4. The indicators of physicommechanical properties which are given in Table 4 are averages of magnitudes which vary between the limits  $M \pm 3\sigma$ , where  $M$  is the average value of the indicator from Table 4, and  $\sigma$  is the root-mean-square deviation, calculated from the formula  $\sigma = Mv/100$ . The values of the coefficient of variation  $v$ , which enters the above formula can be found in Table 5.

The majority of mechanical properties indicators is reduced substantially when the moisture content is increased to the saturation point. The value of an indicator for a given moisture content can be determined by the formula:  $\sigma_w = \sigma_{15}/K_w$ , where  $\sigma_{15}$  is the value of the indicator at 15% moisture content, given in Table 4,  $K_w$  is a conversion coefficient. Table 6 presents rounded-off value of the conversion coef-

coefficients  $K_w$ , which make it possible to approximately estimate the limits of variation of indicators in the moisture content range of 5-30%. For moisture content in excess of 30% these indicators practically do not change.

Natural wood, particularly softwoods, has very high quality coefficients, which are defined as the ratio of the mechanical properties indicators to the specific weight.

TABLE 5

| 1<br>Показатели                                | 2 Коэффициент изменчивости $\gamma$ (%) |
|--|---|
| 3 Объемный вес . . . . .                       | 10                                      |
| 4 Коэффициент усушки:                          |   |
| 5 радиальной . . . . .                         | 27                                      |
| 6 тангенциальной . . . . .                     | 28                                      |
| 7 Удельная работа при ударном изгибе . . . . . | 32                                      |
| 8 Твердость торцовая . . . . .                 | 17                                      |
| 9 Предел прочности при:                        |   |
| 10 сжатии вдоль волокон . . . . .              | 13                                      |
| 11 статическом изгибе . . . . .                | 15                                      |
| 12 растяжении вдоль волокон . . . . .          | 20                                      |
| 13 скалывании вдоль волокон                    |   |
| 14 радиальном . . . . .                        | 21                                      |
| 15 тангенциальном . . . . .                    | 19                                      |

1) Indicators; 2) coefficient of variation  $\gamma$  (%); 3) specific weight; 4) coefficient of shrinkage on drying; 5) radial; 6) tangential; 7) modulus of resilience in impact bending; 8) end hardness; 9) ultimate strength in:; 10) compression along the fibers; 11) static flexure; 12) tension along the fibers; 13) cleaving along the fibers; 14) radial; 15) tangential.

TABLE 6

| 1<br>Показатель                                | 2 Коэффициент $K_w$ при |          |
|--|-------------------------|----------|
|  | $w=5\%$                 | $w=30\%$ |
| Предел прочности при: 3                        |                         |          |
| 4 сжатии вдоль волокон . . . . .               | 0.7                     | 1.9      |
| 5 статическом изгибе . . . . .                 | 0.8                     | 1.5      |
| 6 скалывании вдоль волокон . . . . .           | 0.7                     | 1.5      |
| 7 растяжении вдоль волокон . . . . .           | 0.9                     | 1.3      |
| 8 Удельная работа при ударном изгибе . . . . . | 0.8                     | 1.1      |
| 9 Твердость хвойных пород . . . . .            | 0.7                     | 1.9      |
| Твердость лиственных пород . . . . .           | 0.7                     | 1.5      |

1) Indicator; 2) coefficient  $K_w$  for; 3) ultimate strength in:; 4) compression along the fibers; 5) static flexure; 6) cleaving along the fibers; 7) tension along the fibers; 8) modulus of resilience in impact bending; 9) hardness of softwoods; 10) hardness of hardwoods.

TABLE 7

| Порода   | 2 Модули упругости (тыс. кг/см <sup>2</sup> ) при |       |       |              |       |       |          |          |          |
|----------|---|-------|-------|--------------|-------|-------|----------|----------|----------|
|          | 3 Сжатия  |       |       | 4 Растяжения |       |       | 5 Сдвига |          |          |
|          | $E_a$   | $E_r$ | $E_t$ | $E_a$        | $E_r$ | $E_t$ | $G_{ra}$ | $G_{ta}$ | $G_{rt}$ |
| 6 Сосна  | 117   | 6.2   | 5.0   | 117          | 5.1   | 4.2   | 11.4     | 7.1      | —        |
| 7 Ель    | 142   | 5.9   | 3.8   | 143          | 6.2   | 6.2   | —        | —        | 0.3      |
| 8 Дуб    | 149   | 7.9   | 9.1   | 140          | 11.0  | 8.3   | 13.2     | 9.1      | 4.4      |
| 9 Береза | 158   | 6.0   | 4.5   | 181          | 6.0   | 4.2   | 14.5     | 8.0      | 2.0      |

1) Species; 2) modulus of elasticity (thousands of kg/cm<sup>2</sup>) in; 3) compression; 4) tension; 5) shear; 6) pine; 7) spruce; 8) oak; 9) birch.

TABLE 8

| Порода | 1 | 2 Коэфф. поперечной деформации |            |            |            |            |            |
|--------|---|--------------------------------|------------|------------|------------|------------|------------|
|        |   | $\mu_{ra}$                     | $\mu_{ta}$ | $\mu_{ra}$ | $\mu_{ra}$ | $\mu_{rt}$ | $\mu_{rt}$ |
| Сосна  | 3 | 0.490                          | 0.410      | 0.030      | 0.790      | 0.017      | 0.380      |
| Ель    | 4 | 0.440                          | 0.411      | 0.017      | 0.480      | 0.031      | 0.250      |
| Дуб    | 5 | 0.430                          | 0.410      | 0.070      | 0.830      | 0.090      | 0.340      |
| Береза | 6 | 0.580                          | 0.450      | 0.043      | 0.610      | 0.040      | 0.490      |

\*The first subscript of  $\mu$  denotes the direction of transverse deformation, the second denotes the direction of force.

1) Species; 2) coefficient of transverse deformation; 3) pine; 4) spruce; 5) oak; 6) birch.

Table 7 presents the average values of the moduli of elasticity of certain species of natural wood for a 15% moisture content. The subscripts a, r, t of E denote the direction of force, i.e., a denotes force along the fibers, r pertains to radially applied force and t to tangentially applied force; the subscripts ra, ta and rt of G denote the directions between which the change in angle takes place.

Table 8 presents average values of the transverse deformation coefficient  $\mu$  for certain species of natural wood for a moisture content of 10-15%.

The average ultimate endurance strength of the material in repeated bending, which is characterized by the stress, comprises for various species 0.2% of the ultimate strength in static bending. The strength of natural wood in prolonged static bending comprises for various species 0.60-0.65 of the ultimate strength in static flexure. Usually the



following engineering properties of natural wood, which are also of significance under production conditions, are taken into account; resistance to cleaving under the impact of a wedge; capacity to hold metallic fasteners, i. e., nails, wood screws, spikes, clamps; resistance to wear or to gradual destruction of surface due to friction and other mechanical factors. The wear resistance is increased with an increase in the hardness of the wood, its specific weight, and is reduced with an increase in the moisture content; the wear of the end surface is by approximately 60% less than that of the side surface. Natural wood of certain species, for example, guaiac, is used for the production of sliding bearing liners using water lubrication, for example, for deadwood bushings of marine screws. In conjunction with this it is necessary to determine the friction coefficient of the wood using various kinds of lubricants and operating under different specific loads.

The mechanical properties of wood, in addition to moisture, are highly affected by wood defects (knots, inclined fibers, cross grain, rot pockets), the duration of load application, dimensions of components, and other factors which must be taken into account when using the above data in calculations.

Natural wood is used extensively in machine building, shipbuilding, in railroads, in building, in the coal, textile, light, woodprocessing and food industries. Natural wood has a high mechanical strength for a low specific weight, has a good resistance to impact and vibration loads, is easily worked and makes it possible to produce components with a complex configuration. It is possible to obtain reliable joining of components and subassemblies from wood using glue and metallic fasteners. The surface of wood is finished well and has high decorative properties. The negative features of wood as an engineering material can be eliminated by special treatments. Wood is made fireproof by im-

I-114G9

pregnating them by special chemical substances, i.e., antipyrines, or by application of protective coatings. The biological resistance is improved by impregnating the wood by antiseptics. Retention of dimensions and shape of components from natural wood is ensured by special moisture insulating coatings and impregnation with synthetic resins and other substances. The anisotropic property of natural wood is reduced by the use of gluing and various plasticization methods.

References: Perelygin, L.M., Drevesinovedeniye [Wood Science], 1957, 2<sup>nd</sup> Edition, 1960.

B.N. Ugolev

Manu-  
script  
Page  
No.

[Transliterated Symbols]

|      |   |
|------|---|
| 2696 | ТН = TN = tochka nasyshcheniya = saturation point                                     |
| 2698 | усл = usl = uslovnyy = conventional   |
| 2698 | НОМ = nom = nominal'nyy = nominal   |
| 2700 | ГОСТ = GOST = Gosudarstvennyy obshchesoyuznyy standar =<br>= All-Union State Standard |

NAVAL (TIN) BRASS is brass containing 59-91% Cu alloyed with tin. Naval brass received its name from its higher corrosion resistance to

TABLE 1

Chemical Composition and Mechanical Properties of the Naval Brasses (GOST 1019-47)

| Сплав<br>1   | Содержание основных элементов (%)<br>2 |           |           | Механич. свойства сплавов среднего состава<br>3 |                 |       |                             | Состояние материала<br>5                                 |
|--------------|--|-----------|-----------|---|-----------------|-------|-----------------------------|--|
|              | Cu                                     | Sn        | Zn        | $\sigma_{0.2}$<br>(кг/мм <sup>2</sup> )         | $\delta$<br>(%) | E     | HN<br>(кг/мм <sup>2</sup> ) |  |
| ЛО90-1 . 6 . | 88-91                                  | 0.25-0.75 | Остальное | 30<br>30<br>30                                  | 50<br>5<br>5    | 10500 | 50<br>130<br>130            | Мягкий 8<br>Твердый (наклеп 50%)<br>Твердый (наклеп 50%) |
| ЛО70-1 . . . | 69-71                                  | 1-1.5     | 7 >       | 65<br>65  | 8<br>8          | 10600 | 75<br>140                   | Мягкий<br>Твердый (наклеп 50%) 9                         |
| ЛО62-1 . . . | 61-63                                  | 0.7-1.1   | >         | 70<br>70  | 38<br>38        | 10000 | 85<br>150                   | Мягкий<br>Твердый (наклеп 50%)                           |
| ЛО60-1 . . . | 59-61                                  | 1-1.5     | >         | 42<br>68  | 4<br>4          | 10500 | 75<br>160                   | Мягкий<br>Твердый (наклеп 50%)                           |

1) Alloy; 2) content of basic elements (%); 3) mechanical properties of alloys of average composition; 4) (kg/mm<sup>2</sup>); 5) material condition; 6) LO90-1; 8) LO62-1; 9) LO60-1; 6) LO; 7) remainder; 8) soft; 9) hard (50% work hardened).

sea water in comparison with the other brasses. They also have good resistance in fresh water. The addition of 0.25-0.75% Sn to the copper-zinc alloys with 90% Cu improves the antifriction properties. GOST 1019-47 includes four types of naval brasses - LO90-1, LO70-1, LO62-1 and LO60-1. LO70-1 and LO62-1 are most widely used. The LO70-1 brass is used for the fabrication of ocean vessel condenser tubes and tubes for various thermotechnical equipment. The LO62-1 brass is produced in the form of strips, sheets and rods and is used for the fabrication of

II-76k1

various details which are required to have high corrosion resistance.

The chemical composition and basic mechanical and technological proper-

TABLE 2

Physical and Technological Properties of Naval Brasses

| Сплав<br>1                    | 2                          | 3                        | 4                                | 5                      | 6                              | 7                   | 8                         |
|-------------------------------|----------------------------|--------------------------|----------------------------------|------------------------|--------------------------------|---------------------|---------------------------|
| $\gamma$ (g/cm <sup>3</sup> ) | $\alpha \cdot 10^4$ (1/°C) | $\rho$ (кал·см·сек / °C) | $\theta$ (ом·мм <sup>2</sup> /м) | Темп-ра плавления (°C) | Темп-ра горячей обработки (°C) | Темп-ра отжига (°C) | Виды полуфабрикатов       |
| ЛО90-1 . . . 9 . . .          | 6.8                        | 18.4                     | 0.3                              | 0.054                  | 1015                           | 700-800             | Полосы и ленты 10         |
| ЛО70-1 . . . . .              | 8.5                        | 19.7                     | 0.22                             | 0.072                  | 935                            | 650-750             | Трубы 11                  |
| ЛО62-1 . . . . .              | 8.5                        | 19.3                     | 0.26                             | 0.072                  | 906                            | 700-750             | Прутки, листы и полосы 12 |
| ЛО60-1 . . . . .              | 8.4                        | 21.4                     | 0.24                             | 0.07                   | 900                            | 750-800             | Проволока для сварки 13   |

1) Alloy; 2) (g/cm<sup>3</sup>); 3) (cal/cm-sec/°C); 4) (ohm-mm<sup>2</sup>/m); 5) melting point (°C); 6) hot-work temperature (°C); 7) anneal temperature (°C); 8) forms of mill products; 9) LO; 10) bands and strips; 11) tubes; 12) rods, sheets and strips; 13) welding wire.

ties of the naval brasses are presented in Tables 1, 2. Figures 1-5 show the variation of the mechanical properties of the naval brasses with degree of deformation and temperature of annealing and heating.

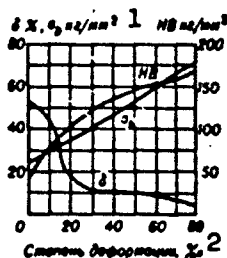

Fig. 1. Variation of mechanical properties of LO90-1 brass with degree of deformation. 1) kg/mm<sup>2</sup>; 2) degree of deformation.

II-76k2

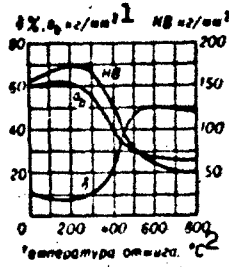

Fig. 2. Variation of mechanical properties of L090-1 brass with annealing temperature. 1)  $\text{kg/mm}^2$ ; 2) anneal temperature.

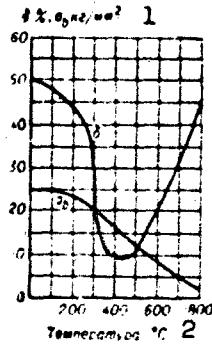

Fig. 3. Variation of mechanical properties of L090-1 brass with temperature. 1)  $\text{kg/mm}^2$ ; 2) temperature.

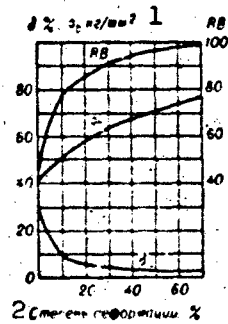

Fig. 4. Variation of mechanical properties of L062-1 brass with degree of deformation. 1)  $\text{kg/mm}^2$ ; 2) annealing temperature.

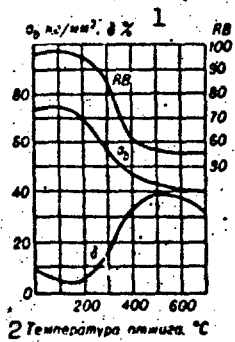

Fig. 5. Variation of mechanical properties of L062-1 brass with annealing temperature. 1)  $\text{kg/mm}^2$ ; 2) annealing temperature.

II-72k3

References: Smiryagin A.P., Promyshlennyye tsvetnyye metally i splavy [Industrial Nonferrous Metals and Alloys], 2nd ed., M., 1956; Mal'tsev M.V., Barsukova T.A., Borin F.A., Metallografiya tsvetnykh metallov i splavov [Metallography of Nonferrous Metals and Alloys], M., 1960; Spravochnik po mashinostroitel'nykh materialam [Handbook on Machine Construction Materials], Vol. 2, M., 1959.

Ye.S. Shpichinetskiy

NECKING - a characteristic of the plasticity of a material, defined as the reduction in area of the cross-section of the specimen during tensile testing. The term necking (reduction in area) is often used to mean the final (terminal) arbitrary relative necking (see Relative necking); we can also distinguish Concentrated necking and Uniform necking. Before necking the reduction in specimen area ( $\psi$ ) is directly proportional to the elongation  $\delta$ :  $\psi = \delta / (1 + \delta)$  ( $\psi$  and  $\delta$  are expressed in relative units). For metals which do not neck ( $\psi \approx \delta$ ) the value of  $\psi > \delta$  indicates the presence of necking; the more intensive the necking, the greater the difference ( $\psi - \delta$ ). Necking is the most stable index of plasticity, since it does not depend to any great degree on cross-sectional nonuniformity or specimen structure.

N.V. Kadobnova

II-23N

NEOLEYKORITE is an ivory-colored cast resin obtained by condensation of phenol with formaldehyde. Specific weight is 1.5, Martens thermal stability no lower than 70°, thermal conductivity 0.35 kcal/m-hr-°C, water absorption no more than 0.02% in 24 hours, Brinell hardness no less than 12 kg/mm<sup>2</sup>, modulus of elasticity 36 kg/cm<sup>2</sup>·10<sup>3</sup>, specific impact strength no less than 8.0 kg-cm/cm<sup>2</sup>, ultimate strength no less than: 600 kg/cm<sup>2</sup> in bending, 2000 in compression, 500 in tension, volume resistivity no less than 1·10<sup>11</sup> ohm-cm, tangent of dielectric loss angle at 50 Hz 0.03. Neoleykorite is produced in the form of blocks of rectangular shape and rods. It is used to fabricate equipment details (knobs, handles, etc.) and products for consumer use.



NEUSILBER is an alloy of copper with nickel and zinc.

GOST 492-52 includes type MNTs15-20 (13.5-16.5% Ni, 18.0-22.0% Zn, remainder copper) Neusilber which has the best properties among the of group of ternary alloys of copper with nickel and zinc.

Type MNTs 15-20 Neusilber is a solid solution of nickel and zinc in copper. It has high corrosion resistance, beautiful silvery color, high strength, and satisfactory plasticity in the cold and hot conditions. Neusilber does not oxidize in the air and is quite resistant in solutions of salts and organic acids. Neusilber is produced in the form of strip (GOST 5063-49 and GOST 5187-49), rod (TsMTU674-41) and wire (GOST 5220-50). Neusilber is used to produce medical instruments, processing vessels, telephone equipment, steam and water handling equipment, articles for sanitary engineering, precision mechanics, household ware, and decorative articles. For physical and other properties see article on Copper-Nickel Alloys. The mechanical properties of Neusilber mill products are presented in Table 1, the mechanical properties of wrought Neusilber as a function of annealing temperature are presented in Table 2.

TABLE 1  
Mechanical Properties of MNTs  
15-20 Neusilber Mill Products

| Вид и состояние полуфабриката<br>1                                 | ГОСТ или ТУ<br>2 | 3 $\sigma_b$ (кг/мм <sup>2</sup> )   $\delta$ (%) |                   |
|--|------------------|---|-------------------|
|  |                  | 4 не менее  |                   |
| Полосы мягкие 5  | 6 ГОСТ 5083-41   | 35  | 35                |
| Полосы твердые 7   | То же            | 55  | 1                 |
| Лента особо твердая 8  | ГОСТ 5187-49     | 65  | 1                 |
| 9 Прутки тянутые и катаные мягкие                                  | 11 ТУ 674-41     | 30  | 30                |
| 10 Прутки диаметром 6-50 мм  | То же            |   |                   |
| 11 Прутки твердые диаметром (мм):<br>8-22<br>23-30<br>32-50        |                  | 45<br>40<br>35                                    | 5<br>7<br>12      |
| Проволока мягкая диаметром (мм):<br>0.2-0.5<br>0.6-1.0<br>1.1-5.0  | 13 ГОСТ 5220-50  | 35<br>35<br>35                                    | 20<br>25<br>30    |
| Проволока полутвердая диаметром (мм):<br>0.6-1.0<br>1.1-5.0        | 14 То же         | 45<br>45  | 3<br>5            |
| Проволока твердая диаметром (мм):<br>0.2-0.5<br>0.6-1.0<br>1.1-5.0 | 15               | 55<br>55<br>55                                    | 0.5<br>0.5<br>1.5 |

1) Form and temper of mill product; 2) GOST or TU; 3)  $\sigma_b$  (kg/mm<sup>2</sup>); 4) no less than; 5) soft strip; 6) GOST; 7) hard strip; 8) same; 9) extral hard band; 10) doft drawn and rolled rods of 6-50-mm diameter; 11) TsMTU; 12) hard rods of diameter (mm); 13) soft wire of diameter (mm); 14) half-hard wire of diameter (mm); 15) hard wire of diameter (mm).

TABLE 2  
Mechanical Properties of MNTs 15-20  
Neusilber as a Function of Annealing Temperature

| Темп-ра отжига (°C)<br>1 | $\sigma_b$ (кг/мм <sup>2</sup> )<br>2 | $\delta$ (%)<br>3 |
|--------------------------|---------------------------------------|-------------------|
| Исходный материал 3      | 85                                    | 3                 |
| 200                      | 86                                    | 4                 |
| 400                      | 84                                    | 8                 |
| 500                      | 75                                    | 15                |
| 600                      | 60                                    | 22                |
| 700                      | 52                                    | 30                |
| 800                      | 48                                    | 32                |

\*Deformed rods (50% work hardening) of composition 15.1% Ni, 19.8% Zn, remainder copper.

1) Annealing temperature (°C); 2)  $\sigma_b$  (kg/mm<sup>2</sup>); 3) original material\*

References: Mal'tsev M.V., Barsukova T.A., Borin F.A., Metallografiya tsvetnykh metallov i splavov (Metallography of Nonferrous Metals

II-16X

and Alloys), Moscow, 1963; Spravochnik po mashinostroitel'nykh materialam (Handbook on Machine Design Materials), Vol. 2, Moscow, 1955.

Ye.S. Shpichinskiy

II-15N

NEVYANSKITE is iridium-osmium, a mineral of the native element group. The variety with predominance of iridium over osmium is termed siserskite. Impurities are rhodium, ruthenium, platinum, gold. The structure is close to the structure of chemically pure osmium. It has perfect cleavage along (0001). Mohs hardness is 6-7. Brittle. Specific weight 17-21. Color of nevyanskite is tin-white, siserskite is gray. Nevyanskite is weakly anisotropic. It has high chemical resistance: does not dissolve in acids, alkalis or aqua regia. Nevyanskite is used for producing fountain pen points, tips for surgical instruments, refractory crucibles, thermocouples; its is used as an additive in many alloys; high brittleness limits the independent application of nevyanskite.

References: Betekhtin A.G., Kurs mineralogii (Course in Mineralogy), 3rd edition, Moscow, 1961; Mineraly (Minerals), Handbook, Vol. 1, Moscow, 1960.

V.V. Nasedkin

II-74n

NICHROME - see Alloys with High Ohmic Resistance.

END

DATE

FILMED

9-22-67