

AFOSR 66-0873

June 1966

Best Available Copy



AD 637488

INFORMATION SYSTEM NETWORKS

.... Let's Profit From What We Know

ROWENA W. SWANSON

Directorate of Information Sciences

AIR FORCE OFFICE OF SCIENTIFIC RESEARCH

Code 1

PEARL HARBOR	
FOR SCIENTIFIC AND TECHNICAL INFORMATION	
1300	1950/54
ARCHIVE COPY	



20050222025

OFFICE OF AEROSPACE RESEARCH  
UNITED STATES AIR FORCE  
Arlington, Virginia

11 1966

Best Available Copy

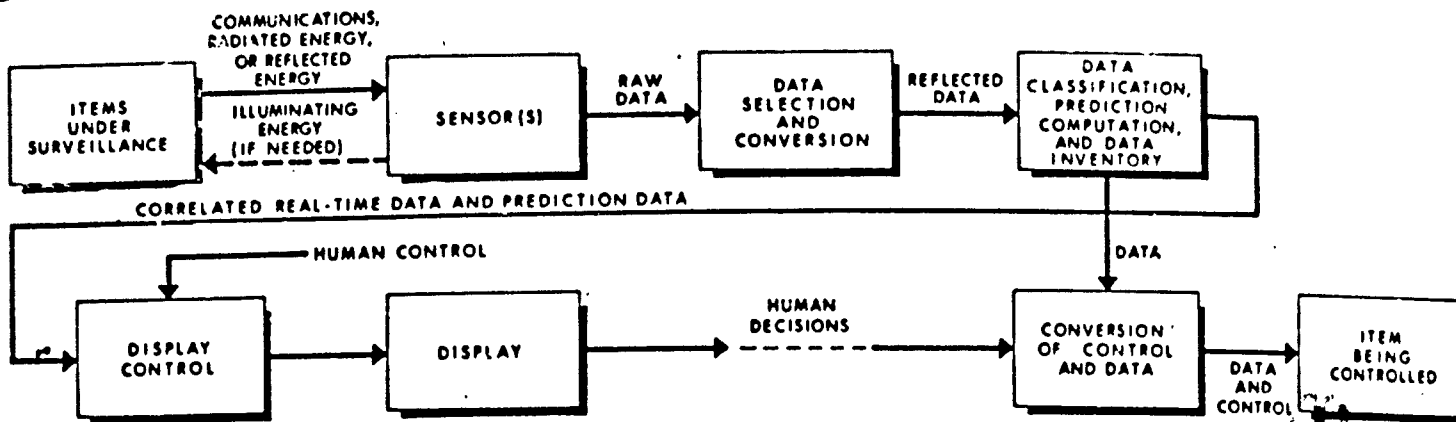

# INFORMATION SYSTEM NETWORKS

.... Let's Profit From What We Know

ROWENA W. SWANSON  
 Directorate of Information Sciences  
 Air Force Office of Scientific Research

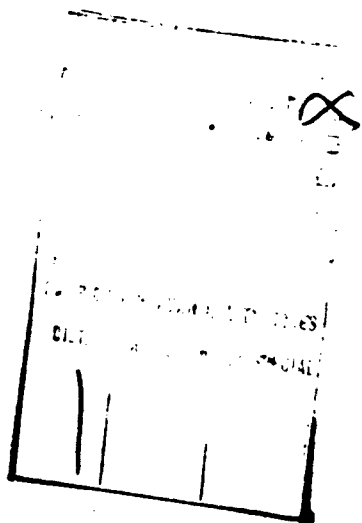

AFOSR 66-0873

June 1966

Paper presented at The Third Annual National Colloquium on Information Retrieval, University of Pennsylvania, Museum Auditorium, 12-13 May 1966.

*Continuing effort to achieve technological superiority, especially in the air and in space, is not merely a matter of national prestige, scientific ambition or economic interests; because of its military implications, such superiority is indeed a matter of vital importance to the security of the entire Free World whose leadership and defense have been thrust upon us.*

General J. P. McConnell  
Chief of Staff  
United States Air Force  
/la/

*Unless the technology is applied by designers who know what the user's criteria of effectiveness are, it is likely to be wasted.*

Honorable Harold Brown  
Secretary of the Air Force  
/lb/

## P R E F A C E

One should not, I have been told, begin a paper or a talk with disclaimers. Therefore, I should not start by saying that this paper is not a comprehensive survey of on-going information systems, nor is it an evaluation of all proposals for network designs. I have found some merit, however, in proceeding by exclusion. This enables focusing on objectives with the ever-present danger, of course, that the bare bones can be too easily seen.

The objective of this paper is to look at what has been done toward building efficient and effective information systems. Although the impetus for this paper arose from my desire to underscore, to proposers of vast information networks for science and technology, some of the problems that persist at the systems level, much less the network level, information is a commodity needed by all members of society. Principles and tools that are developed to process it may ultimately benefit the housewife as well as the industrialist, the artist as well as the scientist, the school child as well as the military commander. My bird's-eye viewing in this paper of a variety of systems for a variety of purposes is an attempt to preclude parochialism among those who are and will be building the systems and the networks of the future.

Man discovers the knowledge and builds the tools that catapult him into increasingly complex states. These, in turn, impose increasing demands on his intellect and his creativity. In his work on information processing, he is homing in on methods by which he can further exploit the natural and material resources that have been given to him.

ROWENA W. SWANSON

Directorate of Information Sciences  
AIR FORCE OFFICE OF SCIENTIFIC RESEARCH

Arlington, Virginia  
June 1966



"HeadQrs. 2nd Division - 2nd Corps  
Camp near Falmouth, Va. April 30th 1863

"General,

The present system of Accountability for property is defective and gives rise to too great a Multiplicity of papers.

"Every Company in the Service has more or less property worn out, which has to be inspected and condemned by the Division Inspector Gen'l. Under the old system where the number of companies was small, the thing was practicable, but now each Brigade in our large Armies has four or five Regiments and each Division Three Brigades, making from 125 to 150 Cos. Each Co. Comd'r must make out *triplicate* inventories of each kind of property, so that to get rid of a few worthless muskets and a few pieces of damaged clothing or Camp and Garrison Equipage in each Company from 750 to 900 papers must be prepared and examined by the Inspector Gen'l, who has to make from 250 to 300 separate (*John Gibbon was turned back in his yearling year at the Point for deficiency in spelling. It is not a record that he was ever deficient in fighting.*) inspections and this not once a month or once a quarter but sometimes twice a few days, from the want of care and experience on the part of the Co. Officers, in not including all the property that needs condemnation. In this way the mere labor of preparing for inspection and condemnation becomes interminable, without taking into account the additional invoices and receipts for property turned in for repairs.

"To remedy this defect, I propose that whenever a Company Officer has property which he considers worthless, he make out invoices of it, which shall be endorsed by the Regimental Commander or some Officer appointed by him, certifying to the condition of the property, and then this property be turned over, in the case of Ordnance, to the Division Ord. Officer. In the case of Clothing and Camp and Garrison Equipage to the Brig. Q'r Master's to be by them brought before the Insp. Genl, for Condemnation, when he has a sufficient quantity on hand; when the triplicate inventories can be made out.

".....

"I am General  
Very Respectfully Your Ob't Serv't  
John Gibbon  
Brig. Genl., Comdg. Div.

Armed Forces Management  
vol. 8, no. 3, December 1961

## TABLE OF CONTENTS

Preface	.....	ii
1 - Introduction	.....	1
2 - Definitions	.....	1
3 - Information Systems for Scientists	.....	3
4 - Information Systems for Industry and Commerce	.....	6
5 - Information Systems for Managers	.....	9
6 - Information Systems for the Military	.....	13
7 - Information Systems for Libraries	.....	18
8 - Proposals for Networks	.....	20
9 - Research for Information Systems	.....	24
9a - Plans and Surveys	.....	24
9b - Programs	.....	26
9c - Hardware	.....	29
10- Recapitulation	.....	33
11- References	.....	35
12- Bibliography	.....	44
13- Addendum	.....	46
14- DD Form 1473	.....	48

## 1 - INTRODUCTION

The information problem has been characterized as a problem of abundance /2/. Machines can measure and produce more data and men can discover more variables and objects to measure than either man or machine can cope with. This paper summarizes some of the attempts that have been and are being made to systematize the behavior of both so that both can be maximally effective and continue to enlarge their spheres of activity.

The abundance of activity and the demands that systems make for a variety of talents for a variety of purposes have tended to mask common problems and common phenomena. The hardware designer, the language designer, the systems designer, and the many users too often isolate themselves in the fields of their special skills and fail to relate how their specialties should or could contribute to over-all system objectives.

This paper, therefore, preliminarily reviews systems from a systems engineering viewpoint. Thereafter it considers systems that have been and are being developed for particular classes of users -- scientists, managers, persons in industry and commerce, the military, and librarians. A discussion follows of proposals for integrating systems and establishing information networks. The paper closes with a survey of some of the research, both on-going and needed, to perfect existing systems and create new ones.

The intent of the paper is to show the spectrum of efforts that are natural parts of a whole concerned with information systems. A system can be as effective as its weakest component. Analysis and synthesis both depend on identification of the component as well as on an understanding of its systems context.



## 2 - DEFINITIONS

It is not the intent of this section to play semantic games, but to characterize several terms that will be used repeatedly in this paper. These terms too frequently go undiscussed, or are discussed too narrowly. (Don Black's delightful spoof, and thoughtful commentary, "The Designer's Tools," contains a number of remarks on the flagrant use of terms without substantive definition in the information systems field. /3/).

"Information" is an item in some representational form that at least one person wants, wanted, or will want. The author does not equate information with knowledge. Knowledge is produced through the use of information. Representational forms are embodiments of coding schemes that can be recognized or perceived by one or more sensors or the human mind. Men and lower animals have sensory systems, but "sensor" includes artificial receivers. Thus, sounds, printed patterns, pulses, and words are all representational forms. The coding schemes are languages. Information is time bounded. What may have been information to someone fifty years ago may never again be information. This, however, does not affect its having been information. The time factor highlights one aspect of the difficulty in trying to provide for future information needs. What may become information is not 100% predictable.

The words, "information" and "system," each contribute meaning to the term, "information system." Failure of information specialists to provide a definitional specification of systems concepts is all too prevalent and may indicate lack of understanding of them. This understanding is second nature to systems and industrial engineers and operations researchers. A large body of current, potentially exploitable literature may well be unintelligible to those having no knowledge of systems fundamentals.

## INFORMATION SYSTEM NETWORKS . . . . .

The 1966 revision of the McGraw-Hill Encyclopedia of Science and Technology contains a brief, well-considered essay on systems engineering. One finds the following definitions: /4/

A "system" is a collection of matter within prescribed boundaries.

A "system quantity" or variable is any characteristic of a system measurable by an observer stationed outside the system.

An "input quantity" is a variable whose value at any instant of time is determined by events occurring outside the system.

An "output quantity" is a variable whose value at any instant of time is determined by events occurring within the boundaries of a system in response to changes in input quantities.

A "constant quantity" is a characteristic of a system whose value does not change with time over the interval under observation.

"Systems engineering" encompasses the design, prediction of performance, building, and operation of large and complicated combinations of elements or subsystems. Systems engineering emphasizes the requisites for optimizing performance under changing conditions of load, environment, and information inputs.

These are idealized definitions. For example, the McGraw-Hill article notes that an input quantity is, in practice, affected by performance of the system, and output quantities depend on events occurring outside the system. Idealizations, as most engineers know, are simplifications to enable model building. Implicit, however, are both the awareness that a model is an approximation to reality and that an approximation may require a number of modifications before it can be accepted as a description of an actual situation.

The recurring attitude is stated

in at least one report, that the librarian must retain the responsibility to decide and direct the course of automation in libraries /5/. The attitude is not limited to librarians. To what extent does this view fail to recognize system requirements? The following McGraw-Hill excerpt gives a glimpse at an answer:

"The design and building of many large systems encompass many fields of endeavor, such as the various fields of engineering and science, mathematics and computation, and the social sciences. Hence, specialists in many areas must be called upon. Perhaps the greatest responsibility, however, falls upon those who carry the burden of the design of the over-all system from initial conception to a working prototype. Such leaders must have broad outlooks. While they cannot be specialists in every field, they must be able to communicate with and lead groups of specialists and bring the best tools available to bear upon the problems which arise in large systems."

A system is an integration of men, materials, and equipment. Its construction and operation are team efforts. Many different skills may be needed, and the control function may shift among different members of the team during the course from design to implementation. For example, in the survey phase, a librarian or information specialist may provide direction to mathematicians, engineers, social scientists, and economists. In the modeling phase, an industrial engineer may guide the work analysis, flow diagraming, layout preparation, and simulation programming. In the model manipulation phase, the information specialist, engineer, mathematician-programmer, and economist may share control. /6/. Repeatedly emphasized in the systems engineering literature is the importance of creative imagination in the development of alternate designs and modifications leading to a final selection. There is no room for not-invented-here thinking in a systems enterprise.

An "information system," as defin-



## Let's Profit From What We Know

ed by A. F. Moravec, consists of "the procedures, methodologies, organization, software, and hardware elements needed to insert and retrieve selected data as required for operating and managing a company." /7/ In two papers, Moravec discusses two current, alternative concepts for systems design /8/. The "total systems" approach attempts to unite all existing subsystems into a single integrated system. The intent is to include data for the needs of all operating and management levels. The "single information flow" approach limits the data base to that essential to operations; other data for specific user groups are processed outside the system. The total systems concept is output oriented and processing is predominantly of the batch type. Moravec favors the single information flow concept as more efficient for management planning. John Dearden holds an opposing view based on the state-of-the-art. "We should not be sacrificing today the real gains from practical computer applications for the sake of the will-o'-

the-wisp concept of 'total systems.'" /9/ Several years ago, J. C. R. Licklider described a "system system," a computer-centered meta-system that plans, builds, and operates another system /10/. It is an approach analogous to that used in computer design. The system-system was proposed to coordinate the functions of the object system and to track particular situations as they arose. Licklider suggested the monitor since it is not usually possible to keep a large, complex, dynamic system in operation under sufficiently close control to permit experimentation on it. Licklider views partitioning as an absolute prerequisite to research on systems.

### 3 - INFORMATION SYSTEMS FOR SCIENTISTS

It is often said that the few scientists who lead their field need no information systems. They belong to invisible colleges, and communication by correspondence, telephone, and meetings is their information source. On the other

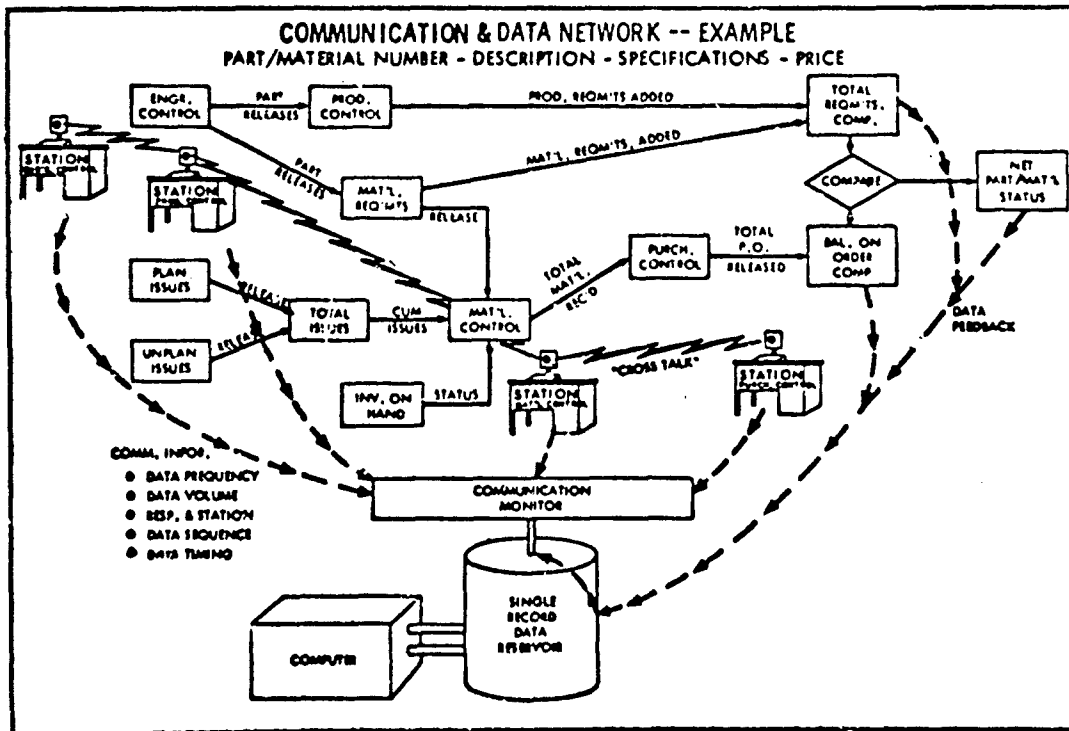

Management Services, ref. 7

## INFORMATION SYSTEM NETWORKS . . . . .

hand, it is said that the scientist is drowning in a sea of data, and that increasingly sophisticated automatic methods of analysis and vast machine memories are his only salvation. Both of these situations are at least partly true. It is necessary to distinguish categories of information, the nature of the scientific activity, etc. A given scientist, over a period of time, may be at one or the other end of the information-need spectrum. In an analytic phase, he may require as much data as he can obtain. In a concept-development phase, a casual remark of a colleague may be the necessary and sufficient trigger.

Conceivably, information systems can be established that may be able to assist scientists in concept-development phases. However, this is not their primary objective now. The function of today's information system is to make recorded information readily available in useful formats. The information system having more humanoid research-assistant qualities is a realistic possibility, but it will depend on what its less imaginative predecessors are able to accomplish.

Estimates have been made on the number of information systems that exist in the United States. These have been based on various criteria. Significance lies in the size of the tally (400 to 700+). No enumeration of these is given here; references 11-17 provide several compilations. Perhaps as many as 1000 systems have escaped surveys because they do not fall within criteria or they have not disclosed themselves through publication. (It is paradoxical that many information specialists are among the poorest communicators, in the author's experience).

The information systems that are investigated and tabulated most frequently are those that provide access to document collections through descriptive terms. The terms include names of authors and originating institutions, words from titles, series

numbers, and words characterizing disciplines or subjects. These systems vary in size and scope. Among the largest in both aspects are the federally sponsored Clearinghouse for Federal Scientific and Technical Information (Dept. of Commerce), the Defense Documentation Center (DDC) (Dept. of Defense), NASA's Scientific and Technical Information Facility (at Documentation, Inc.), and the Atomic Energy Commission's Division of Technical Information Extension (DTIE). /18/ Variants of the basic configuration pervade government, industry, and academic institutions. They provide similar services -- periodic abstract bulletins announcing newly processed acquisitions, documents on request in full size or photoreduced form, and bibliographies incorporating retrospective search of the collection. Several federal systems recently initiated user-oriented quick announcement services. The Clearinghouse's Fast Announcement abstracts accessions deemed noteworthy in various subject categories, e.g., communications. NASA's Tech Briefs publicize new products and research results to promote rapid assimilation by industry. The Defense Documentation Center Digest discusses and clarifies DDC procedures and policies and is, in essence, a folksy newsletter to educate and communicate with the user. Several systems are exploring more personalized and substantive selective dissemination approaches. Smaller systems use the services of the federal systems and augment them with internally generated accession lists, bibliographies, etc. The service picture might be bright but for a few system problems, e.g.: (a) acquisition, i.e., getting the documents that belong in the collection when they are issued; (b) overlap, i.e., establishing interfaces through which one system could switch into another to minimize duplication; (c) responsiveness, i.e., being able to retrieve information that is asked for which presupposes comprehensive, detailed subject classification, infallible indexing, machines with large storage capacities, and programs providing rapid answers to complex questions; and (d) releasability, i.e., removing barriers not required by security restrictions to the dissemina-

## Let's Profit From What We Know

tion of documents to those outside particular groups, e.g., DOD or NASA contractors.

Numeric records have been more tractable for machine-based systems. Illustrative of systems for such data are those that store and process properties of materials under federal and private sponsorship. The Air Force Materials Laboratory, for example, sponsors a Machinability Data Center, a Ceramics and Graphite Information Center, a Defense Metals Information Center, an Electronic Properties Information Center (EPIC), a Mechanical Properties Data Center (MPDC), a Radiation Effects Information Center, and a Thermophysical Properties Research Center (TPRC). These are analysis as well as storage centers. EPIC, started in 1961, has issued over 2000 data sheets and special reports on 34 materials based on a 17,000+ document collection, and offers literature searches and bibliographic compilations on specific materials or specific properties of specific materials. Of 1000 documents screened, about 100 are selected, and 25 of these are used in compiling data sheets. A 500-document bibliography, arranged by materials and properties, costs about \$15 to produce /19/. MPDC, also started in 1961, has a file exceeding 370,000 cards on most static and dynamic mechanical properties for over 800 metal alloys, and over 20,000 cards for reinforced plastics. An inventory report notifies users of the data available. MPDC performed 301 searches in 1964. An average search costs \$150 and yields about 300 items. Users found 50-70% of the data useful /20/. TPRC, founded under the sponsorship of 26 industries and federal agencies in 1957, conducts theoretical and experimental research as well as data analyses. It issues a Retrieval Guide to Thermophysical Properties Research Literature and periodically up-dated loose-leaf Data Books that report most probable values of a particular property for a particular substance as of a particular date. TPRC services U.S. and foreign requests for special searches, critical evaluations of spe-

cific data, and estimates or predictions of new data /20a/.

Francois Kertesz discusses the characteristics of 16 information centers at the Oak Ridge National Laboratory /21/. The centers range from the Nuclear Data Project that began on the Manhattan Project in Chicago to the Isotopes Information Center that is in the planning phase. Most of the centers are staffed by researchers, are highly individualistic, and collaborate with national and international organizations, professional societies, and individuals in their spheres of interest. The Nuclear Data Project issues Nuclear Data Sheets, Nuclear Theory Index Booklets, and Nuclear Data Tables periodically, and aims toward 99.5% retrieval /22/. The Radiation Shielding Information Center, that originally relied on information from the American Nuclear Society, is now the field's primary information source. It issues data compilations, bibliographies, critical reviews, and states-of-the-art. Experience at the Battelle Memorial Institute also reflects the advantage of having researchers part time on information center staffs. The effect of 5 - 25% participation of about 20 scientists and engineers in the Radiation Effects Information Center and 15 - 30% participation of about 40 specialists in the Defense Metals Information Center is the information feedback, e.g., the reporting of information gaps and significant items of information, as well as knowledgeable servicing of information requests /23/.

The most advanced of today's data-handling networks are serving the military and allied groups (see Section 6). Rivaling military requirements, either in complexity of the data record or in complexity of the network configuration, are those of the biological, behavioral, and social sciences. A total of 619 biomedical computer applications were identified by Milton Aronson and Josephine Martin in 1964 /24/. Many of these involve the extraction of numeric data from physiological records and the analysis of these, clinical data, and research data. The use of automa-

## INFORMATION SYSTEM NETWORKS . . . . .

tic data handling systems as a means of quality control to minimize errors in the practice of medicine is the principle topic of a 1964 issue of Methods of Information in Medicine that includes a bibliography on the topic /25/. C. J. Chung of the National Institutes of Health describes systems for the genetic analysis of human family and population data /26/. Information systems are also being developed for psychiatric /27, 28/, psychophysiological /29/, and human factors /30/ data. Burt Green's recent book on the role of computers in the behavioral and social sciences discusses such applications as statistical analyses of experimental data, stimulus generation, and the formulation and testing of models of neural activity, learning, pattern recognition, problem solving, and game playing /31/. Programs have been written for handling numeric and non-numeric data for plant taxonomists /32/. The new Drug Literature Program of the National Library of Medicine is expected to become a central information source. The biomedical and social sciences have the same need as other sciences for systems for data acquisition and reduction, model construction and testing, and theory development. Additionally, current systems software and hardware offer the opportunity for integration with the physical sciences, as in biochemistry, biophysics, and biomedical engineering /33/. Conversely, the knowledge gained from systems application in the study of biological flow and control processes should contribute to the design of more advanced systems.

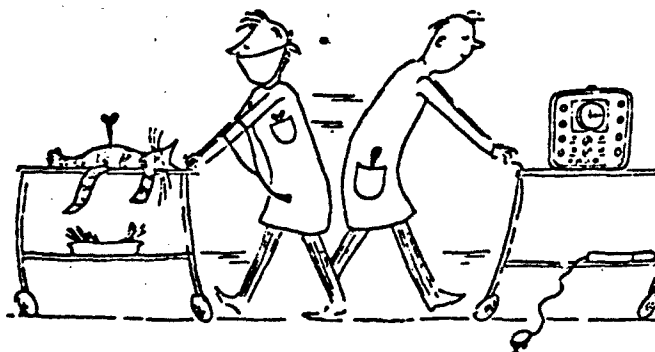

Physics Today, March 1966

## 4 - INFORMATION SYSTEMS FOR INDUSTRY AND COMMERCE

The information processing potentials of computers have and are affecting major changes in systems in industry and commerce. This section gives only a brief indication of the system organizations and operations that have been realized.

Production and inventory control has been a major area of application. A number of departments in a business, including purchasing, accounting, production, and marketing, need current information on different aspects of the same operations for a variety of analyses and reports. Automation of data processing has allowed more items of information to be collected, a more timely understanding of system operations, and agreement in reports of different departments /34/. Novel techniques can often be developed that further advance particular operations. For example, at the Cleveland Graphite Bronze Division of Clevite Corp., a pocket radio scheme for sending trouble alerts and paging foremen has been integrated with punched card equipment and a board display that tracks production machines. The cards furnish data to the computer facility for payroll, cost, production, and performance reports /35/. The Freeman Coal Mining Corp., in cooperation with the Illinois Bell Telephone Co. and the Standard Register Co. (a forms designer), uses a procedure that combines continuous business forms, punched paper tape, and a wire communications network with one-time data input to satisfy the information requirements of the shipper, billing to railroads, sales, accounting, and the customer /36/.

The new systems of commercial enterprises such as banks and insurance companies have influenced business volume and may enhance flexibility in exploring new ventures. The John Hancock Mutual Life Insurance Co., whose systems

## *Let's Profit From What We Know*

network is described in the April 1966 issue of Systems, is a case in point /37/. Hancock was the first large insurance company to extensively automate underwriting. The first system, installed in 1955, has been extended to encompass new policy development, policy issuing, billing, posting, and claims settlement. The present system, using nine computers that work three shifts five days a week, is the result of 100 man-years of effort over a 2½ year period. Over 1000 policies can be underwritten, calculated, and edited in less than 30 minutes. The first Hancock system did bread-and-butter tasks such as billing and collection. The single source records eliminated multiple file searches, enabled daily up-dating, and reduced lead times for preparing premium notices and other mailings. Subsequent applications to production and inventory control and sales are stated to be more valuable uses of the machines. In the sales program, an agent records information on a formatted data sheet that is coded by a clerk. System processing of the record (after keypunching and conversion to a tape) yields a printed proposal containing three suggestions to meet the customer's needs. Salesmen are enthusiastic since they have more time for personal contacts.

Forms control can significantly affect systems operations. At Hancock, about 5000 numbered forms are managed through a Forms Control unit in the Printing and Purchasing Department. The unit works both with methods and equipment people and with a forms representative or alternate in each department. Well maintained, two-way communication has been essential in this network. Effects on business include an increase in the company expense/income ratio (from 12.9 to 13.2% from 1964 to 1965) and doubling of the insurance in force over the last ten years. The system itself created the need for new skills, many of which were taught to those whose work was computerized. Plans include record transfer to a random access memory to give field offices direct access to

the data store.

Banks have similarly begun to absorb computers to "process banking," rather than paper /38/. They are thinking in terms of data networks and data links, on line and in real time /39/. They are making fundamental system changes through use of such devices as the Touch-Tone telephone and universal credit cards /40/. They expect to develop new customer services and anticipate the centralization of customer records and the processing of customer inquiries by telephone. Several institutions are studying IBM's PARSAL (Program for Allocation of Resources of Savings and Loan Associations) for investment budgeting and forecasting /41/. The changes are also introducing new job requirements -- for research, service development, programming, statistics, sales, merchandising, and systems design.

Systems for scheduling airlines traffic are fairly well known. Railroads have also produced information processing innovations. New York Central, for example, has linked its Car Tracing Center with its Transportation Computer Center /42/. Data on movements of individual cars, that once were bound in voluminous ledgers, are now manually recorded on waybills, transferred to cards, and transmitted over narrow-band telegraph lines to the Transportation Center and to the train's destination yard. Inputs from the yards continuously up-date the disk-file record on a car through pickup, drop off, and shunting to sidings. Clerks at the Car Tracing Center answer about 400 inquiries daily from video displays linked to the computer. Northern Pacific handles 20 to 25 high-wide load requests daily through automatic comparison of dimensions of the load with outlines of restrictive structures previously computer stored /43/. Data are tape stored on tunnels, railroad and overhead bridges, wire crossings, and rock cuts, and are up-dated as structures are changed. Southern Railroad's Control and Coordination Center is consolidating agency and yard offices and is developing new procedures for centralized billing,

## INFORMATION SYSTEM NETWORKS . . . . .

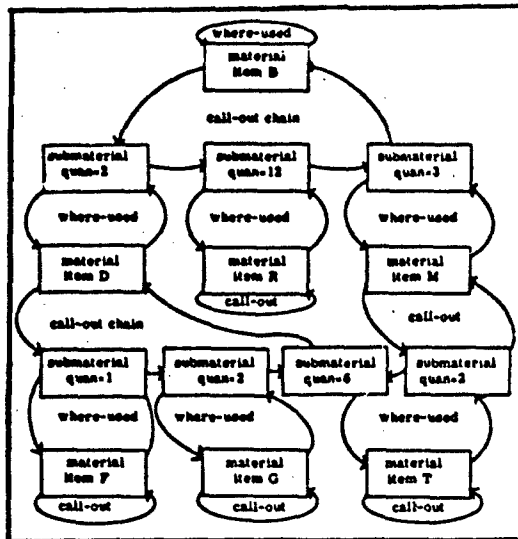

and five generation pedigrees are obtainable on request and are used for research purposes.

Since Monsanto tested direct digital control (DDC) in 1962, DDC has become a "full-fledged, applied control concept in the process industries" /49/. DDC replaces individual analog controllers now in common use on process equipment. Data loggers, explored by industry ten to fifteen years ago, didn't become popular because benefits didn't justify investments (\$50,000 to \$100,000+) /50/. The loggers converted process variables to digital form, made rudimentary calculations for data conversion and summation, and recorded via electric typewriters. DDC uses general-purpose computers with stored programs. Programs are planned for algebraic equations that optimize 15 to 20 variables and for optimization through linear programming. Economic justification, however, seems dependent on coordinating process control with other data manipulation processes such as production planning, scheduling, and customer and production orders. Much of present-day process control consists of control of the process machinery because of difficulties in measuring process variables and understanding process complexities. Even the systems in modern integrated steel plants control comparatively few process variables. Systems for blast furnaces, for example, calculate burden (charge) requirements (feed-forward control) and do data logging and alarm monitoring but only a limited amount of feedback control. There are no general automatic feedback systems for the basic oxygen steelmaking process. Computer-based systems are most sophisticated for the hot-strip mill that converts slabs to finished products at high speeds and narrow variable tolerances /51/. Problem areas outlined in Thomas Stout's tutorial on process control seem cautionary for systems in general /52/. They concern:

- a) people - adequacy and competence of the team and degree of management support
- b) project definition - how well are

transmitting data to the Interstate Commerce Commission, and analyzing traffic operations /44/. Battelle Memorial Institute, under Department of Commerce sponsorship, is studying the railroad rate problem /45/. Traffic experts foresee the development of uniform commodity, geographic, and routing codes, a uniform conveyance code that will identify both the boxcar and its type, and a uniform code for tariff rules.

Information system concepts have also been invading the agriculture industry. The Saskatchewan Wheat Pool, a farmer-owned cooperative, uses an NCR 315 and two CRAM files primarily for inventory control, and services about 15,000 transactions daily /46/. The Western Farm Management Co. offers an accounting service to farmers and ranchers /47/. Field auditors periodically collect farm records and provide monthly accounts of revenue and cost on a per-acre and per-unit basis. The system of the American Hereford Association provides three-generation pedigree certificates for each of the 2000 calves registered daily. Each certificate lists names and registration numbers of 14 ancestors that is information valuable for breeding purposes /48/. The file contains records on 13 million Herefords. Four

## Let's Profit From What We Know

system objectives and performance capabilities understood and preplanned?

c) system concepts - adequacy and realism of the system design

d) equipment - knowledge of performance capabilities

The systems have not reduced over-all manpower requirements. They can, nevertheless, be profitable. Their principal value may be in putting management in real control of operations.

Experience with the new systems is providing feedback that should aid future designs. R. W. Parker of American Airlines suggests early design of utility routines and early concentration on how to operate and control the implemented system /55/. He recommends software for monitoring the computer time of each type of transaction and the quality of input from field stations. In a review of numeric control for directing the operation of machines and machine systems, Lawrence Williams and C. Brian Williams consider the consequences of these systems on factory organization, the decision-making process, and occupational categories /56/. The systems have intensified interaction between divisions, departments, and units of business organizations, and have introduced new decision-making groups. However, they introduce a new language and shifts in control points that create problems when personnel view the system as only introducing new hardware. High capital expenditure demands high operating performance and imposes pressures for cooperation and communication that must sometimes be forced. The required skill and technical competence of operators remain about the same as with conventional equipment. Most of the 33 users and 6 producers of numerically controlled equipment whom the authors interviewed train or hire programmers, but programming is often considered a "dead end" job. Most organizations retrain existing staff for maintenance, but some separate the diagnostic function from the repair and service function. Multi-departmental committees whose members reflect the

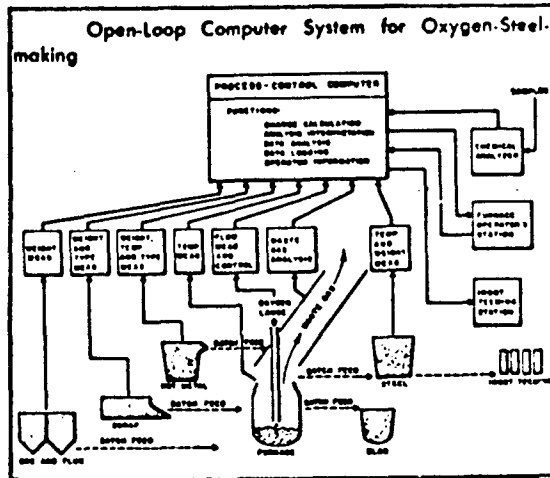

Datamation, ref. 51

opinions or authority of the heads of the organizational units appear essential to achieve the closer cooperation that the systems require.

## 5 - INFORMATION SYSTEMS FOR MANAGERS

The essential function of management is decision making. To some extent, any activity is the result of a decision. The distinction applied here assigns to management a command or control function over significant aspects of the capabilities of a system through decisions that affect the acquisition and allocation of human and material resources, scheduling and the selection of priorities, the replacement or termination of processes and procedures, etc. Good management is necessary, though not sufficient, for effective operation.

New information systems may be changing the role of the manager from analyst to synthesizer. The systems furnish the data, the manager that knowledge, experience, and creative ability that will enable him and his organization "to survive administrative jungle warfare" /57/. A number of tools and techniques are being developed as management assistants. Decision tables are applicable when decision making involves a selection of combinations of conditions that can be reduced to num-

## INFORMATION SYSTEM NETWORKS . . . . .

bers, as in economic analyses and the scheduling of airline reservations, insurance and tax rates, transportation costs, and credit rates /58/. Several Data Processing Digest papers of Roger Sisson describe other tools. For example, linear programming gives best operating conditions for specified inputs, outputs, and process constraints /59/. Queuing theory, "the scientific analysis of waiting," gives managers insights into how performance will change as the variables change, and enable an informed selection of alternatives /60/. Limits on the theory, however, do not permit the derivation, for example, of a simple formula for waiting time and queue length distributions, for average waiting times, for number of items in the system, or for facility utilization in this type of complex situation. For complex systems, simulation is used to suggest consequences of alternative plans and enable approximations to best operating conditions /61/. Most alternatives involve a tradeoff between added costs and added benefits, and prediction involves risk. Simulation is costly both because of the effort to

define, program, and test the simulator itself and the effort to establish and maintain a fast-response data processing system to test operating conditions /62/. Sisson cites only one simulator in daily use, that of Hughes Aircraft Co. that tracks 100 new orders and 1200 job moves in less than 40 minutes on an IBM 1410 with a 1301 disk file. About 2000 to 3000 orders move through an average of 7 work centers each in the Hughes operation during a cycle time of 3 to 4 weeks. Success of the simulator is attributed to "an excellent data processing system."

Tools, however, have little value in themselves. Richard Kaimann cites a 1964 McKenzie and Co. survey that reported over 60% of commercial computer installations operating below a self-sustaining basis /63/. His implications are clear. The impact of modern methods and technology on data processing is still not too well understood. Significant as collection and rearrangement of bits may be, cost effectiveness and data volume demand systems that can digest (correlate, evaluate, etc.) data and present as output only the bits relevant to decision making. The burden

EXAMPLES OF QUEUE PROCESSES

Process	Service	Facility	Items
1. landing aircraft	use of runway	runway	aircraft
2. loading and unloading ships	unloading and loading	docks, cranes	ships
3. automobile parking	parking	land and men	automobiles
4. taxi loading	entering taxi	curb space	taxi
5. clinics	entering taxi	taxi	people
6. toll collecting	medical service	doctor	patients
	collecting toll	toll gate (with collector)	automobiles
7. telephone switching	interconnect lines	switch system	waiting calls
8. machine maintenance	repair machines	maintenance man	broken machines
9. traffic control	passing through intersection	intersection	automobiles
10. job shop	processing jobs	machines	jobs
11. bank floor	banking	teller	customers
12. data processing	processing records	computer	transaction records
13. message traffic	communicating	communication channel	messages

Data Processing Digest, ref. 60



## Let's Profit From What We Know

is on management to establish the profitability of new methods and operations, and management is failing to properly exploit electronic data processing. An Aerospace Industries Association-Air Force conference recently examined the data management spectrum from concepts reduced to practice to new frontiers /64/. Major General Goldsworthy, in closing remarks, commented that opportunity "generally comes disguised as hard work." He ascribed to the manager a critical role in the forecasting process that is more than unsubstantiated prophecy. It is based on data, its recording, protection, and preservation, and on skilled observation, objective analysis, and know-how coming from experience, as well as imagination. Kaimann views the manager as a "human catalyst who gets prompt results from creative synthesis of ideas and his catalytic effect upon the thoughts of others."

A system at North American's Atomics International is an illustration of management's use of new tools.

A program called PAT (Pricing Automation Technique) was introduced to provide financial summaries that are being used in writing proposals and determining group-labor-load requirements /65/. The need for a tradeoff arose in the processing of sub-accounts. Though manual and machine costs for the operation were about the same (and manual may have been preferred), mechanization was selected to link the data with others for combined reports such as summaries by project and by line organization, and for forecasting.

Local, state, and regional government groups are actively investigating new approaches to management. A number of projects are reviewed in several issues of the SDC Magazine. The Winter 1965-1966 issue concerns innovations in the administration as well as the process of education /66/. The May and October 1965 issues describe plans for fiscal, law enforcement, and other public systems /67, 68/. Facing a population growth that threatens to saturate utilities and resources, Gov. Brown of California innervated a management-con-

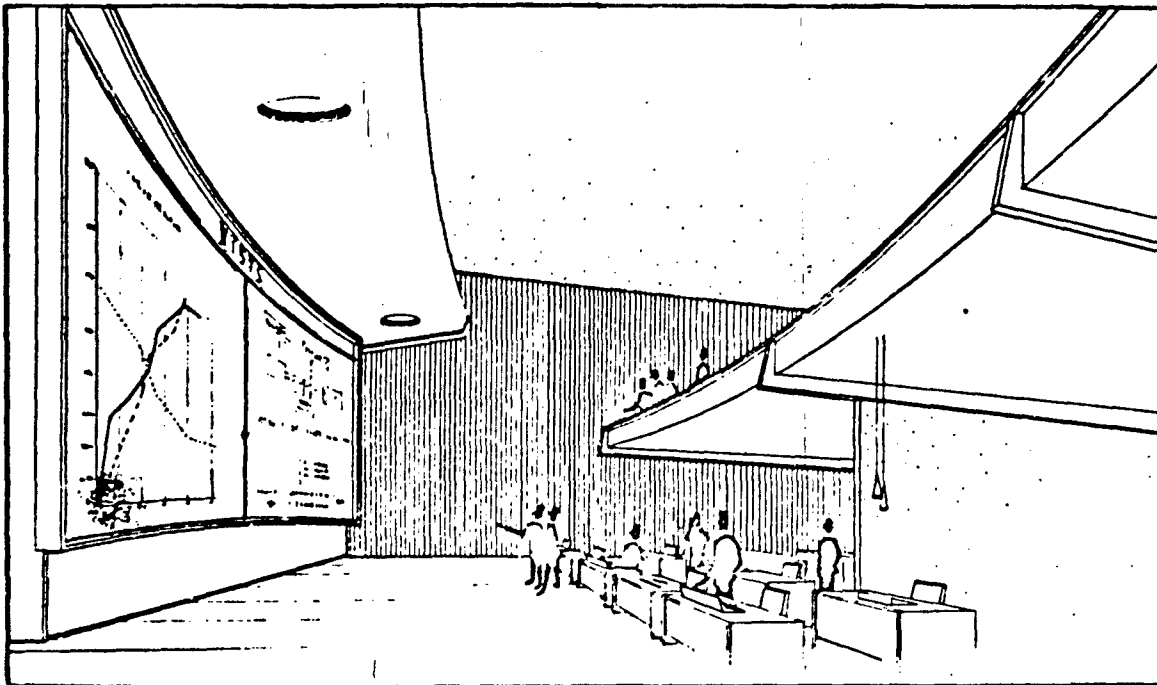

Information Display, Jan/Feb 1965

## INFORMATION SYSTEM NETWORKS . . . . .

tractor team of over 100 scientists, engineers, and public administrators who are designing fact-gathering systems to cope with such urbanization problems as air pollution, traffic jams, juvenile delinquency, and unemployment. The design for the New York State Identification and Intelligence System (NYSIIS) is the product of feasibility studies begun in 1961 on the application of electronic data processing techniques to the administration of criminal justice. NYSIIS incorporates the contributions of all affected agencies numbering over 3600 in the state. An example of the operation of a system within a network is the planned interface between NYSIIS and the Department of Motor Vehicles system. NYSIIS will have access to, but not duplicate, the Department's motor vehicle records, except for vehicles stolen or owned by major subjects. NYSIIS will also not duplicate voluminous reports in individual case jackets but will provide adequate references to them. Security precautions preserving legal, right-to-know, and need-to-know restrictions and distribution limitations imposed by contributing agencies are included in the design. Implementation on a "building-block" approach calls for the mechanization of a fingerprint file, a personal appearance file, a fraudulent check file, and a storage and search capability for summary criminal histories by the summer of 1967. The New York City government already spends \$13 million for 29 computers and an electronic data processing staff of 900. Mayor Costello recently announced plans for a "total information system" /69/. Common operations and information needs such as census data, grade reporting, attendance accounting, student scheduling, and payroll and encumbrance accounting are drawing schools into regional educational data system networks. The California Pilot Project in Educational Data Processing, initiated in 1959, showed the economic and quality advantages of such a venture. Plans in Iowa include use of the data and the location of computers in schools for educational research. Computer-based

control systems have been suggested for school boards to handle such information as student populations, teacher qualifications, and facility uses /70/. The Illinois Institute of Technology experiment with high schools in the Chicago area provides thought-provoking data on the impact of computers on education. Special Saturday and summer sessions started three years ago have trained about 500 teachers and 5000 students from 200 schools. About 50 schools plan to link to the IIT 360 by teletypes. Student graduates have formed clubs to use the computer for problems in mathematics, business, economics, and other fields /71/.

The Hill-Burton program enacted by Congress in 1946 has greatly influenced the development of management information systems in the medical and health fields. The program aims toward optimizing the use and coordination of services, facilities, and resources of hospitals and other medical institutions /72/. Studies sponsored under the program are looking to automatic data processing for such operations as the reporting and retrieval of patient medical care records; communication among various stations in a hospital; collecting, retrieving, and interrelating clinical and laboratory research data; determining staff and material requirements for various hospital functions; and training employee, medical, and supervisory groups. Jordan Baruch recently reviewed the design elements for a time-shared, computer-based hospital communication network centered on the patient file record that could satisfy information needs for patient care, administration, and clinical research /73/. He is testing these concepts on data from several units at the Massachusetts General Hospital. The system is expected to be valuable, for example, in an epidemiological demographic survey of the Preventive Medicine Unit. Data must be assembled from scattered hospital sources to show distribution patterns of admissions to various services, the nature of the care given, and its result. These records provide a background for management decisions on medical care and facilities, as well as

*Let's Profit From What We Know*

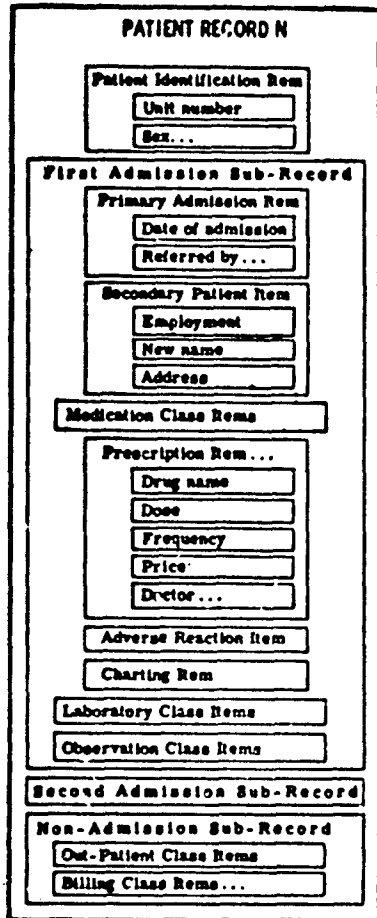

Organization of the patient file

Jordan Baruch, ref. 73

for medical education /74/. Erling Dessau of Denmark noted that few consequences can be predicted now for medical data processing /75/. Estimates indicate that about 25% of hospital expenses and about 25% of the full-time employee workload are consumed in information handling. Need for data exchange among hospitals, rehabilitation clinics, social-medical institutions, private doctors, and national health services add to the volume, complexity, and expense. Limited experience with automated information systems raises the hope of better and more reliable care and beneficial psychic effects on patients as well as better records for effect-

ing economies in manpower and material allocations and the planning of medical care and facility construction at local and national levels.

**6 - INFORMATION SYSTEMS FOR THE MILITARY**

The military world is a cosmos having information needs mirroring those of the civilian world plus needs peculiarly its own. The military complex ranges from scientific research units to factories, warehouses, hospitals, universities and training centers, board rooms, and battle sites. Systems within this complex not only penetrate the known parts of the universe and push into the unknown, but they also can tolerate little error. For the output of many systems, Zero Defect is not a goal; it is the difference between a victory and a defeat.

The type of network that automatic data processing puts within realizability is exemplified by that being developed for the North American Air Defense Command (NORAD). NORAD's mission is to give warning of and provide defense against aerospace attack of North America. The March 1966 issue of the SDC Magazine describes part of the NORAD structure /76/. The Combat Operations Center (COC) is the focal point for the following information flow:

**Inputs from:**

- Ballistic Missile Early Warning System (BMEWS)
- SAGE air defense system
- Dew line
- Bomb alarm system
- NUDETS system
- Space Defense Center
- Back-up Interceptor Control System (BUIC)
- NORAD COC operator personnel

**Outputs to:**

- Strategic Air Command
- Joint Chiefs of Staff
- Other lateral and higher commands

Characteristics of the COC system include: an input/output data controller that translates received data to the

## INFORMATION SYSTEM NETWORKS . . . . .

language of the COC computer (a Philco 2000/212); a closed-circuit TV network that transmits information external to the computer among units in the COC; display consoles at command party and battle staff positions that retrieve pictorial and tabular data for analysis and modification; a large (12x16) group display in the command room; and a capability of performing equipment checkout maintenance and diagnostics without terminating system operations.

The Space Defense Center is the central collection, processing, and communication point for data on all man-made objects in orbit in space (about 1000 since the Sputnik I launching in 1957). About 300,000 observations are received monthly from an extensive sensor network that includes ground-based radars, telemetry stations,

and optical equipment. These data arrive via high-speed data links, teletype, open and secure telephone circuitry, and the U.S. mails. The data are converted to a standard format; analyzed to separate valid observations from noise; corrected by predictive models that specify adjustments for the bias of individual sensors and atmospheric effects on the orbits of the objects; and stored according to a classification scheme. The Space Defense Center also has a real-time system that generates BMEWS displays in the COC.

Sharing the Cheyenne Mountain home of NORAD with the Centers will be the terminal points for the NORAD support system processing intelligence data and systems operated by the Air Weather Service and the Defense Communications Agency. The "will be" should be noted.

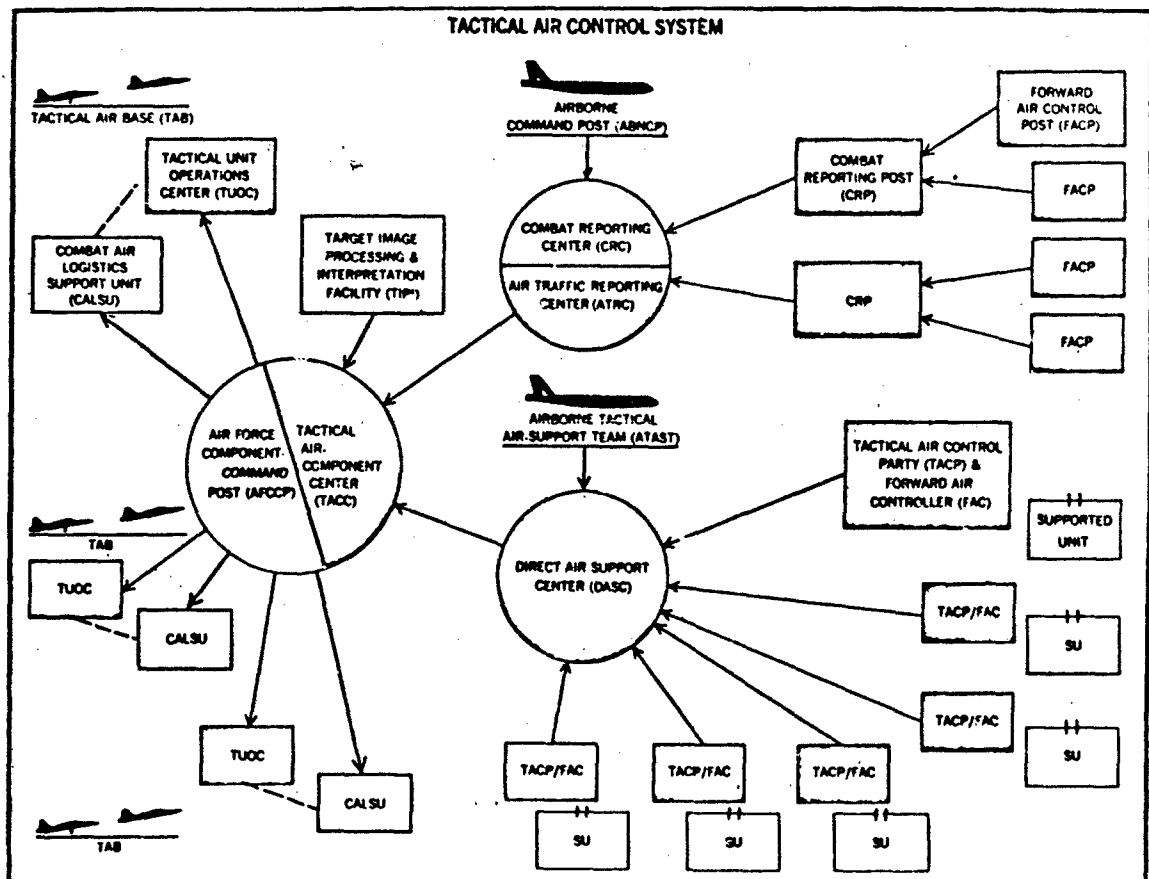

Space/Aeronautics, ref. 78

## Let's Profit From What We Know

The present versions of the COC and Space Defense Centers were begun in 1961. The systems for both have progressed through preliminary analyses and simulations, the formulation of operational specifications, development and testing of computer programs, training of personnel, and testing and evaluation of implemented system designs. For both Centers, special intensive courses were developed for personnel: for the COC, programmer training and human factors courses, and for the Space Defense Center, an orbit analyst course that encompasses astrodynamics and theories of satellite detection, recognition, and tracking. Both systems will be successors of existing systems. These iterations have been instructive, not only toward mission accomplishment, but toward understanding how best to organize men and machines for complex communication and problem solving. These systems also suggest new capabilities that will be required, both of men and machines, for more sophisticated systems. The time factor from inception to operation indicates, however, the maturation period for large-scale systems.

Progress in electronic technology, coupled with current experience in limited warfare and global questions of strategy, are influencing the design of command and control systems. Tom Cheatham, Deputy Director of Defense Research and Engineering for tactical warfare programs, views tactical operations as more complex than strategic operations and relatively neglected over the past decade /77/. Tactical warfare involves close interaction between men and machines and the integration of ground, sea, and air forces. Tactical operations may require many simple, reliable systems based on many models, tailored for specific tasks. The military are now wrestling with such questions as how to match machine capability to particular problems, and how far to automate tactical functions. Frank Leary of Space/Aeronautics recently reviewed the current state of tactical command and control systems /78/. The oldest, the Naval Tactical Data System (NTDS), is a weapons-control system with an integrated data assimilation and processing capability. It gathers information (if properly formatted)

### DEFINITIONS OF MILITARY WEAPONS SYSTEMS FUNCTIONS

Some functions that are automated in modern military weapons systems include the following (the definitions are typical but not necessarily restrictive):

**Navigation**—inertial (usually doppler aided) calculations providing present position and course and time to destination with a high degree of accuracy.

**Stabilization**—momentum dumping or impulse corrections to orient a space vehicle and maintain correct orientation with the earth, a star, etc.

**Time Sequencing**—switching signals generated by a programmer purely as a function of accurately measured elapsed time.

**Track-While-Scan Radar Data Processing**—correlative processing based on time-position data collected from multiple targets. Involves matching new target return data with accumulated track data without ambiguity.

**Electronic Countermeasures Control**—collection and sorting of large quantities of data to measure and define radar signals. Examination of received data to determine selection and switching of countermeasure devices with little or no time delay.

**Antijamming Radar Data Processing**—collection and processing of data from one or more radar sources to determine target range when true target range is normally denied by jamming.

**Communications Data Processing**—nonnumerical processing involving encoding, format changing and buffering at high rates.

**Reconnaissance Data Reduction and Processing**—similar to electronic countermeasures processing in some respects. Involves encoding, sorting, storage and recognition of redundant data.

**Flight Control**—real time calculations to control attitude and aspect of aerospace vehicle; includes stabilization, fuel monitoring, cruise control, etc.

**Synthetic Display Generation**—logical and numerical processing to display collected or calculated data in symbolic form.

**Fire Control**—general category of weapon control processing including:

- (1) threat evaluation and target selection
- (2) bombing computations (free-fall, glide, or powered, nonballistic bomb or missile)
- (3) ballistic computations
- (4) remote (mid course) guidance computations

**Self and Systems Testing and Check Out**—logical and numerical processing to exercise and monitor responses of the system as well as the functioning of the computer itself.

Westinghouse Engineer, May 1962

## INFORMATION SYSTEM NETWORKS . . . . .

from all types of sensors, compiles friendly and hostile track data, and displays complete air, surface, and subsurface situations. It matches and correlates inputs to determine target probabilities; it performs target course predictions; and it recommends weapons for particular targets. It uses the input/output versatile Sperry Rand AN/USQ-20. It can process up to 40 inputs or outputs simultaneously. The Marine Tactical Data System is related to the NTDS and the Navy's Air Tactical Design System (ATDS) in function and language. MTDS is concerned only with the air environment, and is more automatic than NTDS and ATDS. Air-control squadrons in Tactical Air Operations Centers (TAOC) of MTDS use 19-in. geographic displays of computer-processed tracks in decision making. Sector maps can be electronically superimposed on the display to aid air traffic management or battle control. The display distinguishes interceptors, close air support, tracks of friendly vs. hostile vehicles, returns to base, and fire units. TAOCs can operate independently or with other units of MTDS, NTDS, and other systems. The Air Force distinguishes command from control systems. The only system labeled "tactical" is 407L for aircraft control and warning, direct air support, command communications, and air traffic control; the system is partially in being.

Cheatham considers target acquisition the most challenging problem for tactical systems. All services, for example, need a new kind of airborne radar for tracking targets over land against severe ground clutter. New sensors, however, seem less vital than being able to derive information from the data that can be obtained. Vietnam is teaching that systems must be flexible and designed for real targets, not generalized average arrays. Leary notes that "the command decision making function remains stubbornly un-machineable; no one wants to automate that particular human element." Of the staff functions, "1" (personnel and administration) and "4" (supply and logistics) are the most highly sy-

stematized. The "2" function (intelligence) is proving easier to automate than "3" (operations). Operations are closely associated with human performance and decision making.

Today's communications load is twice as heavy on the Army Strategic Communications Command (STRATCOM) as it was in World War II; about 60 million messages were transmitted in 1965 /79/. The STRATCOM network extends into more than 30 nations and connects with systems of the Department of Defense (DOD), Dept. of State, other federal agencies including Civil Defense, AUTOVON (automatic voice network), AUTODIN (automatic digital network), and satellite systems. AUTODIN has six switching centers in the United States; three others are planned in the U.S., three in Europe, and seven in the Pacific, including Alaska and Panama /80/. The DOD expects shortly to realize limited communications capability with the Initial Defense Communications Satellite System. The system has benefited from NASA and Communications Satellite Corp. experience and will be used instead of commercial systems only for "unique and vital national security needs" /81/. In discussing DOD's decision to proceed with its own system, Lt. Gen. Starbird itemizes some of the stringent factors imposed on military as distinguished from civilian systems: survivability, reliability, flexibility, remote-area mobility, and security.

Varied and numerous records for the support and accounting of military operations led to "compound confusion and inability to provide proper and timely data" because of different sets of codes and definitions of terms /82/. One finding during initial phases of DOD's current data standardization program was that reconciliation for data interchange or system integration was impossible in some cases. Standard contract administration procedures, a uniform pay system, and a National Military Command System are among twelve standardization projects begun since Sept. 1964. Geographic names are the first data elements to be standardized; they provide a means of interfacing among such DOD systems as procurement, supply, and com-

*Let's Profit From What We Know*

mand and control. Many data elements pervade other federal and some industrial systems. The federal government, under Bureau of the Budget guidance, began eight coordinating projects in 1965. Extension to industry is being considered by the Business Equipment Manufacturers Association through the X.3 committee of the American Standards Association. The data jungle (not exclusive to military systems) is apparent from such findings as 77 ways of expressing calendar date.

Many cooperative data storage and retrieval systems exist between the military, industrial, and scientific communities. The Interservice Data Exchange Program (IDEP) was chartered in July 1959 as a switching center for test performance data on electronic components of missile and space systems. A new charter expands the program to other equipment and systems of interest to IDEP participating agencies /83/. The data base emphasizes results of

controlled tests of users rather than vendors; proprietary and classified information are not included. Over 170 contractors and federal agencies in the U.S. and Canada participate. The average contractor is estimated to receive 100 times the data he contributes. The Defense Atomic Support Agency (DASA) plans and coordinates DOD's nuclear weapons programs. Its Information and Analysis Center (DASIAC) in Santa Barbara serves the nuclear research field. The Center collects data from nuclear and non-nuclear tests, and research reports from agencies within and not directly associated with DASA-funded programs. It issues a bimonthly abstract journal and a classified quarterly technical journal, The Nuclear Weapons Effects Review, that includes evaluation and state-of-the-art reports and facility and instrumentation surveys. Its Computer Program Library Services includes fully documented in-house programs when transfer to users is practical /84/. Several DOD-sponsored pro-

TACTICAL COMMAND-CONTROL STRUCTURE IN JOINT TASK FORCE OPERATIONS

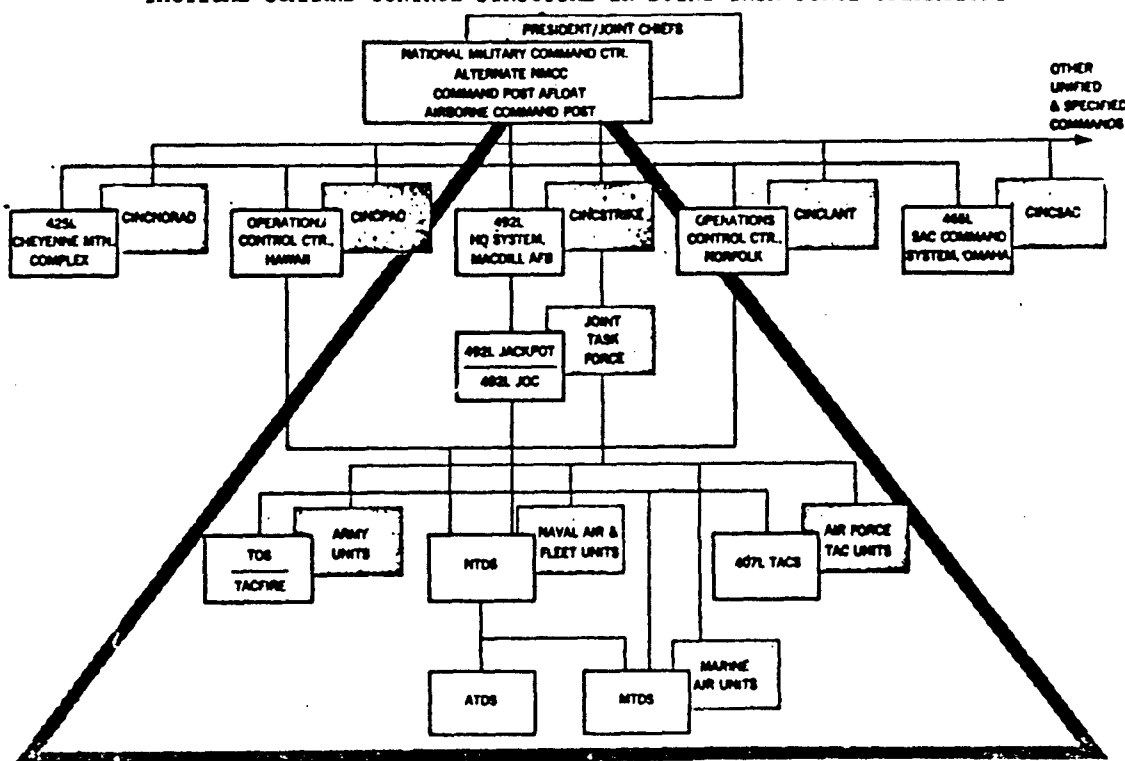

Space/Aeronautics, ref. 78

**INFORMATION SYSTEM NETWORKS . . . . .**

perties data centers were discussed in Section 3 above. The DOD Scientific and Technical Information (STINFO) program is sponsoring surveys of information flow patterns as part of an effort to improve procedures for disseminating information /85/.

**7 - INFORMATION SYSTEMS FOR LIBRARIES**

"The use of machines to accomplish the work of the university library will be limited to clerical tasks, and a useful criterion to judge the intellectual quality or professionalism of a position will be its lack of adaptability to automation" /86/. This somewhat misleading statement of Donald Hammer, Purdue University Libraries, introduces a high-density, 11 1/2-page assortment of computer-based ideas for library operations. Does an intellectual process cease to be so when it is sufficiently understood to become a computer routine? Nevertheless, the Hammer paper explores the values of automatic data processing for cataloging, serial records, gifts and exchanges, acquisition, circulation, interlibrary loan, budgeting and accounting, and even reference -- i.e., all functions short of detailed subject retrieval and the handling of technical reports. Much of the relief from workload in li-

braries centers on the "computer catalog" in lieu of the card catalog. Moreover, system design and programs can link main entry data with order, circulation, accounting, and other input and handling processes enabling various shelf and book list printouts and statistical and forecast reports limited, as Hammer observed, only by the data and the imagination of the systems designer and the librarian. On the debit side are cost effectiveness factors. Hammer estimated 20 man-years of key-punching to convert Purdue's 400,000 author cards to machine-readable form. Libraries that most need automation face the greatest expense and pose the most complex design problems. Huge cheap stores affording the rapid random access that libraries require are not yet off-the-shelf items. Nevertheless, lower keyed systems are feasible and practical today, and cooperative ventures offer possibilities of achievement a single library could not manage alone. One of these could be Library of Congress distribution of machine-acceptable catalog card copy that would eliminate most of the cataloging in other libraries. Another could be the preparation by publishers of punched cards or tapes for at least certain parts of text simultaneous with typesetting for dissemination to libraries /87/. A third could be a sharing of workload and equipment by groups of libraries naturally allied by geogra-

BROC	ERIN	GLPH	SCAR	TREN	Author	Title	Year	Other
					Thompson, Faith	Magna Carta; its role in the making of the English Constitution, 1296-1629. Minneapolis, University of Minnesota Press [1960]	JN 137. T48	PT 2619. B336 B663
					Thompson, George Greene, 1914- Jt. author Gardner, Eric F.	Social relations and morals in small groups. 1956. 1v, 312 p.	MN 251. G35	
					Thornton, Hugh Ansfrid	Partial differentiation. Englewood Cliffs, N.J., Prentice-Hall, 1961. 1v, 168 p. diagra. (Prentice-Hall mathematics series)	QA 304. T5	
					Tillot, Arthur Augustus, 1881-1942, ed.	Medieval France, a companion to French studies. New York, Hafner Pub. Co., 1946.	DC 33.2 T5 1944	
					Tolson, John Ronald Ronald, 1892- Seeuiff; the masters and the critics. London, Oxford University			PR 1808. T6 121
								(continued)



## *Let's Profit From What We Know*

graphic proximity or mission orientation.

Many libraries have already progressed from thought to action. One ambitious effort is ONULP, the Ontario New Universities Library Project. The Province of Ontario, Canada, recently established five new universities and colleges. In 1963, the Province asked the University of Toronto library to compile a 35,000-volume basic college library collection and catalogs for these institutions, the first scheduled to open in the fall, 1964. Ritvars Bregzis viewed the assignment as dual: the selection, acquisition, and processing of about \$35,000 of books monthly, and the development of a system of catalog production that could accommodate the acquisition rate and keep five sets of catalogs updated /88/. The Toronto library, in cooperation with the university computer center and in consultation with Yale, Florida Atlantic, and other U.S. groups, used this opportunity to examine the general problem of automated bibliographic control. The result is an IBM 7094 program that generates shelf-list cards, author-title and subject book catalogs, and other bibliographically controlled reports. The author-title catalog contains main entry records, added entry records, and references to the entries of these records. The subject catalog contains only subject entry records and references. The main entry record is in full catalog form; added entries and subject entries are abbreviated automatically. Each entry notes the library locations of the item /89/. Toronto plans to use the record for current awareness services, checking acquisition requests, and statistical and inventory control including the forecasting of physical growth. The staff adjusted rapidly to the new procedures and products. The abbreviation program indicates the feasibility of automated editing of records of other systems to a desired format. Bregzis observed that the display of entries in book form tends to reduce the distinction between main and secondary entries. The main restriction is the common one of limited subject access.

The concept of the library as an information system for a community is gaining proponents and support. Under Council on Library Resources (CLR) auspices, the Harvey Mudd College studied the requirements for a machine-based regional library to serve the Claremont Colleges and industry in the physical sciences, mathematics, and engineering /90/. Howard County, Md., authorized a review of library-related problems and opportunities posed by the construction of Columbia City, a new approach to urban planning /91/. Robert Hayes has proposed a Library Research Institute for the Universities of California that can spearhead a renaissance in librarianship /92/. The National Science Foundation sponsored an Information Dynamics investigation of the feasibility of establishing a national inventory of the world's scientific and technical serial publications /93/. CLR is funding a Library of Congress pilot program for distributing library catalog data in machine-readable form /94/ and a Michigan State inquiry into costs for converting existing records and automating library procedures /95/. CLR has also given a grant to the New York Metropolitan Reference and Research Library Agency to determine means of coordinating reference and research library services in the New York metropolitan area /96/. These activities will introduce change that may or may not be gradual. As Donald Hammer remarked, "when the decision is made to automate a library fully, the end of many old and familiar 'institutions' appears in sight. 'Sentimentalists' will soon lament the passing of the circulation file, the card catalog, the periodical check-in file or the central serials file, the outstanding order file, and the daily posting of accounts, among other things." Change affects technical processes, but it also alters services, communication patterns, and management and administrative structures. Change may bring loss, but it also creates an opportunity for gain. Realization of gain depends on the willingness of those affected to learn and to adapt, and on their resourcefulness.

## INFORMATION SYSTEM NETWORKS . . . . .

### 8 - PROPOSALS FOR NETWORKS

The current wave of federal government concern with dissemination of scientific and technical information dates back at least to Executive Order 9912 of December 24, 1947, that established the Interdepartmental Committee on Scientific Research and Development (ICSRD). Although the ICSRD primarily considered problems of recruitment and retention of qualified scientific and technical personnel, the Subcommittee on Scientific Information, the Subcommittee on Foreign Scientific Information, and others studied the same questions that are still being asked about "the information problem." Its successor, the Federal Council for Science and Technology (FCST), was recommended by the President's Science Advisory Committee (PSAC) as a forum for policy-level scientific administrators within the government. President Kennedy's Reorganization Plan No. 2 created the Office of Science and Technology (OST) in May, 1962. The first director, Dr. Jerome Wiesner, also was the chairman of PSAC and FCST. The Committee on Scientific and Technical Information (COSATI) was constituted in 1963 based on a Task Force study (the "Crawford Report") for Dr. Wiesner /97/. COSATI has been an interagency advisory committee, not the central authority the Crawford Report envisioned. Wiesner as PSAC chairman also commissioned a panel (the "Weinberg Panel") that examined the responsibilities of the government and the technical community in the transfer of information /98/. At the request of Dr. Donald Hornig, Wiesner's successor, an ad hoc task group of COSATI recently completed a comprehensive investigation of requirements for a national-scale network of information systems /99/. This year, the National Academy of Sciences and the National Academy of Engineering jointly formed a Committee on Scientific and Technical Communication at NSF's request. Under the chairmanship of Dr. Robert Cairns with Dr. F. J. Weyl as executive secretary, fourteen leaders in academic and industrial research will review information activities and policies of

private groups and non-profit organizations in the U.S. and abroad /100/.

The COSATI report relies on twelve "basic assumptions," the most salient of which concern the extent of federal government responsibility for S & T information. COSATI's recommendations rest on the assumptions that: (a) the government should ensure the existence of an accessible copy of each significant publication of the world-wide S & T literature in the U.S., "accessible" and "significant" being thereafter defined; (b) the government should ensure the acquisition, processing, and dissemination of such publications to qualified individuals and organizations in the U.S., "qualified" being thereafter defined; and (c) the government should ensure the integration of nongovernment portions of a national system with the national portion. The COSATI report echoes the Crawford recommendation that central planning and policy authority be assigned to the OST; that OST initiate and guide a program of system design in collaboration with all organizations involved in S & T; and that COSATI begin to study procedures for standardizing document processing, analyzing costs, education and training, and acquisition, translation, and dissemination of foreign documents. COSATI's proposed charter for a Task Group on National System(s) For Scientific and Technical Information would empower the Group to inventory and evaluate resources (men, systems, and machines) and user needs, and suggest system implementations to government and private organizations. Over 500 pages of a two-volume backup compiled by the System Development Corp. review present document handling systems in terms of the organizations involved and document flow. The backup also analyzes the following alternatives for a national-scale system:

A - An S & T Information Bureau within the executive branch having over-all directive and review authority (i.e., the "Capping Agency), including the authority, in consultation with affected federal agencies, to delegate to federal and non-federal agencies (i.e.,

## *Let's Profit From What We Know*

the "Responsible Agents) responsibility over particular subject fields.

B - Centralization in one federal or private organization of all operating responsibilities.

C - A National Library Administration that would amalgamate the major federal libraries, including the Library of Congress, possibly partially through enlargement of the responsibilities of LC.

D - Slow evolution of the existing system with the establishment of small guiding groups in each agency for coordination.

SDC favors the first alternative.

The Licklider Panel, reporting to Dr. Hornig in 1965, noted that "it is not the time, yet, to design a national system for scientific and technical communication. It is the time to start developing an over-all conceptual framework for a national system; a plan to guide research and development. Moreover, it is time to build experimental or exploratory systems capable of handling actual problems and perhaps of growing or evolving into operational systems." COSATI endorses this view and appears to suggest its implementation through the proposed Task Group.

For its breadth of scope and clarity of presentation, the pocketbook-size, 52-page Weinberg report remains the most enlightened blueprint known to this author on information systems for S & T. The following is excerpted from its Summary and Major Recommendations:

"Transfer of information is an inseparable part of research and development. All those concerned with research and development - individual scientists and engineers, industrial and academic research establishments, technical societies, Government agencies - must accept responsibility for the transfer of information in the same degree and spirit that they accept responsibility for research and development itself.

"The later steps in the information trans-

fer process, such as retrieval, are strongly affected by the attitudes and practices of the originators of scientific information. The working scientist must therefore share many of the burdens that have traditionally been carried by the professional documentalist. The technical community generally must devote a larger share than heretofore of its time and resources to the discriminating management of the ever-increasing technical record. Doing less will lead to fragmented and ineffective science and technology.

"Since strong science and technology is a national necessity, and adequate communication is a prerequisite for strong science and technology, the health of the technical communication system must be a concern of Government.

"The Government's concern with technical communication is complicated by the impact of modern science and technology on national defense. This Panel has not analyzed in detail these difficult problems of secrecy and classification; they may well bear further thought and analysis by another group." /102/

Under Recommendations to Government Agencies, the Weinberg report continues:

"We preface our recommendations to the Federal agencies with the statement that Government information activities must not be allowed to swamp non-Government activities. The special sensitivity of non-Government, decentralized information services to the needs of the user as well as the variety of approaches offered by these services is precious and must be preserved. Support by Government does not necessarily mean domination by Government but this danger must always be guarded against.

"1. Each Federal agency concerned with science and technology must accept its responsibility for information activities in fields that are relevant to its mission. Each agency must devote an appreciable fraction of its talent and other resources to support of information activities."

## INFORMATION SYSTEM NETWORKS . . . . .

Finally, under Uniformity and Compatibility, the Weinberg report states:

"Since the entire information system is a network of separate subsystems, rapid and efficient switching between the different elements of the system is essential."

The rest appears to this author to be implementation.

Does the circular flurry of activity with respect to scientific and technical information suggest something amiss? Is the problem with scientific and technical information different from that for other types of information? Where is the crux of the inadequacy that manifests itself in continuous investigation with little implementation of recommendations? Is the information problem real? Are national information networks wanted by users rather than by investigating committees? What efforts have existing document systems made toward information control rather than bibliographic control? What has been the effect of such efforts on users?

A system represents a merger of two structures: that for the data base and that for the tools and equipment. Procedures are the glue -- procedures that specify how the equipment is to operate in accordance with procedures for manipulating the data. The whole is more than the sum of its parts, insofar as the parts, individually, are inert, needing each other to reach a nascent state. How closely related are

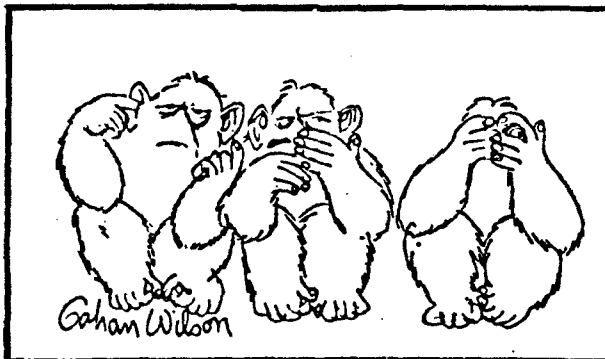

The Village Voice, May 16, 1963

the poorly shaped information systems of the past two decades to repetitive abortive phenomena? How many systems are planned, how many ad hoc? Is it the fault of the system or the environment in which it was born or not permitted to grow that a system cannot respond meaningfully to its interrogators? Does one admonish the product, or the producer?

H. F. Mitchell looked at the future of the computer in early 1965. He foresaw a remote on-line facility costing less than \$100,000 (a \$30,000 computer, a \$1000 cathode-ray-tube console, and a \$40,000 disk file) and time-sharing costing as little as telephone service by 1970 /102/. He did not belittle the electronic and communications problems to be solved, but he noted, as essential ingredients, "the pioneering spirit (or willingness to experiment) of the manager, and the willingness of the scientific, engineering, military and business users to serve as the guinea pigs of progress." If the computer is, as Mitchell characterized it, an adjunct to the main objective of information processing, and much of the equipment is on the shelf now, where are the information processing pioneers? Do information system designers in science and technology, and possibly managers and investigating groups, subscribe to the belief, expounded in the popular press, that automatic information handling depends on computers? /103/ Non-library trained documentalists invaded the librarians' territory with systems departing from rules for cataloging and indexing, the invasion succeeding almost by default, because librarians would not, or could not, process the report literature. Computer and programming-language trained scientists are similarly beginning to replace documentalists, as the latter fail to exploit the tools being made available to them. The systems described in the foregoing sections disclose a new pattern of cooperation between groups having particular information problems and computer people leading to procedures that merge data base with equip-

## Let's Profit From What We Know

ment into a dynamic entity. Documentalists and librarians could bring valuable knowledge of classification, indexing, and methodology to such team efforts, but the teams can fill the gaps if necessary. Similarly, while investigations of network feasibility continue, networks are being built, again by user groups. This activity has not solved the scientific and technical information problem, nor does it relieve the need for networks to link and maximally exploit the systems or a fact-seeking and advisory Task Group such as COSATI recommends.

The COSATI report seems primarily valuable for the impetus it gives to think about what could be done to improve information handling. However, collection of all of the world's "significant" literature at this time would be a heavy burden on systems already overloaded. The strength in the COSATI recommendation lies in the possibility of integrating and providing leadership for the inventorying and evaluating of facilities, personnel, equipment, services, user needs, and financing of systems that are now disjoint, sporadic, and less effective than they could be. The Task Group could be both a fact-seeking and evaluating unit and a central source and consultative body to give guidance and advice, on its own motion and on request, to all concerned with information handling problems. Such a group would not need "Capping Agency" authority, at least initially, principally because it could not use it until it had enough knowledge to exercise it. It is also probably a truism that the expert need not seek authority; it finds him. Earlier recommendations probably suffered from incomplete implementation. The fine question is, what will be the fate of COSATI's? Words are not only drowning the information in scientific and technical reports; they seem also in danger of obscuring information about information and of burying the urgency for action under complaisant verbosity. Have not sufficient investigative guidelines been defined to a pioneering manager to warrant the next step -- convening a

group for planning and experimentation?

Indeed, the sections above do not begin to exhaust the account of network planning and implementation groups whose experiences the Task Group could already exploit. The American Institute of Physics (AIP), publisher of about one third of the world's journal literature in physics, has, for example, been considering its responsibilities both to physicists and scientists in neighboring fields, at the national and international levels. Officers of the AIP view systems for past literature as important but less so than current awareness services enabling selective dissemination of individual papers to individual physicists /104/. AIP cooperates with the British in the production in London of Physics Abstracts and the new Current Papers in Physics. The AIP is organizing an ad hoc group to examine such question as how to cope with trends in physics toward specialization, how new information systems will affect physicists' communication patterns, how individuals can acquire information, how systems can purge themselves of obsolete information, whether abstract journals

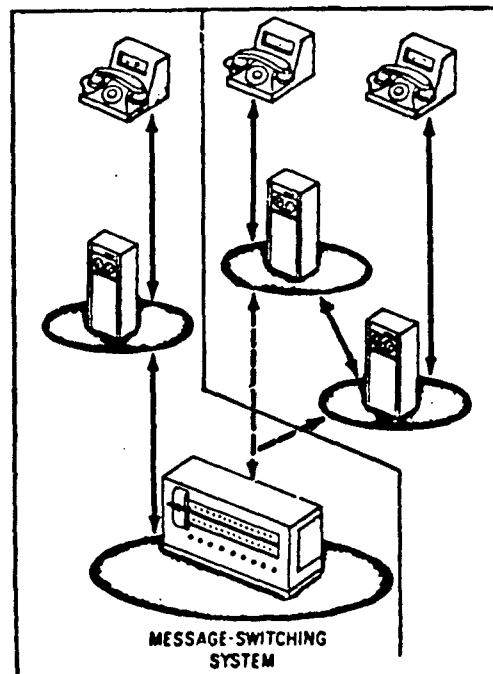

Harvard Business Review, ref. 109

## INFORMATION SYSTEM NETWORKS . . . . .

should be continued, etc. The National Standard Reference Data System (NSRDS) program, established by the OST in 1963 and administered by the National Bureau of Standards, aims toward coordinating and integrating existing data evaluation and compilation activities. The Bureau's NSRD Center encourages the operation of independent critical data projects /105/. Systematization, however, should promote standardization and broad dissemination of the outputs of the various centers and should disclose gaps and areas that need to be expanded. The Engineers Joint Council (EJC) and the DOD have launched a joint program for a mutually compatible vocabulary. The EJC has been working toward a United Engineering Information System since 1962 /106/. The Fund for the Advancement of Education, through the Association for Educational Data Systems, began last year to develop a national center to provide educational data processing services to the nation's schools /107/. The City University of New York's experiments with URBANDOC represent the Urban Renewal Administration's interest in a national information service for urban renewal, planning, and related fields /108/. Extra-organizational systems, i.e., systems that cross company boundaries, are also being explored /109/. The more sensitive these systems are to special-interest groups, the more remote they may be to integration in a single network. Science and technology may well develop bases for compatibility and switching in the fashion of military information networks. The potentials of time sharing, information utility, and computer network schemes appear to obviate the need for a single structure.

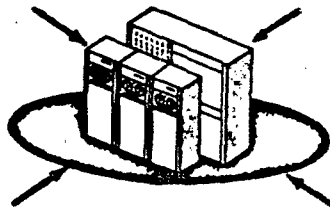

## 9 - RESEARCH FOR INFORMATION SYSTEMS

Research potentially relevant to future information systems ranges from studies of methods for classifying and organizing data to designs for machines capable of self-generated synthesis and creativity to the development of new fundamentals in mathematics and logic /110, 111/. Research may alter concepts of how information can be characterized or what information may consist of. This section is not, however, addressed primarily to basic research, but to the products of basic and applied research and engineering that can be tested or exploited by the pioneers. The products are categorized as plans, programs, and hardware, with broadly overlapping interfaces.

### 9a - Plans and Surveys

Progress is slow with respect to the development of useful new ideas for classifying and coding data, methods of extracting information from noise, and services that meet user requests and needs. Toward understanding how to make systems serving science and technology more effective, one approach has been to evaluate search procedures, relevance of retrieval, etc. /112 - 118/. A preliminary goal to evaluation, establishing criteria for evaluation and test methods, has frequently been the stumbling block to further effort /119/. Francois Kertesz sees no possibility of formulating a single set of measures, insofar as methods used in operating information systems vary and their scopes and purposes vary /120/. He stresses an advertising campaign, i.e., educating and informing potential users of existing services. Alan Rees, who finds merit in relevance assessment, is attempting by simulation to recreate the research environment of a completed project and measure intellectual process by hindsight, interviews, and critical reviews of "relevance judges" /121/. William Goffman applied deterministic and stochastic models of epidemic processes to information transmission that enable realistic questions to be asked basic to the design and operation of retrieval systems /122/. Such

## *Let's Profit From What We Know*

questions include: where and when does activity in a discipline grow to epidemic proportions; what is the expected duration; what is the intensity; what are the "initial infectives," i. e., the papers that start the outbreak.

A second approach in the science and technology area has been to qualitatively survey users. Richard Rosenbloom and Francis Wolek sampled 2177 scientists and engineers, primarily engaged in development or design in several corporations. They found that oral communication accounted for 55% of information transmission, books and journals another 25%. Over 30% of information useful to individuals had been volunteered to them by others /123/. The pattern found by Rosenbloom and Wolek, that scientists had more personal contacts outside the corporation, was also observed by Nelson and Hodge at the Army Biological Laboratories /124/. The ABL respondents, as a group, exhibited a curious lack of awareness of an outside world (information services, journals, etc.), perhaps because of internal security restrictions. One respondent's comments raises questions about the environment:

"Communication implies a willingness to give of one's own knowledge, opinions, and attitude. This can be achieved only in an atmosphere of mutual respect, trust, and cooperation."

Gerald Jahoda's preliminary survey of 75 graduate school faculty members at Florida State disclosed that 46 maintain personal indexes, 60% of the files contained 2000 or fewer documents, and 80% of the indexes were updated at least weekly /125/. How information specialists can interface with researchers is part of Jahoda's study. In the specialized world of atomic and molecular physics, Feinler and others found that about 14% of 350 scientists did not know of the existence of such information centers as DDC, and about 10% were unfamiliar with such secondary sources as NASA's bulletin, STAR, but 30 to 50% who apparently knew of

the media never used them /126/. Interviews disclosed a preference for expanding such sources as Physics Abstracts and keeping them current rather than beginning new services; some interviewees characterized the products of information services as an "indigestible avalanche of mediocre information." The community is apparently an "invisible college" that takes care of its own needs. Analogously, members of the New York State Section of the American Physical Society have been keeping themselves informed through semiannual tutorial symposia on topics of their own choosing /127/. Among scientists having access to electronic data processing, pattern of use differ. Robert Spinrad of the Brookhaven National Laboratory found that younger colleagues, and those in the physical as distinguished from the biomedical sciences, were the heaviest users of computers /128/. Two comments of respondents may span the concerns of scientists:

"The greatest danger in the future is increased indulgence in numerology, that is, calculating something not because of fundamental interest, but merely because it can be calculated."

and

"What is needed among physical scientists is an awareness of what computers can do. ... I would personally never touch the computer if competent people were available to do all the necessary liaison work."

A sophisticated user, Frank Cooper of Haskins Labs., described his problem solving as with, but not by, the computer:

"We chose this half-automated way of processing our data, rather than the fully automated way of feeding it directly into a computer, for two principal reasons: one was that we did not want to let questionable items get into the averages, and the other was that we wanted freedom to work with the data before averaging.... In short, we wanted the computer to help us, but not to run the show." /129/

## INFORMATION SYSTEM NETWORKS . . . . .

A third approach has been to try to determine what people will pay, in time or money, for information, and how much information they need to make a decision /130/. Paisley and Parker examined information storage and retrieval systems as receiver-controlled systems for the communication of information through space and time /131/. They raise distinctions among people's "association maps" and note the anomalous phenomenon that the greater the receiver's familiarity with the universe of messages, the less he can learn from the source. They suggest that user satisfaction is a behavioral criterion rather than a structural one, and that behavioral research can furnish guides to such types of information need as "brushing up," i.e., bringing the scientist up-to-date on an area; "certifying," i.e., establishing reliability of an information source; redirecting or broadening a scientist's field of vision; and "locating," i.e., helping a scientist assess a topic in the research market. The Intrex program at the Massachusetts Institute of Technology, a planned coordinated series of information transfer experiments leading to new concepts in information service, includes the study of teaching and learning processes in on-line interactive computer contexts as well as the study of more traditional library operations /132/.

Studies more directly concerned with introducing computers into information systems are yielding methods of coping with file organization, programs and programming languages, and measures of computer effectiveness. Fossum and Kaskey found, for example, that a postulated reduction in lists traversing a given document cannot be realized for the types of retrieval required by systems such as DDC's /133/. They suggest use of separate inverted and document-sequenced files when inverted files alone don't suffice. The System Development Corp. recently issued a planning guide for the Naval Command Systems Support Activity that applies systems engineering procedures to the development of

computer-based information systems /134/. The guide emphasizes the computer program portion of the systems. Two Auerbach Corp. reports are tutorial. Larry Berul's state-of-the-art discusses basic information storage and retrieval concepts and systems functions and relates these to hardware implications, software programs, and potential products and services of systems /135/. The second furnishes guidelines for evaluating the performance effectiveness of a computer installation based on characteristics of the hardware, the software, hardware-software interaction, and the problem tasks /136/. Stepwise multiple regression is used to determine the relative significance of the various elements. Robert Shapiro's use of Anatol Holt's Mem Theory to analyze several retrieval systems has provided insights for several modifications /137/. For example, viewing a file as a repeating group whose name gives the structural information for everything "under" it suggests the possibility of file structure organizations that don't resemble the physical equivalent of file cabinets. Stoller of the Rand Corp. has applied several widely used concepts of industrial capacity to an analysis of the performance of logistics systems /138/. Andrew Clark of Rand studied means of reducing the cost and effort of implementing research results in operational inventory management systems /139/. He suggests a library for computer subroutines representing decision models and techniques of practical significance that could be used as an interface between researchers and implementers.

### 9b - Programs

The term "program" refers generically here both to the languages and the procedures for the computer processing of information, and to the system operations the procedures implement. The programs are approaches either to the manipulation of non-numeric information or to methods of applying software or hardware to industrial or military systems.



## Let's Profit From What We Know

Reports of Russell Kirsch, Mary Stevens, and Jean Sammet are state-of-the-art in several program areas. Kirsch suggests procedures for systematically studying problems in information retrieval based on procedures that have been examined in automata theory. For example, sequential search through an information collection might not disclose the relevance of an item until a subsequent one is found that relates back to the first. The counterpart in computability theory is a theorem that no decision procedure for membership exists for sets that are recursively enumerable but not recursive. Kirsch suggests a counterpart to use of the Kleene-Mostowski hierarchy theorem to find questions answerable by increasingly complex classes of machines, in the development of a priori measures of the complexity of search prescriptions /140/. Stevens surveyed automatic indexing systems, i.e., systems that use machines either to compile or generate indexes. She reviews experiments on automatic assignment indexing, automatic classification, computer use of thesauri, statistical association techniques, and linguistic data processing. Over 40 routines were found for keyword-in-context indexing and variants of keyword permutations. However, Stevens views the evidence she expertly assembled as leaving the question moot to the possibility of automatic indexing in the sense of machine substitution for the human "to identify, categorize, classify, index, select, and list particular items in a collection of items" /141/. Sammet concentrates primarily on the characteristics of programs that have been written to manipulate formal mathematical expressions. Her comments on theorem proving procedures and list and string processing are brief /142/.

Computer Associates classified software systems in six categories: general-purpose programming and executive systems, functional systems, man-machine interface systems, special-purpose systems, time-sharing systems, and generalized data-management systems /143/. The availability of de-

vices that enable direct communication with a computer has intensified work on languages that non-programmer scientists, managers, and the military can use in on-line problem solving. The direction is toward natural language structures with restricted vocabularies. Languages for particular purposes frequently incorporate the special terminologies of the subject fields. The Computer Associates report describes features of the Culler-Fried and JOSS systems for solving mathematical representations of scientific and engineering problems; SKETCHPAD that initiated man/machine interaction via cathode-ray-tube displays and light pens; and BASEBALL and DEACON that enable constrained English language conversation. The National Bureau of Standards' OMNITAB is claimed to be a general-purpose program for statistical and numeric analysis and for a wide variety of computations in applied mathematics, science, and engineering /144/. It responds to simple English language instructions. IBM's QUICKTRAN has become popular in industry. Monsanto, for example, has been testing it as a collateral device for supplying data during on-going research, as a debugging facility, as an aid to simulation, and as a means of keeping engineers updated to new techniques /145/. AESOP, a Mitre Corp. prototype

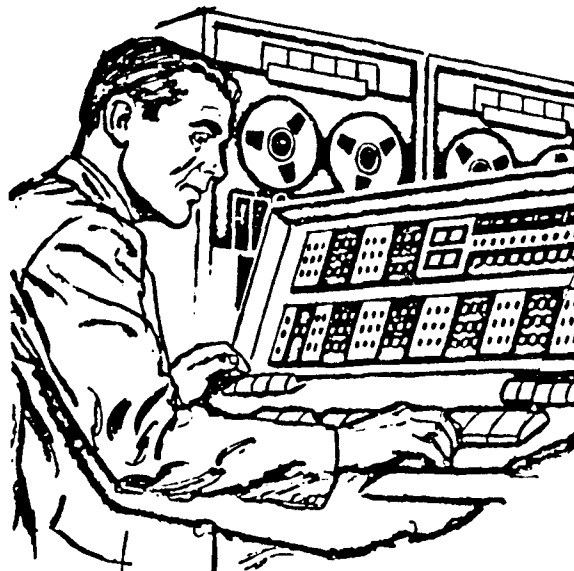

Data Processing Magazine, ref. 145

**INFORMATION SYSTEM NETWORKS . . . . .**

for a class of management and command systems, was designed for fast input/output via displays but not for storage economy /146/. Carnegie Tech's Formula Algol, an extension to Algol, is an effort to combine the advantages of formula manipulations, list processing, and limited string processing /147/. Computer Research Corp.'s MAGIC PAPER system is being designed for symbolic operations on linear algebraic equations. The user can create new operators and introduce special notational conventions /148/. The Bell Labs' L<sup>6</sup> (Low-Level Linked List Language) contains features of IPL, LISP, COMIT, and SNOBOL but puts the user closer to machine code for faster running programs, a wider variety of linked data structures, and more efficient storage. Preliminary experiments indicate possible running times an order of magnitude faster than with higher languages /149/. Paging techniques devised for BBN's LISP enable list processing with large, slow drum memories; the techniques appear applicable to the design of efficient LISP systems embedded in time-sharing systems /150/. Ned Chapin notes that many users feel bound by the program "packages" supplied by manufacturers /151/. Some users apparently don't know about available alternatives or about possible gain from them. In comparing program-

ming languages, Jules Schwartz considers the possibility of either a language combining the mathematical capability of Algol, the structured-data-definition of JOVIAL, the unstructured data and expression capability of LISP, and the ability to express input/output file operations in a general fashion, or a technique for generating compilers that could apply to any unique program /152/.

The General Inquirer program of P. J. Stone and others is an attempt to formalize procedures for research involving non-numeric data. It was designed for analyses of psychological protocols, literature abstracts, biographic materials, and other types of verbal text. The program is written in COMIT, an MIT language for processing continuous text /152/. A vocabulary and coding scheme were recently added for analyzing national and international psychopolitical phenomena /153/. Bertram Raphael devised a program that demonstrates one approach to building an "intelligent" machine /154/. His SIR (Semantic Information Retriever) exhibits a behavior somewhat similar to such predecessors as SDC's SYNTEX and Bobrow's STUDENT. SIR realizes intelligent behavior through the specification of relationships in interlinked property lists of pairs of elements. Raphael noted several obstacles to expanding SIR: restrictions on the input language that requires more research on the problem of translating from English into a formal language; lack of computer memory for additional programs and data; and increasing search times caused by the exponential growth of the tree structures. Advocates of "natural language" programs fail too frequently to discuss their cost in space and access time. Executive routines, time-sharing monitors, and similar programs are often written in machine language that produces the best code in terms of these parameters.

High costs and long lead times associated with constructing and modifying computer programs are a spur for studies toward improving data processing capability, first with respect to existing machines, and second with respect to hardware potentials. The situation is particularly critical for command and man-

```

THE NEXT SENTENCE IS . . .
FROM AND THE NAME OF EACH PERSON

THE FUNCTION USED IS . . .
PARTIAL-SORT

ADDRESS - PERSON (12 - NAME)
THE APPLY . . .
II DETERMINES THE SUPPLEMENT-OF-EACH RELATION BETWEEN PERSON AND NAME
II DETERMINES THE SUPPLEMENT-OF-EACH RELATION BETWEEN NAME AND PERSON

THE NEXT SENTENCE IS . . .
FROM AND THE NAME OF EACH PERSON

THE FUNCTION USED IS . . .
PARTIAL-SORT

ADDRESS - PERSON (12 - NAME)
THE APPLY . . .
II DETERMINES THE SUPPLEMENT-OF-EACH RELATION BETWEEN PERSON AND NAME
II DETERMINES THE SUPPLEMENT-OF-EACH RELATION BETWEEN NAME AND PERSON
II DETERMINES THE SUPPLEMENT-OF-EACH RELATION BETWEEN PERSON AND PERSON

THE NEXT SENTENCE IS . . .
FROM AND THE NAME OF EACH PERSON

THE FUNCTION USED IS . . .
PARTIAL-SORT

ADDRESS - PERSON (12 - NAME)
THE APPLY . . .
II DETERMINES THE SUPPLEMENT-OF-EACH RELATION BETWEEN PERSON AND NAME
II DETERMINES THE SUPPLEMENT-OF-EACH RELATION BETWEEN NAME AND PERSON
II DETERMINES THE SUPPLEMENT-OF-EACH RELATION BETWEEN PERSON AND PERSON
    
```

SIR, ref. 154

## Let's Profit From What We Know

agement systems of the military. A seven-point program was recommended by an Air Force Systems Command ad hoc task force in 1964 that ranges from evaluation of a generalized data management systems concept to the development of generalized file processing routines for small- to medium-scale tape and card machines /155/. One design philosophy is SDC's GENISYS, a user-oriented generalized information system for data management /156/. It contemplates relative machine independence and both multiple-access, interactive, on-line operation and off-line multiprogrammed batch processing. Features aimed toward program flexibility include a minimum but extendable basic executive and multiple control programs for change and expansion by the addition of entire subsystems. A series of Information System Sciences conferences is providing a forum for the review of such areas as the man/machine interface, command system simulation, the impact of automated systems on organizations and missions, and computer control through language design /157/.

### 9c - Hardware

Hardware -- digital and analog computers, mass memories, tape typewriters, etc. -- have matured through several generations since World War II. The significance of future developments will reside, not in technological advance per se, but in the jobs the hardware could or should be able to do. Although this paper has discussed conceptual software and system designs separately, they are not in fact distinct from the tools for implementing them. Research and exploratory development should be, and for information systems must be, closely interactive to maximize the achievements of both.

Norman Statland's review of twenty years of computer-based information processing finds the field catching up to where it should have been in 1958 /158/. Transistorized computers, more reliable, larger, and cheaper than their predecessors, have been increas-

ingly available for systems integration and the establishment of on-line remote access facilities. The period 1958-1965 seems to have been needed for overcoming inertia and acclimating to the computer as an assistant as well as a clerk. Statland cites such realizable areas for payoff as trend analysis, the testing of new theories of business operation through simulation, and decision making according to guidelines, e.g., controlling inventory levels, preparing production schedules, and distributing labor charges. However, experience with advanced systems teaches that new systems approaches often require major restructuring of data bases, methods of acquisition, and internal reorganization.

Though the Bell Labs. operated relay computers with remote consoles twenty years ago, time sharing and on-line information processing waited for readily available, flexible peripheral equipment. MIT's Project MAC and MIT's Computation Center are two of today's frontiers. Progress reports of both groups give detailed descriptions of individual and team projects /159 - 161/. Graphical input/output devices are being used, for example, in the design of ship hulls and other structures and for locating highway routes based on terrain, traffic, and other considerations. A teaching machine project that explains MIT's compatible time-sharing system (CTSS) employs a teletype or 1050 unit as the remote console and a looseleaf binder with index tabs as the display device. COGO, a language primarily for solving civil engineering problems, is being explored

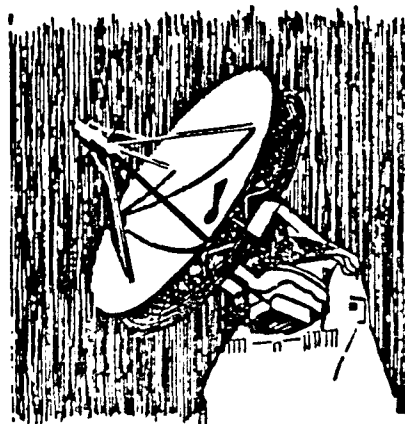

## INFORMATION SYSTEM NETWORKS . . . . .

in conjunction with a graphic display system called COGO T-Square. The program emphasizes man-machine interaction and program interrupt for modification, since many civil engineering problems involve successive approximations for solution. Speech analysis on the Electrical Engineering Dept.'s TX-O includes the use of displays of speech spectral data as a function of time, display of speech spectra specified through typewriter adjustment of parameters, and visual comparisons of the calculated spectrum with the actual speech spectrum and difference curve. The ability to manipulate large, complex data bases is aiding the modeling of such social processes as the diffusion of information in a national population (the Concom Project) and the decision behavior of an individual in the context of distorted transmission and remembering and forgetting phenomena (the Crisiscom Project). F. J. Corbato takes a public utility view of a computer center as a large multi-user, multi-processor, multi-channel system. For the user to be independent of the processors and be able to initiate jobs of arbitrary or indeterminate duration at will, interrelated problems remain that concern clocks, memory protection, program relocation, parallel tasks within a job, common simultaneous use of sub-programs by many users, growth and shrinkage of program segments, and memory allocation. These considerations affect hardware selections.

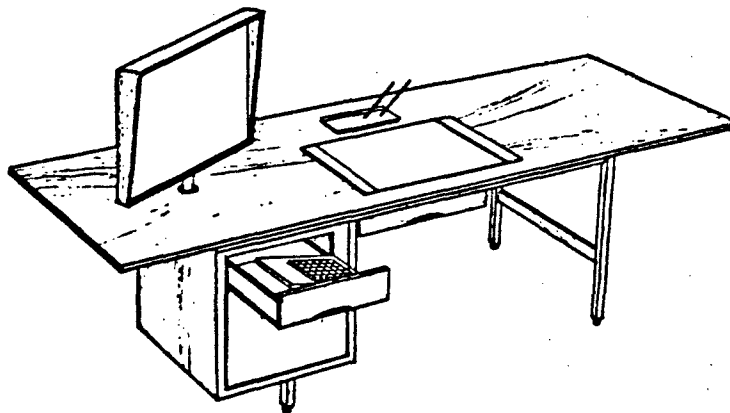

Jack Dennis and Ted Glaser note that the multifunctional nature of on-line computation both increases productivity of "computer-catalyzed research" and creates the demand for the resolution of issues that can often be dormant in conventional computer installations /162/. Multiprogramming with a modular system structure is viewed as the key to an efficient sharing of resources with the flexibility for expansion. MAC's artificial intelligence group is conducting basic and applied research on a computer-operated, visually oriented machine that can physically manipulate objects in complicated spatial situations. A real-time, on-line TV camera interface built for a PDP-6 has tracked the motion of simple visual objects.

Statistics are being gathered on the MAC system with respect to efficiency of use of the central computer and user satisfaction. Printouts for the user-oriented data contain a rough plotting device that assists human interpretation. A. L. Scherr measured some aspects of system operation in terms of the reaction of the hardware to user demands /163/. His analysis, based on Markov models and CTSS data, suggests that only mean think time, mean processor time including swapping, and the number of users interacting with the system have first order effect. Scherr found that a two-processor, two-queue, real-world system could improve the performance of CTSS to serve 45 users with the same mean response time as 30 through the addition of hardware (including one channel and a file control for the 1302 disk) for a cost of less than 10% the monthly rental of CTSS. Cal Tech similarly found that a 7288 Communication Control Channel that accommodates up to 48 sub-channels for data transmission to its 7040 core enabled its 7094 to handle about twice the computational load as the 7094 would have by itself /164/. Cal Tech pays about 20% more in rental costs for a 50% increase in productive capacity. The

## Let's Profit From What We Know

Cal Tech computers share two 1301 disk files with a memory capacity of 106 million characters. The Computer Center processes about 300 individual jobs daily in a single shift. Its programs operate under IBSYS control, one hour daily being reserved for QUICKTRAN that permits up to 40 programs to run concurrently from remote consoles.

Argonne National Lab.'s CDC 3600 based system represents user-manufacturer cooperation for adaptation to local needs. ANL is modifying CDC's SCOPE system to use the 828 disk for scheduling and handling input/output functions. ANL developed programs that link a cathode-ray-tube display and camera recorder to the system for recording graphic and tabular data. ANL's Standard Peripheral Processor, a 160A package, includes an ANL modification for introducing a microwave link for high-speed data transmission. The Processor allows tape-to-tape transmission in either direction and tape-to-printer transmission from the user to the computer system. A data link from an ASI-2100 computer allows real-time interrupt to users of the 4.5 MEV and 12 MEV Tandem Van de Graff accelerators. ANL's PAULETTE is a computer-controlled device that counts tracks made by sub-atomic particles in a fine grain photoemulsion. A hybrid computing system recently installed joins two PACE analog computers to a PDP-7. The hybrid enables analysis of dynamic systems that yield discrete and continu-

ous data. CHLOE, an automatic film scanning system, digitizes data from bubble-chamber photographs and oscilloscope traces. The system is being evaluated for fingerprints, radiological photographs, optic nerve signals, galactic shapes, etc. /165/.

Though innovation and invention in hardware design may continue to occur in isolated environments, the major proportion of useful devices are likely to be the products of interaction between the manufacturer and the consumer. Of current relevance, for example, is the role of the small, special-purpose computer. Litton Industries has found a profitable market for special-purpose machines for automatic fare collection; they simultaneously provide data for revenue control and traffic flow studies /166/. Rudy Stiefel indicates a trend toward small computers based on economic mass production of multiple arithmetic units and the ability of personnel to use the machines with little instruction /167/. Use in the U.S.S.R. of the SEVM for automatic field geodetic computations lends international character to the trend /168/. The study of new materials and data processing techniques portends change in several basic components of computers. Battelle recently reviewed the applicability of magnetic reluctance techniques, optical rulings, Hall generators, ring lasers, and nuclear radiation sources for semidigital transduction /169/. The Lincoln Lab. developed an optical communications sys-

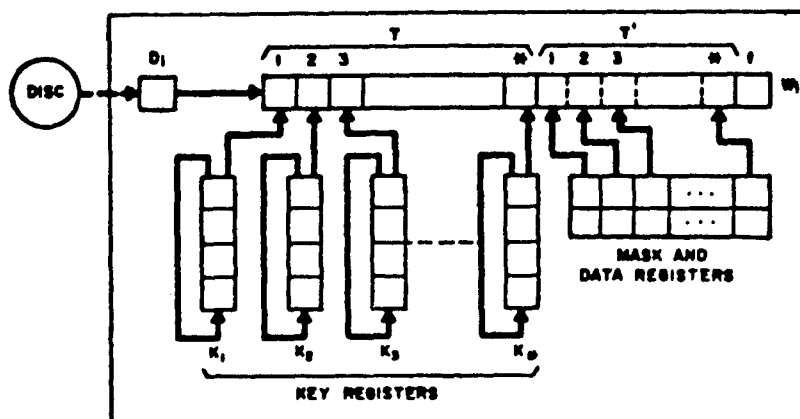

Relationships Between Elements of an Associative Search System, ref. 172

## INFORMATION SYSTEM NETWORKS . . . . .

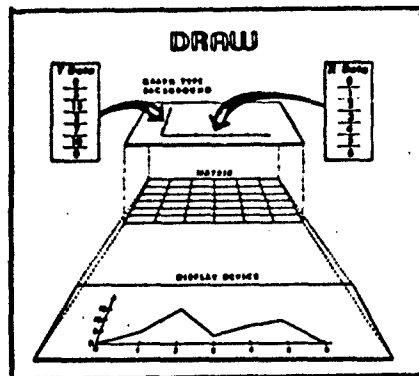

tem based on an array of multiple semiconductor lasers that propagates pulses through a 1.8-mile path in most weather conditions /170/. Time sharing has effected changes in the character of such component structures of a computer as the buffer than now has the program flexibility of a small computer /171/. Time sharing has also spawned such new hardware as Cal Tech's Biological Computer for screening data and connecting a variety of instruments to the computer. The exploitation of distributed associative logic may be only in an initial stage. Fuller, Bird and Worthy recently described two machines: an associative parallel processor programmed to abstract properties from visual and other patterns and classify the patterns from the properties; and associative file processors for rapid parallel search of large, complex data bases /172/.

Limits posed by storage capacity have set upper bounds on computer use for some problems. Magnetic recording media are most widely used now. Research and development are needed to reconcile performance, capacity, and cost factors for these and other materials /173/. New photographic films offer a medium for image-digital system combinations /174/. Dense, cheap storage alone, however, is not the objective for dynamic information systems. The large data file has value only when coupled with procedures that rapidly retrieve particular bits.

Peripheral devices for man-computer oriented users appear to be hav-

ing the effect of eliminating the awe barrier between man and one of his newest machines. The familiar typewriter and common tools of telephony and telegraphy are being adapted for communication with and data transmission to the computer /175/. The quotation service of the New York Stock Exchange is linked to its Market Data System, and brokers are becoming accustomed to receiving voice responses over regular telephone sets /176/. The Bankers Trust Co. noted both favorable response and rapid adjustment of bank personnel and the public to its audio response installation /177/. Although the military services and aerospace industries are today's major market for display equipment, mass production and reduced costs of the devices and acclimation to computerized data processing is expected to enlarge the sphere of users. Daniel Teichrow notes several factors that might delay applications /178/. Limitations on the quantities of information that can be presented and short display time require the user to know in advance what he will be looking for. Data bases organized by function must often be restructured into integrated files for rapid retrieval and storage. Managers accustomed to reports must be educated to new procedures. The cost of displays is not usually offset by eliminating other equipment, and the generation of displays requires substantial computer time. Widespread acceptance of displays in business may depend on advantages demonstrated through research. Ivan Sutherland notes several of these, and other unsolved problems /179/. Those that derive from the graphics themselves include flicker, ease of use, coupling to programs to do substantive computations, the language of discourse, and the desirability of half-tone capability. Other restrictions derive from the need of programs to solve hidden-line problems, to recognize context, and to make abstractions. Sutherland envisions displays that make programs less inscrutable, for example by disclosing their unique features.

Nevertheless, design engineering and education experiments with display devices are suggesting ways that machines can help man become more productive, and

## Let's Profit From What We Know

possibly more creative /180/. One architect paints a "Portrait of the Computer as a Young Craftsman." Noting that the Golden Mean and the Modulor are reducible to a Fibonacci series and programmable, Allen Bernholtz foresees a man-computer-displays complex for testing designs structurally, acoustically, mechanically, and aesthetically /181/. Extensive experimentation is underway on computer-assisted instruction via remote consoles for academic and industrial purposes /182/. Several projects were noted in Section 5 above. Bolt, Beranek, and Newman found computer-based classroom aids potentially useful for teaching mathematics in elementary and secondary schools /183/. Unanswered questions concern the characteristics of programs that have maximum instruction potential, the degree of training the instructor requires, the amount of on-terminal time the student needs, the language that should be used, etc.

The design of display devices may be in its infancy. The Rand tablet, a low cost, stylus tablet device, is a new graphic man-computer link. Connected to an input channel of a general-purpose computer and a cathode-ray-tube display, it provides a 10x10 in. writing surface with a resolution of 100 lines/in. vertically and horizontally /184/. As the person writes, the image appears on the CRT. Track histories can be regenerated onto the display from the computer. Kynmore Engineering announced the Co-ordinatograph, a computerized drawing board with a 45x43 in. surface for developing three-dimensional shapes and for nesting the resultant two-dimensional shapes /185/. L. G. Roberts of Lincoln Lab. predicts the availability of vector scopes, conic scopes, and storage scopes, as well as the present point scopes, in a few years, some in the \$5,000 to \$10,000 range /186/. Storage scopes, that transmit data at a slower rate, should be useful for text editing and review. Roberts also expects modifications of the ultrasonic 3-D wand for three-dimensional figures that will prevent signal blocking by other objects in the field. Andries van Dam has sur-

veyed the state of the art from a user's viewpoint with respect to consoles and printer-plotters, facsimile transmission, analog storage and retrieval, digital encoding (optical scanning and reading), and possibilities for man/machine interaction /187/. New developments at Project MAC include a low-cost remote display terminal with alphanumeric and line-drawing capabilities /188/ and an analog technique employing a four-point tracking pattern to reduce pen tracking time /189/.

## 10 - RECAPITULATION

This paper undertook an inquiry into the systems man has been building in the last decade or so to satisfy his information needs for a variety of purposes.

This activity of system building is one that the federal government has considerable interest in. The unique capability of computers to store and manipulate vast quantities of information (when it is in machine recognizable form) has induced the government to invest in over 2000 computer installations /190/. Moreover, the government is said to spend between \$200 and

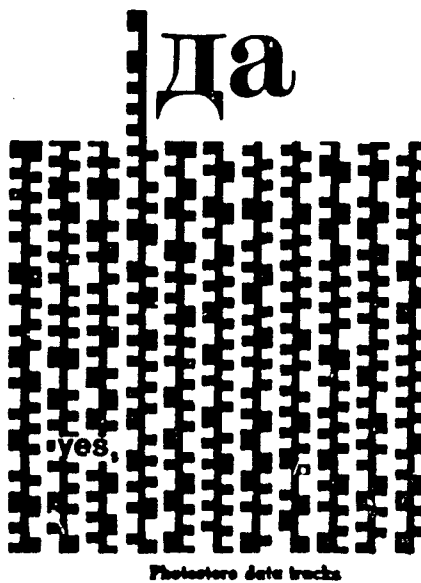

Photostere data tracks

## INFORMATION SYSTEM NETWORKS.....

\$300 million annually in handling reports, articles, books, translations, patents, catalogs, speeches, and films for a "general audience" and an additional \$500 million to \$1 billion annually for the mission-oriented DOD audience /191/.

Section 8 reviews some of the efforts the Executive Branch of the government has made in the past decade to discover how to improve the efficiency and effectiveness of a comparatively small number of information systems, those concerning science and technology. The concern of the DOD is reflected principally in the discussion of Section 6. The review of Congressional investigations would be a lengthy one.

The work reported in this paper shows conclusively that all groups involved in handling information are actively engaged in modifying existing systems or building new ones to improve the handling process. Some groups are advancing faster than others. Some groups seem to understand the problems they face better than others. Some groups have integrated themselves with the mainstream of the technological developments they must exploit, and other groups have not.

The level of technology reported in this paper shows that hardware is available that could be profitably used to satisfy many of the information processing requirements of the various groups. Some hardware does not exist or cannot be economically justified now. The software, however, lags the hardware that does exist. Moreover, poor software increases cost through an inefficient use of hardware.

This paper was conceived to consider proposals for a national network of information systems for science and technology. This could not be done by the author except by looking first at information systems in general. That look suggests that it might well be taken by others, because many problems are common at the general level, and benefit can be derived from integration of effort at this level. At the specific level, the look discloses that networks are not only feasible but necessary. However, the technology has changed the physical construct. There is no longer need for physical centralization. The network can now be a design implemented through switching that can couple and decouple data banks by suitable programs. It is no longer necessary, therefore, to ask whether networks can be built. It is time, instead, to ask about the sorts of networks that are needed, and to set about providing the innovative software and the flexible, inexpensive hardware to bring them into being.

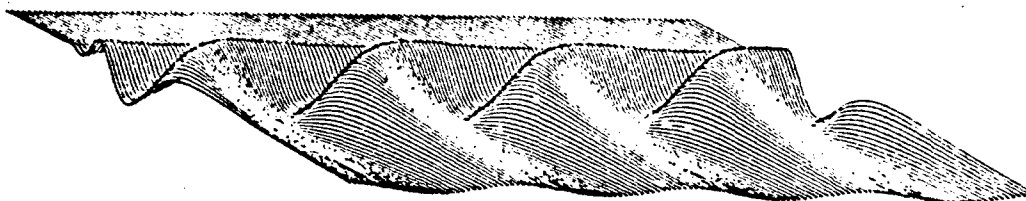



*Let's Profit From What We Know*

11 - REFERENCES

- 1a. General J. P. McConnell. "The Fallacy of the "Nuclear Stalemate." Address, Air Force Association, Carswell AFB, Texas, Mar. 1966.
- 1b. Hon. Harold Brown. "The Next Twenty Years in the Life of the Air Force." Address, Air Force Association, Dallas, Texas, March 1966.
2. "The National Information Problem." SDC Magazine, vol. 9, no. 2, Feb. 1966.
3. Donald V. Black. "The Designer's Tools," in Information Systems Workshop, The Designer's Responsibility and His Methodology. (Proceedings, Conference held at Lake Arrowhead, Calif., May 29 - June 1, 1962). Washington, D. C.: Spartan Books, 1962, p. 97-112.
4. McGraw-Hill Encyclopedia of Science and Technology. New York: McGraw-Hill Book Co., 1960, 1966. "Systems Engineering" in vol. 7, p. 375-380.
5. Patricia T. Sievers and Paul J. Fasana. "Automated Routines in Technical Services." Feb. 1964. AFCL-64-70.
6. Oliver J. Sizelove. "Systems Design." Chap. 1 in Section 7 on Control Procedures. Industrial Engineering Handbook (H. B. Maynard, ed.). New York: McGraw-Hill Book Co., 1956, 1963.
7. A. F. Moravec. "Basic Concepts for Designing a Fundamental Information System." Management Services, July/Aug. 1965, 37-45.
8. Ibid., and A. F. Moravec. "Basic Concepts for Planning Advanced Electronic Data Processing Systems." Management Services, May/June 1965, 52-60.
9. John Dearden. "How To Organize Information Systems." Harvard Business Review, vol. 43, no. 2, Mar/Apr. 1965, 65-73.
10. J. C. R. Licklider. "The System System." Jan. 1962. AFOSR-1673. Bolt, Beranek, and Newman, Inc., AF 49(638)-355. In AD-424,284.
11. H. H. Bernstein and Sylvia Gabbai. Inquiry on Non-Conventional and Conventional Documentation Systems in Use. Ispra (Varese), Italy: European Atomic Energy Commission, Scientific Data Processing Center (CETIS), 1963. EUR 331.e.
12. Charles de Vore. "Directory of Department of Defense Information Analysis Centers." Office of Naval Research, Aug. 1965. ONR-23.
13. Karl F. Heumann. Scientific Information Activities of the National Academy of Sciences - National Research Council. Wash., D. C.: NAS-NRC, rev. 1965. Pub. 1291.
14. National Science Foundation. Non-conventional Technical Information Systems in Current Use, No. 3. Oct. 1962. NSF-62-34.
15. National Science Foundation. Specialized Science Information Services in the United States. Nov. 1961. NSF-61-68. (Compiled by Battelle Memorial Institute, Columbus, Ohio)
16. Office of Aerospace Research. Directory of R and D Information Systems. Aug. 1961. OAR-1. (A listing of centers, services, sources and systems engaged in collecting, storing, and disseminating scientific data and information applicable to aerospace research and technology)
17. Martin H. Weik and Violet J. Confer. "Survey of Scientific and Technical Information Retrieval Schemes Within The Department of the Army." July 1962. Aberdeen Proving Ground, Md.: Ballistic Research Labs. BRL Rept. No. 1169.
- 18a. "Information in Depth." (Papers on the National Bureau of Standards, Office of Technical Services, and U.S. Patent Office). Research/Development, vol. 15, no. 1, Jan. 1964.
- 18b. Rowena Swanson. "Documentation Activities in the United States of America." Bull. Assn. Int'le des Docu-

## INFORMATION SYSTEM NETWORKS . . . . .

mentalistes et Tech. de l'Information, vol. 3, no. 2, June 1964, 11-21.

19. H. Thayne Johnson and Donald L. Grigaby. "The Electronic Properties Information Center." Nov. 1965. Hughes Aircraft Co., AF 33(615)-1235. AMRL-TR-65-68.

20. R. C. Braden and C. S. Wright. "A Review of the Mechanical Properties Data Center Operation and Expansion." Sept. 1965. Belfour Engineering Co., AF 33(615)-1061. AFML-TR-65-193.

20a. Y. S. Touloukian. "Annual Report of the Thermophysical Properties Research Center." Dec. 1964. TPRC, West Lafayette, Ind.

21. Francois Kertesz. "Information Centers at the Oak Ridge National Laboratory (A Study in Diversity)." Nov. 1964. ORNL-TM-996.

22. K. Way. "All the Red-Legged Partridges ... or ... 99.5% Retrieval of Scientific Information." Physics Today, vol. 18, no. 11, Nov. 1965, 57-9.

23. Personal communication.

24. Milton H. Aronson and Josephine N. Martin. Survey of Biomedical Computer Applications. Pittsburgh, Pa.: Medical Electronic News, 1964.

25. Methods of Information in Medicine (Methodik der Information in der Medizin), vol. 3, no. 3/4, July/Oct. 1964. Bibliography at 133-150.

26. C. S. Chung. "Applications of Digital Computers in Human Genetics." Methods of Information in Medicine, vol. 3, no. 2, Apr. 1964, 67-72.

27. A. G. Law and A. Richman. "Processing Psychiatric Research Data." Data Processing for Science/Engineering, vol. 2, no. 1, Jan/Feb. 1964, 29-33.

28. Howard P. Iker and Norman I. Harway. "A Computer Approach Toward the Analysis of Content." Behavioral Science, vol. 10, no. 4, Apr. 1965, 173-

182.

29. Bernard Tursky, David Shapiro, and P. Herbert Leiderman. Behavioral Science, vol. 11, no. 1, Jan. 1966, 64-70.

30. Irvin R. Whiteman. "The Role of Computers in Handling Aerospace Systems Human Factors Task Data." Dec. 1965. Computer Concepts, Inc., AF 33(615)-1557. AMRL-TR-65-206.

31. Burt F. Green, Jr. Digital Computers in Research, An Introduction for Behavioral and Social Scientists. New York: McGraw-Hill Book Co., 1963.

32. D. J. Rogers and T. T. Tanimoto. "A Computer Program for Classifying Plants." Science, vol. 132, no. 3434 (1960) 1115-1118.

D. J. Rogers and Henry Fleming. "A Computer Program for Classifying Plants. II. A Numerical Handling of Non-numerical Data." BioScience, vol. 14, no. 9 (1964) 15-28.

33. Hun H. Sun. "The Role of Computers in Research." Data Processing Magazine, vol. 7, no. 6, June 1965, 26-27.

34. Stanley W. Corbett. "Conception, Execution, Operation." Systems, vol. 6, no. 7, Oct. 1965, 16, 18.

35. James Fox. "Correct Combination Pays Off in Production Control." Systems, vol. 6, no. 7, Oct. 1965, 20, 46.

36. John W. Riedy. "Fast, Smooth, Accurate, Satisfying and Economical." Systems, vol. 6, no. 7, Oct. 1965, 22, 23, 57.

37. "The John Hancock Story." Systems, vol. 7, no. 4, Apr. 1966.

38. Dale L. Reistad. Banking, June 1965, p. 115-6.

39. See Datamation, vol. 11, no. 7, July 1965. Six papers discuss data processing in banking.

40. See Martin Greenberger. "Banking and the Information Utility." Compu-

*Let's Profit From What We Know*

ters and Automation, vo. 14, no. 4, Apr. 1965, 28-31.

41. "Computer Tests Investment Decisions." Savings and Loan News, Aug. 1965, 41-43.

42. Charles F. Rozema. "Video Track for Rolling Stock." Business Automation, Apr. 1965, 50-53.

43. "How the NP Uses a Computer for 'Measuring' Clearances." Railway Age, May 1965, p. 18, 19, 29.

44. "Southern's Revolutionary Room at the Top." Railway Age, Sept. 1965, 26-31.

45. Nancy Ford. "Computers: The Washington Story." Modern Railroads, Mar. 1965, 120-122.

46. A. J. Kirby. "Wheat Pool Handles 17,000 Tickets a Day." Office Equipment and Methods, July 1965, 32-35.

47. "This Little Piggy Went to Storage." Data Management, May 1965, 22-24.

48. "Automation 'On The Hoof.'" Data Management, Feb. 1965, 15, 16.

49. "Many Systems Are Now Available For DDC." Chemical and Engineering News, vol. 43, Apr. 5, 1965, 48-49.

50. Thomas M. Stout. "Process Control." Datamation, vol. 12, no. 2, Feb. 1966, 22-27.

51. Thomas R. Schuerger and Frank Slamar. "Control in the Iron and Steel Industry." Datamation, vol. 12, no. 2, Feb. 1966, 28-32.

52. Thomas M. Stout, ref. 50.

53, 54 - error of omission.

55. R. W. Parker. "The Sabre System." Datamation, vol. 11, no. 9, Sept. 1965, 49-52.

56. Lawrence K. Williams and C. Brian Williams. "The Impact of Numerically Controlled Equipment on Factory Organ-

ization." California Management Review, Winter 1964, 25-34.

57. John W. Haslett. "Is Analysis Yielding to Synthesis?" Business Automation, Apr. 1965, 34-40.

58. James I. Morgan. "Decision Tables." Management Services, Jan/Feb. 1965, 13-18.

59. Roger L. Sisson. "Management Science Selection - Decomposition and Decentralization." Data Processing Digest, vol. 11, no. 10, Oct. 1965, 1-6.

60. Roger L. Sisson. "Management Science Selection - Hurry Up and Wait (Part 1)." Data Processing Digest, vol. 11, no. 2, Feb. 1965, 1-9.

61. Roger L. Sisson. "Management Science Selection - Hurry Up and Wait (Part 2)." Data Processing Digest, vol. 11, no. 4, Apr. 1965, 1-10.

62. Roger L. Sisson. "Management Science Selection - The Vexing Job Shop." Data Processing Digest, vol. 11, no. 8, Aug. 1965, 1-12.

63. Richard A. Kaimann. "Data Processors Today and Tomorrow." Data Processing Magazine, vol. 7, no. 3, Mar. 1965, 28-30.

64. Proceedings of Air Force/Industry Data Management Symposium, Sept. 28-30, 1965, Beverly Hilton Hotel, Beverly Hills, Calif. Ballistics Systems Div., Norton AFB, Calif. AD-626,032.

65. Jacquelyn H. Pruitt and J. B. Williams. "PAT: Pricing Automation Technique." Data Processing for Science/Engineering, vol. 2, no. 1, Jan/Feb. 1964, 17-20.

66. SDC Magazine, vol. 8, no. 2, vol. 9, no. 1, Winter 1965-1966.

67. "Application of Electronic Data Processing: State and Local Government." SDC Magazine, vol. 8, no. 5, May 1965.

68. "System Development For Regional, State and Local Government." SDC Maga-

**INFORMATION SYSTEM NETWORKS . . . . .**

zine, vol. 8, no. 10, Oct. 1965.

69. "New York City's Top Officials Envision Information System for Total Organization at ACM Symposium." Communications of the ACM, vol. 9, no. 5, May 1966, p. 392.

70. G. Truman Hunter. "An Information System for School Management." Educational Data Processing Newsletter, June/July 1965, 1-9.

71. "Chicago High Schools Link Up To Computer at IIT." Communications of the ACM, vol. 9, no. 5, May 1966, p. 348.

72. "Hospital Administrative Research." June 1964. U.S. Dept. of Health, Education and Welfare, Public Health Service. PHS Pub. No. 930-C-8.

73. Jordan J. Baruch. "Hospital Automation via Computer Time-Sharing." Chap. 12 in Computers in Biomedical Research, vol. 2. New York: Academic Press, Inc., 1965, 291-312.

74. G. Octo Barnett and Jordan J. Baruch. "Hospital Computer Project." Memorandum Eight, Status Rept., 1965. (to the National Institutes of Health and the American Hospital Assn.)

75. Erling Dessau. "Introducing ADP in a Hospital System." Paper distributed at the Symposium on Economics in ADP, Rome, Italy, 19-22 Oct. 1965.

76. "Hard Site." SDC Magazine, vol. 9, no. 3, March 1966.

77. "Deputy DDRE (Tactical Warfare) Discusses Surveillance Systems." Army R & D Newsmagazine, vol. 7, no. 3, Mar. 1966, p. 2, 18, 19.

78. Frank Leary. "Tactical Command and Control." Space/Aeronautics, vol. 45, no. 4, Apr. 1966, 94-109.

79. "Growing STRATCOM Maintains 24-Hour Worldwide Wartime Vigilance." Army R & D Newsmagazine, vol. 7, no. 4, Apr. 1966, p. 16.

80. "AUTODIN Communications Network Expanding." Army R & D Newsmagazine, vol. 7, no. 1, Dec. 1965-Jan. 1966, p. 45.

81. Alfred D. Starbird. "The Defense Communications Satellite Program." Defense Industry Bulletin, vol. 2, no. 5, May 1966, p. 5, 8.

82. "Data Standardization Progresses." Defense Industry Bulletin, vol. 2, no. 5, May 1966, p. 17, 21.

83. "IDEP To Convert Files to Roll Microfilm Jan. 1." Army R & D Newsmagazine, vol. 7, no. 1, Dec. 65-Jan. 1966, p. 11.

84. "DASA Information and Analysis Center Services Nuclear Research Field." Defense Industry Bulletin, vol. 2, no. 5, May 1966, p. 10.

85. Auerbach Corp. Interview Guide Handbook. May 1964. Contract SD-219. AD-439,956.

86. Donald P. Hammer. "Automated Operations in a University Library - A Summary." College and Research Libraries, vol. 26, no. 1, Jan. 1965, 19-29, 44.

87. Computerized Typesetting, A Management Report on the State of the Art. Los Angeles, Calif.: Composition Information Services, 1964.

88. Ritvars Bregzis. "The Ontario New Universities Library Project - An Automated Bibliographic Data Control System." College and Research Libraries, vol. 26, no. 6, Nov. 1965, 495-508.

89. Ontario New Universities Library Project. Author-Title Catalogue. April 1965.

90. "A Joint College/Industry Library with Automata." Claremont, Calif.: Harvey Mudd College, Science and Engineering, 1964.

91. C. Walter Stone. A Library Program For Columbia. Oct. 1965. Maryland State Dept. of Education.

92. Robert M. Hayes. "The Library Re-

*Let's Profit From What We Know*

- Research Institute of the University of California." April 1964.
93. William A. Creager and David E. Sparks. "A Serials Data Program for Science and Technology." 1965. Final rept., NSF-C-413. IDC-8521.
94. "Machine-Readable Catalog Data to be Distributed by Library of Congress in the Fall." Scientific Information Notes, vol. 8, no. 1, Feb/Mar. 1966, p. 13.
95. "Automation Costs For Libraries to be Studied at Michigan State University." Council on Library Resources Release No. 188, April 1966.
96. "NYC Libraries Working Toward Improved Reference and Research Services." Scientific Information Notes, vol. 8, no. 2, April/May 1966, p. 11,12.
97. J. H. Crawford, et al. "Scientific and Technical Communications in the Government." Apr. 1962. Task Force Report to the President's Special Assistant for Science and Technology. AD-299,545.
98. Science, Government, and Information. The Responsibilities of the Technical Community and the Government in the Transfer of Information. Jan. 1963. A Report of the President's Science Advisory Committee.
99. "Recommendations for National Document Handling Systems in Science and Technology." Nov. 1965. Committee on Scientific and Technical Information (COSATI), Federal Council for Science and Technology. PB 168,267; AD-624,560.
- Title as above. Appendix A, A Background Study, Vol. I and II. Lauror F. Carter, et al., System Development Corp. PB and AD numbers as above.
100. "New Committee on Scientific and Technical Communication Formed." USAF INFO Newsletter, vol. 3, no. 4, Apr. 1966, p. 1.
101. Ref. 99, p. 11.
102. Ref. 98, p. 1, 2.
103. "When a Computer Needs A Friend." Business Week, Mar. 6, 1965.
104. Van Zandt Williams, Elmer Hutchisson, and Hugh C. Wolfe. "Toward National Information Networks. 2. Consideration of a Physics Information System." Physics Today, vol. 19, no. 1, Jan. 1966, 45-53.
105. Edward L. Brady and Merrill B. Wallenstein. "National Standard Reference Data System, Plan of Operation." Dec. 1964. National Bureau of Standards. NSRDS-NBS 1.
106. Proceedings of the Second National Symposium on Engineering Information. Held in October 1965. New York: Engineers Joint Council, 1966.
107. "Points of Interest." Data Processing Digest, vol. 11, no. 4, April 1965, p. 33.
108. "URBANDOC Progress." ADI Newsletter, vol. 5, no. 2, March/April 1966, p. 6.
109. Felix Kaufman. "Data Systems That Cross Company Boundaries." Harvard Business Review, vol. 44, no. 2, March/April 1966, 141-155.
110. Rowena Swanson. Information Sciences, 1965. Jan. 1966. Air Force Office of Scientific Research. AFOSR 66-0130. AD 630,521.
111. Rowena W. Swanson. "Information Sciences: Some Research Directions." Air University Review, vol. 17, no. 3, March/April 1966, 56-67. AFOSR 66-0632.
112. Paul W. Abrahams, Michael F. Lipp, and Jacques Harlow. "Quantitative Methods of Information Processing System Evaluation." Oct. 1963. International Telephone and Telegraph Corp., AF 19(628)-2842. ESD-TDR-63-670.
113. Robert R. Freeman. "Research Project for the Evaluation of the UDC as the Indexing Language for a Mechanized Reference Retrieval System: Progress Report for the Period July 1, 1965 - January 31, 1966." Feb. 1966. American

**INFORMATION SYSTEM NETWORKS . . . . .**

- Institute of Physics, NCF GN-433. Oct. 1964, 225-228. AF-AFOSR-403-64.
114. National Science Foundation. "Summary of Study Conference on Evaluation of Document Searching Systems and Procedures, Oct. 2-3, 1964, Washington, D. C." Feb. 1965.
115. Ann F. Painter. "An Analysis of Duplication and Consistency of Subject Indexing Involved in Report Handling at the Office of Technical Services, U.S. Department of Commerce." Mar. 1963. PB 181,501.
116. Monroe B. Snyder, *et al.* "Methodology for Test and Evaluation of Document Retrieval Systems: A Critical Review and Recommendations." Jan. 1966. Human Sciences Research, Inc., NSF C-418.
117. Ralph H. Sprague, Jr. A Comparison of Systems For Selectively Disseminating Information. Bloomington: Indiana University, Bureau of Business Research, 1965. Ind. Business Rept. No. 38.
118. William L. Wolfe, *et al.* "How Can Effectiveness of Analysis Centers Be Measured." Panel discussion, Addendum to the Proceedings of the Ad Hoc Forum for Information Analysis Center Managers, Directors, and Professional Analysts, Nov. 9-11, 1965, Columbus, Ohio.
119. See ref. 114.
120. Francois Kertesz. "The Role of Information Centers: Evaluation of Their Effectiveness." Nov. 1965. Oak Ridge National Laboratory. ORNL-TM-1339.
121. Alan M. Rees and Douglas G. Schultz. "A Field Experimental Approach to the Study of Relevance Assessments in Relation to Document Searching." Formal Progress Rept. No. 1, July 1 - Dec. 31, 1965. Western Reserve University, NSF C-423.
122. William Goffman and Vaun A. Newill. "Generalization of Epidemic Theory, An Application to the Transmission of Ideas." Nature, vol. 204, no. 4955, Oct. 1964, 225-228. AF-AFOSR-403-64.
123. Richard S. Rosenbloom and Francis W. Wolek. "Studies of the Flow of Technical Information. I. A Survey in Selected Industrial Laboratories. II. A Survey of Selected Members of the Institute of Electrical and Electronics Engineers. III. Studies of Decision-Making in Development Projects." Interim rept., Jan. 1966. Harvard University, NSF GN-305.
124. George H. Nelson and Donald M. Hodge. "Biological Laboratories Communication. Dec. 1965. U.S. Army Biological Labs. Misc. Pub. 13. AD-625,712.
125. Gerald Jahoda, Ronald D. Hutchins, and Robert R. Galford. "Characteristics and Use of Personal Indexes Maintained By Scientists and Engineers in One University." Mar. 1966. Florida State U., AF-AFOSR-895-65.
126. E. J. Feinler, *et al.* "Attitudes of Scientists Toward a Specialized Information Center." American Documentation, vol. 16, no. 4, Oct. 1965, 329-333.
127. Dale T. Teaney. "What Do Other Specialists Do?" Physics Today, vol. 19, no. 3, Mar. 1966, 43-46.
128. Robert J. Spinrad. "The Computer and You." Physics Today, vol. 18, no. 12, Dec. 1965, 47-54.
129. Franklin S. Cooper and Peter B. Denes. "Computers in Speech Research. Part II." Sect. 4 in Status Report on Speech Research. Nov. 1965. Haskins Labs., NIH DE-01774-03, FR-5596. Rept. No. SR-4 (1965).
130. John T. Lanzetta and Vera T. Kanareff. "Information Cost, Amount of Pay-off, and Level of Aspiration as Determinants of Information Seeking in Decision Making." Behavioral Science, vol. 7, no. 4, Oct. 1962, 459-473.
131. William J. Paisley and Edwin B. Parker. "Information Retrieval as a Receiver-Controlled Communication System," in Education for Information Science, 1965, 23-31.

*Let's Profit From What We Know*

132. Carl F. J. Overhage and R. Joyce Harman, eds. Intrex, Report of a Planning Conference on Information Transfer Experiments, Sept. 3, 1965. Cambridge, Mass.: The M.I.T. Press, 1965.
133. Earl G. Fossum and Gilbert Kaskey. "Optimization and Standardization of Information Retrieval Language and Systems." Jan. 1966. Final Rept. Sperry Rand Corp., Univac Div., AF 49(638)-1194. AD-630,797.
134. Leonard Farr, Victor LaBolle, and Norman E. Willmorth. "Planning Guide For Computer Program Development." May 1965. System Development Corp., Nonr-4543(00). TM-2314/000/00. AD-465,228.
135. "An Approach to Computer Installation Performance Effectiveness Evaluation." June 1965. Auerbach Corp. AD-617,613.
136. Lawrence Berul. "Information Storage and Retrieval, A State-of-the-Art Report." Sept. 1964. Auerbach Corp. AD-630,089.
137. Robert M. Shapiro. "An Illustration of the Use of Theory." Sect. 16 in Information System Theory Project, Vol. I. Nov. 1965. Applied Data Research, Inc., and Computer Associates, Inc., AF 39(602)-3324. Final rept. RADC-TR-65-377, vol. I. AD-626,819.
138. D. S. Stoller. "Logistics Systems Capacity." Jan. 1966. Rand Corp. AD-629,131.
139. Andrew J. Clark. "A Program Library Approach for Implementing Results of Logistics Research." July 1965. Rand Corp. RM-4615-PR. AD-618,033.
140. Russell A. Kirsch. "The Application of Automata Theory to Problems in Information Retrieval (with Selected Bibliography)." Mar. 1963. National Bureau of Standards. NBS Rept. 7882.
141. Mary Elizabeth Stevens. "Automated Indexing: A State-of-the-Art Report." Mar. 1965. National Bureau of Standards. NBS Monograph 91.
142. J. E. Sammet. "Survey of the Use of Computers for Doing Non-Numerical Mathematics." Mar. 1966. International Business Machines Corp. TR 00.1428.
143. "Advanced Programming Developments: A Survey." Feb. 1965. Directorate of Computers, Electronic Systems Div., L. G. Hanscom Field and Computer Associates, Inc. ESD-TR-65-171. AD-614,704.
144. J. Hilsenrath, et al. OMNITAB, A Computer Program for Statistical and Numerical Analysis. Mar. 1966. NBS Handbook 101.
145. Donald J. Kaufman. "Monsanto's 'Conversational' Mode Computer Network to Increase Engineer's Efficiency." Data Processing Magazine, vol. 7, no. 7, Aug. 1965, 48-50.
146. E. Bennett, E. C. Haines, and J. K. Summers. "AESOP: A Prototype For On-Line User Control of Organizational Data Storage, Retrieval and Processing." Nov. 1965. Mitre Corp. MTP-23.
147. Alan J. Perlis, Renato Iturriaga, and Thomas Standish. "A Preliminary Sketch of Formula Algol." July 1965. Carnegie Institute of Technology, ARPA SD-146.
148. L. C. Clapp et al. "MAGIC PAPER: An On-Line System For The Manipulation of Symbolic Mathematics." Apr. 1966. Computer Research Corp., for AFCRL. R-105-1.
149. Kenneth C. Knowlton. "A Programmer's Description of L<sup>0</sup>, Bell Telephone Laboratories' Low-Level Linked List Language." Feb. 1966.
150. Daniel G. Bobrow, et al. "The BBN-LISP System." Feb. 1966. Bolt, Beranek, and Newman, AF 19(628)-5065. Scientific Rept. No. 1. AFCRL-66-180. BBN Rept. No. 1346.
151. Ned Chapin. "What Choice Of Programming Languages?" Computers and Automation, vol. 14, no. 2, Feb. 1965, 12-14.
152. Philip J. Stone, et al. "The Gene-

## INFORMATION SYSTEM NETWORKS . . . . .

- ral Inquirer: A Computer System For Content Analysis and Retrieval Based on the Sentence as a Unit of Information." Behavioral Science, vol. 7, no. 4, Oct. 1962, 484-498.
153. Ole R. Holsti. "An Adaptation of the 'General Inquirer' for the Systematic Analysis of Political Documents." Behavioral Science, vol., 9, no. 4, Oct. 1964, 382-388.
154. Bertram Raphael. "A Computer Program Which 'Understands.'" Proceedings, Fall Joint Computer Conference, 1964, 577-589.
155. Report of AFSC Ad Hoc Task Force, Implicitly Programmed Systems Working Group. Vol. I. Oct. 1964. Air Force Systems Command. AD-458,659.
156. "Report On Initial Planning For GENISYS (GENeralized Information SYSTEM)." July 1965. System Development Corp., AF 19(628)-3418. ESD-TR-65-463. TM(L)-2335/000/01.
157. Second Congress on the Information System Sciences. Wash., D. C.: Spartan Books, Inc., 1965.
158. Norman Statland. "Information Processing: Fact, Fiction and Future." Data Processing Magazine, vol. 8, no. 2, Feb. 1966, 19, 21-23.
159. Massachusetts Institute of Technology, Project MAC, Progress to July 1964. July 1965. MAC-PR-1. AD-465,088.
160. Project MAC, Progress Report II, July 1964 to July 1965. July 1965. MAC-PR-2. Massachusetts Institute of Technology, Nonr-4102(01).
161. M.I.T. Computation Center, Research and Educational Activities. Progress Rept. No. 17 of the Research and Educational Activities in Machine Computation by the Cooperating Colleges of New England. June 1965.
162. Jack B. Dennis and Edward L. Glaser. "The Structure of On-Line Information Processing Systems." In ref. 157, 5-14.
163. Allan Lee Scherr. "An Analysis of Time-Shared Computer Systems." June 1965. Massachusetts Institute of Technology. MAC-TR-18.  
See also, A. L. Scherr. "Time-Sharing Measurement." Datamation, vol. 12, no. 4, Apr. 1966, 22-26.
164. G. D. McCann, K. J. Hebert, C. B. Ray, and S. H. Caine. "Advanced Shared File System Extends Capabilities of Caltech Computing Center." Data Processing Magazine, vol. 7, no. 9, Sept. 1965, 24-27.
165. Argonne National Lab. Applied Mathematics Division Summary Report, July 1, 1964 through June 30, 1965. ANL-7129.
166. "Look Ahead." Datamation, vol. 12, no. 4, Apr. 1966, p. 19.
167. Rudy C. Stiefel. "Small Computers: A Billion Dollar Market by 1970?" Computers and Automation, vol. 14, no. 5, May 1965, 19-21.
- For pros and cons on time sharing and small vs. large computers, see also Data Processing Magazine, Sept. 1965, and Computers and Automation, Sept. 1965.
168. Zhelikhovskiy. "Specialized electronic computers for geodetic computations." ATD Press, vol. 4, no. 208, Apr. 19, 1966, p. 7. (This is an abstract of a paper appearing in Geodeziya i kartografiya, no. 2, 1966).
169. W. E. Chapin. "A Summary of Digital Transducers, Developments and Techniques." July 1965. Battelle Memorial Institute. AD-465,867.
170. E. J. Chatterton. "Optical Communications Employing Semiconductor Lasers." June 1965, released April 1966. Lincoln Lab. AD-630,243.
171. Raymond A. Edwards. "Time-Shared Computers in Research." Industrial Research, vol. 8, no. 5, May 1966, 63-6, 68, 70, 72.



## Let's Profit From What We Know

172. R. A. Fuller, R. M. Bird, and R. M. Worthy. "Study of Associative Processing Techniques." Aug. 1965. General Precision, Inc., AF 39(602)-3371, RADC-TR-65-210. AD-621,516.
173. Albert S. Hoagland. "Storing Computer Data." International Science and Technology, no. 37, Jan. 1965, 52-8.
174. 1965 Symposium on Photography in Information Storage and Retrieval. Advance printing of invited papers and summaries, Oct. 21-23, 1965. Wash., D.C.: Society of Photographic Scientists and Engineers, 1965. AD-625,029.
175. "Data Transmission Systems, Data Acquisition Systems." Datamation, vol. 11, no. 9, Sept. 1965, 29-37.
176. "'Talking Computer' Quotative Service." Data Management, May 1965, 14-17.
177. John P. Roche and Earl S. Rodgers. "Audio-Response in Banking." Datamation, vol. 11, no. 7, July 1965, 34-38.
178. Daniel Teichroew. "Information Systems in Information Display." Information Display, vol. 2, no. 6, Nov/Dec. 1965, 33-39.
179. Ivan E. Sutherland. "Computer Graphics." Datamation, vol. 12, no. 5, May 1966, 22-27.
180. Sullivan G. Campbell. "Time Sharing - Some Problems, Potentialities, and Implications." Data Processing Magazine, vol. 17, no. 9, Sept. 1965, 30-33.
181. Allen Bernholtz. "Computer Graphic Displays in Architecture." Information Display, vol. 3, no. 2, Mar/Apr. 1966, 52-53.
182. Journal of Engineering Education, vol. 56, no. 8, April 1966. The issue is devoted to various roles of the computer in education.
183. "The School Computer Experiment." BBN Activities, vol. 1, no. 1, Apr. 1966, p. 3.
184. "The Rand Tablet: A Man-Machine Communication Device." Computer Design, vol. 4, no. 4, Apr. 1965, 36-8, 40.
185. "Computerized Drawing Board." Data and Control, vol. 3, no. 12, Dec. 1965, 46.
186. "Dr. L. G. Roberts Outlines The Present and Future in Computer Graphics." Computopics (D.C. chapter, ACM), vol. 7, no. 10, May 1966, 6-9.
187. Andries van Dam. "A Survey of Pictorial Data Processing Techniques and Equipment." Aug. 1965. University of Pennsylvania, Nonr-551(40). Moore School Rept. No. 66-19. AD-626, 155.
188. Thomas B. Cheek. "Design of a Low-Cost Character Generator for Remote Computer Displays." Mar. 1966. Massachusetts Inst. of Tech., Proj. MAC, Nonr-4102(01). MAC-TR-26. AD-631,269.
189. William D. Stratton. "Investigation of an Analog Technique to Decrease Pen-Tracking Time in Computer Displays." Mar. 1966. Massachusetts Inst. of Tech., Proj. MAC, Nonr-4102(01). MAC-TR-25. AD-631,396.
190. Carl W. Clewlow. "Data Processing in the Federal Government." The Federal Accountant, Summer 1965, 35-62.
191. "EJC Seminar Report, Information." Engineer, vol. 7, no. 1, Spring 1966, p. 8.

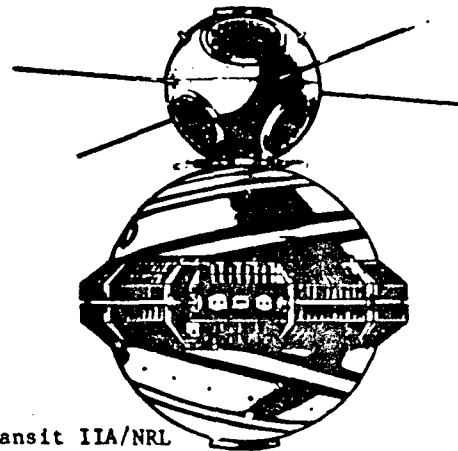

Transit IIA/NRL  
Satellite

## INFORMATION SYSTEM NETWORKS . . . . .

### 12 - BIBLIOGRAPHY

This is primarily a bibliography of bibliographies. Some result from states-of-the-art analyses or are supplemental to a research report. These, or annotated listings, the author would encourage, since growth of the literature makes assessment of its parts imperative, if, perhaps, embarrassing to some.

The references are ordered alphabetically by last name of first author.

1. Lawrence Berul. "Information Storage and Retrieval, A State-of-the-Art Report." Sept. 1964. Auerbach Corp. AD-630,089. The report contains a bibliography to the text, and a supplemental bibliography on automatic indexing and automatic abstracting.
2. Charles P. Bourne. "Bibliography on the Mechanization of Information Retrieval." Unannotated. In five parts: Feb. 1958; Supplement I, Feb. 1959; Supplement II, Feb. 1960; Supplement III, Feb. 1961; Supplement IV, Feb. 1962. Stanford Research Institute.
3. Launor F. Carter, et al. "Recommendations for National Document Handling Systems in Science and Technology." Appendix A, A Background Study, 2 vols. Nov. 1965. System Development Corp. (report to COSATI, ref. 99 above). Sections 8 and 11 in the second volume contain selected bibliographies on user studies and hardware and software, respectively.
4. Clearinghouse for Federal Scientific and Technical Information. "Classification - Indexing, A Report Bibliography." Sept. 1965. A computer printout with AD numbers, descriptors, and abstracts for the references.
5. Richard F. Filipowsky and Louise C. Bickford. "Space Communications: Theory and Applications. A Bibliography." 4 vols. July 1965. National Aeronautics and Space Administration. NASA SP-7022(03). Volume 3 concerns Information Processing and Advanced Techniques. The references are ordered by subject classification.
6. Madeline M. Henderson. "Tentative Bibliography on Evaluation of Information Systems." Feb. 1965. National Bureau of Standards. Unannotated, but this is a companion volume to ref. 114 above.
7. A. E. Hickey and J. M. Newton. "Computer-Assisted Instruction, a Survey of the Literature." Dec. 1965. Entelek, Inc. AD-628,953.
8. H. Holzbauer. "Mechanized Bibliography of Documentation and Information Sciences, and Selected Examples Thereof." Mar. 1966, preliminary listing. U.S. Department of Interior. Unannotated computer printout, references ordered by subject, with a separate section for books and monographs.
9. Russell A. Kirsch. "The Application of Automata Theory to Problems in Information Retrieval (With Selected Bibliography)." See ref. 140, above. This is a classic.
10. Charles H. Kriebel. "A Resume of Mathematical Research on Information Systems." Feb. 1965, rev. Apr. 1965. Carnegie Institute of Technology, Nonr-760(24). Management Sciences Research Rept. No. 33. AD-616,113. A very disappointing report, in comparison with Kirsch's.
11. A. A. Kunze. "Military Communications Switching System Design." Jan. 1966. Rome Air Development Center. A state-of-the-art review.
12. Lawrence Radiation Lab., University of California. "Monte Carlo Methods: A Bibliography Covering the Period 1949 to 1963." Apr. 1964. UCRL-7823D.
13. A. E. Murray and H. R. Leland. "Information Processing Relevant to Military Command: Survey, Recommendations, and Bibliography." Feb. 1963. Cornell Aeronautical Lab., Inc., AF 19(628)-1625. ESD-TDR-63-349, 2 vols. Volume 2 is a

*Let's Profit From What We Know*

card bibliography of references with abstracts. The study examines the contributions of heuristic programming, adaptive networks, artificial intelligence, pattern recognition, and information storage and retrieval to command and control.

14. Frances Neeland. "A Bibliography on Information Science and Technology." 4 parts, rept. nos. TM-2625/001, /002, /003, /004 dated Aug. 65, Oct. 65, Nov. 65, Jan. 66, respectively. System Development Corp. Unannotated, ordered alphabetically by author, cross-referenced to corporate authors and a list of conferences. The bibliography is intended for use by authors of chapters in the first volume of "Annual Review of Information Science and Technology" scheduled for publication in 1966.

15. Office of Technical Services, U. S. Dept. of Commerce. OTS Selective Bibliography: "Computers." SB-472 (Supplement to CTR-371), and SB-472, Supplement 1.

16. Office of Technical Services, U. S. Dept. of Commerce. OTS Selective Bibliography: "Computer Related Research." SB-473, Suppl. 1.

17. Office of Technical Services, U. S. Dept. of Commerce. OTS Selective Bibliography: "Data Processing and Programming." SB-474, and SB-474, Suppl. 1.

18. Office of Technical Services, U. S. Dept. of Commerce. OTS Selective Bibliography: "Information Storage and Retrieval." SB-475, and SB-475, Suppl. 2.

19. Office of Technical Services, U. S. Dept. of Commerce. OTS Selective Bibliography: "Magnetic Recording Systems." SB-471, revised.

The OTS bibliographies are unannotated.

20. J. E. Sammet. "An Annotated Descriptor Based Bibliography on the Use of Computers for Non-Numerical Mathematics." Mar. 1966. International Business Machines Corp. TR 00,1427. A computer printout, companion to ref. 142 above.

21. Andrew M. Sherrington. "An Annotated Bibliography of Studies on the Flow of Medical Information to Practitioners." Methods of Information in Medicine. vol. 4, no. 1, Mar. 1965, 45-57.

22. Monroe B. Snyder, et al. "Methodology for Test and Evaluation of Document Retrieval Systems: A Critical Review and Recommendations." See ref. 116, above. Appendix B lists the references reviewed for the study.

23. Mary E. Stevens. "Automatic Indexing: A State-of-the-Art Report." See ref. 141, above.

24. Irvin R. Whiteman. "The Role of Computers in Handling Aerospace Systems Human Factors Task Data." See ref. 30, above. The report contains a separate, unannotated bibliography on automatic data processing.

25. W. W. Youden. "Computer Literature Bibliography, 1946-1963." 1965. National Bureau of Standards. The bibliography contains references to over 6,000 papers in 9 journals and over 100 proceedings volumes. It includes an author index and a keyword-in-context subject index (based on titles).

26. Hans M. Zell and Robert J. Machesney. An International Bibliography of Non-Periodical Literature on Documentation and Information. Oxford, England: Robert Maxwell & Co., Ltd., 1965. Unannotated, with a permuted title index.

## INFORMATION SYSTEM NETWORKS . . . . .

### 13 - ADDENDUM

*Dr. D. I. Hydrohom  
Federal Science Division  
Office of Science Information  
Washington 208, D.C.*

*February 1, 1965*

DEAR DR. HYDROHOM:

I have read, by my newly devised Ultra Rapid Program Scanning (URPS) method, the BSID renewal request submitted to PSD by AABS. I am impressed with the handsome development of FIEIS, CBE, ISCISP, BAIT, ASIRC, HTC, and CWS and especially the strong relationships that have been formed with MILC, NAL, ICA, FID, UNESCO, INSDOC, BA, ICSU, NML, LC, AID, HIN, PANSDOC, and IUBS. I feel sure that these efforts will be of great service as well to DOD, NRC, UCLA, MSC, GM, HLB, and HBS. I think you should give them a third year.

As I wrote you last year, I am a querulous old man, but one virtue of old age is the ability to make time-flights into the future. On a recent expedition I ran across a letter written by one of my grandchildren. I am happy to inclose an excerpt for you. While this excerpt is free, I hasten to point out that it was written in KW's, and translation to the crude extended writing form of your Division takes time. Therefore I will need a grant should PSD need the benefit of more of my future grandchild's ultimate wisdom.

Aloha,

H. BURR STENBACH

HBS/MGH  
Incl.

---

*Excerpt from letter to Dr. D. I. Hydrohom III, Supreme Director, Cosmic Foundation for Integration of Things, January 1, 1999:*

"... in reply to your request for advice as to what to do with the small group of human scientists discovered sequestered in the wilds of antarctica. It is, of course, to be regretted that they should have been found since it is quite clear that the present system of extension of knowledge by the rearrangement of stored information is vastly superior to the old laborious method of recording man's puny observations under the mistaken assumption that they were meaningful.

"It might be well to recapitulate the development of our glorious new system—the historical method has its virtues and is verifiable by machine records.

"In the middle of the century chaos reigned. Individual Scientists (S) did experiments (E) and wrote papers (P). These were then abstracted (A) and reviewed (R), all items returning to S. This system broke down because S could rarely get through SEP, let alone make PAR. Thus attention turned to selecting titles (T), but titles were obviously much too long, so the key word (KW) was invented. In order to handle all these and convert all products of S to KW, the magnificent centers with machines were set up.

- 1) Centers Receiving Ultimate Details (CRUD).
- 2) Centers Organizing Regional Primary Scientific Exercises (CORPSE).
- 3) Cumulative Repositories of Abstracts and Periodicals
- 4) International Transmission Centers, Holding, Exploring, Sending (ITCHES).

## *Let's Profit From What We Know*

"Since similar complexes were needed for each phase of science, it was obviously necessary to establish Programs for Interdisciplinary Communication on National, International, and Cosmic bases (PICNIC's). Since all this naturally became mechanized, a single question directed at the Principal Cosmic Information Center would result in the final receipt by S of a coherent, collated series of reports of all relevant information, together with appropriate KW suggestions. It was early suspected that permutations of KW were then fed back into the CRUD's by S without E or P, but the two-month typhoon of 1980 illustrated clearly that the role of S had become that of only one link in the information cycle obviating all such excess steps as E and P. As you will recall, ten thousand leading scientists were isolated on the island of Oahu for this period. During that time the PICNIC showed no drop whatsoever in new KW's recorded for each man and our technology expanded at an accelerated rate. This led to the finding that the S's had devised machines (M) of their own to feed appropriate combinations of KW's automatically to all CRUD's immediately upon receipt of control information. Careful questioning of PICNIC by specially designed computers then uncovered the elementary fact that E and P fed in by S without an appropriate KW load merely confused issues and complicated otherwise commercially useful correlations. Furthermore, the machine showed clearly that the existing load of KW's was nearly optimal.

"In view of these findings and since M's cost less than S's, all S's were returned to the newly formed Department of Cogitation for ultimate integration into the colonial expedition to Mars. It is indeed regrettable that this arctic antarctic remnant of a useless social appendix should be found. I recommend that. . . ."

Perspectives in Biology and Medicine  
Winter 1965, 268-270.

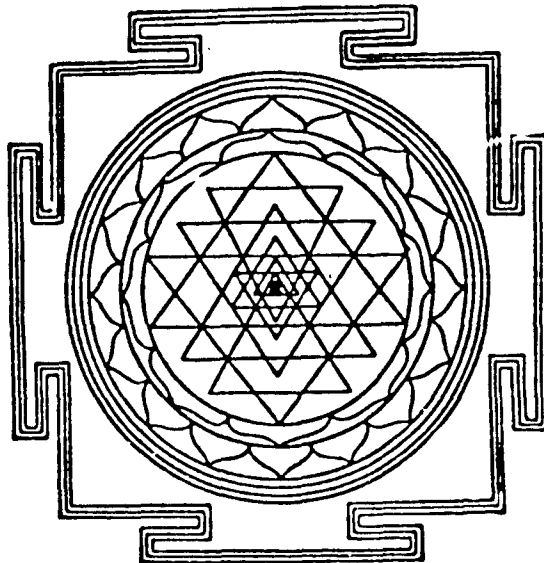

DOCUMENT CONTROL DATA - R&D

(Security classification of title, body of abstract and indexing annotation must be entered when the overall report is classified)

1. ORIGINATING ACTIVITY (Corporate author) Directorate of Information Sciences Air Force Office of Scientific Research Arlington, Virginia 22209	2A. REPORT SECURITY CLASSIFICATION <input checked="" type="checkbox"/> Unclassified <input type="checkbox"/> Other - Specify
	2B. GROUP

3. REPORT TITLE  
INFORMATION SYSTEM NETWORKS - Let's Profit From What We Know

4. DESCRIPTIVE NOTES (Type of report and inclusive dates)  
 Scientific Report  Final Report  Journal Article  Proceedings  Book

5. AUTHOR(S) (Last name, first name, initial)  
Swanson, Rowena W.

6. REPORT DATE AS PRINTED June 1966	7A. TOTAL NO. OF PAGES 48	7B. NO. OF REFS 217
--	------------------------------	------------------------

8A. CONTRACT OR GRANT NO. n/a	8A. ORIGINATOR'S REPORT NUMBER(S) (if given) AFOSR 66-0873
B. PROJECT NO. 9769	8B. OTHER REPORT NO.(S) (Any other numbers that may be assigned this report) AFOSR 66-0873 AD
C. 61445014	
D. 681304	

10. AVAILABILITY/LIMITATION NOTICES  
Distribution of this document is unlimited.

Available from DDC  
 Available from CFSTI  
 Available from Source  
 Available Commercially

11. SUPPLEMENTARY NOTES (Citation) Paper presented at The Third Annual National Colloquium on Information Retrieval, University of Pennsylvania, Museum Auditorium, 12-13 May 1966.	12. SPONSORING MILITARY ACTIVITY AF Office of Scientific Research (SRI) Office of Aerospace Research Washington, D.C. 20333 Arlington
--	---

13. ABSTRACT  
The paper reviews information systems that are being built or planned for use in science and technology, industry and commerce, management, libraries, and military activities. The paper takes a systems engineering approach to information systems and discusses how this is applicable and relevant. The paper considers several proposals for information system networks, particularly those of the "Weinberg Panel" and COSATI, and suggests functions appropriate for a Task Group such as COSATI has recommended. The paper also discusses current research projects concerned with systems design and evaluation, programs for implementing designs, and hardware that may be expected to be useful in the modification of present systems and the creation of new ones. The author contends that technology has significantly changed the concept of network structures, and suggests that networks can be fluid structures exploiting the switching capabilities of machines.