

STRESS RELIEF OF GRAY CAST IRON

CLEARINGHOUSE FOR FEDERAL SCIENTIFIC AND TECHNICAL INFORMATION	
Handcopy	Microfilm
\$ 2.00	\$ 0.50
26-10-1	
PROCESS	

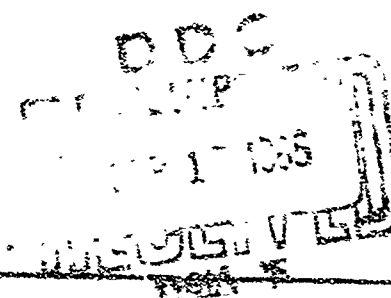

ARCHIVE COPY

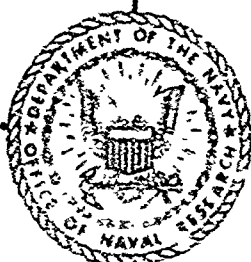

NAVAL RESEARCH LABORATORY

WASHINGTON, D.C.

STRESS RELIEF OF GRAY CAST IRON

J. H. Schaum

June 9, 1948

Approved by:

Mr. R. W. Tindula, Head, Melting and Casting Section
Dr. O. T. Marzke, Superintendent, Metallurgy Division



NAVAL RESEARCH LABORATORY

CAPTAIN W. A. SCHADE, USN, DIRECTOR
WASHINGTON, D.C.

CONTENTS

Abstract	iv
Problem Status	iv
Authorization	iv
INTRODUCTION	1
CONFLICTING OPINIONS	1
EXPERIMENTAL PROCEDURE	4
DISCUSSION OF EXPERIMENTS	8
Relaxation Tests	8
Stress Wheel Tests	17
Stress Relieving by Other Methods	19
CONCLUSIONS	21
ACKNOWLEDGMENT	21

ABSTRACT

This report describes a number of experiments on the stress relief of gray cast iron. One set of experiments consisted of making relaxation tests and using the rate of relaxation as a means of evaluating stress relief. These studies showed that: (1) the rate of stress relief is most rapid during the first hour at temperature; (2) the rate of stress relief is very slow below 1000°F, but increases as the temperature is raised; and (3) initial stress and alloy composition have an important influence on the rate of stress reduction by heat treatment. Observations of heat treatments on highly stressed cast wheels revealed that (1) indoor aging and low-temperature (600°F) heat treatment are ineffective for stress relieving, (2) furnace cooling after heat treatment produces lower residual casting stresses than air cooling, and (3) relaxation tests agree closely with results of stress-relief heat treatments of experimental castings.

PROBLEM STATUS

This report concludes the work on the problem, and unless otherwise advised, the problem will be closed one month from the mailing date of this report.

AUTHORIZATION

NRL Problem M06-01.

STRESS RELIEF OF GRAY CAST IRON

INTRODUCTION

With the increased use of gray cast iron in highly stressed mechanical parts, more attention is being directed toward adequate stress relief before the castings enter into service.

Internal stresses are generated in castings by differences in the rate of contraction of various sections due to temperature gradients set up during cooling. Such temperature differences usually arise from variations in size in cross section and from distance of the metal from heads and gates. The resulting stresses are often large enough to cause cracks which may or may not be detected before the castings go into service, but in most instances the stresses are not large enough to cause the casting to fail until a normal service load is applied. Internal stresses may also lead to distortion during machining as well as in service, since the removal of metal by machining disturbs the balance of the internal stresses and causes distortion to take place in such a way as to restore this balance. The relief of these internal forces by means of heating is generally considered a creep phenomenon in which the stress is reduced through plastic flow.

This report describes the results of a series of stress relief tests made with the Naval Research Laboratory relaxation machine and on a large number of cast wheels containing high stresses.

CONFLICTING OPINIONS

Past studies of stress-relief heat treatments for cast iron have resulted in a series of conflicting opinions and observations. The extent of this confusion will be readily appreciated from the following summary of a number of papers written on this subject.

Prior to 1915, practically no investigations of the heat treatment of cast iron were reported. In the year 1915, however, an anonymous author reported that casting strains in small hardware parts could be relieved by heating for eight hours at a dull red heat (1100°F) followed by very slow

cooling for about one day.¹ Castings so treated were softened because of the precipitation of some of the combined carbon as graphite.

In 1917, L. M. Sherwin² found that equivalent strain removal was obtained by heating a series of low-silicon irons at either 1100°F or at 400°F for 24 hours, followed by slow cooling.

According to C. J. Wiltshire,³ casting strains were completely eliminated by heating slowly to 700°F, holding for 7 hours, and cooling to 300°F in 20 hours.

Harper and MacPherran⁴ relieved casting strains by heating at 1150°F for one hour. With longer holding times the strength and hardness decreased materially.

R. T. Rolfe⁵ heated iron in the temperature range 750°F - 1830°F for one hour and cooled slowly in hot sand. He concluded that casting strains could be removed by heating to 1110°F for one hour followed by slow cooling. Tensile strength was reduced only 6.5 percent, and hardness 2.5 percent.

J. W. Bolton⁶ observed that strains could be removed by heating slowly to 700° - 1000°F and furnace cooling. In a later paper,⁷ he recommended 700° - 800°F.

F. Grotts⁸ recommended a 600°F anneal for quick strain removal, and J. A. Capp⁹ advised that iron castings be stress-relieved by heating to 930° - 1020°F for a period of four to ten hours.

Benson and Allison¹⁰ found complete stress relief after a six-hour soak at 1110°F, but cautioned that increase in dimension caused by oxidation commences at 1020°F and becomes serious at 1110°F.

¹ E. E. Marbaker, Iron Age, 122: pp. 282-85, (1928)

² L. M. Sherwin, Trans. Am. Foundrymen's Assoc., 26: pp. 509-26, (1917)

³ C. J. Wiltshire, Trans. Am. Foundrymen's Assoc., 28: pp. 346-47, (1919)

⁴ J. F. Harper and R. S. MacPherran, Trans. Am. Foundrymen's Assoc., 30: pp. 167-85, (1922)

⁵ R. T. Rolfe, Metal Ind. (London), 24: pp. 500-02, 525-26, 551-52, (1924)

⁶ J. W. Bolton, Iron Age, 114: pp. 820-22, (1924)

⁷ J. W. Bolton, Iron Age, 120: pp. 611-12, (1927)

⁸ F. Grotts, Trans. Am. Soc. for Steel Treating, 7: pp. 735-42, (1925)

⁹ J. A. Capp, Am. Machinist, 63: 385-87, (1925)

¹⁰ L. E. Benson and H. Allison, Proc. Inst. Brit. Foundrymen (London), 31: p. 124, (1937-38)

J. E. Hurst¹¹ recommended a stress-relief temperature of 750°F. He stated that pearlite decomposition commenced at 840°F and cautioned against heating above 750°F.

According to C. H. Morken,¹² an ordinary treatment for relief of internal stresses consists of holding four hours at 900°F. Because of the graphitizing tendency of silicon, he stated that it is advisable to use lower temperatures for high-silicon irons, and higher temperatures for low-silicon irons.

Le Thomas¹³ states that the French Admiralty specification for stress relief of cast iron requires "prolonged heating to a temperature of the order of 500°C [930°F], but lower than 625°C [1155°F], followed by extremely slow cooling. The total duration will be from 24 to 48 hours".

In a recent publication, P. H. Russell¹⁴ arrived at the following conclusions in his research on the subject of stress relief of fully pearlitic high-duty irons.

1. Exposure for four months to varying atmospheric conditions and temperatures reduced internal casting stresses about fifteen percent.
2. Heat treatment at 400°C [750°F] was ineffective.
3. Temperatures in excess of 525°C [975°F] were required to relieve fifty percent of the internal stresses.
4. Internal stresses were not completely relieved at 600°C [1110°F].
5. The physical properties of the irons were not impaired by treatment up to 600°C [1110°F], except that some falling off in transverse strength was occasionally observed.

Figure 1, taken from this report by Russell, depicts graphically the observations of a few additional investigators on the effect of stress-relief temperature on percent stress removal.

These excerpts from numerous papers are indicative of the differences of opinion on proper stress-relief heat treatments. Recommended temperatures range from 400°F to 1150°F, and soaking time from one to twenty-four hours.

¹¹ J. E. Hurst, Iron and Steel, p. 29, October 1939, p. 61, November 1939, and p. 134, January 1940

¹² C. H. Morken, Trans. Am. Soc. for Metals, 22: pp. 227-248, (1934)

¹³ A. Le Thomas, Foundry Trade Journal (London), 62: pp. 217-18, (1940)

¹⁴ P. H. Russell, Foundry Trade Journal (London), Vol. 80, No. 1568, pp. 3-9, (1946)

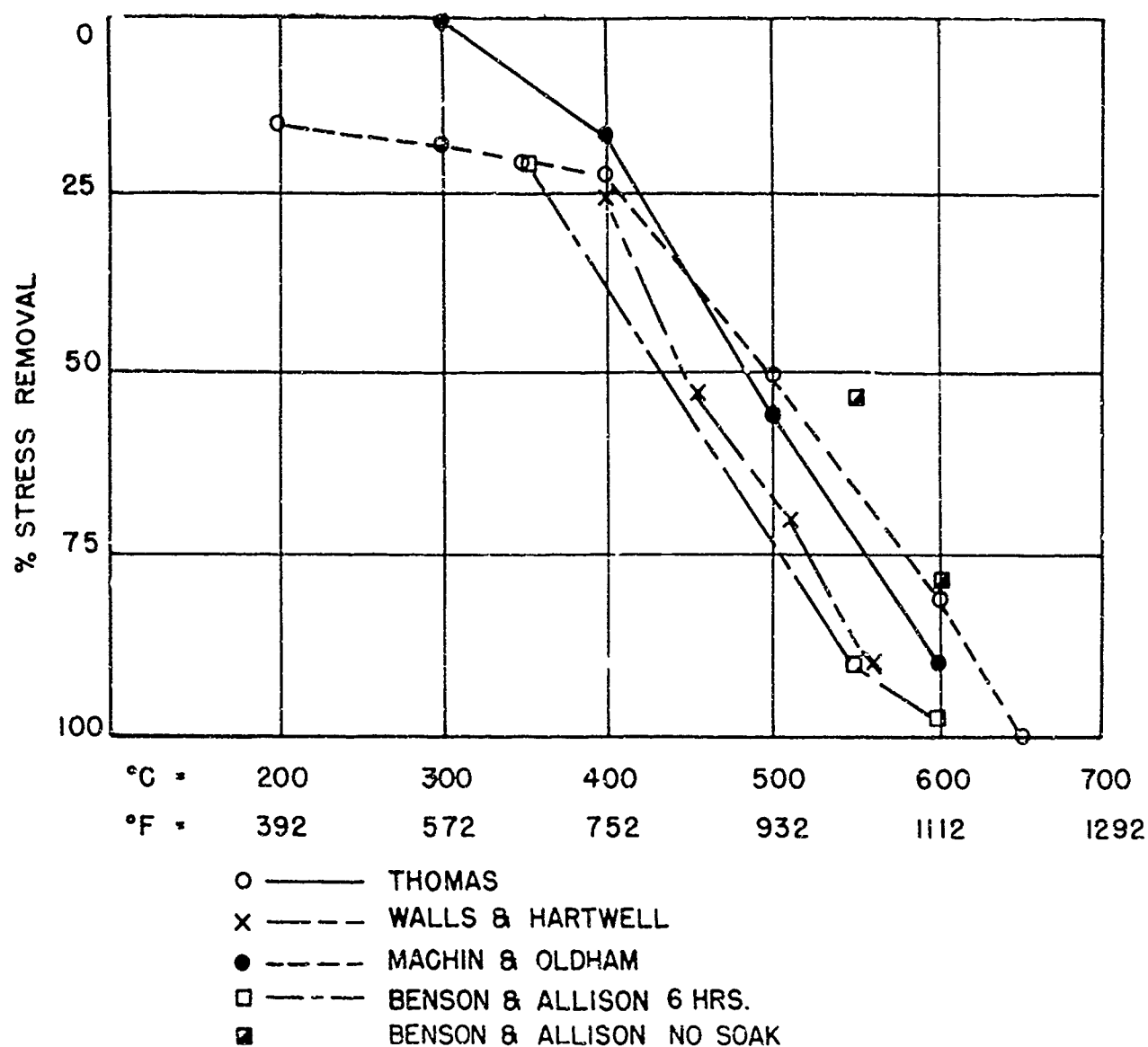

Fig. 1 - Observations of Several Investigators on the Effect of Stress Relief Temperature on Percent Stress Removal

EXPERIMENTAL PROCEDURE

In the first phase of this work, the effect of time and temperature on the relief of internal stresses was studied with the aid of a relaxation machine, built at NRL with minor changes in design on the basis of a machine described by Nadai and Boyd.¹⁵

This machine, shown in Figures 2 and 3, consists of three essential parts - the furnace, the loading mechanism, and the extensometer control system. A test specimen, of the type shown in Figure 4 is held by threaded grips in an electric furnace, B, and heated to any desired temperature.

¹⁵ A. Nadai and J. Boyd, Proc. Fifth Internat. Congr. of Applied Mechanics, p. 245, Cambridge, (1938)

Temperature controller, D, maintains the specimen at constant temperature for the duration of the test. The specimen is next stretched a definite amount by applying a tensile stress through the lever arm, A, by means of G and H. The elongation is measured with extensometer, E, and the load with Ames dial, J. The machine is then set for automatic operation. As the specimen stretches plastically, owing to the load and temperature imposed on it, the extensometer contact, F, closes and starts the motor, H, which reduces the applied stress just enough for the specimen to contract elastically and open the extensometer contact, stopping the motor. The above cycle continues to be repeated, and the load on the specimen is gradually reduced until a stress level is reached at which the rate of plastic flow is so slow that no perceptible change is observed for several hours. Thus the specimen is held at constant length throughout the test. A movie camera equipped with an automatic device takes single-frame pictures of the load-indicating dial and of a clock underneath it so that a time-versus-load record is obtained. A detailed description of the relaxation equipment is contained in "Stress Relief of the Steel Casting" by E. A. Rominski and H. F. Taylor.¹⁶

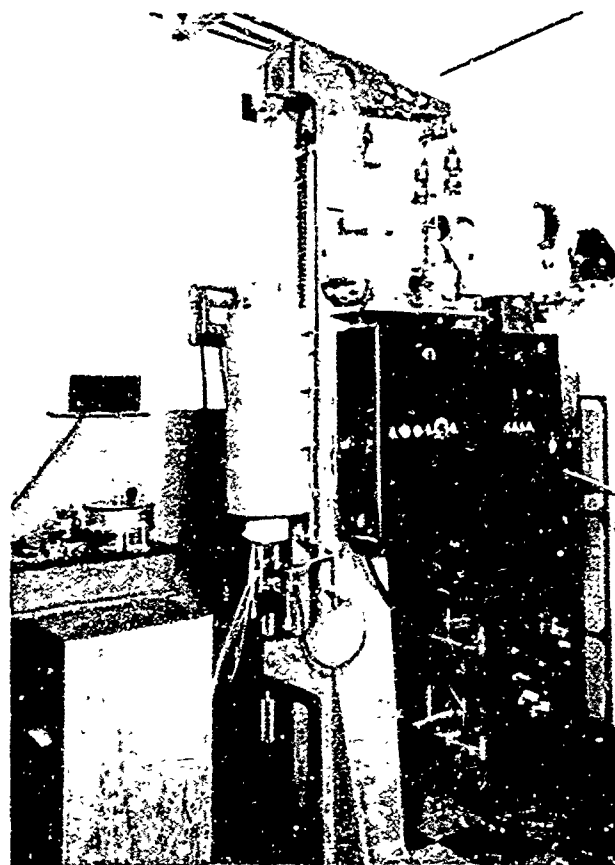

Fig. 2 - Relaxation Testing Machine

The relaxation specimens were made from a cast ingot of special design developed at the Naval Research Laboratory. (See Figure 5). The four rounded corners were removed by sawing longitudinally and then machined as shown in Figure 4.

Relaxation rates of these specimens were compared with stress reductions effected by heat treatments of the special type of casting shown in Figure 6. This four spoke wheel casting was adopted because large stresses were present in the "as cast" condition since the thin spokes cooled faster than the heavy rim. Tensile stresses are first set up in the spokes tending to pull them away from the rim. Since cast iron will flow readily at low stress levels and high temperatures, the spokes stretch to relieve the stress. The spokes, being colder, reach room temperature and stop contracting before the rim, which continues to contract and exert a compressive stress on the spokes. The magnitude of stress retained in these wheels before and after heat treatment was

¹⁶ E. A. Rominski and H. F. Taylor, Trans. Amer. Foundrymen's Assoc., 51: pp. 709-731, (1943)

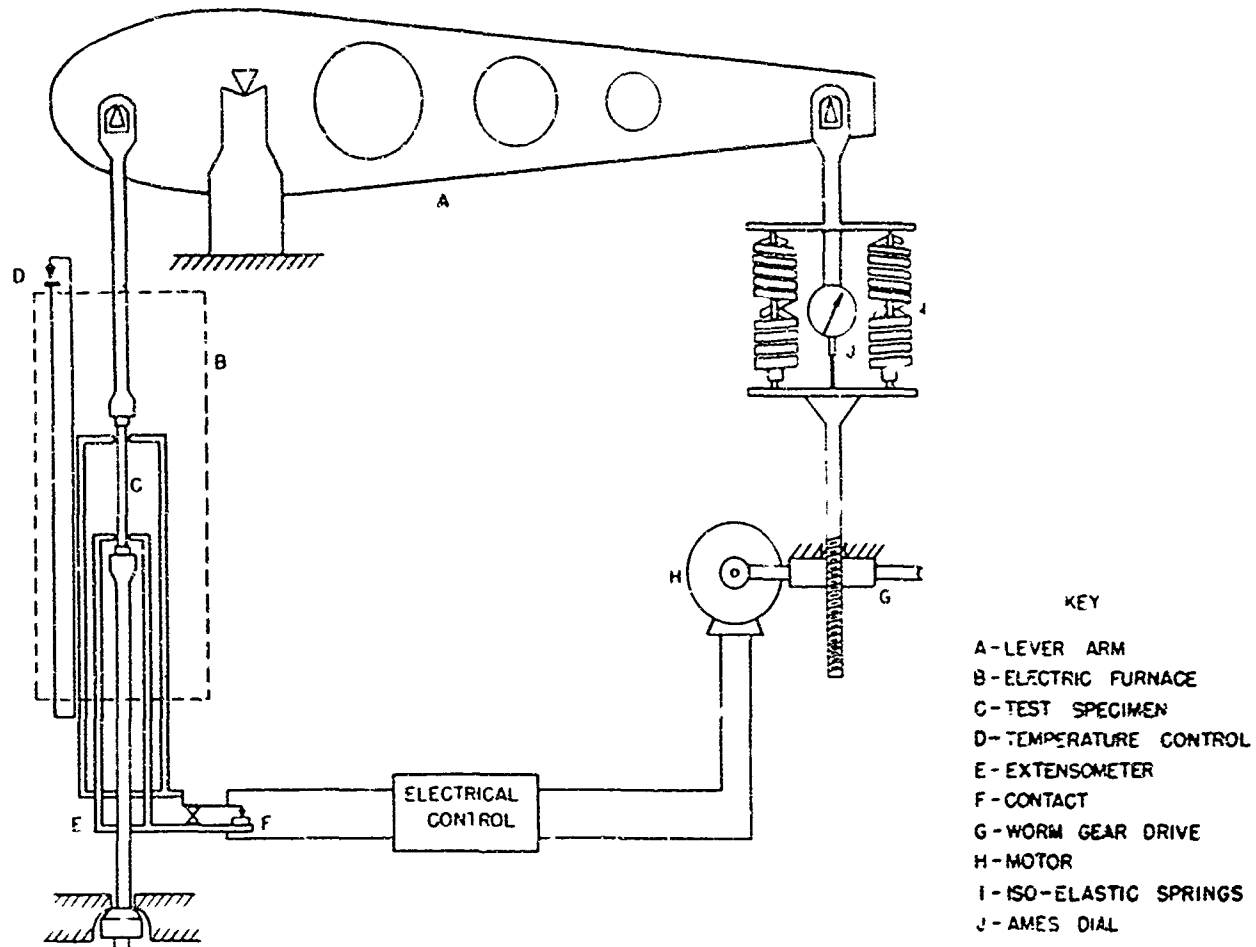

fig. 3 - Sketch of Relaxation Machine

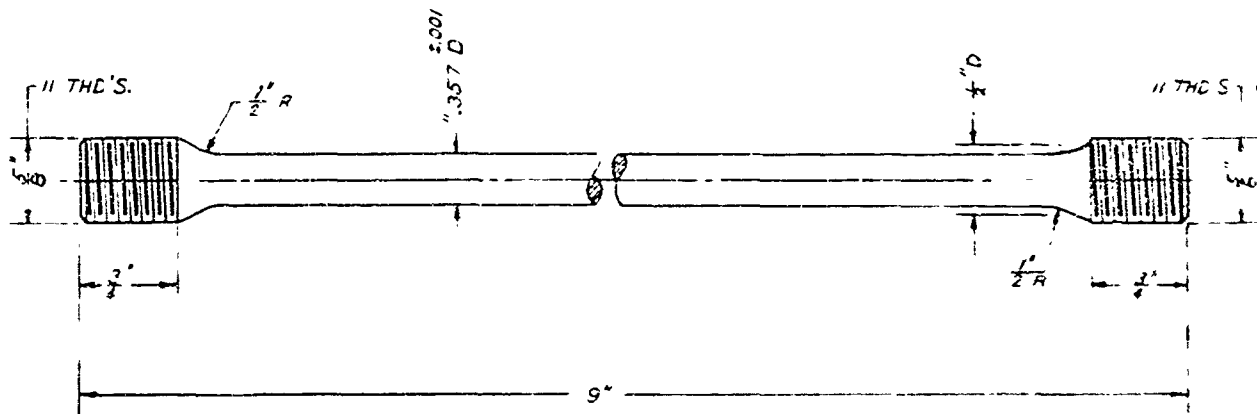

Fig. 4 - Relaxation Test Specimen

determined by drilling reference marks approximately two inches apart on the rim and spoke and by measuring the distance between these marks to within $1/10,000$ of an inch with a Whittemore Strain Gage. The rim was sawed on both sides of the reference spoke so that both the rim and spoke were free to

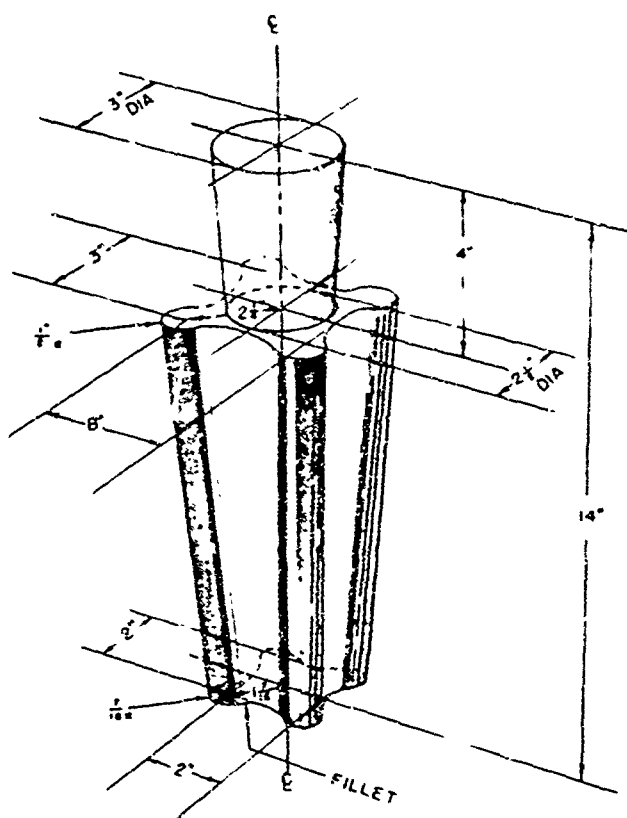

Fig. 5 - Ingot from which Relaxation Test Specimens Were Made

move in such a manner as to relieve the internal stresses. The distance between the reference marks was then measured again and the net change indicated the degree of internal stress. Figure 7 shows the position of the reference marks, the saw cuts, and a measurement being made on the spoke with the gage. Since the expansion was much greater across the saw cuts in the rim than along the spoke, the former measurements were used in tracing the removal of stress by heat treatment.

The first experimental work consisted of a series of relaxation tests on a heat poured at the Naval Research Laboratory to determine the general effect of time and temperature. This was followed by relaxation tests on bars of different chemistry supplied by the Gray Iron Founders' Society to find the influence of chemistry. The analyses of these bars are given in Table 1. Stress-relief studies were

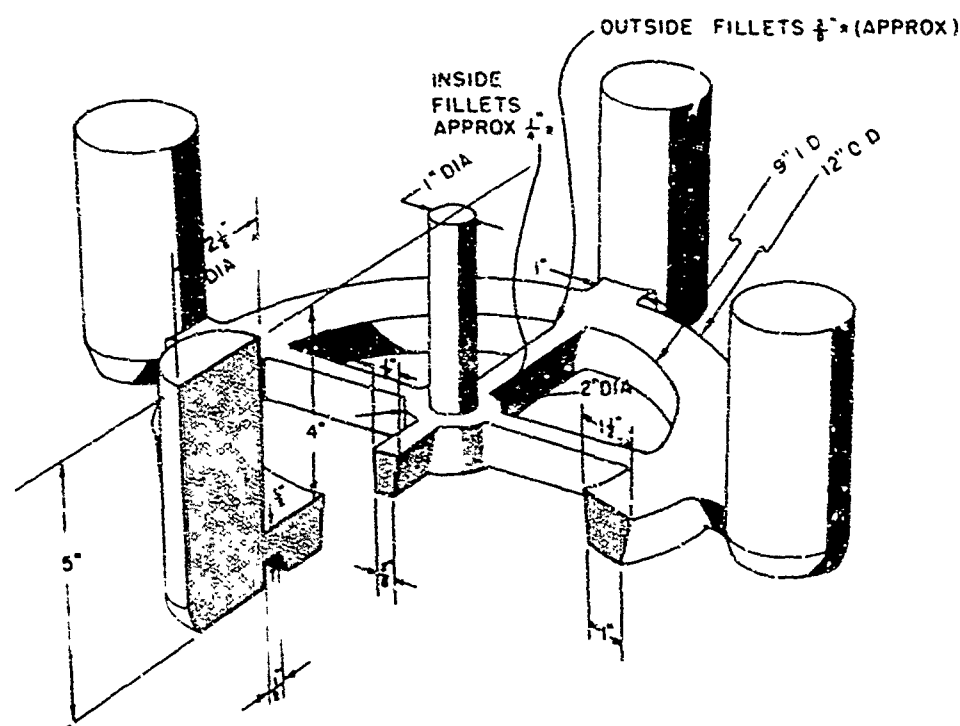

Fig. 6 - Test Casting Containing High "As-Cast" Stresses

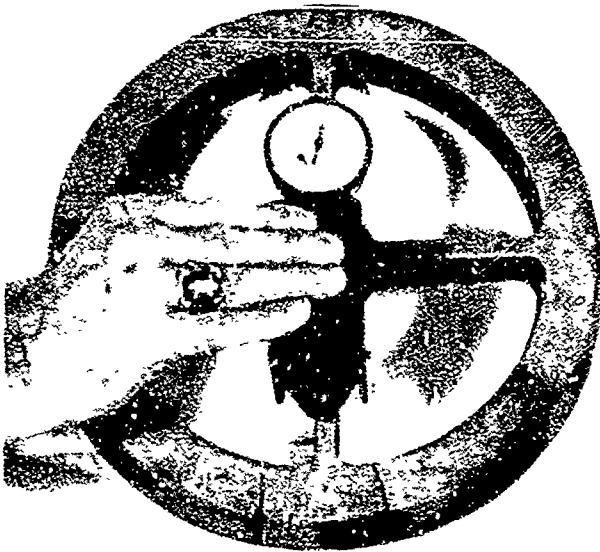

Fig. 7 - Measuring Strain in Stress Wheel after Saw Cuts Have Been Made

then made on some stress-wheel castings poured at the Naval Research Laboratory to determine what effect the cooling rate from the heat treating temperature might have, and then stress-wheels supplied by the Gray Iron Founders' Society and poured from the same heats as the relaxation bars were heat treated using the cooling rate that was found to introduce the minimum of stress.

DISCUSSION OF EXPERIMENTS

Relaxation Tests

An investigation of effects of temperature and time on relaxation was conducted on some Naval Research Laboratory experimental sand-cast ingots containing 2.72% C - 1.97% Si - 0.51% Mn - 0.080% S - 0.141% P. Relaxation specimens were loaded to a

Table 1
Chemical Analysis of Groups of
Relaxation Specimens and Stress Wheels

Group Number	C	Si	Mn	S	P	Ni	Cr	Mo
1	3.21	1.74	0.70	0.094	0.111	1.05	0.15	0.53
2	3.82	2.19	0.85	0.044	0.115	0.10	0.47	0.42
3	3.58	2.24	0.64	0.092	0.140	0.10	0.08	0.04
4	3.41	2.33	0.62	0.124	0.244	0.10	0.03	0.04
5	3.60	2.49	0.64	0.076	0.378			
6	3.51	2.15	0.69	0.113	0.138	0.25	0.25	0.04
7	3.29	2.18	0.97	0.135	0.112	0.25	0.25	0.05
8	3.16	1.70	1.13	0.109	0.064	0.10	0.10	0.03
9	3.00	1.65	0.92	0.086	0.057	1.44	0.28	0.50
10	3.47	1.90	0.89	0.089	0.097	0.10	0.20	0.04
11	3.01	2.36	0.70	0.095	0.344	0.20	0.05	0.04

value which produced between 0.2 - 0.4 percent strain on the 6-inch gage length. As would be expected, the higher the testing temperature, the lower was the applied stress required to produce this amount of strain. Typical loading curves for three different temperatures are given in Figure 8. As the temperature increases, the strain for any given stress increases and since gray iron has no definite yield point, but instead a small plastic strain component at all stress levels, this strain represents both elastic and plastic deformation.

Fig. 8 - Effect of Temperature on Stress - Strain Curves Obtained when Specimens Were Loaded in Relaxation Machine

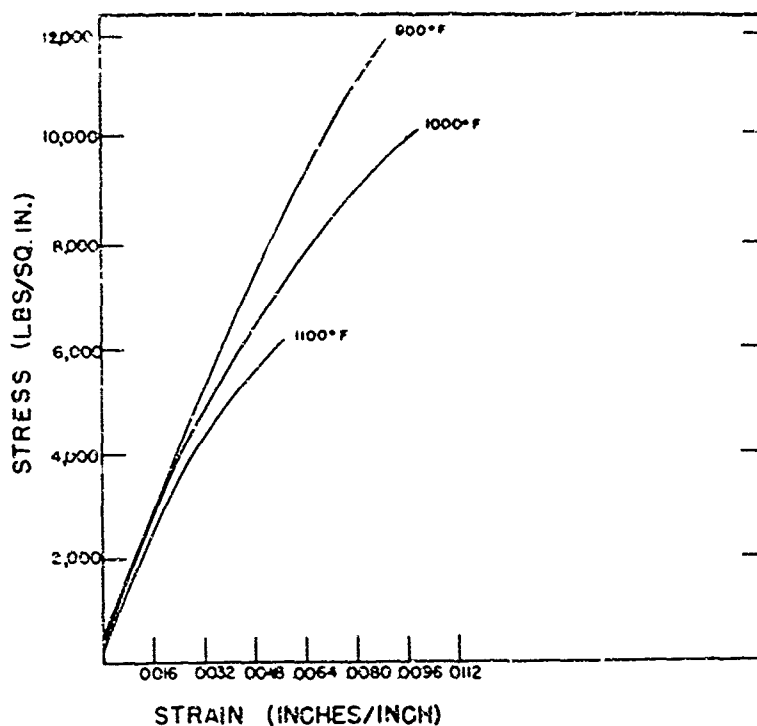

Duplicate specimens were tested at temperatures ranging from 72°F to 1100°F. The effect of testing temperature on the rate at which the applied stress was reduced is shown in Figure 9. Low temperature treatments had only a slight effect on lowering of stresses; sixteen hours at room temperature had practically no effect. Treatment at 900°F reduced the stress only from 14000 to 10000 pounds per square inch in 100 minutes, but when the

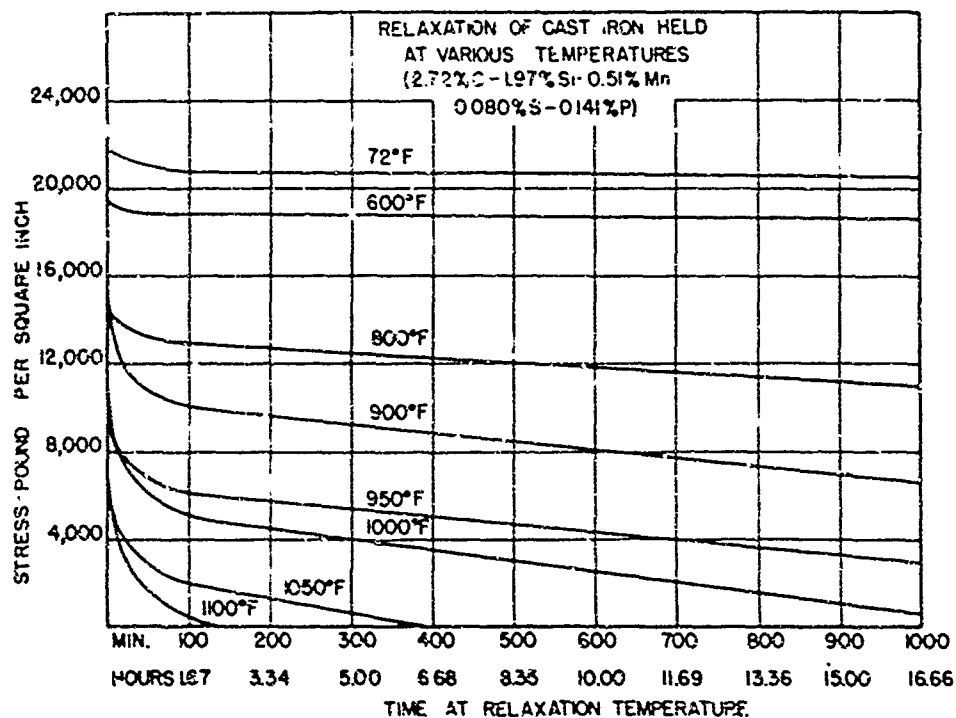

Fig. 9 - Effect of Temperature on Relaxation Rate

testing temperature was raised to 1100°F, essentially complete relaxation took place in approximately one and a half hours. In all cases the rate of stress relief was greatest during the first hour at temperature, and then decreased as the time at temperature increased.

Of special interest was a test in which a specimen was reloaded to the original stress level and given a second relaxation test. As may be seen in Figure 10, the second relaxation rate was slower than the first indicating a decreased rate of plastic flow. Thus only one relaxation test could be made on each specimen.

Since these tests showed the ineffectiveness of low-temperature heat treatment of stress relief, the commercial sand-cast ingot specimens were tested in the temperature range of 800°F - 1150 F. Figures 11 through 21 show the relaxation rates for the 11 groups of commercial cast irons at various temperatures. The following general observations may be drawn from these graphs:

(1) By a comparison of the relaxation curves of the alloy irons, Groups 1, 2, and 9 (Figures 11, 12, and 19), with the plain carbon irons, Groups 3, 8, 10, and 11 (Figures 13, 18, 20, and 21), it is apparent that the former require higher temperatures and/or longer holding times to reach the same stress level or the same percentage of stress relief.

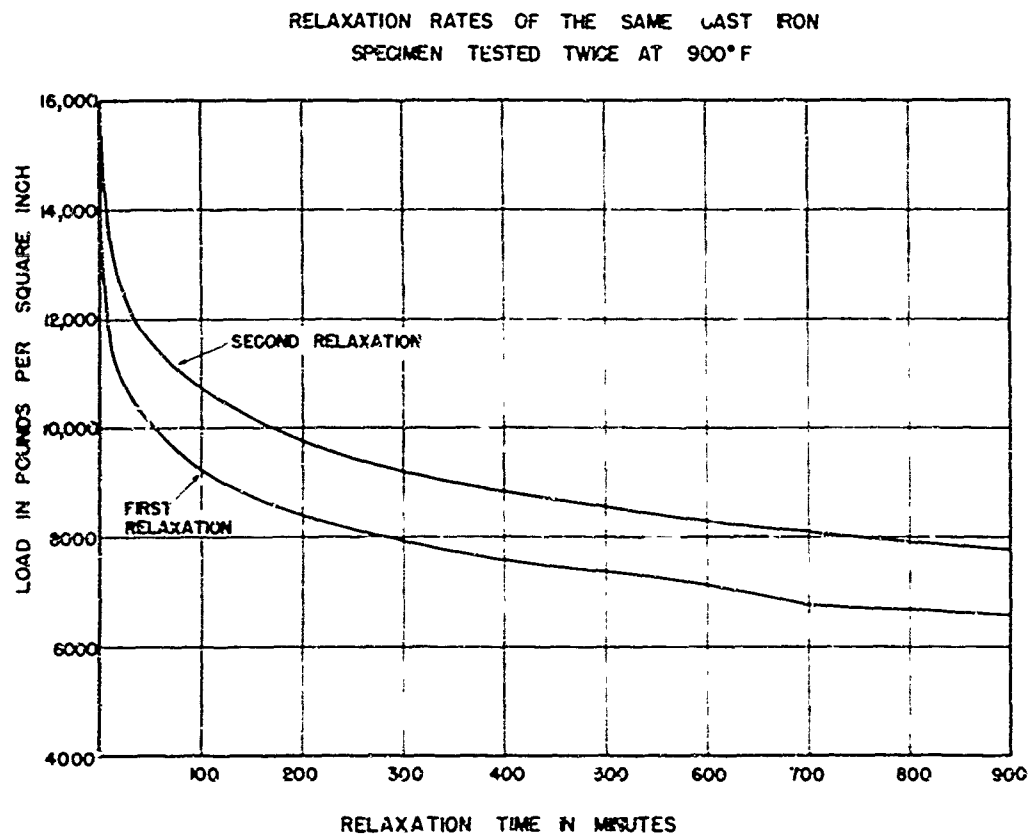

Fig. 10 - Effect of Work Hardening on Relaxation Rate

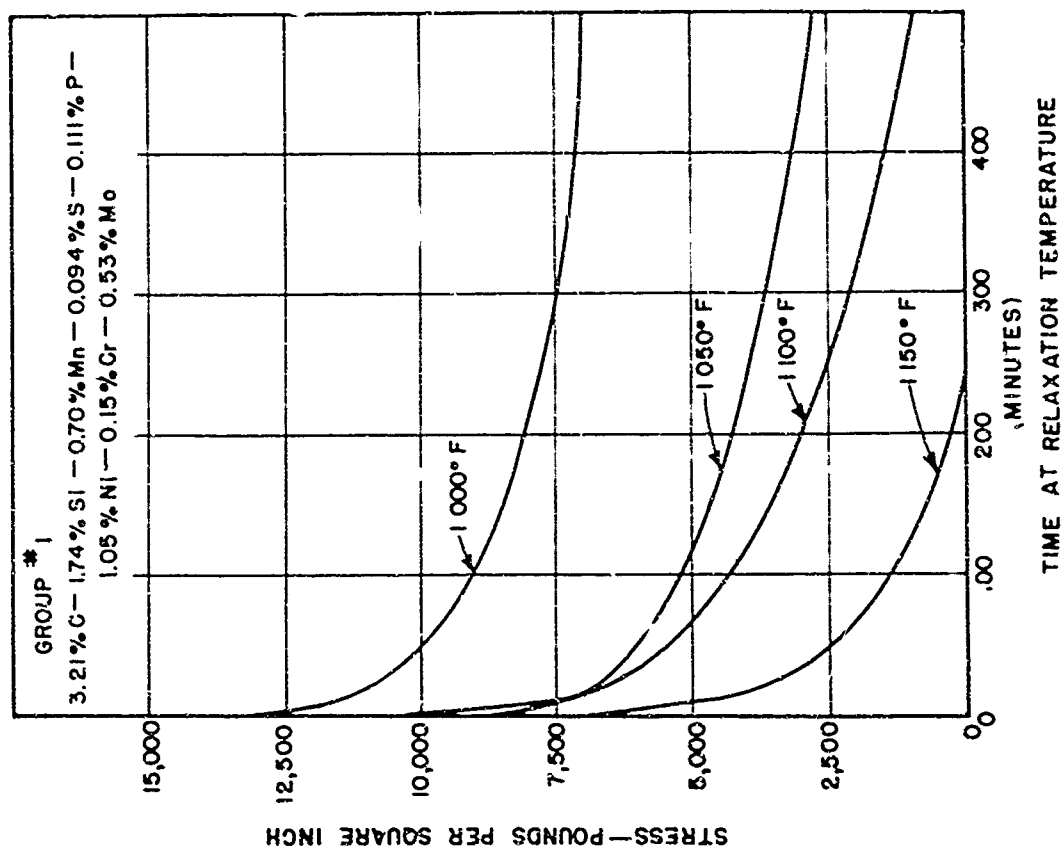

Figure 11

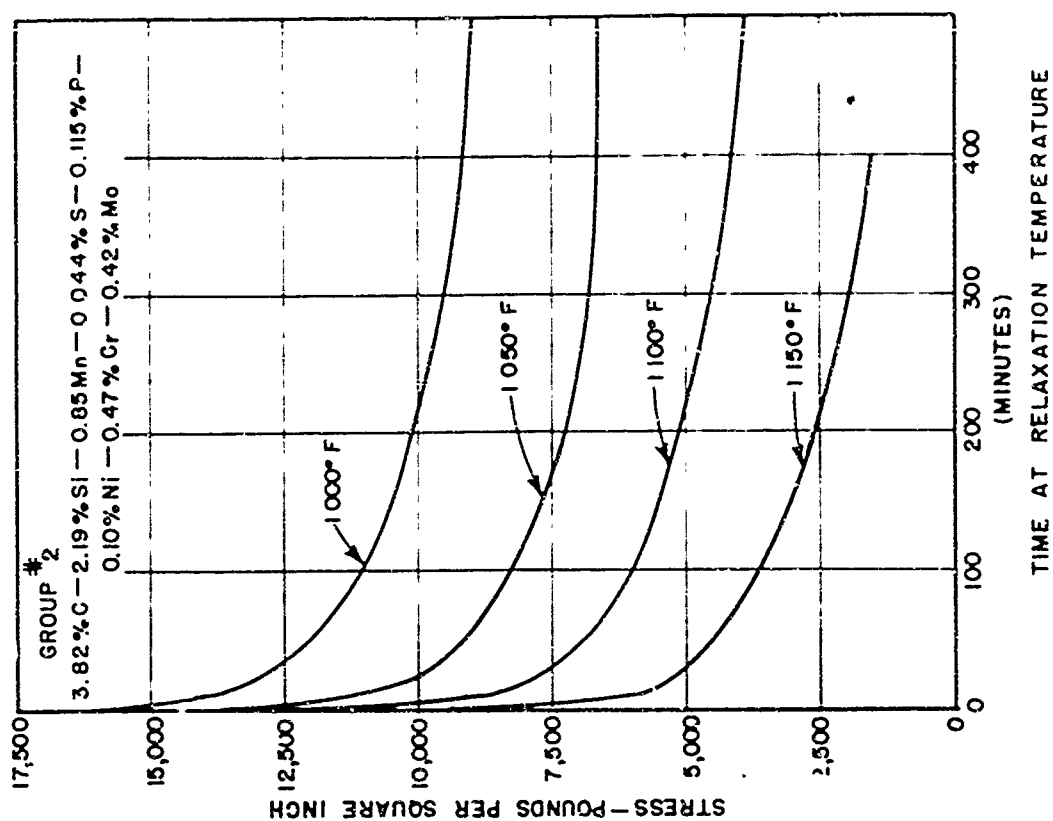

Figure 12

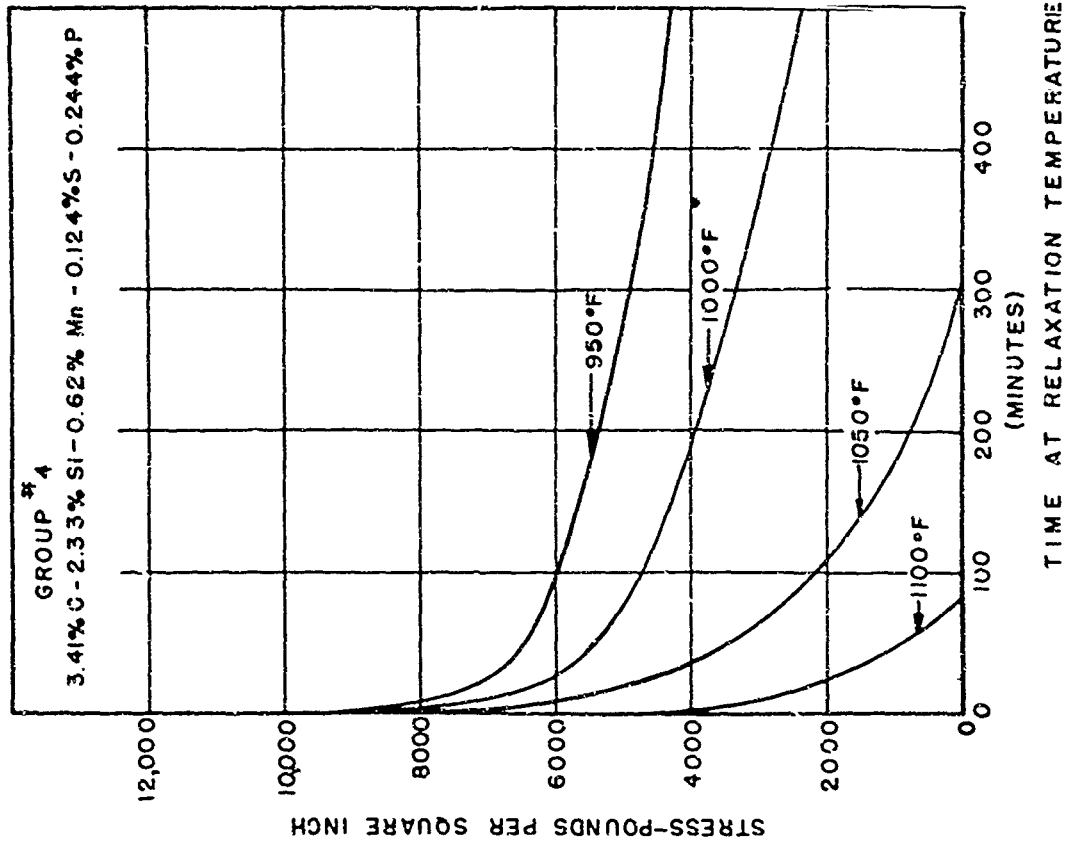

Figure 14

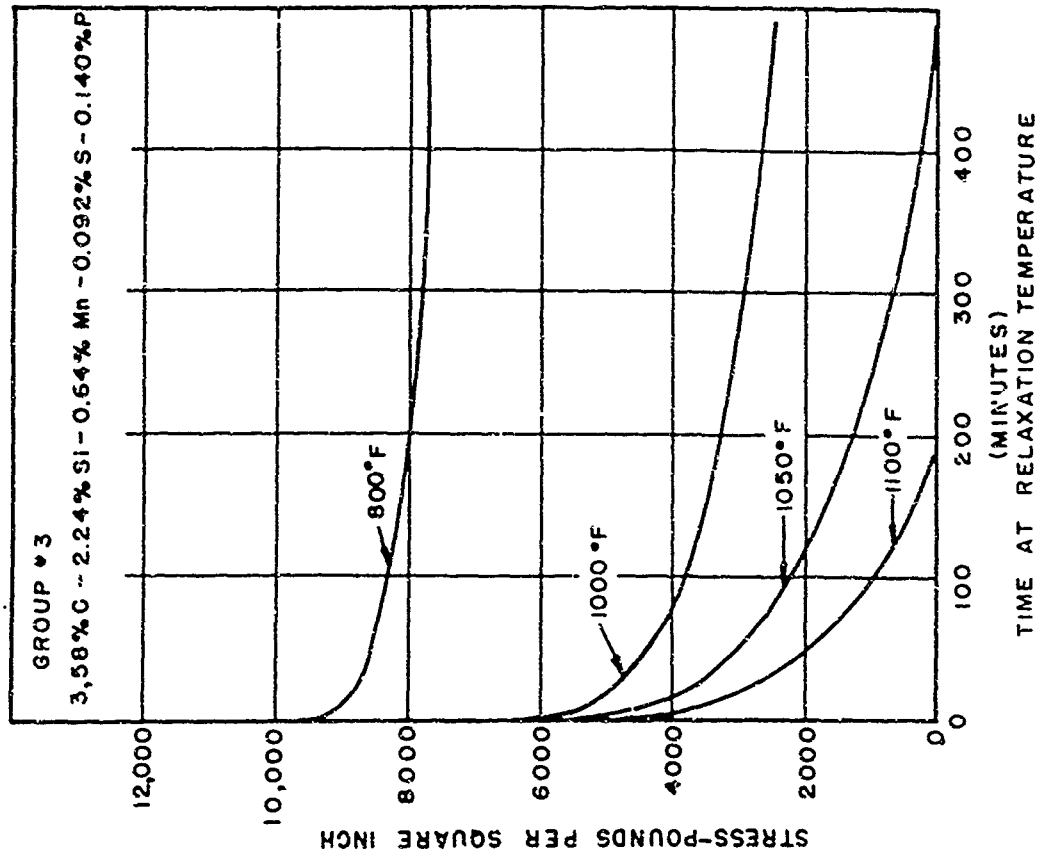

Figure 13

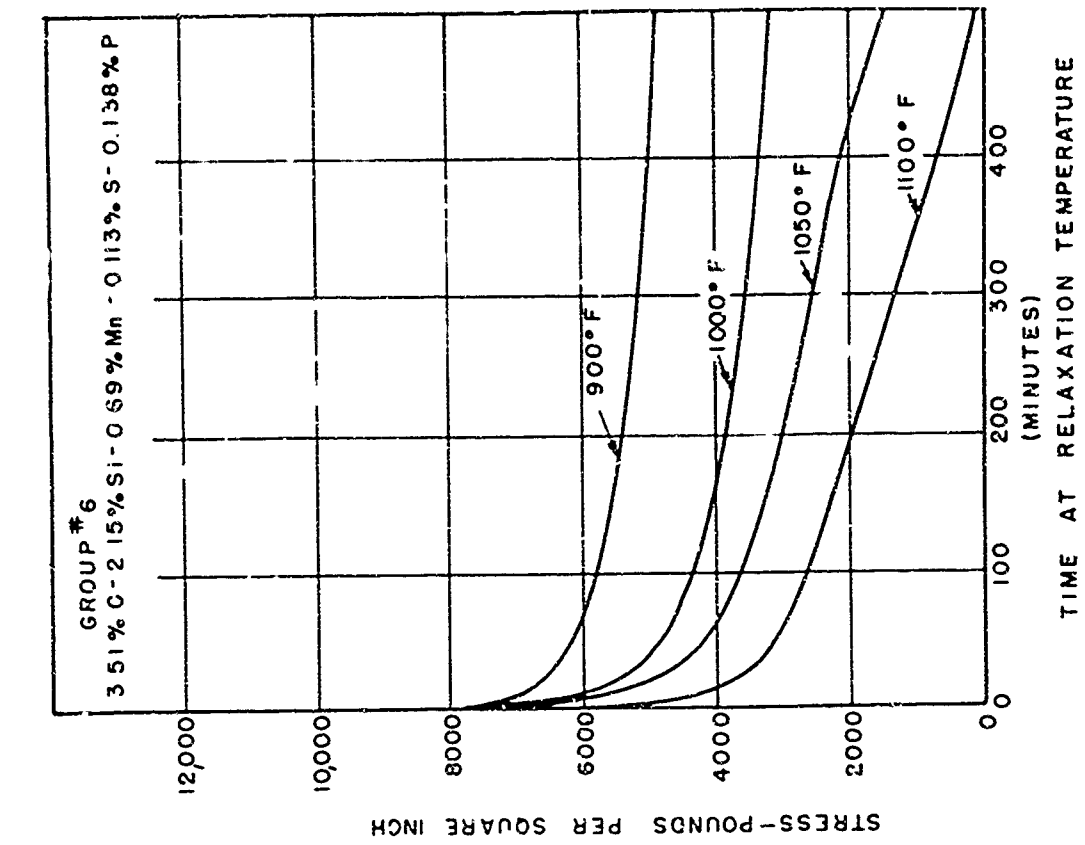

Figure 16

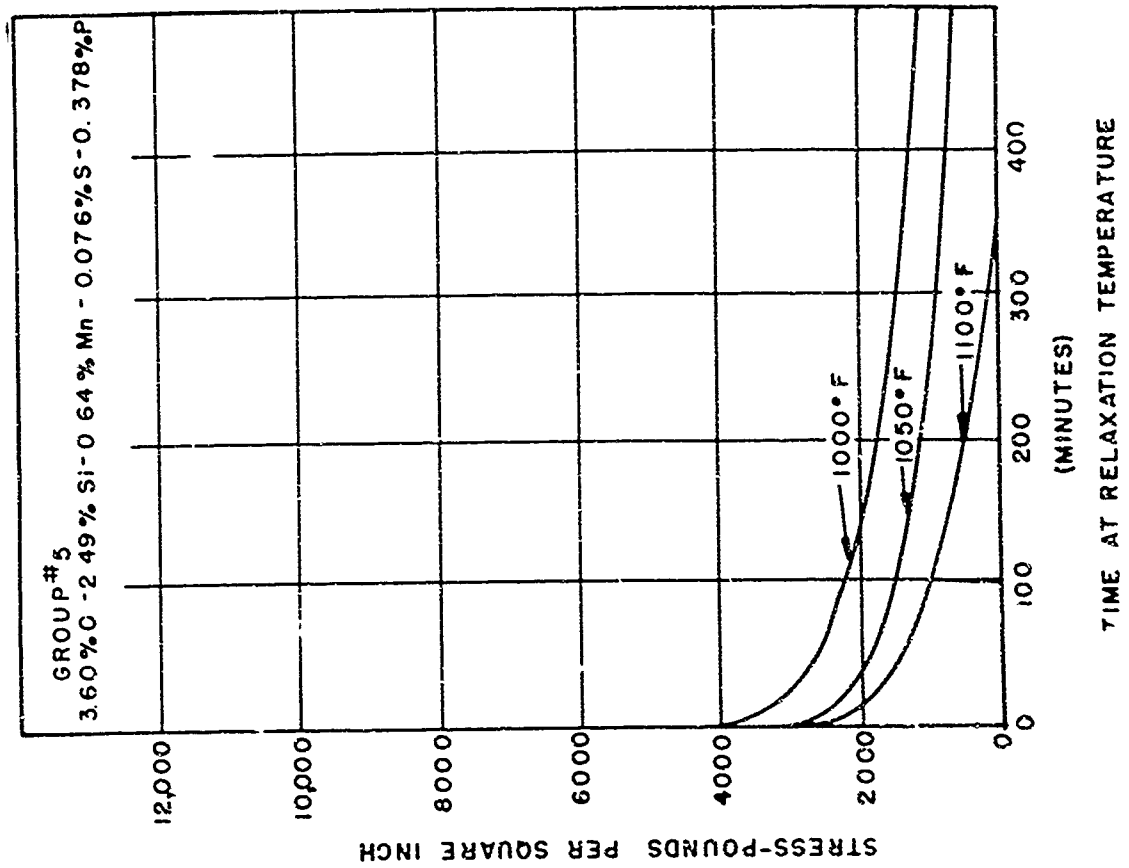

Figure 15

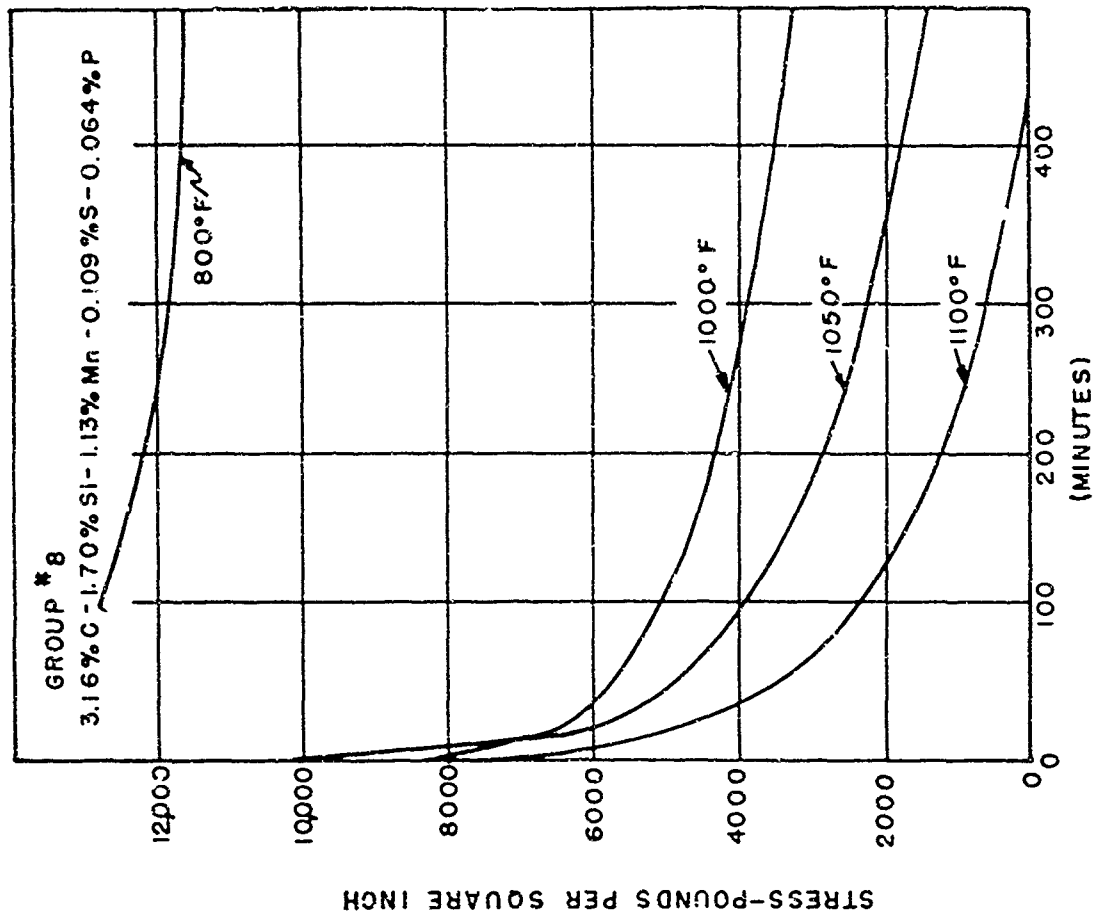

Figure 18

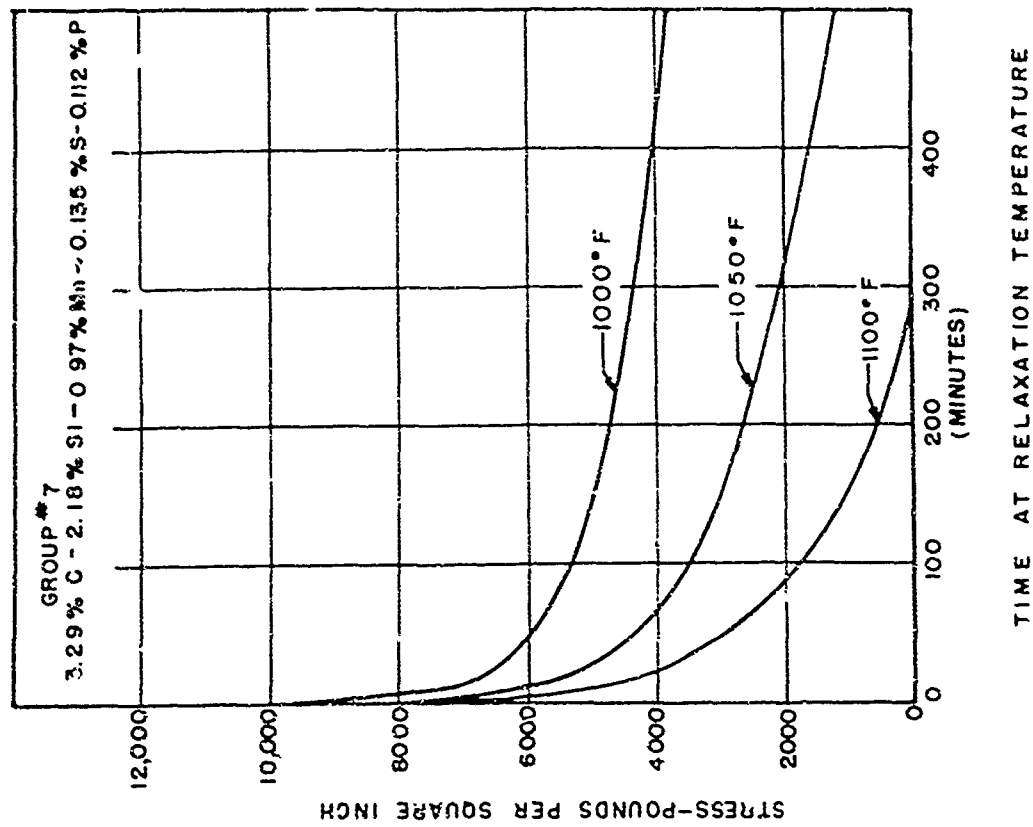

Figure 17

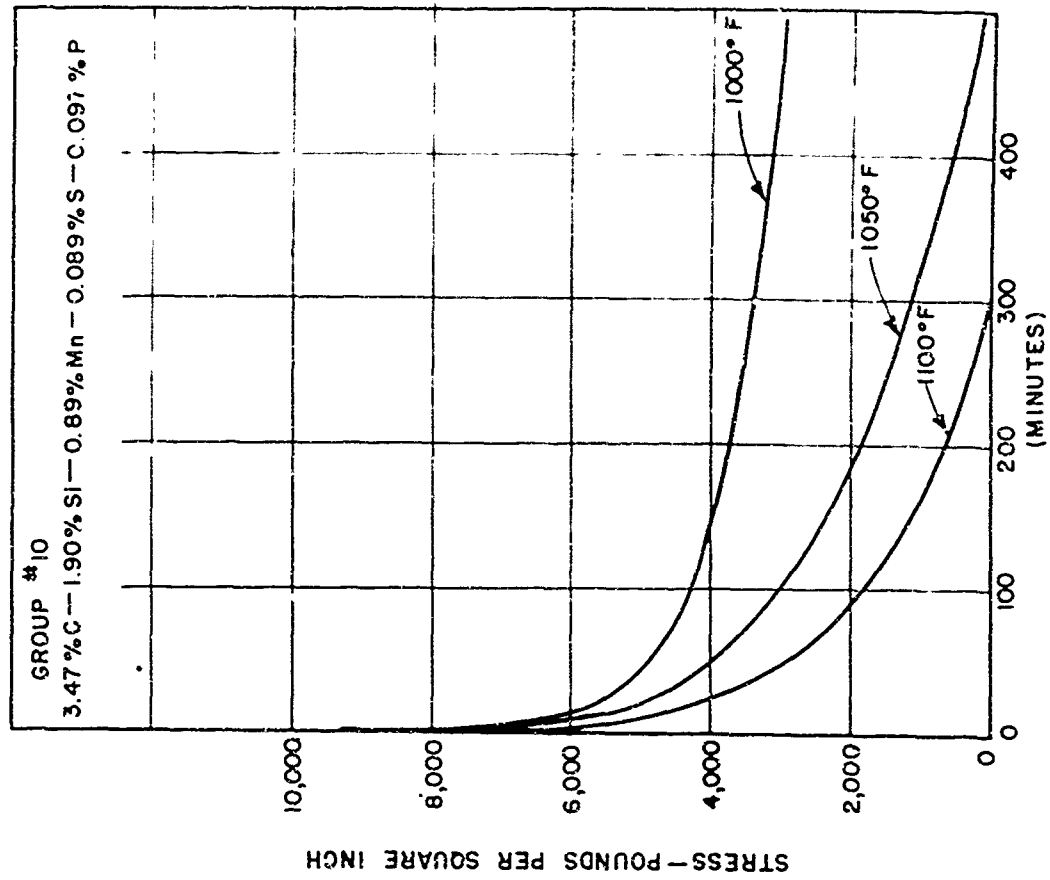

Figure 20

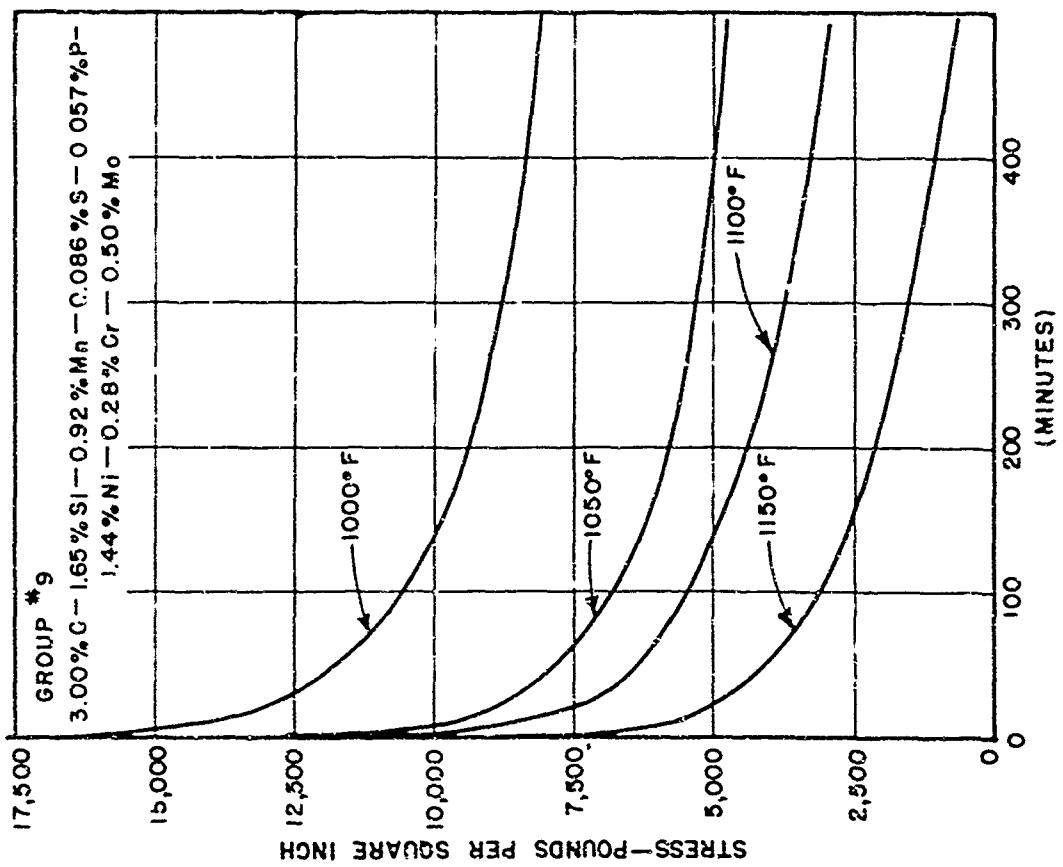

Figure 19

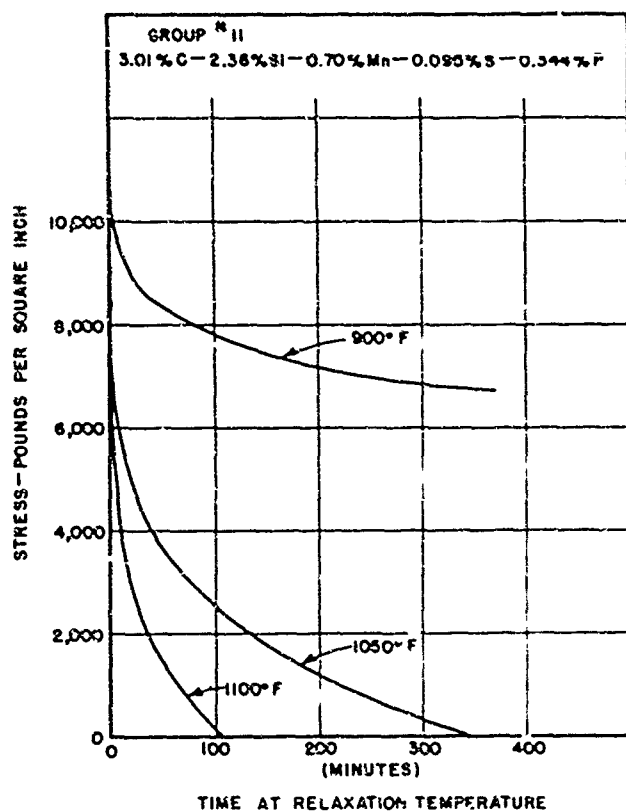

Figure 21

(2) No correlation was found between relaxation rate and equivalent carbon.

(3) Group 10 (Figure 20) shows that if duplicate specimens have the same initial applied stress, the relaxation rate and the total amount of relaxation increase as the testing temperature is increased.

(4) Figure 22 shows the results when three of the specimens were loaded to different stress levels but tested at the same temperature, i.e., 1050°F. By a comparison of the three curves it is evident that for any given temperature the higher the initial stress, the faster the relaxation rate, but the longer the time required to reach any specific residual stress level.

Figure 23 has been constructed from data contained in Figure 21. The various points on the graph show the original applied stress and the

RELAXATION RATE OF GRAY CAST IRON AT 1050°F SHOWING THE EFFECT OF INITIAL STRESS

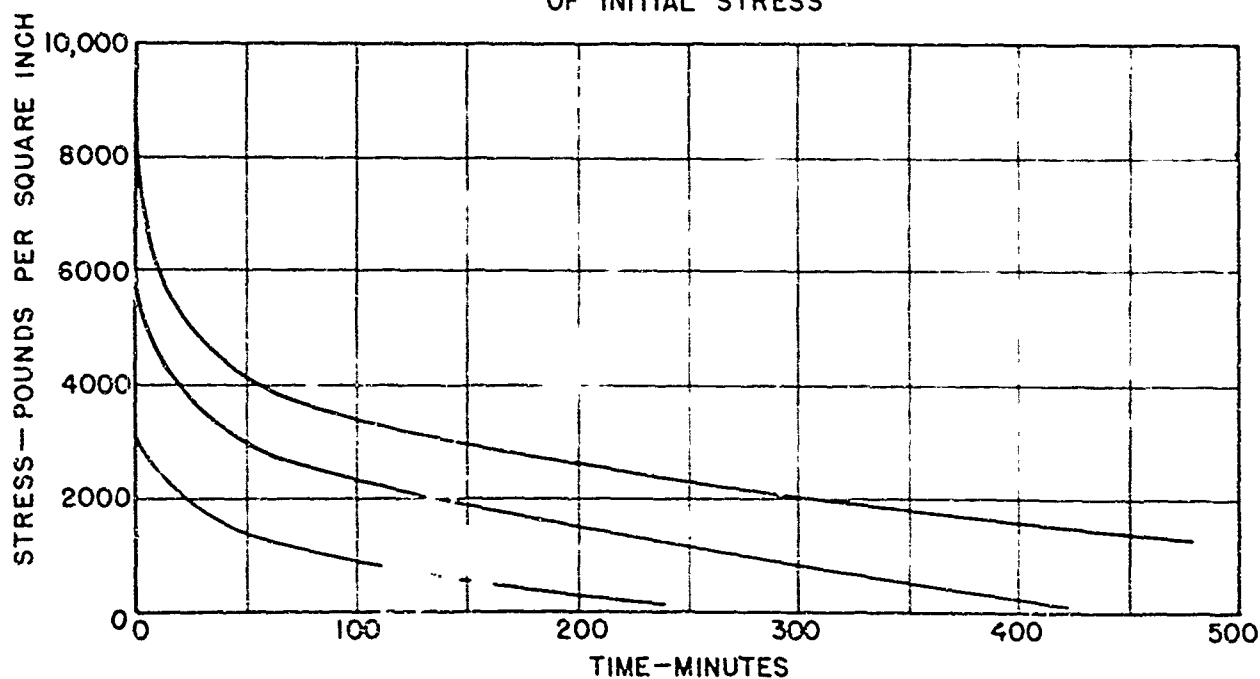

Fig. 22 - Effect of Work Hardening on Relaxation Rate

stress remaining after two hours at the various testing temperatures. The two curves bound the maximum and minimum points. Stress is lowered slowly and incompletely at temperatures below 1000°F, but rapidly and more completely at higher temperatures. The spread of data results from the differences in chemical analyses and in initial maximum stress. Since the modulus of elasticity varies for each alloy, there is unavoidable variation in the ultimate load for each test when loading to 0.2 - 0.4 percent strain on the 6-inch gage length. Nevertheless, the general trend of an increasing rate of stress relief at higher temperatures is clearly shown.

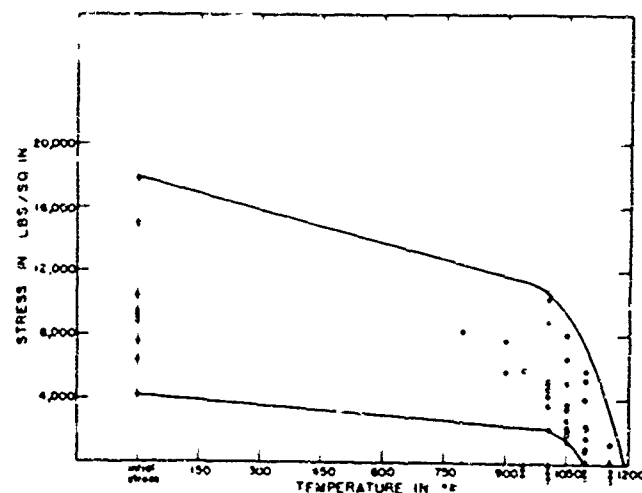

Fig. 23 - Residual Stress in Relaxation Specimens at the End of Two Hours at the Indicated Temperature

The relaxation data are summarized in a different manner in Figure 24. The points on this graph represent the initial stress, and that remaining after the specimens were held at 1050°F for the indicated time. The reasons for the spread of data have been previously given. The curves of maximum and minimum stress show the rapid initial rate of stress relief and the leveling off after the first hour at temperature.

Stress Wheel Tests

Before conducting stress-relief heat treatments on the limited number of stress wheels received from the commercial foundries, an experiment was

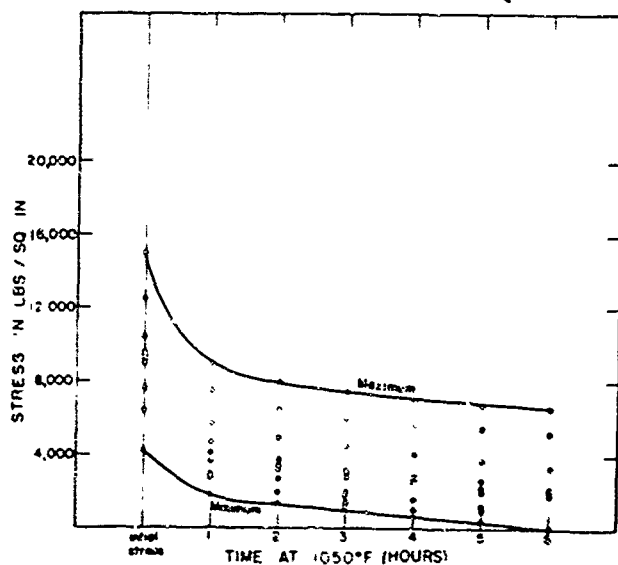

Fig. 24 - Residual Stress in Relaxation Specimens Heat Treated at 1050°F for the Indicated Time

conducted on Naval Research Laboratory wheels to determine the effect of furnace versus air cooling from the stress-relieving temperature.

The following strain gage measurements were obtained in this experiment:

<u>Heat Treatment</u> <u>of Wheel</u>	<u>Rim Strain* (Inches)</u>	
	Air Cooled	Furnace Cooled
1 hr at 1050°F	.0089	.0034
24 hr at 1050°F	.0052	.0019

* As Cast rim strain - 0.0183

The difference between the residual stresses in air-cooled and furnace-cooled castings results from

the unequal cooling rates existing between heavy and thin sections when air-cooled; the slower furnace cooling keeps all parts of the casting at approximately the same temperature during cooling. It is interesting to note that one hour at 1050°F followed by furnace cooling results in lower residual stress than 24 hours at temperature followed by air cooling. Thus air cooling may introduce considerable additional stresses. For this reason furnace cooling was adopted for all commercial stress wheels studied.

On the commercial wheels, studies were made to determine:

- (1) The strain reduction effected by two hours at various temperatures, and
- (2) The strain reduction effected by varying lengths of time at 1050°F.

The procedure followed in treating the wheels was to place them in a furnace at room temperature, to heat to the desired maximum, to hold for a specified period of time, and then to furnace-cool.

Although a casting may be held at the maximum heat-treating temperature for only one hour, during the heating and cooling cycle, the temperature of the casting is sufficient to effect further stress relief. Therefore the extent of stress relief in a casting held one hour at temperature will be slightly greater than that obtained in a specimen held at similar temperature and time in the relaxation machine.

The data on effect of temperature variation at constant time are shown in Figure 25. They are in agreement with the relaxation data in Figure 23. The stresses in the rim are reduced only slightly by two hours of heat

treatment below 800°F. However two hours at temperatures above 950°F produce substantial reductions of stress.

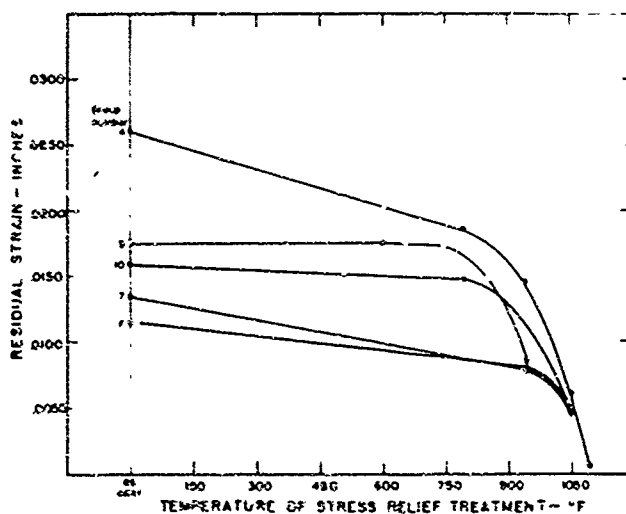

Fig. 25 - Strain Reduction Effected by Holding Industry Wheels at Varying Temperatures for Two Hours and Furnace Cooling

In a test to show the ineffectiveness of long stress-relief treatment at low temperatures, stress wheels of two different metal compositions were held at 600°F for 24 hours. Wheel A had an as-cast rim strain of 0.0174 inches and a final strain after heat treatment of 0.0168 inches. Wheel B tested 0.0187 inches originally and its duplicate 0.0157 inches after treatment. Thus appreciable stress relief is not obtained at 600°F for one day.

The data on effect of time variation at constant temperature are summarized in Figure 26. The temperature

of 1050°F was selected because preceding experiments had indicated considerable stress-relief action at this temperature. A marked reduction of internal stresses occurred during the first and second hours at temperature, after which the rate decreased rapidly in a way similar to the relaxation data given in Figure 24. The spread of data has been previously explained

The results of tests on the stress-wheel castings appear to agree closely with those from the relaxation tests. The advantage of the relaxation test for obtaining stress-relief data is apparent, since one such test gives a complete stress-time curve while a large number of wheel castings are required to yield the same information.

Stress Relieving by Other Methods

Since many foundries claim to have stress-relieved castings by aging them outside for periods ranging from six months to a year, several tests were made in an attempt to evaluate this practice. In the first test, four stress wheels were poured from the same ladle of metal having a composition of 3.52% C - 1.93% Si - 0.46% Mn - 0.130% S - 0.148% P. One wheel was sawed the following day and the others were allowed to age inside the foundry for varying periods of time. The following data summarizes the effect of time on stress reductions:

Aging Time	Strain Observed in Rim by Sawing
1 day	0.0088 inches
3 months	0.0088 inches
1½ years	0.0089 inches

Indoor aging obviously did not reduce the "as cast" stress in these wheels.

The effect of outdoor aging has been said to be due to the alternate heating and cooling of the casting. A rapid check on this theory was made by placing a stress wheel in a dry-ice box at 0°F for two hours and then transferring it to an oven at 220°F for two hours. After four complete cycles

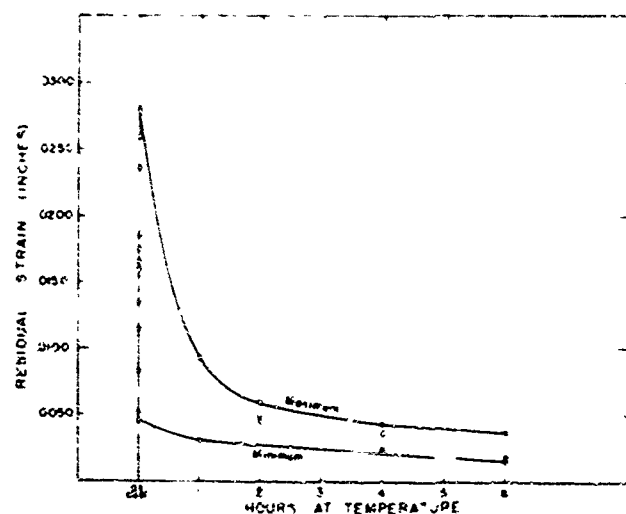

Fig. 26 - Strain Reduction Effected by Holding Industry Wheels at 1050°F for Varying Lengths of Time Followed by Furnace Cooling

of alternate heating or cooling, the rim was sawed and 0.0191 inches of strain was measured. Before this treatment, a duplicate wheel showed 0.0209 inches of strain. Thus only a small amount of stress reduction was obtained by this treatment.

Besides the temperature changes to which castings are subjected in outdoor aging, the possibility that corrosion relieves a part of the stresses locked in the outer skin of the casting has been suggested. To determine the effectiveness of such corrosion, a rapid test was conducted by completely immersing a stress wheel in a 6 percent solution of sulfuric acid for 20 minutes at a temperature of 165°F. Sawing of the wheel revealed a residual strain of 0.0130 inches compared with the "as cast" strain of 0.0164 inches. From this observation, it is possible that corrosion might contribute slightly toward relief of casting stresses.

The manner in which stresses are generated in the test wheel were described earlier in this report. In addition to the stress induced by differential cooling, some may result from the resistance that the sand mold offers to the contraction of the rim as it cools. The possible magnitude of this effect was determined by ramming a pattern in the space between the spokes and rim so that relief cavities were produced with approximately one half inch side wall of sand between the outer periphery of the cavities and the inner contour of the wheel. Two wheels were poured with and two without these cavities. The strain amounted to 0.0218 and 0.021 inches on the two wheels without cavities and 0.0211 and 0.0177 inches on the wheels with relief cavities. The difference is not great but does show a trend in the expected direction. Another way to reduce the restricting effect of the sand is to shake out the castings shortly after pouring. That this practice might be helpful is shown by the data in the following table which lists the strain measurements made on five wheels poured from the same ladle of metal and shaken out at various time intervals.

<u>Casting Number</u>	<u>Time Interval</u>	<u>Rim Strain</u>
1	5 Min	0.0035
2	10 Min	0.0041
3	20 Min	0.0084
4	1 Hr 20 Min	0.0114
5	13 Hr 36 Min	0.0114

Up to about the first hour after pouring the strain increased with time; after this it remained constant, indicating that the resistance offered by the sand may increase the degree of internal stress.

CONCLUSIONS

Relaxation Tests indicate that:

- (1) If the initial stress and the composition of specimens are the same, the relaxation rate and degree of stress reduction increases as the temperature is increased.
- (2) Rate of stress reduction is very slow below 1000°F.
- (3) Rate of stress reduction is most rapid during the first hour at temperature, and decreases as the time at temperature increase..
- (4) For any given temperature, the higher the initial stress, the faster the initial relaxation rate, but the longer the time required to reach any specific residual stress level.
- (5) Alloy irons require higher temperatures and/or longer holding times to reach the same stress level as plain carbon irons.

Stress Wheel Tests indicate that:

- (1) Two hours at temperatures below 800°F are ineffective, whereas at temperatures above 950°F substantial stress reductions are effected in the same time.
- (2) The greatest reduction of internal stresses occurs during the first hour at temperature.
- (3) Heat treatment at 600°F for 24 hours shows practical' no stress reduction.
- (4) Air cooling after stress-relief heat treatment may introduce considerable additional stresses which do not develop with furnace cooling.

Other Tests indicate that:

- (1) Indoor aging is an ineffective method for stress relieving.
- (2) Alternate heating and cooling of stress wheels between 0°F and 220°F produces only a very slight stress reduction.
- (3) Corrosion of stress wheels with a mineral acid results in a very slight relief of internal stress.
- (4. The resistance of the mold sand may hinder the contraction of a casting in such a way as to materially increase the internal stress.

The relaxation machine gives a good indication of the stress-relief characteristics of gray cast iron and provides this information more easily than can be obtained from actual castings.

ACKNOWLEDGMENT

The author wishes to gratefully acknowledge the assistance of F. A. Brandt and W. O. Baker in conducting the relaxation tests and interpreting the data.

* * *