

TR 13623  
Cop. 3

**U. S. A R M Y**  
**TRANSPORTATION RESEARCH COMMAND**  
**FORT EUSTIS, VIRGINIA**

TRECOM TECHNICAL REPORT 64-34

**GEMINI 1-TON, AMPHIBIOUS, OFF-HIGHWAY,  
AIR-TRANSPORTABLE VEHICLE  
CONCEPT EVALUATION PROGRAM**

FINAL REPORT

Task 1D021701A04813  
Contract DA 44-177-AMC-21(T)

July 1964

PROPERTY OF U. S. ARMY  
TRECOM  
TECHNICAL LIBRARY

AD-607345

prepared for:

CANADIAN COMMERCIAL CORPORATION  
Toronto, Ontario, Canada

by:

Engineering Division  
Hawker Siddeley Canada Ltd.

OCT 26 1964



## DISCLAIMER NOTICE

When Government drawings, specifications, or other data are used for any purpose other than in connection with a definitely related Government procurement operation, the United States Government thereby incurs no responsibility nor any obligation whatsoever; and the fact that the Government may have formulated, furnished, or in any way supplied the said drawings, specifications, or other data is not to be regarded by implication or otherwise as in any manner licensing the holder or any other person or corporation, or conveying any rights or permission, to manufacture, use, or sell any patented invention that may in any way be related thereto.

\* \* \*

## DDC AVAILABILITY NOTICE

Qualified requesters may obtain copies of this report from

Defense Documentation Center  
Cameron Station  
Alexandria, Virginia 22314

\* \* \*

This report has been released to the Office of Technical Services, U. S. Department of Commerce, Washington 25, D. C. , for sale to the general public.

\* \* \*

The findings and recommendations contained in this report are those of the contractor and do not necessarily reflect the views of the U. S. Army Mobility Command, the U. S. Army Materiel Command, or the Department of the Army.

HEADQUARTERS  
U S ARMY TRANSPORTATION RESEARCH COMMAND  
FORT EUSTIS, VIRGINIA 23604

The principle of air cushion assist for wheeled vehicles has been demonstrated by models and by skirted conventional vehicles. Little data has been available, however, relative to the effect of the cushion strength on tractive effort.

The configuration investigated was a full-scale test bed of a four-wheeled, articulated, off-road vehicle conceived by Hawker Siddeley Canada, Ltd., employing annular jet air cushion assist in both sections.

Tests in moist clay and FI muskeg demonstrated (1) that there is an ideal wheel loading for each soil/vehicle relationship that is less than can be economically achieved in an off-road vehicle and (2) that air cushion assist can be utilized to adjust the vehicle weight to permit operation at the optimum wheel loading.



WILLIAM E. SICKLES  
Group Leader  
Ground Effect Research Group

APPROVED.

FOR THE COMMANDER:

  
LARRY M. HEWIN  
Technical Director

U.S. Contract DA 44-177-AMC-21 (T)  
Canadian Contract DDP File 91-338 S.N.4MX3-2  
Task 1D021701A04813  
TRECUM Technical Report 64-34  
July 1964

GEMINI 1-TON, AMPHIBIOUS, OFF-HIGHWAY,  
AIR-TRANSPORTABLE VEHICLE -  
CONCEPT EVALUATION PROGRAM -  
FINAL REPORT

Prepared for Canadian Commercial Corporation by  
Hawker Siddeley Canada Ltd.  
Engineering Division  
Toronto, Ontario

for  
U.S. ARMY TRANSPORTATION RESEARCH COMMAND  
FORT EUSTIS, VIRGINIA



## PREFACE

The work described in this report was carried out by Hawker Siddeley Canada Ltd., Engineering Division. The principal engineering members of this organization who were involved in the project are as follows:

Mr. F.P. Mitchell, Vice President Engineering  
Mr. G.C. Best, Deputy Chief Engineer  
Mr. F.H. Keast, Director of Research  
Mr. P.K. Peterson, Engineering Laboratories Manager  
Mr. R.F.C. Tanner, Engineering Manager - Defence Vehicles  
Mr. R.G.A. Chisholm, Engineer  
Mr. N.B. Herbert, Engineer  
Mr. W.U. Shaw, Senior Engineer

The fan hub and bearings used in the test vehicle were provided by the National Research Council of Canada through Dr. D.C. MacPhail, Director of the Division of Mechanical Engineering, and this assistance is gratefully acknowledged.

Acknowledgement is also made of the assistance rendered by the following members of the Organic and Associated Terrain Research Unit of McMaster University, Hamilton, Ontario.

Dr. N.W. Radforth, Chairman  
Dr. D.B. Sumner  
Prof. J.N. Siddall  
Prof. W.R. Newcombe  
Prof. N.E. Wilson  
Prof. H.A. Wood  
Mr. K. Ashdown

## CONTENTS

	<u>Page</u>
PREFACE	iii
LIST OF ILLUSTRATIONS	vi
SUMMARY	1
CONCLUSIONS AND RECOMMENDATIONS	2
DISCUSSION	3
Introduction	3
Description of Test Vehicle	4
Test Instrumentation	15
Preparation of Clay Beds	20
Muskeg Site	22
Test Results	27
APPENDIX I - ORGANIC AND ASSOCIATED TERRAIN RESEARCH UNIT REPORT	55
APPENDIX II - DRIVER'S NOTES	107
DISTRIBUTION	117

## ILLUSTRATIONS

<u>Figure</u>		<u>Page</u>
1	Three-Quarter Front View of Gemini Phase I Test Vehicle	10
2	General Arrangement of Gemini Phase I Test Vehicle	11
3	Engine Installation Showing Double Radiator	13
4	Drive Train	14
5	Instrumentation Package	19
6	Grain Size Distribution	23
7	Plot of Mohr's Circles - Consolidated Drained Triaxial Tests (Brown Silty Clay)	24
8	Penetrometer Readings - West Clay Bed	25
9	Penetrometer Readings - East Clay Bed	26
10	Velocity Distribution Behind Fan at 5750 R.P.M.	39
11	Characteristics for Gemini Fan	40
12	Engine Power vs. Cushion Height	41
13	Gemini Tests on Asphalt	42
14	Gemini Phase I Test Vehicle Crossing Muskeg	43
15	Tractive Effort vs. Slip - East Clay Bed	44
16	Tractive Effort vs. Slip - East Clay Bed	45
17	Tractive Effort vs. Slip - East Clay Bed	46
18	Tractive Effort vs. Slip - Muskeg Site 3	47

ILLUSTRATIONS (Cont'd)

<u>Figure</u>		<u>Page</u>
19	Ratio of Airborne to Total Weight vs. Time in Seconds	48
20	Ratio of Airborne to Total Weight vs. Time in Seconds	49
21	Ratio of Airborne to Total Weight vs. Time in Seconds	50
22	Ratio of Airborne to Total Weight vs. Time in Seconds	51
23	Drawbar Pull vs. Slip - East Clay Bed	52
24	Wheel Speed, Vehicle Speed, and Slip vs. Time in Seconds During Drawbar Pull Test	53
25	Graph 1	66
26	Graph 2	67
27	Area 10f Map	69
28	Area 10g Map	71
29 to 94	Photographs Taken at Muskeg Trials	73-105

## SUMMARY

This report presents the results of testing a full-scale, mock-up chassis representative of a 1-ton, amphibious, off-highway, air-transportable vehicle which utilizes air cushion principles to permit mobility in low-bearing terrain otherwise impassable by a wheeled vehicle. As the main objective of the program was to demonstrate mobility in low bearing terrain, the test vehicle was purely a wheeled platform lacking steering and other essential features of the final version.

The test platform was subjected to tests in prepared clay beds of low cone index and also in FI type muskeg impassable to normal wheeled vehicles. In addition, tests were made on a level hard surface to measure air cushion lift as a function of height.

The clay and muskeg testing demonstrated that air cushion assistance can make mobility possible under conditions which would immobilize conventional wheeled vehicles.

Reference should be made to the conclusions given by Dr. N. W. Radforth in Appendix I, page 55, which were the results of the muskeg testing conducted by the Organic and Associated Terrain Research Unit of McMaster University of Hamilton, Ontario.

The hard surface tests gave results which indicated reasonably good agreement with accepted air cushion theory.

## CONCLUSIONS AND RECOMMENDATIONS

The main conclusion of the test program which was conducted was that the addition of an air cushion to a wheeled vehicle can without doubt provide a new potential in vehicle mobility on low-bearing terrain. Multiple passes were made over surfaces that would not have permitted even a single pass for a conventional vehicle. The terrain surface suffered little damage on the first passes, so that following vehicles would not be confronted by a torn-up or heavily rutted area.

Recordings showed that up to 83% of the 9200 pound weight of the test vehicle was airborne on the cushion at times. In addition to permitting the vehicle itself to progress through the terrain, the air cushion allowed drawbar pull on the order of 1000 pounds to be recorded.

Fan performance appeared to be very good with a probable efficiency of over 90%; and the duct losses were lower than expected being about 17% of fan delivery pressure for the rear duct and 11% for the front duct. Deflecting the side jets in the rearward direction had been expected to add a 200 pound thrust in the forward direction. However, the deflecting vanes in the front unit were found to give an undesirable loss of lift, so only the rear unit was equipped with jet deflection. This resulted in a thrust on the order of 120 to 150 pounds. The value of deflecting the jets to assist propulsion is questionable, since the test vehicle moved equally well in reverse, so that the main propulsive effort was provided by the wheels.

Tests on hard surface gave results that were in reasonably good agreement with the theoretical work of Strand\*.

The successful demonstration of the value of the air cushion used in conjunction with wheels leads to the recommendations that this program be continued toward a prototype configuration incorporating the features proposed for the final vehicle. In future work, the addition of skirts to the vehicle should be studied to remove the possibility of local irregularities' interfering with the maintaining of full cushion pressure.

---

\* T. Strand, "Inviscid-Incompressible-Flow Theory of Static Peripheral Jets in Proximity to the Ground", Journal of the Aerospace Sciences, Volume 28, Number 1, January 1961, p. 27.

## DISCUSSION

### INTRODUCTION

A proposal was made in July 1962 to USATRECOM and the Canadian Department of Defence Production by Hawker Siddeley Canada Ltd., for construction of a 1-ton, amphibious, off-highway, air-transportable vehicle. The vehicle would consist of a front power unit with a rear load carrier. In addition to articulated steering, a capability of following ground contours would be provided by a back-breaking feature together with freedom in roll between front and rear units. However, the most important difference between the Gemini and other wheeled vehicles would be the incorporation of air cushion assistance to increase mobility.

It is evident that for overland operation, the pure air cushion machine has severe restrictions associated with poor grade capability, problems of stability, control, and poor propulsive efficiency. Wheels are the most efficient propulsive means for road use, and their use would solve the stability, control, and grade problems of the pure air cushion vehicle. At the same time, it was believed that the air cushion could greatly assist mobility of a wheeled vehicle in low-bearing terrain. This would be achieved by reducing the load supported by the wheels, thereby allowing wheel traction to be developed without excessive penetration resulting in the bogging of the vehicle.

Phase I of this program, with which this report is concerned, was undertaken to demonstrate the lift-tractive efforts of a full-scale vehicle by means of tests conducted on a mock-up chassis designed expressly for this program. The main objective was to assess the increase in soft-terrain mobility of a wheeled vehicle by the use of an air cushion assist. A secondary objective was to measure the height achieved by the system on a smooth, flat surface with varied loading.

Subsequent pages contain a detailed report on Phase I of the program, categorized as follows:

- (a) Description of the test vehicle.
- (b) Instrumentation used to measure and record test data.

- (c) Preparation of clay beds for vehicle tests.
- (d) Description of muskeg site used for vehicle tests.
- (e) Details of test results and analysis of data.

## DESCRIPTION OF TEST VEHICLE

### General

For this phase of the project, a vehicle was designed and manufactured which would fulfill the requirements of testing with a minimum expenditure of time and money for its production. At the same time, the configuration of the critical elements of the projected final vehicle was incorporated, including ducting system, fan intake, ground cushion structure, and size and location of traction tires and wheels. (See Figures 1 and 2.)

### Frame and Body

The main structural chassis is in the form of a space frame built of mild steel square tubing with welded joints. Two extra-heavy steel tubes were incorporated transversely to provide pivots for the suspension trailing arms. To avoid having to drill the frame tubing and to fit spacers for attachment of removable components, extensive use was made of angle and channel brackets, welded to the frame tubing, to which components were attached by bolts.

All components, including the ducting, ground cushion structure, and body, were attached to the frame by means of bracketry. Two towing eyes were attached to each end of the frame.

The body was constructed of .051 gauge aluminum alloy sheets of 30-H14 composition. Side sheeting extended from the top rail down to the air cushion jets. The top edge was reinforced by welding the sheets to a square aluminum alloy tube extending completely around the perimeter. Vertical stiffeners at intervals reinforced the body sides in a vertical direction. All joints were waterproofed to render the vehicle buoyant.



## Power Plant

Power to operate the fan and hydraulic pumps was provided by an eight-cylinder gasoline fuel-injected General Motors "Corvette" engine of 327-cubic-inch displacement. The engine faced aft and was supported on rubber mounts over the main frame. The normal thermostatically operated fan was retained, but two large-size radiators were mounted in series, with a shroud over the fan, to provide adequate cooling. (See Figure 3.) These provisions were necessary since full power was required with very low or even zero forward velocity, and thus no ram air flow through the radiators was available.

Additional oil cooling capacity was provided by routing oil flow from the pump output through a heat exchanger contained in the lower tank of one of the radiators, through a filter, and back to the engine main oil manifold.

A 30-U.S.-gallon fuel tank was mounted on the right-hand side within the main frame, adjacent to the engine. Starting batteries were installed on the left-hand side of the vehicle adjacent to the engine. Two 12-volt batteries were arranged for 12 volts to be used for starting and engine services, while 24 volts was available for instrumentation load. The standard "Stingray" clutch was used, hydraulically operated from the cockpit by means of a conventional master cylinder and small hydraulic jack. Throttle control was by an aircraft-type throttle lever connected through a "Controlex" cable to the throttle.

Normal automotive dashboard engine instruments, provided in the cockpit for the driver, indicated engine r.p.m., coolant temperature, engine oil pressure, and generator charging rate.

## Fan

The ground cushion fan was located centrally over the forward ground cushion structure with the fan axis vertical. A fan was provided by the National Research Council (N.R.C.) of Canada. As the design point for this fan was not suitable for the test vehicle, new blades were designed by Hawker Siddeley Canada Ltd., Engineering Division and manufactured by the Orenda Engines Division. These blades were used with the hub and bearings supplied by N.R.C. The fan incorporated a rotor blade section with 29 blades and a stator blade section using 48 blades,

the stator being immediately below the rotor. A central "bullet" and an outer flared section on the casing provided the inlet for air.

The rotor disc was mounted on two roller bearings housed on a central column. The stator plate was also attached to this column and the whole assembly was mounted on a heavy base plate of steel. This base supported the bevel gear drive on its bottom surface, while the drive from the bevel box to the rotor took the form of a splined quill passing up through the hollow columnar support.

The fan ducting consisted of an outer shell, an inner shell and an intermediate splitter. The latter extended downward from just below the stator. The fan output was thus split into two portions, the outer being ducted to the rear cushion and the inner to the front cushion. Radial vanes extending between inner and outer shells provided means for transferring loads to the outer casing from the inner fan section. Fan torque reaction was supplied by four steel rods connecting the inner and outer shell reinforcing rings. The rod axes were triangulated, thus resisting torque by axial loads in the rods. All construction in the vicinity of the fan assembly was of steel, and the whole was supported on the chassis frame by a bracketed ring.

Drive to the fan was transmitted through a universal jointed propeller shaft, splined to provide the necessary degree of movement in rotation, passing through the three duct walls and enclosed in a streamlined fairing.

The fan bearings and bevel gearbox received lubrication from a self-contained lubrication system driven by the bevel gearbox.

A wire mesh guard covered the fan intake.

The bevel gearbox provided a reduction of 3:4 in r. p. m. from the engine.

### Drive Train

The engine output from the clutch was transferred through a short-coupled splined propeller shaft to a Dana Type 80A power take-off (see Figure 4). This take-off was of the split-shaft type with provision for mounting additional power take-offs on either side. The

side-mounted power take-offs were Dana Type 81A. These three power take-offs were each provided with dog clutches; hence, any combination of drive could be obtained from the three outputs. The gearing of the two lateral power take-offs was such as to provide 51% of engine r. p. m., with rotation of both in the same direction. The central split power take-off was used to drive the fan while two hydraulic pumps were driven by the lateral power take-offs through flexible couplings. The three power take-off clutches were operated by "Controlex" cables from three centrally placed levers in the cockpit.

The hydraulic pumps were purchased from Canadian Acme Screw & Gear Co. and were Type 42. These pumps are of the variable displacement, seven-piston type with self-contained compensating gear. Integral relief valves were set at 2200 p. s. i. An additional relief valve was fitted to each pump and relief pressure was set at 1750 p. s. i. This was to provide hydraulic motor protection, since the nominal limiting pressure on the motors was 1750 p. s. i.

Each pump was piped to supply power to the two traction motors on its own side of the vehicle. Output to the motors was controlled by Waterman Hydraulics Model 1467-8 flow dividers.

Fixed hydraulic lines were of the finned type to provide oil cooling. Flexible lines were provided between pumps and flow dividers and at the suspension pivots.

Pump displacement was manually controlled. The wobble plate controls of each pump were operated from a common torque tube with provision for individual adjustment. The torque tube was controlled from the cockpit by a long notched lever operating a push-pull rod.

A hydraulic tank of 18-U.S.-gallon capacity was installed on the right-hand side at upper rail level with connections to each pump and to the leakage return from each motor. Gauges to read the pump output pressure were installed in the cockpit. Bypass valves were located in the cockpit connected across the wheel motors. These could be manually operated by the driver and, when open, allowed the vehicle to be towed without motoring the pumps.

## Wheels and Suspension

The four traction wheels consisted of Firestone All Traction Utility tires, size 14.9-28, 6-ply. These were mounted on steel rims.

The wheels were driven by five-cylinder, positive-displacement, hydraulic motors purchased from Trump Engineering, Ltd., Type 15-40-5. These motors formed the wheel hubs, the cylinders rotating with the wheels, and the shafts being clamped to the trailing arms. Motor pistons operated on a two-lobe cam, providing ten power impulses per wheel revolution. The wheel rims were modified by adding a disc structure which was bolted to lugs on the motor cylinder casting. The brochure torque of these motors was such that a total wheel force of 1520 pounds could be applied to the vehicle with the hydraulic system at the nominal limiting pressure of 1750 p. s. i.

The suspension trailing arms were of hollow square welded steel construction, pivoting on the chassis cross tubes. Vertical adjustment of the wheels was accomplished manually by means of screw jacks anchored by trunnions to the trailing arm extremities, the adjusting nuts at the upper level being operated by a large socket wrench. These nuts reacted through needle thrust bearings on the frame anchorage. A total adjustment of 24 inches was provided, allowing from zero to 24 inches ground clearance from the base of the vehicle.

## Ducting

All ducting with the exception of the fan section was constructed of welded aluminum alloy sheet.

The ground cushion structures were rectangular with radiused corners, and incorporated peripheral jets whose axes inclined inward at 45 degrees.

The front cushion jets were supplied with air from a plenum formed in the top of the cushion structure. This plenum terminated in a radiused connection to the inner annulus from the fan. The outer annulus from the fan terminated in a circular plenum of rectangular cross-section, the air being guided into it by turning vanes formed from spinings. This plenum terminated on the rear side in a converging duct which in turn connected to a rectangular duct running

aft in the frame. At the forward portion of the rear cushion, the duct made a 90-degree turn downward and was here connected to two peripheral ducts forming the outer structure of the rear cushion. All bends incorporated turning vanes both in the supply duct and in the rear cushion duct.

The jets for both cushions incorporated removable sections on the sides.

These sections were supplied in several versions with small turning vanes of different configurations. One set was designed for vertical lift only, while the other set was designed to provide a rearward component to the jet to assist tractive effort.

Both cushions were sheeted in, over the total area, the cushion load being transferred to the primary frame by means of intermediate structure.

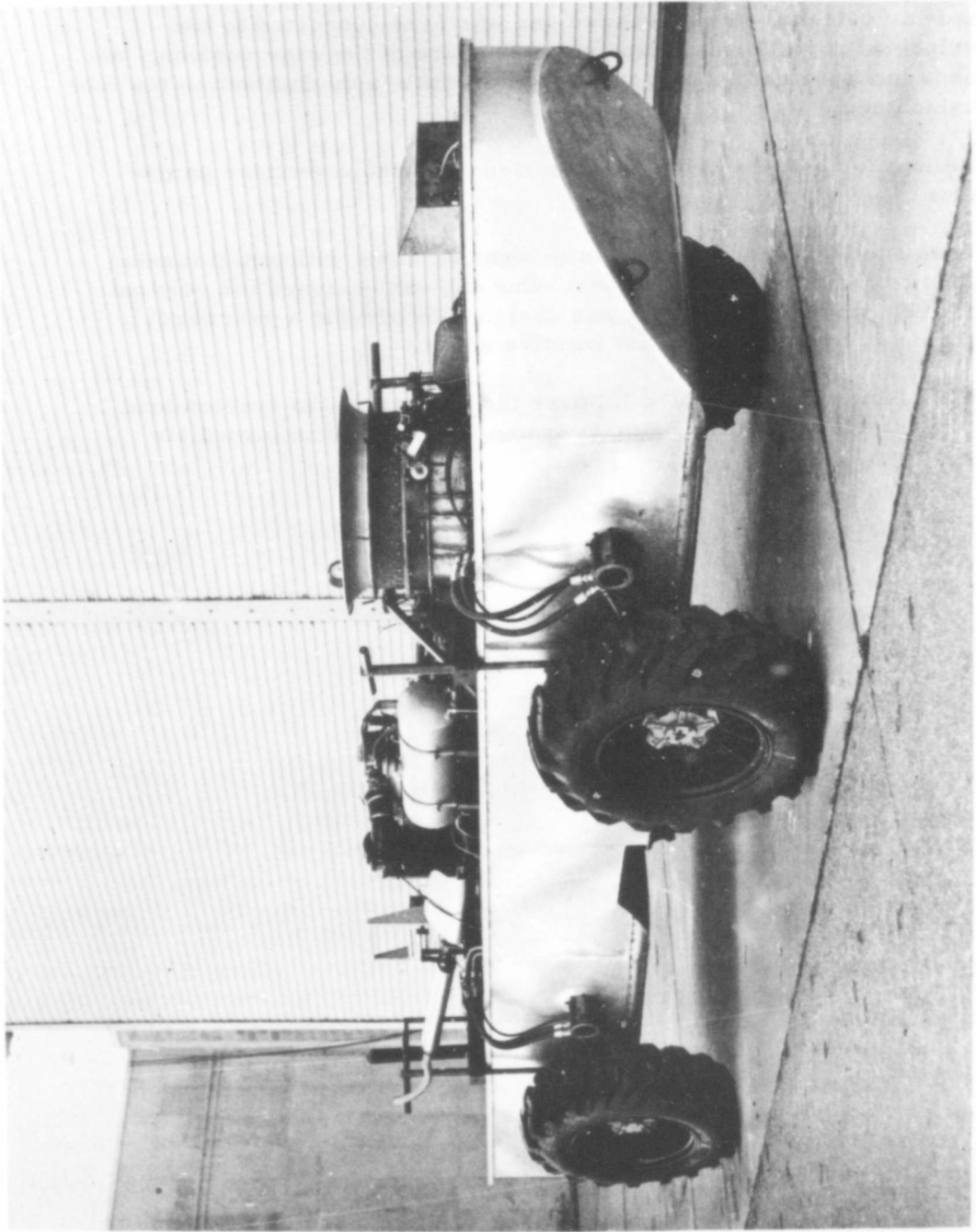

Figure 1. Three-Quarter Front View of Gemini Phase I Test Vehicle

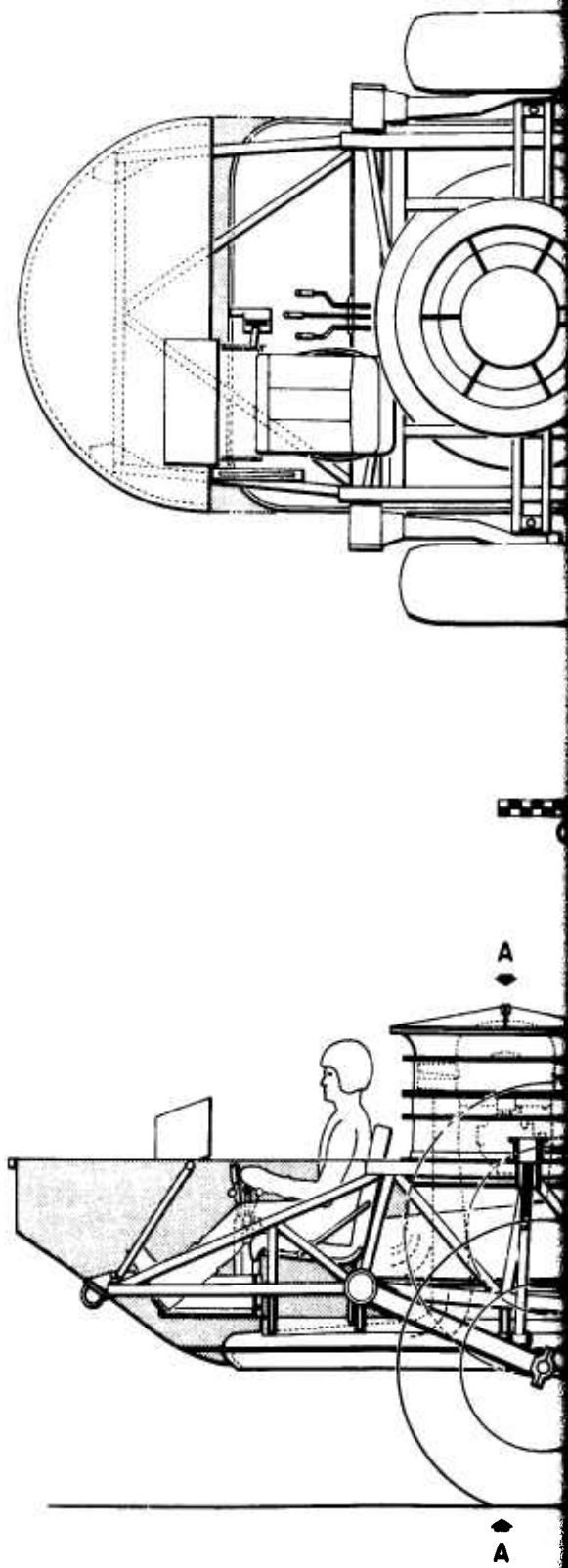
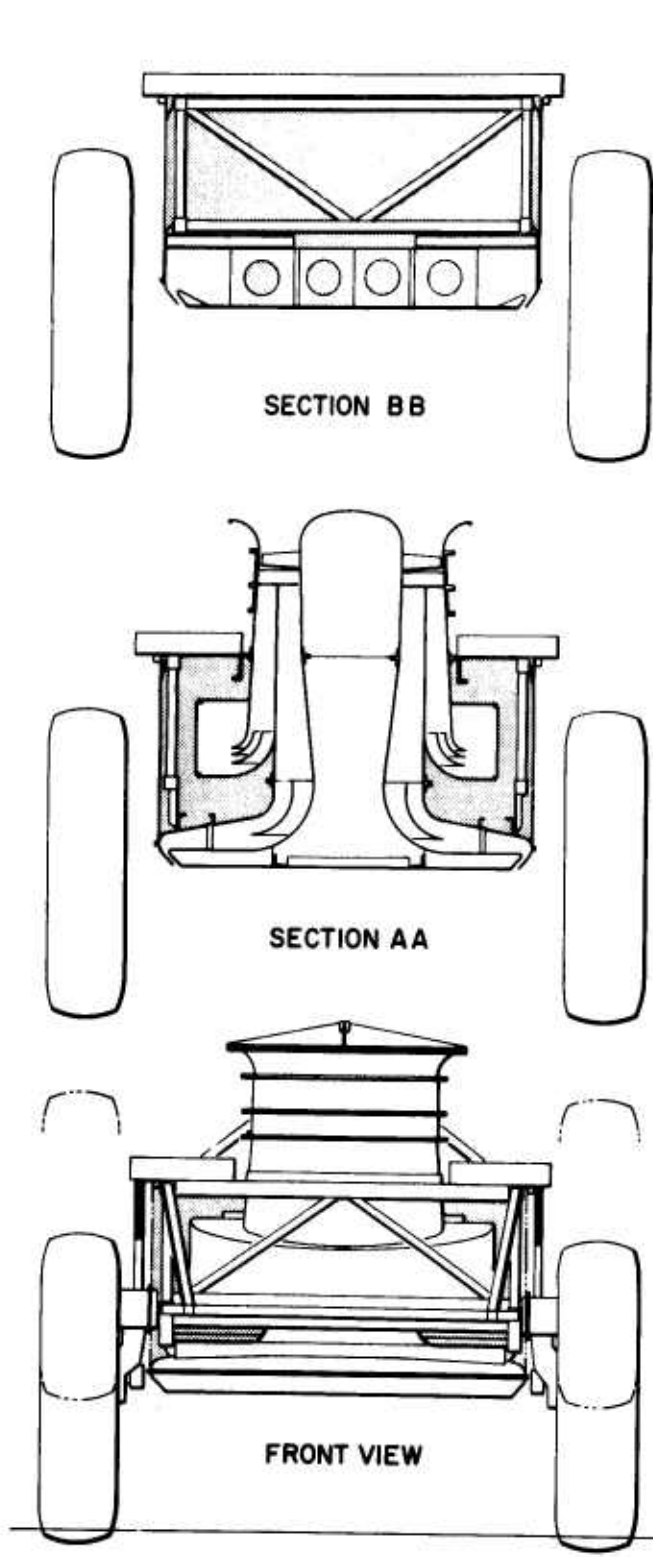
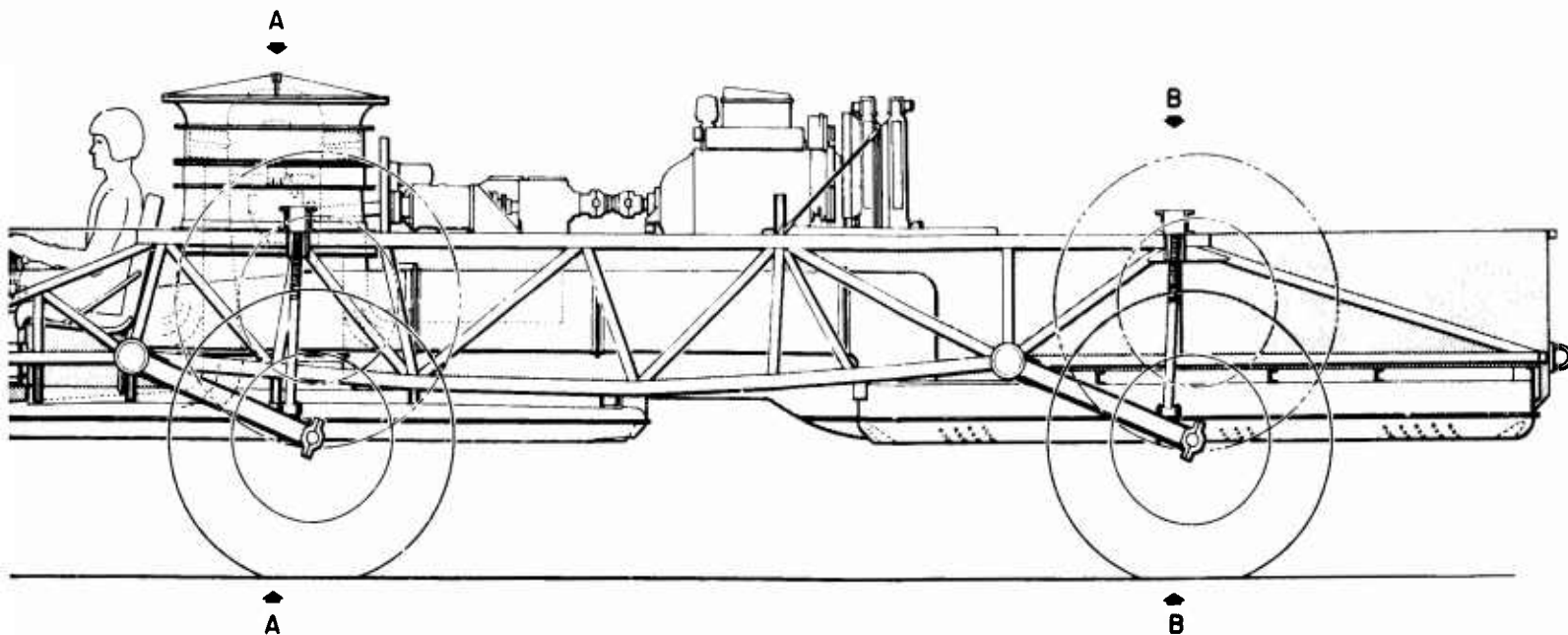
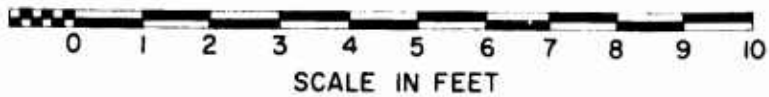
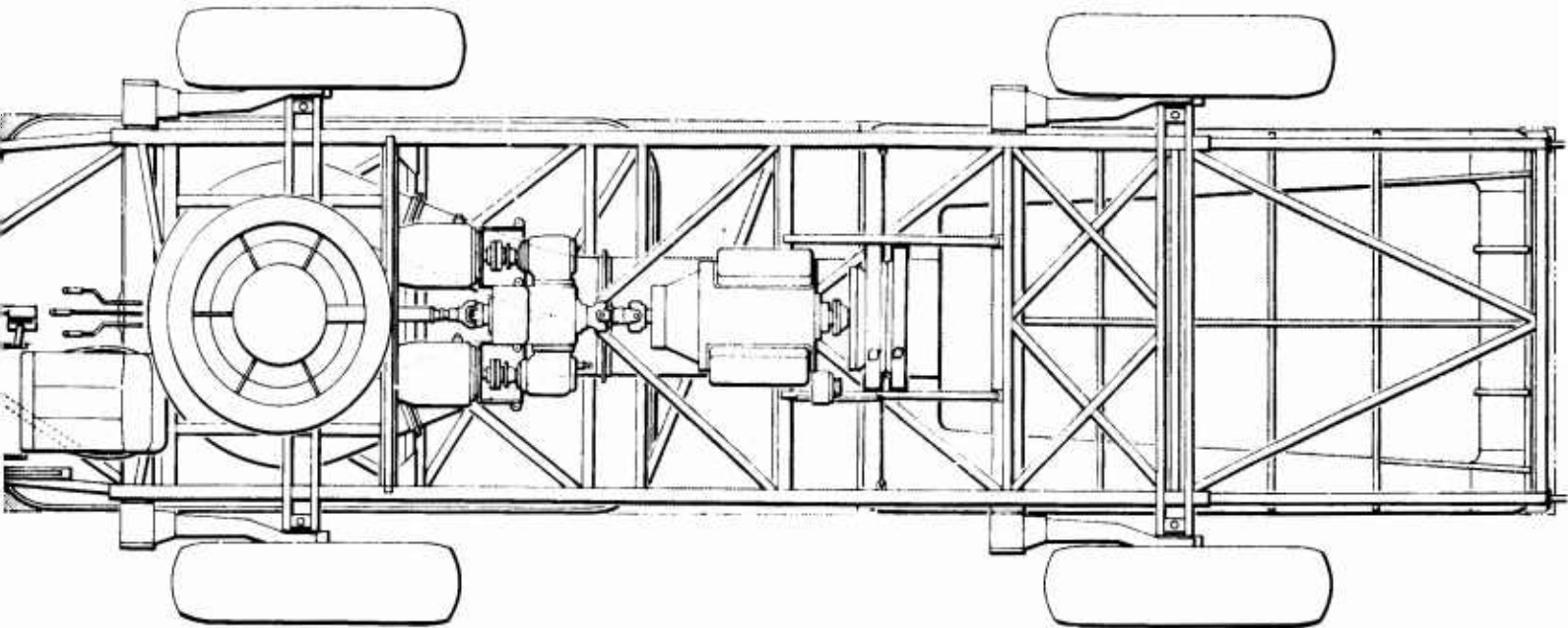

Figure 2. General Arrangement



General Arrangement of Gemini Phase I Test Vehicle



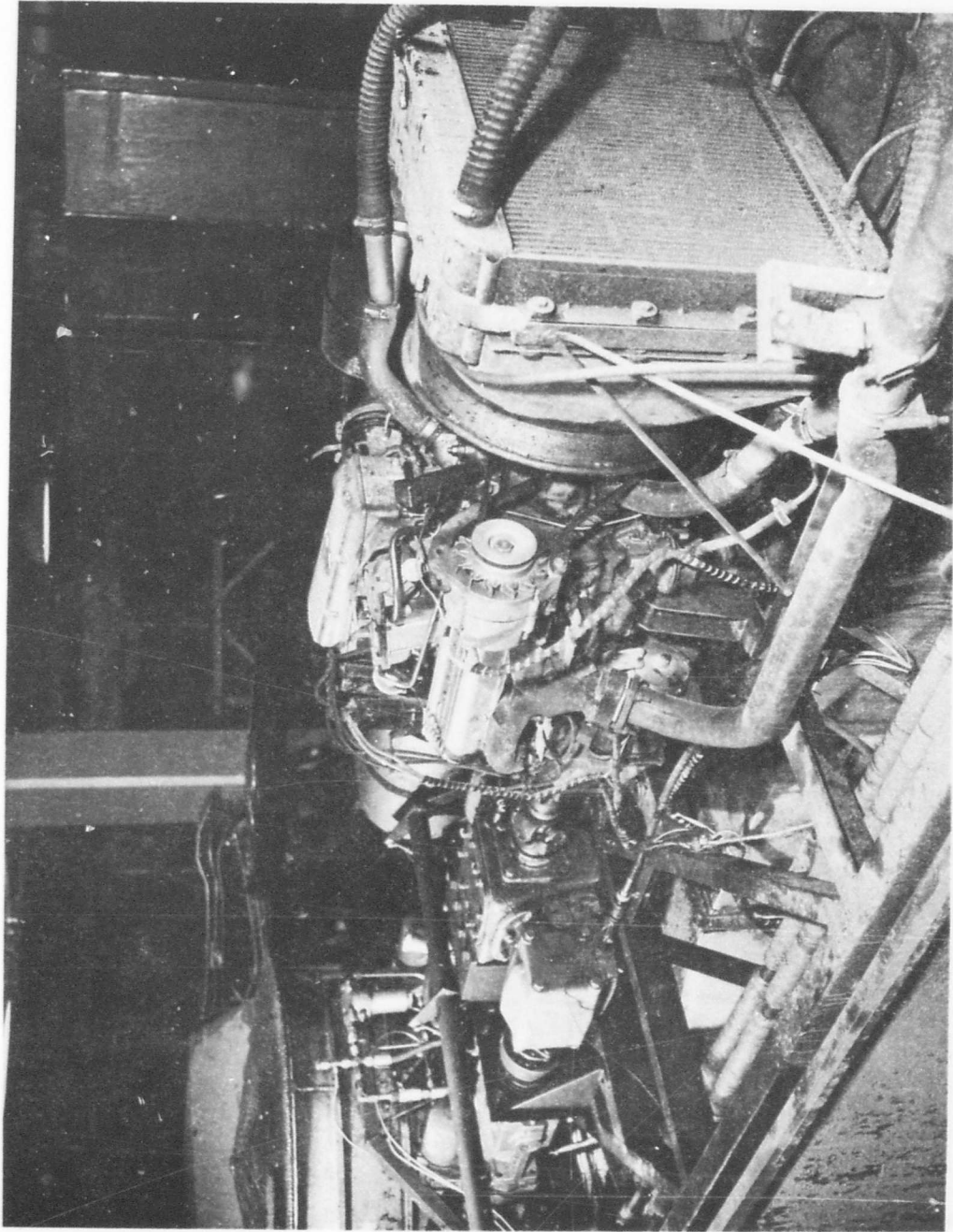

Figure 3. Engine Installation Showing Double Radiator

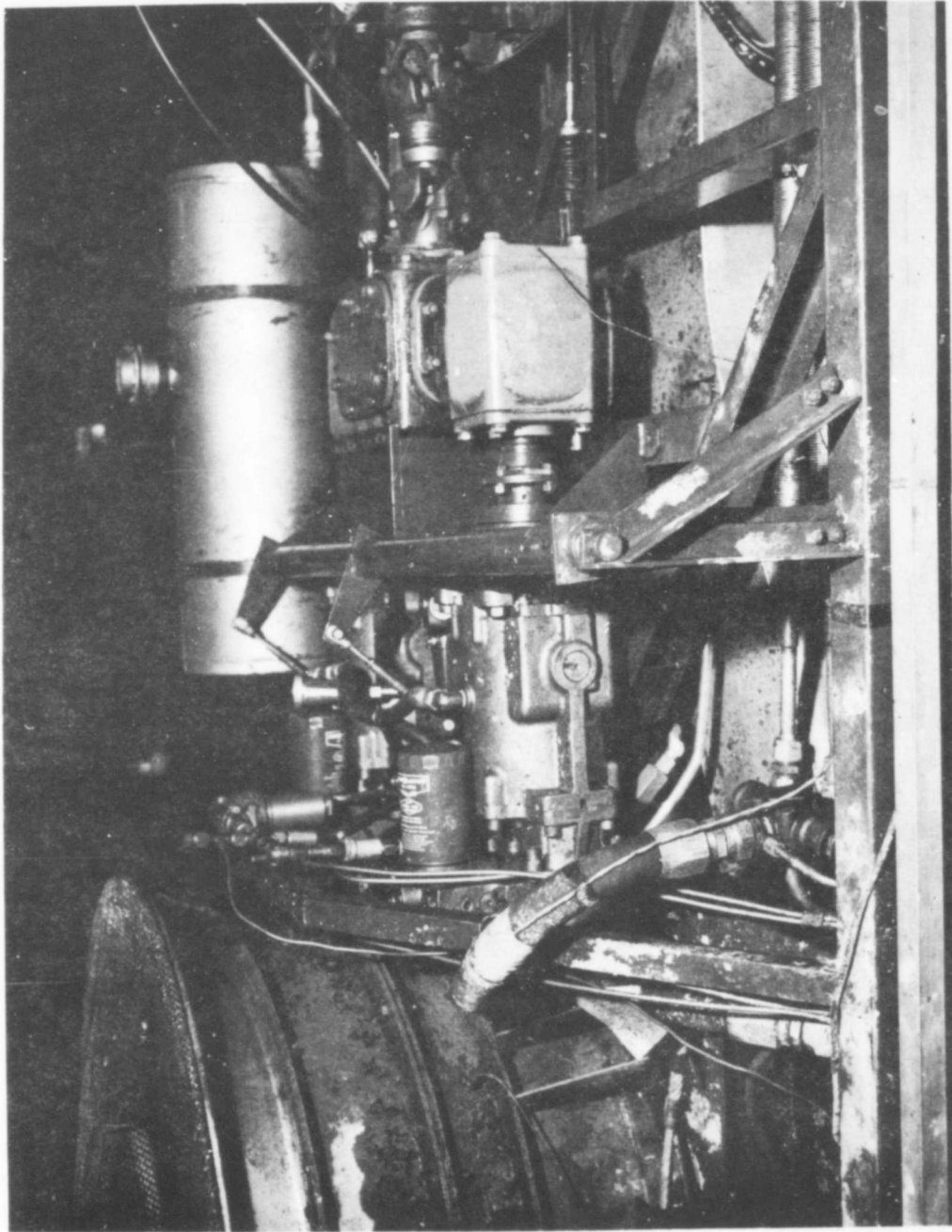

Figure 4. Drive Train

## TEST INSTRUMENTATION

The Gemini Phase I test vehicle was equipped with a Consolidated Electrodynamics Corporation Type 5-124 direct-reading recording oscillograph which was mounted in a rack panel in the rear of the vehicle. (See Figure 5.) Balance units, power supplies, and an inverter control were also accommodated in the rack panel.

Static and dynamic pressures were measured with Statham strain gauge transducers. Fan, wheel, and vehicle speeds were measured directly in frequency against a 1-second time base.

Table 1 details the locations of sensing devices used.

The recording oscillograph was powered by a 24-volt input, 115-volt 60-cycle output inverter. The output was fed to the inverter control, where it was adjusted and metered to maintain optimum operating characteristics. A series-parallel arrangement was employed for recharging the two 12-volt batteries during periods when the engine was running but no recording was in progress.

All operating channels were calibrated immediately before each recorded test run.

TABLE 1  
TEST INSTRUMENTATION LOCATIONS

Sensing Device No.	Type of Sensing Device	Reading	Location	Recorded During	
				Hard Surface Tests	Field Tests
1	Electromagnetic pickup	Fan speed	Fan hub	Yes	Yes
2	Kiel probe	Fixed total pressure	Inner duct	Yes	No
3	Kiel probe	Fixed total pressure	Outer duct	Yes	No
4 )		Wall static at traversing plane	Inner duct	Yes	Yes
5 )		Wall static at traversing plane	Outer duct	Yes	Yes
6 )	Manifolded	Wall static at diffuser exit	Inner duct	Yes	No
7 )	statics	Wall static at diffuser exit	Outer duct	Yes	No
8 )		Wall static	Centre duct section	Yes	No
9 )		Base static pressure	Front section	Yes	Yes
10 )		Base static pressure	Rear section	Yes	Yes
11	Total pressure rake	Fixed total pressure	Front duct	Yes	No
12	Total pressure rake	Fixed total pressure	Rear duct	Yes	No
13	Rotary potentiometer	Vehicle ground clearance	Right front	Yes	No
14	Rotary potentiometer	Vehicle ground clearance	Left front	Yes	No

TABLE 1  
TEST INSTRUMENTATION LOCATIONS (Cont'd)

Sensing Device No.	Type of Sensing Device	Reading	Location	Recorded During	
				Hard Surface Tests	Field Tests
15	Rotary potentiometer	Vehicle ground clearance	Right rear	Yes	No
16	Rotary potentiometer	Vehicle ground clearance	Left rear	Yes	No
17	Kiel probe	Fixed total pressure (traversing)	Inner duct	Yes	Yes
18	Kiel probe	Fixed total pressure (traversing)	Outer duct	Yes	Yes
19	Ring dynamometer	Forward thrust or draw bar pull	Rear towing eyes	No	Yes
20	Transducer	Wheel motor pressure	Right front	No	Yes
21	Transducer	Wheel motor pressure	Left front	No	Yes
22	Transducer	Wheel motor pressure	Right rear	No	Yes
23	Transducer	Wheel motor pressure	Left rear	No	Yes
24	Electromagnetic pickup	Wheel speed	Right front	No	Yes
25	Electromagnetic pickup	Wheel speed	Left front	No	Yes
26	Electromagnetic pickup	Wheel speed	Right rear	No	Yes

TABLE 1  
TEST INSTRUMENTATION LOCATIONS (Cont'd)

Sensing Device No.	Type of Sensing Device	Reading	Location	Recorded During	
				Hard Surface Tests	Field Tests
27	Electromagnetic pickup	Wheel speed	Left rear	No	Yes
28	Electromagnetic pickup	Vehicle speed	Rear of vehicle	No	Yes

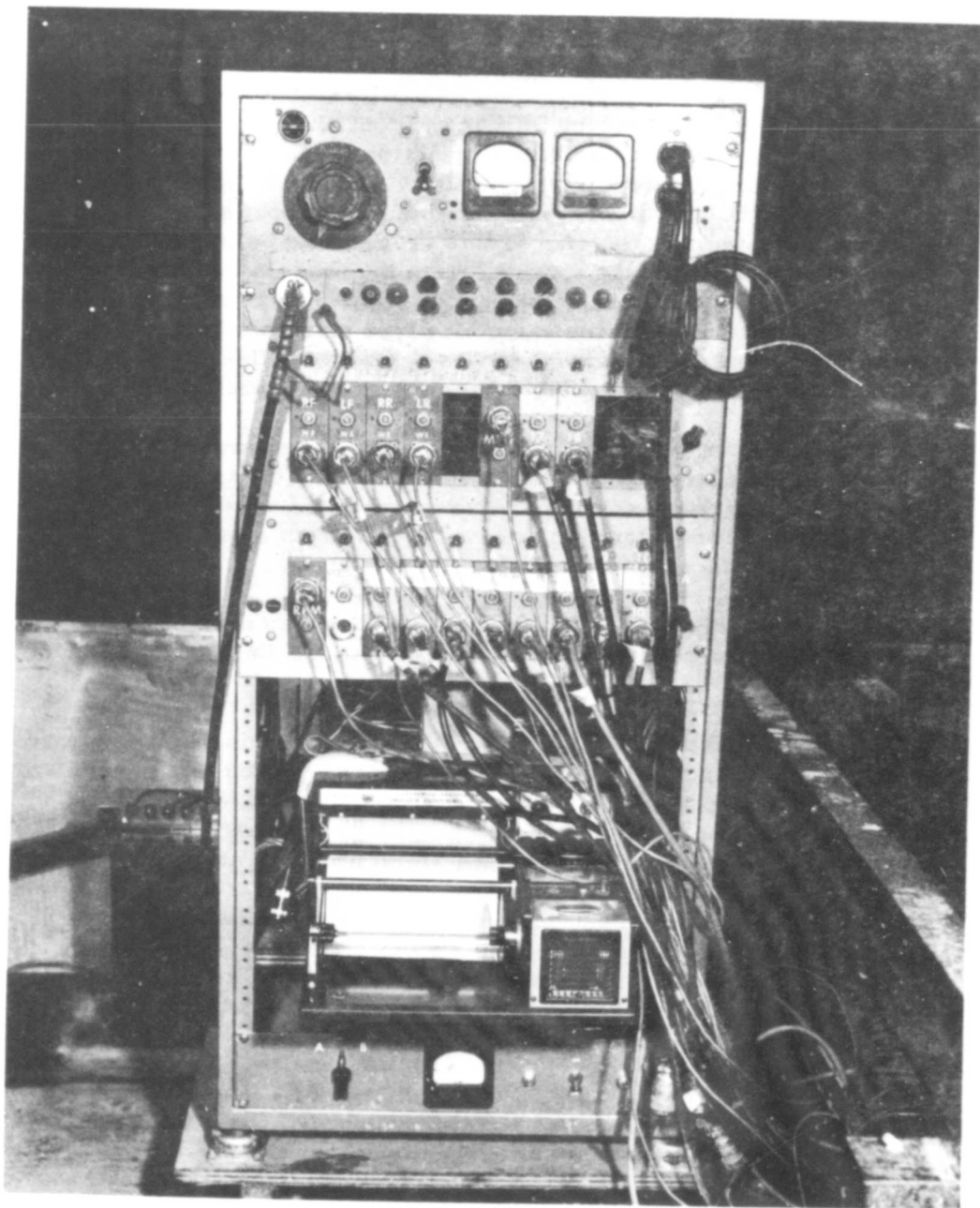

Figure 5. Instrumentation Package

## PREPARATION OF CLAY BEDS

Discussions with the Project Officer at USATRECOM and with the Canadian Department of Defence Production (D. D. P. ) with respect to soil suitability for test were initially based on Canadian Department of Transport (D. O. T. ) surveys of the Malton Airport area. These surveys indicated that the clay in this area should be suitable. Checks were made with soil maps obtained from the Ontario Government Department of Agriculture, Guelph, Ontario, which confirmed that the test sites available were the same clay type as shown in the D. O. T. airport surveys. On this basis it was agreed with USATRECOM and D. D. P. that Malton clay would be suitable for the tests.

A number of sites within the perimeter of the Company's Malton property were examined for establishment of two clay beds for vehicle tests. The initial sites considered were rejected because laboratory tests of the soil revealed that they were not virgin areas but had been disturbed at some stage during plant construction.

The site finally chosen for the two test beds was an area of virgin clay located within the Malton property adjacent to the Company's tank farm.

A laboratory analysis of samples of the clay from this site was carried out by Geocon, Ltd., a soil engineering company which is a member of the Foundation group of companies, and which has been associated with major engineering and construction projects both inside and outside Canada. The results of the analysis are set out in Table 2.

Seven natural water content determinations were made on samples of the clay. These gave values ranging from 11.0 to 15.6 percent on the soil from the east side of the test area and values of 15.9 percent on the soil from the west side.

Three Atterberg limits were carried out on the clay. These gave liquid and plastic limits of 27.1 and 20.0, and 31.7 and 20.2 percent respectively from the east bed and the west bed. These results indicate that the material is an inorganic clay of low plasticity.



**TABLE 2**  
**ANALYSIS OF SAMPLES OF CLAY FROM TEST BEDS**

Sample No.	Water Content (%)	Unit Weight (p.c.f.)	Liquid Limit	Plastic Limit	Plasticity Index
<u>East Clay Bed</u>					
1	14.0	-	27.1	20.0	7.0
3	13.8	-	-	-	-
4	13.6	138	-	-	-
5	11.0	144	-	-	-
6	15.6	139	-	-	-
<u>West Clay Bed</u>					
7	15.9	-	31.7	20.2	11.5
9	15.9	-	-	-	-
<p>Note: Grain size analysis was carried out on Sample 2 (see Figure 6). Consolidated drained tests were carried out on Samples 4, 5 and 6 (see Figure 7).</p>					

A grain size analysis was carried out on a sample of the clay, and the results are presented as a grain size distribution curve on Figure 6.

This test indicates that the sample contains about 20-percent sand and gravel size, 50-percent silt size, and 20-percent clay size particles.

Three consolidated drained tests were carried out on undisturbed samples of the clay at confining pressures of 3.06, 4.08, and 5.10 tons per square foot (see Figure 7). The resulting effective angle of shearing resistance is 29 degrees. The effective cohesion was found to be 1800 pounds per square foot.

The east and west clay beds at the vehicle test site were prepared in a similar manner by first removing the topsoil from two 100-foot x 40-foot areas and also from a similar area at each end of the proposed beds.

It was necessary to prepare the clay to a depth of 24 inches by a process of pulverization and adjustment of moisture content. Moisture content analyses were made at 8-, 16-, and 24-inch depths by the Chemical Laboratory of the Sopwith Engineering Laboratories, Hawker Siddeley Canada Ltd., Engineering Division. To prepare the site without bogging down the equipment used in the preparation, 16 inches of clay was excavated from each bed and distributed equally to a depth of 8 inches at the ends of the beds.

The 8 inches of clay remaining in each bed was then pulverized by a Seaman-Andwall "Pulvi-mixer", and water was added to the amount required as revealed by the moisture content analyses. It is worth noting that even with an 8-inch depth of the prepared bed, the equipment used was marginal in its mobility, and proceeded with difficulty in the beds under preparation. The clay piled at each end of the beds was similarly pulverized and watered and returned to the beds. A Gradall was employed to level the surface of the beds, by standing on the hard surface at the side and reaching across the bed to scrape it.

Charts are attached (Figures 8 and 9) showing the readings observed in both clay beds using the penetrometer supplied by USATRECOM. In all tests to date in these beds, the maximum wheel rut depth has been 9 inches (and for most of the tests, less than 6 to 7 inches), so that the readings for the top 12 to 18 inches are a good indication of the consistency of the clay in which the operations were conducted. It will be observed from the plots on Figures 8 and 9 that the center of the clay beds where the runs were made had cone penetrometer readings of about 30 for the top 12 inches.

### MUSKEG SITE

Details of the muskeg site are included in Appendix I, the report on the muskeg trials prepared by Dr. N.W. Radforth of the Organic and Associated Terrain Research Unit, McMaster University, Hamilton, Ontario.

M.I.T. GRAIN SIZE SCALE

COBBLE SIZE	GRAVEL SIZE		SAND SIZE			FINE GRAINED	
	COARSE	MEDIUM	FINE	COARSE	MEDIUM	FINE	CLAY SIZE

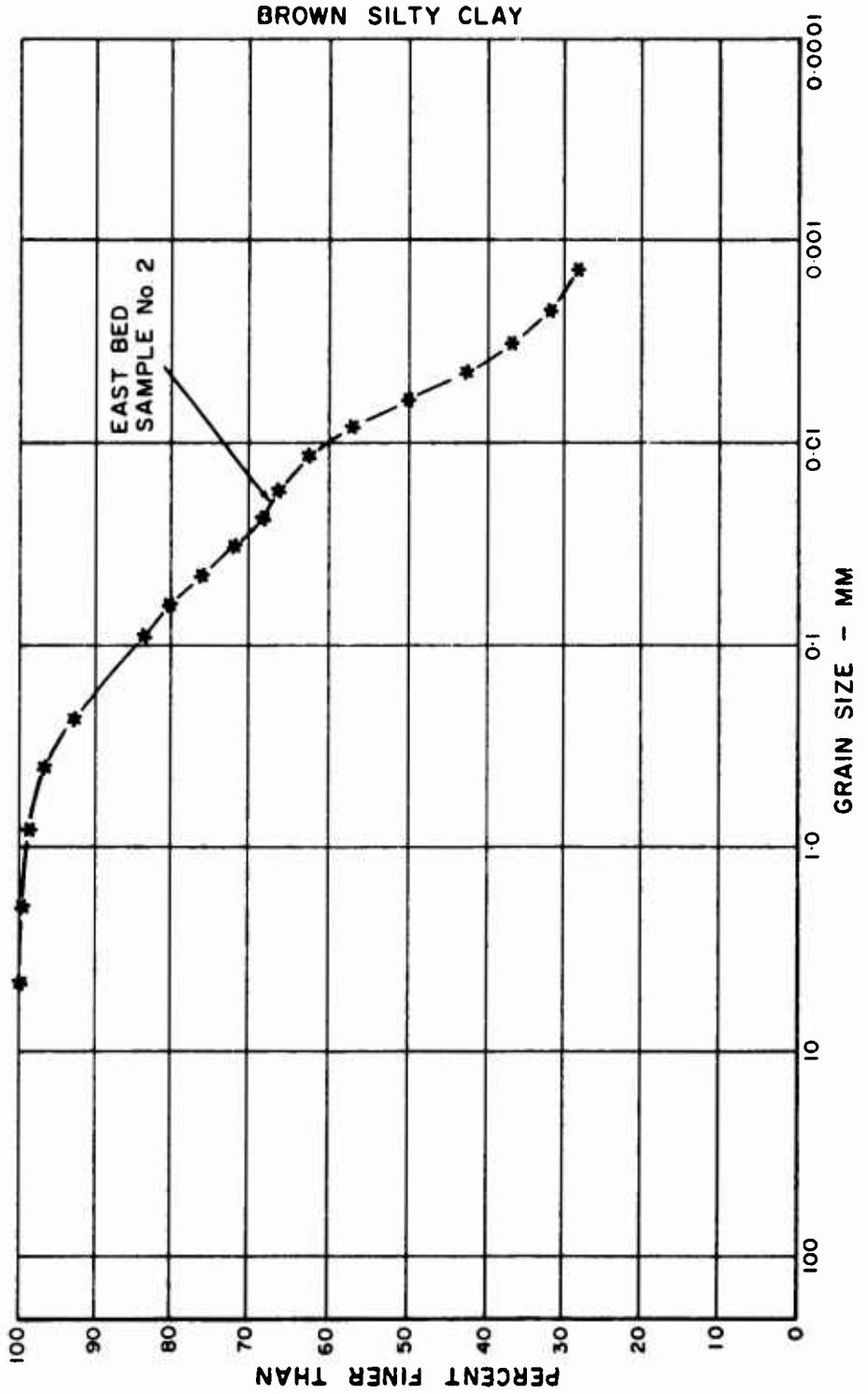

Figure 6. Grain Size Distribution

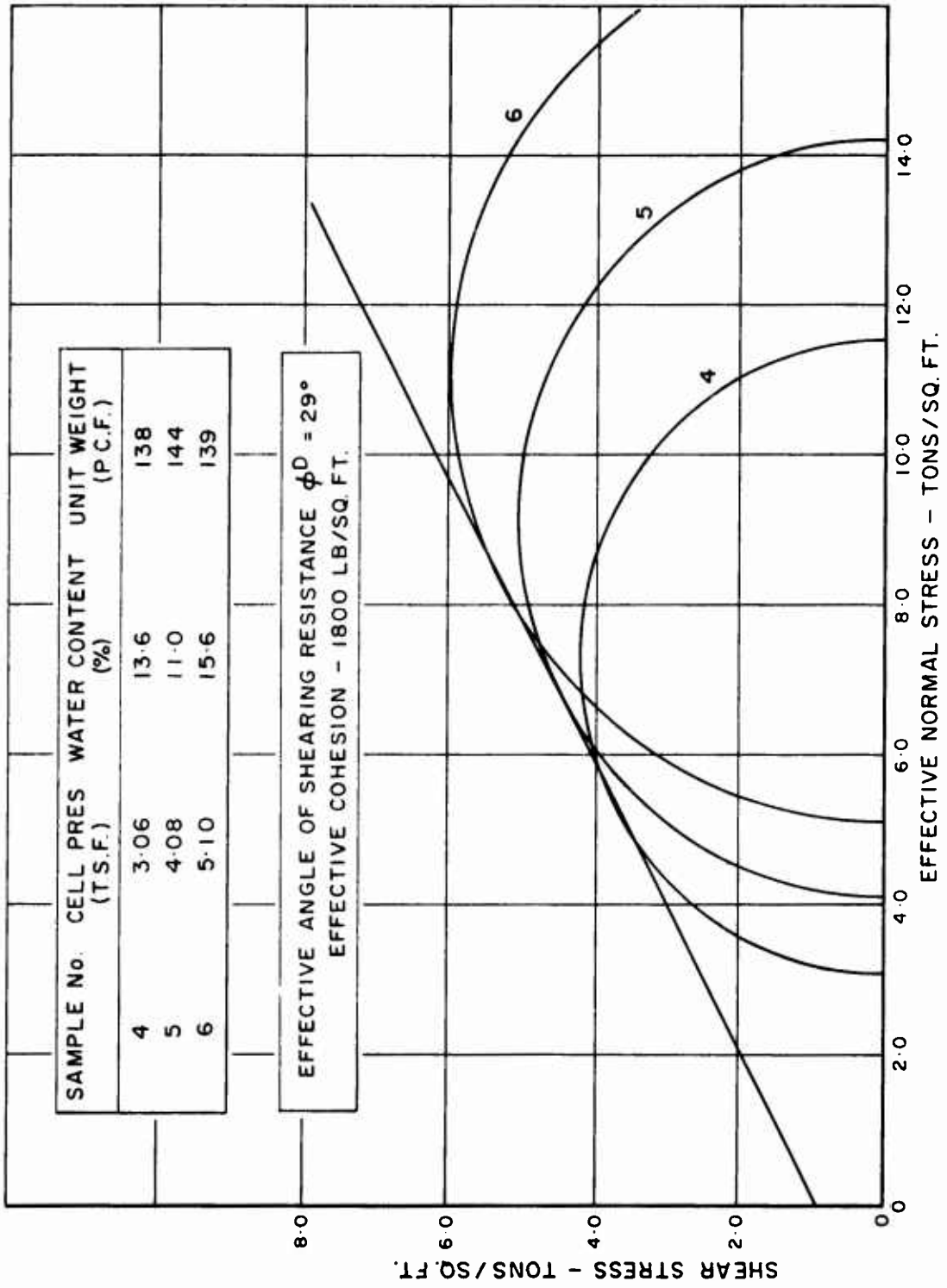

Figure 7. Plot of Mohr's Circles - Consolidated Drained Triaxial Tests (Brown Silty Clay)

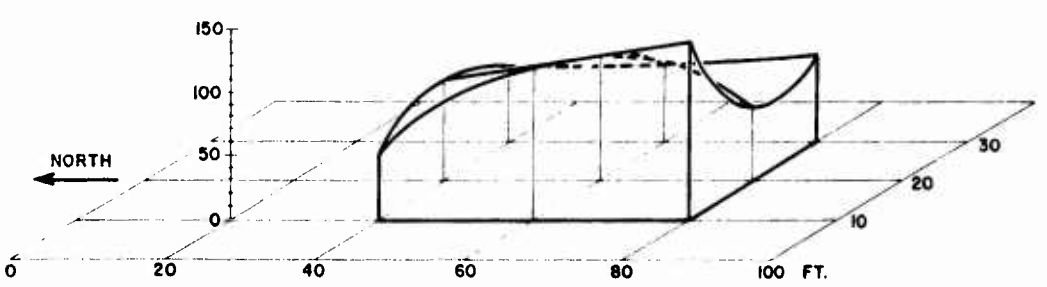
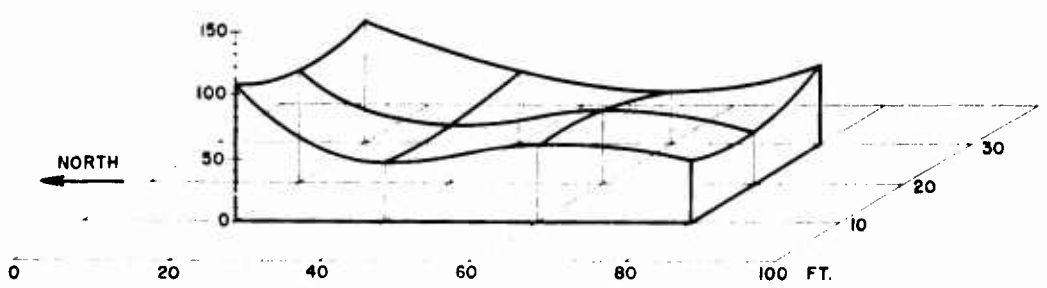
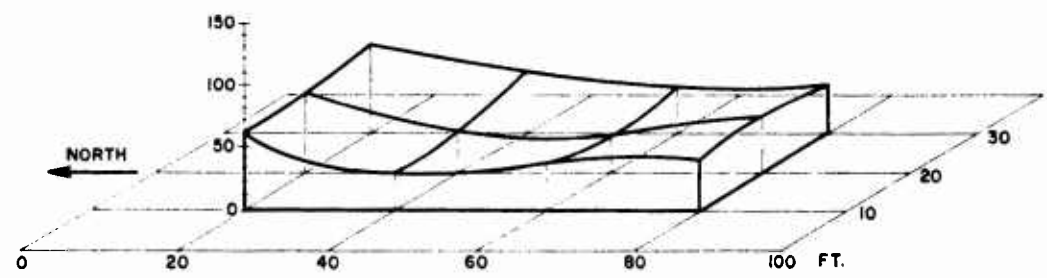
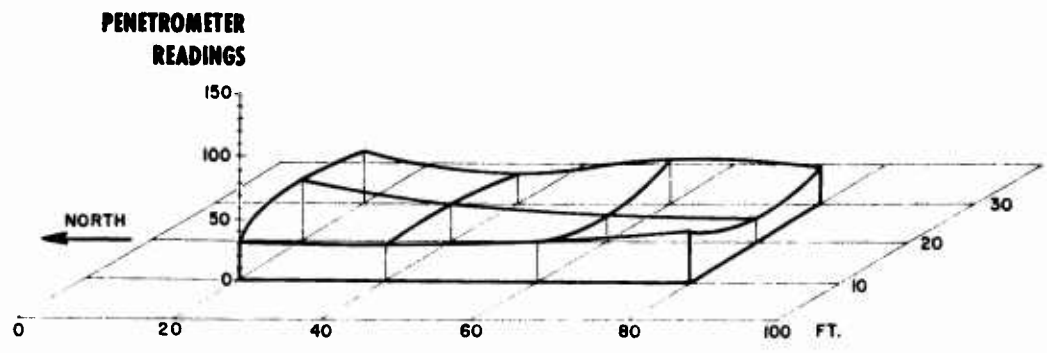

Figure 8. Penetrometer Readings - West Clay Bed

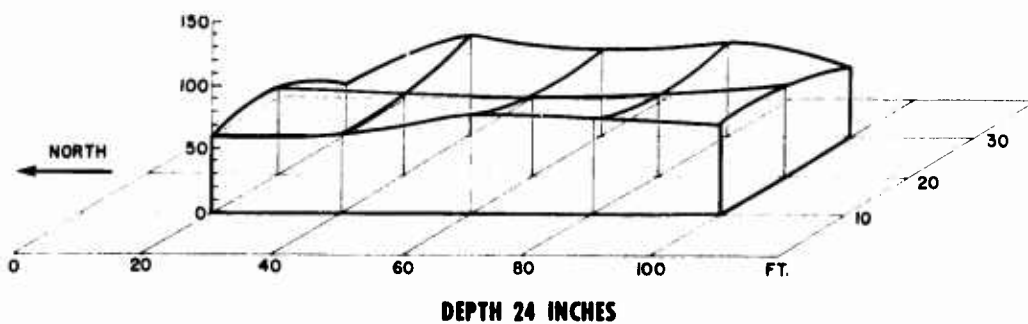
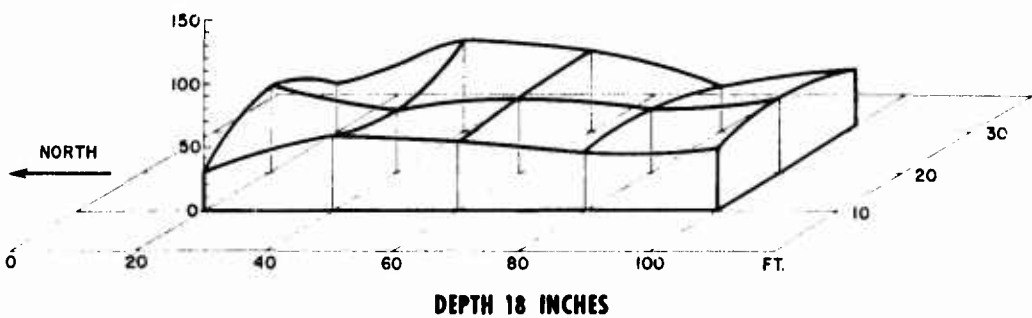
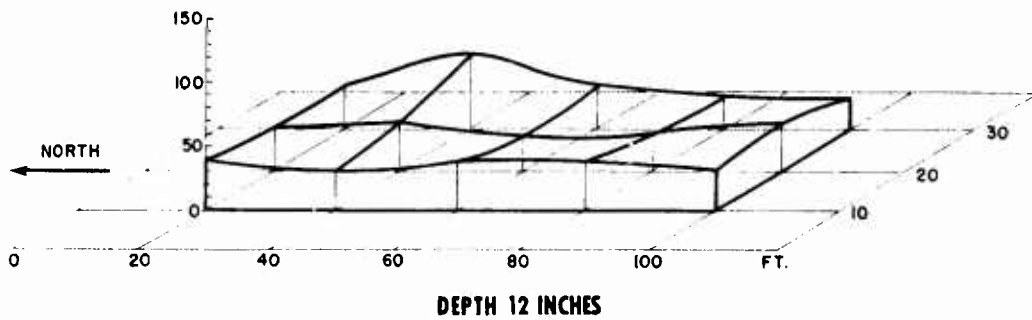
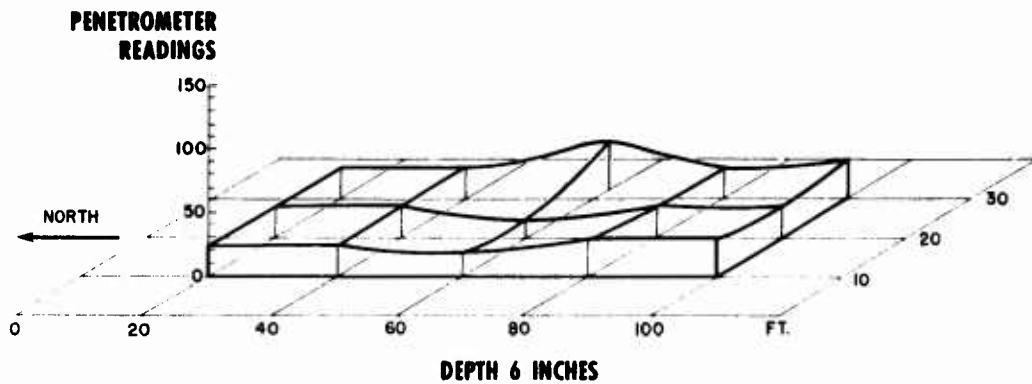

Figure 9. Penetrometer Readings - East Clay Bed

## TEST RESULTS

### Hard-Surface Testing - Out of Cushion

Aerodynamic testing of the Gemini commenced in the first week of October 1963. The vehicle was mounted on 6-inch blocks, the engine was run at three speeds (up to two-thirds of the maximum), and measurements were taken of the flow parameters through the fan ducting as well as the base pressure under each section.

The pressure ratio and air mass flow of the fan were determined and compared with the estimated fan characteristic. Measured points tended to fall on the lower or choke side of the fan characteristic; that is, operation at a lower pressure ratio than design but at a larger mass flow. This was also found to be the case at higher engine r. p. m. Traverses of the total pressure were made across the front and rear ducting behind the fan stators and indicated that about 10 to 20% more air was flowing through the front ducting than through the rear.

As the cylindrical splitter downstream of the fan was arranged to divide the area equally, this means that a flow breakaway takes place on the inner side of this splitter. This is clearly shown by a loss of total pressure on this side of the splitter shown in Figure 10. Despite this, the air horsepower delivered by the fan compares very well with the value of engine horsepower measured by General Motors on a dynamometer check of the engine before shipping. The fan efficiency is probably in excess of 90%. The splitter flow breakaway indicates that nozzle trimming and/or a change of splitter radius could be used to improve performance further.

Fan traverses were made after completion of the field tests with jet nozzle width reduced to 0.35 inch at the front and 0.3 inch at the rear with the vehicle set at 1.0 inch clearance. These tests indicated that the fan total pressure traverse had been forced into an almost constant value of total pressure across the fan sections supplying the inner and outer ducts. The splitter breakaway evident in the earlier traverse shown in Figure 10 was eliminated, as was the tip loss close to the outer shroud. Pressure ratios were 1.07 for the inner section of the fan and 1.084 for the outer section at an engine speed of 5800 r. p. m. true speed or 6030 r. p. m. corrected for ambient temperature. Base pressures during this test were measured at 81.2 pounds per square

foot for the front and 63.5 pounds per square foot for the rear. As the wall static readings were incorrectly indicated by the recorder during this run, an estimate of mass flow was not possible.

Losses in the ducting were measured, and those for the front were found to be about 11% of the fan head while those from the rear were found to be about 17%. The latter quantity is about 40% less than anticipated. Measurements of the base pressure indicated that there was about 40 to 60% more pressure under the front section than under the rear. While this result is desirable to accommodate the extra weight of the front section, it is due to a loss in head of about 25% of the rear flow as it is turned from about 60° from the horizontal to the vertical. Further development work on these turning vanes seems necessary if they are to turn the air efficiently. The distribution of fan total pressure around the periphery was found to be uniform for each section except at the corners. Plates were fitted to the corners to make the amount of flow through the corners coincide with that over the rest of the periphery.

#### Hard-Surface Testing - In Cushion

In order to assess the performance of the fan and the lift generated under each section at higher engine speeds, four runs were made in the vicinity of design r. p. m. without the wheels. Removal of the wheels gave a reduction of weight to 7375 pounds. The runs provided data about the performance of the fan and ducting and verified the initial results.

Three of these runs were done with a jet slot width of 0.55 inch and with the vehicle sitting on blocks at heights of 1 inch, 1.5 inches and 2 inches. Engine r. p. m. was increased until the vehicle lifted off. At 1 inch the vehicle lifted off at 5000 r. p. m., while lift-off at 1.5 inches was at an engine speed of 5300 r. p. m. Complete lift-off did not occur at a height of 2 inches.

In comparing the fan mass flow and pressure ratio with those estimated at the design point, it was again found that the fan was operating on the bottom end of its characteristic. In order to increase the pressure ratio delivered by the fan, a small jet nozzle width of 0.45 inch was tried. This produced an 8% rise in pressure ratio, but about a 25% rise is required to achieve design fan head (Figure 11).



In addition, about 600 pounds more lift was generated under the vehicle with these smaller jets.

To show the cushion height being achieved for a given horsepower, vehicle weight, and cushion area, Figure 12 is included.

Tests were also made on hard surfaces when the rearward thrust vanes were installed on the sides of both sections. These were intended to direct the air backward at about  $40^{\circ}$  from the horizontal. Using a wool tuft, this angle was estimated to be about  $30^{\circ}$ , giving a greater thrust at the expense of lift. Moreover, as some separation seems to be occurring in these vanes, producing a 20% loss in fan head, some development work seems necessary if they are to function efficiently. Using the thrust vanes, the lift was found to be reduced by about 35% in the front section and about 20% in the rear section. Quantitative measurements of the thrust from these vanes have not been made to date.

Because of this large loss in lift in the front section and the excess of weight there, it was decided to keep the undeflected jets in the front but to use the thrust vanes in the rear section when testing the vehicle in the clay and muskeg.

Base pressures were recorded by five 1/2-inch diameter holes under each of the cushion areas. Figure 13 gives the estimated lift on the vehicle versus engine speed for clearance heights of 1.0, 1.5, and 2.0 inches, for two different slot configurations. It appears that the pressures measured are too low since the vehicle, weighing 7375 pounds without wheels, lifted off the support blocks at 5400 r. p. m. engine speed for a clearance of 1.0 inch. The estimated lift from base pressure measurements at this condition gives only 6600 pounds or 90% of the vehicle weight. It appears that the base pressure measurement underestimates the lift by 10%. In the analysis of field tests this factor has not been included, as there was no certainty that the factor remained constant for all clearances and all engine speeds. It is possible therefore that the analysis of the field tests overestimates the wheel-supported weight.

The ratio of the estimated lift on the front cushion to that on the rear is given in Table 3 for the jet configuration used in most of the field tests.

**TABLE 3**  
**RATIO OF LIFT - FRONT CUSHION TO REAR CUSHION**

Clearance (inches)	Ratio Front Lift to Rear Lift
1.0	1.43
1.5	1.65
2.0	1.0

In field tests, the average ratio measured varied from 1.00 to 1.42, although readings of instantaneous values varied very widely from about 0.6 to 4.0, attributable to a momentary drop in pressure under one of the cushion areas due to spillage. It is expected that such extreme variation would be greatly reduced if the test vehicle had the freedom in roll and pitch proposed for the final vehicle.

Measurements were made on hard surfaces to estimate the effective jet thrust with the jet deflection vanes fitted to the rear unit only. Since the jet thrust was insufficient to move the vehicle even after the hydraulic motors had been drained of oil, it was decided to tow the vehicle and to measure the towing force with and without the fan. The Polecat was used for this purpose, and the results are given in Table 4.

**TABLE 4**  
**RESULTS OF JET DEFLECTION TESTS**

Engine Speed (r. p. m.)	Clearance Setting (inches)	Towing Force (pounds)	Reduction in Force (pounds)
0	12	538	-
5000	12	459	79
5800	12	384	154
5300	1.75	231	307

From Table 4 it will be seen that an effective jet thrust of 154 pounds was present at 5800 r. p. m. with the vehicle at 12 inches clearance, at which height there would be little airborne weight. The reduction of 307 pounds in towing force at 1.75 inches clearance is a combination of jet thrust and reduction of resistance due to unloading. It is estimated that about 120 pounds is due to jet thrust and 187 pounds is due to reduction of wheelborne weight.

### Field Tests in Clay and Muskeg

While the hard-surface testing was proceeding, the two clay beds were prepared. The west clay bed gave an average penetrometer reading of 37 over a 12-inch depth and down the center of the bed, while the average penetrometer reading for the east clay bed was 28.6 for similar conditions.

The following description of the clay tests is summarized from the driver's notes, which form Appendix II to this report.

The first runs made were in the west clay bed, without rearward jet deflection, their object being to determine optimum setting of the wheels. Clearance of the vehicle was first determined on level concrete and related to the position of the screw jacks measured from a datum on the vehicle. This allowed equivalent hard-surface clearance measurement on the uneven clay bed to be made by measurement of the change in screw jack position relative to the vehicle datum. The initial setting was 10.5 inches hard-surface clearance.

The fan was brought up to speed, and the vehicle was driven into the clay bed. It became bogged down when all four wheels were on the prepared surface. Wheel rut depth was subsequently measured as 9 inches. It was evident that the wheels were incapable of driving a 9-inch-deep rut once all four wheels were on the soft clay. However, the vehicle backed out of the clay bed in the same ruts without external assistance.

The screw jacks were then used to reposition the wheels to a 3-inch reduction of clearance, giving 7.5 inches equivalent hard-surface clearance. The vehicle was moved so that it would not be travelling in the ruts previously made and was driven again into the west clay bed.

A complete pass through the bed was made successfully, and the vehicle then backed through it again.

One abortive test was made with the fan disengaged and, after the vehicle bogged down, an attempt was made to recover by using the fan. In this case, recovery was not achieved, as the approach angle into the pit was such that a considerable mound of clay had been bulldozed by the front of the vehicle and the thrust of the rear wheels had rammed clay into the jet slots.

The vehicle was moved over so that it would make new ruts, and again it traversed the bed until it ran into a side wall of the pit due to its lack of steering. The engine was reduced to idle speed, allowing the vehicle to sink to its belly. The fan was then run up, causing the vehicle to lift and, when the wheels were reversed, the vehicle backed out of the pit. An attempt was made to repeat this run.

Once again the vehicle was stopped by the side wall of the pit. The wheels were put into reverse; but even with 2000 p.s.i. hydraulic pressure applied to the wheel motors, the wheels rotated very slowly and intermittently and the vehicle did not move. As the light was failing rapidly, the vehicle was towed out and returned to change the jet nozzles to give rearward deflection on the back unit. No obvious fault was found with the hydraulic system, so the vehicle was returned to the clay beds two days later.

Following these tests the rearward jet deflectors were fitted to the rear unit only. (As mentioned above, the loss of lift was excessive when the deflectors were fitted to the front unit.) All subsequent tests were made with this configuration.

Initially, at a clearance height of 7.5 inches, the vehicle bogged down. After the clearance height was reset at 5.5 inches, the vehicle successfully negotiated the east clay bed. Two more successful runs were done at clearance heights of 4.5 inches and 7.5 inches. The fact that the vehicle got through the second time with a clearance height of 7.5 inches is attributed to the influence of wheel ruts and the consequent change in base pressure and wheel torque.

To demonstrate use of the fan for recovery after bogging, the vehicle was driven into the clay pit with the fan inoperative. The vehicle made little progress before being immobilized with the belly on the ground

and the wheels slipping. The fan was then engaged and brought up to full speed. When drive was again applied to the wheels, the vehicle moved forward and completed the traverse of the bed. Clearance setting on this run was 4.5 inches.

Other tests are described in Appendix II.

On completion of these clay tests, the vehicle was transported to a muskeg site north of Parry Sound, Ontario. Figure 14 shows the vehicle making a pass across the muskeg test site. The vehicle successfully performed 32 passes through low-bearing FI-type muskeg along the same path. It was then moved to an undisturbed area of the same site, and 33 passes were made. At intervals, the screw jacks were used to lower the wheels further as the ruts became deeper until finally the wheel rut depth was on the order of 18 to 20 inches below the original surface level.

In the course of the field tests, 14 recordings were made in the clay beds and 14 in muskeg. During 10 of these recordings, the vehicle was in reverse so that the hydraulic pressure traces were meaningless since the transducers were connected to the motor inlet for forward rotation of the motor. In the remaining 18 traces, various troubles with the recorder were encountered which reduced the amount of data analysis possible. In particular, the 10 recordings taken on the last day's tests in muskeg were very disappointing. Two wheel speeds failed to record and for the last eight tests the vehicle speed trace was absent.

Figures 15 to 24 present results of analysis of one muskeg test and three clay tests. Initially, an attempt was made to correlate the wheel force and slip for individual wheels, but the scatter was such that no correlation was possible. This procedure was necessarily abandoned, and average wheel force for the four wheels was plotted against average slip. Better correlation resulted, but the scatter was still high for muskeg. Figures 15 to 18 show the plot of tractive effort deduced from motor hydraulic pressure versus average wheel slip. The tractive effort has been made nondimensional by dividing by the wheel-borne weight. Figures 19 to 22 show the fraction of weight supported by the air cushion for these tests calculated from the measurement of base pressure.

Referring to Figure 18, which was the first test run in muskeg, it will be seen that considerable scatter is evident. The duration of this run

was 16.5 seconds. The ratio of tractive effort to the weight supported on the wheels was calculated at 1/4-second intervals and gave a mean value of 0.188 for a mean slip value of 0.169. Because of the large scatter which resulted from point-by-point plotting, other results were calculated on this basis of the mean values for the complete run.

Analyses of tractive effort in clay versus slip are shown in Figures 15 to 17. These show less scatter than the tests in muskeg, but the slopes of the curves differ from each other.

Referring now to Figures 19 to 22, which show the variation of the weight supported by the air cushion, it is seen that the maximum value recorded was 0.83, which occurred in the early clay test and represented a lift force of 7640 pounds from the air cushion resulting from pressures of 77.6 and 81.4 pounds per square foot under front and rear cushions respectively. At this condition, the wheels were producing an estimated tractive force of 585 pounds, which is 6.5% of the total vehicle weight. The problem of determining height in the air cushion during field testing was one which was approached with some initial doubts, which were soon justified. The transmitting height gauges at the four corners of the vehicle were very rapidly immobilized by a build-up of mud in spite of attempts to protect them by plastic covers. Only during the hard-surface testing were any valid recordings received from these gauges.

Table 5 gives mean values of tractive effort, base pressures, fraction of lift air supported and the ratio of front to rear lift during these runs.

There were occasions during the tests when the vehicle was immobilized. Where such failure was encountered, it was attributable to one or more of four reasons. These were: (1) the clearance height of the vehicle was set too high so that too great a penetration of the wheels was permitted before the air cushion became effective; (2) after several passes over the terrain, buried obstacles such as tree stumps were encountered; (3) the hydraulic motors delivered insufficient torque when a wheel was jammed into a previously formed rut; and (4) loss of air cushion assist was experienced because of surface irregularities such as a rapid change in slope when approaching the test site or from tilting of the vehicle when one side sank deeper than the other.

In the final form of the vehicle, such difficulties should be overcome by the features to be incorporated. Taking the items in the order given above, the following comments can be made:

TABLE 5  
 REPRESENTATIVE AVERAGE PERFORMANCE DURING FIELD TESTS

Site	Test	Pass	Wheel Setting (Inches)	F/WW	Base Pressure (P.S.F.)		L/W	Slip	LF/LR
					Front	Rear			
2	1	1	4.5	.250	48.9	43.8	.485	.1975	1.00
2	12	13	5.0	.246	62.8	43.5	.555	.290	1.42
2	13	15	7.0	.244	56.2	40.8	.507	.427	1.36
3	1	1	4.5	.188	53.5	43.8	.508	.179	1.20

SITE 2 - EAST CLAY BED

SITE 3 - FIRST MUSKEG BED

- F = TOTAL WHEEL FORCE
- WW = WEIGHT ON WHEELS
- LF = FRONT CUSHION LIFT (POUNDS)
- LR = REAR CUSHION LIFT (POUNDS)
- L = TOTAL CUSHION LIFT (POUNDS)
- W = TOTAL VEHICLE WEIGHT

- (1) Control of the wheel height by the driver will be provided; this will permit the height to be adjusted for optimum traction for the terrain.
- (2) Steering will enable the vehicle to find its way around obstacles and at the same time the wheel height control can be used to assist passage over them.
- (3) The higher torque capabilities of the final hydrostatic transmission together with oscillation in the steering mode (duck-walking) will prevent jamming in ruts.
- (4) The ability to contour the vehicle by back breaking to adjust to the terrain plus the freedom in roll of the two units will reduce loss of cushion assistance. The use of extended skirts to overcome local interruptions in the air gap has also been suggested.

The complete fulfilment of the field test program was hampered by various mechanical delays which robbed the program of valuable test time as the winter approached and freezing of the test beds began. The first engine received lacked sufficient power to operate the fan at a high enough speed and showed a very high oil consumption. It was returned to the manufacturer, where it was found that the piston rings had failed. Two weeks of the test program were lost due to the replacement of this engine and in the correction of oil leaks in the fan bearing seal. It was essential to interrupt the clay testing in order to ship the vehicle about 150 miles north so that muskeg testing could be undertaken before freeze-up. The vehicle was returned to the Malton clay beds for completion of clay testing in mid November. A further delay was caused by a necessary overhaul of the hydraulic pumps, since the low-pressure filters had burst during the muskeg tests, allowing foreign matter to enter the pumps. The maximum pressure attainable had fallen to 400 p.s.i. Because of this, clay testing could not be resumed until the end of November. At this date it was found necessary to remove frozen clay from the surface of the bed to a depth of two inches to uncover the soft clay below.

Because of the approach of winter, therefore, tests were not conducted with different loading of the vehicle; instead, a compromise was made to add 400 pounds of load to the rear of the vehicle, which, together with the instrument observer and recorder in the rear and the driver in the front, gave a total weight of 9200 pounds to the vehicle, which is in excess



of the total loaded weight estimated for the final vehicle. All field tests were conducted at this weight with slight variations due to gasoline consumption. A rudimentary skirt about 6 inches long had been applied to the vehicle, but after a few hard-surface tests it was pulled up and had no significance in the field tests.

### Drawbar Pull

In tests in clay, a maximum value of 960 pounds drawbar pull was measured; this occurred with a slip of 0.42. In this test, the clearance height was set at 5 inches and the wheel-supported weight at the time of maximum pull was 45.5%, or 4190 pounds. Immediately following this test, the clearance height was changed to 7 inches and a maximum drawbar pull of 503 pounds was recorded with 0.83 slip. The wheel-supported weight here was 30%, or 2760 pounds. The ratios of drawbar pull to wheel-supported weight in these two tests were 0.23 and 0.18 respectively. Figure 23 is a graph of drawbar pull versus slip for the latter of these tests. Figure 24 shows the variation of wheel speed, vehicle speed, and slip during this test.

In muskeg, the maximum value of drawbar pull recorded was 540 pounds with 6.5 inches clearance setting.

As mentioned in the section on the drive, the maximum force which the motors could produce was 1520 pounds at their nominal pressure limit.

### Field Test Recordings

Details of field tests recorded are given in Table 6.

**TABLE 6**  
**TABULATION OF FIELD TESTS RECORDED**

Test Site	Description	Recording No.	Pass No.	Clearance Setting (Inches)	Direction
1	Clay West	1	1	7.5	F
1	Clay West	2	2	7.5	R
2	Clay East	1	1	4.5	F
2	Clay East	2	3	4.5	F
2	Clay East	3	5	5.5	F
2	Clay East	5	1	4.5	F
2	Clay East	6	2	4.5	R
2	Clay East	7	3	4.5	F
2	Clay East	8	4	4.5	R
2	Clay East	9	5	4.5	F
2	Clay East	10	6	4.5	R
2	Clay East	11	7	7.5	F
2	Clay East	12	13	5.0	F
2	Clay East	13	15	7.0	F
3	Muskeg	1	1	4.5	F
3	Muskeg	2	2	4.5	R
3	Muskeg	3	3	4.5	F
4	Muskeg	1	1	6.5	F
5	Muskeg	1	1	6.5	F
5	Muskeg	2	2	6.5	R
5	Muskeg	3	3	6.5	F
5	Muskeg	4	4	6.5	R
5	Muskeg	5	5	6.5	F
5	Muskeg	6	6	6.5	R
5	Muskeg	7	7	9.5	F
5	Muskeg	8	9	9.5	F
5	Muskeg	9	10	9.5	R
5	Muskeg	10	11	9.5	R

F = FORWARD

R = REVERSE

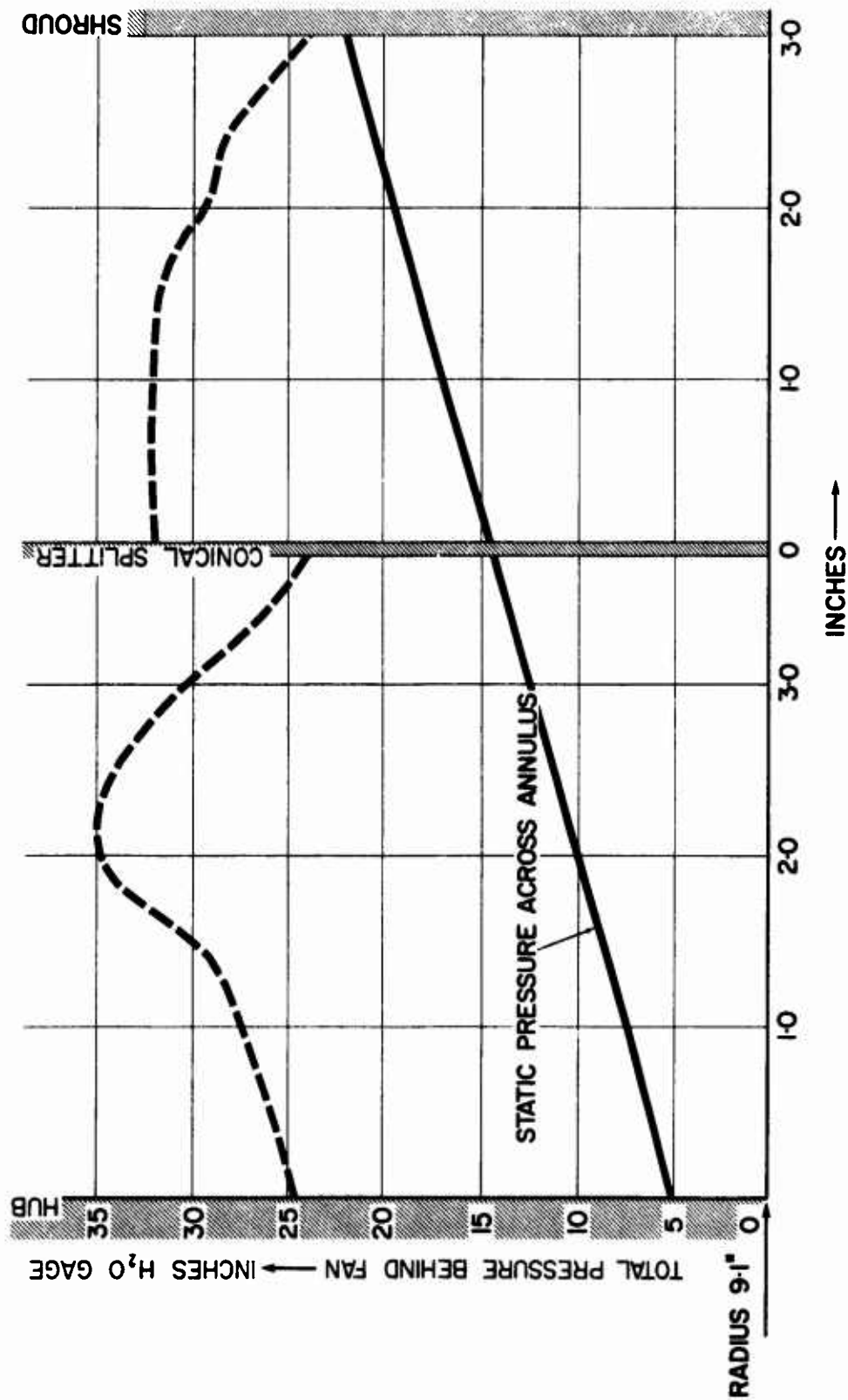

Figure 10. Velocity Distribution Behind Fan at 5750 R. P. M.

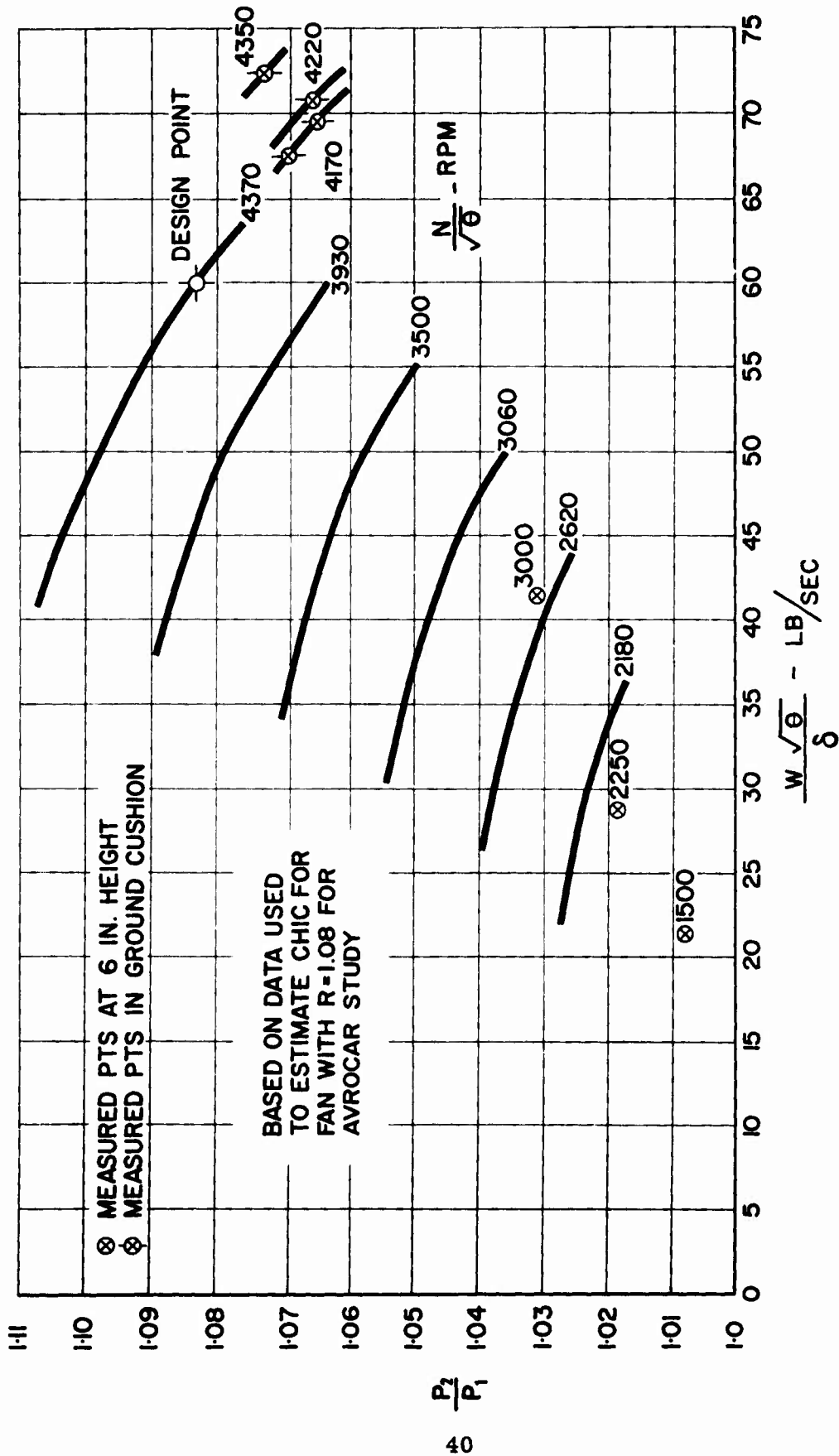

Figure 11. Characteristics for Gemini Fan

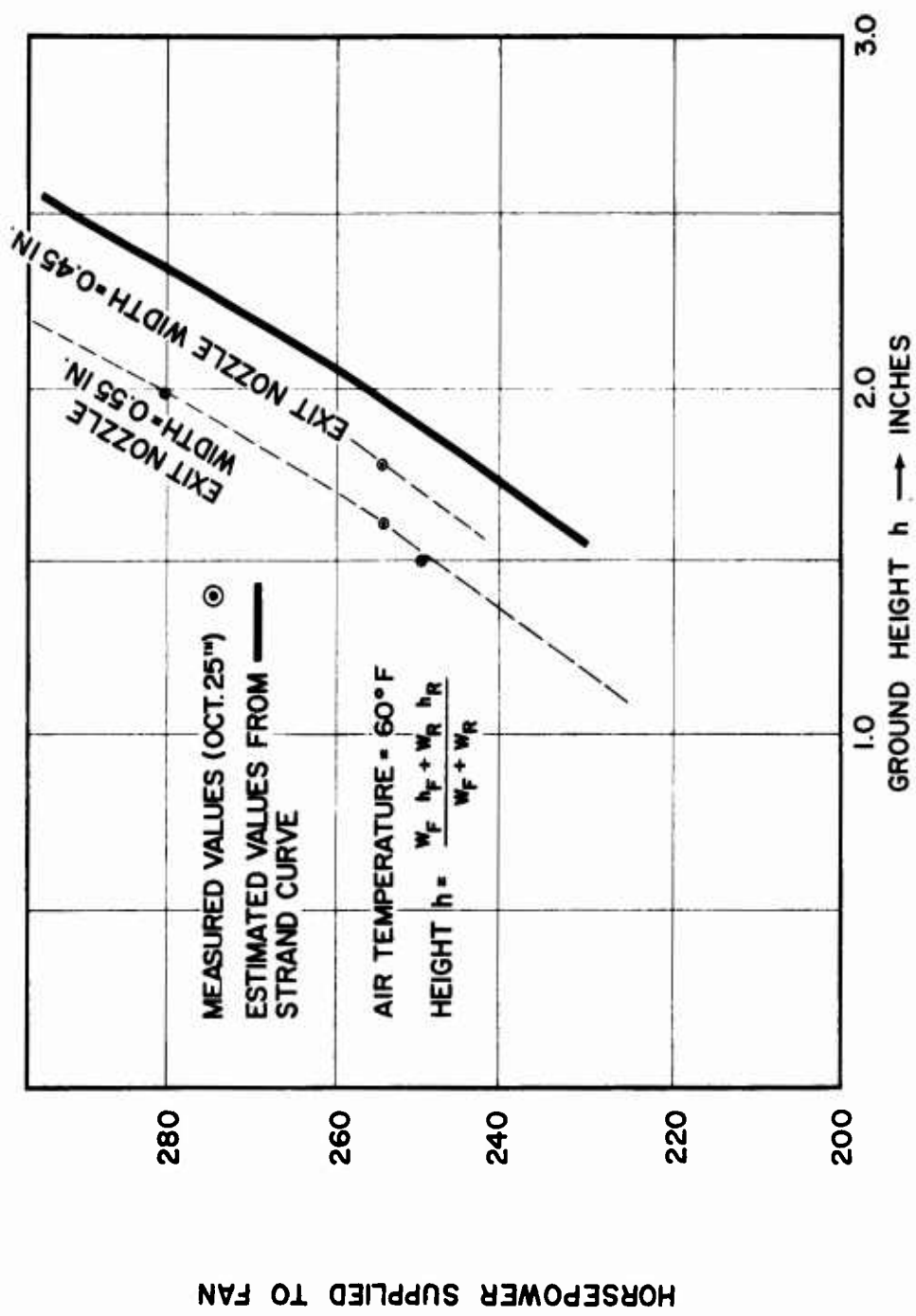

Figure 12. Engine Power vs. Cushion Height

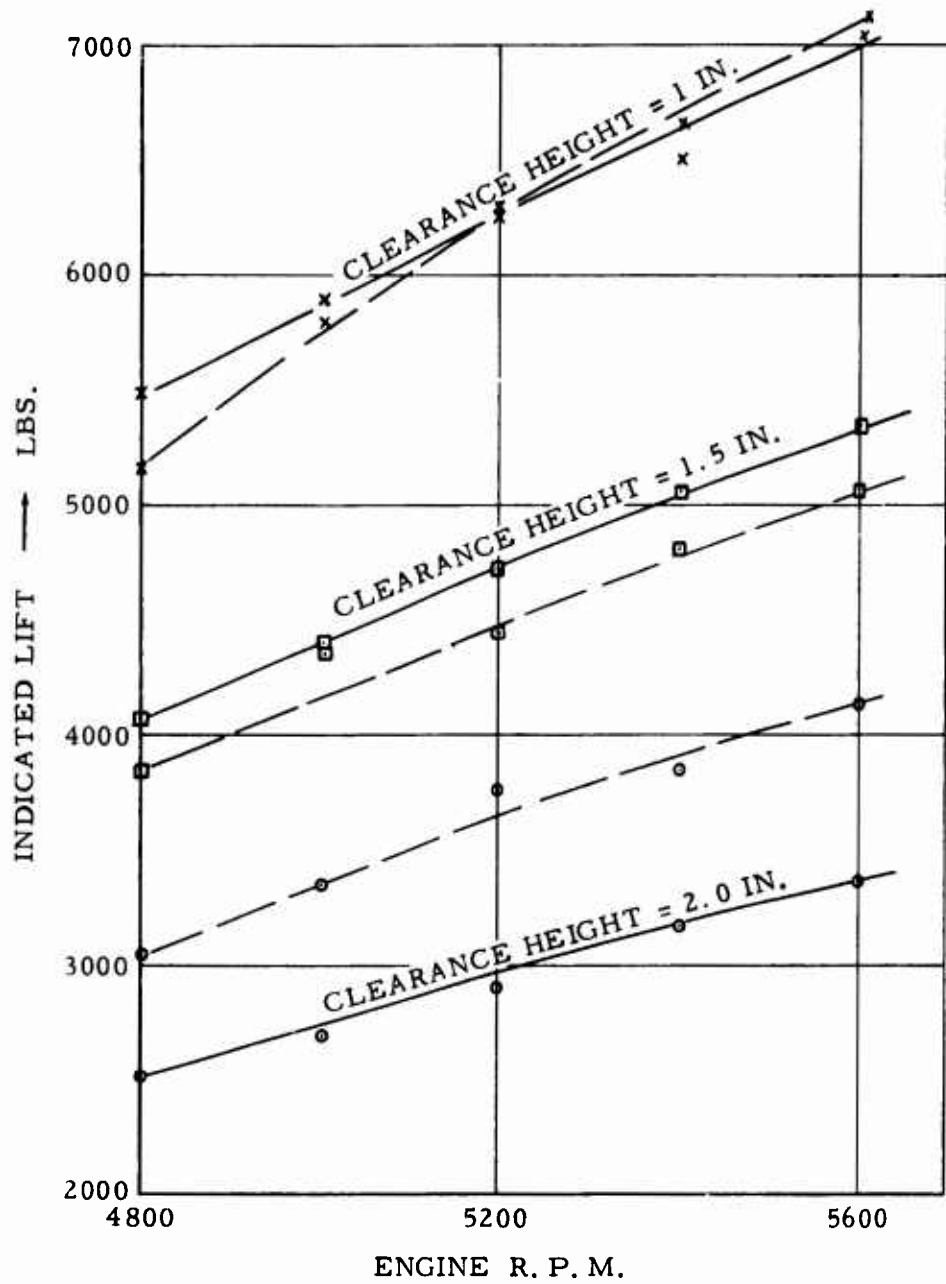

Figure 13. Gemini Tests on Asphalt



Figure 14. Gemini Phase I Test Vehicle Crossing Muskeg

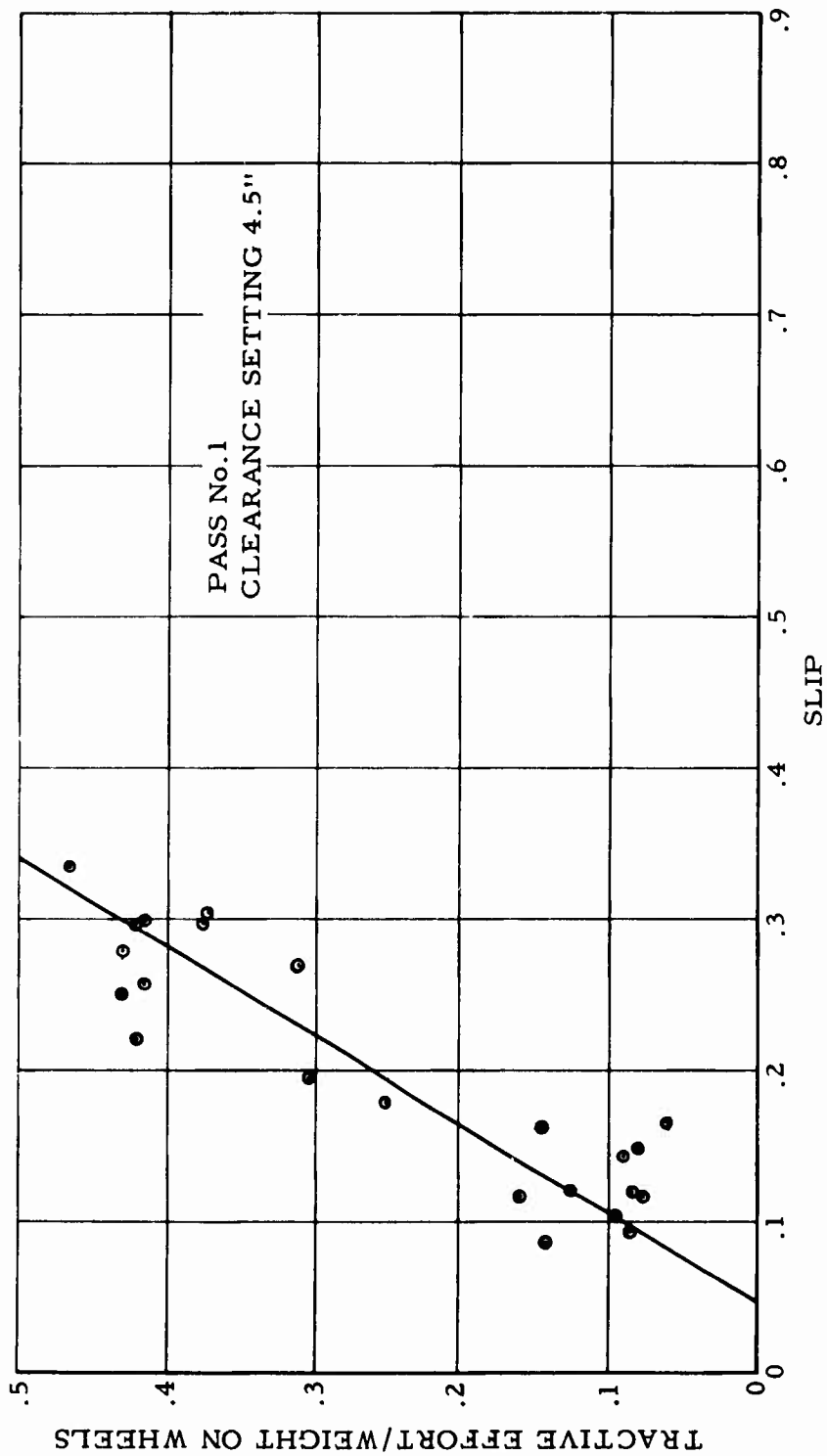

Figure 15. Tractive Effort vs. Slip - East Clay Bed



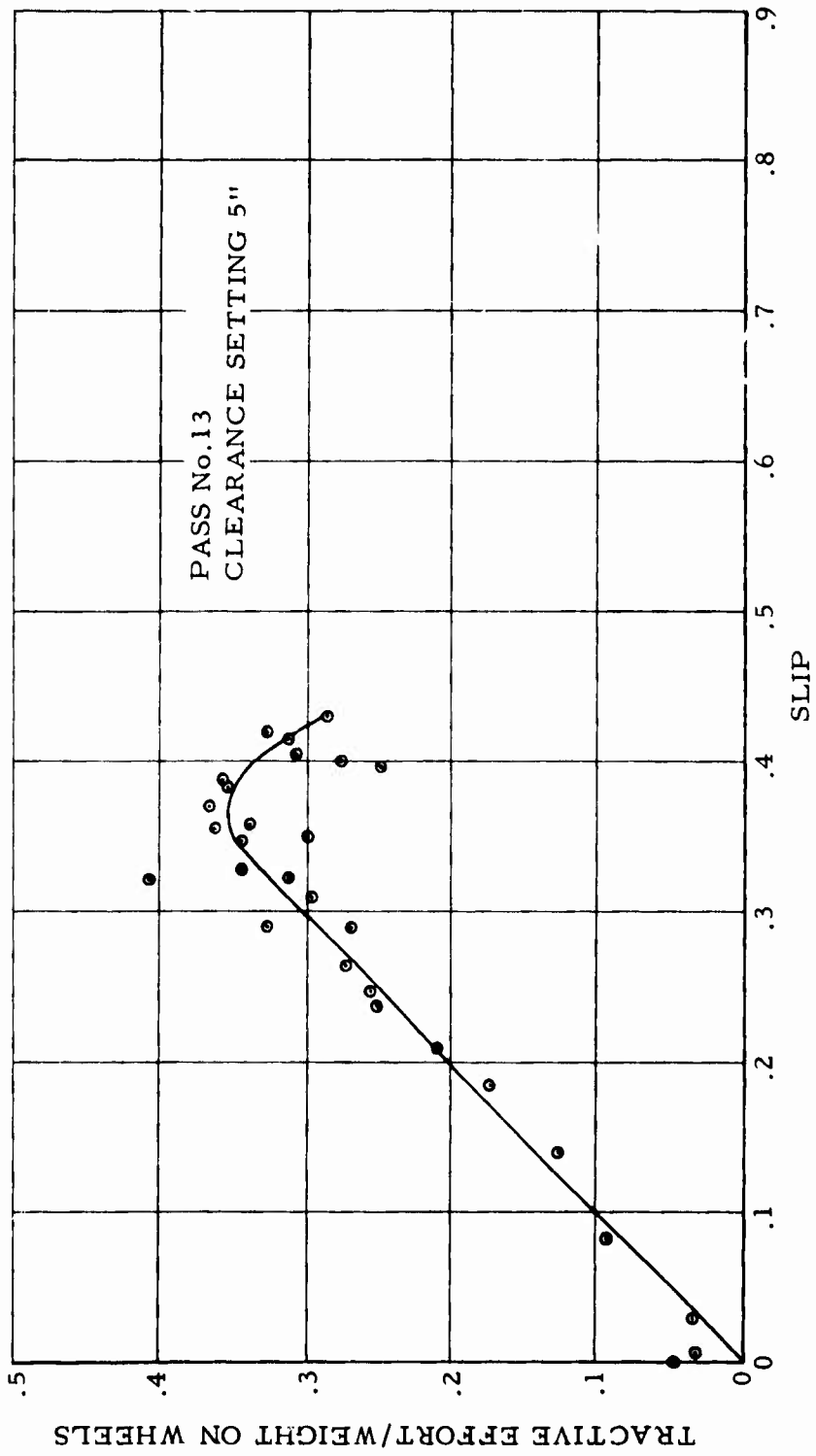

Figure 16. Tractive Effort vs. Slip - East Clay Bed

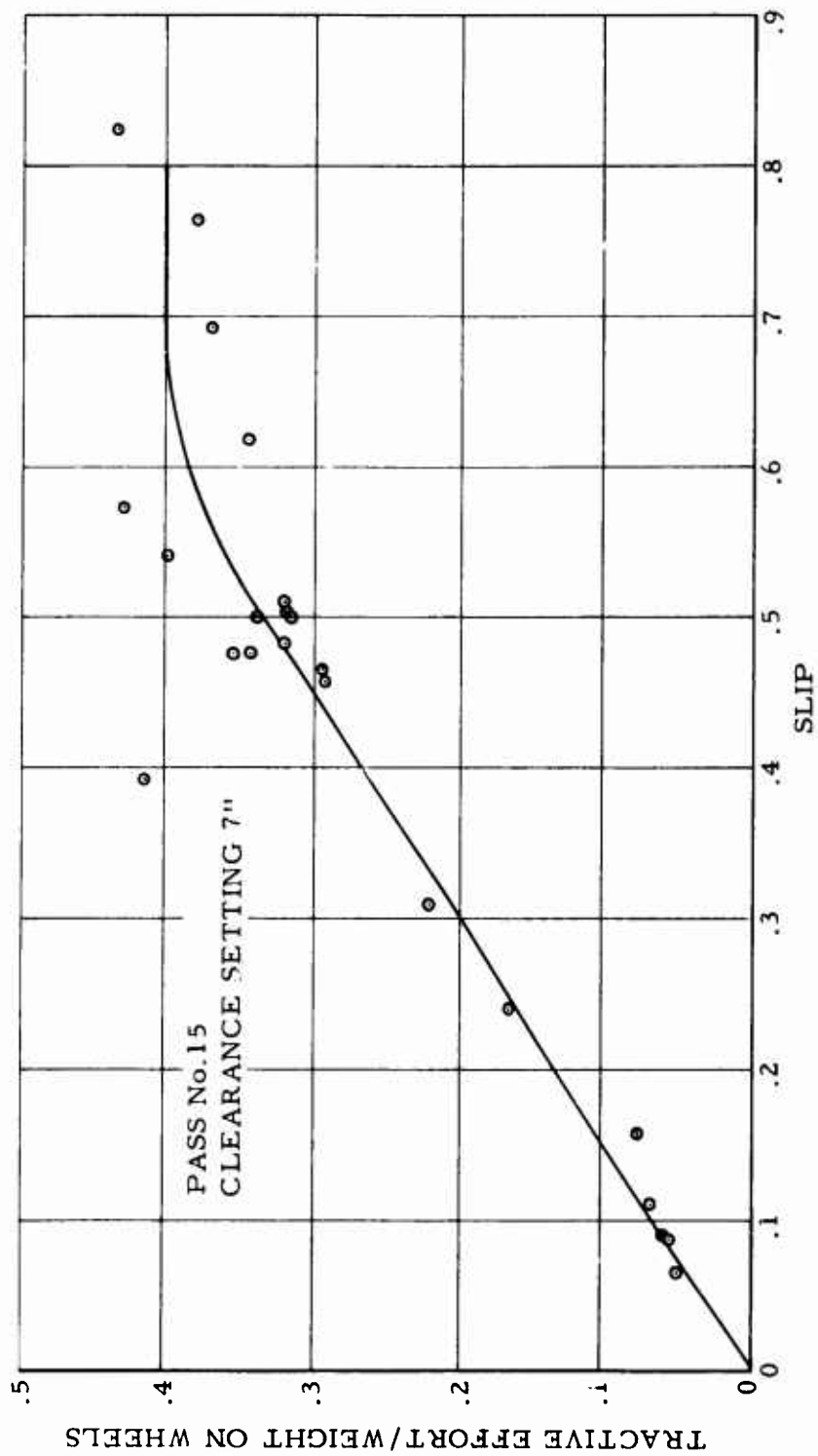

Figure 17. Tractive Effort vs. Slip - East Clay Bed

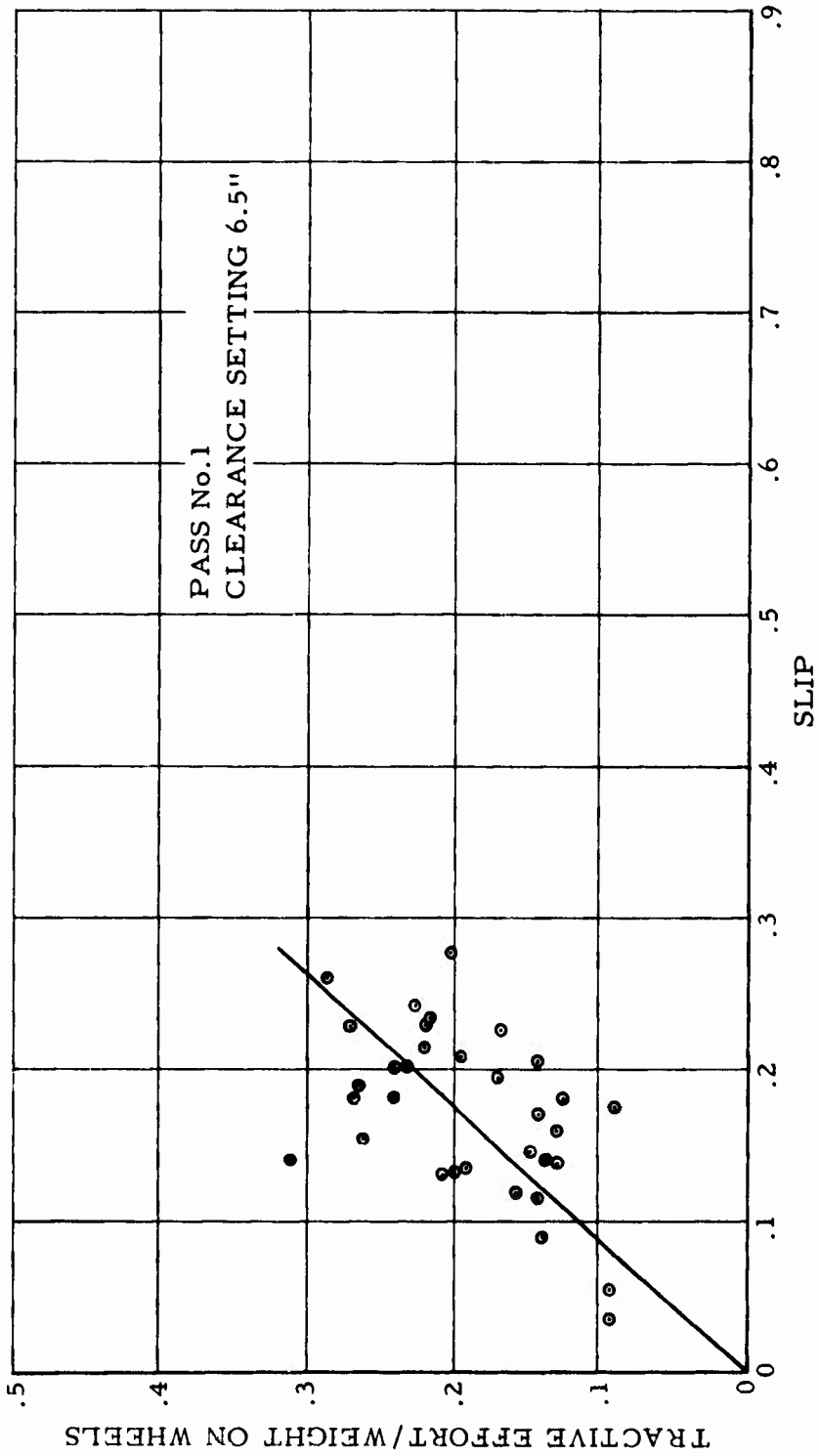

Figure 18. Tractive Effort vs. Slip - Muskeg Site 3

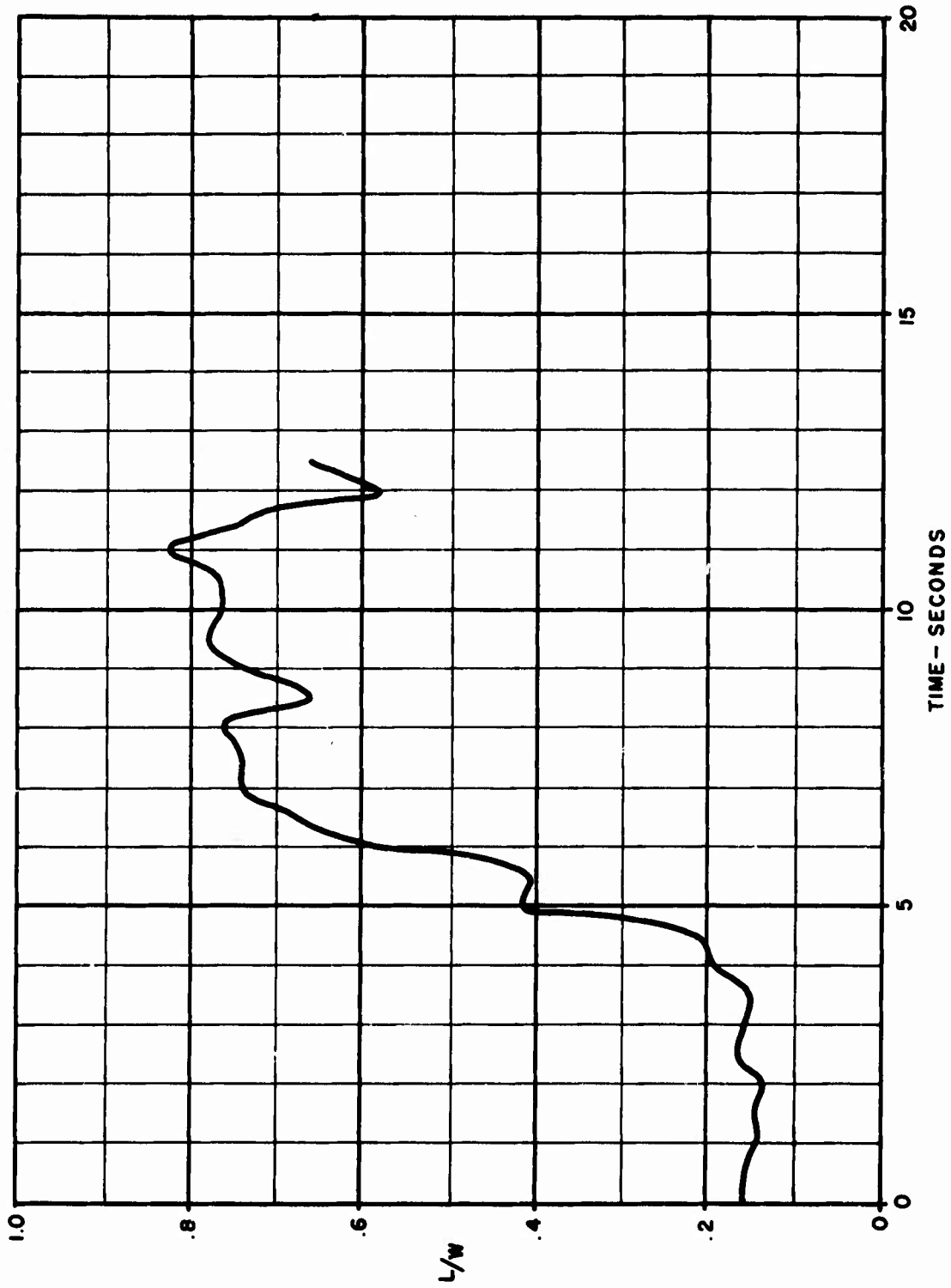

Figure 19. Ratio of Airborne to Total Weight vs. Time in Seconds

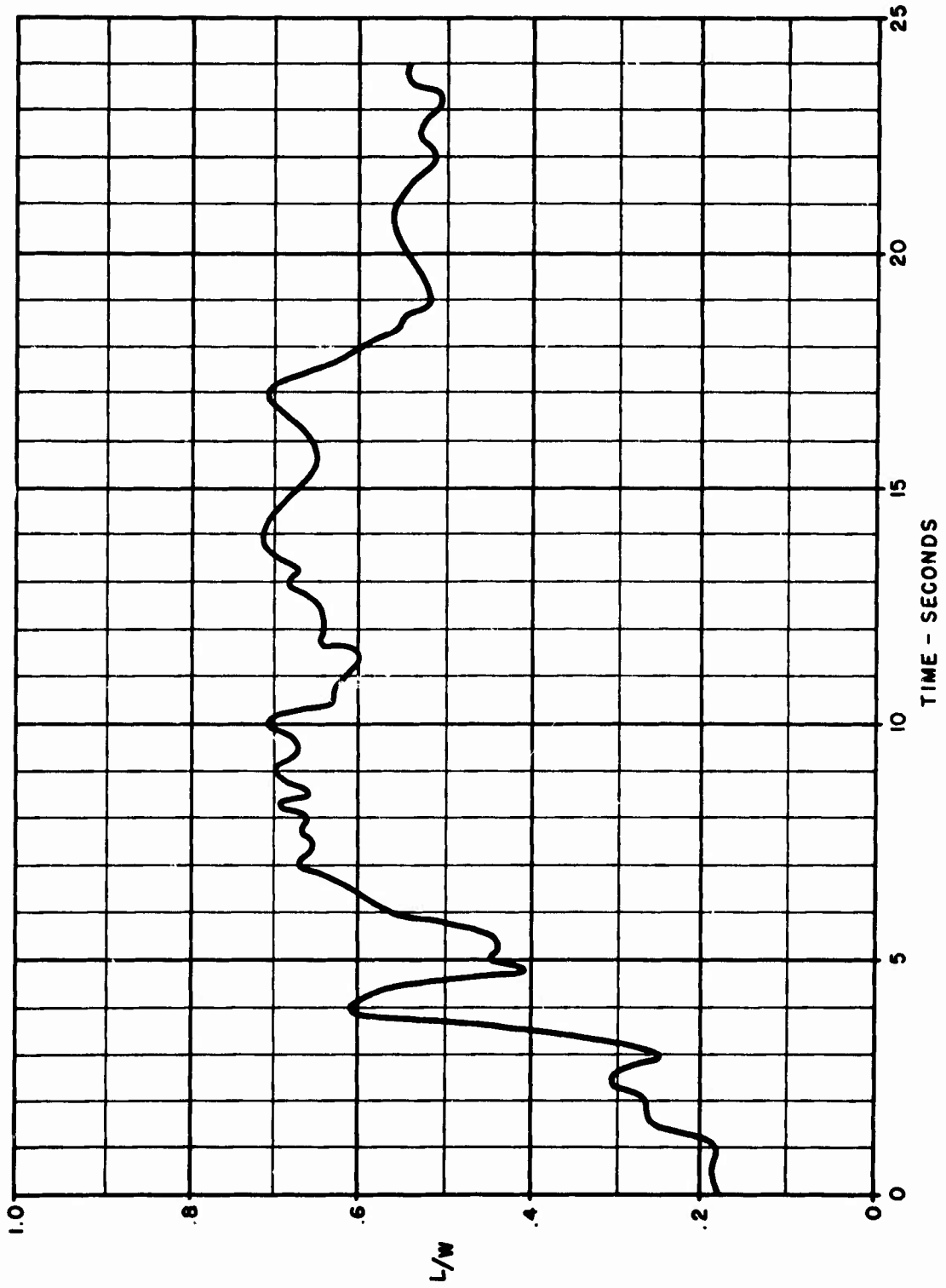

Figure 20. Ratio of Airborne to Total Weight vs. Time in Seconds

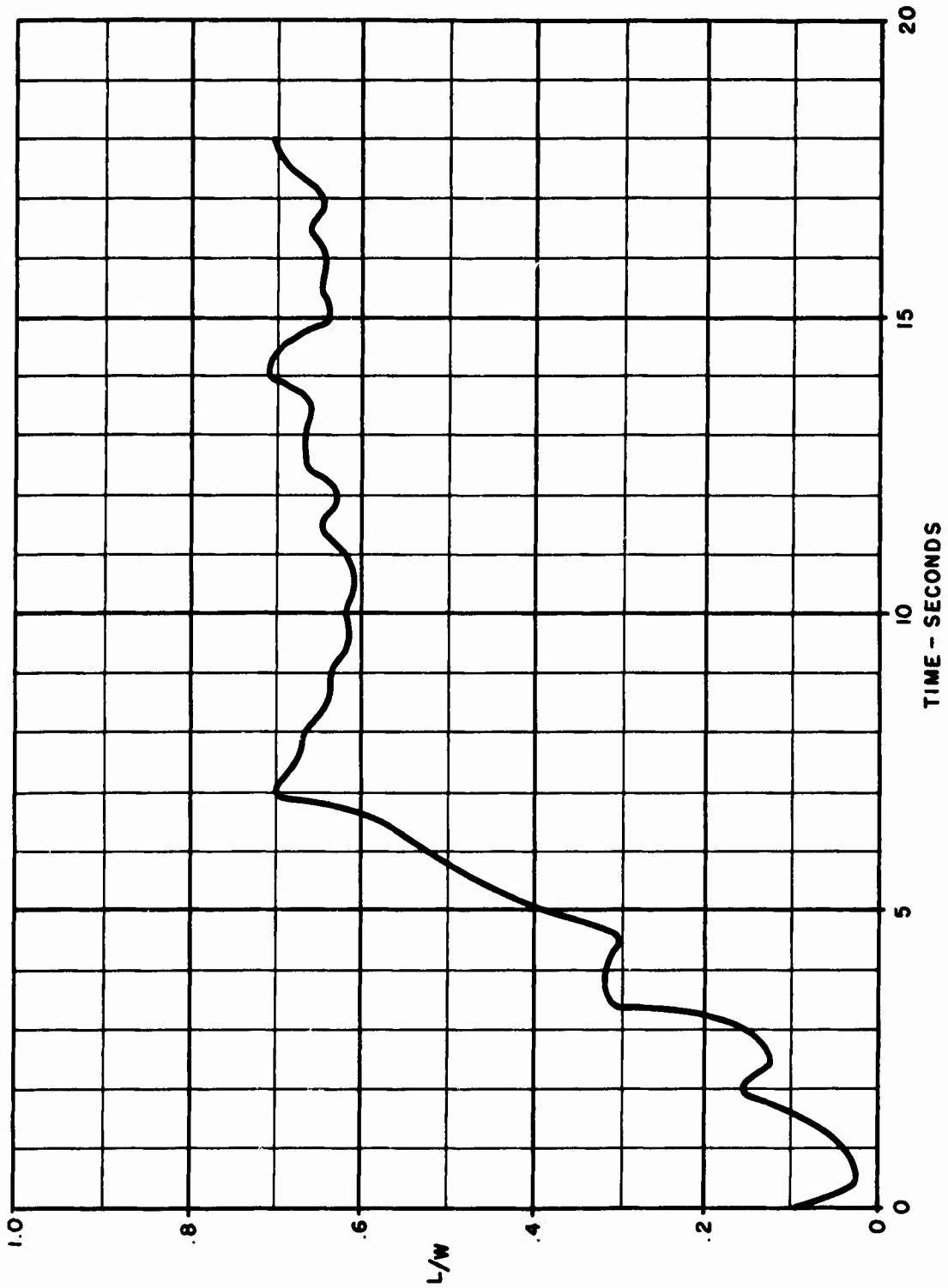

Figure 21. Ratio of Airborne to Total Weight vs. Time in Seconds

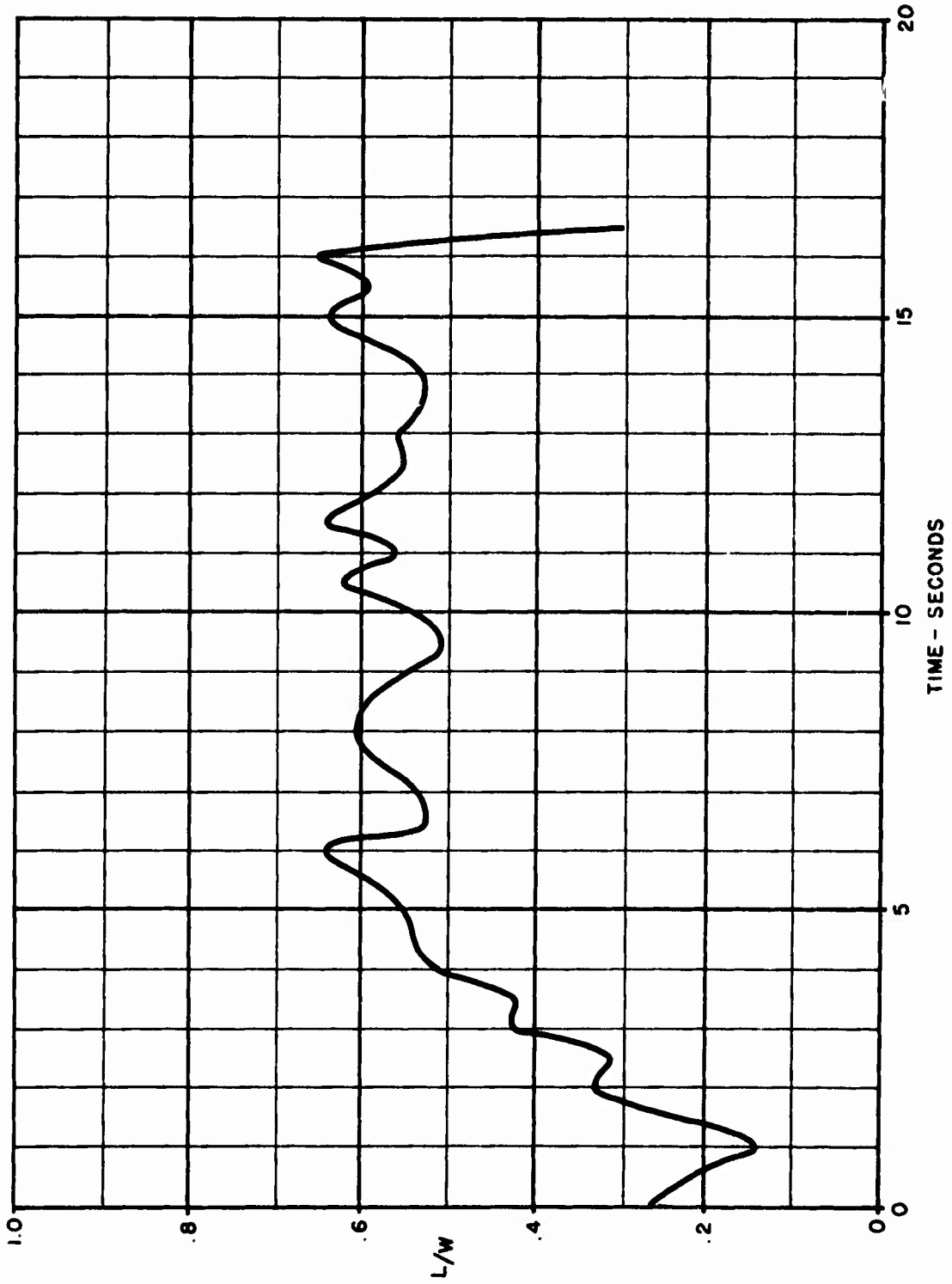

Figure 22. Ratio of Airborne to Total Weight vs. Time in Seconds

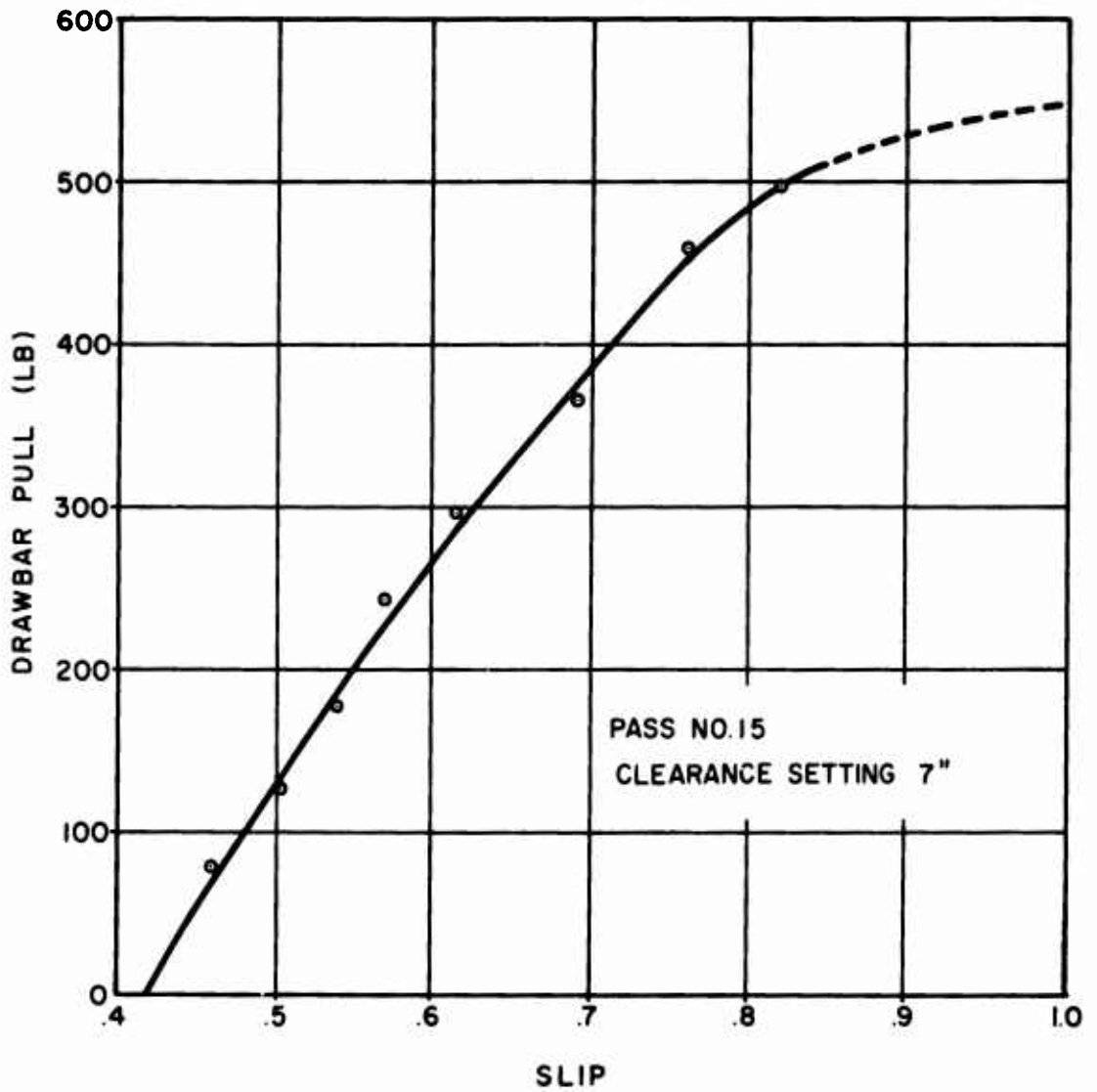

Figure 23. Drawbar Pull vs. Slip - East Clay Bed



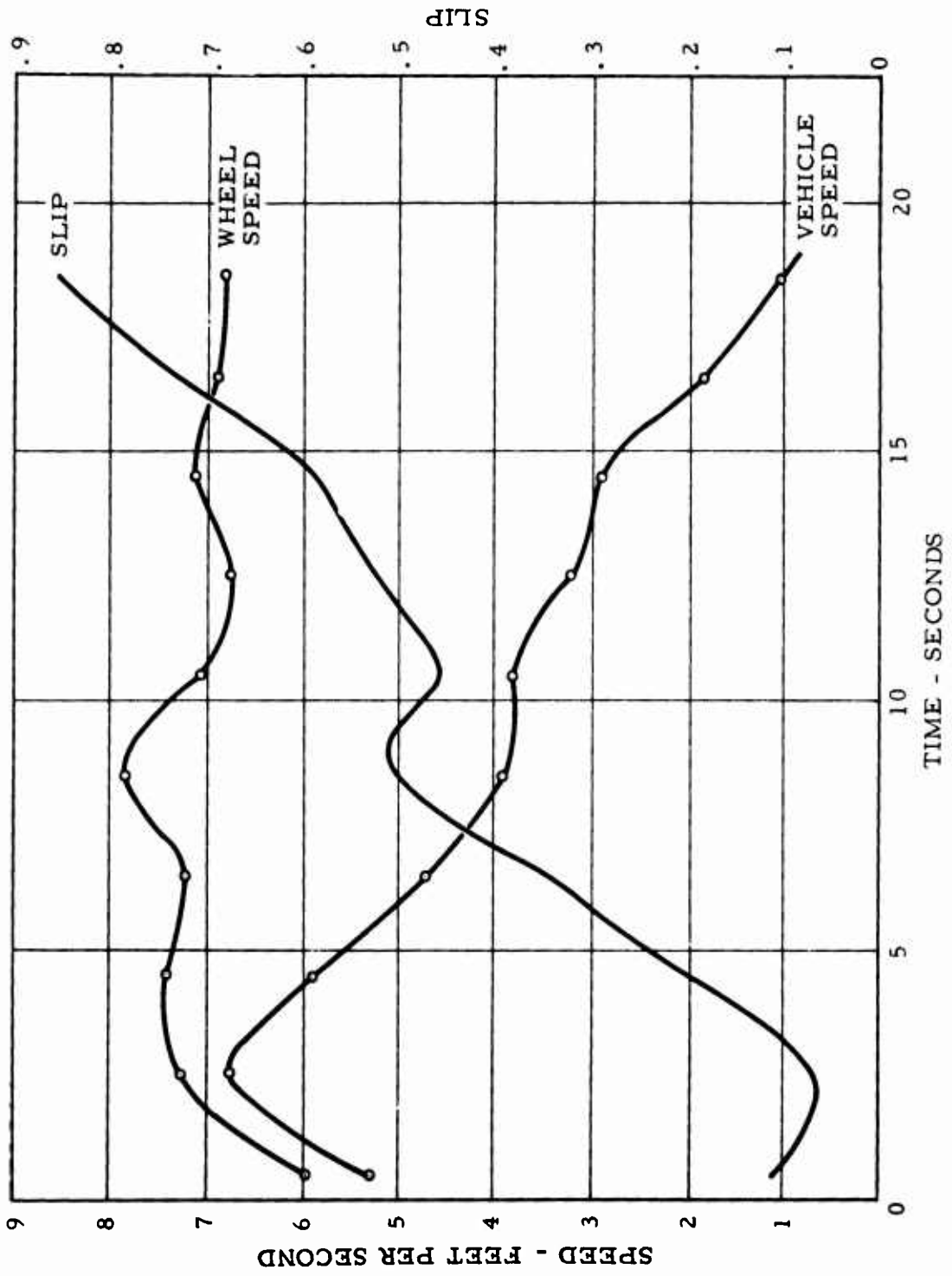

Figure 24. Wheel Speed, Vehicle Speed, and Slip vs. Time in Seconds During Drawbar Pull Test

## APPENDIX I

### MUSKEG TRIALS PROJECT GEMINI

by

ORGANIC AND ASSOCIATED TERRAIN RESEARCH

UNIT (OATRU)

McMASTER UNIVERSITY

#### INTRODUCTION

It is to be understood that this account has pertinence to the context of Phase I of the development program for Gemini and is not intended as a prediction on performance of the test vehicle as envisioned for Phase II.

#### PURPOSE

The objective of the OATRU investigation was to evaluate the ground effects concept as envisioned by Hawker Siddeley Canada Ltd., as it applied to specified limiting conditions offered by organic terrain.

In order to document the study, it was proposed in the arrangements for test to procure qualitative and quasi-quantitative data characterizing the terrain on which the machine was to operate. In this way the device tested would be classifiable on a utility basis as compared with vehicles already in production and having a degree of success on designated kinds of organic terrain. Also, the terrain having been appraised and categorized would be known in relation to frequency of occurrence (internationally) and the kind of experience it characteristically affords.

#### SPECIAL CIRCUMSTANCES OF OPERATION

The selection of the test location had to be a function of several factors not indigenous to the proposed field experiment. The machine, because of its necessary mechanical limitations, had to be tested in an area to which it could be conveniently delivered, maintained and protected, and

to which personnel could have ready access.

Off-road routes over which the machine was to be towed had to be appropriate in terms of microtopography, vegetation and soil to the condition of limited mobility characterizing the machine. Also, at all times during access to site and in test the vehicle had to be retrievable. Thus, the operation required the use of two supporting vehicles, one of which was adjusted mechanically for hauling and retrieving.

### SITE SELECTION

In the final arrangements, OATRU was requested to test only in organic terrain. Therefore, all the tests were arranged for at the OATRU Muskeg Proving Grounds near Parry Sound, Ontario.

### MACROTOPOGRAPHY OF THE LOCATION

The region typifies precambrian shield landscape comprising characteristic granitic folds (Fig. 29 background) and plateaus (Fig. 30) with lakes or muskeg or both (Fig. 29) occupying the depressions.

The muskeg is known as confined organic terrain in gross terminology because it is limited geographically by sharply rising mineral terrain (in this case, granite). This is in contrast to unconfined organic terrain which is comparatively very extensive often for 10 to 100 miles without interruption of mineral outcrops.

It is necessary to know that in confined organic terrain there is sometimes a high frequency of change in constituent type of organic terrain. Thus, in selecting the site for tests, only portions of the total area satisfied the conditions of test.

### ORGANIC TERRAIN TYPE

Within this macrotopographic complex, the desired muskeg medium was of medium and high water regime with F1 vegetal cover formula. Because of uncertainty as to buoyancy and general performance response of the machine, the terrain had to be of the nonfloating kind. Finally, because the preliminary specifications limited the scope of mobility of the vehicle, the gradient of approach to the muskeg from the granitic "shore" line had to be very shallow (e.g., Fig. 67).

## THE ACCESS ROUTE

The off-road traverse to the locations commenced at the shoulder of highway 69 about 12 miles north of Parry Sound and proceeded westward first to Muskeg Area 10g (Figs. 35 and 28) and later to 10f (Figs. 94 and 27), a distance of about half a mile.

Granitic plateaus were utilized in travel to the natural launching ramp at the shore of Area 10g and later 10f (cf. Figs. 28, 27, 35 and 94).

### The Test Sites Within Areas 10g and 10f

From the launching ramp adjacent to Area 10g, the vehicle went under its own power to test strips 1 to 4 inclusive. In Area 10f, the location of high water regime, the water depth was too great to facilitate the type of observation required at this stage in the test and development program. Therefore, a site near the ramp was selected for purposes of convenience.

It must be emphasized that the selection of these sites was an item of special study requiring frequent investigation of change in water level in order that the sites ultimately selected would be appropriate to the conditions of test. It was also necessary to select those sites in which, after failure in performance, the effect could be conveniently measured and evaluated. Water regime, surface vegetation, mat structure, peat structure, depth of peat, physical condition of mineral subsurface, micro-topographic constitution, weekly weather considerations and seasonal evolution of drainage were factors that had to be assessed in order that appropriate conditions would obtain for the time at which it was proposed to make the tests.

Test site elimination during the selection process began in August; Areas 10g and 10f during October and the first half of November satisfied the requirements of test and operation of all sites within an area of approximately 100 square miles of the Parry Sound Proving Grounds.

## TERRAIN ANALYSIS

### PREDICTION

With FI cover, the peat category is almost invariably nonfibrous as to its major constituent. In unconfined muskeg, the nonfibrosity indicated

by the amorphous granular condition usually forms the bulk of the three-dimensional peat mass below a superficial layer somewhat consistent as to depth and constituted of a nonwoody fibrous element making the amorphous granular component much more cohesive. If, on occasion, a mounding or ridging condition occurs as a microtopographical feature, the fibrosity becomes occasionally woody.

Largely because this total composition has been found to recur with the FI cover, the situation has been viewed as predictable. Area 10g produced this condition beneath its FI cover with the amorphous granular sublayer approximately 1 foot down from the surface of the mat. In Area 10f FI mounding and ridging were absent. Fibrosity in the peat in these circumstances would be relatively unimportant, and such proved to be the case.

One important feature in connection with this type of peat constitution is that the muskeg mat is readily sheared, and the amorphous granular constituent offers negligible bearing strength as soon as it is remolded.

### STRENGTH TESTS

Cone penetrometer values indicating strength measurements as applied on a three-dimensional grid are shown for each of the test lanes shown on Figs. 27 and 28 immediately before the vehicle was applied.

## VEHICLE TESTING

### PRELIMINARY RUNS

Test lanes 1 and 2 (Fig. 43) were used to gain first experience with respect to behavior of the vehicle and the method of measuring subsidence. During this interval, adaptation and adjustment of instrumentation were considered.

It was determined early in the testing that the vehicle could not proceed under its own power so far as forward thrust was concerned, in other words, on muskeg. Resistance offered by any sort of friction, be it surface or subsurface obstruction, could not be overcome. Even with 2000 p.s.i. of hydraulic pressure, the torque on the wheel motors was insufficient to move the wheels. Our notes show that the air cushion effect was tried with a fan speed of 5700 r.p.m., but no movement was

noted. With the wheels lowered to 15.5 inches to give more clearance and the air cushion developed at 5900 r.p.m., there was no appreciable movement forward. The ruts caused by the wheels were approximately 12 inches deep.

The vehicle was then removed to the launching ramp, where the wheels were lowered to the maximum of 24 inches. This time, with air cushion applied and power transmitted to the wheels, the vehicle made its way over the surface of the muskeg. It was subsequently found that even with the wheels at half the maximum depth (at 12 inches), the machine would move forward provided the air cushion was established, utilizing very high revolutions (order of 5900) at the time that the vehicle was launched from the ramp.

If very high revolutions were maintained, forward progress could be arrested and later resumed. Also, with the air cushion maintained, the vehicle could go into reverse and complete a second pass.

The typical microtopographic feature of EI mounds and ridges of approximately 1 foot in amplitude of depth despite their lack of resistance to vertical bearing pressure, at first provided effective obstruction. There was loss of lift as the nose of the vehicle rose. Later, on the other hand, the machine could cope with this condition provided it had generated good forward momentum.

In the preliminary tests, attempts were made to regenerate maximum lift from a static position. At full r.p.m., the front left rose 5/8 inch and the rear right rose 1-1/4 inches. At normal r.p.m., the vehicle settled; within 1 minute of shutdown of power, the settlement point was 1-1/4 inches below the initial datum.

#### THE EFFECT OF MULTIPLE PASS

In the course of the main test, the directive was given to persist with to and fro passes in test lane 3. At the fifth pass, a lateral roll developed wherever mounds were encountered. This continued through the tenth pass until the right rear wheel seemed to lock and skid several inches. This was caused by a subsurface obstacle designated in the classification system as a woody erratic. This was removed and an additional 15 passes were completed before another portion of the original obstacle offered resistance. In that portion of the test lane where no obstacle occurred, a total of 20 passes was attained.

In an attempt to pass the obstacle, the wheels were finally lowered an additional 2 inches (now at 8.5 inches) and three more passes were achieved before the wheels had to be lowered a further 2 inches (to 10.5 inches). When the vehicle finally became immobilized on the 32nd pass, the loss of traction was complete. Lowering the wheels an additional 2 inches (to 12.5 inches) was ineffective. The wheels were then lowered a further 4 inches (16.5 inches) but the treads ripped off the putty-like amorphous granular peat from its foundation in a layer at tread depth and no traction was procured.

By this time the machine had settled differentially with the left side higher than the right and no lift was attained. In an attempt to right the vehicle, the wheels on the left side were raised 3 inches and though this had the effect of making the gap between the muskeg and the belly uniformly equal in depth, the power to turn the wheels was insufficient, possibly because of a binding effect caused by friction on the side walls of the wheels. Lowering the wheels on the right by 2 inches did little to relieve this situation and the test was considered complete.

#### THE CHECK RUN

In order to examine consistency of performance, the conditions of test called for a second multiple pass performance to be made on the same kind of terrain and therefore categorized in accordance with the description of test site 3.

The 33 passes achieved were followed by the same circumstances as for test lane 3. The notes record that adjustments in wheel depth were made at 2 inch increments after passes 5, 11, 15, 22 and 29.

#### THE TEST IN 10f

Some difficulty was encountered in launching the vehicle because of slight irregularities in the ramp which at the point of launching caused one wheel to lift off the ground. Thus the Gemini had to be towed into position by a vehicle that was amphibious and travelling with the lower run of its track 32 inches below water level on a peat structure category similar to that applying for 10g but with less woody fibre. Note in Kodachrome motion picture the position of the Gemini about 20 feet from shore. In an attempt to develop the air cushion at 5800 r.p.m., a plume of water rose to a height of about 15 feet, some of it being thrown to the side and some back into the vehicle. At full revolutions the vehicle

raised itself 1-3/4 inches in a lift from standing position. In these circumstances, the wheels were set for maximum ground clearance of 24 inches and the air jet ports were submerged 8 inches below the surface of the water. Though the vehicle could edge forward slightly, vegetation under the water stopped all progress.

### DISCUSSION AND EVALUATION

At this time it may be useful to summarize the field activities by reference to photographs. It is recommended that the Kodachrome motion picture showing aspects of testing be consulted in this connection. In addition to this, the accompanying black and whites will be helpful.

In 10g, the major component of cover FI is shown in Figs. 35, 43, 46, 47, 53 and 71.

The vehicle is poised at the ramp of 10g in Figs. 38, 39, 41 and 42.

The recovery vehicle is shown near the ramp in Figs. 67, 68, 69, 70, 86 and 87.

Microtopographic features as mounds and ridges are shown in Figs. 68, 82 foreground, and 91. The cover on these mounds contrasts with that of FI. The darker coloration is due to the E class. The I can be seen at the tip of the hand in Fig. 44 and in front of the feet of the observer in Fig. 45.

Photographs of the vehicle making headway over FI muskeg are shown in Figs. 53, 74, 77, 78, 79, 80, 90 and 91.

Obstruction by microtopographic feature begins to become evident where EI becomes marked, for example Figs. 80, 81, 82 and 56.

Rutting and the path made by the vehicle are shown in Figs. 49, 50, 52 and 57.

When the wheels are clean (Figs. 37, 40, 53, 56, 75, 76 and 83), traction is still positive; this results despite the fact that fibrous material is often thrown up by the force of the jets or sometimes by the wheels (Figs. 63, 64, 65 and 66).



When fibrous material gives way to amorphous granular, the latter material becomes more evident. Notice the wheels in Figs. 58 and 59 and a trace where the condition is just becoming evident in 62.

This marks the beginning of bogging down when adjustment in wheel depth is essential. Weaknesses in the terrain are often caused by shearing either before or after microtopographic features have been traversed. Note the difference in cover at the beginning of a hole where the observer is standing in Fig. 57 as compared with the EI cover behind it where the floor of the rut is locally raised. In fact, one wheel is shown on such a rise having been withdrawn from the depression behind it in Fig. 60. Loss of traction in a single wheel when all wheels are depressed at the same height can cause immobilization. Figs. 58, 62 and 65 front right are examples of this.

The free water or water of capillarity when freed by tearing of the mat and mechanical maceration is shown in Figs. 45, 47, 52 and 72. It is close to the surface even in the center of mounds (Fig. 51) and is expressed as the wheels traverse the mat.

Refusal of the vehicle to rise because of limitations in hydraulic power applied to the wheels to take advantage of cushion effect is shown in Fig. 84.

Despite this, drawbar pull to 1200 pounds (shear pin broke) was demonstrated on two occasions (Figs. 89 and 90).

The vehicle was never difficult to recover (Figs. 86 and 87) even if microtopographic features (Fig. 92) were encountered on recovery.

Mechanical relations in the peat were examined with the cone penetrometer (Fig. 50 foreground) and with the aid of pressure cells (Fig. 47 which shows a diaphragm of a cell at the surface before it was inserted 12 inches down in the terrain in front of the passing wheels, and Fig. 48 which shows the continuous recording device associated with the pressure cell system).

#### FIELD MEASUREMENTS WITH PRESSURE CELLS

The cells were installed at various depths under the Gemini during the tests on FI muskeg; the water level at the site was approximately at surface level.

The cells placed at the surface level and under the centerline of the vehicle (Fig. 80 Pass 2, cushion height 6.5 inches) showed that the average pressure was 0.15 p.s.i., and that slightly higher pressures, up to 0.25 p.s.i., occurred a few points along the centerline of the vehicle; these points were at the front and rear of each ducting. The pressure under the vehicle was not uniform and varied from 0.25 p.s.i. to 0.10 p.s.i.; this nonuniformity could be due to the nonuniform surface of the muskeg and the change in height of the cushion as the vehicle moved.

It is also noted that the rear portion of the rear ducting gave consistently lower values for the pressure on both forward and reverse runs; this could be due to some blocking in the ducts or the loading of the vehicle.

The influence of stress dissipation within the peat was investigated by placing the cells at a depth of 12 inches. This depth was chosen because of the existence of a layer of firm peat. The stresses applied by the vehicle to the peat at that depth were less than 0.1 p.s.i. and were fairly uniform; the uniform stress applies to the portions of the vehicle within the ducting as the stresses dropped to zero between the ducting at the location of the proposed articulation joint.

The most significant information from the earth pressure cells was obtained from measurements taken under the wheels. In the initial stages, the stresses under the wheels (in the wheel rut, not ground surface level) were higher than the range of the cells. As the vehicle continued to make passes over the peat, the stresses under the wheels were reduced even as the wheels' positions were lowered.

#### The Terrain As An Index Of Performance

Reference to the series of graphs 1 and 2 (Figs. 25 and 26) shows that cone index values increased at depths 3, 6 and 9 inches after ten passes, perhaps indicating compaction of fibrous material, decreased rapidly between 12 and 18 inches, perhaps indicating considerable remolding at the fibrous-amorphous granular peat interface and were quite close to initial values down to 4 feet.

After 32 passes, cone index values were substantially lower at all depths. The low values between zero and 12 inches were due to the presence of fluid amorphous granular peat and water, and the increase

in values beyond 12 inches indicates a lessening of the remolding effect below the fibrous-amorphous granular interface.

### CONCLUSIONS IN SUMMARY

In FI muskeg, the pattern of failure is the same as for all other vehicles.

But it must be emphasized that at the time of writing, no other four-wheeled vehicle has crossed FI muskeg in this water regime with one pass, much less 33. On this basis alone, it must be admitted that the Gemini has demonstrated its success as to principle of performance without question.

In anticipation of Phase II of the project, when mechanical adaptations are more appropriate, (for example, articulation and ability to conveniently change position of wheel depth, etc. as planned), and when power for forward thrust is more appropriate, the vehicle will indeed be difficult to bog down.

Vehicles of this order of ground pressure and of this kind of geometry have heretofore proven useless in FI muskeg and in other kinds of muskeg as yet not tried with reference to the application of the Gemini. Despite the rutting shown in several of the photographs, it must be admitted that no vehicle can compare with the Gemini in avoidance of shear with respect to the mat on which the vehicle must travel to facilitate initial strengthening through compaction and the avoidance of remolding effect. Unless bogging down is induced as it was in the case of the tests, the Gemini was not aggressive in its contact with the surface of the traverse.

It may be useful to point out that the terrain vehicle relationships with respect to the Gemini, certainly so far as the muskeg work is concerned, are fully documented for a case that is most common in many parts of Canada, northern Europe, U.S.A., South America, parts of Africa and southern New Zealand.

It is recommended that this documentation be given careful consideration as design is perfected for the development of Phase II of the vehicle.

It is also recommended that design be conceived so far as Phase II is concerned with reference not only to FI type muskeg but to all other

types to which the vehicle must be applied, so that, for instance, not only terrain structure and conditions of water regime be considered, but that orders of frequency and amplitude of microtopographic features and vegetal surface obstruction are evaluated.

### ACKNOWLEDGMENTS

OATRU wishes to acknowledge the kind co-operation of Messrs. Keast, Petersen and Herbert, and the willing and effective support of all the Hawker Siddeley staff who assisted in the field. The Chairman of OATRU as editor of this report is grateful for the opportunity of association with his colleagues in the course of the work to mention in particular Dr. D.B. Sumner (microtopographic frequency), Professors J.N. Siddall and W.R. Newcombe (transport design analysis and test approach), Professor N.E. Wilson (soil mechanics) and Professor H.A. Wood (mapping and geomorphology).

The above staff of OATRU and the writer are personally grateful to Mr. Kenneth Ashdown, Laboratory and Field Manager for the Muskeg Laboratories, not only for his wisdom and good effect in implementation and expediting of plans, but also for his enthusiasm and interpretation in the many difficult aspects of the job.

Miss Lily Usik (B.Sc.) has served as field recorder and photographer, and others have assisted technically from time to time as listed:

Miss J. Ryder  
K. Cardwell  
R. Hofstetter  
A. Paul  
G. Thaler

OATRU staff acknowledges with appreciation their interest and valuable help.

Norman W. Radforth.

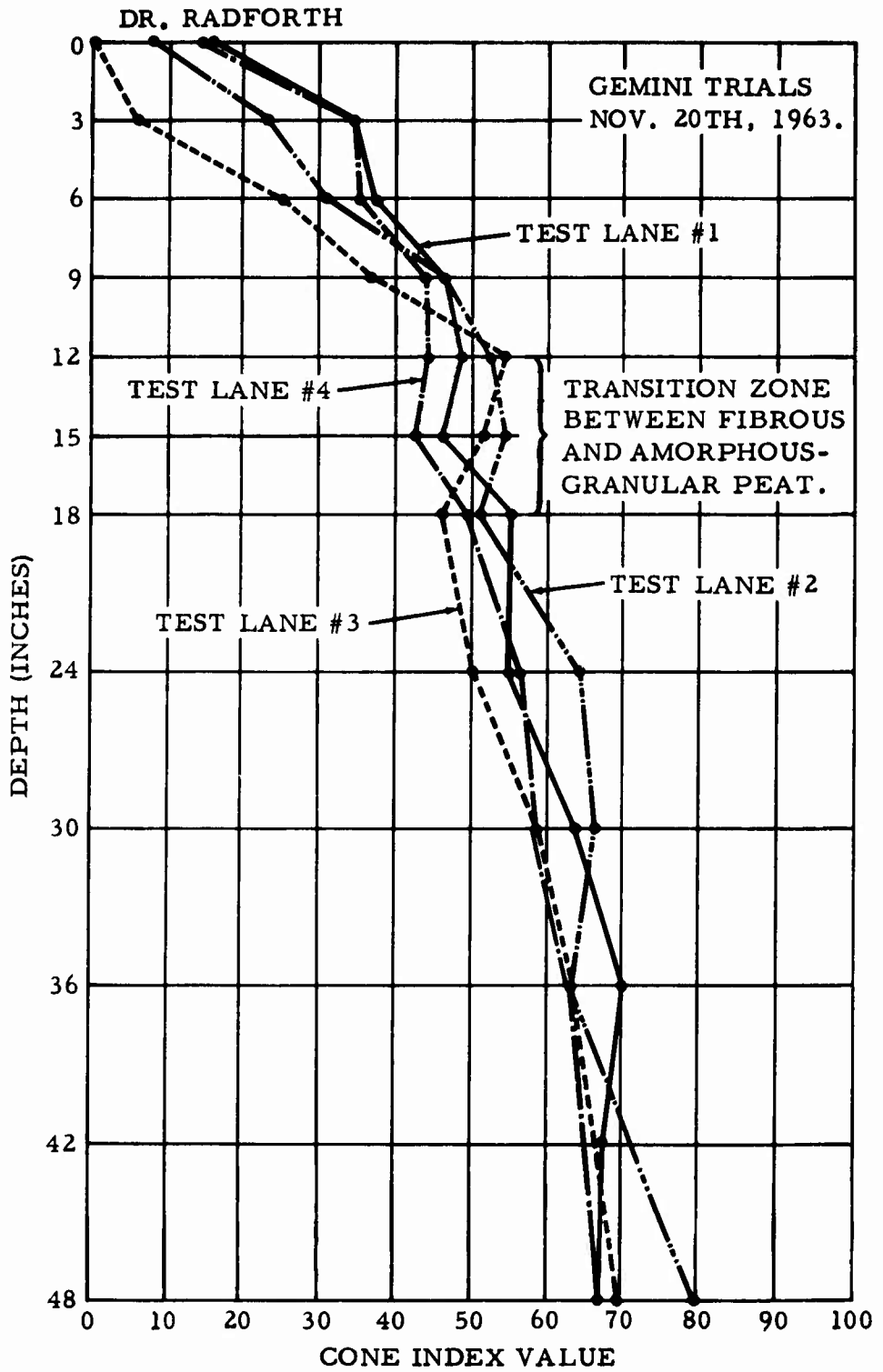

Figure 25. Graph 1

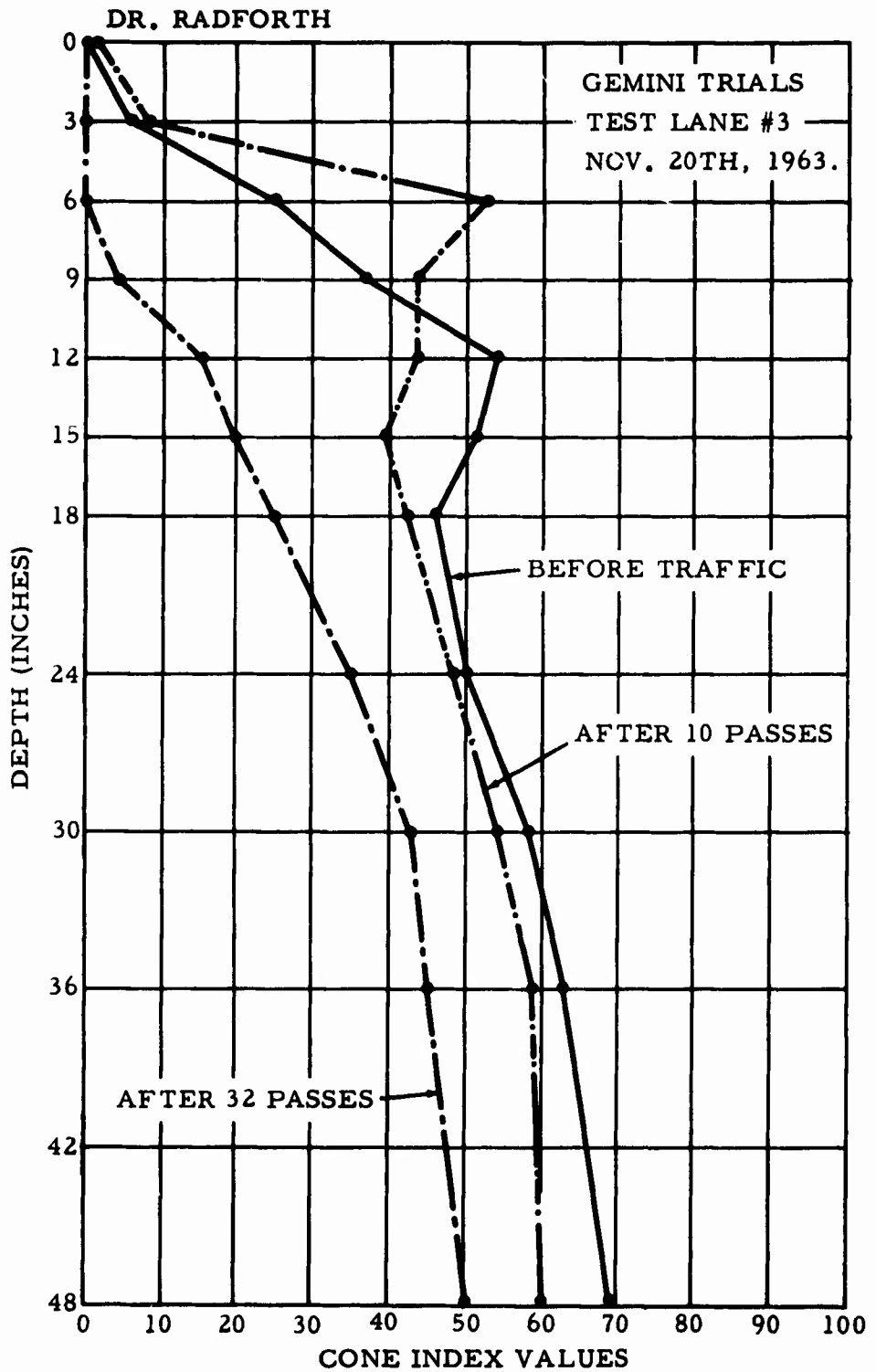
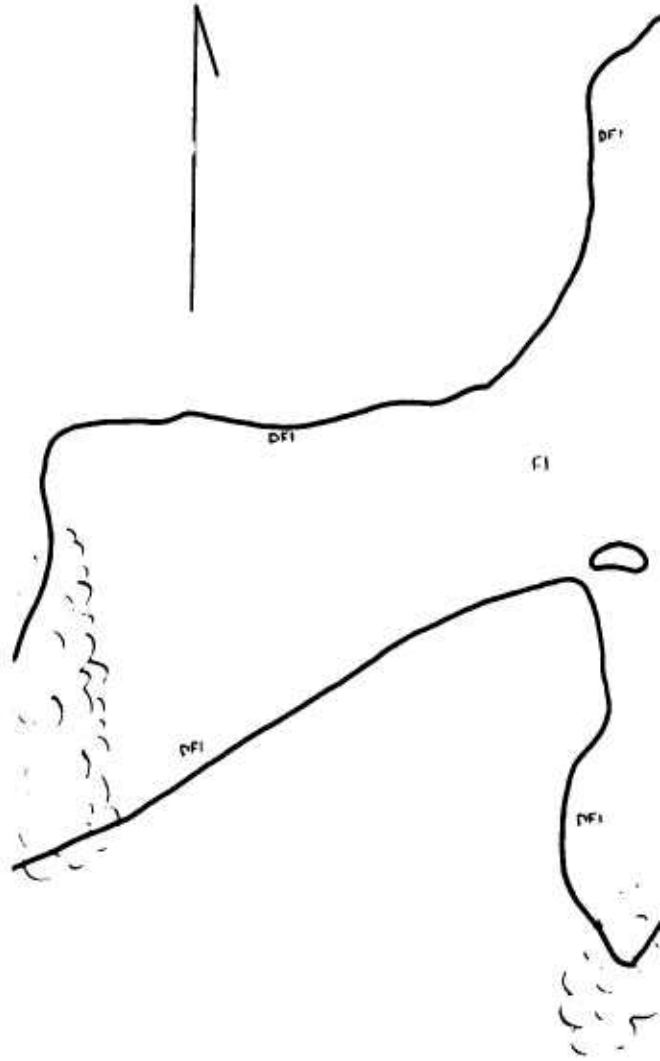

Figure 26. Graph 2

# AREA "IO F"



## LEGEND

{ } - groups of trees and shrubs

### FEATURES OF ACCESS ROUTE

- ▲ - rock pavement
- $\frac{12}{30^\circ}$  - rock step with height and maximum gradient indicated
- ↔ - average gradient over section of trail covered by arrow

"10 F"

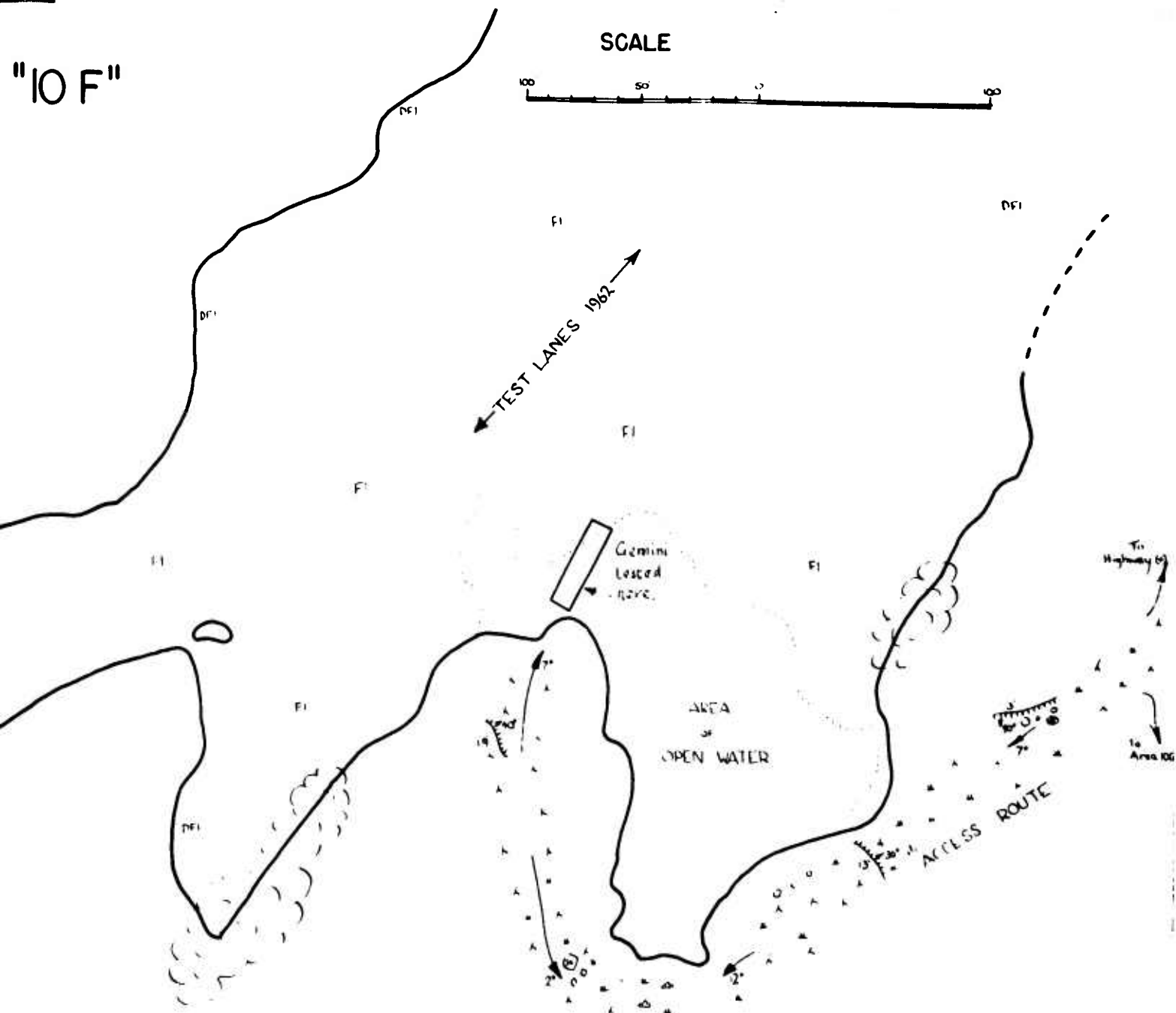

ND

groups of trees and shrubs.

FEATURES OF ACCESS ROUTE

- rock pavement
- rock step with height and maximum gradient indicated
- average gradient over section of trail covered by arrow

- (O) - boulders
- ▲ - moss
- △ - grass
- ab - low woody shrubs

PRECEDING PAGE BLANK-NOT

Figure 27. Area 10f Map



To Area 10F and Highway 69

LEGEND.

- ^ ^ - prominent rock outcrops
- (C) - groups of trees and shrubs
- ..... - boundary between main vegetation zones.
- - - - - sub-surface contours.
- - vehicle test lanes.



SCALE

metres

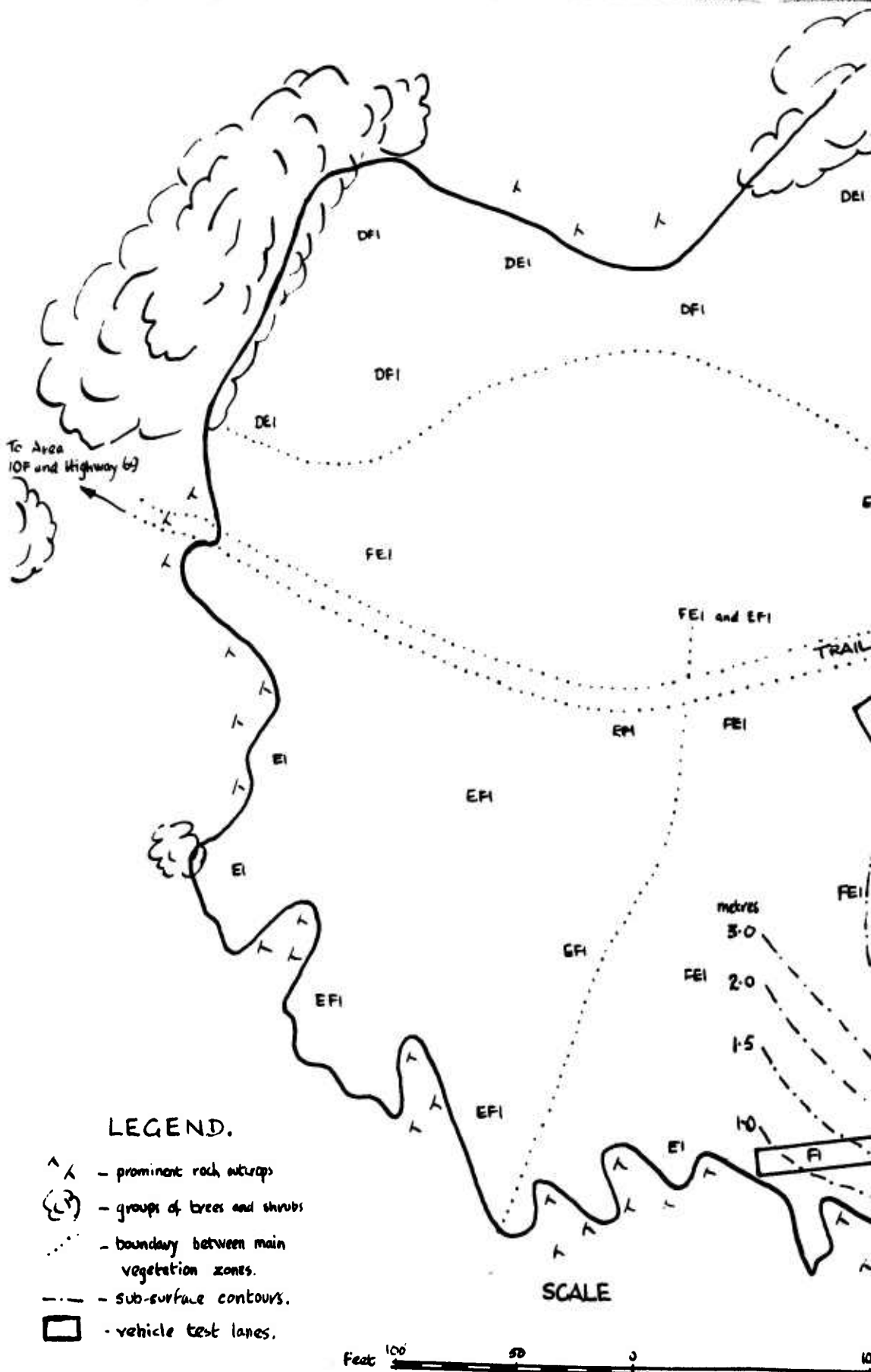
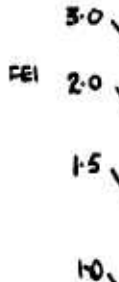

Figure 28. Area 10g

# AREA 10G

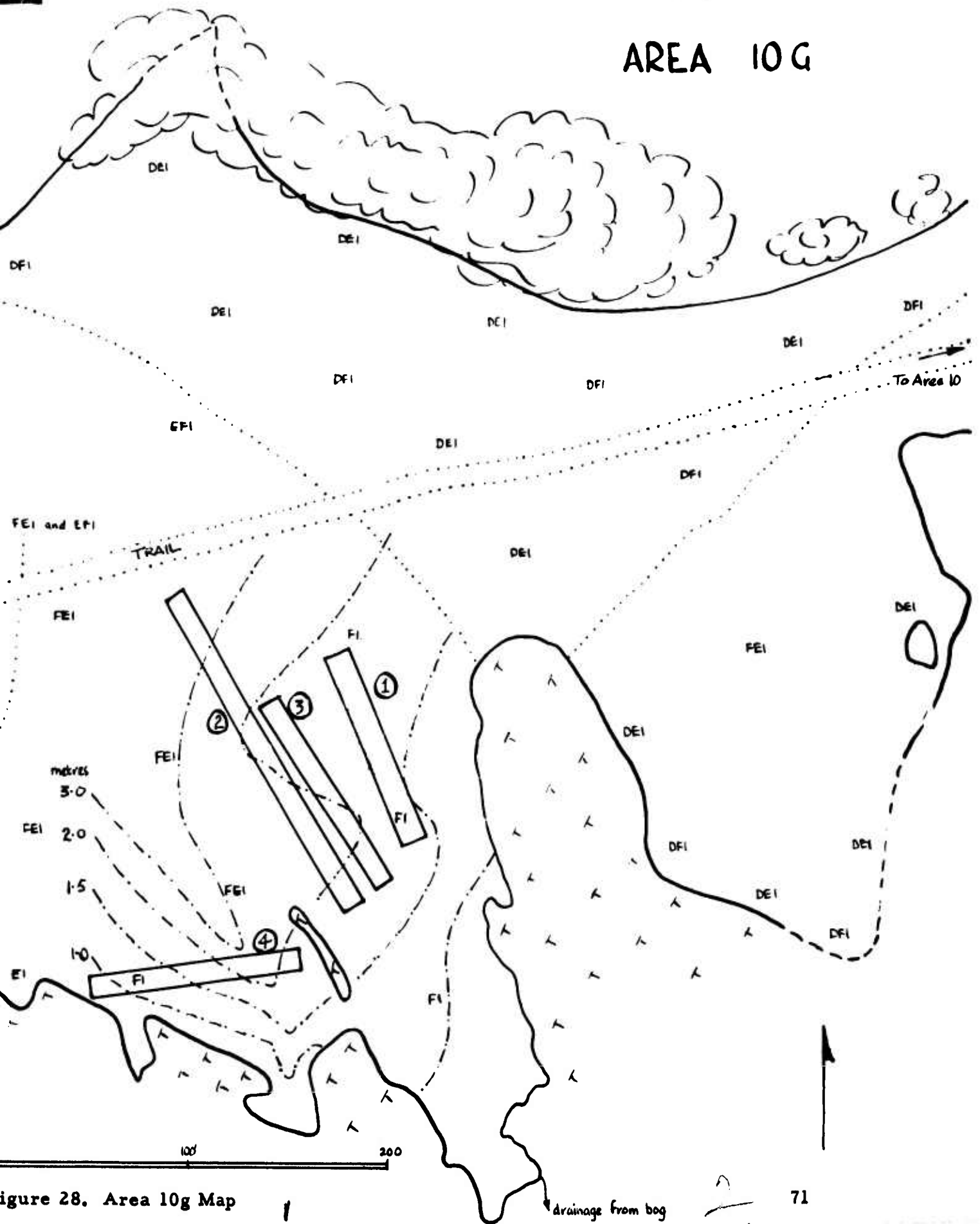

Figure 28. Area 10g Map



Figure 29.



Figure 30.



Figure 31.

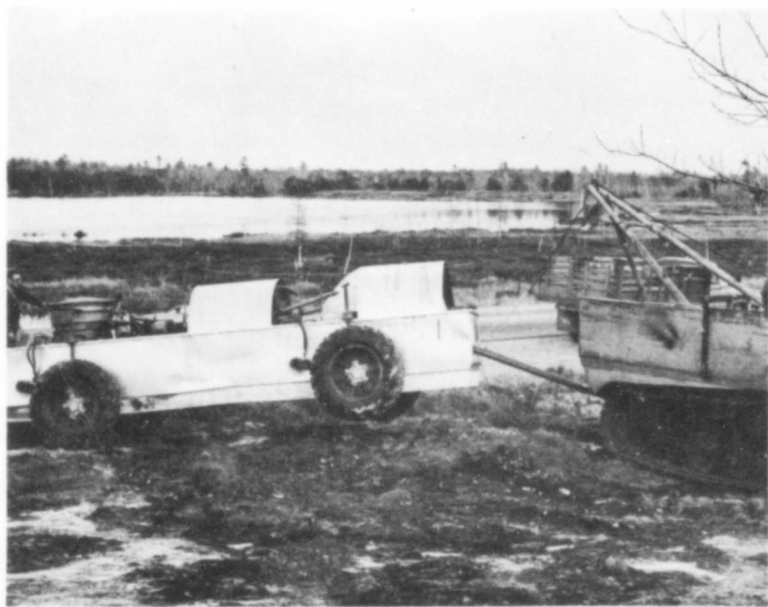

Figure 32.

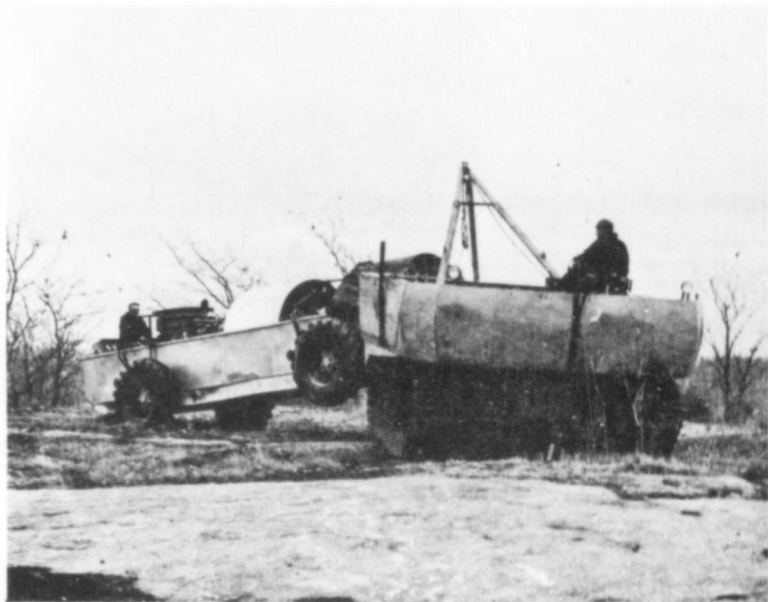

Figure 33.



Figure 34.



Figure 35.



Figure 36.



Figure 37.



Figure 38.



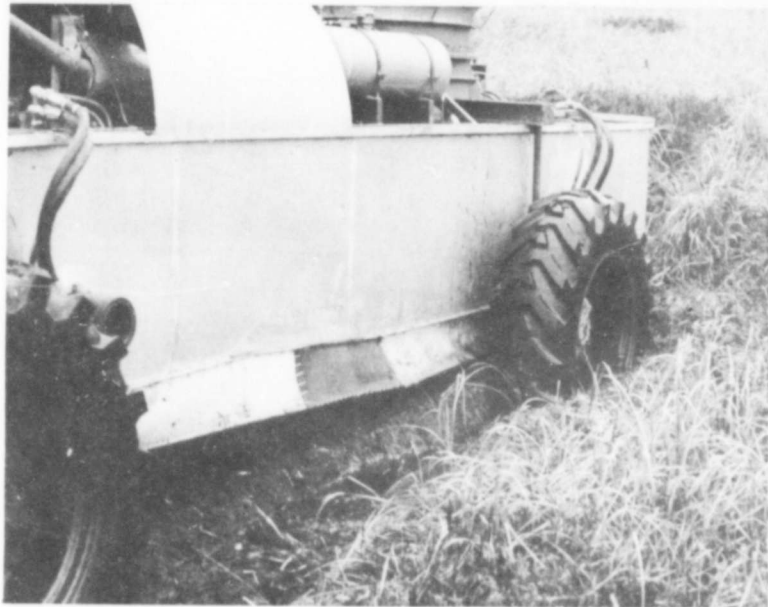

Figure 39.



Figure 40.





Figure 41.



Figure 42.



Figure 43.



Figure 44.



Figure 45.



Figure 46.



Figure 47.



Figure 48.



Figure 49.



Figure 50.





Figure 51.



Figure 52.



Figure 53.



Figure 54.



Figure 55.

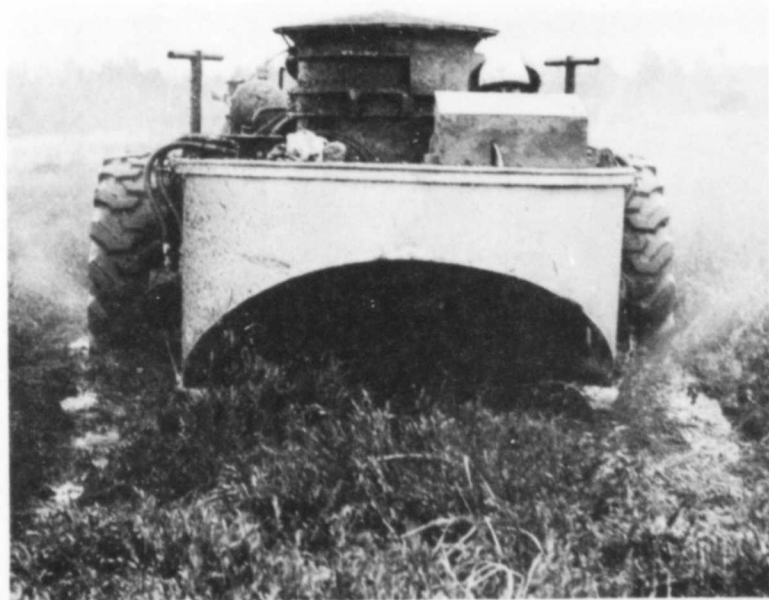

Figure 56.





Figure 57.

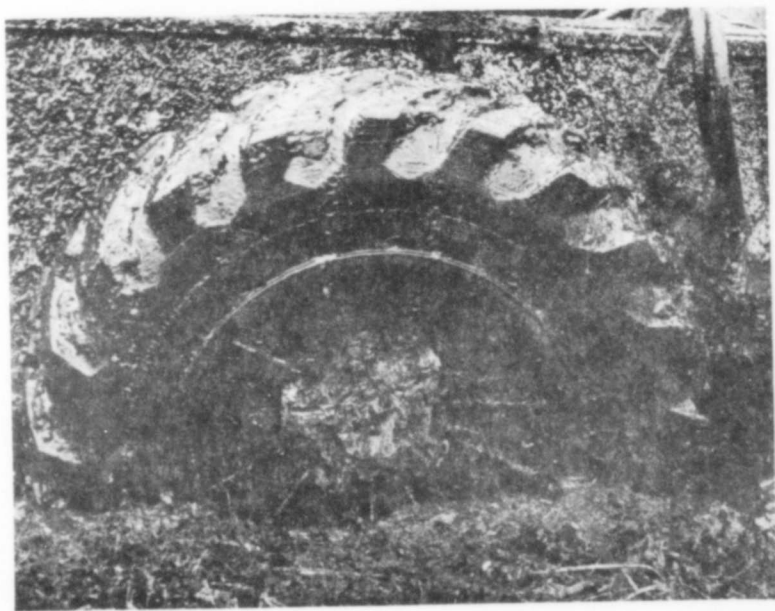

Figure 58.



Figure 59.



Figure 60.



Figure 61.



Figure 62.

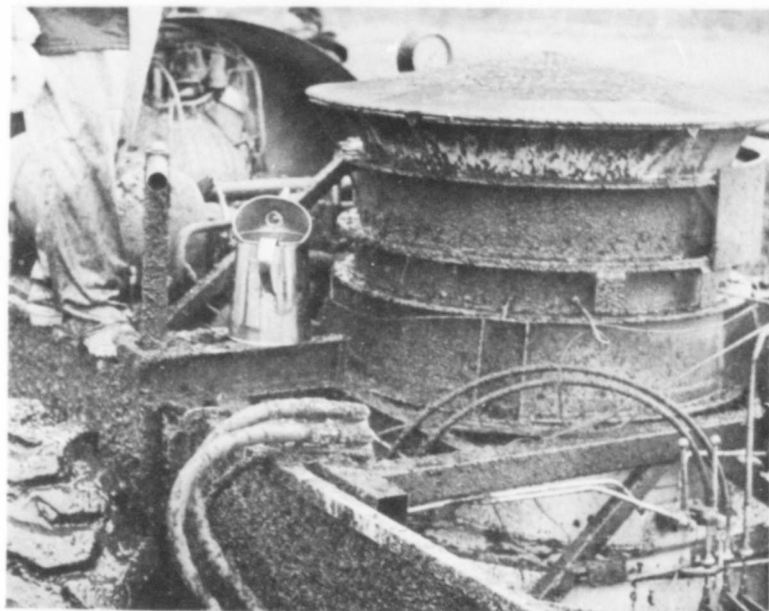

Figure 63.



Figure 64.

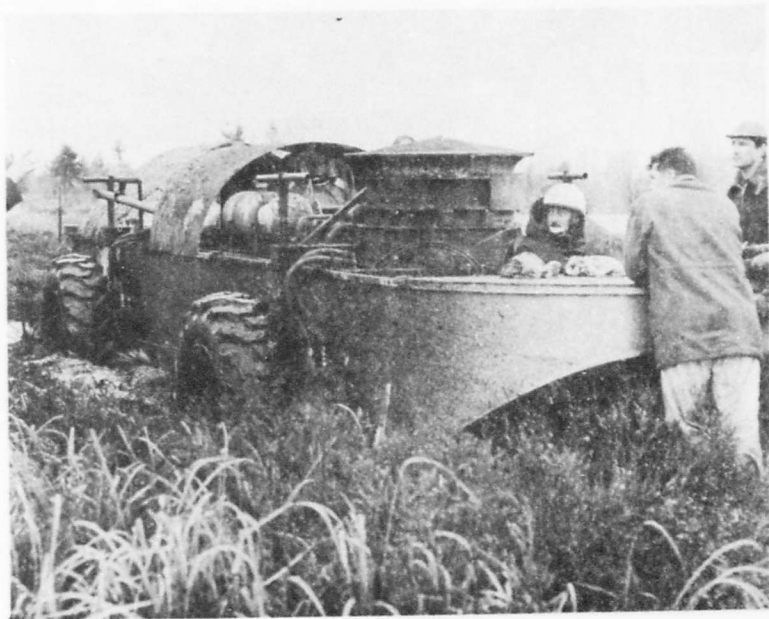

Figure 65.

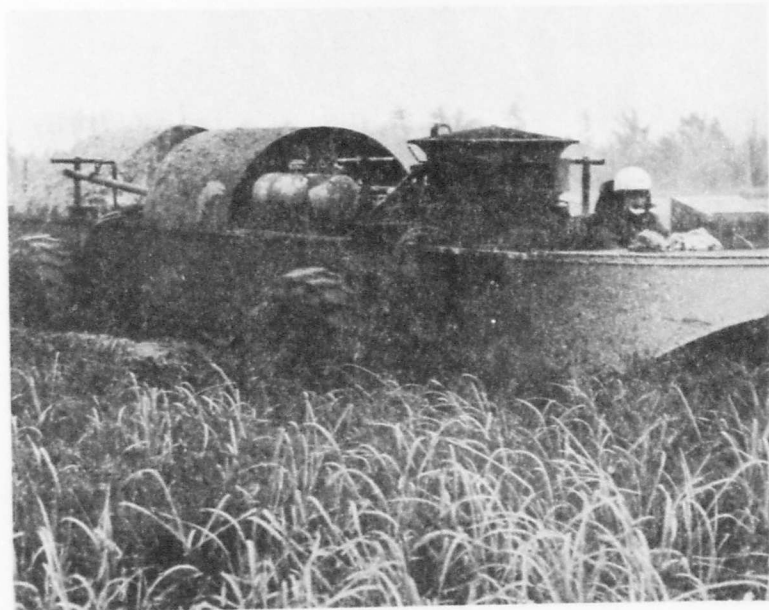

Figure 66.





Figure 67.



Figure 68.



Figure 69.

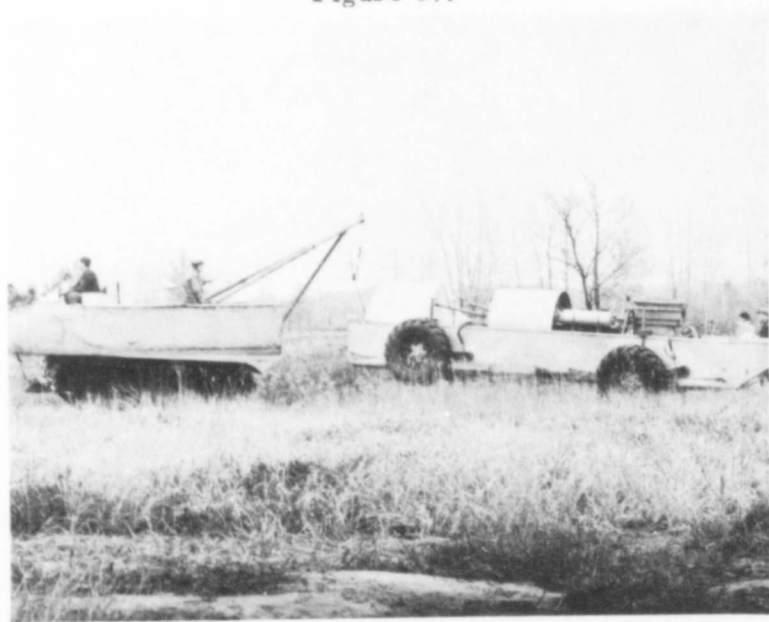

Figure 70.



Figure 71.



Figure 72.





Figure 73.



Figure 74.

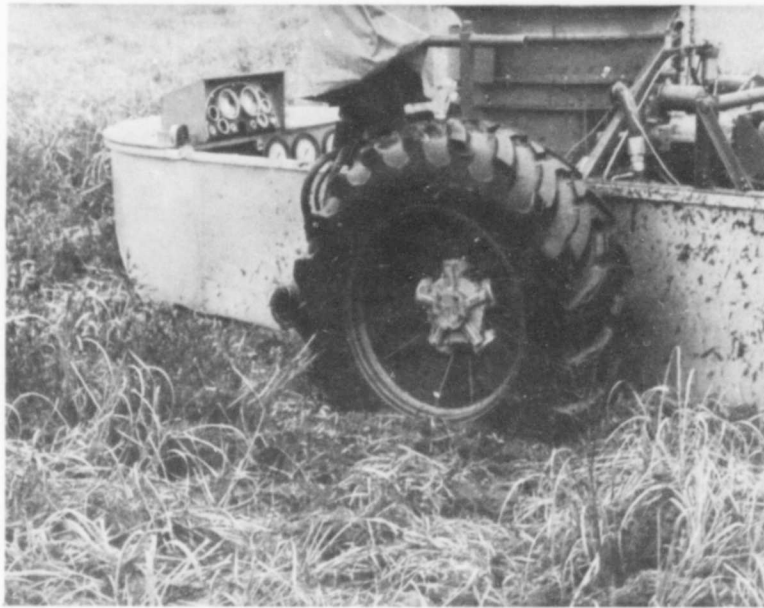

Figure 75.



Figure 76.



Figure 77.



Figure 78.



Figure 79.

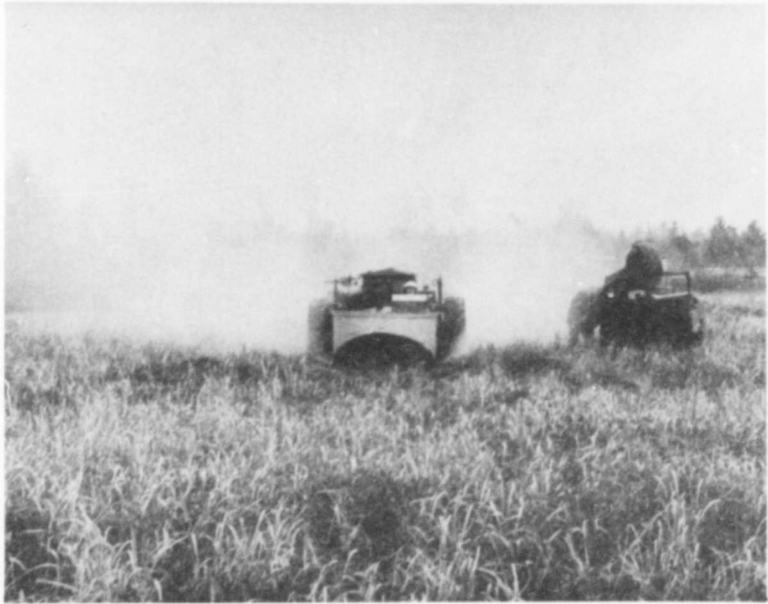

Figure 80.



Figure 81.



Figure 82.





Figure 83.



Figure 84.



Figure 85.



Figure 86.



Figure 87.



Figure 88.





Figure 89.



Figure 90.



Figure 91.

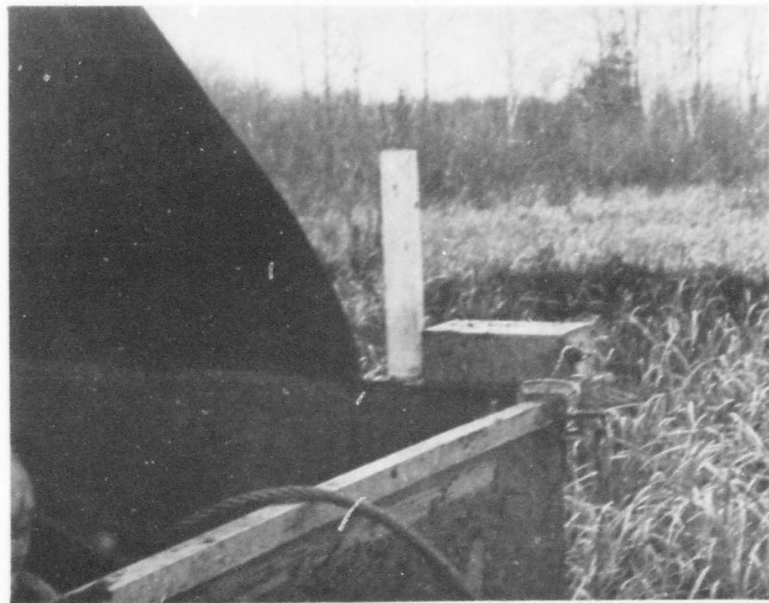

Figure 92.

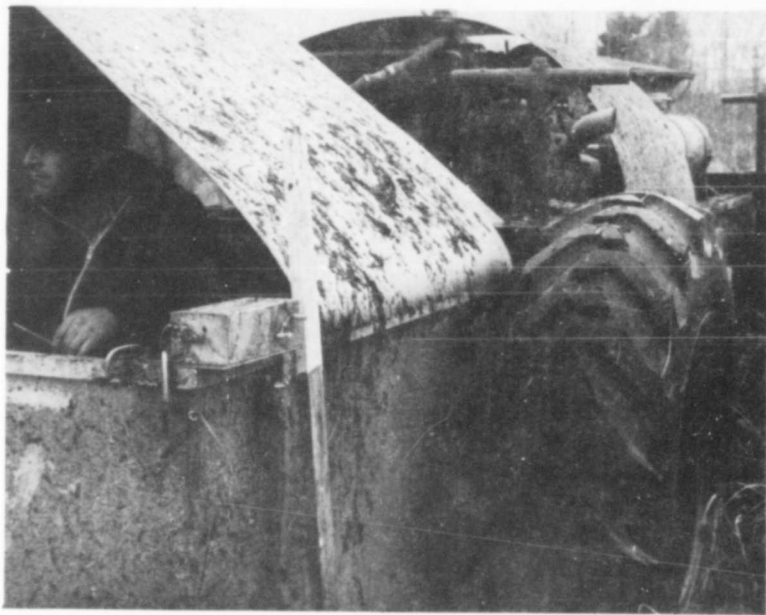

Figure 93.



Figure 94.

## APPENDIX II

### DRIVER'S NOTES

TEST NO. 1: October 29, 1963.

ITEM: Vehicle Fitted with Vertical Nozzles

The pit used was the farthest from the road, this being the drier of the two. \*

#### PIT CONDITION

When facing the Orenda Plant, the right-hand side appeared drier than the left. Puddles of water were present on the left-hand side which seems slightly lower. Water content 23%.

#### FIRST RUN

Vehicle ground clearance 10-1/2 inches. Ran fan up to 5000 before driving in with stroke about 1/3 forward. Vehicle veered to left and slowed down. Full throttle applied going to about 5500 with plenty of wheel stroke, wheels spinning vigorously. Vehicle forward motion stopped. The vehicle was then rocked back and forth at full throttle about six times, each time slightly more fore and aft motion was achieved; finally, vehicle moved out of pit (in reverse).

The above run was conducted on the right or drier side of pit. Front jets of the vehicle were completely blocked and required cleaning.

#### SECOND RUN

Ground clearance lowered to 7-1/2 inches. Fan ran up to 5000 prior to pit entry. Vehicle nearer left side of the pit. As vehicle slowed down in the mud, the throttle was opened and wheel speed increased; engine speed about 5300 r.p.m. Vehicle proceeded through pit rather slowly, but at no time did it stop.

\* West Clay Bed

### THIRD RUN

The vehicle now being at the other end of the pit after run No.2, it was decided to back through. Fan ran up to 5000 r.p.m. and stroke control advanced about halfway. As all four wheels entered the soft mud, throttle was advanced fully, r.p.m. being about 5400. The vehicle proceeded through with no hesitation and speed appeared to be reasonably constant throughout. The vehicle passed through the same ruts as made in run No.2.

### FOURTH RUN

This run was done with the fan nonoperative in order to determine if a pass could be made in this configuration. The starting point coincided with the finish point of run No.3, i.e., attempted to run through same ruts. The engine was run up to 4000 r.p.m. prior to entry, and the pit was entered. As soon as all four wheels were in the mud, the vehicle stopped. Full throttle was applied but the vehicle refused to move. A mound of muck had built up in front of the vehicle. Throttle retarded and fan engaged and run up to full power. The vehicle was felt to lift, but forward or aft progress could not be made. The front wheel ground clearance was then increased to 13 inches. The fan and wheels were then started and run up to 5000 r.p.m. It was noted that in attempts to move, hydraulic pressure went in excess of 2000 p.s.i. and the front wheels were not rotating (could not see rear wheels). Fore and aft movement was no more than a few inches; finally, vehicle was towed out with fan assisting.

### FIFTH RUN

Ground clearance reset all round to 7-1/2 inches. The vehicle was maneuvered to a point closer to the right side of the pit but angled such as to hit the left far corner. This would allow the vehicle to pass through the wettest part of the pit, where free water was present on the surface. The fan was run up to 5000, and the pit was entered. The vehicle moved forward very smoothly and at fairly constant speed. Unfortunately the forward progress described an arc. The left side of the pit was contacted, the throttle was pulled back, and the vehicle would have gone right through if the course had permitted.

### SIXTH RUN

This run consisted of reversing out from the final position of run No.5

and attempting to follow in the same ruts. The fan was run up until lift was felt, then wheels were started, full throttle was applied, and unit was reversed out to solid ground at constant speed and with no difficulty.

### SEVENTH RUN

This run was a repeat of run No.5, i.e., forward in same ruts until bank was contacted.

### EIGHTH RUN

This run was an attempt at a repeat of run No.6, i.e., reversing out after being stopped at the bank. Engine speed was increased until vehicle was felt to lift; the wheels were engaged, and full power employed. The vehicle started to move but then stopped. The wheels were then stopped, and all power was applied to the fan. Engine speed increased to about 6200 r.p.m. and additional lift could be felt; the wheels were then engaged. Plenty of stroke employed; engine speed then fell to 54-5500 r.p.m. (still at full throttle). Hydraulic pressure rose to above 2000 p.s.i., and front wheels were noted to either rotate very slowly or not at all. The vehicle was finally towed out employing both fan and wheels for assistance.

This concluded testing.

### GENERAL NOTES

- (1) The vehicle definitely performs better in reverse, being smoother and pulling better. This may be due either to the rear of the vehicle lifting more than the front or possibly to tire lug configuration. The former appears to be the best bet.
- (2) The torque available at the wheels seems insufficient at times, in view of the fact that pressures go to above 2000 p.s.i. and wheels do not rotate or rotate very slowly. The power being consumed by the wheels is considerable, engine speed falling some 5-600 r.p.m. as full stroke of the pumps is employed.
- (3) The vehicle always veers to the left. This may be due to imbalance between the wheels or partially due to the fact that the pit consistency gets softer from right to left.

- (4) The technique of applying power very gradually to the wheels when going is heavy (as employed when driving a car in snow) does not work too well with this vehicle. It appeared that the best technique is to apply rapid, vigorous wheel spin and then ease off, alternately speeding up and easing off as necessary. It may be that this technique tends to clear the tire treads due to C.F. force. Also the easing back allows additional lift to be gained due to fan speed up.
- (5) No abnormal engine conditions were noted. Coolant and oil temperatures were low, being at maximums of 180°F and 90°C respectively. Power take-off maximum temperature was 80°C.

TEST NO. 2: October 31, 1963.

ITEM: Vehicle Fitted with Vertical Front Nozzles and 45° Rear Nozzles.

### FIRST RUN

Pit farthest from road was used \* (drier of the two). The vehicle was lined up nearer the left-hand side and aimed diagonally for the far right corner. Ground clearance was set at 7-1/2 inches. The engine speed was run up to 5200 for the entry. The pit was entered, and the vehicle was felt to slow down immediately all four wheels were in the mud. Full throttle was applied, revolutions rose to 5500 r.p.m., hydraulic stroke advanced to almost full momentarily. Vehicle came to a stop about in the center of the pit. The fan and wheels were disengaged, and the tow cable was attached. Fan and hydraulics put into operation, and vehicle moved out with a very slight initial pull from the "Polecat".

### SECOND RUN

This run utilized the wetter (or nearer to the road) pit. The vehicle was lined up to traverse starting from the end nearest the Orenda Plant and nearer the right-hand side, which appeared slightly drier than the left. Ground clearance was left at 7-1/2 inches. Engine speed 5500 r.p.m. prior to entry and about half stroke on hydraulics. After all four wheels entered the mud, the unit slowed noticeably. Full hydraulics were applied, the pressure rising in excess of 2200 p.s.i. Forward progress stopped and with the hydraulics set at near full stroke, the engine revolutions fell to 4500 r.p.m. and front wheels were both turning. Run stopped and vehicle towed out, with fan and hydraulics assisting.

### THIRD RUN

Vehicle ground clearance lowered to 5-1/2 inches, and vehicle lined up at end of wet pit furthest away from Orenda Plant in the center of the pit. This path would take the vehicle through the wettest portion of the site. Engine speed at entry was 5300 r.p.m.; hydraulics set about 1/3 stroke. Throttle was advanced fully when all four wheels entered the mud - 5500 r.p.m. The vehicle passed through with no hesitation, and hydraulic control was left untouched throughout.

\* West Clay Bed



#### FOURTH RUN

The vehicle was lined up to traverse through the same ruts and direction as run No.3. Ground clearance lowered to 4-1/2 inches. Same technique as used in run No.3. Vehicle traversed through with no difficulty.

#### FIFTH RUN

Repeat of run No.4 - Same direction. Same ruts. No problems.

This concluded passes for the day.

#### GENERAL NOTES

- (1) On run No.2, the power available was definitely insufficient at the particular ground clearance. The mud encountered was extremely viscous and offered too much resistance to the wheels. Once engine speed falls below about 5200 r.p.m., the unit bogs down owing to lack of cushion.
- (2) The vehicle is definitely better when the going is very sloppy. The secret of success is to keep the fan speed as high as possible and the wheel speed as slow as possible in order to conserve power. If the vehicle slows down under these conditions, the wheel speed is rapidly accelerated and then slowed down immediately. This allows greater power to the wheels without too much penalty in terms of drop-off in fan performance.

TEST NO. 3: November 1, 1963.

ITEM: Vehicle Fitted with Vertical Forward Nozzles and 45° Rear Nozzles.

The pit used was that closer to the road \* (the wetter of the two).

### PIT CONDITION

Due to rain the previous night, the pit was very sloppy and free water was present on most of the surface.

### TESTING

As several runs were done in a short period of time (because of the presence of the official observers), the driver did not have time to make notes between each run; therefore, general impressions only are recorded.

Ground clearance was set at 4-1/2 inches for about 4 passes. The vehicle traversed the course easily both forward and in reverse, although reversing was more of an effort, presumably due to overcoming forward thrust of the rear nozzles. For the above runs, full engine power was used, with hydraulic power kept to a point where fan performance was not adversely affected.

One pass in a forward direction was made with forward speed kept to a minimum. This was quite uneventful, engine speed was kept at a maximum, with hydraulic pressure juggled between zero and about 1/4 stroke. Although forward speed was maintained at all times, it was felt that the vehicle could be stopped and maintained above the mud by the fan only.

One run was made into the pit without the fan, engine speed was 4000 r.p.m. at entry into the mud. The front wheels reached very sloppy conditions, but the vehicle did not get in far enough for the rear wheels to get into the full muck. The vehicle consequently assumed a somewhat nose-down attitude and stopped. Attempts at full-power full-hydraulics forward or reverse failed to produce any significant vehicle movement.

At this point, engine speed was reduced to minimum (1500 r.p.m.), and the fan was engaged. With no wheel power, the fan was run up to

\* East Clay Bed

maximum speed, the vehicle was felt to rise by the nose, then a slight amount of forward hydraulic power was applied to the wheels. The vehicle inched forward very slowly and then picked up momentum and moved through with no further difficulty.

A further run through was made with ground clearance set to 7-1/2 inches in order to demonstrate the adverse effect of additional clearance. The pit was entered under full throttle power, about 5600 r.p.m. The vehicle immediately slowed down when all wheels were in the mud, this being with about 1/3 to 1/2 stroke on the wheels. At the point where the vehicle almost stopped, the hydraulic power was reduced to practically nil, this allowed the fan to speed up and the vehicle to lift more. At this point vigorous hydraulic power was applied momentarily and forward speed picked up. This technique was repeated several times and the pass was completed successfully although it was considered marginal. It was necessary to watch the front wheels quite closely to achieve the delicate balance between excessive hydraulic speed and vehicle forward speed.

This concluded the testing of the Gemini for the day. The Polecat was then placed in position for an attempted pass through the pit, straddling one rut made by the Gemini. Bottom gear was used, and both front and rear drive were engaged. The vehicle entered and passed through the pit with no difficulty whatsoever. Engine revolutions held constant throughout, and the vehicle showed no signs of laboring. The vehicle did not sink very deeply, leaving a rut about 2-3 inches deep.

TEST NO. 4: November 6, 1963.

ITEM: Gemini Testing on November 6, 1963, in Muskeg at Nobel.

Vehicle fitted with vertical front nozzles and 45° rear nozzles. The skirt which had been fitted was raised and tied up out of the way.

Ground clearance was set to 4-1/2 inches and the vehicle was lined up on a flat tablelike rock which sloped gently into the muskeg pit. It was possible to run about 15-20 feet prior to entry of the front wheels. Engine speed was at its maximum (5800 r.p.m.) prior to commencing the run. Wheel stroke was about 1/3 at entry. The vehicle entered and proceeded forward in the normal manner except that forward speed seemed somewhat slower than that in clay under the same fan and wheel conditions. The run was terminated by the driver after about 100 feet had been achieved, owing to uncertainty as to how long a run was required. It was noted that progress of the vehicle was impeded at times when a bushy woody growth was encountered in the muskeg. An immediate attempt to go forward or reverse from the stopping point was unsuccessful. After a period of about 5 minutes, during which the fan screen was cleared of leafy vegetation, the vehicle was lifted on the fan and after two or three "rocks" fore and aft, a successful reversal was achieved.

The next run was done with no momentum being achieved prior to entry into the bog. Ground clearance was left at 4-1/2 inches. The vehicle lifted and forward motion was achieved immediately. The same ruts as previously were followed, but further forward progress into virgin muskeg was achieved. The vehicle speed was slowed by successive clumps of the aforementioned woody shrubs, until one was encountered that stopped forward motion but wheels were still turning.

Once again the fan was disengaged and ground clearance was lowered to 2-1/2 inches and an attempt to get out was made. This setting was worse, the wheels spun rapidly but no motion was achieved. Ground clearance was raised to 6-1/2 inches and the unit was reversed out with little difficulty. In the reversal, the vehicle slewed, left the normal path, traversed virgin territory once more, and was stopped as the rock-table was approached.

The vehicle was driven forward once more in an attempt to get it in the proper path by free wheeling the wheels on one side. This was only

partially successful, so it was towed back to the starting point. This terminated the driving.

In contrast to running in clay, the wheels never seemed to stop or require excessive hydraulic pressures; this resulted in fan speeds sufficiently high enough to stay on the cushion at all times. This is due to the very watery, low-viscosity nature of the muskeg. At times, the wheels spun vigorously owing to "lack of bite". This explains the better performance at higher ground clearances as opposed to clay. The slower forward speed can also probably be attributed to this lack of traction. The lift out by the fan under bogged conditions seemed to be higher than in clay, being in the order of about 2 inches. This is possibly due to the fact that the vehicle settles in to about 6 inches with the fan off and the vegetation seems to form a seal or skirt around the base.

The swath cut through the muskeg by the vehicle was deeper than that in clay and this also is probably a result of the resiliency of the material. It was noted that once a swath was formed, successive passes were easier, indicating that packing of the vegetation was providing a more dense surface for the cushion to work against.

Collection of vegetation on the fan may be a problem. It was estimated that at times blockage amounted to about 10% of the area. The blades appeared to be clean; the only material entering appeared to be clear water. Except for the leafy vegetation, only free water was thrown up, no earth or muck being present in the muskeg.

The vegetation present on the site was possibly 2 feet high, being mostly reeds but interspersed with woody, shrubby growths; it probably requires a fair amount of forward power to batter this growth down.

## DISTRIBUTION

U. S. Army Materiel Command	7
U. S. Army Mobility Command	4
U. S. Army Aviation Materiel Command	4
U. S. Strike Command	1
Chief of R&D, D/A	3
U. S. Army Transportation Research Command	68
U. S. Army Research and Development Group (Europe)	2
U. S. Army Engineer Research and Development Laboratories	4
U. S. Army Limited War Laboratory	1
U. S. Army Human Engineering Laboratories	1
Army Research Office-Durham	2
U. S. Army Polar Research and Development Center	1
U. S. Army Medical Research and Development Command	1
U. S. Army Engineer Waterways Experiment Station	1
U. S. Army Combat Developments Command	
Transportation Agency	1
U. S. Army War College	1
U. S. Army Command and General Staff College	1
U. S. Army Transportation School	1
U. S. Army Tank-Automotive Center	2
U. S. Army Arctic Test Center	1
U. S. Army General Equipment Test Activity	1
U. S. Army Airborne, Electronics and Special Warfare Board	1
Chief of Naval Operations	1
Bureau of Ships	1
Bureau of Supplies and Accounts, N/D	1
U. S. Naval Supply Research and Development Facility	1
U. S. Naval Postgraduate School	1
David Taylor Model Basin	1
Marine Corps Landing Force Development Center	1
Marine Corps Educational Center	1
Ames Research Center, NASA	2
NASA-LRC, Langley Station	2
Lewis Research Center, NASA	2
NASA Representative, Scientific and Technical Information Facility	2
Human Resources Research Office	2
National Tillage Machinery Laboratory	1

U. S. Army Standardization Group, Canada Canadian Liaison Officer,	2
U. S. Army Transportation School	3
British Army Staff, British Embassy	4
U. S. Army Standardization Group, U. K.	1
Defense Documentation Center	10
U. S. Government Printing Office	1

Hawker Siddeley Canada Ltd. Engineering Division, Toronto, Ontario, GEMINI 1-TON, AMPHIBIOUS, OFF-HIGHWAY, AIR-TRANSPORTABLE VEHICLE - CONCEPT EVALUATION PROGRAM - FINAL REPORT, TRECOM Technical Rept. 64-34, July 1964. 116 pp. (Contract DA 44-177-AMC-21(T), Task 1D021701A04813.

Unclassified Report  
This report presents the results of testing a full-scale mock-up chassis (over)

Hawker Siddeley Canada Ltd. Engineering Division, Toronto, Ontario, GEMINI 1-TON, AMPHIBIOUS, OFF-HIGHWAY, AIR-TRANSPORTABLE VEHICLE - CONCEPT EVALUATION PROGRAM - FINAL REPORT, TRECOM Technical Rept. 64-34, July 1964. 116 pp. (Contract DA 44-177-AMC-21(T), Task 1D021701A04813.

Unclassified Report  
This report presents the results of testing a full-scale mock-up chassis (over)

1. Gemini Vehicle
2. Contract DA 44-177-AMC-21(T)

Hawker Siddeley Canada Ltd. Engineering Division, Toronto, Ontario, GEMINI 1-TON, AMPHIBIOUS, OFF-HIGHWAY, AIR-TRANSPORTABLE VEHICLE - CONCEPT EVALUATION PROGRAM - FINAL REPORT, TRECOM Technical Rept. 64-34, July 1964. 116 pp. (Contract DA 44-177-AMC-21(T), Task 1D021701A04813.

Unclassified Report  
This report presents the results of testing a full-scale mock-up chassis (over)

1. Gemini Vehicle
2. Contract DA 44-177-AMC-21(T)

Hawker Siddeley Canada Ltd. Engineering Division, Toronto, Ontario, GEMINI 1-TON, AMPHIBIOUS, OFF-HIGHWAY, AIR-TRANSPORTABLE VEHICLE - CONCEPT EVALUATION PROGRAM - FINAL REPORT, TRECOM Technical Rept. 64-34, July 1964. 116 pp. (Contract DA 44-177-AMC-21(T), Task 1D021701A04813.

Unclassified Report  
This report presents the results of testing a full-scale mock-up chassis (over)

1. Gemini Vehicle
2. Contract DA 44-177-AMC-21(T)

1. Gemini Vehicle
2. Contract DA 44-177-AMC-21(T)



representative of a 1-ton, amphibious, off-highway, air-transportable vehicle which utilizes air cushion principles to permit mobility in low-bearing terrain.

The test vehicle was subjected to tests in prepared clay beds of low cone index and also in FI type muskeg impassable to normal wheeled vehicles. In addition, tests were made on a level hard surface to measure air cushion lift as a function of height.

The clay and muskeg testing demonstrated that air cushion assistance can make mobility possible under conditions which would immobilize conventional wheeled vehicles. The hard surface tests gave results which indicated reasonably good agreement with accepted air cushion theory.

representative of a 1-ton, amphibious, off-highway, air-transportable vehicle which utilizes air cushion principles to permit mobility in low-bearing terrain.

The test vehicle was subjected to tests in prepared clay beds of low cone index and also in FI type muskeg impassable to normal wheeled vehicles. In addition, tests were made on a level hard surface to measure air cushion lift as a function of height.

The clay and muskeg testing demonstrated that air cushion assistance can make mobility possible under conditions which would immobilize conventional wheeled vehicles. The hard surface tests gave results which indicated reasonably good agreement with accepted air cushion theory.

representative of a 1-ton, amphibious, off-highway, air-transportable vehicle which utilizes air cushion principles to permit mobility in low-bearing terrain.

The test vehicle was subjected to tests in prepared clay beds of low cone index and also in FI type muskeg impassable to normal wheeled vehicles. In addition, tests were made on a level hard surface to measure air cushion lift as a function of height.

The clay and muskeg testing demonstrated that air cushion assistance can make mobility possible under conditions which would immobilize conventional wheeled vehicles. The hard surface tests gave results which indicated reasonably good agreement with accepted air cushion theory.

representative of a 1-ton, amphibious, off-highway, air-transportable vehicle which utilizes air cushion principles to permit mobility in low-bearing terrain.

The test vehicle was subjected to tests in prepared clay beds of low cone index and also in FI type muskeg impassable to normal wheeled vehicles. In addition, tests were made on a level hard surface to measure air cushion lift as a function of height.

The clay and muskeg testing demonstrated that air cushion assistance can make mobility possible under conditions which would immobilize conventional wheeled vehicles. The hard surface tests gave results which indicated reasonably good agreement with accepted air cushion theory.