

CLEARINGHOUSE FOR FEDERAL SCIENTIFIC AND TECHNICAL INFORMATION CFSTI  
DOCUMENT MANAGEMENT BRANCH 410.11

LIMITATIONS IN REPRODUCTION QUALITY

ACCESSION # AD 605 389

1. WE REGRET THAT LEGIBILITY OF THIS DOCUMENT IS IN PART UNSATISFACTORY. REPRODUCTION HAS BEEN MADE FROM BEST AVAILABLE COPY.
2. A PORTION OF THE ORIGINAL DOCUMENT CONTAINS FINE DETAIL WHICH MAY MAKE READING OF PHOTOCOPY DIFFICULT.
3. THE ORIGINAL DOCUMENT CONTAINS COLOR, BUT DISTRIBUTION COPIES ARE AVAILABLE IN BLACK-AND-WHITE REPRODUCTION ONLY.
4. THE INITIAL DISTRIBUTION COPIES CONTAIN COLOR WHICH WILL BE SHOWN IN BLACK-AND-WHITE WHEN IT IS NECESSARY TO REPRINT.
5. LIMITED SUPPLY ON HAND: WHEN EXHAUSTED, DOCUMENT WILL BE AVAILABLE IN MICROFICHE ONLY.
6. LIMITED SUPPLY ON HAND: WHEN EXHAUSTED DOCUMENT WILL NOT BE AVAILABLE.
7. DOCUMENT IS AVAILABLE IN MICROFICHE ONLY.
8. DOCUMENT AVAILABLE ON LOAN FROM CFSTI ( TT DOCUMENTS ONLY).
- 9.

NBS 9/64

PROCESSOR:

10

605389

AD 605389

*Bel*



GEST-2035

Final  
 Technical Summary Report  
 of  
RESEARCH AND DEVELOPMENT PROGRAM  
OF  
THERMIONIC CONVERSION OF HEAT TO ELECTRICITY

Volume I

COPY	/	OF	/	178-0
HARD COPY				\$ . 5.00
MICROFICHE				\$ . 1.00

June 30, 1964

O.T.S.

Contract Number NObs-88578  
 Project Serial Number SR007-1201  
 Order Number ARPA 219, Task No. 1 and Task No. 2  
 Program Code Number 3980

GENERAL ELECTRIC COMPANY  
 SPECIAL PURPOSE NUCLEAR SYSTEMS OPERATION  
 VALLECITOS ATOMIC LABORATORY  
 P. O. BOX 846  
 PLEASANTON, CALIFORNIA

DDC  
 RECEIVED  
 SEP 17 1964  
 TISIA E

RESEARCH AND DEVELOPMENT PROGRAM  
OF  
THERMIONIC CONVERSION OF HEAT TO ELECTRICITY

June 30, 1964

This work was supported by ARPA funds  
through United States Navy, Bureau of  
Ships Contract Number NObs-88578

General Electric Company  
SPECIAL PURPOSE NUCLEAR SYSTEMS OPERATION  
Post Office Box 846  
Pleasanton, California

### LEGAL NOTICE

This report was prepared as an account of Government sponsored work. Neither the United States, nor the Department of Defense, nor any person acting on behalf of the Department of Defense:

- A. Makes any warranty or representation, express or implied with respect to the accuracy, completeness, or usefulness of the information contained in this report, or that the use of any information, apparatus, method, or process disclosed in this report may not infringe privately owned rights; or
- B. Assumes any liabilities with respect to the use of, or for damages resulting from the use of any information, apparatus, method, or process disclosed in this report.

As used in the above, "person acting on behalf of the Department of Defense" includes any employee or contractor of the Department, or employee of such contractor, to the extent that such employee or contractor of the Department of Defense, or employee of such contractor prepares, disseminates, or provides access to, any information pursuant to his employment or contract with the Department of Defense, or his employment with such contractor.

Technical Program Management:

Dr. V. C. Wilson - General Electric Research Laboratory

Dr. J. E. VanHoomissen - Special Purpose Nuclear  
Systems Operation

Major Contributors:

R. H. Bristow - Tube Department

L. N. Grossman - Vallecitos Atomic Laboratory

Dr. A. J. Kaznoff - Vallecitos Atomic Laboratory

## TABLE OF CONTENTS

	<u>Page</u>
I. INTRODUCTION AND SUMMARY	I-1
II. INSULATOR MATERIALS DEVELOPMENT TASK -	II-1
THE ELECTRICAL CONDUCTIVITY OF LUCALOX ALUMINA IN THE PRESENCE OF CESIUM	II-1
A. General	II-1
B. Summary	II-2
C. Experiment Specimens	II-2
D. Experiment Procedures	II-5
E. Effect of Temperature on the Conductivity of Lucalox Alumina	II-12
III. CERAMIC-TO-METAL SEAL DEVELOPMENT	III-1
A. General	III-1
B. Summary	III-5
Cesium Resistant Metallizing	III-5
Multilayered Cermets	III-6
Active-Alloy Sealing	III-6
Metal-to-Metal Joining	III-7
Cesium Corrosion Testing	III-9
C. Cesium Resistant Metallizing	III-11
Introduction	III-11
Selection of Bonding Oxide	III-14
Ceramic-to-Metal Seal Preparation and Evaluation	III-16
High Temperature Life Testing of Ceramic-to-Metal Seals	III-25
Conclusions and Recommendations	III-27

	<u>Page</u>
D.    Multilayered Cernets	III-28
Introduction	III-28
Results and Discussion	III-32
Conclusions and Recommendations	III-39
E.    Active-Alloy Sealing	III-39
Introduction	III-39
Experimental Procedure	III-41
Results and Discussion	III-43
1. Ceramic-to-Nickel Sealing	III-43
2. Alumina-to-Refractory Metal Seals With Nickel Buffer Washers	III-57
3. Alumina-to-Niobium Seals	III-62
Conclusions and Recommendations	III-70
F.    Metal-to-Metal Joining	III-70
Introduction	III-70
Diffusion Bonding	III-72
Brazing	III-73
Experimental Procedure	III-78
1. Diffusion Bonding	III-78
2. Brazing	III-79
Results and Discussion	III-80
1. Diffusion Bonding	III-80
2. Brazing	III-82
Conclusions and Recommendations	III-92
G.    Cesium Corrosion Testing	III-95
Introduction	III-95
Experimental Procedure and Equipment	III-99
Results and Discussion	III-99
General	III-99
Chromium and Chromium-Containing Cermet	III-106
Iron	III-106
Nickel	III-107
Niobium	III-107
Palladium and Palladium Alloys	III-107
Platinum	III-108

	<u>Page</u>
Tantalum	III-108
Coors AD-995 Alumina Ceramic	III-109
Silk City SC-95D Alumina Ceramic	III-109
G-E A-976 Alumina Ceramic	III-109
Ultra-High-Temperature Brazes - AS-501, AS-514, AS-540, AS-546, AS-547	III-110
Other Materials	III-110
Conclusions and Recommendations	III-111
References	III-138



LIST OF FIGURES

<u>Figure No.</u>		<u>Page</u>
II-1	Lucalox Alumina Configuration for Conductivity Experiment	II-3
II-2	Instrumented Lucalox Tube Inside Current Concentrator	II-4
II-3	Schematic of Conductivity Experiment	II-7
II-4	Temperature Dependence of Resistance for Two Alumina Tubes	II-9
II-5	Current Versus Voltage Across Insulator	II-10
II-6	Temperature Dependence of Resistivity for Lucalox Alumina	II-13
II-7	Temperature Dependence of Electrical Conductivity for Lucalox Alumina	II-14

### LIST OF FIGURES

<u>Figure No.</u>		<u>Page</u>
III-1	Typical Metallized Ceramic	III-13
III-2	Photomicrographs of Ceramic-to-Metal Seals (500X)	III-19
III-3	Photomicrographs of Ceramic-to-Metal Seals (500X)	III-20
III-4	Photomicrographs of Ceramic-to-Metal Seals (500X)	III-24
III-5	Section of LT-1 Chromium-Alumina Cermet	III-30
III-6	Multilayered Cermet Structure. Linde A Alumina M&R Molybdenum Sintered 3 Hours at 1860°C. Vacuum Tight. (13X)	III-35
III-7	Photomicrographs of Alumina-to-Nickel Seals Made at Four Different Sealing Temperatures	III-45
III-8	Titanium-Nickel Phase Diagram	III-46
III-9	Alumina-to-Nickel Seal After 1850 Hours at 900°C (500X)	III-51
III-10	Alumina-to-Nickel Seal After 2280 Hours at 900°C (500X)	III-51
III-11	Failure of Seal at Surface of Ceramic (500X)	III-56
III-12	Alumina-to-Molybdenum Seal with Nickel Buffer Washers After 20 Thermal Cycles to 900°C (500X)	III-59
III-13	Alumina-to-Tantalum Seal with Nickel Buffer Washers After 20 Thermal Cycles to 900°C (500X)	III-59

<u>Figure No.</u>		<u>Page</u>
III-14	Alumina-to-Molybdenum Seal with Nickel Buffer Washers After 240 Hours at 1075°C (500X)	III-60
III-15	Alumina-to-Tantalum Seal with Nickel Buffer Washers After 240 Hours at 1075°C (500X)	III-60
III-16	Alumina-to-Niobium Seal at a Temperature of 1430°C (500X)	III-63
III-17	Alumina-to-Niobium Seal After 2020 Hours at 900°C (500X)	III-66
III-18	Molybdenum-Nickel Phase Diagram	III-74
III-19	Nickel-Niobium Phase Diagram	III-75
III-20	Nickel-Tantalum Phase Diagram	III-75
III-21	Diffusion Bond to Mo to Mo Using Chromium Plating to Promote Diffusion	III-84
III-22	Niobium Brazed to Molybdenum With G-E J8400	III-84
III-23	Photomicrographs Illustrating Variation in Penetrating Phase With Hold Time and Shim Thickness	III-89
III-24	Tantalum Nickel Brazed to Metallized A-976 Ceramic	III-93
III-25	Schematic Cross-Section of Ceramic Test Vessel	III-100
III-26	Summary Data Sheet of Cesium Attack for Tantalum	III-113
III-27	Summary Data Sheet of Cesium Attack for Palladium	III-114
III-28	Summary Data Sheet of Cesium Attack for S-20 Metallizing on A-976 Ceramic	III-115
III-29	Summary Data Sheet of Cesium Attack for Iron	III-116

<u>Figure No.</u>		<u>Page</u>
III-30	Summary Data Sheet of Cesium Attack for Silk City SC95D Metallized Ceramic	III-117
III-31	Summary Data Sheet of Cesium Attack for H-1 Metallizing on A-976 Ceramic and Similar Ceramics Brazed Together With Premabraze 101	III-118
III-32	Summary Data Sheet of Cesium Attack for Niobium	III-119
III-33	Summary Data Sheet of Cesium Attack for Chromium	III-120
III-34	Summary Data Sheet of Cesium Attack for Nickel Brazed Tantalum-to-Molybdenum and Molybdenum-to-Molybdenum	III-121
III-35	Summary Data Sheet of Cesium Attack for 60-40 Palladium-Nickel	III-122
III-36	Summary Data Sheet of Cesium Attack for Active Alloy Seals	III-123
III-37	Summary Data Sheet of Cesium Attack for SP Nickel	III-124
III-38	Summary Data Sheet of Cesium Attack for Nickel Brazed Tantalum to Molybdenum	III-125
III-39	Summary Data Sheet of Cesium Attack for Palco and Palco Brazed Metallized Ceramics	III-126
III-40	Summary Data Sheet of Cesium Attack for Coors Metallized AD995 Alumina Ceramic	III-127
III-41	Summary Data Sheet of Cesium Attack for Platinum	III-128
III-42	Summary Data Sheet of Cesium Attack for Nickel Brazed Niobium to Molybdenum and Metallized A-976	III-129

<u>Figure No.</u>		<u>Page</u>
III-43	Summary Data Sheet of Cesium Attack for Molybdenum to Molybdenum Brazed With Nickel and Cobalt Base Brazes	III-130
III-44	Summary Data Sheet of Cesium Attack for Ultra-High Temperature Brazes	III-132
III-45	Summary Data Sheet of Cesium Attack for LT-1 Cermet	III-133
III-46	Summary Data Sheet of Cesium Attack for H-1 Metallizing on A-976 and Coors AD995 Alumina Ceramics	III-134
III-47	Summary Data Sheet of Cesium Attack for Molybdenum-Alumina Cermet and Diffusion Bonded Mo to Mo Using Palladium Interleaf	III-135
III-48	Summary Data Sheet of Cesium Attack for Nickel Brazed Niobium and Molybdenum-to-Metallized A-976 Ceramic	III-136
III-49	Summary Data Sheet of Cesium Attack for 60-40 Palladium-Nickel Brazed Mo, Nb, and Ta to A-976 Ceramic	III-137

## LIST OF TABLES

<u>Table No.</u>		<u>Page</u>
II-1	Spectroscopic Analysis of Tube #2 After Conductivity Measurements	II-11
III-1	Ceramic-Metal Seal Results	III-18
III-2	Bonding Oxide Reactions with A-976 X-Ray Diffraction Results	III-22
III-3	Flexural Strength Results	III-26
III-4	Cermet Sintering Shrinkage	III-38
III-5	Seals Life Tested at 700°C and 900°C	III-67
III-6	Seals Life Tested at 1075°C	III-68
III-7	Seals Thermally Cycled at 700°C and 900°C	III-69
III-8	Resistance of Materials to Attack by Cesium	III-101
III-9	Cesium Corrosion Tests	III-104

I. INTRODUCTION AND SUMMARY

This is Volume I of the third technical summary and final report describing progress on the research and development program on thermionic conversion of heat to electricity under the Department of the Navy, Bureau of Ships contract, NObs-88578. The period covered by this report extends from October 31, 1963 to June 30, 1964. Volume I of this report describes the work performed under the Insulator Materials Development Task performed at the Vallecitos Atomic Laboratory and the Ceramic-to-metal Seals Task, performed at the Tube Department, Schenectady.

The work performed on the other major tasks under this contract are reported in Volume II of this report. These tasks include the Emitter-Collector Spacing Development Task, the Intercell Discharges Between Series-Connected Thermionic Converters Task and the UO<sub>2</sub>-Refractory Metals Reaction Kinetics Task. These three tasks are reported in a separate volume due to the possibility of security classification.

A summary of work performed in each of the tasks reported in Volume I follows:

✓ The electrical conductivity of Lucalox alumina has been measured under conditions representing the operational environment of a thermionic diode.

✓ Tungsten and molybdenum based coatings have been developed, metallized to alumina and tested in cesium vapor

for over 2000 hours. Multilayered cermets were prepared but failed to prove electrically insulating. Alumina-to-nickel and alumina-to-niobium shim seals were prepared and tested for extended periods of time. The joining of various refractory metals to metallized alumina using diffusion bonding, brazing, and braze-diffusion bonding techniques were investigated. The cesium corrosion resistance of various materials and seals was determined at 1000°C.

( )  
↑



II. INSULATOR MATERIALS DEVELOPMENT TASK -  
THE ELECTRICAL CONDUCTIVITY OF LUCALOX ALUMINA  
IN THE PRESENCE OF CESIUM

A. General

The proposed use of alumina insulators for nuclear thermionic energy converters has raised some interesting questions about insulator properties under extreme conditions. The environment of the converter is strongly reducing due to the presence of cesium vapor, which is in equilibrium with a liquid cesium reservoir at about 300°C. The insulators experience temperatures between about 100°C and 1500°C depending on the insulator location and the type of nuclear thermionic reactor. Potential gradients of at least one volt/mil are likely to be imposed across some of the insulators. In addition, the insulators must be chemically compatible with their neighboring materials and must maintain their desirable properties in the radiation field of a power reactor.<sup>1</sup>

The purpose of this study was to measure the electrical conductivity of a candidate material for nuclear thermionic insulation in the cesium and temperature environment of a converter. Another purpose was to determine the breakdown potential of the insulator in that environment. The material chosen for this study was Lucalox (brand) high purity alumina. Alumina was selected as the primary design material due to known desirable properties,<sup>1</sup> the advanced state of its fabrication art, and its successful use in laboratory thermionic devices.<sup>2</sup>

## B. Summary

The electrical conductivity of Lucalox alumina has been measured in the temperature range 700 to 1250°C. The experimental arrangement approximated the environment of a thermionic diode; cesium vapor was present on one side of the alumina. Volt amp curves obtained across the 0.0307-inch thick sample show ohmic behavior over the full voltage range investigated ( -150 to +400 volts). The observed conductivity of Lucalox alumina is similar to that reported for high purity polycrystalline alumina under reducing conditions. An activation energy of 3.55 ev was observed for the conductivity in the temperature range 1020 to 1250°C.

## C. Experiment Specimen

Five tubes of Lucalox alumina were obtained from the Large Lamp Department, General Electric Company. A tube is shown in Figure II-1. The tubes were about 1/2-inch diameter, 0.030-inch wall thickness and 4 inches long. Each end was sealed to a niobium end piece which lead to a 1/8-inch niobium tube about 1 inch long. A 0.394-inch long niobium cylinder was placed in the center of the Lucalox tube to serve as one electrode. The other electrode was a 1.05-inch long coating of tantalum metal applied to the exterior of the tube by flame-spraying. Each tube was checked upon receipt for vacuum tightness by the He mass spectrometer method; all proved leak-free.

Two of the Lucalox tubes were ultrasonically cleaned in methanol and transferred into an argon glove box for cesium introduction. In the glove box, one of the 1/8-inch niobium tubes was inert-arc welded shut and liquid cesium was injected into the other

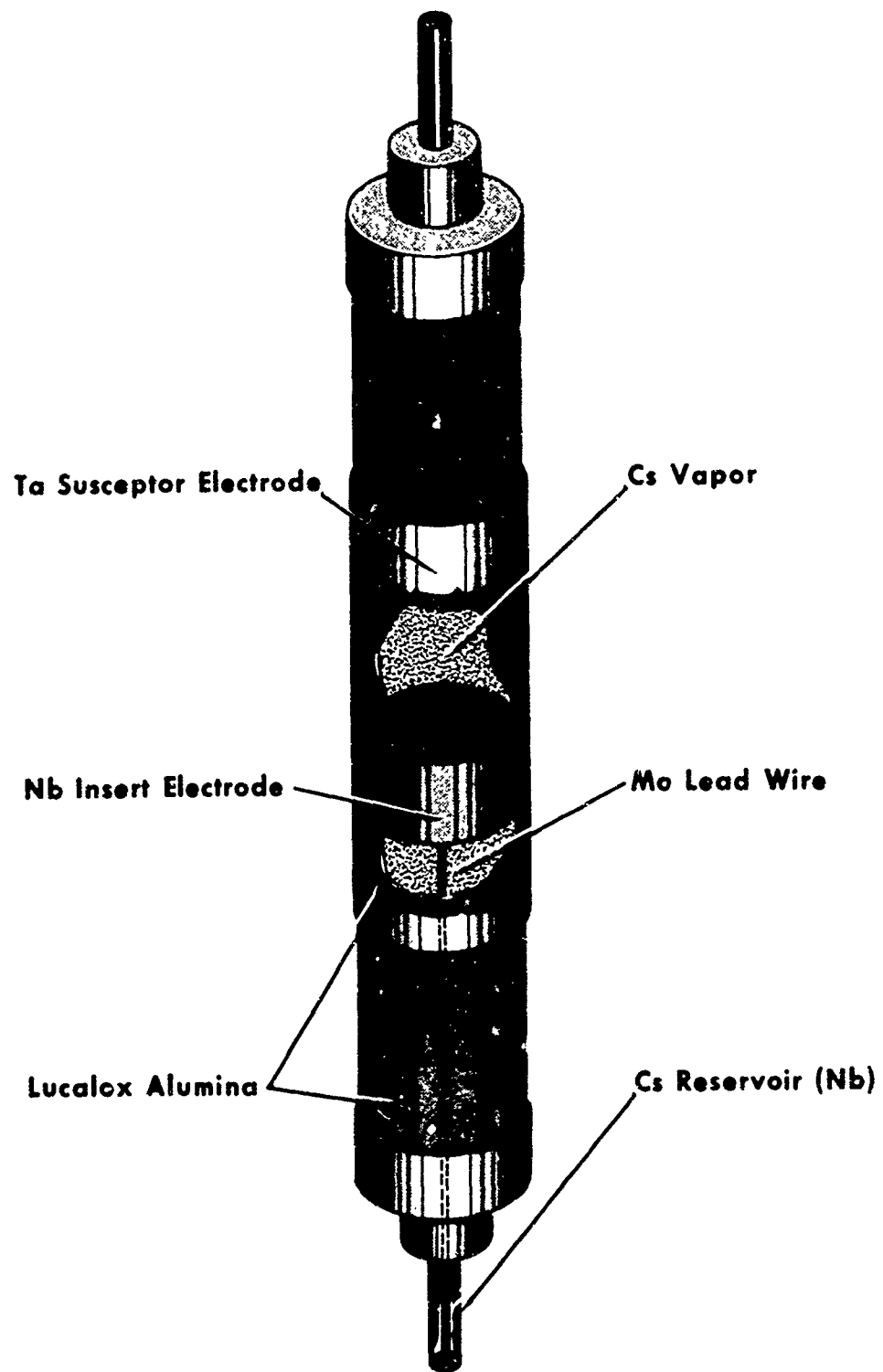

FIGURE II-1. LUCALOX ALUMINA CONFIGURATION FOR CONDUCTIVITY EXPERIMENT

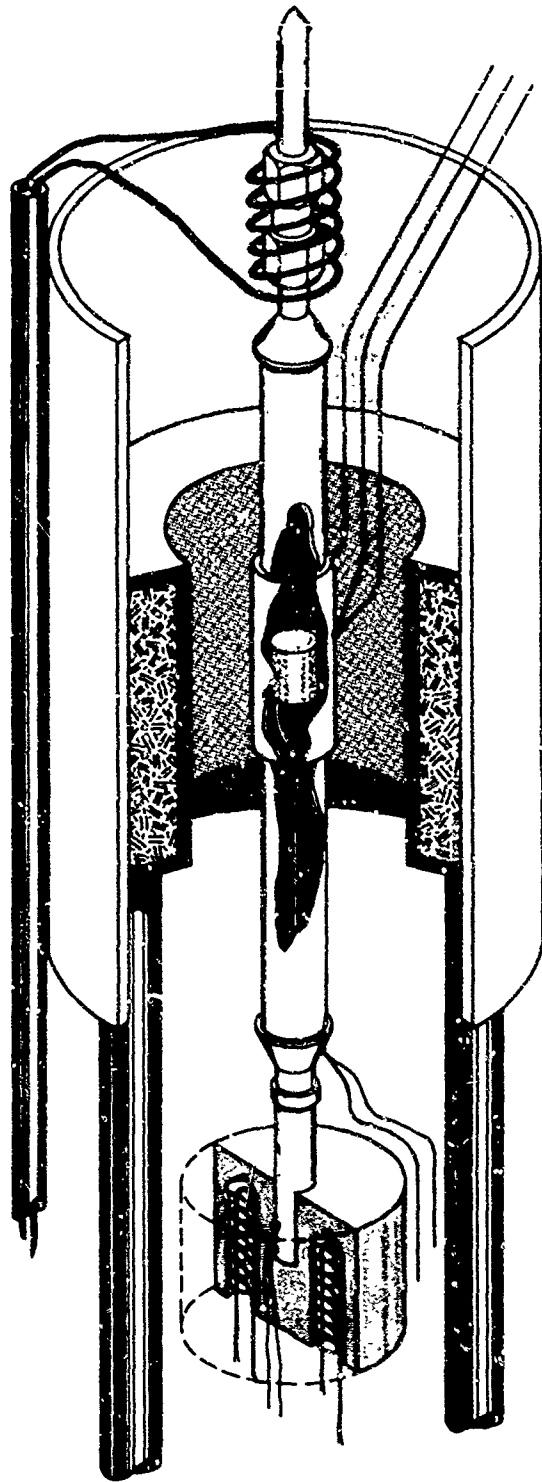

FIGURE II-2. INSTRUMENTED LUCALOX TUBE  
INSIDE CURRENT CONCENTRATOR

end. A Swagelok fitting connected the 1/8-inch niobium tube to a 1/4-inch tantalum tube. After evacuating each tube to less than 0.01 torr argon pressure, the Ta appendage was pinched off. To assure leak-tightness, the pinched area was beaded (welded) using the inert-arc torch. Following cesium introduction, each tube was placed in a helium-filled pressure chamber over night. Subsequent leak checking for helium showed the cesium-filled tubes to be leak tight.

Heaters were added to both ends of the tubes for the purpose of controlling the cesium pressure. The heaters consisted of platinum wire wrapped on an alumina base and covered with a Sauerizen cement. The lower heaters (cesium wall heaters) were imbedded in a copper block containing the 1/8-inch niobium well for cesium, to provide better temperature control. Thermocouples (Pt-Pt/Rh) were attached to the seal areas and to the cesium reservoir heater. A sheathed thermocouple was attached to the Ta electrode by wrapping several layers of Ta foil around the susceptor; the Ta sheath also was used as the lead to the outer electrode.

D. Experiment Procedure

The Lucalox tubes were heated by rf currents induced in the tantalum susceptor-electrode. A water-cooled copper current concentrator was utilized to direct the rf field into the susceptor and away from the metal ends of the tube. Figure II-2 illustrates the specimen and the concentrator. The assembly shown in Figure II-2 was placed inside a dynamic vacuum system which maintained the pressure between  $10^{-6}$  and  $10^{-5}$  torr during experimentation. Figure II-3 is a schematic illustration of

the electrical circuitry used for obtaining conductivity values. Only dc measurements were made; the technique is a 2-probe technique utilizing both potentiometer and electrometer current measurements.

Contact resistance of the tantalum-alumina interface was estimated to be less than  $10^3$  ohms from prior experiments. Contact resistance between the Nb insert and the alumina was much higher than  $10^3$  ohms in the absence of cesium. It was found that below about one torr cesium pressure, the observed current through the Lucalox was dependent on cesium pressure. For cesium pressures greater than about 10 torr, the measured current was independent of cesium pressure. Hence the contact resistance of the Nb-Cs vapor-alumina interface was not significant at high cesium pressures. The cesium pressure in the tube was determined by the temperature of the seal above the cesium reservoir. This was the coldest spot in the tube.

Conductivity was measured after an initial heating of each specimen to about  $1500^\circ\text{C}$  for about 4 hours. After this treatment, no significant changes in conductivity with time were observed for any given temperature and for times up to one hour. After a change in power input to the susceptor, about 3 minutes were required for temperature equilibrium to be obtained in the electrode area. Temperature equilibrium at the ends of the tubes was very slowly reached and generally was not obtained during the experiment; however, for high cesium pressures, temperature transients in the tube ends did not affect the measurements.

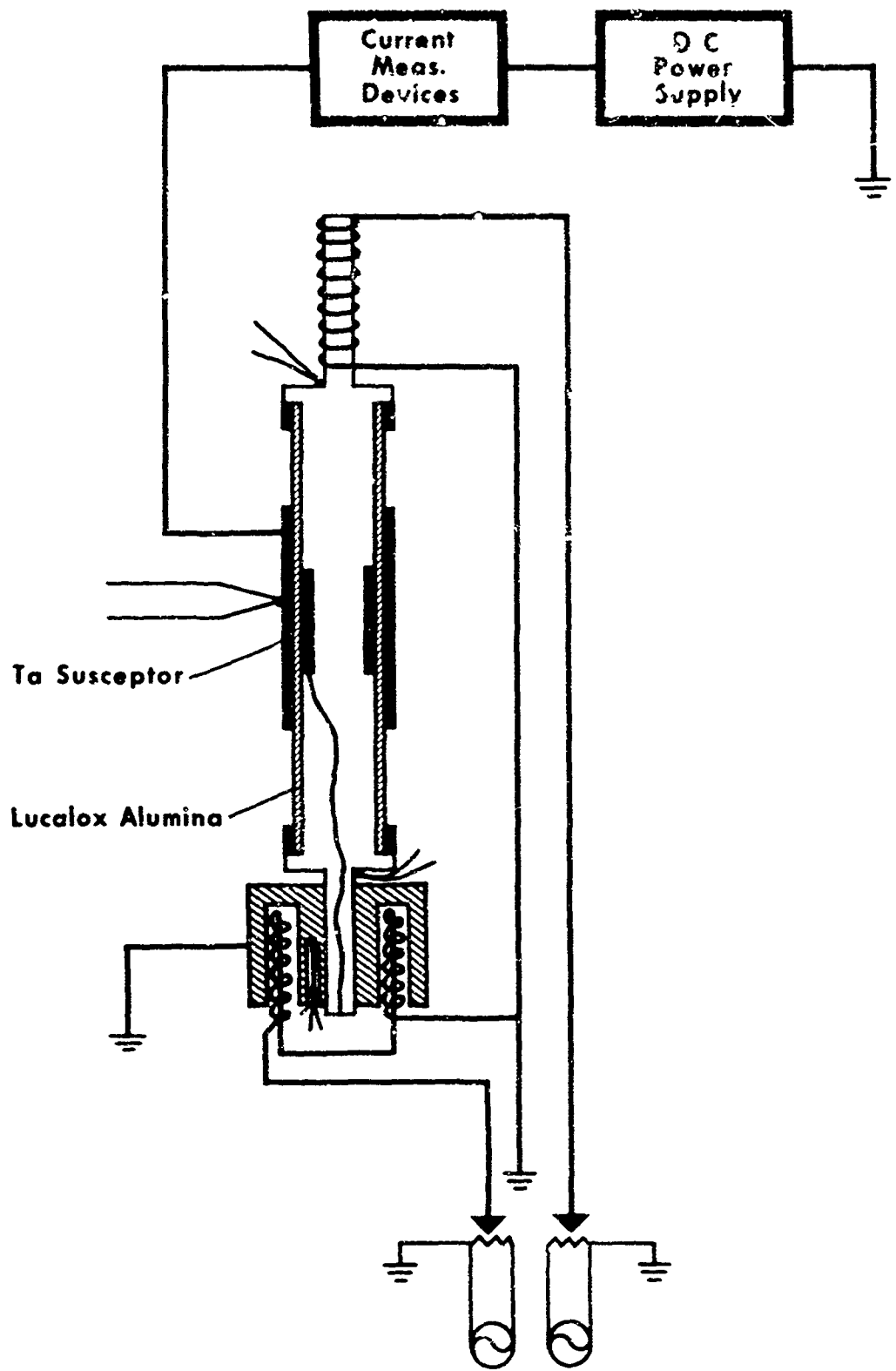

FIGURE II-3. SCHEMATIC OF CONDUCTIVITY EXPERIMENT

Currents above  $10^{-7}$  amp were measured using a potentiometer and a 198 ohm resistor in series with the specimen. Between  $10^{-10}$  and  $10^{-7}$  amp, an electrometer was used. Below  $10^{-10}$  amp, currents could not be measured reproducibly. The error in current measurement was less than 1% above  $10^{-7}$  amp and about 20% between  $10^{-10}$  and  $10^{-7}$  amp. The observed resistance values are given in Figure II-4 for the two specimens. Points on Figure II-4 designated by a letter E are values determined using the electrometer.

The voltage across the specimen was varied between 0 and  $\pm 6.7$  volts using a precision rheostat and batteries; it was varied between -400 and +150 volts using a dc power supply with about 0.01% ripple. Some volt-amp curves are shown in Figure II-5. When the Ta electrode was made positive, a short transient effect was noted with each increase in voltage; the current across the specimen would rise to some initial value and then drop to about 1/2 that value over about 10 seconds (at 1250°C); no further change with time would occur. The curve in Figure 5 labeled 918°C shows non-ohmic behavior typical of that observed for low cesium pressures.

After the resistance measurements, tube #2 was sectioned and examined microscopically. The alumina wall thickness was found to be  $0.0307'' \pm 0.0002''$ . No solid-state reaction-phases were present in the alumina microstructure; much less than 1% porosity was observed. Spectroscopic analysis of the alumina tube #2 was obtained after the conductivity studies and the results are given in Table II-1. Tube #1 was neither sectioned nor analyzed.



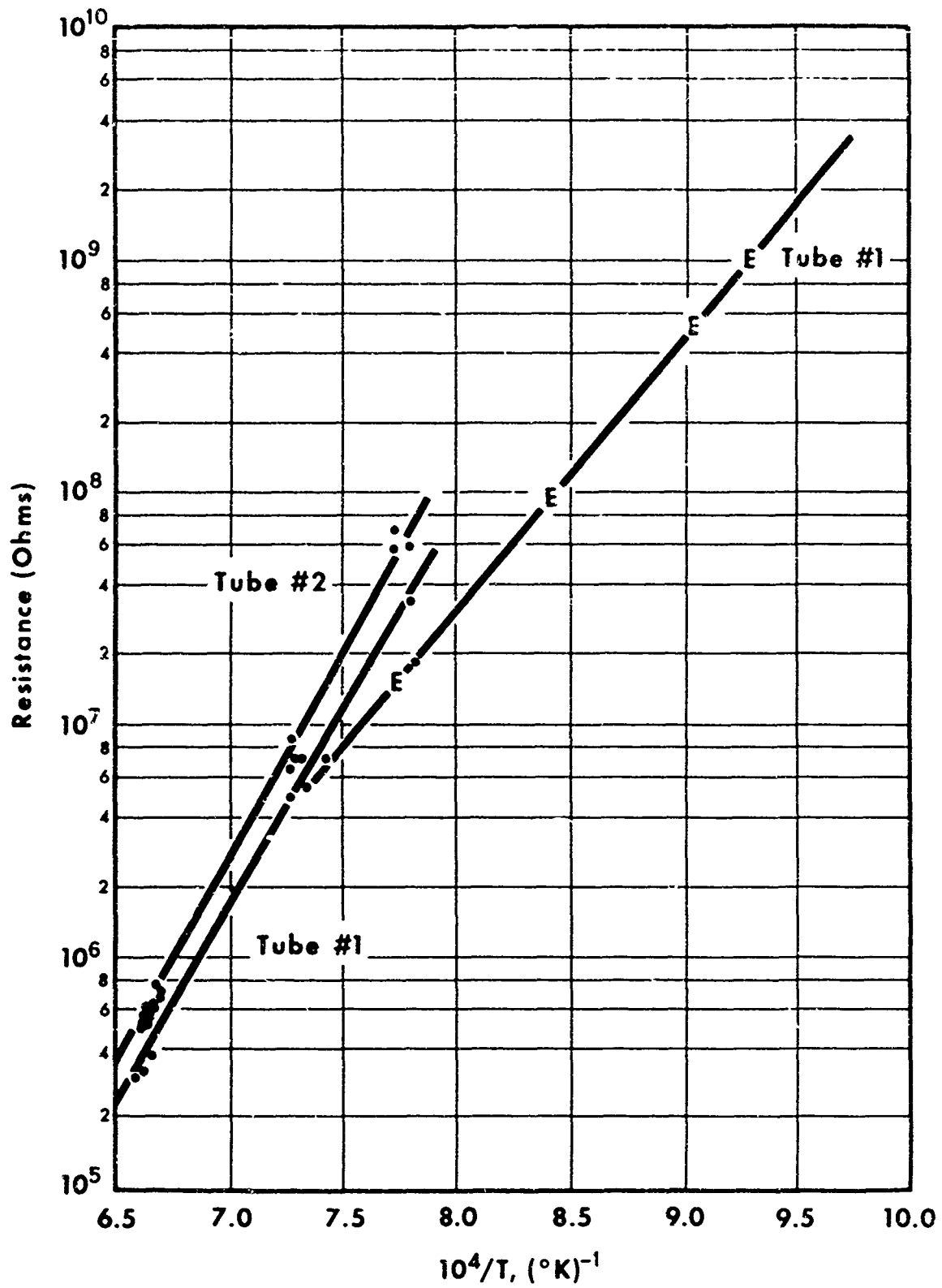

FIGURE II-4. TEMPERATURE DEPENDENCE OF RESISTANCE FOR TWO ALUMINA TUBES

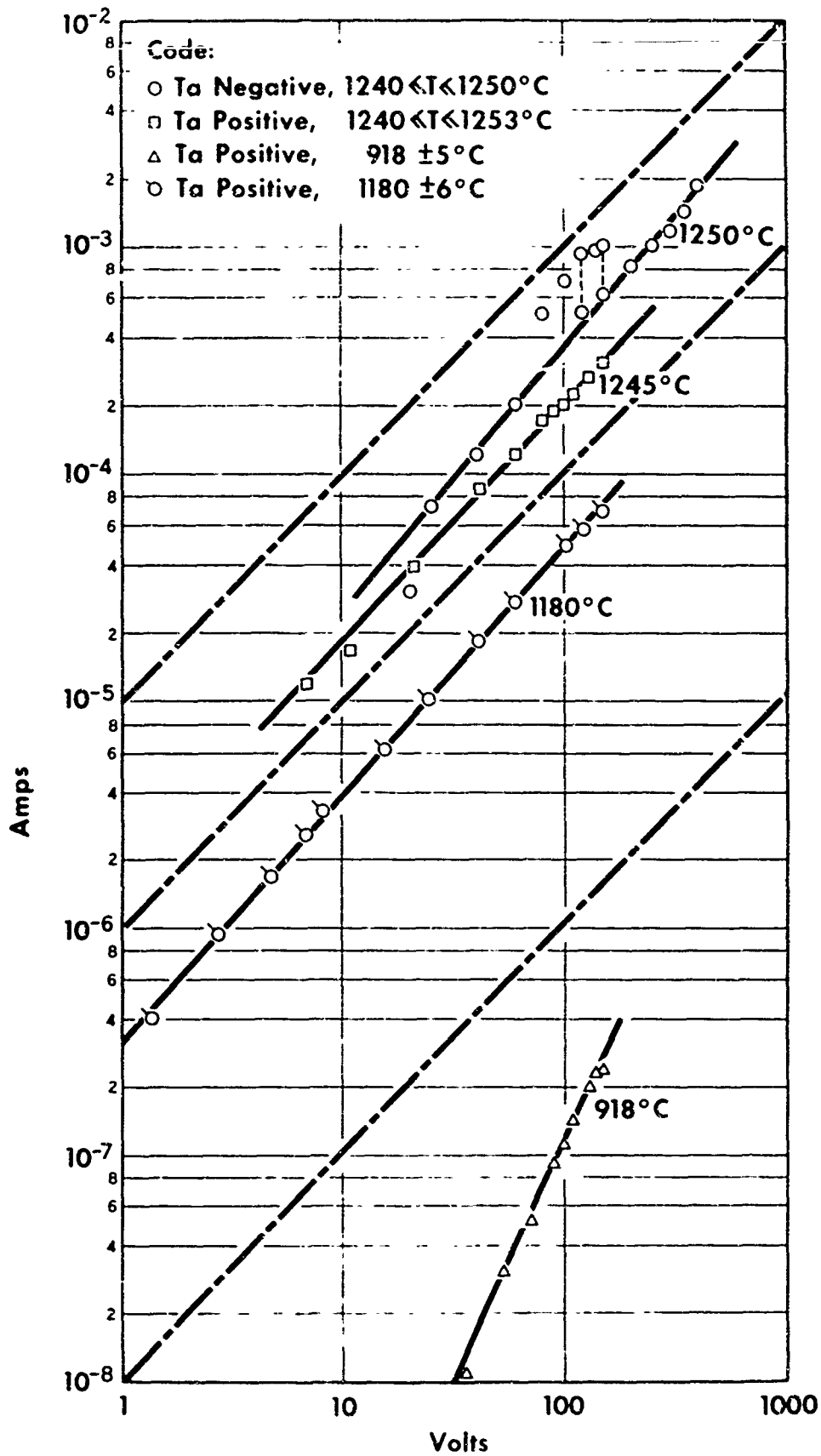

FIGURE II-5. CURRENT VERSUS VOLTAGE ACROSS INSULATOR

TABLE II-1

Spectroscopic Analysis of Tube #2  
After Conductivity Measurements

Material: Aluminum Oxide (solid)

Date of results: 4/22/64

Al	-----	Major
Sb	-----	< 10 ppm
B	-----	< 10
Ba	-----	< 10
Bi	-----	< 50
Cd	-----	< 100
Ca	-----	10
Cr	-----	< 1
Co	-----	< 10
Cu	-----	5
Fe	-----	10
Pb	-----	< 10
Mg	-----	5000
Mn	-----	1
Mo	-----	< 10
Ni	-----	< 10
K	-----	< 10
Si	-----	400
Ag	-----	< 1
Na	-----	50
Sn	-----	< 50
Ta	-----	< 10
V	-----	< 10
Ti	-----	< 10
Zn	-----	< 50
Sc	-----	< 10
Nb	-----	< 100
Cs	-----	< 1
Y	-----	< 10
W	-----	< 100

All data reported in parts per million

E. Effect of Temperature on the Conductivity of Lucalox Alumina

Resistivity values may be obtained from the data in Figure II-4 for Tube #2 by multiplying the resistance values by 9.33. The resistance data shown in Figure II-4 are characteristic of oxide insulators. A comparison of the data obtained from the two specimens shows the two to be essentially identical except for wall thickness and perhaps relative impurity content. The data obtained in tube #2 using the potentiometer is of sufficient accuracy to allow giving careful attention to the temperature dependence of the resistivity. The resistivity is shown in Figure II-6 as a function of temperature while the conductivity is shown in Figure II-7 in the usual way for thermally activated processes.

The activation energy associated with the conductivity of Lucalox alumina (Figure II-7) is 3.55 electron volts between 1020 and 1200°C. The same activation energy (slope) was observed for both Lucalox tubes in the high temperature regime of Figure II-4. The low temperature activation energy from Figure II-4 is 2.32 ev. The high temperature values are similar to those obtained by Pappis and Kingery on polycrystalline alumina under  $10^{-10}$  atmospheres oxygen pressure.<sup>3</sup> The temperature at which transition to the higher activation energy conduction mechanism occurs was observed to be about 1520°C by Pappis and Kingery, while about 1000°C was observed in this study. The difference may be due to lower impurity concentrations in the present specimens; however, Pappis and Kingery did not present detailed analyses of their specimens for comparison.

Pappis and Kingery observed for single-crystal alumina a maximum activation energy of 5.5 to 5.8 ev at high temperatures.<sup>3</sup>

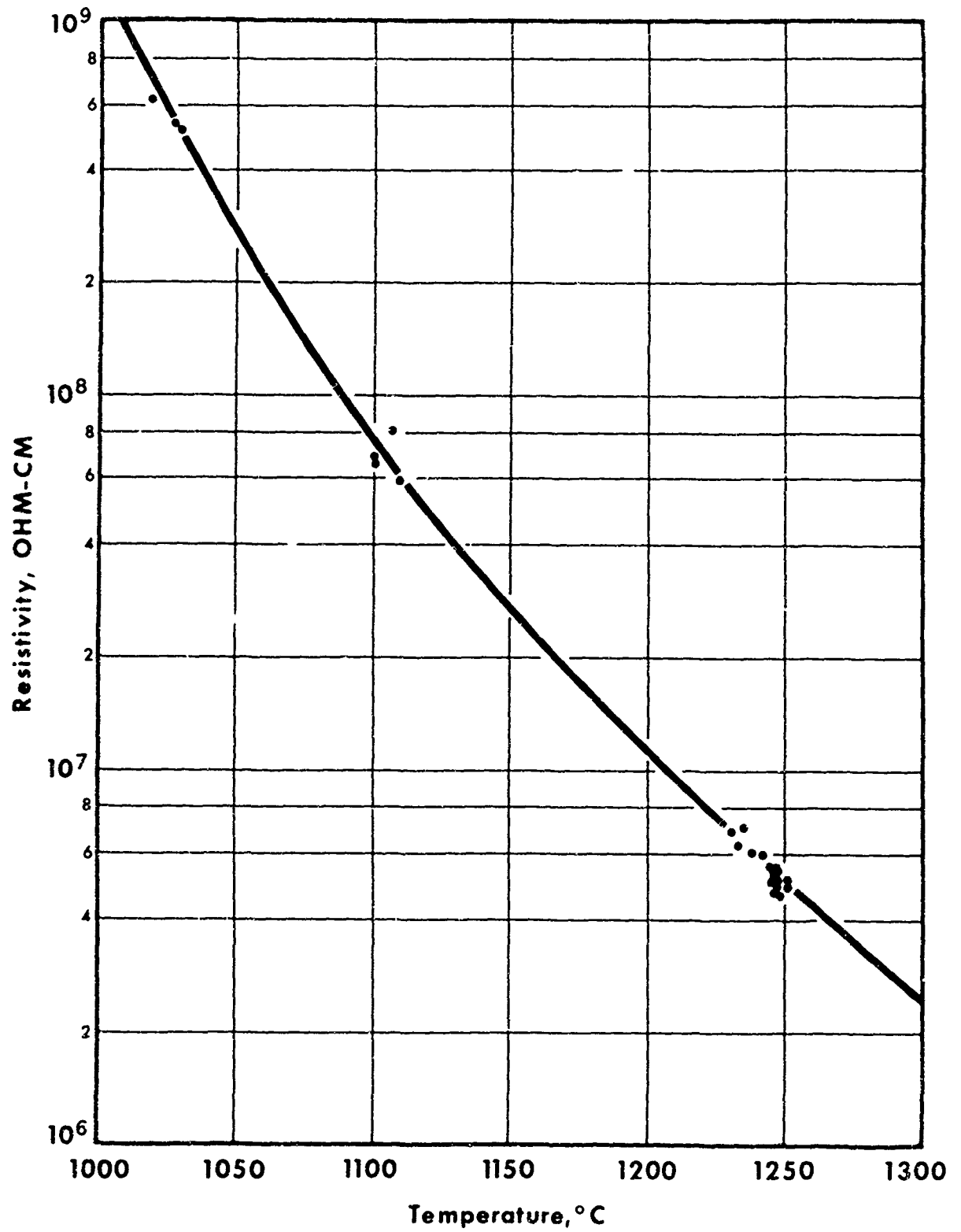

FIGURE II-6. TEMPERATURE DEPENDENCE OF RESISTIVITY FOR LUCALOX ALUMINA

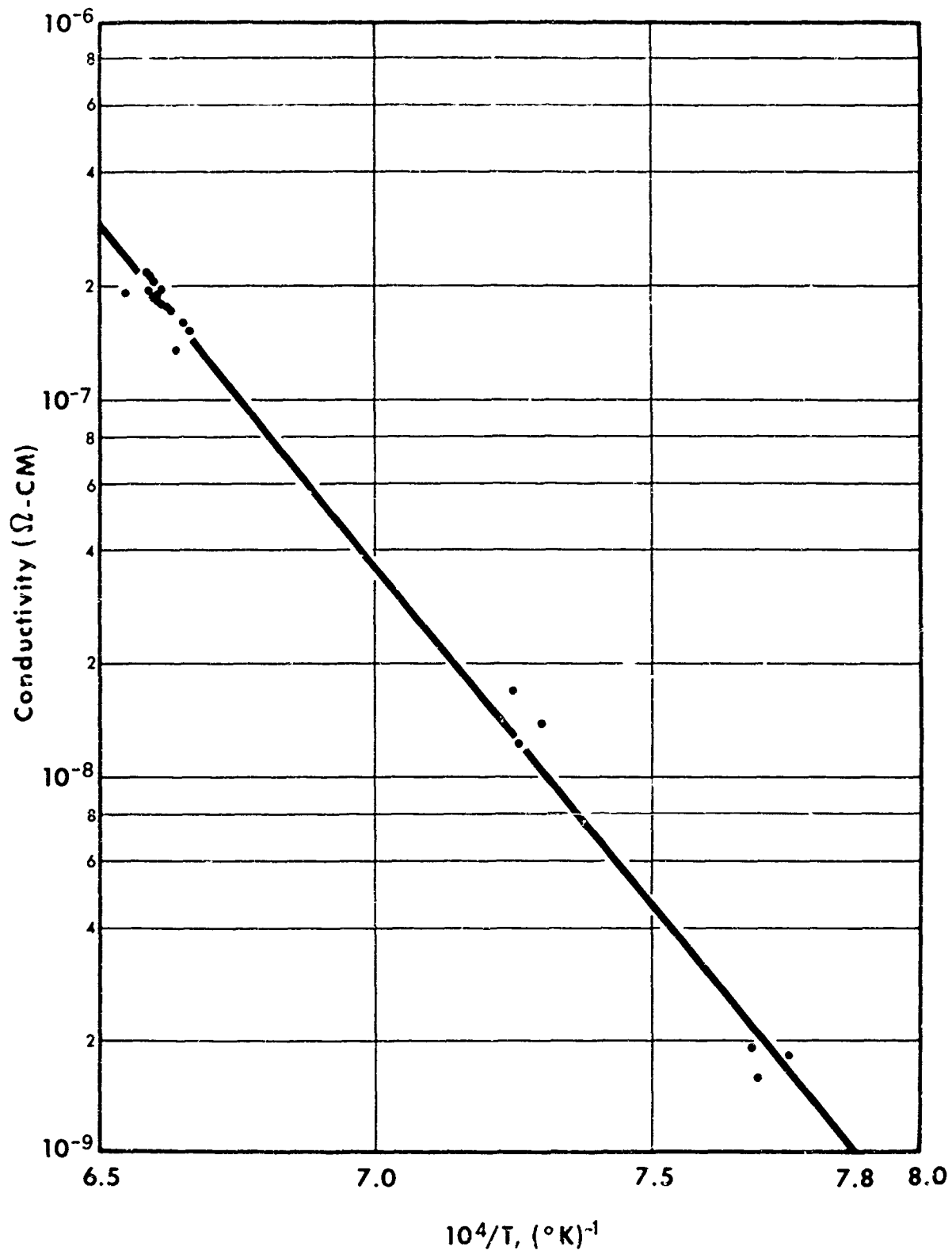

FIGURE II-7. TEMPERATURE DEPENDENCE OF ELECTRICAL CONDUCTIVITY FOR LUCALOX ALUMINA

Assuming this figure to be representative of intrinsic conduction a corresponding band gap of about 11 eV is found. Those authors found no activation energies higher than 3.6 eV for polycrystalline alumina with temperatures up to 1777°C. That observation is confirmed by the present study for temperatures up to 1250°C. The conductivity of polycrystalline alumina was apparently impurity dominated for both studies.

CHAPTER II  
REFERENCES

1. L. N. Grossman, "Electrical Insulators and Spacers for Nuclear Thermionic Devices," GEST-2022 (1964).
2. "Survey of the State-of-Art in Thermionic Power Conversion Diode Utilization," GESR-2008 (1963), p. I-24.
3. J. Pappis and W. D. Kingery, "Electrical Properties of Single-Crystal and Polycrystalline Alumina at High Temperature," J. Am. Cer. Soc. 44 (9), 459 (1961).



### III. CERAMIC-TO-METAL SEAL DEVELOPMENT

#### A. General

High-temperature tolerant, alkali metal vapor-resistant ceramic-to-metal seals are needed for application in many of the electrical power generating systems currently under development. These systems include the nuclear fuel heated thermionic converters developed under this contract, solar and fossil fuel heated converters, as well as nuclear turbo-electric power systems. Although a need exists for 1500°C tolerant seals, the present interest is in systems capable of sustained operation at temperatures up to approximately 900°C as an interim goal.

Two distinctly different sealing techniques have come into widespread use for sealing ceramics to metal for electronic as well as mechanical applications: (1) active-alloy sealing, and (2) refractory metal metallizing. In the former method, a molten brazing alloy is suitably "activated" to impart ceramic wetting and bonding characteristics, thereby permitting direct union of the ceramic and the metal members to be joined. In the second method, a thin layer of powdered refractory metal (usually with admixed metals or oxides) is sintered to the surface of the ceramic to provide a metallic layer to which a conventional braze can be made.

Work under a previous BuShips contract,<sup>1</sup> together with the results of related programs, have shown that state-of-the-art seals are not suitable for application in high-temperature thermionic converters. Their inadequacy stems largely from the use of vitrified high alumina ceramics (usually 94

percent to 99 percent alumina). Such ceramics contain silica, and it has been shown<sup>1, 2, 3</sup> that even very small amounts of silica cause the ceramic to undergo rapid attack by cesium vapor at temperatures above approximately 600°C. Hall et al<sup>2</sup> investigated the attack on a number of commercial alumina bodies at 750°C in a pressure of 10 Torr cesium. Of the many ceramics studied, only two (a 95 percent and a 98 percent alumina which were claimed by the manufacturer to be silica free) showed no degradation. Levinson,<sup>3</sup> on the other hand, observed during a study of seal and insulator problems in thermionic converters that "alumina is the most desirable insulator material and the principal current temperature limitation is imposed by the brazing processes rather than the insulator material." Cowan,<sup>4</sup> however, supports the observed deleterious effect of cesium on silica-containing, high-alumina ceramics, and stated, "The problem of resistance to cesium vapor may be minimized by avoiding the intentional use of silica in the ceramic. The limits of silica concentration have not been established but at temperatures below 1000°C, approximately one percent silica does not appear to be harmful. For the ultimate seal utilizing alumina and operating at 1200°C for 10,000 hours, it is probably wise to keep the silica content as low as possible." M. J. Slivka<sup>1</sup> found that of all the ceramics which he tested, including a commercial 99.5 percent alumina body, only pure sintered alumina ceramics (such as Lucalox\* alumina and General Electric Schenectady

---

\*Lucalox is a General Electric trade name for a high-purity alumina ceramic

Tube Operation body A-976) were sufficiently resistant to cesium attack as to permit application at 900°C. Feingold,<sup>5</sup> in a study of cesium attack on silica-doped alumina ceramics, concluded that pure polycrystalline alumina was resistant to cesium attack at temperatures as high as 1500°C. The pure alumina- and silica-doped alumina bodies studied by Feingold were prepared in the Ceramic Laboratory of the Schenectady Tube Operation, Tube Department, and it is this same polycrystalline alumina (body A-976) which was found resistant at 1500°C, that has been the backbone of our seal development studies.

Another deficiency<sup>4</sup> of state-of-the-art seals lay in the common use of brazing alloys such as copper, silver-copper, gold-copper, and gold-nickel... alloys which are lacking in the need for low vapor pressure and resistance to cesium corrosion. Few commercial brazing alloys are available which would be predicted to be cesium resistant and even fewer alloys have actually been tested.

Active alloy seals of the titanium hydride type are inadequate since they, too, generally utilize one of the noble metal brazing alloys referred to previously. Even ceramic-to-tantalum seals (bonded with a titanium-nickel alloy), which have been found so reliable in moderate temperature applications, were shown<sup>2</sup> to have an extremely short life at a temperature of 900°C due to embrittlement of the bonding alloy through continued reaction with the ceramic. Titanium shim seals to nickel, prepared so as to contain only TiNi<sub>3</sub> or nickel solid solution at the interface, were, however, so

successful on preliminary testing as to warrant further evaluation and life testing.

Although additional study of the aforementioned alumina-to-nickel seals constituted a portion of the program of seal development and evaluation performed under this contract, primary emphasis was placed upon two new approaches to ceramic-to-metal sealing: (1) the development of multi-layered cermet structures having an electrically insulating core but with metallic surfaces, and (2) the development of cesium resistant metallizing for pure alumina ceramics. Both of these approaches required the development of a brazing, welding, diffusion bonding or other joining technique to hermetically seal the metallic surface of the insulator to the structural metal members of the converter.

Thus, the program of seal development and evaluation comprised five separate but related studies:

1. Cesium resistant metallizing for pure alumina ceramics
2. Multilayered cermets
3. Active-alloy ceramic-to-metal sealing
4. Metal-to-metal joining for high temperature, cesium-vapor environments
5. Cesium corrosion testing of materials and seals.

This final technical report treats each of these studies separately, presenting further background information on the subject, results obtained and recommendations for future work.

This program of seal development and evaluation was performed by the Tube Technology Subsection of the Schenectady Tube Operation. The program was under the technical direction of R. H. Bristow, Senior Ceramist. Engineers responsible for specific tasks were: (1) multilayered cermets - R. D. Hanna, Ceramist; (2) cesium resistant metallizing - R. D. Hanna; (3) active-alloy sealing - R. H. Bristow; (4) metal-to-metal joining - K. P. Zeman, Metallurgist; and (5) cesium corrosion testing - K. P. Zeman.

B. Summary

Cesium Resistant Metallizing

Several refractory metal (molybdenum or tungsten) based coatings, containing calcia, magnesia, alumina or yttria as bonding oxides, have been developed for the metallizing of essentially pure sintered alumina ceramics (such as G-E body A-976). Sintering schedules which will yield strong, vacuum-tight coatings have been determined and flexural strengths as high as 35,600 pounds per square inch have been measured on brazed specimens. Similar specimens remained vacuum tight after heat treatment for 2020 hours at a temperature of 900°C in vacuum, and withstood repeated thermal cycling to room temperature. Metallized specimens, brazed with cesium-resistant brazing alloys, were subjected to a 20 Torr cesium vapor atmosphere at 1000°C for periods ranging up to 1000 hours and showed no detectable degradation.

### Multilayered Cermeis

The sintering behavior of a number of types of molybdenum and alumina powders have been studied. Materials selected from these studies have been incorporated in cermet compositions, containing from 5 to 75 volume percent (v/o) molybdenum. Sintering cycles were established which produced vacuum-tight structures from these cermet powder blends. Multilayered cermet specimens were prepared and sintered to a vacuum-tight condition, but were not electrically insulating. The necessity of using a very alumina-rich composition as the core layer to prevent electrical conduction greatly aggravated fabrication problems, making difficult the production of a composite which was both vacuum-tight and electrically insulating. Cold pressing, isostatic and hot pressing techniques were utilized and further development using these fabrication methods is recommended to achieve the desired multilayer cermet properties.

### Active-Alloy Sealing

The preparation of titanium shim seals of alumina-to-nickel, and alumina-to-refractory metals using nickel buffer washers was studied and sealing parameters were optimized. Alumina-to-niobium seals using nickel foil to form a liquid phase at the interface were also investigated. Specimens of each type of seal were life tested at temperatures of 700°C, 900°C and 1075°C, and thermal cycle tested between room temperature and 900°C.

At a life test temperature of  $900^{\circ}\text{C}$ , one-third of the alumina-to-nickel and alumina-to-refractory metal specimens had developed leaks (detectable by the helium mass spectrometer leak detector) by the end of 1370 hours. One group of specimens accumulated 2280 hours of exposure and was still vacuum tight. At a test temperature of  $1075^{\circ}\text{C}$ , the rate of failure markedly increased and one-half of the specimens had developed leaks by the end of 240 hours of exposure. The  $\text{TiNi}_3$  layer initially present at the alumina-nickel interface disappears during high-temperature life testing due to solutioning by the nickel washer. Seals containing a nickel solid solution at the interface possess a lower mechanical strength which, coupled with the stresses induced by thermal expansion mismatch, causes failure at the metal-ceramic interface.

No failures were recorded among the alumina-to-niobium seals which were exposed to a temperature of  $900^{\circ}\text{C}$  for 2020 hours or those which were tested at  $1075^{\circ}\text{C}$  for 240 hours. The excellent thermal expansion match between alumina and niobium, the apparent stability of the nickel-niobium intermetallic which is formed at the interface, and the lack of hardening of the niobium, are undoubtedly responsible for their excellent behavior on high-temperature testing.

#### Metal-to-Metal Joining

The joining of molybdenum to itself, niobium, and tantalum was studied. It was assumed that the molybdenum would be

ina- present as a metallized coating on a pure alumina ceramic  
ter or as the metallic surface of a graded cermet. Diffusion  
ci- bonding, high-temperature brazing, and braze-diffusion-  
bonding are the techniques that were considered.

Diffusion bonding of molybdenum-to-molybdenum using  
palladium and chromium as active diffusing metals was  
shown to be possible. A joint made with palladium was still  
vacuum tight after 500 hours of testing in 20 Torr cesium  
vapor at 1000°C.

High-temperature brazing with palladium alloys and with  
commercially available nickel and cobalt-based braze alloys  
was studied and vacuum-tight joints were produced. However,  
it was found that unless the palladium alloys were used very  
sparingly, they continued to react with the refractory metals.  
during testing, forming pores and, in the case of metallized  
ceramics, causing disruption of the metallizing. The nickel-  
and cobalt-based braze alloys were subject to brittle phase  
formation, due to reaction with the refractory metals. Even  
though vacuum-tight joints could be obtained by properly con-  
trolling the brazing cycle, the continued reaction which occurs  
during testing causes extensive brittle phase formation. The  
mechanical stresses imposed by thermal expansion mismatch  
can fracture such brittle phases, resulting in leakage paths  
through the joint.

Nickel braze-diffusion-bonding, which consists of initially  
forming a liquid by reaction of nickel foil with the surface of



a refractory metal member, followed by a holding period sufficiently long to absorb this liquid into the refractory metal, has been very successful. Bonds of molybdenum-to-molybdenum, niobium-to-molybdenum, and tantalum-to-molybdenum have been developed which are free of intermediate phases and, therefore, should have remelt temperatures limited only by the structural members.

Molybdenum discs have been bonded to metallized ceramic rings and the resulting seals have remained vacuum tight after 500 hours exposure to 20 Torr of cesium vapor at 1000°C, and through 12 thermal cycles to 900°C in vacuum. Similarly prepared niobium-to-metallized-alumina seals have remained vacuum tight through the same test conditions. Tantalum discs nickel braze-diffusion-bonded to molybdenum rings have remained vacuum tight through 500 hours in cesium and tantalum washers bonded to metallized ceramics have remained vacuum tight through 12 cycles to 900°C in vacuum.

#### Cesium Corrosion Testing

Cesium corrosion resistance of various materials and seals was determined at 1000°C and 20 Torr cesium pressure. The test vessels were made of high purity alumina (G-E A-976) ceramic, while the end closure and cesium reservoir were made from high purity nickel.

The following metals, which are of interest in thermionic converter construction, were not attacked during exposure times ranging from 200 to 1000 hours: chromium, iron, nickel, niobium, palladium, platinum, and tantalum.

Other materials which did not exhibit cesium attack when exposed for 500 to 1000 hours were:

1. palladium based braze alloys (65-35 Pd-Co, 60-40 Pd-Ni, 54-36-10 Pd-Ni-Cr)
2. ultra-high-temperature titanium- and vanadium-based braze alloys supplied especially for refractory metals
3. commercially available nickel- and cobalt-based high-temperature braze alloys
4. commercially available alumina ceramic, Coors AD-995
5. metallizing coatings and metallizing bonding oxides developed under this program when applied to cesium resistant substrates
6. molybdenum-alumina graded cermets developed under this program.

Although the alumina-to-nickel active-alloys seals studied during this program were not attacked by cesium vapor, they developed leaks due to continued reaction of the braze with the seal components at 1000°C.

The following materials were found to be attacked by cesium vapor at 1000°C:

1. commercially available alumina ceramic, Silk City SC 95D
2. Coors metallizing applied to Coors AD-995 alumina ceramic

3. silica containing metallizing (designated S-20) applied to cesium resistant G-E A-976 alumina ceramic
4. commercially available chromium-alumina cermet, LT-1 (produced by the Haynes Stellite Division, Union Carbide Corporation).

C. Cesium Resistant Metallizing

Introduction

The study conducted under this portion of the contract concerns the development of a silica-free metallizing for pure alumina ceramics. The need for such a technique and the problems involved in its development can be best understood by considering the chemistry of a state-of-the-art refractory metal metallizing process as currently practiced by many manufacturers of electronic devices.

In the now widely used molybdenum-manganese metallizing process, finely divided molybdenum and manganese powders are dispersed in a suitable organic vehicle and a thin coat of this suspension is applied to the surface of the ceramic. Following drying, the ceramic is heated in a wet hydrogen atmosphere at a relatively high temperature (1200 to 1600°C) to promote adherence of the coating to the ceramic. The metal surface thereby produced can be plated and brazed using conventional techniques.

Pure molybdenum does not react with pure aluminum oxide in the 1200 to 1600°C temperature range, and any adherence in such a system is assumed to be purely mechanical. (Studies

related to this point as well as other reactions during metallizing have been reported by Cole.<sup>6)</sup> It is the manganese in the above discussed coating, as well as the fluxing oxides present in a so-called high-alumina ceramic, which promote adherence. Consider the specific case of metallizing of a high alumina body having a composition of 96 w/o (weight percent) alumina and 4 w/o other oxides. During sintering of the metallizing coating, the dew point of the hydrogen atmosphere is maintained sufficiently moist to insure oxidation of the manganese. The resulting manganous oxide then reacts: (1) with alumina forming manganese-alumina compounds, and (2) with the fluxing oxides of the ceramic, producing a glassy phase which fills the interstices of the sintered molybdenum coating and serves to strongly lock it to the ceramic. A photomicrograph of such a coating on a high alumina ceramic is shown in Figure III-1. The reaction products mentioned can be seen in this illustration.

Commercial alumina bodies often contain the same total alumina content, but incorporate different fluxing oxides or different ratios of these oxides. These differences not only change the temperature at which the desired liquid phase is obtained but may also produce melts with widely varying viscosities. In cases where the flux content of a ceramic body is small or of a refractory nature, oxides are usually added to the metallizing mix to produce the desired liquid phase for proper reaction.

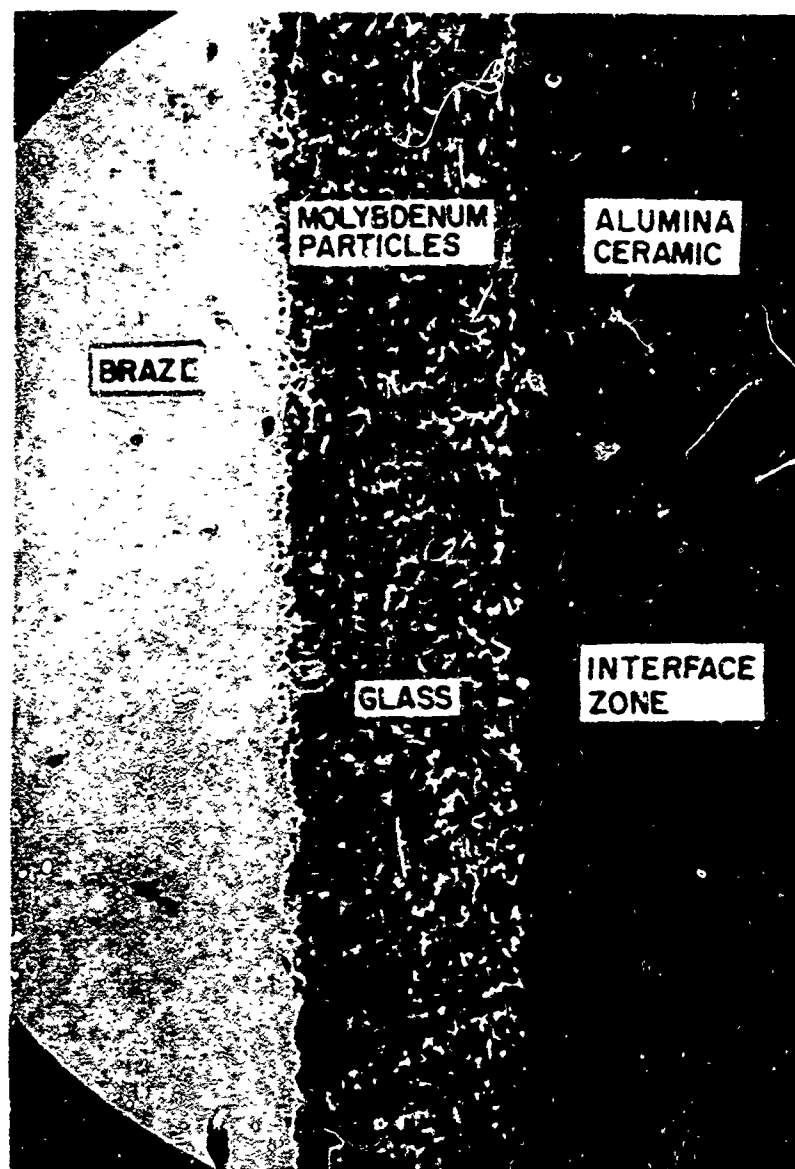

Figure III-1

Typical Metallized Ceramic

As mentioned previously, silica must be eliminated from a ceramic-to-metal sealing system which is to be exposed to high temperatures in a cesium vapor environment. An essentially pure, silica-free polycrystalline alumina ceramic, Schenectady Tube Operation body A-976, has been proven suitable for this application, and was used extensively in this ceramic-to-metal seal study. Since, a liquid phase for bonding purposes is not available from this ceramic short of its destruction; the metallizing composition must contain the oxides which will supply the needed liquid at the sintering temperature.

#### Selection of the Bonding Oxide

The liquid phase which is present in a molybdenum-manganese metallizing coating solidifies, during cooling, to a partially or predominately glassy material. With the bonding oxides considered for use in a silica-free metallizing composition, glass formation was not anticipated nor was it desirable. With the possible exception of the calcia-alumina system, glass formation is not common in the systems considered. If a glass were to be formed on cooling, there was a low probability of it remaining stable during subsequent high-temperature exposure of the seal, and consequent devitrification could cause failure of the metallizing-to-ceramic bond. Thus, it was desired to select a bonding oxide or oxides which, upon heating to the metallizing temperature, would form a strong, stable bond to the alumina as well as a strong bond (mechanical

and possibly chemical) to the sintered molybdenum particles. Such a "flux" should possess a viscosity during sintering which allows flow throughout the molybdenum matrix but which would not drain out of this structure through excessive reaction with the alumina body. Ideally, the reacted flux should consist of stable microcrystals of one or more phases which would have thermal expansion characteristics compatible with the alumina and molybdenum.

Included among the bonding oxide systems studied were CaO-Al<sub>2</sub>O<sub>3</sub>, MgO-CaO-Al<sub>2</sub>O<sub>3</sub>, BaO-Al<sub>2</sub>O<sub>3</sub>, Y<sub>2</sub>O<sub>3</sub> and Y<sub>2</sub>O<sub>3</sub>-Al<sub>2</sub>O<sub>3</sub>. These are all refractory oxides systems which, from limited test data, appeared to be compatible with cesium vapor environment.

In a recent study<sup>7</sup> of ceramic-to-metal sealing mechanisms, it has been reported that a eutectic composition consisting of 41.5 percent CaO, 6.7 percent MgO, 51.8 percent Al<sub>2</sub>O<sub>3</sub>, when placed in contact with molybdenum and heated to 1600°C in a forming gas atmosphere with a dew point of +80°F, produces a contact angle of 10 degrees. This wetting is desirable but it does not necessarily insure a strong bond. However, it does indicate that conditions are favorable for distribution of the molten oxides through as well as the retention of the melt in the interstices of the molybdenum particles of a metallizing layer. Spectrographic analysis of the contact angle specimen, after being melted on the molybdenum, indicated that two percent of molybdenum was present in the

melt. Thus, apparently, a reaction took place between the oxides and the molybdenum, which might contribute to chemical bonding.

Baria has been reported to attack molybdenum when heated in a hydrogen atmosphere at  $1600^{\circ}\text{C}$ .<sup>8</sup> This reaction, if it could be controlled, might also assist in producing a strong bond to molybdenum.

Preliminary information relating to these oxide systems was obtained by blending various powder compositions, and pressing compacts which were sintered at various temperatures in a hydrogen tube furnace. Stability of the reaction products and the melting ranges of the various bonding oxide compositions were observed, and X-ray diffraction data were obtained on selected oxide melts. Information related to the chemical analysis of the initial powders as well as the preliminary test results has been reported.<sup>9</sup>

#### Ceramic-to-Metal Seal Preparation and Evaluation

Metallizing mixes were prepared by blending M&R Type P\* molybdenum powder with bonding oxide raw materials in the proportion 60-70 v/o (volume percent) molybdenum, 30-40 v/o oxides. These powder mixtures were dispersed in an organic vehicle and milled for 144 hours in a high purity alumina jar mill. (This operation reduced the metal particle size as well as intimately blending all of the powders.) Then, after addition of an organic binder, the mixture was applied to the G-E A-976 alumina ceramic specimens using the screen process method.

---

\*M&R Refractory Metals, Inc., Springfield, N. J.



This method of metallizing mix preparation is preferred since a fine particle, homogenous mixture is obtained which can be applied uniformly. It does, however, consume time and material. In some instances, therefore, mixes were prepared by: (1) manually stirring the powders with the vehicle to form a thin paste, or (2) modifying a ball-milled mix by adding more oxides. Mixes prepared by these methods were suitable for the study of the reactions which occur during sintering but are not as desirable as ball-milled mixes for producing vacuum-tight seals, since uniform application of a coating is much more difficult.

The compositions which were studied in greatest detail, together with the leak check results obtained with various sintering treatments, are shown in Table III-1. Photomicrographs revealing the structure of the metallizing and reaction zone are shown in Figures III-2 and III-3. Sintering was performed in a dry hydrogen atmosphere tube furnace with a soak time of one hour.

Variations in sintering temperature cause different metallizing interface structures. For example, Figure III-2 shows metallizing mix No. 1 sintered at three different temperatures. In the 1680°C sample, the interface is fractured; in the 1760°C sample, the interface is slightly modified but intact; while the 1855°C sample shows no apparent interface reaction zone.

In an attempt to identify the reaction products present after such sintering treatments, a series of samples were prepared

Table III-1  
Ceramic-Metal Seal Results

Mix No.	Metallizing		* Oxide Constituents w/o					** Sintering Temp.	*** Leak Check Results	
	Oxide Composition No.		Al <sub>2</sub> O <sub>3</sub>	CaO	MgO	BaO	Y <sub>2</sub> O <sub>3</sub>		Vacuum Tight	Leakers
1	26		51.8	41.5	6.7	-	-	1610	0	6
								1680	0	6
								1750	3	1
								1755	5	1
								1760	3	0
								1800	3	0
								1850	7	0
18	20		80	17	3	-	-	1700	0	3
								1750	0	3
								1800	0	6
								1850	3	0
								1900	3	0
21	47		95	4.3	7	-	-	1700	0	2
								1750	0	3
								1800	3	3
								1850	1	2
								1900	0	3
26	48		80	20	-	-	-	1700	0	3
								1750	0	3
								1800	1	5
								1850	3	0
								1900	3	0
34	44		60	-	-	40	-	1750	0	3
55	46		65	-	-	-	-	1800	3	0
								1850	2	1
								1900	3	0
56	-		-	-	-	-	2	1890	0	3
60	-		-	-	-	-	2	1890	2	1

\* Bonding oxides comprise 30 to 40 volume percent of a mix, except in mixes No. 56 and No. 60 where only 2 weight percent was added.

\*\* All sintering times were for one hour.

\*\*\* These results include the flexural strength samples reported in Table III-3.

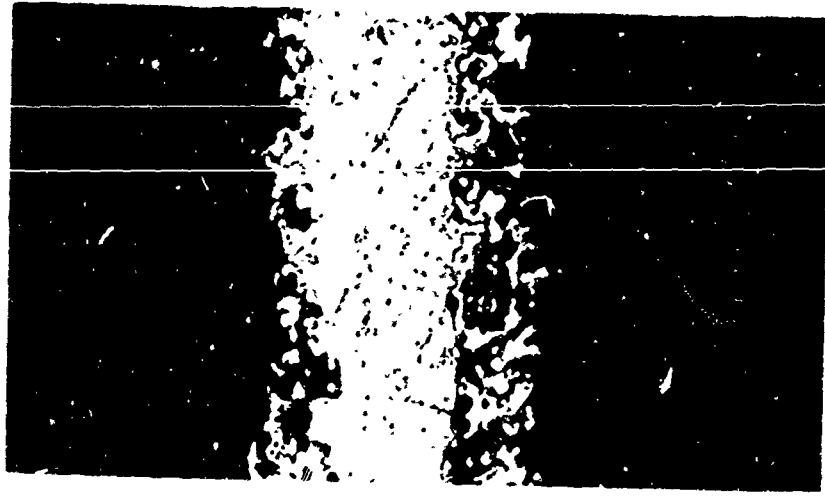

A      1680°C      Leaker

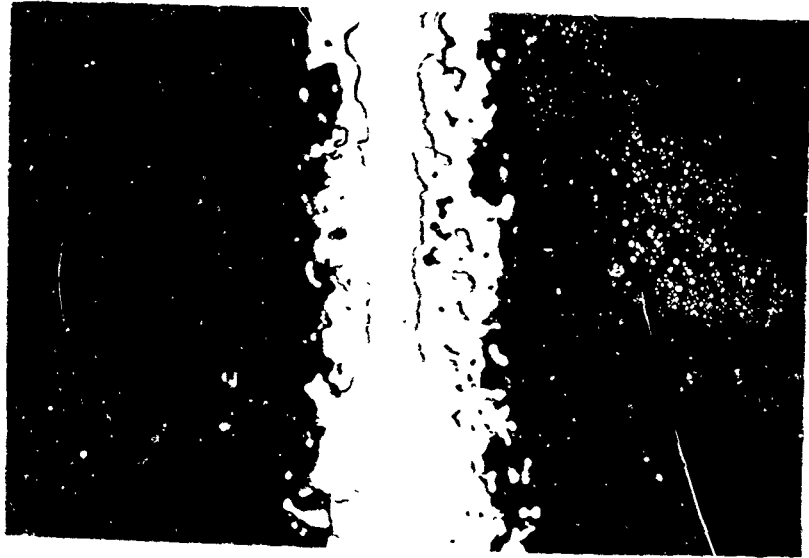

B      1760°C      Vacuum Tight

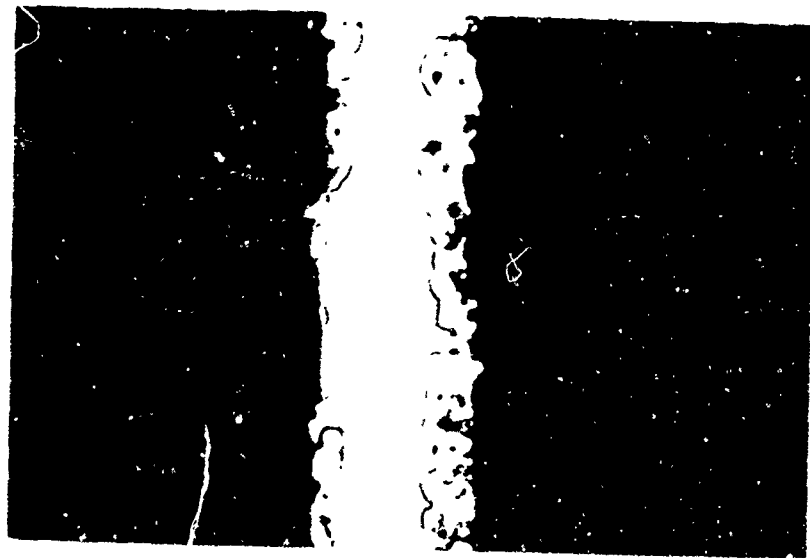

C      1850°C      Vacuum Tight

Figure III-2

Photomicrographs of Ceramic-to-Metal Seals (500X)



A

Mix No. 18



1800°C

Leaker



B

Mix No. 18

1900°C

Vacuum Tight



C

Mix No. 54

1750°C

Leaker

Figure III-3

Photomicrographs of Ceramic-to-Metal Seals (500X)

by coating the bonding oxides (excluding all molybdenum) on the ceramic surface. These samples were heat treated at various temperatures and the reacted surface analyzed using X-ray diffraction techniques. Results of these analyses are presented in Table III-2.

From the limited testing performed, it appears that the CaO-Al<sub>2</sub>O<sub>3</sub> is undesirable (possibly because of a poor thermal expansion match) and that the CaO-6 Al<sub>2</sub>O<sub>3</sub> reaction product may be the most desirable. The CaO-6 Al<sub>2</sub>O<sub>3</sub> compound is isostructural with alpha alumina (not apparent in the photomicrographs).

It was observed that the metallized layer of high fired (1850°C) metallizing mix No. 1 is quite dense. This is attributed to the fluidity of the eutectic composition bonding oxide, which permitted good sintering of the molybdenum particles. It was theorized that the bonding strength of such a structure (where the molybdenum layer approaches a single sheet with a consequent reduction in mechanical interlocking to the substrate), might be less than that produced in a structure possessing more oxide constituent in the metallizing area. Metallizing mixes Nos. 18, 21 and 36 contain bonding oxide compositions having increased alumina contents in an attempt to impede densification of the metallic phase. Although a reduction in molybdenum particle sintering can be noted in the specimen shown in Figure III-3A (mix No. 18 - 1800°C sinter), it was not vacuum tight and failed at the interface. The higher

Table III-2

## Bonding Oxide Reactions with A-976 X-Ray Diffraction Results

<u>Oxide Composition No.</u>	<u>Reaction Temperature (°C)</u>	<u>Phase Detected</u>
26	1550	CaO-Al <sub>2</sub> O <sub>3</sub>
	1650	CaO-2Al <sub>2</sub> O <sub>3</sub>
	1750	CaO-2Al <sub>2</sub> O <sub>3</sub>
	1850	CaO-6Al <sub>2</sub> O <sub>3</sub>
44	1700	BaO-Al <sub>2</sub> O <sub>3</sub> , beta Al <sub>2</sub> O <sub>3</sub>
	1750	Beta Al <sub>2</sub> O <sub>3</sub>
	1800	Beta Al <sub>2</sub> O <sub>3</sub>
	1850	Beta Al <sub>2</sub> O <sub>3</sub>
46	1750	3Y <sub>2</sub> O <sub>3</sub> -5Al <sub>2</sub> O <sub>3</sub> , alpha Al <sub>2</sub> O <sub>3</sub>
	1800	Alpha Al <sub>2</sub> O <sub>3</sub>
	1850	Alpha Al <sub>2</sub> O <sub>3</sub>

sintering temperatures (1850°C and 1900°C) required to eliminate interface failures, produced leak tight samples with the structure shown in Figure III-3B. This coating is similar to that of mix No. 1 sintered at 1850°C (Figure III-2C) in that both are very dense and show no interface region. It appears that all four of these compositions, when sintered at 1850 to 1900°C, result in the same structure and composition. Strength results discussed later will show that the dense metallizing was not weak as feared, but actually produced excellent strengths.

Metallizing mix No. 54 (Figure III-3C) did not produce leak-tight seals. Porosity in the metallizing resulted from the baria instability and adequate sintering of the molybdenum did not occur.

Metallizing mix No. 55 (Figure III-4A) yielded excellent results. A desirably dense metallizing with no apparent interface was produced even at 1800°C.

It was reported by Cowan,<sup>4</sup> that a tungsten - 2 weight percent yttria metallizing produced good ceramic-metal seals. Mix No. 60 represents this composition while mix No. 56 represents a molybdenum counterpart. The leak check results given in Table III-1 should be considered in light of the fact that the nickel plate (0.1 mil) usually applied prior to copper-gold brazing had been omitted on these parts. It should be noted that the usual 30-40 v/o bonding oxide is not present in these two mixes. Mix No. 56 (Figure III-4B), with



A                      Mix No. 55                      1800°C                      Vacuum Tight

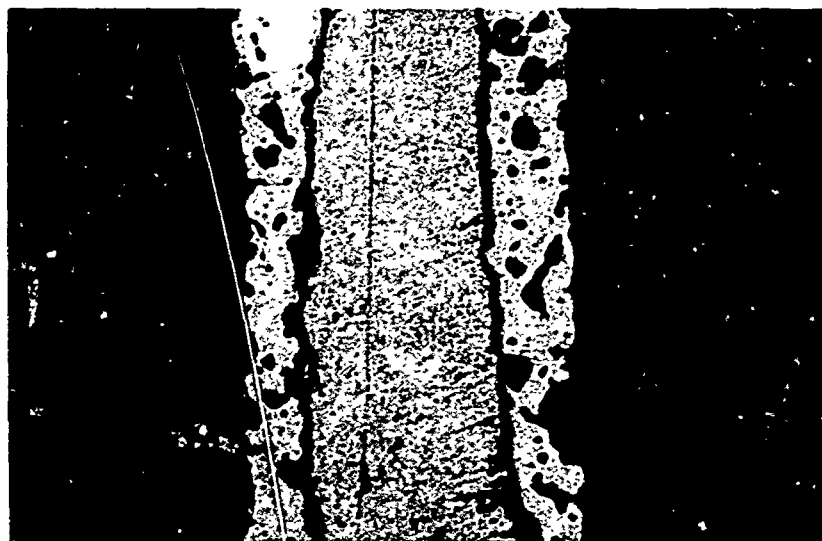

B                      Mix No. 56                      1890°C                      Vacuum Tight

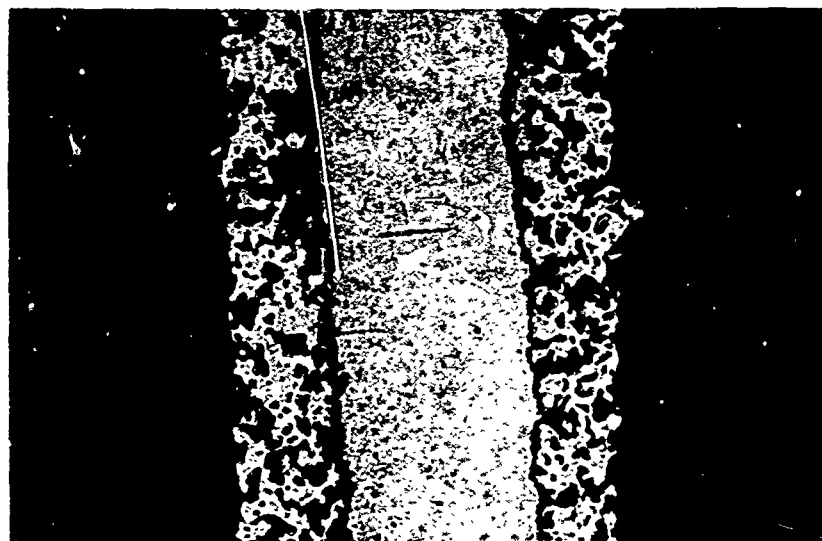

C                      Mix No. 60                      1890°C                      Vacuum Tight

Figure III-4

Photomicrographs of Ceramic-to-Metal Seals (500X)



approximately 5 v/o oxide, produced a very dense structure as a result of the reactivity of molybdenum and the low percentage of bonding oxide. Mix No. 60 (Figure III-4C), with approximately 10 v/o oxide, and the more refractory tungsten powder produced a dense two-phase metallizing. Interfacial compounds were not noted in either case. Further evaluation of these compositions is recommended.

A number of flexural strength samples were prepared using the G-E A-976 ceramic and copper-gold brazing. The results displayed on Table III-3 show that the strengths compare well with those reported by Bristow<sup>9</sup> for active alloy seals. Several of the samples which had low strengths and were leakers failed in the braze joint and the data, therefore, are of questionable value. The mix No. 36 - 1800°C series, however, fractured at the metallizing-ceramic interface. All leak tight samples failed at the interface with varying quantities of ceramic also being torn loose.

#### High-Temperature Life Testing of Ceramic-to-Metal Seals

Seven copper-gold brazed ceramic-to-metal seals using metallizing mix No. 1 sintered at temperatures ranging from 1755 to 1855°C were placed in a vacuum chamber and heated to 900°C for 2020 hours. These samples were cycled to room temperature every 240 hours; all samples remained leak tight after this testing.

Thermal cycle testing was conducted to evaluate vacuum tight seals which had been prepared incorporating metallizing mix

Table III-3  
Flexural Strength Results

Mix No.	Sintering Temperature (°C)	Leak Check Results	Strength (psi)
1	1750	Tight	25,200
		Tight	23,200
		Leaker	19,350
	1800	Tight	19,350
		Tight	20,100
		Tight	23,200
	1850	Tight	23,200
		Tight	34,800
		Tight	27,100
18	1800	Leaker	11,600
		Leaker	10,070
		Leaker	12,400
	1850	Tight	25,200
		Tight	31,000
		Tight	27,100
	1900	Tight	22,400
		Tight	23,200
		Tight	34,000
21	1800	Leaker	3,870
		Leaker	1,935
		Leaker	3,100
	1850	Tight	30,200
		Leaker	5,800
		Leaker	8,510
	1900	Leaker	7,740
		Leaker	18,600
		Leaker	16,250
36	1800	Leaker	17,000
		Leaker	12,400
		Leaker	6,190
	1850	Tight	31,700
		Tight	31,000
		Tight	31,700
	1900	Tight	27,900
		Tight	27,100
		Tight	35,600

No. 1 and cesium resistant braze alloys. Four ceramic-to-ceramic seals brazed with Palco (65 w/o Pd - 35 w/o Co)\* remained vacuum tight after 12 cycles from room temperature to 900°C. Six vacuum-tight ceramic-to-metal seals, which incorporated a nickel braze-diffusion-bond between refractory metals and metallized ceramics, also passed this test. Three of these latter samples were joined to 0.010-inch thick molybdenum, two to 0.010-inch thick tantalum and one to 0.015-inch thick niobium. Additional data on the joining techniques and the seal test results are presented in the sections entitled "F. Metal-to-Metal Joining" and "G. Cesium Corrosion Testing".

Alumina bodies G-E A-976 and Coors AD-995\*\* were metallized with mix No. 1 and subjected to a 20 Torr cesium vapor atmosphere at 1000°C for periods ranging up to 1000 hours. No apparent degradation was noticeable. These test results are detailed in the section entitled "G. Cesium Corrosion Testing."

#### Conclusions and Recommendations

Several refractory metal metallizing compositions have been developed which produce strong, vacuum-tight alumina-to-metal seals that are compatible with a high-temperature cesium vapor environment.

Additional testing is required to select the particular metallizing composition and processing treatment which, in conjunction with a cesium-resistant braze material, will produce the strongest, most reliable sealing system for this application.

---

\*Western Gold and Platinum Co., Belmont, Calif.

\*\*Coors Porcelain Co., Golden, Colo.

D. Multilayered Cermet

Introduction

A new but quite promising approach to the development of very high-temperature tolerant, cesium resistant ceramic-to-metal seals was investigated under this contract. It comprises joining the metallic members of the device to the surfaces of a multilayered or graded cermet, the cermet consisting of an insulating oxide core with integrally bonded metallic surface layers. The structure may grade smoothly in composition from a predominately oxide core to a predominately metallic surface, or it may occur in discrete steps or layers. In either case, it is important that the composition gradient be such that, in systems where the metal and oxide possess different thermal expansion coefficients, internal stresses are minimized.

For purposes of this discussion, a cermet shall be defined as a "heterogeneous combination of metals or alloys with one or more ceramic phases in which the latter constitutes approximately 15 to 85 percent by volume and in which there is relatively little solubility between metallic and ceramic phases at the preparation temperature."<sup>10</sup>

The system which was chosen for initial study and evaluation is a two-phase system. . . . aluminum oxide and molybdenum metal. The choice of this system was based upon the high-temperature stability, low vapor pressure, resistance to cesium attack, and freedom from phase transformations of

the two materials and their known compatibility at high temperatures.

Many cermet systems have been studied during the past twenty years with useful structures and a knowledge of bonding mechanisms evolving simultaneously. One of the first cermet systems to receive attention was chromium-alumina, and useful compositions containing from 30 to 77 w/c chromium have evolved. It is fortuitous that the thermal expansion of chromium closely matches that of alumina, thus minimizing stresses, and that chromium has a stable oxide which is soluble in alumina, leading to good bonding. Shevlin<sup>11</sup> and Marshal<sup>12</sup> have presented an excellent summary of the developments which led to the availability of present commercial materials.

Figure III-5 shows a polished section of a sample of the chromium-alumina cermet, LT-1, produced by Haynes Stellite Division of Union Carbide Corporation. The white areas shown in the illustration are molybdenum while the gray areas are alumina. The fine grained, essentially pore free structure of this 77 w/o chromium cermet can be seen. This sample was found to be vacuum tight (at 0.100-inch thickness) and, as would be expected, was electrically conducting.

Chromium is not, however, believed to be a desirable major constituent of cermets destined for high-temperature vapor thermionic converter applications. Not only does chromium

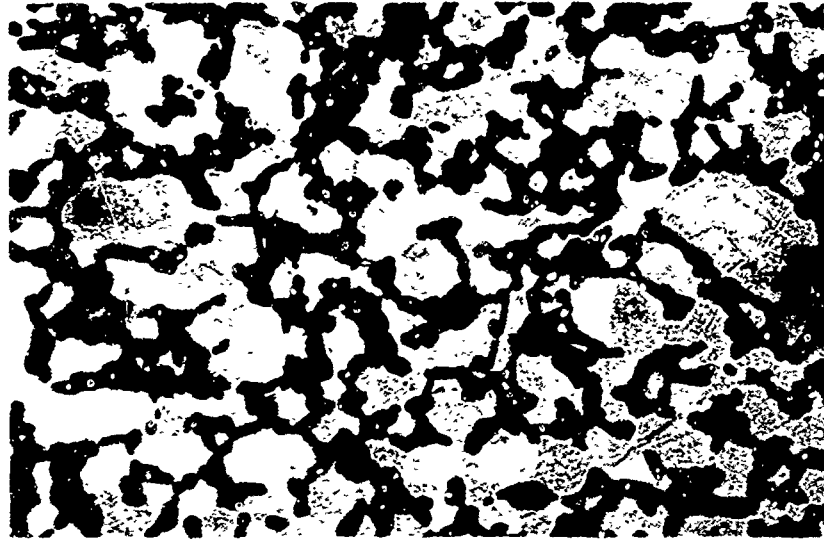

Figure III-5

Section of LT-1 Chromium-Alumina Cermet

have an undesirably high vapor pressure at the temperatures of interest ( $10^{-6}$  Torr at  $977^{\circ}\text{C}$ ,  $10^{-5}$  Torr at  $1062^{\circ}\text{C}$ ) but its oxide is not stable in vacuum at these temperatures. It is possible, of course, that alloys containing small amounts of chromium may be tolerable.

The presence of chromium oxide has previously been considered important in establishing a strong bond in the chromium-alumina cermet. Specimens are said to be relatively weak and porous if oxidation of the chromium, forming the solid solution with alumina, is not established. Cermets containing refractory metals, such as molybdenum and tungsten, combined with chromium and alumina, have also yielded successful structures. Although these cermets have not been developed for vacuum retention applications, the densities reported are very near theoretical for several of the compositions and there is a good probability that the structures are vacuum tight. Recently<sup>13</sup> an alumina-molybdenum cermet, containing no chromium, was reported for use as a structural refractory possessing good thermal shock resistance. This material was said to possess a high strength and density, but no information was presented as to its vacuum tightness.

The formation of a strong, stable bond between the ceramic and metallic phases of an alumina-molybdenum cermet was initially considered to be a potential problem area. Although vacuum tight structures had already been demonstrated, as will be detailed later, the strength of the bond and its long

time, high-temperature stability had yet to be more exhaustively assessed.

The development of multilayered ceramic-to-metal seals produced by powder pressing techniques has been reported,<sup>14</sup> Vacuum tight structures were obtained using a modified 85 percent alumina ceramic sintered simultaneously with a tungsten-copper-nickel-chromium metallizing. Although many of the materials used in that development are not of interest in the present work, many of the processing considerations are similar.

#### Results and Discussion

A major problem in the fabrication of multilayered or graded cermets is the preparation of a series of alumina-molybdenum mixtures which will sinter at the same rate to near theoretical density at a chosen temperature, and which will have substantially identical sintering shrinkages. Thus, if end members of the series (molybdenum and alumina) can be found which exhibit the same shrinkage rate and total shrinkage, there is a good probability that blends of these powders will do likewise.

Company-sponsored work prior to initiation of this contract showed that the sintering of alumina-molybdenum mixtures to near theoretical density was feasible and, although graded cermets were prepared therefrom, the differential shrinkage of the several layers resulted in bowing of the specimen. The observed excessive distortion of multilayered compacts



prompted a study of the densification behavior of several types of alumina and molybdenum powders for the purpose of selecting several "matched" systems for subsequent cermet preparation. Chemical analyses and particle size measurements (when available) of these powders were reported in an earlier Technical Summary Report.<sup>9</sup> Compacts of these powders were cold pressed (3/8-inch diameter die) at several pressures and sintered at various temperatures in a high-temperature hydrogen atmosphere tube furnace. Firing shrinkage, apparent specific gravity, water absorption and apparent porosity measurements were made on these specimens and the results, along with photomicrographs showing the microstructure of these materials, were presented in the earlier report.

These preliminary sintering studies showed that dense, leak-tight structures could be obtained by sintering at temperatures in the 1800 to 1900°C range for four hours. All of the alumina powders contained 1/4 w/o of MgCO<sub>3</sub> to inhibit grain growth during sintering.

Measured shrinkage values showed that the M&R Type P molybdenum had a total shrinkage similar to the A-14 alumina powder.\* The Linde A alumina<sup>#</sup> and G-E Type 61-8-1 molybdenum<sup>†</sup> were also well matched. Further studies were, therefore, centered around these two combinations of powders.

Blends of 75 volume percent (v/o) metal, 50 v/o metal and 25 v/o metal, with the remainder alumina were prepared from

---

\*Aluminum Company of America, Pittsburgh, Pa.  
#Linde Company, Division of Union Carbide, East Chicago, Ind.  
†General Electric Lamp Metals and Components Dept., Cleveland, Ohio

the two powder combinations mentioned. Compacts prepared from these powder blends were sintered at 1745°C for three hours. As reported in the previous Technical Summary Report all samples made from the fine powders (Linde A alumina - G-E molybdenum) were vacuum tight while the M&R molybdenum - A-14 alumina combination were still porous. Subsequent sintering studies showed that sintering in the 1850-1900°C range produces leak tight samples from all of these powder blends.

The next step was to fabricate the multilayered or graded cermet structure. Five layered compacts grading from a metallic-rich surface to an alumina-rich core and back to a metallic-rich surface were pressed, prefired at 1000°C, a hole drilled through a cylinder to permit leak detection, and then sintered. The photomicrograph shown in Figure III-6 details such a multilayered cermet structure. One half of the cermet is shown and the effect of die wall friction during pressing is obvious. Although this cermet was leak tight, it was not electrically insulating. This sample was subjected to high-temperature cesium vapor testing with no apparent attack noted (see section entitled "G. Cesium Corrosion Testing" for a description of this test).

During earlier work performed on Company funds, sintered compacts were produced from a blend of 75 v/o Linde A alumina and 25 v/o G-E No. 877 molybdenum\*which were electrically insulating. During the present study, however,

---

\*General Electric Lamp Metals and Components Dept., Cleveland, Ohio

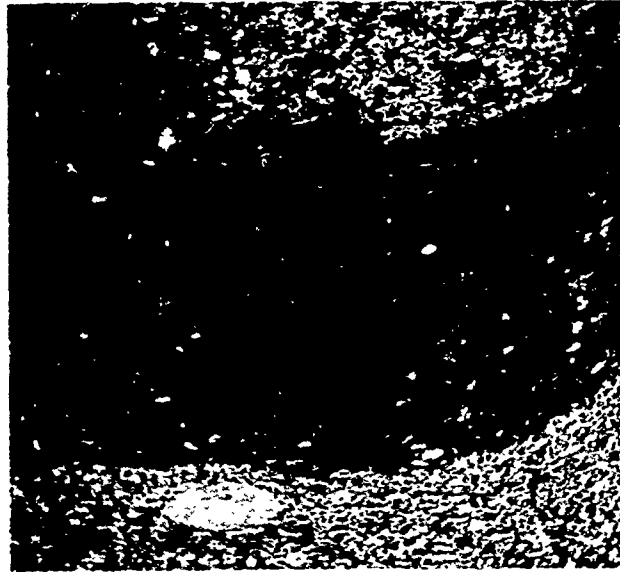

Figure III-6

Multilayered Cermet Structure. Linde A Alumina M&R  
Molybdenum Sintered 3 Hours at 1860°C. Vacuum Tight.  
(13X)

all of the specimens which were prepared using this metal-oxide ratio were conducting. Although various types of alumina and molybdenum were used (including Linde A alumina and G-E No. 877 molybdenum) and several blending techniques were tried, the earlier results could not be duplicated. Uniform dispersion of molybdenum and alumina was noted in the metallographic specimens and the reason for their conductivity was not obvious.

In order to produce an insulating layer in a cermet structure a 95 v/o alumina - 5 v/o molybdenum blend was used, resulting in a multilayered structure which did not conduct electricity. The necessity of using a very alumina-rich powder blend to prevent conduction greatly aggravated fabrication problems making production of a vacuum-tight multilayer cermet extremely difficult.

Fabrication of the multilayered cermet structure is complicated by several factors. Loading of the die with uniformly thick layers of the several powder blends is important if nonuniform compaction and shrinkage is to be avoided. The usual problems of interparticle friction, die wall friction, and air entrapment during cold pressing are also present. This is particularly evident with the fine Linde A powder blends.

The total sintering shrinkage is not exactly the same for all powder blends at a given pressing pressure and the possibility of these pressed layers shrinking at different rates also

exists. Additional sintering studies, with results shown in Table III-4, were conducted to further clarify the sintering shrinkage problem. Differences in the rates of sintering do not appear to be as great as the approximately two percent difference in total shrinkage which exists between various compositions in the multilayer composite at any given time during the sintering cycle.

Cracking of the multilayered compacts is sometimes apparent after pressing while other samples appear sound until after the prefiring or sintering operations. The cracks generally occur adjacent to the highest alumina content layer and are believed to be formed during pressing. Cracking was not caused by thermal shock since batch type sintering experiments did not eliminate this defect. Although the difficult-to-press Linde A powder could be successfully isostatically pressed, this same technique did not yield sound, one-piece multilayered specimens. The addition of various lubricants to the powders was investigated but they did not eliminate the formation of cracks in either dry or isostatically pressed specimens.

Hot pressing is a fabrication method which minimizes some of the compaction difficulties inherent in cold pressing since sintering and densification is assisted by the application of external pressure. Other problems are, however, present, including probable graphitization of the surface of the piece, high mold cost and a high unit cost. Nevertheless, the

Table III-4  
Cermets Sintering Shrinkage

	Pressure (tons/in <sup>2</sup> )	Sintering Time at 1900 <sup>o</sup> C			
		10 Min.	30 Min.	1 Hr.	3 Hrs.
75 v/o Mo	15	19.1	21.3	21.9	22.9
25 v/o Al <sub>2</sub> O <sub>3</sub>	20	18.2	20.1	20.3	21.3
	25	17.4	18.6	18.7	19.5
50 v/o Mo	15	20.5	22.3	23.7	24.6
50 v/o Al <sub>2</sub> O <sub>3</sub>	20	19.5	21.2	21.1	22.7
	25	17.0	19.5	20.4	21.3
25 v/o Mo	15	21.1	22.7	23.5	23.5
75 v/o Al <sub>2</sub> O <sub>3</sub>	20	19.9	20.9	22.1	22.5
	25	19.1	20.8	21.1	21.3
5 v/o Mo	15	21.5	22.5	22.7	22.7
95 v/o Al <sub>2</sub> O <sub>3</sub>	20	20.3	21.7	21.9	-
	25	19.9	20.7	21.1	-

- NOTE: 1. M&R Type P molybdenum powders and Alcoa A-14 alumina powders were used in the above cermets.  
2. Sintering shrinkage is expressed in percent based on the fired dimension.

application of hot pressing to this problem was assessed and a multilayered cermet was fabricated using this technique. The powders were placed in an induction-heated graphite die and sintered at 1600°C for 10 minutes with a continuously applied pressure of 4000 pounds per square inch. This heat treatment appears inadequate to produce a dense alumina structure and cracking of the compact also occurred. This approach to multilayer cermet fabrication does, however, appear encouraging and should be continued.

#### Conclusions and Recommendations

Cermets composed of alumina and molybdenum with widely varying oxide ratios have been prepared which are structurally strong and vacuum tight. Fabrication of a multilayered or graded cermet structure which is both vacuum tight and electrically insulating requires the development of improved fabrication techniques including the study of lubricants for cold pressing, isostatic pressing techniques and control of hot pressing parameters.

#### E. Active-Alloy Sealing

##### Introduction

Several types of active-alloy seals were investigated and their tolerance to high temperatures was assessed, a task which comprised approximately one-sixth of the total effort under this contract. Seals were prepared by the "active metal shim" process introduced by Beggs.<sup>15</sup> In this process, a thin metal foil member (shim) is interposed between the metal and the

ceramic to be sealed. Upon heating to the eutectic temperature of the particular binary alloy system under consideration, a liquid phase is formed which wets and bonds to the ceramic. The "active" metal may comprise either the massive metal member or the foil, since it is only necessary that the liquid contain a small percentage of the active metal in order to reduce the solid-liquid interfacial energy thus permitting wetting to occur.

Under a previous contract,<sup>1</sup> an evaluation was made of the high-temperature capability of alumina-to-metal seals bonded with titanium-nickel alloy; seals wherein the metal member comprised titanium, tantalum, stainless steel, Kovar, or nickel. Summarizing briefly, it was found that seals which contained a titanium phase ( $\alpha$  or  $\beta$  solid solution), either in the sealing alloy at the interface or as the metallic structural member of the seal, exhibited very short lives when tested at high temperatures in vacuum. Seal failure resulted from severe hardening and embrittlement of the titanium phase and/or the formation of new phases at the interface, due to continued reaction of the sealing alloy with the ceramic. For a detailed discussion of the experimental procedure and results obtained, the reader is referred to the final report on that contract.

Preliminary evaluation of titanium shim seals to nickel, prepared so as to preclude the formation of alpha titanium or the brittle intermetallic  $Ti_2Ni$  in the sealing alloy (conducted



under Contract NObs-86220), indicated improved high-temperature tolerance. A more thorough study of the metallurgy of such seals, as well as their resistance to high-temperature vacuum and cesium-vapor environments, is reported herein.

In addition, the results of a brief study of alumina-to-niobium seals, effected through the formation of an "active" nickel-niobium alloy at the ceramic-niobium interface, is reported.

#### Experimental Procedure

The test specimens used in this study consisted of two polycrystalline alumina ceramic cylinders (0.699-inch outside diameter, 0.480-inch inside diameter, 0.200-inch long) which were butt sealed to either side of a metal washer through the use of thin metal foil washers which formed an "active" liquid alloy at the sealing temperature. In the seals to nickel, titanium foil washers formed this active binary liquid alloy, while in the seals to niobium, nickel foil promoted liquid formation.

Two types of ceramics were used: (1) a polycrystalline alumina (designated Schenectady Tube Operation body No. A-976) containing a small amount of MgO as a grain growth inhibitor, which was sintered to a density of approximately 99.5 percent of theoretical, and (2) a 97 percent alumina (designated G-E body A-923)\*containing CaO, MgO, and SiO<sub>2</sub> as fluxing oxides. Body A-976 was used because of its proven resistance to cesium corrosion, while body A-923 was used to assess the effect of its higher mechanical strength.

---

\*General Electric Schenectady Tube Operation, Schenectady, N. Y.

Nickel washers of several different purities were used: (1) Grade A, (2) Type 499, and (3) an ultra pure nickel, designated "SP", which was obtained from Metals for Electronics, Inc. The nickel foil used in seals to niobium was 0.0003-inch, Type 499. The electron beam grade niobium was 0.010-inch thick and was obtained from Fansteel Metallurgical Company. Grade A-75 titanium foil was used in thicknesses of 0.001-inch and 0.0005-inch while the 0.00025-inch foil which was used was Grade A-35.

All metal washers and foil were cleaned using accepted electron tube processing methods but were not, with a few exceptions, given any vacuum or hydrogen firing treatment prior to sealing. Ceramic specimens were cleaned ultrasonically and were then air fired to 1000°C for one hour.

All specimens were sealed by heating in a resistance-heated tantalum oven contained within a vacuum bell jar at a pressure lower than  $2 \times 10^{-5}$  Torr. A Pt-Pt, 10 percent Rh thermocouple, whose hot junction was held in contact with one face of the specimen to be sealed, permitted accurate monitoring of temperature. Thermocouple millivoltage was fed to an X-Y recorder and any desired heating schedule could be accurately followed by manually adjusting the current to the oven. A typical schedule comprised heating to 900°C for ten minutes to allow the system to equilibrate, followed by heating to the desired sealing temperature within about one-half to three minutes. Soak times at the sealing temperature ranged from

a few seconds to five minutes. Although most of the specimens were cooled with no power in the oven, resulting in a temperature drop of about 300°C during the first minute, some tests were conducted with controlled slow cooling.

Life testing of seals in vacuum was conducted in a dual chamber vacuum life test system at a pressure of  $1 \times 10^{-5}$  Torr. Each ceramic chamber was separately heated, thus permitting simultaneous testing of specimens at two different temperatures. Specimens to be tested were helium mass spectrometer leak checked, cleaned in xylene and acetone, loaded onto molybdenum boats and inserted into the ceramic test chamber. Sheet titanium spot welded to the molybdenum radiation shields, which blocked the chamber openings, acted as getters and minimized the possibility of back streaming oil vapor contacting the specimens under test. During life testing, each chamber was cycled to room temperature every 240 hours. This was done in order to induce mechanical stresses in the test specimens by virtue of the differential contraction of the component parts.

### Results and Discussion

#### 1. Ceramic-to-Nickel Sealing

The time-temperature sealing conditions, which effect the best seals of alumina-to-nickel, were determined and reported in the semiannual report<sup>9</sup> on this contract. A portion of that discussion is repeated, since it is necessary for an understanding of the life test results.

Figure III-7 shows polished sections of alumina-to-nickel seals made at four different sealing temperatures. The seals were made to 0.010-inch thick SP nickel washers using 0.0005-inch titanium foil to form a liquid phase at the sealing temperature.

The titanium-nickel phase diagram, Figure III-8, shows that the first liquid to form would have the composition of the lowest melting eutectic, 71.5 w/o titanium, 28.5 w/o nickel. As the temperature is raised, the melt dissolves more nickel and the composition drifts toward the composition of the brittle intermetallic compound  $Ti_2Ni$ . Figure III-7A shows the structure which is obtained when sealing is performed at a temperature of about  $1070^{\circ}C$ . The region next to the ceramic is predominately  $Ti_2Ni$  and contains many cracks. Equilibrium conditions are not, however, attained in such a seal because of the "infinite" supply of nickel in contact with the melt. This results in a layer of  $TiNi$  adjacent to the  $Ti_2Ni$  layer, at whose surface the aforementioned cracks terminate. A thin layer of  $TiNi_3$  lies between the  $TiNi$  and the Ni washer.  $TiNi_3$  is optically anisotropic and is readily identified using polarized light. Heating a seal to a temperature of  $1180^{\circ}C$ , slightly above the  $1118^{\circ}C$  eutectic, results in the structure shown in Figure III-7B. Here both  $TiNi$  and  $TiNi_3$  are seen, as predicted by the phase diagram.

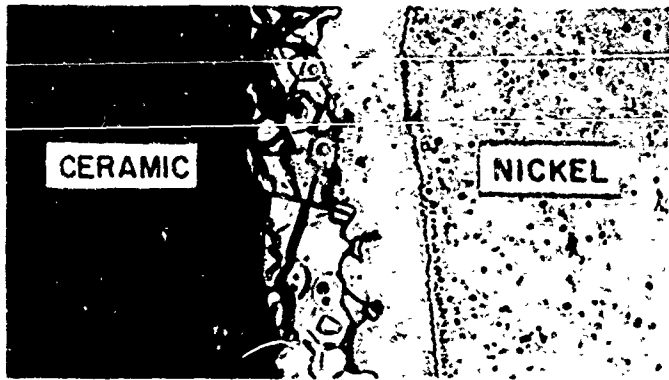

A 30 seconds at 1070°C

500X



B 20 seconds at 1180°C

500X



C 60 seconds at 1275°C

750X

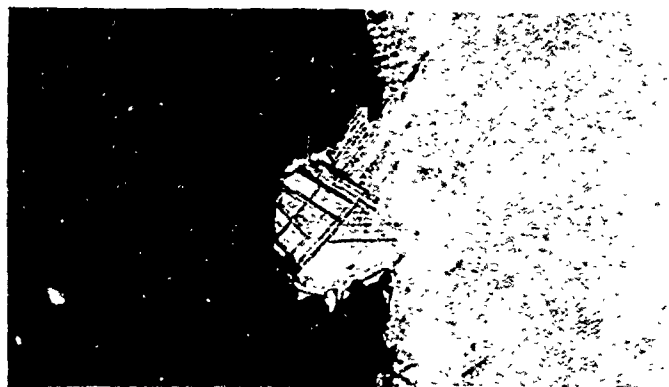

D 60 seconds at 1315°C

750X

Figure III-7

Photomicrographs of Alumina-to-Nickel Seals Made at Four Different Sealing Temperatures

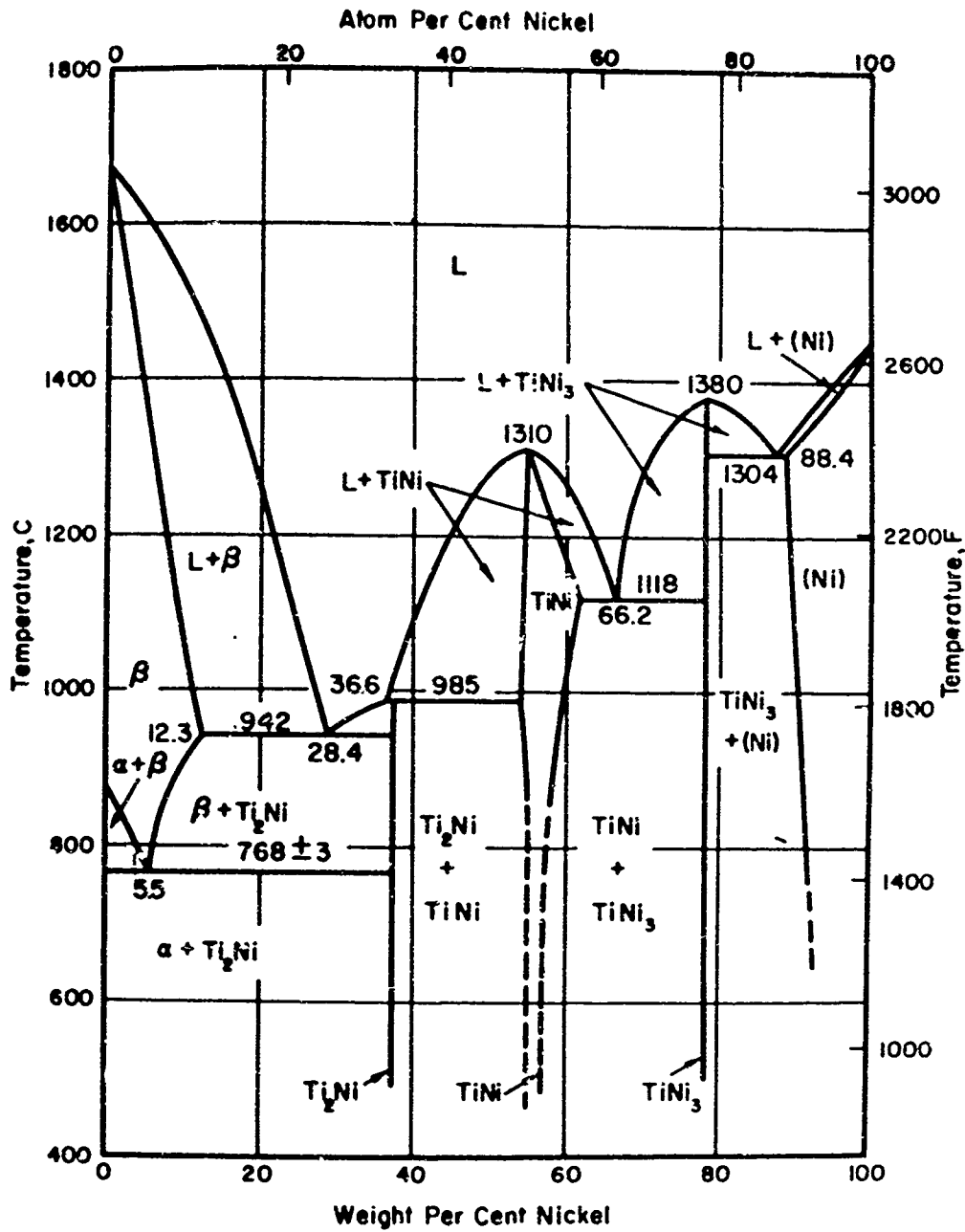

Figure III-8

Titanium-Nickel Phase Diagram<sup>42</sup>

Heating a similar seal to a maximum temperature of about  $1275^{\circ}\text{C}$  results in the structure shown in Figure III-7C. The sealing alloy is predominately equiaxed  $\text{TiNi}_3$ . If the temperature had been slightly lower, the time at sealing temperature slightly less, or the thickness of this layer somewhat greater, some isolated patches of  $\text{TiNi}$  would remain at the ceramic interface.

When sealing is carried to an even higher temperature, above  $1304^{\circ}\text{C}$ , the  $\text{TiNi}_3$ -Ni eutectic reaction occurs. Depending upon the time-temperature treatment, the structure may range from a nickel solid solution containing needles or plates of  $\text{TiNi}_3$  at the interface, as in Figure III-7D, to one having all nickel solid solution at the interface.

Seals having a layer of  $\text{TiNi}_3$  at the interface are very strong, easily prepared and vacuum tight. Seals containing the nickel solid solution at the interface possess lower mechanical strength and are considerably more sensitive to the time-temperature sealing treatment.

Small, rounded orange and/or brown colored particles of one or more extraneous phases have been repeatedly observed in seals to nickel. Although identification of the composition and origin of these phases was inconclusive, as discussed in the semiannual report, several comments and observations can be made. Electron probe microanalysis showed that both phases were

predominately titanium and did not contain any other elements with atomic numbers greater than 11. It is believed that the most probable composition of these particles is the oxide, carbide, and/or nitride of titanium. Experiments made with materials of varying purity failed to pinpoint the source of the particles. They continued to be observed in seals made above and below the 1304<sup>o</sup>C eutectic, seals to impure (Grade A) as well as ultra pure (SP) nickel, seals to impure (A-75) as well as pure (A-35 and iodide) titanium, and seals made with grossly different cleaning treatment of the component parts, including the ceramic. Although it was desired to prepare and test seals with and without these extra phases in or near the interface, this was not possible. Since, however, no definite relationship could be observed between the presence of these phases and the hour of failure in the life test, they are believed to have but a minor effect on seal performance.

Seals were prepared for life testing using different time-temperature sealing schedules as well as materials having different thicknesses and purities in order to assess their effect on seal life. Tables III-5, III-6 and III-7 (pages III-67, III-68 and III-69) summarize the test results.

Since primary interest was in life-test results at high temperatures, the 700<sup>o</sup>C life test (Table III-5) was



discontinued after 1370 hours. Sixteen percent of the seals which started the 700°C life test had developed leaks at the end of 1370 hours, while one group (which had received some previous testing) successfully accumulated 2090 hours without a failure.

Of the 28 alumina-to-nickel seals which were started on the 900°C life test (Table III-5), 27 reached 410 hours life and were still vacuum tight while a group of seven specimens (which had received previous testing) had by then successfully accumulated 1320 hours without any failures. Further exposure to this temperature, however, caused an increasing failure rate. By the end of 1370 hours, approximately one-third of all of the specimens had developed leaks. Included, however, was the group of seven specimens mentioned above, which had accumulated 2280 hours and were still vacuum tight.

Figure III-9 is a section through one of the seals to Type 499 nickel (group of three, Table III-5) which had developed a leak when checked at 1850 hours. The  $TiNi_3$  layer, which was initially present at the interface, has been completely solutioned by the nickel washer and some void formation in this region can be seen. A section through the one specimen of this group, which was still vacuum tight at the end of 1850 hours, appeared identical. Both specimens contained a concentration of the unidentified orange-colored particles near the midpoint of what had originally been the  $TiNi_3$  layer.

Figure III-10 is a photomicrograph of a polished section through one of the seven seals which was still vacuum tight at the end of 2280 hours at 900°C. It appears similar to other seals (both vacuum tight as well as leakers) which were exposed to this temperature for 1500 hours or more, in that the TiNi<sub>3</sub> layer which had initially been present at the ceramic-metal interface has been completely solutioned by the nickel washer. Like the several other seals just discussed, this one contained a concentration of the orange colored phase near the interface, some void formation, but no separation of the nickel from the ceramic at the interface. It is not known why this group of seven seals yielded such excellent life test results....it may be the result of having an optimum thickness of TiNi<sub>3</sub> initially present, or a ceramic surface condition which was conducive to better bonding.

The presence of residual TiNi<sub>3</sub> at the interface of a seal after 1370 hours at 900°C, but none in the seal of Figure III-9 after 1850 hours at the same temperature, suggested that solutioning of TiNi<sub>3</sub> was highly time-temperature dependent at temperatures approaching 900°C (seals tested at 700°C did not show loss of the TiNi<sub>3</sub> layer).

A higher temperature life test, Table III-6, was performed in order to ascertain the rate at which this solutioning could be expected to occur, as well as the effect

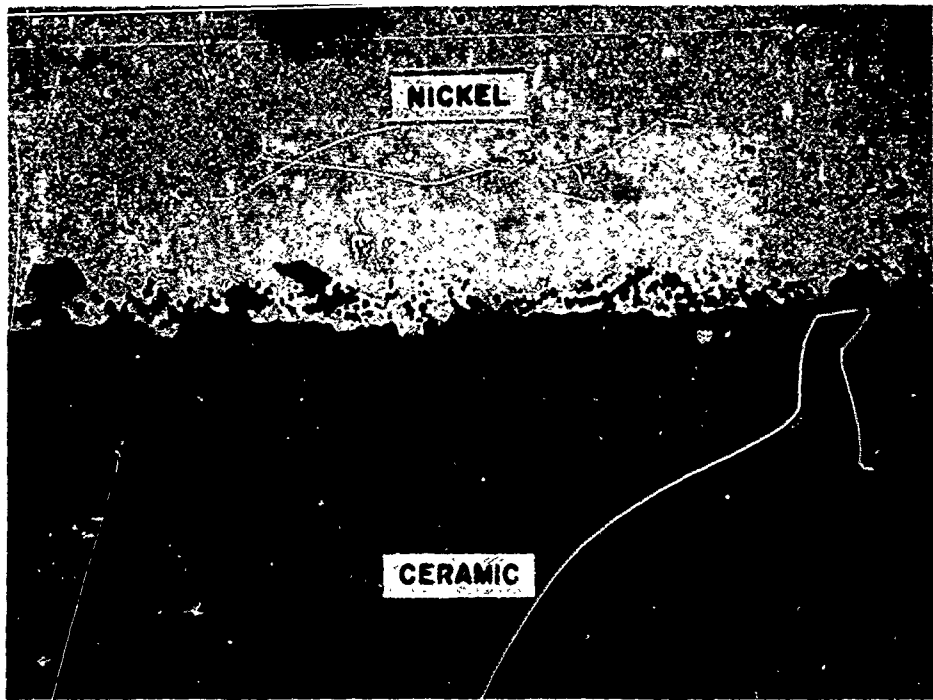

Figure III-9

Alumina-to-Nickel Seal After 1850 Hours at 900°C (500X)

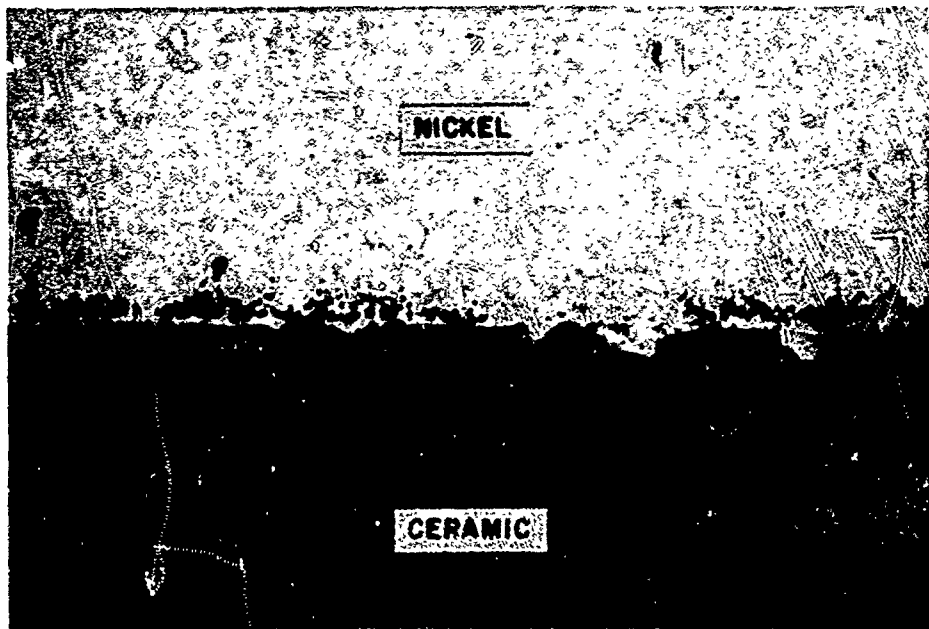

Figure III-10

Alumina-to-Nickel Seal After 2280 Hours at 900°C (500X)

of the higher temperature on seal life. In addition, a thermal cycling test, Table III-7, was begun to determine whether failure of alumina-to-nickel seals was primarily the result of mechanical stress induced by the differential thermal expansion which accompanied each excursion to room temperature (at the end of every 240 hours in the life test) or was the result of chemical reactions occurring at high temperature. In the cycling test, the oven was turned off a few minutes after the specimens reached the desired temperature and the total exposure to high temperature was thus kept to a minimum.

The 1075°C life test was made for a total period of 240 hours at the end of which time less than one-half of the specimens were still leak tight. Polished sections showed that the  $TiNi_3$  layer which had initially been present at the interface, had completely disappeared. Seals which leaked usually, but not always, showed separation of the alloy from the ceramic at the interface. In this test, the rate of failure of seals to the pure sintered alumina (body A-976) was not significantly different from seals to the somewhat higher strength 97 percent alumina (body A-923).

Thermal cycle testing of seals was begun with 10 cycles from room temperature to 600°C....no failures were recorded! The temperature was then raised to 930°C

and after an additional 10 cycles, 18 percent of the specimens had developed leaks. An additional 10 cycles to 900°C brought the total to over 38 percent failures.

No change in the thickness of the  $\text{TiNi}_3$  layer was observed nor would it be expected since the specimens had been subjected to a total of only 13 hours at 900°C. Small cracks were, however, apparent in the  $\text{TiNi}_3$  layer of many of the seals but it is uncertain as to whether they were actually present in the seal or were caused by metallographic mounting, sectioning and polishing. In this test, separation of the  $\text{TiNi}_3$  layer from the alumina at the interface was usually observed in seals which leaked.

The seals to 0.010-inch nickel showed a higher failure rate than seals to 0.005-inch nickel as would be predicted from stress considerations. The only seals to the high strength 97 percent alumina body which were thermal cycle tested were nickel buffer washer seals to molybdenum and tantalum... all of which remained vacuum tight.

It has been previously reported<sup>9</sup> that "compensated butt seals between alumina (A-923) and 0.010-inch thick nickel, sealed in such a manner as to form only the nickel solid solution at the interface, show flexural strengths approximately one-third that which is obtained

if sealing is performed so as to form a thin layer of  $TiNi_3$  at the interface." Thus, if high-temperature exposure causes solutioning of the  $TiNi_3$  layer, as has been observed in the life tests, a reduction in strength would be expected to occur. The reduced strength of the alloy-oxide bond, coupled with the mechanical stresses arising from the differential contraction between alumina and nickel, could then cause failure at the interface.

As mentioned in the "Introduction" to "E. Active-Alloy Sealing", two different ceramic bodies were used in testing in order to assess the effect, on seal life, of their differences in chemical composition and mechanical strength. The pure sintered alumina (A-976) possesses the lower mechanical strength due to its larger grain size (the anisotropy of thermal expansion of alpha alumina generates stresses at the grain boundaries of a glass-free polycrystalline alumina and as the grain size increases, the mechanical strength decreases). If, in a seal to alumina, transgranular or intergranular failure were observed in the alumina, the strength of the body would be expected to have a significant effect on the strength of the seal. This mode of failure was not, however, observed in the seals of this study. If physical separation was noted in any of the polished sections of seals which had failed the helium leak check, it was

predominately at the interface between the sealing alloy and the original ceramic surface, indicating that the alloy-oxide bond was the weakest link in the system. Figure III-11 clearly shows this type of failure. On the other hand, in some of the seals to pure alumina, an occasional alumina grain could be observed to have been pulled from the surface of the ceramic and could be found adhering to the  $TiNi_3$  layer. This was never observed in the case of seals to the higher strength 97-percent alumina body.

The type of ceramic can affect seal strength (and probably seal life) in several other ways --- (1) through differences in surface roughness and consequent mechanical interlocking of the sealing alloy to the surface, and (2) differences in chemical bonding to the ceramic surface caused by the presence of a glassy phase and/or crystalline phases other than alumina.

In summary, the thermal cycling tests show that pure alumina-to-nickel seals (with  $TiNi_3$  at the interface) fail after a relatively few thermal cycles from room temperature to  $900^{\circ}C$ . Failure is believed to result from the mechanical stresses induced by thermal expansion mismatch between alumina, nickel and  $TiNi_3$ . Similar seals (to pure sintered alumina as well as 97-percent alumina) also fail when exposed to  $900^{\circ}C$  for long periods of time and generally show solutioning of the



Figure III-11

Failure of Seal at Surface of Ceramic (500X)



TiNi<sub>3</sub> layer at the interface. Since these long time life tests included periodic thermal cycling to room temperature (10 cycles during every 2400 hours of testing), this could have accelerated the onset of failure. Exposure of seals to a temperature of 1075°C, however, resulted in a very high rate of failure in a very short time (240 hours), clearly showing the deleterious effect of temperature alone.

2. Alumina-to-Refractory Metal Seals with Nickel Buffer Washers

Seals of alumina-to-molybdenum and alumina-to-tantalum, prepared with nickel buffer washers, showed quite different results on thermal testing, as shown in Tables III-5 and III-6.

Life testing at 900°C in vacuum, with thermal cycling to room temperature every 240 hours, resulted in failure of all of the tantalum seals at 1370 hours, but no failures in the seals to molybdenum. Cracks were apparent in the wide multiphase braze region between the tantalum and the nickel buffer washer and may constitute the leak path. No such cracks were noted in the several alumina-to-molybdenum seals which were sectioned at the end of 1370 hours.

Thermal cycle testing caused the failure of one specimen of each type of seal after 10 cycles to 900°C. The remaining specimens withstood an additional 10 cycles

with no more failures occurring. The one specimen of each type which failed was a seal to the pure alumina ceramic (A-976) and a polished section showed separation at the  $TiNi_3$  - alumina interface. No failures occurred among the several seals to the 97-percent alumina body.

Figure III-12 is a photomicrograph of a vacuum-tight nickel buffer washer seal of A-923 to molybdenum after 20 cycles to  $900^{\circ}C$  showing the  $TiNi_3$  layer at the ceramic-nickel interface and the wide braze region between the nickel and the molybdenum. Figure III-13 shows a similar seal to tantalum. Although cracks were visible in the wide multiphase region between the nickel buffer washer and the tantalum as well as in the  $TiNi_3$  layer, the seal checked leak tight after 20 cycles. Life testing of several seals of each type to  $1075^{\circ}C$  resulted in no failures among the seals to molybdenum but total failure of the seals to tantalum. Figure III-14 is a photomicrograph of one of the vacuum-tight seals to molybdenum after 240 hours at  $1075^{\circ}C$ . Loss of the  $TiNi_3$  layer at the interface, due to solutioning by the nickel buffer washer, can be seen, as can the changes which occurred in the braze region between the nickel buffer washer and the molybdenum. Figure III-15 shows one of the seals to tantalum which failed. Diffusion at the interface between the nickel buffer washer and the

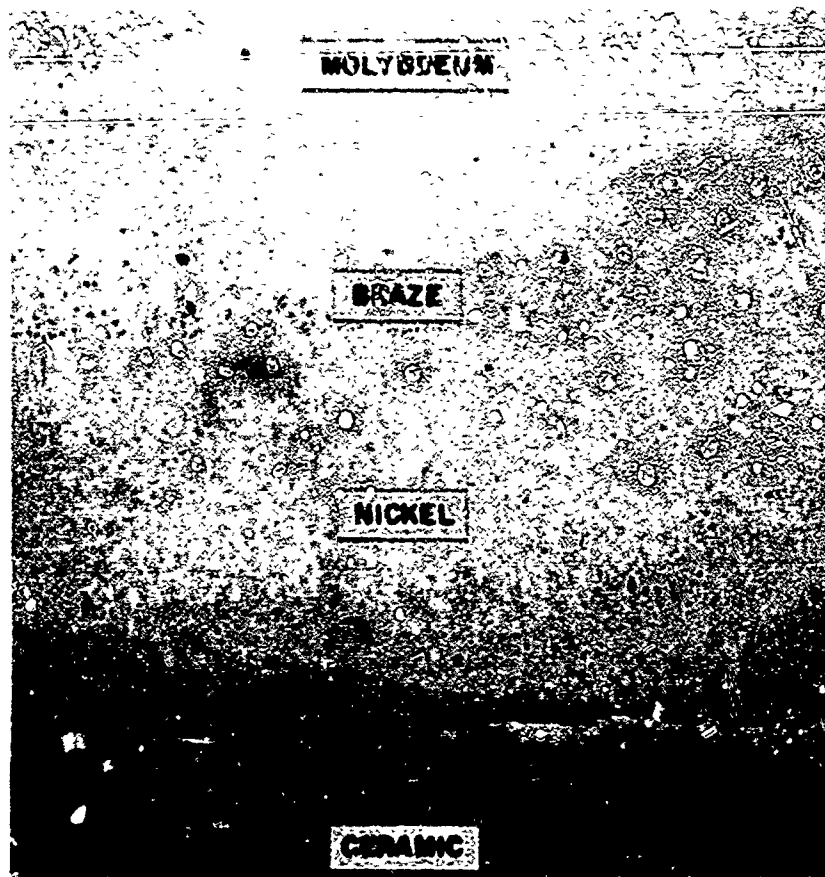

Figure III-

Alumina-to-Molybdenum Seal with Nickel Buffer Washers  
After 20 Thermal Cycles to 900°C (500X)

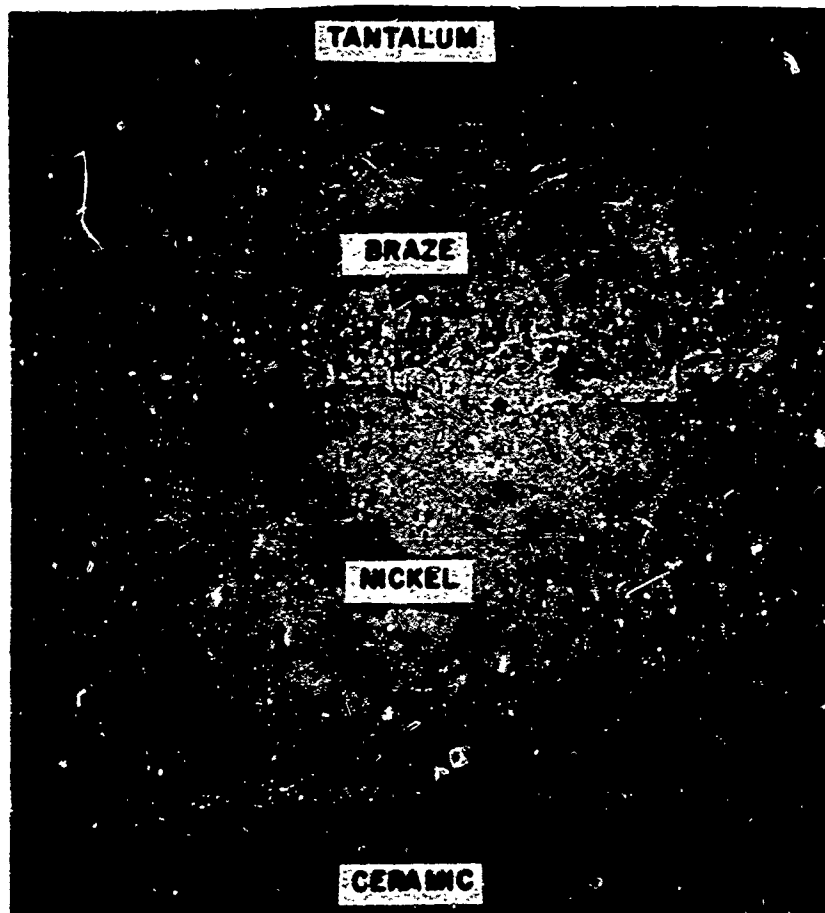

Figure III-1

Alumina-to-Tantalum Seal with Nickel Buffer Washers  
After 20 Thermal Cycles to 900°C (500X)

Figure III-12

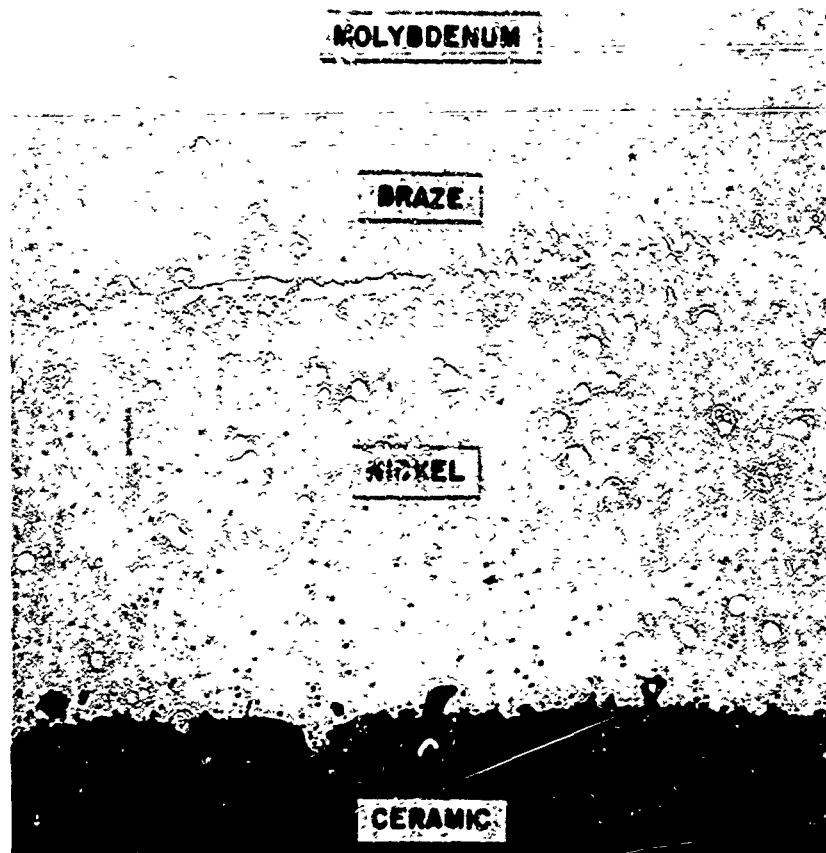

Figure III-14

Alumina-to-Molybdenum Seal with Nickel Buffer Washers  
After 240 Hours at 1075°C (500X)

Figure III-13

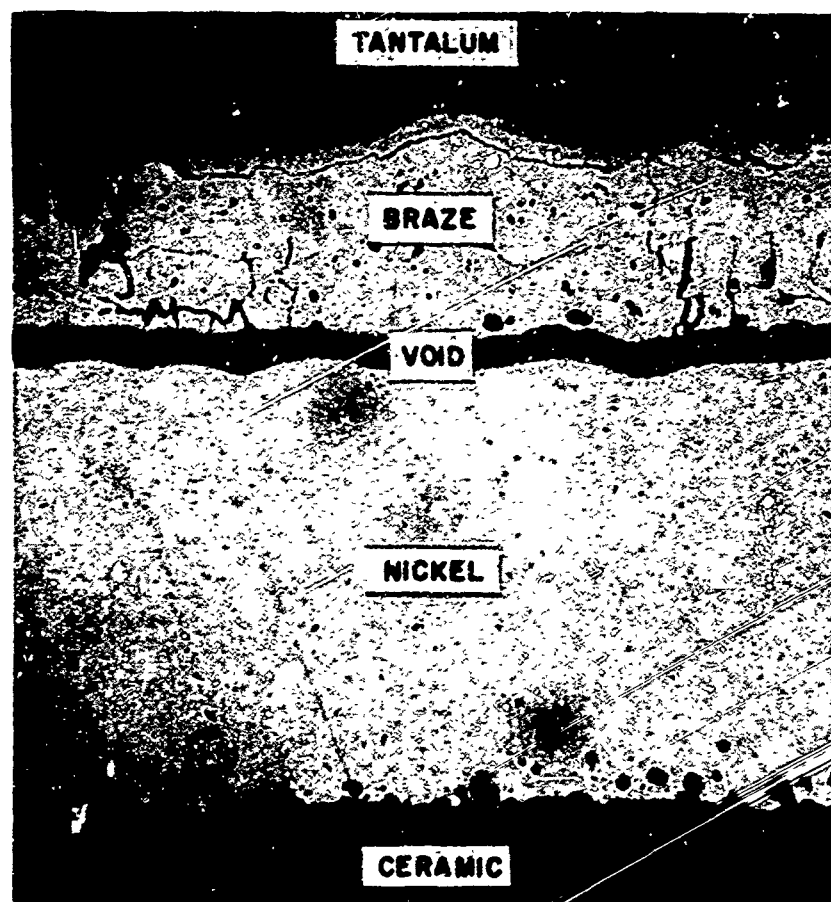

Figure III-15

Alumina-to-Tantalum Seal with Nickel Buffer Washers  
After 240 Hours at 1075°C (500X)

tantalum-nickel braze region has created a long crack-like void which probably constitutes the leak path.

Small voids have also formed on the ceramic side of the nickel buffer washer where the  $TiNi_3$  layer initially present was solutioned by the nickel.

Thus, nickel buffer washer seals of alumina-to-refractory metals are subject to several kinds of failure. In seals to tantalum, failure will occur at high temperatures ( $900^{\circ}C$  and above) through the formation of cracks in the nickel-tantalum braze region, or separation at the ceramic interface. Since voids are observed to be formed near the ceramic interface (at the  $TiNi_3$ -nickel interface which was initially present) of seals to both tantalum and molybdenum, but the latter type do not develop leaks, it is concluded that void formation at the interface does not constitute a leak path in either type of seal. Since the  $TiNi_3$  layer initially present in nickel buffer washer seals to molybdenum is solutioned (just as it is in seals to nickel alone), but no failures occurred on either the  $900^{\circ}C$  or  $1075^{\circ}C$  life test, it is theorized that the very low thermal expansion of molybdenum must offset the high expansion of the nickel buffer washer to effect a low shearing stress at the ceramic interface which never exceeds the strength of the alloy-oxide bond. If this is true, then an optimum thickness of molybdenum and nickel buffer washer must exist for each seal design.

### 3. Alumina-to-Niobium Seals

Alumina-to-niobium seals were prepared with many different time-temperature sealing conditions in order to assess the effect of sealing parameters on seal strength, vacuum tightness, and structure of the alloy which was formed. Figure III-16 is a photomicrograph of a seal which was made at a temperature of  $1430^{\circ}\text{C}$  with a two-minute soak. Seals made at other temperatures and with soak times up to ten minutes looked virtually identical. Although all of the polished sections showed many cracks through the intermetallic layer, all were vacuum tight. The width of the cracks which appear in the photomicrographs has been exaggerated by etching and, as mentioned previously, it is possible that these cracks are formed during preparation of the polished section. Since the phase equilibrium diagram for the nickel-niobium system is incomplete (see Figure III-19), identification of the intermetallic compounds formed at the interface was not attempted. Microhardness measurements were made, at the midpoints of the intermetallic layer and the niobium washer, on seals prepared with different time-temperature conditions. Sealing conditions ranged from  $1270^{\circ}\text{C}$  for two minutes, through  $1416^{\circ}\text{C}$  for ten minutes, to  $1433^{\circ}\text{C}$  for two minutes. Knoop hardness (10-gram load) of the several layers was virtually identical in all of the seals which were measured and averaged 150 KHN in the

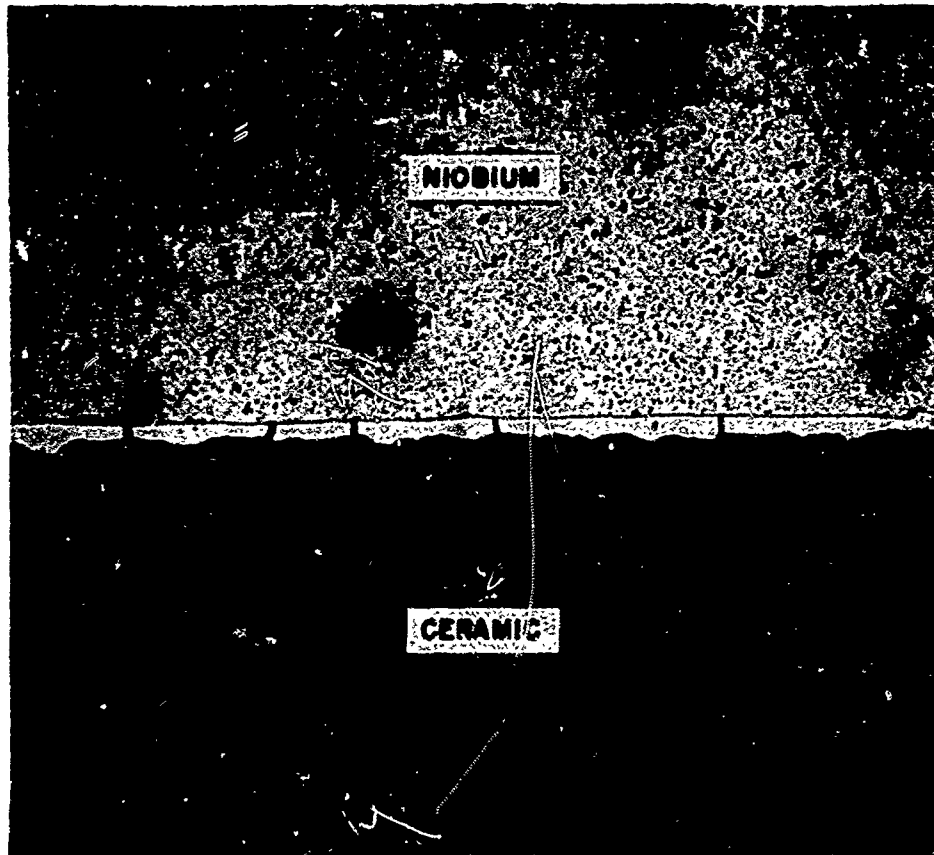

Figure III-16

Alumina-to-Niobium Seal Made at a Temperature of  
1430°C (500X)

niobium washer, and 680 KHN in the intermetallic layer.

Although no quantitative mechanical strength testing was performed, breaking of alumina-to-niobium seals showed that they were less strong than the alumina-to-nickel seals previously discussed (particularly those containing  $TiNi_3$  at the interface). The virtually identical thermal expansion match between alumina and niobium, together with the ductility and low modulus of elasticity of niobium, is undoubtedly responsible for their excellent performance on life and thermal cycle testing...in spite of their low mechanical strength. Since the intermetallic should be a stable compound at the life test temperatures of interest, the strength of the bond to the ceramic may not change with time, as contrasted with seals to nickel where the  $TiNi_3$  ceramic bond is gradually replaced by the lower strength nickel solid solution-ceramic bond.

Several seals were prepared in which a thin coating of titanium hydride had been applied to the surface of the ceramic to promote better wetting yet not to be present in such quantity as to form a titanium-containing phase. Such seals showed a definite improvement in strength but time did not permit comparative life testing.

Life testing of nickel shim seals of alumina-to-niobium yielded the most promising results. All of the seals



which were placed on 900°C life test (Table III-5 were still vacuum tight when last leak checked with the helium mass spectrometer at 2020 hours. Figure III-17 is a polished section through one of these seals showing no apparent change in the thick intermetallic layer at the interface but the formation of a new, thinner, phase layer at the niobium surface.

In addition, all five of the specimens which were tested at a temperature of 1075°C were still vacuum tight after 240 hours exposure, whereas most of the alumina-to-nickel seals in the same test chamber had failed.

Microhardness measurements were made on the seal of Figure III-17 and it was found that the hardness of the niobium washer was 127 KHN and the hardness of the intermetallic layer was 1075 KHN. It is believed highly significant that the hardness of the niobium had not increased (but apparently decreased) as a result of two thousand hours of testing at 900°C. Although reaction would probably occur between niobium and alumina at 900°C, resulting in gradual hardening of the niobium, the presence of the nickel-niobium intermetallic layer apparently prevents this reaction. This is in marked contrast to seals to titanium<sup>9</sup> where severe embrittlement occurs in much less than two thousand hours.

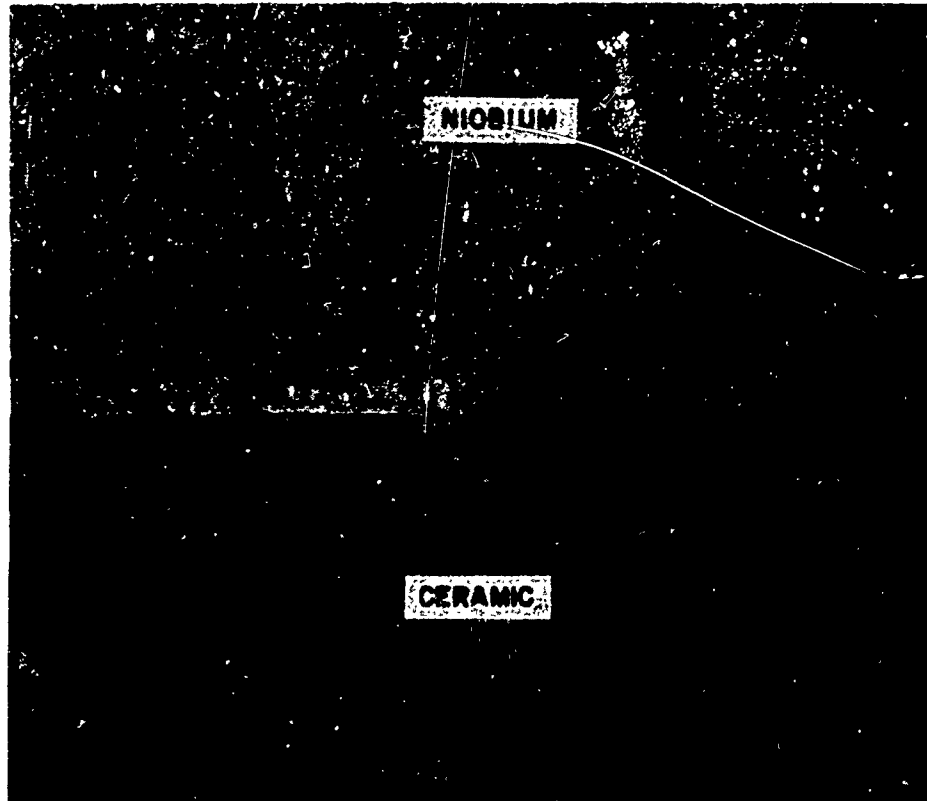

Figure III-17

Alumina-to-Niobium Seal After 2020 Hours at 900°C (500X)

Table III-5

## Seals Life Tested at 700°C and 900°C

<u>Seal Type</u>	<u>Leak Tight at Start</u>	<u>Leak Tight after Indicated Hours of Exposure</u>
<u>Seals Life Tested at 700°C</u>		
Alumina-to-Nickel		
(a) TiNi <sub>3</sub> at interface, SP nickel	9	9 at 410 hr; 8 at 1370 hr
(b) TiNi <sub>3</sub> at interface, 499 nickel	4 3	4 at 1130 hr; 4 at 2090 hr 3 at 410 hr; 2 at 1370 hr
(c) Solid solution at interface, SP nickel	4	3 at 410 hr; 3 at 1370 hr
Alumina-to-tantalum, nickel buffer washers	5	5 at 410 hr; 4 at 1370 hr
Alumina-to-molybdenum, nickel buffer washers	5	4 at 410 hr; 4 at 1370 hr
<u>Seals Life Tested at 900°C</u>		
Alumina-to-Nickel		
(a) TiNi <sub>3</sub> at interface, SP Nickel	10	10 at 410 hr; 6 at 1370 hr
(b) TiNi <sub>3</sub> at interface, 499 nickel	7 3 2	7 at 1320 hr; 7 at 2280 hr 3 at 890 hr; 1 at 1850 hr 1 at 410 hr; 0 at 1370 hr
(c) Solid solution at interface, SP nickel	6	6 at 410 hr; 4 at 1370 hr
Alumina-to-Tantalum, nickel buffer washers	11	3 at 410 hr; 9 at 1370 hr
Alumina-to-Molybdenum, nickel buffer washers	7	7 at 410 hr; 7 at 1370 hr
Alumina-to-Niobium	6	6 at 410 hr; 6 at 1370 hr; 6 at 2020 hr

NOTE: All seals contained G-E A-923 ceramic.

Table III-6  
Seals Life Tested at 1075°C

<u>Seal Type</u>	<u>Leak Tight Specimens</u>	
	<u>At Start</u>	<u>After 240 Hours</u>
<u>Seals to Sintered Alumina (G-E A-976)</u>		
Alumina-to-nickel		
(a) 0.005-inch nickel	6	2
(b) 0.010-inch nickel	4	0
Alumina-to-niobium	5	5
<u>Seals to 97% Alumina (G-E A-923)</u>		
Alumina-to-nickel		
(a) 0.005-inch nickel	12	6
(b) 0.010-inch nickel	3	0
Alumina-to-tantalum		
(a) 0.005-inch nickel buffer washers	3	0
(b) 0.010-inch nickel buffer washers	2	0
Alumina-to-molybdenum		
(a) 0.005-inch nickel buffer washers	2	2
(b) 0.010-inch nickel buffer washers	2	2

NOTES:

- A. SP nickel used in all seals.
- B. All seals to nickel had  $TiNi_3$  at interface.

Table III-7

## Seals Thermally Cycled at 700°C and 900°C

Seal Type	Leak Tight after Indicated Number of Cycles			
	At Start	10 Cycles to 600°C	10 Cycles to 900°C	20 Cycles to 900°C
<u>Seals to Sintered Alumina (A-976)</u>				
Alumina-to-Nickel				
(a) 0.005-inch nickel	9	9	9	7
(b) 0.010-inch nickel	12	12	8	3
Alumina-to-Tantalum, 0.005-inch				
Nickel Buffer Washers	5	5	4	4
Alumina-to-Molybdenum, 0.005-inch				
Nickel Buffer Washers	4	4	3	3
<u>Seals to 97% Alumina (A-923)</u>				
Alumina-to-Tantalum, 0.005-inch				
Nickel Buffer Washers	2	2	2	2
Alumina-to-Molybdenum, 0.005-inch				
Nickel Buffer Washers	2	2	2	2

## NOTES:

- A. All seals were prepared with  $\text{TiNi}_3$  at the interface.  
 B. Total exposure at maximum temperature was 10 hours at 600°C,  
 13 hours at 900°C.

The desirability of using niobium as a structural metal, the simplicity of making nickel shim seals to niobium, and their excellent behavior at high temperatures continues to make this system particularly interesting.

### Conclusions and Recommendations

Alumina-to-nickel seals and alumina-to-refractory metal seals prepared with nickel buffer washers, although suitable for moderate temperature applications, cannot be considered for long time exposure to high temperatures (above about 900°C) due to the degradation of the metal-ceramic bond which accompanies solutioning of the TiNi<sub>3</sub> layer initially present at the interface.

Alumina-to-niobium seals (prepared with nickel shims), on the other hand, displayed excellent high-temperature performance. Hardening of the niobium does not occur and must be prevented by the presence of a thin layer of a nickel-niobium compound at the interface. The very desirable properties of niobium, together with the excellent test data recorded for alumina-to-niobium seals, makes this system worthy of further evaluation.

## F. Metal-to-Metal Joining

### Introduction

The metal-to-metal joining problem of primary interest during this study is that encountered when a metallized ceramic or a cermet, such as those discussed in the preceding sections

of this report, must be joined to the structural metal members of a thermionic converter.

During this study, molybdenum received principal attention as the metallic constituent of the surface layer of a multi-layered cermet or metallized ceramic. The structural metal members or conductor portions of the metal-to-ceramic seal undoubtedly require, by present and anticipated service temperatures, fabrication from molybdenum, niobium, tantalum, tungsten, or alloys thereof. During this study, effort was limited to the problem of joining molybdenum to either itself, niobium, or tantalum.

Although the mechanical strength of the metal-to-metal joint is not of primary concern, it must be stable at the desired operating temperature, must be resistant to cesium corrosion, and preferably should be free of brittle phases. The probable thinness of the metallic layer which will be provided on the surface of the insulator imposes additional restrictions and makes the use of inert arc or electron beam welding unattractive. Electron beam welding of ceramics, both bare and metallized, has met with very limited success.<sup>16, 17</sup> Ultrasonic welding is a possibility, but the lack of encouraging results by others<sup>16</sup> has eliminated it from further consideration at this time. Thus, the joining methods having the greatest applicability to this problem are brazing and diffusion bonding.

### Diffusion Bonding

Solid-solution diffusion can be conducted at relatively low temperatures; an added advantage is that other materials of unknown attack resistance are not added to the joint. Usually, however, this type of diffusion requires very high pressures. The pressure is considered the first stage of the two stages required to obtain strong diffusion bonds. It serves to plastically deform the interfaces to achieve intimacy of contact and to disrupt oxides so that the second stage of strengthening, diffusion, can readily occur.

Others<sup>18</sup> have found, with refractory metal alloys, that the creep strength is so high that it becomes almost impossible to fulfill the pressure requirement. However, by using a thin interleaf of the base metal or a softer lower melting metal, the pressure required can approach a reasonable value.<sup>19</sup> Use of an interleaf of a lower melting metal, even though its melting point is not exceeded, also appears to increase the diffusion rate providing the interleaf is completely soluble at the diffusing temperature.

Considerable study<sup>19</sup> has been conducted on diffusion bonding of molybdenum, niobium, and tantalum alloys using various interleaf materials. Niobium and tantalum interleafs 0.001-inch thick produced good bonds with both the niobium and tantalum alloys. Titanium interleaf and electroplates of nickel, rhodium, palladium, platinum, and ruthenium produced good bonds with TZM alloy (0.5 w/o titanium,



0.1 w/o zirconium, remainder molybdenum). Electroplates of rhenium and chromium, however, did not produce bonds with TZM. The high melting point of rhenium was suggested as the reason for its inability to cause bonding. The inability of the argon or hydrogen atmosphere to break down the oxides on the chromium was possibly the cause of the chromium failure. Since chromium was indicated<sup>20</sup> to be completely soluble in molybdenum, this system was studied further under this program, using a low dew point hydrogen atmosphere. Palladium has been stated to have relatively good solubility in molybdenum and to be free of intermetallic compounds with either molybdenum or tantalum. Therefore it is of interest as a diffusion bonding interleaf material. Attempts have been made to diffusion bond molybdenum and niobium alloys with iron, nickel, and cobalt alloys.<sup>21</sup> Brittle intermetallic compounds are formed at the interface as anticipated from the restricted mutual solubility between nickel, iron, or cobalt and the refractory metals. The intermetallics that are believed to be formed with nickel-molybdenum, nickel-niobium, and nickel-tantalum are illustrated in the phase diagrams shown in Figures III-18,<sup>22</sup> III-19,<sup>23</sup> and III-20,<sup>24</sup> respectively.

### Brazing

Brazing can be accomplished in various ways, and again the method chosen will, in part, be determined by the effect of the

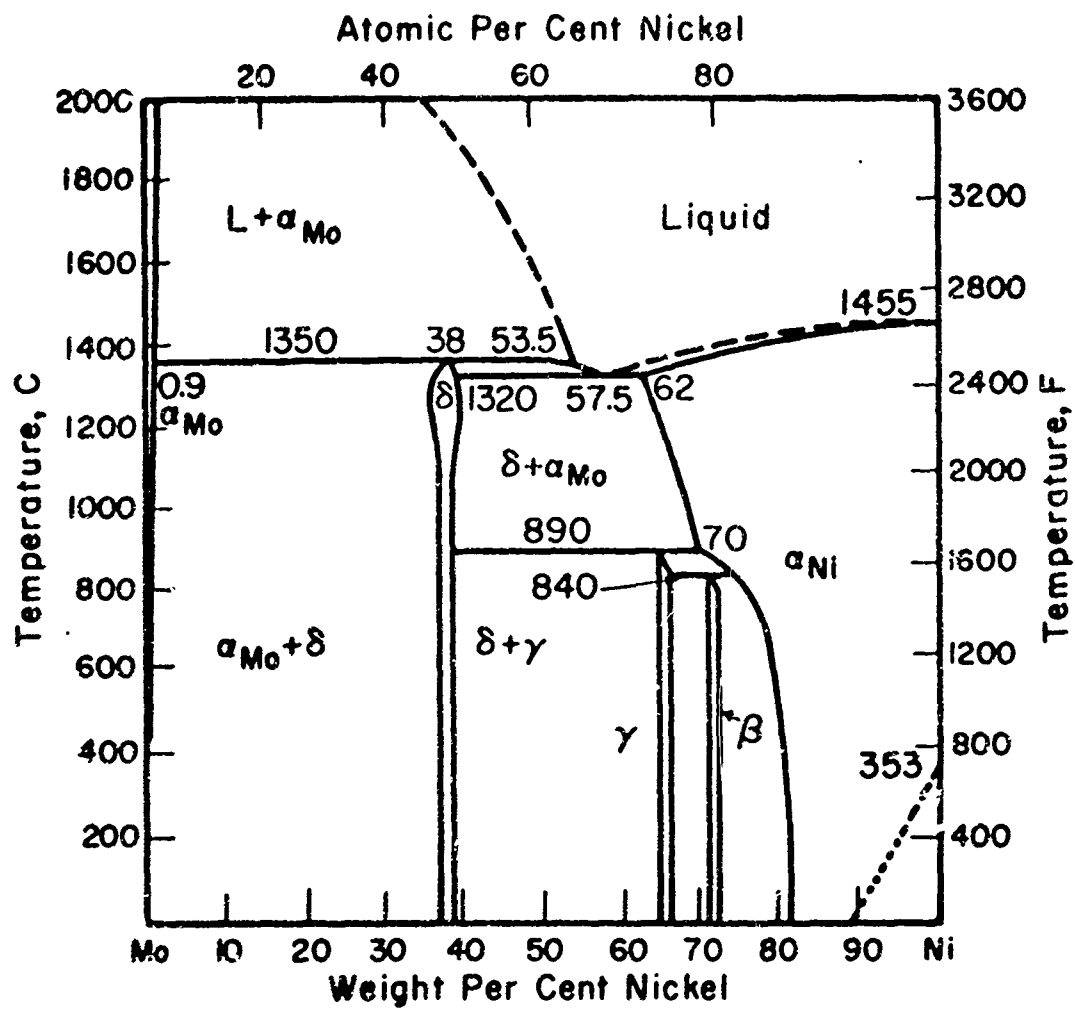

Figure III-18

Molybdenum-Nickel Phase Diagram<sup>22</sup>

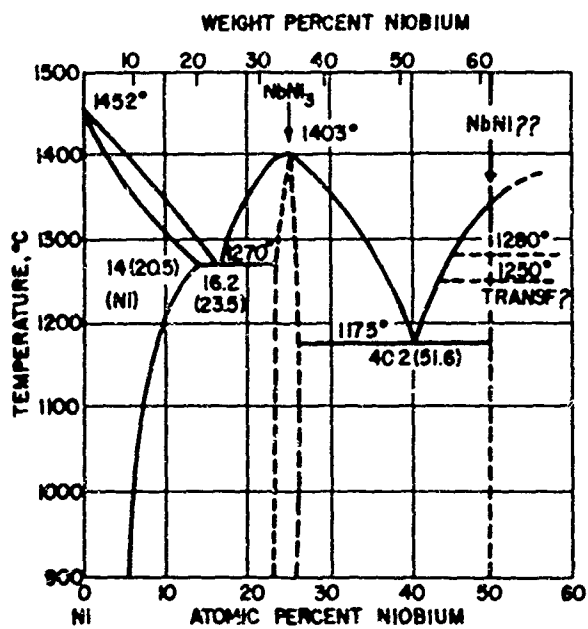

Figure III-19  
 Nickel-Niobium Phase Diagram<sup>23</sup>

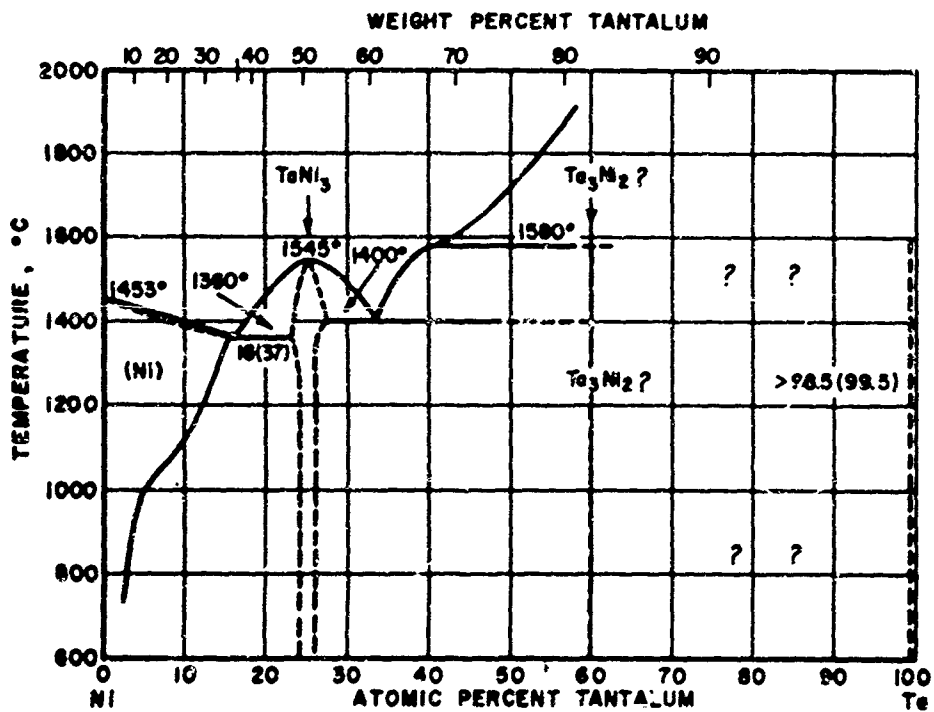

Figure III-20  
 Nickel-Tantalum Phase Diagram<sup>24</sup>

braze on the metallizing or cermet. Of course the braze must also be resistant to cesium attack and have long time stability at the seal operating temperature.

One method of brazing involves the use of high-temperature braze materials specifically designed for use with refractory metals and alloys.<sup>21,25,26,27,28</sup> This method offers the possible advantage of limited solutioning of the base metals (which may be important when brazing to a thin metallized coating or a graded cermet) and the advantage of having rather good ductility.<sup>21</sup> Unfortunately, many of these brazes contain large percentages of titanium or zirconium which have been shown by others<sup>2a</sup> to have poor cesium attack resistance as low as 750°C (see Table III-8 located in section on "G. Cesium Corrosion Testing") or vanadium whose cesium attack resistance has not been studied. However, brazes containing these metals have been found to survive in potassium vapor at 1000°C for 1000 hours.<sup>29</sup> The nickel and cobalt based braze alloys, developed for high-temperature nickel and cobalt based heat resistant alloys, may be useful, providing reaction with the refractory metals during brazing does not cause formation of brittle phases. However, a possible problem with these brazes is the continued diffusion of the various elements into the base metal while at the service temperature. This diffusion could be either beneficial in strengthening the bond or detrimental by causing the formation of brittle intermetallic compounds. It may be possible,

however, to improve the strength and attack resistance of a braze by heat treatment at a temperature above the service temperature. Often this is done<sup>21,26</sup> to increase the remelt temperature of the braze for very high-temperature applications.

Another method of brazing is to use a reactive type braze whereby the metal added to the joint reacts with the structural members forming a composition which melts at a temperature below the melting point of the added metal. This type of braze necessarily requires some solutioning of the base metal, but depending on which component is solutioned (the metallized layer, the graded cermet, or the conductor portion of the seal), this effect may or may not be serious.

The most common metals that are used for reactive brazes are chromium, cobalt, iron, and nickel. These metals have low melting compositions with the three refractory metals of interest, i. e., molybdenum, niobium, and tantalum. Unfortunately, these metals also form intermetallic compounds with the refractory metals as previously mentioned. However, it has been demonstrated<sup>30</sup> with nickel-molybdenum that, when the temperature used was high enough and maintained for about five hours, almost all of the brittle phase was eliminated by diffusion of the nickel into the molybdenum. Figure III-18 illustrates why this treatment is successful. By heating to slightly above a temperature of 1350°C, the intermetallic compound is not formed, and providing the temperature

is maintained long enough to lower the percentage of nickel in the joint to its solubility limit in molybdenum, the inter-metallic compound will not form on cooling. Other systems which could conceivably be handled the same way are nickel-niobium (Figure III-19) and nickel-tantalum (Figure III-20). The chromium-niobium, chromium-tantalum, cobalt-molybdenum, cobalt-tantalum, and iron-molybdenum systems are similar to the nickel-molybdenum system shown in Figure III-18, except that considerably higher temperatures are required. Although the cobalt-niobium, iron-niobium and iron-tantalum systems are similar to the nickel-tantalum system (Figure III-20) they also require higher temperatures. Therefore, studying the nickel-molybdenum, nickel-niobium, and nickel-tantalum systems should provide basic information which would be applicable to all of the other systems mentioned.

Although this braze-diffusion-bonding technique requires relatively high temperatures as compared with diffusion or interleaf diffusion bonding or use of common ductile braze alloys, it should form a bond (1) almost as strong as the structural members, (2) free of localized attack by cesium vapor and (3) possessing a high remelt temperature.

#### Experimental Procedure

##### 1. Diffusion Bonding

The diffusion bonding studies were conducted in a simple fixture consisting of a stack of molybdenum

plates which had been riveted together and through which a rectangular hole had been cut. The specimens to be bonded along with alumina ceramic spacers and wedges were placed snugly in the hole. The pressure applied to the specimens was then directly related to the thermal expansion mismatch between the molybdenum fixture and alumina ceramics, and therefore increased with temperature. With the fixture used, the calculated pressure at  $900^{\circ}\text{C}$  was in excess of 100,000 pounds per square inch. Therefore, the pressure during bonding changes in relation to the yield and creep strength of the materials to be bonded and the interleaf which is used. The specimens can be heated either by placing the fixture in a hydrogen furnace or by induction heating of a surrounding tantalum susceptor in vacuum.

## 2. Brazing

Specimens to be brazed were placed between two high alumina pusher ceramics and loaded in a molybdenum spring-loaded fixture. Brazing was performed in a vacuum bell jar using r-f heating of a tantalum susceptor placed over the fixture. The temperature was monitored by a Pt-PtRh thermocouple wired to the specimens. For braze metals and alloys which melted above  $1400^{\circ}\text{C}$ , temperatures were monitored with an optical pyrometer. •

The specimens used were the same for both brazing and diffusion bonding. A molybdenum ring 3/16-inch high with a 0.480-inch inside diameter and 0.700-inch outside diameter was brazed or bonded to a 0.750-inch diameter, 0.010-inch thick molybdenum disc, a 0.015-inch thick niobium disc, or a 0.010-inch thick tantalum disc with the braze or interleaf placed between them. Those braze materials that were not sufficiently thin or in powder form were placed around the inside of the ring. The molybdenum ring very nearly matched the size of the metallized alumina ceramic specimens and allowed the braze or bond to be checked for leak tightness before and after cesium attack.

## Results and Discussion

### 1. Diffusion Bonding

A chromium-plated molybdenum ring specimen was placed in contact with a bare molybdenum disc in the diffusion bonding fixture and held for 95 hours at 1000°C in very dry hydrogen. Very little bonding occurred and the structure was not vacuum tight. A photomicrograph of a portion of the bonded area is shown in Figure III-21. Failure to produce complete bonding, with molybdenum in contact with molybdenum, was blamed on the non-uniform and exceptional thickness of the plating. Further attempts using thin uniform chromium platings and holding at 1400°C for 2 hours in vacuum were completely



unsuccessful. A recent report<sup>51</sup> gives strong evidence that chromium and molybdenum do not have complete solid solubility and, therefore, considerable difficulty would be anticipated in attempting to obtain a molybdenum-to-molybdenum joint that was free of chromium or a chromium phase. Further work with chromium was stopped when it became apparent that the use of still higher diffusion temperatures would offer no advantage over straight brazing.

Palladium foil (0.0002-inch thick) was used between bare molybdenum rings and discs and the fixtured parts were heated to 1200°C for 5 hours in vacuum. This treatment resulted in vacuum-tight seals. The cross-section of an as-bonded specimen, along with one that was tested for 500 hours at 1000°C in cesium and remained leak tight, is shown on the summary data sheet for corrosion test No. 33, Figure III-47 (page III-135). Complete solutioning of the palladium in the molybdenum has not occurred and due to the unequal diffusion coefficients for palladium into molybdenum and molybdenum into palladium (Kirkendall effect), some pores have formed in the joint. No brittle intermetallics and associated cracks were detected, as occurred when using a nickel interleaf (discussed in the semiannual report). Since still higher service temperatures (above 1000°C) were contemplated it was

felt that palladium should be studied as a braze material rather than as a diffusion bonding interleaf.

## 2. Brazing

Some of the most promising (based on mechanical properties) ultra-high temperature refractory metal braze alloys studied on contract AF 33(616)-7484<sup>21, 26</sup> were supplied by W. R. Young. These alloys had the following compositions:

AS-501 - 30 w/o V; balance Ti

AS-514 - 35 w/c Nb; balance V

AS-540 - 60 w/o V; 30 Nb, 10 Ti

AS-546 - 60 w/o V; 30 Nb; 10 Zr

AS-547 - 59 w/o V, 29 Nb; 10 Zr; 2 Si

Unfortunately, the form in which the alloys were furnished....thick strips and chunks....did not permit ready application in the test joint and time did not permit converting them into more usable forms. However, a cesium corrosion test (Test No. 29) was performed on the alloys as received with the results reported in Figure III-44 (page III-131.) The lack of attack on these titanium and zirconium containing alloys makes them worthy of further investigation.

Brazes were made using the following commercially available heat resistant alloy brazes:

Standard Microbraz\* - 13.5 w/o Cr; 4.5 Fe; 3.5 B;  
0.8 C; 4.5 Si; balance Ni

Microbraz 50 - 17 w/o Mn; 8 Si; 0.15 max. C;  
balance Ni

Microbraz 150 - 15 w/o Cr; 3.5 B; 0.15 max. C;  
balance Ni

G-E J8400\*\* - 21 w/o Cr; 8 Si; 21 Ni; 0.8 B; 0.4 C;  
3.5 W; balance Co.

Although some of the joints were leak tight all contained brittle intermetallic phases and varying numbers of transverse cracks. Figure III-22, niobium brazed to molybdenum with G-E J8400, shows the formation of various cracked phase layers from reaction of the braze with the refractory metals. Other photomicrographs of bonds formed by these brazes appear in the Summary data sheet for Test No. 27, Figure III-43 (page III-130). This figure also shows that holding at 1000°C for 500 hours greatly increases the amount of brittle intermetallics in the joint. Although these brazes do not appear to be attacked by cesium vapor, they are not suitable for making high-temperature tolerant seals to refractory metals, unless the amount of braze alloy in the joint can be critically limited or a post-treatment

---

\*Wall Colmonoy Corp., Detroit, Michigan

\*\*General Electric Metallurgical Product Department, Detroit, Michigan

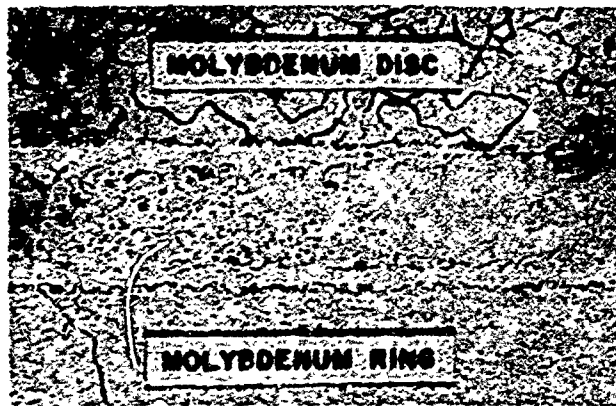

1600°C, 95 Hours, Dry H<sub>2</sub>  
Leaker

250X

Figure III-21

Diffusion Bond to Mo to Mo Using Chromium Plating  
to Promote Diffusion

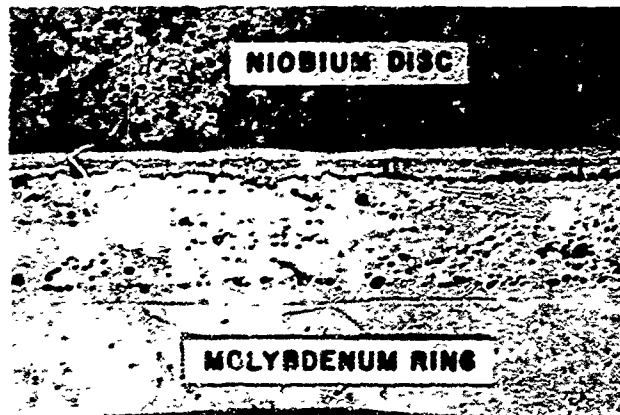

Braze: G-E J8400  
1220°C, 1 Min, Vacuum

Leaker

250X

Figure III-22

Niobium Brazed to Molybdenum With G-E J8400

developed to solution the brittle phase forming elements.

Brazees were also attempted with palladium and 60-40 w/o palladium-nickel alloy. Because of the rapid diffusion of palladium into the refractory metals at the braze temperature (approximately 1600°C) and the inability to obtain good optical pyrometer readings, due to metal vapor deposition of the inside of the bell jar, very little success was realized using this metal as a braze. Others<sup>32</sup> have studied the use of palladium for brazing niobium and found that critical control of the temperature was necessary to prevent severe erosion and pore formation. It is believed that this sensitivity to temperature is due to the fact that the melting point of palladium is very near that of the palladium-niobium eutectic. In addition to causing erosion, the noble metals are known<sup>33,34</sup> to form brittle phases.

The 60-40 palladium-nickel material was not thin enough to use as a braze washer and therefore had to penetrate the joint by capillary action. This penetration occurred when using a niobium disc, but did not occur when using a tantalum or molybdenum disc. This phenomenon is undoubtedly related to the two niobium-nickel eutectics (see Figure III-19) being below the brazing temperature (1280°C). A photomicrograph of the bond which was formed as well as its appearance

after 500 hours at 1000<sup>o</sup>C is shown in Figure III-49 (page III-137). The microstructure is very similar to that obtained when brazing niobium with pure nickel at a temperature of about 1380<sup>o</sup>C. Therefore, this braze may have some advantage over nickel when applied in the joint and used sparingly for prevention of erosion.

Brazing of molybdenum discs either to molybdenum rings or metallized A-976 ceramic rings, using nickel braze washers, has been quite successful. Vacuum-tight seals were relatively easy to produce with 0.0005-inch nickel shims but the joint contained the brittle Mo-Ni intermetallic, either as a continuous layer or as isolated islands. Even heating to almost 1500<sup>o</sup>C and holding for 10 minutes did not completely prevent the formation of this brittle intermetallic. However, when the nickel was reduced to 0.0001-inch, heating to 1480<sup>o</sup>C and holding for 5 minutes produced joints that were almost entirely free of the intermetallic; therefore they should have remelt temperatures almost equal to the melting point of pure molybdenum. When brazing to metallized ceramics with the 0.0001-inch nickel, it was found necessary to grind the metallizing flat to insure good contact. The seal formed is essentially a graded seal having metal-to-cermet (metallizing)-to-ceramic. This seal is illustrated in Figure III-48 (page III-136) before and after exposure to cesium for 500

hours at 1000°C. Two similar seals were still leak tight after this exposure, even though failure had been expected due to the poor thermal expansion match between molybdenum and alumina. The continued formation of the brittle MoNi intermetallic, which occurs when the nickel is not completely in solid solution in the molybdenum prior to testing, was brought out in cesium corrosion Test No. 17 and illustrated in Figure III-34 (page III-121). Two other specimens, similarly brazed to 5 MNA (Figure III-48) but with a ceramic ring on each side of the molybdenum disc to minimize bending stresses, were cycled 12 times to 900°C in vacuum and remained vacuum tight.

Others<sup>32</sup> have tried similar approaches to form graded seals. However, solid-state (rather than liquid-metal) diffusion was used with chromium, (instead of nickel) as the active diffusing metal. With solid-state diffusion, the diffusion rates are inherently lower and therefore bonding to the metallizing required heating to 1800°C and holding for one hour. Besides requiring a very high bonding temperature, this system has the disadvantage of requiring the mating pieces to be quite smooth and parallel, whereas with braze diffusion bonding the liquid can, to a certain extent, move around and increase contact.

Nickel braze diffusion bonding of niobium discs, either to molybdenum rings or metallized A-976 ceramic rings, was also quite successful. However, the resulting structures are not as ideal as those obtained with molybdenum discs. While complete bonding between the niobium and molybdenum was developed, isolated islands of a Nb-Ni intermetallic phase were never completely eliminated. The variation in the distribution of this phase with hold time and nickel shim thickness is illustrated in Figure III-23. Holding at 1400°C for 10 minutes with a 0.0005-inch nickel shim (5 CNM) produces a structure approaching that obtained when holding at 1400°C for 2 minutes with a 0.0001-inch nickel shim (8 CNM). When using a 0.0005-inch nickel shim and only holding for 2 minutes at 1400°C (7 CNM) the Nb-Ni intermetallic phase forms in a continuous band across the seal. This band is very brittle and can easily result in a leak path if thermal stresses cause it to fracture (as apparently was the case with specimen 7 CNM). The as-brazed structure of specimen 1 CNA, which was brazed at about 1200°C for 10 minutes using a 0.0005-inch nickel shim, is shown in Figure III-42 (page III-129). This figure shows that at 1200°C the braze does not penetrate the niobium, but a continuous band of brittle phase, as illustrated by the cracks, is formed. It is interesting to note that holding this joint



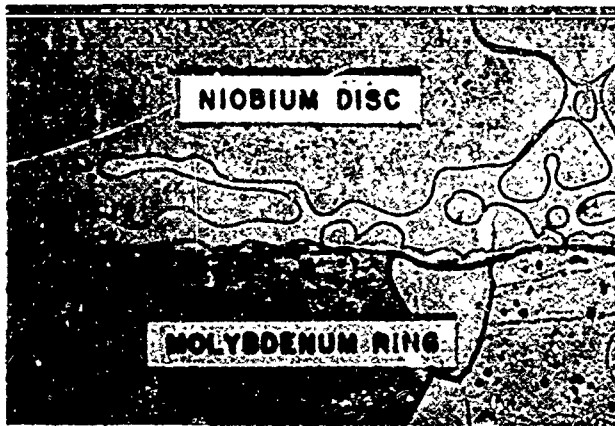

5 CNM 1400°C, 10 min, 0.0005 in. Ni  
Vacuum Tight

250X

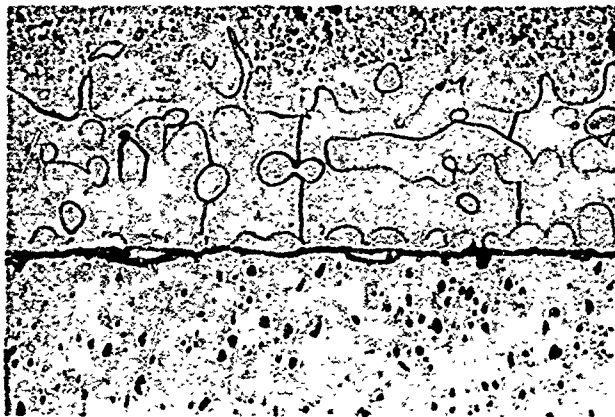

7 CNM 1415°C, 2 min, 0.0005 in. Ni  
Leaker

250X

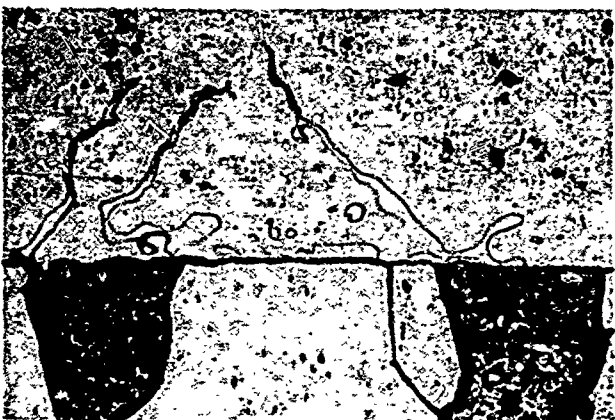

8 CNM 1415°C, 2 min, 0.0001 in. Ni  
Vacuum Tight

250X

Etch: 30 Latic, 30 HNO<sub>3</sub>, 3 HF

Figure III-23

Photomicrographs Illustrating Variation in Penetrating Phase  
With Hold Time and Shim Thickness

at 1000°C for 500 hours causes the structure to change to one similar to that developed from brazing at higher temperatures (1400°C). Also shown in Figure III-42 is specimen 2 CNM, which was brazed at 1300°C for 2 minutes using a 0.0005-inch nickel shim. These parameters did not prevent formation of a continuous band of intermetallic phase at the joint. However, like the 1 CNA specimen, the 500-hour treatment at 1000°C changed the structure to that which would be formed when brazing for short times at temperatures higher than 1300°C. Figure III-48 shows that brazing at 1420°C for 5 minutes (9 CNM), rather than 2 minutes (8 CNM), results in very little difference in braze structure. This figure also shows that the testing of a high temperature braze structure causes very little change in this structure, although a second phase appears to have precipitated in the penetrating phase. Another specimen, similar to 9 CNA (shown in Figure III-48) was thermally cycled 12 times to 900°C and remained vacuum tight.

Nickel braze diffusion bonding of tantalum, either to molybdenum rings or metallized A-976 ceramic rings, was quite successful but, similar to niobium, resulted in a less ideal structure than was obtained with molybdenum to molybdenum. Also, when brazing to metallized ceramics it was found necessary to use tantalum

washers, rather than discs, to prevent cracking of the ceramic, whereas with molybdenum, slow cooling was sufficient and with niobium no precautions were necessary. As pointed out in the semiannual report,<sup>9</sup> there is an apparent temperature above which penetration of the braze into the tantalum starts to occur and transverse cracking in the braze is virtually eliminated. This temperature now appears to be around 1470°C (incorrectly suggested as about 1370°C in semiannual report). Figure III-38 (page III-125) shows the braze structure obtained below this temperature (specimen 6 TNM) and that obtained above this temperature (specimen 7 TNM). Hardness measurements indicated higher temperature brazes did not crack because they were much softer (480 Knoop compared to 690 Knoop), and, therefore, more ductile than the lower temperature brazes. It is interesting to note that the thermal treatment received during cesium corrosion testing did not grossly change the as-brazed microstructure of the lower temperature brazes, as it did to niobium, even though the exposure time was twice as long for the tantalum. This difference is undoubtedly due to the high melting point of tantalum and the associated lower diffusion rates.

Vacuum-tight seals of tantalum to metallized A-976 were obtained too late in the study to be tested in cesium.

Difficulties were not only experienced with cracked ceramics, due to thermal expansion mismatch, but also with metallizing which was not sufficiently flat for good contact as well as metallizing that was too thin to avoid being completely solutioned by the braze. Figure III-24 shows the microstructure of one of the latter seals, made with a tantalum washer rather than a disc, which appears worthy of cesium testing. This seal, 8 TNA, was brazed at 1500°C for 5 minutes. The slight difference in the microstructure between this seal and 7 TNM shown in Figure III-38 may have been due to the shorter brazing time (5 minutes instead of 15 minutes) and the use of only 0.0001 inch of nickel rather than 0.0005 inch. Note that the metallizing appears to have been only slightly dissolved by the braze. Two similar specimens to 8 TNA were thermally cycled to 900°C in vacuum 12 times without developing leaks.

#### Conclusions and Recommendations

Braze diffusion bonding using a nickel shim can be used to develop near ideal bonds between the refractory metals and alumina ceramics metallized with the metallizing developed during this program. Since these seals appear to be only limited in temperature by the structural members themselves, they should be capable of much higher service temperatures than the 1000°C employed for cesium corrosion testing and

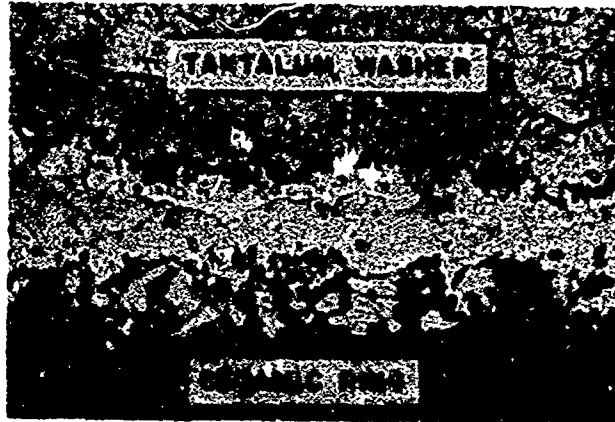

8 TNA brazed 1500<sup>o</sup>C, 5 min, .0001 in. Ni (500X)

Figure III-24

Tantalum Nickel Brazed to Metallized A-976  
Ceramic

the 900°C used during thermal cycling. Therefore, further study of these seals is warranted to determine their maximum service temperature and their resistance to thermal cycle fatigue.

The commercially available heat resistant nickel and cobalt based braze alloys do not offer any advantages over braze diffusion bonding, (possibly some disadvantages), and therefore do not warrant further consideration for use in joining the refractory metals.

Brazing with palladium based braze alloys can yield structures similar to those obtained with nickel, with the possible advantage of a lower brazing temperature. These alloys, therefore, deserve further investigation using the braze diffusion bonding techniques used for nickel.

Brazing with ultra-high-temperature brazes (titanium and vanadium based) developed for refractory metals should be further investigated since they have been shown to be free from attack by cesium and may have applications where braze diffusion bonding is not practical.

Diffusion bonding does not offer any advantages over braze diffusion bonding and, therefore, further consideration of diffusion bonding is not recommended.

## G. Cesium Corrosion Testing

### Introduction

The design of thermionic converters capable of 10,000 hours or more of life required additional information concerning the stability of the structural materials and seals in cesium. The purpose of this program was: (1) to obtain design data on the resistance of various materials (both insulators and conductors) to attack by cesium vapor, and (2) to study the attack on metal-to-metal and metal-to-ceramic seals that are designed for exposure to elevated temperatures (1000°C).

The need for studying actual seals is very great when all of the ways a seal can fail are considered. For example, failure can be caused by: (1) cesium attack of the sealing or braze material or a particular phase within the joint; (2) anodic behavior of the joint or braze material with respect to the other materials forming the seal; (3) cesium dissolving in the joint material causing failure by formation of brittle or low melting phases; and (4) cesium transferring elements from other materials in the system to the joint material where brittle phases can form. This list is by no means complete and in fact there may be effects due to ionized cesium but its study was beyond the scope of this investigation.

Although seals have received very little study in regards to stability in cesium vapor, effects have been noted from various alkali metal studies which may be extrapolated to

illustrate the suggested causes of seal failure. For instance, in the first example (which deals with selective attack), cesium has been found to leach titanium from Type 321 stainless steel,<sup>35</sup> remove carbon from Type 310 stainless steel,<sup>36</sup> and both cesium<sup>36</sup> and potassium<sup>37</sup> have been shown to be responsible for the removal of oxygen from various refractory metals. Intergranular attack by potassium of the weld metal of niobium<sup>38</sup> and of a niobium alloy<sup>39</sup> suggests anodic behavior of these boundaries due to segregation of impurities or alloying elements during solidification. Also, the formation of a reaction product on niobium when placed with nickel in potassium<sup>38</sup> at 980°C suggests electrolytic behavior of the type that would cause seal failure under Example (2). The formation of a glassy surface,<sup>40</sup> from exposure to cesium vapor, on an alumina ceramic containing one or more percent SiO<sub>2</sub> was attributed to the formation of a cesium-aluminum-silicate, and thus illustrates Example (3) where failure of a seal can occur from formation of a lower melting cesium phase.

The possibility of failure by the fourth example, or by embrittlement from cesium transfer of other elements in the system to the joint material, was demonstrated<sup>41</sup> when tantalum, used for a specimen rack, was embrittled by transfer of carbon from Type 304 stainless steel in the same system.



Unfortunately, not all of the corrosion or attack data in the literature have been obtained using the same experimental procedures. Most studies have used a loop or reflux type of test in which various portions of the system are at different temperatures so that boiling and condensation occur simultaneously. This type of test more nearly simulates the application of liquid metals (in place of water) to drive turbo-machinery. Vapor pressures of four or more atmospheres are not uncommon; these high pressures exist because the cooler-condensing portion of the system is only slightly cooler than the boiling portion. This type of test is undoubtedly severe because of the high rate at which the liquid-metal atoms arrive at the surface and the constant washing of the container surface by the liquid metal. This latter effect alone can cause weight loss just by erosion. In fact, attack has also been attributed to cavitation in the boiling liquid.

Another method of studying cesium attack more nearly simulates the conditions in a thermionic converter. Here the specimens are maintained at the anticipated elevated operating temperature and exposed to alkali metal vapor of relatively low pressure (fractions of an atmosphere). The vapor pressure is controlled by maintaining a connecting reservoir at a relatively low temperature. With this type of test, the specimens are exposed only to the alkali metal vapor under fairly stable static conditions. However,

because of the relatively large differences in temperature used, weight loss can occur from vaporization of the material being tested and condensation in the cooler reservoir portion of the system.

This lack of uniformity of obtaining cesium attack data made it desirable to retest many materials under simulated thermionic converter conditions, particularly since the published results cannot be compared directly as illustrated in Table III-8.\* Materials previously found to be unacceptable in reflux or high-pressure studies may actually be acceptable under thermionic converter conditions.

There are other materials which require further study due to apparent conflicting data. For example, tantalum was found by one investigator to be resistant at 750°C but attacked at 1300°C, whereas another investigator found it to be resistant to attack at 1730°C. Platinum was reported to have poor attack resistance at 900 and 1300°C, but iridium and rhodium appeared to be unaffected at 1300°C.

Other materials also warranted investigation because they had not been previously tested or because they had not been tested as high as 1000°C. For example, chromium is of interest because of its potential applications in diffusion

---

\*Note: Table III-3 has its own set of references. These references do not correspond with those listed in the section entitled "References".

bonding and in graded cermets, and certain commercial alumina ceramics have been reported to be resistant at 750°C but have not been tested at higher temperatures.

#### Experimental Procedure and Equipment

The test vessels used to contain the samples of materials and seals during testing were made of high purity alumina (A-976) and had high purity nickel closures and cesium reservoirs. Figure III-25 shows a schematic cross-section of the test vessel. A complete discussion of the construction of this vessel was given in the semiannual report on this contract. Also included in that report is a complete description of the experimental procedure. The only change made in this procedure was to cool the vessels in dry ice while driving the cesium from the crushed ampoule into the vessel. This extra step appeared to improve the efficiency of cesium transfer and also the reliability of the pinch-off made between the vessel and the cesium ampoule. A chemical analysis of the cesium was furnished by the vendor, Dow Chemical Company, and was included in the report.

#### Results and Discussion

##### General

Table III-9 gives a summary of all the successful cesium corrosion tests completed during this study and they are discussed in the sections to follow. Many of the results obtained are given in Table III-8 for easy comparison of results with those of others, and are

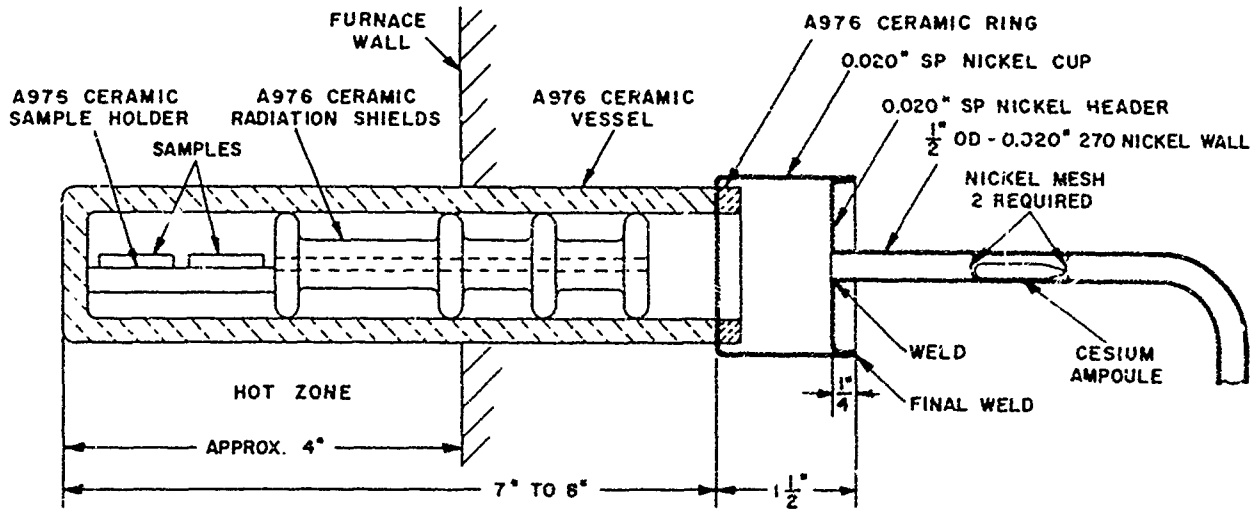
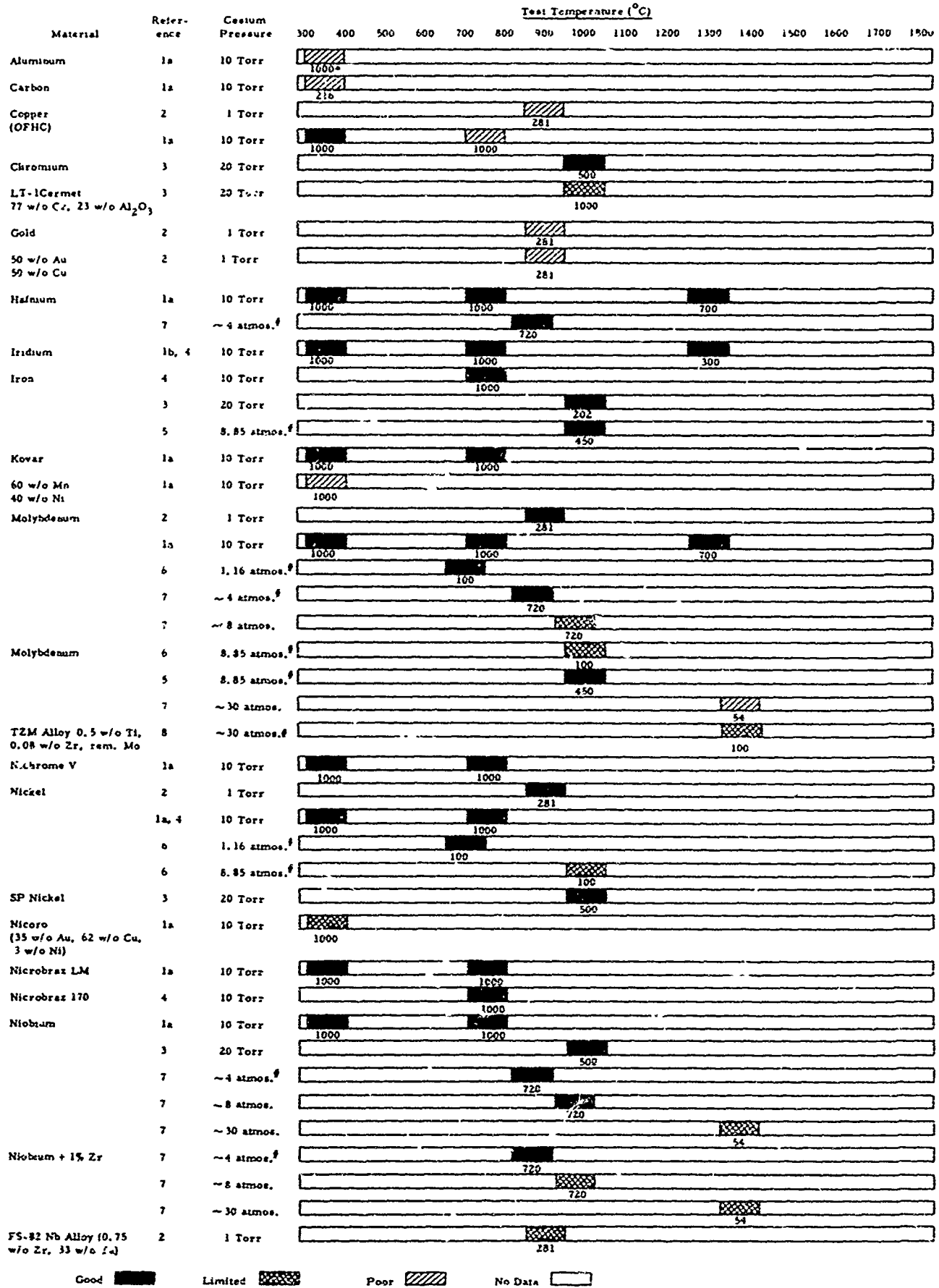

Figure III -25

Schematic Cross-Section of Ceramic Test Vessel

Table III-8

Resistance of Materials to Attack by Cesium



Good [Solid Black] Limited [Cross-hatched] Poor [Diagonal Lines] No Data [White]

Table III-8 (contd)

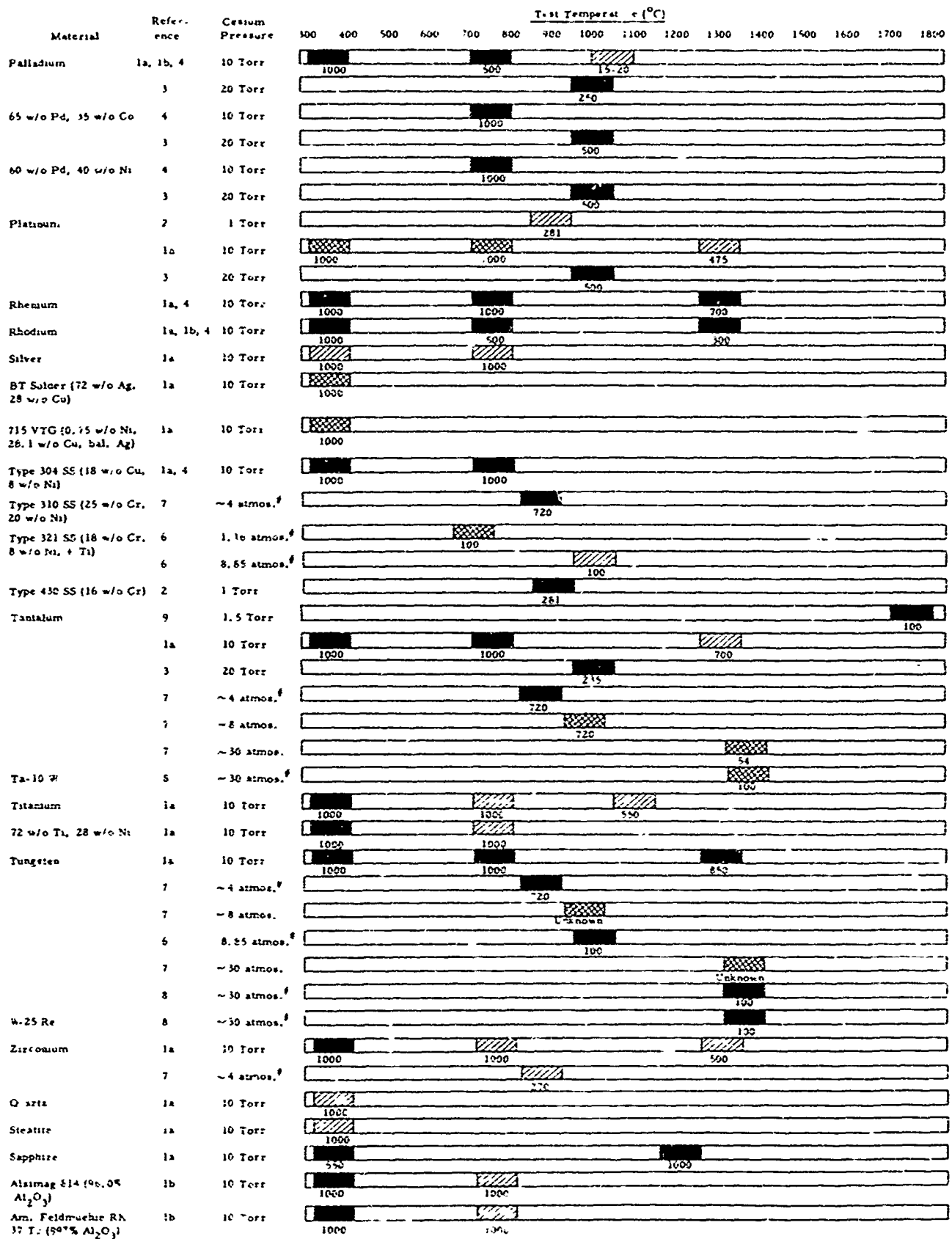

Good [Solid Black] Limited [Cross-hatched] Poor [Diagonal Lines] No Data [White]

Table III-8 (contd)

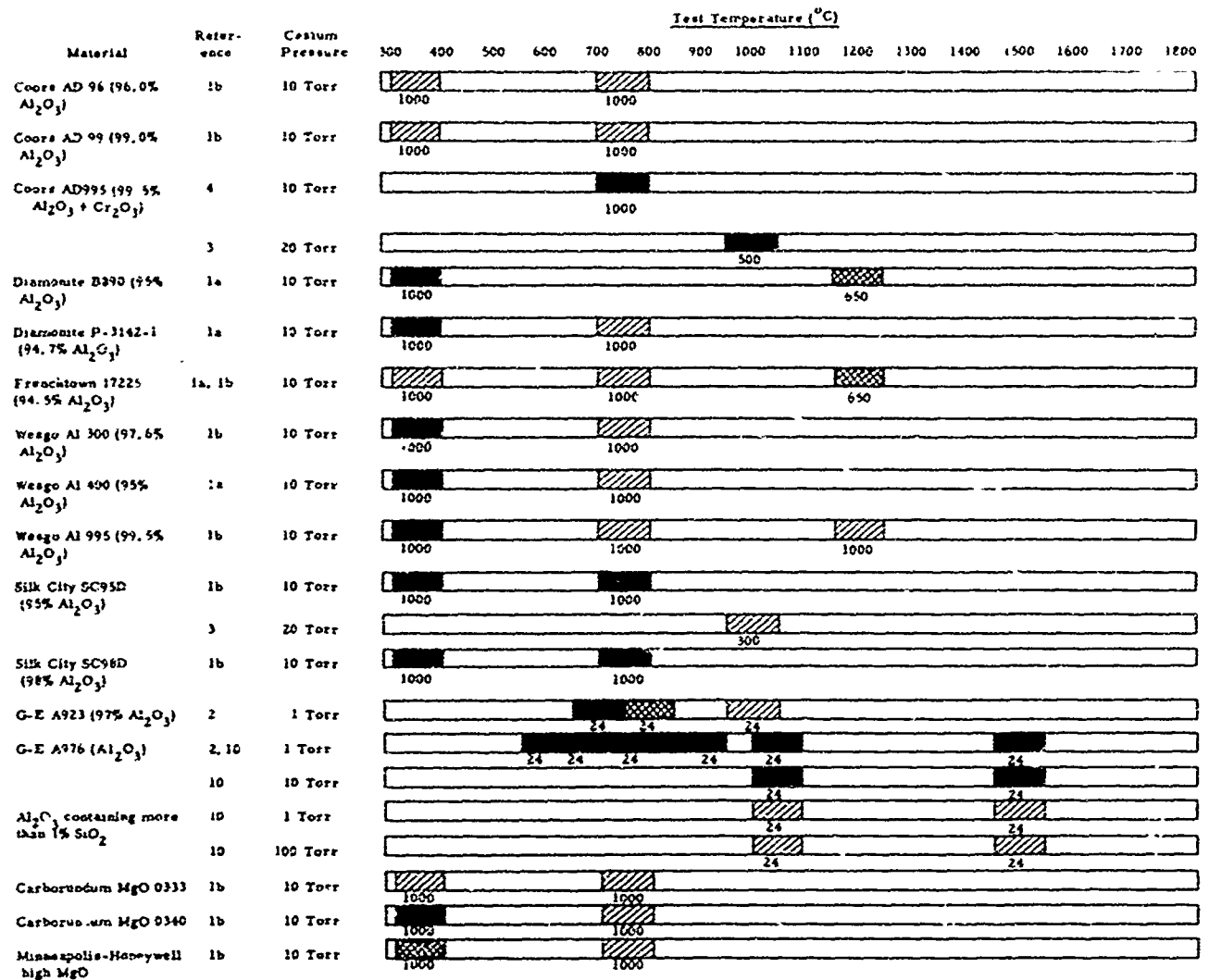

Good  \* Hours tested  
 Limited  # Static test  
 Poor   
 No Data 

REFERENCES

- W. B. Hall and J. J. O'Grady, Radio Corporation of America, "The Development of an Auxiliary Electrode Thermionic Converter," AF 33(657)-8005, 1962.  
 a. Third Quarterly Technical Report, 1962.  
 b. Fourth Quarterly Technical Report, 1962.
- M. J. Slivka, R. H. Bristow, and M. D. Gibbons, General Electric Company, "Vapor Filled Thermionic Converter Materials and Joining Problems: Plasma Research Pertinent to Thermionic Converter Operation," Final Technical Summary Report, Contract NObs-86220, 1962.
- R. H. Bristow, R. D. Hanna, and K. P. Zeman, General Electric Company, "Research and Development Program of Thermionic Conversion of Heat to Electricity," Section III of Final Technical Summary Report, Contract NObs-88578, 1964.
- W. B. Hall and S. W. Kessler, Radio Corporation of America, "Cesium Compatibility of Thermionic Converter Structural Materials," Contract No. NObs-84823 (from Thermionic Conversion Specialist Conference, Gatlinburg, Tennessee, October 7, 8, and 9, 1963).
- E. N. Petrick, O. K. Husmann, and H. W. Szymanski, Curtiss-Wright Corporation, "Analytical and Experimental Investigation of Compact Charge Ionisation," Final Report, Contract No. NOur 288(60) (DDC AD-240709), 1960.
- C. R. Dulgeroff and G. D. Seale, Rocketdyne, "Experimental Electrical Propulsion Study," Final Report, Contract AF 49(638)-351 (DDC AD-243217), 1960.
- W. T. Chandler and N. J. Hoffman, Rocketdyne, "Effects of Liquid and Vapor Cesium on Container Metals," TDR No. ASD-TDR-62-965, Contract AF 33(616)-8435 (DDC AD-405432), 1963.
- J. A. DeMaistry, Battelle Memorial Institute, "Investigation of High-Temperature Refractory Metals and Alloys for Thermionic Converters," Second Quarterly Progress Report, Contract AF 33(657)-10404, 1963.
- Westinghouse Research Laboratories, Long Life Closed Loop MHD Research and Development Unit, Interim Scientific Report No. 3, Contract AF 33(657)-8311 (DDC AD-33438), 1962.
- Dr. E. Feingold, General Electric Company, IV. The Attack by Cesium Vapor on Impure Alumina Bodies at Temperatures up to 1500°C, ASTIA AD-284958.

1200

Table III-9  
Cesium Corrosion Tests

Test No.	Material	Hours Exposed	Weight Change (%)	Remarks <sup>b</sup>
5	Tantalum	235	< -0.02	No attack
6	Palladium	250	Nil <sup>a</sup>	No attack
9	S-20 metallizing on A-976 ceramic	209	metallizing +5	Metallizing attacked
11	Iron	202	-0.07	No attack
12	Metallized Silk City SC95D alumina ceramic	300	total +0.6	Metallizing & ceramic attacked
14	H-1 metallized on A-976 ceramic	500	0	No attack
	H-1 metallized A-976 ceramic brazed together with P-ema-braze #101		Nil	Still vacuum tight
15	Niobium	500	< -0.03	No attack
16	Chromium	500	< -0.02	No attack
17	Molybdenum disc to molybdenum ring using nickel braze	500	Nil	No longer vacuum tight
	Tantalum disc to molybdenum ring using nickel braze		Nil	Still vacuum tight
18	60-40 w/o Palladium - nickel braze alloy	500	-0.13	No attack
19	6 active alloy seals from this program	500	Avg. total < +0.02	None still leak tight
20	SP Nickel	500	Est. -0.1 <sup>**</sup>	No attack
21	Halves of TNN specimens 1, 2, 3, 4, 6, 7.	1000	Avg. < 0.01	No attack
23	Palco (65 w/o Palladium - 35 cobalt)	500	Avg. -0.6 <sup>##</sup>	No attack 3 of 4 bonded together
	Palco brazed, H-1 metallized, A-976 ceramic		Nil	Two complete seals no longer vacuum tight

<sup>a</sup>Weight change of 0.0002 g or less listed as nil change

<sup>b</sup>For more complete description see Summary Data Sheets

<sup>\*\*</sup>Before testing weight in error - weight surmised from weighing similar untested samples

<sup>##</sup>Average weight of specimens was less than 0.05 g



Table III-9 (contd)

Test No.	Material	Hours Exposed	Weight Change (%)	Remarks
24	Metallized Coors AD995 alumina ceramics	500	total +0.17	Metallizing attacked
25	Platinum	500	< +0.05	No attack
26	Halves of CNM specimens 1, 2, 3, 4, 5, 6, 8 and 1 CNA	500	All Nil	No attack
27	Molybdenum-to-molybdenum brazed with standard Microbras Microbras 150 Microbras 60 GE J8400	500	< +0.02  < +0.03 ] -0.05 <sup>***</sup>	No attack
28	Oxide melts from this program 46-1800 (65 w/o Al <sub>2</sub> O <sub>3</sub> -35 Y <sub>2</sub> O <sub>3</sub> ) 48-1750 (60 w/o Al <sub>2</sub> O <sub>3</sub> -20 CaO)	500	Samples damaged when removed from vessel	No attack
29	Ultra-high temperature brases AS 501 (Ti - 30 w/o V) AS 514 (V - 35 Nb) AS 540 (60V, 30 Nb, 10 Ti) AS 546 (60V, 30 Nb, 10 Zr) AS 547 (59V, 29 Nb, 10 Zr, 2 Si)	500	+0.6 Nil < +0.1 Nil Nil	Reacted with pallet No attack No attack No attack No attack
30	LT-1 Cermet 77 w/o Cr, 23 w/o Al <sub>2</sub> O <sub>3</sub>	1000	+0.27	Turned dull blue gray with sweaty appearance pores developed in structure
31	Niobium nickel brazed to H-1 metallized A-976 (1 & 5 CNA)	1000	Nil	No attack - microstructures similar to test 34 - specimens leaked due to irregular metallizing
	Molybdenum nickel brazed to H-1 metallized A-976 (1 & 2 MNA)	1000	Nil	No attack - one seal vacuum tight - other ceramic cracked. Seals not initially free of MoNi intermetallic
32	H-1 metallizing on A-976 H-1 metallizing on Coors AD 995	500	0 or Nil 0	No attack - 6 specimens No attack - 2 specimens
33	Mo - Al <sub>2</sub> O <sub>3</sub> Cermet (this program) Diffusion bonded molybdenum-to-molybdenum using palladium interleaf	500	0 Nil	No attack - still vacuum tight No attack - still vacuum tight
34	Specimens 7 & 8 CNA Specimens 4 & 6 MNA & 1/2 5 MNA	500	All Nil All Nil	No attack - both vacuum tight No attack - both vacuum tight
35	Molybdenum, niobium & tantalum brazed to H-1 metallized A-976 using 60-40 w/o palladium-nickel	500	All Nil	No attack on any - niobium specimen still vacuum tight Mo & Ta specimens brazed poorly

<sup>\*\*\*</sup>specimens bonded together

also presented in the form of Summary Data Sheets in Figure III-26 through Figure III-49. Most of the metal specimens were made from 3/4-inch square pieces of the material with the corners bent down to allow exposure of the underside and provide minimum contact with the high-purity alumina ceramic specimen holder.

#### Chromium and Chromium-Containing Cermet

Chromium was not attacked by cesium vapor at 1000°C as shown in Figure III-33 (Test No. 16). The specimens were machined from a block of arc-cast chromium of unknown purity and had holes drilled through them to provide a higher surface-to-weight ratio. Unlike metallic chromium, LT-1 (77 w/o Cr, 23 w/o Al<sub>2</sub>O<sub>3</sub>) cermet did show considerable weight gain and sweating of cesium after testing. The results on this material are given in Figure III-45 (Test No. 30).

Some increase in porosity in the alumina phase occurred and cesium absorption in these pores could have accounted for the increase in weight and sweating of cesium after testing. Since both chromium and pure alumina are not attacked by cesium vapor, the changes realized may have been due to impurities in the material.

#### Iron

Iron was not attacked by cesium vapor as shown in Figure III-29 (Test No. 11). The results of other tests

at 750°C and 1000°C confirm the results of this test, which was discussed in the semiannual report.

#### Nickel

Nickel developed a slight etched appearance when tested at 1000°C, Figure III-37 (Test No. 20), but this was attributed to metal vaporization and not cesium attack. Other investigators, using high cesium pressure (8.85 atmos) have attributed the etched appearance at 1000°C to cesium attack but no mention was made of the use of microsections to confirm this conclusion.

#### Niobium

Niobium was not attacked by cesium vapor at 1000°C, as shown in Figure III-32 (Test No. 15). The marginal results reported by others for Nb - 1 percent Zr and FS-82 Nb alloy at 980°C and 900°C, respectively, may have been due to reaction of the cesium with zirconium oxide, which is formed by the gettering of dissolved oxygen by the zirconium in these alloys.

#### Palladium and Palladium Alloys

Palladium, 65-35 w/o palladium-cobalt, and 60-40 w/o palladium-nickel, Figures III-27, -39 and -35 (Tests 6, 23 and 18), respectively, were not attacked by cesium vapor at 1000°C. Some surface etching did occur but this, as in the case of nickel, was attributed to metal vaporization and not attack. The poor attack resistance

of palladium at 1050°C reported by others may have been a result of loss of strength due to very extensive grain growth, and not a result of cesium attack of the filament type specimen which was used. The failure of seals brazed with 65-35 w/o palladium-cobalt (Falco), Figure III-39, was attributed to continued solutioning of the molybdenum metallizing in the braze during the corrosion test. A seal brazed with Premabraze 101\* (54 w/o Pd, 36 Ni, 10 Cr) was still vacuum tight after 500 hours, Figure III-31 (Test No. 14), even though diffusion pores and some solutioning of the metallizing occurred.

#### Platinum

Figure III-41 (Test No. 25) gives the results of cesium-attack for platinum, and shows that no apparent attack occurred. This result does not agree with other investigators who found attack at 750°C, 900°C and 1300°C. However, the lack of attack was not unexpected since palladium had been shown to be resistant and others had reported that iridium and rhodium were not attacked at 750°C and 1300°C.

#### Tantalum

Tantalum, as shown in Figure III-26 (Test No. 5), was not attacked by cesium vapor at 1000°C. This test was discussed in the semiannual report for this study.

---

\*Handy and Harmon, New York 22, N. Y.

#### Coors AD-995 Alumina Ceramic

This ceramic was not attacked by cesium vapor at 1000°C which is in agreement with results reported at 750°C. However, the metallizing applied by Coors was attacked, as shown in Figure III-40 (Test No. 24). The Coors metallizing was removed and metallizing mix No. 1\* from this program (see section entitled "C. Cesium Resistant Metallizing") applied. Subsequently, both ceramic and metallizing were then found to be resistant to attack by cesium vapor, Figure III-46 (Test No. 32).

#### Silk City SC-95D Alumina Ceramic\*\*

This ceramic was badly attacked (spectrographic analysis showed it to contain nearly 1 percent SiO<sub>2</sub>) at 1000°C, as shown in Figure III-30 (Test No. 12). In fact, the attack of the ceramic negated evaluation of the attack resistance of the metallizing applied by Silk City. Others found that this ceramic was not attacked at 750°C.

#### G-E A-976 Alumina Ceramic

This ceramic was previously shown to be resistant to cesium attack up to 1500°C, and so was used during this study for evaluating metallizing coatings. Figure III-28 (Test No. 9) shows the attack, which was anticipated, when a silica-containing metallizing (designated S-20) is corrosion tested on this ceramic. Metallizing mix No. 1 developed under this program was also tested on

\*Metallizing mix No. 1 is identical with the H-1 metallizing material referred to on pages III-118, III-126, III-129, III-134, III-136, and III-137.

\*\*Silk City Ceramics, Hawthorne, N. J.

this ceramic and the results given in Figure III-31 (Test No. 14) and the rerun results in Figure III-46 (Test No. 32). No attack or degradation of the mix No. 1 metallizing was detected from these tests.

Ultra-High-Temperature Brazes - AS-501, AS-514, AS-540, AS-546, AS-547

These braze materials (studied and furnished by Young<sup>21,26</sup> previously discussed under "F. Metal-to-Metal Joining," were not attacked at 1000°C, as shown in Figure III-44 (Test No. 29). Only one alloy, AS-501, (Ti 30 w/o V) showed any significant change...the weight gain due to reaction of the titanium with the ceramic sample holder and etching due to recrystallization and grain growth. The results obtained on these braze alloys, all of which contain at least 10 w/o titanium or zirconium, except AS-514, do not support the results of others who found titanium attacked at 750°C and 1100°C, and zirconium at 750°C and 1300°C under low cesium pressures. Still others found titanium leached from Type 321 stainless steel at 700°C and 1000°C under high cesium pressures.

Other Materials

Two bonding oxide compositions (discussed in section "C. Cesium Resistant Metallizing"), 46-1800 (65 w/o Al<sub>2</sub>O<sub>3</sub> - 35 Y<sub>2</sub>O<sub>3</sub>) and 48-1750 (80 w/o Al<sub>2</sub>O<sub>3</sub> - 20 CaO), melted onto molybdenum boats were tested at 1000°C.

Neither composition showed signs of attack. Damage to the extremely brittle recrystallized molybdenum boats did not permit accurate weight loss measurements.

A multilayered molybdenum-alumina cermet (Figure III-6), developed under the Multilayered Cermets portion of this program, was tested at  $1000^{\circ}\text{C}$ . It was not attacked and still leak tight. The fabrication of this cermet is discussed under the section entitled "D. Multilayered Cermets."

Various active-alloy seals, developed under the Active-Alloy Sealing portion of this program, were tested at  $1000^{\circ}\text{C}$  with the results presented in Figure III-36 (Test No. 19). All of the seals leaked after testing, but did not show signs of cesium attack. Failure was attributed to continued diffusion of the titanium into the essentially unlimited supply of nickel, causing loss of bond and considerable pore formation.

#### Conclusions and Recommendations

The refractory metals of interest in thermionic converter construction, -molybdenum, niobium, and tantalum, -are free from cesium attack at  $1000^{\circ}\text{C}$  when exposed for a minimum of 200 hours in 20 Torr cesium. In addition, iron, nickel, palladium and platinum, as well as the alloys 65-35 palladium-cobalt, 60-40 palladium-nickel, and 54-36-10 palladium-nickel-chromium, which are potential braze materials for

thermionic converter components, are also free from attack at 1000°C. Various commercially available nickel and cobalt based braze alloys, as well as the ultra-high-temperature titanium and vanadium based braze alloys are also free of attack at 1000°C. Further testing of these materials should be restricted to insuring attack resistance at higher temperatures and their compatibility with other construction materials.

The alumina ceramics, G-E A-97b and commercially available Coors AD-995, were not attacked by cesium nor was the metallizing developed during this program when applied to these ceramics. Also, the molybdenum-alumina cermets developed under this program are free from attack. Knowledge of the resistance of these materials to cesium at higher temperatures is desirable for higher (above 1000°C) temperature seal development.

Alumina-to-nickel active-alloy seals are not attacked by cesium; however, the rather rapid diffusion of the braze into the structural members at 1000°C indicated that these seals would be limited to service temperatures somewhat below 1000°C.

Commercially available chromium-alumina cermet LT-1 is attacked by cesium vapor at 1000°C, as are materials containing about 1 percent or more silica, such as commercially available alumina ceramic Silk City SC-95D and a silica-containing metallizing (designated S-20). These results emphasize the importance of a very low silica content in new insulators and seals for use in thermionic converter construction.



Test No. 5

Material: Tantalum, 0.010-inch thick

Test conditions: 1000°C, 20 Torr cesium pressure

Hours tested: 235

Appearance (approx. 2X)

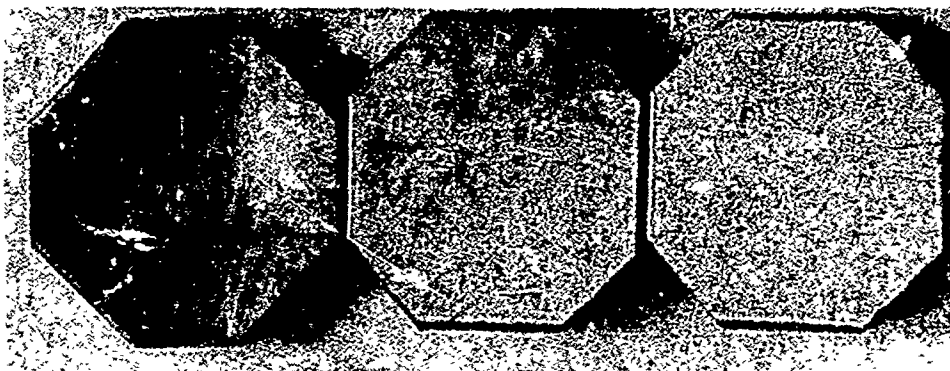

	Before	After Specimen 3	After Specimen 4	
Weight:		1.5318 g	1.5391 g	Before
		1.5320 g	1.5395 g	After

Microstructure (100X)

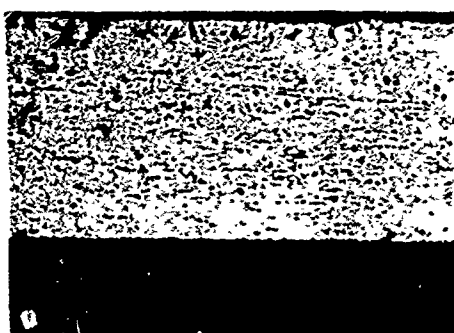

Before

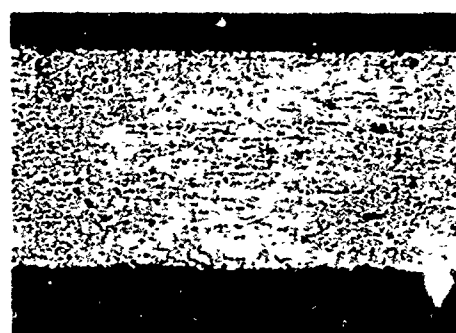

After  
Specimen 3

Etch: 50 ml H<sub>2</sub>SO<sub>4</sub>  
20 ml HNO<sub>3</sub>  
20 ml HF

Remarks: Specimens received very very slight etching from cesium. Microstructure shows no significant attack. Pits in microstructure partially due to etch pitting of dislocations.

Figure III-26

Summary Data Sheet of Cesium Attack for Tantalum

Test No. 6

Material: Palladium, 0.010-inch thick

Test Conditions: 1000°C, 20 Torr\* cesium pressure

Hours tested: 250

Appearance (2X)

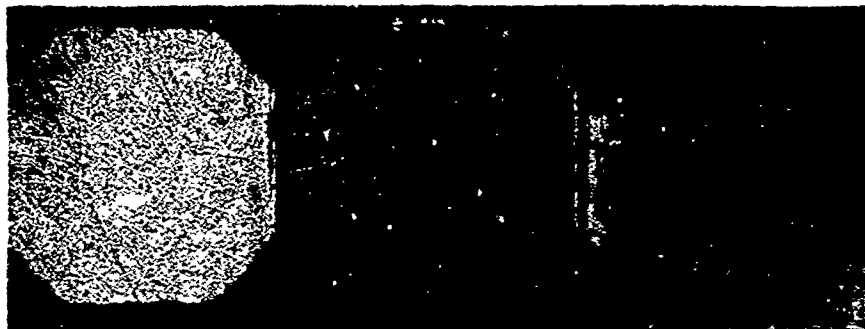

	Before	After Specimen 1	After- Specimen 2, after washing	
Weight:		1.1022 g 1.1021 g	1.0762 g 1.0761 g 1.0759 g	Before After After washing

Microstructure (100X)

Etch: Aqua-Regia

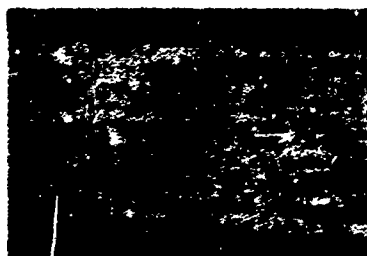

Before

After

Remarks: Surface of specimens covered with white film which could only be partially washed off. Material etched by cesium - very slight attack of grain boundaries not shown in "after" microstructure.

\*May not have been this pressure during full time as indicated by lack of cesium in reservoir at end of test.

Figure III-27

Summary Data Sheet of Cesium Attack for Palladium

Test No. 9

Material: S-20 metallizing on A-976 ceramic

Test conditions: 1000°C, 20 Torr cesium pressure

Hours tested: 209

Appearance (approx. 2X)

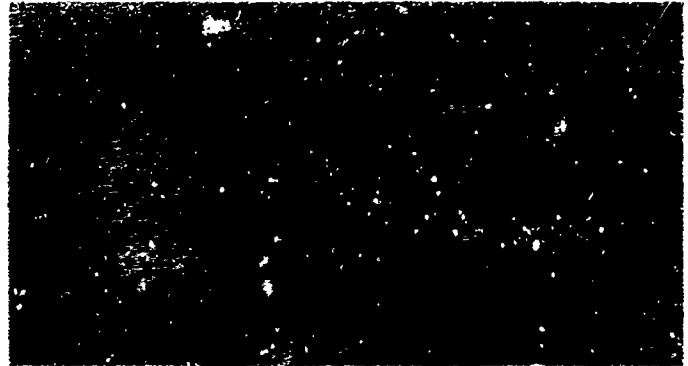

Before

After

Weight:

2.2450 g Before

2.2462 g After

Microstructure (100X)

Unetched

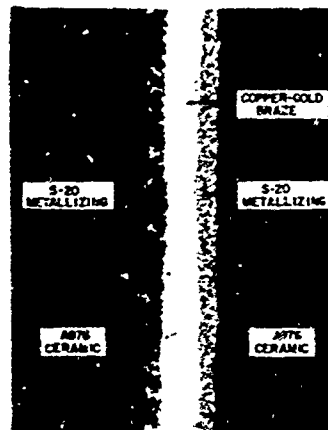

After

Before

Remarks: Staining of tested specimen occurred after prolonged exposure to air after test. Before and after specimens brazed together after testing. Note attack of glass phase in metallizing.

Figure III-28

Summary Data Sheet of Cesium Attack for S-20  
Metallizing on A-976 Ceramic

Test No. 11  
 Material: Iron, 0.010-inch thick  
 Test Conditions: 1000°C, 20 Torr cesium pressure  
 Hours Tested: 202

Appearance (2X)

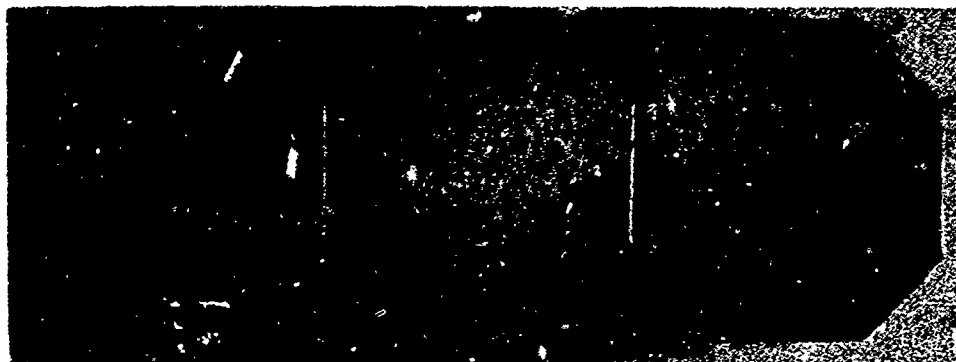

	Before	After Specimen 1	After Specimen 2	
Weight:		0.7627 g	0.7691 g	Before
		0.7621 g	0.7686 g	After

Microstructure (100X)  
 Etch: 2% Nital

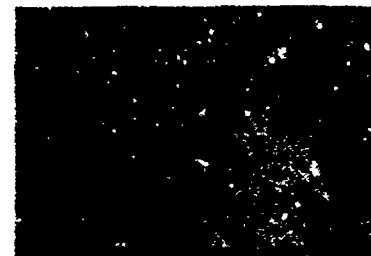

Before

After

Remarks. Specimens had rough surface after testing and were covered with thin white film. Microstructure indicates that roughness was due to shifting of grains during growth realized during testing.

Figure III-29

Summary Data Sheet of Cesium Attack for Iron

Test No. 12

Material: Silk City SC95D alumina ceramics metallized by Silk City

Test Conditions: 1000°C, 20 Torr cesium pressure

Hours Tested: 300

Appearance (approx. 2X)



Before

After

Specimen 3

Weight:

1.5293 g Before

1.5385 g After

Microstructure (50X)

Unetched

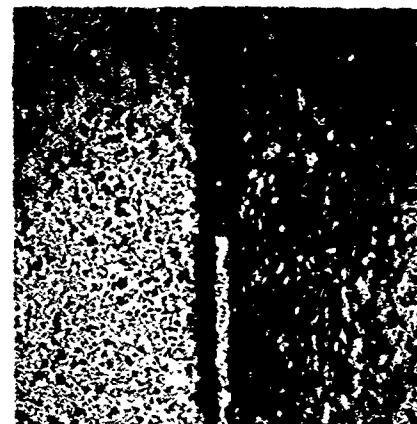

Before

After

Remarks: Ceramic darkened from cesium attack. Before and after specimens brazed together after testing. Extensive attack of ceramic prevented evaluation of metallizing.

Figure III-30

Summary Data Sheet of Cesium Attack for Silk City SC95D  
Metallized Ceramic

Test No. 14

Material: H-1 metallizing on A-976 ceramic

H-1 metallized A-976 ceramic brazed together with  
Premabraz 101 (54 w/o Pd, 36 w/o Ni, 10 w/o Cr)

Conditions: 1000°C, 20 Torr cesium pressure

Hours Tested: 500

Appearance (2X)



Before

After

	Brazed Specimen	Specimen 1	
Weight:	4.5740 g	2.2552 g	Before
	4.5739 g	2.2552 g	After

Microstructure (250X)

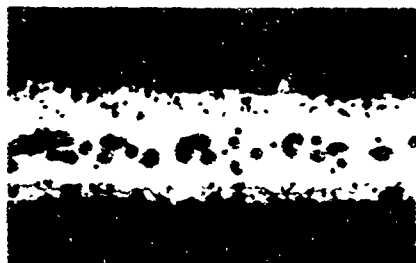

After



Before



After

Remarks: No apparent attack of Premabraz 101 or metallizing. Brazed specimen still leak tight at end of test. Pores in brazed specimen formed during the test from Kirkendall type diffusion. Copper-gold braze applied to metallizing after testing.

Figure III-31

Summary Data Sheet of Cesium Attack for H-1 Metallizing on A-976 Ceramic and Similar Ceramics Brazed Together With Premabraz 101

Test No. 15  
 Material: Niobium  
 Test Conditions: 1000°C, 20 Torr cesium pressure  
 Hours Tested: 500

Appearance (2X)



	Before	After	After	
Weight:		Specimen 1	Specimen 2	
		1.0622 g	1.0605 g	Before
		1.0619 g	1.0602 g	After

Microstructure (100X)

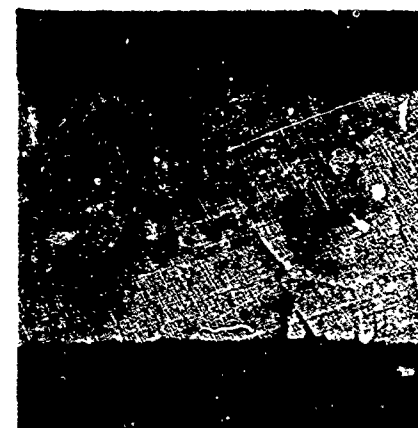
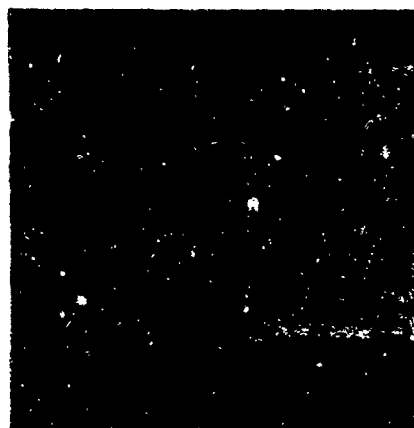

Before

After

Remarks: No apparent attack. Note increase in grain size from thermal treatment of test.

Figure III-32

Summary Data Sheet of Cesium Attack for Niobium

Test No. 16

Material: Chromium

Test Conditions: 1000°C, 20 Torr cesium pressure

Hours Tested: 500

Appearance (2X)



Weight:

After  
Specimen 3  
7.5629 g  
7.5615 g

After  
Specimen 4  
8.1049 g Before  
8.1040 g After

Microstructure (100X)

Etch: 10 HCl, 90 Methyl Alcohol, 6V DC



Before

After

Remarks: No apparent attack. Specimens made from arc-cast chromium of unknown purity.

Figure III-33

Summary Data Sheet of Cesium Attack for Chromium



Test No. 17

Material: Nickel brazed tantalum-to-molybdenum (No. 5 TNM) and  
molybdenum-to-molybdenum (No. 2 MNM)

Test Conditions: 1000°C, 20 Torr cesium pressure

Hours Tested: 500

Microstructure (250X)

Molybdenum-to-Molybdenum

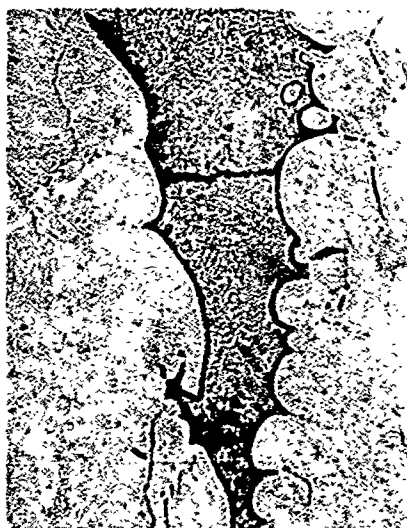

Before (No. 6 MNM)



After (No. 2 MNM)

Tantalum-to-Molybdenum

Microstructure similar to No. 7 TNM Test No. 21

Weight:	5 TNM	2 MNM	
	7.4697 g	7.0621 g	Before
	7.4701 g	7.0622 g	After

Remarks: No apparent attack of either specimen. Specimen No. 5 TNM still leak tight after testing, No. 2 MNM leaked. Note coarsening of braze structure in No. 2 MNM.

Figure III-34

Summary Data Sheet of Cesium Attack for Nickel Brazed Tantalum-to-Molybdenum and Molybdenum-to-Molybdenum

Test No. 18  
 Material: 60-40 w/o Palladium-Nickel  
 Conditions: 1000°C, 20 Torr cesium pressure  
 Hours Tested: 500

Appearance (2X)



Weight:	Before	After Specimen 1	After Specimen 3
		0.9898 g	0.9723 g Before
		0.9887 g	0.9709 g After

Microstructure (100X)  
 Etch: 50 Acetic, 50 HNO<sub>3</sub>



Before

After

Remarks: Slight etching believed to be due to vaporization and not attack.  
 Note recrystallization and grain growth.

Figure III-35

Summary Data Sheet of Cesium Attack for 60-40 Palladium-Nickel

Test No. 19

Material: Active alloy (Ti-Ni) seals

Test Conditions: 1000°C, 20 Torr cesium pressure

Hours Tested: 500

Microstructure (250X)

Etch: 4-1/2 H<sub>2</sub>O 4-1/2 HNO<sub>3</sub>, 1 HF, 9 Lactic

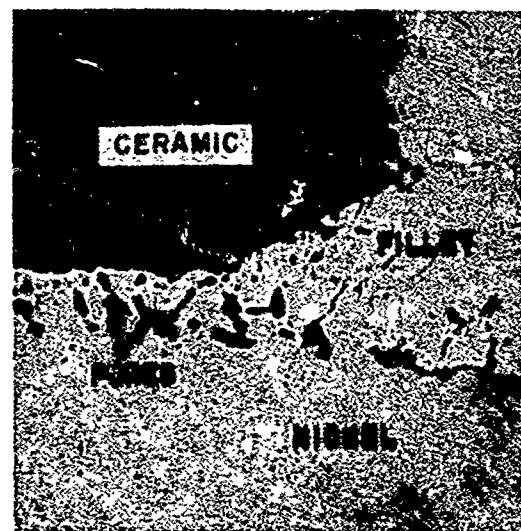
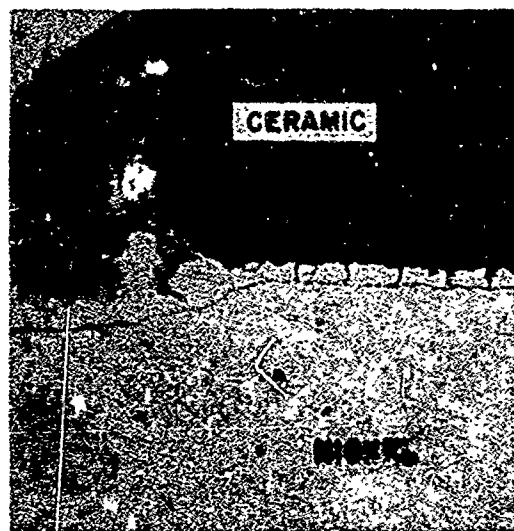

Specimen B 86B Before

Specimen B 86B After

Weight:	Specimen 94A	94B	95A	95C	B76A	B86B	
	4.6124 g	4.6069	4.6082	4.6043	4.0528	4.0995	Before
	4.6129 g	4.6075	4.6090	4.6050	4.0535	4.0977	After

Remarks: Pores formed and bonds lost in all specimens from continued diffusion of titanium into nickel. Intermetallics in fillet still bonded to ceramic. As tested microstructures of other specimens looked similar to that shown. No attack by cesium was noted on any of the specimens.

Figure III-36

Summary Data Sheet of Cesium Attack for Active Alloy Seals

Test No. 20  
Material: SP\* Nickel  
Test Conditions: 1000°C,  
Hours Tested: 500

sure

Appearance (2X)

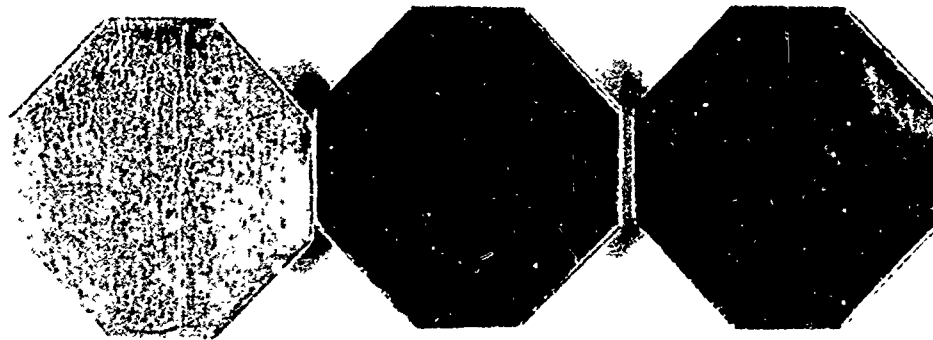

Weight:

Before

After  
Specimen 5  
Estimated Weight  
Initial weight inaccurately taken

After  
Specimen 6  
Loss approx. 0.1%

Microstructure (100X)  
Etch:

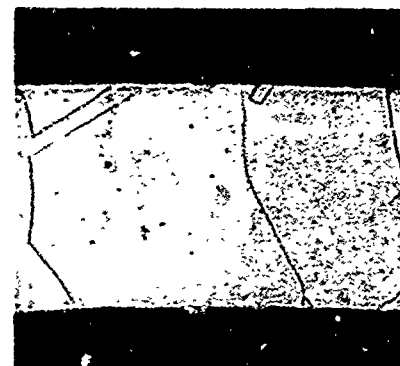
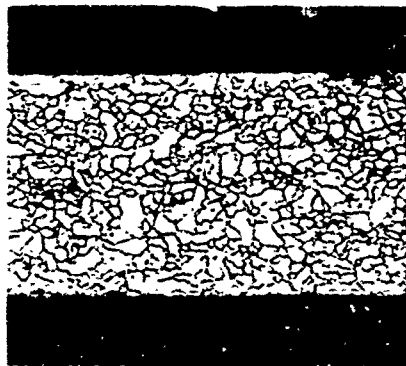

Before

After

Remarks: Slight etching believed to be due to vaporization and not attack.  
Note recrystallization and grain growth.

\*Trademark Metals for Electronics Co.

Figure III-37

Summary Data Sheet of Cesium Attack for SP Nickel

Test No. 21

Material: Nickel brazed tantalum to molybdenum

Test Conditions: 1000°C, 20 Torr cesium pressure

Hours Tested: 1000

Microstructures

Etch: 50 H<sub>2</sub>SO<sub>4</sub>, 20 HNO<sub>3</sub>, 20 HF

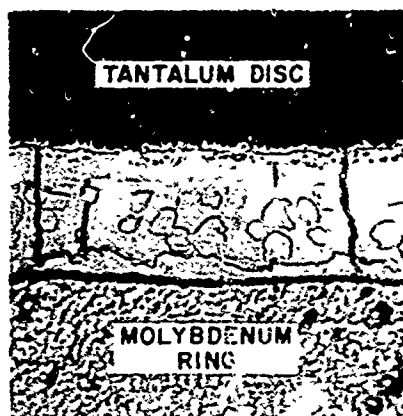

Before (500X)

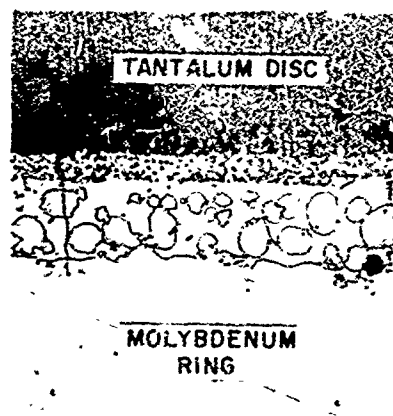

After

6 TNM brazed approximately 1450°C, 10 min., 0.0005-inch nickel shim

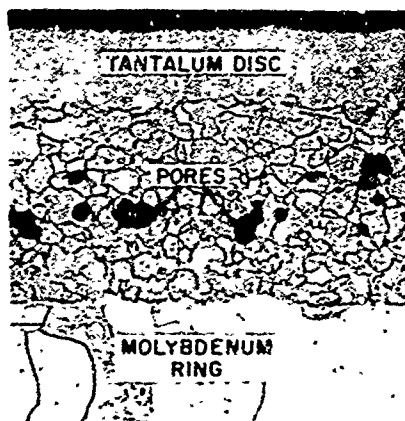

Before (125X)

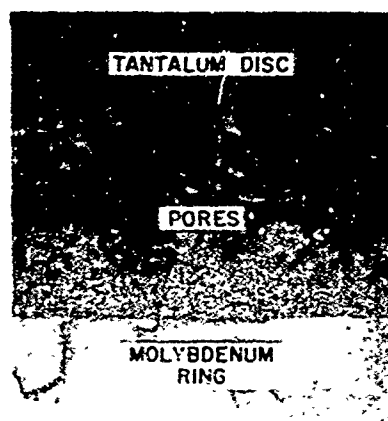

After

7 TNM brazed approximately 1480°C, 15 min., 0.0005-inch nickel shim

Weight: Weight change less than 0.02% for all specimens

Remarks: No apparent attack. Note widening of phase adjacent to tantalum in lower temperature brazed specimen from corrosion testing.  
Pores in 7 TNM due to unbalanced diffusion during brazing

Figure III-38

Summary Data Sheet of Cesium Attack for Nickel Brazed Tantalum to Molybdenum

Test No. 23

Material: Palco (65 w/o palladium - 35 cobalt) and Palco  
brazed, H-1 metallized, A-976 ceramics

Test Conditions: 1000°C, 20 Torr cesium pressure

Hours Tested: 500

Appearance (2X)

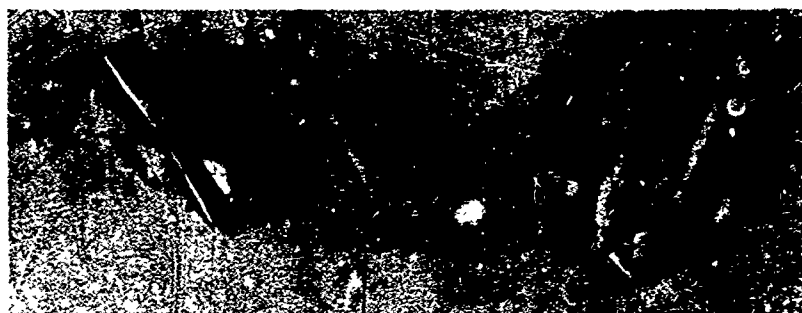

	Before	After	After	
Weight: Brazed specimens (not shown above)		Specimen 1	Specimens 2, 3, 4	
Nil weight change		0.0480 g	0.0507, 0.0480, 0.0490 g	Before
		0.0474 g	0.1468 g	After

Microstructure

Etch: 30 Lactic, 30 HNO<sub>3</sub>, 3 HF

50 Acetic, 50 HNO<sub>3</sub>

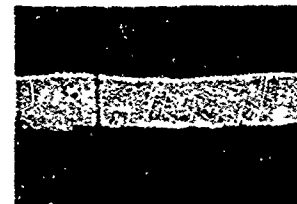
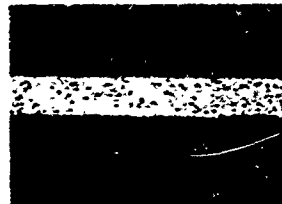
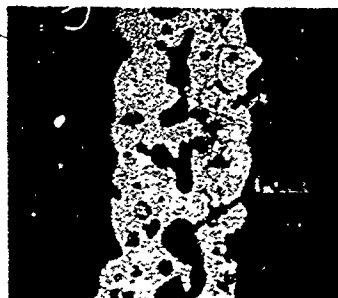

Before

After (100X)

Before

After (250X)

Remarks: Specimen 1 damaged when removed from vessel. Specimens 2, 3, and 4 bonded together during testing. Etching of Palco believed to be due to vaporization and not attack. Pores in center of braze and loss of bond due to diffusion of Palco into molybdenum of metallizing.

Figure III-39

Summary Data Sheet of Cesium Attack for Palco and Placo Brazed Metallized Ceramics

Test No. 24

Material: Coors AD995 alumina ceramic metallized by Coors

Test Conditions: 1000°C, 20 Torr cesium pressure

Hours Tested: 500

Appearance (2X)

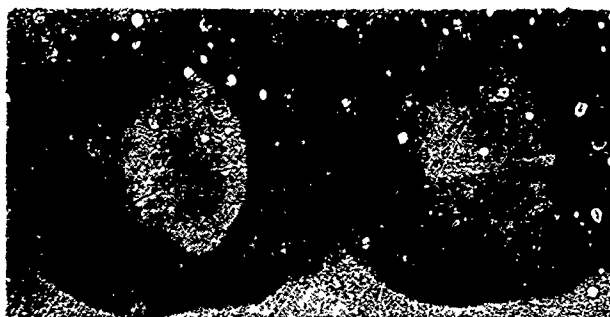

Weight:

After  
Specimen 1

After  
Specimen 2

1.4861 g

1.3351 g

Before

1.4884 g

1.3375 g

After

Microstructure (100X)

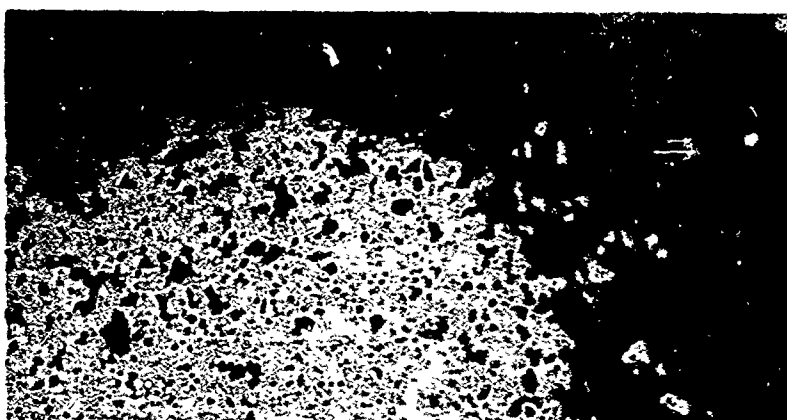

After

Metallized Surface

Remarks: Attack appears limited to metallized surface. Flaking of specimens made final weighings inaccurate.

Figure III-40

Summary Data Sheet of Cesium Attack for Coors Metallized AD995 Alumina Ceramic

Test No. 25  
Material: Platinum Strip  
Test Conditions: 1000°C, 20 Torr cesium pressure  
Hours Tested: 500

Appearance: Specimen after test was very bright and shiny  
with very slight amount of grain boundary etching.

Weight: .8235 g Before  
.8239 g After

Microstructure (100X)  
Etch: Aqua Regia, warm, slightly dilute



After

Remarks: No apparent attack. Metal still very ductile after testing.

rface

Figure III-41

Summary Data Sheet of Cesium Attack for Platinum



Test No. 26

Material: Nickel brazed niobium to molybdenum and H-1 metallized  
A-976 ceramic

Test Conditions: 1000°C, 20 Torr cesium pressure

Hours Tested: 500

Microstructures

Etch: 30 Lactic, 30 HNO<sub>3</sub>, 3 HF

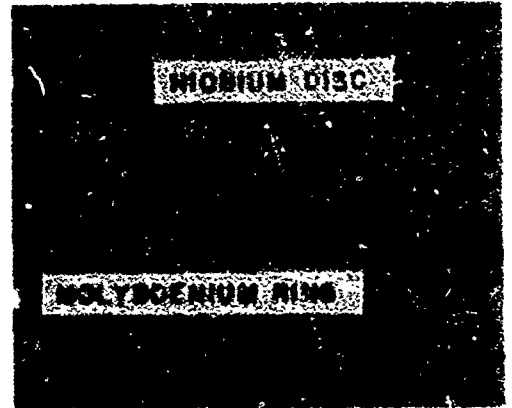
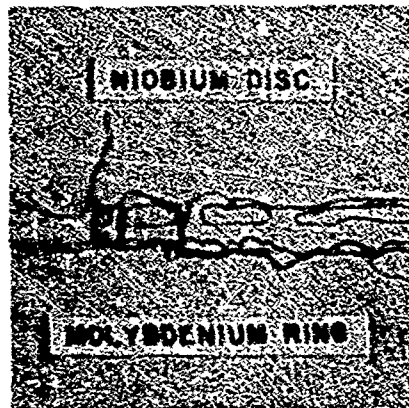

Before (250X) After  
2 CNM brazed approx. 1300°C, 2 min., .0005-inch nickel shim

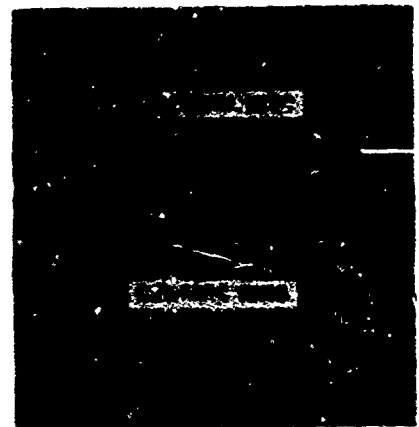

Before After  
1 CNA brazed approx. 1200°C, 10 min., .0005-inch nickel shim

Remarks: No apparent attack. Note change in microstructures due to the prolonged holding at the test temperature.

Figure III-42

Summary Data Sheet of Cesium Attack for Nickel Brazed Niobium to Molybdenum and Metallized A-976

Test No. 27

Material: Molybdenum to molybdenum brazed with standard Nicrobraz,  
Nicrobraz 150, Nicrobraz 60 and GE J8400

Conditions: 1000°C, 20 Torr cesium pressure

Hours Tested: 500

Microstructures (250X)

Etch: 4-1/2 H<sub>2</sub>O, 4-1/2 HNO<sub>3</sub>, 9 Lactic 1 HF

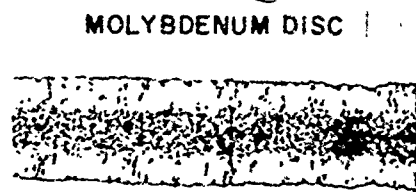

MOLYBDENUM RING

Before

1M60M - brazed 1120°C, 1 min.,  
Nicrobraz 60

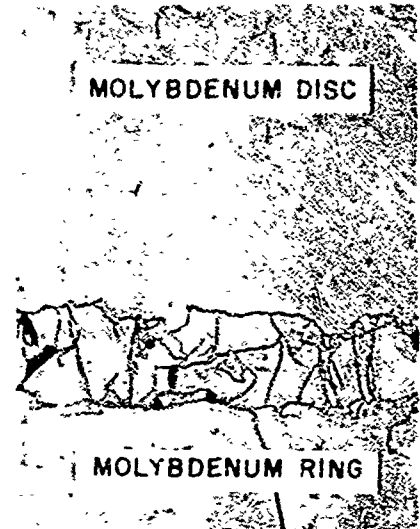

MOLYBDENUM RING

After

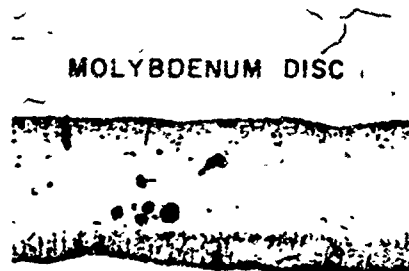

MOLYBDENUM RING

Before

1M84M - brazed 1200°C, 30 sec.,  
GE J8400 braze



MOLYBDENUM RING

After

Remarks: No apparent attack. Note formation of very brittle (cracked) intermetallic compounds from testing. Specimen brazed with Standard Nicrobraz similar to 1M60M and specimen brazed with Nicrobraz 150 similar to 1M84M after testing.

Figure III-43

Summary Data Sheet of Cesium Attack for Molybdenum to Molybdenum  
Brazed With Nickel and Cobalt Base Brazes

Test No. 29

Material: Ultra-high temperature brazes: AS 501, Ti-30 w/o V,  
AS 514, V-35 Nb, AS 540, 60V - 30 Nb - 10 Ti, AS 546  
60V - 30 Nb - 10 Zr, AS 547, 59V - 29 Nb - 10 Zr - 2 Si

Test Conditions: 1000°C, 20 Torr cesium pressure

Hours Tested: 500

Appearance (2X)

Before



After



	AS 501	514	540	546	547	
Weight:	0.5193 g	0.2323 g	0.5535 g	0.8200 g	1.5055 g	Before
	0.5224 g	0.2325 g	0.5539 g	0.8201 g	1.5056 g	After

Microstructures (100X)

AS 501



Before



After

(contd on next page)

Test No. 29 (contd)

Before

After

AS 514

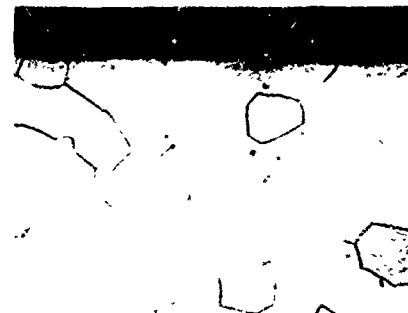

AS 540

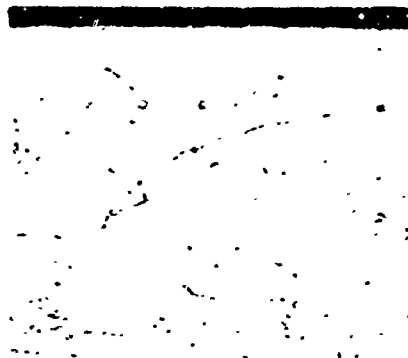

AS 546

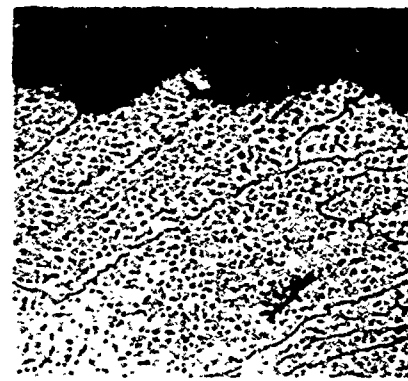

AS 547

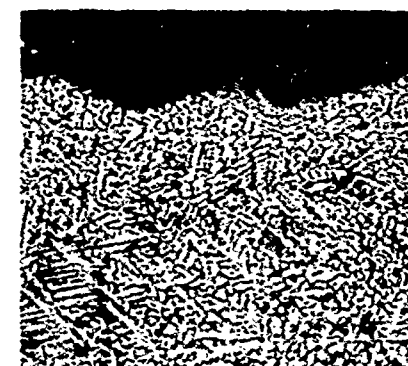

Remarks: AS 501 reacted with pallet, no Cs attack, recrystallized -  $\alpha$  Ti precipitated on cooling. AS 514 no attack - recrystallized. AS 540 no attack - recrystallized. AS 546 no attack - possibly some solutioning of network phase. AS 547 no attack - no apparent change in structure.

Figure III-44

Summary Data Sheet of Cesium Attack for Ultra-High Temperature Brazes

Test No. 30

Material: LT-1 Cermet, 77 w/o Cr, 23 w/o Al<sub>2</sub>O<sub>3</sub>

Test Conditions: 1000°C, 20 Torr cesium pressure

Hours Tested: 1000

Appearance (approx. 2X)

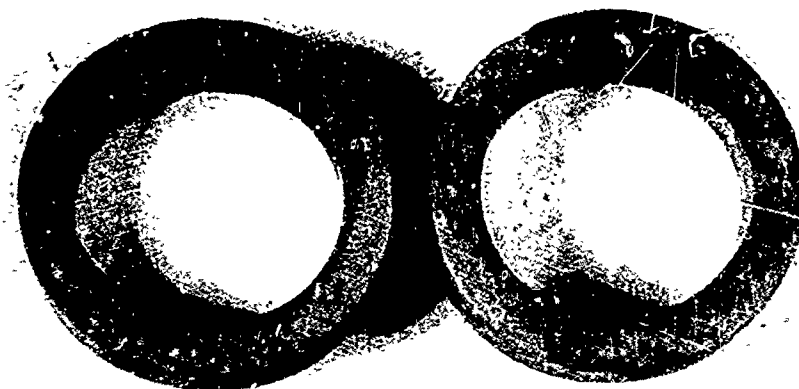

Weight:

After  
Specimen 3  
6.2572 g  
6.2721 g

After  
Specimen 4  
7.2195 g Before  
7.2416 g After

Microstructure (500X)

Etch: 10 HCl, 90 methyl  
alcohol, 6 VDC

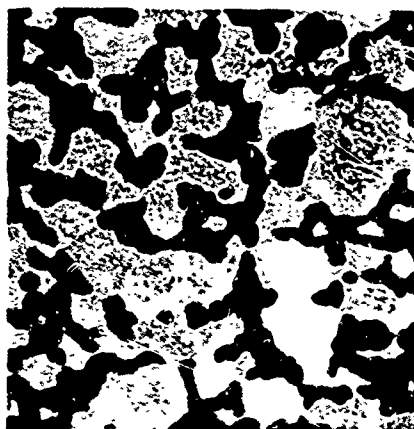

Before

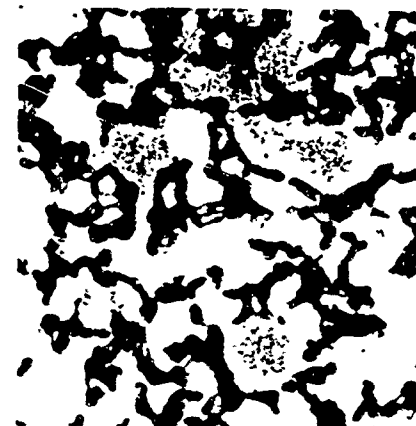

After

Remarks: Specimens turned from metallic gray to bluish gray from testing.  
Sweating of specimens after testing indicated bleeding of cesium.  
Note apparent increase in porosity of microstructure from testing.

Figure III-45

Summary Data Sheet of Cesium Attack for LT-1 Cermet

Test No. 32

Material: H-1 metallizing on A-976 and Coors AD995 alumina ceramics

Test Conditions: 1000°C, 20 Torr cesium pressure

Hours Tested: 500

Appearance (approx. 2X) Coors AD995

See Test No. 14 for appearance of H-1 metallizing on A-976



Weight:

After Single Coat  
Specimen CS-5  
1.5598 g  
1.5598 g

After Double Coat  
Specimen CD-5  
1.5704 g Before  
1.5704 g After

Microstructure (250X)



After Coors AD995



After A-976

Remarks: No attack of either ceramic or of H-1 metallizing on either ceramic. Specimens brazed together with Cu-Au before sectioning. Double coating of metallizing on ceramics on left, single on right.

Figure III-46

Summary Data Sheet of Cesium Attack for H-1 Metallizing on A-976 and Coors AD995 Alumina Ceramics

Test No. 33

Material: Molybdenum-Alumina Cermet from this program and  
Diffusion bonded Mo to Mo using palladium interleaf

Test Conditions: 1000°C, 20 Torr cesium pressure

Hours Tested: 500

Microstructure (250X)

Etch: 80 cc H<sub>2</sub>O, 10 g CuSO<sub>4</sub>, 20 cc NH<sub>4</sub>OH

Mo Disc



Mo Ring



	Before	After	
Weight:	Specimen 5 Pd	Specimen 4 Pd	
		7.0851 g	Before
		7.0850 g	After

Both seals formed by holding clamped at 1200°C for 5 hours in vacuum using .0002-inch palladium

Remarks: No signs of attack on cermet or Pd diffusion bond. Both specimens still leak tight. Cermet discussed under Multilayered Cermets section of this report. Pores due to faster diffusion of Pd into Mo than Mo into Pd.

Figure III-47

Summary Data Sheet of Cesium Attack for Molybdenum-Alumina Cermet and Diffusion Bonded Mo to Mo Using Palladium Interleaf

Test No. 34

Material: Nickel brazed niobium and molybdenum discs to H-1  
metallized A-976 ceramic

Test Conditions: 1000°C, 20 Torr cesium pressure

Hours Tested: 500

Microstructures (250X)

Etch: 30 Lactic, 30 HNO<sub>3</sub>, 3 HF

Nb Disc

Metallizing

A-976 Ceramic

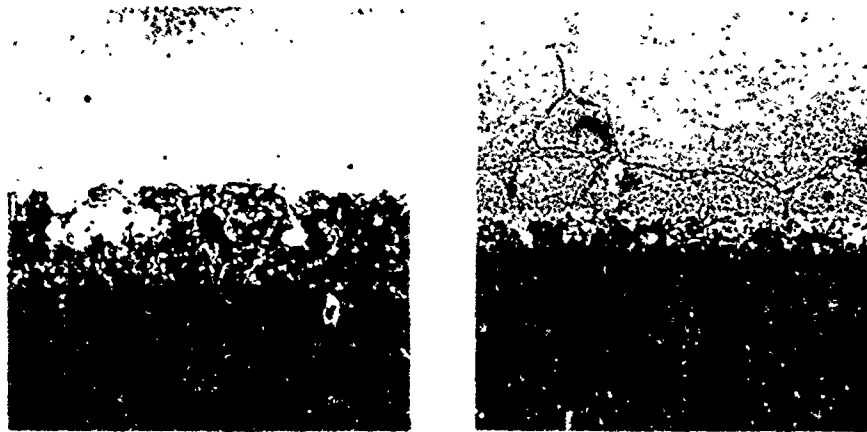

Before Specimen 9 CNA After Specimen 7 CNA

Brazed at approx. 1420°C for 5 min., with .0001 inch nickel  
Metallizing on 9 CNA initially thicker than on 7 CNA

Mo Disc

Metallizing

A-976 Ceramic

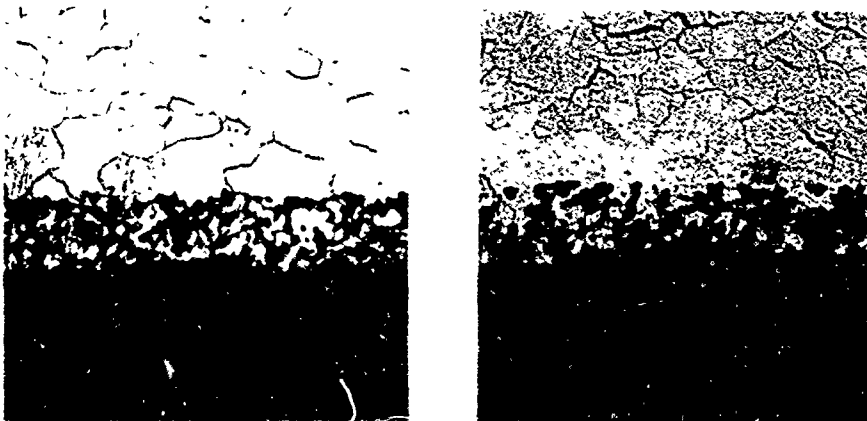

Before Specimen 5 MNA After

Brazed at approx. 1480°C for 5 min., with .0001 inch nickel

Remarks: No apparent attack on any of the specimens. Specimens 7 CNA,  
8 CNA, (Nb) 4 MNA and 6 MNA (Mo) all leak tight after testing.  
Note nil change in Mo specimen and precipitation of another  
phase in Nb specimen.

Figure III-48

Summary Data Sheet of Cesium Attack for Nickel Brazed Niobium  
and Molybdenum-to-Metallized A-976 Ceramic



Test No. 35

Material: 60-40 w/o Palladium-nickel brazed Mo, Nb, and Ta discs  
to H-1 metallized A-976 ceramic

Test Conditions: 1000°C, 20 Torr cesium pressure

Hours Tested: 500

Microstructure (250X)

Etch: 30 Lactic, 30 HNO<sub>3</sub>, 3 HF

Nb Disc

Metallizing

A-976 Ceramic

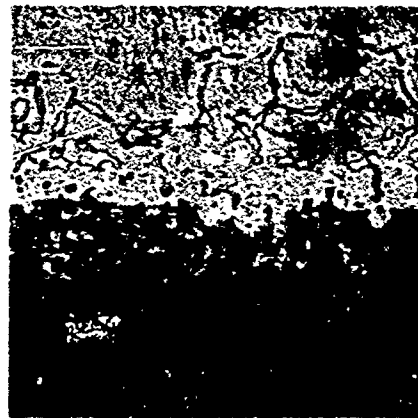

Before

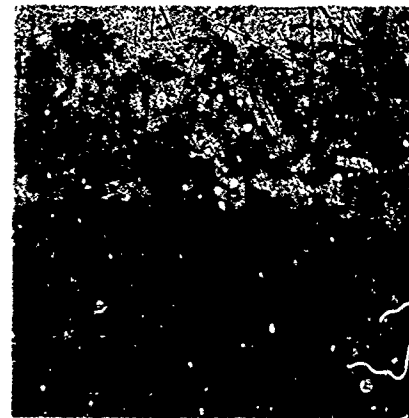

After

Brazed approx. 1410°C for 2 min.

Weight: All specimens showed nil weight change

Remarks: No apparent attack of any of the specimens. Specimen 2C6-4A still vacuum tight after test. Both molybdenum and tantalum specimens leaked after testing due to almost no flow of braze into joint. Note formation of another phase in the phase that penetrates the niobium.

Figure III-49

Summary Data Sheet of Cesium Attack for 60-40 Palladium-Nickel Brazed Mo, Nb, and Ta to A-976 Ceramic

CHAPTER III  
REFERENCES

1. M. J. Slivka, R. H. Bristow, and M. D. Gibbons, General Electric Company, "Vapor Filled Thermionic Converter Materials and Joining Problems; Plasma Research Pertinent to Thermionic Converter Operation." Final Technical Summary Report, Contract NObs-86220, 1962.
2. W. B. Hall and J. J. O'Grady, Radio Corporation of America, "The Development of an Auxiliary Electrode Thermionic Converter," AF 33(657)-8005, 1962.
  - a. Third Quarterly Technical Report 1962.
  - b. Fourth Quarterly Technical Report, 1962.
3. D. W. Levinson, "Seal and Insulator Problems in Thermionic Converters," Summary Report, NONR-33(00), 1962.
4. R. E. Cowan and S. D. Steppard, Los Alamos Scientific Laboratory, "Ceramic Materials for Nuclear Thermionic Converters." Paper presented at 65th Annual Meeting of the American Ceramic Society, 1963.
5. Dr. E. Feingold, General Electric Company, "The Attack by Cesium Vapor on Impure Alumina Bodies at Temperatures up to 1500°C," Final Report, AF 49(638)-1092, 1962.
6. S. S. Cole and G. Scherrer, "Glass-Migration Mechanism of Ceramic-to-Metal Seal Adherence," J. Am. Cer. Soc., 44, No. 6, p. 265, June 1961.
7. L. Reed et al, Eitel-McCullough, Inc., "Metallurgical Research and Development for Ceramic Electron Devices," Second Quarterly Report, Contract DA 36-039 SC-90903, 1962.
8. L. Navias, General Electric Research Laboratory, "Attempts to Diffuse Oxides Other than MgO into Sapphire ( $Al_2O_3$ )," Report 61-RL-2807M, August 1961.

9. R. H. Bristow, R. D. Hanna, and K. P. Zeman, General Electric Company, "Ceramic-to-Metal Seal Development for High Temperature Cesium Vapor Environments," Semiannual Report, Contract NObs-88578, 1963.
10. J. R. Tinklepaugh and W. B. Crandall, editors, "Cermets." Reinhold Pub. Co., 1960.
11. Tinklepaugh, ibid, Chapter 5, "Alumina-Metal Cermets," T.S. Shevlin, p. 97.
12. Tinklepaugh, ibid, Chapter 5, "Chromium-Aluminum Base Cermets," C. L. Marshall, p. 109.
13. A. E. S. White and Dr. W. Brown, British Patent 844, 773.
14. H. C. Dunegan, "A Study and Evaluation of Producing a Ceramic-to-Metal Seal by Pressed Powder Techniques for Automatic Mass Production," Contract AF 33(600)-27329, 1956.
15. J. E. Beggs, U.S. Patent No. 2,857,663. "Sealing Metal and Ceramic Parts by Forming Reactive Alloys," IRE Transaction Component Parts, 4, pp. 28-31 (March 1957).
16. Bendix Corp., "Ceramic to Metal Seals for High-Temperature Thermionic Converts," Second Quarterly Technical Report, Contract AF 33(657)-10038 (DDC AD-402679), 1963.
17. Narmco Research & Development, Telecomputing Corp., "Alumina Radome Attachment; Part 1 - Chemical Bonding," TDR No. ASD-TDR-62-545, Part I, Contract AF 33(616)-8157, 1963.
18. J. P. King and R. R. Janssen, North American Aviation, Inc., "Diffusion Bonded Honeycomb Sandwich Panels," Interim Engineering Progress Report, Contract AF 33(657)-8788 (ASTIA AD-405758), 1963.
19. A. G. Metcalfe, et al, Solar, "Diffusion Bonding of Refractory Metals," Interim Technical Documentary Report 3, Contract AF 33(657)-8789 (ASTIA AD-404262), 1963.

20. Defense Metals Information Center, Battelle Memorial Institute, "Binary and Ternary Phase Diagrams of Columbium, Molybdenum, Tantalum, and Tungsten," DMIC Report 152 (OTS PB 171421), p. 41, 1961.
21. W. R. Young and E. S. Jones, General Electric Company, "Joining of Refractory Metals by Brazing and Diffusion Bonding," TDR No. ASD-TDR-63-88, Contract AF 33(616)-7484 (ASTIA AD-299711), 1963.
22. Defense Metals Information Center, op. cit., p. 41.
23. Max Hansen, "Constitution of Binary Alloys." McGraw-Hill Book Co., Inc., Second Edition, p. 1011, 1958.
24. Hansen, ibid., p. 1046.
25. Defense Metals Information Center, Battelle Memorial Institute, "Brazing and Bonding of Columbium, Molybdenum, Tantalum, Tungsten, and Graphite," Contract AF 33(616)-7747 (ASTIA AD-278193), 1962.
26. W. R. Young, General Electric Company, "Alloy Systems for Brazing of Columbium and Tungsten," TDR No. ASD-TDR-61-592, Contract AF 33(616)-7484 (ASTIA AD-273693), 1962.
27. J. W. Welty, Solar, "Joining of Refractory Metal Foils," Quarterly Progress Report 3, Contract AF 33(657)-9442 (ASTIA AD-402713), 1963.
28. Defense Documentation Center, AD 293756, "Development of Brazing Alloys and Techniques for Joining Refractory Alloys and Ceramics."
29. Private communication with W. R. Young, 1963.
30. L. Feinstein, Stanford Research Institute, "Investigations of Electron Device Materials Technology Studies," Final Report, Contract 19(604)-7323 (ASTIA AD 264459), 1961.

31. Foreign Technology Division, Air Force Systems Command, Wright-Patterson Air Force Base, Ohio, FTD-TT-63-266, "New Thermomdiffusion Data on the Chromium-Molybdenum System," D. A. Prokashkin and O. I. Sidunova.
32. Bendix Corp., "Ceramic to Metal Seals for High-Temperature Thermionic Converters," Final Report, Contract AF 33(657)-10038 (DDC AD-402679), 1963.
33. Narmco Research and Development, Telecomputing Corp, "Alumina Radome Attachment; Part I - Chemical Bonding," Semiannual Report, Contract AF 33(616)-8157.
34. C. W. Fox, R. G. Gilliland and G. M. Slaughter, Metals and Ceramics Division, Oak Ridge National Laboratory, "Development of Alloys for Brazing Columbium," Welding Research Supplement, American Welding Society, December 1963.
35. C. R. Dulgeroff and G. D. Seele, Rocketdyne, "Experimental Electrical Propulsion Study," Final Report, Contract AF 49(638)-351 (DDC AD-243217), 1960.
36. W. T. Chandler and N. J. Hoffman, Rocketdyne, "Effects of Liquid and Vapor Cesium on Container Metals," TDR No. ASD-TDR-62-965, Contract AF 33(616)-8435 (DDC AD-405432), 1963.
37. R. G. Carlson, General Electric Company, "Corrosion Studies of Columbium-1% Zirconium Weld Material in Potassium," General Electric Technical Information Series No. R63FPD200, 1963.
38. National Aeronautics and Space Administration, "NASA-AEC Liquid-Metals Corrosion Meeting," December 7-8, 1960, Washington, D. C., NASA TN D-769, 1961.
39. R. G. Carlson, et al, General Electric Company, "Evaluation of a High Strength Columbium Alloy (AS-55) for Alkali Metal Containment," Interim Report for Nov. 25, 1961 to July 25, 1962, NASA Contract NAS3-2140, 1962.

40. Dr. E. Feingold, General Electric Company, "IV. The Attack by Cesium Vapor on Impure Alumina Bodies at Temperatures up to 1500°C." ASTIA AD-284958.
41. A. I. Kaznoff and E. W. Hoyt, General Electric Company, "Section V - Cesium Compatibility with Selected Thermionic Emitter Materials," General Electric Co. Report GEST-2009.
42. D. J. Maykuth, H. R. Ogden, and R. I. Jeffee, Battelle Memorial Institute, "The Effects of Alloying Elements in Titanium, Volume A: Constitution," DMIC Report 136A, 1960.