

UNCLASSIFIED

AD NUMBER

AD595766

CLASSIFICATION CHANGES

TO: unclassified

FROM: restricted

LIMITATION CHANGES

TO:
Approved for public release; distribution is unlimited.

FROM:
Distribution authorized to DoD only; Foreign Government Information; JAN 1972. Other requests shall be referred to British Embassy, 3100 Massachusetts Avenue, NW, Washington, DC 20008.

AUTHORITY

DSTL ltr dtd 15 Feb 2007; DSTL ltr dtd 15 Feb 2007

THIS PAGE IS UNCLASSIFIED

JOURNAL
OF THE
ROYAL NAVAL
SCIENTIFIC SERVICE



20090126 063

R100
V277

Vol. 27 100,157 *

JANUARY 1972

*

No. 1

RESTRICTED

157
#1
72
(1)

This information is released by the U.K. Government to the recipient Government for defence purposes only. This information must be accorded the same degree of security protection as that accorded thereto by the U.K. Government. This information may be disclosed only within the Defence Departments of the recipient Government, except as otherwise authorized by the Ministry of Defence. This information may be subject to privately owned rights.

AD-595766

PICATINNY ARSENAL
SCIENTIFIC AND TECHNICAL INFORMATION BRANCH

Journal of the

Decl OADR

ROYAL NAVAL

Volume 27

SCIENTIFIC SERVICE

Number 1

January 1972

EDITORIAL BOARD

CHAIRMAN: Mr. N. L. Parr
Director of Research/
Materials 1

Mr. H. L. R. Hinkley
Defence Research Information
Centre

Mr. R. V. Alred
Directorate of Naval Research
and Development

Mr. D. J. Strong
Staff of Scientific Adviser
Director General Ships

Mr. V. H. Taylor
Assistant Director
Admiralty Underwater Weapons
Establishment

Mr. J. W. Snowdon
CM(S)N
Scientific Careers

Dr. B. W. Soole
Admiralty Research
Laboratory



RESTRICTED

CONTENTS

SPECIAL FEATURES

The Saclant Anti-submarine Warfare Research Centre, La Spezia, Italy. <i>By J. P. Bethell, B.Sc., M.Sc., F.R.G.S.</i>	2
Marine Anti-Fouling. <i>By D. R. Houghton, B.Sc., M.I.Biol., R.N.S.S.</i>	8
Production of Prototype Hybrid Micro-Electronic Modules, using Thin Film Substrates. <i>By H. R. Purchase, R.N.S.S.</i>	13
Resistance Loading of Large Electrical Power Sources. <i>By C. K. Aked, A.M.I.E.E., R.N.S.S.</i>	17
A History of the Torpedo, Parts 1 and 2. <i>By G. J. Kirby, B.Sc., F.R.A.S., R.N.S.S.</i>	30
An Apparatus for Fatigue Testing Materials at Ultrasonic Frequencies. <i>By Instructor Lieutenant Commander G. C. George, M.Sc., R.N. and Instructor Lieutenant Commander R. Daw, B.Sc., R.N.</i>	56

RETIREMENTS

J. Grensted	16
S. Bolshaw	29
F. R. W. K. Mansell	61
J. Ray	66
P. T. W. Bakcr	68
C. E. Poole	72

NOTES AND NEWS

A.E.L. - A.E.W. - A.M.E.E. - A.M.L. - A.O.L. - A.S.W.E. - A.U.W.E. - C. D. L. - D.C.V.D. - D.N.O.R. - N.A.M.L. - S.E.R.L. - S.V.T.L.	61
--	----

BOOK REVIEWS

.....	73
-------	----

R 100/157

THE SACLANT ANTI-SUBMARINE WARFARE RESEARCH CENTRE, LA SPEZIA, ITALY

J. P. Bethell, B.Sc., M.Sc., F.R.G.S.

*Head of Scientific and Technical Information,
SACLANTCEN*

Introduction

In recent years NATO's anti-submarine warfare research centre in La Spezia, Italy, has become increasingly better known to members of the Royal Navy and Royal Naval Scientific Service. Apart from the British contribution to the civilian research, support and administrative staff of the Centre, and the succession of Royal Navy officers who have been attached as "Programme Officers", past years have seen an increasing number of British visitors to discuss scientific problems or to attend the frequent scientific conference held there. Nonetheless, the purpose and programme of the SACLANT ASW Research Centre, or SACLANTCEN as it is commonly called, merits wider dissemination in naval research circles if full advantage is to be taken of the Centre's existence.

Purpose

The Centre was established 12 years ago to perform

- (a) Operations research and analysis, including the application of scientific expertise to the problems encountered by naval commanders in combining the ASW resources of the NATO nations into an effective fighting force.

- (b) Research, studies and investigations to improve the performance of ASW detection, classification and identification systems.
- (c) Oceanographic research, studies and investigations in direct support of the ASW tasks listed above.

In the *Journal of the Royal Naval Scientific Service* it is unnecessary to elaborate on the nature of anti-submarine warfare or on the reasons for research into methods of improving its effectiveness: the closely-fought scientific battles of two World Wars emphasize the need for continuing these efforts in the light of constantly increasing Soviet submarine power. The question that can more profitably be answered is why NATO has its own research centre when there are many national research laboratories in the NATO nations. The answer is that one of the main purposes for establishing SACLANTCEN was to assist NATO's Supreme Allied Commander Atlantic (SACLANT) in his specific ASW problems by providing an exchange centre for the various lines of research being pursued nationally. In addition, an internationally-staffed centre would be able to attract some of the scientific capabilities within the NATO nations (especially the smaller ones) that would not otherwise be directed towards ASW.

History

The SACLANT ASW Research Centre was first established as the result of an exploratory visit by members of the U.S. Naval Research Advisory Committee to Canada, Denmark, France, Germany, Italy, The Netherlands, Norway and the United Kingdom, during which agreement was reached to co-ordinate ASW research by pooling data and personnel. Of the offers made for laboratory space, the Italian offer to provide facilities within the naval base at La Spezia was accepted as the most suitable because La Spezia's climate and position on the Italian Riviera permits experiments in both deep and shallow water throughout the year.

In June 1958 the Supreme Allied Commander Atlantic approved the formation of such a research centre and, because of the urgent need, the U.S. Secretary of Defence agreed to provide the necessary funds until agreement for NATO multi-national funding could be obtained. During a 4-year interim period the Centre was organized under a SACLANT "Deputy" by SIRIMAR, an Italian non-profit company managed first by the Raytheon Company (U.S.) and later by the Pennsylvania State University. At the end of this period, on 1st February 1963, SACLANTCEN was established as a NATO International Organization.

Organization

In its present form the Centre is managed for SACLANT by its Director, assisted by a Deputy Director and by a Naval Adviser appointed by SACLANT. His senior staff comprise the Group Leaders of the five research groups and the Heads of the administrative and support divisions.

The present Director is Ir M. W. van Batenburg, previously Deputy Director of the Physics Laboratory of the Netherlands National Defence Research Organization. His Deputy Director, who joined SACLANTCEN last summer, is Mr. A. W. Pryce, recently Director of Research at the U.S. Office of Naval Research; Mr. Pryce was a physicist in the Royal Naval Scientific Service from 1940 to 1951 before becoming a U.S. citizen.

In the scientific direction of the Centre, the Supreme Allied Commander Atlantic is assisted by the SACLANTCEN Scientific Committee of National Representatives, which reviews the proposed scientific programme and the annual report and provides scientific and

technical advice. The Committee, which meets in La Spezia twice a year, is formed of leading ASW scientists from each of the nations. The representative of the United Kingdom is Mr. A. W. Ross, O.B.E., Chief of Naval Research. In the routine relations between the Centre and the nations—such as obtaining personnel, equipment and classified documents—the Director is assisted by National Liaison Officers in the Ministries of Defence. The U.K. liaison officer to SACLANTCEN is Mr. H. W. K. Kelly, M.B.E., of the Department of Naval Physical Research.

SACLANTCEN's annual scientific programme is drafted by the Director and his senior staff at the beginning of the preceding year, staying within the broad frame of a five-year plan and incorporating proposals forwarded by the nations and the NATO maritime commands. In May the draft is reviewed for SACLANT by the Scientific Committee of National Representatives, which hears a full justification of the proposed programme from each Group Leader. The draft, with the Committee's amendments is then sent to SACLANT for his approval and submission to the NATO Defence Planning Committee—the ambassadors of the fourteen NATO countries participating in the military part of the alliance. With the annual programme the Defence Planning Committee also receives an annual budget approved by the NATO Military Budget Committee (representatives of the nations' financial authorities), which authorizes SACLANTCEN to spend the necessary funds. At the end of each year's work an annual report is submitted by the Director through the same channels.

Research Programme

The work of the programme is divided between five scientific groups. Passing from the studies of the ASW environment to those of ASW application, the Groups cover Oceanography, Sound Propagation, Target Classification and Operations Research. The fifth group—Theoretical Studies—concerns itself with special mathematical problems and computer applications. It is specifically intended, however, that the work should not be too strictly divided, and the particular atmosphere of SACLANTCEN has in fact always ensured an easy interchange of ideas between the various projects. At present the Groups are engaged in projects that cover the following items.

Oceanography Group. The variabilities of parameters in the upper ocean that are most likely to influence sonar operation. The influence of meteorology on those parameters. Optimum methods of sampling those parameters so as to predict acoustic transmissions. The bottom and sub-bottom structure as inputs to an acoustic model. The scattering of sound by biological phenomena (DSL).

Sound Propagation. Development of sonar techniques applicable to the special conditions of sound propagation in (a) deep water and (b) shallow water. The degradation of information in underwater signals caused by the random character of the propagation medium and its boundaries. The investigation of propagation techniques by simulation models. The development of advanced digital techniques of data analysis as a working tool for the other projects.

Target Classification. Development of classification techniques that can be applied to existing and proposed sonar systems. Studies of the use of the reliable acoustic path by means of an experimental deep sonar system.

Operations Research. Studies that will assist in the better utilization of ASW units and equipment. Studies of ASW aspects of NATO exercises. Evaluation of the operational significance of concepts studied by the other Groups.

Theoretical Studies. Development of a unified acoustic propagation model. Methods of calculating acoustic energy when ray theory fails. Problems in the statistical theory of signal detection.

In addition, SAACLANTCEN has undertaken the processing and analysis of data from the 1970-71 oceanographic-acoustic survey of the Norwegian Sea (MILOCSURVNORLANT) organized with NATO research ships by the Commander-in-Chief Eastern Atlantic (CINCEASTLANT) for the NATO Group on Military Oceanography. This three-year project forms part of the Oceanography Group.

STAFF

SAACLANTCEN's 57 scientific research staff—who are divided more or less evenly between the Groups—are drawn from all the NATO nations having naval forces, as shown in Table I.

TABLE I.
Nationalities of Research Staff at SAACLANTCEN

<i>Nation</i>	<i>Since 1 May 1959</i>	<i>On 1 July 1971</i>
Belgium	5	4
Canada	8	3
Denmark	8	3
France	11	5
Germany	9	2
Greece	1	0
Italy	15	8
Netherlands	12	5
Norway	16	7
Portugal	2	1
Turkey	1	1
U.K.	17	8
U.S.	30	10

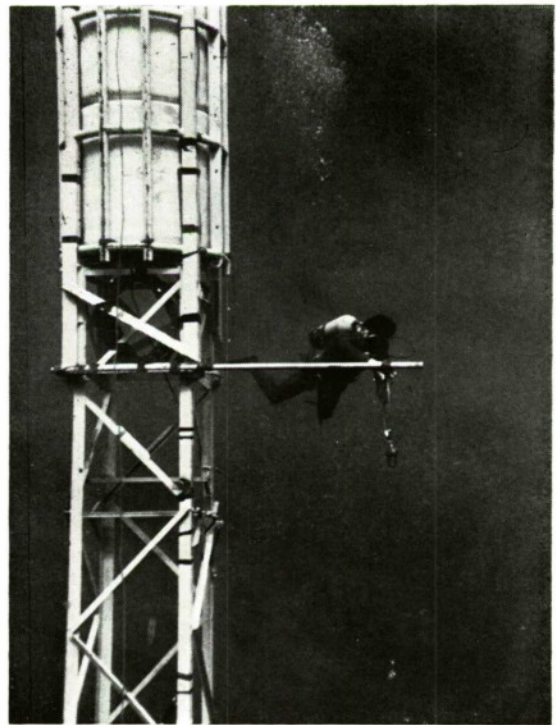

FIG. 1. A SAACLANTCEN oceanographer attaching underwater sensors to a 30-m long spar buoy used for measuring air/sea interaction parameters.

The research staff are selected—generally with the help of the members of the Scientific Committee of National Representatives—from national research establishments, universities or industry to satisfy particular requirements in the programme. Initial appointment is for three years, at a level determined by a scientific rating board; possible extensions of contract and upgradings depend on the requirements of the programme and the capabilities

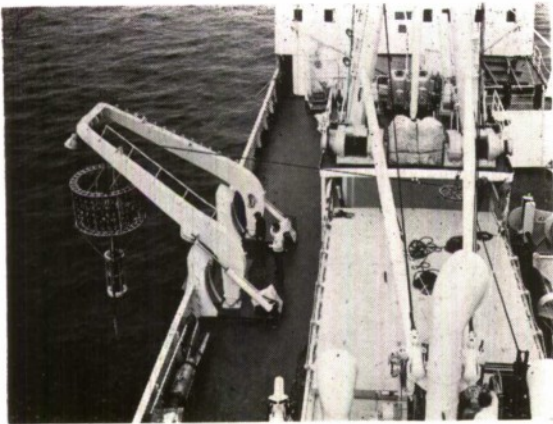

FIG. 2. Lowering an experimental deep sonar system from SACLANTCEN's research ship.

of the individual. The research staff generally hold the equivalent of an M.Sc. or Ph.D. degree. While some are chosen because of their long experience in a particular field, others come almost directly after their post-graduate studies. This, together with a turnover rate of about one research scientist a month, creates a valuable mixture of experience and capabilities within the Centre.

To supplement the scientific complement, to participate in NATO's policy of scientific exchange between the nations, and to identify potential staff for the future, SACLANTCEN awards grants to ten "Summer Research Assistants" to work on certain subjects for about three months each summer. These are post-graduate students selected from the universities by the members of the Scientific Committee of National Representatives. Their contributions—especially in such rapidly-developing subjects as computer applications—are often significant.

Although SACLANTCEN is primarily staffed by civilians, its purpose is directed to military ends and it is appropriate that there should be a leavening of naval staff within it. Primarily this is provided by the Naval Adviser and three "Programme Officers" who each have personal knowledge of one of the elements of ASW operations. The Naval Adviser is always a Commander of the U.S. Navy and the other NATO nations take turns in appointing the three Programme Officers; at present the latter are a submarine commander of the Royal Netherlands Navy, a destroyer commander of the Hellenic Navy and an ASW helicopter-quadron commander of the Royal Navy. Financial matters are admin-

istered by a financial officer on loan from the Italian Navy and an officer of the U.S. Navy Supply Corps. Security is the responsibility of an Italian naval officer and a guard force of Carabinieri. Recent years have also seen a regular succession of Instructor Commanders of the Royal Navy's Meteorological and Oceanographic Service, who have spent three to six months with the Oceanographic Group to familiarize themselves with the type of work being conducted at the Centre.

Apart from the direction of the Finance Division, mentioned above, the administrative and support services of the Centre are performed by a civilian staff of 172, comprising 150 Italians, 17 British and one each from Belgium, Denmark, Germany, The Netherlands and Norway. Such staff generally hold permanent or renewable contracts.

Facilities

SACLANTCEN is housed within the grounds of the Italian Navy's Weapon Research Establishment alongside the naval base at La Spezia. The main building houses offices, library and conference rooms on the upper floor and computer rooms, laboratories, drawing office and workshops on the lower floor and the mezzanine. Plans are ready for an extension wing to be added to the main building to ease the present overcrowding.

The computer facilities at present consist of an Elliott 503 with Honeywell DDP 516 satellite for scientific computation, and three Hewlett Packard 2116B data acquisition systems (one of which is on the research ship) for on-line application and interactive time-series analyses. Negotiations are at present proceeding to replace the Elliott computer with a computer of a later generation. In addition to the usual magnetic tape handlers, line printers and plotters, the computer peripherals include Fast Fourier Transform consoles and light-pen displays.

For its research vessel SACLANTCEN has always chartered a merchant ship: the s.s. *Aragone* of 2200 g.r.t. between 1959 and 1964, and now the m.v. *Maria Paolina G.* of 2000 g.r.t. The *Maria Paolina G.* has accommodation for 16 scientific and technical staff in addition to her regular crew of 24. Her cargo holds have been converted to three spacious air-conditioned laboratories and a power-generator room. The forward laboratory contains a large well for the lowering of a transducer plate or other underwater equip-

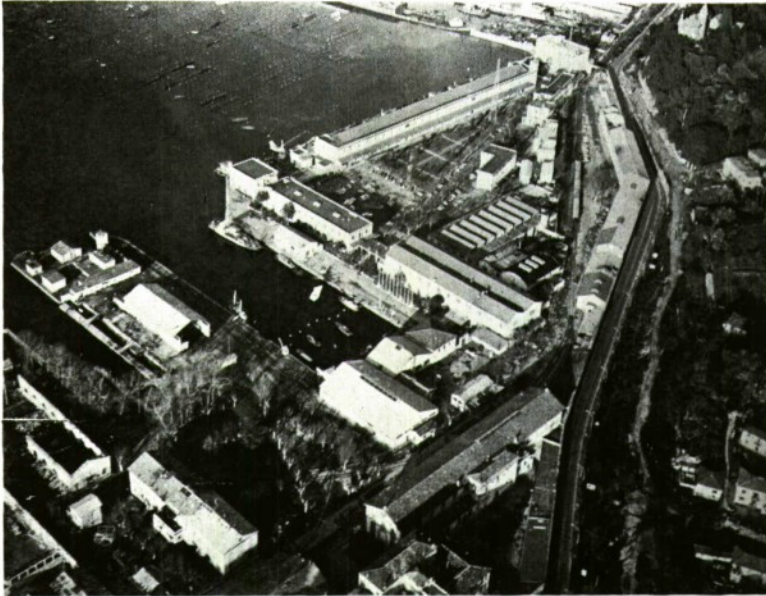

FIG. 3. SACLANT ASW Research Centre from the air.

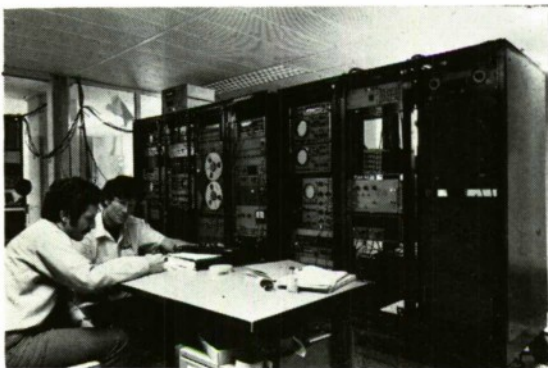

FIG. 4. A Belgian and a U.S. scientist working on target classification problems in a SACLANTCEN laboratory.

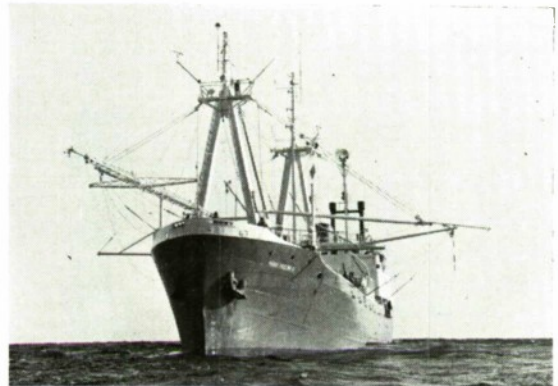

FIG. 5. SACLANTCEN's Research Vessel Maria Paolina G. at sea during a research cruise.

ment. The inboard midships laboratories are a navigation laboratory, which contains C-band and X-band radars, LORAN-A and LORAN-C receivers and a rented satellite navigator unit, and an experimental laboratory that holds racks of whatever experimental equipment is being carried aboard at the time. The experimental laboratory also houses the shipboard computer. On the deck above these laboratories there is a "wet" oceanographic laboratory for the analysis of hydrographic casts. Extra booms, A-frames and special winches installed at several points about the ship permit the handling of a variety of types of large underwater equipment. An active rudder allows the ship to be steered at speeds down to half a knot.

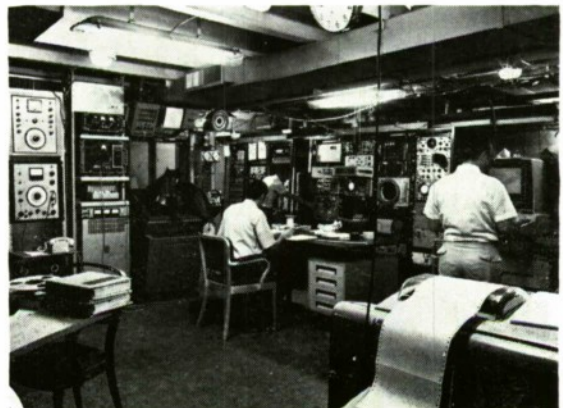

FIG. 6. The experimental laboratory aboard SACLANTCEN's research ship. The computer installation is on the right.



FIG. 7. One of the conferences held at SACLANTCEN. The Director, Ir M. W. van Batenburg is seated behind the NATO flag.

The research ship averages 170 days a year at sea and another 100 in preparations and equipment tests in harbour. For small-scale experiments in and around the Gulf of La Spezia the Centre owns a converted air/sea rescue launch. For calibration work, use is made of a barge moored on a local lake.

In addition to the services of its own research ship and workboat, SACLANTCEN receives considerable assistance from the NATO navies for performing experiments at sea. This is usually by the loan of submarines to serve as targets or of minesweepers to assist on the surface, but cruisers, research or survey ships and aircraft have also been provided for special purposes. A recent development is the use of Italian naval helicopters from a nearby NATO base for the rapid dropping of explosive charges at varying ranges from the research ship. The contributions of the navies in this way are indicated by the ship plaques in the entrance hall of SACLANTCEN; these include those of H.M. Submarines *Opossum*, *Otter*, *Turpin*, *Valiant* and *Walrus*, of H.M. Frigate *Aurora* and of H.M. Despatch Vessel *Surprise*.

Publications and Conferences

It has often been said that the output of a research centre such as SACLANTCEN—which is not responsible for the design or production of any hardware—can only be in the form of the written or spoken word. SACLANTCEN's production of 200 Technical

Reports, 170 Technical Memoranda and about 75 other scientific documents has been widely distributed to all the NATO Ministries of Defence—for redistribution to national commands, laboratories and document services—and to NATO maritime commanders. In the United Kingdom they are available from the Defence Research Information Centre. A bibliography of unclassified documents, and copies of the documents themselves, may be obtained from SACLANTCEN.

In recent years SACLANTCEN has taken advantage of its international character and—dare one say it—of its attractive location, to bring together scientists from NATO nations for working-level conferences on pertinent issues. So far the subjects have been: The Reliable Acoustic Path, Bottom Reflection, Scattering of Sound by the Sea Surface, Scattering of Sound by the Deep Scattering Layers, Digital Analysis Techniques, and Geometrical Acoustics. The great success of these conferences, which usually last three or four days and are each attended by from 30 to 50 scientists, suggests that SACLANTCEN is developing a new contribution to research studies within NATO.

Within the usual limits of security, the Director of SACLANT Anti-submarine Warfare Research Centre welcomes co-operation with scientists of the NATO countries and trusts that readers of the *Journal* will not hesitate to draw attention to common fields of interest.

MARINE ANTI-FOULING

D. R. Houghton, B.Sc., M.I.Biol., R.N.S.S.

Central Dockyard Laboratory Exposure Trials Station

David Houghton joined R.N.P.L. in 1950 after Army service in Singapore. Transferred to C.M.L. in 1951, educated at St. John's College, Portsmouth and attended Portsmouth Municipal College as a part-time student. On the closure of C.M.L. in 1957 he became Officer in Charge of Exposure Trials Station, Eastney and was promoted to Experimental Officer in 1960. Having obtained a London University External degree he was promoted (class to class) S.S.O. and in 1967 to his present grade of P.S.O.

Introduction The fouling problem is a very ancient one and probably dates from the first time that man ventured in primitive craft upon the waters of this planet. Despite the attempts, over the years, to control fouling, we are still far from an absolute answer. Even today the economic problem is not always fully realised, partly because of the difficulty in obtaining figures which represent the true loss that occurs in increased fuel consumption, loss of earnings and time spent in carrying out the remedial measures necessary and partly because ships come into dock for purposes other than restoring the effectiveness of the anti-fouling system. Nevertheless, estimations of the cost have been made and the following figures indicate something of the magnitude of the sums involved.

In the United Kingdom it has been estimated that £50,000,000 per annum is spent in extra docking fees and other associated costs and in an estimate originating from Norway the amount is stated to be about £10,000 a year for a 10,000 ton ship. Any increase in the effectiveness of antifouling measures would make a very significant contribution to the economic effectiveness of the shipping industry and to the navy.

With more and more industries turning to the sea to provide cooling water there is a problem in controlling fouling in seawater intakes. There is also the associated difficulty of preventing fouling from growing in seawater systems on board ship.

Ship Fouling

It is well known that any non-toxic surface, when exposed in coastal waters or harbours, will quickly become colonised by a number of plant and animal species. Barnacles, tubeworms (Figs. 1 and 2) sea-squirts (Fig. 3) and hydroids are the principal members of the macro-fauna. Among the algae, species of *Enteromorpha* (Fig. 4), *Ectocarpus*, *Ulva*, *Laminaria*, *Polysiphonia* and many others are frequently present in the fouling community. These organisms, on a ship, increase the skin frictional resistance of the hull causing a large increase in the fuel consumption in maintaining cruising speeds and rendering top speeds unattainable. Prevention is the real answer, either by poisoning the spores of algae and larvae of animal species so that they die before becoming too well established or by using a deterrent which prevents them from settling in the first place.

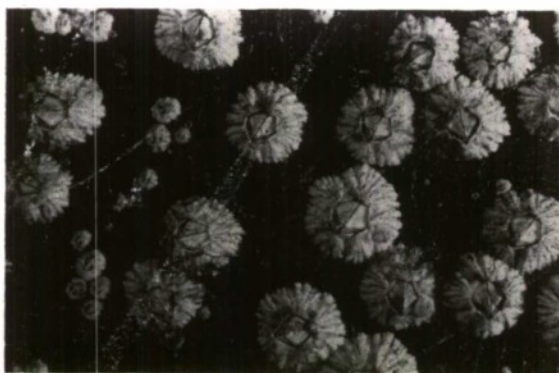

FIG. 1. Settlement of barnacles

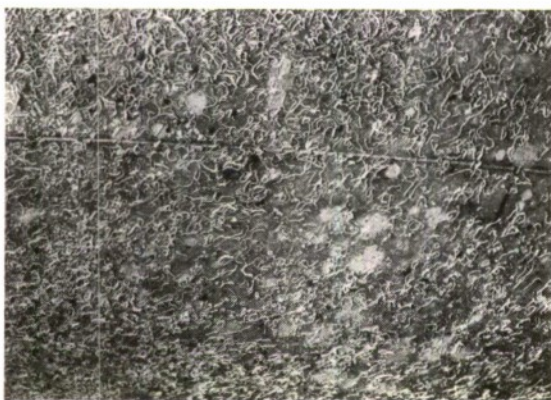

FIG. 2. Settlement of tubeworms



FIG. 3. Settlement of sea-squirts



FIG. 4. Settlement of green weed

The most successful means available for controlling fouling, at present, is by the use of antifouling paints; many of which employ cuprous oxide as the poison, sometimes with the addition of mercurial and other compounds. Organic materials are also being used either on their own or more frequently in conjunction with inorganic poisons.

Ships with a quick turn-round period do not need to be coated with antifouling paint. The species which have established themselves on the hull are unable to develop before being swept off when the vessel reaches higher speeds. The presence of weed on the water-line has been shown, in recent years, to be as important a factor in increasing the drag of the hull as comparable settlements of animal

larvae and in the case of tankers, fouling of the boot-topping area, which can be as much as 30-40ft. between the laden and unladen level, forms an important problem. This area is frequently colonised by algae—particularly by species of the green seaweed *Enteromorpha*. The special requirements of the tanker have been tackled with considerable promptitude by the paint trade and the comparatively new tri-butyl tin oxide has been used as the poison. Nature, however, is not so easily controlled as we should like and although TBTO is very effective against *Enteromorpha* species, those of the brown weed *Ectocarpus* appear to be little affected by this poison. In consequence other tri-butyl tin compounds in conjunction with more conventional poisons are now being evaluated for weed control.

There is a growing body of evidence which suggests that algal spores are capable of attaching to a surface over which water is moving at comparatively high speeds. The larvae of animal fouling species on the other hand are unable to settle on surfaces over which the water speed is two knots or more.

Fouling of Seawater Intakes

If seawater is passed through a system of pipes at high velocity, there is little or no risk of antifouling organisms settling in the system. In practice, however, there are always parts of the system through which the velocity is reduced or which are used only intermittently allowing fouling to accumulate. The materials used in the construction exclude light so that fouling by seaweeds cannot occur. The problem is therefore somewhat different from that of the fouling of the underwater hull.

The most important effects under these circumstances are first the restriction of flow because of the build up of settlements of barnacles, hydroids, polyzoans and in particular mussels (Fig. 5). Secondly, complete blockage of the pipes and/or valves may occur either by the growth of a large number of fouling organisms; by accumulation of shell from detached living mussels or by the shells of those which have died. This type of accumulation is particularly serious in seawater systems used for fire fighting purposes. Settlement of organisms in condenser tubes is also highly undesirable, because of the risk of impingement attack on the tubes resulting in their perforation. In large seawater intakes the settlement of barnacles and hydroids in most cases can be tolerated, unless the build



FIG. 5. Seawater pipes partially blocked with mussel fouling

up of shell is very pronounced. This is not so in the case of mussels where there is again the risk of the shell accumulating in large masses which may be torn away, thereby blocking the system.

Prevention of fouling in this situation is usually achieved by the use of sufficient quantities of chlorine. It is, however, a very expensive way of ensuring protection because continuous chlorination has to be maintained throughout the fouling season. More recently large intakes have been coated with comparatively long life antifouling paints with a fair measure of success, but smaller bore systems do not lend themselves to this treatment. Where metal pipes are used there is a risk that the poison of the antifouling paint may cause an increase in the corrosion rate of the pipes.

It is a commonly held misconception that smooth surfaces are unattractive to settling larvae and this view has been held in particular with respect to plastics. It is not infrequently suggested that the non-stick material polytetrafluoroethylene will remain free from fouling. Unfortunately this is not true. All plastics become colonised by fouling organisms but in some cases, where a toxic substance is used as a plasticiser, there may be a short period when settlement is prevented. This, however, has little or no practical value.

High copper-bearing alloys of copper/nickel/iron are used in some cases for seawater systems and these have an intrinsic antifouling action. Care has to be taken to see that nothing adheres to the inner surface which could provide a point of attachment for fouling and also to see that they are not joined to materials which renders them more noble, thus inactivating them.

It is well known that chlorine can be generated from seawater by electrolytic means and considerable effort has been expended on developing equipment for this purpose. The essentials of such a system are that it be completely reliable with an efficient feed-back mechanism to maintain a residual level of 0.25-0.5 ppm. Care must also be taken to ensure that the chlorine does not attack any component in the system.

Alternative Methods for Fouling Control

The basic problem for fouling control is a distributional one; whatever agent is employed must be present in the right place at the right time. As stated above, a water speed of two knots past a surface will prevent the settlement of the larvae of fouling species on that surface; a method based on this fact was developed 30 years ago. Air bubbles released from pipes laid alongside the keel kept the hull clean by passing over it as they rose to the surface (Fig. 6).

Where the bubbles were able to travel at a fairly rapid rate and maintain contact with the surface, fouling settlement as prevented. It was found, however, that the bubbles could not protect indentations or areas where they moved too slowly or lost contact with the surface. A more recent modification of this system employed kerosene with an added poison.

In earlier days electricity was suggested as a means of fouling control but the current densities required were impossibly high. The use of ultrasonics has been tried but like all the other methods mentioned above it proved to be only partially successful. In the control of fouling there must be no halfway house; to be effective it has to give complete protection. Even comparatively light settlements of animal and weed fouling can give rise to a very sharp increase in skin frictional resistance.

Development of New Methods

At the beginning of the last world war the high priority need in the antifouling field was to develop a paint capable of giving complete protection for a period of six months. The need today is very different. Tankers of 250,000 ton dw are already in service and are being operated with very small crews which means that little effort is available from the ships' staff to undertake work outside the normal handling of the ship.

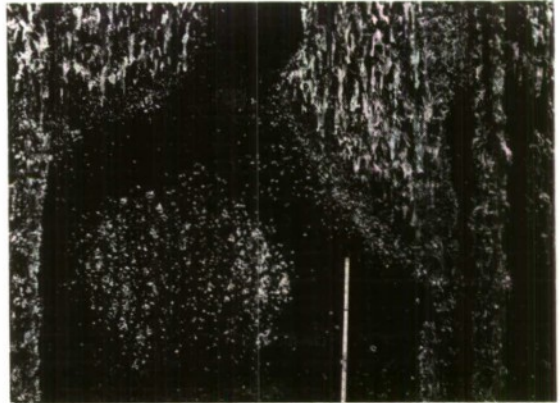

FIG. 6. The effects of air bubbles in protecting a surface from the settlement of fouling species. Where the bubbles have adhered and travelled at a reasonable speed settlement is entirely prevented.

There is little reserve of power above the cruising speed of these vessels and there are only four docks in the world capable of accommodating ships of this size. The total cost of a week in dry dock is about £100,000-£150,000, and it is therefore desirable that they be docked as infrequently as possible.

With the increasing effectiveness of other technologies associated with the equipment of such ships, it has already been established that there is a need for antifouling coatings capable of lasting for four years or more out of dock. The naval requirement is tending towards the same end but for somewhat different reasons. It may be possible to increase the life of existing formulations to meet the immediate requirement either by increasing the thickness of the antifouling coats or by improvements in the formulation. It appears to the author, however, that a very serious and hard look needs to be taken at the ways of devising new poisons and alternative methods of control for the future. The ideal would be for an initial treatment during construction which would last for the whole life of the ship.

The ideal poison would be one that is effective in comparatively small amounts, is equally effective against weed and animal fouling and completely non-toxic to man. Added to this it should work only when the vessel is at anchor. The ideal will almost certainly not be reached but there is a very good case for the chemist to attempt to tailor compounds to suit the purpose for which they are required. To this end a close liaison must be maintained with the

chemical industry, especially those firms developing insecticides, algicides and pharmaceutical compounds.

There is a very real need for an attempt to find alternative methods to those used at present. In the field of entomology a considerable amount of work has been carried out on the hormonal control of mechanisms such as moulting, and ecdysone and juvenile hormone have been studied extensively. The Zoecon Corporation are already producing synthetic hormones which appear likely to be used instead of chemicals such as DDT. Similar studies are being made on barnacles in an attempt to develop a control method along analogous lines.

A good deal of attention has been paid to the formation of cement by means of which barnacles are attached to the substrate and it is possible that the same hormone that controls moulting may also be responsible for initiating the cementing process. Another important mechanism is that by which barnacles and other shell-forming species calcify their shells. Interference with this mechanism, causing lack of calcification, would provide a major step forward in the control of these organisms. It is to be expected that a detailed knowledge of the mechanisms involved in settlement, cementation and calcification will lead to the discovery of chemicals of natural or synthetic origin which will interfere with and upset these processes.

Investigation of the mechanisms associated with the settlement of spores in *Enteromorpha* have already been carried out and further work on the effect of enzymes on spore settlement has yielded valuable results. The effect of auxins and algal hormones are soon to be investigated and will provide a more thorough understanding of the processes associated with settlement and development of algal spores. This knowledge should lead to the possibility of discovering new means of controlling these organisms.

If hormones or enzymes are proven to be a practical means of control in both fouling plants and animals, they will have the advantage of working in very small quantities and should be capable of giving protection for very long periods to the surface to which they are applied. These advantages, together with that of being non-toxic to man, make these compounds extremely attractive as antifouling agents.

It may be argued that even if success attended the biological approach to fouling control, the compounds would be very expensive to manufacture. This is almost certainly true but if the cost is balanced against the cost per week of docking a large tanker, they will probably prove to be economic. Increased demand will also tend to lower manufacturing costs.

Methods of control have been investigated using metal coatings such as cadmium/zinc which, if applied as metal to the hull, would give anti-corrosive protection and because of their toxicity may well prove valuable in preventing fouling. Such an alternative method is also very attractive.

It is important to look at all possibilities, and even to dream somewhat about the ideal solution even though in the present state of knowledge it is impracticable. A means of exuding substances through the hull, as in sintered metal bearings, would allow for the release of poisons whilst the ship was in harbour or at anchor, of anti drag compounds whilst at sea and of corrosion inhibitors all the time. In the event of plastic hulls being widely used in the future then inhibitors would of course be unnecessary.

References

- Banfield, T. A. (1969). "High performance coatings". *Fairplay International Shipping Journal* Anti-corrosion survey.
- Christie, A. O. and Shaw, M. (1968). "Settlement experiments with zoospores of *Enteromorpha intestinalis* (L) Link". *British Phycological Bulletin*, 3, 529-534.
- Crisp, D. J. (1965). "The ecology of marine fouling ecology and the industrial society". Fifth Symposium of the British Ecological Society, 99-117.
- Evans, L. V. and Christie, A. O. (1967). "The fouling of ships". Abstract, B.A. meeting, Leeds, 1967.
- Houghton, D. R. (1968). "Mechanisms of marine fouling". In *Biodeterioration of Materials* (A. H. Walters & J. S. Elphick eds). Elsevier, Barking, Essex, 55-61.
- Mortlock, A. M. (1968). "Studies of possible mechanisms for the control of moulting and metamorphosis in barnacle larvae". In *Biodeterioration of Materials* (A. H. Walters & J. S. Elphick eds). Elsevier, Barking, Essex, 639-657.
- Lacombe, D. (1967). "Histoquímica e Histofootometria das glandulas de cimento di *Balanus tintinnabulum* (Balandae-Cirripedia). Publicaco No O11 do Instituto de Pesquisas da marinha, Rio de Janeiro, Brazil.
- Tighe-Ford, D. J. (1967). "Possible mechanism for the endocrine control of breeding in a cirripede". *Nature*, 216-920-921.
- British Patent 1, 176, 274, "Anti-fouling treatment". Lockheed Aircraft Corp., California, U.S.A., Patent Abstract 70/04/25 in Patents Abstracts Section of *Underwater Science and Technology Bulletin*, 2, No. 4.

PRODUCTION OF PROTOTYPE HYBRID MICRO-ELECTRONIC MODULES USING THIN FILM SUBSTRATES

R. H. Purchase, R.N.S.S.

Admiralty Underwater Weapons Establishment

The usual techniques used in the manufacture of thin film micro-electronic circuits are not ideally suited for research and development applications, where relatively small numbers are required.

This article describes a facility which has been established at AUWE, and which we consider is well suited to meet a need for hybrid micro-electronic modules of high accuracy, in small numbers.

It does not require the normal artwork, photographic, and drawing office facilities, hence the work can be done by a small self-contained unit.

In consequence the time to produce a new circuit is very short.



Rex Purchase was educated at South Dorset Technical College. He joined the RNSS in 1959 as a radio mechanic, and progressed to his present position as an Experimental Officer employed in the micro electronics department.

Introduction

In the limit, a device can be made within one day, from the circuit diagram. The procedure for manufacture is as follows:

1. From the circuit diagram a layout for the film circuit is drawn, preferably on squared paper, or in some cases by laying out a plateau of building bricks (Lego).
2. From the layout, a programme is typed, on a teleprinter, and a punched tape obtained which ultimately controls an X-Y table. This table carries an uncommitted gold/nickel/chromium thin film substrate on a vacuum chuck.
3. The "writing in" head holds a stylus primed with an etch resistant ink, which is held above the table.
4. Resist is deposited on to a substrate in accordance with the instructions on the punch tape.
5. After "writing in" the gold pattern, the substrate, is removed for etching. Then the nickel/chromium pattern is "written in" and etched.

The nominal line width definition for "writing in" is $\pm 5\%$ of the stylus diameter, which may be as small as 0.006 inch. Nominal resistance values after etching are $\pm 10\%$ but these may be later adjusted to $\pm 0.1\%$ of the design value by micro-engraving.

6. The micro-engraving is carried out on the same X-Y table, using a spark erosion technique.
7. The discrete components are then added to the substrate, and the substrate itself attached to the Motherboard, before assembly onto the 10 lead or 20 lead header. This completes one hybrid micro-circuit level, and up to four of these levels may be assembled onto the header to complete the package.
8. A cover is then soldered into position and the package evacuated.
9. Upon releasing the vacuum, a fluorocarbon coolant is allowed to flow into the package via a small hole in the side, which is then sealed with a sealing pin.

The complete package measures 1.1 in. \times 0.8 in. \times 0.6 in. high, and could for example contain a 6th Order active filter.

Uncommitted thin film substrates are used at the heart of the hybrid micro-electronic modules produced at the Admiralty Underwater Weapons Establishment. Tiny engraving lines on the nickel chromium (the grey areas in Fig. 1) adjust the resistors to the required value.

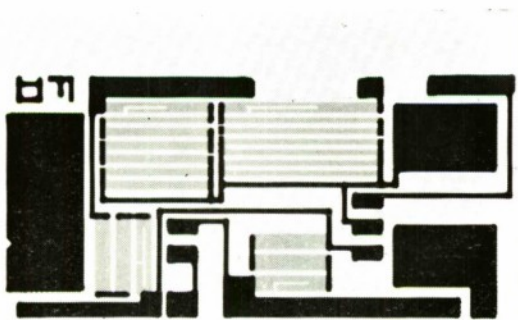

FIG. 1.

The method adopted for processing these uncommitted film substrates to a completed hybrid micro-electronic module are as follows:

From the circuit diagram a rough layout is obtained preferably on squared paper. This is then followed by a more detailed layout at

which stage the design calculations for area and power dissipation are considered. A programme may then be written, or it may be transferred to a legoboard layout which makes programming easier, particularly for the less trained programmer. A punch tape is obtained from a teleprinter which ultimately controls the X-Y table. A skilled teleprinter operator may obtain a punch tape directly from the detailed layout.

The table has a maximum movement in both X and Y directions of 6 in. and may be jogged in 12 micron steps. The uncommitted substrate, which consists of a piece of 2 in. \times 1 in. glass 0.023 in. thick, has evaporated on its surface a layer of nickel chromium, followed by a layer of gold⁽¹⁾ which is then diced to 1 in. \times $\frac{1}{2}$ in., and loaded onto the vacuum chuck attached to the X-Y table. The gold and nickel chromium patterns are "written in" by means of the "writing in" head, which consists of a stylus whose diameter is chosen to suit the programme. The stylus whose diameters range from 5 thou. to 25 thou., are first primed with resist, and the table set into motion. First the gold pattern is "written in," baked and etched, and the resist removed. Then the nickel chromium pattern is "written in," baked and etched and resist removed (Fig. 2 shows nickel chromium pattern etched).

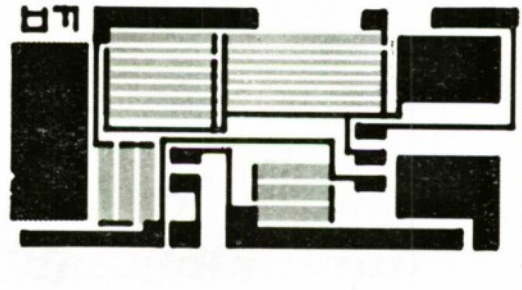

FIG. 2.

At this stage the substrate is baked to stabilize the nickel chromium. After stabilization the "writing in" head is replaced by the micro engraving head, which uses a spark erosion technique to vapourise the film circuit. Adjustment of resistors to better than 0.1% is obtainable with this method.

The discrete components, *i.e.* Flat pack amplifier, chip capacitor, etc., are then attached to the substrate by means of hand soldering.

These discrete components would normally be added before engraving, if adjust to function techniques were required. Similarly if a precise time constant was required, then the chip capacitor would be attached and the resistor engraved to the desired value.

Flat pack amplifiers require their leads to be shaped and cropped to suit the film layout (in Fig. 3 the left hand illustration shows the jig developed "in house" for this task).

The substrate itself is then attached to a motherboard by an adhesive, and the lead out wires from the substrate to the motherboard are soldered in position. This motherboard may be used for interconnections between levels if

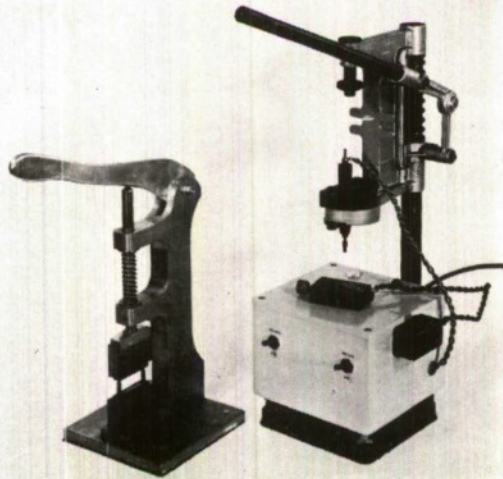

FIG. 3.

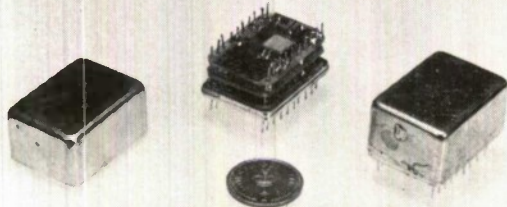

FIG. 4.

required. This completes one microcircuit hybrid level, up to three of these levels (Four if there are no discrete components) may be assembled into the micro circuit package in their required order to give correct pin connections for the package being used, which may be 10 lead or 20 lead. (Fig. 4 shows the package with and without cover).

The cover is then soldered in position and the whole package evacuated. Upon release of the vacuum, Fluorocarbon coolant is allowed to flow through a .032 in. diameter hole in the side. A $\frac{1}{2}$ cc of Fluorocarbon is then removed (by means of a hypodermic needle) to allow for possible expansion. A seal pin is then placed into the hole and solder sealed under pressure to prevent the expanding Fluorocarbon pushing the pin out. (In Fig. 3 the right hand illustration shows the sealing pin equipment, again developed "in house").



FIG. 5.

The complete "writing in" etching, washing and inspection facilities are housed within a clean area of 100 square feet (Fig. 5 shows the equipment housed within the clean area) whilst Fig. 6 shows the hybrid assembly (which utilises a lamina flow bench) and testing area.

Typical yields obtained using this method of production are 74% on 270 complete circuits.

A total of 900 resistors were adjusted to better than 1% and in some cases 0.3% giving a resistor yield of 96%. The failures were categorised as follows:

Writing in failures . . . 11%

These failures could be caused by substrate-contamination causing poor adhesion of the resist, or hairline cracks appearing in the resist during baking (this being a function of vis-

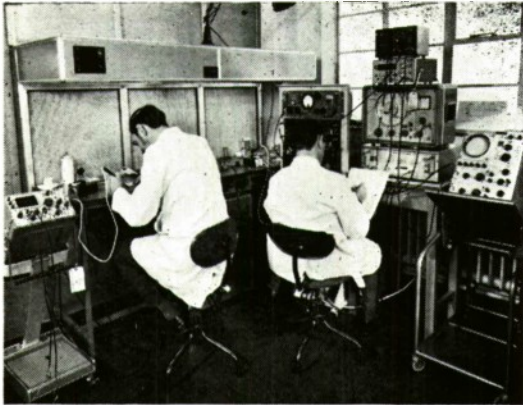

FIG. 6.

cosity of the resist, table speed, or oven temperature). Both types of faults cause open circuit nickel chromium tracks when etched.

Engraving failures . . . 13%

As the resistors were at this stage manually adjusted, operator error due to "overshoot"

contributed towards this failure rate, as well as pinholes or a contaminated or scratched substrate, causing a sudden change of resistance value when the engraving head cuts into the damaged area.

Cutting failures . . . 2%

This was the result of uneven breaking of the glass substrate when dicing a 2 in. \times 1 in. substrate into four 1 in. \times $\frac{1}{2}$ in. substrates.

Acknowledgements

The co-operation of the Standard Telephones Laboratory, at Harlow, and the film circuit division of STC Paignton are gratefully acknowledged, also that of my colleagues at AUWE, Messrs. M. Scard, T. G. Penn and D. R. Burden, and in particular the assistance of Mrs. P. M. Shaw.

Reference

- ⁽¹⁾ STC Film circuits handbook type 371 KBQ Substrates.



John Grensted retired at the end of December. Since 1961 he had been in charge of the recruitment of Scientists to the RNSS and over the years he had personally evolved the present system of close contact with the Universities on recruitment now in use by both the RNSS and others in the Ministry of Defence. He owed much of his success in this field to his enthusiasm and to his tireless dedication to the cause of maintaining the high standard of the RNSS of which he was a very faithful believer.

John Grensted took his B.Sc. degree in Engineering, London, from City and Guilds College in 1934 and after four years with the International Marine Radar Co. he was awarded his Masters degree. He then joined H.M. Signal School, Portsmouth, as a Scientific Officer in 1938. The war years were spent in developing and commissioning new communication systems in H.M. Ships and from this experience and his realisation of the many deficiencies in that field, the post-war 600 series of wireless transmitters emerged. After the war and on the introduction of the then novel Project System Organisation, John Grensted joined the Type 992 High Power Radar Team of which he later took charge until the completion of this work in the late fifties.

John Grensted has now left us to continue with undiminished energy and drive the cause of recruitment and training in a more general way. He has joined the International Association for the Exchange of Students for Technical Experience. At the RNSS Cocktail Party just before Christmas, he was presented with a cheque and a commemorative plaque with the best wishes of all his colleagues in the RNSS for continued happiness in the years ahead.

RESISTANCE LOADING OF LARGE ELECTRICAL POWER SOURCES

C. K. Aked, A.M.I.E.E., R.N.S.S.

Admiralty Engineering Laboratory



Charles Kenneth Aked was educated at Pudsey Grammar School, Leeds, and Leigh and Southall Technical Colleges; joining the R.N.S.S. in 1947 at the A.S.E. Extension at Risley to work in the Radar and W.T. sections, and later the Quartz Crystal section. He moved to the Admiralty Engineering Laboratory in 1955, transferred from the Technical Class in 1958 to become E.O., promoted to S.E.O. in 1962 and took up the post of Works Manager (L) in the Electrical Department. From 1967-9 engaged in the development of "Quaver", returning to works management and took over the two posts previously held by the Works Manager (L) and (M). Interested in horology and historical research, he is currently Librarian and Curator to the Antiquarian Horological Society and also Chairman of the Electrical Horology Group.

The Admiralty Engineering Laboratory at West Drayton has undertaken research and development in both electrical and mechanical engineering for the last 50 years. From the early beginnings, when relatively simple investigations were carried out with the minimum of ancillary test equipment, has evolved the present sophisticated era where data acquisition, processing equipment, computer systems, storage oscilloscopes, etc., are necessary to complete a project. No longer can the solitary genius exclaim "Eureka" and bound into his laboratory to bring his ideas to fruition in the old classical manner. Team work is now the only efficient way to deal with the complex research of to-day.

As an illustration of the changes resulting over the years, even in equipment that might almost be taken for granted, it is proposed to deal in this article with the improvements in the electrical resistance loading used in both Electrical and Mechanical Departments of AEL. Whereas when the Laboratory's activities commenced in 1917 the electrical power supply was a single phase supply of 50 KVA, it now stands at 1500 KVA with measures in hand for an increase to 3000 KVA. Additionally there is a main battery of submarine lead-acid cells which can be arranged to give 880 volts with a capacity of 20,000 ampere hours, and will give 10 megawatts at a one hour rating. Some indication of the increase in power levels over the years may be gained from these figures.

Whilst the Electrical Laboratory of AEL is constantly making use of large resistive and reactive loads up to a maximum of 1,500 KVA for experimental work, the Mechanical Laboratory has always had the need for the majority of the resistive loads in conjunction with the electrical generators driven by diesel engines. Until the advent of alternating current supplies on board ship, generators were naturally direct current. Now of course they are of 450 volt 60 Hz 3 phase alternating current output.

Early engine tests utilised some form of mechanical brake to dissipate the energy from the prime mover. Readers will no doubt remember from their youthful studies the rope brake and water-cooled pulley, the Prony brake and other such contrivances. Useful as these devices were for testing early gas and steam engines of low brake horse power output, they are of little importance today. The most general form of mechanical brake today is the hydraulic dynamometer in which water is used as a medium to convert the mechanical energy into heat energy which is then removed by circulating water from the dynamometer to a cooling system. There are severe disadvantages inherent in the use of this method, e.g. cavitation erosion of the dynamometer paddles and internal channels due to the violent agitation of the water, necessitating constant servicing and renewal of parts, static heat exchangers are necessary, and large scale water-purification is essential in hard-water areas. Nevertheless the method is extremely simple to use in practice, is readily accepted by mechanical engineers; and as cooling water of high quality is necessary for the engine cooling systems, the extra cost of supplying the dynamometer is small. The hydraulic dynamometer is flexible in operation and can be adjusted smoothly from zero to full load dissipation over a range of speeds.

It has long been realised that in the case of a diesel engine intended for driving an electrical generator, it is much more realistic to test the engine whilst coupled to the generator and provide an electrical load, i.e. to test the power system as such rather than load the engine with a hydraulic brake. The large loads suddenly connected to an electrical generator cannot be simulated correctly by a hydraulic dynamometer, nor can step loads from one power level to another be made. Coupled generators however have the disadvantage of possessing considerable mass-inertia and can cause considerable damage to an engine in the

case of engine crankshaft failure and associated components. The hydraulic dynamometer has low inertial mass and results in less consequential damage compared to an electric generator.

Before proceeding further it will be well to briefly review the operation of a diesel engine. Fuel is fed to the engine cylinders via injectors controlled by a fuel pump and mechanical governor driven from the engine crankshaft. On the compression stroke air is highly compressed in the cylinder by the piston and near the top dead centre an accurately measured amount of fuel is injected at the correct instant, burning rapidly and converting the chemical energy of the fuel to heat energy as it oxidises. A rapid rise in gas pressure results and the piston is forced down against the resistance of the crankshaft, allowing the gases to expand and convert some of the heat energy to mechanical energy, about 30-35 per cent. At the end of the power stroke the gases are exhausted to atmosphere, carrying with them a large amount of heat energy, approximately 30-35 per cent of the theoretical input heat energy supplied by the burning of the fuel. A smaller amount, 25-30 per cent, passes through the cylinder walls and is removed by the cooling water circulating through the engine water jacket, a further small amount, 5-10 per cent, is removed by the lubricating oil and passes to the oil cooling system, whilst relatively insignificant amounts are lost by radiation and convection from the engine itself (wild heat), although if one is working near a diesel engine one may be inclined to doubt this.

We have already seen that the diesel engine and its associated generator constitutes a mechanical system that is not easily simulated, therefore the present tendency is to carry out tests on the complete assembly and load the electrical generator by suitable means.

Here arises the first difficulty for what constitutes suitable means? A curious trait of both electrical and mechanical engineers is that their thoughts turn immediately to devising ways of putting the surplus electrical energy to some useful purpose. Common-sense analysis soon shows that the difficulties of doing so far outweigh any possible advantage to be gained. Ten to 20 per cent of the output of the electrical generator could be used to power the auxiliaries connected with the engine under test but this is similar to pulling oneself up by one's own bootlaces. The ships' generators of to-day are

60 Hz output and cannot be fed directly into the local mains supply network even if the Electricity Board regulations would allow of this. A frequency converter would be necessary, involving high capital cost, to overcome this objection, however since engine tests commence and finish without warning, other users would be most annoyed if their supplies were cut off in the middle of their own tests, similarly engine testers would be equally annoyed to find their engine test loads increased or decreased without warning by electrical power users switching equipment on and off. Lighting circuits, particularly those incorporating gas discharge lamps, could not possibly be fed from such sources because of the inherent danger to personnel with any cessation of power unless rapid change-over supply facilities were provided. In any event, even in the largest establishments, the entire lighting load will not exceed a few hundred kilowatts.

As an electrical engineer it seems strange to the writer that everyone can evince such enthusiasm to use the 20 to 30 per cent of the input heat energy which is ultimately converted to electrical energy and yet blissfully ignore the considerably larger amount of heat exhausted to the atmosphere *via* the engine exhaust and cooling systems. Heat transfer in the cooling water system requires considerable evaporation of water, the heat being used to provide the latent heat of evaporation, and results in the loss of 12,000 gallons of chemically treated water per diem at AEL (approximately 54 tons!). No one has yet suggested that the use of this waste heat in conjunction with a heat pump system might make the main heating boiler redundant. In order to make use of the surplus electrical energy from large diesel engine generator sets it is unfortunate that expensive capital equipment is necessary and alternative permanent supplies would not be rendered unnecessary as a result. The largest load available would be limited to the maximum demand of the establishment, assuming no other supply being used, sufficient at AEL only for one of the largest engines presently under test. Such equipment would have a very low factor of use, and without going into the technicalities of electricity supply tariffs, calculations show that the resulting cost per kilowatt-hour would greatly exceed the cost of electrical energy supplied by the Electricity Board even on the assumption that the electrical power at the test generator terminals costs nothing to produce. The low factor of

use would result from the intermittent nature of engine tests and the working hours of the establishment.

One possibility is that of using the surplus electrical power to provide space heating throughout the establishment, although naturally advantage of such use can only be made during the normal heating season, and then only as a substitute for existing permanent heating, and not as a replacement. Use has been made at AEL of the surplus electrical energy for extra heating in workshop and experimental areas by locating resistance load bank units inside buildings, initially as a boost to existing heating systems of insufficient capacity, later when the main heating boiler was put out of action during a particularly cold spell and emergency measures were taken to prevent the closing down of the establishment whilst boiler repairs were carried out. Considerable modifications to the load banks are necessary to allow ducting of the heated air either within the building or to the external atmosphere as required *via* an aperture in the building roof or wall. Another approach intended for future investigation is that of using electrode boilers raising steam at 150 p.s.i. for direct injection into the main steam heating system. Advantages of this method include the large steady load available (during the heating season) and utilisation of electrical energy whenever available, regardless of the period of availability.

Mention was made at the beginning of the article of the large lead-acid battery installation at AEL, the largest in Europe. Consideration has been given to the use of this battery as a load with the apparent advantage of storing the electrical energy. Here the main disadvantage is that one must commence with a battery in a discharged state, whilst the experimental sections which make use of the battery installation always require it to be fully charged for test purposes. Nor can a battery easily be arranged to provide a constant load, for the charging current must be progressively reduced as the charge approaches completion in order to avoid damage to the cells, and of course a large rectifier is necessary to convert the generated alternating current to the direct current required for charging the battery. When the battery is fully charged no further loading can be available until the stored energy has been dissipated. It would be necessary also to step up the generator output to the normal high voltage necessary for the input of a large rectifier by means

of a suitably rated step-up transformer—an expensive and bulky item. It is evident, without further discussion, that any method involving storage of electrical energy is of little practical use for long term engine testing. Additionally shared facilities are not designed to improve relationships between users since relative priorities become a constant source of irritation.

Having discussed some of the difficulties of utilising the surplus electrical energy available from diesel engine-generator sets under test, we may now turn to methods of converting the electric power to heat and discharging this directly to the atmosphere or *via* a cooling water system and heat exchanger. One of the earlier methods of dissipating large amounts of electrical energy is by connecting the generator to large plates, generally of steel, and submerging these in water. By adjusting the submerged area of the plates and the distance apart, the power dissipation may be adjusted to the required value. It is a very cheap method but is messy in use because of corrosion products and results in a great deal of steam if an unlimited amount of water is not available. Unwanted corrosion too may be set up in nearby structures by earth leakage currents unless precautions are taken, and the safety factor is low. The method does not lend itself to precision loading for the power dissipated varies considerably with the temperature and conductivity of the water, however it is cheap and useful in an emergency.

Similar in use and effects, and also of low initial cost, is the use of steel tape immersed in water as a resistance load. The water merely acts as a heat removal medium but it also rapidly corrodes the steel tape, especially in hard water areas consequently the method is of little practical use except in an emergency. Another method, useful for very large currents at low voltages, is the use of iron or nickel-steel tubing as a resistance element and passing water through as a cooling medium. Nickel-steel tubing eliminates the large resistance change with temperature associated with the use of iron tubing. The generated heat may be removed by the cooling water running to waste or passing through a water cooler. At low voltages corrosion products are not troublesome.

None of the methods so far outlined is flexible or precise enough for meeting the conditions specified for testing engines today. For many years at AEL natural air cooled resistance elements in small units were

employed coupled as appropriate for the required loads. Some of these units were of a suitable size and shape to house a small canine and were thus affectionately referred to as “dog kennels” except when the insulation broke down or a sagging resistance element resulted in the framework becoming alive and causing a shock to the poor unfortunate who unwisely made contact. On such occasions much more descriptive terms have been heard! As engines increased in power so did the number of resistance units employed until the need to economise on space became paramount, in addition stricter safety precautions dictated the use of resistance load banks designed specifically for engine tests. Therefore for many years prior to 1962 the standard procedure, when a new diesel engine-generator was to undergo trials, was that the required loads would be calculated for the necessary tests on the particular generator, a specification for the resistance load bank and associated switch and control gear prepared and submitted, financial approval obtained, tendering action taken, and finally the load procured and installed. The normal time scale from start to finish on average would be (a) One year to insert in the financial programme (b) One year for tendering action, acceptance, and manufacture of the load bank (c) Three to six months for installation and test of the loading facility.

Such was the situation when the writer found himself made responsible, amongst other things, for such installations. One of the engines about to commence a test programme was a Paxman YHA diesel engine driving a 350 kVA generator and the resistance load bank units were already connected, having been calculated on the basis of a quoted power output from the engine. One of the tests specified that the engine would continue to run at 110% of nominal output but when the extra 10% load was added to the normal full load, the engine could not be induced to deliver the extra energy. As normal the mechanical engineers blamed the electrical engineers and vice-versa, but eventually it was found that the quoted figure for output was in error by almost 10%. As a result the whole of the load bank had to be re-calculated and modified, involving several weeks of work, before the engine tests could be resumed.

Other disadvantages of the method just outlined were: The load bank had to be calculated for five separate fixed sections corresponding to the 25%, 50%, 75%, 100% and 110% loads

required for the engine load test programme, each separate load section required an individual circuit breaker, together with an overall full-load rated circuit breaker in addition, a total of six. Thus a lot of electrical equipment and cabling of large physical dimensions had to be installed for each engine test programme. At the end of the test programme the load bank could not be used elsewhere without extensive modifications and in fact was normally relegated to the scrap heap as being beyond economical repair. All this expensive electrical equipment could also stay unused for weeks or months in the case of major engine failures, and yet other test programmes might be at a standstill because suitable test loads were not yet available. Another serious problem was the amount of time spent on these installations by skilled tradesmen since two or three men might take up to three months to complete the electrical load installation and its control panel, yet the engine test programmes were rapidly expanding. This was a matter of some concern for the craft grades at AEL were 30% under normal complement at the time, and 40% of the tradesmen were over 60 years of age, including three men in their middle seventies! Considering all these points convinced the writer that he could evolve a system not only to make better use of the equipment, but also to reduce installation time and make it easier for the engine test staff to make use of the loading facilities.

In 1963 the opportunity occurred to put into practice some ideas that the writer had in mind regarding the provision and use of large electric loads. A large forced-air cooled resistance load bank intended for use on 220 and 440 volt direct current circuits was condemned as beyond repair by the Navy Works Department and consigned to the scrap heap, the engine-generator set for which it was obtained having completed all tests. The load bank had stood outside for a very long time and presented a very sorry sight, yet it seemed to the writer that here was a suitable vehicle to try out his ideas on load banks providing the internal resistance elements were suitable. Such was the physical deterioration of the load bank that inspection of the resistance elements was only possible by chiselling off the screw-heads securing the metal panels to the frame. The resistance elements were woven wire and asbestos mats in an extremely delicate physical state through the asbestos being saturated with moisture. What was most encouraging however was that the layout of the elements consisted

of two physically separated halves, series connected for 440 volt and parallel for 220 volt operation. Each half of the load was identical and made of three well separated vertical groups of resistance elements, and a quick assessment based on the physical layout of the resistance elements seemed to indicate a reasonable hope of conversion to a three-phase alternating current mode of operation.

A small current at a reduced voltage was passed through the load bank and as the water was slowly driven off the asbestos regained its normal physical strength and electrical insulation value. Meanwhile calculations showed that each resistance element was capable of approximately 5 kw dissipation at 240 volts r.m.s. and enquiries made of the manufacturer of the resistance mats confirmed the estimate and the suitability of the resistance units for the purpose intended. Further inspection indicated that the mechanical condition of the load bank could be rectified fairly easily and that the cooling fan motors were serviceable. Permission was sought to investigate some form of conversion and this was granted subject to a strict financial ceiling.

Each vertical group was found to contain a total number of 18 resistance elements, i.e. an overall total of 108 resistance elements (3 x 18 x 2) in the three main groups of the load bank. This arrangement was therefore suitable for a total power dissipation of 540 kw on a continuous basis. A great deal of thought was applied in determining how to make the best use of this load and in view of the imminent requirement of the Mechanical Department for a load of approximately 450 kVA it was decided to draw up a design that could cater not only for the various engine test programmes but would also be suitable for use in the test programmes of the Switchgear, Machinery, and other sections in the Electrical Department. Because of the large physical size and weight of the load bank and the limited space available for locating the load bank near the test positions, a decision was made to locate it in a permanent position as conveniently near to the test areas as possible. A suitable site was found in the main workshop area that could not be utilised easily for experimental work and this site had the great merit that a three phase supply was available for running the cooling fans. In addition the heat produced would be a welcome addition to that provided by the normal heating system which at this time was awaiting a modernisation programme. With the addition of a short

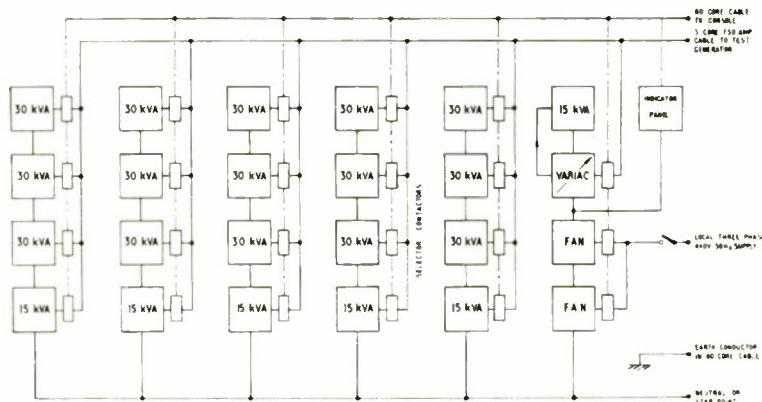

FIG. 1. Block diagram 540kVA Resistance Load Bank.

length of trunking from the top of the load bank the waste heat could alternatively be directed through a convenient aperture in the roof glazing.

A list of the desirable features of a universal resistance loadbank was drawn up as follows:

- (a) Local or remote control of load setting without the use of connecting links or archaic knife switches.
- (b) Operation on 440 volt 3-phase 50 - 60 Hz alternating current supplies in either delta or star mode of connection and also 440 volt or 220 volt direct current supplies.
- (c) Connection of the appropriate experimental supply to be by use of one main alternating current circuit breaker and one direct current circuit breaker only.
- (d) Load bank to be equally suitable for use with engine trials, or for ordinary loading conditions, without modification.
- (e) The maximum electrical loading of the resistance load bank to be approximately 500 - 600 kW.
- (f) Five electrically isolated main sections of equal loading to be provided, corresponding to steps of 25%, 50%, 75%, 100%, and 110% of full load rating for engine test generators.
- (g) Infinite resolution of electrical loading from zero to full load.
- (h) Indication at the load bank and at the remote test site control panel of the electrical loading setting in use.
- (i) Indication of all circuit conditions *e.g.* phase voltage, phase current, test supply frequency, power factor, and total power dissipation to be displayed on meters mounted on the control panel.
- (j) Automatic shutdown of equipment in the case of cooling fan failure.
- (k) Automatic disconnection of the load bank three phase, and the control panel single phase supplies in the event of failure of the continuity of the earth lead between the load bank and the healthy state of this conductor and also its failure state.
- (l) Control panel to be capable of remote control working up to a distance of 100 yards from the resistance load bank.
- (m) Indication of the energised state of any controlling contactors used in the load bank to be given at the remote control panel.
- (n) Emergency shutdown control switches to be fitted both at the load bank position and the remote control panel position.
- (o) All circuits in the control panel to be electrically isolated with the control panel switch in the "off" position.
- (p) The cost of automatic load changing and remote control to be kept to a minimum, and a maximum use made of naval stores items in any conversion of the existing resistance load bank.
- (q) Application and removal of electrical loading to be initiated from the control panel only, in order to avoid potentially dangerous conditions which could possibly arise with dual control.

The scheme finally adopted is shown in Fig. 1, the final configuration being decided by the electrical components available and the requirements listed previously.

Each of the three main groups of the resistance loading elements was allocated to a separate phase to prevent the possibility of inter-phase shorts. The best arrangement of the load steps proved more difficult to arrive at since the ideal solution would mean continuously variable loading from the minimum to the maximum values. A compromise solution was reached by arranging that any value of load could be obtained by suitably proportioned steps with a vernier adjustment to arrive at the exact value. As it was desired to have five equal and distinct stages of loading corresponding to the percentages steps used in the engine test programmes, each stage load maximum was limited to 105 kVA, this left a single 15 kVA section spare. The subdivision of each stage was arranged in 3 x 30 kVA sections, and a 1 x 15 kVA section, thus the maximum loading of 105 kVA could be reached in increments of 15 kVA by selection of the appropriate steps. The preferred arrangement of 1 x 60 kVA, 1 x 30 kVA, 1 x 15 kVA sections could not be employed owing to the disproportionate cost of a 60 kVA capacity contactor. In order to get the infinite resolution of loading the easiest solution appeared to be the use of a motorised variac transformer of 15 kVA rating connected to the spare 15 kVA section to obtain the continuous variations from 0-15 kVA necessary to cover the whole range of 0-540 kVA in 15 kVA steps with a final vernier adjustment of 0-15 kVA at any point. The cost of having a vernier adjustment for all five stages was not at this point considered justified because of the high cost of three phase variac transformers of this rating. The maximum error possible would only be ± 7.5 kVA for a given loading and this could be corrected for by a very slight voltage adjustment of the generator under test. The single vernier adjustment could be used, for a more critical application, at any point chosen. For use in the development and testing programmes of the Electrical Department where single value resistance loads are normal, the resolution would be infinite and the resistance loading could be adjusted to the exact value required for a particular test.

Load Bank Modifications

Having decided on the particular configuration to be employed, details of the physical dimensions of the proposed contactors were obtained. It was found that by arranging the contactors along the top of the load bank it would be just possible to

accommodate the number of contactors required in a single row, with the connections running from the top of the resistance sections to the contactors in a short direct run. This was essential as the insulation of conductors at this point would be difficult owing to the high temperatures obtaining at the top of the load bank and mechanically stiff self supporting bare conductors were desirable. An asbestos insulated sleeving would have to be employed where reduced spacing between conductors made this necessary and ceramic beads at some other points.

With this layout the changes from the original connections to the new arrangement were found to be surprisingly few and in the event took only a few hours to effect the changeover. The 15 kVA motorised variac transformer required was fitted in the base of the load bank and situated in the path of the incoming cooling airstream. An indicator panel was affixed in a prominent position on the load bank with indicator lamps, operated by auxiliary contacts in each contactor, the energising current being supplied from a six volt tapping on the 240 volt operating solenoid. Fig. 2 shows the modified load bank with the large trunking fitted on top.

Control Console

This control console (see Fig. 3) was designed as a two-part unit consisting of a top half comprising a vertical panel carrying all the instrumentation at eye-level for accurate reading, and a sloping panel with the operating controls arranged for ease of manipulation and access. This unit could be stood on a bench or on the base of the console which was fitted with drum storage for the 100 yards of control cable containing 60 cores. This cable is quite heavy and bulky and the drum storage enabled the cable to be neatly stored when not required and only the required length of cable needed run out when in use. A removable handle was fitted to the drum storage unit to wind the cable in and out as required. The weight of the cable was useful in stabilising the control console which was arranged to be approximately 5 ft 6 in. in height. The whole assembly was fitted with rubber tyred wheels for ease of transport from one test site to another. The reason for the two part construction was that it was not known at the time which method of use would be preferable but the passage of time has shown that the preference for a console is universal, mainly because of the ease of trans-

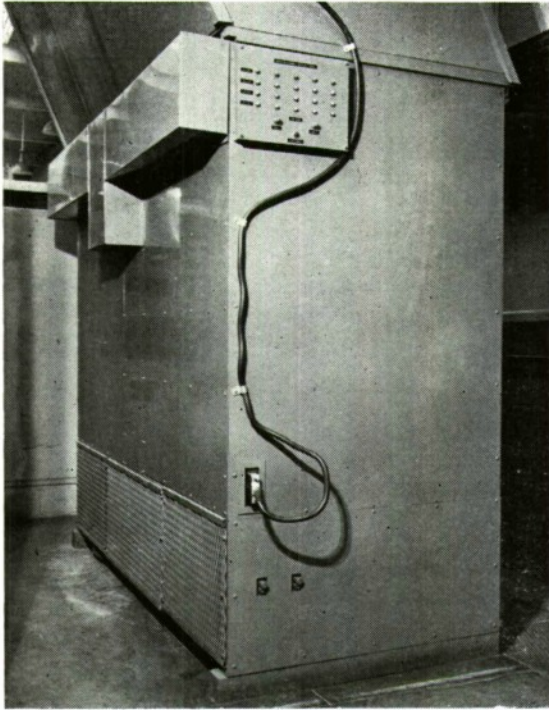

FIG. 2. Converted Hedrin 540 kW Resistance Load Bank.

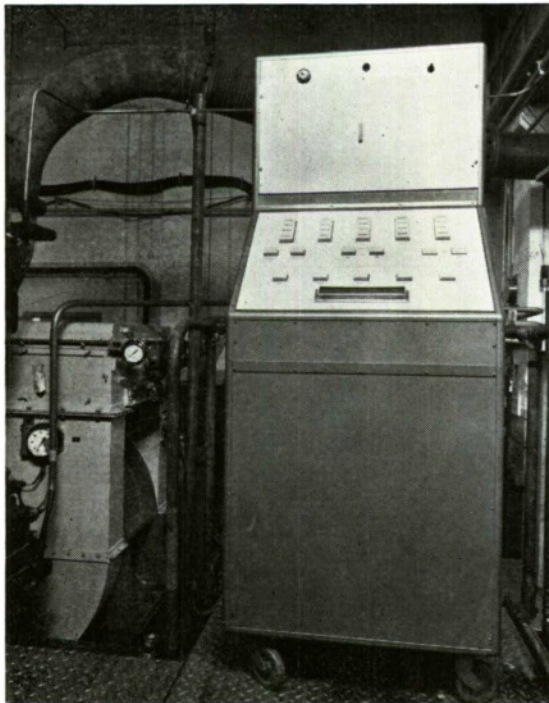

FIG. 3. Control Console for Hedrin Resistance Load Bank with 500 kVA A.C. Generator.

port and the facility of placing the console in any convenient position. A multi-way plug was fitted to the end of the cable for connection to the load bank, this cable carries all the interconnecting control circuits. It was intended to derive the control unit energising power from a local mains socket at the experimental item test site but this method was later abandoned in favour of concentrating all the supplies needed at the load bank position. This meant that the load bank could be electrically isolated locally for any maintenance work without fear of the load bank being energised without warning from the remote point. In addition a key-switch was fitted to cut off all supplies at the console to avoid unauthorised interference with the controls.

An arrangement of five vertical rows of press switches fitted with illuminated press buttons was fitted to the control panel. Each vertical row of press switches controlled one stage of 25% loading and was used to set the resistance load bank to the power level required. A further press switch was used to connect each stage total into the circuit with a final summation press switch controlling a contactor to provide the simultaneous energisation of all the selected contactors for a given load setting. Three illuminated press switches were fitted for the variac transformer connection and control of the vernier loading up or down as desired. Two further press button switches control the supply to the cooling fans, with a protective circuit fitted at the load bank so that in the event of the fans failing to start or ceasing to run with the load bank in operation, power dissipation in the resistance load cannot then take place. After some deliberation it was thought that the best protection would be given by the use of pressure operated switches situated in the cooling air stream. At the base of the sloping control panel a long bar, boldly marked **EMERGENCY — PRESS**, controls a switch fitted to remove all energising supplies. A slight pressure on the bar at any point is sufficient to de-energise the control unit and remove the resistance loading from the test circuit. After this emergency operation the control unit has to be re-energised by a press-switch on the vertical panel, and as this needs a deliberate action on the part of the operator there is no danger that the load will be connected again without consideration. A large press-button switch coloured red is fitted at the control load bank for local emergency action.

The preceding pages outline briefly the conversion of the old load bank, the design details of the control console, the safety features incorporated, and the philosophy of the new technique.

Resistance Load Bank in use When first introduced some years ago the new system was not enthusiastically received because the operators normally had a packaged control scheme but this attitude quickly vanished when the ease of control possible was realised. The converted load bank was at that time the largest power-dissipation load available in the Laboratory and it has since run under various conditions for many thousands of hours with no difficulty whatsoever. Maintenance has been minimal and no replacements have been required except for a damaged plug on the control cable. On one occasion the load bank was programmed to load three separate experimental items on a shared basis over a 24 hour cycle, the appropriate switching being performed by a clock controller.

Advantages The concept of setting up the resistance load bank in the manner described has resulted in the following advantages:-

- (a) A large saving in money by not using expensive circuit breakers for each engine under test.
- (b) A great saving in time and skilled labour by not having to adjust the loading conditions by means of manually operated knife switches or links on a terminal panel for each individual experimental item.
- (c) The improved safety factor through not having to require men to change links or operate knife switches with the circuits energised.
- (d) A great saving in time and skilled labour in making up loads for large scale tests.
- (e) A large saving in money by not having to purchase load banks for specific experimental items.
- (f) A great saving in time and skilled labour through the facility of load-setting *at the location of the experimental item*, where this operation is best carried out.
- (g) The ability to switch the use of the load bank from one experimental item to another in a few minutes.

- (h) A substantial reduction in the number of heavy cables connecting the experimental item to the load bank.
- (i) Control of the load bank by relatively unskilled staff is possible after a short period of instruction.
- (j) The load bank may be situated in any convenient position.
- (k) Indication is given of the amount of loading in use at any instant both at the resistance load bank and at the remote control point.

Manual Adjustment of Load Banks Fig. 4 illustrates the 350 kw resistance load bank for the Paxman YHA diesel engine. It is in three separate sections and each section is set to the required load level by a link panel shown in Fig. 5 (left). Fig. 5 (right) shows a rather more complicated load adjustment panel for a 220 kw DC or single phase AC resistance load bank. The inconvenience of walking back and forth between the engine test cell and load to make adjustments can be imagined. From a safety point of view the method leaves much to be desired since the power could be applied whilst adjustments were being made. With the remotely controlled load setting method, the engine tester need not even know where the loads are situated and is not subjected to onerous conditions when making adjustments nor exposed to the risk of electrical shock.

Later Designs The prototype control system design described had to be tailored to make use of the resistance load bank available for conversion and it was fortunate that the alterations needed were relatively easy to carry out. The difficulties associated with the original conversion were accepted and it was not possible to obtain the most favourable values for the increments of loading.

It was clear that a more sophisticated version would be quite practical without increase of cost if the resistance load bank was arranged to meet the control system requirements more closely. The specification of such a resistance load bank and its associated control console was drawn up and submitted to three firms, at least one firm was willing to manufacture such a resistance load bank and its control console providing that the technical details of the control circuits of the prototype were provided in order to avoid the otherwise necessary development costs.



FIG. 4. 350 kW Resistance Load Bank for Paxman YHA Diesel Engine.

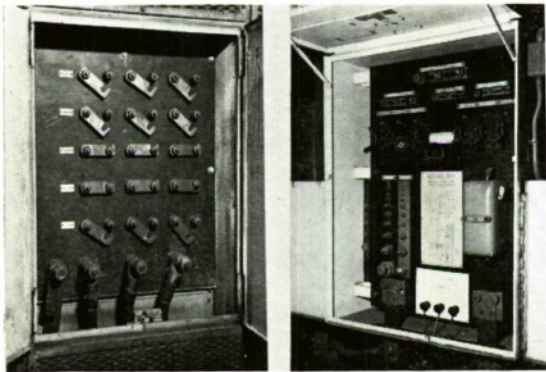

FIG. 5. Typical Manual Controls for Resistance Load Bank adjustment.

Fig. 6 illustrates the load bank resulting from the specification and its associated control console. Whilst all circuit conditions are indicated on the instrument panel, laboratory instruments of higher accuracy are used to measure the experimental power levels. Rated at a nominal 550 kVA at 450 Volts 3 phase, this load bank was the largest ever made by the firm who secured the contract, and the load bank had to be brought to AEL for test-

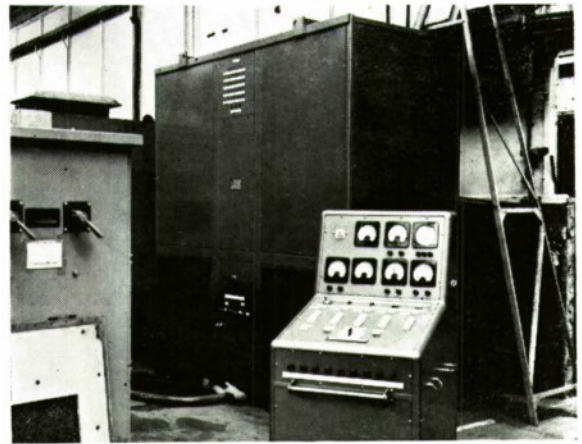

FIG. 6. BERCO 550 kW Resistance Load Bank

ing and commissioning since the firm was unable to provide the amount of electrical power necessary for test purposes. Apart from a few initial teething troubles the load has proved a most useful addition to existing facilities. Less than half of the load bank cubicle is occupied by the resistance load elements, the remainder is used for the cooling fans and motors, five motorised variac transformers, and control gear.

A two megawatt load bank has recently been manufactured to the writer's specification, based on the use of four separate units of 500 kVA capacity, with arrangements for the addition of a fifth unit in the future, all the units being controlled from one single console, (see Fig. 7). It has been found that a nominal 500 kVA unit is the most versatile for use in the Laboratory and is convenient for handling on site.

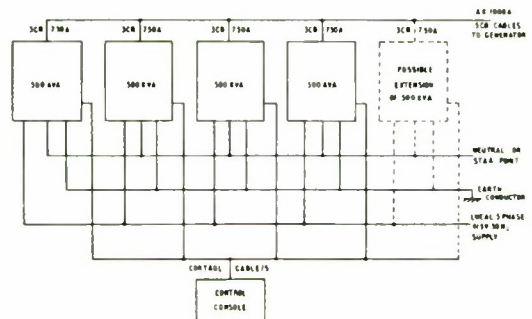

FIG. 7(a). 2000 kVA Resistance Load Bank.

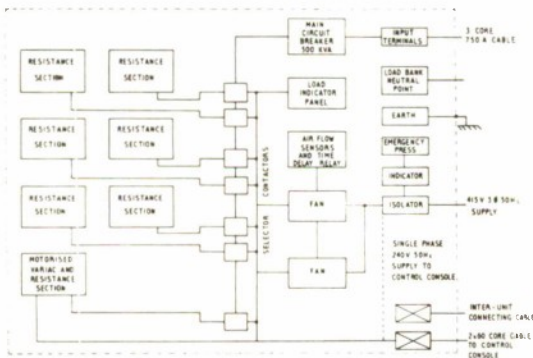

FIG. 7(b). Load Bank Unit.

Fig. 8 shows a 0.75 megawatt load bank designed for either pulse or continuous direct current loading where the associated circuit inductance had to be of a very low value. The load bank contains two resistance load units of 0.375 megawatt capacity each which consist of a number of nickel-steel tubes of small diameter and wall thickness approximately twenty inches in length and connected in parallel to two header connections for the cooling water. The overall diameter of the assembly is only 3½ in. hence the physical volume of the units is extremely small in relation to the power dissipated. However, the necessary control equipment, water pressure boost pump, fail-to-safe features, and isolating switchgear take up a great deal of space and the resulting load bank becomes large and heavy. Also it must



FIG. 8. 1.5 megawatt Resistance Bank for pulse or continuous loading. (Manufactured by Brentford Electric Ltd.)

be remembered that the generated heat has to be dispersed and heat exchange facilities are therefore required. Power levels of this order result in a considerable amount of heat which in turn necessitates the use of heat exchange equipment of large size. Unless large amounts of cooling water are available at low cost, the small physical volume and relatively low cost of the water cooled nickel steel tube load is more than counter-balanced by the additional cost of the cooling towers necessary, whilst the need for piped water of good quality and high pressure is a limiting factor when siting the load bank. These loads are easily damaged by overload or loss of cooling water as the resistance tubes have little thermal inertia and any failure is spectacular and catastrophic. Furthermore the flexibility of adjustment is inferior to the air cooled resistance type, being limited to simple divisions such as ¼, ½, and full load by series and parallel connection of the load units, the preferred arrangement being that two units are connected in series such that the cooling water enters and leaves the units at earth potential to ensure electrical safety.

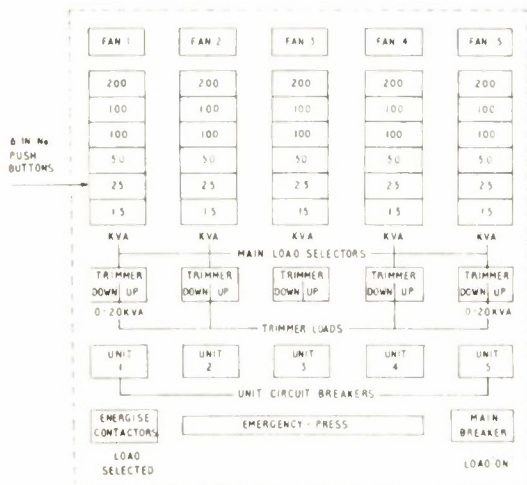

FIG. 7(c). Press Button Control Panel Layout 0 - 500 kVA per unit.

From an inductance point of view the multi-parallel circuit paths of the tubes reduces the self-inductance to a very low amount, typically a fraction of a milli-henry. The load bank shown in Fig. 8 is guaranteed to have less than 0.1 milli-henry at the input terminals.

Power Factor and Inductive Reactance As most readers will be aware, normal AC power circuits on board ship do not run at the unity power factor that the resistance load banks present to a generator. For purposes of merely providing a load for the diesel engine the resistance load bank is sufficient; if however the generator is to be tested for its electrical performance in addition then inductive reactance is necessary. Leading power factors requiring the use of capacitive reactance for simulation are never met with on board ship. Generally speaking an AC generator is rated by its power output at 0.8 power factor *e.g.* 1250 kVA at 0.8 P.F. Such a generator will put 1,000 kw of useful power into a circuit of 0.8 P.F. and yet have sufficient current carrying capacity to include the lagging current component caused by any inductive equipment, *e.g.* squirrel cage motors etc. Whilst the lagging current does not contribute power to the circuit nevertheless the connecting cables and windings of the generator must be able to carry the idle circulating current and be rated accordingly. Those readers wishing to know more about the testing of electrical generators are referred to *Standard Electrical Specification No. 2, "Rotating Electrical Machinery for use in H.M. Ships"*.

The provision of reactance to give 0.8 P.F. is not as easy as the provision of resistive loading, since the reactances required are bulky, very heavy, and very expensive. The largest reactance at AEL is 585 kVA at a 24 hour rating, is 9 ft. in height, 5 ft. in diameter and weighs 5.25 tons. Although it has a number of tapped windings it is never easy to get the exact value of reactance required whilst the switching requirements for inductive reactance are much more severe than for resistive loads. It is preferable to select the value of reactance required whilst off-load circuit conditions obtain. In order to provide inductive reactance for 0.4 P.F. levels at the megawatt levels it is necessary to design and install a permanent installation and site it as near to the engine test cells as possible at the "Centre of

Gravity" of the generators under test to reduce the cost of the heavy cables used. The main reasons for a permanent installation are (a) the extreme weight of the inductive reactances (b) the need to contain the large quantities of insulating oil, used to cool the reactances, in the case of leakage of oil through failure (c) the associated heavy switchgear. Pyrotenax mineral insulated cable is preferred for connection purposes to reduce the risk of fire and the damage from fire. As these cables can be run at elevated temperatures without detriment, the cross-sectional area of the conductors can be appreciably reduced compared to conventional cables which require derating when run in close proximity.

Future Requirements

Looking into the future it appears that loading levels of approximately ten megawatts will arise. It is difficult to visualise any new method arising for the dissipation of electrical energy and improvements are mainly sought to reduce the space required and to improve the efficiency of operation of the loading systems. Safety is of paramount importance when dealing with these large power levels and the operating procedures must be foolproof, nothing must be left to chance. In other words safety must be an inherent part of the system and not made the responsibility of the individual operator. It is also true to say that requirements are becoming more critical as the performance of automatic voltage regulators and electronic governors associated with diesel engine driven generators steadily improve, for whereas the earliest design of the author switched large amounts of load using numbers of cheap small contactors, the more stringent switching requirements mean that the contactors can now only be used to pre-select the required load level and the final power connection be made via a large circuit breaker. The operating time of individual contactors vary slightly and when testing a highly sophisticated automatic voltage regulator such as QUAVER, the step of load application and removal is not sharp enough with numbers of small contactors connecting a large load. Ultimately it will be necessary to ensure simultaneous closing and opening of the contacts in each phase of a circuit breaker and also point of wave selection to open and close the load circuit at the precise point desired in a voltage or current waveform. At present the

precise instant of opening or closing of the load circuit is fortuitous and this may be reflected in the test results. Therefore, it appears that there is still room for improvement even in such mundane equipment as the large loads described.

The amount of such improvements will depend on the demand and the money avail-

able. One of the original ideas considered was the use of a radio control link to eliminate the control cable and enable the engine operator to move freely round the engine under test whilst switching loads, another was the use of control equipment to automatically select and switch loads to an arranged programme, but these have not been further developed to date.



Sam Bolshaw retired on January 3rd, 1972 from his post as Chief Scientific Advisor to the Director General Ships. After his early training with Messrs Automatic Telephone & Electric Co. Ltd., Liverpool, he spent some years in the Power Transmission Laboratories of the Central Electricity Board working on the development of the Supervisory Control Systems for the Central Scotland, North West, South West and South East areas. He entered Admiralty service at ARL Teddington in 1939 as a Technical Assistant, Grade II. His rapid rise to Chief Scientist in a space of less than 20 years speaks volumes, both for his own ability, and for the perception of the RNSS in recognising and rewarding efficiency on the job.

After assimilation into the RNSS as an SSO in 1946, he joined the select band of experts who did so much to establish the pre-eminence of the Royal Navy in the field of weapon control. His drive and skill at getting the best out of staff were recognised at the Admiralty Gunnery Establishment. By 1949 he was in charge of B Group, whose activities included the development of the control system for the first beam riding ground to air missile test vehicle (RTV1), the control of *Pentane*—the first homing torpedo—and the master stable element for Radar Type 984.

In 1952 he was promoted SPSO and transferred back to ARL, to take charge of Z Group. This was a new group formed to deal with the eddy current problem in minesweepers and the sweeping of pressure mines. Having successfully demonstrated solutions for both of these problems, he spent 1955 at the Imperial Defence College and was subsequently appointed Deputy Director (Engineering) under Colonel Kerrison, the Director of Engineering and Materials Research.



During the next two years he stimulated the exploitation of high damping alloys for Naval purposes and the basic work on the waterside attack of diesel engine cylinder liners, which culminated in the Development of the oil cushion piston.

With the formation of Ship Department, Mr. Bolshaw was appointed Chief Scientific Advisor to the Director General Ships with a seat on the Board of Ship Department. During the last 12 years in Bath, while working in an environment dominated by the day to day problems of procurement, he has consistently and successfully fostered the scientific method, by his insistence on quantifying facts by rational analysis before leaping to conclusions. To work for him was a joy because, provided one had done one's homework, he would give every possible support.

Mr. Bolshaw would go to extraordinary lengths to resolve the difficulties of a subordinate, whether these difficulties were technical or administrative.

With all his pragmatism, he was often ahead of his colleagues in exploiting and developing new techniques. His pioneering drive in such diverse fields as superconducting motors, high power-density hydraulic machinery and the application of modern control techniques to ships and machinery has left the Navy with permanent assets.

A HISTORY OF THE TORPEDO

PART I—THE EARLY DAYS

G. J. Kirby, B.Sc., F.R.A.S., R.N.S.S.

Admiralty Underwater Weapons Establishment

Abstract

The development of the torpedo is traced from the fireboats of the sixteenth century, through the first Automobile Torpedoes of Robert Whitehead to the modern sophisticated underwater guided weapon. The history is traced over the course of four articles.

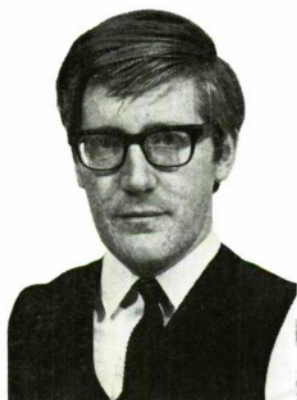

Geoff Kirby graduated from London University in 1960 and worked for six years with the UKAEA carrying out fluid flow and boiling heat transfer research as part of the power reactor programme. Transferred to AUWE, Portland in 1966 since when he has been employed on torpedo research problems as a Senior Scientific Officer.

The Torpedo fish is an electric ray capable of delivering a stunning shock to its prey and in the eighteenth century an American, David Bushnell, first applied the name to a weapon of his invention. This first torpedo was simply a mine which was attached to the hull of a ship and exploded either by remote control or by a clockwork fuze. The name was also applied to floating mines and even blazing barrels of pitch carried into harbours by the tide. Within this general application of the name the history of the torpedo up to about 1860 is synonymous with the history of the mine. In order to give a continuous account of the torpedo's development we will go back to Roman days and note the use of fireships to destroy enemy fleets. The use of drifting weapons of destruction, powered by the ocean currents, is not so very far removed from destructive weapons powered by other means as in the present understanding of the name "torpedo."

This work has been undertaken as an extra-mural project and the opinions expressed here are those of the author and do not necessarily correspond to those of the Ministry of Defence (Navy).

The next stage in the sophistication of sea weapons appears in 1585 when the Italian Zambelli destroyed a bridge by means of a drifting boat loaded with explosives which were detonated by a clockwork delay fuze.

The first reference to the idea of a self-propelled underwater weapon appears in a play by Ben Jonson where the following dialogue occurs:-

Thos.—They write here one Cornelius Son hath made the Hollanders an invisible eel to swim the Haven at Dunkirk, and sink all the shipping there.

Pennyboy.—But how is't done?

Cymbal.—I'll show you, Sir, it is an automa, runs under water, with a snug nose, and has a nimble tail made like an augur, with which tail she wriggles betwixt the costs of a ship, and sinks it straight.

Pennyboy.—A most brave device to murder their flat bottoms."

The Staple of News, Act iii, Sc. 1.

We next find David Bushnell on the scene again with his submarine, Fig. 1. This remarkable one manpower vessel actually once sank a ship. The operation of the boat is quite obvious from the diagram. The operator used both hands and feet to control the forward and vertical motion by means of screws as well as operating a footpump and rudder. The "torpedo" was a charge of explosive fixed to a ship's hull by means of the woodscrew illustrated and ignited by delayed action fuze. The operator then cranked himself furiously away from the area before the "torpedo" exploded. The best documented attack by a Bushnell boat was made against the flagship of the British fleet sent to quell the unruly colonists towards the latter end of the eighteenth century. The submarine was successfully positioned under the ship but the woodscrew failed to penetrate the copper sheathing recently introduced onto the hulls of British warships.

Robert Fulton, another American, developed Bushnell's submarine into a more workable version named *Nautilus*. With this boat he sank several ships during demonstrations but was not very successful in selling his submarine to the American Navy. Working successively with

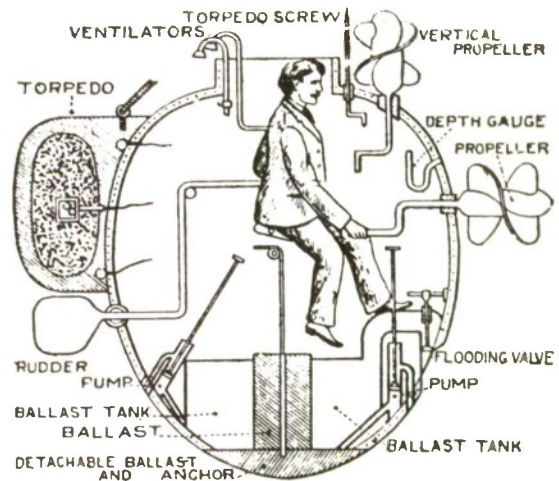

FIG. 1. Bushnell's Boat (1775).

the French against the British, with the British against the French and finally with the Americans against allcomers, he appears to have been a brilliant inventor and an opportunist. A very glamourised account of Fulton's machinations at the end of the eighteenth century recently appeared on B.B.C. television as a children's adventure series. Fulton must however be credited with the development of the submarine and its weapon, the mine, to a point where it could be used in wartime.

Soon after Fulton's work the name "Torpedo" became applied to a new class of weapons and the development of the mine continued on its own separate path. This new weapon was the Spar Torpedo Boat⁽¹¹⁾.

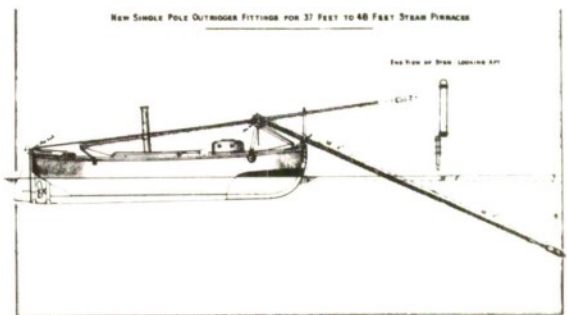

FIG. 2. British Spar Torpedo Boat.

Many forms of Spar Torpedo were used, particularly during the American Civil War. Nearly all types were basically the same and consisted of a steam launch having an ex-

plosive charge mounted at the end of a long pole projecting ahead of the boat. Fig. 2 shows a typical form as used by the Royal Navy⁽⁷⁾ around the 1880's. The launch carried a small crew one of whom viewed the external world through a steel conning tower. The launch approached an enemy ship under cover of darkness and placed the explosive charge against the ship's side and detonated it electrically.

The spar torpedo was quite successful and one of the most successful types was the "David" boat operated by the Southern States in the American Civil War. These carried a 60 lb charge on the end of a 25 ft long pole and the explosion was set off 6 ft below the waterline. A crew of eight was used and the boat ran awash. Indeed, it was fitted with hydroplanes for brief dives but these were often fatal.

Although spar torpedoes were extensively used by the Americans, French, Russians and Chinese, the British considered them "unsporting" and were late introducing them. Indeed, the spar torpedo arrived in Britain just as the automobile torpedo as we think of it today was entering service and the spar torpedo then soon went into a decline in popularity.

Because I wish primarily to cover those aspects of torpedo development not covered in the literature at present I will pass on from the spar torpedo pausing only to mention the Lay spar boat. This was controlled by a crew of one. To each leg and arm was attached a string and each string controlled a different part of the mechanism! It seems quite a knotty problem, and reminds me of the apocryphal "cat-guided bomb" supposedly devised during the recent World War. The cat, slung beneath a bomb dropped in the vicinity of a ship, had strings running from its paws to vanes on the bomb. Appalled by the sight of water beneath it the cat pedalled its way towards the "safety" of the ship and thereby guided the bomb, *via* the moving vanes onto the ship. It seems unlikely that the idea could work but the Lay spar boat is recorded with one ship sinking!

The spar boat was easily hit by gunfire and therefore became unpopular. As a result the automobile or "fish" weapon was invented and I shall now begin the story of the weapon known universally as the Torpedo.

Whitehead's Flash of Genius

Robert Whitehead was born at Bolton in 1823, the son of the owner of a cotton-bleaching business. He was apprenticed at 14 to an engineer and thereafter travelled widely throughout Europe showing the way to improve silk-weaving machinery. In 1856 he became manager of an Austrian engineering company, Stabilimeno Technico Fiumano. The company was heavily engaged in providing engines for the Austrian Navy which was at war with Italy. It was through Whitehead's connections with the Navy that he was approached by a Captain Giovanni Luppis who had an idea for controlling a spar torpedo boat remotely by two ropes strung out from the tiller. Whitehead built a model but decided that the idea was not viable.

He did however start to think about the problem of setting off explosive charges remotely below a ship's waterline—this being far more effective than above water bombardment. In 1866 his ideas took shape in the form of the first automobile torpedo.

The weapon was built with the help of Whitehead's 12 year-old son and an old workman. The exact form of this first weapon is not known because Whitehead never revealed drawings even many years later and refused to describe the machine to inquirers. Eyewitness accounts⁽²⁾ describe it as blunt nosed "like a dolphin" with four long fins extending almost along the whole body length. The engine was driven by compressed air stored at 370 p.s.i.* and regulated to approximately constant speed by a simple valve. The engine is generally described as a twin cylinder Vee but this probably refers to the later models of 1868. The original engine was based on two eccentric cylinders having a sliding vane to divide the volume into two parts. In this fashion the air pressure caused direct rotation of the outer cylinder which was coupled to the single propeller⁽³⁾.

The weapon was designed to be fired from an underwater tube and a constant depth was aimed at by means of a hydrostatic valve acting directly on the elevator controls. Azimuth control was simply by means of trim tabs set by trial and error over a 400 yards range at Fiume. The weapon achieved about six and a half knots to 200 yards and a further 100 yards at lower speed. The propeller speed on this first weapon was about 100 r.p.m.

* Although keen on S.I. units I consider them inapplicable here!

The depth keeping on this first weapon was very erratic. Within two years two new weapons had been produced which incorporated a device to be known for decades afterwards as "The Secret." This consisted of a hydrostat-pendulum combination after the fashion of Fig. 3. The simple hydrostat controlled depth according to the law

$$\frac{d^2D}{dx^2} \propto D_0 - D$$

where D_0 is the set depth and x is the distance run. Such a control law has no inherent damping and as a result the original weapon oscillated wildly. The introduction of the pendulum by means of the lever system illustrated introduced an additional term in the above equation proportional to pitch angle which is very nearly proportional to depth rate. Thus a damping term has been introduced. The depth errors were found to reduce from ± 40 ft to as little as ± 6 in. Such was the success of Whitehead's "Secret" that it remained in use virtually unchanged until the end of World War II, a remarkable tribute to a great Victorian engineer.

In 1868 Whitehead demonstrated two new models before representatives of the Austrian Navy; a 14 in and a 16 in type. The weapons carried wet gun-cotton warheads and achieved speeds of about seven knots to about 700 yards. Fig. 4 shows the probable form of these early weapons. The propeller is shrouded to prevent damage and a large azimuth control vane is at the rear. These two features were soon to disappear however.

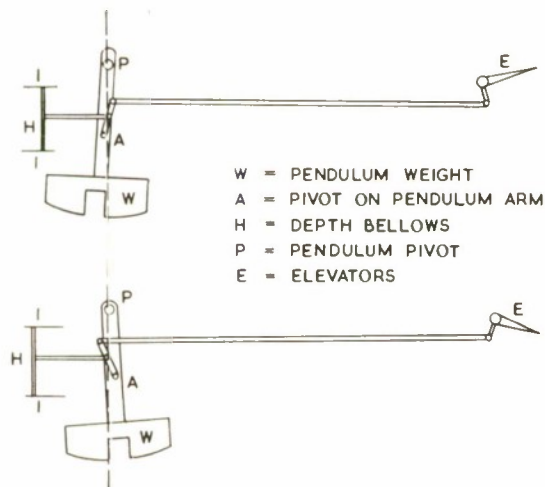

FIG. 3. Pendulum-Hydrostat depth gear of early torpedoes.

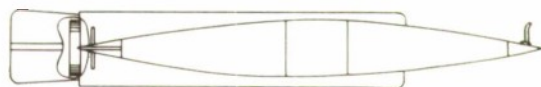

FIG. 4. Probable form of Whitehead Torpedo (1868).

The Austrian Naval Officers attending the trials were impressed sufficiently to order weapons to be produced but were unable to buy the patent rights outright.

British Torpedoes Enter Service In the Autumn of 1869 Royal Navy representatives visited Fiume and reported favourably on the weapons being tested.

As a result Whitehead was invited to England to demonstrate the ability of his weapons. He brought two types of torpedo with him, a 16 in. by 14 ft. carrying 67 lbs. of wet gun-cotton and a second weapon of 14 in. diameter and a little under 14 ft. in length. This latter weapon carried a warhead of dynamite weighing 18 lbs. The table at the end of Part I summarises the main characteristics of these and later weapons.

The weapons were fired either from the surface or from a submerged tube built by Whitehead into *Oberon*. Over 100 firings were made during September and October of 1870, the average weapon performance being seven knots to a range of 600 yards.

As a grand finale a wooden coal hulk was moored off Cockleshell Hard and surrounded with protective nets. A 16 in. weapon with its warhead charged by Professor F. A. Abel was fired from a range of 134 yards. The weapon, determined to demonstrate its potency, went around the net and blew a hole measuring 20 ft. by 10 ft. in the old corvette and it sank at once. Faced with such conclusive evidence of the weapon's capability the Royal Navy ordered a batch of Whitehead torpedoes which were received in 1870.

It was most appropriate therefore that one century later a new torpedo trials ship should have been launched with the name E.T.V. *Whitehead*.

Two types of weapon were received from Whitehead's works at Fiume; these being 14 in. and 16 in. diameter. In 1871 the Admiralty bought the manufacturing rights for £15,000 and production was started at the Royal Laboratories, Woolwich the following year. This sum of money seems very small for

such an important weapon especially when only a decade later a certain Mr. Brennan was paid nearly 10 times as much for the rights of an inferior type of torpedo.

The example of the Royal Navy was quickly followed by the French, Germans and Chinese and soon Whitehead was exporting his torpedoes around the world. Several countries started building their own pirated copies of the Whitehead but these were notably unsuccessful. The stringent specifications laid down by foreign navies caused Whitehead to give consideration to the improvement of performance. He appears to have regarded the weapon as primarily for use in harbours against moored ships. Under these circumstances a speed of only seven knots is acceptable and the main areas for improvements lie with the accuracy of steering and the reliable operation of the impact fuse. However, the Germans specified a weapon performance of 16 knots to 550 yards. Whitehead carried out various improvements including the replacement of the twin cylinder Vee engine by a three-cylinder engine built by Peter Brotherhood, Ltd., of Peterborough. Thus by 1875 a 14 in. weapon was produced having a performance of 18 knots to a range of 550 yards.

In 1872 Whitehead bought the firm and re-named it Silurificio Whitehead. A remarkable feature of this story is the instant success of the novel weapon. The very first experimental torpedo worked well and was being mass produced for export within four years. An envious record for any new product!

With the introduction of the new engine and contrarotating propellers (this latter by a foreman mechanic at Woolwich) no significant improvements were then made until the introduction of the gyroscope for azimuthal steering in 1895. Fig. 5 shows the transitional form of the weapon in about 1875. The extended fins thereafter were not needed because of

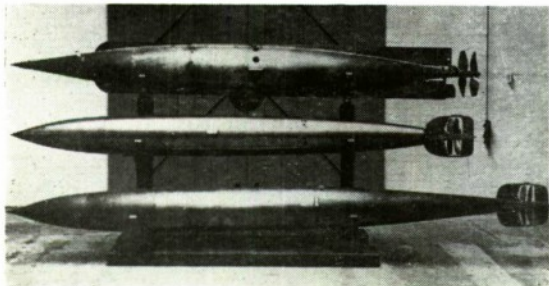

FIG. 5. A selection of Fiume weapons (c1874 - 1880).

the lack of roll forces. Fig. 5 shows typical Fiume-built torpedoes of the 1880s period with their pointed noses and small control fins with the control surfaces placed aft of the propellers. This latter feature distinguished Fiume weapons from the Woolwich types (Fig. 6) which carried the surfaces ahead of the screws. The latter practice persists (unfortunately) to the present time.

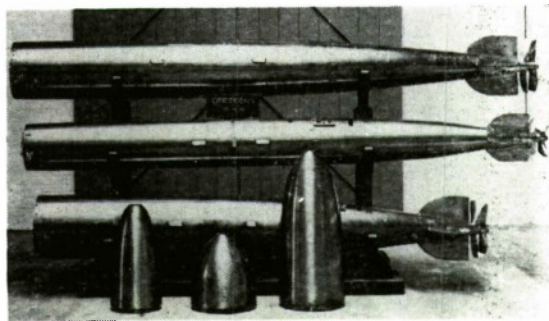

FIG. 6. R.G.F. Weapons (c1894).

Weapons of various types were produced during the first few decades of the life of the automobile torpedo. In particular, many obscure types of unorthodox propulsion were produced in the United States, as we shall see. The Whitehead type did not however undergo significant change although many new Mark numbers were introduced. Table 3 summarises the main weapon types and their performances. It can be seen that the improvements in performance were steady and unspectacular.

The Germans, in addition to ordering Whitehead torpedoes in 1873, began building their own on the Whitehead principle. The firm of L. Schwartzkopf—later the Berliner Maschinenbau A.G.—began making excellent torpedoes in phosphor-bronze. The firm was soon exporting weapons to Russia, Japan and Spain. In 1885 Britain ordered 50 of these weapons because the output at home and at Fiume could not satisfy the demand. These weapons cost £450 each which was £120 more than the corresponding Fiume type (the 14 in. Mk. II).

The output at Whitehead's works was continually increasing and Table 1 shows a sample of his products.

In addition to the standard weapons many special types were produced to the specifications of foreign navies. In fact no less than 17 different types of weapon were produced

at Fiume in 1884 and Table 2 shows the countries to which weapons had been exported up to 1881.

TABLE 1.

Extract from the Whitehead catalogue 1882.

<i>Dia.</i> (in.)	<i>Length</i> ft. in.	<i>Material</i>	<i>Wt</i> (lbs)	<i>Cost</i>
15	18 9½	Steel	904½	£350
15	18 9½	Bronze	904½	£380
14	14 6	Steel	647	£300
14	14 6	Bronze	647	£325
14	12 3	Steel	498½	£290
14	12 3	Bronze	498½	£315
14	11 0	Steel	435	£280
14	11 0	Bronze	435	£300

TABLE 2.

Sales of Whitehead torpedoes up to 1881.

<i>Country</i>	<i>Type</i>		
	<i>16 in.</i>	<i>15 in.</i>	<i>14 in.</i>
Argentine			40
Belgium		40	
Denmark		58	25
Germany		103	100
England			254
France		105	113
Italy			70
Greece		30	40
Austria			100
Portugal			50
Russia	25	215	10
Others		51	27

The 14 in. by 11 ft. weapon was built originally to the specification of the Russians who wanted a minimum speed output of 20 knots. This was achieved and all Whitehead weapons exceeded this speed from this time.

The speed improvements were made by increasing the inlet pressure to the engine (with consequent improvements to engine details) and a corresponding increase in air vessel pressure. By 1882 the vessels were being built to withstand at least 1,500 p.s.i. and Britain led the world in the construction of bronze pressure vessels.

Figures for weapon range were not reliable up to this time because range was not an important parameter. Ranging at Fiume was carried out from an underwater tube aimed at a net 400 yards distant. The maximum running distance was only measured when requested by a customer. After all, the chance of hitting a ship decreases rapidly with range because of the errors inherent in the weapon and the aiming process so that there was little point in firing a torpedo at a range greater than about 400 yards even if the weapon was capable of greater range. Thus the ranges tabulated at the end of Part I are nominal only but in many cases the maximum range is not very much greater than the quoted value.

At about this time the Italians built their own version of a Fiume torpedo but it ran at only 7 knots. Whitehead rebuilt it and it achieved 20 knots. As a result the Italians gave up building their own weapons and bought from Whitehead.

In external appearance the various weapons were very similar. The torpedoes were often built up with standard tail and nose sections but with different middle sections. These composite torpedoes each carried different mark numbers but were in fact very similar in performance. In 1883 a committee, set up to examine various aspects of torpedo design, carried out trials to test whether the nose shape had any effect on weapon speed. The pointed nose was assumed to cleave the water best but the great hydrodynamicist Dr. Froude advised that blunt head should show no disadvantage in speed performance and would allow much larger warheads to be carried.

Comparative trials were carried out using the Mk IV Fiume and R.L. Mk XI torpedoes each fitted with blunt and pointed noses. The tests showed that the blunt-nosed torpedoes had a full knot advantage over the pointed nosed version. This meant that heavier warheads could be carried without loss of propulsive performance and the ultimate in blunt nose designs during this period appeared in 1909 with the American hemispherical heads.

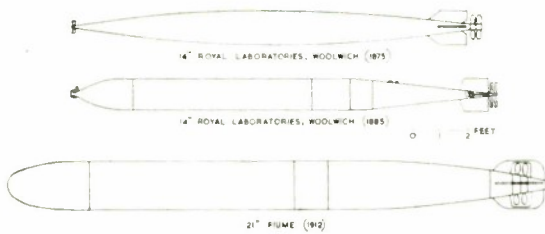

FIG. 7. Evolution of the Blunt-Nosed Torpedo.

Fig. 7 shows the development of the torpedo shape to the form (in 1912) from which few departures took place in the following four decades.

During the period covered above the United States had not taken advantage of the offers in 1869 and 1874 to manufacture Whitehead torpedoes under licence and followed an independent and generally unsuccessful development programme of her own. This, together with the extensive efforts in many countries to develop rivals to the supremacy of the Whitehead torpedo will be described later.

Last Cold Compressed Air Whitehead Weapons.

Whitehead torpedoes were being manufactured at a considerable rate during the last 15 years of the 19th century. From Fiume the Silurificio Whitehead was sending hundreds of weapons around the world and many more were being manufactured under licence in foreign countries or being simply pirated. A typical year's intake to the Royal Navy is listed on page 41 as an example of the activity around this period.

The German Schwartzkopf firm were manufacturing about 400 weapons annually which were sent to Spain, Italy, China and Britain (see Table 4).

It was soon after the mid-1880s that torpedo performance began to improve. This was largely as a result of competition from improved gunnery. Indeed, in 1904 the battle of Tsushima was settled by gunfire at a range of 6,000 yards and no torpedo could at that time compete with such performance. The torpedo's saving grace was its ability to deliver with stealth an explosive charge to the most vulnerable part of a ship. Torpedo range was increased by the introduction of the 18in. Whitehead weapon in 1888 but not by a very great amount; the advantage being taken rather to increase the size of warhead.

Meanwhile at Woolwich torpedo performance improvements made the specially constructed canal too short and a new range was set up at Horsea Island in 1888 and 10 years later the Bingleaves range was set up near Weymouth. In 1890 Whitehead opened his factory at Weymouth which survived until recently under the ownership of Vickers, Armstrong Ltd. In 1893 the Royal Navy decided to transfer the torpedo works at the Royal Laboratories to the Royal Gun Factory (thus weapons became known as R.G.F. types) and as a result the Weymouth works did not get the British orders that were expected. Henceforth the Whitehead torpedoes produced at Weymouth were mostly sent for export to countries not able to manufacture their own. Similarly, Whitehead had opened a factory at St. Tropez at the same time as the Weymouth venture and this also exported to countries such as Brazil, Holland, Turkey and Greece. Some torpedoes from the Weymouth works did enter service with the Royal Navy especially during the 1914 - 18 war period. The last association of the works with the Royal Navy appears to have been in the early stages of the Mark 23 torpedo in the mid-1950s.

Whitehead always regarded his torpedoes as primarily for launching from underwater tubes. The Royal Navy however seems to have favoured above-water firing devices. Under water tubes can be placed either in the bow where the ramming effectiveness of the ship is weakened (ramming was a most popular means of naval warfare in the 1870s) or they can be placed across the ship for broadside shots. In the latter position the torpedo experiences a strong twisting force as it emerges due to the water flow along the ship. A device for overcoming this effect was invented by Capt. A. K. Wilson, V.C. and consisted of a guide bar projecting from the ship along which the emerging weapon slid until free of the disturbing effect of the ship's motion. Another device ejected a tube with the torpedo for a distance of several feet such that the water flow forces were taken by the tube and not the weapon.

These devices were adopted by the British but were not generally popular. The first above-water launching was made by sliding a 14in. weapon off a mess table out through a port-hole and, having thus proved the feasibility of the scheme, several methods were evolved for launching weapons from a ship's deck. Most of the early methods consisted of a simple frame for holding the torpedo over

the water and releasing it in approximately the right direction. Light torpedo boats used a frame which was lowered about 2ft. into the water for launching.

The tube working on the pea shooter principle was invented in about 1880. The weapons were ejected by compressed air but within a few years the propelling gas was generated by slowburning gunpowder in granular form. This remained the method of tube launch for many decades; indeed the present deck-mounted tubes work on exactly the same scheme but with different propelling cartidges.

The British method of discharging torpedoes from above the waterline was viewed with some concern by Whitehead. His son-in-law and partner, Count George Hoyos, reported after a visit to Britain that "such delicate weapons are not meant to be fired like shot from a gun" but the weapons seemed to tolerate their rough treatment for in 1879 there were already 33 British warships fitted with launching equipment.

Introduction of the Gyroscope

In 1895 came the first significant improvement to the torpedo since its invention. Whitehead introduced the gyroscope for azimuth control using the type invented by an Austrian, Ludwig Obry. In this device a $1\frac{3}{4}$ lb. wheel some 3in. in diameter was held in gimbals with its axis along that of the torpedo. The wheel was spun up to maximum speed 2,400 r.p.m. by means of a pretensioned spring. The wheel reached this speed before the weapon left the tube so that the torpedo followed the aimed-for track in the water irrespective of the impulsive forces acting on hitting the water. This greatly improved the overall accuracy of firing and with the new device fitted it was possible to fire to an accuracy of $\frac{1}{2}^\circ$ thus enabling a beam-on target to be hit at a range of about 7,000 yards—except that torpedoes at that time had ranges not exceeding 1,000 yards.

This clearly provided a considerable impetus for torpedo designers to increase performance. The original Obry gyroscope wheel only contained a maximum of 20ft. - lbs. of energy. This had the effect of allowing the gyro to topple after an inconveniently short time of running. The toppling was induced by the fact that the gyroscope gimbals were required to directly operate a rudder servo control.

Whitehead soon introduced an intermediate servo however which greatly reduced the forces acting on the gimbals and the way was then opened up for long range weapons.

The version of the Obry gyroscope supplied to the United States was provided with an angling gear which enabled the weapon to change course after firing, thus giving greater flexibility in the firing procedure. This refinement was introduced into the Royal Navy in 1900.

The turn of the century saw a radical change in torpedo design with the introduction of the heated, or steam torpedo. This is therefore an opportune time to study the torpedo development of nations, such as the United States, who did not adopt the Whitehead compressed air method of propulsion.

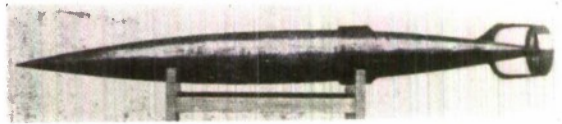

FIG. 8. First United States Automobile Torpedo.

Departures from Whitehead Principles

The Torpedo Test Station was set up in 1870 at Rhode Island, U.S.A. to work on spar torpedoes but in 1871 an automobile torpedo was built, Fig. 8. This was built on the supposed lines of the Whitehead weapons and indeed the propulsive performance was similar, *i.e.* 7 knots to a range of 300 yards. The warhead was 70 to 90 lbs. of dynamite or guncotton. Here the similarity to the Whitehead torpedo ends for the American version refused to run a straight course. This is not surprising in view of the minimal control surface area provided. Another weapon was built in 1874 but this was no more successful. The air vessel was made of bronze in the latter case because no American firm would undertake to make a steel vessel of sufficient strength. The British were masters of the forging and rolling art for pressure vessels at this time. The Japanese had many failures in this respect and eventually bought their pressure vessels from England.

Having failed to produce a working automobile torpedo and having turned down two offers of the Whitehead plans (one offer being quite unofficial from an ex-foreman from Woolwich—industrial sabotage at an early

age!) the Torpedo Test Station set about building under the inventive eye of J. L. Lay, an officer in the U.S. Navy, a series of strange and generally unsuccessful weapons.

Most of the weapons floated and thus did not have the ability to vary the striking depth at the enemy ship. The Lay torpedoes floated with only a few inches of hull showing and were controlled by an operator by means of electrical impulses sent down a wire. The power unit was a gas engine driven by compressed carbon dioxide and the steering impulses transmitted down the wire operated electromagnetic relays on the rudder. The position of the weapon was indicated by two flags or discs. Fig. 9 shows an early form of the Lay Torpedo as built in the 1870s. A later form used liquified CO₂ as the power source with the liquid warmed in pipes external to the weapon. Still later we find the Lay-Haight weapon driven by gas generated by the action of sulphuric acid on lime. The later weapons had their propeller near the forward end of the hull partially recessed to avoid damage. It also avoided efficient propulsion!



FIG. 9. Lay Dirigible Weapon.

These weapons were never really successful on account of their unreliability and vulnerability to gunfire. In a trial carried out off the British coast for the Royal Navy the Lay weapon heeled over badly so that the propeller was only half under the surface.

Two Lay torpedoes were sold to the Peruvian Government for use in the war against Chile. In 1879 a Lay weapon was fired from the Peruvian ironclad *Huascar* at a Chilean ship. Half-way to the target the weapon turned around and "hurtled" at 15 knots back at the mother ship despite the frantic knob twiddling of the operator. The ship was saved by the heroic action of a ship's officer who swam out to intercept the weapon and deflect it. The relieved captain promptly took the two weapons to a local graveyard where they were buried—only to be later exhumed by the Chilean rebels!

The performances of the Lay torpedo together with several other weapons of this period are tabulated at the end of Part 1.

The vulnerability of these weapons was overcome in the 'Patrick' and 'Wood-Haight' torpedoes by suspending them beneath unsinkable floats. These floats were either wood or thin copper sheet cylinders containing water-proofed cotton waste. The floats could be shot again and again without sufficient buoyancy being lost to sink the weapon. The propulsion was by compressed carbon dioxide gas expanded through a gas engine—usually a three-cylinder Brotherhood type, similar to the version used extensively by Whitehead.

The electric torpedo made its appearance in about 1873 with the Ericsson which was propelled by sending power down a cable unreel from the weapon (Ericsson was the builder of 'Novelty', one of the locomotives tested at the Rainhill competition in 1829 at which Stephenson's 'Rocket' was the winner.) A direct development of the Ericsson torpedo was the Sims-Edison which was similarly powered down a trailing wire. A speed of 10 knots was attained using a Siemens motor drawing 30 amps at 600 volts. Several versions of this weapon appeared, all carried under a large float and very similar in external appearance to the weapon of Fig. 10, and the last version built in 1889 carried a 400lb. warhead to a range of over two miles.

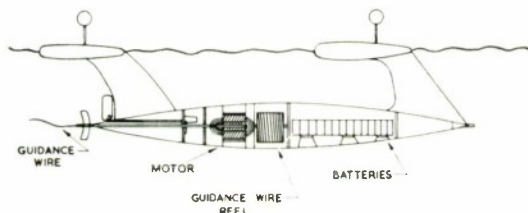

FIG. 10. Nordenfelt Wire-Guided Electric Torpedo.

The Nordenfelt torpedo, illustrated in Fig. 10, was invented by the great Swedish engineer who also produced the first really successful submarine. Motive power was from a vast stack of batteries, the early version having 108 storage cells which produced 18 S.H.P. Guidance was by means of electrical impulses transmitted down a wire paid out from the weapon. A British intelligence report of the period described the early weapon as being supported by a wooden float and carrying one mile of guidance wire. The weapon described by Sleeman⁽²⁾ and illustrated in Fig. 10 was said to have been buoyant and held down by the heavy fins. It is difficult to see how this weapon could have remained upright. The

sloping edge to the fin was supposed to assist the weapon to pass under torpedo nets. This weapon, the forerunner of the present generation of wire-guided electric torpedoes, achieved 16 knots to a range (for the later version) of two and a half miles.

Superheated steam was a popular means of propulsion in the 1880s and the American 'Hall' torpedo was typical. Water at 550°F and under high pressure was fed directly from the boiler of the torpedoboat. Evaporation of the water under reduced pressure provided a propulsive performance comparable with contemporary Whitehead models. None of these steam torpedoes reached the production stage, largely because of the lengthy preparation time required. Hall's weapon had a strange roll control system based on a transverse mercury-filled U-tube. Any rolling action of the weapon caused wings to be pushed in and out under the action of the mercury. The wings were angled to provide lift in such a fashion that the weapon maintained, in theory at least, an even keel. Another superheated-water weapon, the Paulson, was kept on a straight heading by a mariner's compass in the nose. Electrical contacts on the compass could be set just before launch and the weapon followed that setting after launch.



FIG. 11. Cunningham's Rocket Torpedo.

Rocket propulsion has been often considered even up to the present time. One of the first automobile torpedoes built after the Whitehead model made its appearance was rocket propelled. Both the Weeks and the Ericsson rocket achieved about 40 to 60 knots to a range of 100 yards. Lt. F. M. Barber of the Naval Torpedo Station, Rhode Island, produced an underwater rocket in 1873. This was 7 ft. long by 1 ft. diameter and weighed 287 lbs. The warhead was 48 lbs. of gunpowder and the 51 lbs. of rocket fuel were stored inside a cast iron tube wrapped in asbestos and having an outer casing of oak!

Mr. Cunningham, an American shoemaker, built rocket torpedoes and once celebrated the 4th July by setting off one of his torpedoes up

the town's main street. It shot off at high speed scaring old ladies and horses and finally came to rest in the butcher's shop where it set fire to the icebox!⁽¹²⁾

The *Berdan* (sometimes called the Borden) was a rocket propelled floating torpedo which towed another small weapon. Fig. 12 shows how the rocket over was converted to rotary power by means of a turbine acting on a set of propellers. When the *Berdan* struck the torpedo nets surrounding a ship the slackening of the towline caused the small weapon to go into a programmed dive under the nets and strike the ship under the keel — in theory that is! British intelligence reports of trials carried out before the Turkish Navy indicate that this weapon was not a success.

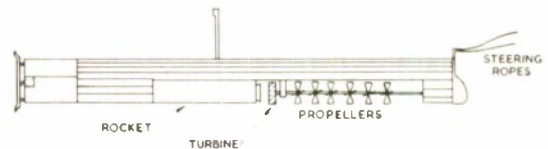

FIG. 12. Berdan Torpedo.

Rockets were not the only alternative propulsion systems to challenge the conventional propeller drive. One torpedo invented during this period was propelled by an umbrella-like contraption at the rear. This was operated by an oscillating shaft which opened and shut the "umbrella" and so propelled the vehicle rather in the fashion of a frog's foot! We must not be too scornful of such outrageous devices because nature has settled on that system for frogs after many millions of years R & D work. During the last war the Germans devised a torpedo propelled by a flapping wing. This was claimed to be at least as efficient as a conventional propeller and much quieter. Once again we can note that nature has used this method for some time without complaint. The advantages of blunt noses on torpedoes might also have been realised earlier if the first torpedoists had studied the salmon.

Only two torpedoes, apart from the Whitehead patterns, went into successful quantity production before the turn of the century. (The Lay weapon was exported to Russia for harbour defence work but only in small quantities). The Brennan torpedo was invented by an Australian watchmaker and was driven by pulling two 18 gauge piano wires out of the weapon. This was achieved by a steam winch

mounted on the shore. The use of this torpedo from ships was ruled out by the need for a stable winch platform. The wires were unreeled from two drums inside the weapon and these directly drove the contrarotating propellers. Steering was achieved by varying the relative tension of the wires. This caused the weapon to heel over and a compensating pendulum applied steering control. Fig. 13 shows a later version of this weapon where the drums were on a common longitudinal axis. A depth control similar to that used by Whitehead was installed. The performance of the Brennan was 20 knots to a range of 3,000 yards—this being considerably better than the contemporary Whitehead weapon—and the range was only limited by the length of wire carried. The weapon was used exclusively for coastal defence by the Royal Engineers over a 20 years period around the turn of the century. The huge Brotherhood winches were installed in concrete blockhouses and the torpedoes were run down to the water on rails. The derelict remains of a Brennan torpedo station have recently been discovered on the Thames estuary⁽¹⁴⁾.

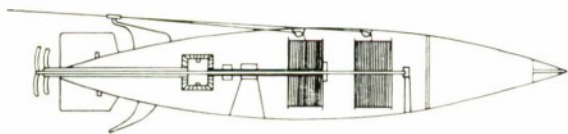

FIG. 13. The Brennan Torpedo.

A scandal blew up over the adoption of this torpedo when the Government paid Brennan no less than £110,000 for his invention and paid him a vast salary to act as production chief. Compare this sum with the miserable £15,000 paid for the manufacturing rights of the much more worthy Whitehead weapon only 15 years previous.

Maxim, brother of the famous gun manufacturer, produced in the United States a wire-powered torpedo suspiciously similar to the Brennan except in the detail of depth keeping. The Maxim torpedo actually pumped water into or out of a ballast tank. Such fanciful devices are not confined to the last century. In 1944 a torpedo was built in Britain that varied its depth by pushing the main battery to and fro to alter the position of the centre of gravity.

Finally we will consider the Howell torpedo which was the mainstay of the United States Navy for 20 years up to about 1895 and was a serious contender to the supremacy of the

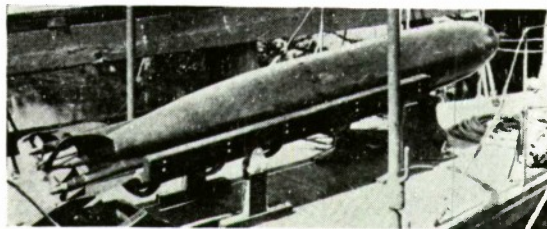

FIG. 14. The Howell Flywheel Torpedo (1892).

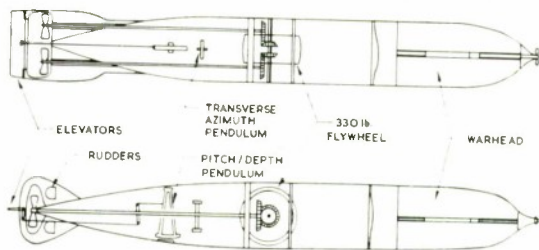

FIG. 15. Howell Torpedo.

Whitehead torpedo outside the United States^(8,11). Fig. 14 shows the appearance of the weapon and Fig. 15 shows the internal construction. The propulsive power was derived from a heavy flywheel and transmitted to twin propellers. The weapon was ship-launched from a tube and the flywheel was spun just prior to launching by a steam winch external to the launching tube.

A wheel speed of 12,000 r.p.m. was obtained in the later versions of the weapon and with a wheel weighing 130 lbs. this gave a weapon performance of 30 knots to 800 yards with a decreasing speed for a further 400 yards. This was comparable with the Whitehead weapons of the same period (see the table at the end of Part 1). This relatively good performance combined with simplicity of construction and operation resulted in the Whitehead torpedo not making its appearance in the United States until 1892.

The Howell torpedo had three advantages over the Whitehead apart from simplicity. The weapon left no track, it did not vary its trim and, more important, it kept to a straight course. This latter was achieved by using the gyroscopic action of flywheel. Because the wheel axis was transverse any departure of the weapon from a straight line caused the weapon to heel over. This was detected by a transverse mounted pendulum which was directly connected to rudders which produced a correction to the course and hence a righting torque. This was in fact the first application of the gyroscope to torpedoes. When the

TABLE 3. Selection of cold air torpedoes.

Type	Date	W	C	V	R	Remarks
14 in. Fiume	1866	265	18†	7	200	Original model
14 in. Fiume	1868	346	40	7	200	Models demonstrated to Austrians
16in. Fiume	1868	650	67	7?	600?	
14in. RL Mk1	1875	530	26	18	600	First British make.
15in. Fiume	1882	904	94	21	800	
14in Fiume	1882	498	?	24	400	Built for Russians
14in Fiume	1883	?	117	20	800	Largest 14in. warhead
14in. German	1883	581	44	21	650	'Schwartzkopf'
12in. Fiume	1883	272	33	21	200	
14in. RL MkV	1886	660	58	24	600	
18in. Fiume	1890	1236	198	30	800	First 18in. in Royal Navy
18in. Fiume	1906	1609	220	35	1000	Last 'cold compressed air' in Royal Navy

W—Weight, lbs.
 C—Warhead weight, lbs. Guncotton except where † indicates dynamite.
 V—Speed, knots.
 R—Range, yards. Not necessary maximum range.

TABLE 4. Royal Navy intake 1886

14in. R.L. Mk V	200	
14in. Fiume Mk IV	200	
14in x 11ft. Fiume	2	Experimental
12in. Fiume	10	Experimental
14in. German	50	
14in. R.L. Mk V	2	Built privately

Obry gyroscope was used in Whitehead torpedoes in 1895 Howell started a legal battle over patent rights⁽¹¹⁾.

The above weapons were departures from the Whitehead compressed air principle but one weapon, again the brainchild of Ericsson, eliminated the heavy air vessel by supplying compressed air through an 800 ft. hose. The drag on the hose greatly slowed down the weapon however.

Having taken the technical development of the torpedo up to the turn of the century we will finish this section with a look at the aggressive use of the weapon. The first sinking by a torpedo was during the Chilean revolutionary war. Two Birkenhead-built torpedo boats attacked the *Blanco Encalada* on the night of April 23rd, 1891. The first boat, *Almirante Conte* fired three Whiteheads at the ironclad but these all missed. The second torpedo boat, the *Almirante Lynch* fired another salvo of three weapons and one hit. The effect of the 58 lb. of guncotton in the 14 in. weapon was to blow a hole 15 ft. by 7 ft. below the waterline. The ship sank immediately with the loss of 180 officers and men. The ship had left her torpedo nets at port and the water-tight doors were not closed. One consequence of the explosion was the ejection of the Captain, Don Luis Gofii, up a ventilation shaft and into the sea where he was later seen swimming ashore with one arm around the

Table 5. Torpedo performances.

Type	Date	W	C	V	R	Remarks
14 in. Fiume	1882	498	?	24	400	Typical Whitehead
18 in. Fiume	1890	1236	198	30	800	Royal Navy's first 18 in.
18 in. Fiume	1906	1609	220	35	1000	Last cold air weapon.
<i>Types other than compressed air</i>						
18 in. Lay	1880	2500	200	16	4000	Compressed CO ₂
22 in. Patrick	1886	6000	200	21	2000	Similar to Lay
16 in. Ericsson	1880	1500	300	61	100	Rocket
29 in. Nordenfelt	1888	5000	300	16	4000	Wire-guided battery driven
14 in. Howell	1894	520	100	26	400	Flywheel drive
18 in. Howell	1895	700	180	30	1200	Flywheel drive
21 in. Brennan	1885	?	200	20	3000	Wire powered
<p>W — Weight in lbs. C — Warhead weight in lbs. V — Speed in knots R — Range in yards</p>						

ship's mascot, a tame llama. The animal was then taken as mascot onboard H.M.S. *Warspite* until it was sent to the London Zoo in disgrace for eating the epaulettes off an Admiral's dress uniform!

The Chinese had little success with their Schwartzkopf weapons in the war of 1894 largely because theirs were fired at very long ranges. Local fishermen recovered them from the beaches and sold them back to the Chinese for 100 dollars each. Such inefficiency is only to be expected from officers who pawned their ship's guns in the ports!

References

- (1) Jane, F. T., "The Torpedo in Peace and War", W. Thacker & Co., 1898.
- (2) Sleeman, C., "Torpedoes and Torpedo Warfare", Griffin & Co., 1889.
- (3) Armstrong, G. E., "Torpedoes and Torpedo Vessels", Bell & Co., 1901.
- (4) Sueter, M. F., "The Evolution of the Submarine Boat, Mine and Torpedo from the Sixteenth Century to the Present Time", Griffin & Co., 1908.
- (5) Laubeuf, M. and Stroh, H., "Sous-Marins, Torpilles et Mines", Ballière et Fils, 1923.
- (6) Bethell, P., "The Development of the Torpedo", *Engineering*, Vols. 159-61, 1945/6.
- (7) "Annual Reports of the Torpedo School", H.M.S.O., 1881 onwards.
- (8) "Improvements in Propulsion of Torpedoes", U.S. Patent Office, No. 121052, November 21st, 1871. John Adams Howell, U.S.N.
- (9) "The Automobile Torpedo and its Uses", L. H. Chandler, Lieut., *Proc. U.S. Navy Inst.* (March 1900).
- (10) "Lecture on the Whitehead Torpedo", F. M. Barber, U.S.N. U.S.N. Torpedo Station, November 20th, 1874.
- (11) Howell versus Bliss. Transcript of evidence, 1898.
- (12) "Torpedo Propulsion Systems", F. A. Maxwell, *J. Amer. Rocket Soc.* (December 1949), *J.R.N.S.S.*, 5 (1950), 125.
- (13) "The Origin and Evolution of the Torpedo", Stockard, J. M., *Collier's Encyclopedia*, 1948, (*J.R.N.S.S.*, 2, 396).
- (14) Private Communication from Mr. V. T. C. Smith, Northfleet, Kent.

Part 2

Abstract

The history is continued with the introduction of the 'heated' or 'steam' torpedoes and the technical developments during and following the Great War are described. A connection with Julie Andrews is established.

The Heated Torpedo

With increasing air pressures it was found that freezing could occur on the expansion phase of the standard compressed air engine and as a cure heating was introduced. This produced spectacular results apparently to the surprise of the designers. It is not clear whether the first effective heating system was introduced by Britain or United States. The earliest form was the "Elswick" heater as patented by Sir W. G. Armstrong, Whitworth and Company in 1904. Fuel was sprayed into the air vessel of a conventional weapon and ignited. The device was demonstrated in an 18 in. Fiume Mk. III at Bingleaves in 1905 before a distinguished audience of British and Japanese experts. The weapon speed was nine knots more than for the unheated version. The system had the disadvantage of badly sooting the air vessel however and large temperature excursions could sometimes occur.

The Whitehead heater system, introduced two years after Robert Whitehead's death in 1905, mixed the fuel and air after the pressure reducer so that only a small volume was exposed to the heat of combustion. Even so the combustion chamber had to be cooled and for this reason water was swirled around to the walls. The vaporisation of the water greatly added to the energy available for propulsion. These systems became known as the "dry heater" and "wet heater" respectively. Although also known as "steam" torpedoes it can be seen that these wet heater weapons were still primarily hot air driven with the steam providing extra energy.

The engines then in use had to be modified to cope with inlet temperatures of the order of 1,000°F by changing the valve arrangement and adding a cylinder to give a four-cylinder radial engine capable of 180 H.P. as shown in Fig. 16.

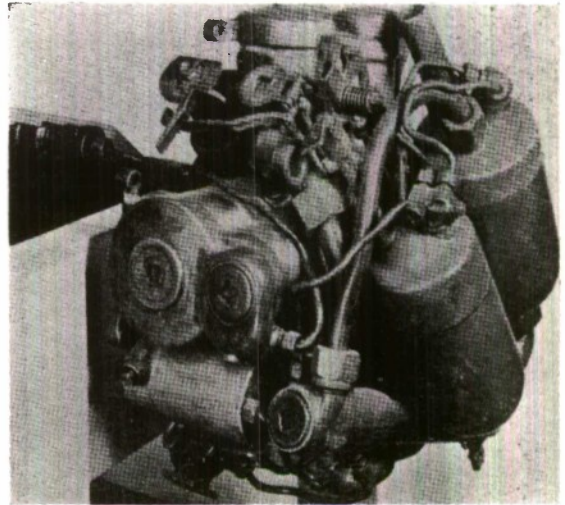

FIG. 16. Four-Cylinder Brotherhood Radial Engine as used by Whitehead.

Fig. 17 shows the layout of the R.G.F. wet heater system and it can be seen that the water supply pressure is used to force the fuel into the combustion pot. Thus, if the water feed should fail for any reason, the fuel would be automatically cut off, thus preventing the combustion pot from burning out. In fact, a rather simpler system was invented in 1908 by Engineer Lieut. Hardcastle and became known as the R.G.F. heater.

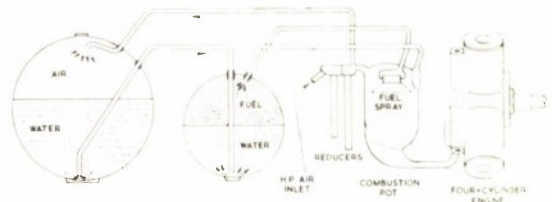

FIG. 17. R.G.F. Heater System.

The United States had taken up the manufacturing rights for the Whitehead cold compressed air weapons in 1892 and Fig. 18 shows the Mark I weapon produced in that year. The Mark II and III weapons embodied slight improvements but the Mark V was the first to carry a heater. Although the British had experimented with a Parsons turbine as early as 1899 and later with a Curtis type the results were not encouraging and the four-cylinder engine remained in vogue with British torpedoists for many years. Mr. F. Leavitt, who worked for the E. W. Bliss concern where the Whitehead weapons were made under licence,

regarded the Brotherhood engines as "corny" and set about building a Curtis-driven weapon which became known as the Bliss-Leavitt Mark I. This was accepted into the U.S. Navy in November 1905. The propulsion was by dry heater using alcohol as fuel without water diluent. This latter was acceptable on account of the relatively low calorific content of alcohol. From this point in time until the introduction of the electric torpedo during the last war the U.S. Navy have stood by the turbine and the British by the reciprocating engine.

The gearing was to be a source of much concern in later years when the noise of torpedoes became an important feature of torpedo detection and it was found that the tail gearing was the primary source of high frequency noise. The need for a relatively low inlet temperature to the turbine also reduced efficiency due to the use of either a low performance fuel or water injection. The requirement to carry a diluent (and hence reduce the payload of the weapon, was overcome during the last war when the Japanese injected seawater directly into their turbines. This policy was not universally popular however. The French in fact were experimenting with a seawater diluent turbine engine in 1913 with which it was claimed a 50 knot torpedo would be powered. This does not appear to have materialised and the French continued to rely on piston engines at least for another decade.

In the period from the introduction of the heated torpedo until the Great War many attempts were made to improve weapon performance but few of these experiments reached service in time for the war. A contrarotating direct drive turbine was developed in Britain by two midshipmen named Montagu and Larcum but the Board of Enquiry rejected the idea and this marked the end of turbine drive in British weapons. Further experiments were carried out at R.A.E. Farnborough after the First World War but with no better success.

The reciprocating engine was, by the outbreak of war, well established and although the Whitehead concern had produced a huge two-cylinder engine just prior to the war it never entered service during that period. The problems of improving performance were setting designers thinking of ways to eliminate the very heavy air pressure vessel which often accounted for one third of the weapon weight.

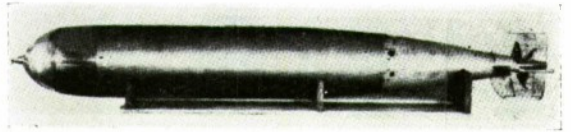

FIG. 18. 18in. Fiume-type built in U.S.A. (1892).

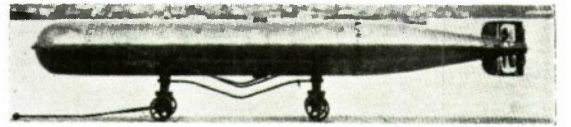

FIG. 19. U.S Bliss-Leavitt, Mark 3 (1911).

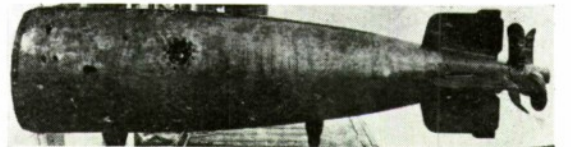

FIG. 20. Tail of 19.7in. German Torpedo (1917). Note curved propellers.

The use of enriched air and even pure oxygen had been considered at an early date but rejected on account of the capricious nature of these gases. The British tried adding Ammonium Nitrate to the torpedo's "drinking water". This chemical broke down into water and Nitrous Oxide (N_2O), this latter being an oxidant. Although some propulsive improvements were found these were not sufficient to warrant building service weapons.

As part of this search for greater propulsive efficiency, the three-bladed propeller was introduced in 1893 and the four-bladed by 1897. Further increases did not occur until recent times. Propeller design was empirical at the turn of the century because the necessary theory had not then been developed but even so quite good designs were found. Indeed, a speed difference of only $\frac{1}{4}$ knot was considered significant. Fig. 20 shows the curiously curved blades adopted around the period of the First World War. Good examples of German 19.7 in. weapons with these blades can be seen at the Armoury Museum, Valletta. The purpose of the blades was to assist the torpedo to slip through holes in anti-torpedo netting used extensively for ship protection.

These nets were arranged to be swung out on booms at short notice and were popular for several decades. Fig. 21 shows two torpedoes caught in nets around H.M.S. *Diamond* during practice shots in the pre-First War period.

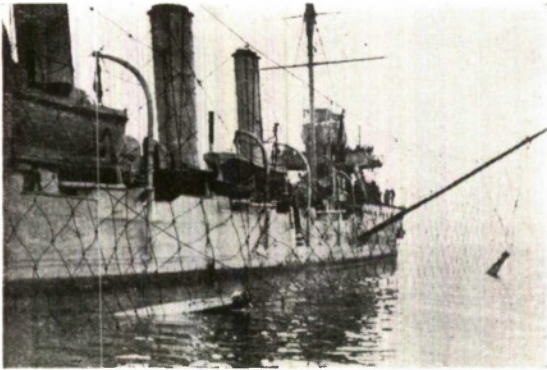

FIG. 21. Net protection of H.M.S. *Diamond*. Two torpedoes caught at $8\frac{1}{2}$ knots.

Several counters to the nets were devised, many of them by the Whitehead firm. Fig. 22 shows one device fitted to weapon noses designed to force the net apart. Other devices included explosive charges in the nose which fired a circular cutter into the net. The torpedo then slipped through the hole so produced.

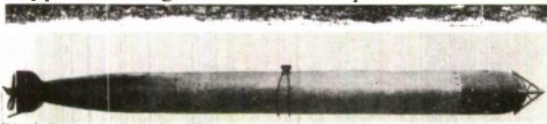

FIG. 22. Experimental net piercing nose cap (1914)

Nets became unpopular for battle engagements because of the slow speed enforced on the ship by their use. Eventually they were restricted to the protection of ships in harbour; a use which survived through the last war.

The first 21 in. torpedo, the forerunner of the present submarine weapon, appeared in 1908 as the R.G.F. Mk. I having a range of 3,500 yards and a speed of 45 knots. The corresponding United States weapon was the Bliss-Leavitt Mk. VIII which appeared in 1913. The 21 in. weapons were by no means the largest diameter "conventional" torpedoes. A 26 in. diameter weapon had been produced in 1900 and Whitehead built a 27.5 in. weapon for the Japanese Navy. These were experimental weapons however and were not successful on account of dynamic instabilities resulting from their relative shortness.

Around the turn of the century the American firm of Bliss-Leavitt introduced the air-blast gyroscope whereby the wheel was run up to a speed of 10,000 r.p.m. in only 0.35 seconds from firing. This gyro provided adequate control over the weapon from firing to impact despite the long ranges now being obtained (see the table on page 50).

This type of gyroscope remained virtually unchanged until the introduction of the air-blast maintained wheels of the last war.

British torpedoes in the first two decades of this century were produced at the Royal Naval Torpedo Factory (opened at Greenock in 1910), the Royal Gun Factory at Woolwich and external purchases from the Weymouth and Fiume factories of Robert Whitehead. The main production prior to the war was the R.G.F. Mk. VII and the Whitehead Weymouth Mk. I, both 18 in. weapons as was the R.N.T.F. Mk. VIII which was a submarine-launched weapon and the first type to be produced at Greenock.

The Weymouth works produced their first 21 in. torpedo in 1909 but only two experimental models were built and after unsuccessful trials they were scrapped in favour of the much more successful Weymouth Mk. II which was sold extensively abroad and to the Royal Navy. Just before the war Whitehead's empire came under the strong influence of Vickers, Armstrong Ltd. This influence was to dominate the British Whitehead Factory until after the Second World War when the independent torpedo production ceased after a series of abortive ventures.

By the outbreak of war in 1914 most of the old "cold air" torpedoes had been converted and a new type of torpedo known as a pattern runner was invented by Lieut. F. H. Sandford. This weapon could be sent to run a preset distance and then zig-zag back and forth along a given track. This made the chance of hitting a ship much greater when the speed of the target was not accurately known.

Practice with torpedoes in the Royal Navy was carried out at the rate of 8,000 test shots per year with a hitting rate of 98%. It must be admitted that the test was not nearly as severe as one would expect to experience in wartime. The firing of torpedoes was by 1914 the main means of attack by submarines. A highly embellished account of a trip in a submarine is given in Jane's book *Torpedoes and Torpedo Warfare* published just before the turn of the century. The reader is left in a claustrophobic state of mind after only a few pages but it is interesting to note the rapid and parallel development of the submarine and torpedo and the way they eventually became essential to each other's effectiveness as a fighting system.

Before relating the wartime development of the torpedo it is perhaps worth recalling the incident at Simonstown Naval Base when a mechanic stripped down a torpedo believing it to have been run and exhausted. In fact the air vessel was fully charged to over 2,000 p.s.i. As the man unscrewed the air vessel drain plug the screw stripped the last three threads and the complete torpedo shot off, literally, like a rocket. It hit the far wall of the workshop at roof level and bounced 30 feet back to land as a crumpled mess of metal at the mechanic's feet. The man suffered only shock and presumably a desire to be more careful in future! In the same year an 18 in. weapon broke the then world high jump record for torpedoes by leaping 40 feet into the air as a result of an elevator malfunction at over 45 knots! This record has been broken several times in more recent times.

Torpedoes in World War I

The torpedo faced its first real challenge with the outbreak of war since we cannot draw conclusions as to its tactical usage from the sporadic firings by badly trained crews in the South American revolutions and wars and the Sino-Japanese war. The torpedo still had limited range compared with gunfire but the vastly more damaging effect of an underwater explosion gave the torpedo a useful capability when fired at ships. The real success of the torpedo lay in its use as a submarine weapon against convoys. Here, as in the last war, Britain was nearly beaten into submission by the ruthless sinking of merchant shipping and it was here that the torpedo ruled supreme.

The first actions during the Great War showed up serious deficiencies in British weapons. The failure at H.M.S. *Vernon* to carry out representative trials with live war-shot weapons had resulted in the fuze and detonator system being unreliable. The effect of a successful hit was not always up to expectation. The failure at H.M.S. *Vernon* to produce adequate submarine radio sets, torpedoes and mines (both very inferior compared with German products) caused Admiral Fisher to write apoplectically to Jellicoe in 1915:

Our torpedoes seemed to be filled with sawdust!!! There's a heavy reckoning coming to everyone connected with Vernon during the last four years . . . I hope to get a good many officers disgraced for it!

Fisher expressed the desire to have Charlton, the Assistant Director of Torpedoes from



FIG. 23. Torpedo-Carrying aeroplane, Sopwith (T) carrying 18 in. Mark IX with heavy head (250 lbs. explosives).

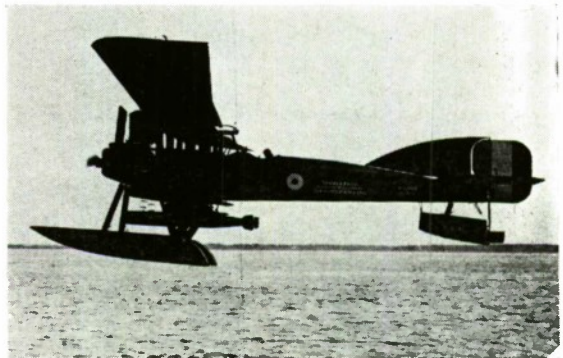

FIG. 24. Short '320' at Calshot (1918).

1911 to 1914, "blown from a gun" and swore to have the senior officers hung or shot; he did not express a preference as to method.

In fact, no reprimands appear to have been given and British torpedoes were soon coming up to expectations. Life at *Vernon* was difficult during the early part of the war due to the removal of nearly every able-bodied engineer to the battle front. As a result torpedo training and testing was largely carried on by long-retired torpedomen, few of whom had worked with heated torpedoes. However they seem to have settled into the work well and some sort of continuity was maintained.

It cannot in truth be said that the torpedo played a great part in the sea battles such as Jutland and Dogger Bank. The power of the torpedo was derived as much from its threat as its use. During the Battle of Jutland for example the British fleet broke off an attack when they found themselves threatened by a salvo of torpedoes. In fact the threat did not materialise but the torpedoes of the German High Seas Fleet had played an important role by just their existence. At the time of Jutland

the British fleet carried 382 21 in. torpedo tubes compared with the German fleet armoury of 362 19.7 tubes. Such capabilities clearly demand respect.

It was found after the war in experimental firings against the U.S.S. *Washington* that at least four hits were needed with warheads exceeding 300 lbs. to cripple a capital warship and a further four hits were needed to sink it. This may well account for the small number of large ships sunk in battle.

As noted above, the outstanding success of the torpedo in the Great War was its ability to strike at merchant shipping from submarines. The main armament of British submarines was the 18 in. R.N.T.F. Mark VIII and the 14 in. R.G.F. Marks V, VI and VII. It is not the intention here to describe the tactical use of the torpedo in either World Wars because this deserves a history of its own. One aspect of torpedo usage which cannot be passed by however is the invention and development of the aircraft torpedo.

Aircraft Torpedoes in World War I

The idea of dropping torpedoes from the air appears to have been conceived around 1910 when it was proposed that airships might be used to approach surface craft and fire a torpedo at several thousand yards range. The first practical ideas were put forward in a paper by Lieut. Douglas Hyde-Thompson and Commander Murray Sueter (later Rear-Admiral Sir Murray Sueter, C.B., M.P.) in 1912. A few static dropping trials were carried out in 1913 and on July 28th, 1914 the first successful dropping of a torpedo from an aircraft was achieved. The craft was a Short seaplane based at Calshot.

Sueter now pressed hard for Admiralty support and in 1915 a flight of Short 184's were sent to the Dardanelles in a makeshift carrier called the *Ben-My-Chree* (a name now carried by a British Rail ferry boat). The 'planes carried R.G.F. Mk. X weapons of 1897 vintage which were modified for the task. They were however unheated. Three ships were sunk, one of them by a weapon launched from a seaplane taxiing on the surface. Following this success progress was slowed down by the fact that the Short 184's could only take off with a single 14 in. torpedo if the weather was good and the 'plane in a good mood. The 14 in. torpedo's warhead was not nearly powerful enough to badly damage a large warship and so a larger aircraft was built, the Short 320, which could carry an 18 in. weapon at 72

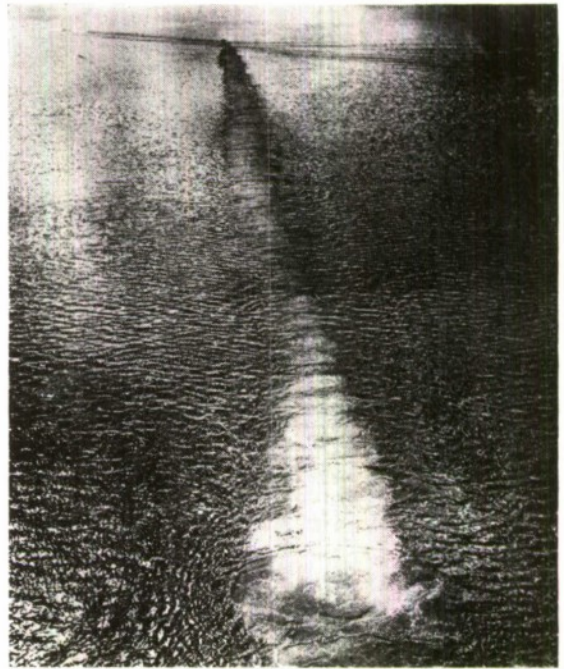

FIG. 25. The deadly track of an air torpedo!

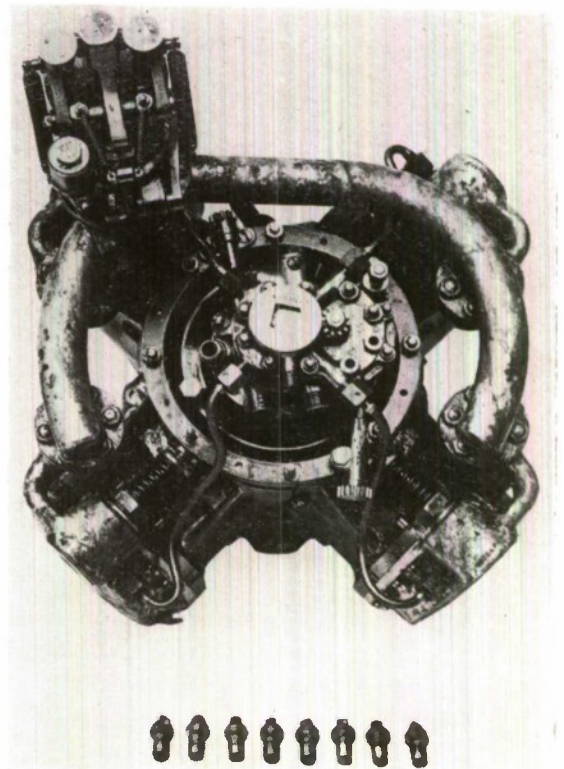

FIG. 26. B-Cycle Engine with Combustion Pot.

m.p.h. to a range of 100 miles. This seaplane went into production in 1917 following very successful trials the previous year. Sueter was anxious to have a land-based force of torpedo-planes that could also operate from aircraft carriers. With the help of Mr. T. O. M. Sopwith he designed the *Cuckoo*, a 200 h.p. single seater torpedo carrier with a range of 160 miles and a speed of 103 m.p.h.

While waiting for the *Cuckoo* to appear Sueter took a flight of Short 320s on rafts to Cattaro from their base across the Adriatic at Otranto to attack the Austrian fleet with R.G.F. Mk. IX 18 in. weapons but due to an unexpected storm the attack was cancelled.

Meanwhile the *Cuckoo* project had ground to a halt because of Sueter's absence. However, the unfinished prototype was spotted at the Sopwith works by a browsing naval officer and the aircraft was then completed and tested. Despite efforts to get 350 of these into service before the Armistice the first squadron was formed in 1918 just too late for active service.

Thus the torpedo became an aircraft weapon as well as a ship and submarine weapon but it must be admitted that its air-dropped role played little part in the winning of the First World War. The Germans developed the Brandenburg twin-engined aircraft for carrying their equivalent of the British R.G.F. Mk. IX. The Germans also carried out trials with torpedo-carrying gliders which were released from airships. These gliders were guided towards the enemy ships by trailing wires. These weapons were nearly ready for service at the end of the war.

Very little innovation occurred during the war—indeed it was discouraged in order that full effort be concentrated on getting reliable weapons to the fleet in large numbers. Although several different marks of torpedo were introduced during the war (six mark nos. of 21 in. torpedo were built by the Royal Navy for or during the war—one of these being experimental and not issued to the fleet) these were all very similar in performance, as seen from the table below. The differences were mostly in minor internal constructional details. It is interesting to note in passing that the Mark IV torpedo which gave excellent service in the First World War was also used 25 years later in the next war.

At the end of the war two problems were immediately tackled. The failures in the impact fuze were cured and the tactical use of torpedoes in surface battles was reconsidered. It was decided that the poor sinking rate

observed during the war was largely due to the torpedo attacks not being pressed home with sufficient aggressiveness. A new policy was adopted whereby a salvo of as many as 162 torpedoes could be launched towards a group of battleships.

In the next of these articles the developments between the wars will be described but we will interrupt this part of our story with an anecdote concerning the life of Robert Whitehead*.

Robert Whitehead married a young Austrian lady and they became the proud parents of three sons and two daughters; two other children having died in infancy. All the sons were successful in life and the daughters married well. The eldest son John helped to run the Whitehead factories around the world, Robert Boveille became a very successful solicitor and James married the daughter of Viscount Middleton and became Ambassador to the Court of Austria. James had seven children. The youngest, a girl of outstanding beauty named Frances after her grandmother, was invited in 1912 to launch a new submarine for the Austrian Navy. The commander of the vessel, a Captain Von Trapp, fell in love with her and they were soon married. The captain was a brave submariner and at the end of the World War it was expected that he would become Admiral of the Austrian Navy. However, Austria was left without a coastline and he and his wife had to settle to a commercial existence. His wife died during a scarlet fever epidemic and the Captain became very withdrawn from his many children and life in general. He obtained assistance for his family from the local convent in the form of a young novice.

Devotees of "The Sound of Music" will know the rest of this romantic drama and I will not develop the story further but just note that the Von Trapp children who formed the nucleus of the "Von Trapp Singers" were (and are) the great-grandchildren of the inventor of the automobile torpedo.

We saw earlier that the standard method of torpedo
Propulsion Improvements 1918 - 1939 propulsion at the end of World War I was either the wet heater system in which steam and hot gas were used to drive a gas engine (the British and French systems) or the

*I am indebted to Mr. Alan Wolstencroft for permission to relate this story.

turbine system in which alcohol was burnt either with or without water diluent (the United States method). The Japanese were at that time trying without much success to build heater torpedoes using reciprocating engines. Their failures were due to poor pressure vessel techniques which resulted in them having to purchase pressure vessels from Britain. This situation was to be sadly changed in the last war when Japanese torpedoes were seen to be the best in the world. But that is a story to be told later.

The British wet heater engine in 1918 was a bronze four-cylinder affair in which the heads, bores and manifolds were integral. The disadvantage of this motor was the high consumption rate of air—12lb. per b.h.p./hr. The engine was not very reliable and the inlet valves often leaked. Following the Armistice the R.N.T.F. at Greenock and several outside firms investigated possible improvements in torpedo propulsion. Included in the systems studied was the use of hydrogen peroxide as a low pressure oxidant. This had the advantage of high density, low weight container and a catalytic decomposition into oxygen and water with the release of appreciable heat.

These investigations were carried out in 1923, long before other nations were considering such "exotic" oxidants. It was not until 1936 that dynamometer trials were carried out on British hydrogen peroxide systems however, by which time the Germans were developing similar systems.

Between 1920 and 1926 studies were made of enriched air as an oxidant. Although a heavy pressure vessel was still needed, a greater weight of oxygen could be carried. This work resulted in the 21 in. Mk. VII torpedo of 1928. This weapon, no less than 306 in. in length, used air enriched to 57% oxygen content and achieved a propulsive performance of 33 knots to a range of 16,000 yards—which is some 1.7 times the performance of the Mk. VIII torpedo in service with the Royal Navy at the present time. The enriched air weapon was fitted to the London class cruisers but was unpopular on account of the capricious nature of enriched air (it is said that the weapons were never left charged on deck during a thunderstorm!) and the rapid corrosion in the pressure vessel. An advantage, apart from the increased performance, was the tracklessness due to the low proportion of insoluble gases in the exhaust. This is primarily an advantage

for submarines attacking convoys because, without the obvious track, the first indication of an attack is the explosion and no indication is given of the position of the submarine. The Mk. VII was not a submarine weapon and thus the advantage of tracklessness was small. The one thing that killed the enriched air torpedo was the invention of the Brotherhood Burner Cycle engine.

The Burner Cycle engine was invented in the late 1920s and is still in service today albeit in improved form. The remarkable success of this engine compared with foreign turbines will be demonstrated quite clearly in Table 7 where it can be seen that this engine is far superior in power/weight ratio and weight of fluids consumed per b.h.p. per hr.

The Burner Cycle or semi-internal combustion engine has a clear advantage by not requiring a diluent. A further advantage would be to carry oxygen in a more convenient form such as hydrogen peroxide. This form of oxidant was not to be run in service until the mid nineteen forties however. In its "air" form the burner engine was a four-cylinder radial engine fed with air at about 840 p.s.i. taken from the main air vessel at about 3,000 p.s.i. A small quantity of fuel (paraffin—the early weapons used Broxburn Lighthouse Shale Oil) was atomised into the air and burned. This raised the air temperature to about 1,000°C and only slightly depleted the oxygen content. The hot gas was then fed into the engine through four poppet valves. More fuel was injected into each cylinder a little before top dead centre. Spontaneous ignition occurred and supplied the driving force. Exhaustion was through two auxiliary ports in the piston crown and four main ports in the cylinder liner. The exhaust gases left through the hollow propeller shaft.

By the end of the World War II this engine had, with minor modifications achieved a power of 465 b.h.p., sufficient to achieve 50 knots in a 21 in. weapon. Following the war an 800 b.h.p. engine was built in an attempt to reach 60 knots but this is a story for later.

Although the semi-internal combustion engine underwent few changes between the wars, or indeed since the last war since it is still in service with the Royal Navy, this was not through lack of initiative. Many alternative means of propulsion were tested but none was better than the Burner engine.

TABLE 6. Comparison of weapons used in World War I.

Type	Year	W	C	V	R	Remarks
18 in. Fiume	1908	1609	253	42 34 28	1090 2190 4370	Dry heater
18 in. R.G.F. Mk. VII	1908	1553	200	30 41	5500 3000	Warhead increased to 320 lb. in 1917
18 in. R.G.F. Mk. VI	1909	1490	200	29	6000	Cold type converted
18 in. Fiume	1911	1620	253	42 27	1090 6560	Wet heater
18 in. Fiume	1911	1743	220	44 31	2190 6560	New 2-cylinder engine
21 in. Weymouth Mk. II	1914	2794	225	29	10000	
23 6 German	1916	4410	550	28	18590	
18 in. R.N.T.F.	1917	1077	250	29	2000	First aircraft torpedo designed as such
18 in. German	1917	1680	350	35	1640	Aircraft torpedo
21 in. R.N.T.F. Mk. IV	1917	3190	515	40	5000	Used in World War II
21 in. U.S.	1917	3050	385	27	13500	Turbine driven

W — Weight in lbs.
C — Warhead weight in lbs.
V — Speed in knots.
R — Range in yards.

Turbine propulsion was always under review in Britain as well as France. (Progress in the United States was limited to steady improvements to the well established alcohol/turbine system). In 1926 the Royal Aircraft Establishment, Farnborough produced the turbine shown in Fig. 27. Designed to run on methylated spirit diluted with water and using air enriched with oxygen to 57½% by weight, this two stage turbine was intended to give 200 b.h.p. A novel feature of this turbine was the epicyclic gear used to transmit power to the contrarotating propellers. An overall gear reduction of 27·6 was achieved. This turbine unfortunately broke up during dynamometer trials so that full tests were not completed. It seems unlikely that the use of enriched air would have been acceptable in view of the experience with the Mark VII.

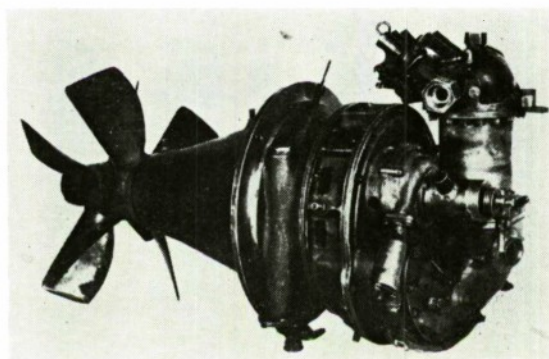

FIG. 27 R.A.E. Enriched-air turbine.

TABLE 7. Comparison of Performance of Inter-War Period Torpedo Systems

Origin	Engine type	R.P.M.	B.H.P.	Fluid rate of consumption, lb./b.h.p./hr.			Total rate of fluid consumption lb./b.h.p./hr.	Total weight lbs.	Weight/Power ratio
				Air	Fuel	Diluent			
U.K. 21 in. Mk. 8	Burner cycle	1350	407	7.66	0.64	—	8.3	265	0.65
U.K. 18 in.	Burner cycle	1350	300	8.20	0.70	—	8.9	162	0.54
U.S. Mk. X	Turbine	13800	158	15.00	1.60	5.0	21.6	158	1.00
Swedish	Turbine	60100	310	13.80	1.00	9.6	24.4	411	1.32
French	Turbine	15000	175	14.20	1.60	1.7	17.5	190	0.92

A Swedish turbine was obtained by R.N.T.F. in 1936 from Aktiebolaget Lesto of Stockholm. It was not very good, as can be seen from the above table. A French torpedo produced in 1926 and having a diameter of 15.7 in. was driven by what must have been one of the most successful turbine systems built in the inter-war period. Despite its early date this weapon was still in production during the second World War. It can be seen from the above table that the turbine was the most efficient of those tested largely on account of the high nozzle temperature of 1,300°C.

The French continued to develop turbine systems and these reached a peak of performance with an oxygen torpedo produced towards the end of the last war but we will return to this in due course.

The American Bliss-Leavitt turbine, shown in Fig. 28, had two contrarotating wheels so that gyroscopic and torque effects were negligible. This was not the case in their early turbines and in 1911 the Americans were having serious trouble with the then current turbine mounted on a longitudinal axis. The newer turbines had the wheels on a transverse axis as illustrated. Three nozzles were used in the two-stage impulse system—this system allowing reasonable wheel speeds and no intermediate stator. The latest design to be produced before World War II was for the 22.4 in. aircraft torpedo, the U.S. Mark XIII. This turbine produced 95 b.h.p. at a rotor speed of 11,000 r.p.m. and a gas condition at the nozzles of 395 p.s.i. and 840°F.

We have already seen that some improvements had been considered whereby the weight of oxygen carried in a torpedo might be increased without increasing the weight of vessel needed to contain the oxidant. The enrichment of the air with oxygen is an obvious solution and resulted in the British Mark VII in 1928, many years before similar developments in other countries. When it is pointed out that 4 lbs. of pressure vessel are needed to carry each pound of gas and that 77% of air is useless track-forming

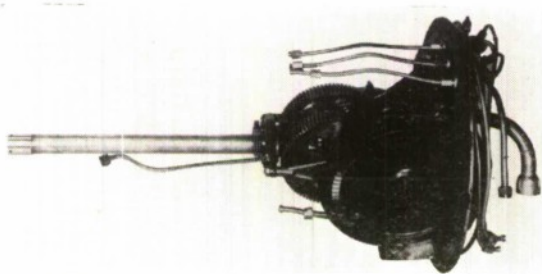

FIG. 28. American Torpedo Turbine.

TABLE 8. Torpedo Types at Outbreak of World War II

Type	W	B	V	R	Remarks
Aircraft Weapons ⁽¹⁴⁾					
15·7 in. French	1486	313	44	2190	1926 Vintage
18 in. U.K. Mk. XII	1548	388	40	1500	
18 in. German LF5	1626	440	30	2500	
18 in. Italian	1631	287	38	2200	
18 in. Japanese '91'	1720	338	45	1600	
18 in. Norwegian	1758	401	40	4000	
22·4 in. U.S. Mk. 13	1927	401	33½	6000	
Other Weapons ⁽¹⁵⁾					
21 in. U.S. Mk. 15	3840	825	{ 26½ 33½ 45	15000 10000 6000	D
21 in. U.K. Mk. VIII	3353	750	{ 40 44½	7000 5000	S
21 in. U.K. Mk. IX	3731	750	{ 35 40	14000 10000	D—C
21·6 in. French	3300	680	35	7600	S 1924 Vintage
21 in. U.S. Mk. 14	3280	600	{ 31½ 46	9000 4500	S
21 in. German G7e	3545	655	30	5470	S Electric
21 in. German G7a	3334	660	{ 30 44	15310 6560	S—D—C
21 in. U.K. Mk. VII	4106	740	33	16000	C Enriched air
24½ in. U.K. Mk. 1	5287	742	{ 35 30	15000 20000	C Enriched air. Built 1924

W is weight in lbs.

B is warhead weight in lbs.

V is speed in knots

R is range in yards

Usage: S—Submarine, C—Cruiser, D—Destroyer

nitrogen, it can be seen that there is a strong incentive towards using oxygen-rich gases or liquids—the latter being capable of storage in vessels of equal weight to the liquid.

In Britain various oxygen-rich fluids were tested before the last war. Ammonium nitrate has already been referred to in a previous part of this series of articles. It showed some improvement but not enough to warrant extended tests. Hydrogen peroxide has the advantage of being a liquid requiring, therefore, a low weight vessel but was not available in Britain in a sufficiently stable or concentrated form before the war. Although some tests were carried out at Greenock in 1936 no further work was pursued until the American and Germans had developed peroxide weapons towards the end of World War II. We will look at these later developments below. Tetranitromethane was also tested as an oxidant in Britain but not pursued.

Of the liquid oxidants considered at the Torpedo Experimental Establishment, Greenock before the last war probably the most successful was nitric acid. This is rich in oxygen, cheap, easy to store and safe to handle (with care of course). Acid with a specific gravity of 1.51 can yield 62% by weight of oxygen. Tests were carried out with acid of 1.42 specific gravity yielding 44% oxygen by weight using methanol or Benzol as fuel. The engine parts were made of steel and bronze. Nitric acid was tried with the Burner cycle engine in three ways. In the first, the acid was decomposed in a generator by the combustion of a little fuel and the oxygen-rich gas then fed into a radial engine for further ignition. In the second method the nitric acid was injected into the engine cylinders to burn a methanol fuel already preheated by a complete combustion in the generator. The third method, which could be used with a standard torpedo was to inject the acid into the hot gases just prior to the engine intake. A study of the first system showed it to be capable of delivering 750 b.h.p. which could produce a speed of approximately 60 knots.

A short range torpedo, designated the 21in. U.B., was designed to run with nitric acid and was 90% complete on the outbreak of World War II. The propulsives were carried in spherical containers of 1½ cubic ft. capacity. This torpedo was never run because of the outbreak of war. It was felt by those in command that although the nitric acid torpedo was four times as powerful as the Mark

VIII, the standard British war torpedo, it would never be ready in time to be used in the war and the staff involved would be more usefully engaged in work other than research. It is perhaps interesting to note that the German research projects suffered a similar hiatus on the outbreak of war for the same reason, namely that the war would soon be over. How fortunate that both sides suffered the same false optimism and not just the British!

In 1936 the British experimented with a jet torpedo with the object of producing a short range, high speed weapon for aircraft use but this was not produced for the war.

Britain was not alone in pursuing the search for new oxidants. The Japanese had enjoyed little success with their torpedoes mainly on account of the poor pressure vessel technology. At the Kure Torpedo Institute the position was drastically changed in 1928 when Rear-Admiral Kaneji Kishimoto and Captain Toshihide Asakuma started experimental work on the use of pure oxygen. The weapons developed were of a high performance and quality. When, at the start of the war, the Americans and Germans were desperately trying to get their torpedoes reliable, the Japanese torpedoes were inflicting heavy damage. Although performance was considered important the Japanese laid greater stress on reliability and tracklessness. The latter feature gave Japanese submarines a very large measure of protection from detection and, indeed, during the first two years of the war against Japan many ship sinkings were attributed to mines on account of the lack of torpedo wake before explosion.

The peak of Japanese propulsion developments was the Type 93, a huge weapon of 24 in. diameter and nearly 30 ft. in length weighing 6,500 lbs. with half a ton of explosives in the nose. Pure oxygen was used to give tracklessness and high efficiency. Seawater was used as diluent to save weight and 500 b.h.p. was developed corresponding to about 50 knots speed. The range was 20,000 yards. This performance is some five times greater than the present Royal Navy thermal weapon, the "Old Faithful" Mark VIII.

The development of the hydrogen peroxide weapons and the electric torpedo took place mainly during the last war and their story will be told later. We will next look at warhead developments.

Warhead Developments Between the Wars

The very first warhead filler was dynamite but wet guncotton was soon introduced and clung to by the Royal Navy for many decades. Although rather inferior to other explosives as far as power is concerned it was very stable. It has been a noticeable feature of British torpedoes that safety is usually put before performance—this seems to be the reason for the Royal Navy at the present time having a compressed air torpedo in service rather than an oxygen or hydrogen peroxide weapon. Warhead fillers of many types have been experimented with however—including in the last century the curiously named *Mammoth* and *Giant Powders*!

In 1907 the Germans introduced Hexanite and used it throughout World War I. This consisted of a mixture of T.N.T. and hexanitrodiphenylamine, the latter being extremely poisonous. This material was very stable to shock as witness the fact that no sympathetic explosions occurred onboard the *Moltke* when a British torpedo hit the torpedo store. The same explosive was used by the Japanese during the last war and called "Type 97" explosive.

Outside Germany the popular explosive was trinitrotoluene, known variously as tritolo, trotyl, trinol, Fullpulver '02, and type 92. T.N.T. was preceded briefly by picric acid in the 1880's but was later reserved for other forms of ammunition on account of its instability. Shortage of T.N.T. during the "Great War" led to the use of amatol which is a mixture of T.N.T. and ammonium nitrate. This is a very inferior mixture and was not popular.

The advantage of adding finely divided metals to explosive mixtures was appreciated before the first World War but, although some torpedoes were so filled in Britain, the shortage of aluminium caused a return to amatol in 1917. In 1933 the Germans started filling warheads with a mixture of hexanite and aluminium, the metal being in a 25% concentration. Another contemporary warhead filler was *Tialen* which consisted of a cocktail of T.N.T., Aluminium and hexagen, this latter being a cyclonite (cyclotrimethylenetrinitramine). Cyclonite by itself was used by the Italians between the wars but not elsewhere on account of its friskiness.

In 1943 the material now known as R.D.X. was used in Britain and a mixture of R.D.X., T.N.T. and aluminium was devised and named

Torpex. Despite its name this explosive was used extensively in other armaments including the "dam busting" bombs of Dr. Barnes Wallis.

Having taken the story of the torpedo up to the last war in all its important aspects we will briefly look at its other improvements up to the same time.

The Germans, who with the British share the honour of making nearly every important torpedo improvement since its invention, invented the magnetic proximity exploder and used it during the World War I. A rotating armature in the torpedo nose generated a current when near a ship and initiated warhead detonation. This system was not successful on account of the wide variations in the ship's field due to the variations in the Earth's field over the oceans. A British fuze, the *Duplex*, consisted of a coil having thousands of turns of fine wire mounted on a mumetal rod. Basically similar to the early German fuze, the same principle was used. The current developed in the coil as the weapon passed beneath a ship fired the warhead. The *Duplex* fuze suffered the same tribulations of a strong dependence on magnetic latitude, ship's heading and sea conditions. The latter effected the motion of the torpedo and induced false signals.

The failure of the *Duplex* fuze was one of the major setbacks to the effective use of the torpedo in World War II as we shall see later. Premature explosions occurred, especially on water impact for aircraft-dropped torpedoes and after firing from submarines. It is believed in fact that one U.S. submarine and its crew were lost because of a premature explosion caused by the *Duplex* fuze.

It might be of value at this point to say why a magnetic fuze has an advantage over a contact detonator. For one thing the magnetic fuze increases the range from the ship at which an explosion would, in theory, be initiated. Thus the ship appeared larger by effectively about five to ten feet. The other reason, often quoted *ad nauseam*, is that an explosion under a ship's keel has three times the damaging effect of an explosion on the side on account of the double hull protection afforded by blisters and the ballast tanks. In fact, an analysis of ship sinkings up to 1943 showed that most torpedoed ships sank by loss of stability rather than flooding. This report

asserted that a hit on the side was therefore more likely to cause a ship to sink.

However, in the event of the failure of the magnetic fuze, there was no option but to use the impact fuze. The Germans had experienced similar influence fuze troubles and only the Japanese had torpedoes that were reliable from the start of the Second World War. This was because they had, before the war, sunk literally dozens of old ships in practice shots to perfect their weapons.

Even the impact fuze was unreliable in American weapons. During the period of the war up to 1943 it was found that 70% of U.S. torpedoes were "duds" either because of propulsion failures or fuze failures. The peak of impotence must surely have been when the U.S.S. *Tinosa* fired fifteen torpedoes in succession at an unprotected Japanese whaler the *Tonan Maru* 3. The commander saw through the periscope the torpedoes leap into the air like playful dolphins as each hit the side of the ship and failed to explode. These failures caused morale to sink low in the U.S. as well as the German submarine services—the latter were experiencing just the same troubles.

Eventually a reliable magnetic fuze was developed and it is in service even today but we will look at this one later.

We have seen that some remarkable innovations and improvements were made in torpedo technology between the World Wars. It may come as a surprise to find how little of this work was applied to the torpedoes with which the first battles of the last war were fought. In Britain, the submarine torpedo was the 21 in. Mark VIII and the ship torpedo the 21 in. Mark IX, both of them compressed air and burner cycle driven, The aircraft weapon was the 18 in. Mark XII similarly driven.

Torpedo shortages at the outbreak of war brought into service the 21 in. Mark II, the Mark IV, Mark V and Mark VII. Similarly we find the 18 in. Marks VIII, and XI pressed into service from semi-retirement.

The United States navy was equipped with three types of torpedo. The 21 in. Mark 14 was the standard submarine weapon, the 21 in. Mark 15 standard for destroyers and the 22.4 in. Mark 13 for aircraft use. As in Britain, old weapons were pressed in service including the Bliss Mark X for submarines. All of these weapons were driven by the same basic power unit of a turbine driven by alcohol fuel and fresh water diluent that was developed during World War I.

In Germany the two weapons were the thermal engined G7a driven by a four-cylinder radial reciprocating engine fueled with *decalin* and using air as oxidant, and the G7e electric weapon. The thermal weapon had much the same performance as the British Mark VIII but it was the electric weapon, despite (or even because of) its inferior performance, that opened up a whole new aspect of torpedo warfare. Namely the homing torpedo. In the next part of this series of articles we shall follow the development of the homing weapon as well the other research pursued in the quest for better torpedoes.

To be continued in the next issue of J.R.N.S.S.

References

- (15) "The Propulsive Performance of Modern Torpedoes"
R.N.T.F. Scientific and Technical Report. No. 131 (1941)
- (16) "Summary of Aircraft Torpedo Data"
R.N.T.F. Scientific and Technical Report. No. 200 (1941)



AN APPARATUS FOR FATIGUE TESTING MATERIALS AT ULTRASONIC FREQUENCIES

Instructor Lieutenant Commander G. C. George, M.Sc., R.N.
and Instructor Lieutenant Commander R. Daw, B.Sc., R.N.
Royal Naval Engineering College, Manadon

Introduction At the Royal Naval Engineering College, Plymouth, research equipment has been constructed which allows the fatigue testing of materials in a longitudinal tension-compression mode at a frequency of 20 kHz. This much accelerated testing appears to have interested many Royal Naval Scientific Service visitors to the College and it is felt that some detailed discussion of the apparatus may be of value.

Apparatus

The apparatus can be most conveniently described by considering it to be a resonant closed loop consisting of four systems, as shown in Fig. 1.

The electrical system drives the mechanical system through an electro-mechanical transducer and the loop is closed by a feedback from the photo electric device.

The Electro-Mechanical System

This is a half wavelength, lead zirconate-titanate transducer, resonant at a nominal frequency of 20 kHz, and fitted with a nodal plate which is attached to a rigid stand.

The end masses of the transducer are of an aluminium alloy to ensure a good acoustic match with the mechanical system to which it is attached by means of a screwed stud.

The Mechanical System (Fig. 2)

This is an acoustic transmission line excited in a longitudinal tension-compression mode by the transducer and consisting of three half wavelength components:

- (a) Connected to the transducer by a screwed stud is a double cylinder velocity transformer the end diameters of which were chosen to give a magnification ratio of 6.25 : 1. The design of such transformers has been discussed by Neppiras^(1, 2, 3) and by Balamuth⁽⁴⁾.
- (b) The high amplitude end of the double cylinder transformer is joined to a Fourier transformer as designed and described by Eisner^(5, 6) and which provides a magnification ratio of 10 : 1. Both transformers are made of RR58 in the optimum hardened condition.
- (c) The specimen to be fatigued (in this case a cylindrical rod of L65) is attached to the high amplitude end of the Fourier transformer.

In this longitudinal tension-compression mode of vibration, the positions of minimum stress will coincide with those of maximum displacement amplitude and the designing of the components of the acoustic train to be half wave length at 20 kHz ensured that the displacement amplitude antinodes of the stand-

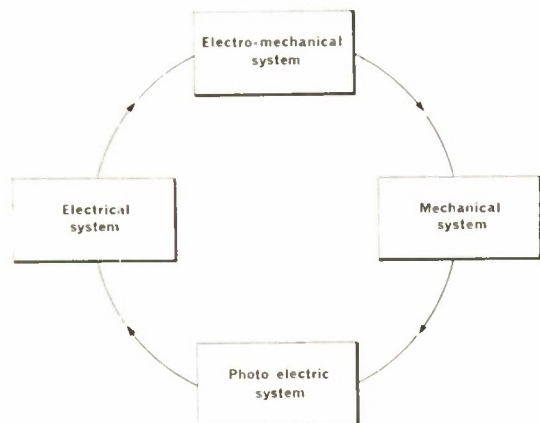

FIG. 1. Closed loop system.

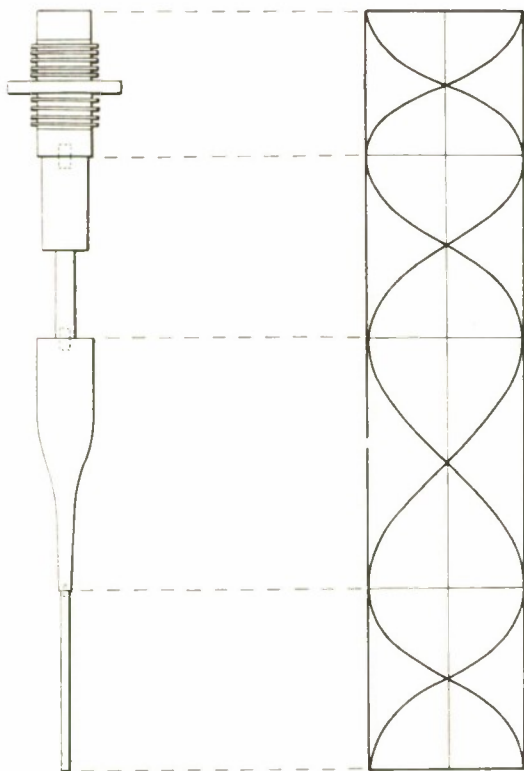

FIG. 2. The mechanical system.

ing wave set up in the train coincided with the coupled surfaces. The theoretical displacement amplitude variation along the acoustic transmission line is indicated in Fig. 2.

The Photo-Electric System

As shown diagrammatically in Fig. 3, the free end of the cylindrical specimen partially interrupts a beam of light falling upon a silicon photodiode. The longitudinal vibration of the specimen causes a fluctuation in the amount of light falling upon the photodiode and a consequent modulation of its direct current output. The frequency of the alternating current component of this signal is the frequency of vibration of the specimen.

The preamplifier accepts the current from the photodiode and produces a voltage output, the magnitude of which is proportional to that of the input.

The Electrical System

As shown in the block diagram of this system (Fig. 4) the output voltage from the Photo-electric System is fed to an amplifier which has a voltage gain of 100. One output from this amplifier is fed through a full wave rectifier to a dc amplifier and low pass filter. Comparator I accepts both this dc voltage and one from the amplitude control potentiometer. If the voltage from the amplifier exceeds that pre-selected on the amplitude control potentiometer then a current is fed to the variable attenuator and the drive to the transducer is reduced. If the input from the amplifier is less than or equal to that from the amplitude control potentiometer then no current is fed to the attenuator. If the voltage received by Comparator II from the dc amplifier exceeds that received from the "trigger" attenuator, then a signal is received by the electronic counter which continues to count the cycles and the variable attenuator continues at low attenuation. If, however, the "trigger" attenuator signal exceeds that from the dc amplifier then the counter is stopped and the variable attenuator changes to cause high attenuation and stops the vibration.

The second output from the initial amplifier is fed to a phase shift control. The phase change round the closed loop must be zero if the system is to be driven at its resonant frequency and this phase shift was made variable so that changes in the specimen under test, which might result in an alteration in the phase shift round the loop, could be compensated for.

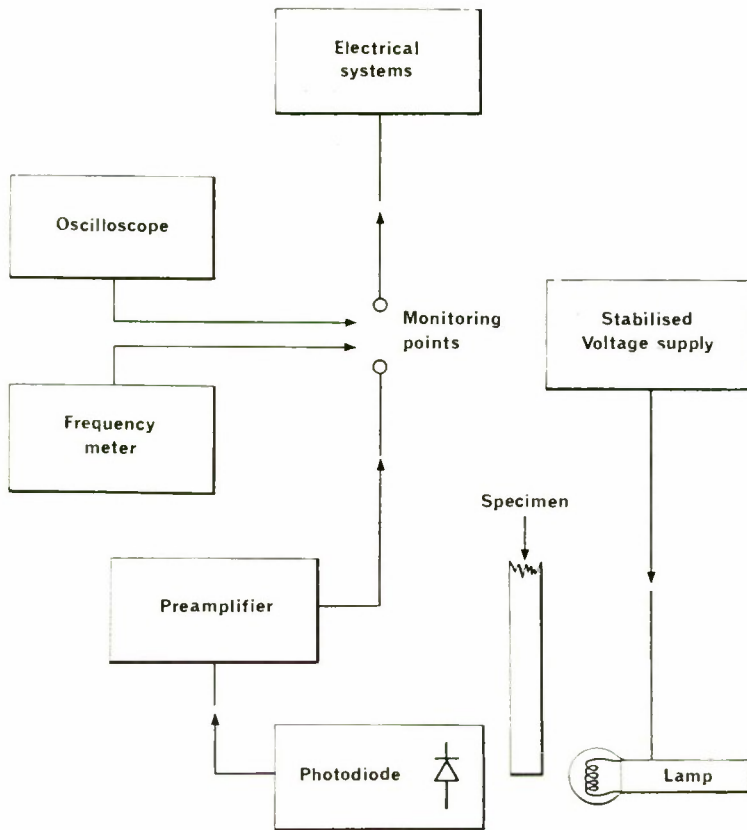

FIG. 3. The photo-electric system.

Complete Apparatus

The assembled equipment is shown in Fig. 5 with a cathode ray oscilloscope and a frequency meter connected to the monitoring points (Fig. 3).

The phase shift control is followed in the diagram by a switch with positions marked "OFF", "SET" and "RUN". In the "SET" position, Comparator II is rendered inoperative. This is necessary because the signal from the "trigger" attenuator to Comparator II builds up more quickly than that which reaches Comparator II from the photo-electric system. This situation is the criterion (as noted above) for switching off the counter and producing high attenuation in the variable attenuator.

The limiter and tuned amplifier act to inhibit unwanted modes of vibration and harmonics, should any occur in the system. The output from the tuned amplifier is fed to a driver and power amplifier *via* the variable attenuator which attenuates the signal (as described above) by an amount dependent upon the current from the comparators.

The power amplifier output is the input to the electro-mechanical transducer and a meter attached at this point monitors both the voltage and the current supplied to the transducer from the electrical system.

Determination of Strain Amplitude

The strain and displacement vary along the length of the specimen as indicated by the sketched wave forms in Fig. 2.

The equation for displacement is given by

$$\alpha = A \sin \frac{2\pi x}{\lambda}$$

where A = end displacement amplitude
 α = amplitude at a point x away from the centre of the specimen
 λ = wavelength

$$\text{strain} = -\frac{\delta\alpha}{\delta x} = A \cos \frac{2\pi x}{\lambda} \cdot \frac{2\pi}{\lambda}$$

Thus the strain will be a maximum at $x=0$. *i.e.* midway along the length of the specimen.

Then

$$\begin{aligned} \epsilon_{\max} &= \frac{A \cdot 2\pi}{\lambda} \\ &= \frac{\pi}{2} \cdot \frac{\text{double displacement amplitude}}{\text{half wavelength}} \\ \epsilon_{\max} &= \frac{\pi}{2} \cdot \frac{\text{measured end amplitude}}{\text{specimen length}} \end{aligned}$$

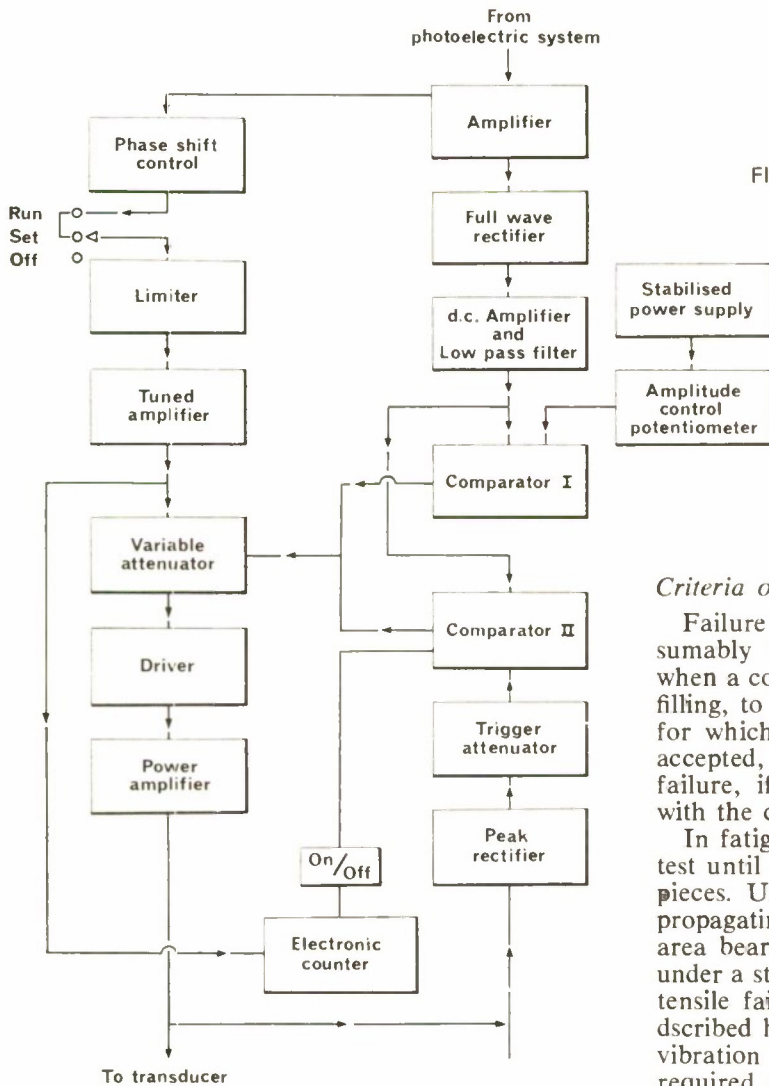

FIG. 4. The electrical system.

Criteria of Failure

Failure is difficult to define and must presumably be considered as having occurred when a component is no longer capable of fulfilling, to the required efficiency, the function for which it is designed. If this definition is accepted, then it follows that the criteria of failure, if not arbitrary, must at least vary with the circumstances and application.

In fatigue testing it is usual to continue the test until the specimen has fractured into two pieces. Under conditions of constant load, a propagating crack reduces the cross sectional area bearing the load and the test continues under a steadily increasing stress until ultimate tensile failure occurs. In the resonant system described here, a propagating crack damps the vibration and an increasing power output is required of the electrical system in order to maintain the amplitude of vibration that is set on the amplitude control potentiometer. A point must be reached when the power requirement exceeds that available in the system and after this point, further crack propagation will be accompanied by a steadily decreasing amplitude of vibration until final failure. Under either of these conditions doubt must be cast upon the validity of the stress levels plotted on an S-N curve.

If, however, in this resonant system, the test is stopped as soon as the amplitude level starts to fall then the stresses (or strains) plotted on S-N curves are much more meaningful since they hold through the whole life of the specimen.

The magnitude of the alternating current component of the Photodiode output was found to be linearly related to the amplitude of the longitudinal vibration of the specimen which was measured with an optical microscope fitted with a vernier scale eyepiece. A calibration graph was plotted of the setting on the amplitude control potentiometer (Fig. 4) against the amplitude of vibration of the specimen measured optically and the direct linear relationship obtained allowed the potentiometer settings to be converted directly into strain amplitudes without the need for the tedious microscope readings.

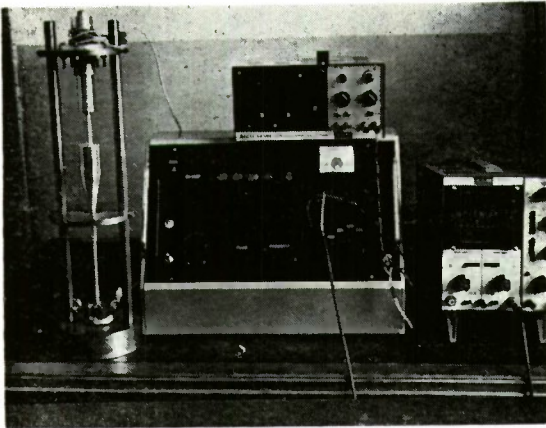

FIG. 5. The complete apparatus.

The point of failure was thus taken to be that instant when the amplitude of vibration had decayed by a fixed and predetermined amount, *i.e.* when the "trigger" attenuator signal to Comparator II (Fig. 4) exceeds that from the d.c. amplifier by a fixed percentage. This percentage can be varied by adjustment of the "trigger" switch so that the test may be stopped at any time after the onset of Stage II crack propagation or be allowed to continue until the specimen breaks into two pieces.

Experimentation and Results

A number of research investigations have been carried out at R.N.E.C. using this equipment over the last three years and since, with one exception⁽⁷⁾, these are unpublished, it is hoped to discuss some of them in future papers.

Certainly enough information is available to allow comment upon the performance of the test equipment described above.

Its virtue as a teaching/demonstration aid is clear. The ability to produce, in 30-40 seconds of testing, a fatigue fracture surface, which contains all the classical markings and features at both optical and electron microscope levels, is too obvious to require further elaboration.

As a research tool it is considered to have the following advantages:

- (a) The time of testing is enormously reduced when compared with more conventional methods.

- (b) Its operation is simple and the machine proceeds automatically from switch on to completion of the test and thus requires no tending.
- (c) The scatter of results, so troublesome in fatigue testing, is extremely small when this equipment is used. (Presumably because the stress amplitude is so accurately known and controlled.)
- (d) The machining and preparation of specimens is simple and inexpensive.
- (e) The equipment is light and portable so it is easily enclosed in a cabinet where the environment can be carefully controlled.
- (f) Although this equipment demonstrates clearly the "Frequency Effect" and this makes impossible the extrapolation of quantitative results to lower frequencies, all work so far has shown that "orders of merit" of materials, heat treated conditions, coatings or environments that are obtained at this ultrasonic frequency are maintained at other more conventional frequencies of testing.

Conclusion A much accelerated fatigue testing method has been described. It has produced consistent results over an extended range of tests and has many obvious applications, not only in the fields of teaching and fundamental research but also as a tool for use in the selection of materials.

References

- ⁽¹⁾ E. A. Neppiras. *Proc. Phys. Soc., Sect. B.*, **70**, 393, 1957.
- ⁽²⁾ E. A. Neppiras. *Proc. Am. Soc. Test. Mat.*, **59**, 691, 1959.
- ⁽³⁾ E. A. Neppiras. Inst. of Mech. Engrs., "Conference on Technology of Engineering Manufacture" Paper No. 6, 1958.
- ⁽⁴⁾ L. Balamuth. *Trans. I.R.E. (Professional Group Ultrasonic Eng.)*, **23**, 1954.
- ⁽⁵⁾ E. Eisner. *Jnl. Acoust. Soc. of America*, Sept. 1963., **35**, No. 9, 1397
- ⁽⁶⁾ E. Eisner and J. S. Seager. *Ultrasonics*, April-June 1965.
- ⁽⁷⁾ G. C. George. "Internat. Conf. Corrosion Fatigue", Univ. Connecticut. June 1971, Paper 63 (Proc. to be published).



NOTES AND NEWS

Admiralty Engineering Laboratory

The Head of the Electrical Department Mr. F. R. W. K. Mansell, Superintending Electrical Engineer, retired on January 24th, 1972 after nine years in the post. Mr. S. W. Bullen, formerly N.S.P.O. East Anglia, took over the post from the same date.



Captain W. G. Mc. C. Burn presenting the Imperial Service Medal to Mr. E. C. Sims.

Mr. E. C. Sims, formerly Technical Officer III and now retired, was presented with the Imperial Service Medal on November 18th, 1971 by the Superintendent Captain W. G. Mc C. Burn. Mr. Sims enlisted in the Royal Engineers in 1923 as a boy apprentice and was discharged as a Warrant Officer Class I (Electrical and Mechanical) in 1945. He was taken prisoner of war at Hong Kong by the Japanese and received a special commendation for his resourcefulness for maintaining camp facilities under Prisoner of War conditions. Eleven years service with the R.A.F. at West Ruislip fol-

lowed, after which he joined the staff at A.E.L. in 1957 when the Ruislip base was taken over by the U.S. Air Force, was upgraded to TG III (L) in November 1965 and retired in August 1971. His work as a craftsman was superlative, one of his models being displayed at the House of Commons during the Defence Estimates debates and attracting many favourable comments from M.Ps.

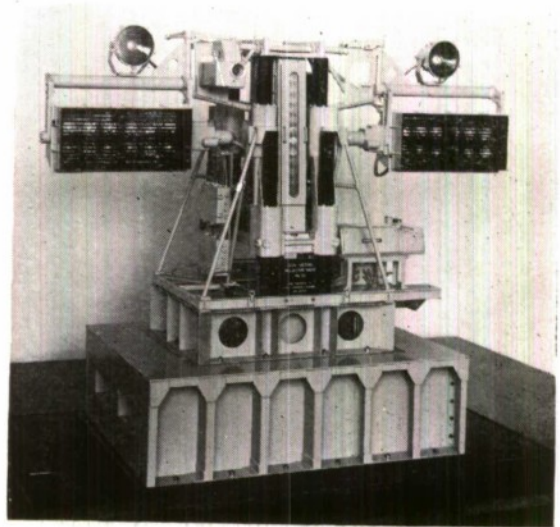

Model of Deck Landing Projector Sight Mk. III constructed by Mr. Sims.

In conjunction with the Royal Navy the Admiralty Engineering Laboratory participated in the "Electronics in Action" Exhibition held at the Angus Hotel, Dundee, October 26th to 28th, 1971. The exhibition was conjointly organised by the Scottish Section of the Insti-

tution of Electronic and Radio Engineers, the Electronics and Control Section of the Institution of Electrical Engineers (Scottish Centre) and the Electrical Association for Women; the principal aim of the exhibition being to give young people and their parents an opportunity of assessing the scope of careers in Electronic Engineering. Rear Admiral D. A. Dunbar-Nasmith, C.B., D.S.C., R.N., Flag Officer for Scotland and Northern Ireland, officially opened the exhibition at 11.30 a.m. on Tuesday, October 26th, 1971. Three examples of the research and development work in electronics carried out at AEL were displayed. The Deck Landing Projector Sight for providing visual indication of correct glide path to pilots of high speed fixed-wing aircraft was shown which required complex electronic control circuits to stabilise the display against the motion of the aircraft carrier under all Service conditions. An all solid state electronic control system developed by the Machinery Control section under the direction of Mr. A. Duberley was demonstrated on a model Leander Class frigate. It has been adopted as the standard equipment for future Naval ships including the Type 42 Frigates. From roll angle input only the control system stabilises the ship by Active Fins and reduces the rolling to a fraction of that without stabilisation. The final item was the Position Measuring System developed by Mr. E. Lloyd Thomas and Mr. J. A. Le Warne described in *J.R.N.S.S.* Vol. 26, No. 4, July 1971, pp. 218 - 234. Although the system is provisionally patented it is available to commercial users under licence. Mr. J. Nugent of the Services Section A.E.L. organised the display stands which were visited by several thousand people.



Captain W. G. Mc. C. Burn, Rear Admiral L. D. Dymoke, Director of Engineering (Ships), Mr. F. R. W. K. Mansell, Head of Electrical Department.

Reports from H.M.S. *Berwick* indicate that the "QUAVER" is performing extremely well in service at sea and that the ship's staff are delighted with the results. "QUAVER" was fully described in *J.R.N.S.S.*, Vol. 23, No. 4, July 1968, pp. 219 - 231.

A visit to A.E.L. was made by Rear Admiral Dymoke, F.I.Mech.E., M.I., Mar.E., Director of Engineering Ships on Friday, September 17th, 1971. He spent a full day touring the Research and Development facilities at AEL visiting the Sections in the Electrical Department in the morning and the Sections in the Mechanical Department in the afternoon.

‡ ‡ ‡

Admiralty Experiment Works

On 28th August Mr. Kowalski of Rhode Island University, whose field is ocean engineering, visited AEW.

Deputy Superintendent Mr. E. P. Lover visited Holland at the beginning of September for a Symposium on propulsion devices sponsored by Lips of Drunen, Netherlands.

The Mechanical Engineering Department of University College, London, organised a two-week (27th September - 8th October) course at AEW on the Mechanics of Marine Vehicles as an introduction to their university post graduate course. Two members of AEW, Mrs. S. F. Meek and Miss W. E. Bolton, attended this introductory course which, apart from touching on the important aspects of marine engineering, also included visits to facilities at AEW, British Hovercraft, H.M.S. *Dolphin*, Vosper Thornycroft and AMEE.

Prior to the two-day Anglo-American meetings held on 4th and 5th October, Captain L. H. Beck, USN of Naval Ship Systems Command visited AEW on 29th September and Commander T. M. Barry, USN, the US NAVSHIPTECHREP, on 4th October. The main US team was led by Dr. W. Cummins and comprised seven members of NSRDC, two of NSSC and four of NESC. The talks were in connection with closer collaboration on subjects of mutual interest.

18th October saw the visit of another member of NSRDC, namely Mr. W. F. Brownell who came primarily to view the Circulating Water Channel and to discuss instrumentation techniques associated with it.

‡ ‡ ‡

Admiralty Marine Engineering Establishment

On October 21st and 22nd, Commander T. Pellinkhof and Lt. Cdr. J. B. de Winter of the Royal Netherlands Navy visited the Establishment. The visitors toured the Establishment on the first day of their visit. The staff of AMEE were joined by headquarters staff, including the Deputy Director of Engineering (Mechanical) Captain P. E. Melly, on the second day for discussions concerning the integration of R and D effort in areas of interest to both Navies.

‡ ‡ ‡

Admiralty Materials Laboratory

Sir George MacFarlane, CER and Mr. B. W. Lythall, CB, CS RN, DCEREA, visited AML on November 5th, 1971 to meet Senior Staff and tour the laboratory. Mr. N. Coles, DCER(C) accompanied by Mr. E. W. Russell (D Mat (Av)) and DMR(N) also visited AML on October 22nd, 1971.



Dr. R. G. H. Watson (centre) with Mr. B. W. Lythall, CB, CS (RN), DCERE on his right and Sir George MacFarlane, CER.

Dr. R. G. H. Watson visited the USA during the period September 10 - 25th, 1971 and gave a talk "Fibre Reinforced Plastics in the Royal Navy" to a meeting of the American Society for Testing and Materials Committee D30 and the Philadelphia Chapter of the Plastics Industry in Philadelphia. He also visited Naval Centers concerned with R & D in the materials field and had discussions on the recent exchange scientist exercise at the US Materials and Mechanics Research Centre at Watertown, Boston.

Mr. Farrand visited USA September 29th - October 9th, 1971 as a member of the British Delegation to the meeting of International Standard Organisation Technical Committee 45 on Rubber which was held at ASTM Offices, Philadelphia.

Dr. M. W. Lindley has recently returned from participating in a UN/USA Scientific Exchange Programme organised through the TTCP Sub-Group Panel P.2. Dr. Lindley spent 4½ months (June - October '71) at the Ceramics Division, US Army Materials and Mechanics Research Center, Watertown, Boston, Mass, USA, studying ceramics for armour and gas bearing applications. Dr. D. R. Messier of US Army Materials Mechanics Research Center, similarly spent four months at AML studying silicon nitride ceramics for high temperature applications. Dr. Lindley also visited various industrial firms, Government Laboratories and Universities in the East and Central USA relating to his work and that of his colleagues at AML. During his stay at ANMRC a joint paper by Dr. Lindley and Dr. R. Nathantiatz—Chief Ceramics Division ANMRC entitled "A High Temperature Engineering Ceramic (Si_3N_4) by Powder Metallurgical Methods" was read at the 18th Sagamore Army Materials Research Conference (September 1971) on "Powder Metallurgy for High Temperature Applications" held at Raquette Lake, New York State.

Mr. J. C. Rowlands attended the 2nd European Sea Horse Meeting at Noordwijk and visited the Royal Netherlands Navy College at Den Helder, Holland, in September. A paper "A Survey of Marine Corrosion Properties of Copper Base Alloys" by J. N. Bradley (ret. ex CDL) and J. C. Rowlands was provided for the Indian Copper Information Centre Corrosion Symposium.

Mr. G. Brown visited Singapore November 1st - 15th to assist the RM Trial Team on materials aspects of the development of inflatable boats.

Mr. B. H. Nicholls visited the USA during the period November 12th - 20th, 1971 to attend a meeting arranged under the US/UK Joint Sonar Programme on Hull Coating Treatments at the Naval Underwater Research and Development Center, San Diego, and to visit Naval Establishments to discuss Materials Aspects of the same topic.

Mr. F. J. Tribe joined the Materials Engineering Group from Chatham Dockyard Laboratory in September.

Dr. R. Dukes and Mr. B. Barnett presented a paper on "Interlaminar Shear Tests and Their Uses" to the Plastics Institute Research Conference on November 11th.

Mr. D. Birchon gave a talk on "Hidaments" to the Conference on Advanced Engineering Materials in London on November 10th and on "Philosophy of Testing" to the West of Scotland Iron and Steel Institute and Institute of Metals Joint Meeting in Glasgow on November 11th, 1971.

Mr. K. Wright, TG III awarded *ex gratia* payment of £50 and a Certificate of Merit in respect of a Method of Producing Hemispherical Shells from Lead/Titanate Zirconate (PZT).

Peter Maurice Wingfield, aged 49, died from a heart attack on December 14th, 1971.

During the war he piloted Hurricanes, Mosquitoes, Defiants and Beaufighters on night fighter, photo-reconnaissance and day sorties from this country and over North Africa. After the war he spent a short period with a firm of business machine manufacturers, then moved to Woolwich Arsenal and R.A.E. Farnborough where he worked on metallurgical control and analytical processes. In 1957 he joined the Royal Naval Scientific Service and was posted to A.M.L. where it was our privilege to know him for his last few years.

His ingenuity and talent were matched only by his enormous zest for life, his constant good humour and his inexhaustible kindness.

Chief among his wider interests was amateur radio, through which he had built up a world-wide circle of friends who knew him as G3 SKO., and who will mourn his sudden death as keenly as those of us who had the fortune to share his personal friendship. As one would expect from such a man, his was the dependable, patient, helping hand behind many kindly activities including Talking Books for the Blind, the Radio Amateurs' Invalid and Bedfast Club and remedial therapy for retarded children.

His contribution to the work of his own group within A.M.L. was invaluable, and many other groups had the benefit of his neat solutions to electrical and electronic problems, for he always made time to help others. His ideas live on in *Amlec*, *Magneprint*, the *Wingfield Fibre Meter* and the stress wave emission work now in hand, and in which he was so passionately interested; but his greatest contribution was his unflinching humanity, loyalty and dedication. His name will always be in the hearts of his many friends, whose sympathy goes out to his wife Jo, daughter Susan and son Michael.

‡ ‡ ‡

Admiralty Oil Laboratory

Fire and Explosion Hazards

The disastrous explosions in three very large tankers some time ago have been the subject of investigations by Shell and others. AOL have an active interest in the hazards from petroleum fuels and lubricants and have attended the technical sessions of the Public Enquiry into the explosion in an empty tank of the S.S. *Mactra* during cleaning. Mr. R. G. H. Clutton was invited to give evidence at one point and one of the Assessors is Professor F. Morton of the University of Manchester Institute of Science and Technology (UMIST) who is Chairman of the Navy Department Fuel and Lubricants Advisory Committee (NAFLAC) and has been AOL's consultant for some years.

Mr. J. Ritchie and Mr. R. G. H. Clutton attended a Symposium on Explosion Hazards in the Chemical Industry at UMIST on September 16th - 17th, 1971. Mr. P. S. Ekins, whose duties include being AOL Fire Officer, attended a Symposium on Major Loss Prevention in the Process Industries at the University of Newcastle-on-Tyne from July 6th to 9th, 1971.

Tribology

Mr. J. Ritchie has been appointed Project Officer for information exchange on tribology with the French Navy. Capitaines de Frigate Perrier and Le Her and L'Ingenieur en Chef de l'Armement Cavailles were at AOL for discussions on November 24th - 25th, 1971.

Professor Hirst who holds a Chair in Tribology at the University of Reading is now a member of NAFLAC and a consultant to

AOL. Dr. Hamilton on his staff has been developing a capacitance method of studying oil film thickness in engines and is now trying this out on a diesel oil test engine at AOL.

Mr. P. R. Eastaugh, Scientific Officer (old style) who joined AOL from Rolls-Royce in June 1971 attended a short course on tribology at Cranfield Institute of Technology on October 4th - 8th, 1971. Mr. A. W. Morgan who has examined a large number of failed rolling bearings was at the National Centre of Tribology, Risley, for a course on Rolling Element Bearings on November 4th, 1971.

Applied Chemistry

Mr. C. E. Carpenter attended a Royal Institute of Chemistry Summer School on Quantitative Treatment of Experimental Data in Chemistry at UMIST on September 19th - 23rd 1971. Mr. D. T. Pailthorpe attended a Weekend Course on Recent Advances in Analytical Chemistry at the Royal Military College of Science.

Visiting Groups

The CERA Course for HMS *Sultan* visits AOL six times a year. On October 16th, 1971 a party of Technical Grade Officers from Naval Ship Production Overseer (South East) visited AOL for the first time and it is expected that

the visit will be repeated in later years. DFMT arranged for two groups of his oil fuel depot staff to come to AOL in July 1971 for practical instruction in the fuel testing equipment issued to depots.

Transatlantic Visitors

Mr. R. N. Hazlett from US Naval Research Laboratory was at AOL on July 7th, 1971. He is particularly interested in the detection and removal of water in oil. An old friend, Mr. R. G. Grimsy from Canadian Forces Headquarters in Ottawa came to discuss common interests on November 29th, 1971, carrying good wishes from Mr. E. C. Davis of NAVSEC, Washington. Mr. J. M. Leonard, Liaison Scientist at the US office of Naval Research in London, spent the day at AOL on November 12th, 1971 to discuss various matters including oil pollution.

Pollution

Mr. L. F. Butcher was a delegate at a Symposium on Air Pollution Control in Transport Engines sponsored by the Institution of Mechanical Engineers at Solihull on November 9th - 11th. Dr. D. Wyllie attended a Group Research Discussion on Motor Vehicle Exhaust Emissions and Air Pollution at City University on December 2nd. AOL received a visit from Mr.



The first visit of Capt. P. E. Melley after he joined Ship Department as Deputy Director Engineering (Mechanical) was the occasion of the first group photograph of AOL staff on record. Mr. R. P. Langston, Superintendent AOL is seated in the centre of the front row with Captain Melley, Mr. Ray, Mr. Ritchie and Mr. Taylor on his left and Dr. Wyllie and Mr. Clutton on his right.

R. J. Down of the Chamber of Shipping UK and Mr. P. Rose, Marine Industries Centre, University of Newcastle to discuss oil pollution of water, on August 26th, 1971.

International Standardisation

Mr. C. E. Carpenter was a UK delegate at Working Group 19, Methods of Test for Petroleum Products of the European Committee for Standardisation (CEN) in Stockholm on October 4th to 7th, 1971. Mr. R. P. Langston was a UK delegate at the meeting in Rome on October 18th - 19th, 1971 of the Co-ordinating European Council for the Development of Performance Tests for Lubricants and Engine Fuels. In particular he presented promising data obtained at AOL from the proposed Institute of Petroleum Supercharged Petter Test for engine oils. Dr. Wyllie has revised and rewritten part of the forthcoming Institute of Petroleum publication on Quality Criteria for Petroleum Products.



“Jimmy” Ray entered Admiralty Service in 1926 when he joined Portsmouth Dockyard as an Engineering Apprentice. After completing his apprenticeship he continued his studies at evening classes at Portsmouth Municipal College obtaining his B.Sc.Eng. and later becoming a Member of the Institute of Mechanical Engineers. Meantime he progressed to draughtsman in the dockyard and in 1937 obtained one of four vacancies for Assistant II advertised at AEL. Here he became well acquainted with diesel engines working on the development of submarine engines for the S, T and A Class until he became a SSO on the formation of the RNSS in 1946.

He was now to take part in a new activity. There was considerable concern at the unduly high incidence of extensive fractures in welded merchant ships built in wartime in large numbers in the US. A report published in Washington in 1946 stated that “the fractures in many cases manifested themselves with explosive suddenness and exhibited a quality of brittleness which was not ordinarily associated with the behaviour of a normally ductile material such as ship steel”. The Admiralty Ship Welding Committee tackled this problem and Jimmy Ray served on the structural panel for five years for most of which he was Secretary. He remembers in particular stress analysis studies in two ships, *Ocean Vulcan* and *Clan Alpine*, one welded and the other riveted.

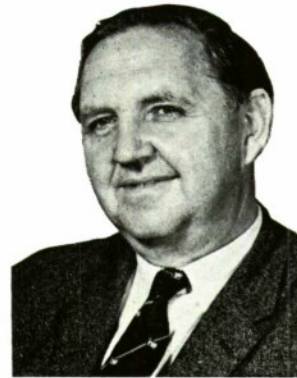

The Structural Group moved to AML where it was disbanded a year or so later. He returned to AEL and worked on diesel engines and gas turbines, being promoted to PSO in 1953. He was concerned with problems associated with Deltic, Ventura, ASRI, Foden and other diesel engines in use in the Fleet.

He came to AOL to take charge of the engineering section at a vital period in 1966. Plans were underway for moving AOL from congested premises at Brentford to the present laboratory at Cobham. It fell to Jimmy Ray not only to work out in detail and supervise the installation of all engineering activities at Cobham but to be co-ordinator and progress chaser of the whole transfer. His dynamic energy is largely responsible for the excellent facilities we now enjoy.

Under him the engineering section has grown in stature. The diesel engine lubricating oil OMD-113 has been proved as an oil for all Navy diesel engines and its specification has been revised in the light of experience to improve its availability on a world-wide basis. An oil test kit which allows ships to base their oil changes on actual oil condition rather than on running hours has been put into general use. Work on lubrication and wear also covers turbine oils and hydraulic fluids under various practical combinations of oil, metal and conditions of contact.

His many friends wish him every happiness on his retirement which was in December, 1971.



Admiralty Surface Weapons Establishment

Sir George MacFarlane (C.E.R.) accompanied by Mr. B. Lythall (C.S.R.N. and D.C.E.R.A.) and Mr. D. S. Watson (D.G./E.R.P./A) visited the Establishment on the 23rd November for a presentation and discussion on the Management of Large Development Projects. A brief visit was also made by Mr. D. G. Rayner, C.E.P.E., on 6th December.

The end of an era came on 26th November, 1971 when the Director of ASWE switched off the Establishment's 984 radar for the last time. This large radar with its 26 ton antenna was developed by ASWE to provide continuous long range three-dimensional radar coverage for aircraft carriers. (See J.R.N.S.S. 13 (1958) 159 - 163 *et seq.*) If it were not for the demise of the aircraft carrier it would probably have remained in operational use for many years to come and as such remained at ASWE for Post Design activities.



The 3D Radar Aerial being installed at ASRE in 1953 in the new "3D Radar Building". This was the first experimental radar fitted at ASRE, Portsmouth.

It is of interest to note that the development of the radar and its associated comprehensive display system started at ASRE Witley in November 1947 under the present CM(S) 1, Mr. J. Snowdon. Other RNSS personalities involved with the design include the present CS (RN) who was responsible for the revolutionary multiple scanning beam lens aerial and Dr. R. Benjamin who was project leader for the associated comprehensive display system.

The radar was first fitted in H.M.S. *Victorious* in 1958 and this was followed shortly afterwards in H.M.S. *Hermes*. More recently the same basic radar was fitted in H.M.S. *Eagle* although in this case the associated manually operated display system was replaced by a computer assisted system known as Action Data Automation (ADA).



The Director ASWE presents Mr. F. W. Rogers with 984's "safe-to-transmit" and "safe-to-rotate" keys (26 November 1971).

After the 984 was switched off the Director presented the two switch keys to Mr. F. W. Rogers (SSA), the only member of ASWE's staff who has worked continuously on the set since the concept of the project.

A combined A.S.W.E./D.G. Ships mission, led by Mr. A. R. Heaton, head of A.S.W.E.'s two Communications Divisions, visited the United States for the week beginning September 12, 1971, to discuss and exchange information on aerial systems for submarines. A.S.W.E. was also represented by Mr. R. D. Holland and Mr. G. W. Murray from the Submarine Group and D.G. Ships was represented by Cdr. P. Howlett, R.N. (Retd.) and Mr. R. R. Phillips of the Forward Design Group.

Detailed discussions were held in the U.S. Navy Offices at Hyattsville, Washington D.C. Visits were made to U.N., U.S.L., New London, Connecticut, and N.R.L., Washington D.C.

Combined meetings of the British, Australian and United States navies were held in Washington at the beginning of August 1971 to discuss a joint communications project. The British team was made up of Cdr. P. C. Burfield, R.N., of British Navy Staff, Washington and Messrs. R. D. Holland and R. C. Mingay of A.S.W.E.

Messrs. B. N. C. Amos, J. H. Riley and M. F. Wintle attended the AGARD Symposium on "Guidance and Control Displays" in Paris from October 19th - 22nd, 1971. Although the symposium was largely directed towards cockpit displays for landing, it contained information of general interest, e.g. operator characteristics and work-load, ergonomics and display techniques.

Mr. David Black Quinn, Scientific Assistant in A.S.W.E.'s Communications Division, died in St. Mary's Hospital at Portsmouth on September 27th, 1971, at the early age of 50. Although he only served with the establishment for eight years, he had previously served for 25 years in the Navy, which culminated with his acting as a radio Communications Instructor at H.M.S. *Mercury*. His work in the establishment represented a radical change in that he had to exchange his morse key and headphones for electromechanical teleprinters. His arduous and detailed work on the Defect Reports on the Teleprinter No. 12 contributed to a better understanding of these complex electromechanical machines. He was admired by his colleagues for his strength of purpose which led him to undertake further educational courses at Highbury Technical College. His many friends and colleagues within the establishment were deeply shocked to hear of his unexpected death, and their heartfelt sympathy is extended to his widow and family.

‡ ‡ ‡

The retirement of **Mr. P. T. W. Baker** in December came after 35 years service with the establishment. When he joined the Experimental Department of H.M. Signal School in November 1936, the Receiver Section in which he then worked, was still housed in 'temporary' huts which had been erected on the periphery of the parade ground at the Royal Naval Barracks in Portsmouth during the first world war. One of his first tasks was the development, testing and installation of a combined warning telephone and sound reproduction equipment which effectively served as a ship's broadcast system with a built-in 'music-while-you-work' facility. Despite some unfavourable comment from the more musically-minded, the severe problems raised by such things as the dialects of the various announcers and the very indifferent acoustic qualities of many ships' spaces, were all successfully overcome.

The outbreak of war saw substantial changes in the Department and Baker found himself working on small ships in the North Sea investigating firstly, the use by German craft of faulty submarine telegraph cables as a homing device through the East Coast mine-fields, and secondly, the possible use of 'leader' cables as a navigational aid for our own ships in the same area. During the course of this work, he was commissioned Lieutenant R.N.V.R. After successfully denying the



enemy any possible use of submarine cables as a navigational aid, he was subsequently concerned in the development of intercept equipment and its operational use in the Western Approaches. As a result of his success in this field he was transferred to the Mediterranean theatre where he flew on night sorties with the R.A.F. over Greece, Crete, Syria, Libya and Tunisia. His outstanding contribution to the success of these operations was marked by the award of the Distinguished Service Cross. Baker's activities in the area came to a dramatic end in March 1942 when an operation to land him, together with his intercept equipment on enemy-held shores, by rubber canoe launched from an aircraft, ended in disaster.

Following engine-failure and a fire, the aircraft 'ditched' off Rhodes, and the crew, after swimming ashore were taken prisoners-of-war. Luckily, the Italians did not suspect the nature of Baker's activities and he was not singled out for any special attention. Fortunately, he was nominated for exchange a little over a year later and returned home *via* Turkey and Suez.

Following a year's appointment as the Admiralty Signal Establishment's Electronic Warfare Liaison Officer at the Telecommunications Research Establishment at Malvern, Mr. Baker came up with proposals for a leader cable navigational system for assault operations and swept-channel clearance. It was intended that the cable could be laid from fast surface craft or aircraft, and although the system was developed and underwent successful sea-trials, the war ended before it could be put to further use. The work was subsequently published at the International Conference on Radio Aids to Marine Navigation held in 1946. Although the patent lapsed some 10 years later, the system has recently been used in Sweden to assist ferries in foggy conditions.

The post-war years brought less hazardous but varied tasks which included the installation of recording facilities in H.M.S. *Vanguard* for the Royal Tour to South Africa, developments of X-Band direction-finding equipment for submarines. For the next 10 years or so, Mr. Baker was solely employed on underwater communication projects which included those on VLF phase propagation and submerged-reception techniques, buoyant-cable receiving aerials for use under ice and a towed communication buoy. This work took him on a month's voyage with one of the earlier Royal Naval 'excursions' by conventional submarine to the northern polar ice-cap. Mr. Baker's more recent work has all been concerned with direction-finding equipment for use either in ships or submarines.

Philip Baker's unusual combination of air-borne, surface and sub-surface experience has made him a mine of information on radio development work, and his sound advice on the preparation and conducting trials was much appreciated by all who sought it. Even his pastime of car rallying proved most useful to his immediate colleagues who accompanied him on 'duty' trips which were accomplished in record time.

The Director presented Mr. Baker with a telescopic rifle-sight on behalf of his colleagues and wished both him and his wife many happy years of retirement in their new home on the Isle of Mull.

‡ ‡ ‡

Admiralty Underwater Weapons Establishment

Messrs. A. B. Cotton and C. Foggon represented A.U.W.E. in the U.K. delegation to the Magnetic Anomaly Detection (MAD) Symposium which was sponsored by the U.S. Naval Ordnance Laboratory and the U.S. Office of Naval Research and held at White Oak on October 5th to 7th. The meeting was attended by approximately 200 people representing the government establishments of the United States, Canada and the United Kingdom, and the North American industries concerned in this work.

A total of 37 papers were presented covering various subjects associated with MAD ranging from geophysical discussions of the geological noise problem through the latest hardware development to the operational implications.

In particular, a number of papers described the present research being carried out in the U.S. to develop more sensitive detectors and the concomitant work in both Canada and the U.S. on the application of signal processing techniques. A.U.W.E. presented three papers dealing with the submarine target, the noise background and the operational use of a helicopter-borne MAD system.

The annual meeting of the NATO Military Agency for Standardisation's Mine Warfare Working Party and its Technical Panel was held in November 1971 at the Naval Ordnance Laboratory, Whiteoaks, Maryland, U.S.A.—very close to Washington D.C. The U.K. delegation consisted of Cdr. D. F. Watts (DNW), Lt. Cdr. J. Wilson (Captain MCM), Lt. Cdr. H. F. Caisley (H.M.S. *Vernon*), Lt. Cdr. (Rt'd.) S. Parsons and Mr. D. Henley (DGW(N)) and the following members of A.U.W.E.: Messrs. H. A. Hudson, A. B. Cotton, C. Harrington and D. F. Walker—the last as Chairman of the M.W.W.P. Technical Panel.

The main conference room provided for the meeting was NOL's Jungle Room—a fairly comfortable, air-conditioned room for perhaps 30 to 35 people, although somewhat crowded by the 50-70 delegates present for much of the two weeks of the meeting. Other minor conference rooms for the sub-groups and sections were scattered around NOL and also at a neighbouring military establishment some three miles away; consequently it was not possible for delegates to move, as the occasion demanded, from one meeting room to another.

On the first day, the delegates were welcomed and addressed by Vice Admiral King, U.S.N., Deputy Chief of Naval Operations (Surface). The Technical Panel then went into a joint session with the "Books" section (ATP-6, 19 and 24) to discuss the technical content and the appropriate place for a new U.S. book on the planning and evaluation of MCM procedures. The technical content of the publication, incomplete as it is as present, was with some exceptions generally agreed as satisfactory, but it was not possible to agree where it should appear; although a number of nations opted for it to become a self-contained Annex to ATP-24. The U.K.'s attitude was that since it is meant for planning purposes, the book could well be limited in distribution to planning authorities and not be included amongst the books carried by MCM Vessels.

The rest of the first week, the Technical Panel met alone although split up into a number of groups dealing with degaussing, operational research, minesweeping, minehunting and clearance diving problems. The books section also continued on their own for the rest of this first week, having to collect their classified papers from the Jungle Room each morning, and meet in an establishment a few miles away.

The first half of the second week saw the meeting of the Joint Session (that is, Working Party and Technical Panel together). This was followed by full Mine Warfare Working Party Meeting. Again, as in previous years, much of the business was concerned with doctrine and tactics in the field of minesweeping; however, interest in U.K.'s Captain MCM General Memoranda on minehunting was marked.

The U.S. Navy gave a cocktail party on the Tuesday evening of the second week in the Officers' Club of the Bethesda Hospital.

Admiral Zumwalt, U.S.N., Chief of Naval Operations addressed the MW Working Party Meeting on the last Thursday of the session; his theme was an impressive account of the importance of mine warfare (however, as our U.S. delegate commented to the writer, this did not mean that the funds for MCM flowed any easier!).

Next year's meeting will be held in London with the U.K. as host for the first time. This meeting has in fact been held in London on at least three previous occasions in the 1960s, but they were held at the Old MAS Headquarters at Chesham Place with MAS as host.

An ICL 1904A computer has been installed to supplement the computer service to research establishments at present given by ARL.

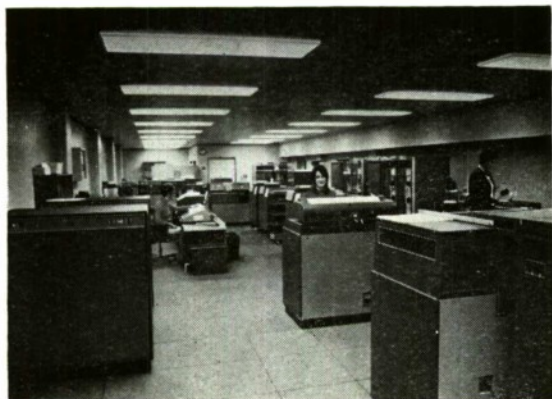

General view of Computer Hall.

Acceptance tests were completed on October 27 and a service to internal and external users is developing.



To mark several years service by HMS *Penelope* to the hydro-acoustic research and sonar development programmes of AUWE, her Commanding Officer, Commander J. B. Powell was presented with an inscribed plaque by the Director, AUWE, Dr. G. L. Hutchinson.

AUWE's new scientific trials tender RDV *Crystal* was designed and built in H.M. Dockyard, Devonport to very stringent structural requirements and was completed in the very short time of 18 months. This unique vessel is over 400 ft. long, 56 ft. beam and with a displacement of nearly 3,300 tons.

Within the vessel are large trunks which are open to the sea and associated with these trunks are "stations" which support, raise, lower and rotate scientific devices. These stations are hydraulically powered and the largest can handle a load of 130 tons.

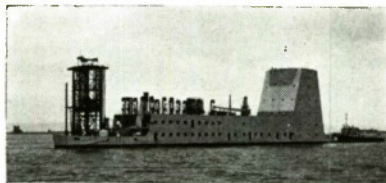

The main source of electrical power will be an 11 kV supply taken by underwater cable from the Central Electricity Generating Board's grid. A voltage of this magnitude is rarely connected to a vessel afloat and is another unusual feature of this project. The 11 kV supply is transformed aboard and provides electrical power at various voltages and frequencies to the laboratories and control rooms between decks.

The vessel is not fitted with propulsion machinery, but auxiliary machinery and systems include diesel generators, air compressors, hydraulic plant, chilled water plant, ventilation and steam heating. An operational ballasting system for trim adjustment and the usual ship board salt and fresh water systems are also installed.

Limited accommodation is provided for a combined complement of about 50 scientists and civilian crew.

R.D.V. *Crystal* will be moored inside the outer breakwater arm of Portland Harbour and her unconventional shape and 100ft. high tower will undoubtedly provide an unmistakable landmark.

M. G. W. Charter Senior Scientific Assistant at the Admiralty Underwater Weapons Establishment Portland was recently awarded a Certificate of Merit and a cheque by the Awards Committee of the Ministry of Defence (Navy).

Mr. Charter's award was for his work on a Narrow Beam Optical Director System and a Variable Square Wave Signal Generator, both of which have been used to good effect regularly in AUWE Trials.



Dr. Hutchinson (Left) Director AUWE made the presentation to Mr. Charter at Bingleaves recently.

Central Dockyard Laboratory

Mr. J. Smith visited the Dutch Naval Yard at Den Helder on 19th - 20th October as part of Surface Preparation Panel team to see open abrasive blasting being carried out on a Dutch warship. Mr. J. Smith and Mr. W. Weaver attended the sixth meeting in London of ISO TC/35/519 "Methods of tests for Paints" and its associated Task Groups.

Mr. D. R. Houghton attended the 2nd International Biodeterioration Symposium held from the 13th - 18th September in Lunteren, Holland, where he chaired the session on "Biodeterioration in the marine environment."

‡ ‡ ‡

Department Co-ordination Valve Development

Dr. C. S. Whitehead attended the European Microwave Conference in Stockholm in August 1971, and presented a paper entitled "A very high quality varactor diode for use at high idler frequencies" by C. S. Whitehead, J. C. Vokes*, H. A. Deadman* and J. C. Thomson*. (* from SERL)

As from 11th October, 1971 responsibility for research and development of passive components under RCRDC (TL9) and the co-ordination of policies on standardization of electronic parts (TL5) was transferred to DCVD. Changes in organizational arrangements are under discussion.

Mr. L. N. Large visited U.S. firms between 18th and 29th October 1971 to view and discuss the latest development in a wide area of solid state technology, particularly microelectronics. The visit included a TTCP Sub-Group I meeting on solid state devices with representatives of Canada and the U.S.

‡ ‡ ‡

Directorate of Naval Operational Research

On the 27th October 1971, at the Annual General Meeting of the Institute of Navigation, Messrs. A. Stratton (Director, Defence Operational Studies, Ministry of Defence, Byfleet) and W. E. Silver (Directorate of Naval Operational Studies, Ministry of Defence, Whitehall) were jointly awarded the Institute's Bronze Medal for the best paper published in the Institute's Journal for 1970.

The paper entitled "Operational Research and Cost Benefit Analysis on Navigation with Particular Reference to Marine Accidents" was first presented at the International Navigation Conference in Rome, May 1970, and printed in the Journal of the Institute in July 1970".

‡ ‡ ‡

Naval Aircraft Materials Laboratory

Mr. E. J. Hammersley, Officer-in-Charge NAML, has recently visited Australia and New Zealand to attend a meeting of the Air Standardisation Co-ordinating Committee Working Party 84, NBC Defensive Measures, which was held in Canberra. Following this meeting, discussions were held with the Superintendent Aircraft Maintenance and Repair in Sydney on a number of topics concerning naval aircraft operating and materials problems and also short discussions with staff of the Defence Standards Laboratories on techniques of engine health monitoring.

In New Zealand, meetings were held with the Defence Scientific Establishment for an exchange of information on Spectrometric Oil Analysis and on system monitoring techniques generally, including hydraulic system cleanliness requirements and counting techniques. Discussions also took place with the Royal New Zealand Navy and Royal New Zealand Air Force in Auckland and at RNZ Defence Headquarters Wellington, on aircraft materials problems generally. An interchange of further information as a follow-up to these visits is in hand.

‡ ‡ ‡

Services Electronics Research Laboratory

Dr. H. A. H. Boot was elected last August to Life Fellowship of the Franklin Institute (USA) in recognition of contributions made by him to science.

‡ ‡ ‡

Services Valve Test Laboratory

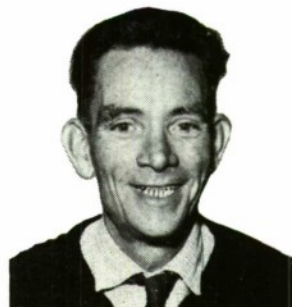

Charles Edward Poole retired on December 31st, 1971, after 28 years' service in the R.N.S.S. "Charlie" made first contact with electronics in 1939 as a Driver/Wireless Operator in the Royal Armoured Corps, subsequently seeing service in the Middle East, Sicily, Italy and, on D-Day + 1, in Normandy. He was invalided out of the Army in 1944.

His career with the RNSS started in 1944, as an Assistant Scientific Officer, serving in DREL, DRC4 and GX Divisions at ASRE, Witley until the end of 1950. Then a transfer to SVTL at Liss, where unfortunately his health broke down, leading to major surgery. He went with SVTL when it moved to Haslemere in 1952, and has served there ever since. Now that SVTL has closed down, Charlie, at 56, has chosen to take a premature retirement rather than face a tedious journey from his home in the village of Chiddingfold to a post at Portsdown.

A lot of his spare time has been taken up since 1958 as a member of Chiddingfold Parish Council, where his quick mind and memory for detail, particularly of rules and regulations, must be of great value.

We wish Charlie and Mrs. Poole a long and happy future.



BOOK REVIEWS

Swords for Sea Service. By Commander W. E. May and P. G. W. Annis. Two Volumes; pp. xxii + 398 with 5 colour plates, 140 plates and 32 figs. London; Her Majesty's Stationery Office. 1970. Price £8 net.

This book, superbly produced, is in fact designed to bring up-to-date a previous catalogue of swords in the National Maritime Museum, which was compiled in 1955 by Captain H. T. A. Bosanquet. Since then, some 350 swords have been added to the collection and "Swords for Sea Service" not only deals with these but also includes much additional material, particularly concerning the Sword Cutlers and the weapons used in other countries.

Though the book may at a glance seem a somewhat esoteric form of Museum Catalogue in fact there is a wealth of history and anecdote to be found in it. The illustrations are magnificent and the two volumes would form a most welcome and decorative addition to any library.

A. V. Thomas

Underwater Acoustics. By Leon Camp. Contributing authors Richard Stern and B. M. Brown. Pp. xi + 308. Wiley-Interscience, 1970. £8.25.

The choice of title for this book is unfortunate for two reasons. First, it is misleading as to content, the book being mainly concerned with sound sources and receivers. It is the contention of the chief author that these justifiably occupy the centre of the stage in underwater acoustics. But other workers with other interests and other prejudices would surely place different aspects in the centre.

For example the present writer, who is well known to be completely without bias, would choose the acoustics of the ocean medium for this place of honour. Although Dr. Camp is entitled to his opinion the result is a book which rather falls between two stools—it is not balanced enough to cover the whole field of underwater acoustics adequately, but neither is it whole-hearted enough to be a thorough text on transducers. The explanation of this, as offered in the preface, is that it is the book of the "short course" on underwater acoustics given for a number of years in the University of California at Los Angeles.

The second reason is that two books titled "Underwater Acoustics" were published only about a month apart at the end of last year, one by Camp and one edited by Stephens (see the review following). Both books were published by the same division of John Wiley, and are comparable in length and price. It is good to see this level of support for the subject, but it is thought the publishers would have done well to avoid the possible confusion. Note also that the same title was last used for yet another book only a few years ago.

Six out of the 10 chapters are on transducers or on matters directly relevant to transducer design. Perhaps the most important of these are on electroacoustic, magnetostrictive and piezoelectric systems. The stress here is on the mathematical analysis of fairly complete mechanical models, rather than on more severely practical matters. The author is helpful to the student by going back to first principles, and including for example very readable accounts of basic magnetic theory and tensor analysis.

The two chapters by Stern introduce basic wave acoustics, and then very briefly underwater sound propagation in terms of ray acoustics. Camp contributes one general chapter covering listening and echo-ranging. The book finishes with a useful account of sonar signal processing by Brown, where the primary division is into incoherent and coherent processors rather than into passive and active systems.

The editing is careless in a number of places. For example the loss of the promised table of logarithms in Table A3.3 is not all that serious, but it is a pity instead to waste two pages completely by repeating Table A3.1.

D. E. Weston

Underwater Acoustics. Edited by R. W. B. Stephens. Pp. vii + 269. Wiley-Interscience, 1970. £6.75.

This book is based on a series of eight lectures delivered at Imperial College in 1967. Dr. R. W. B. Stephens was responsible both for organizing the lectures and for editing this book. His interests and manifold activities in acoustics extend well beyond the underwater world, and it was very fitting that about the time of his recent retirement from Imperial College he should be given the Rayleigh Gold Medal of the British Acoustical Society.

As often happens with multiple authorship there is considerable inhomogeneity—showing up here in the quality of the writing, the level at which it is pitched, the length of the contributions, and the degree of specialisation. The quality varies from the really excellent to the rather poor, but the book would be worth having for the one or two top papers alone. Those papers aiming at a high level contain a reasonable amount of mathematics, but care is taken to relate this to the physics. Length of papers is not necessarily of the first importance, but for the record the shortest is 18 pp. long and the longest is 69 pp. The former is an interesting and well-organised account by B. Ray of audio communication between free divers, stressing that the practical problems can be more important than the esoteric technical ones. The latter is a paper by R. W. G. Haslett on target echoes, describing in particular detail Haslett's own work on fish targets, and filling over a quarter of the whole book. Three of the papers cover a very wide field: Stephen's introductory lecture, W. F. Hunter's talk on acoustic

"exploration" which gives the flavour of the sonar detection problem, and D. M. J. P. Manley's rather mixed bag on instrumentation. The other five papers are more specialist, and somewhat arbitrarily three of these are chosen for further comment below.

The writer enjoyed A. O. Williams Jr. on normal-mode methods in propagation of underwater sound, considered here mainly in deep-water applications. It is easy in such a subject to be either excessively rigorous and mathematical, or sloppy and uninformative. This elegant paper avoids both extremes with ease and humour, and provides a good introduction to the mode approach. It progresses from the spherical to the not-so-spherical cow; here the explanation of this joke will most meanly be withheld and the reader referred to the book. But don't let this piece of frivolity make you think there is no meat in this lecture.

There are plenty of problems left in working with normal-mode ideas in the real sea, but perhaps even more problems connected with surface scattering. Thus the first part of H. Medwin's excellent paper is a derivation of the effect of surface waves, using the Helmholtz surface integral method. This is applied both to backscatter and to the near-specular direction, and also compared to experiment. One interesting point is the apparent necessity to take into account the contribution of scattering by near-surface bubbles. But it is only just now beginning to be possible to set limits to their relative importance; as a function of frequency, wind speed, geometry etc.

V. G. Welsby's article efficiently introduces non-linear acoustics, a subject which may well become increasingly important as techniques advance and source intensities become higher. He discusses both the basic theory and a number of applications. The application with perhaps the longest history is the endfire array of virtual sources. Two beams of high-frequency sound, differing only slightly in frequency, are superimposed in space. Their non-linear interaction produces a line of virtual sources at the sum and difference frequencies. The main point is that a very narrow beam can be produced at the difference frequency, using a projector of surprisingly small size. This is of high academic interest, but it remains to be seen how soon the idea can be used at sea (or elsewhere) in a device which is truly competitive with more conventional equipment.

D. E. Weston

Information Transmission, Modulation and Noise. By Mischa Schwartz. 2nd Edition, McGraw Hill Book Company, 1970. £1.39.

Since the early 1940s there has been an enormous expansion in the communications field and an increase in the number and variety of signal processing and information transmission techniques employed. The first edition of this book (1959) fulfilled the need of both students and practicing engineers for an authoritative text on the fundamental and unifying principles of communications systems. Having used it frequently myself as a reliable source of reference I looked forward to studying it and comparing it with its esteemed predecessor.

The two opening chapters have changed little, the first being an introduction into information transmission with a discussion of the factors affecting the information capacity of a system, while the second deals with transmission through electrical networks. Together they show, in lucid fashion, that information capacity is bandwidth limited due to the presence of energy storage devices and unavoidable noise fluctuations. The Fourier series, Fourier integral, and concept of frequency spectrum are developed and related to time response.

Chapter 3 on "Digital Communication Systems" first reveals the substantial revision that the earlier edition has undergone and the new emphasis on digital methods. The conversion of analogue signals to digital form by sampling and subsequent quantisation is covered in some depth and attention is given to problems arising such as time synchronisation, inter-symbol interference and quantisation noise.

The digital emphasis is again reflected in Chapter 4, entitled "Modulation Techniques". The earlier edition included an excellent and comprehensive section on this subject including a.m., S.S.B., narrow and wide-band f.m. This has been substantially repeated and improved upon but, in addition, there is an entirely new section on Binary Communications with an essentially mathematical treatment of OOK (on-off keyed), PSK (phase-shift keyed), FSK (frequency-shift keyed), systems.

Statistical concepts are essential to a study of modern communication systems and Chapter 5, "Statistical Methods in Systems Analysis", caters for this and includes a well

written and conventional introduction to the elements of probability theory. The new edition follows this up, however, with the Axiomatic approach to probability which is somewhat more abstract and dependent on set theory. Discrete and continuous probability distributions, statistical averages and probability density functions are then dealt with thoroughly before some important practical applications of statistical methods are discussed, e.g. error rate in P.C.M., the transmission of signals through random fading media (Rayleigh and Rician fading).

A new chapter on "Random Signals and Noise" is concerned with the efficiency of modulation and demodulation techniques in the presence of noise. The point is made early on that real signals are time varying and unpredictable (otherwise why transmit them?). In the 127 pages of this chapter there is a wide ranging attack on the subject matter and topics include Auto-correlation Function and Spectral Analysis, Matched Filter-detection, Narrow-band Noise, Synchronous Detection of Binary Signals in Noise, to mention but a few. Only the actual mechanisms of noise generation are left until later in Chapter 7, "Physical Sources of Noise", which is an updated version of that in the first edition, but with the same thorough treatment.

The final chapter, "Statistical Communication Theory and Digital Communications" concerns itself with the problem of optimising systems by maximising information transmission rate within prescribed constraints of error probability, signal power, noise and bandwidth.

Mischa Schwartz has again demonstrated his understanding of good communication by producing this very readable revised version of his earlier work. The quality of content is matched by that of the binding, print and diagrams which are excellent, and the book is a worthy successor to the first edition.

J. H. Riley

In-Water Photography—Theory and Practice.

Lawrence E. Mertens, Wiley-Interscience 1970. Pp. xiii + 391. £1.90.

The production of an underwater photograph is fraught with difficulty and complications. Apart from the practical problems of the protection and operation of so delicate an instrument as a camera in such a difficult environment, there are the vagaries in the

behaviour of light in this medium to be taken into account. This is all in addition to the usual considerations of terrestrial photography which is, after all, a complete and complicated science (and art) in its own right: very many large works have been written on it. Obviously, then, a concise treatment of underwater photography is going to involve precision mechanical engineering, optics and higher physics as well as the pure photography.

After a brief introductory section, the transmission of light in water is considered, including both natural and artificial light sources, the air/water interface, and the physical properties of water that affect the transmission of light. Image contrast and the use of filters is discussed, supplementary lighting in much detail, lenses and optical parts, cameras and their necessary water-tight protection, films and image tubes, and the biological aspects of light and colour in the sea are all considered in turn. The practical side is then dealt with under the sub-headings of applications, modern photographic techniques, and then, of course, diving methods.

An enormous amount of information is contained in the book, and it is very obvious from the large number of extremely useful references (included at the end of each of the 12 main sections), that a lot of careful literature research and forethought has gone into its compilation. Graphs and tables are plentiful, and make reference to the book a simple task. As with large text-books on its terrestrial counterpart, it does tend to get mathematical in places, but this, of course, is necessary if one is to get a true understanding of the subject: this may, however, tend to discourage its purchase by the "non-professional", such as an amateur skin-diver who "fancies the idea of taking a few pictures underwater".

This apart, however, the book gives the subject matter a very thorough treatment, and will be of great assistance to those involved in the production of photographs of situations in underwater surroundings.

J. Kirby

Nuclear Reactor Theory. By George I. Bell and Samuel Glasstone. Pp. xviii + 619. New York. Van Nostrand Reinhold Company 1970. Price £12.25.

This first systematic treatment of neutron transport theory will undoubtedly become the standard reference book in the field within a short period of time. The authors are well qualified to produce such a textbook with Dr. Bell having over 20 years experience at Los Alamos in both practical and theoretical applications of Transport Theory, and S. Glasstone having a lifetime's experience in the production of excellent textbooks in the field of Nuclear Science and Technology.

The 10 chapters of the book cover a considerable variety of topics concerned with solutions of the Transport Equation and their application to practical reactor analysis. Much of the information presented was previously only available in government authority reports. Chapters one to five cover the derivation and solution of the Transport Equation and the Integral Transport Equation in considerable detail. The treatment will appeal to physicist and engineer alike in that the mathematical derivations are thorough without being too detailed. The main numerical methods of solution covered are Spherical Harmonics, Discrete Ordinates and Collision Probabilities though surprisingly, little mention is made of multi-group collision probability (or Monte Carlo) methods. Chapter six covers applications of the adjoint function to perturbation theory and to variational methods. The presentation is extremely lucid with the discussion of variational methods particularly useful. Students and workers in the field alike will welcome Chapters seven and eight on Neutron Thermalisation and Resonance Absorption respectively. The presentation is much clearer and a great improvement on present texts available. Chapters nine and ten on Reactor Dynamics are interesting though perhaps not as outstanding as the earlier chapters. The section on flux flattening using burnable poisons is, however, most welcome.

This textbook then, although superficially expensive at £12.25, is good value especially to workers in the field of core assessments and to lecturers and students in reactor physics. Two additional and welcome features of the book are the excellent examples at the end of each chapter and the comprehensive reference list associated with each chapter. A suggested useful addendum to the book would be a set of worked solutions to the examples!

A. Wilkie

NOTICE TO READERS

The Editor extends to all readers of the Journal and particularly those of the younger generation, a cordial invitation to contribute articles of R.N.S.S., naval or general scientific and technical interest.

Authors are requested particularly to note that as the Journal is in the Restricted category the printing of material within its pages does not constitute open publication and does not prejudice the subsequent use of the material in the Journal of a learned society or institution, or in the scientific and technical press.

Manuscript should be typewritten if possible, in double spacing and on one side of the paper only. It should include, in addition to the title, the name of the Author together with initials, degrees and department, establishment or ship. Pseudonyms are acceptable only in special circumstances. A convenient length is between 3,000 and 5,000 words, but other lengths are acceptable and no contribution would be debarred on this ground alone. Illustrations are in most cases a desirable addition. Photographs should be of good quality, glossy, unmounted and preferably between two and three times the size of the required final picture. Graphs and line drawings should be made on a similar large scale, with bold lines to permit reduction in block making. A recent photograph and biographical note of the Author(s) will also be welcomed.

Views and opinions expressed in the Journal are not necessarily endorsed either by the R.N.S.S. or by the Editor.

All communications should be addressed to:--

The Editor,
Journal of the Royal Naval Scientific Service,
Ministry of Defence,
Station Square House,
St. Mary Cray, Orpington, Kent. BR5 3RF
Telephone: Orpington 32111, ext. 345.
Telex: 896394

RESTRICTED



*Information Centre
Knowledge Services*
[dstl] Porton Down,
Salisbury
Wilts
SP4 0JQ
Tel: 01980-613753
Fax 01980-613970

Defense Technical Information Center (DTIC)
8725 John J. Kingman Road, Suit 0944
Fort Belvoir, VA 22060-6218
U.S.A.

AD#:
Date of Search: 15 February 2007

Record Summary:

Title: Journal of the Royal Naval Scientific Service
Covering dates 1972 Jan 01 - 1972 Jan 31
Availability Open Document, Open Description, Normal Closure before FOI
Act: 30 years
Held by The National Archives, Kew

This document is now available at the National Archives, Kew, Surrey, United Kingdom.

DTIC has checked the National Archives Catalogue website (<http://www.nationalarchives.gov.uk>) and found the document is available and releasable to the public.

Access to UK public records is governed by statute, namely the Public Records Act, 1958, and the Public Records Act, 1967. The document has been released under the 30 year rule. (The vast majority of records selected for permanent preservation are made available to the public when they are 30 years old. This is commonly referred to as the 30 year rule and was established by the Public Records Act of 1967).

This document may be treated as UNLIMITED.