

UNCLASSIFIED

AD NUMBER	
AD504684	
CLASSIFICATION CHANGES	
TO:	unclassified
FROM:	confidential
LIMITATION CHANGES	
TO:	Approved for public release, distribution unlimited
FROM:	Distribution authorized to U.S. Gov't. agencies and their contractors; Administrative/Operational Use; 30 APR 1969. Other requests shall be referred to Assistant Chief of Staff for Force Development, Department of the Army, Washington, DC 20310.
AUTHORITY	
AGO D/A ltr dtd 29 Apr 1980; AGO D/A ltr dtd 29 Apr 1980	

THIS PAGE IS UNCLASSIFIED

SECURITY

MARKING

The classified or limited status of this report applies to each page, unless otherwise marked.
Separate page printouts MUST be marked accordingly.

THIS DOCUMENT CONTAINS INFORMATION AFFECTING THE NATIONAL DEFENSE OF THE UNITED STATES WITHIN THE MEANING OF THE ESPIONAGE LAWS, TITLE 18, U.S.C., SECTIONS 793 AND 794. THE TRANSMISSION OR THE REVELATION OF ITS CONTENTS IN ANY MANNER TO AN UNAUTHORIZED PERSON IS PROHIBITED BY LAW.

NOTICE: When government or other drawings, specifications or other data are used for any purpose other than in connection with a definitely related government procurement operation, the U.S. Government thereby incurs no responsibility, nor any obligation whatsoever; and the fact that the Government may have formulated, furnished, or in any way supplied the said drawings, specifications, or other data is not to be regarded by implication or otherwise as in any manner licensing the holder or any other person or corporation, or conveying any rights or permission to manufacture, use or sell any patented invention that may in any way be related thereto.

CONFIDENTIAL

**DEPARTMENT OF THE ARMY
OFFICE OF THE ADJUTANT GENERAL
WASHINGTON, D.C. 20310**



IN REPLY REFER TO

AGDA (M) (27 Aug 69)

FOR OT UT 692088

17 September 1969

SUBJECT: Operational Report - Lessons Learned, Headquarters, 4th Infantry
Division Artillery, Period Ending 30 April 1969 (U)

AD 504684

SEE DISTRIBUTION

1. Subject report is forwarded for review and evaluation in accordance with paragraph 5b, AR 525-15. Evaluations and corrective actions should be reported to ACSFOR OT UT, Operational Reports Branch, within 90 days of receipt of covering letter.
2. Information contained in this report is provided to insure appropriate benefits in the future from lessons learned during current operations and may be adapted for use in developing training material.

BY ORDER OF THE SECRETARY OF THE ARMY:

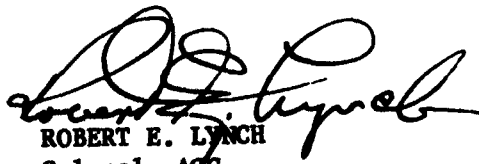
ROBERT E. LYNCH
Colonel, AGC
Acting The Adjutant General

1 Incl
as

DISTRIBUTION:

Commanding Generals

US Continental Army Command

US Army Combat Developments Command

Commandants

US Army War College

US Army Command and General Staff College

US Army Air Defense School

US Army Armor School

US Army Aviation School

US Army Civil Affairs School

US Army Combat Surveillance School

US Army Engineer School

US Army Field Artillery School

US Army Infantry School

US Army Intelligence School

US Army Missile and Munitions School

US Army Ordnance School

Regraded unclassified when separated
from classified inclosure.

CONFIDENTIAL

CONFIDENTIAL

DISTRIBUTION (Cont'd)

- US Army Signal School
- US Army Southeastern Signal School
- US Army Special Warfare School
- US Army Transportation School

Copies furnished:

- Office, Chief of Staff, US Army
- Deputy Chiefs of Staff
- Chief of Research and Development
- Assistant Chiefs of Staff
- Chief of Engineers
- OSD(SA) Assistant for Southeast Asia Forces
- Director, Defense Research and Engineering
- Office, Joint Chiefs of Staff
- Commanding Generals
 - US Army Materiel Command
 - US Army Electronics Command
 - US Army Weapons Command
 - US Army Security Agency
- Deputy Chief of Staff, Air Force, Plans & Operations
- Commandant of the Marine Corps
- Senior Army Representative, Marine Corps Development & Education Command
- The Air University Library
- Director, Weapons Systems Evaluation Group
- Security Officer, Hudson Institute
- Commanding Officers
 - US Army Limited War Laboratory
 - US Army Logistics, Doctrine Systems & Readiness Agency
 - US Army Mobility Equipment Research & Development Center
 - 4th Infantry Division Artillery
- Defense Documentation Center

CONFIDENTIAL

CONFIDENTIAL

DEPARTMENT OF THE ARMY
HEADQUARTERS 4TH INFANTRY DIVISION ARTILLERY
APO San Francisco 96262

AVDDD-AC

30 April 1969

SUBJECT: Operation Report - Lessons Learned for the Period Ending 30 April 1969,
RCS CSFOR -65 (R1)

SEE DISTRIBUTION

SECTION 1 (C) Significant Organization or Unit Activities

1. (C) General.

a. During the period 1 Feb 69 -30 Apr 69 the 4th Infantry Division Artillery commenced participation in Operation HINES which was effective for execution 312400 Jan 69. Commencing on 151200 Apr 69 Operation Washington Green was also initiated in support of the CY 1969 GVN Pacification and Development Plan. The pacification operation was in addition to the requirements of Operation Hines and was initiated by all elements of Division Artillery

b. Task Organization is shown at Inclosure 1.

c. Commanders and Principal Staff is shown at Inclosure 2.

d. Mission.

(1) Primary: The mission of the artillery was to support the 4th Infantry Division with available artillery, radar, automatic weapons, searchlights and meteorological resources.

(2) Special Missions: In support of Operation Washington Green, the mission of the Artillery is to increase the combat effectiveness of RVNAF artillery elements and enhance the security of the civilian population in the Pleiku Province less the Pleiku Defense.

2. (C) Intelligence

a. Area of Operations

(1) Kontum. During February and March, intelligence indicated the following major enemy units were operating in Kontum Province: 24th NVA Regiment; 66th NVA Regiment; 40th NVA Arty Regiment; 406th and 408th Sapper Battalions; 304th and 306th Local Force Battalions. The 24th NVA Regiment operated south, southwest, and west of Kontum City. The 66th NVA Regiment operated to the north and northwest and west of Kontum City. The two Sapper Battalions and Local Force Battalions have operated to the north and northeast of Kontum. The 40th Arty Regi-

FOR OT UT
692088

1

**DOWNGRADED AT 3 YEAR INTERVALS;
DECLASSIFIED AFTER 12 YEARS.
DOD DIR 5200.10**

Inclosure

CONFIDENTIAL

CONFIDENTIAL

AVDDD-AC

30 April 1969

SUBJECT: Operation Report - Lessons Learned for the Period Ending 30 April 1969,
RCS CSFOR -65 (R1)

ment has elements in support of the maneuver units. Enemy forces maneuvered much in the same manner as used during TET 1968; however, a major offensive did not materialize. The enemy exploited the use of ambushes, stand-off attacks, and attacks by indirect fire in order to interdict lines of communications and harass US/GVN installations. Small guerrilla forces continued to terrorize outlying villages and capture prisoners to be used to carry supplies for NVA/VC units. In early April, it appeared that the major enemy units were withdrawing to Cambodia and the Tri Border Area. Major ground operations were conducted against infiltration routes and enemy losses were heavy in this apparent attempt to withdraw. Interrogation of prisoners indicates that enemy forces are suffering from malaria and lack of medical supplies. Morale is a continuing problem.

(2) Duc Co. During the period 23 Feb to 1 March, enemy activity in the Duc Co area increased significantly with the Duc Co CSF Camp receiving 75 RR and 82mm mortars daily. From 1 March to the end of April, the NVA and the VC Forces continued their stand-off, sapper, and limited objective attacks. A major shift in emphasis occurred as the mining of roads, acts of terrorism, propaganda efforts were conducted by NLF. During March the enemy shifted its emphasis towards Local Force elements. The majority of the terrorism of villages and interdicting of lines of communication was done by the X-45 VC Bn and H-15 VC Bn. Intelligence indicated that recon elements of X-45 had been in close proximity of LZ Oasis, Plei Me, and Edap Enang Area, and were building up in the vicinity 10 KM SE of LZ Oasis, C-6 of X-45 was operating north of Than An between Highway 509 and 19W. C-5 and C-7 of X-45 were operating south and SW of LZ Oasis. The mission of these units was to interdict the highway by mining and sniper incidents. They were also to terrorize the villages and harass US and Thanh An defense forces. This minor harassment and terrorism continued throughout April.

(3) Plei Mrong, Polei Kleng. Throughout the reporting period, friendly elements operating in the Plei Mrong, Polei Kleng, and Chu Pa Mountain areas continued to make contact with enemy units. The 3d Brigade supported by 2d Bn, 9th Arty moved against the 24th NVA Regiment and its supporting elements in the Chu Pa Mountains west of Plei Mrong. The enemy forces consisted of the K4 and K6 Battalions which were heavily engaged by ARVN and US Forces. The enemy was well fortified and determined to protect its position. Supporting K-4 and K-6 were elements of the 31st NVA Arty Bn of the 40th NVA Arty Regiment. Also deployed in this area, 1st Bde moved its Tac CP; first to Plei Mrong and subsequently to Polei Kleng. Beside the 24th NVA Regiment, friendly elements found evidence of the following enemy units: 306th LF Bn operating 45 kilometers NNE of Kontum; 204th Bn, 21st NVA Regiment operating in vicinity of BR 2234; C2/32d Bn of the 40th Arty Reg operating 17 kilometers SW of Polei Kleng; 66th Reg operating at YA 782750; 1st Production Plt, Zone 6 Production Group, 95B Reg was growing rice in three areas (BR 075305, BR 120340, and BR 145325); K-31 Bn, a transportation unit; 5th Bn, 24th Reg operating at ZB 168018; K-25 Engineer Bn, B-3 Front operating in the Polei Kleng area, 208th VC Company operating a base camp area. Activity in the area was moderate during the middle of February; the regions west and southwest of Polei Kleng were the most active. There was initial evidence of eastward movement against 4th Division Firebases, Polei Kleng, Plei Mrong and Kontum City. Toward the end of the month activity consisted of small contacts with sightings

CONFIDENTIAL

CONFIDENTIAL

AVDDO-14

30 April 1969

SUBJECT: Operation Report - Lessons Learned for the Period Ending 30 April 1969
RCS CLFOR -65 (R1)

and indications of enemy movement culminating in attacks throughout the Division AO on 23 February. The widespread heavy attacks of 23 February inaugurated the Spring phase of the Winter-Spring offensive which continued into March. Enemy tactics included attacks by fire, ground attacks, minings and ambushes along Highway 14. Activity tapered off toward the middle of the month and friendly units relocated in the Plei Trap Valley area to block enemy resupply and withdrawal routes. Harassing attacks by fire and ground probes against friendly firebases increased sharply as the enemy initiated renewed activity in the Spring Offensive. The Central Plei Trap area, 23 kilometers SW of Plei Kleng, was the scene of the heaviest action during the early part of April. It appeared from all intelligence sources that this was a base area complex consisting of the HQ and 8th Bn, 66th NVA Reg, K25B Engineer Bn and the 28th Recon/Sapper Bn. In addition, two new artillery battalions were identified as being organic to the 40th Regiment. These two battalions, K-41 and K-42, were believed to have 105mm artillery weapons. As April progressed, activity in the Plei Trap Valley area decreased considerably. Sporadic small arms and artillery exchanges and a few firing contacts were the major incidents. Activity in the Plei Kleng area during this period was almost at a standstill.

b. Tactical Area of Responsibility

(1) Base Camp Defense. During the reporting period there were no significant changes in the defensive plans for Camp Enari. The physical defenses were altered however, when the new bunker line was completed and manned. This provided a decrease in the total number of bunkers around the 9000m perimeter (from 117 to 118). At the present time, the towers of the old bunker line are still being utilized; construction of new tower facilities began 28 April 1969. The density of defensive devices (claymores, CS dispensers, trip flares, puff markers, etc.) was increased to provide better coverage for the perimeter. Existing fougasse contacters are being blown and replaced. The defense of Camp Enari consisted of extensive daily patrolling, aerial reconnaissance, counter mortar radar, personnel detection radar and bunker line defense. These operations are controlled by the Installation Coordination Center (ICC). Each sector is responsible for maintaining daily patrols. Patrol routes, SP's and RP's are varied each day. Where feasible, patrols' night locations are positioned near friendly villages which do not have a self defense capability. Aerial reconnaissance is accomplished daily by assigned aerial observers. Sweeps are made at first light in the morning and immediately before dark in the evening. Special areas are given deliberate and extensive coverage while the remainder of the TAOR is given general coverage. To facilitate rapid clearance of fires, a written agreement has been executed between ICC and Fleiku Sector whereby blanket political clearance is granted once each night for the entire Camp Enari TAOR.

(2) Activity (TAOR). During the reported period, enemy activity was generally light within the TAOR. The enemy continued to harass friendly villages and to employ sniper fire. On 21 March 1969 and 15 Apr 1969, rocket attacks were initiated against Camp Enari. Discussion of these attacks follows: 1. 21 March 1969 - Nine (9) rounds of 122mm rocket were received in an attack which began at 0531 hours and lasted for two (2) minutes. The Counter rocket program was initiated with unknown results. Crater analysis indicated that the launch site was approx-

3.

(CONFIDENTIAL)

CONFIDENTIAL

REF ID: A67747
SUBJECT: Operation Report - Lessons Learned for the Period Ending 30 April 1969
RCS- CSFOR -35 (R1) 30 April 1969

imately 11 Kilometers west of Camp Enari. A VR of the area produced no results. Personnel casualties as result of the attack were one (1) WIA (lightly). Equipment losses were much more extensive. They were as follows: one (1) AH1G Acft destroyed; one (1) AH1G Acft heavily damaged; two (2) UH1C Acft heavily damaged; one (1) LOH heavily damaged; one (1) 3/4 ton truck slightly damaged. 2. 15 April 1969 - Thirteen (13) rounds of 122mm rocket were received in an attack which began at 0750 hours and lasted for five (5) minutes. A counter mortar program was initiated immediately on a location approximately one (1) Kilometer SW of Base Camp (A LCP team operating in that area reported what it believed to be mortar tubes firing on Camp Enari). Subsequent crater analysis and examination of shell fragments indicated that the incoming rounds were Russian made, 122mm Rockets. A total of 13 craters were found. Shelrep revealed that three (3) rounds had delay fuses and ten (10) were point detonating. Gunships performing VR within the TAOR located the launch site at ZA 195354, approximately 7 Kilometers west of Camp Enari and one (1) complete round was captured. Fourteen (14) US personnel and one (1) VN civilian employee were wounded. The 124th Signal Battalion messhall took a direct hit and was destroyed.

(3) Discreet Signaling System. With increasing concern being placed on the protection of friendly villages, a Discreet Signaling System is presently being tested for possible deployment in villages without self defense capabilities. This device may be activated at a range of up to 10 Kilometers. It emits a high frequency signal which registers on a base station monitored at the Installation Coordination Center. By knowing the numeral designation of the activated device monitor personnel know from what point the signal was sent. The signal will indicate that there are enemy elements in the village or that the village is under attack. Plans are presently being formulated to devise the appropriate response to the distress signal. Additionally, MI personnel are formulating a list of reliable agents to whom the devices can be disseminated.

(4) Operation Cleansweep VI. Operation Cleansweep VI took place 050645 - 051600 February 1969. The entire force consisted of 4,744 personnel making up five (5) Task Forces and supporting force elements. The operation was designed to search and clear portions of Sector Black of the TAOR (W to NW of Camp Enari). The sweep zone extended two kilometers outside the normal limits of the TAOR. The line of departure for three (3) task forces was a line running along Highway 19 West for approximately 12 Kilometers. These forces swept an area to the north of and perpendicular to the other task forces from a line of departure two (2) kilometers outside the TAOR boundary. A fifth task force provided screening forces along the northern boundary of the sweep zone. Findings included the following: TF Red found and destroyed an AT mine; 4th Aviation elements found three (3) caves containing clothing and documents; TF Black initiated S/A fire against two (2) individuals with negative results; TF Black received a hand grenade thrown from 30 meters away with negative damage. There were no friendly or enemy personnel losses. Operation Cleansweep VI was considered a successful operation. It demonstrated to the enemy the US capability of putting large numbers of forces on the ground in a short period of time.

CONFIDENTIAL

CONFIDENTIAL

AVDD-46

30 April 1969

SUBJECT: Operation Report - Lessons Learned for the Period Ending 30 April 1969
RCS- CSFOR -65 (RL)

c. Survey.

(1) Division Artillery. During the reporting period, a 5th order survey of 15 villages within the TAOR was completed and the village limits were established. Overlays with the exact locations of each village were distributed to the Camp Enari 105mm, 155mm and mortar batteries for appropriate plotting in the fire direction center.

(2) 6th Battalion, 29th Artillery. The survey section was able to survey in the Q4 radar location at FSB McNerney (BR 023522) and the battery position also located at FSB McNerney. Due to the location of the various firebases occupied by the batteries during the reporting period complete surveys were not performed. However, directional control obtained from a sun shot was obtained for each firebase occupied.

(3) 4th Battalion, 42d Artillery. The battalion survey section surveyed all extensive bunkers on LZ Mary Lou and an accurate map of the area was made. Surveys were also provided to mortar platoons occupying LZ Mary Lou and adjacent Special Forces Camps. The survey section was able to survey the majority of the firebases occupied. Directional control was obtained for all firebases.

(4) 2d Battalion, 9th Artillery. Survey operations continued as new firebases were surveyed in by the battalion survey section. The roads and ditches at LZ Oasis were also surveyed for the 4th Division Engineers.

(5) 5th Battalion, 16th Artillery. The survey section completed the survey of several battery positions within the Division AO to support operations. Registration points for the base camp 105mm and 155mm batteries were also surveyed.

d. Radar. The Radar (TPS-25) operated for 1030 hours and had no down time during the 89 days covered by this report. There were 210 radar locations with the size of the contacts ranging from 1 man to 150 men. All large contacts were confirmed by another agency. The greatest problem encountered was the time required for clearance to fire on the targets. Since the rate of march of VC/NVA units is 1 Km every 15 minutes, many times the radar contact was lost or the hostile forces had passed the target area by the time the guns could obtain clearance and fire. This problem was partially solved by obtaining blanket political clearance for the entire TAOR every night.

3. (C) Operations:

a. Plans: During this period the 4th Infantry Division participated in Operation Hines and Operation Washington Green.

b. Operation Hines: 312400 January 1969 - Present.

(1) Concept of Operation. Direct support artillery was provided on a maneuver battalion - artillery battery basis, with batteries changing OPCON from their parent battalions as the brigade task organization changed. Medium and

5.

CONFIDENTIAL

CONFIDENTIAL A1

AVDDD-AC

30 April 1969

SUBJECT: Operation Report - Lessons Learned for the Period Ending 30 April 1969
RCS- CSFOR -65 (R1)

heavy artillery were used in general support reinforcing and general support missions to weight critical areas and influence the battle. Artillery and automatic weapons were used for convoy and firebase/base camp security. Artillery coverage was provided in the border areas, especially in the vicinity of the USSF/USF camps.

(2) Execution:

(a) The 6th Battalion, 29th Artillery was in direct support of the 1st Brigade; the 4th Battalion, 42d Artillery was in direct support of the 2d Brigade; and the 2d Battalion, 9th Artillery was in direct support of the 3rd Brigade; 5th Battalion, 16th Artillery and the 52d Artillery Group units were employed in general support and general support reinforcing roles.

(b) The reporting period began with the activity in the 1st and 2d Brigade AO relatively quiet, but the activity in the 3rd Brigade AO continued to be moderate. The 1st Brigade was operating north of FSB McNerney and in conjunction with the 2d Mobile Strike Force Battalion in an AO in the vicinity of VC Valley. Contact was very light and sporadic throughout the 1st Brigade AO during the early part of February. The 2d Brigade was operating between Kontum and Dak To and in the area between Hwy 14 and the Cambodian border. Activity continued to be light throughout the entire month of February. The 3rd Brigade was operating generally in the vicinity of the Chu Pa Mountains against the 24th NVA Regiment supported by the 31st NVA Artillery Battalion. The US Infantry Battalions operating against the 24th NVA Regiment made numerous and heavy contacts with the enemy. Friendly forces made excellent use of available fire support. In the first two weeks of February American artillery supporting the 3rd Brigade was credited with 108 enemy kills. Contacts with the enemy in the Chu Pa area decreased as February came to a close. By mid-February the 1st Brigade had moved west to the area southwest of Kontum City in the vicinity of Plei Mrong. Contacts with elements of the 24th and 66th NVA Regiment were numerous but generally light and of short duration. The 1st Brigade terminated operations in the Plei Mrong area on the last day of February.

(c) The month of March was highlighted by the enemy's Post Tet Offensive. Action in the 1st and 2nd Brigade AO's increased significantly. Standoff attacks by mortars, rockets and artillery were launched against populated areas and American fire support bases. The 1st Brigade was deployed in the Plei Trap Valley with their tactical headquarters in Plei Kleng. They remained in this area until mid April. The infantry elements operating in the Plei Trap Valley made numerous and heavy contacts with the enemy. The artillery batteries and their security elements received counter battery fire off and on throughout the entire month of March. The enemy was dealt heavy casualties and lost significant amounts of weapons (including 9 105mm howitzers, 8 trucks) and ammunition. The second brigade countered the enemy's Post Tet Offensive in the same general area they had occupied since November 1968. The brigade and its supporting artillery were involved in several heavy ground actions and were the recipients of numerous standoff rocket and mortar attacks. DivArty and 52d Group units fired in support of the defense of Ben Het SF Camp in early March. The enemy used tanks in this attack. Although the enemy hit Ben Het on a daily basis for the first week of

CONFIDENTIAL
CONFIDENTIAL

CONFIDENTIAL

AVDD-AC

30 April 1969

SUBJECT: Operation Report - Lessons Learned for the Period Ending 30 April 1969
RCS- CSFOR -65 (RL)

March they were never successful in penetrating the Camp's Defense. They suffered heavy casualties, lost two tanks and other weapons and equipment in their unsuccessful attacks.

Enemy resistance decreased in March for the Third Brigade as they continued their search and clear operations. The preponderance of the 3rd Brigade forces were deployed to the West of Pleiku between Highway 14 and the Cambodian border.

(d) April was a relatively quiet month throughout the Fourth Infantry Division area of operations. The Division placed emphasis on pacification in conjunction with operation Washington Green.

The 1st Brigade's contact with the enemy diminished considerably during the first two weeks of April. On 14 April the brigade along with its DS artillery battalion (6-29th) deployed to An Khe. The brigade initiated operations against the local enemy forces in conjunction with their pacification program. The first brigade had no significant contacts during the last two weeks of April. The second brigade continued to operate in the Kontum area throughout the month of April. Artillery action was generally confined to night fire programs. The brigade had no significant contacts with the enemy during April. Emphasis was shifted from the destruction of enemy forces to the pacification of the inhabited area around Kontum City. The Third Brigade continued operations in the Pleiku, Oasis, Duc Co area as enemy activity in this area also diminished. On 23 April the brigade sent a task force to the Ban Blech - Tieu Atar area. This deployment was considered necessary to counter an enemy build up to the South. This task force did not make significant contact with the enemy during the last week of the reporting period.

c. Operation Washington Green: 151200 April 1969 - Present

The Division Artillery Battalions initiated limited pacification operations in support of Operation Washington Green effective 151200 April 1969. At the end of the reporting period plans were being finalized for the full support of the operation in conjunction with the CY 1969 GVN Pacification and Development Plan.

d. Chronological Summary of Significant Activities (See inclosure 4)

e. Ammunition Expenditures (1 Feb 1969 - 30 Apr 69)

<u>UNIT</u>	<u>TYPE</u>	<u>AMOUNT</u>
A/6-29	105T	15,005
B/6-29	105T	18,988
C/6-29	105T	21,312
A/4-42	105T	11,589
B/4-42	105T	27,676
C/4-42	105T	12,909
A/2-9	105T	4,349

7

CONFIDENTIAL

CONFIDENTIAL

AVDCD-AC

SUBJECT: Operation Report - Lessons Learned for the Period Ending 30 April 1969
 PC3- CSPOR -65 (R2)

30 April 1969

R/2-9	105T	13,405
C/2-9	105T	7,760
Provisional BC Battery	105T	1,546
A/3-6	105SP	12,761
B/3-6	105SP	4,377
C/3-6	105SP	6,780
A/3-17	105T	1,977
B/3-17	105T	988
TOTAL	105mm	170,742
A/5-16	155SP	6,182
B/5-16	155SP	12,583
C/5-16	155SP	8,963
Provisional BC Battery	155SP	1,555
A/1-92	155T	7,353
B/1-92	155T	11,699
C/1-92	155T	9,363
TOTAL	155mm	58,708
B/5-16	81SP	8,582
A/6-14	81SP	2,644
C/6-14	81SP	3,874
B/7-15	81SP	3,434
A/5-22	81SP	460
B/5-22	81SP	817
TOTAL	81	19,831
A/6-14	175SP	4,738
B/6-14	175SP	3,853
C/6-14	175SP	4,286
C/7-15	175SP	1,545
A/5-22	175SP	455
B/5-22	175SP	516
TOTAL	175mm	15,398

GRAND TOTAL 264,681

4. (C) Trainings:

a. General. The Division Artillery continued with scheduled training as required by 4th Infantry Division Regulation 350-1. Emphasis on cross training of personnel continued in all Division Artillery units.

b. Division Artillery. Division Artillery conducted replacement training for newly assigned Liaison Officers and Forward Observers. In addition, two classes for non-artillerymen were conducted on the duties of the forward observer. The classes and dates were as follows:

CONFIDENTIAL 6.

CONFIDENTIAL

30 April 1969

AVTTC
SUBJECT: Operation Report - Lessons Learned for the Period Ending 30 April 1969
FORM 101-65 (R1)

<u>(1) TYPE CLASS</u>	<u>DATES</u>	<u>NUMBER ATTENDING</u>
Liaison Officer	15-16 Feb 69	4
	25-26 Feb 69	5
	25-26 Apr 69	2
Forward Observers	24-26 Apr 69	8
Non-Artillery Forward Observers	3-5 Mar 69	5
	3-5 Apr 69	5

(2) The FOI for the above courses is as follows:

(a) Liaison Officers:

Artillery Adjustment	8 Hours
Rules of Engagement	2 Hours
Lessons Learned	1 Hour
Improved Conventional Munitions	1 Hour
Fire Planning	2 Hours
Duties of the Liaison Officer and Application of Fire Planning	4 Hours
Communications	2 Hours

(b) Forward Observers:

Artillery Adjustment	8 Hours
Rules of Engagement	2 Hours
Lessons Learned	1 Hour
Improved Conventional Munitions	1 Hour
Fire Planning	2 Hours
Land Navigation	6 Hours
Responsibilities of the FO	3 Hours
Survival	2 Hours
Communications	2 Hours

(c) Non-Artillery Forward Observers:

Communications	2 Hours
Artillery Weapons	1/2 Hour
Artillery Employment	1 Hour
Target Location and Bracketing (Dragon Mt)	4 Hours
Artillery Adjustment	2 Hours
Danger Close Adjustment	3 Hours
Safety and Rules of Engagement	3 1/2 Hours
Map/Land Navigation	6 Hours
Review	2 Hours

CONFIDENTIAL

CONFIDENTIAL

AFDP-AC

30 Apr 1969

Operation Report - Lessons Learned for the Period Ending 30 Apr 1969
RCS-CSFOR -65 (R1)

(3) Eleven Officers also attended the IFV Artillery Fire Direction course during the reporting period.

c. **Battalion Training.** The field artillery battalions in Division Artillery conducted unit and individual training whenever the tactical situation permitted. Training was conducted in all the mandatory subjects with special emphasis on safety, communications security, M-16 care and maintenance and CHR. Units were also given training in enemy sapper attacks and the safe handling of US and enemy ammunitions.

d. **Artillery Assistance Training:** Division Artillery units continued their aggressive assistance program throughout the reporting period. Battalions instructed supported Infantry units in proper adjustment of fire techniques. Liaison Officers and Forward Observers also gave classes in the proper planning and utilization of artillery fire. Classes in artillery adjustment were also given to special forces personnel, American Advisors, ARVN and Regional Force/Popular Force units, MSF personnel and civil affairs personnel. The 4.2"/81mm mortar battery located at Camp Enari and controlled by the 5-16th Artillery conducted MOS and refresher training for mortar crewmen.

5. (C) Logistics:

a. Basic Loads of Ammunition

(1) Current basic loads of ammunition continued at the same level stocked in previous quarters.

<u>WEAPON</u>	<u>TYPE AMMUNITION</u>	<u>STOCKAGE AT POSITION</u>
105 Howitzer (5 tubes)	HE	1250
	ILL	100
	WP	100
	SMK	50
155 Howitzer (5 tubes)	F	750
	ILL	50
	WP	50
	SMK	60
8 Inch	HE	400

(2) Variations of stockage at battery positions were authorized based on enemy contact and imminence of unit movement.

b. The concept of stockage at the Oasis ASP was changed during the period to provide a stockpile for artillery ammunition to offset possible future shortages based on ASR restrictions. During the period the stockage was gradually increased to capacity.

CONFIDENTIAL

10.

CONFIDENTIAL

CONFIDENTIAL [A]

30 April 1969

**SUBJECT: Operational Report - Lessons Learned for the Period Ending 30 April 1969
RCS-CS70G -65 (PL)**

c. Available Supply Rates:

(1) 105 mm

<u>PERIOD</u>	<u>ASR</u>	<u>FIRED</u>	<u>TACTICAL SAVINGS</u>
241801 Jan--091800 Feb	30.7	27.5	3.2
091801 Feb--241800 Feb	25.3	26.3	-1.0
241801 Feb--091800 Mar	52.0	37.1	14.9
091801 Mar--241800 Mar	49.4	51.4	-2.0
241801 Mar--091800 Apr	36.1	33.8	2.3
091801 Apr--241800 Apr	31.0	11.7	18.3

(2) 155 mm

<u>PERIOD</u>	<u>ASR</u>	<u>FIRED</u>	<u>TACTICAL SAVINGS</u>
241801 Jan--091800 Feb	22.9	18.4	4.5
091801 Feb--241800 Feb	26.3	17.4	8.9
241801 Feb--091800 Mar	26.1	22.9	3.2
091801 Mar--241800 Mar	25.9	24.3	1.6
241801 Mar--091800 Apr	22.2	12.3	9.9
091801 Apr--241800 Apr	20.4	8.3	12.1

(3) 8 Inch

<u>PERIOD</u>	<u>ASR</u>	<u>FIRED</u>	<u>TACTICAL SAVINGS</u>
241801 Jan--091800 Feb	15.6	16.9	-1.3
091801 Feb--241800 Feb	30.0	19.7	10.3
241801 Feb--091800 Mar	26.9	24.1	2.8
091801 Mar--241800 Mar	25.0	24.5	0.5
241801 Mar--091800 Apr	15.6	5.0	10.6
091801 Apr--241800 Apr	16.7	2.6	14.1

(4) Because of heavy artillery ammunition expenditures, increases in artillery ASR authorizations were received as follows:

<u>PERIOD</u>	<u>105 mm</u>	<u>155 mm</u>	<u>8 Inch</u>
241801 Jan--091800 Feb	6,000	2,000	-----
091801 Feb--241800 Feb	-----	2,500	800
241801 Feb--091800 Mar	15,000	1,000	300
091801 Mar--241800 Mar	15,000	1,500	400
241801 Mar--091800 Apr	6,000	1,000	-----
091801 Apr--241800 Apr		NONE REQUESTED	

d. Equipment

(1) Deadline rates during the period 30 February 1969--30 April 1969:

CONFIDENTIAL

CONFIDENTIAL (A)

AVDDP-AC

SUBJECT: Operation Report - Lessons Learned for the Period Ending 30 April 1969
AG3-CSFOR -65 (R1)

30 April 1969

30 April 1969

<u>ITEM</u>	<u>DOWN DAYS</u>	<u>PERCENT</u>
Truck 1/4 Ton	391	7.0
Truck 3/4 Ton	711	9.9
Truck 2 1/2 Ton	1224	7.5
Truck 5 Ton	310	12.9
Truck 5 Ton Wrecker	360	20.0
Carrier M577	41	6.5
Carrier M548	392	29.0
Howitzer M101A1	370	4.6
Howitzer M102	43	2.7
Howitzer M109	104	6.4
Howitzer M110	25	6.9

(2) The overall vehicle deadline rates increased during the period primarily because of the increasing vehicle age resulting from non-receipt of any but 2 1/2 ton cargo trucks for replacements, heavily increased vehicular commitments, and a lengthy period during which the Support Maintenance Technical Supply was operating at a minimum issue level due to extensive inventories and computer malfunctions.

(3) The deadline rate for the 5 ton cargo truck and wrecker remained high during the entire period because of Support Maintenance difficulty in obtaining engines.

(4) A significant reduction in howitzer M102 deadlines was achieved primarily through increased crew and Support Maintenance familiarization with the weapon.

(5) Track recovery vehicles organic to the 5th Battalion, 16th Artillery were both due-in to the unit during the entire period. This lack of lift capability within the battalion resulted in greater periods of deadline than might otherwise have been experienced.

(6) Major Equipment Losses. One each M101A1 howitzer from 4-42d Arty was air dropped. Two each 2 1/2 ton trucks were destroyed by mines (one from 6-29th Arty and one from 2-9th Arty). One each 5 ton cargo truck from 5-16th Arty was destroyed by a B-40 rocket. One each 3/4 ton truck from HHD, Division Artillery was destroyed as a result of small arms fire and the resultant wreck.

CONFIDENTIAL (A)

CONFIDENTIAL **AL**

30 April 1966

DD-AC
SUBJECT: Operational Report - Lessons Learned for the Period Ending 30 April 1966
RCS CSFOR -65 (RI)

3. (C) Organization

a. Strength. Authorized and assigned strength as of the end of the reporting period were as follows:

(1) Authorized

<u>UNIT</u>	<u>OFFICER</u>	<u>WO</u>	<u>EM</u>	<u>AGG</u>
HHB	38	11	164	213
5-16	36	2	577	593
2-9	44	3	26	26
4-42	44	3	479	526
6-29	44	3	479	526
TOTAL	205	22	2178	2384

(2) Assigned

<u>UNIT</u>	<u>OFFICER</u>	<u>WO</u>	<u>EM</u>	<u>AGG</u>
HHB	40	9	234	233
5-16	36	2	535	593
2-9	48	1	453	504
4-42	49	3	485	537
6-29	44	2	473	519
TOTAL	217	19	2150	2386

b. Replacements and Rotation. Division Artillery received a total of 38 Officers and 589 enlisted replacements. During the same period 25 Officers and 455 enlisted men rotated out of Division Artillery.

c. Casualties

<u>UNIT</u>	<u>FEBRUARY</u>			<u>MARCH</u>			<u>APRIL</u>		
	<u>KIA</u>	<u>WIA</u>	<u>MIA</u>	<u>KIA</u>	<u>WIA</u>	<u>MIA</u>	<u>KIA</u>	<u>WIA</u>	<u>MIA</u>
HHB		NONE		0	2	0		NONE	
5-16		NONE		4	11	0	0	2	0
2-9	0	3	0	0	4	0	0	2	0
4-42		NONE		1	24	0		NONE	
6-29		NONE		6	26	0		NONE	

d. Morale and Personal Service

(1) Awards and Decorations. During the reporting period the following awards and decorations were awarded:

(a) Medal of Honor - None

(b) Other Awards

SS	SM	SV	AW	ACMV	SA	BSS	AM	ACMA	ACMS	PH
7	4	25	3	11	7	46	40	2	375	47

e. Promotions. Total promotions by grade during the reporting period were as follows:

13.

CONFIDENTIAL **AL**

SUBJECT: Operations Report - Lessons Learned for the Period Ending 30 April 1967
 RCS-CSFOR -65 (RI)

E-4	E-5	E-6	E-7	E-8	E-9
350	162	22	3	3	0

(3) Rest and Recuperation. During the reporting period Division Artillery received and used 553 R & R Allocations.

7. (C) Other

a. Aviation:

(1) Aircraft Status:

(a) Disposition of aircraft during reporting period:

- as of 28 Feb; 9 aircraft authorized, 8 on hand
- as of 31 Mar; 9 aircraft authorized, 9 on hand
- as of 30 Apr; 9 aircraft authorized, 8 on hand

(b) The month of February began with 4 OH-6A helicopters and 4 OH-23G helicopters on hand. All OH-23G aircraft were turned in prior to 14 Feb and replaced with OH-6A aircraft. One OH-6A was obtained on 3 Mar to bring the section up to its authorized aircraft strength. One OH-6A, Serial Number 67-16512 suffered major damage on 10 April and was turned in for retrograde. The damage was caused by an autorotative landing after a governor failure. A replacement aircraft is expected shortly.

(2) Personnel:

(a) The personnel situation has stabilized and new personnel are being given extensive refresher training. One Warrant Officer was reassigned to CONUS and two Warrant Officers have arrived from CONUS. One Chief Warrant Officer was transferred into the unit from 1-10 Cavalry. There has been no change in enlisted personnel status.

(b) Personnel status at the end of the reporting period:

- 1 Aviation Officer authorized - 1 assigned
- 6 Commissioned Officers authorized - 7 assigned
- 7 Warrant Officers authorized - 4 assigned

Enlisted Status:

- 20 Enlisted Men authorized
- 15 Enlisted Men assigned

(3) Operations: Due to the location of the Direct Support Artillery Battalions supported by the Div Arty Avn Section, all aircraft were based at Camp Enari rather than with the individual units for the majority of this reporting period. This centralization has resulted in increased availability, better maintenance and more efficient aircraft utilization. In addition to the Direct Support Battalions the General Support Bn and Div Arty Headquarters are supported

CONFIDENTIAL

AVDDE-AC

30 April 1969

SUBJECT: Operation Report - Lessons Learned for the Period Ending 30 April 1969
RCS-CSFOR -65 (RI)

by the section. Emphasis during this period has been on pilot training, safety and the education of the supported units as to efficient utilization. One pilot received his I. P. orders and another pilot is in the process of being checked out as an I. P. On 16 April 69, two aircraft with pilots and crew-chiefs moved to An Khe in support of 6-27th Arty. This is an interim measure for the monsoon season.

(h) Summary of aircraft utilization:

	Feb	Mar	Apr
Hours Flown	520	638	520
Passengers Carried	1664	2747	2365
Cargo Carried	4 Tons	8 Tons	8 Tons
Sorties Flown	1199	1633	1375

Since conversion to all OH-6A aircraft, missions are being accomplished with less blade time per mission. This is because of the increased capacity and higher cruising speed of the OH-6A. The parts situation for the OH-6A has improved considerably over the last reporting period. Long EDP periods have been significantly reduced. An improved maintenance program coupled with a more reliable aircraft has resulted in a significantly improved availability rate.

	Feb		Mar	Apr
	OH-6A	OH-23G		
Percent Availability	87	78	91	90
Percent NORMS (EDP)	3	10	2	3
Percent NORM	10	12	7	7

Continued emphasis on the quality of maintenance and crew-chief training should result in continued high availability rates.

b. Chaplain: During the past quarter, 1 February 1969 - 30 April 1969 the Div Arty Chaplain's Section, comprised of two chaplains and three chaplain's assistants, functioned as follows:

- (1) Conducted 39 Protestant Worship Services with a total of 1,394. (Including Memorial Services)
- (2) Conducted 165 Catholic Masses and Services with a total attendance of 3,190. (Including Memorial Services).
- (3) Made a total of 20 visits to confined men of our units in the hospital.
- (4) Made a daily visit to troops located at base camp and an average of four visits weekly to men in the forward fire bases.
- (5) Began showing religious films on Thursday nights.
- (6) Attended four Chaplain's Retreats.

CONFIDENTIAL

CONFIDENTIAL A1

AVDDD-AC

30 April 1969

SUBJECT: **Operation Report - Lessons Learned for the Period Ending 30 April 1969**
RCS-CSFOR -55 (R1)

(7) In addition to regular coverage of Div Arty units the Protestant chaplain provided coverage for:

- (a) 124th Signal
- (b) War Dogs Detachment
- (c) Division units co-located with artillery units
- (d) 278th Signal
- (e) Two CA Villages (Yellow Sector)

(8) In addition to regular coverage of Div Arty units the Catholic chaplain provided coverage for:

- (a) Division units co-located with artillery units
- (b) 20th Engineers
- (c) Two CA Villages (Yellow Sector)
- (d) Dragon Mountain Personnel
- (9) Conducted 22 Character Guidance Lectures
- (10) The Div Arty Chapel was also used for denominational services including:
 - (a) Fourteen Jewish Services with a total of 143 in attendance
 - (b) Thirteen Latter Day Saints Services with an attendance of 120
 - (c) Thirteen Church of Christ Services with an attendance of 97

c. Signal. During the reporting period, Division Artillery used the following means of communications: VHF and wire, secure and non-secure FM Radio, Radio Teletype, and messenger. This portion of the report is divided into two parts; artillery communications, and base camp defense communications.

(1) Artillery communications:

(a) VHF & Wire: Division Artillery operates no VHF systems, but uses VHF circuits provided by the Division Signal Battalion and the area system provided by the 43rd Signal Battalion. Primary VHF circuits include one to each forward direct support 105 battalion, one to 52d Group Artillery and one circuit to 52d Group subordinate battalions when required. Local service is provided primarily by the base camp dial system. Hotlines are provided to the Fire Support Coordination Element, the Division Tactical Switchboard, the Battalion Headquarters, its Operations Center, and its FDC. Hotlines are also provided to those locations required by ICC for base camp defense coordination. (See also para 2.b).

CONFIDENTIAL

CONFIDENTIAL

AVDDD-AC

30 April 1969

SUBJECT: Operation Report - Lesson Learned for the period Ending 30 April 1969
RCS- CSFOR -65 (R1)

(b) FM Radio: The following nets provided the majority of Div Arty FM communications during the reporting period: Div Arty CF A (Secure only), the Div Arty Air-Ground, Survey, Sector Defense and Base Camp Command (ICC). A CF B is available when required.

(c) Radio Teletype: Div Arty maintains a 24 hour RTT net with subordinate battalions using AN/GRC-142s. Div Arty also operates a station in the Division General Purpose RTT Net, providing an alternate route to the artillery battalions co-located with the brigades.

(d) Messenger: Messengers are used within the base camp extensively, and the forward areas as required.

(2) Base Camp Defense Communications: As Division Artillery has the additional mission of coordinating base camp defense operations, additional wire and radio communications are required for this purpose.

(a) Wire: The control center for base camp defense operations, IDD, has direct lines to G3, 4th Aviation, 4th Med, the CG bunker, and a "hot loop" to all sector controls. Routine communications are provided by the dial system.

(b) FM Radio: FM provides back up communications to the sector controls and, when required, communications to patrols, villages, and/or aircraft in the base camp TAOR. No secure is in use at this time on ICC FM net.

d. Civil Affairs

(1) Division Artillery; 5th Battalion; 16th Artillery; and 124th Signal Battalion.

(a) During the reported period the Division Artillery S5 had staff supervision of Civil Affairs activities within Yellow Sector of the Division TAOR.

(b) On 23 Feb 69 the consolidated village, Plei Ho By was attacked. Forty-three houses were burned down and twenty-two villagers were taken. An immediate reaction by US units to assist the village in replacing items lost, shelter, and added security created a better relationship with the village. As a result much better cooperation has been received in working on existing and new projects.

(c) A new type of rice, IR 5, has been introduced to village persons. They have shown enthusiasm about growing the rice to increase their yield.

(d) Sanitation programs and medical assistance have continued to improve the living standards and decreased the sickness rate.

(2) 2d Battalion 9th Artillery.

(a) During the reporting period, the S5 Civil Affairs Team continued their activities in the TAOR and Thanh An areas. The battalion contributed a 3 man detail, OPCON to 1-8 Inf, to work in the 1-8 Inf consolidated village in the TAOR.

CONFIDENTIAL

CONFIDENTIAL

AVDDD-AC

30 April 1969

SUBJECT: Operation Report - Lessons Learned for the Period Ending 30 April 1969
RCS-CSFOR -65 (R1)

(b) In the forward area a battalion, 5 man, Civil Affairs Team, operates in two villages, Plei Gao Del and Plei Jung Lee. During the reporting period this team conducted approximately 90 medcaps, resulting in 3,241 Montagnards receiving medical treatment. Extensive repair of the dispensaries in both villages was accomplished. A play ground in Plei Gao Del was constructed and an athletic program was initiated in both villages.

(c) Over all, 1.5% of the personnel in this battalion are involved in Civil Affairs/Pacification Operations. It should be noted that the battalion is providing CA teams to both the rear and forward areas.

(3) 6th Battalion, 29th Artillery: The battalion has been actively engaged in a vigorous CA program during the reporting period. Since CA activities are conducted both in base camp and the forward areas, they will be discussed separately.

(a) Base Camp. During the reporting period this unit has been primarily engaged in pacification of the hamlets. The main effort has been in village 14, Plei Hlu Kluh (AR 840323). Subjected to intense psychological operations both from Division G-5 and the CA unit from this organization, the people of this village completed numerous projects. A concrete water point, wire barrier, punji stake obstacle field and minor improvements to the defensive perimeter were constructed. Long range plans, including the establishment of a local school and a rice growing project have been initiated. The training of a self defense force has been completed with total success. The people have been found to be willing to patrol and conduct operations in the area. One villager recently turned in the names of 4 VC from the village (# 37). To improve the economic situation in the area, villagers make artifacts which are sold at Camp Enari. A sand bag filling project is also in progress at Camp Enari. The med-cap program in the village has materially cut the disease in the area and has improved sanitation and personal hygiene standards. A Montagnard nurse from Special Forces has taken over the majority of medical responsibilities in the village.

(b) Forward Area: During the first portion of this reporting period the battalion moved to a forward area at FSB McNerney. Medcap teams from this unit made bi-weekly visits to three villages (#2, #3 and #4). On each visit, which lasted two or more hours, normal first aid was administered and serious or questionable diagnosis were referred to 4th Medical Battalion personnel. Eventually the program was taken over by the 1st Bde Medcap Team with medics from this unit assisting. When the tactical CP was deployed to Plei Kleng, medical personnel from the unit assisted the Special Forces in treatment of the local population. A plan for civic action is presently being formulated at the new forward area in An Khe.

(4) 4th Battalion, 42d Artillery: The battalion civil affairs team consists of five enlisted personnel who work under the operational control of the 2d Bde, 4th Infantry Division.

CONFIDENTIAL

CONFIDENTIAL

AVDDD-AC

30 April 1969

SUBJECT: Operational Report - Lessons Learned for the Period Ending
30 April 1969, RCS- CSFOR -65 (R1)

SECTION 2 (C) Lessons Learned: Commander's Observations, Evaluations and Recommendations.

1. (U) Personnel. None

2. (C) Operations:

Construction of Personnel Bunkers:

Observation. It is extremely difficult and usually impractical to construct personnel bunkers that will withstand direct hits from projectiles larger than 82mm mortars.

Evaluation. Several personnel were either killed or wounded in Division Artillery units when personnel bunkers received direct hits from rockets and artillery. Three layers of sandbags will normally protect personnel against small mortar rounds with fuze point detonating, but larger caliber weapons and projectiles with delay fuzes will easily penetrate this cover.

Recommendation. That units construct a second bunker within the personnel bunker. This "bunker within a bunker" should have two layers of sandbags overhead and an exit outside the personnel bunker. See Inclosure 5.

Enemy Standoff Attack Tactics

Observation. Frequently, the enemy covers the sound of its own counterbattery fire with the sound of friendly artillery fire when multiple volleys are fired. This method is used both with the sound of the guns firing and the impact of the volleys.

Evaluation. This tactic delays the location of enemy indirect weapons positions. The enemy has, on occasions, modified this tactic by using the friendly artillery's noise to cover the sound of sniper and other small arms fire.

Recommendation. Units should use single volley fire whenever the threat of enemy incoming exists and the tactical situation permits. Personnel should be alerted to concentrate on locating the source of enemy fire immediately following the volley.

Security of M102 Base Plates.

Observation. Difficulty has been experienced in preventing displacement of the M102 Howitzer when emplaced in soft soil. In several instances, the carriage stakes were uprooted after firing as few as three rounds at charge seven. After many attempts to brace the howitzers, the following method appears to have solved the problem.

Evaluation.

Step 1: Place the howitzer in the selected position and mark the stake position on the ground. Then move the howitzer out of the area.

CONFIDENTIAL

AVDDD-AC, SUBJECT: Operation Report - Lessons Learned for the Period Ending 30 April 1969 RCS- CSFOR -65 (R1)

Step 2: Carefully dig trenches, to the exact size of the timbers or ammo boxes depending on availability of materials. See inclosure 6 and 6a.

Step 3: Place the timbers/ammo boxes into the prepared trenches so that they are flush with the ground surface and tie them together by nailing sides of ammo boxes. NOTE: If ammo boxes are used, they must be packed firmly with soil to prevent crushing.

Step 4: Move the howitzer over the platform and lower the baseplate. Insure that the holes are directly over the marks made in step 1 above.

Step 5: Drive the baseplate stakes in between the timbers/ammo boxes as shown in inclosures 6 and 6a.

NOTE: In loose dry soil, water should be poured over the platform after the howitzer is staked down to cause compaction of the soil between the boxes/timbers.

Recommendation. That all artillery battalions equipped with the M102 howitzer be informed of the units solution to the problem.

Plotting of Friendly Village Locations.

Observation. It is sometimes difficult to determine the exact location of a friendly village due to outdated maps and recent moves of the villages.

Evaluation. Friendly villages within the range of a Q4 radar can be accurately plotted by hovering a helicopter over the village while the Q4 determines the place coordinates to the location. This method may be used also to verify deserted villages.

Recommendation: That all Arty units be advised of this procedure.

Dial-a-Quad

Observation. When lists of minimum quadrant elevations (MQE) are used, it is possible, in the rush to compute the initial data, to read an incorrect figure. Therefore a need exists for a simple way to read MQE.

Evaluation. One battery was located near the Polei Kleng Special Forces camp. Due to the many masks in the area, MQEs had to be computed every 400m, which resulted in a total of more than 600 MQEs. To solve the problem, the unit devised the "Dial-a-Quad" system of recording MQEs. To construct a "Dial-a-Quad, cover a cardboard cylinder with lined paper. The lined paper then is covered with acetate. The deflections (i.e.-0400-0800) and the related MQEs are written on the cylinder under the appropriate charge in grease pencil, and the cylinder is enclosed in a cardboard box which has a slit in it so that only one line of MQEs can be read. When a mission is received, the cardboard cylinder is rotated until the appropriate piece and charge can be read in the slit. See inclosure 7.

Recommendation. That the "Dial-a-Quad" be used to simplify the storage and read out of MQEs.

CONFIDENTIAL

AVDDD-AC, SUBJECT: Operation Report - Lesson Learned for the Period Ending 30 April 1969 RCS-CSFOR -65 (R1)

Air Advisory Made Easy-The Maximum Ordinate Graph

Observation. The posting of an accurate air advisory is necessary to warn aircraft of artillery fire.

Evaluation. There are three parts to an artillery air advisory; direction in degrees, distance in meters and maximum ordinate in feet above sea level. Direction is determined from the firing chart by use of degree markers placed every 10 degrees around the edge of the chart. Distance is found by using the RDP chart range and adding a 1000 meter buffer zone. Maximum ordinate above sea level can be found in table G (Supplementary data) of the appropriate Tabular Firing Table. To this figure the altitude of the battery must be added. The resultant is the maximum ordinate. The requirement to consult the tables for each mission introduces not only a confusion factor into the conduct of the mission but also adds to the time required to post the air advisory. This unit has constructed graphs, an example of which is shown in Inclosure 8, which graphically depicts the maximum ordinate as a function of range. The chart is placed on a hard surface and covered with acetate. Upon occupation of a new position the altitude of the battery is determined. This altitude is rounded up to the next higher 500 foot interval and is established as the base line of the graph. The ordinate is labeled in 500 foot intervals. With the desired charge and range known, the maximum ordinate can easily be found.

Recommendation. That maximum ordinate graphs be used in the computation of an air advisory.

Tactical Command Post Located Outside the Unit's Area of Operations

Observation. It is possible that a tactical command post will be located outside the unit's area of operations, and beyond the range of the artillery under its control to fire counter battery fires.

Evaluation. It has been established that enemy forces habitually use the same positions to locate their weapons. If at all possible these positions should be gotten from the unit into whose area the tactical command post is moving prior to the move. A map inspection should also be made and all likely weapons positions added to the list. Detailed coordination must be made between the artillery battalion CP and the Artillery headquarters controlling fires in the area to insure all Counter Battery Targets are passed to the firing units. A quick fire frequency is established and grid clearance problems are resolved.

Recommendation. That the above mentioned actions be accomplished prior to any move of the Tactical Command Post to insure fast and accurate counter fires on any enemy weapons positions conducting a standoff attack.

Control of Artillery when Two Infantry Battalions are Located on the Same

Fire Base

Observation. Whenever two infantry battalions are co-located on the same

CONFIDENTIAL

CONFIDENTIAL

AVDDD-AC, SUBJECT: Operation Report - Lesson Learned for the Period Ending 30 April 1969 RCS-CSPOR -65 (R1)

firebase and operating in the same area of operations, problems arise in controlling the supporting artillery which could result in lengthening reaction time.

Evaluation. This problem was reduced by locating both artillery liaison officers in one area with wire communication to the tactical operation centers. Thus fires could be cleared on both sides of the FCL simultaneously. In addition, GT problems were minimized by combining the assets of both battalions. "Quick Fire" channels were established locally and monitored by all personnel concerned. Liaison personnel monitoring the "Quick Fire" channels never entered the net unless there were conflicting priorities to be settled.

Recommendation. When two or more liaison teams are located on the same firebase, "Quick Fire" channels and the FCL must be established as soon as possible. Whenever possible, the liaison officers should be co-located to insure that accurate and timely fires are not delayed by control problems.

Actions to Reduce Effects of Ground to Air Fire Against Aircraft:

Observation. Aircraft carrying artillery resupply received ground fire while attempting to land at firebases.

Evaluation. In each case the NVA deployed their anti-aircraft weapons after the heli-pads were cleared and constructed. The weapons were well concealed by the triple canopy, enabling them to fire at aircraft on short final only.

Recommendation. That units construct at least two heli-pads at opposite ends of the firebase, so class V and other critical resupply can continue without delay caused by the necessity of waiting for the infantry to sweep areas from which helicopters have received ground fire.

Improved Conventional Munitions Canister Clearance Procedure:

Observation: Firing tables for Improved Conventional Munitions (ICM) provide no information on canister impact or predicted point of impact for a round which fails to function.

Evaluation. To prevent injuries to friendly elements, the area in which the ICM canister and associated debris fall must be clear of friendly elements. Present firing tables do not give such information. This unit has devised a procedure for area clearance which is shown in Inclosure 9. The procedure has been accepted by the 4th Div Arty for use in all battalions. The point of fuze function is computed by using proper ICM gunnery procedures. The point of HE impact is that point at which an HE round fired at the final ICM quadrant (QE) would impact.

Recommendation. That until further tests and experiments can be conducted, the ICM canister clearance diagram as shown in Inclosure 9 be adopted for use in those artillery units having ICM capability.

3. (U) Training. None
4. (U) Intelligence. None

CONFIDENTIAL **IAL**

ASD&S, SUBJECT: Operation Report - Lesson Learned for the Period Ending 30 April 1969 RCS-CSPOR -65 (RI)

5. (U) Logistics. None
6. (U) Organization. None
7. (U) Tactical Cover and Deception. None
8. (C) Signal

Use of KY38 with the AN/VRC-46

Observation. The KY8 secure voice device is very sensitive to voltage input. The instability of power supplies at the line batteries does not provide reliable secure FM communications capability.

Evaluation. The 4th Division Communications Security Logistics Support Section (CSLSS) has developed a cable which allows use of the KY-38 with AN/VRC-46. (The KY-38 was designed primarily for use with the AN/PRC-77). The KY-38's superior performance over wider voltage ranges, as well as its virtual elimination of over heating problems, makes it ideal for providing secure FM capability at line batteries. The cable fabricated by the 4th Division CSLSS allows the user to take advantage of the qualities of the KY-38 and the greater range of the AN/VRC-46.

Recommendation. That the system developed by the 4th Division CSLSS be adopted for use wherever power or over heating problems reduce the effectiveness of the KY-8.

Use of Amplifier-Power Group OA-3633/GRC for KY-38 Power:

Observation. The KY-38 is powered by two BA-386s or a power pack. The shortage of power packs necessitates use of BA 386s in most installations. The need to conserve batteries increases the tendency to use the KY-38 only where absolutely required. This is not in accordance with the preferred policy of using full-time secure communications.

Evaluation. The Amplifier Power Supply Group OA-3633/GRC, used with the RT-505/PRC-25, produces sufficient power at the voltages required for operation of the KY-38. Use of this power supply allows use of the KY-38 on full time cipher while eliminating the requirement for frequent replacement of the BA-386s. The power may be tapped inside the OA-3633/GRC or from the cable connector on front of the OA-3633/GRC. As many units normally use the AN/PRC-25 independent of the amplifier power supply, these units are usually available for use in the manner described above.

Recommendation. That the OA-3633/GRC be used as a power supply for KY-38s where standard power packs are not available.

FOR THE COMMANDER:

10 Incl
as
Incls 1,2,3,4,10 wd HQ, DA

John C. Rose
JOHN C. ROSE
Captain, USAF
14860

CONFIDENTIAL **AL**

AVDDH-GC-MH (30 Apr 69) 1st Ind
SUBJECT: Operational Report of Division Artillery, 4th Infantry Division
for Period Ending 30 April 1969

DA, HEADQUARTERS 4TH INFANTRY DIVISION, APO SF 96262 14 May 1969

Commanding General, I Field Force Vietnam, ATTN: AVFA-GC-HIST, APO SF 96350

(U) This headquarters has evaluated and concurs with the Division Artillery
Operational Report - Lessons Learned.

FOR THE COMMANDER:

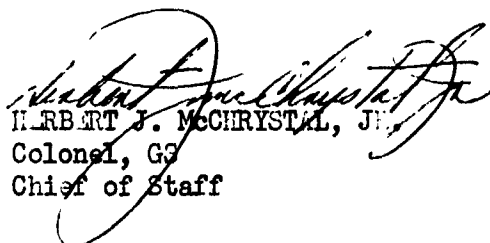
HERBERT J. MCCHRISTAL, JR.
Colonel, GS
Chief of Staff

AVFA-GC-HIST (30 Apr 69) 2d Ind
SUBJECT: Operational Report of Division Artillery, 4th Infantry Division
for Period Ending 30 April 1969

DA, Headquarters, I Field Force Vietnam, APO 96350

TO: Commanding General, United States Army Vietnam, ATTN: AVHGC-DST,
APO 96375

This headquarters has reviewed and concurs in the attached report, with the following comments:

a. Reference Section 1, paragraph 2a(3), Flei Mrong, Polei Kleng: the 204th Bn, 21st NVA Regt is not listed in the I FFORCEV G-2 Order of Battle.

b. Reference Section 2, paragraph 2, Construction of Personnel Bunkers: the recommendation is considered valid; however, since sapper attacks often accompany stand-off attacks, all personnel can not be located within the second bunker.

c. Reference Section 2, paragraph 2, Control of Artillery when Two Infantry Battalions are Located on the Same Fire Base: the recommendation outlines an inherent responsibility of the direct support artillery battalion commander.

d. Reference Section 2, paragraph 2, Actions To Reduce Effects of Ground To Air Fire Against Aircraft: the recommendation is considered valid; however, an effective flak suppression and countermortar program must also be implemented.

FOR THE COMMANDER:

Frederick E. Allen
11ND

Cy furn:
2 - ACSFOR, DA
1 - CG, 4th Inf Div

CONFIDENTIAL

AVHGC-DST (30 Apr 69) 3d Ind

SUBJECT: Operational Report - Lessons Learned for the Period Ending 30 April 1969, RCS CSFOR - 65 (R1) (U)

HEADQUARTERS, UNITED STATES ARMY, VIETNAM, APO San Francisco 96375 17 J

TO: Commander in Chief, United States Army, Pacific, ATTN: GPOF-DT,
APO 96558

1. (U) This headquarters has reviewed the Operational Report-Lessons Learned for the quarterly period ending 30 April 1969 from Headquarters, 4th Infantry Division Artillery.

2. (C) Comments follow:

a. (U) Reference item concerning "Dial-a-Quad", section 2, page 20, paragraph 2e; concur. This is a valid field expedient. Recommend that the Field Artillery School, Fort Sill, Oklahoma, further evaluate this procedure.

b. (U) Reference item concerning "Air Advisory Made Easy-The Maximum Ordinate Graph", section 2, page 21, paragraph 2f; concur. The trajectory charts are also printed in the appendices to the firing tables (FT) and the maximum ordinate can be easily read for each charge and range directly from the FT.

c. (U) Reference item concerning "Control of Artillery when Two Infantry Battalions are Located on the Same Fire Base", section 2, page 21, paragraph 2h. Concur with 2d Indorsement, paragraph c. This is standard artillery coordination procedure. Recommend no action by USARPAC or LA.

d. (U) Reference item concerning "Improved Conventional Munitions Canister Clearance Procedure", section 2, page 22, paragraph 2j; concur. The United States Army Ballistic Research Laboratories (USABRL) is currently conducting tests to determine case and debris impact patterns for ICM projectiles. Recommend USABRL expedite completion of testing and dissemination of results in order to decrease the hazard to friendly troops and noncombatants in RVN.

e. (C) Reference item concerning "Use of KY38 with the AN/VRC-46", section 2, page 23, paragraph 8a; concur. This matter has been previously recognized by USARV. A number of the required interconnect cables have been locally fabricated and distributed to units. Currently 300 additional cables are being fabricated by the USAECOM and will be shipped to USARV for distribution at a rate of 100 per month commencing in September 1969. No further action is required.

DOWNGRADED AT 3 YEAR INTERVALS;
DECLASSIFIED AFTER 12 YEARS.
DOD DIR 5200.10

CONFIDENTIAL

CONFIDENTIAL

AVHGC-DST (30 Apr 69) 3d Ind

SUBJECT: Operational Report - Lessons Learned for the Period Ending 30 April
1969, RCS CSFOR - 65 (R1) (U)

f. (C) Reference item concerning "Use of Amplifier-Power Group OA-3633/GkC for KY-38 Power", section 2, page 23, paragraph 8b. This appears to be an acceptable expedient measure, but it involves modification of speech security equipment and requires knowledgeable technical evaluation. Recommend this item be referred to the US Army Security Agency at Arlington Hall, Virginia for evaluation and advice to this headquarters.

FOR THE COMMANDER:



C. D. WILSON

1LT, AGC

Assistant Adjutant General

Cy furn:
4th Inf Div Arty
I FFV

CONFIDENTIAL

GPOP-DT (30 Apr 69) 4th Ind (U)
SUBJECT: Operational Report of HQ, 4th Infantry Division
Artillery for Period Ending 30 April 1969,
RCS CSFOR-65 (R1)

HQ, US Army, Pacific, APO San Francisco 96558 13 AUG 69

TO: Assistant Chief of Staff for Force Development,
Department of the Army, Washington, D. C. 20310

This headquarters has evaluated subject report and forward-
ing indorsements and concurs in the report as indorsed.

FOR THE COMMANDER IN CHIEF:

C. L. SHORT
CPT, AGC
Asst AG

CONFIDEN CONFIDENTIAL

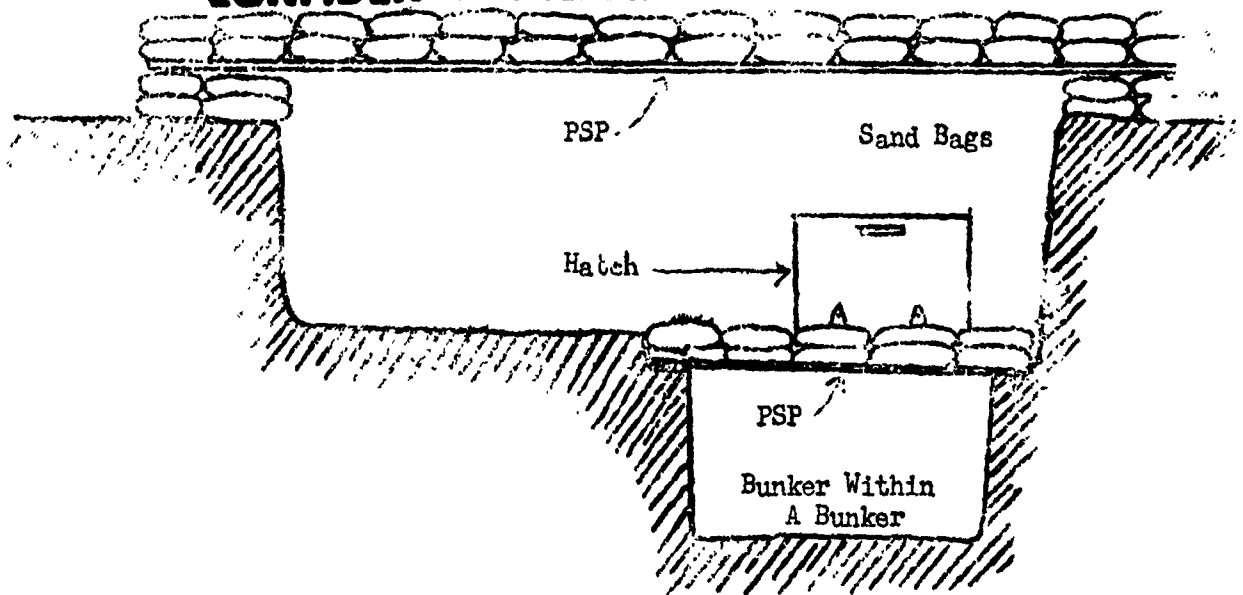

Bunker within a bunker (side view).

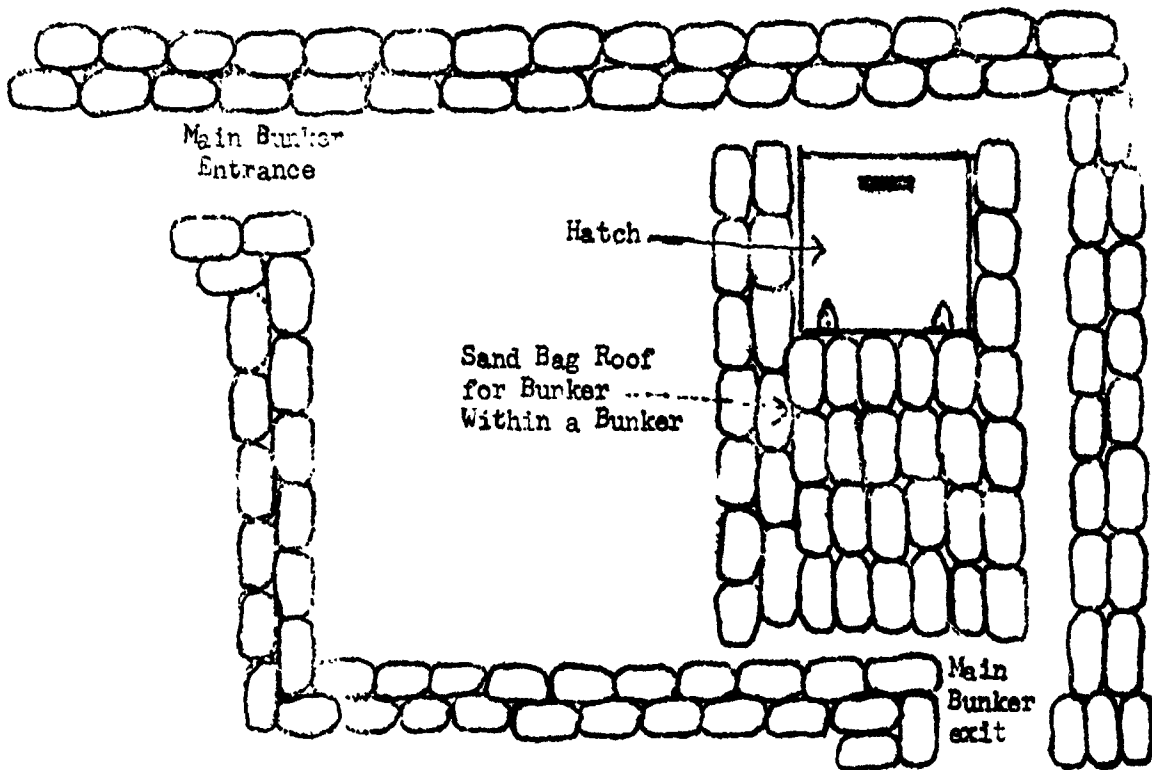

Bunker Within A Bunker (top view)

Incl 5

CONFIDENTIAL
~~CONFIDENTIAL~~
29

CONFIDENTIAL

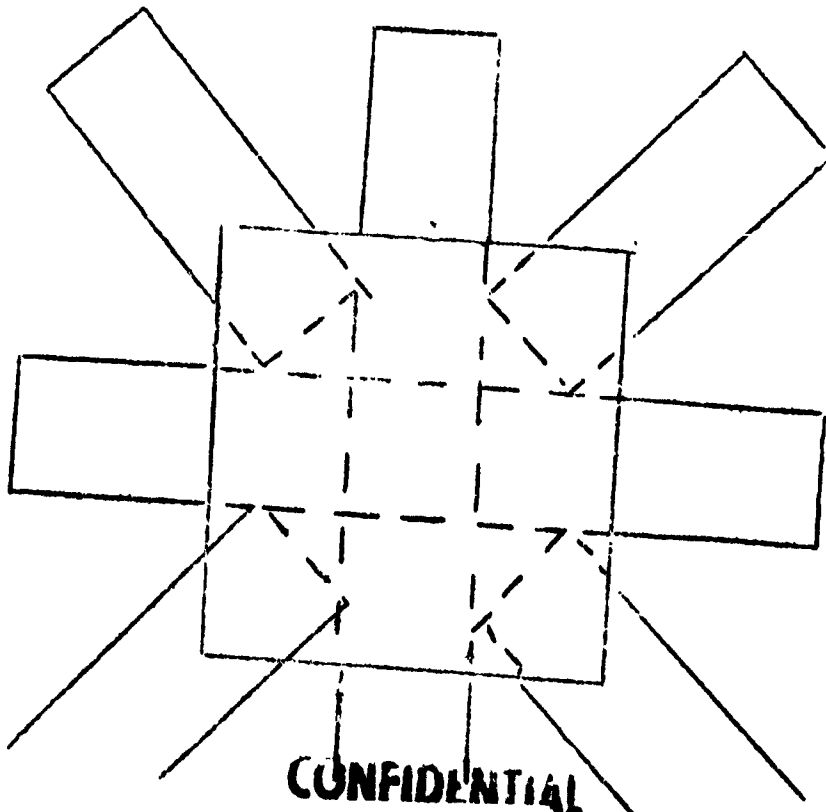
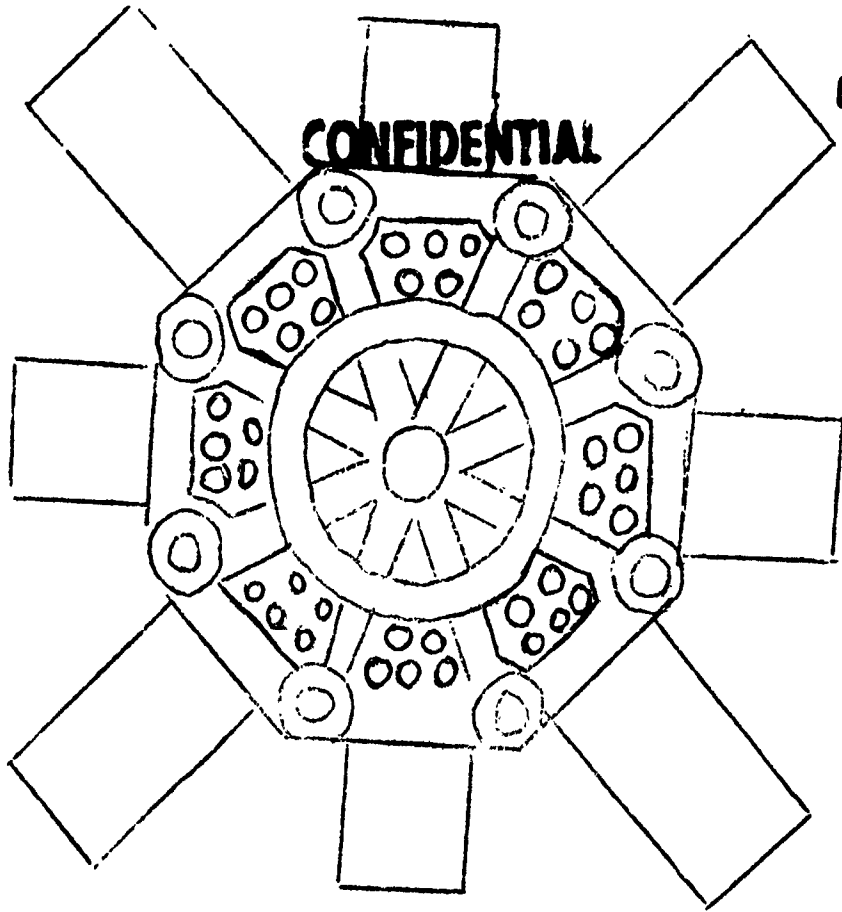

Incl 6

CONFIDENTIAL
CONFIDENTIAL 30

CONFIDENTIAL
CONFIDENTIAL

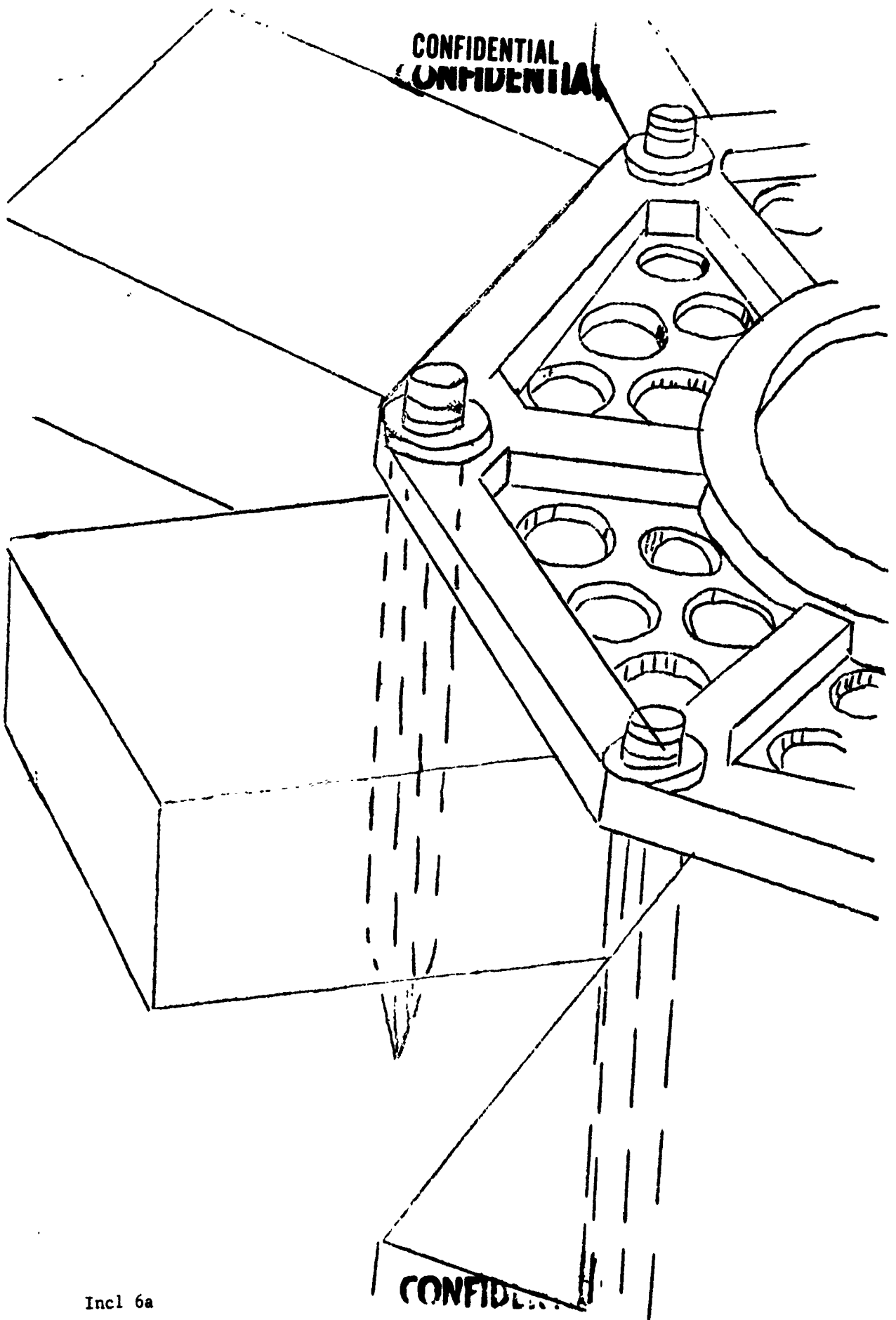

Incl 6a

CONFIDENTIAL
CONFIDENTIAL

31

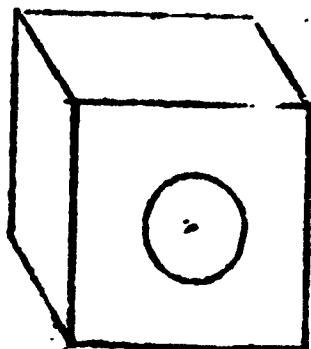

The largest min QB determined for each charge would be recorded here

Minimum QB's for Howitzers 3,4 and 5 would also be included

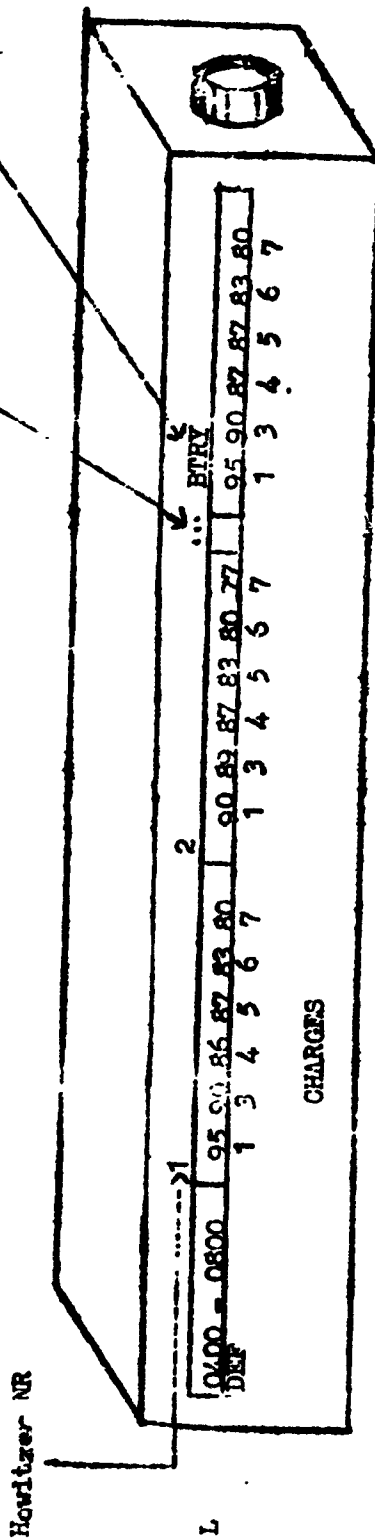

LIAL-A-QUAD

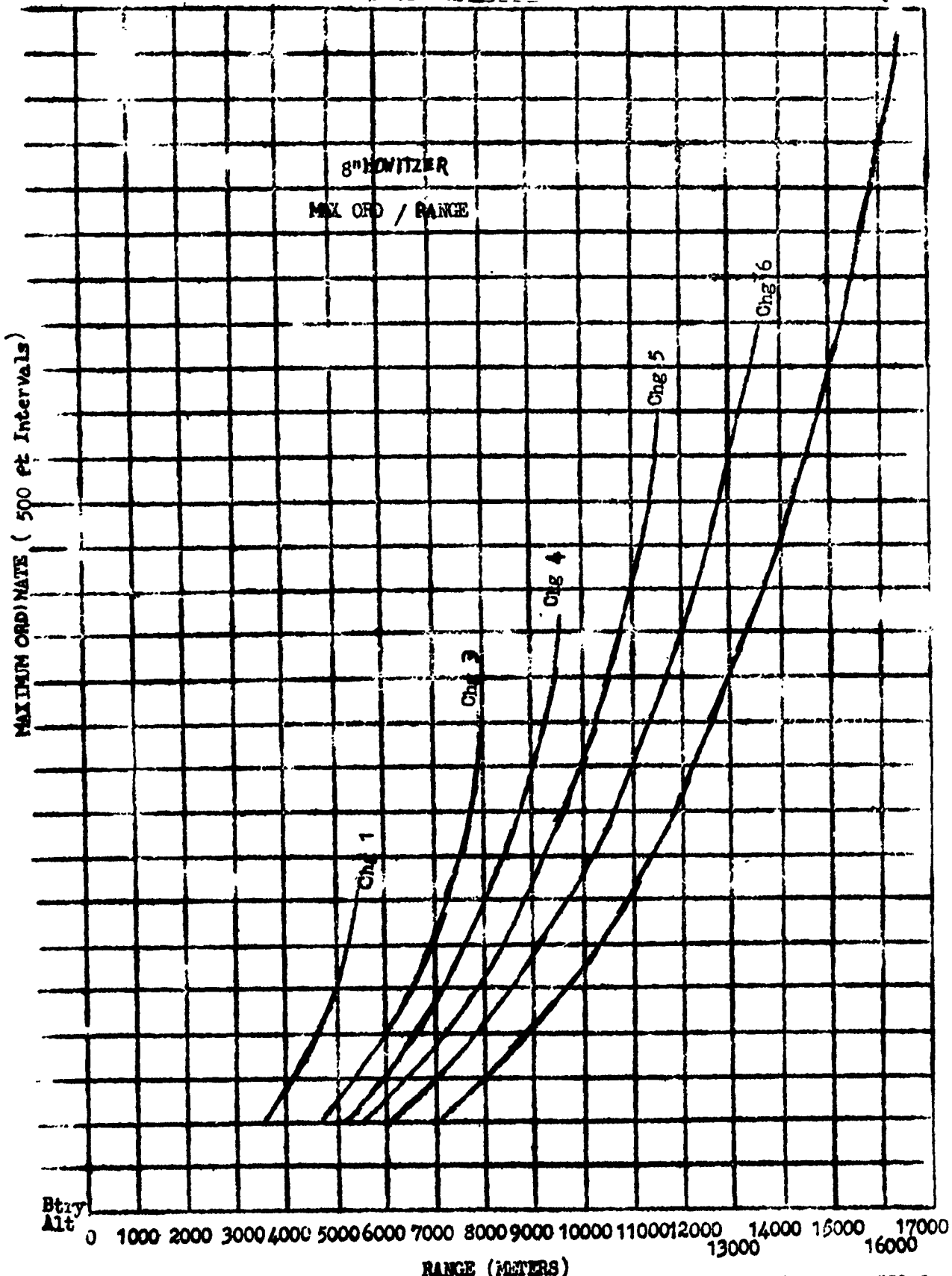

To set up, compute the battery altitude in feet. Round off to the next higher 500 f- interval and label the ordinate of the graph in 500' intervals with the battery alt. The base

Incl 8

CONFIDENTIAL

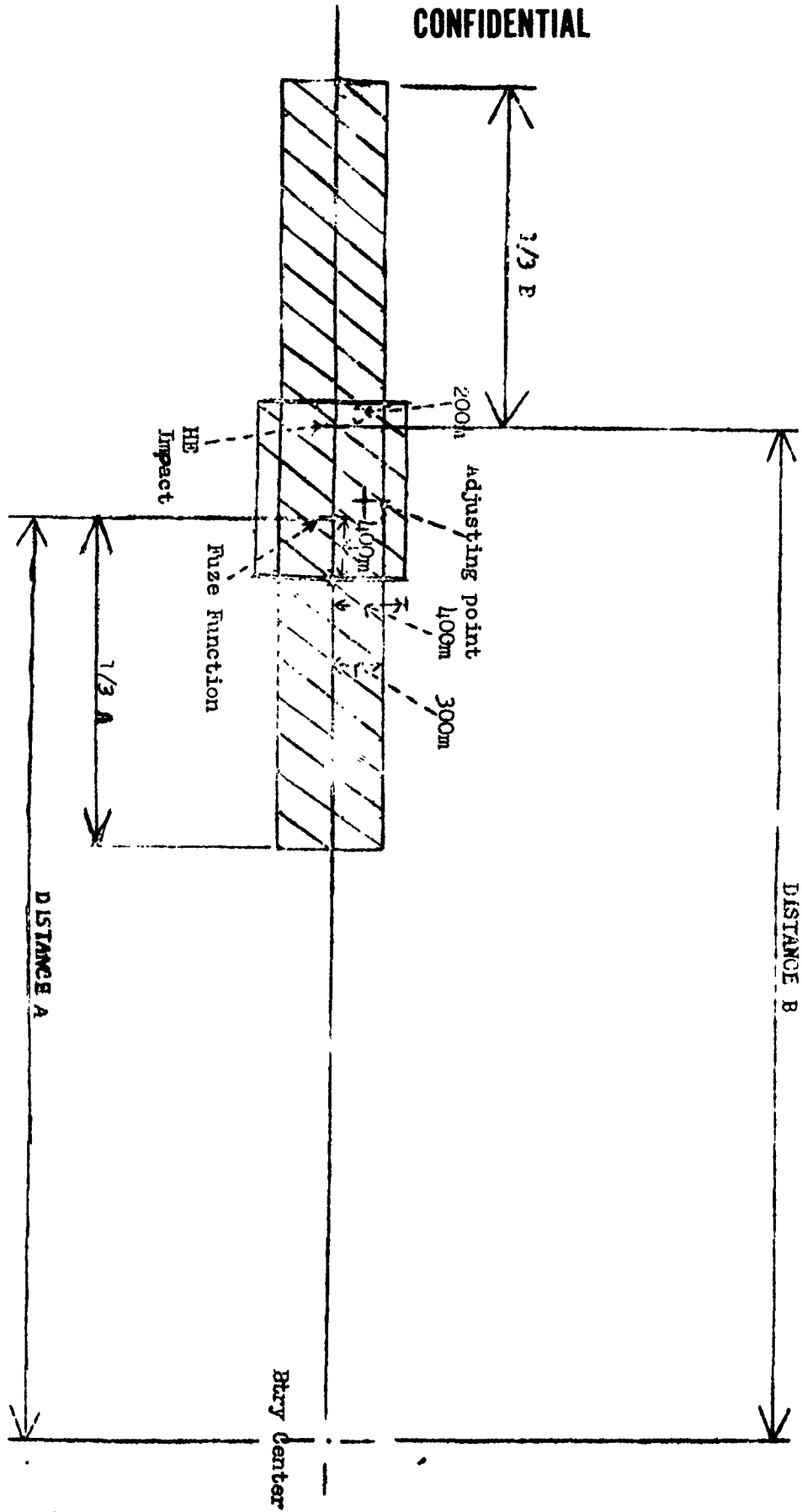

INCL 9

Bury Center

34

CONFIDENTIAL

UNCLASSIFIED

Security Classification

DOCUMENT CONTROL DATA - R & D

(Security classification of title, body of abstract and indexing annotation must be entered when the overall report is classified)

1. ORIGINATING ACTIVITY (Corporate author) HQ, OACSFOR, DA, Washington, D. C. 20310		2a. REPORT SECURITY CLASSIFICATION CONFIDENTIAL	
		2b. GROUP 4	
3. REPORT TITLE Operational Report - Lessons Learned, Hq, 4th Infantry Division Artillery			
4. DESCRIPTIVE NOTES (Type of report and inclusive dates) Experiences of unit engaged in counterinsurgency operations, 1 Feb - 30 Apr 69.			
5. AUTHOR(S) (First name, middle initial, last name) CO, 4th Infantry Division Artillery			
6. REPORT DATE 30 April 1969		7a. TOTAL NO OF PAGES 37	7b. NO. OF REFS
8a. CONTRACT OR GRANT NO		9a. ORIGINATOR'S REPORT NUMBER(S) 692088	
b. PROJECT NO		9b. OTHER REPORT NO(S) (Any other numbers that may be assigned this report)	
c. N/A			
d.			
10. DISTRIBUTION STATEMENT			
11. SUPPLEMENTARY NOTES N/A		12. SPONSORING MILITARY ACTIVITY OACSFOR, DA, Washington, D.C 20310	
13. ABSTRACT			

THIS REPORT HAS BEEN DELIMITED
AND CLEARED FOR PUBLIC RELEASE
UNDER DOD DIRECTIVE 5200.20 AND
NO RESTRICTIONS ARE IMPOSED UPON
ITS USE AND DISCLOSURE.

DISTRIBUTION STATEMENT A

APPROVED FOR PUBLIC RELEASE;
DISTRIBUTION UNLIMITED.