

Author(s)	Sheingold, Abraham.
Title	Transistor Electronics
Publisher	Monterey, California. Naval Postgraduate School
Issue Date	1963 04
URL	http://hdl.handle.net/10945/31910

This document was downloaded on April 28, 2015 at 10:21:10



<http://www.nps.edu/library>

Calhoun is a project of the Dudley Knox Library at NPS, furthering the precepts and goals of open government and government transparency. All information contained herein has been approved for release by the NPS Public Affairs Officer.

**Dudley Knox Library / Naval Postgraduate School
411 Dyer Road / 1 University Circle
Monterey, California USA 93943**



<http://www.nps.edu/>

Abraham Sheingold
TRANSISTOR ELECTRONICS.

TA7
.U6
no. 35

Library
U. S. Naval Postgraduate School
Monterey, California

UNITED STATES
NAVAL POSTGRADUATE SCHOOL

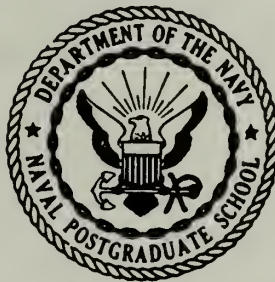

TRANSISTOR ELECTRONICS

by

Abraham Sheingold

Professor of Electronics

RESEARCH PAPER NO. 35

April 1963

TRANSISTOR ELECTRONICS

In solid-state, as in vacuum electronic technology, the devising of two-terminal circuit components with unilateral-conductivity properties has led, in turn, to the development of three-terminal devices with transfer control properties useful for signal amplification. The most common solid-state amplifying device is the junction transistor. It consists of a semiconductor crystal containing a pair of p-n junctions. The two junctions are formed by locating a thin p- or n-type region between sections of the other type. The two possible spatial configurations, n-p-n and p-n-p, respectively, are shown in Figure 1. Both types find application and are functionally analagous. In the operation of either device one junction ordinarily forms part of an input control circuit while the other is part of an output circuit through which controlled current flows.

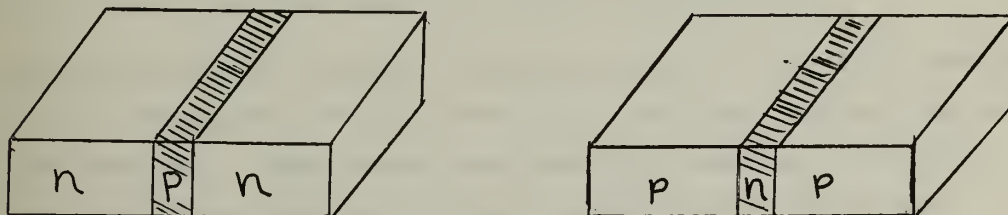

Fig. 1 Spatial arrangements of n-p-n and p-n-p transistors

1-1 TRANSISTOR ACTION

Transistor amplifiers apply the properties of a reversed-biased junction, where the reverse current is relatively independent of the bias-voltage magnitude, but is a function of the minority charge-carrier concentration on either side of the junction. Therefore, an appropriate control signal is one that can influence this carrier concentration. The desired control action is obtainable in a two-junction system having closely adjacent junctions by forward-biasing the neighboring junction. By thus lowering the potential barrier to charge-carrier diffusion across this junction, a substantial rate of carrier entry into the region between the junctions may be obtained. Confining the middle region to a width of about 10^{-3} cm or less serves to minimize recombinations as the emigrated carriers diffuse to the vicinity of the reverse-biased junction, where they augment the reverse current. When the appropriate bias conditions have been provided, an input signal may be applied so that it regulates the barrier height of the forward-biased junction and, hence, exercises sensitive control over the feed-through of charge carriers to the output-circuit junction. A signal of given amplitude applied in this manner can have a substantially greater effect on output current than it would have if applied directly in the output circuit. Thus, this mechanism can serve as the basis for signal amplification.

Figure 2 shows an elementary transistor-amplifier circuit arrangement. It has the appropriate bias-voltage polarities for the type n-p-n transistor employed. These polarities would be reversed if a p-n-p transistor were used. External circuit connections to the three sections are made by means of low ohmic resistance metal contacts. The lower end section, associated with the forward-biased junction, is referred to as the emitter, inasmuch as it is the source of the charge carriers which cross the unit. The end section to which the emitter-injected carriers are delivered is appropriately referred to as the collector. The middle region is designated the base because

of its physical orientation. The emitter and collector sections functionally resemble the cathode and anode, respectively, of a triode vacuum tube. A similar comparison may be made between the tube's control grid and the transistor's base region. However, the latter not only serves as a means of current control, but also as the medium through which the charge transport is effected.

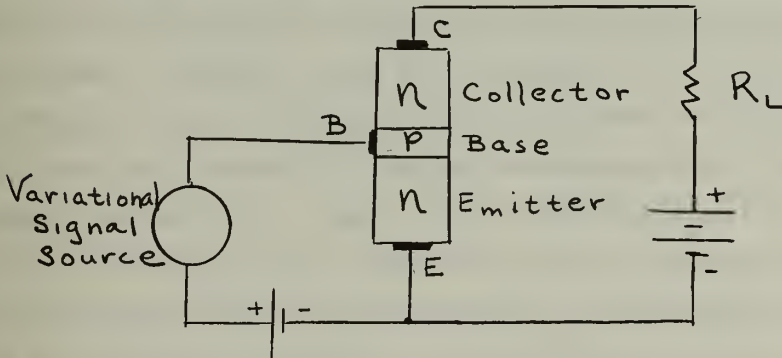

Fig. 2 An elementary transistor signal amplifier

In the elementary arrangement of Figure 2, a signal source is inserted in series with the forward-biased emitter junction. Due to the relatively low resistance presented by the input circuit, a fraction of a volt of input-voltage variation may result in several milliamperes of current variation flowing through the unit. Because collector-junction voltage variations have little effect on the collector current, it is feasible to use a relatively large value of load resistance, R_L . Thus, the realizable magnitudes of signal output voltage and power can be substantially larger than the corresponding input quantities.

The electronic processes upon which transistor action is based are illustrated in Figure 3. As indicated by the representative values given in Figure 3a, the impurity concentration in the emitter region is made substantially higher than in the base region, a ratio of about 100 to one being typical. Figure 3b shows the corresponding

charge distribution and Figure 3c the resulting equilibrium-providing potential distribution under a zero-current condition, i.e., before bias voltages are applied.

Application of the bias voltages, as in Figure 3d, alters the potential-distribution profile to that shown in Figure 3e. The lowering of the emitter-junction potential barrier increases both the electron diffusion into the base and hole passage into the emitter from the base. However, with each diffusion rate a function of the corresponding density gradient across the junction, the resulting emitter-junction current is carried predominantly by electrons injected into the base. Hence, with practically all of the injected electrons diffusing to the collector side of the base and, from there, being swept into the collector by the potential gradient across the collector junction, the resulting collector current is nearly equal to the emitter current. The current in the base lead, equal to the small difference between emitter and collector currents, is primarily formed by hole passage from the base into the emitter, with a minor added component stemming from electron-hole recombinations in the base. For emitter and collector currents of several milliamperes, typical corresponding values of base current would be a few hundredths of a milliampere. Figure 3d shows the pattern of major charge motion in a biased n-p-n transistor. The corresponding pattern in a p-n-p transistor involves holes as the primary current carrier.

With the relative values of emitter, base and collector currents determined primarily by the structural features of the transistor, their respective ratios tend to remain constant over a wide range of instantaneous values. Hence, if an input signal source is connected so that it delivers a variational current component of desired wave shape to either the base or emitter terminals, these variations are linearly imposed on the collector current. Moreover, if the input current variations are applied to the base, as in the circuit of

Figure 2, current gain as well as voltage and power gains may be realized, inasmuch as the collector-current variations will ordinarily be of substantially greater amplitude than the impressed base-current variations.

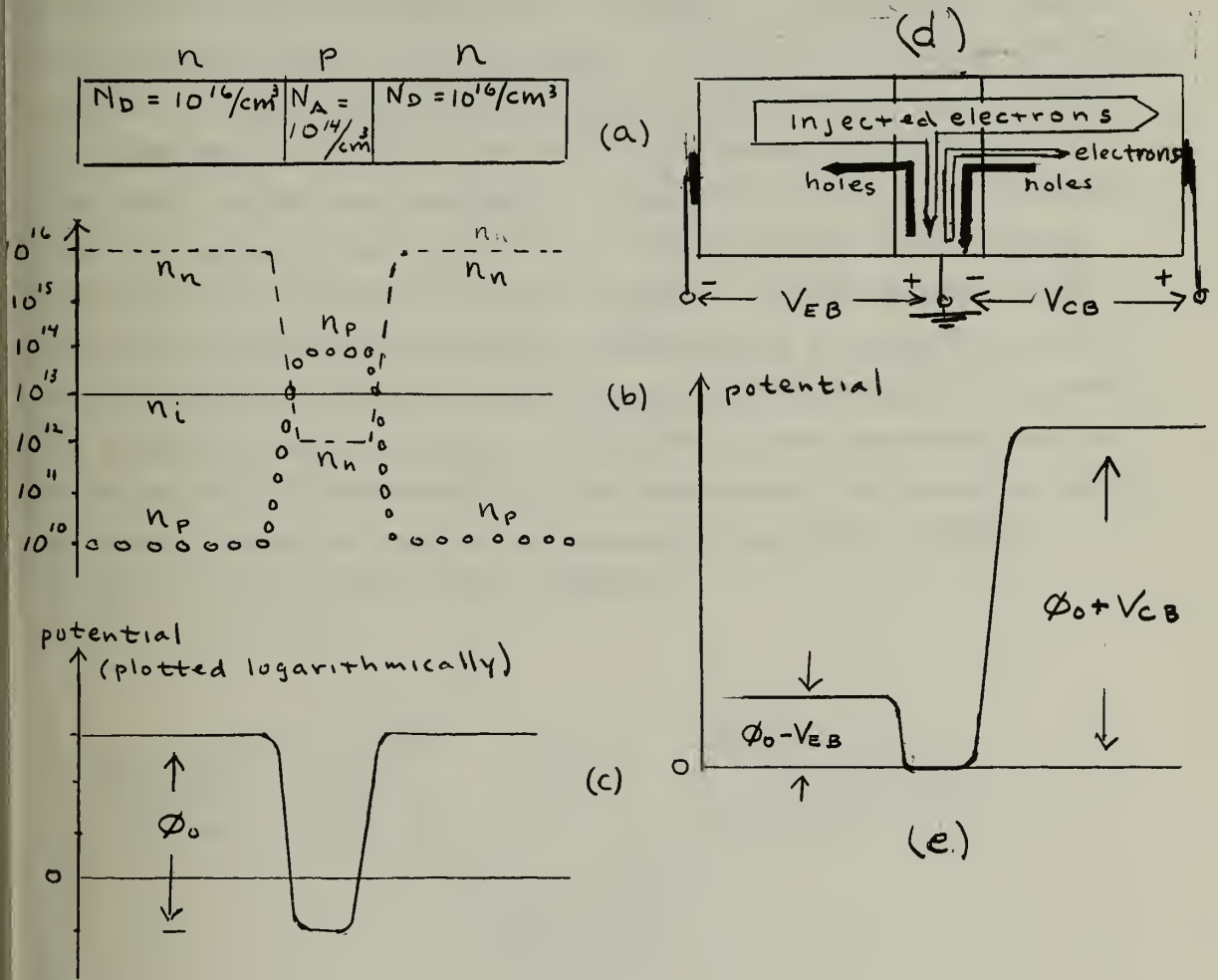

Fig. 3 (a) Impurity concentrations; (b) charge-carrier concentrations; (c) zero-current potential distribution; (d) charge-carrier flow with biases applied; (e) potential distribution with biases applied

1-2 THE TRANSISTOR AS A CIRCUIT ELEMENT

In predicting and analyzing the operational properties of a transistor circuit, the general procedure is similar to that employed in tube-circuit analysis. With the circuit arranged in the basic configuration shown schematically in Figure 4, characteristic relations are established between terminal currents and voltages consistent with the internal electronic mechanisms of the active device. These relations may deal with either the total currents and voltages or just their variational components. Consideration of total quantities leads to the development of sets of voltage-current characteristic plots useful in graphical circuit analysis. If the analysis deals only with variational components, consideration is usually confined to small-signal conditions where linear relations among the incremental quantities may be assumed. Consequently, the transistor characteristics may be represented by fixed parameters, the relations given by explicit equations and AC or incremental equivalent models effectively utilized in the circuit analysis.

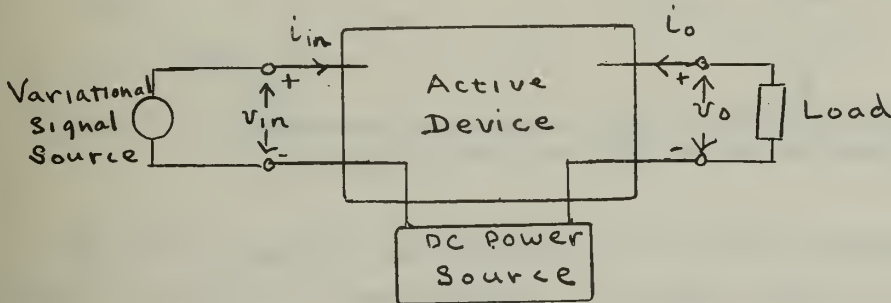

Fig. 4 General schematic amplifier arrangement

The transistor is conventionally symbolized as shown in Figure 5. The p-n-p and n-p-n types are distinguished from one another by the arrow on the emitter lead. It points, in each case, in the actual direction of flow of the emitter current when the emitter junction is

forward biased. Also shown in Figure 5 are the conventions of sign for the currents and voltages. These are in accord with general circuit-analysis practice, whereby the positive reference for a terminal current is directed into the device. Thus, for a normally biased p-n-p transistor, the instantaneous emitter current, i_E , flows into the junction and is, therefore, designated a positive quantity, whereas i_C and i_B are negative. In a normally biased n-p-n transistor i_E is negative while i_C and i_B are positive. For either arrangement, the sum of the three terminal currents equals zero, i.e.,

$$i_E + i_B + i_C = 0 \quad (1)$$

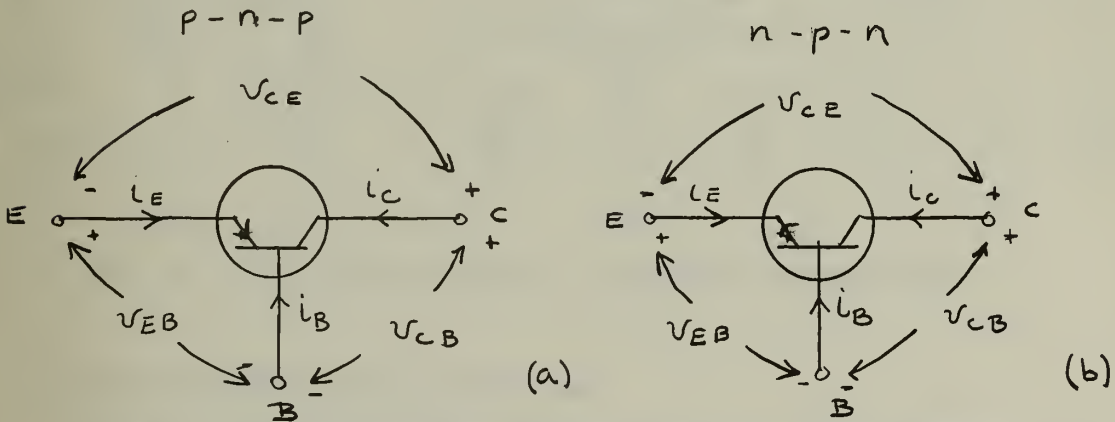

Fig. 5 Transistor symbols and sign conventions for (a) a p-n-p transistor, (b) an n-p-n transistor

When the transistor is employed as the active element of a circuit, it acts as a four-terminal or two-port device, i.e., one of the three connecting leads forms part of both the input and output circuits and the input and output voltages are taken with reference to a common terminal. Any of the three terminals may serve as the common one, so there are three possible amplifier configurations. These are illustrated in Figure 6, where the indicated voltages, v_{eb} , etc., represent variational quantities. Thus, the circuit shown in Figure 6a, illustrating the common-emitter configuration, depicts the variational aspect of the circuit shown in Figure 2. This circuit can provide amplification

for input variational quantities of current, voltage and power. With regard to the other two configurations, transistor theory indicates that the common-base amplifier, Figure 6b, does not furnish current amplification and that the common-collector amplifier, Figure 6c, has a less-than-unity voltage gain. However, both types are useful variational power amplifiers and each of the three arrangements has discrete attributes which make it suitable for given applications.

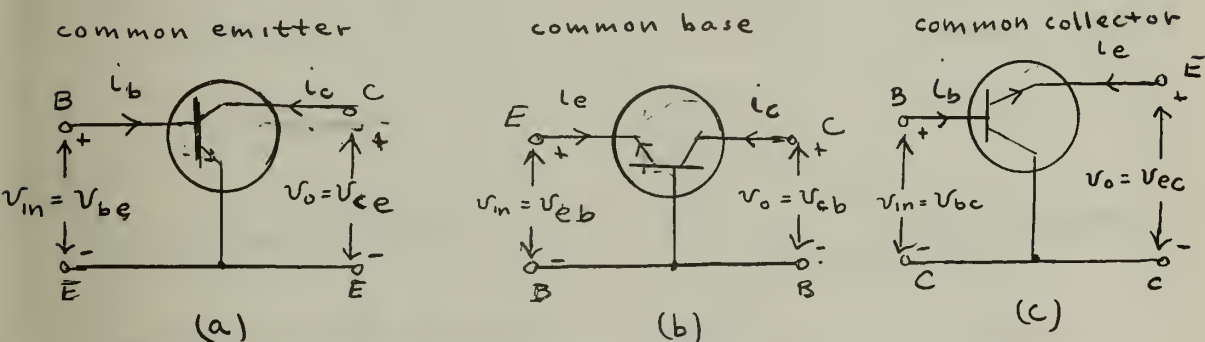

Fig. 6 The three transistor amplifier configurations

1-3 TOTAL CURRENT-VOLTAGE RELATIONS

Figure 7 shows circuit arrangements for obtaining useful sets of total current-voltage relations. In the circuit of Figure 7a, the collector current, a function of the collector-to-base voltage and the emitter current, may be adjusted by varying either the v_{CB} control, V_2 , or the i_E control, R_1 . Thus, measurements can be taken to plot a family of i_C versus v_{CB} curves for discrete values of i_E . In the circuit of Figure 7b, the collector current is controlled by collector-to-emitter voltage variations and base-current changes. Hence, this circuit can furnish data for a family of i_C versus v_{CE} curves for discrete values of i_B . Figures 4c and d show representative plots for each circuit arrangement. These two sets of graphical data are, of course, interdependent, since they are based on the internal processes of a particular transistor. However, the set of

collector characteristics associated with the circuit of Figure 7a is directly applicable in the analysis of a common-base amplifier, where i_E is the control current, while that of Figure 7b is useful in analyzing a common-emitter amplifier, where i_B is the control current.

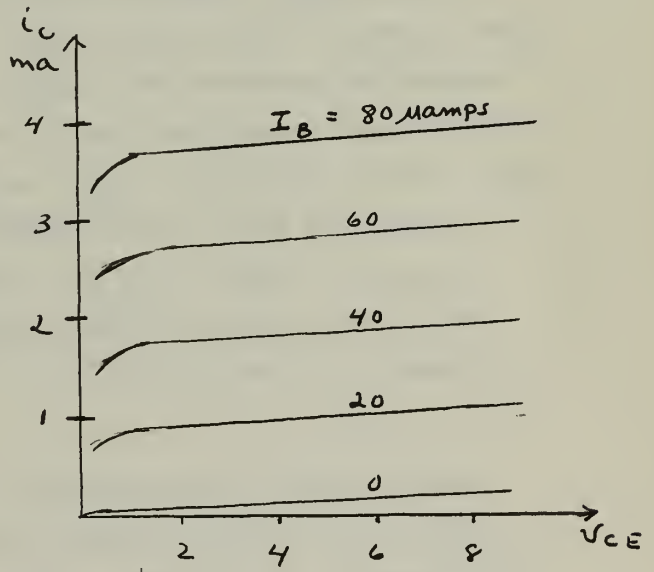
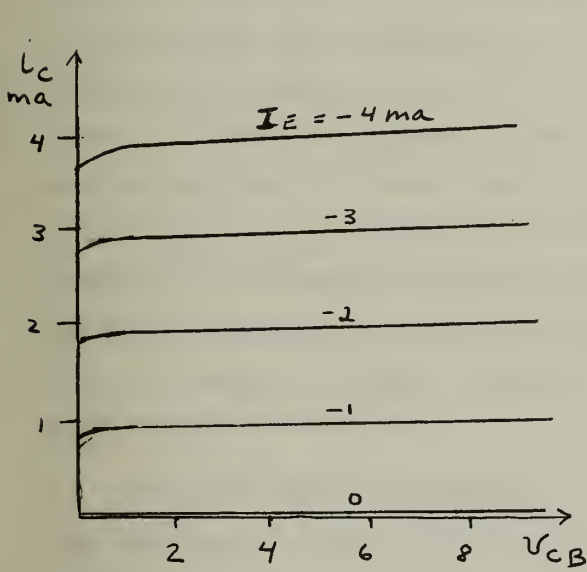
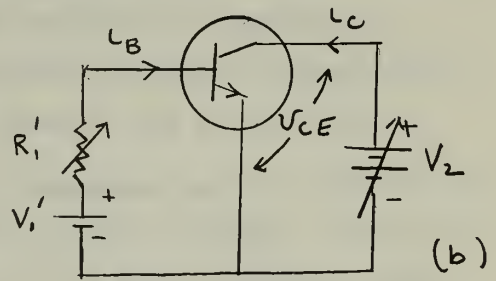
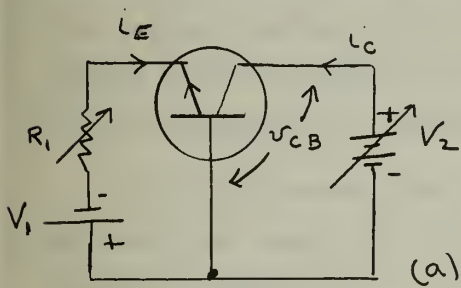

Fig. 7 (a) Circuit for obtaining collector characteristics with emitter-current control
 (b) Circuit for obtaining collector characteristics with base-current control
 (c) Collector characteristics, emitter-current control
 (d) Collector characteristics, base-current control

The general form of these sets of collector characteristics is predictable from the mechanics of transistor action whereby, in effect, the current developed in a forward-biased diode is fed through to a collecting circuit containing a reverse-biased diode. Moreover, if the current-voltage characteristic of each diode is idealized, a simple resistive model may be evolved whose operational characteristics approximate, to a useful degree, those of the actual device.

Figure 8a shows the same circuit arrangement given in Figure 7a, but with the base split apart to produce a pair of diodes, each in a separate current loop. Figures 8b and c show diode voltage-current plots for forward and reverse operating conditions, respectively. If the diodes are considered to be "piece-wise linear" elements, each curve may be idealized into a line having a representative, constant slope, as shown in Figures 8d and e. Thus, the forward-biased diode can be depicted by a small resistance, $r_{E(f)}$, determined by the slope of the $v_{(f)} - i_{(f)}$ line, and the reverse-biased diode by a correspondingly determined large resistance, $r_{C(r)}$. Typical values of forward resistance are 25 to 100 ohms; typical reverse resistances are one megohm or larger. Figures 8f and g show resistive models of each idealized circuit.

When the base is re-formed as a charge-carrier bridge between the junctions, a large fraction of the emitter current reaches the collector. This current transfer ratio, symbolized α , is considered constant in the idealized transistor, regardless of the current increment. Thus,

$$\alpha = \left| \Delta I_C / \Delta I_E \right| \quad (2)$$

for any fixed value of V_{CB} . Appropriate values for α are typically from 0.95 to 0.99. With this parameter established, the elementary model for the idealized transistor may be completed, as shown in Figure 9, by inserting a current generator, αi_E , so that its output augments the collector current. The collector characteristics of

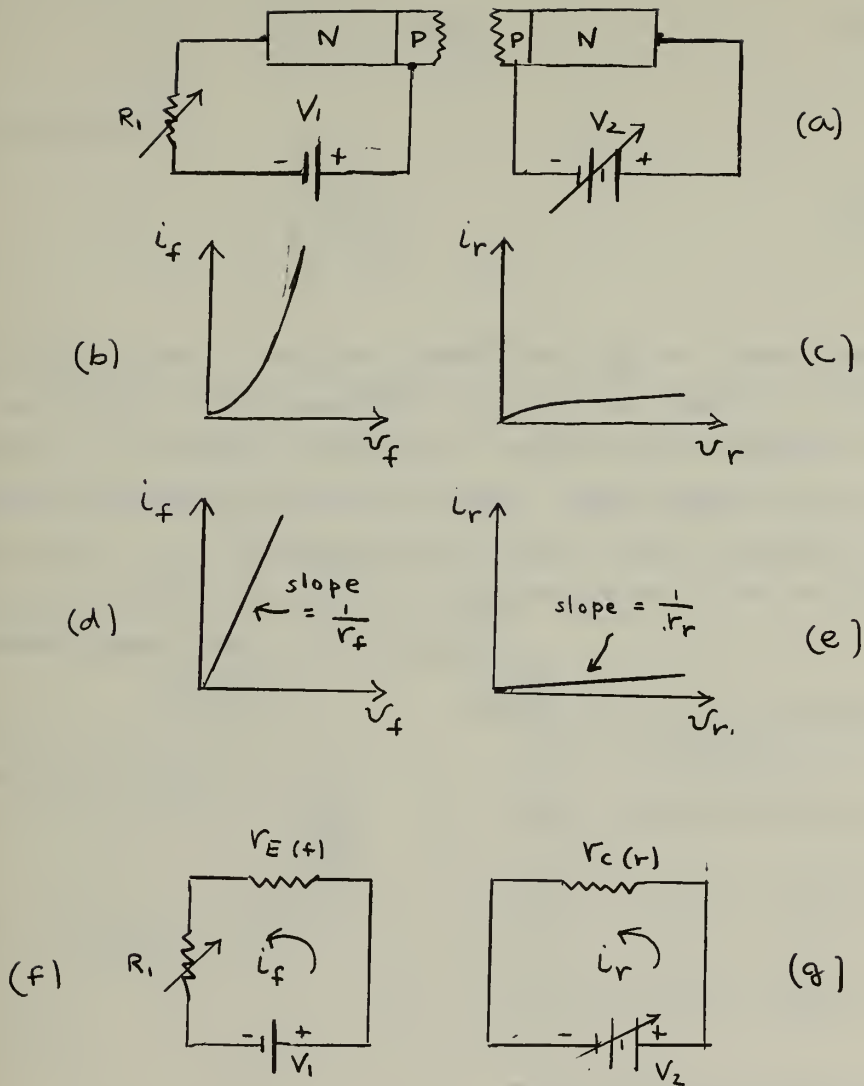

Fig. 8 Evolution of resistive models for separated sections of a transistor

this model are shown in Figure 9b and are comparable with those of the actual transistor, Figure 7c. Moreover, in the idealized version, the total output current can be determined analytically if the transistor parameters are specified. Thus, the collector current is given by

$$i_C = \frac{V_2}{r_C} - \alpha i_E \quad (3)$$

and i_E is given by

$$i_E = - \frac{V_1}{R_1 + r_E} \quad (4)$$

The term V_2/r_C in Eq. 3 is often symbolized I_{CBO} or, more simply, I_{CO} . This current term represents, for both the idealized and actual transistor, the collector current at a particular collector-to-base voltage when the emitter current is zero. With regard to the i_E relation, Eq. 4, r_E is ordinarily sufficiently small compared with R_1 that i_E is given to an excellent approximation by the ratio of the external quantities, i.e., by $-V_1/R_1$.

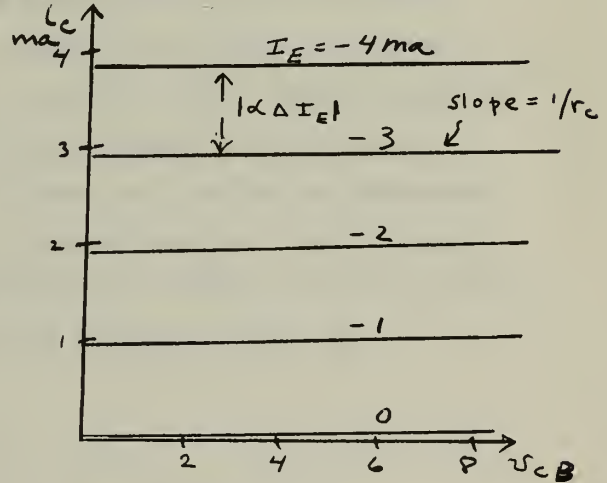
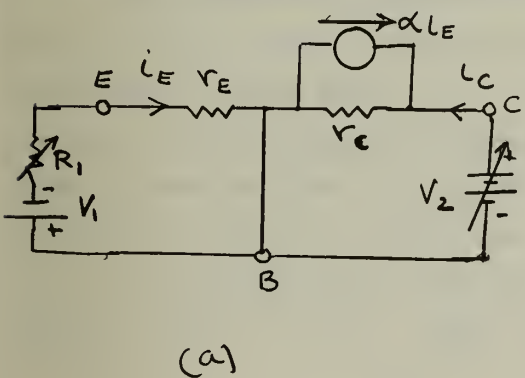

Fig. 9 (a) Elementary resistive transistor model
 (b) Idealized collector characteristics, emitter-current control

The Common-emitter Model. With the collector current a function of base current in the common-emitter amplifier, it is useful to have an idealized resistive model of the form shown in Figure 10a where the controlled current source in the collector circuit is a function of the base current. The required current transfer ratio can be determined readily. With $i_E + i_B + i_C = 0$ and with $i_C = -\alpha i_E$ for a fixed collector-junction voltage, it is seen that i_C as a function of i_B is given by

$$i_C = \frac{\alpha}{1 - \alpha} i_B \quad (4)$$

The transfer ratio has typical values ranging from about 20 to 100. The symbol β is often used to represent this quantity, i.e.,

$$\beta = \frac{\alpha}{1 - \alpha} \quad (5)$$

The appropriate resistance to be inserted in shunt with the βi_B current source is one that will limit the collector current to its correct value when $i_B = 0$. This current is much larger than the reverse current across an isolated reverse-biased junction because charge carriers from the emitter join base- and collector-generated minority carriers in supporting the collector-emitter loop current flow. To evaluate this current, cognizance is taken of the fact that, when $i_B = 0$, $i_C = -i_E$. Then, using the relation of Eq. 3,

$$I_C = \frac{V_{CB}}{r_C} - \alpha I_E = -I_E$$

and

$$I_E = -\frac{V_{CB}}{r_C(1 - \alpha)} = -I_C \quad (6)$$

Thus, the current-limiting resistance is equal to $r_C(1 - \alpha)$ and the collector current with $i_B = 0$ is seen to be greater by a factor of $1/(1 - \alpha)$ than the collector current when $i_E = 0$. The former current is commonly symbolized as I_{CEO} so that

$$I_{CEO} = \frac{I_{CBO}}{1 - \alpha} \quad (7)$$

The elementary resistive model of the common-emitter circuit is shown in Figure 10b and the collector characteristics of this model in Figure 10c. The total output current for this circuit is given, explicitly, by

$$i_C = \frac{V_2}{r_E + r_C(1 - \alpha)} + \frac{\alpha}{1 - \alpha} i_B$$

$$= I_{CEO} + \beta i_B \quad (8)$$

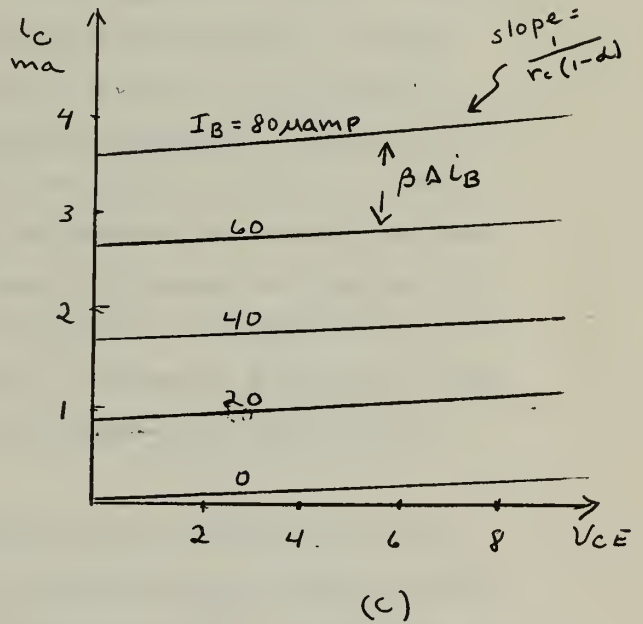
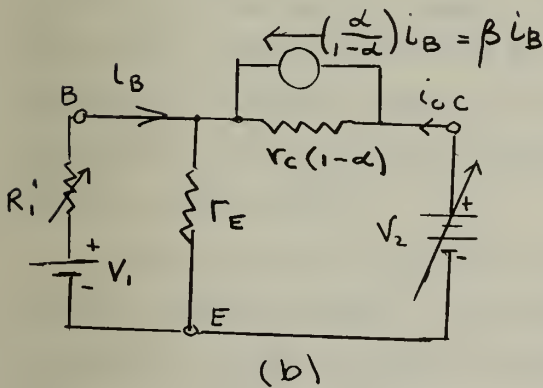
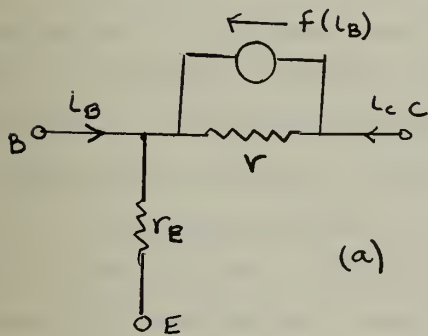

Fig. 10 Elementary common-emitter resistive model and idealized collector characteristics, base-current control

Complete Resistive Models. Although the elementary resistive models of Figures 9 and 10 may usefully serve as operational counterparts of transistor circuits with regard to output characteristics, it is necessary to insert an additional resistive component if a similar correspondence is to be shown with regard to other terminal relations. For example, in the circuit of Figure 9a, a variation in collector voltage would have no effect on the input circuit, whereas actually, a variation in v_{CB} does produce a small change in a transistor's emitter-to-base voltage. This reverse transfer effect is implemented by the base material between junctions. The base region forms a coupling resistance common to both input and output circuits. Moreover, its effective width is a function of collector voltage. A variation in collector voltage alters the width of the carrier-depletion region adjacent to the collector junction, thereby altering the distance between its base edge and the emitter junction. This "base-width modulation" process also influences the current-voltage relation of the emitter diode. Therefore, in order to simulate the operational properties caused by these effects, a resistance r_B is inserted in the base lead of the model as shown in Figure 11a. The appropriate value for this resistance is usually of the order of several hundred ohms.

Figure 11b shows the input characteristics furnished by the complete resistive model. The small reverse-voltage transfer ratio is given by $r_B / (r_C + r_B)$ and is usually less than 10^{-3} . The slope of the characteristics gives the variational input resistance, i.e., $\Delta V_{EB} / \Delta I_E$, for constant V_{CB} . The presence of r_B in the input circuit has but a minor effect on the input resistance because only the small base-current difference between emitter and collector currents flows through this element. If the ratio of emitter to base current is taken as $1/1-\alpha$, the input resistance is given by $r_E + r_B (1 - \alpha)$. This usually amounts to about 50 ohms or less. However, as is seen from the set of actual transistor input

characteristics, Figure 11c, the slope and, hence, the transistor's input resistance, varies considerably with I_E .

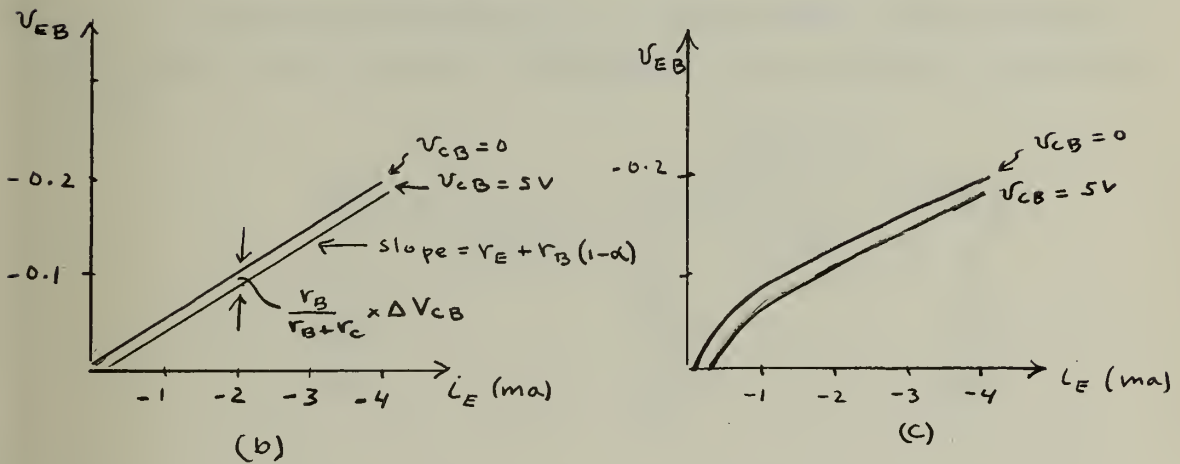
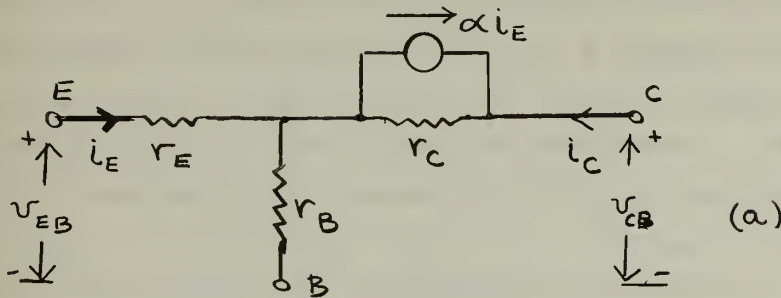

Fig. 11(a) A complete resistive model, (b) idealized input characteristics, (c) actual transistor input characteristics

The inclusion of r_B in the resistive model produces little deviation in the normal-range output characteristics from those furnished by the more elementary model. There is a small additional forward current-transfer effect due to the conductive coupling element and the slope of the characteristics is given by $1/(r_C + r_B)$ instead of $1/r_C$. Both factors are ordinarily negligible, however, so that the characteristics of Figure 9 may be taken to apply to the model of Figure 11a.

Figure 12a shows a suitable resistive model for common-emitter

operation and Figure 12b, the input characteristics it furnishes. These may be compared with actual transistor characteristics, shown in Figure 12c. It is seen from the idealized arrangement that the reverse-voltage transfer ratio is based on a voltage division between r_E and $r_C (1 - \alpha)$. It has the same 10^{-3} order of magnitude as the corresponding factor in the common-base arrangement. The slope of the input characteristics, a measure of the input resistance with constant V_{CE} , is equal to $r_B + r_E / (1 - \alpha)$ and, hence, is larger than that of the common-base arrangement by a factor of $1 / 1 - \alpha$. This is in consonance with the $1 / 1 - \alpha$ ratio between the current magnitude drawn into the emitter terminal and that delivered to the base terminal.

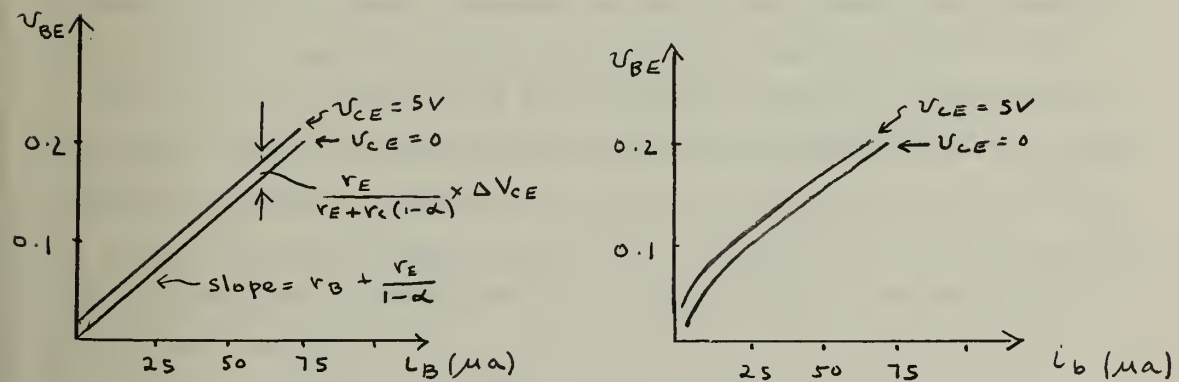
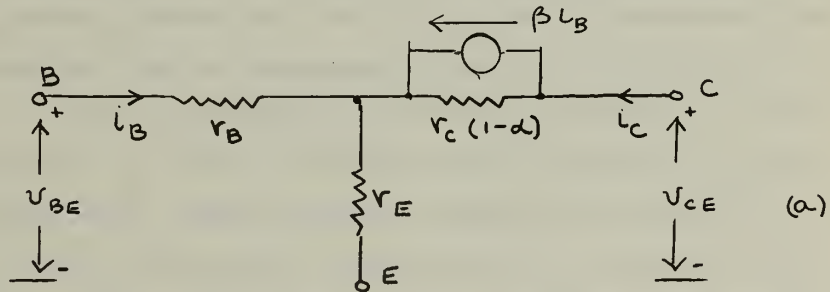

Fig. 12 (a) Complete resistive model for common-emitter operation
 (b) Idealized input characteristics
 (c) Actual transistor input characteristics

Graphical Analysis of a Transistor Amplifier. Although resistive models are very useful for predicting transistor-amplifier performance and relating the performance characteristics to physical processes within the transistor, the assumption of constant parameters inherent in their use leads to obvious inaccuracies, particularly in analyses involving substantial current and voltage variations. Therefore, a graphical technique is ordinarily used to evaluate total currents and voltages at the transistor terminals. Such an analysis makes use of average voltage-current plots furnished for the particular transistor type by the manufacturer.

The graphical analysis of a transistor amplifier is similar to that of a corresponding vacuum-tube circuit. A basic common-emitter circuit arrangement and the corresponding graphical construction are shown in Figure 13. The input signal generator is shown as a variational current source, i_s . Also, the bias-source voltage, V_{BB} , is assumed to be sufficiently larger than the required DC base-to-emitter voltage so that the average base current, I_B , can be taken as equal to V_{BB}/R_B . Thus, direct entry can be made into the output characteristics without recourse to preliminary graphical construction or other analysis involving the input characteristics. In general, it is desirable for the non-linear internal emitter-base resistance to play a negligible role in determining values of input current components. Therefore, if this condition is met, both the DC and variational input sources can be regarded as current supplies of self-determined magnitudes. For this circuit, the expression for total base current is

$$i_B = \frac{V_{BB}}{R_B} + i_s = I_B + i_b$$

and, if

$$i_b = \sqrt{2} I_b \cos \omega t$$

$$i_B = I_B + \sqrt{2} I_b \cos \omega t \quad (9)$$

To determine instantaneous output current and voltage values for instantaneous input currents, the transistor collector characteristics are used in conjunction with the external output-circuit current-voltage relation, viz.,

$$v_{CE} = V_{CC} - i_C R_L$$

or

$$i_C = -\frac{v_{CE}}{R_L} + \frac{V_{CC}}{R_L} \quad (10)$$

This equation is represented graphically by the load line drawn in Figure 13b. Its slope is given by $-1/R_L$, its current-axis intercept is V_{CC}/R_L and its voltage-axis intercept is V_{CC} . The quiescent operating point is located along the load line where it intersects the I_B curve whose value equals V_{BB}/R_L . At this point are also found the values of quiescent collector current, I_C and quiescent collector voltage, V_{CE} . As the instantaneous base current is varied sinusoidally between maximum and minimum values of $I_B + \sqrt{2} I_b$ and $I_B - \sqrt{2} I_b$, respectively, the corresponding variations in v_{CE} and i_C about their respective quiescent levels may be readily ascertained from the graph. Figure 13c shows the total current and voltage waveforms. If negligible signal distortion can be assumed, the average values of collector current and voltage are equal to their respective quiescent values.

In order to ascertain the variational range over which relatively undistorted amplifier response may be obtained, it is useful to plot a curve of i_C versus i_B for the given circuit, using the points of intersection of the load line with the various i_B curves of the output characteristics. Such a dynamic current-transfer characteristic is shown in Figure 14. Its slope at a particular point is a measure

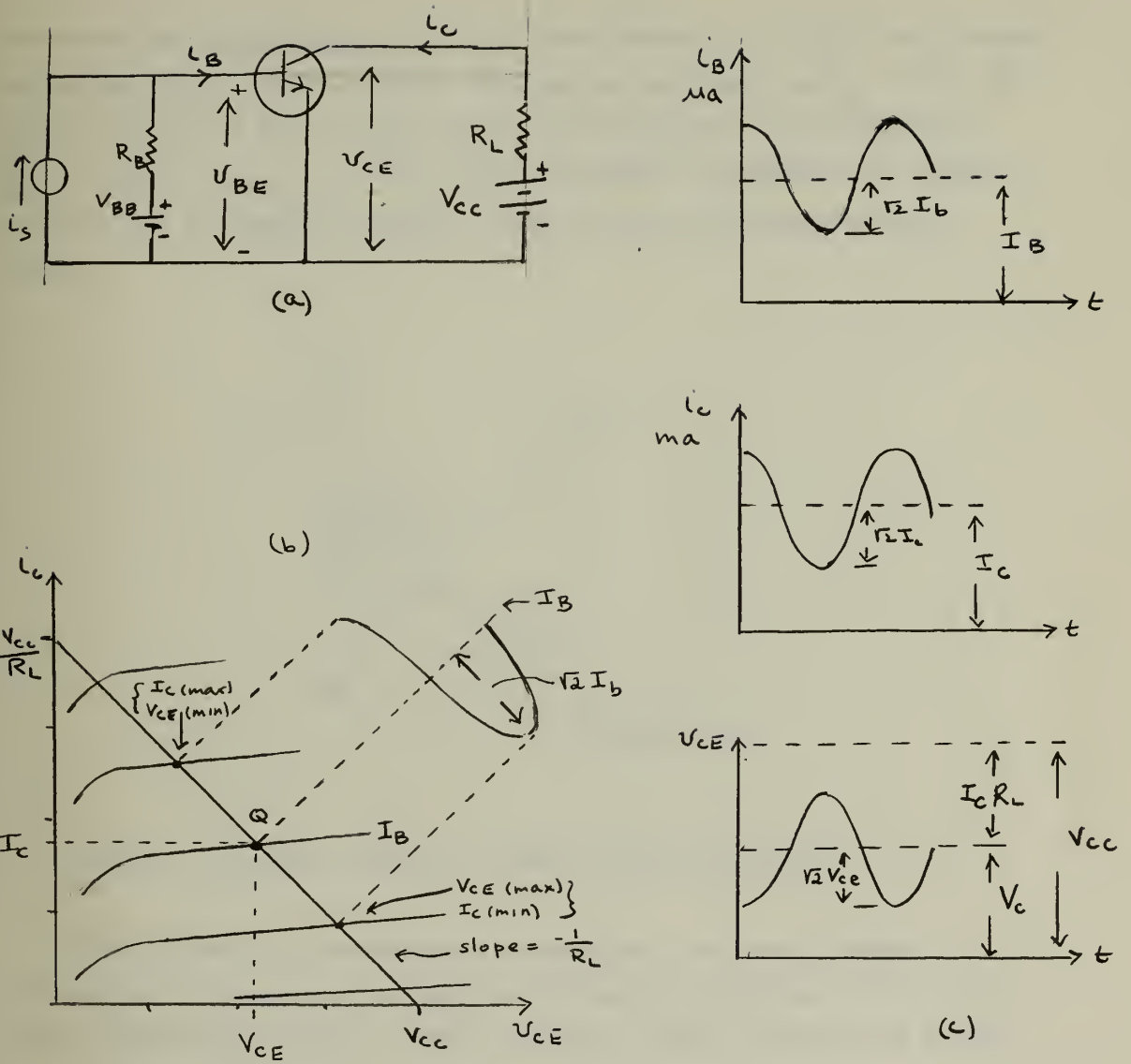

Fig. 13 Graphical analysis of a common-emitter amplifier
 (a) Basic circuit arrangement
 (b) Graphical construction
 (c) Waveforms

of the circuit's variational current gain about that point. This slope is seen to be less than the β slope-value of a static transfer characteristic plotted for a fixed magnitude of V_{CE} . The dynamic transfer curve is quite linear until it approaches the i_C level

representing saturation, i.e., the level where $i_C = V_{CC}/R_L$ and further increases in i_B cannot produce responsive increases in i_C . Thus the active region of this circuit may be delineated as extending from $I_B = 0$ to $I_B = I_{B(\text{sat.})}$. For linear response, operation is normally confined to a somewhat narrower range centered within the active region.

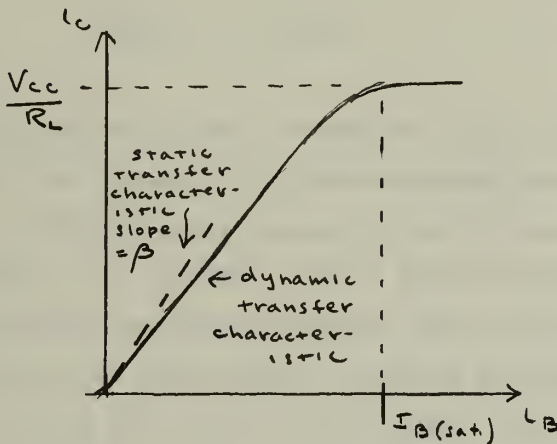

Fig. 14 Dynamic current transfer characteristic

With sinusoidal variational quantities, the total output current and voltage can be used for a ready evaluation of collector-circuit power quantities. Thus, the power drawn from the DC source, P_{CC} , is given by

$$P_{CC} = V_{CC} I_C \quad (11)$$

This power is delivered to and dissipated by the transistor and the load resistance. The power delivered to R_L includes both DC and AC components and is given by

$$P_{R_L} = I_C^2 R_L + I_C V_{ce} \quad (12)$$

Therefore, the average power delivered to the collector is

$$\begin{aligned}
 P_C &= P_{CC} - P_{R_L} \\
 &= V_{CC} I_C - I_C^2 R_L - I_c V_{ce} \\
 &= I_C (V_{CC} - I_C R_L) - I_c V_{ce} \\
 &= V_{CE} I_C - I_c V_{ce} \qquad (13)
 \end{aligned}$$

Thus, in this example of Class A operation where collector current flows throughout the signal cycle, the average power dissipated by the collector is maximum under quiescent conditions and decreases as a variational signal is applied. For a given transistor, there is ordinarily a specified maximum collector power dissipation capability. Therefore, care must be exercised in circuit arrangement to secure a quiescent operating point within this power limit. A curve may be drawn on the transistor's output characteristics, as shown in Figure 15, giving the locus of maximum permissible $V_C I_C$ products. The quiescent point should be located to the left of this curve.

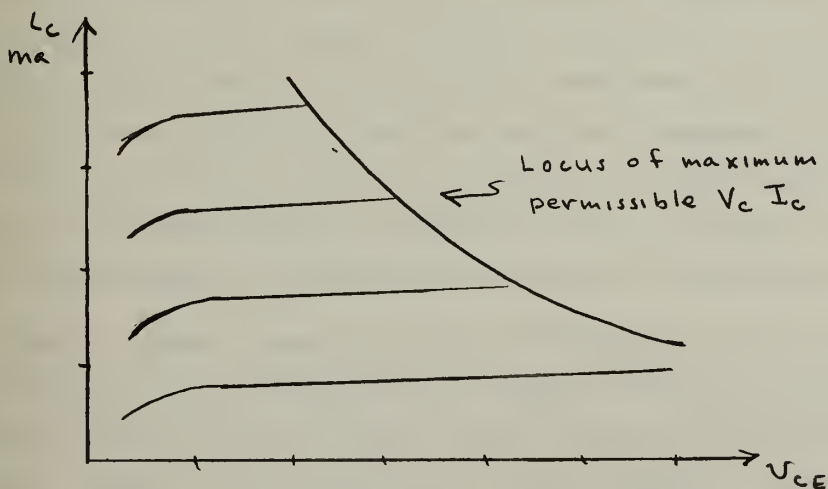

Fig. 15 Operational limit due to power-dissipation capability

1-4 BIASING CIRCUITS AND OPERATING-POINT STABILIZATION

It is evident from the foregoing consideration of graphical analysis that the selection and maintenance of appropriate bias conditions are practical requirements for the realization of a linear transistor amplifier. A proper quiescent operating point can be decided upon by reference to a set of average output characteristics for the given transistor and a suitable DC circuit arranged for obtaining it. However, under actual operating conditions, the quiescent current levels may deviate considerably from the selected ones, thereby causing distortion, operational failure or even the destruction of the transistor. To minimize these possibilities, practical biasing circuitry usually involves an elaboration of the elementary arrangement shown in Figure 13a.

The chief cause of bias-level instability during operation is temperature fluctuation, particularly with germanium transistors. In general, as has been previously indicated, the voltage-current relation for a p-n junction is a function of temperature. Thus, both the emitter-junction current-voltage relation, as represented in the idealized transistor by r_E , and I_{CO} , the unaugmented reverse-current flow across the collector junction, are affected by temperature changes. The influence of an r_E change in the emitter circuit can be minimized by using a sufficiently large external resistance in series with an appropriate bias source so that the external components, primarily, determine the emitter current. (See Eq. 4.) With regard to I_{CO} changes, bias-stabilization techniques seek to minimize the extent to which these changes are magnified in effect by transistor action.

Another common cause of biasing difficulty is the replacement of one transistor with another having somewhat different characteristics. The variation in current-transfer ratio from unit to unit may be sufficiently great to have serious and even disastrous consequences. For example, with an increased transfer ratio, the power delivered to

the collector junction is increased. If the rate at which thermal energy is released at the junction exceeds that at which it is transferred to the external surroundings, the junction temperature will rise. Inasmuch as collector current increases with increased temperature, a progressive increase of both collector current and junction temperature may result. This process, known as thermal runaway might continue until the transistor becomes permanently inoperative. In general, bias arrangements designed to minimize the effects of I_{CO} changes will also tend to stabilize operation with regard to changes in transistor characteristics.

The importance of circuit arrangement in determining the effect of a given I_{CO} change on collector current is illustrated in Figure 16. In the circuit of Figure 16a, the emitter current is shown, schematically, to flow from a constant-current source so that I_E will remain constant regardless of any change in I_{CO} ; in the circuit of Figure 16b, I_B is to be considered independent of I_{CO} changes. In each circuit, a measure of the sensitivity of I_C to changes in I_{CO} may be obtained by differentiating the expression for I_C with respect to I_{CO} . The resulting incremental ratio, $\partial I_C / \partial I_{CO}$, is sometimes referred to as the stability factor and is symbolized S . It is seen that this factor equals unity for the circuit of Figure 16a and $1/(1 - \alpha)$ for the circuit of Figure 16b. These represent the limits that S may have in practical bias circuits with, of course, the lower limit the more desirable one. Thus it is seen that, for good bias stability, I_E should be kept as invariant as possible.

To illustrate the significance of the stability factor, assume, for example, that an original quiescent I_C value equal to 1 ma is selected for each circuit, that $\alpha = 0.99$ and that $I_{CO} = 5 \mu\text{a}$ at an original temperature of 20°C . When the temperature changes, I_{CO} will approximately double for every 10°C temperature rise. Thus, if the temperature increases to 60°C , I_{CO} rises to $80 \mu\text{a}$. In the

circuit of Figure 16a, this produces an I_C variation of less than 10%. However, in the circuit of Figure 16b, the resulting change in I_C amounts to 7.5 ma, perhaps sufficient to produce saturation or even thermal runaway.

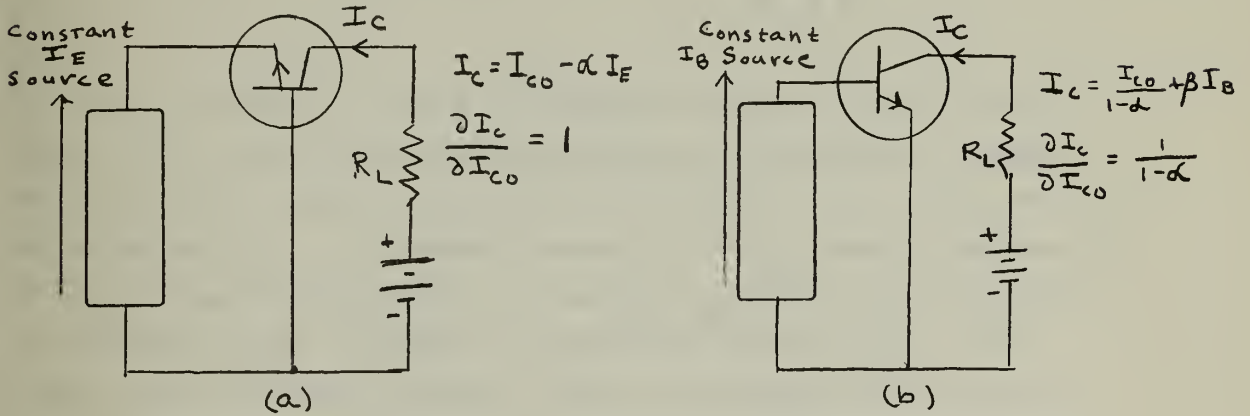

Fig. 16 Circuits illustrating the effects of I_{CO} change

Bias Circuit Arrangements. Figure 17 shows a basic two-battery circuit arrangement for obtaining desired quiescent current levels with various possible degrees of bias stability. An expression for I_C as a function of I_{CO} can readily be derived. If the base-to-emitter voltage can be assumed to be negligible, application of Kirchhoff's voltage law to the base circuit yields

$$V_1 = I_B R_B + (I_B + I_C) R_E \quad (14)$$

Also, I_B may, in general, be related to I_C by

$$I_B = \frac{I_C (1 - \alpha) - I_{CO}}{\alpha} \quad (15)$$

Substituting for I_B in Eq. 14 and solving for I_C yields

$$I_C = \frac{\alpha V_1}{R_E + R_B (1 - \alpha)} + \frac{I_{CO} (R_E + R_B)}{R_E + R_B (1 - \alpha)} \quad (16)$$

The stabilization ratio may be obtained by differentiating I_C with respect to I_{CO} , giving

$$S = \frac{R_E + R_B}{R_E + R_B(1 - \alpha)} = \frac{1}{1 - \alpha \left(\frac{R_B}{R_E + R_B} \right)} \quad (17)$$

It is seen from Eq. 17 that S will have an optimum value of unity when $R_B = 0$. The circuit then corresponds to that shown, schematically, in Figure 16a, i.e., I_E has the fixed value of $-V_1/R_E$ and is not affected by I_{CO} . Conversely, when $R_E = 0$, I_B remains constant as in the arrangement of Figure 16b, and the I_{CO} effects are magnified to a maximum degree, leading to a stability factor of $1/(1 - \alpha)$. Finite values for both R_E and R_B lead to intermediate values for S and, in general, good stability is obtained by making R_E large compared with R_B .

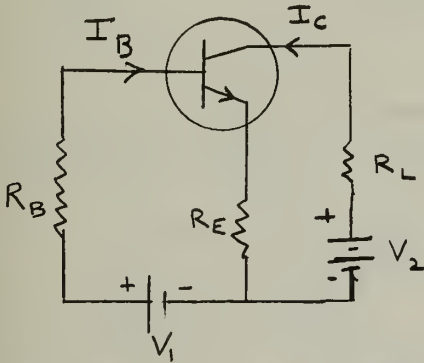

$$I_B \approx \frac{V_1}{R_B + \frac{R_E}{1 - \alpha}}$$

$$V_C \approx V_2 - I_C (R_L + R_E)$$

Fig. 17 Basic biasing arrangement

The practicality of providing a large R_E to R_B ratio may be limited by a number of factors. For example, if the DC circuit is to furnish bias for a common-emitter variational amplifier, R_B will be effectively shunted across the amplifier input terminals, in the position shown in Figure 13a. Thus, R_B should be of sufficient size so that it does not absorb a significant amount of variational input

power. Then, in order to secure good stability, R_E must be made quite large and, hence, a relatively large DC supply voltage V_1 will be required to obtain desired quiescent current levels. Therefore, in this basic arrangement temperature stability is gained at the cost of either DC or variational input power.

With appropriate values selected for R_L and R_B on the basis of AC amplifier performance, the remaining external components may then be chosen to give a desired operating point and stability. The relations between operating point and component values are given, approximately, in Figure 17. More precise relations may be obtained by substituting the expression for I_C given by Eq. 16 into the equation for I_B , Eq. 15, and by applying Kirchoff's voltage law around the collector-circuit loop.

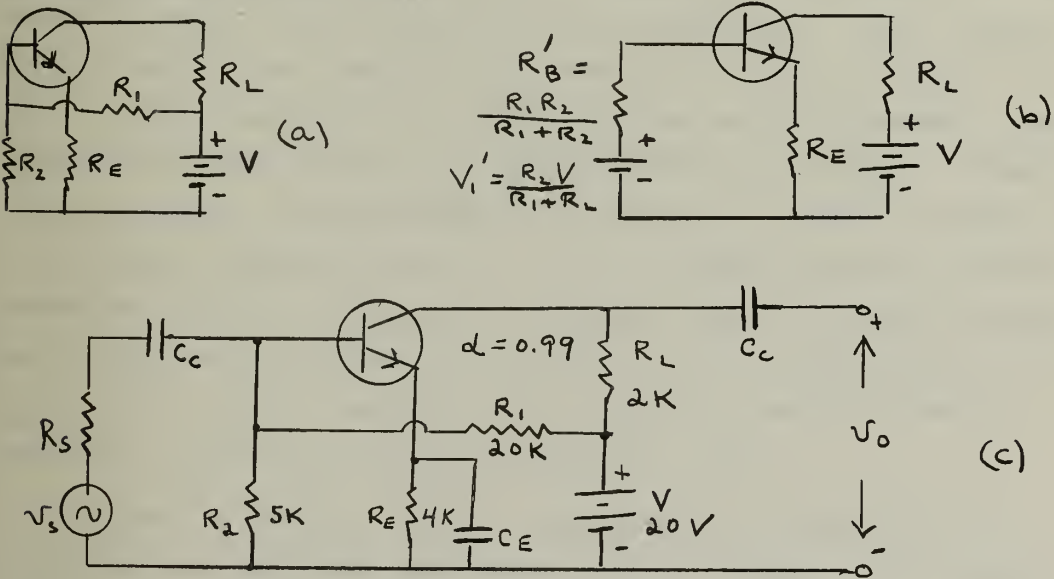

Fig. 18 Practical bias circuit using a single source

- (a) One-source bias circuit
- (b) Thevenin's equivalent circuit
- (c) Complete signal amplifier

In practical bias circuits, the basic arrangement shown in Figure 17 is usually modified to the extent that a single DC source is used in place of the two shown. This might be achieved in the circuit of Figure 17, while still providing the correct polarity of bias for each junction, by simply returning R_B to the positive terminal of V_2 , thereby eliminating the need for V_1 . However, a major shortcoming of this arrangement would be its lack of flexibility. With both I_B and V_C functions of V_2 , it would be difficult to select circuit component values which simultaneously provided both a desired operating point and temperature stability and also had no adverse AC loading effects.

A more feasible arrangement for achieving these ends, and one commonly employed, is that shown in Figure 18a. In this circuit, the resistance of R_1 and R_2 in parallel versus R_E determines the stability while the value of R_1 relative to R_2 determines I_B . Thus, separate control can be exercised over the stability and the selection of a desired operating point. The respective roles of the various components can be more clearly seen if the network is replaced, between base and ground, by its Thevenin's equivalent, as shown in Figure 18b. It is evident that this circuit is in the form of the basic biasing arrangement shown in Figure 17. Therefore, The S relation given by Eq. 17 applies to the one-source circuit as well, with R_B given, for this circuit, by the resistance of R_1 and R_2 in parallel and the equivalent input-circuit source by $VR_1/(R_1 + R_2)$.

Figure 18c shows a complete common-emitter signal amplifier employing the stabilized one-source bias arrangement. The capacitor across R_E by-passes to ground the variational component of the emitter current and thus serves to maintain the emitter effectively at AC ground potential. The biasing network components have been selected to give a quiescent operating point in the vicinity of $I_C = 1 \text{ ma}$, $I_B = 10 \mu\text{a}$ and $V_{CE} = 4 \text{ v}$, as can be verified by application of the

approximate relations given in Figure 17. If S is evaluated, using Eq. 17, it is found to have the excellent value of 1.98. However, the network does have the unfavorable effect of shunting the AC input terminals of the amplifier with a resistance of 4 K. Thus, if the variational input resistance of the amplifier should amount to 2.5 K, a typical order of magnitude, then more than one third of the variational input power would be dissipated in the biasing network. This signal loss could be mitigated by, for example, doubling the values of R_1 , R_2 , R_E and V and adjusting R_L to maintain the same V_{CE} . However, the obvious cost of the resulting conservation of signal power would be a doubling of the power drawn from the DC source. Thus, the selection of actual bias-network components must often be based on a compromise between attainment of desired amplifier performance characteristics and efficiency.

1-5 TRANSISTOR LINEAR AMPLIFIERS

The analysis of a transistor amplifier often deals primarily with the variational components of input and output currents and voltages. Under this circumstance, consideration of total quantities is ordinarily confined to the selection of a proper quiescent point and maintenance of a sufficiently small variational range so that an essentially linear response will be obtained. Once linear relations among the variational terminal quantities may be assumed, they can be represented by explicit equations derived from a general consideration of the circuit as a linear four-terminal or two-port network, without regard to the specific network components or their arrangement. These general relations may then be used to determine the performance characteristics of a particular transistor amplifier.

Figure 19 shows, schematically, a general two-port linear network with its four variational terminal quantities. These quantities are

interdependent so that a specification of any pair thereby determines the other pair. For example, if V_i and V_o were applied voltages from a pair of independent voltage sources, these quantities, when impressed across their respective terminals, would determine I_i and I_o . Thus, the terminal electrical properties of the network could be described by two equations giving I_i and I_o , respectively, as functions of V_i and V_o . To express these relations explicitly, a pair of proportionality constants must be determined for each equation. These constants, like the vacuum-tube coefficients g_m and $1/r_p$ in the linear incremental equation for plate current, give the discrete effect of each independent variable on the dependent one. The desired constants for a given network are obtained by taking appropriate measurements at the network terminals.

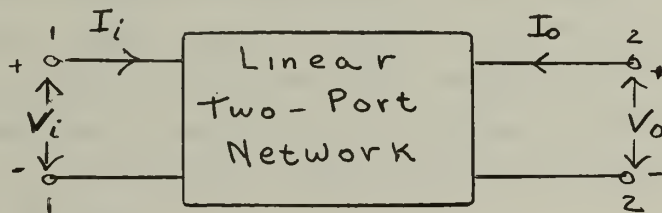

Fig. 19 Terminal quantities of a general two-port network

In the analysis of transistor circuits, the quantities corresponding to I_i and V_o are commonly taken as the independent variables in the circuit-defining equations. This is in conformity with the actual manipulations typically involved in transistor action. Also, the appropriate terminal measurements required for the equation constants can readily be made with a good degree of accuracy. Thus, the typical functional relations used to describe the incremental response of a linear transistor amplifier are

$$V_i = f(I_i, V_o)$$

$$I_o = f'(I_i, V_o) \quad (18)$$

These lead to explicit equations of the form

$$V_i = k_1 I_i + k_2 V_o$$

$$I_o = k_3 I_i + k_4 V_o \quad (19)$$

The constants in Eq. 19 have mixed dimensions, viz., $k_1 = \text{ohms}$ and $k_4 = \text{mhos}$, whereas k_2 and k_3 are dimensionless voltage and current ratios, respectively. Therefore, these constants are known as hybrid parameters and are conventionally symbolized h . Also, to distinguish one parameter from another, use is made of definitive subscript notation. Thus, the subscripts i and o specify ratios of incremental quantities within the input and output circuit, respectively, while the subscripts f and r serve to designate forward and reverse transfer ratios, respectively. Therefore, the circuit-defining equations assume the form

$$V_i = h_i I_i + h_r V_o$$

$$I_o = h_f I_i + h_o V_o \quad (20)$$

where

$$h_i = \left. \frac{V_i}{I_i} \right|_{V_o = 0} ; \quad h_f = \left. \frac{I_o}{I_i} \right|_{V_o = 0}$$

$$h_r = \left. \frac{V_i}{V_o} \right|_{I_i = 0} ; \quad h_o = \left. \frac{I_o}{V_o} \right|_{I_i = 0} \quad (21)$$

The parameter definitions give indication as to how they may be determined for a particular circuit. Thus, h_i is found by measuring the input resistance with the output terminals shorted so that $V_o = 0$; h_o is the output admittance measured with the input terminals open so that $I_i = 0$. Similarly, h_f is the forward current transfer ratio measured with a short-circuited output and h_r is the reverse voltage transfer ratio measured with the input terminals open. It is because the required incremental short- and open-circuit terminations can be well approximated in transistor circuits that the hybrid parameters have become the most common means for specifying transistor incremental characteristics. Once a transistor's hybrid parameters are known, the performance characteristics of a given amplifier employing this transistor as its active element can readily be derived.

Amplifier Performance Factors. Figure 20 shows, schematically, a complete linear amplifier arrangement with a signal source applied to the input terminals and a load resistance connected across the output terminals. Also indicated are the various performance factors which describe the basic operational characteristics of the amplifier, viz., the current, voltage and power gains, A_i , A_v and A_p , and the input and output resistances, R_{in} and R_o . The amplifier factors are interdependent so that, if A_i and R_{in} are determined for a finite R_L , A_v may be evaluated from the relations

$$A_v = \frac{V_o}{V_i} = - \frac{I_o R_L}{I_i R_{in}} = - A_i \frac{R_L}{R_{in}} \quad (22)$$

and A_p may be obtained from the relations

$$A_p = \frac{I_o V_o}{I_i V_i} = A_i A_v = - A_i^2 \frac{R_L}{R_{in}} \quad (23)$$

The factor R_o is useful in considerations of power transfer from the active element to the load resistance.

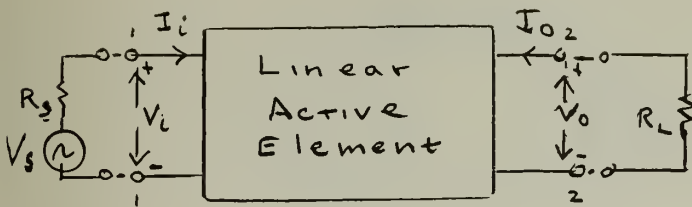

$$R_{in} = \frac{V_i}{I_i}; \quad A_v = \frac{V_o}{V_i}$$

$$A_i = \frac{I_o}{I_i}; \quad R_o = \frac{V_o}{I_o}$$

$$A_p = \frac{V_o I_o}{V_i I_i}$$

Fig. 20 General linear incremental amplifier

In applying hybrid-parameter relations to determine amplifier performance, it is useful to develop an equivalent-circuit representation of the active element based on these relations. Such a circuit is shown in Figure 21. The circuit equations are, for the input network,

$$\begin{aligned} V_i &= h_i I_i + h_r V_o \\ &= V_s - I_i R_s \end{aligned} \quad (24)$$

and, for the output network,

$$\begin{aligned} I_o &= h_f I_i + h_o V_o \\ &= -\frac{V_o}{R_L} = h_f I_i - h_o I_o R_L \end{aligned} \quad (25)$$

These equations are seen to be in conformity with the hybrid-parameter network-defining relations, Eq. 20, and with the external circuit current-voltage relations.

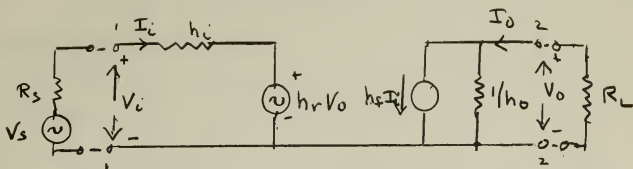

Fig. 21 Equivalent amplifier circuit employing hybrid parameters

Inspection of the equivalent circuit serves to illustrate a number of general amplifier characteristics. For example, with regard to the input resistance of the amplifier, this quantity will differ from h_i because of the feedback of voltage from the output circuit, as represented by the equivalent generator, $h_r V_o$. Whether the input resistance is greater than or less than h_i depends on the phase relation between the $h_r V_o$ generator and the signal source, V_s . In either case, with V_o dependent on R_L , the input resistance will be a function of R_L if, as in transistor circuits, there is any feedback effect from output to input circuits. Also, it is seen that the amplifier current gain depends on a current division between the resistances $1/h_o$ and R_L . Thus, A_i will approximate h_f to the extent that $1/h_o$ is large compared with R_L .

An expression for current gain, A_i , can be derived directly from Eq. 25, i.e.,

$$A_i = \frac{I_o}{I_i} = \frac{h_f}{1 + h_o R_L} \quad (26)$$

The current gain may be used to determine the input resistance. Thus, from Eq. 25,

$$V_o = -I_o R_L = -A_i I_i R_L$$

Substituting for V_o in Eq. 24 yields

$$R_{in} = \frac{V_i}{I_i} = h_i - A_i h_r R_L \quad (27)$$

Equation 27 is applicable for all finite values of R_L . When the output is open-circuited, i.e., $I_o = 0$, V_o may be obtained from Eq. 25 as

$$V_o = \frac{-h_f I_i}{h_o}$$

Substituting, now, for V_o in Eq. 24 yields

$$R_{in(o-c)} = h_i - \frac{h_f h_r}{h_o} \quad (28)$$

Thus, it is seen that, if the value of R_L is varied between zero and infinity, R_{in} will range in values between those given by h_i and $(h_i - h_f h_r / h_o)$, respectively.

To find the output resistance R_o , appropriate equations may be derived from the circuit arrangement shown in Figure 22. The ratio V_o / I_o represents the resistance presented to the output terminals by the amplifier when the signal source, of internal impedance R_s , is connected to the input terminals. It could be found experimentally by applying a test signal to the output terminals with the input signal source connected but with $V_s = 0$. It may be determined analytically from the circuit equations

$$h_r V_o + I_i (R_s + h_i) = 0$$

$$I_o - h_o V_o - h_f I_i = 0$$

Eliminating I_i and solving for V_o / I_o yields

$$R_o = \frac{V_o}{I_o} = \frac{1}{h_o - \frac{h_f h_r}{R_s + h_i}} \quad (29)$$

If R_s is relatively large, R_o may not differ appreciably from $1/h_o$.

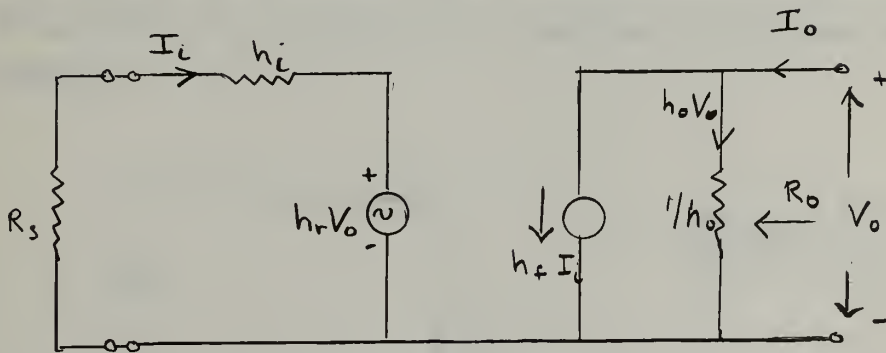

Fig. 22 Evaluating the output resistance

With regard to voltage amplification, Eq. 22 gives the voltage ratio between output and input terminals of the active element for all finite values of R_L . The overall circuit voltage gain, $A_{v(s)}$, is the ratio of output voltage to signal-source voltage and is given by

$$A_{v(s)} = -A_i \frac{R_L}{R_{in} + R_s} \quad (30)$$

It is also useful to have a relation for the voltage gain when the output is open-circuited. Towards this end, I_o is set equal to zero in Eq. 25, giving

$$I_i = -\frac{h_o V_o}{h_f}$$

Substituting for I_i in Eq. 24 and solving for V_o / V_i yields

$$A_{v(o-c)} = \frac{-h_f}{h_o h_i - h_r h_f} \quad (31)$$

With R_o and $A_{v(o-c)}$ evaluated, a simple Thevenin's equivalent circuit can be used to represent the amplifier as an incremental power source. This circuit is shown in Figure 23. It will be recognized as a form commonly used for vacuum-tube equivalence, where $A_{v(o-c)}$ is the tube voltage amplification factor μ and R_o is the incremental plate resistance r_p . Because a tube functions as a voltage-controlled device, the constants of the Thevenin's equivalent circuit are wholly determined by the active element. With current-controlled devices, such as transistors, R_o is necessarily a function of the input signal-source impedance.

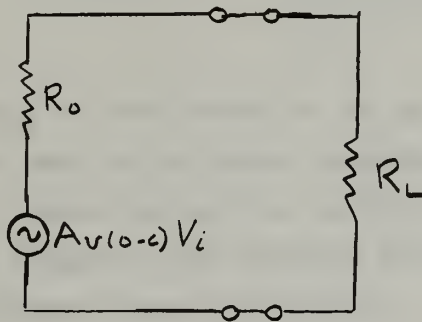

$$P_o = \frac{(A_{v(o-c)} V_i)^2}{(R_o + R_L)^2} R_L$$

Fig. 23 A Thevenin's equivalent circuit

The power gain, when defined simply as the ratio of output to input power, is given by Eq. 23. However, a basic figure of merit for the active device is its power amplification capabilities under optimum power-transfer conditions. For the output circuit, this is seen, by reference to Figure 23, to be met by matching the value of R_L to that of R_o ; for the input circuit, the signal-source impedance R_s would be matched to R_{in} . Appropriate values for R_s and R_L to meet these conditions for maximum available gain may be found by solving, as simultaneous equations, the relations

$$\begin{aligned} R_s &= R_{in} = h_i - A_i h_r R_L \\ R_L &= R_o = \frac{1}{h_o - \frac{h_f h_r}{R_s + h_i}} \end{aligned} \quad (32)$$

The results are

$$R_s = h_i \sqrt{1 - \frac{h_f h_r}{h_i h_o}}$$

$$R_L = \frac{1}{h_o \sqrt{1 - \frac{h_f h_r}{h_i h_o}}} \quad (32)$$

When these results are substituted in the power gain equation, they yield an expression for maximum available gain given by

$$A_{P(m-a)} = \frac{h_f^2}{\left(\sqrt{h_o h_i - h_r h_f} + \sqrt{h_i h_o}\right)^2} \quad (33)$$

By substituting in this equation the appropriate parameters of a transistor in each of its three possible circuit configurations, i.e., common-base, common-emitter and common-collector, a useful basis is obtained for comparing the relative effectiveness of the configurations as incremental power amplifiers.

Table I contains a tabulation of relations that serve to delineate the major incremental amplifier performance characteristics. Although these characteristics may all be derived as functions of the hybrid parameters of the active element, several are given here as functions of other amplifier characteristics, e.g., as a function of the current gain. Such equations are not only less cumbersome, but also indicate a logical sequence for determining the overall set of characteristics.

TABLE I

$$A_i = \frac{h_f}{1 + h_o R_L}$$

$$R_{in} = h_i - A_i h_r R_L$$

$$R_{in(o-c)} = h_i - \frac{h_f h_r}{h_o}$$

$$A_v = -A_i \frac{R_L}{R_{in}}$$

$$A_{v(o-c)} = \frac{-h_f}{h_o h_i - h_r h_f}$$

$$R_o = \frac{1}{h_o - \frac{h_f h_r}{R_s + h_i}}$$

$$A_p = A_i^2 \frac{R_L}{R_{in}}$$

$$A_{p(m-a)} = \frac{h_f^2}{\left(\sqrt{h_o h_i - h_r h_f} + \sqrt{h_i h_o} \right)^2}$$

Transistor Parameters. The parameter data required for the analysis of a variational transistor amplifier is usually furnished in the form of either common-base or common-emitter hybrid parameters. Figure 24 shows the basic circuit for each configuration and gives the corresponding sets of parameter definitions, at a specified quiescent operating point, in terms of the total terminal currents and voltages. It is seen that these definitions conform to those given by the general incremental ratios of Eq. 21. As indicated in Figure 24, an added subscript, b or c, is used to specify whether the given parameter has been measured in the common-base or common-emitter configuration, respectively. The two sets of parameters are, of course, interdependent, and conversion relations can be established for converting from one set to the other.

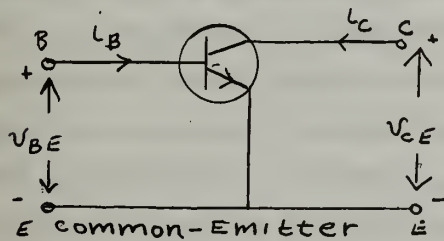

$$h_{fe} = \left. \frac{\partial I_C}{\partial I_B} \right|_{V_{CE} = \text{const}}$$

$$h_{ie} = \left. \frac{\partial V_{BE}}{\partial I_B} \right|_{V_{CE} = \text{const}}$$

$$h_{oe} = \left. \frac{\partial I_C}{\partial V_{CE}} \right|_{I_B = \text{const}}$$

$$h_{re} = \left. \frac{\partial V_{BE}}{\partial V_{CE}} \right|_{I_B = \text{const}}$$

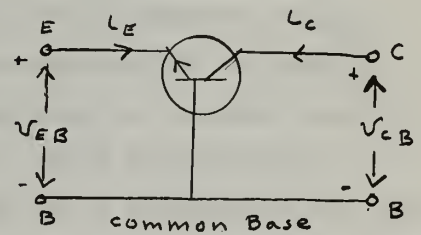

$$h_{fb} = \left. \frac{\partial I_C}{\partial I_E} \right|_{V_{CB} = \text{const}}$$

$$h_{ib} = \left. \frac{\partial V_{EB}}{\partial I_E} \right|_{V_{CB} = \text{const}}$$

$$h_{ob} = \left. \frac{\partial I_C}{\partial V_{CB}} \right|_{I_E = \text{const}}$$

$$h_{rb} = \left. \frac{\partial V_{EB}}{\partial V_{CB}} \right|_{I_E = \text{const}}$$

Fig. 24 Transistor common-base and common-emitter hybrid parameters

The values of the hybrid parameters for a particular configuration may be estimated from the overall total current-voltage relations of the transistor, i.e., from the graphical characteristics and their idealized approximations. Thus, it is seen from the common-base

output characteristics graph, Figure 7c, that the slope of the characteristics gives, at a particular operating point, the parameter h_{ob} , while the ordinate displacement for an increment of input current determines the magnitude of h_{fb} . Similarly, it is seen from the input characteristics, Figure 11c, that the slope of these characteristics is identifiable with h_{ib} at a particular operating point and that the ordinate displacement on this graph, for an increment of output voltage, determines h_{rb} .

The idealized common-base resistive model and its characteristics, shown in Figures 11a, c and 9b, respectively, lead to a realization of representative values for the h_b parameters. For example, with r_C predictable from transistor physical processes to be in the megohm range, the corresponding order-of-magnitude for h_{ob} is 10^{-6} mho. The h_{fb} magnitude is identifiable with that of α . However, these quantities are of opposite sign, since α is arbitrarily defined as a positive quantity, whereas there is a phase reversal between the i_c and i_E increments, so that h_{fb} is negative. With α magnitudes ordinarily ranging between about 0.95 and 0.99, a representative value for h_{fb} is -0.98. Then, with typical values that may be predicted for r_E and r_B of 30 and 500 ohms, respectively, corresponding representative values for h_{ib} and h_{rb} are seen to be 40 ohms and 5×10^{-4} , respectively.

A similar identifying process may be used to deduce representative values for the h_e parameters. Thus, from the graphs of Figures 7d and 10c, it is seen that, if an α -value of 0.98 is used to evaluate the slope of the curves, h_{oe} is of the order of 5×10^{-5} mhos and that h_{fe} , identifiable with the transistor quantity β , is equal to 49. Also, using values of $r_E = 50$ and $r_B = 500$ in the relations for slope and separation of the characteristics shown in Figure 12b lead to the evaluations $h_{ie} = 2000$ ohms and $h_{re} = 1.5 \times 10^{-3}$.

Since a particular incremental ratio may differ substantially from one operating point to another and from one transistor to another, parameter values for use in amplifier analysis are actually determined by suitable terminal measurements. Towards this end, in determining h_i and h_f for either configuration, a variational current source of high internal impedance compared with the input resistance of the transistor is connected to the input terminals while the output terminal connection is made of low impedance compared with the output resistance of the transistor. Effecting these terminations, while providing appropriate biasing voltages, usually involves no practical difficulties because the transistor's input resistance is typically low and its output resistance is high. Similarly, to measure h_o and h_r , a test signal provided from a voltage source of negligible internal impedance compared with the transistor's output resistance, is connected to the output terminals, while the input terminals are kept essentially open-circuited. This, too, can readily be accomplished by, for example, completing the input-circuit DC connection with a large choke coil.

Of the two configurations, the common-base circuit is ordinarily preferred for hybrid-parameter measurement and specification because its input resistance is lower and its output resistance higher than the corresponding common-emitter quantities. However, h_{fe} can usually be measured more accurately than h_{fb} because the latter is a ratio of two nearly equal quantities. Hence, transistor manufacturer's data sheets commonly include values for h_{fe} , h_{ib} , h_{ob} and h_{rb} to specify the transistor's incremental characteristics.

In order to use given parameter data in the analysis of a particular amplifier, it is obviously often necessary to convert from one set of hybrid parameters to another. Simple general conversion relations can be established if a minor degree of approximation is accepted, such as was used to obtain representative values for each set. Thus, by applying the relation between common-base and common-emitter current transfer ratios given by Eq. 5, viz., $\beta = \alpha / (1 - \alpha)$,

and identifying α with $-h_{fb}$ and β with h_{fe} , the relation between these hybrid parameters becomes

$$h_{fe} = \frac{-h_{fb}}{1 + h_{fb}} \quad (34)$$

and

$$h_{fb} = \frac{-h_{fe}}{1 + h_{fe}} \quad (35)$$

Also, a comparison of the slopes of the common-base and common-emitter idealized output characteristics of Figures 9 and 10, respectively, show that these slopes and, hence, h_{ob} and h_{oe} are related by the factor $1 / (1 - \alpha)$. A similar relation exists between h_{ib} and h_{ie} , as seen from the idealized input characteristics of Figures 11 and 12. It is convenient to represent this conversion factor in terms of the commonly available h_{fe} parameter. Thus,

$$\frac{1}{1 - \alpha} = \frac{\beta}{\alpha} = \frac{-h_{fe}}{h_{fb}}$$

which, on substituting for h_{fb} from Eq. 34, yields

$$\frac{1}{1 - \alpha} = h_{fe} + 1 \quad (36)$$

Therefore, the h_o and h_i conversion relations may be given as

$$h_{oe} = h_{ob} (h_{fe} + 1) \quad (37)$$

$$h_{ie} = h_{ib} (h_{fe} + 1) \quad (38)$$

The least obvious conversion relation is that involving the h_r parameters. However, it may be obtained by comparing the common-base and common-emitter input circuits when the output is open-circuited. It is clear, from examination of their idealized resistive models, Figures 11 and 12, that the input resistances are the same under

this circumstance. Hence, the R_{in} relation given by Eq. 28 may be used to equate h_{re} and h_{rb} . Thus,

$$h_{ie} - \frac{h_{fe} h_{re}}{h_{oe}} = h_{ib} - \frac{h_{fb} h_{rb}}{h_{ob}}$$

By converting h_{ie} , h_{re} and h_{oe} to h_b parameters, the desired relation is found to be

$$h_{re} = h_{ib} h_{ob} (h_{fe} + 1) - h_{rb} \quad (39)$$

Table II lists the various parameter conversion factors and the representative value for each parameter in each configuration. Each pair is seen to be correctly related by its conversion factor. It should be emphasized that these conversion factors are not precise. However, they ordinarily constitute valid working approximations. Exact relations may be developed by an appropriate analysis of the general incremental equivalent circuit, but the resulting equations are cumbersome and do not add insight with regard to the respective characteristics of the two configurations.

TABLE II

h_b	Representative values	h_e	Representative values
$h_{fb} = \frac{-h_{fe}}{1+h_{fe}}$	-0.98	h_{fe}	49
h_{ib}	40 ohms	$h_{ie} = h_{ib} (h_{fe} + 1)$	2000 ohms
h_{ob}	10^{-6} mho	$h_{oe} = h_{ob} (h_{fe} + 1)$	5×10^{-5} mho
h_{rb}	5×10^{-4}	$h_{re} = h_{ib} h_{ob} (h_{fe} + 1) - h_{rb}$	1.5×10^{-3}

A matter of considerable practical importance regarding hybrid-parameter values is the fact that they are, in varying degrees, functions of the operating point. Typical patterns of variation of h_{ib} , h_{ob} , h_{rb} and h_{fe} with emitter current are shown in Figure 25. From these variations, it is evident that an incorrect selection of operating point or its instability during operation may drastically affect the operational characteristics of the amplifier.

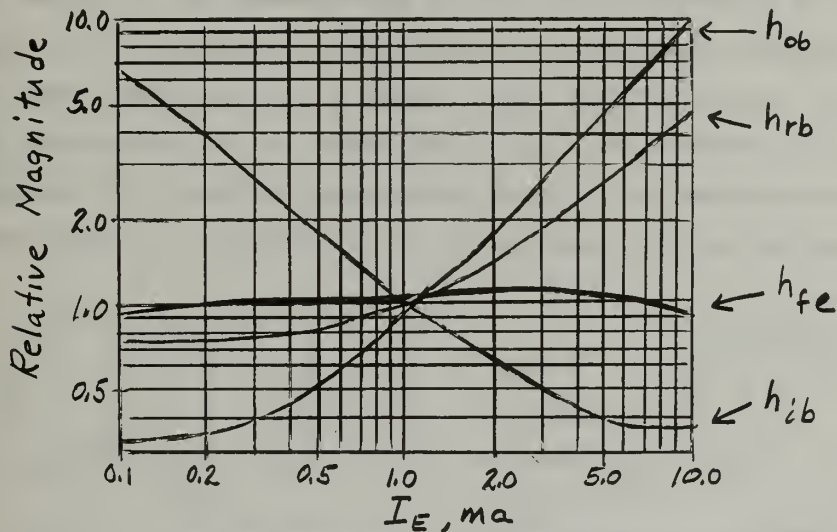

Fig. 25 Hybrid parameters as functions of emitter current

Common-base and Common-emitter Amplifier Characteristics.

Figure 26 shows basic common-base and common-emitter incremental amplifier arrangements. The active element of each circuit has been assigned the representative parameter values previously specified. The evaluations given for A_i , R_{in} , A_v and A_p are based on the general relations tabulated in Table II and have been made with $R_L = 10 K$.

The circuit of Figure 26a may be used to gain insight into the general performance characteristics of a common-base incremental amplifier. Thus, it is seen that the current transfer involves a phase reversal, whereas the voltage transfer does not. While the current-gain magnitude is necessarily less than unity, it is closely approximated by h_{fb} over most of the range of feasible R_L values. The input-resistance range would extend, using this transistor, from a minimum of 40 ohms, given by the value of h_{ib} , to a maximum of

530 ohms, if R_L were varied from zero to infinity. However, in typical circuits, it ordinarily exceeds h_{ib} by relatively few ohms.

With the common-base amplifier current gain usually close to unity, the voltage and power gain magnitudes are essentially equal to one another and are given, to a close approximation, by the ratio of R_L to R_{in} . It is, of course, necessary that this ratio be greater than unity if the common-base circuit is to serve as an amplifier. Thus, this arrangement is not useful in cascaded similar stages where the input resistance of a stage serves effectively as the incremental load resistance of the preceding stage. To achieve multistage amplification with similar common-base stages, an impedance-transformation device must be included in the interstage coupling mechanism.

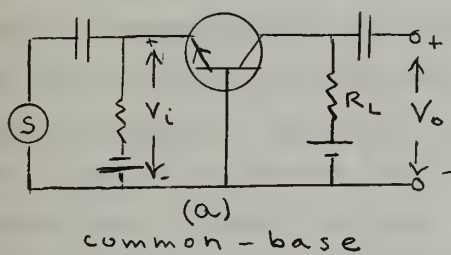

$$\begin{aligned}
 h_{fe} &= 49 \\
 h_{ib} &= 40\Omega \\
 h_{ob} &= 10^{-6} \text{ mho} \\
 h_{rb} &= 5 \times 10^{-4} \\
 R_L &= 10 \text{ K}
 \end{aligned}$$

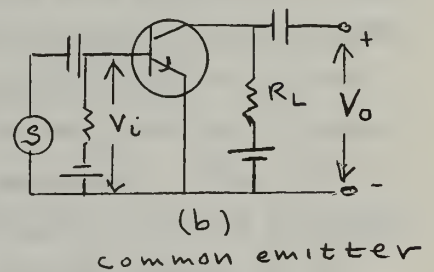

$$A_{i(b)} = \frac{-0.98}{1 + 10^{-6} \times 10^4} = \underline{-0.97}$$

$$R_{in(b)} = 40 + 0.97 \times 5 \times 10^{-4} \times 10^4 = \underline{44.9 \Omega}$$

$$A_{v(b)} = 0.97 \times \frac{10^4}{44.9} = \underline{216}$$

$$A_{p(b)} = 0.97 \times 216 = 210 = \underline{23.2 \text{ db}}$$

$$A_{i(e)} = \frac{49}{1 + 5 \times 10^{-5} \times 10^4} = \underline{32.7}$$

$$R_{in(e)} = 2000 - 32.7 \times 1.5 \times 10^{-3} \times 10^4 = \underline{1,510 \Omega}$$

$$A_{v(e)} = -32.7 \times \frac{10^4}{1510} = \underline{-216}$$

$$A_{p(e)} = 32.7 \times 216 = 7063 = \underline{38.5 \text{ db}}$$

Fig. 26 Common-base and common-emitter amplifiers

Referring to the common-emitter amplifier, Figure 26b, it is seen to have a higher input resistance than that of the common-base circuit. If R_L were varied from zero to infinity in this circuit, $R_{in(e)}$ would decrease from a maximum of 2000 ohms, corresponding to h_{ie} , to a minimum of 530 ohms, equal to the maximum attainable $R_{in(b)}$ value. Typical values of $R_{in(e)}$ are ordinarily much closer to h_{ie} than to $R_{in(o-c)}$.

The common-emitter amplifier provides voltage rather than current phase reversal. Although its current-gain magnitude may be substantially greater than unity, it cannot ordinarily be well approximated by h_{fe} , unless R_L is quite small.

With a given load resistance, the voltage gain magnitude is similar for common-emitter and common-base stages, despite the difference in their current-gain magnitudes. This is attributable to the fact that the ratio of the input resistance of the two circuits is essentially equal to that of their current-gain magnitudes. Thus, for a given input-terminal voltage, the current-transfer ratio is considerably greater for the common-emitter stage, but the current to be transferred is correspondingly lower. However, because the application of input voltage to the circuit with the higher input resistance is achieved with a lesser expenditure of signal power, the power gain realized with the common-emitter circuit is greater than that obtainable with a common-base circuit using the same value of R_L . This is borne out by a power-gain computation for each circuit. Since they have similar voltage-gain magnitudes, the ratio of their power gains is equal to that of their current gains. Thus, in the circuits of Figure 26, with $R_L = 10\text{ K}$, the common-emitter power gain is greater than that of the common-base circuit by more than 15 db.

As has been previously indicated, an apt basis for comparing the two amplifier circuits is their maximum available power gains, i.e., A_p when R_L is matched to R_o and R_s is matched to R_{in} . Substituting the parameters of these circuits in Eqs. 32 and 33 gives the following results:

$$R_{in(\text{matched})(b)} = 146 \text{ ohms}$$

$$R_o(\text{matched})(b) = 275 \times 10^3 \text{ ohms}$$

$$R_{in(\text{matched})(e)} = 1,028 \text{ ohms}$$

$$R_o(\text{matched})(e) = 39 \times 10^3 \text{ ohms}$$

$$A_p(m - a)(b) = 1300 = 31.14 \text{ db}$$

$$A_p(m - a)(e) = 10,500 = 40.02 \text{ db}$$

The fact that the common-emitter maximum available gain exceeds that of the common-base circuit, for this transistor by about 9 db, constitutes an intrinsic facet of amplifier-performance superiority for common-emitter amplifiers.

Another practical advantage of the common-emitter over the common-base amplifier stems from the fact that the realization of voltage gain does not hinge on making R_L larger than R_{in} . Thus, the common-emitter amplifier does lend itself to direct cascading where the incremental load resistance of a given stage may be furnished, in effect, by the input resistance of a succeeding similar stage. Under this circumstance, the voltage-gain magnitude is equal to that of the current gain.

Common-collector Amplifier. Both the common-base and common-emitter amplifiers have relatively low input and high output resistances. These characteristics may constitute serious operational limitations when, for example, input signal power is to be derived from a high impedance source and is to be delivered after amplifications to a low-impedance load. Under such conditions, a common-collector circuit may be utilized effectively. Figure 27 shows a basic common-collector amplifier.

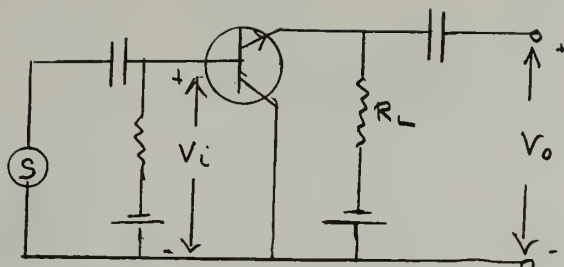

Fig. 27 A common-collector amplifier

The amplifier characteristics of the common-collector circuit may be determined by use of the general equations given in Table I once its hybrid parameters have been evaluated. The relations between h_{oc} , h_{ic} and h_{fc} and their respective h_e counterparts may be readily ascertained by consideration of the circuit arrangements for measuring these parameters. Outlines of such circuits are shown in Figure 28. Thus, it is seen that the arrangements depicted in Figure 28a are identical, so that $h_{oc} = h_{oe}$. Similarly, the arrangements for measuring h_{ic} and h_{ie} are indistinguishable and, hence, these parameters are equal. Also, the relation $i_e = -(i_c + i_b)$ gives

$$\frac{i_e}{i_b} = h_{fc} = -\left(\frac{i_c}{i_b} + 1\right) = -(h_{fe} + 1)$$

Finally, $h_{rc} = v_{ec}/v_{bc}$ and, if the small emitter-to-base voltage difference between these increments is disregarded, this parameter may be equated to unity. These determinations are summarized in Table III, where the representative values included are consistent with h_e values previously derived.

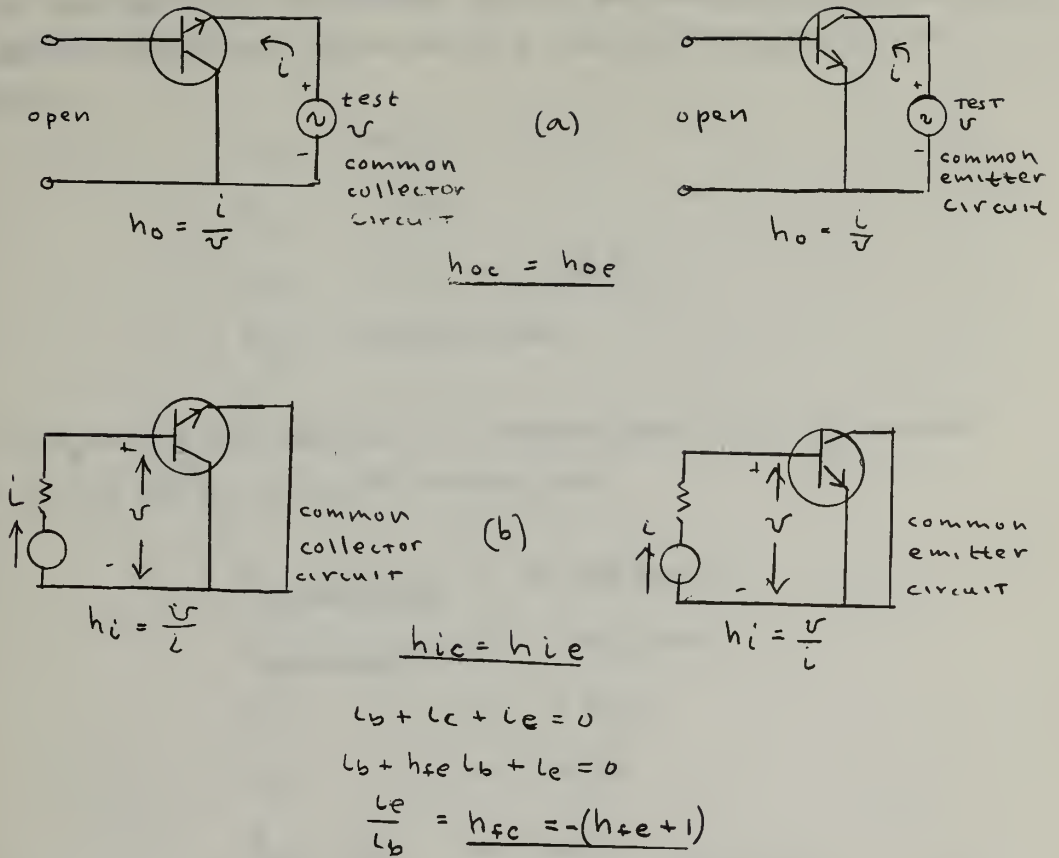

Fig. 28 Incremental circuit outlines for measuring common-collector and common-emitter parameters

TABLE III

h_c	Representative Values
$h_{fc} = -(h_{fe} + 1)$	-50
$h_{ic} = h_{ie}$	2,000 ohms
$h_{oc} = h_{oe}$	5×10^{-5}
h_{rc}	1

If the amplifier performance factors are determined for the circuit of Figure 27 using an R_L value of 10 K, the following results are obtained:

$$\begin{aligned} A_i &= -33.4 \\ A_v &= 0.99 \\ A_p &= 33.1 = 15.2 \text{ db} \\ R_{in} &= 336,000 \text{ ohms} \end{aligned}$$

If R_s and R_L are adjusted for maximum gain, i.e., R_s is made equal to R_{in} and R_L to R_o , the results are

$$\begin{aligned} R_{in(\text{matched})} &= 44,900 \text{ ohms} \\ R_{o(\text{matched})} &= 890 \text{ ohms} \\ A_i &= -47.9 \\ A_v &= 0.96 \\ A_{p(m-a)} &= 45.7 = 16.6 \text{ db} \end{aligned}$$

These results illustrate the general amplifier characteristics of this arrangement. Thus, the current transfer involves a phase reversal while the voltage transfer does not. The voltage gain magnitude is ordinarily only slightly less than unity. The input resistance is relatively large and, for small values of R_L , is approximately equal to $h_{fc} R_L$. The output resistance, on the other hand, is relatively small and usually is approximately equal to R_s/h_{fc} . Therefore, this circuit has the properties of an impedance transformer, with the transformation ratio given approximately by h_{fc} or, perhaps more conveniently, by h_{fe} .

Although the maximum available power gain is 23.4 db less for the common-collector than for a corresponding common-emitter amplifier, the former configuration may be preferable under operating conditions where the signal-source impedance has a fixed high value and the load resistance a fixed low value. These conditions are illustrated

schematically, for either amplifier, in Figure 29. If R_s is considerably larger than the input resistance, the voltage applied to the input terminals is approximately $V_s R_{in}/R_s$ for each circuit. Then, each output voltage would be given, approximately, by $V_s h_{fe} R_L/R_s$ and similar amounts of incremental power would be delivered to the load resistance. Under this circumstance, the common-collector arrangement might be the preferable one, since its higher input resistance will result in a lesser power drain from the signal source and its lower output resistance may be advantageous with regard to such considerations as frequency response.

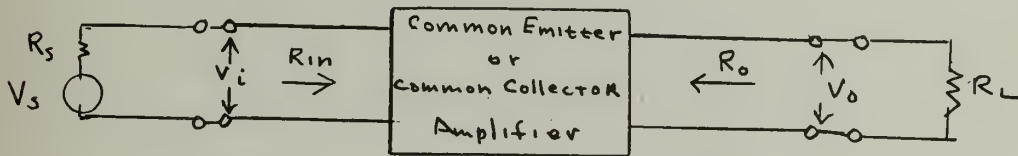

For either circuit:

$$R_s \gg R_{in}$$

$$R_L \ll 1/h_o$$

$$V_{in} \approx V_s \times \frac{R_{in}}{R_s}$$

$$A_i \approx h_{fe} \approx h_{fc}$$

C-E

$$V_o = |V_{in} \times A_v|$$

$$\approx \left| \frac{V_s h_{fe} R_L}{R_s} \right|$$

C-C

$$R_{in} \approx h_{fe} R_L$$

$$A_v \approx 1$$

$$V_o \approx \frac{V_s h_{fe} R_L}{R_s}$$

$$A_p \approx \left(\frac{V_s h_{fe}}{R_s} \right)^2 \times R_L$$

Fig. 29 Common-collector and common-emitter amplifier characteristics when source impedance is large and load resistance is small

genTA 7.U6 no.35

Transistor electronics.



3 2768 001 61484 5

DUDLEY KNOX LIBRARY