

UNCLASSIFIED

AD 297 099

*Reproduced
by the*

**ARMED SERVICES TECHNICAL INFORMATION AGENCY
ARLINGTON HALL STATION
ARLINGTON 12, VIRGINIA**



UNCLASSIFIED

NOTICE: When government or other drawings, specifications or other data are used for any purpose other than in connection with a definitely related government procurement operation, the U. S. Government thereby incurs no responsibility, nor any obligation whatsoever; and the fact that the Government may have formulated, furnished, or in any way supplied the said drawings, specifications, or other data is not to be regarded by implication or otherwise as in any manner licensing the holder or any other person or corporation, or conveying any rights or permission to manufacture, use or sell any patented invention that may in any way be related thereto.

27000
AFCRL 62-834
60709

0
A-23-0-1

Physics and Astrophysics
No. 21



Research Report

ASTIA
REPRINTED
MAR 2 1968
ASTIA

27000

for Constant Level Flight

L. A. GRASS

PROPERTY OF
RASS
TECHNICAL LIBRARY

Request for additional copies by Agencies of the Department of Defense, their contractors, and other government agencies should be directed to the:

Armed Services Technical Information Agency
Arlington Hall Station
Arlington 12, Virginia

Department of Defense Contractors must be established for ASTIA services, or have their 'need-to-know' certified by the cognizant military agency of their project or contract.

All other persons and organizations should apply to the:

U.S. DEPARTMENT OF COMMERCE
OFFICE OF TECHNICAL SERVICES,
WASHINGTON 25, D. C.

**Instrumentation for Geophysics and Astrophysics
No. 21**



Superpressure Balloon for Constant Level Flight

L. A. GRASS

RESEARCH INSTRUMENTATION LABORATORY PROJECT 6665

AIR FORCE CAMBRIDGE RESEARCH LABORATORIES, OFFICE OF AEROSPACE RESEARCH, UNITED STATES AIR FORCE, L.G. HANSCOM FIELD, MASS.

Abstract

The superpressure balloon is a sealed, virtually non-extensible plastic cell that will float at a constant density altitude despite diurnal fluctuations in the "superheat" of the lifting gas. This type of balloon does not require ballast to maintain altitude. Instead, it depends upon the ability of the plastic cell to retain all of the lifting gas without significant change in volume, at varying pressures that always remain higher than ambient. The superpressure balloon is more efficient, and is considerably smaller than the valved balloon designed for the same altitude, payload and duration. It provides a highly stable platform for long-duration experiments in the stratosphere.

General equations relating superpressure, superheat and free lift are derived and the allowable temperature-fluctuation limits for maintaining altitude are considered. The stringent physical requirements imposed upon suitable materials and some of the special materials-testing procedures for superpressure application are discussed. Design equations are given for the cylindrical, tetrahedral, onion and spherical shapes.

Comparison of the load-carrying efficiencies, maximum safe-pressure, heat absorption and film leakage characteristics of these basic shapes shows clearly that the sphere is the most desirable for superpressure balloons. Consequently, efforts have been concentrated upon improving fabrication processes to realize the full pressure-holding capability. Significant progress has been made by careful attention to every detail in the handling, fabrication, packing and launching procedures. In particular, the over-all strength of the tailored sphere fabricated from Mylar has been considerably increased through the design of pre-formed Mylar end-discs and special "bi-tape" seals. A recently developed technique for

laminating very thin plastic films should make possible greatly improved materials for the superpressure application.

The relationship between stability of a sphere and the elastic modulus of the material is considered. A sample calculation based upon leakage measurements on a model balloon is used to indicate the potential flight duration of larger balloons.

Telemetered records of altitude and superpressure are shown for flights of two 34-ft diameter tailored spheres, carrying 38-lb payloads at 70,000 ft altitude. The first was a nine-day flight, by a balloon made of single-sheet Mylar. The second was a ten-day flight, to test a highly-promising material formed by laminating two extremely thin Mylar films. Both flights were terminated by pre-set timer, and the data indicate that both balloons were capable of maintaining floating altitude for a much longer period.

With present techniques, Mylar superpressure balloons of thicknesses between 0.5 and 2.5 mils can be constructed for a wide variety of payloads and altitudes. Work continues to further improve strength of seals, to decrease the possibility of leaks, and to set standards for quality control. Further investigation of laminated materials is planned.

Acknowledgments

The author is most grateful to Mrs. Catherine Rice, Mr. Thomas Kelly, and Mr. James Dwyer, for technical assistance in preparing this report.

Contents

	Page
Abstract	iii
Acknowledgments	v
List of Illustrations	ix
List of Symbols	xi
1. Introduction	1
2. Theory of Superpressure Flight	2
2.1 General	2
2.2 Superheat	2
2.3 Free Lift	3
2.4 Superpressure and Superheat	4
2.5 Altitude Stability	6
3. Research Program	7
3.1 Balloon Shapes	7
3.1.1 Cylinder	7
3.1.2 Tetrahedron	9

CONTENTS (Cont.)

	Page
3. 1. 3 The Onion	12
3. 1. 4 Sphere	14
3. 2 Comparison of Shapes for Superpressure Applications	16
3. 3 Materials and Inspection	19
3. 3. 1 Mylar	20
3. 3. 2 Inspection	21
3. 4 Leakage	24
3. 5 Chamber Testing	31
3. 6 Flight Tests of Prototype Balloons	33
4. Conclusions and Future Plans	45
Appendix I	47
1. Free Lift, Superpressure, and Superheat	47
Appendix II	51
Appendix III	54
1. Effect of Elastic Modulus on Stability	54
Appendix IV	57
Bibliography	59

Illustrations

Figure		Page
1	Design Curves for Pillow End Cylinder	10
2	Design Curves for Tetrahedron	13
3	Diagram for Gore Width of Sphere	16
4	Design Curves for Tailored Sphere	17
5	Stress vs. Strain for 1-mil Mylar at -70°C	22
6	Effect of Temperature on Strain Rate	23
7	Helium Permeability Constant vs. Temperature for Mylar "A"	26
8	Curves Showing Calculated Values of Ratio of Final to Initial Pressure vs. Time	28
9	Mylar Sphere at Launching	34
10	Mylar Sphere Ascending	35
11	Payload	36
12	Flight Paths	37 & 38
13	Graphs Showing Superpressure and Altitude vs. Time (Balloon A)	39 - 42
14	Graph Showing Superpressure and Altitude vs. Time (Balloon B)	44
15	Diagram for Side Wall Stress on Cylinder	51
16	Diagram for Circumferential Stress on Sphere	52
17	Diagram for Expansion of Sphere	54

Symbols

A	area of balloon surface: cm^2 ; ft^2
B	escape rate of lifting gas: cc/sec
E	modulus of elasticity; psi
F	free-lift: $\%/100$
F'	$\Delta P_1/P_a$
G	gross load: gm; lb
ΔG	free-lift: gm; lb
h	length of basic cylinder; altitude of tetrahedron: cm; ft
K	constant
K_1	constant
K_2	constant
L	payload: gm; lb
M_a	mass of displaced air: gm-mass; lb-mass
M_g	mass of lifting gas: gm-mass; lb-mass
M_H	mass of helium: gm-mass; lb-mass
m_a	molecular wt of air
m_g	molecular wt of lifting gas
m_H	molecular wt of helium
N	number of gores in balloon
Δn	number of moles of escaped gas
n_a	number of moles of displaced air
n_g	number of moles of lifting gas
n_H	number of moles of helium
Δn_1	$= n_g - n_a$
P	pressure differential across area A: dynes/cm^2

SYMBOLS (Cont.)

P_a	ambient pressure: dynes/cm ²
P_g	lifting gas pressure: dynes/cm ²
P_H	helium pressure: dynes/cm ²
ΔP	total superpressure: dynes/cm ² ; mb; cm Hg
ΔP_1	initial superpressure: dynes/cm ² ; mb; cm Hg
P_0	initial gas pressure in permeation test: dyne/cm ²
p_1	final gas pressure in permeation test: dyne/cm ²
Δp	= $p_0 - p_1$: dyne/cm ²
Q	volume of gas lost by permeation: cc at SPT
R	universal gas constant: 8.31×10^7 erg/mole °K
R'	specific gas constant for air: 2.87×10^6 erg/gm °K
r	inner radius: cm; ft
r'	radius of expanded sphere
r_1	design value for radius: cm; ft
Δr	increase in radius due to expansion
r''	outer radius of spherical wall
S	stress within balloon material: psi
S_0	latitude on sphere: radians
t	thickness of balloon material: cm, in; mils
T_a	temperature of air: °K
T_g	temperature of lifting gas: °K
T_H	temperature of helium: °K
ΔT	superheat: °K
V	volume of expanded balloon: cc; ft ³
V'	volume of expanded balloon: cc; ft ³
W	weight of balloon: gm; lb
W_1	weight of accessories: gm; lb
X	"balloon factor": mil ⁻¹ ft ⁻¹
x	floating altitude: cm; ft
x'	altitude of displaced balloon: cm; ft
Y	time rate of gas loss per unit area per unit pressure differential: mol/hr/cm ² per cm Hg
Z	arc subtended by central angle: radians
Z'	expanded arc
α	central angle: radians
δ_T	permeability constant
ϵ	efficiency of balloon vehicle
ρ_a	density of air gm/cc; lb/ft ³
ρ_g	density of lifting gas; gm/cc; lb/ft ³
ρ_M	density of Mylar: gm/cc; lb/ft ³
ω	gore width at latitude S_0
τ	time: hrs; days

Superpressure Balloon for Constant Level Flight

1. INTRODUCTION

Since 1957, the Balloon Research Branch of the Research Instrumentation Laboratory, Air Force Cambridge Research Laboratories, has been conducting a program of study and experimentation with the goal of developing fully-operational superpressure vehicles for a wide variety of applications.

To appreciate fully the advantages to be gained from this type of balloon, it is first necessary to review the basic problem associated with duration of balloon flight. Characteristically, balloon films absorb and emit radiant energy at a faster rate than does the surrounding air mass. Consequently, after sundown, the decrease in the quantity of available radiant energy causes the temperature of the balloon gas to drop with respect to ambient temperature. In the case of the conventional "zero-pressure", or vented balloon, the diurnal cooling of the lifting gas is accompanied by a decrease in balloon volume, which, if stability is to be maintained, necessitates a proportional reduction in the mass of the balloon system. Periodic adjustment of the mass of the system by automatically dispensing ballast during flight becomes necessary. For the same payload, an increased quantity of ballast must be carried for each required day of flight, and the size of the necessary balloon increases accordingly. The alternative to a ballasted-flight system is the superpressure balloon, which does not need ballast, and consequently is smaller than the valved balloon designed for the same altitude, payload and duration.

Its relatively small size has several practical advantages. Problems in fabrication, handling, shipping and the complexity of the launching procedure all increase with balloon size.

In theory, flight duration of a superpressure balloon is limited only by permeation or leakage of the lifting gas through the balloon film. Moreover, as a platform for supporting scientific equipment in the stratosphere, the superpressure balloon offers much greater altitude stability than the valved balloon.

2. THEORY OF SUPERPRESSURE FLIGHT

2.1 General

The superpressure balloon is a sealed, pressurized, non-extensible cell that floats at a level of constant air density. Its ability to maintain constant altitude during periods when the lifting gas may be either gaining or losing heat from the environment is contingent upon its ability to retain a constant mass of lifting gas at a varying pressure, P_g , that is always higher than external, ambient pressure, P_a , without any significant change in volume. The superpressure, ΔP , is defined as the difference between gas pressure and ambient pressure.

When a superpressure balloon, of fully-inflated volume, V , has been designed to carry a gross load, G , (payload plus balloon weight) to the altitude where the air density is ρ_a , the weight of the displaced air at floating altitude is:

$$V\rho_a = G + V\rho_g \quad (1)$$

where ρ_g is the density of the enclosed lifting gas. If the balloon is effectively sealed, the mass of lifting gas does not change, and, despite changes in gas temperature, the balloon remains at the altitude where air density is ρ_a , as long as the volume, V , remains constant. (A ballast-dispensing balloon system is incapable of maintaining constant-density altitude because its gross load decreases each time that ballasting occurs.)

2.2 Superheat

At various times during flight, a floating balloon and its surrounding air mass may be absorbing more heat from the sun and earth than they are radiating, and, at other times, one or both may be losing heat to the environment. Since the rate at which either of these processes occurs is different for the balloon film than for

the surrounding air mass, the lifting-gas temperature varies with respect to ambient temperature. This temperature difference, ΔT , is termed "superheat". The superheat is, first of all, a function of the heat absorption and emission characteristics of the balloon material from which heat is transmitted to the balloon gas. The value of ΔT at any time in a particular flight is dependent, of course, upon the quantity and wavelength distribution of the radiation that is reaching the balloon. In the daytime, the superheat usually rises to some maximum positive value because the balloon absorbs direct solar energy at a faster rate than does the air. During the night, cooling of the lifting gas is offset, to some extent, by absorption through the balloon material of infra-red radiation coming from the earth. The amount of available infra-red energy varies with the balloon material, the terrain over which the balloon is passing, and also the thickness of cloud cover between earth and balloon.

The pressure of the lifting gas, of course, varies with changes in its temperature--its instantaneous value being thus dependent upon floating altitude, time of day, changes in atmospheric conditions and the geographic location of flight.

2.3 Free Lift

A successful flight depends upon the provision of a sufficiently high "initial" superpressure (measured when superheat is zero) to ensure that the superpressure never becomes negative even when the superheat drops below zero. This is accomplished by sealing within the balloon a number of gram-molecules of lifting-gas that is sufficiently greater than the number of gram-molecules of air to be displaced at floating altitude. If the balloon should cool so far below ambient temperature that the gas pressure drops below ambient, thus decreasing the volume of displaced air, the balloon will descend. On the other hand, the "initial" superpressure must not be so high that, at times when the lifting gas temperature rises to its maximum value, the superpressure reaches a value at which the balloon will be stressed beyond its structural capability. The maximum allowable superpressure is a function of both the limiting safe stress possible with a particular skin material and the dimensions and shape of the balloon. The volume of a balloon is chosen according to Eq. (1), so that, at the desired floating altitude, where ambient pressure is P_a , the balloon will displace a weight of air, $V\rho_a$, equal to the sum of the gross load and the weight of the lifting gas. The quantity of lifting gas to be used is that mass which, at the fully-inflated volume, V , and at the same temperature as the air at floating altitude, will have a pressure, P_g , that is higher than ambient pressure at floating altitude by some chosen value, ΔP_1 . As the balloon rises, there is some intermediate level where it first becomes fully inflated. At this level,

ambient pressure is equal to the pressure of the lifting gas, but the displaced air is more dense than at floating level, and the displaced air weighs more than the total weight of the balloon system, $(G + V\rho_g)$, by an amount ΔG . The quantity ΔG is called free-lift, and the more generally used ratio $F\% \equiv \Delta G/G\%$ the percent free-lift.

2.4 Superpressure and Superheat

It is customary to discuss the flight of a superpressure balloon in terms of the variable parameters, superpressure, ΔP , and superheat, ΔT . The value of superpressure measured when gas and air temperatures are equal, ΔP_1 , is directly related to the free lift of the balloon and the ambient pressure at floating altitude. It can be shown that:

$$F \equiv \frac{\Delta G}{G} \simeq \frac{\Delta P_1}{P_a} \quad (2)$$

When helium is the lifting gas,

$$F \simeq \frac{\Delta P_1}{P_a} = \frac{29}{4} \frac{M_H}{V\rho_a} - 1 \quad (3)$$

Eq. (3) determines the mass of helium, M_H , needed to carry a balloon of volume, V , to the altitude where air density is ρ_a , and ambient pressure, P_a , when the balloon is to be provided with initial superpressure, ΔP_1 . The total variable superpressure, ΔP , which produces stress on the balloon material, is related to the superheat, free lift, ambient pressure and ambient air temperature by the following expression:

$$\Delta T \simeq \frac{\Delta P - FP_a}{1 + F} \left(\frac{T_a}{P_a} \right) \quad (4)$$

Eqs. (2), (3), and (4) are derived in Appendix I.

For the balloon to remain at altitude when its temperature is dropping with respect to ambient, it is necessary that $P_g \geq P_a$; in the limiting case, $\Delta P = 0$. Eq. (4) then becomes:

$$\begin{aligned} \Delta T &= - \frac{F}{1+F} T_a \\ \Delta P &= 0 \end{aligned} \quad (5)$$

Because the mass of lifting gas is such that, when its temperature is equal to ambient temperature, its pressure is higher than the pressure of the displaced air by the amount ΔP_1 , it is possible for the temperature of the lifting gas to drop below ambient (negative superheat), while its superpressure remains positive. The maximum value of negative superheat that can occur without the balloon's descending is determined by the initial superpressure, ΔP_1 , or the directly-related free-lift, F , Eq. (2), and is given by Eq. (5).

The maximum positive value of superheat must be considered in obtaining a design figure for the maximum allowable superpressure the balloon will experience during diurnal hours. Insofar as possible, the solar and terrestrial radiation to be expected at the time and location of flight are taken into account; but, at the time of writing, there are still so few data available that this type of forecast can be no more than a very rough estimate, and the design value for maximum positive superheat must be based largely upon flight experience. Flight records indicate, for example, that for a Mylar balloon at 70,000 ft. altitude, the superheat has not exceeded $+25^\circ\text{C}$.

Solving Eq. (4) for the superpressure ΔP gives:

$$\Delta P = FP_a + (1 + F) \frac{P_a \Delta T}{T_a} \quad (6)$$

The quantity ΔP is total superpressure; the first term is equal to initial superpressure due to free-lift, ΔP_1 , Eq. (2), and the second term gives the variable increase or decrease in superpressure caused by the variable superheat ΔT . If one assumes the same free lift and approximately the same maximum superheat at different levels in the atmosphere, it is evident from Eq. (6) that the order of magnitude of ΔP is determined by the value of ambient pressure, P_a , at the desired level. Thus, a balloon to float at the lower altitudes, where P_a is high, must withstand much higher superpressures than a balloon destined to float at high altitudes, where P_a is low.

When a balloon is designed, the usual procedure is to obtain an estimated value of maximum allowable superpressure from estimated maximum superheat using Eq. (6), at the desired altitude; and, then, from the appropriate design equations, to choose the dimensions and material thickness so that the stress will not exceed the safe value that has been determined in cold-chamber measurements for the particular material. The design equations for the four basic configurations are given, and discussed in paragraph 3.1 of this report. These are, of course, general equations, applicable to any material when its physical characteristics are known.

2.5 Altitude Stability

In the expression for balloon equilibrium, Eq. (1), it is postulated that the volume V should remain constant while the superpressure varies during flight. Actually, the plastic films used as barrier materials are elastic, even at very low temperatures, and the balloon volume increases slightly when increased superpressure increases the stress upon the film. The balloon then rises to an altitude of lower air density, and equilibrium is reestablished. The value of stress produced by a given value of superpressure differs with the shape of the balloon, according to equations given in paragraph 3.1 of this report. The altitude change produced by any value of stress, S , can be predicted from the modulus of elasticity, E , of the balloon material.

It is shown in Appendix III, that, if the balloon is a sphere of volume V , when fully inflated and $\Delta P = 0$, the new volume, V' , when it is subjected to the stress, S , is given by:

$$\frac{V'}{V} = (1 + 3S/E) . \quad (7)$$

The total mass of air displaced by the volume V' is the same as that displaced by the volume V , since the weight to be supported does not change. The balloon rises from the height, x , where the atmospheric pressure is P , to the height x' , where the atmospheric pressure is P' .

In the stratosphere, where the temperature is assumed to remain essentially constant with height, the "gas law" applied to the constant mass of the displaced air at the two altitudes gives:

$$V'/V = P/P' .$$

In Appendix IV the well-known barometric equation for change in altitude with atmospheric pressure is given as:

$$x' - x = \frac{R' T_a}{g} \ln P/P' \quad (8)$$

where T_a is the isothermal temperature in $^{\circ}K$

$$g = 981 \text{ cm/sec}^2$$

$$R' = 2.87 \times 10^6 \text{ erg/gm } ^{\circ}K .$$

Therefore,

$$x' - x = \frac{R' T_a}{g} \ln V'/V$$

and from Eq. (7)

$$x' - x = \frac{R' T_a}{g} \ln (1 + 3S/E) . \quad (9)$$

It may be of interest to compute the maximum change in altitude predicted by Eq. (9) for a Mylar sphere in the stratosphere, in the extreme case, when the superpressure varies from zero to the maximum allowable value, so that the stress reaches the maximum safe stress for which the balloon was designed. In this case,

where $S = 10,000$ psi

$E = 800,000$ psi

$T_a = 216.7$ °K .

Inserting these values in Eq. (9) gives:

$$x' - x = \frac{2.87 \times 10^6 \times 217}{981} \times \frac{1 \times \ln 1.038 \text{ feet}}{30.48}$$

where the factor $1/30.48$ converts centimeters to feet,

$$x' - x = 765 \text{ feet.}$$

3. RESEARCH PROGRAM

3.1 Balloon Shapes

3.1.1 CYLINDER

A cylindrical balloon is fabricated from flat sheets of film approximately 54 inches wide, joined by straight seams that are parallel to the height of the cylinder, and usually completed by single, straight seals across each end and an aluminum clamp at each corner. One corner clamp of the "pillow ends" is used to attach the payload*. Its chief advantages are the ease of fabrication due to its straight seams, and a very rapid rate of ascent that is particularly useful in certain types of meteorological experiment.

In Appendix II, it is demonstrated that the circumferential stress, S , on the balloon fabric forming the wall of the cylinder is given by:

$$S = \Delta P r/t \quad (10)$$

*Information regarding the early engineering study and results of cold chambers tests can be found in the Feasibility Study by R. J. Slater, under Contract AF19(604)-2286. For information regarding latest design of the cylinder balloon reference should be made to the Final Report, Superpressure Balloon Study, dated 4 May, 1960, (Report No. AFCRL TR 60-273), and to reports issued under Contract AF19(604)-4985. These reports are listed in the Bibliography.

where ΔP is the superpressure

r the radius of the cylinder

t the thickness of the plastic.

The volume depends upon the type of end design. From volume measurements on model balloons, a shape constant, K , has been defined so that the volume, V , can be calculated from the equation:

$$V = r^2 \pi h - Kr^3 \quad (11)$$

where h is the length of the cylinder. For a pillow end, $K = 4.5$; when the ends are gathered into a fitting (banded ends), $K = 5.68$.

The weight of the cylinder, W , is given by

$$W = 2\pi rht \rho_m \quad (12)$$

where ρ_m is the density of the plastic.

The dimensions of the balloon are related to the specified payload, L , by the equation of equilibrium: viz, the weight of the displaced air at the altitude, x , is equal to the sum of the weight of the payload, the weight of the balloon vehicle and accessories, and the weight of the lifting gas.

$$\rho_a V = L + 2\pi rht \rho_m + W_1 + \rho_g V \quad (13)$$

where ρ_a is density of air at altitude x

ρ_g is density of the lifting gas

W_1 is the weight of balloon accessories.

Substituting in Eq. (13) the expression for V in Eq. (11), above, and solving for h gives:

$$h = \frac{L + W_1 + Kr^3 (\rho_a - \rho_g)}{\pi r^2 (\rho_a - \rho_g) - 2\pi rt \rho_m} \quad (14)$$

The dimensions of the cylinder are determined by a trial and error procedure. First, a value of fabric thickness, t , is chosen arbitrarily. A value for radius, r_1 , is then calculated from Eq. (10), using S , the maximum safe stress for the balloon material that has been determined from experiments on model balloons, and for ΔP , the maximum superpressure estimated from expected flight conditions. It has been found better not to split the standard gore width, because the cut edge is apt to pucker upon being sealed. Therefore, the number of full gore widths to best approximate the circumference $2\pi r_1$ is used, and a corrected radius, r , is

obtained for the cylinder formed from that number of full gore widths. This corrected value for r is substituted in Eq. (10) to find a new value for ΔP , and if this value for ΔP is reasonable, r and ΔP are chosen as design parameters and used in Eq. (14) to obtain the height, h . The weight of accessories, fittings, etc., is usually about 10% of the balloon weight for pillow ends, and 15% for banded ends.

It should be noted that design procedure for the cylinder differs from that for the other shapes in that the value for thickness of the plastic may be chosen independently. The radius is then adjusted to satisfy the pressure-holding requirement, and the cylinder height chosen to provide the volume needed to take a given payload to the desired height.

By substituting the expression $\frac{St}{\Delta P}$ for r in Eq. (14), an equation is obtained for gore length, h , and film thickness, t , in terms of payload and altitude. A family of design curves can thus be plotted; for example, payload vs. altitude, with gore length as parameter, for any specified film thickness. A typical set of curves for a pillow end cylinder is shown in Figure 1. Such curves are useful for rapid, graphical determination of approximate design parameters.

It is clear that for each gore length and cylinder diameter there is a maximum payload for a definite altitude. Ratios of cylinder height to diameter of values less than 4 are not used because when so designed, the inflated balloon does not assume the true cylindrical shape. Unfortunately, a cylinder designed to meet even moderate payload altitude requirements has such a long length that it is difficult to launch.

3.1.2 TETRAHEDRON

A tetrahedron is formed from a basic cylinder of length, h , and circumference equal to $2.31 h$. One end is sealed to form a pillow end. On the opposite end, the points that correspond to the center of the sealed pillow end are used as the corners of the second pillow end, so that the end seams are skew lines running in perpendicular directions. The length, h , of the basic cylinder becomes the altitude of each triangular face of the fully-inflated tetrahedron. The payload is attached to one corner, and the opposite triangular face forms the top of the balloon in flight. The corners are sealed with aluminum clamps similar to those used presently in pillow-end cylinders. A larger clamp fastens the payload.

A tetrahedral configuration is easier to launch than a cylinder designed for the same payload. The tetrahedron has been used as an interim vehicle for obtaining data to evaluate flight characteristics of the superpressure balloon. The inherent disadvantages of this shape are the problems involved in packaging this vehicle in a manner to avoid wrinkles, folds, and sharp corners that damage the film.

As might be expected, the true tetrahedral shape is not maintained under pressure. Test data show that the triangular faces are bi-axially stressed at their

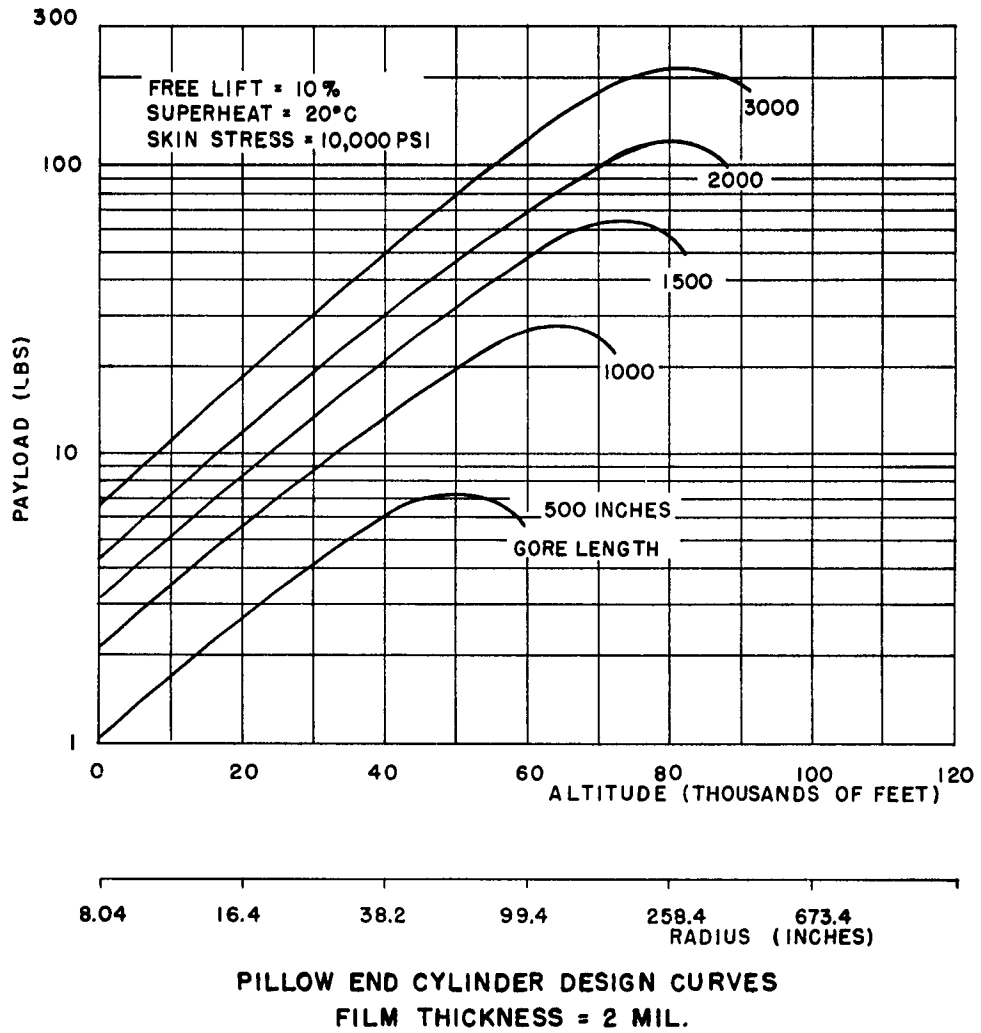

Figure 1. Design Curves for Pillow End Cylinder

center points, and these are the locations of maximum stress. An empirical equation relating superpressure and stress to balloon dimensions is used for design purposes:

$$S = \Delta P h/4t \quad (15)$$

where S = maximum allowable stress on material

P = maximum allowable superpressure

h = length of basic cylinder

t = thickness of skin material

It should be recognized that there is a wide variation in stress value over the surface of this configuration. Eq. (15), above, does not indicate this distribution, but because it permits computation of dimensions of the tetrahedron to satisfy the maximum stress requirement it is a useful design criterion. An expression for the volume of the inflated tetrahedron has been determined from measurements of lift made on model balloons within the cold chamber:

$$V = 0.26 h^3 . \quad (16)$$

The surface area is that of the basic cylinder:

$$\text{Area} = 2.31 h^2 . \quad (17)$$

The equilibrium equation for the balloon is

$$V\rho_a = L + W_1 + 2.31 h^2 t\rho_m + V\rho_g . \quad (18)$$

Substitution of the expressions for volume and surface area, Eqs. (16) and (17), and addition of 10% of the balloon weight for accessories (W_1), gives,

$$0.26 h^3 \rho_a = 0.26 h^3 \rho_g + L + 2.54 h^2 t\rho_m \quad (19)$$

$$h^3 = \frac{L}{0.26 (\rho_a - \rho_g) - \frac{2.54\rho_m}{4S} \Delta P}$$

In designing a tetrahedron, a value for gore length, h, is calculated from Eq. (19), above, substituting for $(\rho_a - \rho_g)$ the densities at the required altitude, x, and using the known maximum safe stress value, S, and estimated superpressure, ΔP . Film thickness is then calculated from Eq. (15). The nearest standard thickness in which the film is supplied--higher than t, so that the corresponding value of S

is not increased--is chosen, and with the same value of S as before, a new value for ΔP is obtained. With this set of values for t, ΔP and S, a corrected value for gore length, h, is obtained from Eq. (19). The necessary number of gores is used to make the circumference of the basic cylinder equal to 2.31 h.

When values of payload, L, are plotted vs. h^3 , with altitude as parameter, Eq. (19) a family of straight lines is obtained. A set of such curves is shown in Figure 2. When points of equal thickness values are connected, the dashed lines result. These curves, like those for the cylinder, are useful for quick estimates.

3.1.3 THE ONION

Like the cylinder and the tetrahedron, the onion is made of rectangular gores to form a cylinder of material. The onion-shape results when the ratio of diameter to length of the basic cylinder is 0.764. The ends are gathered into a gas tight fitting. The stress on the material is chiefly uni-axial, from pole to pole, so that the onion-shape can make use of material which has more strength in machine than in transverse direction, and seals that have poor strength in the transverse direction. This inherent characteristic results from the fact that sufficient material is provided at the equator to alleviate the circumferential stress. Onion-shaped cells appeared promising in room-temperature tests, but, in the cold chamber, they gave evidence of uneven stress-distribution around the equator with consequent highly-stressed areas that caused them all to fail at very low superpressures. The failures in cold-chamber tests, together with the fact that the onion is the least efficient of the four basic shapes, led to the decision to concentrate efforts on the more desirable vehicles, particularly on development of the tailored sphere.

To allow comparison of the onion balloon with the other basic shapes, the basic design equations are as follows:

$$S = \Delta P r / 2t$$

or, since $2r/h = 0.764$

ΔP = superpressure

t = thickness

h = gore length

$$S = 0.191 \Delta P h / t . \quad (20)$$

The volume and weight are, respectively,

$$V = (0.534 h)^3 \quad (21)$$

$$W = 0.764 \pi h^2 t \rho_m . \quad (22)$$

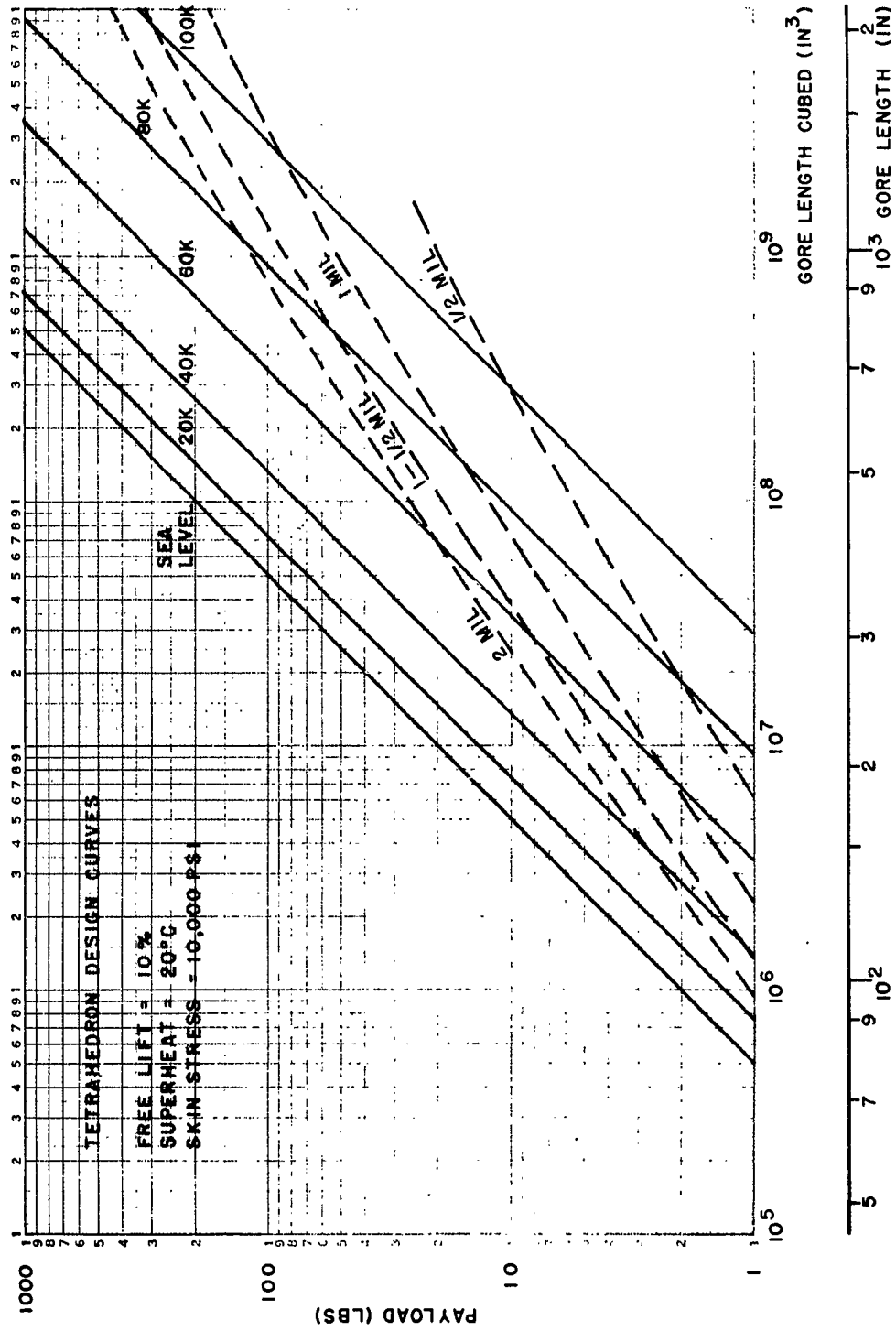

Figure 2. Design Curves for Tetrahedron

The equation of equilibrium, relating volume, V , to payload, L , and density at altitude, ρ_a , solved for gore length, h , is:

$$h = \frac{L^{1/3}}{\left[0.1522 (\rho_a - \rho_g) - \frac{0.764}{4S} \rho_m \Delta P \right]^{1/3}} \quad (23)$$

3.1.4 SPHERE

The sphere is, without doubt, the most desirable of the four basic shapes considered for superpressure applications. It will be evident in paragraph 2 of the Research Program section in this report, that this configuration is inherently capable of retaining the highest values of internal pressure for a given maximum safe stress on the material. It has, in addition, the highest efficiency. When the payload is heavy enough to require a long cylinder, or an unwieldy tetrahedron, the equivalent sphere is easier and safer to launch.

The stresses on the spherical balloon are bi-axial, so that the skin material must be equally strong in machine and transverse directions. The seals must also have this property, and a great deal of effort has been directed toward improving the quality of the seals, especially at the very cold temperatures, in order that the full strength of the material can be utilized.

The tailored sphere is shaped from gores cut from flat sheets of plastic. The sphericity is a function of the number of gores used, and also the accuracy to which the gores can be cut and assembled. Appreciable deviation from the true spherical configuration results in stress concentrations which may cause the maximum safe stress to be exceeded at some location on the distorted sphere.

In Appendix II, it is demonstrated that the stress on the skin material of a spherical balloon is given by:

$$S = (P_g - P_a)r/2t$$

$$S = \frac{\Delta P r}{2t} \quad (24)$$

where S = stress

r = radius

t = thickness of plastic.

The surface area of the balloon, A , is:

$$A = 4\pi r^2 \quad (25)$$

The weight is given by:

$$At\rho_m = 4\pi r^2 t\rho_m$$

An allowance of 10% of the plastic weight is added for seals and accessories, so that the total weight of the uninflated balloon is:

$$W = 1.1 (4\pi r^2 \rho_m) . \quad (26)$$

From actual measurements on inflated balloons, the volume of a sphere with Mylar end caps is given by:

$$V = 1.005 (4/3 \pi r^3) . \quad (27)$$

The equation of equilibrium for the sphere at the desired altitude, where the air density is ρ_a is:

$$V\rho_a = L + V\rho_g + 1.1 (4\pi r^2 \rho_m t)$$

$$1.005 \left(\frac{4}{3} \pi r^3 \right) \rho_a = L + 1.005 \left(\frac{4}{3} \pi r^3 \right) \rho_g + 1.1 \left[2\pi \rho_m r^2 (2t) \right]$$

Substituting for $2t$ the expression $\frac{\Delta P r}{S}$, from Eq. (24), and solving for r gives:

$$r = \frac{L^{1/3}}{\left[1.34\pi (\rho_a - \rho_g) - \frac{2.2\pi \Delta P}{S} \rho_m \right]^{1/3}} \quad (28)$$

This equation gives an approximate value for the radius of the sphere. As in the design of the tetrahedron, the value of S known from cold-chamber tests to be safe for the skin material is used, together with an estimated maximum super-pressure ΔP , to calculate r_1 from Eq. (28). Then Eq. (24) is used to find the corresponding value of t . The nearest, higher, value of standard thickness in which the film is manufactured is chosen; and, with the same value of S , the resulting ΔP is determined. If the value of ΔP is feasible, the new value of r is calculated. The gore length is then πr . The number of gores depends upon the available width of the material, and the desired sphericity. The gore pattern is cut by specifying the required width of the gore, ω , at specified distances, S_0 , above the horizontal center axis. The arc S_0 is divided into 5° intervals, measured in radians. From the diagram in Figure 3, taking N the number of gores to be used:

$$N\omega = 2\pi r'$$

$$r' = r \cos \Theta$$

$$N\omega = 2\pi (r \cos \Theta)$$

$$\text{since } S_0 = r \Theta$$

$$\omega = \frac{2\pi r}{N} \cos \frac{S_0}{r}$$

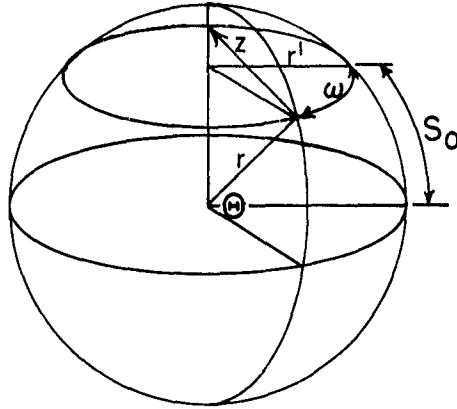

Figure 3. Diagram for Gore Width of Sphere

Measurements of the sphericity of model spheres constructed from this design equation showed that the fully-inflated balloons were flattened at the poles. A 1-meter diameter sphere, for example, had the pole-to-pole diameter shortened by 4 cm. By increasing each value of the parameter S_0 by 0.5%, the polar curvature is improved; on the 1-meter sphere, the polar diameter is corrected to within 1 cm. The corrected gore-pattern equation is given by:

$$S_0 = 1.005r \Theta$$

$$\omega = (2\pi r/N) \cos (S_0/1.005r) . \quad (29)$$

Figure 4 shows two families of curves obtained by plotting values of L vs r^3 calculated from Eq. (28). One set has altitude as parameter, the other set material thickness as parameter. Such curves, like their counterparts for the other balloon shapes, are useful for determining preliminary design values.

3.2 Comparison of Shapes for Superpressure Application

The merits of the four simple balloon configurations can be compared in several ways:

It has been shown that, for the same film, that is, the same value of maximum safe stress on the fabric, the corresponding maximum allowable superpressure differs for the various shapes. The higher the value of this parameter, the more

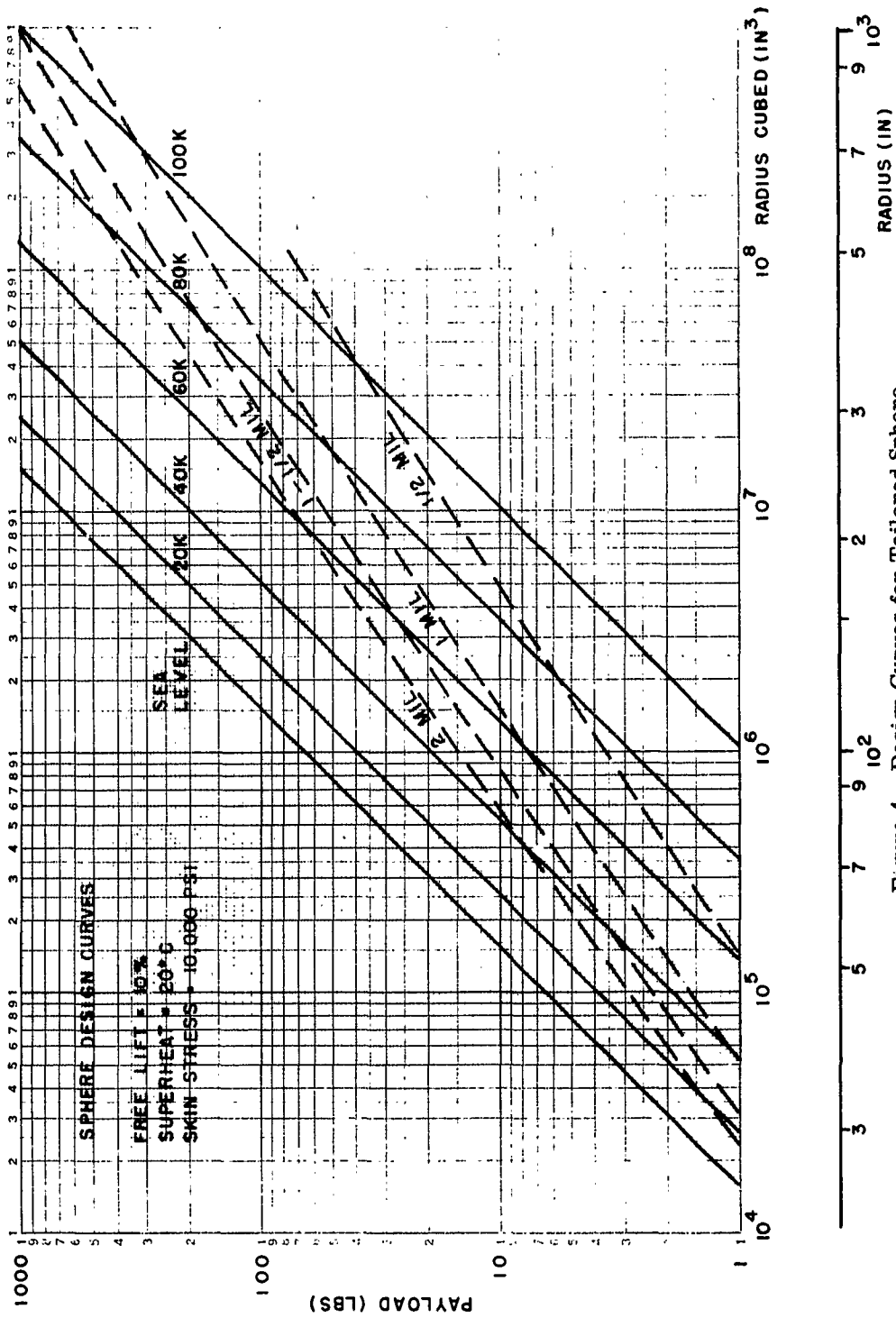

Figure 4. Design Curves for Tailored Sphere

reliable the balloon during environmental changes in flight, because the temperature of the lifting gas with respect to ambient temperature, and hence, the superpressure, can safely fluctuate over a wider range.

The efficiency, ϵ , is the ratio of the payload, L , to the lifting force, $V\rho_a$. Let W equal the weight of the balloon, including the weight of lifting gas and accessories. Then

$$V\rho_a = L + W$$

and

$$\epsilon = L/V\rho_a = \frac{(V\rho_a - W)}{V\rho_a}$$

$$\epsilon = 1 - \frac{W}{V} \times \frac{1}{\rho_a}$$

Hence the efficiency depends upon the ratio of balloon weight to volume; and at high altitudes, where the factor $(1/\rho_a)$ is high, it is particularly important to have as small a ratio of W to V as possible.

The ratio of surface area to volume is of special interest because helium is transparent to the radiation present in the stratosphere and the amount of energy absorbed (or radiated) by the balloon is an increasing function of the surface area of the plastic skin. This energy is transferred as heat to the lifting gas. Since the mass of gas to which the heat is transferred is proportional to the volume of the balloon, the change in temperature--which is proportional to the heat energy divided by the mass of gas--is measured by the ratio of surface area to volume. The extent to which the superpressure rises or falls about the initial superpressure during flight is thus dependent upon this parameter.

The ratio of surface area to volume is also of particular significance in planning long-duration flights, since the leakage due to permeation of gas through the plastic film depends upon this ratio.

Tables I and II compare the four designs using the above parameters as criteria. It is clear that the sphere is by far the most desirable shape for superpressure balloons. However, it should be noted that, although this shape makes the most economical use of the fabric, it does require more labor to fabricate. Thus, applications when high efficiency may not be important--if the payload is light, the flight duration short, and perhaps many small balloons are to be launched--the tetrahedron or cylinder might well be adequate. An experiment which demands a very fast rate of rise would make use of that characteristic of the long, narrow cylinder. When, however, the task requires maximum reliability, or if a large,

Table I

Shape	Volume	Thickness	Max. All. Stress	Max. Super-pressure	Vol/Wt
Sphere	1000 ft ³	200-gauge	10,000 psi	37 mb	143 ft ³ /lb
Tetrahedron	"	"	"	30	117
Onion	"	"	"	32	77
Cylinder	"	"	"	30	91

Table II

Comparison of balloon dimensions required to carry a 10-lb load to 40,000 feet, assuming 30 mb of superpressure (maximum)

Shape	Volume	Weight	Skin Thickness	Wt/Vol
Sphere	1000 ft ³	6 lb	1.7 mil	0.006 lb/ft ³
Tetrahedron	1500	13	2.4	0.0087
Onion	2500	31	2.5	0.0124
Cylinder	1560	13.5	2.0*	0.0087

*Cylinder thickness chosen arbitrarily

efficient balloon is needed, or success depends upon a long-duration flight, the high efficiency and high allowable-superpressure advantages of the sphere make it the logical choice. The fact that it is less awkward to handle, and hence less liable to accident during inflation and deployment, indicates its use when a balloon is to be launched from the air, or by any automatic device.

3.3 Materials and Inspection

The fact that the balloon must maintain a positive, varying superpressure without leakage, and without significant change in volume at the very low temperatures in the stratosphere, imposes stringent requirements upon the physical properties of the skin material. A suitable material must be available in very thin, large-area sheets, with low fault count, and be relatively resistant to deterioration caused by atmospheric constituents or solar radiation. Very high tensile strength, and low permeability to lifting gases are obvious prerequisites. To prevent changes in superpressure beyond the safe limits for the balloon, the skin material should be as nearly transparent as possible to all the radiation in the broad solar spectrum

that reaches the stratosphere during the diurnal hours. In order that the increase in volume be very small when the superpressure does increase, a relatively high modulus of elasticity is required. Stretching is to be avoided not only because it results in balloon instability, but also because any perceptible elongation of the very thin plastic film may open up tiny imperfections, causing holes, even though the stress may be within the theoretical elastic limit for the material. The stress-strain curve should be very nearly linear over a wide range of stress values so that the stress produced by the maximum allowable superpressure is well below that value at which the material starts to yield. It must be possible to seal the material so that the strength of seal is at least equal to material strength in shear, in both transverse and longitudinal directions. It is also desirable that the seals possess reasonably high strength in peel. Most difficult to meet is the requirement that all of these physical properties be retained over the very wide range of atmospheric temperatures from ground level to the stratosphere--taken for test standards from 30° to -60°C.

The physical parameters usually furnished by a manufacturer can be useful as a basis for immediate rejection of a material for superpressure balloons, but, otherwise they are wholly inadequate for forecasting the probable suitability of a material for this application. A necessary and very important phase of this program has been to devise appropriate materials-testing and inspection procedures. Many materials have been evaluated, but only a very few have been found to be appropriate for superpressure balloons.

3.3.1 MYLAR

To date, the plastic film, Mylar, polyethylene terephthalate, manufactured by E. I. Dupont & Co., has been the material principally used for superpressure balloons. It is tough, durable, and reasonably resilient, even at -70°C. Mylar is not directly heat-sealable; the necessary heat causes it to become brittle and to lose 50% of its strength. Instead, pretreated tape, with adhesive, is heat-sealed to the butt-type, Mylar joint. The greatest possible care in handling, and meticulous control of every detail in the fabrication process are necessary to retain the theoretical strength and low leakage of this plastic. This is quite generally true of balloon manufacture.

Three distinct types of Mylar film are manufactured:

Type A, a film with low fault count; definitely translucent in gauges 500 and above; and slightly hazy in 50-gauge and below.

Type C, primarily for use as a dielectric.

Type D, a highly transparent film with a minimum of surface defects.

Although Type D film would appear preferable to Type A for superpressure use, it was found, in fact, that the smoother surface of the Type D Mylar made it

difficult to seal. The Type A film is presently being used in thicknesses from 0.5 mil to 2.0 mil for superpressure balloons. Mylar in thicknesses greater than 2.5 mil has an increased stiffness characteristic that makes it difficult to seal, and more susceptible to fracture at low temperatures. It is recommended that it not be used for superpressure balloon fabrication utilizing sealing and manufacturing techniques presently known.

Stress vs strain curves for 1-mil Mylar at -70°C are shown in Figure 5. The effect of strain rate and of temperature on the stress-strain relationship is shown in Figure 6. These data were taken during a study of balloon-barrier materials under Contract AF19(604)-3876 with General Mills, Inc. Strain measurements were made by photographing bench marks on the elongating specimen with a motion-picture camera. It is evident that the strain produced by a given stress decreases with decreasing temperature, and also with increased strain rate. The influence of temperature is much greater than the effect of varying strain rate in the range studied.

Some effects of moisture, oxygen and heat on Mylar are discussed in an article, "Degradation Studies of Polyethylene Terephthalate", by William McMahon, J. Chem. Eng Data, 4, 1:57-79 (1959). High temperature and high humidity were found to be the most effective degradation agents. At 30° to 40°C , with 20% humidity, the exposure time to reduce the tensile strength of 0.5-mil Mylar to $1/3$ the normal value was estimated to be in excess of ten years.

In a study made by General Mills, Inc., samples of 0.5 mil Mylar were exposed to a constant-energy light source containing ultra-violet. The light dosage (watt-hrs/cm²) required to produce the same degree of degradation at different ambient temperatures was measured. Since this type of plastic is apt to be susceptible to degradation by oxygen alone, particularly at high temperatures, the data were taken both in air and in an atmosphere of nitrogen. The data showed that high temperature, in this case, also, greatly accelerates the degradation process, and it is expected that in the extremely dry, low-density and low-temperature environment of the stratosphere, the degradation caused by exposure to ultra-violet radiation will be much less, even, than at ordinary temperatures. There are, as yet, too few data available upon which to base an accurate estimate of safe exposure time of Mylar to the environment of the stratosphere. It appears reasonable to assume, however, that degradation of Mylar need not be considered for flights less than thirty days.

3.3.2 INSPECTION

Mylar sheets may have small holes caused by resin particles that do not flow with the film when it is oriented. There may also be an occasional scratch or tear. Areas of slight thickness build-up are sources of serious trouble in a super pressure

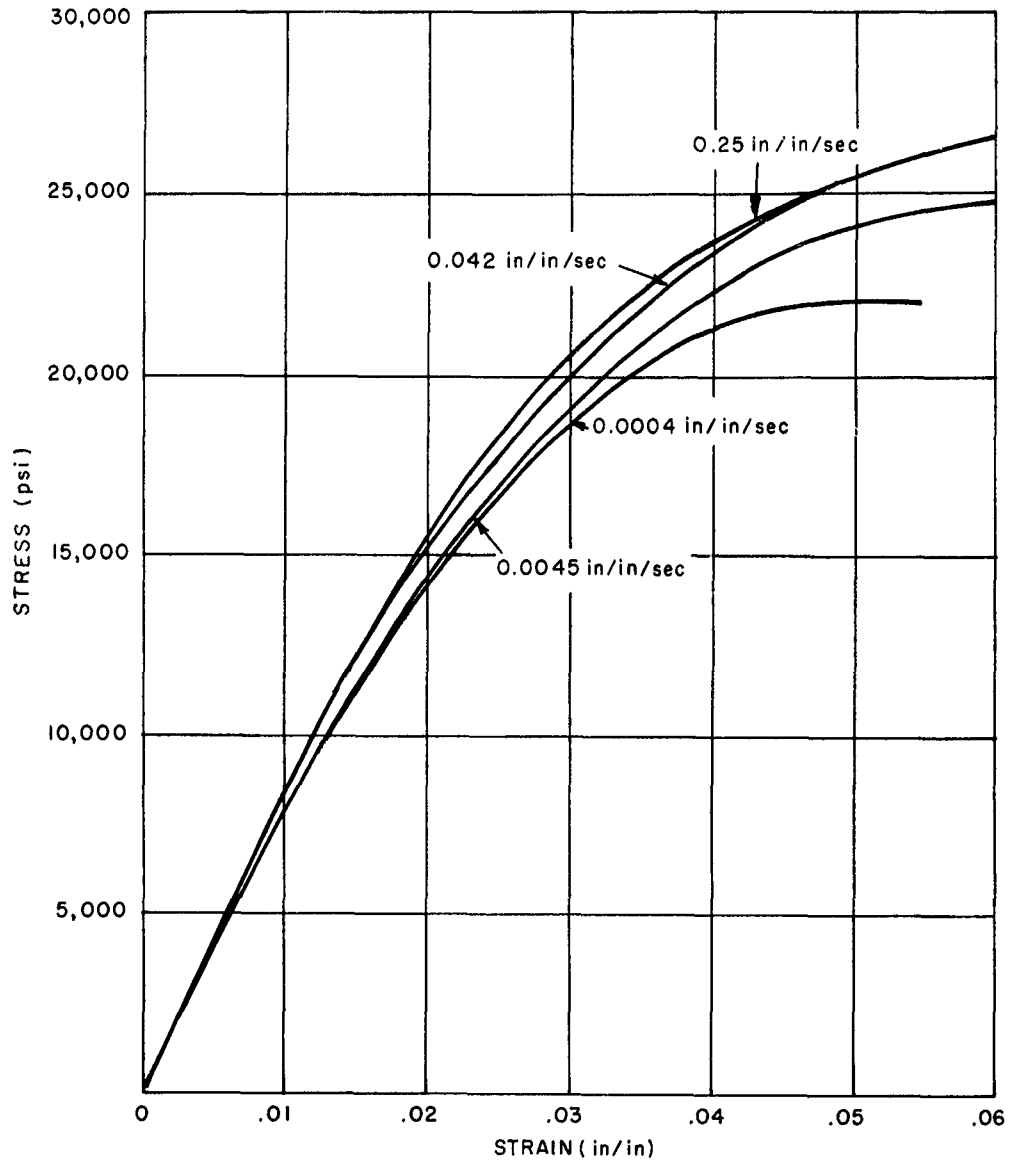

Figure 5. Stress vs. Strain for 1-mil Mylar at -70°C

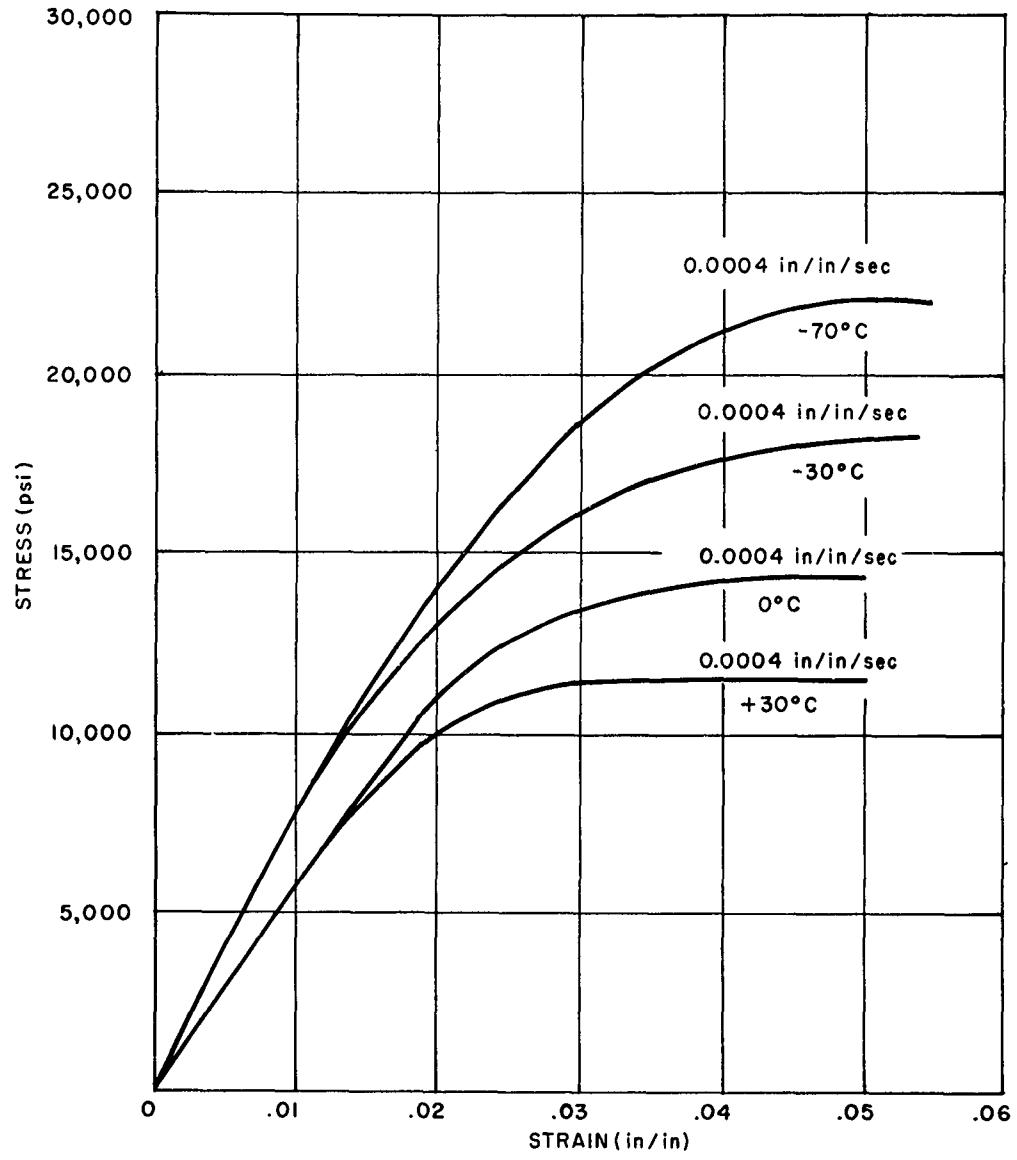

Figure 6. Effect of Temperature on Strain Rate

balloon because they result in shape distortion, with unequal distribution of stresses in the pressurized balloon. Various methods for detecting such flaws are fully described in the final report of the "Mylar Balloon Fabrication Study", Contract AF19(604)-7254, G. T. Schjeldahl Co. This work was performed primarily for large, zero-pressure balloons, but it is equally applicable to the superpressure balloon program. One procedure is to pass the film over a light source and inspect it by refracted light. Another method is to pass the film between crossed polarizing sheets. Small holes then appear black, and other defects are clearly visible. To date, visual inspection by a careful worker is preferable to mechanical inspection, because folds in the thin, transparent material are not detected by the automatic method. Since Mylar is essentially black to radiation below 3000^oA, inspection by ultra-violet light has been considered. When the film is kept in intimate contact with a glass surface coated with a special fluorescent paint* holes 0.01 inch in diameter are clearly visible, but with even slight separation, the fluorescent light becomes diffuse, and the method is unreliable.

Unfortunately, very thin Mylar film is particularly susceptible to damage from abrasion, and a balloon that has passed a stringent inspection may develop a few tiny holes or cracks during preparation for launching, even when handled as carefully as possible. A material formed by laminating two very thin sheets of Mylar appears to have much lower fault count and increased resilience, with less tendency to develop tiny flaws after the inspection process. At the time of this writing, a 34-ft diameter superpressure balloon fabricated from a laminated Mylar has just been terminated by command after a flight of 19 days. This balloon maintained a constant altitude of 68,400 feet both day and night with no significant loss in the lifting gas.

3.4 Leakage

The flight of a well-designed superpressure balloon will be terminated, eventually, by loss of superpressure due both to slow permeation of the lifting gas through the barrier material, and to leakage through tiny holes. The permeation rate of helium through Mylar for the thicknesses being used for balloons has been measured as part of the Balloon Barrier Materials Study carried out by General Mills under Contract AF19(604)-3876. Measurements of the volume of helium escaping across the film area, A, per unit time, were made with a mass spectrometer, at the differential pressures 1.5, 3.0, 5.0 and 7.5 cm Hg, for the temperatures 0, -25, -50 and -75^oC. Mylar thicknesses were 0.5, 1 and 2 mils.

*Lemon-Yellow Paint "Lawter's Bold" Manufactured by Lawter Chemicals.

Let the measured rate at which helium escaped across the area, A , be called B cc/sec (SPT). The values of B at a given temperature were found, as expected from theory, to be proportional to P , the pressure differential across the area A , and inversely proportional to the film thickness t ;

$$B \propto \frac{AP}{t}$$

It is therefore possible to define a constant of proportionality, δ_T , for each temperature, that measures the permeation rate across unit area, for unit thickness, and unit pressure differential.

$$B = \frac{\delta_T AP}{t}$$

$$\text{or } \delta_T = \frac{Bt}{AP} \frac{\text{cc}}{\text{sec}} \times \frac{1}{\text{cm}} \frac{1}{(\text{cm Hg.})}$$

With B in moles/sec and P in dynes/cm², δ_T values will be expressed in moles-cm/dyne-sec suitable for use in the gas equation. Values of δ_T vs. the absolute temperature, T_H , follow the equation:

$$\ln \delta_T = \frac{-K_1}{T} + K_2$$

where K_1 and K_2 are constants. Measurements taken by General Mills are shown in Figure 7. Similar measurements at temperatures above 0°C, by Brubaker and Kammermeyer in an independent investigation, are plotted in the same diagram.

To express the gas lost from permeation in a balloon of volume V , in terms of the ratio of final to initial gas pressure inside the balloon, let the volume of gas lost, in cc at standard pressure and temperature (SPT), in the time $d\tau$ be Q :

$$Q = Bd\tau \text{ cc}$$

and let Δn represent the number of moles of gas equivalent to $Qd\tau$.

$$p_0 = \text{the initial gas pressure}$$

$$p_1 = \text{the final gas pressure}$$

$$\Delta p = p_0 - p_1 \quad .$$

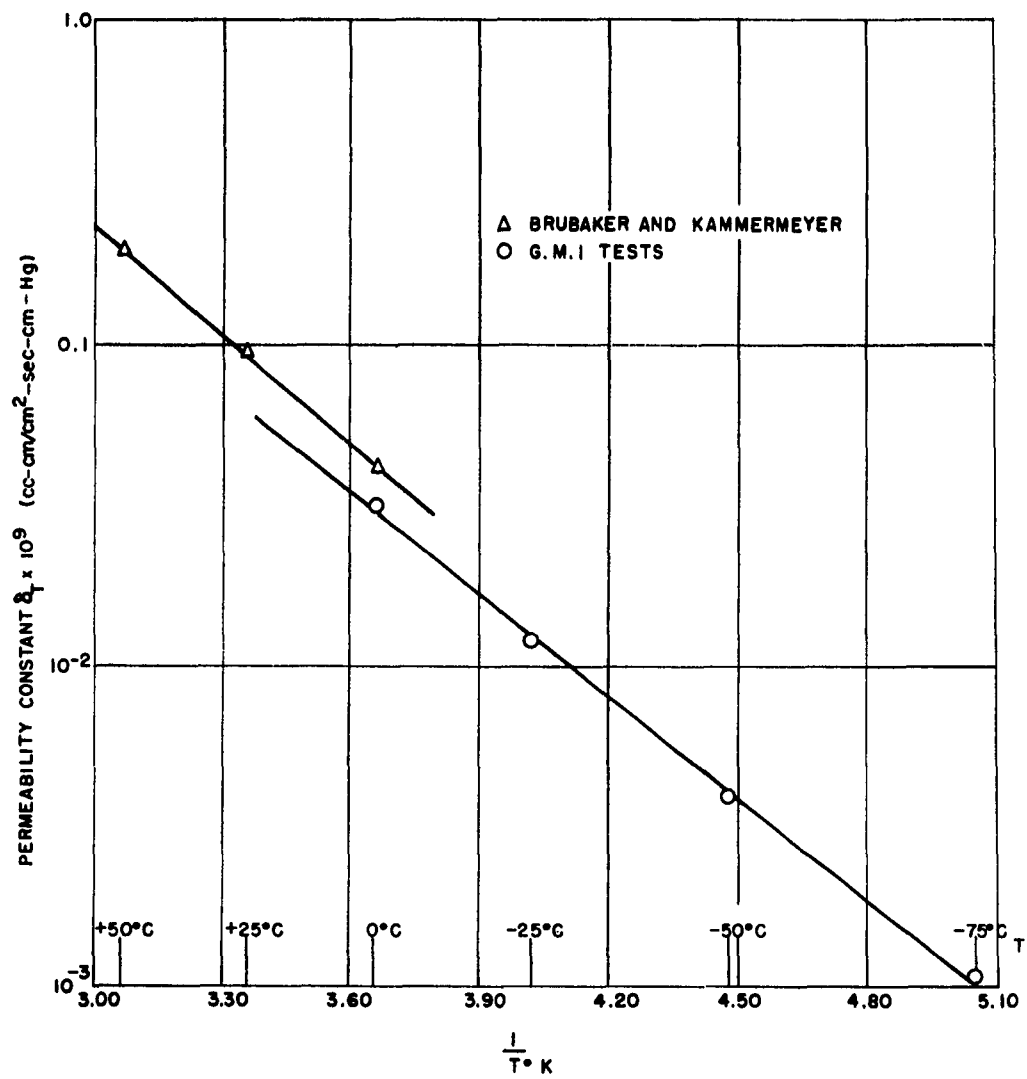

Figure 7. Helium Permeability Constant vs. Temperature for Mylar "A"

From the "gas law", the loss in pressure inside the balloon is given by:

$$\Delta pV = \Delta n RT_g$$

$$\Delta n = \frac{\Delta pV}{RT_g}$$

Since $Q = \delta_T \frac{A}{t} Pd\tau = \Delta n$ moles.

$$\frac{\Delta pV}{RT_g} = \delta_T \frac{A}{t} Pd\tau$$

$$\frac{\Delta p}{P} = \delta_T R \frac{A}{tV} T_g d\tau \quad \frac{\Delta p}{P} \rightarrow \frac{dP}{P}$$

Integrating between limits p_1 and p_0 gives:

$$\ln \frac{p_1}{p_0} = -\delta_T R \frac{A}{tV} T_g \tau \quad (30)$$

It is convenient to measure the balloon volume in cubic feet, the area in square feet, the thickness in mils, the temperature in degrees Kelvin, the time in hours, the pressure in cm mercury, and δ_T in cc/sec per cm per cm Hg.

Eq. (30) then becomes

$$\ln \frac{p_1}{p_0} = -13 \times 10^3 T_g \delta_T \frac{A\tau}{tV} \quad (31)$$

The quantity $X = A/tV$ is a characteristic of the particular balloon considered. For convenience X is called, here, the "balloon factor". Figure 8 shows a set of curves for p_1/p_0 vs. time, for several values of the product $T_g \delta_T X$.

For example, consider a sphere of area 767 ft², volume 2000 ft³, and thickness 2 mils. If the proposed skin material has a measured permeability constant, $\delta_T = 1 \times 10^{-9}$ cc/sec per cm per cm Hg, then the parameter $X \delta_T T_g$, taking $T_g = 216^\circ\text{K}$, is:

$$\frac{A \delta_T T_g}{tV} = \frac{767 \times 216^\circ}{2000 \times 2} \times 1 \times 10^{-9} \simeq 4 \times 10^{-8}$$

If a flight of 23 days is expected, then the curve in Figure 8 corresponding to $X \delta_T T_g = 4 \times 10^{-8}$ shows that, in that time, the balloon will lose 25% of its initial pressure from permeation ($p_1/p_0 = 0.75$).

The time scale in Figure 8 is too short to include Mylar, but it is conceivable that new materials with other highly desirable characteristics would have permeability constants within this range. The time scale can be expanded by any factor, for example, 10^n , simply by dividing the parameter $T_g \delta_T X$ by the same factor.

It must be emphasized that Eq. (31) expresses gas loss due only to permeation of the lifting gas through the balloon material. This is a very important consideration when choosing a suitable material, but in some materials, permeation may account for only a small part of the total leakage in a large balloon. True leakage may occur through spaces large in diameter compared to molecular dimensions, both in the skin material, and around fittings and seals. The amount of leakage depends on the tendency of the material to develop tiny, true holes, during handling processes, and on the quality of seals that can be achieved with that material.

Measurements of the total leakage in model balloons have been made as a first step toward setting standards for quality control. A sample calculation from measurements on a typical model tetrahedron made of Mylar is given below:

Gore length	4.5 ft	
Area	46.9 ft ²	435 x 10 ² cm ²
Volume	23.7 ft ³	671 x 10 ³ cc
T _g		295°K
Time		264 hours
Gauge pressure P ₀		10.5 cm Hg
Gauge pressure P ₁		5.8 cm Hg
R		8.31 x 10 ⁷ erg/mole °K

To find Δn , the number of moles corresponding to a pressure loss of 10.5 - 5.8 = 4.7 cm mercury:

$$(P_0 - P_1) V = \Delta n R T_g$$

$$\Delta n = \frac{(4.7 \times 13.6 \times 980) \times 671 \times 10^3}{8.31 \times 10^7 \times 295} = 1.71 \text{ moles}$$

If it is assumed that the quantity of gas lost, Δn moles, is proportional to the area of the balloon, the time, and the average gauge pressure, then the rate, Y , may be expressed by

$$Y = \frac{\Delta n}{\frac{P_0 + P_1}{2} \times \tau \times A} \quad \text{moles/hours/cm}^2/\text{cm Hg} \quad (32)$$

where $\frac{P_0 + P_1}{2}$ is the average gauge pressure, τ , the time in hours, and A, the balloon area in cm^2 . Then

$$Y = \frac{2 \times 1.71}{16.3 \times 264 \times 43,500} = 1.83 \times 10^{-8} \text{ moles/hr} - \text{cm}^2 - \text{cm Hg} .$$

If it is further assumed that this leakage rate is applicable to a large balloon, then the time for a stated pressure loss to occur in a large tetrahedron, for example, would be calculated in the following way:

V	$283 \times 10^6 \text{ cc}$
A	$252 \times 10^4 \text{ cm}^2$
T_g	233°K
Stated pressure loss	0.37 cm Hg
Gauge pressure P_0	1.12 cm Hg
Gauge pressure P_1 ($1.12 - 0.37$)	$= 0.75 \text{ cm Hg}$

The stated pressure loss, 0.37 cm Hg , is equivalent to Δn moles, where

$$(P_0 - P_1) V = \Delta n R T_g$$

$$\Delta n = \frac{(0.37 \times 13.6 \times 980) \times 283 \times 10^6}{8.31 \times 10^7 \times 233} = 72 \text{ moles.}$$

Using the rate measured for the model balloon,

$$Y = 1.83 \times 10^{-8} \text{ moles/hr} - \text{cm}^2 - \text{cm Hg}$$

and substituting in Eq. (32) gives:

$$\tau = \frac{2 \Delta n}{(P_0 + P_1) Y A} \times \frac{1}{24} \text{ days}$$

$$= \frac{2 \times 72}{1.87 \times 1.83 \times 10^{-8} \times 252 \times 10^4 \times 24} = 70 \text{ days.}$$

It is recognized, of course, that the value of leakage rate, Y, measured for the typical model balloon under the conditions shown, would not in any case be the rate to be expected for a large, helium-filled balloon in the environment of the upper atmosphere. Moreover, since the measured escape rate of helium through

Mylar is so very low, the total leakage rate measured for the model balloon must have been largely due to slow leaks in the film, or possibly in the seals or fittings. Although the possibility of such tiny leaks does increase with the area of the balloon, especially with Mylar, the assumption that the total quantity of escaped gas is proportional to the area of the balloon is of questionable validity. However, when the estimated leakage time for a large balloon, calculated from Eq. (31), using a rate measured on its model, is sufficiently high, it is reasonable to assume that the materials and methods used in fabricating the model are acceptable.

It is evident from Figure 7 that the measured escape rate of helium through Mylar is considerably less at -50°C than at room temperature. Moreover, the quality of seals at the present time is sufficiently high to warrant the assumption that satisfactory leakage tests at room temperature will impose requirements that are at least equal to, and are probably more stringent than those that would be set at low temperatures. Unfortunately, room temperature tests will not uncover the occasional flaw in the material that shows up only under the combination of high stress and low temperature, when the Mylar is less pliable. Such imperfections can only be eliminated at the source through extreme care in the manufacturing.

3.5 Chamber Testing

Design of a successful superpressure balloon requires detailed information concerning the behavior of the barrier material and adhesives when subjected simultaneously to high stresses and the very low temperatures of the stratosphere. Such measurements are obtained in cold chambers that simulate the environment of the stratosphere. It must be emphasized that each material, and, to a lesser extent, each thickness of the same material, poses special problems in type of adhesive and exact technique of sealing to be employed. After an apparently satisfactory sealing process has been devised for a promising material, model balloons are built and they, too, are subjected to cold chamber tests.* Stress distribution over the surface of a configuration is found from strain-gauge data; inadequate seals and film leaks that develop only under pressure and low temperature are detected directly; and weak areas and over-all strength of the balloon are determined from burst tests. Finally, relatively large balloons are fabricated and tested in actual flight.

*Contracts for materials-testing, fabrication of model balloons and cold-chamber testing have been awarded to Schjeldahl Co., and General Mills, Inc. Contract numbers, and pertinent reports are listed in the Bibliography. All of the contracted work has been directed, and performed under close cognizance of technical personnel of the Research Instrumentation Laboratory of the Air Force Cambridge Research Laboratories.

As explained earlier, superpressure cylinders were tested and flown primarily to obtain basic information concerning adequacy of sealing techniques and materials, and, except for very special applications, large balloons in the other configurations are generally more desirable. Cold chamber tests of the latest design of model tetrahedrons indicate that the full yield strength of the material can now be utilized, i. e., the over-all strength of the balloon is approximately equal to the strength of the material itself. These results have been applied in fabricating full-scale balloons for flight test. The largest of the tetrahedrons successfully flown was made from Type A Mylar, of thickness 2 mils, and had a gore length of 50.5 feet.

In the early tests on model spheres made of Mylar, failures, particularly in the polar areas, occurred at superpressures much lower than the values predicted. Nylon polar caps were investigated both as a means of relieving the stresses in the polar areas, and also as a system for suspending the payload. Cold-chamber tests indicated a significant increase in the pressure-holding capabilities of model spheres made with Nylon caps, but subsequent flight tests of the prototype spheres revealed excessive absorption of solar energy. Consequently, another solution to the end seal problem was sought. However, the advantage of using a Nylon, cap-shaped load-suspension system was clearly demonstrated.

End seals for spheres are now being made from flat Mylar discs that are preformed to the radius of curvature of the balloon. The disc material should be at least 1-1/2 times as thick as the balloon skin. The preformed disc is much smaller than the equivalent Nylon polar cap. The spherical shape is substantially retained, and about 80% of the basic material is utilized.

Burst tests indicated that the gores on the sphere should be terminated before meeting at the poles, at a latitude where the separation between gore seals is at least one-half inch, without metal or tape reinforcements in that area. Fabrication of the sphere is completed by addition of the Mylar end discs. The discs are sealed to the cut edge of the terminated gores with the disc perimeter on the inside of the balloon, using a 2-3 inch overlap. Extreme care must be taken during this operation to avoid heat shrinkage of the plastic.

Cold-chamber tests showed that this end design substantially increased the pressure-holding capability of the tailored sphere. Failures at higher superpressure were now occurring near the equator, and were caused by delamination along the edges of the gore seals. In an effort to minimize delamination, the Mylar "mono-tape", sealed over the butt joint, was replaced by "bi-tape", i. e., one Mylar tape above, and one underneath the butt joint, sealed simultaneously. By using a relatively wide tape, of suitable thickness, with a thin layer of adhesive, on the convex surface of the balloon, and a narrow tape, with a thick layer of adhesive on the concave balloon surface, a seal has been achieved that has maximum strength along its center, and at the same time, has the ability to stretch with the

AFCRL-62-824
August 1962

ERRATA SHEET
SUPERPRESSURE BALLOON FOR CONSTANT LEVEL FLIGHT

1. Page 15, change Eq. (26) to read:

$$W = 1.1 (4\pi r^2 t \rho_m)$$

2. Page 27, change Eq. (31) to read:

$$\ln \frac{p_1}{p_0} = - 13 \times 10^3 T_g \delta_T \frac{A\tau}{tV}$$

3. Page 50, change Eq. (I-4) to read:

$$1 + F' = \frac{29}{4} \frac{M_H}{V\rho_a} \approx 1 + F$$

4. Page 57, third line from bottom, change "R/M" to "R/m_a."

skin material, rather than peel, along its thinner, outer edges. In addition to providing a more reliable bond, bi-tape seals give double insurance against gas leakage.

Cold-chamber tests of balloons fabricated with the new end discs, and sealed with bi-tapes, have resulted in extremely high bursting stresses. During recent tests at -70°F , stresses above 16,000 psi were achieved consistently, with no significant delamination of seals. It should be emphasized, that the optimum thickness of each tape, and the material used, are contingent upon the special requirements, size and design of each balloon.

3.6 Flight Tests of Prototype Balloons

Flight tests of two 34-ft. Mylar spheres illustrate the capability of the super-pressure vehicle at the time of writing. The balloons had the following characteristics:

	Balloon "A"	Balloon "B"
Material	1.5 mil Mylar	1.5 mil laminated Mylar
Balloon Weight	41.7 lb	48.5 lb
Payload	38.2 lb	39.1 lb
Parachute	1.32 lb	1.21 lb
System gross weight	81.21 lb	88.8 lb
Free-lift	6.5 lb	8.88 lb
Gross inflation	87.7 lb	97.7 lb

A partially inflated balloon and its instrument package are shown in Figures 9, 10, and 11. Flight paths are shown in Figure 12. The telemetered values of super-pressure and altitude vs. time are plotted in Figures 13 and 14.

Balloon "A" was made from single-film Mylar. Flight was terminated by a pre-set timing mechanism, nine days after launching. Diurnal maximum and minimum superpressure values and the corresponding balloon altitude are listed in Table III.

Table III
Maximum and Minimum Superpressure, Balloon "A"

Date	Min. SP	Altitude	Max. SP	Altitude
1961				
17 April	-	-	6.7 mb	70.6×10^3 ft
18	0 mb	69.2×10^3 ft	7.3	70.1
19	1.4	69.7	6.5	70.2
20	2.4	69.7	5.7	69.7
21	-	-	3.5	69.6
22	negative	45	3.4	68.8
23	1.0	69.7	6.2	69.9
24	2.5	69.7	6.0	69.9
25	0.8	69.9	6.0	70.1
26	2.0	69.9	-	-

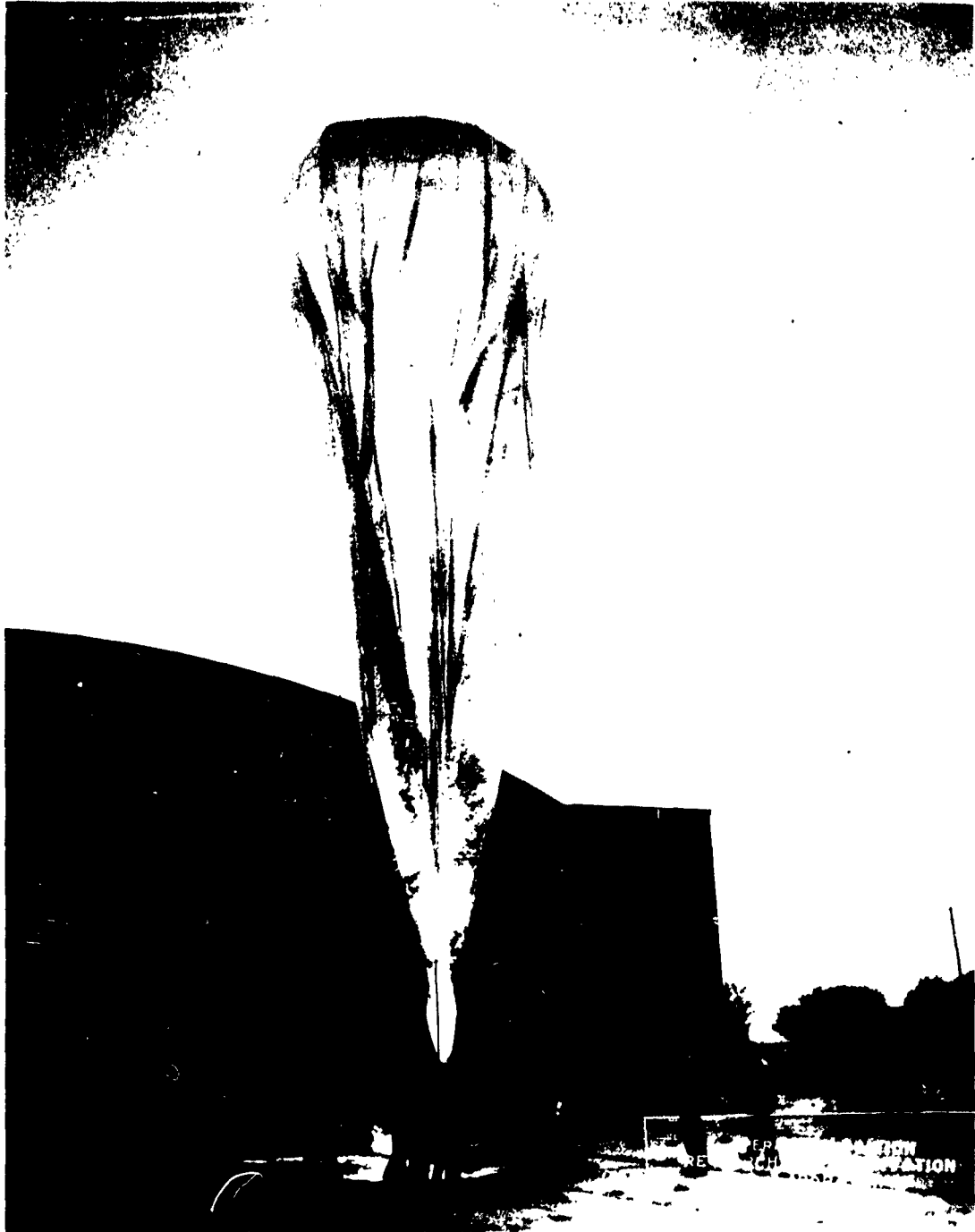

Figure 9. Mylar Sphere at Launching



Figure 10. Mylar Sphere Ascending

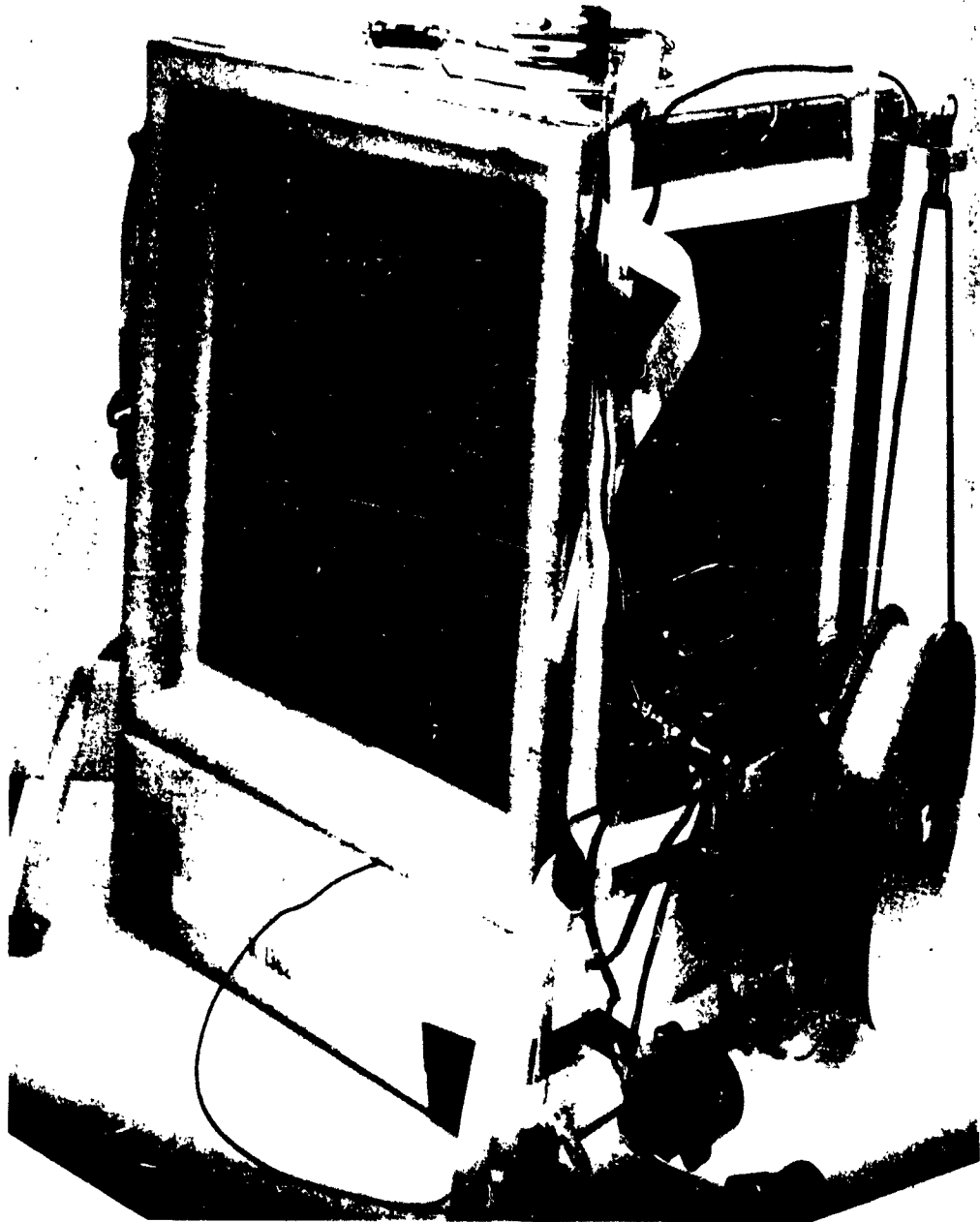

Figure 11. Payload

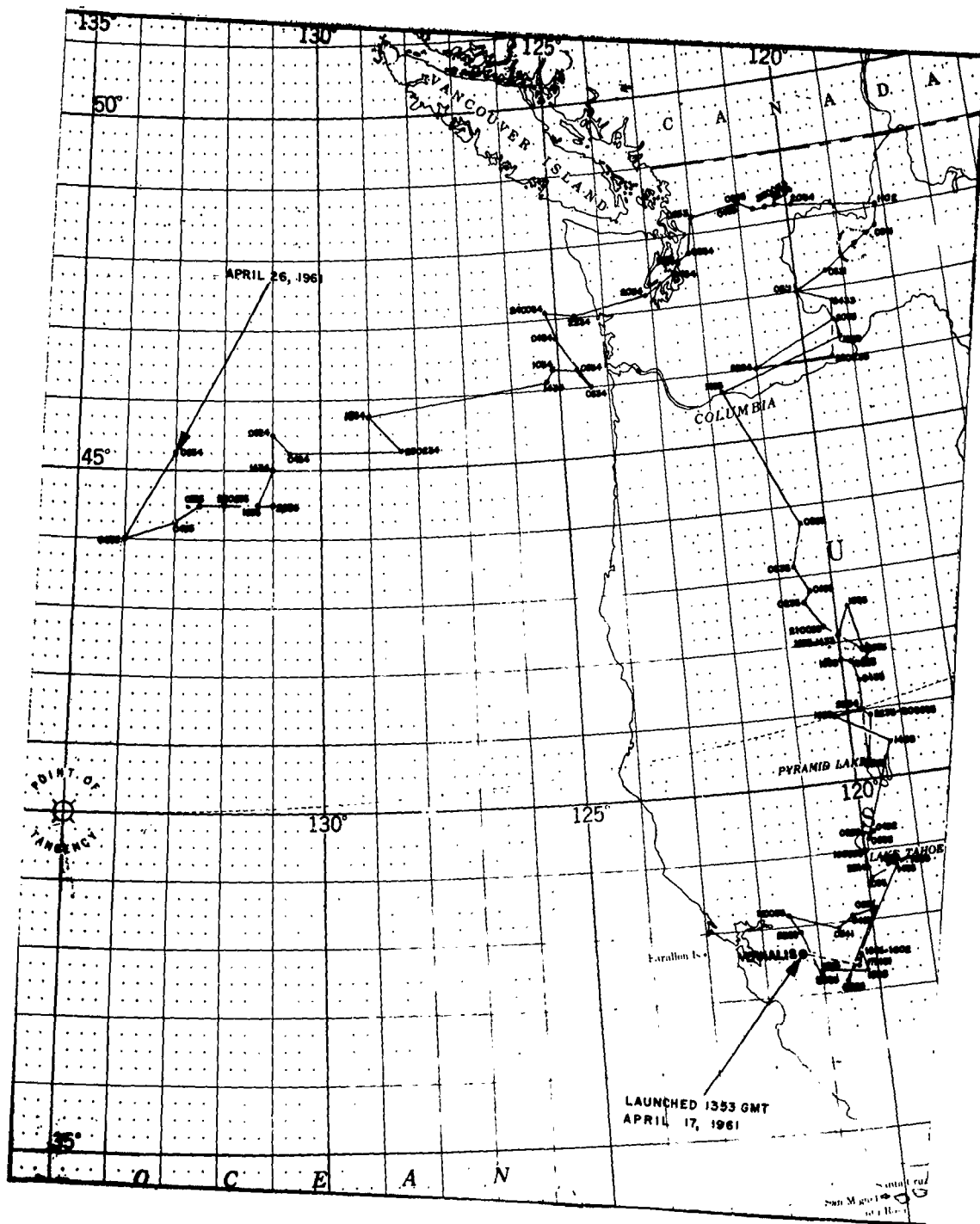

Figure 12a. Flight Paths

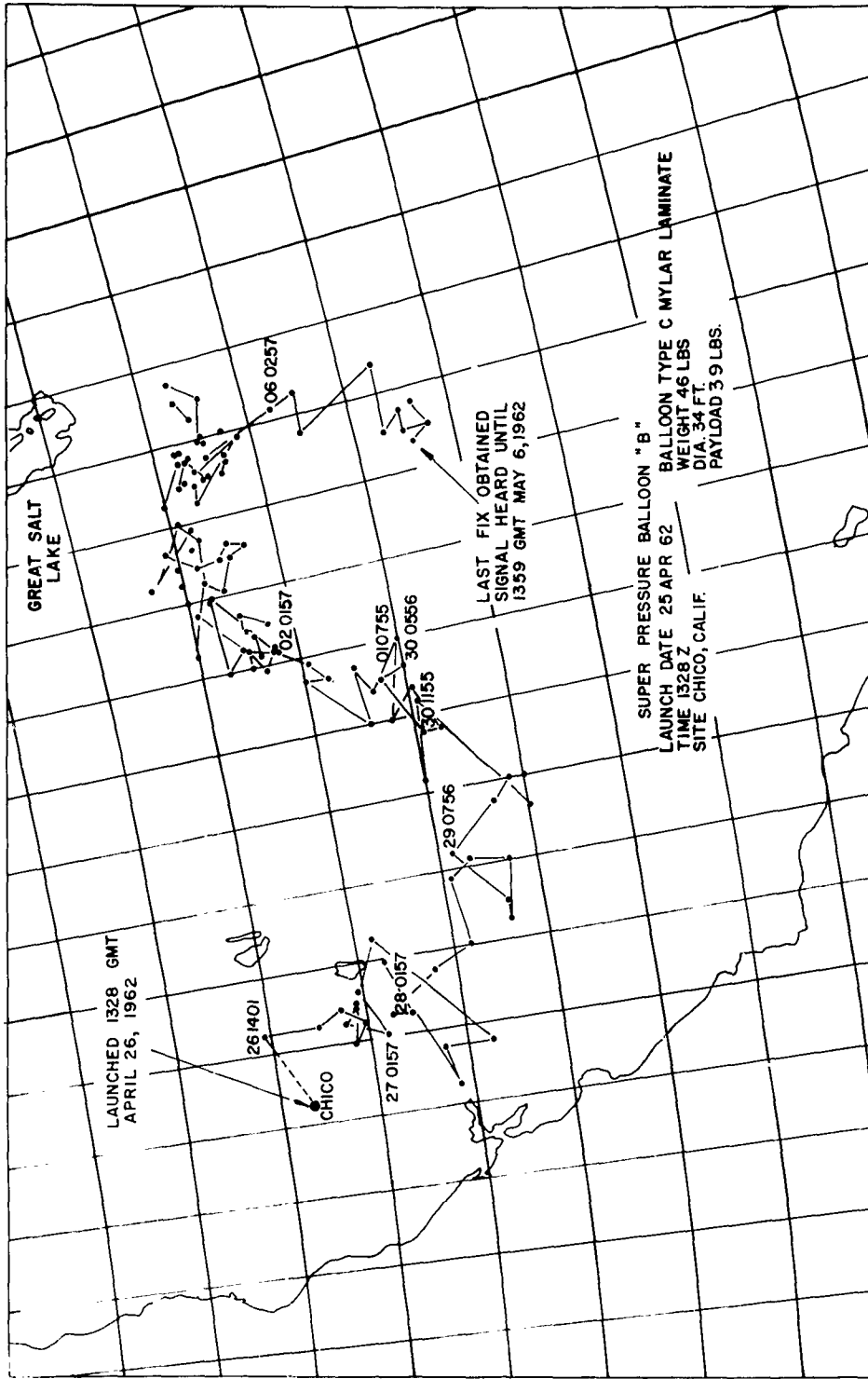

Figure 12b. Flight Paths

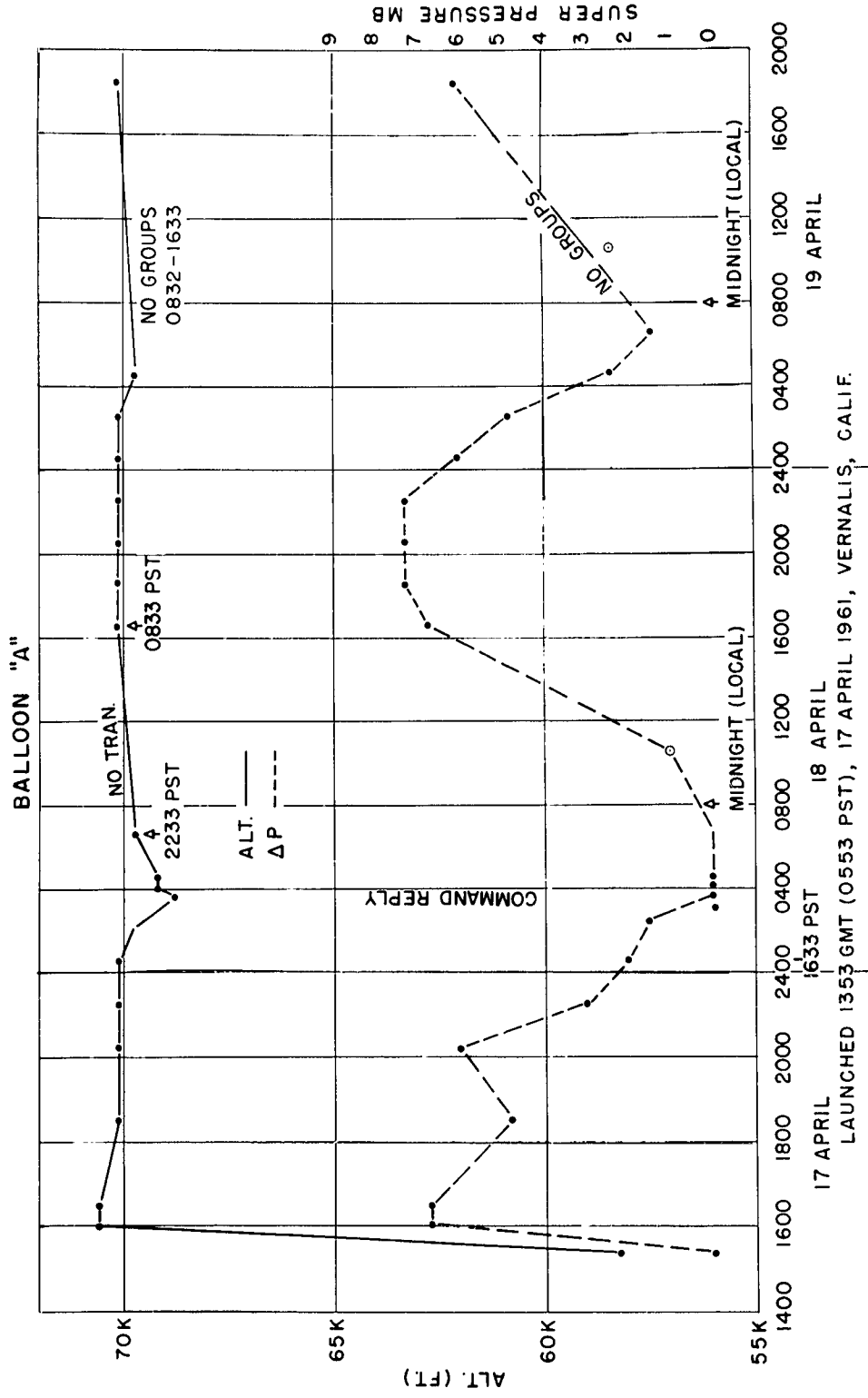

Figure 13a. Graph Showing Superpressure and Altitude vs. Time

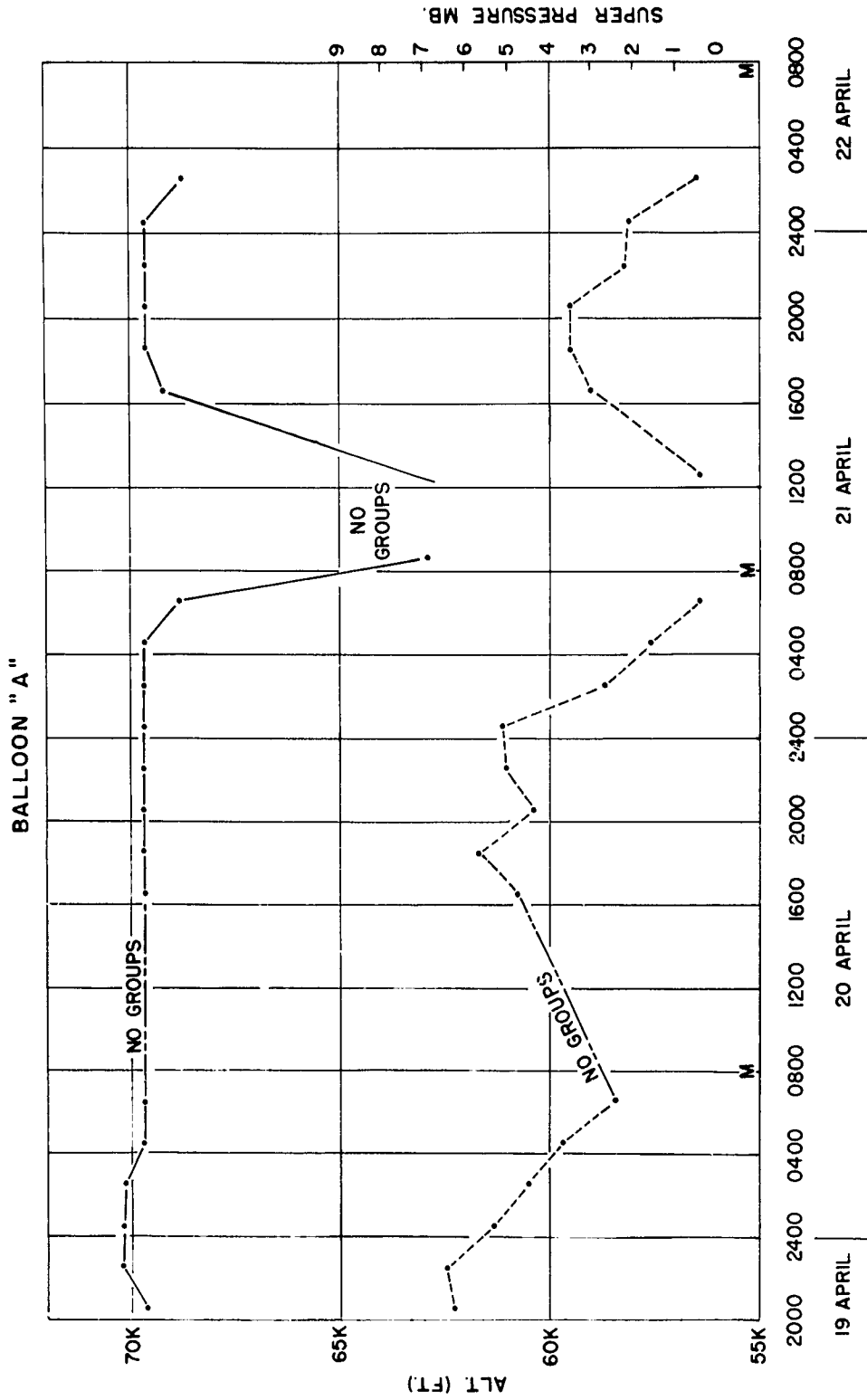

Figure 13b. Graph Showing Superpressure and Altitude vs. Time

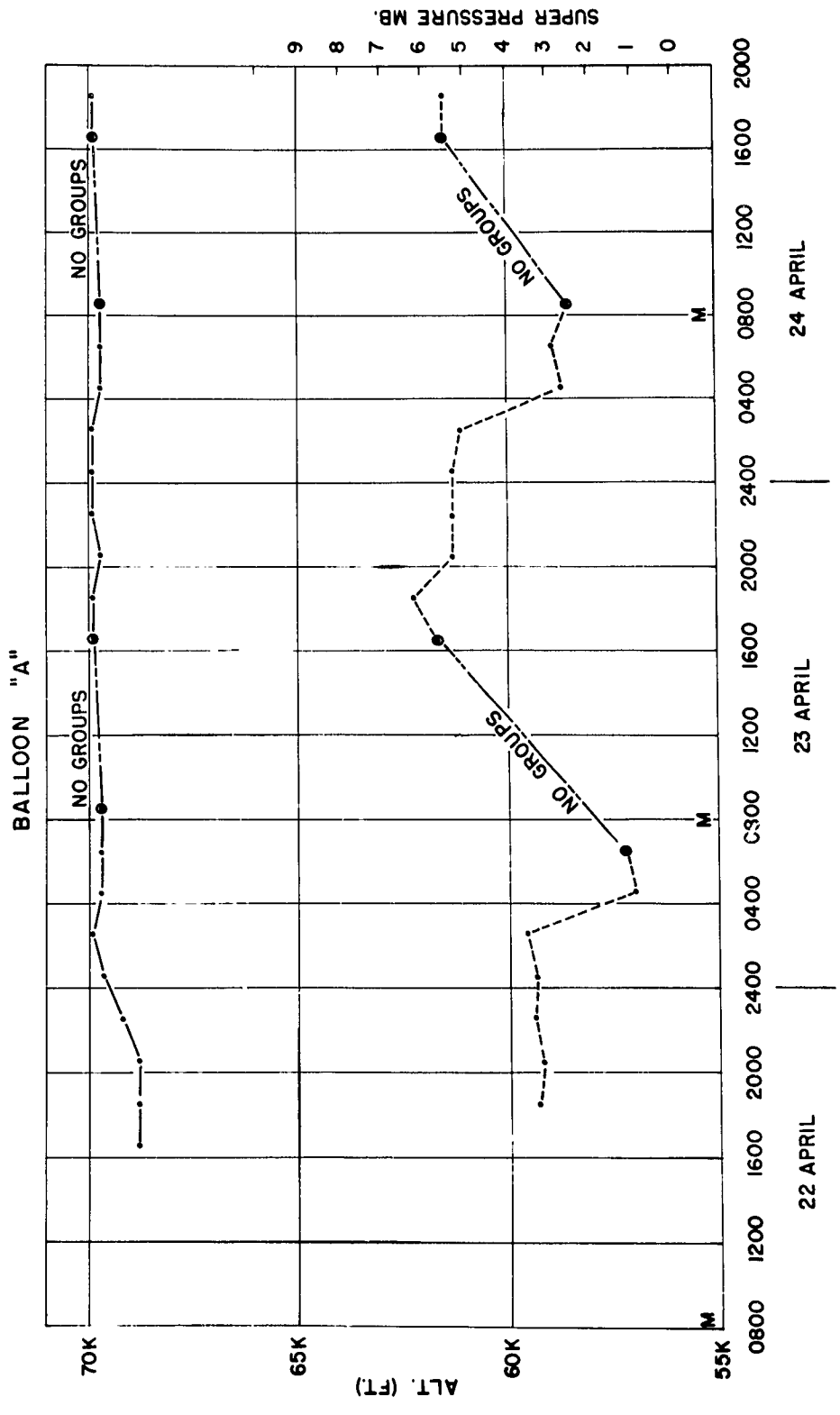

Figure 13c. Graph Showing Superpressure and Altitude vs. Time

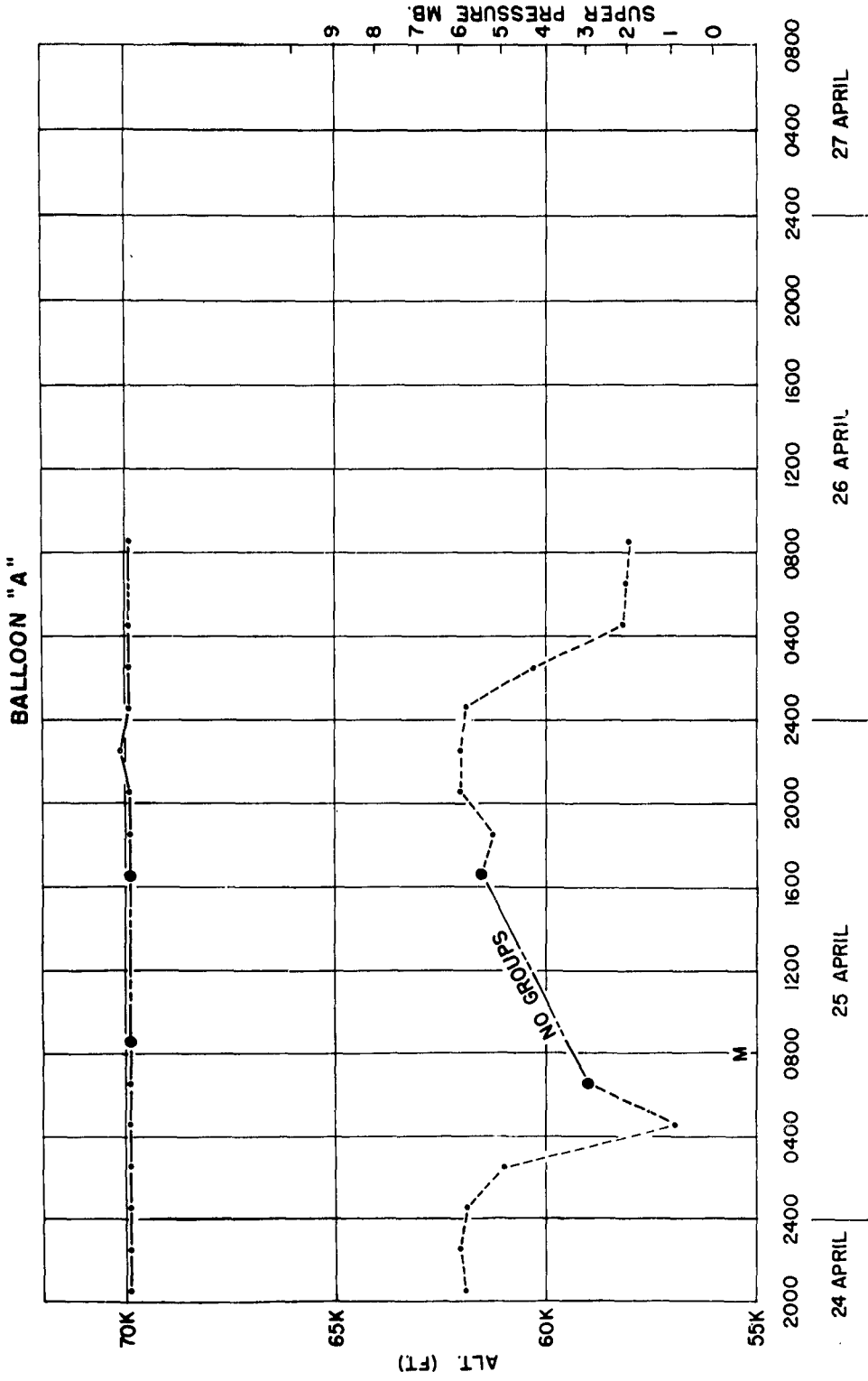

Figure 13d. Graph Showing Superpressure and Altitude vs. Time

Because of transmission difficulties, telemetered data were not received during early-morning periods when the superpressure is expected to be near minimum. However, the values of superpressure and altitude recorded immediately after these periods make it reasonably certain that the superpressure remained above zero on all but two occasions, on 21 and 22 April. Data received on 22 April show that the balloon did drop to approximately 45,000 feet. Since it regained its floating altitude and maximum superpressure on the four succeeding days, there is no doubt that the temporary loss in altitude was caused chiefly by decrease in volume due to loss of superpressure, and not to leakage.

In a letter to the author, Capt. George Nolan of the Operating Location, Research Instrumentation Laboratory, Hdqrs, AFCRL, Vernalis, California, has confirmed the existence of a solid cloud layer below the balloon on 22 April, from a few hundred feet above the earth's surface to 14,000 feet. A cloud 100 meters thick is effectively a black body in the infra-red wave lengths; the Mylar balloon, also, acts as a black body in this energy range, while the surrounding air is not affected. As pointed out earlier--at night, in the absence of direct solar radiation, the balloon loses heat. On a clear night the balloon usually receives infra-red radiation from the earth's surface which helps, to some extent, to offset a temperature drop. As long as the balloon can maintain positive pressure, the balloon volume will remain essentially unchanged and consequently it will float at a constant density altitude. If during the night, heavy cloud cover blocks the radiation flux from the earth's surface, this causes lower equilibrium temperature of the balloon, due to radiation equilibrium with the cooler upper cloud surface. Such a phenomenon may cause the balloon volume to change due to loss of positive superpressure and the balloon starts to descend.

Balloon B was made from laminated Mylar, a 3/4-mil film to a 3/4-mil film. This ten-day flight was also terminated by preset timer. Diurnal maximum and minimum values of superpressure and the corresponding altitudes are given in Table IV. These data, together with the superpressure-altitude flight record plotted in Figure 14, show the excellent altitude stability of this balloon over wide variation in superpressure. Very little data loss occurred on this flight. On only one occasion, 3 May, 1962, there was a three-hour data gap coincident with expected minimum superpressure. However, the constant altitude, and the superpressure values recorded just prior to and after this short period are high enough to give strong indication that superpressure did not become negative. Data taken before and after a single data omission on 2 May indicate that the superpressure was still dropping and the minimum was recorded in the next transmission.

From the records of maximum superpressure recorded on successive days it is clear that very little leakage took place in either of these balloons during the nine and ten day periods. There is every reason to conclude that they were capable of floating at the 70,000 foot level for a much longer period of time.

SUPERPRESSURE BALLOON "B"

LAUNCH DATE 26 APR 62
 TIME 1352
 SITE ORCO, CALIF
 BALLOON TYPE C MYLAR LAMINATE
 WEIGHT 46 LBK
 PAYLOAD 39 LBS
 FLIGHT DURATION 10 DAYS

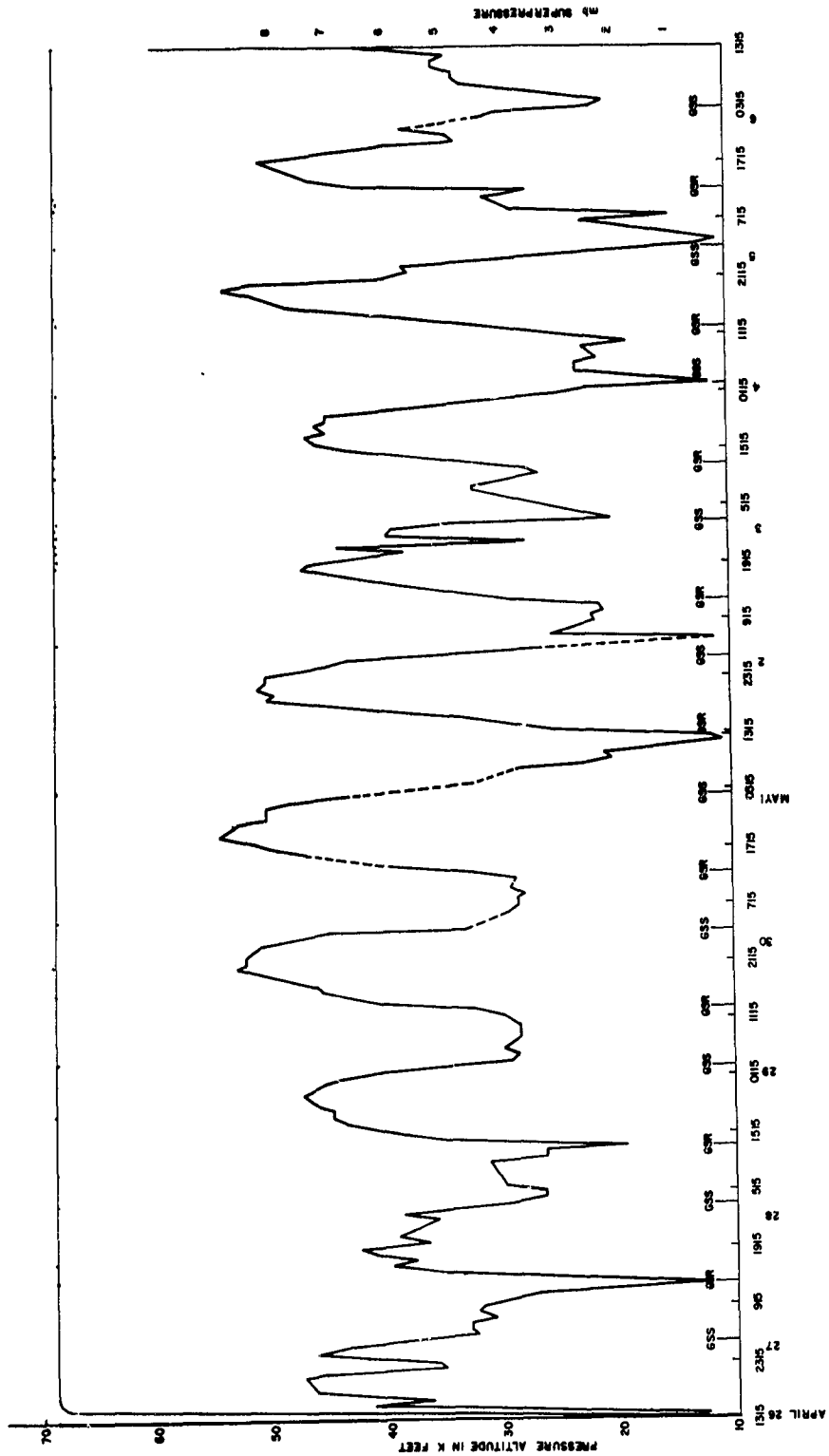

Figure 14. Graph Showing Superpressure and Altitude vs. Time

Table IV
Maximum and Minimum Superpressure, Balloon B

Date	Min. SP	Altitude	Max. SP	Altitude
1962				
26 April			7.6 mb	68.8 x 10 ³ Ft
27	0.55 mb	68.6 x 10 ³ Ft	6.46	68.8
28	1.88	68.6	7.45	68.8
29	3.70	68.6	8.60	69.0
30	3.60	68.6	8.88	68.8
1 May	0.15	68.6	8.20	68.8
2	2.20	68.6	7.44	68.8
3	2.05*	68.6	7.55	68.8
4	0.15	68.6	8.78	68.8
5	0.15	68.6	8.18	68.8
6	2.15	68.8	7.0**	69.4

* probably not minimum value

** last transmission, prior to time
of expected maximum

4. CONCLUSIONS AND FUTURE PLANS

The feasibility of the superpressure balloon has been established. It is now possible to fabricate a balloon vehicle that will satisfy a broad spectrum of Air Force requirements. The basic structural problems pertaining to balloons of diameters up to 100 feet fabricated from 0.5 to 2-mil Mylar have been solved.

One inherent disadvantage of very thin Mylar sheets is the possibility of developing a few tiny pinholes from handling the film during fabrication and launching. These pinholes may enlarge under pressure at the low atmospheric temperatures. Emphasis is now being placed upon investigating the use of laminated film, which holds great promise as a means of reducing the leakage rate, increasing flight duration, and improving reliability. A laminate of two sheets of 3/4 mil Mylar bound together by a very thin layer of adhesive weighs little more than a sheet of regular 1.5 mil Mylar of the same area. The laminate has greater flexibility, greatly improved abrasion resistance and substantially improved leakage characteristics.

Work will be continued to improve the overall performance of large Mylar spheres, to establish specifications, and to set standards for quality control. New materials that appear to have desirable characteristics for superpressure requirements will be investigated. It is anticipated that "blackball" studies and investigation of radiation temperatures in the atmosphere by other researchers will make possible more accurate determinations of necessary free lift and superpressure requirements for any particular flight. By the end of 1962, the Research Instrumentation Laboratory hopes to prove that superpressure balloons can be built and flown to carry payloads of 80 - 100 lbs to altitudes of 100,000 ft and above, for

durations in excess of 25 days, with a high degree of reliability. Also envisioned is the possibility of incorporating the natural shape and superpressure theory to achieve the goal of heavier payloads to higher altitudes for longer durations. Such a balloon could carry payloads in excess of 3000 lbs to altitudes well over 100,000 feet for extended durations, flying at a relatively constant density.

Appendix I

1. FREE LIFT SUPERPRESSURE, AND SUPERHEAT

At floating altitude, (ambient pressure, P_a), a balloon of volume, V , displaces n_a moles of air, equal in weight to the gross load, G , plus the weight of the lifting gas. The sealed, superpressure balloon contains n_g moles of lifting gas such that $n_g > n_a$, at pressure, P_g , higher than P_a .

There is some intermediate altitude where ambient pressure is equal to the internal pressure of the gas in the fully-inflated balloon. If air and gas are assumed to be at the same temperature, the number of moles of displaced air at this level is equal to n_g . The buoyant force of this displaced air, in proper units equal to $n_g m_a$, is greater than that required to float the balloon, $n_a m_a$, by the amount ΔG , called in conventional balloon terminology the "free lift" of the balloon. The ratio

$F\% = \frac{\Delta G}{G} \times 100$ is called percent free lift.

$$(n_g m_a - n_a m_a) = \Delta G$$

or $\Delta n_1 m_a = \Delta G$

where m_a = molecular wt of air

$$\Delta n_1 = n_g - n_a .$$

At floating altitude:

$$G = n_a m_a - n_g m_g$$

where m_g = molecular weight of lifting gas.

$$F \equiv \frac{\Delta G}{G} = \frac{\Delta n_1 m_a}{n_a m_a - n_g m_g}$$

If the weight of the lifting gas is neglected, $n_g m_g \ll n_a m_a$, then

$$F \simeq \frac{\Delta n_1}{n_a} \tag{I-1}$$

The "gas law" applied to the gas inside the balloon is:

$$VP_g = n_g RT_g$$

For the displaced air:

$$VP_a = n_a RT_a$$

where T_g and T_a are gas and air temperatures and R is the universal gas constant.

Dividing the first of these expressions by the second, and subtracting 1 from each side of the result gives

$$\frac{P_g - P_a}{P_a} = \frac{n_g T_g}{n_a T_a} - 1 \tag{I-2}$$

Let ΔP_1 be the value of superpressure measured when $T_g = T_a$ then

$$\frac{\Delta P_1}{P_a} = \frac{\Delta n_1}{n_a} \equiv F'$$

and from Eq. (I-1), $F' = F$, the free lift, when the weight of the lifting gas is neglected, or if G is redefined, to include the weight of the lifting gas*.

$$\frac{\Delta P_1}{P_a} \simeq \frac{\Delta G}{G} = F$$

This is Eq. (2) in the text.

In Eq. (I-2),

$$n_g = \frac{M_g}{m_g} \quad \text{AND} \quad n_a = \frac{M_a}{m_a} = \frac{V \rho_a}{m_a}$$

where M_g and M_a are respectively the mass of lifting gas and displaced air at floating level. Substituting these expressions in Eq. (I-2) gives

$$\frac{P_g - P_a}{P_a} = \left(\frac{m_a}{m_g} \right) \frac{M_g}{V \rho_a} \cdot \frac{T_g}{T_a} - 1 \quad (\text{I-3})$$

When $T_g = T_a$, and the lifting gas is helium, Eq. (I-2) gives

$$F' = \frac{\Delta P_1}{P_a} = \frac{29}{4} \frac{M_H}{V \rho_a} - 1 \simeq F.$$

This is Eq. (3) in the text.

*The weight of the lifting gas, $n_g m_g$ is actually a fixed fraction of the total required buoyant force of a superpressure balloon system for the same ratio $\frac{\Delta P_1}{P_a}$.

For helium:

$$\frac{n_g m_g}{n_a m_a} = \frac{4}{29} \frac{n_g}{n_a} = \frac{4}{29} \left[1 + \frac{\Delta P_1}{P_a} \right]$$

Since $\frac{\Delta P_1}{P_a}$ is usually < 0.10 ,

$$\frac{4}{29} < \frac{n_g m_g}{n_a m_a} \leq \frac{4}{29} [1.1] \leq 0.15$$

It follows that

$$1 + F = \frac{29}{4} \frac{M_H}{V\rho_a} \simeq 1 + F' . \quad (I-4)$$

Substituting this expression in Eq. (I-3), with helium as lifting gas, gives an "equation of state" for the balloon, viz.

$$\frac{P_H}{P_a} = (1 + F') \frac{T_H}{T_a} \simeq (1 + F) \frac{T_H}{T_a} \quad (I-5)$$

By rewriting Eq. (I-5) and again subtracting 1 from both sides of the result, an expression is obtained for the variable superheat; $\Delta T = T_g - T_a$, in terms of the corresponding value of superpressure, $\Delta P = P_g - P_a$:

$$\frac{\Delta T}{T_a} = \frac{T_g - T_a}{T_a} = \frac{\left(\frac{1}{1+F'}\right) P_g - P_a}{P_a}$$

$$\frac{\Delta T}{T_a} = \frac{P_g - P_a - F'P_a}{(1 + F') P_a} = \frac{\Delta P - F'P_a}{(1 + F') P_a} .$$

Solving for ΔT and simplifying results in

$$\Delta T = \frac{\Delta P - F'P_a}{1 + F'} \cdot \frac{T_a}{P_a} \simeq \frac{\Delta P - F'P_a}{1 + F} \cdot \frac{T_a}{P_a}$$

which is Eq. (4) in the text.

Appendix II

To obtain an expression for the circumferential stress on the thin, side wall (see Figure 15) of a cylindrical balloon inflated with gas at a positive differential pressure ΔP , consider the forces on a plane parallel to the length of the cylinder, through the center.

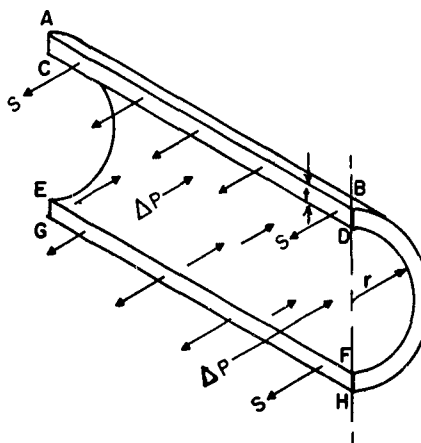

Figure 15. Diagram for Side Wall Stress on Cylinder

Let S = stress (force per unit area) acting on the cross-sections of the plastic wall, ABCD and EFGH.

t = thickness of the plastic

r = radius of the cylinder

h = an arbitrary length of cylinder

The force on the plane due to the differential pressure is:

$$\Delta P \times \text{area CDEF} = 2r \times h \times \Delta P.$$

The opposing, balancing force within the balloon wall is:

$$S \times \text{area ABCD} + S \times \text{area EFGH} = 2 S \times t \times h.$$

Therefore $2 r \Delta P h = 2 S t h$ or $S = \Delta P r / t$.

The stress in a thin-walled sphere (see Figure 16) is obtained in the same manner. Consider the forces on a plane through the center of a sphere of radius r .

Let S = stress (force per unit area) acting on the cross-section of the plastic wall, i. e., the ring of thickness t .

The force due to the differential pressure ΔP is:

$$\Delta P \times \pi r^2$$

The opposing force within the balloon wall is:

$$S \times \pi (r''^2 - r^2) = S \pi (r'' + r) (r'' - r)$$

where r'' is the outer radius = $r + t$.

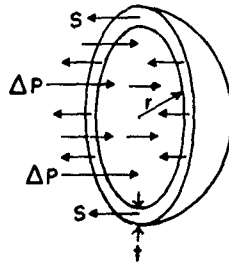

Figure 16. Diagram for Circumferential Stress on Sphere

Since this is a thinned-walled cylinder, $(r'' + r)$ is approximately equal to $2r$. $(r'' - r)$ is equal to t . Hence

$$\Delta P \pi r^2 = S 2r t \pi$$

or

$$S = \Delta P r / 2t .$$

Reference:

"Resistance of Materials", Fred B. Seely & James O. Smith, University of Illinois, Wiley & Sons Inc., 1957, pp 41-42.

Appendix III

1. EFFECT OF ELASTIC MODULUS ON STABILITY

Let the radius of the balloon, inflated at zero superpressure, be r , and let Z be any arc on the surface, subtended by the central angle α radians, as shown in Figure 17. Then:

$$r\alpha = Z.$$

(III-1)

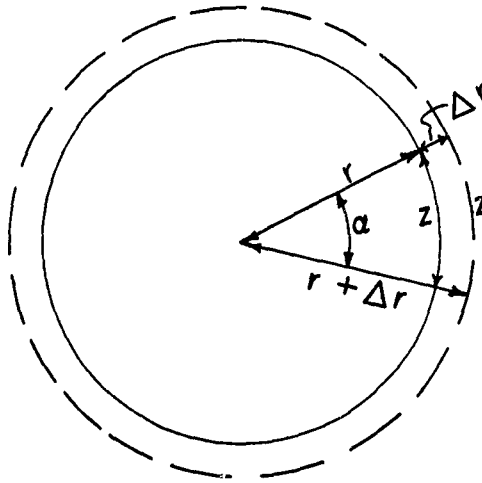

Figure 17. Diagram for Expansion of Sphere

When the superpressure rises to the value ΔP , corresponding to the stress, S , the arc Z stretches and becomes Z' , and the radius increases by the length Δr . Then, also

$$(r + \Delta r) \alpha = Z' . \quad (\text{III-2})$$

By definition, Young's modulus, E , is the ratio of stress to strain. In this case, the ratio of $(Z' - Z)$ to Z is the strain, i. e. ,

$$E = \frac{S}{\frac{Z' - Z}{Z}} . \quad (\text{III-3})$$

Dividing Eq. (III-2) by Eq. (III-1) gives

$$\frac{Z'}{Z} = \frac{r + \Delta r}{r}$$

and

$$\frac{Z' - Z}{Z} = \frac{\Delta r}{r} . \quad (\text{III-4})$$

Substituting this expression for the strain in Eq. (III-3) gives

$$S/E = \Delta r/r . \quad (\text{III-5})$$

If V' is the volume of the balloon when its radius is $(r + \Delta r)$.

$$\begin{aligned} V' &= \frac{4}{3} \pi (r + \Delta r)^3 \\ &= \frac{4}{3} \pi (r^3 + 3r^2 \Delta r + 3r \Delta r^2 + \Delta r^3) . \end{aligned}$$

Neglecting higher orders of Δr ,

$$V' \simeq \frac{4}{3} \pi (r^3 + 3r^2 \Delta r)$$

Then, since $V = (4/3) \pi r^3$

$$V'/V = (1 + 3\Delta r/r).$$

Substituting S/E of Eq. (III-5) for $\Delta r/r$, we obtain

$$V'/V = (1 + 3S/E)$$

which is Eq. (7) in the text.

Appendix IV

In an isothermal atmosphere, the difference in height, $x' - x$, between two levels, x' , where the atmospheric pressure is P' , and x , where the pressure is P , can be expressed in the following way:

From the hydrostatic definition of pressure,

$$dP = -\rho_a g dx$$

where ρ_a is the mass density of the air in a thin layer of thickness dx , g is the acceleration of gravity, and pressures are in absolute units.

The "gas law" for a mass of air, M_a , may be written

$$P V = \left(\frac{M_a}{m_a} \right) R T,$$

where m_a is the molecular weight of air, R , the universal gas constant, and T the absolute temperature. Since $\frac{M_a}{V}$ is the mass density, this equation becomes

$$P = \rho_a R' T \quad \text{where } R' \text{ equals } R/M$$

and

$$\rho_a = P/R'T.$$

Substituting this expression for ρ_a in the equation defining pressure, above, gives

$$dP = \frac{-P}{R'T} g dx$$

$$\frac{-dP}{P} = \frac{g}{R'T} dx$$

Integration between the limits x' and x and P' and P , in the case when T is constant, gives

$$\ln P/P' = (g/R'T) (x' - x)$$

or

$$x' - x = (R'T/g) \ln P/P'$$

Bibliography

1. Schjeldahl, G. T. Co., Super Pressure Mylar Polyester Balloons, by R. J. Slater. Final Technical Summary, Contract AF19(604)-2286 (May 1, 1957 - March 1, 1958), AFCRC-TR-58-265. Confidential.
2. Gergen, John L., Atmospheric Infrared Radiation over Minneapolis to 30 Millibars. J. Meteorol, 14:495-504 (1957).
3. DuPont, E. I. de Nemours and Co., Inc. Film Department, Technical Report TR-1. Mylar - Polyester film; physical, electrical and chemical properties of Mylar (December 1957).
4. General Mills, Inc., Mechanical Division. Report No. 1684. Balloon Barrier Materials, by A. A. Anderson. Annual Technical Report, Contract AF19(604)-1393 (March 15, 1956 - June 14, 1957). AFCRC-TN-57-291.
5. General Mills, Inc., Mechanical Division, Report No. 1412. Balloon Materials Evaluation, by A. A. Anderson, C. D. Fitz and R. Pohl. Final Report, Contract AF19(604)-718 (June 1, 1954 - March 31, 1955).
6. General Mills, Inc., Mechanical Division, Report No. 1525. Balloon Barrier Materials, by A. A. Anderson. Final Report, Contract AF19(604)-1393 (April 1955 - March 1956). AFCRC-TR-56-262.
7. General Mills, Inc., Mechanical Division, Report No. 1837. Balloon Barrier Materials, by A. A. Anderson. Final Technical Report, Contract AF19(604)-1393 (March 15, 1957 - March 14, 1958). AFCRC-TR-58-211.
8. McMahon, William, et al. Degradation studies of polyethylene terephthalate. J. Chem. Eng. Data 4, 1:57-79 (1959).
9. General Mills, Inc., Mechanical Division. Report No. 1914. Balloon Barrier Materials, by A. A. Anderson and G. L. Morfitt. Final Report Contract AF19(604)-3876. (November 1959). AFCRC-TR-60-204.
10. General Mills, Inc., Mechanical Division. Report No. B-1083. Mylar Balloon Fabrication Study, by L. A. Bushay and L. R. Flink. Final Report Contract AF19(604)-5210 (November 30, 1959).

11. General Mills, Inc., Mechanical Division. Report No. B-1085. Super Pressure Balloon Study - Report on Environmental Tests, by L. R. Flink. Contract AF19(604)-4985 (December 4, 1959).
12. General Mills, Inc., Mechanical Division. Report No. 2045. Super Pressure Balloon Study, by L. R. Flink. Final Report, Contract AF19(604)-4985. (May 4, 1960). AFCRC-TR-60-273.
13. Schjeldahl, G. T. Co., Superpressure Balloons, by R. J. Slater. Final Report, Contract AF19(604)-3901, June 30, 1959.
14. Schjeldahl, G. T. Co., Mylar Balloon Fabrication Study, by R. A. Schaefer. Final Report, Contract AF19(604)-7254. February 28, 1961.

INSTRUMENTATION FOR GEOPHYSICS AND ASTROPHYSICS
(Formerly: Instrumentation for Geophysical Research)

- No. 1. A Digital Electronic Data Recording System for Pulse-Time Telemetering, Gilbert O. Hall, Feb 1953.
- No. 2. A Rocket-Borne Equipment for the Measurement of Infrared Radiation, R. M. Slavin, Feb 1953.
- No. 3. Balloon-Borne Conductivity Meter, S. C. Coroniti, A. Nazarek, C. S. Stergis, D. E. Kotas, D. W. Seymour and J. V. Werme, Dec 1954.
- No. 4. Magnetic Compensation of Aircraft, J. McClay and B. Schuman, Aug 1955.
- No. 5. Lovotron - A Low Voltage Triggered Gap Switch, E. H. Cullington, W. G. Chase and R. L. Morgan, Sep 1955.
- No. 6. Balloon-Borne Air Sampling Device, Charles W. Chagnon, Apr 1957.
- No. 7. Instrumentation for Studies of the Exploding Wire Phenomenon, W. G. Chase and E. H. Cullington, Aug 1957.
- No. 8. Device for Lowering Loads from High-Altitude Balloons, W. C. Wagner and F. X. Doherty, Jul 1958.
- No. 9. Equipment and Techniques for In-Flight Deployment of Long Train Instrumentation Packages from High-Altitude Balloons, Arlo E. Gilpatrick and Romain C. Fruge, Sep 1958.
- No. 10. Study of a Pulsed Logarithmic Photometer, Michael R. Zatzick, Sep 1960.
- No. 11. Study of a Pulsed Logarithmic Photometer, Michael R. Zatzick, Sep 1960.
- No. 12. Theoretical Analysis of the PAR-Scope: An Oscilloscope Display for Weather Radars, Edwin Kessler, III, Jul 1959.

- No. 13. Evaluation of Visual Distance Computer, CP-384(XD-1), P. I. Hershberg, Apr 1960.
- No. 14. Hypsometer for Constant Level Balloon, W. C. Wagner, Jun 1960.
- No. 15. Magnetic Photomultiplier with Large Cathode for Extreme Ultraviolet, L. A. Hall and H. E. Hinteregger, Dec 1960.
- No. 16. AIDE -- Altitude Integrating Device, Electronic, P. I. Hershberg, J. R. Griffin and R. H. Guenther, Dec 1960.
- No. 17. Switching Devices for Very High Currents, E. H. Cullington and W. G. Chace, April 1961.
- No. 18. Cedar Hill Meteorological Research Facility, D. W. Stevens, Jun 1961.
- No. 19. Evaluation of Control Monitor AN/GGA 11 Prototype, R. S. Menchel, Aug 1961.
- No. 20. A Microwave Refractometer with Fast Response and Absolute Digital Recording, R. H. Shaw and R. M. Cunningham, Mar 1962.
- No. 21. Superpressure Balloon for Constant Level Flight, L. Grass, Jul 1962.

<p>UNCLASSIFIED</p> <p>1. Aeronautics--Balloons 2. Geophysical Science-- Meteorology--Astronomy</p> <p>I. Grass, L.</p>	<p>AF Cambridge Research Laboratories, Bedford, Mass. Geophysics Research Directorate SUPERPRESSURE BALLOON FOR CONSTANT LEVEL FLIGHT, by L. Grass. August 1962. 60 pp incl. illus. AFCRL-62-824</p> <p>Unclassified report</p> <p>Superpressure balloons are highly stable platforms for long-duration experiments in the stratosphere, capable of remaining at constant-density altitude, without ballast, despite diurnal fluctuations in 'superheat' of the lifting gas. Duration is theoretically limited only by eventual deterioration of the plastic or loss of gas by permeation. Equations relating superpressure, superheat, and free lift are derived. Developmental problems, design, cold-chamber testing, and relative merits of cylinder, tetrahedron, onion, and sphere are discussed. Flight data confirm capability of laminated-Mylar spheres with preformed end caps and bi-tape seals.</p>	<p>UNCLASSIFIED</p> <p>1. Aeronautics--Balloons 2. Geophysical Science-- Meteorology--Astronomy</p> <p>I. Grass, L.</p>
<p>UNCLASSIFIED</p> <p>1. Aeronautics--Balloons 2. Geophysical Science-- Meteorology--Astronomy</p> <p>I. Grass, L.</p>	<p>AF Cambridge Research Laboratories, Bedford, Mass. Geophysics Research Directorate SUPERPRESSURE BALLOON FOR CONSTANT LEVEL FLIGHT, by L. Grass. August 1962. 60 pp incl. illus. AFCRL-62-824</p> <p>Unclassified report</p> <p>Superpressure balloons are highly stable platforms for long-duration experiments in the stratosphere, capable of remaining at constant-density altitude, without ballast, despite diurnal fluctuations in 'superheat' of the lifting gas. Duration is theoretically limited only by eventual deterioration of the plastic or loss of gas by permeation. Equations relating superpressure, superheat, and free lift are derived. Developmental problems, design, cold-chamber testing, and relative merits of cylinder, tetrahedron, onion, and sphere are discussed. Flight data confirm capability of laminated-Mylar spheres with preformed end caps and bi-tape seals.</p>	<p>UNCLASSIFIED</p> <p>1. Aeronautics--Balloons 2. Geophysical Science-- Meteorology--Astronomy</p> <p>I. Grass, L.</p>