

AD-221598

Unclassified

UNCLASSIFIED

SUMMARY TECHNICAL REPORT
OF THE
NATIONAL DEFENSE RESEARCH COMMITTEE

This document contains information affecting the national defense of the United States within the meaning of the Espionage Act, 50 U. S. C., 31 and 32, as amended. Its transmission or the revelation of its contents in any manner to an unauthorized person is prohibited by law.

This volume is classified ~~CONFIDENTIAL~~ in accordance with security regulations of the War and Navy Departments because certain chapters contain material which was ~~CONFIDENTIAL~~ at the date of printing. Other chapters may have had a lower classification or none. The reader is advised to consult the War and Navy departments on the reverse of this page for the current classification of this material.

~~CONFIDENTIAL~~
UNCLASSIFIED

UNCLASSIFIED

Manuscript and illustrations for this volume were prepared for publication by the Summary Reports Group of the Columbia University Division of War Research under contract OEMsr-1131 with the Office of Scientific Research and Development. This volume was printed and bound by the Columbia University Press.

Distribution of the Summary Technical Report of NDRC has been made by the War and Navy Departments. Inquiries concerning the availability and distribution of the Summary Technical Report volumes and microfilmed and other reference material should be addressed to the War Department Library, Room 1A-522, The Pentagon, Washington 25, D. C., or to the Office of Naval Research, Navy Department, Attention: Reports and Documents Section, Washington 25, D. C.

Copy No.

140

This volume, like the seventy others of the Summary Technical Report of NDRC, has been written, edited, and printed under great pressure. Inevitably there are errors which have slipped past Division readers and proofreaders. There may be errors of fact not known at time of printing. The author has not been able to follow through his writing to the final page proof.

Please report errors to:

JOINT RESEARCH AND DEVELOPMENT BOARD
PROGRAMS DIVISION (STR ERRATA)
WASHINGTON 25, D. C.

A master errata sheet will be compiled from these reports and sent to recipients of the volume. Your help will make this book more useful to other readers and will be of great value in preparing any revisions.

UNCLASSIFIED

UNCLASSIFIED

PB 166 281
86.00

SUMMARY TECHNICAL REPORT OF DIVISION 11, NDRC

VOLUME 3

FIRE WARFARE

INCENDIARIES AND FLAME THROWERS

OFFICE OF SCIENTIFIC RESEARCH AND DEVELOPMENT
VANNEVAR BUSH, DIRECTOR

NATIONAL DEFENSE RESEARCH COMMITTEE
JAMES B. CONANT, CHAIRMAN

DIVISION 11
H. M. CHADWELL, CHIEF

Classification **UNCLASSIFIED**
changed to

AUTH: *Sec of Def memo, 2 Aug 60*
By *Chester C Beckel (ASTIA)*
Signature and Grade

Date *1 June 62*

WASHINGTON, D. C., 1946

UNCLASSIFIED

UNCLASSIFIED

NATIONAL DEFENSE RESEARCH COMMITTEE

James B. Conant, *Chairman*

Richard C. Tolman, *Vice Chairman*

Roger Adams Army Representative¹

Frank B. Jewett Navy Representative²

Karl T. Compton Commissioner of Patents³

Irvin Stewart, *Executive Secretary*

¹*Army representatives in order of service:*

Maj. Gen. G. V. Strong	Col. L. A. Denson
Maj. Gen. R. C. Moore	Col. P. R. Faymonville
Maj. Gen. C. C. Williams	Brig. Gen. E. A. Regnier
Brig. Gen. W. A. Wood, Jr.	Col. M. M. Irvine
	Col. E. A. Routheau

²*Navy representatives in order of service:*

Rear Adm. H. G. Bowen	Rear Adm. J. A. Furer
Capt. Lybrand P. Smith	Rear Adm. A. H. Van Keuren
	Commodore H. A. Schade

³*Commissioners of Patents in order of service:*

Conway P. Coe	Casper W. Ooms
---------------	----------------

NOTES ON THE ORGANIZATION OF NDRC

The duties of the National Defense Research Committee were (1) to recommend to the Director of OSRD suitable projects and research programs on the instrumentalities of warfare, together with contract facilities for carrying out these projects and programs, and (2) to administer the technical and scientific work of the contracts. More specifically, NDRC functioned by initiating research projects on requests from the Army or the Navy, or on requests from an allied government transmitted through the Liaison Office of OSRD, or on its own considered initiative as a result of the experience of its members. Proposals prepared by the Division, Panel, or Committee for research contracts for performance of the work involved in such projects were first reviewed by NDRC, and if approved, recommended to the Director of OSRD. Upon approval of a proposal by the Director, a contract permitting maximum flexibility of scientific effort was arranged. The business aspects of the contract, including such matters as materials, clearances, vouchers, patents, priorities, legal matters, and administration of patent matters were handled by the Executive Secretary of OSRD.

Originally NDRC administered its work through five divisions, each headed by one of the NDRC members. These were:

Division A—Armor and Ordnance
Division B—Bombs, Fuels, Gases, & Chemical Problems
Division C—Communication and Transportation
Division D—Detection, Controls, and Instruments
Division E—Patents and Inventions

In a reorganization in the fall of 1942, twenty-three administrative divisions, panels, or committees were created, each with a chief selected on the basis of his outstanding work in the particular field. The NDRC members then became a reviewing and advisory group to the Director of OSRD. The final organization was as follows:

Division 1—Ballistic Research
Division 2—Effects of Impact and Explosion
Division 3—Rocket Ordnance
Division 4—Ordnance Accessories
Division 5—New Missiles
Division 6—Sub-Surface Warfare
Division 7—Fire Control
Division 8—Explosives
Division 9—Chemistry
Division 10—Absorbents and Aerosols
Division 11—Chemical Engineering
Division 12—Transportation
Division 13—Electrical Communication
Division 14—Radar
Division 15—Radio Coordination
Division 16—Optics and Camouflage
Division 17—Physics
Division 18—War Metallurgy
Division 19—Miscellaneous
Applied Mathematics Panel
Applied Psychology Panel
Committee on Propagation
Tropical Deterioration Administrative Committee

UNCLASSIFIED

NDRC FOREWORD

AS EVENTS of the years preceding 1940 revealed more and more clearly the seriousness of the world situation, many scientists in this country came to realize the need of organizing scientific research for service in a national emergency. Recommendations which they made to the White House were given careful and sympathetic attention, and as a result the National Defense Research Committee [NDRC] was formed by Executive Order of the President in the summer of 1940. The members of NDRC, appointed by the President, were instructed to supplement the work of the Army and the Navy in the development of the instrumentalities of war. A year later, upon the establishment of the Office of Scientific Research and Development [OSRD], NDRC became one of its units.

The Summary Technical Report of NDRC is a conscientious effort on the part of NDRC to summarize and evaluate its work and to present it in a useful and permanent form. It comprises some seventy volumes broken into groups corresponding to the NDRC Divisions, Panels, and Committees.

The Summary Technical Report of each Division, Panel, or Committee is an integral survey of the work of that group. The first volume of each group's report contains a summary of the report, stating the problems presented and the philosophy of attacking them, and summarizing the results of the research, development, and training activities undertaken. Some volumes may be "state of the art" treatises covering subjects to which various research groups have contributed information. Others may contain descriptions of devices developed in the laboratories. A master index of all these divisional, panel, and committee reports which together constitute the Summary Technical Report of NDRC is contained in a separate volume, which also includes the index of a microfilm record of pertinent technical laboratory reports and reference material.

Some of the NDRC-sponsored researches which had been declassified by the end of 1945 were of sufficient popular interest that it was found desirable to report them in the form of monographs, such as the series on radar by Division 14 and the monograph on sampling inspection by the Applied Mathematics Panel. Since the material treated in them is not duplicated in the Summary Technical Report of NDRC, the monographs are an important part of the story of these aspects of NDRC research.

In contrast to the information on radar, which is of widespread interest and much of which is released to the public, the research on subsurface warfare is largely classified and is of general interest to a more restricted group. As a consequence, the report of Division 6 is found almost entirely in its Summary Technical Report, which runs to over twenty volumes. The extent of the work of a Division cannot therefore be judged solely by the number of volumes devoted to it in the Summary Technical Report of NDRC: account must be taken of the monographs and available reports published elsewhere.

One can claim on behalf of Division 11 that the results of its work contributed directly and dramatically to the successful prosecution and triumphant termination of World War II. It was Division 11, under the leadership first of R. P. Russell, then of E. P. Stevenson, and later of H. M. Chadwell, which developed the incendiary bombs with which Japan's industrial plants were reduced to ashes. Filled with jellied gasoline, the AN-M69 incendiary was credited with the highest efficiency of any bomb against Japanese factories and dwellings. More than 40,000 tons of AN-M69 bombs were dropped on Japanese cities.

Division 11 likewise applied the use of thickened fuels to portable and mechanized flame throwers, which were employed with great success against the enemy in the Pacific. Other sections of the Division did important work in developing improved techniques for the production of oxygen for military uses, and in solving numerous other problems in the field of chemical engineering, one of the most valuable contributions being the development of new hydraulic fluids.

This Summary Technical Report of Division 11, prepared under the direction of the Division Chief and authorized by him for publication, describes the activities of the Division and its contractors. It stands as a testimonial to the imagination and resourcefulness of American scientists and industrial engineers and as a record of wartime accomplishment worthy of grateful recognition.

VANNEVAR BUSH, Director
Office of Scientific Research and Development

J. B. CONANT, Chairman
National Defense Research Committee

UNCLASSIFIED

FOREWORD

FOR ADMINISTRATIVE purposes and because of the diverse nature of the problems studied by Division 11 (Chemical Engineering) of NDRC, three independent sections were created: Section 11.1 (Oxygen Problems), Section 11.2 (Miscellaneous Chemical Engineering Problems), and Section 11.3 (Fire Warfare). The work of each of the three sections is presented in an individual volume of the Summary Technical Report.

This volume describes the research and development work of Section 11.3 (and its predecessor organizations) in the fields of incendiaries, flame throwers, and incendiary fuels. This work was carried out under the direction of Mr. R. P. Russell (January and February 1943), Mr. E. P. Stevenson (March 1943 to February 1945), and Dr. H. M. Chadwell (March 1945 to termination) as Chiefs of Division 11 for the periods indicated, and of Mr. N. F. Myers (January 1943 to April 1943) and Dr. H. C. Hottel (May 1943 to termination) as Chiefs of Section 11.3. Assisting them were Dr. R. H. Ewell, Dr. C. S. Keevil, and Dr. C. E. Reed as Section Technical Aides, and Mr. S. M. Jones, Dr. E. C. Kirkpatrick, Mr. R. E. Loop, and Mr. R. M. Newhall as Technical Aides on specific assignments. Whereas all the contractors working under Section 11.3 (listed in an appendix to this volume) made valuable contributions, particular mention should be made of the contributions of the Standard Oil Development Company, Factory Mutual Research Corporation, Eastman Kodak Company, Massachusetts Institute of Technology, Harvard University, and Arthur D. Little, Inc., in the fields of incendiaries, flame throwers, and incendiary fuels.

The editor, and principal contributor, of this volume was Dr. Raymond H. Ewell, Technical Aide in Section 11.3 (and its predecessor organizations) from December 1941 to January 1946. Assistant editor of the volume was Mr. Robert M. Newhall, Office of Field Service, OSRD, who was later Technical Aide in Section 11.3. Professor H. C. Hottel as Chief of Section 11.3 kept in close touch with the preparation of the volume and reviewed all material as prepared by the editors. The following authors wrote one or

more sections under the supervision of the editors.

E. E. Bauer, Eastman Kodak Company
A. Bogrow, Arthur D. Little, Inc.
G. W. Engisch, Standard Oil Development Company
M. D. Haworth, Standard Oil Development Company
E. P. Hershberg, Harvard University
S. M. Hulse, Standard Oil Development Company
C. S. Keevil, Technical Aide, Section 11.3, and Section 11.3 representative at Edgewood Arsenal
W. T. Knox, Standard Oil Development Company
E. L. McMillen, Eastman Kodak Company
R. F. Messing, Office of Field Service, OSRD, and Member, Incendiary Evaluation Group, Edgewood Arsenal
K. H. Mysels, Stanford University
C. E. Reed, Technical Aide, Section 11.3
G. R. Stanbury, Ministry of Aircraft Production and Member, Incendiary Evaluation Group, Edgewood Arsenal

The coordination within the Division was supervised first by R. H. Ewell and later by D. Churchill, Jr. To all these men the Division Chief wishes to express his sincere thanks.

The developments described in this volume were carried out in close cooperation with the Chemical Warfare Service (incendiaries), the Army Ground Forces (flame throwers), and the Navy Bureau of Ordnance (flame throwers). Besides reporting work done at establishments of Section 11.3 contractors, some work on Section 11.3 developments is reported which was carried out at Army and Navy establishments, including Edgewood Arsenal, Dugway Proving Ground, Huntsville Arsenal, Eglin Field, Fort Belvoir, Fort Knox, Fort Benning, and others. Particular mention should be made of the close liaison and high degree of cooperation with the Chemical Warfare Service, without which the successful completion of many of these projects would not have been possible.

The Division Chief also wishes to acknowledge with thanks the valuable help and guidance in broad phases of the program and policy of Dr. Roger Adams, member of the NDRC.

H. M. CHADWELL
Chief, Division 11
H. C. HOTTEL
Chief, Section 11.3

CONTENTS

CHAPTER	PAGE
Summary	1
1. Incendiary Bombs and Clusters by <i>R. H. Ewell, E. B. Hershberg, and C. S. Keevil</i>	7
2. Miscellaneous Incendiary Items by <i>R. H. Ewell and E. B. Hershberg</i>	44
3. Testing and Evaluation of Incendiaries by <i>C. S. Keevil, R. F. Messing, R. H. Ewell, W. Knox, and H. C. Hottel</i>	53
4. Portable Flame Throwers by <i>R. H. Ewell, N. F. Myers, A. Bogrow, R. M. Newhall, and G. W. Engisch</i>	95
5. Mechanized Flame Throwers by <i>A. Bogrow, N. F. Myers, R. M. Newhall, M. D. Haworth, and E. E. Bauer</i>	103
6. Miscellaneous Flame Warfare Items by <i>A. Bogrow, R. M. Newhall, C. E. Reed, N. F. Myers, and S. H. Hulse</i>	147
7. Studies on Flame-Thrower Design by <i>R. M. Newhall and R. H. Ewell</i>	166
8. Fuels for Incendiaries and Flame Throwers by <i>E. K. Carver, E. E. Bauer, R. H. Ewell, A. Bogrow, E. L. McMillen, and R. M. Newhall</i>	192
Glossary	227
Bibliography	229
OSRD Appointees	245
Contract Numbers	247
Service Project Numbers	251
Index	253

SUMMARY

THIS VOLUME DESCRIBES the research and development work of Section 11.3 (and its predecessor organizations) in the fields of incendiaries, flame throwers, and incendiary fuels. Chapters 1, 2, and 3 deal with incendiaries, Chapters 4, 5, 6, and 7 with flame throwers, and Chapter 8 with incendiary fuels. This program was carried out under 33 research and development contracts with 28 universities and industrial concerns as contractors. The results of this work contributed in no small measure to the successful prosecution and termination of the war, the most spectacular contributions being the incendiary bombs with which the Japanese cities were bombed and destroyed, and the thickened gasoline fuels which were used so successfully in incendiaries, flame throwers, and "blaze" bombs.

AN-M69 Incendiary Bomb. The most important single development in Section 11.3 was the AN-M69 incendiary bomb. This bomb, developed by the Standard Oil Development Co., was a small tail-ejection bomb utilizing jellied gasoline as a fuel and deriving much of its effectiveness from the tail-ejection feature. The bomb consisted essentially of a hexagonal can of thin sheet steel, 2 $\frac{7}{8}$ by 19 $\frac{1}{2}$ in., weighing 6.2 lb complete, and containing 2.6 lb of jellied gasoline. The nose contained an impact fuze with a 3 to 5 sec delay and a powder charge which ejected and ignited the fuel charge. Besides the horizontal tail-ejection principle the bomb embodied two new features in bomb design: (1) a horizontally placed impact fuze working by means of a hinged striker in lieu of an axial firing pin as commonly used in bomb fuzes, and (2) cloth tail streamers in lieu of a rigid metal tail as commonly used on bombs. Both these design features were developed in order to economize on the required length of the bomb. The bombs were filled with Napalm or polymer-type thickened gasoline containing about 90 per cent gasoline and 10 per cent of thickening agent.

The bombs were assembled in either quick-opening or aimable clusters of 100- and 500-lb sizes. The cluster produced and used in largest quantity was the M19 (E46) 500-lb size aimable

cluster, containing 38 AN-M69 bombs and weighing 425 lb complete. Forty of these clusters could be carried on a B-29 bomber. When dropped the cluster falls intact in stabilized flight until it bursts open at a predetermined altitude, usually 5,000 ft. As the individual bombs impact on the target they normally come to rest in a horizontal position, and after 3 to 5 sec delay they explode, ejecting the burning fuel charge out the tail. If unobstructed, the burning fuel charge will travel up to 300 ft horizontally, and when it strikes a surface, the flaming fuel charge smears out producing a mass of flames 6 to 10 ft high.

In the form of aimable clusters the AN-M69 bomb had a degree of aimability equal to demolition bombs of the 100-lb class, and hence was suited for either area incendiary bombing in cities or for precision bombing of specific targets. The terminal velocity of the individual bombs was 220 to 230 ft/sec, practically independently of the altitude of release or of opening of the cluster. This velocity was sufficient to enable the bomb to penetrate all types of domestic roofs and the commoner types of industrial roofs.

The fire-starting efficiency of the AN-M69 bomb was thoroughly tested and found to be adequate for starting fires in all types of targets for which its use was contemplated. In fact, the tests indicated that on factories and on Japanese domestic construction the AN-M69 had the highest fire-starting efficiency per cluster, or per ton, or per bomber load of any incendiary bomb.

The principal use of AN-M69 bombs in World War II was in the bombing and destruction of the major cities of Japan in the period January to August 1945. Over 40,000 tons of AN-M69 aimable clusters were dropped on Japanese cities with results which are now well known in history. Analysis of the results indicated that a minimum density of around 125 tons/sq mile was required to completely burn out an area in a Japanese city.

M69X Incendiary Bomb. This bomb, also developed by Standard Oil Development Co., was an anti-personnel modification of the AN-M69

bomb. The nose contained a time-delay element giving time delays up to 6 minutes and a high-explosive charge which shattered the nose into more than 300 fragments. This weapon was highly lethal, particularly at distances up to 20 ft. The M69X bomb weighed 7.1 lb complete and contained 2.0 lb of thickened gasoline fuel. Its ballistic properties, penetrating power, and fire-starting efficiency did not differ significantly from those of the AN-M69 bomb. The M69X bomb was placed in production in March 1945, but none were ever used operationally.

Aimable Clusters for Incendiary Bombs. When the need for aimable clusters became apparent, the Chemical Warfare Service designed and produced the E28 (M18) cluster, which had certain disadvantages. Then the Standard Oil Development Co. developed the E18 cluster, which had other disadvantages. Finally the Chemical Warfare Service combined the best features of both these clusters into the M19 (E46) aimable cluster, which proved to be quite satisfactory and was produced and used extensively in bombing Japan.

E19 Incendiary Bomb. This bomb, developed by Harvard University and Factory Mutual Research Corp., was an 11-lb bomb combining magnesium, oil, and thermite as incendiary materials. It had an extensible metal tail, a steel nose piece, and a novel perforated metal sleeve to impart strength. The tail cone was hollow and contained a charge of white phosphorus which gave off a dense white smoke. When the tail was in the compressed position, as in a cluster, the E19 bomb was identical in size with the AN-M69 bomb, and it could be assembled in the same clusters. The E19 bomb burned with a very hot flame but its overall fire-starting efficiency was inferior to that of the AN-M69 bomb. Its only advantage over the AN-M69 bomb was its greater penetrating power, but this factor diminished in importance as the war went on, and hence the E19 bomb was never seriously considered for production.

E9 Incendiary Bomb. This bomb developed by The Texas Co. was a 40-lb tail-ejection bomb with a time-delay, anti-personnel element. This bomb was 5 by $2\frac{9}{16}$ in. in size (with extensible tail compressed), and contained 9.5 lb of thickened gasoline fuel and 0.8 lb of white phosphorus.

It packed 14 bombs in a 500-lb size cluster. This bomb was characterized by high terminal velocity, great penetrating power, and a high degree of aimability. The anti-personnel charge contained 0.65 lb of tetrytol, and it was an exceedingly lethal weapon. The E9 bomb never reached the production stage because there was no demand for a very highly penetrating bomb in the latter stages of World War II, and the size of the bomb gave it a low fire-starting efficiency on a cluster basis compared to any of the small bombs. However, the bomb incorporated a number of novel features of design which should be of interest to future bomb designers.

One novel feature of the E9 bomb was the cluster designed for its use. Because of the intrinsic aimability of the bomb it was not necessary to assemble it in aimable clusters, and yet it was necessary to provide a cluster mechanism which would not give rise to dangerous, slowly falling metal parts. This was accomplished by making a cluster mechanism consisting of pipes of spear-like members bound together with strong metal cables. These cluster parts fell sufficiently fast that they constituted no hazard for aircraft flying below the dropping airplane. Yet the cluster was the strongest ever produced, sustaining 18 G downward stress.

Miscellaneous Incendiary Items. Besides the major incendiary bombs, a number of minor incendiary items were developed, of which three were used in World War II. A new type of burster was developed by Harvard University for the AN-M47 type of bombs embodying a tube of white phosphorus with a core of TNT or other high explosive. This burster was a replacement for the older black powder type of burster. Harvard University developed two small hand incendiaries, one a fire starter for emergency use and the other a sabotage incendiary, both of which were produced and used in the war. Both were eventually of thickened gasoline contained in a celluloid case. The M1 fire starter was a small cylinder with a match striker ignition mechanism. The H2 vest-pocket sabotage incendiary resembled a cigarette case, and was equipped with a delay incendiary pencil ignition mechanism.

CONFIDENTIAL

Testing and Evaluation of Incendiaries. Many methods for testing incendiaries were devised and used by Section 11.3 and its contractors, ranging from small laboratory tests to large-scale tests involving model villages and factories. The most significant were the full-scale tests on the German-Japanese village at Dugway Proving Ground, which was designed and supervised in construction by the NDRC Standard Oil Development Co. groups, and the model factory tests carried out by the Incendiary Evaluation Project at Edgewood Arsenal.

The full-scale tests at Dugway Proving Ground gave the first reliable indication of the effectiveness of the AN-M69 bomb on Japanese domestic structures, and the results of the tests were used by the Army Air Forces in the fall of 1943 for drawing up preliminary plans for bombing Japanese cities. The Dugway results were later checked by tests on a standardized model Japanese room by the Incendiary Evaluation Project at Edgewood Arsenal.

In the factory tests of the Incendiary Evaluation Project typical combustible objects present in factories, such as workbenches, storage bins, packing cases, cardboard cartons, and wooden partitions were tested with various bombs under realistic conditions such that a mathematical extension of the data to an actual factory layout gave absolute fire-starting probabilities, which it would require long and costly airborne tests to duplicate. These tests indicated the AN-M69 and AN-M50 bombs to be about equal, and the M74 somewhat inferior, for use in factories.

Portable Flame Throwers. In the summer of 1942 the Army M1 portable flame thrower was modified by the Standard Oil Development Co. to allow the use of the newly developed thickened fuels. The resulting M1A1 Model was used extensively during 1942 and 1943 in the Pacific War. The changes consisted of a more efficient type of fuel control valve and an increased opening and other adjustments in the pressure regulator. These changes increased the range from 20 to 25 yd for the M1 Model to 45 to 50 yd for the M1A1, and demonstrated the practicality of using thickened fuel.

The M1A1 Model left much to be desired in flame-thrower performance so that an im-

proved portable flame thrower, the E2 Model, was developed by Standard Oil Development Co. in the winter of 1942-1943. This model embodied a cylindrical roundheaded fuel tank encircled by an oval "doughnut"-type compressed air tank. Maximum use was made of aluminum as a structural metal resulting in a large fuel capacity in relation to the gross weight. Other improvements included an improved ignition system using gasoline instead of hydrogen, diminished pressure loss in the fuel system, improved accessibility of controls and a scientifically designed carrying frame. The E2 Model had only a small superiority in range over the M1A1 Model, but it was vastly superior in full capacity, reliability, and ease of operation. The E2 Model was never put into production because of the simultaneous development of a competitive model, M2-2, by the Chemical Warfare Service.

Some work was carried out on one-shot expendable flame throwers utilizing both pistons and collapsible tubes as media for transmitting pressure to the fuel, but none were brought to the production stage.

Mechanized Flame Throwers. NDRC commenced development work on mechanized flame throwers in March 1942. During the course of this program, 11 different mechanized flame throwers, consisting of a flame gun, fuel tanks, compressed air tanks, and controls, mounted on a tank or other fighting vehicle, were developed. In addition, several experimental, long-range flame guns were developed which were not mounted on vehicles. All the flame guns, except two, used compressed air as the source of pressure. The other two, still in development at the close of World War II, used a pneumatic ram and a pump, respectively, as sources of pressure. None were developed using propellant powder as a source of pressure. Two of the complete mechanized flame throwers, E7-7 and Navy Mark I, saw combat service in the Pacific war, and another, M5-4, was in large-scale production at the end of the war. One flame gun and four of the complete mechanized units, all developed by Standard Oil Development Co., will be described separately and the other models will be mentioned only briefly.

CONFIDENTIAL

E7 Flame Gun. This flame gun, developed by Standard Oil Development Co. in the winter of 1942-1943, was the culmination of earlier models A, B, C, and D. It was immediately successful, and it became the standard United States flame gun. It had a maximum range of over 125 yd for covering operations when applied to open trenches or fox holes, and an effective range of at least 50 yd when penetrating small enclosures such as pill box embrasures. In general principles it resembled standard portable flame throwers, but constructed much heavier and on a larger scale. A 1/2-in. nozzle was used on the early models and interchangeable 1/2-in. and 3/4-in. nozzles on later models (E7R1 and E7R2). The fuel control valve was located far back of the nozzle in contrast to the pintle valve in the nozzle itself as was standard British practice. An important new feature was the use of a secondary fuel of liquid gasoline which was applied in small quantity to the main stream of thickened gasoline fuel through a porous iron annulus at the nozzle. This feature improved both range and ignition. The ignition system used atomized gasoline and a rugged high-tension spark plug. Models E7R1 and E7R2 were improved models differing only in detail from E7. This flame gun was produced by Lecourtenay Co., and used on all four of the mechanized flame throwers described below.

E7-7 Mechanized Flame Thrower. This was the first complete mechanized flame thrower developed by NDRC. It consisted of an E7 flame gun and an E7 fuel system mounted in an M5A1 light tank. The gun, fuel tanks, compressed air tanks, and controls were all contained in a self-contained, turret-basket assembly which could be placed in any M5A1 tank hull. The complete system, filled with fuel (125 gal), added 2,650 lb to the weight of the tank. This arrangement eliminated the 37-mm gun main armament of the M5A1 Tank. This unit was developed by Standard Oil Development Co., and four complete units were fabricated by Cadillac Motor Car Co. These units saw service in the Philippine Islands in June 1945, but the few results only indicated the potentialities of this type of weapon.

Navy Mark I Flame Thrower. This model is of interest as the first long-range, large-capacity

mechanized flame thrower ever used in combat by U. S. Forces. The Navy Mark I Model consisted of an E7 flame gun mounted with fuel tanks, air tanks, and controls in an armored, self-contained box-like unit, weighing about 6,000 lb when filled with fuel (200 gal). The range and other operating characteristics were the same on the E7-7 Model since the E7 flame gun was used in both. This model was originally introduced for use in the cockpits of landing craft for attack of beach fortifications, but they actually were used in LVT-4 amphibious tractors. The Navy Mark I Model was developed by Standard Oil Development Co. Twenty-one units were manufactured by M. W. Kellogg Co. Six units saw service on Pelelieu Island in September-November 1944, where they were highly effective.

E14-7R2 Mechanized Flame Thrower. This model consisted of an E7R2 flame gun mounted with an E14 fuel system in an LVT-A1 amphibious tank. This unit was developed by Standard Oil Development Co., and the first unit was fabricated by Lima Locomotive Works and later units by M. W. Kellogg Co. None were ever used in combat.

M5-4 (E12-7R1) Mechanized Flame Thrower. This model, designed by Standard Oil Development Co. and manufactured by M. W. Kellogg Co., consisted of an E7R1 flame gun and an E12 fuel system in an M4A1 or M4A3 medium tank. The fuel and air tanks were housed in both the hull and turret basket so that it was not a self-contained, turret-basket assembly as the E7-7. The fuel capacity was 315 gal compared to 125 gal for the E7-7. As in the E7-7, the flame thrower displaced the normal main armament of the tank. The performance of this model was essentially the same as the E7-7 Model. The MS-4 was standardized by the Army for large-scale production, and about 75 units had been completed and about 600 were on order at the close of World War II. None were ever used in combat.

Other Mechanized Flame-Thrower Models. Model E8, developed by C. F. Braun and Co., was mounted in an M5A1 light tank with stationary turret body. Model I-3, developed by Shell Development Co., was a simplified flame gun which was never mounted on a vehicle.

CONFIDENTIAL

Model E9, developed by Standard Oil Co. (Indiana), had an original design flame gun with $\frac{1}{4}$ -in. and $\frac{3}{4}$ -in. interchangeable nozzles mounted in an M5A1 light tank and equipped with a 1,200-gal armored fuel trailer. Model E13-13, developed by Morgan Construction Co., used a pneumatic ram as the source of pressure with an E13 flame gun of the pintle valve type and an E13 fuel system mounted in an M4A1 medium tank. Model E13R1-13R2, developed by Massachusetts Institute of Technology, was a modified form of the E13-13 Model, only using compressed air instead of a pneumatic ram as the source of pressure. Model 19-19, which was being developed by the State University of Iowa when World War II ended, was the first United States design to retain the normal main armament of the tank and still provide a long-range effective flame thrower as an auxiliary. After studying several possible locations for installation of such a flame thrower in the M4A3 medium tank, a location on the port side of the turret was selected for further development. Model E20-20 (Ordnance designation T33), which was in development jointly by Standard Oil Development Co., Chemical Warfare Service, and Ordnance Department at the close of the war, was similar to the M5-4 Model, except that the main tank armament was retained and the flame gun was mounted coaxially with the tank's 76-mm gun. If the war had continued, the E20-20 Model would probably have replaced the then standard M5-4 Model. A pump-operated flame thrower was in development by Eastman Kodak Co. at the close of World War II.

Flame Thrower Servicing Units. Model E8 flame-thrower servicing unit, developed by Standard Oil Development Co. and Davey Compressor Co., comprised a thickened fuel mixing tank, fuel storage tanks, an air compressor, and air storage tanks mounted on an Army truck. A power take-off from the truck engine provided power. This unit provided complete field servicing facilities for flame throwers. Sixty-five units were made, of which some were sent to the field. The mixer and compressor were also mounted separately as palletized units for carrying in small landing craft. Other fuel mixing units were developed by other contrac-

tors for use with portable flame throwers and for shipboard use for filling "blaze" bombs.

E1 Anti-Personnel Tank Projector. This unit, the purpose of which was to harass infantry attacking tanks at close range, consisted of a small tank filled with a spontaneously inflammable liquid mixture of phosphorus and sulfur, and fitted with a nozzle controlled from inside the tank. The phosphorus fuel had a strong anti-personnel effect, and also produced a thick white smoke.

Studies on Flame-Thrower Design. Extensive studies were made by Massachusetts Institute of Technology, Factory Mutual Research Corp., Standard Oil Development Co., Eastman Kodak Co., and other contractors on the fundamentals of design and fuel properties which determine flame-thrower performance. These studies contributed materially to the efficient design of many of the flame throwers described herein.

Fuels for Incendiaries and Flame Throwers. The type of fuel used most widely in the above weapons was jellied or thickened gasoline. The value of thickened fuel in incendiaries and flame throwers was demonstrated by the early fundamental work at MIT and Standard Oil Development Co. The most important agent for thickening gasoline developed in World War II was "Napalm," an aluminum soap of naphthenic, oleic and coconut oil acids. Napalm was a cooperative development resulting from the coordinated efforts of Harvard University, Nudex Products Co., Eastman Kodak Co., and the Standard Oil Development Co. About 80,000,000 lb of Napalm were produced and used in many applications. Napalm is a generic term, and the composition can vary widely, although the most commonly used acid composition contained 25 per cent naphthenic acid, 25 per cent oleic acid, 50 per cent coconut oil acids. The successful commercial production of this material involved coprecipitation and drying to form a dry granular powder resembling some commercial soap powders. The variables in the production of Napalm were thoroughly studied, and this resulted in the production of a reliable, uniform product.

The use of Napalm on shipboard for filling "blaze" bombs led to the desirability of having a liquid thickening agent which could be mixed

CONFIDENTIAL

with gasoline in a continuous two-stream operation. Several liquid thickening agents were studied, of which aluminum cresylate (plus stearic acid dissolved in gasoline) was the most promising.

Early in World War II thickening agents which were based on isobutyl methacrylate polymers fortified with sodium soaps were developed by E. I. du Pont de Nemours and Co., Ammonia Department, for filling incendiary bombs.

Fortified fuels for use in both incendiary bombs and flame throwers were studied by several contractors. The principal advantages sought were greater fierceness of burning and more difficult extinguishment by water compared to thickened gasoline. Most of these consisted of hydrocarbon base fuels with added

finely divided metals, such as magnesium, and/or oxidizing agents, such as nitrates.

Self-igniting fuels were the subject of study by Arthur D. Little, Inc., and other contractors. The most useful one discovered was a liquid eutectic mixture of phosphorus and sulfur mentioned in connection with the E1 Anti-Personnel Tank projector.

An extensive program of fundamental studies on the rheological properties of thickened gasoline was carried out by Eastman Kodak Co., which permitted a sound, scientific approach to many of the problems involved in the manufacture and use of Napalm. While many interesting and scientifically valuable results were obtained, little correlation with the performance of incendiary bombs and flame throwers was discovered.

CONFIDENTIAL

Chapter 1

INCENDIARY BOMBS AND CLUSTERS

1.1 INTRODUCTION

INCENDIARY BOMBS WERE used in World War II by all belligerents, but most effectively by the British, United States and German air forces. Incendiary bombs were used against three principal types of targets:

1. Heavy domestic construction as in Germany or Great Britain.

2. Light domestic construction as in Japan and other parts of the Orient.

3. Factories, warehouses and other precision bombing targets. In the attack of British cities, the German air force used 10 to 30 per cent incendiary bombs. Profiting by this example, the British air force used 30 to 70 per cent incendiaries in their attack of German cities. In the attack of Japanese cities, the United States air force used essentially 100 per cent incendiary bombs. In the attack of factory targets by precision bombing, the U.S. air force used incendiary bombs in variable amounts, ranging all the way from 0 to 100 per cent, but usually around 20 to 50 per cent.

For the purpose of orientation the principal incendiaries used or developed to an advanced stage in World War II may be classified as follows.

1. Small incendiary bombs, 2 to 11 lb.
 - 2-lb United States magnesium bomb, AN-M52.
 - 2.2-lb German magnesium bomb, B1.
 - 4-lb British magnesium bomb, Mark IV.
 - 4-lb United States magnesium bomb, AN-M50.
 - 4-lb United States therm-8 bomb, AN-M54.
 - 5-lb German magnesium bomb, B2.2.
 - 6-lb United States gasoline gel bomb, AN-M69.
 - 6-lb United States gasoline gel bomb, M69X.
 - 8-lb United States pyrotechnic gel bomb, M74.
 - 11-lb United States magnesium bomb, E19.

2. Medium-sized incendiary bombs, 18 to 40 lb.

18-lb British magnesium dust bomb, Mark I.

20-lb British naphthalene jet bomb, J20.

30-lb British gasoline gel bomb, Mark IV.

30-lb British liquid gasoline jet bomb, J30.

40-lb United States gasoline gel bomb, E9.

3. Large incendiary bombs, 70 to 550 lb.

70-lb U.S. gasoline gel bomb, AN-M47.

75-lb German fire-pot bomb, Sprengbrand C.50.

90-lb German benzene-phosphorus bomb, Brand C.50.

240-lb German benzene-phosphorus bomb, Brand C.250.

240-lb German gasoline gel bomb, Flam C.250.

250-lb British gasoline gel bomb, Mark II.

400-lb British gasoline gel bomb, Mark I.

500-lb U.S. pyrotechnic gel bomb, AN-M76.

550-lb German gasoline gel bomb, Flam C.500.

4. Super incendiaries, over 550 lb.

1,000-lb British gasoline gel bomb, Mark I.

4,000-lb British gasoline gel bomb.

United States jettisonable gasoline tanks (fire bombs), 75- to 300-gal capacity.

5. Miscellaneous small incendiaries.

Incendiary leaves, United States and British.

Sabotage incendiaries (for hand placement).

This list includes both service types and the principal bombs in development at the close of the World War II. Not included in the list are (1) numerous abortive experimental incendiary bombs, (2) numerous minor variants of the above bombs, (3) Japanese, Italian, French, and Russian incendiary bombs, none of which were significant in World War II.

The first two categories of incendiary bombs, namely small and medium-sized bombs, are ordinarily provided and used in containers or clusters of some description. Such clusters may be either the quick-opening or short-delay type

which open almost immediately below the airplane, or the aimable or projectile type, which are stabilized and provided with a time or barometric fuze allowing them to be dropped intact for thousands of feet before opening. The third and fourth categories, namely large incendiary bombs and super incendiaries, are ordinarily hung individually on either internal or external bomb racks. However, the AN-M47 bomb is usually loaded in multiple suspension with two to six bombs hung on a single bomb station.

Incendiary bombs may also be classified according to the mode of functioning as follows.

1. Static functioning type, which burns where it comes to rest.
 - a. With undirected combustion, e.g., magnesium bombs.
 - b. With directed combustion, e.g., jet bombs.
2. Distributive type, which throws incendiary material some distance from the point of initial impact or the point of rest.
 - a. Instantaneous firing type. (1) Bursting type, which bursts the incendiary bomb, dispersing chunks of the incendiary charge outwards and downwards in a conical pattern due to the downward inertia, e.g., AN-M47 bomb. (2) Tail-ejection type, which ejects the incendiary charge out the tail somewhere between the roof and floor of the target, e.g., M74.
 - b. Delayed firing type. Tail-ejection type, which ejects the incendiary charge out the tail laterally after a time delay sufficient to allow the bomb to come to rest, e.g., AN-M69 bomb.

An incendiary bomb consists essentially of some sort of casing filled with an incendiary material. Materials which have been most prominent in the development of incendiary bombs in World War II are the following:

	Btu per lb
Magnesium	10,800
Gasoline gel, United States motor gasoline	16,000 to 17,000
Gasoline gel, British high benzol	17,000 to 18,500
Pyrotechnic gel, several types	12,000

Incendiary bombs containing gasoline gel are frequently referred to as oil incendiary bombs. This is really a misnomer, but the term has become established through usage. A number of other incendiary materials were investigated which proved to be of little or no value as primary incendiary materials, of which the following might be mentioned:

	Btu per lb
Thermite, including many variants	1,400
White phosphorus	10,500
Celluloid	7,200

1.2 AN-M69, 6-LB OIL INCENDIARY BOMB

1.2.1

Introduction

Development of this bomb was initiated in October 1941 by the Standard Oil Development Co. under Contract OEMsr-183 (later superseded by Contract OEMsr-354). This development was started as a consequence of a letter from General H. H. Arnold to Vannevar Bush on September 24, 1941, emphasizing the serious shortage of magnesium and requesting the development of a substitute for magnesium as an incendiary material. This project was later formalized as Service Project CWS-21 from the Chemical Warfare Service on October 7, and the work was carried out in direct collaboration with the Chemical Warfare Service.

Following a review of the various incendiary bomb designs in use or in development in the fall of 1941, exploratory work on the new bomb developed the following basic conceptions.

1. Use of some petroleum product as the incendiary material because of the high heat of combustion, 17,500 to 19,500 Btu per lb.
2. Use of fuel in the form of a gel or other semi-solid, in order to control the rate of burning.
3. Tail ejection of fuel charge, in order to project the fuel charge into a favorable location for starting a fire.
4. Delay fuze, in order to allow the bomb to come to rest on its side and eject the fuel charge horizontally.
5. Horizontally placed fuze, in order to economize on the available length of the bomb.

CONFIDENTIAL

6. Use of a comparatively thin metal case, in order to yield as high a charge/weight ratio as possible.

7. Cloth streamer tails, in order to stabilize the bomb and slow it down to a striking velocity

bomb consists of a hexagonal thin steel case, 19½ in. in length, before release of tail streamers, and 27⁄8 in. across the flats, weighing 6.2 lb complete and containing about 2.6 lb of gasoline gel (Figure 1). The principal components are

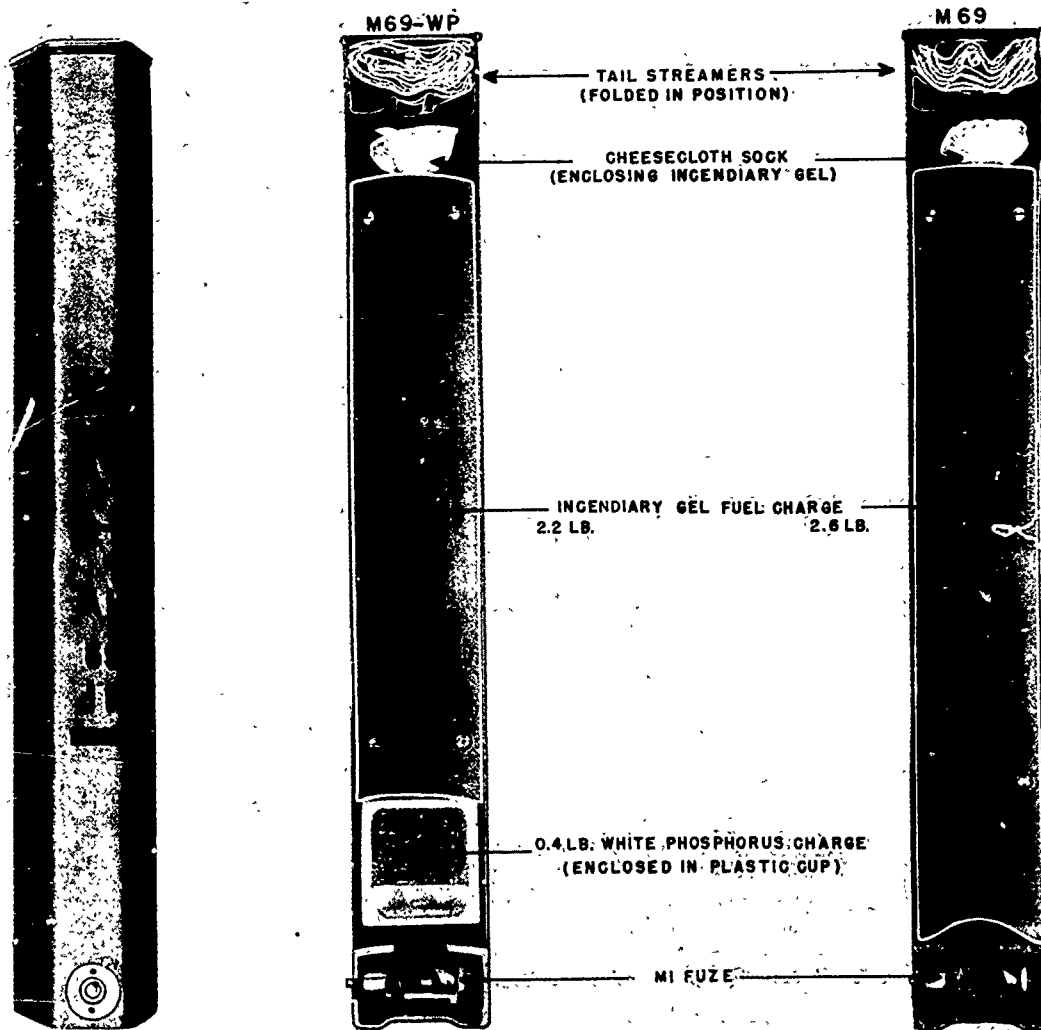

FIGURE 1. AN-M69 incendiary bomb, external and cross-section views. Model M69-WP (center view) was in production at end of World War II but was never used.

appropriate for the thin case, and to accomplish this as economically as possible with respect to length of the bomb.

1.2.2

Description

Brief Description.^{1, 2, 3, 4, 5} As finally developed and produced, the AN-M69 incendiary

briefly described below.

1. Casing, hexagonal in shape, made of 19-gauge steel, butt-welded, extending the entire length of the bomb. In later production beginning May 1945, the tail end of the casing was rounded.^{6, 7}

2. Nose cup, made of 13-gauge steel, brazed into the nose end of the casing. It forms a flat

CONFIDENTIAL

nose and serves to house the fuze and two containers of powder.

3. Fuze, bomb, M1, of the inertia type, embodying a 3- to 5-second delay train (Figure 2).^{8,9} The components of the fuze include a base and a hinged striker made of aluminum, a hinge pin, a spring, a firing pin, a primer cap, a delay spitter fuze, a black powder-magnesium powder booster charge in a celluloid cup, a safety plunger unit, and a cylindrical fuze case.

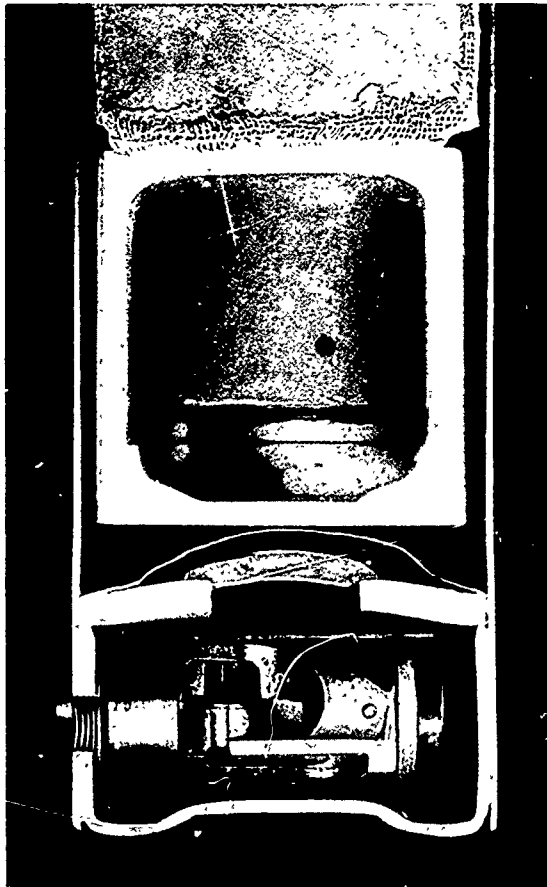

FIGURE 2. Detail of nose end of AN-M69 incendiary bomb. (Model with WP cup illustrated.)

The fuze is screwed into a threaded hole in the side of the casing and nose cup, and it rests directly on the indented bottom of the nose cup. The outside face of the fuze bears an arrow which should point towards the tail of the bomb. In late 1944 an all-ways fuze was developed for the M69 bomb, but the stability of the bomb was such that it was not needed and it never went into production (see Section 2.7).

4. Powder containers, two in number, made of celluloid and filled with an ejection-ignition charge consisting of a mixture of black powder and magnesium powder. The two powder containers fit into the nose cup on either side of the fuze.

5. Impact diaphragm assembly, made of 3/16-in. steel, consisting of a hexagonal member resting on the nose cup, and an impact plug resting loosely in a hole in the hexagonal member. The impact diaphragm assembly takes the impact force of the fuel charge when the bomb strikes and yet allows ready venting of the ejection-ignition charge when the bomb fires.

6. Sealing diaphragm, made of 34-gauge sheet steel, which covers the impact diaphragm assembly and nose cups, and is brazed into the bomb assembly between the casing and the nose cup. The sealing diaphragm forms a hermetical seal for the nose end of the casing, and is supported by the impact diaphragm for strength.

7. Tail cup, made of 26-gauge sheet steel, crimped into the tail end of the casing similar to a tin-can seal, providing a hermetical seal for the tail end of the casing.

8. Tail retainer assembly, made of sheet steel, consisting of a tail retainer cup welded to the bottom of the tail cup, a tail retainer disk which snaps over the tail retainer cup and holds the tail streamer in place, and a tail retainer clip which is wedged across the tail cup in a way so that the tail retainer assembly cannot come out in case the weld between the tail retainer cup and the tail cup should fail.

9. Tail streamers, four in number, each 3x40 in. long, made of mildew-proofed sheeting. The streamers are held in the tail cup by the tail retainer disk, and are folded loosely in the cup.

10. Gasoline gel filling, 2.6 lb in weight, contained in a cheesecloth sack. The gasoline gel may be either of the Napalm type (NP) or the isobutyl methacrylate type (IM).

11. WP cup, screwed-top plastic cup containing 6 oz of cast white phosphorus, which is located between the sealing diaphragm and the gasoline gel fuel charge.^{10, 11, 12} This component was introduced in the spring of 1945 after approximately 20,000,000 AN-M69 bombs of the above description had already been made without it. This model of the AN-M69 weighed 6.4

lb complete and contained 2:2 lb of gasoline gel. None was ever used operationally.

Details of Design.^{1,2} The following presents further details regarding each of the components of the bomb outlined above, including the factors which led to the final selection of characteristics and, wherever pertinent, various alternatives which were tried and discarded:

1. Casing. The casing was made hexagonal in shape for efficient clustering and to provide a firm abutment between adjacent bombs in order to keep the safety plungers of all bombs depressed while in clusters. A later model produced in 1945 was made round at the tail end to facilitate seaming.^{6,7} Electrically butt-welded tubing was selected instead of seamless tubing, since the former was equivalent in strength for this particular bomb and could be butt-welded directly in the hexagonal form, whereas seamless tubing was more limited in supply and also had to be especially formed to the hexagonal shape over a mandrel. Lap welding was not suitable because it gave an unsymmetrical distribution of stresses which resulted in splitting on impact. The thickness of sheet steel was selected as 19 gauge, since 20 gauge proved to be not quite strong enough for impact on concrete at terminal velocity, and 18 gauge was considered heavier than necessary. The corners of the hexagonal case were rounded in order to eliminate thinning and consequent splitting at the corners of the case on impact. Low carbon steel, SAE 1010 or its equivalent, was used since this was the most available grade of steel and was adequate for the purpose. Obviously, the grade of steel, the thickness used, and the striking velocity of the bomb are interdependent factors, but this particular combination proved to be satisfactory.

2. Nose cup. For this component 13-gauge steel, SAE 1010 or its equivalent, was selected on the same general basis as the casing. The nose cup was brazed into the nose end of the casing by a continuous copper brazing method in a hydrogen atmosphere, with the thin sealing diaphragm placed between the nose cup and the casing before brazing so that all three components were brazed together. This process depends on the surface tension of the molten copper to make a perfect hermetical seal, and it

was found superior to silver soldering and other competitive processes. The brazing process also annealed the casing, relieving stresses by the butt-welding process. The bottom of the nose cup was indented for the purpose of supporting the fuze.

3. Fuze, bomb, M1.^{8,9} The principal components of the fuze, namely, the base and the hinged striker, were made of aluminum alloy by die casting because this was the simplest method of making them. Alternative models made of brass or pressed steel were discarded. The base contained recesses for the primer cap, the delay spitter fuze, and the safety plunger unit, and the hinged striker accommodated the firing pin. These two principal components were assembled by means of the hinge pin and the spring, and the whole assembly inserted into the cylindrical fuze case. Four different primer caps were tried: New No. 4, Mark V, M26, and No. 209B. The last was found to be the best. The New No. 4 primer was rejected because of a high rate of deterioration at high temperatures; the Mark V primer was also subject to deterioration but was fairly satisfactory; the M26 primer required a stabbing type firing pin and was too sensitive. A delay fuze was desired in order to allow the bomb to come to rest on its side before firing, and for this purpose Ensign-Bickford lead-coated spitter fuze, providing a 3- to 5-sec delay, was selected. In order to insure transmission of ignition from the primer to the spitter fuze it was found necessary to place a small dab of match composition on the receiving end of the spitter fuze. In order to insure transmission of ignition from the spitter fuze to the booster charge on the back of the fuze it was necessary to extend the spitter fuze beyond the end of its channel in the fuze base and bend it upwards $\frac{1}{2}$ in. into the middle of the booster charge. The safety plunger unit was the standard British-United States design used in the 4-lb magnesium and other incendiary bombs. The firing pin was of the round-headed type, 0.040-in. radius, made of SAE 1112 steel. Numerous tests showed that this type of firing pin was more reliable than the sharp-pointed stabbing type. The sensitivity of the fuze depends on the weight of the hinged striker and the strength of the spring. The spring selected

CONFIDENTIAL

was a 3-turn spring made of 0.055-in. spring steel wire. This combination gave zero probability of firing when dropped two feet onto concrete and 100 per cent probability at six feet. The booster charge located at the back of the fuze consisted of one gram of a mixture of 50 per cent A-4 black powder and 50 per cent Grade B magnesium powder in a flat celluloid cup.

4. Ejection-ignition charge consisted of 0.27 oz A-4 black powder and 0.23 oz Grade B magnesium powder. Black powder alone did not give reliable ignition of the fuel charge at low temperatures. Various grades of aluminum and magnesium powder were tried to overcome this, and Grade B linseed oil-coated magnesium powder was found to be the best.

5. Impact diaphragm was made in a two-piece assembly embodying a loose center plug after tests showed that a solid impact diaphragm was frequently held by a collapsed or distorted casing and interfered with ignition of the fuel charge.

6. Sealing diaphragm was selected of a thickness (34 gauge) which would stand rough treatment during assembly and still be thin enough to rupture reliably with the ejection-ignition charge selected. Bursting pressure was 450-550 lb per sq in.

7. Tail cup was crimped into the casing in standard seaming machinery used in the canning industry. Although the hexagonal closure gave some difficulties, it was used during 1943 and 1944, but in 1945 a round closure was adopted for easier seaming. It was necessary to control hardness of the tail cup from 55 to 70 on Rockwell B scale in order to get proper seaming. A vinylite seaming compound was used in the seam to insure gas-tightness.

8. Tail-retainer assembly was adopted which spread the tail streamers to the periphery of the tail cup, after early models with a central tail suspension gave a large percentage of unstable bombs. The tail retainer clip was devised as an added precaution after it was found that the weld between the tail retainer cup and the tail cup sometimes failed.

9. Tail streamers of bombs in quick-opening clusters were made of surgical gauze in early models, but the switch to aimable clusters in

1943 necessitated changing the tails to cotton sheeting.¹³ When the bombs are clustered, the last 3 in. of the tail streamers are turned back outside the bomb to enable the wind to whip the tails out reliably and rapidly when released from the cluster. The tails were mildew-proofed by dipping in a naphtha solution of copper naphthenate containing one per cent by weight of copper.

10. Gasoline gel fillings will be described in the next section.

11. WP cup was made of either Bakelite or Catalin plastic. The thickness and quality of the plastic were selected in order not to break with ordinary handling of the bombs and clusters, yet break reliably on impact at terminal velocity. The white phosphorus is not intended to aid in ignition of the fuel charge, but only to provide smoke for the purpose of interfering with fire-fighting. The wet phosphorus tended to develop cracks in the plastic by action of phosphorus acids; therefore sodium acetate was added as a buffer.

Fillings for Bomb. Many types of thickened or bodied gasoline fuels were studied as filling for the AN-M69 bomb. The heat contents (Btu) of all these fuels were essentially the same and all fuels showed some degree of effectiveness in starting fires, but comparative burning tests showed certain fuels to be significantly superior to others. The principal requirements, in addition to fire-starting effectiveness, were (1) sufficient strength to withstand ejection without excessive shattering, (2) consistency which would give a burning time of 5 to 10 min when spread in a 1/4 in. thick pad, (3) ease of ignition by the M69 ejection-ignition charge at temperatures down to 40 degrees below zero, (4) availability of required raw materials, and (5) ease of manufacture.

The three principal fuels which were used for filling AN-M69 bombs were the following.

Napalm Filling (NP Type II)	
Napalm thickener	9.0%
Gasoline	91.0%
IM Filling	
Isobutyl methacrylate polymer NR	5.0%
Fatty acids (stearic acid)	2.5%
Naphthenic acid	2.5%
Aqueous solution of caustic soda (40%)	3.0%
Gasoline	87.0%

CONFIDENTIAL

IM Filling (IM Type III)

Isobutyl methacrylate polymer AE	2.0%
Fatty acids (stearic acid)	3.0%
Naphthenic acid	3.0%
Aqueous solution of caustic soda (40%)	4.5%
Gasoline	87.5%

Other satisfactory fillings which involved fewer critical materials than the NP or IM fillings, but which were never used in production, were the following.

S.O.D. Formula 1221, 2

Stearic acid	3.5%
Rosin	1.8%
Cottonseed oil	3.0%
Aqueous solution of caustic soda (33%)	3.3%
Gasoline	88.4%

Cellucotton Filling

Cellucotton chunks	10-15%
Gasoline	85-90%

Clusters of AN-M69 Bombs. For efficient carriage in bombardment aircraft small bombs must be carried in some sort of cluster or bomb container. During World War II, AN-M69 incendiary bombs were manufactured and supplied to the theaters of operation in the following 5 clusters.

1. AN-M12, 100-lb size, quick-opening cluster, consisting of 14 AN-M69 bombs assembled in a M4 cluster adapter (Fig. 3).¹⁴ This cluster has an actual weight of 105 lb and measures 8.4 in. maximum width and 39.3 in. maximum length. The size of the cluster is approximately that

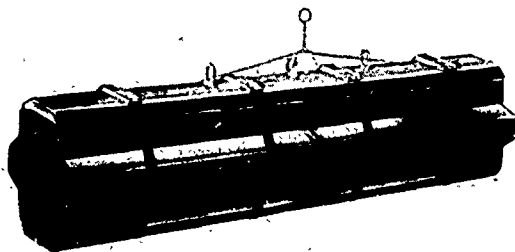

FIGURE 3. AN-M12, 100-lb size, quick-opening cluster of AN-M69 incendiary bombs. AN-M13, 500-lb quick-opening cluster is similar in construction and appearance.

of a 100-lb GP bomb, and it will fit on practically all 100-lb bomb stations.

2. AN-M13, 500-lb size quick-opening cluster

consisting of 60 AN-M69 bombs assembled in a M7 cluster adapter.¹⁵ This cluster has an actual weight of 425 lb and measures 17 in. maximum width and 58.9 in. maximum length. The size of the cluster is somewhat wider than a 500-lb GP bomb, but nevertheless it will fit on practically all 500-lb bomb stations.

3. E28 (also called M18 or E6R2), 500-lb size aimable cluster consisting of 38 AN-M69 incendiary bombs assembled in a E6R2 cluster adapter (Figures 4 and 5).¹⁶ The actual weight

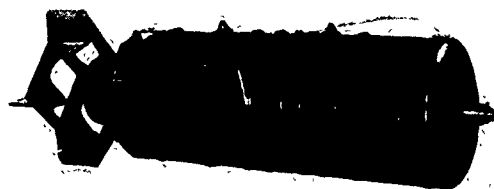

FIGURE 4. E28, 500-lb size aimable cluster of AN-M69 incendiary bombs.

of the cluster is 350 lb and it measures 14.7 in. maximum width and 59.0 in. maximum length. The size of the cluster is practically the same as a 500-lb GP bomb, and it will fit on practically all 500-lb bomb stations. This cluster was used in the initial incendiary attacks on Japanese cities.

4. E36, 500-lb size aimable cluster consisting of 38 AN-M69 incendiary bombs assembled in an E21 cluster adapter. This cluster is a variation of the E28 cluster and its weight and dimensions are the same as the E28 cluster. The E36 cluster was produced in relatively small quantities between production of the E28 and M19 clusters.

5. M19 (E46), 500-lb size aimable cluster containing 38 AN-M69 bombs assembled in a M23 (E23) cluster adapter (Figure 6). The actual weight of the cluster is 425 lb and it measures 14.8 in. maximum width and 59.5 in. maximum length. The size of the cluster is practically the same as a 500-lb GP bomb, and it will fit on practically all 500-lb bomb stations. This cluster was the principal one used in the incendiary attacks on Japanese cities (Figure 7).

CONFIDENTIAL

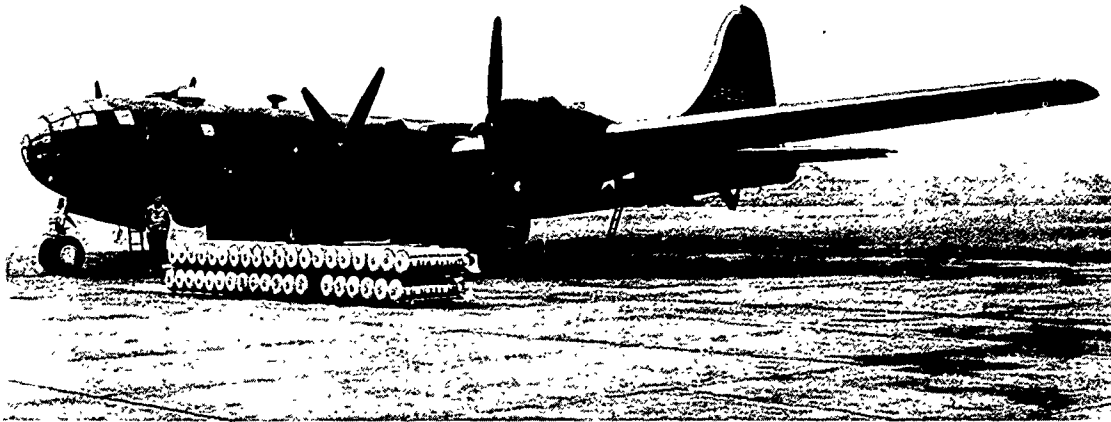

FIGURE 5. B29 load of 40 E28 aimable clusters of AN-M69 incendiary bombs.

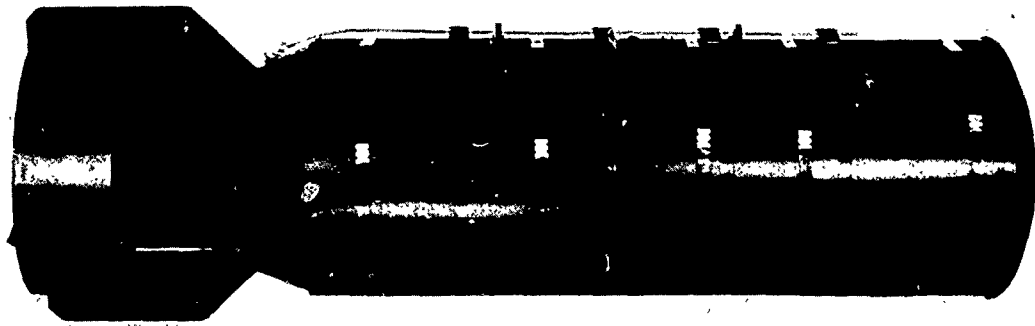

FIGURE 6. M19, 500-lb size, aimable cluster of AN-M69 incendiary bombs.

1.2.3

Performance Data

Mode of Functioning. When a cluster of AN-M69 bombs is dropped from an airplane the following sequence of actions takes place.

1. After dropping some distance, depending on the type of cluster, the cluster breaks open, releasing the individual bombs.
2. The wind catches the tail streamers, pulling them out to their full length, thereby stabilizing the bomb so that it falls nose down.
3. When the cluster disperses, the bombs are armed as the safety plungers are relieved from contact with adjacent bombs.
4. On impact the striker passes through the space occupied by the safety plunger before arming, and the firing pin strikes the primer cap.
5. The flash from the primer cap ignites the spitter fuze.
6. After 3 to 5 sec delay the spitter fuze ignites the booster charge attached to the back of the fuze.
7. The booster charge in turn ignites the main ejection-ignition charge contained in the two celluloid powder containers.
8. The explosion of these charges ruptures the sealing diaphragm, ejecting the impact

CONFIDENTIAL

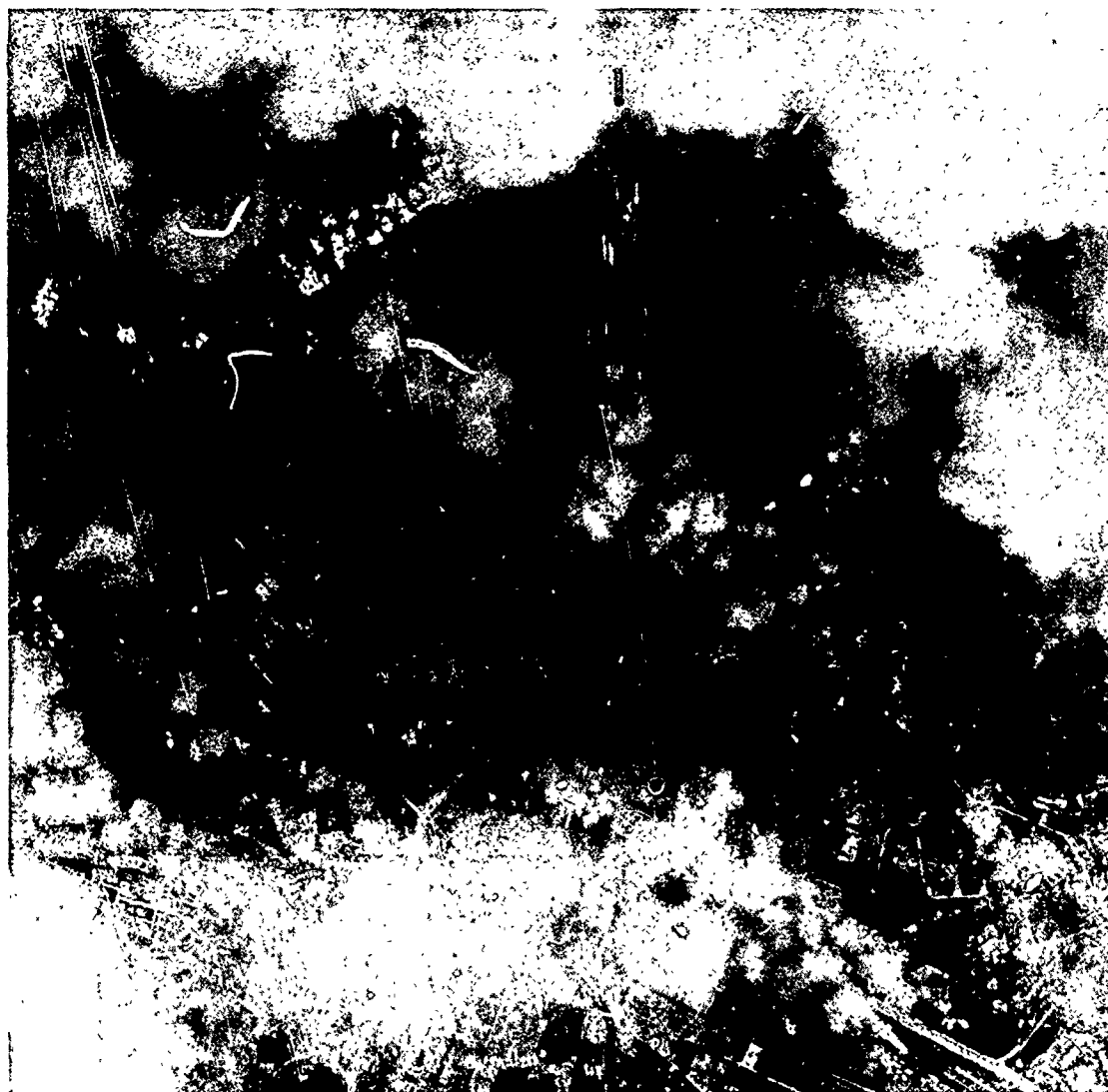

FIGURE 7. Salvo of M19 aimable clusters dropped from a B-29 over Yokohama. Photo shows 28 clusters, although a full load for a B-29 would be 40 clusters.

plug, fuel charge, tail cup and streamers, and simultaneously igniting the fuel charge. Burning magnesium particles from the ejection-ignition charge insure ignition of the fuel charge.

9. The flaming fuel charge in the sock is thrown through the air for distances up to 300 ft until it strikes an obstruction (Figure 8). On impact the fuel charge smears over the surface of the object struck, instantly producing a mass of flames 6 to 8 ft high. The pattern of distribution of the fuel depends on the nature and distance of the object struck and on the consistency of the fuel.

10. In the case of bombs containing the WP cup, this cup is ruptured when the bomb impacts and upon ejection of the fuel charge the phosphorus charge is broken up into many small particles. The burning particles of phosphorus produce a thick white smoke practically instantaneously.

Per Cent Functioning. The per cent functioning of AN-M69 bombs increased steadily with improvements in design of bombs and clusters and in production technique during 1943 and 1944. Table 1 gives some representative figures on the performance of bombs in M19 aimable

CONFIDENTIAL



FIGURE 8. AN-M69 incendiary bombs, firing at workbench target, illustrating horizontal projection of fuel.

clusters, dropped at Eglin Field during the period October 11, 1944 to February 8, 1945.¹⁷ These data are not sufficiently extensive to yield any reliable correlation with altitude of release on opening, even though the single group from 30,000 ft is the lowest figure. The relatively high

clusters is somewhat higher than that from aimable clusters because of the smaller stress on the bombs on release from the cluster and because of the greater time of flight available for stabilization of the bombs.

Fuze failures (0.4 per cent) are also negligibly small. This satisfactory function is the result of many minor improvements in the design and production technique of the M1 fuze, and it attests to the fundamental soundness of the design of this fuze.

Ballistic Characteristics. A novel feature of the AN-M69 incendiary bomb is the cloth streamer tail. This type of tail imparts a high degree of stability to the bomb and also has such a positive drag that on release from a cluster the individual bombs are very quickly stabilized and slowed to their normal terminal velocity. For this reason the striking velocity of this bomb is practically uniform at 220-230 ft per sec from quick-opening clusters dropped from 3,000 ft or higher, or from aimable clusters opened at 3,000 ft or higher. This figure has been determined both by observations of bombs

TABLE 1. Functioning of AN-M69 incendiary bombs in M19 aimable clusters.

Altitude of release, ft	10,000	10,000	15,000	30,000	15,000
Altitude of opening, ft	3,000	5,000	5,000	5,000	7,500
Clusters dropped	7	13	7	14	9	50
Bombs dropped	266	494	266	532	342	1,900
Bombs recovered	261	473	247	504	325	1,810
Bombs functioned O.K.	254	450	241	474	314	1,733
Number of air bursts	0	0	0	0	4	4
Number of duds on ground	7	23	6	30	7	73
Flat landers	0	9	3	18	7	37
Lightly struck primers	0	8	0	2	0	10
Fuze failures	0	6	1	1	0	8
No apparent cause	7	0	2	9	0	18
Per cent functioning*	97.3	95.1	97.6	94.0	96.6	95.7

*On recovery basis.

percentage of flat landers from 30,000 ft is probably due to tail streamers being torn off as a result of the greater velocity of the clusters at opening and the resultant greater stress on the tail streamers when they come out. The per cent of air bursts (0.2 per cent) is of negligible proportions, although this was not true in the earlier E28 and E36 clusters, which had explosive opening mechanisms instead of a mechanical opening mechanism.

The per cent functioning from quick-opening

in flight and by wind-tunnel measurements. If quick-opening clusters are dropped from less than 3,000 ft the bombs strike at less than 220-230 ft per sec, and if aimable clusters are opened at less than 3,000 ft the bombs strike at more than 220-230 ft per sec.

The trajectory followed by AN-M69 bombs depends strongly on the type of cluster involved (Figure 9). When released from quick-opening clusters the bombs rapidly lose their forward component and soon drop practically vertically.

CONFIDENTIAL

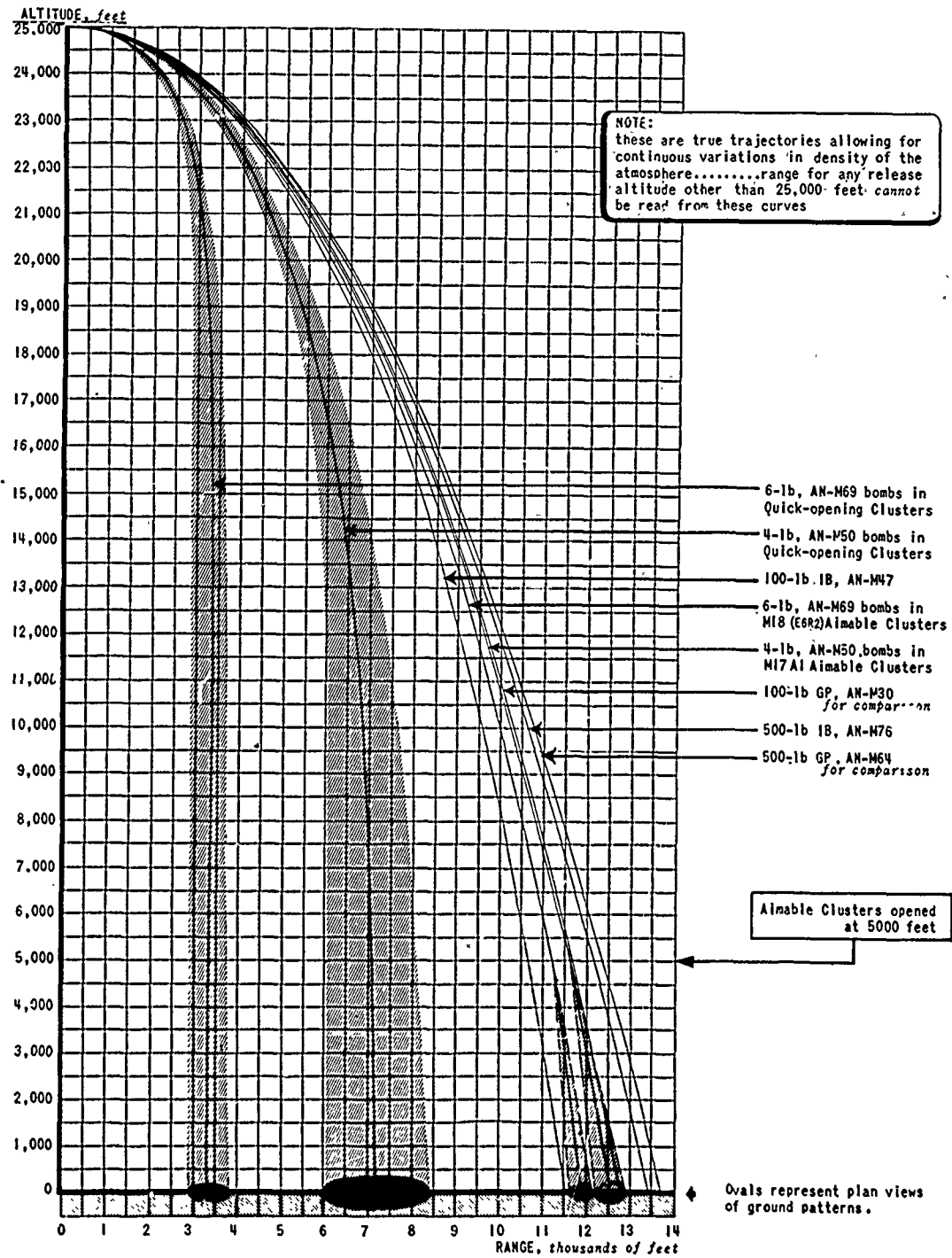

FIGURE 9. Trajectories of AN-M69 incendiary bombs in quick-opening and aimable clusters, together with other bombs for comparison.

CONFIDENTIAL

Therefore, their trail in mils and time of flight are quite large compared to large bombs. In the case of aimable clusters the intact cluster falls essentially the same as a large demolition bomb down to the point of separation, whereupon the individual bombs are released and follow a nearly vertical trajectory to the ground. A few illustrative data are shown in Table 2.

TABLE 2. Ballistic data for clusters of AN-M69 incendiary bombs.*

	AN-M69 in AN-M12 or AN-M13 quick-opening clusters	AN-M69 in M19 aimable cluster opening at 5,000 ft	AN-M69 in E28 aimable cluster opening at 5,000 ft	AN-M64 500-lb GP bombs (for comparison)
Release altitude 10,000 ft				
Trail in mils	2,440	859	61
Dropping angle, degrees	8.7	33.9	41.4
Time of flight, sec	54.4	41.7	25.7
Release altitude 25,000 ft				
Trail in mils	1,467	463	3.9	68
Dropping angle, degrees	7.7	24.0	25.4	28.7
Time of flight, sec	105.6	61.9	54.8	41.9

*For airplane speed of 250 mph.

The AN-M69 bomb has been shown to have the highest flight stability of any small incendiary bomb. This is an interesting result since originally the cloth tails were adopted as a supposedly poor substitute for a metal tail, in order to economize on the length of the bomb. For a considerable number of E28 aimable clusters released at 30,000 ft and opened at 5,000 ft, the average angle of impact on the ground was 13 degrees from vertical. The distribution of impact angles is shown in Table 3.

TABLE 3. Impact angles of AN-M69 incendiary bomb from E28 aimable clusters.

Angle of impact from vertical	Percentage of M69 bombs with given impact angle
0-10°	76
11-20°	6
21-30°	2
31-40°	2
41-50°	4
51-60°	2
61-70°	4
71-80°	0
81-90°	4

While the AN-M69 has a high stability and excellent reproducibility of trajectory, it is adversely affected by cross winds due to its low velocity.

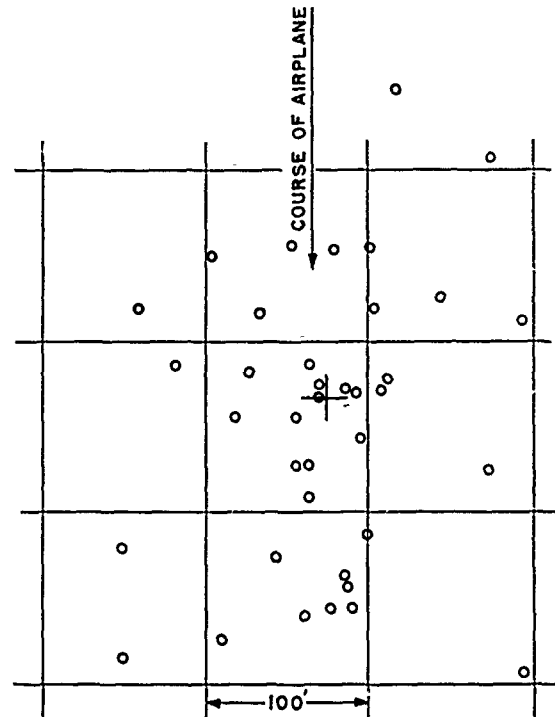

FIGURE 10. Typical dispersion pattern of M19 aimable cluster of AN-M69 incendiary bombs, released from 20,000 ft and opened at 5,000 ft. Circles indicate bombs and cross indicates center of impact. Grid is 100 ft sq. Center of impact was 1,080 ft behind AN-M64, 500-lb GP bomb.

Cluster Dispersion Patterns.^{17, 18, 19, 20, 21} The ground pattern given by the dispersion of a cluster of small incendiary bombs is an elongated oval or racetrack-shaped pattern (Figure 10). In the case of quick-opening clusters the pattern is several times as long as it is wide, while in the case of aimable clusters the elongation is not so pronounced. The dispersion patterns for the several clusters of AN-M69 bombs are as follows.

	Dimensions of racetrack figure which includes 90% of the bombs
Quick-opening clusters (dropped from 10,000 ft)	400 x 1000 ft
E28 Cluster (dropped from 20,000 ft, opened at 5,000 ft)	340 x 510 ft
M19 Cluster (dropped from 20,000 ft, opened at 5,000 ft)	240 x 360 ft

The dispersion pattern is substantially the same for 100-lb or 500-lb quick-opening clusters. In all these dispersion patterns the distribution is fairly uniform throughout most of the pattern area with a thinning out at the edges. For this latter reason the dimensions of the dispersion pattern are specified to contain 90 per cent of the bombs.

Penetrating Power.^{22, 23, 24, 25, 26, 27} The penetrating power of the AN-M69 incendiary bomb, at its normal striking velocity of 220-230 ft per sec, can be classed as fair or moderate compared to other incendiary bombs. It will penetrate practically all light and medium-weight roofs including the following.

Wood planking, about 1 in.

Slate on wood battens or wood sheathing.

Tile on wood battens.

Hollow tile slabs, 2½-3½ in. thick, with or without 2-4-in. cinder concrete for drainage.

Lightweight concrete slabs, 2½-3½ in. thick, with or without 2-4-in. cinder concrete for drainage.

However, the bomb will not penetrate reinforced structural concrete 3 in. or more thick. Of the industrial targets encountered in World War II approximately 80-85 per cent in Germany and 90-95 per cent in Japan had roofs penetrable by AN-M69 bombs.

Fire Starting Efficiency. The fire starting efficiency of small incendiary bombs can be evaluated by a variety of methods, which will be outlined in somewhat greater detail in Chapter 3. Following are a few examples of the fire starting efficiency of the AN-M69 bomb against some typical targets.

1. Factory workbench with a wooden tote-box underneath.²⁸ This setup was ignited by the fuel charge from an AN-M69 bomb whenever the major portion of the fuel charge was deposited on or near the box.

2. Stack of wooden packing boxes.²⁸ This setup was ignited by the fuel charge from an AN-M69 bomb whenever the major portion of the fuel charge was deposited on or near it.

3. German houses at Dugway Proving Ground.^{23, 27, 29} In the tests on these targets resultant fires were classified as follows.

Fire classification	Definition of fire
A1	Beyond fire-guard control in 0-2 min
A2	Beyond fire-guard control in 2-4 min
A3	Beyond fire-guard control in 4-6 min
B	Beyond fire-guard control in 6 min or more
C	Nondestructive fire

The fires resulting from functioning M69 hits on German houses were as follows.

Fire classification	Percentage of fires	
	Inside hits	Ejection hits
A1	16%	0
A2	11%	0
A3	10%	0
B	16%	11%
C	47%	89%

4. Japanese houses at Dugway Proving Ground.^{23, 30, 31} Using the same classification of fires as in (3), the fires resulting from functioning M69 hits on Japanese houses were as follows.

Fire classification	Percentage of fires	
	Inside hits	Ejection hits
A1	32%	4%
A2	22%	2%
A3	14%	13%
B	13%	31%
C	19%	50%

Figure 11 shows the action of the M69 in a Japanese-type house similar to the Dugway houses.

For a more extensive discussion of the methods and results of testing AN-M69 and other incendiary bombs see Chapter 3. The results of these tests were used to make preliminary estimates of the quantities of incendiary bombs required to destroy Japanese cities.^{32, 33, 34, 35}

1.2.4

Operational Results

AN-M69 incendiary bombs were used operationally by the following U.S. Army Air Forces and Bomber Commands.

	Base	Location of targets
5th Air Force	Southwest Pacific	New Guinea, New Britain, etc.
7th Air Force	Central Pacific	Ponape, Truk, Marianas, Palau and other Pacific Islands
10th Air Force	India	Burma
12th Air Force	Italy	Italy and Germany
14th Air Force	China	China and Formosa
15th Air Force	Italy	Italy and Germany
XX Bomber Command	India and China	China and Japan
XXI Bomber Command	Marianas Is.	Japan

CONFIDENTIAL

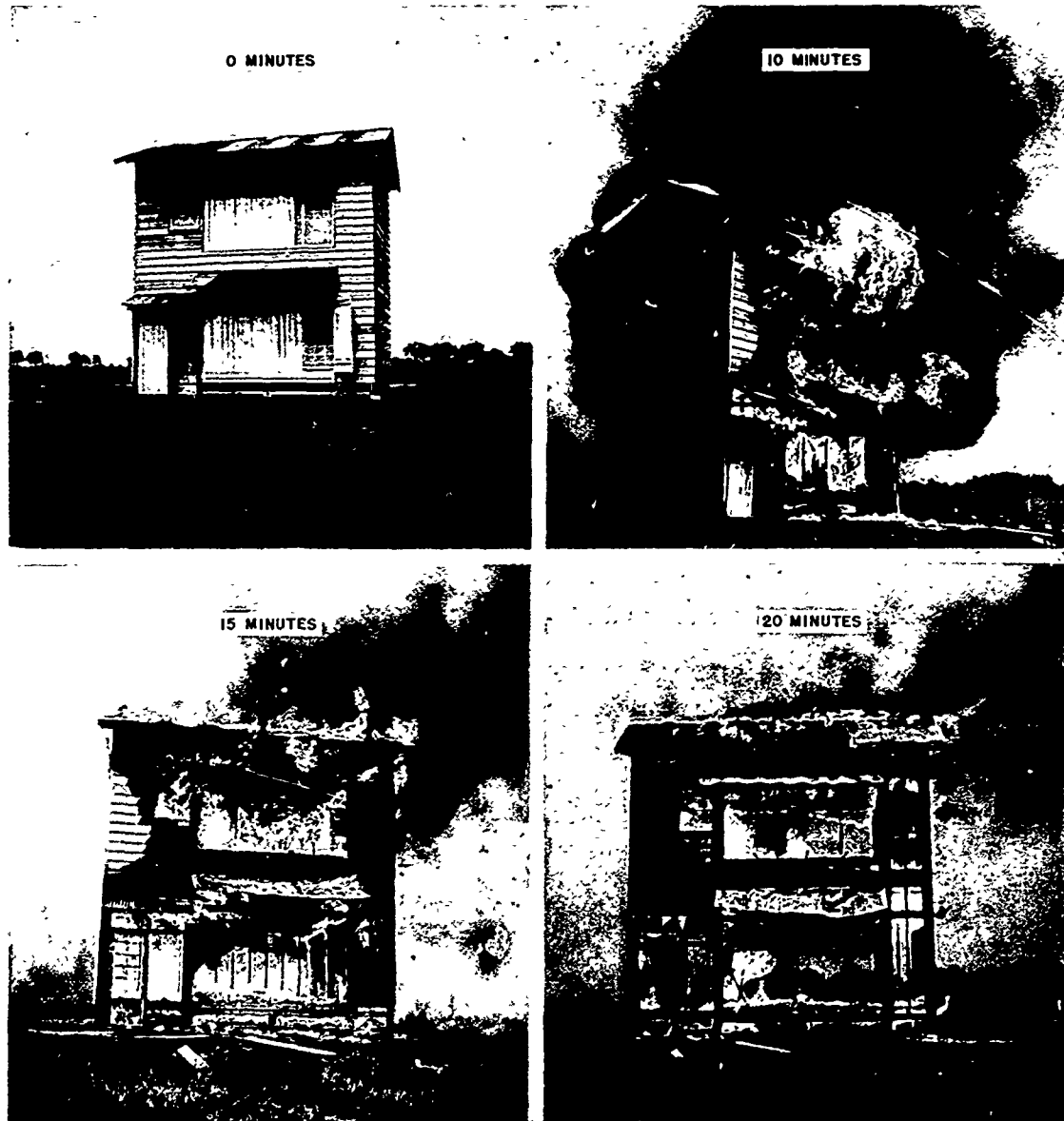

FIGURE 11. Destruction of a Japanese type house by a single AN-M69 incendiary bomb. Pictures were taken at 0, 10, 15, and 20 min after firing of bomb.

The use of this bomb by all these units was of minor importance, except that of the XXI Bomber Command. However, some incidents worthy of note are the burning of Ponape Town in February-March 1944 by the 7th Air Force, the destruction of supply dumps in Italy in 1943 by the 12th Air Force, and the burning of Changsha in October 1944 by the 14th Air Force.

The chief use of AN-M69 bombs was in the great incendiary offensive against the major

Japanese cities by the XXI Bomber Command from the Marianas Islands bases. The first of these attacks was on Nagoya on January 6, 1945, and the first significant one was the historic attack on Tokyo on March 9, 1945 (Figures 13, 14). Figure 12 illustrates the burning of Toyama, a city of 150,000 population, on August 1, 1945, by means of AN-M69 bombs. Although a complete review of these attacks is beyond the scope of this report, Table 4 summarizes the first 27 attacks on Japanese cities.

CONFIDENTIAL

TABLE 4. Incendiary attacks on Japanese cities.

City	Date	No. of B-29's attacking	Square miles destroyed*	Tons AN-M69 IB	Tons AN-M50 IB	Tons AN-M47 IB	Tons AN-M76 IB	Tons M74 IB	Tons HE & Frags	Total tons dropped†
Nagoya	1/6/45	57	0.2	138	0	0	0	0	12	150
Kobe	2/4/45	69	0.1	167	0	0	0	0	14	181
Tokyo	2/25/45	172	0.7	437	0	0	0	0	44	481
Tokyo	3/9/45	279	12.5	1,624	0	129	0	0	0	1,753
Nagoya	3/11/45	285	2.0	1,772	0	114	0	0	0	1,886
Osaka	3/13/45	274	6.6	1,782	0	56	0	0	0	1,838
Kobe	3/16/45	306	2.9	695	1,178	0	352	0	20	2,245
Nagoya	3/18/45	290	2.4	289	105	972	467	0	19	1,852
Tokyo	4/13/45	327	9.3	1,929	0	226	0	0	0	2,155
Kawasaki	4/15/45	194	2.9	812	0	312	0	0	40	1,164
Tokyo	4/15/45	109	8.6	462	0	325	0	0	15	802
Nagoya	5/14/45	472	3.1	2,679	0	0	0	0	0	2,679
Nagoya	5/16/45	457	3.8	81	3,134	129	0	0	0	3,344
Tokyo	5/23/45	520		3,004	45	789	0	0	0	3,838
Tokyo	5/25/45	464	22.1‡	1,406	877	643	328	3	4	3,261
Yokohama	5/29/45	464	6.9	1,899	19	778	0	0	0	2,696
Osaka	6/1/45	458	3.3	743	627	1,348	0	0	94	2,812
Kobe	6/5/45	474	4.4	1,004	860	1,147	0	0	82	3,093
Osaka	6/7/45	409	2.3§	574	0	1,061	0	204	804	2,643
Osaka	6/15/45	444	2.7§	74	2,375	514	0	0	0	2,963
Kagoshima	6/17/45	117	2.0	476	7	360	0	0	0	843
Omuta	6/17/45	116	0.1	393	0	407	0	0	0	800
Hamamatsu	6/17/45	130	1.3	523	7	419	0	0	0	949
Yokkaichi	6/17/45	89	1.2	208	18	356	0	0	0	582
Toyoashi	6/19/45	136	1.7	558	7	426	0	0	0	991
Fukuoka	6/19/45	221	1.3	781	0	797	0	0	0	1,578
Shizuoka	6/19/45	123	2.3	531	0	375	0	0	0	906
Totals				25,041	9,259	11,683	1,147	207	1,148	48,485

*These areas are actual built-up areas omitting rivers, canals, parks, wide boulevards, firebreaks, etc. The overall areas, including open spaces, would be 20% to 40% larger. For example, the overall area destroyed in the Tokyo attack of 3/9/45 was 17 to 18 sq miles.

†These are the total tons dropped on or near the target city, but frequently a large percentage of the tonnage given did not actually fall within the built-up area of the target city.

‡No cover available between these two attacks.

§Includes a small area destroyed in adjacent Amagasaki.

The attacks in this table comprise about one-half the incendiary bomb tonnage dropped on Japanese cities. It will be noted that the AN-M69 bomb was the principal incendiary used, with the AN-M47 and AN-M50 bombs following in importance. Several issues of *Impact* review the results of the incendiary attacks of Japanese cities.^{36, 37, 38} An analysis of some of these attacks is given below in Section 3.6.

project was to develop a modification of the AN-M69 incendiary bomb embodying a delayed-action, anti-personnel element as a deterrent to fire-fighters (see Chapter 3).

1.3.2

Description

Many of the components of the M69X bomb are identical with those in the AN-M69 (Figures 15 and 16).^{7, 39, 40} The principal points of difference between the two bombs are:

1. Gross weight of M69X is 7.1 lb compared with 6.2 lb for AN-M69 (or 6.4 lb for AN-M69 with WP cup).

2. External appearance of M69X is nearly identical with AN-M69, except that the fuze hole is moved 2 $\frac{3}{8}$ in. towards the tail in M69X to make room for the fragmentation unit, and a waterproofing rubber patch covers the out

1.3 M69X, 6-LB OIL INCENDIARY BOMB, X-TYPE

1.3.1 Introduction

Development of this bomb was initiated in May 1942 by the Standard Oil Development Co. under Contract OEMsr-354. The purpose of the

CONFIDENTIAL



FIGURE 12. Toyama, Japan, burning on the night of August 1, 1945, following an attack by AN-M69 incendiary bombs. This city of 150,000 population was one of the most completely destroyed cities in Japan, over 95 per cent.

side face of the fuze. Otherwise the casing is identical with that of the final model AN-M69.

3. A hexagonal steel liner, 0.059 in. thick, 2½ in. high, is brazed to the inside of the casing below the fuze cup for strengthening.

4. Fuze cup is made of 11-gauge steel instead of 13-gauge steel as in AN-M69, because of added strength requirement. Also, fuze cup has 3/22-in. hole in bottom for transmission of powder flash to the delay fuze of the fragmentation unit.

5. Delay fuze unit consisting of one to six ft of Ensign-Bickford safety fuze coiled helically and housed in a thin steel cup. One end of this delay fuze is fitted with a piece of Navy quick-match to catch the powder flash, and the other end is crimped into a special M106 detonator. This type of delay fuze burns at a rate of either 30 or 60 sec per foot. Delays of approximately 1½, 4, and 6 min are provided in quantities of 40 per cent, 40 per cent, and 20 per cent, respectively.

CONFIDENTIAL



FIGURE 13. Nihonbashi District in Tokyo before incendiary attack. Note the intermingling of 10 to 20 per cent modern concrete buildings with 80 to 90 per cent wooden Japanese type buildings.

6. HE unit consisting of an HE cup, made of 13-gauge steel, containing $4\frac{1}{2}$ oz (130 g) of pressed tetryl. This unit is press-fitted in place in the nose end of the casing. A rubber gasket is compressed in place between the delay fuze container and the HE cup, providing moisture-proof protection for the delay fuze unit.

7. Rubber patch cemented to the rubber ring on the outside face of the MI fuze for the moistureproofing. This moistureproofing was found necessary due to the hygroscopicity of the black powder in the delay fuze.

8. Gasoline gel filling is 2.0 lb instead of 2.6 lb in AN-M69.

9. WP cup is similar to that of AN-M69, except that it is shorter and contains 3 oz of white phosphorus instead of 6 oz, as in AN-M69.

10. Booster charge in MI fuze is 1.0 g A-4 powder instead 1 g of 50-50 mixture of A-4 powder and magnesium powder, to avoid instantaneous firing of the HE charge.

Clusters of M69X Bomb. Only one type of

cluster of M69X bombs was manufactured and supplied to the field: M21(E74), 500-lb size aimable cluster containing 38 M69X bombs, assembled in a M23(E23) cluster adapter. This cluster is identical in appearance with the M19 cluster of AN-M69 bombs, but it weighs 465 lb due to the greater weight of the M69X bombs. These clusters were never used operationally.

1.3.3

Performance Data

Mode of Functioning.^{7, 30} The functioning of the M69X bomb is the same as that of the AN-M69, with the following additional actions.

1. The flash from the main ejection-ignition charge ignites one end of the delay fuze.

2. When the ejection-ignition charge ejects the fuel charge, the empty bomb case is propelled in the opposite direction so that the bomb case and the fire are usually some distance apart.

3. After a variable delay of $1\frac{1}{2}$ to 6 min the delay fuze initiates the detonator, which ex-

CONFIDENTIAL



FIGURE 14. Nihonbashi District in Tokyo after attack of March 9, 1945, with AN-M69 incendiary bombs. The area in this picture is within one mile of the area shown in Figure 13 and has the same type of construction. Note the gutted shells of modern concrete buildings and complete destruction of the Japanese type buildings (*Life* photograph).

plodes the tetryl charge.

4. The explosion of the tetryl charge fragments the entire nose end of the bomb including HE cup, fuze cup, fuze, impact diaphragm, and the bottom one-third of the casing, producing over 400 metal fragments.

Per Cent Functioning.^{7, 41, 42, 43} Table 5 gives functioning data observed from 30 M2i aimable clusters of M69X bombs dropped at Eglin Field, Florida, from altitudes of 12,000 to 30,000 ft, opening at 5,000 ft, in January-March 1945. It will be noted that 36 out of 71 complete duds were due to striking on soft earth, which is no fault of the bomb. Later production models of M69X bombs showed somewhat better functioning than that shown in Table 5.

TABLE 5. Functioning of M69X incendiary bombs.

Number of M69X bombs recovered	939
Number functioned properly with respect to both incendiary and fragmentation actions	856
Number of air-burst bombs	5
Number of duds on ground	78
Analysis of duds on ground	
Complete duds	71
Flat landers	28
Tails torn off	4
Lightly struck primer	36
Fuze failures	3
Incendiary duds, fragmentation O.K.	3
Fragmentation duds, incendiary O.K.	4
Total	78
Overall per cent functioning (recovery basis)	91.2%
Overall per cent functioning, eliminating lightly struck primers consequent on impact in soft earth	94.8%

CONFIDENTIAL

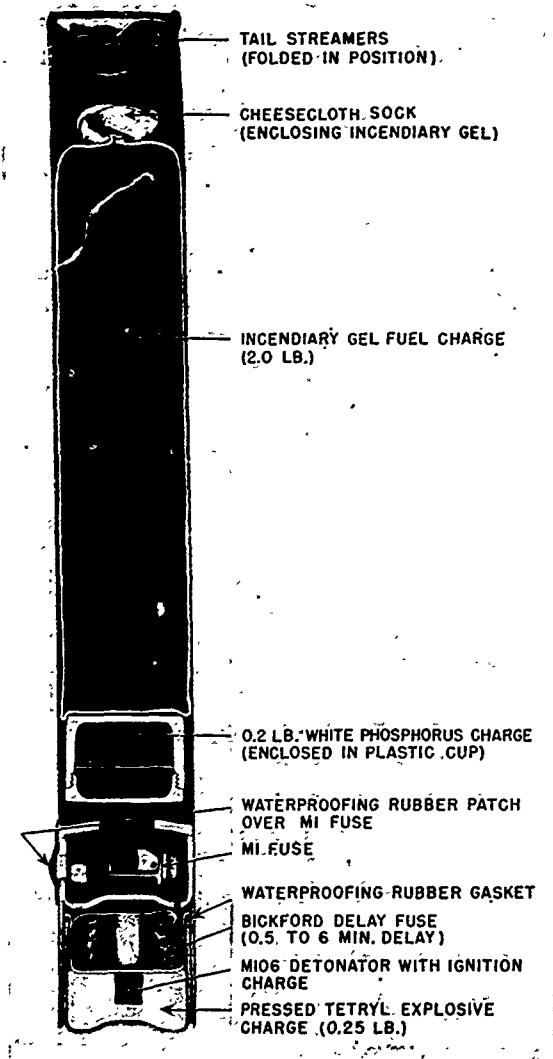

FIGURE 15. M69X incendiary bomb. External view is practically the same as AN-M69 bombs.

Ballistic Characteristics.^{7, 26, 41, 44, 45} Because of the heavier weight the normal striking velocity of the M69X bomb is 240-250 ft per sec, i.e., about 20 ft per sec higher than the AN-M69. The trajectory of the M21 cluster is similar to that of the M19 cluster, but on account of the greater weight of the former it has a somewhat greater range, about 300 ft when dropped from 20,000 ft and opened at 5,000 ft. This would mean that from 20,000 ft its trail would be about 15 mils less. The M69X bomb is somewhat more stable than the AN-M69 due to its greater nose-heaviness:

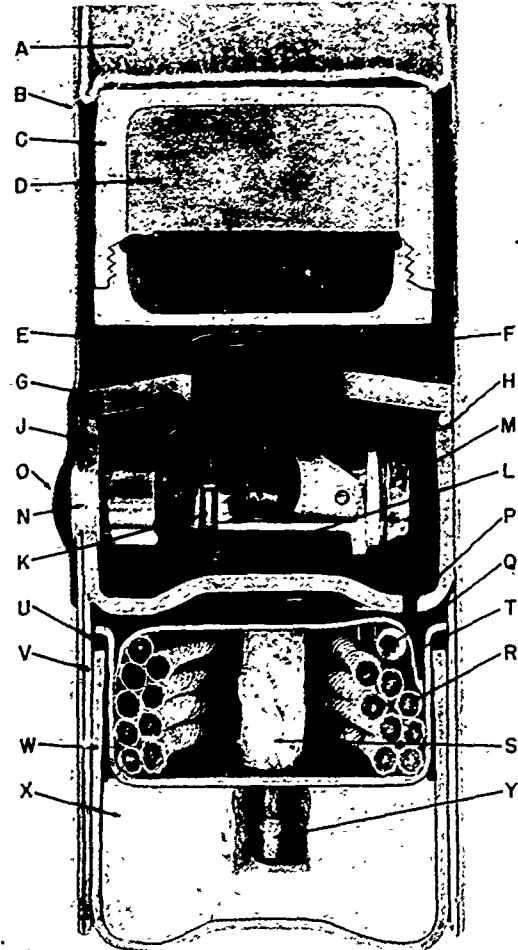

FIGURE 16. Detail of nose end of M69X incendiary bomb.

Cluster Dispersion.^{7, 26, 41, 44, 45} When dropped from 20,000 ft and opened at 5,000 ft, the M21 cluster gives a dispersion pattern (containing 90 per cent of bombs) approximately 200x300 ft, compared with 240x360 ft for the M19 cluster of AN-M69 bombs.

Penetrating Power.^{7, 26, 44} In view of its greater weight and greater striking velocity the M69X has about 35 per cent greater impact energy than the AN-M69. However, this does not change the penetration picture greatly, compared to the AN-M69. Both the M69X and the AN-M69 will penetrate all types of light roofs, but neither will penetrate 3-in., or thicker, reinforced structural concrete. There are very few intermediate types of roofs penetrable by

CONFIDENTIAL

M69X that are not also penetrated by the AN-M69. In actual flight tests at Dugway Proving Ground on Japanese structures no marked difference was observed.

*Fire Starting Efficiency.*⁷ Although the M69X contains 23 per cent less gasoline gel than the AN-M69, it was not possible to detect any appreciable difference in the relative fire starting efficiency of these two bombs against typical combustible targets. Any location in which an AN-M69 fuel charge will start a fire, will also be ignited by an M69X fuel charge, although sometimes it takes a little longer to reach a given stage of development of the fire.

Fragmentation.^{7, 46} The explosion of the tetryl charge fragments the entire nose end of the bomb, including the HE cup, fuze cup, fuze, impact diaphragm, and the bottom one-third of the casing (Figures 17 and 18). Over 400



FIGURE 17. Explosion of M69X incendiary bomb lying on top of the ground, showing force of explosion.

fragments are produced ranging in size from several milligrams up to 2 oz and having velocities up to 4,500 ft per sec. An analysis of the fragment coverage showed that a 6-ft man at a distance of 10 ft from the bomb would have a 22 per cent chance of being hit fatally and an

additional 22 per cent chance of being injured not fatally or a 44 per cent chance of being disabled at least temporarily (Figure 19). In addition, the shock of the explosion will probably incapacitate a man for several minutes even if he is not hit (based on the results of tests with live goats). However, tests showed that the blast of the explosion did not adversely affect fires burning 3 ft or more away from the HE unit.

Moistureproof Characteristics.^{7, 47} In order to make the M69X moistureproof independently of its shipping container, the M1 fuze and HE-delay fuze assembly must be especially waterproofed.

The M1 fuze is waterproofed by the use of a vulcanized Neoprene type GN patch $1\frac{5}{8}$ -in. diameter and 0.020 in. thick, cemented to a neoprene type GN ring $\frac{3}{16}$ in. wide, $1\frac{17}{32}$ in. OD and 0.015 in. thick, which is vulcanized to the casing around the hole.

The HE-delay fuze assembly is waterproofed by the use of a soft vulcanized Neoprene type GN rectangular gasket, $\frac{3}{32}$ in. thick, $\frac{1}{4}$ to $\frac{3}{8}$ in. wide, placed under the lip of the delay fuze cup so that the leading edge of the HE cup rests against the gasket as the HE cup is pressed flush with the end of the casing.

Both the M1 fuze and HE-delay fuze assembly were subjected to a 24-hr submergence test under 6 ft of water and a 7-day storage test at 100 per cent humidity with cyclical temperatures varying every 12 hr from 70 to 125 F. The following results were observed.

1. M1 fuze showed 97 per cent performance out of 266 tested in the submergence test and 97.7 per cent performance out of 87 tested in the storage test.

2. HE-delay fuze assembly showed 98.3 per cent performance out of 120 tested in the submergence test and 100 per cent performance out of 35 tested in the storage test.

1.3.4

Final Status

Production of M69X bombs in M21 clusters was begun in March 1945, and clusters reached operational bases in the Marianas Islands in July 1945, but there is no record of their ever having been used operationally. This bomb

CONFIDENTIAL



FIGURE 18. Fragments recovered from explosion of M69X incendiary bomb.

would undoubtedly have been more effective, possibly twice as effective, as the AN-M69 bomb for incendiary attacks on Japanese cities.

1.4 AIMABLE CLUSTERS FOR AN-M69 TYPE BOMBS

1.4.1 Introduction

Aimable or projectile clusters of incendiary bombs, which drop as a unit to a predetermined height where they are opened by a mechanical time fuze, were first developed and used by the

Germans in 1941. The idea was later adopted by the British (1942) and still later by the United States (1943). The first United States aimable cluster of AN-M69 bombs was the E28 cluster, also called M18 or E6R2, developed by the Chemical Warfare Service in 1943. This cluster had several disadvantages: (1) its trail was larger than desirable, (2) its flight characteristics were not reproducible, (3) it produced about 3 per cent of air-burst bombs due to the shock of opening, and (4) about 5 per cent of the clusters failed to open due to failures of the single mechanical time fuze. The E28 cluster is shown in Figure 20.

CONFIDENTIAL

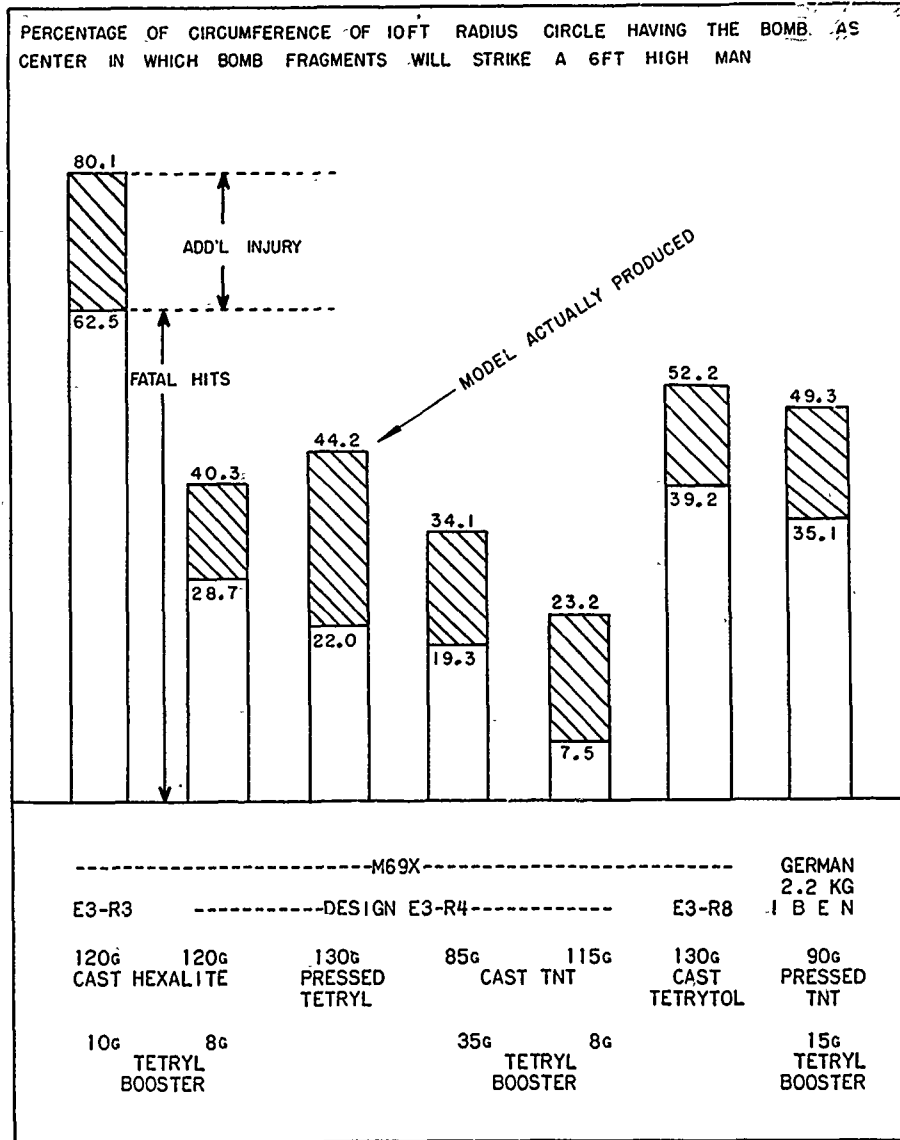

FIGURE 19. Anti-personnel effect of fragments from explosion of M69X incendiary bomb.

1.4.2

E18 Aimable Cluster

In order to overcome the disadvantage of the E28 cluster, the development of the E18 aimable clusters was begun in January 1944 by the Standard Oil Development Co. under Contract OEMsr-354. The E18 cluster (also called C1 cluster) was 14.4 in. diameter and 69.0 in. in length, weighed 425 lb gross and contained 45 AN-M69 bombs, compared to 38 in the E28 cluster (Figure 20). The principal components of the E18 cluster are as follows: (1) hemi-

spherical nose fairing of sheet steel, (2) two hemicylindrical cover sheets, (3) top suspension bar, (4) bottom bar, and (5) tail assembly, including fairing, box-type tail fins, cylindrical tail shroud and two tail fuze adapters. The method of opening was by Primacord bursters similar to the E28 cluster.

In order to produce a well-streamlined cluster, it was believed necessary to increase the length from the standard 59 in. for 500-lb size bombs and clusters to 69 in., which was suitable for nearly all airplanes until the advent of the B-29

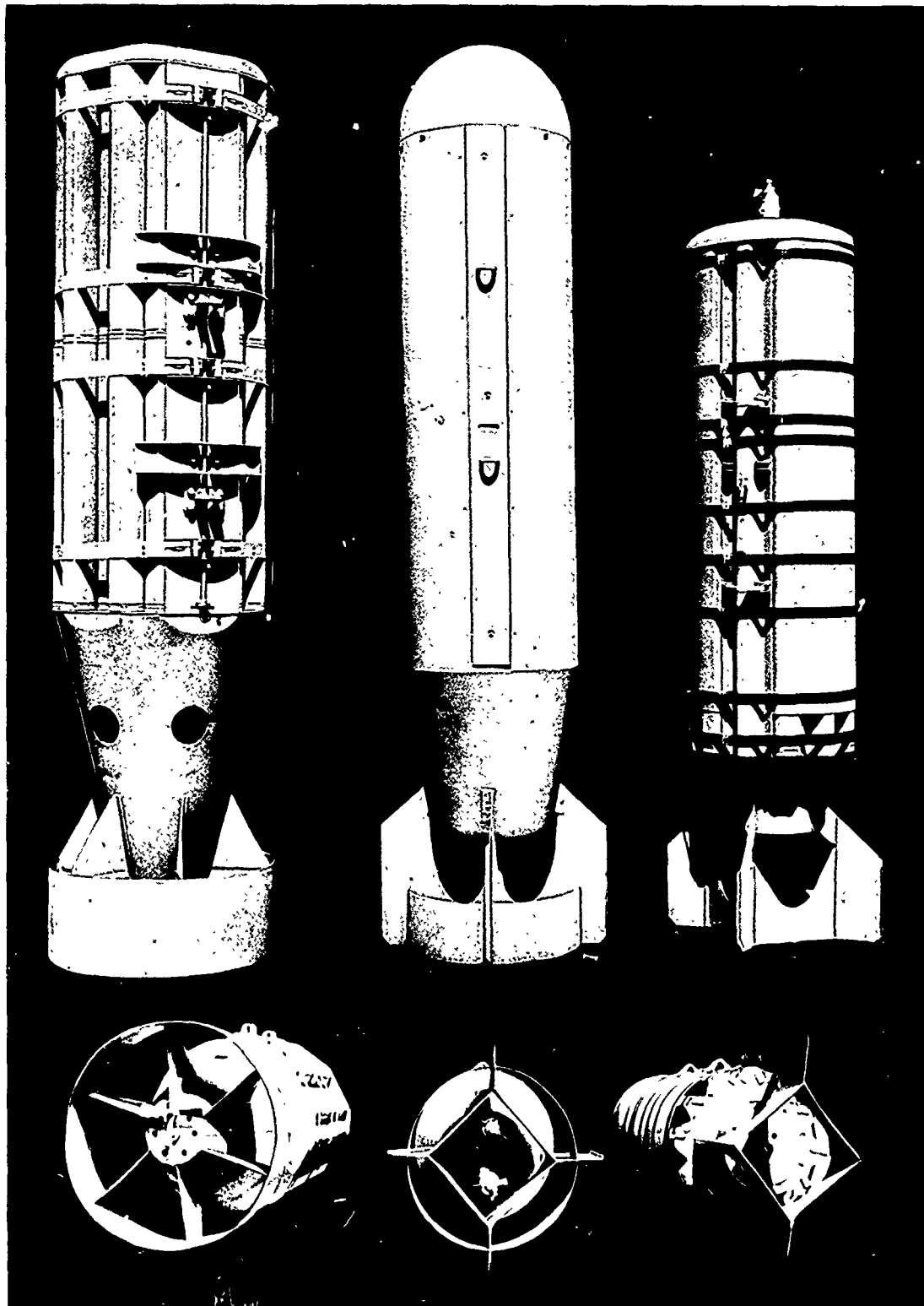

FIGURE 20. Experimental models of aimable clusters of AN-M69 incendiary bombs. Left to right, British No. 20 cluster, E18 cluster, and E28 cluster.

CONFIDENTIAL

and B-32. The resulting cluster proved to be ballistically superior, but the excessive length prevented efficient loading on 500-lb bomb stations in B-29 and B-32 airplanes. For this reason the E18 cluster was never standardized or produced.

For comparative purposes some British No. 20 clusters were made and tested in parallel with the E18 and E28 clusters (Figure 20). This cluster was 18.0 in. in diameter and 67.3 in. in length, weighed 450 lb-gross, and contained 62 AN-M69 bombs. A major difference from the E18 and E28 clusters was the method of opening, which was of the mechanical type instead of the explosive type. The British No. 20 cluster was really of the 1,000-lb size and had to be restricted to 1,000-lb bomb stations in loading on airplanes.

TABLE 6. Comparative data on aimable clusters.

	E28	E18	British No. 20
Cluster weight, lb	350	425	450
Cluster diameter, in.	14.2	14.4	18.0
Cluster length, in.	59.4	69.0	67.3
No. of AN-M69 bombs in cluster	38	45	62
Terminal velocity, ft/sec	675	1,000	515
Trail behind AN-M64, ft*	2,550	335	2,855
Trail angle, mils*	179	135	189
Circular probable error, mils*	30	15	50-75
Cluster pattern, ft	350x450	300x450	300x300
AN-M69 bomb performance*			
% Air-burst bombs	2.4	1.0	0
% Tails torn off	1.7	6.4	1.0
% Flatlanders, other causes	2.8	1.6	2.0
% Fuze failures	1.5	0	0

*For release from 30,000 ft, opening at 5,000 ft, and true airspeed of 250 miles per hr for dropping airplane.

Table 6 gives some comparative data on the E28, E18, and British No. 20 clusters.⁴⁸ These data lead to the following conclusions:

1. The E18 cluster has excellent range, reproducibility of trajectory, and other desirable ballistic characteristics. In fact, its range is nearly identical with that of the AN-M64, 500-lb GP bomb.

2. The British No. 20 has poor ballistic characteristics.

3. The E18 cluster causes an excessive number of AN-M69 tails to be torn off, owing obviously to the high velocity of the cluster at time of opening.

4. The British No. 20 cluster causes no air-

burst bombs, probably because of the mechanical type of opening instead of the explosive type of opening.

1.4.3 M19 (E46) Aimable Cluster

On the basis of these conclusions the Chemical Warfare Service developed a new aimable cluster, the M19 (E46), combining the best qualities of the E18 and British No. 20 clusters, and retaining the 59-in. standard length for 500-lb size bombs (Figures 6 and 21).^{5, 17, 49, 50, 51, 52, 53} The M19 cluster had a blunt rounded

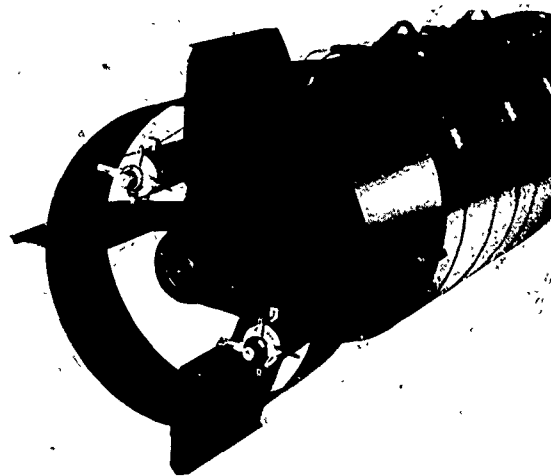

FIGURE 21. Detail of tail end of M19 aimable cluster showing twin tail fuzes and tail shroud construction. For overall external view of this cluster see Figure 6.

nose fairing, a streamlined tail with shroud and twin tail fuzes similar to the E18, and a mechanical type opening which was simpler than the British No. 20 mechanism. This produced a cluster which still had a somewhat undesirably high trail, but its trajectory was very reproducible. The cluster released the bombs with a minimum of air bursts and tail damage, and the twin tail fuzes insured practically 100 per cent functioning of the clusters. Figure 10 shows the dispersion pattern of this cluster when dropped from 20,000 ft and opened at 5,000 ft. The M19 (E46) cluster was produced in large quantities and used extensively in bombing Japan in 1945.

CONFIDENTIAL

1.5 E19, 11-LB MAGNESIUM INCENDIARY BOMB

1.5.1 Introduction

The E19 bomb was originally conceived as a more potent fire-raiser than the AN-M50 for use on German domestic construction. Later, with the development of aimable clusters, its possible use on factory targets in precision bombing was considered. The E19 was a bomb of the same external dimensions as the AN-M69 bomb, but heavier, and had a terminal velocity of about 650 ft per sec, so that its penetrating power was adequate for either use. As compared to existing small incendiary bombs, the E19 has higher penetrating power, in addition to the special features, in that the bomb is propelled to a favorable site after impact, and that the flame resists the action of ordinary extinguishers and is screened from fire fighters by an obscuring phosphorus smoke.

1.5.2 Description

The E19 is identical in outside dimensions to the AN-M69, namely 19½ in. long by 2⅞ in. across the hexagonal flats (Figure 22).^{54, 55} It consists essentially of a magnesium body enclosed in a perforated steel sleeve welded to a steel nose-piece, filled with a mixture of several incendiary materials, and fitted with a spring-out metal tail. The gross weight is 11 lb.

The bomb is a thin-walled magnesium shell encased in a perforated steel sleeve welded to a steel nose-piece. The principal incendiary filling has the following composition:

Flake aluminum	14.8%	Sulfur	1.6%
Sodium nitrate	14.8%	Motor oil	7.1%
Barium nitrate	11.7%	Thermite	50.0%

For a further description of this mixture see Section 8.7. This mixture is loaded under compression into an annulus surrounding a case of solid hydrocarbon wax. A perforated steel diaphragm holds both fillings in place. The incendiary filling is satisfactorily ignited under light confinement by a flash of black powder from the fuze; and no first-fire mixture is required. The mixture of finely divided metal and oxidiz-

ing agents burns with an intense heat sufficient to ignite the magnesium casing and to crack the hydrocarbon wax to volatile gases. The result is a combined jet and magnesium bomb. The perforated diaphragm or propellant cup keeps the filling in place and promotes the development of an internal pressure sufficient to force jets of flame to issue from successive perforations in the steel sleeve. Thus, intensely hot flames, in a series of radial jets, issue from the bomb over a period of 3 to 4 min, and a residual flame and heat effect from the more slowly burning magnesium metal persists much longer. The total heat release is greater than that of the M50 bomb on the basis of either cluster volume or weight and about equals that of the M69 bomb on a cluster basis.^{56, 57}

The fuze is very similar to the M1 fuze used in the AN-M69 bomb. The fuze is waterproofed by a rubber sleeve enclosing the safety plunger.

The tail contains a charge of phosphorus which is dispersed by a central burster. A parting charge separates the tail and the main bomb body after a 3-sec delay.

The E19 bomb is loaded in the same clusters as the AN-M69 bomb, but since the E19 is heavier than the M69, the nose and tail weights of the E23 cluster adapter can be omitted.

1.5.3 Performance Data

The action of the E19 is illustrated in Figure 23. After impact there is a 3-sec delay train in the fuze similar to the action of the M69. After coming to rest an igniter charge of 0.6 g of black powder leads the flash to a separating charge of 7 to 8 g of black powder, which then shears off the tail and, at the same time, ignites the bomb and kicks it in the opposite direction with sufficient force to cause it to come to rest against a wall or other obstacle. The bomb thus has an advantageous feature of tending to come to rest in a site favorable for starting a fire. The tail assembly comprises a streamlined canister loaded with phosphorus, with an extensible extruded magnesium fin-tail making for economy of load in the cluster. The canister carries an explosive charge that operates a few seconds after the tail has been separated from the body of the bomb.

CONFIDENTIAL

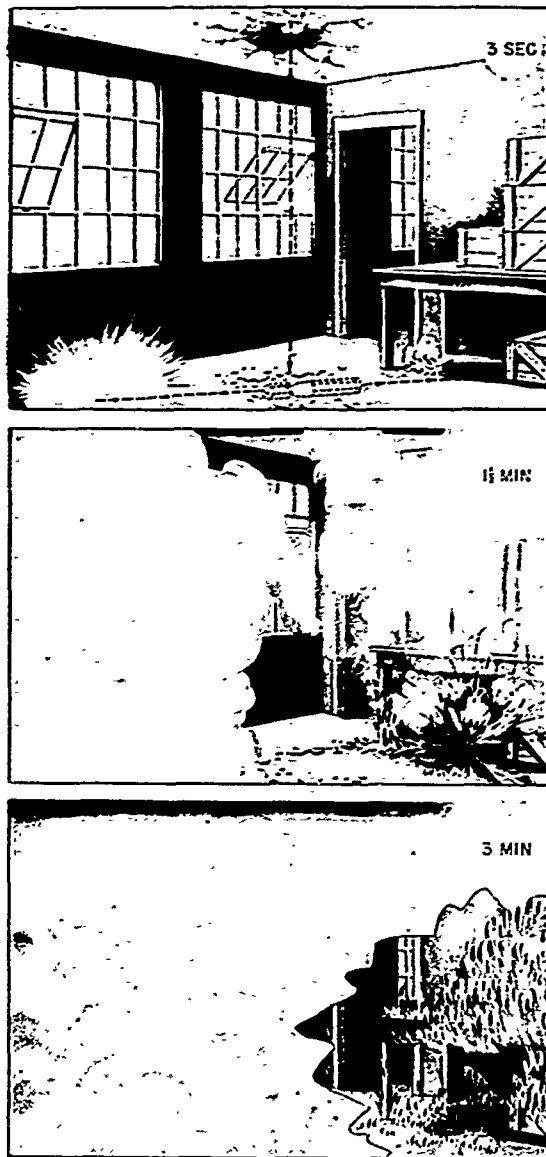

FIGURE 23. Action of E19 incendiary bomb. Note the jet-like flames issuing through the perforated bomb case in the middle view.

Thus, in the normal case the tail explodes at some distance from the body and produces an obscuring screen offering a considerable deterrent to the fire-fighter. In addition, the sudden release of a shower of burning phosphorus produces an explosion wave capable of shattering windows and blowing out doors and frames. The burning phosphorus tends to ignite any readily inflammable material in the area with consequent increase in room temperature and accentuation of the action of the bomb proper.

Penetration tests with bombs fired at velocities up to 650 ft per sec indicate that in the majority of instances the tail stays in place even when the bomb penetrates a thick concrete roof or suffers abrupt setback on a concrete slab. It will penetrate up to 6 in. of singly reinforced concrete slab, unless it hits directly over a reinforcing rod. In some instances of severe punishment, for example in a glancing hit, the tail may be ripped off the body on impact and prior to the operation of the separating charge. However, the bomb is ignited by the fuze even though the tail is lost on impact.

All of the dropping tests indicate that the bomb has excellent ballistics. Its center of gravity is $8\frac{1}{16}$ in. from the nose, while its metacenter is $9\frac{1}{8}$ in. In the event that a lower penetration is required, the striking velocity can be controlled by the addition of three tail streamers of Class A binding tape, each $\frac{3}{4}$ in. wide, looped over the struts of the sliding tail vane and fastened with wire staples. The foot streamers of this material, which is much more effective than sheeting, reduce the terminal velocity to approximately 500 ft per sec when the bombs are released from the cluster at a level above 8,000 ft. The ends of the streamers are dipped into heavy lacquer to prevent them from fraying.

1.5.4

Final Status

Although development of the E19 was satisfactorily completed, the decision was reached not to put the bomb in production, because of the absence of evidence that enough targets existed on which it would show performance superior to existing bombs.

1.6

E9, 40-LB OIL INCENDIARY BOMB

1.6.1

Introduction

Development of this bomb was initiated in February 1943 by The Texas Co. under Contract OEMsr-898. The request for a bomb of this intermediate size came from the Chemical Officer of the Eighth Air Force in England.

The basic conception was to develop a me-

CONFIDENTIAL

dium-size bomb which would have good ballistics, would penetrate a substantial target, and carry the maximum amount of incendiary fuel. The bomb was intended for use in high-altitude precision bombing, and was to be carried in a

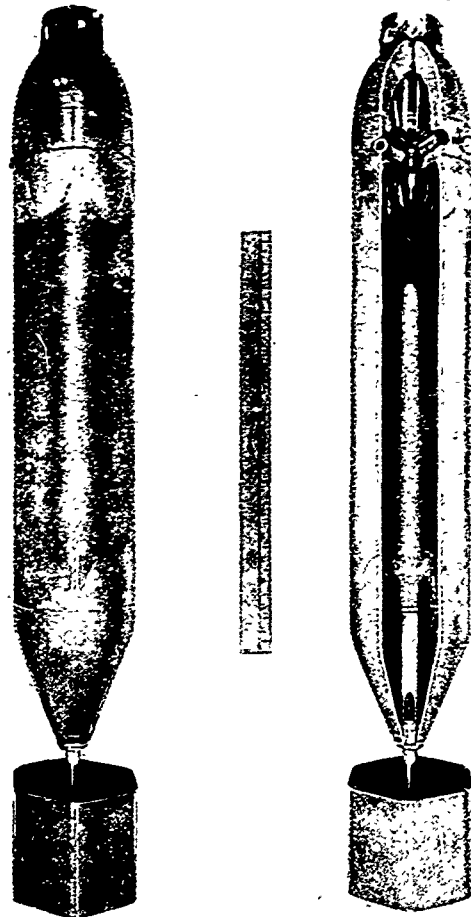

FIGURE 24. E9 incendiary bomb, external and cutaway views. Cutaway view does not have gel filling, white phosphorus, ejection charge, burster charge, or HE charge in place; otherwise bomb is complete.

cluster that would utilize fully the space available on the 500-lb bomb station of American planes. It was planned to incorporate a charge of white phosphorus in addition to the incendiary gel, and to include a high-explosive element that would cause fragmentation of the nose. Thus the bomb would be a highly aimable all-purpose medium-size bomb. It would have

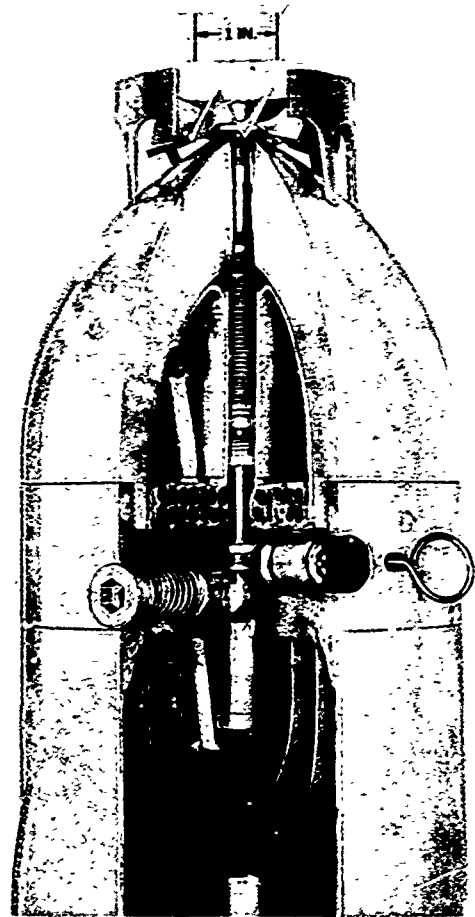

FIGURE 25. Detail of nose end of E9 incendiary bomb.

far greater penetrating power than the M50 4-lb magnesium bomb, the M69 6-lb oil bomb, or the M47 100-lb oil bomb, and would contain a substantial amount of incendiary fuel.

A preliminary design study attempted to meet the required properties in a bursting-type bomb. Concurrently the Chemical Warfare Service had been designing a tail-ejection bomb in this same size range and with some of the same features. On March 31, 1943, at a conference at Edgewood Arsenal, the two designs were amalgamated with the CWS tail-ejection model predominating in the combined model. This project was then turned over to The Texas Co. for development. A principal subcontractor under The Texas Co. was the Foster-Wheeler Corp., which had the primary responsibility for the mechanical design.

CONFIDENTIAL

1.6.2

Description

Brief Description. As finally produced in limited procurement for test purposes the E9 bomb consisted of a heavy steel nose, an hexagonal steel case, and an extensible metal tail (Figures 24 and 25). The overall dimensions were such that fourteen bombs, in two banks of seven, formed a cluster which utilized fully the space available on a 500-lb bomb station. Attached to the nose was an arming vane which permitted an out-of-line detonator to slip into position only after the bomb was separated from the cluster and had fallen away from the airplane. Contained in the nose were a delay train and blasting cap and a high-explosive charge. The heavy nose shell screwed into a forged steel base plate, which carried the out-of-line detonator and the safety pin that prevented arming of the bombs while clustered. Attached to the other side of the base plate were two steel domes and the steel case which contained the incendiary fuel. The inner dome contained the ejection charge, and the space between the two held the white phosphorus. The far end of the hexagonal case was rounded, and attached to it was a thin conical section which carried the extensible metal tail.

Pertinent data on the final design are as follows.

Diameter	5 in.
Length, tail collapsed	29 $\frac{1}{16}$ in.
Length, tail extended	33 $\frac{3}{4}$ in.
Weight empty	29.7 lb
Weight loaded	40.5 lb
Weight of incendiary (13% Napalm-gasoline)	9.5 lb
Weight of WP	0.8 lb
Weight of tetrytol	0.65 lb
Weight of booster charge	
A-4 black powder	2 g
Composition of ejection charge	
75-mm FMH smokeless	
Cannon powder	20 g
A-4 black powder	6 g
Oiled magnesium powder	9 g
Center of gravity, distance from nose	11.1 in.

Details of Design. 1. Nose. The nose of the E9 bomb was a steel forging, shaped into an ogive to provide maximum thickness at the point where impact occurred. A $\frac{3}{8}$ -in. hole provided for the shaft of the vane arming fuze mechanism to pass through the nose. Attached

to the outer surface was a guard ring which protected the arming vane. There were also two sockets for the special wrench with which the nose was screwed onto the base plate.

2. Base plate. This was a steel forging, which carried the out-of-line detonator and the safety plunger. Through it passed the striker pin.

3. HE cup. A spun steel cup, designed to fit snugly into the nose, contained the tetrytol.

4. Delay fuze. A coil of Bickford fuze, contained in a shallow metal cup, fitted inside the nose and into a recess in the base plate. Burning of the delay was initiated by the black-powder ejection charge in the dome.

5. Out-of-line detonator. This was a spring-loaded element which slid into position after the striker pin had withdrawn sufficiently following rotation of the arming vane.

6. Safety pin. A spring-loaded pin was held in position to prevent retraction of the striker pin when the bombs were clustered. When the cluster opened and the bombs separated, the safety pin was thrown out of the way.

7. Booster charge. This was contained in a cellophane cup, in line with the primer and in contact with the black powder in the dome. Its function was to ensure rapid and complete ignition of the black powder.

8. Powder dome. This was a light steel dome, brazed to the base plate and scored to facilitate rupture of the dome near its base.

9. WP dome. The white phosphorus was contained in the space between the inner and outer domes.

10. Casing. The casing was of steel $\frac{1}{8}$ -in. thick, formed from tubing which was left round at both ends for attachment to the base plate and tail cone. The intermediate portion was hexagonal, which facilitated clustering and provided a snug fit to hold the safety pin in place, and also increased the fuel capacity by about 3 per cent.

11. Tail cone. This was a light-gauge tapered shell which was blown off when the bomb functioned.

12. Extensible tail. A finned metal tail was attached to a post which seated into a recess in the tail cone. By means of a coiled spring the tail was extended when the bombs broke out of the cluster.

CONFIDENTIAL

Fillings for Bomb. The only fillings that could be used were those capable of being introduced through the small hole in the tail cone. Gasoline gel containing thirteen per cent Napalm was used in the bombs made for test purposes. An extensive series of tests was conducted to determine the optimum fuel for the E9 bomb. After small-scale laboratory tests had established a preliminary order of merit, a full-scale field test mortar was used for evaluating the fillings. The mortar had the same capacities as the regular bomb and utilized the same rupturable domes and cones. A concrete block framework was erected 36 ft from the mortar. Sound 1/4-in. plywood was mounted on the framework for each shot. A fuel was rated according to the percentage of the plywood target burned within a ten-minute period.

The following fuels are recommended in the order of preference.

1. 12% cellucotton in 5 cylindrical wads, 42 in. long and 3 in. in diameter.
58.5% turpentine.
19.5% furfural extract from lube oil.
10% magnesium, type B, 40/100 mesh.
2. 15% cellucotton in 5 cylindrical wads, 42 in. long and 3 in. in diameter.
85% turpentine
3. 12% cellucotton in 5 cylindrical wads, 42 in. long and 3 in. in diameter.
58.5% turpentine.
19.5% furfural extract from lube oil.
10% ammonium nitrate.
4. 4% polyisobutyl methacrylate polymer containing 0.3% methacrylic acid.
1% 40% aqueous sodium hydroxide.
20% toluene.
75% gasoline.
5. 13% Napalm thickener, type B.
87% gasoline.

It can be noted that a wadding or solid type of filling produced the best results. The use of this material, however, would involve a redesign whereby a full 5-in. diameter opening could be employed. The design of a satisfactorily strong and leak-proof connection or seal of this size was not worked out during this investigation. It is believed, however, that this type of filling would offer more promise than the standard types of thickened gasoline.

1.6.3

E53 Cluster of E9 Bombs

The E9 bomb was originally intended for use in a quick-opening cluster of the 500-lb size. When the Air Forces ruled against the use of quick-opening clusters for release from planes flying in large formations, because of the danger from slowly falling metal components, there was a general trend toward delayed-opening aimable clusters. These require a nose fairing and a tail to give good ballistics. Since there was no room to add these components to the cluster of E9 bombs it became necessary to devise an adapter which would open quickly and consist of parts that would fall nearly as rapidly as the bombs. This was accomplished by using a small number of strong streamlined components and by replacing the conventional steel straps with low air-drag cables attached to the main cluster bar. This adapter was known as the E26 cluster adapter, and the complete cluster of 14 E9 bombs was designated the E53 cluster.

The essential features of the E26 cluster adapter and E53 cluster are illustrated in Figures 26 and 27. The principal components are briefly described as follows.

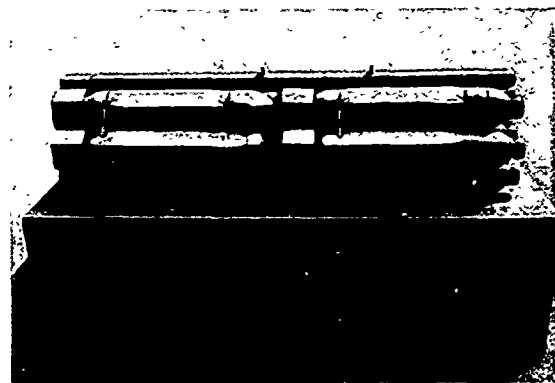

FIGURE 26. E53, 500-lb size, quick-opening cluster of E9 incendiary bombs.

1. Main cluster bar. This is a hollow steel tube 2 in. in diameter, with a heavy rounded nose and an extensible finned metal tail. It contains the mechanism which opens the cluster, and permanently attached to it are the four steel cables that hold the bombs until the cluster opens. It is fitted with a hoisting lug and with

CONFIDENTIAL



FIGURE 27. Detail of nose end of E53 cluster.

carrying lugs for attachment to a standard bomb shackle.

2. Stiffening bars. Two lengths of 1-in. pipe, weighted at one end, and provided with light metal tails, are placed 120 degrees from each other and from the main cluster bar. These serve to hold all bombs firmly in position when the cables are tightened.

3. Javelins. These are three slender steel rods which serve to prevent the central bombs from sliding forward or backward in relation to the outer bombs. One end of each is enlarged and the other end has a flat disk which engages the tails of the rear bombs in the cluster. The three javelins are placed around the two central bombs at intervals of 120 degrees.

4. Cables. These are 5/32-in. woven steel airplane cables, fitted with threaded connectors by which they can be drawn up tightly against the bombs. One end is permanently locked into position inside the main cluster bar. The other end is held by a latch until released by the functioning of the cluster opening mechanism.

5. Cluster release mechanism. In the nose of the main cluster bar is a fuze, consisting of a cocked firing pin, a 1½-sec delay pellet and a charge of black powder contained in a steel cylinder. The firing pin is prevented from moving by a rotating safety pin which cannot turn until the arming wire pulls out as the cluster leaves the airplane. Pressure developed by the burning of the black powder is applied to a

piston. Beyond the piston is a steel rod carrying 4 integral steel latches which hold the free ends of the cables. When the powder burns, the moving piston causes the rod to slide within the main cluster bar, releasing the free ends of the cables and opening the cluster. The four cables then fall with the main bar to which they were attached.

The E26 adapter weighs 58 lb, and the complete E53 cluster of 14 E9 bombs weighs 618 lb. It is noteworthy that this cluster adapter, weighing less than 10 per cent of the total weight of the cluster, was strong enough to meet the latest requirements for strength of clusters as prescribed by the Joint Aircraft Committee in the spring of 1945. New clusters were required to withstand a stress equal to 18 g (18 times the force of gravity) in a vertical direction, 7.5 g fore and aft, and 3 g sideways. None of the clusters in common use by the U.S. Air Forces at the end of World War II could meet these requirements, despite the fact that the relative weight of their adapters was in general much greater than 10 per cent of the total. The novel features of the E26 cluster adapter should be kept in mind in future work on bomb clusters.

1.6.4

Performance Data

Mode of Functioning. When an E53 cluster is dropped the following sequence of actions takes place:

As the cluster leaves the bomb bay the arming wire pulls out of the safety pin, permitting it to rotate and free the spring-loaded striker pin of the cluster fuze. The striker pin moves forward, firing a primer which in turn ignites a delay composition that burns through in about 1½ sec. A small charge of black powder then is ignited and moves a piston and the steel rod which carries the four latches that have locked the free ends of the cables in place. When these are released the cluster disintegrates and the 14 bombs are free to fall individually. The extensible tail on the main cluster bar springs out and the bar, with the four steel cables attached to it, falls rapidly, as do all other members of the adapter.

CONFIDENTIAL

As the bombs separate, each safety pin is thrown out and the propeller arming vane rotates rapidly. This action draws the firing pin toward the nose end of the bomb and soon permits the out-of-line detonator to slide into the firing position. When the bomb strikes the target the firing pin is driven back into the primer-detonator. This fires the booster charge which ignites the black powder ejection charge. The domes are ruptured and the pressure causes the tail cone and bomb tail cone and bomb tail to part from the case, ejecting the gel and white phosphorus. The Bickford delay fuze starts to burn and after approximately 2 min the high-explosive charge shatters the nose and part of the casing.

Per Cent Functioning. Ten clusters of bombs with inert filling in the HE cup were dropped from 20,000 ft onto the clay flats at Dugway Proving Ground. The bombs penetrated from 8 to 14 ft into the clay, and no gel was observed to emerge above the ground level. By probing, it was found that several of the bombs had functioned. However, two bombs were found which had malfunctioned because of deformation of the firing pin.

Fifteen clusters of bombs complete with live HE in the nose were dropped from 20,000 ft onto the industrial target building at Eglin Field, Florida. Several complete duds were found, and in a few instances instantaneous detonation of the high-explosive charge occurred when the bomb hit the target area.

It appears that some further development would be required to insure a satisfactorily high percentage of functioning. Minor changes would be needed to strengthen the firing pin assembly and to prevent the arming vane from bending without transmitting the required thrust to the firing pin. Further study to prevent premature detonation of the HE charge is also indicated. It is believed that the pressure built up in the inner dome causes a flash which sometimes bypasses the Bickford fuze and sets off the blasting cap. The fact that completely satisfactory functioning occurred in some instances suggests that the troubles encountered could be overcome by minor changes in the construction of the bomb.

Ballistic Characteristics. When properly

launched in high-level flight, the E9 bomb exhibited excellent ballistic properties. The trail angle was small compared to most other incendiary bombs and was well within the scope of the standard bombsights, being almost exactly the same as for the M38A2 practice bomb. It was apparent that the design was successful in yielding a bomb that was suitable for precision bombing from high altitude. When released from the cluster, some of the bombs were thrown out at random and exhibited a certain amount of preliminary tumbling and yawing before assuming true flight. This resulted in a separation of the bombs and caused some of them to fall a considerable distance behind the others. It is believed that if a suitable bomb rack were available to release all bombs individually in true flight the ballistic characteristics would leave little to be desired.

Cluster Dispersion Patterns. Ten E53 clusters were dropped from 20,000 ft onto the clay flats at Dugway Proving Ground. One cluster did not open. Of the 14 bombs in a cluster, between 8 and 12 fell into an area the width of which varied from 100 yd to 150 yd and the length varied from 100 yd to 375 yd. From one to three bombs usually landed about 600 yd to the rear, and in three instances from one to three additional bombs landed approximately 1,200 yd to the rear. When the impact patterns of these clusters were superimposed upon a line through the leading bomb in each cluster, it was found that 55 per cent of the bombs fell within an area measuring 200x200 yd, 80 per cent were within an area 200 yd wide by 775 yd long (Figure 28).

The leading bombs in each cluster fell near the M38A2 practice bomb, and most of the bombs were consistently grouped within a reasonable distance of the practice bomb. This is evidence that the E9 bomb, when properly launched, has excellent ballistics; and also indicates a high degree of aimability for the cluster, despite the fact that a few of the bombs usually fell far to the rear. Clusters of other incendiary bombs frequently gave tighter and more uniform patterns, but their centers of impact varied widely with respect to the aiming point where the M38A2 bomb landed. When considered in terms of a stick of clusters from

CONFIDENTIAL

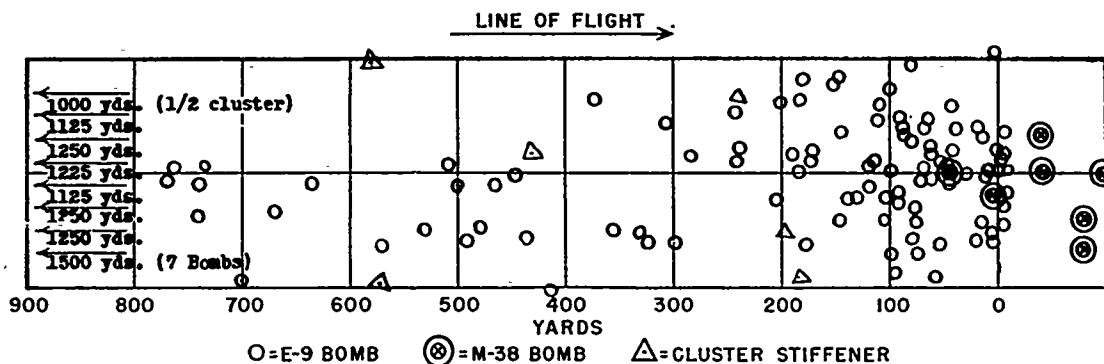

FIGURE 28. Superposition of impact patterns of nine E53 clusters of E9 incendiary bombs dropped from 20,000 ft.

a single plane, or many clusters from a group of planes, the dispersion pattern of the E53 cluster appeared satisfactory. The high intrinsic aimability of the E9 bomb increases the probability that some bombs will hit a specific target, even though a few will trail considerably.

Release from Fighter Planes. E53 clusters were released from P-51 fighter planes at 350 mph at an angle of 30 degrees from 3,000 ft elevation in a glide bombing attack. All the bombs hit close to the target in a pattern about 200 ft by 300 ft. The E53 cluster is probably the only incendiary bomb cluster which could be used for low-level or glide bombing attacks.

Penetrating Power. A number of hits were obtained on the industrial target building at Eglin Field, Florida. One bomb penetrated the 6-in. reinforced concrete roof slab and an 8-in. reinforced concrete floor, and then ejected its gel and disintegrated from premature detonation of its high-explosive charge. A second bomb showed similar penetration of roof and floor, but failed to function. Upon hitting the next lower floor the nose assembly parted from the case. Two bombs which hit light roof construction penetrated cleanly and also went through a plain 6-in. concrete floor, coming to rest about 1 ft below the floor. The incendiary gel was ejected; one HE charge detonated prematurely and the other after the intended delay. No instance of rupture of the bomb case upon impact was noted, and there were no failures of the nose and case to hold together until after the roof had been penetrated by the bomb.

When impacting on sand or clay, in drops from high altitude, the E9 bomb penetrated 12 ft or more into the ground. Ejection occurred after the bomb had gone some distance below the surface, and no incendiary results were to be expected.

Fire Starting Efficiency. The end of World War II came before tests could be run to evaluate the fire starting efficiency of the E9 bomb when actually dropped onto combustible targets. The test mortar, used to determine the optimum fuel for the bomb, simulated the original design in which a delay element permitted the bomb to come to rest before ejection occurred. The final design omitted the delay, so that ejection occurred in a few hundredths of a second after the first impact. But this permitted a bomb that hit on the ground to penetrate to the point where no gel was discharged above the surface; hence, only direct hits on structures would be significant. From the meager data available it appeared that ejection of gel would occur while the bomb was still in flight after penetrating roofs and floors equivalent to the 6-in. roof and 8-in. floor actually penetrated in two instances. Or, after penetrating a light roof in a one-story building the bomb would go through a 6-in. floor and eject its gel upward from its final position just below the floor.

Neither of these modes of functioning was favorable to the starting of a fire, as compared to the horizontal ejection of gel that was originally planned. However, with approximately 10 lb of incendiary gel being ejected, there would be a good chance that several gobs

CONFIDENTIAL

of substantial size would be thrown against combustible material. Moreover, the chance of starting several simultaneous fires which would be mutually supporting increased with the amount of fuel in the bomb. Hence it may be said that the E9 bomb would probably prove to be an effective fire starter, and would be especially valuable for the attack on selected targets where precision bombing and the ability to penetrate a substantial roof were necessary.

It appears unlikely that a bomb of this type could be constructed which would regularly hold together until it came to rest before ejection. The E9 showed no sign of failure in penetrating the roof and floor slab, but in one instance the nose separated from the casing when the next floor was encountered. In slowing down as it passes through roofs and floors, the bomb is certain to turn so that the next impact will not be taken on the nose and in line with the central axis of the bomb. When that occurs, breakup is to be expected. Hence it appears necessary to have the bomb function instantaneously, and a more rapid ejection than was achieved in the E9 would have some advantages. Hits on the ground might not be a total loss, and hits on one-story factories would result in gel being ejected between roof and floor without having to depend on there being a heavy concrete floor to stop the bomb where its gel would still be ejected inside the structure.

TABLE 7. Fragmentation of E9 incendiary bomb.

Description	Number	Weight
Unfragmented portion of case	1	6 lb, 15 oz
Large fragments, ½ lb and over	8	5 lb, 12 oz
Medium fragments, 1-8 oz	40	5 lb, 15 oz
Small fragments, 0.2-1 oz	100	2 lb, 2 oz
Small fragments, 0.2 oz and smaller	1,000 approx.	2 lb, 10 oz
Total	1,150 approx.	22 lb, 12 oz
Original weight of metal, 21 lb, 3 oz		
Recovery, 91.1%		

Fragmentation. A test made in a fragmentation chamber at Edgewood Arsenal gave results shown in Table 7. The detonation of the E9 anti-personnel element makes a very impressive noise, and in field trials fragments were found ½ mile from the point of explosion.

1.6.5

Final Status

When World War II ended, some minor problems remained to be solved in perfecting the E9 bomb and the E53 cluster. In summarizing this development, the following conclusions appear to be justified.

1. The E9 is a medium-sized incendiary bomb which has excellent ballistic characteristics. It can be aimed with current bombsights and has a small trail angle compared to most of the other incendiary bombs.

2. The penetrating power on reinforced concrete exceeds the stated requirements for this bomb, and the performance after penetration appears satisfactory.

3. The quantity of incendiary fuel per cluster is greater than for any other comparable cluster of bombs using gelled fuel.

4. A lethal anti-personnel charge was successfully incorporated, but some further work is required to prevent premature functioning of the HE.

5. Some changes in details of the bomb-fuze mechanism are needed to prevent malfunctioning on impact.

6. The E26 cluster adapter is capable of releasing the bombs with a minimum of tumbling. It utilizes all the space available in a 500-lb bomb station, and its components fall rapidly enough to clear lower flying planes in a formation.

7. The E53 cluster is suitable for high-level, low-level, and glide bombing.

8. The E9 bomb and E53 cluster are adequately safe to handle, transport, and store.

1.7 E3, 25-LB OIL INCENDIARY BOMB

Development of this bomb was initiated in April 1942 by Harvard University under Contract OEMsr-179. The objective was to develop a medium-sized incendiary bomb which would be an improvement on the AN-M46, 30-lb bomb, from the point of view of flight stability and functioning, and on the AN-M47, 70-lb bomb, from the point of view of clustering and loading efficiency. The E3 bomb could be considered either as a small version of the AN-M47 bomb,

CONFIDENTIAL

or as an improved version of the AN-M46 bomb. Some impetus also came from the British 30-lb petrol gel bomb, which was of the same size class. The E3 bomb can be considered as a precursor of the E9, 40-lb oil incendiary bomb (see Section 1.6).

The E3 bomb was of the 25-lb class and of the bursting type. It was intended to be clustered 14 in a 500-lb size quick-opening cluster. The bomb consisted of a hexagonal sheet steel case with an ogival nose and a conical tail section fitted with a fixed hexagonal steel fin. A central burster was of the WP-HE type as in the AN-M47 bomb. The filling was 13.5 per cent Napalm gasoline gel. The nose was fitted with an AN-M110 arming vane type fuze. The overall dimensions were $4\frac{3}{4}$ in. across the hexagonal flats by $26\frac{3}{4}$ in. long. The filled weight was 23.5 lb, of which 11 lb was gasoline gel. The proposed 500-lb size cluster would have been approximately $14\frac{1}{4} \times 58$ in. and would have weighed approximately 375 lb.

Only two rather crude models of this bomb were ever dropped in flight tests. One dropped from 2,500 ft at Jefferson Proving Ground showed good flight characteristics, and the other dropped from 2,500 ft at Edgewood Arsenal yawed badly. These results left the flight characteristics in doubt, so that this project was held in abeyance for some time and was later revived in the development of the E9, 40-lb incendiary bomb.

1.8 E20, 500-LB OIL INCENDIARY BOMB

Development of this bomb was initiated in April 1943 by Harvard University under Contract OEMsr-179. The objective was to develop a large incendiary bomb with a cast-iron case, instead of steel, in order to reduce the force necessary to open the case and thereby prevent dispersion of fuel in such small particles as characterized the performance of the steel-case bomb.

The E20 bomb was very similar to the AN-M76 500-lb incendiary bomb, which in turn is externally identical with the AN-M64 500-lb GP bomb. The principal differences between the E20 and AN-M76 bombs are:

1. The E20 bomb casing is made of cast iron instead of steel.

2. The E20 casing is slightly thicker, with a minimum wall thickness of 0.5 in. and a maximum nose wall thickness of 1.5 in. compared with 0.3 in. and 1.25 in., respectively, for the AN-M76 casing.

3. The E20 bomb used a $\frac{9}{16}$ in. tetrytol burster compared with a $\frac{7}{8}$ in. burster in the AN-M76 bomb.

4. E20 bombs were filled with Napalm type I, methacrylate type I and PT1 fillings, although part of the purpose of using the cast-iron case was to be able to use the Napalm and IM types of filling.

When fired statically the E20 bomb, filled with Napalm type 1 and with $\frac{9}{16}$ -in. tetrytol burster, dispersed burning gel over an area 100 ft x 200 ft. There were 297 fires burning after 5 min and 46 fires after 11 min. The casing broke into many small pieces.

When dropped on buildings from 4,000-5,000 ft, the bomb functioned satisfactorily on striking light roofs. One bomb penetrated a light-weight, concrete tile roof and also a 3-in. concrete slab floor, depositing gel on the first floor over an area 120 ft x 180 ft, with 235 fires burning after 5 min. However, when striking a 7-in. reinforced-concrete slab the bomb broke up so badly that satisfactory penetration and functioning on heavy-roofed buildings seemed doubtful. The E20 bomb is therefore not a substitute for the AN-M76 in this respect.

When dropped 10 ft and 20 ft onto concrete, the bomb broke into 6 to 18 pieces. This fact ruled out the bomb from a safety point of view, and further development was discontinued.

1.9 E22, 500-LB OIL INCENDIARY BOMB

Development of the bomb was initiated in April 1945 by the Factory Mutual Research Corp. under Contract OEMsr-257. The objective was to develop a large incendiary bomb of the tail-ejection type, using cellucotton as the bodying agent for gasoline fuel instead of gelling agents such as Napalm.

The E22 bomb was an attempt to develop a large tail-ejection type incendiary bomb to meet

CONFIDENTIAL

the requirement for a 500-lb size incendiary bomb. This bomb used the casing of the AN-M64 500-lb GP bomb, modified somewhat, and therefore was externally identical with the AN-M76 500-lb incendiary bomb.

The principal components of the E22 bomb were the following.

1. The AN-M64 bomb case scored to a depth of $9/32$ in. clear around at the base of the tail cone ($2/3$ thickness of the casing).

2. A nose burster consisting of a steel wall $1\frac{3}{4}$ in. in diameter by $18\frac{3}{4}$ in. long extending inside the bomb case and filled with 250 g of 70 per cent A4 black powder and 30 per cent coarse magnesium flakes.

3. A cylindrical tail canister containing 5 lb of white phosphorus.

4. A main filling consisting of 92 cellulocotton rolls, 4 in. x 4 in., covered with cheesecloth and 17 gal, or 110 lb, of gasoline. Gel type fillings could also be used.

5. An AN-M103 nose fuze, with the charge reduced from 50 g to 5 g of tetryl, set for instantaneous firing.

6. An AN-M101 A2 tail fuze and M115 burster containing 100 g of tetryl, set for 0.025-sec time delay.

The gross weight of the bomb was about 375 lb, and the external dimensions and appearance were identical with the AN-M64 and AN-M76 bombs.

On functioning, the burster charge blew off the scored tail section and ejected the gasoline-soaked cellulocotton rolls. The spectacular action earned this bomb the name volcano bomb. In static tests about 92 per cent of the cellulocotton units were ejected whole with 85 per cent ignition. At the end of 10 min 57 fires were still burning. There was a large flash burn of excess gasoline at the time of ejection, but this was estimated to consume less than 10 per cent of the gasoline in the bomb. The white phosphorus canister in the tail was burst by the M115 burster and produced an instantaneous white smoke.

Dropping tests were few and inconclusive. A total of 10 bombs were dropped from 5,000 ft altitude, of which 3 hit a building and 7 hit onto ground. The bombs which hit buildings seemed to fragment the case rather than simply

eject the contents, and there was an unusually large amount of flash burn. Also the cellulocotton rolls were shredded and shattered more than in the static tests. However, in one case there were 56 fires burning at the end of 5 min. The general conclusion was that the bombs did not function the same or as promisingly in the dropping tests as in the static tests. One bomb penetrated two floors of 7 in. and 8 in. of concrete respectively, showing its penetrating power to be comparable to the AN-M64 or AN-M76 bombs. The bombs striking onto ground did not add any pertinent data.

Although the results were not conclusive, the development was discontinued at this point in view of the AN-M76 filling the limited requirements for this class of incendiary bombs.

1.10 PLASTIC INCENDIARY BOMB

Development of this bomb was initiated in December 1941 by the Monsanto Chemical Co. under Contract OEMsr-198. The objective was to develop a small incendiary bomb utilizing cellulose nitrate plastic as an incendiary material.

Two principal types of bombs were developed under this project.

1. Bombs in which the cellulose nitrate plastic served as a combustible casing for a therm-8 filling, i.e., the plastic was intended to be an improved substitute for the steel casing in the AN-M54 type of incendiary bomb.

2. Bombs in which the cellulose nitrate plastic was the primary incendiary material with only enough therm-8 filling to assist the burning of the plastic.

The various bombs developed under this project were hexagonal in shape, $1\frac{3}{4}$ in. across the flats by 10 in. long, or roughly half of the length of the AN-M50 and AN-M54 standard bombs.

Many variants of bombs of the first type were tried, and the most important and final model had the components described below.

Plastic casing, hexagonal, $1\frac{3}{4}$ in. across flats by 10 in. long, with inside bore of $1\frac{1}{4}$ in. or $1\frac{1}{2}$ in., giving a minimum wall thickness of $\frac{1}{4}$ in. or $\frac{1}{8}$ in., respectively.

Steel nose plug, with hexagonal section $\frac{1}{4}$ in.

CONFIDENTIAL

thick and a $\frac{5}{8}$ -in. long section extending inside the plastic casing.

Plastic tail plug, made of Resinox plastic, $1\frac{1}{4}$ in. in diameter, $3\frac{1}{4}$ in. long, bored internally to take the firing pin, spring, and primer holder from the AN-M54 bomb.

Filling of 5 pellets of therm-8, each 1 in. thick, and 1 first-fire pellet.

Cloth tape tail streamer, 1 in. wide, 30 in. long. Various other bombs with tails and bombs without tails were also tried.

The gross weight of a bomb of this description was $2\frac{1}{4}$ lb; the burning time was $2\frac{1}{2}$ min.

Drop tests from 1,000 ft onto concrete resulted in breaking and malfunctioning of these bombs, although the flight stability was good. Somewhat better performance on drop tests was obtained by wire reinforcing in the plastic and by use of layer-cloth, tail streamers, and parachutes, but the results were still discouraging. These results caused abandonment of this type of bomb.

Bombs of the second type were similar to those of the first type, except that the bore of the plastic casing was reduced to $\frac{1}{2}$ in., making the bomb primarily a plastic bomb with just enough therm-8 to assist the burning of the cellulose nitrate. These bombs weighed only 1.6 lb compared to 2.25 lb for the first type, so that it was felt the bomb was sufficiently nose heavy with the steel nose plug that the cloth tail could be omitted. Drop tests from 1,000 ft onto concrete showed adequate strength and apparently good flight stability. However, drop tests from 5,000 ft and 10,000 ft showed very poor flight stability, many bombs tumbling badly.

In view of these test results development of this bomb was discontinued in the summer of 1942. Furthermore, comparative burning tests showed that the fire starting capacity of this bomb was quite low, reflecting the relatively low heat of combustion of cellulose nitrate (7,200 Btu per lb).

CONFIDENTIAL

Chapter 2

MISCELLANEOUS INCENDIARY ITEMS

2.1 INTRODUCTION

THIS chapter describes miscellaneous developments in the incendiary field, including a new type of burster for large incendiary bombs which was utilized in the AN-M47 and AN-M76 bombs, several small incendiaries for sabotage and other miscellaneous purposes, an all-ways fuze for M69 type bombs, incendiary leaves, and certain modifications of some standard incendiary bombs. Most of these developments could be described as minor, except the new type burster for large incendiary bombs.

2.2 BURSTER-IGNITER FOR M47 TYPE BOMBS

2.2.1 Introduction

All the incendiary bombs used in World War II were exploded by either base-ejection or central charges of black powder. Chemical bombs, on the other hand, scattered their contents by means of a central burster, usually of tetryl. The phosphorus bombs or shells constructed in this manner were poor incendiaries at best, and the bursting charge was so great that most of the contents were broken into very small particles. With the development of gasoline fuels thickened by rubber or Napalm, a new and comparatively difficult problem of ignition and distribution arose. It was necessary to distribute the burning gel in gobs sufficiently large to start fires under average conditions. Very large lumps may burn for a long time, but they represent an inefficient distribution, while very fine pieces of gel are too short-lived to be effective.

It was found that the M47 series of 100-lb chemical bombs, which make efficient containers for incendiary material, burst unevenly under slowly increasing pressure such as produced by a black powder burst. Usually there was one weak spot at a seam or near the tail that would rupture sufficiently to release the pressure and

eject only a portion of the fuel, while the remainder burned either in the bomb or in the crater below. This was verified by high-speed motion pictures (800-1200 frames a sec) with the M47 100-lb bomb having a 0.032-in. wall, and the same effect was later observed, to a lesser degree, with the M47A1 bomb having a 0.050-in. wall. Bombs loaded with chemical agents did not exhibit this fault, for the liquid transmitted the pressure practically undiminished, but the jellied fuels absorbed much of the energy, causing a slower transmission of the bursting energy to the case.

2.2.2 Description

It was observed that light-wall gallon cans used to test experimental batches of thickened fuel were effectively scattered by one or more detonators. From this observation it was reasoned that a high-explosive central core of primacord or TNT-tetryl should act similarly, and this was found to be the case. A means having been found for distributing the gelled fuel evenly and in regulated size, a large number of igniters were then examined in order to effect ignition of the gel. Among those tried were powdered and grained magnesium, sodium, potassium, sodium-potassium alloy, zinc dimethyl, silicon ethyl, phosphorus, and pyrophoric metals. Larger scale tests were then made on zinc dimethyl and phosphorus confined in an annular tube surrounding the central explosive core. Phosphorus was found to be the better of the two, and from practical considerations of manufacture and loading it was selected as the igniter to be used in conjunction with the high-explosive burster.^{1, 2}

The experimental model is shown in Figure 1. In this unit the central explosive core 31 consists of TNT pellets, contained in a bakelite tube with one or more booster pellets of the more sensitive tetryl at either end. Light brass or aluminum caps retain the pellets in the tube and permit firing the tube at either end. The

burster is held against the fuze by the coil spring 32 which is an integral part of the outer housing. Considerable leeway is permitted in the gap between the fuze and the end of the burster, and reliable firing is obtainable with gaps of from $\frac{1}{8}$ to $\frac{1}{4}$ in. in length. Two pounds of phosphorus is contained in the annular space between the inner burster well and the outer tube. A seal made by the lead washer 26, together with a luting of pipe dope (hydraulic cement ground with linseed oil), retains the phosphorus.

never produced, but after some delay the Chemical Warfare Service modified it somewhat and it was standardized and produced as the AN-M13 burster and AN-M9 igniter for use in AN-M47 series bombs.^{4, 5, 6} These items were produced and supplied separately so that each was made a sealed unit, with the result that the total wall thickness required to be ruptured was increased so much that the production models never equalled the experimental models in performance. The AN-M13 burster is a plastic or aluminum tube, 0.45 in. diameter, 36 in. long,

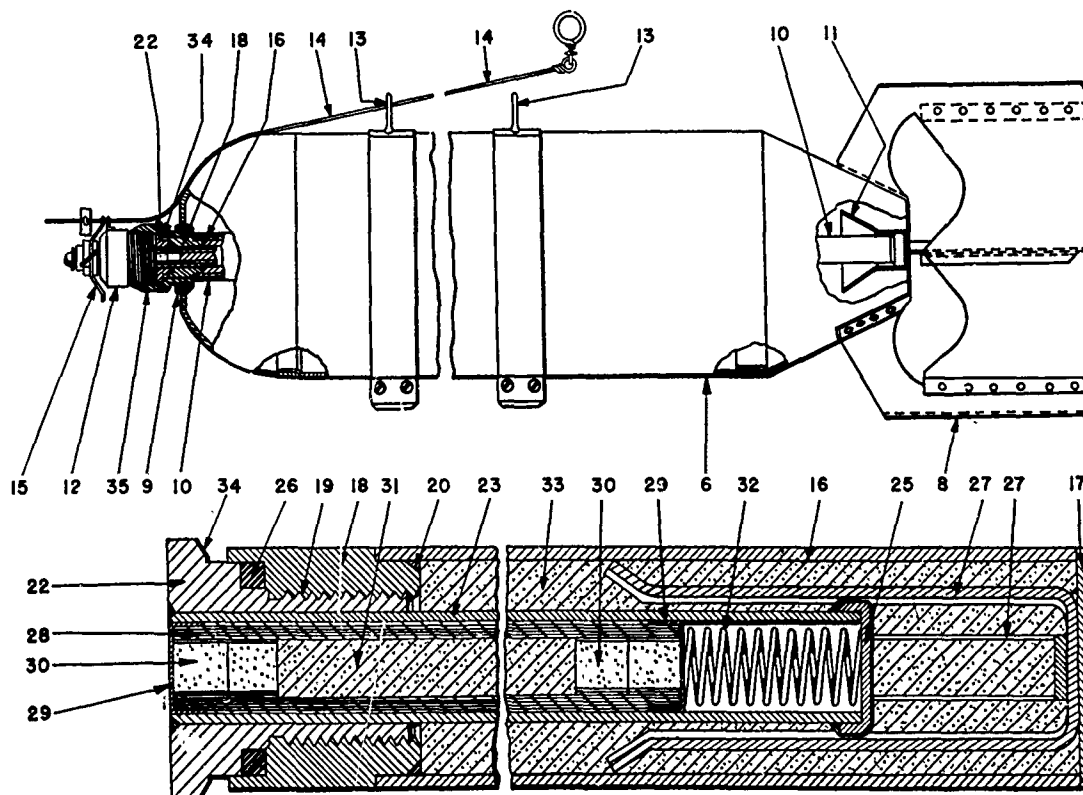

FIGURE 1. WP-HE burster-igniter in place in AN-M47 incendiary bomb and detailed cross section.

The phosphorus was loaded by either the wet method (under water) or the dry method (under carbon dioxide).³ The latter method was preferred and largely used in production, because of the lessened chance for corrosion. The phosphorus was loaded and sealed into the burster well in the factory, and the sealed tube of explosive was inserted into the central well in the field at the time of arming.

The burster-igniter as described above was

filled with TNT pellets containing tetryl pellets at each end. The AN-M9 igniter is a steel tube, 38.5 in. long, filled with 1.6 lb of white phosphorus (WP), and containing a steel well, 0.454-in. inside diameter, to receive the AN-M13 burster. This combination was used extensively in AN-M47 bombs in bombing Germany and Japan. The AN-M12 black powder-magnesium powder burster was also used in this bomb. Tests at Eglin Field failed to show con-

CONFIDENTIAL

clusive superiority for either of these competitive bursters.

This same principle was adopted for use in the AN-M76, 500-lb incendiary bomb. This bomb was a standard 500-lb bomb case filled with 180 lb of PT incendiary gel. The M14 burster and M5 igniter for the AN-M76 bomb were of the same type as the AN-M13-M9 combination used in the AN-M47 bomb. The M14 burster contained one lb of tetrytol, and the M5 igniter contained 9 lb of white phosphorus. This combination worked quite successfully in this bomb. The AN-M76 bomb was used to a limited extent in bombing Germany and Japan.

Another application of this burster-igniter principle was used by the Chemical Warfare Service in the burster-igniter for the jettisonable belly tanks, or fire bombs, filled with Napalm gasoline gel, which were used so effectively in Europe and the Pacific.

2.2.3

Performance Data

This type of burster is always instantaneous firing. In testing this type of burster a sharp distinction must be made among three methods of testing:

1. Firing of statically placed bombs, in which the fuel is thrown outwards and upwards in a fairly circular pattern with the bomb at the



FIGURE 2. Static burst of AN-M47 incendiary bomb using WP-HE burster-igniter.

center (Figure 2). A typical burst of this type would cover an area about 150 ft across and would yield about 50 gobs of gel which would still be burning after 10 min.

2. Bombs dropped from airplanes onto earth, in which the bomb makes a crater and most of the fuel is thrown forward and upwards in an elliptical pattern with the bomb at one end. The area covered was about 50x100 ft, although this varied with the angle and speed of impact.

3. Bombs dropped from airplanes onto buildings, in which the bomb bursts 8 to 15 ft below the roof and the fuel is thrown downwards and outwards in a conical pattern onto the floor below.

Figure 2 shows a burst of type (1). Bombs were frequently tested by method (2) in the early days of World War II, and some limited conclusions could be drawn. Tests by methods (1) and (2) in 1942 indicated a marked superiority of the WP-HE burster over the black powder-magnesium powder burster,^{8, 9, 10} and this led to the decision to use the former. However, only tests by method (3) are really significant in determining the effectiveness of a bomb. Tests by this method at Eglin Field in 1944^{11, 12, 13} failed to show any marked superiority of the AN-M13-M9 burster-igniter combination over the AN-M12 black powder-magnesium powder burster. It is possible that a better adjustment of HE charge and wall thickness of material in the AN-M13-M9 combination might have given the superior results shown by the experimental model.

2.3 SABOTAGE INCENDIARIES AND FIRE STARTERS

2.3.1

Introduction

Small pocket-size incendiaries of this type are used as sabotage incendiaries, usually placed by hand, and for starting campfires in the field, or for heating and cooking in emergencies. The following NDRC contractors developed incendiaries of this type:

Harvard University, Contract OEMsr-179; Factory Mutual Research Corp., Contract OEMsr-257; and University of Chicago, Contract OEMsr-113. The first two contractors later worked directly with the Office of Strategic Services in this line of development.

CONFIDENTIAL

All incendiaries of this type consist essentially of a combustible case, filled with some incendiary material, and fitted with some sort of igniter.

2.3.2

M1, Fire Starter

This unit, developed by Harvard University, consists of a cylindrical celluloid case, 3x1½-in. diameter, filled with 33 g of Napalm gasoline gel, and fitted with a match-head and scratcher



FIGURE 3. M1 fire starter (Harvard Candle), assembly and construction.

igniter (Figure 3).^{14, 15, 16, 17, 18, 19} The gross weight of the unit is 77 g, its heat output is about 1,700 Btu, and it burns for 7 to 9 min. The match-head composition is 50 per cent potassium chlorate, 30 per cent antimony sulfide, 20 per cent dextrin, and water to give a stiff paste. The scratcher composition is 50 per cent red phosphorus, 30 per cent 50-80 mesh sand, 20 per cent dextrin, and water to give a stiff paste. The complete unit is waterproofed with a coating of vinylite.

The fire-starter is ignited simply by rubbing

the scratcher on the match-head. This unit was tested in a packing box test where two packing boxes are placed with 10x25-in. faces, 1½ in. apart. The M1 fire starter started a continuing fire in this test setup, while some other small incendiaries which weighed more would not do so. This test was successful with either dry or wet wood. Other simple wood-burning tests were used in which the M1 fire starter showed up to advantage compared to other incendiaries of similar weight.

This incendiary, originally called the Harvard Candle, was standardized as the M1 fire starter in 1942 and produced in some quantities. There is no record of its use in the field.

2.3.3 H2, Vest-Pocket Sabotage Incendiary

This device, developed by Harvard University, is made to resemble a plastic cigarette case or notebook (Figure 4).²⁰ It consists of a black celluloid case 5½x2¾x¾ in., filled with 133 g of 8 per cent Napalm gasoline gel and fitted with a time-delay ignition mechanism. The gross weight is 189 g, the heat output is about 5,500 Btu, and the burning time is about 15 min.

The time-delay igniter on this unit had to be safe, reliable, silent, and waterproof. It consisted of a standard OSS time-delay pencil actuating a spring-loaded firing pin, which pierced a thin, 0.005-in., celluloid cylinder and fired an ordinary strike-anywhere match-head. The OSS time-delay pencil consisted of a metal wire holding a spring-loaded firing pin and a glass tube of corrosive liquid contained in a thin metal tube which could be pinched to break the glass tube and initiate the mechanism. The fire of the match-head was passed on to the main gasoline gel filling by a potassium chlorate booster charge.

The high Btu output of the H2 incendiary gives a high fire-starting power. On packing-case tests, piles of faggots and logs, a wooden attic, and stacks of packing cases, the H2 was demonstrated to be a potent fire starter. The H2 incendiary was produced in large quantities by the Office of Strategic Services and used abroad in sabotage operations.

CONFIDENTIAL

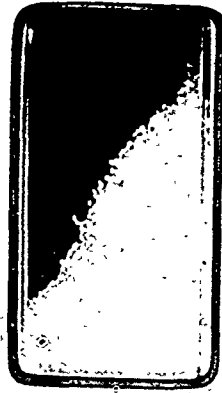

CEMENTED CASE CONTAINING
10.6 g. NAPALM POWDER

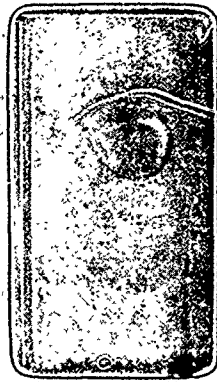

VAR SOL (122.4 g.) INJECTED,
GELATION COMPLETE



H-2, COMPLETE WITH PENCIL
(TOTAL WEIGHT, 189 OZ.)

FIGURE 4. H2 vest-pocket sabotage incendiary, assembly, and construction.

2.3.4

FM Sabotage Incendiary

This unit, developed by the Factory Mutual Research Corp., consists of a cellulosid case, $5 \times 2\frac{3}{4} \times \frac{3}{4}$ in., filled with cotton waste and paraffin wax in which are embedded two cores, $5 \times 1\frac{1}{2}$ in., made of 45 per cent sodium nitrate, 35 per cent aluminum powder, 15 per cent SAE 40 motor oil, 5 per cent sulfur.^{18, 21} The gross weight of the unit is 175 g. The units were ignited by means of a temporary first-fire charge, but a time-delay igniter could be fitted to it for actual use.

These units were tested by burning them between two packing case ends, 24x45 in., placed 3 in. apart, as representative of a sabotage location in a warehouse or supply dump (see Section 3.2 for further description and photographs of this test arrangement). The FM incendiary set fire to such a setup when dry, after being soaked in water, and after being soaked in water and covered with snow, although, of course, the speed of starting the fire varied with the conditions.

The FM incendiary was competitive with the H2 vest-pocket incendiary. The FM unit had the advantage that the filling was stable over a wide range of temperatures, it was not subject to leakage or evaporation, and it would stand very rough handling without malfunctioning. Its fire starting efficiency was comparable to the H2 unit. However, the H2 incendiary was selected for production and use in this class of incendiary.

2.3.5

Chicago Hand Incendiaries

These incendiaries, developed by the University of Chicago, were made in a variety of sizes and types of cases. All were filled with a mixture of polymerized divinylacetylene (SDO, synthetic drying oil, a du Pont product), sodium nitrate, and heavy petroleum oil (Figure 5).^{17, 22, 23} The composition of the mixture was 30 per cent SDO, 60 per cent sodium nitrate, and 10 per cent oil. This project was originally started in the belief that SDO was an incendiary material of superior merit, because it ignited readily and had accidentally caused some bad fires in

CONFIDENTIAL

2.4

E16, ALL-WAYS FUZE FOR
AN-M69 TYPE BOMBS

At one time the stability of AN-M69 bombs when dropped in aimable clusters was in doubt. Therefore development of an all-ways fuze for this bomb was initiated in the spring of 1944

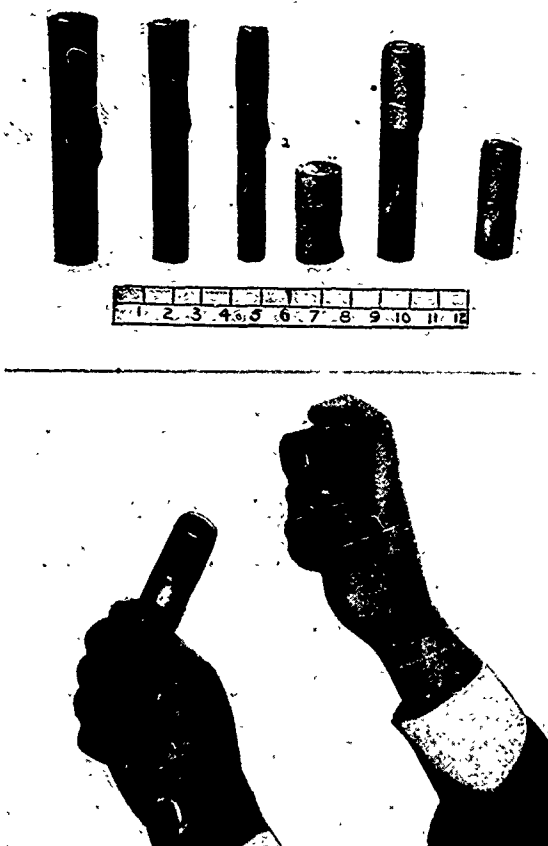

FIGURE 5. Chicago hand incendiaries, external views and method of igniting.

laboratories. However, further investigation showed that the heat output of SDO was the same as that of other hydrocarbon materials, and that it really had no superior fire starting ability. This mixture was placed in tubes made of paper, cellulose acetate, or magnesium. The principal sizes used were approximately $\frac{7}{8} \times 7\frac{1}{2}$ in., $\frac{7}{8} \times 4\frac{3}{8}$ in., $1\frac{1}{4} \times 7\frac{1}{2}$ in., and $1\frac{1}{4} \times 3$ in. The units were fitted with a match-head and scratcher similar to that of the M1 fire starter.

The SDO-sodium nitrate mixture burned with a blowtorch flame which would melt and ignite a magnesium casing. The flame was impressive, but in comparative tests in packing cases these units were not as effective in starting fires as M1 fire starters which weighed less. Development was discontinued in 1942.

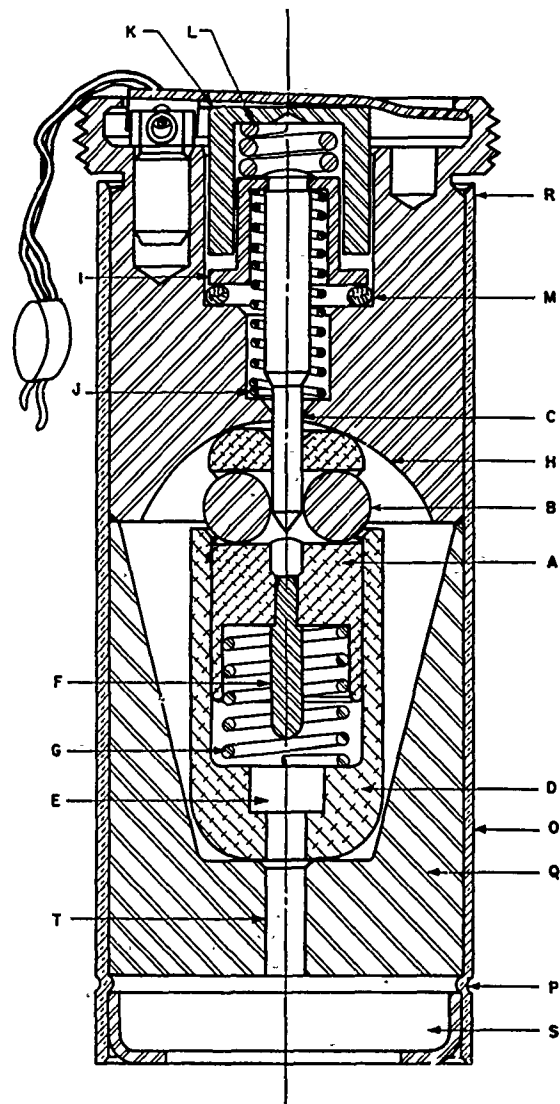

FIGURE 6. E16 all-ways fuze for AN-M69 type bombs.

by Arthur D. Little, Inc., under Contract OEMsr-242. This fuze was to be able to fire at all angles of impact with a sensitivity comparable with that of the M1 fuze, was to be waterproof and have a reliable safety device

CONFIDENTIAL

which would be operative up to the moment of stacking for clustering.

Figure 6 shows the design of the E16 fuze.²⁴ The firing-pin plunger *A* carries the two balls *B* which, when held apart by the safety pin *C*, prevent the firing-pin plunger from entering the primer holder *D*. Parts *A* and *D* are made of either brass or aluminum. The primer used is the M29 and is located in the cavity *E*. The firing pin *F* is of the type that has a rounded end with a radius of curvature of 0.046 in. The firing pin is normally kept away from the firing cap by the spring *G*. The assembly with the firing-pin plunger *A* is forced down onto the primer when the bomb lands because of inertia in either longitudinal direction, or by a squeezing action if it lands sidewise due to the curved surface *H*.

The safety and waterproofing features are contained in the top plug assembly. The safety-pin cap *I* is assembled to the safety pin *C* so that the joint is waterproof. This assembly is forced toward the top by the spring *J* so that the safety pin *C* is disengaged from the balls, unless a force is exerted on the top plunger. The top plunger *K* is separated from the safety cap by the spring *L*. The spring *L* has only a small normal extension with the result that the parts lie much as shown in the lower view on the subassembly drawing of the top plug when no force is applied to the top plunger. When the top plunger is pushed in, the safety pin *C* enters to spread the balls *B* apart and the safety-pin cap flange comes down on the Neoprene gasket *M* making a watertight joint. The spring *L* is necessary only to provide some tolerance for its position when held in place by the other bombs.

The tube *O* has a groove *P* against which the bottom plug *Q* seats. The top plug assembly is then held tightly against the bottom *Q* by crimping in the top of the tube, as indicated at *R*. The chamber *S* is provided to take the booster charge. Provision was made for a delay train to be put in the hole *T*. If no delay is wanted, this hole can be left empty. This fuze is of the same external dimensions as the present M1 fuze in the AN-M69 bomb, and can be substituted for it without any changes in the bomb.

Tests were made by dropping from small heights onto concrete at various angles. The limits found were 2 to 6 ft, none firing at less than 2 ft and all firing at 6 ft, with a large percentage firing at 5 ft. The sensitivity can be adjusted by varying the weights of parts *A* and *D*, the tension of spring *G*, and the clearance between the top of the primer and the end of the firing pin *F*. The shape of the contour *H* is not particularly important.

In the spring of 1945, 500 experimental models of the E16 fuze were turned over to the Chemical Warfare Service for final development and production if needed. However, the stability of the AN-M69 bomb in aimable clusters appeared to be satisfactory so that the E16 fuze would probably not have been needed.

2.5

M1 INCENDIARY LEAF

Development of this item was initiated in September 1940 by Brown University under Contract OEMsr-57. The objective was to develop an impact-sensitive ignition coating for incendiaries, especially celluloid incendiary leaves. The British had used incendiary leaves early in World War II using white phosphorus as a means of spontaneous ignition, and impact-sensitive ignition coating appeared to have possible merit.

The principal incendiaries for which this coating is intended are celluloid disks approximately 7.7-in. diameter by $\frac{1}{4}$ in. thick. The result is an incendiary leaf which fires on impact.^{25, 26, 27} The steps in producing the impact-sensitive coating are as follows.

1. The disks are immersed in a solution composed of 5.0 per cent polyvinyl alcohol (du Pont RH-428), 47.5 per cent methyl alcohol, 45.5 per cent water, and then dried in air. The purpose of this coating is to protect the celluloid against the action of the storage liquid, which is principally carbon tetrachloride.

2. About $\frac{1}{2}$ in. of the periphery of the disks is coated with red phosphorus by rotating the disks at a predetermined depth of immersion in either of two suspensions. Suspension *A* has the composition 17.4 per cent red phosphorus, 1.5 per cent calcium carbonate, 4.1 per cent celluloid, 77.0 per cent nitromethane. Suspen-

CONFIDENTIAL

sion B has the composition 29.3 per cent red phosphorus, 2.4 per cent calcium carbonate, 6.8 per cent celluloid, 61.5 per cent acetone. This coating is then dried in air.

3. The phosphorus coating is then covered by a sensitizing coating by rotating through a solution composed of 17.6 per cent sodium perchlorate, 4.5 per cent pyroxylin, 23.4 per cent ethyl acetate, 54.5 per cent acetone. This coating is dried in air with a relative humidity of at least 60 per cent to prevent spontaneous ignition.

4. Final dehydration and drying is then accomplished by suspending the disks in boiling carbon tetrachloride, or its vapors, until they are sufficiently dried to become sensitive.

5. The sensitized disks are packed in a cylindrical metal container in which they are immersed in a storage solution composed of 80 to 85 per cent carbon tetrachloride and 15 to 20 per cent heptane.

This coating remained sensitive on storage for 155 days at 60 centigrade and for 230 days at room temperature. Surveillance was discontinued at these times so that the stability for longer times is not known. Coatings employing sodium chlorate or potassium chlorate did not remain sensitive for periods of more than a few weeks, and they were discarded for this reason.

These incendiary leaves were carried in airplanes in cylindrical metal bomb cases provided with a time fuze for opening and discharge of the leaves at a predetermined altitude. The disks were blown out of the tail end of the bomb case by an explosive charge in the nose, and after drying out in flight, the leaves would ignite on impact on the ground or a building. However, on flight tests it was found that many of the leaves were ignited in the air by the force of the ejection, while many would still not ignite on impact on the ground. This showed that the limits of allowable sensitivity were quite narrow and great uniformity of the sensitive coating would be necessary for satisfactory performance. The development was discontinued at this point, although some experiments indicated that several means might be used for preventing the ignition of leaves on discharge from the bomb case.

It should be mentioned that the M2 incendiary leaf, developed by Chemical Warfare Service in parallel with the M1 leaf, consisting of a celluloid disk with an insert of white phosphorus, similar to the original British leaves, looked considerably more promising than the M1 leaf. Development of both these items was discontinued because the requirement for this type of incendiary was dropped.

2.6 MODIFIED AN-M52 BOMB FOR LIGHT STRUCTURES

Ever since the tests at Dugway Proving Ground in June and July 1943, it had been apparent that the AN-M52, 2-lb magnesium bomb had definite possibilities for area incendiary attacks in Japanese cities (see Section 3.4). However, the AN-M52 had excessive penetrating power for one-story Japanese houses at its normal striking velocity of about 325 ft per sec, and the bomb was on the verge of being unstable because the center of gravity was about 5½ in. back from the nose. Therefore, the problem of correcting both these features was assigned to Harvard University under Contract OEMsr-179 and the Factory Mutual Research Corporation under Contract OEMsr-257.

The first step was to build some Japanese structures and determine the proper striking velocity of the AN-M52 bomb by shooting bombs down onto the structures at various velocities from an overhead mortar. Variables studied were one-story and two-story structures, tile and sheet-metal roofs, presence and absence of tatami mats on floors. It was found that the tatami mats offered the greatest resistance to passage of the bomb. On the basis of these tests it was concluded that the effective striking velocity of the AN-M52 could be anywhere between 200 and 300 ft per sec, with 225 ft per sec selected as the optimum value if the distribution of one-story and two-story houses was assumed to be 50-50.

The striking velocity of the bomb could be reduced and its stability improved by the simple expedient of adding some small cloth streamers to the metal tail assembly (Figure

CONFIDENTIAL

7).²⁸ Three streamers, $\frac{3}{4}$ x 36 in., gave the desired striking velocity of 225 ft per sec. Three streamers, $\frac{7}{8}$ x 30 in., gave equivalent results. This minor change solved both difficulties of the AN-M52 bomb.

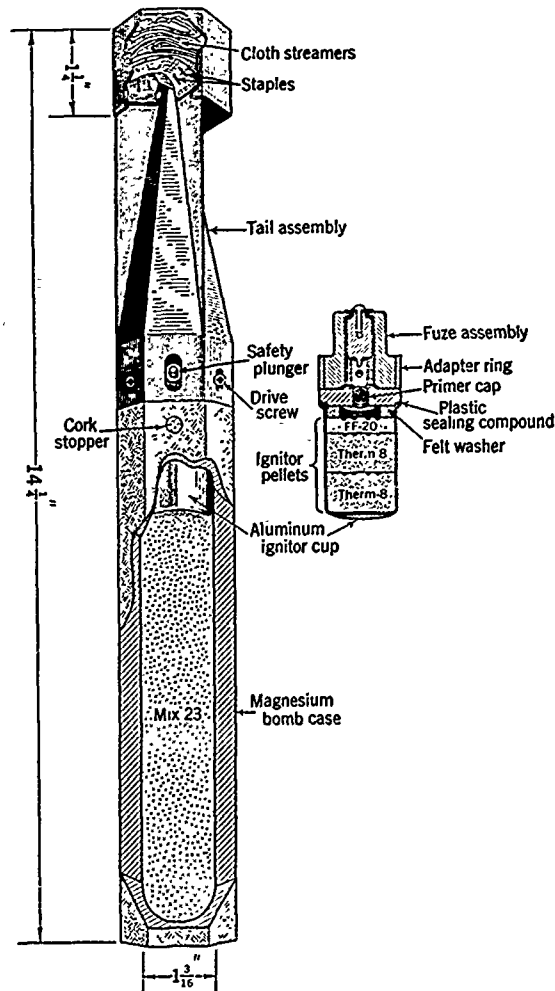

FIGURE 7. Modified AN-M52 incendiary bomb for use on light structures.

In addition to this improvement, the investigators made a further improvement in the incendiary composition of the bomb. The inside diameter of the magnesium body was increased from 1 to $1\frac{3}{16}$ in. and filled with the following mixture instead of the standard therm-8:

Flake aluminum	17.1%	SAE 40 motor oil	8.3%
Sodium nitrate	17.0%	Sulfur	1.9%
Barium nitrate	13.5%	Thermite	42.2%

This modified bomb showed some improvement in burning characteristics and fire-starting ability over the standard AN-M52 bomb. The oil gave a larger flame, the burning time was increased from 65 to 95 sec, the molten magnesium did not sputter, and the sulfur dioxide gas given off was a valuable fire-fighter deterrent. Comparative burning tests in attic structures consistently showed a slight advantage in favor of the modified bomb.

2.7 MODIFIED FILLING FOR AN-M50 BOMB

Investigations on various types of thermite mixtures at Factory Mutual Research Corporation under Contract OEMsr-257 had indicated that certain mixtures might be superior to ordinary thermite or therm-8 for filling magnesium incendiary bombs, especially the AN-M50 bomb. A mixture which showed great promise for this purpose was the following.²⁹

Aluminum flake	24%
Sulfur	43%
Thermite	33%

This filling weighed 210 g, when pressed into the AN-M50 bomb body under 26,400 lb per sq in., compared to 276 g for the standard therm-8 filling. The heat content of the modified bomb is 16,000 Btu compared to 14,700 Btu for the standard AN-M50. This filling melts and ignites the magnesium bomb body just as well as the standard filling. In addition to a higher Btu content, the modified M50 burns with a larger flame than the standard bomb, the molten magnesium does not tend to sputter as much, and the sulfur dioxide generated acts as a valuable fire-fighter deterrent.

Comparative burning tests on attic structures showed the modified M50 to have a small but definite superiority in fire starting over the standard AN-M50. Considering all factors, it seems probable that use of this filling would have materially increased the effectiveness of the approximately 250,000,000 AN-M50 and British 4-lb bombs dropped in World War II. However, these results came too late to permit a change in production of the AN-M50 bomb.

CONFIDENTIAL

Chapter 3

TESTING AND EVALUATION OF INCENDIARIES

3.1

INTRODUCTION

THE DEVELOPMENT AND application of testing methods were important parts of the program of all NDRC contractors in the field of incendiaries, but the most important contributions were made by the Standard Oil Development Co. under Contracts OEMsr-183 and 354, and the Factory Mutual Research Corporation under Contract OEMsr-257. In the latter phases of World War II also important was the Joint CWS-NDRC Incendiary Evaluation Project at Edgewood Arsenal, the personnel of which was drawn from Factory Mutual Research Corporation, Massachusetts Institute of Technology, under Contract OEMsr-21, Division 11 of NDRC, the Office of Field Service of OSRD, the Chemical Warfare Service Technical Command, and the British Ministry of Aircraft Production.

The ultimate objective of testing and evaluation is to ensure that the incendiary will be capable of starting fires when it is used in actual operations. Final tests should therefore approximate as closely as possible the conditions under which the incendiary will have to function in actual use. Testing and evaluation are necessary at every stage of development, to ascertain that the incendiary device and all of its components will finally perform in the desired manner.

The scope of the tests which must be applied in the development of incendiary bombs is indicated by the military and technical requirements to be met. First and most obvious is the requirement that the bomb must exhibit a high efficiency in starting fires. It must present no undue hazards in manufacture, handling, shipping, and loading into aircraft. It must withstand storage for extended periods of exposure to the extremes of climate and weather without impairing its capacity to function. It must have good ballistic properties so as to fall in true flight along a predictable path to the target. Its mechanical strength must be adequate to sustain the shock and stresses incident to penetrat-

ing roofs and impacting on hard surfaces, without mechanical failure or malfunctioning. The fuze must function reliably after penetration into the target, and bombs which contain an incendiary filling must distribute the filling in a manner conducive to effective incendiary action. Both the area over which fuel is dispersed and the size of the pieces of fuel are important in this connection.

Clusters of small incendiary bombs must similarly be tested for satisfactory ballistics and proper functioning of the fuze which causes disintegration of the cluster. It must be determined that the individual bombs will withstand the shock of being released from a cluster falling at high velocity, will not function prematurely in the air, will fall in true flight, and will be dispersed in a satisfactory pattern of impact on the target area.

The complete testing program, throughout development and manufacture, involves a host of tests which are applied to the various components of the bomb as well as to the complete munition. In this chapter the discussion will be chiefly concerned with tests that pertain to the penetration, functioning, and incendiary action of the bombs.

Simple Tests for Functioning and Penetration. Small incendiary bombs usually have an inertia type fuze, so that they will function when dropped from a specified minimum height, or when clamped in a pendulum and made to swing against a vertical surface. The former test is often used to determine the safe height from which a bomb may be dropped without functioning and the additional height from which functioning is certain to occur. The bombs may be dropped down a tube, or, if it is desired to test the functioning of an all-ways fuze, they may be dropped at random behind a safety barrier. The pendulum test is a safe and convenient method for tail-ejection bombs, since the bomb is securely held and pointed in a definite direction.

The ability of bombs to withstand impact on a hard surface and function reliably is often

it simulates the approach of a bomb released from high altitude, and gives data on penetration, functioning, and incendiary action which correlate well with data obtained in airborne tests and actual incendiary raids. With a mortar suitably mounted on a movable support, it is possible to fire bombs through every part of a roof and to repeat the shots until an adequate basis has been established for drawing firm conclusions from the data. No such control of the point of impact of the bomb is possible in airborne tests, in which conclusions must often be based on a limited number of hits on the target.

A mortar is equally suitable for tests with industrial targets. Bombs can be fired directly into such wooden targets as work benches, stacks of packing cases, bins, and can be fired into adjacent locations to determine the radius of action of a bomb that penetrates into a factory without scoring a direct hit on combustibles.

In the case of a bomb like the M74, which functions immediately after penetrating a light roof and ejects gel while the bomb is still in motion, mortar shots provide the only acceptable method of performing tests to determine the chance that the bomb will deposit gel in a location favorable for setting fire to combustible objects.

With a bomb like the M69, the terminal velocity of which in free fall can be measurably controlled by varying the length of the cloth tail streamers, mortar tests can indicate the velocity that will give a desired degree of penetration through roofs, and the length of the streamers can be adjusted accordingly.

Details such as the strength of the case and of the fuze to withstand impact on hard surfaces can be tested with the mortar, as also can the sensitivity of the fuze needed to give reliable functioning upon hitting a very light roof. From accumulated experience it appears that future testing of small incendiaries should concentrate on tests in which the bombs are fired from a movable mortar into full-scale rooms and buildings, both domestic and industrial, where type of roof, floor and occupancy could be varied to include all cases likely to be encountered in actual attacks. Airborne tests would be em-

ployed to determine satisfactory performances, aimability, dispersion patterns on the target area, and general ballistic properties, for which no incendiary targets would be required. A final airborne test employing full-scale target buildings would serve as an overall check on the readiness of the bomb for standardization and operational use.

Evaluation of Incendiary Effectiveness. First of all the necessary improvements were made in design, development, and manufacture to ensure satisfactory mechanical properties of the bomb, and when at last the bomb was dropped onto a combustible target, the sole utility of the incendiary lay in its ability to start a fire. It was natural therefore that much of the early experimental work was directed toward the inherent incendiary power of fuels. Small-scale laboratory tests sufficed to indicate a relative order of merit among the fuels whose availability and low cost made them otherwise attractive. As experience indicated the profound effect of the nature of the target on the incendiary results obtained in tests, larger and more elaborate targets were employed. Full-scale rooms and buildings were finally used, in order to obtain data directly applicable to the design and development of the kind of bombs that would be effective against enemy targets.

Because of the great number of factors that influence the results obtained in incendiary testing, it is of the highest importance that all conditions of the experimental work be controlled. This is true despite the lack of any such control over enemy targets; absence of such control can reverse the relative performance of two munitions differing enough in merit to make the right choice important. Adequate ventilation with exclusion of drafts, control of wood moisture content, and careful placement of the fuel in a definite position are among the factors that must be controlled. Static placement of fuel will often give results quite different from those obtained when fuel is ejected from a bomb. It is apparent that no single simple target is adequate for the purpose of determining the incendiary merit of bombs for all uses. Some targets are more responsive to heat transferred by convection from flame and hot gases, while others respond better to radiant

CONFIDENTIAL

heat. Only by use of a series of simple targets can the relative effectiveness of bombs be determined, and their absolute effectiveness can only be gauged by tests which involve full-scale target structures and which duplicate other conditions obtained in the enemy targets.

Even with the utmost care in performing controlled experiments there is enough variation in the results to require that tests be repeated until sufficient data are obtained to express the probability that a fire will be started under the given conditions.

3.2 SMALL-SCALE LABORATORY TESTS

3.2.1

Introduction

The burning trials classified as small-scale tests are those which employ small structures of major dimensions under 2 ft. These structures are usually arbitrary arrangements of pieces of wood, and do not necessarily imitate combustibles occurring in a dwelling or factory. The tests are of some value in determining the relative merits of various fuels, and were used in early work to select the most promising incendiary fuels from among those available.

In developing a target suitable for a relative evaluation of fuels, the combustibility of the structure is first adjusted so that it will react to reasonable amounts of the fuels to be compared. This is accomplished by using a quantity of fuel which can be weighed or measured with adequate precision and which will burn for a reasonable time, and by conducting preliminary trials in which the dimensions and arrangement of the wood are varied until it is found that the target is sufficiently vulnerable to attack. Targets which are so resistant that any of the fuels will only char the surface slightly, or targets which are so combustible that a very small amount of fuel will cause complete burning, are not useful.

Since various types of targets react differently to heat transferred by radiation or by convection, the disposition of the combustible surfaces with respect to the fuel warrants consideration in the choice of a target for small-scale tests. If a target consists of vertical sur-

faces placed near but not touching the fuel, it will be most susceptible to radiant heat, whereas a vertical target in contact with the fuel, or one constructed of horizontal surfaces supported at some distance above the fuel, will be attacked most effectively by flame and hot gases rising from the fuel. A reversal of the apparent relative effectiveness of two dissimilar fuels may

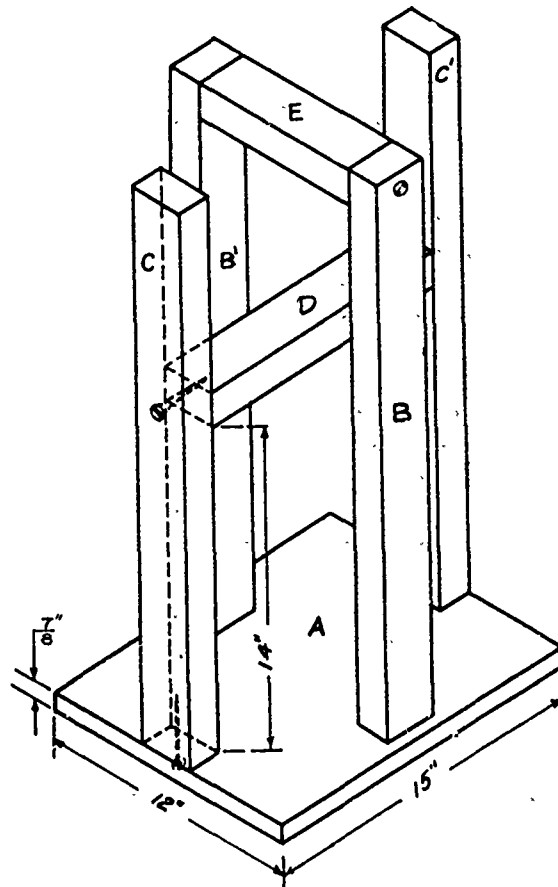

FIGURE 2. Harvard University incendiary test setup.

therefore take place if tests are carried out using two different types of targets. An adequate comparison of fuels may be made by employing a target embodying both horizontal and vertical surfaces, or by separate tests using each type of surface.

3.2.2

Description of Tests

Harvard University Test.^{1,2,3,4} This test arrangement, illustrated in Figure 2, was the

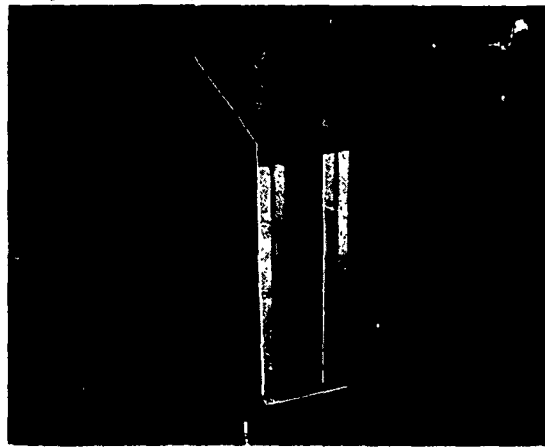

5 MINUTES

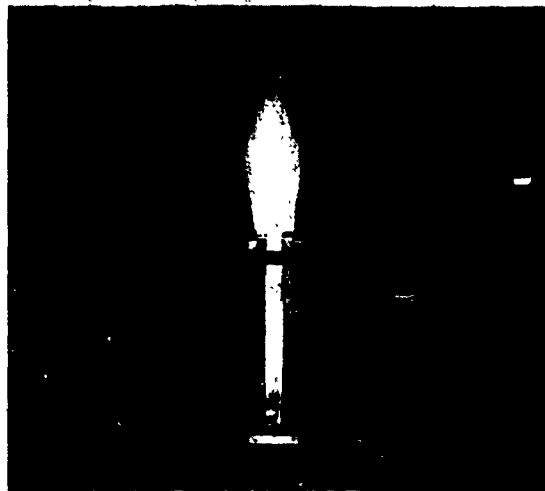

8 MINUTES



15 MINUTES

FIGURE 3. Factory Mutual packing case ends. Test shown used 0.14-lb gasoline soaked in cellulocotton.

first incendiary test used in World War II. A 3-oz fuel sample was placed in the center of the base, and the following data were recorded: time of aggressive burning, loss of weight after buffing off charred wood, and surface area attacked. This type of test served for early rough comparisons of incendiary materials, but as a rough gauge was little used after early 1942.

*Factory Mutual Vertical Strip Test.*⁵ This test arrangement was even simpler than the previous one. It consisted simply of two wooden strips $24 \times 2 \times \frac{3}{4}$ in., nailed to a wooden base $8 \times 8 \times \frac{3}{4}$ in., and spaced at the top by a narrow strip of transite. A 30-g fuel sample was placed in the center of the base, and the loss in weight of base and uprights determined after burning.

Factory Mutual Packing Case Ends.^{5, 6, 7, 8} This test setup consisted of a pair of wooden structures representing the ends of two adjacent packing cases. Figure 3 shows the arrangement and a typical burning test. This test was used primarily for testing sabotage incendiaries for which packing cases represent logical targets.

*University of Chicago Roof Section.*⁹ This setup illustrated in Figure 4 was the first of

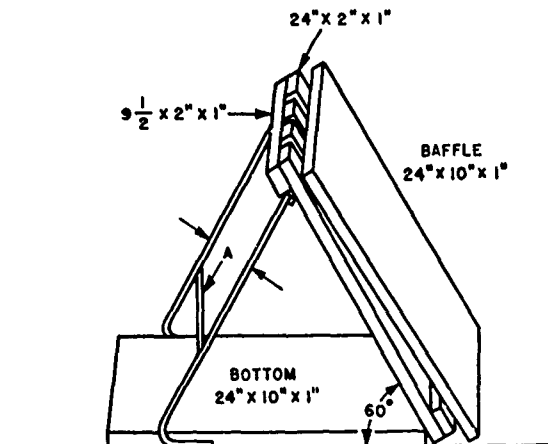

FIGURE 4. University of Chicago roof-section test setup. Baffle on back is transite.

the eaves, or half-attic type, although much smaller in size than those used extensively later on. The baffle shown was made of transite. Various incendiaries were placed in a standard position and comparative results observed qualitatively.

CONFIDENTIAL

*Standard Oil Development Co. Temperature Measurement.*¹⁰ This test consisted of a structure resembling the Harvard setup, but made of angle iron, supporting 8 thermocouples at various distances from a sample of fuel burning in a pan on the base. The test showed the superiority of gasoline gels to either liquid gasoline or to heavy oils in that they maintained the highest temperatures for the longest times. This test was useful in the early stages of development of the AN-M69 incendiary bomb.

*Texas Company Corner-Burning Tests.*¹¹ This test, illustrated in Figure 5, is simply a

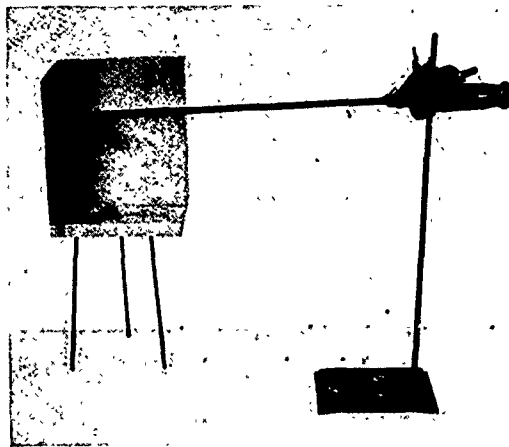

FIGURE 5. Texas Co. corner-test setup.

wooden corner, 8x8x8 in., in which a 100-g fuel sample is burned and temperatures recorded by a thermocouple placed 5 in. above the base and 1 in. from each vertical board. The time-temperature curves obtained were quite useful in a preliminary comparison of incendiary fuels, and they showed a worthwhile correlation with later larger-scale tests. Loss in weight of the structure also was determined. Some of the interesting conclusions indicated were (1) cellucotton-bodied fuels were superior to jellied fuels, (2) turpentine and toluene were superior to gasoline, (3) fortifying agents such as magnesium powder and ammonium nitrate were valuable additives.

3.2.3

Discussion

The necessity of close control of all variables affecting burning became apparent in the small-

scale evaluation tests. After the dimensions of the target had been fixed, such factors as the kind of wood, moisture content, draft, gel consistency, area of burning fuel, placement of fuel with respect to target, and the amount and particle size of additives in the fuel, were shown to have an influence on the burning of the target.

Small-scale tests proved useful in demonstrating the value of some oxidizing agents in improving the burning characteristics of the jellied fuels. Although oxygen is preferably drawn from the air rather than carried with the fuel, the time of aggressive burning of the fuels and their capacity for destroying the small targets was increased by addition of small quantities of oxidizing agents. The shortened total burning time still permitted destruction of the small-scale targets, but tests on larger and more difficult targets indicated the need for longer burning fuels.

The advantage of small-scale tests lies in their simplicity. Their value appears to be limited to selecting the more-promising fuels for further study on a larger scale. Careful choice of the target and good control of all experimental variables must be exercised if the results of small-scale tests are to have any significance. Small differences among fuels subjected to small-scale tests should be disregarded, and more adequate test methods should be employed (see Sections 3.3 and 3.4).

3.3 LARGE-SCALE LABORATORY TESTS

3.3.1

Introduction

Since the results of incendiary tests are functions of the targets used as well as of the incendiaries tested, results are of doubtful value, unless a careful simulation of targets of practical interest is made. Accordingly, the small-scale tests used early in World War II were soon replaced by tests on structures simulating actual targets such as parts of houses and combustible contents of factories. These test targets usually had a minimum dimension of at least 4 ft. Vertical tongue-and-groove wooden partitions, whole or half-attics, factory work-

CONFIDENTIAL

benches, stacks of packing cases, etc., were used as representative targets.

Large-scale tests are useful for determining the relative incendiary values of fuels and for testing incendiary bombs. With proper design of targets and control of experimental conditions, large-scale laboratory tests can go a long way toward establishing the absolute incendiary effectiveness of a bomb or quantity of fuel on the structures tested. In such tests many factors that influence the burning of a target become less critical than they are in small-scale tests, and therefore the results are more consistent and give a reasonably good indication of the incendiary action that may be expected in actual attacks. Such large-scale tests, utilizing a mortar to shoot bombs downwards onto the targets, can give answers to all the variables of penetration, functioning, and fire starting, except the final answer involving the ballistic properties and flight stability of the bombs, for which airborne tests are required. However, intelligent application of the principles of large-scale laboratory testing can reduce the requirements for airborne testing to a minimum.

Tests may be conducted by placing bombs or weighed quantities of fuels in definite positions in relation to the test structures, by causing bombs to eject fuel against or into the test structures, or by shooting bombs down onto the test structures from a mortar. When such tests are carried out with a variety of structures which are faithful replicas of enemy targets, they serve to establish the optimum quantity of fuel and hence, the required size of bomb to destroy such targets. The following sections describe the principal test arrangements used, representing both domestic and industrial targets.

3.3.2 Standard Oil Development Co. Half-Attic Structures

The prototype of this category of test structure is the half-attic structures designed and used by the Standard Oil Development Co. in the winter of 1941-42. The design shown in Figure 6 had 2x4-in. joists on 16-in. centers

with 1-in. boarding below the joists. Other designs used were similar to the one illustrated, but with 1-in. floor boards above the joists, or with a lath and plaster ceiling below the joists. Still others had 2x6-in. joists on 24-in. centers. The roof section of rafters, battens, and transite baffle was similar in all cases.

Fuel was placed statically at definite distances from the eaves line, or was ejected into the eaves. The principal data recorded were (1) whether a destructive fire was obtained or not, (2) the time taken by the structure to collapse, and (3) the time the fire reached the low point.

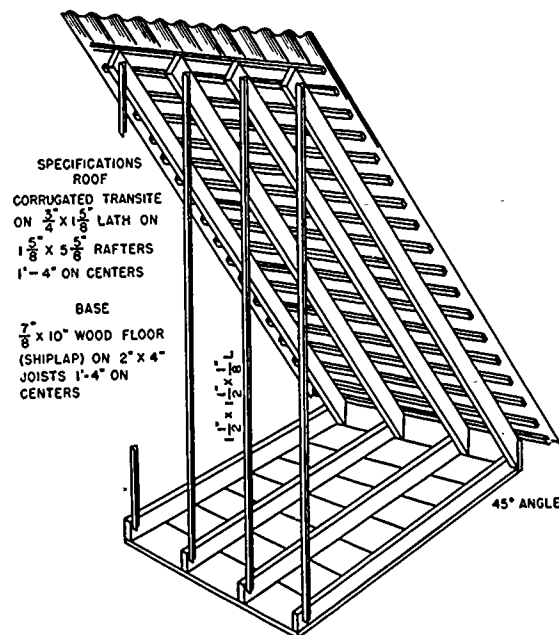

FIGURE 6. Standard Oil Development Co. half-attic test structure.

Tests in these structures showed clearly the advantage of gel fuels over liquid gasoline or heavy oils. The efficiency of the tail-ejection or target-seeking principle also was clearly demonstrated. A great deal of the mechanism of fire starting was learned in these tests; namely, the importance of reinforcing radiation from two burning surfaces or of two pieces of fuel. An important result observed was a quantitative relationship between the distance from eaves line and the weight of gel required to start a destructive fire. This relation is illustrated in Figure 7, which shows that for the structure used 10 lb of gel are required at 3 ft from the

CONFIDENTIAL

eaves, 20 lb at 4 ft, etc. The tests showed that for this type of structure, gasoline gel was slightly superior to magnesium and greatly superior to therm-8. Tests on these structures were remarkably reproducible, although con-

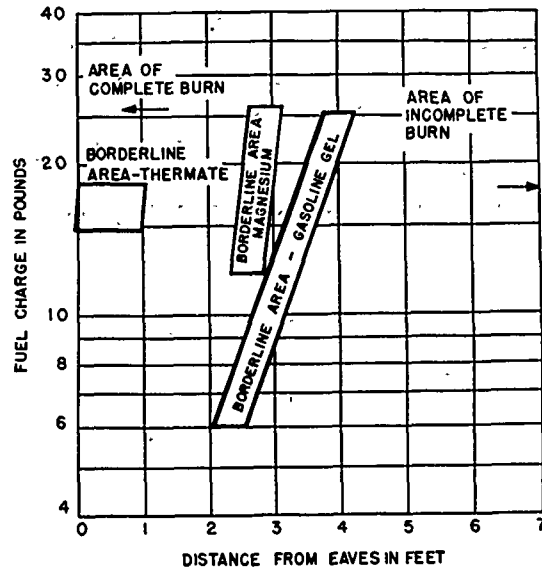

FIGURE 7. Relationship between fuel charge required to produce a destructive fire and the distance from the eaves.

sideration had to be given to wood species, wood moisture content, ambient temperature, and other factors.

Tests with the half-attic structures were of vital importance in the development of the AN-M69 incendiary bomb. The tests outlined above gave assurance that the bomb would contain enough fuel to be an effective incendiary.

3.3

Factory Mutual Half-Attic Test Structures^{5, 12, 13}

The Factory Mutual group employed a structure which was quite similar to that used by Standard Oil Development Co., the main difference being that it was somewhat more difficult to ignite. It was set up inside a specially constructed wooden room, which in turn was enclosed by a noncombustible building. With these precautions there was relative freedom from drafts, and the confinement of heat and

radiation from surrounding surfaces simulated the conditions that would normally be found in small rooms. This structure was primarily used in the early stage of development of the E19 bomb.

In an endeavor to develop a single target that would prove adequate for the evaluation of small bombs, about 10 small attic-type structures were devised and used in tests. It was concluded that no single target was entirely satisfactory, but for small magnesium bombs excellent results were obtained with a half-attic structure having a floor 2 ft sq and a sloping-roof section 2x4 ft set at an angle of 60 degrees to the horizontal (Figure 8). When made of 1-in. boards, it has a suitable response to the initial flame and residual radiant heat from small magnesium bombs having different incendiary fillings to reveal second-order differences.

3.3.4

Factory Mutual Industrial Type Targets^{14, 15, 16, 17}

The Factory Mutual Research Corporation was the first NDRC contractor to become interested in fire starting in industrial rather than domestic occupancies. The principal targets

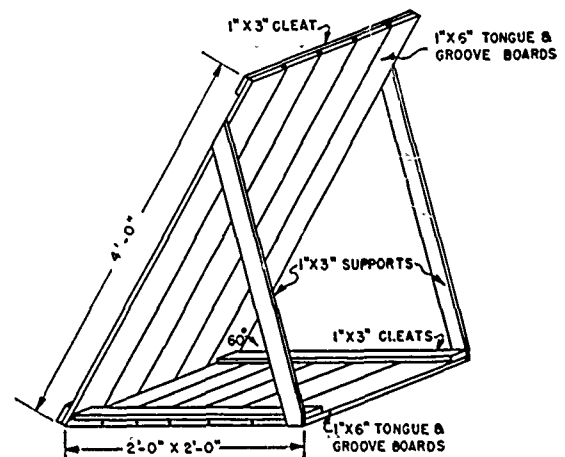
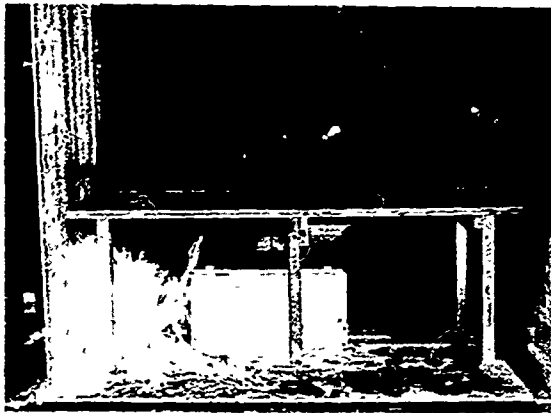

FIGURE 8. Factory Mutual small half-attic test structure.

with which they worked were a light workbench, a heavy workbench (Figure 9), a section of tongue-and-groove wooden partition (Figure 10), and pairs of packing case ends (see Sec-

CONFIDENTIAL



A TIME: 1 SEC

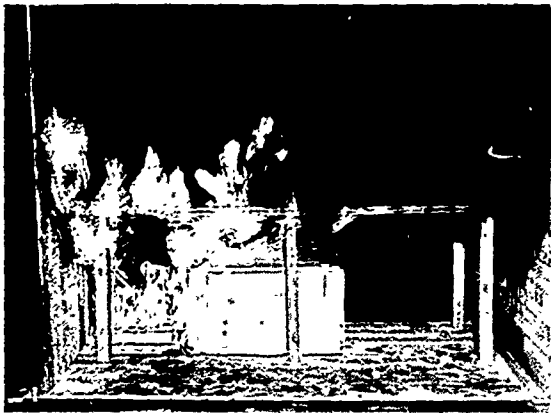

B TIME: 17 SEC



C TIME: 16 MIN 15 SEC

FIGURE 9. Heavy workbench-incendiary test structure. Test shown was made with gasoline soaked in cellucotton.

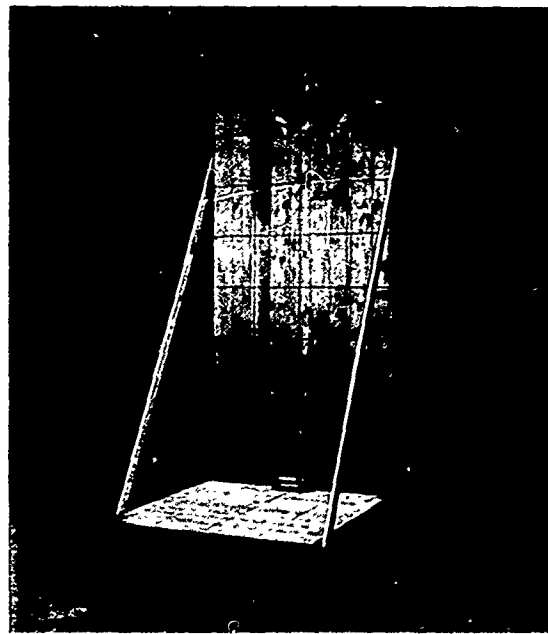

PLACEMENT OF FUEL

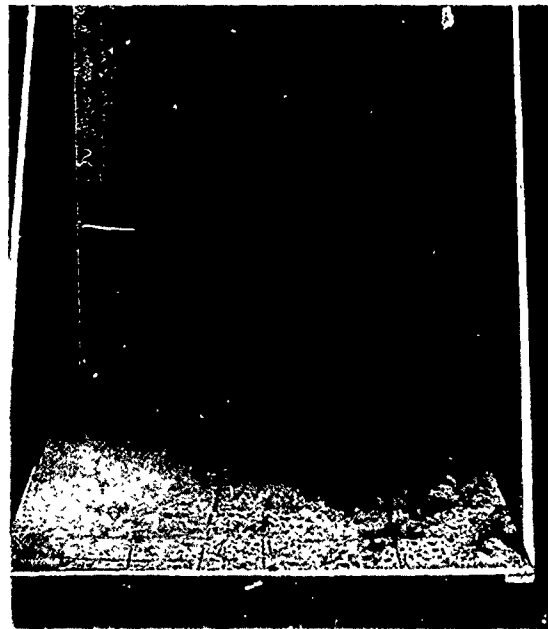

BURNED-OUT AREA

FIGURE 10. Tongue-and-groove wooden partition test structure, showing test with four M52 incendiary bombs.

CONFIDENTIAL

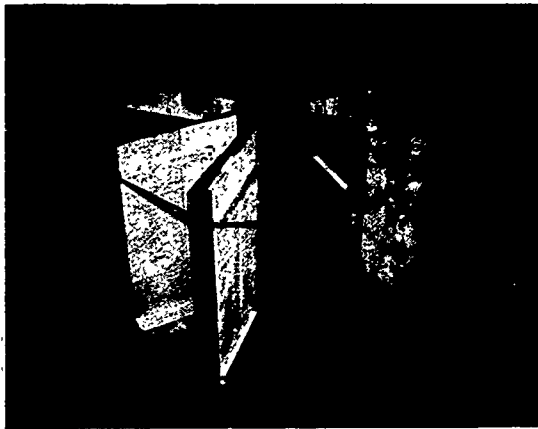

FIGURE 11. Factory Mutual radial incendiary-test structure, closed-center, 8-panel type.

tion 3.2). Tests were made on these four targets with various fuels and bombs at different distances. The relative impotence of the 4-lb magnesium bomb against most of these targets and the equivalence of gelled and cellulose-bodied fuels were among the significant conclusions resulting from these studies.

In an attempt to develop a universal incendiary target, Factory Mutual designed some radial targets of the type shown in Figure 11. These did not represent any actual targets, but it was thought that they could be calibrated in terms of various actual targets, and thus be useful as a universal yardstick of incendiary merit. While the idea was interesting, it proved to be too awkward and too far from reality to be greatly useful.

3.3.5 Incendiary Evaluation Project Industrial Targets¹⁸

The Incendiary Evaluation Project group at Edgewood Arsenal extended the Factory Mutual work on industrial targets in an extensive series of tests on five typical combustible objects usually found in factories, viz., light workbenches with tote box underneath, vertical storage bins, vertical tongue-and-groove partitions, stacks of eight packing boxes, and corrugated cardboard cartons, all of which are illustrated in Figure 12. These targets were finally chosen as being representative after inspection of a number of industrial plants. The

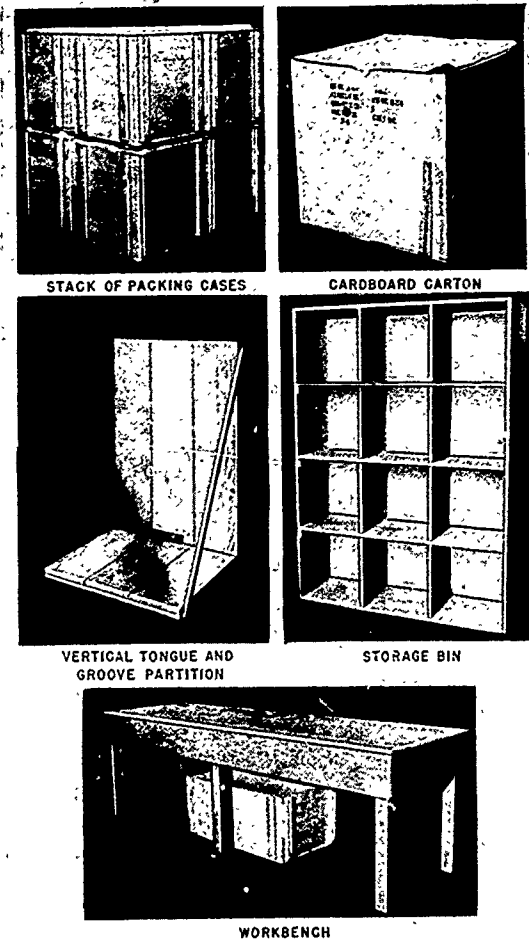

FIGURE 12. Industrial targets for incendiary testing used by the Incendiary Evaluation Project at Edgewood Arsenal.

targets were constructed of two kinds of wood, 1-in. Douglas fir for the workbenches, storage bins and partitions, and 1-in. Sitka spruce for the tote boxes and packing cases.

Tests were carried out with the AN-M69, AN-M50, and M74 bombs by firing the bombs from the mortar downwards onto or near the targets. It was possible to substitute statically placed bombs for part of the tests on the M50 and M69, but in the case of the M74 all tests had to be made with the mortar in order to simulate the true action of the M74. The results are described in the following sections.

AN-M69 Bomb. 1. The total length of travel of the gob of gel in an ejection along the floor (unobstructed) is 100 ft.

CONFIDENTIAL

2. If the gob strikes normal to a smooth vertical surface, or within 30 degrees of the normal, the gob sticks against the surface.

3. If the gel strikes a smooth vertical surface at an angle greater than 30 degrees to the normal, it is deflected at an angle of approximately 5 degrees and then travels for an average distance of 15 ft.

4. When the bomb lands directly in a stack of cardboard cartons, wooden packing cases, or in a storage bin, a fire will always be started.

5. When the gel strikes the side of a stack of cardboard cartons at any angle, sufficient gel will remain on the cartons to cause a fire.

6. If the gel strikes the side of a stack of wooden packing cases at an angle within 60 degrees of the normal, a fire is started.

7. When the gel strikes the vertical tongue-and-groove partition at an angle of 30 degrees to the normal or less, the chance of starting a fire is 0.63 if some other combustible, such as cardboard cartons, boxes, etc., is present immediately behind the partition to provide re-radiation for the flame on the back side. If the gel sticks at a point where no other members which will support fire are present, or if the gel rebounds from the surface, a negative result is obtained with the partition.

8. If the bomb lands directly in a tote box under a workbench, the ejection will blow the gel from the box without setting it afire, and the probability of a fire becomes the same as if the bomb hit on an open floor.

9. If the gel strikes the side of a tote box under a bench at an angle of 30 degrees to the normal or less, the gel sticks and a fire is started. When striking at angles over 30 degrees to the normal the gel rebounds and a negative result is obtained. (The legs of the benches are assumed not present.)

10. If the gel strikes the open side of a storage bin at any angle, a fire is started. When gel strikes the end of a bin at an angle of 30 degrees or less to the normal, the gel will stick. At greater angles it rebounds, but when it sticks, the chance of starting a fire is 0.63.

AN-M50 Bomb. 1. If the bomb lands directly in a stack of cardboard cartons, wooden packing case, storage bin, or tote box under a bench, a fire will always be started.

2. If the bomb lands within 9 in. of a stack of cardboard cartons, the radiation and glowing sparks will cause a fire. The distance of 9 in. is the maximum for 100 per cent probability of fire. At greater distances up to 4 ft, the bomb gives lower probabilities of destruction.

3. If a bomb lands outside of a stack of wooden packing cases, even if directly against the side, no fire results.

4. If the bomb lands outside of the tote box under a bench, even if against the side of the box, a negative result is obtained.

5. If the bomb lands within 2 in. of the vertical tongue-and-groove partition at a point where some other combustible is at the back side, a fire is started. If no other fire-supporting surface is present, or if the bomb is at a greater distance from the partition, no fire results.

6. If the bomb lands immediately in front of the open compartments of the storage bin, a fire is started, but at any greater distance, negative results are obtained. If the bomb is within 2 in. of the partition forming the end of the bin, a fire will result.

M74 Bomb. 1. If the gel from an M74 lands on top of a stack of cardboard cartons, or hits the side of the stack, or lands on the floor within 12 in. of the side of a stack, a fire is always started.

2. When the bomb is yawed and the gel lands on top of a stack of wooden packing cases, the chance of starting a fire is 0.93. If the gel strikes the side of the stack, the probability of starting a fire is 0.59. When gel lands on the floor within 5 in. of the side of the stack, a fire will always be started.

3. If the gel from an M74 bomb hits the side of a vertical tongue-and-groove partition at a point where some other combustible is at the back side, the chance of starting a fire is indicated to be approximately 0.60. When gel lands on the floor within 8 in. of the partition, a fire will always be started. If no other fire-supporting surface is present, or if the gel lands at a greater distance from the partition, no fire results.

4. When the gel from an M74 lands on top of a storage bin, the probability of starting a fire is 0.75. When the gel strikes the shelves on the open side of the bin, or on the floor within

CONFIDENTIAL

6 in. of this side, a fire may always be expected. If the gel strikes the end of the bin, the chance of starting a fire is assumed to be the same as that for gel hitting the matched partition, or 0.60. Finally, when gel lands on the floor within 8 in. of the end of the bin, a fire will always be started.

5. If the gel from an M74 lands on top of a workbench, it burns harmlessly without effect other than to burn a hole through the bench top. When the gel strikes the side of the tote box under the bench, or on the floor within 6 in. of the side of the box, a fire is always started.

These conclusions do not cover all possibilities that could be envisioned, but they indicate the general order of fire-starting probabilities for each combination of bomb and target. In the next section these results will be combined into an analysis of the probability of starting a fire in a given factory.

3.3.6 Application of IEP Tests to a Model Factory Target

Incendiary tests of the kind described in the previous section answer the question whether a given incendiary will start a fire in a given position relative to a combustible object in a factory. In order to combine these isolated results into the overall probability of starting a fire in a factory, a model factory layout was made and calculations carried through for each type of bomb. The factory layout used contained the five combustible objects which have been used in the burning experiments: namely, workbenches, storage bins, wooden partitions, wooden packing cases, and cardboard cartons. Other combustibles such as trash, oil, and waste, may be present in an actual factory, but their quantities are unknown; therefore they were ignored in this calculation. Experimental work has dealt primarily with initiation of fires in targets without regard to the probability of spreading fires; hence the analysis given here indicates only the probability of starting a fire—not of its spreading or destroying the factory.

Description of Model Factory. The factory layout is shown in Figure 13. Stacks of cardboard cartons and wooden packing cases, each

15 ft high, are present in the receiving and shipping section. One workbench with tote box is also present in this section. In the main working section are 16 benches plus tote boxes, and 16 storage bins, each 10 ft high, placed back to back. A vertical tongue-and-groove partition, extending to the roof (20 ft), separates the two sections. The total combustible floor loading is 24.8 per cent, distributed as follows:

	Area, sq ft	% of total floor area
Cardboard cartons	126	4.9
Wooden packing cases	127	4.5
Workbenches	319	11.4
Storage bins	108	3.9
Vertical partitions	3	0.1
	693	24.8

The total area of the factory is 2,800 sq ft.

Analysis for M69 Bomb. The plant layout was first divided into 112 sections as shown in Figure 13. Each of these sections was then further divided into nine equal subsections, so that a total of 9×112 or 1,008 separate areas were created. In order to minimize the number of points required for analysis, one out of each group of nine subsections was chosen according to a table of random numbers, and the probability of starting a fire if a bomb came to rest in the center of each of these areas was determined. An earlier analysis of the factory layout using 1,681 separate points yielded the same overall probability of starting a fire as found by the random number method.

In order to find the probability of fire in each case, a measurement was made of the total angle within which a gob of gel ejected from an M69 would start a fire. The angle that was subtended by a surface from which the gel bounced to a combustible object was counted as part of the total angle in which a fire could be started. The probability of starting a fire was then determined by dividing the angle within which fires would be initiated by 360 degrees. In order to show the contribution of each target in the factory to the overall probability, separate totals were kept for each of the various combustibles.

A sample calculation is here given for point No. 58 (Figure 13) to illustrate the method used in obtaining the data. By use of a transparent overlay, the angles subtended by the

CONFIDENTIAL

various combustible objects and within which gel will stick and cause a fire, are determined. The total effective angles subtended for each type of target within range of point No. 58 are as follows.

Tote boxes under benches	55°
Storage bins (open sides)	70°
Storage bins (ends)	55°
Wooden partitions (side)	25°
Cardboard cartons (side)	5°

The angles for all 112 points are averaged, and this average angle is divided by 360 degrees to obtain the probability of gel from an M69

fires in this target is obtained. The sum of these probabilities for all types of targets then gives the overall probability of starting fire in the factory. For the M69 bomb the final probabilities of fire starting were calculated to be as shown below.

Tote boxes under benches	0.126
Storage bins	0.141
Wooden partitions	0.018
Packing cases	0.086
Cardboard cartons	0.113
Total	0.484

Thus an M69 bomb dropped at random into this factory has a 0.484 probability of starting a fire.

Analysis for M50 Bomb. Since no complete data are as yet available on the nature of the bouncing which occurs when an M50 strikes the floor of a factory, the analysis has been carried out assuming that the bomb stays where it lands. The probability of starting a fire is then merely the ratio of the area within which the M50 is effective to the total area. The area within which the M50 is effective is made up of two parts: (1) The area of the combustibles within which the M50 will start a fire, and (2) a small strip of area around these combustibles wherein the bomb will cause a fire. If it is assumed that the bomb does bounce an appreciable distance, the probability of fire is increased somewhat over the values shown, although even if the bomb bounces against some of the targets (wooden packing cases and tote boxes under benches), no fire is obtained.

Applying the same approach as used for the M69 bomb, the final probabilities of fire starting for the M50 bomb were calculated to be the following:

Tote boxes under workbenches	0.023
Storage bins	0.040
Wooden partitions	0.001
Packing cases	0.045
Cardboard cartons	0.065
Total	0.174

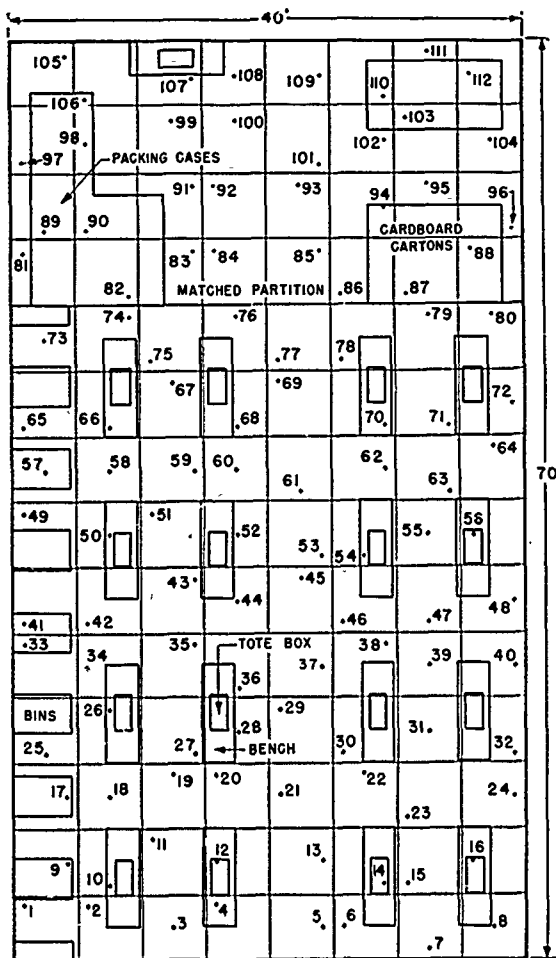

FIGURE 13. Plan view of model factory used for estimation of incendiary-bomb effectiveness.

bomb hitting a particular target. If this probability is then multiplied by the probability of starting a fire in the particular target under the conditions, the overall probability of starting

Thus an M50 bomb dropped at random into this factory has a 0.174 probability of starting a fire.

Analysis for M74 Bombs. It is known that

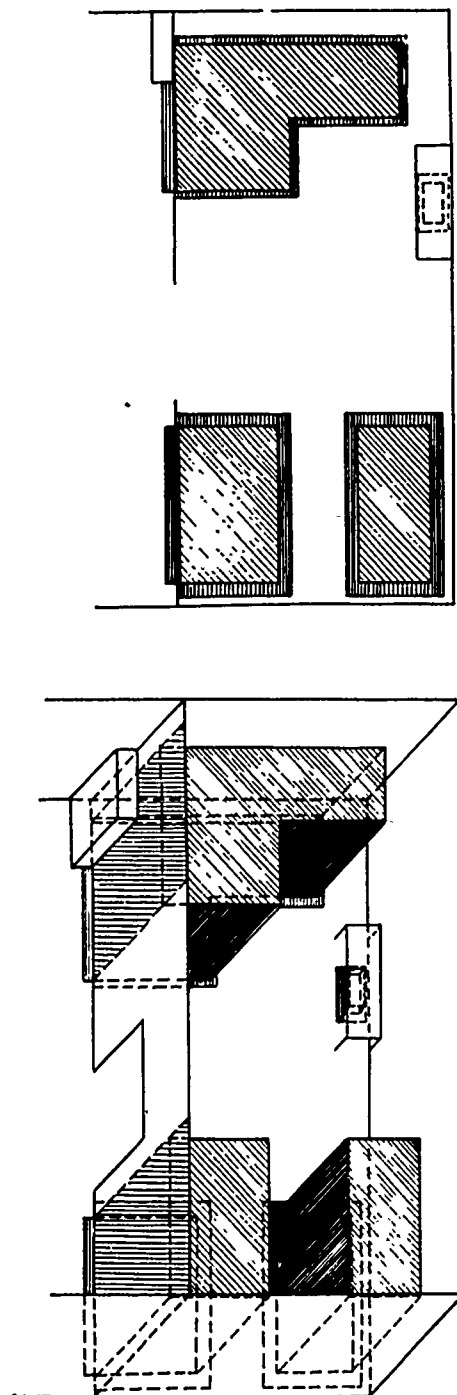

FIGURE 14. Comparison of vertical and 26° oblique views of storage section of model factory, for use in estimating hits by M76 incendiary bomb.

M74 bombs ordinarily yaw so that the gel charge descends at an angle, with the result that the gel and the case do not follow the same path. A study of the gel paths of M74

bombs dropped on the prototype factory building at Edgewood Arsenal led to the conclusion that 26 degrees from vertical was a good average angle of descent for the gel charge from M74 bombs.

The analysis for the M74 bomb is similar to that for the M69 bomb, except that the circular distribution of hits from a given point involves three dimensions instead of two dimensions, as with the M69. Since a complete integration around 360 degrees proved to be quite laborious, the problem was simplified by taking shots from 16 evenly spaced directions at intervals of 22½ degrees. Perspective drawings were made of the factory from 16 directions, all at an angle of descent for the gel charge of 26 degrees. As an example, Figure 14 shows the comparison of the plan view and 26 degrees perspective view of a section of the factory. The vulnerable exposed areas are shown shaded. The shaded areas of these views projected onto the horizontal plane are a measure of the probability of an M74 bomb projecting its gel charge against a combustible surface. The analysis for the M74 bomb was made in terms of 16 directions instead of 112 points, and the analysis was kept separate for each target type as before. If the vulnerable areas of each type of target are multiplied by the respective probabilities of starting a fire, the overall probability of starting a fire in this type of target is obtained.

The final probabilities of fire starting for the M74 bomb were calculated to be the following:

Tote boxes under workbenches	0.011
Storage bins	0.052
Wooden partitions	0.018
Packing cases	0.051
Cardboard cartons	0.070
Total	0.202

Thus an M74 bomb dropped at random into this factory has a 0.202 probability of starting a fire. The M74 loses efficiency by the nearly vertical descent of its gel and the inability of the gel to break through 1-in. board surfaces when it hits them.

Discussion of Results. Table 1 summarizes the results given in the above sections, with two additional variables, the length of time for fires to become self-sustaining and the number

CONFIDENTIAL

TABLE 1. Probability of fire starting in model factory layout. Number given equals fractional number of functioning bombs penetrating to interior of factory building which start fires capable of consuming the local target; called probability of fire start, P_f .

	M50 Bomb Self-sustaining within*			M69 Bomb Self-sustaining within*			M74 Bomb Self-sustaining within*		
	3 min	10 min	40 min	3 min	10 min	40 min	3 min	10 min	40 min
Fires which extend to roof									
Packing cases	0.045	0.045	0.045	0.086	0.086	0.086	0.049	0.051	0.051
Cardboard cartons	0.065	0.065	0.065	0.113	0.113	0.113	0.070	0.070	0.070
Matched partition	0.001	0.001	0.018	0.018	0.018
Storage bins	0.039	0.039	0.030	0.111	0.111	0.141	0.021	0.034	0.052
Subtotal (fires to roof)	0.149	0.150	0.151	0.310	0.310	0.358	0.140	0.173	0.191
Fires which do not extend to roof									
Tote boxes under benches	0.023	0.023	0.023	0.126	0.126	0.126	0.011	0.011	0.011
Total	0.172	0.173	0.174	0.436	0.436	0.484	0.151	0.184	0.202

*Time limit given is time within which fire grows to such proportion that incendiary material may be removed without fire going out.

of fires which are likely to ignite the roof. This last point is important as analysis of attacks on German factories shows that a major damage is usually obtained if the roof is combustible and is ignited. All the targets are assumed to be capable of igniting a combustible roof, except workbenches, due to their low height.

In preparing Table 1, time intervals of 3, 10, and 40 min were selected as being of interest in indicating the relative effectiveness of the bombs in starting quick fires. In Table 1 the values given in each column include the values for lesser times. Thus, for the M74, the chance that a bomb will produce within 40 min a fire that will eventually involve the roof is 0.191. Of this total chance, 0.140 is the chance of such a fire being established within 3 min. On account of the probable importance of a quick-starting fire and the relatively great importance of starting a fire which ultimately reaches the roof, the chance of fire starting is so subdivided.

From Table 1, the following may be noted:

1. For every 100 functioning bombs entering a factory layout such as that shown in Figure 13, fires will be started as shown below.

	Total fires	Fires that can eventually reach the roof		
		Total	Self-sustaining within 10 min	Self-sustaining within 3 min
M50	17	15	15	15
M69	48	36	31	31
M74	20	19	17	14

2. For the number of bombs in a 500-lb aimable cluster, assuming penetration and 100

per cent functioning in the factory layout, fires will be started as shown in the chart below.

	Total fires	Fires that can eventually reach the roof		
		Total	Self-sustaining within 10 min	Self-sustaining within 3 min
M50	19	17	17	17
M69	18	14	12	12
M74	8	7	6	5

For full details on the calculations and more detailed data see reference 8.

3.3.7 Texas Company Panel Test¹¹

This test arrangement consists of plywood panels supported on a cement block wall (Figure 15). The purpose of the test was to find the best incendiary filling for the E9 40-lb oil bomb. Accordingly, a mortar was built to hold the same volume of fuel as the bomb contained and to eject it in a manner that duplicated normal ejection from the bomb at rest. The ability of the various fuels tested to avoid excessive breakup and to adhere to the target was observed. The percentage of the wooden panel destroyed within 10 min was adopted as the basis for comparing the incendiary merit of different fuels.

Some conclusions reached in tests on this structure are as follows.

1. An incendiary filling made up of units of a predetermined size is better than one the unit size of which is dependent on the ejection forces.

2. The best filling is one which combines

CONFIDENTIAL

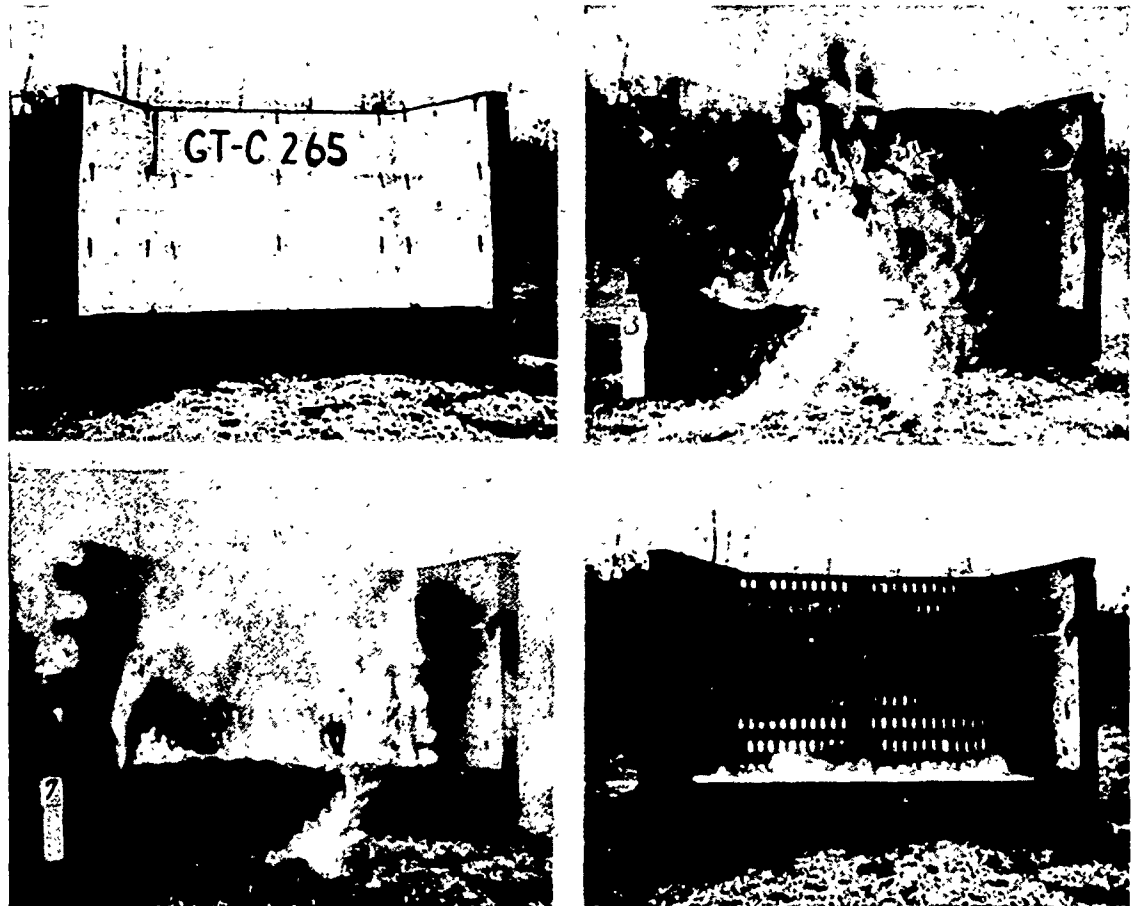

FIGURE 15. Texas Co. panel test setup. Fire was extinguished in 10 min.

TABLE 2. Penetrating power of small incendiary bombs.

Description of roof	Normal striking velocity ft/sec					E19 600
	AN-M69 230	M69X 245	AN-M52 325	M74 420	AN-M50 420	
Metal sheeting, 20-26 gauge	P*	P	P	P	P	P
Asbestos sheeting, $\frac{1}{4}$ in. (6 mm)	P	P	P	P	P	P
Wood planking, 1 in. (2.5 cm)	P	P	P	P	P	P
Slate on wood sheathing	P	P	P	P	P	P
Tile on wood battens	P	P	P	P	P	P
Hollow tile slabs, $2\frac{1}{2}$ - $3\frac{1}{2}$ in. thick, with or without 2-5-in. cinder concrete for drainage	P	P	P	P	P	P
Lightweight reinforced concrete (1,000 psi), $2\frac{1}{2}$ - $3\frac{1}{2}$ in. thick, with or without 2-5-in. cinder concrete for drainage	P	P	P	P	P	P
Reinforced structural concrete (3,000-4,000 psi), 3 in. thick	NP†	NP	?	P	P	P
Heavy tile slab, 8 in. thick, with 2-5-in. cinder concrete for drainage	NP	NP	NP	P	P	P
Reinforced structural concrete (3,000-4,000 psi), 4 in. thick	NP	NP	NP	?	?	P
Reinforced structural concrete (3,000-4,000 psi), 5 in. thick	NP	NP	NP	NP	?	P
Heavy tile slab, 8 in. thick, with 2-in. reinforced concrete	NP	NP	NP	NP	NP	P
Reinforced structural concrete (3,000-4,000 psi), 6 in. thick	NP	NP	NP	NP	NP	P

*P = penetrates

†NP = does not penetrate

CONFIDENTIAL

maximum heat of combustion with satisfactory burning characteristics.

3. Rolls of cellucotton saturated with turpentine gave the best results, originating from the combination of high heating value of fuel and retention in large masses.

4. Addition of furfural extract from lube oil refining to fuel mixture increases the heating value, while addition of powdered magnesium promotes more rapid burning. Both additions seem to be desirable.

3.3.8 Penetrating Power of Bombs

The vertical mortar setup at the Standard Oil Development Co. was utilized to make a systematic study of the penetration, or perforation, of domestic and industrial roof types by small incendiary bombs. Sections of various roof types were constructed and placed under the mortar in a horizontal or pitched position, depending on the roof type, and then subjected to test by bombs at their normal striking velocities. The bombs tested in this manner included the AN-M50, AN-M52, AN-M54, AN-M69, AN-M69X, and M74. The AN-M52 and E19 bombs were tested by similar technique at the Factory Mutual Research Corporation. The data obtained are summarized in Table 2.

3.1 TESTS IN FULL-SCALE ROOMS AND BUILDINGS

3.4.1 Introduction

Tests in full-scale rooms and buildings surpass all others in significance because the data can be applied directly in estimating the results to be expected in actual incendiary raids. Airborne tests permit an evaluation of the overall performance and incendiary effectiveness of the bomb, and are therefore to be conducted in the late stages of development and as service tests prior to standardization. However, all essential information regarding penetration, performance, and fire-starting ability can be obtained from mortar shots where bombs are fired downward into the structures. In such tests the bomb can be delivered through any desired part of the roof, and it is not necessary to employ the extensive array of targets that

are needed to get a reasonable percentage of hits in airborne tests. It is believed that future test work should be concentrated on mortar shots into full-scale rooms and buildings, with a final minimum number of airborne tests as an ultimate check on overall performance.

3.4.2 Tests at Huntsville Arsenal

Among the earliest tests in full-scale buildings were those conducted by the Chemical Warfare Service at Huntsville Arsenal in April 1942. One- and two-story farm buildings of frame construction were used in static tests of the small magnesium and therm-8 bombs and the experimental 7-lb base-ejection oil bomb. It was reported that the AN-M54, AN-M50A1, and AN-M52 were of comparable effectiveness when fired statically in buildings of light construction. The small oil bomb was judged the most effective of the bombs tested, despite the observation that the burning fuel was easily extinguished.

In airborne tests very few hits were obtained so that no conclusions could be drawn regarding fire-starting efficiency, but it was noted that the M50 and M54 had excessive penetration for this type of structure.

3.4.3 Tests at Jefferson Proving Ground

In July 1942 tests were run by CWS and the Ordnance Department at Jefferson Proving Ground, with NDRC participation. Several groups of typical farm buildings were used as targets, and dropping tests were conducted with the M50 and M52 magnesium bombs, the M54 therm-8 bomb, a plastic incendiary bomb, the M47 oil bomb, and two sizes of small base-ejection oil bombs, weighing 4.8 and 6.2 lb, respectively. The objectives of the tests were to determine the relative merits of the various munitions. Data were obtained on stability in flight, penetration, functioning, incendiary effectiveness in structures, ability to set grass fires, number of duds and their cause, dispersion pattern of clustered bombs, and ignition and dispersion of gel from the M47 bomb. The majority of the tests were conducted from 2,500 ft altitude, with a few from 5,000, 10,000, and 20,000-ft.

CONFIDENTIAL

The flight stability of the M50 was found good, and its functioning and incendiary effectiveness satisfactory. The M54 had good flight stability and reliable functioning, but was not as good an incendiary as the M50. The M52 showed marked instability in flight and poor functioning. However, it was considered to have promising incendiary properties for a bomb of its weight. The 6-lb oil bomb (M56, later M69)

3.4.4

Tests by Standard Oil Development Co. ^{19, 20, 21}

The previous tests at Huntsville Arsenal and Jefferson Proving Ground had suffered from the usual difficulty of getting a desirable number of significant hits in airborne tests. Furthermore, the buildings used as targets served only to establish a relative order of effective-

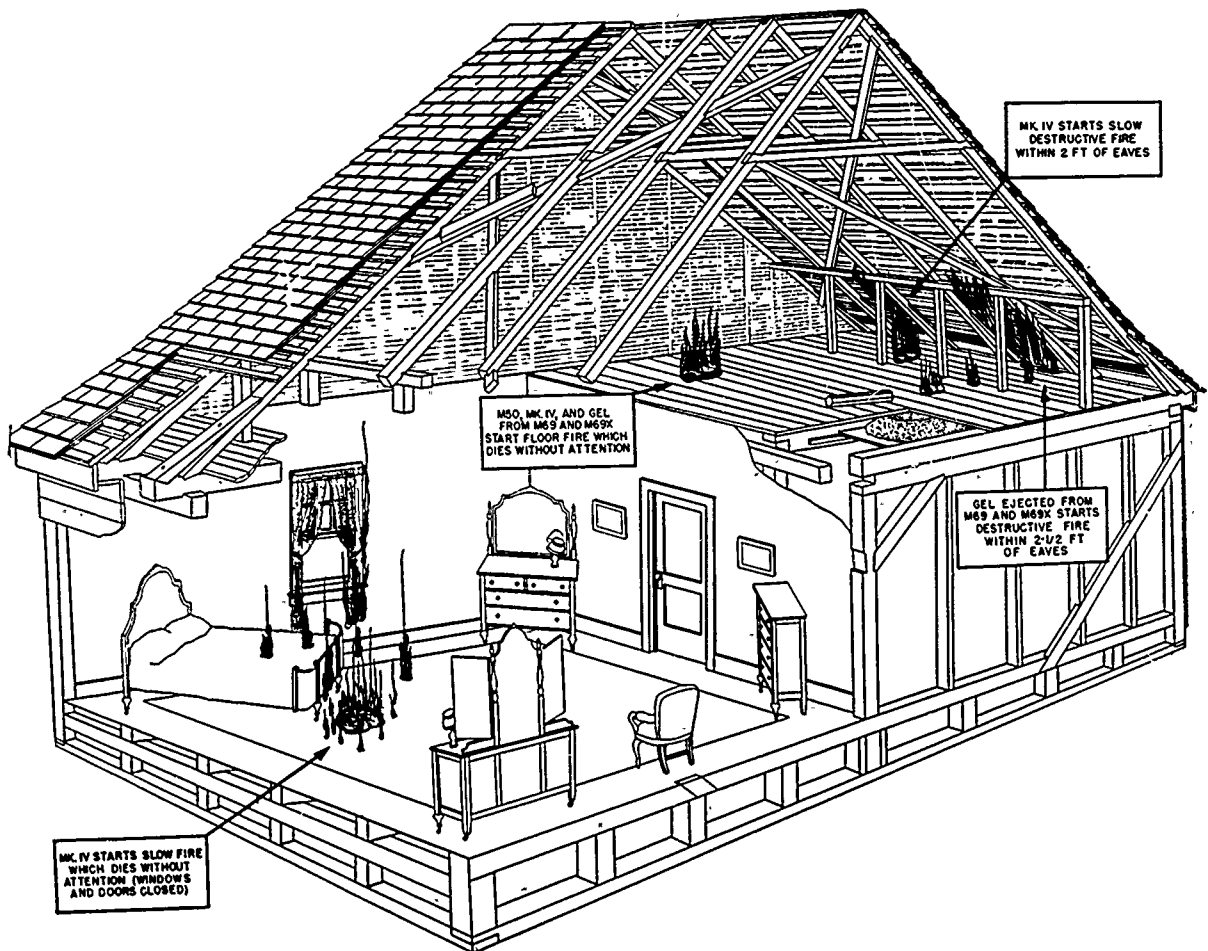

FIGURE 16. Construction and summary of tests in Central German structure.

was considered promising and superior to the 5-lb bomb. It was recommended by CWS that development work to improve the M47, M56, M50, and M54 bombs be undertaken and that these bombs should be manufactured in quantity. NDRC observers concluded that the principle of delayed ejection of gel had been shown to have considerable merit.

ness of the bombs. In order to obtain sufficient quantitative data on authentic structures, it was decided to conduct mortar tests on target buildings that would be exact reproductions of German houses. Three types of houses were designed and built, typical of Rhineland, Central German, and Eastern German construction. Tests with the Rhineland and Central German

CONFIDENTIAL

structures were completed prior to construction of the target village at Dugway Proving Ground, and constitute an important record of large-scale tests and demonstrations. Figures 16, 17, 18 show the construction and typical tests in these structures.



FIGURE 17. Outside view of incendiary test in Central German structure.

*Tests with Rhineland Structures.*¹⁹ The M50, M69, and M69X bombs were fired from a movable mortar, aimed at rafters and between rafters, and at points near the ridgepole and near the eaves. Inert bombs were used for penetration tests, and live M69 and M69X bombs were fired for performance. A limited number of fires were permitted to go to the point where the incendiary effectiveness of the bombs could be demonstrated.

It was found that the M50 frequently penetrated the roof and the attic floor when no rafter was encountered. The M69 did not pene-

trate through the attic floor when fired at its normal terminal velocity of 225 ft per sec. A substantial proportion of the M69X bombs, fired at 270 ft per sec velocity, penetrated through the roof and attic floor. Satisfactory performance of the M69 after penetrating the roof was demonstrated, and it was determined that if from one-third to one-half of the gel is ejected into the eaves the M69 will start a destructive fire in these structures. However, it was shown that neither the M50 nor the M69 will start destructive fires in a typical Rhineland attic if the incendiary contents are more than 4 to 5 ft from the eaves.

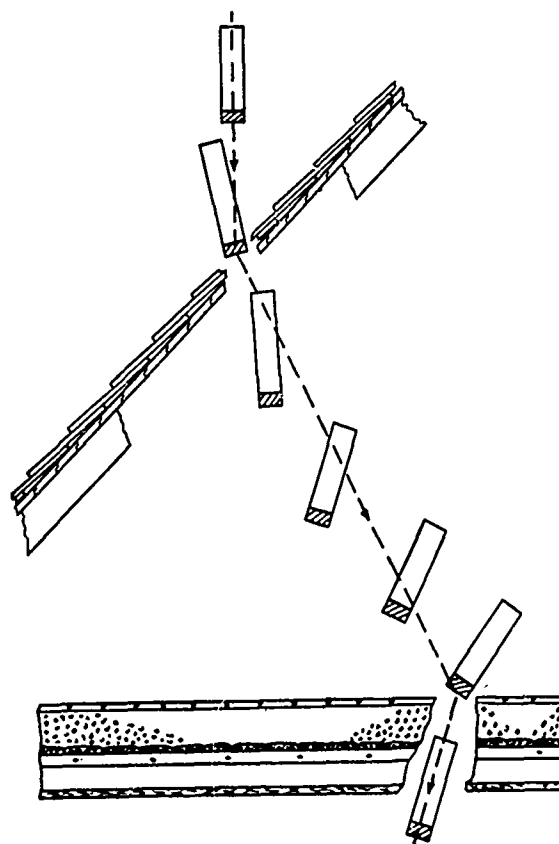

FIGURE 18. Penetration of M69X bomb in German structure.

*Tests in Central German Structures.*²⁰ The M50, M69, and M69X bombs were used in tests similar to those performed with the Rhineland structures. The Central German structure had a tile-on-batten roof instead of the slate-on-sheathing roof generally found in Rhineland

CONFIDENTIAL

structures. Data on penetration, functioning, and fire-raising power were obtained. Bedroom furnishings were placed in the room below the attic floor, to test the incendiary capacity of the M50, which often penetrates to that level. Particular attention was paid to the moisture content of the structures, tests for destruction being performed only when the moisture content was not lower than 10 to 12 per cent. A few tests were run with moisture content in the range of 20 to 25 per cent.

It was found that the tile roof offered the major resistance to the M69 bomb, little difference in ultimate penetration being found as the shots progressed towards the eaves line. Approximately 25 per cent of the M69 bombs remained sticking upright into the attic floor, none penetrating through the floor.

The penetration of the M50 was dependent on the position where the bomb came through the roof. When entering near the ridge, all M50's remained in the attic; in the middle of the roof from 21 to 40 per cent of the bombs penetrated through the attic floor, depending on the velocity at which they were fired. Near the eaves, all bombs penetrated the attic floor, 14 per cent of them at higher velocities penetrating two floors below the attic.

Tests with live bombs showed that the M69 and M69X started rapidly destructive fires when the fuel charge was ejected into the eaves of the attic. No bomb (M50, M69, or M69X) was effective when the fuel charge was more than 6 ft from the eaves. In a closed furnished bedroom, the M50 started slowly destructive fires.

*Miscellaneous Tests in Attic and Sub-attic Structures.*²¹ An extensive series of tests was conducted to study the effect of fuel consistency, fuel distribution, burning rate of fuel, effect of ventilation and design of structure, on the initiation and propagation of fire. These tests were conducted with the M69 bomb, and employed a Rhineland type attic and a furnished bedroom representative of German practice.

The results of the investigation may be summarized as follows.

1. Ample ventilation must be provided in order for incendiary bombs to be effective in establishing destructive fires.

2. Napalm fuel having a consistency of 400 to 600 g Gardner, appears to give optimum breakup and optimum burning rate in furnished bedrooms, being superior to the 9 per cent Napalm gels and IM gels used in M69 production.

3. In attics, fuel consistency is not so critical, but again the 400 to 600 g consistency appears best.

4. The burning rates of thickened gasoline fuels depend on the surface exposed to the air. For equal surface areas the IM2, IM3, and Napalm fuels containing from 2 to 9 per cent thickener burned at the same rate as gasoline.

5. The surface area of the fuel exposed after ejection depends on the consistency of the fuel, the force of ejection, and impact against a target. These factors must be kept in mind in formulating the fuel for a particular bomb.

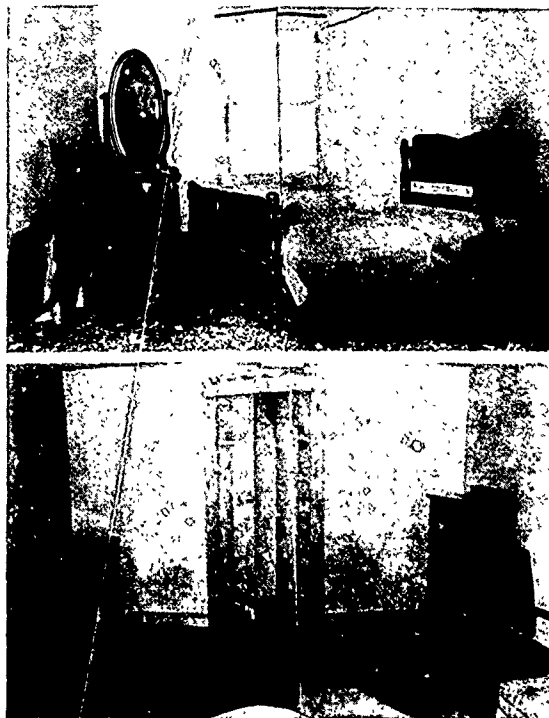

FIGURE 19. Views of Factory Mutual incendiary-test room (upper) from the door and (lower) from the window.

6. In furnished rooms, considerable breakup of fuel, with simultaneous ignition of several incendiary centers and a rapid build-up of temperature, appears desirable.

7. From a consideration of the geometry of

CONFIDENTIAL

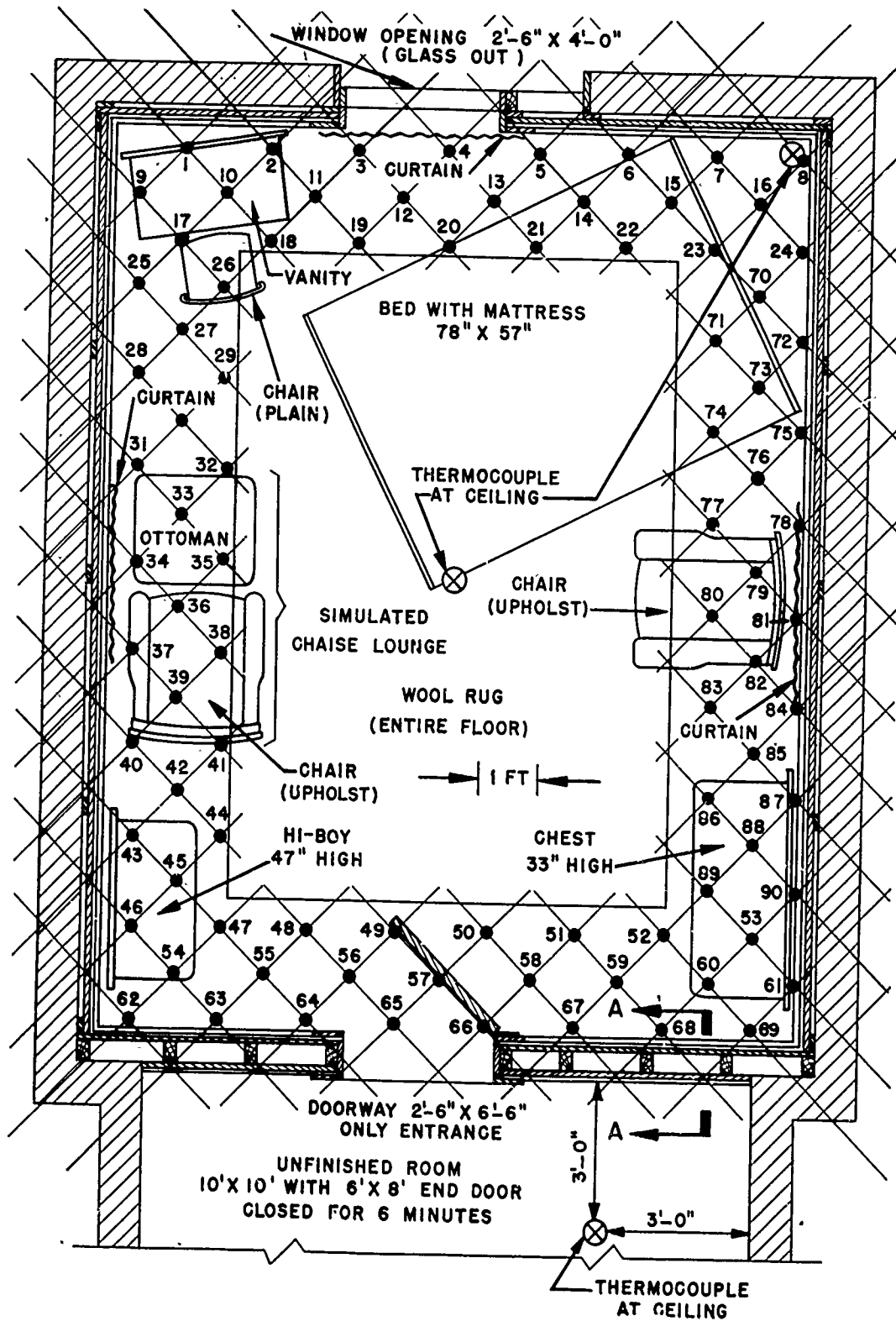

FIGURE 20. Layout and location of test points in Factory Mutual room.

CONFIDENTIAL

the furnished bedroom, combined with all the test data, it was estimated that 20 per cent of all M69 bombs ejecting within the room would

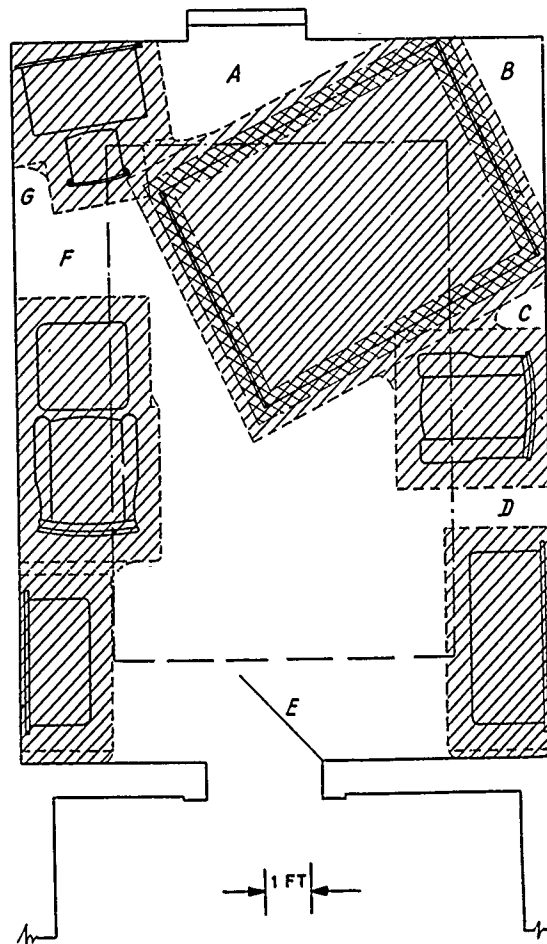

FIGURE 21. Areas in Factory Mutual room vulnerable to E19 bomb.

cause destructive fires if they contained gel of the optimum consistency.

3.1.5 Tests by Factory Mutual Research Corporation^{17, 22}

Comparative evaluations of small incendiary bombs were made under controlled conditions in a furnished bedroom. The bombs were compared by determining the relative areas in which fires were started and went out of control by a stirrup pump after a waiting period of 6 min.

Description of Test Room. The test room measured approximately 12 ft by 15 ft, with a ceiling height of 7½ ft. Figures 19 and 20 show the layout of the room. The walls and ceiling were covered with gypsum board for easy replacement. The average weight of the furnishings was 3.2 lb per sq ft of floor area.

Test Procedure. The bombs were placed in locations shown in Figure 20, and fired statically. After 6 min elapsed, an experienced fire fighter and helper attacked the fire with a stirrup pump, approaching through the adjoining room, where he encountered heat and smoke from the bedroom. If he was unsuccessful in dealing with the fire it was judged out of control.

Results. The tests indicated that the E19 incendiary bomb would cause uncontrollable fires when burning within areas that amounted to 67 per cent of the floor area. In Figure 21 the crosshatching shows the vulnerable area for the E19 bomb. The M50 4-lb magnesium bomb was found to be effective in only 7.2 per cent of the total area in similar tests. It was found that the temperature reached within the room

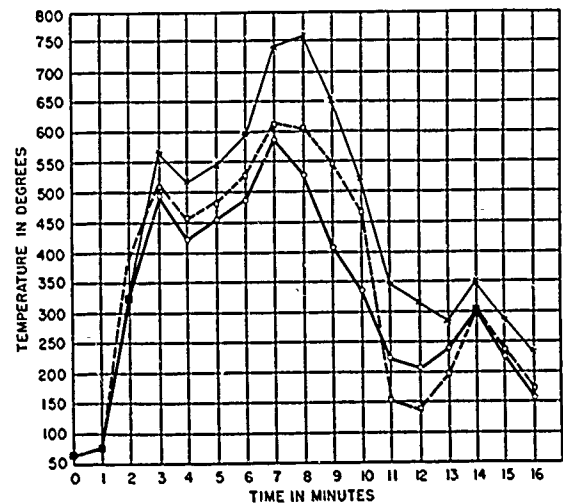

FIGURE 22. Typical time-temperature curves for incendiary test in Factory Mutual room. Three thermocouples were at ceiling in locations shown in Figure 20.

at the end of the 6-min waiting period was not a reliable index of the outcome of the test. In one test a temperature of 320 F at 6 min was recorded for a fire that could not be controlled,

CONFIDENTIAL

whereas in another test a temperature of 620 F was reached in 6 min, but the fire was put out. These observations have been confirmed by later work which has shown that when furnished rooms attain a maximum intensity of burning the temperature may reach 1800 F. Figure 22 shows typical time-temperature curves during an incendiary test.

3.1.6 Tests at Dugway Proving Ground^{25,27}

Although much valuable information regarding the penetration, proper functioning and incendiary effectiveness of small bombs had been obtained from mortar tests, it was recognized that airborne tests on full-scale target structures would be required in order to obtain a complete quantitative evaluation of the bombs. Such factors as the flight characteristics of the cluster, the functioning of the cluster fuze, the dispersion pattern of the individual bombs when released from a cluster, and the performance and functioning of the bombs could be evaluated by airborne tests without having an incendiary target, but it was felt that there might be factors the existence and importance of which would be revealed in full-scale airborne incendiary tests. Such an appraisal seemed necessary in order to be sure that the bombs would be effective when released upon enemy targets. A location suitable for these tests was found at Dugway Proving Ground of Chemical Warfare Service, situated some 70 miles southwest of Salt Lake City, Utah. Figure 23 shows some views of this project.

Description of Target Structures. 1. German structures. Six adjoining houses were built, three of the Rhineland type and three of the Central German type, similar to the Standard Oil Development Company structures, but much larger. Three had roofs of slate on sheathing, and three had tile on battens. The second-story rooms contained heavy furnishings characteristic of German custom.

2. Japanese structures. The Japanese dwellings were faithful reproductions of row houses occupied by factory workers. They were equipped with authentic straw floor mats and simulated furniture in an amount usually

found in such dwellings. No trouble or expense was spared in making all details of these dwellings correspond with authentic Japanese practice.

Description of Tests. An elaborate program of tests included dropping the M50 and M52 magnesium bombs, the M54 therm-8 bomb, and the M69 6-lb oil bomb. Both live and inert bombs were released at altitudes of 3,500 ft and 10,000 ft, from quick-opening clusters. Extensive data were taken on every point of functioning and performance, in order to have a sound basis for establishing the relative merits of the bombs. When hits on the targets were obtained, a complete record of each bomb was made, including the point of entry, the path of the bomb through the structure until it came to rest, the location where the functioning and incendiary action occurred, and the incendiary result achieved. Fires were classified according to the time it took for them to reach various stages. Thus, the classifications A1, A2, and A3 were assigned to fires which were judged to be going out of control by stirrup pumps within 2, 4, and 6 min, respectively. Fires that did not develop rapidly, but which would eventually go out of control, were classified as B fires. Small fires which would go out even if unattended were called C fires. Dud bombs were designated D. In order to avoid excessive damage, the fires were attacked with garden hose or full-scale fire-fighting equipment as soon as the expert evaluators had established the classification of the fire. Data were likewise taken on fires caused by gel ejected by M69 bombs onto buildings (ejection hits). Figure 24 shows a typical destruction fire in progress in a Japanese structure.

Results. Early in the program the M54 therm-8 bomb proved to be such a poor incendiary that it was given no further consideration. The M50 bomb was found to have excessive penetration for the Japanese structures. In the German dwellings it penetrated to the attic or to the floor below, but caused no rapid fires, being effective only when it burned in a favorable location. The M52 magnesium bomb exhibited marked instability of flight, but showed that its penetrating characteristics and incendiary effectiveness were adequate for Japanese con-

CONFIDENTIAL

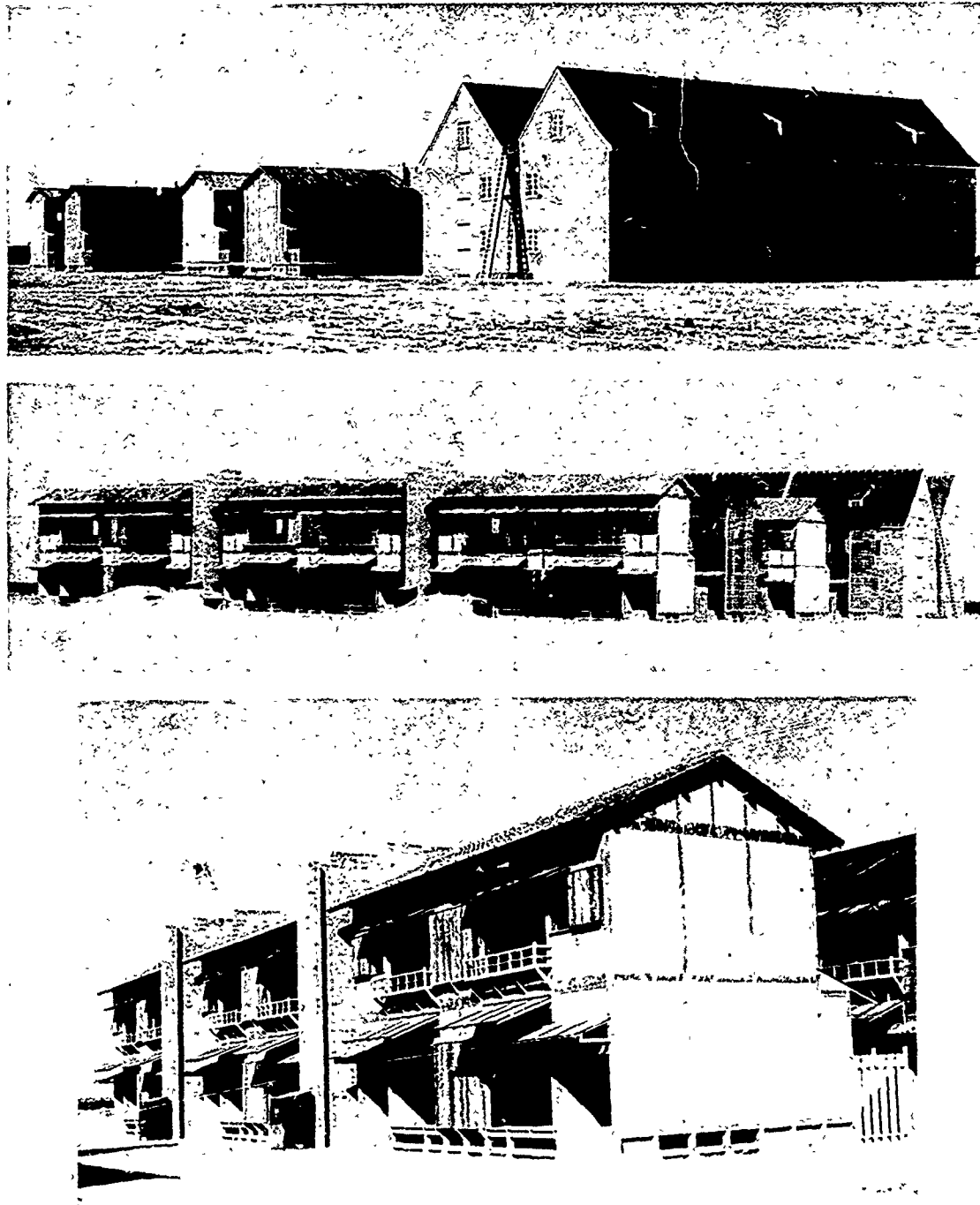

FIGURE 23. Views of Dugway incendiary-test "Village."

struction. The M69 bomb was the most effective of the bombs tested, and showed itself to be a potent weapon against Japanese construction. It also caused some good fires in the German buildings, and it was adjudged the best of the

bombs tested on these structures. Table 3 summarizes very briefly the results of these incendiary tests; for more detailed data the reader is referred to the official report.

Fire-Fighting Tests with the M69. Because of

CONFIDENTIAL

the belief that the Japanese are resourceful and determined fire fighters, it was decided to conduct a series of tests in which the fires would be attacked soon after the bomb had functioned. M69 bombs were placed so as to eject gel into predetermined locations, selected on the basis of earlier airborne tests. The bomb was fired electrically, and immediately thereafter a man equipped with stirrup pump or sand and shovel was permitted to enter the building, search for the fire and endeavor to put it out. An assistant was available to operate the pump. Tests were also made in which two bombs were fired simultaneously. The fire fighter and his assistant then attacked the most readily accessible fire until it

upward to allow for the defensive measures that would probably be taken by the enemy.

These tests led to the following conclusions.

1. Attack within 1 min would reduce potential fires per 100 AN-M69 bombs dropped from 46 to 10.5 as a minimum.

2. Previous estimates of 6 to 10 tons per sq mile were too low. Based on 50 per cent roof area, of which 50 per cent are multistoned structures, the bomb density should be about 40 tons per sq mile for reliable destruction.

In comparison with bomb densities used in the last six months of World War II, the above figure is quite low. However, it should be pointed out that the densities actually used may

TABLE 3. Results of incendiary bomb tests on Dugway structures.*

Fire classification	Japanese houses			German houses		
	AN-M50	AN-M52	AN-M69	AN-M50	AN-M52	AN-M69
A	22%	26%	68%	0%	0%	37%
B	20%	14%	13%	26%	18%	16%
C	58%	60%	19%	74%	82%	47%

*Dud bombs are excluded from the summary of bomb tests in this table.

was extinguished, and then proceeded to locate and attack the second fire. Both experienced and inexperienced personnel were used during the course of the tests.

Results. Of 36 bombs attacked by both experienced and inexperienced fire fighters using simple fire-fighting methods, 7 caused fires that went out of control. Of the single fires in readily accessible locations, 5 out of 37 went out of control; in locations difficult of access, 3 out of 6 went out of control. When two bombs were fired simultaneously and each caused an A or B fire, 8 out of 16 went out of control, despite attack by fire fighters. The general conclusion was reached that fires initiated by the AN-M69 bomb in Japanese houses could frequently be controlled by fire fighters, and that the important factors in such control were the method utilized, the experience of the individual, the accessibility of the fire, and, above all else, the time that elapsed before the fire was attacked. The results of these tests indicated that previous estimates of the effectiveness of the M69 for the bombing of Japan would need revision

have been unnecessarily high, and that there probably was a big difference between density dropped and density on the target area.

3.4.7 Incendiary Tests in Experimental Japanese Room²⁸

The tests at Dugway had shown that small incendiary bombs, particularly the AN-M69 and the M74, were effective in starting fires in Japanese dwellings, and that these dwellings were vulnerable to incendiary attack and easily destroyed by fire. Tests in England with the AN-M69 and other small incendiary bombs had indicated that small bombs were inadequate, seldom starting fires that would go out of control in a reasonable time, and then only when the bombs functioned in a few favorable locations. It was pointed out that the moisture content of the wood in the Dugway targets had averaged only 11 per cent in the first series of tests, and had been still drier in some later tests, moisture contents in the range of 3 to 6 per cent having been recorded for the hung

CONFIDENTIAL



12 MINUTES



30 MINUTES



50 MINUTES



70 MINUTES

FIGURE 24. Destructive fire in progress in a Japanese structure at 12, 30, 50, and 70 min after impact.

ceilings. Serious doubt was expressed as to the validity of the conclusions drawn from the Dugway tests, in view of claims that the moisture content of wood in Japan might approach 20 per cent. The British urged that larger bombs, such as the jet bombs, J-30 and J-20, were needed for effective attack on Japan. The implications were so serious that a British mission visited the United States in November 1944, and held several discussions in an attempt to reconcile the differences that had been found in the results of tests in America and England.

It was finally agreed that tests would be conducted by both groups, employing an experimental Japanese room designed to embody essential elements of construction, and assembled entirely from panels preconditioned to a proper moisture content.

Description of Test Room. Figures 25 and 26



FIGURE 25. Interior of experimental Japanese room at Edgewood Arsenal.

show the interior and exterior of the unit built at Edgewood Arsenal. The design was agreed upon in conference with British experts, and represented a compromise between American and British test structures. The test room proper measured 9 by 12 ft and was supported by a massive external framework. At one end was a noncombustible enclosure to simulate a plastered hallway. This was furnished with combustible ceiling panels, which would normally be present above a hallway. The test room was assembled immediately before each test, panels being removed from the condition-

CONFIDENTIAL



FIGURE 26. Exterior of experimental Japanese room, with fire in progress.

ing room and set in position in 15 to 20 min.

Since no reliable data were available on the moisture content of wood in Japan, it was decided to conduct wood-moisture equilibrium studies at a location where the climate corresponded closely to the summer climate of the Tokyo district. Key West, Florida, was a suitable place during the winter months, and samples of wood were there exposed out of doors and in several rooms in three different houses. Weights of samples, and determinations of relative humidity and temperature of air, were taken twice a day over a period of several weeks. It was concluded that a maximum wood-moisture content of 15 per cent was to be expected in houses in the Tokyo district. The panels for the experimental Japanese room were therefore conditioned to a moisture content in the range of 15 to 17 per cent.

Test Procedure. The AN-M69 bomb was chosen for the tests, because it was in large-scale production and scheduled for early use on Japan. The periphery of the room was divided into zones within which the combustibility was considered uniform. On the assumption that the angle subtended by a zone at the center of the room was a fair average of the angles subtended from points uniformly distributed over the floor, angles from the center to each zone were measured to determine the probability of ejection into that zone (see Figure 27). By

combining these probabilities with results of incendiary tests on each zone, the fraction of the total ejection shots by AN-M69 bombs found to be effective was established at 77 per cent. Allowing for a decrease of one-half in effectiveness due to penetration of gel through the shutters to the exterior, one concludes that 38 per cent of the bombs penetrating into the room would yield fires that would become uncontrollable within 5 min. This last may be an overcorrection. A few M74 bombs were fired into the room from the vertical mortar, and the results indicated a degree of effectiveness similar to that obtained from the AN-M69.

Conclusions. From the results of these tests it was concluded that (1) Japanese domestic construction of the type occupied by factory workers, and conditioned to a moisture content of 15 to 17 per cent, is easily ignited and vul-

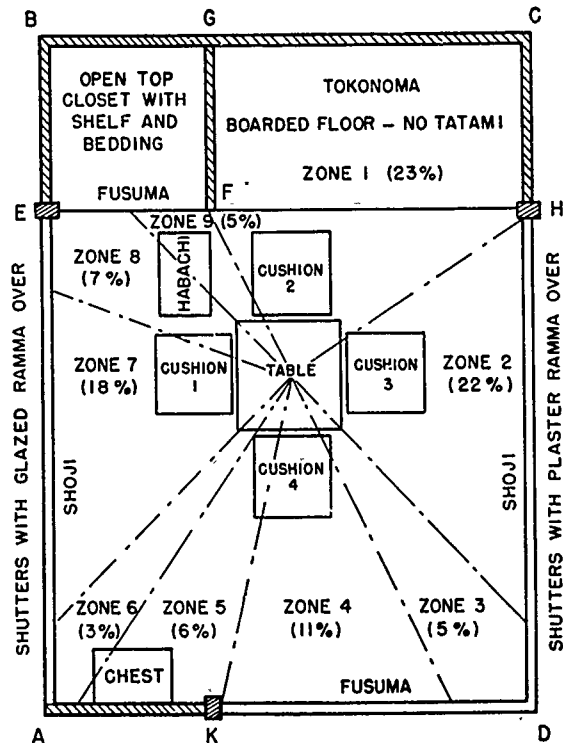

FIGURE 27. Layout and vulnerable zones in an experimental Japanese room.

nerable to fire; (2) the AN-M69 bomb is adequate for the purpose; and (3) the M74 bomb is also adequate for the purpose.

Before these results were published, the his-

CONFIDENTIAL



FIGURE 28. View of an Eglin Field factory-type, incendiary test building.

toric raids of March 1945 on Tokyo with the M69 bomb had amply demonstrated the overall effectiveness of that bomb, particularly when dropped in such numbers as to overwhelm defensive measures which might have coped with smaller numbers of bombs. All tests revealed that small incendiary bombs are easily controlled in the early stage of their burning against a target, and that the indispensable condition for their success in starting fires is that they be undisturbed for periods of time up to 5 or 6 min.

3.4.8

Tests at Eglin Field

Because the policy of the American Air Forces in 1943 and 1944 was to concentrate on the precision bombing of industrial targets, a need was felt to evaluate incendiary bombs by airborne tests employing a full-scale factory structure. The only available structure was one situated on H field at Edgewood Arsenal, Maryland, and the heavy demands on its use by CWS and by Ordnance, combined with the frequent occurrence of weather that prevented bombing from high altitude, made it advisable to erect a new building in a more favorable location. Permission was obtained by NDRC to construct a target building at the AAF Proving Ground at Eglin Field, Florida. Here were available all types of airplanes, all necessary instruments, and a skilled personnel to operate

them. Ground was broken for this structure in November 1943, and it was ready for use in March 1944.

Description of Target Structure. A major consideration in designing the building was to include those types of roof construction which would be representative of the roofs commonly found on enemy factories. The building would then not only serve for testing the penetration and functioning of all incendiary bombs being developed, but would yield data directly applicable to the planning of incendiary raids on enemy targets.

A side elevation of the target structure is shown in Figure 28. The structure was of steel-frame construction, with a concrete floor, except for one section measuring 140 by 68 ft which had wood-block flooring covered with tar. The width of the building was 140 ft, and the total length was 375 ft. There were three sections, the lengths of which were 100 ft, 125 ft, and 150 ft, respectively. The first section was three stories high, of reinforced concrete. The floors of intermediate stories were 8-in. reinforced concrete and the roof was 6-in. reinforced concrete. The second and third sections were laid out in bays measuring 25 by 20 ft, with a height of 20 ft between the floor and roof. In the second section, half the roof was made up of 2 to 5 in. of cinder concrete over 3-in. hollow tile, covered finally by two layers of asphalt felt. The other half was 3 in. of cinder concrete over 3½ in. of light concrete, covered

CONFIDENTIAL

by two layers of asphalt felt. The third section had a sawtooth roof consisting of light steel framing which supported glazed windows and 1-in. wooden sheathing covered with two layers of asphalt felt. The sides of the building were open and there was a concrete apron 50 ft wide surrounding the entire structure. Two hundred yards away was a bombproof shelter from which observers could view the length of the target building.

Use of the Eglin Field Structure. The principal data obtained in hits on the building were on penetration through the various types of roof and on the functioning of the bomb after penetration and subsequent impact on the floor. The AN-M69 bomb was tested on several occasions, being released in aimable clusters at altitudes up to 30,000 ft, with the cluster fuze set to open the cluster at any desired height above the target. It was found that a free fall of the individual AN-M69 bomb of approximately 5,000 ft was necessary to permit the bomb to decelerate to its normal terminal velocity of about 225 ft per sec.

The AN-M69 penetrated the sawtooth roof, and also the various light-weight roof slabs when no reinforcing members or supporting beams were encountered. It failed to penetrate the 6-in. reinforced concrete roof.

By an analysis of data on the prevalence of various roof types in Germany, and by comparison with previous test data, it was concluded that the common incendiary bombs would penetrate the following percentages of German industrial roof area: M50, 81 per cent; M47, 87 per cent; M69, 74 per cent; M69X, 75 per cent.

Subsequent photocover indicated that the AN-M69 and M69X would penetrate the roofs on over 90 per cent of the high-priority industrial targets in Japan.

In cooperation with Chemical Warfare Service, NDRC conducted a series of tests with the M47A2 70-lb oil bomb, to determine whether the M12 burster, black powder and magnesium, or the M13 burster, tetryl and white phosphorus, should be preferred for this munition.²⁹ The M12 burster is slower in its action and does not bring down as much roof material as the M13 when the bomb penetrates cinder con-

crete or tile roof slabs. The faster action of the M13 burster appears to cause more gel to lodge against sawtooth roofs, frequently causing roof fires. The general conclusion was reached that either burster gave satisfactory ignition of gel and that neither appeared to have any marked superiority over the other.

In the tests at Eglin Field no attempt was made to evaluate the incendiary effectiveness of the bombs. Circumstances were noted under which roof fires occurred, and in some tests rough wooden benches were placed about the floor.

As in other airborne tests, observations were made as to the ballistics and functioning of the cluster, the flight characteristics of the individual bombs, and the dispersion pattern around the center of impact. Recovery of bombs was frequently made, and causes of malfunctioning determined. The overall results of these tests contributed much valuable information that could be gotten in no other way, and provided a sound basis for predicting the results that might be expected from bombs dropped in actual attacks.

3.4.9 Tests at Edgewood Arsenal^{18, 30}

The industrial target structure at Eglin Field proved to be so useful that the Chemical Warfare Service erected a similar structure at Edgewood Arsenal in the fall of 1944.

Minor changes over the Eglin Field structure were made, such as omitting the tar-covered wooden block flooring, and the substitution of metal or laminated plastic for most of the glass panes in the sawtooth section. An important change was the addition of hinged metal panels which enclosed the structure on all sides and minimized the effect of wind while still permitting adequate ventilation. The Incendiary Evaluation Project provided wooden benches, stacks of packing cases, storage bins, radial targets, and cardboard cartons, which were arranged in the two sections having light roofs. These covered approximately 5 per cent of the floor area, and permitted an evaluation of the incendiary effectiveness of the bombs. This particular floor loading was selected for tests with the

M47 bomb, which distributed gel over an area of about 3,000 sq ft, and provided a good chance that several different targets would receive gel when an M47 hit into the building.

In tests on this building with the M74 8-lb incendiary bomb, the angle of descent of the PT gel was determined by noting the hole in the roof and the position on the floor where the gel had struck. In 25 hits on the sawtooth section the angle between the vertical and the path followed by the gel varied from zero to 60 degrees, the average being 26 degrees. This important fact was combined with other data obtained in mortar tests to establish the probability of an M74 starting a fire in a factory setup which contained combustible targets covering 25 per cent of the floor area. (See Section 3.3.)

In tests with the AN-M50A2, it was found that a high percentage of bombs that penetrated the sawtooth roof failed to function upon reaching the floor. This was apparently caused by the failure of the fuze to be activated by the slight deceleration that accompanied penetration through such a light roof, which, however, rendered the fuze insensitive to the subsequent shock upon hitting the floor. These results indicated the need for a more sensitive fuze than the one that had been incorporated to meet safety requirements in handling the bomb, in order to insure a satisfactorily high percentage functioning on light roofs.

Tests were also run with the AN-M69, the E19, and several 500-lb incendiary bombs being developed by CWS.

An evaluation was also made of incendiary fillings for the 4.2-in. mortar shell, which was fired into the building containing the incendiary targets.

3.5 FUNDAMENTAL STUDIES ON THE IGNITION OF WOOD

Most of the combustible material used in building construction and furnishing is wood, and a knowledge of the factors which govern the burning of wood is fundamental to the development of a sound technique of incendiary bomb testing.

When wood is heated the first result is that

some of the moisture it contains is vaporized and driven off. Decomposition of the wood substance also begins to take place with the evolution of heat, and the volatile products of this decomposition are also driven off. If the source of heat is large enough to raise the temperature of the wood continuously, a point is reached at which this endothermic decomposition proceeds with almost explosive violence if a pilot flame is applied. At higher temperatures ignition takes place spontaneously. The continuance of this burning, once it has been started at the surface, can only take place if the heat liberated at the surface, plus the heat from the initial source, are together sufficient to drive off the interior moisture, raise the temperature of successive layers of wood to the ignition point, and supply heat loss out through the wood to its unheated face. These various factors are considered in more detail under the following headings.

3.5.1 Radiation Density Required for Ignition

This factor in the problem was studied by exposing woodblocks of various species of wood to heat from a standard radiating source and measuring the time necessary for ignition. At average moisture contents it was found that a minimum value of about 18,000 Btu/hr/sq ft was necessary for self-ignition. At an intensity of 20,000 Btu/hr/sq ft ignition occurred in 25 sec; at 50,000, in 3 sec. These results correspond to total inputs of 125 and 40 Btu/sq ft, respectively, illustrating the decrease in total energy required as the rate of input increases. When a gas pilot flame is applied, instead of relying on spontaneous ignition, the intensity of irradiation required drops markedly, 12,000 Btu/sq ft per hr for ignition in 25 sec compared to 20,000 without a pilot flame. Although initiation of fire is accomplished with a minimum of total energy if its intensity is a maximum, persistence of the flame is very brief after removal of the heat source, because of the substantial absence of any stored heat in the wood layer behind the flame. A sustained intensity of irradiation of about 10,000 Btu/sq ft per hr was found necessary to maintain the flame on a

CONFIDENTIAL

wood surface indefinitely, or until an edge or supporting member was involved.

Little difference in inflammability was found for a number of wood species tested.

3.5.2 Effect of Moisture Content³¹⁻³⁶

In the tests just referred to blocks of different moisture content were used, but there was little effect on the time required for either pilot-ignition or self-ignition under the conditions of high irradiation density used, since only the surface of the wood was then involved. When, however, the continuance of burning was at stake, moisture content was found to have a material effect.

In another series of tests, sticks of Douglas fir 1x2x7½ in. of different moisture contents were located in such a way with respect to the burning fuel used as a heat source that the transference of heat was effected more by convection and conduction than by radiation. The samples were exposed to various input rates and the ignition times measured as well as the weight loss after 1 min burning. A marked difference in the behavior of 8 and 15 per cent wood moisture was found. Depending on the rate of heat input, the ignition time of the drier wood was from 43 to 78 per cent of that for the wetter wood when using a pilot flame, and from 60 to 80 per cent without a pilot. With pairs of samples spaced ½ in. apart and the 2x7-in. surface facing, those containing 8 per cent moisture continued to burn 3.7 times as long as the samples having 15 per cent moisture when the heat source was removed immediately after ignition.

This effect was strikingly demonstrated by using pairs of vertical planks spaced 2 in. apart, with a known amount of incendiary material burning between them at the base. In one test using 0.6 lb gasoline soaked in 0.1 lb cellucotton as the fuel, it was found that with 11 to 12 per cent wood moisture, flames reached the top of the planks (12 ft) after 3 min and the structure continued to burn to destruction, whereas, with 21 to 22 per cent wood moisture the flames took 5 min to reach 7 ft, after which they receded and the fire died out.

In all subsequent tests, therefore, the wood used was preconditioned to a known moisture content, and special rooms were built for this purpose for the Incendiary Evaluation Project at Edgewood Arsenal.

The actual value of moisture content to use for any set of tests involved a knowledge of (1) the relation between the relative humidity of the atmosphere and the equilibrium moisture content, and (2) the average relative humidity in the locality selected for incendiary bombing.

The generally accepted equilibrium relation between relative humidity and wood moisture content was found to be only approximately true. Since this relation was established as a result of tests carried out on wood shavings with a high specific surface, tests were therefore made in which wood slabs of different thicknesses were exposed to atmospheres of controlled temperature and relative humidity, and allowed to approach their equilibrium moisture content first from above and then from below.³⁶ The direction of approach, the species of the wood, and its previous heat treatment were all found to have a marked effect on the final moisture content established. Especially was this so in the case of Douglas fir, which is frequently kiln-dried at a higher temperature than other woods, a process which appears to lower its equilibrium moisture content by as much as 2 to 4 per cent.

Studies were made of existing climatic data for Germany and Japan, and estimates made of the probable effect of building construction and living conditions on the inside relative humidity in relation to the outside relative humidity, which is normally recorded by the Weather Bureaus.

For Germany it was predicted that the values for wood moisture content would be as follows:

	Attic		Living quarters	
Summer	Winter	Summer	Winter	
8-12	12-15	11-13	10-12	

Information from German sources indicated that it would be more accurate to work at the higher ends of these ranges.

In the case of Japan, a detailed study was made in houses in Key West, Florida, where climatic conditions in winter are generally sim-

ilar to those of Tokyo in the summer, and where living conditions and occupational densities could be found which were comparable with those known to exist in Japan.³⁶ As a result of this study, it was established that the most likely value for the moisture content of interior wood in Japan in the summer (the dampest period) was 15 per cent, a value which was used in all subsequent tests.³⁶

3.5.3

Effect of Wood Thickness

In early experiments it was found that isolated wood panels over a certain thickness, about $\frac{1}{4}$ - $\frac{1}{2}$ in., would not continue to burn after the igniting source had been removed. For example, two vertical planks spaced 2 in. apart, one $\frac{1}{4}$ in. and the other $\frac{3}{4}$ in. thick, were ignited on their inside faces with burning incendiary fuel at the base and allowed to burn until both surfaces were burning vigorously. The panels were then separated, and while the $\frac{1}{4}$ -in. plank continued to burn to destruction, the fire on the $\frac{3}{4}$ -in. plank died out. Measurements showed that only a small proportion of the heat produced at the burning surface was transmitted inwards, and in the case of the thick wood was conducted away from the surface too rapidly for the temperature of the next adjacent layer to reach the ignition point and thus allow burning to continue. Much of this heat lost from the surface could be saved, and the general level of temperature raised considerably, by placing the incendiary fuel in such a way that two or more adjacent surfaces were ignited simultaneously and could establish mutual interchange of heat. For example, it was shown that a 4-lb magnesium bomb burning on the floor outside, but close to an open-topped box made of 1 in. thick wood, did not start a continuing fire. When, however, the bomb was placed inside the box where mutual support was provided by all the interior faces, a rapidly destructive fire resulted.

In many instances (light paneled European furniture, Japanese screens, shutters, etc.) it was found that the wood could be fired directly, provided the burning time of the incendiary fuel was longer than the minimum necessary to

ignite the surface. In other instances when the objects were heavy constructional members of German attics, heavy furniture and industrial furnishings, etc., it was found necessary to locate the fuel so that more than one surface could be ignited at a time. An interesting case in point was the adoption of the horizontal gel ejection principle in the AN-M69 bomb, which enables the gel, in a German attic, for example, to be thrown right into the eaves where the fires on the floor and the sloping boarded roof can reinforce one another and grow.

3.5.4

Effect of Wood Species³⁷

The existing literature on the relation between the burning properties of wood and species was found to be somewhat conflicting, although there was general agreement on the fact that the higher the density of the wood the more difficult it was to ignite. The problem became acute when it was necessary to select an American wood that would be a satisfactory substitute for the mahogany and oak furniture which was stated to be prevalent in Germany. Two kinds of test samples were used: sticks 1x1x18 in. and boards 1x6x18 in. In both cases the ignition source was allowed to impinge at an angle on to the sample. As a result of a large number of tests, it was found that the average ignition time varied from 46 to 162 sec for the following species of wood in order: Eastern spruce, Mexican mahogany, white oak, Philippine mahogany, Douglas fir, rock maple, and West Virginia maple. From this it was concluded that standard American maple furniture would be as difficult to ignite as the wood of typical furniture in Germany.

For Japan the problem was different, since the Japanese house contains practically no furniture and reliance must be placed on ignition of the light wooden screens and shutters which take up most of the periphery of the room. The woods most frequently used for this purpose in Japan are hinoki and sugi, and experts advised that the closest available substitute for these woods from the point of view of density and essential oil content was Sitka spruce. In tests at Dugway a good deal of pine had been

CONFIDENTIAL

used, and in England, Japanese type houses had been built of Douglas fir. It was therefore desirable to carry out a direct comparison of these three species under conditions simulating the burning of thin vertical surfaces. Vertical panels, 5 ft square, made of carefully selected $\frac{1}{4}$ in. thick, butt-jointed boards of each species, were preconditioned to the same moisture content and then ignited by burning a given amount of incendiary fuel at the base of one side. The progress of the burning was noted, and when the fires had died out the unburnt material was weighed. The results are shown in Table 4 and Figure 29. From these results it was concluded that these three species show appreciable differences in their burning characteristics, corresponding roughly with their differences in density.

TABLE 4. Comparative burning characteristics of wood.

	Douglas fir	Sitka spruce	Ponderosa pine
Density of wood	0.57	0.44	0.33
Time of maximum intensity of fire	4'30"	4'0"	3'20"
Time of marked diminution of fire	6'	6'	9'
Proportion burned	28%	30%	66%

Confirmatory evidence of the difficulty of starting fires with Douglas fir was obtained during the series of tests with the Jap structures at Edgewood. Sitka spruce was usually used, but on two occasions comparative tests were carried out with Douglas fir, and in both cases the fires were more sluggish. The particularly high-density Douglas fir used in England was considered to be an important contributory factor in the difficulty of starting fires there.

3.6 ANALYSIS OF ATTACKS ON ENEMY TARGETS

In the last analysis the evaluation of an incendiary is its effectiveness on enemy targets. Most of the analyses of air attacks on enemy targets were made by the Ministry of Home Security, RAF Air Intelligence, and U. S. AAF Air Intelligence, including the Joint Target

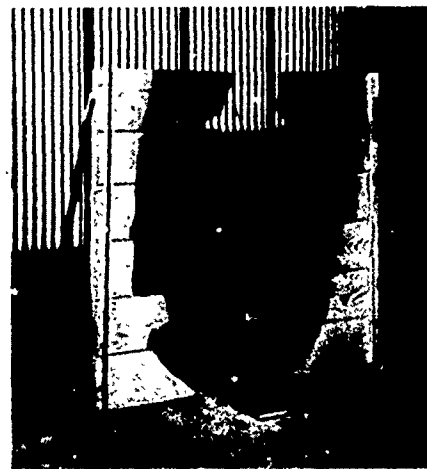

FIR



SPRUCE



PINE

FIGURE 29. Comparative burning test of three wood species.

CONFIDENTIAL

Group, but some analyses were made by NDRC groups. Below are summarized 2 of NDRC's contributions in this field: One covering the analysis of attacks on German targets by the group established under Service Project AN-23, and one giving an analysis of incendiary attacks on Japanese cities by W. T. Knox of the Standard Oil Development Co.

3.6.1 Analysis of Air Attacks by NDRC AN-23 Group

In August 1944, Divisions 2 and 11 and the Applied Mathematics Panel jointly accepted Service Project AN-23, the objectives of which were to gather data on the results of bomb attacks on European factory targets, analyze the results to establish the effectiveness of the various weapons used, and, if possible, evolve a technique of predicting the results of planned attacks, particularly on Japanese industry. Primary concern was the prediction of damage due to combined high-explosive and incendiary attack. The work of collecting data, described in detail in EWT-1d, was carried out in Europe. After elimination of all the American attacks on which data were incomplete or unsatisfactory, 38 remained. These yielded data on the physical character, before and after attack, of 1,276 separate building units, together with the probable density of attack on them. In addition, complete data were collected on one RAF attack, involving damage to 14 different industrial plants. The data have proved adequate in quantity and quality for establishing many illuminating generalizations concerning bombing operations, and have yielded vulnerability equations which should be useful in planning attacks. A summary of the results of the study appears below.

In the spring of 1945 a program of control attacks for the 20th Air Force was prepared. This was adopted in the field; the results were sent to Washington and were analyzed with a view to improving the effectiveness of attacks against Japanese industry.

Data Collection and Recording. For each of the attacks complete damage assessments were obtained from photo-interpretation carried out chiefly by DIDAS of the 8th Air Force and the

Interpretation Unit of RE8 at Princes Risborough. The following additional data were collected at their source: the number of bombs aimed at the target, their type, size and fuzing, the identification number of the attacking groups, the number of planes and shape of formation flown, intervalometer setting used, bombing altitude, heading, track, time of bomb release. The study of a number of attacks had to be abandoned because the data were found at the source to be confusing, incomplete, or occasionally contradictory. Bomb plots were made of the locations of HE bombs within the site rectangle, based on pre- and post-attack photocover, for all the attacks studied.

To permit a quick and accurate examination of the data for indication of various suspected relationships among the variables, a punch-card system was adopted, with one card for each of the 1,276 building units (see EWT-1, 1). The punches on each card recorded the raid number, the building number, per cent of the floor covered by combustible material, roof classification as to combustibility, per cent of floor area subject to fire, building plan area to nearest 100 sq ft, number of floors, damage in hundreds of sq ft to structure and contents (separated into HE, fire, and mixed damage), superficial and contents damage (separated into fire and mixed damage), internal damage (separated into HE and fire), type of weapon used, approximate density of attack for each weapon (low, medium, or high).

Preliminary Tests on Validity of Data. Accurate estimation of the number of hits on a target is obviously a first requirement for assessing the performance of the various weapons. Determination of HE hits on a site rectangle was by actual plotting of bomb craters. To check the identification of bomb hits from photocover, the number of total photo-identified hits in a given target area was multiplied by the fractional built-up-ness of the target. The result was compared with the number of building hits identified. The agreement was from +6 per cent to -3 per cent (see EWT-1e).

Incendiary bomb density on a site rectangle was calculated by multiplying the actual density of HE bombs (determined as described above) by the ratio of incendiaries to HE bombs in the

CONFIDENTIAL

plane loads. In EWT-5a, this method was checked by comparison with a few known-to-be-incomplete M47 IB plots, and a method was developed for correcting these plots to a completed basis for comparing densities in different parts of the target area. The results are in fair substantiation of the simpler procedure relied on exclusively in the weapon analysis studies.

The accuracy of roof classification is important in incendiary studies. Pre-attack photocover had been used at Princes Risborough to classify roofs. In EWT-1f this classification was compared with the better classification based on post-attack photocover. It was found that 80 per cent of the roofs had been classified correctly. Based on a classification of 1,233 roofs, 68.5 per cent of building units had combustible roofs, and 60 per cent had both combustible roofs and combustible floors.

A homogeneous target is one comprising building units in which all units are essentially equally responsive to attack by a particular bomb. A reasonable approximate vulnerability equation for such a target is $F = 1 - e^{(M_1 D_1 - M_2 D_2)}$. Let x = the fraction of the total density, $d = (D_1 + D_2)$ which is of type (2), i.e., $x = D_2 / (D_1 + D_2)$. It is then easy to show that the gross MAE based on the total density varies from M_1 when $x = 0$ to M_2 when $x = 1$, and is linear in x . This provides a test for homogeneity of targets. When applied, the test indicates that noncombustible roof buildings are moderately homogeneous, but combustible ones are not (see EWT-1h).

Building Types. Classification of buildings by roof type has already been mentioned above. The spans of the principal structural members, the number and spacing of columns, the height of the structure, presence of traveling-crane runways are all features significantly affecting the resistance of a building to HE damage. Based on a classification of 1,276 building units, the dominant types were found to be industrial, single-story buildings of less than 10,000 sq ft floor area (38.4 per cent), multistory framed and wall-bearing buildings (9.6 and 11.6 per cent), and large single-story buildings without traveling cranes, of simple beam-and-column or truss construction (11.1 and 15.4 per cent).

Structural HE Damage. Based on 178 build-

ing units, the mean area of effectiveness of the 500-lb U. S. GP bomb was found to vary for 5 building types from 2,600 to 3,300 sq ft per bomb hit including no-damage hits, or from 3,100 to 4,100 sq ft excluding such hits. These are plan areas in multistory buildings. The floor damage is represented by the figures above, multiplied by the number of stories. For details see EWT-2f.

The near-miss effects of the 500-lb GP bomb were studied in EWT-1j. Based on 433 analyzable cases of misses within 45 ft of a building, it was concluded that a 500-lb GP bomb falling more than 15 ft from a European industrial building causes insignificant damage and that near-misses within 15 ft are but 10 per cent as effective as direct hits.

Fire Spread. The determination of the importance of fire spread in industrial buildings was essential to the development of a satisfactory quantitative relationship for predicting damage. Spread of fire damage was first studied in the case of pure HE attacks. Thirty-four analyzable incidents were available in which no incendiaries were used. It was found that HE fires starting in a single-story fire division with combustible roof usually spread through the fire division regardless of its size; in 10 to 14 combustible-roof cases the fire completely burned out the fire division, and in 3 of the remaining 4 the fire was stopped by interior partitions (the average plan area per fire division was 20,000 sq ft). By contrast, in fire divisions with noncombustible or fire-resistant roofs, the average spread was 33 per cent; the average plan area of single-story fire divisions in this category was 100,000 sq ft. Spread to an adjoining fire division occurred whenever the HE bomb fell within 40 ft of a fire division (see EWT-2g).

Mixed HE-IB attacks on single-story buildings were studied next. An analysis of 148 fire divisions with combustible roofs and 28 with noncombustible roofs led to the conclusion that combustible roof fire divisions burn out completely. Fire divisions with noncombustible roofs burn out completely if the plan area is up to 10,000 sq ft; for larger fire divisions, a limiting size of about 35,000 sq ft of burn-out is approached. A quantitative expression of this

generalization is $E = 35,000(1 - e^{-A/35,000})$. It shows that the area of damage E approaches a limit of 35,000 as A increases (see EWT-3c).

If the buildings are multistory and the roofs and floors are combustible, a complete burn-out occurs due to fires from mixed attacks. If the roof is combustible and the floor noncombustible or resistive, 2- and 3-story buildings burn out about 1.5 floors (see EWT-3d).

Sometimes several building units are grouped by target analysis into a single composite fire division. An analysis of 94 building units comprising 36 composite fire divisions was made. Assuming that if a building unit in a composite fire division was not involved in a fire that destroyed the other buildings, then that building unit had been wrongly classified; it was found that at most 18 errors of assignment had been made on the 94 units.

From the above studies it appears that the concept of a fire division is essential in the estimation of damage to be expected by incendiary attack on industrial structures, and that knowledge of the areas of fire divisions in enemy targets is essential.

The Probability of Starting a Serious Fire. The method of analyzing data to determine p , the probability of starting a serious fire, is presented in EWT-3b for the 500-lb U. S. GP bomb, and in EWT-5b for incendiary bombs. These will be discussed separately.

Probability of Fire Starting by HE. Based on 440 fire divisions in 14 targets attacked by HE bombs alone, their probability of starting a fire was estimated in several ways. The values center around 0.17, the extremes found in reasonable samples being 0.15 and 0.19. This probability of one-sixth is independent of roof construction and height, but probably depends on building type and combustibility of contents. The probability of a 15-ft near-miss causing a fire is 0.05 ± 0.05 .

From the above, it is concluded that when the area of a combustible-roof fire division is about 6 times the high-explosive mean area of effectiveness of the bomb, the bomb damage by fire will equal its HE damage. Since the MAE for a 500-lb HE bomb is around 3,000 sq ft, this calls for a fire-division area of around 18,000 sq ft to make the two effects equal. This is actually in

the middle range of European industrial buildings. It follows that fire damage by HE bombs is not a minor correction factor in calculating total damage, but is rather of about the same magnitude as the HE damage.

Probability of Starting a Fire with an M47 IB (EWT-5c). Based on 560 fire divisions attacked with M47's, of which 186 were damaged by fire, the p for the M47 was found to depend on height and estimated occupancy^a when the roof is combustible. A decrease of p with increase in height was observed in all but the highest occupancy class. Considering the facts that occupancy is an estimated quantity depending on available Intelligence and photo interpretation, and that true occupancy was for most cases unknown, deviations from a reasonable pattern of results are to be expected. It was concluded that p could be expressed^b as the product of a roof-height factor, decreasing from unity for an 8-ft roof to 0 for a 55-ft roof, by an occupancy factor increasing from $\frac{1}{3}$ for 5 per cent occupancy to unity for 45 per cent occupancy. These functions are presented in Table 5.

TABLE 5. Probability of starting a serious fire with an M47 bomb.*

Height	Height factor	Occupancy per cent	Occupancy factor
8	1.0	5	0.33
15	1.0	15	0.66
25	0.5	25	0.78
35	0.2	35	0.89
45	0.1	45	1.00
55	0.0		

*Combustible-roof, European industrial buildings.

Table 6 presents a comparison of the observed and calculated number of fires found in each height-occupancy class.

The agreement is seen to be good. For noncombustible and fire-resistant roofs no dependence of p on height was found, but p does depend somewhat on occupancy. The value of p is around 0.05-0.06, varying from 0 for 15 per cent occupancy to 0.13 for 35 per cent occupancy.

Because there is generally a relation between

^a Occupancy is numerically measured as the per cent of the floor area covered with combustible material.

^b $p = \text{height factor} \times \text{occupancy factor}$.

CONFIDENTIAL

TABLE 6. Comparison of observed and calculated number of fires in each height and occupancy class.*

Occupancy (%)	5	15	25	35	45	Totals in height class
Height, ft 7 to 9			5 4.0 (22)	2 2.0 (7)	0 0.6 (2)	7 6.6 (31)
10 to 19		2 1.7 (5)	20 20.3 (54)	19 17.3 (46)	1 1.2 (2)	42 40.5 (107)
20 to 29		2 1.6 (3)	6 7.7 (19)	6 4.1 (10)	2 2.1 (6)	16 15.5 (38)
30 to 39		0 0.6 (1)	1 2.5 (9)	2 1.7 (4)		3 4.8 (14)
40 to 49	0 0.0 (1)	0 0.2 (1)	1 0.9 (4)	0 0.5 (2)		1 1.6 (8)
50 to 59		0 0.0 (1)	0 0.5 (2)	0 0.0 (1)		0 0.5 (4)
Totals in occupancy class	0 0.0 (1)	4 4.1 (11)	33 35.9 (110)	29 25.6 (70)	3 3.9 (10)	69 69.5 (202)

*Combustible-roof buildings, attack No. 10 excluded.

Upper left entry is observed number of fires.

Upper right entry is calculated number of fires.

Lower entry in parentheses is number of fire divisions in sample.

building type and roof height, one may expect p to vary with building type. This is borne out by the data. Small single-story buildings of less than 10,000 sq ft have a high p , near unity; when the area exceeds 10,000 sq ft but the span is less than 75 ft, p drops to 0.39; when the area exceeds 10,000 sq ft and the span exceeds 75 ft, $p = 0.02$.

Probability of Starting a Serious Fire with an M50 IB (EWT-5d). The available data were not sufficient to establish p with the same certainty as for the M47. 135 fire divisions, of which 51 were damaged, were analyzed. In addition to the inadequacy of the data, there is some doubt as to the right to determine number of hits on a fire division from the average density over the site rectangle, because of the non-random fall of bombs released in clusters. However, the same general trends in p were noted as for the M47; namely, the distinct difference between combustible and noncombustible roofs ($p_{nvc} = 0.05$ and 0.01, respectively), and a strong effect of height and of occupancy. Smoothing the data leads to recommended values of p given in Table 7.

TABLE 7. Probability of starting a serious fire with an M50 IB.*

Height in ft	Occupancy in %				
	5	15	25	35	45
7 to 19	0	0.02	0.05	0.10	0.15
20 to 29	0	0.01	0.03	0.05	0.07
30 to 39	0	0	0.02	0.03	0.04

*Combustible-roof, European industrial buildings.

Similarly to the M47 study, the relation of p to structural class of building was determined (all combustible-roof structures). Single-story small buildings, larger buildings with small spans, and larger buildings with spans above 75 ft have p values of 0.07, 0.05, and 0, respectively.

Data on noncombustible roof buildings were not available to an extent permitting determination of p .

Overall Damage Prediction. An attempt to fit the data by a pair of simplified vulnerability equations, one for combustible-roof buildings and one for noncombustible buildings, was not successful (EWT-1i).

Direct-Hit Effects of 500-lb GP Bomb (EWT-3f and EWT-4). Calculation of expected total

CONFIDENTIAL

damage was carried out in each of two ways. In the first, the actual number of counted hits on the target was used to predict damage. In the second, actual observed number of hits was replaced by a probability of hitting using the average density of bombs over the site rectangle. The corresponding equations developed are:

$$g = A \{1 - [1 - (pE + qM)/A]^h\} \quad (1a)$$

$$\text{and } g = A \{1 - e^{-(pE + qM)D}\} \quad (1b)$$

in which g = total damage area,

A = plan area of target,

p = probability of HE bomb to start serious fire = 0.17 (See EWT-3b),

E = expected area of extent of an individual fire. Depends on roof type. For combustible-roof buildings, $E = A$.

For other buildings E (in 1,000's of sq ft) = $35 \times (1 - e^{-A/35})$.

$q = 1 - p$,

M = HE structural MAE (See EWT-2f),

h = observed number of direct hits,

D = density of bombing, number of bombs per unit area.

Note that g , A , E , and M are to be expressed in the same units. The above equations apply only to single-story fire divisions consisting of one building unit. For modifications to allow for multiple-story buildings and composite fire divisions, see original report.

A comparison of observed and expected damage, based on structural class of buildings, indicates an overall average error of 6 per cent when equation (1a) is used. As expected, when actual counted number of hits is replaced by the use of an average attack density D , the average error in prediction of results increases. On 13 attacks it is 11 per cent.

Miscellaneous. In EWT-1k the requirements for adequate pre-attack, attack, and post-attack photographic cover are discussed.

The experience of the AN-23 group in obtaining suitable data and the conflicting views held in various circles on inadequate evidence, led to the outline of a program of control attacks (described in NDRC Memo. No. A109N,

OSRD Report No. 5034) designed to settle some of the outstanding questions in choice of airborne weapons.

3.6.2 Analysis of Incendiary Attacks on Japanese Cities

The information on which this analysis is based was obtained from the Joint Target Group, Air Intelligence, Army Air Forces, and from the Operations Analysis Section, Twentieth Air Force. This information was preliminary in nature and subject to revision on the basis of ground observations.

The data cover the first 27 attacks on Japanese cities during the period from January 3 to June 19, 1945, which have already been summarized in Table 4 of Chapter 1.

Incendiaries Used. The total tonnage of bombs dropped on these cities was 48,000 tons, of which 47,000 (97.4 per cent) were incendiary bombs. Out of 281 sq mi of built-up area in these cities, 107 sq mile (38 per cent) were burned out completely. Seventy-five hundred B-29's attacked these targets in order to deliver the 48,000 tons of bombs; 2,500 B-29's bombed visually and 5,000 bombed using radar, mostly on night raids.

The tonnage of bombs dropped through June 19 was less than one-half of the total incendiary tonnage dropped on Japanese urban areas until the cessation of hostilities. Detailed data regarding these latter raids are not yet

TABLE 8. Summary of munitions used in destroying Japanese city areas, January 3 to June 19, 1945.

Bomb	Cluster	Tons dropped	% of total
AN-M69	E28, E36, M19	25,000	53.0
AN-M47	...	12,000	25.4
AN-M50	M17	9,000	19.1
AN-M76	...	1,000	2.1
M74	M20	200	0.4

available. Attacks made subsequent to June 19 were on cities of less than 200,000 population.

Table 8 is a summary of the munitions used in destroying these Japanese city areas up to June 19, 1945.

Strategy, Tactics, and Operational Results. A brief description of the general strategy and

CONFIDENTIAL

operational results during this period of large-scale incendiary attacks follows.

1. During January and February 1945, three small, high-altitude precision, daylight attacks were made on Nagoya, Kobe, and Tokyo. 800 tons of AN-M69 incendiaries in E6R2 clusters were dropped on these three raids, resulting in a total damage of only 1 sq mile burned out. Post-raid photos of these raids indicated excessive scattering of the incendiary bombs on the target. This was probably due to the abnormally high winds prevailing from 20,000 to 30,000 ft over Japan and the relatively poor aimability of the E6R2 cluster. The low tonnage of bombs probably permitted effective fire fighting.

2. Following the small-scale incendiary raids, five big night raids were made during the period of March 9 to 18 on Tokyo, Kobe, Nagoya, and Osaka. These raids were made at low altitude, with each individual plane dropping its bombs on the target by radar. Ninety-five hundred tons of all types of incendiaries were dropped on these five raids, destroying a total of 26.4 sq miles (360 tons dropped per sq mi destroyed). These raids proved the vulnerability of the large Japanese cities to incendiary attack, and it was indicated that the raids would have to be made at low altitude in order to obtain a high degree of accuracy and with large tonnages of bombs in order to saturate the target and nullify fire-fighting efforts.

3. Following the five big night raids, there was a delay of 1 month before the next incendiary raid due to a lack of incendiary bombs at Guam.

4. On April 13 and 15 three large-scale night raids were made on the Tokyo area from low altitude employing saturation bombing tactics. Forty-two hundred tons of AN-M69 and AN-M47 incendiaries were used on these raids and destroyed 20.8 sq miles of the city area (200 tons dropped per sq mile destroyed). These raids were made possible by the arrival of a shipload of incendiaries at Guam consisting of approximately 80 per cent AN-M69 and 20 per cent AN-M47 bombs.

5. Following these 3 night raids, another delay of 1 month ensued, again caused by a shortage of incendiaries at Guam.

6. Beginning May 14, super raids, 500 planes each, were made on the 5 largest Japanese cities of Tokyo, Nagoya, Yokohama, Osaka, and Kobe. In an attempt to confuse the Japanese anti-aircraft defenses, these raids were made both during the day and night and varied from low to medium altitudes. It was the opinion of JTG that fire fighting was probably abandoned by the Japanese air-raid defenses during these raids. 27,500 tons of all types of incendiaries dropped on these raids resulted in 48.6 sq miles of damage (565 tons dropped per sq mile destroyed).

7. After June 15, the large cities of Japan were considered to be burned out and no further incendiary raids were conducted on them. The focus of attack was shifted to cities between 200,000 and 400,000 population. Between June 17 and 19, about 1,000 tons each of AN-M69 and AN-M47 incendiaries were dropped on Kagoshima, Omuta, Hamamatsu, Yokkaichi, Toyohashi, Fukuoka, and Shizuoka. These raids were all made at night from low altitude and employing saturation bombing tactics. Most of the built-up area of each city was burned out on the first raid, about 1½ to 2 sq miles in each city.

8. From June 19 until August 10, attacks were centered on cities under 200,000 population because of the burning out of the larger cities. These raids were made mainly at night and from low altitudes. Plane losses during this period were negligible.

Observations concerning the tactics and conditions surrounding the raids include the following.

1. The rapid development of smoke during daylight attacks made precision bombing even from medium altitudes most difficult. This smoke in some instances obscured the target in 5 min, indicating exceedingly rapid fire development. Since these raids were conducted over a period of 1 to 1¼ hr and used formation bombing, the formations following the lead planes frequently were forced off course in order to obtain a bearing on the target. This resulted in the bombs landing as much as 2 to 4 miles away from the target. For example, during the May 14 raid on North Nagoya, only 14 per cent of the bombs released fell within 4,000 ft of

CONFIDENTIAL

the assigned aiming point. Of the total of 12,000 clusters dropped, 64 per cent fell within the city, 17 per cent fell outside the city, and 19 per cent were unaccounted for. In this particular raid the area which received the heaviest concentration of bombs was approximately 2,000 ft away from nearest aiming point and was relatively unsettled farming and manufacturing area.

2. The effect of rapid smoke obscuration of the target during daylight raids on formations following the lead plane at an average altitude of 18,000 ft is shown in Table 9.

TABLE 9. Accuracy of day incendiary missions.

Period of attack	% of bombs within			Average distance of bombs from target*
	½ mile	1 mile	2 miles	
First quarter	27	55	20	4,300 ft
Remaining quarters	13	35	38	5,300 ft
Whole	17	41	30	5,000 ft

*Excluding bombs falling more than 2 miles from target.

3. Data regarding the accuracy of night incendiary missions employing individual radar bombing are given in Tables 10, 11, and 12.

TABLE 10. Accuracy of night incendiary missions.

Location of cities	Radius of circle containing 50% of ident. patterns (CEP)	Per cent of identified patterns which fell within		
		2,000 ft	4,000 ft	6,000 ft
Inland	6,250 ft	8	24	50
Coastal	4,000 ft	18	50	75

It appears from the data in Table 10 that the accuracy achieved on coastal cities was substantially higher than that achieved on inland cities, probably because of the greater accuracy

TABLE 11. Accuracy of night incendiary missions.

Altitude in feet	Per cent of identified patterns which fell within 4,000 ft AP		
	7,500-8,500	9,500-11,000	15,000
Coastal cities	58%	50%	33%
Inland cities	26%	16%

of radar in delineating between water and land, as compared to areas completely surrounded by land.

The data in Table 11 indicate that the accuracy of bombing on night incendiary missions

decreased significantly with an increase in altitude.

The data given in Table 12 confirm that the first quarter of the attack achieved a signifi-

TABLE 12. Accuracy of night incendiary missions.

Period of attack	Radius of circle which contained 50% of the ident. patterns (CEP)	Per cent of identified patterns which fell within		
		2,000 ft	4,000 ft	6,000 ft
First quarter	4,200 ft	23	49	72
Remaining quarters	5,500 ft	8	33	60

cantly higher accuracy than succeeding quarters, which phenomenon was first noticed in the precision daylight missions. The severe thermals encountered by the planes over the target after fires have been set may offer an explanation.

It is generally believed that the effect of natural ground wind on fire propagation during these attacks was negligible in comparison with the tremendous draft created by the fires. For instance, on one raid in Tokyo there was reported a 70 mph ground wind in the city. Never in the history of the Tokyo weather observatory had there been a wind over 55 mph during that month. In general, the average wind over most of these Japanese urban areas varies from 10 to 15 mph.

Efficiency of AN-M69 Bomb. The most reliable estimate of the minimum bomb load required to accomplish substantially complete (80 per cent) destruction of typical Japanese dwelling areas is about 125 tons per sq mi, as shown in the table following below. These raids are discussed in greater detail in the following sections. The minimum bomb load was determined by excluding those areas which were supersaturated with bombs and excluding that part of the bomb load which was dropped on supersaturated and unsettled areas. Areas chosen for analysis were residential in which between 50 and 100 per cent destruction occurred, in order that a threshold value of bomb load required for 80 per cent destruction of residential areas (20 to 80 per cent roof coverage) could be determined.

CONFIDENTIAL

City	Raid date	Tons of incendiary dropped		Total area destroyed sq mi	Minimum tons incendiaries per sq mi of residential area required for 80% damage
		AN-M69	AN-M47		
Nagoya	5/14	2,679	0	3.1	160
Osaka	3/13	1,782	56	6.6	125
Kagoshima	6/17	476	360	2.0	120 avg
Toyohashi	6/19	558	426	1.7	
Shizuoka	6/19	531	375	2.3	

North Nagoya Raid, May 14, 100 Per Cent AN-M69. This raid was the only large-scale, daylight, 100 per cent AN-M69 attack on a Japanese city. Strike photos were available to permit a reasonably good analysis of the bomb-fall location³⁸ and pre-raid and post-raid damage photos have been analyzed for the extent of damage to various areas. Since most of the other large incendiary raids were either made at night with few strike photos or else employed a mixture of incendiary bombs, it is believed that this raid is probably the best source of data for a direct analysis of the efficiency of the AN-M69 bomb.

Possible errors in this analysis, however, limit its accuracy to about ± 50 tons per sq mile. These errors include (1) only 80 per cent of the bomb falls were able to be plotted, (2) the plotted location of a given bomb fall is estimated as varying up to 2,500 ft from the true location, and (3) this raid was conducted using formation bombing at five different aiming points located between previously burnt-out areas and farmland which resulted in numerous bomb falls landing in these waste areas. Also, in view of the relatively poor bombing accuracy on this mission (only 6 out of 42 plotted formation bomb falls fell within 4,000 ft of the assigned aiming point), it is probable that the concentration of bombs within the target areas was not uniform but spotty, thus leading to bomb requirement values in excess of the true tonnage required.

In summary, the conditions under which the Nagoya raid was carried out and the analysis made, make the 160 tons per sq mile value more likely to be higher than the true value. The subsequent analyses tend to confirm this statement.

Osaka Raid, March 13, 97 Per Cent AN-M69. This raid was the first large-scale raid on Osaka,

and thus has the advantage over the Nagoya raid of striking virgin target areas. The raid analysis made by JTG³⁹ which led to the bomb requirement value of about 125 tons per sq mile may be summarized as follows: This raid was made at night, with all planes bombing individually using radar, a condition which should result in a normal distribution of bombs about the aiming point. With no strike photos available, a computation of the density of damage in circular areas about the mean center of damage was made. The values obtained indicated a good correlation with the normal distribution curve. Then, assuming that the density of bomb fall paralleled the density of damage, and that the center of damage coincided with the center of bomb fall, it was found that 125 tons per sq mile of M19 clusters (of AN-M69 bombs) was adequate to insure over 80 per cent destruction of Japanese city dwelling areas, about 40 to 80 per cent roof coverage.

This indirect analysis of AN-M69 fire-raising efficiency appears sound in principle, and may offer a more accurate solution than the direct analysis of the Nagoya raid, considering all the errors possible in trying to locate each bomb fall precisely. The values of 160 and 125 tons per sq mile obtained by the two methods are not, however, significantly different, and may be considered confirmatory.

Kagoshima, Toyohashi, and Shizuoka Raids, June 17, 19, 57 Per Cent AN-M69, 43 Per Cent AN-M47. As a further check on AN-M69 fire-raising efficiency, an attempt was made to analyze raid results on smaller cities. Most of these raids involved the use of several types of incendiaries, and thus are not strictly comparable with the Osaka and Nagoya raids. This analysis was undertaken for the raids on Kagoshima, Toyohashi, and Shizuoka using data on bombing accuracy from the Operations Analysis Section, XXI Bomber Command.^{40, 41} The method of analysis employed was similar to that used for the Osaka raid: Bomb distribution was assumed to follow the normal distribution curve, since these raids were made at night using radar individual bombing. Exact values for the density of bombs were obtained from OAS, e.g., the circular probable error for this type of bombing has been found to be 6,250

CONFIDENTIAL

ft.^c The aiming points for these raids fortunately coincided with the centers of damage; thus it could be assumed that the aiming points coincided with the center of bomb density. Damage to various areas around the aiming points was estimated from post-raid photos. Calculations for the three raids have been averaged in the following table.

Radius of annulus about aiming point, ft	Annulus area, sq mi	Area burned out in annulus, sq mi	Bombs striking annulus area, tons (clustered)	Tons of bombs per sq mi damaged
0-2000	0.45	0.43	146	340
2000-4000	1.35	0.95	146	169
4000-5000	1.02	0.40	74	185

Since large areas in the outer annuli were not built up but comprised mountainous and farming areas, a further series of calculations

^c Unpublished data from Joint Target Group (JTG).

were made to limit the bomb requirement to residential areas which showed more than 20 per cent roof coverage.

Radius of annulus about aiming point, ft	Built-up annulus area, sq mi	Built-up area burned out, sq mi, %	Bombs striking built-up area, tons (clustered)	Tons of bombs per sq mi damaged
0-2000	0.44	0.43 98	143	330
2000-4000	1.08	0.92 85	117	123
4000-5000	0.51	0.35 69	37	106

The bomb-requirement value of about 120 tons per sq mile for 80 per cent destruction of residential areas is, of course, based on the mixed bomb load of 57 per cent AN-M69's and 43 per cent AN-M47's, and as such is not strictly comparable with the Osaka and Nagoya values. However, this analysis tends to confirm the order of magnitude of the previous values.

CONFIDENTIAL

Chapter 4

PORTABLE FLAME THROWERS

4.1

INTRODUCTION

THE USE OF PORTABLE flame throwers as they are thought of today dates back to World War I. These early models used a fuel mixture of a heavy and volatile oil which was propelled by compressed gas. At the start of World War II, few experiments had been made on the

existed and that development should be undertaken.

In this chapter, the NDRC contribution to the Portable Flame Thrower Program is summarized. As an expedient, the initial step consisted of redesigning the inefficient M1 portable flame thrower in order that thickened fuel as well as unthickened fuel could be used.

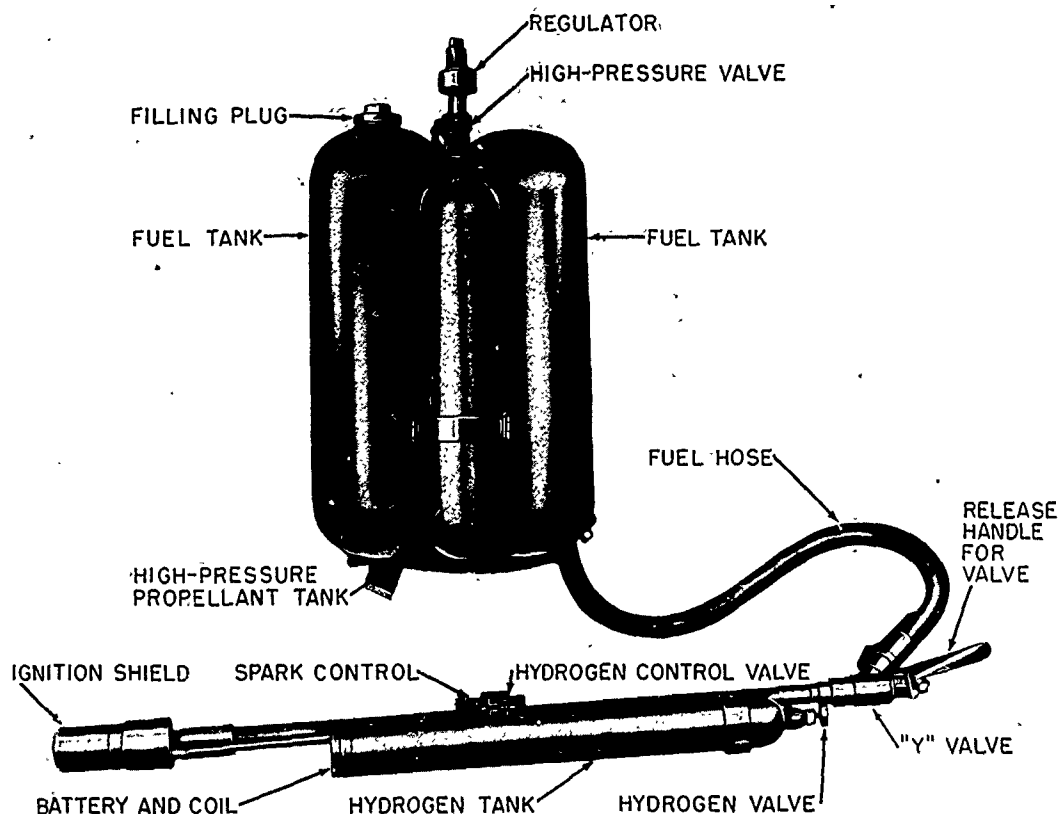

FIGURE 1. M1A1 portable flame thrower.

weapon, but the German army used them successfully against strongly held positions in the 1940 invasion of the Lowlands. With the United States entry in the war and the beginning of close jungle warfare, interest in flame throwers increased. A report of the Ad Hoc Committee on Flame Throwers in June 1942 showed that a limited interest in portable flame throwers

Realizing the limitations of the M1 model, or any improved model designed in the same manner, a development program was begun on an entirely different design. From this development work emerged the E2 flame thrower of Standard Oil Development, and E3 flame thrower of the Chemical Warfare Service. Comparative tests of the E2 and E3 by the using

Services resulted in standardization of the E3 as the M2-2.

As a result of the British development of the Snapshot model, a 1-shot flame thrower, work was undertaken on similar models by both Divisions 3 and 11 of NDRC. The end of World War II interrupted completion of the development work on this type of model.

4.2 M1A1 FLAME THROWER

4.2.1 Introduction

When the Chemical Warfare Service's M1 portable flame thrower gave evidence that the advantage of thickened fuel was not being attained, the Standard Oil Development Co. was directed in July 1942, under Contract OEMsr-390, to undertake modifications of the flame thrower in order that the weapon might successfully be used with either thickened or unthickened fuel.¹ It was stated that these changes were to be few in number and simple in design to avoid the creation of extensive procurement problems (Fig. 1). In using thickened fuel, tests of the M1 flame thrower revealed that the optimum pressure for maximum range was not being attained and the pressure drop in the system was excessive. This condition suggested changes in both the pressure regulator and piping system.

4.2.2 Description of Modifications

Regulator. To increase the operating pressure from 275 psi to from 350 to 375 psi, the pressure regulator was adjusted by resetting the adjusting screw, thereby increasing the spring tension on the regulator diaphragm. In addition, the relief valve in the regulator was adjusted for 400 to 430 psi discharge pressure. This required using a thicker release button which resulted in additional compression of the relief valve spring. It was found that the restricted flow of pressured gas through the regulator resulted in a gradual drop in pressure in the fuel tank while firing. Increased flow capacity was obtained by enlarging the openings in the regulator valve seat and the seat holder.²

Fuel Discharge Valve. Pressure gauges in the fuel line and gun tube, when using thickened fuel, indicated excessive pressure drop, 100 psi, through the whistle type valve used as the fuel discharge valve in the gun unit. This

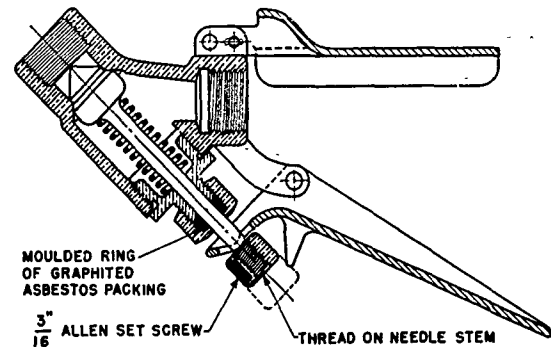

FIGURE 2. Cutaway of quick-opening Y valve for M1A1 portable flame thrower.

valve was replaced with a Y-type, quick-opening valve which reduced the pressure drop to about 35 psi with thickened fuel (Figure 2).³

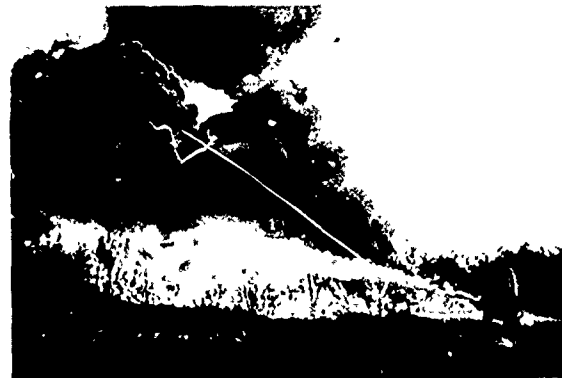

FIGURE 3. M1A1 portable flame thrower firing unthickened fuel, range 20 yd. Note the intense flame and dense smoke.

4.2.3

Performance

Tests with unthickened fuels using both the standard M1 and the modified flame thrower showed that the mechanical changes outlined above did not impair performances (Fig. 3). Maximum ranges varied from 20 to 25 yd with either unit. Effective ranges depended on the target; for example, when neutralizing a Jap-

CONFIDENTIAL



FIGURE 4. M1A1 portable flame thrower firing thickened fuel, range 60 yd. Note the breakup near the end of trajectory and the flame adhering to the rod.

anese bunker, the maximum effective range was approximately 5 yd with either unit.⁴

Using 4 per cent Napalm thickened fuel, the modified unit gave an effective range of approximately 20 yd (Fig. 4). This range represented a considerable increase over that attained from an M1 flame thrower. On the basis of these tests the modified unit was standardized as the M1A1 flame thrower.⁵

4.3 E2 PORTABLE FLAME THROWER

4.3.1 Introduction

In an effort to eliminate undesirable characteristics still retained by the M1A1 portable flame thrower, the Standard Oil Development Co. was directed in August 1942, under Contract OEMsr-390, to completely redesign the portable flame thrower.⁶ The new design as outlined by the Chief of Technical Division, Chemical Warfare Service, was to include the following characteristics.

1. Decrease the weight of the unit for the same quantity of fuel, or increase fuel capacity for the same weight.

2. Eliminate need of supplying to the field pressure cylinders of compressed nitrogen and hydrogen, and eliminate small flame-thrower pressure cylinders which had shown excessive leakage.

3. Render ignition unit waterproof and more dependable.

4. Reduce to a minimum the pressure loss in the fuel system, and establish optimum conditions for use with thickened fuels without impairing use of unthickened fuels.

5. Eliminate need for two-man operation and improve overall ease of operation and portability.

The portable flame thrower E2 was designed to accomplish these improvements, and was capable of effective, reliable, and convenient operation by 1 man (Fig. 5).⁷ The unit was constructed largely of aluminum alloy and was light in weight, had a large fuel capacity varying from 3 to 6 gal depending on the permissible

CONFIDENTIAL

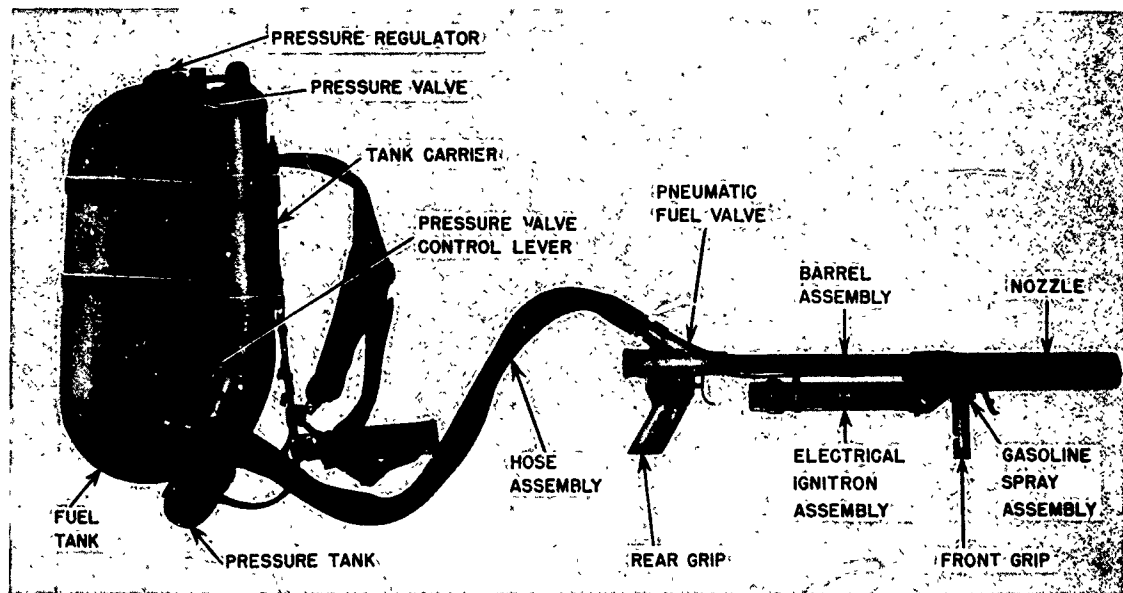

FIGURE 5. E2 portable flame thrower.

load, and used either thickened or liquid fuels. Either nitrogen or compressed air could be used for propelling the fuel. Reliable ignition of the fuel was accomplished by an atomized gasoline torch ignited by an electric spark. Table 1 compares the characteristics of the E2 and M1A1.

TABLE 1. Comparison of E2 and M1A1.

Description	M1A1	E2
Overall weight, lb		
Complete apparatus, empty	34.5	30
Complete apparatus, filled (approx)	63	67
Fuel unit		
Gross capacity, gal	5	6.5
Fuel capacity, gal	4.5	6
Shape	Dual tanks	Single tank
Recommended operating pressure, psig	375	240
Pressure tank		
Shape	Cylindrical	U shaped
Capacity, cu in.	157	270
Recommended operating pressure, psig	1800 to 2000	1800
Resistance to shattering	Early tests showed tendency to shatter	Resistant to shattering
Gun unit		
Weight complete, lb	9	9
Fuel discharge valve, type	Y or slide ball valve	Pneumatic Y valve

Description	M1A1	E2
Igniter fuel	Compressed hydrogen	Atomized gasoline
Primary ignition Type	Electrical	Electrical
Battery type	Multiple	Wet cell
Battery voltage	3	2
Duration of fire, sec	10	11
Field supplies	Napalm thickener, motor gasoline, air compressor, compressed hydrogen	Napalm thickener, motor gasoline, air compressor

4.3.2 Description

Tank Unit. The tank unit (Figure 6) comprised the following principal parts:^s

1. A single aluminum fuel tank of 6.5 gal gross capacity, equipped with a brass fuel inlet plug containing a frangible safety disk.

2. A high-pressure aluminum U tank (partly surrounding the fuel tank) with a capacity of 270 cu in. of compressed nitrogen or air, equipped with a valve for pressuring (similar to the type used in pressuring tires).

3. A high-pressure valve which released the compressed nitrogen or air from the pressure tank to the fuel tank and was operated by a control lever easily accessible to the operator.

4. A pressure regulator which maintained

CONFIDENTIAL



FIGURE 6. Rear view of E2 portable flame thrower in position. Note narrow silhouette smaller than operator's shoulder.

a constant pressure of nitrogen or air over the fuel during discharge. Initially the regulator was slightly larger but similar in principle to the M1A1 regulator. However, failures occurred because of the loosening of the bonded synthetic rubber insert; a dome-type regulator was later substituted.

5. A tank carrier which secured the tank unit to the operator's back and consisted of a canvas back pad, shoulder and waist straps, and a quick emergency release mechanism for dropping the tank. The carrier was designed under advice from the Quarter Master Corps and tests, carried out at the Harvard University Fatigue Laboratory, showed that there was no significant difference in metabolic cost between the fully loaded M1A1 and the equally weighted E2.

A high tensile strength aluminum alloy was utilized in the construction of the tank unit. It was shown that such vessels could be satisfactorily fabricated by commercial production methods. Tests conducted by the Aluminum Company of America, using sodium chloride

and peroxide as the corroding medium, showed that the alloy was not subject to inter-granular attack under pressure of 2,000 psi for 8 weeks at temperatures of 80 to 100 F, and that no effect was evident under contact with Napalm thickened gasoline after 3 weeks at 170 F. The pressure vessels, after undergoing pressures to 2,000 psi, were also demonstrated by test to be shatter-proof when pierced with .30 cal armor-piercing ammunition at various representative sections.

Gun Unit. The gun unit comprised the following principal parts:³

1. Two flexible hoses: the large hose conveyed fuel from the fuel tank to the gun barrel and was equipped with a quick-disconnect coupling; the small hose conveyed compressed air from the high-pressure tank to the fuel-discharge valve and gasoline atomizer.

2. A Y-type plug fuel-discharge valve (on breech end of gun tube) which released the fuel through the gun at the time of firing. The valve which had an aluminum cast body and stainless steel parts was operated by a trigger which opened a pilot valve and in turn allowed compressed air or nitrogen to actuate the valve directly. A safety was provided for the trigger.

3. A gun tube made of $\frac{3}{4}$ -in. aluminum pipe with a special discharge nozzle. The tube supported the ignition assembly and discharged through a cylindrical ignition chamber.

4. An ignition assembly consisting of a gasoline spray which supplied atomized gasoline (the same principle as the common nasal spray) to ignite the fuel as it was propelled from the barrel, and a waterproof high-tension electrical system consisting of a rechargeable wet-cell storage battery of the same size as a flashlight dry cell, vibrator, coil, condensers, and switches. The high-tension spark initially ignited the gasoline spray and remained in operation during the shot. A trigger mechanism, provided with a safety, simultaneously operated the gasoline spray and the electrical system.

4.3.3

Performance

A summary of the E2 firing test using 4 per cent Napalm (Gardner consistency of 90 to 175 g) is given on the next page.

CONFIDENTIAL

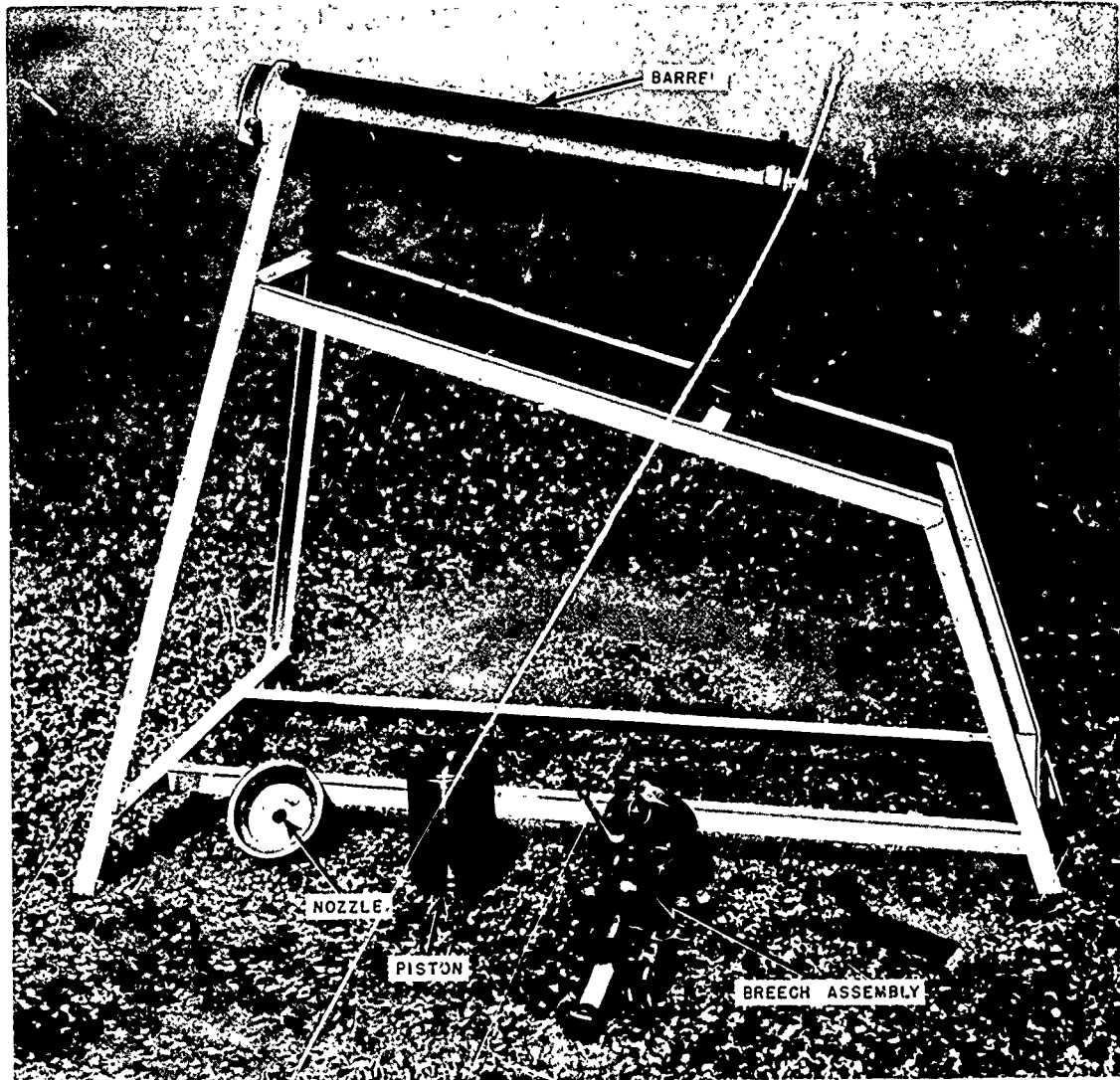

FIGURE 7. Piston model of expendable flame thrower.

Firing at 15 degrees elevation with a tail wind of 4.5 to 10.2 mph, atmospheric temperature 32 to 47 F.

	Min	Max	Average
Ignition of rod in air, %	70	95	90
Ignition of fuel on ground, %	90	95	93
Range, center of deposit, yd	54	65	60
Spread of fuel on ground, yd from 10 to 90%	15	33	24
Fuel discharge, gal/sec	0.47	0.52	0.5
Emptying of fuel tank, % fuel remaining after firing	1.5	4.5	3.0

Comparative tests of the E2 portable with the E3 portable unit developed concurrently by

CWS were carried out. On the basis of these tests, which indicated the greater potentialities of cartridge ignition over the gasoline-electric ignition and the more rugged construction of the E3 gun, the E3 unit was standardized as the M2-2. However, the recommendation was made by the Infantry Board that aluminum fuel and air tanks be used in conjunction with the E3 gun (cartridge ignition), since the resulting lighter weight for the same amount of fuel, or increased capacity for the same weight, seemed advantageous.^{9, 10}

CONFIDENTIAL

4.4 ONE-SHOT EXPENDABLE FLAME THROWER

4.4.1

Introduction

The development of 1-shot expendable flame throwers for use with self-igniting fuels was undertaken in May 1944 under Contract OEMsr-242. During investigation of phosphorus-phosphorus sesquisulfide eutectic (EWP) as a flame-thrower fuel¹¹ and the evaluation of its casualty-producing properties, it became necessary to provide a means of ejecting the fuel, and thus the general objectives of the project included the design of a small, expendable flame thrower adapted to the specific properties of EWP fuel, and serving as a prototype for further development into an acceptable military weapon.

The need for a special design arose from the fact that the use of self-igniting fuels in any standard flame thrower adapted for conventional thickened gasoline would lead to considerable difficulty and hazard, especially in filling the tanks. On the other hand, full advantage could be taken of the special properties inherent in such fuels by their employment in a simple, small, prepackaged expendable device, which would require no refilling, but would be discarded after use.

Such an instrument was designed and built, and with the aid of this flame thrower the casualty-producing properties of EWP were evaluated in physiological experiments. While the one-shot expendable flame thrower was not developed beyond the experimental stage, the principles embodied in the device appeared to be sound for the purpose intended.¹²

4.4.2

Description

Piston Model. The expendable flame thrower, illustrated in Figure 7, consisted of a steel shell approximately 4 in. in diameter and of 1 gal capacity, terminating at one end in a $\frac{1}{4}$ in. nozzle for the ejection of the fuel, and at the other end in a percussion-breech assembly containing a cartridge, charged with a slow-burning cordite propellant. A hollow piston placed

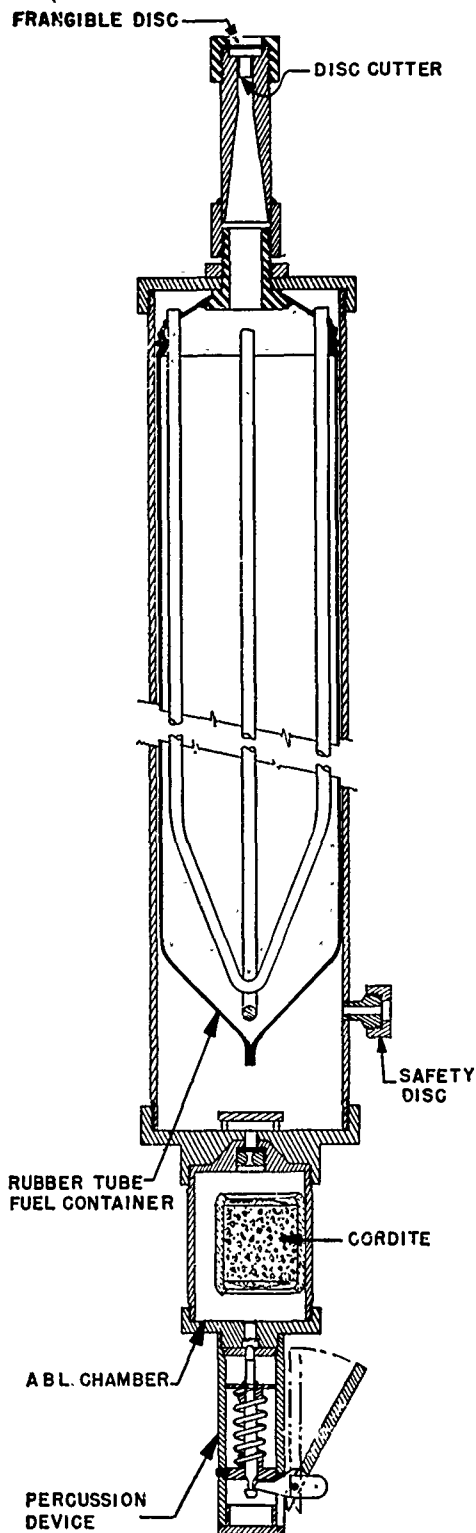

FIGURE 8. Collapsible tube model of expendable flame thrower.

CONFIDENTIAL

between the breech and the main body of the shell served to transmit the pressure created by the burning cordite to the fuel, which was thus expelled from the flame thrower. On account of the chemical nature of the fuel, no provision for ignition was required, the fuel igniting spontaneously immediately upon contact with air. The nozzle of the flame thrower was sealed with a frangible metal diaphragm which was broken by a cutting disk actuated by the pressure of the fuel; it was further protected by a threaded shipping cap.

Collapsible Tube Model. Another design is illustrated in Figure 8. In this design, the piston was replaced by a collapsible tube containing the self-igniting fuel. The collapsible tube of approximately 1 gal capacity, originally made of sheet lead, was ultimately manufactured of $\frac{3}{32}$ -in. cottonfabric reinforced neoprene sheeting. Tubes of this material, strengthened with metal rods and cemented to the nozzle member, were adopted as standard and used in all fuel evaluation and range work. The modified design incorporated a $\frac{5}{16}$ -in. nozzle and an improved percussion device for setting off the cordite propellant.

Propellant. The propellant powder found to give the best and most consistent range was a special modified, restricted-burning, Russian-type cordite, which was used in the form of a

single grain 1.5 in. long by 1.26 to 1.55 in. in diameter. This powder was contained in a detachable combustion chamber connected to the main flame-thrower chamber through a small orifice about 0.1 in. in diameter, which served as a pressure regulator. The combustion chamber, in addition to the cordite propellant, also contained a black powder primer and a percussion cap.

4.4.3

Performance

Although some difficulty was always experienced with non-uniformity of propellant performance, the collapsible tube model gave fairly consistent center-of-deposit ranges, varying under different conditions from 50 to 70 yd for unthickened EWP fuel, and attaining 86 to 90 yd with thickened fuels. The ejection time for 1 gal was approximately 2 sec with a $\frac{7}{16}$ -in. nozzle. The piston model gave considerable difficulty and was really never very successful. If this development had been carried further to a field model stage, it appears that the collapsible tube model had more promise.

In a parallel development, the Allegheny Ballistics Laboratory of Division 3, NDRC developed a piston type, 1-shot portable flame thrower, designated E16, which was about to go into production when World War II ended.¹³

CONFIDENTIAL

Chapter 5

MECHANIZED FLAME THROWERS

5.1

INTRODUCTION

THE DEVELOPMENT OF long-range, large-capacity flame throwers installed in armored tanks was a slow process. In 1942 the Ad Hoc Reviewing Committee, after reviewing the needs of the Services, concluded that only portable flame throwers were definitely required and that the need for long-range mechanized flame throwers was problematical. This indicated a divergence from thought in England and Canada, where the mechanized flame thrower was regarded as a potentially important weapon. Notwithstanding the conclusions of the Ad Hoc Reviewing Committee, NDRC began some studies on large flame throwers which were subsequently demonstrated to the using Services. These demonstrations gave rise to increased interest in the potentialities of large flame throwers, with the result that in 1943 Model Q, developed by Standard Oil Development Co., was installed in an M5A1 light tank. Continued testing and demonstrating led to the initiation of several projects on the design of flame guns in armored tanks.

Originally the development was on the installation of flame throwers in the M5A1 light tank, with the main armament removed. When the M5A1 became obsolete, work was begun on modifying the M4 medium-tank series for installation of a large flame thrower. In the first models the main armament was replaced by the flame gun. However, in subsequent developments toward the end of World War II the main armament was retained, and the flame gun was mounted coaxially with it. Besides the development of flame throwers in tanks, the U.S. Navy had a unit designed and built for installation in landing craft.

In this chapter a review of the NDRC mechanized flame thrower developments is presented, including such developments as were carried out by the Services with NDRC acting as engineering consultants. In order to follow the flame-thrower developments in this country and in others, Table 1 below summarizes the prin-

cipal characteristics of all mechanized flame throwers.

5.2 MODELS A, B, C, AND D FLAME THROWERS

5.2.1

Introduction

As a consequence of an NDRC group meeting at MIT on March 3, 1942,¹ work was begun jointly by Factory Mutual Research Corp. (Contract OEMsr-167), Massachusetts Institute of Technology (Contract OEMsr-21), Gilbert and Barker Manufacturing Co. (Contract OEMsr-470), and Standard Oil Development Co. (Contract OEMsr-390) on the design and construction of a large experimental flame thrower designated as Model A. This unit, having a 1-in. nozzle, was modeled after the smaller British Ronson Lighter flame gun, but with the feed system changed to provide automatically interrupted firing in order to prolong firing time at high discharge rates.

Following the construction and testing of Model A, Model B was designed but never built. This was followed in turn by Model C, which was sent to Shell Development Co. for testing, and by Model D, a simple experimental single-shot flame thrower. Although none of these models ever passed beyond the experimental stage, the experience gained in their development later made the rapid development of Model Q possible.

5.2.2

Model A

Flame-Thrower System. Model A consisted of a flame gun, high-pressure feed accumulator, low-pressure feed storage, and a high-pressure feed pump. The flame gun (Figure 1) was an automatic axial nozzle or pintle valve (seat diameter 1.4 in.) which was opened by fuel pressure against a 2-in. diameter piston and closed by adjustable spring action.

The fuel flowed from the low-pressure stor-

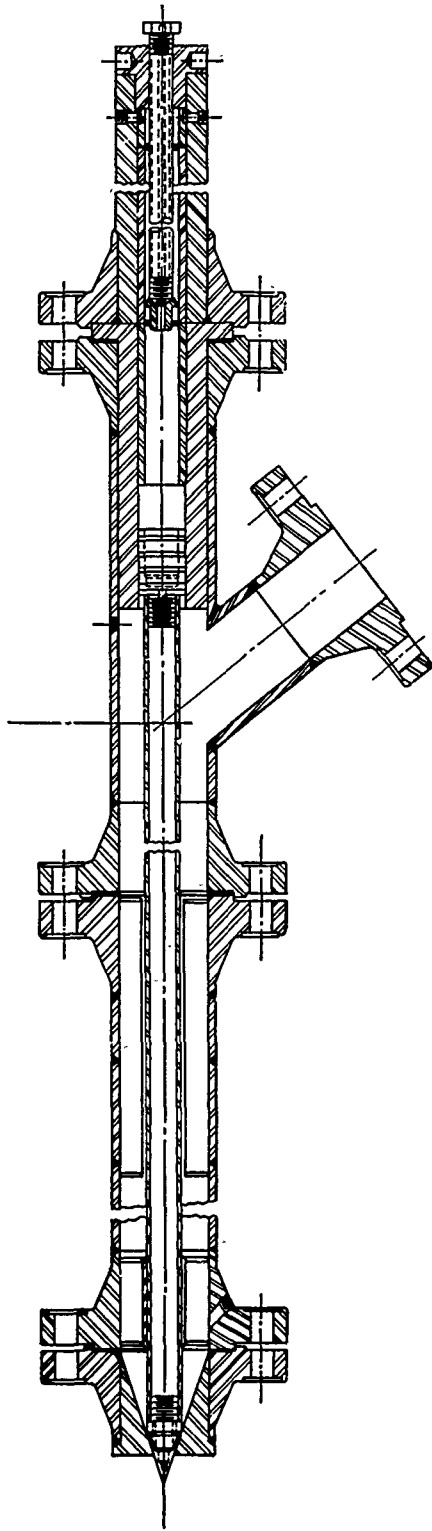

FIGURE 1. Cutaway view of Model A flame gun.

age tank of 65-gal capacity to a gasoline engine-driven Sundstrom multicylinder high-pressure feed pump, thence to the high-pressure feed accumulator of 10-gal capacity, and finally in intermittent bursts, to the flame gun. This type of pump was later found to be unsuitable for thickened liquids, and a Moyno rotor pump was substituted.^{2,3}

Operation. Fuel was pumped at a steady rate from the low-pressure tank to the high-pressure accumulator under a gas cushion. The desired volume and pressure of the initial gas cushion was supplied by means of a compressor or inert gas bottles. The gun valve was spring-loaded to release at the desired pressure, release being accomplished by pumping fuel against the gas cushion into the high-pressure accumulator until the hydraulic force on the gun-valve piston was equal to the force of the spring normally holding the valve closed. This unseated the valve, after which additional hydraulic pressure acting upon the face of the valve aided in forcing the valve rapidly away from the nozzle opening. When sufficient fuel had been released to drop the gas cushion pressure about 20 per cent, the gun spring force exceeded the hydraulic force on the valve stem and piston, and the valve closed. The frequency of gun-valve operation and fuel ejection depended upon the capacity of the high-pressure accumulator and the rate at which it was refueled. In the experimental model the fuel pump capacity permitted a maximum of only 2 shots per min of 1,000 psig maximum pressure.

Performance. Tests showed that with unthickened fuels the 1-in. nozzle caused an increased range about 75 yd over that obtained with the $\frac{1}{16}$ -in. nozzle of the Ronson unit (30 to 40 yd). Thickened fuel gave effective ranges of 100 to 110 yd and the addition of powdered lead in methacrylate-thickened fuel gave effective ranges up to 190 yd. At the time these ranges were obtained (low for a 1-in. nozzle) the importance of a straight section at the nozzle of a gun using thickened fuels was not realized.⁴

After testing it was apparent that certain weaknesses existed in the design; namely, a more satisfactory pump had to be developed and a faster valve action was required.

CONFIDENTIAL

CONFIDENTIAL

TABLE 1.—CHARACTERISTICS AND PERFORMANCE OF FLAME THROWERS

1	Designation	E2	E4-5	M3-4-E6R3	E-12R2 gun	E7-7 (E7-M5 AL)
2	Developer	CWS—(EA)	CWS—Edgewood	CWS(EA)	CWS (EA)	Built by NDRC.—SOD
3	Nationality	U. S.	U. S.	U. S.	U. S.	U. S.
4	Vehicle	M2 tank #8	M4 tank series	M4 A1 & M4 A3 medium tank	M4 A1 tank	M5 A1 light tank
5	External silhouette	..	E4 (24 gal)	M4 A3 M4 A1 tank	M4 A1 tank	75-mm. howitzer
6	Fuel system	E2	E5 (Modified E3 portable with spark ignition)	M3 & M4	E4 R4—4R5	E7
7	Gun	E6R3	E12 R2	E7
8	Mount	M2 tank	In place of lower front M.G.	Periscope (1)	Turret periscope	Turret
Flame-Thrower Data						Flame-Thrower Data
9	Nozzle diameter (inches)	$\frac{1}{2}$	$\frac{1}{2}$	$\frac{1}{2}$	$\frac{1}{2}$	0.5
10	Inlet diameter (inches)	2.0
11	Included angle of convergence (degrees)	7(1)	7(1)	30	..	15
12	Length nozzle straight section (diameters)	3	3	0	..	10
13	Rate of firing (U. S. gal per second)	1.8 & 2.8	0.8 (approx.)	0.7 1.0 1.2	1	2.4
14	Gun elevation (degrees)	-8 to +12	Same as bow machine gun	-20 to +24	-17 to +19	-10 to +30
15	Gun traverse (degrees)	360	Same as bow machine gun	90R to 45L	105R 60L	360
16	Fuel valves—type	Modified needle (2)	Pistol type, needle type, pintle	Pintle	..	Poppet (mushroom)
17	Location relative to nozzle	At tip	Front end of barrel	Front end of barrel	..	17.5" upstream (1)
18	Opened by	Manual operated toggle linkage	Squeezing pistol trigger after releasing safety	Air-opened	..	Air pressure
19	Closed by	Manual operated toggle linkage	Release of trigger spring action	Spring closed	..	Spring (+oil pressure)
20	Total capacity fuel tanks—U. S. gal—Gross	120	24	50	10/25	112
21	Net	..	22	47	..	105
22	Number of fuel tanks	2	1; additional tank can be mounted over transmission	2	1-10 or 1-25	5
23	Description and arrangement of tanks	..	16 $\frac{1}{2}$ "x28 $\frac{1}{2}$ " cyl. O. D.	Cyl.—parallel conn. M3 Sponson mount	..	Series connected
24	Location and orientation fuel tanks	..	Right-Sponson shelf	Horiz. M4 transmission mount	..	Vertical in basket
25	Fuel tank operating pressure—psig	240 to 300	350/375	375±	375	340 to 380
26	Fuel propellant	Nitrogen	Air	Air	Air	Air or nitrogen
27	Total capacity propellant tanks—cu ft	660 (free air)	0.6 (approx.)	2	0.24 or 0.7	21 (+2 to expel secondary fuel)
28	Number of propellant tanks	3	1	..	1	Cylindrical—parallel
29	Description and arrangement of tanks	Parallel conn.	9 $\frac{1}{2}$ "x21 $\frac{1}{2}$ " cyl. O. D.	Cyl.—similar to E4-5	Cylindrical	20 vert. 3 horiz. in basket
30	Location & orientation of propellant air tanks	Horiz. on rear deck	Above and to one side of fuel tank	Above and to one side of fuel tank	Above & to side of fuel tank	2000
31	Propellant initial pressure psig	2000	1800/2100	1800/2100	1800	2000
32	Type secondary fuel	None	None	None	None	Gasoline, kerosene, etc.
33	Secondary fuel pressure psig	400 to 440
34	Type ignition	HT spark	H.T. electric spark	Atom jet—electric spark	Atom jet—electric spark	Electric high-tension spark
35	Ignition fuel	Propane	$\frac{1}{2}$ pt. gasoline 25/30 psig	Gasoline 15/30 psig	Gasoline	Gasoline, air atomized
36	Igniter air supply	Induced	Electric blower	Air bottle	Air under press. tank	Induced
37	Independent igniter operation	Yes, trigger switch in handle	No	No	..	Yes
Vehicle Data						Vehicle Data
38	Tracked	Yes	M4 tank	Yes	..	Yes
39	Armored	Yes	Yes	Yes
40	Amphibious	No	No	No	..	No
41	Approximate combat weight—tons	FT only—1.0	35	35	..	18
42	Turret	..	Standard	Standard	..	Slightly modified
43	Number in crew	..	5	5	..	3
44	Armament ("T" turret) .30-cal. machine guns	..	1-T	1-T	..	2 (1-T)
45	.50-cal. machine guns	..	1-T	1-T	..	None
46	37-mm rifle	..	None	None	..	None
47	75-mm rifle	..	None	None	..	None
48	Gun displaced by flame gun	37 mm	Bow-machine gun .30 cal.	None	..	37 mm
Performance						Performance
49	Fuel or Gardner Consistency	Oils 7 $\frac{1}{2}$ % Al. stearate	4.2% Napalm	..	75/125 Gardner	Napalm 7%
50	Discharge rate—U. S. gallons per second	..	1	..	1	2.4
51	Range yards (10° elevation—5-10 mph tail wind) Effective	$\frac{1}{2}$ " nozzle	60	..	65/80	105 to 115
52	Maximum	45 to 58 75 (400f)	..	40/60	..	125 to 135
Notes						Notes
<p>(1) 9° & 10.5° also tried (2) Tried gate valve at first which gave drooling.</p>			<p>(1) Mounted in specially designed periscope holder installed in assistant driver's door hatch or turret periscope mount.</p>		<p>(1) Relative to discharge opening of tapered nozzle, inlet to straight section. 4 units completed by Jan. 1945, in combat, Luzon P. I. April 1945. Construction by Cadillac Div. and SOD, 1st unit tested by CWS and Armored Board.</p>	

CHARACTERISTICS AND PERFORMANCE OF FLAME THROWERS—U. S. MODELS

CONFIDENTIAL

	E-12R2 gun	E7-7 (E7-M5 AL)	E12-7R1 (E12-7R1 in M4-A1)	M5-4 (E12-7R1)	-E7 (USN Mark I)	E14-7R2 (E7-LVT-A1)	-E8		
Model	E-12R2 gun	E7-7 (E7-M5 AL)	E12-7R1 (E12-7R1 in M4-A1)	M5-4 (E12-7R1)	-E7 (USN Mark I)	E14-7R2 (E7-LVT-A1)	-E8	1	
Developed by	CWS (EA) U. S.	Built by NDRC—SOD U. S.	NDRC—SOD U. S.	NDRC—SOD U. S.	NDRC—SOD U. S.	NDRC—SOD U. S.	NDRC—KLAAS U. S.	2	
Mounting tank	M4 A1 tank	M5 A1 light tank	M4 A1 medium tank	M4 A1 or M4A3 medium tank	Integral unit for LCVF, LCM, LCT	LVT-A1 amphibious tank	M5 A1 tank	3	
Weight	M4 A1 tank E4 R4—4R5 E12 R2	75-mm. howitzer E7 E7	75-mm. rifle E12 E7 R1 (extended nozzle in dummy 75-mm. rifle barrel)	Same as E12-7R1	Cylindrical tube USN—Mark I E7	75-mm. howitzer E14 E7R2	Shielded mantlet E8	4 5 6 7	
Scope (1)	Turret periscope	Turret	Turret	Same as E12-7R1	On top of fuel tank	Turret	Special small turret	8	
Flame-Thrower Data									
Range	..	0.5 2.0 15 10	0.375 0.5 0.75 2 15 85 (approx.)	Same as E12-7R1 Same as E12-7R1 Same as E12-7R1 Same as E12-7R1	0.5 2 15 10	0.5 2 15 10	0.5 0.625 0.75 2.75 Constant acceleration curve 8.8 ..	9 10 11 12	
Velocity	1.0 1.2 to +24	2.4 -10 to +30	1:1 2.2 4.4 -12 to +25	Same as E12-7R1 Same as E12-7R1	2.4 (approx.) -10 to +30	2.4 -10 to +30	.. 3.5 -7 to +25	13 14	
Direction	to 45L	105R 60L	360	Same as E12-7R1	90 left to 90 right	120 left to 120 right	90 left to 90 right	15	
Igniter	..	Poppet (mushroom)	Poppet (mushroom)	Poppet (mushroom)	Poppet (mushroom)	Poppet (mushroom)	Primary poppet Secondary poppet	16	
Location of barrel	..	17.5" upstream (1)	17.5" upstream (1)	17.5" upstream	17.5" upstream (1)	17.5" upstream	Primary upstream Secondary at nozzle	17	
How opened	..	Air pressure	Air pressure	Air pressure	Air pressure	Air pressure	Primary air pressure Secondary fuel pressure	18	
How closed	..	Spring (+oil pressure)	Spring (+oil pressure)	Spring (+oil pressure)	Spring (+oil pressure)	Spring (+oil pressure)	Primary spring & fuel pressure Secondary spring	19	
Weight	50 47 2	10/25 1-10 or 1-25	112 105 5	297 285 3	291 275 3	220 200 1	210 200 2	240 210 to 215 2	20 21 22
Parallel conn.	..	Series connected Vertical in basket	Series 2 horiz. in hull 1 vert. in basket	Series 2 horiz. in hull 1 vert. in basket	Vert. above 2 bottles	Series connected Vertical in hull	Cyl.—series connected Vertical in rt. compartment	23 24	
Sponson mount	25	
Transmission mount	26	
Weight	375	340 to 380	325/350	325/350	350-425	325-350	400 approx.	27	
Air	Air 0.24 or 0.7 1	Air or nitrogen 4 21 (+2 to expel secondary fuel)	Air or nitrogen 12.8 7	Air or nitrogen 12.6 (earlier) 11.5 (later) 7	Air or nitrogen 10.5 7	Air or nitrogen 8.4 8	Air 9.3 4	28	
Similar to E4-5	Cylindrical	Cylindrical—parallel	Cylindrical—parallel	Cylindrical—parallel conn.	Cylindrical—parallel	Cylindrical—parallel	2 sets of 2 in parallel	29	
Location of fuel tank	Above & to side of fuel tank 1800	20 vert. 3 horiz. in basket 2000	6 horiz. in hull 1 vert. in turret 2000	Horiz. hull, 1-vert.-basket 2000	Horiz. in row under fuel tank 2000	Side of hull horiz.—2 each 2000	2-Sponson—2 in F.T. comp. 2000/2500	30 31	
None	None	Gasoline, kerosene, etc. 400 to 440	Gasoline, kerosene, etc. 450-540 1/2 520/530 for 1/2" & 1"	Gasoline, kerosene, etc. 520-540	Gasoline, kerosene, etc. 550 to 500	Gasoline, kerosene, etc. 500 to 550	Gasoline, kerosene, etc. ..	32 33	
Atom jet— electric spark	Atom jet— electric spark	Electric high-tension spark	Electric high-tension spark	Same as E12-7R1	Electric high-tension spark	Electric high-tension spark	Electric high-tension spark	34	
Gasoline	Gasoline	Gasoline, air atomized	Gasoline, air atomized	Same as E12-7R1	Gasoline, air atomized	Gasoline, air atomized	Gasoline, vaporized	35	
Air under press. tank	Air under press. tank	Induced Yes	Induced Yes	Same as E12-7R1	Induced Yes	Induced Yes	Yes	36 37	
No.	..	Yes	Yes	Same as E12-7R1	Yes	Yes	Yes	38	
Vehicle Data									
Yes	..	Yes	Yes	Same as E12-7R1	Front and sides	Yes	Yes	39	
No	..	No	No	Same as E12-7R1	Integral complete	Yes	No	40	
35	..	18.	35-38 (est.)	Same as E12-7R1	3-ton unit which can be placed in any suitable carrying craft or vehicle	19	18 (est.)	41	
Standard	..	Slightly modified	Standard	Same as E12-7R1	..	Slightly modified.	Replaced with fixed turret	42	
5	..	3	4	Same as E12-7R1	..	6 (2 in turret)	3	43	
1-T	..	2 (1-T)	2 (1-T coaxial)	Same as E12-7R1	..	3 (1-T coaxial with F.T.)	3 (2-7)	44	
1-T	..	None	1(T) (AA)	Same as E12-7R1	(Number of men in crew and armament dependent on carrying craft or vehicle)	None	None	45	
None	..	None	None	Same as E12-7R1	..	None	None	46	
1	..	None	None	Same as E12-7R1	..	None	None	47	
None	..	37 mm	75 mm	Same as E12-7R1	..	37 mm	37 mm	48	
Performance									
..	75/125 Gardner	Napalm 7%	8% Napalm	Same as E12-7R1	6/7% Napalm	6/7% Napalm	..	49	
..	1 65/80	2.4 105 to 115 125 to 135	1"-1.1; 1"-2.2; 1"-4.4 88 110 125 105 130 150	1"-2.2, 1"-4.4 10-125 30-150	2.4 105 to 115	2.4 105 to 115	..	50 51 52	
40/60	..	Notes	Notes	Notes	Notes	Notes	Notes	53	
Mounted in spe-	Designed peri-	Installed in	Driver's door	turret peri-	scout.	54	
..	..	(1) Relative to dis-	(1) Relative to dis-	Three hundred units	21 units built by Kel-	Prototype tested Fort	Prototype tested at	55	
..	..	charge opening of tap-	charge opening of tap-	under construction by	logg Lecourtenay used	Ord. Built by Lima	Edgewood summer 1944.	56	
..	..	ered nozzle, inlet to	ered nozzle, inlet to	Kellogg will have no	by Navy at Palau.	Locomotive.	..	57	
..	..	straight section.	straight section.	turret tank, other	(1) Relative to dis-	50 units under con-	..	58	
..	minor modifications:	charge opening of tap-	struction by M. W.	..	59	
..	..	4 units completed by	20 units constructed	(1) Relative to dis-	ered nozzle, inlet to	Kellogg.	..	60	
..	..	Jan. 1945, in combat,	Nov. '44-Apr. '45. 17	charge opening of tap-	straight section.	(1) Relative to dis-	..	61	
..	..	Luzon P. I. April 1945.	sent to Pacific. None in	ered nozzle, inlet to	..	charge opening of tap-	..	62	
..	..	Construction by Cadil-	combat prior V-J Day.	ered nozzle, inlet to	..	ered nozzle, inlet to	..	63	
..	..	lac Div. and SOD. 1st	Construction by M. W.	straight section.	..	straight section.	..	64	
..	..	unit tested by CWS	Kellogg Co. 1st units	65	
..	..	and Armored Board.	tested by CWS and	66	
..	Armored Board.	67	

CONFIDENTIAL

TABLE 1.—CHARACTERISTICS AND PERFORMANCE OF FLAME THROWERS—(Contd)

1	2	-13 NDRC—Shell Development Co. U. S. Prototype gun only	-E9 NDRC—Std. of Ind. U. S. M5 A1 tank with trailer	E13-13 NDRC—Morgan Construction Co. U. S. M4 A1 tank	E13R1-13R2 NDRC—MIT U. S. M4 A1 tank	POA-CWS—H-1 CWS (POA) U. S. M4, M4 A1 & M4 A3
3	Designation					
4	Developer					
5	Nationality					
6	Vehicle					
7	External silhouette	M4 A1 dummy 75-mm rifle E13	M4 A1 dummy 75-mm rifle E13R1	..
8	Fuel system	..	Compressor and tanks on trailer E9	E13	E13R2	..
9	Gun	I3	Experimental	Turret	Turret	Modified Iglehart- Rousson Turret in 75-mm tube
10	Mount	Test				
Flame-Thrower Data						
11	Nozzle diam—_inches	0.625	0.25 and 0.75	0.375 0.5 0.625	0.375 0.5 0.625	19/32
12	Inlet diam—_inches	1.5	2.25 3.125	2	2	1.5/2
13	Included angle of convergence—degrees	90 & Curve 1 1/2" rad.	Approximately 30	Curve 3 2.5	Curve 3 2.5	30
14	Length nozzle straight section—diam	8	14	4	4	0
15	Rate of firing—U. S. gal per second	3.5 (approx)	0.75"—5.8 at 440f	-10 to +25	1"-1.3 1"-2.2 1"-3.6	Same as 75-mm gun.
16	Gun elevation—degrees	-15 to +43	-6 to +37	360	-10 to +25	270
17	Gun traverse—degrees	360	25 R and 25 L		360	
18	Fuel valves—Type	Pintle	Pintle	Pintle	Pintle	Pintle
19	Location relative to nozzle	At nozzle	Between vert & horiz trunnion	At nozzle	At nozzle	At nozzle
20	Opened by	Fuel pressure	Fuel pressure	Fuel pressure	Fuel pressure	Fuel pressure
21	Closed by	Air pressure	Air pressure + spring	Air pressure & spring	Air pressure & spring	CO2 pressure
22	Total capacity fuel tanks—U. S. gal—Gross	500	1,200	315	289	290
23	Net	500 (approx)	600	3	259	4
24	Number of fuel tanks	1	1	3	3 (1 @ 74 gal. 2 @ 107.5 gal)	4
25	Description and arrangement of tanks	Air in rubber bag	Fitted with air driven agitator	Parallel conn.	Parallel connected air in rubber bags	Series connection
26	Location and orientation fuel tanks	On ground	Horiz.—trailer	Hull—horiz.	74 gal in turret	Hull—below basket (1)
27	Fuel tank operating pressure, psig	500 (approx)	475/500	50/75	2-107.5 gal below basket; 300/350 at nozzle	300/350
28	Fuel propellant	Air	Air	2 rams & compressed air	Air	CO2 (liquid)
29	Total capacity propellant tanks—cubic ft	..	80	6 gal & 11.12 cu ft	9.36	150 lb
30	Number of propellant tanks	..	1	Turret-3 hull-6	3 @ 3.12 cu ft	3
31	Description and arrangement of tanks	..	Space above oil in- main tank	3000f Navy bottle	Parallel 3,000f Navy bottle	..
32	Location and orientation of propellant air tanks	..	Trailer	Turret & hull	1 in turret	Right sponson
33	Propellant initial pressure, psig	..	500	2,000	2,000	850 at 70° F
34	Type secondary fuel	..	50% gasoline & SAE 30	Lube oil, gasoline, Diesel oil	Lube oil, gasoline, Diesel oil	Gasoline
35	Secondary fuel pressure, psig	..	90	400	400	..
36	Type ignition	Electric, high-tension spark	Electric, high-tension spark	Electric, high-tension spark	Electric, high-tension spark	Electric, high-tension spark
37	Ignition fuel	Gasoline, air atomized	Gasoline and SAE 30 pressure atomized	Gasoline, air atomized	Gasoline, air atomized	Gasoline sprayed
38	Igniter air supply	Air bottles	Induced	..	Main pressure tanks	..
39	Independent igniter operation	Yes	Yes	..	Yes	Yes
Vehicle Data						
40	Tracked	..	Yes	Yes	Yes	Yes
41	Armored	..	Yes	Yes	Yes	Yes
42	Amphibious	..	No	No	No	No
43	Approximate combat weight—tons	..	Tank 18—trailer 13	35-38 (est.)	35-38 (est.)	M4 A1 + 1,500 lb
44	Turret	..	Standard	..	Slightly modified	..
45	Number in crew	4	..
46	Armament ("T" turret) .30-cal machine guns	..	Standard	..	3—2 (1-T)	2 (1-T coaxial)
47	.50-cal machine guns	..	Standard	..	1*	..
48	37-mm rifle	..	Standard
49	75-mm rifle	..	Standard
50	Gun displaced by flame gun	75 mm	76-mm rifle	75 mm
Performance						
51	Fuel or Gardner	2.5% Napalm 8%	10% Napalm 500f	..	8% Napalm	6% Napalm at
52	Discharge rate—U. S. gal per sec	..	100/120	..	1"-2.2, 1"-3.6	200/250f
53	Range yds (10° elevation—5-10 mph tail wind)	35	90	..	95	60/80
54	Effective Maximum	135	160	..	107	..
55	Notes	Prototype built by Grove Regulator tested with stationary fuel tank — first tested early 1944.	Built by Merz Eng- Marmou Herrington. Tested by Std. Ind.	Fires 12 gal or two cylinders full in 4 to 6 sec.	E13 gun modified by replacing Morgan yoke joint by more compact swivel joint capable of replacing M76 gun mount. Prototype constructed by Bar- bour-Stockwell. *Also carried 4.45-cal. subm. g Nozzles interchange- able.	Notes Sixty-two built in theater completed about January 1, 1945 for use in theater operations. (1) Basket shortened and new floor installed.

STATISTICS AND PERFORMANCE OF FLAME THROWERS—(Continued) U. S. MODELS

CONFIDENTIAL

E13-13 M4 A1 tank		E13R1-13R2 M4 A1 tank		POA-CWS—H-1 CWS (POA)		Satan CWS—(POA)		T-33 ORD—CWS (NDRC-SOD)						
U.S. M4 A1 tank		U.S. M4 A1 tank		U.S. M4, M4 A1 & M4 A3		U.S. M3 A1 lt tank		U.S. M4A3—E2 hull—new turret						
75-mm rifle E13		75-mm rifle E13R1			Extended 75-mm howitzer						
E13		E13R2		Modified Iglehart-Ronson		Modified Ronson		Series containers in hull turret E7R3						
Turret		Turret		Turret in 75-mm tube		..		Turret						
										Flame-Thrower Data				
0.5 0.625		0.375 0.5 0.625		19/32		..		0.5 2.0 0.75						
Curve 2		Curve 2		1.5/2		..		15						
3 2.5		3 2.5		30		..		Approx. 40						
3		3		0							
-10 to +25		1" 1.3 1" 2.2 1" 3.6		Same as 75-mm gun		1.5 (approx.)		2.2 -15 to +4.4						
360		-10 to +25		270		-15 to +18		360						
360		360							
Pintle At nozzle		Pintle At nozzle		Pintle At nozzle		..		Poppet (mushroom) 17.5 upstream (1)						
Fuel pressure		Fuel pressure		Fuel pressure		..		Air pressure						
Air pressure & spring		Air pressure & spring		CO ₂ pressure		..		Spring						
315		289		290		170		265 (approx.)						
3		259		4		..		250 (approx.)						
3		3 (1 @ 74 gal. 2 @ 107.5 gal.)		Series connection		..		4						
Parallel conn.		Parallel connected air in rubber bags		Hull—below basket (1)		..		Series connection						
Hull—horiz.		74 gal in turret			2 Horiz. hull: 2 turret						
50/75		2-107.5 gal below basket		300/350		180/250		350						
..		300/350 at nozzle							
.. & compressed air		Air		CO ₂ (liquid)		..		Air or nitrogen						
.. @ 11.12 cu ft		9.36		150 lb							
.. turret-3 hull-6		3 @ 3.12 cu ft		3		..		8						
.. Navy bottle		Parallel 3,000 Navy bottle			Cylindrical parallel						
.. turret & hull		1 in turret		Right sponson		..		7 horiz. hull 1 vert. basket						
.. 2,000		2 in right sponson		850 at 70° F		..		3,000						
.. oil, gasoline, Diesel oil		Lube oil, gasoline, Diesel oil		Gasoline		..		Gasoline, kerosene						
.. 400		400			500						
.. electric, high-tension spark		Electric, high-tension spark		Electric, high-tension spark		..		High-tension spark						
.. line, air atomized		Gasoline, air atomized		Gasoline sprayed		..		Gasoline, air atomized						
..		Main pressure tanks			Induced						
..		Yes		Yes		..		Yes						
										Vehicle Data				
Yes		Yes		Yes		..		Yes						
Yes		Yes		Yes		..		Extra armor of M4A3E2						
No		No		No		..		No						
35-38 (est.)		35-38 (est.)		M4 A1 + 1,500 lb		..		Over 40 tons						
..		Slightly modified			Special design						
..		4			5						
..							
..		3—2 (1-T)		2 (1-T coaxial)		..		2 (1-T)						
..		1*			1-T						
..			No						
..			M6 (light)						
75 mm		76-mm rifle		75 mm		..		None						
										Performance				
..		8% Napalm		6% Napalm at		Napalm		..						
..		95		200/250							
..		1" 2.2, 1" 3.6		60/80		60/80		..						
..		107							
										Notes				
.. 12 gal or two		E13 gun modified by		Notes		24 built by POA com-		Also to carry small						
.. ers full in 4 to 6		replacing Morgan yoke joint by more compact swivel joint capable of replacing M76 gun mount. Prototype constructed by Barbour-Stockwell.		Sixty-two built in theater completed about January 1, 1945 for use in theater operations.		pleted May, '44.		AP periscope-mounted flame gun in turret. Unit under design by ORD-CWS (with SOD Kellogg). 20 to be constructed with possible later increase.						
..		*Also carried 4.45-cal. subm. g		(1) Basket shortened and new floor installed.		..		(1) Relative to discharge opening of tapered nozzle inlet to straight section.						
..		Nozzles interchangeable.							

CONFIDENTIAL

TABLE 1.—CHARACTERISTICS AND PERFORMANCE OF FLAME THROWERS—(Contd)

1	Designation	Crocodile (trailer)	Wasp Mk II (formerly known as Mk II former Wasp Mk II now Mk I)	Salamander (No. I)	Salamander (No. II)	Salamander (No. III)
2	Developer	PWD	British	PWD	Lagonda	Lagonda
3	Nationality	British	British	British	British	British
4	Vehicle	Trailer towed by Churchill VII or M4 tank	Universal Bren carrier	M4 A4 or 3, or Churchill	Sherman medium tank	Sherman
5	External silhouette	Armored sheath	Armored sheath	Armored sheath below 75-mm dummy barrel	Regular; dummy gun with FT nozzle	Regular FT; nozzle inside dummy 75-mm barrel
6	Fuel system	Normal Wasp type	Wasp MK (Weight filled 2,000 lb)	Wasp IIA	Modern Wasp extended barrel (see Note 1)	Modern Wasp with extended barrel inside dummy 75-mm barrel
7	Gun					
8	Mount	Tank hull, left asst. drive (replace bow-machine; permanent installation)	Front of vehicle	Turret-below 75-mm	Inside dummy 75 mm	..
Flame-Thrower Data						Flame-Thrower Data
9	Nozzle diam—inches	1.0 0.842	0.6 0.76 0.9 (approx.)	0.799		
10	Inlet diam—inches	3.25 3.25	3.25 3.25 3.25
11	Included angle of convergence—degrees	30 30	30 30 30
12	Length nozzle straight section—diam	3.5 4.1				
13	Rate of firing—U. S. gal per second	5.6 6.8	2.4 (3.2) 4.4 6.8	4.4 Intermittent or continuous	4.4 Intermittent or continuous	4.4 to 5.4 Intermittent or continuous
14	Gun elevation—degrees	-9 to +15	-14 to +25	-10 to +25	-10 360 +25	-10 360 +25
15	Gun traverse—degrees	15 right or left (30)	25 left to 25 right	360		
16	Fuel valves—Type	Primary pintle (secondary electric contact pneum. gate)	Primary pintle (secondary electric contact pneum. gate)
17	Location relative to nozzle	At nozzle	Nozzle
18	Opened by	Fuel pressure	Fuel pressure
19	Closed by	Gas pressure and spring	Gas pressure
20	Total capacity fuel tanks—U. S. gal.—Gross	480	120 (1-48 gal 1-72 gal)	240 to 300	320	240
21	Net	430	100	240 to 275
22	Number of fuel tanks	2	2	3	2	4 (1-28 gal, 2-69 gal, 1-38 gal)
23	Description and arrangement of tanks	Series	..	Series, right to left to lower tank	Series, charged with 5 HP air compressor on drive shaft	Cylindrical vertical series
24	Location and orientation fuel tanks	In trailer (Proof against 7.9-mm A.P. shell; Total wt 6 tons full)	..	2 in sponsons (2x78 gal) 1 below basket (1x120 gal)	Longitudinal hull floor	Turret basket
25	Fuel tank operating pressure, psig	300	200 (180 to 250)	300	600	..
26	Fuel propellant	N ₂ or flue gas	CO ₂ (liquid) (note 2)	N ₂ or flue gas	..	CO ₂
27	Total capacity propellant tanks—cubic ft	5	40 lb	4.5
28	Number of propellant tanks	5	1 CO ₂ or 2 inert gas	6 (Ronson type)	..	2 to 3; Electrically heated evaporator
29	Description and arrangement of tanks	Parallel with check valve from each tank	Parallel
30	Location and orientation of propellant air tanks	In trailer betw. fuel tanks	..	Behind assistant driver, under base of turret basket	..	Turret
31	Propellant initial pressure, psig	3,000	600 to 1,000 or 2,000 to 3,000	3,000
32	Type secondary fuel	Gasoline	Gasoline	Gasoline
33	Secondary fuel pressure, psig	None
34	Type ignition	Electric high-tension spark	Electric high-tension spark (twin)	Electric high-tension spark
35	Ignition fuel	Gasoline spray (0.1 sec at start of shot)	Gasoline spray (0.1 sec at start of shot) (see Note 1)	Gasoline jet
36	Igniter air supply	Yes
37	Independent igniter operation	Yes	No	No
Vehicle Data						Vehicle Data
38	Tracked	Yes	Yes	Yes	Yes	Yes
39	Armored	Yes	Yes	Yes	Yes	Yes
40	Amphibious	No	No	No	No	No
41	Approximate combat weight—tons	7 (trailer only)	1 (FT equipment only)	35-38 (est.)	Angular tank replaces turret basket & base junction modified	Standard
42	Turret	Standard	None	Standard	4	..
43	Number in crew	Normal	2	5	..	4
44	Armament ("T" turret) .30-cal machine guns	..	None	2 (1T)	2 (1 bow, 1 turret)	2 (1 turret right mantlet)
45	.50-cal machine guns	..	None	1 (T)	None	None
46	37-mm rifle	..	None	None	None	None
47	75-mm rifle	75 or 95 mm (T)	None	None	Yes	Yes
48	Gun displaced by flame gun	BESA. (7.92 mm)	None	75 mm
Performance						Performance
49	Fuel or Gardner	@ 6.5° Nozzle Elev. Unstated Wind				
50	Discharge rate—U. S. gal per sec	7.8 .. 5.6 6.8
51	Range yd (10° elevation—5-10 mph tail wind) Effective	84 90	80 100 120
52	Maximum	90 95	.. 140 150	90 .. 100
Notes						Notes
		In production — used during invasion of France. In a test of production prototype 1-26-44 firing 3 shots of 1 to 4 sec duration, FRAS (443.4 sec @ 5.5 C ball drop British standard), a discharge rate of 4.4 U. S. gal per sec, ranges to center of maximum deposition of 80 to 100 yd were obtained while heavy ground deposit, with considerable burning, ranged 70 to 120 yd. Ignition was practically troublefree. A falling off of range was noted on shots of 4 sec duration.	Canadian Wasp is similar but has 70-gal fuel tank positioned across and at rear of carrier. Note (1) In MK I gasoline spray is fed from positive servo-operated pump linked to trigger valve by gas pressure from separate tank, whereas in Mark II gasoline is fed from carburetor gasoline pump—Note (2) CO ₂ evaporator uses water from both banks of cylinders; designed for 250 psi working pressure.	Prototype reported August 8, 1944. Several models, including variations retaining 75-mm rifle in vehicle, are being considered.	Note (1) Also flame gun in loader's periscope. Requires 5 hp from engine. (2) LP gas supplied from reservoirs and recompressed by compressor driven by tank engine after firing.	3 to 5 hp required from engine to drive pump during refueling only.

CONFIDENTIAL

TABLE 1.—CHARACTERISTICS AND PERFORMANCE OF FLAME THROWERS—(Continued)

1	Designation	Salamander No. VIII	Ronson	Rattlesnake Mk II	Frog Mk I	Adder		
2	Developer	PWD	Canadian	Canadian	Australian	PWD		
3	Nationality	British	Universal Bren carrier	Canadian	Matilda Mk IV or Mk V	British		
4	Vehicle	Sherman		..		Sherman or Churchill		
5	External silhouette	..	Cylindrical tube		
6	Fuel system	..	Ronson FUL Mk IV	Rattlesnake Mk II	Frog Mk I	..		
7	Gun	Non-pintle sleeve		
8	Mount	In blister on turret side	Left of vehicle	Prototype gun only	..	Periscope rear of tank, not turret		
	Flame-Thrower Data						Flame-Thrower Data	
9	Nozzle diam—_inches	..	0.44	0.565	0.5	0.625	1.125	
10	Inlet diam—_inches	..	1.75	1.75	
11	Included angle of convergence—degrees	..	35	35	15	
12	Length nozzle straight section—diam	..	0	0	
13	Rate of firing—U. S. gal per second	3.6 to 4.8 Intermittent or continuous	2	2.4	2.25	3.32	..	
14	Gun elevation—degrees	-10 to +90	-15 to +20	-5 to +34	18 left and 36 right	..	-45 to +45	
15	Gun traverse—degrees	360	90 left to 40 right	180	
16	Fuel valves—Type	..	Primary: gate	Secondary: pintle	Primary: Grove flexible	Secondary: pintle	Pintle	
17	Location relative to nozzle	..	CO ₂ pressure	At nozzle	Upstream	At nozzle	At nozzle	
18	Opened by	..	Spring	Fuel pressure	Fuel pressure	Fuel pressure	..	
19	Closed by	Spring	Air pressure	Spring	Spring and fuel pressure acting on pintle control piston	
20	Total capacity fuel tanks—U. S. gal—Gross	100	72	Experimental tank used for testing only—44 U. S. gal	250	..	30	
21	Net	..	64	
22	Number of fuel tanks	6	2	1	4	1	1	
23	Description and arrangement of tanks	Cylindrical series	Series connected	..	Parallel connection (see note 1)	..	1	
24	Location and orientation fuel tanks	Horizontal on hull floor	Rear of vehicle	..	2 in sponsons, (1 below basket) (1 jettisonable)	..	Rear of tank outside	
25	Fuel tank operating pressure, psig	..	160 to 200	350 300 (200 at base of nozzle)	Right sponson	
26	Fuel propellant	N ₂ or Cordite (as per design IV)	CO ₂ (liq) (see note 2)	Air	10 gal floating piston pump filled by fuel pumps	Inert gas	Inert	
27	Total capacity propellant tanks—cubic ft	..	40 lb	..	Air compressed in pump jacket during filling	
28	Number of propellant tanks	5	1	..	Thirty-five sec required to fill cylinder	..	1 High pressure	
29	Description and arrangement of tanks	High-pressure cylinders or Cordite	
30	Location and orientation of propellant air tanks	Sponson	Rear of vehicle	..	Cylinder in basket	
31	Propellant initial pressure, psig	3,000	600 to 1,000	1,800	2,200	3,000	..	
32	Type secondary fuel	..	Gasoline	None	Gasoline	
33	Secondary fuel pressure, psig	..	None	None	None	
34	Type ignition	..	Electric high-tension spark (single)	Electric high-tension spark	Electric high-tension spark	..	Flash	
35	Ignition fuel	..	Gasoline spray (0.1 sec at start of shot, note 1)	Premixed gasoline and air (below torch) (3 jets of 10 cc/sec)	Gasoline spray at start of spark	
36	Igniter air supply	
37	Independent igniter operation	..	No	Yes	
	Vehicle Data						Vehicle Data	
38	Tracked	..	Yes (universal carrier)	Yes (universal carrier)	
39	Armored	..	Yes, hull	Yes	
40	Amphibious	..	No	
41	Approximate combat weight—tons	..	0.6 ton (flame-thrower equipment only)	
42	Turret	Modified base junction	None	
43	Number in crew	5	2	5	
44	Armament ("T" turret) .30-cal machine guns	2 + 100% normal ammunition	None	2	
45	.50-cal machine guns	..	None	
46	37-mm rifle	..	None	
47	75-mm rifle	Yes + 40% ammunition	None	Yes (Low ammo)	
48	Gun displaced by flame gun	..	None	None	..	
	Performance						Performance	
49	Fuel or Gardner	..	FRAS, Marine Diesel, special	..	6%	
50	Discharge rate—U. S. gal per sec	2.25	3.32	3.25	..	
51	Range yd (10° elevation—5-10 mph tail wind) Effective	..	50	40 to 45	80	100	95	
52	Maximum	150	125±10 (15° elev)	115	..	
	Notes						Notes	
	mechanized flame throwers. (1) Positive displacement pump mechanically actuated from actuating arm. Pump fed by vehicle fuel pump. (2) CO ₂ evaporator uses water from left bank of cylinders only. Designed to withstand tank pressure of 180 psig.						Early unit now obsolete. One of earliest mounted on frame with experimental fuel tankage only. Report 4 August 1944.	
							(1) Fuel pumped from reserve tanks to main 98-gal tank. 25 built in late 1944 and mounted in Matilda tanks for Australians.	
							Experimental gun (only preliminary specifications available).	

Weslake Mk II	Frog Mk I	Adder	Adder	Barracuda	Crocodile (design features)	1
Canadian	Australian Matilda Mk IV or Mk V	PWD British Sherman or Churchill	PWD British ..	British	British Cromwell (fast cruising type) Trailer, detachable	German PZKW III	German Vehicle towed self-contained	2 3 4
Weslake Mk II	Frog Mk I	..	Sleeve valve gun	..	Evolution of Barracuda with best features of others	5 6 7
.. type gun only	..	Periscope rear of tank, not turret	Wireless base	Replace 50-mm cannon in simulated gun barrel	On trunnions on spigot on top of fuel tank	8
Flame-Thrower Data								
0.625	1.125	0.74	1 1/4", variable	0.394	9/16	9
..	15	2.5	..	2	..	10
..	11	11
..	12
3.32	..	3.2	1.6 Intermittent or continuous -10 to +45 Limited only by line of hull and periscope vision	4.0	6	..	1.75	13
-5 to +34 left and 36 right	..	-45 to +45 180	..	-5 to +25 ±40	-10 to +45 180	..	-10 to +30 ±45	14 15
Secondary: pintle	Pintle	Gate operated by piston	..	16
At nozzle	At nozzle	At nozzle	..	17
Fuel pressure	Fuel pressure	Fuel pressure on piston controlled by trigger	..	18
Spring	Spring and fuel pressure acting on pintle control piston	Spring	..	19
Experimental tank used testing only—44 U. S. gal	250	..	30 60	..	400 gal	180	48	20
1	4	1	1 Standard Ronson type	2 Cylindrical	1	2 (1-80; 1-10) Series connected	42 1 Welded plate const. & sump	21 22 23
..	Parallel connection (see note 1)	..	Right sponson	Right sponson	Fuel inside rubber bag being considered; also floating piston Trailer, armored, 6-ton castor wheel hitch	Below basket	..	24
300/200 at base of nozzle	2 in sponsons, (1 below basket) (1 jettisonable)	Rear of tank outside	400 lb	Atmospheric	Atmospheric	25
Air	10 gal floating piston pump filled by fuel pumps Air compressed in pump jacket during filling Thirty-five sec required to fill cylinder	Inert gas	Inert gas Inert gas	CO ₂ (liq) (see note 1)	Cordite considered	2-Stage centrifugal pump driven by 28 hp 2 cylinder engine rated at 1.6 gal/sec at 135 psig—220/250 psig shut-off head Pump located in tank engine compartment	2 1/2" & 3 1/2"—2-stage centrifugal pump driven by standard DKW 1085 cu cm 2 cylinder off at top Piston 2 stroke 3 1/2 x 3" Gas engine	26 27 28 29
..	Cylinder in basket	3,000	1 High pressure	6 Medium pressure	85/170	30 31
None	Gasoline	Gasoline	..	Main fuel	Gasoline	32
None	None	None	30 gal	33
Electric high-tension spark	Electric high-tension spark	..	Flash cartridge same as Wasp	Twin HT spark gaps continuous	Still experimental. Pyrotechnic will be tried. Continuous	Electric high-tension spark	High-tension spark. Reliable	34
Mixed gasoline and (below torch) jets of 10 cc/sec	Gasoline spray at start of spark	Gasoline from separate pressure tank	Gasoline, FT fuel heated to 70 F oil jacket	Fuel spray	Atomized gasoline	35
Yes	36 37
Vehicle Data								
(universal carrier)	Yes; wheeled trailer	..	Ball bearing disc wheels without brakes 6" x 16" pneumatic tires No 7.5 mm fronted plate. And plate to protect operator's head 0.9	38 39 40
Yes	Yes	41
..	No	42
..	43
..	0.65 (equipment only)	..	No	44
..	5	5	45
..	2	2	46
..	47
..	..	Yes	Yes	Yes	48
..	..	None	(Less 17 rounds ammunition)	None	..	49
Performance								
6%	Marine Diesel Fuel Special	FT fuel #2	Mixture of fuel oil and creosote oil	Creosote (150#) WD gas oil (135#)	50 51 52
125±10 (15° elev)	3.32	3.25	..	50-55 75 120 (l/in ²)	150 (unbroken rod) 300	60 90	35/40 30/35 45/50 35/40	..
..	95 125
.. type gun mounted same with experimental fuel tankage part 4 August 1944.	(1) Fuel pumped from reserve tanks to main 98-gal tank. 25 built in late 1944 and mounted in Matilda tanks for Australians.	Notes Experimental gun (only preliminary specifications available).	..	(1) CO ₂ evaporator used water of both banks of cylinders; designed for 1,000-lb water pressure.	..	A number of these guns have been captured, some mounted in tanks, others in half-tracks and trailers.	Notes	..

CONFIDENTIAL

TABLE 1.—CHARACTERISTICS AND PERFORMANCE OF FLAME THROWERS—(Cont.)

1	Designation	..	Strahlrohr
2	Developer
3	Nationality	German	German
4	Vehicle	Pz Jc 38
5	External Silhouette
6	Fuel System	..	Pump*
7	Gun
8	Mount	..	(Armored half-track)
Flame-Thrower Data						Flame-Thrower Data
9	Nozzle diam—inches	14 mm (0.55')	5.5
10	Inlet diam—inches
11	Included angle of convergence—degrees	..	0
12	Length nozzle straight section—diam
13	Rate of firing—U. S. gal per second	21	2.1
14	Gun elevation—degrees	-5 to +35	-19 .. ±20
15	Gun traverse—degrees	20L to 40R	80R to 80L
16	Fuel valves—Type	Hand operated
17	Location relative to nozzle
18	Opened by
19	Closed by
20	Total capacity fuel tanks—U. S. gal—gross	..	185
21	Net	185	2
22	Number of fuel tanks
23	Description and arrangement of tanks
24	Location and orientation fuel tanks
25	Fuel tank operating pressure, psi, ga.
26	Fuel propellant	See note
27	Total capacity propellant tanks—cubic ft
28	Number of propellant tanks
29	Description and arrangement of tanks
30	Location and orientation of propellant air tanks
31	Propellant initial pressure, psi, ga
32	Type secondary fuel
33	Secondary fuel pressure, psi, ga
34	Type ignition	Cartridge	Spark ignition of fuel jet
35	Ignition fuel
36	Igniter air supply
37	Independent igniter operation
Vehicle Data						Vehicle Data
38	Tracked
39	Armored
40	Amphibious
41	Approximate combat weight—tons	Projector—37½
42	Turret
43	Number in crew
44	Armament ("T" turret)
45	30-cal machine guns
46	50-cal machine guns
47	37-mm rifle
48	75-mm rifle
	Gun displaced by flame gun
Performance						Performance
49	Fuel or Gardner	..	Coal tar
50	Discharge rate—U. S. gal per sec
51	Range yd (10° elevation—5-10 mph tail wind) Effective	55-66	40
52	Maximum
Notes						Notes
		122 GPM, pump 231 psi closed disch. pressure 190 psi open disch. press. (14-mm jet) 28 hp FW 1101 DKW, 2 cycle engine. Also captured was FT on armored FT. Vehicle SD.KFZ. 251/16 and FT trailer.	*Driven by 2-cylinder in-line engine. Vehicle has 2 flame guns, one on each side.			

CHARACTERISTICS AND PERFORMANCE OF FLAME THROWERS—(Continued) FOREIGN MODELS

CONFIDENTIAL

..	1
..	2
..	3
..	4
..	5
..	6
..	7
..	8
		Flame-Thrower Data					Flame-Thrower Data	
..	9
..	10
..	11
..	12
..	13
..	14
..	15
..	16
..	17
..	18
..	19
..	20
..	21
..	22
..	23
..	24
..	25
..	26
..	27
..	28
..	29
..	30
..	31
..	32
..	33
..	34
..	35
..	36
..	37
		Vehicle Data					Vehicle Data	
..	38
..	39
..	40
..	41
..	42
..	43
..	44
..	45
..	46
..	47
..	48
		Performance					Performance	
..	49
..	50
..	51
..	52
		Notes					Notes	

5.2.3

Model B

Model B consisted of a gun similar in principle to Model A, but with a nozzle valve designed to open and close rapidly during a very small part of the full operating cycle of the piston. A large spring behind the valve-operating piston replaced the Model A gas cushion. However, calculations indicated that the design was impractical since for 1,000 psig maximum operating pressure a piston spring over 90 in. long, weighing 300 to 400 lb would be required. Model B design was therefore abandoned, and no units were built.²

5.2.4

Model C

Model C (Figure 2) was similar to Model A except that, despite the increase to 2-in. nozzle size, the weight of the valve stem was reduced

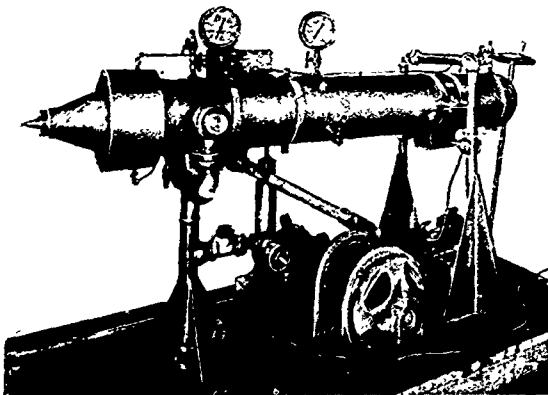

FIGURE 2. Experimental assembly in Model C.

considerably and an air cushion behind the valve stem was substituted for the valve piston spring. An air cushion behind a floating piston to the rear of the valve mechanism in the gun also was substituted for the Model A high-pressure accumulator. The maximum rearward valve travel was 3 in. with a dash pot included to prevent valve stem damage against a rear stop. It was expected that this design, like Model A, would operate with the valve opened automatically and intermittently at a rate depending on the pump. Since the open-valve flow rate was about 160 gal per sec, a fractional time open of 10 per cent or less was planned.

With a few additional modifications, Model C2 (Figure 3) was sent to Shell Development Co. for further testing.^{5, 6, 7, 8}

Investigations at Shell revealed the following:

1. The anticipated long range from the 2-in. nozzle was never realized, the range being of the order of 150 yd.

2. Even if the hoped-for range had been obtained, Model C appeared to be much too large to be of practical interest.

5.2.5

Model D

Model D was a simple experimental single-shot flame thrower. Fuel was ejected from the open nozzle by means of an internal compressed gas-operated piston, with no internal nozzle valve. Piston stop-sleeves of various lengths could be inserted in the fuel chamber to vary the quantity of fuel ejected (Figure 4). A quick-acting, air-actuated valve installed between the compressed-air storage tank and the air chamber in the gun behind the piston was designed to facilitate rapid piston operation and fuel ejection. In operation, a temporary plug was inserted in the gun-nozzle opening, fuel was charged into the nozzle chamber ahead of the piston, forcing the piston to the rear, and then sudden air pressure was applied behind the piston to eject fuel from the weapon. Ignition was accomplished by firing through a continuous hydrogen flame inside a cylindrical chamber mounted in front of the flame gun nozzle.

In addition to tests on thickened fuel of varying Napalm concentration at different pressures, a number of tests were made ejecting thickened fuel in lightweight cotton or rayon socks. These socks were approximately 2-in. diameter tubing, closed at one end, and varying in length from 10 to 25 ft. In operation, the socks were telescoped compactly on a cylindrical sleeve, about 8 in. long, placed concentrically in front of the nozzle. The ejected gelled gasoline entered the tubing which then stretched out in line of fire to its original length as it was carried through the igniter. In effect, the single shots thus fired were thrown out in cloth bags which prevented premature breakup of

CONFIDENTIAL

fuel in the air, and hence greatly increased range (Figure 5).

Performance. Without the sock, thickened-fuel ranges up to 170 yd to center of deposit were obtained with a 2-in. nozzle bore.

Confining the fuel in a sock, which in effect increased the size of the gob, resulted in increased range. Thickened-fuel ranges up to 330 yd were realized with a 2-in. nozzle when ejecting the fuel in a sock at approximately 1,000 psig pressure.⁹ This indicated that improvements in range could be effected if a fuel could be made which would hold together and could be ignited after ejection in appreciable mass at a high velocity. Further work along these lines was discontinued on Model D to expedite development of a large flame gun, Model Q, more suited to mechanized installation.

5.3 MODEL Q AND E7 SERIES FLAME GUNS

5.3.1

Introduction

As the need arose, the Standard Oil Development Co. in November 1942, under Contract OEMsr-390, began the design of a long-range flame thrower gun designated as Model Q and developed for mechanized installations.¹⁰ After the original prototype Model Q was built, the gun was modified, as a result of tests^{11, 12} and combat experience, into the improved Model Q (later designated as the E7), the E7R1, E7R2, and E20. However, although these later modifications included several refinements and improvements, the basic design of the original Model Q remained unchanged. In several instances, the gun design was altered slightly to make possible an installation in a specific vehicle, but in general there was very little difference among the various models. To identify the gun model with the correct installation, the relationship is summarized below.

Gun model	Installation
Q	Trailer-mounted prototype
E7	E7-7 in M5A1 light tank USN Mark I
E7R1	M5-4 (E12-7R1) in M4A1 and M4A3 medium tanks
E7R2	E14-7R2 in LVT-A1 amphibious tank
E20	T-33 (E20-20) in M4A3E2 medium tank

In the following discussion the E7 will be described in some detail, rather than the original Model Q, which it resembled closely. Later the various modifications of subsequent models will be given. For a complete detailed description of each model, the reader is referred to the references appearing in the bibliography.

5.3.2

E7 Improved Model Q

Introduction. The E7 flame gun^{13, 14} consisted of the following integral parts (Figures 6 and 7): (1) nozzle, (2) gun body (vertical trunnion), (3) trunnion elbows, (4) air chamber, (5) main spring housing, (6) main control valve, and (7) supplemental assemblies comprising the pilot valve for gun actuation, and the atomizer valve for igniter operation.

Nozzle. The bronze nozzle was bolted to the front flange of the gun body. The conical portion of the nozzle tapered from 2-in. ID at the entrance to 1/2-in. ID (15 degree included angle), with a 5 in. long and 1/2-in. ID straight section. The nozzle was encased in a cylindrical cover, the forward end of which comprised the ignition chamber.

Gun Body and Trunnion Elbows. The gun body was a bronze casting housing the main fuel valve seat, which was a beveled stainless steel ring press-fitted in place. The gun body also housed a perforated, hollow brass cylinder through which secondary fuel (liquid gasoline) was forced under pressure (400 to 450 psi) to coat the exterior of the main flame-thrower fuel stream passing through the gun body. Attached to two diametrically opposed flanges on the sides of the gun body were the two trunnion elbows which carried main fuel into the weapon, supported the gun, and permitted its elevation and depression around special rotary joints. These rotary joints consisted of a machined sleeve (part of the trunnion elbow) which slipped inside the flange on the side of the gun body. The inside of the flange was grooved to hold a rubber O sealing ring which prevented fuel from leaking out. Each trunnion elbow was held in place by a split collar bolted to the gun body flange.

Air Chamber and Main Spring Housing. The

CONFIDENTIAL

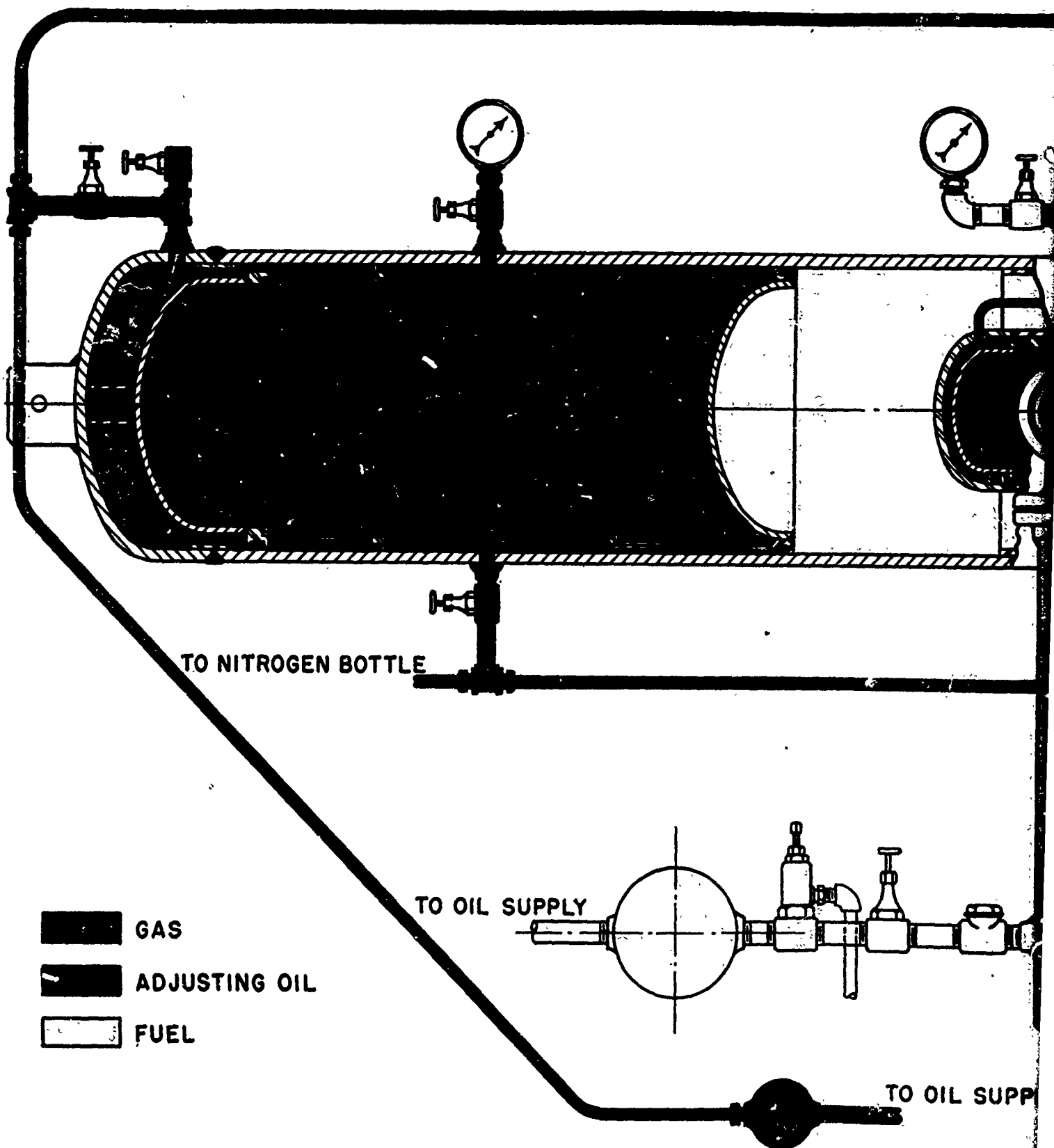

FIGURE 3. Schematic diagram of Model C2.

CONFIDENTIAL

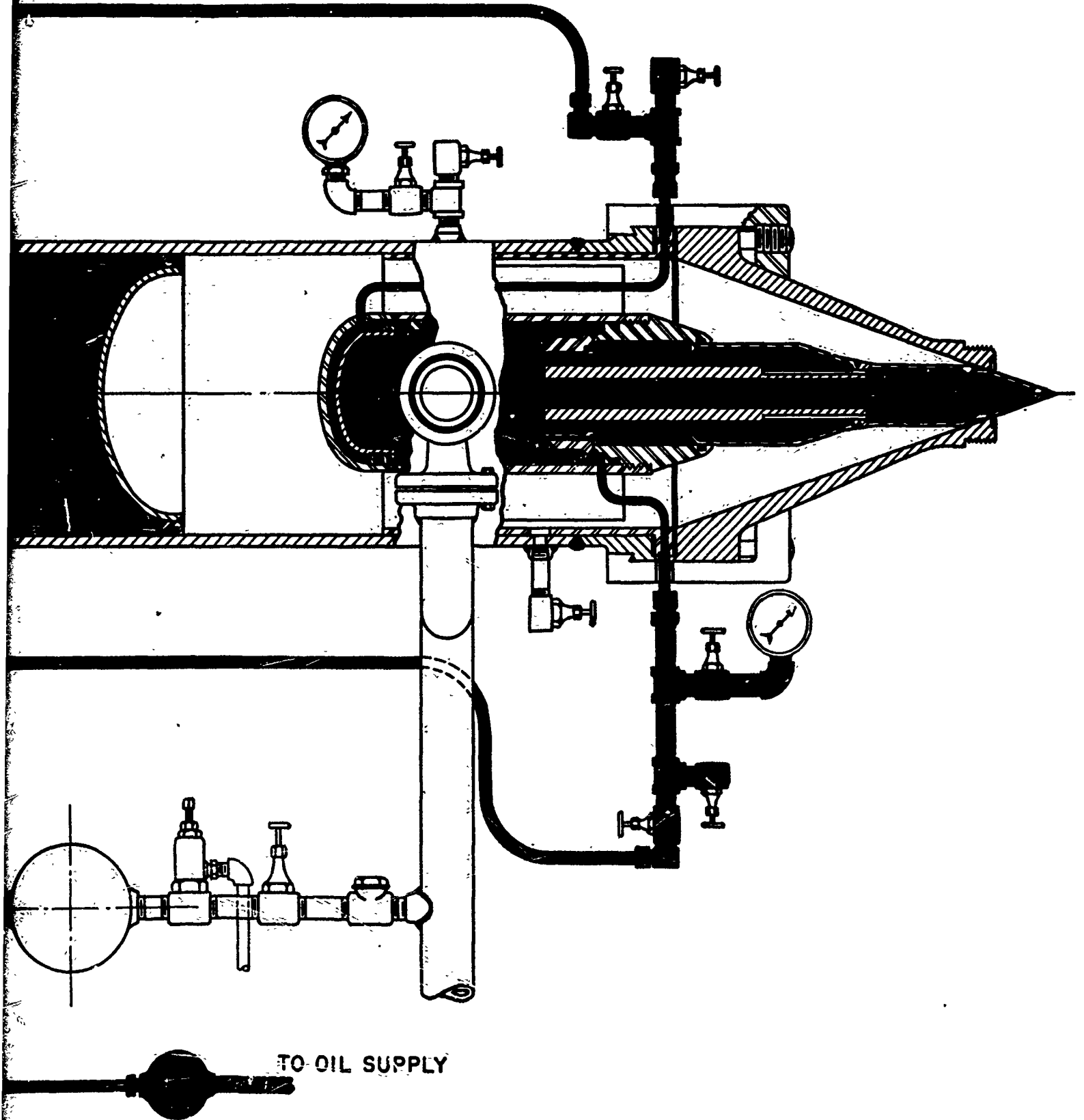

FIGURE 3. Schematic diagram of Model C2.

CONFIDENTIAL

air chamber was a bronze cylindrical flanged casting, which carried and guided the main fuel valve and was bolted to the rear of the gun body. The main spring housing was a steel tube

limited the rearward travel of the valve, was a rod extending through the core of the spring.

Main Control Valve. The function of the main control valve, which was a cast bronze dual control bolted over the air chamber, was (1) to admit high-pressure air (375 to 400 psi) to the main air chamber, forcing the main fuel valve backwards (open) so that the main fuel was expelled from the gun, and (2) to allow secondary fuel to flow into the forward gun body and thence through the perforated secondary fuel cylinder to coat the main fuel.

The rear section of the main control valve body contained two machined liners cut so that two separately sealed annular spaces were formed between the body and the liner. These spaces communicated with the interior of the valve by small holes drilled radially through the liners. Main air was supplied to the forward annular space and entered through the liner holes between two flanges on an internal sliding

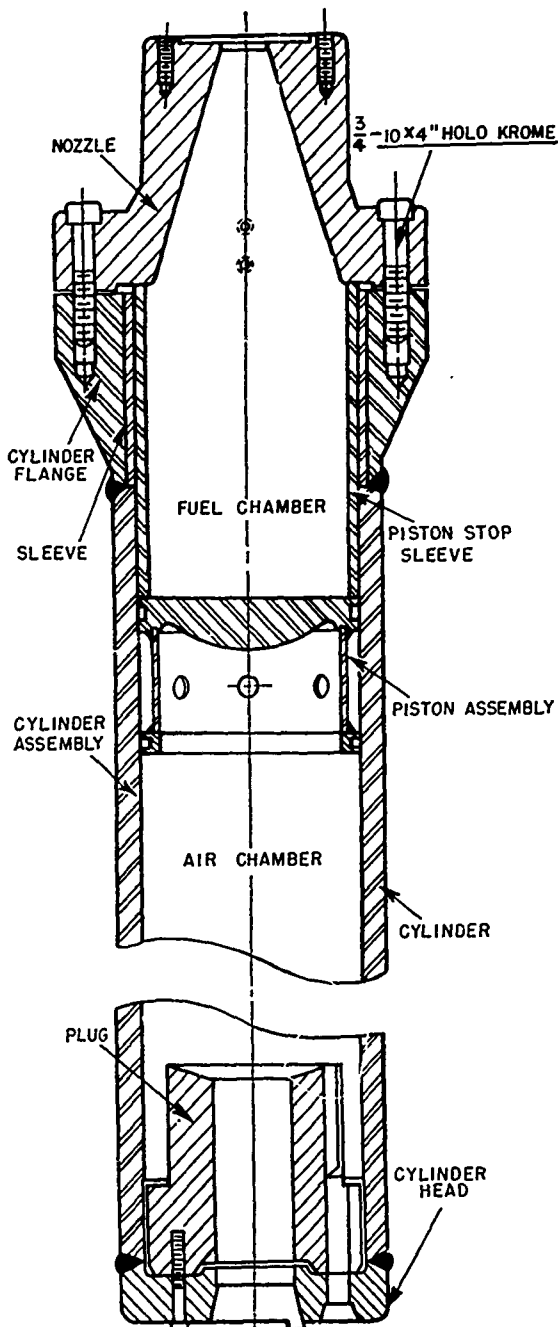

FIGURE 4. Cutaway view of Model D flame gun.

which was in turn bolted to the rear of the air chamber, and held the main spring, the valve stop, and the breech nut. The valve stop, which



FIGURE 5. Flaming sock fired from Model D flame thrower.

piston. The piston was held in the forward or closed position by a spring. Air delivered by the pilot valve entered a separate chamber in the forward end of the valve cylinder ahead of the piston forward flange, forcing the piston backward and compressing the spring. This movement caused the two piston flanges to straddle the liner holes to the two annular

spaces, and connected the main air inlet of the forward annular space with the air outlet of the rear annular space, which discharged into the air chamber and opened the main fuel valve in the gun. The forward end of the piston passed through an opening in the forward valve section (piston bonnet), which contained a valve port that was closed by the conical end of the piston. Secondary fuel entered one side of the bonnet and, when the piston was forced to the rear, flowed out through the forward end of the bonnet into the gun body. The rear opening of the bonnet through which the piston slid was made air- and gasoline-tight by a synthetic rubber O sealing ring in the piston bonnet partition. Similar sealing rings rode in grooves in the two piston flanges.

Pilot Valve. The pilot valve was a small

air for the main control valve. The pilot valve consisted of a valve body, cylindrical perforated liners, and valve body covers, as well as a sliding piston, piston sealing rings, and spring.

Atomizer Valve. The atomizer valve was a dual purpose piston-type shut-off in a small bronze cylindrical casting which supplied air and gasoline to the atomizer nozzle for the flame-thrower igniter. The valve body consisted of two sections, (1) the air body, which was identical with the pilot-valve body, and (2) the atomizer gasoline body, which was bolted to the forward end of the air body. An internal, two-piece sliding piston, opened manually and closed by spring, acted as an air valve at the rear and as a gasoline valve on the forward end. Synthetic rubber O sealing rings sealed the air from the gasoline chamber.

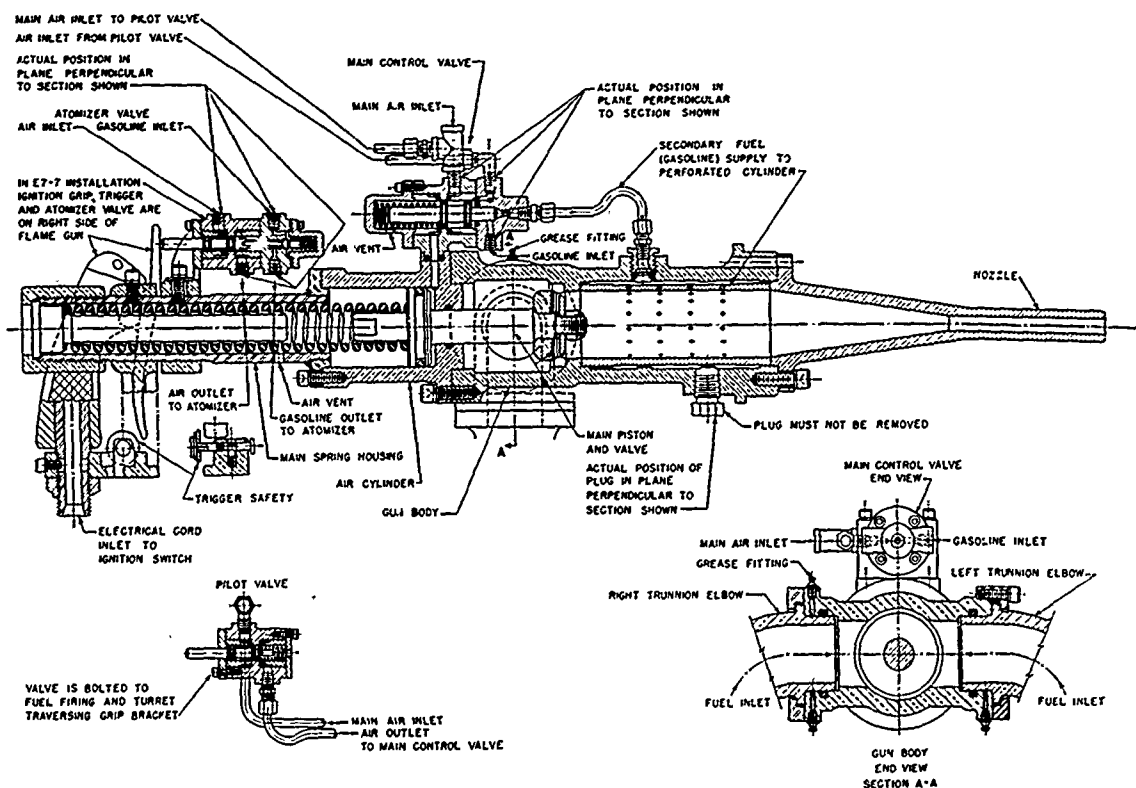

FIGURE 6. Sectional elevation of E7 flame gun.

bronze cylindrical piston-type air shut-off valve. The function of this valve, which was manually actuated by trigger pressure against a sliding piston, was to supply high-pressure actuating

Operation. The gun was fed through two diametrically opposed rotary trunnion elbow joints which permitted movement of the weapon in elevation or depression (-10 to $+30$ de-

CONFIDENTIAL

grees). Horizontal movement of the E7 was permitted through a rotary joint in the vertical feed pipe over the main fuel container (U.S. Navy Mark I unit), or by traversing the turret

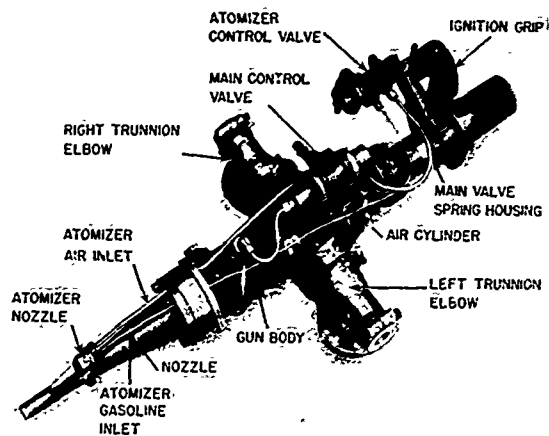

FIGURE 7. E7 gun for M5A1 light tank.

(E7-7 unit). Operating controls for the weapon were dual firing handles bracketed to the breech of the gun. These handles were also used to move the gun in elevation and (for the Mark I unit) traverse. Actuation of a trigger on the left handle closed an electrical switch sending high-tension current to dual spark gaps in the ignition chamber through which the flame gun fired, and actuated the atomizer valve sending gasoline and air through an atomizer nozzle into the ignition chamber as a spray around the spark gaps. This produced a blow torch flame for ignition of main fuel. Actuation of the trigger on the right firing handle operated the pilot valve, which opened the dual main control valve on the E7 gun. Opening of the main control valve injected (1) air into the gun to open the main fuel valve and (2) secondary fuel into the weapon to coat the main fuel.

5.3.3

Modifications of the E7

E7R1. The development of a flame-thrower unit for an M4 tank required minor changes in the gun design.^{15, 16} Inasmuch as the E7 flame gun was designed with a relatively short nozzle unsuited for use in an extended dummy gun tube simulating the 75-mm rifle installed in medium tanks, it was necessary to add a nozzle

extension. To meet the requirements, the tapered nozzle was redesigned with a $\frac{3}{4}$ -in. bore flanged outlet. To this tapered nozzle was bolted a short $\frac{3}{4}$ -in. bore extension. Interchangeable long extensions of $\frac{1}{2}$ in. and $\frac{3}{4}$ in. were provided with flanged inlets for bolting to the short extension.

The hand-operated trigger mechanisms for the gun controls were replaced with foot controls. A right foot button switch in front of the turret gunner actuated a solenoid which opened the pilot valve. An emergency foot pedal could also be used to actuate the pilot valve in case of solenoid or local electrical failures. Ignition of the main fuel rod ejected from the flame-gun nozzle was initiated by pressing the gunner's left foot pedal prior to depression of the fuel-firing button. The pedal mechanically actuated the atomizer valve and closed the electrical circuit to dual spark gaps in the ignition chamber downstream of the flame-gun nozzle outlet.

The flame gun was moved in elevation by means of an elevating handwheel, and moved in traverse with the vehicle turret.

E7R2. For installation of the E7 flame gun in the LVT-A1, both $\frac{1}{2}$ -in. and $\frac{3}{4}$ -in. bore interchangeable nozzles were provided, unchanged in length.¹⁷

Dual-firing handles were bracketed to the weapon for direct elevation or depression. Depressing a button in the right handle actuated a solenoid which opened the pilot valve. Depressing of a right foot pedal actuated the igniter identically with the E7R1 system. The gun moved in traverse with the turret.

E20. The E20 had a medium-length, interchangeable nozzle extension (20 in.) of $\frac{1}{2}$ - or $\frac{3}{4}$ -in. bore. The firing controls were actuated by one foot pedal which accomplished the following in sequence.

1. Actuation of the E20 igniter in the muzzle of the dummy gun tube, sending air and gasoline through an atomizer nozzle to spray around dual high-tension spark gaps in the ignition chamber, forming a burning blowtorch through which the flame gun fires.

2. Operation of the E20 flame gun, indirectly opening the internal main fuel valve and simultaneously coating the ejected thickened fuel with unthickened gasoline or secondary fuel.

CONFIDENTIAL

The E20 foot-pedal control permitted essentially independent operation of the igniter.

The gun elevated (-15 to $+45$ degrees) by handwheel also geared to the 75-mm rifle, and traversed with the turret.³

arranged to accommodate the flame-thrower equipment. The periscopes in the turret roof were relocated for convenience of turret and gun operation by the single turret occupant.

5.4 E7-7 FLAME THROWER IN M5A1 TANK

5.4.1

Introduction

The development of the E7-7 mechanized flame thrower for the M5A1 light tank was initiated in January 1943 by the Standard Oil Development Co. under Contract OEMsr-390. The general objectives of the project included the design and construction of a practical modified turret-basket flame-thrower unit of long range, complete for ready installation in a standard light tank.¹⁸

The development was an outgrowth of the work previously done on the design of Models A, C, D, and Q flame throwers (see Sections 5.2 and 5.3). Model Q had been successfully demonstrated in January 1943 as part of a trailer-model pilot device, and extensive tests of the system resulted in the decision that a similar unit be mounted for service tests in an M5A1 tank. The design was further refined to modify the M5A1 turret and turret-basket assembly, so as to permit the installation of the E7 (Model Q) gun and all auxiliary fuel and propellant gas equipment within the basket. Four complete units were ultimately constructed and delivered to the theater of operations.

5.4.2

Description

Carrier. The E7-7 flame thrower was mounted in the M5A1 tank, which weighed 31,000 lb exclusive of crew, armament, and stowage. Modification for the flame gun weighed 2,650 lb, including fuel. The usual conical turret basket of the M5A1 tank was replaced by a cylindrical basket to provide maximum capacity for fuel tanks and air cylinders (Figure 8). Hull stowage was slightly modified and reduced to accommodate this wider base basket, and normal turret equipment was modified or re-



FIGURE 8. Turret-basket assembly for E7-7 flame thrower in M5A1 light tank.

Additional tank armament consisted of three .30-caliber machine guns and one .45-caliber sub-machine gun. The hydraulic-power traverse assembly was shifted to the rear turret shelf, displacing the radio, which was moved to the right hull sponson.³

Propellant System. Compressed air, nitrogen, or inert gas could be used as propellants. The compressed gas was stored in 21 interconnected high-pressure gas cylinders under a pressure of 2,000 psi for expulsion of the main fuel, and 2 interconnected cylinders for expulsion of secondary fuel (Figure 9). Automatic pressure regulators provided a working pressure of 340 to 380 psi over the primary and 400 to 440 psi over the secondary fuel. Gas under 70 psi was used in the atomizer nozzles of the igniter.

Fuel System. The primary fuel consistency recommended was approximately 400 g Gardner, corresponding to 7 per cent Napalm-gasoline gel. It was carried in five drums connected in series, having a total net fuel capacity of 107 gal, which was sufficient for about 45 sec firing time at 2.4 gal per sec. The resulting fuel holdup in the tanks was about 3 to 5 gal.

The secondary fuel or unthickened gasoline was used to enhance the degree of ignition of the fuel rod. It was supplied under 400 to 440 psi pressure at a rate of approximately 200 ml

CONFIDENTIAL

per. sec from a single 3-gal container capable of 56 sec of operation. The supply of secondary fuel was controlled by a valve synchronized with the main valve. The ratio of primary to secondary fuel was approximately 19/1.

E7 Gun. The E7 gun (see Section 5.3) which replaced the normal 37-mm gun of the tank

by sparking an atomized spray of gasoline.¹⁹ An atomizer nozzle supplied with air at 70 psi and gasoline at 5 psi directed a cone of atomized gasoline down an 11-in. section of 4-in. pipe, which served as the igniter shield. Two independent ignition systems, each consisting of a high-tension spark gap, 12,000 volts alternating

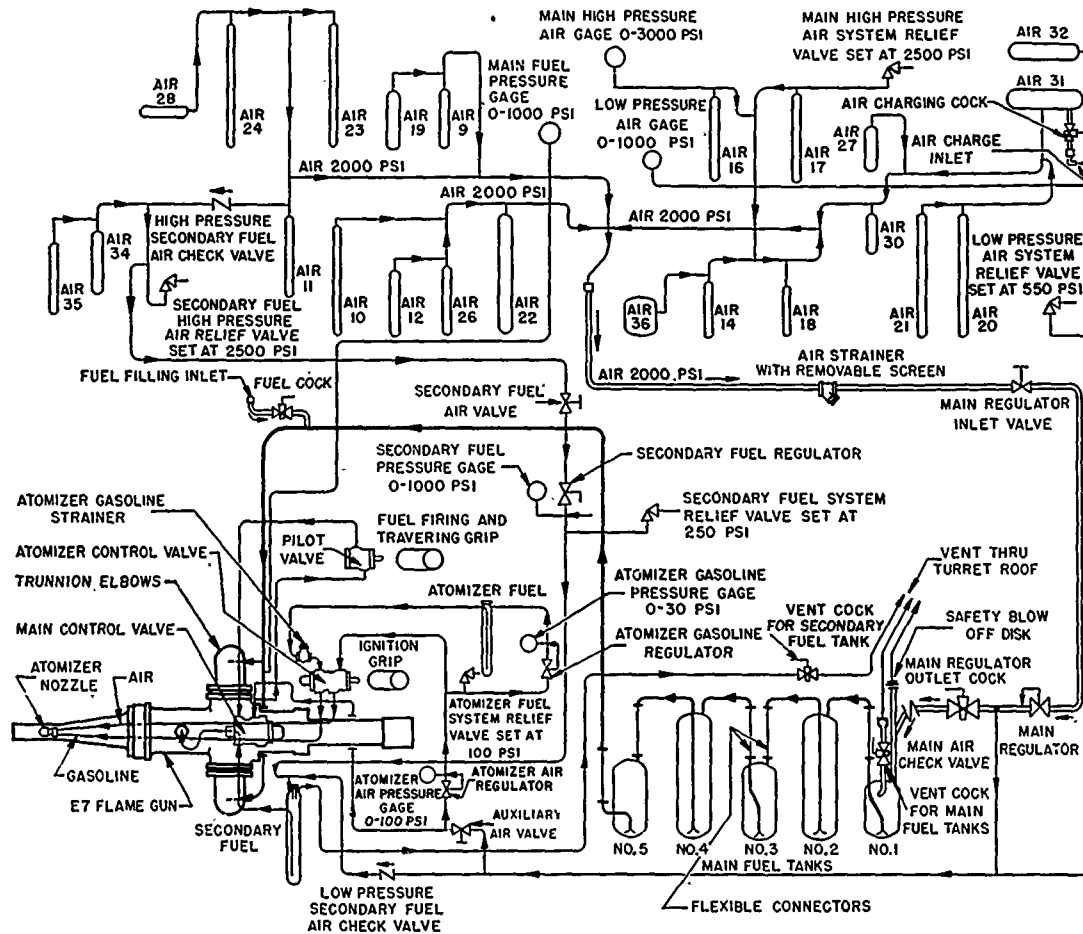

FIGURE 9. Flow plan E7-7 flame-thrower system.

was mounted at the top of the tank, in a turret which could be traversed, manually or by power, through 360 degrees. The gun could be depressed through 10 degrees, or elevated through 30 degrees, from the horizontal. It was mounted in a simulated 75-mm howitzer muzzle, from which the ignited fuel was fired. A .30-caliber machine gun was mounted coaxially with the flame gun, and the front of the turret included a special large armored shield.

Ignition System. Ignition was accomplished

current, actuated by a spark coil operated from the 12-volt tank storage battery, were mounted in the igniter shield in such a way that the spark points protruded inside the boundaries of the spray cone.

5.4.3

Performance

Testing of the prototype in November 1943 resulted in the decision to build three additional units as pilot models for training. The proto-

CONFIDENTIAL

type underwent additional tests by the Chemical Warfare Service²⁰ and the Armored Board.²¹ The latter recommended armoring of all four units to make them battleworthy, but to discontinue production because of obsolescence of the M5 tank. Operational tests of the battleworthy units²² revealed no weaknesses. An operational and maintenance manual was issued,¹³ and the four units, together with one E8 servicing unit, were sent to a theater of operations.

Field tests of the prototype unit, using 7 per cent Napalm gasoline, showed a center-of-deposit range of 105 to 115 yd at 10 degrees elevation and 120 to 130 yd at 20 degrees elevation, with a 5 to 10 mph tail wind (Figure 10).



FIGURE 10. E7-7 mechanized flame thrower firing thickened fuel (8% Napalm) at embrasure, range 60 yd.

Liquid kerosene could be projected 30 to 40 yd at 0 to 10 degrees elevation and with a 0 to 10 mph tail wind (Figure 11). The range data on thickened fuels were generally confirmed in a series of tests by several groups.

5.4.4

Operational Use

The E7-7 saw action on Luzon. The first mission was unsuccessful because of the terrain; the target was too far below the line of fire at maximum gun depression.^{23, 24} On a subsequent mission, definite targets were not apparent, but the approximate position of strong points was known. Bursts of 3 sec were fired onto the opposite ridge until the flame-thrower tanks were emptied. Eight of the enemy were flushed out by the fire and killed by infantry, as a result of which enemy resistance was broken. An infantry attack followed, and the position was



FIGURE 11. E7-7 mechanized flame thrower firing unthickened fuel (kerosene). Note intense flame and heavy smoke.

taken, six fatally burned men being found at a heavy gun emplacement. Later official figures indicated that the combined flame thrower-infantry operation accounted for 56 enemy troops.

During one week of heavy rains the ignition system of each unit was checked daily; no ignition failures were encountered. Other actions are given in some detail in a separate report.¹⁴

No troubles were encountered from faulty ignition or fuel instability. To minimize deposition of fuel on the tank, rapid release of the trigger controlling the fuel valve and proper use of air blowdown were found essential. Occasional leaks were encountered in safety relief valves, around the ends of high-pressure hose, and around valve stems, none incapable of being readily repaired. Two spark-plug porcelain insulators were cracked. The sighting vane was made more rigid. One rubber O ring in a gun operating pilot valve required replacement due to slight wear.

As to the overall adequacy of the flame-thrower installation in the tank, it was reported that, with all the equipment recommended, there was not sufficient room for the turret gunner, and that vision from inside the tank was poor. Other reported weaknesses were specific to the tank itself.

5.5

NAVY MARK I UNIT WITH E7 FLAME THROWER

5.5.1

Introduction

Following demonstrations of Model Q to the Navy in December 1943 and January 1944, the Navy Department Bureau of Ordnance ordered

CONFIDENTIAL

limited procurement of a flame thrower similar in design to Model Q to be constructed by M. W. Kellogg Co., with Standard Oil Development Co. under Contract OEMsr-390 contributing to basic design, necessary development, inspection, and testing.²⁵ These units, designated U.S. Navy Mark I, were to be complete with armor protection suitable for crane loading ashore or afloat on LCVP or LCM landing boats.

Twenty-one U.S. Navy Mark I units and ten additional pressure-vessel assemblies as spares or for use in series operation were constructed. In addition to acting as consultants during the construction, the Standard Oil Development Co. also trained Navy personnel and assisted in preparing operating and maintenance manuals²⁶ as well as instructional movies.

5.5.2

Description³

Introduction. Protected by front and side armor plate, the U.S. Navy Mark I flame thrower (Figure 12) was a compact unit comprising an E7 flame gun and a pressure-vessel system carrying 200 gal of fuel with the necessary propellant air, nitrogen, or inert gas. The unit was designed primarily to operate with Napalm-thickened gasoline fuels, although liquid, unthickened fuels could be employed. Main fuel was coated with secondary fuel (motor gasoline) in the flame gun, prior to ejection through a cylindrical ignition chamber surrounding the gun nozzle (Figure 13).

Propellant System. Propellant air, nitrogen, or inert gas at 2,000 psig was carried in seven standard cylinders. 10.5 cu ft total capacity, bracketed horizontally in parallel close under the main fuel container. These cylinders discharged to the rear through a pipe manifold into the adjustable automatic main pressure regulator which fed propellant gas to the main fuel container and the atomizer (igniter) fuel tank, and provided flame gun actuating and atomizer air to corresponding operating controls. Gas directly from the storage cylinders was also directed through a separate pressure regulator as propellant for secondary fuel. Propellant gas was charged through a connection on the discharge manifold. Spring-loaded safety

relief valves protected (1) the high-pressure, (2) main fuel, and (3) secondary fuel systems. The propellant gas cylinders were protected by vertical front and side armor plate.

Fuel System. The main fuel system included a 220-gal gross capacity, vertical, cylindrical, steel container with ellipsoidal heads, provided with a propellant air inlet at the top, a central vertical fuel discharge pipe, an overflow vent line,

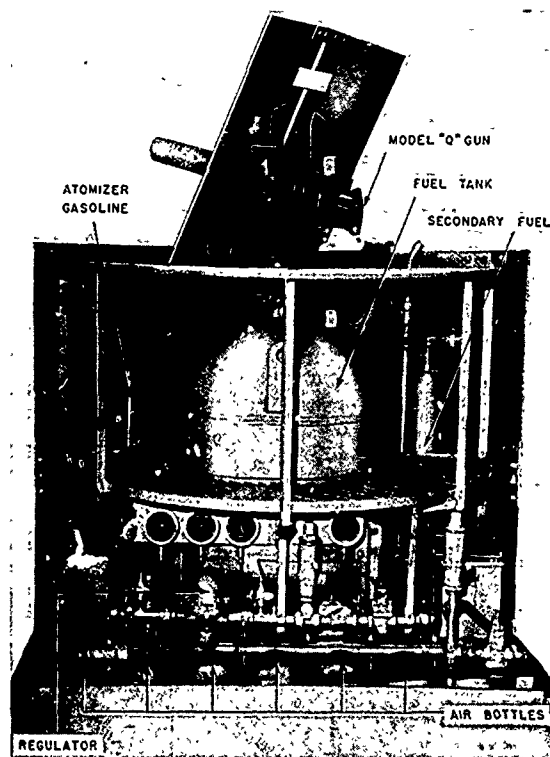

FIGURE 12. Rear view of U.S. Navy Mark I flame thrower.

and a flanged top inlet for use in tandem with a second unit. The fuel discharge pipe extended internally from the bottom head through the top to feed and support the flame gun. The overflow vent extended into the top sufficiently to create a 20-gal void space for expansion when the container was filled through a valved connection in the fuel discharge pipe above the vessel. A frangible rupture disk which burst at 600 psig was installed in a safety blowoff connection in the propellant air inlet line. A semi-circular platform was built around the rear wall of the container as standing support for the

CONFIDENTIAL

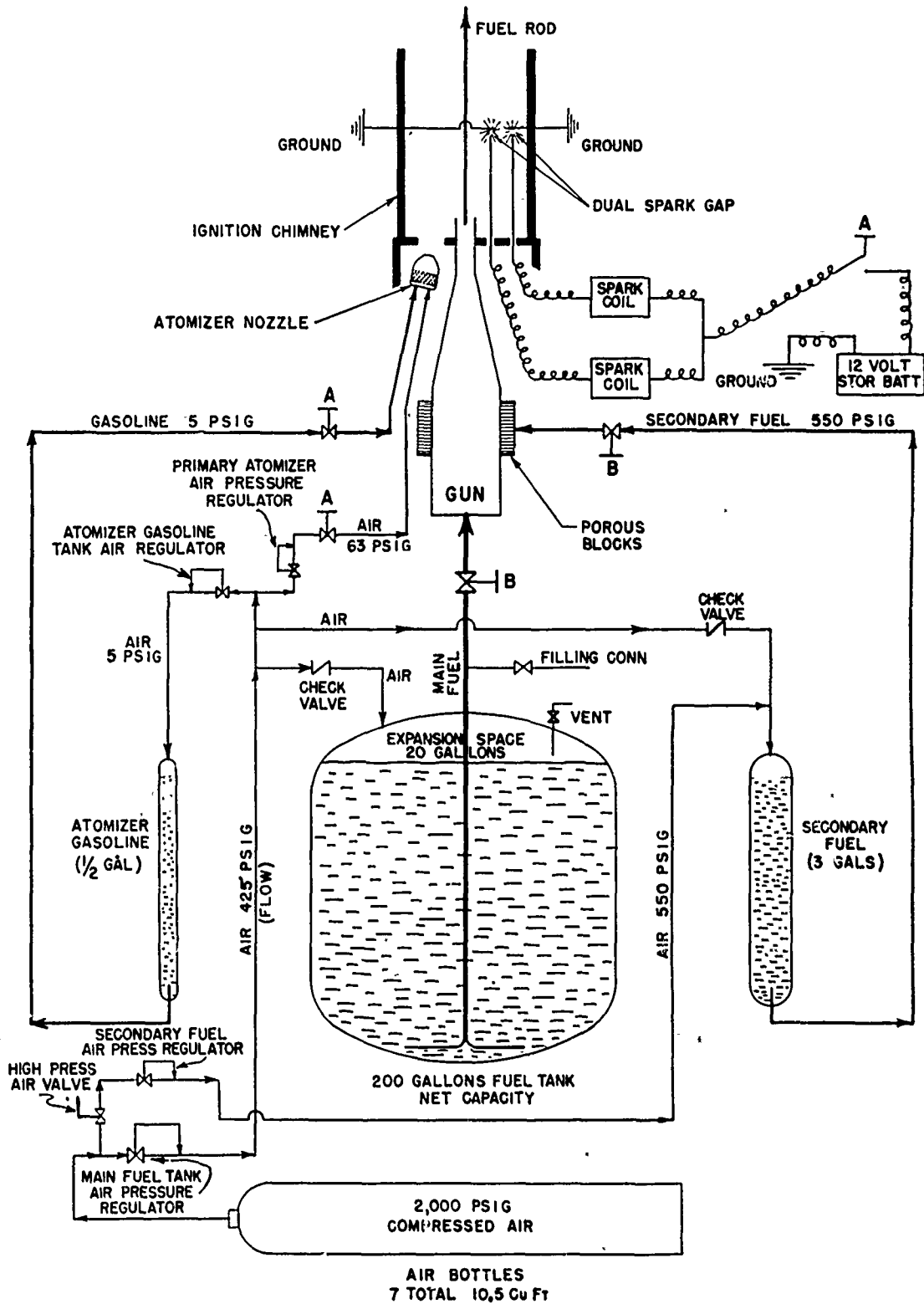

FIGURE 13. Flow diagram of U.S. Navy Mark I flame thrower.

CONFIDENTIAL

gunner. A vertical front and side armor plate was bolted around the vessel for protection of the container and the operator.

Secondary fuel was carried in a 3-gal vertical, cylindrical container mounted at the right of the main fuel container. Propellant gas at 500 to 550 psig entered the top of the vessel. Secondary fuel was ejected through a bottom discharge pipe to the forward end of the dual main control valve on the flame gun. The secondary fuel container was charged through a plugged top connection leading to a valved vent. An emergency propellant line extended from the main pressure regulator discharge through an air-check valve to the secondary fuel container top inlet, assuring positive flow of secondary fuel to the gun in case the secondary fuel regulator discharge pressure was inadvertently set below the main fuel operating pressure.

E7 Gun. The E7 gun (see Section 5.3) was mounted on the vertical discharge pipe directly over the main fuel container.

Ignition System. The U.S. Navy Mark I ignition system included facilities for producing an air-atomized spray of gasoline around dual spark gaps in the ignition chamber through which main fuel was ejected from the flame gun. Atomizer fuel ($\frac{1}{2}$ -gal motor gasoline) was stored in a vertical, cylindrical container to the left of the main fuel tank. Propellant gas at 4 to 7 psig entered the top of the container from the atomizer-fuel pressure regulator taking part of the discharge from the main pressure regulator. Atomizer fuel was discharged from the bottom of the container through the dual atomizer control valve to the atomizer nozzle. The container was filled through a top plugged connection. Air at 60 to 65 psig to the atomizer nozzle was supplied through a separate regulator also fed by the main pressure regulator. This air passed through the dual atomizer control valve to the atomizer nozzle simultaneously with atomizer fuel. Twelve volts direct current for the ignition system was supplied from two 6-volt storage batteries, mounted one on each side of the main fuel container over the bank of propellant gas cylinders. This low-tension current was led through the left firing-handle trigger switch to dual special splash-proof coil boxes mounted behind the gun shield.

From each coil box, 12,000 volts alternating current was delivered to 1 of two special igniter spark plugs mounted parallel to the flame-gun nozzle in the ignition chamber. Here dual sparks were generated to grounding electrodes in the chamber wall simultaneously with ejection of a spray of gasoline from the atomizer nozzle. Sparking of either igniter plug alone was capable of igniting the atomizer gasoline, the dual high-tension circuit being employed as an ignition safety factor. The ignition chamber consisted of a 12-in. extension of a cylindrical tube surrounding the flame-gun nozzle and forward of it. The ignition chamber was bolted at the rear end to a vertical ballistic plate through which the dual spark plugs were screwed. The E7 nozzle projected approximately 2 in. through this plate and ejected concentrically through the ignition chamber. The atomizer nozzle was mounted to the rear of the ballistic plate and ejected through it into the ignition chamber. The ignition chamber was removable for servicing or replacing spark plugs. Bolted to the ballistic plate and the forward gun-body flange, a cylindrical nozzle cover to the rear of the plate and ignition chamber was split horizontally and encased the ignition lead wires, the spark plug rear terminals, the atomizer nozzle feed lines and the atomizer nozzle. These could be serviced by removal of the top half of the nozzle cover. Twenty holes drilled into the bottom half of the nozzle cover supplied necessary secondary air drawn into the ignition chamber by the jet action of the atomizer spray passing through a hole in the top half of the ballistic plate.

Units in Tandem. To increase fuel capacity and firing time for waterborne assault where sufficient landing boat cargo space was available, it was originally planned to connect two Mark I units in tandem, back to back, using the flame gun only on the forward unit. Tests showed satisfactory tandem operation with the propellant gas, main fuel, and secondary fuel systems connected in series through flexible hoses, and controlled by the pressure regulators on the rear unit. The ignition system and igniter fuel supply on the forward unit alone were adequate in this case. Main fuel flowed from the rear unit fuel-charging inlet to the special

top inlet on the forward main fuel container. Inasmuch as the U.S. Navy Mark I units were transported in combat in LVT-4 amphibious tanks of limited cargo capacity, series operation of two units in tandem was not employed in battle.

5.5.3

Performance

One of the twenty-one units was assigned with Navy personnel for extended testing by the Chemical Warfare Service, Technical Division, at Edgewood Arsenal. Navy personnel accompanied production units to the West Coast for a limited period of additional training and testing. This was continued at Pearl Harbor, where a U.S. Navy Mark I unit was installed in an obsolete M3 medium tank during further flame-thrower studies. Meanwhile, practice landings with a Mark I unit mounted in an LCVF indicated the need for employing a carrier which would not immobilize the flame thrower after reaching the beach.

Typical range data for the unit are given below.

	Firing 8 per cent Napalm-thickened gasoline	
	10° elevation	20° elevation
Nil wind	100 yd	110 yd
5-mph tail wind	110	123
10-mph tail wind	120	135
5-mph cross wind	75	81
10-mph cross wind	56	60

Firing liquid fuel (kerosene)	
0 to 10-mph tail wind	30 to 40 yd (extreme range)
0 to 10° elevation	

Six U.S. Navy Mark I flame throwers were effectively employed in combat in the Palau operations on Peleliu Island from September 15 to November 26, 1944.²⁷ Carried in the open cargo compartments of LVT-4 lightly armored amphibious tractors, the units were used successfully during flame attacks against large Japanese pillboxes, caves, foxholes, hillsides, ammunition and food dumps, and emplacement areas which rendered conventional attack costly (Figure 14). At a cost of only 11 casualties to the operating personnel, over 300 entrenched enemy troops were killed directly or indirectly because of the flame-thrower action. Fifty loads of fuel were fired, and a total of 23 LVT-4 tractors were employed to maintain operation of the

six Mark I units until the island was secured. The units proved rugged in combat and were still operable at the end of the campaign. Although employed effectively, the LVT-4 carriers proved mechanically deficient and offered insufficient protection to operating personnel.

The U.S. Navy Mark I demonstrated beyond reasonable question the important tactical value



FIGURE 14. Action of U.S. Navy Mark I flame thrower mounted in LVT-4 amphibious tractor on Peleliu Island, October 1944.

of a large-capacity, long-range flame thrower in combat, emphasizing the need for improved mobility and adequate protection of operating personnel in battle. In combat, the unit proved most effective in reducing enemy emplacements and flushing out occupants where conventional weapons, aerial bombing, or artillery fire failed to minimize personnel casualties during assault or mopping-up operations. Use of up to 9 per cent Napalm-thickened fuel effected ammunition explosions inside enemy emplacements and permitted accurate penetration of small embrasures from 80 yd range with the 1/2-in. nozzle employed.

5.6 E14-7R2 FLAME THROWER IN LVT-A1 AMPHIBIOUS TANK

5.6.1

Introduction

The development of the E14-7R2 was initiated by the Chemical Warfare Service, who in January 1944 requested that a flame-thrower in-

CONFIDENTIAL

stallation in an LVT-A1 amphibious tank be built by the Lima Locomotive Works, with Standard Oil Development Co. under Contract OEMsr-390 acting as engineering consultants for CWS-Technical. The E14-7R2 prototype unit, designated E7-LVT-A1,²⁸ when tested, was basically satisfactory as a flame thrower, but with full standard LVT-A1 combat stowage was somewhat overweight and bow-heavy while waterborne in moderate surfs.²⁹ To overcome this difficulty, several modifications were made and the resulting unit, E14-7R2, was built by the M. W. Kellogg Co. Basic corrections included weight reduction of the flame-thrower installation wherever possible, with movement of the pressure vessels downward and towards the rear of the vehicle.^{30, 31}

In addition to the furnishing of basic design and development work, assistance was given in preliminary testing, establishing inspection procedure, instructing Armored Force personnel, and preparing informational movies and manuals.

5.6.2

Description^{3, 17, 32}

Carrier. The E14-7R2 essentially duplicated the standard LVT-A1 amphibious tank with the exception of a few modifications. The 37-mm rifle, gun mount, and counterweight were replaced by the E7R2 flame gun and integral trunnion mounting, dummy gun tube, and special counterweight. The .30-caliber coaxial machine gun was retained, but the coaxial sighting telescope was eliminated. All gun gyro stabilizer equipment was removed.

It was necessary to broaden slightly the turret front in order to accommodate both the flame gun and the coaxial machine gun. The turret power-traverse control was changed from the standard rotatable pistol grip to a left foot pedal for the flame gunner. Also, mechanical stops were installed to prevent turret traverse beyond 120 degrees to the right or left of the vehicle longitudinal center line. This prevented any possibility of firing the flame gun over the heads of the two rear scarf gunners. Other minor changes were made in the turret (Figure 15).

Similarly, the hull had to be modified to accommodate the flame-thrower fuel and pressure system. In addition, three 10-lb CO₂ cylinders were installed in the right side of the engine room. These were manifolded to discharge horns distributed through the cargo compart-

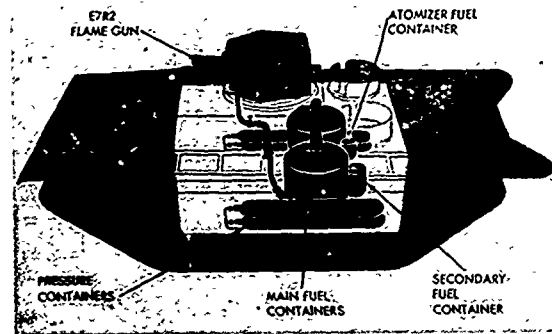

FIGURE 15. E14-7R2 flame-thrower installation showing position of gun and containers.

ment and bilges, and were provided with internal and external pulls to save the equipment in case of fire accompanying relatively minor damage.

Propellant System. Stored at 2,000 psig pressure in the cargo compartment, 8.2 cu ft total of propellant air, nitrogen, or inert gas was carried in four interconnected horizontal cylinders of equal capacity, located in pairs against each side bulkhead. This stored pressure was directed through adjustable, automatic pressure regulators (1) to propel main fuel from the containers through the flame gun, (2) to propel secondary fuel through the gun to coat the main fuel prior to ejection, (3) to propel atomizer (igniter) fuel through the atomizer nozzle into the dummy gun-tube ignition chamber, (4) to provide atomizer air, mixing with atomizer fuel in the nozzle as described in 3, and (5) to provide flame gun actuating air to open the E7R2 main fuel valve.

The main regulator supplied controlled 375 to 400 psig pressure into the top of the right main fuel container and also fed this pressure to individual regulators as described in 3, 4, and 5. Secondary fuel pressure was controlled through a separate regulator at 500 to 550 psig.

Fuel System. Main fuel for the flame gun was

CONFIDENTIAL

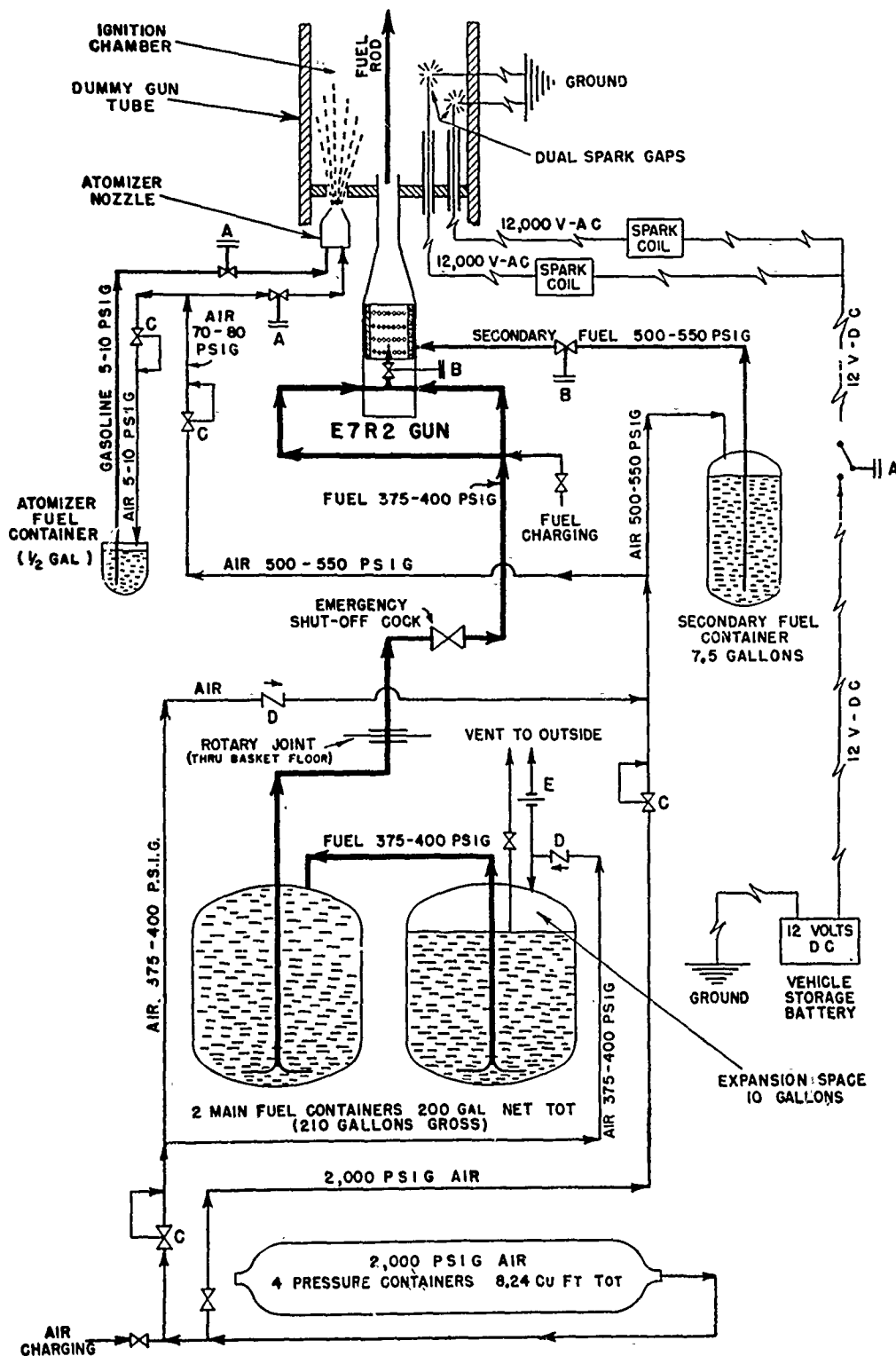

FIGURE 16. Schematic flow plan of E14-7R2 mechanized flame thrower.

CONFIDENTIAL

carried in two 105-gal vertical, cylindrical pressure vessels connected in series in the cargo compartment (Figure 16). These containers were placed symmetrically in the hull to maintain lateral trim of the vehicle afloat, and were limited to the indicated capacity because of vehicle weight limitations for acceptable stability while waterborne. The containers were piped to the flame gun in the turret through a special rotary joint in the basket floor.

Fuel was charged to this system through an external armor-protected inlet in the right rear turret wall, flowing in reverse through the fuel piping in the turret into the hull containers in series. When these containers were full, fuel overflowed outside through a vent pipe over the right fender, connected by a temporary hose to a waste receiver on the ground.

Secondary fuel, ordinary motor gasoline, was carried in a 7.5-gal vertical cylinder in the left rear cargo compartment. This fuel, propelled at 500 to 550 psig pressure, flowed through the E7R2 main control valve into the flame gun when the main fuel valve in the weapon was actuated.

E7R2 Gun. A description of the E7R2 was given in Section 5.3. Although the flame gun does not differ much from the E7, it had to be thoroughly waterproofed for amphibious use.

Ignition System. Propelled by 5 to 10 psig pressure supplied in series through the main air, atomizer air, and atomizer fuel regulators, 1/2 gal of atomizer fuel (ordinary motor gasoline) was stored in a vertical cylindrical container in the right rear cargo compartment. When the ignition pedal was pressed by the flame gunner, the fuel flowed through the atomizer valve into the atomizer nozzle discharging into the ignition chamber at the forward end of the dummy gun tube. In the atomizer nozzle, the fuel was mixed with air under pressure (regulated to 70 to 80 psig, also controlled through the dual atomizer valve) and expelled as a finely atomized spray around dual spark gaps in the ignition chamber.

Simultaneously, the ignition pedal closed an electrical switch which sent 12-v direct current, obtained from the vehicle storage battery, to two special coil boxes located under the for-

ward turret roof. Each coil box independently fed 12,000 v interrupted potential to one of two special spark plugs placed in the ignition chamber at the muzzle end of the dummy gun tube. The air-atomized gasoline spray was released into the ignition chamber where it surrounded and was ignited by the dual sparks emitted by the spark plugs to grounding electrodes on the dummy tube walls. Sparking of either spark plug alone was sufficient to ignite the atomizer spray. As long as the ignition pedal was fully depressed, the resulting flame persisted as a blowtorch through which the main fuel rod, coated with secondary fuel, had to pass.

5.6.3

Performance

As a large-capacity, long-range, main-armor, mechanized flame thrower, the E14-7R2 unit was designed principally to fire gasoline fuels thickened with up to 10 per cent by weight of Napalm. Fuel thickened with 6 to 8 per cent Napalm was generally employed for optimum combined performance and serviceability (Figure 17). Liquid, unthickened fuel could also be

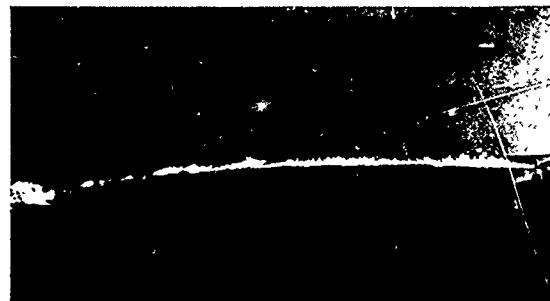

FIGURE 17. E14-7R2 firing 8% Napalm-thickened fuel using 5° elevation, range 80 yd.

used, although at very appreciable sacrifice in range, aimability, and burning time on the target. With liquid unthickened fuels, about one pint residual remained after each prolonged shot in the E7R2 gun nozzle downstream of the internal main fuel valve.

The unit was capable of ejecting a total of 190 to 195 gal of thickened fuel at approximately 2.4 gal per sec for 80 sec with 1/2-in.

CONFIDENTIAL

bore nozzle, or 4.8 gal per sec for a total of 40 sec with $\frac{3}{4}$ -in. nozzle. These nozzles were interchangeable between missions.

Either rapid ($\frac{1}{2}$ to 1 sec bursts) or prolonged fire, ignited or unignited at the will of the gunner, was permitted with the E7R2 gun. Typical average ranges measured from the gun to the center of the ground pattern on level terrain were as follows.

	Approximate range in yards to center of ground deposit			
	$\frac{1}{2}$ -in. nozzle		$\frac{3}{4}$ -in. nozzle	
Nil wind				
10° Elevation	95		105	
20° Elevation	105		125	
5-mph wind	Tail	Cross	Tail	Cross
10° Elevation	105	75	115	85
20° Elevation	115	80	140	95
10-mph wind				
10° Elevation	110	60	125	65
20° Elevation	125	60	150	75

The end of World War II prevented the use of the E14-7R2 in actual combat, but ten units were completed.

5.7 M5-4 (E12-7R1) FLAME THROWER IN M4A1 AND M4A3 MEDIUM TANK

5.7.1

Introduction

The development of the E12-7R1 mechanized flame thrower for the M4A1 medium tank was initiated in August 1944 by Standard Oil Development Company under Contract OEMsr-390. The replacement of the main armament in the M5A1 light tank by a large-capacity flame thrower had resulted in the construction of four Model E7-7 mechanized flame throwers, which were delivered to the theater of operations and successfully used in the Pacific Theater (see Section 5.4). However, the basic vehicle of the E7-7 lacked sufficient power and sturdiness, and in the spring of 1944 NDRC was convinced of the need for mechanized flame throwers of still higher range and capacity, mounted in medium tanks. By summer, M4A1 tanks had been secured for two new projects, E13-13 and E13R1-13R2. Military interest in mechanized flame throwers was growing so rapidly during this period that by autumn of 1944 the imme-

mediate production of 20 flame throwers in M4A1 tanks was requested. Since both the above projects involved untried design principles and an untested gun, it was considered unwise to go into production on them. The present project was accordingly launched, the design to be based on the battle-tested E7 gun and on the use of conventional, air-pressurized fuel bottles in series.

The general objectives of the project, therefore, included the development of a main-armament mechanized flame thrower for medium tanks which would permit a large fuel capacity, a high rate of fuel discharge, and a long effective range, in excess of 100 yd. With these objectives in view, the final design incorporated a modified Q(E7) flame gun, the principal flow and operating features of the system being quite similar to those of the E7-7 (see Section 5.4). Principal differences consisted in the design of specific component parts to adapt the flame thrower to an M4A1 or M4A3 medium tank.

5.7.2

Description^{3, 15, 16, 33, 34, 35}

Carrier. The E12-7R1 flame thrower was mounted in the M4A1 or M4A3 tank. The turret basket was rebuilt and shortened by 7 in. to accommodate the flame-thrower system. Turret stowage was modified to include one main fuel and three auxiliary pressure containers in the left half of the basket along with operating controls for the flame gun, eliminating the cannoner (gun loader) and retaining the tank commander and gunner in their original turret positions.

The 75-mm cannon, gun mount, and counterweight were replaced by the E7R1 flame gun and dummy 75-mm gun tube, rotor mount, and special counterweight. All M4A1 or M4A3 armament other than the 75-mm cannon was retained. Externally, the flame-thrower tank had the appearance of a standard M4A1 or M4A3 medium tank with 75-mm gun.

Where the main generator was originally placed on the hull floor near the driver, it was replaced by a standard generator mounted over the driveshaft. The batteries and generator regulator were moved from the hull floor to the

CONFIDENTIAL

left sponson, the hull was rewired, and the other hull and sponson stowage was modified to accommodate flame-thrower fuel and air-pressure containers.

The vehicle, as modified, was thus equipped with the following armament: one flame thrower, mechanized, E12-7R1, two .30-caliber machine guns (one gun coaxial with the flame gun in the turret, one bow gun operated by the assistant driver), one .50-caliber AA machine gun, external mount on turret. The total operating crew consisted of four men.

Propellant System. Compressed air was used as propellant, and was stored in six high-pressure air cylinders (Figure 18). Two of these, placed in the right and left sponsons, were connected to four smaller cylinders located around the hull fuel containers. The air used for actuating the flame gun was carried in a separate container in the turret basket.

The air system can be tabulated as follows.

Total number of cylinders	7
In hull, to expel main fuel	6 (total 10.1 cu ft)
In turret basket, auxiliary and gun operating air	1 (2.7 cu ft)
Total capacity	12.8 cu ft
Starting pressure	2,200 psi
Final pressure, after firing main fuel load	Approx 500 psi in hull Approx 1,400 psi in basket

Fuel System. The recommended primary fuel was 7 per cent Napalm-gasoline gel of approximately 400 g Gardner consistency. It was carried in two horizontal, internally baffled main fuel containers accommodated in the hull, and in a third vertical main fuel container located in the turret basket (Figure 19). All three fuel containers were connected in series and had a combined capacity of 315 gal. The static pressure setting of the high-pressure regulator in the air line to the fuel containers was 375 to 400 psi, producing an operating pressure at the gun of 325 to 350 psi.

The secondary fuel, unthickened gasoline, was carried in one 15-gal container located in the turret basket and was supplied under approximately 500 psi pressure at a rate of 150 to 300 ml per sec. The supply of secondary fuel was controlled by a pedal valve synchronized with the main fuel valve.

E7R1 Gun. The E7R1, described in Section

5.4, had a 360-degree traverse and an elevation of from -12 to +25 degrees.

Ignition System. Gasoline from the 2-gal atomizer fuel container passed at 7 to 8 psi

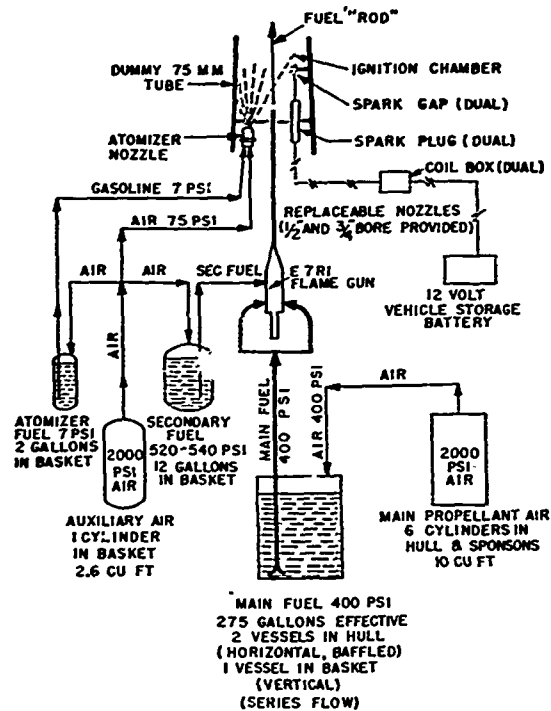

FIGURE 18. Simplified flow plan of M5-4 (E12-7R1) mechanized flame thrower.

through the atomizer nozzle installed near the end of the dummy 75-mm gun tube, was mixed and atomized with air at 70 to 80 psi, and was ignited by dual spark plugs. This ignited mixture, discharged at about 1.5 to 3.0 ml per sec, in turn ignited the main fuel rod leaving the flame gun. Current for the two high-tension spark plugs was drawn from one 12-volt storage battery of the vehicle.

E12R1-7R1 Modification. The E12-7R1 flame thrower, simplified by certain modifications, constituted the E12R1-7R1 flame thrower.

In converting the fuel and air systems, the basket primary fuel tank was omitted, thereby reducing the fuel storage capacity to 235 gal gross, 210 gal net. The capacity of the secondary fuel tank was reduced from 15 to 11.5 gal. The number of air cylinders was reduced to two in the hull and 1 in the basket, with a total capacity of approximately 10 cu ft. The ignition

CONFIDENTIAL

gasoline container was reduced in capacity to 2 gal.

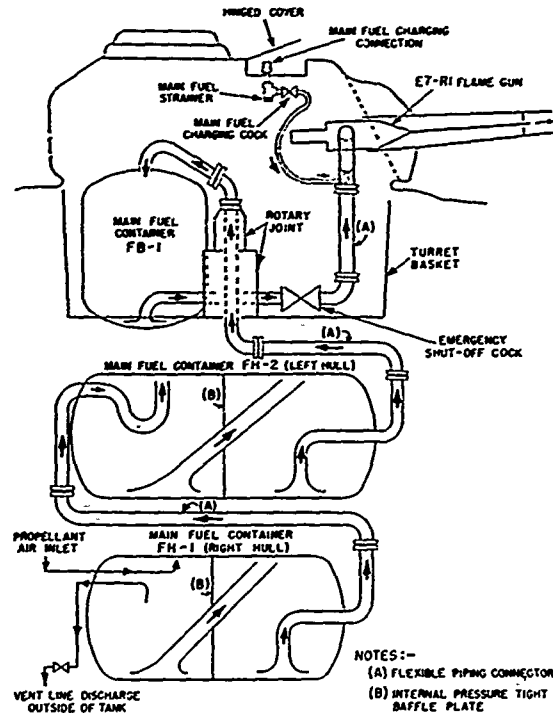

FIGURE 19. Schematic flow diagram of the main fuel system of M5-4 (E12-7R1) flame thrower.



FIGURE 20. M5-4 (E12-7R1) firing 8% Napalm-thickened fuel, range 65 yd.

fuel.³⁸ The group found the following center-of-deposit ranges with the E12-7R1 unit firing under various conditions at a 5-degree elevation and a head wind of 5 to 10 mph:

Fuel, g Gardner	Nozzle, in.	Range, yd
230	$\frac{3}{4}$	89
239	$\frac{1}{2}$	79
400	$\frac{3}{4}$	75
400	$\frac{1}{2}$	74
700	$\frac{3}{4}$	74
700	$\frac{1}{2}$	65

On the basis of a series of physiological tests in a typical pillbox, the group, in conjunction with the CWS Toxicological Laboratory, arrived at the conclusion that the optimum fuel consistency for use with the $\frac{3}{4}$ -in. nozzle of the E12-7R1 flame thrower would be one of 200 to 250 g Gardner or 6 to 6.5 per cent Napalm, and that the maximum effective range for lethal conditions in the enclosure would be approximately 80 yd, that is, considerably less than indicated by open field tests.³⁹ The bunker tests were generally confirmed by dispersion target tests devised and carried out by the Evaluation Group.

5.7.3

Performance^{36, 37, 38}

Typical range data (center of ground deposit) as obtained by the contractor when firing 8 per cent Napalm-thickened gasoline (Figure 20), is shown below in yards.

Nil wind	10-degree elevation	20-degree elevation
$\frac{3}{8}$ -in. nozzle	78	95
$\frac{1}{2}$ -in. nozzle	95	105
$\frac{3}{4}$ -in. nozzle	113	140
5-mph tail wind		
$\frac{3}{8}$ -in. nozzle	88	106
$\frac{1}{2}$ -in. nozzle	103	121
$\frac{3}{4}$ -in. nozzle	125	154

A special CWS-NDRC Mechanized Flame-Thrower Evaluation Group set up at Edgewood Arsenal carried out exhaustive tests of the performance of the E12-7R1 flame thrower, and arrived at the conclusion that the mechanical functioning of the unit was substantially faultless, except for the desirability of increasing the diameter of the refueling line and connections to insure more rapid filling with thickened

5.8 E8 FLAME THROWER IN M5A1 LIGHT TANK

5.8.1

Introduction

The development of the E8 mechanized flame thrower mounted on the M5A1 light tank was initiated in January 1943 by C. F. Braun & Co. under OSRD Contract OEMsr-943. The general objectives of this project included the development of an easily installed, self-contained unit of large fuel-carrying capacity, incorporating a flame gun of flexible design, and intended

CONFIDENTIAL

to discharge 3 to 5 gal of thickened fuel per sec to an effective range of approximately 200 yd. Although pump propulsion was contemplated, the final design provided for propulsion by means of compressed air carried in separate cylinders, and high fuel capacity was obtained at the cost of removing the turret, traversing mechanism, and all armament from the tank. Later, a machine gun was reinstalled in a small armored turret on the outside of the tank.

Preliminary experimental work included comparative studies of propulsion methods by straight gas pressure from a vessel, by pump alone, and by pump with hydromatic accumulator, as well as investigations into pressure drops, nozzle shapes, jet forms, and trajectories.

5.8.2

Description^{40, 41, 42}

Carrier. The E8 flame thrower was designed for installation in a modified M5 tank. In order to achieve a high fuel-carrying capacity, the turret and its traversing mechanism were removed. The engine compartment bulkhead and doors were left in place. A fireproof bulkhead was installed just behind the driver's compartment. The tank roof between the two bulkheads was removed, the sidewalls were raised, and a new roof was installed on a level with the M5 turret. The resulting silhouette was slightly shorter and about 40 per cent wider than the M5 turret. The flame gun was mounted in a small turret placed at the forward end of the new roof assembly.

The flame-thrower equipment was assembled as a single unit and was attached to the roof. Thus it could be installed in the tank with limited shop facilities.

Propellant System. Compressed air at about 2,000 psi was carried in four bottles, two installed in the tank sponsons and two smaller ones mounted vertically alongside the fuel bottles. The total capacity of the bottles was about 9 cu ft. The air bottles were divided into two groups, each of which was provided with a check valve. Thus the system was protected against total loss of air pressure, should any one of the bottles be punctured. A Grove regulator controlled the air pressure at 350 to 400 psi for

ejection of fuel. Another small regulator provided 100 to 150 psi air for valve operation.

Fuel System. Fuel was carried in two bottles connected in series. Their total capacity was approximately 240 gal. The bottles were mounted vertically in the forward part of the flame-thrower compartment. They were rigidly tied together and were used as a base to which all other parts of the flame thrower were attached. As a result, the entire flame-thrower system could be lifted out of the M5A1 tank and operated independently or in another carrier.

Fuel was admitted to the gun by the main valve, located downstream from the fuel bottles. This valve was opened by compressed air and was closed by a spring. The force to open or close the valve was nearly independent of the working pressure, thus allowing very rapid opening and closing.

Gun. The gun contained a pintle valve operated by fuel pressure and consisted of the following three principal elements: nozzle, retractor tube and tip, and barrel (Figure 21).

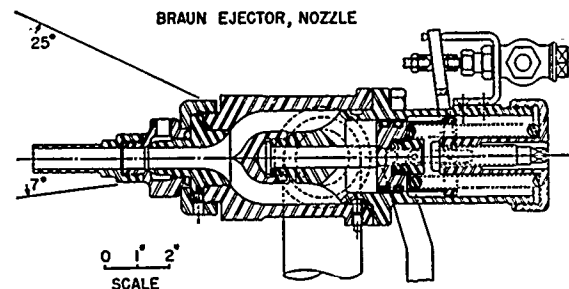

FIGURE 21. Cutaway of Braun ejector nozzle showing pintle valve in open position.

The nozzle and the conical retractor tip formed the nozzle pintle valve; the included angle of the retractor tip cone was slightly larger than that of the nozzle cone. The function of the pintle valve was to ensure a sharp cutoff of fuel at the nozzle at the end of a shot, after the main fuel valve had closed. The pintle valve was operated by fuel pressure. Its backward motion was opposed by a spring which continually exerted a pressure less than the 160 psi operating pressure on the upstream face of the valve. Thus, when the fuel pressure in the gun was greater than the spring pressure, the pintle valve was forced open; when the fuel

CONFIDENTIAL

pressure dropped to less than the spring pressure, the valve was closed by the spring. The pintle valve could be locked in the closed position by means of a manual screw feed provided for this purpose.

The retractor tube served as a support for the retractor tip. It was supported and aligned near the nozzle by a short sleeve through which it was free to slide. The sleeve was held in position by four symmetrically placed, thin, streamlined fins which extended between the sleeve and the gun barrel. A portion of the retractor tube served as a case for the pintle valve opposing spring.

In the gun, fuel flowed in the annulus between the retractor tube and the gun barrel.

Directly following the pintle valve was the convergent section of the nozzle. It was so designed that when the pintle was in the open position, the fuel would accelerate at a constant rate in passing through the section. Interchangeable nozzles of 1/2-in., 5/8-in., and 3/4-in. diameters were provided. Following the minimum cross section was a straight section six diameters long. Secondary fuel, gasoline, from a 7 1/2-gal pressurized tank was introduced just upstream from the beginning of the straight section through an annular opening.

Fuel was passed to the gun through a hollow swivel joint and hollow trunnions, allowing traverse and elevation of the gun. Traverse was limited to 180 degrees, frontal, by the turret construction. The gun could be elevated 25 degrees and depressed 7 degrees from the horizontal.

The gun was controlled by a single vertical lever, which was given a sidewise motion to traverse the gun; a forward or backward motion depressed or elevated the gun. A push-button in the lever handle fired the gun by admitting compressed air to the main fuel valve.

Ignition System. The blowtorch principle was used for ignition. When starting cold, gasoline was vaporized by means of an electric heater operated from the battery circuit of the tank. After the unit had warmed up, ignition gasoline was vaporized by heat from its own flame as it passed through a coil in the flame. The capacity of ignition gasoline storage was

1 1/2 gal, which was sufficient for 15 hours' continuous burning of the two torches used.

5.8.3

Performance

Work on the E8 flame thrower was continued only to the point of constructing a prototype and demonstrating it at Edgewood Arsenal,^{12, 13} but no exhaustive performance tests were subsequently made. The demonstration at Edgewood suffered somewhat because of the excessively high consistency of the Napalm-gasoline gel used, 460 g Gardner, which resulted in imperfect ignition. Kerosene was used as secondary fuel.

Although the unit performed well, and was excellent with respect to fuel cutoff as well as the ease and rapidity of mounting and dismounting, no future development was undertaken, chiefly because of the obsolescence of the M5A1 model tank which was used as the carrier.

5.9

MODEL I-3 FLAME THROWER

5.9.1

Introduction

The development of the I-3 mechanized flame thrower was initiated in October 1943 by Shell Development Co. under Contract OEMsr-916. The general objectives of this project included the design of a flame thrower incorporating a simple pintle valve design which would lend itself readily to adaptation to any particular vehicular mounting without major modification of the design.

The original I-1 gun design was a simplified adaptation of the E8 gun (see Section 5.8), involving elimination of the quick-acting valve mechanism of the latter, the pintle valve serving as the main valve. Further simplification of the design resulted in the I-2 model, which combined the nozzle and valve into a single angle valve and provided connection to the fuel line through a standard Unibolt ball joint. The final I-3 design incorporated an improved method of mounting, including suitable trunnion and swivel joints. Development of the I-3

CONFIDENTIAL

gun never proceeded to the point of designing a complete production model, although several tests were run with a large fuel tank specially constructed for the purpose (Figure 22).

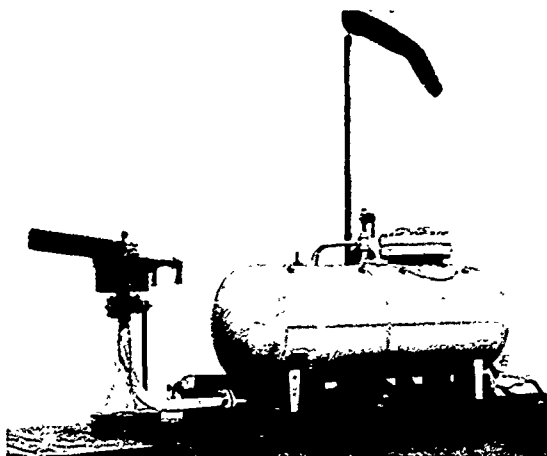

FIGURE 22. Experimental Model I-3 with 500-gal fuel tank.

5.9.2

Description^{44, 45}

Carrier. Development did not proceed to the point of selecting the most suitable carrier for the system.

Propulsion System. Compressed air was used for propulsion of the fuel, and was supplied at operating pressure from the compressed-air storage through a Grove regulator to the fuel tank, in which it was kept separated from the Napalm gel by a synthetic rubber bag diaphragm.

Fuel System. The system used in field tests of Model I-3 consisted of a 500-gal tank employing a synthetic rubber bag which served to transmit air pressure to the fuel (Figure 23). The synthetic rubber bag contained four longitudinal reinforcing straps of $\frac{1}{4}$ x 2-in. steel at 30 degrees from the vertical plane with welded-in studs to secure the bag to the upper part of the steel tank. Three dished steel plates built integral with the bag provided reinforcement covering the 2-in. discharge ports on the bottom of the tank. The air inlet to the bag was through a 2-in. molded flange in the top. In filling the tank with fuel, the bag diaphragm was filled with air to about 15 psi, and fuel was pumped into the steel tank through the bottom ports, the air being expelled from the inside of



FIGURE 23. Diagrammatic sketch showing the action of synthetic rubber diaphragm.

the bag through a bleeder valve. After charging the tank with fuel, the fuel inlet valve was closed, and air to fuel operating pressure was applied to the bag by means of the Grove regulator.

Gun Unit. The I-3 gun, which was provided with a $\frac{5}{8}$ -in. nozzle, had full 360-degree rotation, 43-degree elevation, and 15-degree depression. The pintle valve was kept closed by air at the same pressure as in the main fuel tank, and firing of the gun was accomplished by releasing the air pressure through a three-way valve, the gel pressure itself opening the pintle valve (Fig. 24). At the end of firing, the release

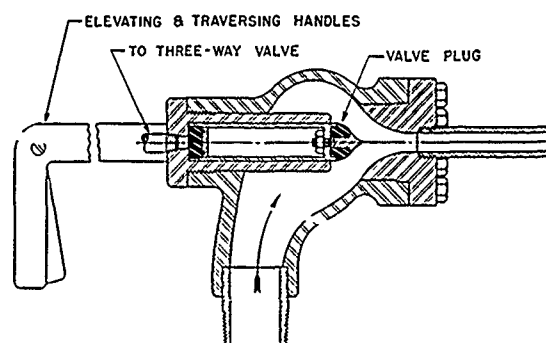

FIGURE 24. Model I-3 flame-thrower nozzle showing pintle valve in open position.

of the trigger readmitted air behind the pintle, shutting off discharge.

Although provision was made for admission of secondary fuel, the jet showed satisfactory ignition with primary fuel alone under the not very severe conditions of test used. It is expected that cold weather would have established the need for secondary fuel.

CONFIDENTIAL

Ignition System. The ignition system consisted of a 2-gal gasoline tank on the left of the gun, and batteries and spark coil on the right. The gasoline was atomized with air from the air bottles and ignited by an automobile spark plug.

5.9.3

Performance

In field tests, the I-3 gun showed excellent operating characteristics.⁴⁵ With 8 per cent Napalm gels, maximum ranges of 135 to 150 yd to the center of deposit of the burning fuel were obtained with the $\frac{3}{8}$ -in. nozzle; the corresponding ranges with 2.5 per cent Napalm were 35 to 90 yd. The pintle valve, which was the only moving part, performed satisfactorily, and cut-off was rapid and clean. Fuel holdup in the tank was only 1 per cent of the 500-gal charge.

5.10

E9 FLAME THROWER IN M5A1 LIGHT TANK WITH FUEL TRAILER

5.10.1

Introduction

The development of the E9 mechanized flame thrower for the M5 light tank was initiated in April 1943 by Standard Oil Co. of Indiana under OSRD Contract OEMsr-1011. The general objectives of this project included attainment of greater effective range (approximately 200 yd) and the use of increased nozzle diameters ($\frac{3}{4}$ in.) higher consistency Napalm gels (8 to 10 per cent Napalm) and working pressures of 600 to 1000 psi. Difficulty experienced with satisfactory ignition of thick fuels in the portable flame thrower indicated that more information on factors affecting ignition of fuel during flight was also needed.

Discussion brought out the desirability of retaining as much of the fire power of the M5 tank as possible, while the necessity of providing adequate fuel capacity for a large flame thrower was recognized. The use of a trailer was not originally desired, but was ultimately adopted. Performance of the tank was not to be reduced by more than 50 per cent, and the

trailer, if adopted, was to be resistant to machine gun fire. It was desired to use air pressure for fuel propulsion, and the question of air compression versus precompressed air was to be included as a subject for investigation.

Preliminary field experiments were carried out with two pieces of equipment: a small model with $\frac{1}{4}$ -in. jet, and a 300-gal truck-mounted model with an experimental gun producing $\frac{1}{4}$ -in., $\frac{1}{2}$ -in., and $\frac{3}{4}$ -in. jets.

5.10.2

Description^{46, 47, 48}

Carrier. With the exception of the flame gun, all of the flame-thrower equipment was carried in an auxiliary armored trailer unit.

The trailer was mounted on two pneumatic-tired wheels, and was attached to the tank through a 10-in. diameter ball-socket joint, which permitted the trailer to be turned through an angle of 105 degrees from the center line in any direction (Figure 25). The fuel line between



FIGURE 25. General view of M5A1 light tank with trailer unit attached.

the ball-socket joint and the trailer was braced in such a way that it could serve as a drawbar. The joint in the hitch was fastened by a toggle chain which could be released by remote control from within the tank if it became necessary to jettison the trailer. A special valve, built into the joint, prevented loss of fuel from the trailer when the joint was open. The fuel line had a plug valve before the ball-socket joint to shut off the fuel tank when the trailer was disconnected (Figure 26).

The fuel bottle was supported on bent axle rods, and the other equipment on a structural

CONFIDENTIAL

steel frame. A skid plate was placed under the fuel bottle so that the trailer could be dragged over obstructions, and permitted operation at reduced speed in the event of a tire failure.

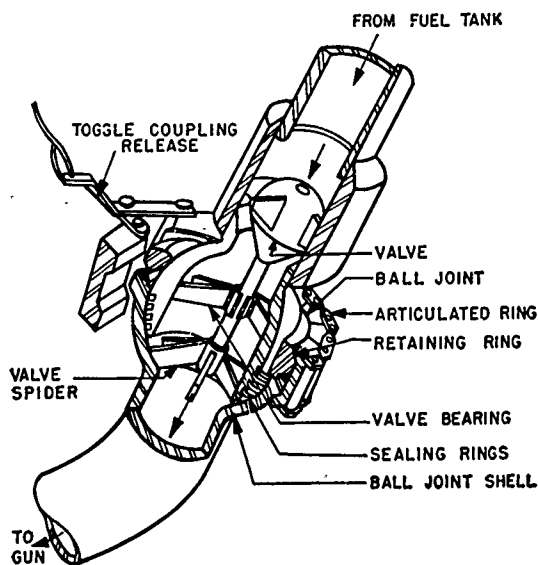
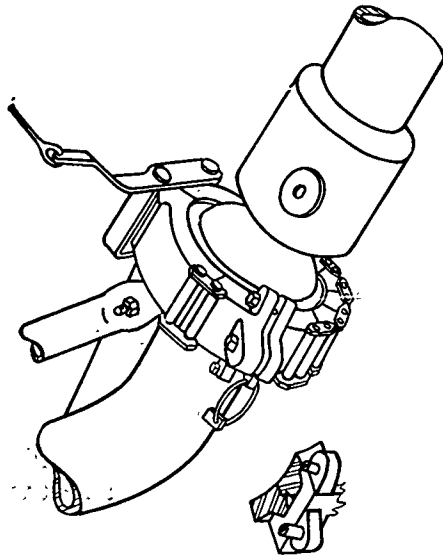

FIGURE 26. Sketch of ball-socket joint of hitch between trailer and M5A1 light tank with the E9 flame thrower.

The available information indicated that an M5A1 tank should be able to pull the trailer up

a 30 per cent grade in loose sand at a speed of 2 to 3 mph, and in level loose sand at a speed of 20 mph.

The total weight of the trailer unit loaded was approximately 12 tons.

Propulsion System. Compressed air was used for propulsion of the fuel. The air was supplied at 800 psi by two compressors, modified Lycoming O-435-T airplane engines. This is a six-cylinder opposed engine of about 85 hp. Conversion to a compressor was accomplished by removing three cylinders on one side of the motor and substituting three two-stage compressor cylinders. The cooling fan on the engine provided intercooling. No provision was made for aftercooling. The compressed air was stored in the fuel bottle itself, directly above the fuel.

Fuel System. Fuel was carried in a 1,200-gal fuel bottle. Normally the bottle would be charged with 600 to 800 gal of fuel, the remaining space being used as an air cushion. The bottle was of odd shape in order to provide high fuel capacity and still keep the height and width of the trailer about equal to the height and width of the M5A1 tank. It was constructed of armor plate, the thickest plates being $1\frac{5}{8}$ in. Normally, the bottle was charged with pre-mixed Napalm-thickened gasoline. A large propeller mixer, powered by an air turbine, was provided so that fuel could be mixed in the fuel tank if this should prove desirable. The line which conducted fuel from the fuel bottle to the gun unit was of 5-in. DXH pipe. It left the fuel bottle at the bottom well forward of the center. The outlet was shielded with a baffle plate to prevent coning of air into the fuel line.

Gun Unit. The gun unit was mounted at the front center of the tank on a hollow swivel fitting which allowed 60 degrees traverse of the gun unit to the right or left of the center line. After passing through the swivel fitting the fuel stream divided into two smaller streams which reached the gun unit through hollow trunnions, thus permitting elevation, 30 degrees from horizontal, and depression, 15 degrees from horizontal, of the unit. Motion of the unit was controlled by a system of pulleys and cables.

The duplex gun consisted of two separate systems, each with its own nozzle, barrel, and

CONFIDENTIAL

pintle valve. The $\frac{3}{4}$ -in. and $\frac{1}{4}$ -in. nozzles had rates of discharge of 7 and 0.7 gal per sec, respectively. The guns were mounted in a single housing with their axes parallel. The pintle valves, mounted in the trunnions, were opened by air pressure and closed by fuel pressure. The two guns could not be fired simultaneously (Figure 27).

Secondary fuel was distributed over both fuel jets before they were ejected from the nozzles. The secondary fuel, a mixture of gasoline and lubricating oil, was carried in two small tanks in the trailer unit.

Ignition System. Pressure-atomized gasoline ignited by a high-tension spark was used to ignite the fuel. The atomizer nozzle was mounted between the gun nozzles in such a way that the fuel ejected from the gun nozzles passed through the cone of gasoline spray ejected by the pressure-atomizing nozzle.

5.10.3

Performance

Tests of performance were quite incomplete, but some data were obtained on operation of separate elements.⁴⁸

Using 10 per cent gel and 500 psi pressure on the $\frac{3}{4}$ -in. orifice, a center-of-deposit range of 160 yd could be obtained under optimum conditions. With the $\frac{1}{4}$ -in. orifice, the corresponding range was 90 yd. Rod ignition was excellent with the $\frac{3}{4}$ -in. orifice, but was affected by strong cross winds with the $\frac{1}{4}$ -in. orifice. The ignition mechanism was reliable under all conditions, including immersion in salt water. One defect of the gun as installed was limited traverse, only 50-degree total. Elevation as installed was from -6 to +37 degrees.

The capacity of the compressor was adequate; in one test, with 300 gal of fuel and 900 gal of air space in the bottle, the pressure was raised from atmospheric to 500 psi in 33 min.

The performance of the hitch was very promising, although it was uncertain whether the surface would stand up under continuous rough use.

Trial of the mixing agitator was not sufficiently complete to determine the quality of per-

formance; visual observation indicated that the degree of agitation was adequate.

When the equipment was ready for actual trial, a batch of gel was made up in the bottle, which was then pressured to 500 psi.⁴⁹ The compressors were started to pressure the fuel bottle, and this proceeded normally up to a pressure of about 400 psi, when the engine for the right-hand compressor faltered, necessitating taking off the load. Shortly after, the fuel bottle exploded and ignited, resulting in demolition of the entire trailer, with fatal injuries to personnel.

5.11 E13-13 FLAME THROWER IN M4A1 MEDIUM TANK

5.11.1

Introduction

The development of the E13-13 mechanized flame thrower for the M4A1 medium tank was initiated by Morgan Construction Co. in February 1944 under Contract OEMsr-1364. This development was undertaken in response to a Chemical Warfare Service directive, in which the general objectives of the project were stated as follows (see also Section 5.7) :

"This development should cover the design of a model mounted in M4A1 tank, which may be stripped of all items except those necessary for the operation of the tank, the radio, and the .50-caliber machine guns plus ammunition. It is contemplated that a dummy 75-mm gun will be installed. The flame thrower should have a minimum effective range of 100 yd, and it is desirable to have a burning time approaching 5 min."

The E13-13 flame thrower was distinguished by the following features: (1) the use of low-pressure fuel storage, offering the advantages of additional safety and of the use of unconventionally shaped fuel tanks to increase the maximum quantity of fuel carried; (2) the use of synthetic rubber bladders in all fuel containers to separate the fuel from the air, thus eliminating the hazard of accumulation of explosive vapors and offering increased safety; (3) the installation in the turret of a double pneumatic ram system, the cylinders of which alternately supplied high-pressure fuel to the flame gun from the low-pressure storage tanks.

CONFIDENTIAL

5.11.2

Description⁵⁰

Carrier. The E13-13 flame thrower was mounted in the M4A1 tank, modified to accommodate the installation. The main 75-mm gun was removed, and a hinged dummy-gun barrel

stabilizer for the main gun was removed, for its use was not felt necessary in conjunction with the use of a gun of such relatively short range.

Propellant System. Air was used as propellant for the fuel, and was supplied in two

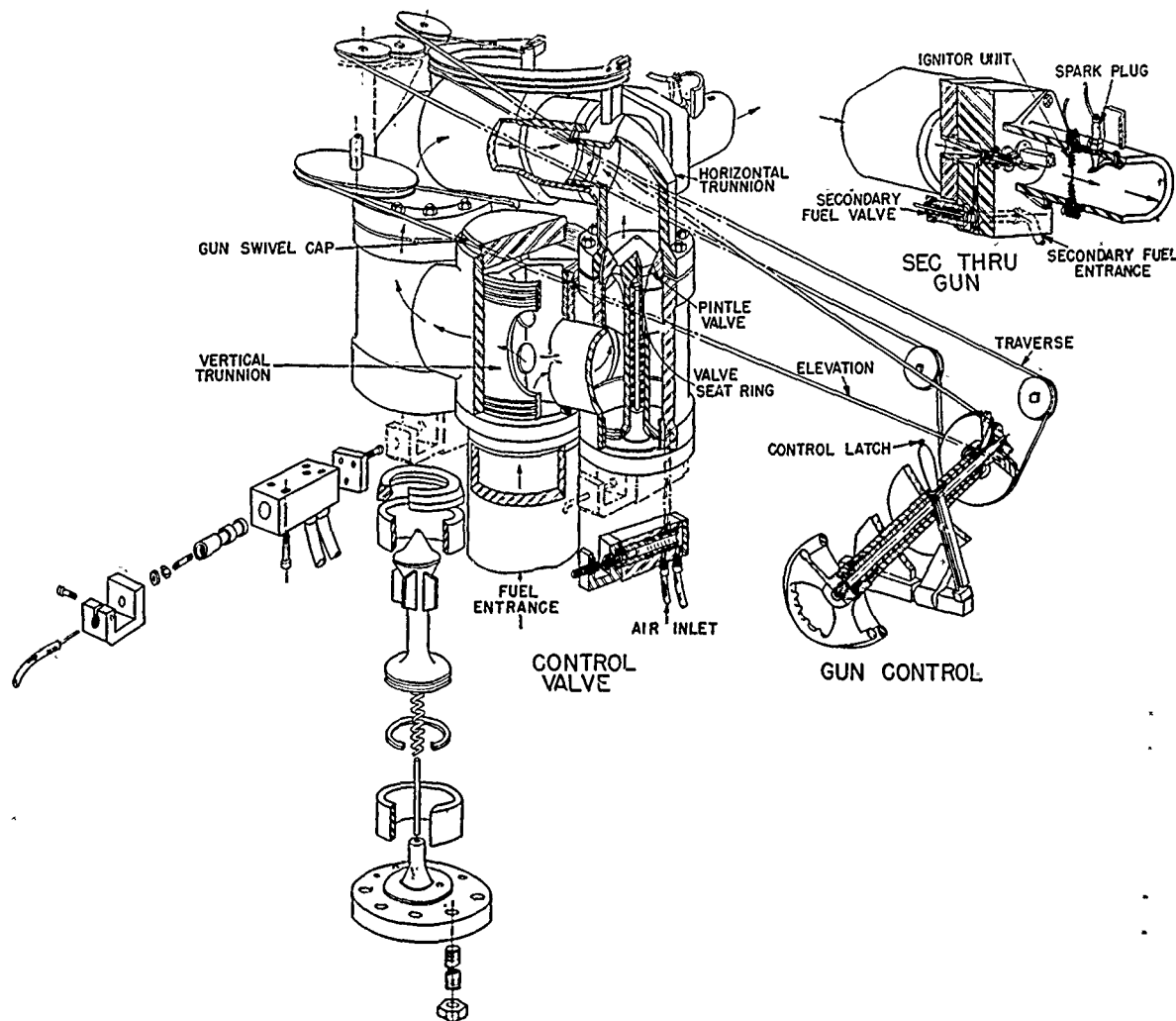

FIGURE 27. E9 prototype flame-thrower gun showing the controlling mechanism.

of similar dimensions, housing the igniter chimney and the flame gun, was substituted. The auxiliary armament of the tank remained unchanged, and consisted of one .30-caliber bow-machine gun, one .30-caliber coaxial turret machine gun, and one .50-caliber turret machine gun.

The firing controls were altered to include controls for the flame gun. The turret traverse mechanism was left intact, but the gyroscopic

separate systems. All compressed air for operating the ram cylinders, igniter, and pilot control valves, and for pressurizing the secondary fuel was stored in the turret (Fig. 28) in 3 Navy-type air bottles, which had a safe operating capacity of 3,000 psi, but were actually maintained at 2,000 psi. Two of the bottles had a capacity of 4 cu ft each, and the third contained 3.12 cu ft, making the total turret air capacity equal to 11.12 cu ft. All three turret air

CONFIDENTIAL

bottles were resiliently mounted in a vertical position.

The hull air supply was provided in six small air bottles charged at 2,000 psi, and possessing a combined capacity of 2.23 cu ft. This air was used for pressurizing the bladders in the main fuel tanks at 50 to 70 psi, the reduction in air pressure being effected by means of a Grove

truding the fuel from the tanks through the swivel joint in the turret floor, and delivering it to the intake manifold of the pneumatic ram unit. All three of the fuel tanks were connected in parallel, with outlets feeding into a common manifold header connected to the turret swivel joint. The fuel-outlet manifold for each fuel tank was provided with a quick-acting shutoff

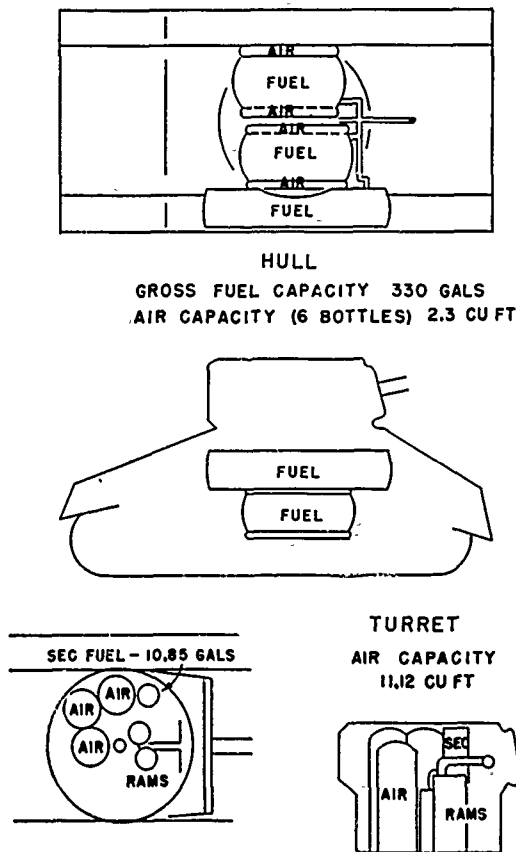

FIGURE 28. General arrangement of E13-13 (Morgan) flame-thrower installation.

regulator located on the side of the hull back of the assistant driver's seat.

Fuel System. All primary flame-thrower fuel was carried in the hull in three tanks, the gross capacity of which was 350 gal. Two of these tanks, of 115 gal each and cylindrical in shape, were located on either side of the driveshaft (Figure 29), and the third tank, of odd shape and holding 100 gal, was located in the right-hand sponson. Each tank contained a synthetic rubber bladder to which air was supplied at 50 to 70 psi, the expansion of the bladders ex-

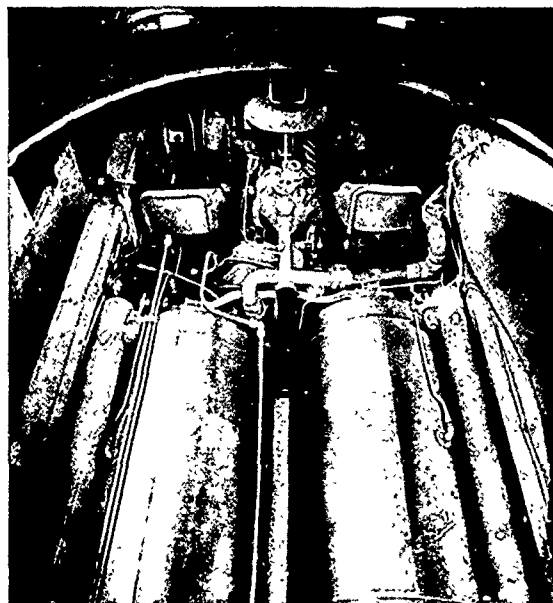

FIGURE 29. View looking into hull of M4A1 tank showing arrangement of E13-13 fuel tanks.

truding the fuel from the tanks through the swivel joint in the turret floor, and delivering it to the intake manifold of the pneumatic ram unit. All three of the fuel tanks were connected in parallel, with outlets feeding into a common manifold header connected to the turret swivel joint. The fuel-outlet manifold for each fuel tank was provided with a quick-acting shutoff

valve, accessible to the assistant driver. These valves made it possible to supply main fuel selectively from any desired tank. Damage to the synthetic rubber bags by fuel-outlet opening was prevented by molding to the bag two hand holes with aluminum inserts which covered the outlet ports when the fuel in the tank had been exhausted. Flexible connections were employed as required in the fuel lines to allow for differential movement of parts.

Secondary fuel, supplied at approximately 450 psi, was carried in one 10.6-gal tank located in the turret. Igniter fuel was contained in a 1.56-gal tank. Both these tanks were provided with synthetic rubber bladders.

Pneumatic Ram Cylinders. Located in the turret were two pneumatically operated propulsion cylinders, which delivered fuel to the flame gun at the desired operating pressure.

CONFIDENTIAL

After passing through the swivel joint, the fuel was conducted vertically to the cylinder intake manifold, from which it passed to one of the two ram cylinders. Each cylinder was equipped with a floating piston, and was provided with an inlet and an outlet poppet valve in the upper cylinder head. These poppet valves were spring-balanced and automatic in operation. Air for operating the cylinders was supplied to the lower cylinder heads through a four-way air valve, which admitted air alternately to the cylinders, so that only one at a time was under firing pressure, whereas the other was open to exhaust. Pressure being applied to a loaded cylinder, the fuel pressure automatically closed the fuel-intake valve and opened the fuel-outlet valve, permitting fuel to flow through the outlet manifold to the main pintle valve. Upon exhaustion of the fuel in a cylinder, the piston contacted a small lever located in a recess in the upper cylinder head, and the lever in turn tripped a three-way pilot valve, permitting air, under 60 to 80 psi, to operate a small air cylinder, which reversed the main 4-way valve. This immediately applied pressure to the other fully loaded cylinder, while the air in the discharge cylinder was opened to exhaust. This cylinder then recharged with low-pressure fuel, which forced the piston to the bottom of the stroke, ready for the next cycle.

Each cylinder had a net capacity of 6 gal.

Gun. The main armament of the flame thrower was the E13 flame gun, which was operated by a pintle valve located at the nozzle (Fig. 30). Four interchangeable nozzles, $\frac{3}{8}$, $\frac{1}{2}$, $\frac{5}{8}$, and $\frac{3}{4}$ in. in diameter, were provided. Turret traverse was 360 degrees; flame gun elevation was from -12 to $+25$ degrees.

Normally, the pintle valve was held closed by the pintle spring and air pressure equal to or greater than the fuel pressure. When the firing circuit was closed, the air back of the pintle piston was exhausted through a three-way magnetic valve, and the fuel pressure forced the pintle to its open position. At the end of a shot, the pintle was closed by re-establishing the air pressure back of the pintle. The nozzle pressure under normal operating conditions was approximately 300 to 350 psi.

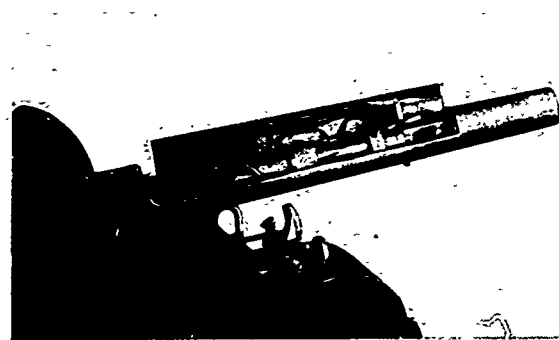

FIGURE 30. Dummy-gun barrel showing arrangement of pintle valve and igniter for the E13 flame gun.

When firing the gun, a slight interval of time occurred during the transition period when pressure was shifted from an empty ram cylinder to a full one. During this interval, there was a momentary drop in the fuel pressure at the pintle valve. With the firing trigger held open, there would naturally be a tendency for the gun to drool during this interval. In order to counteract this tendency, a compression spring was installed back of the pintle piston, the capacity of this spring being such as to cause the pintle to close automatically when the fuel pressure dropped below 125 to 150 psi and to reopen when fuel pressure was re-established. A momentary interruption in the jet during the change from one ram cylinder to the other resulted from this arrangement.

Secondary fuel was introduced through a narrow annulus located in the convergence to the nozzle just back of the point where the pintle seats. The secondary fuel was under the same pressure as the main fuel, and its flow was controlled by a solenoid-operated valve. Under normal conditions, the flow of secondary fuel was 80 to 100 ml per gal of main fuel.

Ignition System. The igniter consisted of an air-atomized gasoline jet operating at 60 to 80 psi, and ignited by sparks from two special plugs actuated by 2 high-tension coils. The atomizer nozzle was mounted inside the cover of the dummy gun barrel.

5.11.3

Performance

The performance of the E13-13 flame thrower, using the $\frac{1}{2}$ -in. nozzle, closely dupli-

CONFIDENTIAL

cated that of the E12-7R1 and E13R1-13R2 flame throwers, as determined by a special CWS-NDRC Mechanized Flame Thrower Evaluation Group.³⁸ It was noted that, while the 2-in. diameter fuel lines were adequate for feeding a 1/2-in. nozzle, they were not adequate for assuring optimum results with the larger nozzles.

5.12 E13R1-13R2 FLAME THROWER IN M4A1 MEDIUM TANK

5.12.1

Introduction

The development of the E13R1-13R2 mechanized flame thrower for the M4A1 medium tank was initiated in July 1944 by MIT under OSRD Contract OEMsr-21. This development was undertaken in response to a Chemical Warfare Service directive,⁵¹ in which the general objectives of the project were stated as follows (see also Section 5.7):

"This development should cover the design of a model mounted in M4A1 tank, which may be stripped of all items except those necessary for the operation of the tank, the radio, and the .50 caliber machine guns plus ammunition. It is contemplated that a dummy 75-mm gun will be installed. The flame thrower should have a minimum effective range of 100 yd, and it is desirable to have a burning time approaching 5 min."

Consideration was first given to the advantage of additional safety inherent in low-pressure storage, and the use of fuel tanks of unconventional shape to increase the quantity of fuel carried. However, it was finally decided that the space available in the M4 tank lent itself well to the installation of fuel tanks of conventional shape, so that one of the advantages of low-pressure storage was considerably reduced. The use of rubber bladders to separate the flame-thrower fuel from the air in the fuel tanks eliminated the hazard of accumulation of explosive vapors in the tanks, and thus offered a promising method of increasing safety. Accordingly, it was decided to combine the rubber-bladder technique with a straightforward high-pressure fuel storage system.

5.12.2

Description^{52, 53}

Carrier. The E13R1-13R2 flame thrower was mounted in the M4A1 tank, with 76-mm gun and wet stowage. This vehicle had two important advantages: first, the batteries were located in the left sponson, resulting in a reduction of necessary rewiring; and secondly, greater space was available in this tank than in those mounting a 75-mm gun.

The main armament of the tank was replaced by the E13R2 flame gun, which was mounted in a dummy 75-mm gun. The auxiliary armament of the tank consisted of three .30-caliber machine guns, one .50-caliber machine gun, and small arms.

Propellant System. Air was used as propellant for the fuel and was supplied in two separate systems (Figure 31). The hull system provided propellant air for the two hull fuel tanks. The turret system provided air pressure for the closure of the gun pintle valve, and also supplied air for igniter fuel atomization and for propelling the main fuel, secondary fuel, and igniter fuel contained in separate tanks located in the turret.

The hull air supply was provided by two 3.12-cu ft capacity Navy air flasks connected in parallel, and another flask of the same size served the turret. The air was carried at 2,000 to 2,500 psi, and the combined capacity of the flasks, 9.36 cu ft, was sufficient to give a final pressure of about 250 psi in the hull tanks and about 550 psi in the turret tank.

High-pressure hose was used in the air lines to insure flexibility of movement between equipment items.

Fuel System. The fuel system consisted of three separate parts: the main fuel system, the secondary fuel system, and the igniter fuel system. The recommended primary fuel was Napalm-gasoline gel of approximately 400 g Gardner consistency. In each of the three systems, air was used as propellant, and contact between the air and the fuel was prevented by means of synthetic rubber bladders in the tanks. The fuel was stored outside the bladders, and was expelled from the tanks by inflating the bladders with air.

The main fuel system consisted of two hull

CONFIDENTIAL

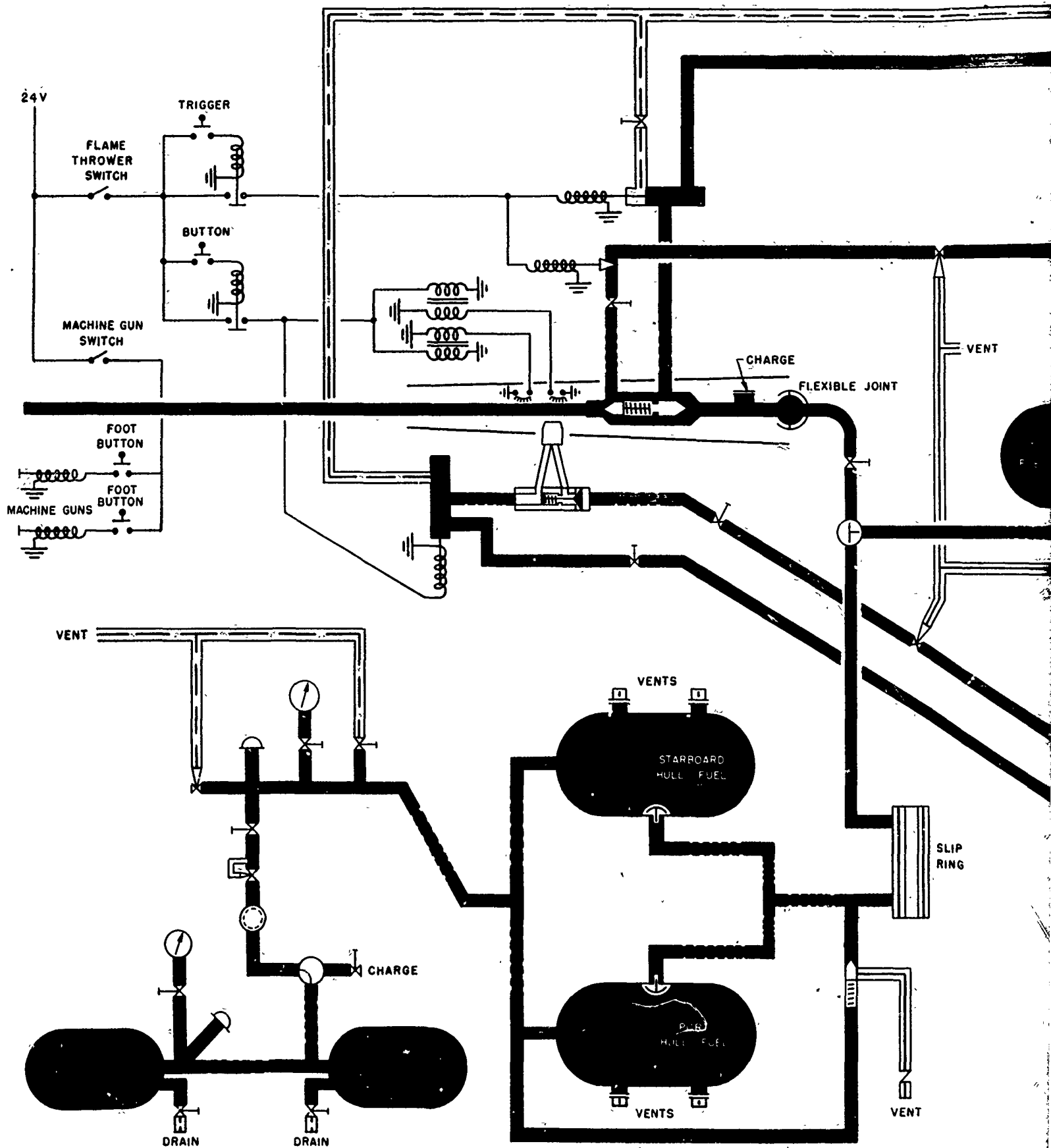
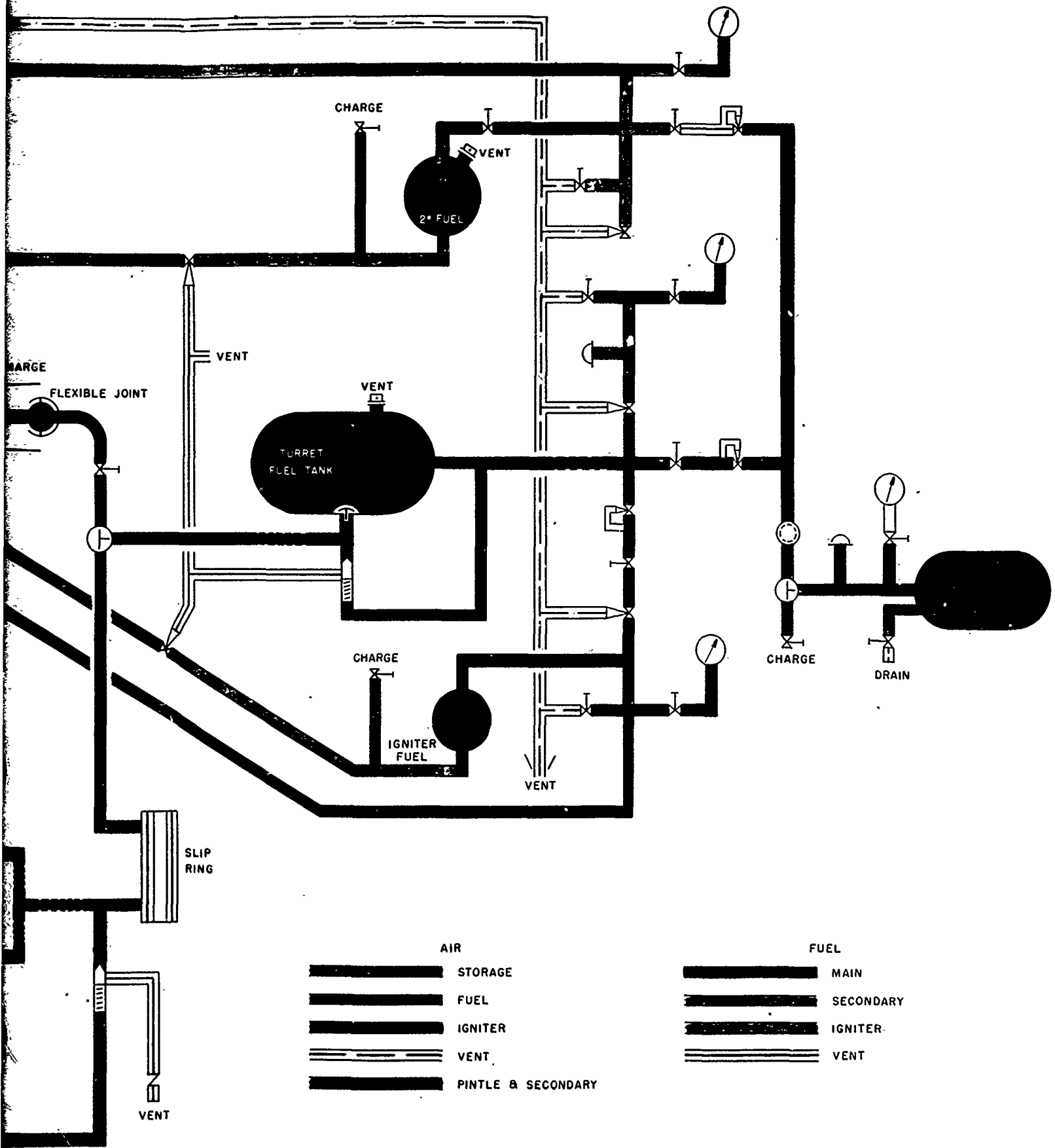

FIGURE 31. Flow sheet and wiring diagram for E13R1-13

CONFIDENTIAL



Sheet and wiring diagram for E13R1-13R2 flame thrower.

CONFIDENTIAL

fuel tanks located on either side of the vehicle driveshaft and the turret fuel tank, together with accessories and piping leading to the gun in the turret. All three tanks operated in parallel, but it was possible to select either the hull or the turret fuel separately by proper setting of a three-way fuel valve.

The fuel capacity of the tanks, in gallons, was as follows.

	Two hull tanks	Turret tank	Total
Internal volume	215	74	289
Capacity with bladders in place	209	71	280
Fuel delivered	193	66	259

In order to avoid damage to the synthetic rubber bags by fuel-outlet openings when the

the fuel lines to allow for differential movement of parts (Figure 32).

Secondary fuel was carried in one 14-gal cylindrical tank located in the turret, and the fuel was supplied at approximately 500 psi. Igniter fuel was contained in a 1-gal tank, which was designed for a safe working pressure of 6,000 psi, although operating pressure never exceeded 125 psi. Expansion relief valves protected all fuel systems against pressure due to temperature expansion.

Gun. The main armament of the flame thrower was the E13R2 flame gun, which was operated by a pintle valve located at the nozzle and was provided with interchangeable nozzles of $\frac{3}{8}$ -in., $\frac{1}{2}$ -in., and $\frac{3}{4}$ -in. diameters (Figure 33). The chief advantages of this type of gun

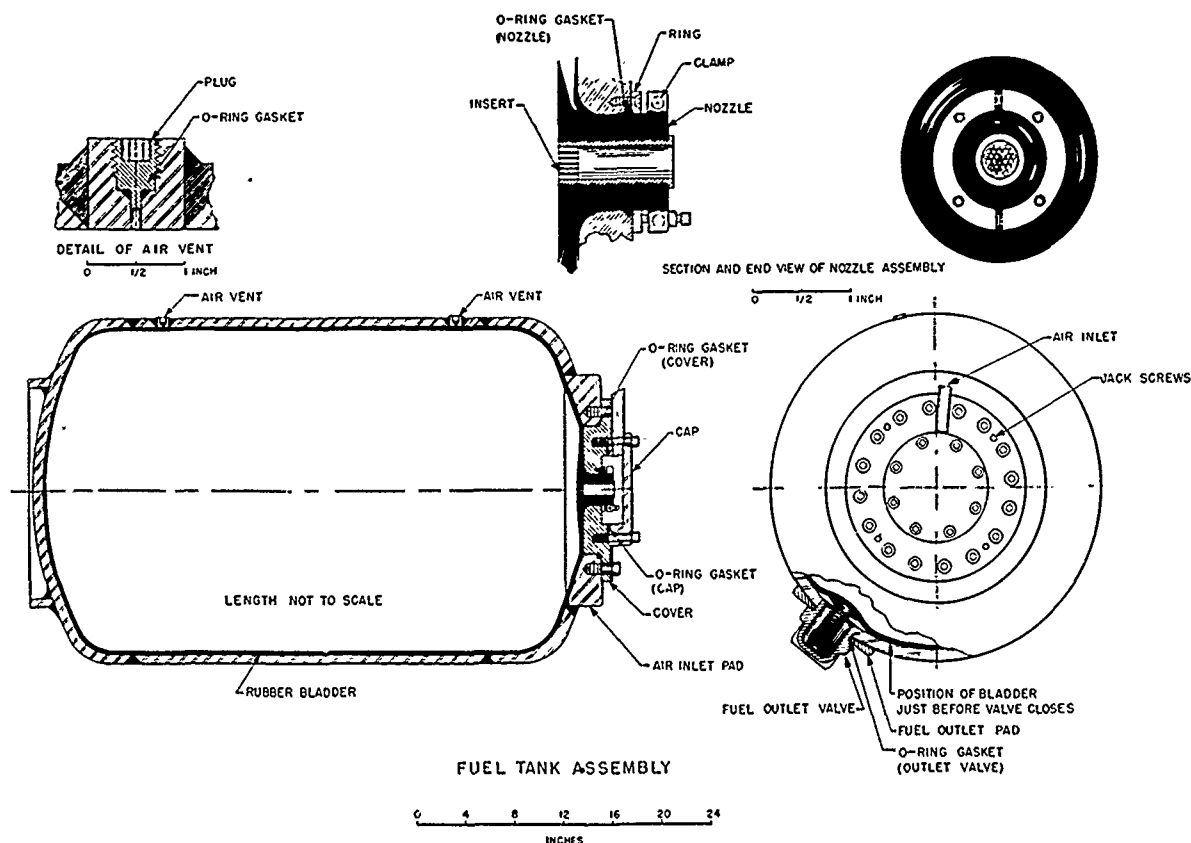
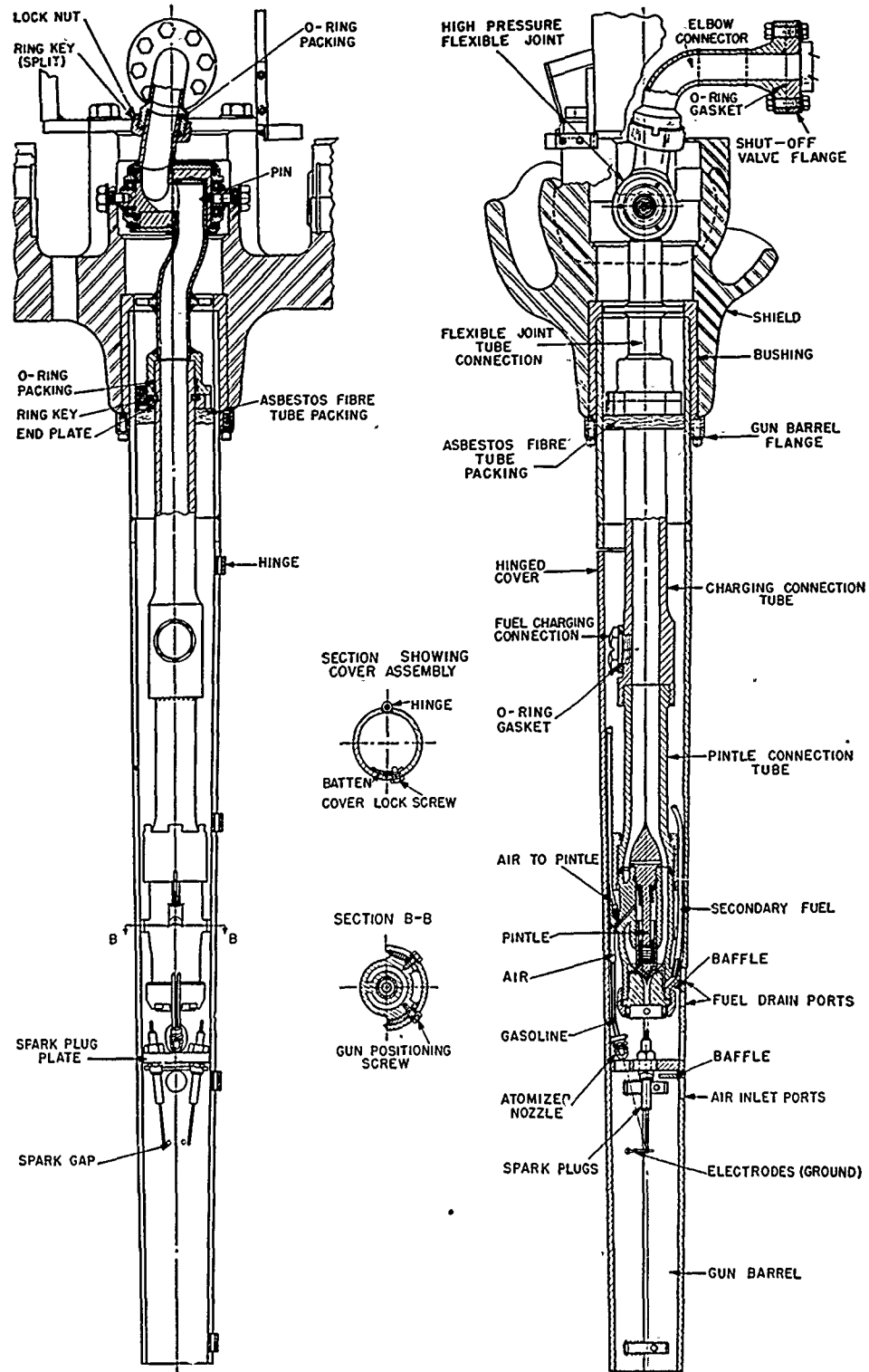

FIGURE 32. Cutaway of fuel-tank assembly for E13R1-13R2 flame thrower.

fuel tanks had been emptied, provision was made in the design for a suitably arranged spring-loaded poppet valve at each outlet. Flexible connections were employed as required in

appeared to be simplicity of construction and maintenance, and rapid and positive cutoff. The disadvantages lay in the fact that important control equipment was carried in the dummy

CONFIDENTIAL



GUN AND FLEXIBLE JOINT

FIGURE 33. Cutaway of gun and flexible joint for E13R1-13R2 flame thrower.

CONFIDENTIAL

gun barrel, which might be shot away in action.

Normally, the pintle was held closed by the pintle spring and air pressure in the pintle housing equal to or greater than the fuel pressure. The pintle was operated by releasing the air pressure in the pintle housing, permitting the fuel pressure to move the pintle backwards against the force of the spring to full open position. Admittance of air to the pintle housing closed the pintle. The nozzle pressure under normal operating conditions was approximately 300 to 350 psi.

Secondary fuel, controlled by a solenoid-operated valve, which was activated by the same circuit as the three-way air valve controlling the air and pintle, was admitted to the nozzle through a large number of radial orifices located just back of the position of the pintle seat on the nozzle.

Ignition System. The igniter was an adaptation of that used on the E7 gun (see Section 5.3). It consisted of an air-atomized gasoline jet which was ignited by high-tension sparks from two special plugs. The atomizer nozzle was mounted inside the cover of the dummy gun barrel. In order to prevent muzzle fires from igniter gasoline, a special air-operated atomizer control valve was installed just in the rear of the pintle-valve body.

5.12.3 Performance

Typical range data are cited in the following tabulation.⁵²

Nozzle, in.	Range, yd	Firing time, sec
$\frac{3}{8}$ "	90-105	200
$\frac{1}{2}$ "	110-125	110
$\frac{5}{8}$ "	125-140	70

A special CWS-NDRC Mechanized Flame Thrower Evaluation Group set up at Edgewood Arsenal carried out extensive tests of the performance of the E13R1-13R2 flame thrower, and arrived at the conclusion that the functioning of the unit was substantially faultless.⁵⁸ The group found that the ranges obtained with this

^a This size was later replaced by the $\frac{3}{4}$ -in. nozzle.

unit closely duplicated those obtained with the E12-7R1, in the description of which they are reported in more detail.

5.13 E19-19 FLAME THROWER IN M4A3 MEDIUM TANK

5.13.1 Introduction

The development of the E19-19 mechanized flame thrower for the M4A3 medium tank retaining its main armament was initiated by Iowa University under OSRD Contract OEMsr-1480 in April 1945. Until that time, emphasis had been placed on the development of mechanized flame throwers which displaced the main armament of the armored vehicle, this displacement being considered necessary in order to obtain sufficient fuel capacity in existing tanks. On the basis of objections to the resulting lack of fire power and the need for supporting tanks during combat operations, work was undertaken on the design of a flame thrower with a large-capacity flame gun and fuel storage, combined with full main armament and adequate ammunition.

The M4A3 medium tank, equipped with a 76-mm gun with wet ammunition stowage in the hull, was selected as the basic vehicle, the following requirements being imposed upon the design. The gun, as well as all other existing armament, was to be retained, although about half of the 76-mm ammunition-stowage capacity was to be sacrificed to make room for the flame-thrower installation. The tank silhouette was to be altered as little as possible, and the modifications to the tank were not to displace any member of the tank crew. The flame gun employed in the design was to be capable of operation with conventional thickened fuel and liquid secondary fuel. The nozzle diameter was set at $\frac{3}{4}$ in., and the main fuel pressure was to be about 450 psi; otherwise, it was proposed to employ any current flame gun best fitted for the design with as few modifications as possible. The flame thrower was to be capable of field installation in existing M4A3 tanks, all necessary equipment being supplied in kit form.

CONFIDENTIAL

Work on the development of the E19-19 was halted at the end of World War II because of obsolescence of the M4 tank. Prior to termination, the design for the flame gun and mount had been completed, working drawings for all parts of this assembly being nearly ready. A wooden "mock-up" of the flame gun assembly had been completed, and working experimental models of the flame gun proper and of the ignition system had been constructed, and were ready for tests.

5.13.2 Preliminary Location Studies

Preliminary to the detailed design of the mechanized flame thrower, studies were made as to placement of the flame gun on the tank structure. These studies resulted in the examination of six different plans by means of layout drawings and scale models (Figure 34).

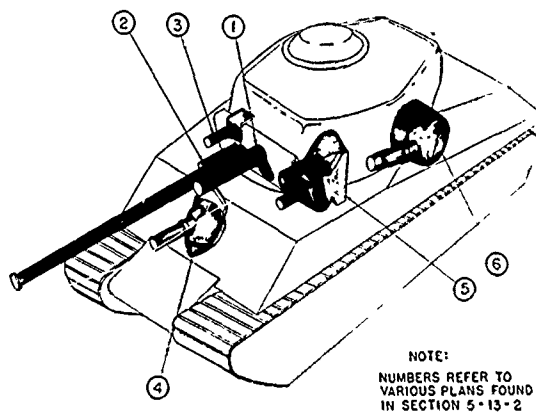

FIGURE 34. Various positions of flame-thrower gun installation for E19 mechanized flame thrower.

The plans were numbered 1 through 6; Plans 2 and 3 were abandoned at an early stage; and Plan 5 was finally adopted for the location of the flame gun and mount.

Plan 1 Coaxial Gun-Shield Mount. This plan mounted the flame gun on the main gun shield, on the port side of the 76-mm gun; thus the flame gun shared the elevation and depression limits of the 76-mm gun, viz. +25 to -10 degrees. Elevating, traversing, and sighting controls were the same as used for the 76-mm gun. Because of insufficient available space near the 76-mm gun, the flame gun flexible joints could

not be mounted on the axis of rotation, and 3 such joints were therefore required.

Plan 2 Starboard Coaxial Gun Mount. The design differed from Plan 1 only in that the flame gun was mounted on the starboard side of the 76-mm gun, and was abandoned because it offered no advantage over Plan 1.

Plan 3 Starboard Front Turret Mount. This plan mounted the flame gun above the main gun shield and to the starboard of the 76-mm gun, and elevation of the gun was accomplished through a linkage to the 76-mm gun. This design had the disadvantage of insufficient space for adequate armor without interfering with the gunner's vision, and it was therefore abandoned in favor of the generally similar Plan 5.

Plan 4 Center Front Hull Mount. This design was attractive because it required no slip ring below the turret. Flame gun traverse was 180 degrees; elevation was from +60 to -10 degrees. A complicating factor was the possibility of interference between flame gun and 76-mm gun.

Plan 5 Port Turret Mount. This plan was selected for full development. The flame gun was mounted to the left of the gun shield, and was attached to the turret. The flame gun trunnion axis was collinear with the 76-mm gun trunnion axis. Flame gun elevation, obtained by a 2:1 gearing connected to the main gun shield, was from +50 to -20 degrees. Detailed description of this gun mount is presented elsewhere in this section.

Plan 6 Pistol Port Mount. This plan utilized the pistol-port opening for mounting the flame gun, permitting traverse of 360 degrees with the turret and elevation from +60 to -10 degrees.

5.13.3 Description of Approved Design

Carrier. The E19-19 flame thrower was to be mounted in the M4A3 tank, which retained its main armament but was slightly modified to accommodate the flame-thrower system. The right side of the hull was made available for main fuel storage, at the sacrifice of slightly less than half of the 76-mm ammunition-stowage capacity. Secondary and igniter fuel were

CONFIDENTIAL

to be carried in the turret, while the compressed air for the expulsion of the main fuel was to be stored on the right sponson. The flame gun mount consisted of a blister to the port side of

cutting off the left end of the shield 19.5 in. from the 76-mm center line and welding on a transition section to replace the cutoff portion. This transition section served the dual purpose

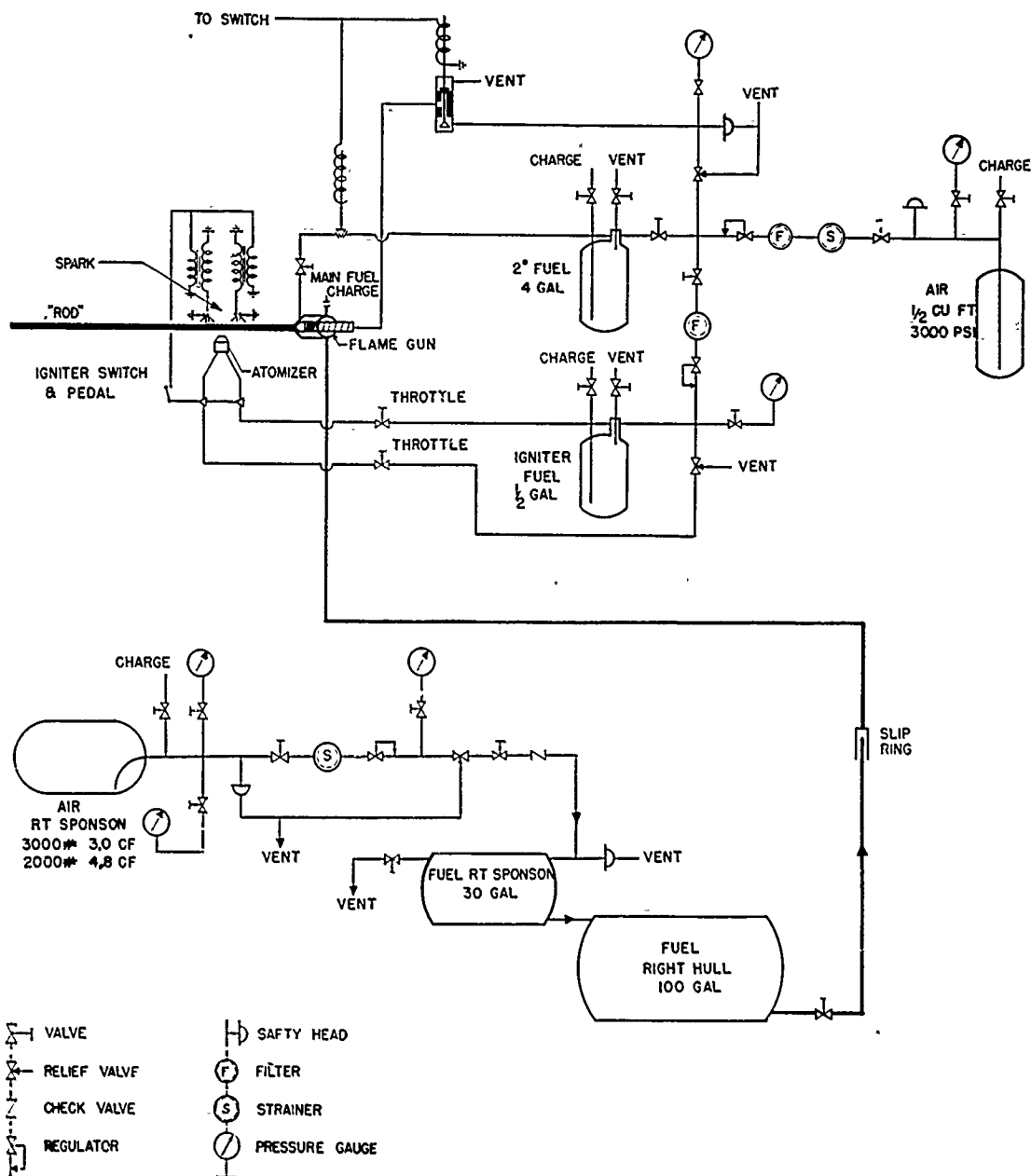

FIGURE 35. Flow diagram for E19-19 flame-thrower installation.

the turret in such a manner that the axis of elevation of the flame gun coincided with the trunnion axis of the 76-mm gun. The gun shield, as it existed in the M4A3, was modified by

of providing a shield for part of the flame gun blister and of transmitting the motion of the 76-mm gun to the flame gun.

Propellant System. Compressed air was con-

CONFIDENTIAL

templated as propellant in the E19-19 flame thrower, the air for expelling the main fuel being stored at 3,000 psi in 1 cylinder of 3 cu ft capacity located in the right sponson, while the air for expelling the secondary fuel and atomizing the igniter fuel was stored at 3,000 psi in one cylinder of 0.5 cu ft capacity located in the turret. The compressed-air cylinder communicated with the fuel tanks through pressure regulators, maintaining 390 psi over the main fuel, 440 over the igniter fuel. The high-pressure air storage cylinders were equipped with safety heads set at 3,750 psi.

Fuel System. The main fuel for use in the E19-19 flame thrower was to be thickened gasoline, stored in a 100-gal fuel tank in the hull and a 30-gal fuel tank in the right sponson (Figure 35), the fuel tanks being equipped with 550 psi relief valves and 700 psi safety heads. The limited fuel capacity of 130 gal resulted in a total firing time of 25 to 30 sec for the $\frac{3}{4}$ -in. nozzle recommended.

The secondary fuel consisted of liquid gasoline, stored in one 4-gal container located in the turret. Secondary fuel was normally to be supplied at the rate of 3 per cent of total fuel, but the exact rate was controllable by means of a throttle valve. Igniter fuel was stored in one 0.5-gal fuel tank in the turret, allowing the use of the fuel at a rate of 2 gal per hr for twice the total firing time.

Gun. The flame gun used in the E19-19 flame thrower was essentially a modified combination of the I-3 gun and the E13 gun (see Sections 5.9, 5.11, 5.12). The E19 gun employed the same pintle and spring as was used in the E13 gun; provision was also made for admitting secondary fuel around the nozzle in the same location relative to the pintle valve, and the internal contours of the nozzle were quite similar to those of the E13 gun (Figure 36). The E19 gun resembled the I-3 gun in that the main fuel feed came in at right angles to the axis of the flame gun, and the axis of rotation for elevation coincided with the fuel line. To permit elevation and depression, a simple slip joint was provided. Main fuel cutoff was at the pintle valve. The nozzle diameter was $\frac{3}{4}$ in.

The flame gun could be elevated and depressed in a 2:1 ratio with respect to the 76-mm

gun, the actuating torque being supplied from the special extension attached to the 76-mm gun shield. This ratio was accomplished by the use of a pinion gear on an actuating arm meshing with a stationary gear sector on one side and a similar sector on the other side attached to the gun. Maximum elevation was 50 degrees, maximum depression was 20 degrees, from the horizontal. Traverse was full 360 degrees.

Ignition System. The ignition system of the E19 gun substantially resembled that of the E13 gun, although the mechanical details differed considerably. The two spark plugs were Champion 0a45-Ex. 1, and were mounted in such a manner as to be removable from the front. The spark-plug wires led from the spark plugs forward along grooves in the ignition barrel, and ultimately returned through the turret wall to the source of high tension necessary for operation of the spark.

The atomizer nozzle was the same as in the E13 gun (De Vilbiss Model 5100), and was located in almost the same position. The total axial length from the front tip of the pintle valve to the spark-plug point at the ground electrodes was 9 in. The distance from the tip of the atomizer nozzle to the spark point at the ground electrodes was 6.25 in.

Controls. Flame gun elevation and depression control was effected by use of the 76-mm gun elevation hand wheel; traversing control was obtained by rotating the turret.

Individual firing controls were contemplated for the igniter fuel and for the main fuel. The igniter control, a foot pedal, turned on the fuel and air to the atomizer nozzle and actuated the sparks. The trigger-operated main fuel control simultaneously exhausted the air behind the pintle valve, thus allowing the latter to open under the main fuel pressure, and opened a valve in the secondary fuel line to permit flow of secondary fuel into the flame gun nozzle.

Sighting for the flame gun was through the gunner's periscope, which would have to be rebuilt to function properly as a sighting device for both guns. This rebuilding would have to include the provision of a 2/1 actuating linkage to permit the periscope to be rotated either directly with the 76-mm gun or at twice the angular rate with the flame gun.⁵⁴

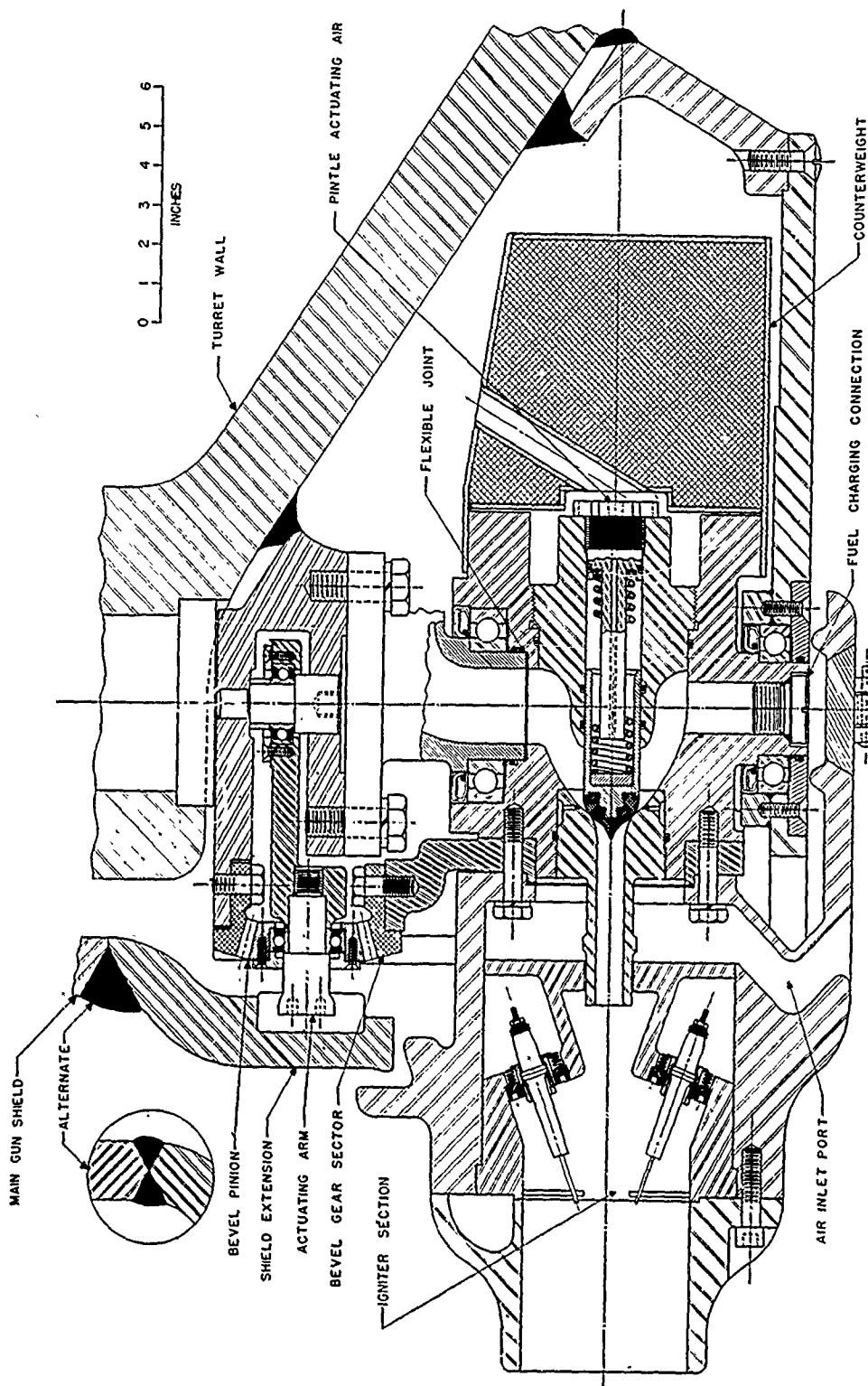

FIGURE 36. Cutaway of E19 gun, flexible joint, and mount.

CONFIDENTIAL

5.14 E20-20 (T33) FLAME THROWER IN M4A3 MEDIUM TANK

5.14.1 Introduction

The development of the E20-20 was begun in May 1945, with the Standard Oil Development Co. under Contract OEMsr-390 acting as consultants.⁵⁵ This particular development of installing a long-range, large-capacity flame gun in an M4A3E2 (heavily armored M4A3), with the main armament retained, resulted from the success of the British Crocodile tank-trailer unit and the POA Model with the 75-mm cannon and flame gun mounted coaxially. In addition to the cannon and flame gun, it was planned to install a small auxiliary turret flame thrower, E21 (CWS periscope gun E6). Although projecting through separate turret shields the flame gun E20, improved Model Q or E7, and the 75-mm cannon are essentially coaxially mounted. To accommodate these weapons, it was necessary to design a special turret. The construction was done by M. W. Kellogg with the CWS and Ordnance furnishing additional help. Upon termination of Contract OEMsr-390, basic design of the flame-thrower installation had been completed and a trial mockup made in the hull. Prior to the termination of World War II it was anticipated that the E20-20 (T33) would ultimately replace the M5-4 (E12-7R1) main-armament, medium-tank flame thrower then in commercial production (Figure 37).

5.14.2 Description³

Carrier. The E20-20 (T33) was mounted in an M4A3E2 (heavily armored M4A3) medium tank (Figure 38). The major difference between the standard M4A3E2 and the flame-throwing installation was the special turret with broadened front, extended rear overhang, slightly increased height, approximately 4 in., and a double-barrel main armament.

The 75-mm gun was an M-6 light weapon which was employed in aircraft and in the M-24 light tank. This weapon was chosen principally because the assembled unit was smaller than

the 75-mm cannon normally installed in United States medium tanks, providing more working space in the turret and permitting sufficient clearance for installation of the special M5-4 flame-thrower rotary joint in the basket floor. The M-6 used standard 75-mm ammunition, of

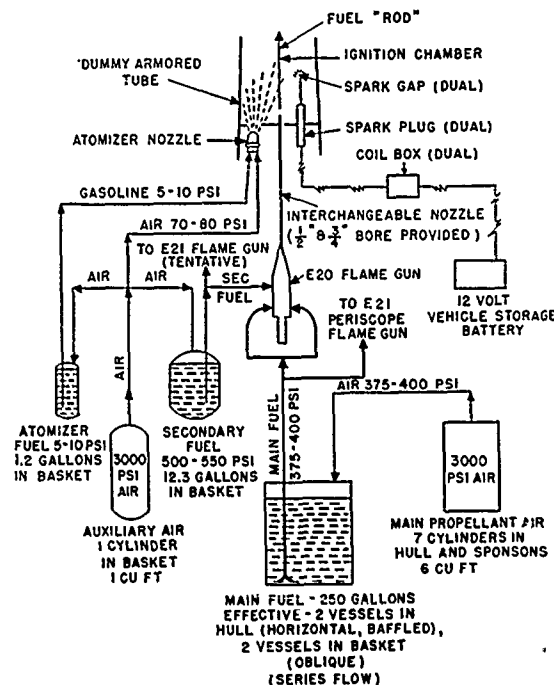

FIGURE 37. Simplified flow plan of flame-thrower tank T-33.

which 5 to 10 ready rounds were carried in the E20-20 basket to augment the 40 to 45 rounds stowed in the right sponson.

Propellant System. Propellant gas was stored in 2 segregated systems at an initial pressure of 3,000 psig, this high starting pressure being employed to minimize storage space requirements and allow maximum room for stowage of 75-mm ammunition. Main propellant gas was carried in seven horizontal cylinders, 6 cu ft total, connected in parallel and located in the sponsons and hull. Sufficient space was allowed to store 75-mm ammunition on the forward right sponson shelf. Propellant gas from the seven containers discharged through a pressure regulator to the top of the right hull main fuel tank, maintained 375 to 4,000 psig operating pressure behind the fuel. Auxiliary propellant gas was stored in a 1-cu ft vertical cylinder be-

CONFIDENTIAL

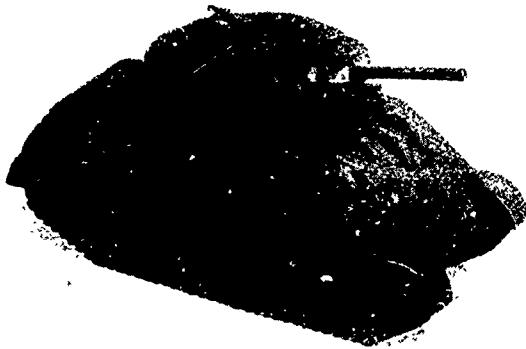

FIGURE 38. Model of T-33 flame-thrower tank. Note enlarged turret and dual guns.

hind the gunner in the left rear basket. This supply through pressure regulators furnished propellant pressure for secondary and igniter fuels for the E20, igniter air for the E20 atomizer nozzle, and operating pressure for both the E20 and E21 flame guns.

Fuel System. The same main fuel supplied both the E20 and the E21 flame guns, and was carried in four cylindrical pressure containers, 270 gal gross capacity, piped in series. Two of these vessels were horizontal containers with internal baffles for improved outage located in the hull beneath the turret basket (Figure 39), which was shortened approximately 7 in. to accommodate the containers. The hull fuel system was piped to the turret through a special rotary joint (same as employed in the E12-7R1 medium-tank flame throwers) in the center of the basket floor. The rotary joint carried both main fuel and multiple electrical power and interphone circuits from the hull to the turret, discharging flame-thrower fuel in to the turret fuel containers. Two main fuel containers were located beneath the turret roof, each vessel sloping downward to the rear for improved outage (Figure 40). These vessels straddled the tank commander's position in the rear center of the turret basket, and discharged forward along the right turret wall to the trunnion elbows feeding the E20 flame gun. A valved feeder from this line also led through a flexible hose to the E21 periscope gun. Approximately 260 gal of main fuel was charged through a protected connector in the turret roof, flowing in reverse through the fuel system to the hull

containers and overflowing, when filled, from the right hull vessel through an external vent.

Secondary fuel was stored in a vertical container, 12.3 gal, behind the loader in the right rear basket. This fuel was delivered into the

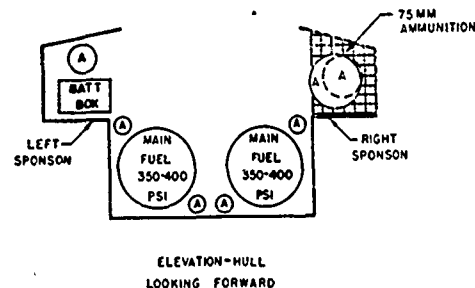
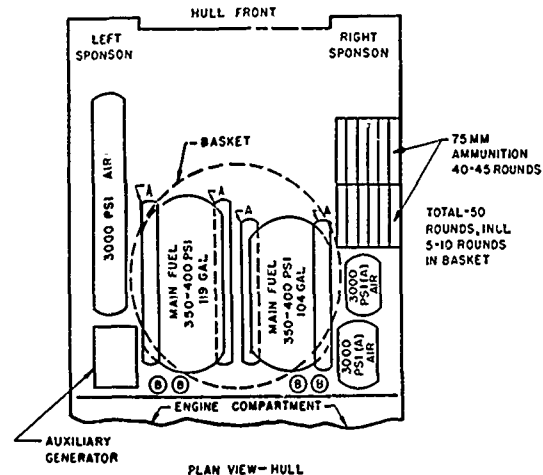

FIGURE 39. Flame-thrower tank T-33 (E20-20) in M4A3E2 medium tank showing schematic layout of hull.

E20 flame gun at 500 to 550 psig through the main control valve, which simultaneously opened the weapon internal fuel valve. Pending development by CWS of necessary E21 modifications, it was tentatively planned to supply secondary fuel from the source described above to the periscope flame gun. This would permit the auxiliary flame thrower to use heavier thickened fuels, commonly employed with larger flame guns and relatively difficult to ignite without secondary fuel in adverse winds or in cold or wet weather. The supply of secondary fuel was based upon anticipated employment of both main and auxiliary flame throwers. Secondary fuel filling and venting was effected through protected external openings adjacent to the

CONFIDENTIAL

main fuel charging connection in the turret roof.

E20 Gun. The E20, a slightly modified E7R1 flame gun, has been described in Section 5.3.

traverse of the auxiliary flame gun, relative to the turret, over approximately a 240-degree arc to the rear. The E21 gun will be limited to the elevation and depression available through the periscope holder, forward fire from the turret

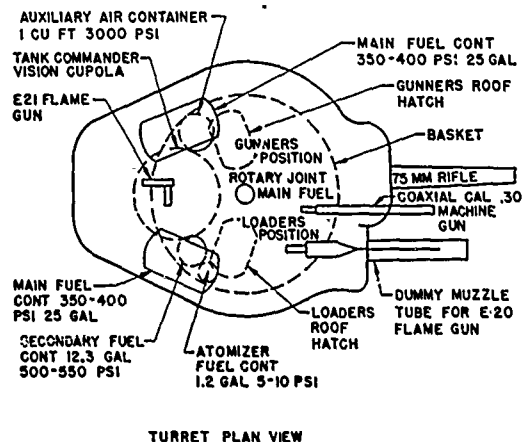
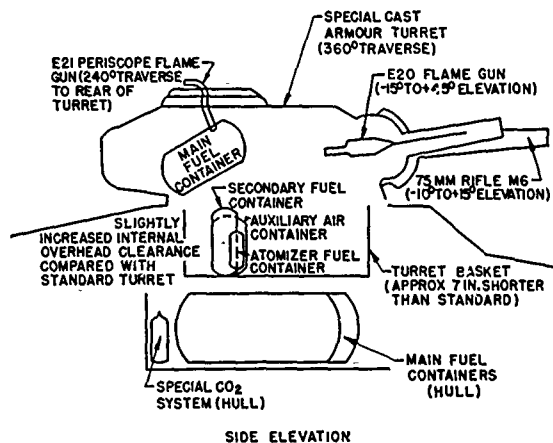

FIGURE 40. Flame-thrower tank T-33 (E20-20) in M4A3E2 medium tank showing schematic layout of turret.

The major difference was the length of the nozzle extension, which was 21 in. for the E20. The auxiliary flame gun, E21, was designed for flank protection in jungle or close fighting, and was the CWS periscope gun E6 which could be installed or removed quickly in the field. The E21 could be mounted in the normal manner through the periscope holder in the center of the tank commander's vision cupola. This vision cupola was located in the rear center of the turret roof over the tank commander's position in the basket, and provided for limited direct manual

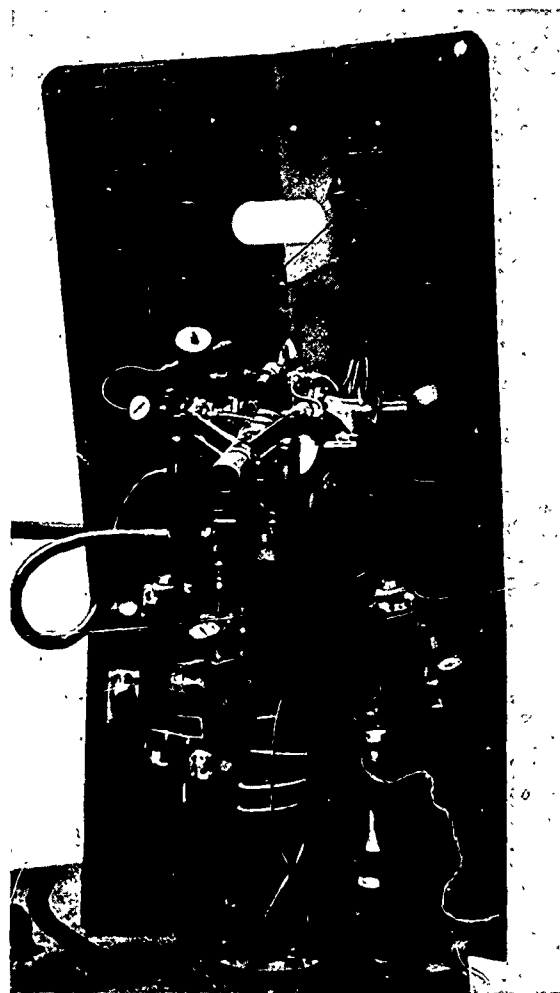

FIGURE 41. E7 gun mount for pump-operated flame thrower.

being eliminated to preclude firing into the turret roof at maximum E21 depression. The remaining operation of the gun remains the same.

Ignition System. Atomizer or igniter fuel for the E20 flame gun is carried in a 1.2-gal vertical container adjacent to the secondary fuel tank. This fuel flows at 5 to 10 psig through a dual atomizer valve which is actuated by the E20 main fuel-firing pedal and simultaneously delivers gasoline and air to the atomizer noz-

CONFIDENTIAL

zle ejecting into the dummy tube ignition chamber. Protected external filling and vent connections are adjacent to those for secondary fuel in the turret roof.

The E20 ignition system consists of atomizer fuel, atomizer air, and electrical circuits simultaneously actuated by the flame gun-firing pedal prior to opening of the internal fuel valve. Atomizer fuel and air form gasoline spray in the dummy gun tube ignition chamber to be

5.15 PUMP-OPERATED FLAME THROWER IN MEDIUM TANK

5.15.1

Introduction

An experimental investigation of pump-operated flame throwers was begun in 1945 by the Eastman Kodak Co. under OSRD Contract OEMsr-538. Earlier attempts at pump-propelled flame throwers in 1942-1943 had been

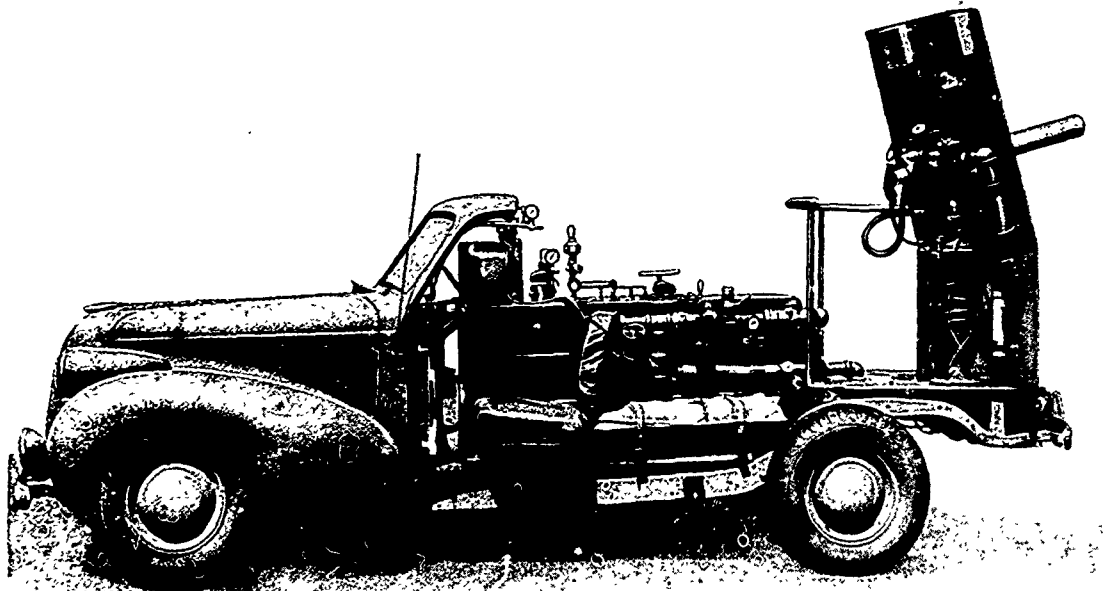

FIGURE 42. Experimental pump-operated flame thrower mounted on Buick chassis.

ignited by dual sparks. Dual spark-coil boxes feed 12,000 v potential to the ignition-spark plugs from the vehicle 12-v d-c supply, delivered through the firing pedal ignition switch. The ignition system is identical with the E12-7R1, described in Section 5.7, a simplified flow plan of which is shown in Figure 18.

5.15.3

Performance

Performance data on the flame throwers installed in the E20-20 was not obtained at the time of writing, since the units had yet to be completed.

unsatisfactory, and compressed gas was accepted as a standard means of fuel propulsion. In 1944 a theoretical paper on the relative merits of pump propulsion as opposed to compressed gas was published.⁵⁶ In this paper the results of calculations, based upon certain assumptions, indicated that pump propulsion possessed an advantage over the accepted compressed-gas method only with units having small nozzles and large fuel capacity. In the light of this, pumps received little attention until early 1945 when a reconsideration of the theoretical aspects of pumps, especially with regard to pump speeds, indicated a possible advantage in their use.⁵⁷ Accordingly, NDRC

CONFIDENTIAL

launched a project to study the behavior of fuels in pump-propelled flame throwers.

Preliminary experiments with several pumps and jets indicated that the characteristics of the pump-propelled jet differed somewhat from the gas-compressed flame thrower.^{58, 59} These differences called for the incorporation of several new features of design. Besides the substitution of a pump for the air bottles, a surge chamber has been introduced to eliminate the pulsating due to the pump action, a blower has been added to maintain a positive pressure on the fuel tank, and a by-pass system has been used to permit the pump to operate at low pressures. Since the object of the project was to demonstrate the advantages of a pump-propelled flame thrower, it was not considered advisable to design a new gun. Therefore, the E7 gun was used, though this made necessary the provision of a pump for the secondary fuel and a small compressor to supply compressed air to actuate the valves.

5.15.2

Description^{60, 61, 62}

The Eastman pump-operated flame thrower shown in Figures 41 and 42 may be briefly described as follows: An Imo screw pump utilizing standard rotors, the same size as those of the Imo A32P, is mounted inside a rectangular fuel tank. This tank is mounted on a Buick chassis and the power for the pump is taken from the Buick driveshaft by means of a chain drive. The discharge of the pump passes

through a four-way pilot-operated hydraulic valve in conjunction with an ordinary relief valve, thence through a surge chamber and to the standard E7 flame gun. Provision is made for pressurizing the main fuel tank to about 5 psi by means of a rotary positive-displacement blower. Air pressure for actuation of the valves of the E7 gun is provided by a small compressor. The flow design is shown in Figure 43.

The Pump. The Imo pump, specially designed for the purpose, is fitted with a large bell-mouth inlet placed $\frac{1}{2}$ in. above the floor of the fuel tank. The outlet at the top of the pump is 2 in., and the piping is standard 2 in. with extra heavy fittings.

By-Pass System. The four-way hydraulic valve with its relief valve is mounted directly above the pump inside the fuel tank. The solenoid-operated pilot valve is mounted at the top of the fuel tank with leads from the main fuel pump and to the four-way valve as shown in Figure 43. With the pilot valve open, the four-way valve passes the fuel back to the tank at low pressure. With the pilot valve closed, the fuel passes to the flame gun line. The maximum pressure in either line, by-pass or flame gun, is limited to 440 psi by a regular relief valve which returns any excess fuel to the supply tank. The pilot valve, which controls this system, is actuated by a 12-volt solenoid.







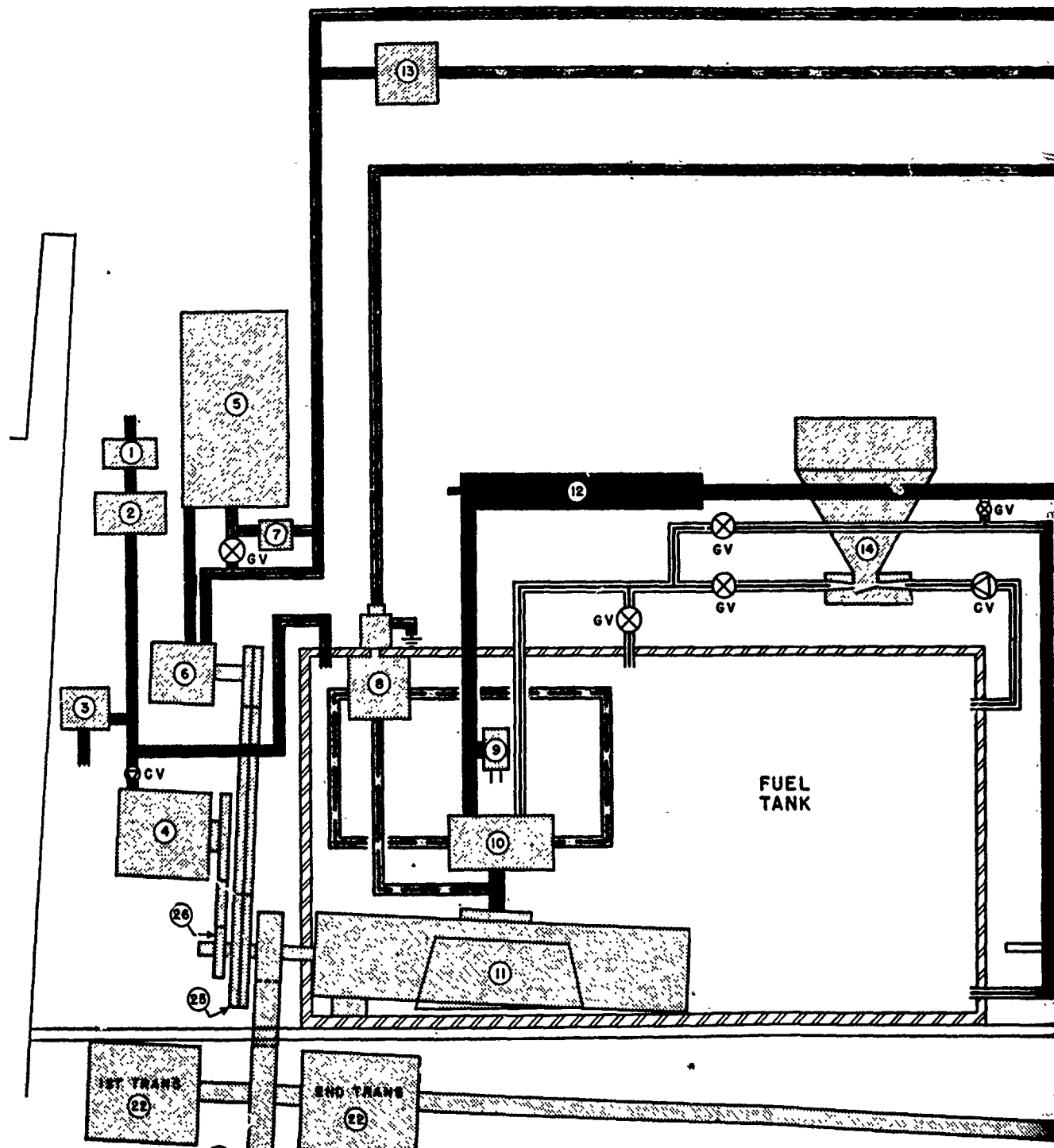

The Fuel Tank. The fuel tank is 26x26x66 in., approximately 185 gal; the bottom and the end, through which power and piping connections pass, are of $\frac{3}{8}$ -in. steel plate. The remainder,

1. 1-in. Kodak Park standard type flame arrester.
2. $\frac{3}{4}$ -in. standard 125-lb quick-opening valve.
3. $\frac{3}{4}$ -in. Star brass 10-lb relief valve.
4. B-W superchargers blower, 3,600 rpm, 20 cfm, at 5 psi.
5. 15-gal drum type gas tank.
6. IP, 739 C 500 psi, 5 gpm, 1,000 rpm, (by-pass) Pesco pump.
7. $\frac{3}{4}$ -in. 500-lb Vickers relief valve.
8. $\frac{1}{4}$ -in. solenoid actuated pilot valve.
9. 2-in. 400-lb Ashton hydraulic relief valve.
10. $1\frac{1}{2}$ in. 1,500-lb pilot operated Logansport four-way valve.
11. Special 32P 231 1,800 rpm, 150 gpm, 500-lb Imo pump.
12. Kodak Park designed surge chamber.
13. Grove reducing valve, 500-lb to 7-lb for igniter gasoline.
14. S 2J National foam generator, navy-type mixer injector, 2-in. pipe.
15. Regular E7 flame-thrower gun.
16. Shield.
17. Grove reducing valve, 1,650-lb to 500-lb for pintle actuation and gun control.
18. Cornelius compressor, 1,500-lb, 52 cu in. per 12 min, weight 10-lb, 24-v, d-c motor.
19. Grove reducing valve, 1,650-lb to 50-lb for igniter air.
20. 1,500-lb air bottle, 200 cu in.
21. Four 6-v batteries to give 24 v.
22. Standard 39 Buick transmissions.
23. Morse silent-chain transmission system, 1- $\frac{3}{4}$ x $\frac{3}{4}$ -in. pitch.
25. Double V-belt drive for Pesco pump.
26. Single V-belt for BW superchargers blower.

FIGURE 43. Flow diagram of Eastman pump-operated flame thrower.

CONFIDENTIAL



-  MAIN FUEL LINE
-  INJECTION AND RECIRCULATION
-  AIR LINES
-  SECONDARY FUEL
-  IGNITER FUEL
-  BATTERY LINES
-  PILOT LINES FOR FOUR-WAY VALVE
-  BLOWER SYSTEM FOR MAIN TANK

CONFIDENTIAL

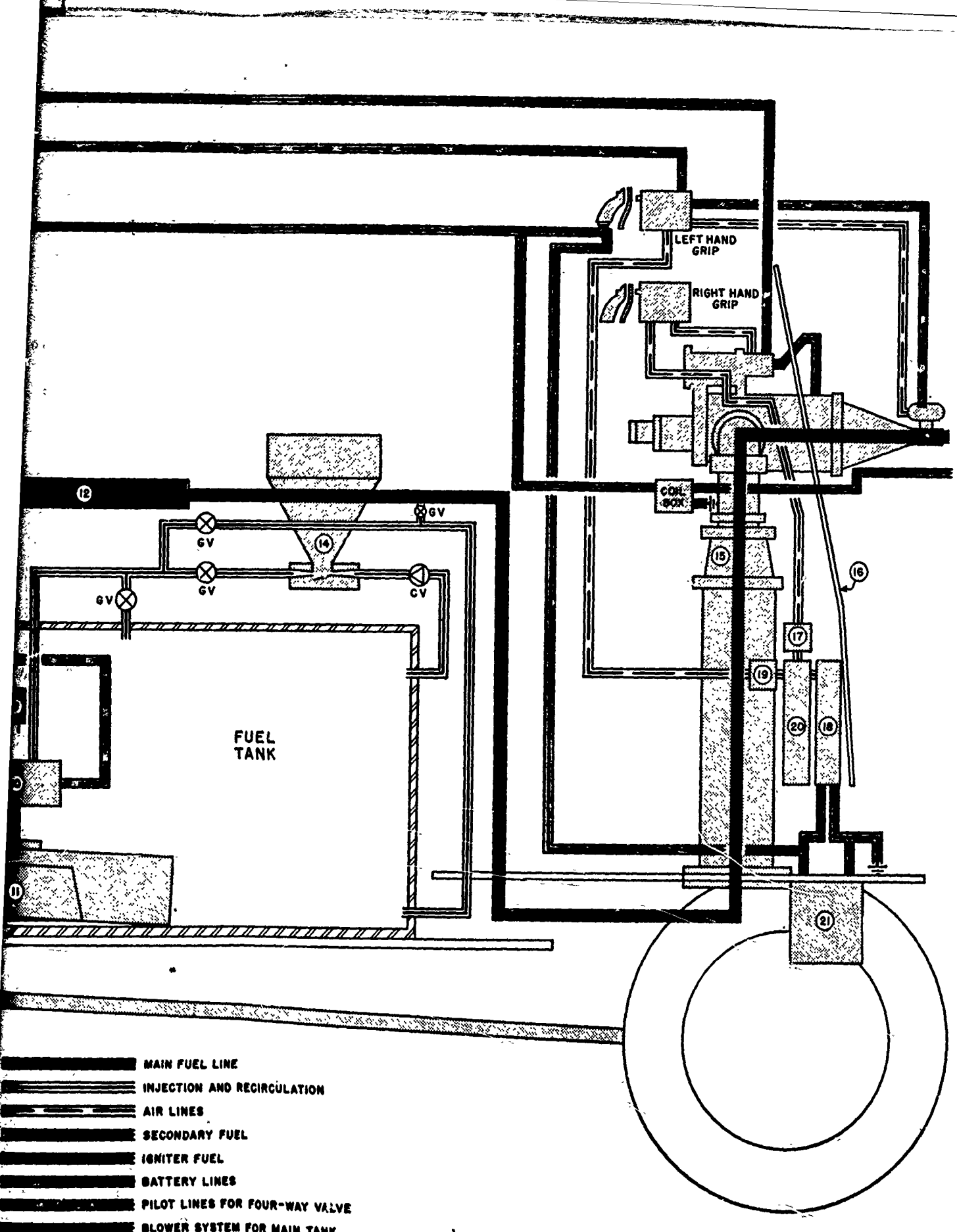

- MAIN FUEL LINE**
- INJECTION AND RECIRCULATION**
- AIR LINES**
- SECONDARY FUEL**
- IGNITER FUEL**
- BATTERY LINES**
- PILOT LINES FOR FOUR-WAY VALVE**
- BLOWER SYSTEM FOR MAIN TANK**

CONFIDENTIAL

except for a 24x24-in. manhole, is 1/8-in. plate strengthened with horizontal pressed ribs 8 1/2 in. apart and 1 3/4 x 1/4-in. vertical bars tack-welded 9 in. apart inside the tank. The tank will withstand 20-psi hydrostatic pressure without any appreciable distortion. Its total weight including a 90-lb, 26x26 3/8-in. steel plate cover is 635 lb.

A blower which can supply air to the fuel tank up to 7 psi at the required rate has been installed in order to overcome cavitation at the pump inlet as the boiling point of gasoline is approached.

is set to operate whenever the pressure in the air bottle drops below 1,500 psi. The bottle pressure is reduced to 500 psi for gun actuation and 50 psi for atomizer air by means of regulators. The gasoline for secondary and ignition fuel is supplied by a fuel-injection pump which delivers at 500 psi the 5 gal per min required for secondary fuel and through a reducing valve (7 psi) the 0.05 gal per min required for ignition fuel.

Power Source. The unit is powered by a Buick engine equipped with compound carburation. Power for the pump is transmitted by a chain

TABLE 2. Comparison of pump-operated and air-pressurized flame throwers. Eastman pump-operated flame thrower on Buick chassis with 1/2-in. regular nozzle (E7-R1 Gun) vs E12-7R1 flame thrower with 1/2-in. extension nozzle (in M4A1 tank).

Fuel for both guns, 6% Imperial 230 g Gardner

Nozzle height above ground: E12-7R1, 7 1/2 ft; EPOFT, 6 ft

Code No.	Gun elev.	Rpm Main fuel pump	Main fuel pressure		Surge chamber pres. operating (preloads to 100 psig)	Wind velocity mph	Wind direction	Range† Center of deposit
			Pump or fuel tanks	Nozzle*				
P‡	5°	1,500	400	340	360	1	Cross	85
SOD§	5°	350	0	83
P	10°	1,500	380	340	360	0	100
SOD	10°	350	0	100
P	10°	1,250	270	250	240	3	Cross	87
SOD	10°	300	3	Cross	85
P	10°	1,350	305	270	265	1	Head	97
SOD	10°	350	1	Head	97
P	4°	1,250	265	240	235	1.5	Cross	83
SOD	4°	350	1.5	Cross	87

*Measured 3 ft behind nozzle.

†Each value represents the average of two runs.

‡EPOFT.
§E12-7R1.

Surge Chamber. The surge chamber consists of a synthetic rubber bag in a 3-in. perforated tube, both being enclosed in a 4-in. pipe. The fuel passes through the annular space between the bag and the outer shell. The rubber bag is preloaded with air to a pressure lower than the operating pressure of the pump. Its contractions and expansions remove pressure pulsations from the pump discharge. Only by this design of a surge system of minimum inertia was it found possible to remove pump pulsations sufficiently to protect the fuel jet against breakup in the air.

Flame Gun. The compressed air for the E7 gun is furnished by a small compressor which

drive, and power for the blower and secondary pump by V-belt drives from the main pump shaft.

5.15.3

Performance

Pulsations. The serious pulsations associated with earlier pumps were not found in the present Imo pump. With the surge chamber preloaded to 100 psi, and with operating pressures of 200 to 330 psi, no visible pulsations were recorded. However, when the pre-loaded pressure was increased to a pressure higher than operating pressure, equivalent to no surge chamber, a pulsation of but 1 to 2 psi was obtained. A

CONFIDENTIAL

major function of the surge chamber is that of absorbing shock when going from low to high pressure or closing the main gun valve.

Range. A fuel of approximately 250 Gardner gives an effective range of 100 yd using a 1/2-in. nozzle and 200- to 350-psi pressure. The range data compare favorably with those of the E12-

7R1 flame thrower operating under similar conditions (Table 2).⁶²

Holdup. The fuel left in the tank after channeling first occurred was about 6 in. for a 6 per cent fuel and 8 in. for an 8 per cent fuel. This amounts to 20 to 30 per cent of the total fuel capacity.

CONFIDENTIAL

Chapter 6

MISCELLANEOUS FLAME WARFARE ITEMS

6.1 INTRODUCTION

THIS CHAPTER DESCRIBES a variety of miscellaneous developments and investigations undertaken by Division 11 of NDRC in conjunction with the general field of flame warfare. These activities comprised work on fuel mixing and flame-thrower servicing equipment, the development of devices for the utilization of self-igniting fuels, investigations into the casualty-producing effects of flame, and the devising of countermeasures against flame attack.

6.2 E8 AND E8R1 SERVICE UNITS

6.2.1 Introduction

With the development of mechanized flame throwers requiring up to 300 gal of Napalm-thickened fuel and approximately 4 cu ft of 2,000 psi air per 100 gal of thickened fuel, it became necessary to develop equipment which could supply these weapons in the field. To fulfill this requirement, a project to design a mobile flame-thrower servicing unit was initiated in November 1943 by Standard Oil Development Co. under Contract OEMsr-390.¹ Later equipment was assembled by the Davey Compressor Co. under Contract OEMsr-1266.

Information was already available on the simple batch process of mixing fuel for portable flame throwers.² Some consideration was given to continuous mixing methods but none were readily available, and it appeared that a continuous process would require considerable development work.

In cooperation with CWS the following general requirements were established for flame-thrower service units.

1. Air compressor must be balanced in capacity with fuel-mixing capacity, approximately 4 cu ft 2,000 psi air per 100 gal of thickened fuel. It must be light in weight but rugged and compact for mobile field use. The discharge pressure requirement was raised from 2,000 to 3,000 psi in February 1945.

2. Mixing facilities must be simple and rugged, of maximum capacity as permitted by carrying vehicle, and capable of operating in all theaters on available Napalm thickeners.

3. Vehicle must be standard U.S. Army type, capable of traveling as close to the combat lines as the unarmored vehicles which commonly supply armored units. For most areas the Army considered the 2½-ton 6x6 truck to be adequate, but for special operations, such as on beaches and swampy or mountainous terrain, amphibious or tracked carriers would be required.³

6.2.2 Description

Preliminary Units. To meet the above field requirements, the following features were incorporated in preliminary units:

1. Early studies showed that a 2½-ton 6x6 truck would be seriously overloaded when carrying a skid-mounted, engine-driven air compressor of adequate capacity as well as fuel-mixing equipment. To reduce overload and bulk, it was necessary to eliminate separate engine drives through the use of a power take-off which permitted all equipment to be driven by the truck engine. This required the factory mounting of equipment on the truck, reduced the availability of the vehicle for hauling miscellaneous cargo, but assured maximum mobility when servicing advancing mechanized flame throwers.

2. A new, high-pressure air compressor developed by the Clark Bros. Co. under Contract OEMsr-370, Model HO-6-4, six-cylinder, four-stage, air-cooled, 63 cfm, was selected as the lightest weight machine available with the desired capacity.

3. Development work on fuel mixing included tests to determine the pumpability of thickened fuels containing from 4 to 10 per cent Napalm. It was found that heavy-duty, positive-displacement gear pumps were entirely satisfactory, provided the suction head was sufficient to keep the pumps filled with fuel. This study also pro-

vided necessary data on the pressure drop through pipes and the power required to pump thickened fuel.⁴

These units prepared and delivered 500 gal of thickened fuel and compressed 25 cu ft of 2,000 psi air per hr.⁵ From the experience with these units, various weight-saving changes were made, reducing the truck overload from 60 to 16 per cent with considerable simplification of equipment, and resulting in the E8 service unit (Figure 1).⁶

pressor in order to deliver a maximum pressure of 3,000 psi (E8R1 service unit).

Mixing Tank and Fuel Pump. The mixing tank was cone-bottomed and had a capacity of 280 gal. To thoroughly agitate the Napalm and gasoline, the tank was provided with a power-operated propeller stirrer. In cool weather when mixing became difficult, it was possible to heat the contents of the tank by circulating hot coolant from the truck engine through a jacket surrounding the tank.

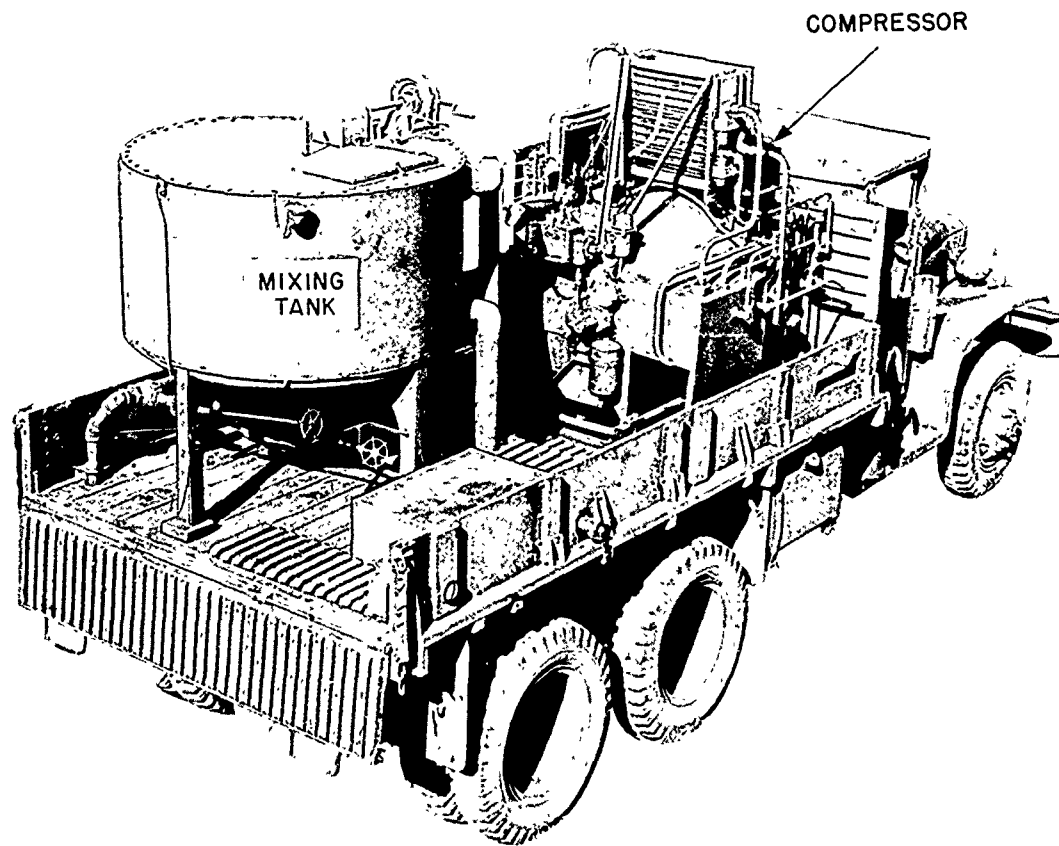

FIGURE 1. E8R1 servicing unit in place on 2½-ton truck.

Air Compressor. The Clark Bros. air compressor incorporated in the preliminary unit was found to perform satisfactorily. The compressor was capable of a maximum pressure of 2,250 psi (E8 service unit), but later requirements made it necessary to modify the com-

The fuel pump was of the gear type and had a capacity of 35 gal per min at 175 psi.

Power Supply. As has been indicated, the power for the various units was provided by the truck engine through a heavy-duty power take-off, belts and countershaft.

CONFIDENTIAL

6.2.3

Performance

Procedure. In operation the service unit functioned in the manner outlined below (Figure 2).

1. Gasoline was pumped into the mixing tank from the available source, i.e., drums or tank truck.

2. Napalm was poured into the tank and the contents were agitated by a power-driven propeller until thickening was complete.

3. The thickened fuel was pumped into the tanks of the flame thrower.

II terminated before the units were put into operation.

6.3 E6 MIXER AND E8 COMPRESSOR^{9, 10}

6.3.1

Introduction

In order to provide service equipment equivalent in capacity to the E8R1 service unit, but capable of transportation in amphibious or tracked vehicles over terrain not suited to a standard truck, the design of a skid-mounted unit was assigned in January 1945 to the Stand-

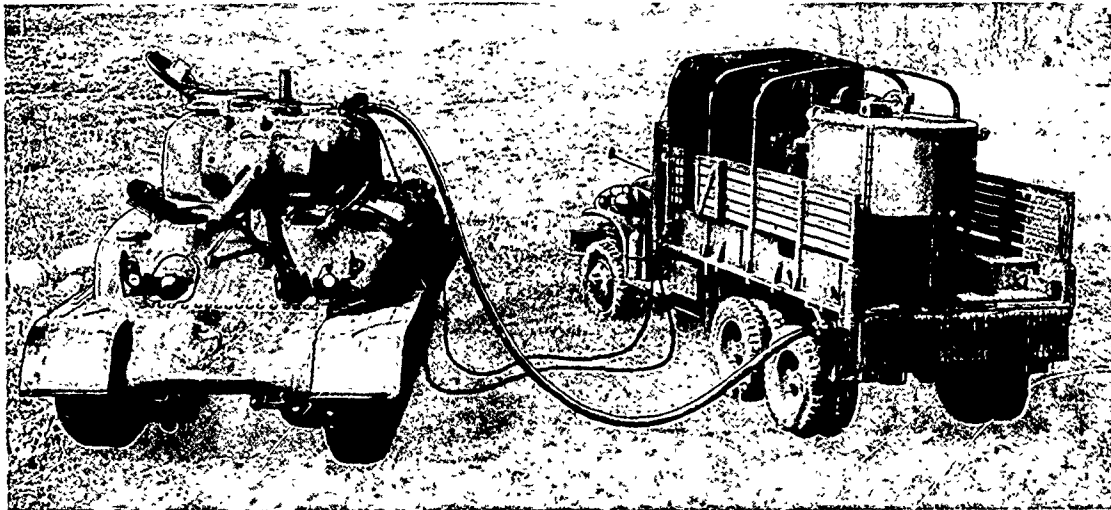

FIGURE 2. View of E8R1 servicing unit and M5-4 mechanized flame thrower.

4. While the above was being accomplished, the compressor was pressuring the flame thrower.

For 280 gal of fuel the entire operation required about 30 min.

Servicing Tests. Both the Standard Oil Development Co. and the various branches of the Army conducted a series of service tests which showed that the unit was completely satisfactory.^{7, 8} The unit was capable of delivering 560 gal per hr of thickened fuel containing from 4 to 8 per cent Napalm at atmospheric temperature between 20 F and 100 F. Fuels containing 10 per cent Napalm could be produced at a somewhat lower rate.

A total of 65 of these units were actually produced by the Davey Compressor Co. under Contract OEMsr-1266. However, World War

and Oil Development Co. under Contract OEMsr-390.¹¹ Relatively little development work was required because of the experience gained in establishing the E8R1 service unit design. However, the arrangement and mounting of the equipment was new (Figure 3).¹²

6.3.2

Description

E6 Mixer. The E6 mixer incorporated a 13-hp, four-cylinder, Wisconsin gasoline engine driving a gear-type fuel pump and a mixing propeller located in a 285-gal cone-bottomed, batch-mixing tank, with fuel hoses and other accessories, all mounted on a heavy skid.^{8, 13}

For low temperatures the mixer could be heated by supplying coolant from the engine-cooling system to the jacket of the mixer.

CONFIDENTIAL

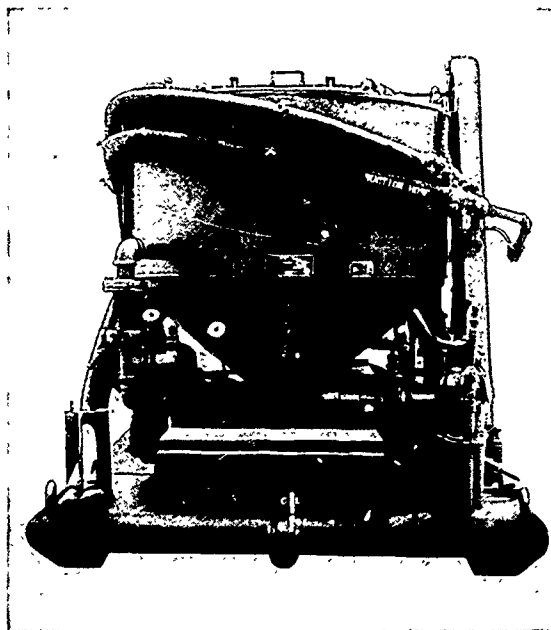

FIGURE 3A. View of E6 mixer mounted on skid.

E8 Compressor. The E8 compressor consisted of a modified Navy type-40 compressor, Ingersoll-Rand Model GC-50-BW, six-cylinder, four-stage, liquid-cooled, set to deliver air at 2,250 psi, and mounted on a skid with its gasoline

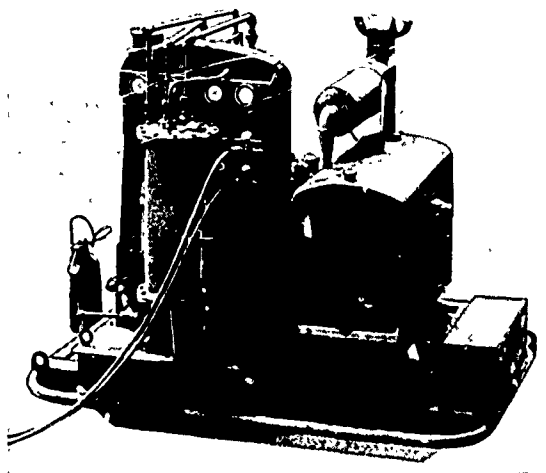

FIGURE 3B. View of E8 compressor.

engine and all accessories. Tackle was provided with each unit to facilitate handling and loading onto vehicles. The compressor is shown in Figure 3B.

6.3.3

Performance

The compressor E8 had a capacity of 27 cu ft per hr of 2,000 psi air, and the mixer was capable of mixing 560 gal of thickened fuel per hr (Figure 4). These rates were equal to the rates developed by the E8R1 service unit, but the E8R1 weighed half as much as the combined weights of the E6 and E8 units. A comparison of the units will be found listed in Table 1. These were subjected to preliminary service tests by various boards, and all units performed satisfactorily.¹⁴

TABLE 1. Comparison of units E8R1, E6, and E8.

Mount	E8R1	E6	E8
	2½-ton 6x6 Army truck		Skid
Portability	Fixed on 2½-ton Army truck	Amphibious, full-tracked, or wheeled vehicles	
Power	Power take-off from 2½-ton truck engine	13-hp gas engine	57-hp gas engine
Capacity gal of thickened fuel/hr	560	560	...
Cu ft/hr of 3,000 psi air	26	...	27
Weapons serviced	2 E14-7R2 or 2 M5-4 (E12-7R1) per hr		
Wt of servicing equipment lb, exclusive of vehicle	5,760	4,800	6,900
Dimensions of servicing equipment			
Overall length, in.	104	107	105
Overall width, in.	79	68	74
Max height, in.	64	80	81

6.4 FERRO-CLEAVER BROOKS MIXING UNIT¹⁵

6.4.1

Introduction

To fill the field requirements for a small mixing device for continuous mixing of Napalm and gasoline, a project was begun in February 1944 by the Ferro-Drier & Chemical Co. under Contract OEMsr-1281. Originally the equipment was to be a readily portable, hand-oper-

CONFIDENTIAL

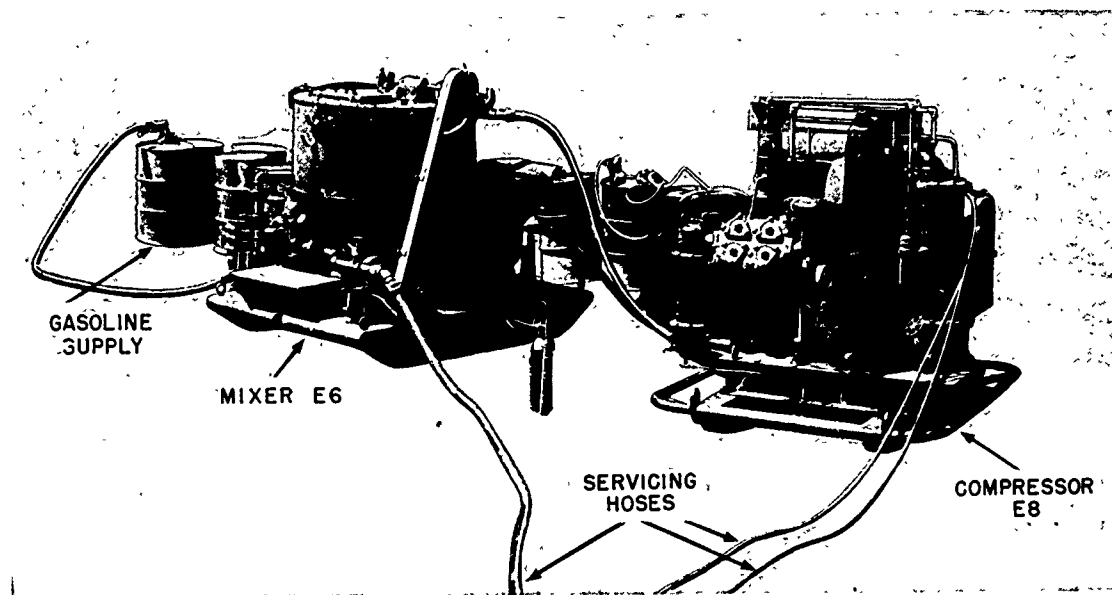
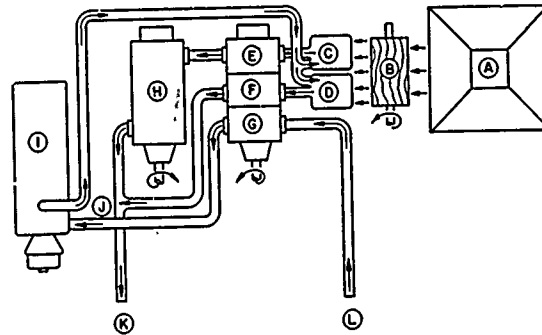

FIGURE 4. Mixer E6 and air compressor E8 in position for servicing mechanized flame thrower.



- | | |
|--|---------------------------|
| A Napalm hopper. | G Gasoline metering pump. |
| B Napalm helical feeder. | H Grinder. |
| C Funnel for gasoline and Napalm to be ground. | I Gasoline heater. |
| D Funnel for gasoline and Napalm to remain unground. | J Mixing tee. |
| E Pump to pass gasoline and Napalm to grinder. | K Gel discharge hose. |
| F Pump to pass gasoline and Napalm to mixing tee. | L Gasoline inlet hose. |

FIGURE 5. Flow diagram of Ferro mixer.

ated mixer, capable of mixing concentrations between 2 and 8 per cent of the various types of Napalm. As the development progressed, the many complicated problems of mixing led to a more elaborate design.¹⁶

At the expiration of Contract OEMsr-1281, the project was continued by Ferro-Drier under a sub-contract of the Eastman Kodak Co. Contract OEMsr-538. Since Ferro-Drier did not have suitable manufacturing facilities, the proj-

ect was finally turned over to the Cleaver-Brooks Co. for completion.

6.1.2

Description

Introduction. In Figure 5 the schematic flow diagram of the mixer is shown. Essentially, the process consisted of feeding Napalm at a fixed rate with preheated gasoline and forcing

the mixture through a grinder. This concentrate was then mixed with a secondary gasoline stream. If a more concentrated final product was desired, additional Napalm was added, without grinding, to the secondary stream. The unground mixture was prevented from settling by the viscosity of the ground mixture, and the

tion. The rate of delivery of Napalm could be adjusted by means of a slide at the bottom of the hopper which permitted smaller or larger portions of the paddle to be exposed to the Napalm. Correction was made for the bulk density of the Napalm by measuring the height to which one can, e.g., $5\frac{1}{4}$ lb, of Napalm filled

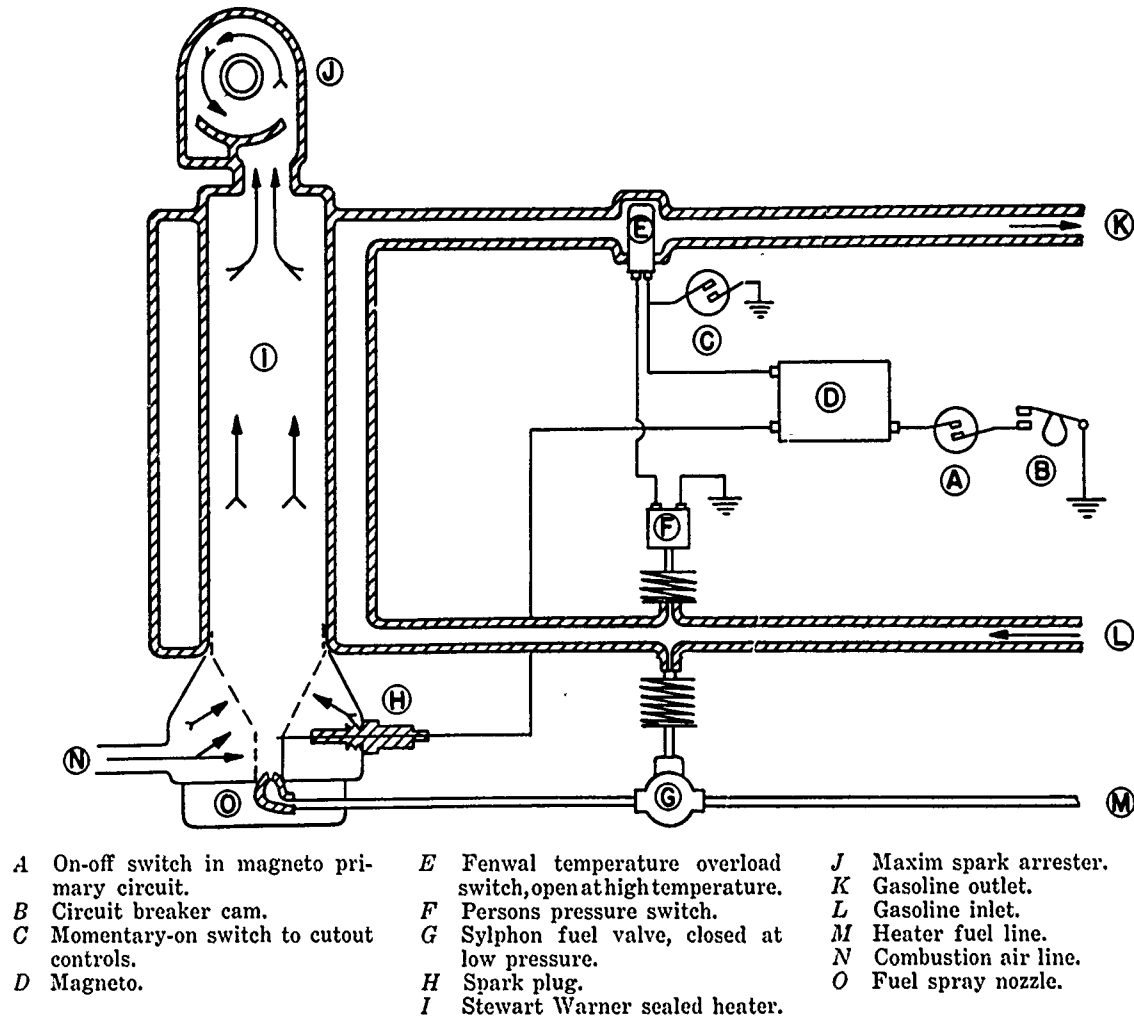

FIGURE 6. Flow diagram of gasoline-heater system showing electrical circuit.

total grinding necessary was kept to a minimum. The mixture became homogeneous after setting.

Metering Device. Work with various metering devices led to a hopper feeder with a rotating paddle wheel below it. The pockets of the paddle wheel were filled with Napalm and would deliver a given volume with each rota-

tion. The rate of delivery of Napalm could be adjusted by means of a slide at the bottom of the hopper, and setting the adjustment accordingly. The rate of delivery of Napalm to gasoline was coordinated by directly connecting the Napalm feeder to the Blackmer vane pump which metered the gasoline.

Grinding Devices. After various experiments it was found that if the Napalm-gasoline slurry could be forced through a fine-toothed gear

CONFIDENTIAL

pump running backwards, sufficient grinding could be obtained almost eliminating the settling of the Napalm. If stirred for about 20 to 30 sec after this grinding, no further settling of the Napalm occurred. The grinding process was later improved by substituting for the reverse gear-pump grinder a series of perforated rotating disks separated by perforated stators. The chief objection to the disk type of grinder was the additional horsepower that was required.

Heater. Unless the temperature of the gasoline was about 90 degrees, mixing was unsatisfactory. To raise the gasoline to this temperature, a small gasoline heater consisting of concentric shells of large, stainless steel tubes was devised (Figure 6). This type of heater was able to heat 300 gal of gasoline per hr through a temperature rise of 45 degrees. Situations were visualized in which this capacity would be inadequate. In addition, the heater was difficult to manufacture, and to keep clean.

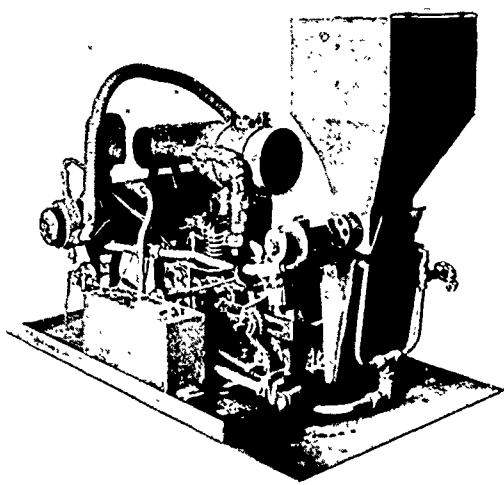

FIGURE 7. View of Ferro mixer on base plate.

Power Device. From the original idea of a hand-operated mixer, the apparatus grew so extensive that the need for power drive arose. A small, one-cylinder gas engine was installed and found to be satisfactory when operating at a rate of 2 gal per min of mixed fuel. When the unit was redesigned for greater ruggedness and the disk type of grinder introduced, a motor of 15 hp was required. These improvements in-

creased the weight to 1,000 lb, a much heavier unit than field operations would allow.

6.1.3

Performance

The unit as originally designed by Ferro-Drier (Figure 7) was tested at Edgewood Arsenal and found to be inadequate for the following reasons: (1) it was under-powered; (2) there was excessive vibration; (3) the pre-heater lacked capacity; and (4) the grinder and pumps were inadequate.

From these tests and additional development work by the Cleaver-Brooks Co., it appeared that a different approach should be considered. This led to the E11 mixing unit described in the next section.

6.5

E11 MIXING UNIT

6.5.1

Introduction

When the Ferro-Drier mixing unit was turned over to the Cleaver-Brooks Co. for manufacturing under sub-contract of Eastman Kodak Co., Contract OEMsr-538, the Cleaver-Brooks Co. also initiated a new approach to the



FIGURE 8. E11 mixing unit mounted on jeep.

problem of field mixing. The result of their efforts was a simplified drum-type, circulating mixing unit E11 that could be conveniently transported in a jeep (Figure 8).¹⁵

CONFIDENTIAL

6.5.2

Description

In Figure 8 the layout for the mixing process including a heater is shown. Raw gasoline is pumped from some storage source to the mixing drum, illustrated in Figure 11, into which the required amount of Napalm is dumped. The pump circulates the slurry until mixing is complete, at which time the gel is pumped to the storage tank. This entire process is controlled by two 2-way valves, one located on the suction side of the pump and the other on the storage side. The two pumps, operating

a temperature rise of 60 F. Its weight was approximately 160 lb.

6.5.3

Performance

Tests indicated that the unit could satisfactorily mix most Napalms of 3 to 8 per cent concentrations at a rate of 500 to 600 gal per hr, provided the gasoline was 90 F or above. For lower temperatures, with the pre-heater in the line, the rate is reduced to 250 gal per hr (Figure 9).

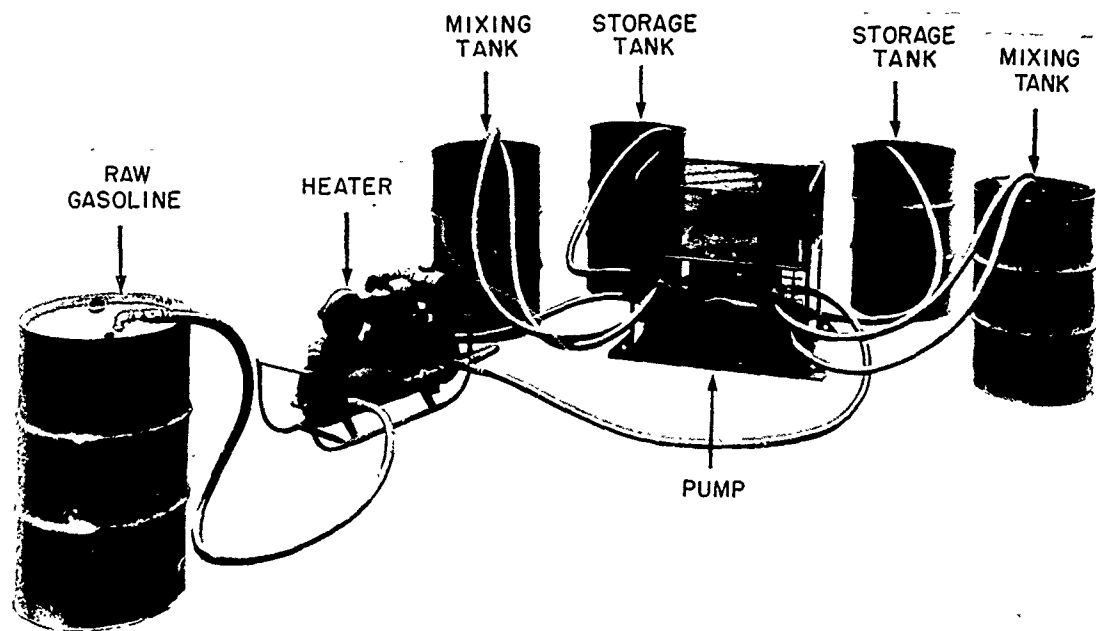

FIGURE 9. E11 mixing unit with heater in position.

independently of each other, are driven by a 2-cylinder, 4-cycle gasoline engine.

In a cool environment the temperature of the raw gasoline must be raised to about 90 F in order that mixing may be accomplished in a reasonable length of time. For this purpose a heating unit of the coil-and-tube, gasoline-fired type, driven by a gasoline engine, was developed as illustrated in Figure 10. The heater was designed to heat 20 gal of gasoline per min in

Some trouble was encountered when very fast setting Napalms were used. In these cases the gels would set so rapidly that some of the Napalm would not be mixed into the gasoline. The majority of the unmixed Napalm could be taken up after the lumps were broken up and particles forced through the pump. For the Navy-ground Napalm, which must be introduced into the gasoline stream rather than into the drum, the National Foam type venturi

CONFIDENTIAL

mixer was tried. Metering difficulties with the apparatus led to the use of the Ferro-Drier paddle wheel feeder mentioned in the previous section. This operated fairly satisfactorily although the paddle wheel tended to become gummed from the splashing of the gasoline.

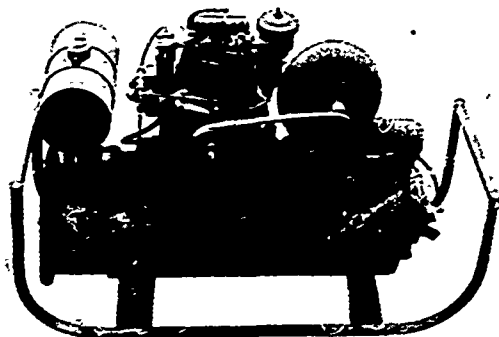

FIGURE 10. Gasoline heater with E11 mixing unit.

NAVY MARK I MIXING UNIT

6.6.1

Introduction

The Mark I Napalm mixing unit was developed by the Navy; NDRC was informally invited in July 1944 to act as technical consultants. The development of the jettisonable fuel tank as a fire bomb introduced the problem of obtaining a rapid Napalm mixing unit to fill the tank with thickened fuel after the empty fire bomb was attached to the plane. Such a unit had to be capable of rapidly mixing a 6 per cent Napalm-gasoline gel which could be forced into the jettisonable fuel tank. In addition, since a large portion of the mixing had to be done for carrier-based planes, freedom from fire hazards and portability were requisites.

6.6.2

Description

The mixing unit introduced the Napalm into the gasoline stream by the venturi principle as the gasoline passed through a venturi at a rate of approximately 30 gal per min.¹⁷ From the venturi, the stream containing the dispersed

Napalm continued through a short section of hose of approximately 1¼ in. ID and 20 ft in length, and finally discharged through a controllable orifice into the jet'isonable tank. The ground Napalm was poured into a funnel-like hopper perpendicularly superimposed on the venturi. The gasoline stream was pressurized by the tank-pressuring system of the ship or by a small pump, if the process was done on land.

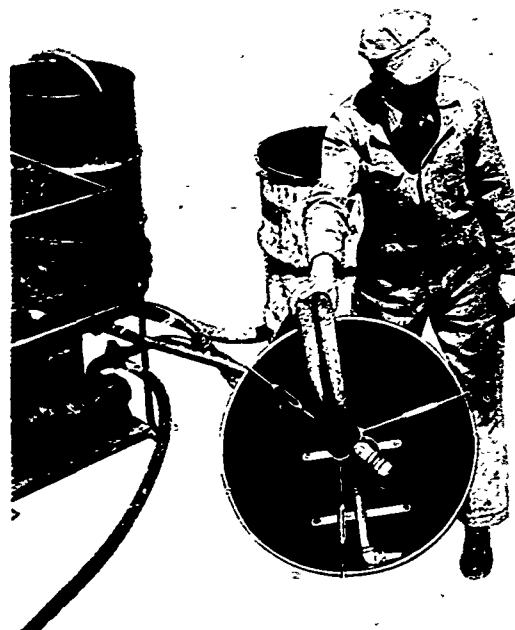

FIGURE 11. View of interior of barrel in which mixing occurs.

6.6.3

Performance

The introduction of the finely ground Napalm into the gasoline stream through the venturi to produce a turbulent suspension of the soap in the liquid was intended to give good dispersion leading to the formulation of a homogeneous gel. The upstream pressure of the stream was maintained at 25 psi; the downstream back-pressure was 5 to 10 psi. The controllable discharge orifice served to regulate the percentage of Napalm concentration by controlling the pressure at the venturi. The unit was operable unaided within the normal temperature range established for Napalm mixing; however, with the use of an accelerator (xylenol

CONFIDENTIAL

or cresylic acid) good gelation had been obtained at temperatures as low as 8 F.

This device was simply constructed and could be improvised from fire-fighting equipment. When gasoline was transported in drums or tanks, the unit could have a small engine-driven rotor pump (standard equipment), discharging approximately 30 gal per min, added to the venturi system to supply the pressure.

6.7 E1 ANTI-PERSONNEL TANK PROJECTOR

6.7.1

Introduction

The development of the E1 anti-personnel tank projector was initiated in December 1944

a near-by foxhole or concealed position and held a mine to the side of the tank until it detonated. This usually resulted in considerable damage to the tank, and in the death of the attacker. The problem of defense against such attacks was complicated by several factors, among them the very rough terrain of operations, which prohibited the employment of any devices projecting materially beyond the existing outlines of the tank, and the limited range and angle of vision of the tank commander, which made it difficult to observe directly the approach of enemy personnel carrying mines to the tank. On the other hand, the tank commander possessed the advantage of direct radio communication with near-by ground forces, who frequently warned him of the approach of an

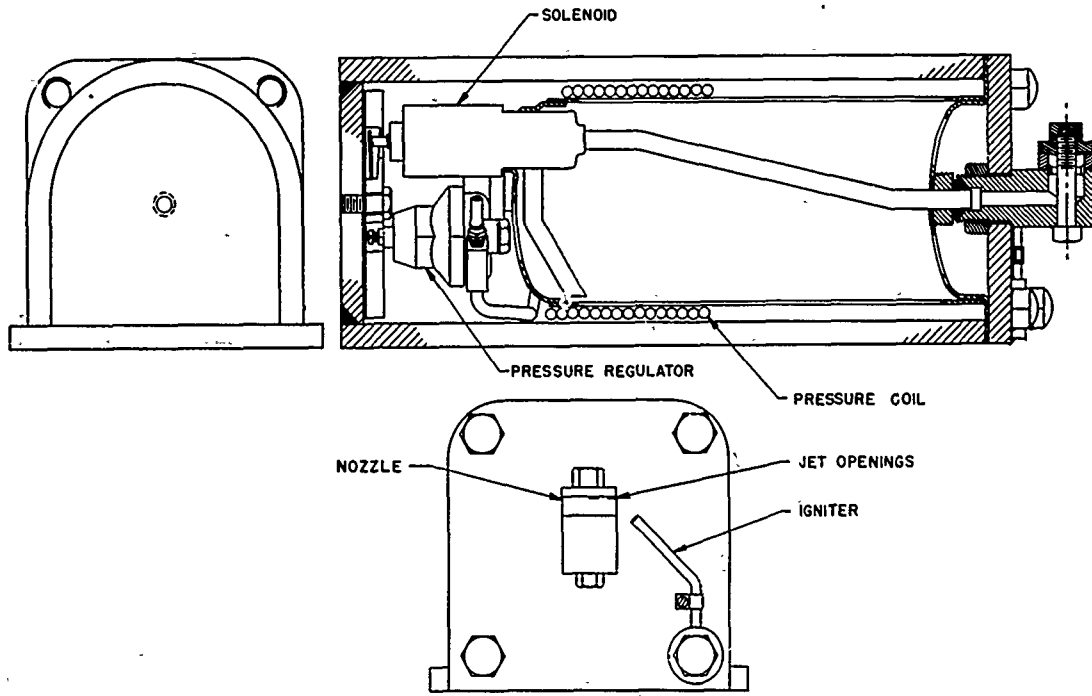

FIGURE 12. Cutaway of E1 anti-personnel tank projector.

by Arthur D. Little, Inc., Contract OEMsr-242. The device is essentially a small special-purpose flame thrower which is mounted externally, in multiple, on tanks to ward off enemy personnel attempting to attack the vehicle by means of hand-borne bombs or mines.

Many tank casualties had resulted from action in which an enemy approached a tank from

enemy and indicated the general direction of approach.

The eutectic mixture of phosphorus and phosphorus sesquisulfide (EWP) which spontaneously ignites upon contact with air and which had been previously evaluated as a flame-thrower fuel (see Sections 4.4, 6.8, and 8.8), appeared to have promise as a fuel for a special-

CONFIDENTIAL

purpose flame thrower adaptable for coping with the situation described above. A simple device easily attachable to a tank was accordingly designed, constructed, demonstrated, and placed in limited procurement under a special contract with CWS.

6.7.2

Description

A complete description of the E1 anti-personnel tank projector in its final form appears elsewhere.¹⁸ Figure 12 illustrates the device, which is an electrically controlled flame thrower delivering a blanket of flame covering areas within 15 yd of the vehicle. The nozzle of the device can be adapted to produce almost any fan-shaped field of fire desired. The fields of

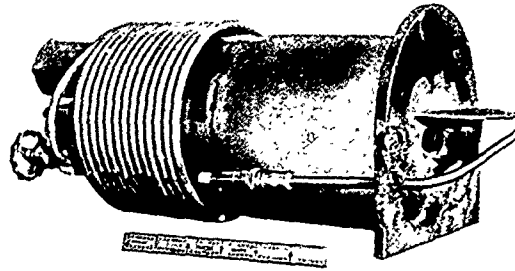

FIGURE 13. Exterior view of E1 anti-personnel tank projector.

or any combination can be fired simultaneously. The combined 15-yd and 10-yd forward jets on either side are fired simultaneously.

The only parts of the device mounted inside the armor of the vehicle are the electrical con-



FIGURE 14. E1 anti-personnel tank projector showing three units firing simultaneously (right-front unit not firing).

fire adopted were evolved from actual tests on M4 tanks at Edgewood Arsenal¹⁹ and Fort Knox.²⁰ For this coverage, four individual flame-thrower units are used. Each unit is controlled electrically from within the vehicle by a push-button switch; any unit can be fired alone,

or any combination can be fired simultaneously. The combined 15-yd and 10-yd forward jets on either side are fired simultaneously. The only parts of the device mounted inside the armor of the vehicle are the electrical con-

CONFIDENTIAL

switch is on, a warning light shows both on this box and on the portable box mentioned below. The fixed box also contains a set of four firing buttons. Two-conductor armored cables about $\frac{1}{4}$ in. in diam run from this box to each of the four flame-thrower units. A six-conductor portable cable about $\frac{1}{2}$ in. in diam runs to a portable control box intended for use within the turret by the tank commander. This box is only 2 in. in diameter and about 3 in. deep, and can be worn on the chest without imposing a burden greater than 20 oz. It may also be hung on any convenient hook.

The flame-thrower unit consists of a 1-gal pressure tank containing the EWP fuel and accessory equipment which supplies carbon dioxide at a regulated pressure of about 75 psi to the tank (Figure 13). The solenoid valve controls delivery of the fuel under pressure to the nozzle. The fuel tank and carbon-dioxide system are arranged in cartridge form for simplicity and safety in reloading. Cartridge units can be either factory-charged with both the fuel and carbon dioxide, or charged at advanced bases by trained personnel with a small amount of charging equipment.

Although the EWP fuel ordinarily ignites spontaneously immediately upon ejection, ignition is further assured by providing a small electrically operated "hot finger" heating element near the flame-thrower nozzle.

6.7.3

Performance

In tests at Edgewood Arsenal¹⁹ and at Fort Knox^{20, 21} of the E1 anti-personnel tank projector in its early form, the device was found to function satisfactorily for the general purpose intended (Figure 14). Following these tests, minor changes were made, after which final acceptance tests were carried out at Norwood, Massachusetts. The Norwood tests also adequately proved the absence of excessive contamination of the tank exterior due to dripping or scattering of fuel. In spite of the small quantity of EWP fuel charged, it was established that each 1-gal unit was capable of firing between 20 and 30 effective bursts before requiring a new charge.

6.8 STUDIES OF PHYSIOLOGICAL EFFECTS OF FLAME

6.8.1

Introduction

An investigation into the physiological effects of flame attack against occupants of an enclosed structure was initiated in August 1944 by Arthur D. Little, Inc. under Contract OEMsr-242. The work was undertaken primarily as part of an experimental program for the evaluation of EWP as a special flame-thrower fuel, compared with conventional Napalm-thickened gasoline, and the experiments were devised with a view toward providing such a comparison, rather than to furnish complete data on the effect of either fuel alone under a variety of conditions.²²

6.8.2

Experimental Work

Pillbox. The enclosed fortification used for evaluating the casualty-producing effects of flame-thrower fuels was a German type concrete pillbox of hexagonal shape. The external length of each edge was 11 ft and the walls were 4 ft thick, so that the internal length of each edge was 6 ft. The height of the pillbox above ground was $7\frac{1}{2}$ ft, the floor level was 2 ft below ground, and the roof consisted of a concrete slab 1 ft in thickness. The total volume of the pillbox was 900 cu ft.

A loophole with intricately designed approaches was provided in each wall of the structure, and access to the pillbox was through a $3\frac{1}{2} \times 3$ ft entrance under one of the loopholes. The pillbox was provided with a Y-shaped, radially symmetrical baffle, constructed of concrete blocks, each leg of the baffle being 32 in. wide and 8 in. thick. The baffle separated the pillbox into three equal compartments, designated respectively as the door compartment, the fire compartment, which included the loophole attacked, and the off compartment.

Fuels and Flame Throwers. The fuels used were 4 per cent Napalm-gasoline gel shot from a standard M2-2 portable flame thrower, and EWP fuel (described in Section 8.4) shot from

CONFIDENTIAL

a special flame thrower (described in Section 4.4).

Animal Experiments. Two series of experiments were conducted to gain information on the casualty-producing effects of the two flame-thrower fuels studied. In the first series individual small white domestic swine were used as the experimental animals. The instrumentation attached to the animals during attack included pneumograph, thermocouples, special disks to measure caloric bombardment, and electrocardiograph. Conditions within the pillbox were determined by continuous recording of temperatures and gas compositions of representative locations.

In the second series of experiments, rabbits were used along with pigs, and six of each species were simultaneously exposed in each test, one rabbit and one pig being suspended by means of Fiberglas cords in each of six representative locations.

The experiments consisted in placing the animals in predetermined positions within the pillbox, installing the various instruments and starting their operation, and finally attacking the pillbox by injecting a measured quantity of the fuel under test, usually 1 gal, into the pillbox from a fixed distance. At the conclusion of each experiment, the animals were removed from the pillbox for autopsy and microscopic inspection of tissue.

6.8.3

Conclusions

The following general conclusions were reached as a result of this work.

1. One gal each of 4 per cent Napalm-gasoline and of EWP were compared in field experiments involving pigs and rabbits in a concrete pillbox.

2. External burns were more extensive and severe in shaved pigs exposed to EWP than in similar animals exposed to Napalm.

3. Damage to the coat and skin burning were slightly more severe in rabbits exposed to Napalm than in those exposed to EWP.

4. Arranged in order of decreasing hazard to occupants from the point of view of burns, the pillbox compartments are: fire, off, door—high

positions being more dangerous than low positions.

5. No clear relation between position in the pillbox and incidence of respiratory damage was indicated.

6. The respiratory lesions were chiefly patchy atelectasis and emphysema, pulmonary congestion, oedema, and hemorrhage.

7. Less prevalent were tracheobronchial lesions.

8. EWP produced greater respiratory damage than Napalm.

6.9 COUNTERMEASURES AGAINST FLAME THROWERS

6.9.1

Introduction

Development work on countermeasures against flame attack was initiated in August 1944 by Arthur D. Little, Inc., under Contract OEMsr-242. The work was undertaken in response to a directive received from the Navy Department, Bureau of Ships, Damage Control Section, under Project N5-317, and its general objective consisted in studying possible countermeasures against flame attack upon enclosed spaces, and devising methods and equipment for putting such countermeasures into effect.²³ At that time, studies of the physiological effects of flame were being conducted in a German type pillbox at Norwood, Massachusetts (see Section 6.8), and it was decided to use the facilities available at Norwood for the work on countermeasures.

6.9.2

Experimental Work

Preliminary Work. The conditions prevailing in the Norwood pillbox during flame attack from a portable flame thrower using 4 per cent Napalm-gasoline gel had been thoroughly investigated and the action of the flame upon unprotected pigs and rabbits placed in various positions within the enclosure had received exhaustive study.

In view of the findings resulting from the in-

CONFIDENTIAL

vestigation of conditions prevailing in the pillbox during flame attack, it was postulated that the primary lethal action of flame under the conditions studied was thermal, respiratory damage being only a contributory factor. In consequence, it was decided to concentrate the initial stages of the work upon protection by means of ultra-rapid fire extinguishment.²⁴

In this connection, the application of water fog appeared to present especially attractive possibilities, and several experiments were made to test the effectiveness of water fog in extinguishing fires.

For the production of water fog, several nozzles were procured from two manufacturers; all of these nozzles produced a satisfactory fog.

Water-Fog Curtains. Attempts to extinguish ignited rods of thickened gasoline with "fog curtains" directed parallel to the loophole of attack resulted in little success, and showed that the principle of fog curtains as such is not useful for the purpose contemplated. Even with the largest fog nozzle tested, it was very seldom that extinguishment of an ignited 4 per cent Napalm-gasoline gel was complete when the gel was injected into the pillbox from a distance of 10 yd from an M1A1 flame thrower. In most instances, some fuel would arrive in the pillbox ignited, and any extinguished fuel would catch fire from it.

Napalm Extinguishment. A permanent water line was constructed to the pillbox, and a fog nozzle was placed near the ceiling of the fire compartment, the fog being directed toward the base of the baffle inside the pillbox. It was found that such an arrangement was extraordinarily effective in extinguishing Napalm-gasoline gels injected from a flame thrower within a very short time, and with small quantities of water. It was found that, with any one of the nozzles tested, it was usually possible to extinguish the entire 4.5 gal of fuel within 2 to 4 sec, using between 0.3 and 0.8 gal of water.

Liquid Fuels. Extinguishment of liquid fuels, whether gasoline or gasoline and heavier oil mixtures, is quite difficult to accomplish with water fog when the burning fuel is introduced by being injected with a flame thrower. Reignition of partially extinguished fuel persists for so long a time that the protective value of

fog would probably be nullified.

Fog Applicator. A small portable fog applicator was designed and built. This applicator consists essentially of a 6-gal steel vessel capable of withstanding approximately 200-psi pressure and equipped with a water-filling tube, a pressure attachment, and a water-outlet tube leading to a flexible metal hose, valve, and fog nozzle. The vessel can be filled only partially with water, leaving a gas space, which is pressured from a small carbon dioxide or nitrogen cylinder attached to the vessel. The applicator, filled with water and compressed gas, is ready for use, and several such applicators can be placed in the structure to be protected, the nozzle being fixed in predetermined positions. In addition to these fixed installations, one or two portable applicators with movable nozzles may serve to extinguish stray gobs of burning fuel.

Immediately upon the first indication of flame attack the occupants of the structure attacked would pull a chain, or several chains, which would actuate quick-acting valves releasing water fog in the structure. The fog would be applied until all fire is extinguished. In the Norwood pillbox, it is believed that three fixed nozzles and two portable nozzles would be sufficient to serve this purpose.

Tests with Animals. A number of experiments with animals were carried out to test the effectiveness of water-fog extinguishment as a countermeasure against the anti-personnel action of flame.

In all experiments a full charge of 4 per cent Napalm-gasoline gel was injected into the pillbox from a distance of 10 yd. Extinguishment, whenever attempted, was carried out with a fog nozzle operating under 100-psi water pressure. The nozzle was placed in the pillbox, 6 ft above the floor, and the fog was directed toward the base of the baffle. Temperatures were measured in the three compartments at 4-ft elevation. Gas samples were taken at the same locations. Total combustibles in the gas, i.e., largely gaseous hydrocarbons, were measured in the locations indicated by means of a Citic Service power prover. In some of the experiments protective clothing was used on the animals, either alone or in combination with water fog.

CONFIDENTIAL

6.9.3

Conclusions

1. Water fog offers an ultra-rapid method of extinguishing flaming Napalm-gasoline gel in a pillbox with small volumes of water.
2. The extinguishment of liquid fuels is more difficult.
3. A simple device has been designed for applying water fog in the field.
4. Partial protection against flame attack may be accomplished with water fog.
5. Even the ultra-rapid extinguishment does not avail against severe momentary flash burns.
6. Water and clothing alone have not afforded complete protection to animals in the experiments, but the degree of casualty is limited by their use.
7. The unburned fuel which floats on the water after extinguishment may offer a continuing hazard of reignition. This can possibly be corrected by additional drainage.
8. Danger is introduced by the asphyxiating and explosive potentialities of atmosphere high in hydrocarbon vapors.
9. All possible information should be obtained about special protective fabrics, and an attempt should be made to evaluate under service conditions the usefulness of a garment which could be constantly worn.

6.10 PROTECTION OF SHIP CONNING TOWERS AGAINST SUICIDE PLANE ATTACK

6.10.1

Introduction

The investigation of countermeasures against suicide plane attacks upon conning towers of warships was undertaken in February 1945 by Arthur D. Little, Inc., under Contract OEMsr-242. During the latter part of World War II considerable loss of life and damage was being inflicted by Japanese crash-diving planes loaded with liquid fuel, and thus it became imperative to develop effective methods for protecting the occupants of enclosed spaces, such as conning towers, from the heat and fumes generated by the burning fuel. For this study an actual conning tower of a ship was set up in coopera-

tion with the Damage Control Section of the Bureau of Ships, U.S. Navy, at the Boston Fire Fighters' School.

6.10.2

Approach

Burning fuel about an enclosed tower will raise the internal temperature of the tower through heat transfer and will fill the interior with flames and gases, provided there are any open ports. By providing some method of closing the ports,²⁵ the remaining problem is one of reducing the heat transfer through the walls of the tower.

In order to evaluate the effect of different variables and the effectiveness of any countermeasures, it was necessary to establish some means of measuring the heat transfer. For this purpose two criteria, thermal efficiency and countermeasure index, were introduced. Thermal efficiency represented the ratio of the total heat input to the walls, as measured by the temperature increase and total heat capacity of the conning tower, to the total heat available from the fuel used. The thermal efficiency represented a convenient method of evaluating the effect of external variables such as wind and drainage on the amount of heat transferred.²⁶ As the project progressed the need for evaluating internal countermeasures led to the conception of the countermeasure index.²⁷ Tests with animals had indicated that the internal air temperature was the factor which determined survival within the tower. Therefore, the ratio of maximum air temperature to total heat input, when multiplied by 100,000, provided a convenient index of countermeasure effectiveness.

6.10.3

Experimental Conditions

Conning Tower. The conning tower was from a cruiser of the Wichita class (Figure 15) with an overall height of 16 ft, and the enclosed space was divided into two 8 ft high compartments by a horizontal plate. The top compartment, the conning tower itself, was constructed of class B armor plate and the compartment

CONFIDENTIAL

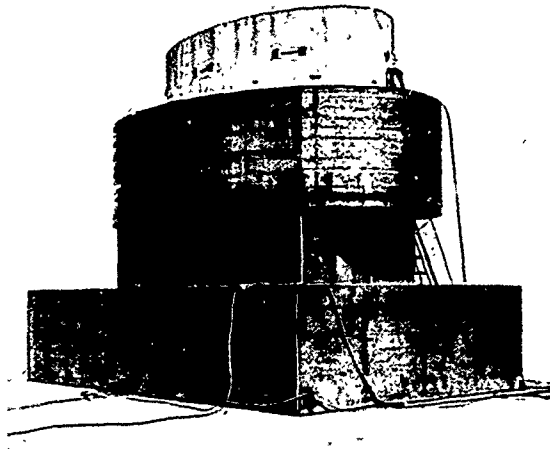

FIGURE 15. Front view of conning tower from a cruiser of the Wichita class.

below, of light steel. The tower was 14 ft 9½ in. through the long axis by 7 ft 5¾ in. through the short axis and had a total mass of 80,920 lb, corresponding to a total heat capacity of 8,920 Btu/F. Figure 16 gives additional details on the construction of the tower.

Fuel. Since the quantity of fuel deposited by a suicide plane would be difficult to predict, a standard amount of three 55-gal drums of gasoline was used. These drums were placed in fixed positions on the upper passageway of the tower and were simultaneously split open and ignited by a charge of black powder and tetryl.

Instrumentation. To measure the variables (1) wind velocity and direction, (2) humidity of outside and inside air, (3) temperature in walls, floor, and ceiling, (4) ambient air temperature in the tower, (5) radiant heat in the tower, (6) changes in atmospheric composition within the tower, and (7) outside air temperature, the following instruments were used: (1) recording anemometer, (2) sling psychrometer and Foxboro recording psychrometer, (3) three iron constantan thermocouples connected to recording potentiometers, (4) gas analysis equipment and Cities Service heat prover for measuring oxygen concentration, and (5) thermometers.

Test Animals. The test animals, young domestic pigs, were placed in stiff wire cages and hoisted by means of cables to any desired location within the towers. The cable system was so

constructed that a person standing in the bottom of the hatchway could remove one or both of the animals at any time during an experiment.

Spray and Fog Nozzles. Special nozzles were used to produce either a spray or a fog within the conning tower. The spray nozzles were capable of delivering approximately ¾ gal of water per min when under 100 lb of pressure, and the fog nozzle delivered 2.5 and 3.4 gal of water per hr when under pressures of 50 and 110 lb, respectively.

Forced Ventilation. In some of the runs forced ventilation was provided through a 6-in. duct which terminated 2 ft below the deck of the conning tower. The air was supplied by a ½-hp fan located at the end of a 10-in. duct which was connected to the 6-in. line. The quantity of air was regulated by means of a damper placed in the line below the fan. The air passed out of the tower through a 10-in. duct in the roof.

Insulation. In some of the runs the inside of the tower was insulated by blankets of glass wool 1 in. thick, fastened to the roof and walls. A 4-in. layer of glass wool was packed between the false floor and the deck. The hatchway was insulated with a 2-in. blanket of glass wool to provide protection against fires in the lower compartment. The blankets were held in place by stud bolts welded to the conning-tower walls.

6.10.4

Results

Port Plugs. The requirements for port plugs were that the plugs must be transparent, not decrease the angle of vision, be able to withstand shock and intense fire, be able to seal the port completely, and be easily replaced. To meet these requirements, a laminated glass block (Figure 17) was tested and found to be satisfactory under the conditions of the tests. Although the heat severely cracked the outer layers of glass, impairing the vision, these plugs withstood repeated fires and sudden chilling. There was no leakage whatsoever and damaged plugs were easily replaced.

Drainage. Referring to Figure 16, the possibility of large quantities of liquid accumulating in the top passageway can be seen. To minimize

CONFIDENTIAL

TABLE 2. Effectiveness of countermeasures.

Run No.	Type of run	Net heat input to walls (Btu)	Max. air temp. rise (F)	Air temp. rise (F) (0-15 min)	Air temp. rise (F) (15-30 min)	Counter-measure index	Number of pigs used	Time 1st pig was exposed (min)	Temp. of animal (F)	Fate of 1st animal	Time 2nd pig was exposed (min)	Temp. of animal (F)	Fate of 2nd animal
36	Three-drum fire, ports closed	746,000	85-163=78	85-97=12	97-144=47	10.5	2	40	106.7	Survived	70	112.5	Died
44		569,000	55-120=65	55-88=33	88-108=20	11.4	2	55	105.5	Survived	55	106.0	Survived
45		873,000	69-165=96	69-117=48	117-149=32	11.0	2	50	112.0	Died	80	Dead on removal
72	Four-drum fire, ports closed	1,192,000	76-195=119	76-157=81	Over 10 min per. 157-195=38	10.0	2	30	109.7	Survived	30	112.0	Survived
37	Three-drum fire, ports open	1,093,000	63-155=92	63-144=81	144-155=11	8.4	2	80	112.0	Died	145	109.5	Survived
46		709,000	66-148=82	66-132=66	132-146=14	11.6	2	30	104.0	Survived	30	107.8	Survived
40	Three-drum fire, ports open, spray	448,000	80-120=40	80-106=26	106-115=9	8.9	2	60	102.7	Survived	120	104.0	Survived
43	Spray nozzles delivered 1/2 gal/min per pig	694,000	58-132=74	58-107=49	107-127=20	10.7	2	75	103.1	Survived	120	102.9	Survived
41	Three-drum fire, ports closed, spray	870,000	64-164=100	64-100=36	100-141=41	11.5	2	60	111.9	Died	60	Dead on removal
42	Spray nozzles delivered 1/2 gal/min per pig	970,000	62-159=97	62-101=39	101-141=40	10.0	2	45	106.5	Survived	90	Dead on removal
47*	Spray nozzles delivered 1/2 gal/min per pig	920,000	124-222=98	123-158=35	158-208=50	11.2	1	20	Dead on removal
48	Three-drum fire, ports closed, fog	910,000	92-183=91	92-9=28	120-165=45	10.0	2	30	110.2	Survived	34	111.0	Survived
49	5 fog nozzles per pig, total amt water=25 gal/hr	1,328,000	96-234=138	96-115=19	115-195=80	10.4	2	30	Dead on removal	30	Dead on removal
65	Three-drum fire, ports closed, ventilation	1,059,000	87-155=68	87-121=34	121-144=23	6.4	2	46	Dead on removal	46	Dead on removal
66	740 cu ft per min delivered by fan	984,000	85-136=51	85-102=17	102-132=30	5.2	2	36	111.5	Survived	39	113.0	Died
67	170 cu ft per min delivered by fan	1,188,000	66-130=64	66-92=26	92-117=25	5.4	None
68	Three-drum fire, ports closed, ventilation-fog	933,000	81-142=61	81-105=24	105-142=37	6.5	2	25	108.2	Survived	25	Dead on removal
69	360 cu ft of air per min, 5 fog nozzles per pig 25 gal/hr	977,000	70-159=69	70-81=11	81-127=46	7.1	2	38	104.4	Survived	40	109.1	Survived
70	680 cu ft of air per min, 5 fog nozzles over duct 17 gal/hr	963,000	78-135=57	78-91=13	91-135=44	5.9	2	32	107.1	Survived	32	107.2	Survived
71	460 cu ft of air per min, 5 fog nozzles over duct 12 gal/hr	963,000	80-172=92	80-114=34	114-182=68	9.6	2	28	107.8	Survived	30	111.0	Survived
73	Three-drum fire, ports closed, insulation	1,652,000	67-128=61	67-75=8	75-100=25	5.6	None
74	Three-drum fire, ports closed, insulation, ventilation	626,000	62-71=9	62-64=2	64-67=3	1.4	None
75	740 cu ft of air per min delivered by fan	1,230,000	76-97=21	76-87=11	87-91=4	1.7	None
76	360 cu ft of air per min delivered by fan	1,103,000	85-97=12	85-87=2	87-91=4	1.1	None
77	170 cu ft of air per min delivered by fan	1,007,000	87-119=32	87-98=11	98-106=8	3.2	None
78	265 cu ft of air per min delivered by fan	895,000	95-123=28	95-103=8	103-109=6	3.1	None
79	Four-drum fire, ports closed, insulation, ventilation†	89-160=71	89-160=71	160-155=5	None

*One-drum fire preceded test to warm tower as ambient air temperature was low. †3 drums topside and contents of fourth drum emptied in lower compartment for fire below.

the amount of fuel collected in the passageway, two 2-in. drain pipes were installed. Figure 18 shows the material reduction in thermal efficiency that was accomplished by drainage. In addition to the drain pipes, slots were cut in the base of the splinter shield in the upper passageway. The slots, however, were effective only for a short period of time because of excessive warping of the deck.

Wind. The wind had a very pronounced effect

flames would be directed over the sides of the ship and would make fire control easier.

Spray and Fog Nozzles. In Table 2 there is given a complete summary of the effectiveness of the countermeasures as measured by the countermeasure index. Spray nozzles did not show any significant change in this index as compared to tests without spray nozzles.

Similarly, fog nozzles did not prevent the interior temperature from rising. It is evident

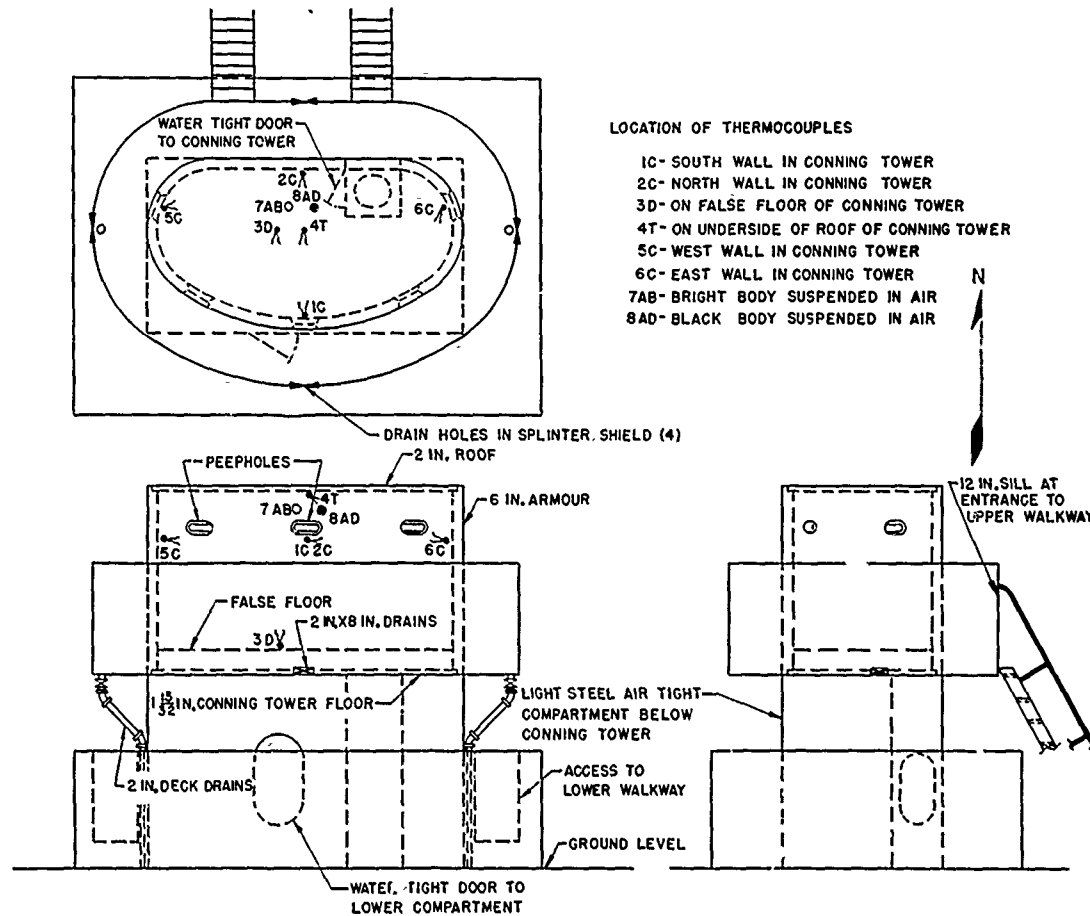

FIGURE 16. Diagrammatical views of conning tower showing experimental conditions.

on the thermal efficiency. Referring again to Figure 18, the sharp decrease in thermal efficiency with increasing wind velocity will be noted. Since, however, the wind is not a controllable variable, advantage can only be taken by directing the ship into the wind. If the ship is free to maneuver, practical utilization of the wind would be to set the course of the ship 40 to 50 degrees with the wind. In this way the

that beside the discomfort incurred in a closed room filled with spray or fog there appeared to be no beneficial results from the use of nozzles.

Ventilation. When tests were conducted using forced ventilation, considerable reduction in the index occurred. Using a rate of 740 ft per min, the index was reduced by 50 per cent (Table 2, runs 66 and 45). To further substantiate the effect of ventilation, the fan was alternately

CONFIDENTIAL

turned on and off during one test. A temperature rise and fall which corresponded with the fan off and on was noted. No evidence could be found that a combination of fog and ventilation possessed any advantage over ventilation used alone.

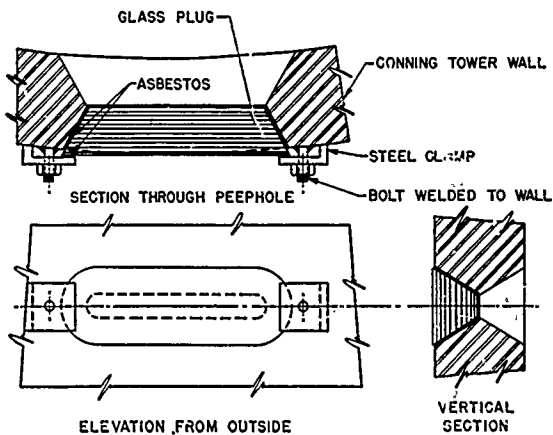

FIGURE 17. Sketch of glass plug for conning-tower portholes showing plug in position.

Insulation. Glass-wool insulation used independently had the same effect on the counter-measure index as forced ventilation. A compari-

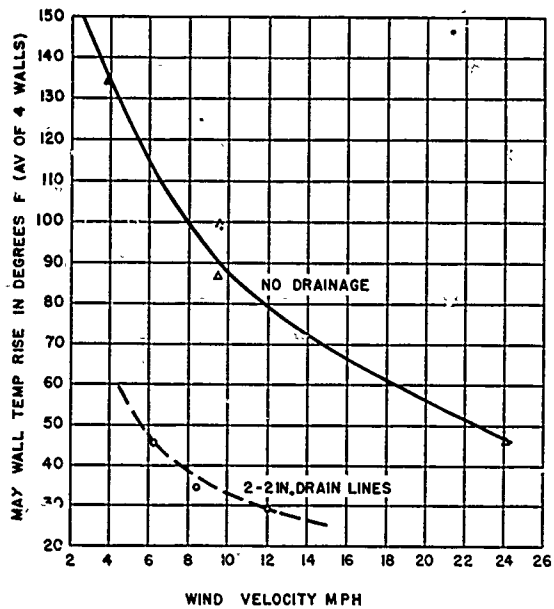

FIGURE 18. Effect of wind and damage on steel wall temperature rise.

son of runs 73 and 45 shows about 50 per cent reduction in the index. The use of insulation and forced ventilation in combination produced the most favorable condition, as evidenced by comparing runs 74 and 75 with either 66 or 73.

STUDIES ON FLAME-THROWER DESIGN

7.1

INTRODUCTION

THE VALUE OF a flame thrower depends upon (1) the distance that the fuel can be projected, (2) the amount of burning fuel that can be placed on the target in a given time, (3) the burning rate of the fuel, and (4) the reliability of the weapon.

The independent variables determining these performance characteristics may be divided into two classes: (1) the design variables, which include nozzle shape and size, nozzle flow control, ignition mechanism, propulsion mechanism, and controls; (2) the operating variables, which include fuel composition and consistency, fuel pressure, gun elevation, composition and proportion of secondary fuel, wind direction and velocity, and temperature, some of which are controllable and some are not.

Some of the factors of design, particularly those affecting ruggedness and general reliability of the weapon, are best appraised by actual battle experience or by field shakedown tests simulating or exaggerating battle conditions. Others are susceptible of evaluation only by careful laboratory or field tests under reproducible conditions. The present chapter presents results of studies of factors of the latter type.

Next to reliability the range of a flame thrower is its most important characteristic. Unfortunately, the term has been used too casually. In the assessment of two different flame throwers by two different groups a small difference in the choice of angle of elevation, wind velocity, or fuel consistency can completely mask a real, and perhaps important, difference in the range of the weapons. In this chapter the term range will refer to the distance to the center of ground deposit of the fuel, and pertinent operating conditions will be specified.

The material for this chapter is drawn from the work of all NDRC contractors on flame throwers. This group includes, in chronological order of initiation of work, Massachusetts Institute of Technology, Factory Mutual Research Corp., Standard Oil Development Co., Eastman

Kodak Co., E. I. du Pont de Nemours & Co. (Section 11.2), Standard Oil Co. (Indiana), Shell Development Co., C. F. Braun & Co., Morgan Construction Co. and State University of Iowa. Also, it has been necessary to refer occasionally to the parallel work of the British and Canadians, but no attempt has been made to present their results in detail.

7.2

NOZZLE DESIGN

Introduction. It is generally recognized that the range and physical characteristics of fluid jets are influenced, to some degree, by the nozzle design. The exact portion of a flame thrower designated by the term nozzle is a matter of definition; the term will refer here to that section which reduces the flow from a large cylinder to an orifice, or, in general, to the last mechanical section prior to the discharge of the jet from the apparatus. In several of the designs the situation will be somewhat complicated by the addition of secondary fuel at the point of contraction. Also, both pintle valves and straight-section extensions will be considered a part of the nozzle.

Newtonian Liquids. Early work, as might be expected, was based on Newtonian fluids. Non-Newtonian fluids were included later when their utility as flame-thrower fuels was recognized. Preliminary experiments with high-speed photography on a nozzle converging in diameter from $4D$ to D formed by a part-circle revolution (radius = $13D$), followed by a straight section $6D$ long, showed an early breakup of the jet.¹ The use of a straight section was considered not only unnecessary, but even a possible source of turbulence generated in the liquid; and for this reason straight sections were early abandoned on experimental models.

Previous studies by the British, as reported in a conference on flame throwers held March 3, 1942, indicated that there was little difference in the ranges obtained from nozzles of varying designs having the same *vena con-*

*tracta.*² These conclusions were substantiated by the work of Factory Mutual Research Corp., which tested three nozzles having included angles of 15, 37, and 90 degrees. When the nozzle diameters were adjusted to give equal discharge at equal pressure, the results showed no effect of rate of contraction on the range of the jet.³ On the basis of these findings and those of Shell Development Co. on high-pressure hydraulic nozzles, it was concluded that the possibility of a further increase in the range from improved nozzle design was small in comparison to the increase that might be expected from changing some of the other variables. The emphasis, therefore, was shifted to the other variables.⁴

Non-Newtonian Liquids. Initially the nozzles for Newtonian fluids were used in the study of non-Newtonian fluids. However, British experiments with high-speed photography on various nozzle designs and using FRAS (aluminum stearate-thickened fuel) showed that the addition to the nozzle of a straight section of several nozzle diameters reduced jet breakup.⁵

Since the range is dependent upon jet breakup, it was concluded that the addition of a straight section should give an increased range. Experiments by the NDRC groups at MIT and Standard Oil Co. (Indiana) confirmed this conclusion.^{6,7} Figure 1 illustrates the increased range obtained by the addition of a straight section to the nozzle. It will be noted that the per cent increase in range is somewhat greater for the smaller-sized nozzles. In addition, there appears to be an optimum length for the straight-section extension. This has been thought to take care of a period of relaxation after the jet is accelerated through the nozzle with attendant deformation of the jet.⁵ Shell Development Co. found that extremely long extensions of 3 to 5 ft did not only fail to improve the range but impaired the ignition.⁸ However, more recent studies by Standard Oil Development Co. do not appear to agree with the earlier findings on maximum extensions; they have found that an extension of several feet definitely improves the performance.

Introduction of Secondary Fuel into Nozzle. Regardless of the performance of an unignited jet, it must always be remembered that for best

flame-thrower performance complete ignition of the jet is essential. To accomplish this, the principle of secondary fuel addition was introduced (see "Secondary Fuel and Pintle Valve"). Several nozzles were designed which introduced the secondary fuel on the periphery of the main

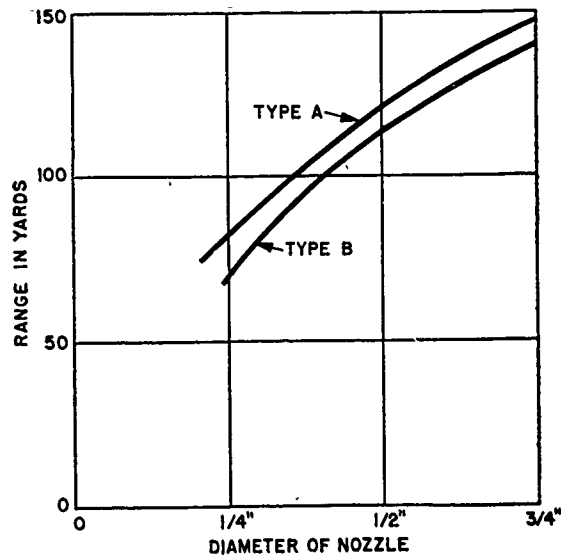

FIGURE 1. Effect of nozzle design on range.

gel rod at the point of contraction⁶ while others introduced the secondary fuel in a section preceding the nozzle.

In type A (Figure 2A) the secondary fuel entered the main stream near the beginning of the contraction and, therefore, the mixture of thickened fuel and gasoline contracted together. In all probability a venturi effect was established but not to any great extent, since in operation it was necessary to maintain the secondary fuel at a higher pressure than the main fuel. Because of the difficulty with reproducibility of results from nozzle A, a new nozzle, type C, was designed (Figure 2B), in which the secondary fuel was introduced after the main jet had contracted. In this way the secondary fuel was applied in a very thin film. With momentum transfer increased, the required secondary fuel pressure could be reduced. Type C proved to be much easier to adjust than type A, possibly through the reduction of disturbances which might have been set up during the contraction of the mixed jet. In an effort to maximize the venturi effect, a nozzle was designed in which

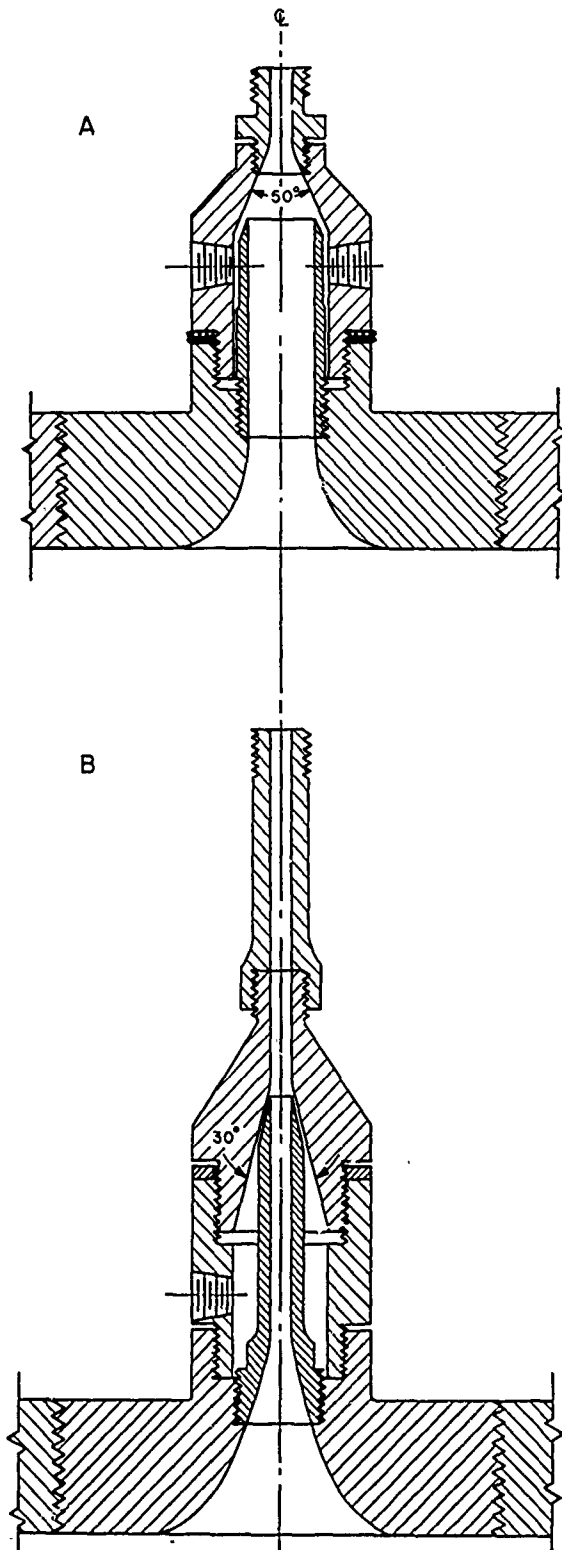

FIGURE 2A. Nozzle for 1.2-gal flame thrower, type A.
 FIGURE 2B. Nozzle for 1.2-gal flame thrower, type C.

the gel stream expanded after the point where the secondary fuel was introduced. Although the venturi effect was increased considerably, the nozzle was much too sensitive to adjust. Since no comparative tests have been made, no conclusions can be drawn on the relative performance of the Indiana nozzle with others.

Secondary Fuel and Pintle Valve. Introduction of secondary fuel in the annulus of a nozzle fitted with a pintle valve gave rise to further complications. A spring-operated pintle valve was designed with the purpose in mind that the fuel flowing through the nozzle when the pintle was open would accelerate at a constant rate. To accomplish this, the convergent section of the nozzle had the same curvature as the pintle. The secondary fuel for this nozzle was introduced through an annular opening upstream from the straight section. Insufficient tests of this type of design prevented a true evaluation of the nozzle.⁹

A similarly designed nozzle was developed and tested by another group.¹⁰ It was stated that in this nozzle the secondary fuel did not reach the same velocity as the main gel stream and, consequently, burned off too rapidly. In order to prevent this premature burning a venturi throat was inserted ahead of the pintle valve. The secondary fuel remained on the rod longer, but the rod appeared to have greater breakup. Further experiments indicated that the optimum point for admission of the secondary fuel was in the convergence just back of the point where the pintle piston seats.

Nozzle Smoothness. The character of the jet periphery, in part determined by the nozzle smoothness, affects the range by controlling the degree of ignition. In the instances where no secondary fuel is used ignition becomes more difficult with increasing fuel consistency and, over the range of practical interest, with nozzle pressure. If a roughly machined nozzle is used, the slight surface disturbance created on the jet makes it possible for a flame to remain on the jet,⁷ whereas there is a tendency for the flame to blow out on very smooth jets. Thus one concludes that under conditions of absence of ignition trouble, such as warm weather and thin fuel, a smooth nozzle is desirable to minimize jet breakup; but if ignition is controlling, a rough nozzle is better.

CONFIDENTIAL

Pintle Valve. The introduction of the pintle-valve principle for flame throwers would seem to lead to a possible disturbance in the jet. This fact was demonstrated in the high-speed photographic work by the British.⁵ However, they also showed that the straight-section extension eliminated any visible disturbance at the nozzle. The effects of the pintle valve on breakup and range have never been adequately studied, although there is some evidence, from work at Edgewood Arsenal, that the pintle valve has some effect on the jet (see section on Effect of Approach Conditions).¹¹

Nozzle Diameter. As will be shown later in the section on Correlation of Range Data, increasing the jet diameter reduces the tendency for the jet to break up and, therefore, increases the range (Figure 3). However, the rate of in-

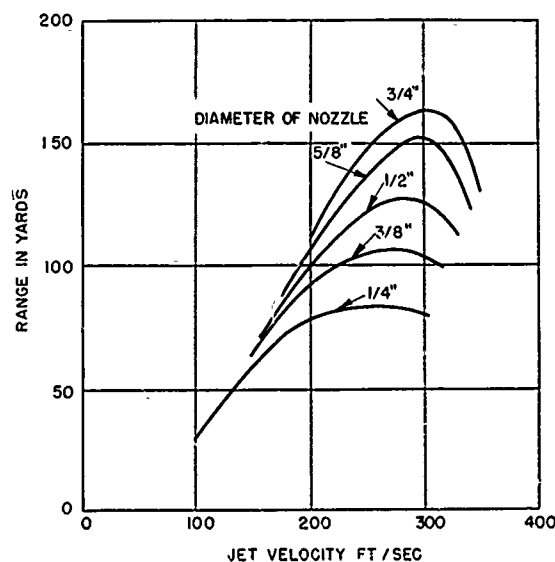

FIGURE 3. Effect of nozzle diameter and velocity on range.

crease of the range with increased diameter is much less for larger nozzles. An additional important consequence of increased diameter is the increased fuel-discharge rate. Consequently, the extent to which the diameter can be increased depends largely upon the fuel capacity of the flame thrower.

7.3 EFFECT OF APPROACH CONDITIONS

Introduction. The approach to the nozzle exerts several effects upon the range of a flame

thrower. First, pressure losses between the fuel supply and nozzle due to friction are common to both thickened and unthickened fuels. Second, turbulence in the issuing jet is associated primarily with Newtonian liquids, and consequently is of reduced interest in modern flame-thrower design. A third is "gel working." Although data available on this last phenomenon are very limited, evidence exists that various obstructions cause the gel to undergo internal changes which cause an early breakup of the jet, with consequent reduction of range.

Valves. A specific example of gel working caused by approach conditions was studied by the Eastman Kodak group.¹² Using high-speed photographic technique, they observed the characteristics of the stream issuing from the downstream side of a ball valve and Y valve, such as used in different models of an M1A1 flame thrower (Figure 4). Similarly, they observed the jet from an M1A1 flame thrower, first provided with a Y valve, then with a ball valve, and also compared these to an M2-2 flame thrower having a pintle valve. In all cases for two pressures and two types of gels, the photographs of the jets showed a greater disturbance for the Y valve than for either the ball or pintle valve. The pintle valve performance appeared to lie between the other two valves.

The range data for ignited jets were consistent with the results of the photographs of the unignited jets. The ball and pintle valve gave substantially greater ranges than the Y valve (Table 1).

Disturbance in Fuel Line. In an attempt to determine the effect on the range of obstructions in the line, cylindrical and multiple expansion-contraction plugs were inserted prior to a straight section leading to the nozzle.¹³ In Figure 5, Section E illustrates the type of plug used. The plugs were held in place by supports which had slits 22 nozzle areas in cross section to allow for the passage of the fuel. The annular cross section was equivalent to 15 nozzle areas for the cylindrical plug and varied from 15 to 20 for the multiple expansion-contraction plugs. Careful measurement of range disclosed that these disturbances did not appear to have any consistent effect whatsoever on the range.

Straight Sections. Some effects of straight

4.2% IMPERIAL NR-651, WARM 1 DAY, GOLD 3 DAYS (FIRED GOLD)
GARDNER CONSISTENCY 300

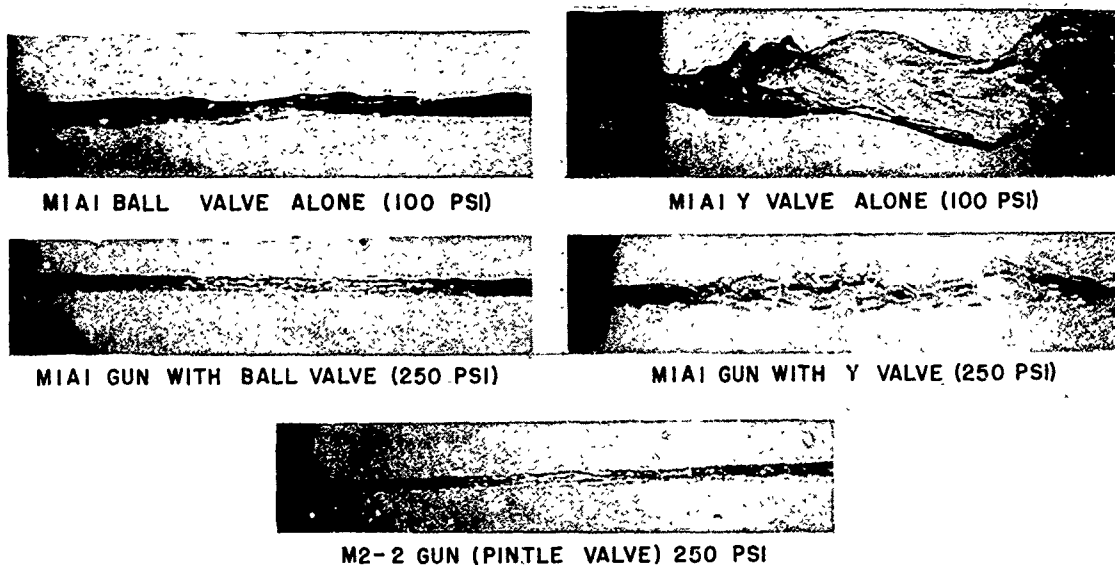

4.2% IMPERIAL NR-651, WARM 4 DAYS (FIRED WARM) GARDNER CONSISTENCY 100

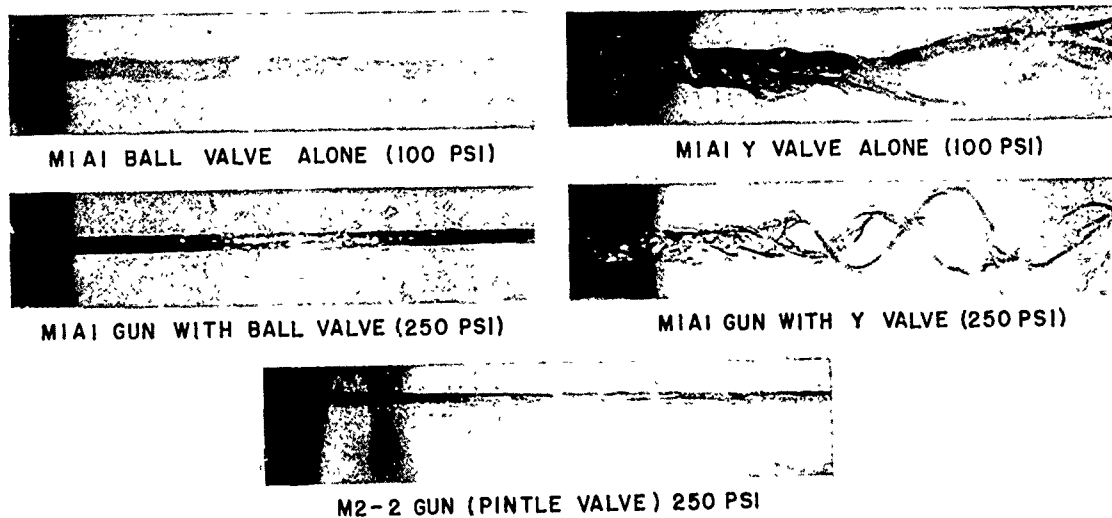

FIGURE 4. Breakup of thickened fuels in flame-thrower valves and nozzles.

sections have been observed.¹³ Figure 6 shows that a long, narrow approach gives a somewhat greater range than a short wide section. It is possible that in the long section the gel molecules become better aligned than they do in the shorter section, and the gel structure is less

subjected to further deformation in the contraction from $\frac{1}{4}$ in. to $\frac{1}{8}$ in. than in the 1-in. to $\frac{1}{8}$ -in. contraction. The lower per cent gels give no evidence of increase in the range under the same conditions.

Bends. Tests on other types of obstructions

CONFIDENTIAL

substantiated the gel working theory. Figure 7 shows the effect of gel viscosity on the range for two nozzle sizes. A pair of acute bends, acute bends plus a mock pintle, a pair of smooth bends

The smooth bends caused the greatest reduction in range. These results are interesting when compared with friction losses, in which sharp bends and obstructions give greater pressure losses than smooth bends. A possible explanation for the reduced range of thickened

TABLE 1. Comparison of M1A1 gun with ball and Y valves with M2-2 gun fired from E5R1 fuel tanks, 250 psi.

Temperature when fired (F)	Gardner consistency at temperature when fired (g)	Gun	Valve	Flame diameter (ft)	Range (center of deposit) (yd)
26	250	M1A1	Y	1.8	48
26	250	M1A1	Ball	0.8	54
26	250	M2-2	1.3	54
26	250	M1A1	Y	0.6	48
26	250	M1A1	Ball	0.6	52
30	300	M1A1	Y	1.1	43
30	300	M1A1	Ball	0.5	61
30	300	M2-2	0.9	51
70	100	M1A1	Y	2.0	45
70	100	M1A1	Ball	0.6	65
70	100	M2-2	1.5	60
32	210	M1A1	Y	1.8	43
32	210	M1A1	Ball	1.0	58

(tube turns) and a dwarf pintle valve set in a straight section of pipe gave up to 20 per cent reduction in the range for the 3/4-in. nozzle.⁶

FIGURE 6. Comparison of effects of short 1-in. and long 1/4-in. straight sections on range of 7.8 per cent Napalm gels, unignited, issuing from a 1/8-in. nozzle.

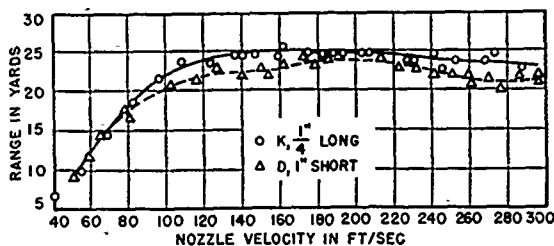

liquids after passing through smooth bends is that the gel stream has time to become deformed and turbulent, or to produce an inside fold. On the other hand, when the gel stream passes through a sharp bend, there is not sufficient time for permanent deformation to take place, the elastic forces in the gel causing a return to its original structure (see Chapter 8).

It will be noted that the 1/4-in. nozzle gave almost no variation in the range due to ob-

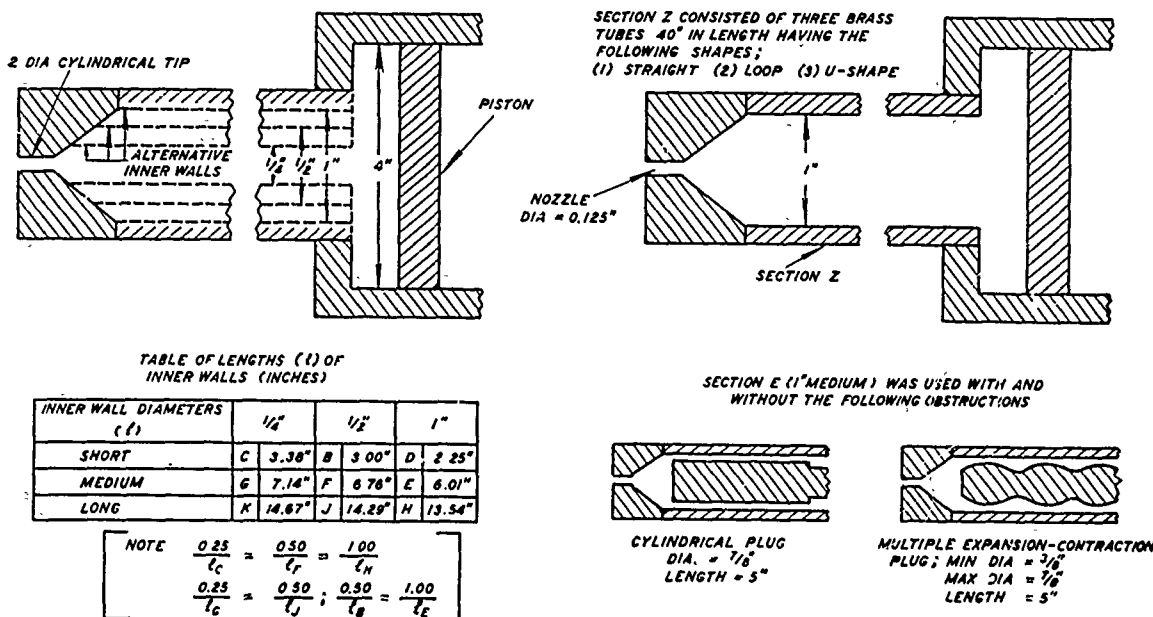

FIGURE 5. Diagrammatic sketches of MIT 1/8-in. nozzle with various types of approach sections.

structions, except for smooth bends. This was possibly because of the much lower velocity in the $\frac{1}{4}$ -in. apparatus. These results on bends have been confirmed by other investigators.¹³

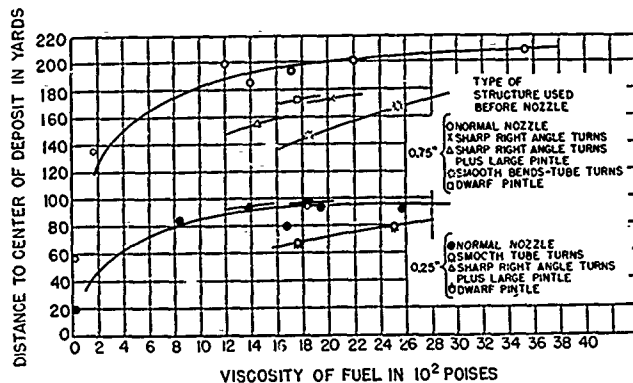

FIGURE 7. Relation between gel disturbance and range.

However, the lack of sufficient data prohibits any definite conclusions to be made on the exact effect of gel working.

Pumps and Water Hammer. In a study of pump propulsion, the Eastman Kodak group observed that the pump-propelled jet was broken up a short distance from the nozzle, while the compressed-gas propelled jet remained intact at similar distances (Figure 8).¹⁴ By using a piezoelectric crystal pickup, the pressure oscillations caused by the pump were measured. However, the oscillations were found to be substantially reduced by placing a surge chamber consisting of a synthetic rubber bag in a 3-in. perforated tube inclosed in a 4-in. pipe. As the gel flowed through the annular space between the outer shell and the bag, which was preloaded to a pressure lower than the operating pressure, the pressure oscillations were absorbed by the rubber bag.

During a study at Edgewood Arsenal of the "water hammer" effect in the E13R2 flame gun, the piezoelectric crystal pickup showed a pressure fluctuation during the entire burst.¹¹ Since the oscillations persisted throughout the burst, it seems likely that the phenomenon is a steady effect rather than a transitional one (Figure 9). Again these oscillations were reduced by introducing a surge chamber upstream from the pintle valve. No further investigations were

made on this effect other than to note that there appeared to be no significant decrease in the range.

7.4 PRESSURE LOSSES IN PROPULSION SYSTEMS

Introduction. In a flame thrower the magnitude of the pressure of the fluid at the nozzle is one of the major factors governing the range. Any pressure loss that occurs from the fuel tank to the nozzle reduces the effective pressure and, therefore, the efficiency of the flame thrower. For the portable flame thrower the pressure loss has been shown to be approximately 55 per cent of the fuel-tank pressure for M1A1 and 30 per cent for M2-2.¹⁵ For tank-mounted flame throwers and other systems in which the distance to the nozzle is considerably more and the path more complicated the pressure losses become even more significant. In the design of early apparatus to be used with unthickened fuels sufficient data existed to make rough estimates of pressure losses. With the introduction of thickened fuel, the viscosity of which was a function of the rate of shear, no information was available to make comparable predictions. A limited amount of data on the flow of thickened fuels has been collected since then to permit a fair correlation of the various operating variables with the pressure drop.

Pressure Loss in Straight Pipes. A number of groups have measured the pressure losses in sections of straight pipe.^{11, 13, 16, 17, 18} Since the thickened fuels are non-Newtonian, the analysis of the flow becomes complicated, but a correlation has been found in the viscous flow region. If Q/D^3 (proportional to shear rate) is plotted against $D(\Delta P)/4L$ (shear intensity at the pipe wall) on logarithmic paper, a straight line is obtained at the lower flow rates (see "Nomenclature" at the end of this chapter). For the same gel the flow curve is independent of the pipe diameter over a considerable range, as illustrated by the curves at left in Figure 11. In order to represent all the data for various gel strengths, an empirical relation has been determined involving the factor $D(\Delta P)/L$ divided by Gardner number +40.¹¹ Figure 10

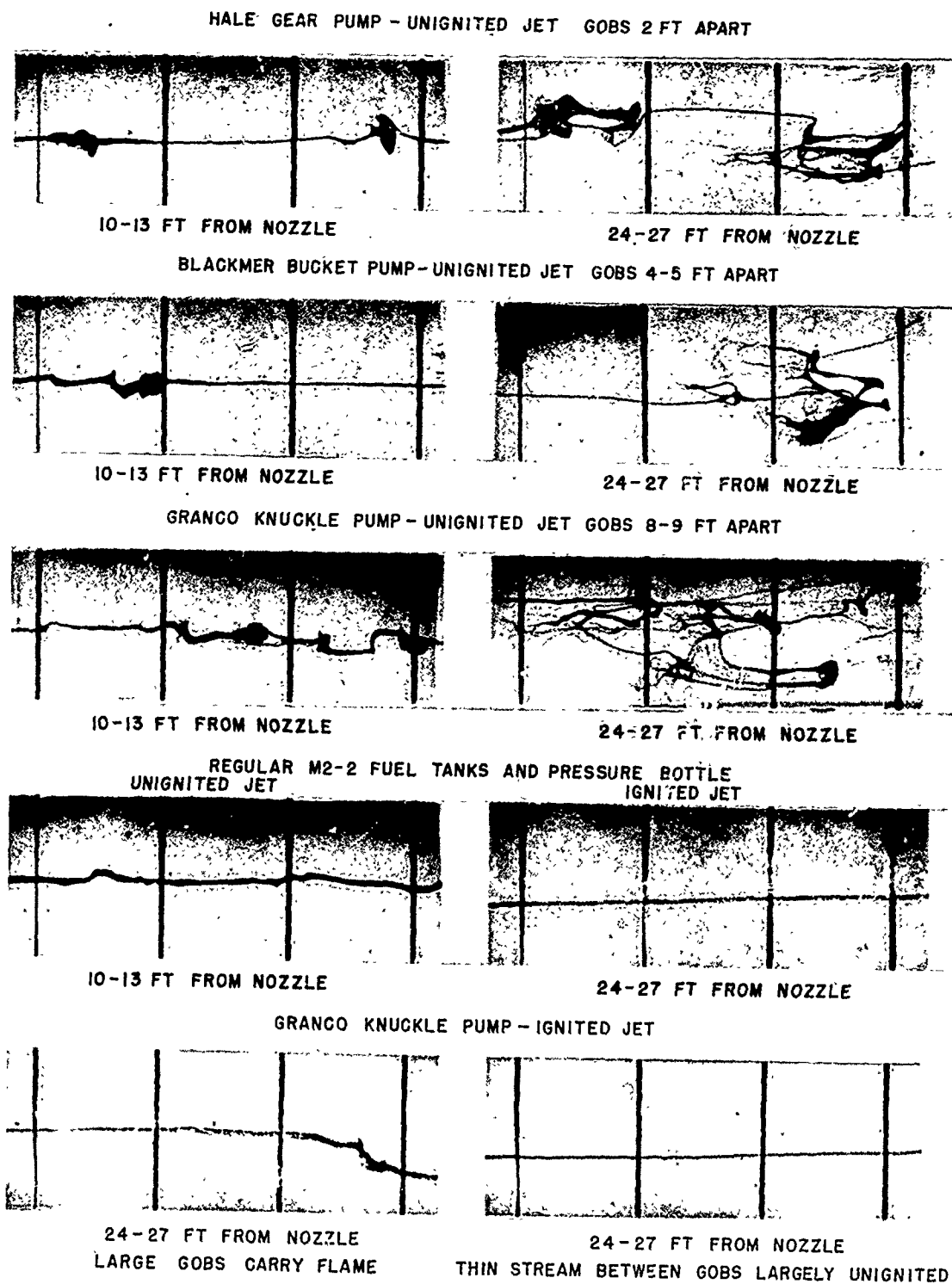

FIGURE 8. Single frames from high-speed (2,500 frames/sec) movies of jets of thickened fuels propelled by pumps.

CONFIDENTIAL





	FLAME THROWER	YARDS FROM NOZZLE	IGNITED	SECONDARY FUEL	SURGE CHAMBER
	MIT	2-4	NO	NO	NO
	MIT	2-4	NO	YES	NO
	MIT	2-4	NO	YES	YES
	MIT	10-12	NO	YES	NO
	MIT	10-12	NO	YES	YES
	MIT	10-12	YES	YES	NO
	SOD	2-4	NO	NO	NO
	SOD	2-4	NO	YES	NO
	SOD	10-12	NO	YES	NO

FIGURE 9. Prints from high-speed movies of MIT and SOD flame-thruster jets, with 400 Gardner fuel, $\frac{3}{4}$ -in. nozzles, and 400-psi regulator set pressure in every case. All movies taken at 3,000 to 3,200 frames/sec.

CONFIDENTIAL

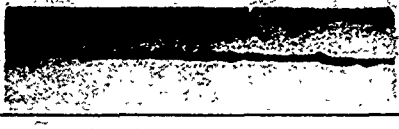
shows the curve resulting from plotting this new factor against Q/D^3 , utilizing data on four pipe sizes and three Gardner consistencies. To test this relationship, the data from another group¹⁸ were used in the same correlation. For the limited data at disposal it appears that Figure 10 represents the best available correlation on pressure drop in straight sections of pipe at flow rates up to 10, 60, and 120 gal per

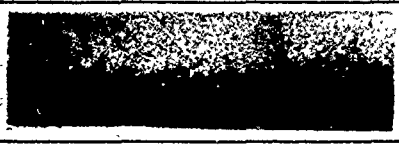
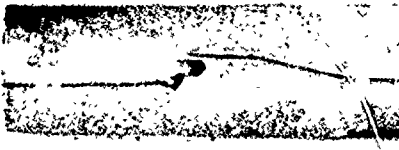
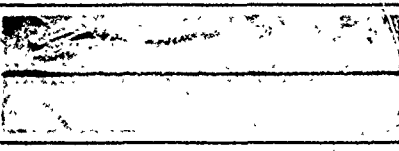
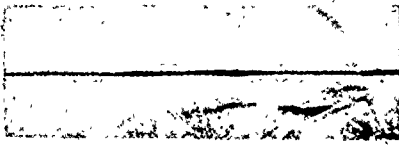
flow rates the curve for a 2.5 per cent Napalm solution is a continuation of that obtained for lower flow rates (Figure 11, bottom curve). However, it is probable that, if additional concentrations and pipe sizes were studied, the curve would branch out into a family of curves at these higher flow rates in such a manner as characterizes the group of curves shown for Newtonian liquids.

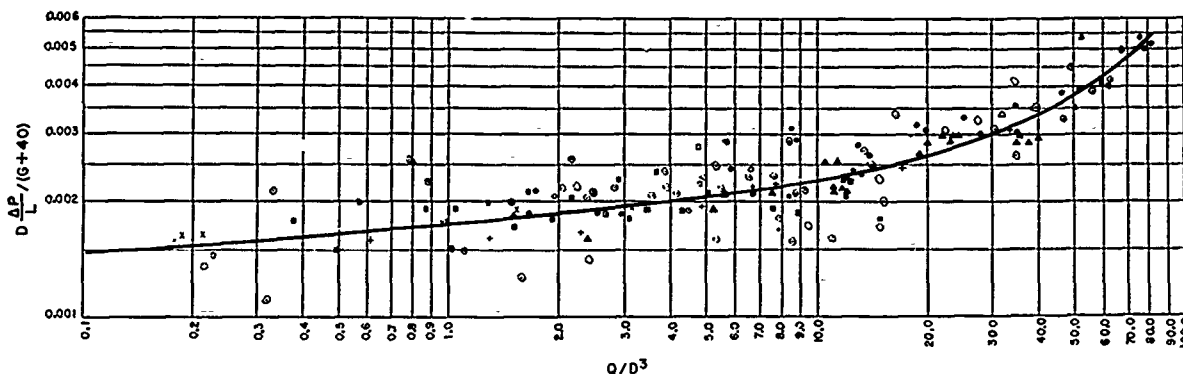

NOTATION	LEGEND	EXPERIMENTAL RANGES
Q = FLOW RATE IN US GALLONS/MINUTE	DIAMETER	Q - 0 TO 75
D = PIPE DIAMETER IN INCHES	1/2" 3/4" 1" 1 1/2" 2"	D - 1/2 TO 2
P = PRESSURE IN POUNDS/SQUARE INCH	GARDNER 110 ○ △ □	G - 110 TO 850
L = PIPE LENGTH IN FEET	" 390 ● ▲ ■	IMPERIAL NAPALM BATCH 2255
G = GARDNER CONSISTENCY IN GRAMS	" 850 ● + ×	
	EASTMAN 88-485 ○ ○	

FIGURE 10. Flow of Napalm gels in pipes. Generalized curve.

min in 1/2-in., 1-in., and 2-in. pipes, respectively.

Few data exist for higher rates of flow. A comparison of Figure 10 with the known performance of Newtonian liquids in pipes suggested that at high or intermediate flow rates diluted Napalms should show lower pressure loss on pumping than straight gasoline. Accordingly, a limited amount of data at higher flow rates was obtained. Figure 11, right-hand side, shows the pressure loss for gasoline and 2.5 per cent Napalm at these higher rates. It can be seen that at equal flow rates the pressure loss is less for the thickened fuel than for gasoline. This unusual circumstance has been attributed to the fact that in the region of turbulent flow under identical operation conditions, the degree of turbulence for the Napalm solution is less than for gasoline.

The data show that in the region of higher

Pressure Losses in Pipe Fittings. The pressure loss of thickened liquids in valves, bends, and most other fittings has not been reported. A few experiments were made on the effect of a contraction in the line.¹⁸ In this work 3 per cent Napalm gel was pumped into a 3/4-in. pipe (reduction in diameter 1/2) and into a 1/8-in. pipe (reduction in diameter 1/3). Figure 12 shows the pressure plotted against the distance from the contraction. For these conditions the pressure loss up to 40 in. from the point of contraction was not a linear function of the length as was the case beyond 40 in. downstream. By extrapolating the linear portion of the curve backwards to zero length, an uncorrected contraction loss of 6.4 psi for a 3/4-in. to 1/8-in. reduction and 2.9 psi for a 1 1/2-in. to 3/4-in. reduction was obtained, using a 3 per cent Napalm gel.

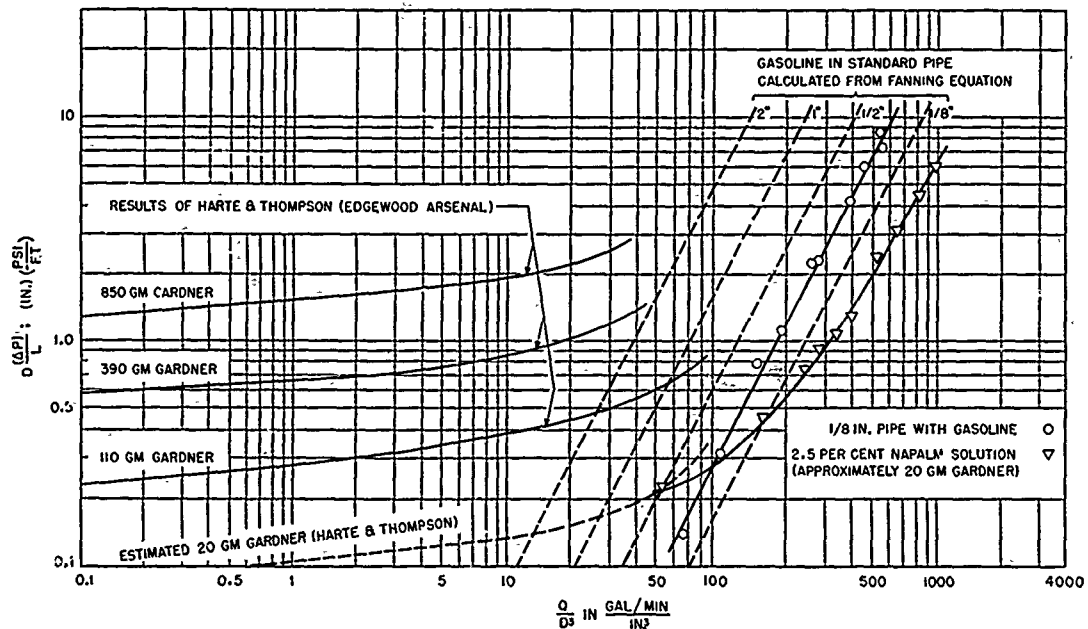

FIGURE 11. Flow characteristics of Napalm solutions in gasoline.

The uncorrected contraction loss is the sum of the increase in kinetic energy of the stream and the corrected contraction loss. The kinetic energy of a plastic stream is dependent upon

can be estimated, it is possible to compute the kinetic energy change accompanying the contraction. Subtraction of the increase in kinetic energy from the observed total contraction loss gives the corrected contraction loss.

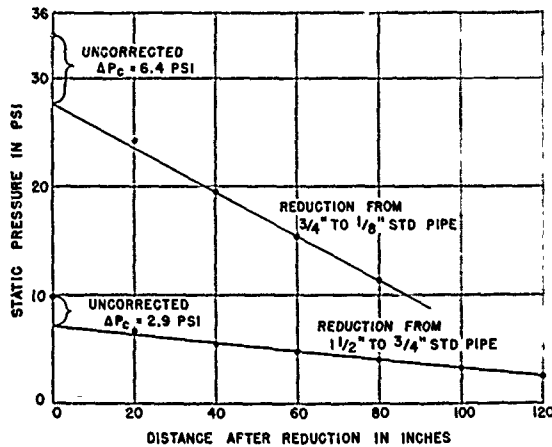

FIGURE 12. Pressure drop in pipe following reduction in cross section for a 3 per cent Napalm gel.

Nozzle Discharge Coefficients. The mechanical energy loss in a nozzle as expressed by the discharge coefficient has been studied quite extensively for Newtonian fluids. In order to compare the discharge coefficients of Newtonian and non-Newtonian fluids, an investigation of several gel strengths was made on different nozzles.¹⁰ Although the Gardner's of the various gels were not determined, their strengths varied from 6 to 9 per cent Napalm. Basing the calculations on the formula¹⁰

$$C = \frac{1.25 Q \sqrt{S}}{D^2 \sqrt{P} \sqrt{1-B^4}} \quad (1)$$

the velocity (average) and the extent of plug flow (c) and varies from $\rho_L(u')^2/g$ when $c=0$ to $\rho_L(u')^2/2g$ when $c=1$. Hence, if the constants of the plastic material are known so that the extent of plug flow (c) before and after contraction

a series of coefficients for four nozzles was obtained over a range of pressure up to 240 psi. The results for a 5/16-in. nozzle are shown in Figure 13 along with the curve for the coefficient of discharge for water. Whereas the coefficient of discharge for water does not vary with the pressure down to fairly low pressures, for values below 120 psi the coefficient for the gel

becomes a function of the pressure within that range.

Subsequent work partially confirms these results.¹³ Figure 14 shows results on a 1/8-in. nozzle, using different fuel consistencies and

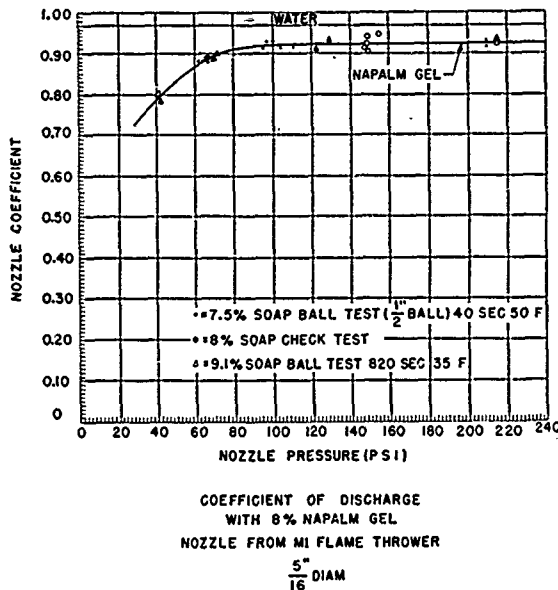

FIGURE 13. Coefficient of discharge of nozzle from M1 flame thrower.

approach sections. However, the values plotted are overall coefficients which include the fuel piston, fuel cylinder, approach section, and nozzle. The nozzle coefficient itself probably corresponds to curves drawn through the tops of the groups of data for the three fuels used.

An attempt was made to bring the curves of discharge coefficients onto a common curve by plotting discharge coefficient versus a Reynolds number evaluated from the Gardner consistency by the formula

$$\mu = k (G - 6) \tag{2}$$

In consequence, the curves reversed their relative positions and were actually more separated than without the viscosity allowance.

Another approach was tried by assuming that the apparent or effective viscosity μ for Napalm is given by the relation

$$\mu = \mu_0 R^{-k} \tag{3}$$

which leads to the conclusion that the Reynolds number is approximately proportional to

$$\left(\frac{D^{1-k} \mu_0^{1+k} \rho L}{\mu_0} \right)^{2/2-k}$$

and consequently, the discharge coefficient may be plotted versus

$$\frac{D^{(1-k)/(1+k)} \mu_0 \rho^{1/1+k}}{\mu_0^{1/1+k}}$$

If k is assumed to have a mean value of 0.7, the above reduces to

$$\frac{D^{0.18} (\mu_0 \rho^{0.6})}{\mu_0^{0.6}}$$

As shown in Figure 15, the curves again become reversed, indicating that there is still an over-correction.

7.5

OPERATING VARIABLES

Fuel Consistency. Fuel consistency is an important factor in determining the range of a flame thrower; it is this property which has given the additional range that thickened fuels have over unthickened fuels. In addition, for both unthickened and thickened fuels the specific gravity affects the range,²⁰ but to a much less degree than consistency affects it.

The many factors that determine the consistency of a gasoline gel are discussed in Chapter 8. In Figure 16 is shown the dependency of the range on the Gardner consistency. The solid curves of perfect ignition show the increase in range with increasing gel consistency. Within the limits of the data no optimum consistency is attained, provided perfect ignition is maintained, by means of secondary fuel. However, in practice the upper limit of gel strength is limited by supply of thickener and the mixing difficulties that occur at the higher concentrations.

Certain thickened fuels will have identical Gardner consistencies, but will differ in their relative "shortness." Several investigators have shown that the shortness of the gel does affect the jet characteristics^{21, 22, 23} and in some instances the range for a "long" gel is 10 to 20

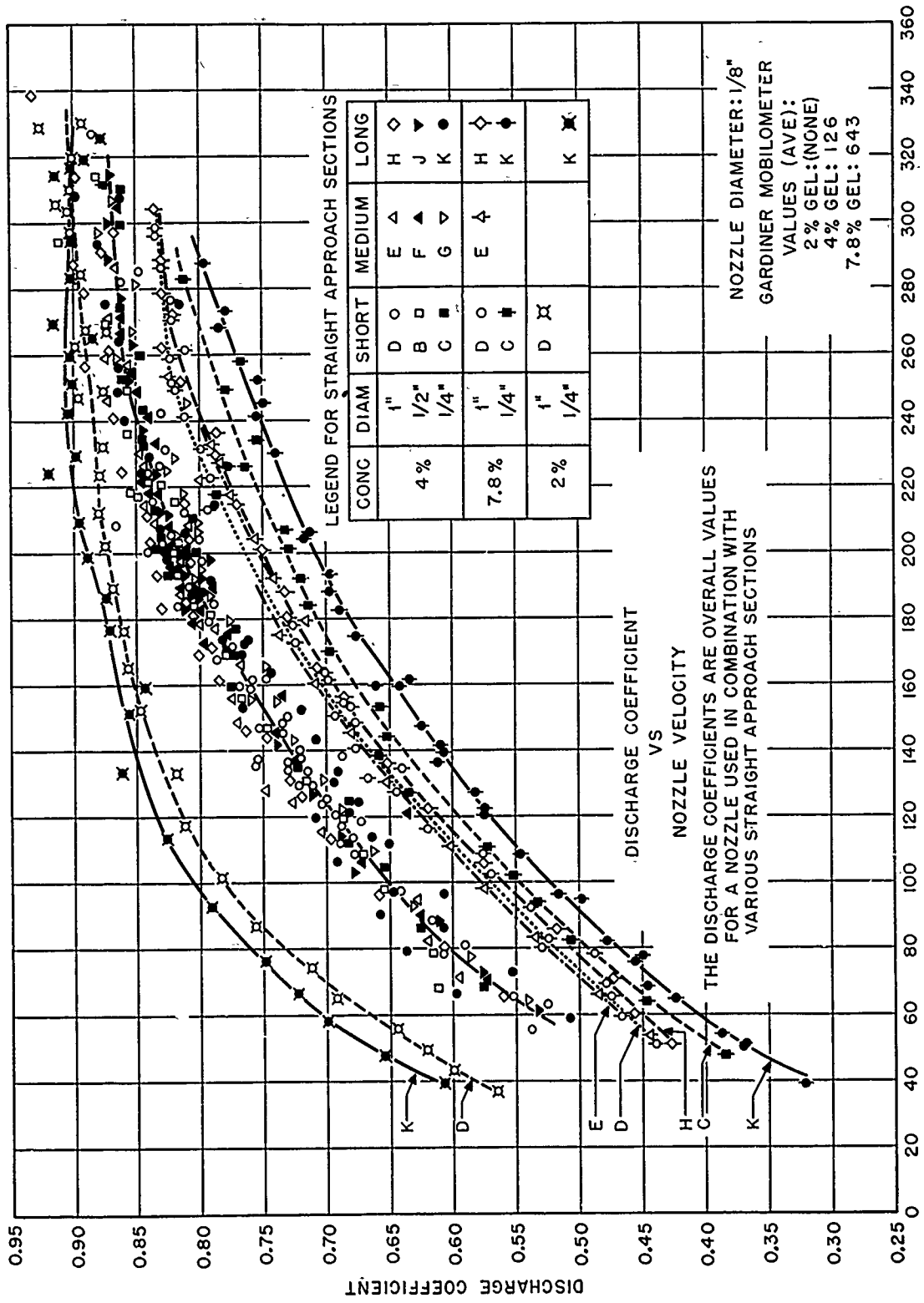

FIGURE 14. Discharge coefficient versus nozzle velocity.

CONFIDENTIAL

per cent greater than for a "short" gel. However, it has been found that this effect of gel shortness on the range does not occur over a minimum of about 1/2 in. measured on the ex-

has been made from high-speed photographs (Figure 17).²⁰ The distance a low-velocity jet will travel before breakup depends primarily on the nozzle diameter, surface tension, and viscosity. As the velocity increases, the jet takes the form of a wave resembling that in a whipped rope. The whipping action in the jet reduces the distance that the jet travels before breakup and hence decreases the range. By increasing the pressure at the nozzle, a critical velocity of the fluid is reached beyond which atomization occurs. This is readily observed in Newtonian liquids, but less frequently in thickened liquids which have much higher critical velocities.

Within the limits of practical operating pressures of flame throwers so far developed, it has been shown that the curve of range versus nozzle pressure is relatively horizontal at the optimum pressure.²⁵ Thus, considerable variation of the operating pressure will have only a slight effect upon the mean range, though the dispersion of fuel on the ground may materially change.

In addition to imparting velocity to a jet, the pressure affects the degree of ignition of a jet.

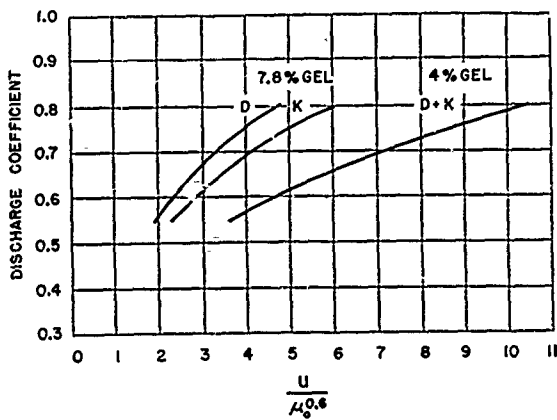

FIGURE 15. Discharge coefficient versus $\frac{u}{\mu_0^{0.6}}$.

tensionmeter apparatus of Eastman Kodak.²⁴ Later work at Suffield on peptized fuels that have the same Gardner consistencies as unpeptized fuel showed no appreciable difference in range.

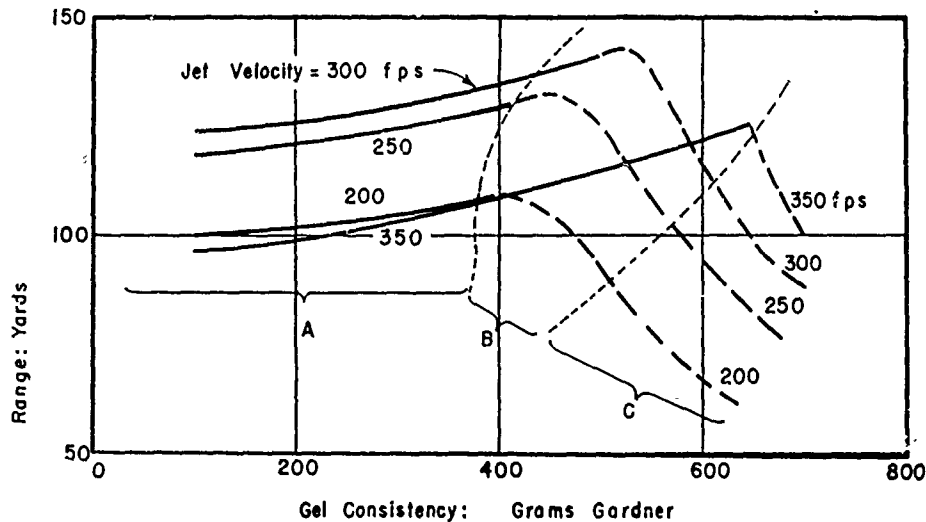

FIGURE 16. Effect of gel consistency on the range.

Nozzle Pressure. Referring again to Figure 3, the effect of nozzle pressure and of nozzle velocity upon the range is evident. For a given nozzle diameter there is an optimum nozzle pressure above which the range decreases. An analysis of a jet under varying nozzle pressures

In Figure 18 the actual range with imperfect ignition is plotted against the jet velocity, along with the theoretical range attainable with good ignition. At a low velocity of 150 ft per sec or less complete ignition is obtained, but as the velocity increases there is a tendency for the

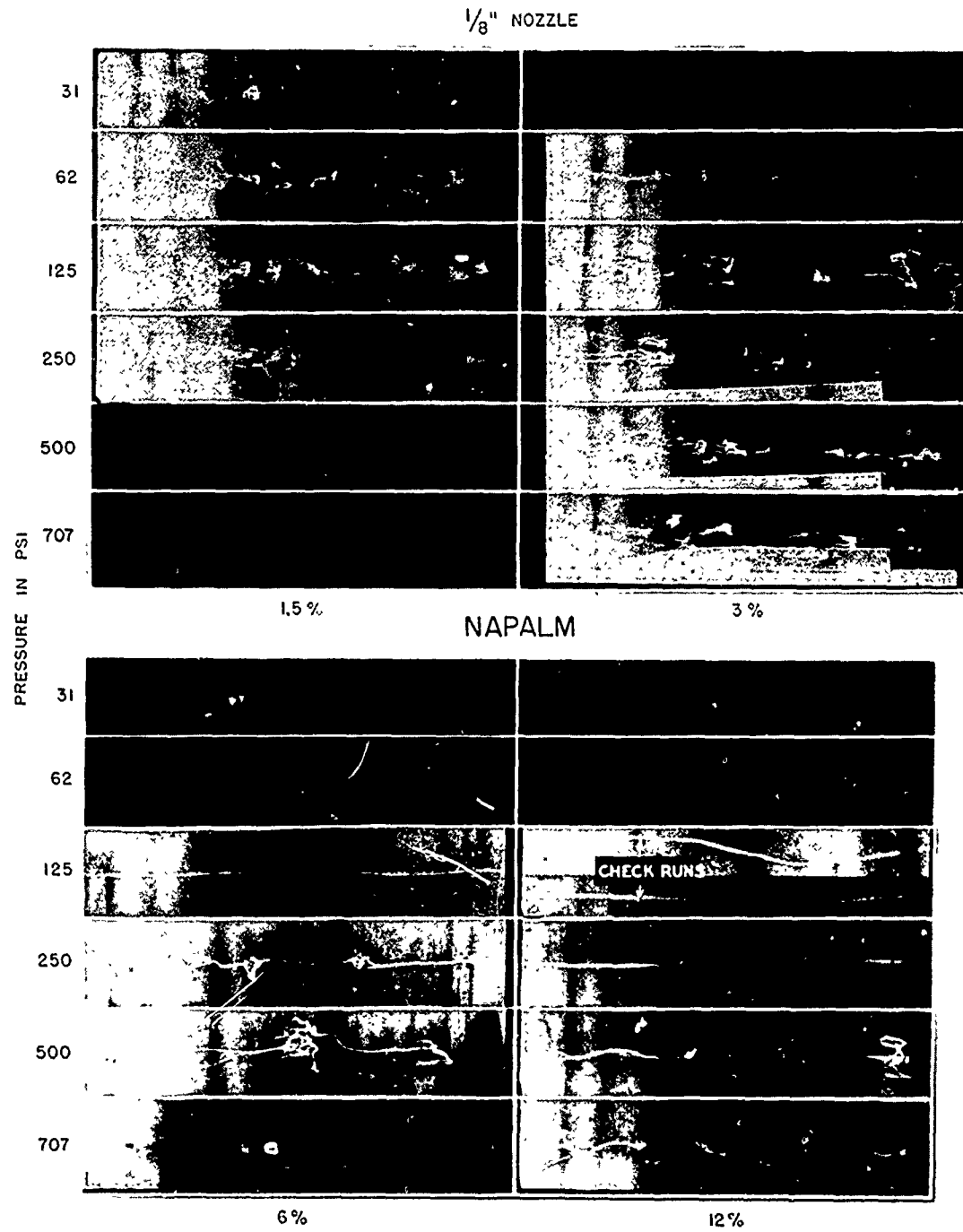

FIGURE 17. The breakup of jets of Napalm gels of various concentrations.

CONFIDENTIAL

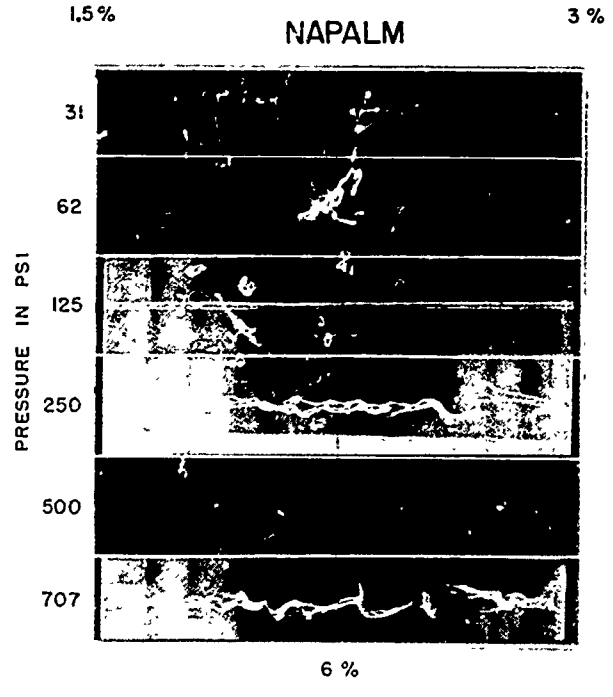
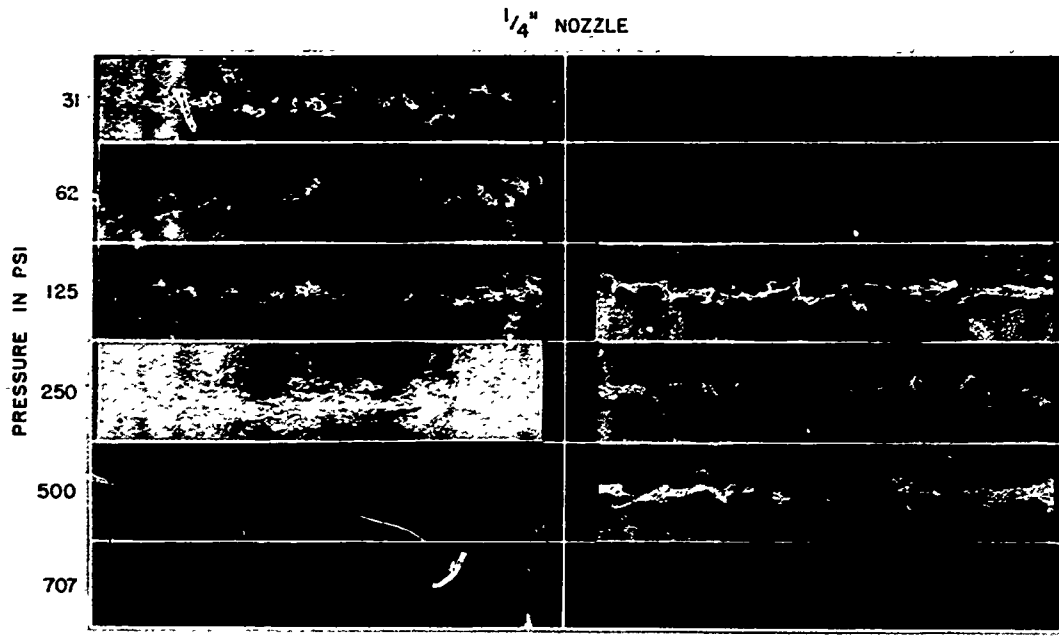

FIGURE 17. (Continued.)

CONFIDENTIAL

flame to blow out. As long as the jet remains smooth, the blow-out tendency continues to increase, and the range is reduced. However, a velocity is finally reached where the jet no longer remains smooth, and consequently there is an opportunity for the flame to remain on the jet. If secondary fuel is used, good ignition is maintained on the rod at all times.

the maximum range occurs at an angle of elevation somewhere between 20 and 30 degrees, but for larger jets the optimum angle of elevation is 15 to 20 degrees.²⁶

Using the same analysis which appears below in the section on wind, it can be shown that the effect of wind on the range is a function of the angle of elevation, particularly when

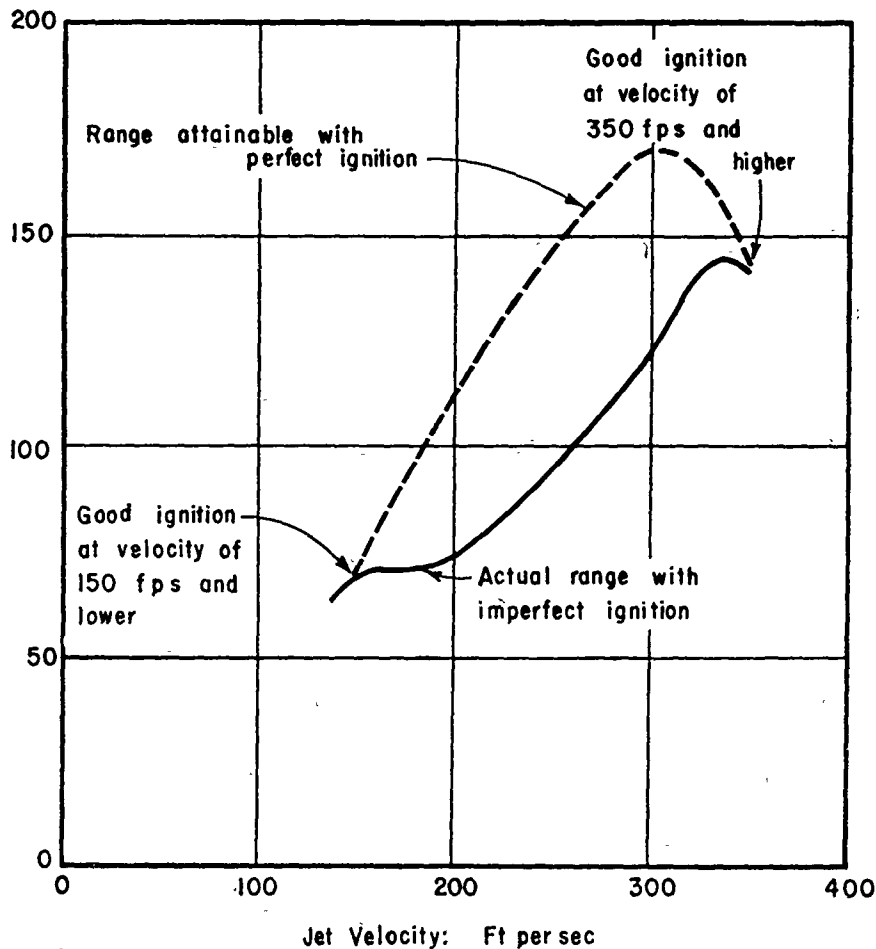

FIGURE 18. Example of a condition in which ignition depends on jet velocity.

Gun Elevation. In still air the range of a jet, like that of any projectile, is a function of the elevation. Theoretical calculations have been made of the effect of elevation on the range, and they are in close agreement with experimental results for elevations under an angle of 15 degrees. At elevations above an angle of 15 degrees considerable differences are noted between the calculated and observed ranges. Experimental data show that for jets up to $\frac{1}{4}$ in.

shooting into a head wind. In the case of an ignited jet firing into a head wind, the component of the wind normal to the jet is low at low angles of elevation, and therefore the hot gas envelope which accounts for the greater range of an ignited jet is only slightly affected. At higher angles of elevation the wind component normal to the jet is increased, the hot gas envelope tends to be more completely blown off, and the range is decreased.

CONFIDENTIAL

With increased wind velocity the above effect at higher elevations becomes so large that the reduction in the range due to the wind is greater than the gain in the range due to the greater angle of elevation (Figure 19). Consequently,

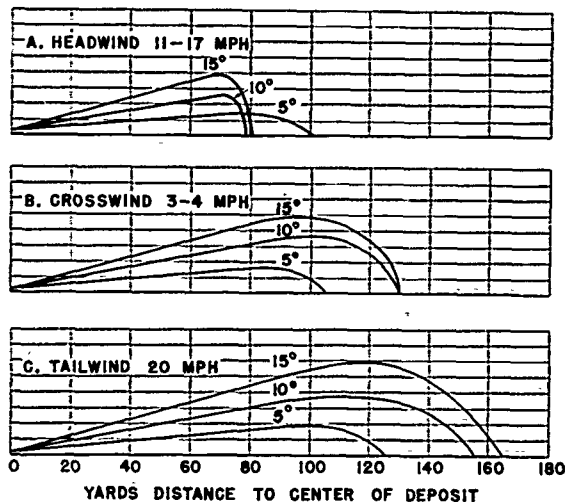

FIGURE 19. Effect of elevation on range of 0.75-in. nozzle using 8 per cent gel.

the optimum elevation of a jet shooting into a wind of high velocity is considerably lowered.

Temperature. The viscosity of thickened fuels, like that of Newtonian liquids, is dependent to some extent on the temperature. However, no general relation has been found which expresses fuel consistency as a function of temperature. The temperature-consistency curves (Figure 20) exhibit low values at low temperatures and then pass through a maximum in the vicinity of 50 F.²⁷ It will also be noted that the percentage of decrease appears to be greater for the low concentrations. However, the relatively flat consistency-range curves shown in Figure 16 indicate the small effect that temperature could have upon the range by changing the consistency. The temperature coefficients for peptized fuels are even more difficult to predict, but their magnitude is small¹⁸ though somewhat greater than for unpeptized fuel.

A more important effect of fuel temperature is its influence upon the ease of ignition. For unthickened fuels and thickened fuels up to 200 Gardner consistency, ignition is complete over the entire range of temperature that might be

encountered in operation. As the consistency increases, ignition at the lower temperatures becomes increasingly more difficult until finally no ignition occurs at all. In Figure 21 a fuel of 200 Gardner consistency shows no variation in range with temperature, while a fuel of 400 Gardner is independent of temperature only above 80 F. Below 80 F there is only partial ignition, and hence there is a proportional reduction in range. For still greater consistencies no ignition occurs at all below certain temperatures. It is this sensitivity of thickened fuels to ignition at low temperature that has led to the continued use of secondary fuel.

Wind. Wind has two effects upon an ignited jet. First, the component of the force of the

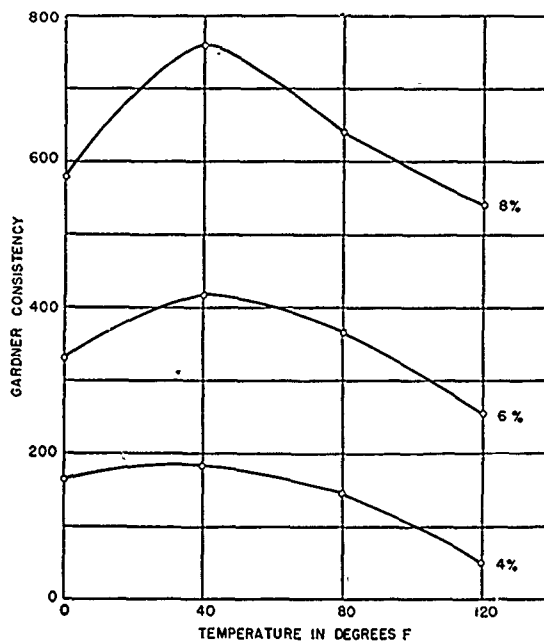

FIGURE 20. Influence of temperature upon the consistency of Napalm gels.

wind along the jet tends either to decrease or increase the range, depending upon the wind direction with respect to the jet. Secondly, the factors which increase the range of an ignited jet over an unignited jet (see Section 7.6) are substantially reduced by the wind. Although the force along the jet can act either in a positive or negative direction with respect to the direction of the jet, the factors that make greater range possible for an ignited jet are always adversely affected.

In Figure 22 range data at several wind intensities are shown as a function of wind direction. If the effect of wind on range were only the effect of the force component, the per cent

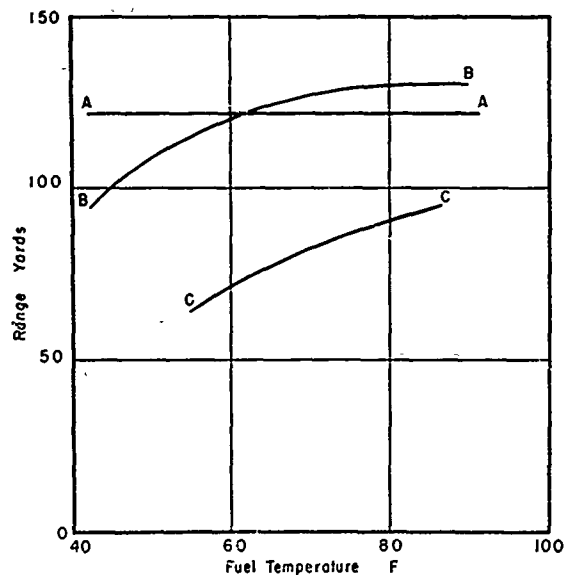

FIGURE 21. Effect of fuel temperature on jet ignition and range. (Gardner consistency: A, 200; B, 400; C, much higher.)

increase for a tail wind would be approximately the same as the per cent decrease for an equivalent head wind, but from Figure 22 it is clear that this is far from the case. For a 10-mile head wind the per cent reduction of the range is about 40 per cent, but with a tail wind of the same intensity the per cent increase is less than 10 per cent. This effect of wind probably accounts for more mistaken judgments of flame-thrower performance in field demonstrations than any other factor.

Calculation of the expected effect of wind on flame-thrower range for a given nozzle elevation involves a consideration of the two effects mentioned above. By a simple vector analysis, the normal and forward components of any wind on the jet may be determined. The range of an unignited jet relative to the wind may then be computed from the Rosin-Fehling correlation based on the Froude number (u^2/gD) and the Reynolds number ($u\rho D/\mu$). From an estimation of the time of flight, the range relative to the ground may be approximated. For unignited jets such an analysis yields results

which agree within 10 per cent of experimental values.

The problem of predicting the effect of wind on an ignited jet is considerably more complex. One method of approach is to consider the effect of wind on a factor τ' which corrects for the range of ignited jets from unignited ones. The only analysis of this problem was based upon the Rosin-Fehling correlation of range versus Reynolds and Froude numbers, and therefore τ' does not quite correspond with the final τ that is given in the section on Range Correlation.²⁶

A possible method of relating τ'_w and τ' to measurable quantities is to express the dimensionless group $\tau'_w - \tau'/1 - \tau'$ as a function of the angle that the jet makes with the wind for various values of the Froude number. The smooth curves in Figure 23 are based on data from several sources.^{6, 28} τ' was assumed to have a constant value of 0.3, and the choice of the Froude number using the normal component of the wind was based on the evidence that large jets were less affected by wind than smaller ones.

This method of analysis is at best only approximate but represents the best correlation with the available data.^a The effect of gun elevation with wind upon range has already been discussed under gun elevation.

Ignition and Secondary Fuel. The dependence of the range upon ignition makes it absolutely necessary that good ignition be assured. The numerous techniques of igniting the jet have been discussed under the individual flame throwers in Chapters 4 and 5. The major requirement is that the ignition system function under the most adverse conditions. Careful engineering design, with an appreciation for field conditions, has produced quite reliable ignition systems.

It has been pointed out already that if ignition depended upon the flame produced by the combustion of a gasoline spray on a jet, the fuel consistency would have to be low and the fuel temperature high. For the purpose of reinforcing ignition of the jet some flame throwers have secondary fuel which reduces the minimum

^a More comprehensive data on wind effect, not available at the time of the above correlation, appear in OSRD Report 5933, Figures 4-7.

CONFIDENTIAL

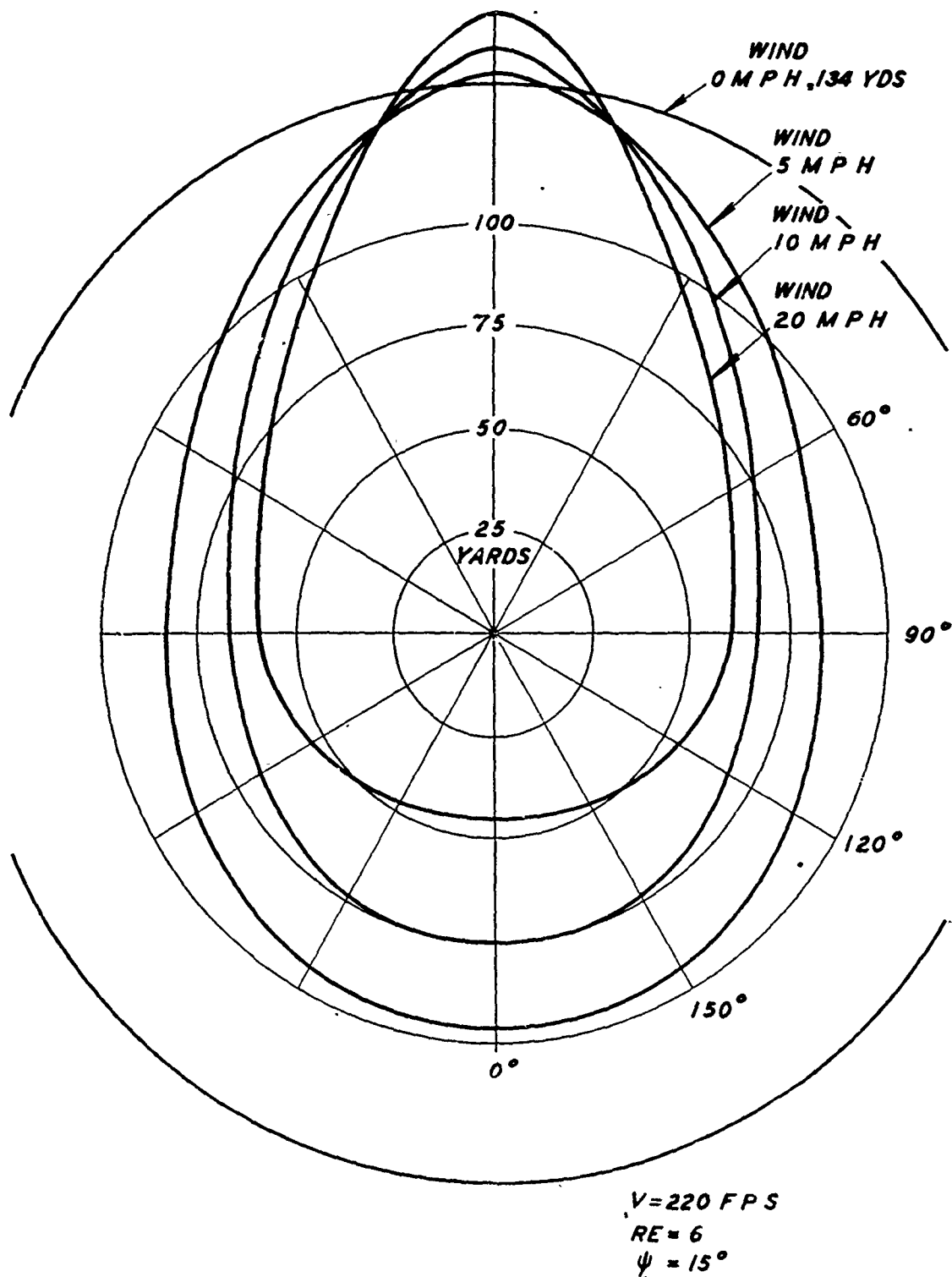

FIGURE 22. Effect of wind on range of 1/2-in. flame-thrower nozzle.

CONFIDENTIAL

operating temperatures, maintains ignition in wind, and raises the maximum usable fuel consistency. Another method, besides the use of secondary fuel for maintaining ignition on the rod, is the provision of a hot flame confined

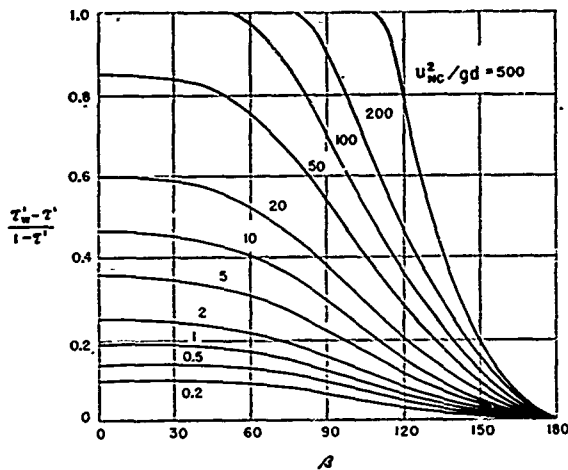

FIGURE 23. Relation between τ , β , and U_{wc} , where β is the angle that the jet makes to the wind.

between the gun barrel and the outer shroud.²⁹ It is believed that this method would prove inadequate under adverse conditions of wind and temperature.

The data available on the application of secondary fuel are meager, although several flame throwers have been designed with secondary fuel. Model Q was the first to incorporate the principle of secondary fuel, and in this early model the gasoline was added to the rod through a porous metal sleeve located just before the nozzle. The porous metal was later replaced by a perforated cylinder. For a 1/2-in. nozzle a rate of 1.0 per cent of the primary fuel was used at first, but was later increased to 3.5 per cent. This higher rate reduced the minimum operating temperature to 10 F for an 8 per cent gel. For an additional factor of safety the rate was further increased to 4 per cent.

Somewhat more detailed experiments on the optimum operating conditions for secondary fuel were reported by the Standard Oil Co. (Indiana) group.⁶ The method that this group used to apply the secondary fuel to the jet has already been described in the section on nozzle design. A study of the rate of addition of secondary fuel indicated that there is an optimum

rate. At high rates, the rod burns with a bush flame, the appearance of which indicates that too much fuel has been added and the excess is being burned off. For a 1/4-in. jet it has been found that 3 to 5 per cent by volume gives the best results.

In the initial stages of the investigation it was thought that the viscosity of the secondary fuel would be a measure of the efficiency of the fuel. However, experiments failed to show any correlation between the viscosity and the ignition of the rod. The Indiana group finally arrived at a 50-50 blend of gasoline and No. 30 SAE motor oil, which appeared to give the best performance for their particular gun.

7.6 CORRELATION OF RANGE DATA

Unignited Jets. The desirability of being able to predict the range of a flame thrower under a given set of conditions is obvious. Several investigators have analyzed small experimental jets under controlled conditions,^{7, 21, 23} and the results of the work have been extended to actual flame-thrower jets.

An early correlation by the Eastman Kodak group showed the range of an unignited jet to be a function of the apparent viscosity of the fluid. In their analysis a large number of Newtonian liquids varying in viscosity from 0.006 to 190 poises, pseudoplastic liquids with pronounced rigidity, a dilatant mixture, and a pseudoplastic material having a yield value were ejected from an 1/8-in. nozzle at varying momentums. The range-momentum plot of the data gave a variety of curves, but all curves lay in order of their viscosity, or apparent viscosity, measured on the MacMichael viscosimeter. This relationship suggested a possible correlation of apparent viscosity and range which is shown by plotting on semilog paper the range at an initial kinetic energy equivalent to $u_0^2 \rho_L = 50,000$ against the apparent viscosity (poises) at this rate of shear, 30 reciprocal sec (Figure 24). For the fluids studied the correlation appeared to give good results, as was evidenced by the smooth curve that was obtained.

A more general correlation for unignited Newtonian liquids, and valid for some non-

CONFIDENTIAL

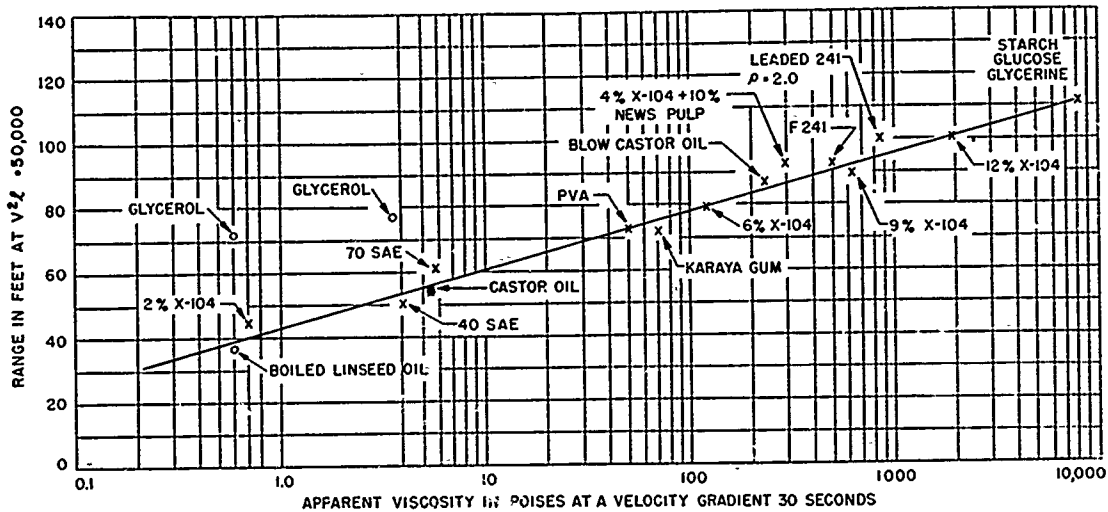

FIGURE 24. Range versus apparent viscosity for $\frac{1}{8}$ -in. nozzle.

Newtonian liquids, was found by Rosin and Fehling. This was based upon the range number $x/D \cdot \rho_A / \rho_L$, a modified Froude number $u_0^2 \rho_A / gD \cdot \rho_A / \rho_L$, and the Reynolds number $Du_0 \rho_L / \mu_L$. Figure 25 shows the curves obtained from this correlation, which was difficult to apply to the ignited jet.

In one series of experiments a du Pont group measured the momentum of a jet at a target located a known distance from the nozzle.²³ Figure 26, showing jet reaction (force of a jet on a target) plotted against the distance of the target from the nozzle, illustrates the type of curves obtained for all liquids that were studied. The horizontal portion of each curve corresponds to substantially frictionless projection of the jet, but as the jet begins to break up, the fractional decrease in momentum becomes linear in distance. An analysis of the forces acting on the jet to produce this effect follows.

The drag force on the unit mass of the jet is expressed in terms of the drag coefficient by the equation:

$$F = \frac{C_D u^2 \rho_A A'}{2g} \quad (4)$$

or in terms of deceleration

$$F = \frac{\rho V'}{g} \cdot \frac{du}{dt} = \frac{\rho V' u du}{g dx'} \quad (5)$$

whence,

$$C_D = \frac{2\rho_L V' du}{\rho_A A' u dx'} \quad (6)$$

The jet reaction is given by the expression

$$P_R = \frac{\bar{u} u}{g} \quad (7)$$

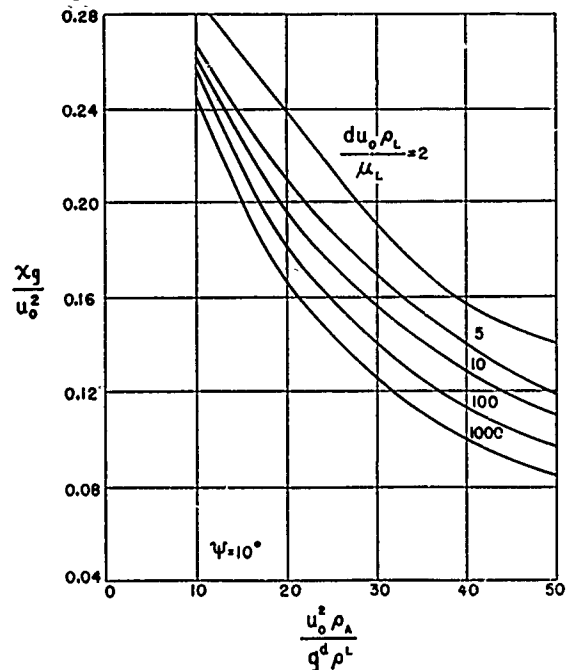

FIGURE 25. Rosin-Fehling correlation for flame-thrower range.

Then the change of jet reaction with distance from the nozzle is

$$\frac{d \ln P_R}{dx'} = \frac{C_D \rho_A A'}{V' \rho_L} \quad (8)$$

CONFIDENTIAL

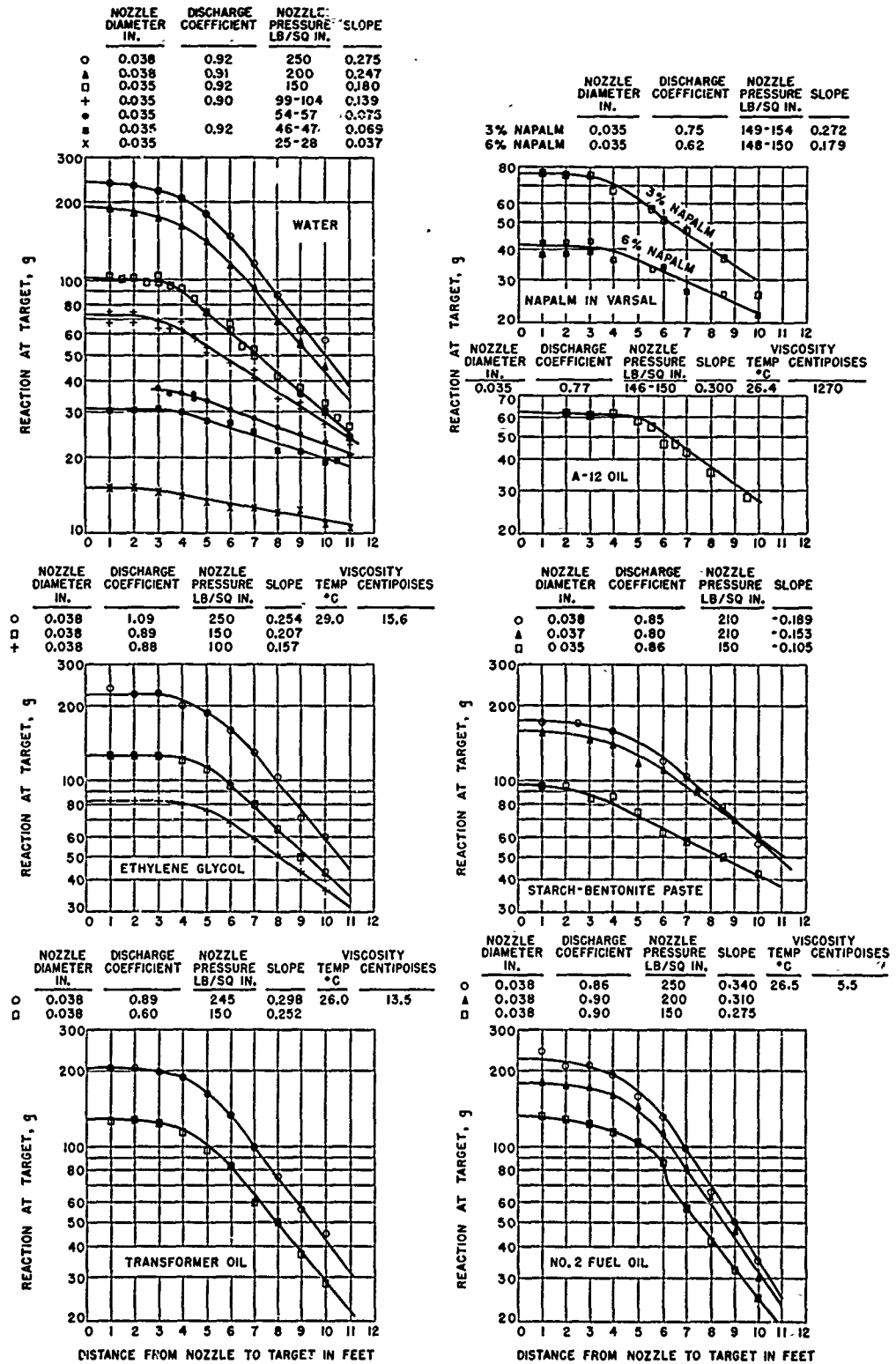

FIGURE 26. Jet reaction data.

CONFIDENTIAL

Denoting $C_{D\rho_A A'}/2V'\rho_L$ as α , equation (8) becomes $\alpha = d \ln \rho_L / dx'$. It is apparent, then, that the slope of the curves in Figure 26 is α . By making the heuristic assumption of a constant α over the entire trajectory, thereby neglecting the initial portion of the curve, an analysis of the trajectory can be made.

Although equations have been derived for the trajectory of a jet,^{7, 23} they are too cumbersome for direct practical use. However, it is possible to express the relationship in the form

$$\phi \left(\frac{xg}{u_0^2}, \frac{yg}{u_0^2}, \frac{\alpha u_0^2}{g}, \psi \right) = 0. \quad (9)$$

In Figure 27, xg/u_0^2 is plotted against $\alpha u_0^2/g$ for various values of ψ , and from these curves it can be seen that once the value of α is determined, the range can be estimated. From the definition of α ; $\alpha D = (C_{D\rho_A})/2\rho_L (A'D/V')$. If it is assumed that

question is assumed a simple power product of these variables αD may be expressed as follows:

$$\alpha D = K \left(\frac{l u_0 \rho_A}{\mu_A} \right)^m \left(\frac{D u_0 \rho_L}{\mu_L} \right)^n \left(\frac{u_0^2}{gD} \right)^p. \quad (10)$$

The drag force from equation (4) becomes

$$F = \frac{\alpha u_0^2 V' \rho_L}{g}. \quad (11)$$

The shearing stress f is given by

$$f = \frac{F}{A}. \quad (12)$$

Substitution from (11) into (12) gives

$$f = \left(\frac{\alpha u_0^2 \rho_L}{g} \right) \left(\frac{V'}{A} \right) = \left(\frac{\alpha u_0^2 \rho_L}{g} \right) \frac{D}{\beta} \quad (13)$$

where β equals four for a cylindrical jet of diameter equal to nozzle diameter and six for a

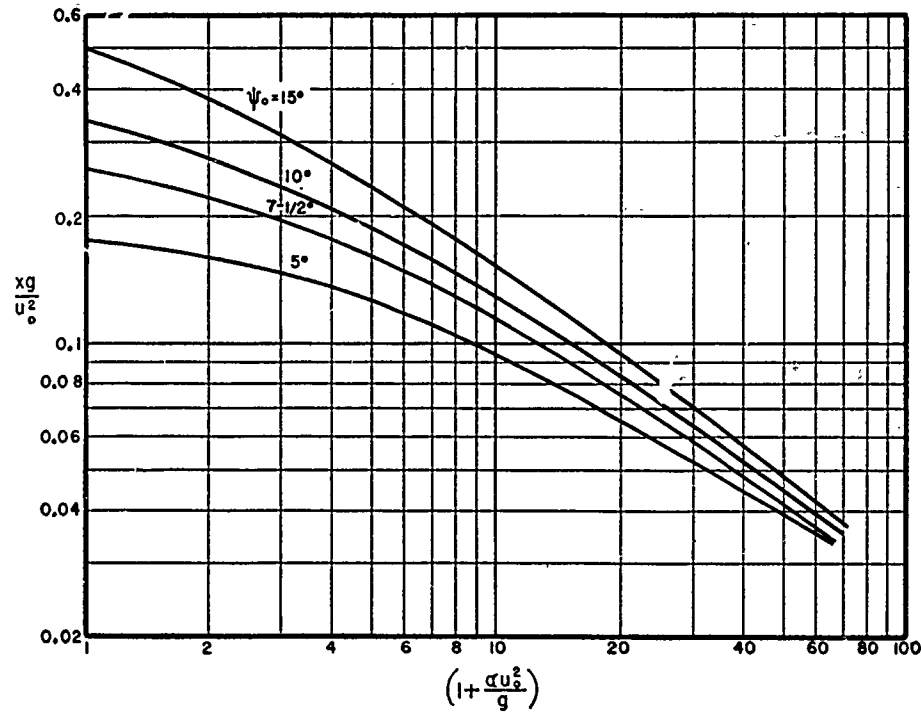

FIGURE 27. Relation of xg/u_0^2 to u_0^2/g .

C_D and the particle shape, as measured by $A'D/V'$, are determined by (1) the Reynolds number $l u_0 \rho_A / \mu_A$ which affects the shearing force of the atmosphere against the jet, (2) the Reynolds number $D u_0 \rho_L / \mu_L$ which depends upon the internal shearing forces in the liquid jet, (3) the Froude number u_0^2/gD , and if the function in

spherical particle of diameter equal to nozzle diameter. As an approximation, a value of five is assumed.

Using experimental data, with equation (10) as a guide to a correlation, the following relations were determined for fuels having a specific weight of 47 lb per cu ft.

CONFIDENTIAL

For nozzles with a short cylindrical section

$$\alpha D = 1.07 \times 10^{-4} \left(\frac{D^{0.15} u_0^{0.35}}{\mu_L^{0.06}} \right) \quad (14)$$

and for conical nozzles

$$\alpha D = 1.18 \times 10^{-4} \left(\frac{D^{0.21} u_0^{0.39}}{\mu_L^{0.03}} \right) \quad (15)$$

Similarly, by applying the above equations to equation (13), the shearing stress becomes for cylindrical nozzles

$$f = 10.1 \times 10^{-4} \left(\frac{D^{0.18} u_0^{0.36}}{\mu_L^{0.06}} \right) \frac{u_0^2}{g} \quad (16)$$

For conical nozzles

$$f = 11.4 \times 10^{-4} \left(\frac{D^{0.21} u_0^{0.39}}{\mu_L^{0.03}} \right) \frac{u_0^2}{g} \quad (17)$$

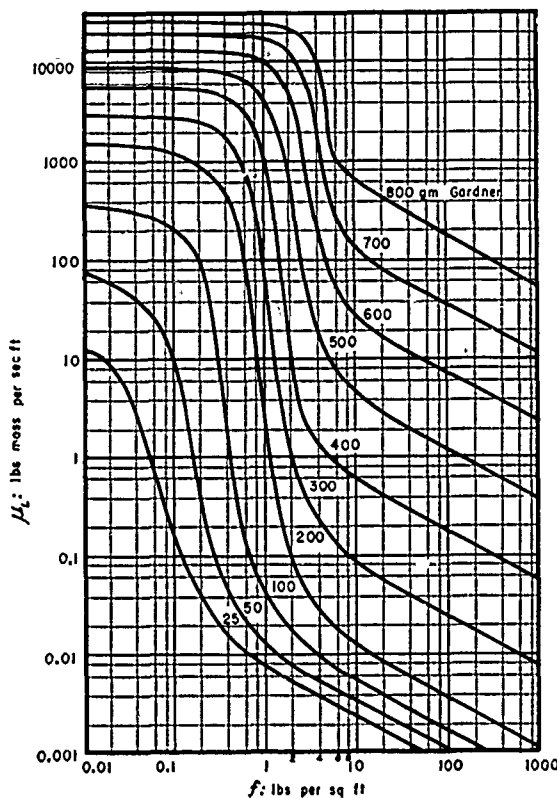

FIGURE 28. Viscosity of Napalm gels.

To be able to calculate the range for non-Newtonian liquids from these equations, it is necessary to find the relation between the shearing stress f and the viscosity μ_L . In Figure 28 the smoothed curves were plotted from experimental data for a range of Gardner consistencies. Using Figure 28 together with equation (16) or (17) it is possible to determine the

range of an unignited jet when the nozzle velocity, nozzle diameter, fuel consistency, and nozzle elevation are known. By trial-and-error, that value of f is found which predicts the same value for μ_L from Figure 28 and by use of equation (16) or (17). Equation (14) or (15) is then used to determine α , after which Figure 27 may be used to determine range.

The above procedure leads to a prediction of average range. Experimental data indicate that the ratio of α for the maximum range to α for the center of deposit varies from 0.55 to 0.85. Using an average value of 0.7, the difference between the farthest particles and the center of deposit can be estimated.

Ignited Jets. Referring to equation (9), it can be seen that the only change in an ignited jet over an unignited one is a change in the value of α . An analysis of an ignited jet shows that the following factors affect the value α and, hence, the magnitude of the range.

1. The temperature of the air, or rather the envelope of the jet, is increased, with a corresponding decrease in ρ_A resulting in a decreased α .

2. The reaction due to the generation of combustion products at the trailing ends of the jet particles reduces the net drag forces and thus decreases α .

3. The combustion of fuel tends to reduce the weight-to-area ratio of the particles and, therefore, increases α .

An additional factor, which has the same effect on range as a reduced α , is the lessening of the net downward force acting on the jet on account of the up-draft of the combustion gases. Since a reduced α causes an increased range, all but one of the above effects tend to increase the range of an ignited jet.

In order to predict the range of an ignited jet a factor τ has been introduced, which is the ratio of α_i ignited to α unignited. From experimental data it appears that τ for complete ignition is approximately a function of $\alpha u_0^2/g$, as is shown in Figure 29. τ is in effect the ratio of the absolute temperatures of the gas mantles around cold and ignited jets, respectively.

Partially Ignited Jets. In the zone of partially ignited jets prediction of the range is much less reliable. The intensity of ignition depends at

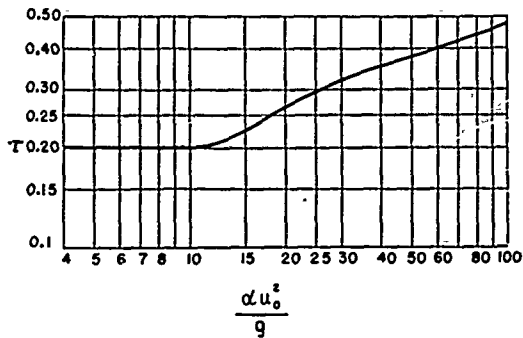

FIGURE 29. Relation of τ to $\alpha u_0^2/g$ in region of complete ignition.

least upon the jet velocity, fuel viscosity, and fuel temperature. In Figure 30 the Reynolds number at fair ignition is plotted against the Froude number for different temperatures. For a constant Reynolds number there exists a

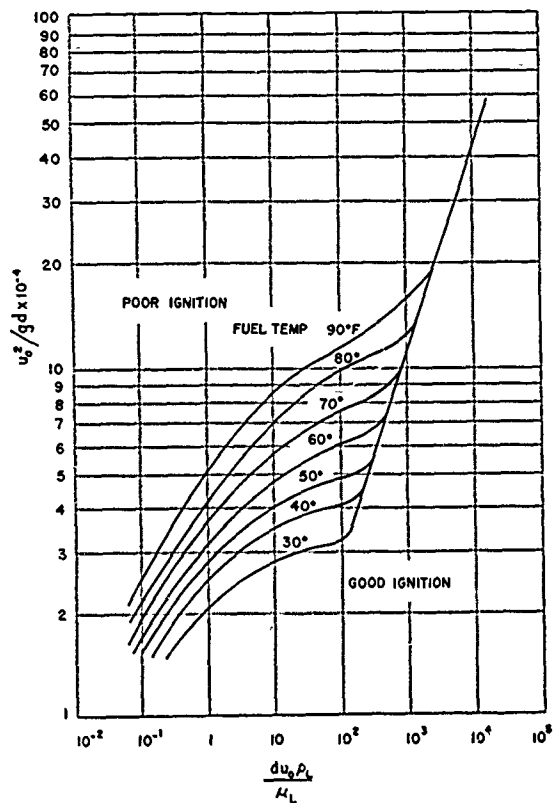

FIGURE 30. Relation among Reynolds number, Froude number, and fuel temperature, defining regions of good and poor ignition.

velocity above which a jet cannot hold a flame; with higher Reynolds numbers, disturbances become greater and consequently the flame holds to the jet more easily.

Nomenclature

Symbol	Quantity	Units	Dimensions
A	Surface area of unit mass of jet	ft ² /lb	L^2/M
A'	Total frontal area of particles comprising unit mass of jet	ft ² /lb	L^2/M
B	Nozzle diameter/piezometer ring diameter		
C	Nozzle discharge coefficient		
C_D	Coefficient of drag based on frontal area of particles		
D	Inside diameter of nozzle or pipe	ft	L
F	Drag force on jet per lb fluid	lb/lb	W/M
G	Consistency of fuel	g	Arbitrary
K	Numerical constant		
L	Length of pipe	ft	L
P	Pressure	lb/ft ²	W/L^2
P_R	Jet reaction	lb	W
Q	Rate of flow	ft ³ /sec	L^3/T
R	Shear rate	sec ⁻¹	$1/T$
S	Specific gravity		
V'	Volume of particles/lb	ft ³ /lb	L^3/M
d	Denotes differential		
f	Shear stress	lb/ft ²	W/L^2
g	Acceleration of gravity	ft/sec ²	L/T^2
k	Numerical constant	t/sec ²	L/T^2
l	Average length of particle	ft	L
m	Numerical constant		
m'	Average weight of particle of jet	lb	W
n	Numerical constant		
p	Numerical constant		
u	Jet velocity	ft/sec	L/T
\bar{u}	Mass velocity of jet	lb/sec	M/T
u_0	Velocity of jet from a nozzle	ft/sec	L/T
u'	Velocity of fluid in conduit	ft/sec	L/T
x	Horizontal distance from nozzle	ft	L
x'	Distance along trajectory from nozzle	ft	L
y	Vertical distance from nozzle	ft	L
α	$C_D \rho A A' / 2 V' \rho_L$, unignited conditions	ft ⁻¹	$1/L$
α_i	$C_D \rho A A' / 2 V' \rho_L$, ignited conditions	ft ⁻¹	$1/L$
β	Numerical parameter		
Δ	Finite increment		
μ	Effective viscosity	lb mass sec ⁻¹ ft ⁻¹	M/LT
μ_0	Viscosity at standard shear rate	lb mass sec ⁻¹ ft ⁻¹	M/LT
μ_L	Viscosity of fuel	lb mass sec ⁻¹ ft ⁻¹	M/LT
μ_A	Viscosity of atmosphere surrounding jet	lb mass sec ⁻¹ ft ⁻¹	M/LT
ρ_L	Specific weight of fuel	lb/ft ³	W/L^3
ρ_A	Specific weight of atmosphere surrounding jet	lb/ft ³	W/L^3
τ	Ratio α ignited to unignited		
τ'	Density number modifier for no wind		
τ'_{ic}	Density number modifier		
ϕ	Denotes "function of"		
ψ	Slope of trajectory		
ψ_0	Angle of nozzle with horizontal		

Chapter 8

FUELS FOR INCENDIARIES AND FLAME THROWERS

8.1 INTRODUCTION

FUELS USED IN incendiary bombs and flame throwers played an important part in World War II. In fact, the contribution of these fuels resulted in using fire as a weapon to a far greater extent in this war than in any previous war in history. Of the fuels used, by far the most important was gasoline gel thickened with Napalm. This fuel, in varying consistencies, was used in the following important weapons in World War II:

AN-M47, 100-lb incendiary bomb, AN-M69, 6-lb incendiary bomb, portable flame throwers, flame throwers mounted in tanks, and jettisonable gasoline tanks, dropped from fighter airplanes.

This type of fuel was developed by NDRC. During 1942 and 1943 some AN-M47 and AN-M69 bombs were filled with gasoline gel thickened with isobutyl methacrylate polymer (IM). This material was developed by the duPont Co. under the joint sponsorship of NDRC and the Chemical Warfare Service.

The only other fuels actually used in the war were some fortified or pyrotechnic fuels (PT) consisting of mixtures of hydrocarbons, metals, and oxidizing agents which were used in the M74 and AN-M76 incendiary bombs. These fuels were developed by the Chemical Warfare Service.

The other types of fuels described in this chapter were experimental attempting to correct one drawback or another of Napalm-thickened gasoline fuels, or which were developed for some special use. In Section 8.3 are described liquid thickening agents, which arose from the desirability of mixing fuels in the field or on an aircraft carrier by simply mixing two liquids rather than a solid and a liquid. Section 8.4 describes methacrylate thickening agents, which were a valuable substitute until Napalm was fully developed. Sections 8.5 and 8.6 describe two possible substitutes for Napalm or methacrylate thickening agents in case both of these became in short supply. Section 8.7 de-

scribes fortified fuels which were more fiercely burning and less easily extinguished by water than ordinary gasoline gels. Section 8.8 describes self-igniting fuels which have an obvious interest both in flame throwers and in incendiary bombs. Sections 8.8, 8.9, and 8.10 describe fundamental studies which were undertaken better to understand the nature and modus operandi of thickened fuels.

8.2 NAPALM¹⁻⁵⁴

8.2.1 Introduction

The gasoline thickening agent called Napalm is an aluminum soap of naphthenic, oleic, and coconut oil acids, of which the most common formula uses 50 per cent coconut oil acids, 25 per cent naphthenic acid, 25 per cent oleic acid. The development of a new thickening agent for gasoline made from readily available materials was dictated by the unavailability of rubber for this purpose after December 1941. The development of Napalm was initiated by Harvard University in December 1941 under Contract OEMsr-179. In March 1942 Nuodex Products Co. came into the picture and made major contributions to the early development of Napalm, although their work was not formalized by Contract OEMsr-677 until August 1942. Other contributors to the development and improvement of Napalm were Arthur D. Little, Inc., working under Contract OEMsr-242, Standard Oil Development Co. under Contracts OEMsr-183, 354 and 390, Eastman Kodak Co. under Contract OEMsr-538, Harshaw Chemical Co. under Contract OEMsr-847, and Ferro-Drier and Chemical Co. under Contract OEMsr-882.

By February 1942 three types of soap thickening agents which showed considerable promise had been developed by Harvard University.¹ These were designated as (1) Palmene, aluminum palmitate and neo-fat 3R (40 per cent oleic, 60 per cent linoleic acid), (2) oleo-palm, aluminum oleate and aluminum palmi-

tate, and (3) Napalm, aluminum naphthenate and aluminum palmitate.

The first Napalm was made by putting aluminum naphthenate through a meat grinder with wood flour and milling aluminum palmitate into the mixture. A dry powder resulted which could be dispersed in gasoline at ordinary temperatures. A subsequent mixture of one part aluminum palmitate, one part aluminum naphthenate, and two parts of kerosene agitated in a dough mixer at 100 F was found to be greatly superior in toughness and stability. This tough, gummy mixture was incorporated into gasoline by passing it through a meat grinder and agitating the disintegrated material in the gasoline with a stirrer, or by circulation through a gear pump. Later, half the naphthenic acid was replaced with oleic because of the reported shortage of the former. Nuodex Products Co. found that this modified Napalm could be produced by means of a coprecipitation process as a dry granular solid readily dispersible in gasoline at ordinary temperature. Because of the ease of manufacture and of mixing with gasoline, this material was standardized, and manufacture was begun in December 1942. A total of about 80,000,000 lb was produced before the end of World War II.

Although practically all Napalm has been manufactured according to the standard formula (25 per cent oleic, 25 per cent naphthenic, 50 per cent coconut oil acids), additional research, both in this country and in England, has shown that the aluminum soaps of practically all combinations of these acids, including 100 per cent oleic or 100 per cent naphthenic, are moderately satisfactory gasoline thickeners, although varying considerably in specific physical properties. However, if more than about 80 per cent coconut acids are used, the resulting soap cannot be dispersed in gasoline at room temperature. The British used aluminum stearate-thickened fuels exclusively. These fuels were factory-mixed at 120 to 130 F.

8.2.2

Manufacture

General. At various times during the period 1943-1945 the following nine companies were

engaged in large-scale production of Napalm: Nuodex Products Co., Imperial Paper and Color Corp., Ferro Enamel Corp., McGean Chemical Company, Pfister Chemical Co., J. S. and W. R. Eakins Co., California Ink Co., Oronite Chemical Co., and Harmon Color Works. In addition, a few batches were manufactured by Colgate-Palmolive-Peet Corp. All manufacturers used some variation of a process in which the water-insoluble, basic aluminum soaps of the mixed acids were coprecipitated from aqueous solution. Variations in precipitation and drying methods were largely attributable to differences in the equipment which was available to the individual manufacturers.

The most commonly used precipitation process is a batch process in which the total amount of caustic required, about 60 per cent in excess of the amount necessary to neutralize the acids, is added to the mixed acids, the alum then being added gradually until the precipitation is complete. In one variation of this method only enough caustic is added to the mixed acids to produce the stoichiometric soap solution, the balance being added with the alum solution. In this second method the precipitation is begun at a lower pH and the separation of aluminum soap is more gradual than in the standard batch method. In addition to the batch methods, a continuous two-stream precipitation technique was developed by one manufacturer, Eakins. This involves the addition of controlled streams of the alum and sodium soap solutions to a vessel supplied with vigorous agitation. The alum added in the first stage is insufficient to cause coagulation of the soap, and the resultant milky solution overflows into a second vessel along with another stream of alum to form an excess of this reagent. The suspended precipitate then flows to a washing and draining device. The first-mentioned batch method has been most generally used and was early recommended as a standard process.¹⁰ The two-stream method requires less space for the equipment used, and in addition, yields a particularly fast setting variety of Napalm which is desirable in certain applications.

*Raw Materials.*¹¹ Variations in acid quality may be responsible for considerable differences in the character of the soap produced. Regular

CONFIDENTIAL

laboratory testing of new shipments of acid is a necessity for satisfactory Napalm production. The following specifications have been found suitable.

	Coconut oil acids	Naphthenic acid	Oleic acid
Acid number	260-270	230-245	190-200
Iodine number	Below 15	Below 10	85-90
Iron	Below 0.01%	Below 0.01%	Below 0.01%
Unsaponifiable	2% maximum	Below 8%	Below 2%
Titer, F.	75-77	46-54

At first it was considered necessary to use only rectified naphthenic acids, but as supply became critical, crude naphthenic was used with entirely satisfactory results. The use of high acid-value coconut oil acids results in Napalms of exceptionally high thickening power; hence this variable should be carefully controlled.

Some difficulty was encountered at first with war-grade alums made from clay; this was on account of their high iron content. If possible, the iron content should be below 0.03 per cent and manganese below 0.01 per cent. These materials are deleterious because of their action as oxidation catalysts; hence somewhat larger percentages can be tolerated if an oxidation inhibitor such as alpha-naphthol is incorporated in the Napalm.⁵¹ It is recommended, however, that metallic impurities be kept at a minimum even if an inhibitor is used.

Dewatering and Drying. The type of dewatering used prior to drying has little effect on the product. However, there is some evidence that if the wet pump is allowed to stand overnight or longer before drying, the thickening power of the Napalm is increased. Tray and continuous belt drying have been successfully used, the first being the most common. In tray drying, an air temperature of 160 F is optimum and a drying time of 15 to 20 hr is common for cake depths of approximately 2 in. In general, it is advantageous to use as high a drying temperature as possible without causing undue oxidation or fusion. With belt driers and thin layers of material the drying temperature may be as high as 200 F and the drying time reduced to about 1 hr. At the end of World War II some

contractors were beginning to install infrared drying equipment.

Packaging. Napalm is packed in hermetically sealed containers. Package sizes for regular Napalm are 5¼ lb, 15¾ lb, and 100 lb; the first two were primarily for overseas shipment for field mixing of flame throwers and blaze bombs, and the last for shipment to arsenals and factories filling incendiary bombs. Ground Napalm for the Navy is packed in 60-lb containers. Because of the moisture susceptibility of Napalm it is necessary that care be exercised in handling the Napalm between drying and packaging. Containers used for overseas shipment have been quite successful in preventing contamination of the soap by moisture, as evidenced by testing of numerous samples returned from the various war theaters.

*Specifications.*¹¹ The most important Napalm specification is the one regarding thickening power, which is evaluated by the Gardner mobilometer. Gardner consistency is the weight in grams required to force the plunger through the material in the tube at a rate of 0.1 cm per sec. Originally, consistency was specified only for 8 per cent gasoline gels, the allowable range being 500 to 800 g after storage for one day at 77 F and at 150 F. Later special consistency tests were instituted for 6.2 per cent and 11.5 per cent gels. The test gasoline used after about February 1944 was a high-boiling fraction (naphtha) supplied by the Continental Oil Co., Baltimore, Maryland. This gave, in general, higher consistencies than the Standard Oil Development Co. test gasoline used previously; the change was made because the naphtha, being low in unsaturates, was less likely to oxidize on long storage, and having a high boiling point lost less weight on handling and testing of the Napalm gels made from it.

Additional specifications include moisture, 0.4 to 0.8 per cent by CWS benzene distillation method, oxidation-inhibitor content, and general gel characteristics, stringiness, healing, etc. Gelation rate in gasoline was originally specified, but this specification was not in force during most of the period of production.

Variability. Although comparatively little difficulty was encountered by most manufacturers in producing Napalm which would pass speci-

CONFIDENTIAL

fications, the resulting products were quite different in some respects. In general, however, each manufacturer's product was quite uniform from batch to batch. The most important differences were in setting rate, variation of consistency with concentration, and susceptibility to water and other additives. In general, Eakins Co., Pfister Chemical Co., and California Ink Co. produced fast setting Napalms, Nuodex Products Co. slow setting, and the Napalms produced by others were intermediate. Setting times (6.5 per cent gels in test naphtha, 77 F) of ten samples from each manufacturer, produced in the period June 1944 to January 1945, were determined by the Chemical Warfare Service Technical Command⁴⁰ by using the disap-

TABLE 1. Consistency, stability, and moisture susceptibility of representative Napalms (1943).

Manufacturer	Condition % of relative humidity	Moisture CWS benzene distillation	Gardner consistency, grams			
			1 day	4% gel 32 days	1 day	8% gel 32 days.
McGean 462	As received	0.75	195	130	770	730
	90 F-20	0.85	245	90	720	660
	90 F-50	1.45	85	46	550	440
	90 F-70	2.2	22	8	280	220
Ferro 184	As received	0.65	258	140	770	760
	90 F-20	0.55	255	130	770	660
	90 F-50	1.0	170	55	670	515
	90 F-70	1.45	72	27	445	295
Pfister N3-2432-94	As received	0.7	145	88	645	625
	90 F-20	0.7	145	84	675	640
	90 F-50	1.05	90	54	575	490
	90 F-70	1.30	57	33	490	390
Harmon R 11285	As received	0.7	160	80	660	600
	90 F-20	0.75	170	80	690	610
	90 F-50	1.0	84	42	610	410
	90 F-70	1.2	32	21	310	215
Oronite J-33-C	As received	0.5	250	100	960	805
	90 F-20	0.45	290	115	990	840
	90 F-50	0.7	175	54	900	680
	90 F-70	0.95	133	27	760	460
California Ink 98	As received	0.7	160	72	620	520
	90 F-20	0.85	138	74	560	480
	90 F-50	1.1	66	34	390	320
	90 F-70	1.55	24	17	235	225
Imperial NR-232	As received	0.7	110	60	640	575
	90 F-20	0.7	74	64	830	590
	90 F-50	0.95	60	37	510	410
	90 F-70	1.45	51	24	330	305
Nuodex 19889	As received	0.7	200	125	760	690
	90 F-20	0.95	150	120	670	650
	90 F-50	1.2	104	69	550	500
	90 F-70	1.7	50	43	370	360
Colgate-Palmolive-Pect N3-2854-56	As received	0.4	190	90	790	630
	90 F-20	0.5	150	72	710	570
	90 F-50	0.75	91	51	610	435
	90 F-70	0.95	62	36	470	325
Eakins N3-2981-431	As received	0.65	90	50	570	430
	90 F-20	0.45	102	66	590	515
	90 F-50	0.7	82	51	550	380
	90 F-70	1.05	62	42	355	310

CONFIDENTIAL

pearing vortex method. The average values for the different manufacturers are: Eakins 1.4 min, Pfister 1.5 min, California Ink Co. 2.2 min, Imperial 4.9 min, Ferro 5.2 min, McGean 5.8 min, Oronite 6.7 min. The fast setting of the Eakins soap appeared to be a result of the two-stream precipitation process. Ferro Enamel Corp. later changed to the two-stream method in order to produce fast setting Napalm for the Navy. Nuodex Products Co., which was no longer producing Napalm when the tests mentioned above were carried out, obtained slow setting by wet densification and controlled comminution. It is known that the setting rate can be controlled to some extent by means of the excess caustic ratio during precipitation.

Table 1 gives data on variation in consistency, stability, and susceptibility to water for ten representative Napalms manufactured in 1943.²¹ Table 2 gives fragmentary data on samples received from six manufacturers early in 1945.

The differences in concentration-consistency relationships were quite pronounced for Nuodex and Imperial Napalms. This was especially important because for a time in 1943-1944 these two varieties were packaged for field mixing of flame-thrower fuels (5¼-lb packages). Although both passed specifications and had similar consistencies at 8 per cent, they were quite different at 4.2 per cent, the concentration commonly used in the portable flame thrower. Comparison of ten Imperial and ten Nuodex soaps showed a consistency range for 4.2 per cent gel of 52 to 96 for the former and 117 to 250 for the latter.²⁸ Differences in setting rate were just as pronounced, the average for Nuodex samples being 25 min, for Imperial 13 min (4.2 per cent gels in motor gasoline). Because of probable confusion to men in the field, who might obtain either of these varieties from time to time, the Imperial product was in late 1944 standardized as the Napalm for flame throwers. Thereafter it was the only variety packaged in the 5¼-lb container.

As a result of the above mentioned variability in the soaps from different manufacturers, Napalm was placed on cooperative procurement in August 1944. During this period no specifications were in force, and attempts were made by

TABLE 2. Consistency and stability of representative Napalm gels (1945).

Manu- facturer	%	Xylenol, %	Gardner consistency grams	
			1 day	2 weeks
Imperial NR-1764	3	16	
	4	48	
	5	135	127
	6	250	210
	7	390	350
	8	505	540
	6	1.25	34	
	9	1.5	173	185
	McGean 4778	2	15
3	40		
4	151	< 84	
5	270	167	
6	410	260	
7	500	425	
8	680	555	
6	1.25	24		
9	1.5	240	250	
Eakins 480	2	7	
	3	64	
	4	171	129
	5	295	260
	6	410	385
	7	575	565
	8	740	
	6	1.25	80	
	9	1.5	470	405
Pfister N5-157-702	2	26	
	3	78	
	4	164	124
	5	245	215
	6	375	385
	7	490	560
	8	660	
	6	1.25	97	
	9	1.5	565	465
Ferro	3	32	
	4	89	
	5	200	9
	6	305	210
	7	485	370
	8	670	540
	6	1.25	41	
	9	1.5	295	305
	Harmon N5-139-78	2	10
3		42	
4		138	
5		260	230
6		380	370
7		515	560
8		750	750
6		1.25	90	
9		1.5	460	600

CONFIDENTIAL

Chemical Warfare Service in cooperation with the manufacturers to modify their various procedures so as to produce more nearly identical soaps. These investigations resulted in special specification tests concerning inhibitor content of the finished soap, and consistency of 6.2 per cent and 11.5 per cent gels were instituted.⁴⁵ The inhibitor-content specification was a result of tests indicating that susceptibility to peptizers was a function of the alpha- or beta-naphthol concentration in the finished soap. Another specification change was reduction of the consistency range for the 150 degree test (8 per cent gels) to 550 to 750 g Gardner. The effect of these changes on Napalm uniformity has not been fully evaluated because World War II ended soon after Napalm went off cooperative procurement. Consistencies of 6.2 per cent gels of some of the last batches which were manufactured are: Eakins 120, 140, 123; Imperial 157, 190, 175, 148, 133; Ferro Enamel 172, 133; California Ink 107, 210; McGean 160, 235, 192, 260; Oronite 157, 156; and Pfister 250, 260.

The success of most of the manufacturers in producing a uniform type of Napalm over long periods indicates that the best means of improving uniformity is production of all the material in a single plant under identical conditions.

8.2.3 Thickened Fuels from Napalm

General. Thickened fuels may be prepared with Napalm by adding the soap to the gasoline and stirring with a paddle, or mechanical stirrer, until the Napalm particles swell to the point that settling does not occur. This point has been termed the stir time, or set time, of the fuel. With 6 per cent Napalm at a temperature of 70 to 80 F the required time of stirring may vary from 0.5 to 10 min with different Napalms. At 4.2 per cent the stir time is somewhat longer, the average for Imperial Napalms being 13 min, as noted above. At temperatures below 60 F the stir time becomes very much longer, and it is almost impossible to mix fuels below 50 F without incorporating a low-temperature peptizer. At temperatures above 90 F the stir time is quite short, particularly at the high concentrations used in incendiary

bombs. In fact, under these conditions it may be impossible to obtain a homogeneous fuel because of the mixture "setting up" before all the Napalm can be incorporated. For this reason incendiary bomb filling plants require refrigeration facilities for cooling the gasoline in the summer months.

In all applications in which thickened hydrocarbon fuels are used, such as flame throwers, blaze bombs, and incendiaries, ordinary Napalm-gasoline mixtures, prepared as described above, give satisfactory performance. However, numerous experiments have shown that Gardner consistency, irrespective of Napalm concentration, is a reliable guide to the performance of these weapons with Napalm fuels. Thus additives which impart properties desirable in the preparation, handling, or storage of Napalm fuels may be incorporated even though they raise or lower the consistency, as long as the Napalm concentration is adjusted to give the desired consistency. Most additives which have been used lower the fuel consistency. These additives, commonly designated as peptizers, will be discussed in the section on "*Peptized Fuels*," p. 199.

Thickened Fuels for Portable Flame Throwers. The recommended mix for the portable flame thrower is 4.2 per cent Napalm in ordinary motor gasoline (one 5¼-lb can in 20 gal). With most Imperial Napalms this produces a consistency of 75 to 100 g, and tests by various groups engaged in research on flame-thrower fuels indicate that this is about the consistency which gives optimum long-range performance in the portable flame thrower. Variations resulting directly from gasoline quality,³³ the use of a different Napalm, or accidental introduction of water or other peptizers during mixing might easily result in 4.2 per cent fuels of consistencies anywhere in the range 25 to 250 g Gardner. Although, generally speaking, no instruments for measuring consistencies were available in the field, men in charge of mixing became capable of estimating consistency of fuels from their handling characteristics, pourability, etc., and reports from the field indicate that numerous alterations in the basic formula were made in order to obtain the desired mixing and firing characteristics. In addition to

CONFIDENTIAL

the change of Napalm concentration, these variations included incorporation of water, xylene, silica gel, diesel oil, and motor oil. Some of these formulations will be discussed in separate sections below.

Thickened Fuels for Mechanized Flame Throwers. Mechanized flame throwers are those which are mounted on a vehicle, as opposed to portables which are carried on a man's back. Mechanized models which have a small, $\frac{5}{16}$ -in. nozzle use about the same fuel as portables, but models with larger nozzles, $\frac{1}{2}$ to 1 in., can profitably employ a fuel of somewhat higher consistency.

Mechanized flame throwers with large nozzles have been used very little by the U.S. Forces. The Navy Mark I flame thrower (E7 gun), developed by Standard Oil Development Co., saw action in the Peleliu invasion. As a result of tests which had been carried out at SOD the fuel recommended for this gun was 7 per cent Napalm, approximately 400 to 500 Gardner. It was found that fuels of this concentration mixed on Peleliu gave a somewhat more bushy flame than desired and the concentration was increased. However, Lt. Williams of the Navy, who was in charge of the mixing operations, stated that the fuels mixed on Peleliu appeared to be considerably below normal in consistency. According to the statements of Lt. Williams, a rod-like flame was desired for ease of aiming, with a burning time sufficient to set off the ammunition stored inside pillboxes.

A critical study of the effect of fuel consistency on mechanized flame-thrower performance has been carried out by CWS-NDRC Flame Thrower Evaluation Group and the Flame Attack Section of the Medical Division, CWS, at Edgewood Arsenal. The bulk of the tests dealt with the lethal effects of thickened fuel shot into a pillbox, live goats being used as subjects. The tests showed that the fuel consistency for the best compromise among lethality, effective range, ease of handling, and aimability is 200 to 250 g Gardner.

The tests further show that for fuels varying from unthickened to 200 g consistency, roughly 1 gal per 1,000 cu ft of volume is required to kill the occupants. The required quantity of fuel increases with increasing fuel thickness up to

approximately 2 gal per 1,000 cu ft for fuels of 700 g consistency. Maximum effective range was construed to be the maximum range at which all goats in the bunker were killed. No increase in maximum effective range, above 80 yd, was observed on increasing the consistency above 200 g. It is possible to refuel flame throwers from light drums with 20 psi pressure with fuels of 200 g consistency, but it is impossible for fuels higher than 400 g consistency. Interference to visibility due to bushy flame is slight for fuels of 200 g consistency, though somewhat greater than for fuels of 400 to 700 g consistency.

Ranges in excess of 200 yd (center of deposit) can be attained with large nozzles if fuel consistency is increased to 1,000 g Gardner.⁵⁴ A gun elevation of 15 degrees or more is required, and the fuel falls at a very steep angle at extreme range. Hence, aimability is greatly reduced, and the usefulness of such a weapon is limited to area firing, as in landing operations and river crossings.

Thickened Fuels for Blaze Bombs. A considerable amount of Napalm was used by both the Army and the Navy for thickening gasoline used in filling the droppable fuel tanks known as blaze bombs. The optimum consistency for this application was 200 to 400 g Gardner. Lower consistencies resulted in too much flash burn, higher consistencies in incomplete ignition of the fuel. Some of the fuel used by the Army in the European theater was mixed by National Oil Refineries Ltd. in England, the remainder, by chemical companies behind the lines. Eakins, Ferro, Imperial, and McGean Napalms were used at Llandarcy. Concentrations of 5.7 to 6.7 per cent were required to obtain the desired consistency. Parts of each batch were retained, and stability was generally satisfactory over a five-month surveillance period.⁴⁷

For Navy use, a thickener was required which could be mixed continuously with gasoline on the deck of an aircraft carrier, since the tanks had to be filled on the planes just prior to the take-off. An injector-type mixer, similar to that used in producing foams for fire fighting, was developed by National Foam Systems, Inc., in conjunction with the Navy. The need for an especially rapid-setting Napalm for use in this

CONFIDENTIAL

equipment led to the development of ground Napalm containing finely divided magnesium carbonate which served as a grinding aid and anti-agglomerant. Practically all this material was produced by Ferro Enamel Co. which converted its plant to use the two-stream precipitation process in order to obtain as fast setting a soap as possible. Laboratory tests have shown that the magnesium carbonate is not entirely satisfactory as an anti-agglomerant, since the ground Napalm is compacted into a solid mass after several days at 150 F. A few drums of the ground soap from regular production have been found to be agglomerated after storage at ambient temperature in the United States. However, since no complaints were received from the war theaters, the use of the ground soap can probably be considered a success.

Thickened Fuels for Incendiaries. Napalm has been used extensively as a thickening agent for gasoline fillings for AN-M69 and AN-M47 bombs. M69 bombs used 9 per cent Napalm, with a specification consistency range of 700 to 1,100 g Gardner. Tests carried out by CWS Technical Command⁸ showed that consistencies of 500 to 1,100 gave satisfactory performance; the lower limit of 700 was set to allow for decrease of consistency on aging. The commonly used performance test for M69 bombs consisted in firing against a vertical plywood target and observing adhesion and scatter of the fuel. The peptized types of Napalm (those on the low side of the specification range) were found to give superior performance in this test, and at one time the use of peptized fuels in the M69 was considered. This was abandoned because of the difficulty of setting up specifications and mixing such fuels reproducibly.

The concentration of Napalm used in the M47 bomb was 11.5 per cent, the higher consistency being required because of the greater shearing force applied to the fuel on the bursting of this bomb.

Peptized Fuels. One of the earliest peptizers to be found useful was xyleneol (and other phenolic compounds). With the use of this additive, it is possible to compound Napalm fuels at temperatures as low as zero F, whereas ordinary Napalm cannot be dispersed in gasoline

in a reasonable time at temperatures lower than 55 F. In addition, the incorporation of peptizers renders Napalm fuels less rigid and elastic, and more like ordinary liquids. Hence, at equal Gardner consistencies peptized fuel can be more readily poured into a flame-thrower fuel than regular Napalm and is less susceptible to channelling in the tank. Peptized fuels are more stable than regular Napalm, especially at low consistencies. Hence, if storage of the fuel for a long time were required, a 6 per cent fuel reduced in consistency to 100 g Gardner with alcohol, xyleneol, etc., would be superior to a 4 per cent Napalm without peptizer. For example, the consistency of a 4.5 per cent Napalm fell from 120 to 75 g Gardner in two months in a steel drum, and that of a 6 per cent Napalm containing 0.1 per cent ethyl alcohol, from 125 to 105.

At the request of the Infantry Board, a flame-thrower fuel was developed in an attempt to combine the principal advantages of unthickened and thickened fuels, i.e., fierceness of burning and long range, respectively.^{26, 27} Flame-thrower shots with peptized and unpeptized fuels of various consistencies showed that the desired characteristics were most nearly attained at about 25 g Gardner. Ordinary 2.5 to 3 per cent Napalm fuels have about this consistency, but such fuels were considered undesirable because of long mixing time and poor keeping characteristics. After a series of tests with peptized fuels of 4 to 8 per cent Napalm, it was decided that a 4.2 per cent Napalm reduced to 25 g Gardner with either 0.5 per cent xyleneol or 0.05 per cent water should be satisfactory if long-time keeping were not required. These fuels were tested by the Infantry Board, and the one prepared with water (one 5¼-lb can Napalm, two tablespoons water, 20 gal gasoline) was adopted for uses for which a "brush flame" was desired.

One important disadvantage of peptized fuels compounded with xyleneol is their large increase in consistency with decrease in temperature. This is in contrast to regular Napalm gels, the consistency of which is relatively independent of temperature. Fuels peptized with water, on the other hand, decrease in consistency with decrease in temperature, and it has been found

CONFIDENTIAL

possible, by using a mixture of xylene and water, to obtain a peptized fuel the consistency of which is essentially independent of temperature.³³ Very little work has been done on this, however, and it is probable that the proportions of xylene and water required by different Napalms would vary considerably. The best single peptizers for low temperature coefficient of consistency are the alcohols.⁴⁹ If base mixing of flame-thrower fuels for shipping abroad should be undertaken, alcohol-peptized fuels would probably be most satisfactory from the standpoint of stability over the range of time and temperature which might be encountered.

Super-Peptized Fuels. When the amount of water in a Napalm fuel is increased beyond approximately one-tenth of the soap content, no appreciable further decrease in consistency takes place. Fuels compounded with excess water have been termed "minimum consistency" or "super-peptized" fuels. The obvious advantage for such fuels, particularly in a humid climate, is that they are not affected by small additional quantities of water, as are regular Napalm fuels. One such fuel used fairly extensively in the Pacific theater consisted of 13 gal of gasoline, one 5 $\frac{1}{4}$ -lb can of Napalm, and 1 $\frac{1}{2}$ qt of water, which corresponds to about 6.3 per cent Napalm and 3.5 per cent water. A number of such fuels prepared from representative Napalms were found to have consistencies of 15 to 20 g¹⁰ and were quite stable at temperatures of 80 to 120 F. When these fuels are prepared and stored at 55 F, however, the one-day consistencies are very much higher, 200 to 400 g, since the peptizing effect of water is retarded at low temperature. After one month storage at 55 F, the consistencies are lower than at room temperature, on account of the inverse temperature coefficient of consistency of water-peptized fuels. Hence, their use should not be recommended at low temperatures.

Performance of the super-peptized fuels described above (15 to 20 g Gardner) in portable flame throwers is similar to that of other Napalm fuels of the same consistency, for example, the brush-flame fuel developed for the Infantry Board. Range in the air was 35 to 40 yd, center of deposit on the ground, 40 to 50 yd.

However, very little fuel reached the ground.

In compounding these fuels in the field, particularly if the drum and paddle method of mixing is used, it is essential that the water be first mixed with the dry Napalm before adding to the gasoline. If the water is first added to the gasoline and agitation is not violent, most of the water remains as a separate layer on the bottom, and the consistency of the resulting fuel may be two to four times what it would be if the water were evenly dispersed.

Fuels Containing Dehydrating Agents. Incorporation of moderately strong dehydrating agents such as silica gel, calcium chloride, and magnesium sulfate in Napalm fuels increases their consistency and stability. Fairly extensive tests have shown that silica gel is the most efficient agent in this respect.¹⁶ Magnesium sulfate is also quite satisfactory, but in most instances it does not produce so great an increase in consistency, and fuels compounded with it are not so stable as those containing silica gel. However, the total moisture capacity of the magnesium sulfate is greater than that of silica gel, making it somewhat superior in cases where water corresponding to more than about 20 per cent of the weight of the dehydrating agent is introduced either during compounding or subsequently.

Comprehensive tests with Napalm samples from a number of manufacturers have shown that incorporation of silica gel does not appreciably increase uniformity of consistency among the various Napalms, and that the increase in stability is not greater than would result from increasing Napalm concentration to give the same consistency.⁴⁸ However, fuels compounded with silica gel (3 per cent Napalm + 2 to 4 per cent silica gel) showed considerably greater resistance to the effect of such peptizers as xylene, alcohol, acid soldering flux, amines, and potassium acetate. This is in keeping with previous experiments which had shown that certain Napalms could not be increased in thickening power by prolonged drying in a vacuum oven at 160 F, even though the incorporation of silica gel resulted in a large increase in consistency. This phenomenon may be accounted for by the adsorption of uncombined acid from the Napalm by the silica gel. It is this adsorp-

CONFIDENTIAL

tion of other polar compounds, in addition to water, which makes silica gel superior to magnesium sulfate as an additive to Napalm fuels.

One possible drawback to the use of silica gel in Napalm fuels is the abrasive effect of the material on pumps which might be used in mixing, transferring or firing the fuel. In one case a high-speed Blackmer vane pump was ruined by 15 min recirculation of a fuel containing "thru 80" (actually, approximately 28 to 200 mesh) silica gel. Another possible difficulty is that of uniformly dispersing the silica gel in the fuel by paddle mixing. This is somewhat easier if the silica gel is added at about the stir time rather than at the beginning of mixing.

Base mixing of flame-thrower fuels stabilized with silica gel has been recommended by the 43rd Chemical Laboratory Company in Hawaii.^{41, 43} Considerable quantities of such premixed fuels were prepared by the 43rd Chemical Laboratory Company, but World War II ended before these fuels could be given a thorough trial in the field. The Company reported that the abrasive effect of the silica gel is negligible if the material is ground to 200 mesh. This has been tentatively confirmed in unreported experiments at the Eastman Kodak Co.

Fuels Containing Heavy Oils. Numerous reports of the incorporation of diesel oil, bunker C oil, or motor oil in Napalm fuels to retard the setting rate at elevated temperatures have come from the field. Because the specifications for diesel oil are less rigid than for gasoline, considerable variation in consistency can result from its incorporation in thickened fuels. Incorporation of as little as 25 per cent of eleven representative diesel oils supplied by the Navy in 4 per cent Napalm fuels resulted in a consistency variation of 26 to 64 g, compared to a consistency of 61 for the fuel prepared with 100 per cent motor gasoline. It was observed that diesel oils which were darkest in color had the greatest deleterious effect.

Experiments conducted by CWS Technical Command showed that homogeneous fuels could be prepared with the fastest setting type of Napalm (Navy ground) at 100 F by first preparing a slurry of the Napalm in motor oil.

The slurry is added through a coarse screen to the gasoline in the mixing drum, the volume of gasoline being reduced by the volume of oil added with the Napalm. Some motor oils contain additives which peptize Napalm, rendering the fuel too thin for use. Representative oils containing no such additives are Navy Symbol 2190, 2250, 3050, 3065, and 3080. These oils have been checked in the laboratory and found not to affect the consistency of Napalm fuel. It is understood that one or more of them are available in large quantity on practically any ship. The effect on Napalm consistency of motor oil available to Army personnel is not known. However, motor oil has been used in the field to retard the setting of Napalm, its peptizing action probably having been compensated by increasing the Napalm concentration.

Field Viscosimeters. As noted above, the Gardner consistencies of Napalm fuels serve as satisfactory guides to their performance in flame throwers, blaze bombs, and incendiaries. Since all fuels for incendiary bombs are mixed in the United States, the Gardner mobilometer is used for measuring their consistency. However, fuels for flame throwers and blaze bombs are usually mixed in forward areas where mobilometers are not available, and probably could not be conveniently used if available. For this reason, considerable research has been carried out in an attempt to develop a simple viscosimeter for field evaluation of thickened fuels.

An early attempt along these lines was a ball viscosimeter developed by Standard Oil Development Co. and the Chemical Warfare Service. The ball viscosimeter consists of a transparent plastic tube, about 2 in. in diameter, and steel balls of six sizes, $\frac{3}{32}$ in., $\frac{1}{8}$ in., $\frac{1}{16}$ in., $\frac{3}{16}$ in., $\frac{1}{4}$ in., and $\frac{1}{2}$ in. in diameter. The diameter of the ball which falls through 10 cm of fuel in 30 sec is the measure of the viscosity of the fuel. Although it does not give perfect agreement with Gardner values, the instrument is quite useful in evaluating fuels between 20 and 200 Gardner, these consistencies corresponding to the $\frac{3}{32}$ -in. and the $\frac{1}{4}$ -in. balls, respectively. Further study showed that somewhat better correlation with Gardner consistency is obtained if a fall time of 100 sec is used,

and the usable range of the instrument can be increased to 600 g Gardner by using balls up to 1 in. in diameter.³⁸

A simple viscosimeter which can be fabricated from materials available in the field has also been developed.^{33, 36, 38} This consists of a C-ration can with a $\frac{1}{4}$ - or $\frac{1}{2}$ -in. circular opening in the bottom and an additional C-ration can for catching the fuel passing through the opening. In operation, the viscosimeter can is filled with the fuel to be tested and placed not over 1 in. above the receiving can. The viscosimeter can is kept full during the test by gradual addition of fuel from another container. The time required to fill the bottom can is a measure of the viscosity of the fuel.

The 100 Gardner fuel commonly used in the portable flame thrower corresponds to about a $\frac{3}{32}$ -in. ball (100 sec fall time), or an efflux time of 15 min with the $\frac{1}{4}$ -in. orifice (1.5 min with the $\frac{1}{2}$ -in. orifice). The 25-g consistency, which gives a brush flame, corresponds to a $\frac{3}{32}$ -in. ball, or an efflux time of 1 min with the $\frac{1}{4}$ -in. orifice. The 200 to 250 g Gardner consistency considered optimum in the mechanized flame thrower corresponds to $\frac{8}{32}$ -to- $1\frac{0}{32}$ -in. ball and an efflux time of 4 min with the $\frac{1}{2}$ -in. orifice. The 200 to 400 g consistency used in blaze bombs corresponds to $\frac{8}{32}$ -to- $1\frac{6}{32}$ -in. ball. The upper limit, 400 g, cannot be satisfactorily evaluated with the efflux viscosimeter, but the minimum efflux time should be about 5 min with a $\frac{1}{2}$ -in. orifice. If this is not attained with 6 per cent Napalm, 6.5 or 7 per cent should be tried. The probability of 6 to 7 per cent Napalm gel having a consistency greater than 400 g Gardner is very slight.

Temperature Effects. The temperature coefficient of viscosity of unpeptized Napalm fuels is small compared with that of ordinary Newtonian liquids. Fuels containing xylene, however, have much higher consistencies at low temperatures than at high; those containing water have lower consistencies at low temperatures. In each case the change is reversible, the fuel regaining its normal consistency on being returned to the higher temperature. There is no good evidence of any Napalm fuel having broken down, either by syneresis or by abnormal reduction in consistency, on storage at

low temperatures (down to -40 F). The normal decrease in consistency, which occurs on aging at ordinary temperatures, is accelerated at elevated temperatures, and the consistency after one day at 150 F is ordinarily considered to be the minimum consistency which will be attained on aging at ordinary temperatures. This is not necessarily true, however, since several 4 per cent Napalms, which had higher consistencies after one day at 150 F than after one day at 77 F, showed the normal decrease in consistency on aging at ambient temperature. The explanation for the increase in consistency at elevated temperature is given by a Napalm substitute containing 80 per cent coconut oil acids and 20 per cent oleic acid which had a consistency of 1,100 after storage at 150 F, as compared to 430 at 77 F.⁵¹ Aluminum soaps of coconut oil acids cannot be dispersed in gasoline at 77 F, and the proportion of oleic acid used in this mixture was not enough to cause total dispersion. Thus, storage at 150 F has two opposite effects, one tending to increase consistency, the other to decrease it, and in certain cases the net effect may be an increase.

The effect of storage of Napalm gels at 120 F for one day to thirty-two days is shown in reference 12. In general, most of the decrease in consistency occurs in one day or two days at this temperature, in contrast with a more gradual decrease over the entire 32-day period at 70 F. The final, 32-day, consistency of 4 per cent gels was lower at 120 degrees than at 70 degrees, which indicates that the aging effect is predominant over the dispersion effect at 120 degrees.

An interesting phenomenon occurs when regular Napalm fuels are mixed and stored at 50 to 60 F, approximately the minimum temperature at which Napalm can be dispersed without a peptizer. Setting rate of the Napalm is greatly retarded and maximum consistency is not attained until two to four days after mixing. This maximum consistency, however, is very much higher than that attained at 80 F. For example, a 2 per cent gel may have a consistency of 80 g instead of 10 g, a 4 per cent may have a consistency of 250 instead of 100. On continued storage at 55 F, the consistency is still higher than normal after two months, although

CONFIDENTIAL

it begins to decrease after a week.⁴⁴ This abnormal consistency is a result of retarded peptizing action of the water and uncombined acids in the Napalm at low temperature. If one of these fuels is brought to 80 F for only an hour, its consistency is found to be normal, even after being returned to the lower temperature.

The difference in flame-thrower performance between these abnormal fuels and ordinary fuels of the same Napalm concentrations is not so great as would be expected on the basis of consistency. In fact, the concentration seems to be a more reliable guide to performance than the consistency, this being the most striking exception to the rule that consistency, irrespective of concentration, determines performance. Gardner consistencies of these fuels, determined immediately after unignited firing from a flame thrower, show that their poor performance is due to mechanical breakdown of consistency in the gun. The "healing rate" at this low temperature is greatly retarded, but the material gradually returns to its abnormal consistency over a period of hours.

Examination of the data for the blaze-bomb fuels mixed at Llandarcy⁴⁷ shows that most of the fuels were mixed in the winter and that the gasoline temperature was generally in the range of 50 to 60 F. This accounts for the initial high consistency of these fuels, many being 500 to 600 g Gardner, and for the decrease in consistency which occurred on aging, the normal consistencies of 200 to 400 being attained in 2 to 3 months.

Another interesting temperature effect is observed on storing Napalm soaps at 150 to 160 F in hermetically sealed containers. Thickening power of representative Imperial Napalms increases from approximately 75 Gardner, for 4 per cent gels, to 150 to 200 in two weeks at the elevated temperature. This increase in consistency is accompanied by an increase in moisture content and a decrease in extractable acid. This indicates that some of the uncombined acid combines with alumina or mono-soap, water being produced by the reaction. Decrease in extractable acid is of the order of 2 to 3 per cent on the basis of total soap. Why this should result in such a large increase in thickening power is not clear. On continued storage at

160 F, the thickening power begins to decrease but is still above normal at sixteen weeks.

Storage at 120 F has comparatively little effect on the thickening power of Napalm in twelve weeks, which indicates that exposure to temperatures which will ordinarily be encountered should not be expected to materially change the thickening properties of the soap.

8.2.4 Substitute Napalm Formulas

As a result of what appeared to be an imminent shortage of naphthenic acids,³² work was undertaken to develop a Napalm formula in which the naphthenic acid would be eliminated or its percentage materially reduced. After soaps of various acid ratios and excess caustic content were made up and tested, it appeared that the optimum composition, in the absence of naphthenic acid, was 80 per cent oleic and 20 per cent coconut oil acids precipitated at an excess caustic ratio of 30 per cent.⁵¹ High ratios of coconut oil acids produce soaps which are not completely dispersible in gasoline at room temperature and gasoline gels which tend to be short and crumbly. Low ratios of coconut oil acid produce soaps which become gummy on drying. In addition, soaps of over 80 per cent oleic acid tend to form thick, clear jellies on cooling, which makes the precipitation of straight aluminum oleates from concentrated soap solution unsatisfactory. However, this tendency is eliminated for all practical purposes by 10 to 20 per cent coconut acid. High basicity (60 per cent excess caustic) produces soaps which are too high in thickening power (greater than 800 g Gardner).

The setting rate of the substitute containing 80 per cent oleic acid is somewhat faster than regular Napalm for corresponding particle sizes. In addition, the average particle size of the substitute is smaller than that of the regular Napalm; hence the overall tendency is for considerably faster setting. The length and healing rate are comparable to regular Napalm. The amount of alpha-naphthol required to prevent oxidation is directly proportional to the oleic acid content.

Several formulations containing reduced

CONFIDENTIAL

quantities of naphthenic acid were also made up and tested. With respect to gel strength, crumbliness, and setting rate these formulations are all between regular Napalm and the aluminum oleates. It was decided to retain 5 per cent naphthenic acid in order to utilize the available supply of the three acids, and several full-scale batches containing 65 per cent oleic, 30 per cent coconut, and 5 per cent naphthenic acids were prepared by the manufacturers. No serious difficulties were experienced in any of the plant operations. The substitute material was tested by CWS Technical Command in M69 and M47 incendiary bombs and was reported to be completely satisfactory. Because of the fast setting of the material, it is felt that additional refrigerating capacity for cooling the gasoline might be required in some of the filling plants. However, before production could be shifted to the substitute formula, the naphthenic acid supply situation eased, and shortly thereafter World War II ended.

8.2.5 Other Aluminum Soap Thickeners

While research in the United States has been concentrated on improving Napalm with respect to uniformity, reliability, etc., numerous other aluminum soap thickeners have been developed in Great Britain.⁵⁴ These include (1) Brascon, a preformed concentrate of aluminum stearate peptized with cellosolve; (2) chan and chol, aluminum naphthenate and aluminum oleate, respectively, prepared by a direct reaction process; and (3) Camgel, consisting of two liquids; namely, aluminum cresylate solution and oleic acid, or a fatty acid solution. When mixed in gasoline these form the aluminum soap of the fatty acid.

Research in the United States has shown that chan and Camgel could be produced here if desired. The former is of little interest because of the naphthenic acid supply situation, but the latter is especially attractive because of the ease of mixing liquid components (see Section 8.3).

Other aluminum soap thickeners which have been produced in quantity are: (1) Metalex, an

aluminum soap of stearic and naphthenic acids peptized with cresylic acid, produced in New Zealand, and (2) geletrol, an aluminum soap of oleic acid, produced in Australia.

8.3 LIQUID THICKENING AGENTS⁵¹⁻⁵⁵

8.3.1 Aluminum Cresylate

This two-liquid thickening agent, known as Camgel in England, was developed as a result of a suggestion of A. E. Alexander of Cambridge University. The aluminum soaps are formed in situ by metathesis between aluminum cresylate solution and oleic acid (or a solution of a fatty acid) when the two are mixed in the gasoline. The aluminum cresylate is prepared by heating cresol with aluminum foil in a suitable solvent such as coal tar naphtha or kerosene, etc. Properties of the fuel are dependent on the ratio of aluminum cresylate to fatty acid, and are improved by the inclusion of such additives as methyl alcohol, cresol, water, and acetone. These peptizers are commonly incorporated in the fatty acid solution, thus limiting the number of liquid additives to two.

Because of the attractiveness of liquid thickeners for the continuous mixing of thickened fuels, particularly for blaze bombs, considerable work has been done in the United States on aluminum cresylate.^{51, 55} It was shown that a satisfactory thickener could be manufactured from petroleum cresylic acids, the largest available source, and that refined lubricating oil could be used as the solvent, in order to reduce the fire hazard for storage on aircraft carriers. Some excess cresol must be incorporated in the lubricating oil solution for the sake of fluidity.

Tests of aluminum cresylate solutions from two NDRC laboratories and from PWD in Great Britain confirmed their essential equivalence, when the same amounts of aluminum cresylate and fatty acid are used. Optimum fuel characteristics are obtained with mixtures corresponding to 1.7 to 2.2 molecules of fatty acid per molecule of aluminum cresylate. Setting rate can be accelerated with water, or decelerated with cellosolve, the latter additive greatly in-

CONFIDENTIAL

creasing the stability of the fuels. When the cresylate solution contains about 0.5 g aluminum cresylate per cu cm, the total additives required to produce a blaze-bomb fuel are 10 to 12 per cent by volume.

Because of the satisfactory performance of the Navy mixer with ground Napalm, aluminum cresylate was never produced in quantity. It was considered that this could be done if required.

8.3.2

Aluminum Alcoholates

Numerous alcohols and phenols, in addition to cresol, can be used in the preparation of liquid thickeners.⁵¹ A very satisfactory thickener has been made by Harshaw Chemical Co. with mixtures of *sec*-butyl and isopropyl alcohol. An 80 per cent solution of this alcoholate in lubricating oil is fluid. The alcoholate is superior to cresylate in that the total additives required to produce a blaze-bomb fuel are only 5 to 6 per cent by volume (approximately 1.5 per cent alcoholate solution) 4 per cent acid mixture.

8.3.3

Sodium Aluminate

This thickener was developed at Harshaw Chemical Co. by Capt. John A. Southern of CWS.⁵¹ One solution consists of sodium aluminate, sodium hydroxide, and water. The other is a special acid mixture of the following composition: 3 parts coconut fatty acids, 1.5 parts oleic acid, 1.5 parts naphthenic acid, 2 parts ricinoleic acid, and 0.25 part triethanolamine. The aluminate solution is prepared by suspending 200 g sodium aluminate and 500 g sodium hydroxide in enough water to make 1,000 cc and drawing off the clear solution after standing. Eight per cent of the acid mixture and 3.25 per cent sodium aluminate solution stirred briefly in gasoline produces a gel of the desired consistency. Prolonged stirring reduces consistency, and the gel does not tend to heal. It is much less stringy than Napalm, but it might be satisfactory in blaze bombs. The ease of manufacture and freedom from fire hazard of the aluminate solution make it particularly attractive.

8.3.4

Valone

Equimolecular quantities of 2-valeryl-1,3-indandione (Valone) and *n*-monododecylamine produce a gel when mixed in gasoline. Solutions of the individual components in gasoline may be used, but a more interesting application is the solution of the two in tetrachloroethane. A 50 per cent solution (25 per cent Valone, 25 per cent amine) is a mobile liquid, and 10 per cent of the solution forms a thick gel in gasoline. This gel, like that from sodium aluminate, is lacking in stringiness, but is of particular interest because of the single-liquid additive. All the two-liquid thickeners must be mixed in the correct proportions in order to be effective, thus requiring rather complicated mixing equipment. With a one-liquid thickener this problem is greatly simplified, the present Navy (injector) mixer, or a similar device, being adequate. In addition, the tetrachloroethane solution is non-inflammable.

It has been found that amines of coconut fatty acids, available commercially, and crude Valone, which can be produced in large quantities, thicken gasoline as satisfactorily as the pure substances.

8.4

METHACRYLATE THICKENING AGENTS^{7, 56-64}

8.4.1

Introduction

A number of synthetic and natural polymers were investigated as possible thickening agents for gasoline for use in various incendiary bombs and flame throwers. Rubber had been investigated for this purpose in 1941 and had proved quite good, but after Pearl Harbor there was no rubber available for these uses. By the time synthetic rubber was available in sufficient quantities, other thickening agents had been developed which were entirely satisfactory for these uses. Among the synthetic polymers investigated, the most successful was isobutyl methacrylate polymer fortified with certain sodium soaps. Thickening agents of this type were used extensively during 1942 and 1943 for

CONFIDENTIAL

filling AN-M47 and AN-M69 incendiary bombs, and they could have been used for flame-thrower fuels if Napalm had not been available and more convenient for field mixing.

The E. I. duPont de Nemours & Co., Ammonia Department, had cooperated with the Chemical Warfare Service during January to April 1942, in the development of a synthetic polymer thickening formula for filling the AN-M47 100-lb oil incendiary bomb. The result was the following formula.⁵⁹

IM Type I	
Isobutyl methacrylate polymer AE	5%
Stearic acid	3%
Calcium oxide	2%
Water	1.25%
Gasoline	88.75%

This filling was used extensively for filling AN-M47 bombs during 1942 and part of 1943 when it was replaced by IM Type IV (see page 207).

In May 1942 duPont was invited to cooperate on an informal basis with the NDRC-Standard Oil Development Co. group in developing an isobutyl methacrylate polymer formula for filling the new AN-M69 bomb. The result was the following formula.⁵⁷

IM Type II	
Isobutyl methacrylate polymer NR	5%
Hydrofol 51 (stearic acid)	2.5%
Naphthenic acid	2.5%
Aqueous solution of caustic soda (40%)	3%
Gasoline	87%

The filling was compared with other competitive gasoline gels in a series of tests in May 1942 with the result that IM Type II was adopted for use in the initial production of AN-M69 bombs. IM Type II was replaced by IM Type III in March 1943 (see page 207).

The code letters AE and NR stand for Arsenal Edgewood and National Research, respectively. Polymer AE was a much higher average molecular weight than polymer NR, although the actual molecular weight was not known for either one.

After the above developments a formal contract was made with E. I. duPont de Nemours & Co., Ammonia Department (OEMsr-744), beginning August 1, 1942, for the purpose of studying the several variables involved in these

formulas and of developing either better formulas, or satisfactory formulas requiring less of critical materials such as isobutyl methacrylate and naphthenic acid. The remainder of this section describes the results obtained under this contract.

8.4.2

Laboratory Studies

The study of gasoline gels thickened by polymers is reviewed by summarizing the effect on gel properties of varying, in turn, the nature and concentration of each of the basic gel components.

*Conclusions.*⁶² Gel preparation usually involves preparation of a low-viscosity gasoline solution containing isobutyl methacrylate polymer and soap-forming acids which are gelled or thickened by the addition of a small amount of aqueous alkali. In general, the polymer determines strength characteristics, while the soap ingredients contribute body to these mixtures.

1. The range of strengths required of gels for the various incendiary munitions was covered by using NR or AE grade isobutyl methacrylate polymer for the weaker gels, and one of a series of interpolymers of isobutyl methacrylate and methacrylic acid for the strongest gels. Polymer content of soap-fortified gels varied from 1 to 10 per cent. The minimum polymer contents consistent with stability and the desired gel strengths were determined.

2. A large number of soap-forming acids were assessed as gel bodying agents. Formulation of the six most effective acids was intensively studied in gels containing various combinations of two or three acids. Of these six acids, stearic and oleic acids impart stiffness, body, and high-temperature stability to all types of methacrylate gels. Naphthenic acid and dimerized soybean oil acids act as gel plasticizers, while rosin and Turkey-red oil normally function as plasticizing agents but occasionally fulfill both of the above-described functions. The most effective acid combinations are stearic acid-naphthenic acid; stearic acid-naphthenic acid-wood rosin; stearic acid-dimerized soybean oil acid; and stearic or naphthenic acids alone.

CONFIDENTIAL

3. To study the effect of the gelation agent, strong and weak bases were tested at various ratios of acids to base to water. Only strong bases caused effective gelation. The use of aqueous sodium hydroxide, ground lime, and calcium hydroxide was studied in detail. Unsuccessful attempts were made to prepare stable gels with ammonia or amines.

4. Stiffness and a reduction in resilience were imparted to strong, fluid gels containing isobutyl methacrylate-methacrylic acid interpolymers by the addition of inert solid materials. Ground alpha-cellulose was the most effective filler tested.

5. Other NDRC research groups studied the gasoline requirements of methacrylate gels and concluded that an aniline point below 105 F was required to obtain gel stability.

Physical Measurements.^{60, 62} The physical properties of various gels were compared with the results of field evaluations, and the sensitivity of various tests to minor changes in composition of a given gel formula were determined. To obtain significant characterization of methacrylate gels, it was necessary to modify existing methods and to develop new techniques. New physical measurements developed under this contract include the impact strength, parallel plate, and burning rate tests. The impact strength, a measurement of consistency at a high shearing force, was useful in gel research to predict behavior of diverse gel formulas in static firing tests of incendiary bombs. The parallel plate test, a measurement of body under a low shearing force, was adapted to plant control on specific gel formulas, where it showed excellent sensitivity to quality of ingredients and method of compounding. The burning rate test gave a comparative measure of the incendiary characteristics of diverse gels.

The stability to exposure to both high and low temperatures of gels prepared during the formulation study was determined and has been correlated with gel composition.

New Gel Formulas.^{60, 62} As a result of the studies made by duPont under Contract OEMsr-744, the following formula was selected to replace IM Type II for filling AN-M69 bombs.

This formula went into production in March 1943, replacing IM Type II for filling AN-M69

IM Type III	
Isobutyl methacrylate polymer AE	2%
Hydrofol 51 (stearic acid)	3%
Naphthenic acid	3%
Aqueous solution of caustic soda (40%)	4.5%
Gasoline	87.5%

bombs, and still later it was replaced by Napalm for this purpose.

The following formula was selected to replace IM Type I for filling AN-M47 bombs.^{60, 62}

IM Type IV	
Isobutyl methacrylate polymer AE	3%
Stearic acid	4%
Calcium oxide	4%
Water	2.5%
Gasoline	86.5%

In this formula 3 per cent additional calcium stearate replaces 2 per cent of isobutyl methacrylate polymer in IM Type I, giving an equivalent gel. IM Type IV was later replaced by Napalm for filling AN-M47 bombs.

Isobutyl Methacrylate Interpolymer Formulas.^{61, 62} An interesting series of gels were developed containing both isobutyl methacrylate polymer and free methacrylic acid, but no stearic or naphthenic acids. A typical formula would be:

Isobutyl methacrylate polymer AE	3 to 6%
Methacrylic acid	0.1 to 0.3%
Aqueous solution of caustic soda (40%)	1%
Gasoline	93 to 96%

Such gels gave strengths equal to IM Types I to IV, and contained materially higher percentages of gasoline, the primary incendiary material. Apparently, the free methacrylic acid, which contains a double bond, forms cross linkages similar to those in vulcanized rubber, thereby imparting high gel strength with a relatively small percentage of gelling agent. At first these gels were not sufficiently stable at low temperatures, but this was later corrected by good control of compounding. Although this type of gel looked attractive it was never used, since in the meantime Napalm had been perfected and dominated the field of thickening agents. Methacrylate interpolymer gels were particularly good when made with a fuel containing around 20 per cent of toluene.

Other Polymers. In a search for isobutyl methacrylate substitutes, a study of other commercial resins was undertaken. A search for

CONFIDENTIAL

gasoline-soluble polymers other than methacrylates revealed only the polyvinyl ethers, Vistanex (polyisobutylene) and the rubber substitutes derived from vegetable oils. Satisfactory strength in gels containing the latter two materials was obtained only when the polymer content exceeded 10 per cent. The polyvinyl ether procured from the General Aniline & Film Corp. was tested as a direct substitute for polyisobutyl methacrylate and as a constituent of soap-free gels. The properties of polyvinyl ether gels are comparable to those prepared from methacrylate polymers. Evaluation of these mixtures as flame-thrower fuels has been undertaken by other NDRC groups. Gel preparation was attempted with other commercial resins, especially ethyl cellulose, by adding an auxiliary solvent to the gasoline. It was concluded that without further modification such polymers do not impart sufficient strength to gasoline-soap gels and that the use of a water-miscible auxiliary solvent results in poor gel stability at high temperatures.

Modification of existing commercial resins and the synthesis of new polymeric gasoline thickening agents was "high-spotted." While several gasoline-soluble cellulose and vinyl resins were prepared, degradation occurred during the introduction of functional groups so that only low molecular weight materials were obtained.

8.4.3

Preparation of Gels

*Batch Preparation.*⁶² The basic method of preparing methacrylate gels involves adding an aqueous solution of a base, such as sodium hydroxide, to a stock solution consisting of polymer and soap-forming acids dissolved in gasoline. The stock solution is prepared by dissolving first the acids, then the polymer, with strong agitation in the gasoline. To insure solubility of stearic acid, the gasoline temperature must exceed 12 C. When mixtures of acids were used it was found convenient to weigh the acids into a container heated on a steam bath or, when rosin was present, on an electric heater, and to add the molten mixture to the gasoline while stirring. Solution of polymer was most readily obtained by adding the entire amount required

at one time. Stirring was continued until solution was complete. Fillers were sometimes added to this stock solution. Gelation was obtained by pouring the aqueous basic solution rapidly into this stock solution while stirring with an electrically driven stirrer. Agitation was continued for 1 min or until the mixture had sufficiently gelled to climb the shaft of the stirrer. The usual size of a laboratory batch was 400 g prepared in a wide mouth, 1-qt bottle. The gels were allowed to set in the closed container at least 24 hr before examination.

When lime was used as the gelling agent, the powdered dry lime was dispersed in the stock solution and water was then added to effect gelation. These mixtures were stirred at least 2 min after the addition of water. Since the particle size of the lime affected the rate of gelation and the final properties of the gel, a standard mixture was obtained by crushing USP lime, screening, and compositing the fractions to give a mixture with the following screen analysis.

35 to 60 mesh	22%
60 to 80 mesh	22%
80 to 100 mesh	22%
100 to 120 mesh	22%
Through 200 mesh	12%
	100%

This synthetic mixture has a screen analysis which is the average of several analyses on limes ground to pass 40 mesh.

Pilot Plant Continuous Preparation. For larger than laboratory scale preparation of methacrylate gels it seemed desirable to develop a continuous rather than a batchwise process. Gelation involves rapid intimate mixing of a gasoline stock solution containing polymer and soap-forming acids with the aqueous caustic solution. In preliminary tests the mixing obtained by injecting the two streams into a centrifugal pump seemed more controllable than the mixing obtained by passing the two solutions under pressure simultaneously through an orifice. The small-scale unit shown diagrammatically in Figure 1 was therefore assembled. The stock solution is prepared batchwise in holdup tank T-1 while the 40 per cent caustic solution is stored in tank T-2. These solutions are drawn from the tanks at calibrated rates by

CONFIDENTIAL

metering gear pumps. The two metered streams join in a tee or Y which immediately precedes the inlet to the centrifugal mixing pumps. Shut-off and sampling valves are so located that the rate of flow of each stream can be calibrated

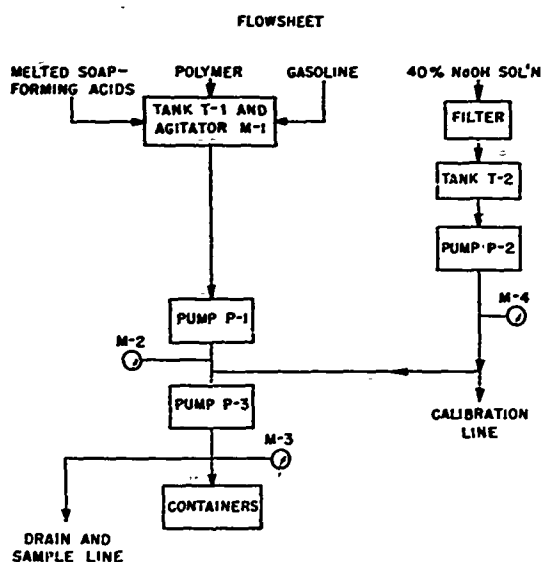

FIGURE 1. Continuous unit for the preparation of methacrylate gels.

separately. The gel produced in the mixing pump is forced through the discharge line and loaded directly into a bomb or container. The maximum production of the experimental unit, limited by pump capacity, was 10 lb of IM-II gel per min. At this rate the back pressure developed in the discharge line, which was 15 ft of standard 1-in. black iron pipe, including two 90-degree bends, was 5 psi.

To obtain the flexibility required for experimental studies, all three pumps were operated by variable speed drives. In the unit producing IM-II and IM-III gel at the Kilgore Manufacturing Co., it was found advantageous to operate both metering gear pumps from the same driveshaft, and to predetermine the ratio of the two streams by the proper choice of gears coupling the pumps to the shaft.

8.5 SODIUM SOAP THICKENING AGENTS^{65, 66}

Before the advent of Napalm and isobutyl methacrylate thickening agents for gasoline, a considerable amount of work was carried out on

formulas using various sodium soaps as the principal gelling agent.^{65, 66} These formulas contained the following compounds: (1) a fatty acid which may be stearic acid, hydrogenated fish oil acid, tallow acid, oleic acid, or cottonseed oil acid; (2) resin; (3) a plasticizer which may be isopropyl alcohol, cottonseed oil, castor oil, fish oil, rapeseed oil, stearine, or glycerine; (4) sodium hydroxide solution; and (5) gasoline, kerosene, or both.

Hundreds of different formulas were tried. On the basis of burning rate, stability, availability of materials, and ease of preparation, the following formulas were considered to be fairly good, although even better formulas might have been worked out:

	SOD formula 122	SOD formula 392	SOD formula 433
Stearic acid	3.5%	4.5%	3.5%
Resin	1.75%	2.25%	1.75%
Castor oil	3.0%
Sulfonated cottonseed oil	...	0.2%	0.2%
Stearine	3.0%
Sodium hydroxide	2.0%	0.8%	2.0%
Water	2.0%	0.8%	2.0%
Gasoline	81.25%	83.2%	81.05%
Kerosene	6.5%	...	6.5%

These formulas were found to perform quite well in the AN-M69 bomb, although they were not suitable for the AN-M47 or other bursting type bombs on account of their low cohesiveness, compared to the NP and IM types of gels. Burning tests in incendiary-test structures showed that the sodium soap gels were not quite as good as NP and IM gels even in the AN-M69 bomb because of their greater breakup on ejection. Therefore the sodium soap gels were discarded and were never used in production of AN-M69 bombs. They were sufficiently satisfactory, however, and might have been used if a serious shortage of NP and IM had developed during World War I.

8.6 CELLULOSE-BODIED FUELS^{8, 23, 67-73}

In addition to gasoline gel fuels, fuels bodied with cellulose wadding (cellucotton) appeared quite promising for use in incendiary bombs. They might also possibly have been used in some types of flame throwers, but could obvi-

CONFIDENTIAL

ously not be used in conventional types. A fuel consisting of 13 per cent cellucotton and 87 per cent gasoline gave very good results in the AN-M69 bomb. The cellucotton simply soaks up the gasoline even though the gasoline weighs almost seven times the cellucotton.

Cellucotton-gasoline fuels have the following advantages over gelled fuels:

1. *Stability.* There is no question of the short or long term stability of this fuel, whereas stability was a major difficulty in the early development and production of Napalm.

2. *Simplicity of production.* This applies particularly to the factory filling of incendiary bombs.

3. *Ignition.* Ignition would be no problem with this fuel, whereas low-temperature ignition was always a problem with gelled fuels.

4. *Temperature effect.* Cellucotton-gasoline fuels would have nearly the same performance at all temperatures, whereas the performance of gelled fuels varied with temperature.

5. *Fuel distribution.* With cellucotton-bodied fuels it is possible to have a uniform, predetermined size of fuel chunks, whereas with gelled fuels the chunks varied very greatly in size, and shattering was always more or less a problem.

6. *Availability.* There would be no supply problem in the case of cellucotton, whereas constituents of both Napalm and methacrylate were in short supply throughout World War II.

7. *Cost.* Cost of filling bombs with these fuels would be much less than for gelled fuels.

Comparative burning tests of cellucotton-gasoline fuels in AN-M69 bombs against various incendiary test structures indicated these fuels to be approximately equivalent to the same weights of gelled fuels. One disadvantage was the greater tendency of cellucotton fuels to bounce off target surfaces and lack of tendency to adhere. However, gelled fuels also bounce off surfaces in striking at small angles, and a thoroughgoing comparison was never made on this point.

The controlled size of fuel chunks would be a matter of minor importance in the AN-M69 bomb, but it might have been very important for bursting-type bombs, such as the AN-M47 and AN-M76. The E22, 500-lb tail ejection bomb, developed by Factory Mutual Research

Corp., used a cellucotton-bodied fuel with very promising results.

In spite of the attractive features of the cellucotton-bodied fuels, they were never used in World War II primarily because the gelled fuels got started first. Cellucotton fuels were never tested for use in flame throwers primarily because the whole emphasis was on conventional nozzle-type flame throwers.

8.7 FORTIFIED FUELS^{23, 72, 74-82}

8.7.1 Introduction

Numerous fuels in which hydrocarbons were fortified by the addition of combustible metals and oxidizing agents, or by the addition of either one, were investigated during World War II and proposed for use in incendiary bombs and flame throwers. The heat outputs of the standard gasoline gel fuels were quite satisfactory for use in incendiary bombs and flame throwers, but they had the drawbacks of burning at comparatively low temperatures and of being easily extinguished by water. It was to correct these two drawbacks that fortified fuels were investigated by NDRC, the Chemical Warfare Service, and by the British Petroleum Warfare Department. However, their use in the war was very limited, largely in the M74 and AN-M76 incendiary bombs, which were developed by the Chemical Warfare Service. NDRC work on fortified fuels was principally in connection with the development of the E9 and E19 incendiary bombs.

The principal advantages to be expected from fortified fuels are outlined below.

1. Higher temperature and greater fierceness of burning. This property is of interest in both incendiary and anti-personnel applications.

2. Less easily extinguished by water. This property is primarily of interest in incendiary-bomb applications.

Other less important advantages of fortified fuels are (1) greater range in flame throwers resulting from higher densities, and (2) production of irritant gases such as sulfur dioxide.

Since all fortifying additives have higher

CONFIDENTIAL

densities than hydrocarbons, the densities of fortified fuels are always higher than gasoline gels. The heat outputs per unit weight of fortified fuels are lower than gasoline gels, but the higher density offsets this, so that the heat outputs per unit volume are usually about the same as gasoline gels. These facts constitute a net disadvantage for fortified fuels when weight is a critical factor as it sometimes is both in incendiaries and in flame throwers. Another disadvantage of fortified fuels is their generally lower degree of cohesiveness (greater shortness).

The following sections describe only NDRC work in this field. The formulas given are representative of a much larger number described in the original references.

8.7.2 Hydrocarbon-Metal-Oxidizing Agent Mixtures^{72, 75, 77-79, 81, 82}

Mixtures under this heading constitute the most important fortified fuels investigated by NDRC. Most of these were investigated by Factory Mutual Research Corp. in connection with the E19 incendiary bomb, or by the Texas Co. in connection with the E9 incendiary bomb. Following are some representative formulas.

1. 25% Motor oil (SAE40)
- 35% Aluminum powder
- 40% Sodium nitrate

This mixture has a heat output of 8,930 Btu per lb and a density of 1.50, which puts it on a par on a volume basis with gasoline gel which has a heat output of about 17,500 Btu per lb and a density of 0.78.

2. 20% Motor oil (SAE40)
- 10% Asphalt
- 15% Aluminum powder
- 55% Sodium nitrate
3. 35% Lubricating grease
- 15% Aluminum powder
- 5% Sulfur
- 45% Sodium nitrate

This mixture has a heat output of 7,800 Btu per lb and a density of 1.54.

4. 7.1% Motor oil (SAE40)
- 14.8% Aluminum flake
- 1.6% Sulfur

- 14.8% Sodium nitrate
- 11.7% Barium nitrate
- 50.0% Thermité

Mixtures 1, 2, and 3 were preliminary formulas developed for the E19 incendiary bomb, and 4 was the final formula for the principal filling for this bomb.

5. 30% Gasoline-rubber gel (7% rubber)
- 11% Aluminum powder
- 14% Sulfur
- 45% Sodium nitrate with or without 2½% cotton or other vegetable fiber for strengthening.

This mixture was investigated as a possible flame-thrower fuel. It showed promise except for the unavailability of rubber.

Nuodex Products Co.⁷⁷ experimented with a variety of mixtures of gasoline gel, oxidizing agents, such as lead nitrate, barium nitrate, and lead oxides, and metals or other reducing agents, such as lead, iron, lead sulfide, and iron sulfide, in an attempt to find a satisfactory high density flame-thrower fuel. Densities in the range 1.3 to 1.6 were achieved. The principal requirements were high cohesiveness, reliable burning, and stability. No mixtures of practical value resulted from this work.

8.7.3 Hydrocarbon-Oxidizing Agent Mixtures^{73, 74, 76}

1. 58.5% Turpentine
- 19.5% Furfural extract, from lube-oil refining
- 10% Ammonium nitrate
- 12% Cellucotton

This mixture was developed for the E9 bomb and was highly recommended for that purpose, except that the final design of the E9 bomb was not adapted to the use of cellucotton-bodied fuels.

2. 30% Polymerized divinyl acetylene (DVA)
- 10% Motor oil
- 60% Sodium nitrate

This mixture was developed at the University of Chicago for use in sabotage incendiaries. The test results showed that divinyl acetylene had no greater fire-starting capacity than other hydrocarbons.

8.7.4 Hydrocarbon-Metal Mixtures^{23, 80}

1. 58.5% Turpentine
19.5% Furfural extract, from lube-oil refining
10% Magnesium powder
12% Cellucotton

This mixture was developed for the E9 bomb. The comparatively high burning temperatures of the hydrocarbons present were sufficient to ignite the magnesium, and it gave a very effective incendiary fuel.

2. 98% Gasoline gel (Napalm)
2% Sodium or potassium

Finely divided sodium or potassium was made by melting the metals under a high-boiling hydrocarbon such as xylene, and then shaking the molten mixture, reducing the metal to fine droplets. The dispersed metal was then suspended in gasoline and the gasoline gelled with Napalm. These mixtures had the interesting property of bursting into flame when water was applied to them.

8.8 SELF-IGNITING FUELS⁸³⁻⁹⁰

8.8.1 Introduction

Substances which ignite more or less spontaneously upon contact with the atmosphere have been known and studied for a long time. Among those considered at one time or another as potentially suitable for use as primary or auxiliary fuels in flame throwers or incendiaries, two groups of substances stand out: organometallic compounds and liquefied white phosphorus compositions, although a variety of other substances has been contemplated as chemical igniters for flame throwers.⁸⁶

Investigations of organometallic compounds within NDRC were initiated in 1940 under Contract NDCrc-61, later changed to Contract OEMsr-97.^{83, 84} Ignition of flame throwers by introducing zinc diethyl as a secondary fuel also received brief study under OSRD Contract OEMsr-21 early in 1944. Liquefied phosphorus compositions were taken up by NDRC as possible flame-thrower fuels in April 1944 under Contract OEMsr-242, and this work resulted in

an intensive study of the preparation, properties, applications, and physiological effects of liquefied phosphorus, as well as in design of instruments for its military use.⁸⁷⁻⁹⁰

8.8.2 Organometallic Compounds

*Nitrated Lead Derivatives.*⁸³ A number of these compounds decompose vigorously or explosively when heated, to give fine lead oxide smokes. The ballistic properties of these substances, however, are too low to warrant their consideration as explosives, although some of them suggest approaches to possible primers. The toxicity of these lead and lead oxide smokes has received only scant investigation.

*Nitrated Arsenic Derivatives.*⁸³ Some of these compounds decompose explosively when heated, to give fine arsenic oxide smokes; this is particularly the case with nitro-aryl arsenic acids and their lead salts. The presence of lead generally increases the explosive properties of nitrated arsenic acids.

*Bismuth Compounds.*⁸³ Organobismuth compounds containing two or more nitro groups in the molecule give off a bismuth oxide smoke upon ignition. However, self-igniting properties are low.

*Aluminum Compounds.*⁸³ Methylaluminum sesquichloride, $(\text{CH}_3)_3\text{Al}_2\text{Cl}_3$, a compound readily prepared by direct interaction of aluminum and methyl chloride, appears to possess some interest as a flame-thrower igniter or primary fuel.

Diethyl Zinc. This compound, although not as yet readily available, appears to possess some interest as a flame-thrower igniter. A disadvantage is the high proportion of zinc diethyl required as a flame-thrower rod coating, especially in cold weather.

*Triethyl Boron.*⁸⁴ In the course of the examination of a number of spontaneously inflammable substances for possible use as incendiary agents, triethyl boron was found to possess certain advantages, such as moderate thermal stability and high stability toward water, which were not exhibited by any other of the possible liquid substances.

The ordinary laboratory procedures for the

preparation of this compound are, unfortunately, not satisfactory for large-scale industrial use. It was, therefore, the object of the research to develop a simple method for the synthesis of the compound from readily available materials and in conventional equipment used by the chemical industries.

In all, forty-three experiments were carried out, using all reasonably available starting materials and a great variety of conditions. Of these, only eight gave any trace of the desired product, and only two were sufficiently convenient and economical of material to merit consideration. These two methods involve the reaction of ethylaluminum sesquibromide (1) with triethyl borate and (2) with gaseous boron trifluoride. Of these two, the procedure employing ethylaluminum sesquibromide and triethyl borate appears to be most satisfactory on the basis of both yield and economy. No solvent is needed, the only starting materials being aluminum turnings, ethyl bromide, and triethyl borate. Scrap aluminum may be employed in place of the pure metal if the latter is not available. The first of the two steps in the reaction may be operated as a continuous process. The conversion of the aluminum compound to triethylboron is quantitative, and it is conceivable that the aluminum residues could be returned to a refining plant and converted to the metal.

8.8.3 Phosphorus-Phosphorus Sesquisulfide Eutectic (EWP)

*Liquid EWP.*⁸⁷⁻⁹⁰ The phosphorus-phosphorus sesquisulfide eutectic consists of 55 per cent by weight of white phosphorus and 45 per cent by weight of phosphorus sesquisulfide. The composition by elements is 80 per cent phosphorus and 20 per cent sulfur. The composition of the fuel is not critical, and a reasonable amount of deviation is allowable from the true eutectic proportions.

The fuel, when settled free from water, is a clear, yellow, heavy liquid of low surface tension, moderate viscosity, and oily appearance.

The specific gravity of the phosphorus-phosphorus sesquisulfide eutectic at 20 C is 1.840, as determined with a pycnometer.

Mixtures containing 40 per cent phosphorus sesquisulfide and 60 per cent white phosphorus possess a viscosity 5 to 6 times that of water at temperatures from 10 to 60 C.

The surface tension of the eutectic fuel has not been measured, but is believed to be much lower than that of water.

The eutectic fuel freezes at approximately -42 C. A tendency toward supercooling has been noted. However, samples of fuel maintained at -40 C for a period of several weeks, with periodic agitation, have remained consistently liquid. Samples solidified at lower temperatures and remelted several times continued to show consistent freezing between -40 C and -45 C.

Upon exposure to light for several days, the eutectic fuel gradually deteriorates and becomes turbid. It is believed that the change is due to the conversion of white phosphorus into the red modification. When the liquid is stored in the dark, or in opaque containers, no deterioration takes place.

When the phosphorus-phosphorus sesquisulfide eutectic is agitated with water, there is a tendency toward some dispersion of water in the eutectic, the clear fuel settling out completely only after several hours. Storage of the eutectic under a layer of water for several weeks at ambient temperature indicates no appreciable reaction beyond the formation of a slight yellow scum at the interface and the gradual acidification of the aqueous phase. Tests to determine stability in contact with water at -40 (ice) and 55 C failed to show any deterioration.

Samples of the eutectic fuel contained in light-proof vessels were placed in a freezing mixture at -40 C and in an oven maintained at 55 C. Another sample was alternately exposed to these temperature conditions for two-hour intervals, with intermediate one-hour intervals at room temperature. The tests, after proceeding for 60 days, disclosed no apparent deterioration of the phosphorus-phosphorus sesquisulfide solution.

A sample of the fuel was placed in a light-proof flask filled with CO₂ and exposed to a temperature of 212 F for 10 hr a day for 30 days. The pressure in the system as measured

CONFIDENTIAL

by an attached mercury manometer showed no appreciable change. The appearance of the fuel was unchanged.

Strips of different materials were immersed in vessels containing the eutectic fuel under a layer of water, and were allowed to remain in contact with the liquid for 24 days. Inspection of the specimens showed the following results:

Material	Condition after test
Steel	Somewhat corroded
Lead	Slightly tarnished
Tin	Slightly tarnished
Copper	Blackened
Aluminum	Unaffected
Rubber	Unaffected
Neoprene	Unaffected
Polystyrene	Unaffected
Ethyl cellulose	Unaffected

A 2-gal sample of eutectic fuel was stored under water in a tightly sealed steel container, at prevailing outdoor temperatures, from January until June 1945. Upon opening the steel drum it was found that only very slight pressure had developed, probably largely attributable to the change in ambient temperature; the eutectic was clear yellow in color; and when poured from the container, the fuel ignited instantaneously.

Self-ignition of the phosphorus-phosphorus sesquisulfide eutectic is a function of temperature and agitation of the fuel. For instantaneous self-ignition in a completely undisturbed state as, for example, when exposed to still air in a flat dish, the temperature of the fuel must be at least approximately 20 C. Any movement of the liquid, however, against the walls of the containing vessels, air currents against the surface of the liquid, exposure to sunlight, etc., tend to lower the self-ignition temperature, so that the exact ignition temperature in a state of rest is difficult to determine without elaborate precautions.

As the eutectic fuel is subjected to more violent mechanical disturbance, its self-ignition temperature drops sharply. To test ignition quality under conditions of violent impact, bottles filled with eutectic fuel were cooled in a dry ice mixture to a temperature of -50 C, at which the fuel was solid. Upon being flung against a wall, the fuel ignited violently im-

mediately upon bursting of the bottle. This test was repeated many times with identical results.

When the eutectic fuel is ejected from an experimental flame thrower at temperatures above approximately 15 C, spontaneous ignition takes place at the nozzle. At lower temperatures, ignition is more likely to occur in flight or upon impact. While impact ignition is likely to decrease somewhat the range of the fuel, it is believed that, in the case of a fuel of the high specific gravity of the eutectic, the difference between ignited and unignited range would not be very significant. On the other hand, the delivery of an increased amount of fuel on the target, without loss by combustion during flight, has obvious advantages. For description and illustrations of devices using EWP fuels see Sections 4.4 and 6.7.

The phosphorus-phosphorus sesquisulfide eutectic burns largely to P_2O_5 and SO_2 , resulting in the production of extraordinary quantities of very dense, white smoke; this smoke is very persistent and highly irritating. Appreciable amounts of sticky residue are also formed during combustion. It is believed that this residue consists largely of syrupy oxides of phosphorus, phosphoric acids (formed by hydration upon contact with atmospheric moisture), some elementary sulfur, and minor amounts of occluded elementary phosphorus. This residue is highly hygroscopic. Combustion of the fuel always results in a strong odor of phosphine in the vicinity; this odor tends to persist for days.

*Thickened EWP.*⁸⁹ When the phosphorus-phosphorus sesquisulfide eutectic (EWP) described above is ejected from a nozzle and ignites upon ejection, the flaming liquid tends to spray out into the air in a bushy pattern somewhat resembling that obtained when using unthickened hydrocarbon fuels in a conventional portable flame thrower. Although the high specific gravity of EWP and its somewhat slower burning rate, as compared with gasoline, permit it to attain an appreciably greater range than the latter under analogous conditions of ejection, much of the thickened EWP tends to burn in the air, the ballistic characteristics of the fuel are mediocre, and not enough of it is deposited on the ground or on a target.

CONFIDENTIAL

It was therefore desirable to modify the EWP fuel in such a manner as to obtain it in thickened, preferably gel form, to make possible improved ballistic characteristics and increased range.

To date, no completely satisfactory thickened EWP fuel has as yet been produced; and much work still remains to be done on the formulation, stabilization, and use of thickened EWP fuels, as well as on the design of appropriate instrumentation for their use.

Attempts to produce an EWP gel analogous to Napalm-thickened gasoline have met with no success to date. Unlike petroleum products, the phosphorus-phosphorus sesquisulfide eutectic appears incapable of forming a gel structure with any known agent. It is immiscible with Napalm or any similar metal soaps; and while mixing with a gasoline-rubber cement results in a fairly stable mixture, the latter is definitely a mechanical suspension, which remains stable merely as a result of the high viscosity of the medium.

A stable mixture has been prepared by incorporating in the liquid EWP 0.75 to 1.00 lb carbon black per gal EWP. The product is a short, thick paste, which has been kept stable under ambient conditions for as long as two months, and which has shown good ignition, range, and burning characteristics. However, not much is known about the stability and viscosity characteristics of this mixture under widely different temperature conditions.

A modification of the above formulation contains 1 gal of liquid EWP, 2 lb carbon black, and 1 gal of a varnish consisting of 200 lb rosin, 15 lb fuel oil No. 2, and 1 qt gasoline. This mixture has been found to result in a stringier fuel than the straight EWP-carbon black formulation, but it suffers the disadvantage of retarded ignition.

In addition to carbon black, the following substances have also been used as thickeners for EWP: baking soda, borax, boric acid, powdered lime rosin, and fuller's earth. As the addition of carbon black considerably increased the range of EWP, and as the effect of this added agent appeared to be caused not so much by the mechanical raising of the viscosity as by delaying the burning rate, baking soda was

incorporated in EWP, with the idea of producing an envelope of carbon dioxide to offset too rapid burning. Borax and boric acid were added to form crusts for the protection of the fuel in transit against excessively rapid burning. These agents gave increased range, but were most helpful in emulsions.

In an attempt to retard the burning speed of emulsions, carbon tetrachloride and water were tried, both without success. The carbon tetrachloride reacted in the flame, merely cutting down on total heat, and the water, probably through rapid volatilization, actually increased the burning rate.

Up to this point in the work the most successful mixture found was an emulsion of about equal parts by weight of rubber cement and EWP, preferably with the addition of bicarbonate of soda. With this mixture, a range of 80 yd could be obtained with good delivery of fuel on the far end of the range, which was always well covered with lumps of the burning mixtures. Rubber cement also has the advantage of being inert to acid and water. While natural rubber was used, oil-soluble synthetics might be of value here.

8.9 FUNDAMENTAL STUDY OF ALUMINUM SOAPS^{29, 34}

In the early development work on Napalm and related thickening agents there were no reliable basic data on the chemistry of aluminum soaps. Even their existence as definite compounds was problematical. Much more knowledge of pure aluminum soaps was needed before applications could be made to the complex mixtures forming Napalm soaps and Napalm-thickened fuels.

The methods used in this study cannot be summarized here because of their highly technical and involved character, and must be found in the pertinent references.^{29, 34} Only the most important conclusions reached by these methods can be summarized here.

The most important aluminum soaps are di-soaps, corresponding to the formula $Al(OH)R_2$, where R is an acid radical. They form the bulk of Napalm soaps.

CONFIDENTIAL

The properties of these soaps depend, of course, on the nature of the acid involved, its molecular weight, whether fatty or naphthenic, etc. In addition, a surprisingly large influence upon both its chemical and physical properties is exercised by the physical state of the soap, the degree of crystallinity of its structure.

For instance, aluminum dilaurate, an important constituent of Napalm, has been prepared in a high degree of purity in forms having the same composition but ranging from a highly crystalline and brittle, to an almost amorphous and fluffy solid. The former is inert to hydrocarbons at room temperature; the latter dissolves readily.

In contradistinction to di-soaps $Al(OH)R_2$, neither the mono-soaps $AlOR$ nor the tri-soaps AlR_3 , play an important role in Napalms. The former exist and can be prepared under special conditions, and the latter have probably never yet been prepared.

Fatty acids, although not combining with di-soap to form tri-soap, are readily sorbed by them and may be held quite tenaciously. Thus the small proportion of acids present in Napalm in excess of that forming di-soaps is neither combined nor truly free. It is held sorbed by surface forces.

In the presence of gasoline and other hydrocarbons aluminum soaps may show the full range of behavior from complete inertness, through swelling and thickening, to complete solution. What occurs in each particular case depends on the physical state of the soap, as mentioned above, as well as the nature of the acid forming the soap and that of the hydrocarbon, the temperature, and the presence of additives. It appears that any typical behavior may be produced, within reason, by varying any of these factors.

At low temperature a distinct gel phase is formed in general, in which the soap imbibes a certain amount of hydrocarbon, sometimes 50 volumes or more, but its particles remain separate and an excess of hydrocarbon will not be taken up. This is an opalescent, noncoherent, nonstringy, "applesaucy," or even synergetic, mass such as formed by Napalm soap at low temperatures and with high aniline-point gasolines.

The *jelly-sol* phase is formed at higher temperatures. Here the discrete particles have disappeared and a coherent, elastic, rigid jelly or a thin, easily flowing sol exists, such as formed by Napalm under ordinary conditions. Excess solvent is taken up spontaneously, and in the case of pure soap a clear system is formed.

The transition from jelly to sol and vice versa is gradual, depending on temperature and concentration without any definite boundary between them.

The transition from gel to jelly or sol, on the other hand, is sharp and may be rather easily observed.

Each of these forms is truly stable over certain ranges of conditions, but the jelly in particular may exist, without being stable, over a much wider range. Changes in viscosity corresponding to changes from jelly to sol may be very slow but start readily. This is the well-known aging of Napalm fuels. The onset of a change from a jelly to gel, on the other hand, does not occur readily in the absence of adequate seeding. The loss of coherence and possible syneresis may therefore be suspended for long periods of time running into years, even under conditions where it is finally bound to occur.

The transition temperature between gel and jelly depends on many factors, but for any given system the jelly cannot be indefinitely stable below this temperature. This fact suggests special problems connected with long-range storage of thickened fuels, particularly at low or cycling temperatures.

The properties of a mixture of aluminum soap with hydrocarbons, such as Napalm and gasoline, can be deeply influenced by the presence of many other substances, sometimes even of small amounts. The additive may accelerate or retard the interaction of the two, increase or decrease the final viscosity, change it toward dilatancy or towards plasticity (thixotropy). Each of the pairs of influences is independent and may be in either direction. The effect of a given additive may depend greatly on temperature, concentration, and even on the particular sample of Napalm studied.

Various samples of Napalm, although satis-

CONFIDENTIAL

fyng the requirements of the specification, differ when tested by other methods or under other conditions, to the point where the name Napalm appears almost to be their only common characteristic. These differences between Napalms manufactured under slightly varying conditions are not surprising. As mentioned above, both the physical state and small amounts of extraneous substances greatly influence the properties of all aluminum soaps. This emphasizes the need for more thorough characterization of Napalm from the point of view of physical state and impurities, and the study of the influence of manufacturing methods upon both.

Only a beginning could be made in the study of physical states of Napalms by various extraction and X-ray methods. Considerable progress was made in identifying in Napalm small amounts of several constituents absent from pure soap. Some of these were quite unexpected. Napalm may contain small amounts of inorganic substances, largely basic aluminum salts; hydrocarbon soluble sodium soaps; nitrogen (may be from proteins); partially volatile un-

combined acids and unsaponifiables, and, of course, water. The bulk of Napalms, as already stated, consists of di-soaps.

8.10 FUNDAMENTAL STUDIES ON RHEOLOGICAL PROPERTIES^a

The superior performance of thickened or gelled hydrocarbon fuels as contrasted to unthickened fuels was early recognized to be due, in large part, to their unusual flow characteristics.

Gels are dispersions which, when slightly stressed, exhibit elastic deformation, or strain, followed by a return to the original position upon removal of the stress. Gels exhibiting only elastic deformation until a definite shearing stress is exceeded may be thought to possess an elastic limit or "yield value," below which no real or permanent flow occurs. Napalm gels containing milled paper pulp and the IM-II gel behave in this manner (see Table 3).

^a See references 14, 16, 18, 19, 21, 22, 25-28, 30, 31, 33, 36, 38, 40, 42, 44, 46, 48, 49, 52, 53, 91-102.

TABLE 3. Elastic properties of incendiary gels.

Incendiary fuel*	Shear† modulus dynes/cm ²	Relaxation‡ time sec	Extensibility in.	Healing time sec	Healing rate constant	Notes
4% Napalm + 10% MPP	21,000	Does not relax	Yield value
6% Napalm	300-550	17-20	10	0.20
8% Napalm	700-1450	0.12
9% Napalm	1400-2800	10-16	1 3/4	35	0.10	Equal range
10% Napalm	1700	3	
8% Napalm + 0.25% PPR	2800	1/2	25% less range
8% Napalm + 2.0% PPR	4100	0	
12% Napalm	3400-4250	6-18	90	0.06	Yield value
13.5% Napalm	2500-5300	6-30	0.04
IM-II	2600	Does not relax	8 hr	Yield value
2% IM + 0.3% IP	24-97	5-10	Work harden
5% IM + 0.3% IP	1020-1250	40	Work harden
3% IM + 0.1% IP	3	75	Work harden
5% IM + 0.1% IP	185-700	16-30	130	Work harden
MI Gel	1100-2700

*MI Gel = Gel described in CWS Spec. 196-131-102.

PPR = Poly pale resin (Hercules).

MPP = Milled paper pulp.

IM = Isobutyl methacrylate.

IP = Interpolymer.

†Measured in Clark-Hodsmen viscosimeter, or Jewler's lathe viscosimeter, or in the Sandvik-Goldberg resonance elastometer. For description of the latter, see Appendix II, Rheological Properties of Thickened Fluids, Eastman Kodak Co., May 7, 1943.³

‡Time for stress needed to maintain constant strain to fall to 1/e its initial value.

Other incendiary fuels possess such low strength that they are unable to support themselves when deprived of the support offered by the walls of their container and possess little, if any, yield value. These gels, after being slightly stressed, momentarily will return to their original position upon removal of the stress, but upon prolonged application of stress fail to do so, the gel accommodating itself to the stress, or relaxing by a slow flow or creep process. Such a process is referred to as relaxation, a gradually smaller force or stress, ultimately approaching zero, being required to maintain the material in the stretched or strained condition. The relaxation experimentally observed in such incendiary fuels accounts for the impossibility of measuring yield value in long-time static tests. Relaxation is a manifestation of imperfect elastic nature and not true flow in the ordinary sense of the word. It may be considered as microflow in contrast to true, real or macroflow.

With gradually increasing stress a point is ultimately reached where gel flow proceeds no longer by the relatively slow creep or relaxation process, but by a process of actual shear or slid-

ing of one complete layer of gel along its neighboring layer. This point may be called the shear initiation point, and the shearing stress required, the shear initiation stress. In actual measurement, such flow transition may appear gradual rather than abrupt, on account of a changing amount of relaxation.

Beyond the shear initiation point, gels flow somewhat as ordinary liquids do. The resistance of an ordinary (or Newtonian) liquid to flow is called its viscosity. The coefficient of viscosity (μ) is defined as the shearing stress (F) divided by the rate of shear or shear gradient (S), and at constant temperature its value is independent of shear rate ($\mu = F/S$).

Incendiary gels are, however, non-Newtonian materials, the viscosity of which varies with the shearing stress to which they are subjected. The viscosimeters which have been employed to measure viscosity of gels are listed in Table 4 in order of shear range. The first four are rotational instruments which measure the viscosity of a confined sample. In the last four instruments a continuously fresh supply of material is forced into the capillary, pipe, or perforated disk. The latter do not attain steady-

TABLE 4. Viscosimeters employed for incendiary gels.

Name	Type	Shear range sec ⁻¹	Steady state	Material renewed	Uniform stress
Clark-Hodsmen	Concentric cylinder, hand-operated. $D_1=2.3$ cm $D_2=2.58$ cm.	0.01-1.0	No	No	Yes
Stormer (modified)	Paddle rotated in cup by falling weights.	0.05-1.0	Yes	No	No
MacMichael	Concentric cylinder in motor-driven cup. Inner cylinder suspended from torsion wire.	3-100	No	No	No
Jeweler's lathe	Concentric cylinder in motor-driven cup $D_1=2.30$ $D_2=2.58$. Inner cylinder suspended from drill rod. Mirror used as optical lever.	10-300	No	No	Yes
High-pressure capillary	Glass capillary tubes $2\frac{1}{2}$ " long. $r=0.0097$ & 0.021 cm. Nitrogen gas pressure to 2,000 psi as force.	1000-100,000	No	Yes	No
Grease gun	Hand-driven screw feed. Pressure drop along length of $\frac{1}{8}$ " pipe measured by gauge.	0.2-120	Yes	Yes	No
Pipe flow	Use of variable speed positive-displacement pump to measure pressure loss over length of $\frac{1}{8}$ ", $\frac{3}{8}$ ", $1\frac{1}{4}$ ", and $1\frac{1}{2}$ " std. pipe.	0.3-11,000	Yes	Yes	No
Gardner mobilometer	Perforated disk pushed into sample in vertical cylinder.		No	Yes	No

CONFIDENTIAL

state flow conditions, except in case of grease-gun and pipe-flow measurements where pressure loss is measured over a length at some distance from the point of entry. The Clark-Hodsman and Jeweler's lathe instruments confine the sample to a narrow annular ring at some distance from the axis so that the entire sample is subjected to nearly the same shearing stress. All other instruments impose a wide range of stresses on different parts of the sample. Thus inflow of gel through a capillary tube or pipe to the central parts may be stressed only elastically and the resulting flow, if any, will be of the creep or relaxation type, while the outer parts may possess actual shear between adjacent layers. Layers being sheared are under a wide range of stresses, with consequent varia-

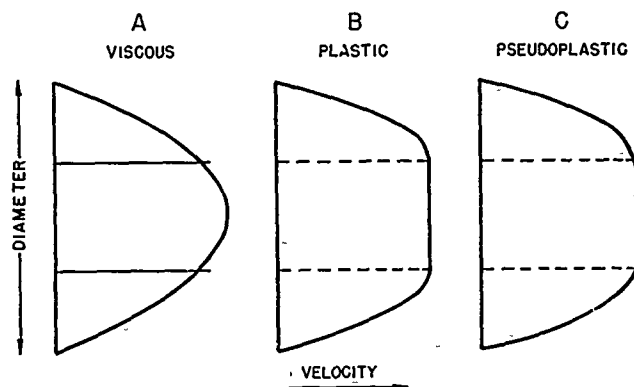

FIGURE 2. Various types of flow.

tion in viscosity from one layer to the next. Under these circumstances, one measures only an apparent viscosity, that is, the sample ap-

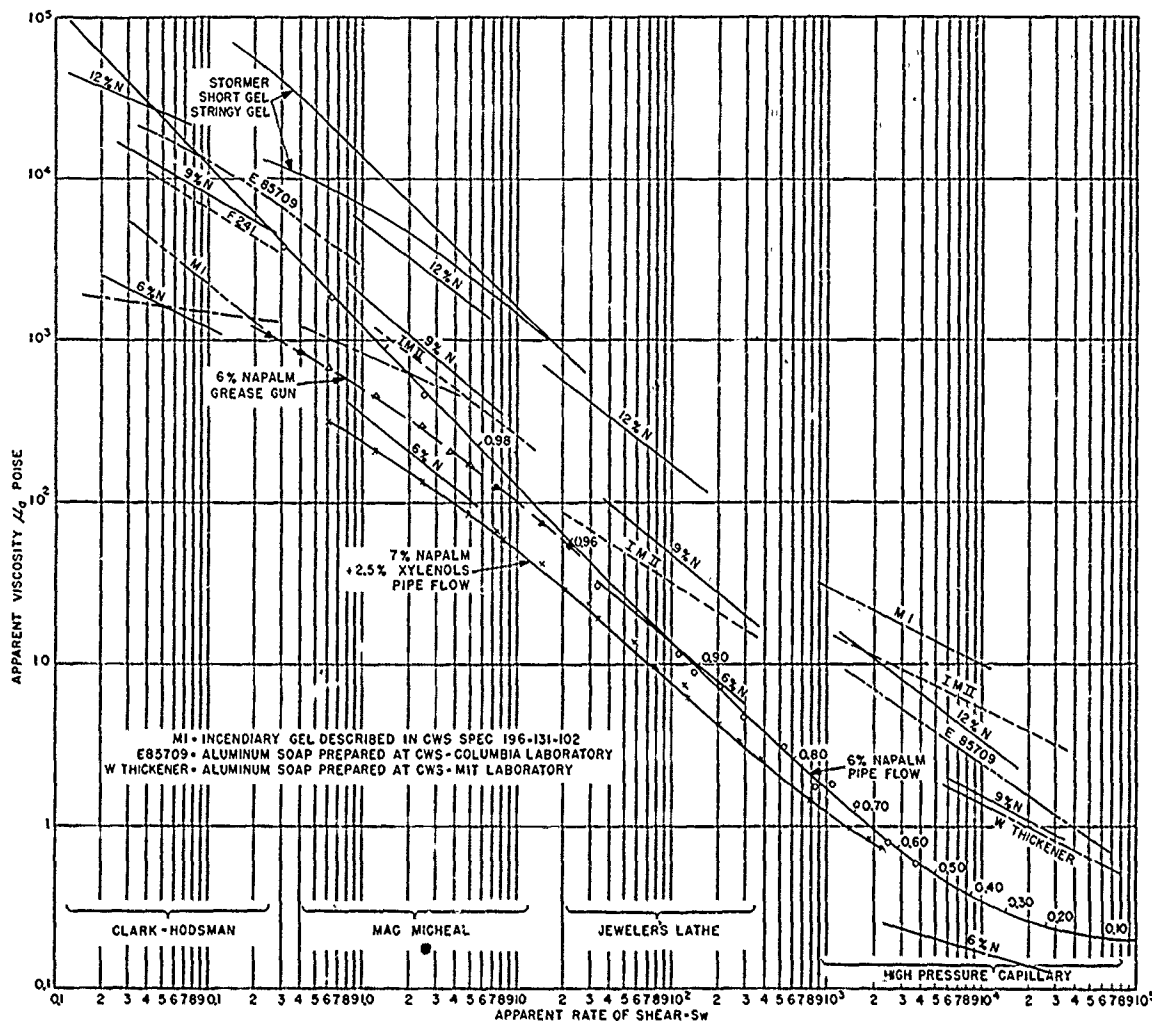

FIGURE 3. Apparent viscosity of incendiary gels.

CONFIDENTIAL

pears to have the same resistance to flow as a normal liquid of the stated viscosity. The shearing stress due to the pressure imposed is zero at the axis and $PR/2L$ at the periphery.

For a normal liquid, the rate of shear is zero at the axis and $4V/R$ at the periphery, velocity distribution being as shown in Figure 2A. Viscosity (μ) thus becomes

$$\mu = \frac{F}{S} = \frac{PR/2L}{4V/R} = \frac{PR^2}{8VL}$$

For a non-Newtonian material the shearing stress at the tube wall, or elsewhere, can still

be computed accurately, but the rate of shear at any layer is uncertain. This is caused by the presence of a central region surrounding the axis in which shearing stress is too low to cause shear or flow to occur. A gel which possesses a definite yield value will not shear at all in those regions where shearing stress (F) is less than the yield value (f). Shear will commence at that radius where shearing stress ($PR/2L$) just equals yield value (f), and the velocity distribution across such a stream of gel will be as in Figure 2B. Such a gel is said

TABLE 5. Steady-state flow of gels in pipe.

Flow rate gal/min	6% Napalm			Std. pipe size	Flow rate gal/min	7% Napalm+2.5% Xylenols		
	Pressure loss/ft lb/in. ²	App. rate of shear at wall sec ⁻¹	Apparent viscosity poises			Pressure loss/ft lb/in. ²	App. rate of shear at wall sec ⁻¹	Apparent viscosity poises
0.033	0.51	0.31	3800	1½"	0.866	0.21	8.11	60
0.067	0.51	0.63	1870		3.58	0.28	33.7	19.2
0.267	0.50	2.50	462		8.33	0.33	78.0	9.8
2.33	0.51	21.8	54		14.00	0.35	131	6.18
8.75	0.58	82	16.4		21.70	0.37	203	4.22
15.00	0.54	140	8.98		29.20	0.40	274	3.38
16.00	0.63	150	9.72					
21.80	0.64	204	7.36					
31.30	0.60	293	4.74					
1.58	1.10	111	11.72		¾"	1.80	0.65	126
7.58	1.36	530	3.04	5.36		0.82	375	2.58
15.25	1.63	1070	1.80	11.20		0.98	781	1.48
22.00	1.75	1540	1.34	20.00		1.16	1400	0.98
				26.3		1.30	1840	0.84
				32.3	1.41	2260	0.74	
0.0165	2.60	33.2	30.4	⅜"	0.01	1.50	20.1	29.00
0.416	3.87	837	1.74		0.43	2.82	864	1.31
1.21	5.04	2435	0.80		0.56	3.87	1125	1.33
1.83	5.60	3680	0.59					
Results below from grease gun viscosimeter								
0.00012	0.675	0.242	1085	⅜"	0.0003	0.49	0.605	314
	0.88	0.400	854			0.65	1.21	206
	1.06	0.605	684			0.83	2.42	132
	1.41	1.21	453			1.08	4.84	86.8
	1.76	2.42	282			1.26	7.26	67.5
	1.94	3.63	208			1.55	14.50	41.4
	2.06	4.84	166			1.78	29.00	23.8
	2.19	7.26	117			2.06	58.00	13.8
	2.58	14.50	69			2.32	121.00	7.44
	0.0144	3.00	29.00			40.4		
	1.86	2.42	299					
	2.13	4.84	171					
	2.31	7.26	123					
	2.83	14.50	75.5					
0.0144	3.85	29.00	51.5					

CONFIDENTIAL

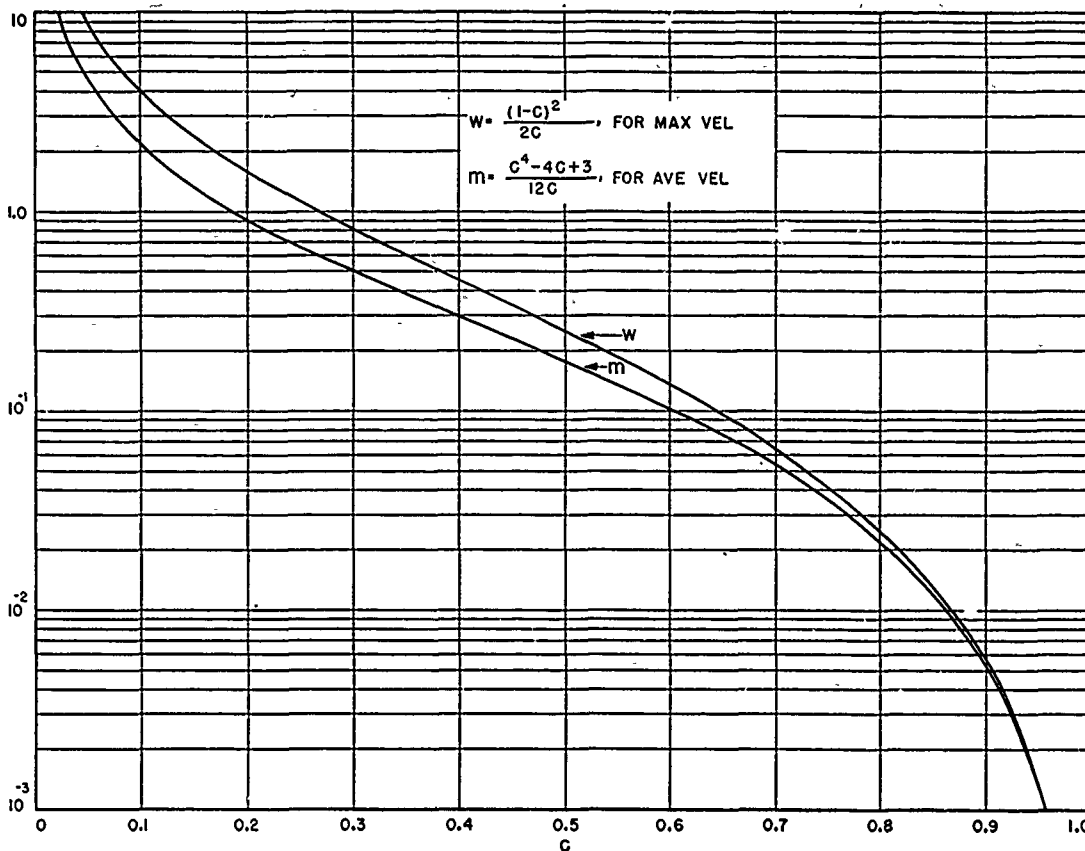

FIGURE 4. Factors for computing velocity of plastic flow in pipes.

to be plastic. If the gel possesses no measurable static yield value, but flows by a creep or relaxation process until a certain shear initiation stress is exceeded, then its flow in capillaries or pipes will resemble Figure 2C with a central region in which stress ($F = PR/2L$) is below the shear initiation stress and flow by the relatively slow creep process only occurs, surrounded by a region in which actual shear or macroflow takes place. Such a gel is called a pseudoplastic gel. Rates of shear at the tube wall are much greater for plastic and pseudoplastic materials, Figure 2B and C, than for a normal liquid (2A) at the same total flow rate. Experimentally, it is practically impossible to isolate a small sample of gel and test it under such conditions that the entire sample is subjected to the same shearing stress. The Clark-Hodsman and Jeweler's lathe instruments approximate this condition, both shearing a narrow layer between 1.15 and 1.29 cm radii, all

the sample being stressed between 89 and 100 per cent of the stress at surface of the inner cylinder. This is equivalent to isolating the 20 per cent of material flowing adjacent to the wall of a tube or pipe. Unfortunately, the Clark-Hodsman instrument usually was not operated under conditions assuring steady-state flow. Consequently, apparent viscosities measured by the Jeweler's lathe instrument more closely approach the true viscosity of the gel than the measurements made with other instruments. The five viscosimeters available for the early work covered various ranges of shear rate, each having an approximately tenfold variation in range. This resulted in discontinuities and uncertainties in the resultant flow curves.

In spite of these uncertainties concerning viscosity measurements on gels, it is possible to show conclusively (Figure 3) that satisfactory incendiary gels possess very high viscosities (1,000 to 100,000 poises) at low rates of shear

CONFIDENTIAL

which gradually decrease as the rate of shear is increased until, at the highest shear rates attainable in the high-pressure capillary (approximately $100,000 \text{ sec}^{-1}$), the viscosities are of the order of 0.1 to 3 poises. According to this picture, flow of these gels in pipes should require considerable applied pressure at low flow rates, but very little additional pressure for much higher flow rates. That this is so is shown in Table 5, where data for flow of regular and peptized Napalm gels in pipes of three different sizes are given. A thousandfold increase of flow

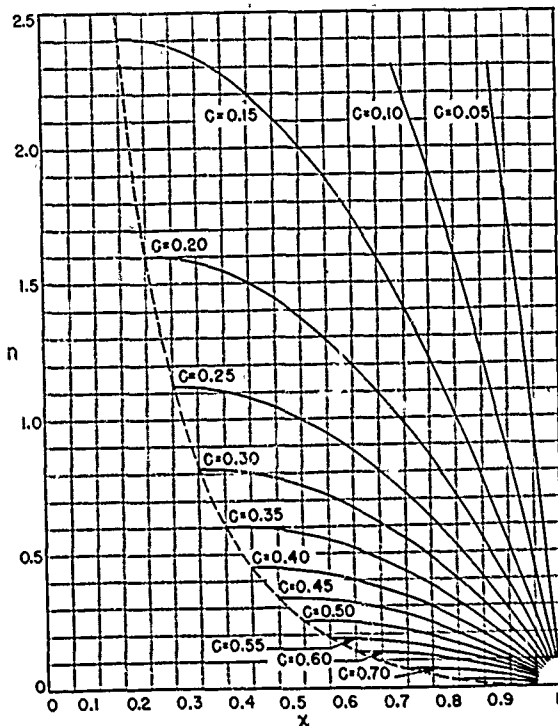

FIGURE 5. Values of $n = \frac{1 - 2c + 2cx - x^2}{2c}$.

rate of the 6 per cent gel in the $1\frac{1}{2}$ -in. pipe required only a 25 per cent increase of pressure. Such pipe-flow data actually constitute viscosimetric data covering a much wider range of shear rates than is possible with any single one of the instruments previously used (see Figure 3). These data are secured under steady-state flow conditions, and are free from the uncertain inlet loss and kinetic energy corrections associated with the use of ordinary capillary viscosimeters for gel measurements. Any single point of Figure 3 represents a composite or average for the stream as a whole. Actual

rate of shear varies from zero at the tube axis to some value higher than the plotted point at the wall, and viscosity varies from some enormously high value, approaching infinity, in the central portion of the tube to a value lower than the plotted point at the tube wall. When very high rates of shear are produced at the tube wall, the viscosity approaches a minimum value somewhat higher than the constant viscosity of the dispersion medium, usually gasoline. The equations given below have been de-

Equations for Plastic Flow in Round Pipes

f = yield value of gel in dynes/cm².

μ_{∞} = minimum gel viscosity at infinite shear rate.

a = radius of tube or pipe.

c = ratio of central unsheared plug radius to tube radius.

x = ratio of any layer's radius to tube radius
 $x = r/a$.

Equation 1. Viscosity at radius x

$$\mu = \frac{\mu_{\infty}}{y} \quad y = 1 - \frac{c}{x}$$

Equation 2. Velocity of central plug (maximum velocity)

$$U_p = U_m = \frac{afw}{\mu_{\infty}} \quad w = \frac{(1-c)^2}{2c}$$

Equation 3. Velocity at radius x

$$U = \frac{afn}{\mu_{\infty}} \quad n = \frac{1 - 2c + 2cx - x^2}{2c}$$

Equation 4. Average velocity in the tube

$$U_a = \frac{afm}{\mu_{\infty}} \quad m = \frac{c^3 - 4c + 3}{12c}$$

Equation 5. Total volume rate of flow

$$Q = \frac{\pi a^3 f m}{\mu_{\infty}}$$

Equation 6. Apparent rate of shear at tube wall

$$S_w = \frac{4fm}{\mu_{\infty}}$$

Equation 7. Shearing stress at tube wall

$$F_w = \frac{f}{c}$$

Equation 8. Apparent viscosity for entire cross section of gel

$$\mu_a = \frac{F_w}{S_w} = \frac{\mu_{\infty}}{4cm}$$

Equation 9. Pressure drop along pipe

$$\frac{\Delta P}{\Delta L} = \frac{2f}{ac}$$

rived for computing the flow of plastic gels in pipes based upon a knowledge of the yield value

CONFIDENTIAL

(f) of the gel, and this limiting viscosity μ_{∞} approached at infinite shear rate.^b

The quantities n , m , w , and γ are dimensionless quantities dependent only on the geometry of the circular path of flow, and are entirely accurate for the flow of any real plastic in a circular pipe. Values of m and w are given in Figure 4, values of n in Figure 5, and values of γ in Figure 6. Figure 5 actually shows relative velocity variation along the tube radius for a

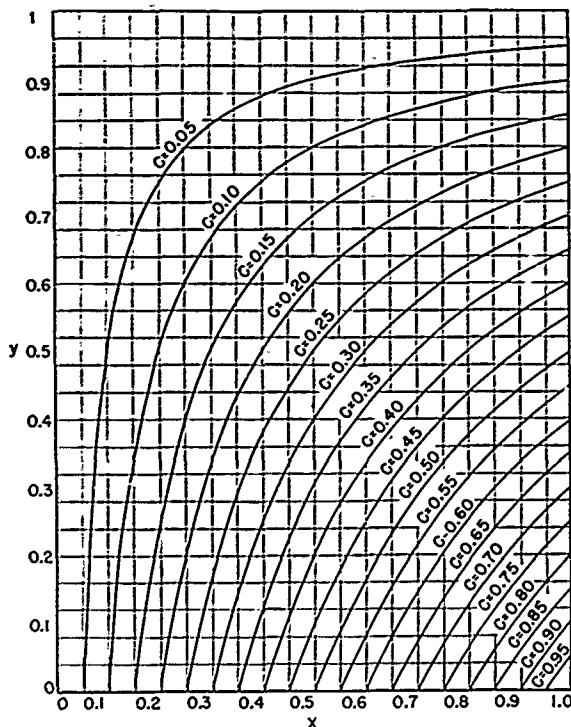

FIGURE 6. Values of $y = 1 - c/x$.

range of c values or central plug ratios. The y values given in Figure 6 allow computation of viscosity of the gel as it varies with radial distance from the tube axis. The quantities f and μ_{∞} are characteristics of the plastic gel; their measurement is at present quite difficult.

These equations apply to plastic flow only; no satisfactory adaptation or correction to make them applicable to pseudoplastic flow has as yet been evolved.

The extent to which a 6 per cent Napalm gel agrees with these flow equations is shown in Figure 3, where the plotted points represent

^b A more empirical but more readily used treatment of pressure drop in piping carrying Napalm gels appears in Chapter 7, Section 7.4.

actual data secured in the order shown in Table 3, and the solid curve is a plot of apparent viscosity from equation (8) against apparent shear rate from equation (6) (see above) for various assumed values of c which are shown alongside the curve. The curve is based upon values of $f=1,200$ dynes/cm² and $\mu_{\infty}=0.18$ poise for the gel. Agreement of the flow data secured in the pump tests with the line representing the equation is excellent. The grease gun viscometric data secured later indicated the gel to be more mobile at the lower rates of shear; however, if we think in terms of a shear initiation stress, rather than yield value, of 1,200 dynes/cm² which must be exceeded before real flow or shear occurs, then even these data begin to conform to the curve, when 96 per cent of the tube is occupied by the central plug. At $c = 0.98$, creep flow within the plug appears to amount to 50 per cent of the shear flow in the outer 2 per cent. When $c = 0.99$, creep flow in the central plug equals shear flow in the outer 1 per cent. One might say that this gel appeared plastic in the first tests in the 1½-in. pipe and pseudoplastic in the later grease gun tests in ½-in. pipe. It is not known whether a yield value and, hence plastic nature of the gel, is actually easier to demonstrate in a larger pipe, or whether the change noted is entirely an aging effect. It is known that Napalm gels are more plastic or short when first prepared, becoming pseudoplastic and stringy upon aging. Pseudo-

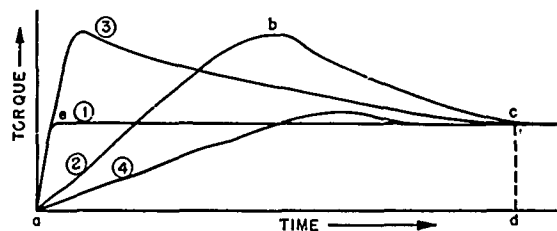

FIGURE 7. Variation of torque on torsion wire with time: (1) ordinary viscous liquid, (2) Napalm incendiary gel, (3) incendiary gels IM-Type II, (4) incendiary gels IM-Type I.

plasticity can also be induced by peptizing Napalm gels with various organic acids, alcohols, and water. The effect of such peptization is shown in Figure 3 for a 7 per cent Napalm, 2.5 per cent xylene gel. The viscosity at low rates of shear is considerably reduced by the use of these peptizers.

In dealing with viscosity of gels, the steady state of equilibrium flow conditions has been stressed. The unsteady flow of gels or time effects in gel behavior are also of interest and may be of great importance in the flame thrower. We have already considered relaxation, a time effect in connection with elastic deformation. When stresses above the shear initiation stress are applied to a gel, flow does not immediately commence against a constant viscosity as in the case of ordinary liquids. Upon starting the Jeweler's lathe viscosimeter instantaneously, the force upon the torsion-wire varies with time and the type of gel, as shown in Figure 7. The ordinary viscous liquid (1) develops a constant torque almost immediately, the rate of the initial steep climb being determined by the speed of rotation and the stiffness of the torsion rod, in other words, the response of the system. Napalm gels (2) produce a trace which usually shows a slight rapid rise at the start similar to the normal liquid. Then the force gradually climbs. This may be interpreted as an elastic stretching of the gel which may be accompanied by relaxation, although the time available for relaxation to occur is limited to from 0.05 to 1 sec depending upon the speed of rotation. The slope of the climbing trace is really a measure of the elasticity or shear modulus of the gel, the fact that a curving line results indicating deviation from Hooke's law. A steep slope indicates high shear modulus or a short gel, while a gradual slope indicates low shear modulus and a stringy gel. Both slope and shear modulus increase with increasing soap concentration in the gel. The faster the rotation the sooner peak or maximum force occurs, but for a single gel the peak always occurs after approximately the same number of rotations. For a typical 9 per cent Napalm gel this may be at one-third of a revolution, at which point the gel originally lying along a radius between the cylinders (0.14 in.) may be thought of as stretched over a curving arc of about 1-in. length; hence it has suffered a sevenfold stretch before real shear has occurred.

Slower speeds of rotation cause the maximum force at the hump to be less, an indication that relaxation or creep during the elastic stretch has, because of the longer time, played a more

important role. Following the maximum, there is a gradual decrease until a constant force or torque is measured at $\frac{1}{2}$ to 2 sec following the start of rotation. The Jeweler's lathe viscosity data of Figure 3 are based upon this part of the trace. This final force increases only slightly with great increase of rotational speed, producing lines on Figure 3 which approach the limiting slope of 45 degrees. Another point of interest in these traces is the excess of area *abcd* over *aecd*, which may be thought of as the additional work that must be done to the gel to start it flowing above that needed for a normal liquid of the same final viscosity. This additional work is greater the faster the rotation, again indicating less relaxation to be possible under such conditions.

When such Jeweler's lathe experiments are repeated upon the same gel after increasing time intervals, it is found that the maximum force developed is less than the original value, until a certain time has elapsed which may be referred to as the healing time of the gel (see Table 3). A 9 per cent Napalm gel shows a healing time of approximately 10 sec after being sheared at a rate of 211 reciprocal sec. The bulk of healing may be completed in half of this time. This means that such a gel possesses the property of thixotropy, that is, a time lag in regain of initial strength following the cessation of the shearing action.

In Figure 7 curves (3) and (4) illustrate traces made by incendiary gels IM-Type II and incendiary gels IM-Type I respectively. Most of the useful incendiary gels investigated are, to some degree, thixotropic. A healing rate constant (similar to a first-order chemical reaction) better characterizes the healing process than the rather uncertain use of the term healing time. Healing rate increases rapidly with increase of temperature. From the temperature dependence of this rate constant, the activation energy associated with this healing process was found to be 9 ± 1 kcal. This suggests that the linking may occur by means of hydrogen bonds.

Incendiary gels are imperfect elastic solids which suffer relaxation when stressed below the shear initiation stress. When stressed more than this, they become liquefied with an apparent viscosity which decreases with increasing

CONFIDENTIAL

severity of stressing, finally approaching a minimum limiting viscosity somewhat higher than that of the dispersing liquid or fuel. Incendiary gels are thixotropic, since upon cessation of stressing, time is required before they regain their initial elastic condition. To completely describe such gels it would be necessary to secure the following data.

- Modulus of rigidity
- Relaxation time
- Extensibility
- Apparent viscosity
 - Variation with shear rate
 - Shear initiation stress
 - Ultimate minimum viscosity
- Thixotropy
 - Healing time
 - Healing rate constant

All the above quantities have been investigated on various gels at various times. To attempt to measure all these quantities in a routine testing of incendiary fuels would be unwise and time consuming. The one property that appeared to be of greatest importance in incendiary fuels was the extreme variation of apparent viscosity with shear rate.

The Gardner mobilometer was finally chosen to serve as a routine testing instrument to determine gel quality. As used, it provides a measure of gel viscosity reported as grams weight necessary to cause a rate of shear corresponding to 10 cm disk travel in 100 sec. In arriving at this point, several weights are employed and a plot of weight versus time obtained. In addition to the 100-sec Gardner consistency,^c the slope of such a plot furnishes a rough measure of the degree of pseudoplasticity (relaxation or stringiness) of the gel. Napalm supplied by different sources varies only to a limited degree in this property.

When ordinary liquids of low viscosity issue at high velocity from small nozzles, they tend to atomize immediately into very fine droplets. Liquids of moderate viscosity produce jets which, at some distance from the nozzle, break up into somewhat larger droplets. Very viscous liquids emerge as a smooth stream or rod that

^c The term commonly used in referring to these values, since the shear rate cannot be precisely determined.

does not break up during the trajectory, which is, however, of limited length due to the high viscosity imposing a low initial velocity at the pressures available. Jet breakup is caused by surface tension of the liquid, frictional drag due to the surrounding air and to some extent aided by turbulent conditions in low viscosity liquids as they issue from nozzles. A very viscous liquid is able to resist the forces tending to cause jet breakup but, on account of the viscous parabolic velocity distribution, requires nearly twice the energy or pressure for a given average jet velocity that a more limpid liquid in turbulent flow does. It is also subject to much higher pressure losses in pipe and nozzle.

To secure maximum jet velocity, jet cohesion, and range, a type of liquid is required which has a sufficiently low apparent viscosity at high rates of shear to flow readily through pipes and nozzles, and a sufficiently high velocity, at the low rates of shear induced by friction with the air, after leaving the nozzle to cohere well in flight. The speed of the change from liquid condition adjacent to the nozzle wall to viscous condition in the emerging jet, apparently plays a significant role. Napalm gels which show much faster healing than, for example, the IM-II gel, have found more favor as a flame-thrower fuel. The IM-II and the Edgewood M1 gel have, on the other hand, proved satisfactory for incendiary bomb use where fast healing is not of such great importance.

Another factor of great importance is the extensibility, or stringiness, of the gel which has been experimentally observed by measuring the length to which a given gel can be stretched or extended at a fixed constant rate before rupture occurs. Some data of this nature are included in Table 3. Napalm gels can be made short (lack of stringiness) by addition of poly pale resin or milled wood pulp. These very short gels are quite plastic, showing a definite yield value. The IM-II gel also possesses a definite yield value. Such short gels do not behave well in flame throwers. The jet of gel issuing from the flame-thrower nozzles consists of an elastic core surrounded by layers of gel which have been sheared. This elastic core is stretched and compressed in the nozzle. If this strain is too great, as in the short gels, the rod of fuel issuing

from the nozzle pulls apart into separate small chunks which offer so great a surface that drag, due to air resistance, reduces the range. A less plastic or pseudoplastic gel which is capable of relaxing or creeping in the central elastic core accommodates itself to the elastic strains set up in going through the nozzle so that it holds together as a continuous rod upon issuing from

the nozzle, contracting only sufficiently to offset the decreasing jet velocity. If the stringiness is too great so that practically no elastic recovery occurs as the jet or rod slows down, then looping into folds may occur. However, there is no definite evidence that excess stringiness, relaxation, or pseudoplasticity exerts a harmful influence on the range.

CONFIDENTIAL

GLOSSARY

EWP. Phosphorus-phosphorus sesquisulfide eutectic.
FRAS. Aluminum stearate-thickened fuel.
IM. Gasoline gel of the isobutyl methacrylate type.
NP. Gasoline gel of Napalm type.

PT. Pyrotechnic mix.
SCFH. Standard cubic foot per hour.
SDO. Synthetic drying oil.
WP. White phosphorus.

BIBLIOGRAPHY

Numbers such as Div. 11-301.4-M1 indicate that the document listed has been microfilmed and that its title appears in the microfilm index printed in a separate volume. For access to the index volume and to the microfilm, consult the Army or Navy agency listed on the reverse of the half-title page.

CHAPTER 1

1. *The Development of Oil Incendiary Bombs*, R. P. Russell, OSRD 382, OEMsr-183, Projects CWS-21 and B-204, Report 176, Standard Oil Development Co., Feb. 7, 1942. Div. 11-301.4-M1
2. *The Development of Oil Incendiary Bombs*, R. P. Russell, OSRD 577, OEMsr-183, Projects CWS-21 and B-204, Report 243, Standard Oil Development Co., May 14, 1942. Div. 11-301.4-M2
3. *Bomb, Incendiary Oil, 6-lb., AN-M69*, Specification 196-131-99D, CWS, Sept. 30, 1944.
4. *Bombs for Aircraft*, TM9-1980, War Department, November 1944.
5. *U.S. Bombs and Fuzes*, U.S. Navy Bomb Disposal School, Sept. 1, 1945.
6. *Round Tail Closure for the AN-M69, 6 Lb. Incendiary Bomb*, TDMR 919, R. L. Ortynsky, CWS, Nov. 9, 1944.
7. *Development of the M-69X Incendiary Bomb*, OSRD 5254, OEMsr-354, Service Project CWS-21, Standard Oil Development Co., June 25, 1945. Div. 11-301.14-M1
8. *Fuze, Bomb, M1*, Specification 196-131-110D, CWS, July 21, 1944.
9. *Fuze, Bomb, M1, Manufacture of*, Service Directive 277, CWS, Aug. 9, 1944.
10. *Effect of White Phosphorus on Ignition of Incendiary Fuels in M-56 Bombs*, Ray L. Betts, NDRC-199, Report PDN-441, Standard Oil Development Co., Oct. 8, 1942. Div. 11-303.3-M1
11. *Investigation of the Use of WP and WPPS as Igniters in the AN-M69 Bomb*, S. G. Ponder, CUMR 17, CWS, Feb. 10, 1943.
12. *The White Phosphorus Grenade in M-69 Obscuration Tests*, H. A. Ricards, Jr., Report PDN-3360, Standard Oil Development Co., Mar. 13, 1945. Div. 11-301.147-M1
13. *Strength of Tail Streamer Assembly of the M-69 Bomb*, W. T. Knox, Jr., Report PDN-1801, Standard Oil Development Co., Nov. 24, 1943. Div. 11-301.141-M4
14. *Cluster, Incendiary Bomb, AN-M12 (100-Lb. Size) (14-6-Lb., AN-M69 Incendiary Bomb)*, Specification 196-131-131B, CWS, July 31, 1944.
15. *Cluster, Incendiary Bomb, AN-M13 (500-Lb. Size) (60-6-Lb., AN-M69 Incendiary Bomb)*, Specification 196-131-126C, CWS, Nov. 24, 1944.
16. *Cluster, Aimable Incendiary Bomb, E28 (500 Lb. Size) (38-6-Lb., AN-M69 Incendiary Bombs)*, Specification 196-131-292, CWS, July 7, 1944.
17. *Operational Suitability Test of Cluster, Aimable Incendiary Bomb, E46*, C. H. Seefeldt, Board Project 3931C471.6, Army Air Forces, June 20, 1945.
18. *Second Test of Incendiary Bombs on Abandoned Farm Houses and Barns at Jefferson Proving Ground*, John D. Armitage and Donald D. Loos, Ordnance Department, August 1942.
19. *Incendiary Tests at Jefferson Proving Ground, Madison, Indiana*, TDMR 416, R. L. Ortynsky and S. G. Ponder, CWS, Aug. 5, 1942.
20. *The E-6R2 Cluster*, J. C. Roediger, Report PDN-2206, Standard Oil Development Co., Mar. 3, 1944. Div. 11-301.15-M2
21. *Test of Clusters, Aimable, M69 Incendiary Bombs*, Board Project (M-5) 140, Army Air Forces, Apr. 29, 1944.
22. *Penetration of M-50, M-69 and M-69X Bombs into Typical Rhineland Structure*, OEMsr-354, Report PDN-1201, Standard Oil Development Co., Apr. 15, 1945. Div. 11-304.21-M1
23. *Tests of Incendiary Bombs AN-M50A1, AN-M52, AN-M54 and M69 at Dugway Proving Ground*, J. R. Adams, CWS, H. C. Hottel, NDRC, TDMR 713, July 1943.
24. *German Industrial Structures. Their Construction and Probable Penetration by Incendiary Bombs*, OEMsr-354, Report PDN-1558, Standard Oil Development Co., Sept. 11, 1943. Div. 11-304.21-M3
25. *Penetration of M-69 on Industrial Targets in Aimable Clusters*, W. T. Knox, Jr., Report PDN-2574, Standard Oil Development Co., June 7, 1944. Div. 11-301.142-M1
26. *Penetration of the AN-M69 and M69X Incendiary Bombs into Japanese Structures When Released from Aimable Clusters*, E. H. Lewis, J. E. Martin, and H. A. Ricards, Jr., DPGSR 39, CWS, Dec. 20, 1944.
27. *Penetration and Performance Tests of Small Incendiary Bombs in a Typical Central German Structure*, OSRD 5522, OEMsr-354, Service Project CWS-21, Standard Oil Development Co., July 30, 1945. Div. 11-304.21-M6
28. *The Comparative Effectiveness of Small Incendiary Bombs on Industrial Targets*, Charles S. Keevil, OSRD 6189, OEMsr-21, Service Project CWS-21, Report IEP/9, Edgewood Arsenal, Oct. 3, 1945. Div. 11-304.2-M3
29. *Evaluation of Incendiary Fuels in German Attic and Sub-Attic Structures*, OEMsr-354, Report PDN-3950, Standard Oil Development Co., Sept. 28, 1945. Div. 11-304.21-M7

CONFIDENTIAL

229

PRECEDING PAGE BLANK-NOT FILMED

30. *Test of Incendiary Bomb M69 Fired Staticly in the Predetermined Locations in Japanese Type Structures*, DPGSR 18, J. R. Adams, W. S. Guthmann, and E. H. Lewis, CWS, Jan. 17, 1944.
31. *Incendiary Tests in Experimental Japanese Room*, C. S. Keevii, OSRD 5120, Report IEP/8, NDRC, May 26, 1945.
32. *Japan—Incendiary Attack Data*, S. de Palma and Raymond H. Ewell, Army Air Forces, Oct. 15, 1943.
33. *M69 Bomb Requirements for Attack of Japanese Targets*, TDMR 801, J. R. Adams and H. C. Hottel, CWS, Jan. 24, 1944.
34. *Incendiary Attack of Japanese Cities, Supplement to Japan—Incendiary Attack Data, October, 1943*, Raymond H. Ewell, Army Air Forces, Aug. 29, 1944.
35. *Incendiary Attack on Japanese Cities*, H. G. Montgomery, Jr., Board Project (T-1)34, Army Air Forces, Sept. 1, 1944.
36. "Area Bombing Wrecks Jap Home Industry," *Impact*, Army Air Forces, April 1945, Vol. III, No. 4, pp. 10-23.
37. "Fire Blitz. Progress Report on the Incendiary Bombing of Japan," *Impact*, Army Air Forces, August 1945, Vol. III, No. 8, pp. 18-39.
38. "Air Victory over Japan," *Impact*, Army Air Forces, September-October 1945, Vol. III, No. 9.
39. *Oil Incendiary Bomb, M-69X. Description of Assembly Methods Used in Semicommercial Production*, OEMsr-354, Report PDN-3700, Standard Oil Development Co., June 20, 1945.
Div. 11-301.4-M7
40. *Development of the M-69X Incendiary Bomb*, OSRD 5254a, OEMsr-354, Service Project CWS-21, Supplementary Report 4000, Standard Oil Development Co., Sept. 28, 1945.
Div. 11-301.14-M2
41. *Test of Incendiary Bomb M69X*, E. M. Downs, Board Project 4216C471.6, Army Air Forces, Apr. 12, 1945.
42. *M-69X Flight Tests*, W. T. Knox, Jr., Report PDN-3823, Standard Oil Development Co., July 31, 1945.
Div. 11-301.143-M1
43. *M-69X Functioning in the Day and Night Flare Corporation Pilot Plant*, W. T. Knox, Jr., Report PDN-3824, Standard Oil Development Co., July 31, 1945.
Div. 11-301.143-M2
44. *Functioning and Dispersion of M69X Bomb When Released from Aimable Clusters into a Ground Target*, E. H. Lewis, J. E. Martin, and H. A. Ricards, DPGSR 38, CWS, Dec. 11, 1944.
45. *Test of E48 Cluster of Eight M69X and Thirty M74 Incendiary Bombs*, FE 1-8, CWS, Mar. 27, 1945.
46. *Fragmentation of the U.S. M56 (M69X) Explosive Incendiary Bomb*, A. C. Whiffer, MAP/45/ACW, Road Research Laboratory, December 1942.
47. *M-69X Waterproofing*, W. T. Knox, Jr., Report PDN-2650, Standard Oil Development Co., June 28, 1944.
Div. 11-301.145-M1
48. *High Altitude Flight Tests of Aimable Clusters for AN-M69 Bomb*, OSRD 3761, OEMsr-354, Service Project CWS-21, Report PDN-2460, Standard Oil Development Co., June 10, 1944.
Div. 11-301.144-M3
49. *Cluster Using E28 Adapter*, TB-CW-19, War Department, Nov. 3, 1944.
50. *Cluster, Aimable, Incendiary Bomb, E46 (500 Lb. Size) (38-6 Lb., AN-M69)*, Specification 196-131-287, CWS, Jan. 1, 1945.
51. *Adapter, Aimable Cluster, E28*, Specification 196-131-282, CWS, Feb. 10, 1945.
52. *The E46R1 Cluster of AN-M69 Incendiary Bomb*, CWS, Feb. 20, 1945.
53. *Development of Aimable Cluster Adapter E28R2, 500 Lb., for Incendiary Bombs AN-M69 and M74*, S. Q. Kline, R. E. Patchel, L. D. Homan, and C. T. Mitchell, TDMR 1004, CWS, Mar. 21, 1945.
54. *Design and Development of the E-19 Incendiary Bomb*, E. B. Hershberg, OSRD 4784, OEMsr-179 and OEMsr-257, Service Project CWS-21, Harvard University, Factory Mutual Research Corp., and Morgan Construction Co., Mar. 8, 1945.
Div. 11-301.15-M8
55. *Design and Development of E19 Incendiary Bomb*, OSRD 4784a, Harvard University, June 15, 1945.
56. *Evaluation of Incendiary Bombs in Furnished Rooms*, N. J. Thompson, OSRD 1502, Factory Mutual Research Corp., June 4, 1943.
57. *Comparative Incendiary Effectiveness of the E-19 and M-50 Incendiary Bombs*, Norman J. Thompson and Morrill Dakin, OSRD 5023, OEMsr-257, Service Project CWS-21, Factory Mutual Research Corp., Apr. 30, 1945.
Div. 11-301.15-M9
58. *Rate of Cooling for 500-lb. Cluster of 5-lb. Oil Incendiary Bombs*, H. A. Ricards, Jr., Report PDN-121, Standard Oil Development Co., May 25, 1942.
Div. 11-301.4-M4
59. *Test of Incendiary Munitions at Huntsville Arsenal, Alabama*, S. G. Ponder and J. E. Gilbert, TDMR 401, CWS, June 1942.
60. *Incendiary Tests at Huntsville Arsenal, Alabama, June 3 to 6, 1942*, N. F. Myers, Report PDN-145, Standard Oil Development Co., June 10, 1942.
Div. 11-301.5-M1
61. *Description and Specifications for the 5- and 6.5-pound Oil Incendiary Bomb (Third Progress Report)*, OEMsr-183, NDRC Project 199, July 8, 1942.
Div. 11-301.4-M5
62. *Service Tests of the 5- and 6-Lb. Oil Incendiary Bomb at Jefferson Proving Ground, July 9 to 22, 1942*, N. F. Myers, W. T. Knox, Jr., and G. L. Matheson, Report PDN-222R, Standard Oil Development Co., July 27, 1942. Div. 11-301.4-M6

CONFIDENTIAL

63. *Incendiary Bomb Tests at Jefferson Proving Ground, July 9 to 22, 1942*, Raymond H. Ewell, Louis F. Fieser, and others, July 28, 1942.
Div. 11-301.17-M2
64. *Penetration Tests of Incendiary Munitions*, TDMR 384, R. L. Ortynsky, CWS, August 1942.
65. *Low Temperature Ignition of Incendiary Fillings in the Bomb, Incendiary 6 Lb., M56*, TR 7, S. G. Ponder, CWS, Sept. 30, 1942.
66. *Test of M52 and M56 Incendiary Bombs*, AAFPGC Proof Department, Army Air Forces, Feb. 11, 1943.
67. *The Use of Cellocotton in the M69 Bomb. Memorandum on Work Done at Kodak Park*, OEMsr-538, Eastman Kodak Co., Feb. 15, 1943.
Div. 11-301.146-M2
68. *Use of Cellocotton in the M-69 Bomb*, G. L. Matheson and Park H. Miller, Jr., OEMsr-354, Report PDN-950, Standard Oil Development Co., Feb. 15, 1943.
Div. 11-301.146-M1
69. *Use of Napalm in the M69, 6 Lb. Incendiary Bomb*, TDMR 571, R. L. Ortynsky, CWS, Mar. 4, 1943.
70. *Characteristics of Aluminum Soap Gels of the Napalm Type (Fourth Progress Report)*, Ray L. Betts and N. F. Myers, OSRD 1345, Standard Oil Development Co., Apr. 15, 1943.
71. *Third Harvard Wind Tunnel Test on M-69 Bomb*, F. R. Russell and N. F. Myers, Report PDN-973, Standard Oil Development Co., Apr. 21, 1943.
Div. 11-301.141-M1
72. *Small Incendiary Bomb, Oil Type (5-10 Lb.)*, W. S. Guthmann and T. M. North, DPGSR 3, CWS, April 1943.
73. *The M-69 Flight Stability Tests*, J. C. Roediger, Report PDN-1301, Standard Oil Development Co., May 7, 1943.
Div. 11-301.141-M2
74. *Fourth Harvard Wind Tunnel Tests*, A. Beerbower, Report PDN-1480, Standard Oil Development Co., July 27, 1943.
Div. 11-301.141-M3
75. *Incendiary Oil, Solid and Viscous, Firing Behavior and Gardner Consistencies of Napalm Type Fillings for the M69 Bomb*, TDMR 694, W. H. Bauer, CWS, Aug. 20, 1943.
76. *Report on Test No. 9 (12/8/43)*, RC(F) Pan 3a/35, Building Research Station, September 1943.
77. *Commentary on Incendiary Tests at Dugway Proving Ground, Utah, May 17 to July 16, 1943*, OEMsr-354, Report PDN-1566, Standard Oil Development Co., Sept. 13, 1943.
Div. 11-304.21-M4
78. *Report on Tests Nos. 10A, 10B, and 10C (3/9/43)*, RC(F) Pan 3a/38, Building Research Station, October 1943.
79. *Fifth Harvard Wind Tunnel Tests*, A. Beerbower, Report PDN-1847, Standard Oil Development Co., Nov. 29, 1943.
Div. 11-301.141-M5
80. *Bombing Tables for Clusters Incendiary Bomb, AN-M12 and AN-M13*, BT 6-A-2, Ordnance Department, Jan. 3, 1944.
81. *First Report on Incendiary Bomb Tests in German-Type Attics*, RC(F) Pan 3a/61, Building Research Station, February 1944.
82. *The Practical Performance Testing of Small Incendiary Bombs, Part II*, RC(F) Pan 3a/66, Building Research Station, April 1944.
83. *Development, Manufacture and Proof Test of 10,000 M-69 Cluster, Type E-6R2*, H. A. Ricards, Jr., W. T. Knox, Jr., and others, Report PDN-2109, OEMsr-354, Standard Oil Development Co., Apr. 15, 1944.
Div. 11-301.144-M2
84. *Penetration of Imitation Burmese Structures by U. S. Type AN-M69 Incendiary Bombs*, Note MAP/117/KLCF, Road Research Laboratory, May 1944.
85. *Second Report on Incendiary Bomb Tests in German-Type Attics*, RC(F) Pan 3a/78, Building Research Station, June 1944.
86. *Bombs, AN-M69, Loading and Assembly*, CWS Directive 280, CWS, Oct. 21, 1944.
87. *Test of American M69 Bomb in B.R.S. Fire Test Building on 8th September 1944*, IBTP/Report/95, Building Research Station, November 1944.
88. *First Report on Incendiary Bomb Tests in Japanese Domestic Buildings*, IBTP/Report/111, Building Research Station, February 1945.
89. *Test of First Production Lot of AN-M69 Incendiary Bombs (Kilgore Mfg. Co.)*, W. G. Franz and J. F. McCanne, TDMR 1097, CWS, July 25, 1945.
90. *High Humidity Surveillance Tests of M-69 Bombs and Clusters*, G. L. Matheson, Report PDN-3924, Standard Oil Development Co., Sept. 10, 1945.
Div. 11-301.145-M2
91. *Stabilization of the AN-M69 Bomb Released from Quick Opening Clusters*, J. E. Martin and W. G. Baird, Jr., TDMR 1167, CWS, Nov. 2, 1945.
92. *Use of High Explosives in Small Incendiary Bomb. Pittsburgh Visit May 15, 1942*, W. T. Knox, Jr., Report PDN-128, Standard Oil Development Co., May 28, 1942.
Div. 11-301.17-M1
93. *Lethal Explosive Charge for M-56 Bomb*, W. T. Knox, Jr., NDRC Project 199, Report PDN-429, Standard Oil Development Co., Oct. 5, 1942.
Div. 11-301.5-M2
94. *Tests Conducted on Incendiary Program at Dugway Proving Ground, Simpson Springs, Utah, between August 3 and October 20, 1943*, H. A. Ricards, Jr., OEMsr-354, Report PDN-1764, Standard Oil Development Co., Nov. 5, 1943.
Div. 11-301.1-M1
95. *Tests of M69X Incendiary Bombs at Dugway Proving Ground, September 19-November 10, 1943*, E. H. Lewis, DPGSR 15, CWS, Dec. 22, 1943.
96. *Striking Velocity of M-69's from Aimable Clusters*, A. Beerbower, Report PDN-1822, Standard Oil Development Co., Nov. 26, 1943.
Div. 11-301.144-M1

CONFIDENTIAL

97. *Aerodynamic Characteristics of the NDRC C-1 420 Lb. Aimable Clusters Incendiary Bombs*, National Bureau of Standards, Dec. 1, 1943.
98. *Aerodynamic Characteristics of the E6R2 Incendiary Cluster Bomb*, National Bureau of Standards, Jan. 7, 1944.
99. *Bombing Table for Cluster, Aimable, 500 Lb., M18(E6R2)*, BT 500-K-2, Ordnance Department, May 18, 1944.
100. *Supplementary Tests of Clusters, Aimable, for M69 Incendiary Bombs*, D. C. Miller, Board Project (M-5) 140a, Army Air Forces, July 27, 1944.
101. *Bomb Clusters Using E6R2 Adapters*, TB-CW-16, War Department, Sept. 16, 1944.
102. *M-69 Stability from E6R2 Aimable Cluster*, W. T. Knox, Jr., Report PDN-2360, Standard Oil Development Co., Oct. 4, 1944. Div. 11-301.144-M4
103. *Bombing Table for Cluster, Aimable, 500 Lb., E46*, BT 500-Q-1, Ordnance Department, October 1944.
104. *Experiments with Incendiary Mixtures. Fire Test Structure and Development of Incendiary Bombs*, Norman J. Thompson, OSRD 657, OEMsr-257, Service Project CWS-21, Report 277, Factory Mutual Research Corp., June 24, 1942. Div. 11-301.3-M5
105. *Report of Burning Tests*, Factory Mutual Research Corp. and Harvard University, Nov. 21, 1942. Div. 11-301.5-M3
106. *Flight Tests on Experimental Incendiaries at Edgewood Arsenal*, Feb. 17, 1943. Div. 11-301.17-M3
107. *Experiments with Alternate Fillings for Bomb Incendiary, 9-pound E-1*, Morrill Dakin, OEMsr-257, Factory Mutual Research Corp., Aug. 23, 1943. Div. 11-301.16-M1
108. *The E-19 (Formerly E-1) Magnesium Bomb and Its Components*, Louis F. Fieser and E. B. Hershberg, Harvard University, Oct. 27, 1943. Div. 11-301.15-M1
109. *Incendiary Bomb Fillings for Industrial Targets*, Norman J. Thompson and Morrill Dakin, OSRD 2048, OEMsr-257, Service Project CWS-21, Factory Mutual Research Corp., Nov. 23, 1943. Div. 11-301.16-M2
110. *Test of E9 Incendiary Bomb*, AAFPGC Proof Department Serial 1-43-76, Army Air Forces, Nov. 9, 1943.
111. *Preliminary Field Tests of Bomb, Incendiary, Oil, 40 Lb., E9*, W. A. Frantz, TDMR 819, CWS, Mar. 6, 1944.
112. *Development of Incendiary Fuels*, Rush F. McCleary and Bill L. Benge, OSRD 3762, OEMsr-898, Service Project CWS-21, The Texas Co., June 10, 1944. Div. 11-301.15-M4
113. *The E-9 Bomb in E-53 Cluster Bomb Bay Loading*, W. S. Quimby, Oct. 2, 1944. Div. 11-301.15-M5
114. *The E-53 Cluster. Its Release from a Fighter Plane*, W. S. Quimby, Feb. 7, 1945. Div. 11-301.15-M6
115. *E-9 Bomb Penetration Tests at Eglin Field, Florida*, W. S. Quimby, Feb. 24, 1945. Div. 11-301.15-M7
116. *Cluster E-53, 14, E-9 (Inert) Incendiary Bombs*, CWS, Apr. 5, 1945.
117. *E-53 Cluster Tests, Dugway Proving Ground, July 19, 1945*, July 1945. Div. 11-301.15-M10
118. *Static G Test of E-53 Cluster of 14 E-9 Bombs in E-26 Adapters*, S. N. Arnold, Foster-Wheeler Corp., July 6, 1945. Div. 11-301.15-M11
119. *Development of Medium Sized Incendiary Bomb, Final Report on the Development of 40-Pound Incendiary Bomb, E-9*, OEMsr-898, The Texas Co., Oct. 15, 1945. Div. 11-301.15-M12
120. *Flight Stability of Bomb Incendiary, 30 Lb., E3*, J. R. Adams, Test Report 9, Chemical Warfare Service, Oct. 4, 1942.
121. *Comparison Tests on New Igniters and Burstere. A Report on Tests Using Three M-46A2 Bombs Fired on Soldiers Field, October 1, 1942*, E. B. Hershberg, Harvard University, Oct. 13, 1942. Div. 11-303.3-M2
122. *E20, 500 Lb., Cast-Iron Incendiary Bomb*, R. L. Ortynsky, TDMR 929, CWS, Nov. 24, 1944.
123. *Cellulose Wadding (Cellocton) with Gasoline as a Fuel for a 500-lb Incendiary Bomb*, Norman J. Thompson, OEMsr-257, Factory Mutual Research Corp., July 28, 1943. Div. 11-301.161-M1
124. *Gasoline-Cellocton Filling for 500-Pound Incendiary Bomb*, Norman J. Thompson, OSRD 1702, OEMsr-257, Service Project CWS-21, Factory Mutual Research Corp., Aug. 11, 1943. Div. 11-301.161-M2
125. *Test of Bomb, Incendiary 500 Lb. E22*, J. R. Adams, TDMR 816, CWS, Mar. 8, 1944.
126. *The E-22 500-lb Bomb Incendiary, Tail Ejection Type*, Norman J. Thompson, OEMsr-257, Service Project CWS-21, Factory Mutual Research Corp., May 23, 1944. Div. 11-301.15-M3
127. *Test of Bomb, Incendiary, 500 Lb., E22 (Modified)*, J. R. Adams and W. H. Daiger, TDMR 968, CWS, Jan. 24, 1945.
128. *Test of 2 Lb. Plastic Bomb*, J. R. Adams, TDMR 342, CWS, Jan. 22, 1942.
129. *Development of a Plastic Incendiary Bomb*, T. S. Carswell, H. K. Nason and others, OSRD 6621, OEMsr-198, Service Project CWS-21, Monsanto Chemical Co., Feb. 21, 1946. Div. 11-301.13-M1

CONFIDENTIAL

CHAPTER 2

1. *Recommendations for Filling and Firing the 100 Lb. Oil Incendiary Bomb*, Louis F. Fieser, OSRD 587, Harvard University, May 25, 1942.
2. *Recommended Specifications for the WP-TNT Burster for the 100-lb Bomb*, Louis F. Fieser, Harvard University, July 24, 1942.
Div. 11-301.11-M2
3. *Dry Loading of White Phosphorus into Burster Tubes*, Howard Adler, OSRD 765, OEMsr-296, Projects CWS-21 and B-246, Report 303, Victor Chemical Works, July 24, 1942.
Div. 11-301.11-M1
4. *Assembly of Burster and Igniter in M47A1 and AN-M47A2 Incendiary Bombs*, TB-CW-10, War Department, July 15, 1944.
5. *Igniter, AN-M9*, Specification 196-131-277A, CWS, Oct. 11, 1944.
6. *Burster, AN-M13*, Specification 96-131-113, CWS, Dec. 7, 1944.
7. *Bomb, Incendiary, 500-Lb. M76(T2E1)*, TB-CW-4, War Department, Apr. 4, 1944.
8. *Incendiary Bomb Tests at Jefferson Proving Ground, July 9 to 22, 1942*, Raymond H. Ewell, Louis F. Fieser, and others, July 28, 1942.
Div. 11-301.17-M2
9. *Incendiary Tests at Jefferson Proving Ground, Madison, Indiana*, TDMR 416, R. L. Ortynsky and S. G. Ponder, CWS, Aug. 5, 1942.
10. *Second Test of Incendiary Bombs on Abandoned Farm Houses and Burns at Jefferson Proving Ground*, John D. Armitage and Donald D. Loos, Ordnance Department, August 1942.
11. *Comparison Test of M-12 and M-13 Bursters*, E. W. McIntosh, Board Report (M-5)123, Army Air Forces, June 12, 1944.
12. *Test of M47A2 Incendiary Bomb with Modified M13 Burster Fuze*, E. W. McIntosh, Board Project (M-5)120, Army Air Forces, June 30, 1944.
13. *Comparison of M-12 and M-13 Bursters in the M-47A2, 100-lb. Incendiary Bomb*, R. L. Ortynsky, Alan L. Kling, and S. Murray Jones, OSRD 4068, Service Project CWS-21, Report IEP/3, Aug. 30, 1944.
Div. 11-301.11-M3
14. *Harvard Candle. A Pocket Incendiary Munition*, Louis F. Fieser, OEMsr-179, Harvard University, Feb. 25, 1942.
Div. 11-301.21-M1
15. *Hand Incendiaries Tested at Edgewood Arsenal*, Edwin A. Blair, Factory Mutual Research Corp., Oct. 8, 1942.
Div. 11-301.22-M1
16. *Tests of Sabotage Incendiaries*, NDRC Project 457, OEMsr-257, Factory Mutual Research Corp., Oct. 26, 1942.
Div. 11-301.23-M2
17. *Observations on the Performance of Incendiary Candles at Edgewood. Tests of November 30, 1942*, H. C. Hottel, S. P. Lovell, and Harris M. Chadwell, November 1942.
Div. 11-301.21-M2
18. *Comparison Tests of Hand Incendiaries*, OEMsr-257, Factory Mutual Research Corp., Jan. 6, 1943.
Div. 11-301.23-M3
19. *Starter, Fire, M1*, Specification 196-131-97C, CWS, Oct. 27, 1944.
20. *Vest-Pocket Time Delay Incendiary*, Louis F. Fieser, OSRD 1211, OEMsr-179, Service Project CWS-21, Harvard University, Feb. 19, 1943.
Div. 11-301.23-M5
21. *Evaluation Tests of FM Sabotage Incendiary*, OEMsr-257, Factory Mutual Research Corp., Jan. 15, 1943.
Div. 11-301.22-M2
22. *Development of SDO as an Incendiary Material Particularly as a Hand Incendiary*, M. S. Kharasch and F. H. Westheimer, OSRD 677, University of Chicago, July 6, 1942.
23. *Report of Test of Fire Starters E-4 and E-5*, George E. Miles and J. F. McCanne, Chemical Munitions Section, Aug. 28, 1942.
Div. 11-301.23-M1
24. *Design of the E-16 Allway Fuse for the AN-M69 Incendiary Bomb*, T. L. Wheeler and Max Knobel, OSRD 5209, OEMsr-242, Service Project CWS-21, Arthur D. Little, Inc., June 15, 1945.
Div. 11-301.12-M1
25. *Phosphorus Ignition*, T. M. Beck, Victor Chemical Works, June 8 and 17, 1942.
26. *Red Phosphorus Incendiary Bomb M1 (Leaf)*, J. S. Carson, TDMR 484, CWS, Dec. 23, 1942.
27. *Sensitized Celluloid Fire Leaves*, Charles A. Kraus, OSRD 1202, OEMsr-57, Service Project CWS-11, Brown University, Feb. 16, 1943.
Div. 11-301.23-M4
28. *Modified M-52 Two-Pound Magnesium Bomb for Use against Japan*, E. B. Hershberg and Morrill Dakin, OSRD 4521, OEMsr-179 and OEMsr-257, Service Project CWS-21, Harvard University and Factory Mutual Research Corp., Jan. 1, 1945.
Div. 11-301.1-M2
29. *Modified M-59 Incendiary Bomb and Development of Test Target*, Norman J. Thompson and Alan L. Kling, OSRD 4601, OEMsr-257, Service Project CWS-21, Factory Mutual Research Corp., Jan. 19, 1945.
Div. 11-301.5-M6
30. *The AN-M-52 Bomb Incendiary. Optimum Velocity for One-Story Japanese Dwellings*, Norman J. Thompson and Edwin A. Blair, OEMsr-257, Service Project CWS-21, Factory Mutual Research Corp., June 3, 1944.
Div. 11-301.5-M4

CONFIDENTIAL

CHAPTER 3

1. *Comparative Tests of Various Incendiary Mixtures* (Report to Sept. 10, 1941), Louis F. Fieser, OEMsr-25; Projects CWS-21 and B-117, Harvard University, Sept. 17, 1941. Div. 11-301.3-M1
2. *Comparative Tests of Various Incendiary Mixtures. Part II, Comparison of Magnesium, Thermite, SDO-Sodium Nitrate and a Gum Incendiary*, Louis F. Fieser, OSRD 173, OEMsr-25, Service Project CWS-21, Report 111, Harvard University, Nov. 10, 1941. Div. 11-301.3-M2
3. *Comparative Tests of Various Incendiary Mixtures. Part III, Preliminary Observations on the Influence of the Rubber Concentration and on the Effect of Finely Powdered Nitrate*, Louis F. Fieser, OEMsr-25, Service Project CWS-21, Report 113, Harvard University, Nov. 10, 1941. Div. 11-301.3-M3
4. *Comparative Tests of Various Incendiary Mixtures. Part IV, Improvements in the Test Procedure and Evaluation of Different Types of Rubber*, Louis F. Fieser, OSRD 275, Projects CWS-21 and B-186, Report 132, Harvard University, Dec. 8, 1941. Div. 11-301.3-M4
5. *Experiments with Incendiary Mixtures. Fire Test Structure and Development of Incendiary Bombs*, Norman J. Thompson, OSRD 657, OEMsr-257, Service Project CWS-21, Report 277, Factory Mutual Research Corp., June 24, 1942. Div. 11-301.3-M5
6. *Tests of Sabotage Incendiaries*, NDRC Project 457, OEMsr-257, Factory Mutual Research Corp., Oct. 26, 1942. Div. 11-301.23-M2
7. *Comparison Tests of Hand Incendiaries*, OEMsr-257, Factory Mutual Research Corp., Jan. 6, 1943. Div. 11-301.23-M3
8. *Evaluation Tests of FM Sabotage Incendiary*, OEMsr-257, Factory Mutual Research Corp., Jan. 15, 1943. Div. 11-301.22-M2
9. *Development of SDO as an Incendiary Material, Particularly as a Hand Incendiary*, M. S. Kharasch and F. H. Westheimer, OSRD 677, University of Chicago, July 6, 1942.
10. *The Development of Oil Incendiary Bombs*, R. P. Russell, OSRD 382, OEMsr-183, Projects CWS-21 and B-204, Report 176, Standard Oil Development Co., Feb. 7, 1942. Div. 11-301.4-M1
11. *Development of Incendiary Fuels*, Rush F. McCleary and Bill L. Bengé, OSRD 3762, OEMsr-898, Service Project CWS-21, The Texas Co., June 10, 1944. Div. 11-301.15-M4
12. *Report of Burning Tests*, Factory Mutual Research Corp. and Harvard University, Nov. 21, 1942. Div. 11-301.5-M3
13. *Modified M-50 Incendiary Bomb and Development of Test Target*, Norman J. Thompson and Alan L. Kling, OSRD 4601, OEMsr-257, Service Project CWS-21, Factory Mutual Research Corp., Jan. 19, 1945. Div. 11-301.5-M6
14. *Incendiary Bomb Fillings for Industrial Targets*, Norman J. Thompson and Morrill Dakin, OSRD 2048, NDCre-231, OEMsr-257, Service Project CWS-21, Factory Mutual Research Corp., Nov. 23, 1943. Div. 11-301.16-M2
15. *Evaluation of Incendiary Fuels and Bombs on Industrial Building Occupancies*, Norman J. Thompson and Alan L. Kling, OSRD 4468; OEMsr-257; Service Project CWS-21, Report IEP/4, Factory Mutual Research Corp., Dec. 15, 1944. Div. 11-304.2-M1
16. *Design and Testing of a Simple Target Structure to Simulate Typical Industrial Incendiary Centers*, Norman J. Thompson and Alan L. Kling, OSRD 4469, OEMsr-257, Project IEP/5, Service Project CWS-21, Factory Mutual Research Corp., Dec. 15, 1944. Div. 11-304.2-M2
17. *Comparative Incendiary Effectiveness of the E-19 and M-50 Incendiary Bombs*, Norman J. Thompson and Morrill Dakin, OSRD 5023, OEMsr-257, Service Project CWS-21, Project Report IEP/7, Factory Mutual Research Corp., Apr. 30, 1945. Div. 11-301.15-M9
18. *The Comparative Effectiveness of Small Incendiary Bombs on Industrial Targets*, Charles S. Keevil, OSRD 6189, OEMsr-21, Service Project CWS-21, Report IEP/9, Edgewood Arsenal, Oct. 3, 1945. Div. 11-304.2-M3
19. *Penetration of M-50, M-69 and M-69X Bombs into Typical Rhineland Structure*, OEMsr-354, Report PDN-1201, Standard Oil Development Co., Apr. 15, 1943. Div. 11-304.21-M1
20. *Penetration and Performance Tests of Small Incendiary Bombs in a Typical Central German Structure*, OSRD 5522, OEMsr-354, Service Project CWS-21, Standard Oil Development Co., July 30, 1945. Div. 11-304.21-M6
21. *Evaluation of Incendiary Fuels in German Attic and Sub-Attic Structures*, OEMsr-354, Report PDN-3950, Standard Oil Development Co., Sept. 28, 1945. Div. 11-304.21-M7
22. *Evaluation of Incendiary Bombs in Furnished Rooms*, N. J. Thompson and E. A. Blair, OSRD 1502, Factory Mutual Research Corp., June 4, 1943.
23. *Design and Construction of Typical German and Japanese Test Structures at Dugway Proving Ground, Utah*, OEMsr-354, Report PDN-1340, Standard Oil Development Co., May 27, 1943. Div. 11-304.21-M2
24. *Tests of Incendiary Bombs AN-M50 A1, AN-M52, AN-M54 and M69 at Dugway Proving Ground*, J. R. Adams, CWS, and H. C. Hottel, NDRC, TDMR 713, July 1943.
25. *Tests Conducted on Incendiary Program at Dug-*

CONFIDENTIAL

- way Proving Ground, Simpson Springs, Utah, between August 3 and October 20, 1943*, H. A. Ricards, Jr., OEMsr-354, Report PDN-1764, Standard Oil Development Co., Nov. 5, 1943.
Div. 11-301.1-M1
26. *Tests of M69X Incendiary Bombs at Dugway Proving Ground, September 19–November 10, 1943*, DPGSR 15, E. H. Lewis, CWS, Dec. 22, 1943.
27. *Tests of Incendiary Bomb M69 Fired Statically in Pre-Determined Locations in Japanese Type Structures*, J. R. Adams, W. S. Guthmann, and E. H. Lewis, DPGSR 18, CWS, Jan. 17, 1944.
28. *Incendiary Tests in Experimental Japanese Room*, Charles S. Keevil, OSRD 5120, Service Project CWS-21, Report IEP/8, Edgewood Arsenal, May 26, 1945.
Div. 11-304.21-M5
29. *Comparison Test of M-12 and M-13 Bursterns*, E. W. McIntosh, Board Report (M-5)123, Army Air Forces, June 12, 1944.
30. *Prototype Target Building*, W. H. Daiger, TDMR 978, CWS, Feb. 14, 1945.
31. *The Inflammability of Wood as Affected by Moisture Content*, Richard E. Messing, OSRD 4067, Service Project CWS-21, Report IEP/2, Office of Field Service, Aug. 30, 1944. Div. 11-304.11-M1
32. *Moisture Content of Wood in Japan*, H. C. Hottel, Nov. 14, 1944.
Div. 11-304.11-M2
33. *Burning Tests of Vertical Planks*, Norman J. Thompson and Alan L. Kling, OEMsr-257, Factory Mutual Research Corp., Nov. 27, 1944.
Div. 11-304.1-M3
34. *Moisture Content of Wood Incendiary Test Structures*, H. A. Ricards, Jr., Report PDN-3150, Standard Oil Development Co., Dec. 18, 1944.
Div. 11-304.11-M3
35. *The Effect of Moisture on Ignition and Burning Characteristics of Douglas Fir*, Norman J. Thompson and Alan L. Kling, OSRD 4797, OEMsr-257, Service Project CWS-21, Report IEP/6, Factory Mutual Research Corp., Mar. 16, 1945.
Div. 11-304.11-M4
36. *Studies in Wood Moisture Content*, George R. Stanbury, Raymond H. Ewell, and Richard F. Messing, OSRD 4988; Service Project CWS-21, Report IEP/6, Edgewood Arsenal, Apr. 27, 1945.
Div. 11-304.11-M5
37. *Ignitability of Various Woods*, Norman J. Thompson and Morrill Dakin, OEMsr-257, Factory Mutual Research Corp., June 21, 1943.
Div. 11-304.1-M2
38. *Mission Analysis*, Report MA-1, Operations Analysis Section, Twenty-First Bomber Command, July 15, 1945.
39. *Analysis of Osaka Urban Area Attack*, JTG Weapon Analysis Memorandum 11, Army Air Forces, Mar. 14, 1945.
40. *Bombing Accuracy*, Report BA-1, Operations Analysis Section, Twenty-First Bomber Command, July 21, 1945.
41. *Report on Bombing Accuracy of Night Incendiary Missions*, Bombing Accuracy Report BA-2, Operations Analysis Section, Twenty-First Bomber Command, Aug. 6, 1945.
42. *Tests for Determining Incendiary Value of Bombs and Bomb Fuels*, Eugene B. Gerry, OSRD 4066, Service Project CWS-21, Aug. 30, 1944.
Div. 11-301.5-M5
43. *The Development of Oil Incendiary Bombs*, R. P. Russell, OSRD 577, OEMsr-183, Projects CWS-21 and B-204, Report 243, Standard Oil Development Co., May 14, 1942.
Div. 11-301.4-M2
44. *The Use of Cellocotton in the M-69 Bomb. Memorandum on Work Done at Kodak Park*, OEMsr-538, Eastman Kodak Co. [?], Feb. 15, 1943.
Div. 11-301.146-M2
45. *German Industrial Structures. Their Construction and Probable Penetration by Incendiary Bombs*, OEMsr-354, Report PDN-1558, Standard Oil Development Co., Sept. 11, 1943.
Div. 11-304.21-M3
46. *Comparison of M-12 and M-13 Bursterns in the M-47A2, 100-lb Incendiary Bomb*, R. L. Ortynsky, Alan L. Kling, and S. Murray Jones, OSRD 4068, Service Project CWS-21, Report IEP/3, Aug. 30, 1944.
Div. 11-301.11-M3
47. *Wood Flammability under Various Conditions of Irradiation*, H. C. Hottel, OSRD 432, Projects CWS-21 and B-205, Report 195, Massachusetts Institute of Technology, Mar. 3, 1942.
Div. 11-304.1-M1
48. *Effects of Weapons on Targets*, Volume 1, OSRD 4918, Report EWT-1, AN-23 Group, Apr. 5, 1945.
49. *Effects of Weapons on Targets*, Volume 2, OSRD 5045, Report EWT-2, AN-23 Group, May 5, 1945.
50. *Effects of Weapons on Targets*, Volume 3, OSRD 5176, Report EWT-3, AN-23 Group, June 5, 1945.
51. *Effects of Weapons on Targets*, Volume 4, OSRD 5321, Report EWT-4, AN-23 Group, July 5, 1945.

CHAPTER 4

1. *Report of Ad Hoc Committee on Flame Throwers*, George A. Richter, Eastman Kodak Co., Revised: July 28, 1942.
Div. 11-302-M3
2. *Modification of Portable Flame Thrower for Thickened Fuels*, N. F. Myers, G. H. Garraway, and others, OSRD 983, OEMsr-390, OEMsr-661, and OEMsr-667, Projects CWS-10, B-270, B-367, and others, Report 391, Standard Oil Develop-

CONFIDENTIAL

- ment Co., Factory Mutual Research Corp., and Nuodex Products Co., Oct. 12, 1942.
Div. 11-302.12-M2
3. *Development of Flame Throwers, Service Units and Thickened Fuels*, OSRD 6376, OEMsr-390, Service Project CWS-21, Report PDN-4027, Standard Oil Development Co., Oct. 31, 1945.
Div. 11-302-M5
 4. *Use of Flame on Japanese Bunkers*, OSRD 2090, OEMsr-390, Service Project CWS-10, Standard Oil Development Co., Dec. 4, 1943.
Div. 11-302.51-M1
 5. *Portable Flame Thrower M1 and M1A1*, TM3-375, CWS, May 1943.
 6. *Memo on CWS-NDRC Committee Meeting—Portable Flame Thrower Design*, CWS, Aug. 27, 1942.
 7. *Portable Flame Throwers E2 and E3*, Infantry Board, Fort Benning, Ga., May 13, 1944.
 8. *Manual on the Operation and Maintenance of the Portable Flame Thrower, E-2*, OEMsr-390, Service Project SPCWT-161, Report PDN-2057, Standard Oil Development Co., Feb. 15, 1944.
Div. 11-302.11-M6
 9. *Comparative Tests of Portable Flame Throwers*, Armored Board, Mar. 3, 1944.
 10. *Development of Portable Flame Thrower, E-2*, OSRD 3574, OEMsr-390, Service Project CWS-10, Standard Oil Development Co., May 4, 1944.
Div. 11-302.11-M7
 11. *Phosphorus-Sulphur Flame Thrower Fuel*, T. L. Wheeler and L. B. Arnold, Jr., OSRD 5355, OEMsr-242, Service Project CWS-21, Arthur D. Little, Inc., June 15, 1945. Div. 11-303.13-M1
 12. *Thickened EWP Fuels and Ejection Devices for Eutectic White Phosphorus Fuels*, T. L. Wheeler and A. Bogrow, OSRD 5524, OEMsr-242, Service Project CWS-10, Arthur D. Little, Inc., Aug. 15, 1945. Div. 11-303.13-M3
 13. *Thickened Eutectic White Phosphorus Fuels and Ejection Devices for EWP Fuels* (Supplementary Report), T. L. Wheeler and J. J. Clancy, OSRD 5524a, OEMsr-242, Service Project CWS-10, Arthur D. Little, Inc., Oct. 22, 1945.
Div. 11-303.13-M4
 14. *Comparative Tests of Portable Flame Throwers*, Project 532, Armored Board, Fort Knox, Ky., Mar. 23, 1944.
 15. *Memo on CWS-NDRC Committee Meeting*, N. F. Myers, Standard Oil Development Co., Oct. 5, 1942.
 16. *Development of Improved Portable Flame Thrower, Design E-2. Meeting of CWS-NDRC Committee, January 18 to 19, 1943*, T. Loew, Arthur L. Brown, and N. F. Myers, January 1943.
Div. 11-302.11-M1
 17. *Design and Construction of Model E-2 Portable Flame Thrower*, G. H. Garraway, Report PDN-959, Standard Oil Development Co., Feb. 15, 1943.
Div. 11-302.11-M2
 18. *Improved Portable Flame Thrower, Model E-2*, G. H. Garraway, Report PDN-1238, Standard Oil Development Co., Apr. 21, 1943.
Div. 11-302.11-M3
 19. *Model E-2 Portable Flame Thrower*, N. F. Myers, Report PDN-1584, Standard Oil Development Co., Sept. 2, 1943. Div. 11-302.11-M4
 20. *New Portable Flame Thrower Equipment*, Project DMS 416, Army Engineers, Fort Belvoir, Va., Sept. 16, 1943.
 21. *Revisions to E-2 Portable Flame Thrower*, M. D. Haworth, Report PDN-1612, Standard Oil Development Co., Sept. 18, 1943. Div. 11-302.11-M5

CHAPTER 5

1. *Memorandum of Meeting of Group at MIT, Tuesday, March 3, 1942, to Discuss Flame Throwers*, H. C. Hottel, Massachusetts Institute of Technology, March 1942. Div. 11-302-M1
2. *Design and Development of Large Experimental Flame Thrower*, D. C. Elliott, OSRD 1952, OEMsr-470, Service Project CWS-10, Gilbert and Barker Manufacturing Co., Oct. 25, 1943.
Div. 11-302.3-M1
3. *Development of Flame Throwers Service Units and Thickened Fuels*, OSRD 6376, OEMsr-390, Service Project CWS-21, Report PDN-4027, Standard Oil Development Co., Oct. 31, 1945.
Div. 11-302-M5
4. *Development of Flame Throwers* (Monthly Progress Report for period from July 15 to Aug. 15, 1942), OEMsr-390, Standard Oil Development Co., Aug. 15, 1942. Div. 11-303-M1
5. *Field Tests on Flame Throwers, Model C* (Monthly Progress Report covering period from Apr. 15 to May 15, 1943), Hugh Harvey, OEMsr-916, Service Project CWS-10, Shell Development Co., May 15, 1943. Div. 11-303-M3
6. *Study of Mechanized Flame Throwers* (Monthly Progress Report), R. D. Dawson, Shell Development Co., June 22, 1943.
7. *Study of Mechanized Flame Throwers* (Monthly Progress Report), R. D. Dawson, Shell Development Co., July 22, 1943.
8. *Study of Mechanized Flame Throwers* (Monthly Progress Reports covering period from May 15 to August 15, 1943), R. D. Dawson, OEMsr-916, Service Project CWS-10, Shell Development Co. Div. 11-303-M4
9. *Development of Flame Throwers* (Monthly Progress Report covering period from Sept. 15 to Oct.

CONFIDENTIAL

- 15, 1942), OEMsr-390, Standard Oil Development Co., Nov. 15, 1942. Div. 11-303-M2
10. *Mobile Flame Thrower, Model Q*, G. H. Garraway, Report PDN-1158, Standard Oil Development Co., Apr. 6, 1943. Div. 11-302.323-M1
11. *Use of Flame on Japanese Bunkers*, OSRD 2090, OEMsr-390, Service Project CWS-10, Standard Oil Development Co., Dec. 4, 1943. Div. 11-302.51-M1
12. *Performance of Thickened Fuels in Flame Thrower, Model E-7(Q)*, Ray L. Betts, Report PDN-2105, Standard Oil Development Co., Feb. 14, 1944. Div. 11-303.12-M6
13. *Flame Thrower, Mechanized, E-7-7, Installed in Light Tank, M-5A1*, OSRD 5125, OEMsr-390, Service Project CWS-10, Standard Oil Development Co., May 29, 1945. Div. 11-302.323-M10
14. *Development and Field Use of E-7-7 Mechanized Flame Thrower*, OSRD 6012, OEMsr-390, Service Project CWS-10, Standard Oil Development Co., Sept. 12, 1945. Div. 11-302.322-M7
15. *Flame Throwers, Mechanized, E-12-7R1 Installed in Medium Tank, M-4A1*, OSRD 5126, OEMsr-390, Service Project CWS-10, Standard Oil Development Co., May 29, 1945. Div. 11-302.322-M4
16. *The M-4-5(E-12-7R1) Mechanized Flame Thrower Installed in M-4A1 or M-4A3 Medium Tanks*, OSRD 6350, OEMsr-390, Service Project CWS-10, Standard Oil Development Co., Oct. 31, 1945. Div. 11-302.322-M10
17. *The E-14-7R2 Mechanized Flame Thrower Installed in LVT-A1 Amphibious Tank*, OSRD 6351, OEMsr-390, Service Project CWS-10, Report PDN-1026, Standard Oil Development Co., Oct. 31, 1945. Div. 11-302.321-M3
18. *General Specifications of the Model Q Tank-Borne Flame Thrower*, G. H. Garraway, Report PDN-1378, Standard Oil Development Co., June 2, 1943. Div. 11-302.323-M2
19. *Ignition Studies on E-7 (Q) Trailer Unit*, J. O. Collins, Report PDN-2027, Standard Oil Development Co., Jan. 28, 1944. Div. 11-303.3-M3
20. *CWS Report-Test of Mechanized Flame Thrower E7 at Edgewood Arsenal*, J. Senter, TDMR 807, Mar. 17, 1944.
21. *Armored Board Report-Test on Q (E7-M5A1)*, V. O. Barnard, P-460-1, June 28, 1944.
22. *The E-7-7 Mechanized Flame Thrower in M-5A1 Light Tank. NDRC Operational Tests*, G. W. Engisch, Report PDN-3772, Standard Oil Development Co., July 12, 1945. Div. 11-302.323-M11
23. *Preliminary Reports on the Operation of Mechanized Flame Throwers*, Report 196, USAFFE Board, May 17, 1945.
24. *Combat Testing of Flame Thrower E-7-7 Mounted in Light Tank, M5A1*, Thirteenth Armored Group Report to Commanding General, Sixth Army, May 31, 1945.
25. *Navy Flame Throwers*, T. V. Moore, Massachusetts Institute of Technology, Feb. 5, 1944. Div. 11-302.2-M1
26. *Flame Throwers—Description and Instructions for Operation*, Ordnance Pamphlet 1139-USN, USN BuOrd, June 14, 1944.
27. *Report to First Amphibious Tractor Battalion, FMF, Pacific Troops, III Amphibious Corps*, Eng. S. W. Holmes, Dec. 11, 1944.
28. *The E-7 (Q)-LVT-A1 Lima Locomotive Installation*, M. D. Haworth, Report PDN-2196, Standard Oil Development Co., Mar. 1, 1944. Div. 11-302.321-M1
29. *Final Report—Mechanized Flame Thrower*, Project 3, Landing Vehicle Board, Feb. 13, 1945.
30. *Informatory Test of LVT Flame Thrower Unit*, SPCVD 400.112, CWS-OC-TD, May 30, 1945.
31. *Flame Thrower, Mechanized, E-14-7R2 with Mixer, Thickened Fuel, E-6 and Compressor, Air, E-8*, Report PDN-3790, Standard Oil Development Co., July 20, 1945. Div. 11-302.321-M2
32. *Flame Thrower, Mechanized, E14-7R2*, TM 3-365, War Department, Aug. 8, 1945.
33. *Demonstration of Mechanized Flame Thrower E-12-7R1 and Servicing Unit E-8 for Chemical Warfare Service*, Report PDN-3370, Standard Oil Development Co., Feb. 22, 1945. Div. 11-302.322-M1
34. *Flame Thrower, Mechanized, E-12-7R1 and Service Unit, Mechanized Flame Thrower, E-8*, Report PDN-3499, Standard Oil Development Co., M. W. Kellogg Co., and the Davey Compressor Co., Apr. 2, 1945. Div. 11-302.322-M2
35. *Technical Manual—Flame Thrower, Mechanized, E12-7R1 (Installed in Medium Tanks M4A1 and M4A3)*, TM3-360, War Department, July 20, 1945.
36. *Field Test of E12-7R1 Mechanized Flame Thrower Mounted in M4A1, Medium Tank, and E8 Service Unit Mounted in 2½ Ton Truck*, Project 627, Chemical Warfare Board, May 9, 1945.
37. *Inspection and Field Operational Tests of 20 E-12-7R1 Flame Throwers*, J. O. Collins, Report PDN-3672, Standard Oil Development Co., June 6, 1945. Div. 11-302.322-M5
38. *Joint CWS-NDRC Mechanized Flame Thrower Evaluation Project*, A. W. Adkins, G. A. Agoston, and others, OSRD 5933, OEMsr-21, Service Project CWS-10, Massachusetts Institute of Technology, June 30, 1945. Div. 11-302.322-M6
39. *Fuel Recommendations for E-12-7R1 Flame Thrower*, A. W. Adkins, Edgewood Arsenal, June 23, 1945. Div. 11-303-M5
40. *Description of C. F. Braun and Company Flame Thrower*, G. P. Klaas, C. F. Braun and Company, Oct. 27, 1943. Div. 11-302.323-M5
41. Letter to T. V. Moore. Subject, "Additional Information about Design of Flame Thrower for

CONFIDENTIAL

- M-5 Tank," G. P. Klaas, C. F. Braun and Co., Dec. 13, 1945. Div. 11-302.323-M6
42. *Development of Mobile Flame Thrower*, G. P. Klaas, OSRD 5443, OEMsr-943, Service Project CWS-10, C. F. Braun and Co., Aug. 12, 1945. Div. 11-302.323-M12
43. *Demonstration of Klaas-Braun Flame Thrower, October 10, 1944*, Charles S. Keevil, Oct. 13, 1944. Div. 11-302.323-M8
44. *A Simplified Form of Flame Throwing Mechanism, Model I*, R. L. Iglehart and R. O. Dawson, OEMsr-916, Service Project CWS-10, Shell Development Co., Mar. 15, 1944. Div. 11-302.33-M1
45. *Mechanized Flame Thrower, Model I-3*, R. D. Dawson and A. S. Grundy, OSRD 4983, OEMsr-916, Service Project CWS-10, Shell Development Co., Apr. 24, 1945. Div. 11-302.33-M2
47. *Description of Indiana-Merz Flame Thrower*, T. V. Moore, Oct. 10, 1943. Div. 11-302.323-M4
46. *Standard Oil Company of Indiana and Merz Engineering Company, Mechanized Flame Throwers*, T. V. Moore, Aug. 14, 1943. Div. 11-302.323-M3
48. *Development of Flame Thrower for M-5 Tank*, OSRD 4432, OEMsr-1011, Service Project CWS-10, Standard Oil Co. of Indiana, Dec. 6, 1944. Div. 11-302.323-M9
49. *Investigation of Accident to Flame Thrower under Development by Standard Oil Company of Indiana and Merz Engineering Company*, OSRD 4374, OEMsr-1011, Service Project CWS-10, Standard Oil Co. of Indiana and Merz Engineering Co., Nov. 30, 1944. Div. 11-302-M4
50. *The E-13-13 Flame Gun and Equipment in M-4A1 Tank*, Myles Morgan, OSRD 5711, OEMsr-1364, Service Project CWS-10, Morgan Construction Co., Sept. 17, 1945. Div. 11-302.322-M8
51. Letter to E. P. Stevenson, W. C. Kabrich, CWS, May 15, 1944.
52. *Development of Mechanized Flame Thrower E-13R1-13R2 in M-4A1 Tank*, T. V. Moore and T. R. Camp, OSRD 4980, OEMsr-21 and OEMsr-1364, Service Project CWS-10, Massachusetts Institute of Technology, Apr. 30, 1945. Div. 11-302.322-M3
53. *Flame Throwers, Incendiaries and Their Evaluation*, Abbott Byfield, W. A. Klemm, and G. A. Agoston, OSRD 6190, OEMsr-21, Service Projects CWS-10 and CWS-21, Massachusetts Institute of Technology, Oct. 1, 1945. Div. 11-300-M1
54. *Design of Mechanized Flame Thrower in M-4A3 Tank Retaining 76-mm Gun*, H. O. Croft, J. M. Trummel, and others, OSRD 6015, OEMsr-1480, Service Project CWS-10, State University of Iowa, Sept. 30, 1945. Div. 11-302.322-M9
55. Letter to H. M. Chadwell, NDRC. Subject, "Responsibilities Related to Development of Flame Thrower Tank T-33," W. C. Kabrich, SPCVD 470.8, CWS, May 28, 1945.
56. *Preliminary Study of the Application of Pumps to Flame Throwers*, T. V. Moore, OEMsr-21, Service Project CWS-10, Massachusetts Institute of Technology, Apr. 20, 1944. Div. 11-302.4-M1
57. *Further Study of the Application of Pumps to Flame Throwers*, Abbott Byfield, OEMsr-21, Service Project CWS-10, Massachusetts Institute of Technology, Feb. 26, 1945. Div. 11-302.4-M2
58. *Studies of Thickened Liquids (Monthly Progress Report)*, E. E. Bauer, and E. K. Carver, Eastman Kodak Co., Mar. 16, 1945.
59. *Studies of Thickened Liquids (Monthly Progress Report)*, E. E. Bauer and E. K. Carver, Eastman Kodak Co., Apr. 14, 1945.
60. *Studies of Thickened Liquids (Monthly Progress Report)*, E. E. Bauer and E. K. Carver, Eastman Kodak Co., May 15, 1945.
61. *Studies of Thickened Liquids (Monthly Progress Report)*, E. E. Bauer and E. K. Carver, Eastman Kodak Co., June 15, 1945.
62. *Studies of Thickened Liquids (Monthly Progress Report)*, E. E. Bauer and E. K. Carver, Eastman Kodak Co., July 24, 1945.
63. *Washington Conference January 12, 1945*, Report PDN-3288, Standard Oil Development Co., Jan. 19, 1945.
64. *Letter Report of Preliminary Test of Flame Thrower, Mechanized, E-14-7R2; Mixer, Thickened Fuel, E6; and Compressor, Air, E8*, 470.71 NDER, Landing Vehicle Board, Aug. 3, 1945.
65. *CWS Letter on Approval of Landing Vehicle Board Recommendations on E14-7R2 Unit*, SPCVD 161, CWS-Technical Division, Aug. 21, 1945.
66. *Report on E12-7R1 Flame Thrower Fuel and Range Performance for Manual and Theatre Letter*, CWS-NDRC, MFTE Group, June 23, 1945.
67. *A Comparison of Space Requirements for Flame Throwers Propelled by Pumps and by Compressed Gas*, Abbott Byfield, Massachusetts Institute of Technology, May 7, 1945. Div. 11-302.4-M3
68. *Trip to Eastman Kodak of May 25, 1945*, H. C. Hottel, Massachusetts Institute of Technology, May 26, 1945. Div. 11-302.4-M4
69. *Agreements Reached at Rochester Conference on Development of Pump-Operated Flame Thrower, August 3, 1945*, H. C. Hottel, Massachusetts Institute of Technology, Aug. 6, 1945. Div. 11-302.4-M5
70. *Studies of Thickened Liquids (Monthly Progress Reports covering period from April 15, 1943, to August 15, 1945)*, E. K. Carver, E. E. Bauer, and others, OEMsr-538, Service Projects CWS-10, CWS-12, and CWS-21, Eastman Kodak Co. Div. 11-303.1-M1

CONFIDENTIAL

CHAPTER 6

1. Letter to Brig. Gen. W. C. Kabrich. Subject, "Servicing Units for Mechanized Flame Thrower," N. F. Myers, Report PDN-2991, Standard Oil Development Co., Oct. 12, 1944.
Div. 11-302.2-M4
2. *Modification of Portable Flame Thrower for Thickened Fuels*, N. F. Myers, G. H. Garraway, and others, OSRD 983, OEMsr-390, OEMsr-661, and OEMsr-667, Project CWS-10, B-270, B-367, and others, Report 391, Standard Oil Development Co., Factory Mutual Research Corp., and Nuodex Products Co., Oct. 12, 1942.
Div. 11-302.12-M2
3. *Description of Mobile Servicing Unit for Flame Throwers*, S. H. Hulse and Ray L. Betts, Report PDN-2440, Standard Oil Development Co., Apr. 29, 1944.
Div. 11-302.2-M2
4. *Development of Mobile Servicing Unit for Flame Throwers*, OSRD 4434, OEMsr-390 and OEMsr-1266, Service Project CWS-10, Report PDN-3000, Standard Oil Development Co., Dec. 7, 1944.
Div. 11-302.2-M5
5. *Mobile Servicing Unit for Flame Throwers*, OEMsr-390 and OEMsr-1266, Report PDN-2760, Aug. 23, 1944.
Div. 11-302.2-M3
6. *Service Unit, E-8, for Use with Mechanized Flame Throwers*, OSRD 5127, OEMsr-390, Service Project CWS-10, Report PDN-3500, Standard Oil Development Co., May 29, 1945.
Div. 11-302.2-M8
7. *Letter Report on Service Unit, Mechanized Flame Thrower E8*, Armored Board, Apr. 4, 1945.
8. *Development of Mobile Service Equipment for Mechanized Flame Throwers*, OSRD 6014, OEMsr-390, Service Project CWS-10, Final Report PDN-3975, Standard Oil Development Co., Oct. 18, 1945
Div. 11-302.2-M9
9. *Operating Instructions for Mixer, Thickened Fuel Flame Thrower, E6*, CWS (Unpublished).
10. *Development of Flame Throwers, Service Units and Thickened Fuels*, OSRD 6376, OEMsr-390, Service Project CWS-21, Report PDN-4027, Standard Oil Development Co., Oct. 31, 1945.
Div. 11-302-M5
11. *Mobile Servicing Unit, E Consideration of Design Changes*, Ray L. Betts and S. H. Hulse, Report PDN-3241, Standard Oil Development Co., Jan. 5, 1945.
Div. 11-302.2-M6
12. *Production of Thickened Fuels Using Fast-Setting Napalm at High Temperature*, OSRD 6011, OEMsr-390, Service Project CWS-10, Report PDN-3900, Standard Oil Development Co., Aug. 31, 1945.
Div. 11-303.11-M15
13. *Instruction Pamphlet No. 1, Compressor, Air, Gasoline Engine Driven, 60 CFM, E8*, CWS (Unpublished).
14. *Letter Report of Preliminary Test of Flame Thrower, Mechanized E14-7R2; Mixer, Thickened Fuel, E6; and Compressor, Air, E8*, Landing Vehicle Board, Aug. 3, 1945.
15. *Ferro-Cleaver Brooks Mixer*, E. K. Carver, Oct. 5, 1945.
Div. 11-303.2-M2
16. *Testing of Ferro Enamel Napalm Gasoline Mixer*, Robert W. Bond, TCIR 251, CWS, Feb. 9, 1945.
17. *Self-Powered Portable Mixing Unit*, C. E. Reed, Apr. 19, 1945.
Div. 11-303.2-M1
18. *Projector, Anti-Personnel, Tank, E1*, War Department, TB CW(32) (Tentative), Aug. 1945.
19. *The Scorpion*, T. L. Wheeler and A. Bogrow, OEMsr-242, Service Project CWS-21, Arthur D. Little, Inc., Feb. 7, 1945.
Div. 11-302.31-M1
20. *Anti-Personnel Protection Device for Tanks (Scorpion)*, H. L. Allen, Armored Board, Feb. 9, 1945.
21. *Anti-Personnel Protection Device for Tanks (Scorpion)*, P-633, L. V. Hightower, Armored Board, Feb. 22, 1945.
22. *Phosphorus-Phosphorus Sesquisulfide Eutectic as a Special Flame Thrower Fuel*, T. L. Wheeler and A. Bogrow, OSRD 5523, OEMsr-242, Service Project CWS-10, Arthur D. Little, Inc., Aug. 3, 1945.
Div. 11-303.13-M2
23. *Countermeasures against Flame. Memorandum of Conference on Project NS-317 on September 22, 1944*, H. C. Hottel, Service Project NS-317, Arthur D. Little, Inc., Sept. 23, 1944.
Div. 11-302.53-M1
24. *Studies of Special Flame Thrower Fuels and Development of Countermeasures against Flame Throwing Equipment* (Monthly Progress Report covering period from January 15 to February 15, 1945), T. L. Wheeler and A. Bogrow, OEMsr-242, Service Project CWS-21, Arthur D. Little, Inc., Feb. 19, 1945.
Div. 11-302.53-M2
25. *Conning Tower Port Plugs*, T. L. Wheeler and Roger C. Griffin, OEMsr-242, Arthur D. Little, Inc., May 21, 1945.
Div. 11-302.52-M1
26. *Protection of Ship Conning Towers*, T. L. Wheeler, Roger C. Griffin, and Arthur L. Brown, OSRD 5356, OEMsr-242, Service Project NS-317, Arthur D. Little, Inc., July 19, 1945.
Div. 11-302.52-M2
27. *Protection of Ship Conning Towers*, T. L. Wheeler and Roger C. Griffin, OSRD 6013, OEMsr-242, Service Project NS-317, Arthur D. Little, Inc., Sept. 17, 1945.
Div. 11-302.52-M3
28. *The Skink, Formerly Scorpion*, Allen Latham, Jr., Arthur D. Little, Inc., Apr. 12, 1945.
Div. 11-302.31-M2
29. *Thickened EWP Fuels and Ejection Devices for Eutectic White Phosphorus Fuels*, T. L. Wheeler and A. Bogrow, OSRD 5524, OEMsr-242, Service Project CWS-10, Arthur D. Little, Inc., Aug. 15, 1945.
Div. 11-303.13-M3

CONFIDENTIAL

CHAPTER 7

1. *Study of Disintegration of Liquid Jets in Air*, H. C. Hottel and L. W. Russum, Nov. 23, 1941. Div. 11-303.42-M1
2. *Memorandum of Meeting of Group at MIT, Tuesday, March 3, 1942 to Discuss Flame Throwers*, H. C. Hottel, Massachusetts Institute of Technology, March 1942. Div. 11-302-M1
3. *Effect of Nozzle Design on the Range of Burning Jets*, OSRD 685, E. W. Cousins, Factory Mutual Research Corp., July 8, 1942.
4. *Studies on Fuel Projection from Nozzles*, H. C. Hottel, OSRD 615, OEMsr-21, Projects CWS-10 and B-109, Report 261, Massachusetts Institute of Technology, June 8, 1942. Div. 11-303.43-M1
5. *Characteristics of Fluid Jets, Interim Report No. 4, a Photographic Study of Jets on Non-Newtonian Liquids from Various Types of Nozzles*, R. P. Fraser, J. M. Connor, and M. O. Coulter, Imperial College of Science, Jan. 31, 1943.
6. *Development of Flame Thrower for M-5 Tank*, OSRD 4432, OEMsr-1011, Service Project CWS-10, Standard Oil Co. of Indiana, Dec. 6, 1944.
7. *Factors Governing the Performance of Flame Throwers*, G. A. Agoston and W. A. Klemm, OSRD 4981, Massachusetts Institute of Technology, Apr. 30, 1945.
8. *Study of Mechanized Flame Throwers* (Monthly Progress Reports covering period from May 15 to August 15, 1943), R. D. Dawson, OEMsr-916, Service Project CWS-10, Shell Development Co. Div. 11-303-M4
9. *Description of C. F. Braun and Company Flame Thrower*, G. P. Klaas, C. F. Braun and Co., Aug. 8, 1944. Div. 11-302.323-M7
10. *The E-13-13 Flame Gun and Equipment in M-4A1 Tank*, Myles Morgan, OSRD 5711, OEMsr-1364, Service Project CWS-10, Morgan Construction Co., Sept. 17, 1945. Div. 11-302.322-M8
11. *Joint CWS-NDRC Mechanized Flame Thrower Evaluation Project*, A. W. Adkins, G. A. Agoston, and others, OSRD 5933, OEMsr-21, Service Project CWS-10, Massachusetts Institute of Technology, June 30, 1945. Div. 11-302.322-M6
12. *Studies of Thickened Liquids* (Monthly Progress Report), E. E. Bauer and E. K. Carver, Eastman Kodak Co., Feb. 15, 1945.
13. *Flame Throwers, Incendiaries and Their Evaluation*, Abbott Byfield, W. A. Klemm, G. A. Agoston, OSRD 6190, OEMsr-21, Service Projects CWS-10 and CWS-21, Massachusetts Institute of Technology, Oct. 1, 1945. Div. 11-300-M1
14. *Studies of Thickened Liquids* (Monthly Progress Report), E. E. Bauer and E. K. Carver, Eastman Kodak Co., Apr. 14, 1945.
15. *Portable Flame Thrower Nozzle Diameter*, J. H. Carpenter and C. H. King, Jr., Massachusetts Institute of Technology—M.R. No. 106, CWS, Oct. 10, 1944.
16. *Flow of Napalm Thickened Gasoline in Pipes and Nozzles*, A. L. Brown and C. W. Cousins, OSRD 3522, OEMsr-661, Service Project CWS-10, Factory Mutual Research Corp., Apr. 25, 1944. Div. 11-303.43-M2
17. *Properties of Thickened Liquids*, R. L. Pigford, OSRD 4284, E. I. du Pont de Nemours and Co., Oct. 25, 1944.
18. *Studies of Thickened Liquids* (Monthly Progress Report), E. E. Bauer and E. K. Carver, Eastman Kodak Co., Nov. 15, 1944.
19. *Fluid Meters*, A.S.M.E., 4th Ed. 1937.
20. *Status of NDRC Projects on Flame Throwers*, H. C. Hottel and G. H. Garraway, Report 272, OEMsr-21, 167, 390, and 470; Service Projects CWS-10, B-109, and others; OSRD 637, Massachusetts Institute of Technology and Standard Oil Development Co., June 20, 1942. Div. 11-302-M2
21. *Rheological Properties of Thickened Liquids*, E. K. Carver and G. Broughton, OSRD 1113, Eastman Kodak Co., Dec. 7, 1942.
22. *Rheological Properties of Thickened Liquids* (Second Report), E. K. Carver and John R. Van Wazer, Jr., OSRD 1389, OEMsr-538, Service Projects CWS-10, CWS-12, and CWS-21, Eastman Kodak Co., May 7, 1943. Div. 11-303.1-M2
23. *Fragmentation of Liquids*, T. H. Chilton, R. L. Pigford, and J. B. Tipe, OSRD 1503, E. I. du Pont de Nemours and Co., May 31, 1943.
24. *Properties of Thixotropic, Dilatant and Other Fluids* (Progress Reports 10 and 11), G. Broughton and E. K. Carver, OEMsr-538, Mar. 15 and Apr. 15, 1943. Div. 11-303.44-M1
25. *U.S. Navy Mark I Flame Thrower. Effect of Operating Pressure and Wind on Range*, J. O. Collins, Report PDN-2602, Standard Oil Development Co., June 19, 1944. Div. 11-303.41-M2
26. *The Effect of Wind on Flame Thrower Range*, OEMsr-21, Service Project CWS-10, Massachusetts Institute of Technology, Feb. 10, 1944. Div. 11-303.41-M1
27. *Studies of Thickened Liquids* (Monthly Progress Report), G. Broughton and E. K. Carver, Eastman Kodak Co., Jan. 15, 1944.
28. *Use of Flame on Japanese Bunkers*, OSRD 2990, OEMsr-390, Service Project CWS-10, Standard Oil Development Co., Dec. 4, 1943. Div. 11-302.51-M1
29. *Report on Mechanized Flame Throwers*, NDRC 11.3 and CWS, July 15, 1945.
30. *Fuel and Nozzle Study. The E-14-7R2 Flame Thrower in LVT-A1 Amphibious Tank*, J. O. Collins, Report PDN 4112, Standard Oil Development Co., Jan. 18, 1946. Div. 11-302.321-M4

CONFIDENTIAL

CHAPTER 8

1. *Memorandum on Incendiaries*, Louis F. Fieser, Harvard University, Feb. 25, 1942.
Div. 11-303.11-M1
2. *Recommendations for the Fillings and Firing of the 100 Lb. Oil Incendiary Bomb*, Louis F. Fieser, OSRD 587, Harvard University, May 25, 1942.
3. *History of Napalm*, Louis F. Fieser, Sept. 24, 1942.
Div. 11-303.11-M3
4. *Compound X-104-B, Formula No. 1*, Arthur Minich, Nuodex Products Co., Inc., Nov. 14, 1942.
Div. 11-303.11-M4
5. *Characteristics of Aluminum Soap Gels of the Napalm Type*, Ray L. Betts and N. F. Myers, OSRD 1345, Standard Oil Development Co., Apr. 15, 1943.
6. *Invention Report on Incendiaries, Part I, Gelled Fuels of the Napalm Type*, Benton A. Bull, May 1, 1943.
Div. 11-303.12-M3
7. *The Stability of Incendiary Gels (First Report)*, OEMsr-538, Eastman Kodak Co., June 1, 1943.
Div. 11-303.12-M4
8. *Incendiary Oil. Solid and Viscous, Firing Behavior and Gardner Consistencies of Napalm Type Fillings for the M69 Bomb*, W. H. Bauer and H. Barnard, TDMR 694, CWS, Aug. 20, 1943.
9. Letter to H. C. Hottel. Subject, "The Inhibition of the Oxidation of Napalm Soap," E. R. White, Shell Development Co., Aug. 30, 1943.
Div. 11-303.11-M5
10. *The Manufacture, Properties and Testing of Napalm Soaps*, G. Broughton and Abbott Byfield, OSRD 2036, Service Projects CWS-10 and CWS-21, Eastman Kodak Co., Nov. 17, 1943.
Div. 11-303.11-M7
11. *Thickener, Napalm*, CWS Specification 196-131-107A, CWS, Dec. 28, 1943.
12. *The Preparation and Properties of Aluminum Naphthenate Soaps*, S. B. Elliott, OEMsr-882, Ferro Drier and Chemical Co., Jan. 3, 1944.
Div. 11-303.11-M8
13. *Oils, Incendiary, Determination of the Consistency of*, CWS Directive 201B, CWS, Jan. 12, 1944.
14. *Studies of Thickened Liquids (Monthly Progress Report)*, G. Broughton and E. K. Carver, Eastman Kodak Co., Jan. 15, 1944.
15. *Oil, Incendiary, NP, Type III*, CWS Specification 196-131-244, CWS, Feb. 8, 1944.
16. *Studies of Thickened Liquids (Monthly Progress Report)*, E. E. Bauer and E. K. Carver, Eastman Kodak Co., Feb. 15, 1944.
17. *The Manufacture, Properties and Testing of Napalm Soaps*, G. Broughton and Abbott Byfield, OSRD 2036a, Service Projects CWS-10 and CWS-21, Eastman Kodak Co., Mar. 7, 1944.
Div. 11-303.11-M9
18. *Studies of Thickened Liquids (Monthly Progress Report)*, E. E. Bauer and E. K. Carver, Eastman Kodak Co., Mar. 15, 1944.
19. *Studies of Thickened Liquids (Monthly Progress Report)*, E. E. Bauer and E. K. Carver, Eastman Kodak Co., Apr. 15, 1944.
20. *Flame Thrower Fuels*, R. D. Dawson and E. R. White, OSRD 3506, OEMsr-916, Service Project CWS-10, Shell Development Co., Apr. 20, 1944.
Div. 11-303.12-M7
21. *Consistency of Napalm Gels*, E. K. Carver and E. E. Bauer, OSRD 3508, OEMsr-358, Service Projects CWS-10 and CWS-21, Eastman Kodak Co., Apr. 20, 1944.
Div. 11-303.12-M8
22. *Studies of Thickened Liquids (Monthly Progress Report)*, E. E. Bauer and E. K. Carver, Eastman Kodak Co., May 15, 1944.
23. *Development of Incendiary Fuels*, Rush F. McCleary and Bill L. Bengel, OSRD 3762, OEMsr-898, Service Project CWS-21, The Texas Co., June 10, 1944.
Div. 11-301.15-M4
24. *Aluminum Soaps for Thickening Gasoline*, G. H. McIntyre and S. B. Elliott, OSRD 3772, OEMsr-882, Service Projects CWS-10 and CWS-21, Ferro Drier and Chemical Co., June 13, 1944.
Div. 11-303.11-M11
25. *Studies of Thickened Liquids (Monthly Progress Report)*, E. E. Bauer and E. K. Carver, Eastman Kodak Co., June 15, 1944.
26. *Studies of Thickened Liquids (Monthly Progress Report)*, E. E. Bauer and E. K. Carver, Eastman Kodak Co., July 15, 1944.
27. *Studies of Thickened Liquids (Monthly Progress Report)*, E. E. Bauer, Eastman Kodak Co., Aug. 15, 1944.
28. *Studies of Thickened Liquids (Monthly Progress Report)*, E. E. Bauer and E. K. Carver, Eastman Kodak Co., Sept. 15, 1944.
29. *Fundamental Study of the Structure and Characteristics of Soap-Thickened Fuels (Report covering period from May 1943 to June 1944)*, J. W. McBain, OSRD 4205, OEMsr-1057, Service Projects CWS-10 and CWS-21, Stanford University, June 1944.
Div. 11-303.11-M10
30. *Studies of Thickened Liquids (Monthly Progress Report)*, E. E. Bauer and E. K. Carver, Eastman Kodak Co., Oct. 15, 1944.
31. *Studies of Thickened Liquids (Monthly Progress Report)*, E. E. Bauer and E. K. Carver, Eastman Kodak Co., Nov. 15, 1944.
32. *Meeting to Consider Eliminating Napthenic Acids from the Napalm Formula, at Dumbarton Oaks, November 3, 1944*, E. E. Bauer, Eastman Kodak Co., Nov. 17, 1944.
Div. 11-303.11-M12
33. *Studies of Thickened Liquids (Monthly Progress Report)*, E. E. Bauer and E. K. Carver, Eastman Kodak Co., Dec. 15, 1944.

CONFIDENTIAL

34. *Fundamental Study of the Structure and Characteristics of Soap-Thickened Fuels*. (Report covering period from July 1944 to December 1944), J. W. McBain, OEMsr-1057, Service Projects CWS-10 and CWS-21, Stanford University, December 1944. Div. 11-303.11-M13
35. *Effect of Thickener and Gasoline Quality on the Properties of Napalm Fuels*, Ray L. Betts, OSRD 4522, OEMsr-390 and OEMsr-354, Service Projects CWS-10 and CWS-21, Standard Oil Development Co., Jan. 1, 1945. Div. 11-303.11-M14
36. *Studies of Thickened Liquids* (Monthly Progress Report), E. E. Bauer and E. K. Carver, Eastman Kodak Co., Jan. 15, 1945.
37. *Oil, Incendiary, NP, Type I*, Specification 196-131-161B, CWS, Feb. 1, 1945.
38. *Studies on Thickened Liquids* (Monthly Progress Report), E. E. Bauer and E. K. Carver, Eastman Kodak Co., Feb. 14, 1945.
39. *Oil, Incendiary, NP, Type II*, Specification 196-131-103C, CWS, Mar. 12, 1945.
40. *Studies on Thickened Liquids* (Monthly Progress Report), E. E. Bauer and E. K. Carver, Eastman Kodak Co., Mar. 15, 1945.
41. *The Effect of Drying Agents on Napalm Thickened Fuels*, 43rd Chemical Laboratory Co., CWS, Mar. 16, 1945.
42. *Studies of Thickened Liquids* (Monthly Progress Report), E. E. Bauer and E. K. Carver, Eastman Kodak Co., Apr. 15, 1945.
43. *A New Theory and Tactic of Flame Thrower Warfare*, 43rd Chemical Laboratory Co., CWS, May 7, 1945.
44. *Studies of Thickened Liquids* (Monthly Progress Report), E. E. Bauer and E. K. Carver, Eastman Kodak Co., May 15, 1945.
45. *Cooperative Procedure Log Reports 1-19*, R. G. DeGray, CWS, August 1944 to May 1945.
46. *Studies of Thickened Liquids* (Monthly Progress Report), E. E. Bauer and E. K. Carver, Eastman Kodak Co., June 15, 1945.
47. *Manufacturing Conditions and Results of Stability Tests on Selected Batches of Incendiary Gel*, National Oil Refineries, Ltd., June 20, 1945.
48. *Studies of Thickened Liquids* (Monthly Progress Report), E. E. Bauer and E. K. Carver, Eastman Kodak Co., July 15, 1945.
49. *Studies of Thickened Liquids* (Monthly Progress Reports covering period from April 15, 1943, to August 15, 1945), E. K. Carver, E. E. Bauer, and others, OEMsr-538, Service Projects CWS-10, CWS-12, and CWS-21, Eastman Kodak Co. Div. 11-303.1-M1
50. *Production of Thickened Fuels Using Fast Setting Napalm at High Temperatures*, OSRD 6011, OEMsr-390, Service Projects CWS-10, Report PDN-3900, Standard Oil Development Co., Aug. 31, 1945. Div. 11-303.11-M15
51. *A Study of Aluminum Soaps for Thickening Gasoline*, K. E. Long and John Dickenson, OSRD 6349, OEMsr-847, Service Projects CWS-10 and CWS-21, Harshaw Chemical Co., Sept. 30, 1945. Div. 11-303.11-M16
52. *Studies of Thickened Liquids and Miscellaneous Flame Thrower Problems*, E. E. Bauer and E. K. Carver, OSRD 6236, OEMsr-358, Service Projects CWS-10, CWS-12, and CWS-21, Eastman Kodak Co., Oct. 23, 1945. Div. 11-303-M6
53. *The Mechanized Gardner Mobilometer*, E. L. McMillen and E. K. Carver, OSRD 6234, OEMsr-358, Service Projects CWS-10 and CWS-21, Eastman Kodak Co., Oct. 30, 1945. Div. 11-303.12-M10
54. *Performance of Peptized Napalm Fuels III* (Report 2029), Experimental Station, Suffield, Alberta, Canada.
55. *Aluminum Cresylate from Petroleum Cresylic Acids*, G. C. Brock and A. G. Orr, OSRD 6237, OEMsr-1468, Service Project CWS-10, California Research Corp., Sept. 29, 1945. Div. 11-303.14-M1
56. *Isobutyl Methacrylate Polymer NR*, Specification 196-131-119, CWS, Nov. 28, 1942.
57. *Oil Incendiary, IM, Type II*, Specification 196-131-120, CWS, Dec. 29, 1942.
58. *Properties and Examination of IM, Type III Incendiary Fuel*, E. C. Kirkpatrick, E. I. duPont de Nemours and Co., Inc., Apr. 26, 1943. Div. 11-303.12-M2
59. *Oil, Incendiary, IM, Type I*, Specification 196-131-102A, CWS, Apr. 29, 1943.
60. *Study of Chemical Warfare Service IM-1 Formula Modifications*, E. I. duPont de Nemours and Co., Inc., May 19, 1943. Div. 11-301.3-M7
61. *Methacrylate Interpolymers as Gasoline Thickening Agents*, E. C. Kirkpatrick, OSRD 3763, OEMsr-744, Service Project CWS-21, E. I. duPont de Nemours and Co., Inc., June 10, 1944. Div. 11-303.12-M9
62. *Synthetic Polymers as Gasoline Thickening Agents*, E. C. Kirkpatrick, OSRD 4202, OEMsr-744, Service Project CWS-21, E. I. duPont de Nemours and Co., Oct. 2, 1944. Div. 11-301.3-M8
63. *Isobutyl Methacrylate Polymer AE*, Specification 196-131-108A, CWS, Mar. 6, 1945.
64. *Oil, Incendiary, IM, Type III*, Specification 196-131-145B, CWS, Mar. 28, 1945.
65. *The Development of Oil Incendiary Bombs*, R. P. Russell, OSRD 382, Report 176, OEMsr-183, Service Projects CWS-21 and B-204, Standard Oil Development Co., Feb. 7, 1942. Div. 11-301.4-M1
66. *The Development of Oil Incendiary Bombs* (Supplement to Report 243), R. P. Russell, OSRD 577, OEMsr-183, Projects CWS-21 and B-204, Standard Oil Development Co., May 14, 1942. Div. 11-301.4-M3
67. *Waste-Gasoline-Oil Mixture for Filling the Esso Incendiary Bomb*, E. A. Blair, Factory Mutual Research Corp., June 9, 1942.

CONFIDENTIAL

68. *The Use of Cellocotton in the M-69 Bomb. Memorandum on Work Done at Kodak Park*, OEMsr-538, Eastman Kodak Co., Feb. 15, 1943. Div. 11-301.146-M2
69. *Use of Cellocotton in the M-69 Bomb*, G. L. Matheson and P. Miller, OEMsr-354, Report PDN-950, Standard Oil Development Co., Feb. 15, 1943. Div. 11-301.146-M1
70. *Cellulose Wadding (Cellocotton) with Gasoline as a Fuel for the 500-lb Incendiary Bomb*, Norman J. Thompson, OEMsr-257, Factory Mutual Research Corp., July 28, 1943. Div. 11-301.161-M1
71. *Gasoline-Cellocotton Filling for the 500-Pound Incendiary Bomb*, Norman J. Thompson, OSRD 1702, OEMsr-257, Service Project CWS-21, Factory Mutual Research Corp., Aug. 11, 1943. Div. 11-301.161-M2
72. *Incendiary Bomb Fillings for Industrial Targets*, Norman J. Thompson and Morrill Dakin, OSRD 2048, OEMsr-257, Service Project CWS-21, Factory Mutual Research Corp., Nov. 23, 1943. Div. 11-301.16-M2
73. *The E-22 500-lb Incendiary Bomb, Tail Ejection Type*, Norman J. Thompson, OEMsr-257, Service Project CWS-21, Factory Mutual Research Corp., May 23, 1944. Div. 11-301.15-M3
74. *Production of Incendiaries from Acetylene. Polymers (DVA and SDO)* (Report to Sept. 15, 1941), Louis F. Fieser, OSRD 174, OEMsr-25, Projects CWS-21 and B-117, Harvard University, Nov. 10, 1941. Div. 11-303.12-M1
75. *Experiments with Incendiary Mixtures. Fire Structure and Development of Incendiary Bombs*, Norman J. Thompson, OSRD 657, OEMsr-257, Service Project CWS-21, Report 277, Factory Mutual Research Corp., June 24, 1942. Div. 11-301.3-M5
76. *Development of SDO as an Incendiary Material, Particularly as a Hand Incendiary*, M. S. Kharasch and F. H. Westheimer, OSRD 677, University of Chicago, July 6, 1942.
77. Letter to R. H. Ewell. Subject, "Thickened Fuels," Henry Gould, Nuodex Products Co., Inc., Sept. 10, 1942. Div. 11-303.11-M2
78. *Development of Incendiary Mixtures*, Norman J. Thompson, and Edwin A. Blair, OSRD 1123, OEMsr-257, Projects CWS-21 and B-231, Factory Mutual Research Corp., Jan. 13, 1943. Div. 11-301.3-M6
79. *Experiments with Alternate Fillings for Bomb Incendiary, 9-Pound E-1*, Morrill Dakin, OEMsr-257, Factory Mutual Research Corp., Aug. 23, 1943. Div. 11-301.16-M1
80. *Exploratory Experiments on the Use of Metallic Sodium in Incendiaries*, J. W. McBain, K. J. Myselsaand, G. H. Smith, Stanford University, Nov. 8, 1943.
81. *The Use of Fortified Fuel in Flame Throwers, Incendiary Bombs and Incendiary Mortars, with an Appendix on: Turpentine, Carbon Disulfide Gels as Flame Thrower Fuels*, Norman J. Thompson, E. M. Cousins, and Edwin A. Blair, OSRD 3196, OEMsr-257, Service Projects CWS-10 and CWS-21, Factory Mutual Research Corp., Jan. 29, 1944. Div. 11-303.12-M5
82. *Studies of Special Thickened Flame Thrower Fuels*, Frederick S. Bacon and A. Bogrow, OEMsr-242, Service Project CWS-21, Arthur D. Little, Inc., Apr. 20, 1944. Div. 11-303.1-M3
83. *Preparation of Organometallic Compounds as Sources of Toxic Oxide Smokes and Flame-Thrower Fuels*, H. Gilman, OSRD 314, Iowa State College, Jan. 9, 1942.
84. *Preparation of Triethylboron to be Used Generally in Incendiaries and for Ignition of Oil on Water*, H. Gilman, OSRD 871, Iowa State College, Aug. 7, 1942.
85. *Investigation of the Use of WP and WPPS as Igniters in the AN-M69 Bomb*, N. Birnbaum and S. M. Edmonds, CUMR 17, CWS, Feb. 10, 1943.
86. *Chemical Ignition of Flame Throwers*, E. C. Kirkpatrick, OSRD 3507, OEMsr-744, Service Project CWS-10, E. I. duPont de Nemours and Co., Inc., Apr. 20, 1944. Div. 11-303.3-M4
87. *Phosphorus-Sulfur Flame Thrower Fuel*, T. L. Wheeler and L. B. Arnold, Jr., OSRD 5355, OEMsr-242, Service Project CWS-21, Arthur D. Little, Inc., June 15, 1945. Div. 11-303.13-M1
88. *Phosphorus-Phosphorus Sesquisulfide Eutectic as a Special Flame Thrower Fuel*, T. L. Wheeler and A. Bogrow, OSRD 5523, OEMsr-242, Service Project CWS-10, Arthur D. Little, Inc., Aug. 3, 1945. Div. 11-303.13-M2
89. *Thickened EWP Fuels and Ejection Devices for Eutectic White Phosphorus Fuels*, T. L. Wheeler and A. Bogrow, OSRD 5524, OEMsr-242, Service Project CWS-10, Arthur D. Little, Inc., Aug. 15, 1945. Div. 11-303.13-M3
90. *Thickened Eutectic White Phosphorus Fuels and Ejection Devices for EWP Fuels* (Supplementary report), T. L. Wheeler and J. J. Clancy, OSRD 5524a, OEMsr-242, Service Project CWS-10, Arthur D. Little, Inc., Oct. 22, 1945. Div. 11-303.13-M4
91. *Rheological Properties of Thickened Liquids*, E. K. Carver and G. Broughton, OSRD 1113, Eastman Kodak Co., Dec. 7, 1942.
92. *Properties of Thixotropic, Dilatant and Other Fluids* (Progress Reports 10 and 11), G. Broughton and E. K. Carver, OEMsr-538, Mar. 15 and Apr. 15, 1943. Div. 11-303.44-M1
93. *Rheological Properties of Thickened Liquids* (Second Report), E. K. Carver and John R. Van Wazer, Jr., OSRD 1389, OEMsr-538, Service Projects CWS-10, CWS-12, and CWS-21, Eastman Kodak Co., May 7, 1943. Div. 11-303.1-M2
94. *Studies of Thickened Liquids* (Monthly Progress

CONFIDENTIAL

- Report), E. K. Carver and G. Broughton, Eastman Kodak Co., May 15, 1943.
95. *Studies of Thickened Liquids* (Monthly Progress Report), E. K. Carver and G. Broughton, Eastman Kodak Co., June 15, 1943.
96. *Studies of Thickened Liquids* (Monthly Progress Report), C. Wynd and G. Broughton, Eastman Kodak Co., July 15, 1943.
97. *Studies of Thickened Liquids* (Monthly Progress Report), E. K. Carver, Eastman Kodak Co., Aug. 15, 1943.
98. *Studies of Thickened Liquids* (Monthly Progress Report), E. K. Carver, Eastman Kodak Co., Sept. 15, 1943.
99. *Rheological Measurements on Thickened Vesicants*, E. K. Carver and J. R. Van Wazer, Jr., OSRD 1893, Eastman Kodak Co., Oct. 5, 1943.
100. *Studies of Thickened Liquids* (Monthly Progress Report), E. K. Carver, Eastman Kodak Co., Oct. 15, 1943.
101. *Studies of Thickened Liquids* (Monthly Progress Report covering period from October 15 to November 15, 1943), G. Broughton and E. K. Carver, OEMsr-538, Service Projects CWS-10 and CWS-21, Eastman Kodak Co., Nov. 15, 1943.
Div. 11-303.11-M6
102. *Studies of Thickened Liquids* (Monthly Progress Report), E. K. Carver, Eastman Kodak Co., Dec. 15, 1943.
103. *Properties of Thickened Liquids*, R. L. Pigford, OSRD 4284, E. I. duPont de Nemours and Co., Oct. 25, 1944.

CONFIDENTIAL

OSRD APPOINTEES

DIVISION 11

Division 11 was organized on December 9, 1942 when former Division B of the NDRC was broken up into four new Divisions, 8, 9, 10 and 11, known as the Chemical Divisions. Former Division B was under the Chairmanship of Roger Adams and had ten sections, each of which had one or more subsections. Division 11 was made up of Sections B-7, B-8, part of B-9 and B-10 (together with subsections B-7-b, B-7-d, B-7-e, B-8-a, B-8-b, B-8-c, B-8-d, B-8-e, B-8-f, B-9-a and B-9-d) of former Division B. Subsections B-9-b and B-9-c of Section B-9 were later incorporated in a new Division 19.

The list which appears below therefore shows essen-

tially the organization since December 9, 1942. Although many changes were made during the years 1943-1945, the names of all appointees who held appointments to Division 11 at any time during this period have been included. In addition, the names of men who held appointments in the sections and subsections of former Division B, but who did not have appointments to Division 11 following the reorganization, have been included so as to give a complete picture of the organization since the beginning of the work under NDRC.

Section 11.3 comprises Subsections B-7-d and B-7-e and Section B-10 of former Division B.

Chiefs

R. P. RUSSELL

H. M. CHADWELL

E. P. STEVENSON

Technical Aide

D. CHURCHILL, JR.

Members

D. CHURCHILL, JR.
E. R. GILLILAND
H. C. HOTTEL
H. F. JOHNSTONE

E. P. STEVENSON

W. K. LEWIS
J. H. RUSHTON
R. P. RUSSELL
T. K. SHERWOOD

SECTION 3

Chiefs

N. F. MYERS

H. C. HOTTEL

Technical Aides

R. H. EWELL
C. C. FURNAS
S. M. JONES

C. E. REED

C. S. KEEVIL
R. E. LOOP
R. M. NEWHALL

Members

H. J. BILLINGS
E. K. CARVER
L. F. FIESER
H. O. FORREST
C. R. HOOVER
H. C. HOTTEL
H. F. JOHNSTONE
C. A. KRAUS

W. E. KUHN
T. V. MOORE
J. D. MURCH
N. F. MYERS
J. K. ROBERTS
R. P. RUSSELL
E. P. STEVENSON
N. J. THOMPSON

CONFIDENTIAL

CONTRACT NUMBERS, CONTRACTORS AND SUBJECT OF CONTRACTS

<i>Contract Numbers</i>	<i>Name and Address of Contractor</i>	<i>Subject</i>
OEMsr-21 (11-109)	Massachusetts Institute of Technology Cambridge, Massachusetts	Design of Flame Thrower Nozzles; Applications of Thickened Fuels; Miscellaneous Problems Relating to Incendiaries and Flame Throwers; Design and Construction and Installation of a Large Flame Thrower in an M-4 Tank, Maintenance and Operation of Facilities for Testing of Incendiaries at Edgewood Arsenal, Md.
OEMsr-25 (11-117) (Superseded by OEMsr-179)	Harvard University Cambridge, Massachusetts	Preparation and Properties of DVA as an Incendiary and the Development of Containers for this Material.
OEMsr-57 (11-146)	Brown University Providence, Rhode Island	Development of Incendiary Devices.
OEMsr-113 (11-157)	University of Chicago Chicago, Illinois	Development of the "Chicago Incendiary" and Possible Use of the Material Developed as a U.P. Propellant.
OEMsr-167 (11-110) (Superseded by OEMsr-661)	Associated Factory Mutual Fire Insurance Companies Boston, Massachusetts	Development of nozzles for the projection of jets of combustible liquids, including nozzles approximately one-half inch in diameter suitable for use on portable flame throwers; studies of the general design of such equipment.
OEMsr-179 (11-186) (Replacing OEMsr-25)	Harvard University Cambridge, Massachusetts	Study of organic incendiary materials and organic materials of possible use as U. P. propellants; development of new types of incendiary bombs; determination of the ballistic characteristics of such munitions by means of wind tunnel tests.
OEMsr-179; Sub- contract No. 1	Morgan Construction Company Worcester, Massachusetts	Fabrication of test samples of E-1 incendiary bomb casings and of E-1 500-lb. incendiary bomb assemblies.
OEMsr-183 (11-204) (Superseded by OEMsr-354)	Standard Oil Development Company New York, New York	Development of oil incendiaries.
OEMsr-198 (11-202)	Monsanto Chemical Company Springfield, Massachusetts	Development of a nitrocellulose container for incendiary materials; development of a nitrocellulose incendiary.
OEMsr-234 (11-205)	Massachusetts Institute of Technology Cambridge, Massachusetts	Studies of the kindling characteristics of wood.
OEMsr-242 (11-203)	Arthur D. Little, Inc. Cambridge, Massachusetts	Development of weapons and munitions relating to chemical warfare including incendiaries, flame throwers and organic and inorganic incendiary mixtures for use therein; development of countermeasures against flame throwers; study of combined HE-IB attack on precision targets.
OEMsr-242; Sub- contract No. 1	William L. Gilbert Clock Corporation Winsted, Connecticut	Production of 600 special fuze units in accordance with Arthur D. Little, Inc., Assembly Drawing No. B1005; development of any modification that may become necessary as a result of the construction of these units.

CONFIDENTIAL

247

PRECEDING PAGE BLANK-NOT FILLED

CONTRACT NUMBERS, CONTRACTORS AND SUBJECT OF CONTRACTS

<i>Contract Numbers</i>	<i>Name and Address of Contractor</i>	<i>Subject</i>
OEMsr-257 (11-231)	Factory Mutual Research Corporation Boston, Massachusetts	Development and testing of incendiary materials and incendiary bombs; selection and provision of certain instruments required for testing of incendiaries by the National Defense Research Committee at Edgewood Arsenal, Maryland.
OEMsr-296 (11-246)	Victor Chemical Works Chicago, Illinois	Development of processes for the utilization of phosphorus incendiaries.
OEMsr-354 (11-204) (Replaced OEMsr-183)	Standard Oil Development Company New York, New York	Development and production of oil incendiaries.
OEMsr-390 (11-270)	Standard Oil Development Company New York, New York	Development of flame throwers, especially the development of thickened fuels.
OEMsr-470 (11-279)	Gilbert and Barker Manufacturing Company Springfield, Massachusetts	Development of nozzles and ignition mechanisms to be used on flame throwers.
OEMsr-538 (11-300)	Eastman Kodak Company Rochester, New York	Study of the properties of thixotropic, dilatant, and other fluids applicable to flame throwers, incendiaries and vesicants.
OEMsr-538; Sub-contract No. 1. (Replaced OEMsr-1281)	Ferro Drier and Chemical Company Cleveland, Ohio	Development, design and construction of equipment for the continuous mixing of dry Napalm and other thickening agents with hydrocarbon fuels to produce uniform gels.
OEMsr-538; Sub-contract No. 2	Cleaver-Brooks Company Milwaukee, Wisconsin	Design and development of apparatus for the continuous mixing of Napalm and hydrocarbon fuels.
OEMsr-661 (11-367) (Replaced OEMsr-167)	Factory Mutual Research Corporation Boston, Massachusetts	Development of flame throwers, and, more particularly, attempt to improve the present portable flame thrower.
OEMsr-677 (11-368)	Nuedex Products Company, Inc. Elizabeth, N. J.	Development of methods and agents for thickening fuels for use in incendiary bombs and flame throwers and for thickening vesicants, with particular emphasis on the application of naphthenate soaps.
OEMsr-744 (11-364)	E. I. duPont de Nemours and Company, Ammonia Department Wilmington, Delaware	Development of agents and methods for thickening fuels for use in incendiary bombs and flame throwers and for thickening vesicants, with particular emphasis on the application of synthetic polymers.
OEMsr-847 (11-412)	Harshaw Chemical Company Cleveland, Ohio	Formulation of aluminum soap thickening agents and practical methods for their manufacture.
OEMsr-882 (11-416)	Ferro Drier and Chemical Company Cleveland, Ohio	Study of aluminum soap thickening agents.
OEMsr-898 (11-422)	The Texas Company 135 East 42nd Street New York, New York	Design, development and test of a medium-sized incendiary bomb, suitable for precision aiming and adapted to efficient loading on American aircraft.
OEMsr-898; Sub-contract No. 1	Foster-Wheeler Corporation New York, New York	Design, development and test of medium-sized incendiary bomb, suitable for precision aiming and adapted to efficient loading on American aircraft.

CONTRACT NUMBERS, CONTRACTORS AND SUBJECT OF CONTRACTS

<i>Contract Numbers</i>	<i>Name and Address of Contractor</i>	<i>Subject</i>
OEMsr-898; Sub-contract No. 2	Standard Products Company Detroit, Michigan (Port Clinton, Ohio)	Design, development and test of a medium-sized incendiary bomb, suitable for precision aiming and adapted to efficient loading on American aircraft.
OEMsr-916 (11-394)	Shell Development Company 400 Bush Street San Francisco, California	Development and production of improved fuels for flame throwers; development of flame throwers; design and development of mobile flame throwers.
OEMsr-943 (11-413)	C. F. Braun and Company Alhambra, California	Design, development, construction, and demonstration of mobile flame throwers.
OEMsr-1011 (11-447)	Standard Oil Company (Indiana) 910 S. Michigan Avenue Chicago, Illinois	Design and development of mobile flame throwers; development of fuels for flame throwers; development of a field unit for servicing flame throwers.
OEMsr-1011; Sub-contract No. 1	Merz Engineering Company Indianapolis, Indiana	Design and development of mobile flame throwers.
OEMsr-1057 (11-455)	Stanford University Stanford University, California	Studies of structure and characteristics of soap-thickened fuels.
OEMsr-1170 (11-470)	Ford, Bacon and Davis, Inc. New York, New York	Design and construction of test structure and bomb-proof shelter at Eglin Field, Florida.
OEMsr-1266 (11-483)	Davey Compressor Company Kent, Ohio	Design, construction and the furnishing of necessary shop drawings and layouts of two (2) servicing units for flame throwers.
OEMsr-1261 (11-488) (Superseded by OEMsr-538, sub-contract No. 1)	Ferro Drier and Chemical Company Cleveland, Ohio	Studies of methods of field mixing of flame thrower fuels.
OEMsr-1364 (11-498)	Morgan Construction Company Worcester, Massachusetts	Design of several different types of tank-mounted flame throwers; construction and installation in a M4A1 tank of an experimental flame thrower; construction of twenty (20) special flame guns.
OEMsr-1386 (11-499)	Consolidated Engineering Company Baltimore, Maryland	Construction of three buildings in accordance with certain drawings, entitled "Preliminary Layout-Test Laboratory for NDRC at Edgewood Arsenal."
OEMsr-1468 (11-512)	California Research Corporation 200 Bush Street San Francisco, California	Development of methods (1) for preparing aluminum cresylate from cresylic acids derived from petroleum and (2) for preparing satisfactory gels by the addition of such aluminum cresylate and fatty acids to hydrocarbon fuels.
OEMsr-1480 (11-514)	University of Iowa Iowa City, Iowa	Studies and experimental investigations in connection with (a) the design and construction of a flame thrower kit and the installation of such kit in a medium tank which will retain the main armament and (b) the construction of several additional flame thrower kits for installation in the field; engineering and consulting services for the construction of additional kits by Chemical Warfare Service contractors.

CONFIDENTIAL

249

SERVICE PROJECTS

The projects listed below were transmitted to the Executive Secretary, NDRC, from the War or Navy Department through either the War Department Liaison Office for NDRC or the Office of Research and Inventions (formerly the Coordinator of Research and Development), Navy Department.

*Service
Project
Number*

Title

Army Projects

CWS-10 Flame Thrower: (a) fuel composition (b) nozzle design.
CWS-12 Materials for Thickening and Increasing the Viscosity of Vesicants.
CWS-21 Study of Incendiary Materials.

Navy Projects

NO-164 Rockets and Rocket Projectors.
NS-317 The Development of Countermeasures Against Flame-Throwing Equipment.

Army-Navy Projects

AN-23 Studies of Combined HE-1B Attack on Precision Targets.

CONFIDENTIAL

251

PRECEDING PAGE BLANK-NOT FILLED

INDEX

The subject indexes of all STR volumes are combined in a master index printed in a separate volume. For access to the index volume consult the Army or Navy Agency listed on the reverse of the half-title page.

- Air compressor, Clark Bros., 148
 Air-drag cables for E53 bomb cluster, 36
 Allegheny Ballistics Laboratory, 102
 Aluminum alcoholates, 205
 Aluminum Company of America, 99
 Aluminum cresylate (camgel), 204
 Aluminum dilaurate, 216
 Aluminum palmitate, 192
 Aluminum soaps, 167, 192, 204, 215-216
 see also Napalm
 Aluminum stearate, 167
 Amines in gels, 205
 Amphibious tanks, flame throwers, 116
 AN-incendiary bomb types; *see under model number of individual bombs*
 Arthur D. Little, Inc., 49, 156-165
 Atelectasis (respiratory lesion), 159
- Ball viscosimeter, 201
 Bickford fuze, 35, 38
 Blackmer pump, 201
 Bombing effectiveness, 85-94
 attacks on Japanese cities, 90-94
 building and roof types, 87
 comparison of bombs, 86-90
 density of bomb hits within an area, 86
 fire spread, 87
 occupancy of floor area, 88, 89
 prediction, 89
 roof height effect, 88, 89
 Bombs, 7-94
 British, 7
 gasoline gel (oil bombs)
 E3; 40
 E9; 33-40, 67
 E20; 41
 E22; 41-42
 M47; 44-46, 81, 82, 88, 199, 206
 M69; 8-30, 49-94, 199, 206
 M69X, 21-27, 68-72
 German, 7
 magnesium
 E19; 32, 33
 M50; 52, 63-69, 81, 89
 M52; 51-52, 69
 plastic bomb, 42
 pyrotechnic gel
 M74; 55, 63-64, 68, 69, 79-82
 M76; 46
 thermate
 M54; 69
 Bombs, bursters, 45
 Bombs, clusters, 13-19, 23-41
 aimable clusters for M69 bomb, 27-33
 British, 30
 E18 aimable cluster, 30
 E28; 13
 E36; 13, 16
 E53 for E9 bomb, 36-40
 M12; 13
 M13; 13
 M19; 13, 15, 30
 M21 (E74), 23
 Bombs, fuels; *see* Incendiary fuels
 Bombs, fuzes; Bickford fuze, 35, 38
 E16 fuze, 50
 Ensign-Bickford, 11
 M1 fuze, 11
 Bombs, igniters, 45
 Bombs, sizes, 7
 Bombs, tests, 53-56
 airborne tests, 55, 59, 75-78
 analysis of destruction, 85-94
 comparison test of bombs, 70
 effect of target material, 69
 effect of target's moisture content, 79
 evaluation of fuels, 56-58, 67
 height tests, 53
 ignition of wood, 82-85
 impact test, 53
 objectives of tests, 53
 on farm buildings, 69
 on German houses, simulated, 19, 70-76
 on house furniture, 72-75
 on industrial targets, 62-64, 80-82
 on Japanese structures, 75-86
 on roof sections, 57
 penetration test, 53, 69
 probability of bomb firing, 63-64
 probability of starting fire, 64, 67
 selection of test target, 56
 uncontrollable fires, 74
 use of air gun, 54-55
 use of high-speed movies, 54
 use of mortar guns, 54
 Boron trifluoride, 212-213
- Brascon (aluminum soap thickener), 204
 British; aluminum soap thickener, 204
 bomb cluster, No. 20; 30
 incendiary bombs, 7
 Ronson Lighter flame thrower, 103
 Snapshot model flame thrower, 96
 Brown University, 50
 Bursters for bombs, 45
- C1 aimable bomb cluster, 28
 Camgel (aluminum soap thickener), 204
 Cellulose-bodied fuels, 209
 Cellusolve, 204
 Chan and chol (aluminum soap thickener), 204
 Chemical Warfare Service; E16 fuze, 50
 incendiary bomb tests, 69
 M2 incendiary leaf, 51
 M14-M5 burster-igniter, 46
 M19 aimable cluster, 30
 Chicago University; Chicago hand incendiaries, 48
 sabotage incendiaries, 46
 tests on incendiary materials, 57
 Clark Bros. air compressor, 147
 Clark-Hodsman viscosimeter, 217
 Cleaver-Brooks flame-thrower fuel mixer, 150-153
 Cluster adapters, 36
 Clusters for bombs; *see* Bombs, clusters
 Cresol, 204
 Cresylic acid, 156
- Davey Compressor Co., 147
 Dehydrating agents for fuels, 200
 Diethyl zinc, 212
 Dugway Proving Ground; airborne incendiary tests, 75-78
 E9 bomb, performance, 38
 fire-fighting tests, 76
 tests on M52 bomb, 51
 du Pont de Nemours & Co.; bomb fillings, 206
 momentum of a jet, 187
 E1 anti-personnel tank flame thrower, 156-158
 E2 portable flame thrower, 97-100

CONFIDENTIAL

253

PREVIOUS PAGE BLANK-NOT FILLED

- E3 oil bomb, 40
 E6 fuel mixer, 147, 148
 E6R2 adapter for bomb clusters, 13
 E7 flame gun, 106-110
 E7-7 flame thrower, 110-112
 E7R1 flame gun, 109
 E7R2 flame gun, 109
 E8 air compressor, 150
 E8 flame thrower, 122-124
 E8 service unit for flame thrower, 147-148
 E9 flame thrower, 126-128
 E9 oil bomb, 33-40, 67
 ballistic characteristics, 38
 design details, 35
 dispersion pattern, 38
 E53 cluster, 36
 fighter planes, use in, 39
 ignition process during fall, 36-40
 performance data, 38
 test on filling for bomb, 67
 E11 fuel mixing unit, 153-155
 E12-7R1 flame thrower, 120-122
 E13-13 flame thrower, 128-132
 E13R1-13R2 flame thrower, 132-135
 E14-7R2 flame thrower, 116-120
 E16 all-ways fuze, 49
 E16 portable flame thrower, 102
 E18 aimable cluster; comparison with British clusters, 30
 components, 28
 E19 magnesium bomb, 32, 33
 E19-19 flame thrower, 135-139
 E20 flame gun, 109
 E20 oil bomb, 41
 E20-20 flame thrower, 140-143
 E21 adapter for bomb clusters, 13
 E22 oil bomb, 41-42
 E26 adapter for E53 bomb cluster, 36
 E28 bomb cluster, 13, 16, 27
 E36 bomb cluster, 13, 16
 E46 (M19) bomb cluster, 13, 15, 30
 E53 cluster of E9 bombs, 36
 E74 (M21) bomb cluster, 23
 Eakins precipitation technique for napalm, 193
 Eastman Kodak Co.; flame throwers, pump-operated, 143, 172
 range of unignited jet, 186
 Edgewood Arsenal; bomb tests on industrial targets, 62-64, 81
 bomb test on Japanese room, 77-80
 tests on E12-7R1 flame thrower, 122
 tests on Mark I flame thrower, 116
 Edgewood M1 gel, 225
 Eglin Field; bomb test on factory structure, 80-81
 E9 bomb, performance, 38
 M69 bomb, performance, 16
 tests on bomb bursters, 45
 Electrically controlled flame thrower, 157
 Emphysema (respiratory lesion), 159
 Ensign Bickford fuze, 11, 22
 Ethylaluminum sesquibromide, 213
 Eutectic fuel for incendiaries, 213
 EWP (phosphorus-phosphorus sesquisulfide), 101, 156, 213-214
 Factory Mutual Research Corp.; bomb tests on house furniture, 74-75
 bomb tests on industrial targets, 60
 E22 bomb, 41, 42
 flame throwers, mechanized, 103
 fortified fuel for E19 bomb, 210
 sabotage incendiaries, 46-48
 tests on flame-thrower nozzles, 167
 tests on incendiary materials, 57
 tests on penetrating power of bombs, 69
 thermite mixtures for bombs, 52
 Ferro Enamel Co., 199
 Ferro-Cleaver Brooks mixing unit, 150-153
 Fire extinguishment, water fog curtains, 160
 Fire fighting tests with M69 bomb, 76
 Fire starters, 47-49
 Flame attack, countermeasures, 159-165
 Flame effect on people and animals, 158-159
 Flame guns; E7; 106-110
 E13; 128-135
 E19; 138
 E20; 109
 Flame throwers, countermeasures, 159-161
 Flame throwers, design, 166-191
 fuel consistency, 177
 fuel system, 167-172
 ignition system, 186
 nozzle design, 166-169, 176, 179
 photography, use of, 166, 169
 pressure losses in propulsion systems, 172-177
 pump propulsion, 172
 valve design, 169, 171
 Flame throwers, electrically controlled, 157
 Flame throwers, fuel; *see* Incendiary fuels
 Flame throwers, fuel mixers, 149-156
 E6 mixer, 149
 E8; 147
 E11 mixing unit, 153-155
 Ferro-Cleaver Brooks mixing unit, 150-153
 Mark I mixing unit, 155-156
 Flame throwers, mechanized, 103-146
 characteristics, 103
 E7-7 for light tanks, 110-112
 E8 for M5 light tank, 122-124
 E9 for light tank, 126-128
 E12-7R1 for medium tanks, 120-122
 E13-13 for medium tanks, 128-132
 E13R1-13R2 in medium tank, 132-135
 E14-7R2 for amphibious tanks, 116-120
 E19-19 in medium tank, 135-139
 E20-20 in medium tank, 140-142
 experimental models, 103-106
 I-3 for vehicular mounting, 124-126
 Navy Mark I for landing boats, 112-116, 198
 pump-operated, in medium tank, 103-106, 142-145
 Flame throwers, portable, 95-102
 British Ronson Lighter, 103
 comparison of E2 and M1A1; 98
 E1 anti-personnel tank projector, 156-158
 E2; 95-100
 expendable flame thrower, 101-102
 M1A1; 96
 M2-2 flame thrower, 100
 Flame throwers, range factors, 166-191
 air temperature, 190
 definition of range, 166
 degree of fuel ignition, 168, 183, 190
 fluid pressure at nozzle, 172-177, 179
 fuel consistency, 177, 198
 gun elevation, 182-184
 internal changes in gel, 169, 184-191

CONFIDENTIAL

- jet break up, 166-169, 225
 nozzle design, 166-169
 obstructions in fuel line, 169
 pressure losses, 169
 range prediction of ignited jets, 150
 valve design, 169, 171
 wind intensity and direction, 182-184
- FM sabotage incendiary, 48
- Fog applicators for fire extinguishment, 160.
- Foster-Wheeler Corp., 34
- Foxboro recording psychrometer, 162
- FRAS (aluminum stearate-thickened fuel), 167
- Froude number, 184-191
- Fuel mixtures; *see* Flame throwers, fuel mixers
- Fuel trailer for E9 flame throwers, 126
- Fuels, cellulose-bodied, 13, 209
- Fuels, fortified, 210
- Fuels, napalm thickened, 192-205
- Fuels, peptized; amines, 200
 super-peptized fuels, 200
 xylol, 199-200
- Fuels, self-igniting, 212-215
 aluminum compounds, 212
 bismuth compounds, 212
 diethyl zinc, 212
 nitrated arsenic and lead derivatives, 212
 organometallic compounds, 212-213
 phosphorus-phosphorus sesquisulfide, 213-214
 triethyl boron, 212
- Fuels, thickeners, 192-226
see also Gels, characteristics
 aluminum alcoholates, 205
 aluminum cresylate, 204
 aluminum soaps, 203, 215-216
 brascon, 204
 camgel, 204
 chan and chol, 204
 Edgewood M1 gel, 225
 fuller's earth, 215
 geletrol, 204
 metalex, 204
 methacrylate thickening agents, 206-207
 napalm, 192-205
 oleopalm, 192
 palmene, 192
 pseudoplastic gel, 221
 sodium aluminate, 204
- sodium soap thickening agents, 209
 valone, 205
- Fuels for flame throwers; *see* Incendiary fuels
- Fuels for incendiary bombs; *see* Incendiary fuels
- Fuzes for bombs; *see* Bombs, fuzes
- Gardner consistency, 194, 197, 225
- Gardner mobilometer, 194, 201, 218, 225
- Gasoline gel bombs; *see* Bombs, gasoline gel (oil bomb)
- Geletrol, 204
- Gels, characteristics, 205-206, 217-225
see also Fuels, thickeners
 elastic properties, 217-226
 equations for plastic flow, 222-224
 gel formulas, 206-209
 healing time of gels, 224
 physical properties of gels, 207
 relaxation of gels, 217-226
 shear initiation stress, 218
 stringiness of gels, 226
 viscosity coefficient, 218
 viscosity measurements, 218-225
 yield value, definition, 217
- German incendiary bombs, 7
- German structures, bomb tests, 70-76, 81-85
 combustibility of German furnishings, 83-85
 industrial targets, 81
 M69 bomb, fire starting efficiency, 19
- Gilbert and Barker Mfg. Co.; mechanized flame throwers, 103
- GP bomb (General Purpose), 87
- Grease gun viscosimeter, 218, 220
- Grove air pressure regulator, 123
- H2, sabotage incendiary, 47
- Harshaw Chemical Co.; fuel thickeners, 205
- Harvard candle (fire starter), 47
- Harvard University; development of napalm, 192
 E3 bomb, 40
 E20 bomb, 41
 sabotage incendiaries, 47
 tests on incendiary materials, 56
- High-pressure capillary viscosimeter, 218
- Huntsville Arsenal, bomb tests on farm buildings, 69
- I-3 flame thrower, 124-126
- Igniters for bombs, 45
- Ignition of wood, factors governing; *see* Wood ignition
- IM (isobutyl methacrylate), 10, 192
- IM-II gel, 225
- Imo pump, 144
- Imperial Paper and Color Corp., napalm manufacturer, 193, 197
- Incendiaries, sabotage, 46-49
 comparison of FM and H2; 48
 pocket size, 46-49
- Incendiary attacks, analysis; night missions, 91
 on Japanese cities 20, 90-94
- Incendiary bombs; *see* Bombs
- Incendiary fuels; aluminum compounds, 212
 amines, 200
 bismuth compounds, 212
 cellulose bodied, 13, 209
 containing heavy oil, 201
 diethyl zinc, 212
 IM filling, 13
 napalm thickened gasoline, 192-205
 nitrated arsenic and lead derivatives, 212
 organometallic compounds, 212-213
 phosphorus-phosphorus sesquisulfide, 213-214
 set time, 195-197
 S.O.D. formula, 13
 thickening agents, 192
 triethyl boron, 212
 xylol, 199-200
- Incendiary gels; *see also* Fuels, thickeners; Gels, characteristics
 formulas, 207
- Incendiary leaf, 50
 M1; 50
 M2; 51
- Incendiary tests; *see* Bombs, tests
- Iowa University, E19-19 flame thrower, 135
- Isobutyl methacrylate interpolymer formulas, 207
- Isobutyl methacrylate polymer, 192, 207
- Japanese cities, bombing, 13, 21, 90-94
 accuracy of bombing raids, 91-94
 description of raids, 90-94
 incendiary attacks, summary, 20-21

CONFIDENTIAL

- M19 bomb cluster, 13
M69, efficiency, 92
minimum effective bomb load, 92
types of munitions used, 90
Japanese structures, bomb tests, 19, 51, 75-86
airborne bomb tests, 75
combustibility of Japanese furnishings, 83-85
effect of M69 bomb, 19, 79
flame gun attacks, 116
industrial targets, 81
moisture content of Japanese wood, 79, 83-84
Javelins for bomb clusters, 37
Jefferson Proving Ground, bomb comparison tests, 70
Jet bombs, 7
Jet force on a target, 187
Jeweler's lathe viscosimeter, 218
- Kellogg Co., M.W. flame thrower, 113, 117
Kilgore Manufacturing Co., methacrylate gels, 209
- LCM boats, flame thrower installations, 113
LCVP boats, flame thrower installations, 113
Lima Locomotive Works, E14-7R2 flame thrower, 117
Little, Arthur D., Inc., 156-165
anti-personnel tank projector, 156-158
E16 all-ways fuze, 49
flame thrower countermeasures, 159-161
physiological effects of flame, 158, 159
LVT-A1 amphibious tank, flame thrower, 116
- M1 bomb fuze, 11
M1 fire starter, 47
M1 incendiary leaf, 50-51
M2 incendiary leaf, 51
M2-2 flame thrower, 100
M4 adapter for bomb clusters, 13
M4 tank, flame thrower unit, 109
M4A1 tank, flame thrower, 128, 120-122, 132
M4A3 tank, flame thrower, 120-122, 135-143
M5 igniter for M76 bomb, 46
M5A1 tank, flame throwers for, 110, 122, 126
M7 adapter for bomb clusters, 13
- M9 igniter for M47 bomb, 45
M12 bomb burster, 45
M12 bomb cluster, 13
M13 bomb cluster, 13
M13 burster for M47 bomb, 45
M14 burster for M76 bomb, 46
M19 (E46) bomb cluster, 13, 15, 30
M21 (E74) bomb cluster, 23
M23 adapter for bomb clusters, 13
M29 primer for E16 fuze, 49
M46 bomb, 41
M47 bomb; bombing industrial targets, 80-82
fillings, 199, 207-208
fuel, 192
fuel thickeners, 207
igniter and burster, 44-46
motion pictures of burst, 44
probability of starting fire, 88
M50 bomb; effect on farm buildings, 69
effect on Japanese structures, 75
German houses, 70-76
penetrating power, 69
probability of causing fire, 65, 89
tests on industrial targets, 63, 80-82
thermite mixtures, 52
M52 bomb, 51-52, 69
effect on Japanese houses, 51
M54 bomb, 69
M69 bomb, design details; bomb clusters, 13, 27-33
cloth streamer tail, 16
ejection-ignition charge, 12
fillings, 10, 12, 199, 206
fuel, 192
fuzes, 10, 11, 49
impact diaphragm assembly, 10, 12
nose cup, 9, 11
principal components, 10-11
tail retainer assembly, 10
M69 bomb, effectiveness, 19-21, 60-63, 70-82, 92-94
attacks on Japanese cities, 92-94
fire-fighting tests, 76
fire starting efficiency, 19, 64-65
mortar gun tests, 55
tests on attic structures, 60
tests on German houses, 19, 70-76
tests on industrial targets, 62-63
tests on Japanese structures, 19, 75-86
M69 bomb, performance factors; ballistic characteristics, 18
dispersion patterns, 18
flight stability, 18
- ignition during fall, 14
penetrating power, 19, 68, 69
M69X bomb, 21-27, 68-72
anti-personnel use, 21, 26
bomb clusters, 23
fragmentation, 26
modifications, 21
moisture proof characteristics, 26
performance, 23
tests on German houses, 70-72
M74 bomb, 62-65, 79-82
mortar gun tests, 55
penetrating power, 69
probability of causing fire, 63, 65
tests on industrial targets, 63-64, 80, 81
tests on Japanese room, 77
M76 bomb; M5 igniter, 46
MacMichael viscosimeter, 186, 218
Magnesium incendiary bombs; see Bombs, magnesium
Mark I flame thrower, 112-116, 198
attacks on Japanese positions, 116
E7 flame gun, 113-115
fuel system, 113-115
ignition system, 115
installation, 112, 116
performance, 116
propellant system, 113
range, 116
tests, 116
Mark I fuel mixer, 155, 156
mixing process, 155
performance, 155, 156
Massachusetts Institute of Technology, 103, 132, 166
E13R1-13R2 flame thrower, 132
flame throwers, mechanized, 103
nozzle design for flame throwers, 166
Medium tanks, flame throwers, 109, 120-122, 142
Metalex (aluminum soap), 204
Methacrylate thickening agents, 104, 205-206
formulas for, 207
isobutyl methacrylate polymer, 207
preparation of gels, 208-209
use in bomb fillings, 205-207
Methacrylic acid, 36
Methylaluminum sesquichloride, 212
Mobilometer, Gardner, 201, 218, 225
Moisture proofing M69X bomb, 26
Monododecylamine, 205

- Monsanto Chemical Co., plastic bombs, 42
- Morgan Construction Co., E13-13 flame thrower, 128
- Moyno rotor pump, 104
- Napalm, 192-205
for blaze bombs, 198-199
ground napalm, 199
healing rate, 204
incorporation of dehydrating agents, 200-201
incorporation of heavy oils, 201
infra-red drying equipment, 194
manufacture, 193-197
peptized napalm, 199-200
raw materials, 193
silica gel, 201
specifications, 192, 194, 196-197, 204
stir time, 197
temperature effects, 202-203
use in flame throwers, 198-199
variability, 194
viscosimeter for measuring consistency, 201-203
- Napalm gels, 196-197
- National Foam Systems, Inc., fuel mixer, 198
- Neo-fat 3R (soap thickener), 192
- Newtonian fluids, 166, 186-191, 202, 218
- Nitro-aryl arsenic acids, 212
- Nitromethane for incendiaries, 50
- Nozzle design for flame throwers, 166
- Nozzle discharge coefficients, 176
NP; *see* Napalm
- Nuodex Products Co., napalm development, 192
- Oedema, 159
- Office of Strategic Services, sabotage incendiaries, 46
- Oil incendiary bombs; *see* Bombs, gasoline gel (oil bomb)
- Oleopalm (soap thickener), 192
- One-shot flame throwers, 96, 101, 105
- Organometallic compounds, 212-213
- OSS time-delay pencil, 47
- Palmene (soap thickener), 192
- Pendulum test for bombs, 53
- Peptized fuels, 199-201
amines, 200
super-peptized fuels, 200
xylenol, 199
- Phosphorus igniter for bombs, 44
- Phosphorus-phosphorus sesquisulfide, 156, 213-214
effect on various materials, 214
liquid EWP, 213-214
self-ignition, 214
thickened EWP, 214-215
- Pipe flow viscosimeter, 218, 220
- Plastic bombs, 42
- Pocket size incendiaries, 46
- Polyisobutyl methacrylate polymer, 36
- Polyisobutylene, 208
- Polystyrene, 214
- Polyvinyl ethers, 208
- Portable flame throwers; *see* Flame throwers, portable
- Primacord bursters, 28
- Primer caps for incendiary bomb M69; 11
- Probability of fire starting with incendiaries, 64, 88-89
- Pseudoplasticity, 221, 226
- Pumps for flame throwers, 104, 143, 201
Blackmer pump, 201
Imo pump, 144
Moyno rotor pump, 104
Sundstrom pump, 104
- Pyroxylin for incendiaries, 51
- Q mechanized flame thrower, 103
- Resinox plastic, 43
- Reynolds number in flame thrower jets, 184, 191
- Ricinoleic acid, 205
- Ronson Lighter flame thrower, 103
- Rosin-Fehling correlation, 184
- Sabotage incendiaries, 46-47
FM; 48
H2; 47
M1 fire starter, 47
- SDO (synthetic drying oil), 48
- Seaming compound, vinylite, 12
- Shell Development Co.; Model I-3 flame thrower, 124
nozzles, high-pressure hydraulic, 166
tests on flame throwers, 105
- Ship conning tower, protection against suicide plane attack, 161-165
- Snapshot model flame thrower, 96
- S.O.D. formula, 12, 13
- Sodium aluminate, 205
- Standard Oil Development Co.; analysis of attacks on Japanese targets, 85
- ball viscosimeter, 201
- bomb tests on attic structures, 59-60
- bomb tests on typical German constructions, 70
- E2 flame thrower, 95-100
- E7-7 flame thrower, 110-112
- E9 flame thrower, 126
- E18 aimable cluster, 28
- E20-20 flame thrower, 140
- flame thrower servicing unit, 147, 148
- M1A1 flame thrower, 96
- M69 bomb, 8-21, 58
- M69X bomb, 21-26
- nozzle design for flame throwers, 167
- Q mechanized flame thrower, 103
test on penetration of bombs, 69
tests on incendiaries, 53, 58
- Stormer viscosimeter, 218
- Suicide plane attacks, countermeasures, 161-165
- Sundstrom pump, 104
- Tanks with flame throwers; installation of flame throwers, 109-112, 116
LVT-A1 amphibious tank, 116
M4; 120, 128, 132, 135-139
M5; 122-124, 126
- Targets for bomb tests; *see* Bombs, tests
- Tests on incendiaries; *see* Bombs, tests
- Texas Co.; E9 oil bomb, 33-40
fortified fuel for E9 bomb, 210
test on incendiary fuels, 67
- Thermate bombs, 42
- Thermite bombs, 52
- Thixotropy, 225
- Tokyo raids, 91
- Trailer model flame thrower, 110
- Triethanolamine, 205
- Valone (gasoline thickener), 205
- Venturi effect, 167
- Vinylite seaming compound, 12
- Viscosimeters; ball viscosimeter, 201
C-ration can viscosimeter, 202
Clark-Hodsmen, 218, 219
grease gun, 218
high-pressure capillary, 218
jeweler's lathe, 218
MacMichael, 186, 218
measurement of napalm consistency, 201-202

- mobilometer, 218
pipe flow, 218
Stormer (modified), 218
Vistanex (polyisobutylene), 208
Water fog curtains for fire extinguishment, 160
- "Water hammer" effect in flame guns, 172
Wood ignition, 82-85
moisture content, 83-84
endothermic decomposition, 82
required radiation density, 82
- wood species, 84
wood thickness, 84
- Xylenol, 155, 198, 199, 202
- Zinc diethyl, 212