

CATALOGED BY ASTIP
AS AD No 14890

CATALOGED BY W0091-3

TL 4184

WADC TECHNICAL REPORT 52-206

~~CONFIDENTIAL~~

35-11-277
54-2424
41017-11/5

SECURITY INFORMATION
DO NOT DESTROY
RETURN TO
TECHNICAL DOCUMENT
CONTROL SECTION
W0091-3

FILE COPY

SPIN AND RECOVERY TESTS OF A 1/28-SCALE
MODEL OF THE YF-93A AIRPLANE

CLASSIFICATION CANCELLED
(OR CHANGED TO *unclassified*)

BY AUTHORITY OF *WADC ctr. (wercfe)* dtd 19 Mar 59
(INDIVIDUAL OR WRITTEN AUTHORITY)

BY *Edna E. Taylor* 20 Mar 59
(NAME & GRADE OF INDIVIDUAL MAKING CHANGE) (DATE)

EUGENE S. ROSE, JR., MAJOR, USAF
DAN M. PARKER, MAJOR, USAF

AIRCRAFT LABORATORY

AUGUST 1952

WRIGHT AIR DEVELOPMENT CENTER

Statement A
Approved for Public Release

20020611020

55 WC-3102-B7

4890

4184

~~CONFIDENTIAL~~

107 FMS

WADC TECHNICAL REPORT 52-206

SECURITY INFORMATION

DO NOT DESTROY
RETURN TO
TECHNICAL DOCUMENT
CONTROL SECTION
WCOS-3

FILE COPY

SPIN AND RECOVERY TESTS OF A 1/28-SCALE
MODEL OF THE YF-93A AIRPLANE

CLASSIFICATION CANCELLED
(OR CHANGED TO *unclassified*)
BY AUTHORITY OF *WADC etc. (reverse) etc 17 March 59*
(INDIVIDUAL OR WRITTEN AUTHORITY)
BY *Edna E. Taylor* 20 March 59
(NAME & GRADE OF INDIVIDUAL MAKING CHANGE) (DATE)

EUGENE S. ROSE, JR., MAJOR, USAF
DAN M. PARKER, MAJOR, USAF

AIRCRAFT LABORATORY

AUGUST 1952

WRIGHT AIR DEVELOPMENT CENTER

Statement A
Approved for Public Release

20020611020

53 WP-3102-101

NOTICES

When Government drawings, specifications, or other data are used for any purpose other than in connection with a definitely related Government procurement operation, the United States Government thereby incurs no responsibility nor any obligation whatsoever; and the fact that the Government may have formulated, furnished, or in any way supplied the said drawings, specifications, or other data, is not to be regarded by implication or otherwise as in any manner licensing the holder or any other person or corporation, or conveying any rights or permission to manufacture, use, or sell any patented invention that may in any way be related thereto.

The information furnished herewith is made available for study upon the understanding that the Government's proprietary interests in and relating thereto shall not be impaired. It is desired that the Judge Advocate (WCJ), Wright Air Development Center, Wright-Patterson Air Force Base, Ohio, be promptly notified of any apparent conflict between the Government's proprietary interests and those of others.



This document contains information affecting the National defense of the United States within the meaning of the Espionage Laws, Title 18, U.S.C., Sections 793 and 794. Its transmission or the revelation of its contents in any manner to an unauthorized person is prohibited by law.

~~CONFIDENTIAL~~

WADC TECHNICAL REPORT 52-206

SECURITY INFORMATION

**SPIN AND RECOVERY TESTS OF A 1/28-SCALE
MODEL OF THE YF-93A AIRPLANE**

*Eugene S. Rose, Jr., Major, USAF
Dan M. Parker, Major, USAF*

Aircraft Laboratory

August 1952

SEO No. 720-86

CLASSIFICATION CANCELLED
(OR CHANGED TO *Unclassified*)
BY AUTHORITY OF *WADC (weh:see) th*
(INDIVIDUAL OR WRITTEN AUTHORITY) *3/19/59*
BY *Edward E. Taylor* *20 Mar 59*
(NAME & GRADE OF INDIVIDUAL AUTHORITY) (DATE)

Wright Air Development Center
Air Research and Development Command
United States Air Force
Wright-Patterson Air Force Base, Ohio

~~CONFIDENTIAL~~

55 WADC-3100 B

~~CONFIDENTIAL~~

FOREWORD

This report was prepared by the Wind Tunnel Branch, Aircraft Laboratory, Directorate of Laboratories, Wright Air Development Center. This test program was initiated at the request of the Weapons Systems Division, Deputy for Operations, WADC, under the project identified by Service Engineering Order No. 720-86, which authorized work in connection with the F-93 airplane. It was conducted in the Wright Field 12-Foot Vertical Wind Tunnel at Wright-Patterson Air Force Base, Ohio. The authors of this report acted as project engineers.

WADC TR 52-206

~~CONFIDENTIAL~~

~~CONFIDENTIAL~~

ABSTRACT

An investigation of the spin and spin recovery characteristics of a 1/28-scale model of the North American YF-93A airplane is described. The test results are presented and discussed. These tests were conducted in the Wright Field 12-Foot Vertical Wind Tunnel using a dynamically balanced model of the airplane. The model generally spins erect and for some cases spins inverted. For many conditions tested, the model exhibits two different types of spin, either steady or with considerable oscillation in roll. It was found that the rudder is relatively ineffective in terminating the spin. Ailerons, on the other hand, have a powerful effect on the spin. It is shown that aileron full "against" the spin, i.e., stick full left during a spin to the right, is the position of ailerons most conducive to the spin; moving the ailerons to the opposite extreme will cause the YF-93A model to recover from the spin. Best recovery of the model is obtained by simultaneously moving the rudder full against the spin (rudder left during a spin to the right) and the ailerons full "with" the spin (stick right for a spin to the right), holding elevator up until the rotation has greatly decreased. Speed brakes were found to be adverse to recovery. Anti-spin parachute test results are presented.

This model does not meet the USAF requirements (AAF Spec No 1816, dated 15 June 1945, paragraph D-2a(4).) that airplanes will recover in two turns or less by rudder reversal alone, holding ailerons "against" the spin. In fact, the airplane generally will not recover at all under these circumstances. However, the recoveries obtained by simultaneous manipulation of rudder and ailerons did take place in two turns or less without exception.

The security classification of the title of this report is UNCLASSIFIED.

PUBLICATION REVIEW

This report has been reviewed and is approved.

FOR THE COMMANDING GENERAL:

R. G. Ruegg
R. G. RUEGG
Colonel, USAF
Chief, Aircraft Laboratory
Directorate of Laboratories

WADC TR 52-206

iii

~~CONFIDENTIAL~~

~~CONFIDENTIAL~~

TABLE OF CONTENTS

<u>Section</u>		<u>Page</u>
I	General Considerations	1
II	Test Equipment and Procedure	3
III	Results	5
IV	Conclusions	13
V	References	15

~~CONFIDENTIAL~~

~~CONFIDENTIAL~~

LIST OF ILLUSTRATIONS

<u>Figure</u>		<u>Page</u>
1	Table of Dimensional Characteristics of the YF-93A Airplane	16
2	Table of Model Mass Distribution	18
3	Table of Airplane Mass Distribution	19
4	Inertia Moment Parameter Chart	20
5	Three View Drawing of YF-93A Airplane	21
6	Side View Photograph of 1/28-Scale Model of the YF-93A Airplane, Clean Condition	22
7	Three-Quarter View Photograph of 1/28-Scale Model of the YF-93A Airplane with Landing Gear and Speed Brakes Extended	23
8	Plan View Photograph of 1/28-Scale Model of the YF-93A Airplane	24
9	Spin Test Program	25
10	Chart of Right Erect Spins at Gross Weight at Take-Off (I) with Recovery by Rudder and/or Aileron Movement	26
11	Chart of Right Erect Spins at Predicted Load Conditions, 0° Stabilizer Setting	27
12	Chart of Effect of Center of Gravity Location on Right Erect Spins, 0° Stabilizer Setting	28
13	Chart of Effect of Mass Extension on Right Erect Spins, 0° Stabilizer Setting	29
14	Chart of Symmetry Tests - Erect Spins, 0° Stabilizer Setting, Design Gross Weight Over Target (A)	30

~~CONFIDENTIAL~~

~~CONFIDENTIAL~~

LIST OF ILLUSTRATIONS (Continued)

<u>Figure</u>		<u>Page</u>
15	Chart of Right Erect Spins Showing Effects of Extended Wing Flaps and of Extended Landing Gear, 0° Stabilizer Setting	31
16	Chart of Right Erect Spins at Predicted Load Conditions, +3° Stabilizer Setting	32
17	Chart of Effect of Center of Gravity Location on Right Erect Spins, +3° Stabilizer Setting	33
18	Chart of Right Erect Spins, Model Clean Versus Both Wing Slats Extended	34
19	Chart of Effect of Speed Brake and Wing Slats on Right Erect Spins, -9° Stabilizer Setting at Minimum Flying Weight (B)	35
20	Chart of Effect of Wing Slats on Right Erect Spins, -9° Stabilizer Setting, at Minimum Flying Weight (B)	36
21	Chart of Right Erect Spins with Speed Brakes and/or Wing Slats Extended, -9° Stabilizer Setting at Design Gross Weight Over Target (A).	37
22	Chart of Effect of Stabilizer Setting on Right Erect Spins	38

~~CONFIDENTIAL~~

~~CONFIDENTIAL~~

LIST OF SYMBOLS

X	airplane roll axis
Y	airplane pitch axis
Z	airplane yaw axis
\bar{x}	location of center of gravity along the fuselage axis measured from Fuselage Station 0, inches
\bar{y}	location of center of gravity along wing axis measured from plane of symmetry, inches
\bar{z}	location of center of gravity along vertical axis measured from horizontal plane 100 inches below fuselage reference plane, inches
I_x, I_y, I_z	moments of inertia about X, Y, Z axes, respectively, slug/ft ²
ρ	mass density of air, slugs/ft ³
m	mass of airplane, slugs
W	weight of airplane, lbs
b	wing span, ft
c	chord, in
g	acceleration of gravity, ft/sec ²
V	rate of descent of airplane, ft/sec
Ω	rate of rotation of model in spin about a vertical axis, rev/sec
α	angle between "X" axis and vertical (approximately equal to the angle of attack), degrees

~~CONFIDENTIAL~~

~~CONFIDENTIAL~~

LIST OF SYMBOLS (Continued)

ϕ

angle between "Y" axis and horizontal (U means inner wing up; D means inner wing down), degrees

$$\frac{I_x - I_y}{mb^2}$$

inertia yawing moment parameter

$$\frac{I_y - I_z}{mb^2}$$

inertia rolling moment parameter

$$\frac{I_z - I_x}{mb^2}$$

inertia pitching moment parameter

~~CONFIDENTIAL~~

~~CONFIDENTIAL~~

INTRODUCTION

The purpose of this report is to describe, discuss, and draw conclusions from an investigation of the spin and spin recovery characteristics of a scale model of the YF-93A airplane in the Wright Field 12-Foot Vertical Wind Tunnel.

~~CONFIDENTIAL~~

~~CONFIDENTIAL~~

SECTION I

GENERAL CONSIDERATIONS

The YF-93A airplane is a single jet engine, single-place fighter. It was desired that information be obtained, by model tests, concerning the spin and spin recovery characteristics of the airplane.

For the investigation, a 1/28-scale model of the airplane was constructed of laminated pine by the contractor, North American Aviation, Incorporated. Wing slats, wing flaps, speed brakes, and landing gear were incorporated in the model design. Three empennage assemblies were provided to make possible tests at three different horizontal stabilizer settings. It was then necessary to bring the weight, center of gravity location, and moments of inertia of the model to the proper scale values, a condition referred to as dynamic balance. This was accomplished by installing lead weights at the proper locations to fulfill the imposed conditions.

The full-scale airplane undergoes important changes of weight, center of gravity location, and moments of inertia as the expendable load is changed or consumed. Tactical use of the airplane frequently demands that the loads as planned during the design stage be altered. Also, the possibility exists that the airplane has a mass distribution such that small changes will produce important changes in the spin behavior. The inherent limitations of accuracy in a model test make it possible that this marginal nature, if it exists, may not be revealed by the model tests if they are limited to a narrow range of load conditions. Consequently, it is desirable to test the spin model over a range of load conditions which is more extensive than that for the full scale airplane.

The model of the YF-93A airplane was arranged to simulate nine load conditions. Four of these were load conditions given by the contractor for the full-scale airplane. Five were extended or exaggerated load conditions selected by the project engineer. After preliminary survey testing, the remainder of the test program was concentrated on those load conditions which had been found to be critical. All load conditions simulated a full scale altitude of

~~CONFIDENTIAL~~

~~CONFIDENTIAL~~

20,000 feet ($\rho = 0.001267$ slugs/ft³). Due to tolerances in the balancing methods and atmospheric changes, this altitude varied for the different tests between 19,300 feet and 21,000 feet. The load conditions tested were:

<u>Load Condition</u>	<u>Description</u>
A	Design Gross Weight over Target
B	Minimum Flying Weight
C	Design Rearmost Center of Gravity
D	Center of gravity moved 5% of MAC aft from design rearmost location
E	Center of gravity moved 10% of MAC aft from design rearmost location
F	Mass extended along the fuselage (that is, $I_{Y_F} = 1.15 I_{Y_B}$)
G	Mass extended along the wing (that is, $I_{X_G} = I_{X_B} + 0.12 I_{Z_B}$)
H	Center of gravity moved 7% of MAC forward from location for Weight Condition B
I	Gross Weight at Take-Off

Measurements of the mass characteristics of the model are believed accurate to the following limits:

Weight, per cent	±0.1
Center of gravity location, inches	±0.01

~~CONFIDENTIAL~~

~~CONFIDENTIAL~~

Center of gravity location, per cent of MAC	±0.3
---	------

Moments of inertia, per cent	±2.
------------------------------	-----

The deviations of model values of weight, center of gravity location, and moments of inertia for all load conditions are given in Figure 2. The maximum deviations found for the nine load conditions are:

Weight, per cent	-2.3
------------------	------

Center of gravity location, per cent of MAC	+3.8
---	------

Moments of inertia, per cent	+3.5
------------------------------	------

Inertia moment parameter values for the full-scale airplane and corresponding model values converted to full scale are presented in Figures 2, 3, and 4. These may be used with Reference 2 in predicting the recovery characteristics of the airplane.

A magnetically-triggered remote control mechanism was installed in the model to permit movement of the rudder and/or ailerons or to release the anti-spin parachute. The control deflections used are the maximum full-scale values given in Figure 1, unless otherwise noted.

Model anti-spin parachutes of the flat, circular type were made of nylon cloth. Drag tests were conducted with the model parachutes to determine their drag coefficients. Values of drag coefficient for the model parachutes varied between 0.81 and 0.83, based on total flat area. An ejection tube was installed in the fuselage of the model to deploy the model parachutes in tests of recovery by anti-spin parachute.

SECTION II

TEST EQUIPMENT AND PROCEDURE

The Wright Field 12-Foot Vertical Wind Tunnel is an atmospheric pressure, annular return, closed circuit wind tunnel with an open throat twelve feet in diameter. The air flow in the test section

~~CONFIDENTIAL~~

is directed vertically upward at a velocity that is controlled by the tunnel operator. The test section is enclosed by cord nets to prevent the model from striking solid objects during its spin and recovery.

With the model controls set at the desired positions for a spin test, the model was launched by hand with a pro-spin rotation into the air stream. The test section velocity was adjusted by the tunnel operator to equal the rate of descent of the spinning model, thus holding the model in a free spin at the level of the test section reference lines. The spin was observed and recorded.

Recording was accomplished by means of special motion picture cameras arranged to superimpose a time indication and an air speed indication on each frame of the film. All tests were recorded by one camera photographing horizontally across the test section. For some tests, additional records were obtained by a similar camera photographing vertically downward along the test section axis. All photographs were taken at a rate of 64 frames per second.

The rate of descent, rate of rotation, number of turns for recovery from the spin, and the angles of pitch and wing tilt were obtained by analysis of the films.

Recovery from the spin was attempted by abrupt movement of rudder alone, or of ailerons alone, or of rudder and ailerons simultaneously. Recovery was also attempted by deployment of an anti-spin parachute in certain tests performed to find the minimum required size of anti-spin parachute.

The test program was organized in the following way (Figure 9). With the 0° stabilizer and the model in the clean condition, symmetry tests were run in Load Condition A comparing right and left spins (Phase I). No essential difference due to possible asymmetry of the model was observed. All further tests were made for right spins. Comparative tests of all load conditions were then performed (Phase II) for the clean model and 0° stabilizer. Tests were also run for the influence of landing gear extended using Load Condition A and the 0° stabilizer. Tests of the influence of wing flaps extended for Load Condition B and 0° stabilizer were run.

~~CONFIDENTIAL~~

~~CONFIDENTIAL~~

Tests were performed next (Phase III) for the influence of all other changes in aerodynamic shape (i.e., wing slats and/or dive brakes extended) for Load Condition B and the -9° stabilizer setting. A limited number of tests were also performed for this stabilizer setting in Load Conditions A and C.

Then tests were performed (Phase IV) comparing selected load conditions for the clean model and the $+3^\circ$ stabilizer setting. Tests were made of the effect of wing slats extended in Load Condition A for this stabilizer setting.

Limited tests of inverted spins were also conducted chiefly for $+3^\circ$ stabilizer settings (Phase V).

Based on the above tests, the worst conditions for recovery were selected and used for the anti-spin parachute recovery tests from which the minimum parachute sizes for both tail and wing-tip installations were determined (Phase VI).

Final recovery tests were made using the worst of the above conditions, and attempting recovery by aileron movement alone and by simultaneous movement of rudder and ailerons (Phase VII).

SECTION III

RESULTS

A. General

The results of the spin tests are presented in Figures 10 through 22. The spin data presented were obtained from the tests and have been converted to corresponding full-scale values for the airplane at an altitude of 20,000 feet assuming that the spin geometry remains the same. The model values which were taken are believed accurate to the true model values within the following limits:

α	degrees	± 2
ϕ	degrees	± 2
V	per cent	± 3
Ω	per cent	± 3
Turns for recovery		$\pm 1/4$

~~CONFIDENTIAL~~

~~CONFIDENTIAL~~

In this investigation, recovery was considered satisfactory when the developed spin could be terminated in two turns or less. Unless otherwise stated, the model was in clean condition. The description of results refers to erect spins, except for the one paragraph specifically referring to inverted spins.

The model tests described were made at Reynolds numbers of the order of 10^{-2} times the full-scale Reynolds number. In general, the difference between model and full-scale Reynolds number causes the model to spin more steeply and recover more rapidly than the full-scale airplane.

The values of α , ϕ , and V obtained from the spin test film usually exhibited some scatter. When the variation fell within the following limits, the readings were averaged. When the limits were exceeded, the extremes were presented in the spin charts. The rate of rotation Ω is by its nature an average since it was measured as the quotient of angular travel divided by elapsed time.

<u>Quantity</u>	<u>Limits</u>
α	$< 6^\circ$ total range
ϕ	$< 4^\circ$ total range
V	< 20 ft/sec, total range

B. Erect Spins

The model exhibited erect spins for every load condition and configuration tested. The various load conditions tested are described in Figures 2 and 4. The combinations of load condition and configuration which were tested are presented in Figure 9.

For many of the conditions tested, it was observed that two types of spin occurred. One type of spin was a steady spin in which the angle of pitch, the angle of wing tilt, the rate of descent, and the rate of rotation were constant or very nearly so. The other type of spin was oscillatory; the chief oscillation was about the roll axis and this was accompanied by an increasing and decreasing of the rate of rotation which is referred to in this report as "whipping".

~~CONFIDENTIAL~~

~~CONFIDENTIAL~~

Another type of spin was observed which was oscillatory; this usually was found alone. In this, the pitch attitude varied irregularly accompanied by changes in the rate of descent.

In some of the spins, the vertical axis about which the model spun did not remain stationary, but translated about the test section. This behavior is referred to as "wandering". At times, the spin axis translated along a curved path which described a number of small loops. This behavior is referred to as "nutating".

C. Effect of Aileron Position

The effect of aileron setting was of major importance. For all combinations of load condition and configuration when the ailerons were held "against" the spin (i.e., stick left for a spin to the right), the model would not recover by full rudder reversal and continued to spin, apparently for an unlimited period. When the ailerons were held neutral, the model exhibited recoveries which varied from satisfactory to unsatisfactory. These are discussed in detail below. When the ailerons were held "with" the spin (i.e., stick right for a spin to the right), the model generally would not spin; instead, the launched spin was usually terminated in a very few turns without control manipulation. The response of the model to aileron position was in agreement with the NACA studies relating to inertia moment parameters (Reference 2).

D. Recovery by Aileron Manipulation

The pronounced effects of aileron position on the spin and recovery characteristics led to tests in which the rudder was held stationary and recovery was attempted by reversing the ailerons from full "against" to full "with" the spin. The test results are presented as part of Figure 10. The model spun with the rudder set full with, neutral, or full against the spin. Recoveries were more rapid when the rudder was set against the spin, and slower when the rudder was set with the spin. With one exception, the recoveries for these tests occurred in two turns or less.

E. Recovery by Rudder and Aileron Movement

Tests were made for the load condition considered most adverse to recovery (Take-Off Gross Weight or I) with the model clean, and also with speed brakes extended, attempting recovery by full

~~CONFIDENTIAL~~

~~CONFIDENTIAL~~

rudder reversal from with to against the spin and aileron movement to full "with" the spin. These results are presented in Figure 10. It can be seen that the recoveries by simultaneous manipulation of rudder and aileron are faster than recoveries by rudder alone, or by ailerons alone. All recoveries by simultaneous manipulation of rudder and ailerons occurred in two turns or less with one exception (2 1/2 turns). Most of these recoveries terminated in vertical rolling dives at high speed.

In general, it may be stated that the ailerons are more effective than the rudder in maintaining the spin and in terminating the spin for the model of the YF-93A airplane.

F. Effect of Elevator Position

The effect of elevator position on turns for recovery was not consistent for all the combinations of load condition and configuration tested. It appears that elevator down more often led to slow recoveries and that elevator up more often gave rapid recoveries. Numerous exceptions can be found.

G. Effect of Stabilizer Setting

The tests run at different stabilizer settings (-9° , 0° , and $+3^\circ$), with all other conditions the same, did not reveal any consistent or predominant trend regarding the turns for recovery. It was observed that down stabilizer (-9°) gave somewhat flatter spins (pitch attitude). Some data from these tests are presented in Figure 22.

H. Model Behavior for Predicted Load Conditions

As stated in Section I of this report, four of the load conditions specified by the contractor were simulated in the test program along with other (exaggerated) load conditions. The following information was obtained from these tests at predicted load conditions. Data are presented in Figures 11 and 16.

1. Design Gross Weight Over Target (A)

Tests of the clean model at this load condition generally showed steady spins; for many of the conditions both steady and oscillatory spins were observed. With ailerons neutral, the recoveries attempted by full rudder reversal were frequently

~~CONFIDENTIAL~~

unsatisfactory (greater than 2 turns). As stated above, when the ailerons were set "against" the spin, rudder reversal never caused recovery. The initial symmetry tests of the model were made at this load condition (Figure 14).

Where steady spins were obtained both to the right and to the left, the data show very close agreement. Since these tests were performed only to verify the model symmetry, no attempt was made to extend the tests of left spins to see whether the two types of spins were found to correspond to those for the right spins.

2. Minimum Flying Weight (B)

Tests of the clean model at this load condition more often exhibited oscillatory spins than Load Condition A. Recoveries for neutral ailerons were generally faster and were satisfactory. Rudder reversal never caused recovery when the ailerons were "against" the spin. For this load condition, the rate of descent and the rate of rotation were generally lower than for the Load Condition A.

3. Design Rearmost Center of Gravity (C)

This load condition differs little from the preceding one, the main difference being a rearward center of gravity shift of about 1% of the mean aerodynamic chord. Only brief tests were made. The data indicate slower recoveries for this load condition than for Load Condition B. This is more likely to have been caused by coincidence and scatter than by essential change in the spin.

The data are interpreted to mean that this small center of gravity shift, with corresponding changes of the other mass distribution quantities, did not produce a discernible change in the spin behavior.

It should be pointed out that the photographic determination of the attitude of the model during the spin permits values to be obtained only twice for each revolution of the model (where the model is correctly, or most nearly, oriented with respect to the film plane). There is no assurance that the values obtained during an oscillatory spin are the extremes of oscillation, unless very long spin records are obtained.

The values obtained for the rate of rotation and the rate

~~CONFIDENTIAL~~

of descent are average values. It appears that the rearward center of gravity shift (from B to C) did cause a small decrease in the rate of rotation; and this is in agreement with the general effect found with rearward center of gravity travel. But the numerous exceptions and the small magnitude of the differences found make it impossible to say that the 1% center of gravity shift was responsible for a decrease in rate of rotation.

4. Gross Weight at Take-Off (I)

This load condition represents the aircraft with additional weight close to the center of gravity as compared with Load Condition A.

It can be seen from the data that the model spun at a higher rate of rotation and a higher rate of descent for Load Condition I than for Load Condition A. The attitude was about the same.

As before, when the ailerons were set "against" the spin, full rudder reversal never produced recovery. With the ailerons set neutral, full rudder reversal produced satisfactory recovery only when the elevator was up.

From the data, it appears that recoveries (ailerons neutral) for Load Condition I were much slower than for Load Condition A. The two slow recoveries for Load Condition I seen in Figure 11 are questionable. The signal flag, indicating rudder movement, malfunctioned on both of these tests; and the film quality was not good enough to permit a positive identification of time of rudder movement. The values given for these two tests were specified after long study of the film, but they may be in error. Later tests, presented in Figure 10 were made with external aileron rigging installed. They exhibited much faster recoveries for Load Condition I.

The data of the model behavior for predicted load conditions indicate in general that Load Conditions A and I are more adverse to recovery than Load Condition B or C. The model never recovered by full rudder reversal ailerons were set "against" the spin. Recoveries by full rudder reversal with ailerons neutral varied from unsatisfactory to satisfactory. Elevator up led to faster recoveries than elevator neutral or down.

~~CONFIDENTIAL~~

~~CONFIDENTIAL~~

I. Effect of Center of Gravity Location

Tests were performed at extreme forward and aft center of gravity locations beyond the limits predicted by the contractor. Data are presented in Figures 12 and 17.

1. Center of Gravity Moved Aft

As the center of gravity was moved aft from the Rearmost Design Location in two increments of about 5% of mean aerodynamic chord each, the radius of the spin increased greatly. The rate of rotation Ω decreased greatly. The model exhibited less stable spins. Recoveries by rudder reversal were satisfactory for ailerons neutral; the model did not recover by rudder reversal when the ailerons were positioned "against" the spin.

2. Center of Gravity Moved Forward

When the center of gravity was moved forward 7% of mean aerodynamic chord from the location corresponding to Minimum Flying Weight (B), the rate of rotation Ω increased. The recoveries seem to have become slower although data are scanty. Recoveries by rudder reversal were satisfactory when the ailerons were neutral. The model never recovered by rudder reversal when the ailerons were positioned "against" the spin.

J. Effects of Extending the Mass Along the Fuselage or Along the Wing

The data for the two mass extended conditions are presented in Figure 13. The condition for Mass Extended Along the Wing (G) was selected to obtain an inertia moment parameter change for this load condition about equal in magnitude to the extreme mass extension along the fuselage. This may be seen in Figure 4.

The model did not exhibit any important differences in spin behavior with the mass extended in either direction from the basic Load Condition B. For both mass extended conditions, the rate of descent increased slightly, probably due to the greater model weight. It appears that the rate of rotation decreased for both extended conditions, but the changes are small. Load Condition F led to one slow recovery. In general, recoveries were about the same as for the predicted load conditions, including the non-recovery by rudder reversal when ailerons were held against the spin.

~~CONFIDENTIAL~~

K. Effects of Speed Brakes

Data from tests with model speed brakes extended are given in Figures 10, 19, and 21. With the speed brakes extended, recoveries were slower and more oscillatory spins were encountered. The general recovery characteristics were the same as before (i.e., no recovery for ailerons "against" the spin).

L. Effects of Wing Slats

Tests were performed with both wing slats extended, right slat extended, left slat extended, and both slats and speed brakes extended. The data are presented in Figures 18, 19, 20, and 21.

On the whole, recoveries were somewhat faster with both wing slats extended than with the model clean. Generally, the rate of rotation was lower and the rate of descent higher with both wing slats extended. The effect of aileron position on recovery was the same as for the clean model.

With the left slat extended and the model launched in a right spin, the behavior was about the same as for both slats extended. The radius of the spin was somewhat greater and the spin less stable.

With the right slat extended and the model launched in a right spin, the spins were somewhat steeper than for the left slat extended. Large radius spins were again encountered as well as marginal spins.

Recoveries for either of the unsymmetrical slat configurations appeared somewhat better than for both slats extended. The generally unsatisfactory recovery by rudder reversal (when ailerons were positioned "against" the spin) were encountered for all slat configurations.

M. Effects of Landing Gear

Data from tests with landing gear extended are presented in Figure 15. No important differences were found between the landing gear extended configuration and the clean model. Recoveries were unsatisfactory throughout, except for ailerons and elevator neutral.

~~CONFIDENTIAL~~

N. Effects of Wing Flaps

Tests were performed with wing flaps fully extended. Data are presented in Figure 15. The spins were somewhat less stable with wing flaps extended than with the model clean. No other general effect was noted. The recovery behavior was essentially the same as before.

O. Inverted Spins

Brief tests of inverted spins were performed. Results are presented as part of Figure 16. The inverted spins were not very stable. Satisfactory recoveries were obtained for those control positions for which the model spun.

P. Parachute Recovery Tests

Tests were performed of recovery by anti-spin parachutes for a number of the more adverse load conditions and configurations, holding all controls in the most pro-spin positions (rudder full with the spin, elevators full down, and ailerons full "against" the spin). Both wing-tip and tail parachute attachments were tested. It was found that a flat circular parachute of drag area $C_{DS} = 28 \text{ ft}^2$ (full-scale) with a 5.5 foot towline would be needed for a wing-tip chute. For a tail parachute the recommended drag area was 86 ft^2 (full-scale) with a 28 foot towline.

SECTION IV

CONCLUSIONS

Based on results of spin tests of a 1/28-scale model of the YF-93A airplane, the following conclusions regarding the spin and recovery characteristics of the airplane at an altitude of 20,000 feet are presented:

1. For all load conditions and configurations tested, with ailerons held "against" the spin (i.e. stick left for a right spin), recovery attempts by full rudder reversal will fail to terminate the spin. With ailerons neutral, recoveries will vary from satisfactory

~~CONFIDENTIAL~~

~~CONFIDENTIAL~~

to unsatisfactory, depending on load condition and configuration.

2. For all load conditions and configurations tested, satisfactory to marginal recoveries will result from full rudder reversal and simultaneous movement of ailerons to full "with" the spin (i.e. stick right for a right spin). The airplane will generally go into a vertical rolling dive. It is believed that the airplane can be recovered from this vertical rolling dive by normal control manipulation.

3. The elevators should be full up during the first part of the spin recovery attempt for fastest recoveries.

4. The Gross Weight at Take-Off and the Design Gross Weight Over Target conditions are more adverse to recovery than any of the other conditions tested.

5. Speed brakes extended will have an adverse effect on recoveries. If a spin is inadvertently entered with speed brakes extended, they should be retracted and recovery be made as outlined above. Wing slats extended will have small, beneficial and rather inconsistent effects on recovery. Landing gear and wing flaps will have small and inconsistent effects on recovery.

6. Satisfactory recovery from inverted spins is expected by rudder reversal.

7. A parachute of drag area $C_{DS} = 28 \text{ ft}^2$ attached to the outer wing tip of the airplane with a towline 5.5 feet in length should give emergency recoveries from any spin encountered. A parachute of drag area 86 ft^2 attached to the rear end of the fuselage by a towline 28 feet in length should also be satisfactory.

8. The YF-93A airplane will not meet the requirement of Army Air Force Specification Number 1816, dated 15 July 1945, Paragraphs D-2a(2)(c) and D-2a(4), which requires that fighter airplanes recover satisfactorily from spins by full rudder reversal, holding ailerons "against" the spin.

~~CONFIDENTIAL~~

~~CONFIDENTIAL~~

SECTION V

REFERENCES

1. Knackstedt, W. F. The Problems of Spin Investigations in a Vertical Wind Tunnel. Office Instruction, Wind Tunnel Branch, Engineering Division, Air Materiel Command, 1948. (Unclassified, English).
2. Neihouse, A. I. A Mass Distribution Criterion for Predicting the Effect of Control Manipulation on the Recovery from a Spin. Advanced Restricted Report, NACA, August 1942. (Unclassified; English).

~~CONFIDENTIAL~~

~~CONFIDENTIAL~~

WRIGHT FIELD 12-FOOT VERTICAL WIND TUNNEL, WADC
SPIN TEST OF THE YF-93A AIRPLANE

<u>Length, overall, ft</u>	42.75
<u>Wing</u>	
Span, ft	38.90
Area, ft ²	306.10
Sweepback at c/4	35° 15.5'
Aspect ratio	4.943
Mean aerodynamic chord, in	98.75
Dihedral,	1° 00'
<u>Incidence</u>	
Root	+1° 00'
Tip	-1° 00'
<u>Section (normal to 25% element)</u>	
Root	NACA 0012 (11.6) -64
Tip	NACA 0011 (10.2) -64
<u>Ailerons (data for one aileron only)</u>	
Area, ft ²	16.36
Span, per cent b/2	46.50
Aileron travel, maximum	15° up, 15° down
<u>Flap</u>	
Type	Single slotted
Area, ft ²	32.51
Span, each, inches	79.01
Flap deflection, maximum	38°
<u>Horizontal Tail</u>	
Total area, ft ²	46.09
Span, ft	14.83
Sweepback at c/4	35° 00'
Elevator area rearward of hingeline, ft ²	12.93
Dihedral	0°
Elevator travel, maximum	35° up, 17.5° down
Horizontal stabilizer deflection	9° down, 3° up

Figure 1: Table of Dimensional Characteristics of the YF-93A
Airplane. (Continued)

~~CONFIDENTIAL~~

~~CONFIDENTIAL~~

WRIGHT FIELD 12-FOOT VERTICAL WIND TUNNEL, WADC
SPIN TEST OF THE YF-93A AIRPLANE

Vertical Tail

Total area, ft ²		33.46
Sweepback at c/4	35°	00'
Rudder area aft of hingeline, ft ²		5.26
Setting of fin with respect to the fuselage plane of symmetry,.....		0°
Rudder travel, maximum	27.5° right, 27.5° left	

Figure 1: (Concluded)

WADC TR 52-206

~~CONFIDENTIAL~~

CONFIDENTIAL

WRIGHT FIELD 12-FOOT VERTICAL WIND TUNNEL, WADC
SPIN TEST OF THE YF-93A AIRPLANE

LOAD CONDITION	DESCRIPTION	W	I _x	I _y	I _z	\bar{x}	Z	$\frac{I_x - I_y}{m b^2} \times 10^4$	$\frac{I_y - I_z}{m b^2} \times 10^4$	$\frac{I_z - I_x}{m b^2} \times 10^4$
A	Design Gross Weight over Target	21700	10700	46200	53700	227.8	86.0	-347	+73	420
B	(Deviations per cent)	-0.7	1.9	0.1	-0.7	-0.2	0			
B	Minimum Flying Weight	15900	9250	39700	46300	230.3	89.6	-407	-89	496
		-0.3	1.5	1.1	0.2	0	0.2			
C	Rearmost Center of Gravity	16100	9250	39500	46400	231.4	89.5	-400	-91	491
		-1.1	1.3	0.1	0	-0.1	0			
D	Center of Gravity Moved 5% MAC aft from C.	16400	9250	43800	50800	236.6	89.5	-449	-91	540
		0.7	—	—	—	-0.4	0			
E	Center of Gravity Moved 10% MAC aft from C	16800	9300	48100	54900	242.2	88.9	-490	-86	576
		3.2	—	—	—	-0.9	-0.5			
F	Mass Extended Along Fuselage	17000	9500	45400	52400	230.5	90.1	-448	-88	537
		—	—	0.6	—	-0.2	-0.3			
G	Mass Extended Along Wing	16600	15000	40400	53100	234.1	89.4	-396	-363	490
		—	2.4	—	—	-3.8	0.4			
H	Center of Gravity Moved 7% MAC fwd. from B	16900	9350	42500	49100	223.4	89.8	-419	-85	503
		6.0	—	—	—	0	0			
I	Gross Weight at Take Off	25900	11050	49900	57700	227.0	87.3	-318	-65	383
		2.3	3.5	-1.5	-1.2	-0.3	1.8			

Weight in pounds
Moments of inertia in slug-ft²
specified about body axes through CG.
Errors in CG location given in % MAC.
Length of MAC is 98.75 inches

Reference planes for CG locations:
Y measured in inches normal to a vertical plane through fuselage station 0 normal to the FRL.
Z measured in inches normal to a horizontal plane 100 inches below the FRL.

In Y direction, CG deviation was less than 0.1% MAC.

FIGURE 2: MODEL MASS DISTRIBUTION TABLE. 1/28-Scale Model of YF-93A Airplane (all values converted to full scale).

WRIGHT FIELD 12-FOOT VERTICAL WIND TUNNEL, WADC
SPIN TEST OF THE YF-93A AIRPLANE

LOAD CONDITION	DESCRIPTION	W	I _x (roll)	I _y (pitch)	I _z (yaw)	X	Z	$\frac{I_x I_y}{m b^2} \times 10^4$	$\frac{I_y I_z}{m b^2} \times 10^4$	$\frac{I_x I_z}{m b^2} \times 10^4$
A'	Design Gross Weight Over Target	21846	10503	46168	54080	227.6	86.0	-343	-76	119
B'	Minimum Flying Weight	15943	9111	39258	46204	230.3	89.8	-397	-92	189
C'	Rearmost Center of Gravity	16284	9135	39455	46377	231.3	89.4	-391	-89	180
D'	Gross Weight at Take-Off	26516	10680	50658	58393	226.7	89.0	-317	-61	378

Weight in pounds.
Moments of inertia in slug-ft²
specified about body axes through CG.
Length of MAC is 96.75 inches.

Reference planes for CG location:

X measured in inches normal to a vertical plane through fuselage station 0 normal to the FRL.
Z measured in inches normal to a horizontal plane 100 inches below the FRL.

FIGURE 3: AIRPLANE MASS DISTRIBUTION TABLE - YF-93A. (From North American Report No. NA-49-477).

~~CONFIDENTIAL~~

WRIGHT FIELD 12-FOOT VERTICAL WIND TUNNEL, WADC
SPIN TEST OF THE YF-93A AIRPLANE

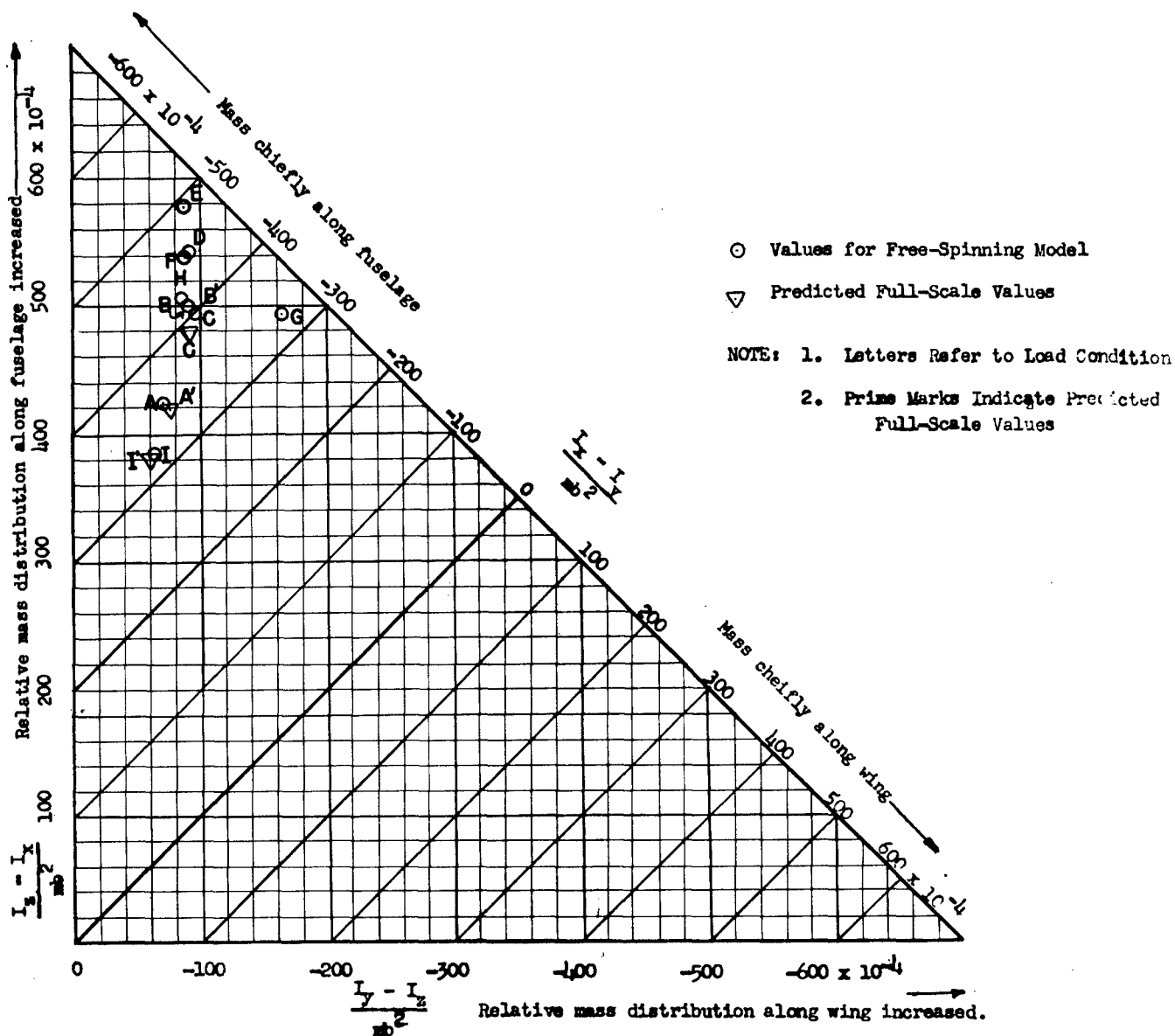
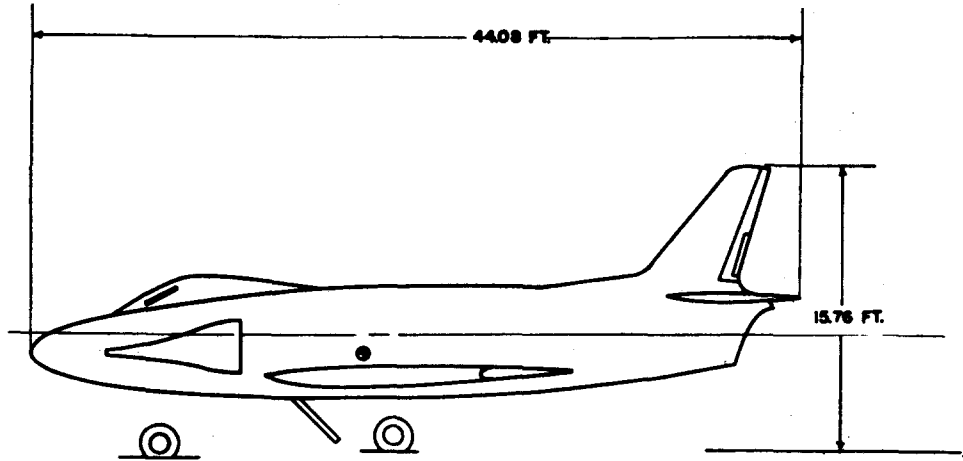

FIGURE 4: INERTIA MOMENT PARAMETER CHART FOR YF-93A AIRPLANE.

WADC TR 52-206

~~CONFIDENTIAL~~

~~CONFIDENTIAL~~



WRIGHT FIELD 12-FOOT VERTICAL WIND TUNNEL, WADC
SPIN TEST OF THE YF-93A AIRPLANE

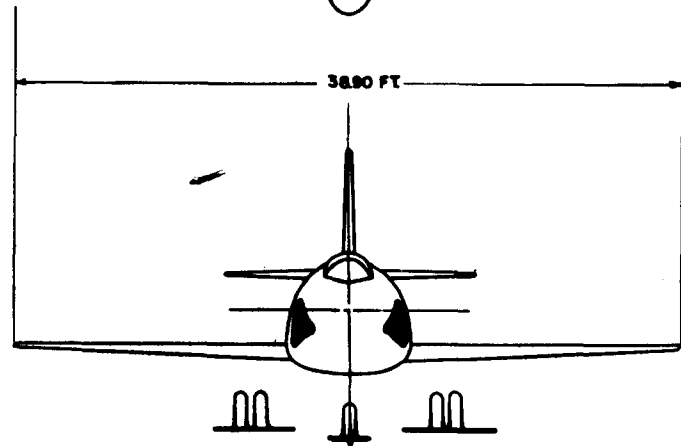
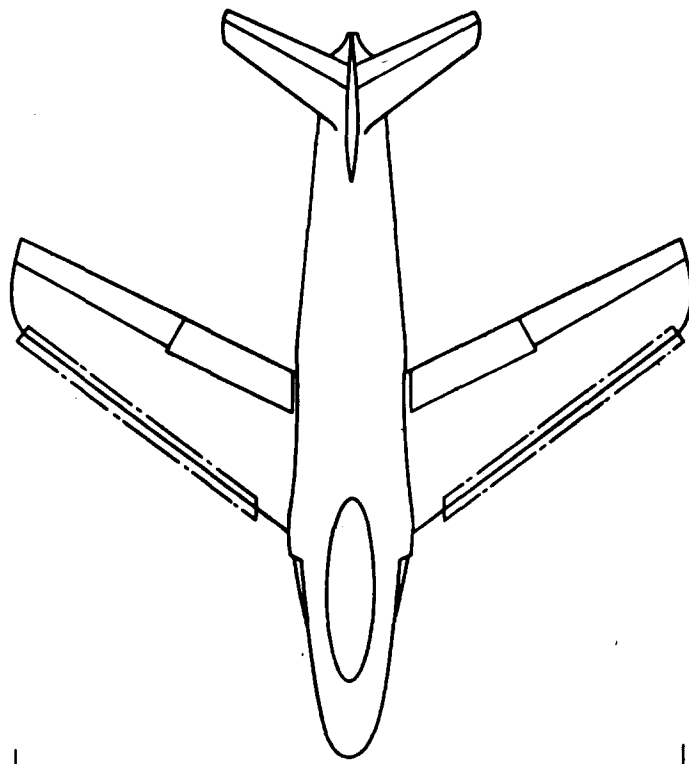

~~CONFIDENTIAL~~

Figure 5: Three View Drawing of YF-93A Airplane

~~CONFIDENTIAL~~

WRIGHT FIELD 12-FOOT VERTICAL WIND TUNNEL, WADC
SPIN TEST OF THE YF-93A AIRPLANE

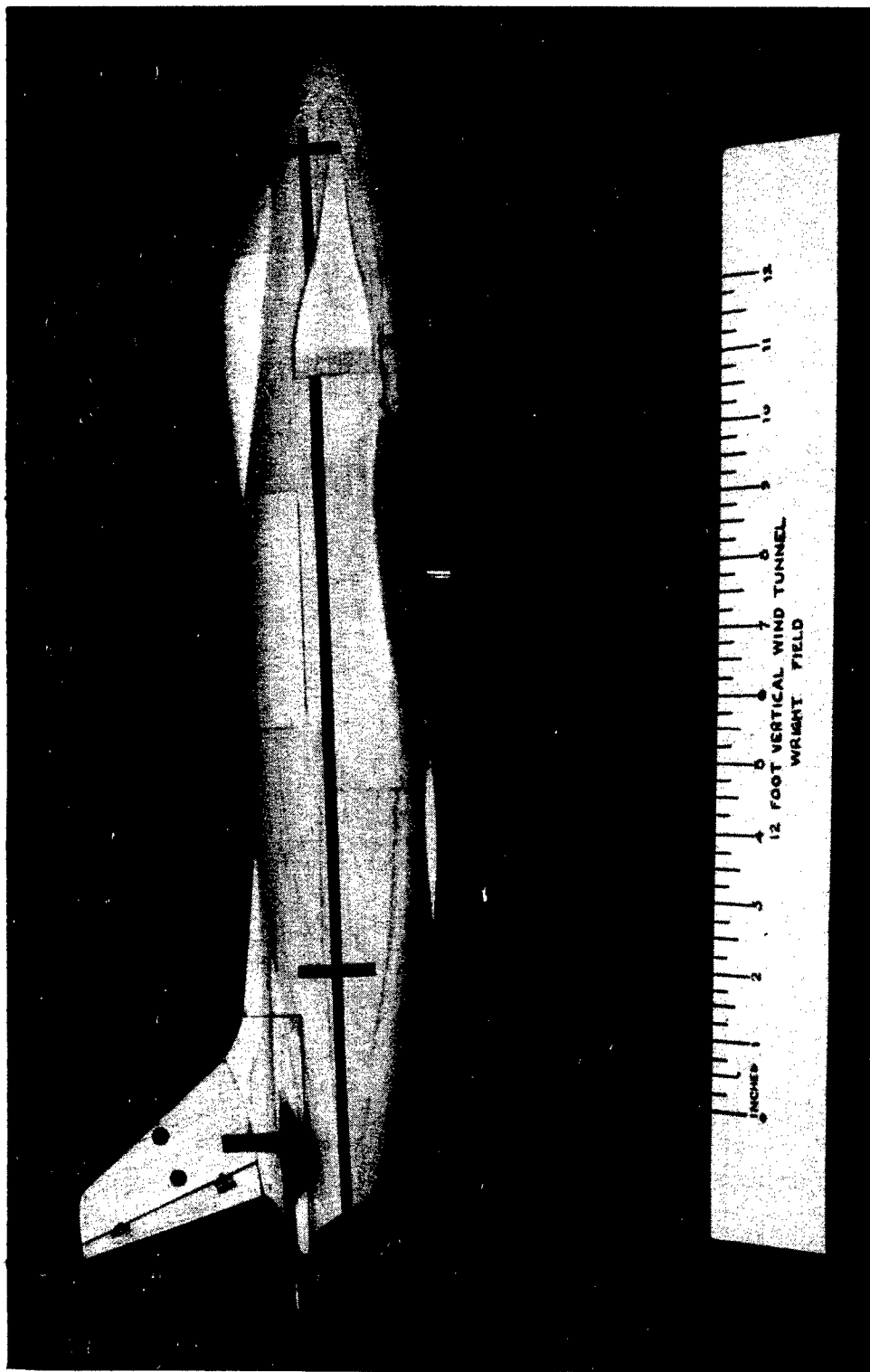

Figure 6: Side View Photograph of 1/28-Scale Model of YF-93A Airplane, Clean Condition

~~CONFIDENTIAL~~

~~CONFIDENTIAL~~

WRIGHT FIELD 12-FOOT VERTICAL WIND TUNNEL, WADC
SPIN TEST OF THE XY-93A AIRPLANE

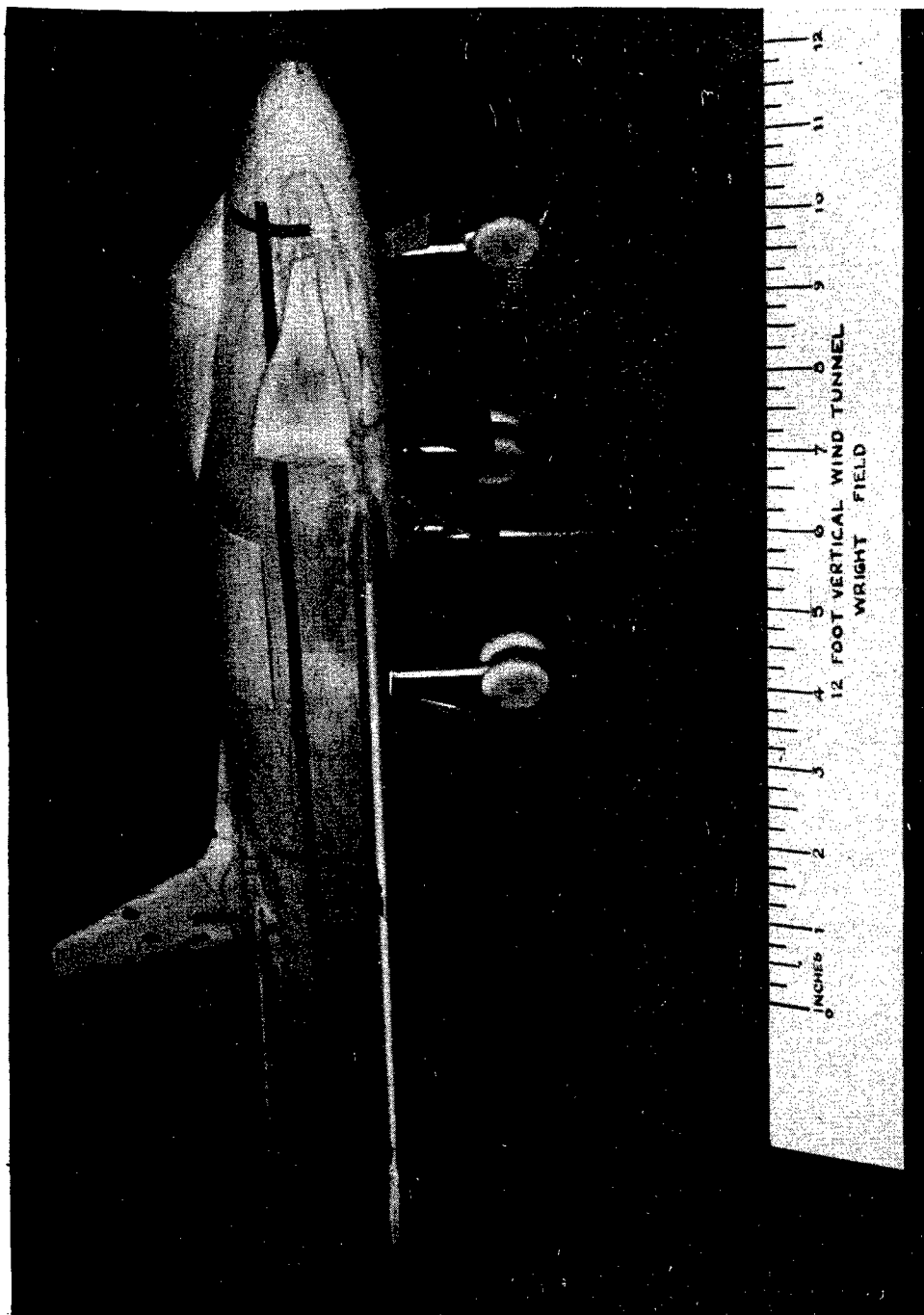

Figure 7: Three-Quarter View Photograph of 1/28-Scale Model of YF-93A Airplane with Landing Gear and Speed Brakes Extended

~~CONFIDENTIAL~~

~~CONFIDENTIAL~~

WRIGHT FIELD 12-FOOT VERTICAL WIND TUNNEL, WADC
SPIN TEST OF THE YF-93A AIRPLANE

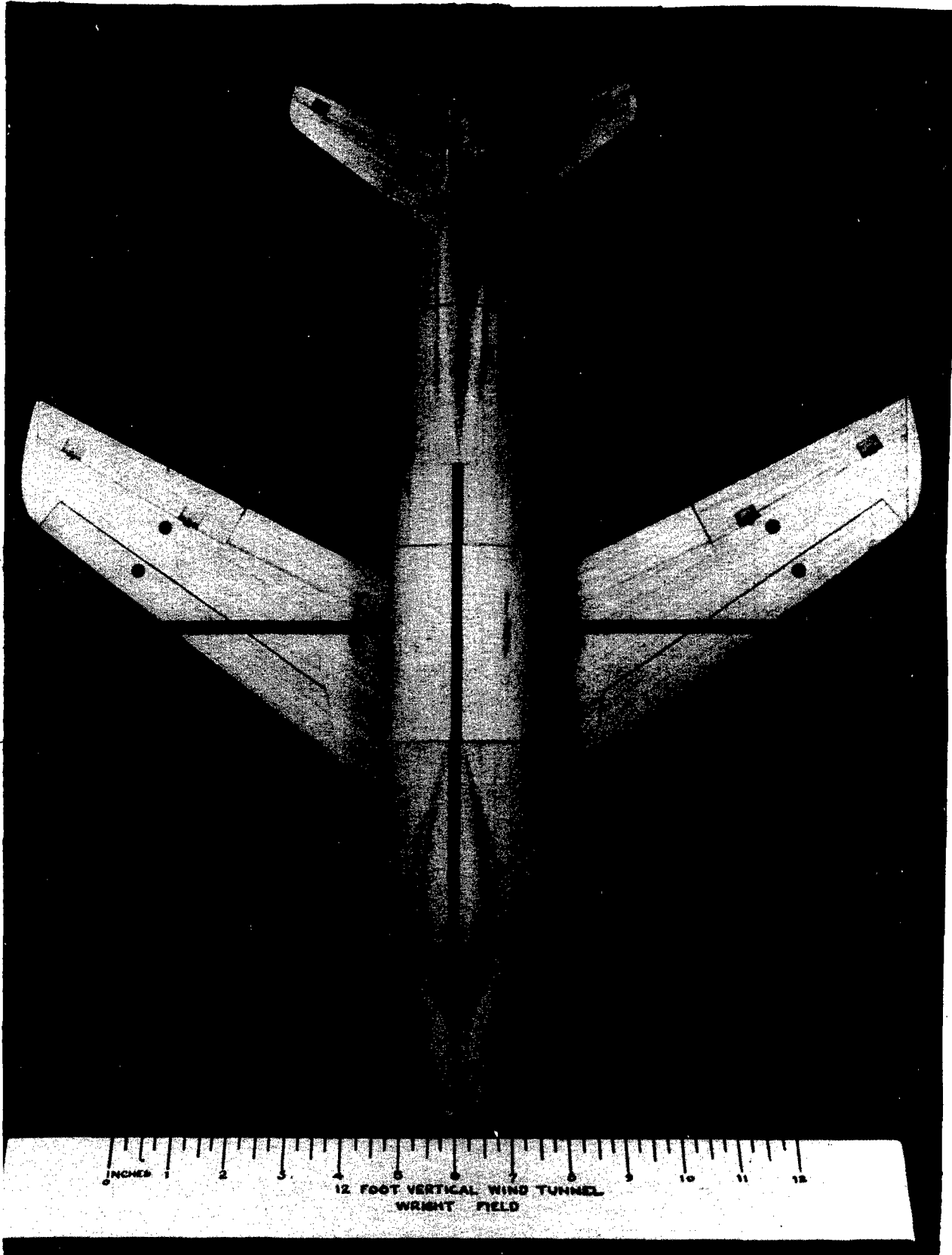

Figure 8: Plan View Photograph of 1/28-Scale Model of YF-93A Airplane

WADC TR 52-206

~~CONFIDENTIAL~~

~~CONFIDENTIAL~~

WRIGHT FIELD 12-FOOT VERTICAL WIND TUNNEL, WADC
SPIN TEST OF THE YF-93A AIRPLANE

LOAD CONDITIONS	DESIGN GROSS WEIGHT OVER TARGET	MINIMUM FLYING WEIGHT	REARMOST DESIGN CENTER OF GRAVITY	CENTER OF GRAVITY 5% OF MAC AFT FROM C	CENTER OF GRAVITY 10% OF MAC AFT FROM C	MASS EXTENDED ALONG FUSELAGE	MASS EXTENDED ALONG WING	CENTER OF GRAVITY 7% OF MAC FORWARD FROM B	GROSS WEIGHT AT TAKE-OFF
	A	B	C	D	E	F	G	H	I
CONFIGURATION	A	B	C	D	E	F	G	H	I
CLEAN	0 +3°	0 +3° -9°	0 +3° -9°	0 +3°	0	0	0	0 +3°	0** +3°
WING SLATS EXTENDED	+3° -9°	-9°	-9°						
LEFT SLAT (OUTBOARD) EXTENDED		-9°							
RIGHT SLAT (INBOARD) EXTENDED		-9°							
WING FLAPS EXTENDED		0°							
SPEED BRAKES EXTENDED	-9°	-9°							0°* -9°*
WING SLATS AND SPEED BRAKES EXTENDED	-9°	-9°							
LEFT (OUTBOARD) SLAT AND SPEED BRAKES EXTENDED		-9°							
LANDING GEAR EXTENDED	0°								
OTHER	a, b	c							

- a. LEFT ERECT SPINS FOR CLEAN MODEL, 0° STABILIZER SETTING.
- b. LEFT INVERTED SPINS FOR CLEAN MODEL, 0° STABILIZER SETTING.
- c. RIGHT INVERTED SPINS FOR CLEAN MODEL, +3° STABILIZER SETTING.

* RECOVERY ALSO ATTEMPTED BY SIMULTANEOUS RUDDER AND AILERON MOVEMENT.
** RECOVERY ALSO ATTEMPTED BY AILERON MOVEMENT ALONE.

FIGURE 9: SPIN TEST PROGRAM 1/28-SCALE MODEL OF THE YF-93A AIRPLANE.

~~CONFIDENTIAL~~

~~CONFIDENTIAL~~

WRIGHT FIELD 12-FOOT VERTICAL WIND TUNNEL, WADC SPIN TEST OF THE YF-93A AIRPLANE

RECOVERY ATTEMPTED BY SIMULTANEOUS MOVEMENT OF
RUDDER AND AILERONS TO EXTREME ANTI-SPIN POSITION **

RECOVERY ATTEMPTED BY RUDDER REVERSAL AND BY SIMULTANEOUS
MOVEMENT OF RUDDER AND AILERONS TO EXTREME ANTI-SPIN POSITION **

STABILIZER SETTING -9° WITH SPEED BRAKES EXTENDED

STABILIZER SETTING 0° WITH MODEL IN CLEAN CONDITION

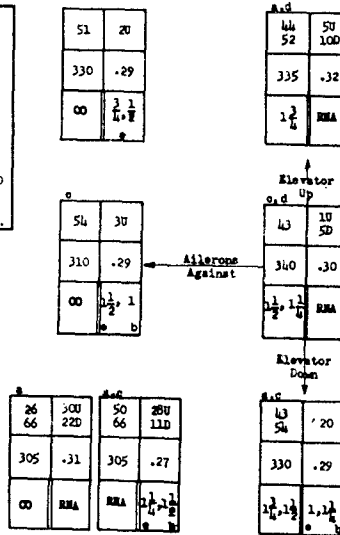
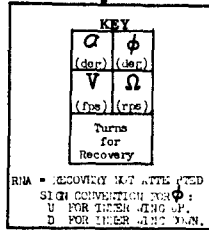
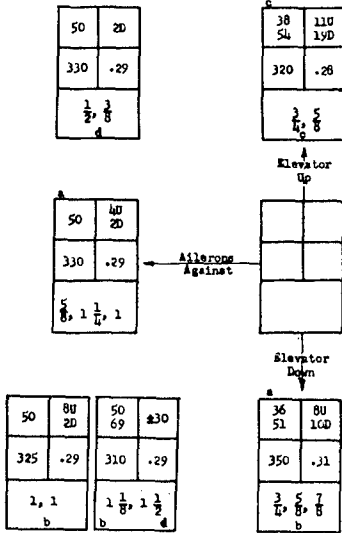

- a. BOTH STEADY AND OSCILLATORY TYPES OF SPIN.
- b. MODEL RECOVERED IN VERTICAL ROLLING DIVE.
- c. WANDERING IN MUTATING MANNER.
- d. ONLY EXTREME VALUES OF TURNS FOR RECOVERY ARE GIVEN.
- ** RUDDER MOVED FROM 27.5° RIGHT TO 27.5° LEFT AND AILERONS MOVED FROM INITIAL POSITION TO POSITION CORRESPONDING TO STICK FULL RIGHT (AILERON DEFLECTION ±15°).

- a. OSCILLATORY, WHIPPING (THAT IS, Ω INCREASES AND DECREASES).
- b. MODEL RECOVERED IN VERTICAL ROLLING DIVE.
- c. BOTH STEADY AND OSCILLATORY TYPES OF SPIN.
- d. WANDERING SPIN (MUTATING).
- ** ONLY EXTREME VALUES OF TURNS FOR RECOVERY ARE GIVEN.
- ** VALUES TO LEFT OF DOUBLE LINES ARE FOR RUDDER REVERSAL. VALUES TO RIGHT ARE FOR SIMULTANEOUS RUDDER AND AILERON MOVEMENT AS DESCRIBED BY a.

RECOVERY ATTEMPTED BY AILERON REVERSAL ***

STABILIZER SETTING 0° WITH MODEL IN CLEAN CONDITION

RECOVERY ATTEMPTED BY RUDDER REVERSAL AND BY SIMULTANEOUS
MOVEMENT OF RUDDER AND AILERONS TO EXTREME ANTI-SPIN POSITION **

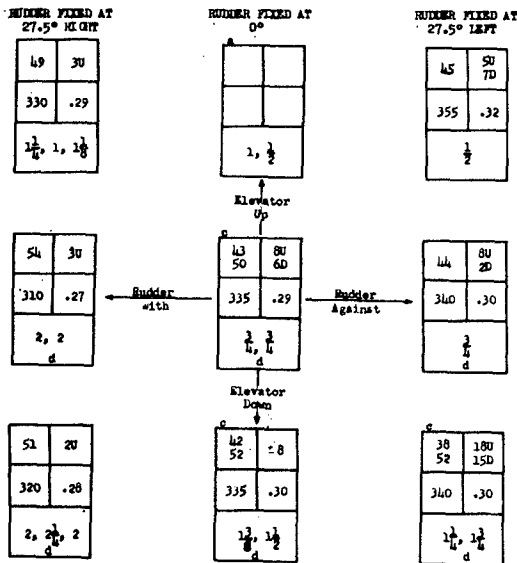

STABILIZER SETTING 0° WITH SPEED BRAKES EXTENDED

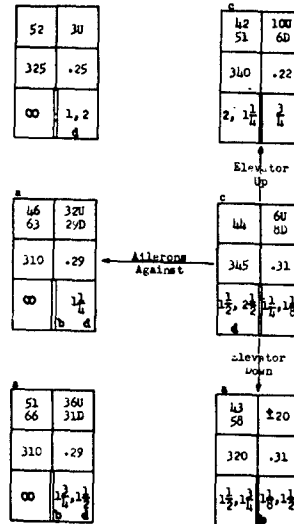

- a. PICTURES OF RECOVERY ONLY - STEADY SPIN.
- b. WANDERING.
- c. OSCILLATORY, WHIPPING.
- d. MODEL RECOVERED IN VERTICAL ROLLING DIVE.

*** AILERONS MOVED FROM FULL PRO-SPIN POSITION (STICK LEFT, OR AGAINST, FOR A RIGHT SPIN) TO FULL ANTI-SPIN POSITION. RUDDER STATIONARY.

- a. OSCILLATORY, WHIPPING.
- b. RECOVERED IN VERTICAL ROLLING DIVE.
- c. WANDERING.
- d. ONLY EXTREME VALUES OF TURNS FOR RECOVERY ARE GIVEN.

Figure 10: CHART OF RIGHT ERECT SPINS AT GROSS WEIGHT AT TAKE-OFF (I), WITH RECOVERY BY RUDDER AND/OR AILERON MOVEMENT. 1/28-Scale Model of YF-93A Airplane. All Values Converted to Full Scale at Equivalent Test Altitude of 20,000 Feet.

**WRIGHT FIELD 12-FOOT VERTICAL WIND TUNNEL, WADC
SPIN TEST OF THE YF-93A AIRPLANE**

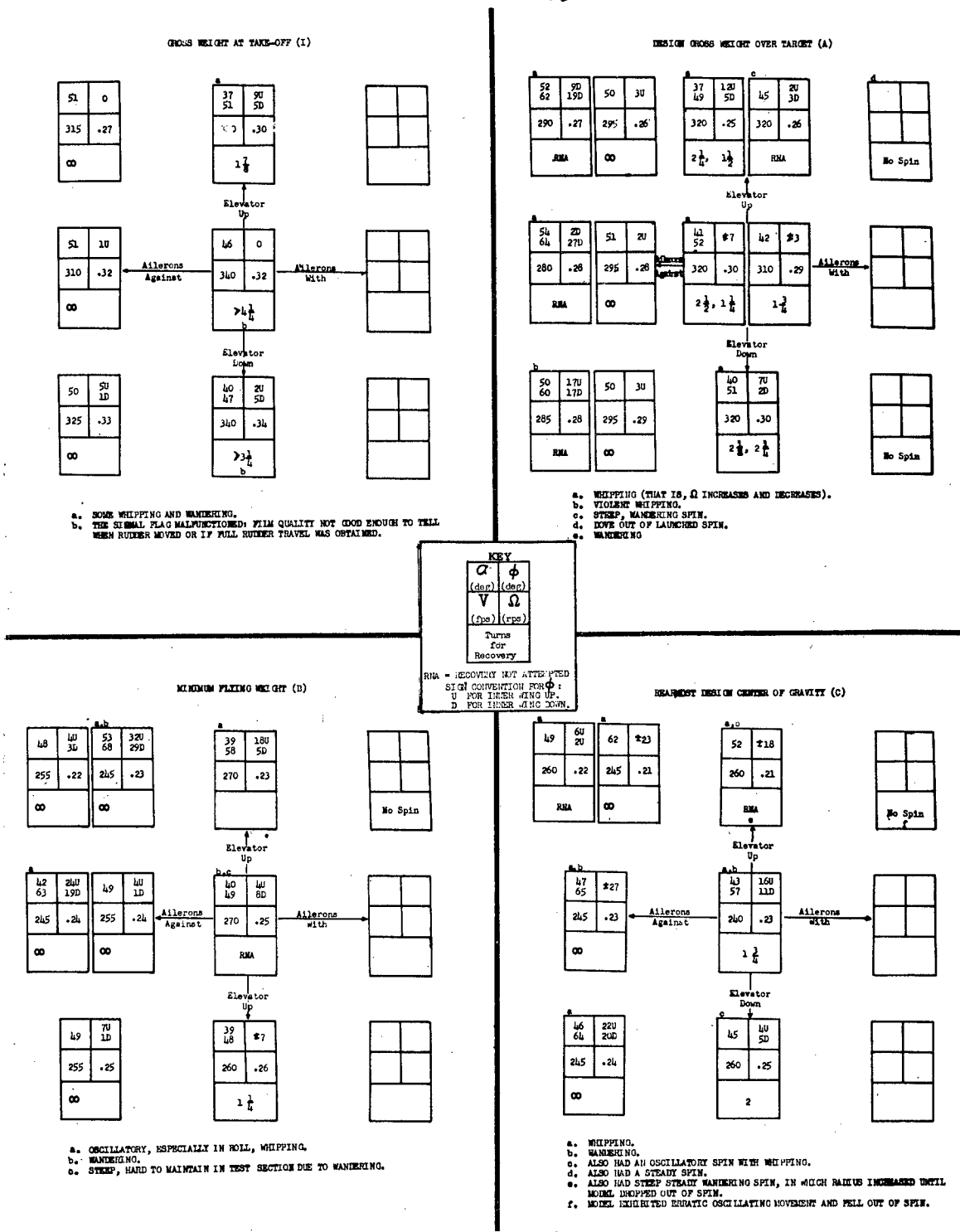
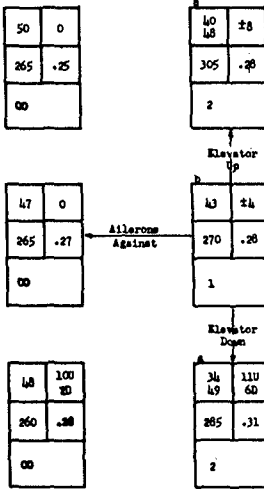

Figure 11: CHART OF RIGHT ERECT SPIN AT PREDICTED LOAD CONDITIONS, 0° STABILIZER SETTING. 1/28-Scale Model of YF-93A Airplane. Model in Clean Condition. Recovery Attempted by Full Rudder Reversal. All Values Converted to Full-Scale at Equivalent Test Altitude of 20,000 Feet.

WRIGHT FIELD 12-FOOT VERTICAL WIND TUNNEL, WADC
SPIN TEST OF THE YF-93A AIRPLANE

CENTER OF GRAVITY 7% OF MAC FORWARD (B)
FROM LOCATION FOR MINIMUM FLYING HEIGHT
(MEASURED CG LOCATION 17.5% OF MAC)



- a. OSCILLATORY.
- b. WANDERED SLIGHTLY WITH ROTATING MOTION.
- c. OSCILLATORY, WANDERING.
- d. MEASURED AFT OF LEADING EDGE OF MAC.

NEAREST SECTION CENTER OF GRAVITY (C)
(MEASURED CG LOCATION 25.5% OF MAC)

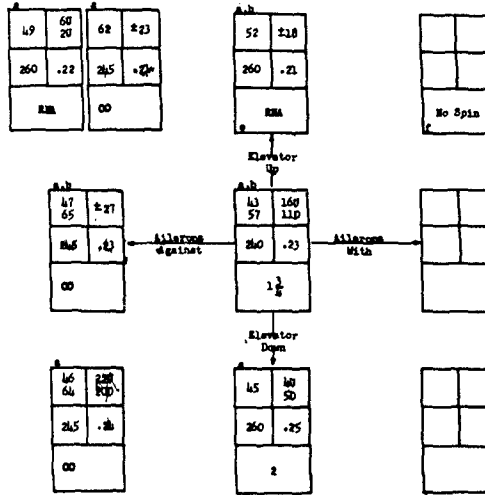

- a. WHIPPING.
- b. WANDERING.
- c. ALSO HAD AN OSCILLATORY SPIN WITH WHIPPING.
- d. ALSO HAD A STEADY SPIN.
- e. ALSO HAD STEADY STEADY WANDERING SPIN, IN WHICH VALUES INCREASED UNTIL MODEL DROPPED OUT OF SPIN.
- f. MODEL EXPERIENCED BERTIC OSCILLATING MOTION AND FELL OUT OF SPIN.

KEY

σ	ϕ
(dep)	(dep)
V	Ω
(rpm)	(rpm)
Turns for Recovery	

RMA = RECOVERY NOT ATTEMPTED
SIGN CONVENTION FOR ϕ :
U FOR TURNING UP,
D FOR TURNING DOWN.

CENTER OF GRAVITY 5% OF MAC AFT (D)
FROM NEAREST SECTION LOCATION
(MEASURED CG LOCATION 31.2% OF MAC)

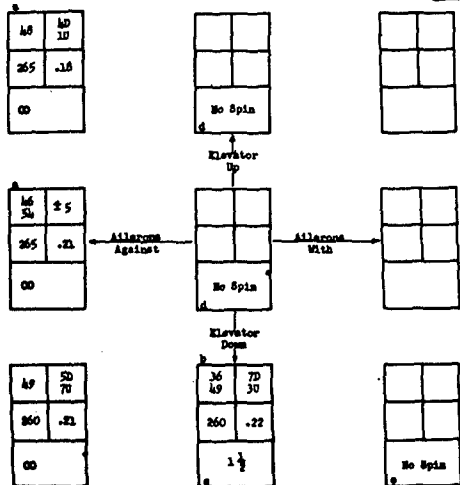

- a. LARGE BANGS SPIN.
- b. WANDERED IN ROTATING MANNER.
- c. MODEL OSCILLATED IN FITTER AND EVENTUALLY PITCHED DOWN STEADILY ENOUGH TO GET OUT OF SPIN. RECOVERY WAS ATTEMPTED WHILE LAUNCHING ROTATION WAS STILL OCCURRING.
- d. DROVE OUT OF SPIN IN STEADY SPIN.
- e. OSCILLATED VIOLENTLY, FELL OUT OF SPIN IN STEADY RATED DIVE.

CENTER OF GRAVITY 10% OF MAC AFT (E)
FROM NEAREST SECTION LOCATION
(MEASURED CG LOCATION 34.7% OF MAC)

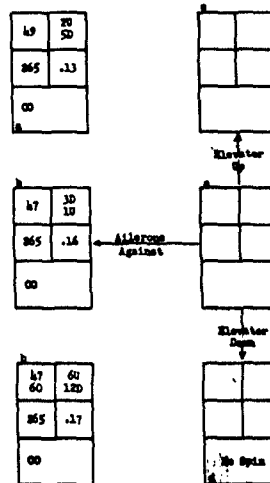

- a. BANGS OF SPIN, ALREADY LARGE, INCREASED AFTER SEVERAL SEVERAL MORE. THIS TIME, POSSIBLY MORE, WILL RECOVER.
- b. LARGE BANGS SPIN.
- c. SPIN WITH VERY LARGE BANGS, MODEL KEY HIT SOON AFTER BEING LAUNCHED.
- d. MODEL PITCHED DOWN SOON AFTER LAUNCH, SPIN OUT.

Figure 12: CHART OF EFFECT OF CENTER OF GRAVITY LOCATION ON RIGHT ERECT SPINS, 0° STABILIZER SETTING.
1/28-Scale Model of YF-93A Airplane. Model in Clean Condition. Recovery Attempted by Full Rudder Reversal. All Values Converted to Full Scale at Equivalent Test Altitude of 20,000 Feet.

WRIGHT FIELD 12-FOOT VERTICAL WIND TUNNEL, WADC
SPIN TEST OF THE YF-93A AIRPLANE

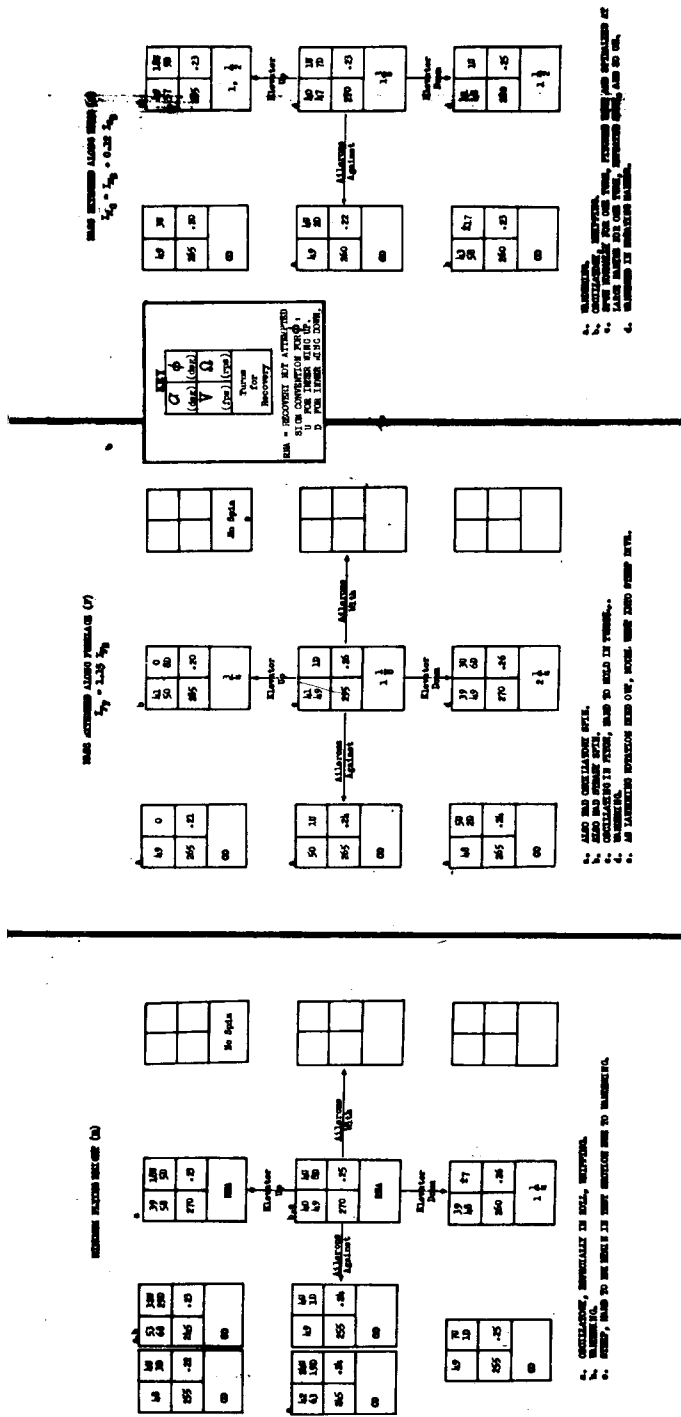

Figure 13: CHART OF EFFECT OF MASS EXTENSION ON RIGHT ERECT SPINS, 0° STABILIZER SETTING. 1/28-Scale Model of YF-93A Airplane. Model in Clean Condition. Recovery Attempted by Full Rudder Reversal. All Values Converted to Full Scale at Equivalent Test Altitude of 20,000 Feet.

WRIGHT FIELD 12-FOOT VERTICAL WIND TUNNEL, WADC
SPIN TEST OF THE YF-93A AIRPLANE

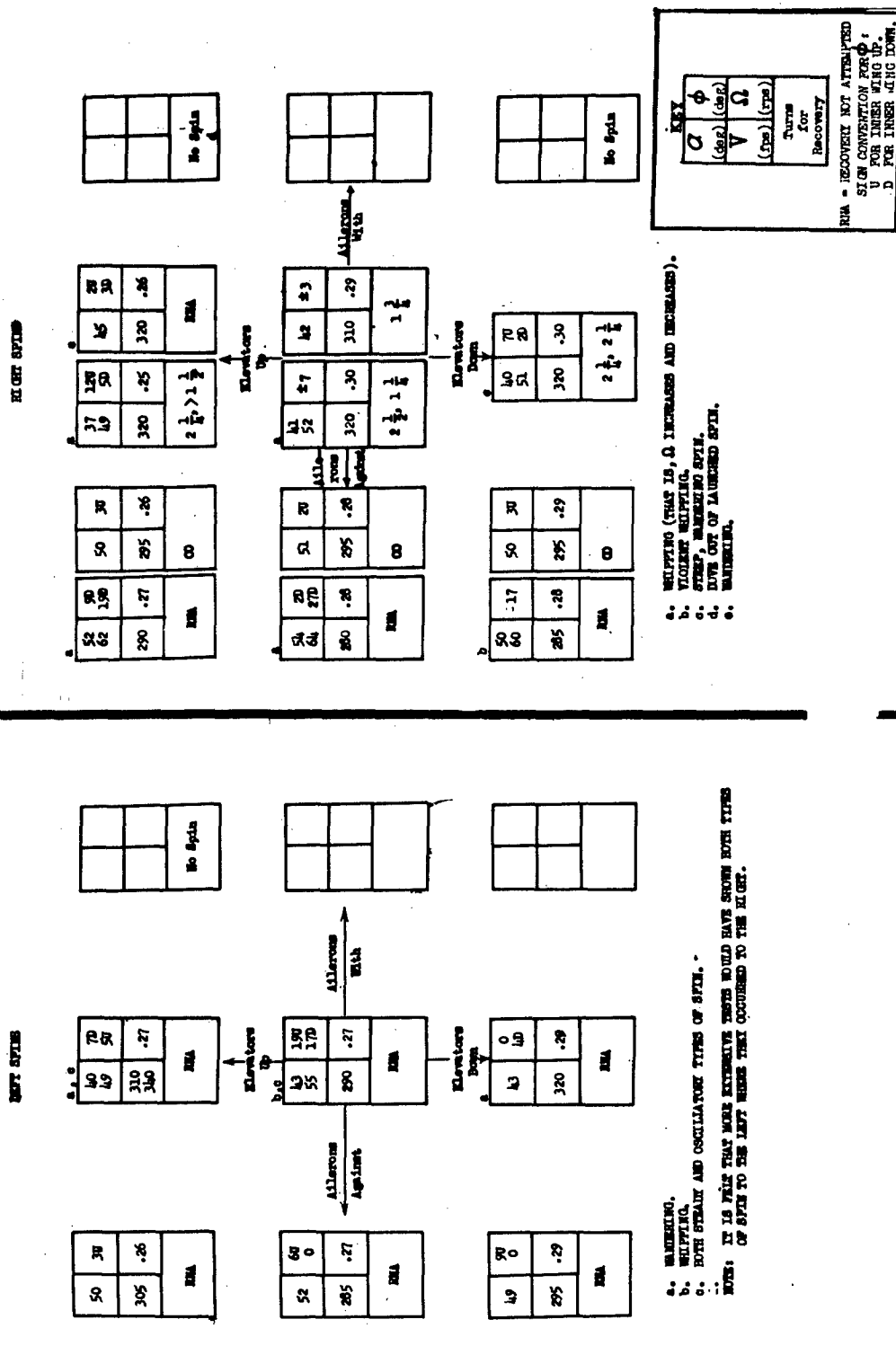
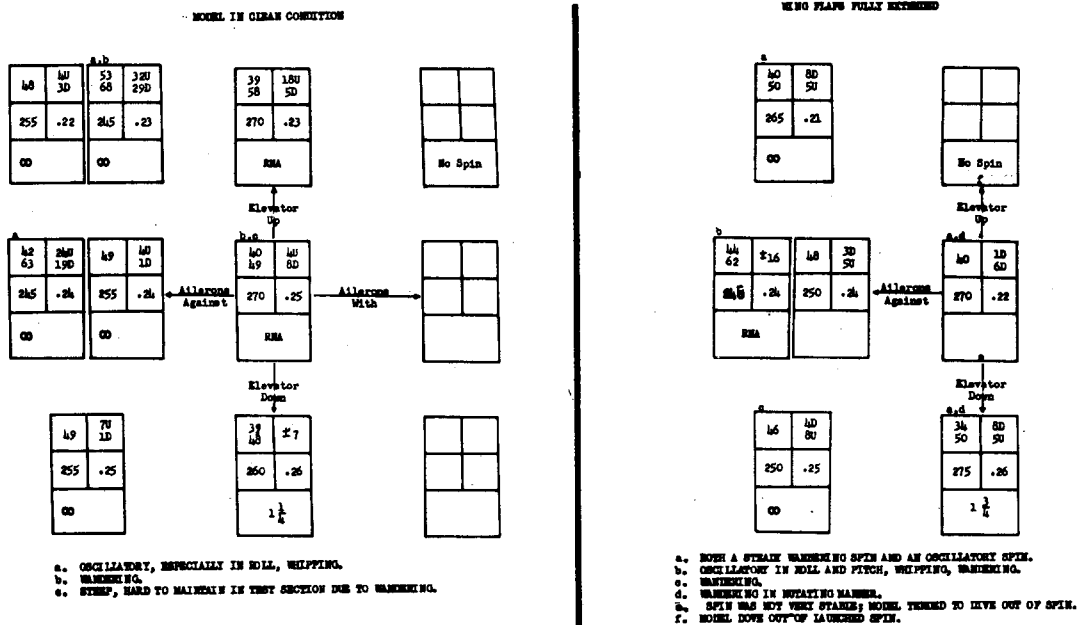

Figure 14: CHART OF SYMMETRY TESTS, ERECT SPINS, 0° STABILIZER SETTING, DESIGN GROSS WEIGHT OVER TARGET (A).
1/28-Scale Model of YF-93A Airplane. Model in Clean Condition, Recovery Attempted by Full Rudder Reversal. All Values Converted to Full Scale at Equivalent Test Altitude of 20,000 Feet.

WRIGHT FIELD 12-FOOT VERTICAL WIND TUNNEL, WADC SPIN TEST OF THE YF-93A AIRPLANE

MINIMUM FLYING WEIGHT (B)



DESIGN GROSS WEIGHT OVER TARGET (A)

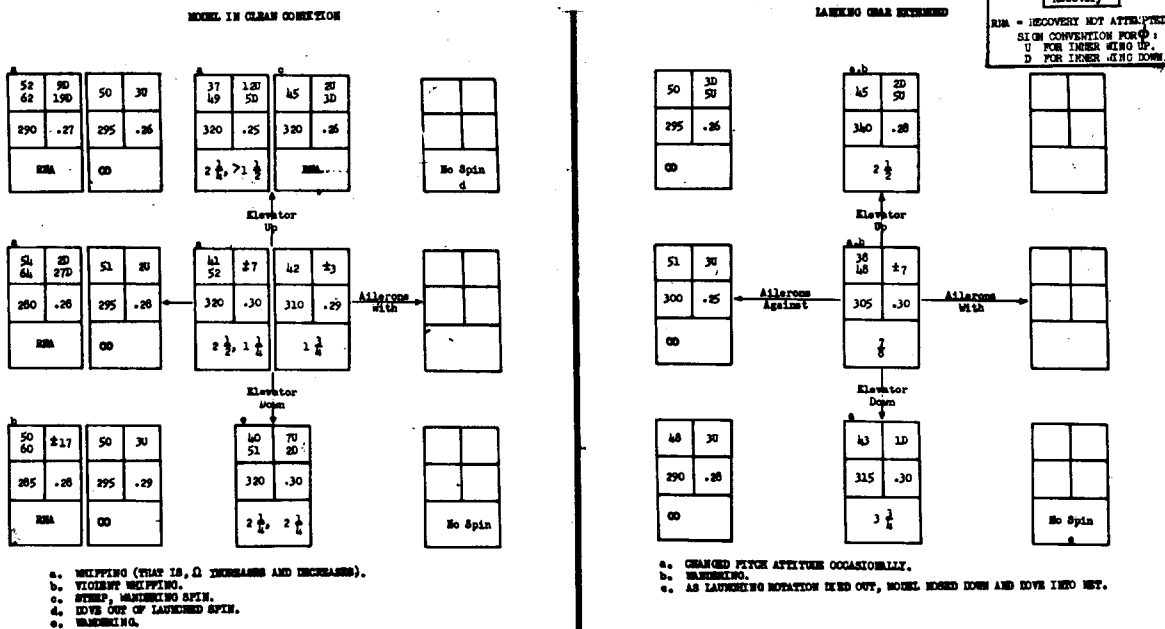

KEY

Ω (deg) ϕ (deg)

V (rpm) Ω (rpm)

Turns for Recovery

RMA = RECOVERY NOT ATTEMPTED
SIGN CONVENTION FOR ϕ:
U FOR INNER WING UP,
D FOR INNER WING DOWN.

Figure 15: CHART OF RIGHT ERECT SPINS SHOWING EFFECT OF EXTENDED WING FLAPS AND OF EXTENDED LANDING GEAR, 0° STABILIZER SETTING. 1/28-Scale Model of YF-93A Airplane. Recovery Attempted by Full Rudder Reversal. All Values Converted to Full Scale at Equivalent Test Altitude of 20,000 Feet.

CONFIDENTIAL

WRIGHT FIELD 12-FOOT VERTICAL WIND TUNNEL, WADC
SPIN TEST OF THE YF-93A AIRPLANE

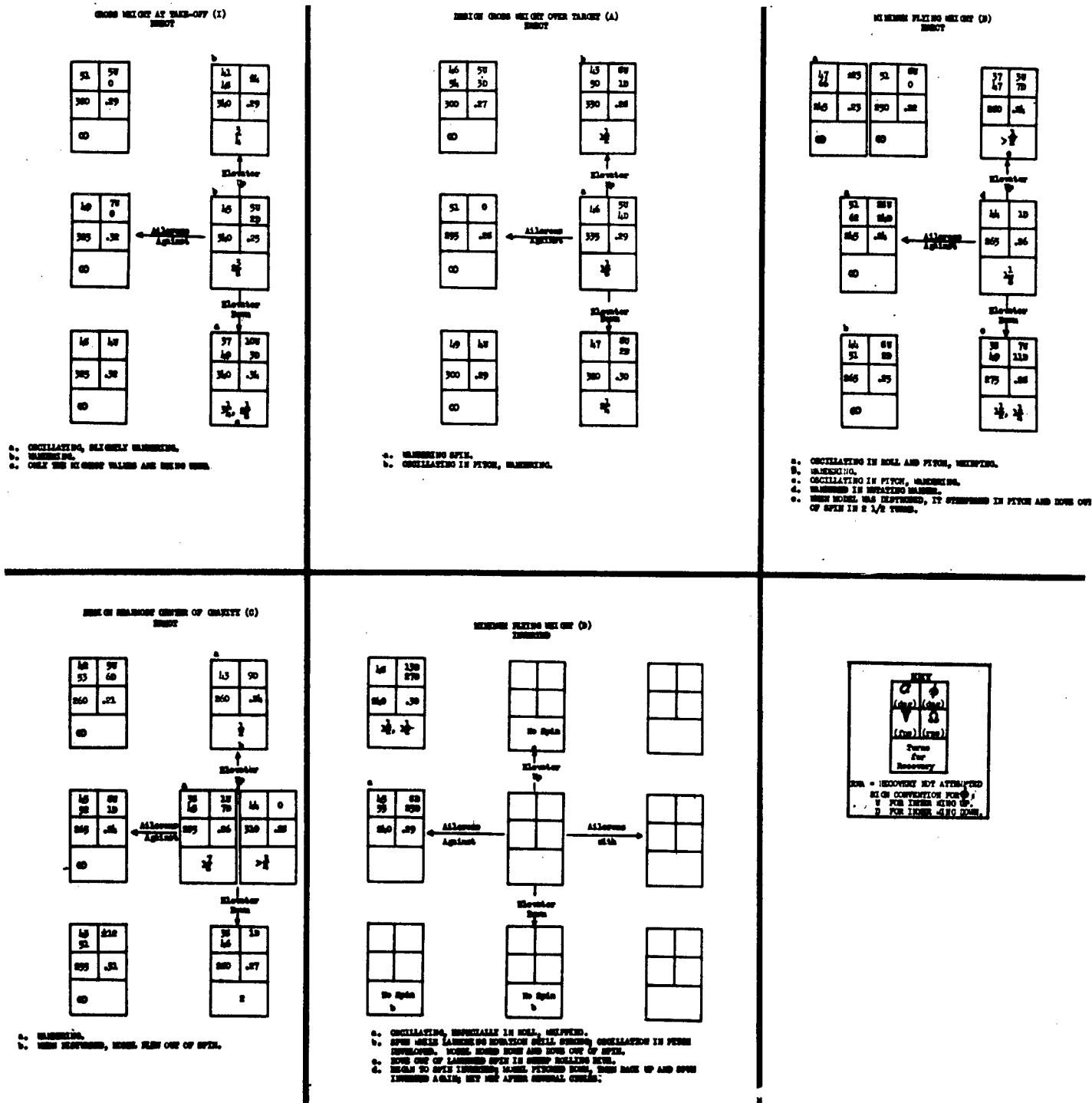

Figure 16: CHART OF RIGHT SPINS AT PREDICTED LOAD CONDITIONS, +3° STABILIZER SETTING.
1/28-Scale Model of YF-93A Airplane. Model in Clean Condition.
Recovery Attempted by Full Rudder Reversal. All Values Converted to Full Scale at Equivalent Test Altitude of 20,000 Feet.

**WRIGHT FIELD 12-FOOT VERTICAL WIND TUNNEL, WADC
SPIN TEST OF THE YF-93A AIRPLANE**

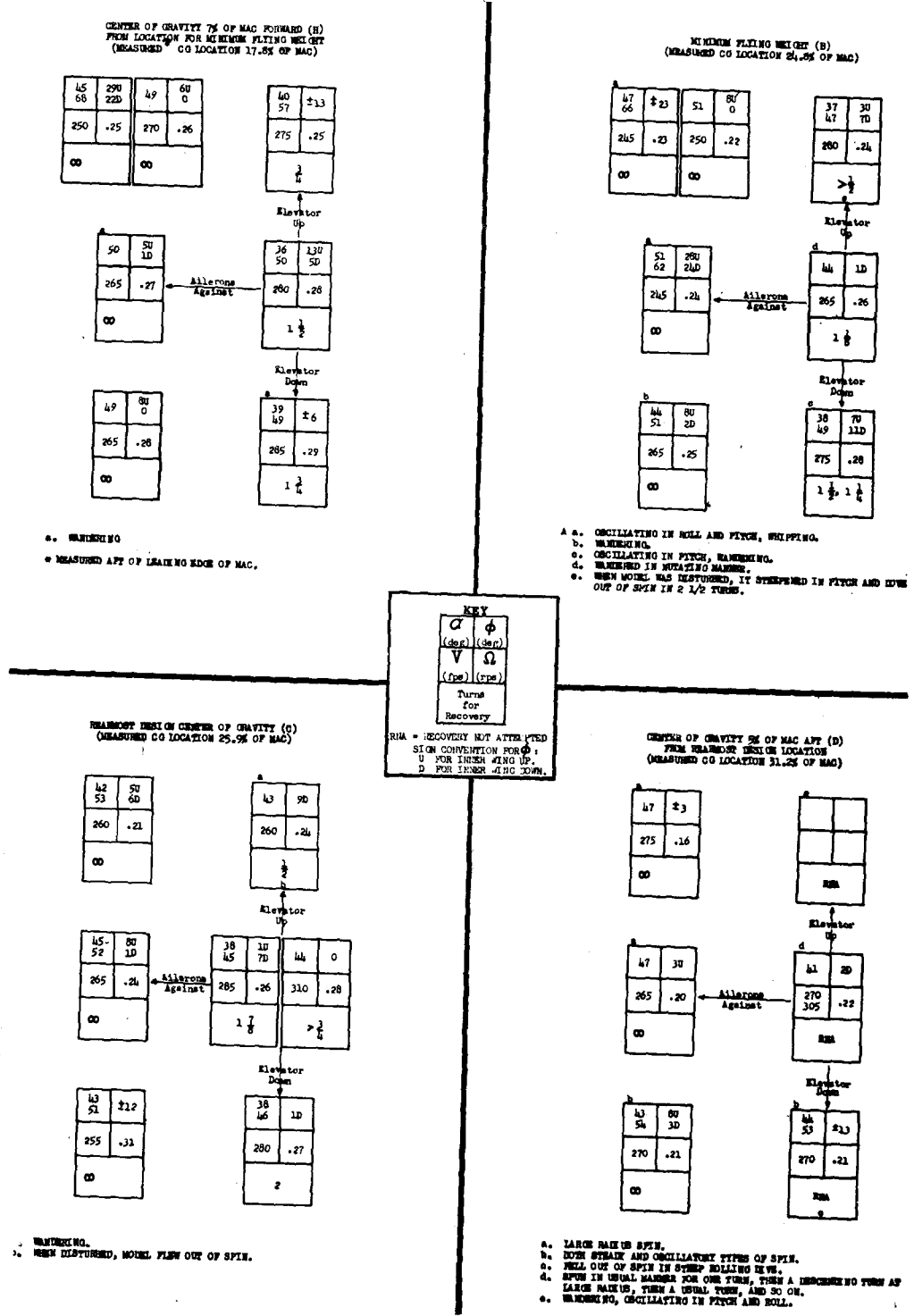
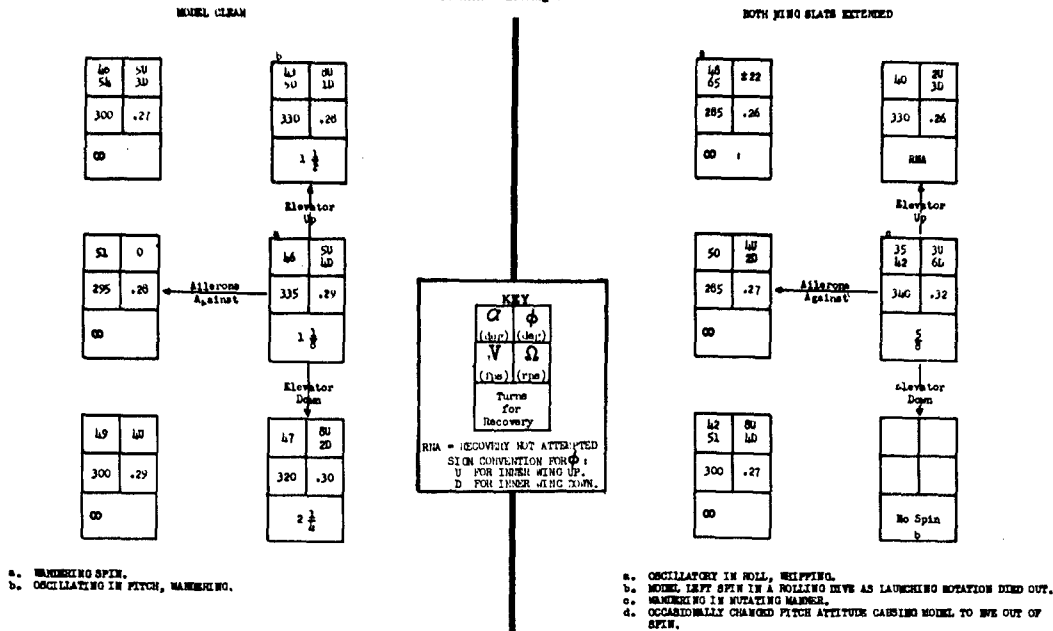

Figure 17: CHART OF EFFECT OF CENTER OF GRAVITY LOCATION ON RIGHT ERECT SPINS, +3° STABILIZER SETTING. 1/28-Scale Model of YF-93A Airplane. Model in Clean Condition. Recovery Attempted by Full Rudder Reversal. All Values Converted to Full Scale at Equivalent Test Altitude of 20,000 Feet.

CONFIDENTIAL

WRIGHT FIELD 12-FOOT VERTICAL WIND TUNNEL, WADC SPIN TEST OF THE YF-93A AIRPLANE

DESIGN GROSS WEIGHT OVER TARGET (A)
Stabilizer Setting +3°



REARMOST DESIGN CENTER OF GRAVITY (C)
Stabilizer Setting -9°

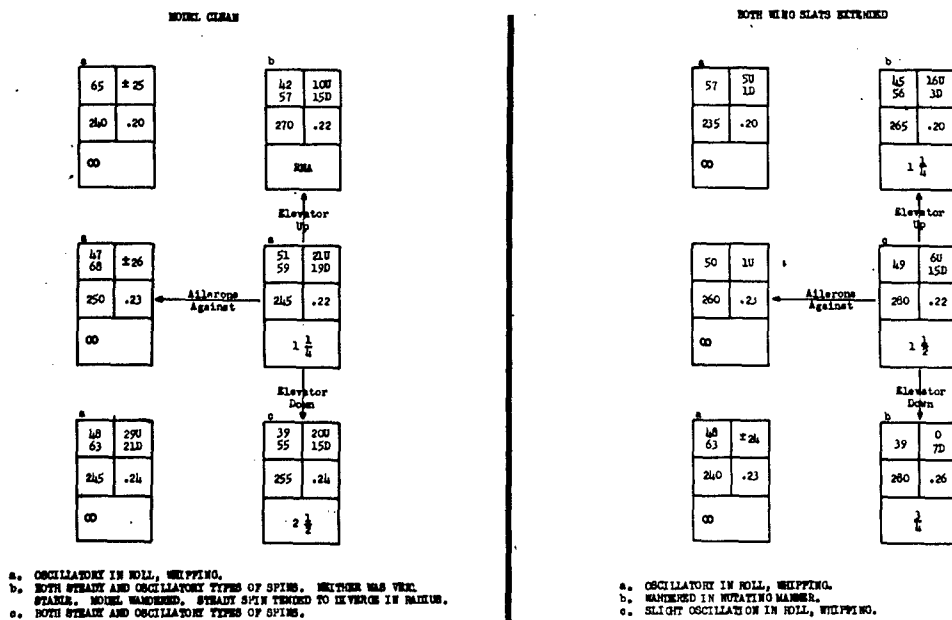

Figure 18: CHART OF RIGHT ERECT SPINS, MODEL CLEAN VERSUS BOTH WING SLATS EXTENDED.
1/28-Scale Model of YF-93A Airplane, Design Gross Weight.
Recovery Attempted by Full Rudder Reversal. All Values
Converted to Full Scale at Equivalent Test Altitude of
20,000 Feet.

**WRIGHT FIELD 12-FOOT VERTICAL WIND TUNNEL, WADC
SPIN TEST OF THE YF-93A AIRPLANE**

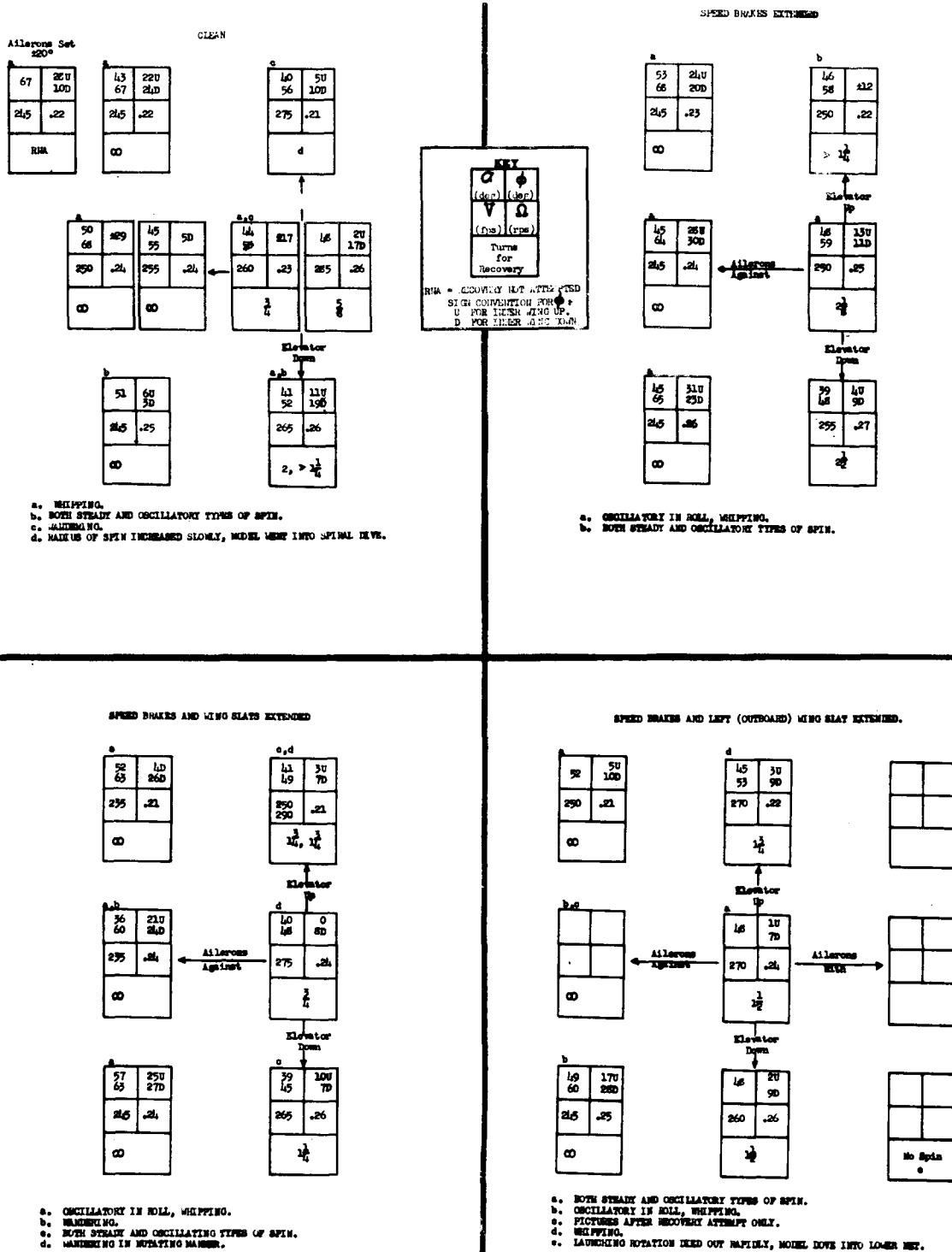

Figure 19: CHART OF EFFECT OF SPEED BRAKES AND WING SLATS ON RIGHT ERECT SPINS, -9° STABILIZER SETTING. 1/28-Scale Model of YF-93A Airplane. Minimum Flying Weight (B). Recovery Attempted by Full Rudder Reversal. All Values Converted to Full Scale at Equivalent Test Altitude of 20,000 Feet.

~~CONFIDENTIAL~~

WRIGHT FIELD 12-FOOT VERTICAL WIND TUNNEL, WADC SPIN TEST OF THE YF-93A AIRPLANE

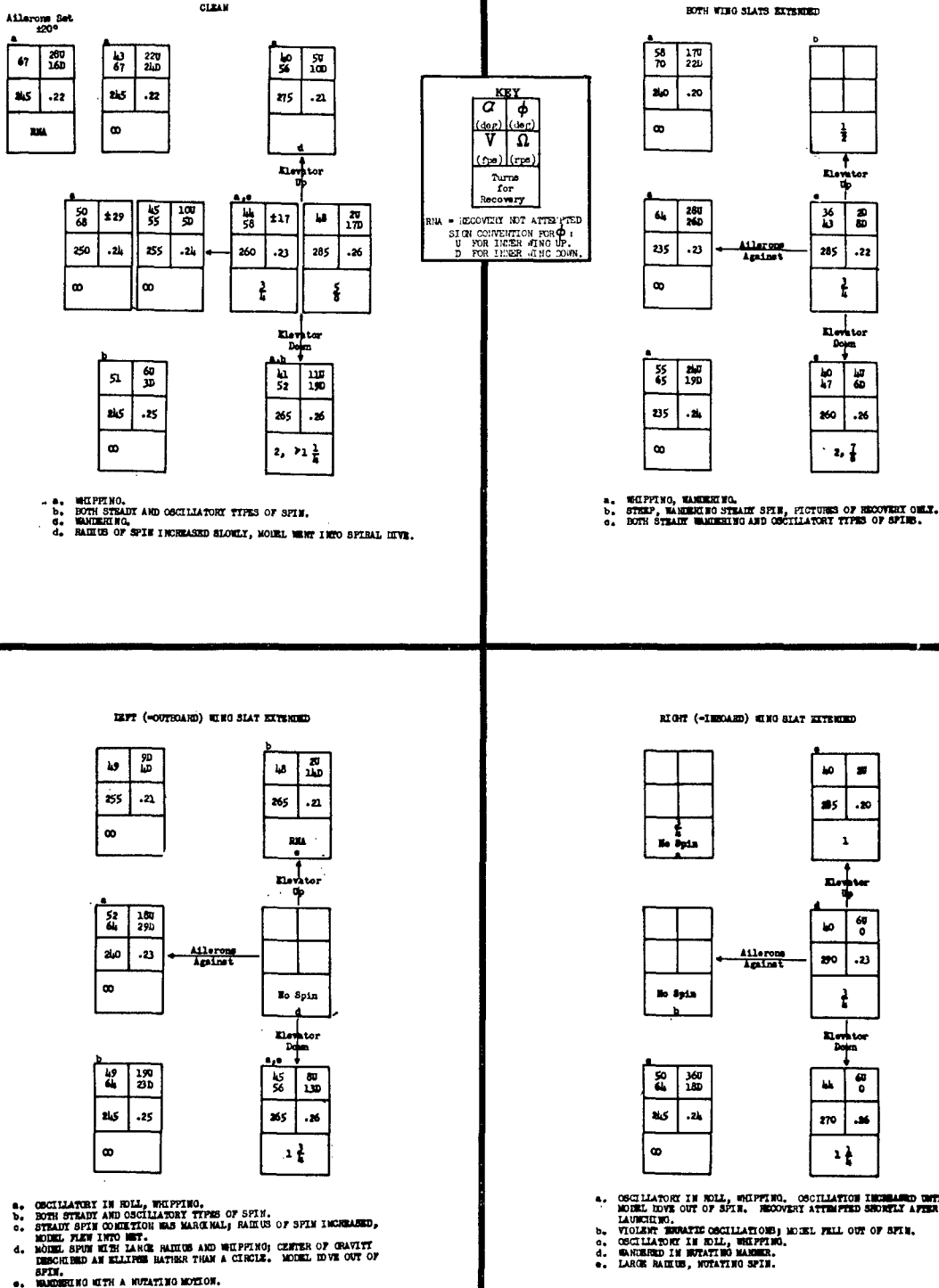

Figure 20: CHART OF EFFECT OF WING SLATS ON RIGHT, ERECT SPINS, -9° STABILIZER SETTING. 1/28-Scale Model of YF-93A Airplane. Minimum Flying Weight (B). Recovery Attempted by Full Rudder Reversal. All Values Converted to Full Scale at Equivalent Test Altitude of 20,000 Feet.

~~CONFIDENTIAL~~

WRIGHT FIELD 12-FOOT VERTICAL WIND TUNNEL, WADC
SPIN TEST OF THE YF-93A AIRPLANE

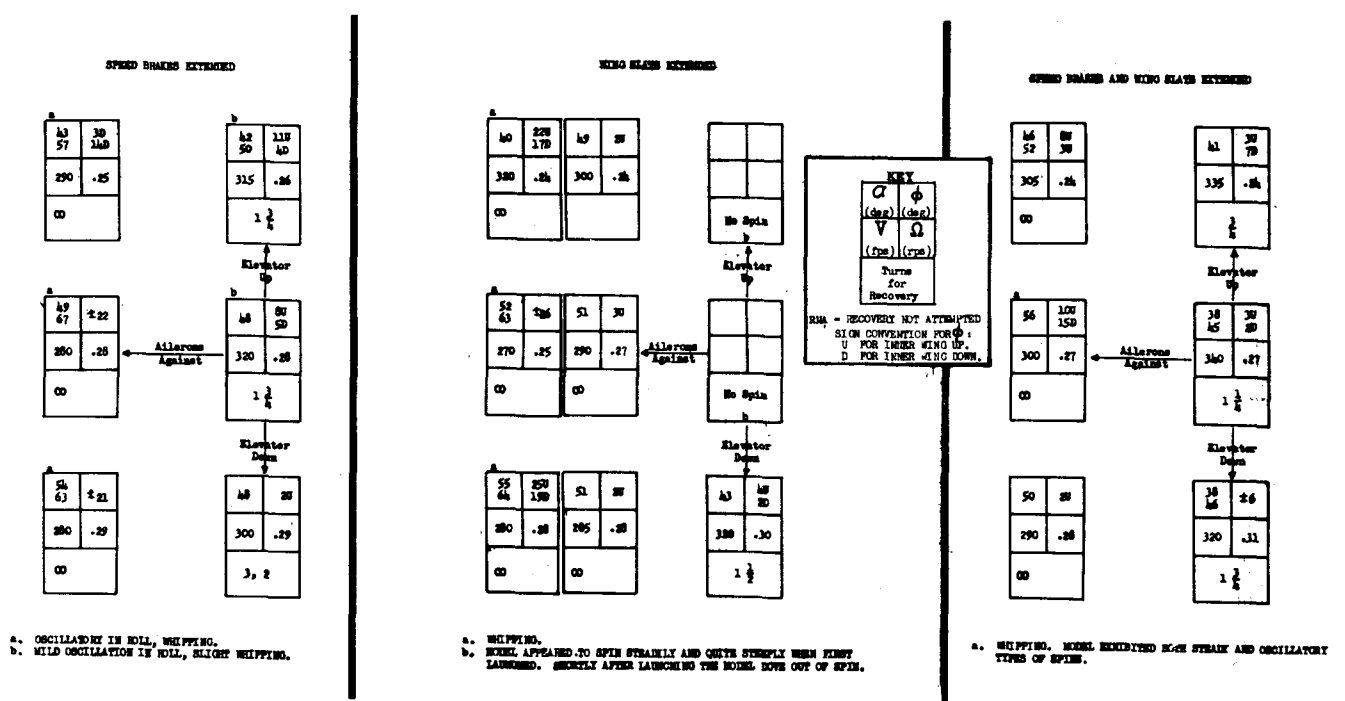

Figure 21: CHART OF RIGHT ERECT SPINS WITH SPEED BRAKES AND/OR WING SLATS EXTENDED. 1/28-Scale Model of YF-93A Airplane. Design Gross Weight Over Target (A). Stabilizer Setting -9°. Recovery Attempted by Full Rudder Reversal. All Values Converted to Full Scale at Equivalent Test Altitude of 20,000 Feet.

~~CONFIDENTIAL~~

WRIGHT FIELD 12-FOOT VERTICAL WIND TUNNEL, WADC
SPIN TEST OF THE YF-93A AIRPLANE

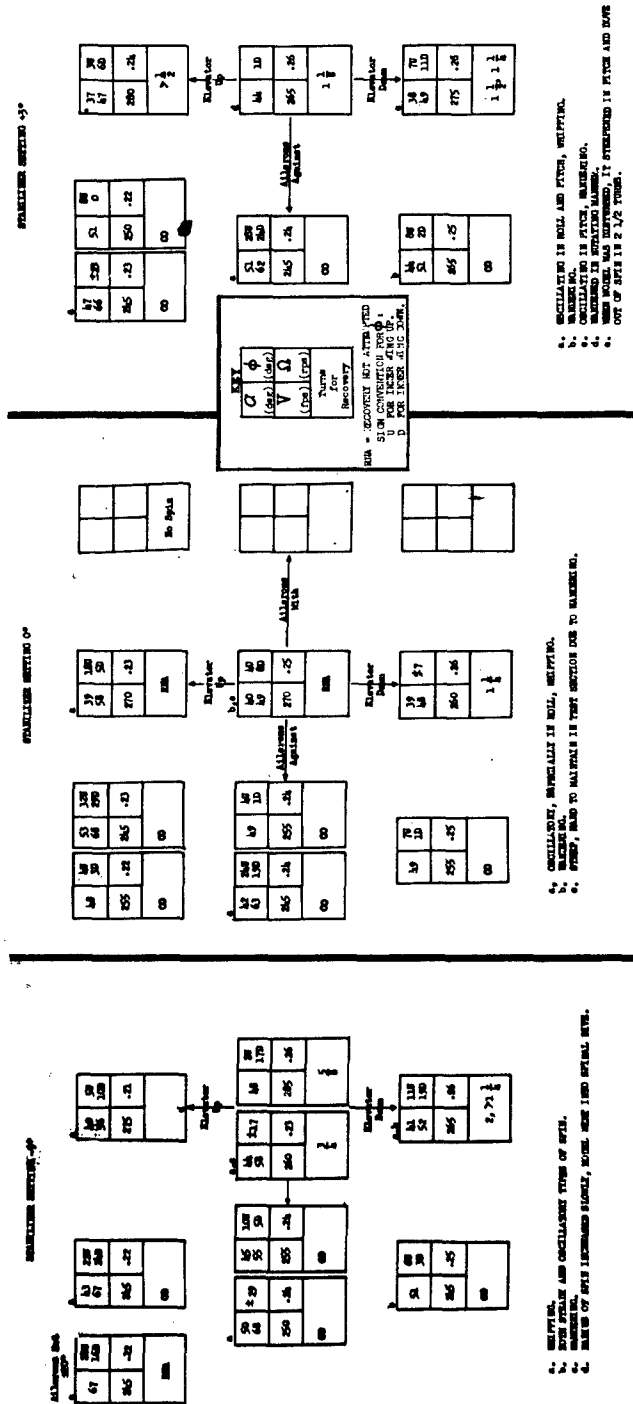

Figure 22: CHART OF EFFECT OF STABILIZER SETTING ON RIGHT ERECT SPINS, MINIMUM FLYING WEIGHT (B).
 1/28-Scale Model of YF-93A Airplane. Model in Clean Condition. Recovery Attempted by Full Rudder Reversal. All Values Converted to Full Scale at Equivalent Test Altitude of 20,000 Feet.