

UNCLASSIFIED

Defense Technical Information Center
Compilation Part Notice

ADP012474

TITLE: Results of a Study for a Long Range Coilgun Naval Bombardment System

DISTRIBUTION: Approved for public release, distribution unlimited

This paper is part of the following report:

TITLE: 10th U.S. Army Gun Dynamics Symposium Proceedings

To order the complete compilation report, use: ADA404787

The component part is provided here to allow users access to individually authored sections of proceedings, annals, symposia, etc. However, the component should be considered within the context of the overall compilation report and not as a stand-alone technical report.

The following component part numbers comprise the compilation report:

ADP012452 thru ADP012488

UNCLASSIFIED

RESULTS OF A STUDY FOR A LONG RANGE COILGUN NAVAL BOMBARDMENT SYSTEM*

Steve Shope, Jeff Alexander, Walt Gutierrez, Ronald Kaye, Marc Kniskern, Finis Long, David Smith, Bob Turman, Barry Marder, Albert Hodapp Jr. and Richard Waverik

*Sandia National Laboratories, Albuquerque**, NM, 87185*

We have evaluated the feasibility of a long range bombardment coilgun launcher and a suite of compatible projectiles. We will present an analysis of the technical feasibility, engineering, and systems implementation issues for shipboard mounting and utilization. Some of the key issues that will be presented are prime power requirements, energy storage, target lethality, ground support, and critical issues. Ranges to be studied are hundreds of nautical miles. At the conclusion of the study we will have sufficient analysis and information to define the requirements and plan for a demonstration program.

*This work was supported by Navy CTO (Order No. N00014-00-F-0452) and DARPA (Contract No. DE-AC04-94AL85000)

**Sandia is a multiprogram laboratory operated by Sandia Corporation, a Lockheed Martin Company, for the United States Department of Energy under contract DE-AC04-94-AL85000.

INTRODUCTION

This paper presents a technical analysis of an enhanced range gun capability for naval surface combatants, based on the concept of an electromagnetic coilgun. The technology base to provide such capability has been demonstrated with small-scale launch experiments, and requires additional development to provide full functionality.

The primary elements of an electric gun are the power source, an energy storage device, a power peaking device, and the conversion elements from electric to kinetic energy. With the potential for very high muzzle velocity, in the range of 2.5 km/s with this electromagnetic coilgun, dramatic new force projection capabilities are possible: This concept gives surface combatants very long-range weapon delivery capability, to 300 NM. It provides time critical delivery of a few minutes from firing to impact (2 minutes to 100 NM, 6 minutes to 300 NM). No explosive powder or propellant is required for the rounds; the ship's propulsion system provides the prime power for the gun. This provides a simplification of logistics, large improvement in the rounds load-out capacity, and simplifies stores handling and re-supply at sea. It provides increased penetrator round and kinetic energy round lethality as a result of the higher impact velocity. It provides flexibility for use of multiple projectile types from the same weapon.

MISSION REQUIREMENTS

Navy mission for littoral and strategic strike will continue to move in the direction of increased range and increased rate of fire on target, using rapid response, cost-effective means. Improved gun technology could aid in this mission, particularly with the potential for hypervelocity, and thus longer range guns based on electromagnetic launch technology [1,2,3,4]. The launch velocity is not constrained by the expansion velocity of the high pressure gas that is the basis for all conventional guns, relying instead on electromagnetic pressure developed from electrical power. For this study we assumed there would be two classes of targets. The first would be hard targets such as bunkers or heavily armored vehicles. The second class was soft targets such as personnel or light armored vehicles. These hard and soft targets allowed us to define projectile types that would be used in the coilgun.

COILGUN

In a coilgun, kinetic energy is imparted to the projectile through a series of sequentially switched coils. The coilgun projectile has no electrical contact, Figure 1, since it couples magnetically, and the forces within the coil are such that the projectile tends to be self-centered within the launch barrel and is magnetically levitated on the launcher centerline. This centering force minimizes wear on the barrel.

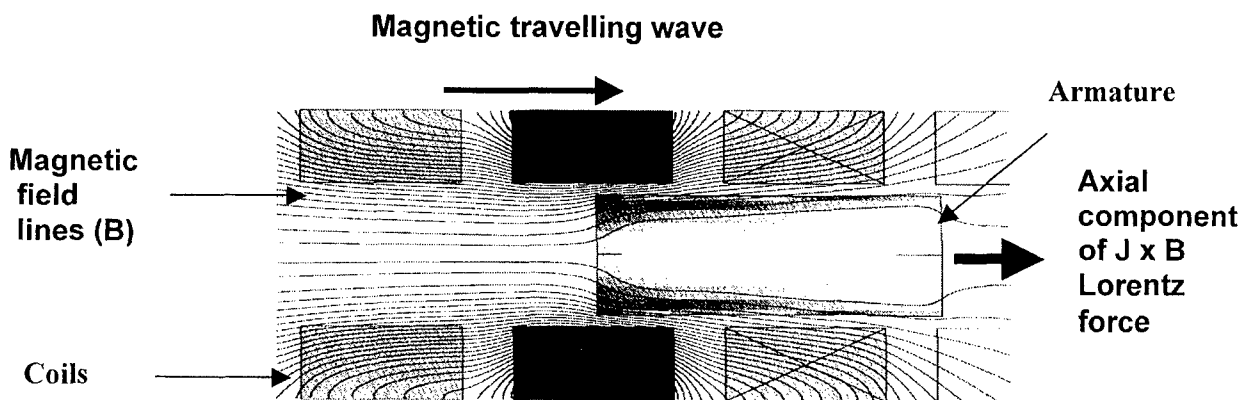

FIGURE 1. Coilgun propulsion comes from interaction of the magnetic field from the coil and the induced currents in the armature. A traveling magnetic wave is created by sequentially switching power into the coils.

In a coilgun, very high launch pressure can be maintained uniformly over the entire length of the gun barrel. The resulting uniform acceleration allows very high velocities to be achieved with the shortest possible barrel. The average pressure in any gun is the muzzle energy of the projectile divided by the volume of the bore. In a coilgun, this pressure is contained by embedded copper windings in the coils. Making high strength coils is the fundamental challenge for coilgun designers; for it is this feature that determines the length of the gun. Test coils in earlier experiments withstood about 1.1 kbars of average pressure [5]. In these experiments velocities in excess of 1 km/s were achieved with a 5-cm diameter, 240-gram aluminum

projectile in a 1.6-meter gun. The experiments demonstrated coil strength, operating reliability and controllability, and benchmarking of simulations.

REQUIREMENTS AND ASSUMPTIONS

For this study of the long range coilgun, analyses were limited to the following requirements:

1. 15, 30, 60, or 75 kg flight vehicles
2. 2 to 3 km/s muzzle velocities
3. 15 and 20 m gun length
4. 6 shots/min firing rate

The mass of the launch package is the combined mass of the flight vehicle delivered to the target, the armature winding and its support structure, and the sabot that couples thrust from the armature to the vehicle and supports it in the gun bore. The size of these individual components were estimated as a function of armature diameter based on the assumptions that:

1. maximum radial pressure on the armature is equivalent to that on the coil but directed inward generating a compressive hoop stress,
2. a boron/epoxy composite shell retaining the radial load has a maximum operational compressive hoop strength of 1.75 GPa,
3. the carbon/epoxy composite axial load transfer ring has a maximum operating shear strength of 319 MPa if the armature thrust is coupled to the flight vehicle structure through a tailored shear interface to the case, and
4. the copper armature wire occupies 40% of the armature winding cross-section with carbon epoxy composite as the balance.

The SLINGSHOT circuit simulation code was used to calculate the electrical, dynamic, and thermal performance of the coilgun using lumped elements for the coils[6]. Velocities that can be achieved in 15 and 20 m length gun with these launch packages are shown in Figure 2 as a function of armature diameter and flight vehicle mass. From this scaling and earlier scalings performed in the study an armature outer diameter of 30 cm was selected for concept evaluation. The coil concept developed in this study builds upon the previous design by adding coolant channels for heat transfer from the winding allowing operation at 6 pulses per minute in steady state. Like the coil developed in 1993, the total winding is a set of individual nested helical winding layers electrically in series. The nested helix uses multiple layers of wires to reduce current density and ohmic heating. To limit the temperature rise the windings were constructed of litz cable to provide as much conductor in each layer as possible. Litz cable is constructed of insulated wire strands twisted in such a way that results in a uniform current distribution across them. Each layer consists of many insulated wires in parallel that occupy the entire circumferential area. The number of wires and number of turns in each layer is consistent with the requirements for the inductance of that coil depending upon its position in the gun. Feeds to the winding inner and outer layers are the azimuthally distributed wires of the winding directed radially outward.

SLINGSHOT simulations and thermal analysis show heating rates of coils vary from 71 to 9 kW from the breech to muzzle of the gun with 90% of a 225 stage gun at 20 kW or less. The required coolant flow per coil is 75 l/min (20 gal/min) or less except for the first 20 coils at the breech end. The required coolant flow rate at the breech end is 1400 gal/min. Estimates of wire temperature from SLINGSHOT and steady-state heat transfer calculations indicate that the

wire conductor peak temperature can be kept below 100°C thus not affecting the strength of the fiber composites. The coolant manifold will be located on the outside of the coil structure.

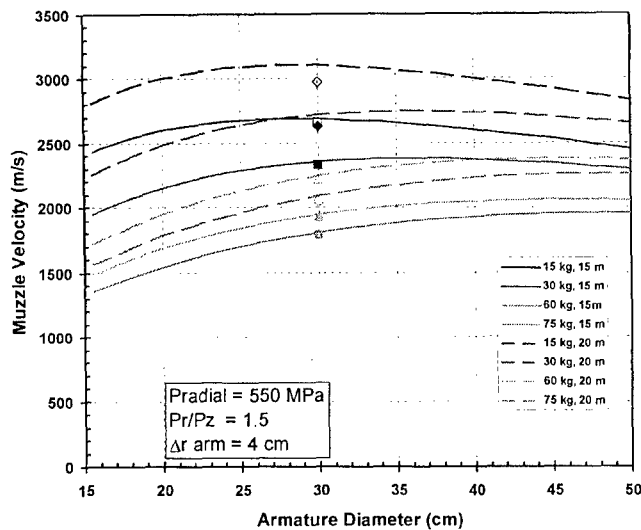

Figure 2. Velocity scaling as function of armature size and flight vehicle mass. Results of SLINGSHOT calculations plotted at 30 cm diameter demonstrate that a coilgun can be configured to meet the criteria of the scaling. SLINGSHOT calculations were performed with armature winding initially cooled to 77°K.

Given the number of winding layers, the radial thickness of the reinforcing shells is determined from the total radial and axial forces on the coil, and a linear load distribution that is assumed as a function of radius over the build of the coil. The radial build of each shell is tailored to work the fiber composite to a maximum operating stress equivalent to the root-mean-square of the axial and hoop stresses from these applied loads. Axial shear loads are compared to the maximum composite shear and the number of winding layers adjusted if necessary. The total radial build and conductor fill fraction of the coils is tabulated as an input to the detailed coil specification for the final SLINGSHOT calculation. Details of the concept are shown in Figure 3, which illustrates a crosssection of three stator coils, a composite barrel, location of radial cooling channels, and the armature at the base of the flight vehicle. The variation of coil parameters over the length of a 15 or 20 m gun is shown in Figure 4 for coils with reinforcement shells constructed of PBO/carbon fiber/epoxy composite. The minimum number of turns in the winding was set at two to keep bank current on the order of a megamp or less. As seen in the chart, most of the gun is constructed of coils similar to the muzzle design, and the first 20 coils have significantly greater radial build. Although not considered here, more optimal solutions may use individually tailored capacitor banks for these early stages to reduce the coil build and improve coupling to the armature. Velocity and acceleration profiles for the coils discussed above are shown in Figure 5. The input file for this run defines a 20 m long coilgun, but velocity values at 15 m are of interest to fit destroyer platforms. Total launch mass of 94.7 kg is comprised of a 60 kg flight vehicle, 17.4 kg, 30 cm OD armature conductor (calculated by the code), and 17.3 kg for armature structural support and sabot. Capacitor banks for each coil are

charged to 40 kV and bank energy increases just under 4% over groups of 50 coil stages. The initial temperature of the copper armature winding is 77°K to reduce the resistance of that circuit.

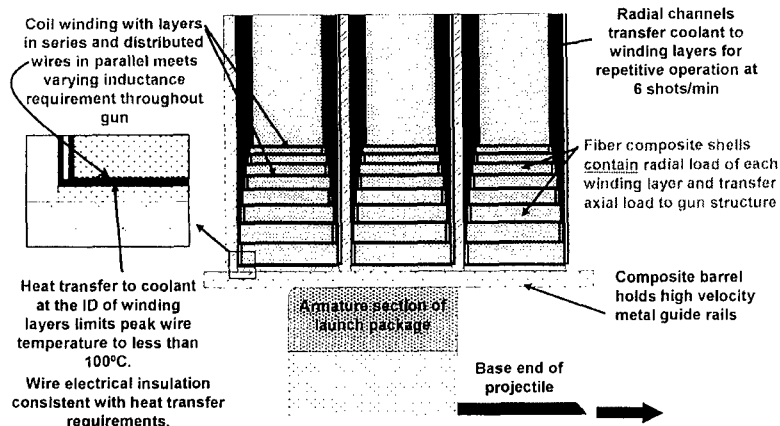

Figure 3. Cross-section of 3 nested helix coils and the armature at the base end of the projectile flight vehicle. Radial and axial coolant channels occupy 50% of the circumferential area with spacers filling the balance for mechanical support.

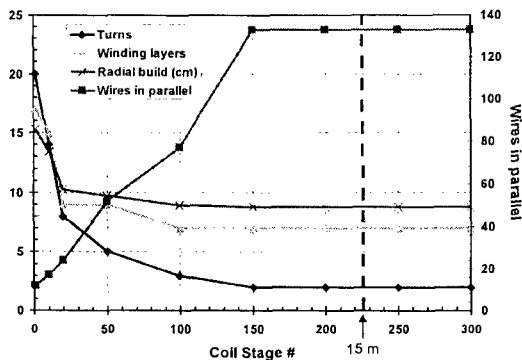

Figure 4. Variation of coil parameters from the breech to muzzle of a 15 or 20 m gun for SLINGSHOT simulation assuming PBO/carbon fiber/epoxy reinforcement shells. All coils have the same winding length of 49 mm at 58 mm center-to-center spacing.

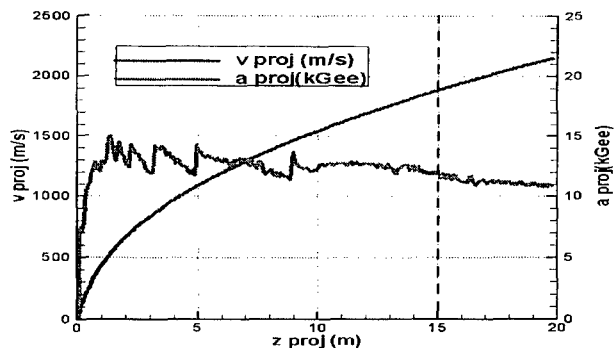

Figure 5. Acceleration and velocity of a 95 kg launch package consisting of a 30 cm OD armature initially at 77°K, sabot structure, and 15.5 cm OD, 60 kg flight vehicle. Total initial stored energy in the 15 m gun of 225 coil stages is 464 MJ.

The 15 m length coilgun accelerates the 95 kg launch package at about 13 g to a velocity of 1.9 km/s in 17.6 ms. The 15 m length gun is comprised of 225 coil stages and the 20 m gun has 300 stages. The current in each stator coil is opened after one full current cycle at a time of a current zero to recover part of the magnetic energy and limit coil heating.

Cryogenic cooling of only the armature winding reduces the ohmic losses resulting in a long time-constant for the decay of induced current. Muzzle velocities for armatures at liquid nitrogen temperature of -193°C are about 13% greater than that achieved with a room temperature initial condition. This represents an increase in muzzle energy of 25 to 30%. Cryogenic cooling of the stator was not considered.

PROJECTILES

A representative projectile design and aerodynamic model were developed to provide realistic simulations of trajectory performance for comparison with mission requirements. Ballistic performance results are presented for 15-kg, 30-kg, 60-kg and 75-kg bodies. A 60-kg reference projectile was scaled, assuming constant packaging density, to obtain the sizes for the other identically shaped projectiles in the set. The ballistic coefficient for the 60 kg reference projectile was 5900 psf at 2 km/sec. Choice of the reference projectile shape, size and mass was based on requirements for long range, hard and soft target missions and on results of a preliminary packaging study. The study was focused on a projectile design that could meet ballistic performance requirements and provide adequate warhead volume using a current Navigation Guidance and Control (NG&C) system design and current heat-protection technology. Results indicate that a 155-mm diameter is desirable for relieving NG&C and thermal-protection packaging constraints to achieve acceptable warhead volume. Results of the coilgun simulation determined an armature diameter of 30.0 cm would give the best performance. The choice of 155 mm projectile diameter would also allow the use of fixed guiding fins and takes advantage of current 155 mm technology.

The Reference Projectile model, shown in Figure 6, was created to explore packaging, sabot interface, aero-heating and flight performance requirements. This fin-stabilized ogive-cylinder shape provides a near optimal balance between minimum supersonic drag and maximum payload volume. Addition of a boattail, to further reduce drag, is dependent on unresolved packaging and sabot interface constraints. Choice of a 60-kg mass and 155-mm diameter was based on three factors: assuring sufficient warhead volume; results of a packaging

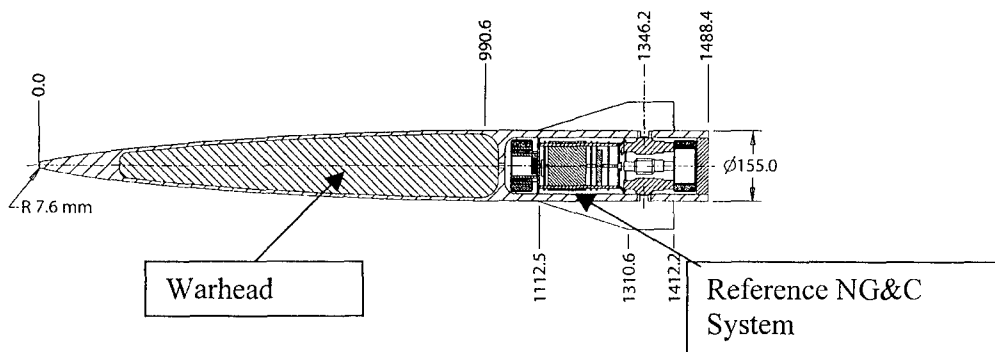

FIGURE 6. 155 mm diameter 60 kg reference projectile.

study, and on Mission Scenario requirements. An aerodynamic model has been developed to provide realistic simulations of performance and aero-heating for projectiles of this shape. The reference 60-kg projectile shape was scaled to 15-kg, 30-kg, and 75-kg sizes, assuming constant packaging density (3-g/cc). Therefore, the smaller less massive projectiles have lower ballistic coefficients. The Trajectory Analysis and Optimization Software (TAOS) was used for the projectile performance in our analysis[7]. The code simulates point mass and rigid-body trajectories for multiple vehicles. Results, based on muzzle velocities for total accelerated mass (projectile, sabot and armature), indicate that the coilgun system should be able to deliver projectiles on target at supersonic velocities over a band of range that extends from tens of nautical miles (nm) out to a maximum that approaches 300-nm. This is demonstrated for projectiles that maneuver on ascent from a fixed quadrant elevation (QE) gun (51-deg, max range). Significant cross range can be achieved, with a small sacrifice in impact velocity at a given range, by maneuvering to change azimuth during ascent, see Figure 7. The 15-kg projectile appears to be capable of reaching 300-nm by maneuvering on descent to extend its 280-nm ballistic range. Results are given in Table 1 for dependence of range on projectile mass and launch velocity. Muzzle velocity was increased for a given mass by increasing the gun tube length from 15-m to 20-m. Muzzle velocities were derived assuming a pusher sabot and using realistic accelerated masses for each projectile. Note that maximum range for the 15-kg projectile approaches the 300-nm requirement. It is very likely that the projectile could maneuver during descent to the extend range to 300-nm. Note also that maximum ballistic range for the 60-kg and 75-kg projectiles exceed the 100-nm requirement for the Mission Scenario. Results of our feasibility study indicate that a projectile may be developed in the near future to satisfy the Mission Requirements for 100-nm plus range, 50-nm per-minute delivery time, and a large payload volume.

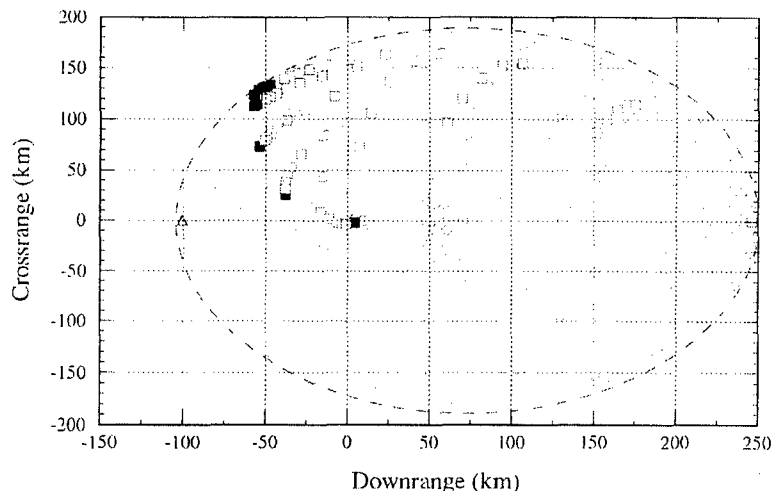

FIGURE 7. The field of fire for a maneuvering projectile.

TABLE 1. Effects of Mass and Velocity on Range

Projectile Mass, kg	15-M TUBE			20-M TUBE		
	Velocity, km/sec	Range, km	Range, nm	Velocity, km/sec	Range, km	Range, nm
15	2.55	338	182	3.00	520	281
30	2.23	276	149	2.53	390	210
60	1.80	188	101	2.00	245	132
75	1.70	172	93	1.90	220	119

ENERGY STORE

The projectile mission places requirements on the coilgun, and the gun performance and design, in turn, puts requirements on the coil driver circuits, which may vary along the length of the gun. Our concepts have been based on a maximum charge voltage of 40 kV that is consistent along the whole length. A requirement for 2 MJ per module suggests a total bank capacitance of 2.5 mF. To keep the modules simple and compact, we have targeted an average module energy density of 4 J/cc, assuming one 1-MA class switch per module. With a nominal capacitor packing fraction of 50%, we require a capacitor energy density of 8 J/cc.

There has been a dramatic increase in the energy storage capability of capacitors in the past ten years, and this trend is expected to continue over the next decade. For the conservative design an average module energy density of 4 J/cc translates into about 8 J/cc for the capacitors, which appears to be achievable. TPL, Inc. of Albuquerque have developed a siloxane polymer film with a higher dielectric constant (~9) and breakdown strength (15-16 kV/mil) than the polypropylene that is used in the typical discharge capacitors. In collaboration with Aerovox Corp., they fabricated a number of small capacitors in which 2 to 3 J/cc has been demonstrated.[8] They feel like they should be able to exploit all the properties of their new polymer and demonstrate 30 to 50-kJ capacitors within three years. An energy density of at least 7.5 J/cc is anticipated.

Jaycor, Inc. in Huntsville, AL and Vanderbilt University in Nashville, TN have collaborated to apply Polycrystalline Diamond Film (PDF) technology to develop HED capacitors. The capacitor application is in its infancy, but the PDF analysis and technology has at least a strong ten-year history behind it.[9] The PDF diamond is considered to be the best thermal conductor (20 W/cm-C), highest electrical insulator (>30 MV/cm), highest temperature compatibility, and hardest material. Its dielectric constant of 5.5 (higher than most plastics and oils, and the $\epsilon_r = 3.5-4$ DLC process developed for Wright Patterson AFB) [10] coupled with the high voltage breakdown threshold makes it attractive as a possible HED capacitor. Developers have established an energy density goal of 30 J/cc, which is still a factor of four below the theoretical limit.

A single switch for each 2-MJ capacitor bank module (225 for a 15-m gun) would conduct peak currents up to 1 to 1.2 MA and transfer approximately 100 Coulombs per shot. The faster discharge circuits require upper limits on the inductance and closed switch resistance of about 100 nH and 1 m Ω , respectively. The switch electrodes will need to be actively cooled, especially for extended scenarios at a rate approaching 20 kJ per shot. There exist a few candidate switches that have demonstrated performance parameters near our coilgun circuit

requirements. Satisfying the module closing switch specifications should not require any significant development. If this switch could be opened after energizing the coil approximately 30% of the capacitor energy could be recovered. This would be a significant volume and weight reduction in the energy store.

SHIP INTEGRATION AND OPERATIONS

The Navy will be building a new 21st century land-attack destroyer, the DD-21. The weapons will be the most advanced available. For this reason the DD-21 was chosen for conceptual layouts of a fixed gun and a trainable gun. The current design could be retrofitted to the Arleigh Burke class destroyers. All design dimensions and parameters were taken from the previous sections. The results of this parametric evaluation are shown in Table 2. A plot of the range versus the projectile kinetic energy is shown in Figure 8. It can be seen from the table and these plots that attractive gun parameters can be achieved at reasonable sizes and weights.

TABLE 2. PARAMETRIC EVALUATION

Coilgun Concepts														
KE	V	Projectile		Armtre & sabot Mass	Coil Bore	Barrel Parameters			Rounds Mass	Energy and Power			System Tonnes	Range
		mass				Length	Mass	Gun Mount		Stored Energy	Energy S Mass	Power & Thrml contrl Mass		
MJ	km/s	kg		kg	m	m	Tonnes	Tonnes	Tonnes	MJ	Tonnes	Tonnes	Tonnes	NM
80	2.2	15		18	0.2	11	5	7	55	200	62	13	142	125
150	3	15		18	0.2	20	9	13	55	375	118	24	219	270
150	2.5	30		18	0.2	20	9	13	81	375	118	24	245	210
190	2.4	30		35	0.3	15	15	22	109	475	149	30	325	180
290	2.8	30		43	0.34	20	25	38	123	725	226	46	458	280
190	2	60		34	0.3	15	15	22	158	475	148	30	373	130
330	2.5	60		45	0.35	22	28	42	176	825	258	53	557	230
220	2	75		35	0.3	20	19	29	185	550	172	35	440	140

Assumptions:
 Energy Storage Density = 8 J/cc, 4 J/gm, 50% volume fraction
 Power striplines/cables = 0.25 x Energy Storage mass
 Number of Rounds Stored = 1400
 Power Density (gas turbine/alternator genset) = 0.3 kg/kw
 Power based on 6 shots per minute
 Thermal Control = 0.5 kg/kw
 Gun Mount = 1.5 barrel mass

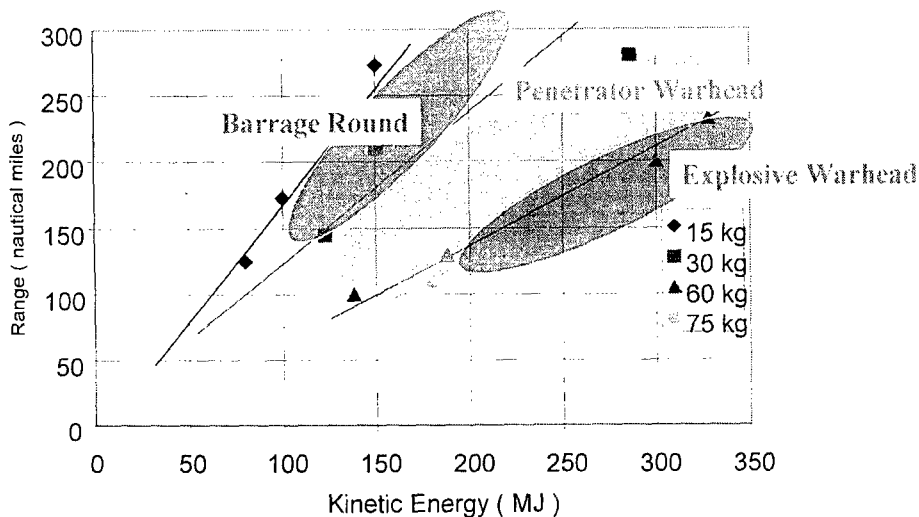

FIGURE 8. The projectile range for varied mass and the initial projectile kinetic energy.

CONCEPTUAL SHIP LAYOUT

The gun barrel is 15m long and 32 cm inside diameter. The capacitors have an energy storage density of 8J/cc and an average energy storage density of 2-4J/cc. The projectile with armature and sabot is 1.5 m in length. The gun length in both options was 15m. Both concepts have their advantages and disadvantages. For both designs the energy storage (total of 450 MJ) is four parallel rows of capacitors with the switches and cabling located between the rows. At 6 shots per minute this will require 45 MW of conditioned power. This could come from ship

Two mounting options were investigated; a fixed and rotating mount, Figure 9. The fixed mount option is angled at 51 degrees elevation for maximum trajectory. The layout of the gun barrel (15 m), energy storage, and projectiles are based on parameters discussed in the previous sections. An advantage of this layout is in the gun placement, which can be entirely below deck, reducing the radar cross-section.

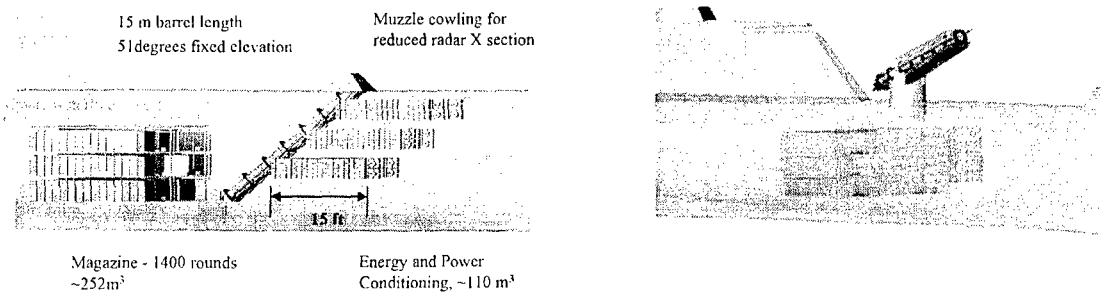

Figure 9. Fixed gun layout is on the left showing the location of the energy store, barrel and magazine. The rotating turret is shown on the right.

For targeting the ship will have to be maneuvering in the proper direction or the projectile guided to target. A plot of the field of fire was shown in Figure 6. While there is some penalty for maneuvering it is a viable option and increases the ship versatility with instantaneous retargeting. It also will simplify the construction and maintenance as well as reduce the gun costs.

The gun parameters for the trainable gun layout are the same as those for the fixed gun. This option has the advantage of rapidly changing target coordinates and reduces the maneuverability requirements on the projectile. The capacitive energy storage can be placed below the waterline. This option does have a higher radar cross section during firing. To reduce the cross section when not in use it could be lowered to deck level or below. This does complicate the design, construction, and increase costs. It also increases the number of power feeds required for the muzzle section. To keep the inductance low it would require twenty-eight parallel sets of cables to power the end coils. All leads would have to have extra slack in them to allow for the turret to rotate and elevate.

CRITICAL TECHNICAL ISSUES

There are a several critical technical issues that must be resolved to bring this capability into operational reality. The first issue for the coilgun launcher is a demonstration of firing control at full velocity. The maximum velocity tested at Sandia to date is at 1.0 km/s.

The next critical issues for the gun launcher itself is, with the combination of high pressure, high heat load, high electric fields, and high stresses within the coils and the integrated barrel structure. These issues are thought to be manageable within the coil design concept that has been presented. Choice of materials (preferably light-weight, high strength composites) is also a challenge to insure that mechanical strength, insulation and thermal properties are all optimized.

Energy storage system design and the size of the energy storage device are also critical issues. In these concept designs, we have extrapolated the current proven capacitor technology to a level of 8 J/cc. This level is anticipated to be achievable on the time-scale of 3 to 5 years on the basis of the trend of current development efforts on three technology fronts, using siloxane polymers, vacuum deposited thin film diamond, and cryogenic ceramic dielectrics.

Design and development of projectile maneuvering capability is a critical issue for the high-speed, long-range projectile. For long-range accuracy, terminal maneuvering will be required, particularly for rounds that require high accuracy, such as a kinetic energy penetrator. Analysis indicates that control surface area from the concept design projectile will be adequate for the maneuvering needed. The projectile maneuvering requirement for a fixed gun concept is within the capability of the control surfaces shown in the projectile concept design. Maneuvering at near-full muzzle velocity also introduces an added amount of aerodynamic heating. Simulation results indicate that aerodynamic heating problems can very likely be overcome with available materials for 155 mm class projectiles launched at < 2.5 km/sec higher velocities and smaller size present a challenge.

SUMMARY

We have developed a conceptual design of a coilgun that will fit on a destroyer. Layouts for a fixed and trainable gun are both feasible. Both layouts rely on capacitor technology reaching 8 J/cc. Projectile ranges and mass are in regions of interest for littoral and inland mission support. The total system weight will adapt to the DD-21. Additional design work needs to be done with Naval Architects to ensure full compatibility with the DD-21.

The coilgun design work has addressed thermal and mechanical design issues and found coils can be designed to meet mission requirements of 100-300 nm. Suitable projectile designs have also been evaluated for use in a coilgun, and again found to satisfy mission requirements for hard and soft targets. Guidance, thermal issues, and trajectories for 15 to 75 Kg have been analyzed.

We have identified critical technical issues that must be resolved to bring this capability into operational reality. We did not find any critical areas that would prevent the deployment of a long-range coilgun.

REFERENCES

- [1]. R. J. Lipinski, "Long-range Gun Induction Launcher," Sandia National Laboratories report to Vic Dawson, Center for Naval Analysis, November 1991.
- [2]. Dent, Philip A., et. al., "Advanced Strike Platform Concept: Feasibility Assessment of a Linear Induction Electromagnetic Launcher on a Naval Surface Combatant," David Taylor Research Center Report DTRC/SD-91-05, June 1991.7
- [3]. W. A. Walls, et al., "Application of Electromagnetic Guns to Future Naval Platforms", IEEE Transactions on Magnetics, Jan 1999, pp 262 -266.
- [4]. David Foxwell, "Renewed Naval Fire Support," Janes International Defense Review, September 1997, pp 83 - 87.
- [5]. R.J. Kaye et al., "Design and Evaluation of Coils for a 50 mm Diameter Induction Coilgun Launcher, " IEEE Trans. Mag., vol. 31, no. 1, January 1995, pp. 478-483.
- [6]. Shokair, I. R., Cowan, M., Kaye, R. J., and Marder, B. M. "Performance of an Induction Coil Launcher", from the proceedings of the IEEE Transactions on Magnetics Conference, Vol. 31, No. 1, January 1995.
- [7]. David E. Salguero, "Trajectory Analysis and Optimization Software (TAOS), SAND-99-0811, Sandia National Laboratories, Albuquerque, NM, Jan 1999.
- [8]. Private communications with Hap Stoller, Kirk Slenes, and Lew Bragg, TPL, Inc., Albuquerque, NM, 13 Sep 00.
- [9]. J. L. Davidson, et. al., "CVD Diamond, A Unique Dielectric, Semiconductor and Thermal Conductor for Electronic Applications," Interface, The Electrochemical Society Magazine, Oct 95.
- [10]. K Systems Patented process (5,844,770, December 1, 1998) for Diamond-Like Carbon thin films developed under an Air Force SBIR Phase II Program with WPAFB. Contact: Dr. Richard L.C. Wu, Vice President, K Systems Corporation, Beavercreek, Ohio.