

COMPONENT PART NOTICE

THIS PAPER IS A COMPONENT PART OF THE FOLLOWING COMPILATION REPORT:

TITLE: Minutes of the Explosives Safety Seminar (22nd) Held in Anaheim,  
California on 26-28 August 1986. Volume 2.

TO ORDER THE COMPLETE COMPILATION REPORT, USE AD-A181 275

THE COMPONENT PART IS PROVIDED HERE TO ALLOW USERS ACCESS TO INDIVIDUALLY AUTHORED SECTIONS OF PROCEEDING, ANNALS, SYMPOSIA, ETC. HOWEVER, THE COMPONENT SHOULD BE CONSIDERED WITHIN THE CONTEXT OF THE OVERALL COMPILATION REPORT AND NOT AS A STAND-ALONE TECHNICAL REPORT.

THE FOLLOWING COMPONENT PART NUMBERS COMPRISE THE COMPILATION REPORT:

ADN: DD05 350 thru DD05 393      ADN: \_\_\_\_\_  
ADN: \_\_\_\_\_      ADN: \_\_\_\_\_  
ADN: \_\_\_\_\_      ADN: \_\_\_\_\_

Accession For	
NTIS GRA&I	<input checked="" type="checkbox"/>
DTIC TAB	<input type="checkbox"/>
Unannounced	<input type="checkbox"/>
Justification	
By _____	
Distribution/	
Availability Codes	
Dist	Avail and/or Special
A-1	

This document has been approved  
for public release and only its  
distribution is restricted.

DTIC FORM 463  
MAR 85

OPI: DTIC-TID

AD-P00j 364

DRAG COEFFICIENTS  
FOR  
IRREGULAR FRAGMENTS

by

Frank McCleskey

Naval Surface Weapons Center  
Dahlgren, Virginia 22448

Autovon 249-7993  
Commercial 703-663-7993

The Naval Surface Weapons Center (NSWC) has a continuing task from the Department of Defense Explosive Safety Board (DDESB) to establish methods for predicting the fragment hazards due to the inadvertent explosion of ordnance items. As part of this task, NSWC has established a computer model which predicts fragment hazards. This computer model was explained in the minutes of the twenty-first DCD Explosives Seminar.

The computer model calculates individual trajectories for each fragment recovered in small-scale fragment arena tests. The following variables affect the individual fragment trajectories:

- EI - Initial Elevation Angle
- VI - Initial Velocity
- A/M - Area to Mass Ratio
- ALT - Altitude
- RHO - Air Density
- MN - Mach Number
- HO - Height of the Origin
- SC - Soil Constant (Ricochet)
- W - Wind Speed and Direction
- $C_D$  - Drag Coefficient

Except for  $C_D$ , all of these variables can be defined with a fair degree of accuracy by tests, measurements, and calculations.

The drag coefficient for any fragment is a function of shape only. For regular fragments, like spheres or cubes, the drag coefficients are reasonably well defined. For irregular fragments, like those from bombs or concrete walls, no two fragments have exactly the same shape. As a result, no two irregular fragments have exactly the same drag coefficient. In all cases, drag coefficient is a function of Mach Number.

The drag coefficients for irregular fragments are not only uncertain but have a pronounced effect on far-field range. Figure 1 shows range versus  $C_D$  for a typical fragment. The range of low subsonic  $C_D$  varies from .5 to 1.5, a factor of three. Associated range varies by a factor of more than 2. This represents a large range uncertainty in trajectory calculations for establishing fragment hazards. If this uncertainty is to be reduced, some correlation must be established between  $C_D$  and the characteristics of the irregular fragments.

$C_D$  is a function of shape only. Therefore any correlating parameter should be dimensionless; that is, geometrically similar fragments which have the same  $C_D$  should have the same correlating parameter. For example, we might take the ratio of the maximum presented area to the minimum presented area as a measure of shape. For a sphere this ratio would always be one no matter what the size of the sphere. For a cube this ratio would always be 1.732.

The impetus for this program was provided by an observation having to do with the data contained in reference (a). That report contained the first systematic look at air drag for fragments. Three regular fragments were studied in the report, i.e., a sphere, a cube and a bar. The bar length,

width and thickness were in the ratio of 5-1-1. Since these fragments were regular, exact ratios of maximum to minimum presented area could be calculated. The results were as follows:

	FRAGMENT SHAPE		
	SPHERE	CUBE	BAR (5-1-1)
$C_D$ (MN .75)	.60	.88	1.12
$A_{MAX}/A_{MIN}$	1.00	1.73	7.14

Note that as the correlation ratio increases so does the  $C_D$ . The report also showed that the  $C_D$  for irregular fragments was greater than those for the sphere or cube. For irregular fragments the area ratio could be expected to be on the order of that for the bar. Everything seemed to support the idea that the  $C_D$  for irregular fragments could be correlated with dimensionless parameters.

To follow up on this idea, it was decided to choose 96 fragments with a wide variation of shapes for test in the vertical wind tunnel at Ballistic Research Laboratory (BRL) in Aberdeen, Maryland. Four different kinds of measurement were made on each fragment.

1. Linear Maxima: Length, width and thickness
2. Linear Averages: Length, width and thickness
3. Perimeters: (3 planes)
4. Presented Areas
  - a. Maximum
  - b. Average
  - c. Minimum
  - d. Variance
  - e. Standard Deviation

Linear dimensions were measured as shown in Figure 2. Note that in calculating average dimensions, the average thickness is calculated to produce an equivalent weight and volume rectangular parallelepiped.

Perimeters were measured in three planes as shown in Figure 3. Note that the perimeters do not exactly follow the contour of the fragment but represent a stretched string around the high points.

Fragment presented areas were measured in two ways. Measurements were made using an icosahedron gage, and calculations were performed on the equivalent weight and volume rectangular parallelepipeds. Figures 4 and 5 show the essentials of these measurements and calculations. The icosahedron gage is an optical device which throws a shadow of the fragment onto a sensing surface. The associated electronics produces a readout of presented area. The optical axis is positioned at 16 approximately equally spaced aspects so as to produce 16 distinct presented areas which can be analysed for a variety

of statistics. The icosahedron gage cannot mount a fragment weighing more than 1500 grains. For larger fragments, presented area statistics are calculated using the rectangular parallelepipeds as shown in Figure 5.

All of the linear, perimeter and area measurements for the 96 fragments are contained in Tables A-1, A-2 and A-3 of Appendix A.

The essential aspects of the vertical wind tunnel are shown in Figure 6. In operation, a fragment is placed on the fragment support screen in either the upper or lower test section depending on the air velocity necessary to raise the fragment. The air speed is controlled by opening the inlet vanes of the constant speed fan. The air speed is adjusted until the fragment rises from the screen and assumes a relatively constant height. At this time, the air stream velocity is read directly from the velocity calibrated manometer. Air density is calculated from the ambient pressure and temperature. Ambient conditions are acceptable because of the relatively low air velocities produced in the tunnel. These parameters together with the weight and average presented area of the fragment are then used to calculate the low subsonic drag coefficient ( $C_D$ ).

Each fragment was tested in the vertical wind tunnel. The velocity of the air stream is increased until the fragment hovers in the air stream at near constant vertical height. In this vertical equilibrium position the drag and gravity forces will also be in equilibrium. From previous measurements we know the weight and average presented area of the fragment. From the wind tunnel we establish the density and velocity of the air stream. As shown in Figure 7, once we know these values, we can calculate  $C_D$ . Since we operate at a single air velocity we can only obtain a single point on the drag curve. This point is in the low subsonic region, roughly about a Mach Number of 0.1. The remainder of the drag curve must be inferred from other sources.

Three regular fragments (sphere, cube and bar) which were tested in reference (a) were also tested in the vertical wind tunnel. In reference (a) however,  $C_D$  was obtained at a Mach Number of approximately .75. The results were as follows:

	$C_D$ Wind Tunnel	$C_D$ Reference (a)	Delta
Sphere	.42	.60	+ .18
Cube	.64	.88	+ .24
Bar	.94	1.12	+ .18

As seen in the table,  $C_D$  at Mach .75 is about .2 higher than  $C_D$  at Mach .1 for all three fragments. Owing to the consistency in the rise of  $C_D$  from Mach .1 to Mach .75 for the three regular fragments, it seems reasonable at this time to accept the same rise in  $C_D$  for irregular fragments. In this way, the shape of the subsonic drag curve (as a function of Mach Number) for irregular fragments is established.

Experience shows that range is more sensitive to changes in subsonic  $C_D$  than to similar changes in supersonic  $C_D$ . This can best be seen in Figures 8 and 9. The shape of the transonic and supersonic portions of the drag curves in Figure 8 are approximations based on the study of scattered data in

reference (a) and (b). On the left side of Figure 8, the subsonic  $C_D$  is held constant while the supersonic  $C_D$  is allowed to vary  $\pm 25$  about the mean. The range differences from the mean are both less than 100 feet. On the right side of Figure 8, the supersonic  $C_D$  is kept about the same as before and the subsonic  $C_D$  is allowed to vary  $\pm 25$  about the mean. If subsonic and supersonic  $C_D$  were equally sensitive then the new range differences (deltas) should be about twice what they were before. In fact, they are about four times as large.

This range sensitivity can be further explained by the data in Figure 9 where velocity is plotted against range ratio for a typical far-field trajectory. The range ratio is the fraction of the total trajectory traversed. From the figure it can be seen that only 25 percent of the trajectory is supersonic while 75 percent is subsonic. Figures 8 and 9 demonstrate that the subsonic portion of the drag curve affects range much more than the supersonic portion.

Tables A-4, A-5 and A-6 of Appendix A list all of the dimensionless ratios considered to date. When plots of  $C_D$  versus the ratios were made, the best correlation was obtained with the ratio  $A_{MAX}/A_{AVG}$ ; that is, the ratio of the maximum presented area to the average presented area. This correlation is shown on Figure 10. The value for  $A_{MAX}/A_{AVG}$  is an average of the values obtained using the icosahedron gage and the equivalent rectangular parallelepiped calculations. The total range of uncertainty for all irregular fragments is from about 0.5 to 1.5. The range of  $C_D$  uncertainty at an average  $A_{MAX}/A_{AVG}$  of 1.45 to 1.5 is about 0.6. On average then, it can be said that the correlation reduces the uncertainty by about 40 percent.

It is important to know what a 40 percent reduction in  $C_D$  uncertainty means in terms of range uncertainty. Figure 11 shows this range uncertainty for a typical fragment trajectory with a presented area ratio of 1.5. The range differences are large, about 18 percent above the average and 28 percent below. In order to reduce the range uncertainty to an acceptable region of about  $\pm 10$  percent, it will be necessary to reduce the  $C_D$  uncertainty by about 75 percent.

In summary, the following observations can be made:

1.  $C_D$  is a function of shape only.
2. Range is more sensitive to subsonic than to supersonic  $C_D$  variations.
3.  $C_D$  correlates with dimensionless parameters.
4. The  $A_{MAX}/A_{AVG}$  parameter correlation reduces  $C_D$  uncertainty by approximately 40 percent.

Significant problems remain unresolved. For an acceptable range uncertainty of about  $\pm 10$  percent, it will be necessary to reduce the  $C_D$  uncertainty by about 75 percent. This might be done in a variety of ways. More efficient correlation parameters might be established. The typical motion of the fragments in the wind tunnel (Figure A-1 thru A-9 of Appendix A) might be used as an added correlation. Possibly, the use of presented area

other than average might be used in calculating  $C_D$ . For example, in Figure A-3 of Appendix A all fragments exhibit a flat rotation such that the area presented to the air stream is much greater than the average presented area.

Another unresolved problem involves the shape of the transonic and supersonic portions of the drag curve. At present, the shape is only an approximation based on scattered data contained in references (a) and (b). A practical method is needed to test irregular fragments for  $C_D$  in a supersonic wind tunnel. The essential problem is the design of a fixture which will allow the fragment to move freely and, at the same time, continually measure drag force.

#### REFERENCES

a) Air Drag Measurements of Fragments, D. J. Dunn, Jr., and W. R. Porter, BRL Memorandum Report No. 915, D. J. Dunn, Jr., and W. R. Porter, (UNCLASSIFIED, August 1955).

b) Subsonic, Transonic and supersonic Drag Characteristics of Nine Shape Categories of Warhead Fragments, NSWC TR 81-112, Peter Daniels et al., (UNCLASSIFIED, May 1981)

# CD - RANGE SENSITIVITY

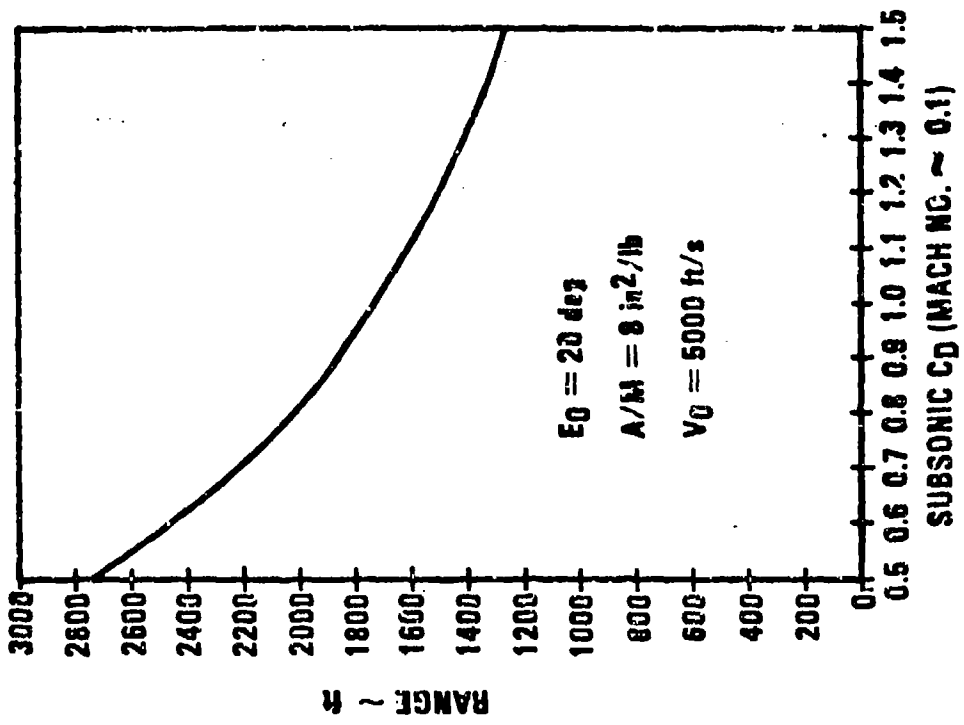
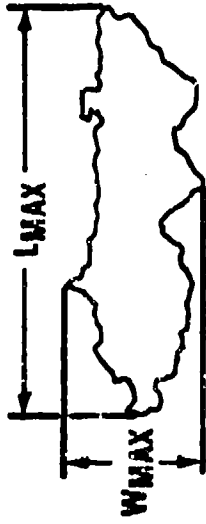

FIGURE 1



# FRAGMENT LINEAR DIMENSIONS

## MAXIMUMS



## AVERAGES

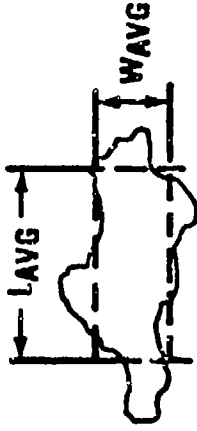

FOR EQUIVALENT WEIGHT AND VOLUME

$$T_{AVG} = \frac{WT}{L_{AVG} \cdot W_{AVG} \cdot \rho}$$

$$WT = \text{FRAG WEIGHT (lb)}$$

$$L_{AVG} = \text{AVERAGE LENGTH (in.)}$$

$$W_{AVG} = \text{AVERAGE WIDTH (in.)}$$

$$\rho = \text{FRAG DENSITY (lb./in.}^3\text{)}$$

$$\rho = 0.28 \text{ (STEEL)}$$

FIGURE 2



# PERIMETER MEASUREMENTS

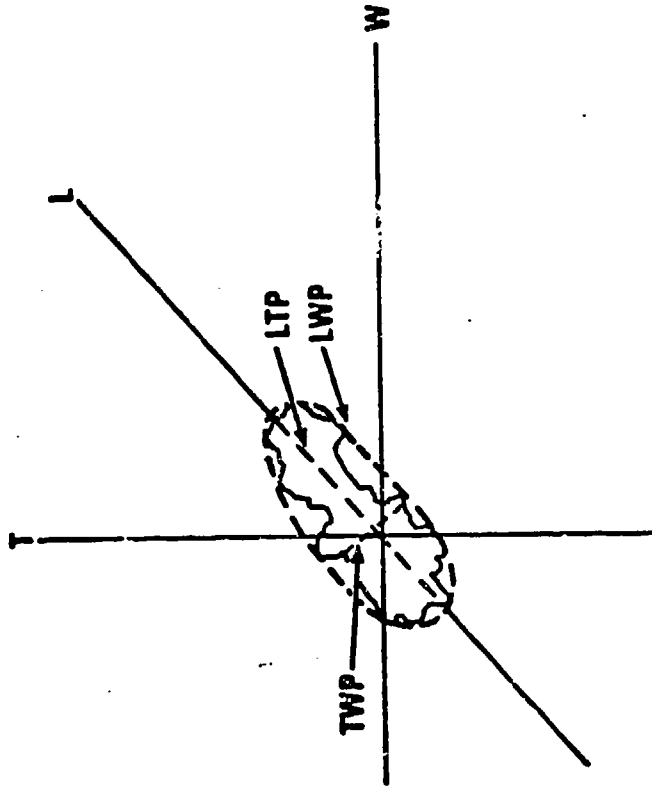

LWP - PERIMETER IN L-W PLANE

LTP - PERIMETER IN L-T PLANE

TWP - PERIMETER IN T-W PLANE

# PRESENTED AREA MEASUREMENTS

(ICOSAHEDRON GASE)

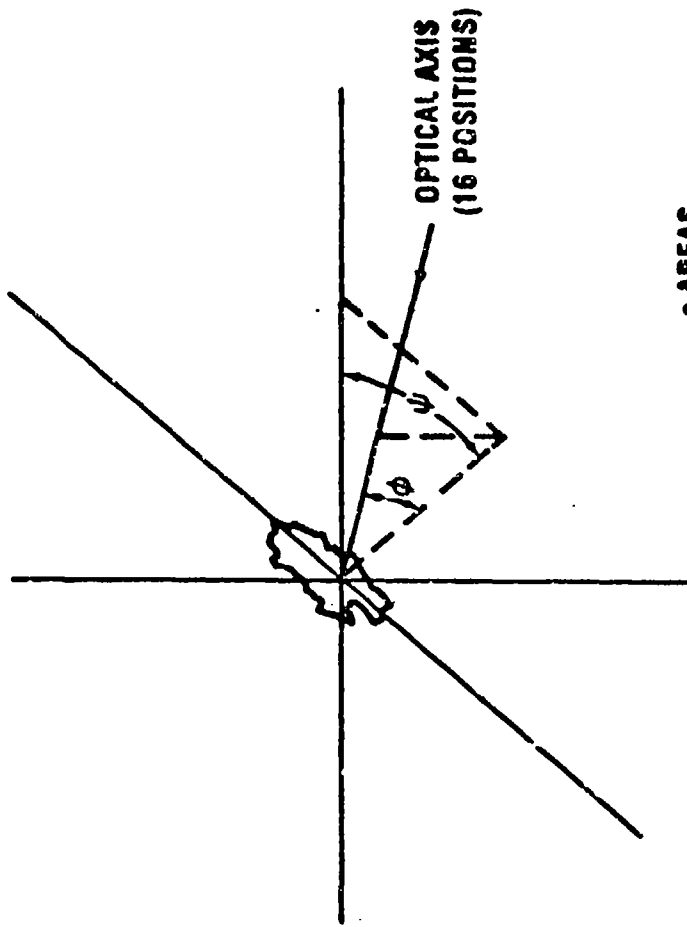

- AREAS
- MINIMUM
- AVERAGE
- MAXIMUM
- VARIANCE
- STANDARD DEVIATION

1558

FIGURE 4

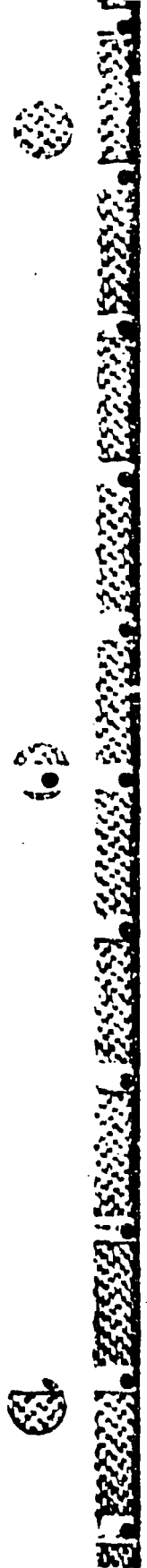

# PRESENTED AREA MEASUREMENTS

(EQUIVALENT WEIGHT AND VOLUME RECTANGULAR PARALLELEPIPED)

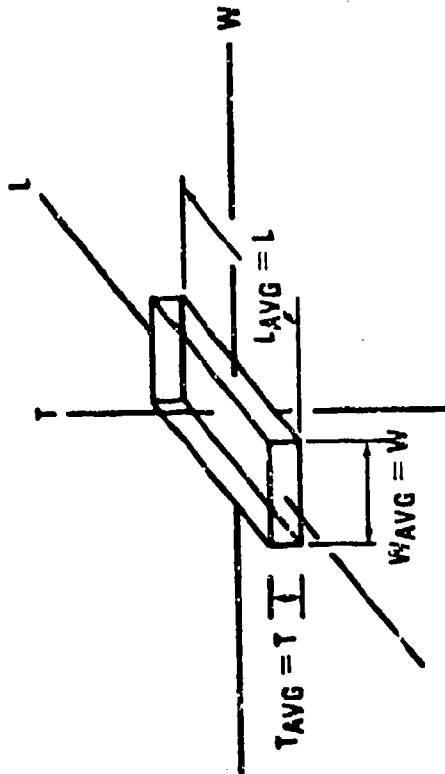

## AREAS

$$\text{MINIMUM} = W \cdot T$$

$$\text{AVERAGE} = 0.5 (L \cdot W + L \cdot T + W \cdot T)$$

$$\text{MAXIMUM} = ((L \cdot W)^2 + (T \cdot L)^2 + (T \cdot W)^2)^{1/2}$$

$$\text{VARIANCE} = 1/12 [(L \cdot T)^2 + (W \cdot T)^2 + (L \cdot W)^2] + [4/3\pi - 1/2] \cdot [L \cdot W \cdot (T)^2 + T \cdot W \cdot (L)^2 + T \cdot L \cdot (W)^2]$$

$$\text{STANDARD DEVIATION} = (\text{VARIANCE})^{1/2}$$

FIGURE 5

# SUBSONIC VERTICAL WIND TUNNEL

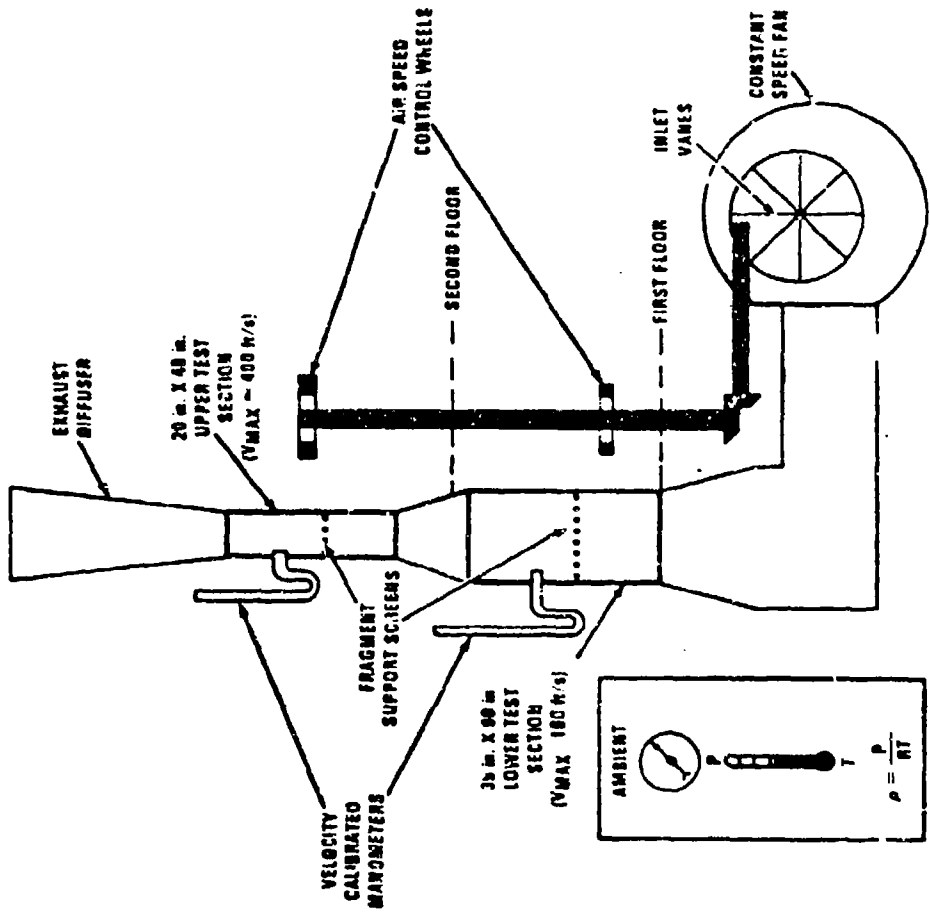
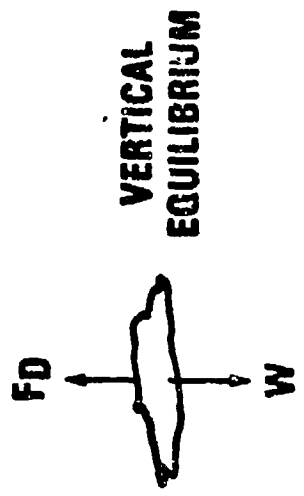

FIGURE 6



$$F_D = \text{DRAG FORCE} = \frac{C_D \rho A V^2}{2}$$

W = FRAG WEIGHT

$$F_D = W = \frac{C_D \rho A V^2}{2}$$

$$C_D = \frac{2W}{\rho A V^2}$$

FIGURE 7

# DRAG COEFFICIENT SENSITIVITY

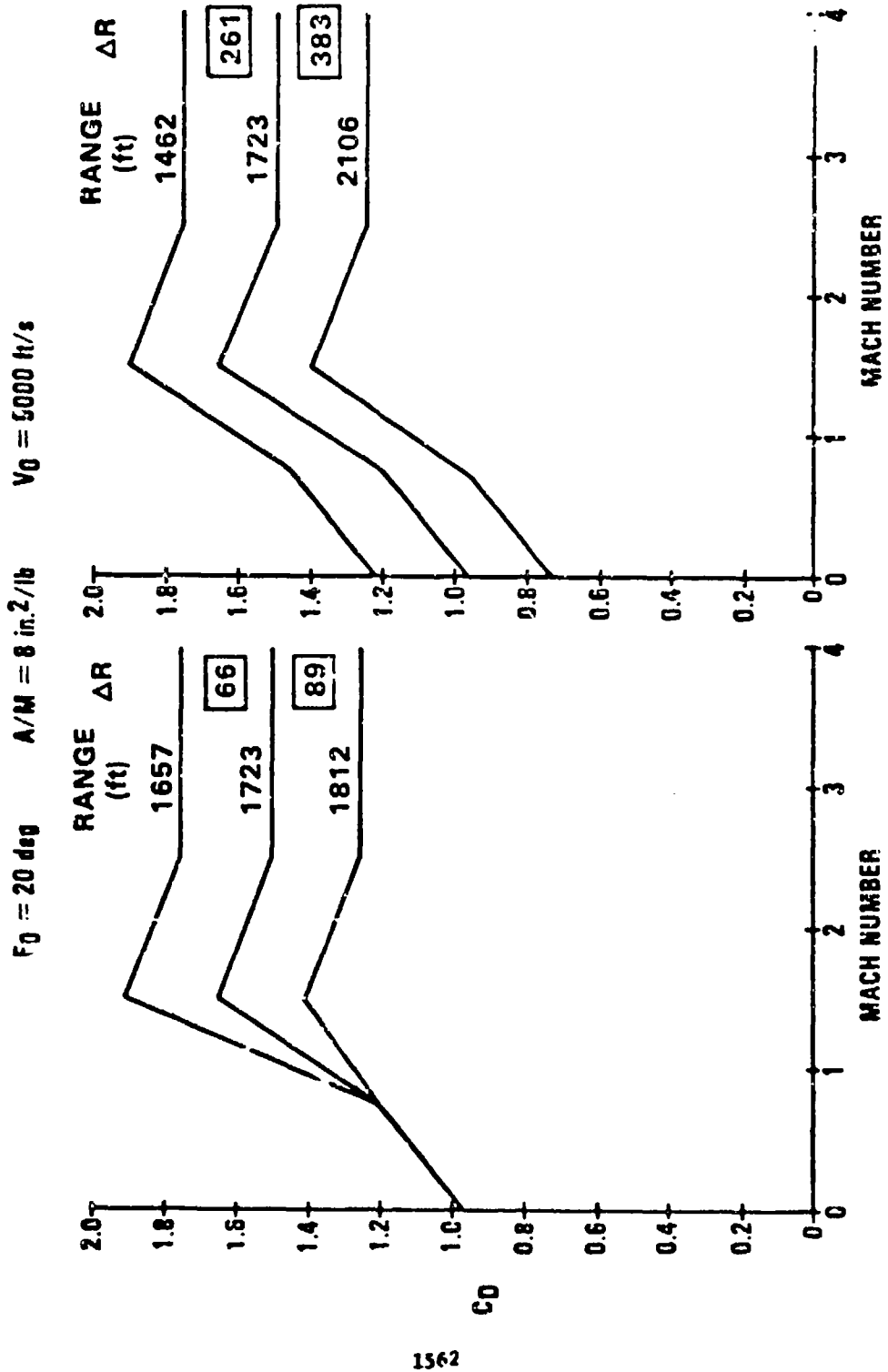
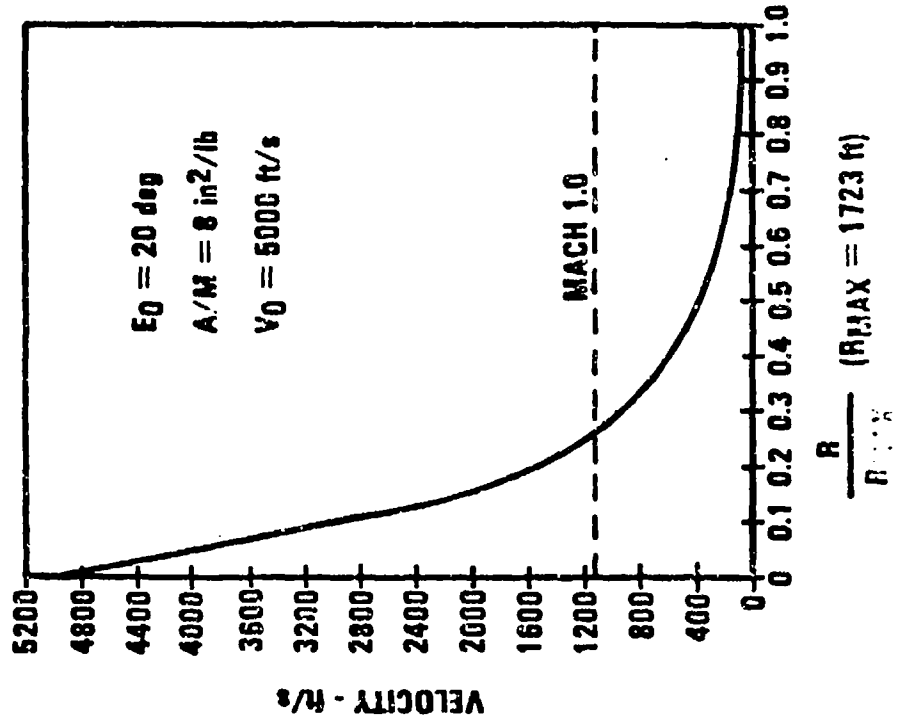

FIGURE 8

# VELOCITY VERSUS RANGE RATIO





# DRAG COEFFICIENT (CD) vs. PRESENTED AREA RATIO (AR)

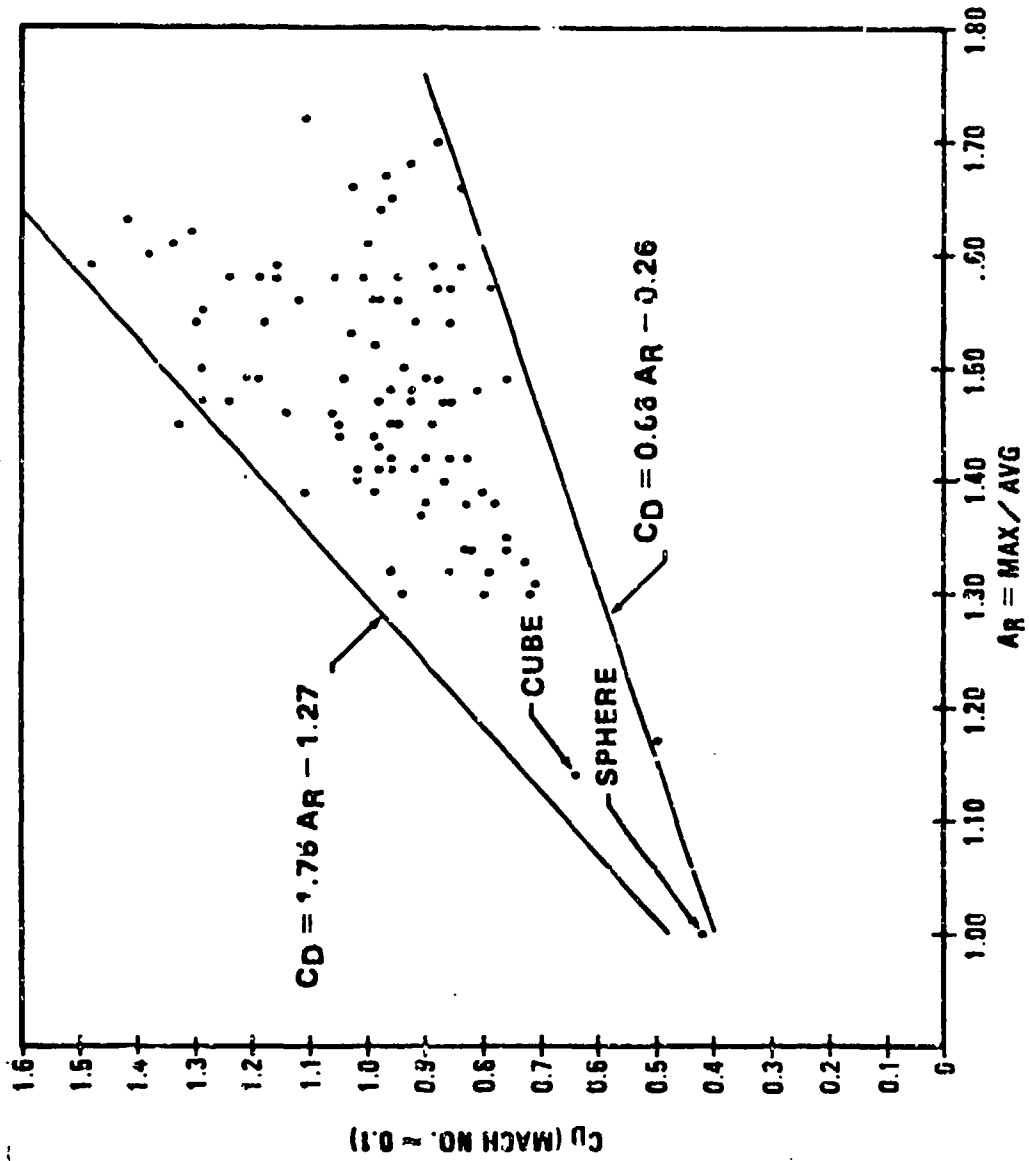

FIGURE 10

# CD AND RANGE UNCERTAINTIES

$A_{MAX}/A_{AVG} = 1.5$        $V_0 = 5000 \text{ ft/s}$        $E_0 = 20 \text{ deg}$        $A/M = 8 \text{ in.}^2/\text{lb}$

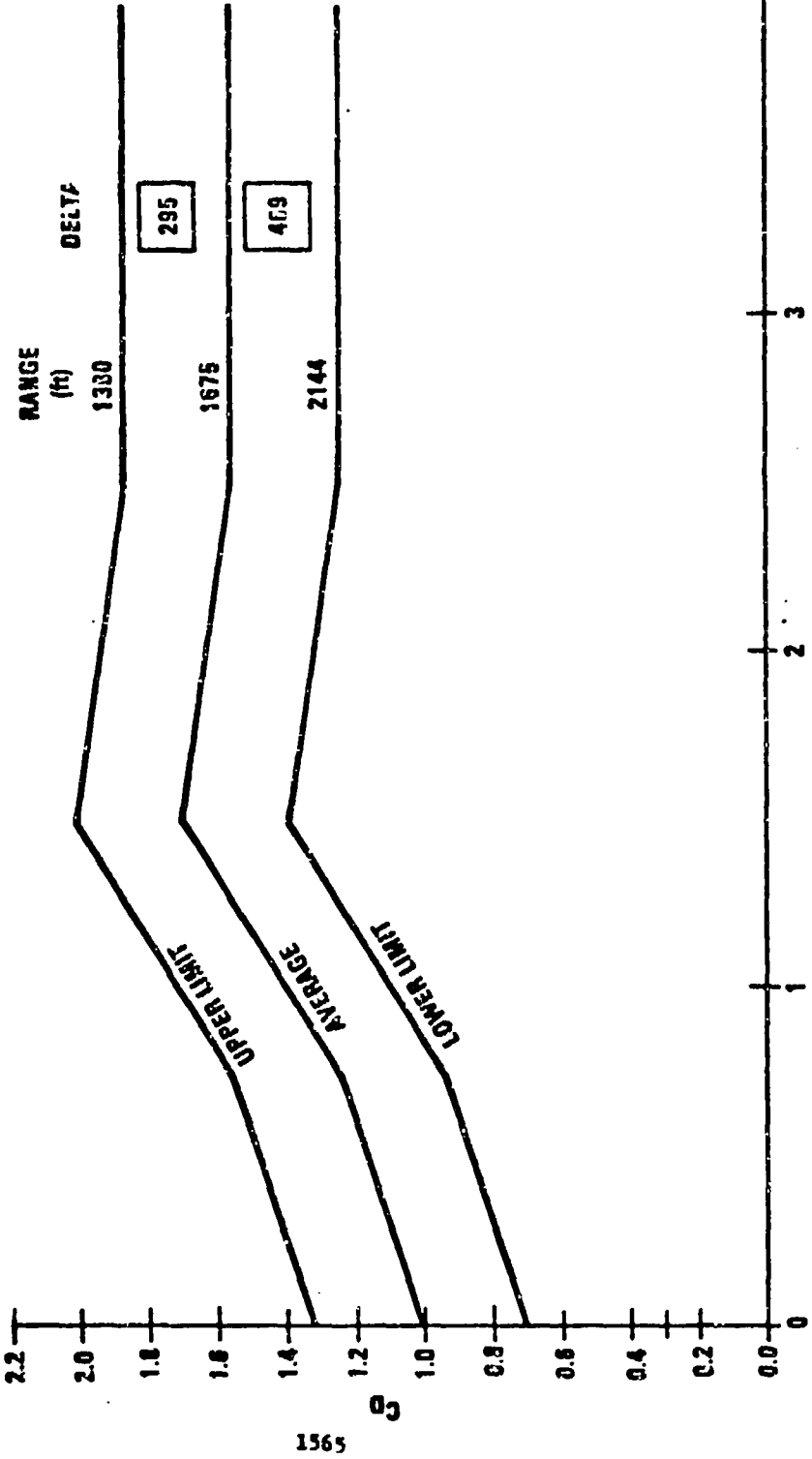

FIGURE 11

**APPENDIX A**

**1566**

This Appendix contains 6 Tables and 9 Figures.

Table A-1 contains 16 presented areas measured by the icosahedron gage for the 84 fragments which could be mounted on the gage. Table A-2 presents the linear and perimeter measurements for all 96 fragments. LWP, LTP and TWP are the perimeter measurements in the LW, LT and TW planes, respectively. Table A-2 also contains the subsonic ( $M = 0.1$ )  $C_D$  measured for each fragment in the vertical wind tunnel. Table A-3 contains the presented area measurements for the 96 fragments obtained from the icosahedron gage and calculations using the equivalent rectangular parallelepipeds. Tables A-4, A-5 and A-6 contain the dimensionless ratios which were investigated as correlation parameters for  $C_D$ . Note that the fragments have been reordered in ascending  $C_D$  to help in the  $C_D$  correlation. The old frag number is that designated in Tables A-1, A-2 and A-3.

During the wind tunnel testing, the motion of each fragment was recorded. It was found that the motions could be defined in 9 distinct types. Each figure shows the plan views (L-W plane) of those fragments exhibiting the distinct motion indicated on the figure. Two numbers are given below each fragment. The first is the fragment number contained in Tables A-1, A-2 and A-3. The second number, in parenthesis, is the subsonic  $C_D$  measured in the vertical wind tunnel. It was hoped that knowing the shape, motion and  $C_D$  might provide an additional method for correlation. Currently, this has not been realized. It is interesting to note that only 35 percent of the fragments tumble randomly. This is at odds with the traditional assumption that all fragments tumble randomly in flight. It is because of the traditional assumption that  $C_D$  is calculated using the average presented area.



TABLE A1 (CONTINUED)  
PRESENTED AREA (SQ. IN.)  
(ICOSAHEDRON GAGE)

NO.	PRESENTED AREA															
	1	2	3	4	5	6	7	8	9	10	11	12	13	14	15	16
51	0.482	0.427	0.568	0.609	0.737	0.737	0.797	0.821	0.836	0.885	0.858	0.893	0.928	0.925	0.988	1.033
52	0.488	0.432	0.492	0.526	0.578	0.625	0.625	0.625	0.632	0.666	0.676	0.676	0.676	1.038	1.078	1.172
53	0.543	0.548	0.567	0.715	0.723	0.723	0.738	0.769	0.779	0.784	0.884	0.914	0.839	0.888	0.888	0.978
54	0.538	0.581	0.535	0.619	0.634	0.663	0.747	0.821	0.934	1.033	1.231	1.248	1.364	1.443	1.526	1.678
55	0.426	0.476	0.633	0.673	0.638	0.742	0.796	0.821	0.831	0.964	0.989	1.018	1.053	1.067	1.132	1.281
56	0.438	0.644	0.684	0.713	0.773	0.882	0.932	0.921	0.936	1.069	1.069	1.079	1.148	1.246	1.236	1.385
57	0.458	0.458	0.562	0.686	0.646	0.678	0.749	0.754	0.775	0.784	0.818	0.828	0.828	0.863	0.931	0.961
58	0.283	0.619	0.619	0.713	0.723	0.738	0.777	0.918	0.918	0.913	1.084	1.064	1.078	1.132	1.281	1.344
59	0.432	0.516	0.536	0.568	0.625	0.728	0.827	0.836	0.866	0.876	1.212	1.264	1.261	1.388	1.318	1.532
60	0.486	0.586	0.538	0.614	0.674	0.688	0.693	0.723	0.748	0.767	0.772	0.882	0.822	0.913	0.923	0.963
61	0.525	0.525	0.684	0.732	0.742	0.821	0.948	0.949	1.048	1.048	1.385	1.385	1.394	1.433	1.433	1.668
62	0.579	0.668	0.732	0.841	0.886	0.861	0.878	0.883	0.983	0.983	0.983	0.983	0.913	0.933	0.933	0.994
63	0.538	0.647	0.713	0.718	0.733	0.882	0.837	0.836	0.943	0.963	1.034	1.034	1.068	1.246	1.323	1.394
64	0.517	0.638	0.633	0.668	0.773	0.783	0.882	0.988	1.137	1.237	1.434	1.333	1.617	1.738	1.884	1.942
65	0.433	0.488	0.618	0.628	0.677	0.697	0.727	0.766	0.786	0.868	0.984	0.938	0.988	1.083	1.027	1.131
66	0.531	0.538	0.533	0.538	0.524	0.733	0.762	0.772	0.782	0.792	1.063	1.088	1.098	1.113	1.117	1.338
67	0.622	0.637	0.733	0.768	0.888	0.834	0.839	0.849	0.898	0.962	1.189	1.288	1.214	1.248	1.288	1.431
68	0.583	0.688	0.619	0.624	0.633	0.733	0.887	0.876	0.836	0.925	0.938	1.084	1.088	1.088	1.113	1.137
69	0.583	0.583	0.737	0.737	0.737	0.836	0.871	0.898	0.979	1.084	1.043	1.083	1.167	1.127	1.147	1.288
70	0.424	0.572	0.687	0.661	0.788	0.788	0.723	0.779	0.788	0.788	0.814	0.833	0.873	0.888	0.983	0.912
71	0.586	0.546	0.792	0.882	0.882	0.978	0.998	1.079	1.079	1.313	1.383	1.434	1.464	1.788	1.788	1.878
72	0.514	0.663	0.678	0.712	0.834	0.938	1.013	1.087	1.338	1.363	1.335	1.683	1.738	1.822	1.938	2.093
73	0.523	0.671	0.788	0.718	0.728	0.833	0.922	1.086	1.031	1.088	1.341	1.351	1.438	1.438	1.438	1.682
74	0.633	0.678	0.788	0.738	0.812	0.912	0.931	0.976	1.038	1.035	1.068	1.088	1.237	1.272	1.336	1.438
75	0.588	0.682	0.834	0.838	0.873	0.893	1.036	1.031	1.138	1.168	1.327	1.376	1.391	1.411	1.411	1.648
76	0.467	0.668	0.748	0.738	0.738	0.882	0.891	1.044	1.217	1.232	1.281	1.488	1.577	1.688	1.723	2.088
77	0.482	0.571	0.837	0.916	1.083	1.023	1.033	1.064	1.133	1.262	1.281	1.311	1.338	1.686	1.746	1.733
78	0.838	0.948	0.977	1.087	1.036	1.133	1.224	1.234	1.383	1.333	1.412	1.588	1.538	1.569	1.747	1.836
79	0.682	0.764	0.988	0.988	0.988	1.117	1.146	1.186	1.176	1.294	1.688	1.638	1.719	1.768	1.788	2.074
80	0.674	0.634	0.964	0.971	1.113	1.138	1.287	1.227	1.267	1.368	1.413	1.464	1.494	1.523	1.583	1.781
81	0.682	0.838	1.046	1.073	1.183	1.123	1.123	1.154	1.174	1.283	1.322	1.342	1.371	1.388	1.548	1.688
82	0.685	0.763	0.813	0.842	0.872	0.897	0.986	1.086	1.088	1.168	1.183	1.281	1.296	1.488	1.583	1.933
83	0.683	0.618	0.776	0.838	0.888	0.988	1.023	1.314	1.343	1.387	1.447	1.634	1.638	1.876	1.933	1.979
84	0.683	0.871	0.898	1.038	1.168	1.157	1.196	1.196	1.344	1.342	1.716	0.729	1.828	1.937	2.068	2.288

TABLE A2  
FRAGMENT DATA

FORM NO.	SOURCE	WEIGHT GRADES	LNK DL	MMN DL	TRNG DL	LANG DL	MMG DL	TRNG DL	LMP DL	LTP DL	TAP DL	CD
1	1	133.3	1.29	0.29	0.25	1.3	0.3	0.25	3.23	3.19	1.13	0.94
2	2	1838.4	SPHERE DIAMETER = 1.00 DL				ALL PERIMETERS = 3.14 DL					CD = .42
3	3	833.0	0.76	0.76	0.76	0.8	0.8	0.76	3.06	3.06	3.06	0.64
4	3	198.7	0.93	0.60	0.49	0.9	0.5	0.13	2.38	2.19	1.75	0.91
5	3	112.3	1.73	0.40	0.21	1.6	0.4	0.09	3.63	3.50	1.25	1.19
6	3	113.2	1.02	0.60	0.25	1.0	0.5	0.12	2.56	2.13	1.50	1.06
7	3	113.2	1.01	0.60	0.27	1.0	0.5	0.12	2.60	2.25	1.50	1.05
8	3	119.7	1.29	0.01	0.21	1.2	0.6	0.00	3.23	2.75	1.75	1.34
9	3	121.9	1.24	0.50	0.29	1.1	0.5	0.11	3.06	2.60	1.50	0.93
10	3	121.8	1.40	0.72	0.22	1.2	0.7	0.07	3.44	2.50	1.50	0.97
11	3	120.6	1.04	0.71	0.27	1.1	0.5	0.12	2.81	2.31	1.50	0.76
12	3	120.8	0.94	0.79	0.20	0.6	0.8	0.10	2.75	2.00	1.75	0.80
13	3	130.0	0.03	0.60	0.44	0.7	0.6	0.16	2.31	2.00	1.94	0.83
14	3	132.9	1.00	0.75	0.33	1.0	0.5	0.14	2.00	2.31	1.94	0.96
15	3	131.5	1.02	0.76	0.32	0.9	0.6	0.13	2.75	2.30	1.60	0.90
16	3	130.1	1.74	0.33	0.20	1.7	0.4	0.11	3.60	3.50	1.50	0.93
17	3	133.5	1.20	0.63	0.32	1.3	0.5	0.12	3.00	2.63	1.50	0.94
18	3	130.6	1.36	0.71	0.34	1.4	0.4	0.14	3.06	2.75	1.01	0.83
19	3	161.1	0.90	0.74	0.26	1.0	0.6	0.14	2.01	2.13	1.60	1.21
20	3	170.2	1.43	0.02	0.37	1.3	0.6	0.12	3.30	2.01	1.01	1.29
21	3	100.5	1.70	0.76	0.27	1.5	0.6	0.11	3.75	3.30	1.63	1.30
22	3	203.7	1.04	0.66	0.30	1.5	0.5	0.12	4.00	4.00	1.44	1.10
23	3	213.0	1.33	0.73	0.30	1.1	0.6	0.17	3.13	2.75	1.00	1.02
24	3	214.6	1.07	0.50	0.26	1.0	0.8	0.14	3.19	2.30	1.94	1.40
25	3	236.4	1.51	0.01	0.29	1.5	0.6	0.13	3.56	2.60	1.94	1.30
26	3	235.4	1.40	0.79	0.41	1.5	0.6	0.14	3.00	3.06	1.75	1.19
27	3	241.6	1.50	0.03	0.43	1.4	0.6	0.15	3.01	3.44	1.63	0.89
28	3	244.0	1.30	0.70	0.40	1.3	0.6	0.16	3.50	3.31	2.06	1.33
29	6	240.7	1.30	0.70	0.30	1.3	0.6	0.16	3.19	3.06	1.63	0.96
30	3	250.1	1.74	0.77	0.33	1.7	0.5	0.13	3.94	3.63	1.75	1.34
31	3	260.0	1.00	0.00	0.47	1.1	0.6	0.21	2.60	2.44	2.06	0.96
32	3	277.4	1.07	0.77	0.46	1.9	0.5	0.15	4.06	3.54	1.94	0.90
33	6	200.2	1.24	1.00	0.46	1.1	0.6	0.22	2.00	2.44	2.13	0.86
34	6	200.2	1.40	0.00	0.44	1.4	0.7	0.13	3.94	3.71	2.66	1.29
35	4	302.0	1.51	0.60	0.32	1.9	0.6	0.14	4.30	4.00	1.01	0.73
36	4	301.0	1.00	0.00	0.36	1.5	0.7	0.13	3.75	3.44	1.75	1.16
37	6	300.4	1.30	0.02	0.37	1.4	0.7	0.16	3.75	3.31	1.00	0.96
38	4	313.1	1.54	0.06	0.30	1.3	0.7	0.10	3.44	3.19	1.01	0.90
39	4	324.9	1.42	1.13	0.36	1.3	0.9	0.14	4.56	2.01	2.60	0.86
40	3	323.7	1.36	0.70	0.57	1.4	0.6	0.20	3.44	3.44	1.01	0.82
41	4	333.2	1.12	1.00	0.00	1.1	0.0	0.19	2.00	2.75	2.60	0.76
42	6	333.0	1.73	0.06	0.33	1.5	0.6	0.19	4.23	3.94	1.75	0.90
43	4	332.0	2.71	0.04	0.19	2.6	0.7	0.10	7.25	6.25	1.94	0.93
44	4	334.0	1.17	0.02	0.74	1.7	0.7	0.23	3.31	3.06	2.23	0.72
45	4	334.9	1.34	0.00	0.30	1.2	0.7	0.22	3.30	3.06	2.23	0.80
46	3	337.9	1.30	1.04	0.51	1.3	0.7	0.20	3.01	3.06	2.23	0.83
47	6	330.2	1.45	0.02	0.63	1.4	0.7	0.19	3.00	3.13	2.31	0.87
48	3	360.2	1.30	1.23	0.46	1.2	0.9	0.17	4.00	2.00	2.01	1.04
49	3	370.3	1.30	0.03	0.43	1.3	0.8	0.10	3.00	2.00	2.06	1.14
50	4	300.0	1.12	1.00	0.02	1.2	0.0	0.20	3.60	2.94	2.56	1.11

TABLE A2 CONTINUED  
FRAGMENT DATA

FNO	SOURCE	METHOD	WGT	WGT	THX	LONG	WGT	THX	LIP	LIP	THP	CD
		GRABING	IN.	IN.	IN.	IN.	IN.	IN.	IN.	IN.	IN.	
51	4	338.2	2.25	0.64	0.51	2.8	0.6	0.17	4.88	4.75	1.65	1.83
52	6	335.3	1.65	1.87	0.48	1.6	0.9	0.16	4.44	3.31	2.31	1.16
53	4	335.1	1.62	0.75	0.52	1.5	0.7	0.19	4.56	4.86	2.13	0.76
54	4	484.6	2.89	1.16	0.27	2.8	0.9	0.11	5.25	4.31	2.58	1.11
55	5	432.7	2.93	0.75	0.42	1.9	0.7	0.17	4.88	4.59	1.69	0.88
56	4	435.9	2.75	0.76	0.37	2.5	0.6	0.16	5.88	5.69	1.81	1.83
57	6	451.7	1.95	0.95	0.47	1.3	0.8	0.25	3.63	3.38	2.13	0.78
58	6	454.8	2.93	0.98	0.52	2.1	0.7	0.16	4.81	4.23	2.23	1.12
59	4	483.2	1.98	1.36	0.33	1.6	1.0	0.15	4.81	3.13	2.94	1.83
60	6	484.1	1.54	0.93	0.61	1.3	0.8	0.24	3.63	3.44	2.58	0.98
61	4	485.7	2.47	1.85	0.37	2.1	0.9	0.13	5.69	5.85	2.31	0.95
62	4	428.3	1.83	0.93	0.39	1.8	0.7	0.28	3.36	4.44	2.81	0.73
63	6	438.9	2.13	1.82	0.39	2.1	0.8	0.13	5.13	4.69	2.88	0.85
64	4	431.1	1.95	1.59	0.38	2.8	1.0	0.13	6.38	3.81	3.23	0.88
65	5	388.8	1.72	0.91	0.41	1.8	0.6	0.24	4.44	3.75	1.94	0.85
66	6	513.6	1.62	1.28	0.39	1.4	1.0	0.19	4.38	3.85	2.81	1.85
67	6	531.9	2.12	1.84	0.48	2.8	0.8	0.17	5.36	4.31	2.38	0.92
68	5	547.9	1.68	1.88	0.42	1.6	0.8	0.22	3.63	3.38	3.44	0.92
69	6	555.2	1.97	1.87	0.42	1.9	0.8	0.19	5.85	4.44	2.23	0.97
70	4	361.2	1.73	0.68	0.67	1.5	0.7	0.27	4.19	4.13	2.85	0.71
71	4	688.4	2.57	0.95	0.35	2.3	0.9	0.15	6.85	5.23	2.13	0.98
72	6	631.7	2.13	1.38	0.38	2.1	1.1	0.14	5.63	4.31	2.75	0.93
73	6	631.4	1.58	1.37	0.44	1.6	1.1	0.19	4.94	3.63	2.94	0.84
74	4	625.8	1.83	1.16	0.65	1.9	0.8	0.22	4.63	4.88	3.88	0.85
75	6	628.5	2.31	1.87	0.64	2.1	0.8	0.28	5.36	5.85	2.69	0.95
76	5	713.9	2.12	1.24	0.58	1.8	1.0	0.28	5.85	4.31	3.88	0.84
77	6	713.1	2.61	0.53	0.38	2.6	0.8	0.18	6.88	5.85	2.19	1.29
78	4	767.8	2.85	1.16	0.53	2.8	0.7	0.28	7.44	6.13	2.88	0.98
79	6	776.7	2.33	1.27	0.43	2.3	1.8	0.17	7.13	5.85	2.69	1.31
80	4	777.8	2.82	0.85	0.38	2.8	0.7	0.28	6.63	6.85	2.19	0.95
81	6	782.2	2.43	0.97	0.43	2.4	0.8	0.21	5.63	5.63	2.13	0.98
82	4	884.8	1.68	1.49	0.38	1.6	1.1	0.23	4.88	3.95	3.44	0.81
83	6	833.7	1.76	1.59	0.48	1.6	1.4	0.19	5.69	3.69	3.38	0.85
84	6	885.3	2.98	1.87	0.43	3.8	0.9	0.16	7.88	5.81	2.31	1.88
85	4	1617.7	3.23	1.27	0.56	2.7	1.1	0.28	7.81	6.75	2.81	0.93
86	6	1628.8	3.37	1.93	0.45	3.3	1.2	0.21	8.81	6.75	4.19	1.24
87	4	1798.4	3.53	2.85	0.66	3.3	1.2	0.23	8.59	6.35	3.69	0.98
88	6	1973.2	3.37	1.95	0.45	3.8	1.2	0.22	9.31	8.83	3.21	0.93
89	4	2883.7	2.38	1.49	0.97	2.5	0.9	0.43	5.75	5.69	3.88	0.88
90	6	2884.2	2.71	2.88	0.73	2.4	1.8	0.43	6.19	5.81	3.95	0.79
91	6	2833.6	3.38	1.84	0.46	3.8	1.4	0.25	8.88	6.25	3.88	0.98
92	4	2763.3	4.38	2.69	0.57	4.3	1.5	0.22	12.25	8.88	5.36	1.42
93	6	3148.8	4.39	1.98	0.46	4.1	1.5	0.26	13.85	18.88	3.31	1.81
94	4	3278.2	3.17	1.89	0.74	2.9	1.4	0.41	8.35	6.81	4.69	1.82
95	7	3393.1	3.17	2.81	2.33	3.1	2.8	1.28	9.63	8.88	8.19	0.95
96	7	23413.5	4.38	3.77	1.79	4.2	3.4	0.84	13.63	9.81	8.63	0.93

SOURCE CODE

- 1 - BAR (1/4 X 1/4 X 1/4)
- 2 - 1.00 IN. DIAMETER SPHERE
- 3 - .75 IN. PER SIDE CUBE
- 4 - 155MM M107 PROJECTILE

- 5 - 76MM MK 165 PROJECTILE
- 6 - MK 84 LOW DRAG BOMB
- 7 - MK 82 LOW DRAG BOMB



TABLE A3  
 ICOSANE IN V3 CALCULATED AREAS

FRAG NO.	MIN AREA		MAX AREA		AVG AREA		STD DEV		VARIANCE	
	ICOS	CALC	ICOS	CALC	ICOS	CALC	ICOS	CALC	ICOS	CALC
1	0.26	0.07	0.43	0.52	0.34	0.38	0.07	0.09	0.005	0.008
2	0.74	0.79	0.79	0.79	0.78	0.79	0.00	0.00	0.000	0.000
3	0.64	0.58	0.98	1.00	0.87	0.87	0.10	0.09	0.009	0.008
4	0.19	0.06	0.37	0.47	0.30	0.31	0.05	0.11	0.003	0.012
5	0.17	0.04	0.58	0.66	0.37	0.41	0.11	0.16	0.013	0.027
6	0.16	0.06	0.41	0.52	0.30	0.34	0.07	0.12	0.005	0.015
7	0.20	0.06	0.41	0.52	0.30	0.34	0.07	0.12	0.005	0.015
8	0.18	0.05	0.58	0.73	0.37	0.44	0.12	0.19	0.015	0.036
9	0.18	0.06	0.58	0.57	0.35	0.37	0.09	0.14	0.009	0.019
10	0.23	0.05	0.70	0.85	0.43	0.49	0.15	0.22	0.023	0.050
11	0.20	0.06	0.49	0.57	0.34	0.37	0.08	0.14	0.007	0.018
12	0.21	0.08	0.51	0.65	0.33	0.40	0.10	0.16	0.010	0.027
13	0.21	0.10	0.36	0.44	0.28	0.31	0.05	0.10	0.002	0.009
14	0.19	0.07	0.46	0.52	0.34	0.35	0.07	0.12	0.005	0.014
15	0.22	0.08	0.46	0.56	0.34	0.37	0.07	0.13	0.005	0.017
16	0.21	0.05	0.57	0.71	0.42	0.46	0.11	0.17	0.011	0.029
17	0.21	0.06	0.55	0.67	0.38	0.43	0.10	0.16	0.009	0.026
18	0.25	0.06	0.52	0.60	0.37	0.41	0.08	0.13	0.007	0.018
19	0.21	0.08	0.52	0.62	0.37	0.41	0.10	0.15	0.010	0.021
20	0.22	0.07	0.62	0.68	0.37	0.50	0.10	0.20	0.010	0.039
21	0.20	0.06	0.74	0.92	0.43	0.56	0.16	0.23	0.026	0.054
22	0.20	0.07	0.60	0.92	0.55	0.57	0.16	0.23	0.025	0.053
23	0.27	0.10	0.61	0.69	0.45	0.47	0.10	0.16	0.010	0.024
24	0.27	0.11	0.75	0.82	0.40	0.52	0.16	0.20	0.025	0.040
25	0.26	0.08	0.79	0.93	0.53	0.59	0.17	0.23	0.029	0.051
26	0.29	0.08	0.76	0.93	0.54	0.59	0.14	0.23	0.020	0.051
27	0.34	0.09	0.75	0.87	0.54	0.57	0.12	0.21	0.015	0.043
28	0.35	0.10	0.75	0.81	0.54	0.54	0.12	0.19	0.014	0.036
29	0.33	0.10	0.69	0.81	0.52	0.54	0.11	0.19	0.011	0.033
30	0.30	0.08	0.74	0.89	0.51	0.59	0.12	0.21	0.016	0.043
31	0.34	0.12	0.57	0.71	0.46	0.51	0.07	0.15	0.005	0.022
32	0.29	0.07	0.81	0.99	0.62	0.65	0.14	0.23	0.019	0.053
33	0.36	0.13	0.68	0.71	0.40	0.51	0.07	0.15	0.005	0.022
34	0.31	0.11	0.84	1.01	0.61	0.65	0.14	0.24	0.018	0.059
35	0.31	0.03	1.05	1.17	0.68	0.74	0.23	0.29	0.053	0.084
36	0.36	0.10	0.99	1.00	0.62	0.69	0.18	0.26	0.031	0.069
37	0.30	0.11	0.85	1.01	0.61	0.66	0.15	0.24	0.023	0.058
38	0.35	0.12	0.79	0.95	0.55	0.63	0.14	0.22	0.019	0.048
39	0.42	0.13	1.05	1.19	0.71	0.74	0.20	0.30	0.040	0.089
40	0.20	0.12	0.77	0.89	0.62	0.62	0.12	0.20	0.015	0.039
41	0.40	0.15	0.70	0.92	0.59	0.62	0.06	0.21	0.004	0.043
42	0.42	0.11	0.80	0.95	0.65	0.65	0.12	0.21	0.015	0.046
43	0.55	0.07	1.43	1.84	1.02	0.97	0.24	0.49	0.056	0.236
44	0.39	0.16	0.66	0.83	0.55	0.60	0.07	0.17	0.004	0.029
45	0.41	0.15	0.79	0.89	0.59	0.62	0.11	0.19	0.012	0.037
46	0.41	0.14	0.83	0.96	0.64	0.66	0.14	0.21	0.020	0.046
47	0.47	0.13	0.82	1.02	0.63	0.69	0.11	0.24	0.012	0.055
48	0.40	0.15	0.97	1.11	0.68	0.72	0.19	0.27	0.037	0.071
49	0.37	0.15	0.90	1.00	0.64	0.71	0.16	0.25	0.025	0.064
50	0.43	0.16	0.83	1.00	0.64	0.68	0.12	0.23	0.015	0.052

TABLE A3 (CONTINUED)  
 ICOSAHEDROM VS CALCULATED AREAS

FRAG NO.	MIN AREA		MAX AREA		AVG AREA		STD DEV		VARIANCE	
	ICOS	CALC	ICOS	CALC	ICOS	CALC	ICOS	CALC	ICOS	CALC
51	0.40	0.10	1.05	1.25	0.70	0.82	0.19	0.30	0.037	0.088
52	0.41	0.13	1.20	1.31	0.77	0.83	0.26	0.32	0.068	0.104
53	0.54	0.13	0.90	1.10	0.75	0.74	0.11	0.25	0.012	0.064
54	0.34	0.10	1.67	1.82	0.96	1.07	0.41	0.49	0.169	0.228
55	0.46	0.12	1.20	1.37	0.85	0.88	0.23	0.33	0.051	0.111
56	0.36	0.09	1.39	1.55	0.93	0.95	0.27	0.38	0.072	0.144
57	0.46	0.18	0.96	1.10	0.73	0.76	0.15	0.24	0.022	0.059
58	0.29	0.11	1.34	1.51	0.87	0.95	0.26	0.37	0.069	0.138
59	0.45	0.15	1.55	1.63	0.92	1.00	0.35	0.41	0.121	0.169
60	0.49	0.19	0.97	1.10	0.73	0.77	0.14	0.24	0.020	0.057
61	0.53	0.12	1.66	1.91	1.03	1.14	0.36	0.50	0.131	0.246
62	0.64	0.14	0.99	1.32	0.86	0.88	0.10	0.31	0.010	0.094
63	0.40	0.12	1.39	1.71	0.93	1.06	0.30	0.43	0.089	0.187
64	0.52	0.13	1.94	2.02	1.15	1.19	0.47	0.53	0.225	0.30
65	0.46	0.14	1.13	1.17	0.79	0.83	0.20	0.25	0.040	0.063
66	0.53	0.19	1.36	1.44	0.85	0.93	0.26	0.35	0.067	0.120
67	0.62	0.14	1.45	1.64	0.97	1.04	0.25	0.40	0.064	0.164
68	0.59	0.17	1.14	1.34	0.86	0.90	0.20	0.31	0.039	0.094
69	0.37	0.15	1.28	1.57	0.92	1.01	0.21	0.38	0.044	0.143
70	0.43	0.19	0.91	1.14	0.75	0.82	0.13	0.24	0.018	0.055
71	0.51	0.13	1.88	2.10	1.15	1.27	0.42	0.54	0.174	0.290
72	0.61	0.16	2.09	2.34	1.26	1.39	0.49	0.61	0.242	0.370
73	0.52	0.21	1.69	1.80	1.06	1.14	0.36	0.44	0.127	0.196
74	0.64	0.18	1.44	1.59	1.01	1.06	0.24	0.37	0.059	0.136
75	0.51	0.16	1.65	1.74	1.10	1.15	0.31	0.42	0.097	0.173
76	0.47	0.20	2.00	1.85	1.14	1.18	0.44	0.45	0.196	0.282
77	0.48	0.14	1.76	2.13	1.17	1.34	0.38	0.53	0.147	0.281
78	0.84	0.14	1.86	2.04	1.29	1.33	0.30	0.49	0.088	0.238
79	0.60	0.17	2.07	2.34	1.30	1.43	0.42	0.59	0.175	1.352
80	0.67	0.14	1.70	2.05	1.24	1.33	0.30	0.49	0.090	0.238
81	0.60	0.17	1.61	1.99	1.20	1.29	0.26	0.40	0.067	0.227
82	0.69	0.26	1.55	1.82	1.08	1.19	0.20	0.43	0.078	0.184
83	0.61	0.27	1.90	2.20	1.27	1.40	0.46	0.57	0.216	0.329
84	0.60	0.15	2.20	2.75	1.41	1.67	0.46	0.70	0.210	0.494
85		0.51		3.98		2.01		0.72		0.535
86		0.26		4.03		2.46		1.03		1.053
87		0.28		4.04		2.50		1.02		1.034
88		0.26		4.64		2.83		1.18		1.400
89		0.41		2.55		1.90		0.50		0.245
90		0.43		2.64		1.93		0.54		0.286
91		0.35		4.20		2.64		1.00		1.151
92		0.33		6.53		3.86		1.71		2.908
93		0.39		6.25		3.81		1.60		2.549
94		0.50		4.27		2.92		0.96		0.925
95		2.57		7.00		6.37		1.11		1.232
96		2.84		14.98		0.32		3.33		11.078

EXPLANATION OF COLUMN HEADINGS  
 MIN AREA - MINIMUM PRESENTED AREA (SQ. IN.)  
 MAX AREA - MAXIMUM PRESENTED AREA (SQ. IN.)  
 AVG AREA - AVERAGE PRESENTED AREA (SQ. IN.)  
 STD DEV - STANDARD DEVIATION OF PRESENTED AREA (SQ. IN.)  
 VARIANCE - VARIANCE OF PRESENTED AREA (IN. 4TH)  
 ICOS - AREAS CALCULATED FROM ICOSAHEDRON GAGE DATA  
 CALC - AREAS CALCULATED FROM APPROXIMATING RECTANGULAR PARALLELEPIPEDS

TABLE A4  
PRESENTED AREA RATIOS

FRAG NEW	NO. OLD	CD	MAX / MIN		MAX / AVG		AVG / MIN	
			ICOS	CALC	ICOS	CALC	ICOS	CALC
1	2	0.47	1.00	1.00	1.00	1.00	1.00	1.00
2	95	0.50		3.04		1.22		2.40
3	3	0.64	1.54	1.73	1.13	1.15	1.36	1.50
4	70	0.71	2.10	3.99	1.22	1.39	1.73	4.32
5	44	0.72	1.69	3.05	1.20	1.39	1.41	3.63
6	62	0.73	1.56	9.49	1.16	1.50	1.34	6.33
7	53	0.76	1.65	8.16	1.20	1.49	1.38	5.40
8	41	0.76	1.44	3.94	1.20	1.47	1.19	4.03
9	11	0.76	2.42	9.53	1.45	1.53	1.67	6.21
10	57	0.78	2.10	6.05	1.31	1.45	1.60	4.18
11	35	0.79	3.36	14.41	1.55	1.59	2.17	9.09
12	90	0.79		6.20		1.37		4.51
13	45	0.80	1.95	5.91	1.34	1.43	1.46	4.14
14	89	0.80		6.24		1.35		4.64
15	82	0.81	2.27	7.08	1.43	1.52	1.58	4.66
16	40	0.82	2.77	7.52	1.23	1.44	2.26	3.21
17	13	0.83	1.72	4.67	1.26	1.42	1.37	3.29
18	46	0.83	2.03	6.81	1.29	1.46	1.57	4.67
19	18	0.83	2.11	10.35	1.37	1.46	1.54	7.23
20	73	0.84	3.24	8.60	1.59	1.58	2.03	5.44
21	76	0.84	4.28	9.13	1.75	1.56	2.44	5.85
22	63	0.86	3.50	14.36	1.51	1.62	2.33	8.86
23	33	0.86	1.66	5.49	1.24	1.39	1.33	3.96
24	74	0.86	2.27	9.21	1.43	1.50	1.59	6.00
25	39	0.86	2.50	9.37	1.47	1.61	1.70	5.82
26	65	0.86	2.49	8.18	1.42	1.42	1.75	5.77
27	47	0.87	1.76	7.81	1.30	1.49	1.35	5.24
28	69	0.87	2.27	10.50	1.39	1.55	1.63	6.78
29	55	0.88	2.63	11.81	1.42	1.56	1.86	7.58
30	64	0.88	3.76	15.99	1.69	1.70	2.22	9.42
31	12	0.88	2.38	7.92	1.52	1.62	1.56	4.98
32	27	0.89	2.20	9.87	1.37	1.53	1.60	6.44
33	83	0.89	3.25	8.56	1.56	1.62	2.08	5.28
34	78	0.90	2.21	14.62	1.43	1.54	1.54	9.51
35	32	0.90	2.81	13.35	1.31	1.52	2.15	8.78
36	60	0.90	1.99	5.80	1.32	1.43	1.50	4.05
37	4	0.91	1.90	7.46	1.23	1.50	1.54	4.99
38	67	0.92	2.33	12.10	1.50	1.50	1.56	7.65
39	68	0.92	1.94	7.66	1.33	1.48	1.47	5.16
40	85	0.93		10.07		1.53		6.59
41	72	0.93	3.41	14.75	1.66	1.69	2.05	8.75
42	9	0.93	2.71	18.05	1.41	1.55	1.93	6.40
43	1	0.94	2.19	6.92	1.29	1.30	1.70	5.33
44	17	0.94	2.63	11.01	1.45	1.55	1.82	7.13
45	88	0.95		17.53		1.64		10.63
46	43	0.95	2.59	26.57	1.41	1.71	1.84	15.50
47	16	0.95	2.75	15.71	1.35	1.54	2.04	10.17
48	60	0.96	2.52	14.44	1.37	1.53	1.84	9.42
49	31	0.96	1.66	5.69	1.23	1.40	1.35	4.06
50	29	0.96	1.97	8.34	1.33	1.49	1.48	5.50

TABLE A4 (CONTINUED)  
PRESENTED AREA RATIOS

FRAG NEW	NO. OLD	CD	MAX / MIN		MAX / AVG		AVG / MIN	
			ICOS	CALC	ICOS	CALC	ICOS	CALC
51	37	0.96	2.84	8.97	1.41	1.54	2.02	5.85
52	61	0.96	3.16	16.18	1.61	1.68	1.96	9.66
53	14	0.96	2.41	7.71	1.34	1.49	1.79	5.19
54	10	0.97	3.04	16.34	1.61	1.73	1.89	9.47
55	87	0.98		14.53		1.62		8.99
56	71	0.98	3.71	15.58	1.63	1.65	2.28	9.45
57	15	0.98	2.06	7.26	1.34	1.52	1.54	4.76
58	39	0.98	2.26	7.70	1.43	1.50	1.57	5.13
59	42	0.98	2.88	8.33	1.36	1.46	1.53	5.69
60	75	0.99	3.24	10.72	1.50	1.53	2.17	6.90
61	96	0.99		5.27		1.45		3.63
62	91	0.99		12.36		1.62		7.64
63	81	0.99	2.67	11.97	1.34	1.54	2.00	7.77
64	84	1.00	3.23	10.65	1.57	1.65	2.06	11.33
65	93	1.01		15.97		1.64		9.72
66	94	1.02		7.41		1.46		5.86
67	23	1.02	2.25	6.98	1.35	1.47	1.67	4.74
68	59	1.03	3.43	10.55	1.60	1.63	2.04	6.49
69	56	1.03	3.07	16.68	1.40	1.57	2.61	10.64
70	40	1.04	2.45	7.75	1.44	1.54	1.70	4.69
71	51	1.05	2.62	12.55	1.35	1.53	1.95	8.19
72	7	1.05	2.09	8.80	1.36	1.53	1.54	5.75
73	6	1.06	2.62	8.94	1.39	1.53	1.89	5.83
74	66	1.07	2.56	7.59	1.61	1.55	1.59	4.90
75	52	1.11	1.95	6.18	1.31	1.47	1.49	4.21
76	54	1.11	4.94	17.61	1.74	1.70	2.04	10.33
77	58	1.12	4.65	13.40	1.54	1.57	3.03	8.51
78	49	1.14	2.42	7.41	1.41	1.51	1.72	4.89
79	36	1.16	2.73	10.40	1.60	1.57	1.70	6.64
80	53	1.16	2.95	10.45	1.57	1.58	1.88	6.60
81	22	1.18	2.86	13.27	1.47	1.61	1.95	8.24
82	5	1.19	3.37	10.34	1.55	1.60	2.17	11.44
83	26	1.19	2.60	11.38	1.41	1.56	1.84	7.20
84	19	1.21	2.43	7.55	1.45	1.52	1.68	4.98
85	86	1.24		13.79		1.64		9.63
86	38	1.24	2.49	11.65	1.43	1.50	1.74	7.75
87	77	1.29	3.64	15.13	1.51	1.59	2.42	9.50
88	34	1.29	2.69	9.50	1.38	1.55	1.94	6.12
89	20	1.29	2.77	11.41	1.41	1.59	1.97	7.16
90	25	1.30	3.85	11.51	1.50	1.57	2.04	7.35
91	79	1.31	3.04	13.58	1.60	1.63	1.90	8.32
92	28	1.33	2.26	8.46	1.40	1.50	1.61	5.64
93	0	1.34	3.17	14.32	1.55	1.67	2.05	8.57
94	21	1.30	3.72	14.29	1.56	1.63	2.30	8.77
95	92	1.42		19.91		1.69		11.77
96	24	1.48	2.01	7.48	1.61	1.57	1.74	4.70

ICOS - PRESENTED AREA RATIOS CALCULATED FROM ICOSAHEDRON ONCE DATA  
 CALC - PRESENTED AREA RATIOS CALCULATED FROM APPROXIMATING RECTANGULAR PARALLELEPIPEDS

TABLE A5  
 LINEAR AND STATISTICAL RATIOS

FRAG NO. NEW	FRAG NO. OLD	FD	L/T (SPHERE)	W/T	L'/T'	W'/T'	SD / ICOS	RAVG CALC	VAR / ICOS	RAVG+2 CALC
1	2	0.42								
2	95	0.58	2.42	1.56	1.74	1.33		0.17		0.03
3	3	0.64	1.00	1.00	1.00	1.00	0.11	0.10	0.01	0.01
4	78	0.71	5.59	2.57	3.43	1.46	0.18	0.29	0.03	0.10
5	44	0.77	4.69	2.98	2.33	1.56	0.12	0.29	0.01	0.14
6	62	0.73	9.06	3.53	4.61	2.03	0.11	0.35	0.01	0.14
7	53	0.76	7.81	3.65	4.38	2.04	0.15	0.34	0.02	0.16
8	41	0.76	5.69	4.14	2.24	1.90	0.11	0.33	0.01	0.19
9	11	0.76	9.22	4.19	5.58	3.11	0.25	0.37	0.06	0.36
10	57	0.78	5.74	3.53	4.11	2.53	0.20	0.32	0.04	0.13
11	35	0.79	14.02	4.43	8.36	2.81	0.34	0.39	0.12	0.21
12	50	0.79	5.63	2.34	4.42	2.66		0.21		0.08
13	45	0.80	5.57	3.25	3.55	2.31	0.18	0.31	0.03	0.15
14	89	0.80	5.58	1.98	3.57	1.68		0.26		0.07
15	82	0.81	6.86	4.71	4.03	3.18	0.26	0.36	0.07	0.11
16	40	0.82	7.08	3.03	3.86	1.80	0.20	0.32	0.04	0.16
17	13	0.83	4.41	3.78	2.55	2.34	0.16	0.30	0.03	0.30
18	46	0.83	6.48	3.49	3.73	2.59	0.22	0.33	0.05	0.16
19	18	0.83	9.69	2.71	5.78	2.29	0.21	0.33	0.05	0.26
20	73	0.84	8.42	5.79	5.06	3.92	0.34	0.39	0.11	0.13
21	76	0.84	8.90	4.94	5.58	3.19	0.29	0.38	0.15	0.12
22	63	0.86	14.09	5.37	7.85	3.38	0.32	0.41	0.10	0.16
23	33	0.86	5.88	2.77	3.40	2.58	0.15	0.29	0.02	0.16
24	74	0.86	8.63	3.63	4.24	2.23	0.24	0.35	0.06	0.11
25	39	0.86	9.20	6.37	5.43	4.05	0.28	0.40	0.08	0.22
26	65	0.86	7.55	2.52	5.43	2.33	0.25	0.30	0.06	0.11
27	47	0.87	7.49	3.74	3.49	1.86	0.17	0.34	0.03	0.17
28	69	0.87	18.18	4.29	6.38	3.08	0.23	0.37	0.05	0.14
29	55	0.88	11.45	4.22	6.71	2.47	0.27	0.38	0.07	0.16
30	64	0.88	15.84	7.92	6.32	4.14	0.41	0.45	0.17	0.17
31	12	0.88	7.79	7.79	4.55	4.15	0.38	0.41	0.09	0.41
32	27	0.89	9.54	4.89	5.10	2.48	0.23	0.37	0.05	0.24
33	13	0.89	8.43	7.37	5.78	5.07	0.37	0.41	0.13	0.12
34	8	0.90	14.02	3.51	7.74	2.55	0.23	0.37	0.05	0.18
35	32	0.90	12.75	3.36	6.19	2.89	0.22	0.36	0.05	0.28
36	68	0.90	5.47	3.37	3.35	2.84	0.19	0.31	0.04	0.13
37	4	0.91	7.17	3.98	2.97	1.79	0.17	0.35	0.03	0.38
38	67	0.92	11.79	4.72	7.23	3.27	0.26	0.39	0.07	0.15
39	60	0.92	7.33	3.66	5.81	2.82	0.23	0.34	0.05	0.13
40	85	0.93	9.72	3.96	7.08	2.83		0.36		0.13
41	71	0.93	14.59	7.64	9.66	5.41	0.39	0.44	0.15	0.14
42	5	0.93	9.76	4.44	5.81	2.68	0.27	0.37	0.07	0.38
43	1	0.94	5.17	1.15	5.16	1.15	0.21	0.23	0.04	0.14
44	17	0.94	18.65	4.18	5.84	2.56	0.26	0.37	0.07	0.32
45	88	0.95	17.21	5.44	18.86	4.31		0.42		0.17
46	43	0.95	26.29	7.88	18.33	5.33	0.23	0.45	0.05	0.19
47	16	0.95	15.18	3.55	8.76	2.42	0.25	0.37	0.06	0.38
48	86	0.96	13.84	3.46	8.85	2.22	0.24	0.37	0.06	0.18
49	31	0.96	5.29	2.89	3.17	2.18	0.15	0.29	0.02	0.17
50	29	0.96	7.99	3.69	4.94	2.47	0.28	0.35	0.04	0.22

TABLE AS (CONTINUED)  
 LINEAR AND STATISTICAL RATIOS

FRAG NO.		CD	L/T	W/T	L'/T'	W'/T'	SD / AVG		VAR / AVG+2	
NEW	OLD						ICDS	CALC	ICDS	CALC
51	57	0.96	8.69	4.35	5.61	2.86	0.25	0.37	0.06	0.20
52	61	0.96	15.98	6.85	9.11	3.89	0.35	0.43	0.12	0.17
53	14	0.96	7.37	3.69	4.30	2.68	0.22	0.34	0.05	0.33
54	10	0.97	16.22	9.46	9.12	4.83	0.35	0.46	0.12	0.43
55	87	0.98	14.23	5.18	7.65	3.64		0.41		0.17
56	71	0.98	15.34	6.00	9.74	3.72	0.36	0.42	0.13	0.14
57	15	0.98	7.03	4.69	4.29	3.04	0.21	0.36	0.05	0.35
58	38	0.98	7.41	3.99	5.11	2.81	0.25	0.35	0.06	0.19
59	42	0.98	7.88	3.15	5.98	2.33	0.19	0.33	0.04	0.17
60	75	0.99	10.34	3.94	6.66	2.91	0.28	0.37	0.08	0.12
61	96	0.99	5.02	4.06	3.34	2.73		0.32		0.10
62	91	0.99	12.13	5.66	8.91	4.58		0.41		0.17
63	01	0.99	11.55	3.85	7.57	2.77	0.22	0.37	0.05	0.11
64	84	1.00	15.33	5.58	10.09	3.32	0.33	0.42	0.11	0.11
65	93	1.01	15.70	5.74	12.05	4.83		0.42		0.18
66	94	1.02	7.04	3.40	5.27	2.86		0.33		0.11
67	23	1.02	6.66	3.63	4.46	2.44	0.22	0.33	0.05	0.24
68	59	1.03	10.38	6.49	6.57	4.88	0.38	0.41	0.14	0.17
69	56	1.03	16.12	3.87	10.00	2.59	0.29	0.38	0.03	0.15
70	48	1.04	7.05	5.29	4.09	3.38	0.28	0.37	0.08	0.19
71	51	1.05	12.06	3.62	6.30	1.83	0.24	0.36	0.06	0.16
72	7	1.05	8.51	4.25	5.19	2.84	0.23	0.36	0.05	0.39
73	6	1.06	8.66	4.33	5.53	3.23	0.24	0.37	0.06	0.40
74	66	1.06	7.39	5.28	5.21	3.00	0.30	0.37	0.09	0.15
75	58	1.11	5.91	3.94	2.82	2.82	0.19	0.33	0.04	0.16
76	54	1.11	17.44	7.63	10.63	3.36	0.43	0.45	0.10	0.19
77	58	1.12	13.82	4.74	6.06	2.47	0.30	0.39	0.09	0.16
78	49	1.14	7.16	4.40	4.25	2.70	0.25	0.36	0.06	0.18
79	36	1.16	10.13	4.73	6.26	2.95	0.29	0.38	0.08	0.21
80	52	1.16	10.21	5.10	5.86	3.36	0.34	0.39	0.12	0.18
81	22	1.18	12.93	5.20	8.04	3.01	0.29	0.40	0.08	0.28
82	5	1.19	17.87	4.47	11.12	2.94	0.31	0.40	0.10	0.39
83	26	1.19	11.05	4.42	5.46	2.55	0.26	0.38	0.07	0.24
84	19	1.21	7.38	4.38	4.99	3.38	0.28	0.36	0.08	0.31
85	96	1.24	15.52	5.64	10.07	4.75		0.42		0.17
86	38	1.24	11.10	3.27	6.84	2.52	0.24	0.35	0.06	0.21
87	77	1.29	14.74	4.54	9.36	3.11	0.33	0.40	0.11	0.12
88	34	1.29	9.24	4.62	4.89	2.69	0.22	0.38	0.05	0.22
89	20	1.29	11.15	5.15	5.61	2.92	0.23	0.40	0.05	0.31
90	25	1.30	11.19	4.48	7.10	3.33	0.32	0.38	0.10	0.25
91	79	1.31	13.35	5.80	7.76	3.65	0.32	0.41	0.10	0.12
92	28	1.33	8.12	3.75	4.19	2.16	0.22	0.35	0.05	0.22
93	6	1.34	14.15	7.87	8.45	4.78	0.33	0.43	0.11	0.43
94	21	1.38	14.84	5.61	8.49	3.56	0.34	0.41	0.12	0.30
95	92	1.42	19.67	6.86	11.16	5.31		0.44		0.28
96	24	1.48	7.31	5.85	5.22	4.28	0.34	0.38	0.12	0.28

HEADINGS

L - AVERAGE LENGTH      W - AVERAGE WIDTH      T - AVERAGE THICKNESS

L' - MAXIMUM LENGTH PLUS AVERAGE LENGTH

W' - MAXIMUM WIDTH PLUS AVERAGE WIDTH

T' - MAXIMUM THICKNESS PLUS AVERAGE THICKNESS

SD - STANDARD DEVIATION OF PRESENTED AREAS (SQ. IN.)

VAR - VARIANCE OF PRESENTED AREAS (IN. 4TH)

AVG+2 - AVERAGE PRESENTED AREA SQUARED (IN. 4TH)

ICDS - AREAS CALCULATED FROM ICOSAHEDRON GAUGE DATA

CALC - AREAS CALCULATED FROM APPROXIMATING RECTANGULAR PARALLELEPIPEDS

TABLE A6  
PERIMETER RATIOS

FRAG NO. NEW	FRAG NO. OLD	CD	LWP/LTP	LWP/TWP	LTP/TWP	LWP/LMAX	TWP/WMAX
1	2	0.42	1.00	1.00	1.00	3.14	3.14
2	95	0.50	1.03	1.18	1.08	3.04	2.91
3	3	0.64	1.00	1.00	1.00	4.03	4.03
4	78	0.71	1.01	2.03	2.00	2.42	3.03
5	44	0.72	1.08	1.47	1.36	2.83	2.74
6	62	0.73	1.25	1.98	1.58	3.04	3.12
7	53	0.76	1.12	2.14	1.91	2.81	2.84
8	41	0.76	1.05	1.07	1.02	2.57	2.47
9	11	0.76	1.22	1.87	1.54	2.70	2.11
10	57	0.78	1.07	1.70	1.59	2.33	2.22
11	35	0.79	1.10	2.42	2.21	2.29	2.66
12	90	0.79	1.07	1.74	1.63	2.28	1.71
13	45	0.80	1.10	1.50	1.36	2.52	2.37
14	89	0.80	1.01	1.48	1.47	2.22	2.60
15	82	0.81	1.37	1.42	1.03	2.90	2.31
16	40	0.82	1.00	1.90	1.90	2.21	2.32
17	13	0.83	1.16	1.19	1.03	2.78	2.43
18	46	0.83	1.25	1.69	1.36	2.82	1.97
19	18	0.83	1.11	1.69	1.52	2.25	2.55
20	73	0.84	1.36	1.68	1.23	3.11	2.15
21	76	0.84	1.17	1.69	1.44	2.39	2.42
22	63	0.86	1.09	2.57	2.35	2.41	1.96
23	33	0.86	1.18	1.35	1.15	2.40	1.93
24	74	0.86	1.16	1.54	1.33	2.53	2.59
25	39	0.86	1.62	1.70	1.04	3.21	2.38
26	65	0.86	1.18	2.29	1.93	2.58	2.13
27	47	0.87	1.24	1.68	1.35	2.68	2.82
28	69	0.87	1.14	2.25	1.97	2.57	2.18
29	55	0.88	1.11	2.89	2.59	2.40	2.23
30	64	0.88	1.67	1.96	1.17	3.26	2.04
31	12	0.88	1.38	1.57	1.14	2.93	2.22
32	27	0.89	1.11	2.34	2.11	2.47	1.96
33	83	0.89	1.54	1.63	1.05	3.23	2.20
34	78	0.90	1.21	2.58	2.13	2.61	2.48
35	32	0.90	1.03	2.09	2.03	2.17	2.52
35	68	0.90	1.06	1.53	1.45	2.36	2.56
37	4	0.91	1.09	1.36	1.25	2.56	2.92
38	67	0.92	1.29	2.34	1.81	2.62	2.25
39	60	0.92	1.04	1.06	1.02	2.27	3.44
40	85	0.93	1.16	2.78	2.40	2.42	2.21
41	72	0.93	1.31	2.05	1.57	2.57	2.12
42	9	0.93	1.14	2.04	1.79	2.47	2.59
43	1	0.94	1.02	2.88	2.82	2.52	3.92
44	17	0.94	1.14	2.00	1.75	2.34	2.38
45	80	0.95	1.16	2.44	2.10	2.37	2.05
46	43	0.95	1.16	3.74	3.22	2.68	2.31
47	16	0.95	1.05	2.46	2.33	2.12	2.73
48	80	0.96	1.09	3.03	2.77	2.33	2.55
49	31	0.96	1.10	1.31	1.18	2.56	2.34
50	29	0.96	1.04	1.96	1.88	2.31	2.20

TABLE A6 CONTINUED  
PERIMETER RATIOS

FRAG NO. NEW	FRAG NO. OLD	CD	LWP/LTP	LWP/TWP	LTP/TWP	LWP/LMAX	TWP/WMAX
51	37	0.96	1.13	1.99	1.76	2.37	2.29
52	61	0.96	1.12	2.46	2.19	2.38	2.28
53	14	0.96	1.25	1.48	1.19	2.88	2.59
54	18	0.97	1.45	2.29	1.59	2.32	2.88
55	87	0.98	1.35	2.41	1.78	2.52	1.88
56	71	0.98	1.15	2.85	2.46	2.36	2.22
57	15	0.98	1.16	1.63	1.41	2.78	2.22
58	38	0.98	1.88	1.98	1.75	2.23	2.18
59	42	0.98	1.08	2.43	2.25	2.46	2.65
60	75	0.99	1.18	2.87	1.88	2.41	2.51
61	96	0.99	1.39	1.58	1.14	2.98	2.29
62	91	0.99	1.42	2.29	1.61	2.69	2.11
63	81	0.99	1.88	2.64	2.64	2.32	2.28
64	84	1.00	1.36	3.41	2.52	2.64	2.16
65	93	1.01	1.31	3.95	3.82	2.85	1.67
66	94	1.02	1.26	1.83	1.45	2.78	2.48
67	23	1.02	1.14	1.66	1.4	2.33	2.58
68	59	1.03	1.54	1.64	1.86	3.84	2.16
69	56	1.03	1.83	3.25	3.14	2.14	2.38
70	48	1.04	1.39	1.42	1.82	2.98	2.28
71	51	1.05	1.83	2.89	2.81	2.16	2.64
72	7	1.05	1.28	1.79	1.58	2.66	2.58
73	6	1.06	1.28	1.71	1.42	2.51	2.21
74	66	1.06	1.47	1.68	1.89	2.78	2.34
75	58	1.11	1.26	1.44	1.15	3.29	2.59
76	54	1.11	1.22	2.18	1.77	2.51	2.16
77	58	1.12	1.13	2.14	1.89	2.37	2.38
78	49	1.14	1.35	1.88	1.48	2.98	2.42
79	36	1.16	1.89	2.14	1.97	2.23	2.19
80	52	1.16	1.34	1.92	1.43	2.67	2.16
81	22	1.18	1.88	2.78	2.78	2.17	2.22
82	5	1.19	1.84	2.98	2.88	2.18	2.68
83	26	1.19	1.27	2.22	1.73	2.62	2.22
84	19	1.21	1.32	1.66	1.26	2.87	2.28
85	86	1.24	1.31	2.18	1.61	2.61	2.15
86	38	1.24	1.89	2.25	2.87	2.26	2.27
87	77	1.29	1.19	2.74	2.31	2.38	2.33
88	34	1.29	1.19	1.91	1.61	2.64	2.31
89	28	1.29	1.28	1.87	1.53	2.36	2.21
90	25	1.38	1.24	1.84	1.48	2.36	2.48
91	79	1.31	1.41	2.65	1.88	2.82	2.12
92	28	1.33	1.86	1.78	1.61	2.54	2.64
93	8	1.34	1.18	1.86	1.57	2.52	2.16
94	21	1.38	1.11	2.38	2.87	2.21	2.28
95	92	1.42	1.38	2.28	1.68	2.72	2.87
96	24	1.48	1.34	1.64	1.23	2.98	2.16

HEADINGS

LWP - PERIMETER IN LW PLANE (IN.)  
 LTP - PERIMETER IN LT PLANE (IN.)  
 TWP - PERIMETER IN TW PLANE (IN.)  
 LMAX - MAXIMUM LENGTH (IN.)  
 WMAX - MAXIMUM WIDTH (IN.)



# RANDOM TUMBLING

0 1 2 3 4 5 6 INCHES

FIGURE A-1

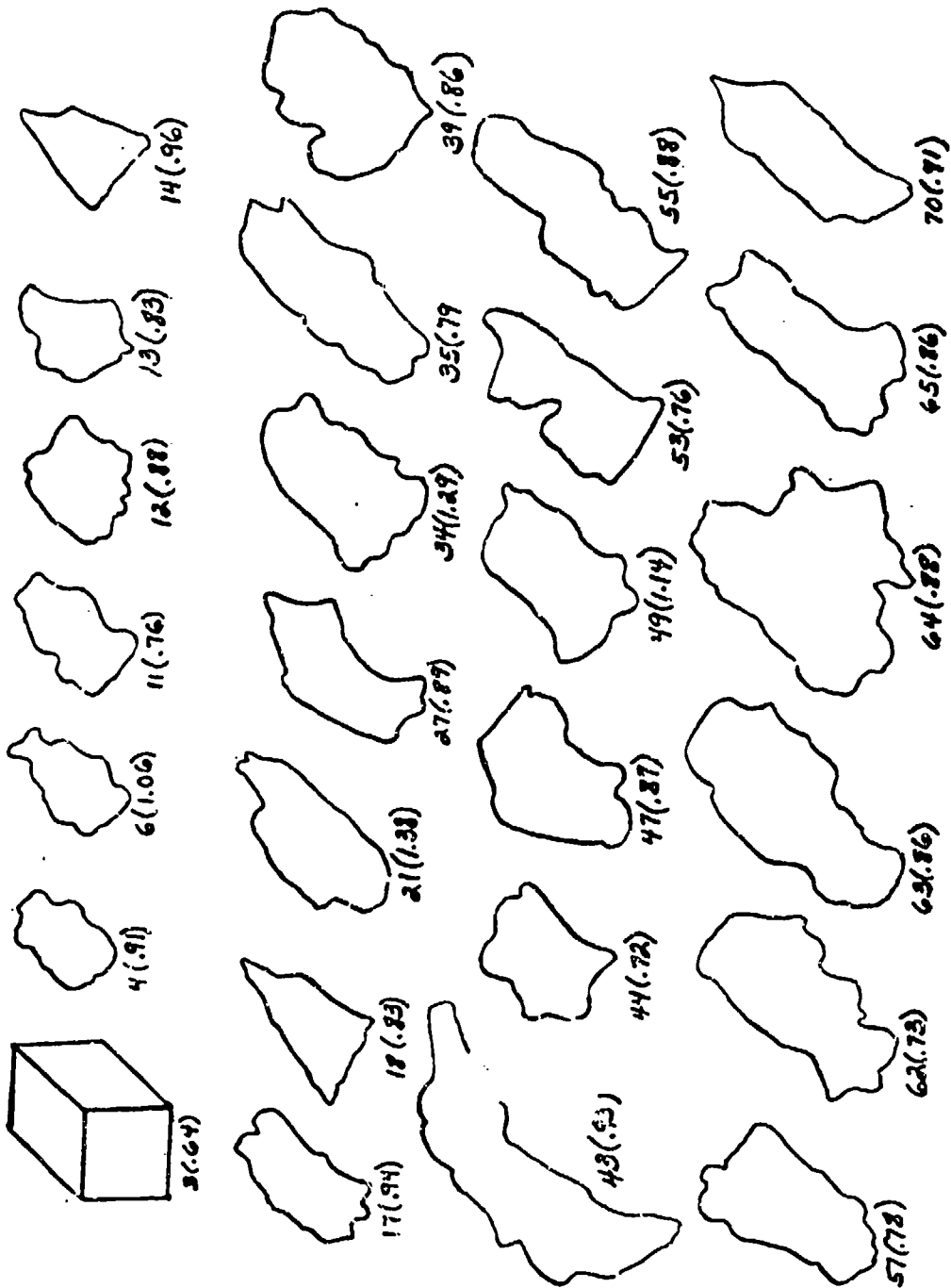

RANDOM TUMBLING

1/2 INCHES

Figure A-1 (Cont'd)

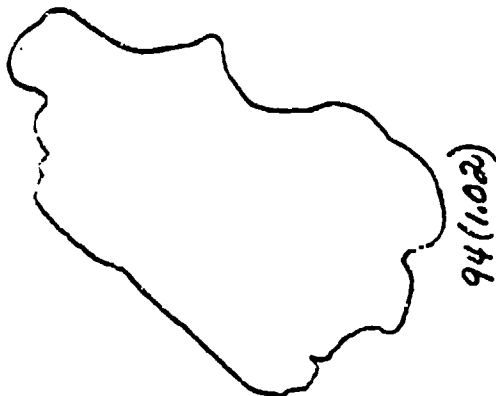
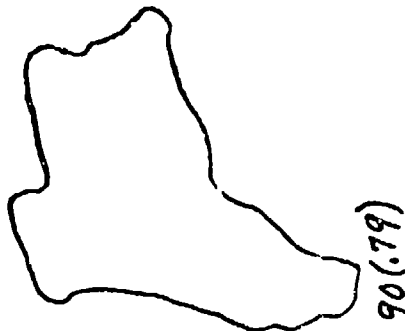
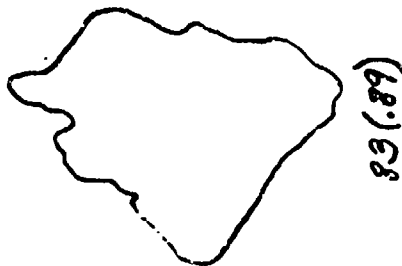
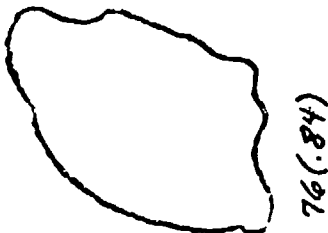
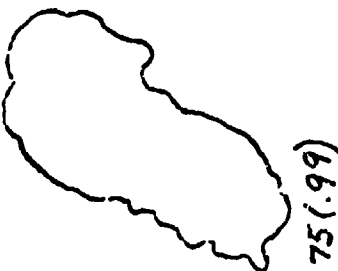
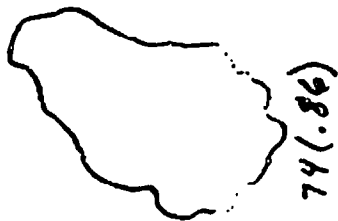
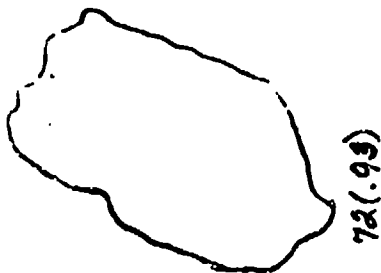

FLOATS MOTIONLESS



Figure A-2

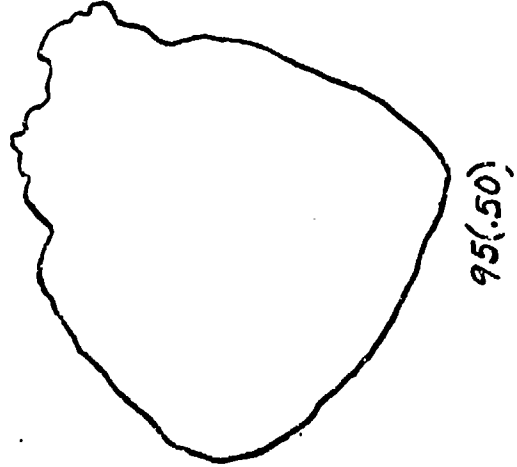
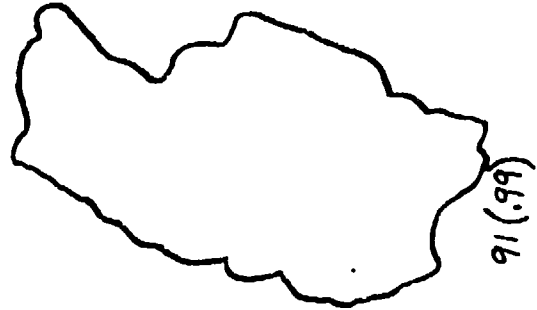
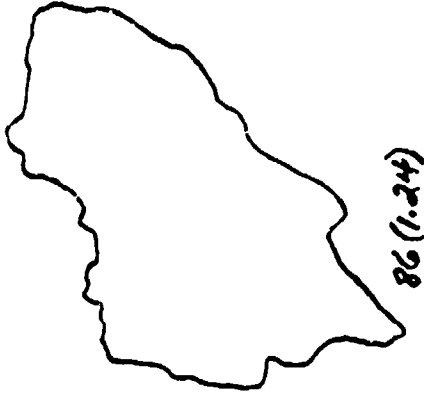
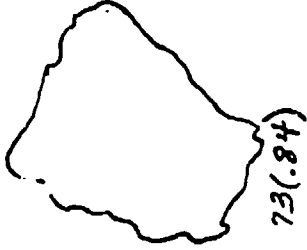
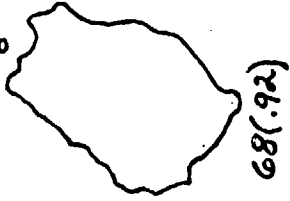
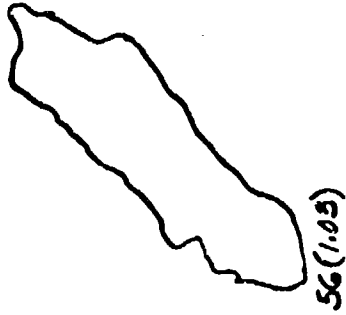
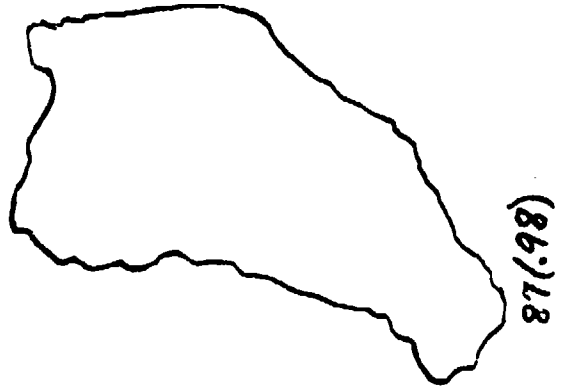
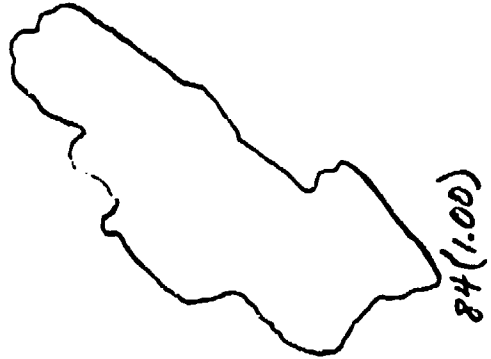
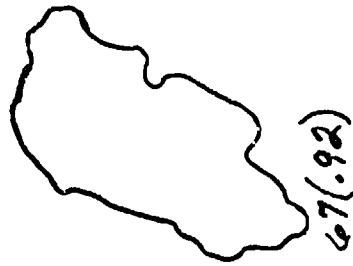
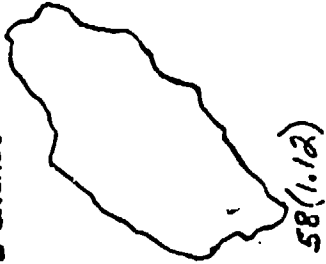
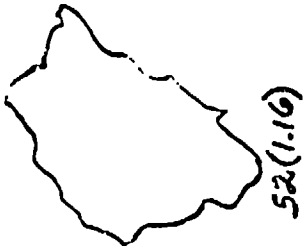
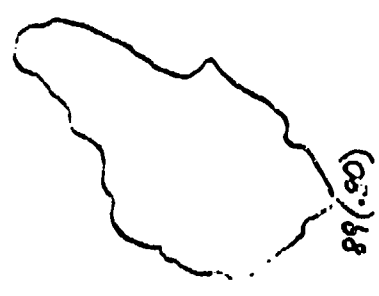
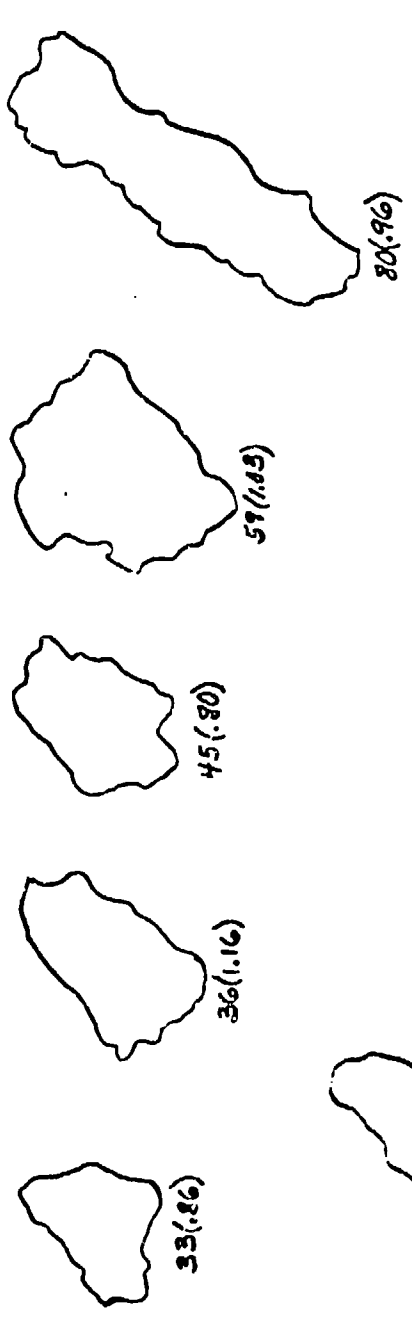
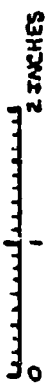

Figure A-3

FLAT ROTATION  
0 1 2 INCHES



ROTATES ABOUT THE LNT AXIS



ROTATES ABOUT THE L+W AXIS



Figure A-5

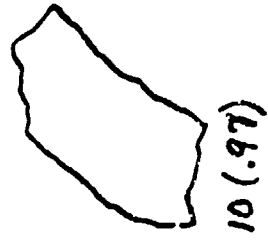

ROTATES AROUND THE T-AXIS

0 2 INCHES

Figure A-6

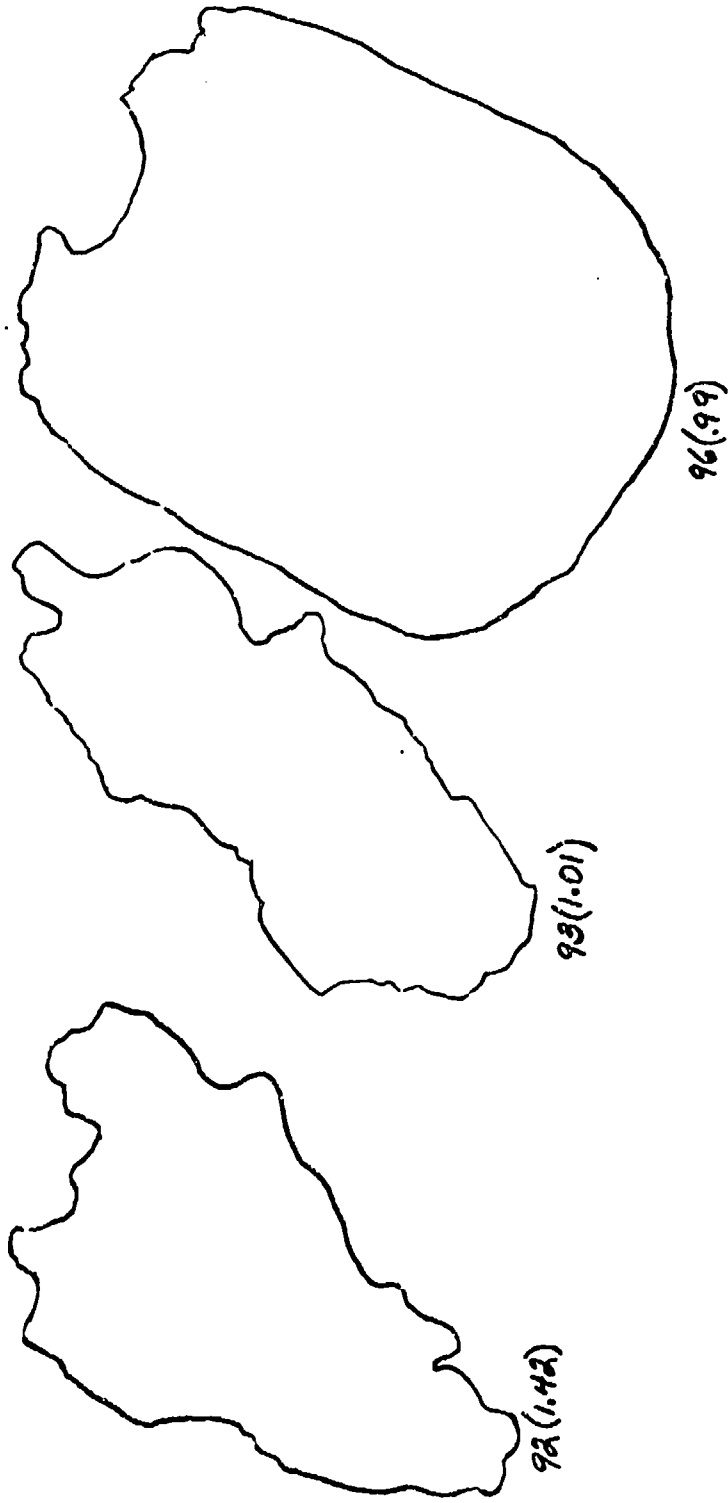

1586

ROTATES AROUND THE T-AXIS

0 2 INCHES

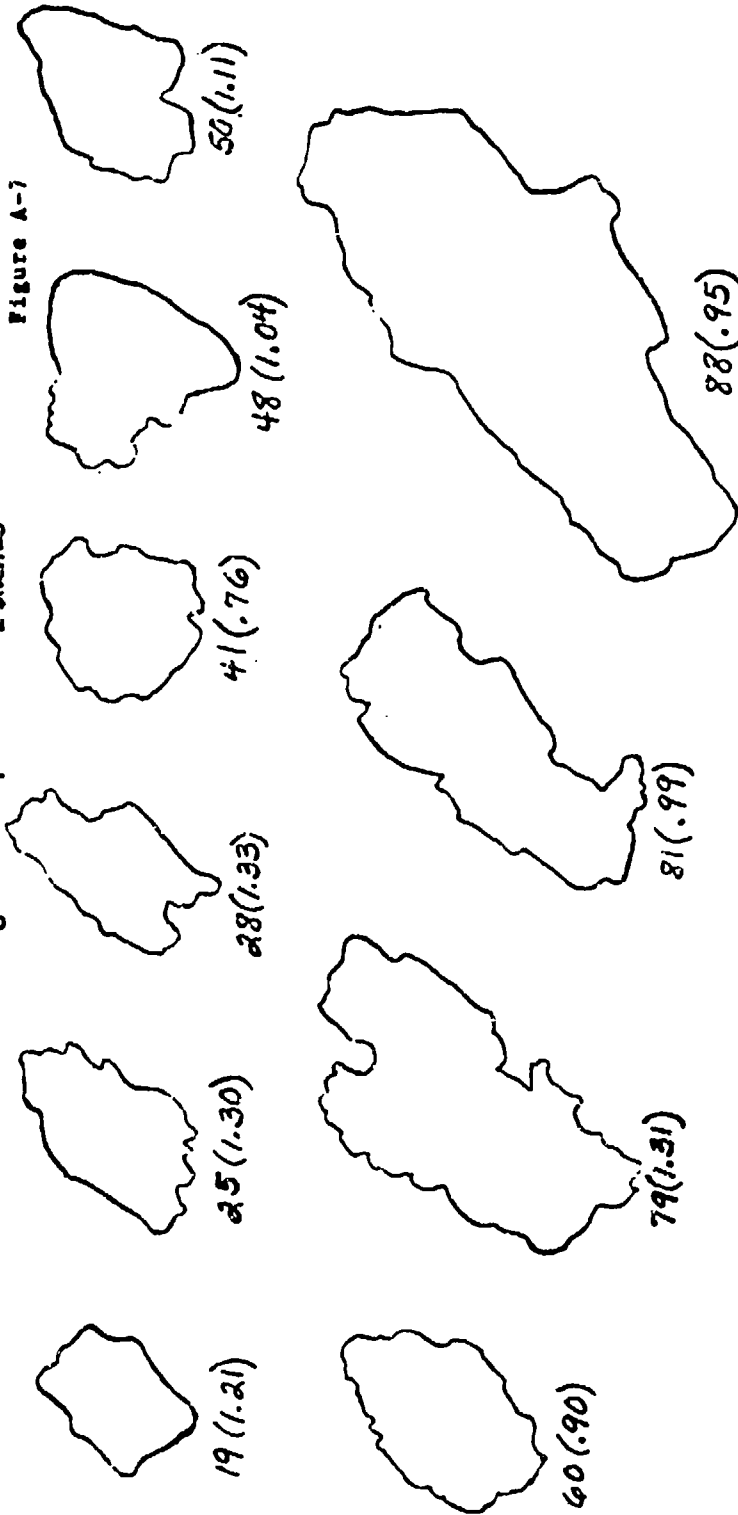



ROTATES AROUND THE L-AXIS

2 INCHES

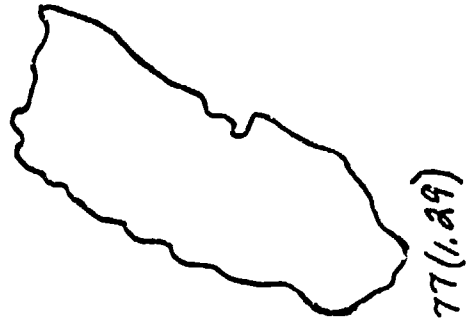
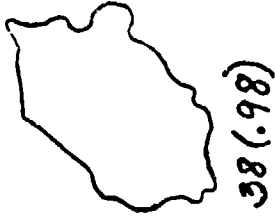
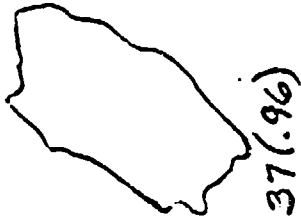
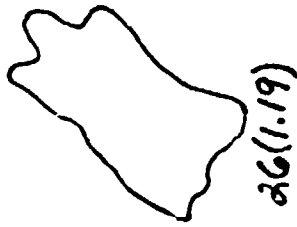
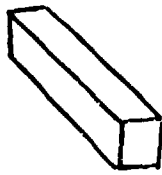

Figure A-8

CONING

0 2 INCHES

FIGURE A-9



1 (.94)



5 (1.19)



9 (.95)



40 (.82)



42 (.98)



51 (1.05)



69 (.87)

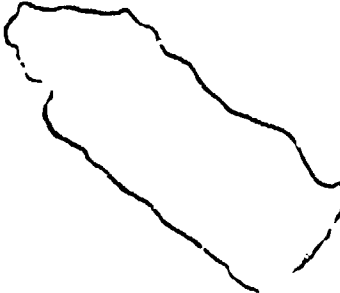

71 (.98)

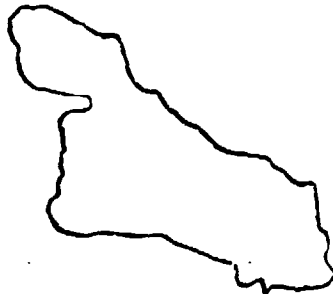

78 (.90)

1580

1590