

UNCLASSIFIED

AD NUMBER

ADC801330

CLASSIFICATION CHANGES

TO: UNCLASSIFIED

FROM: CONFIDENTIAL

LIMITATION CHANGES

TO:
Approved for public release; distribution is unlimited. Document partially illegible.

FROM:
Distribution authorized to DoD only; Administrative/Operational Use; 1945. Other requests shall be referred to Office of Scientific Research and Development, Washington, DC 20301. Pre-dates formal DoD distribution statements. Treat as DoD only. Document partially illegible.

AUTHORITY

OSD/WHS memo dtd 29 Jan 2013; OSD/WHS memo dtd 29 Jan 2013

Office of the Secretary of Defense
Chief, RDD, ESD, WHS
Date: 11 OCT 2012 Authority: EO 13526
Declassify: X Deny in Full: _____
Declassify in Part: _____
Reason: _____
MDR: 12-M-1567

5 U.S.C. 552

#10

Reproduced by
AIR DOCUMENTS DIVISION

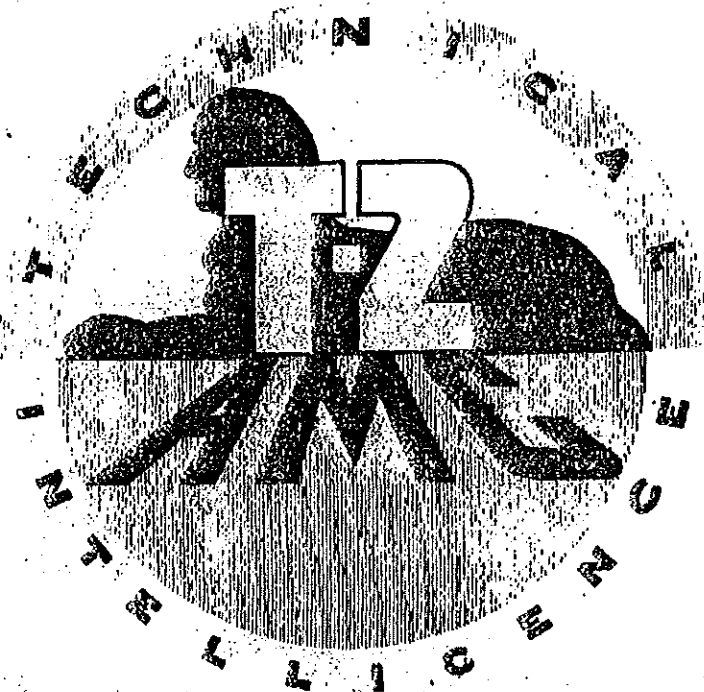

HEADQUARTERS AIR MATERIEL COMMAND
WRIGHT FIELD, DAYTON, OHIO

Page determined to be Unclassified
Reviewed Chief, RDD, WHS
IAW EO 13526, Section 3.5
Date: OCT 1 1 2012

R-1
12-M-1567

REEL

C 6 2

20 9 4

Page determined to be Unclassified
Reviewed Chief, RDD, WHS
IAW EO 13526, Section 3.5
Date: OCT 1 1 2012

DECLASSIFIED IN FULL
Authority: EO 13526
Chief, Records & Declass Div, WHS
Date: OCT 11 2012

512-36

~~CONFIDENTIAL~~

Washington Project
Division 8, National Defense Research Committee
of the
Office of Scientific Research and Development

AN AUTOMATIC PILOT FOR HOMING GLIDE-BOMBS

By
John A. Hart
National Bureau of Standards

A Report to Division 8
from the
National Bureau of Standards

~~This document contains information affecting the national defense of the United States within the meaning of the Espionage Laws, Title 18, U.S.C., Sec. 793 and 794. Its transmission or the revelation of its contents in any manner to an unauthorized person is prohibited by law.~~

Copy No. 009

~~CONFIDENTIAL~~

1-11-44

CONFIDENTIAL

512-36

Washington Project
Division 5, National Defense Research Committee
of the
Office of Scientific Research and Development

AN AUTOMATIC PILOT FOR HOMING GLIDE-BOMBS

By
John A. Hart
National Bureau of Standards

A Report to Division 5
from the
National Bureau of Standards

This document contains information affecting the national defense of the United States within the meaning of the Espionage Act, U.S.C.; 50, 30 and 32. Its transmission or the revelation of its contents in any manner to an unauthorized person is prohibited by law.

Copy No. 009

CONFIDENTIAL

3-1184

C O N F I D E N T I A L

AN AUTOMATIC PILOT FOR BOMBING GLIDE-BOMBS

By
John A. Hart
National Bureau of Standards

A report from the National Bureau of Standards
to
Division 5, National Defense Research Committee
of the
Office of Scientific Research and Development

Approved for National Bureau of Standards by
Lynan J. Briggs, Director.

C O N F I D E N T I A L

C O N F I D E N T I A L

Preface

The work described in this report is pertinent to the projects designated by the War Department Liaison Officer as AC-1, AC-26, and AC-42, and to the projects designated by the Navy Department Liaison Officer as NO-115, NO-174, and NO-235. This work was carried out and reported by National Bureau of Standards under a transfer of funds from OSRD with the cooperation of the Washington Radar Group of the Massachusetts Institute of Technology and Section Re4g of the Bureau of Ordnance, Navy Department.

C O N F I D E N T I A L

Table of Contents

	<u>Page</u>
1. Introduction	1
2. Description and Operation of the Control Gyro	6
3. Description and Operation of the Automatic Pilot	10
4. Detailed Description of the Control Gyro	15
5. Performance	17

Appendix I

Test Specification, Turn Control Gyro	26
Test Specification, Bias Gyro	35

C O N F I D E N T I A L

Preface

The work described in this report is pertinent to the projects designated by the War Department Liaison Officer as AC-1, AC-36, and AC-42, and to the projects designated by the Navy Department Liaison Officer as NO-115, NO-174, and NO-235. This work was carried out and reported by National Bureau of Standards under a transfer of funds from OSRD with the cooperation of the Washington Radar Group of the Massachusetts Institute of Technology and Section Reig of the Bureau of Ordnance, Navy Department.

C O N F I D E N T I A L

Table of Contents

	<u>Page</u>
1. Introduction	1
2. Description and Operation of the Control Gyro	6
3. Description and Operation of the Automatic Pilot	10
4. Detailed Description of the Control Gyro	15
5. Performance	17
Appendix I	
Test Specification, Turn Control Gyro	26
Test Specification, Bias Gyro	28

C O N F I D E N T I A L

AN AUTOMATIC PILOT FOR HOMING GLIDE-BOMBS

I. Introduction

An automatic pilot was developed by the National Bureau of Standards in connection with the guided missile projects sponsored at the Bureau by Division 5, National Defense Research Committee (Washington Project). This auto-pilot has been used successfully to stabilize the glide bombs developed at the National Bureau of Standards in connection with this project, and as an integral part of their control, either as remote radio controlled or as homing bombs. The production SWOD Mark 9 Mod 0 Bat was equipped with this auto-pilot.

Early flight tests, conducted by the National Bureau of Standards, proved that some means of automatically stabilizing the glider was essential. The need for automatic stabilization in roll arises partly from the fact that the glider responds very quickly to rolling moments applied by the control surfaces. Furthermore, since it is impossible to trim the glider perfectly before it is launched from the mother plane, an immediate corrective action by the control surfaces is required when the glider is launched to balance the rolling moment arising from this initial unbalance in trim.

Certain basic requirements restrict the choice of an automatic pilot suitable to this particular problem. The

C O N F I D E N T I A L

C O N F I D E N T I A L

- 2 -

auto-pilot must be capable of keeping the glider stabilized without any tendency to develop an undamped oscillation of large amplitude. Also it must embody means for allowing the glider to execute, without capsizing, corrective maneuvers as directed by the intelligence device. The size and weight of the auto-pilot, together with accessory equipment, must be considerably less than that of any of the automatic pilots commonly used on aircraft. In addition, operational considerations make it desirable that the auto-pilot be rugged and simple in construction, that it require little or no re-adjustment in service, and that it operate satisfactorily under extremes of high and low temperature and high humidity. It must maintain its original adjustments after having been subjected to ordinary handling during shipment over long distances and after having been stored for long periods.

There are two types of gyroscopic movements which may be used in automatic pilots: namely, the free-gyro type and the rate-gyro type. The free-gyro type contains a rotor which is mounted in double gimbals so that the rotor axis will maintain its orientation fixed in space, regardless of changes in the orientation of the glider in space. Therefore, the "pick-off" from a free-gyro type auto-pilot will respond to angular deviations of the glider from a fixed reference plane in space. This type of auto-pilot is essential if it is desired to make the glider fly a pre-set

C O N F I D E N T I A L

C O N F I D E N T I A L

- 3 -

course without the aid of correction signals from some other source of intelligence. Although the free gyro has the advantage of providing a fixed reference plane in space for the purpose of taking off control information, it also has several disadvantages. A caging mechanism must be provided to erect the gyro rotor before the glider is released from the mother plane, and the maneuverability of the glider in flight is restricted to the angular limits of freedom provided in the gyro gimbals. If these limits are exceeded, the gyroscopic rotor "tumbles", and all stabilization information is lost. To discourage violent undamped oscillations, the free-gyro type of automatic pilot must incorporate some type of "follow-up" mechanism which, effectively, will displace the reference position for taking off control information from the gyro movement by an amount that is proportional to the amount of displacement on the control surfaces. The reference position is displaced in a direction which will tend to cause the removal of the control applied to the control surfaces. If it is desired to change the course of a free-gyro stabilized glider, the reference position for "picking off" control signals is, in effect, permanently displaced in the proper direction and at a safe rate.

The rate type of gyro embodies a movement wherein the rotor is not allowed to keep its axis of spin fixed in space.

C O N F I D E N T I A L

C O N F I D E N T I A L

- 4 -

Instaed, the gyro is forced to maintain the orientation of its rotor axis fixed with respect to the glider. When the glider changes orientation so as to force a change in the orientation of the rotor axis in space, a precessional torque is created which tends to tilt the rotor axis about another axis which is perpendicular to both the rotor axis and to the axis about which the glider changes its orientation. But since, in actual construction, the rate gyro is built with its rotor axis suspended in a single spring-centered gimbal, the rotor is free to precess about only one axis--the gimbal pivot axis. Also, a precession of the rotor can be produced only by turning the instrument (thus the glider) about the axis which is perpendicular to both the rotor axis and the gimbal pivot axis. If the glider turns about some other axis, then only the component of turn in the axis perpendicular to the rotor axis and the gimbal pivot axis is effective in producing a precession of the rotor. If the rotational speed of the gyro remains constant, the precessional force is directly proportional to the rate of turn of the glider; and, of course, the direction of the precessional force depends upon the direction of turn of the glider.

The rate gyro has several advantages over the free gyro: Since the rate gyro movement is spring centered and is allowed to deflect only a small amount, no caging device is required to erect the rotor. Furthermore it necessitates no angular

C O N F I D E N T I A L

C O N F I D E N T I A L

- 5 -

limitation on the motion of the glider, because a rate gyro rotor cannot "tumble" or become ineffective. Since the response of the rate gyro to changes in attitude of the glider is much quicker than that of the free gyro, there need be no "follow-up" mechanism to discourage undamped oscillations. A rate-gyro control has no "memory". It will give information that can cause the control surfaces to move so as to resist changes in the attitude of the glider, but once that attitude has been changed, the gyro will try to keep the glider in its new attitude, rather than make the glider return to its original attitude. However, a "memory" is not required when a homing device or other source of intelligence is present which can give directional orders to the gyro.

Upon the basis of the foregoing considerations, it was decided to use the rate gyro as the basis for an automatic pilot. As it was desired to develop the automatic pilot in a period of a few months, it seemed imperative that some already procurable instrument be modified for our purposes. A standard aircraft turn indicator was chosen. This type of instrument had been proven by years of service to be a rugged and dependable instrument, under the identical operational conditions required for the auto-pilot. In addition, the modification required seemed rather simple and feasible.

In the early experimental work, standard Bendix turn indicators were modified by the laboratory shop or under

C O N F I D E N T I A L

C O N F I D E N T I A L - 6 -

contract by Humble Oil Company. Later the Bendix Aviation Corporation built the component gyros for the automatic pilot, redesigning the experimental model in certain details to facilitate production and to improve performance.

3. Description and Operation of the Control Gyro

The basic component of the automatic pilot is the control gyro. The auto-pilot contains two of these control gyros; namely, the turn gyro and the pitch gyro, which are named for their function, as well as a third gyro called a bias gyro, the function of which will be explained later. Figure 1 shows a sketch of the essential elements of the control gyro; figures 2 and 3 show a photograph of a "cutaway" control gyro; and figure 4 shows a complete control gyro.

Referring to figure 1, it is seen that the gyroscopic wheel (spinning about axis XX) is mounted in a single gimbal frame which can rotate only about its pivots (axis ZZ). A precessional torque that will cause the gyro rotor and its gimbal frame to rotate about the gimbal pivot axis ZZ is created when the control gyro is turned about its vertical axis (axis YY). Any motion (of the glider) affecting the gyro must have a rotational component about this axis (axis YY). The direction in which the gyro precesses about its gimbal pivot axis (axis ZZ) reverses whenever the angular motion (of the glider) causing the precession

C O N F I D E N T I A L

C O N F I D E N T I A L

- 7 -

reverses; the strength of the torque causing the gyro to precess is proportional to the rate of the angular motion (of the glider) causing precession; and the precessional torque persists as long as the angular motion (of the glider) causing the precessional torque persists.

The gyro rotor is driven at a constant speed by the action of an air-jet upon the rotor. Suction for the purpose of operating the jet is produced by a venturi tube mounted on the outside of the glider in the wind stream. A pressure regulator on the gyro maintains the pressure in the gyro chamber at two inches of mercury below that of the surrounding atmosphere.

To obtain control information from the gyro, a contact arm is fastened rigidly to the gyro gimbal frame and is located between two contacts which are fastened to the gyro case. Rotation of the gyro gimbal frame on its pivots is constrained by these contacts to less than a degree either way from the center position that is fixed by the centering spring. When the gyro contact arm touches one of its contacts, a magnetic clutch in a servo motor is energized. The servo-motor then moves the control surfaces of the glider in a direction that will oppose the disturbance which caused the gyro to make contact. It is evident that the gyroscopic action, together with the "pick-off" on the contacts will give information that can be used to keep the glider from

C O N F I D E N T I A L

C O N F I D E N T I A L

- 8 -

changing orientation about any desired axis.

The mechanical signal resulting from the gyroscopic action is combined with the electrical signal from the radio or other directional control device by passing the electrical control signals through the appropriate one of two opposing electromagnets mounted in the control-gyro case. As illustrated by figure 1, these electromagnets, when energized, apply a magnetic force to the biasing lever, which in turn mechanically transmits the force through the lever to the gyro-rotor gimbal frame. Thus the direction in which the gyro-rotor gimbal frame rotates about its pivots depends upon the algebraic sum of the torque applied by the biasing electromagnets and the precessional torque applied by the gyroscopic action.

In one type of glider installation, the plate current from each side of a differential amplifier is fed directly through the gyro biasing coils. When the glider is flying exactly on the desired course, the plate current in each side of the differential amplifier is the same (4 milliamperes); hence the magnetic pull of the two opposing electromagnets on the gyro lever arm is balanced, and no biasing torque is transmitted to the gyro gimbal frame. For such a condition, the gyroscopic torques alone determine which contact will be made and the glider will be made to continue on the same course. If, however, the glider

C O N F I D E N T I A L

C O N F I D E N T I A L

- 9 -

deviates from the desired course, the current in one side of the differential amplifier drops and the current in the other side rises. The magnetic pull of the biasing electromagnets is then no longer balanced, and a biasing torque is transmitted by the lever arm to the gyro gimbal frame. This causes the gimbal frame to rotate and make a contact which will cause the glider to correct for the error. As the glider corrects, a precessional torque is created which opposes the biasing torque of the electromagnets. If the glider responds with too high a rate, the gyroscopic torque will become larger than the magnetic torque, and the opposite gyro contact will be made, causing a reversal of the controls.

The differential current of the differential amplifier increases gradually as the glider deviates from the desired course until, when the latter reaches an angle off course of say 5°, the differential amplifier becomes saturated, and further deviation will not increase the biasing torque applied by the biasing electromagnets. Since the rate that the gyro will allow the glider to respond depends upon the strength of the biasing torque applied by the electromagnets, the gyro allows a rate of correction that is proportional to the error in course until the course error reaches the value corresponding to saturation.

C O N F I D E N T I A L

5. Description and Operation of the Automatic Pilot

The automatic pilot consists of three gyroscopic units, namely: the turn gyro, the pitch gyro and the bias gyro. These units, together with their associated electrical and vacuum systems are mounted on a metal auxiliary bulkhead. The auxiliary bulkhead is mounted on the back of the main bulkhead of the glider as shown by figure 5.

Perhaps the most important unit of the auto-pilot is the turn gyro. It is the only gyro that is needed for maintaining the glider in stabilized flight. The other gyro units are necessary only for the purpose of damping out certain undesirable oscillations. The turn gyro is mounted in the glider as shown by figure 6 with its gimbal pivot axis pointing forward and upward about 15°. Tilting the gimbal pivot axis upward this amount makes the gyro, in addition to being mainly sensitive to the yawing or turning motion of the glider, about one fourth as sensitive to the rolling motion of the glider as to the yawing motion. Closing the turn gyro contacts causes the servo-control unit to move the elevons differentially and thereby produces a rolling motion of the glider. Since the gyro is linked to the servo system so that its signals will oppose any motion which causes its rotor to precess, the turn gyro will endeavor to make the rates of roll and yaw become zero. Because a zero rate of yaw is obtained only when the angle of bank is zero, the gyro will,

within the limits of its sensitivity, maintain the glider in straight line flight when no correcting bias is applied by the intelligence device. When a control signal from the intelligence device calls for a turn, the turn gyro allows the glider to bank until an angle of bank is attained at which the glider will turn (or yaw) at a sufficient rate to provide enough precessional force for the gyro to overcome the magnetic bias of the intelligence signal. As long as the bias caused by the intelligence signal persists, the angle of bank will persist. Thus the maximum angle of bank of the glider will be that angle of bank which will produce a rate of yaw sufficient to cause enough precessional force to overcome the magnetic bias caused by a saturated intelligence signal. Since the turn gyro is also sensitive to roll, it will simultaneously limit the rate at which the glider is allowed to assume its final angle of bank. It is necessary to limit the rate that the glider is allowed to bank in order to eliminate the danger of the glider overshooting its maximum angle of bank and rolling over or of developing a violent roll oscillation.

Like the turn gyro, the pitch gyro is of the control gyro type. It is mounted in the glider as shown by figure 6 so that it is sensitive to the angular rate of pitch. Its purpose is to damp pitch oscillations. The motion of the elevons necessary to change the lift coefficient of the

C O N F I D E N T I A L

- 12 -

glider (i.e. that motion where both elevons move either up or down together) is controlled by the pitch gyro contacts, and the intelligence signals calling for a change of glide path angle pass through the biasing solenoids of the pitch gyro. The rate that the glider is allowed to pitch is limited by the pitch gyro in direct proportion to the strength of the intelligence signal bias and thus to the pitch error.

The other gyroscopic element of the automatic pilot is the bias gyro, shown in figure 7. The bias gyro is used to provide a damping effect upon the action of the turn gyro for the purpose of damping oscillations in azimuth about the desired flight path. The bias gyro is of the same type as the other gyros except that the biasing electromagnets and their associated mechanical linkage are omitted. It is mounted in the glider as shown by figure 6 so that the gimbal pivot axis is coincident with the roll axis of the glider. When mounted in this fashion, the bias gyro is insensitive to the roll and pitch motion of the glider and sensitive only to the yaw motion. Whenever the glider makes a turn maneuver in order to correct for an azimuth error in the flight path, a contact is closed in the bias gyro which causes one of the two biasing electromagnets in the turn gyro to be shunted with a 5000 ohm resistor, thereby diminishing the strength of the current from the "homing" intelligence in that electromagnet. The bias gyro always shunts the turn gyro

C O N F I D E N T I A L

electromagnet which corresponds to the direction that the glider happens to be yawing at the moment. Thus the bias gyro always feeds back a bias which opposes the yawing motion of the glider, whichever way it may be, and owing to its action the sense of the control impressed upon the turn gyro by its electromagnets will reverse its direction before the sense of the signal from the homing device reverses. This anticipatory action is very effective for damping yaw oscillations.

4. Detailed Description of the Control Gyro

The gyroscopic element of the control gyro is the same as that in the standard Bendix Turn and Bank Indicator, and is shown in figure 2. The gyroscopic rotor has a moment of inertia about its spin axis of about 0.00005 slug ft² and is driven at a speed of about 8000 r.p.m. by the action of an air jet striking the buckets located on the rim of the rotor. The time constant of the rotor for increasing its speed is approximately 40 seconds. The pressure regulator maintains the gyro cavity pressure at 2 inches of mercury below the outside atmospheric pressure. At this pressure about 0.5 cu ft of air per minute is passed through the air-jet nozzle and air intake filter. The relief valve in the pressure regulator will effectively maintain a constant cavity pressure for rates of flow through the relief valve

C O N F I D E N T I A L
- 14 -

of 0 to 0.7 cu ft/min. Thus effective pressure regulation is maintained when the rate of exhaustion from the gyro cavity of each gyro is kept between 0.5 and 1.2 cu ft / min.; otherwise the operating pressure will either drop appreciably below 2 inches of mercury or will rise above 2 inches of mercury.

The gyro rotor is suspended in a gimbal frame which is free to turn on two gimbal-pivot bearings about an axis perpendicular to the axis of rotation of the wheel. The movement of the gyro gimbal frame is damped by the action of an air damping piston and cylinder. A contact arm is fastened rigidly to the gimbal frame and is provided with a special, coin-silver, contact button. A centering spring fastened to the case at one end, is fastened at the other end to the special silver contact. This is a dual purpose spring. Besides providing a slight centering action on the gyro gimbal frame, it also serves as the electrical path from the gyro case to the contact arm.

Mounted on a bakelite molded end plate are two adjustable contact assemblies which extend down into the gyro cavity so that the contacts are located opposite either side of the special coin silver contact on the contact arm. Rotation of the gyro gimbal frame on its pivots is mechanically stopped by the contacts whenever the contact arm "makes" a contact. In order to avoid contact chatter, a 0.003 inch thick contact

C O N F I D E N T I A L

leaf extends along the contact face and is free to deflect about 0.010 inch before it is depressed against the solid backing of the contact; but, because of a special hook construction, it is prevented from moving away from the contact more than 0.010 of an inch. In this fashion, a stable "soft" contact is obtained. The angular rotation of the gimbal frame from the center position required to close a contact is generally adjusted to about one-half degree. With this adjustment of the contacts, a rate of turn of about 0.25 degree / sec. is sufficient to cause enough precessional torque to overcome the slight centering action of the centering spring and cause an electrical contact to be made.

The magnetic biasing assembly is also mounted on the same bakelite end plate. This assembly consists of two 6000 ohm coils, wound with number 40 copper wire, which are mounted in a magnetic frame made of an iron alloy which has almost negligible hysteresis. A portion of the magnetic frame extending over the ends of both coils is pivoted at the center in differential relay fashion on two burnished steel pivots. Rigidly fastened to the armature or movable portion of the magnetic frame is a lever and fork assembly which extends down into the gyro cavity so that the prongs of the fork extend on either side of a burnished stud which is riveted to the gyro gimbal frame. Whenever either of the solenoids is energized, the armature experiences a magnetic

C O N F I D E N T I A L - 16 -

pull which tends to cause it to rotate on its pivots. This torque is transmitted to the gyro gimbal frame by means of the lever and fork. The strength of the bias torque caused by a specified current in the coils can be adjusted by means of two adjusting screws mounted in the armature which change the size of the air gap between the pole pieces of the coils and the magnetic portion of the armature. By means of this adjustment, the bias force resulting from saturation current (8 milliamperes) may be adjusted to balance the precessional torque created by any rate of turn between 1 and 12 degrees/sec. The lever which transmits the torque to the gyro gimbal frame has a mechanical advantage of one-fourth, so that the movement of the gyro gimbal frame required to close a contact will cause very little change in the air gap between the armature and the coil pole pieces. The very slight motion of the armature which occurs whenever a contact is closed, causes the amount of magnetic flux between the coil pole piece and the armature to change slightly, thus changing the strength of the bias force transmitted to the gyro gimbal frame very slightly. The maximum "backlash" or change in force which can occur as a result of this action is generally less than 2% of the force transmitted to the gyro gimbal frame by a saturated signal.

C O N F I D E N T I A L

5. Performance

The performance and behavior of the automatic pilot is considerably affected by the aerodynamic characteristics of the vehicle in which it is installed, and by the type of servo system and homing intelligence with which it is used. The following description deals principally with the performance of the automatic pilot as used in the SWOD Mark 13 vehicle and in connection with the SWOD Mark 4 servo unit and the SWOD Mark 2 homing intelligence. A block diagram of the complete control system used in the SWOD Mark 13 vehicle is shown in figure 8.

Since the turn gyro and the pitch gyro are very sensitive, a rate of roll and a rate of pitch sufficient to cause both the turn gyro and the pitch gyro to make an electrical contact is always present immediately after the release of the glider from the mother plane; and a corrective displacement of the elevons is immediately initiated. As soon as the glider responds to this corrective displacement by reversing the sense of either the rate of turn or the rate of pitch, the pertinent gyro reverses its signal and starts the elevons moving in the opposite sense until the rate again reverses. In this way a forced oscillation is developed. In the case of the roll stabilization oscillation, both the period and the amplitude of the oscillation are little affected by the control signals received by the turn gyro from the

C O N F I D E N T I A L - 18 -

homing intelligence, but the angle of bank about which the glider oscillates shifts proportionately from zero angle of bank, when no signal for a turn is received from the homing intelligence, to the maximum angle of bank (say 45°) when the bias from the homing intelligence increases to saturation.

If the angle of inclination of the gyro gimbal-frame axis with respect to the longitudinal axis of the glider is increased, making the turn gyro more sensitive to roll, the time lag of the turn gyro in responding to a reversal in the rate of roll of the glider is decreased, causing a corresponding decrease in the amplitude of the roll oscillation. If, on the other hand, the angle of inclination of the gyro gimbal-frame axis is decreased, the amplitude of the roll oscillation will increase, finally reaching the point at which the glider will capsize. With a gyro axis inclination of 15 degrees, the amplitude of the roll oscillation of the glider has been found to be around 5 degrees and the period around 1 second.

The time lag in the gyro arises mainly from the necessity of allowing the gyro rotor to precess the gimbal frame between 1 and 2 degrees when traversing the space between contacts. If the spacing between the gyro contacts is increased, the time lag increases considerably. Additional time lag is introduced into the control system by the eleven servo unit. The servo unit lag is caused by a lag of the magnetic clutches in responding to an electrical signal from the gyro contacts

C O N F I D E N T I A L

C O N F I D E N T I A L

- 19 -

and by play in the servo unit gearing and its associated linkage.

In an oscillatory system of this type, it is evident that unless the time lags of the control system in responding to both directions of movement are the same, a "squin" in the average position of roll will occur. Time lags affecting the roll-stabilization oscillation originate mainly either in the turn gyro or in the elevon servo unit. In the servo unit, unbalanced lags may be introduced by unequal times of operation of the left and right turn magnetic clutches or by unequal amounts of friction in the gearing for the left and right turn movements of the elevons. In the gyro unit, an unbalanced time lag may be caused by a static bias occurring when no signal for a correction is received from the intelligence device and when no rate of turn is present to which the gyro is sensitive. This bias may be caused by a mechanical unbalance of the biasing lever and gyro movement about the gyro, gimbal-frame, pivot axis, by the gyro contacts not being evenly spaced about the spring centered position of the contact arm, or, furthermore, by a bias applied by the biasing electromagnets to the gyro gimbal frame when equal currents are passing through the two opposing electromagnets.

Whenever for any reason the time lags of the control system for both directions of roll are not the same, the glider will not oscillate in roll about zero angle of bank

C O N F I D E N T I A L

C O N F I D E N T I A L

- 20 -

when no signal is received from the intelligence device, but will oscillate about an angle of bank such that the rate of yaw due to the angle of bank will cause a bias just sufficient to balance the bias caused by the unbalance in time lags. For non-homing flights, where the path is controlled only by the gyro information, the maximum rate of drift in azimuth heading that may be caused by unbalances in the control system is about one-half degree per second. In the case of homing flights, an unbalanced time lag in the control system causes a constant angular error in the flight path. For a system in which the homing intelligence saturates at 6 degrees departure from the target line, the maximum angular error that may be caused by unbalances in the control system is about 1 degree.

The turn gyro cannot measure the angle of bank of the glider directly. It must depend upon the rate of yaw which is developed for any given angle of bank to cause a precessional force in the turn gyro that will oppose the bias force from the homing intelligence that initiated the turn maneuver. Thus, if it is desired that a given bias signal from the homing intelligence produce a certain angle of bank of the glider, it is evident that the rate of yaw of the glider for that angle of bank must always be the same. However, with the glide-bomb this is not the case. In a homing flight, the air-speed of the glider is made to change greatly; and,

C O N F I D E N T I A L

therefore, the rate of yaw accompanying any given angle of bank also changes considerably. The turn gyro must be adjusted to limit the maximum rates of turn in accordance with the conditions of flight giving the minimum of maneuverability. This means that for the lower air-speeds, the angle of bank of the glider caused by a saturated homing intelligence signal will be less than it would be for the higher air-speeds.

In addition, since the auto-pilot must depend upon the rate of yaw to limit the angle of bank of the glider, the maximum rate that the glider is allowed to bank by the turn gyro must be slow enough to give the rate of yaw time to develop.

The relationship between the amount of bias torque, transmitted to the gyro gimbal-frame by the magnetic biasing electromagnets, and the amount of current passing through the electromagnets depends upon the manner in which the bias current is applied to the gyro. If, as was done in one type of radio controlled glider, the bias current is sent through only one of the biasing electromagnets at a time, then the bias torque (and thus the rate of response permitted of the glider) varies very nearly as the square of the current passing through the bias electromagnet. This relationship is shown graphically by curves "A" and "B" in figure 9. However, in the homing gliders, currents flow through both bias

C O N F I D E N T I A L - 22 -

electromagnets simultaneously, with the sum of the two currents always remaining fixed at 8 milliamperes. The condition for zero bias torque occurs when 4 milliamperes flow through each of the two opposing bias electromagnets. Then as a bias signal is applied and increased, the currents vary differentially, with the current in one electromagnet decreasing below 4 milliamperes and with the current in the other electromagnet increasing above 4 milliamperes until, at saturation, one current falls to 0 milliamperes and the other current rises to 8 milliamperes. For this method of applying bias currents, the bias torque transmitted to the gyro gimbal-frame varies directly as the difference between the currents flowing in the two electromagnets. This relationship is shown graphically by curve "C" in figure 9. Curve "C" may be obtained by adding algebraically the ordinates of curve "A" and curve "B". Since the current output of the homing intelligence device is approximately directly proportional to the angular error in heading of the glider, the rate of correction permitted by the gyro will be also directly proportional to the error in course.

A special type of iron alloy that is free from hysteresis effects is used for the magnetic frame of the bias electromagnets in all of the production gyros. Consequently, with these gyros, the bias torque applied by the bias electromagnets to the gyro gimbal-frame is independent of the previous history of current flow through the bias electromagnets; and any given

C O N F I D E N T I A L

C O N F I D E N T I A L

value of bias current will always cause the same amount of bias torque. However, in early experimental models, where commercial relay coils were used as the electromagnets, hysteresis effects were present in some degree. While these effects alone were not strong enough to seriously impair the accuracy of a homing flight, they were an added source of "squat" error, and they made the gyros much more difficult to adjust and calibrate at the factory. The curve given in figure 10 shows the effect of hysteresis in one of these early experimental models upon the rate of turn permitted by the gyro control under the influence of varying amounts of bias current. In the case of the production gyros, this same curve becomes merely a straight line as shown by curve "C" in figure 9.

When the bias gyro damping action is superimposed upon the current bias supplied to the turn gyro by the homing intelligence, the rates of correction permitted by the turn gyro are very greatly affected. The curves given in figure 11 show the effect of the bias gyro shunt upon the bias torque transmitted to the gyro gimbal-frame of the turn gyro. The abscissas are the angular errors in heading of the glider to the right and to the left of the target when the homing intelligence device is adjusted to give saturation, differential current output for an error of 6 degrees. Curve "A" shows the bias torque transmitted to the gimbal-frame when

C O N F I D E N T I A L

C O N F I D E N T I A L
- 24 -

the bias gyro shunts the right-turn electromagnet of the turn gyro, and curve "B" shows the bias torque transmitted to the gimbal frame when the bias gyro shunts the left-turn electromagnet of the turn gyro. When neither electromagnet is shunted, the bias torque transmitted to the gimbal-frame is shown by the straight-line curve (curve "C") in the middle. In the process of homing and damping out a yaw oscillation, the torques applied to the turn gyro gimbal-frame follow curve "A" during one direction of yaw and curve "B" during the other direction of yaw. The path of successive torques would move clockwise around loops of decreasing size, moving up along curve "B" and down along curve "A". If the rate of yaw falls below the minimum rate required to close a bias gyro contact, then the torques will follow (in either direction) the values given by curve "C". The curves shown in figure 11 are plotted on the assumption that the relationship between the milliamperes differential output from the homing intelligence device and the angular error in heading is strictly linear with a sharp "cutoff" at saturation.

The individual components of the automatic pilot are adjusted at the factory to give the desired rates of correction in response to differential currents applied to the bias electromagnets. A special test stand is used to adjust and calibrate the component gyros. The stand is equipped with the following items: a precision, variable-speed turn-table;
C O N F I D E N T I A L

C O N F I D E N T I A L

- 25 -

a source of direct current capable of applying any current between 0 and 10 milliamperes to the bias electromagnets; precision meters for measuring the current; and a source of suction. Figure 12 is a photograph of a test stand that is used to adjust and calibrate the component gyros. Appendix I is a copy of the test specification followed at the Bendix Aviation Corporation, where the production components of the automatic pilot were manufactured and adjusted. After the adjustment at the factory no further adjustment of the gyro components is made at any time. In the field, a very simple electrical check is performed to test the "sense" of the control signals sent from the automatic pilot to the servo-unit in response to precessional and homing signal action. At the same time, the auto-pilot is checked to determine that no undue bias is present for the condition when the glider is stationary and when equal currents (4 milliamperes) from the homing intelligence are flowing through each channel of the automatic pilot.

C O N F I D E N T I A L

APPENDIX I

Test Specification

Turn Control Gyro Type: 1799

- I. Whenever the pressure and temperature existing at the time of the test is not specified definitely, it is understood that the test is to be made at atmospheric pressure (approximately 29.92 inches of mercury) and at a room temperature of approximately 20°C. When tests are made at an atmospheric pressure or room temperature differing materially from the above values, proper allowance shall be made for the difference from specified conditions.

The instruments unless otherwise specified shall be mounted with the Case Filter Connection open in a vertical plane downward and shall not be vibrated or tapped while test readings are being taken.

NOTE: All tests shall be performed with the gyro operating under a suction of 2 inches of mercury unless otherwise specified. All tests shall be made with a relief valve installed in the instrument case.

II. Test Equipment

1. A suitable turn stand shall be used for testing the instrument such that rates of turn between 10° and 22° per minute and between 100° and 360° per minute

may be obtained.

2. A source of direct current shall be used, capable of applying any current between 0 and 10 milliamperes to the electromagnets.

The current shall be capable of being applied to either or both electromagnets as desired. The circuit shall include a milliammeter which will indicate current in the electromagnets to within 0.05 milliamperes. Resistances shall be arranged so that the current can be varied in either electromagnet to the required amount as listed herein.

3. The circuit shall incorporate neon lights which will indicate when instrument contacts are closed.

III. Individual Tests

Each instrument shall be subjected to the following tests:

1. Static Balance: With the instrument in any operating position and the gyro not spinning and the instrument lightly tapped, the contacts shall not "make".
2. Starting Friction: With the instrument in normal position, stationary, and not being subjected to vibration, a suction of not more than 0.5 inches of mercury shall cause the gyro to rotate.
3. Dynamic Balance: When the instrument is stationary and in any one position with the gyro operating under proper suction, while the instrument is lightly tapped,

no instrument contact shall be made.

4. Scale Error Test:

a. Contact Setting: With no current applied to the electromagnets, the indicating lights shall "make" when the instrument is rotated about its vertical axis at the rate of turn of 11° to 16° per minute. The rates of turn to the left and right shall not differ by more than $\pm 2.4^{\circ}$ per minute. The contact shall be considered as "made" when the light is on 50 percent of the time. The contact shall be considered as "broken" when the light is off more than 50 percent of the time.

b. Electromagnet Balance: During this test, the gyro shall be spinning under the operating suction, but the instrument shall be stationary. Apply 4.0 mils. current to the right electromagnet and vary the current in the left electromagnet until the indicating light indicates contact. The current in the left electromagnet shall be within the limits specified in Table I. Repeat the test, applying a constant current of 4.0 mils. to the left electromagnet and varying the current in the right electromagnet until contact is indicated. The current in the right

electromagnet shall be within the limits specified in Table I and it shall not differ from the indicated current in the left electromagnet in the first part of this test by more than the difference specified in Table I.

This test shall be performed and the condition of this test satisfied with the instrument mounted in two positions; in the normal position and in a position rotated 90° counterclockwise as viewed from the front.

- c. Control Turn Test: With the instrument in a normal position, apply a current of 8.0 mils. to the left electromagnet. Rotate the instrument to the left about its vertical axis. Vary the rate of turn until the balance point of the contacts is indicated. The rate of turn should not exceed the tolerance specified in Table I. With the current of 8.0 mils. in the right electromagnet, rotate the instrument to the right and repeat the test. The rate of turn to the right should not exceed the tolerance specified in Table I.

Table I - Scale Error Tolerances

	<u>Turn Gyro</u>	<u>Pitch Gyro</u>
a) <u>Contact Setting Difference</u>	11° to 16°/min. ±2.4°/min.	11° to 16°/min. ±2.4°/min.
b) <u>Electromagnet Balance</u>		
<u>Normal Position</u>		
Current Variation	4.00 ±0.60 mils.	4.00 ±1.00 mils.
Difference	±0.10 mils.	±0.20 mils.
<u>Side Position</u>		
Current Variation	4.00 ±0.60 mils.	4.00 ±1.00 mils.
Difference	±0.20 mils.	±0.20 mils.
c) <u>Control Turn</u>	180° ±10°/min.	120° ±6°/min.

5. Case Leak: In a suitable manner, close off the air intake and the "relief valve" connection. The suction connection shall be connected to a mercury manometer and a source of suction. A suction of 10 inches of mercury shall be applied to the case. With the source of suction closed off, the level of the manometer shall not drop more than 0.4 inches of mercury in a period of one minute.
6. Air Flow: Connect the instrument to a suitable air flow gauge. Apply a suction to the instrument until a flow of 1.0 cu. ft./min. is indicated. Suction at the case of the instrument should be 2.0" ±0.2" Hg -0.0" Hg

IV. Type Tests

The following tests shall be performed on at least five out of every five hundred instruments or fraction thereof

manufactured. Tests shall be performed in the following order:

1. Low Temperature: The instrument shall be subjected to a temperature of -50°C . for three hours. With the temperature maintained at -50°C ., the instrument shall be subjected to the following tests:
 - a. Contact Setting: The instrument shall be tested for contact setting in the same manner as specified in Section III, part 4a. The rate of turn to the left and right shall not exceed the value specified in Table II. The difference between the rates of turn to the left and right shall not exceed the tolerance given in Table II.
 - b. Electromagnet Balance: The instrument shall be tested for electromagnet balance in the normal position only and in a manner similar to Section III, part 4b. The biasing currents to operate the left and right contacts shall be within the limits specified in Table II, when the current in the opposite electromagnet is maintained at 4.0 mills. The indicated currents for left and right electromagnets shall not differ by more than the difference specified in Table II.
 - c. Control Turn: The instrument shall be tested in the manner similar to Section III, part 4c, except

that the rate of turn shall be within the limits specified in Table II. The rates of turn for left and right turn shall not differ by more than the tolerance specified in Table II.

Table II - Low Temperature Tolerances

	<u>Turn Gyro</u>	<u>Pitch Gyro</u>
a) <u>Contact Setting</u> Difference	11° to 20°/min. ±4.8°/min.	11° to 20°/min. ±4.5°/min.
b) <u>Electromagnet Balance</u> <u>Normal Position</u> Current Variation Difference	4.00 ±0.90 mils. ±0.25 mils.	4.00 ±1.5 mils. ±0.50 mils.
c) <u>Control Turn</u> Difference	180° ±30°/min. ±24°/min.	120° ±30°/min. ±24°/min.

2. High Temperature: With the gyro not operating, the instrument shall be subjected to a temperature of +71°C. for a period of two hours. No damage to the instrument shall result from this test.
3. Vibration: With the gyro operating but no current in the electromagnets or contacts, the instrument shall be mounted on a vibration stand which can vibrate at a frequency of 500 to 2000 CFM and which can cause a point on the instrument case to describe a circle of 0.003" to 0.005" diameter in a plane 45° from vertical. The instruments shall be vibrated for a period of three hours at 1200 CFM and shall describe a circle of 0.003" to 0.005" diameter. No damage shall result from this test.

4. Scale Error: Following the high temperature and vibration tests, the unit shall be subjected to the following tests in a manner similar to Section III.
- a. Contact Setting: The instrument shall be tested for contact setting in the same manner as specified in Section III, part 4a. The rates of turn to the left and right shall be within the limits specified in Table III. The difference between the rates of turn to the left and right shall not exceed the tolerance specified in Table III.
- b. Electromagnet Balance: The instruments shall be tested for electromagnet balance in two positions in a manner similar to Section III, part 4b. The current to operate the left and right contacts shall be within the limits specified in Table III when the current in the opposite electromagnet is maintained at 4.0 mls. The biasing currents for the left and right electromagnets shall not differ by more than the difference specified in Table III.
- c. Control Turn: The instruments shall be tested in a manner similar to Section III, part 4c, except that the rate of turn shall be within the limits specified in Table III. The rates of turn for left and right turn shall not differ by more than the tolerance allowed in Table III.

Table III - Endurance Scale Error Tolerances

	<u>Turn CYS</u>	<u>Fitch CYS</u>
a) <u>Contact Setting</u> Difference	10° to 17°/min. ±3.0°/min.	10° to 17°/min. ±3.0°/min.
b) <u>Electromagnet Balance</u> <u>Normal Position</u> Current Variation Difference	4.0 ±0.3 mils. ±0.3 mils.	No Test
<u>Side Position</u> Current Variation Difference	No Test	4.0 ±1.0 mils. ±0.4 mils.
c) <u>Control Turn</u> Difference	120° ±10°/min. ±15°/min.	120° ±10°/min. ±15°/min.

Test SpecificationGas Gyro Type: 1728

- I. Whenever the pressure and temperature existing at the time of the test is not specified definitely, it is understood that the test is to be made at atmospheric pressure (approximately 29.92 inches of mercury) and at a room temperature of approximately 20°C. When tests are made at an atmospheric pressure or room temperature differing materially from the above values, proper allowances shall be made for the difference from specified conditions.

The instruments shall be mounted with the axis of the case filter opening in a vertical plane up, and unless otherwise specified, shall not be vibrated or tapped while test readings are being taken.

NOTE: All tests will be performed with the gyro operating under a suction of 2 inches of mercury unless otherwise specified. All tests shall be made with a relief valve installed in the case.

II. Test Equipment

1. A suitable turn stand shall be used for testing the instrument such that rates of turn between 8° and 22° per minute may be obtained.
2. The circuit shall incorporate neon lights which will

indicate when instrument contacts are closed.

III. Individual Tests

The following tests shall be performed on each unit:

1. Static Balance: With the instrument in any operating position and the gyro not spinning and the instrument lightly tapped, the contacts shall not "make".
2. Starting Friction: With the instrument in normal position, stationary, and not being subjected to vibration, a suction of not more than 0.5 inches of mercury shall cause the gyro to rotate.
3. Dynamic Balance: When the instrument is stationary and in any one position with the gyro operating under proper suction, while the instrument is lightly tapped, no instrument contact shall be made.
4. Scale Error Test: The indicating lights shall "make" when the instrument is rotated about its vertical axis at a rate of turn between 8° per minute and 16° per minute. The rates of turn to the left and right shall not differ by more than ±3.4° per minute. The contact shall be considered as made when the light is on 50 percent of the time. The contact shall be considered as "broken" when the light is off more than 50 percent of the time.
5. Case Leak: In a suitable manner, close off the air intake and the relief valve connection. The suction

connection shall be connected to a mercury manometer and a source of suction. A suction of 10 inches of mercury shall be applied to the case. With the source of suction closed off, the level of the manometer shall not drop more than 0.4 inches of mercury in a period of one minute.

6. Air Flow: Connect the instrument to a suitable air flow gauge. Apply a suction to the instrument until a flow of 1.0 cu. ft./min. is indicated. Suction at the case of the instrument should be 2.0° Hg $+0.5^{\circ}$ Hg -0.0° Hg

IV. Type Tests

The following tests shall be performed on at least five out of every five hundred instruments or fraction thereof manufactured. Tests shall be performed in the following order:

1. Low Temperature: The instrument shall be subjected to a temperature of -50° C. for three hours. With the temperature maintained, the instrument shall be tested in the same manner as specified in Section 3, part d. The rates of turn to the left and right shall not exceed 22° per minute. The difference between the rates of turn to the left and right shall not exceed $\pm 4.0^{\circ}$ per minute.
2. High Temperature: The instrument with the gyro not

CONFIDENTIAL - 28 -

operating shall be subjected to a temperature of +71°C. for a period of two hours. No damage to the instrument shall result from this test.

3. Vibration: The instrument with the gyro operating shall be mounted on a vibration stand which can vibrate at a frequency of 500 to 2000 GPM, and which can cause a point on the instrument case to describe a circle of 0.003" to 0.005" in a plane 45° from vertical. The instrument shall be vibrated for a period of three hours at 1200 GPM and shall describe a circle of 0.003" to 0.005" diameter. No damage shall result from this test.
4. Scale Error: Following the high temperature and vibration tests, the unit shall be tested for contact setting in a manner similar to Section 3, part d, except that the indicating lights shall "make" when the instrument is rotated about its vertical axis at a rate of turn not exceeding 18° per minute. The rates of turn to the left and right shall not differ by more than ±3.0° per minute.

CONFIDENTIAL

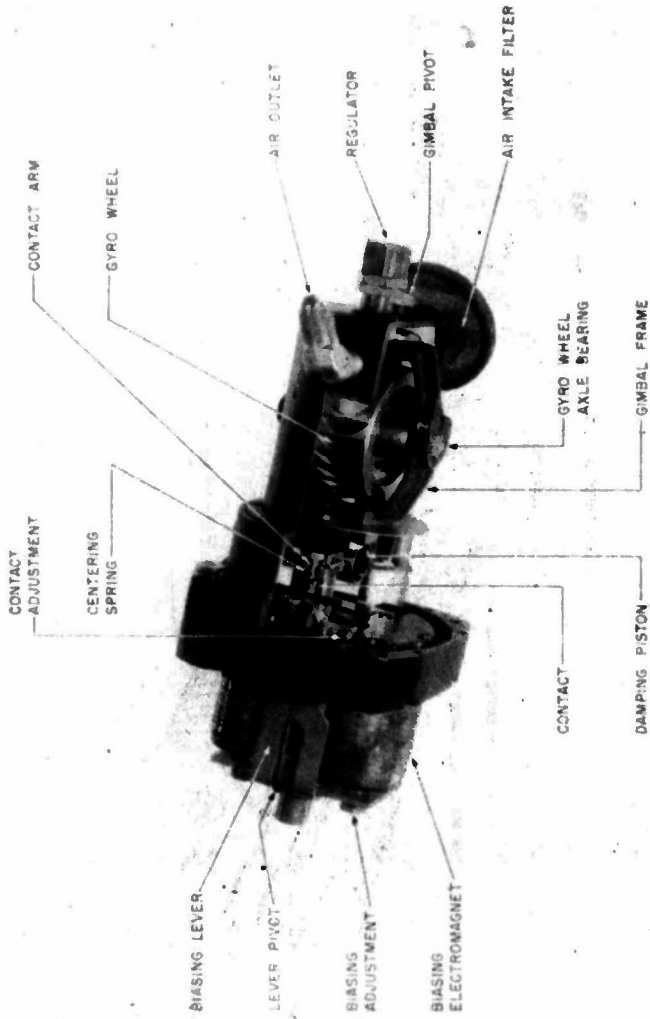

FIG 2

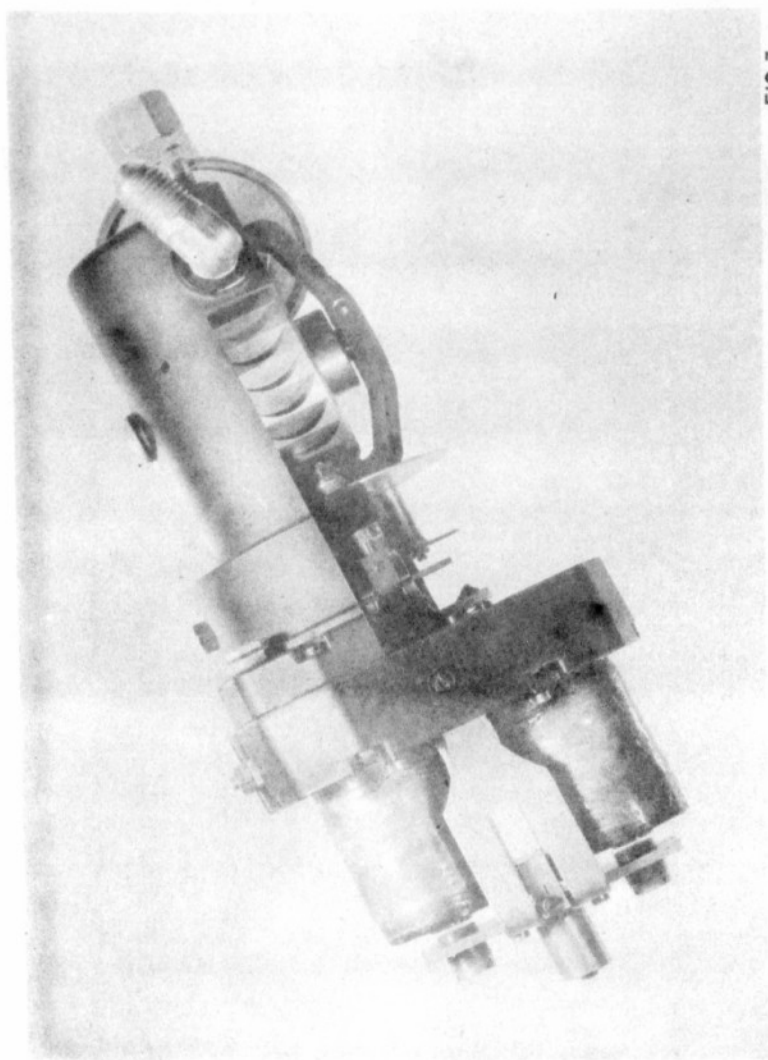

FIG. 3

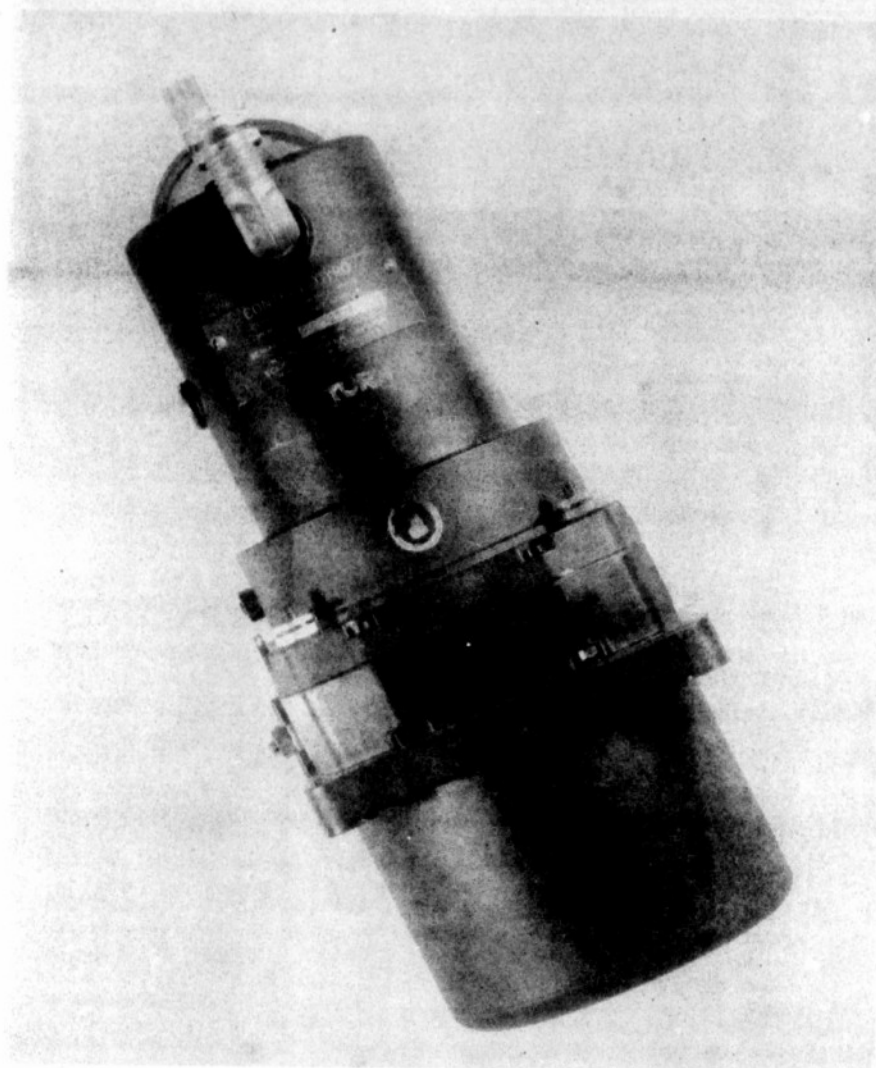

FIG. 4

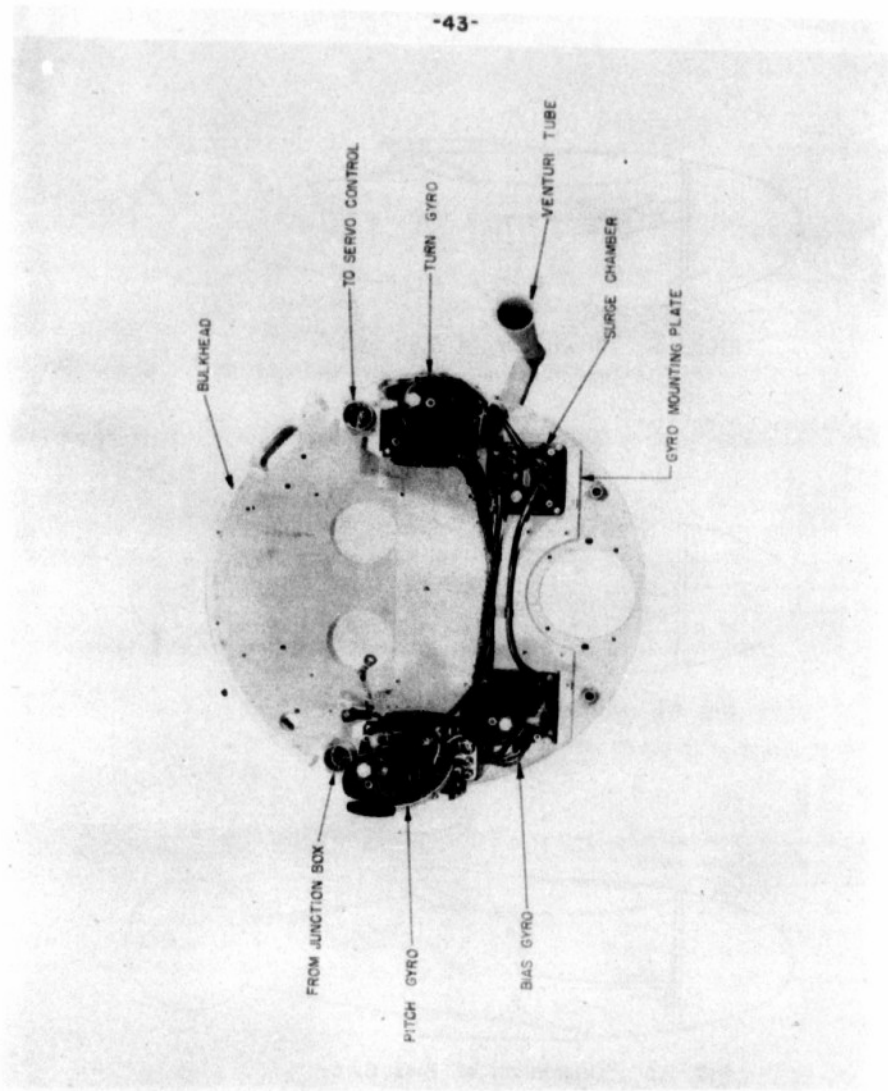

FIG. 5

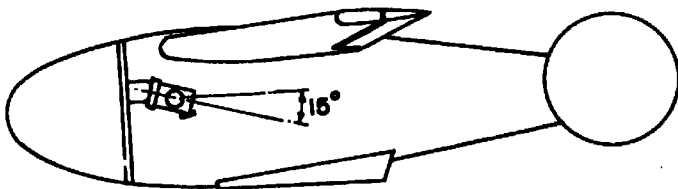

FIG. 6a Orientation of Turn Gyro

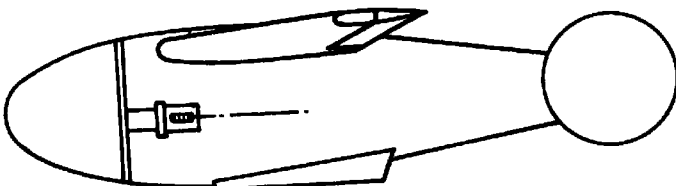

FIG. 6b Orientation of Pitch Gyro

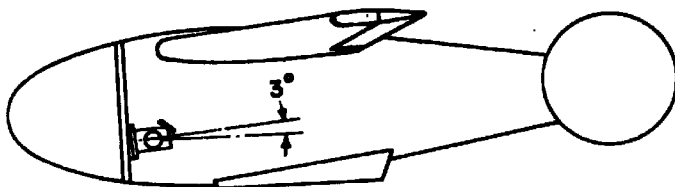

FIG. 6c Orientation of Bias Gyro

POSITION OF GYROS IN GLIDER

FIG. 6

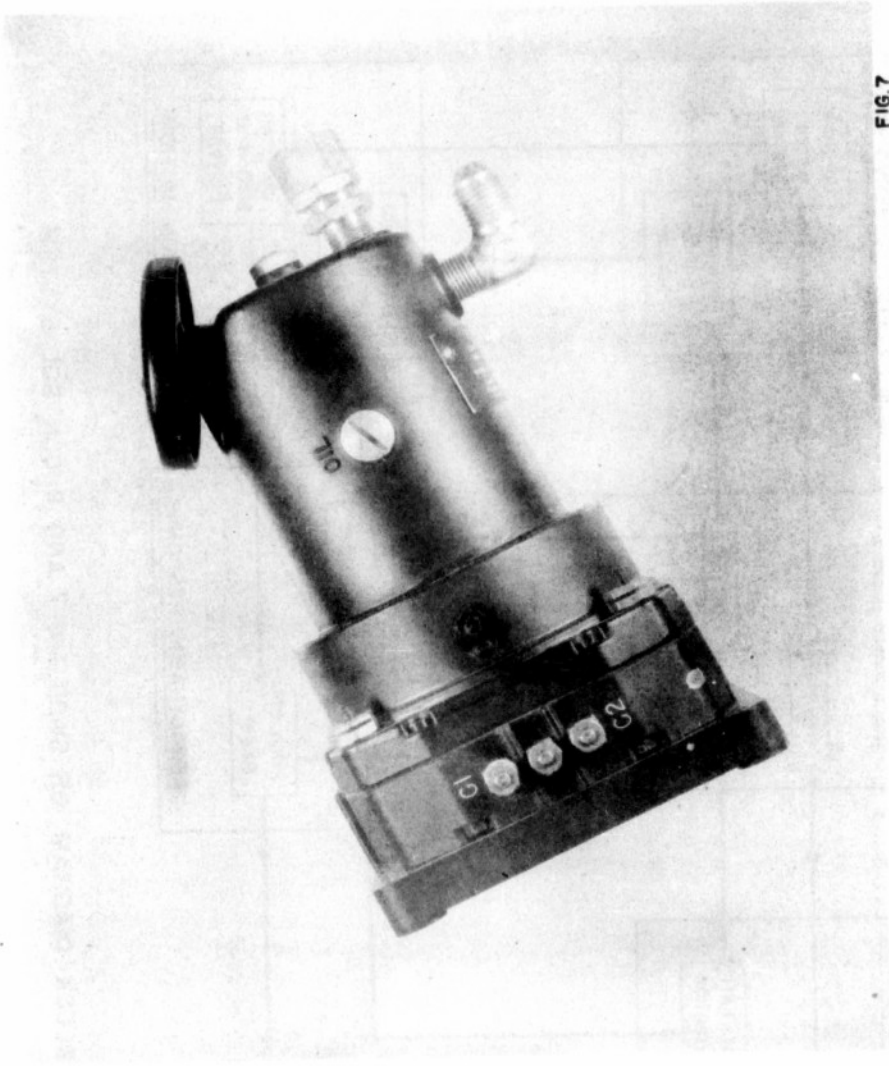
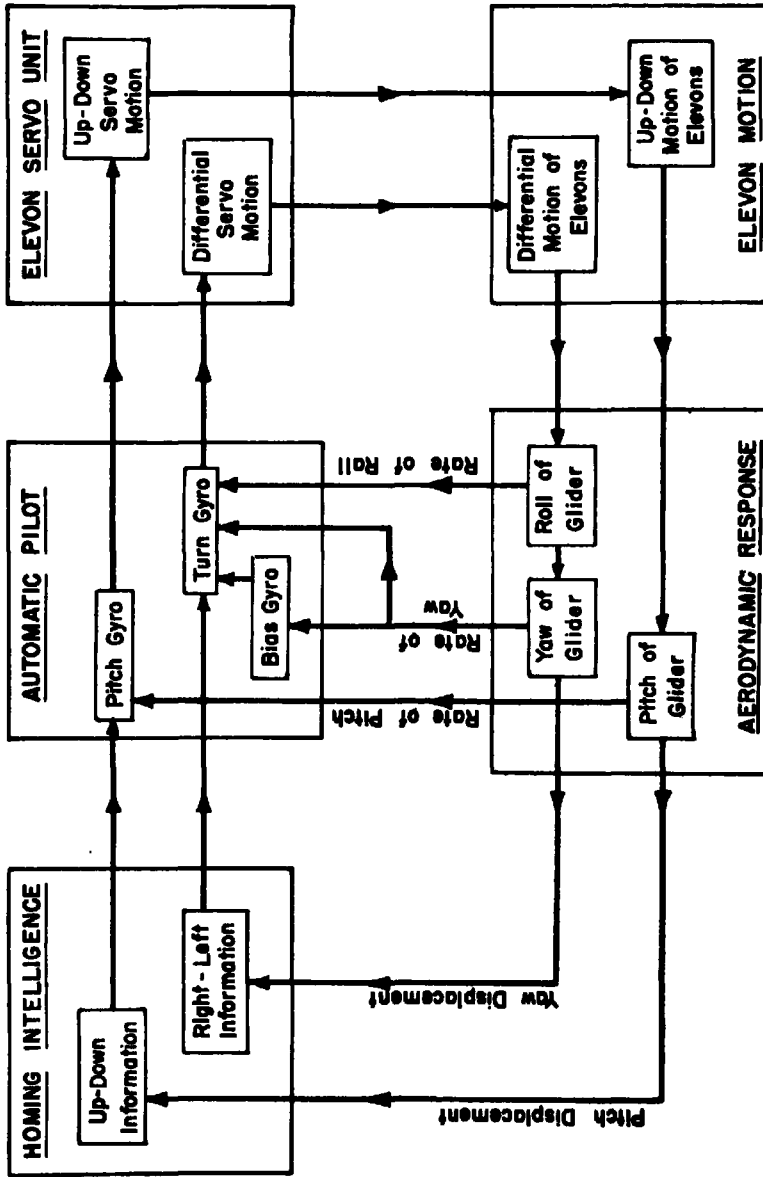

FIG. 7



BLOCK DIAGRAM OF SWOOD MK 7 AND 9 CONTROL SYSTEM

FIG. 6

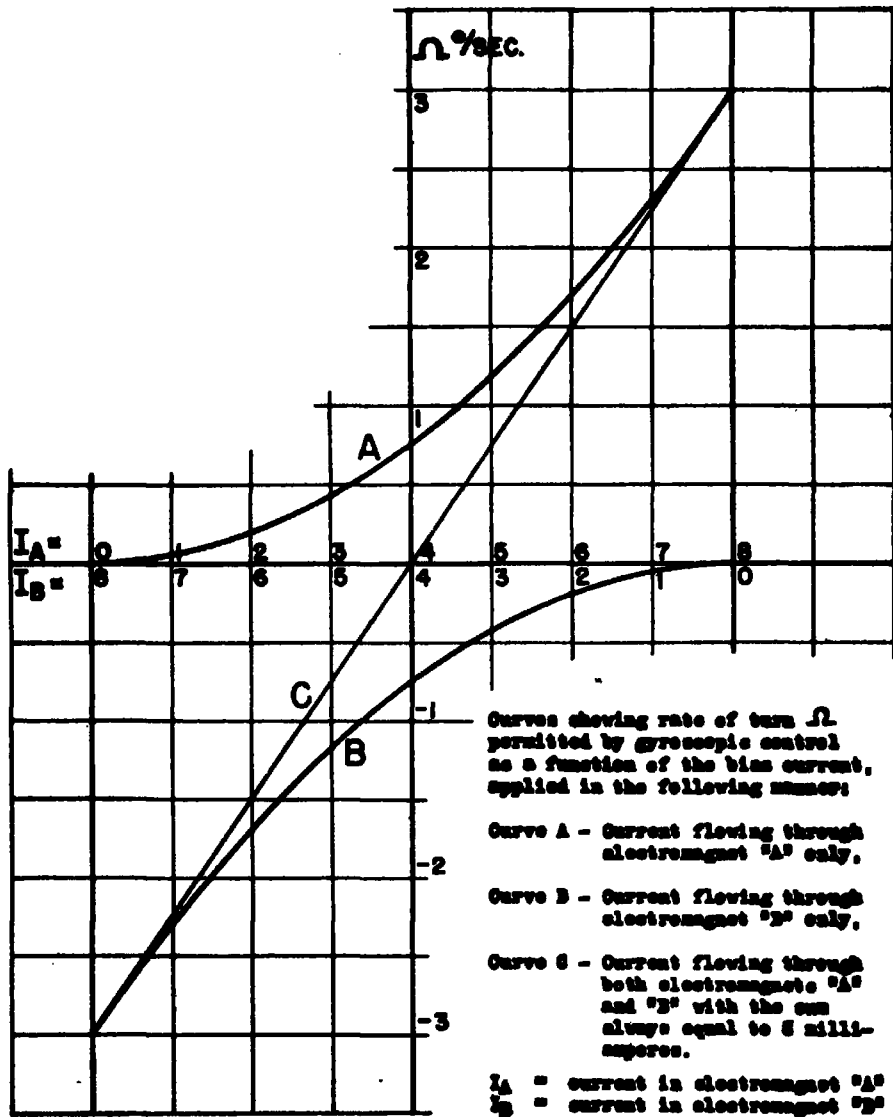

FIG. 9

Hysteresis in an early experimental model of the Control Gyro.

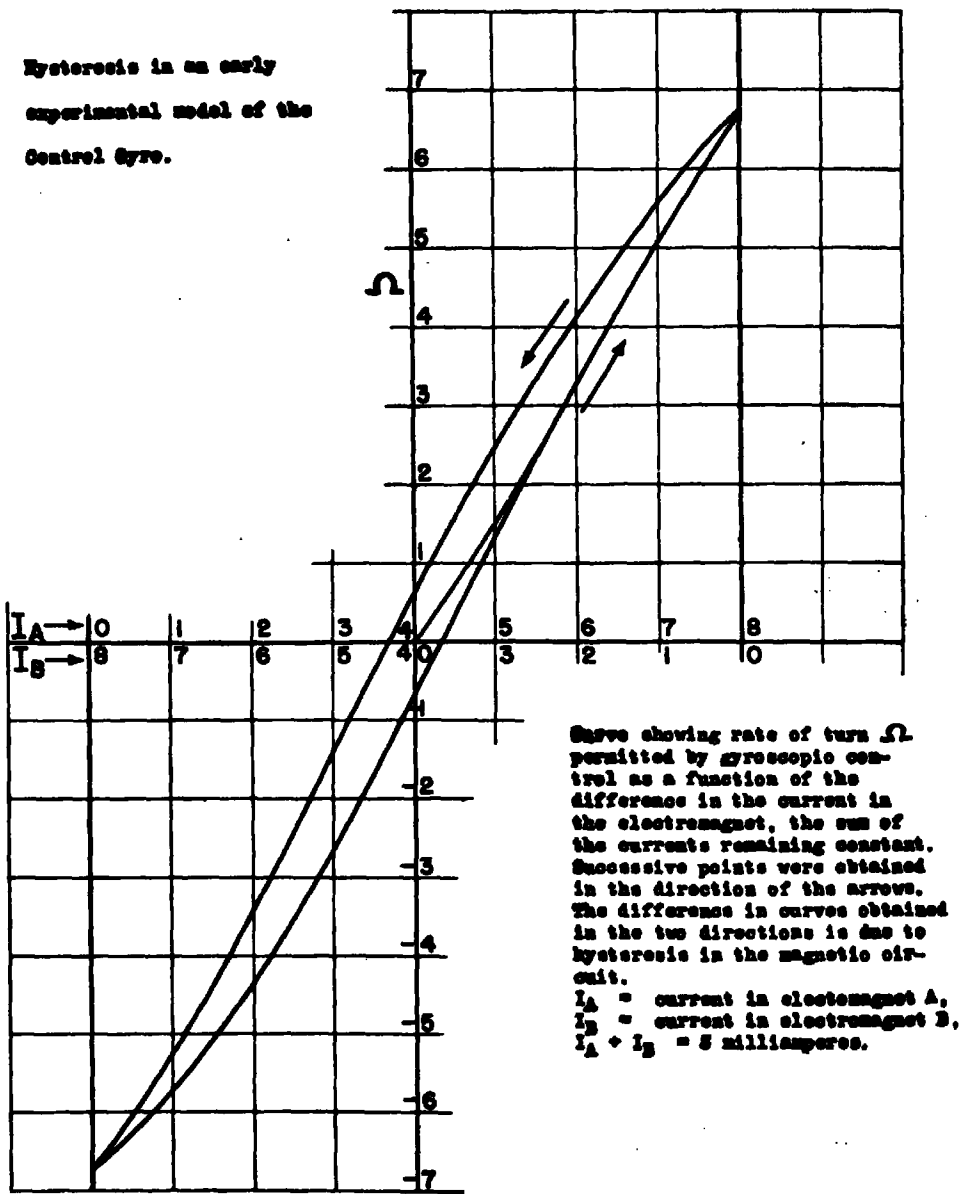

FIG. 10

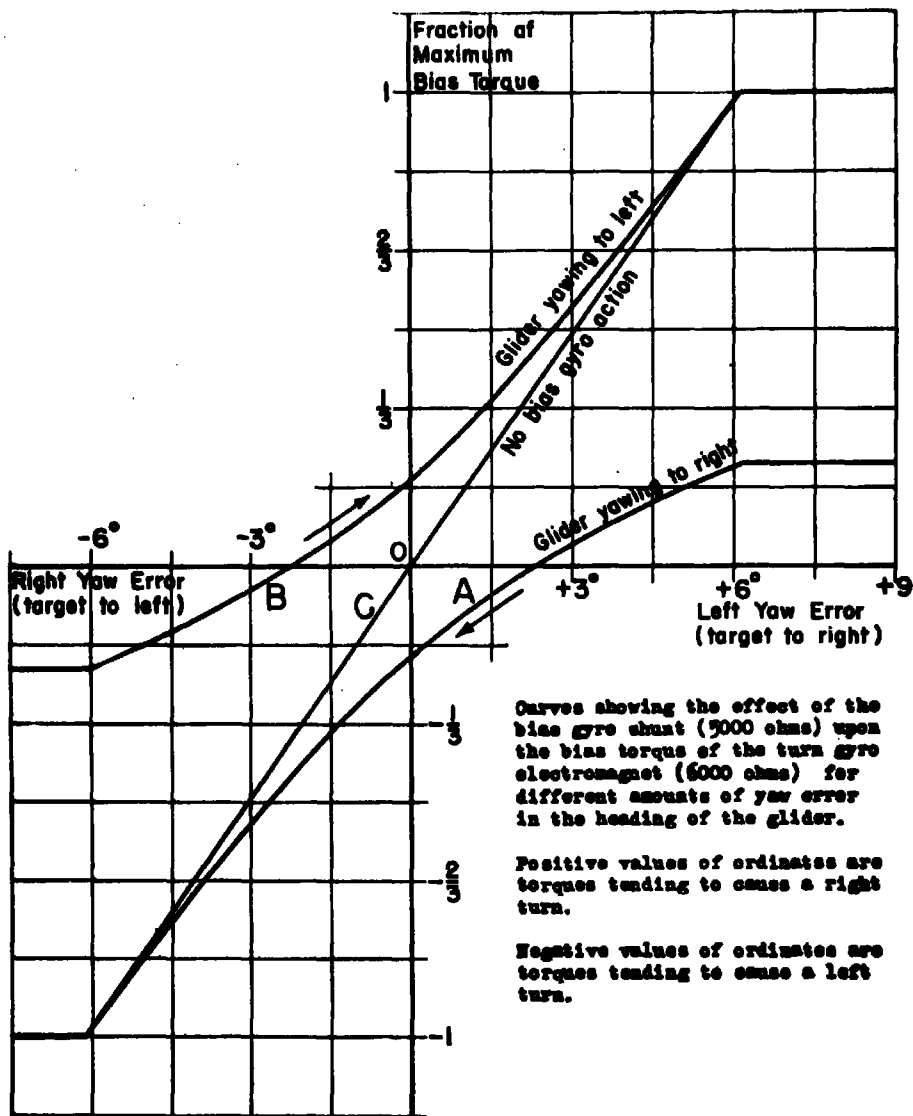

FIG. 11

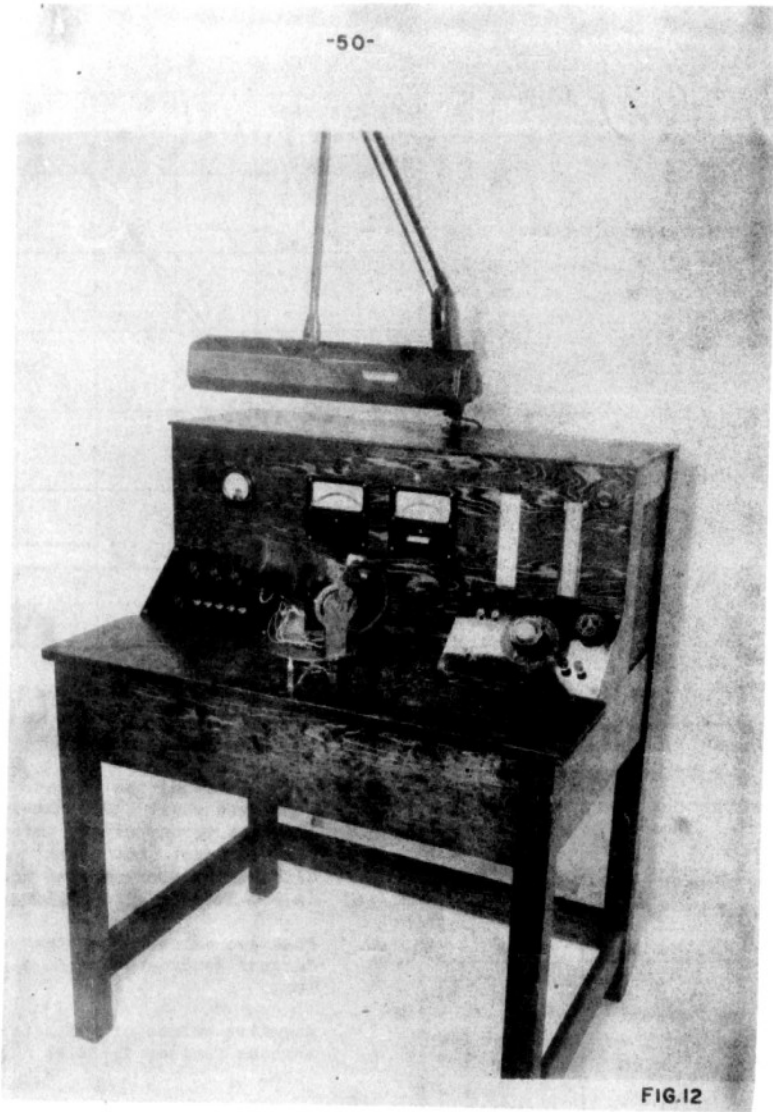
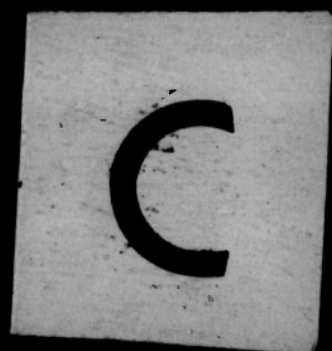

FIG.12

REEL



6

2

FRAME

2

0

9

4

CONFIDENTIAL

ATI-2094

EDIC FORM 30 (13 FEB 47)

Hart, John A.

DIVISION: Guided Missiles (1)

SECTION: Guidance and Control (1)

CROSS REFERENCES: Missiles - Guidance and control (62030); Gyroscopes (47500); Bombs, Glide - Gyro controlled (17403); Automatic pilots (13300)

ORIG. AGENCY NUMBER

REVISION

AUTHOR(S)

AMER. TITLE: An automatic pilot for homing glide-bombs

FORG'N. TITLE:

ORIGINATING AGENCY: National Bureau of Standards, Washington, D. C.

TRANSLATION:

COUNTRY	LANGUAGE	FORG'N. CLASS.	U. S. CLASS.	DATE	PAGES	ILLUS.	FEATURES
U.S.	Eng.		Conf'd'l		50	12	photos, diagrs, graphs

ABSTRACT

An automatic pilot developed by the National Bureau of Standards for homing glide bombs is discussed. Operation of the control gyro and automatic pilot is described. The successful use of the automatic pilot to stabilize the glide bombs developed by the National Bureau of Standards is also discussed.

T-2, HQ., AIR MATERIEL COMMAND

 AIR TECHNICAL INDEX
 CONFIDENTIAL

WRIGHT FIELD, OHIO, USAAF

14
17-0-21 MAR 47 1321



DEPARTMENT OF DEFENSE
WASHINGTON HEADQUARTERS SERVICES
1 155 DEFENSE PENTAGON
WASHINGTON, DC 20301-1155

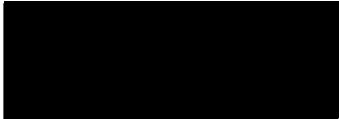

9 JAN 2013

Subject: OSD MDR Case 12-M-1567

Dear [REDACTED]:

We have reviewed the enclosed document in consultation with the Department of the Navy and have declassified it in full. If you have any questions, contact me by e-mail at Records.Declassification@whs.mil or by phone at 571-372-0483.

Sincerely,

Robert Storer
Chief, Records and Declassification Division

Enclosures:

1. MDR request
2. Document 6





DEPARTMENT OF DEFENSE
WASHINGTON HEADQUARTERS SERVICES
1155 DEFENSE PENTAGON
WASHINGTON, DC 20301-1155



MEMORANDUM FOR DEFENSE TECHNICAL INFORMATION CENTER
(ATTN: WILLIAM B. BUSH)
8725 JOHN J. KINGMAN ROAD, STE 0944
FT. BELVIER, VA 22060-6218

29 JAN 2013

SUBJECT: OSD MDR Case 12-M-1567

At the request of [REDACTED], we have conducted a Mandatory Declassification Review of the attached document under the provisions of Executive Order 13526, section 3.5, for public release. We have declassified the document in full. We have attached a copy of our response to the requester on the attached Compact Disc (CD). If you have any questions, contact me by e-mail at storer.robert@whs.mil, robert.storer@whs.smil.mil, or robert.storer@osdj.ic.gov or by phone at 571-372-0483.

Robert Storer
Chief, Records and Declassification Division

Attachment:
CD

