

**UNCLASSIFIED**



NAVAL AIR WARFARE CENTER AIRCRAFT DIVISION  
PATUXENT RIVER, MARYLAND



## **TECHNICAL REPORT**

REPORT NO: NAWCADPAX/TR-2004/86

### **CERVICAL INJURY RISK RESULTING FROM ROTARY WING IMPACT: ASSESSMENT OF INJURY BASED UPON AVIATOR SIZE, HELMET MASS PROPERTIES, AND IMPACT SEVERITY**

by

**Glenn Paskoff**

**21 October 2004**

Distribution authorized to U.S. Government agencies only; Critical Technology; October 2004. Other requests shall be referred to the Naval Air Systems Command, 47123 Buse Road, Patuxent River, Maryland 20670-1547.

DESTRUCTION NOTICE - Destroy by any method that will prevent disclosure of contents or reconstruction of the document.

**UNCLASSIFIED**

DEPARTMENT OF THE NAVY  
NAVAL AIR WARFARE CENTER AIRCRAFT DIVISION  
PATUXENT RIVER, MARYLAND

NAWCADPAX/TR-2004/86  
21 October 2004

**CERVICAL INJURY RISK RESULTING FROM ROTARY WING  
IMPACT: ASSESSMENT OF INJURY BASED UPON AVIATOR SIZE, HELMET MASS  
PROPERTIES AND IMPACT SEVERITY**

by

Glenn Paskoff

**RELEASED BY:**

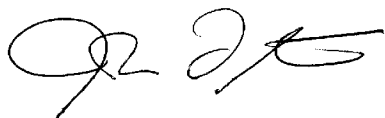

21 Oct 2004

JOHN QUARTUCCIO / 4.6.7 / DATE  
Head, Escape and Crashworthy Systems Division  
Naval Air Warfare Center Aircraft Division

<b>REPORT DOCUMENTATION PAGE</b>			Form Approved OMB No. 0704-0188		
Public reporting burden for this collection of information is estimated to average 1 hour per response, including the time for reviewing instructions, searching existing data sources, gathering and maintaining the data needed, and completing and reviewing this collection of information. Send comments regarding this burden estimate or any other aspect of this collection of information, including suggestions for reducing this burden, to Department of Defense, Washington Headquarters Services, Directorate for Information Operations and Reports (0704-0188), 1215 Jefferson Davis Highway, Suite 1204, Arlington, VA 22202-4302. Respondents should be aware that notwithstanding any other provision of law, no person shall be subject to any penalty for failing to comply with a collection of information if it does not display a currently valid OMB control number. <b>PLEASE DO NOT RETURN YOUR FORM TO THE ABOVE ADDRESS.</b>					
1. REPORT DATE 21 October 2004	2. REPORT TYPE Technical Report		3. DATES COVERED		
4. TITLE AND SUBTITLE  Cervical Injury Risk Resulting From Rotary Wing Impact: Assessment of Injury Based Upon Aviator Size, Helmet Mass Properties and Impact Severity			5a. CONTRACT NUMBER		
			5b. GRANT NUMBER		
			5c. PROGRAM ELEMENT NUMBER		
6. AUTHOR(S)  Glenn Paskoff			5d. PROJECT NUMBER		
			5e. TASK NUMBER		
			5f. WORK UNIT NUMBER		
7. PERFORMING ORGANIZATION NAME(S) AND ADDRESS(ES)  Naval Air Warfare Center Aircraft Division 22347 Cedar Point Road, Unit #6 Patuxent River, Maryland 20670-1161			8. PERFORMING ORGANIZATION REPORT NUMBER  NAWCADPAX/RTR-2004/86		
9. SPONSORING/MONITORING AGENCY NAME(S) AND ADDRESS(ES)  Naval Air Systems Command 47123 Buse Road Unit IPT Patuxent River, Maryland 20670-1547			10. SPONSOR/MONITOR'S ACRONYM(S)		
			11. SPONSOR/MONITOR'S REPORT NUMBER(S)		
12. DISTRIBUTION/AVAILABILITY STATEMENT  Distribution authorized to U.S. Government agencies only; Proprietary Information; October 2004. Other requests shall be referred to the Naval Air Systems Command, 47123 Buse Road, Patuxent River, Maryland 20670-1547.					
13. SUPPLEMENTARY NOTES					
14. ABSTRACT  A total of 43 tests was conducted at the Patuxent River Horizontal Accelerator facility to 1) quantitatively determine the effect of varying helmet weight and center of gravity (CG) during simulated rotary wing crash scenarios, and 2) to perform data analysis using existing injury criteria to identify maximum limits for helmet weight and CG for the extremes of the rotary wing aviator population. Recommendations of risks were based upon aviator size, helmet mass properties, and impact severity. Standard 30-deg pitch down helicopter crash pulses were examined. The pulses used were representative of standard seat qualification crash corridors for a variety of rotary wing platforms. Testing included a Hybrid III 95 <sup>th</sup> percentile male, a 50 <sup>th</sup> percentile male, and a 5 <sup>th</sup> percentile female. A comprehensive analysis of the data was performed using available injury predictors to determine the likelihood of injury to the upper and lower cervical spine.  The results indicated the importance, from a programmatic standpoint, of determining early on what impact level (determined from the mishap data) would provide a sufficient level of protection based upon the mission and user population. However, it is also recommended that further testing be conducted to improve the statistical significance of each tested configuration. Additional testing would provide greater confidence in quantitatively establishing the injury threshold for all aviator sizes given changes to added head weight and impact condition. Mass properties guidelines could then be modified based upon the improved dataset.					
15. SUBJECT TERMS  Rotary Wing Impact, Cervical Injury, Helmet Mass Properties					
16. SECURITY CLASSIFICATION OF:			17. LIMITATION OF ABSTRACT	18. NUMBER OF PAGES	19a. NAME OF RESPONSIBLE PERSON
a. REPORT	b. ABSTRACT	c. THIS PAGE			Glenn Paskoff
Unclassified	Unclassified	Unclassified	SAR	337	19b. TELEPHONE NUMBER (301) 342-8469

## SUMMARY

A total of 43 tests was conducted at the Patuxent River Horizontal Accelerator facility. The primary objectives of this effort were 1) to quantitatively determine the effect of varying helmet weight and center of gravity (CG) during simulated rotary wing crash scenarios, and 2) to perform data analysis using existing injury criteria to identify maximum limits for helmet weight and CG for the extremes of the rotary wing aviator population. Recommendations of risks were based upon aviator size, helmet mass properties, and impact severity. Standard 30-deg pitch down helicopter crash pulses were examined. The pulses used were representative of standard seat qualification crash corridors for a variety of rotary wing platforms. Testing included a Hybrid III 95<sup>th</sup> percentile male, a 50<sup>th</sup> percentile male, and a 5<sup>th</sup> percentile female. In order to achieve the necessary helmet weight and CG values required for the tests, a head-mass fixture was developed and used in place of the manikin's head. This fixture allowed weights to be added both forward and laterally on the head to generate a wide array of weight and CG configurations. A crash-repeatable rigid seat with a fixed generic restraint was used in all of the tests. A validated computer model was used to refine the test matrix due to the large number of variables within the study.

A comprehensive analysis of the data was performed using available injury predictors to determine the likelihood of injury to the upper and lower cervical spine. These criteria, having been developed and established by the automotive and military environments over the past four decades, reflect the most current knowledge and understanding of cervical injury limits and have been jointly agreed upon by the U.S. Navy and U.S. Air Force for use in such programs as Stability Improvement Program and Joint Strike Fighter. While these are noncrashworthy programs, the injury criteria are still valid for use in this study.

Results indicated that pulse severity was the most dominant variable examined during the study. The effect of gender was more related to the different values for the neck injury limits that were scaled according to weight. Therefore, despite the fact that the cervical forces and moments were lowest in magnitude in the small female tests, because the injury criteria limits were also reduced, the benefits were negated. Added head mass and CG statistically had very little effect when contrasted with test variability. All of the aviator sizes tested passed the low severity tests for all of the added head weights tested (up to 6 lb). For the medium severity tests, only the mid-male and large male passed the neck injury criteria for all of the added head weights tested (up to 6 lb). The small female reached the limit at approximately 4 lb. For the high severity tests, the small female and mid-male failed for all of the added head weights tested. The large male passed the neck injury criteria only for the lowest added head weight (2.8-3.0 lb).

An analysis of variance (ANOVA) with a post hoc Tukey-Kramer test to determine the source of the difference was conducted on the principal neck parameters to determine whether any of the factors were statistically significant (defined as  $p \leq 0.05$ ). The results of the statistical analyses indicated that for each of the manikin sizes tested, added head mass did not have a significant effect on the magnitude of the force or moments measured. There was a significant effect of the severity of the applied pulse for all parameters except lower neck tension. Since pulse severity was the dominant factor, as compared to weight or manikin size, ANOVA for the effects of these two factors were also conducted for each individual pulse type. Size was a significant factor (1)

in the low severity tests for all parameters except the upper neck flexion moment, (2) in the medium severity tests for all parameters except the lower neck tension, and (3) in the high severity tests for all parameters except the upper neck tension. It is important to note that the results of these statistics were based upon a small sample size with very few repeated measures.

The results indicated the importance, from a programmatic standpoint, of determining early on what impact level (determined from the mishap data) would provide a sufficient level of protection based upon the mission and user population. However, it is also recommended that further testing be conducted to improve the statistical significance of each tested configuration. Additional testing would provide greater confidence in quantitatively establishing the injury threshold for all aviator sizes given changes to added head weight and impact condition. Mass properties guidelines could then be modified based upon the improved dataset.

## Contents

	<u>Page No.</u>
Introduction.....	1
Background.....	1
Purpose.....	2
Description of Test Equipment.....	2
Rigid Crashworthy Seat System.....	2
Anthropomorphic Test Dummy.....	3
Horizontal Accelerator Facility.....	6
Scope of Project.....	7
Analysis of Naval Helicopter Mishap Data.....	7
Computer Modeling.....	9
Horizontal Accelerator Testing.....	11
Cervical Injury Analysis.....	16
Method of Tests.....	17
Chronology.....	19
Personnel.....	19
Results and Evaluation.....	21
Computer Model Validation.....	21
Rigid Crashworthy Seat Versus Actual Stroking Seat.....	21
Trapezoidal Pulse Versus “Actual” Pulse.....	22
10-Degree Back Pad Validation.....	23
Comparison with 4.0 lb Added Head Weight Test Data.....	23
Small Female Tests.....	23
Mid-Male Tests.....	24
Large Male Tests.....	24
Effect of Aviator Size, Helmet Mass Properties, and Pulse Severity.....	24
Conclusions.....	27
General.....	27
Specific.....	27
Recommendations.....	28
References.....	29
Appendices	
A. Figures (Computer Model Validation).....	31
B. Figures (Small Female Tests).....	67
C. Figures (Mid-Male Tests).....	163
D. Figures (Large Male Tests).....	247
E. Figures (Effect of Aviator Size, Helmet Mass Properties, and Pulse Severity).....	309

	<u>Page No.</u>
F. Still Photographs.....	317
G. Neck Injury Criteria.....	323
Distribution.....	329

## 1.0 INTRODUCTION

### 1.1 BACKGROUND

1.1.1 By design, helicopters have some level of intrinsic crashworthiness. During ground impact, when a helicopter crashes in a normal "belly first" configuration, the landing gear assembly first compresses to failure. Once the landing gear system has failed, the airframe structure crushes. This crush, transmitted to the floor of the cockpit and cabin, causes the floor to buckle and transmits the force to the seat. The pilot and copilot seats are equipped with energy absorbers that attenuate the force to allow no greater than 15 Gz to be transmitted to the occupant. The seat strokes and the occupant lags the seat in this event. Once the seat bottoms out, the occupant receives a marked acceleration (Gz) spike. This force is transmitted up the spine and accounts for the large concern over lumbar and thoracic vertebral fracture. The crash event, however, is not limited only to the vertical axis: the horizontal and lateral crash loads can be extreme as well. Most commonly, the horizontal loads are of concern. After bottoming out, the occupant begins pitching forward in the seat. The restraint systems, typically a four or five-point restraint, allow forward movement due to the stretch of the webbing material. Once this stretch is complete, the occupant's thorax is abruptly halted, but the head and neck continue to translate and rotate. This motion of the head and neck results in cervical tension and shear that approach and can exceed injurious levels.

1.1.2 Helmet-mounted devices (HMDs) that are worn on the head are used for air-to-air and air-to-ground targeting, night vision, forward looking infrared views, and flight control information. As the number of features increases, the total weight of the system increases. Earlier systems that provided a number of features, in addition to the basic functions of a helmet, weighed close to 6 lb. Advances in modern materials have reduced this overall weight to 4.8 lb or less. While the total weight is important, the major factor in the injury potential is the location of the center of gravity (CG) of the head and helmet system combined. Typically, the CG is placed forward of the occipital condyles and results in high pitch moments about the occipital condyles (C0/C1) and C7/T1 which are consistent with cervical injury. The neck injury potential in helicopter crashes is due to force transmission from the vertical acceleration component, extreme head and neck motion which places the neck in hyperflexion and distraction, and neck compression and shear due to head contact with the crew station or cabin structures, sighting systems, and flight controls.

1.1.3 In addition, female pilots are a part of combat missions, where historically they have not been. Crashworthiness design criteria based on a male population will not be applicable to females. Recent findings in vertebral gender differences indicate that males and females of approximately the same size are at equal levels of risk to thoracic and lumbar injuries, but a gender difference may exist in the cervical spine. At this region, females are predicted to have a 13% decrease in vertebral strength versus same-sized males. With the added weight and increased use of HMDs, the potential for injury is increased.



1.1.4 Currently, there is a lack of comprehensive data that can effectively predict the probability of cervical injury during helicopter impact for varying added head masses and all aircrew sizes. Modern systems are being fielded without a complete understanding of the risks that the aviator will be subjected to in the event of a crash.

## 1.2 PURPOSE

1.2.1 The primary objectives of this effort were as follows:

- a. To quantitatively determine the effect of varying helmet weight and CG during simulated rotary wing crash scenarios using the MATHematical DYNAMIC MODELS (MADYMOs). The MADYMO models were used to make predictions of inertial loads upon the neck as a result of the helmet mass properties and to develop the mass/CG test matrix used for the system level testing.
- b. To use system level Horizontal Accelerator (HA) testing to validate the predictions of the computer simulations and provide quantitative data regarding baseline and advanced helmet configurations.
- c. To perform data analysis using existing injury criteria to identify maximum limits for helmet weight and CG for the extremes of the rotary wing aviator population. And to make recommendations of risks were based upon aviator size, helmet mass properties, and impact severity.

## 1.3 DESCRIPTION OF TEST EQUIPMENT

### 1.3.1 RIGID CRASHWORTHY SEAT SYSTEM

1.3.1.1 The rigid crashworthy seat is an in-house fabricated test fixture that represents the seated position of a rotary wing aviator. The system is comprised of an aluminum frame seat pan and seat back and was mounted at a 30-deg angle in the sagittal plane for all tests (figures F-1 and F-3). Attachment points for the restraint system are representative of an actual crashworthy seat. A generic five-point restraint system was used on all the tests. Integrated into the restraint system yoke, in place of a standard H. Koch and Sons MA-16 inertia reel, was a 3,000-lb Denton 1914 load cell to measure belt loading during the impact (figure F-2). The intent of the load cell was to attempt to pretension the restraint system consistently for each test. Pretest preload of the restraint system ranged from 36 to 44 lb throughout the entire test series. The restraint system was replaced frequently during the testing, as specified by the Test Engineer. One-inch thick rate dependent foam was used as a seat cushion. A back pad was used to rotate the torso 10 deg into a more upright position for the highest severity crash pulse. The intent of this pad (validated from simulation analysis) was to increase the forward component of the acceleration vector such that measured upper body accelerations would more closely match those of an individual seated in an actual stroking seat. The detailed test setup is shown in figure 1.

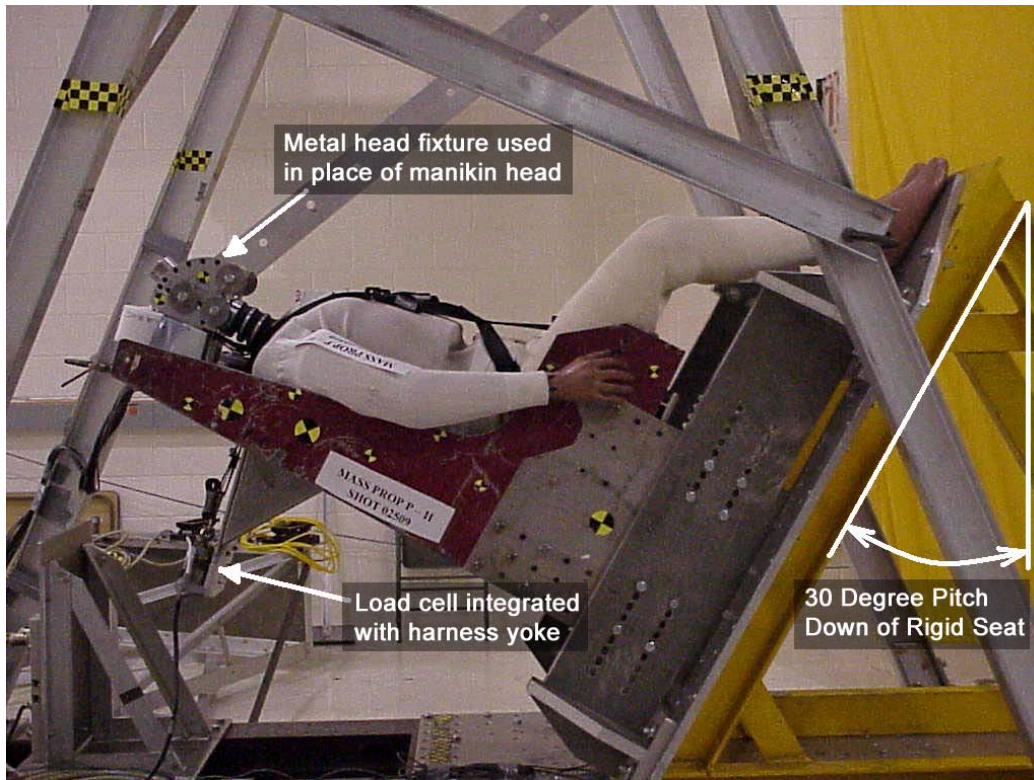

Figure 1: Detailed Test Setup

### 1.3.2 ANTHROPOMORPHIC TEST DUMMY

1.3.2.1 Three anthropomorphic test dummies (ATDs) were used for this study: 1) a 95<sup>th</sup> percentile male Hybrid III (224 lb), 2) a 50<sup>th</sup> percentile male Hybrid III (184 lb), and 3) a 5<sup>th</sup> percentile female Hybrid III (118 lb). The ATDs were dressed only in thermal underwear. Pretest positioning of the manikins complied with typical flight posture and was constant during all tests. An in-house designed and fabricated aluminum head fixture (figure 2) was used in place of each ATDs normal head. The fixture was designed to mount directly to the Hybrid III neck and allowed weights to be bolted vertically (holes designated Z1-Z7), horizontally (holes designated X-1, X1-X5), and radially (holes designated F1-F9) from the head pivot pin as well as at the pivot pin (hole designated OC). Weights were added to the head fixture such that the added head weight varied between 2.8 – 6.0 lb (figures F-4 through F-9), and the CG (referenced from the head pivot pin) varied between 2.25 – 5.0 in. (not including the mass of the head). The angle, theta ( $\theta$ ), that the CG made with the head pivot pin ranged from 66.7 – 77.5 deg for all configurations tested. It was desired to keep this angle between 65 – 75 deg, as this was felt to be representative of the CG of existing HMD systems. An Excel spreadsheet was used to mathematically determine CG location (radius and angle) for each configuration. The minimum and maximum mass properties data (2.8 – 6.0 lb added head mass) for each manikin type is listed in table 1.

Table 1: Min/Max Manikin Head Fixture Mass Properties with Added Head Mass<sup>(1)</sup>

Manikin Size	Total Head Mass (lb)	CG Distance from OC		MOI <sub>xx</sub> (lb-in. <sup>2</sup> )	MOI <sub>yy</sub> (lb-in. <sup>2</sup> )	MOI <sub>zz</sub> (lb-in. <sup>2</sup> )
		(in.)	(angle)			
Small Female	2.79	3.71	79.4 deg	35.28	8.49	42.41
Small Female	5.92	5.67	68.4 deg	32.32	23.34	93.78
Mid-Male	2.87	3.18	53.2 deg	50.83	23.67	29.03
Mid-Male	6.00	5.66	65.1 deg	20.2	51.99	47.51
Large Male	2.89	2.85	47.6 deg	56.19	2.15	43.35
Large Male	6.01	5.44	66.9 deg	84.66	40.65	62.73

NOTE: (1) Mass properties ONLY include added head mass. Mass properties in this table were measured versus calculated.

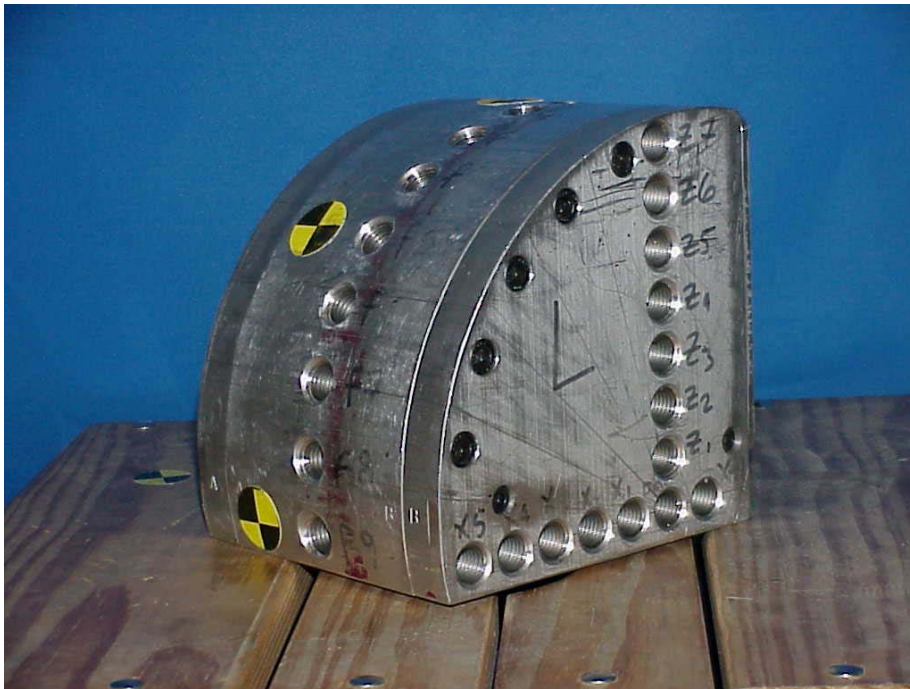

Figure 2: Metal Head Test Fixture

1.3.2.2 The upper neck load cell used in all three manikins was the Denton model J-1716. In order to apply the cervical injury criteria, it was necessary to translate the measured y-moment values from the load cell to the head pivot pin. This location on the manikin approximately mimics the occipital condyles in a human. The equations used to accomplish this transformation are shown in figure 3. In addition, a similar procedure was followed for the lower neck load cell to translate the forces and moments to the base of the neck. The lower neck load cell used in the manikins for the low and medium severity tests was the Denton model J-1794. However, it was determined that the y-moment capability was being exceeded in the high severity tests. Consequently, this load cell was replaced with the Denton model J-5832 that featured a more robust range for recording the y-moment. The equations used to transform the forces and moments in the lower neck load cells are shown in figures 4 and 5.

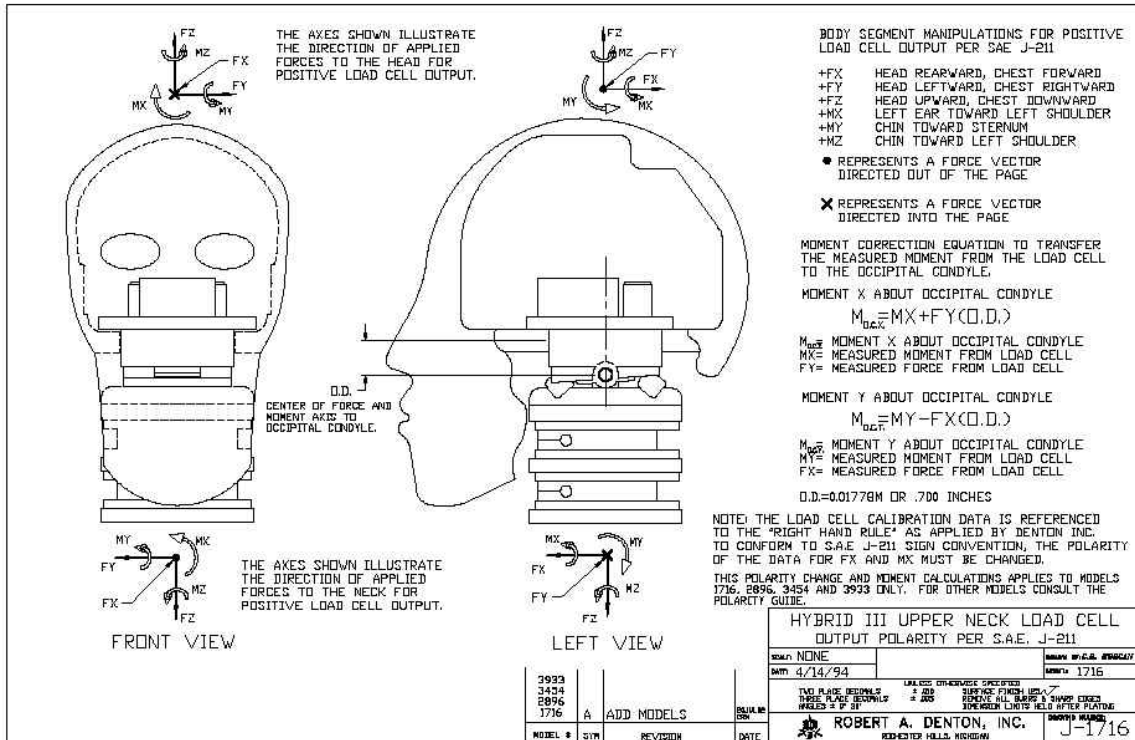

Figure 3: Transformation Equations for the Denton Model J-1716 Upper Neck Load Cell

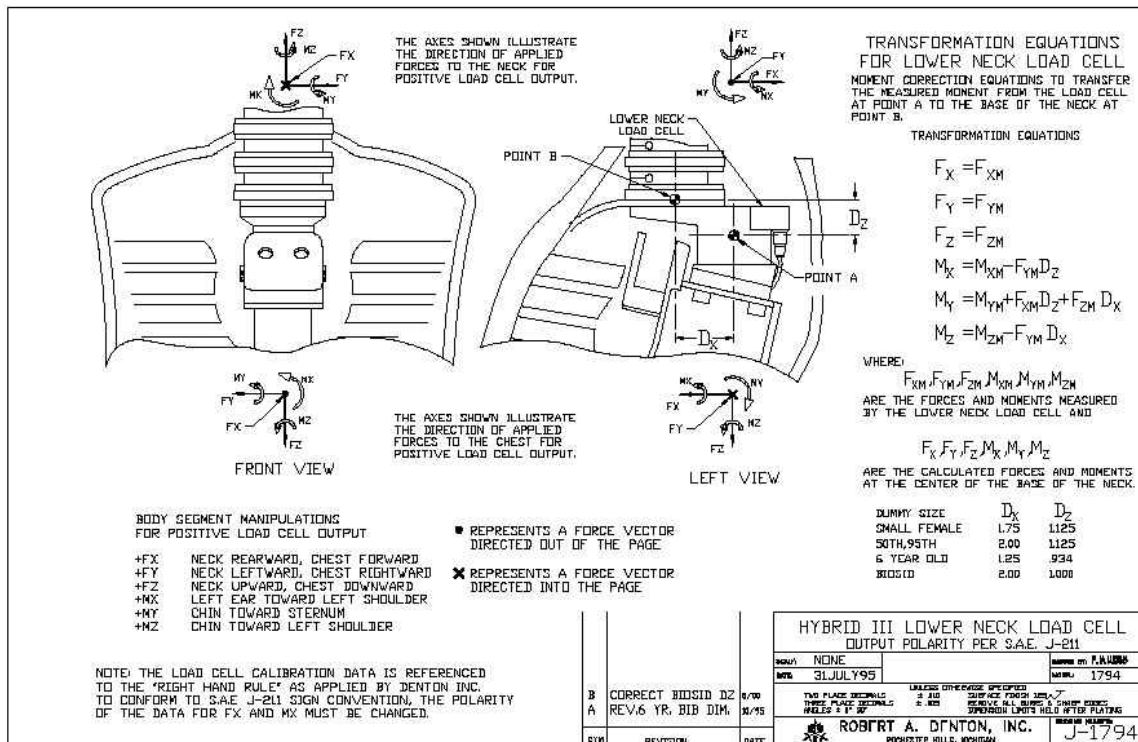
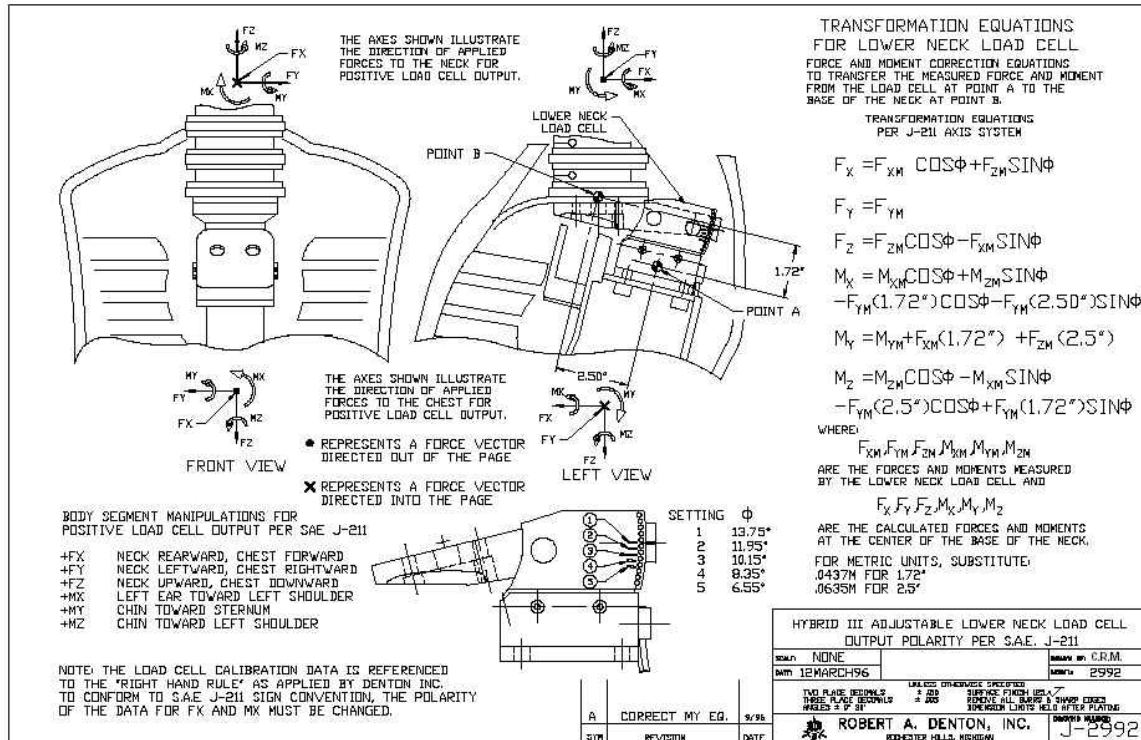

Figure 4: Transformation Equations for the Denton Model J-1794 Lower Neck Load Cell



Note that the equations for the J-5832 are the same as those for the J-2992 shown above.

Figure 5: Transformation Equations for the Denton Model J-5832 Lower Neck Load Cell

### 1.3.3 HORIZONTAL ACCELERATOR FACILITY

1.3.3.1 The HA facility simulates typical decelerative crash forces associated with aircraft mishaps by reversing the orientation of the test article and subjecting the test article to accelerative forces from an initial velocity of zero. The HA consists of three main assemblies: 1) the accelerating mechanism, 2) the test sled, and 3) the guide rails. The accelerating mechanism is a 12-in. HYGGE actuator that consists of a stainless-steel cylinder, divided into two 12-ft long chambers. The energy required to produce the impact acceleration is generated within the actuator cylinder by means of differential gas pressures acting up on a thrust piston. The rear chamber contains compressed air used as the firing pressure. The front chamber is filled with pressurized nitrogen, used to apply braking to the thrust assembly.

1.3.3.2 Upon actuation, air is introduced into the front chamber, accelerating the thrust assembly forward. A metering pin, located between the two chambers, controls the acceleration-time profile applied to the sled. A maximum force of 225,000 lb of gross thrust can be generated. This force is reacted by a reinforced concrete block weighing 75 tons. The result is a smooth transition of energy from the cylinder to the test sled. The length of the power stroke is variable, controlled by the volume of hydraulic fluid within the front chamber.

1.3.3.3 The test sled is 12 ft long and 4 ft wide. It is attached to guide rails that allow the sled to move away from the accelerator with minimum friction. After the accelerating stroke is completed, caliper brakes mounted on the sled are automatically activated to grip the rails and



decelerate the sled to a smooth stop. The total length of the rails is 100 ft. Essential characteristics of the HA facility are:

- Maximum Acceleration: 50 Gs
- Maximum Velocity: 100 ft/sec
- Maximum Payload: 5,000 lb at 20 Gs
- Power Stroke: 10 ft
- Pulse Shape: Variable

#### 1.4. SCOPE OF PROJECT

##### 1.4.1 ANALYSIS OF NAVAL HELICOPTER MISHAP DATA

1.4.1.1 Information was compiled on available Naval helicopter mishap data. Data regarding Naval aircraft impact conditions were analyzed and plotted as cumulative frequency versus resultant velocity for both land and water impacts (figures 6, 7, and 8). Only impacts that were deemed significantly survivable were included on the figures. Significant survivable accidents were defined as those in which substantial structural damage occurred and one or more major injuries to the occupants. Nonsurvivable impacts were defined as those in which the impact acceleration environment exceeded the known limits of human tolerance, and/or the occupied volume was compromised such that survival would have been unlikely. Rotary wing platforms that were included were as follows: AH-1, UH-1, H-2, H-3, H-46, and H-53.

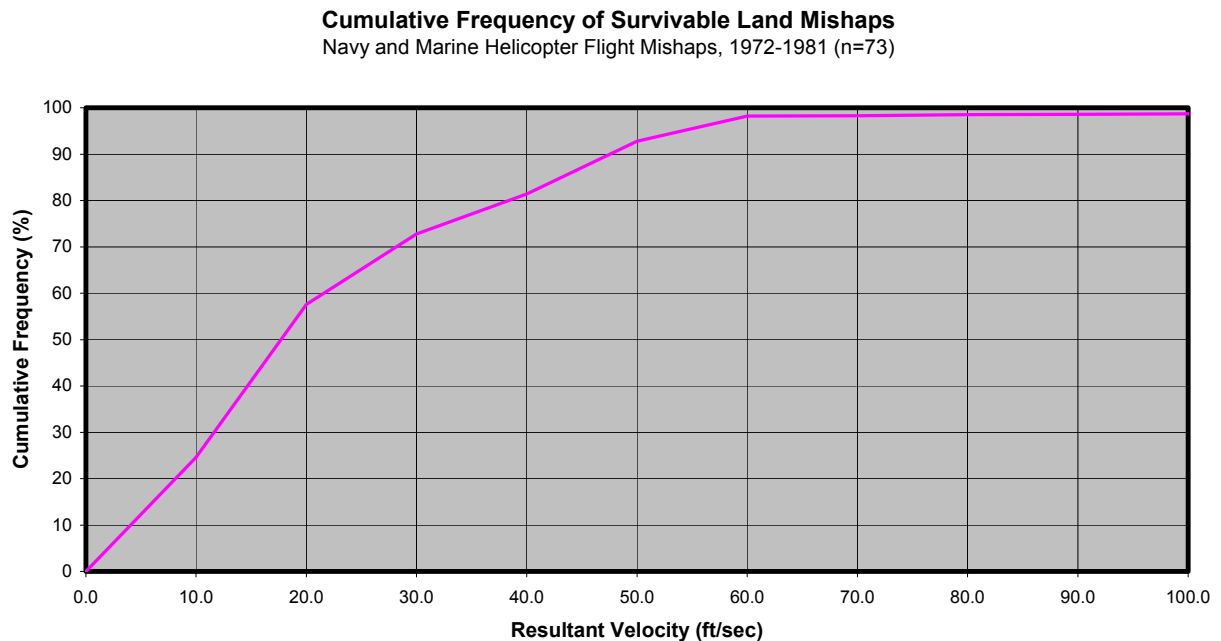

Figure 6: Cumulative Frequency of Survivable Land Mishaps

**Cumulative Frequency of Survivable Water Impacts**  
Navy and Marine Helicopter Flight Mishaps, 1972-1981 (n=62)

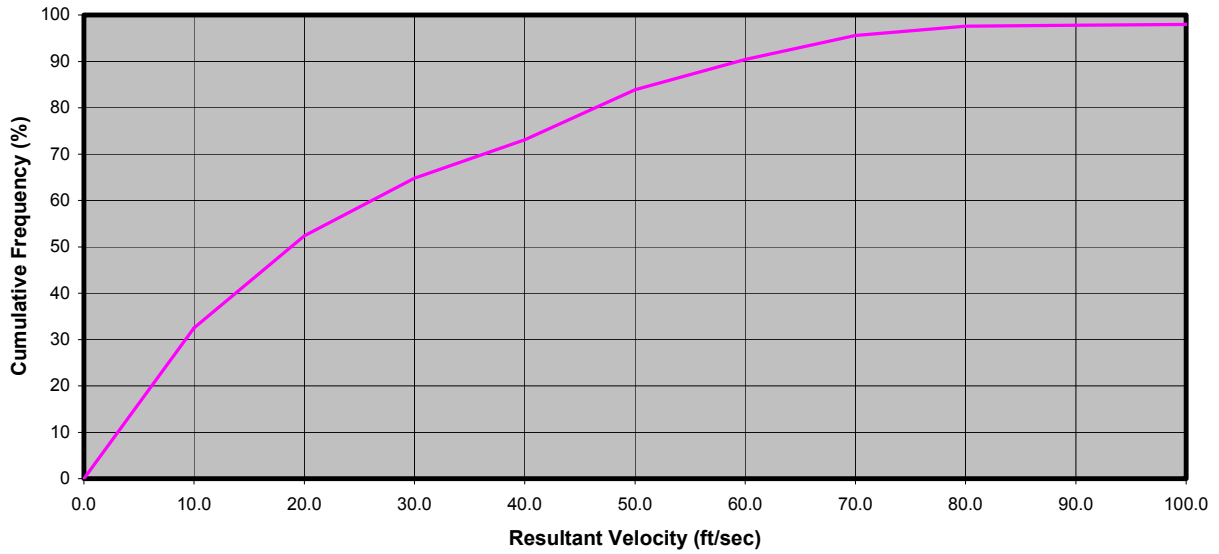

Figure 7: Cumulative Frequency of Survivable Water Mishaps

**Cumulative Frequency of Survivable Land and Water Impacts**  
Navy and Marine Helicopter Flight Mishaps, 1972-1981 (n=135)

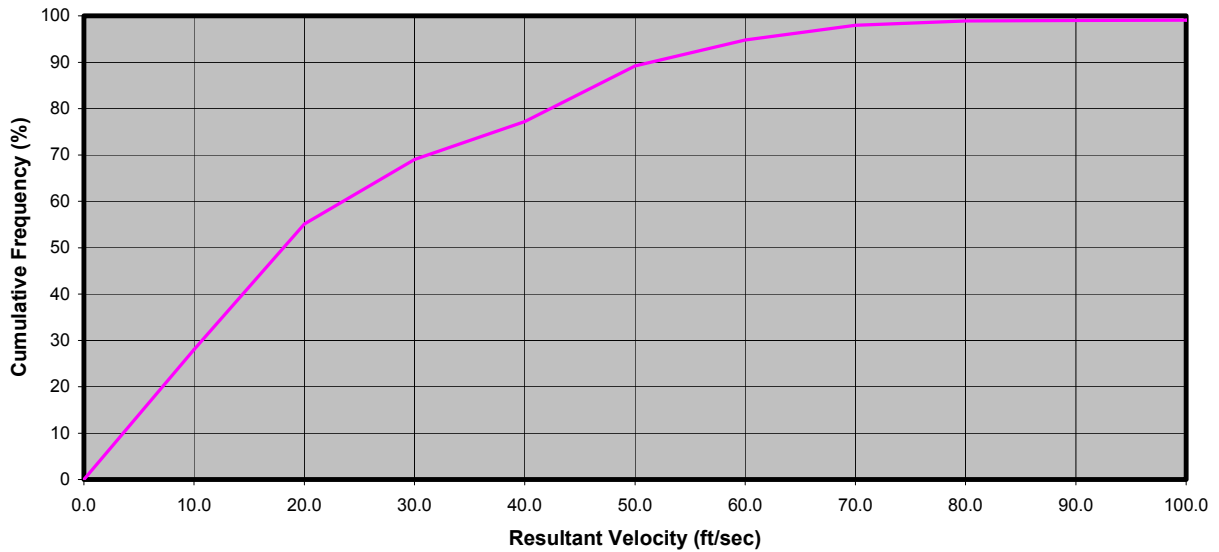

Figure 8: Cumulative Frequency of Survivable Land and Water Mishaps

1.4.1.2 From these figures it was possible to determine the frequency of occurrence for each of the three crash pulse velocities that were used during the testing (table 2). For example, the low severity pulse represents 63% of all survivable Naval helicopter mishaps. This means that 63% of the reported mishaps had a resultant velocity that was at or below this level. Or, in other words, 37% of survivable accidents occurred above this resultant impact velocity. These pulses were originally derived from dynamic structural crashworthy seat requirements tied to specific aircraft platforms. However, it is unclear where these requirements were derived.

Table 2: Cumulative Frequency of Survivable Impacts  
*Navy and Marine Helicopter Flight Mishaps (1972-1981)*

Pulse Severity Classification	Proposed Test Crash Pulse Resultant Velocity (ft/sec)	Frequency of Survivable Impacts (%)		
		Land	Water	Total
Low	25.0	65	58	63
Medium	31.5	74	66	71
High	50.0	93	84	89

## 1.4.2 COMPUTER MODELING

1.4.2.1 A computer model characteristic of a seated figure was validated using the MADYMO modeling software (figure 9). The MADYMO model provided numerous advantages over traditional testing methods such as repeatability, cost, and versatility. The model was validated using data from an earlier phase of testing from this effort in which sled runs were performed with an HGU-84/P helmet. After model validation, head weight, CG, and moments of inertia were varied to determine the effect of these mass properties on the dynamic response and joint forces/moments of the occupant. An analysis of neck injury was conducted on the results. Once the models had identified approximately where the tolerable limits of helmet weight and CG appeared to be (for a given occupant size and pulse severity), systems level HA tests were performed at those limits. The data from the 4.0 lb added head mass were compared with the results of the simulations, as this was the only test configuration that was common to all occupant sizes and test pulses used during the program. The mass properties of the test fixture, used for the computer models, using the 4.0 lb added head mass configuration are shown in table 3.



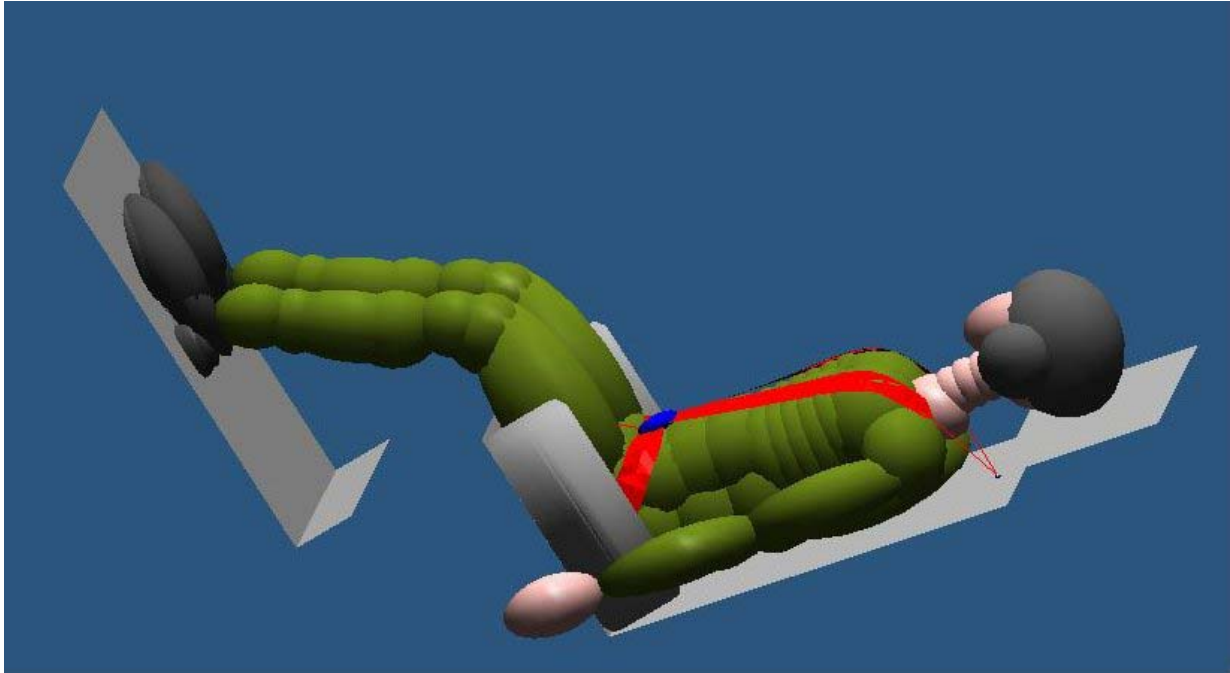

Figure 9: Seated MADYMO Model

Table 3: Manikin Head Fixture Mass Properties with 4.0 lb Added Head Mass

Manikin Size	Total Head Mass (lb)	CG Distance from OC		MOI <sub>xx</sub> (lb-in. <sup>2</sup> )	MOI <sub>yy</sub> (lb-in. <sup>2</sup> )	MOI <sub>zz</sub> (lb-in. <sup>2</sup> )
		(in.)	(angle)			
Small Female	12.11	2.55	70.1 deg	91.96	80.33	89.93
Mid-Male	13.55	2.60	68.6 deg	111.77	103.81	103.82
Large Male	14.72	2.51	72.2 deg	141.53	111.82	107.20

NOTE: (1) CG location from OC includes head and added head mass.

1.4.2.2 Computer modeling was also used to define the crash pulses used during the HA testing. It was determined that the rigid crashworthy seat imparted a much greater acceleration to the seated occupant than an actual stroking seat would. Cost and schedule prohibited using stroking seats for all of the tests. However, simulations were used to determine the acceleration profile that a typical stroking seat would ‘see’ during a standard helicopter impact test and this profile was applied to the rigid seat. Since it was not possible for the HA to match this pulse, simulations were conducted to determine whether a pulse approximation would adversely affect the occupant dynamics. In addition, a back pad was used to rotate the torso 10 deg into a more upright position for the highest severity crash pulse. The intent of this pad was to increase the forward component of the acceleration vector such that measured upper body accelerations would more closely match those of an individual seated in an actual stroking seat. The result was a much closer correlation of the rigid seat simulation to the stroking seat model. The effect of this condition was deemed insignificant for the low and medium severity tests and was validated from simulation analysis. A comparison of the accelerations, forces, and moments of the

occupant subjected to all of these sets of pulses demonstrated the acceptability of the final approach (appendix A).

### 1.4.3 HORIZONTAL ACCELERATOR TESTING

1.4.3.1 Standard 30-deg pitch down helicopter crash pulses were examined. The pulses used were representative of standard seat qualification crash corridors for a variety of rotary wing platforms. Testing included a Hybrid III 95<sup>th</sup> percentile male, a 50<sup>th</sup> percentile male, and a 5<sup>th</sup> percentile female. In order to achieve the necessary helmet weight and CG values required for the tests, a head-mass fixture was developed and used in place of the manikin's head. This fixture allowed weights to be added both forward and laterally on the head to generate a wide array of weight and CG configurations. A crash-repeatable rigid seat with a fixed generic restraint was used in all of the tests. The input pulse supplied to the rigid seat was representative of the acceleration observed by the seat pan of an energy-absorbing seat structure during a standard 30-deg pitch down qualification test configuration for the rotary wing platforms specified in table 4. The only exception to this was the third crash pulse configuration. This pulse was representative of a lower level impact that was expected to be survivable for all occupant sizes and added head masses. Yaw and roll conditions were not examined as part of this effort for several reasons: 1) an analysis of mishap data demonstrated that nearly 60% of all impacts have no roll component, and 80% of all impacts have no yaw component, 2) introducing these variables into the testing increases the test complexity, and 3) neck injury criteria have only been validated and accepted for the sagittal plane. By adding yaw and roll components into the tests, the measured forces and moments in the sagittal plane are decreased, consequently jeopardizing the validity of the results.

Table 4: Proposed Crash Pulses

Rotary Wing Platform	Structural Airframe Crash Pulse		Crash Pulse as Experienced by Seat Pan of Stroking Seat (derived from Computer Simulation)	
	Crash Pulse (Peak G's)	Crash Pulse $\Delta V$ (ft/sec)	Crash Pulse (Peak G's)	Crash Pulse $\Delta V$ (ft/sec)
SH-60, UH-1, V-22, H-53	45-50	45-50	19.0	45-50
AH-1Z	38	31.5	18.5	31.5
All	25-28	25	16.25	25

1.4.3.2 The instrumentation incorporated into the HA test sled and Hybrid III manikin included linear and angular accelerometers, and force/moment load cells at the top and bottom of the neck, thorax, and pelvis. All data were collected at 1000 Hz. Data were filtered at 100 Hz using an 8-pole, zero-shift Butterworth filter.

1.4.3.3 A total of 43 successful tests was conducted as part of this study. Table 5 provides a test matrix describing the impact orientation, pulse severity, occupant size, and helmet configuration for each crash pulse simulated during this test program. The CG locations presented in this table represent the CG of the total head and added head mass for each manikin size. These test conditions are also shown graphically in figures 10, 11, and 12. Calculation of this CG location was done through a program written in Microsoft Excel and used weights and CGs for each of the manikin heads that were measured by the NAVAIR Helmet team.

Calibration of the HYGE acceleration pulse signature was performed prior to conducting the dynamic tests. Peak accelerations and velocities were maintained in accordance with the values specified in table 5. Computer simulations determined that the magnitude of importance of the variables used to define the crash pulse were  $\Delta V$  (ft/sec), Peak Acceleration (G), G-Onset Rate (G/sec), and Pulse Duration ( $\Delta t$ ), respectively. The HA facility was successfully able to accommodate the first two variables of the pulse while needing to sacrifice the last two. The consequence of this tradeoff resulted in pulses that were typically longer in duration with lower onset rates than the simulation study proposed. The Test Engineer deemed that this was acceptable to meeting the requirements of the program. Examples of each of the sled pulses are shown in figure 13.

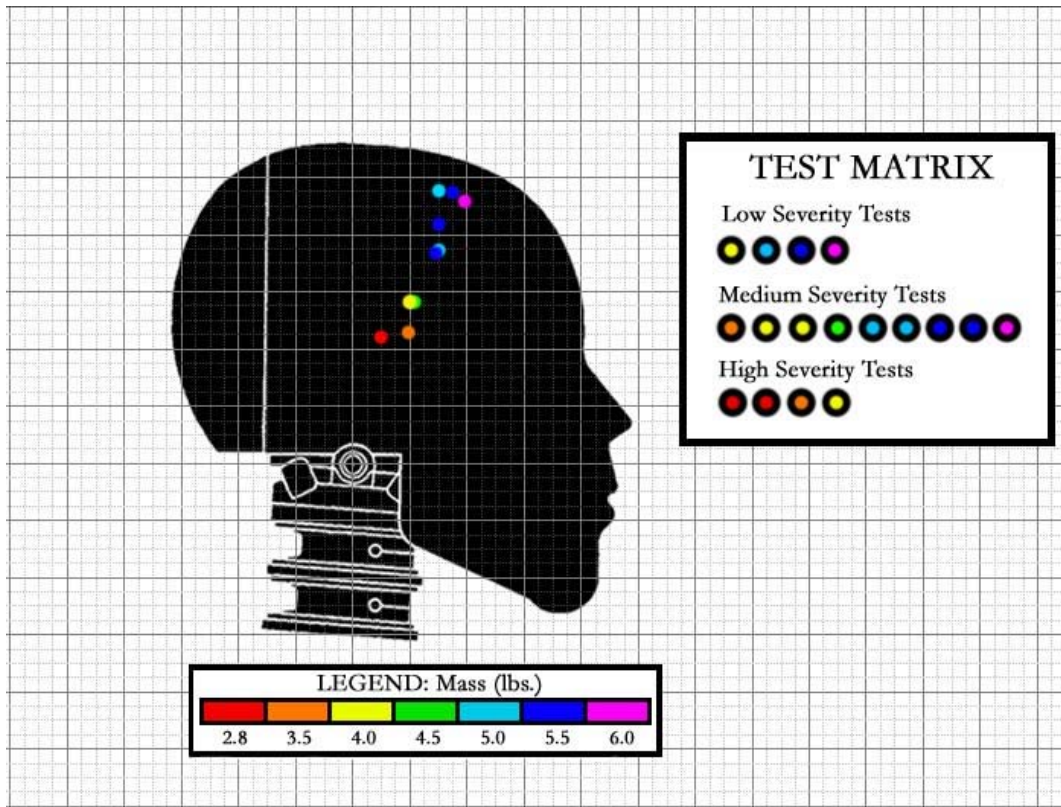

Figure 10: Small Female Added Head Masses Tested

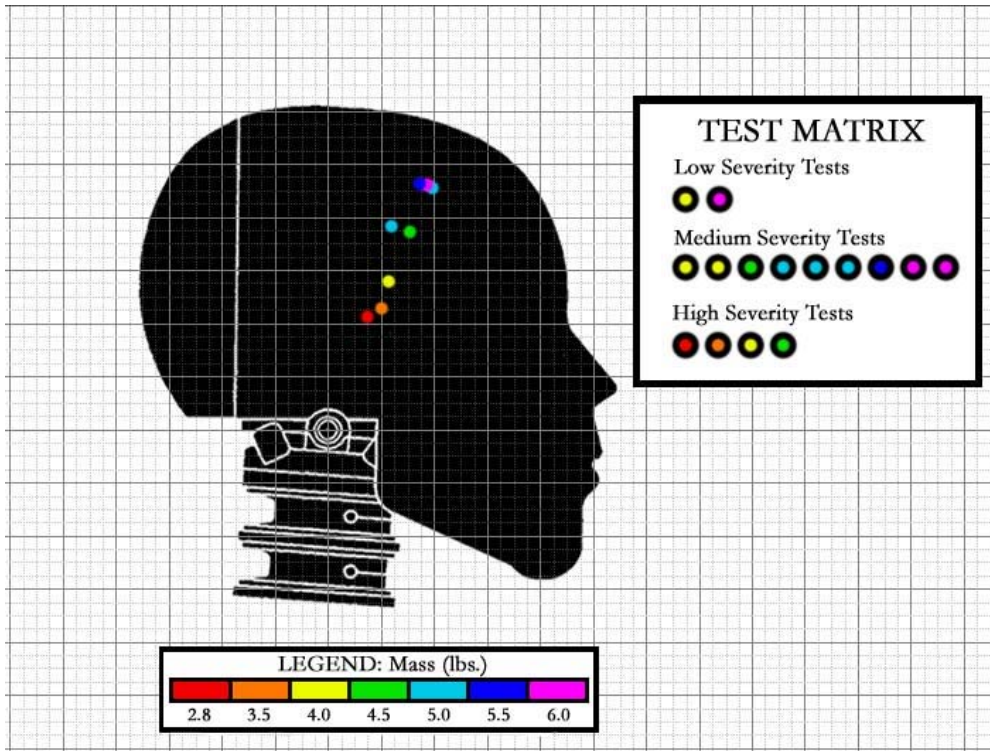

Figure 11: Mid-Male Added Head Masses Tested

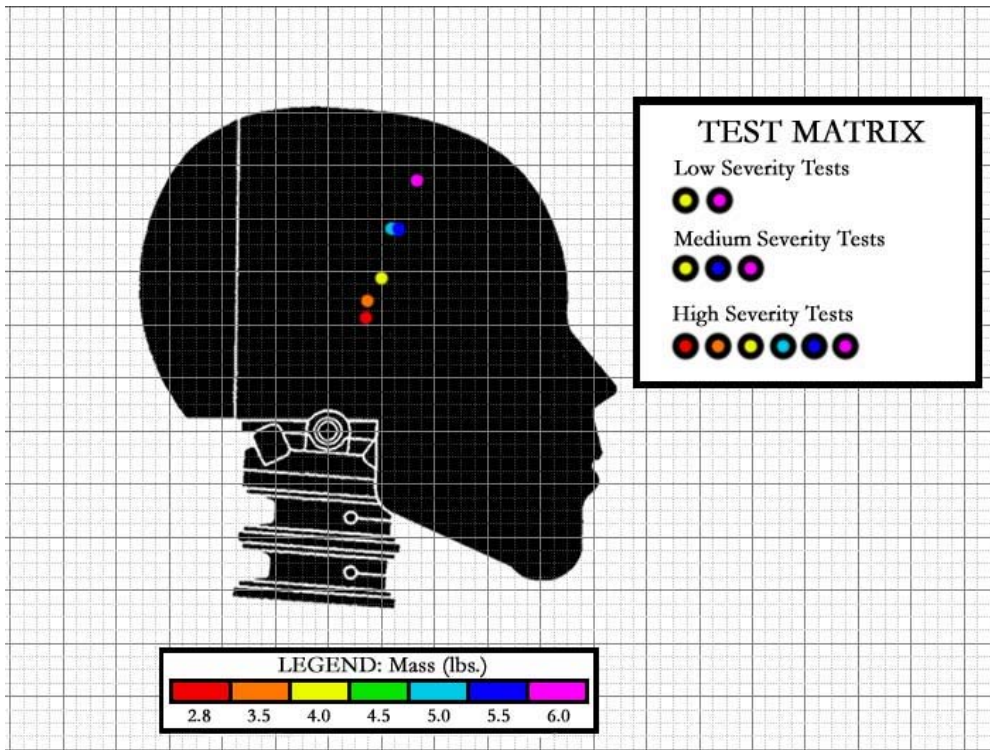

Figure 12: Large Male Added Head Masses Tested

Table 5: Test Matrix for Horizontal Sled Tests  
(All tests were 30-deg pitch down)

Test No.	Manikin (%ile)	Test Pulse Configuration <sup>(1)</sup>	Added Head Weight and CG Location <sup>(2)</sup>	Theta (deg)	Weight Locations	
Low Severity Pulse						
514	5 <sup>th</sup> Female	Max G = 16.25 V (ft/sec) = 25.0	W = 4.0 lb R = 3.0 in.	70.1	F5=1.75 Z2=2	
515	5 <sup>th</sup> Female	Max G = 16.25 V (ft/sec) = 25.0	W = 5.0 lb R = 4.0 in.	67.5	F1=1 F5=2.5	X-1=0.5 X4=0.5
516	5 <sup>th</sup> Female	Max G = 16.25 V (ft/sec) = 25.0	W = 5.5 lb R = 4.5 in.	69.5	F2=2 F6=2	X5=0.5 Z4=0.5
517	5 <sup>th</sup> Female	Max G = 16.25 V (ft/sec) = 25.0	W = 6.0 lb R = 5.0 in.	66.9	F6=3 Z7=2.5	
530	50 <sup>th</sup> Male	Max G = 16.25 V (ft/sec) = 25.0	W = 4.0 lb R = 3.0 in.	67.7	F2=1.25 F7=0.5	X4=1 Z2=1.5
531	50 <sup>th</sup> Male	Max G = 16.25 V (ft/sec) = 25.0	W = 6.0 lb R = 5.0 in.	67.9	F1=2.25 F4=1.5	F7=2 X5=0.5
512	95 <sup>th</sup> Male	Max G = 16.25 V (ft/sec) = 25.0	W = 4.0 lb R = 3.0 in.	70.6	F3=1.75 OC=2	X4=0.5 Z4=1
513	95 <sup>th</sup> Male	Max G = 16.25 V (ft/sec) = 25.0	W = 6.0 lb R = 5.0 in.	70.7	F3=2.5 F6=0.25	X5=2 Z7=2.5
Medium Severity Pulse						
577	5 <sup>th</sup> Female	Max G = 18.5 V (ft/sec) = 31.5	W = 3.5 lb R = 2.5 in.	67.5	F7=1 Z7=0.5	Z2=1.5
578	5 <sup>th</sup> Female	Max G = 18.5 V (ft/sec) = 31.5	W = 4.0 lb R = 3.0 in.	70.1	F5=1.75 Z2=2	
579	5 <sup>th</sup> Female	Max G = 18.5 V (ft/sec) = 31.5	W = 4.5 lb R = 3.0 in.	68.7	F1=0.25 F6=2	Z5=2
518	5 <sup>th</sup> Female	Max G = 18.5 V (ft/sec) = 31.5	W = 4.0 lb R = 3.0 in.	70.1	F5=1.75 Z2=2	
519	5 <sup>th</sup> Female	Max G = 18.5 V (ft/sec) = 31.5	W = 5.0 lb R = 4.0 in.	67.5	F1=1 F5=2.5	X-1=0.5 X4=0.5
520	5 <sup>th</sup> Female	Max G = 18.5 V (ft/sec) = 31.5	W = 5.0 lb R = 5.0 in.	72.2	F1=2 F6=2.75	
521	5 <sup>th</sup> Female	Max G = 18.5 V (ft/sec) = 31.5	W = 5.5 lb R = 4.0 in.	69.5	F2=2 F6=2	X5=0.5 Z4=0.5
522	5 <sup>th</sup> Female	Max G = 18.5 V (ft/sec) = 31.5	W = 5.5 lb R = 5.0 in.	69.6	F2=2.25 F6=2.75	
523	5 <sup>th</sup> Female	Max G = 18.5 V (ft/sec) = 31.5	W = 6.0 lb R = 5.0 in.	66.9	F6=3 Z7=2.5	
524	50 <sup>th</sup> Male	Max G = 18.5 V (ft/sec) = 31.5	W = 4.0 lb R = 3.0 in.	67.7	F2=1.25 F7=0.5	X4=1 Z2=1.5
525	50 <sup>th</sup> Male	Max G = 18.5 V (ft/sec) = 31.5	W = 4.5 lb R = 4.0 in.	67.0	F3=1.75 F6=1.5	Z1=1.5
526	50 <sup>th</sup> Male	Max G = 18.5 V (ft/sec) = 31.5	W = 5.0 lb R = 4.0 in.	72.2	F3=1.75 F6=1	X3=0.5 Z3=2
527	50 <sup>th</sup> Male	Max G = 18.5 V (ft/sec) = 31.5	W = 5.0 lb R = 5.0 in.	66.9	F3=1.5 F6=2.25	Z4=1.5
529	50 <sup>th</sup> Male	Max G = 18.5 V (ft/sec) = 31.5	W = 6.0 lb R = 5.0 in.	67.9	F1=2.25 F4=1.5	F7=2 X5=0.5
590	50 <sup>th</sup> Male	Max G = 18.5 V (ft/sec) = 31.5	W = 4.0 lb R = 3.0 in.	67.7	F2=1.25 F7=0.5	X4=1 Z2=1.5

Test No.	Manikin (%ile)	Test Pulse Configuration <sup>(1)</sup>	Added Head Weight and CG Location <sup>(2)</sup>	Theta (deg)	Weight Locations	
591	50 <sup>th</sup> Male	Max G = 18.5 V (ft/sec) = 31.5	W = 5.0 lb R = 4.0 in.	72.2	F3=1.75 F6=1	X3=0.5 Z3=2
592	50 <sup>th</sup> Male	Max G = 18.5 V (ft/sec) = 31.5	W = 5.5 lb R = 5.0 in.	69.8	F3=1.5 OC=2	X4=0.5 Z4=1
593	50 <sup>th</sup> Male	Max G = 18.5 V (ft/sec) = 31.5	W = 6.0 lb R = 5.0 in.	67.9	F1=2.25 F4=1.5	F7=2 X5=0.5
509	95 <sup>th</sup> Male	Max G = 18.5 V (ft/sec) = 31.5	W = 4.0 lb R = 3.0 in.	70.6	F3=1.75 OC=2	X4=0.5 Z4=1
510	95 <sup>th</sup> Male	Max G = 18.5 V (ft/sec) = 31.5	W = 5.5 lb R = 4.0 in.	70.8	F5=2.5 Back=0.25	X1=2 Z7=2
511	95 <sup>th</sup> Male	Max G = 18.5 V (ft/sec) = 31.5	W = 6.0 lb R = 5.0 in.	70.7	F3=2.5 F6=0.25	X5=2 Z7=2.5
<b>High Severity Pulse</b>						
537	5 <sup>th</sup> Female	Max G = 19.0 V (ft/sec) = 50.0	W = 3.5 lb R = 2.5 in.	67.5	F7=1 Z7=0.5	Z2=1.5
538	5 <sup>th</sup> Female	Max G = 19.0 V (ft/sec) = 50.0	W = 4.0 lb R = 3.0 in.	70.1	F5=1.75 Z2=2	
539	5 <sup>th</sup> Female	Max G = 19.0 V (ft/sec) = 50.0	W = 2.8 lb R = 2.25 in.	77.5	F7=0.5 Z3=2.0	
540	5 <sup>th</sup> Female	Max G = 19.0 V (ft/sec) = 50.0	W = 2.8 lb R = 2.25 in.	77.5	F7=0.5 Z3=2.0	
586	50 <sup>th</sup> Male	Max G = 19.0 V (ft/sec) = 50.0	W = 2.8 lb R = 2.25 in.	70.6	F3=0.75 X4=0.5	Z1=2.0
587	50 <sup>th</sup> Male	Max G = 19.0 V (ft/sec) = 50.0	W = 3.5 lb R = 2.5 in.	66.7	F1=0.25 F5=0.5	X4=1 Z3=2.0
588	50 <sup>th</sup> Male	Max G = 19.0 V (ft/sec) = 50.0	W = 4.0 lb R = 3.0 in.	67.7	F2=1.25 F7=0.5	X4=1 Z2=1.5
589	50 <sup>th</sup> Male	Max G = 19.0 V (ft/sec) = 50.0	W = 4.5 lb R = 4.0 in.	67.0	F3=1.75 F6=1.5	Z1=1.5
580	95 <sup>th</sup> Male	Max G = 19.0 V (ft/sec) = 50.0	W = 2.8 lb R = 2.25 in.	71.4	F5=0.75 X3=0.5	Z2=3.0
581	95 <sup>th</sup> Male	Max G = 19.0 V (ft/sec) = 50.0	W = 3.5 lb R = 2.5 in.	72.9	F2=1.25 F6=2.25	Z5=2
582	95 <sup>th</sup> Male	Max G = 19.0 V (ft/sec) = 50.0	W = 4.0 lb R = 3.0 in.	70.6	F3=1.75 OC=2	X4=0.5 Z4=1
583	95 <sup>th</sup> Male	Max G = 19.0 V (ft/sec) = 50.0	W = 5.0 lb R = 4.0 in.	72.9	F5=2 Back=0.25	X1=2 Z7=2
584	95 <sup>th</sup> Male	Max G = 19.0 V (ft/sec) = 50.0	W = 5.5 lb R = 4.0 in.	70.8	F5=2.5 Back=0.25	X1=2 Z7=2
585	95 <sup>th</sup> Male	Max G = 19.0 V (ft/sec) = 50.0	W = 6.0 lb R = 5.0 in.	70.7	F3=2.5 F6=0.25	X5=2 Z7=2.5

- NOTES: (1) Peak G's and peak velocities are stated as minimum values  $\pm 10\%$ .  
(2) CG location from OC does NOT include the mass of the head.



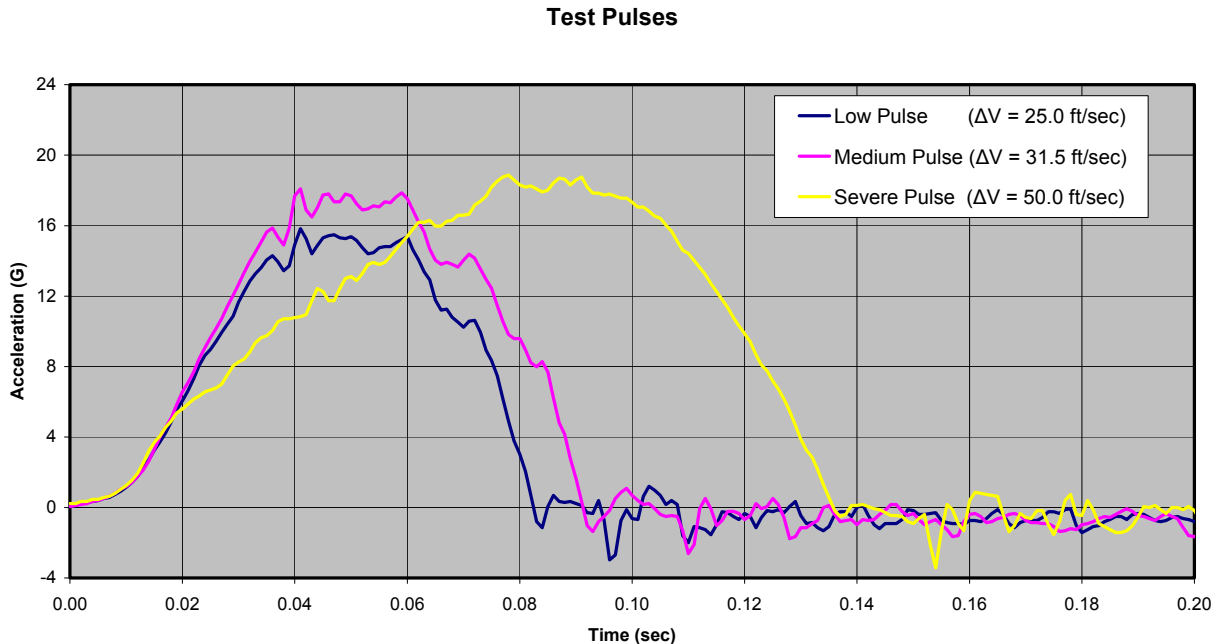

Figure 13: Pulses Used for the HA Testing

#### 1.4.4 CERVICAL INJURY ANALYSIS

1.4.4.1 A comprehensive analysis of the data was performed using the available injury predictors to determine the likelihood of injury to the upper and lower cervical spine. These criteria have been developed and established by the automotive and military environments over the past four decades. These criteria reflect the most current knowledge and understanding of cervical injury limits and have been jointly agreed upon by the U.S. Navy and U.S. Air Force for use in such programs as Stability Improvement Program and Joint Strike Fighter. While these are noncrashworthy programs, the injury criteria are still valid for use in this study. Critical moment values were specified for flexion and extension about the y-axis and force duration curves were generated for axial tension, compression, lateral bending, and shear. The injury criteria are described in more detail in appendix G. It is important to point out that only specific crash pulses and orientations were modeled and tested. Testing was conducted only in the X-Z plane, even though it was understood that helicopters may impact at any orientation, because this was expected to maximize the forces ( $F_x$  and  $F_z$ ) and moments ( $M_y$ ) recorded by the manikin in the sagittal plane. Cervical injury criteria have not been adequately developed for lateral and rotational moments about the neck ( $M_x$  and  $M_z$ ).

1.4.4.2 In addition, it was assumed through the course of this effort that the aviator would be properly restrained in the seat during the crash event. Out of position occupants were not modeled as a course of this effort (i.e., occupant looking back over their shoulder at the time of impact). Occupants who have their heads turned at the time of impact will have much greater risk of cervical injury. The result of this study is a probability of cervical injury, based on aviator size, helmet mass, and impact severity, to be used as design criteria for helmets and helmet-mounted systems for rotary wing aircraft. The results of this analysis are subject to change

following any changes or modifications to the dynamic properties of the seat (i.e., improved crashworthiness) or restraint system (i.e., neck load mitigation devices), interior cockpit structures or configuration, structural crash properties of the helicopter, aviator population, or development of improved neck injury criteria. In addition, the results of this analysis are to be used solely as a baseline for helmet and helmet-mounted system development. Final system configuration may have unforeseen effects that could not be represented in the study. Therefore, systems level testing would still be required with any new helmet or helmet-mounted system.

## 1.5 METHOD OF TESTS

1.5.1 The following criteria were used to determine if the acceptable tests were successful:

- a. The electronic instrumentation data and/or optical data were adequate to allow analysis of the test as determined by the NAWCAD Patuxent River Code 4.6.2.1 Project Engineer. For example, a loss of the critically-designated instrumentation channels would be considered unacceptable.
- b. The test support equipment and the test article were installed correctly and operated properly, resulting in sufficient data for analysis.
- c. The HYGE test facility operated as required during the test. For example, the crash pulse parameters were within the tolerance bands approved by this test plan.
- d. The test items remained structurally intact under crash acceleration.

1.5.2 The HA facility was used to produce dynamic conditions simulating a high-speed impact of a rotary wing aircraft into the ground at a pitch of 30 deg.

1.5.3 Data collected for each test included test records, photographic data, and electronic instrumentation data. All records were identified with the project title and number. To permit independent analysis, they were also labeled with sensor identification, calibration values, resistance, and sensitivity.

1.5.4 In order to allow for posttest data processing, data channels were collected and delivered in ASCII format. These data files were transferred to an IBM-PC compatible computer for additional processing using Matlab. The sensors used had been dynamically calibrated within 12 months prior to the test start date. Table 6 lists the required instrumentation for each test.



Table 6: Instrumentation Index for Horizontal Sled Tests

No.	Sensor Location	Sensor Measurement	Filter Sample Rate (Hz)	Sensor Range
1	Test Sled, Gx	Linear acceleration*	1000	-10/+50
2	Test Sled, Gx	Linear acceleration	1000	-10/+50
3	Test Sled	Seat First Motion	1000	Breakwire
4	Seat Pan	Linear x-acceleration*	1000	±100G
5		Linear z-acceleration*	1000	±100G
6	Yoke Restraint	Tension Gauge	1000	±3,000 lb
7	Manikin Head	Linear x-acceleration*	1000	±100G
8		Linear y-acceleration	1000	±100G
9		Linear z-acceleration*	1000	±100G
10	Manikin Head	Angular y-acceleration*	1000	
11	Manikin Chest	Linear x-acceleration	1000	±100G
12		Linear z-acceleration	1000	±100G
13	Manikin Chest	Angular y-acceleration*	1000	
14	Manikin Upper Neck	Force x-direction*	1000	±2,000 lb
15		Force z-direction*	1000	±2,000 lb
16		Moment y-direction*	1000	±3,000 in.-lb
17	Manikin Lower Neck	Force x-direction*	1000	±2,000 lb
18		Force z-direction*	1000	±2,000 lb
19		Moment y-direction*	1000	±6,000 in.-lb
20	Manikin Lower Thorax	Force x-direction <sup>†</sup>	1000	±2,000 lb
21		Force z-direction <sup>†</sup>	1000	±4,000 lb
22		Moment y-direction <sup>†</sup>	1000	±4,000 in.-lb
23	Manikin Pelvis	Force x-direction	1000	±2,000 lb
24		Force z-direction*	1000	±4,000 lb
25		Moment y-direction	1000	±2,000 in.-lb

\* denotes mandatory channels for all tests.  
<sup>†</sup> denotes additional channels only for 50<sup>th</sup> percentile manikin tests.

1.5.5 Two imagers were positioned to record the crash event. Photographic targets were located on the manikin and crashworthy seat to allow video analysis of angular displacement of the head and torso. The following cameras were required:

- Imager 1 Onboard, 1,000 f/s recording speed, providing front view of ATD head and torso motion.
- Imager 2 Deck, 1,000 f/s recording speed, providing side view of sled travel and ATD head and torso motion.

1.5.6 Still pretest and posttest digital photographic coverage was provided as necessary during the test series. A minimum of four pretest and four posttest still photographs were required for each test. The stills were downloaded onto a CD and provided to the project engineer.

1.5.7 The project engineer maintained a log containing program notes and remarks. These remarks included observations made during the test program.

## 1.6 CHRONOLOGY

1.6.1 The following is a chronology of this test program:

- |                       |  |
|-----------------------|--|
| a. Initial planning   | July 2002  |
| b. Test plan approved | September 2002                                       |
| c. Test dates         | 24 September - 8 October 2002<br>21 –28 January 2003 |
| d. Data reduction     | February/March 2003                                  |
| e. Report drafted     | April 2003   |

## 1.7 PERSONNEL

1.7.1 The following is a list of the core personnel who participated in this test program:

<u>Name</u>	<u>Code</u>	<u>Phone Number</u>	<u>Function</u>
Glenn Paskoff	4.6.2.1	(301) 342-8469	Lead Project Engineer
Edwin Sieveka	4.6.2.2	(301) 342-8433	Computer Modeling Engineer
Angie Starner	4.6.2.2	(301) 342-8443	Project Engineer
John Kerr	4.6.2.2	(301) 342-8415	HA Facility Manager
Tho Do	4.6.2.2	(301) 342-8478	Data Acquisition

THIS PAGE INTENTIONALLY LEFT BLANK

## 2.0 RESULTS AND EVALUATION

### 2.1 COMPUTER MODEL VALIDATION

#### 2.1.1 RIGID CRASHWORTHY SEAT VERSUS ACTUAL STROKING SEAT

2.1.1.1 The rigid crashworthy seat was used during the course of the testing. However, the energy transmitted to the occupant through a rigid seat was drastically different from the energy transmitted to the occupant through a stroking crashworthy seat. It was intended that the tests mimic the head/neck response of an occupant in a stroking seat as closely as possible. Therefore, it was determined that modeling would be used to determine what the correct pulse applied to a rigid seat would need to be to 'simulate' the acceleration profile exhibited by a stroking seat. The MADYMO simulation code was set up for both the stroking seat and fixed seat cases. The stroking seat simulation represented the performance of a crashworthy seat subjected to an actual crash condition, and the fixed seat model represented the HA test condition.

2.1.1.2 The structural dynamic pulse requirements were run through the stroking seat simulation and the resulting seat accelerations were used as the input accelerations for the rigid seat model. Ultimately, the Y-axis neck moments, both upper and lower, were the target variables of interest, but the effort to achieve equivalence began with the pelvic acceleration. Since the interaction between the seat and the pelvis drove the rest of the body's response, it was felt that a reasonable match to the pelvic acceleration was the key to overall agreement. In the first iteration, the X-axis acceleration of the stroking seat was used as the driving acceleration of the fixed seat. This produced the pelvic acceleration shown in figure A-1. The agreement between the fixed and stroking models appeared reasonable, but the fixed model over-predicted the pelvic acceleration initially and under-predicted it later on. This is believed to have been due to the fact that the seat does not stroke horizontally. The seat was rotated 30 deg from horizontal to mimic the 30 deg pitch down test condition used in qualifying rotary wing crashworthy seats. Thus, as the seat stroked, it moved down as well as forward, as shown in figure 14. This led to a vertical component of acceleration,  $A_z$ , which in turn had a component normal to the seat bottom,  $A_z \cdot \sin(30 \text{ deg})$ . This component reduced the pelvic acceleration early in the event, but caused an increase toward the end. A correction factor, shown in the bottom right of figure 14, incorporated into the fixed seat pulse, provided a better overall match to the pelvic acceleration as shown in figure A-2.

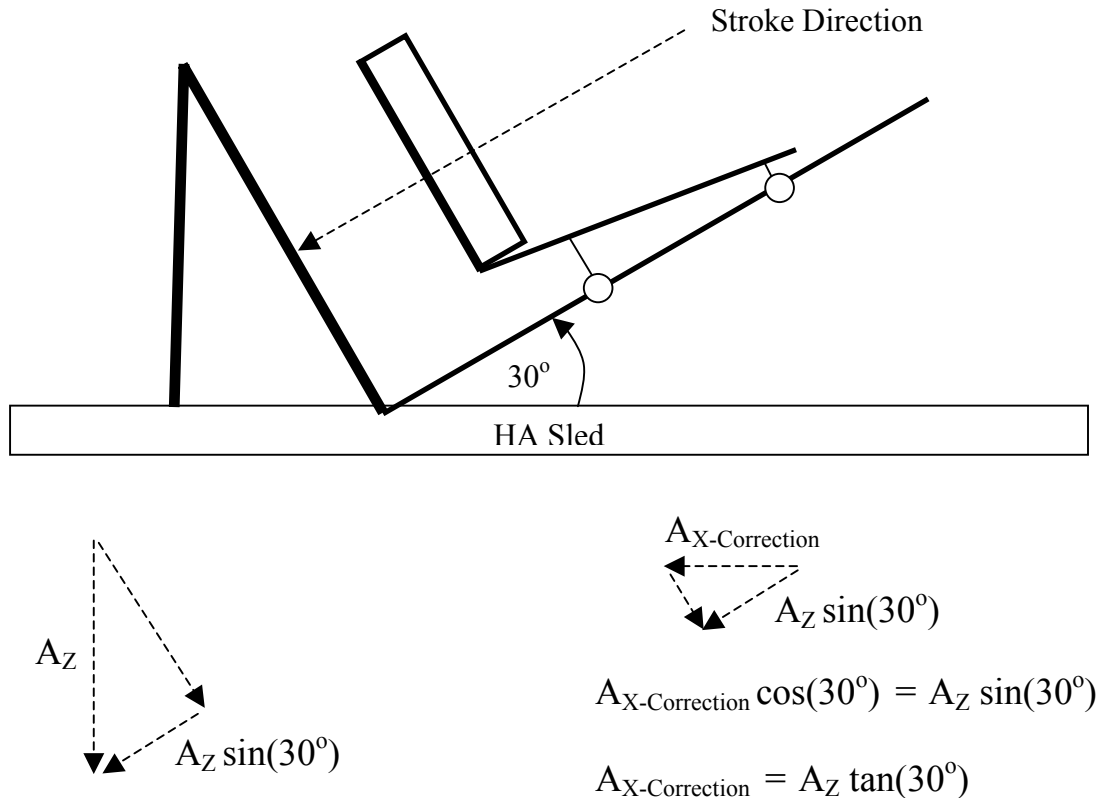

Figure 14: Derivation for Rigid Seat X-Acceleration Correction Factor

2.1.1.3 The stroking seat acceleration was a complex pulse that the HA facility was not able to duplicate. Therefore, simulations using approximations of this pulse (with the same total energy) were compared against the results of simulations using the actual pulse to determine the acceptability of altering the pulse profile.

2.1.1.4 Three stroking seat equivalent pulses were generated that represented low, medium, and high severity impact conditions. Good correlation was obtained for the low and medium severity pulses. It was determined that a 10-deg back wedge was required on the high severity tests to obtain the necessary correlation between models of the principal measurement parameters.

2.1.1.5 Results from the computer simulations using the simplified pulse were compared with results from the test data set under identical conditions.

## 2.1.2 TRAPEZOIDAL PULSE VERSUS “ACTUAL” PULSE

2.1.2.1 The equivalent pulses were integrated to obtain the Delta-V ( $\Delta V$ ) for each. Because the derived, equivalent pulses were too complex to be reproduced on the HA, the  $\Delta V$ 's were used to generate trapezoidal pulses with the same amount of energy absorption. These, in turn, were

“rounded” to produce target pulses that could be closely approximated on the HA. Runs with the original equivalent pulses, the trapezoidal pulses, and the rounded pulses showed little change where the critical neck moment parameters were concerned. This was probably because the peak values for the neck parameters occurred after the pulse was over. Delivering the right amount of energy, over approximately the correct time period appeared to be sufficient to obtain reasonable neck results. The rounded pulses were then used to approximate the centerline of the pulse corridor for the actual HA pulses (see figures A-3, A-4, and A-5).

### 2.1.3 10-DEGREE BACK PAD VALIDATION

2.1.3.1 Subsequent comparison of the neck moments for the low and medium severity pulses showed good agreement between the fixed and stroking seat simulations (figures A-6 through A-11). The high severity case, however, demonstrated large variations between the two models. This discrepancy was due mainly to the extended time-span and seat-stroke distance in these runs. This allowed the body to reposition itself with a significant forward lean, prior to the time of maximum head motion. To compensate for this with the fixed seat, an initial, forward angle of 10 deg was added to the torso of the manikins in the high-energy simulations. This produced much better neck moment agreement, as shown in figures A-12, A-13, and A-14. Additional angles were investigated, but 10-deg appeared to provide the optimal fit of the rigid seat approximation of the stroking seat model.

### 2.1.4 COMPARISON WITH 4.0 LB ADDED HEAD WEIGHT TEST DATA

2.1.4.1 The computer model predicted results of the 4.0 lb added head weight were compared with the test data using the same configuration. Note that the computer model used for comparison used the ‘rounded’ trapezoid pulse (with the 10-deg back pad for the high severity cases). In general, the trends predicted by the model agreed very well with the test data results (figures A-15 through A-68). However, the model tended to under-predict the peak values for most of the neck parameters in the low and medium severity cases. In the high severity cases, the peak values usually occurred earlier in the model than in the sled tests. This was likely due to the fact that the high severity pulse used in the testing was of longer duration with a lower G-onset rate than that used in the simulations.

## 2.2 SMALL FEMALE TESTS

2.2.1 Seventeen tests were conducted with the small female manikin. Plots of the critical parameters are found in appendix B. The manikin total instrumented weight (without any added head mass) was 118 lb. The small female test results demonstrated the increased risk of neck injury to small aviators during helicopter impact conditions. Even during the low severity pulses, the  $N_{ij}$  values and compression duration approached the limits for injury. The principal load vectors were compression and neck flexion/extension during impact.

## 2.3 MID-MALE TESTS

2.3.1 Fifteen tests were conducted with the mid-sized male manikin. Plots of the critical parameters are found in appendix C. The manikin total instrumented weight (without any added head mass) was 184 lb. The mid-male test results demonstrated the most variation in peak values of the three manikin sizes tested. But, this scatter was consistent with results obtained from the computer simulations under identical conditions. Therefore, it is believed that the angle of the restraint yoke, which stemmed from a fixed slot on the rigid crashworthy seat, had a dominating effect on the kinematics of the occupant. However, further testing would be required to validate this theory.

## 2.4 LARGE MALE TESTS

2.4.1 Eleven tests were conducted with the large male manikin. Plots of the critical parameters are found in appendix D. The manikin total instrumented weight (without any added head mass) was 224 lb. The large male manikin was the only manikin size to pass the dual neck injury criteria under the most severe impact conditions tested. However, this only occurred during the test with the lightest added head mass.

## 2.5 EFFECT OF AVIATOR SIZE, HELMET MASS PROPERTIES, AND PULSE SEVERITY

2.5.1 Pulse severity was undeniably the most dominant variable examined during the study. This was evident by the relatively small slope in all of the peak value plots when added head mass was increased (figures E-1 through E-8). The effect of gender was more related to the different values for the neck injury limits that were scaled according to weight. Therefore, despite the fact that the cervical forces and moments were lowest in magnitude in the small female tests, because the injury criteria limits were also reduced, the benefits were negated. Added head mass and CG statistically had very little effect when contrasted with test variability.

2.5.2 The peak values are listed in table E-1. Trends with added head mass were more noticeable during the lower severity pulses, when the total energy experienced by the occupant was not so severe (figures E-1 through E-8). This was evident by the amount of scatter present in the data for the higher severity pulses. A summary of the results of the neck injury analysis is shown in table 6. This table may be used as a guideline when determining the risk to the aviator for a particular helmet system. All of the aviator sizes tested passed the low severity tests for all of the added head weights tested (up to 6 lb). For the medium severity tests, only the mid-male and large male passed the neck injury criteria for all of the added head weights tested (up to 6 lb). The small female reached the limit at approximately 4 lb. For the high severity tests, the small female and mid-male failed for all of the added head weights tested. The large male passed the neck injury criteria only for the lowest added head weight (2.8-3.0 lb). It is important to point out that nearly 90% of all survivable Naval helicopter mishaps occur at an impact level that is equal to or less than the high severity pulse (50 ft/sec) that was used for these tests.

Table 7: Test Results Indicating Pass/Fail Status Regarding Neck Injury Criteria for all Tests

Test No.	Pulse Severity	Added Head Weight (lb)	Pass = <span style="background-color: green; border: 1px solid black; display: inline-block; width: 15px; height: 10px;"></span>	Fail = <span style="background-color: red; border: 1px solid black; display: inline-block; width: 15px; height: 10px;"></span>
			Marginal = <span style="background-color: orange; border: 1px solid black; display: inline-block; width: 15px; height: 10px;"></span>	
		Nij Criteria		Load Duration
Small Female				
514	Low	4.0		
515	Low	5.0		
516	Low	5.5		
517	Low	6.0		
577	Medium	3.5		
518	Medium	4.0		
578	Medium	4.0		
579	Medium	4.5		
519	Medium	5.0		
520	Medium	5.0		
521	Medium	5.5		
522	Medium	5.5		
523	Medium	6.0		
539	High	2.8		
540	High	2.8		
537	High	3.5		
538	High	4.0		
Mid-Male				
530	Low	4.0		
531	Low	6.0		
524	Medium	4.0		
525	Medium	4.5		
526	Medium	5.0		
527	Medium	5.0		
529	Medium	6.0		
590	Medium	4.0		
591	Medium	5.0		
592	Medium	5.5		
593	Medium	6.0		
586	High	2.8		
587	High	3.5		
588	High	4.0		
589	High	4.5		
Large Male				
512	Low	4.0		
513	Low	6.0		
509	Medium	4.0		
510	Medium	5.5		
511	Medium	6.0		
580	High	2.8		
581	High	3.5		
582	High	4.0		
583	High	5.0		
584	High	5.5		
585	High	6.0		



2.5.3 An analysis of variance (ANOVA) with a post hoc Tukey-Kramer test to determine the source of the difference was conducted on the principal neck parameters to determine whether any of the factors were statistically significant (defined as  $p \leq 0.05$ ). The results of the statistical analyses indicated that for each of the manikin sizes tested, added head mass did not have a significant effect on the magnitude of the forces or moments measured. However, forces and moments were still observed to increase as added head mass was increased. There was a significant effect of the severity of the applied pulse for all parameters except lower neck tension. Since pulse severity was the dominant factor, as compared to weight or manikin size, ANOVA for the effects of these two factors were also conducted for each individual pulse type. Size was a significant factor (1) in the low severity tests for all parameters except the upper neck flexion moment, (2) in the medium severity tests for all parameters except the lower neck tension, and (3) in the high severity tests for all parameters except the upper neck tension. It is important to note that the results of these statistics were based upon a small sample size with very few repeated measures. Additional testing under identical test conditions would be required to improve the statistical confidence.

2.5.4 It is important to point out that these results were based upon a single impact orientation. The 30-deg pitch down configuration was chosen because it was believed that this orientation would maximize the forces and moments along a single plane (sagittal) in terms of loading vector and kinematics. However, this may or may not represent the worst-case scenario with regard to injury. Further testing would be required with combinations of pitch, yaw, and roll to resolve this. Injury criteria that were developed for axial loading were deemed not applicable due to the orientation of the applied loads. Instead, the National Highway Traffic Safety Administration (NHTSA) validated Head Nij criterion (appendix G) was used to evaluate the potential for neck injury due to combined loading effects. Critical values for tension, compression, flexion moment, and extension moment were scaled to represent approximately a 5% probability of injury for the different anthropometric sizes tested.

2.5.5 The Nij criterion was evaluated at the base of the neck. Values above 1.5 may be representative of injury to the lower neck. However, an injury criterion at this location of the neck has never been validated and subjective assessments only may be made. Nevertheless, the values are reported and graphed in appendix E.

## 3.0 CONCLUSIONS

### 3.1 GENERAL

3.1.1 The crash pulses used in the course of this study, in conjunction with the rigid crashworthy seat, ranged from an expected survivable impact (for all aviator sizes) to a very severe impact.

3.1.2 Sample sizes for any given configuration were very small due to the large number of variables examined.

3.1.3 The results indicated the importance, from a programmatic standpoint, of determining early on what impact level (determined from the mishap data) would provide a sufficient level of protection based upon the mission and user population.

### 3.2 SPECIFIC

3.2.1 For the low severity pulse tests, neck injury analysis results were below injury threshold levels for all anthropometric sizes tested with all added head mass configurations (paragraph 2.5.2). This impact condition encompassed approximately 63% of all helicopter mishaps (land and water).

3.2.2 For the medium severity pulse tests, neck injury analysis results were below injury threshold levels for the mid-male and large male with all added head mass configurations. The small female approached the limit for cervical tolerance around four pounds of added head mass (paragraph 2.5.2). This impact condition encompassed approximately 71% of all helicopter mishaps (land and water).

3.2.3 For the high severity pulse tests, neck injury analysis results were exceeded for the small female and mid-male with all added head mass configurations. The large male passed the dual neck injury criteria only for the lowest weight configuration tested (paragraph 2.5.2). This impact condition encompassed approximately 89% of all helicopter mishaps (land and water).

3.2.4 The results of the statistical analyses indicated that for each of the manikin sizes tested, added head mass did not have a significant effect on the magnitude of the forces or moments measured. Size was found to have a significant effect on most of the parameters that were measured. Pulse severity was found to be extremely significant (paragraph 2.5.3).

#### 4.0 RECOMMENDATIONS

4.1 Use Phase II test data to further validate computer models. Once validated, computer models may be used to vary helmet weight and CG to provide additional data points for untested configurations.

4.2 Conduct further testing to improve the statistical significance of each tested configuration. Additional testing would provide greater confidence in quantitatively establishing the injury threshold for all aviator sizes given changes to added head weight and impact condition.

4.3 Conduct further testing examining the effects of roll, pitch, and yaw on the observed cervical forces and moments and compare results with current neck injury criteria.

4.4 Revise mass properties guidelines based upon improved dataset.

REFERENCES

1. Chandler, R.F., Development of Crash Injury Protection in Civil Aviation, Accidental Injury: Biomechanics and Prevention, ed. by A. M. Nahum and J. W. Melvin, Springer-Verlag: New York, 1993.
2. Coltman, J.W., Evaluation of the Crash Environment and Injury-Causing Hazards in U.S. Navy Helicopters, SAFE Journal Vol. 16, No. 1.
3. Coltman, J.W., Fax transmittal, of 2 May 2003.
4. Denton drawings for load cells: Model J-1716, J-1794, and J-5832.
5. Department of the Army. Aircraft Crash Survival Design Guide, USAAVSCOM TR 89-D-22, 1989.
6. Eppinger, et al., “Development of Improved Injury Criteria for the Assessment of Advanced Automotive Restraint Systems”, of Nov 1999.
7. Eppinger, et al., Supplement: “Development of Improved Injury Criteria for the Assessment of Advanced Automotive Restraint Systems – II”, of Mar 2000.
8. JSF Joint Model Specifications, Appendix C: Section 3.2, of Jan 2003.
9. Kleinberger, et al., “Development of Improved Injury Criteria for the Assessment of Advanced Automotive Restraint Systems”, NHTSA document, of Sep 1998.
10. Mertz, Irwin, Melvin, Stalnaker, and Beebe, “Size, Weight, And Biomechanical Impact Response Requirements for Adult Size Small Female and Large Male Dummies”, SAE Paper No. 890756, of Mar 1989.
11. Mertz, H., Injury Assessment Values Used to Evaluate Hybrid III Response Measurements NHTSA Docket 74-14, Notice 32, Enclosure 2 of Attachment I of Part III of General Motors Submission USG 2284, of 22 Mar 1984.
12. Mertz, H.J. and Patrick, L.M., “Strength and Response of the Human Neck”, SAE Technical Paper No. 710855, 1971.
13. Mertz, H.J. and Patrick, L.M., “Investigation of the Kinetics and Kinematics of Whiplash”, SAE Technical Paper No. 670919, 1967.
14. NHTSA, “FMVSS 208: Occupant Crash Protection”, Code of Federal Regulations, Title 49, Part 571.208.
15. Shanahan, D.F., “Basic Principles of Helicopter Crashworthiness”, USAARL 93-15, 1993.

16. Shanahan, D.F. and Shanahan, M.O., "Kinematics of U.S. Army Helicopter Crashes: 1979-1985", Aviation, Space, and Environmental Medicine, of Feb 1989.
17. Simula, Inc., "The Naval Aircraft Crash Environment: Aircrew Survivability and Aircraft Structural Response", NADC 88106-60 Final Report, of Sep 1988.
18. Whitley, P.E. and Paskoff, G.R., Gender-Related Spinal Injury Assessment Considerations in Military Aviation Occupant Protection Modeling, International Journal of Crashworthiness, 2000.
19. Whitley, P.E. and McConnell R., "Development of the V-22 Added Head Mass Criteria", Aviation, Space, and Environmental Medicine, 65(5):467, of May 1994.
20. Whitley, P.E. and McConnell R., "Methodology Development for Head-Mounted System (HMS) Analysis", Aviation, Space, and Environmental Medicine, 64(5):444, of May 1993.

APPENDIX A  
FIGURES  
(COMPUTER MODEL VALIDATION)

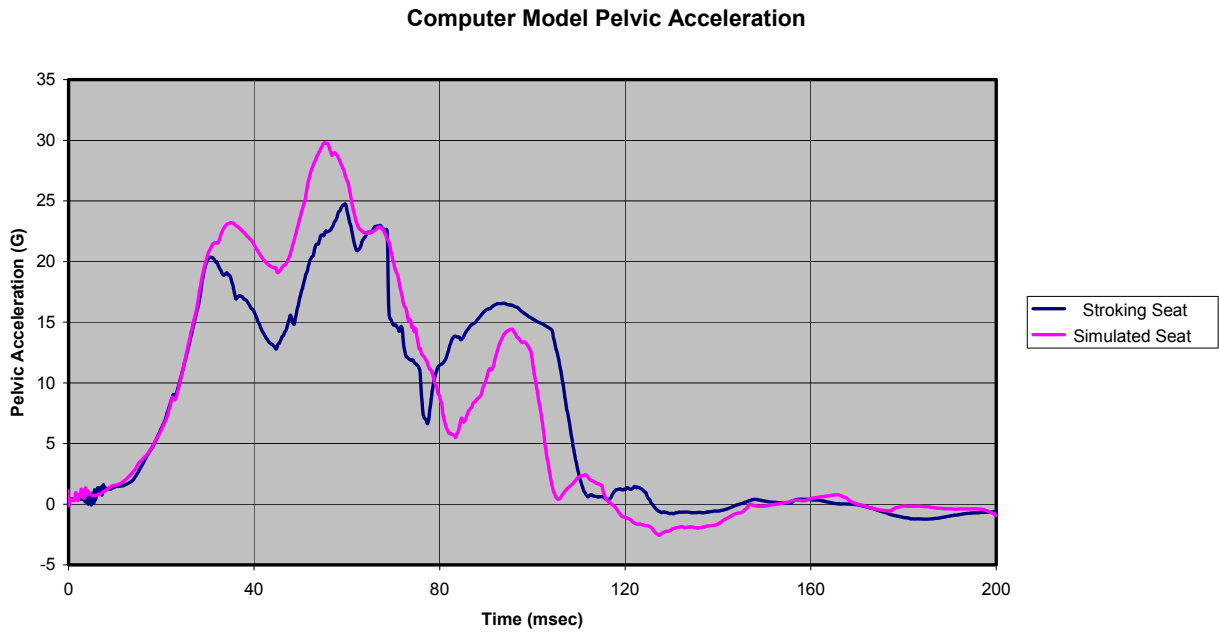

Figure A-1: Computer Model Validation (Strokling Seat versus Rigid Seat)

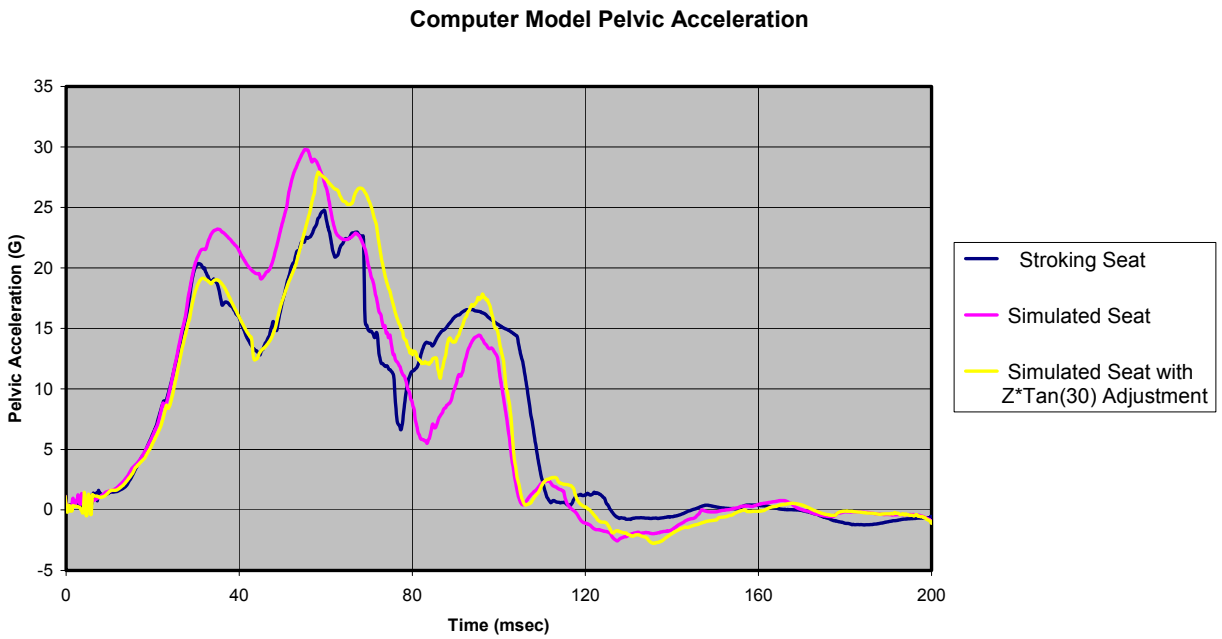

Figure A-2: Computer Model Validation (Strokling Seat versus Rigid Seat with Correction Factor)

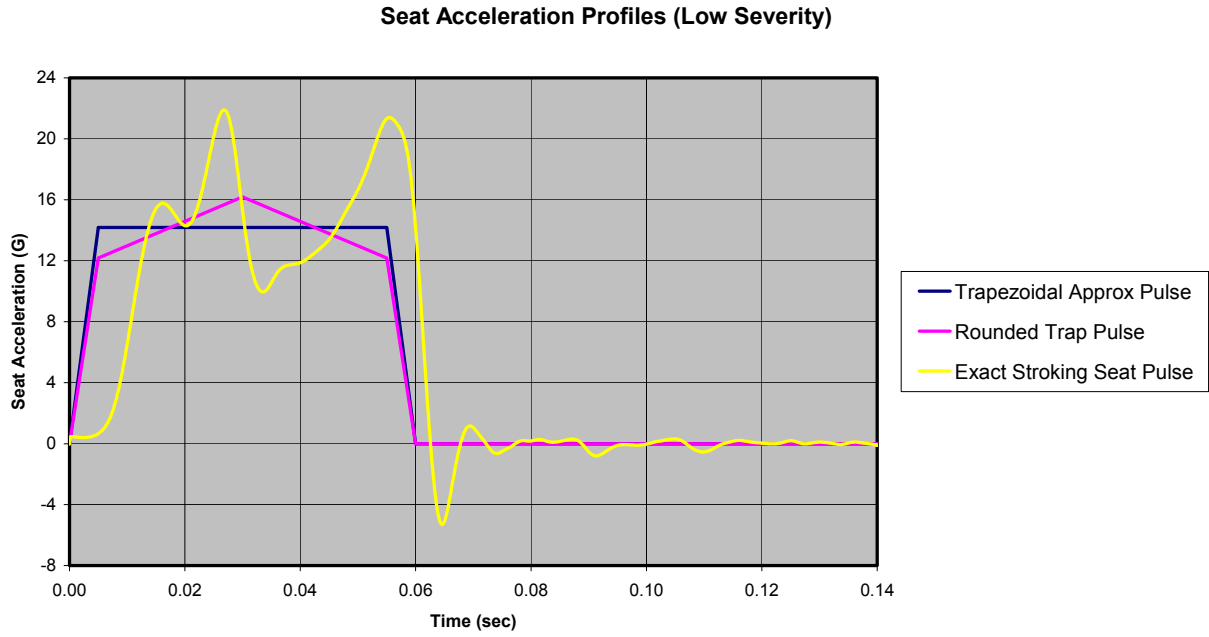

Figure A-3: Low Severity Seat Acceleration Profiles

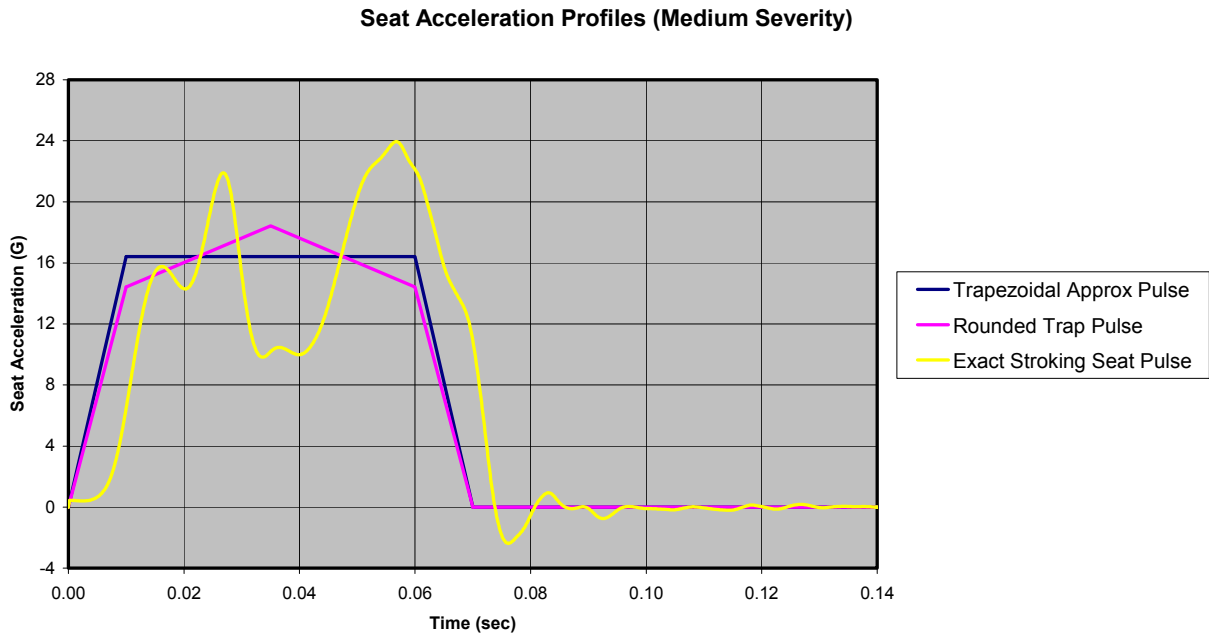

Figure A-4: Medium Severity Seat Acceleration Profiles



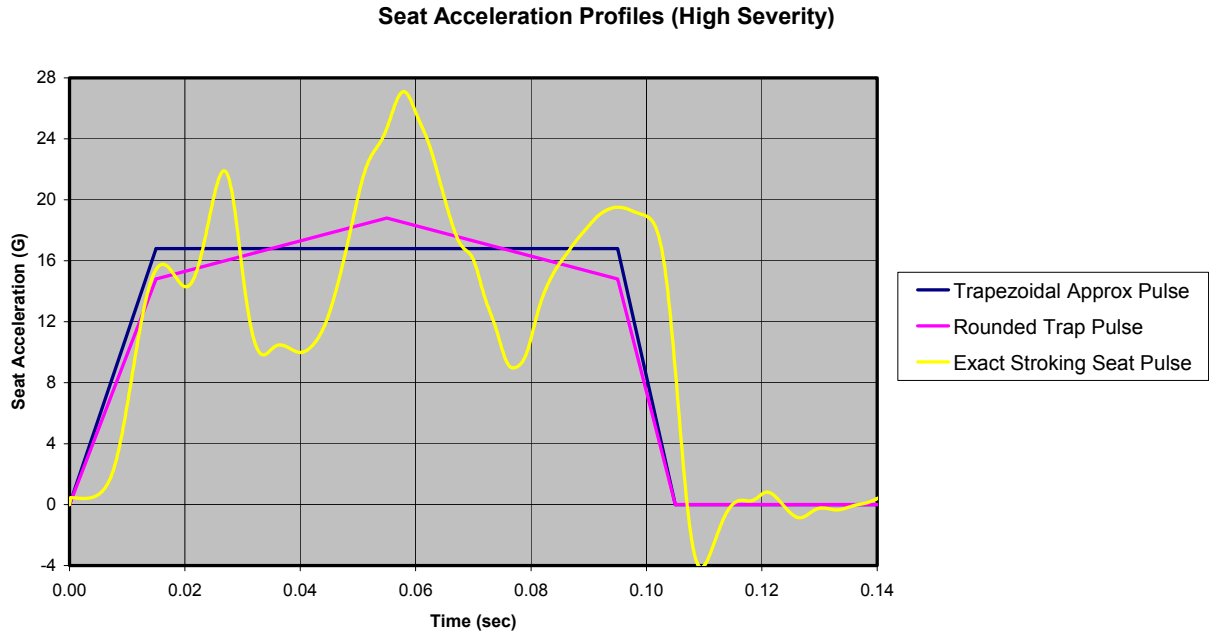

Figure A-5: High Severity Seat Acceleration Profiles

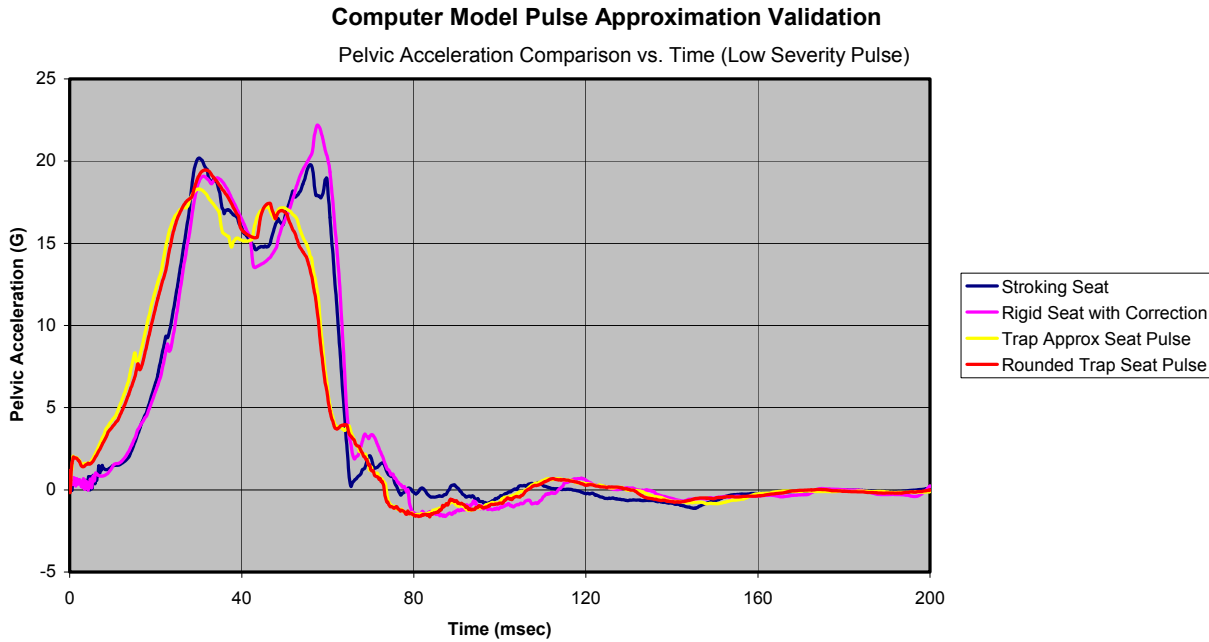

Figure A-6: Computer Model Pulse Approximation Validation (Low Severity Pulse)

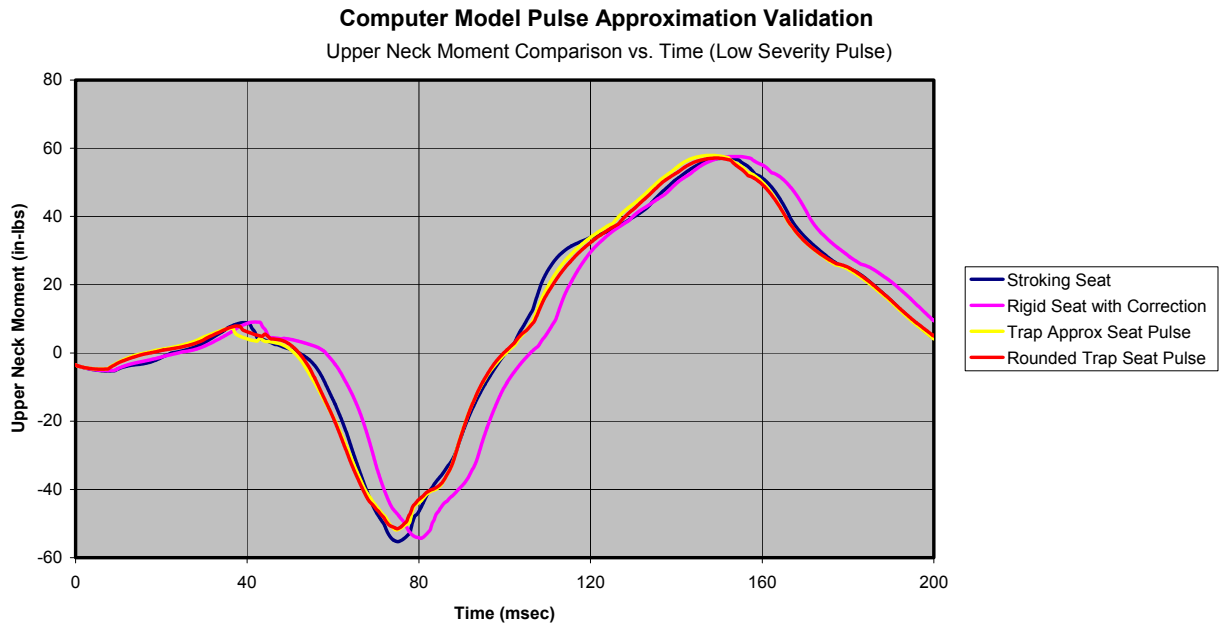

Figure A-7: Computer Model Pulse Approximation Validation (Low Severity Pulse)

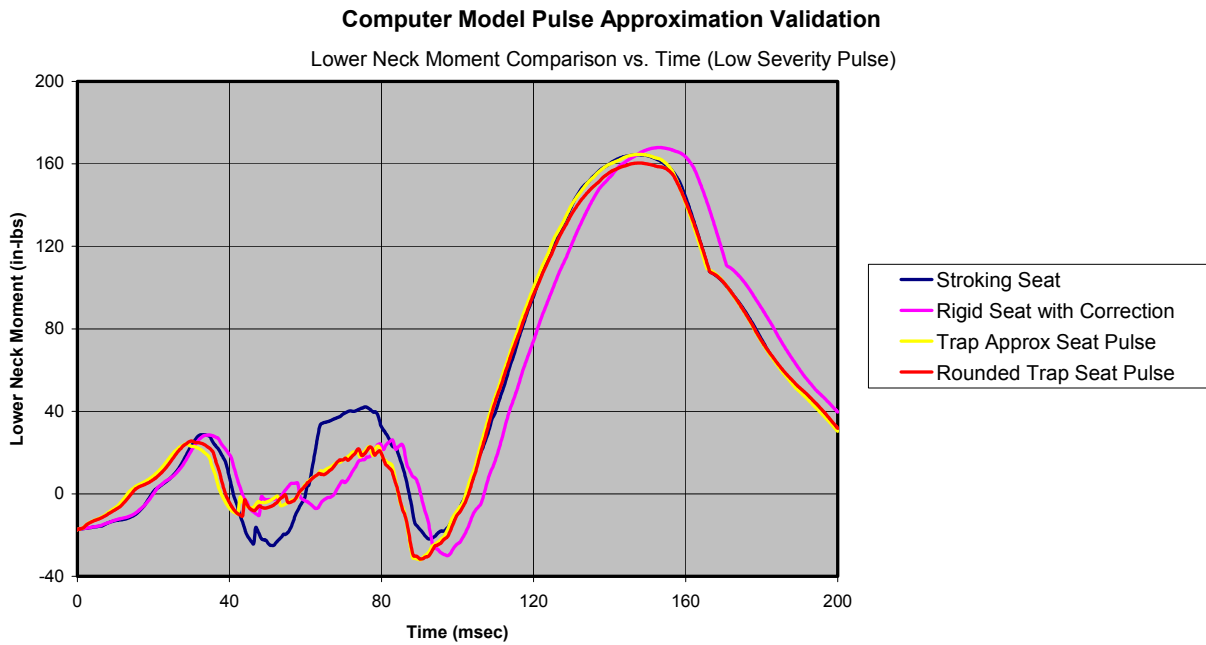

Figure A-8: Computer Model Pulse Approximation Validation (Low Severity Pulse)

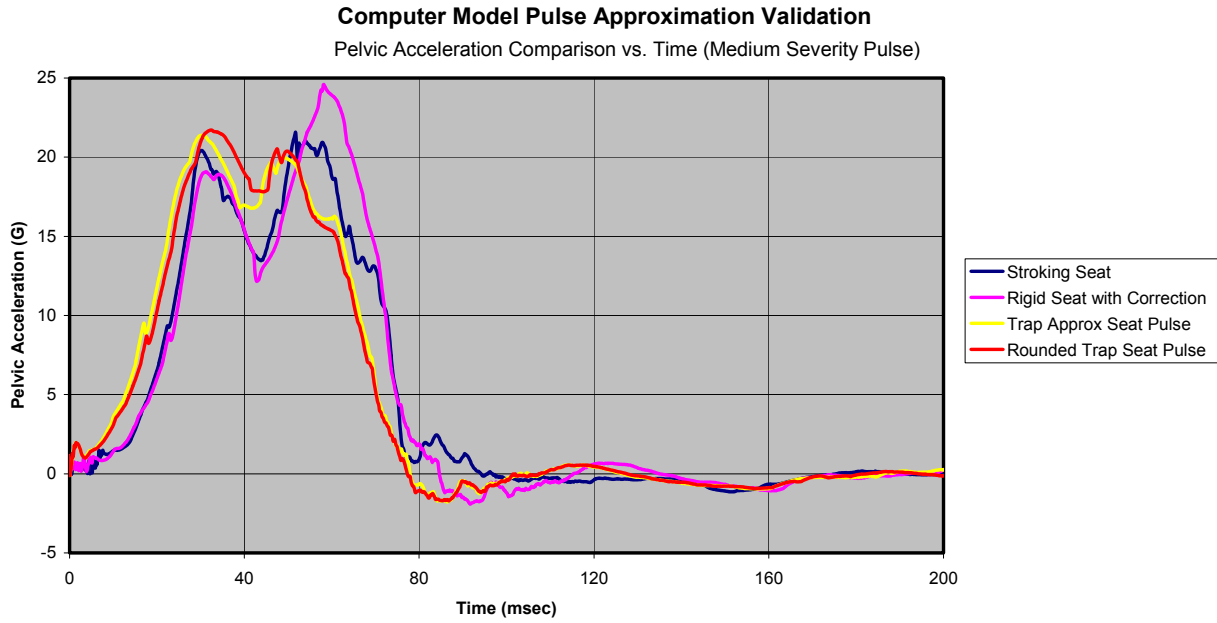

Figure A-9: Computer Model Pulse Approximation Validation (Medium Severity Pulse)

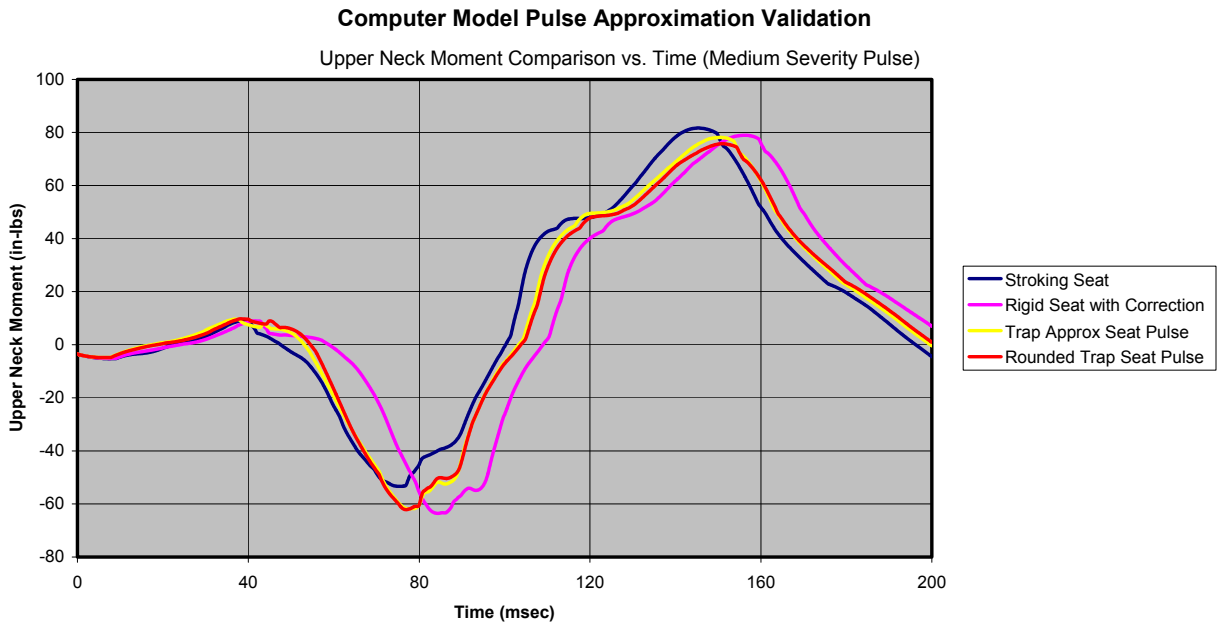

Figure A-10: Computer Model Pulse Approximation Validation (Medium Severity Pulse)

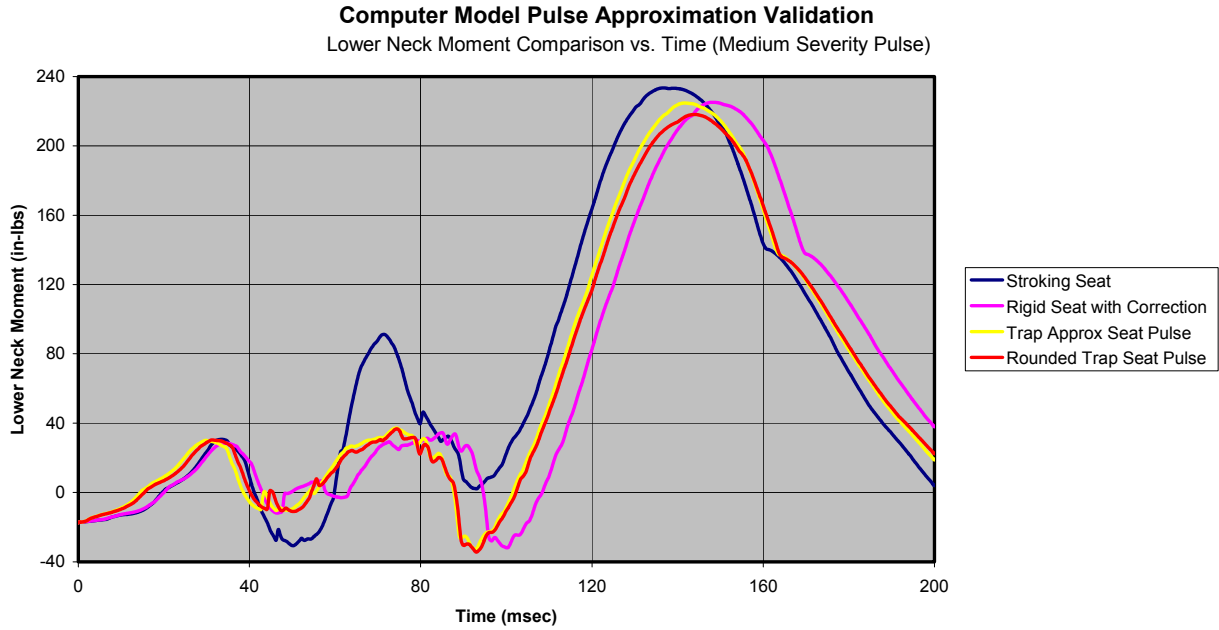

Figure A-11: Computer Model Pulse Approximation Validation (Medium Severity Pulse)

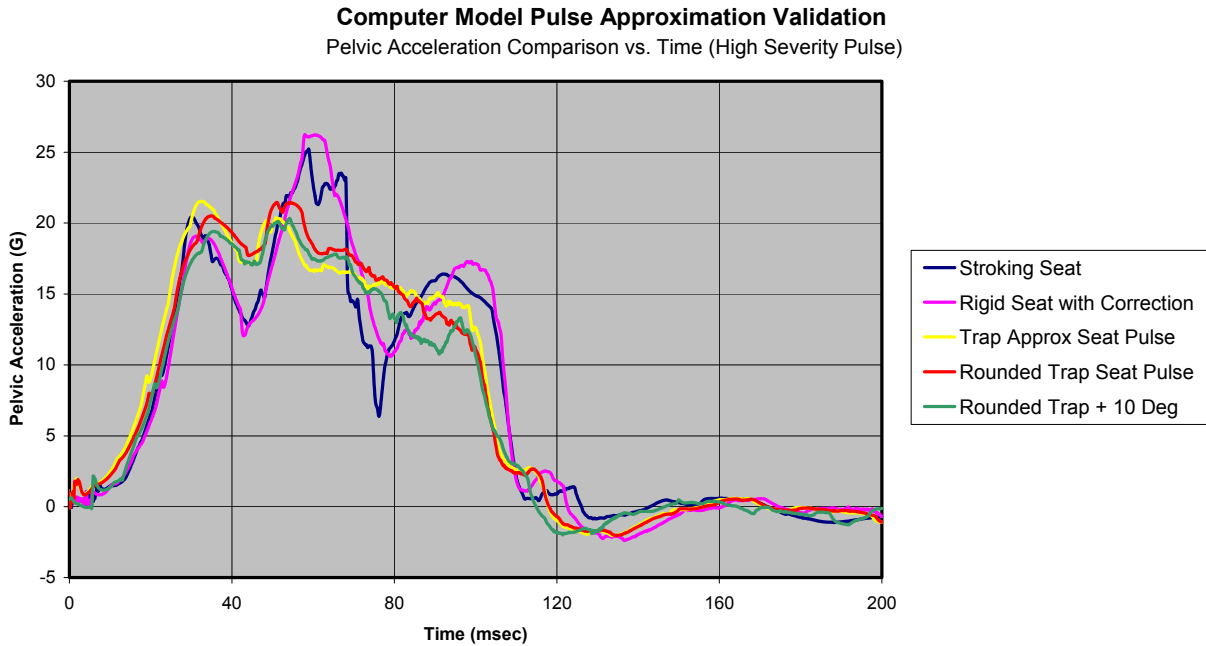

Figure A-12: Computer Model Pulse Approximation Validation (High Severity Pulse)

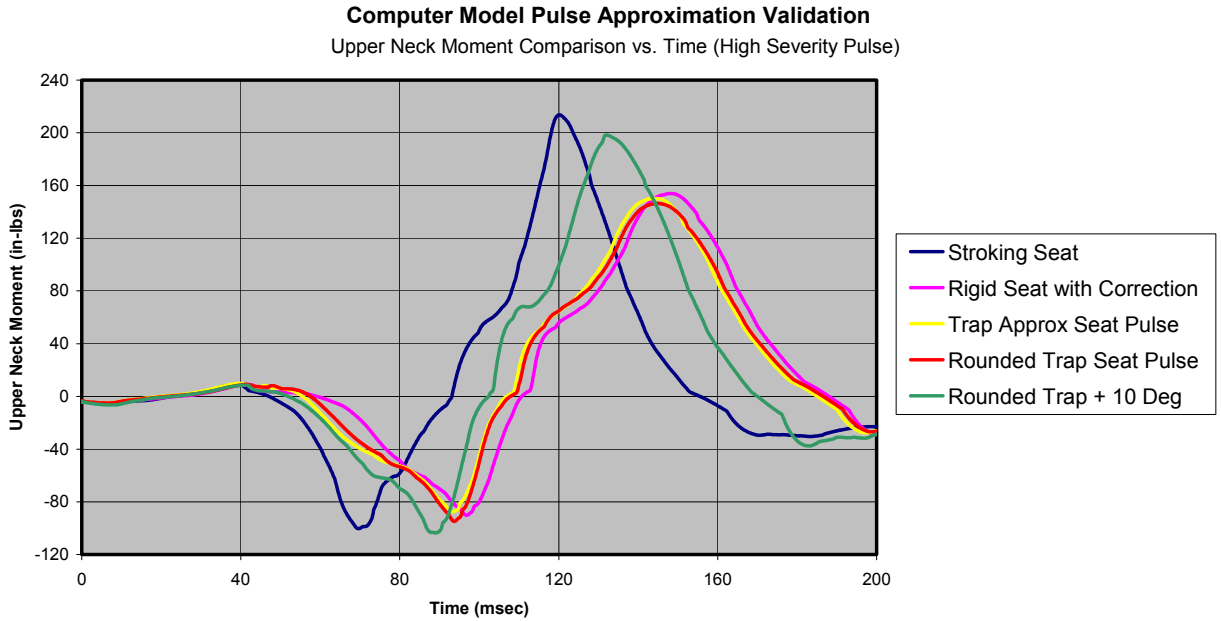

Figure A-13: Computer Model Pulse Approximation Validation (High Severity Pulse)

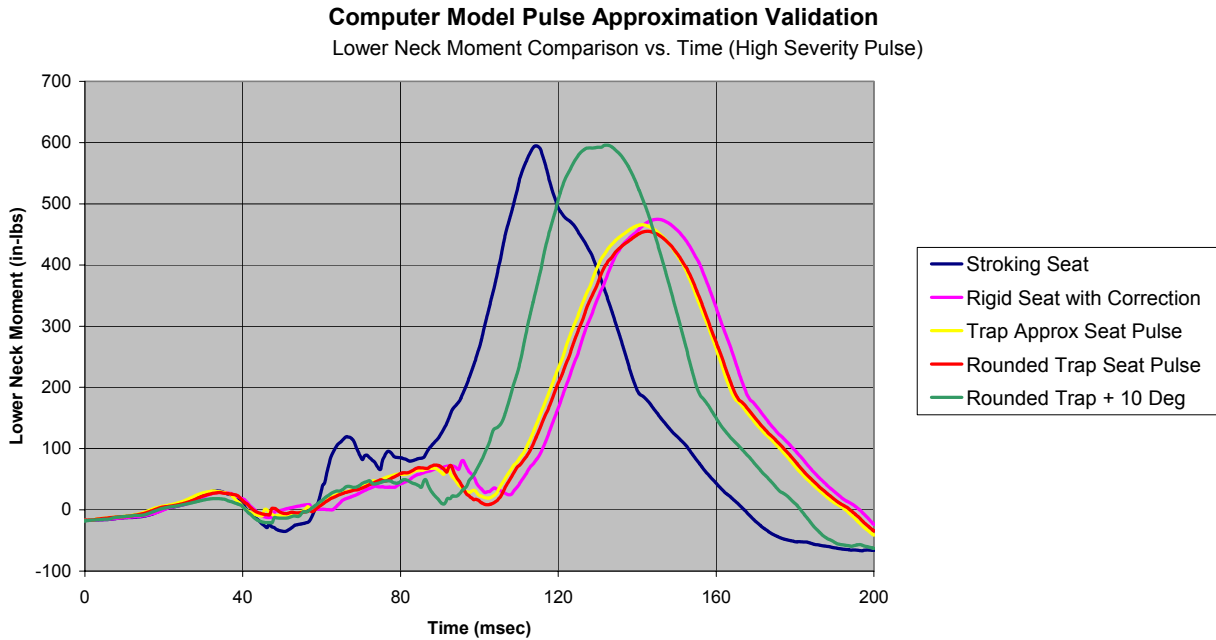

Figure A-14: Computer Model Pulse Approximation Validation (High Severity Pulse)

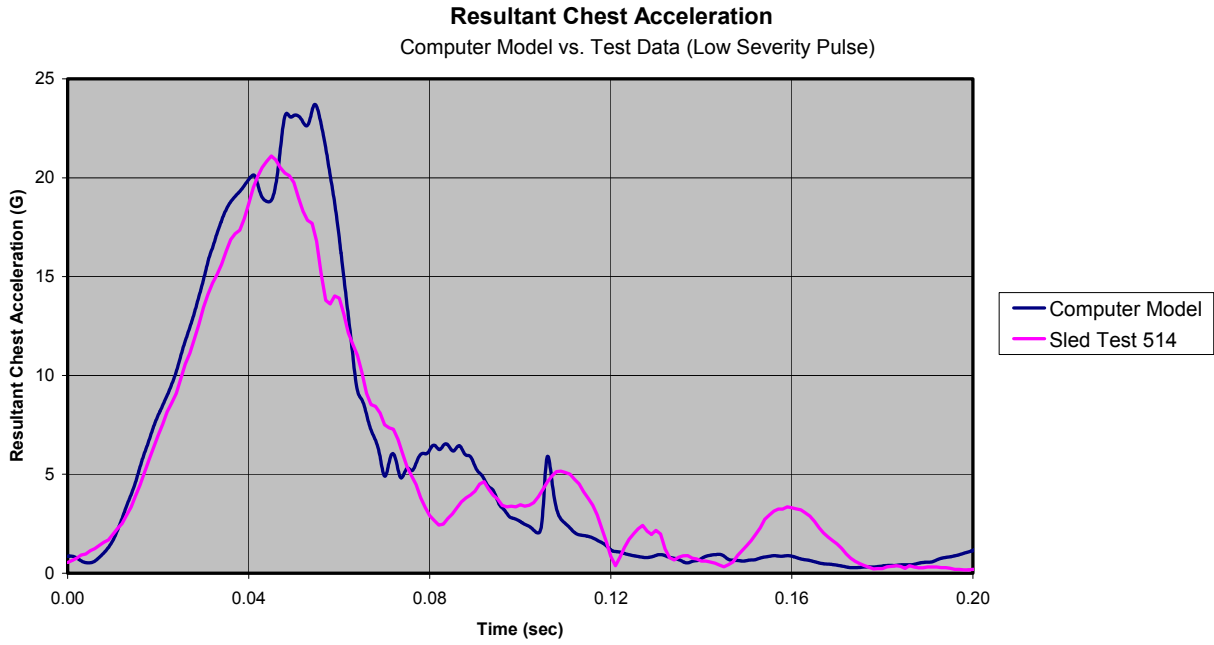

Figure A-15: Computer Model versus Test Data (Small Female - Low Severity Pulse)

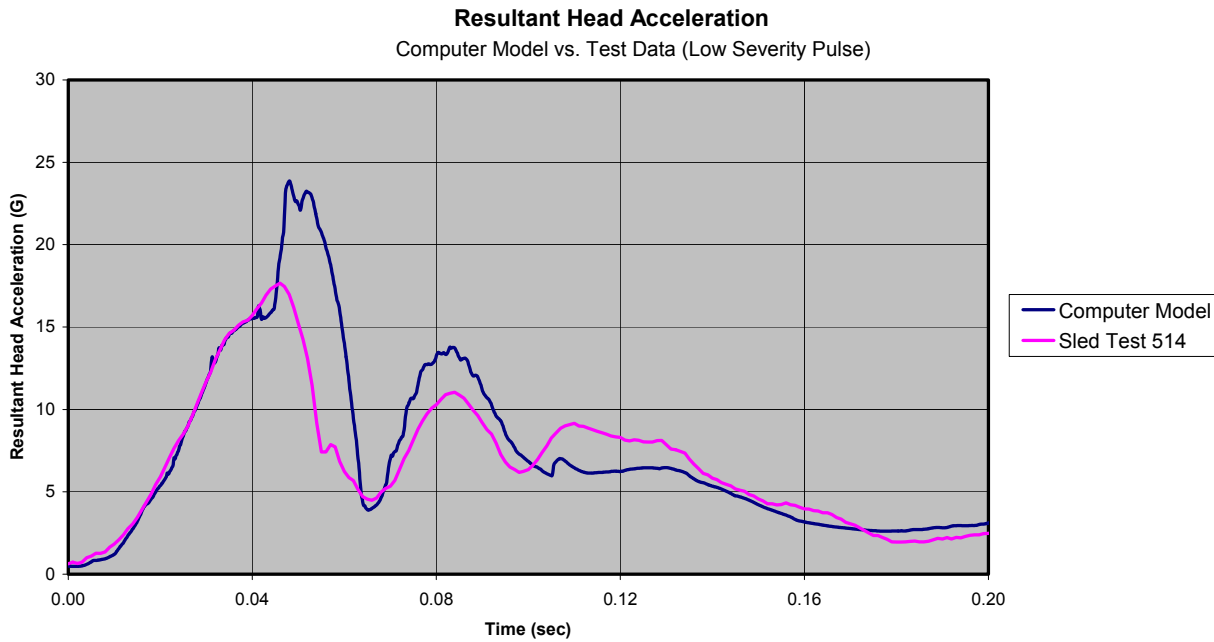

Figure A-16: Computer Model versus Test Data (Small Female - Low Severity Pulse)

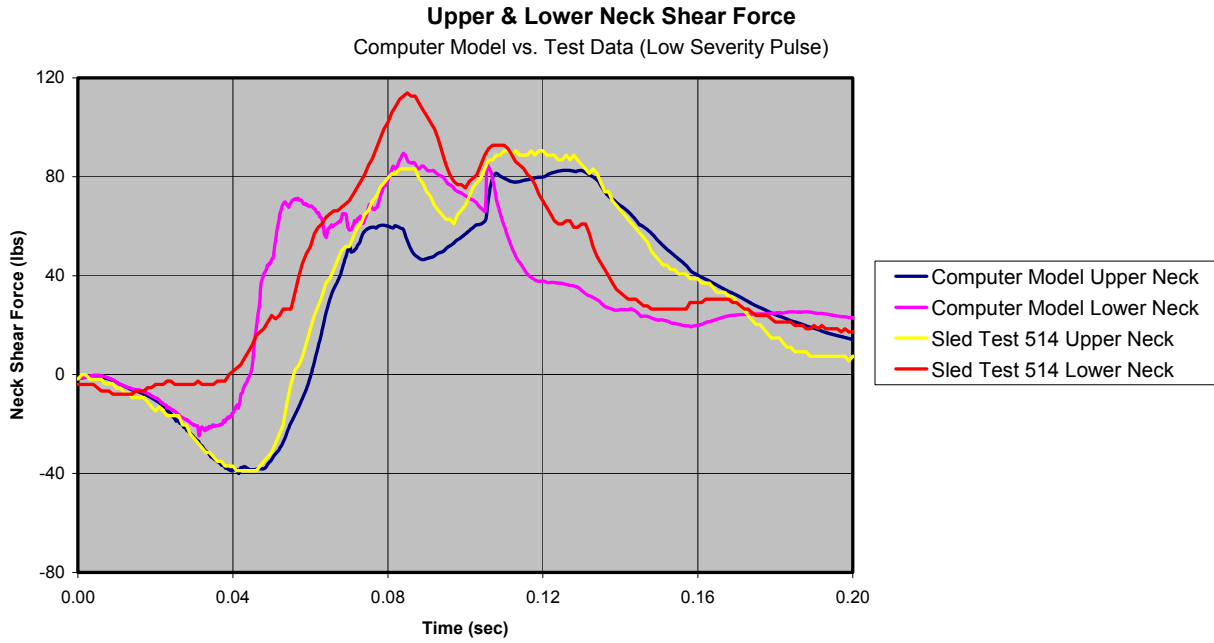

Figure A-17: Computer Model versus Test Data (Small Female - Low Severity Pulse)

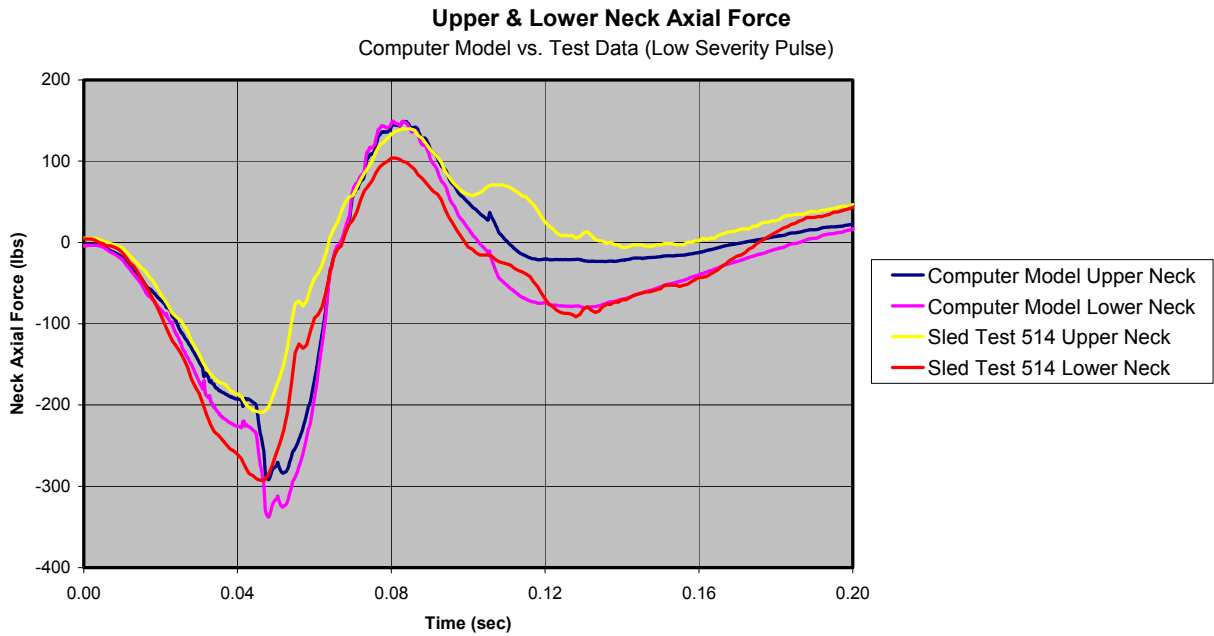

Figure A-18: Computer Model versus Test Data (Small Female - Low Severity Pulse)

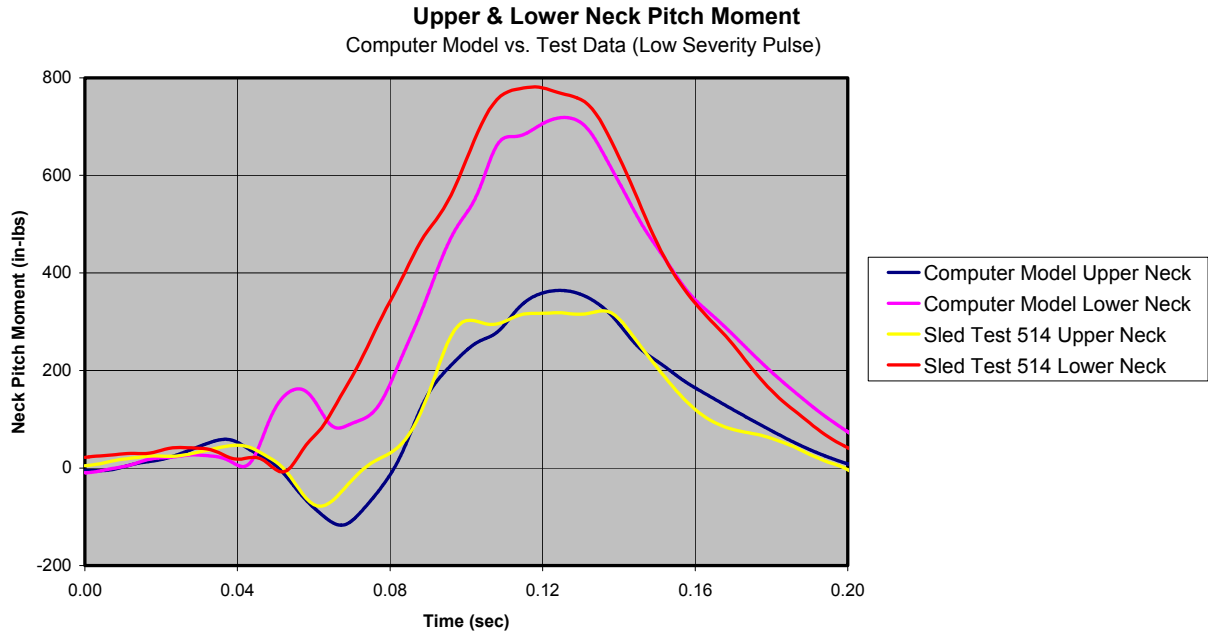

Figure A-19: Computer Model versus Test Data (Small Female - Low Severity Pulse)

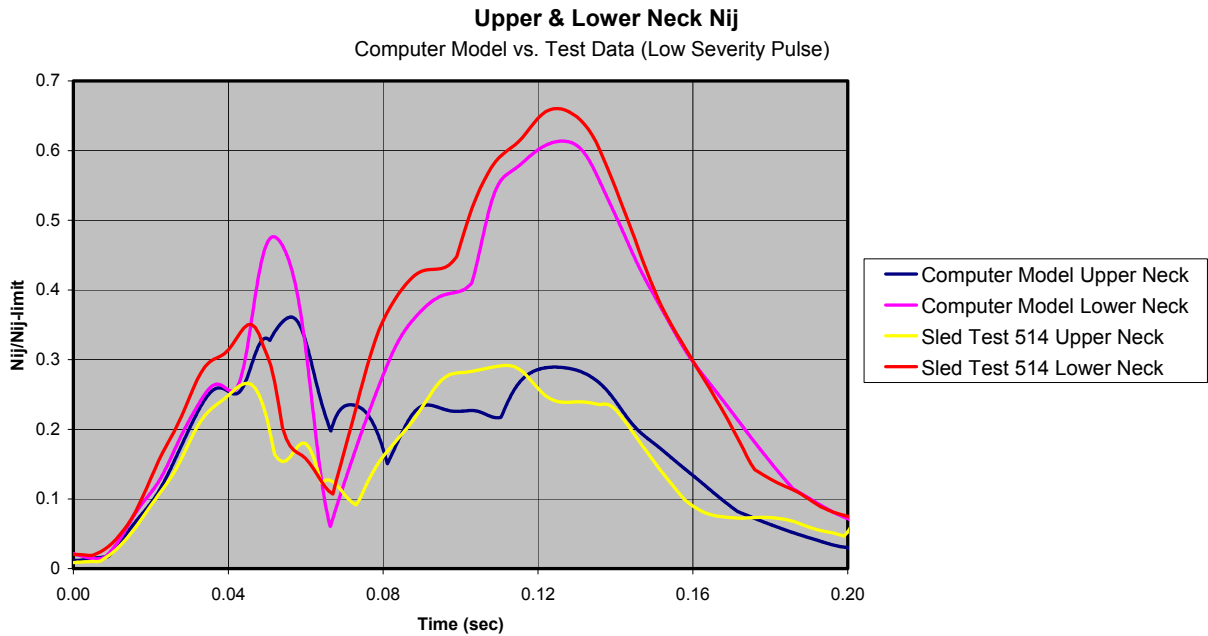

Figure A-20: Computer Model versus Test Data (Small Female - Low Severity Pulse)



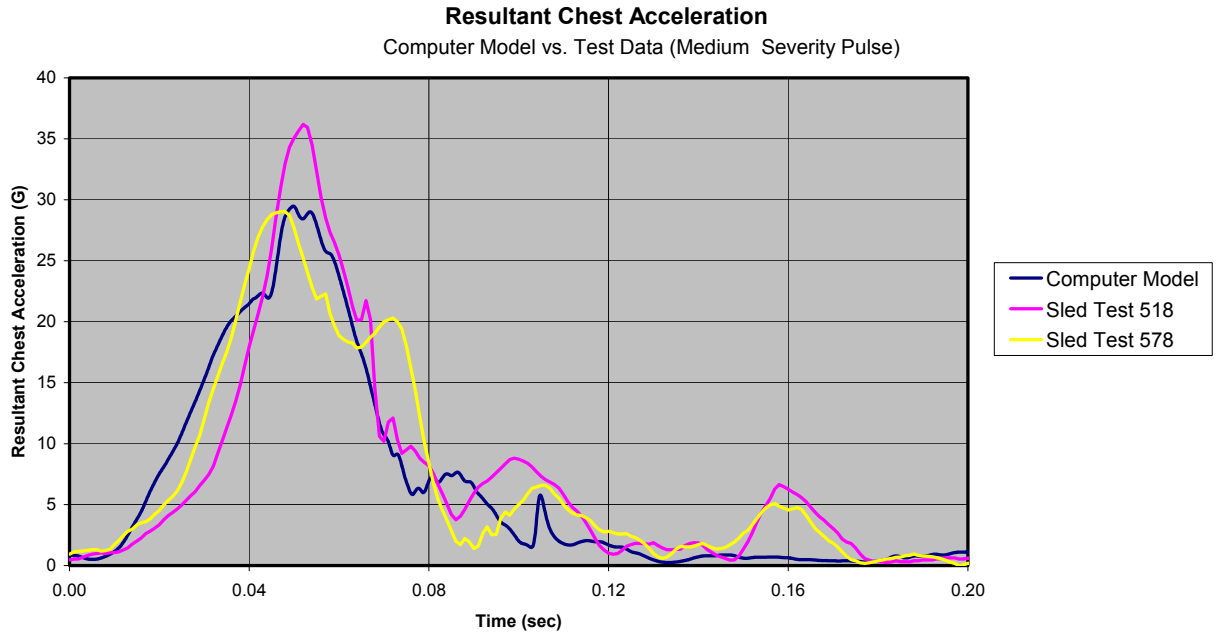

Figure A-21: Computer Model versus Test Data (Small Female - Medium Severity Pulse)

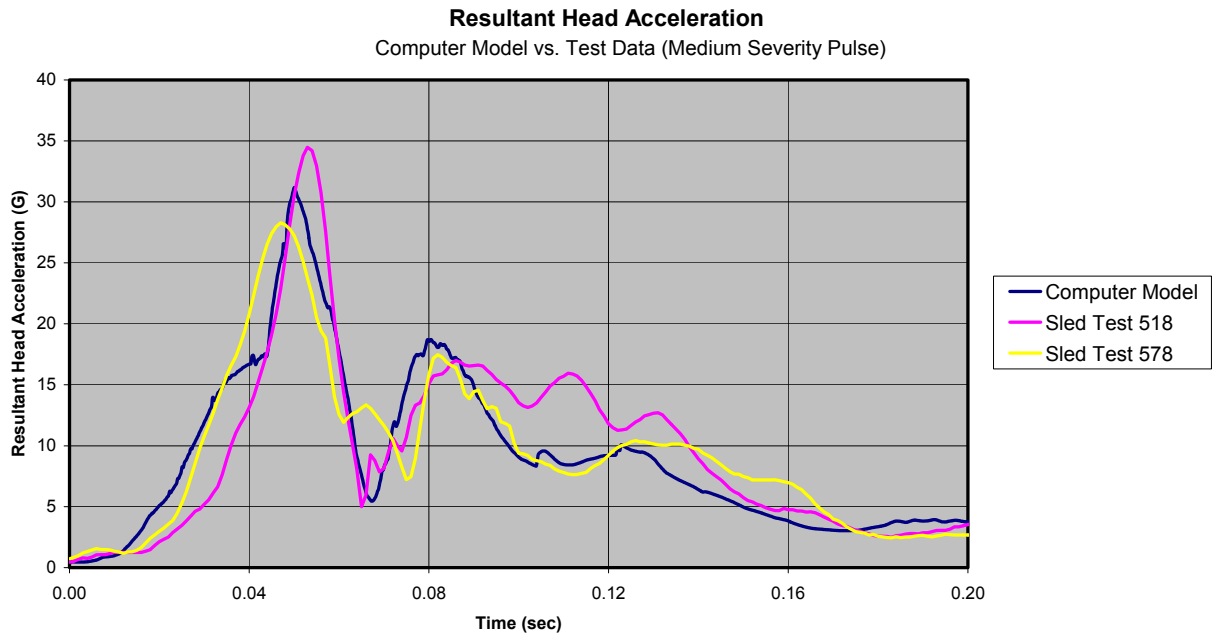

Figure A-22: Computer Model versus Test Data (Small Female - Medium Severity Pulse)

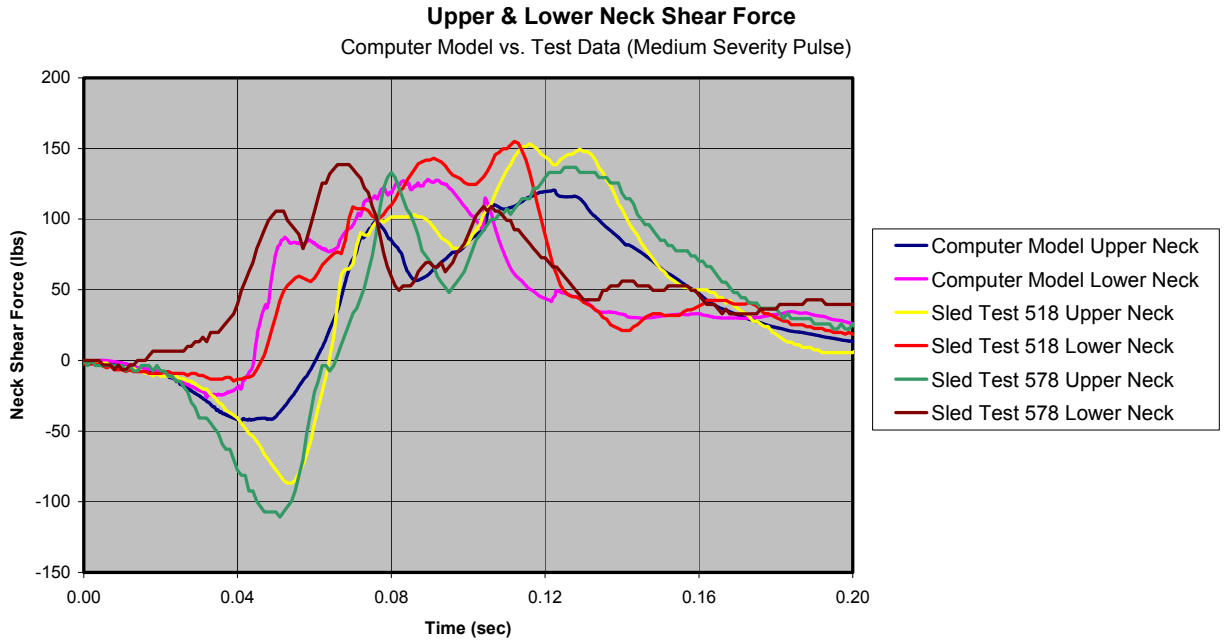

Figure A-23: Computer Model versus Test Data (Small Female - Medium Severity Pulse)

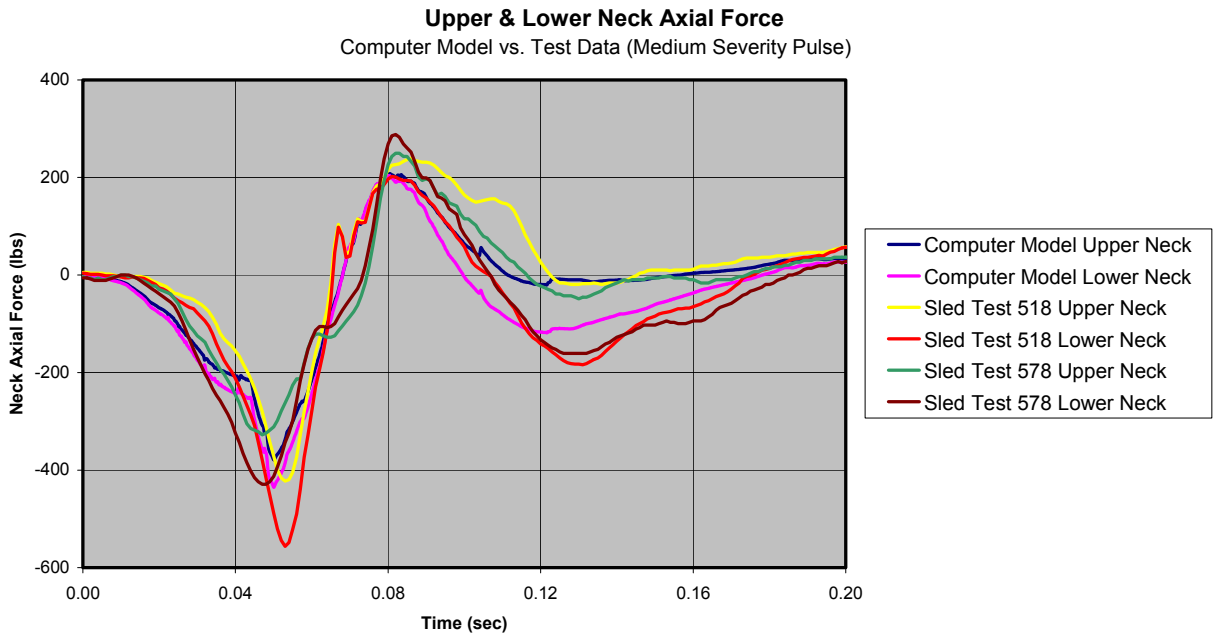

Figure A-24: Computer Model versus Test Data (Small Female - Medium Severity Pulse)

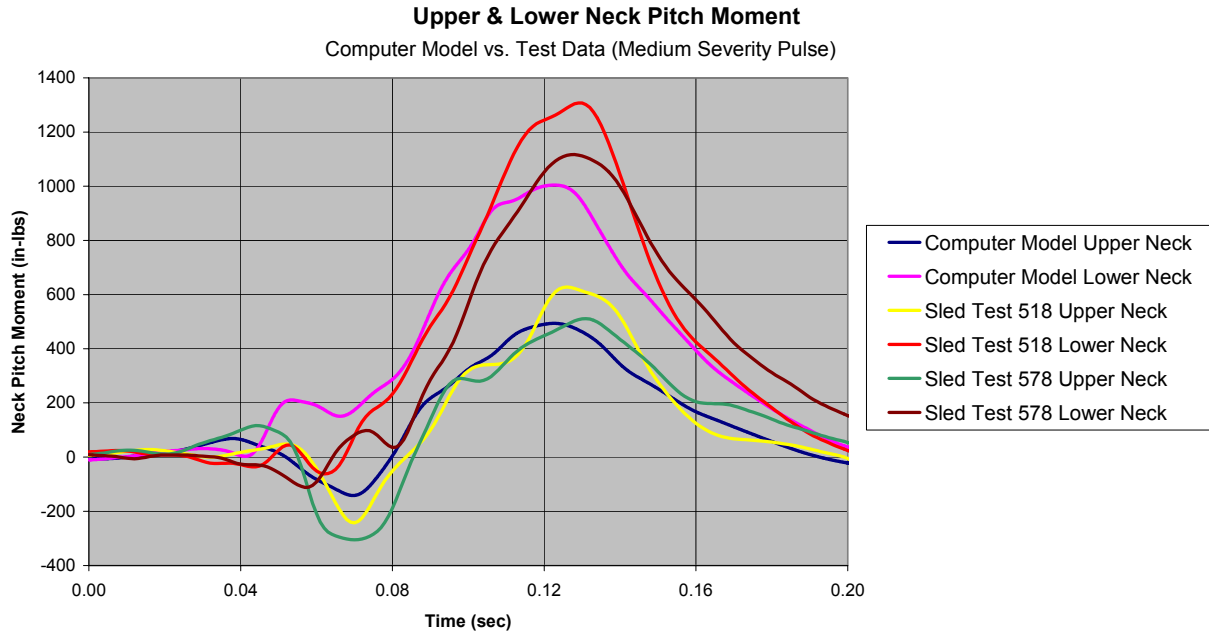

Figure A-25: Computer Model versus Test Data (Small Female - Medium Severity Pulse)

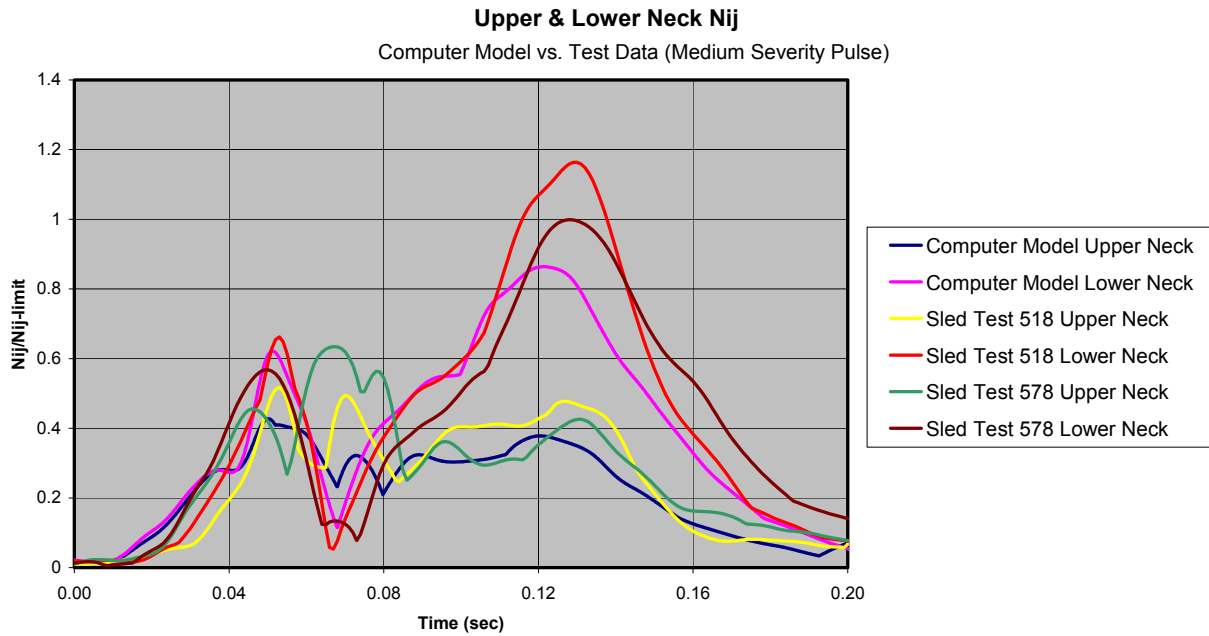

Figure A-26: Computer Model versus Test Data (Small Female - Medium Severity Pulse)

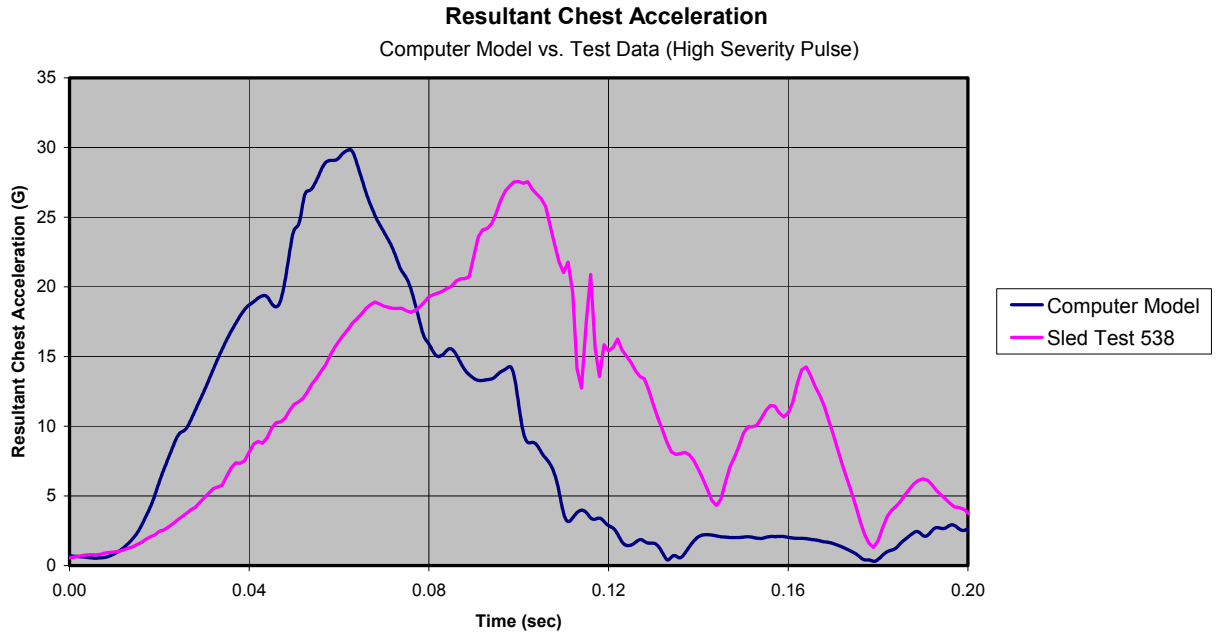

Figure A-27: Computer Model versus Test Data (Small Female - High Severity Pulse)

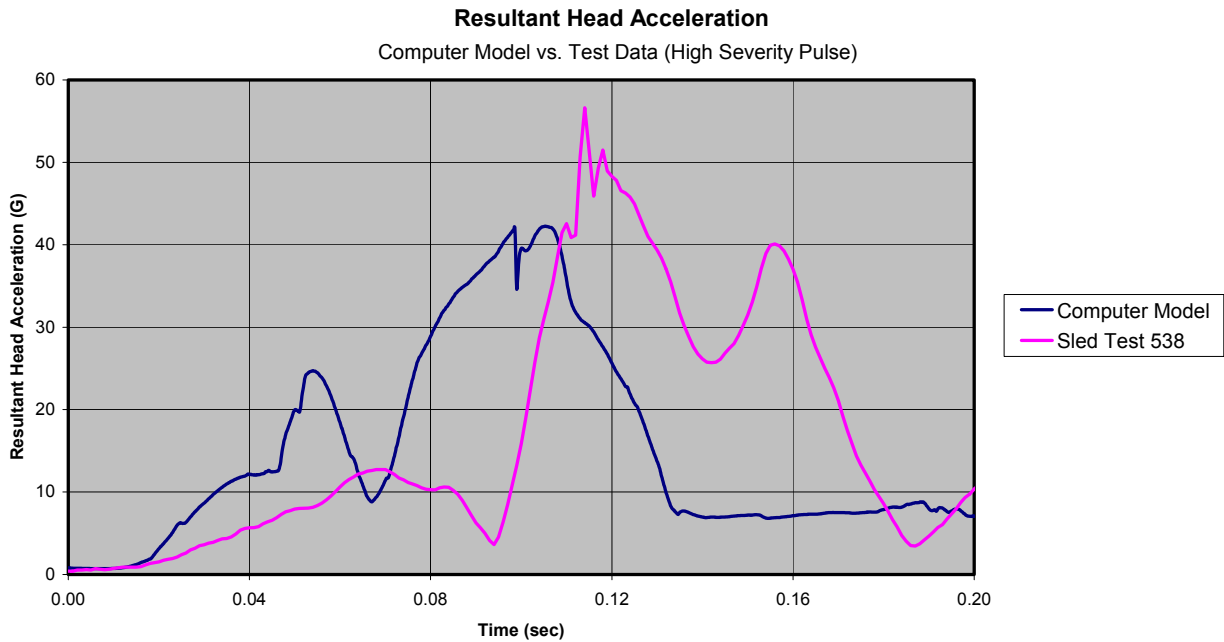

Figure A-28: Computer Model versus Test Data (Small Female - High Severity Pulse)

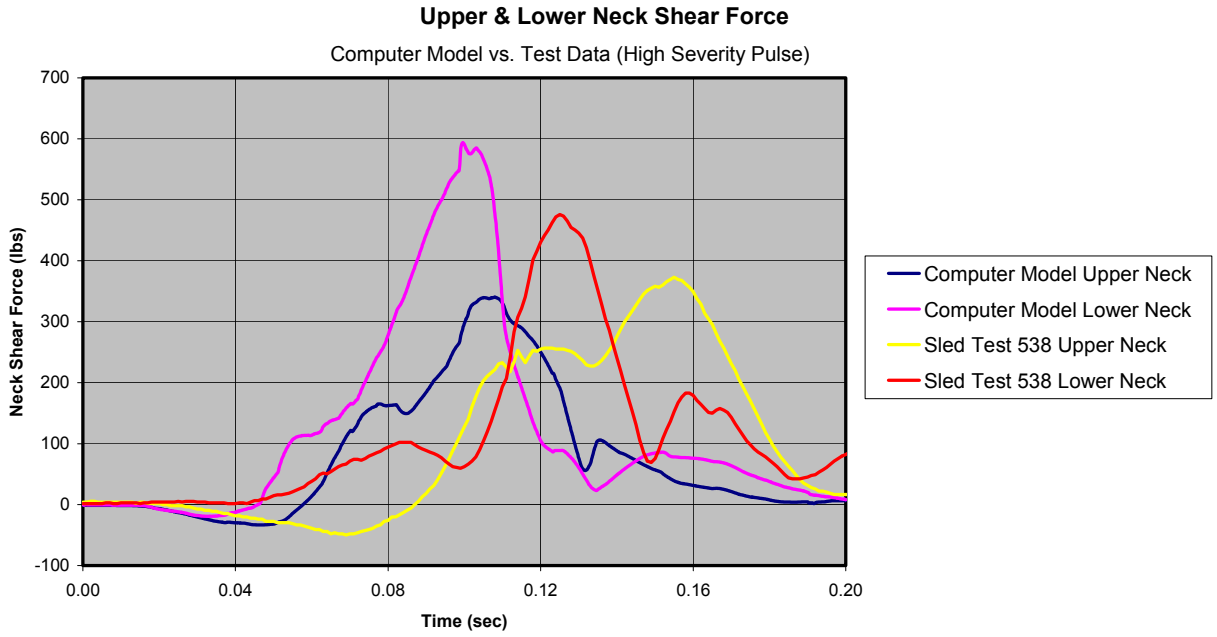

Figure A-29: Computer Model versus Test Data (Small Female - High Severity Pulse)

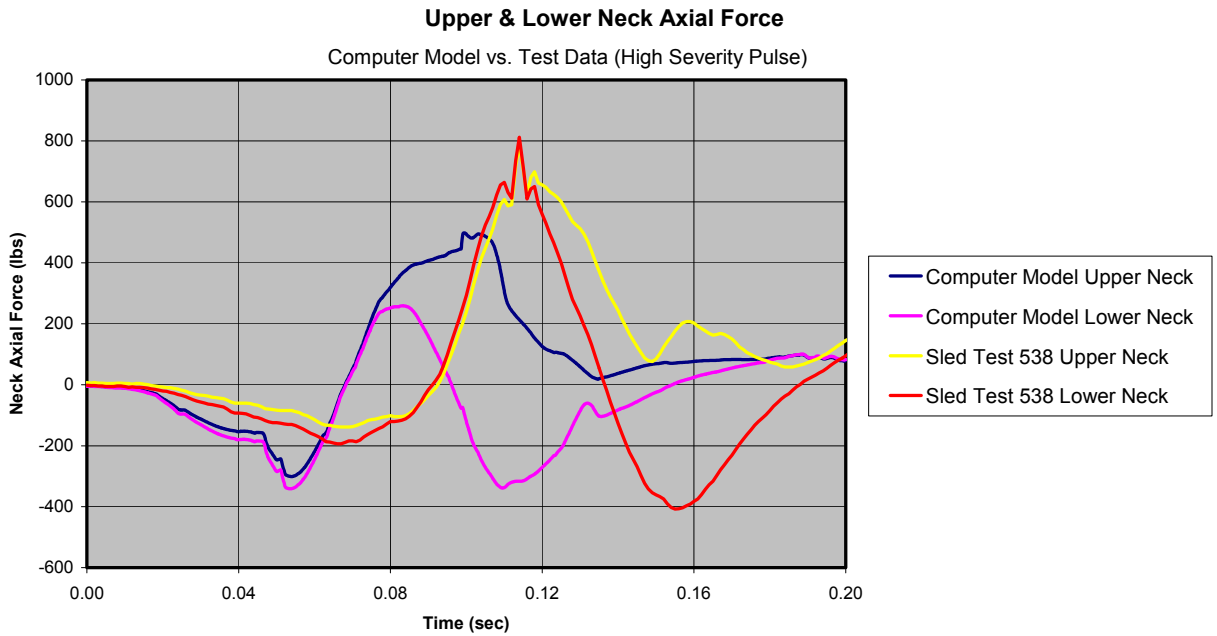

Figure A-30: Computer Model versus Test Data (Small Female - High Severity Pulse)

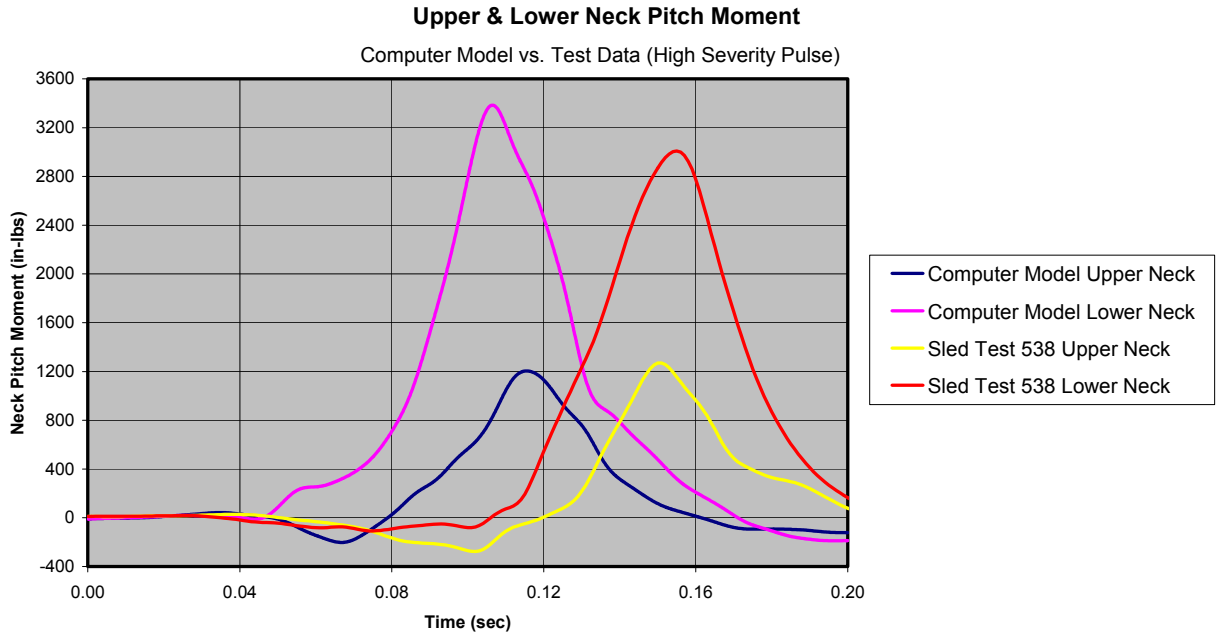

Figure A-31: Computer Model versus Test Data (Small Female - High Severity Pulse)

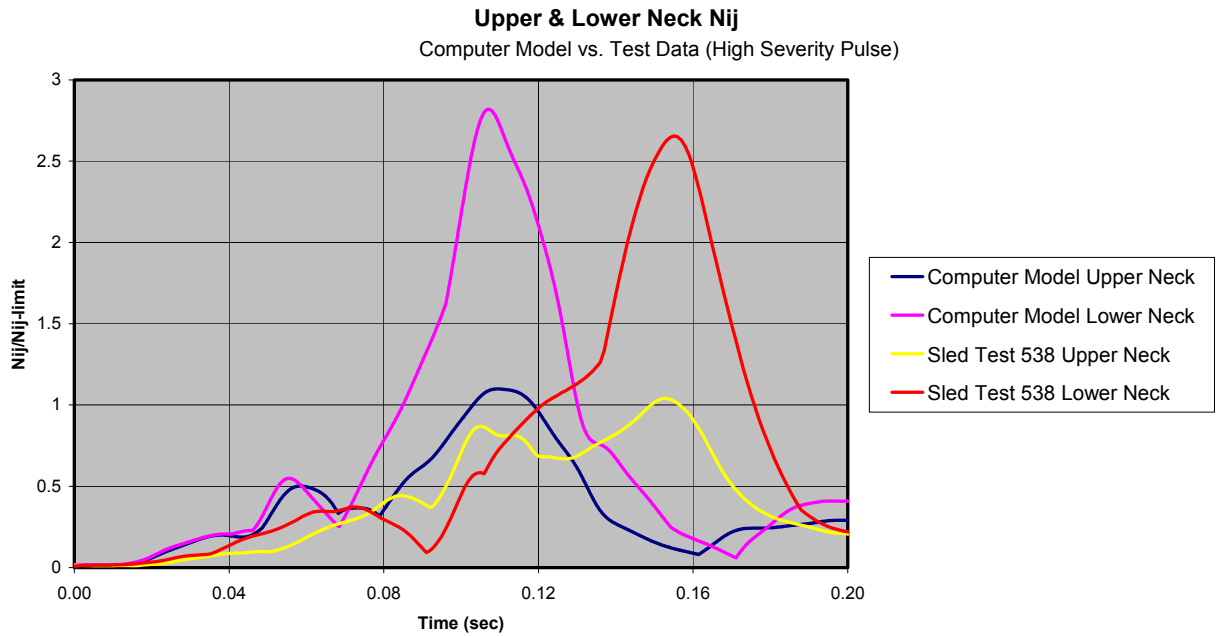

Figure A-32: Computer Model versus Test Data (Small Female - High Severity Pulse)

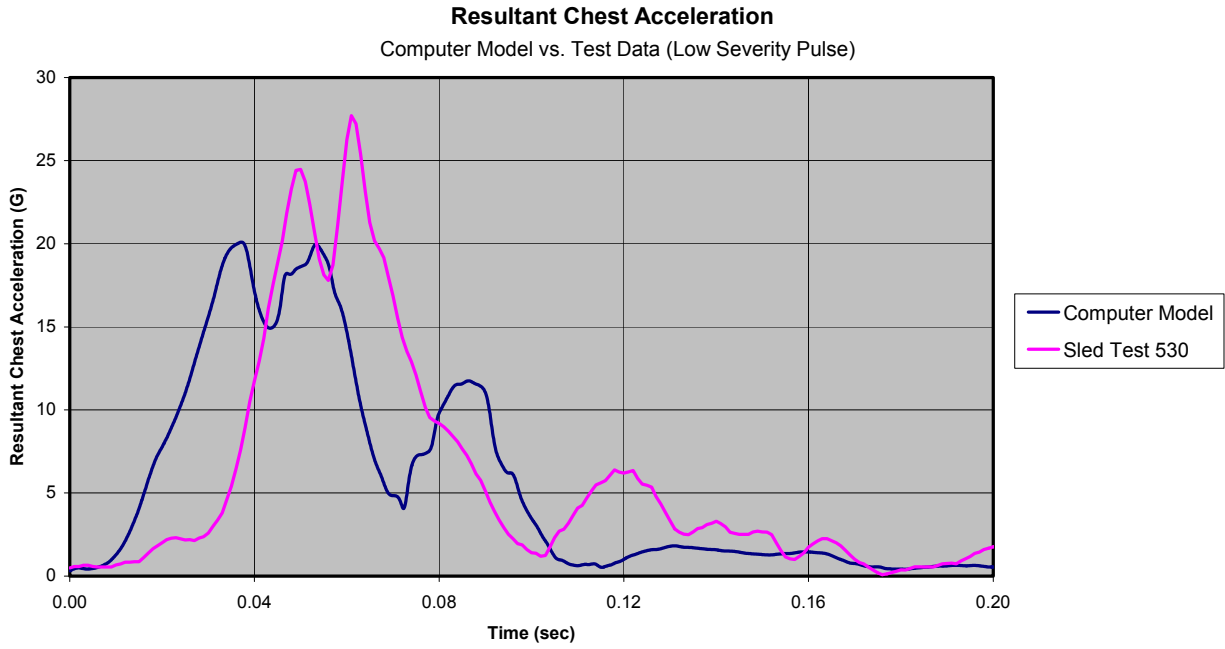

Figure A-33: Computer Model versus Test Data (Mid-Male - Low Severity Pulse)

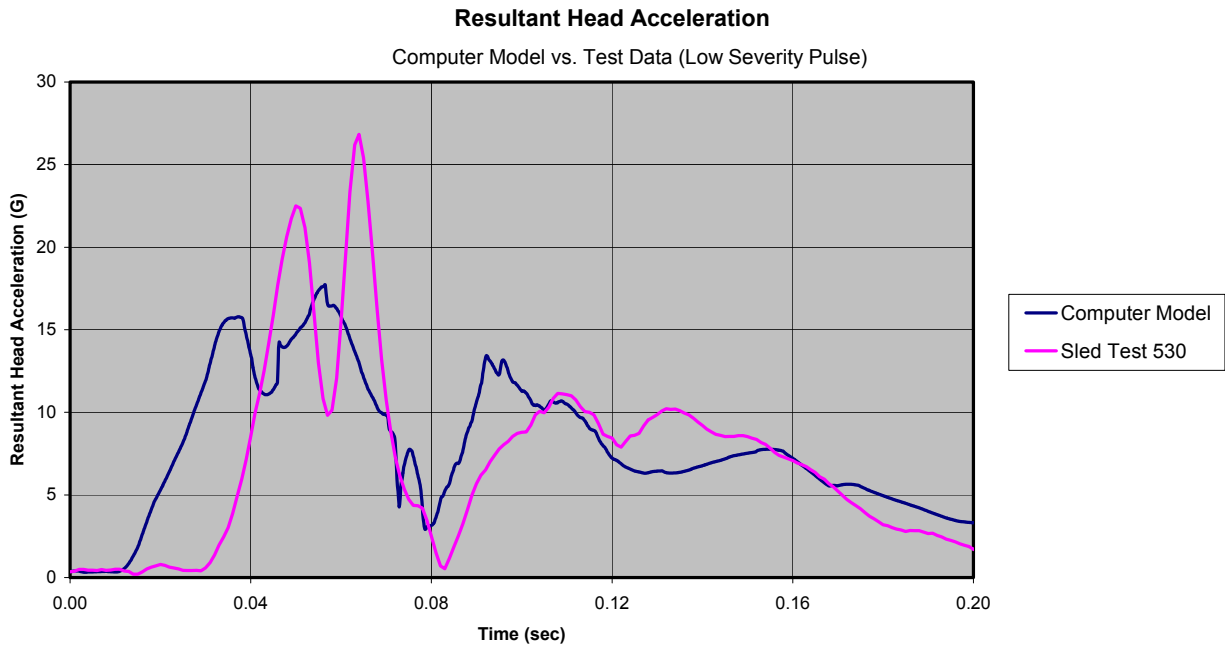

Figure A-34: Computer Model versus Test Data (Mid-Male - Low Severity Pulse)

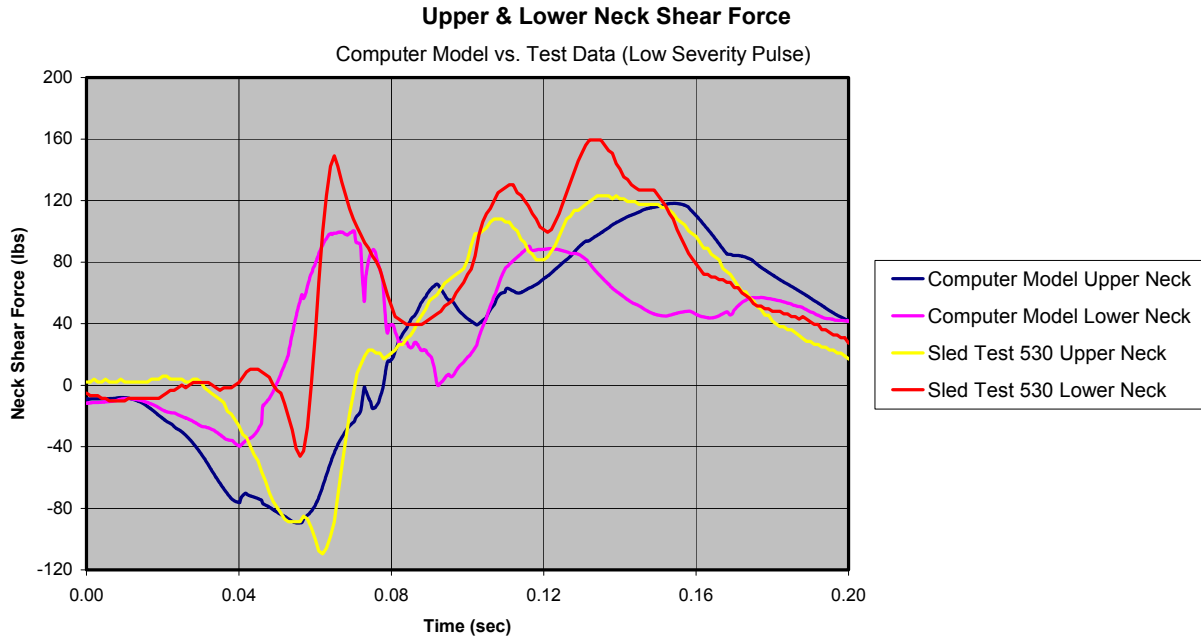

Figure A-35: Computer Model versus Test Data (Mid-Male - Low Severity Pulse)

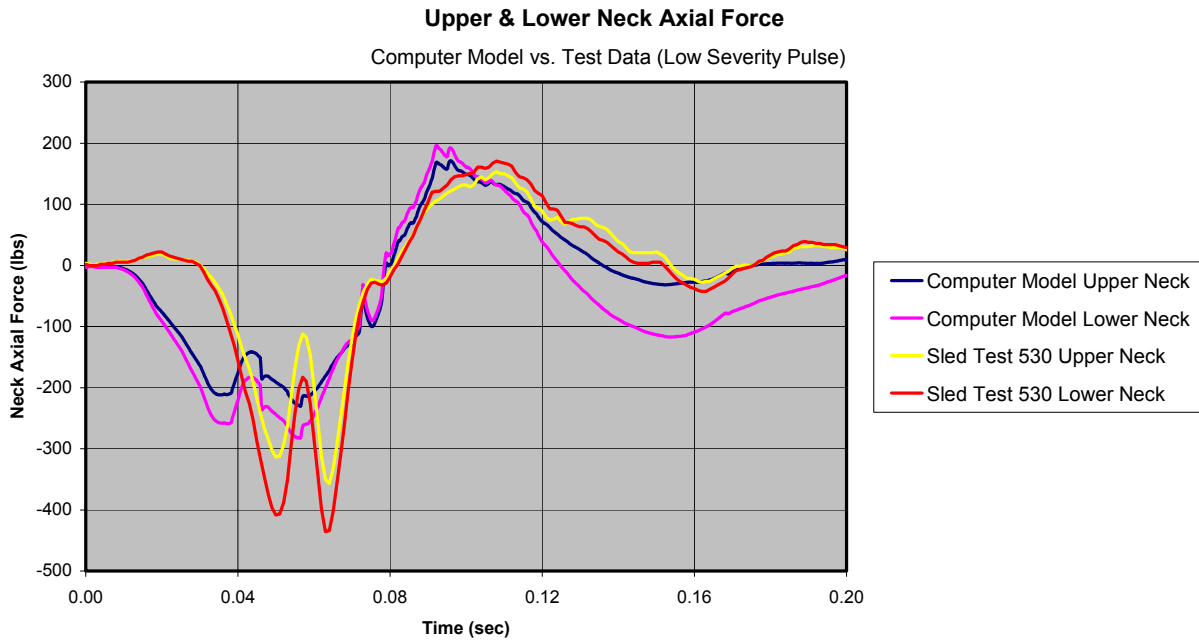

Figure A-36: Computer Model versus Test Data (Mid-Male - Low Severity Pulse)



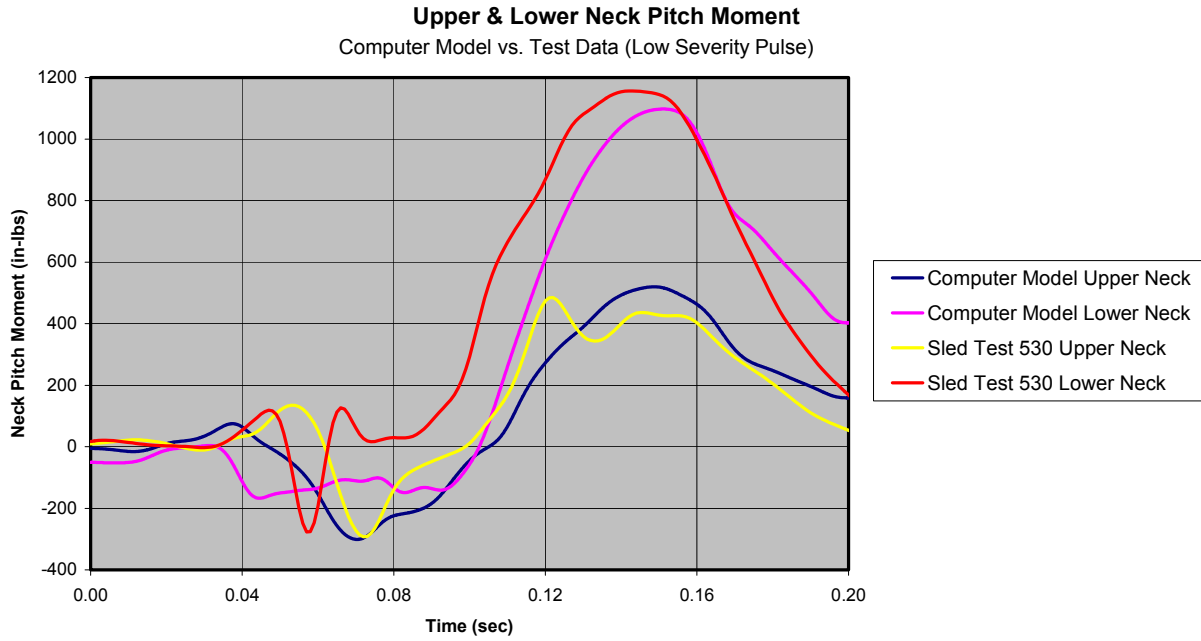

Figure A-37: Computer Model versus Test Data (Mid-Male - Low Severity Pulse)

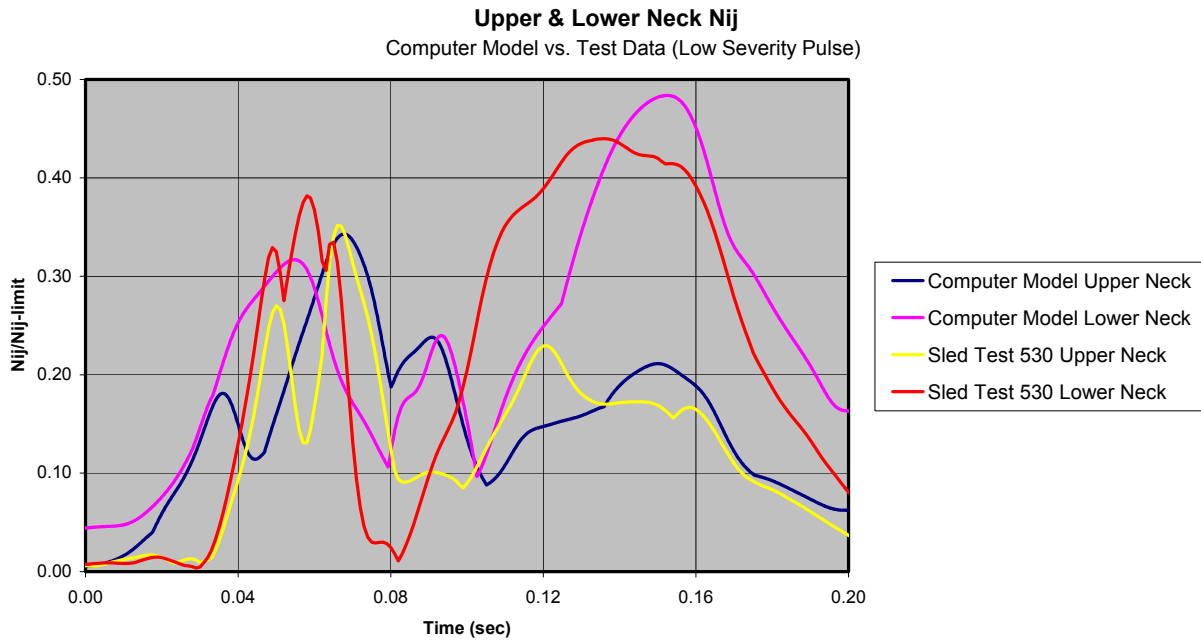

Figure A-38: Computer Model versus Test Data (Mid-Male - Low Severity Pulse)

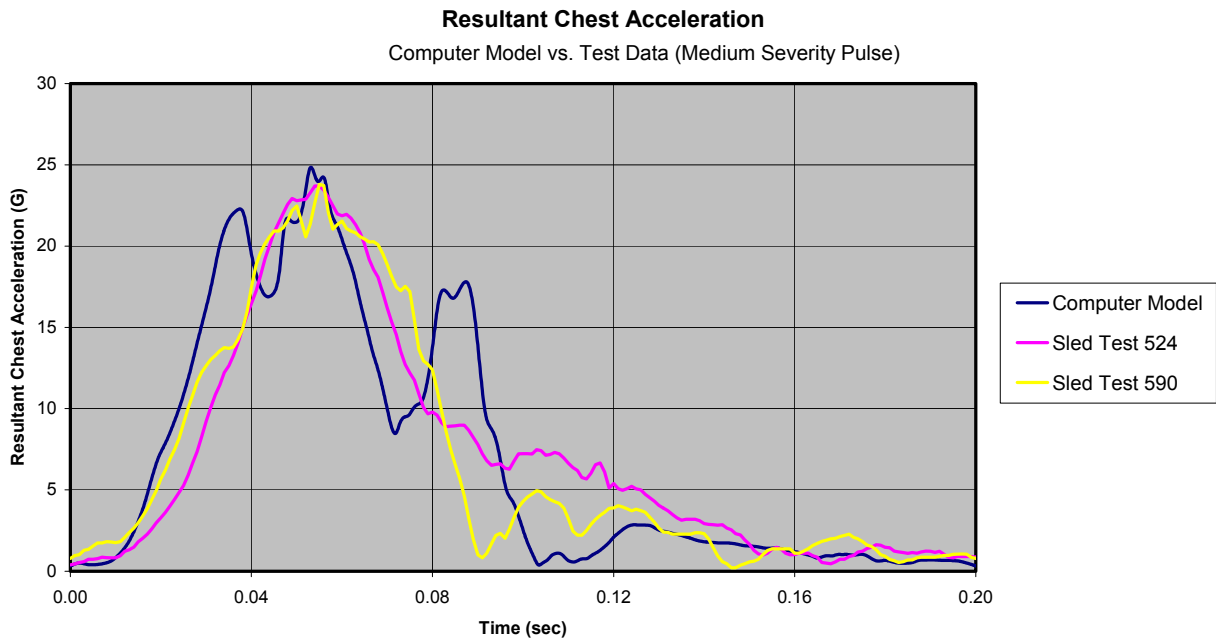

Figure A-39: Computer Model versus Test Data (Mid-Male - Medium Severity Pulse)

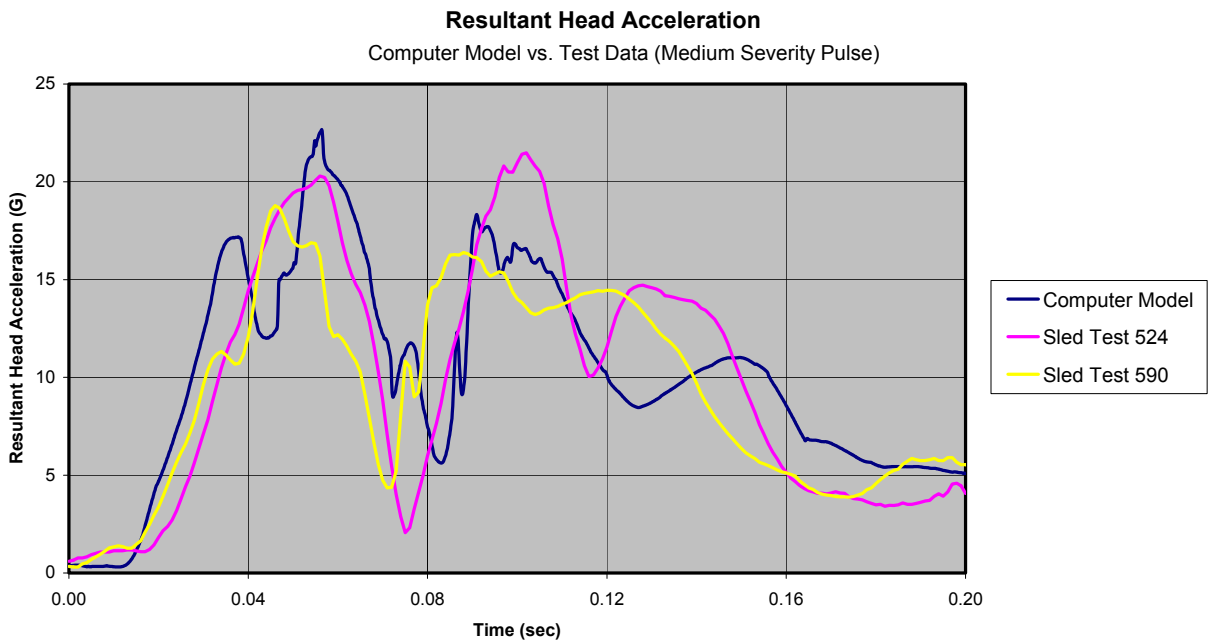

Figure A-40: Computer Model versus Test Data (Mid-Male - Medium Severity Pulse)

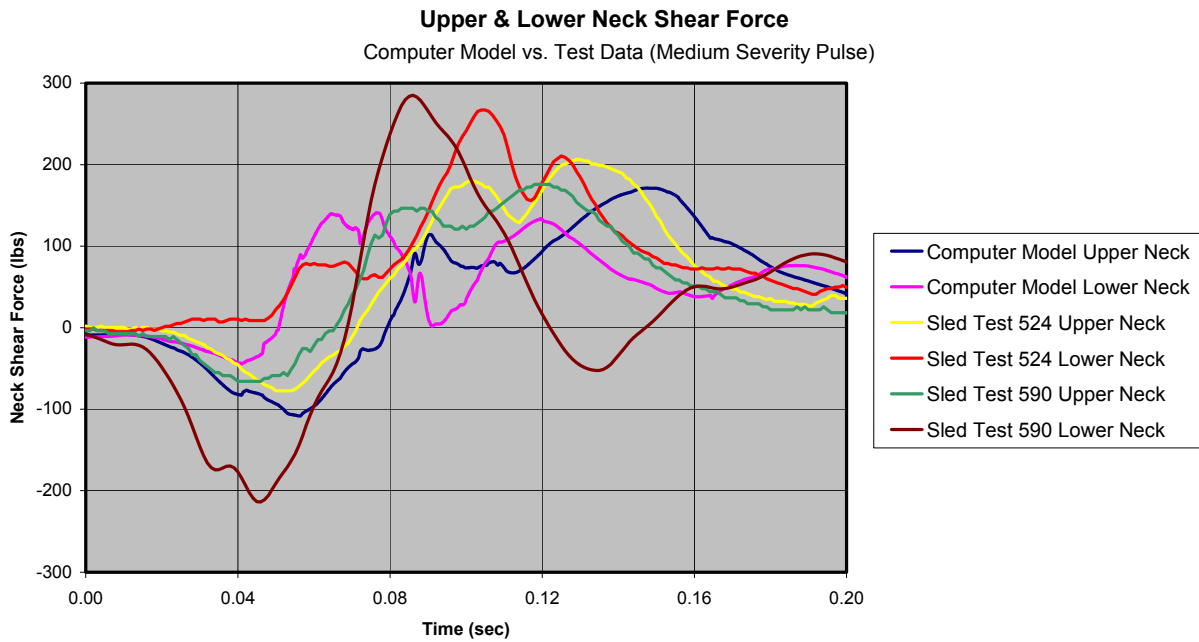

Figure A-41: Computer Model versus Test Data (Mid-Male - Medium Severity Pulse)

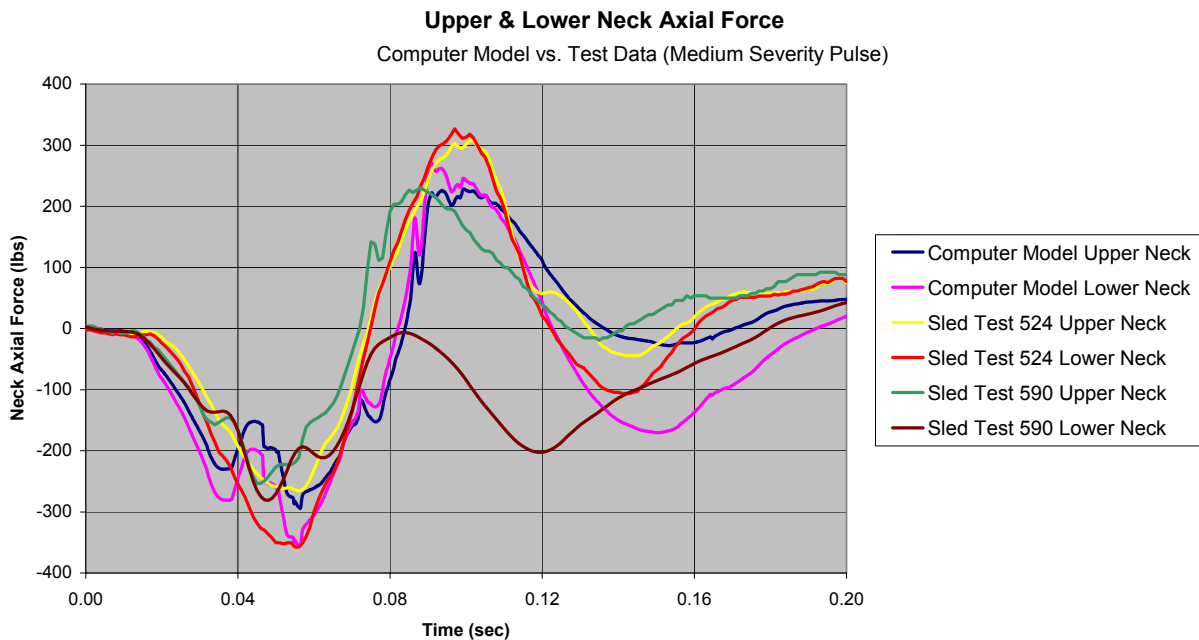

Figure A-42: Computer Model versus Test Data (Mid-Male - Medium Severity Pulse)

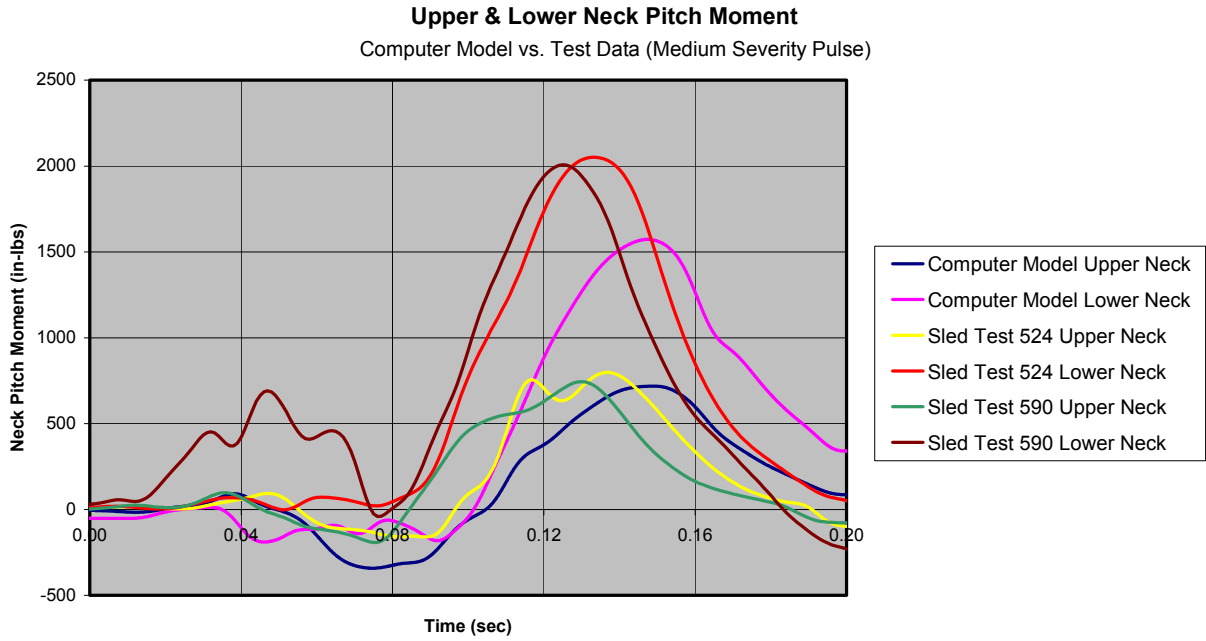

Figure A-43: Computer Model versus Test Data (Mid-Male - Medium Severity Pulse)

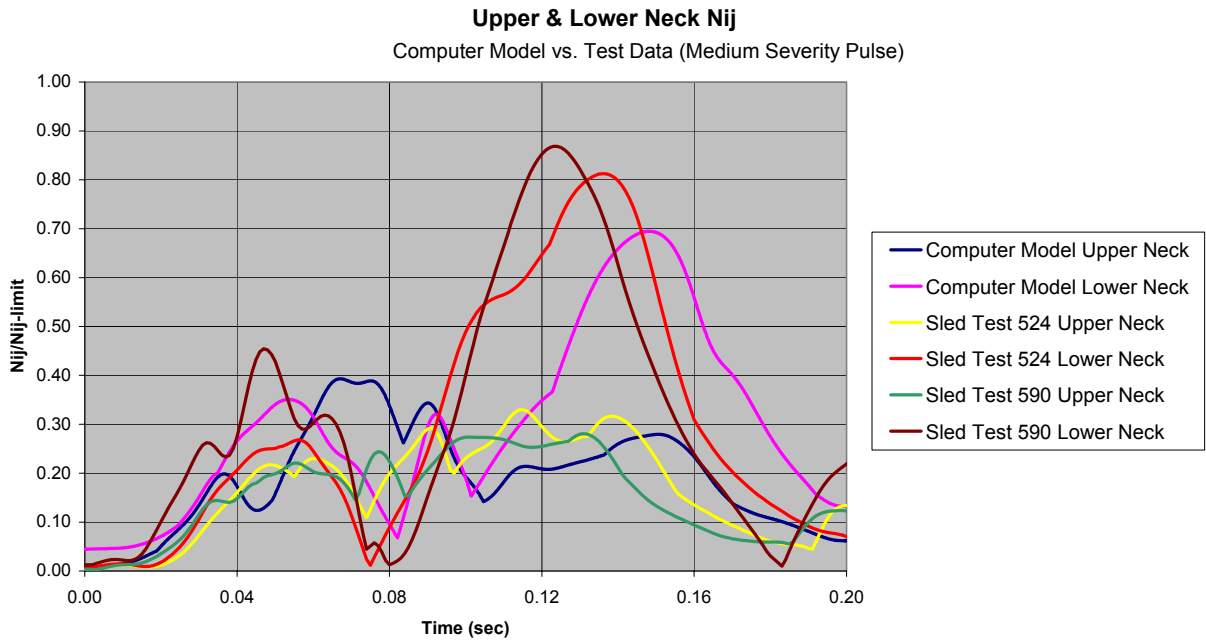

Figure A-44: Computer Model versus Test Data (Mid-Male - Medium Severity Pulse)

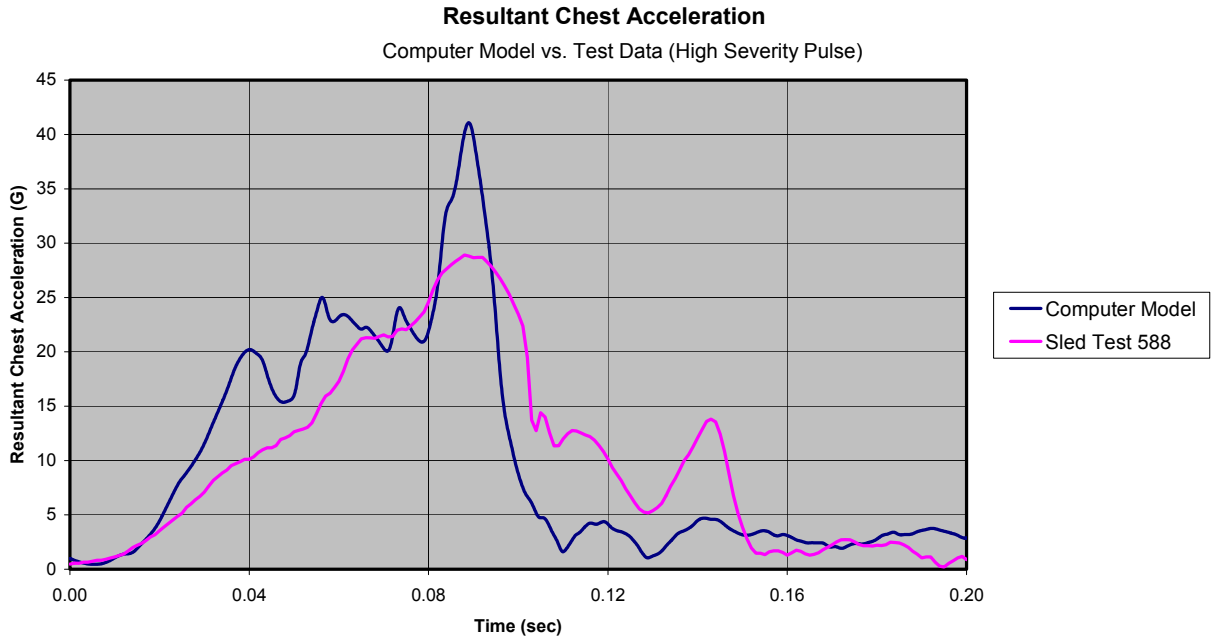

Figure A-45: Computer Model versus Test Data (Mid-Male - High Severity Pulse)

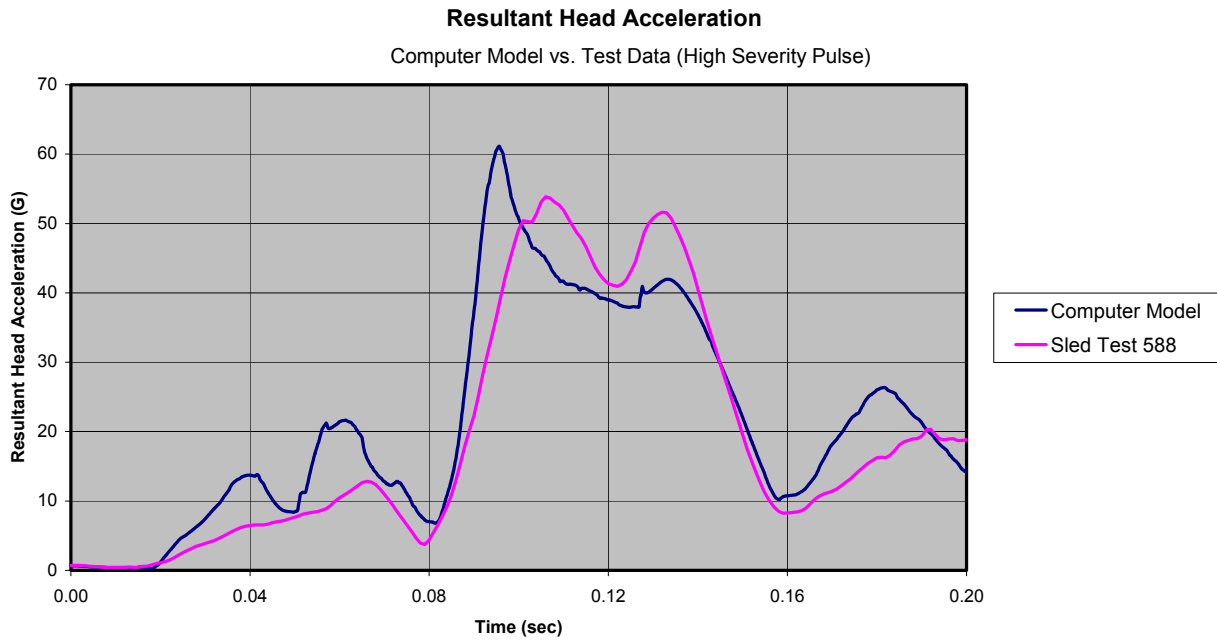

Figure A-46: Computer Model versus Test Data (Mid-Male - High Severity Pulse)

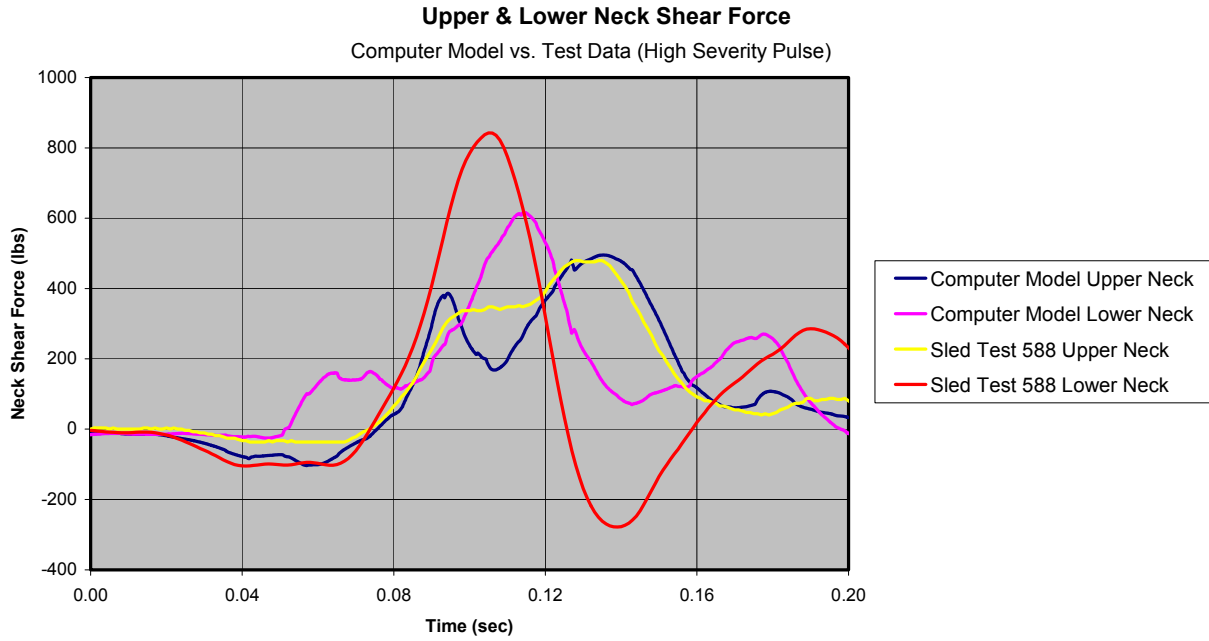

Figure A-47: Computer Model versus Test Data (Mid-Male - High Severity Pulse)

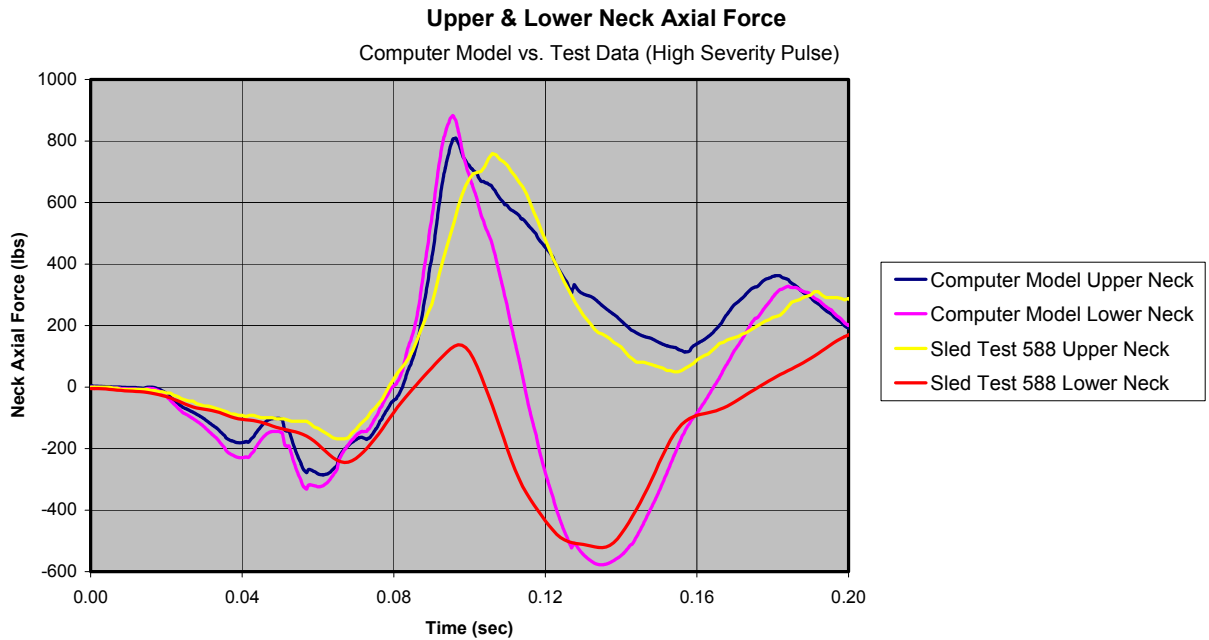

Figure A-48: Computer Model versus Test Data (Mid-Male - High Severity Pulse)

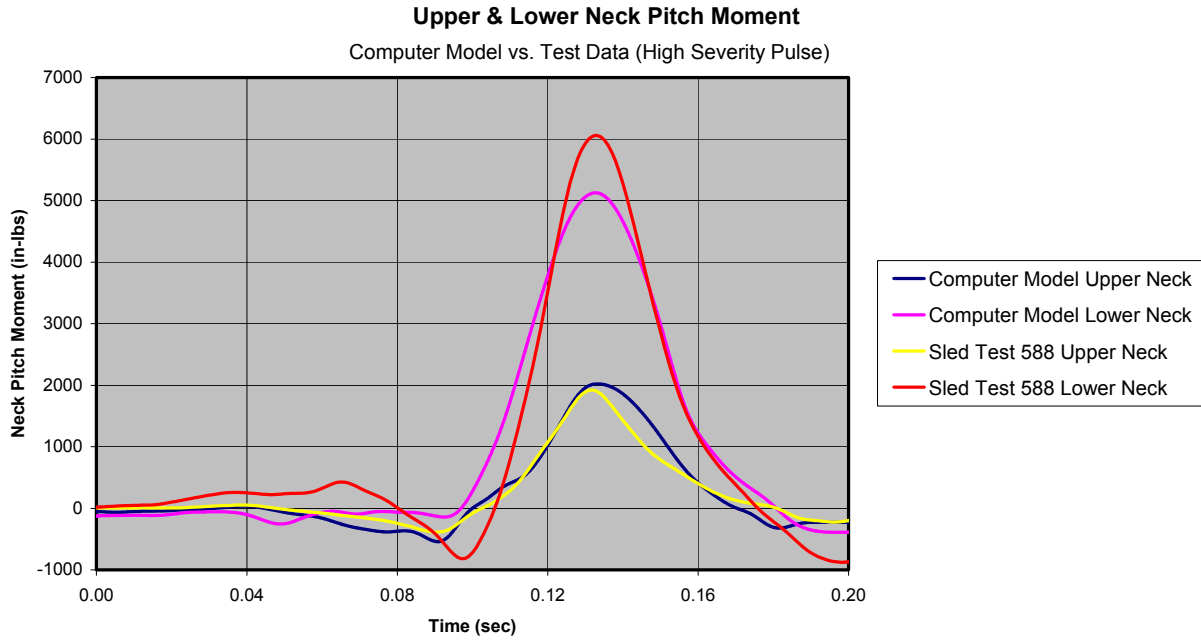

Figure A-49: Computer Model versus Test Data (Mid-Male - High Severity Pulse)

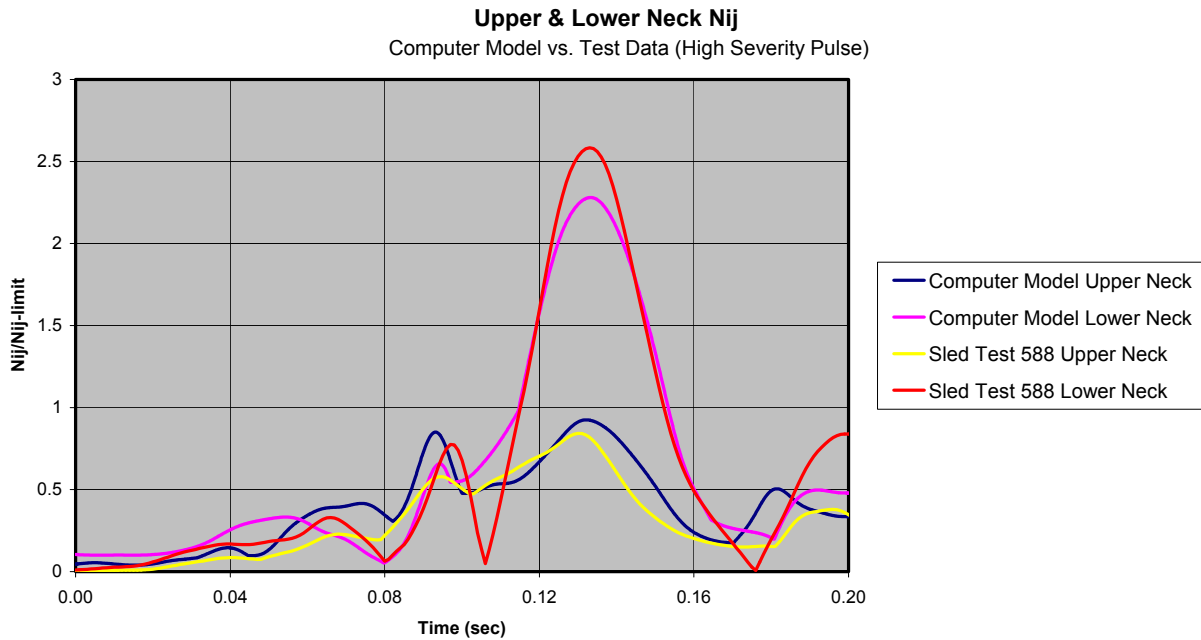

Figure A-50: Computer Model versus Test Data (Mid-Male - High Severity Pulse)

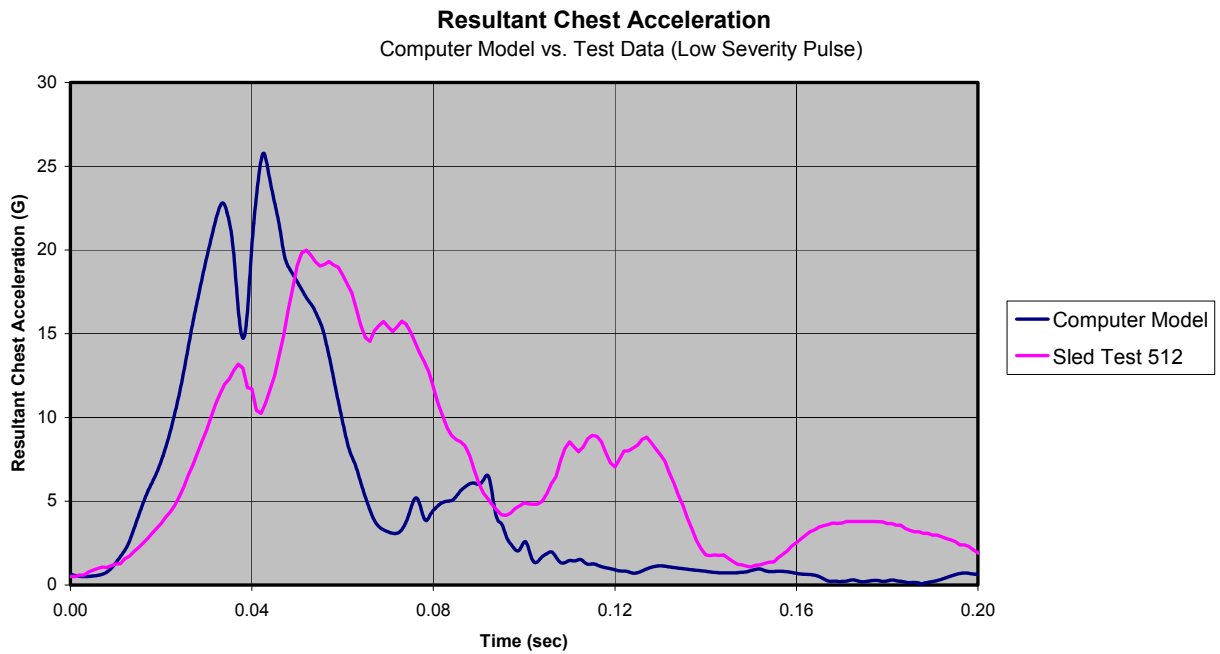

Figure A-51: Computer Model versus Test Data (Large Male - Low Severity Pulse)

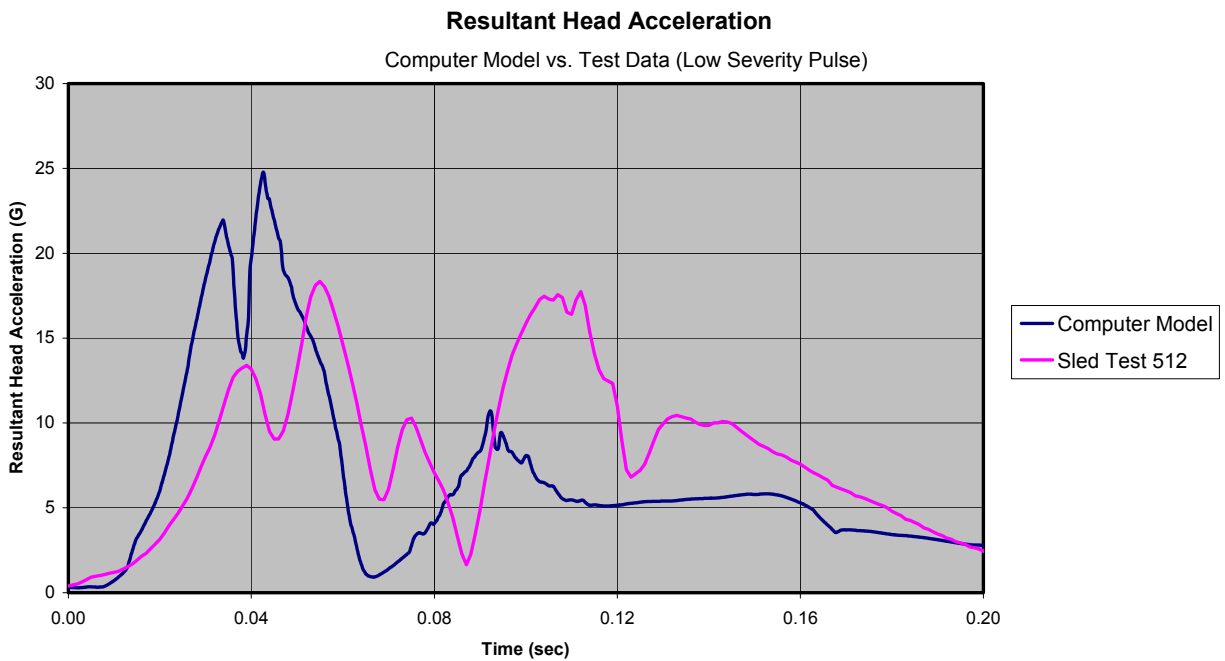

Figure A-52: Computer Model versus Test Data (Large Male - Low Severity Pulse)



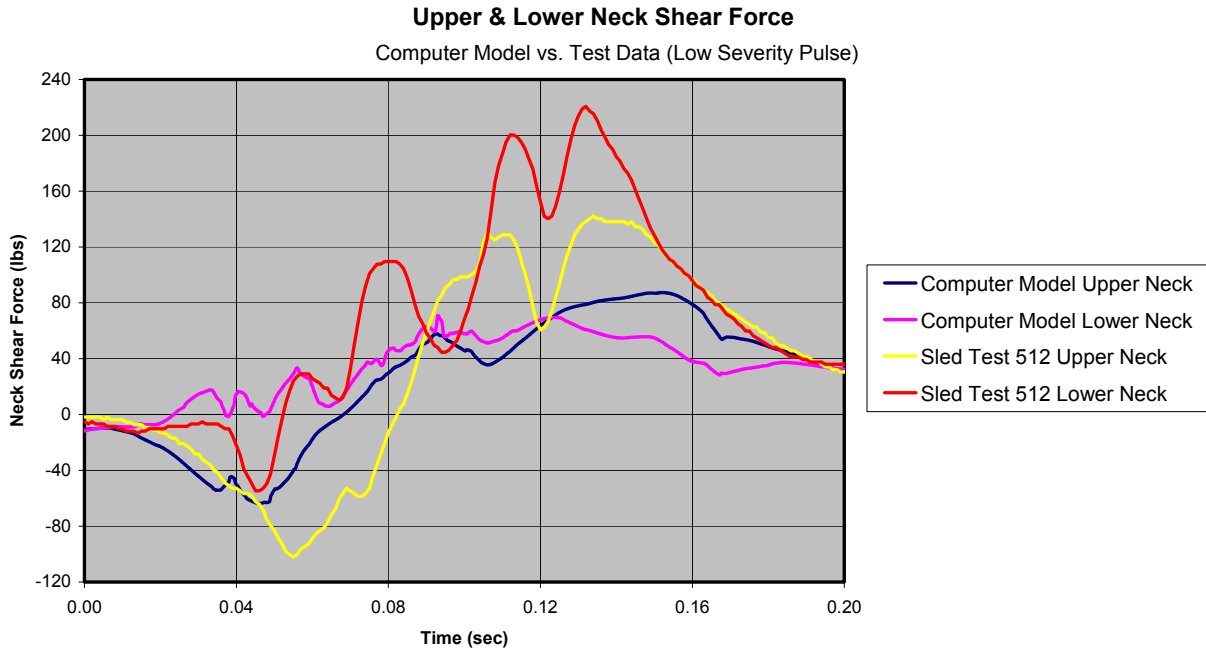

Figure A-53: Computer Model versus Test Data (Large Male - Low Severity Pulse)

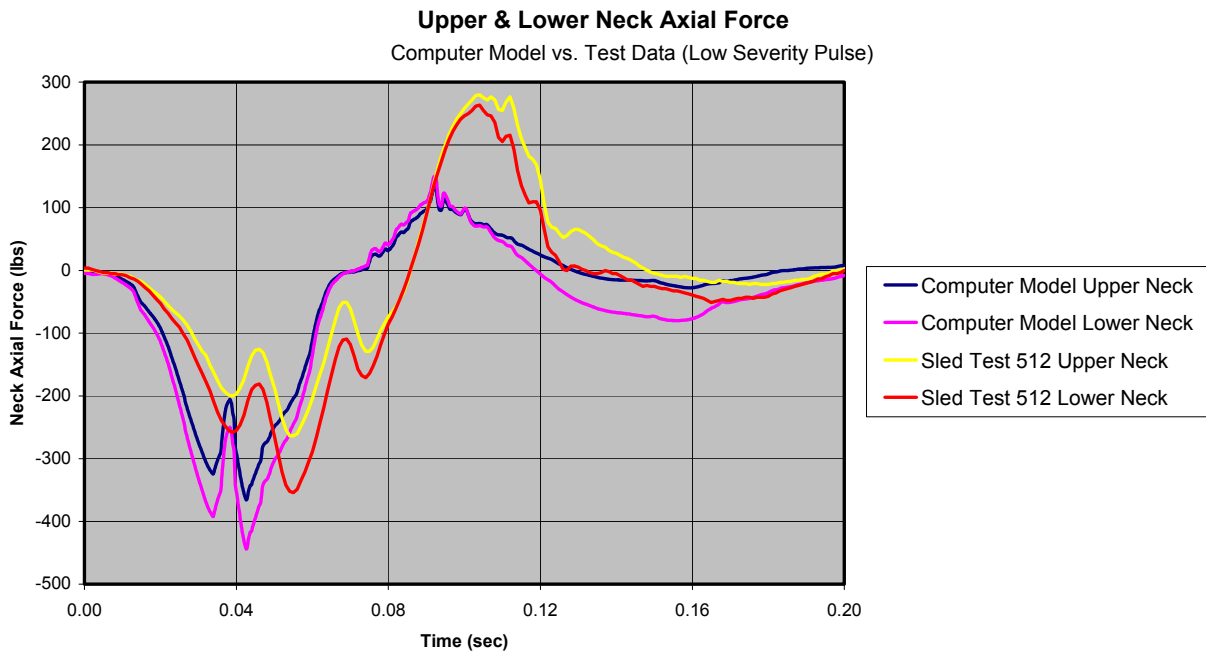

Figure A-54: Computer Model versus Test Data (Large Male - Low Severity Pulse)

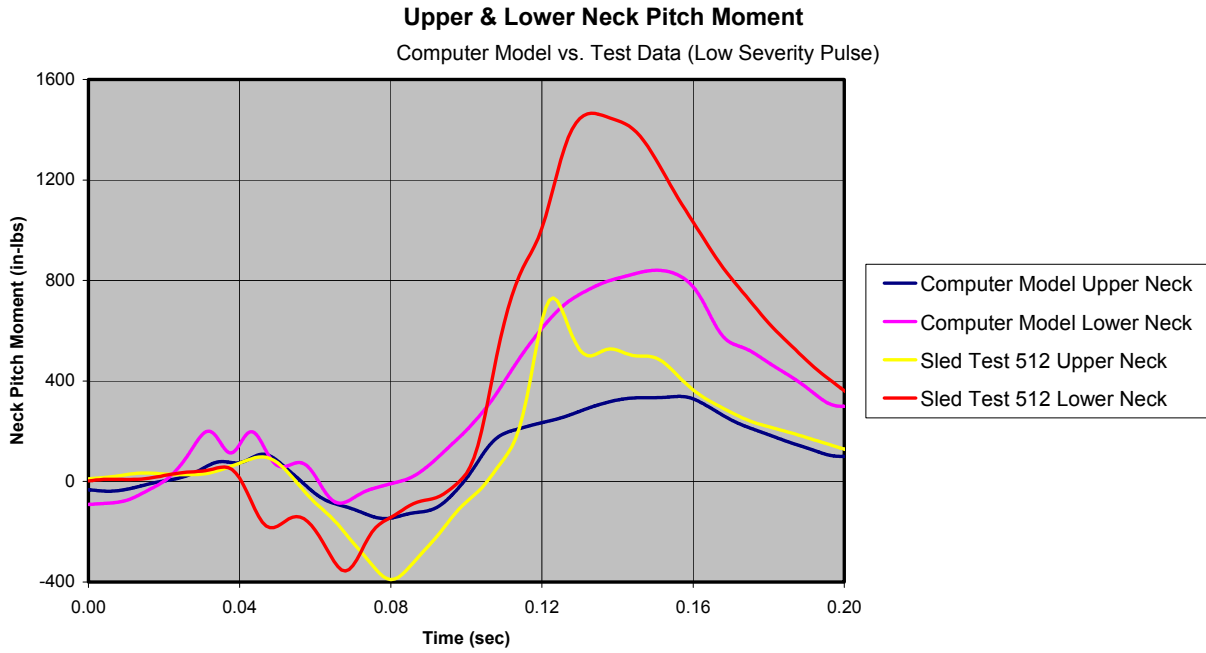

Figure A-55: Computer Model versus Test Data (Large Male - Low Severity Pulse)

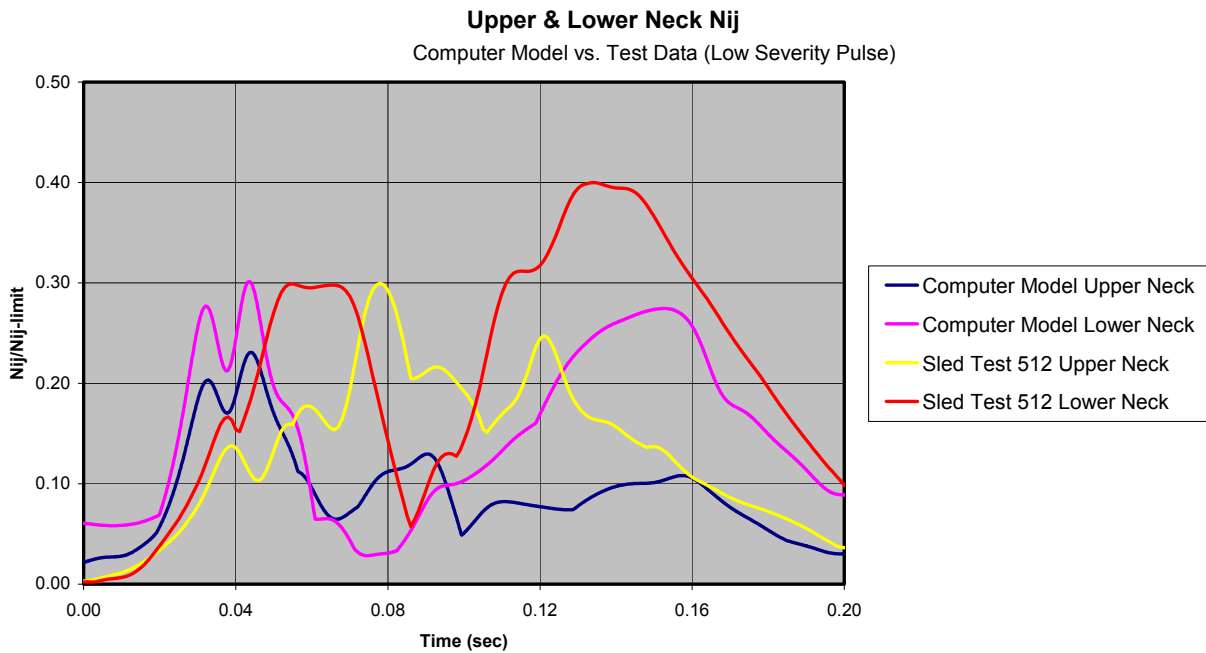

Figure A-56: Computer Model versus Test Data (Large Male - Low Severity Pulse)

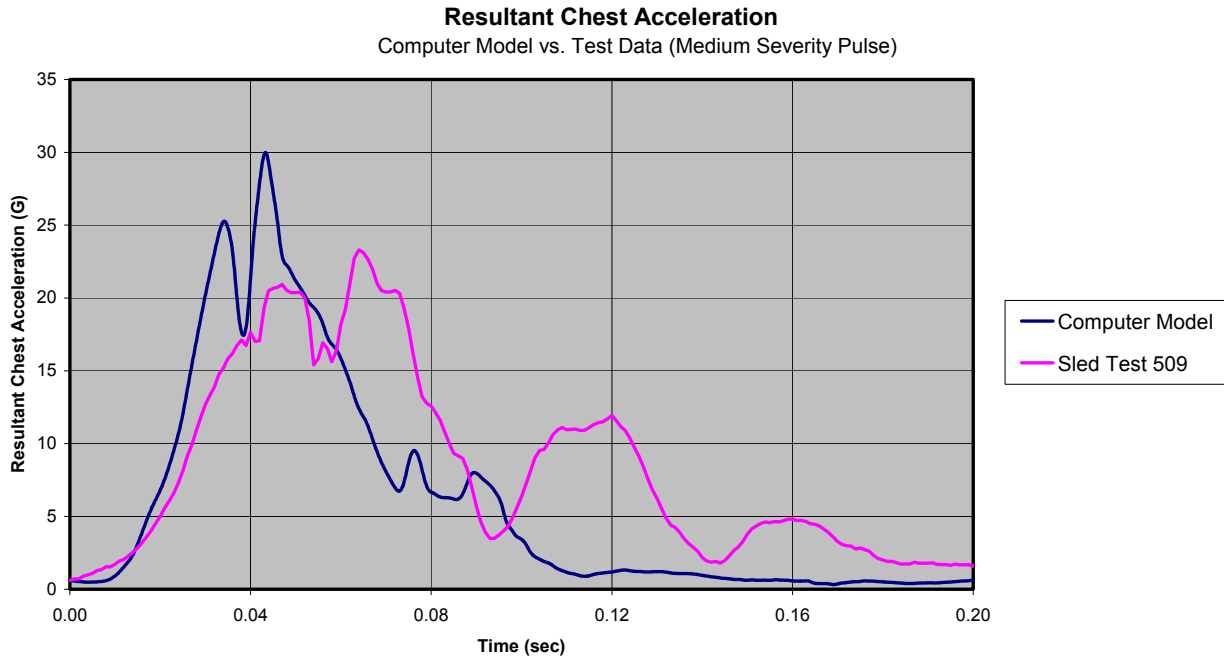

Figure A-57: Computer Model versus Test Data (Large Male - Medium Severity Pulse)

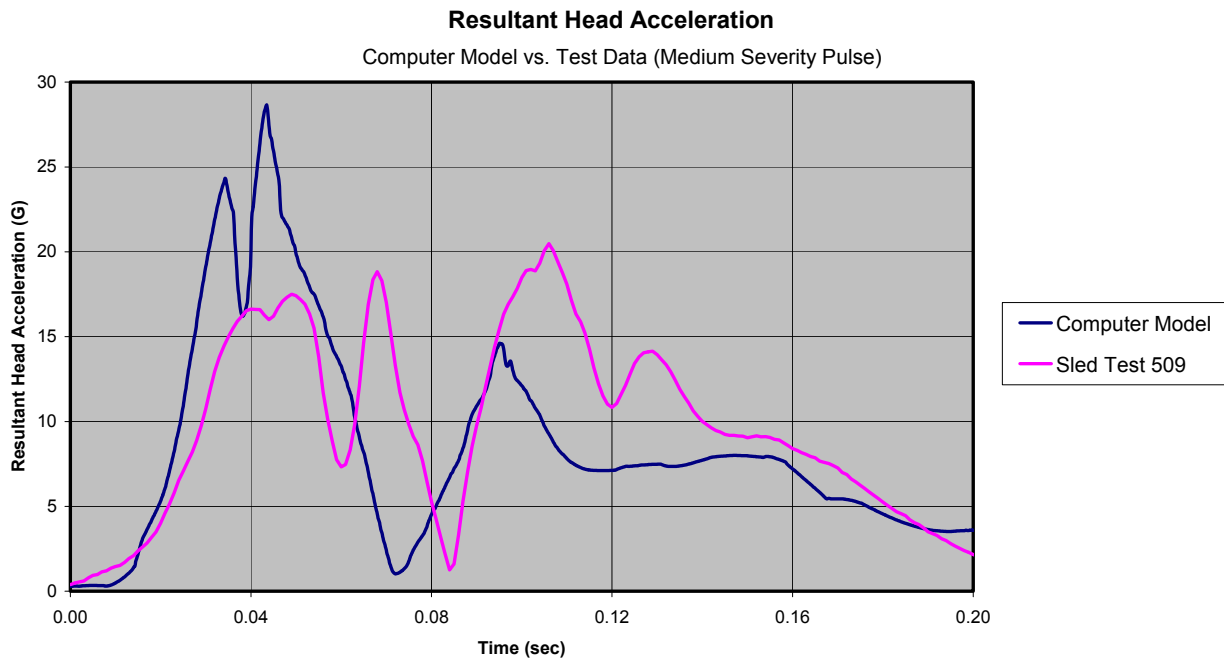

Figure A-58: Computer Model versus Test Data (Large Male - Medium Severity Pulse)

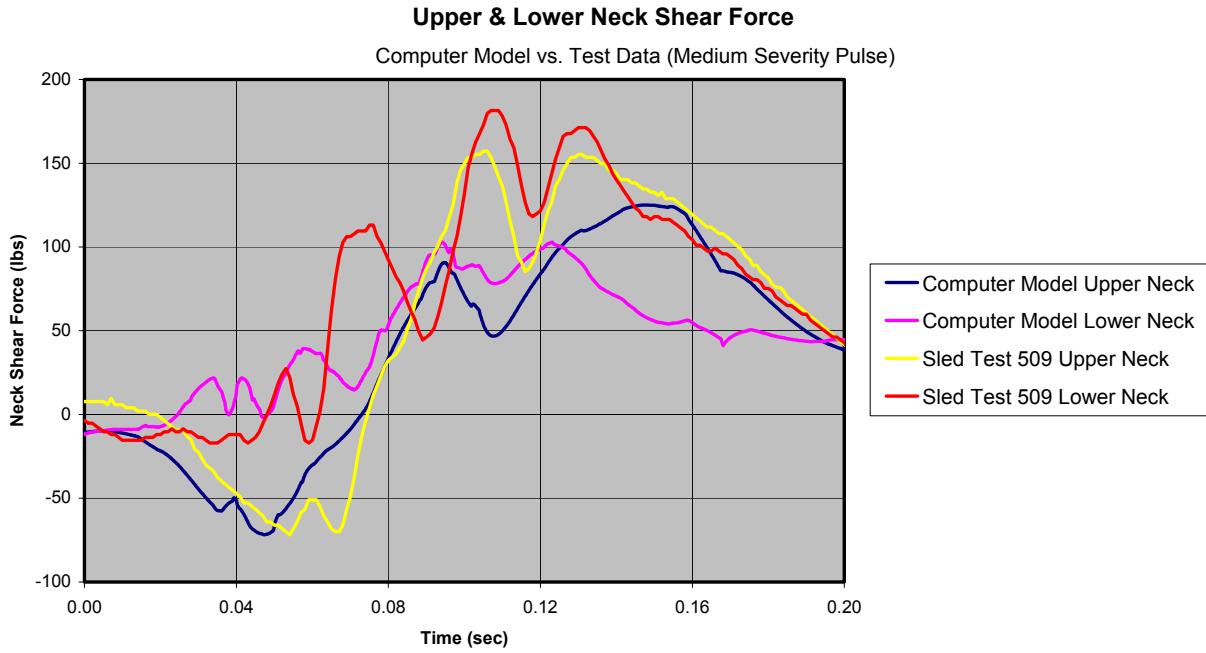

Figure A-59: Computer Model versus Test Data (Large Male - Medium Severity Pulse)

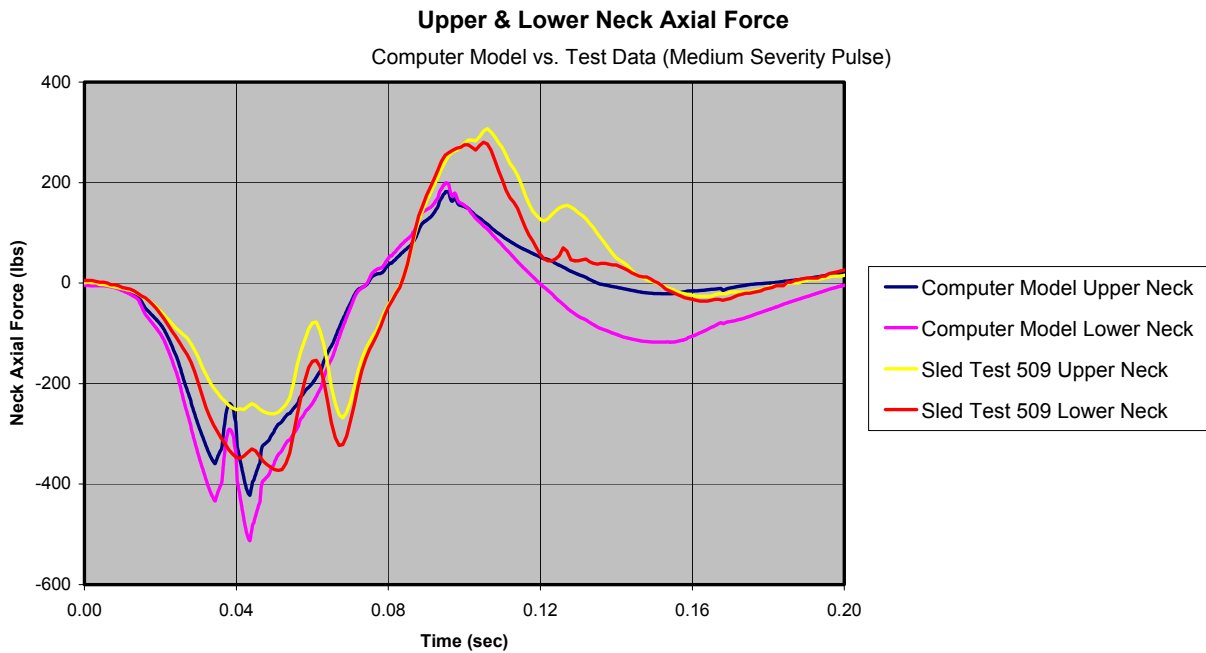

Figure A-60: Computer Model versus Test Data (Large Male - Medium Severity Pulse)

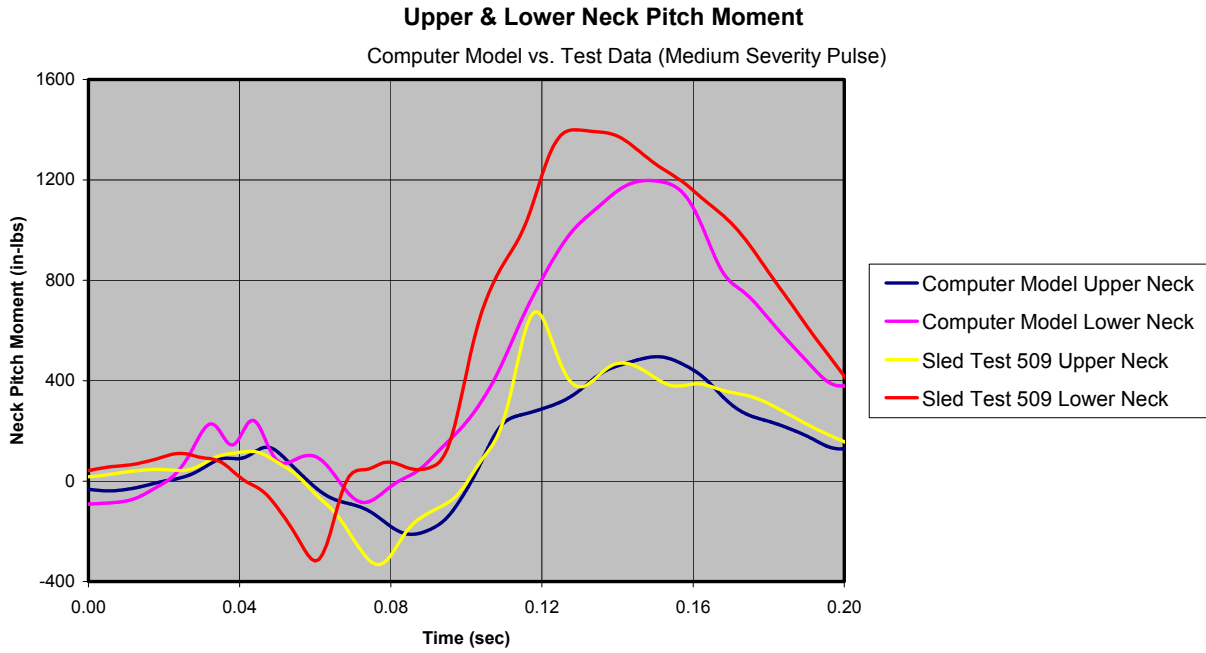

Figure A-61: Computer Model versus Test Data (Large Male - Medium Severity Pulse)

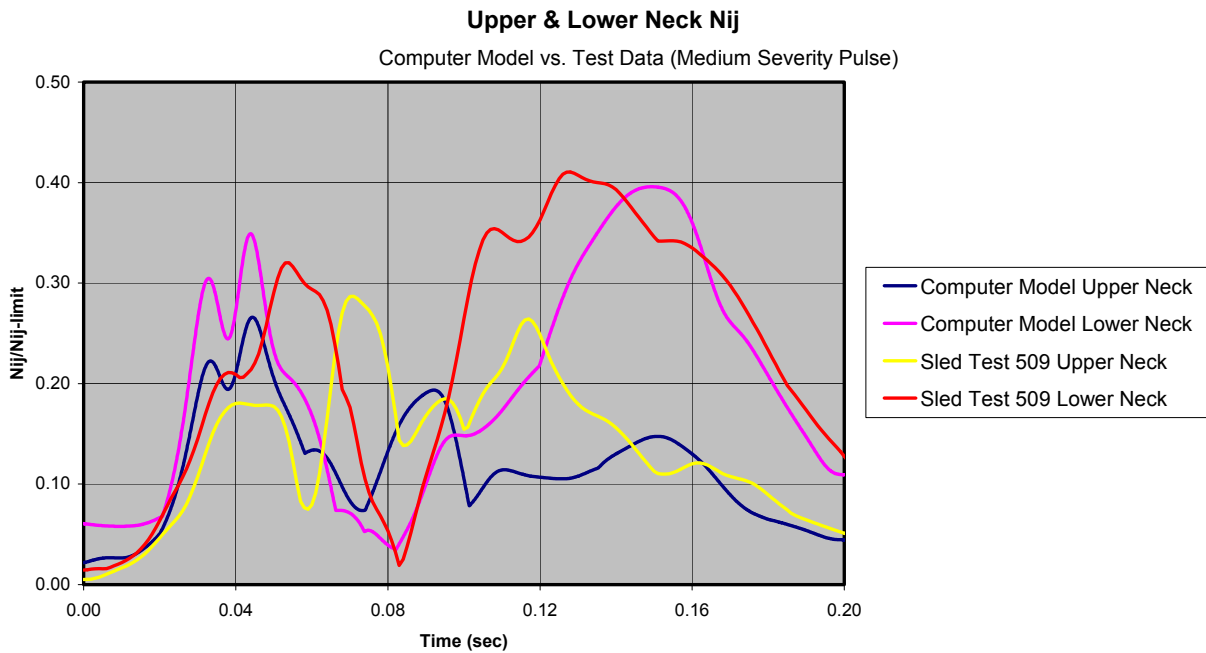

Figure A-62: Computer Model versus Test Data (Large Male - Medium Severity Pulse)

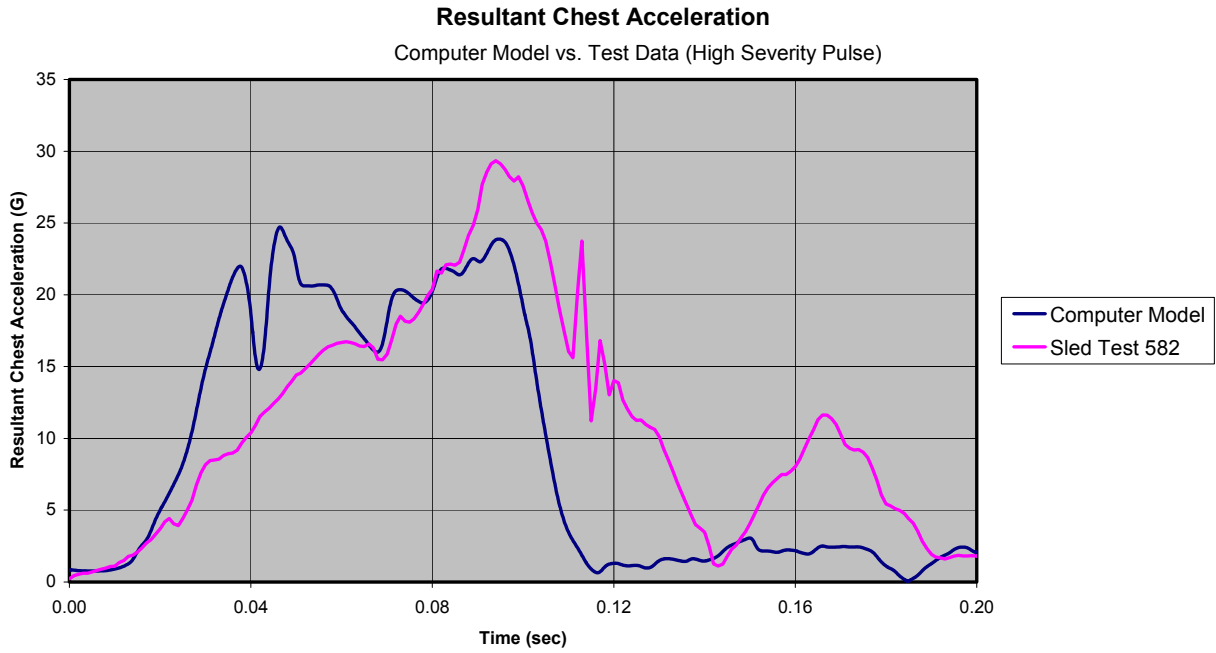

Figure A-63: Computer Model versus Test Data (Large Male - High Severity Pulse)

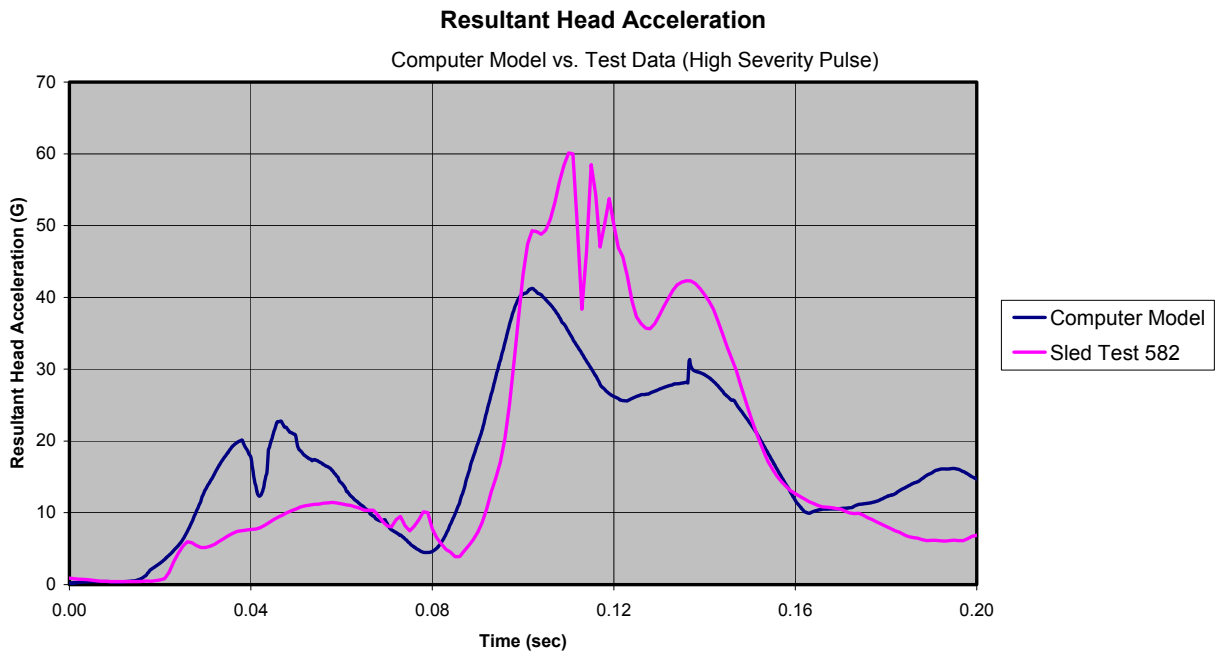

Figure A-64: Computer Model versus Test Data (Large Male - High Severity Pulse)

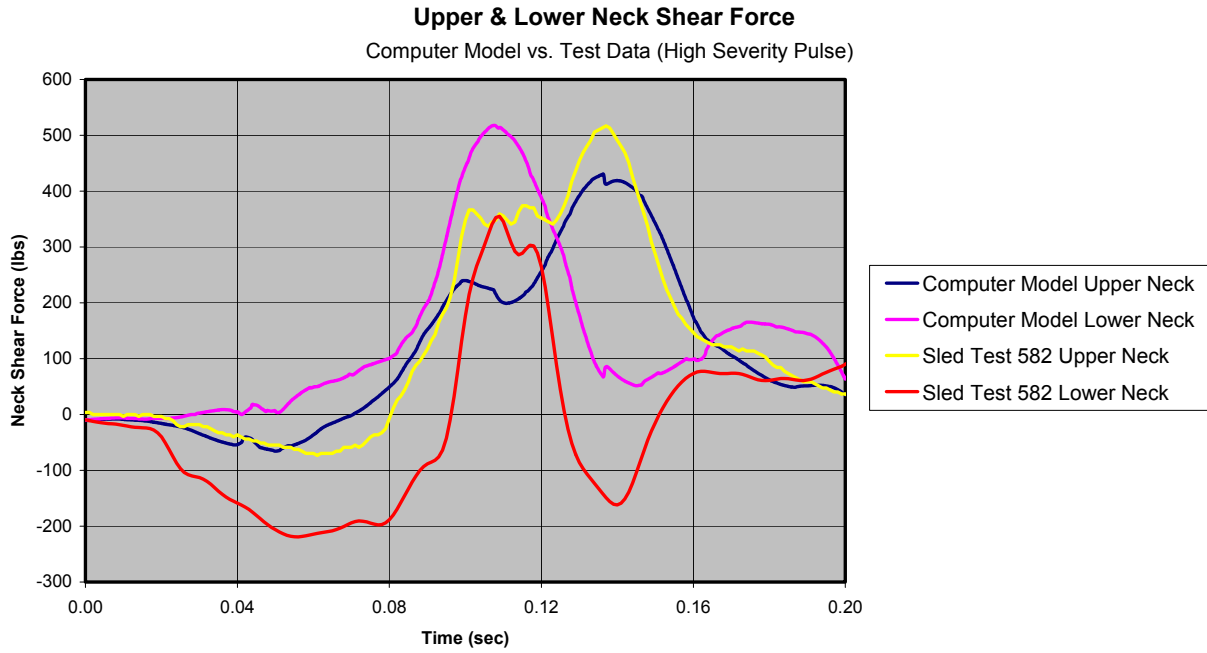

Figure A-65: Computer Model versus Test Data (Large Male - High Severity Pulse)

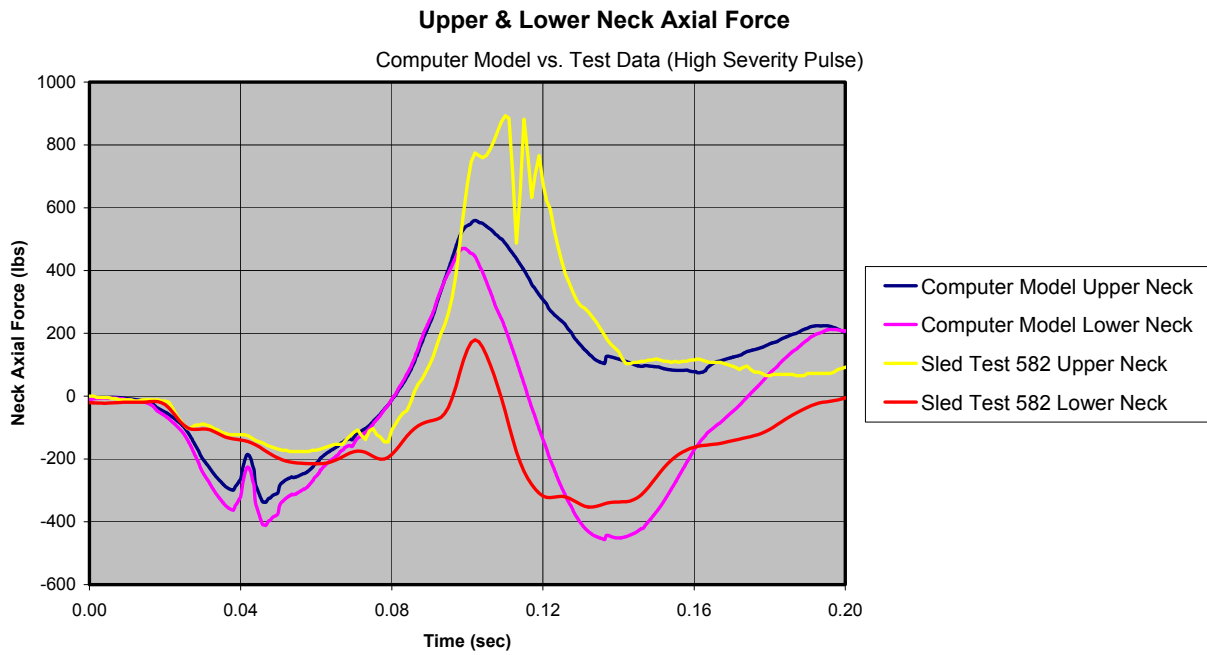

Figure A-66: Computer Model versus Test Data (Large Male - High Severity Pulse)

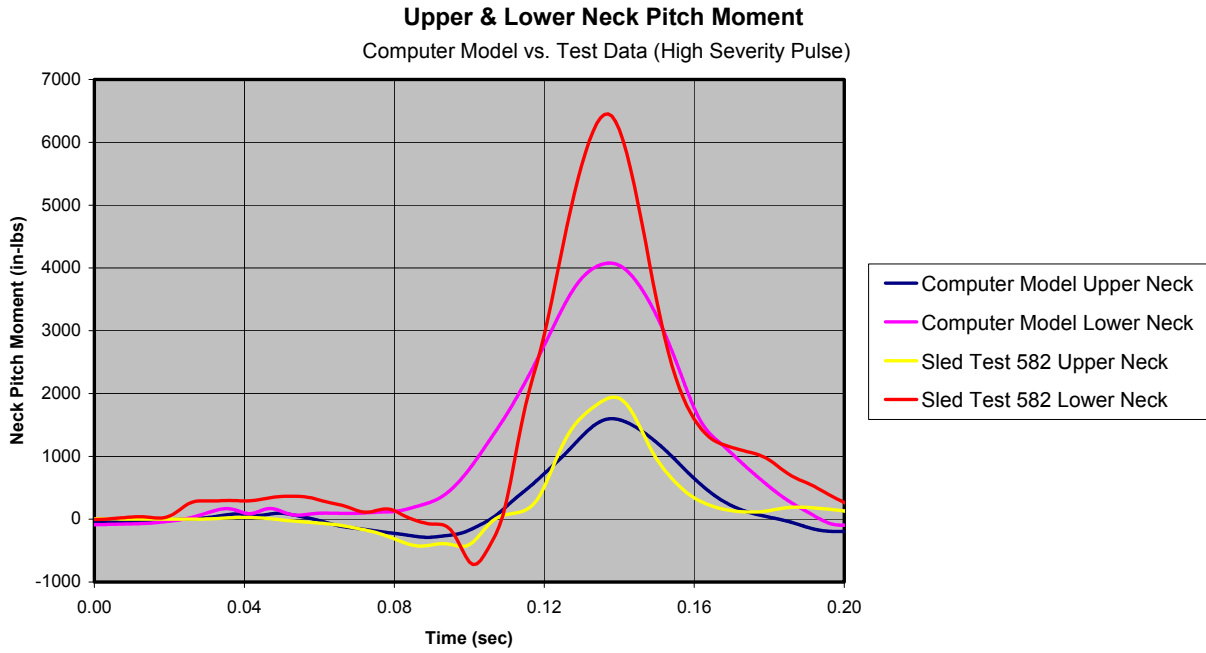

Figure A-67: Computer Model versus Test Data (Large Male - High Severity Pulse)

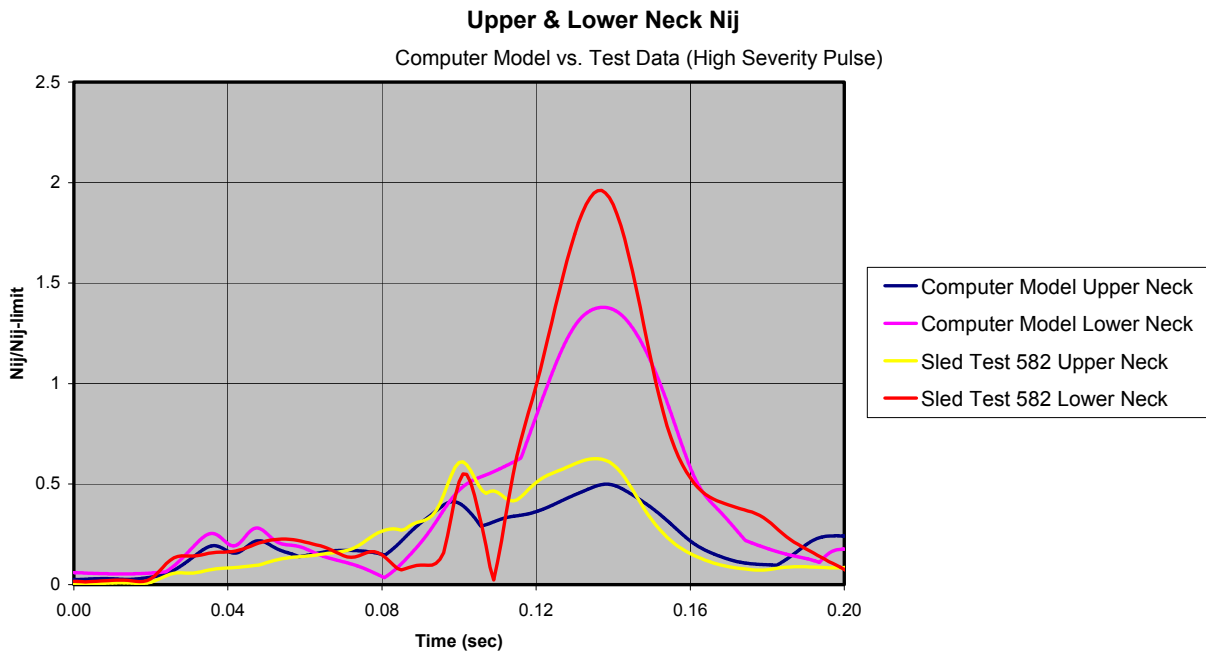

Figure A-68: Computer Model versus Test Data (Large Male - High Severity Pulse)



THIS PAGE INTENTIONALLY LEFT BLANK

APPENDIX B  
FIGURES  
(SMALL FEMALE TESTS)

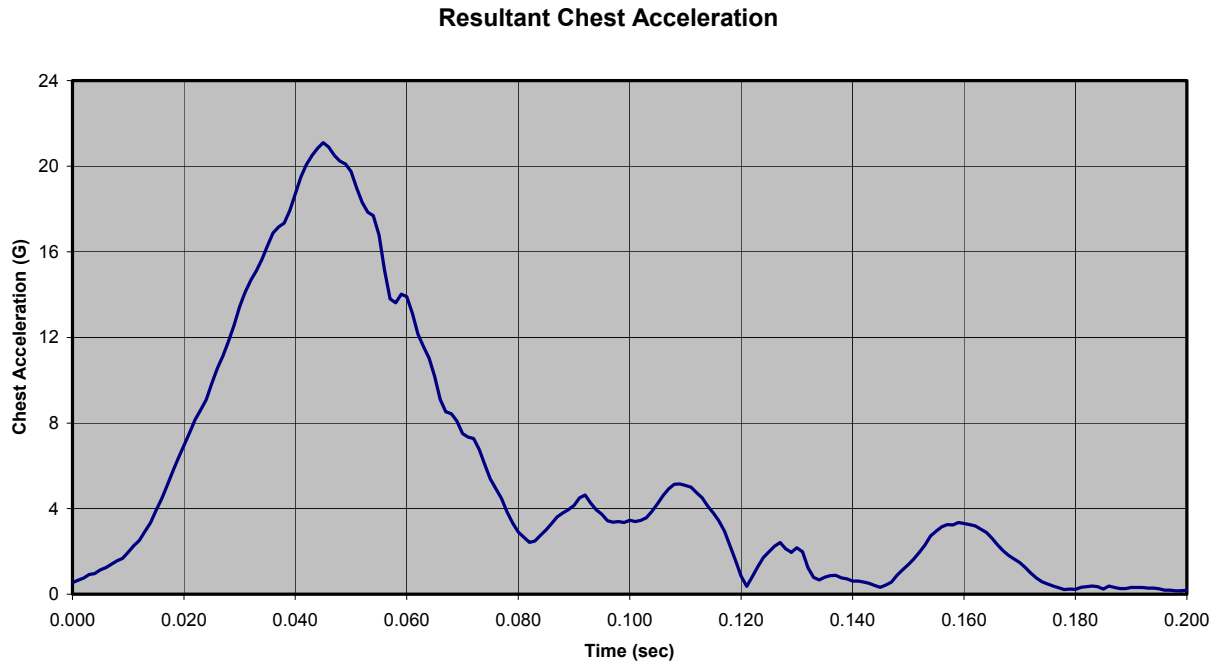

Figure B-1: Test 514 (Low Pulse, 4.0 lb Added Head Weight)

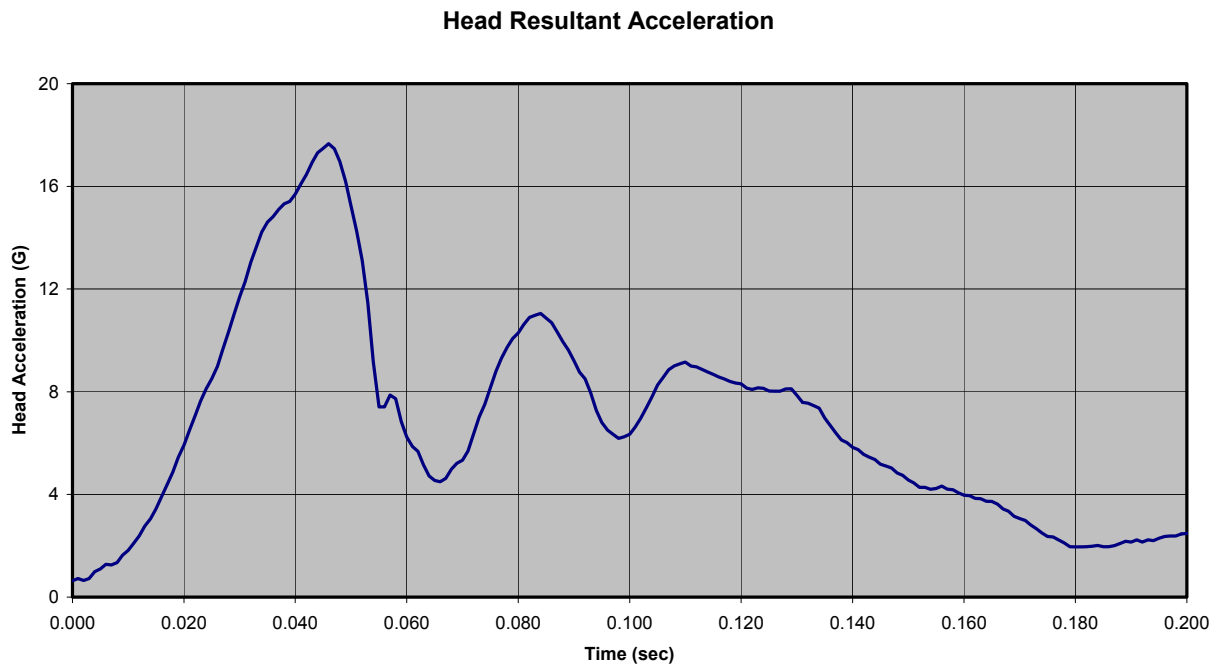

Figure B-2: Test 514 (Low Pulse, 4.0 lb Added Head Weight)

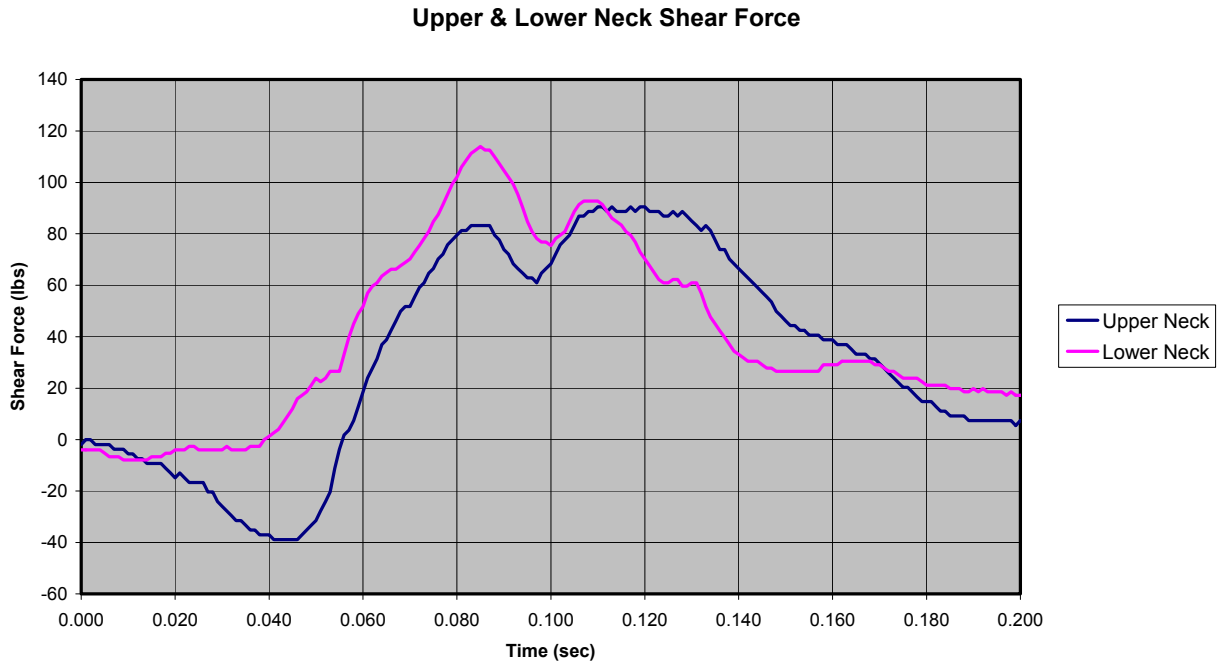

Figure B-3: Test 514 (Low Pulse, 4.0 lb Added Head Weight)

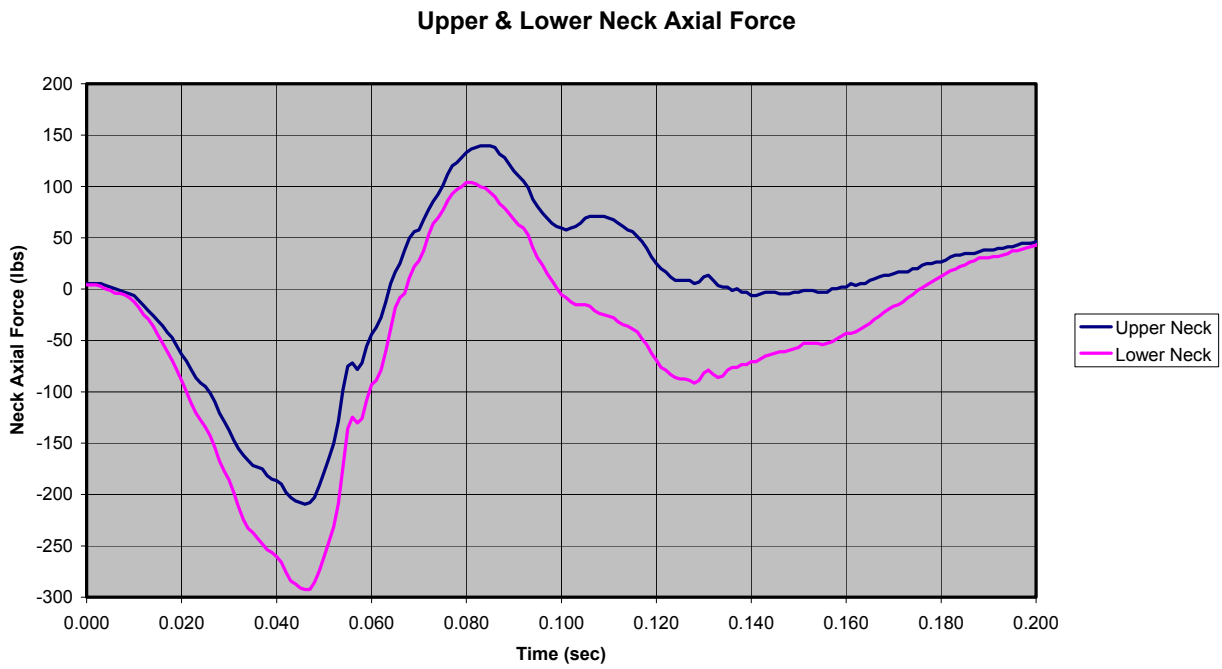

Figure B-4: Test 514 (Low Pulse, 4.0 lb Added Head Weight)

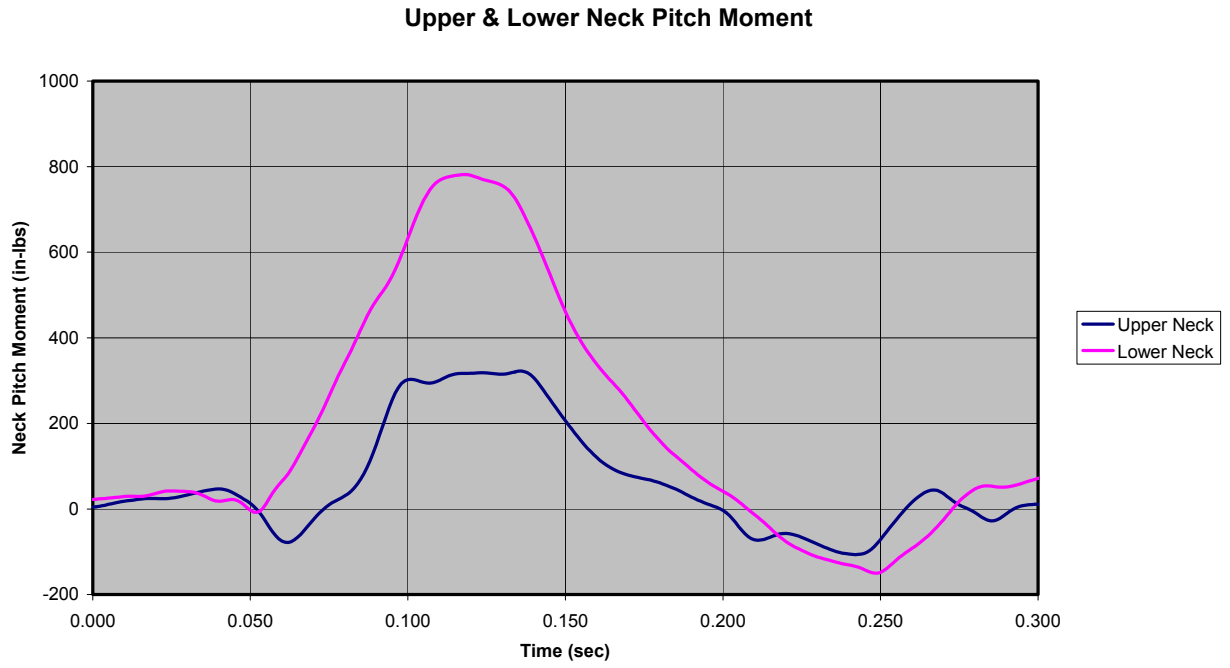

Figure B-5: Test 514 (Low Pulse, 4.0 lb Added Head Weight)

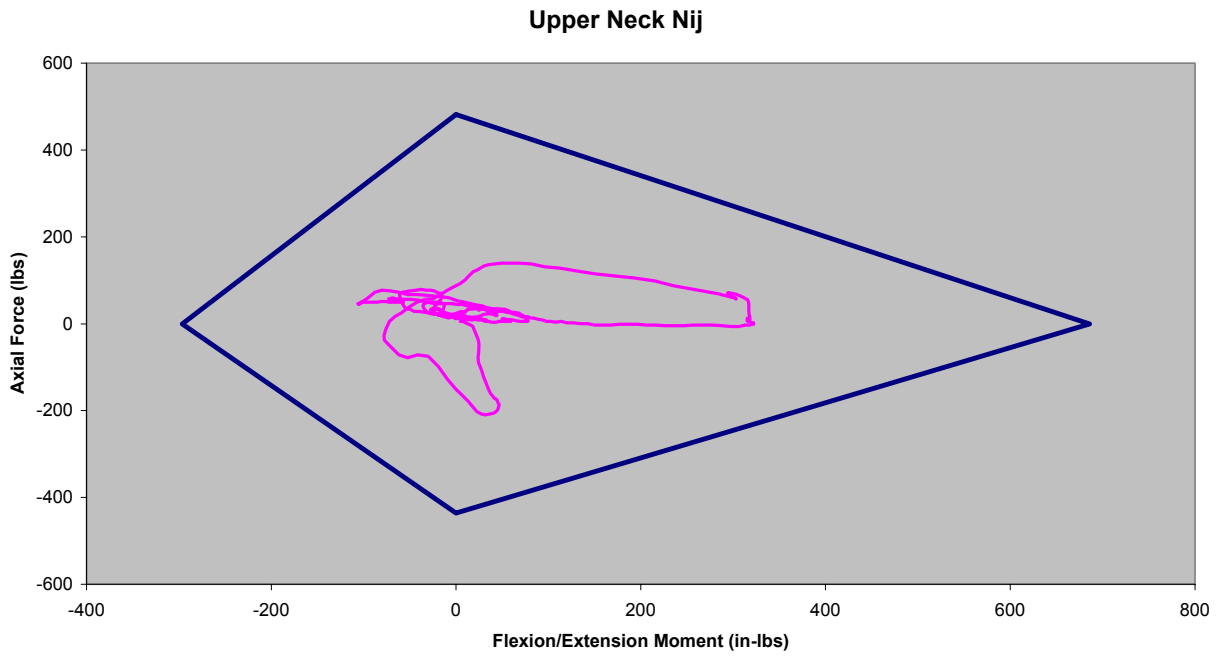

Figure B-6: Test 514 (Low Pulse, 4.0 lb Added Head Weight)

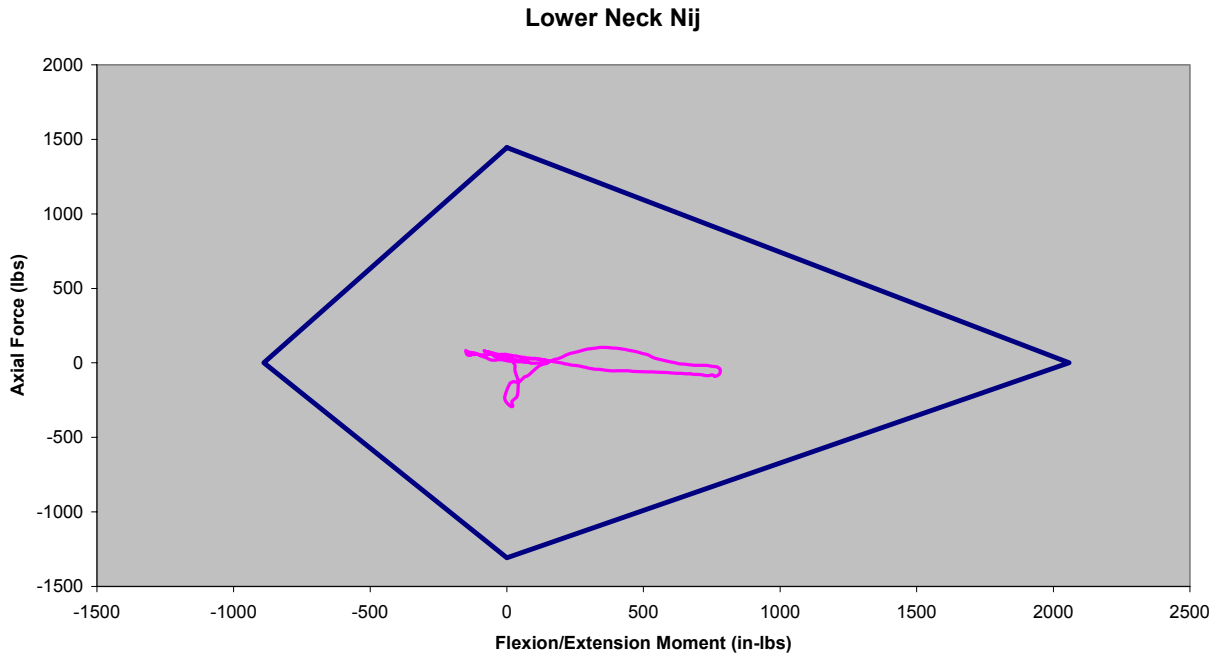

Figure B-7: Test 514 (Low Pulse, 4.0 lb Added Head Weight)

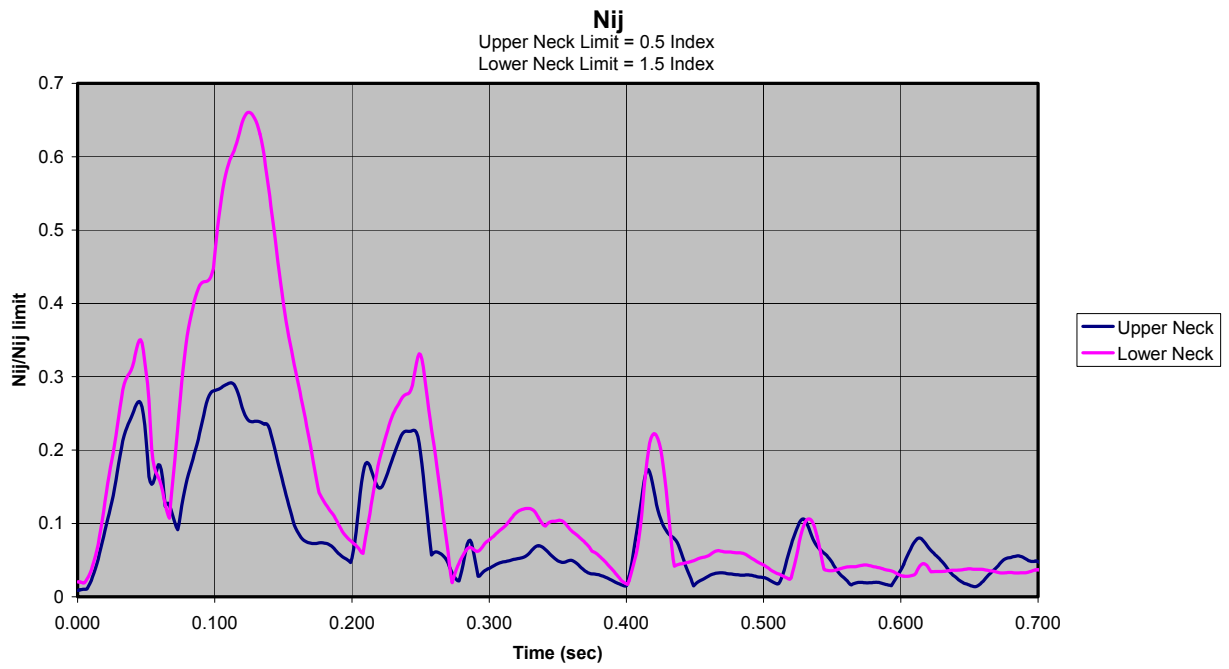

Figure B-8: Test 514 (Low Pulse, 4.0 lb Added Head Weight)

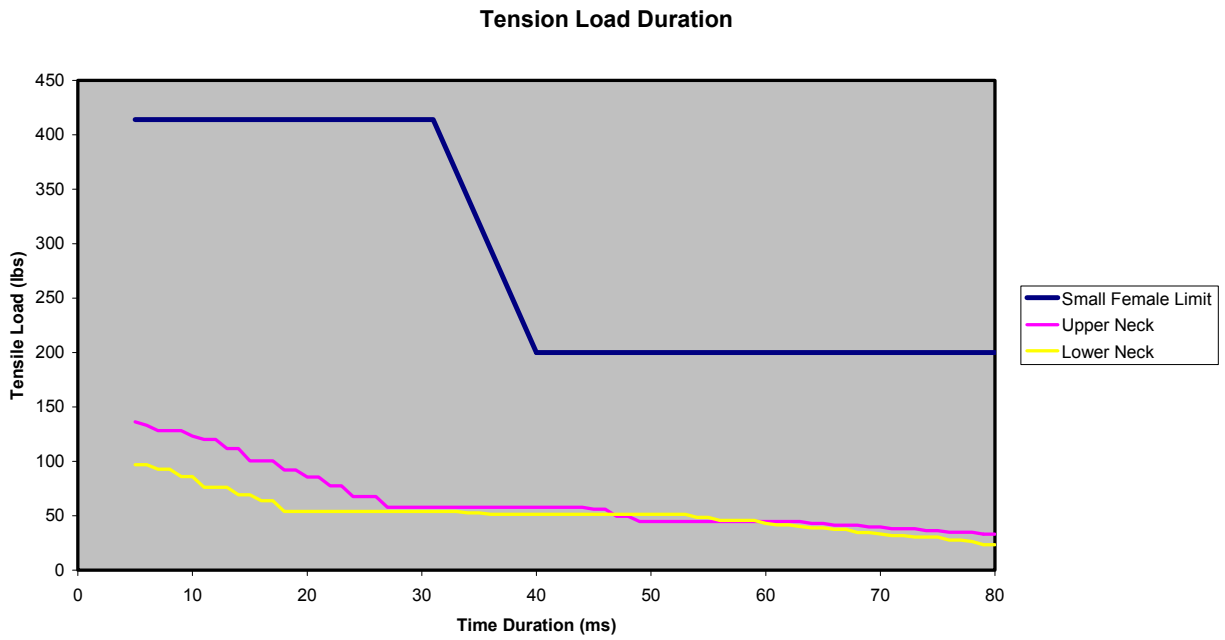

Figure B-9: Test 514 (Low Pulse, 4.0 lb Added Head Weight)

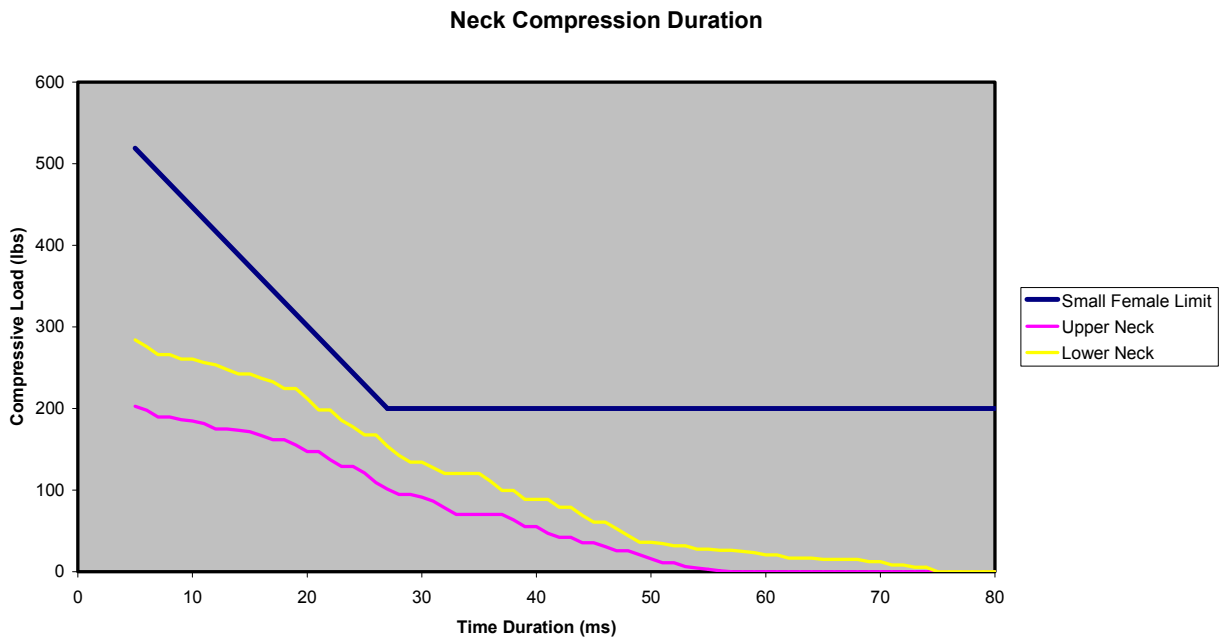

Figure B-10: Test 514 (Low Pulse, 4.0 lb Added Head Weight)

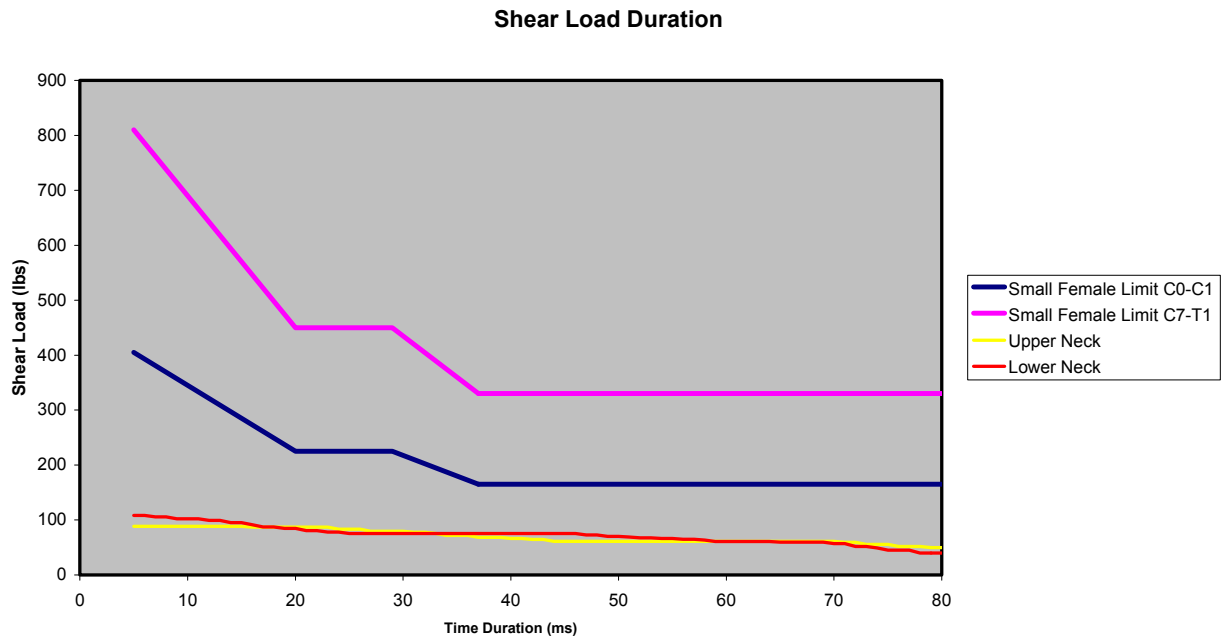

Figure B-11: Test 514 (Low Pulse, 4.0 lb Added Head Weight)

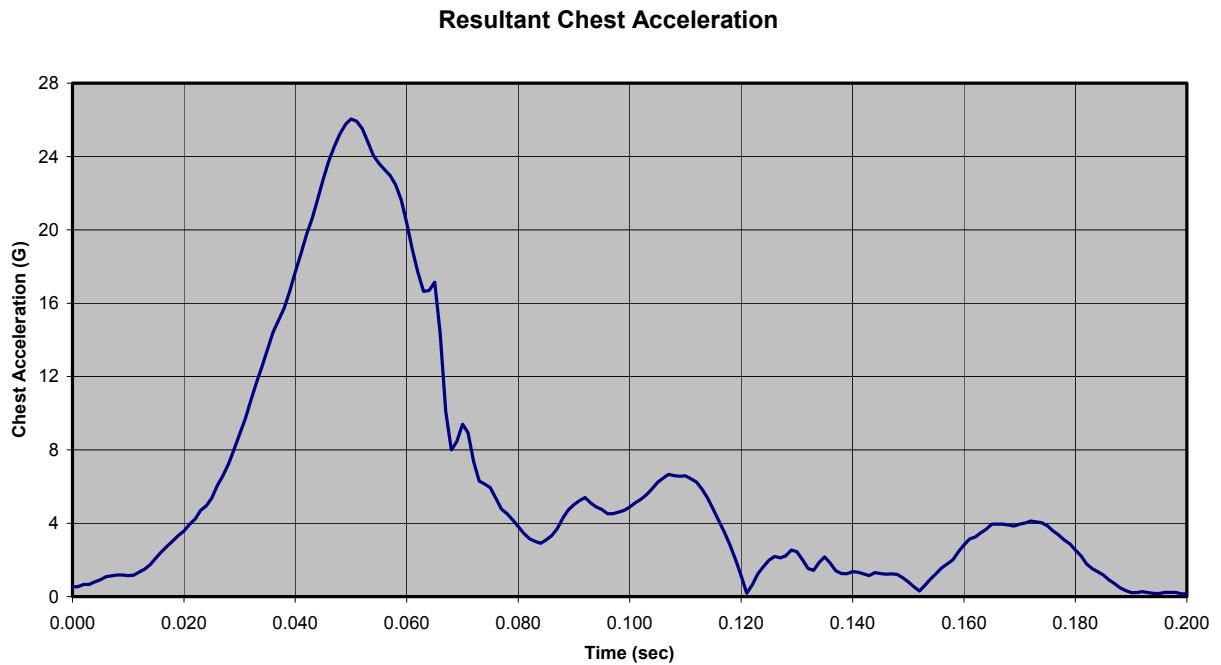

Figure B-12: Test 515 (Low Pulse, 5.0 lb Added Head Weight)



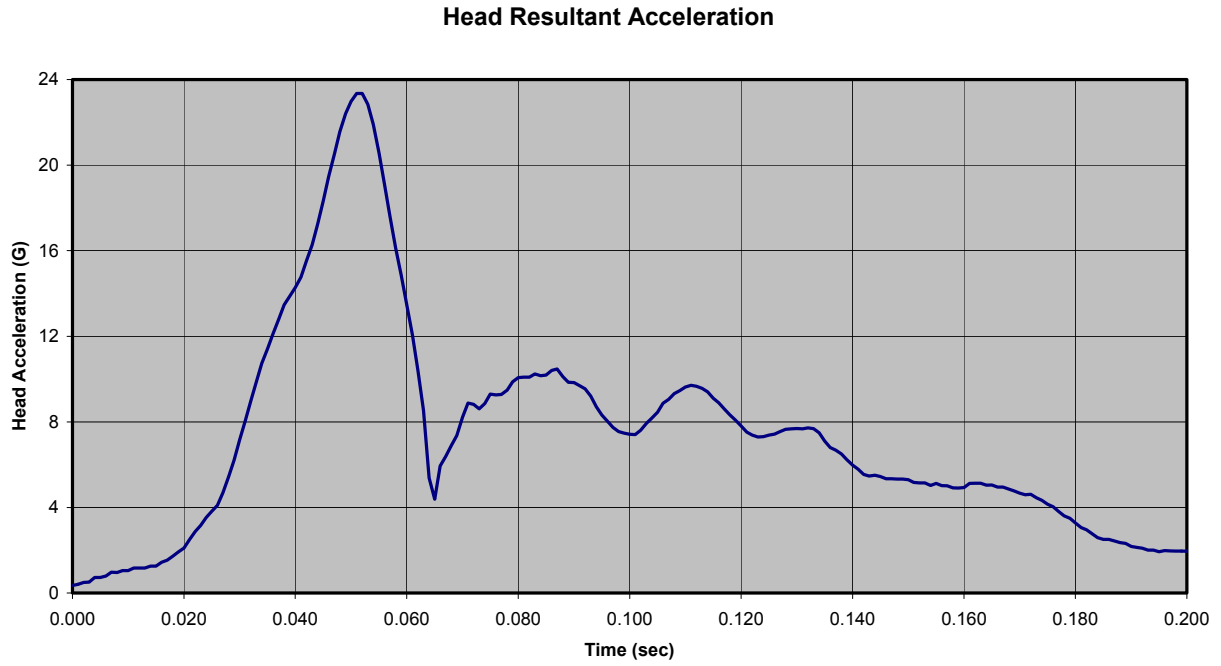

Figure B-13: Test 515 (Low Pulse, 5.0 lb Added Head Weight)

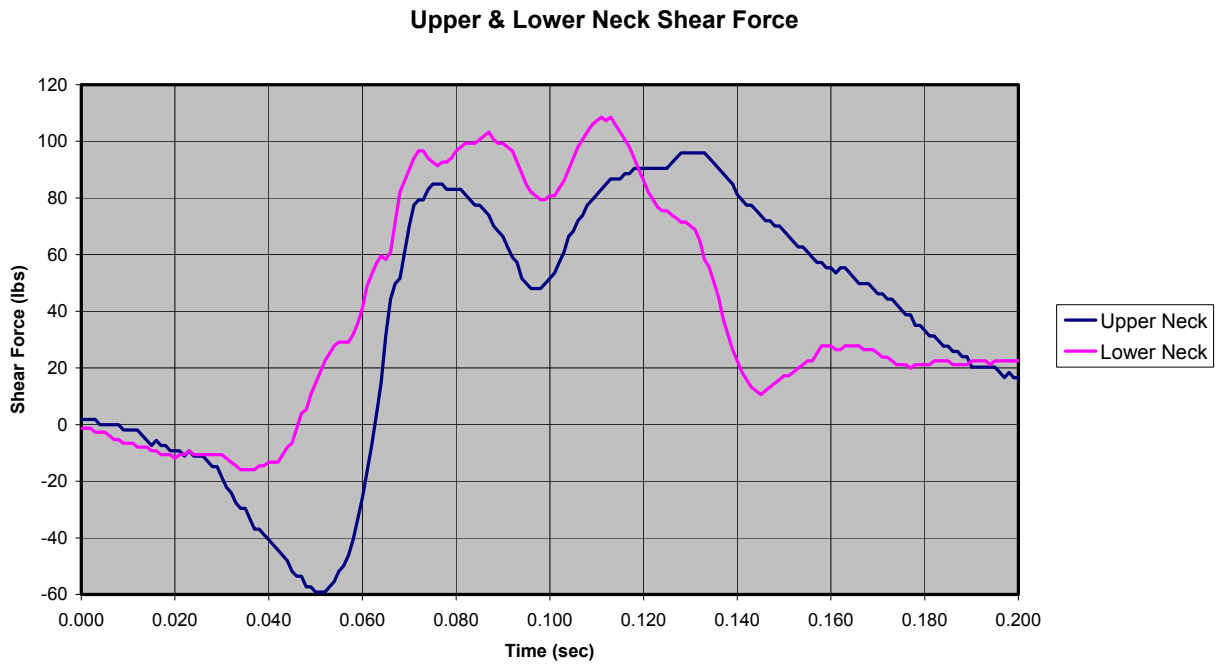

Figure B-14: Test 515 (Low Pulse, 5.0 lb Added Head Weight)

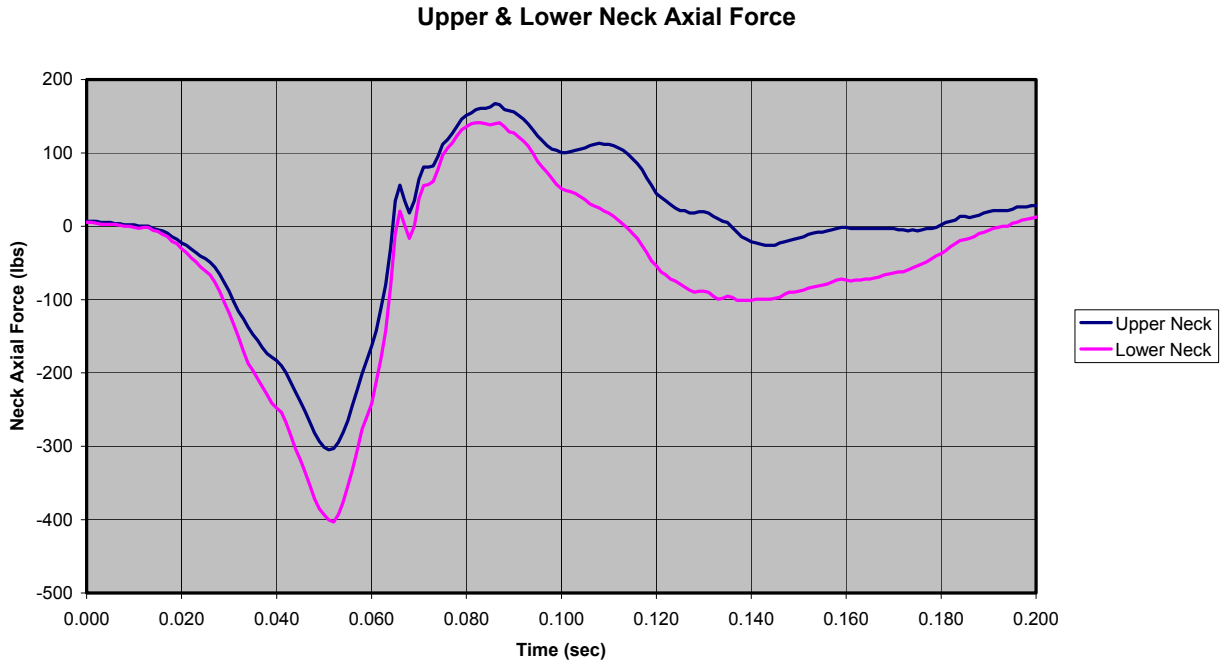

Figure B-15: Test 515 (Low Pulse, 5.0 lb Added Head Weight)

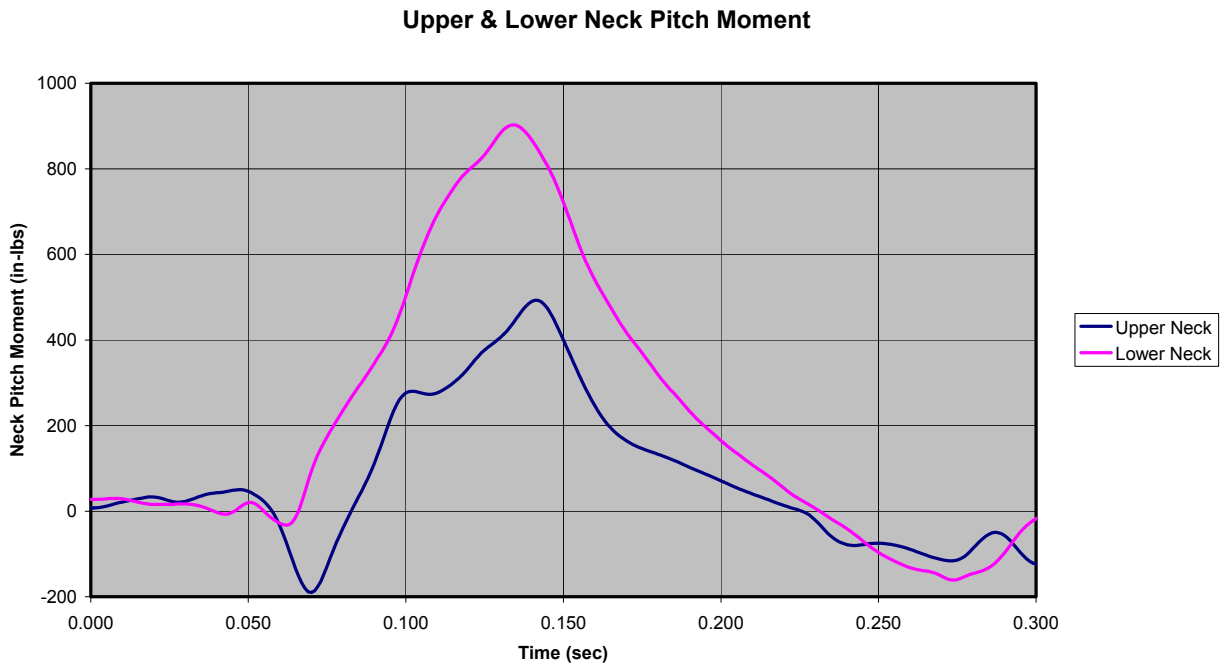

Figure B-16: Test 515 (Low Pulse, 5.0 lb Added Head Weight)

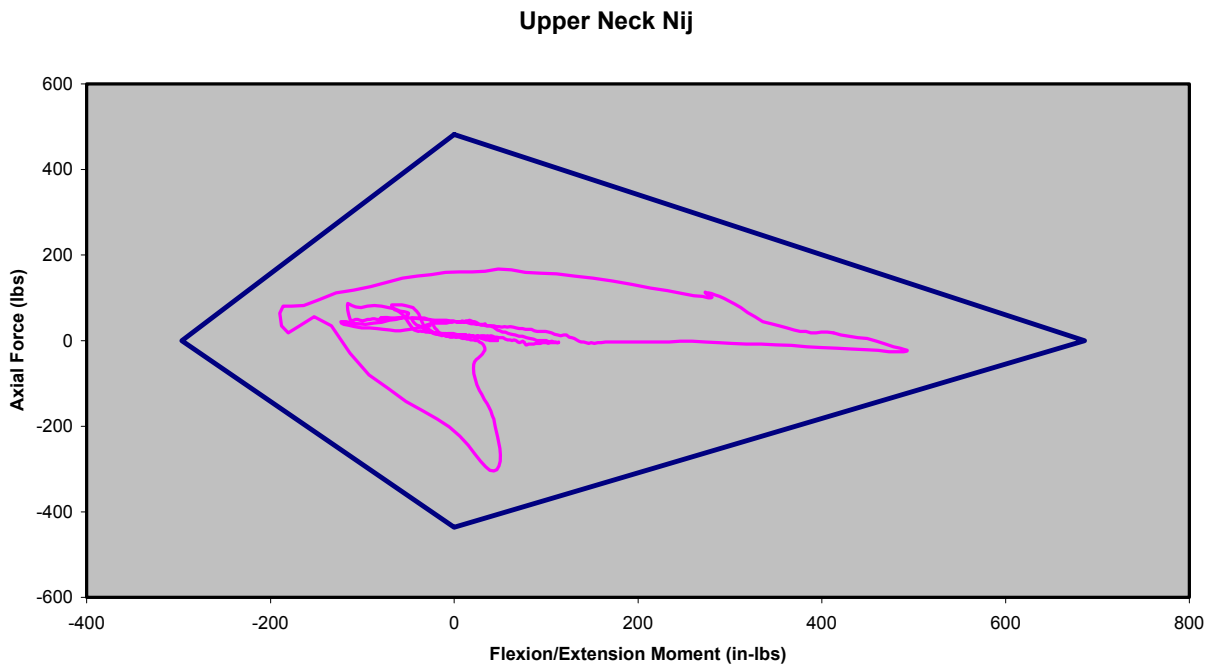

Figure B-17: Test 515 (Low Pulse, 5.0 lb Added Head Weight)

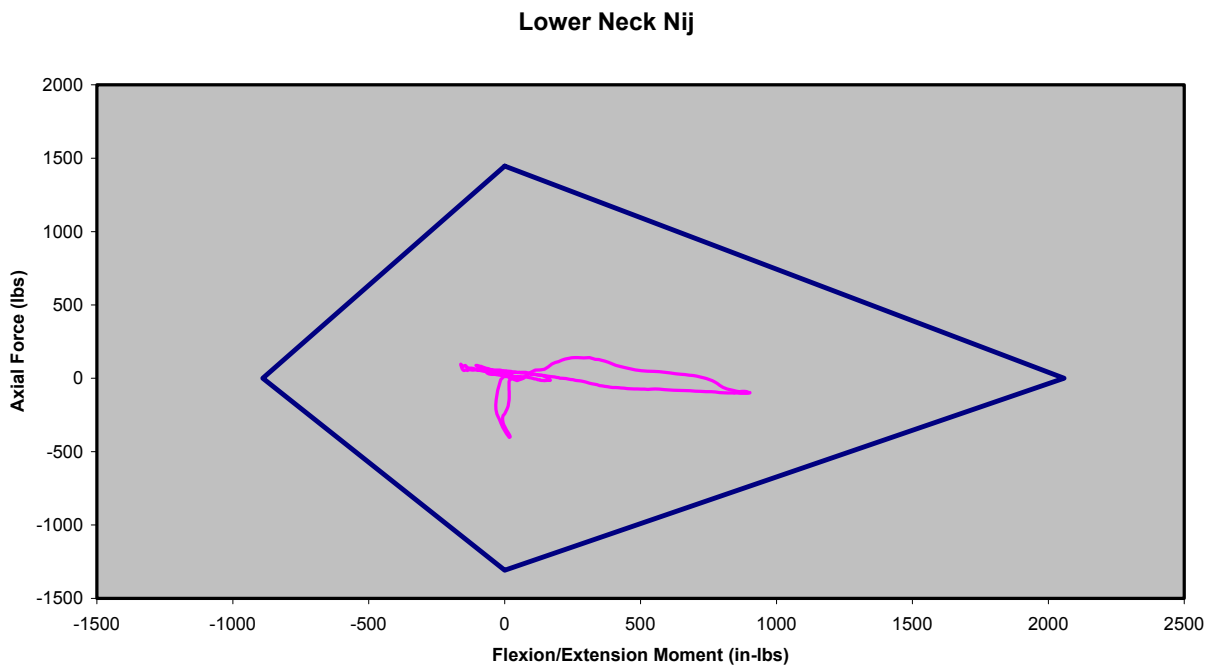

Figure B-18: Test 515 (Low Pulse, 5.0 lb Added Head Weight)

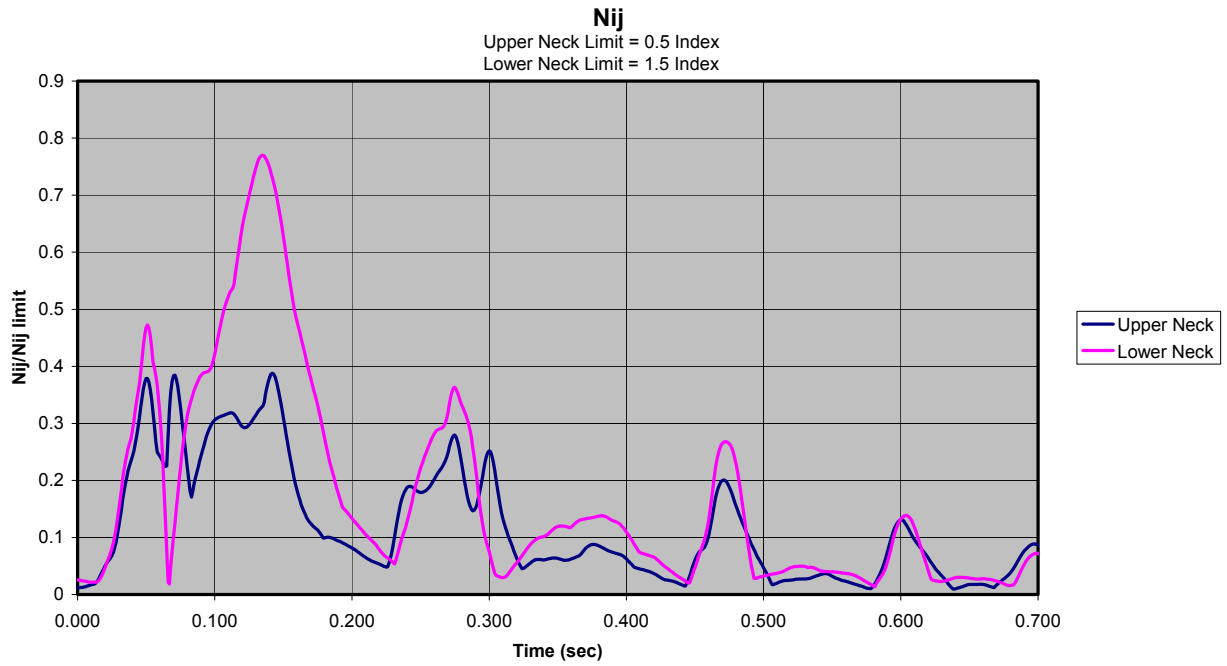

Figure B-19: Test 515 (Low Pulse, 5.0 lb Added Head Weight)

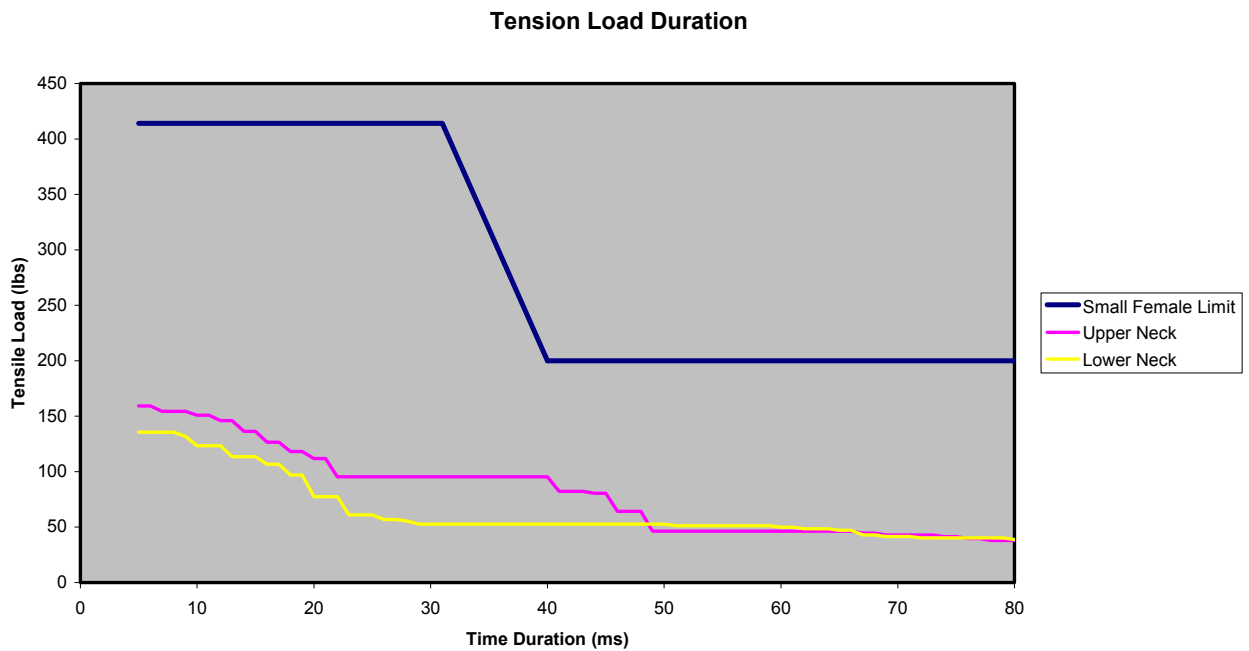

Figure B-20: Test 515 (Low Pulse, 5.0 lb Added Head Weight)

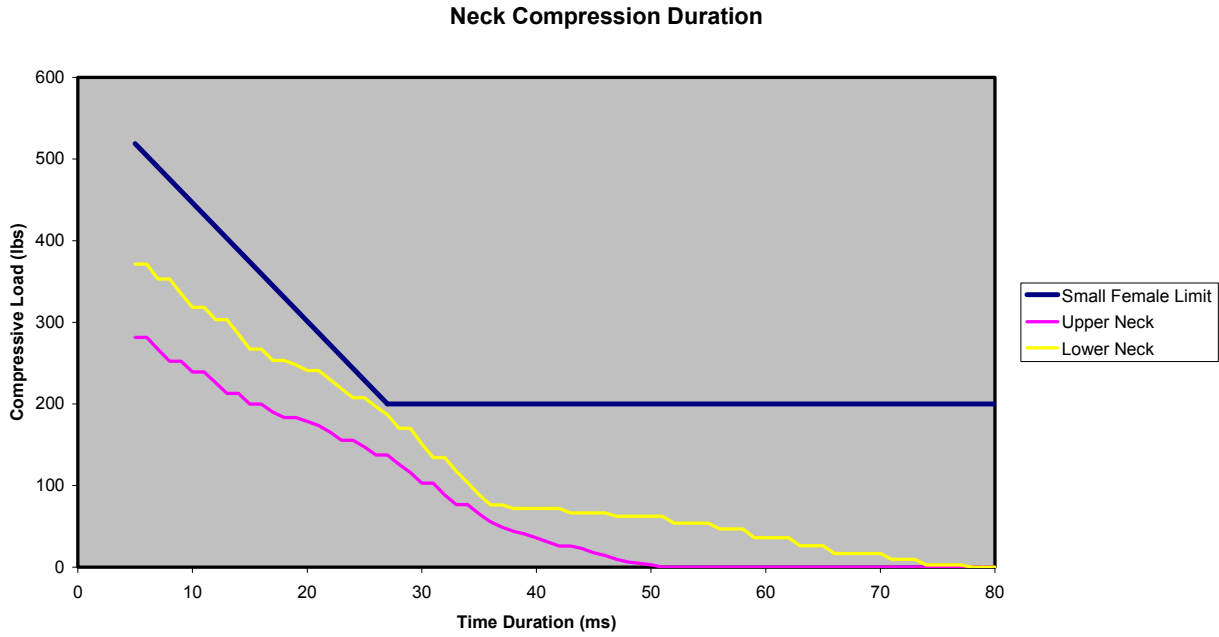

Figure B-21: Test 515 (Low Pulse, 5.0 lb Added Head Weight)

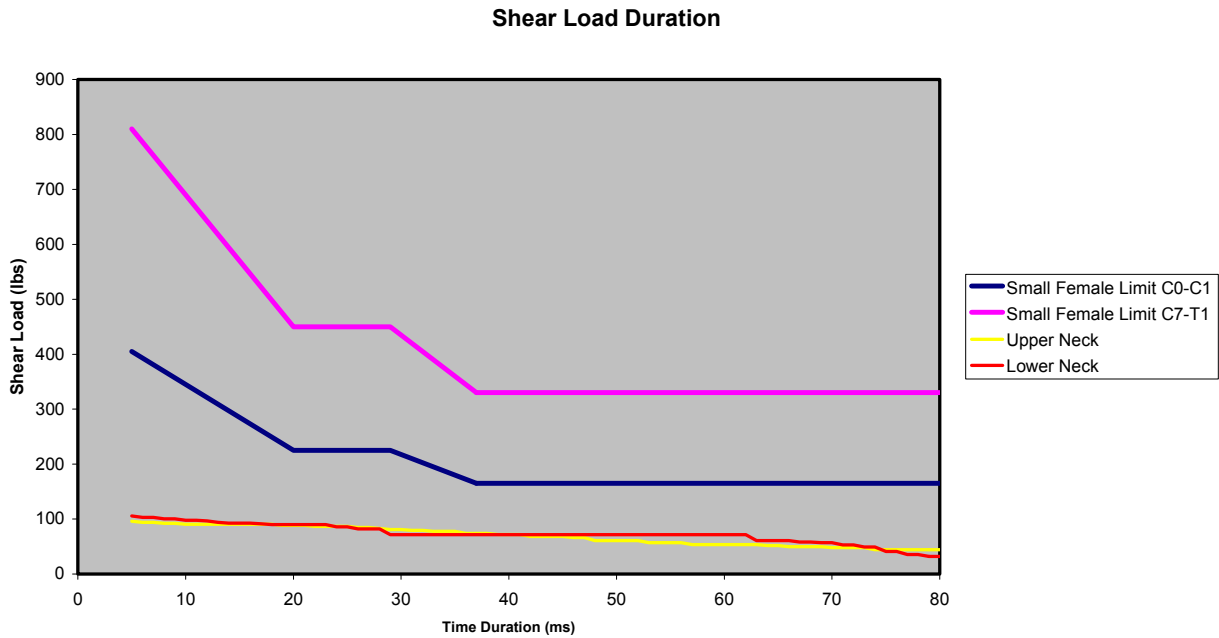

Figure B-22: Test 515 (Low Pulse, 5.0 lb Added Head Weight)

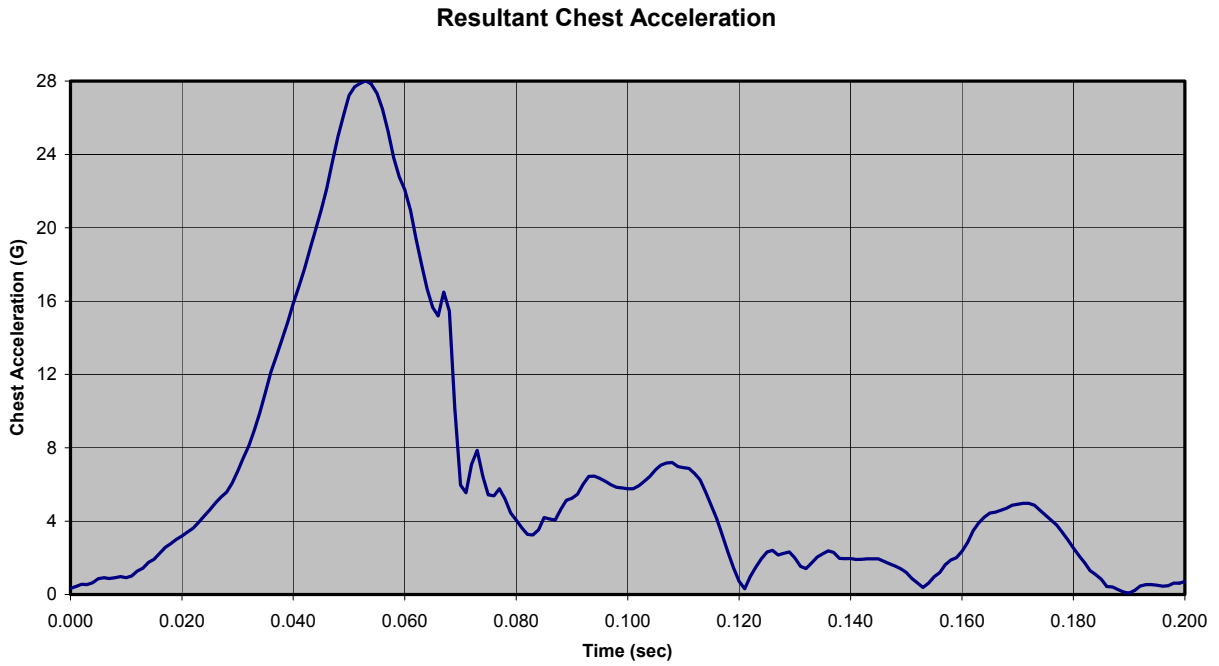

Figure B-23: Test 516 (Low Pulse, 5.5 lb Added Head Weight)

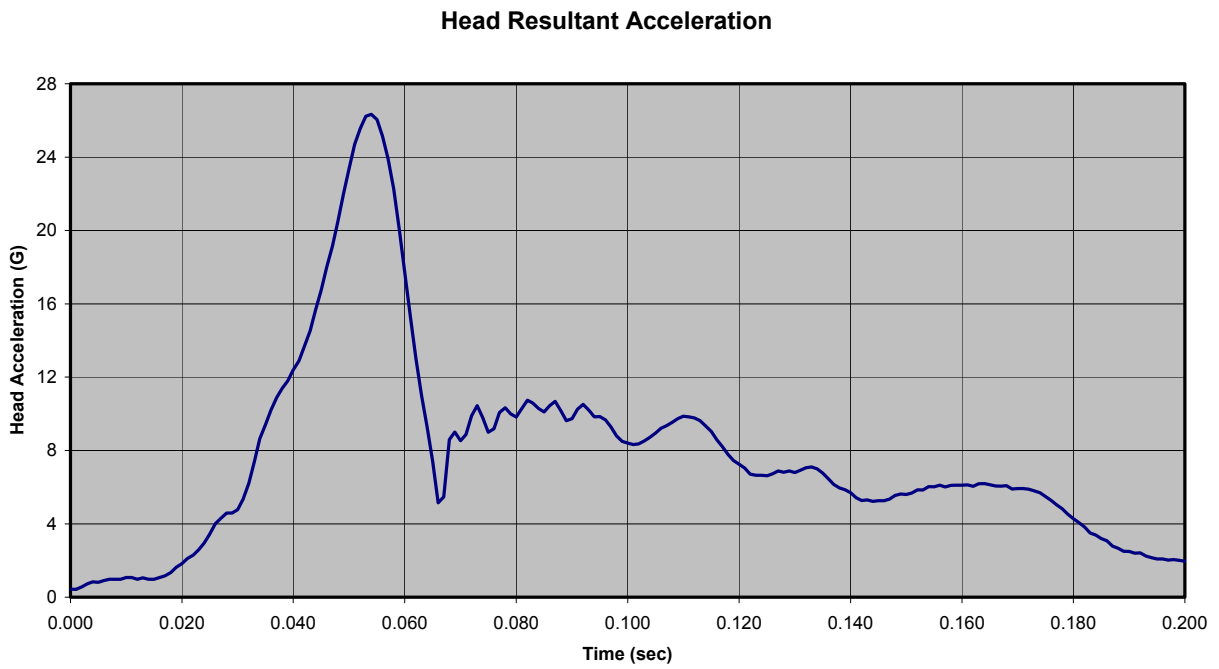

Figure B-24: Test 516 (Low Pulse, 5.5 lb Added Head Weight)

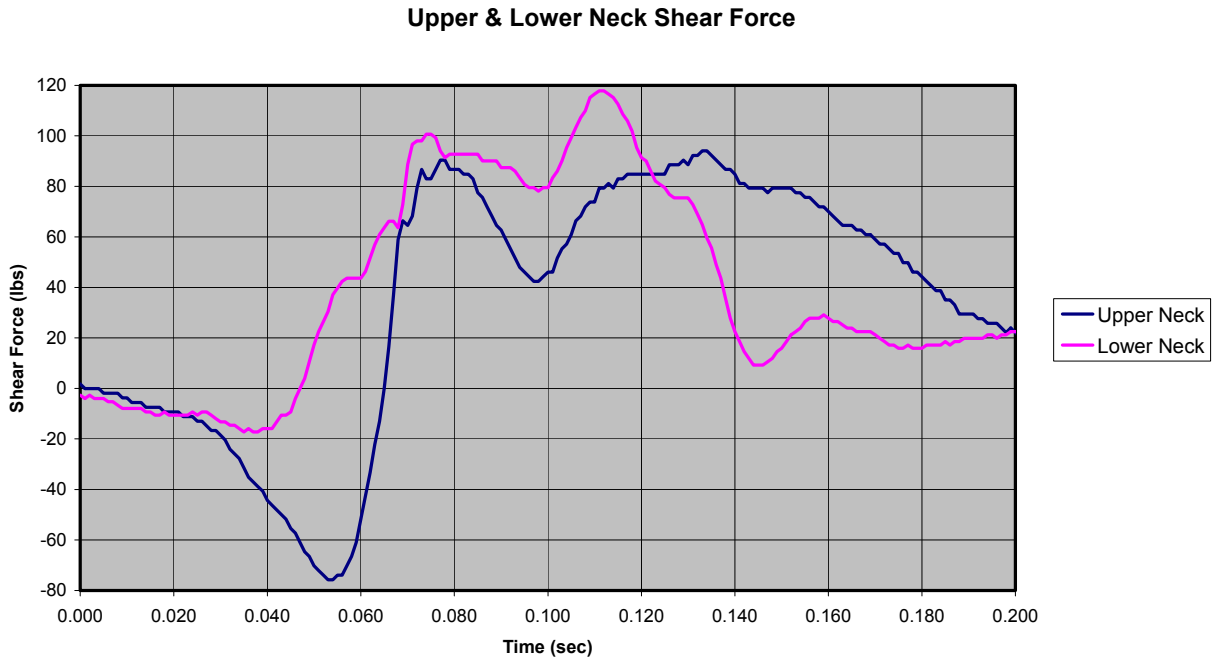

Figure B-25: Test 516 (Low Pulse, 5.5 lb Added Head Weight)

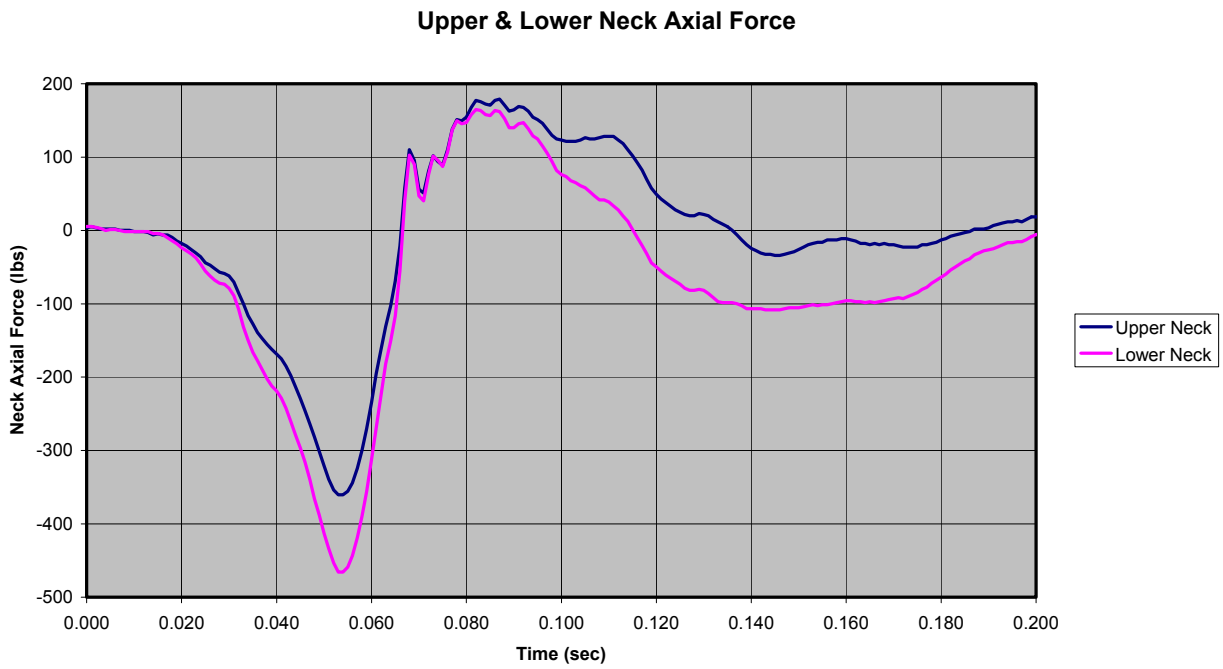

Figure B-26: Test 516 (Low Pulse, 5.5 lb Added Head Weight)

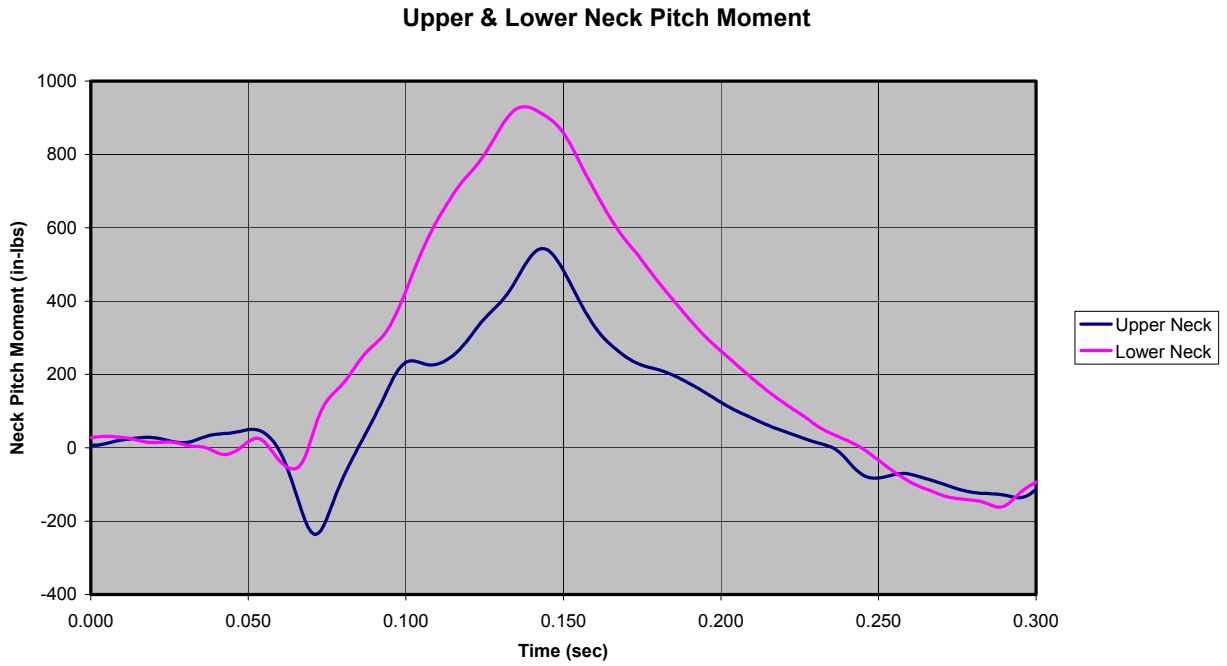

Figure B-27: Test 516 (Low Pulse, 5.5 lb Added Head Weight)

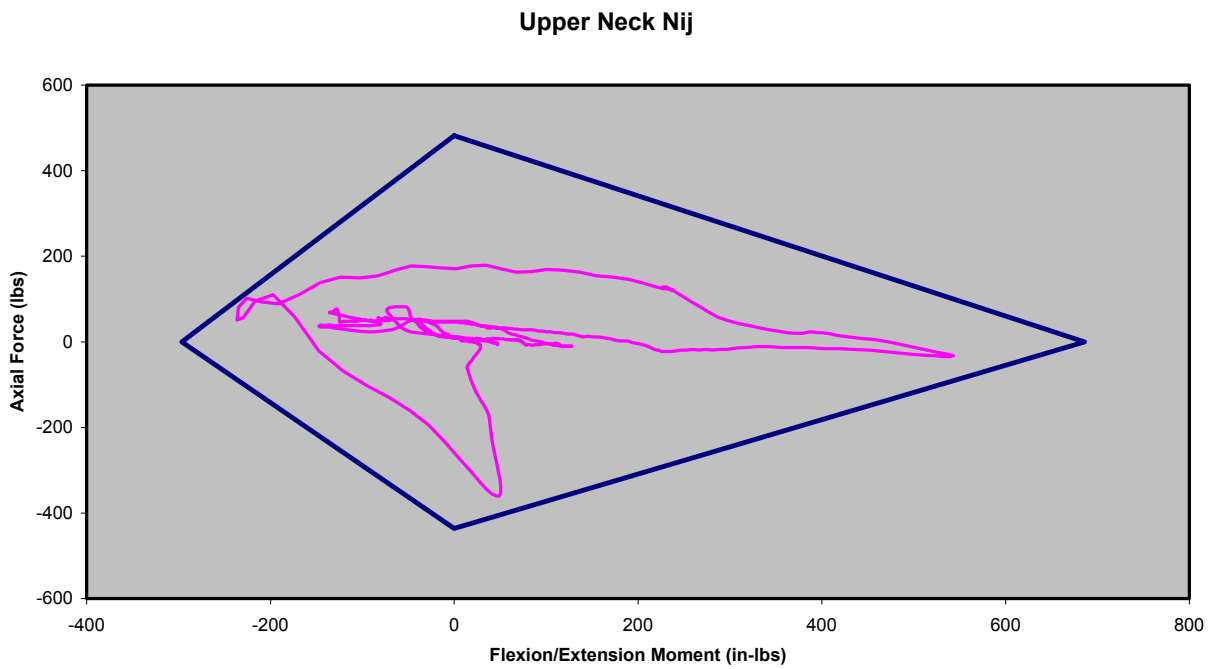

Figure B-28: Test 516 (Low Pulse, 5.5 lb Added Head Weight)



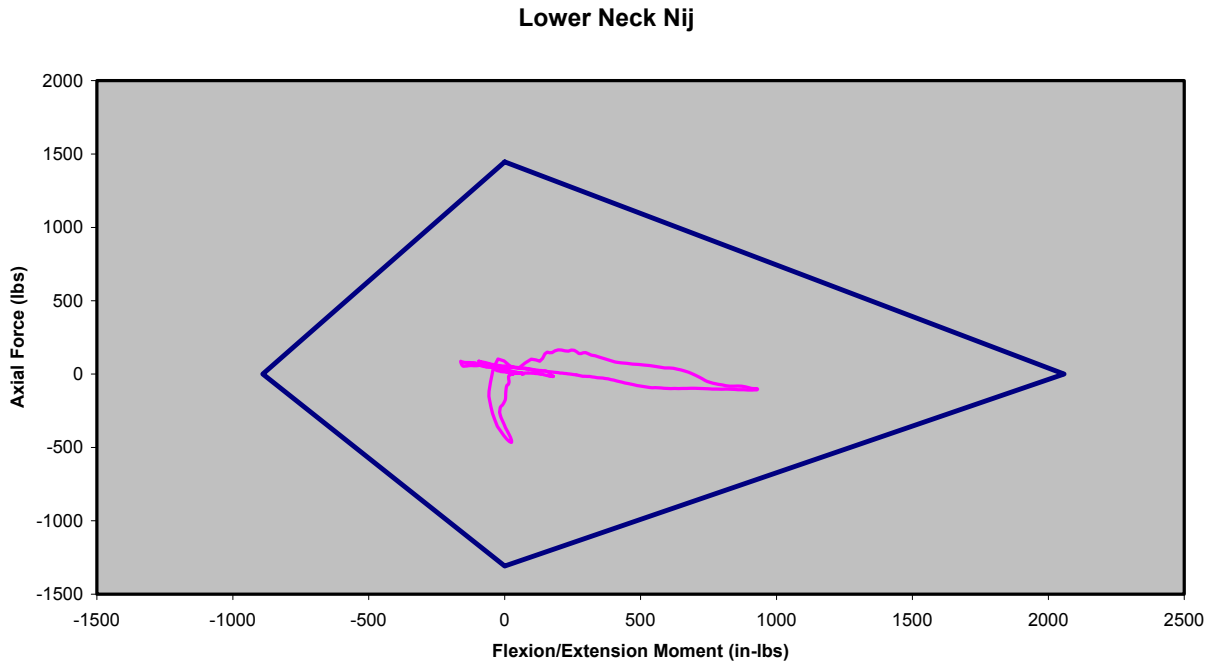

Figure B-29: Test 516 (Low Pulse, 5.5 lb Added Head Weight)

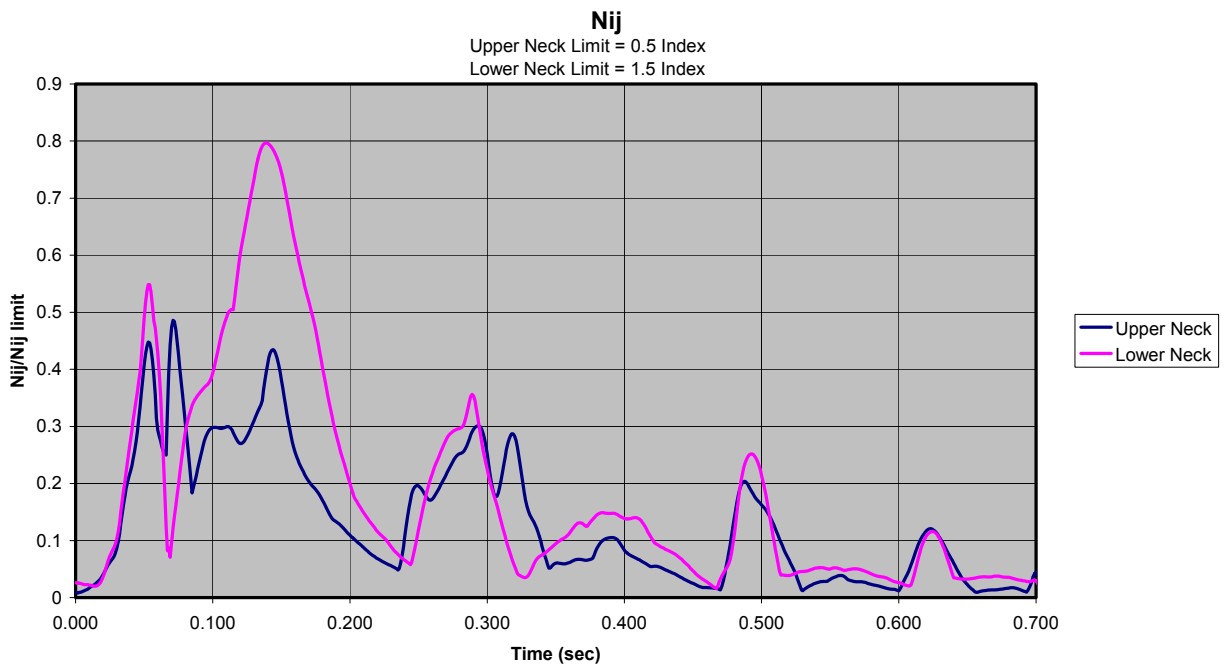

Figure B-30: Test 516 (Low Pulse, 5.5 lb Added Head Weight)

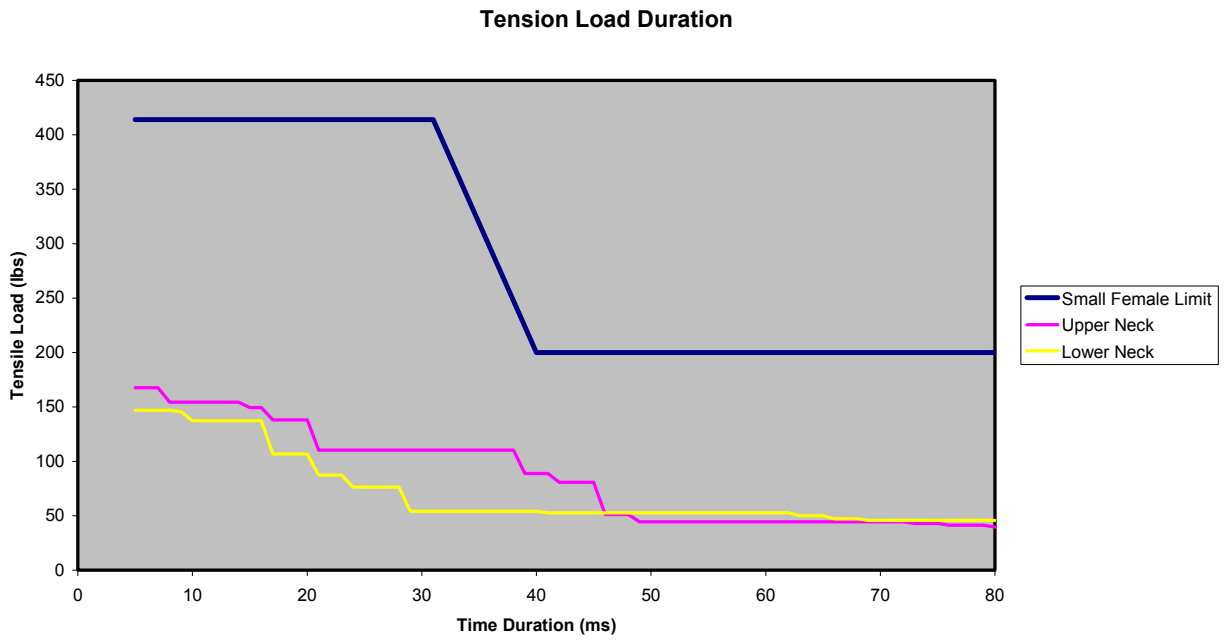

Figure B-31: Test 516 (Low Pulse, 5.5 lb Added Head Weight)

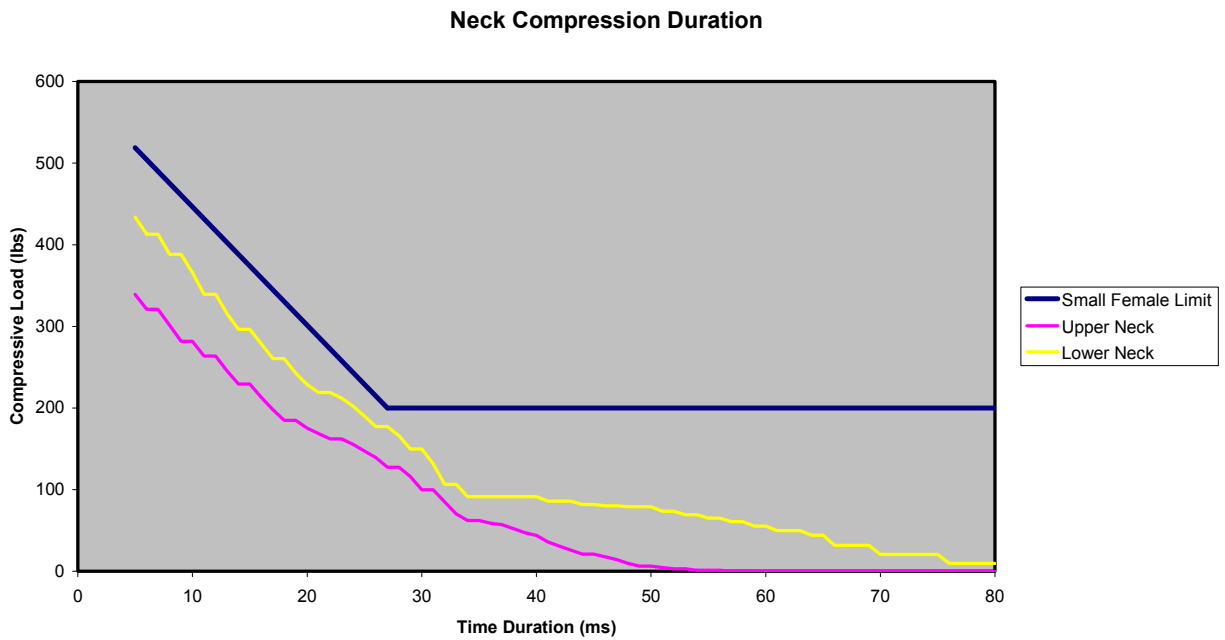

Figure B-32: Test 516 (Low Pulse, 5.5 lb Added Head Weight)

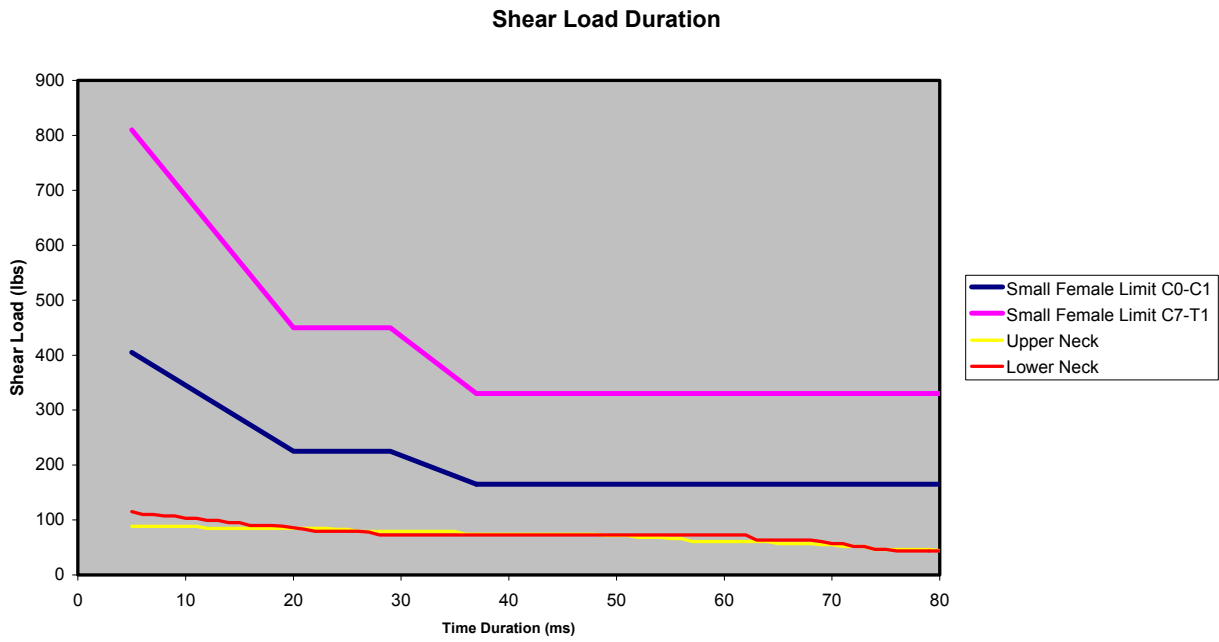

Figure B-33: Test 516 (Low Pulse, 5.5 lb Added Head Weight)

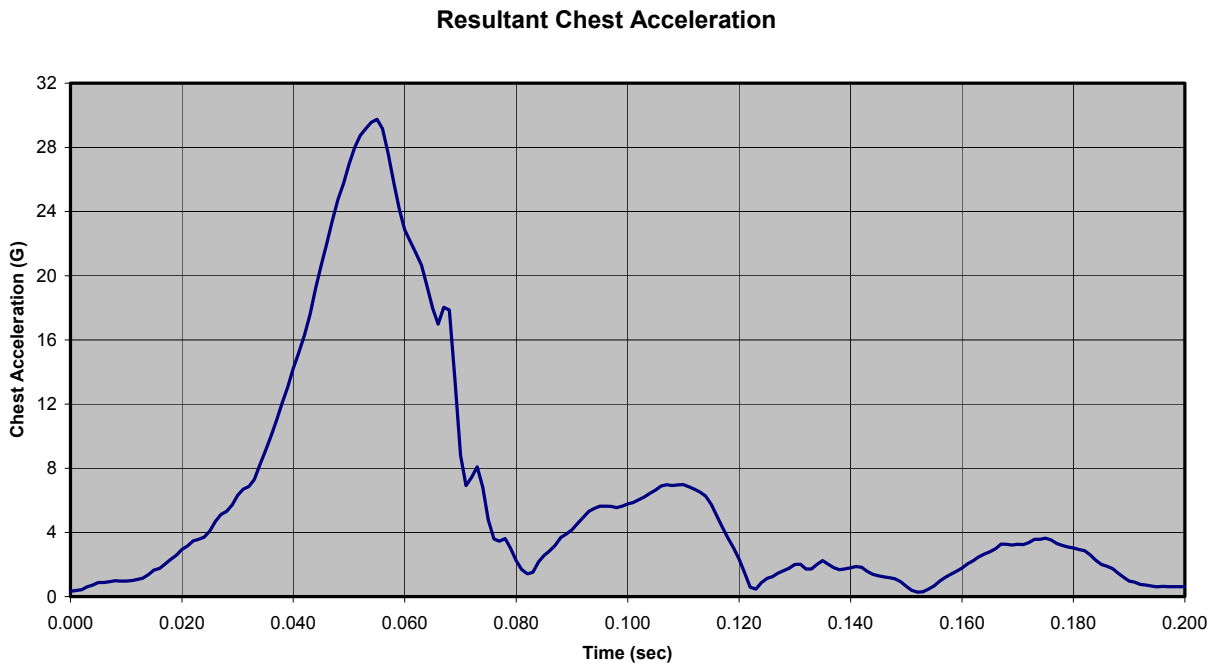

Figure B-34: Test 517 (Low Pulse, 6.0 lb Added Head Weight)

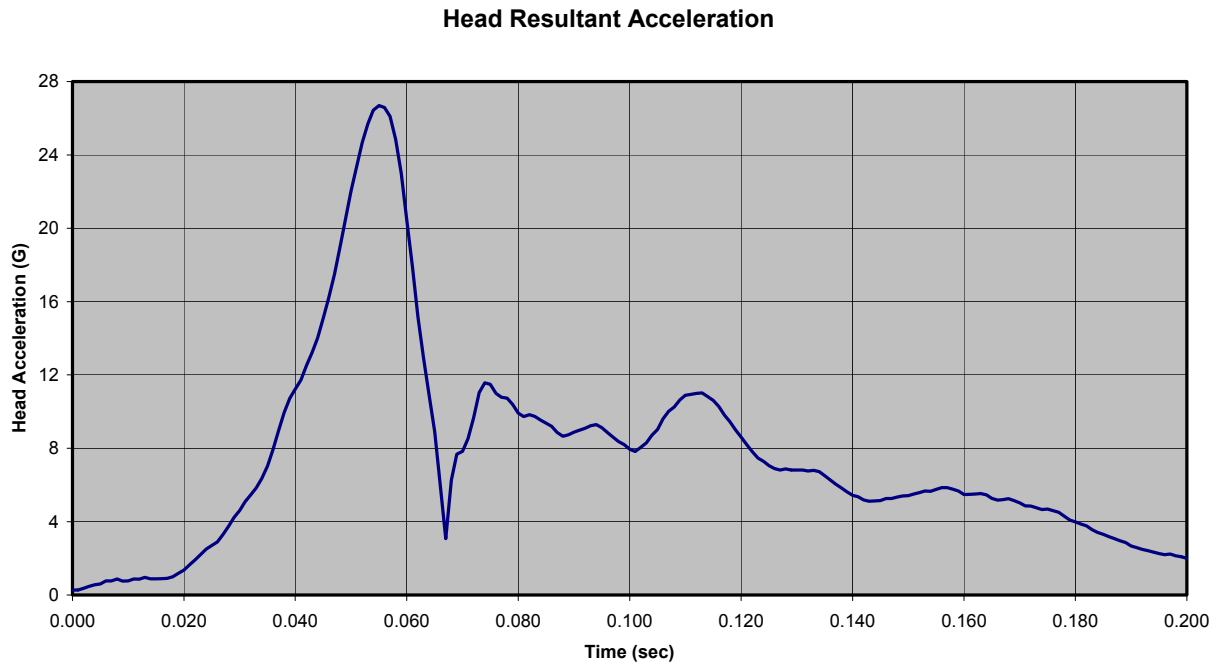

Figure B-35: Test 517 (Low Pulse, 6.0 lb Added Head Weight)

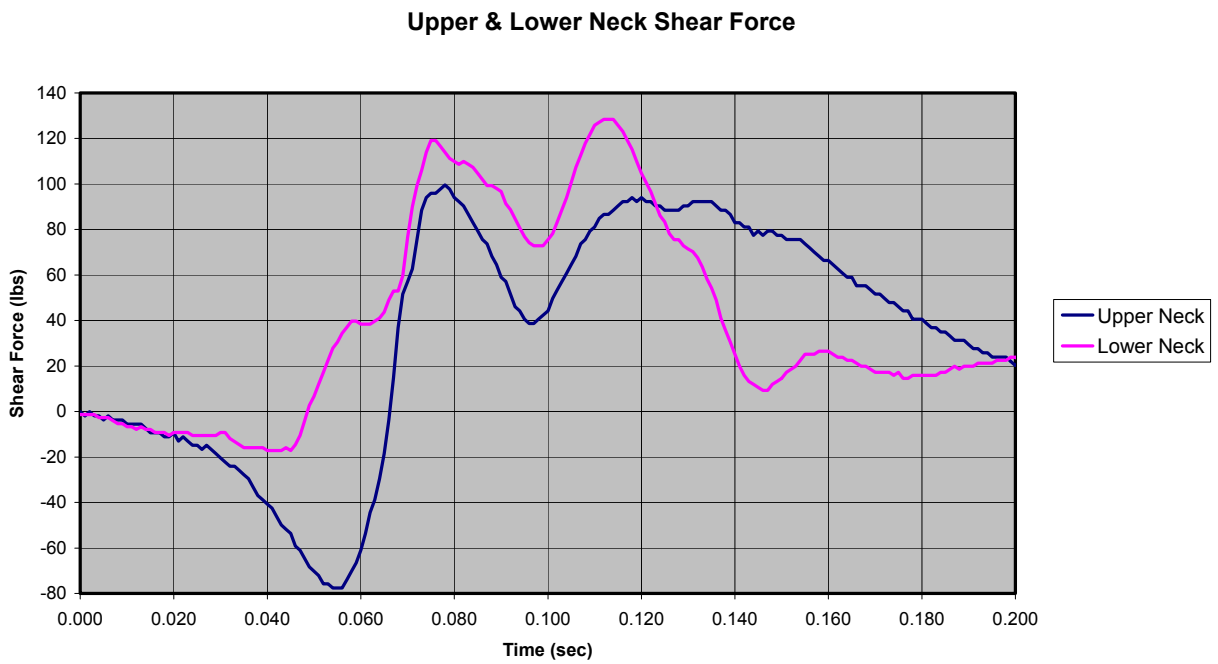

Figure B-36: Test 517 (Low Pulse, 6.0 lb Added Head Weight)

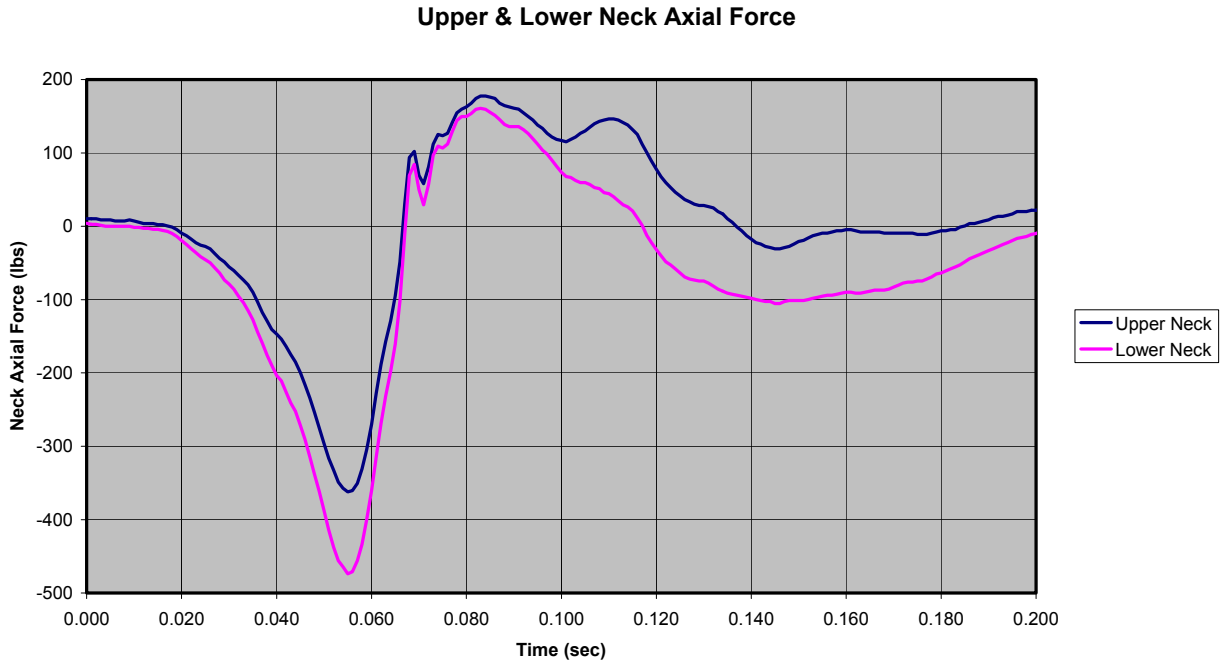

Figure B-37: Test 517 (Low Pulse, 6.0 lb Added Head Weight)

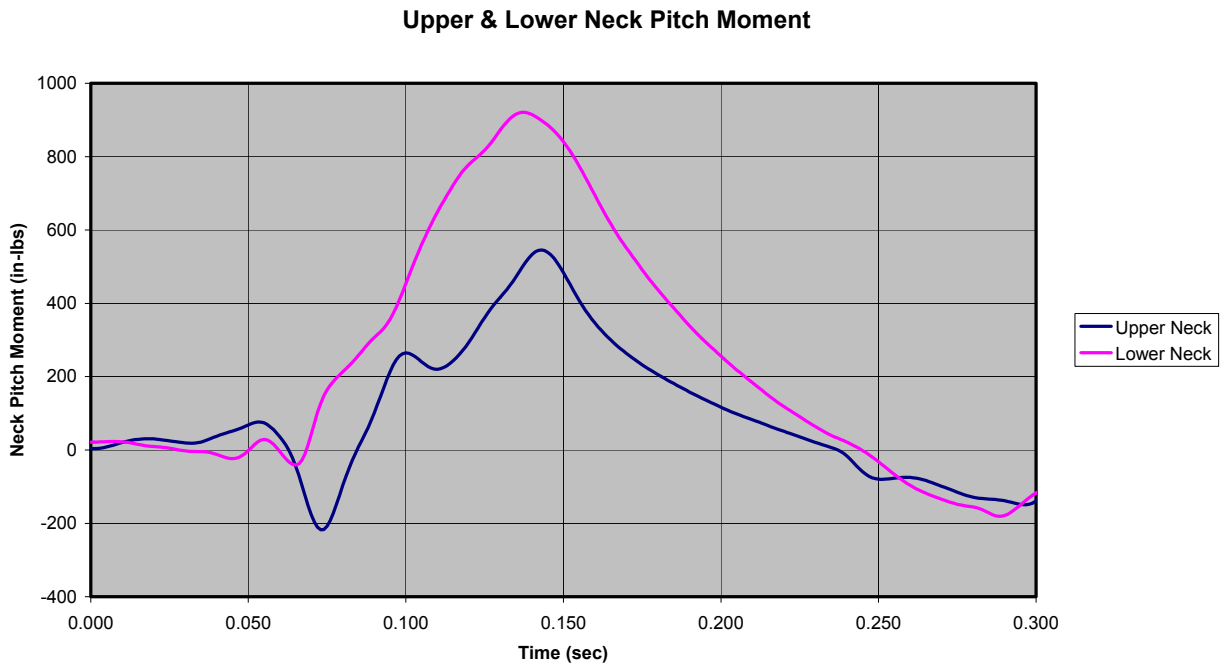

Figure B-38: Test 517 (Low Pulse, 6.0 lb Added Head Weight)

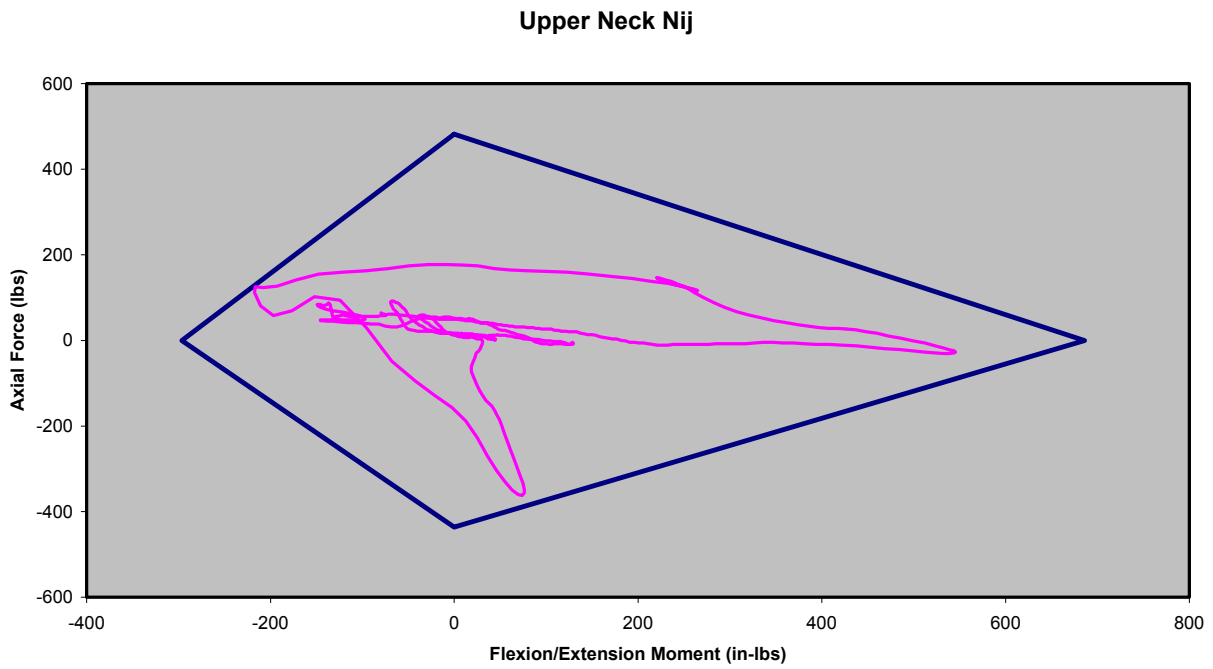

Figure B-39: Test 517 (Low Pulse, 6.0 lb Added Head Weight)

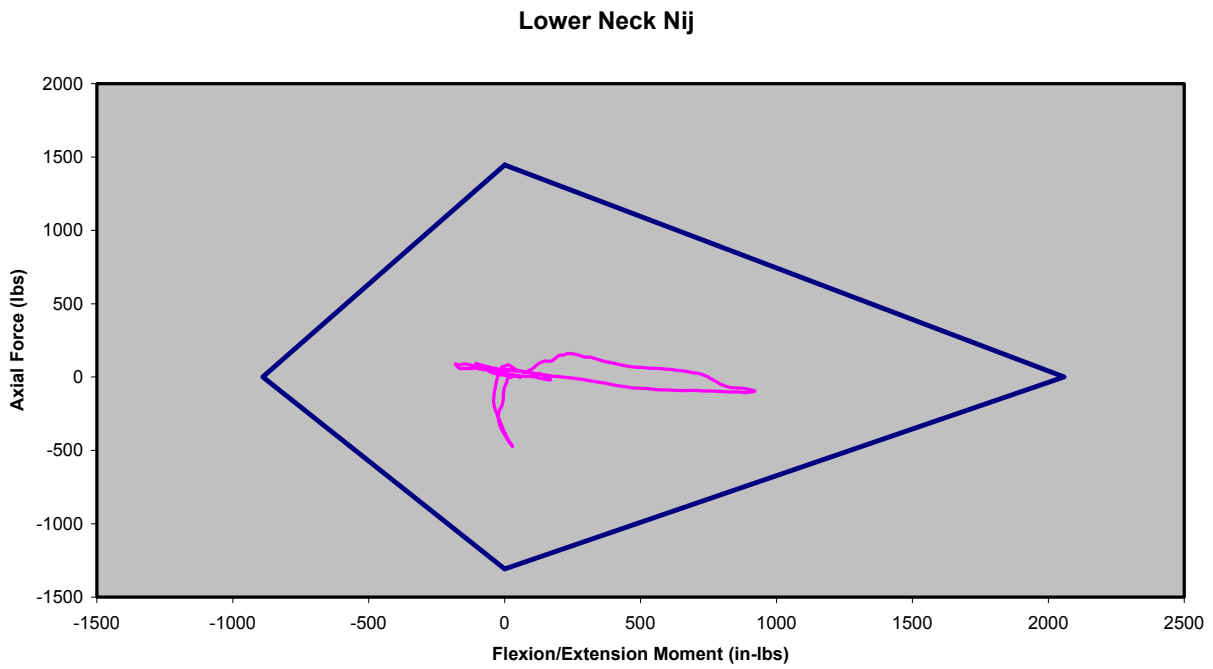

Figure B-40: Test 517 (Low Pulse, 6.0 lb Added Head Weight)

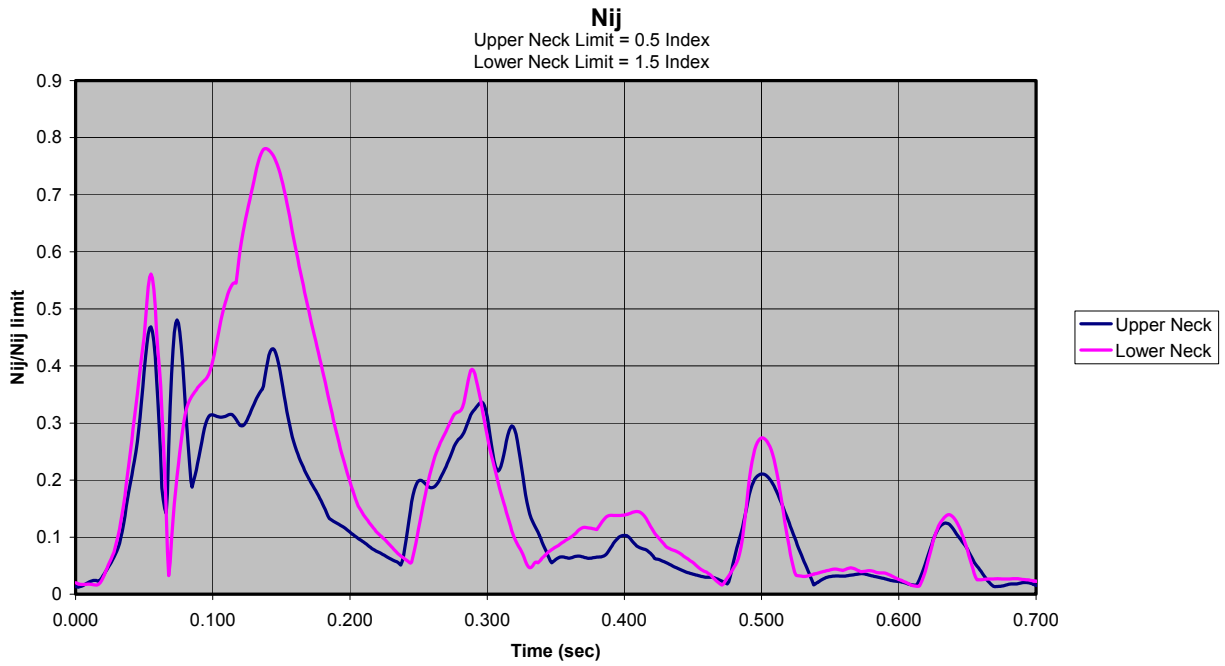

Figure B-41: Test 517 (Low Pulse, 6.0 lb Added Head Weight)

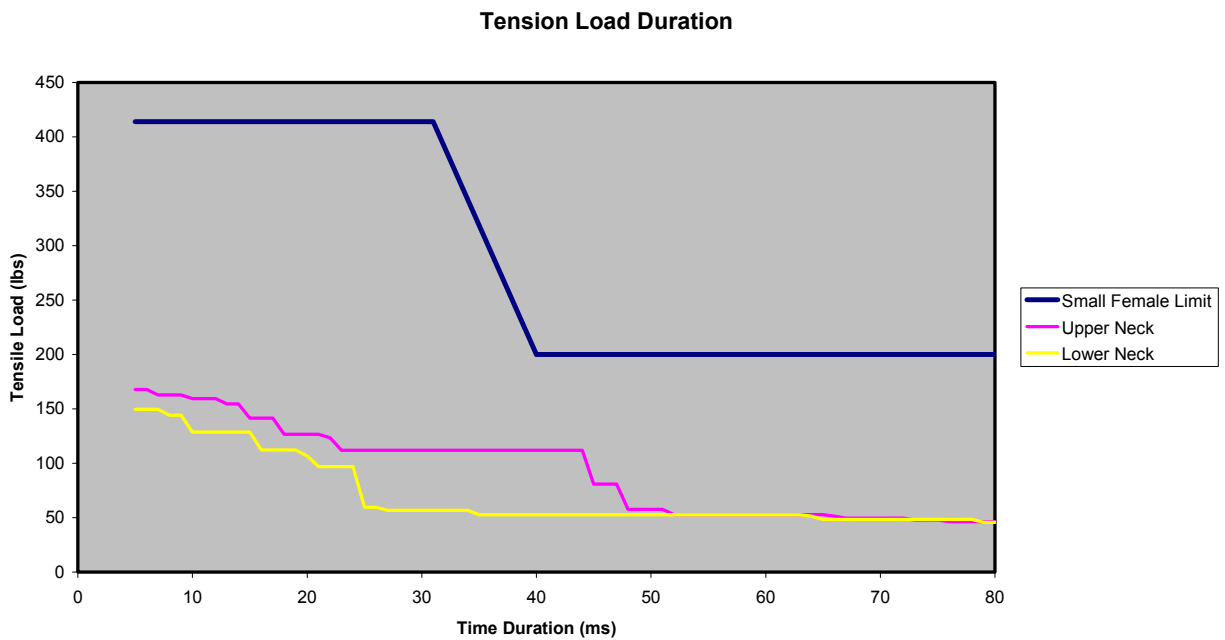

Figure B-42: Test 517 (Low Pulse, 6.0 lb Added Head Weight)

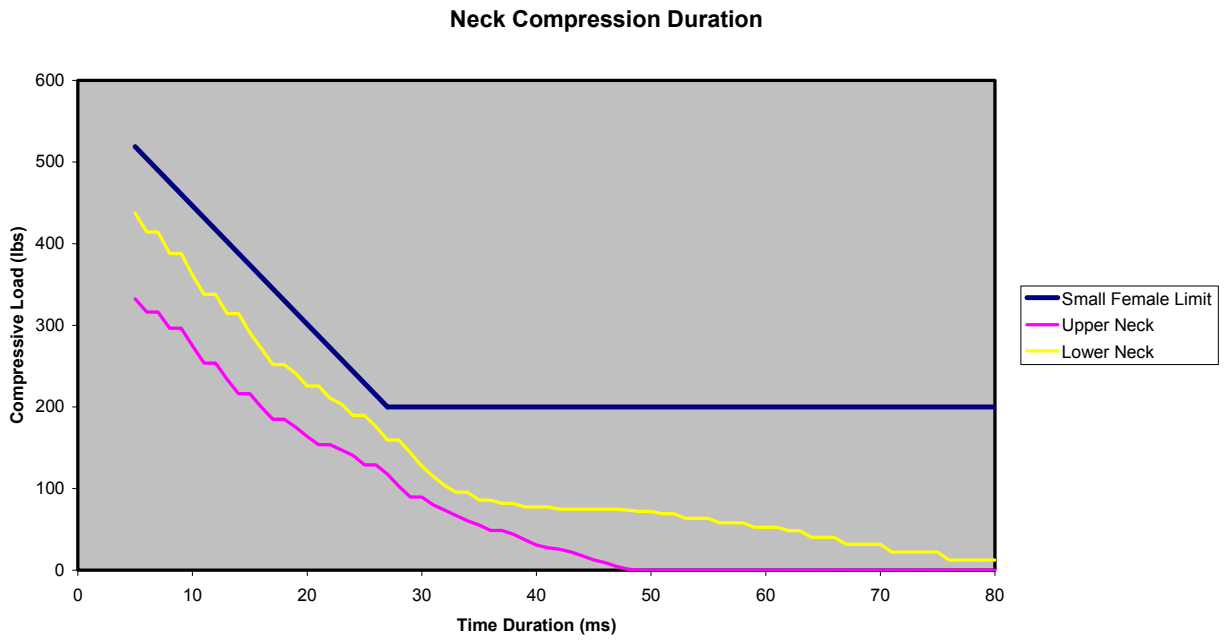

Figure B-43: Test 517 (Low Pulse, 6.0 lb Added Head Weight)

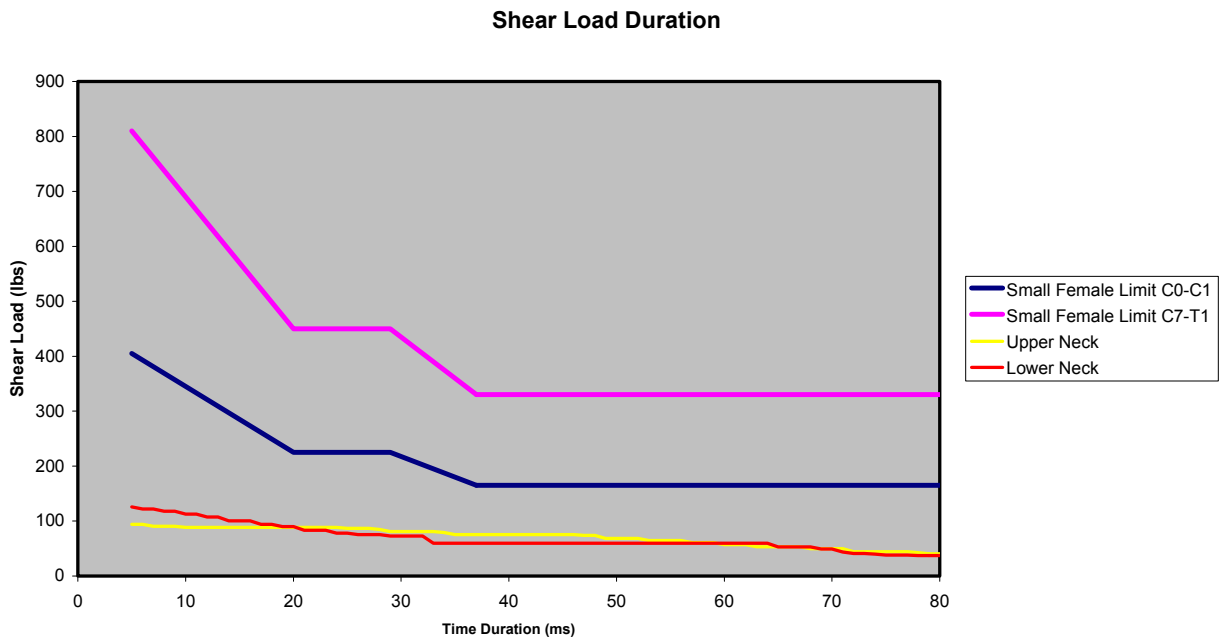

Figure B-44: Test 517 (Low Pulse, 6.0 lb Added Head Weight)



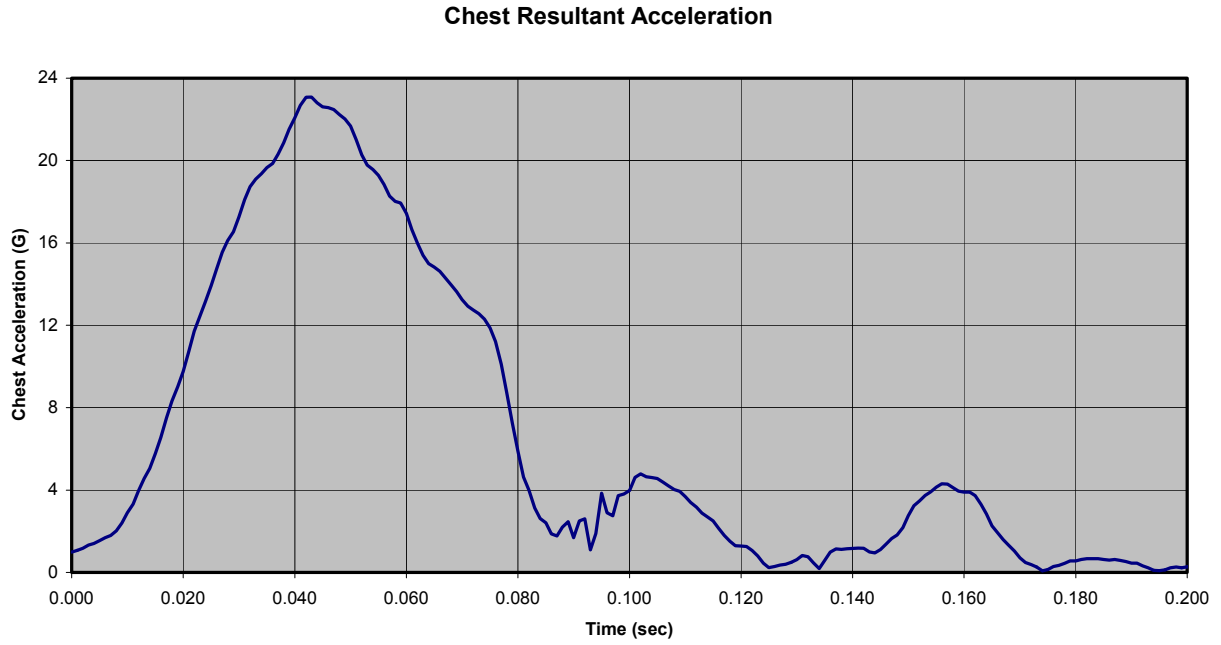

Figure B-45: Test 577 (Medium Pulse, 3.5 lb Added Head Weight)

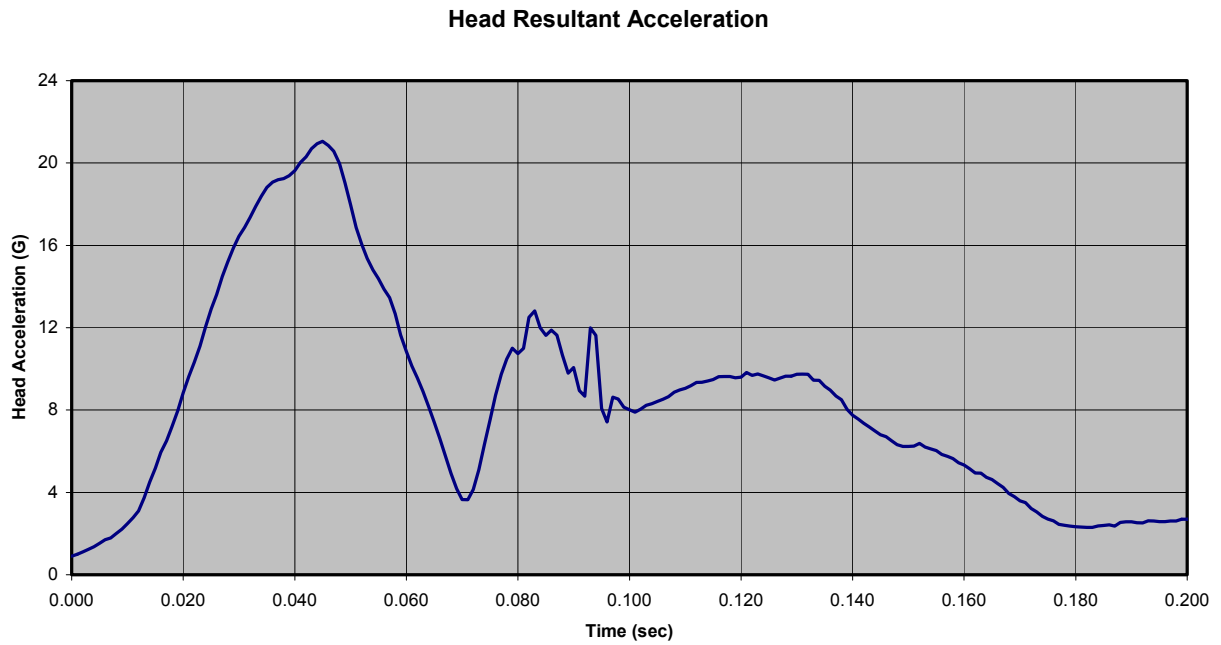

Figure B-46: Test 577 (Medium Pulse, 3.5 lb Added Head Weight)

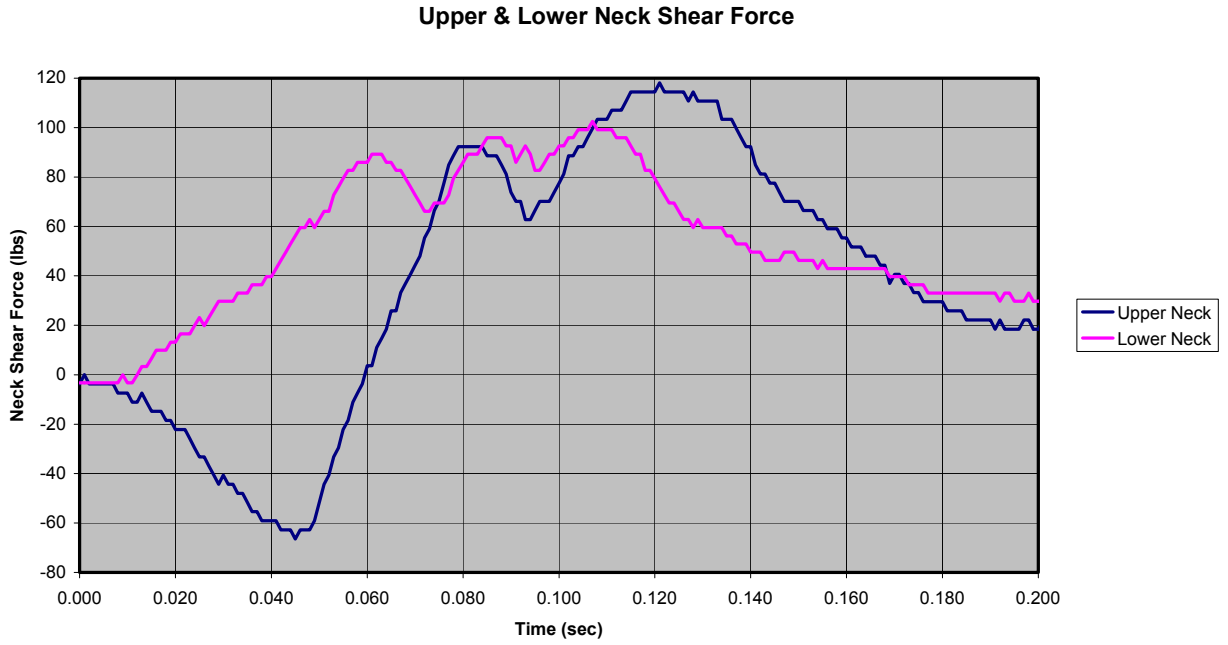

Figure B-47: Test 577 (Medium Pulse, 3.5 lb Added Head Weight)

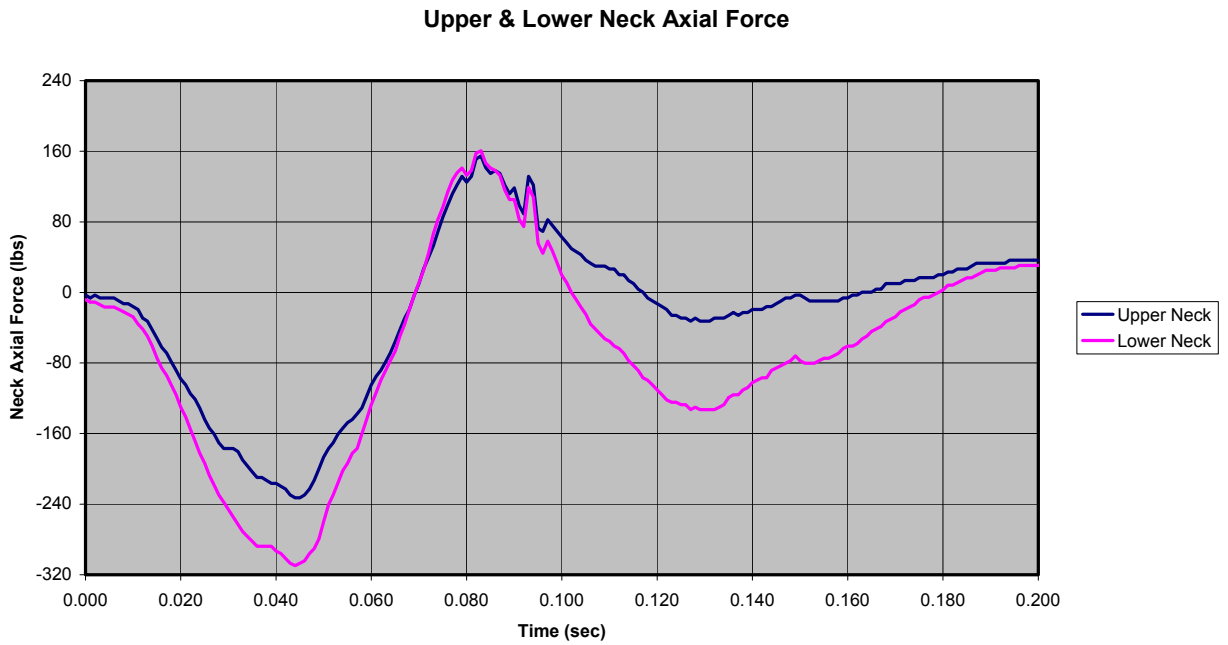

Figure B-48: Test 577 (Medium Pulse, 3.5 lb Added Head Weight)

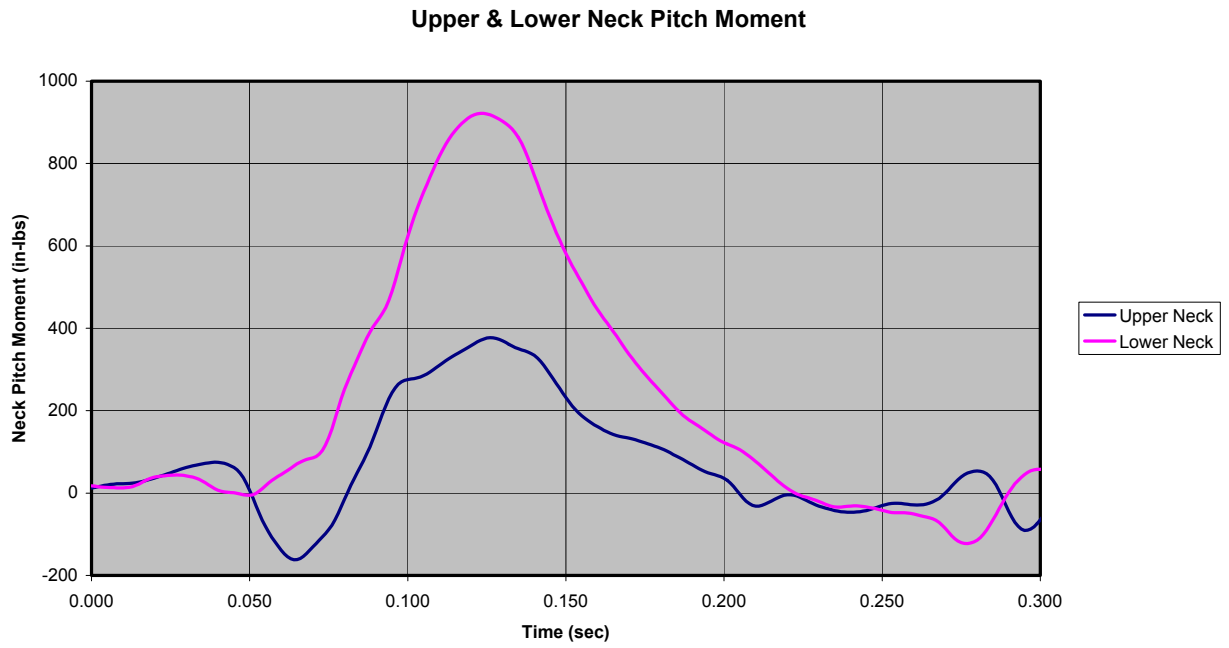

Figure B-49: Test 577 (Medium Pulse, 3.5 lb Added Head Weight)

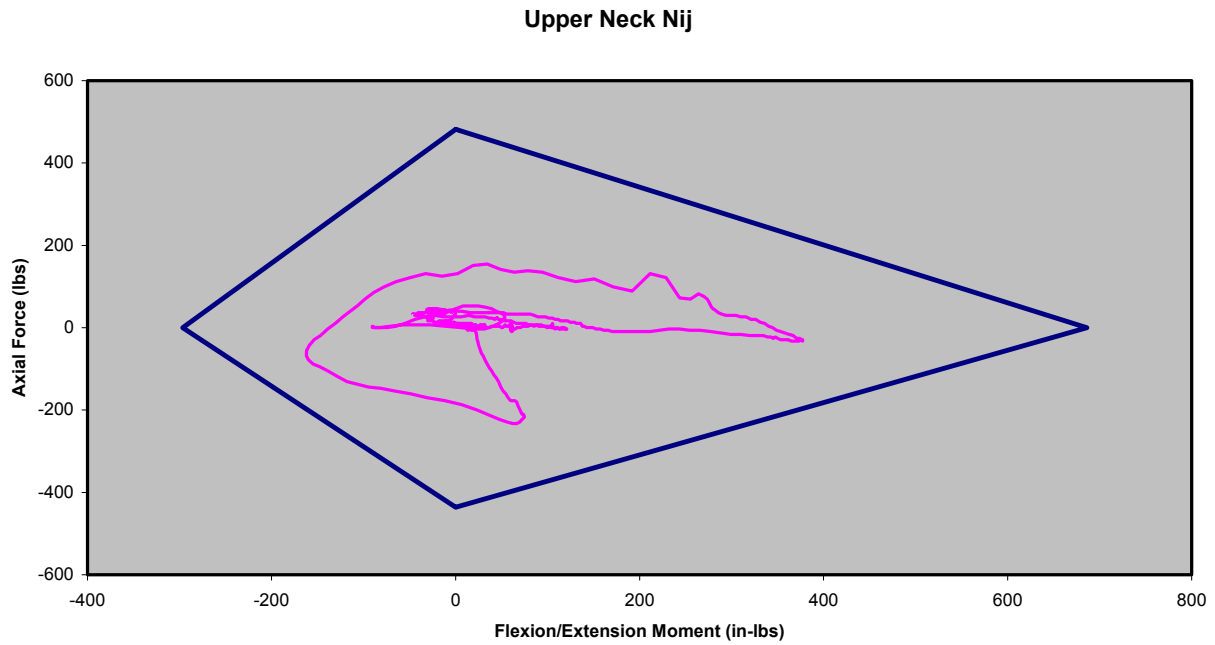

Figure B-50: Test 577 (Medium Pulse, 3.5 lb Added Head Weight)

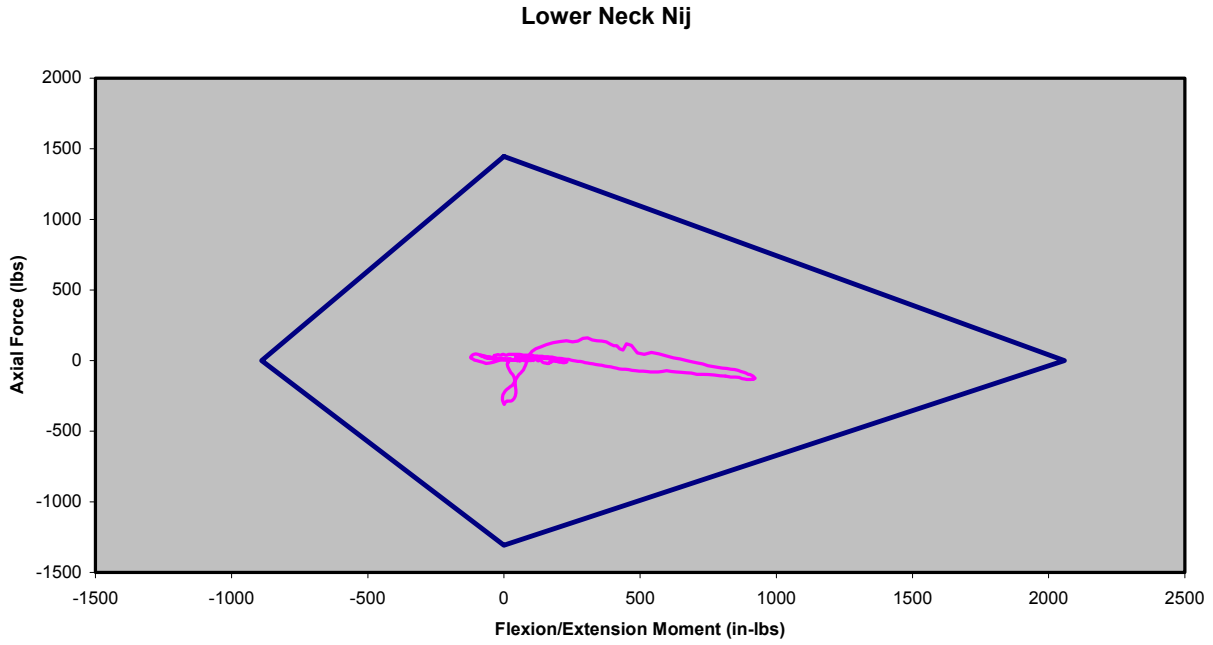

Figure B-51: Test 577 (Medium Pulse, 3.5 lb Added Head Weight)

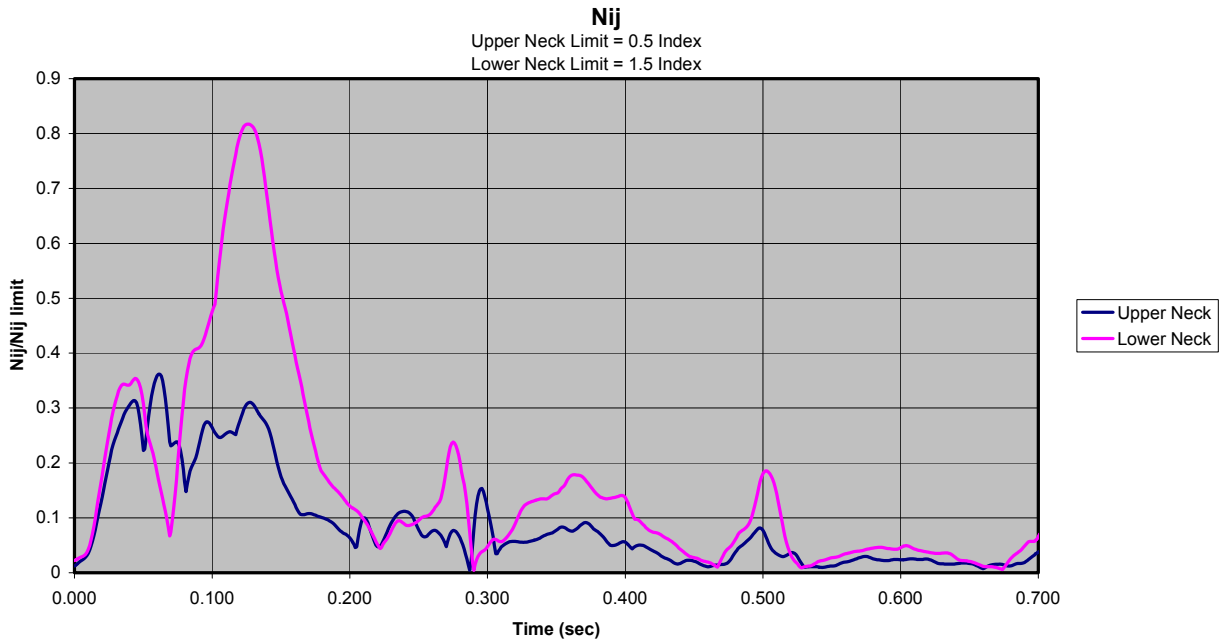

Figure B-52: Test 577 (Medium Pulse, 3.5 lb Added Head Weight)

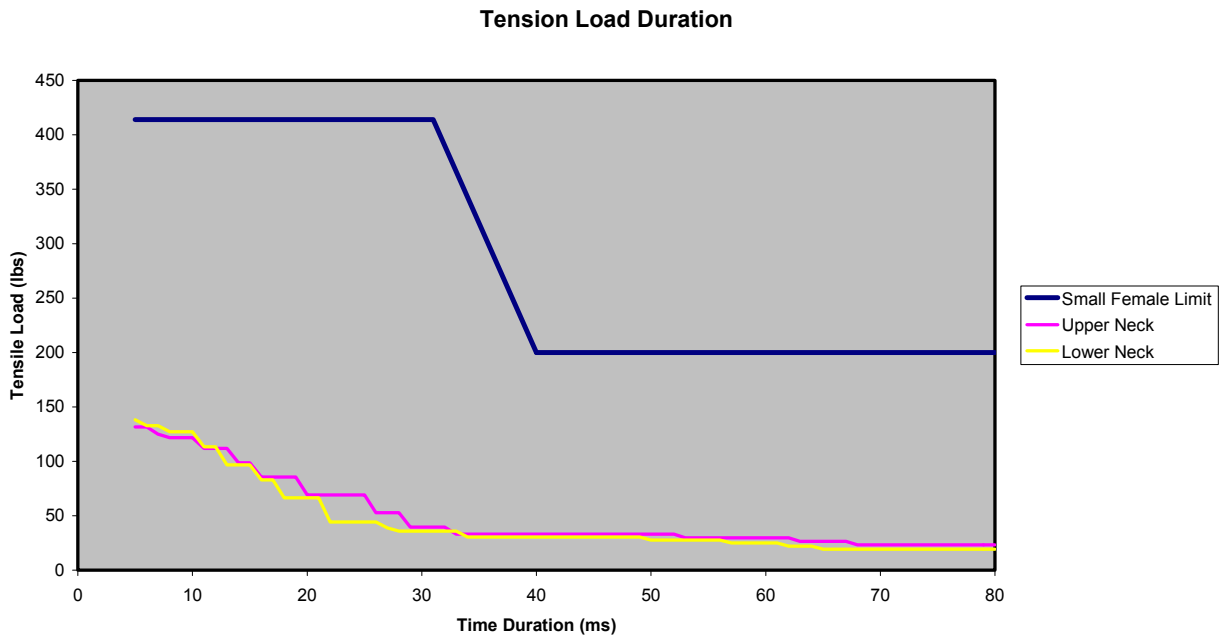

Figure B-53: Test 577 (Medium Pulse, 3.5 lb Added Head Weight)

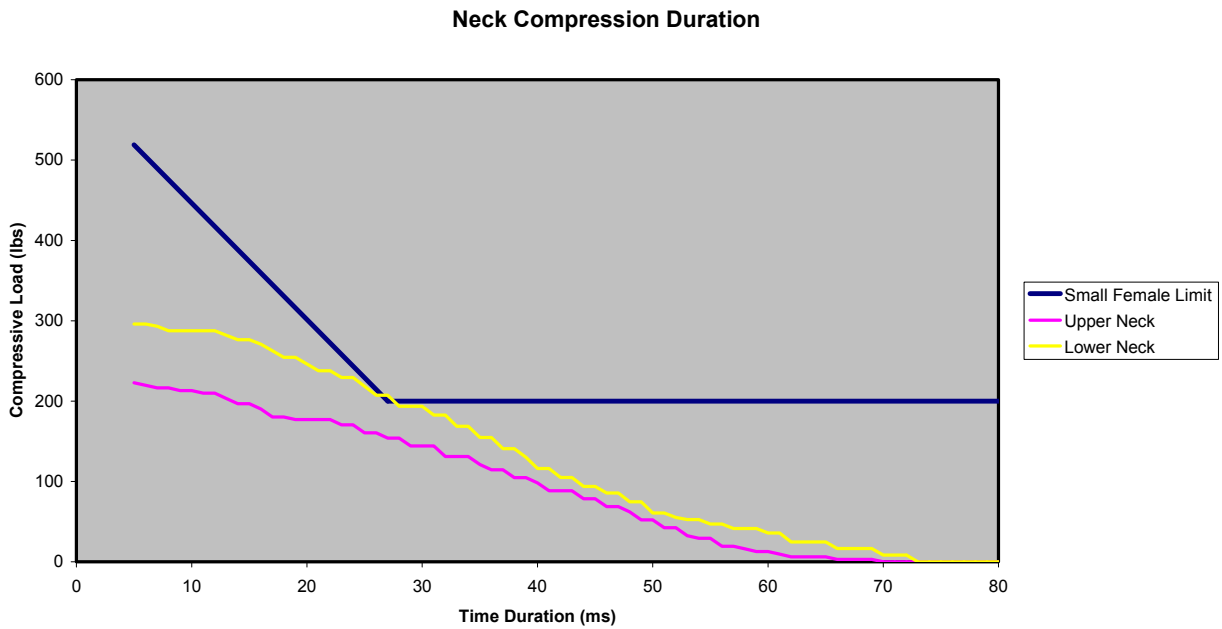

Figure B-54: Test 577 (Medium Pulse, 3.5 lb Added Head Weight)

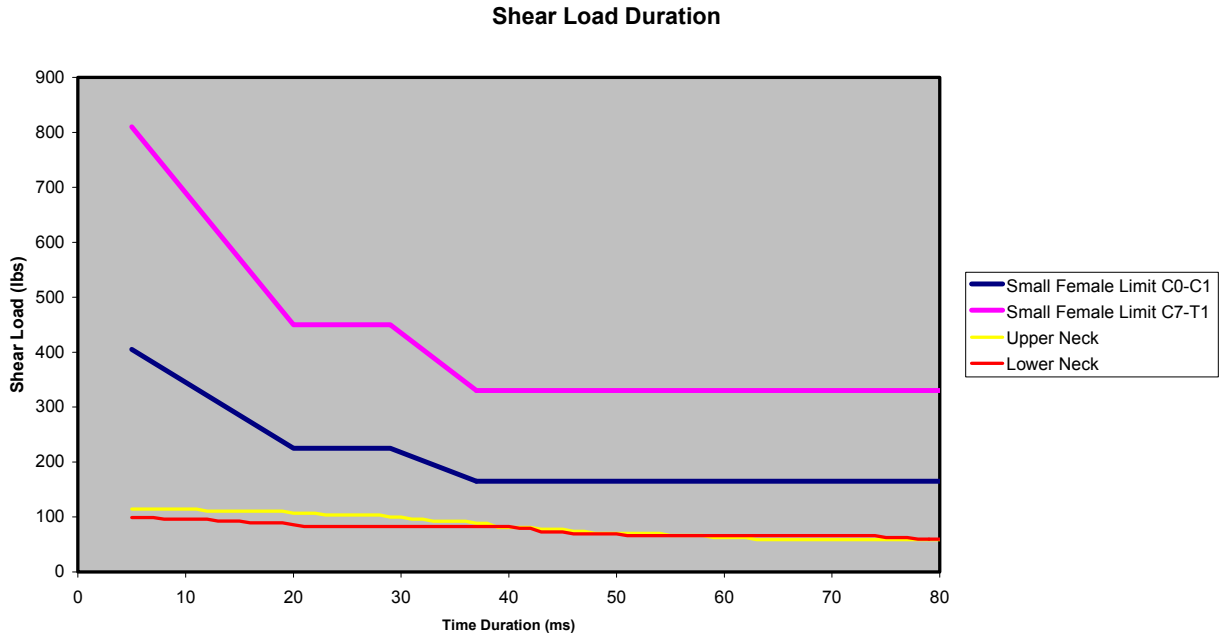

Figure B-55: Test 577 (Medium Pulse, 3.5 lb Added Head Weight)

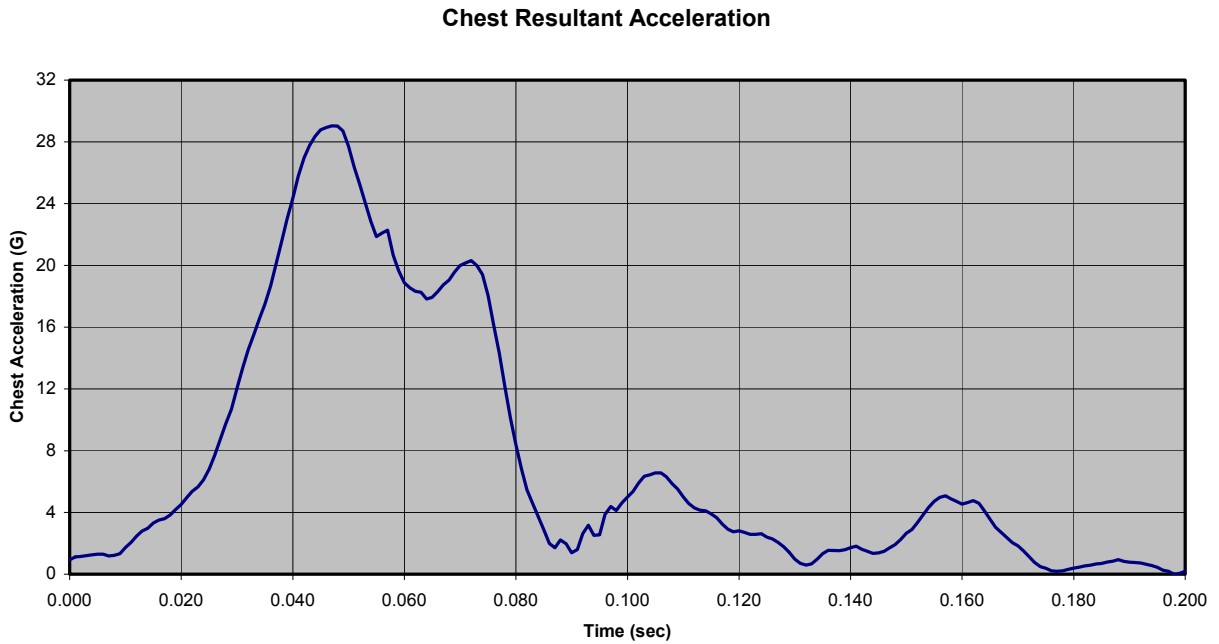

Figure B-56: Test 578 (Medium Pulse, 4.0 lb Added Head Weight)

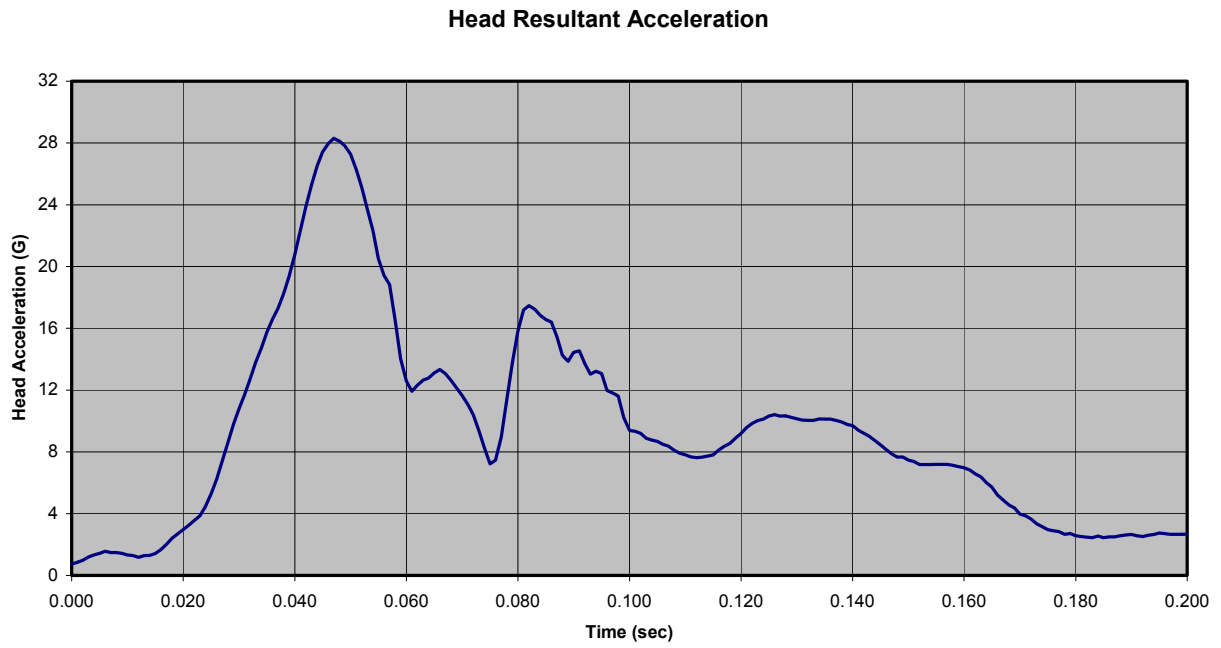

Figure B-57: Test 578 (Medium Pulse, 4.0 lb Added Head Weight)

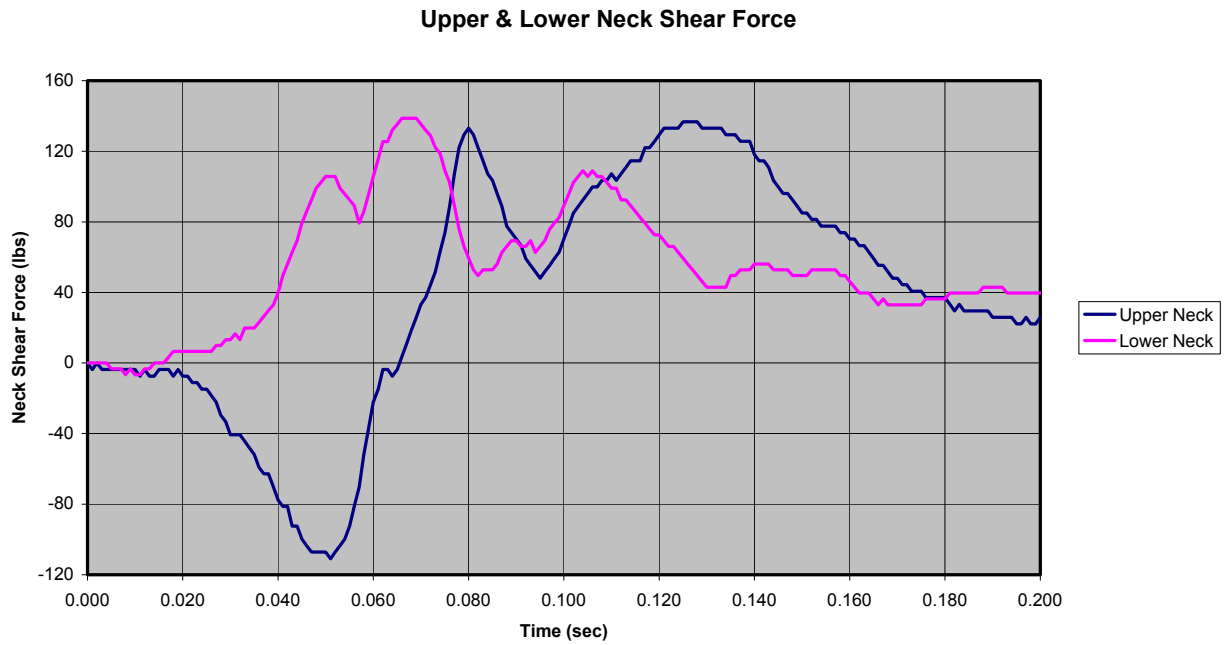

Figure B-58: Test 578 (Medium Pulse, 4.0 lb Added Head Weight)

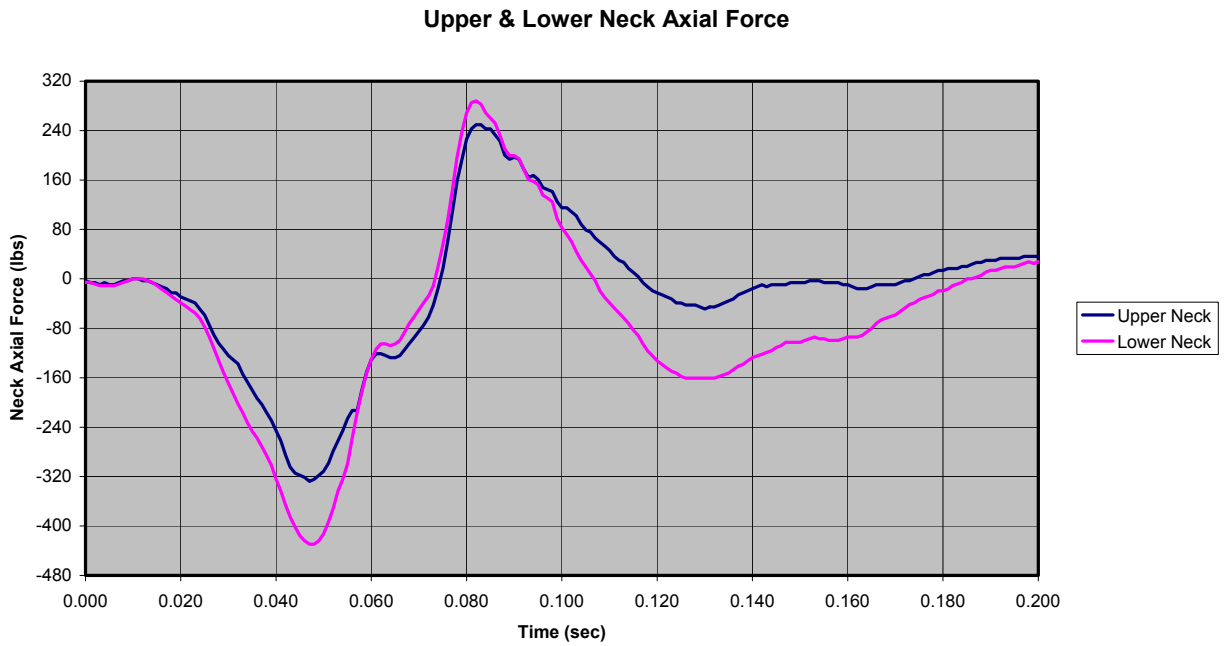

Figure B-59: Test 578 (Medium Pulse, 4.0 lb Added Head Weight)

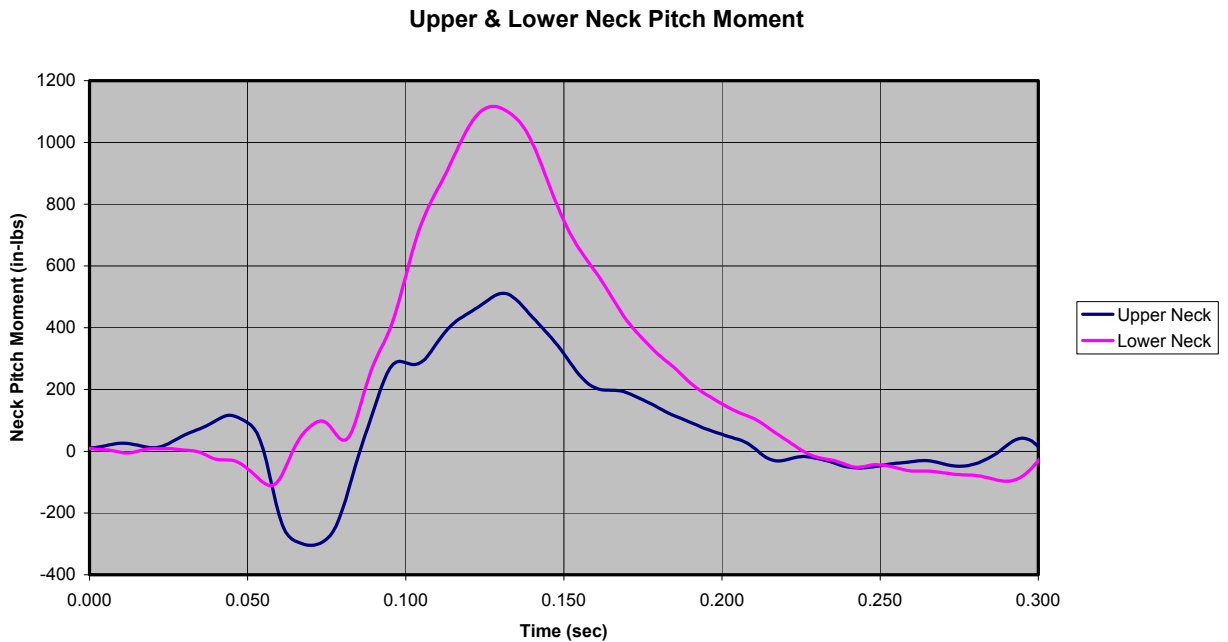

Figure B-60: Test 578 (Medium Pulse, 4.0 lb Added Head Weight)



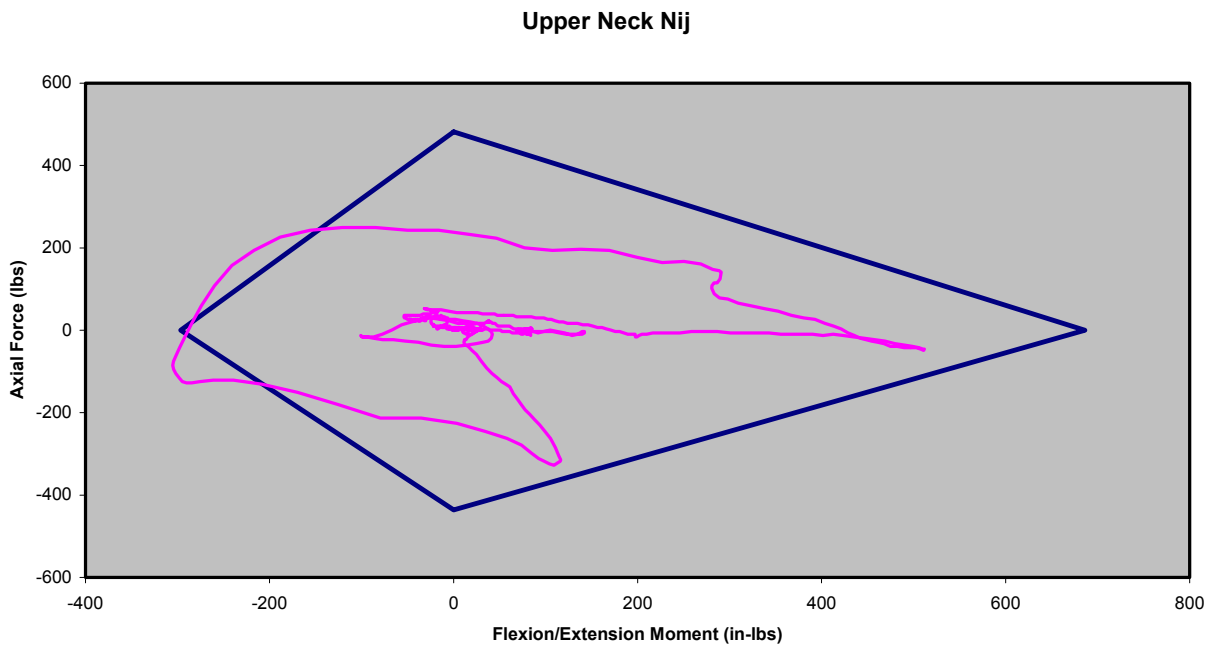

Figure B-61: Test 578 (Medium Pulse, 4.0 lb Added Head Weight)

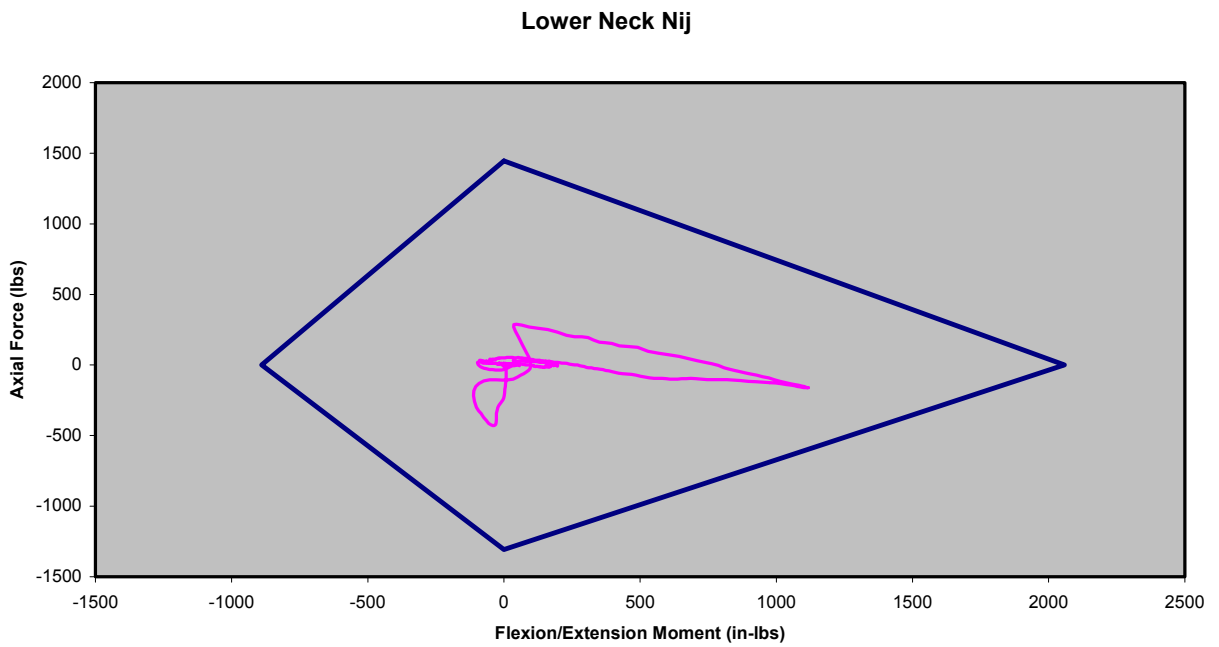

Figure B-62: Test 578 (Medium Pulse, 4.0 lb Added Head Weight)

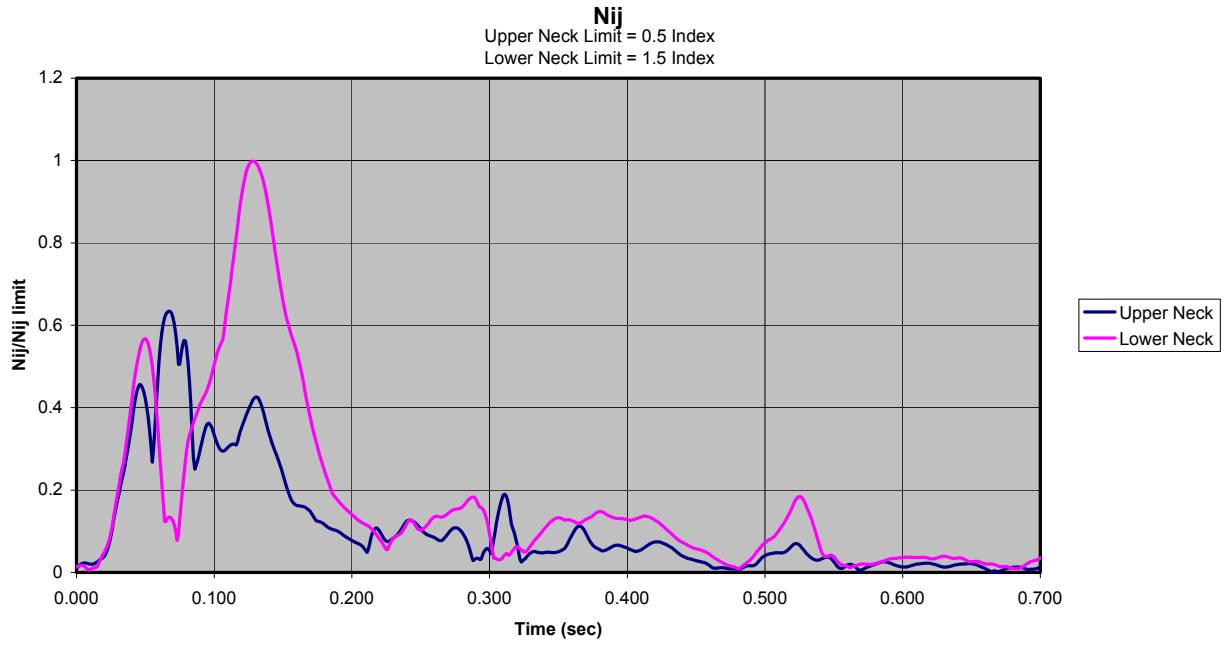

Figure B-63: Test 578 (Medium Pulse, 4.0 lb Added Head Weight)

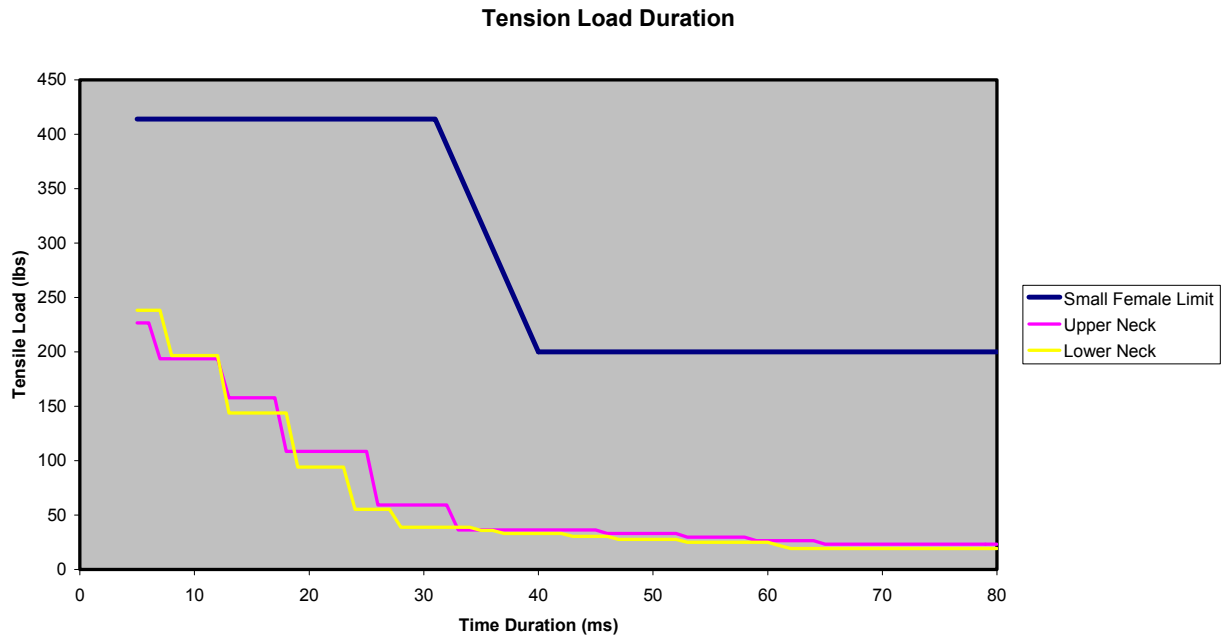

Figure B-64: Test 578 (Medium Pulse, 4.0 lb Added Head Weight)

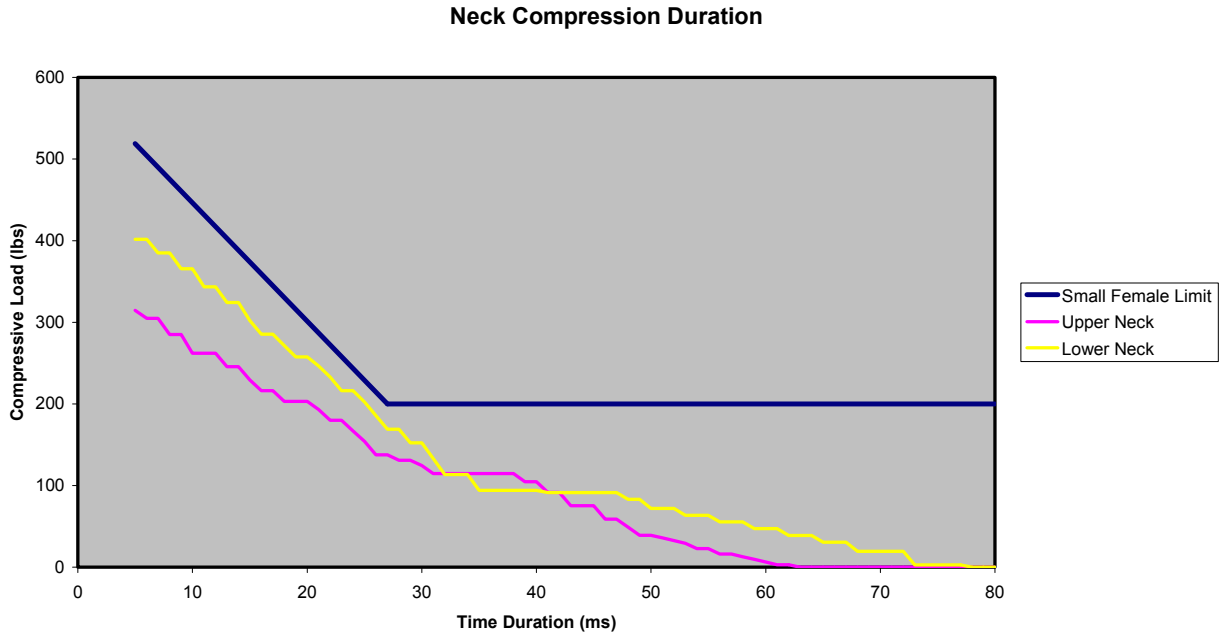

Figure B-65: Test 578 (Medium Pulse, 4.0 lb Added Head Weight)

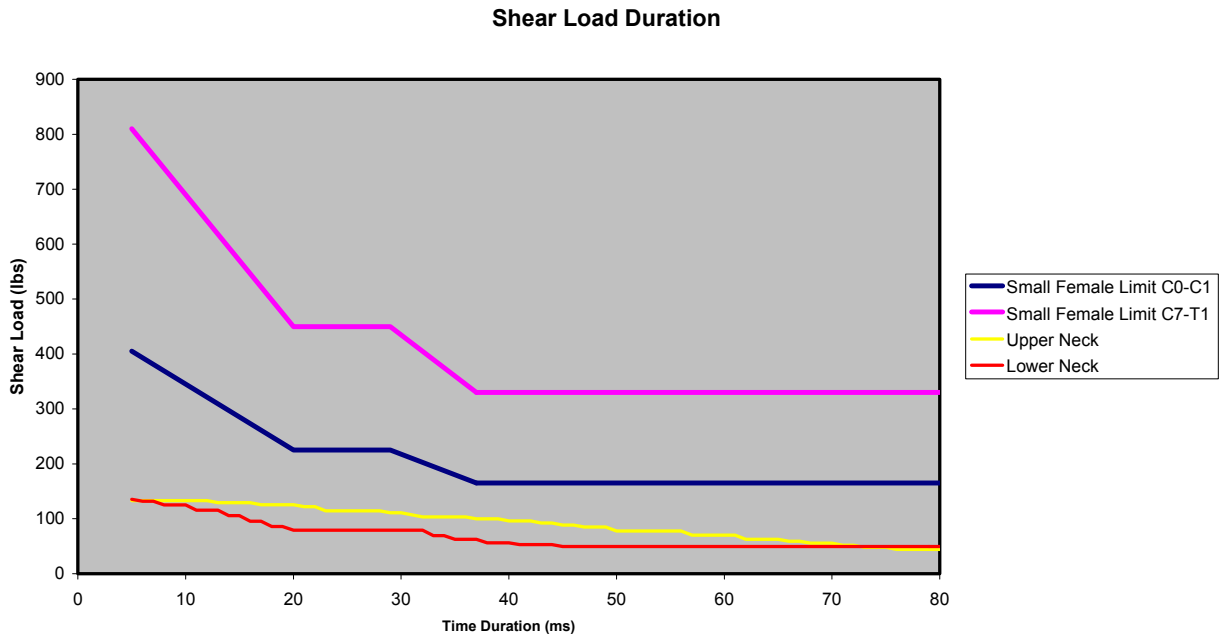

Figure B-66: Test 578 (Medium Pulse, 4.0 lb Added Head Weight)

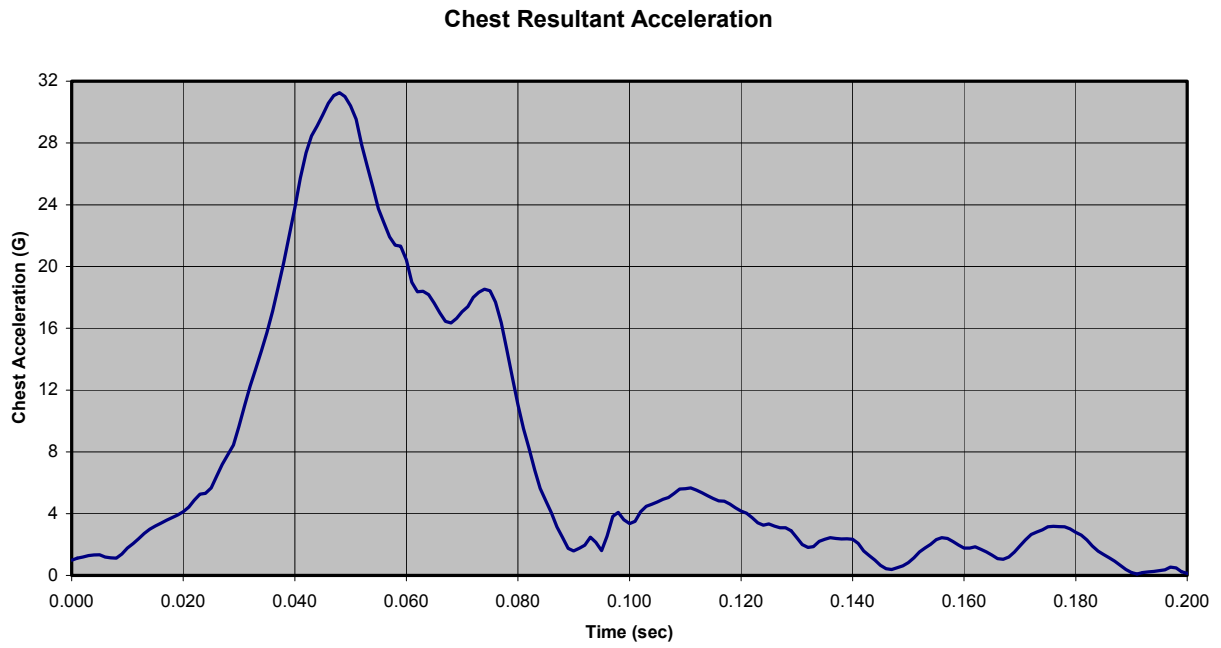

Figure B-67: Test 579 (Medium Pulse, 4.5 lb Added Head Weight)

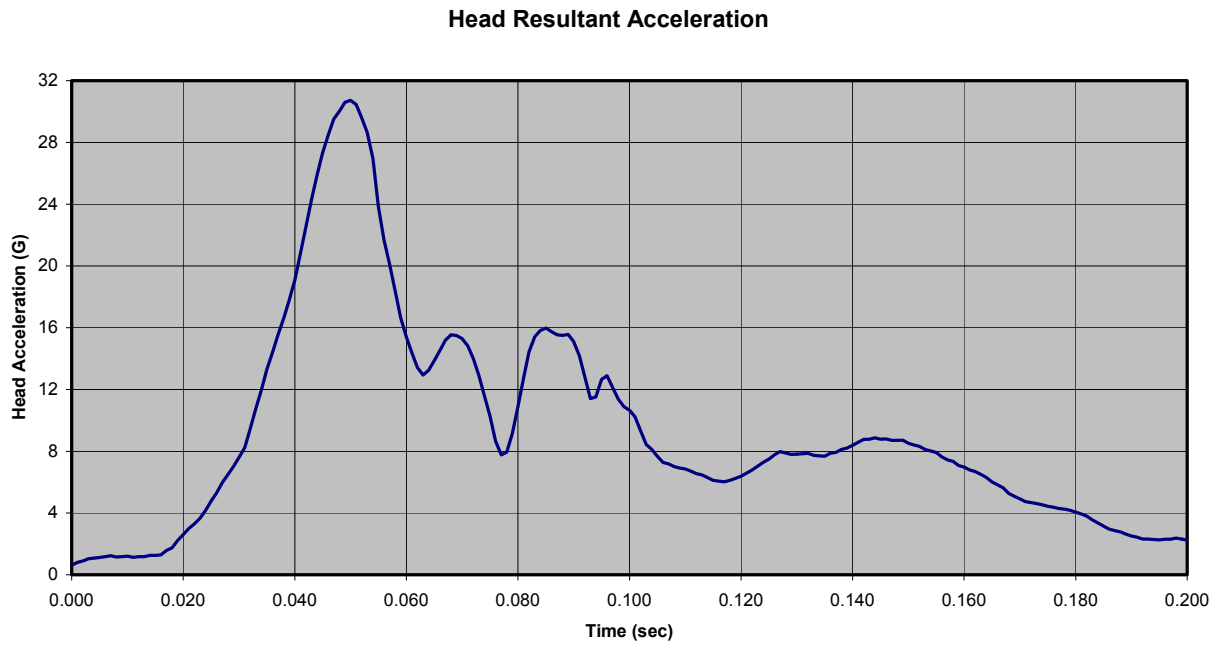

Figure B-68: Test 579 (Medium Pulse, 4.5 lb Added Head Weight)

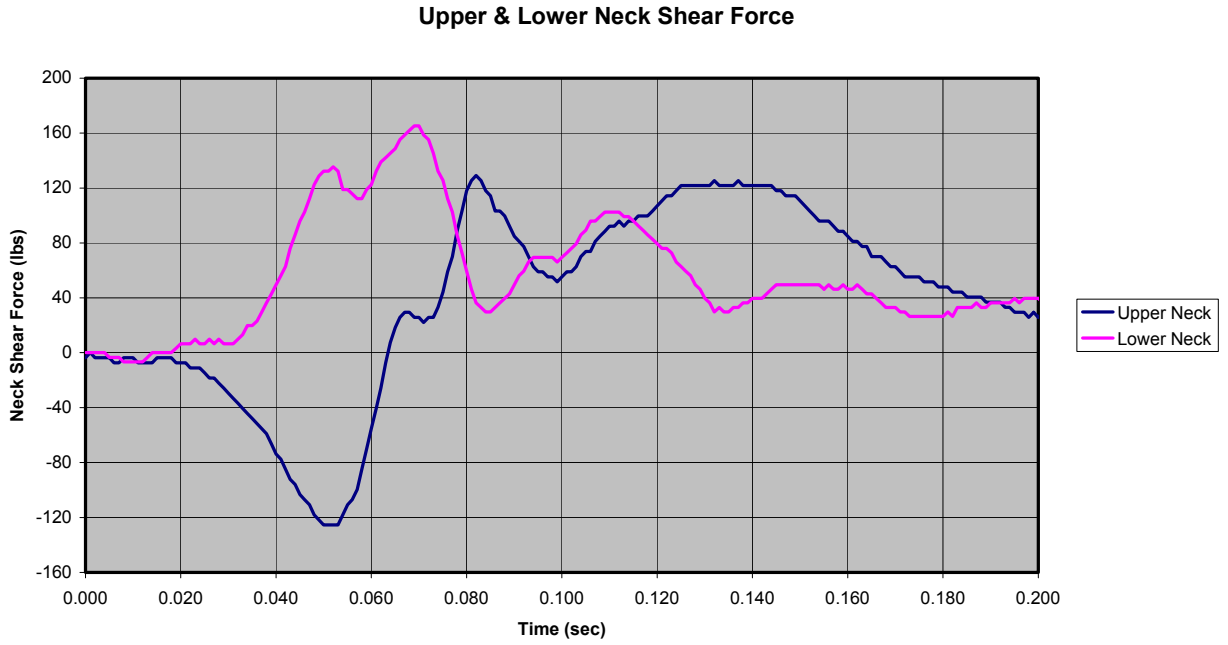

Figure B-69: Test 579 (Medium Pulse, 4.5 lb Added Head Weight)

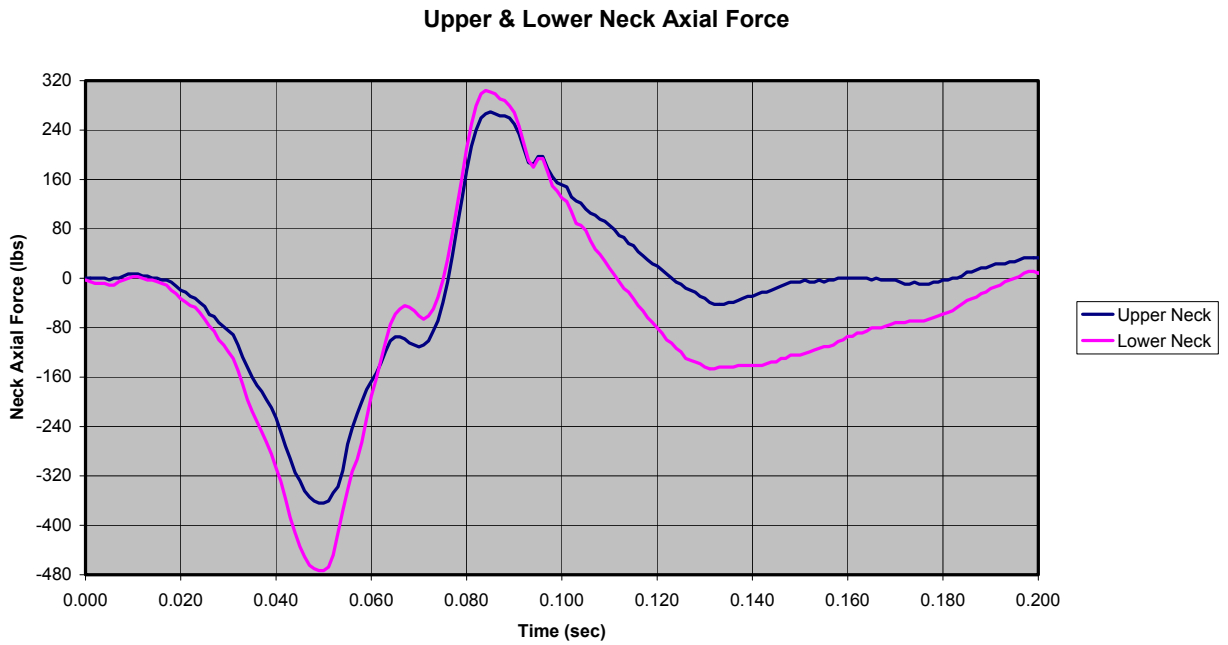

Figure B-70: Test 579 (Medium Pulse, 4.5 lb Added Head Weight)

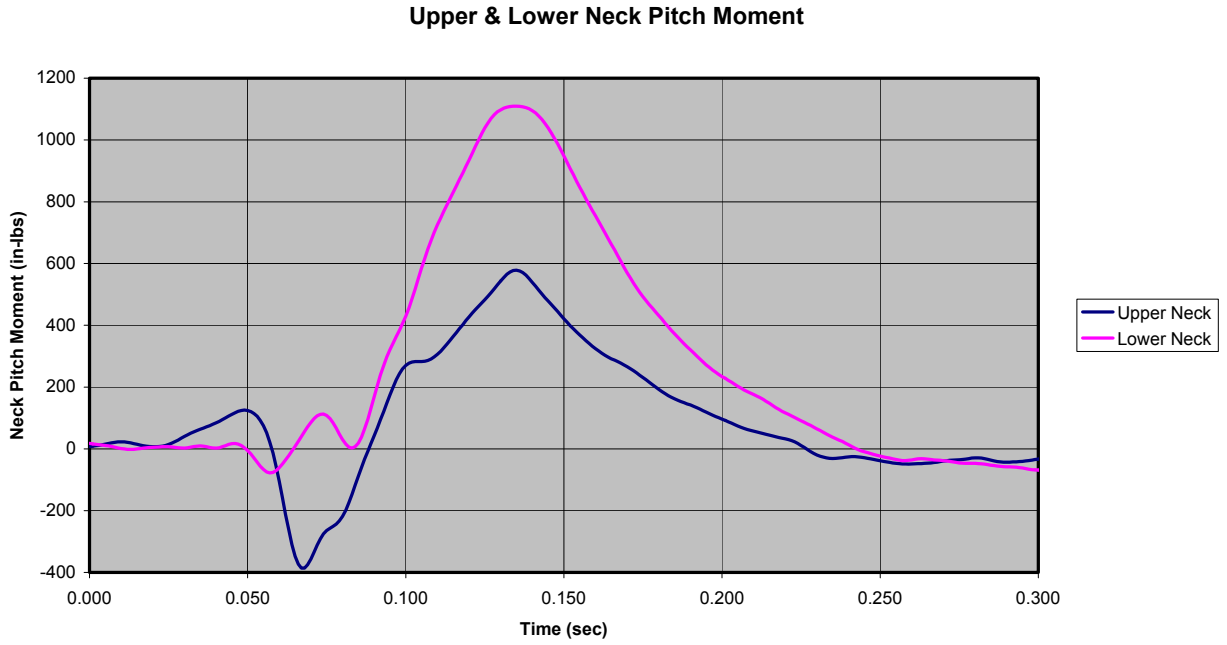

Figure B-71: Test 579 (Medium Pulse, 4.5 lb Added Head Weight)

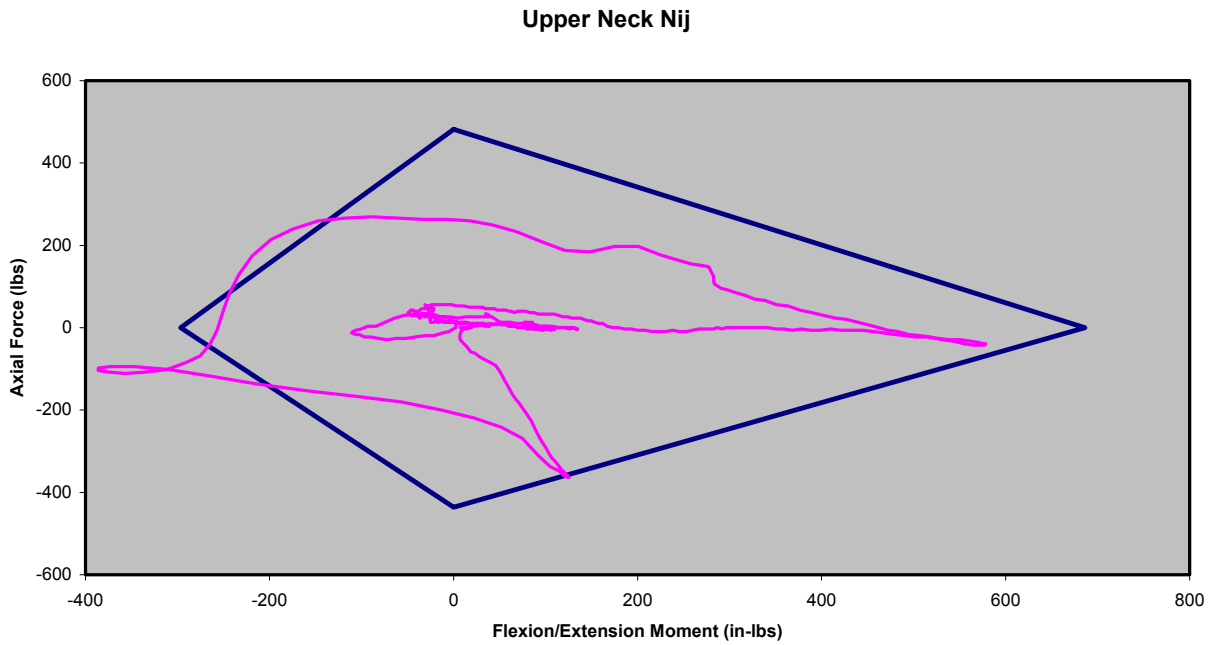

Figure B-72: Test 579 (Medium Pulse, 4.5 lb Added Head Weight)

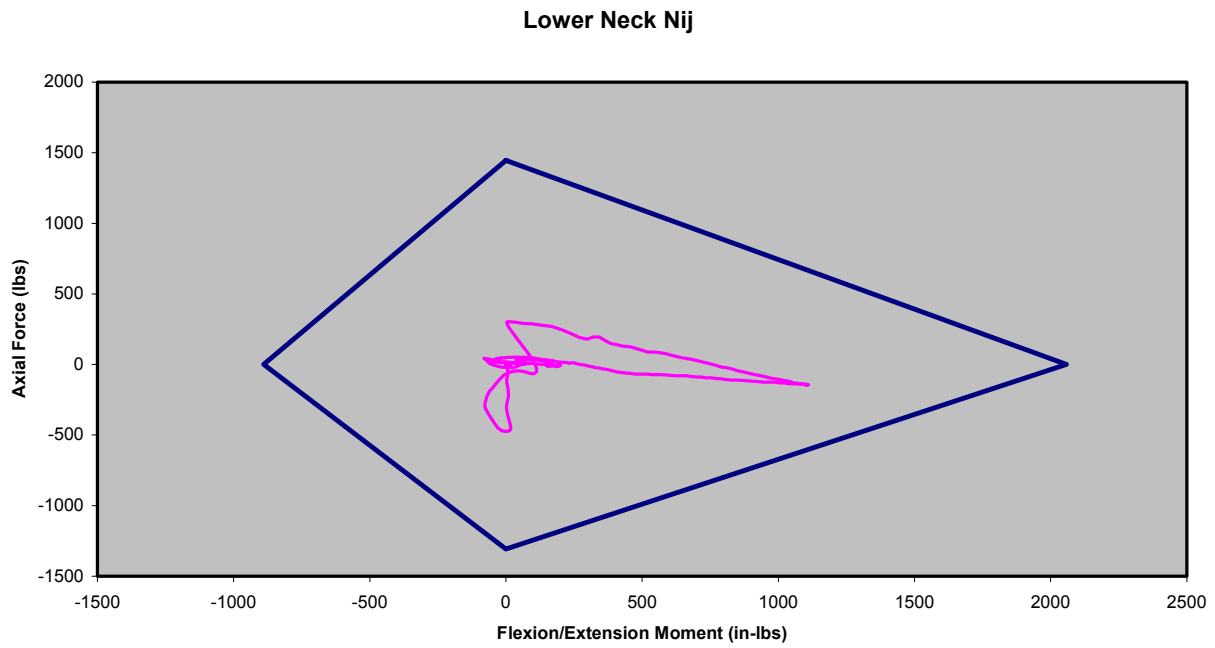

Figure B-73: Test 579 (Medium Pulse, 4.5 lb Added Head Weight)

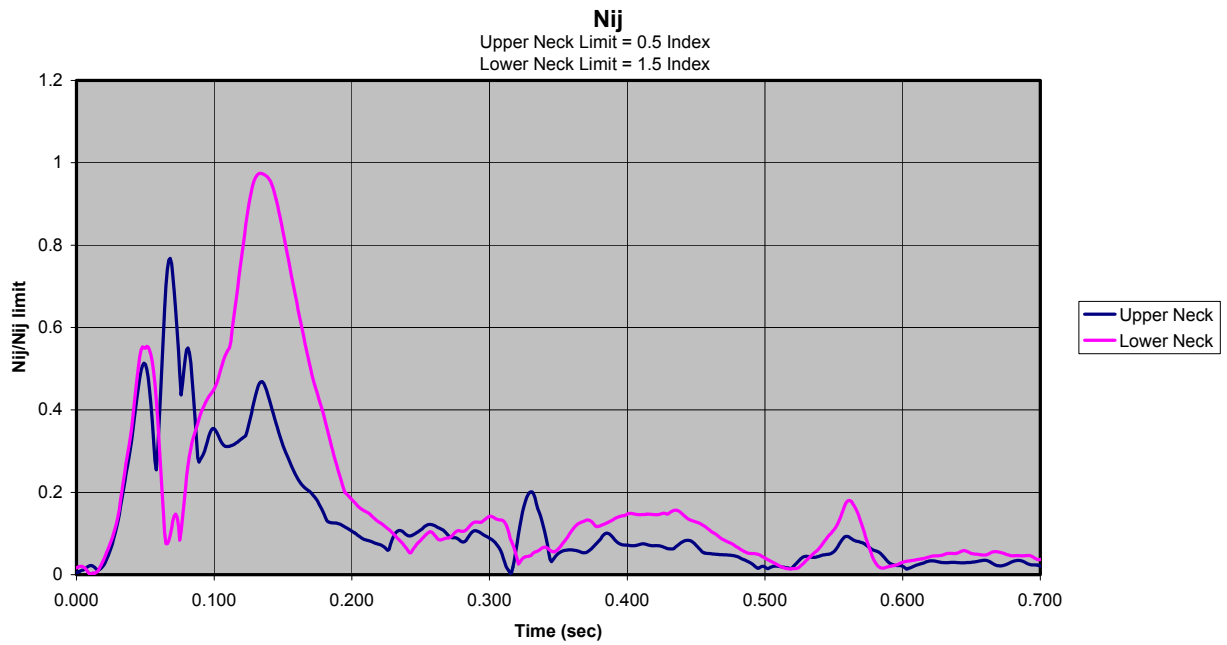

Figure B-74: Test 579 (Medium Pulse, 4.5 lb Added Head Weight)

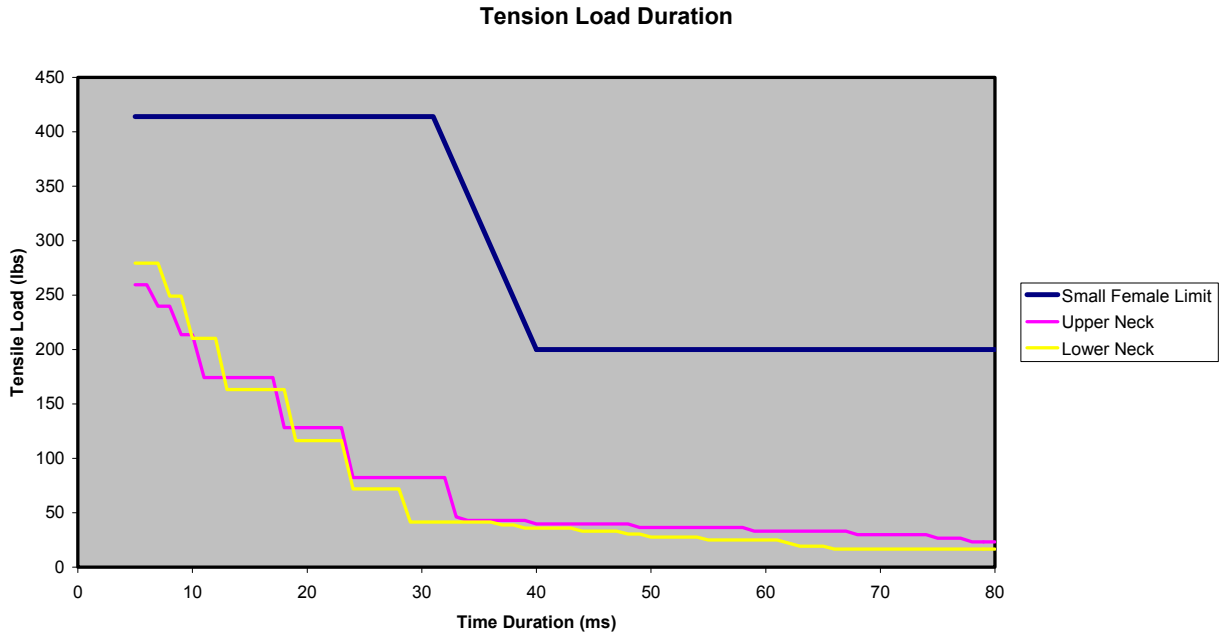

Figure B-75: Test 579 (Medium Pulse, 4.5 lb Added Head Weight)

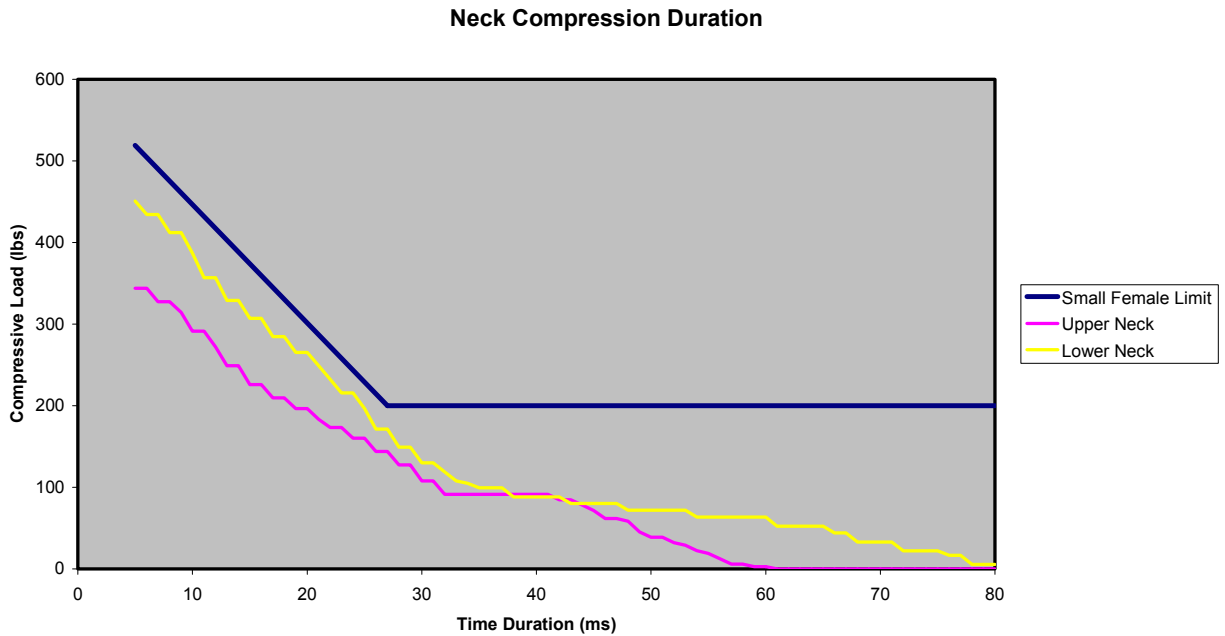

Figure B-76: Test 579 (Medium Pulse, 4.5 lb Added Head Weight)



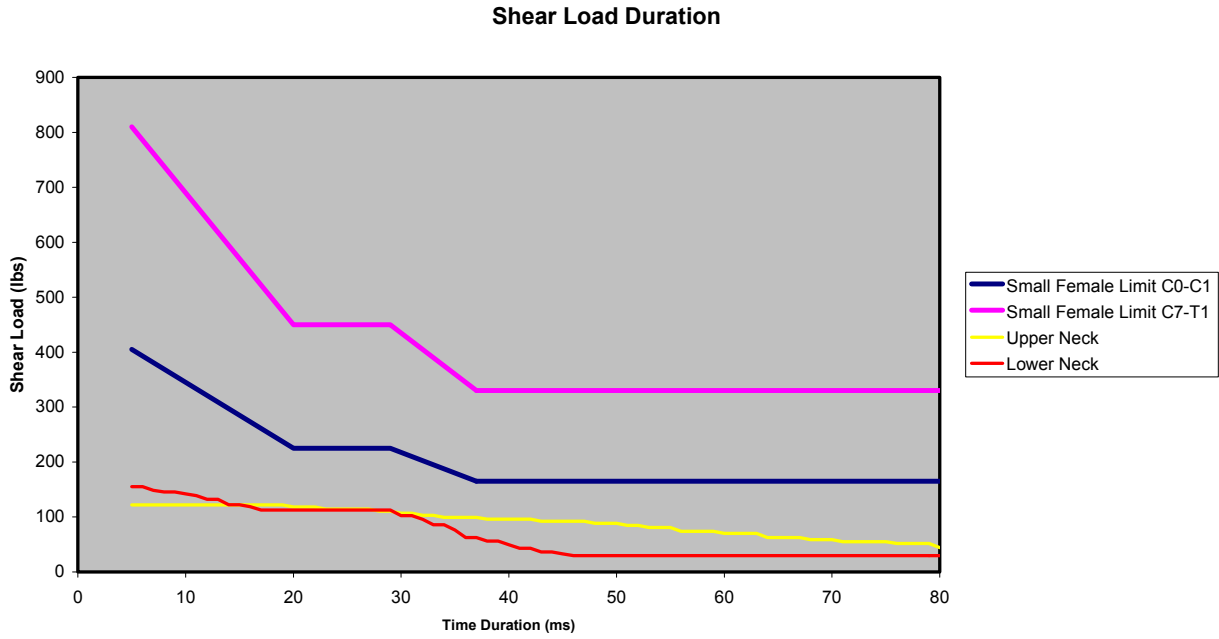

Figure B-77: Test 579 (Medium Pulse, 4.5 lb Added Head Weight)

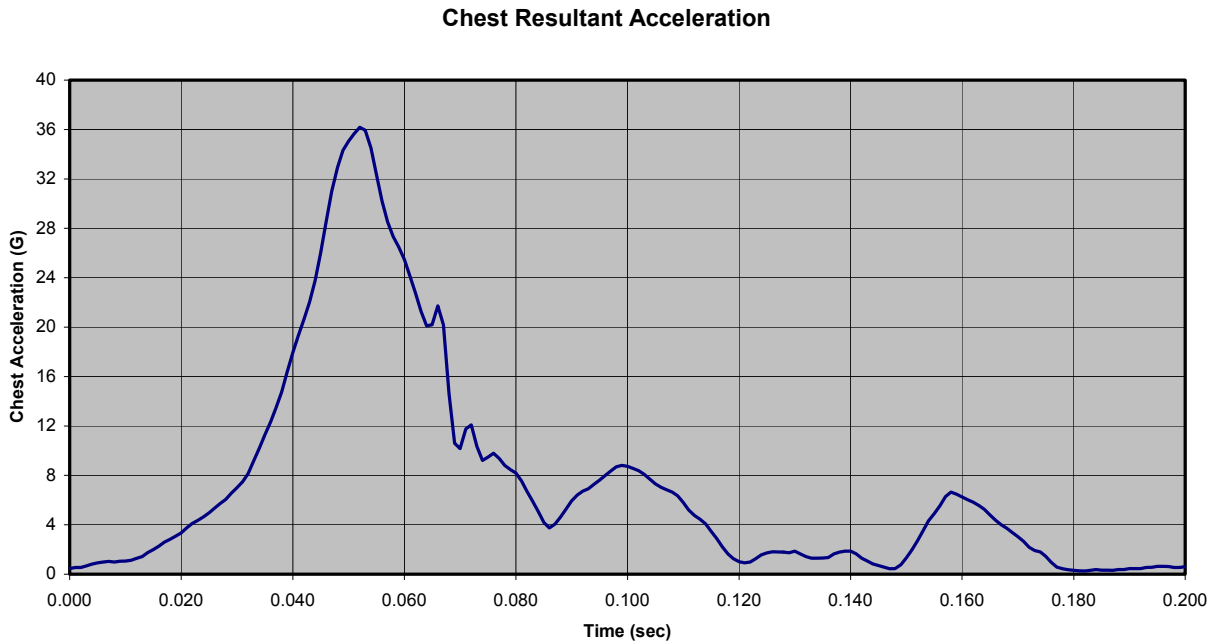

Figure B-78: Test 518 (Medium Pulse, 4.0 lb Added Head Weight)

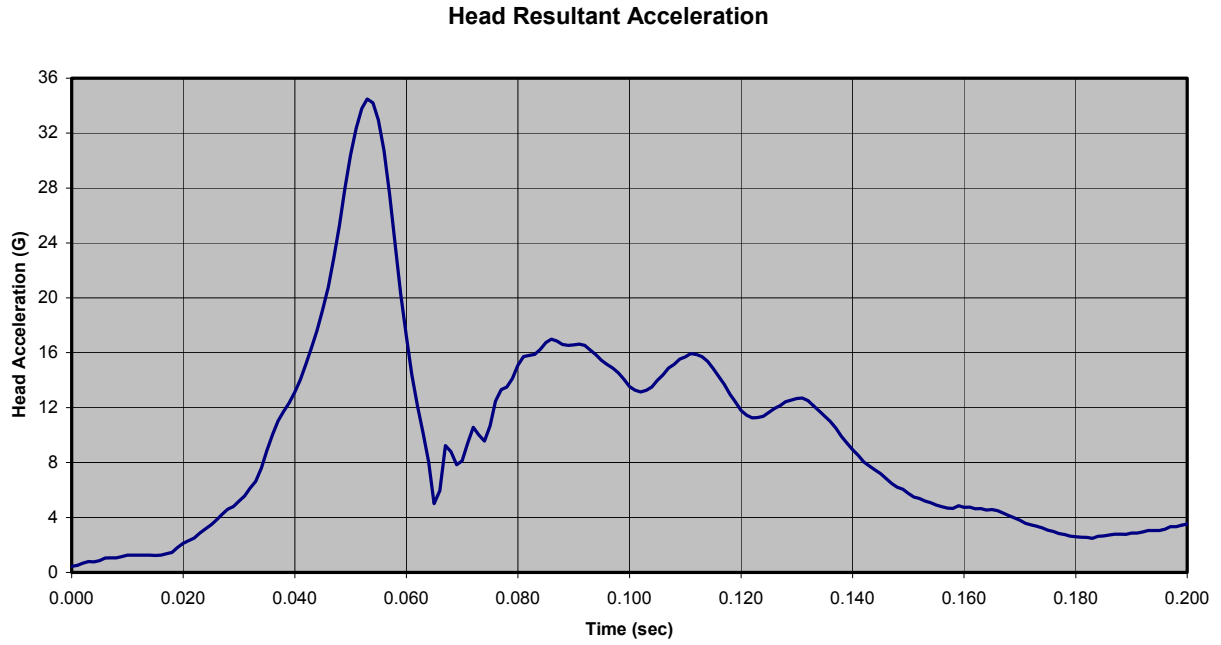

Figure B-79: Test 518 (Medium Pulse, 4.0 lb Added Head Weight)

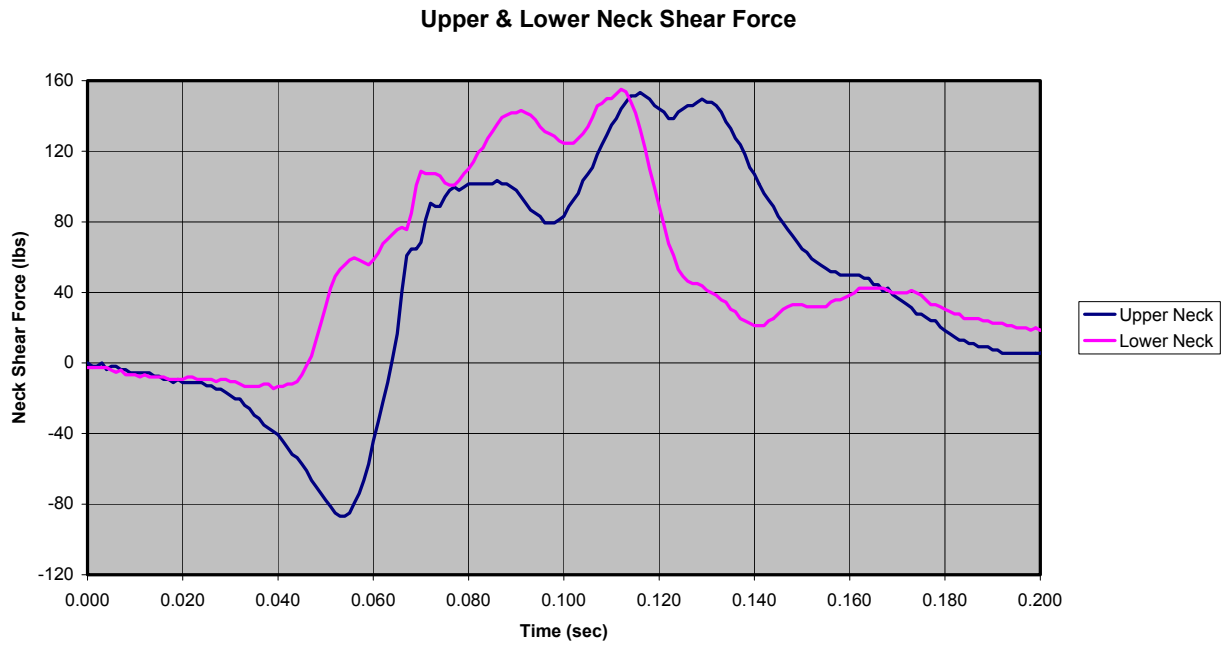

Figure B-80: Test 518 (Medium Pulse, 4.0 lb Added Head Weight)

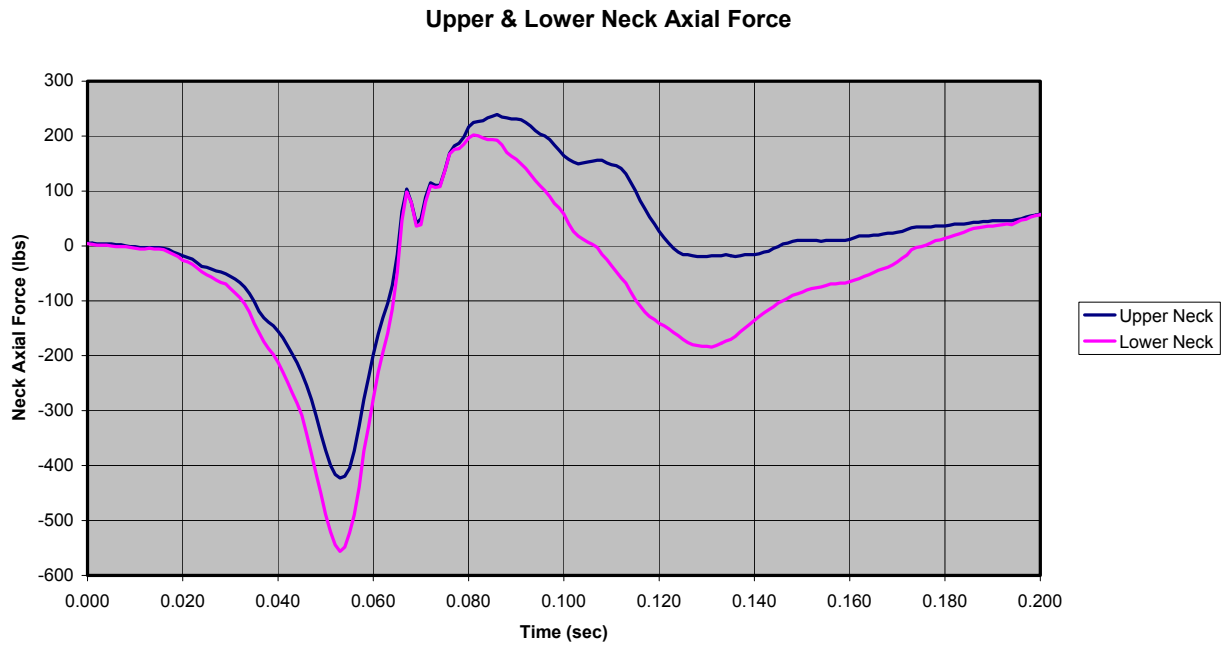

Figure B-81: Test 518 (Medium Pulse, 4.0 lb Added Head Weight)

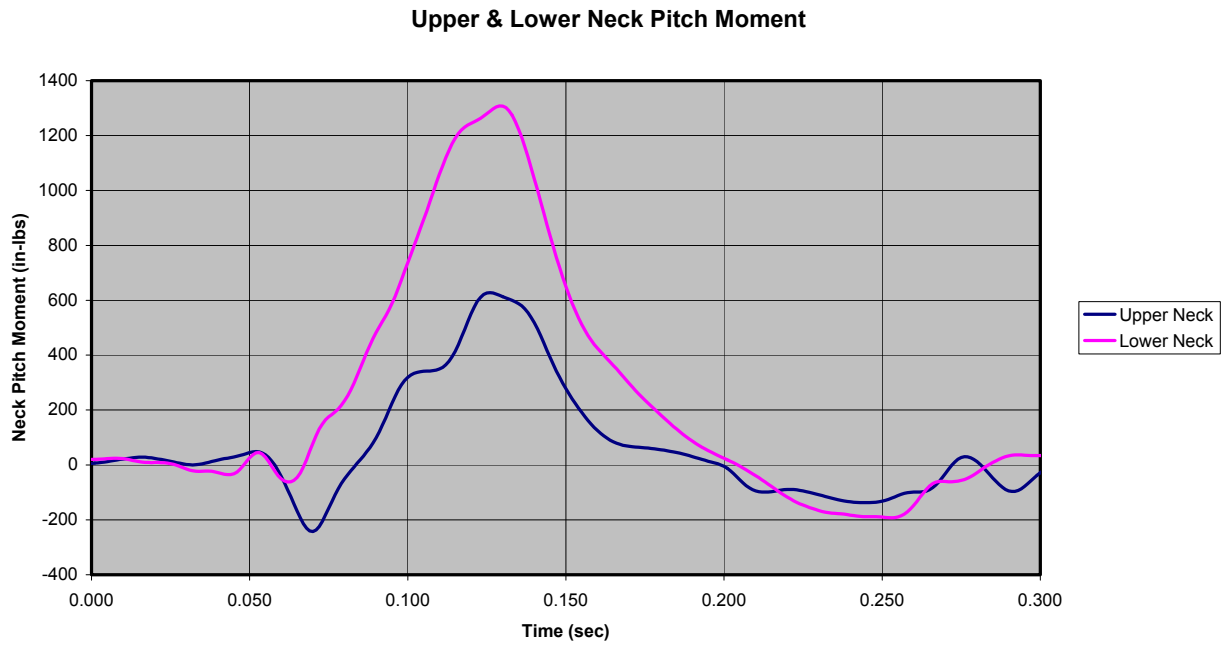

Figure B-82: Test 518 (Medium Pulse, 4.0 lb Added Head Weight)

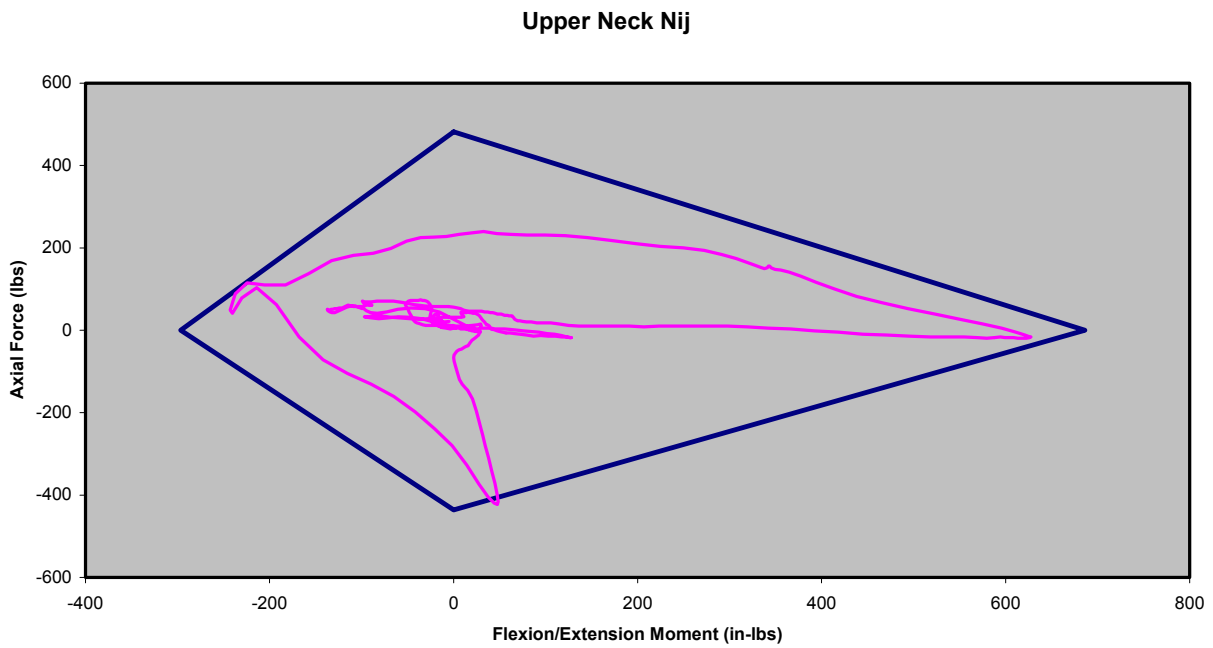

Figure B-83: Test 518 (Medium Pulse, 4.0 lb Added Head Weight)

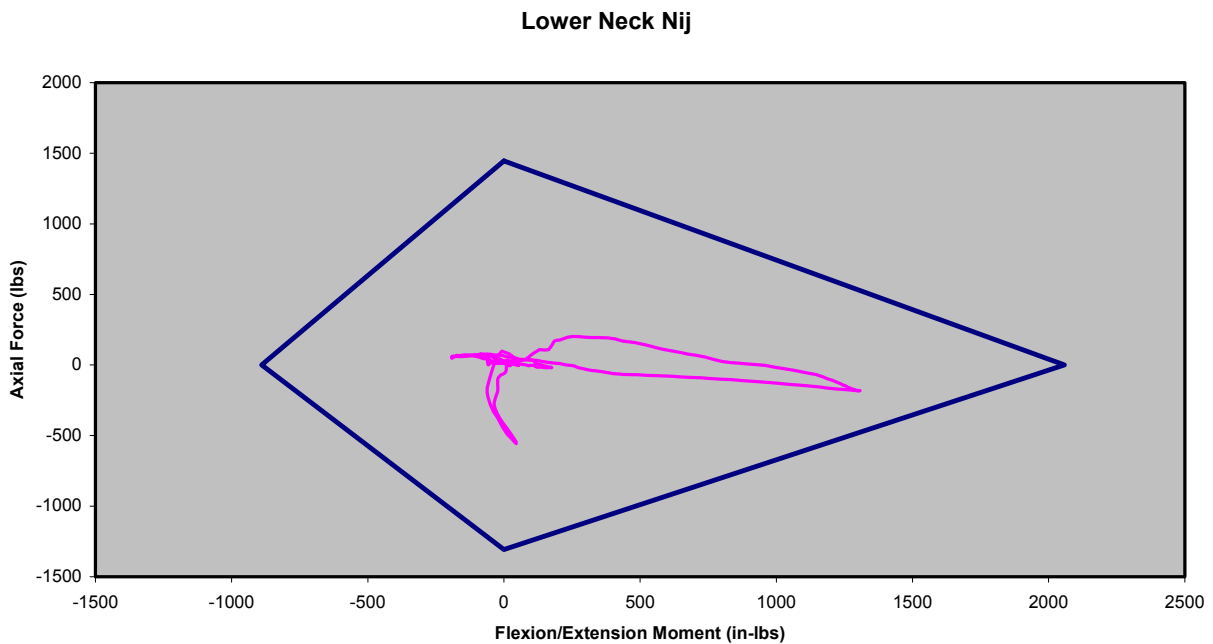

Figure B-84: Test 518 (Medium Pulse, 4.0 lb Added Head Weight)

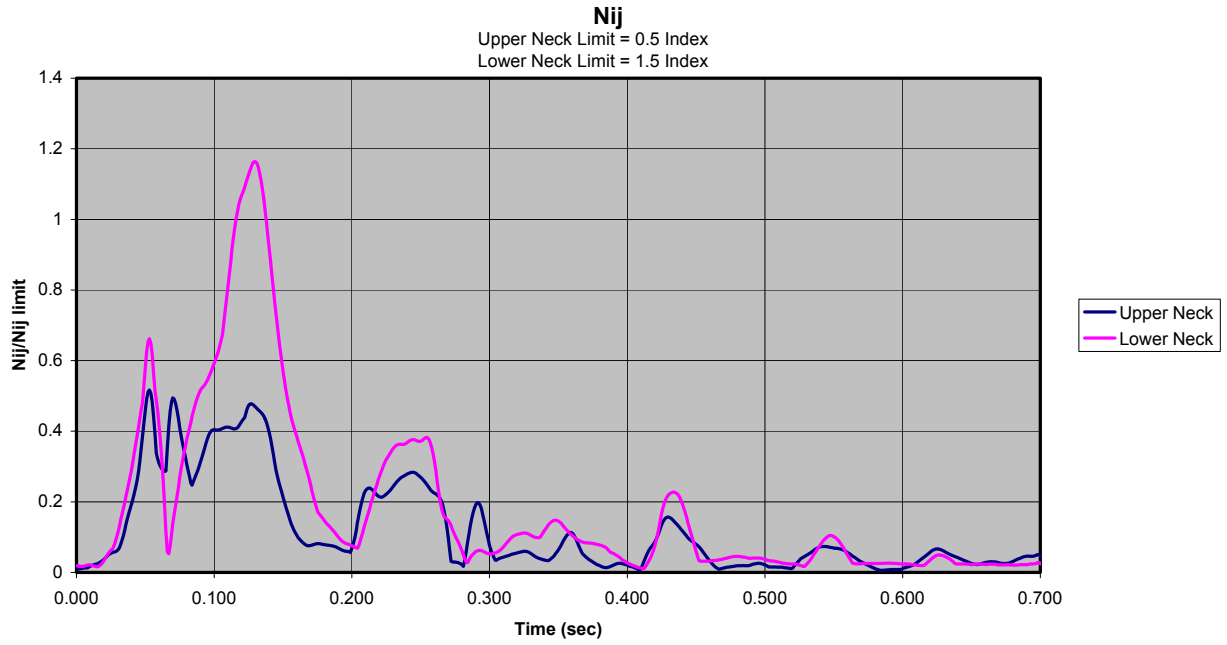

Figure B-85: Test 518 (Medium Pulse, 4.0 lb Added Head Weight)

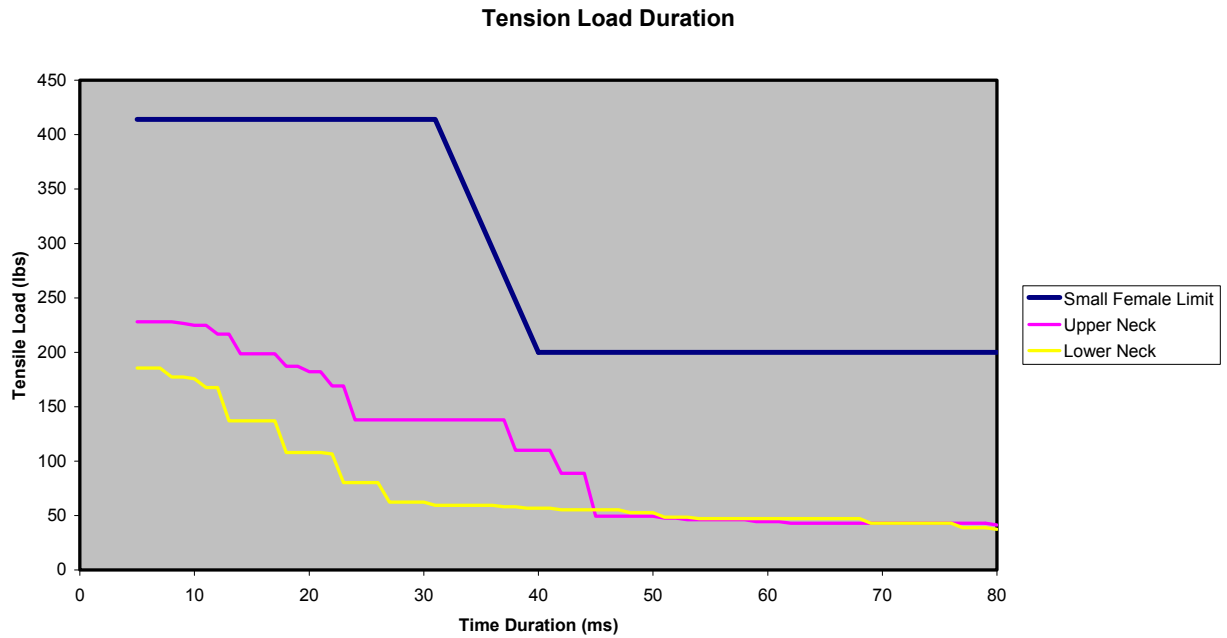

Figure B-86: Test 518 (Medium Pulse, 4.0 lb Added Head Weight)

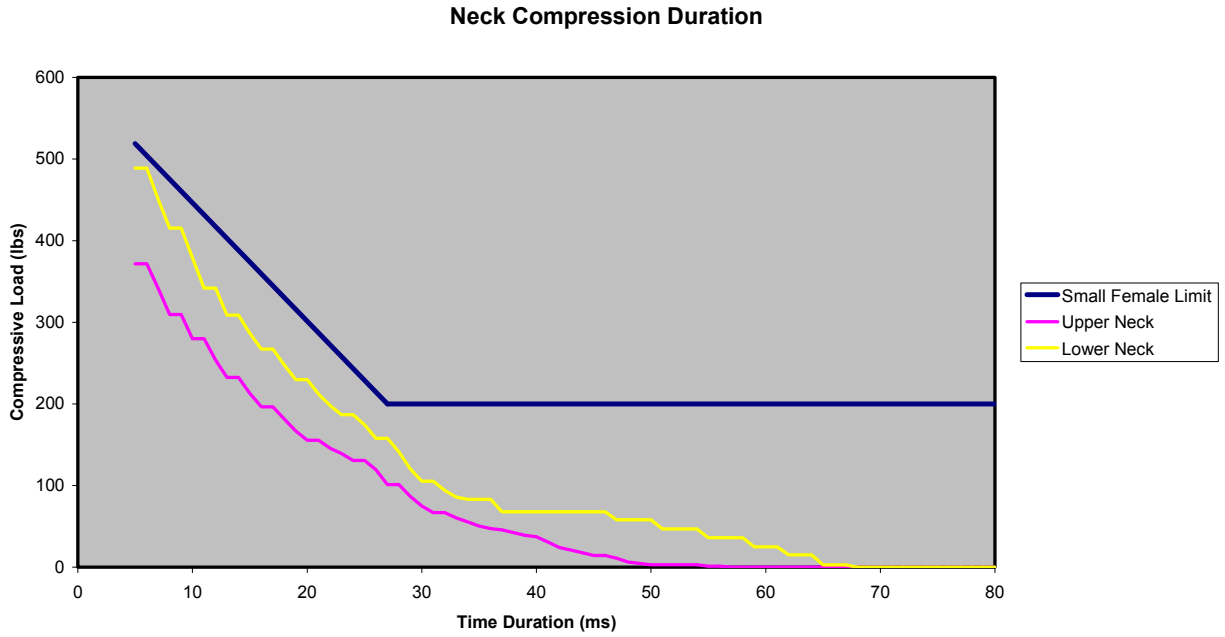

Figure B-87: Test 518 (Medium Pulse, 4.0 lb Added Head Weight)

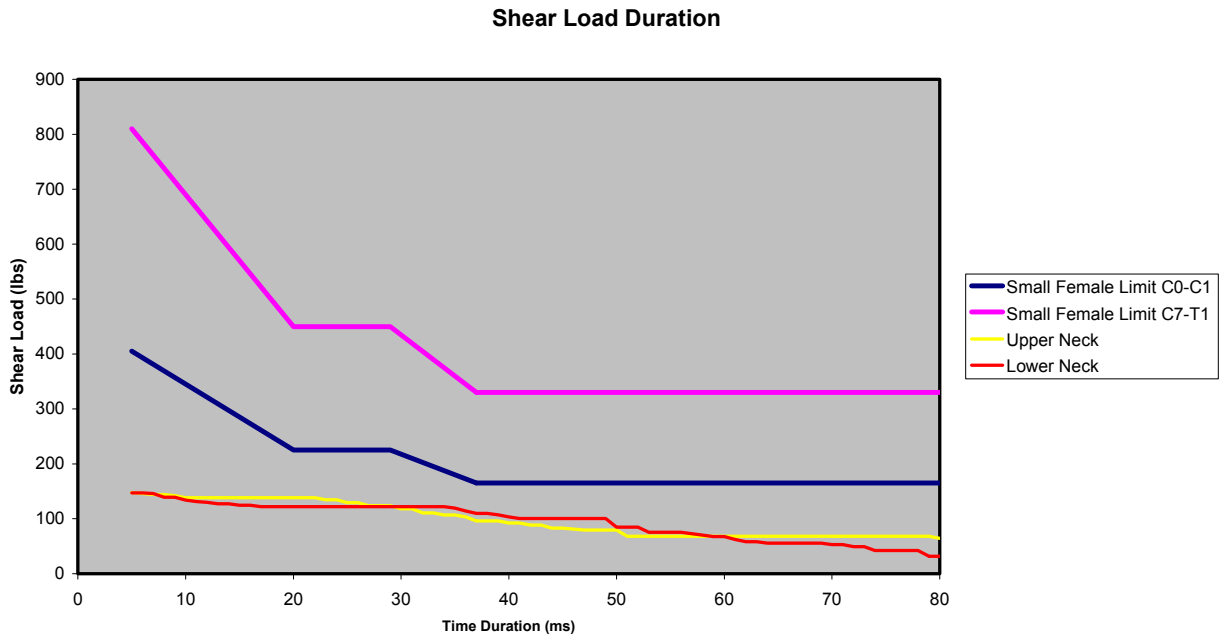

Figure B-88: Test 518 (Medium Pulse, 4.0 lb Added Head Weight)

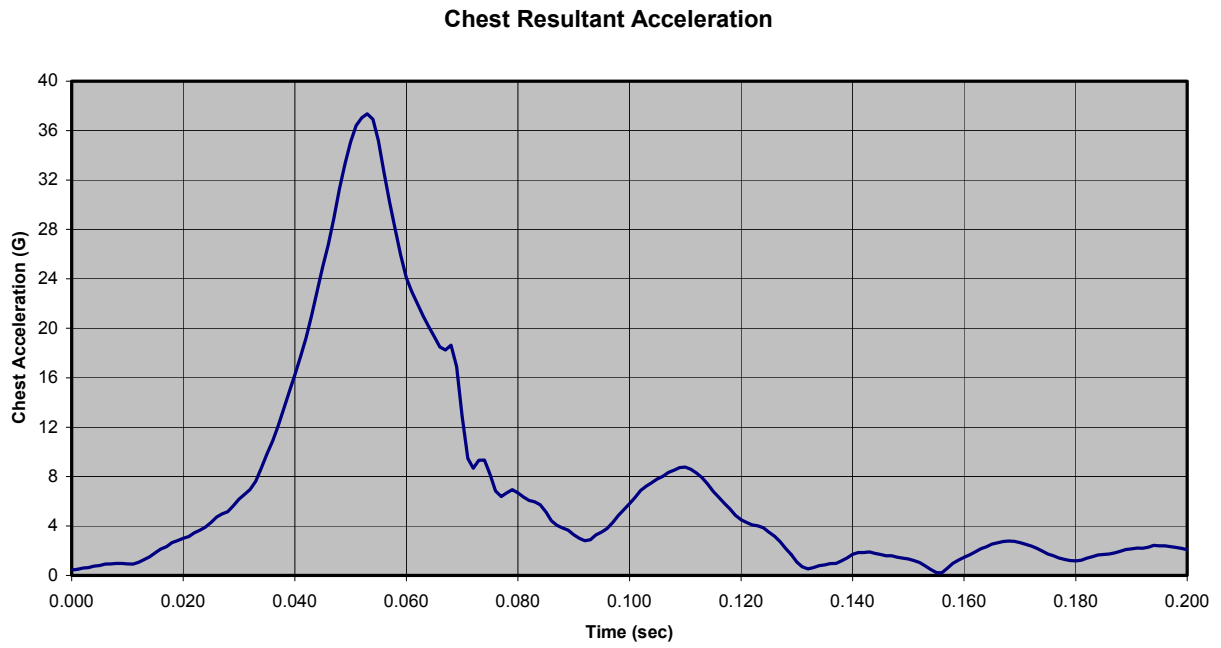

Figure B-89: Test 519 (Medium Pulse, 5.0 lb Added Head Weight)

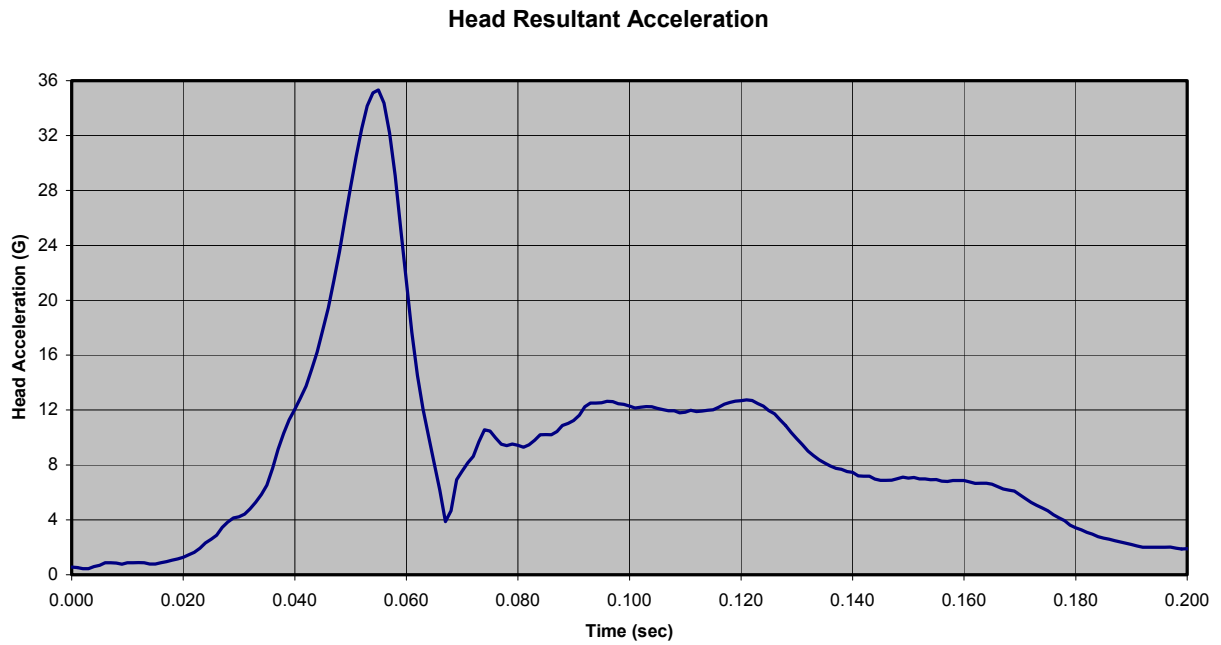

Figure B-90: Test 519 (Medium Pulse, 5.0 lb Added Head Weight)

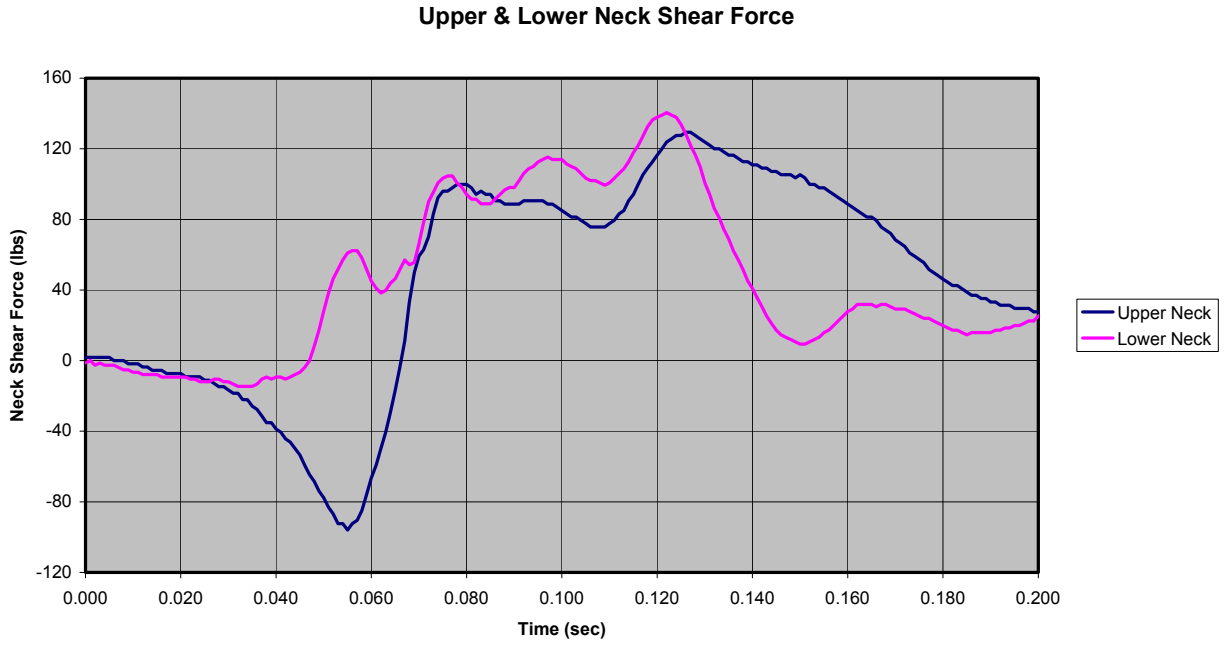

Figure B-91: Test 519 (Medium Pulse, 5.0 lb Added Head Weight)

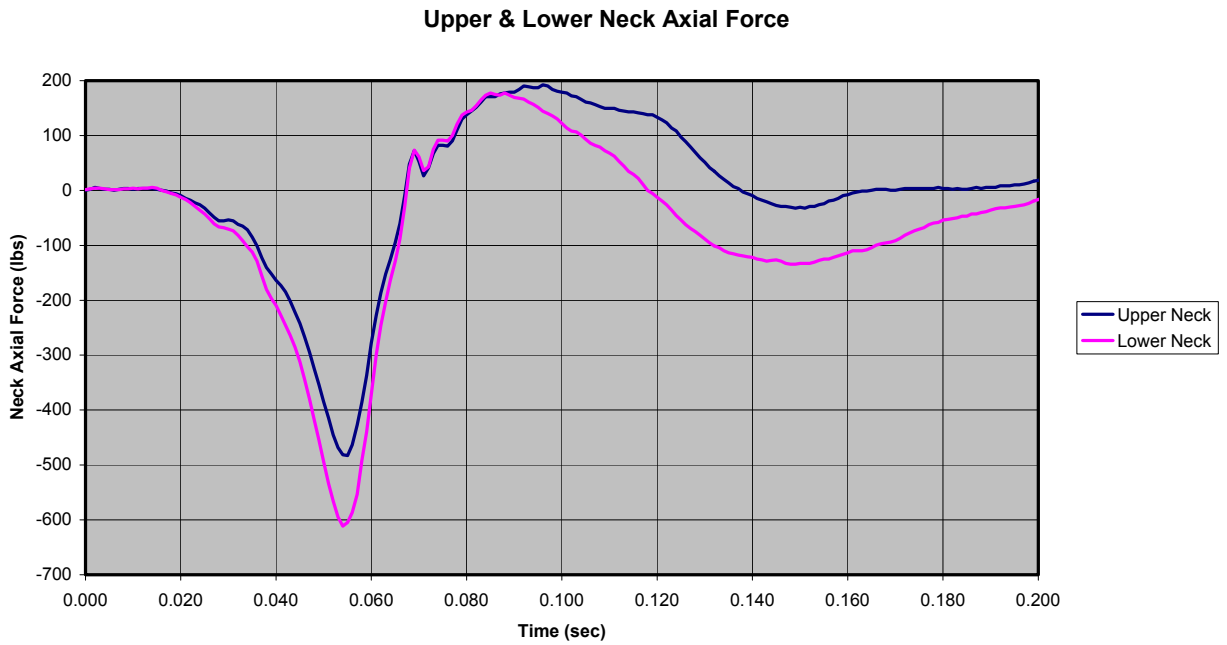

Figure B-92: Test 519 (Medium Pulse, 5.0 lb Added Head Weight)



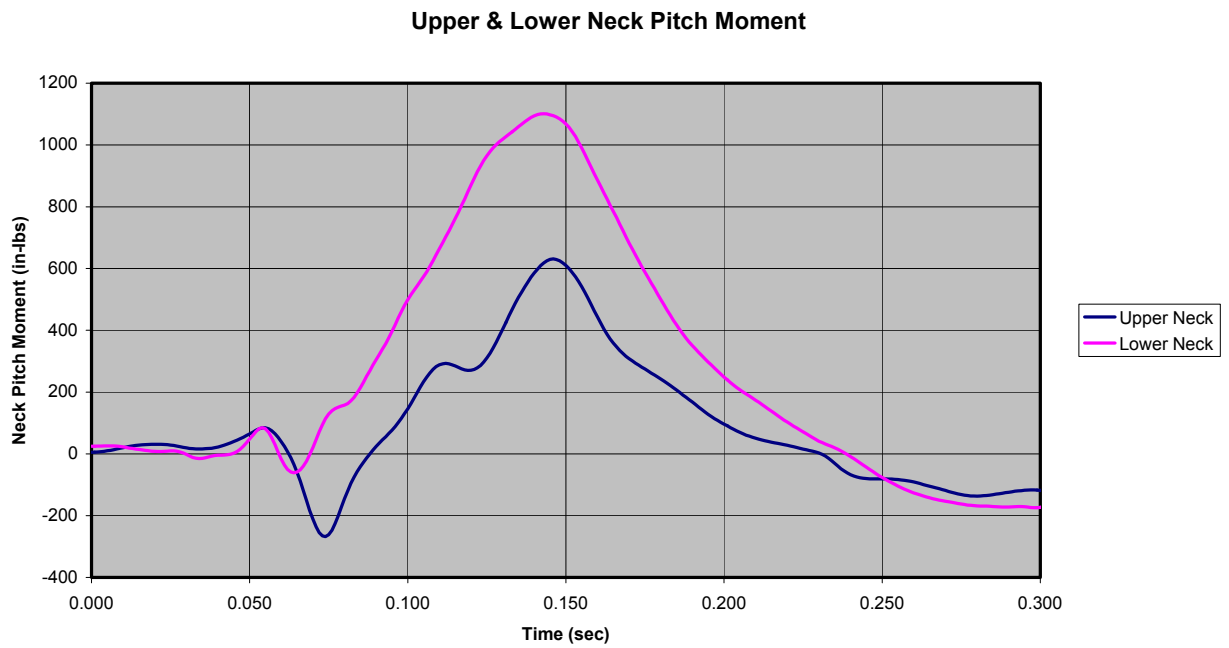

Figure B-93: Test 519 (Medium Pulse, 5.0 lb Added Head Weight)

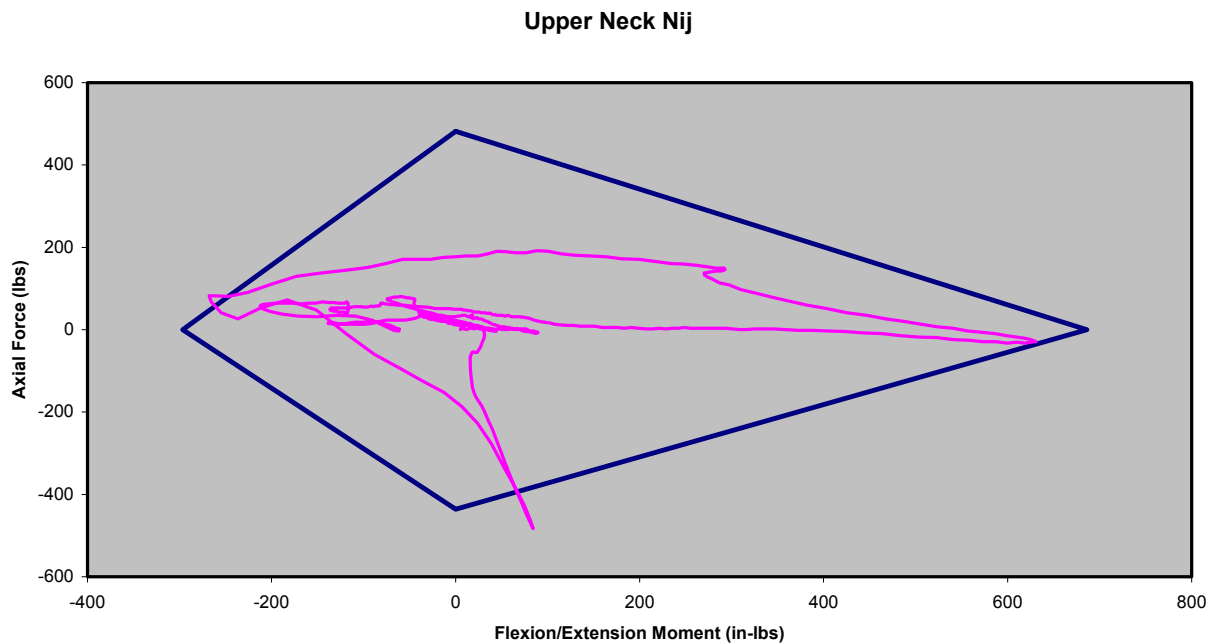

Figure B-94: Test 519 (Medium Pulse, 5.0 lb Added Head Weight)

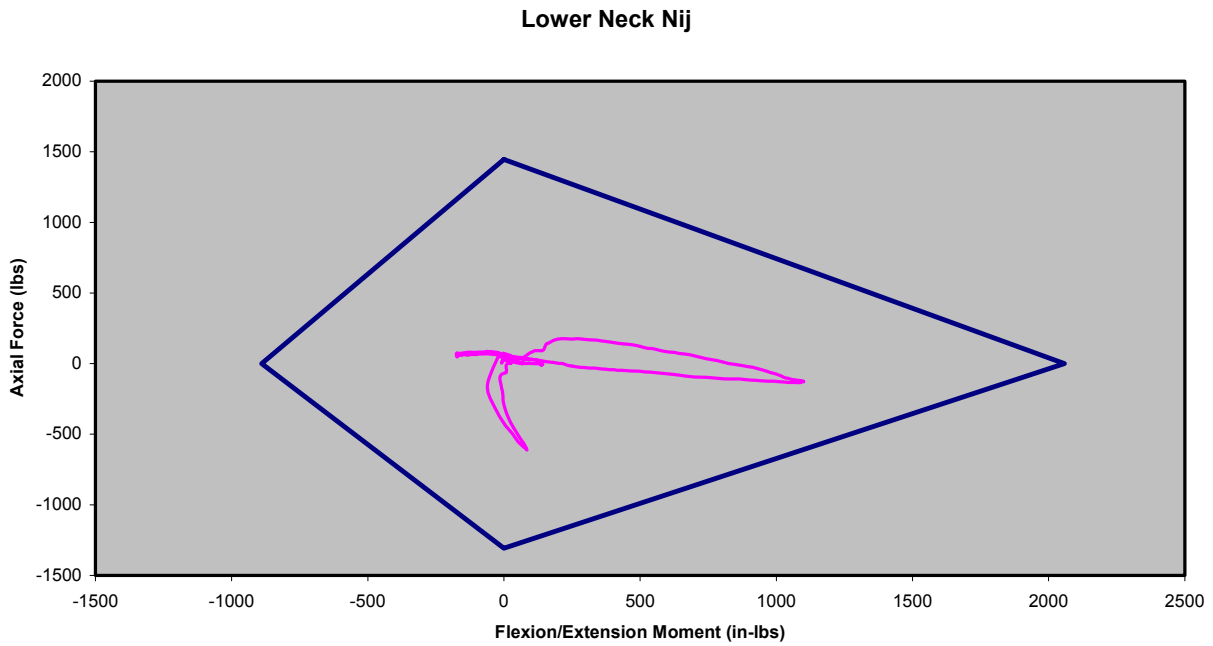

Figure B-95: Test 519 (Medium Pulse, 5.0 lb Added Head Weight)

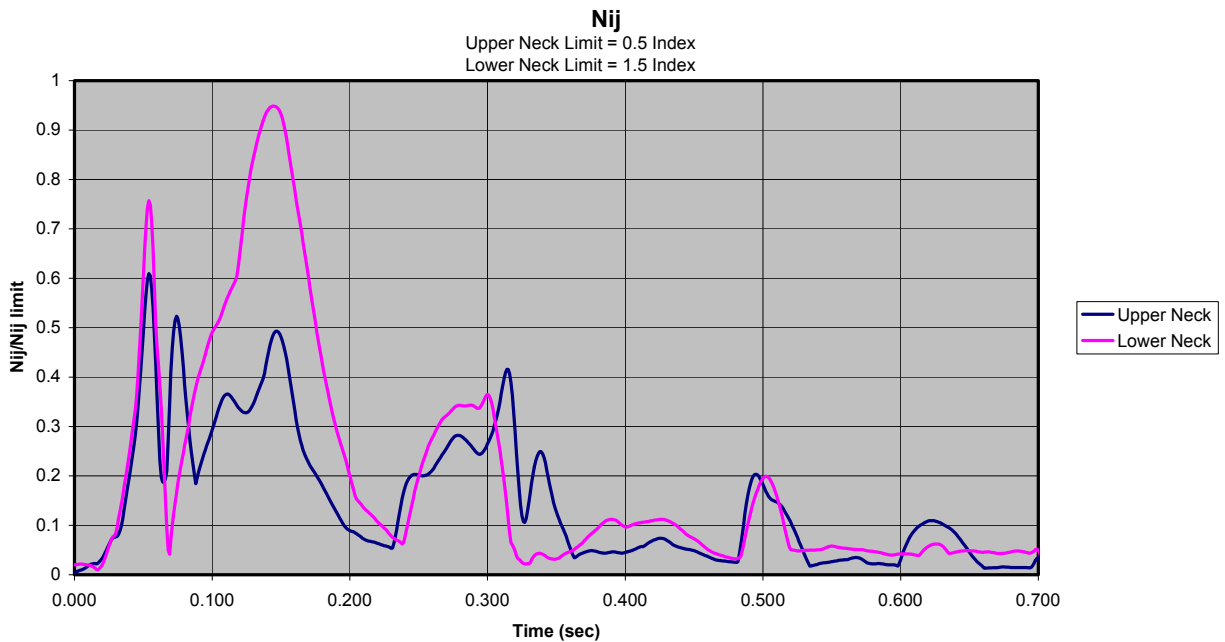

Figure B-96: Test 519 (Medium Pulse, 5.0 lb Added Head Weight)

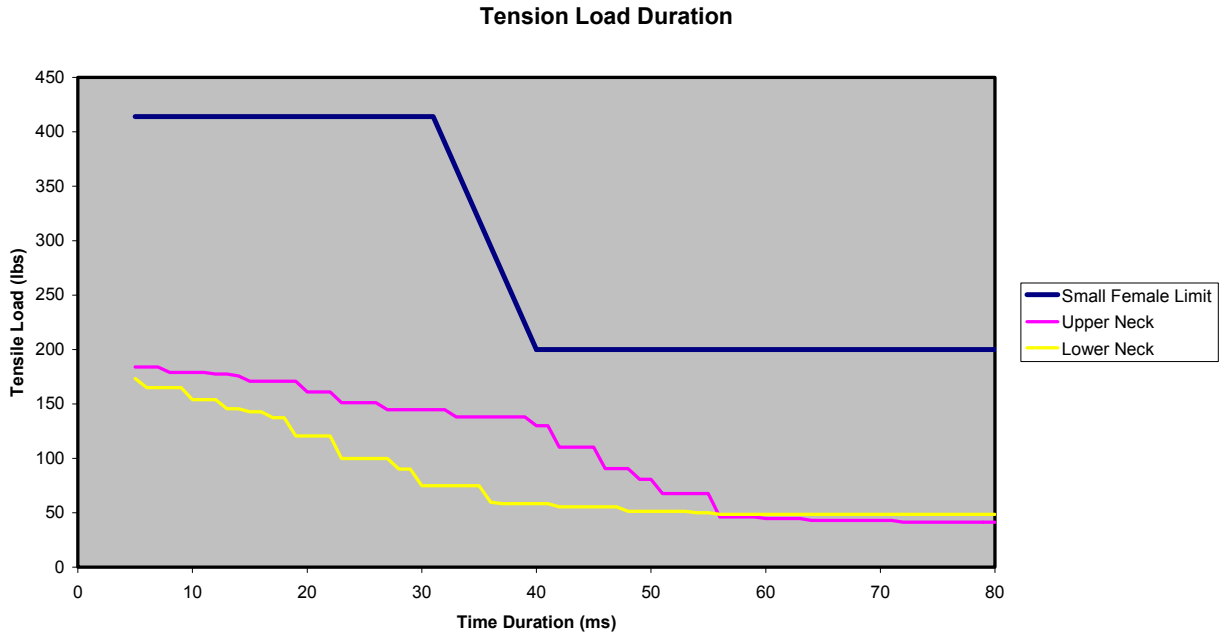

Figure B-97: Test 519 (Medium Pulse, 5.0 lb Added Head Weight)

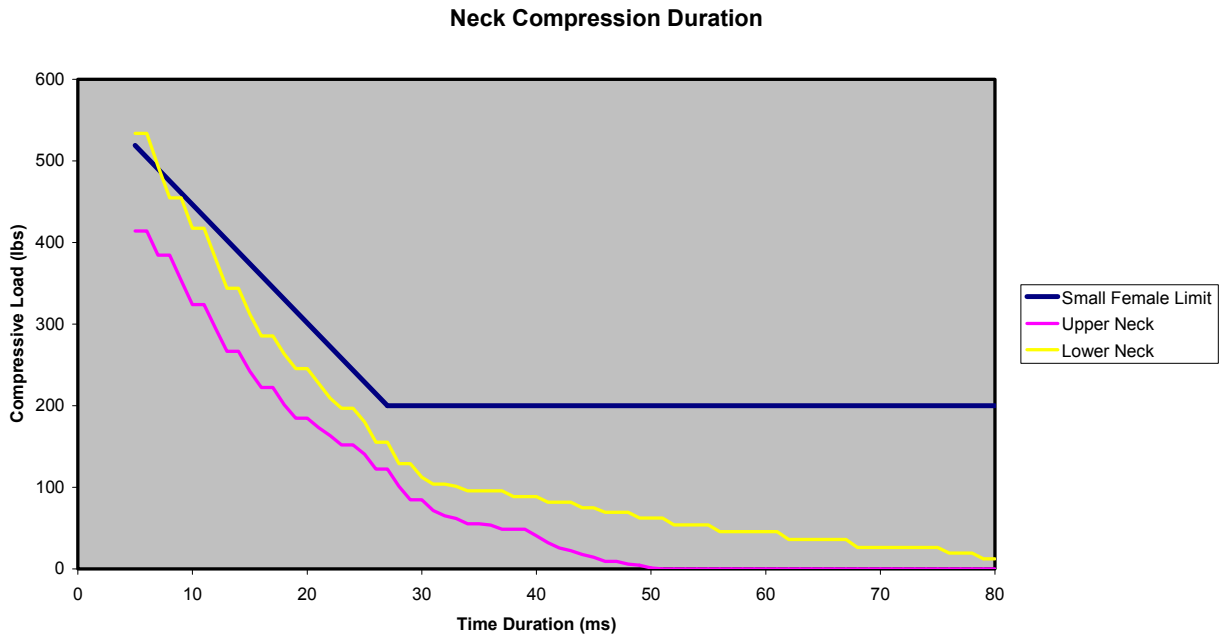

Figure B-98: Test 519 (Medium Pulse, 5.0 lb Added Head Weight)

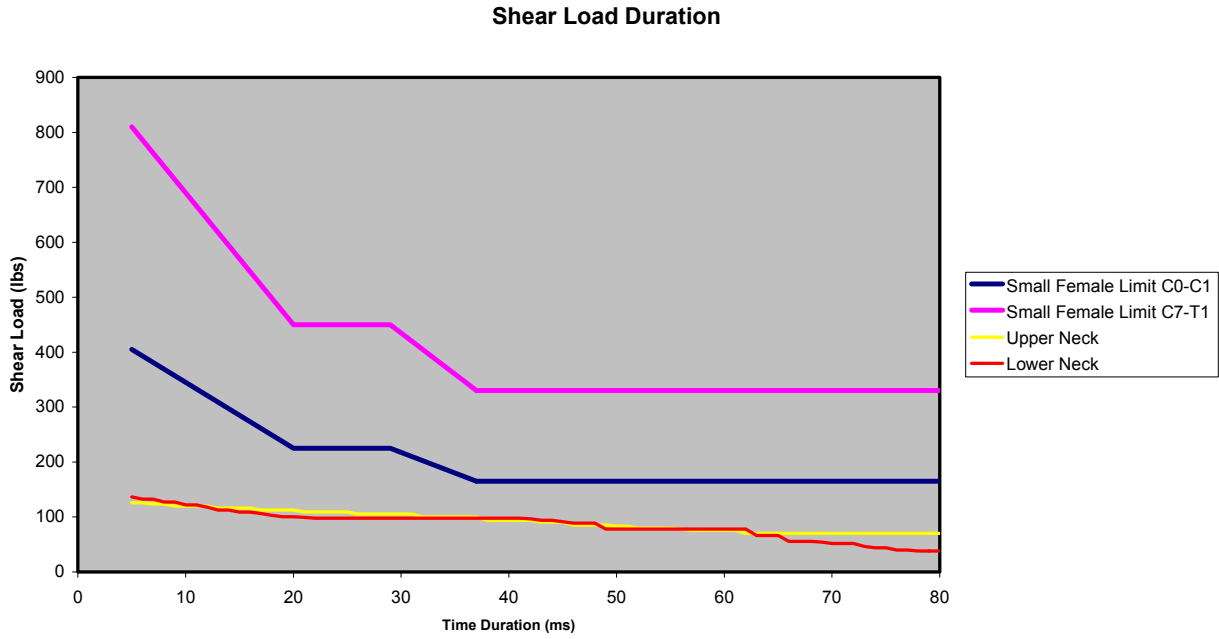

Figure B-99: Test 519 (Medium Pulse, 5.0 lb Added Head Weight)

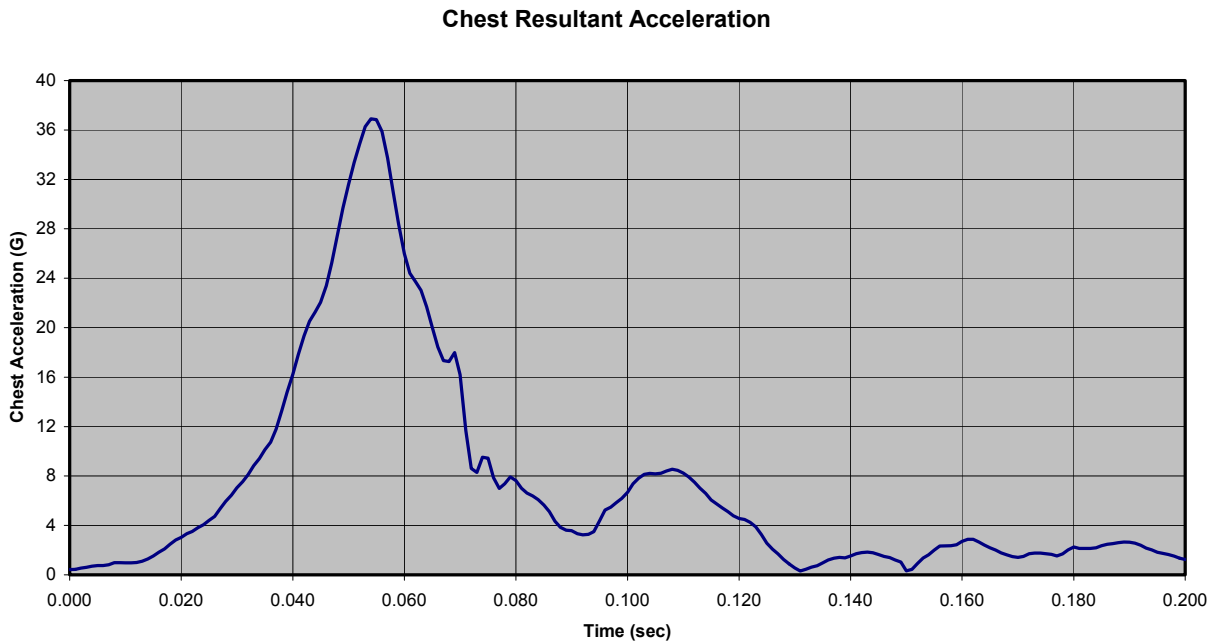

Figure B-100: Test 520 (Medium Pulse, 5.0 lb Added Head Weight)

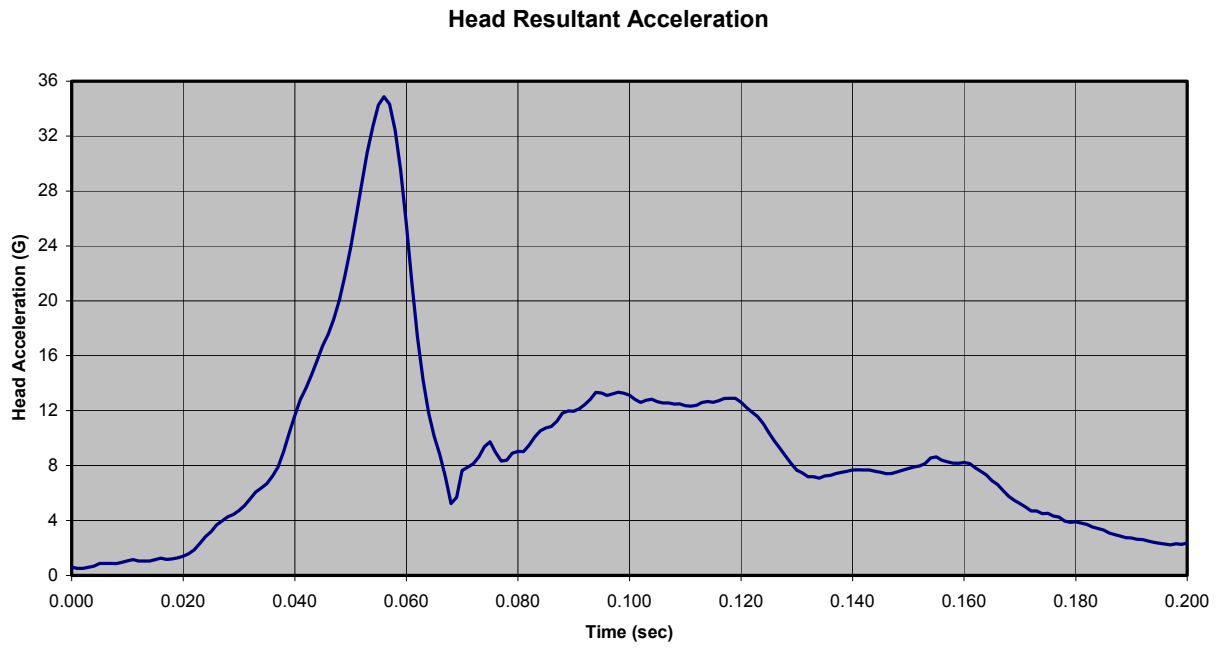

Figure B-101: Test 520 (Medium Pulse, 5.0 lb Added Head Weight)

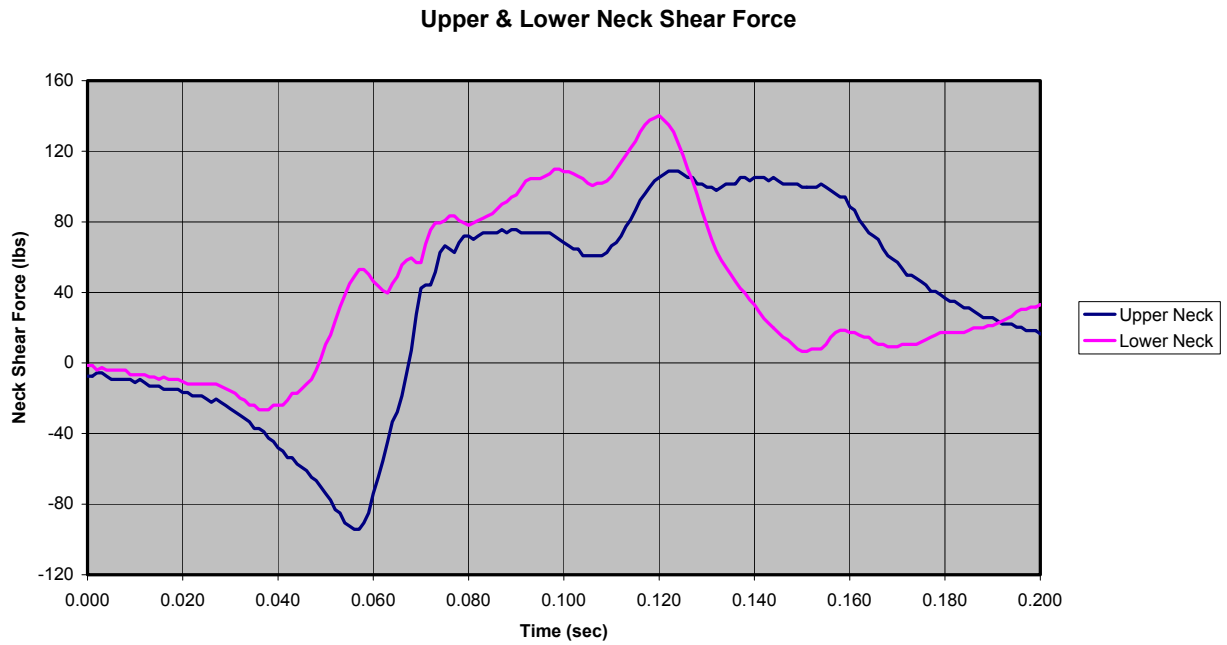

Figure B-102: Test 520 (Medium Pulse, 5.0 lb Added Head Weight)

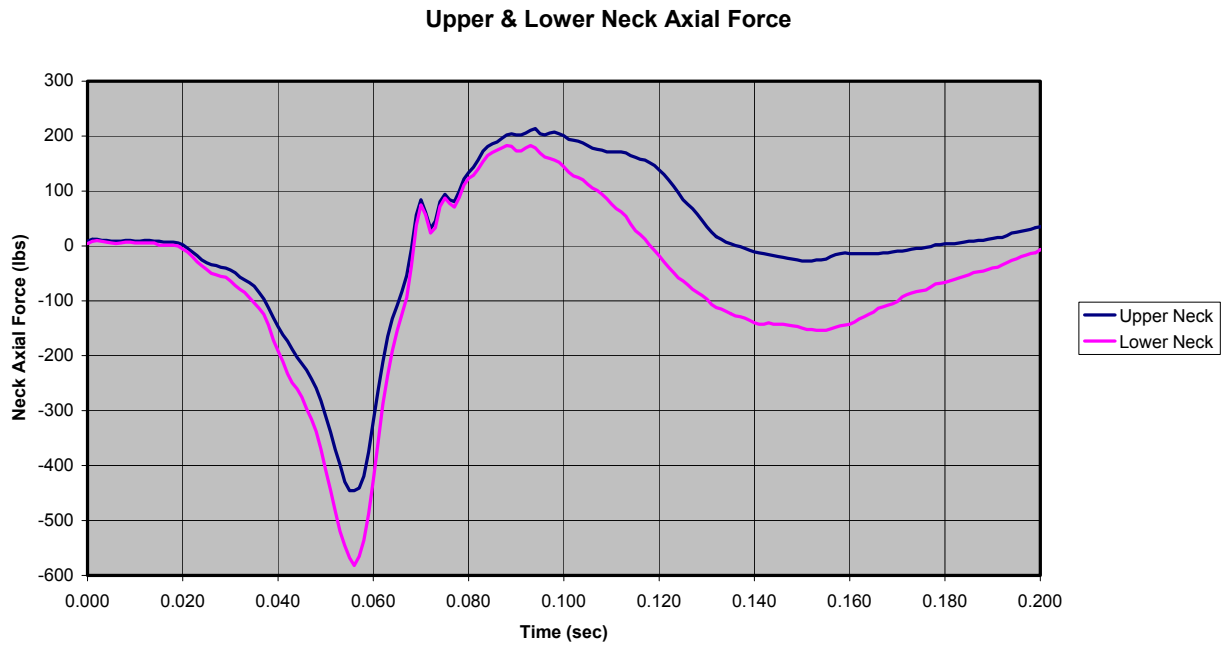

Figure B-103: Test 520 (Medium Pulse, 5.0 lb Added Head Weight)

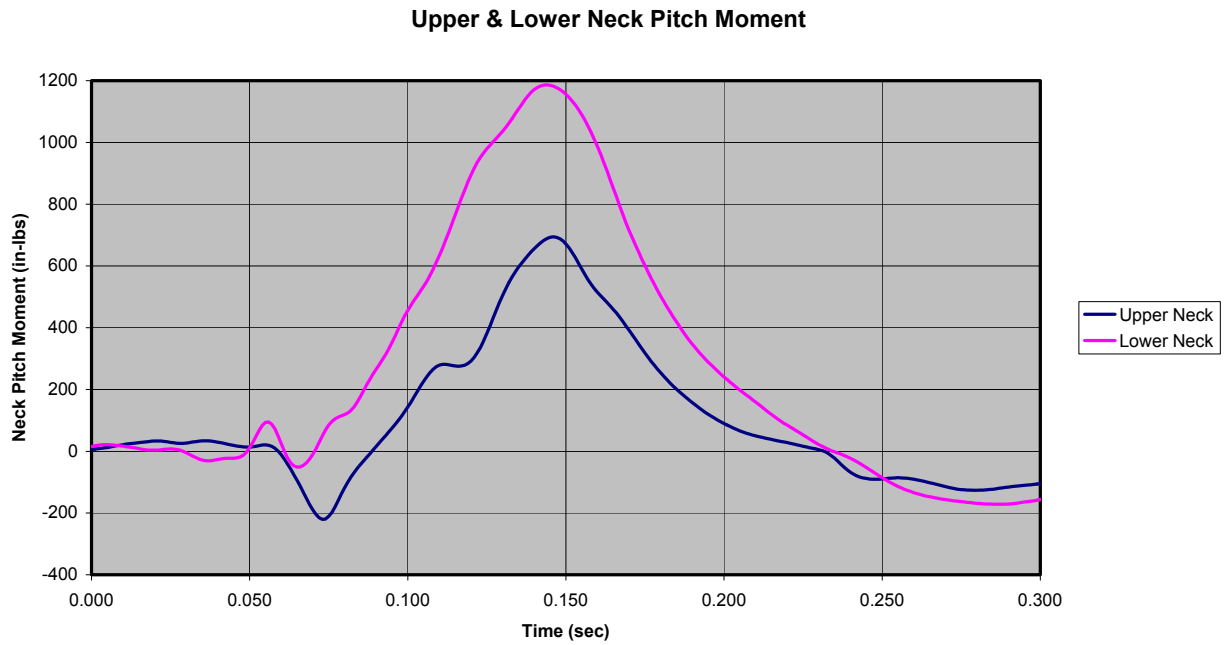

Figure B-104: Test 520 (Medium Pulse, 5.0 lb Added Head Weight)

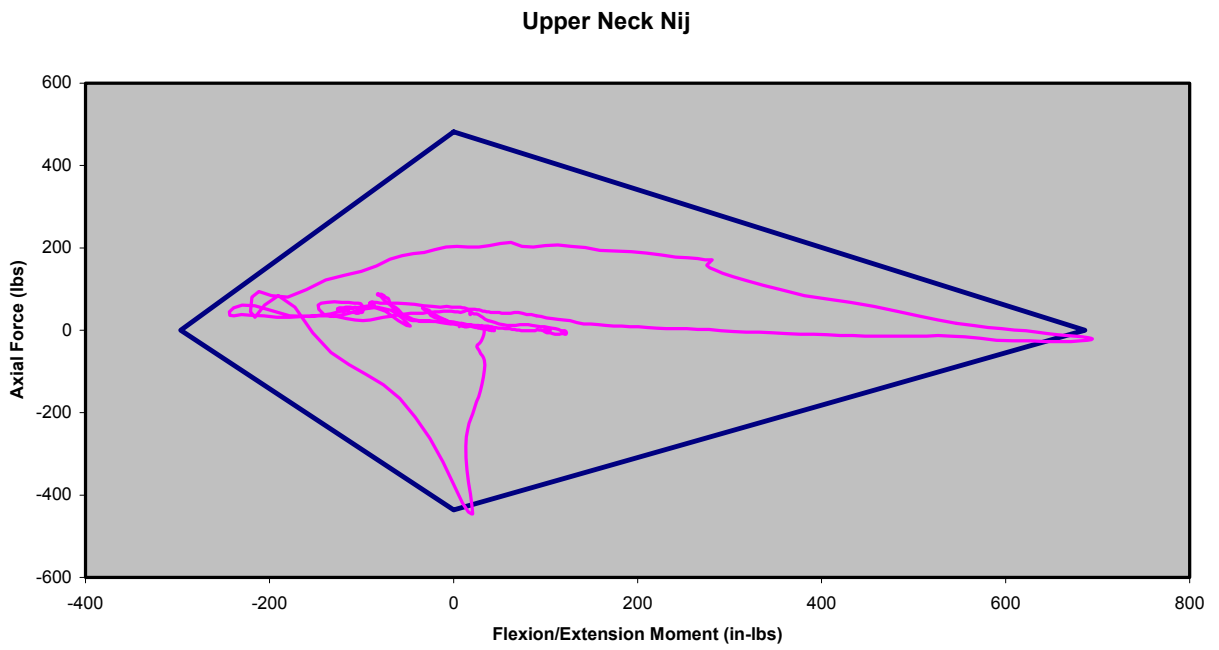

Figure B-105: Test 520 (Medium Pulse, 5.0 lb Added Head Weight)

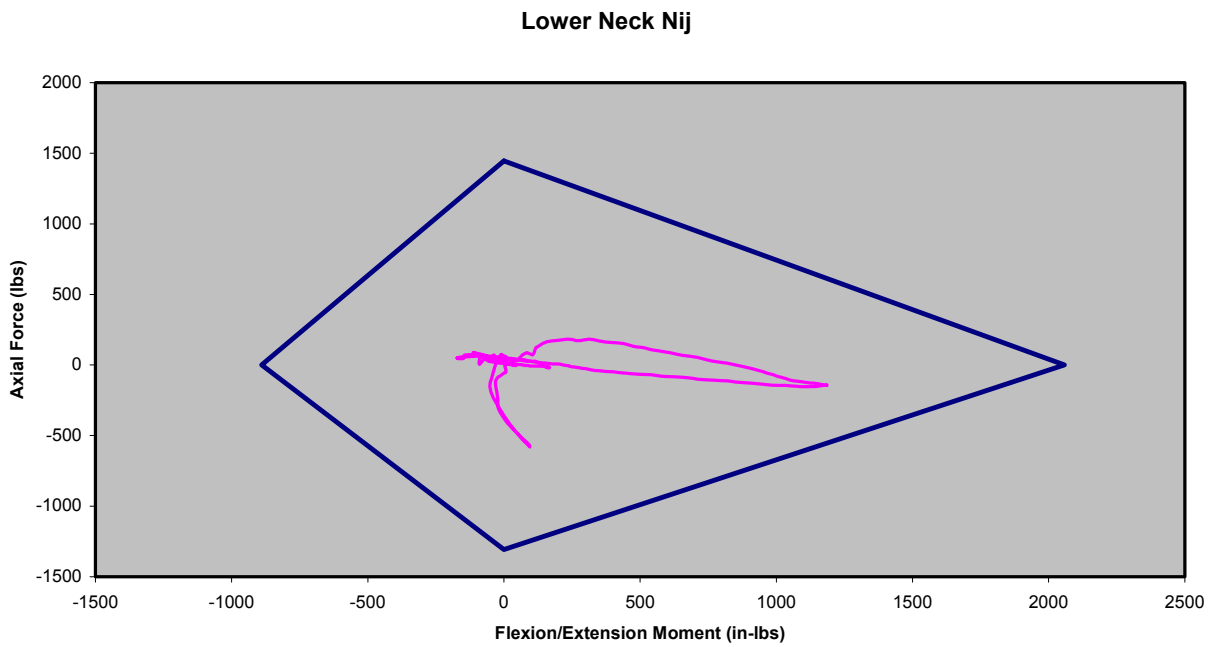

Figure B-106: Test 520 (Medium Pulse, 5.0 lb Added Head Weight)

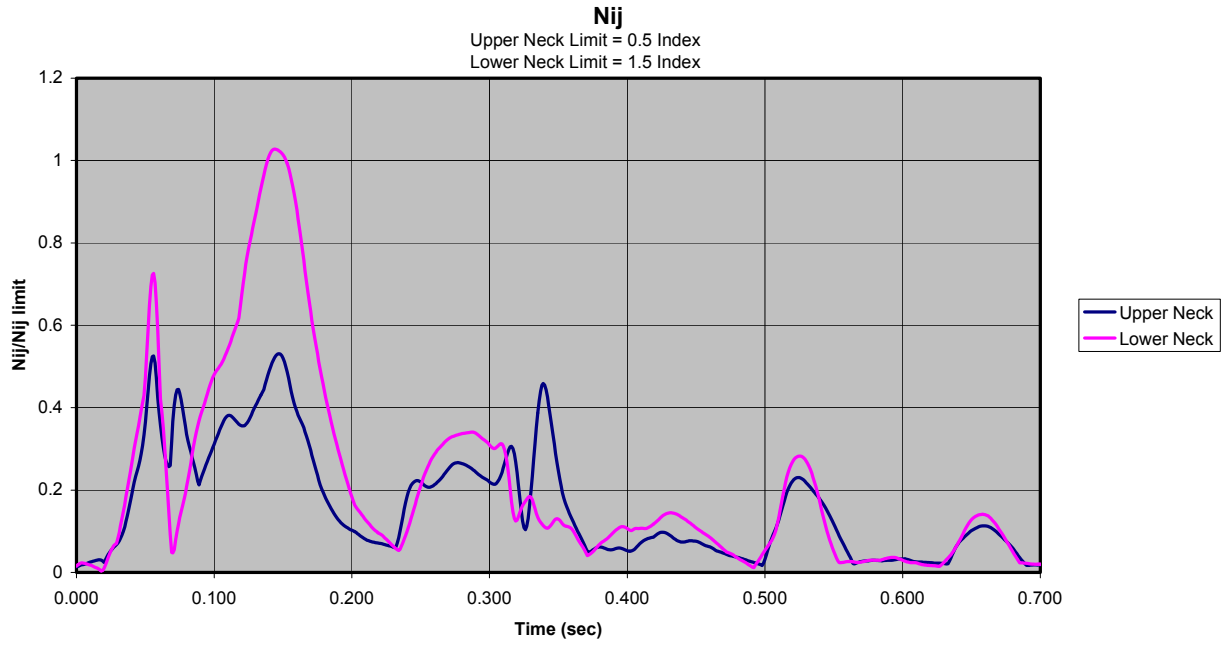

Figure B-107: Test 520 (Medium Pulse, 5.0 lb Added Head Weight)

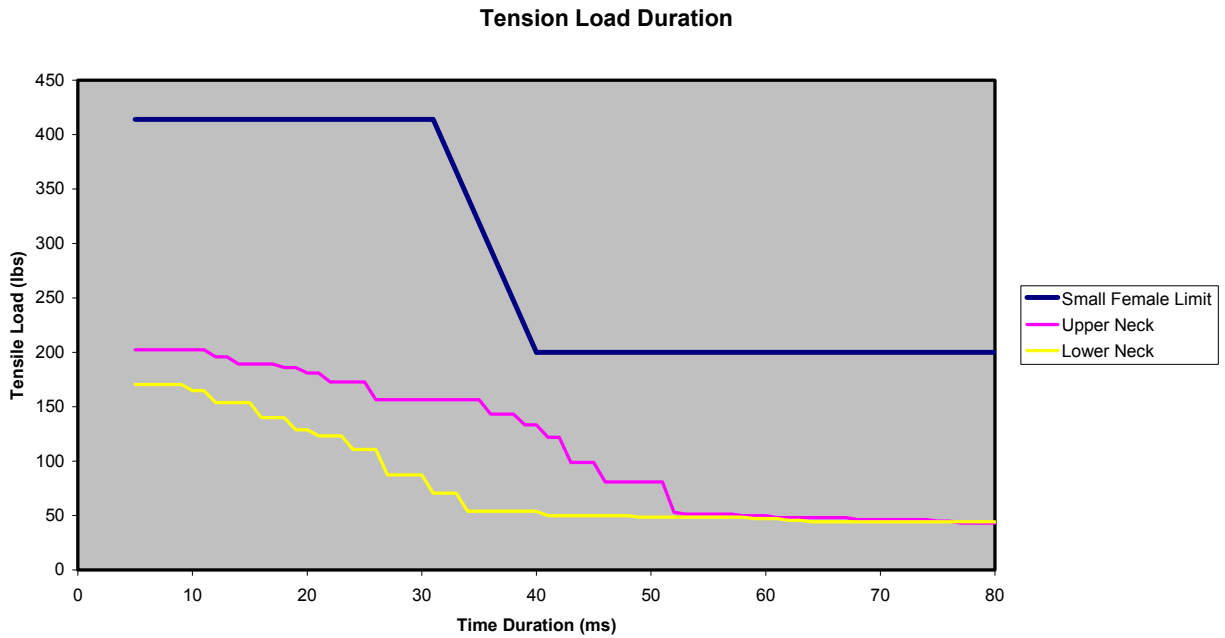

Figure B-108: Test 520 (Medium Pulse, 5.0 lb Added Head Weight)



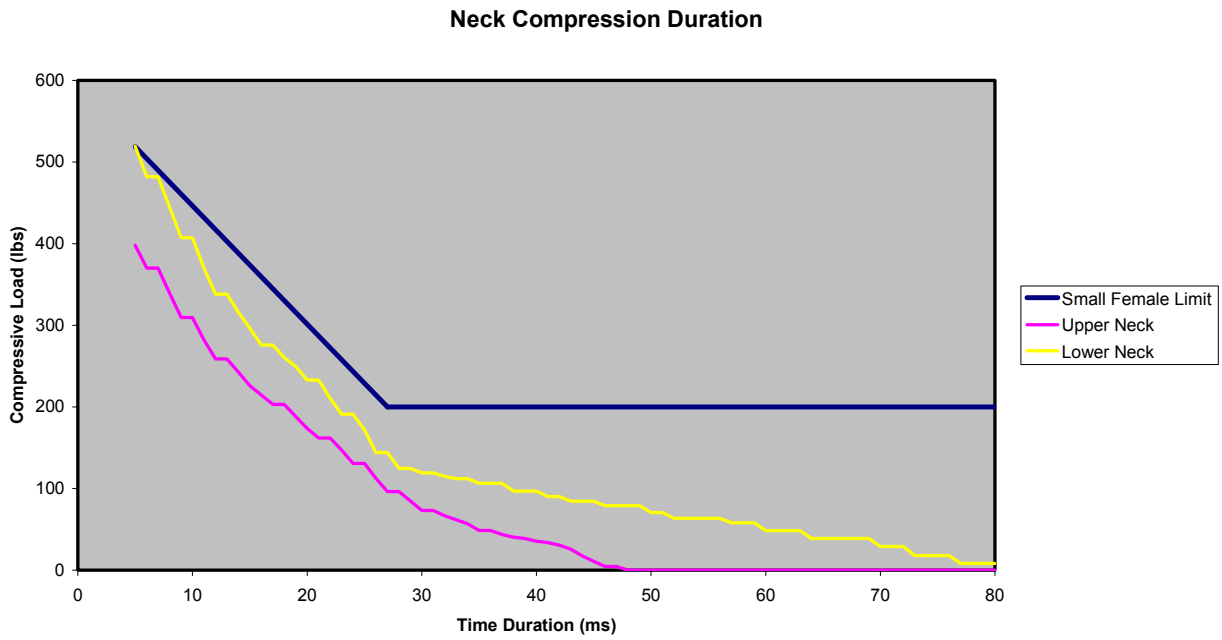

Figure B-109: Test 520 (Medium Pulse, 5.0 lb Added Head Weight)

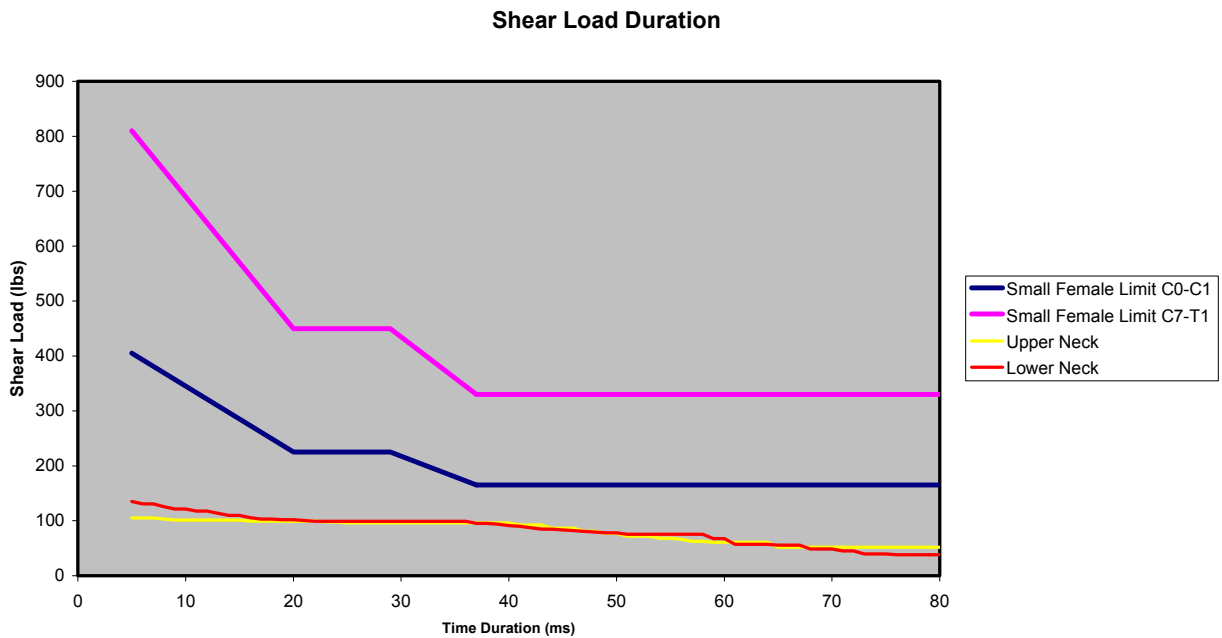

Figure B-110: Test 520 (Medium Pulse, 5.0 lb Added Head Weight)

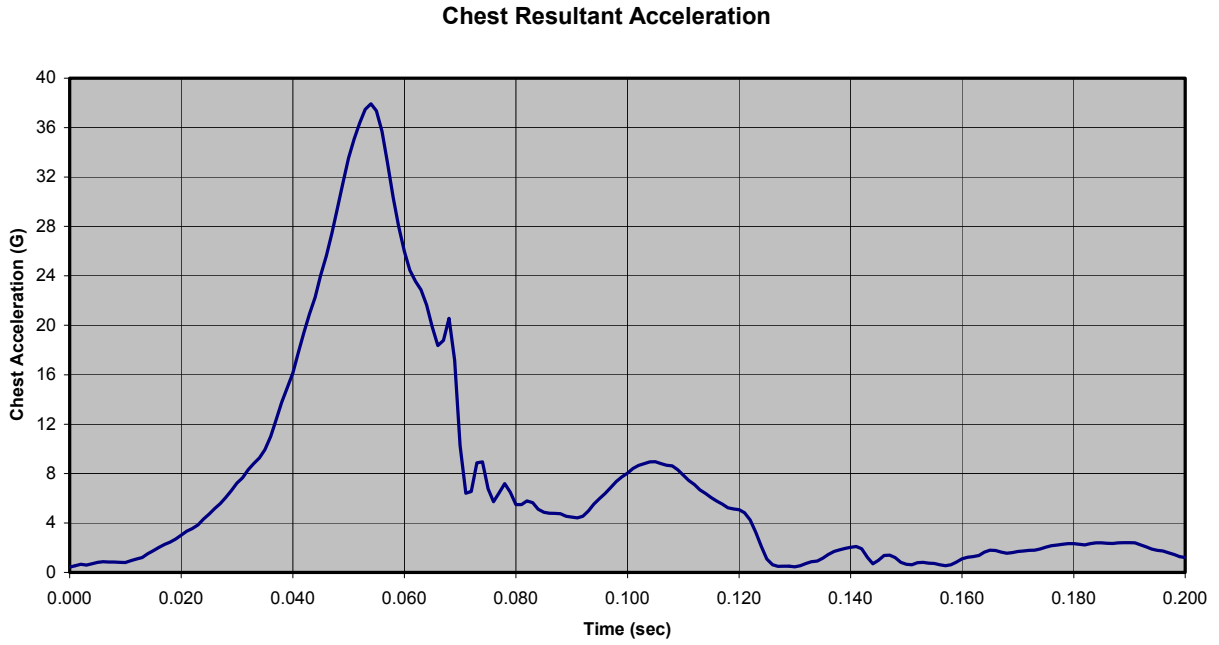

Figure B-111: Test 521 (Medium Pulse, 5.5 lb Added Head Weight)

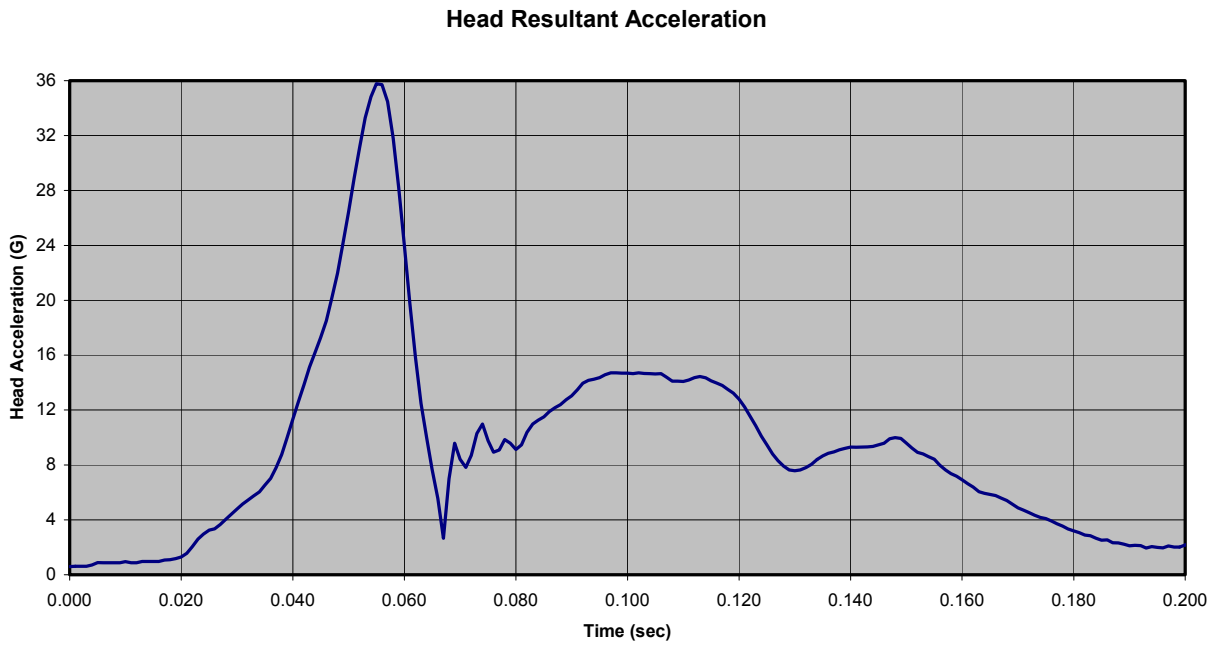

Figure B-112: Test 521 (Medium Pulse, 5.5 lb Added Head Weight)

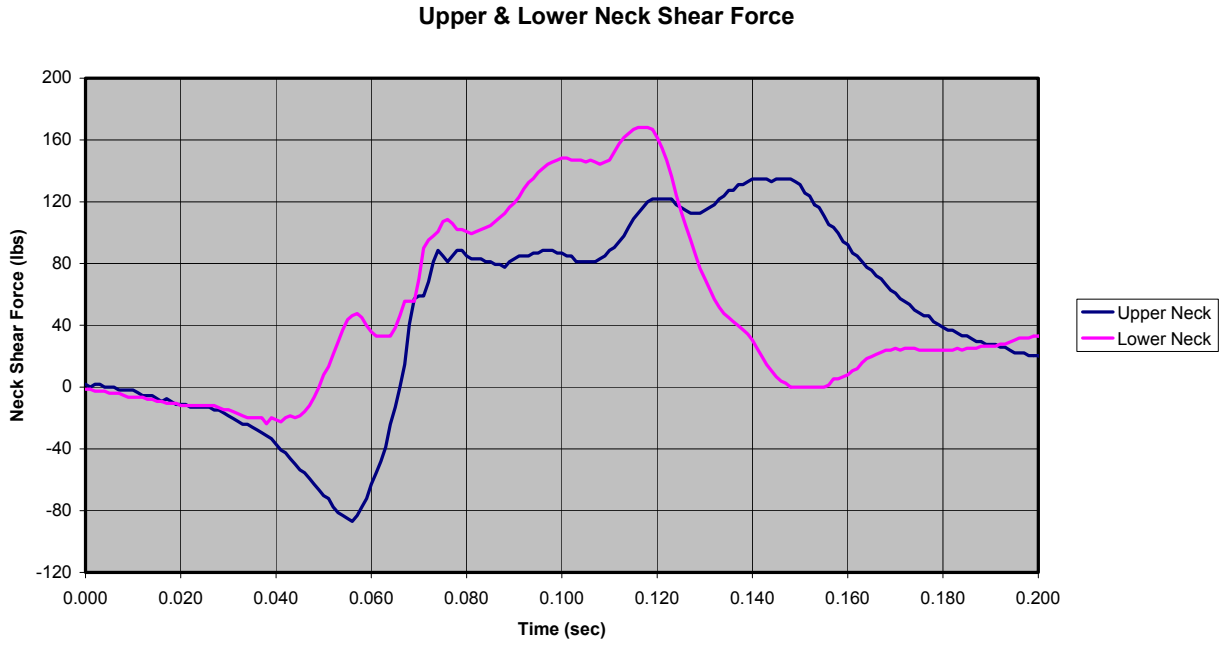

Figure B-113: Test 521 (Medium Pulse, 5.5 lb Added Head Weight)

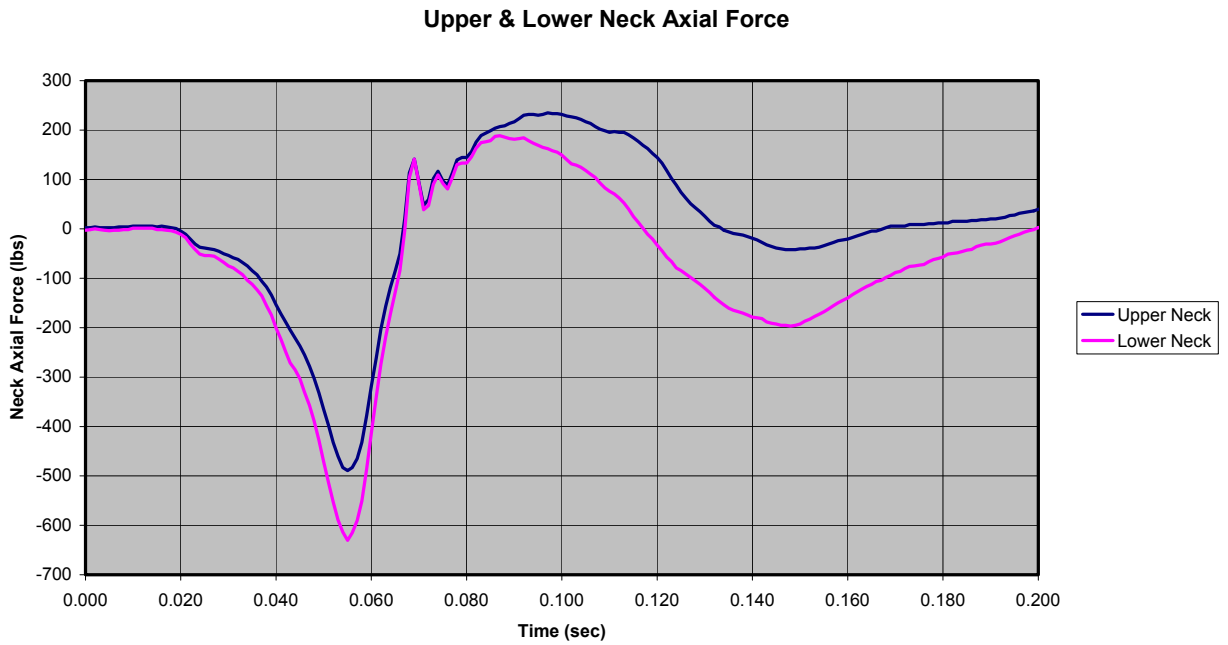

Figure B-114: Test 521 (Medium Pulse, 5.5 lb Added Head Weight)

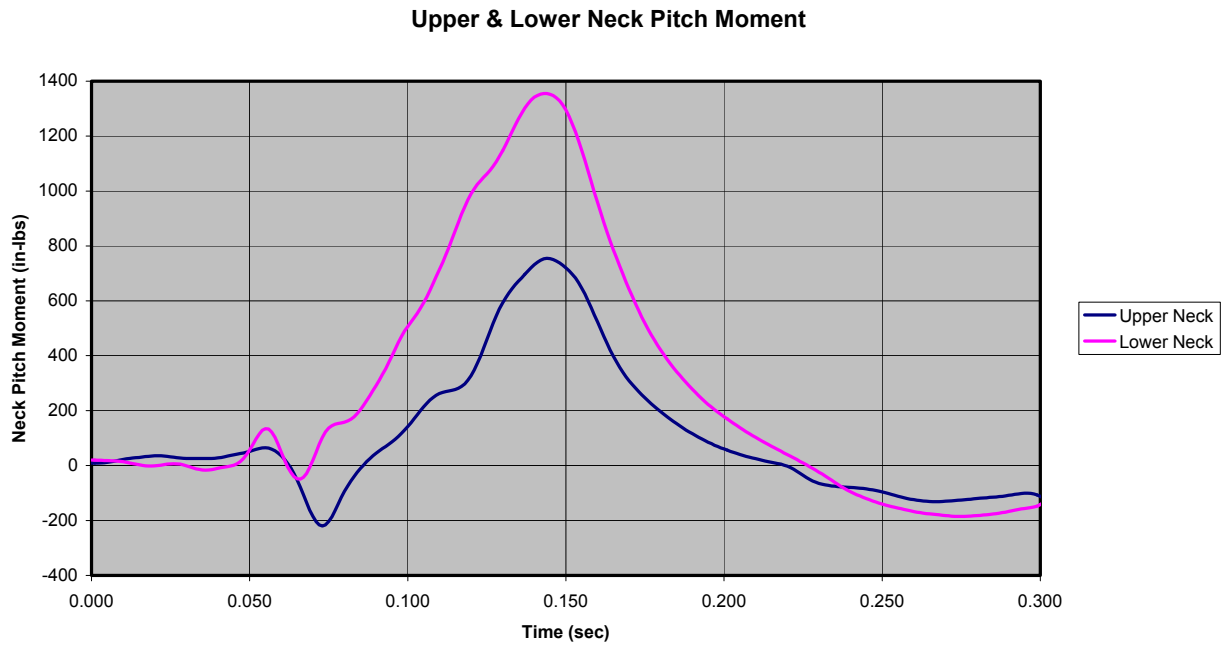

Figure B-115: Test 521 (Medium Pulse, 5.5 lb Added Head Weight)

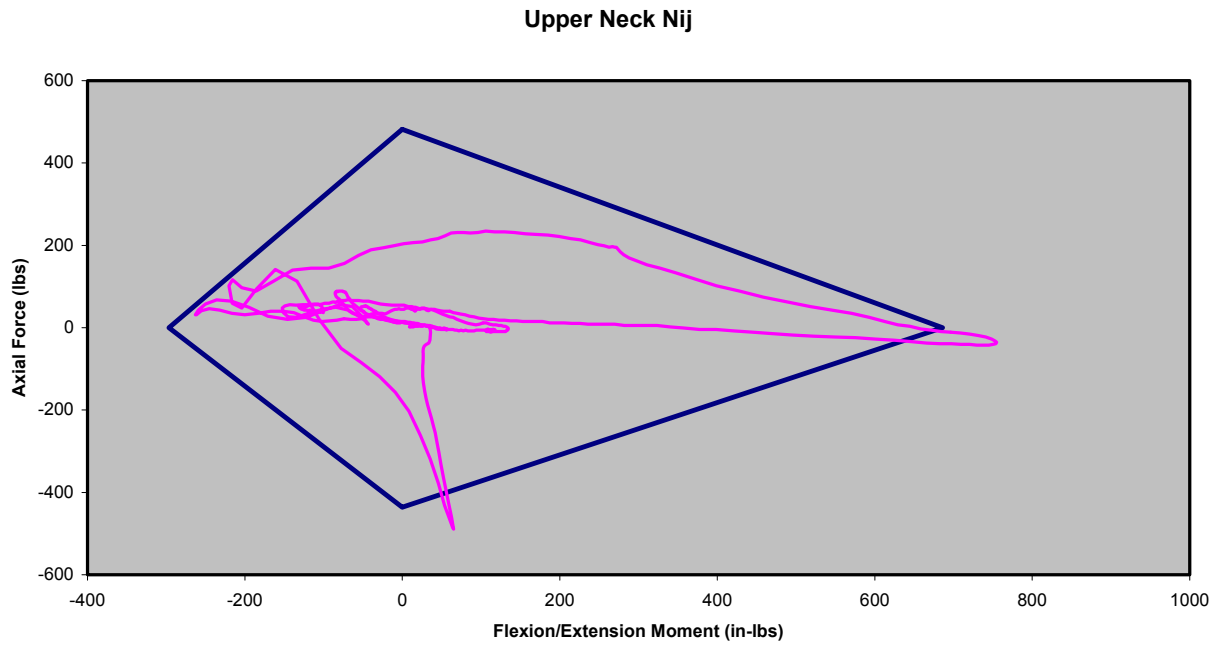

Figure B-116: Test 521 (Medium Pulse, 5.5 lb Added Head Weight)

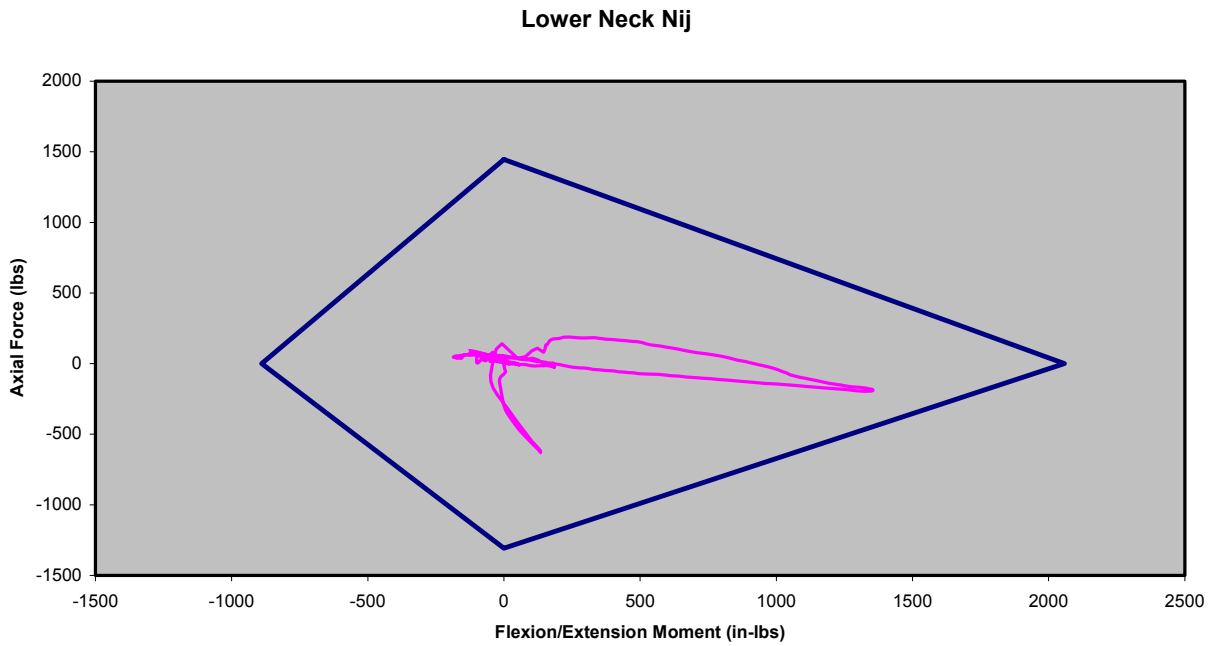

Figure B-117: Test 521 (Medium Pulse, 5.5 lb Added Head Weight)

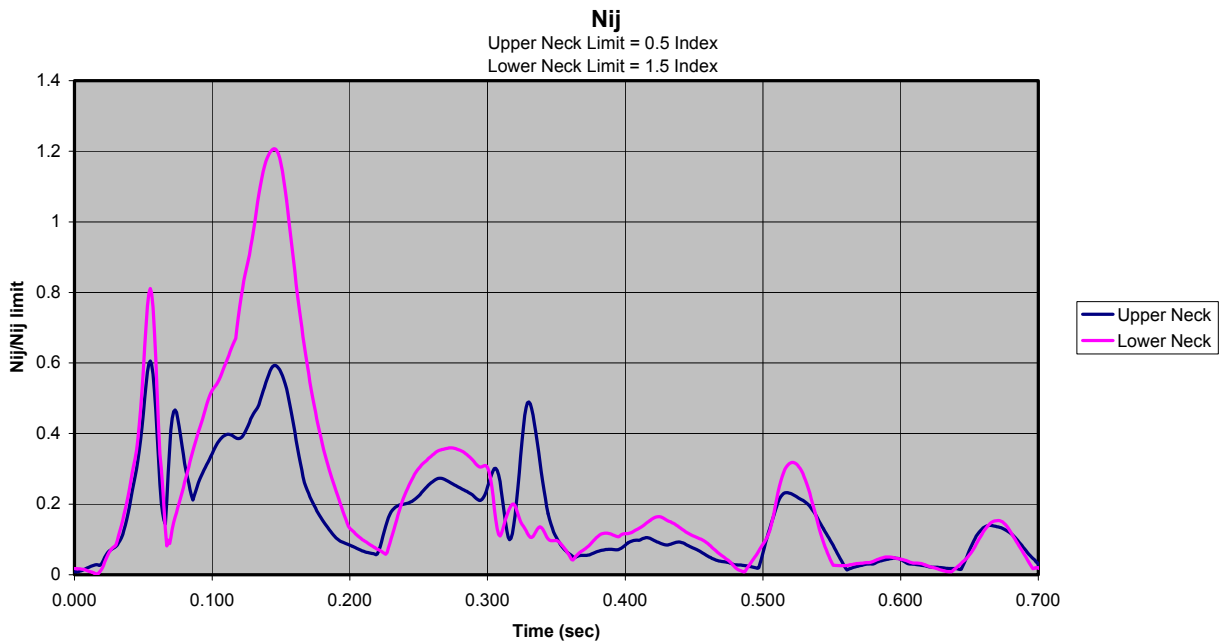

Figure B-118: Test 521 (Medium Pulse, 5.5 lb Added Head Weight)

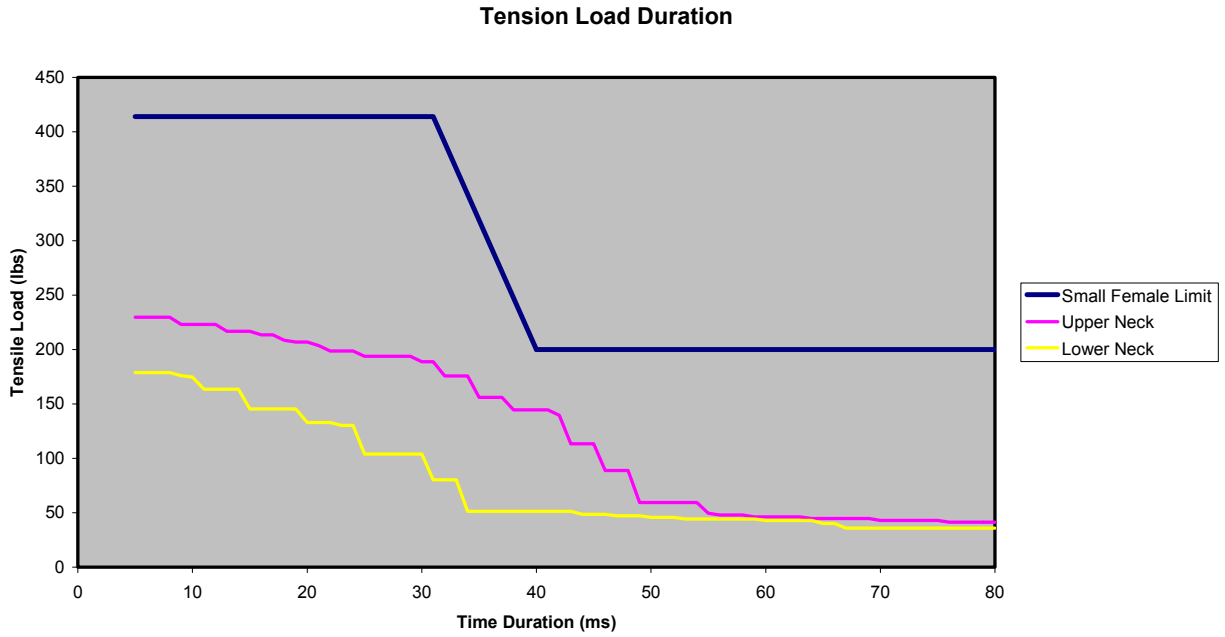

Figure B-119: Test 521 (Medium Pulse, 5.5 lb Added Head Weight)

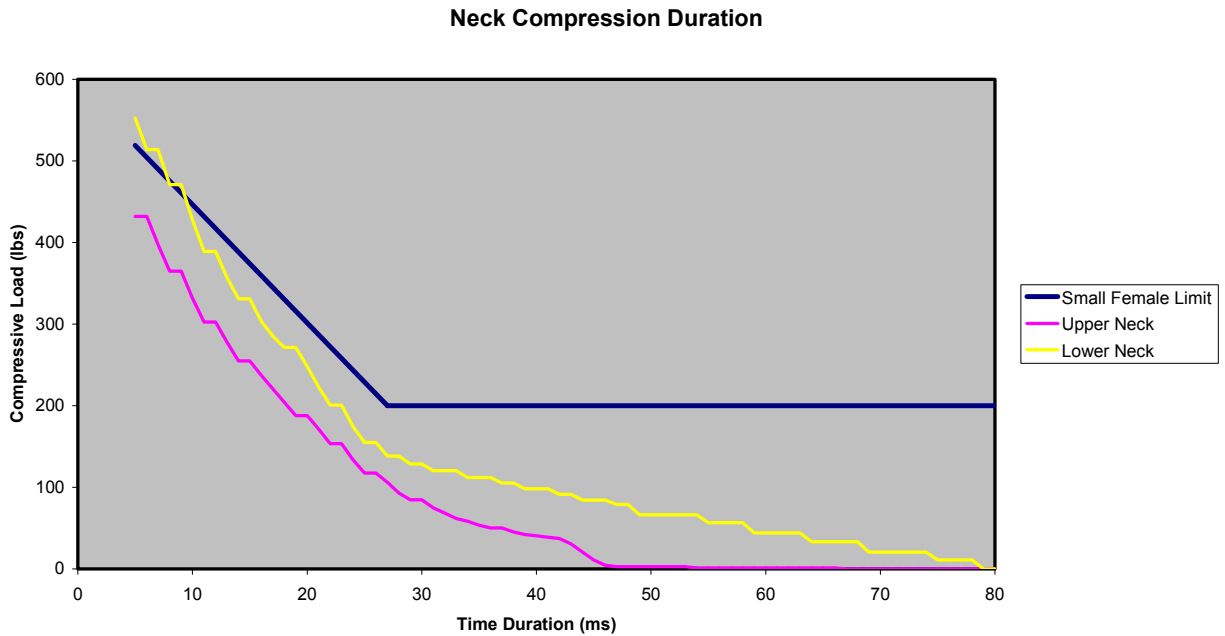

Figure B-120: Test 521 (Medium Pulse, 5.5 lb Added Head Weight)

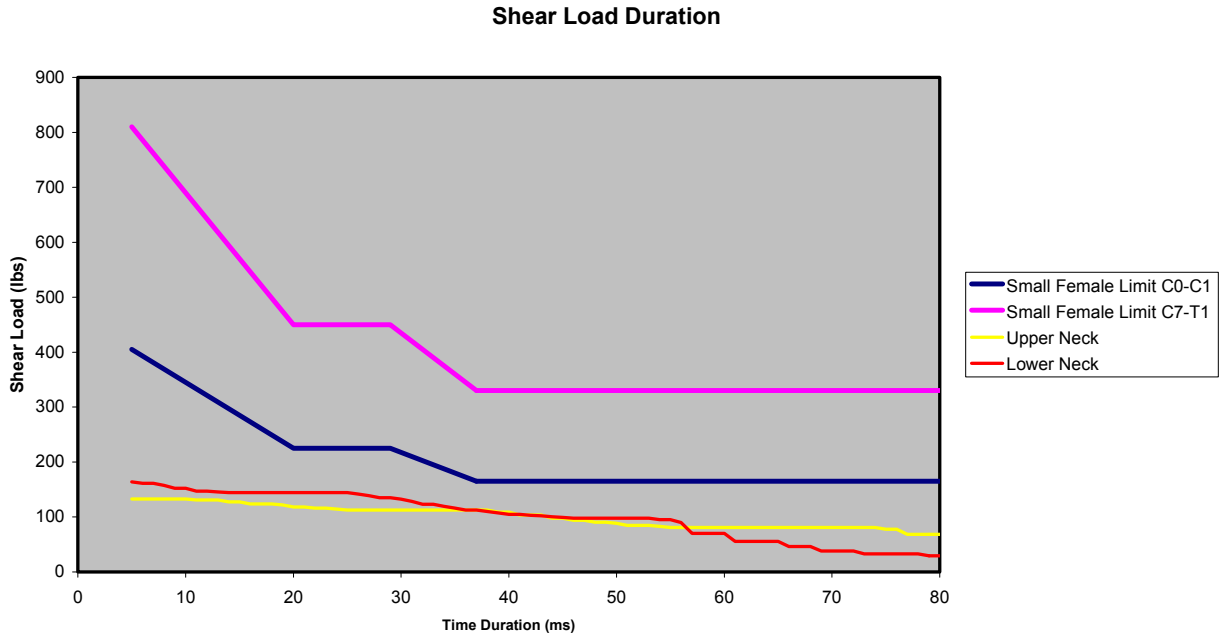

Figure B-121: Test 521 (Medium Pulse, 5.5 lb Added Head Weight)

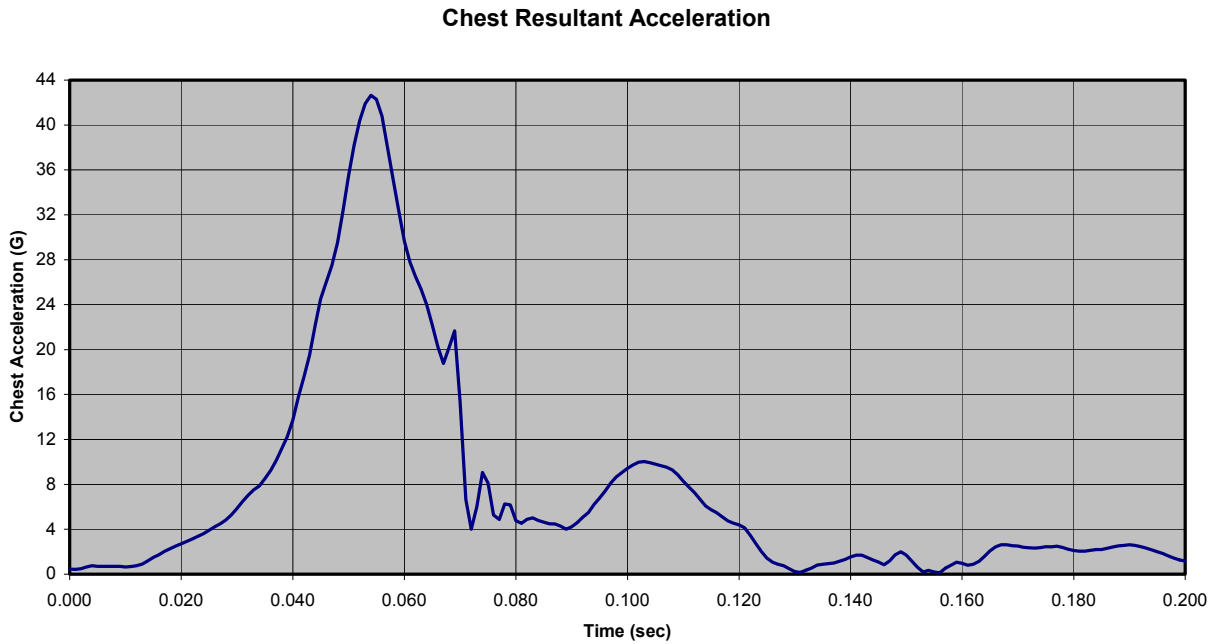

Figure B-122: Test 522 (Medium Pulse, 5.5 lb Added Head Weight)

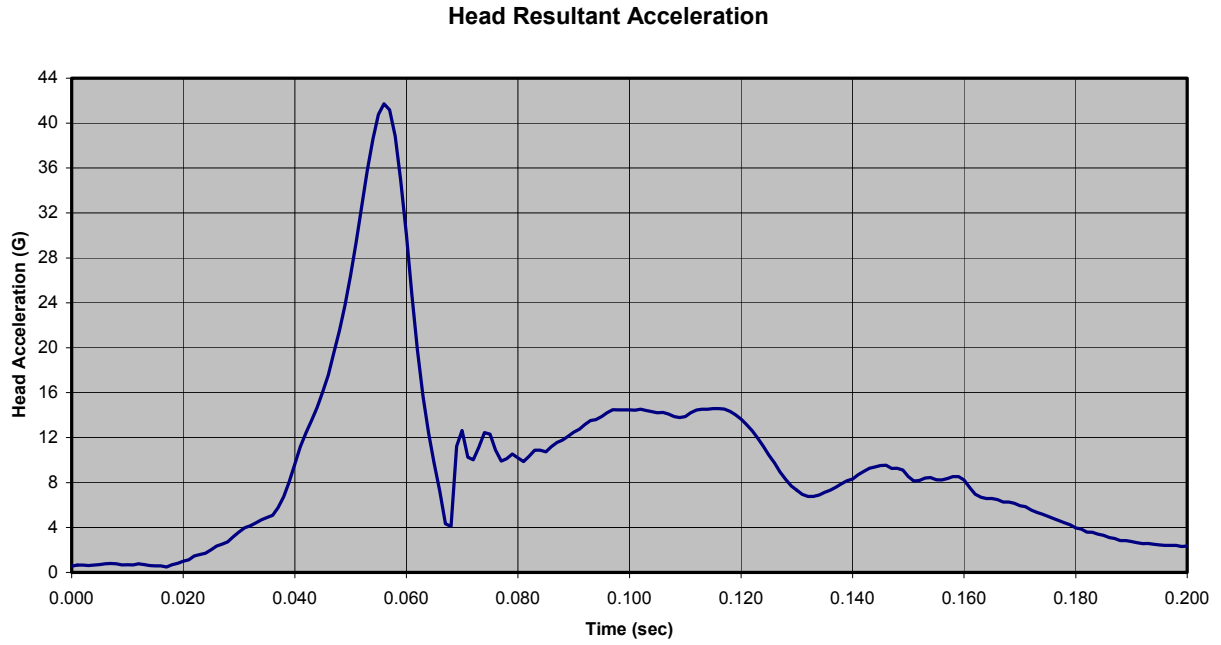

Figure B-123: Test 522 (Medium Pulse, 5.5 lb Added Head Weight)

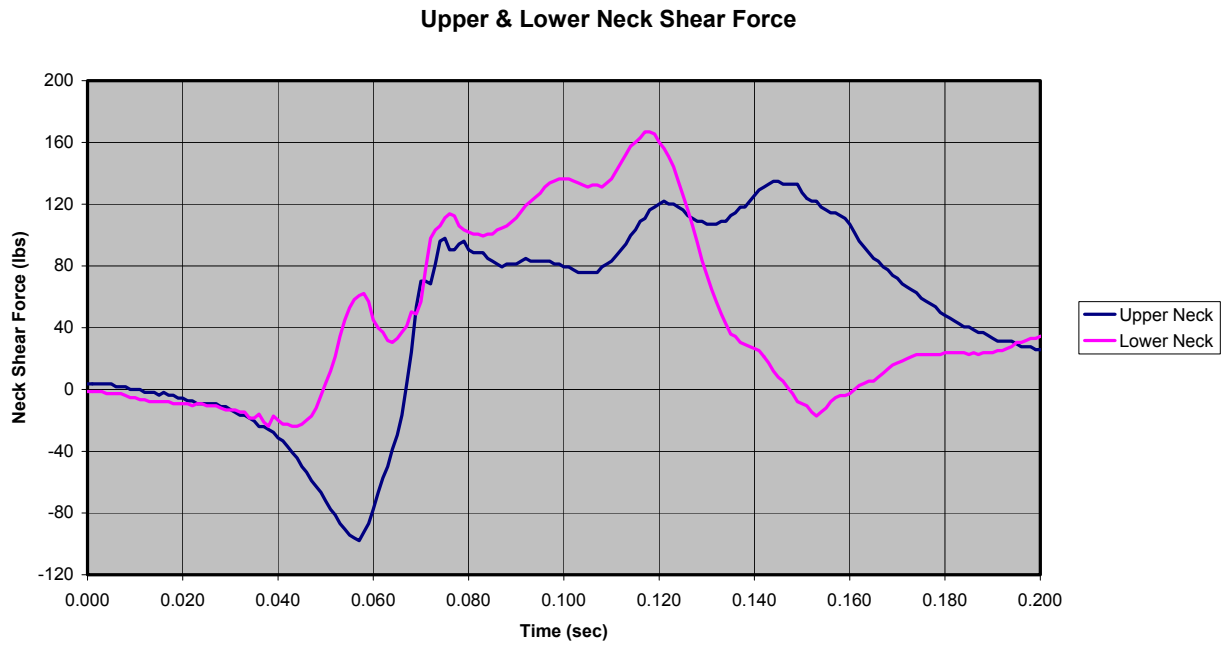

Figure B-124: Test 522 (Medium Pulse, 5.5 lb Added Head Weight)



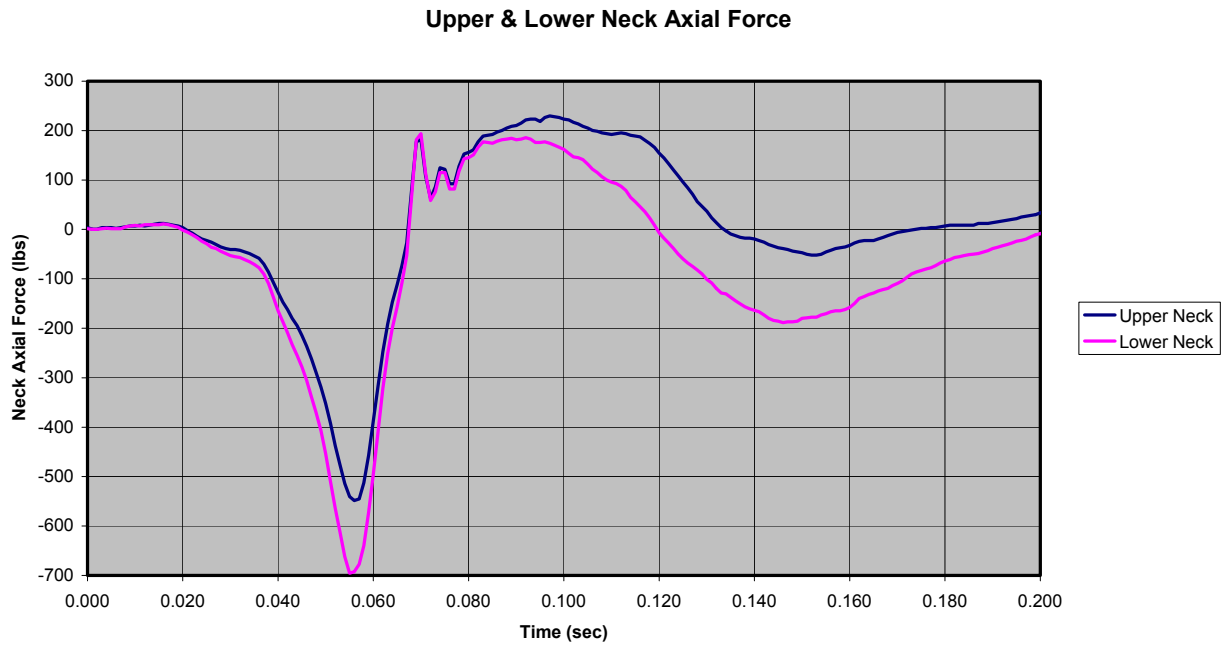

Figure B-125: Test 522 (Medium Pulse, 5.5 lb Added Head Weight)

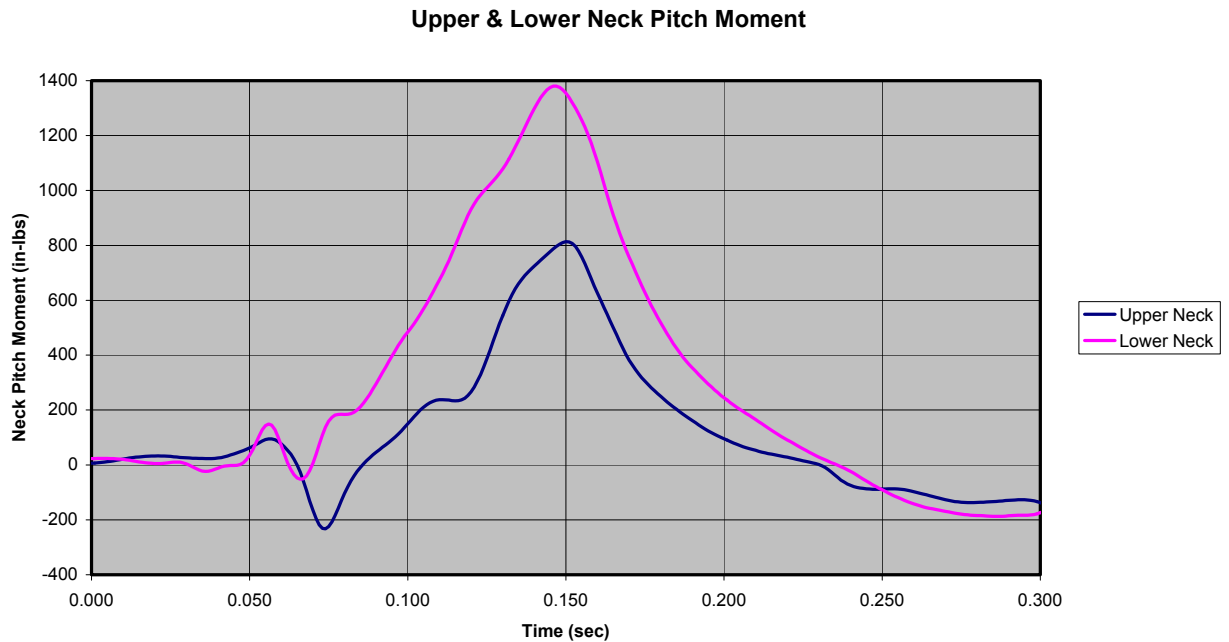

Figure B-126: Test 522 (Medium Pulse, 5.5 lb Added Head Weight)

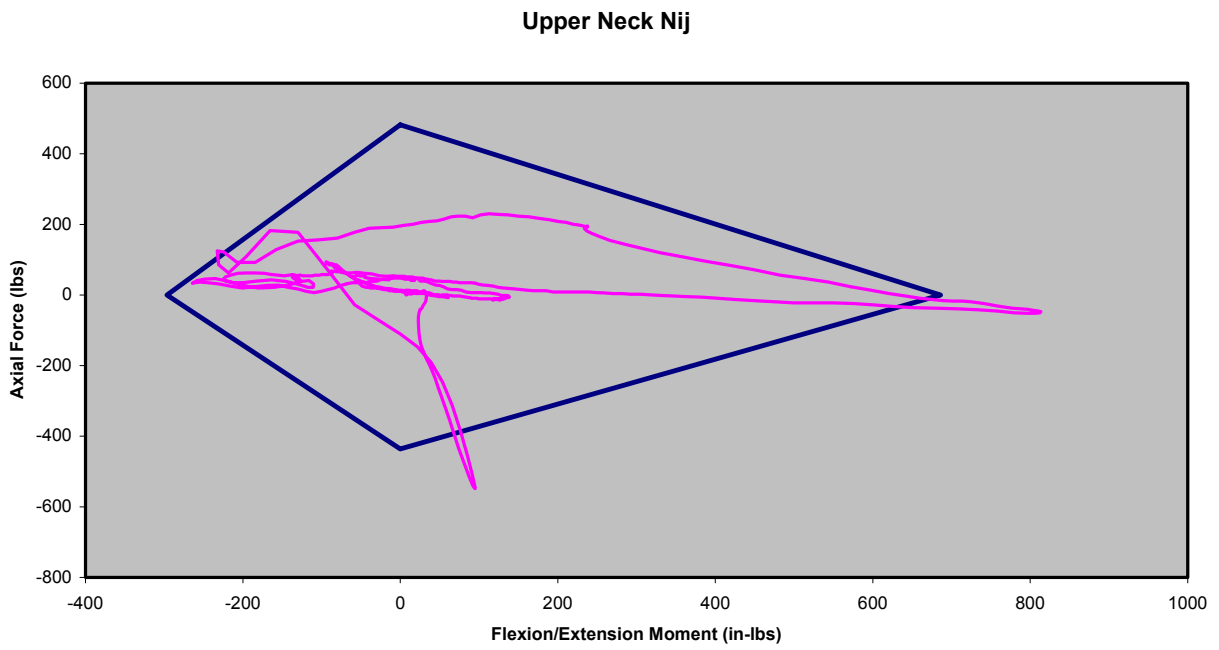

Figure B-127: Test 522 (Medium Pulse, 5.5 lb Added Head Weight)

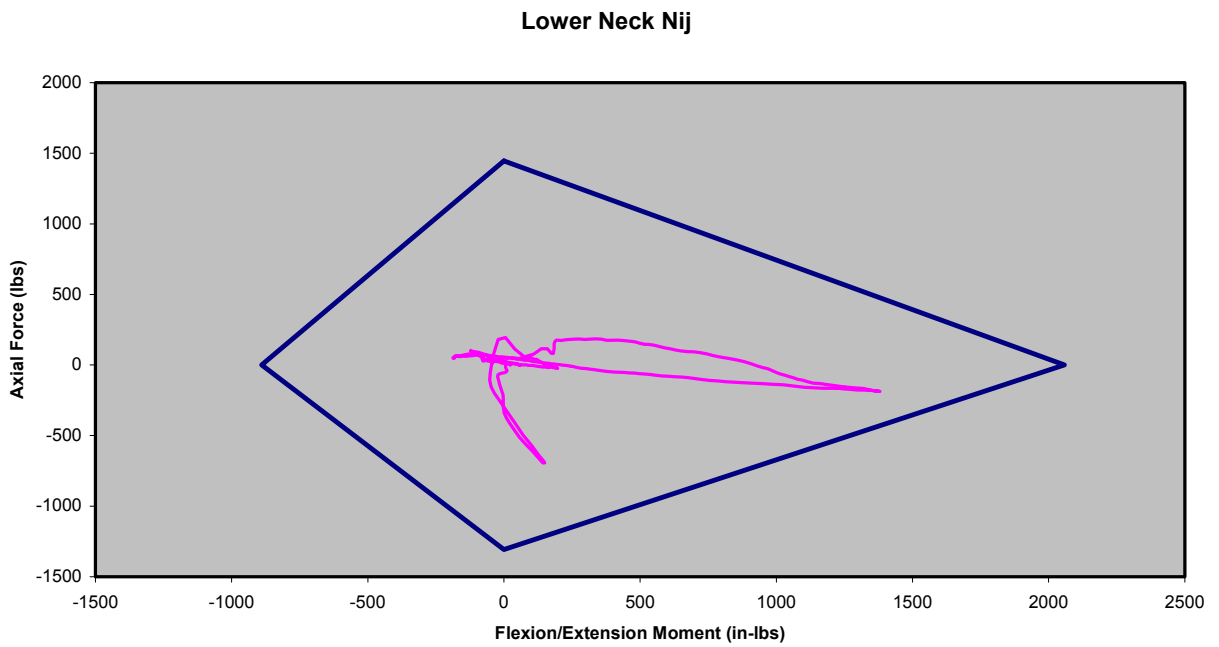

Figure B-128: Test 522 (Medium Pulse, 5.5 lb Added Head Weight)

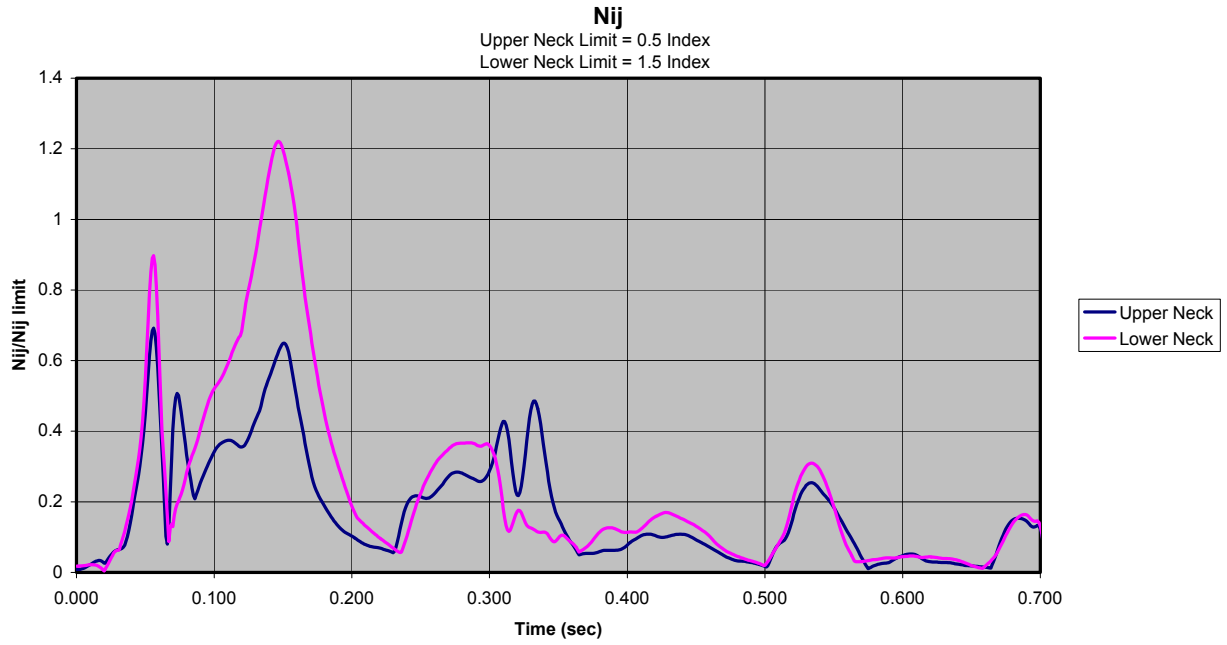

Figure B-129: Test 522 (Medium Pulse, 5.5 lb Added Head Weight)

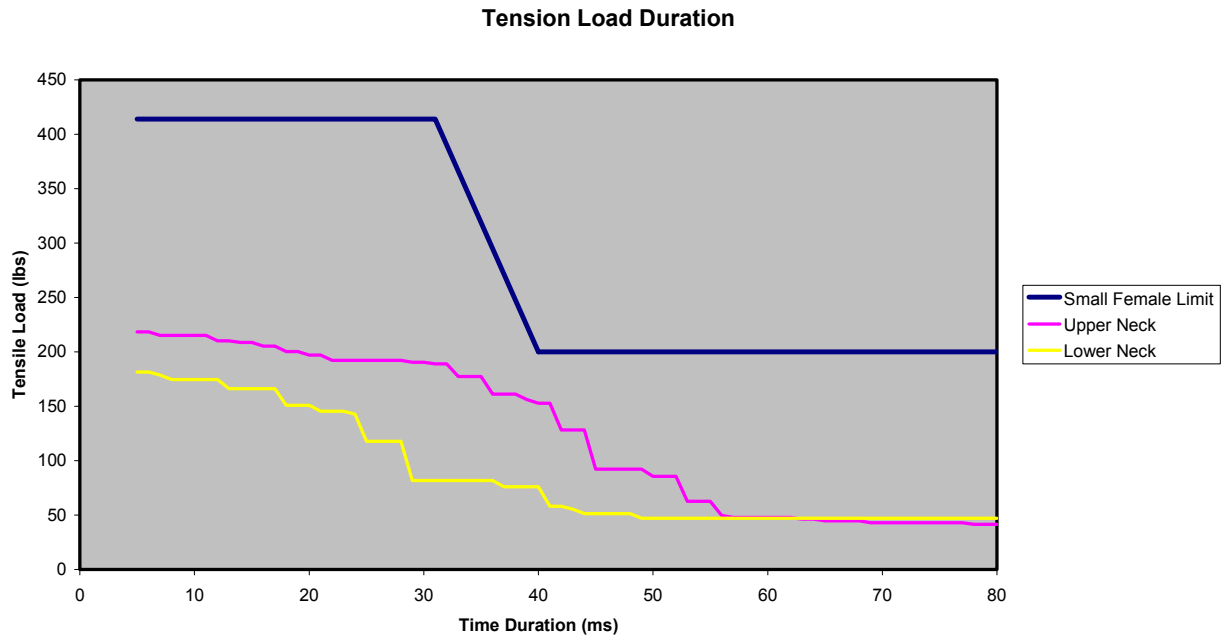

Figure B-130: Test 522 (Medium Pulse, 5.5 lb Added Head Weight)

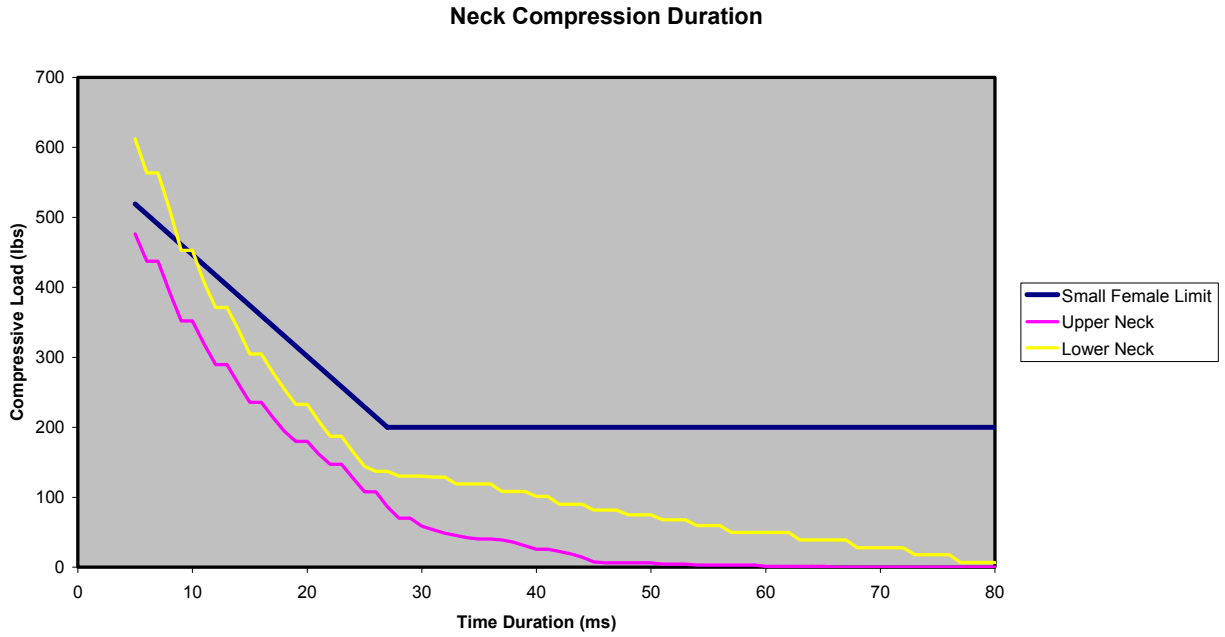

Figure B-131: Test 522 (Medium Pulse, 5.5 lb Added Head Weight)

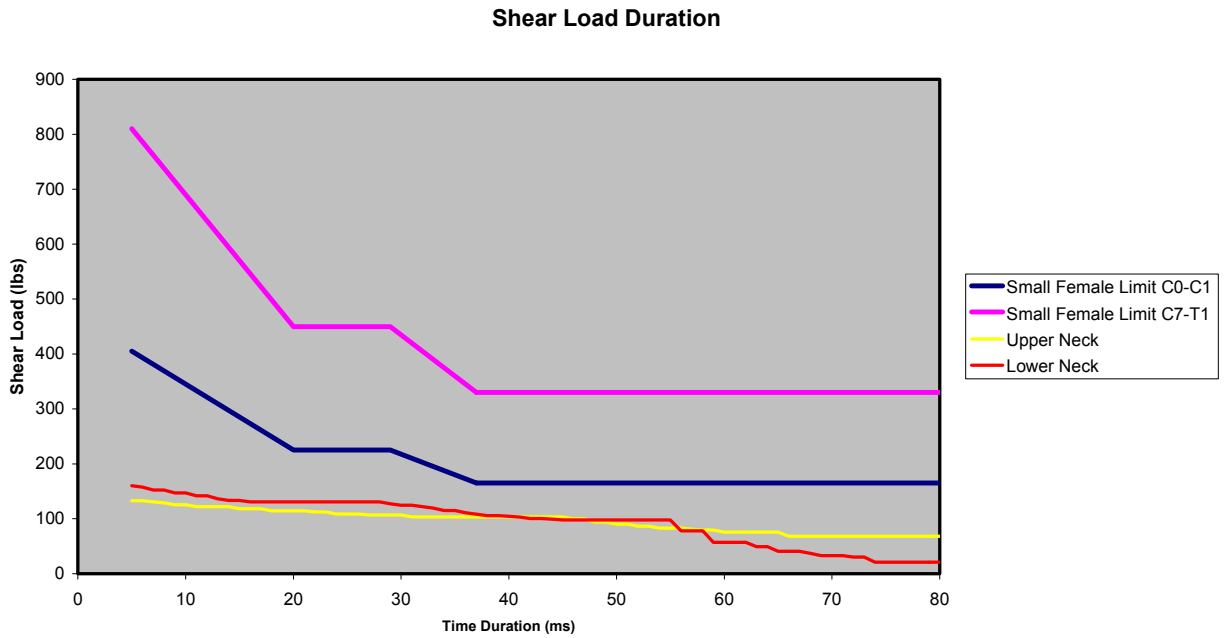

Figure B-132: Test 522 (Medium Pulse, 5.5 lb Added Head Weight)

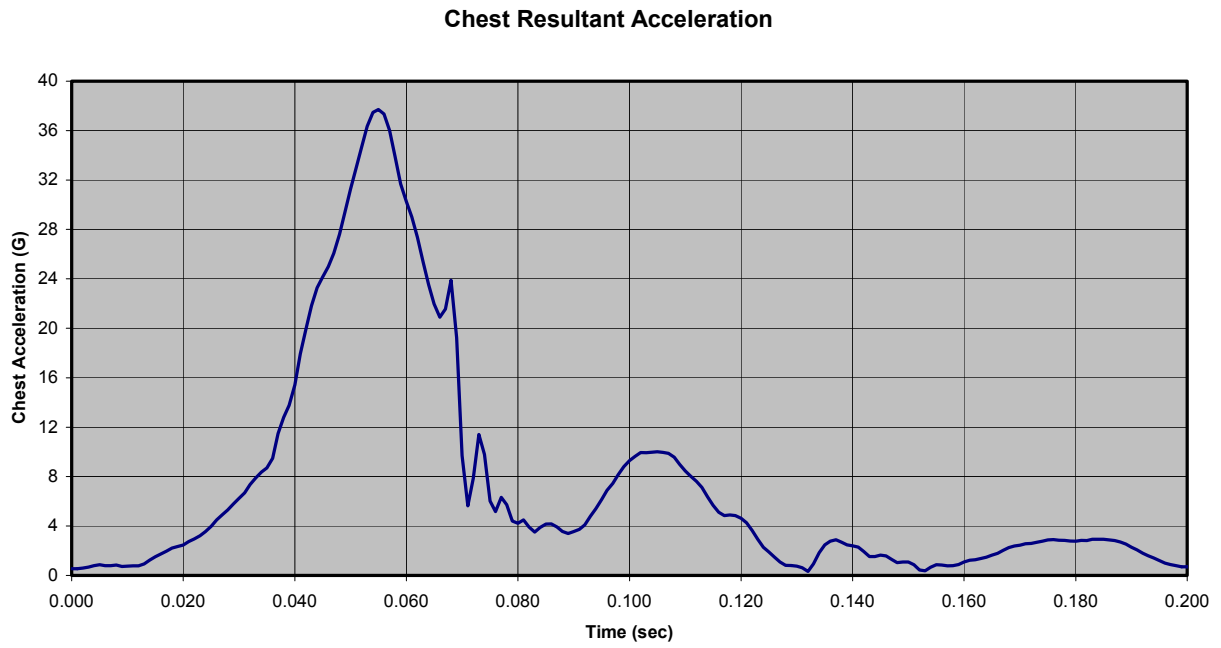

Figure B-133: Test 523 (Medium Pulse, 6.0 lb Added Head Weight)

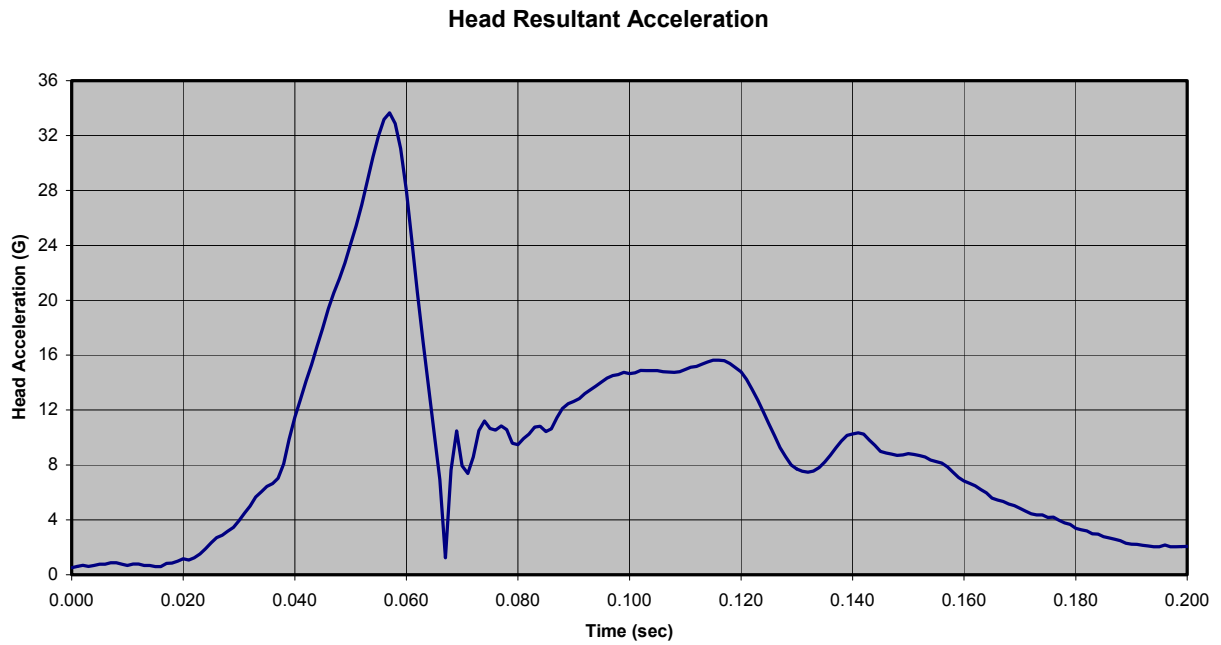

Figure B-134: Test 523 (Medium Pulse, 6.0 lb Added Head Weight)

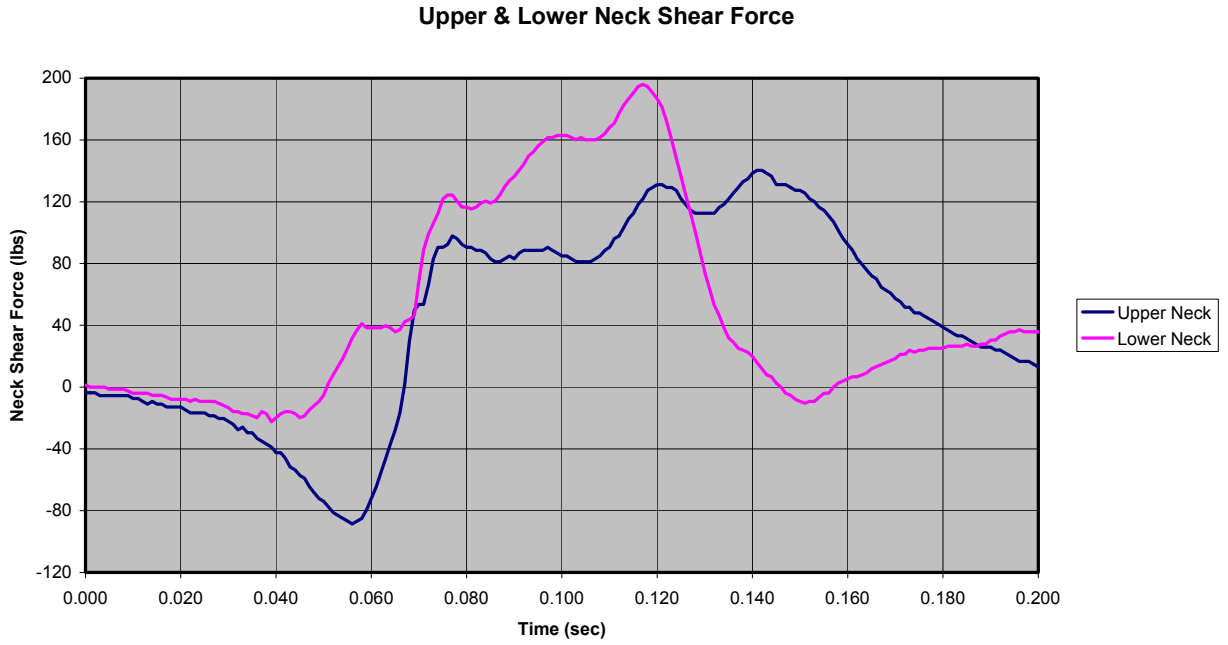

Figure B-135: Test 523 (Medium Pulse, 6.0 lb Added Head Weight)

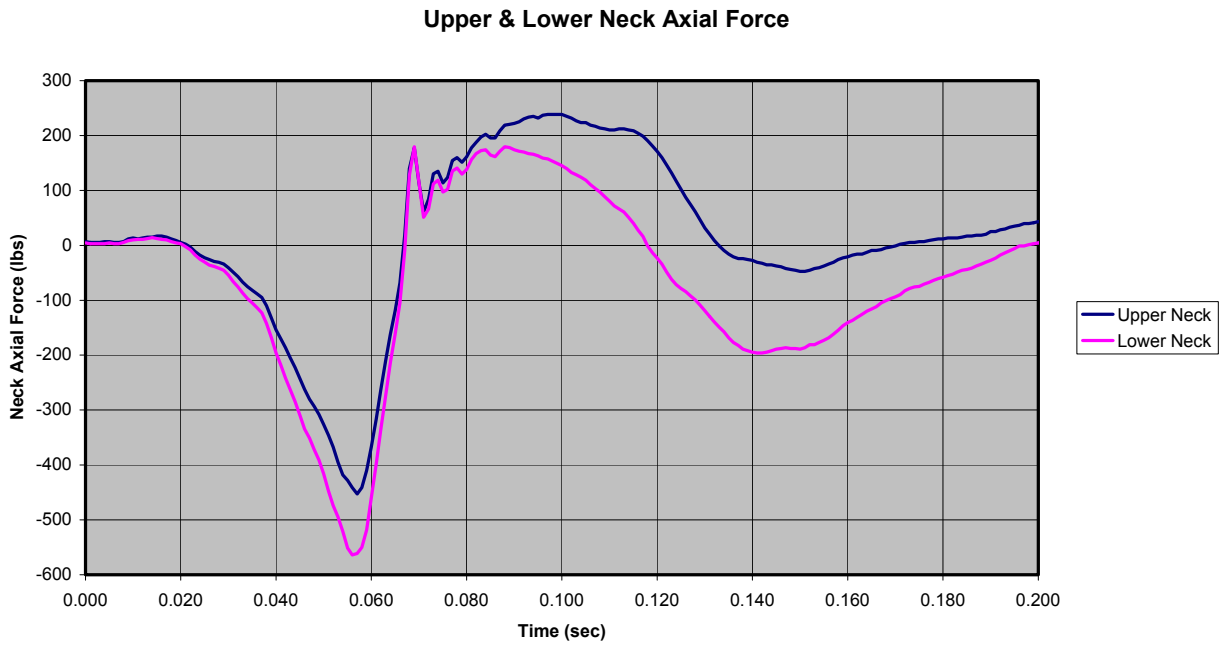

Figure B-136: Test 523 (Medium Pulse, 6.0 lb Added Head Weight)

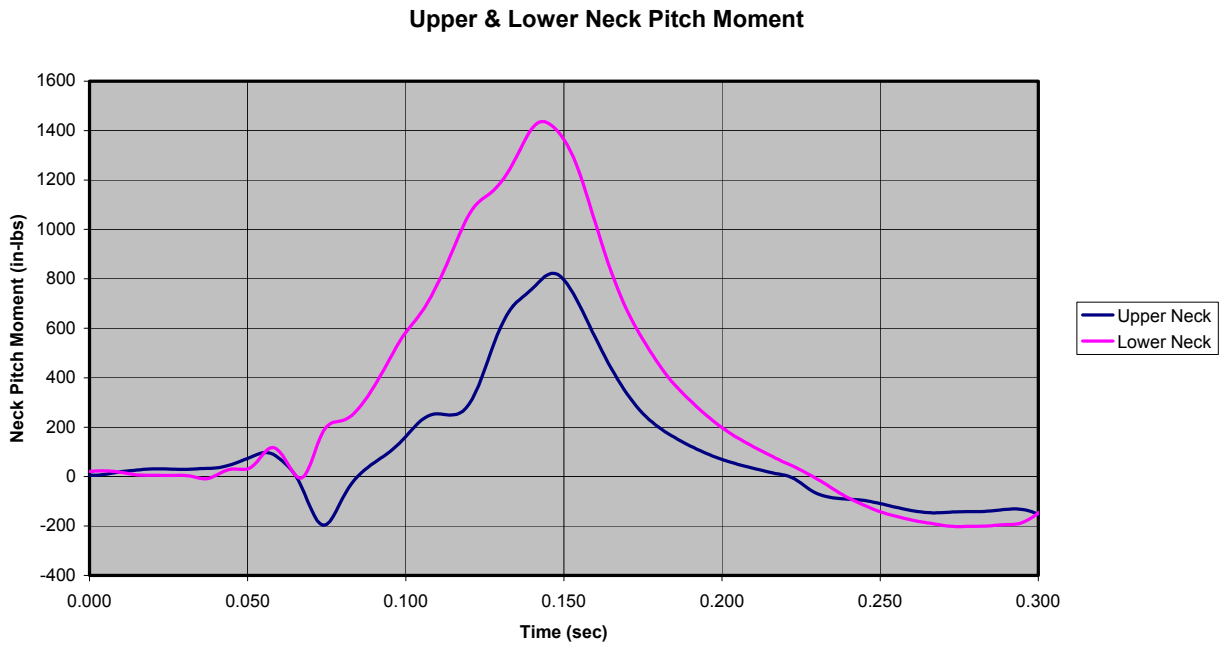

Figure B-137: Test 523 (Medium Pulse, 6.0 lb Added Head Weight)

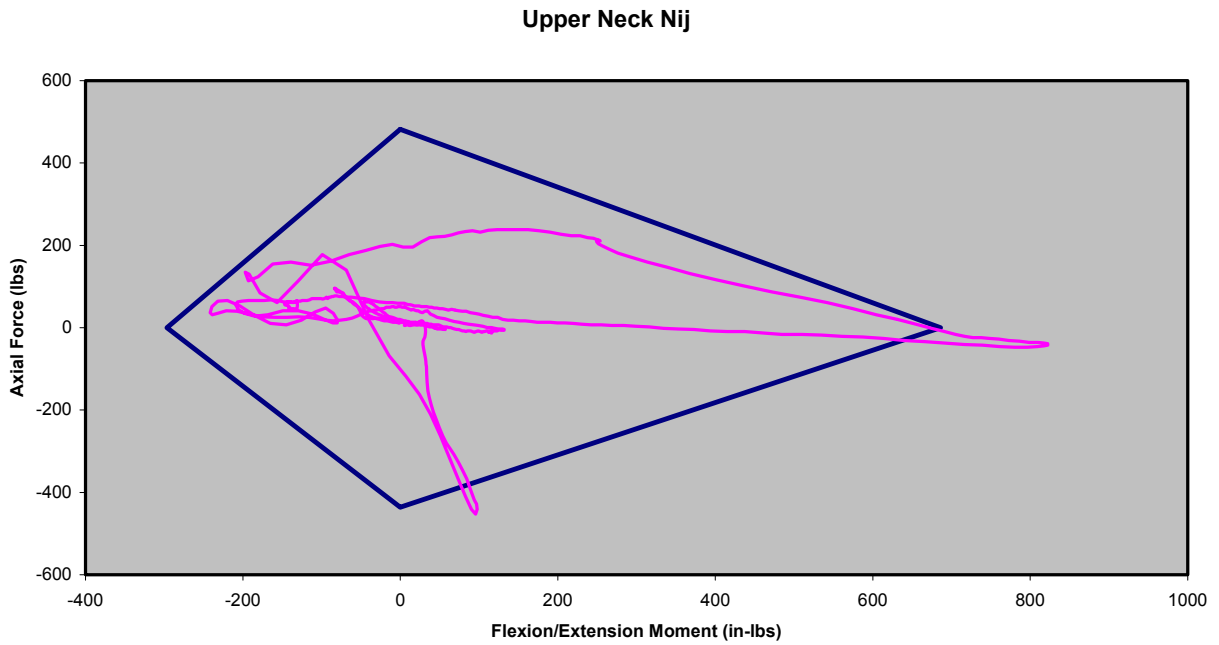

Figure B-138: Test 523 (Medium Pulse, 6.0 lb Added Head Weight)

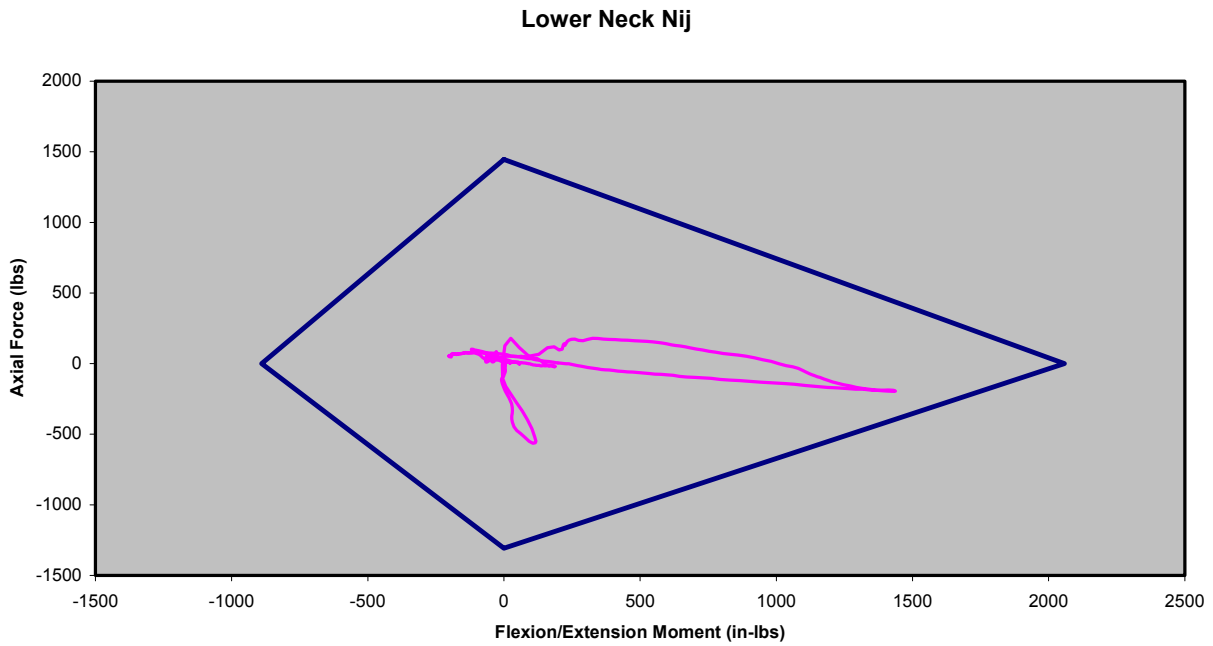

Figure B-139: Test 523 (Medium Pulse, 6.0 lb Added Head Weight)

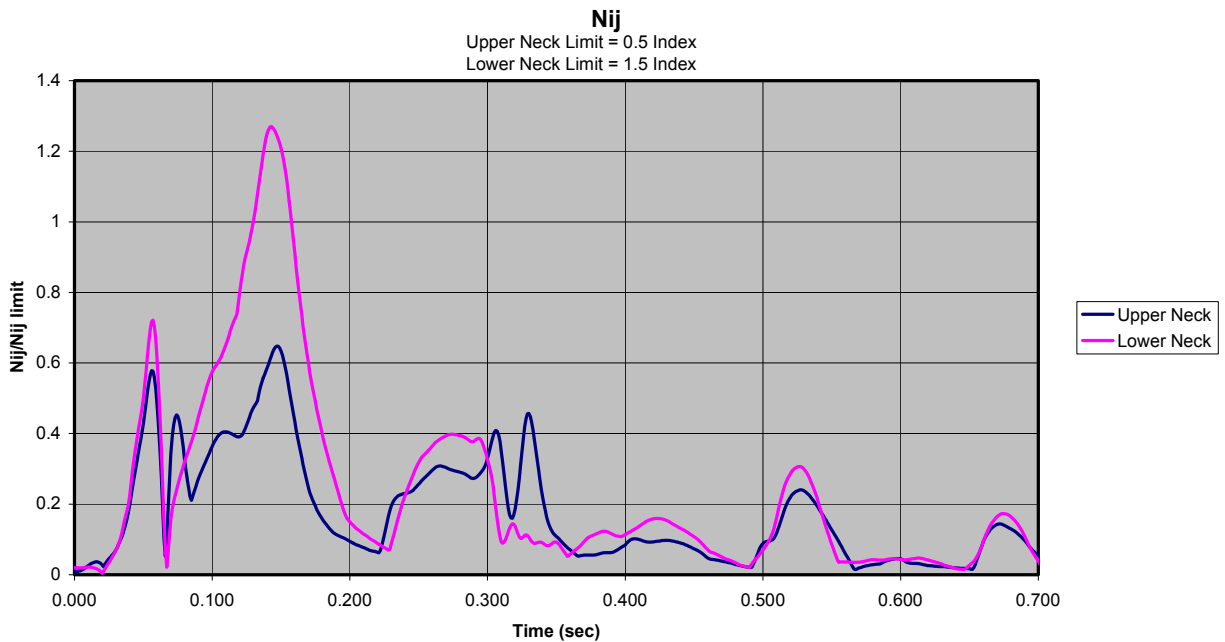

Figure B-140: Test 523 (Medium Pulse, 6.0 lb Added Head Weight)



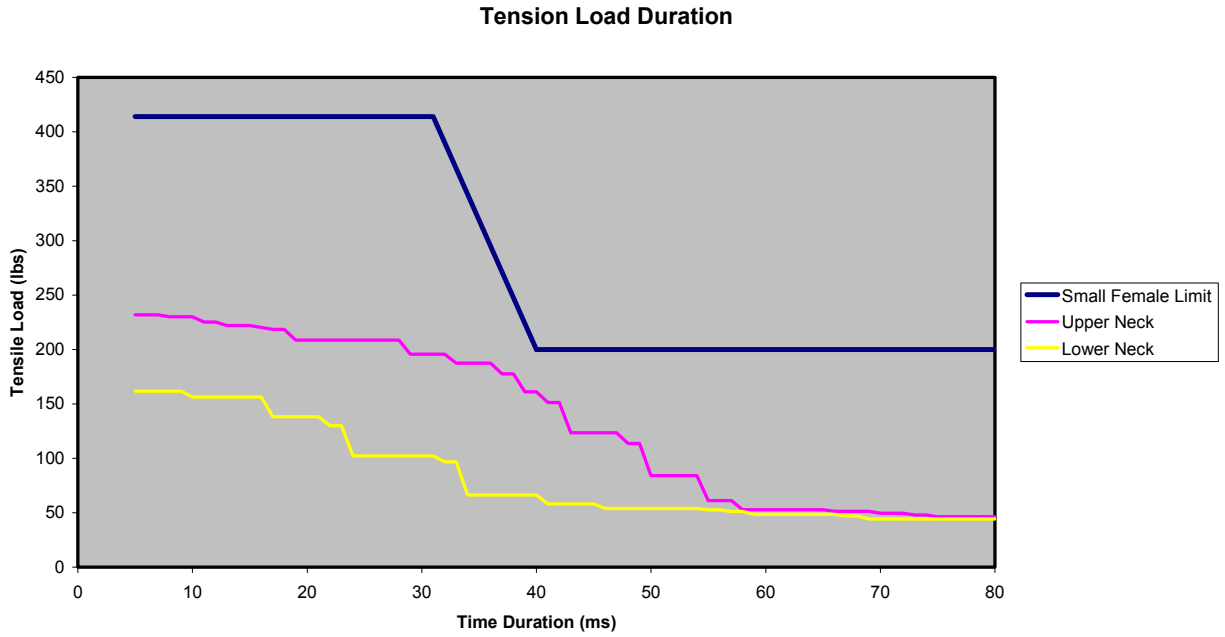

Figure B-141: Test 523 (Medium Pulse, 6.0 lb Added Head Weight)

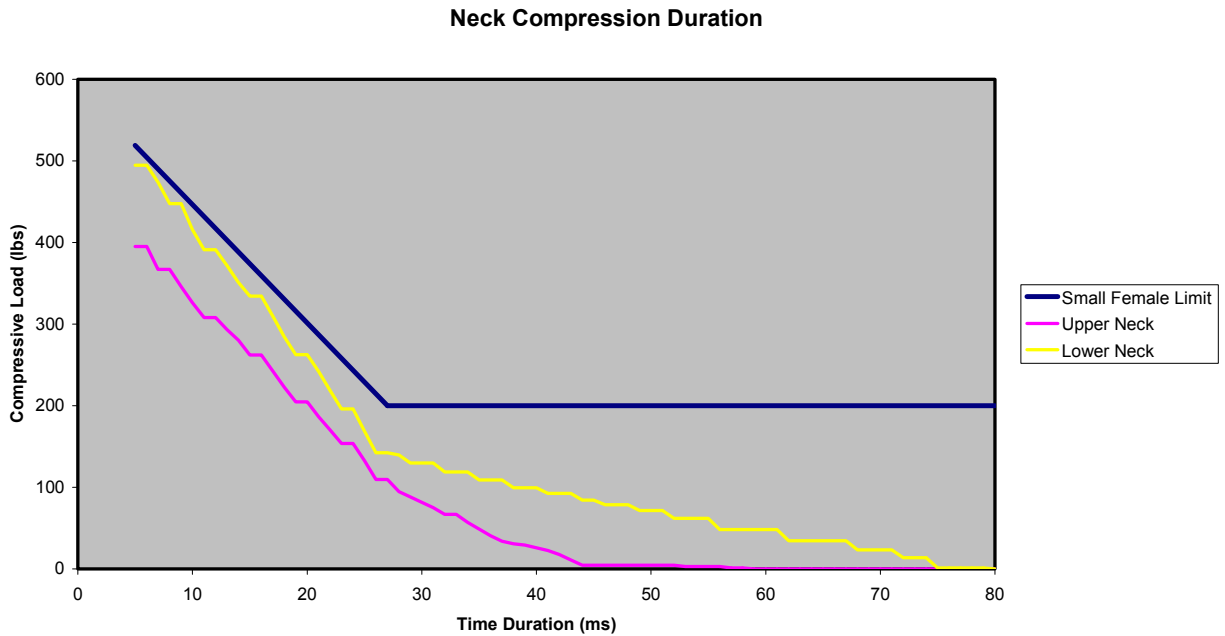

Figure B-142: Test 523 (Medium Pulse, 6.0 lb Added Head Weight)

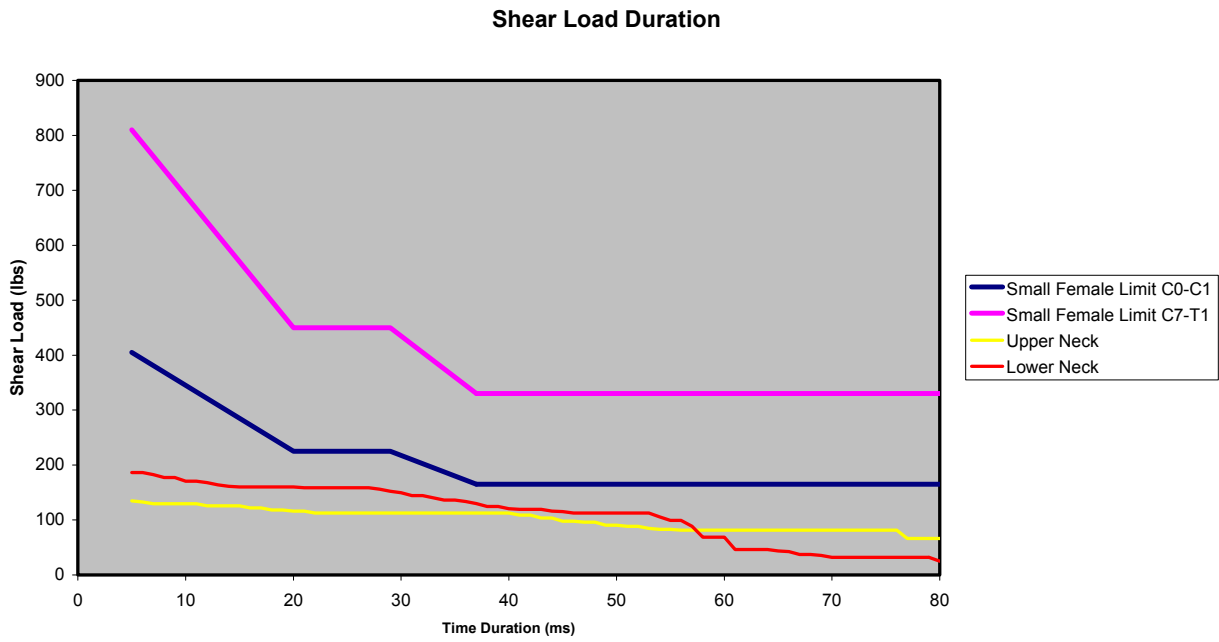

Figure B-143: Test 523 (Medium Pulse, 6.0 lb Added Head Weight)

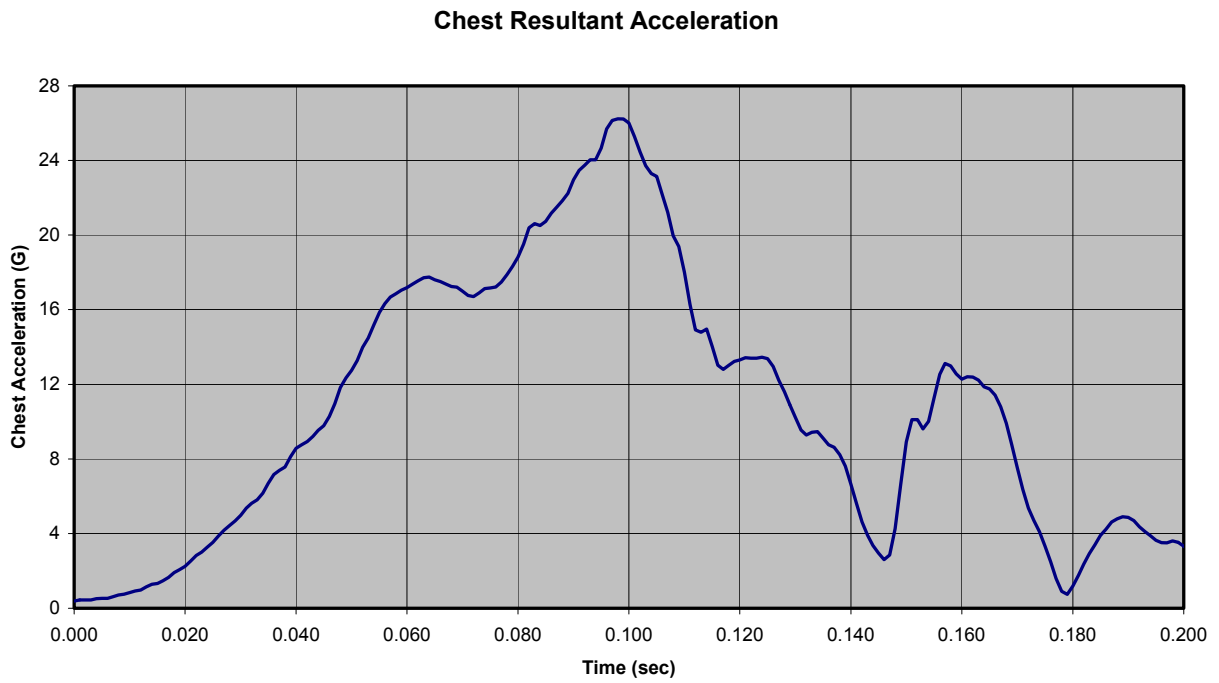

Figure B-144: Test 537 (Severe Pulse, 3.5 lb Added Head Weight)

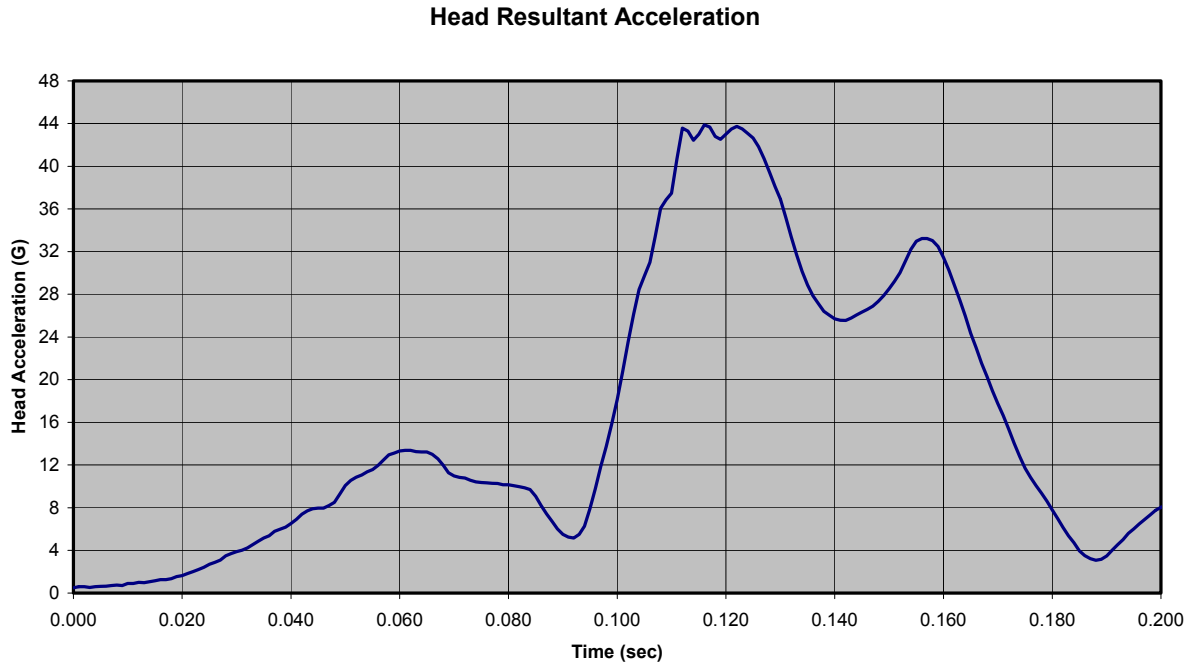

Figure B-145: Test 537 (Severe Pulse, 3.5 lb Added Head Weight)

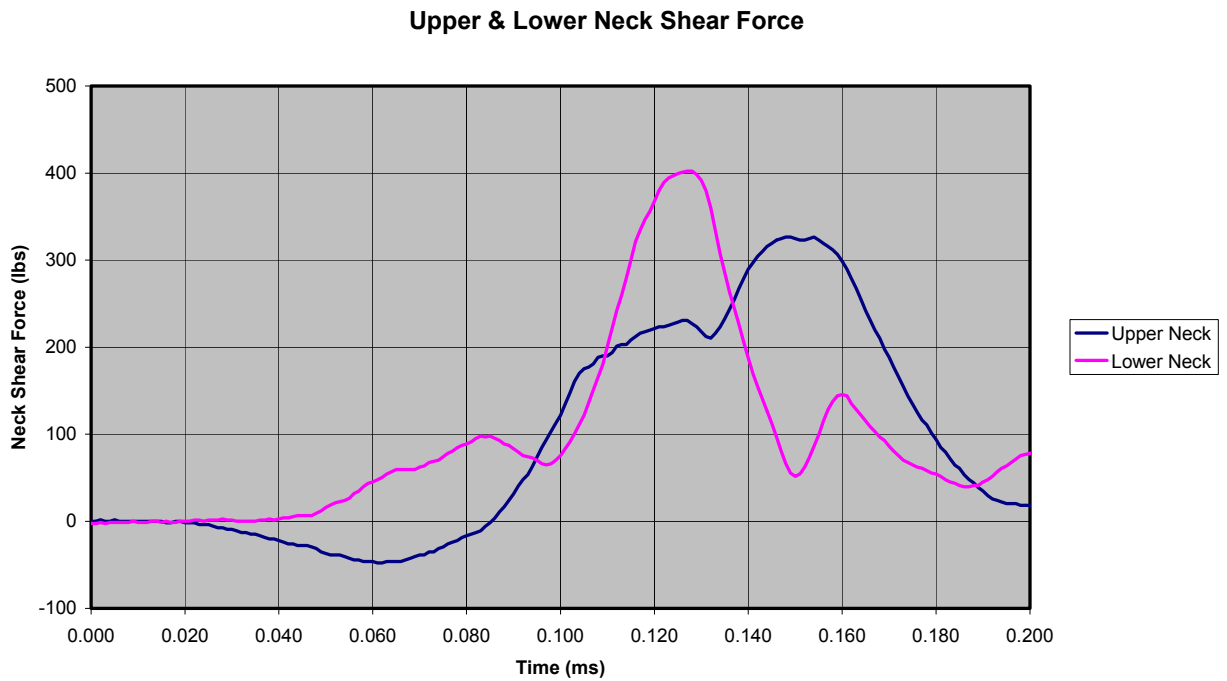

Figure B-146: Test 537 (Severe Pulse, 3.5 lb Added Head Weight)

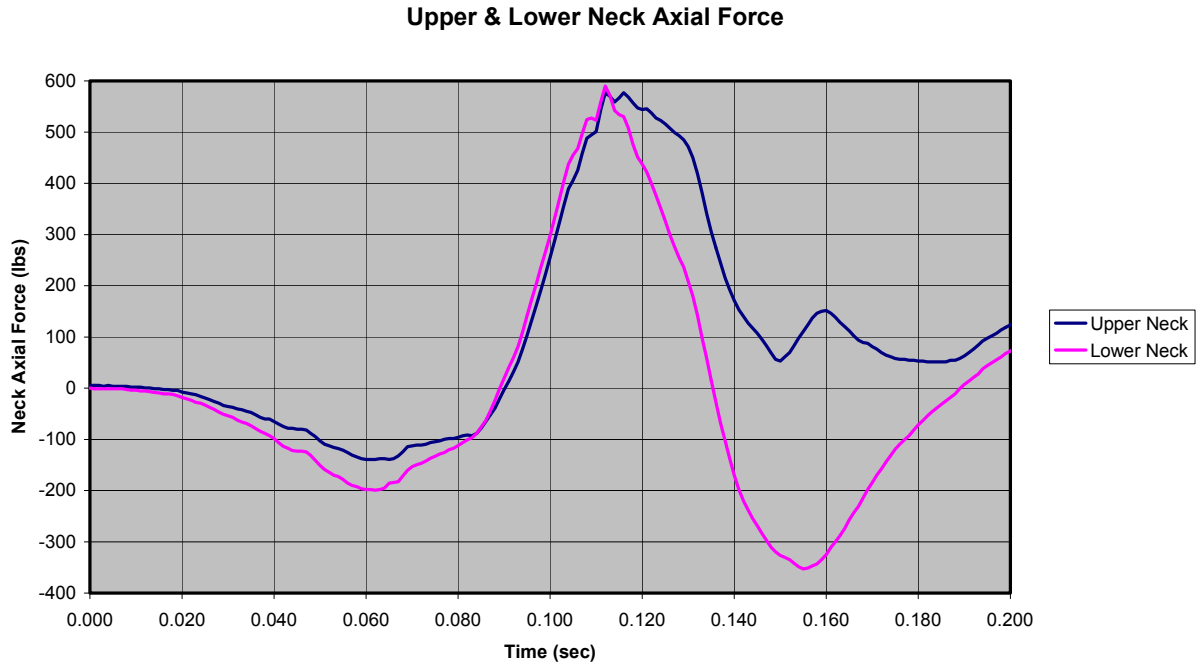

Figure B-147: Test 537 (Severe Pulse, 3.5 lb Added Head Weight)

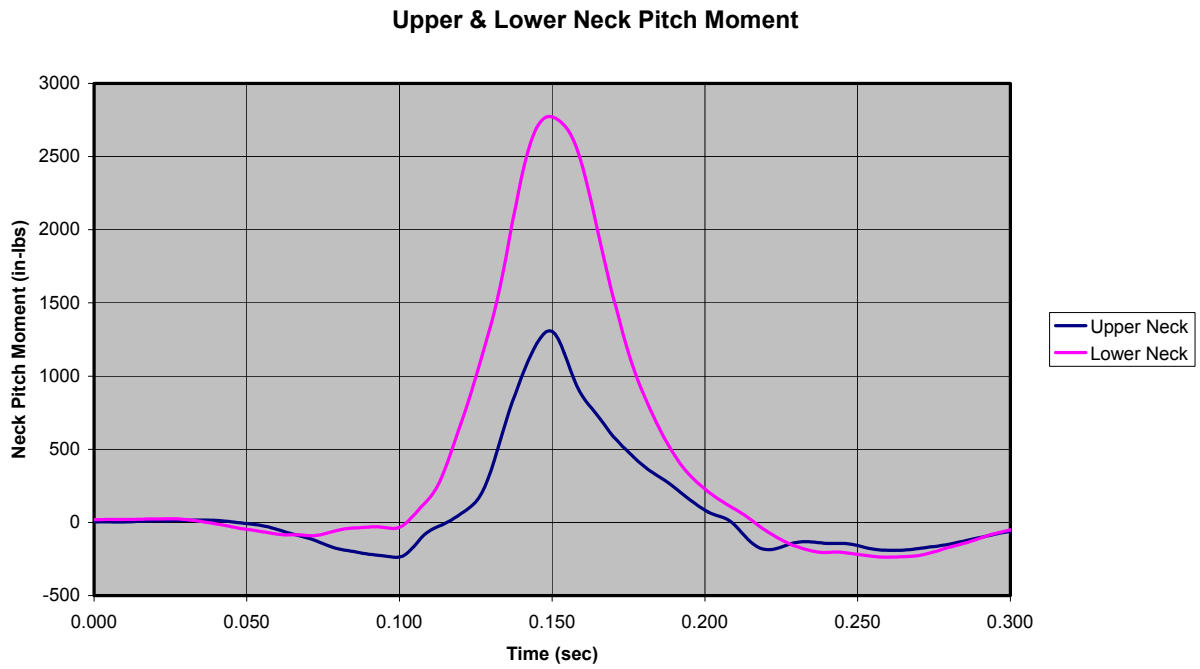

Figure B-148: Test 537 (Severe Pulse, 3.5 lb Added Head Weight)

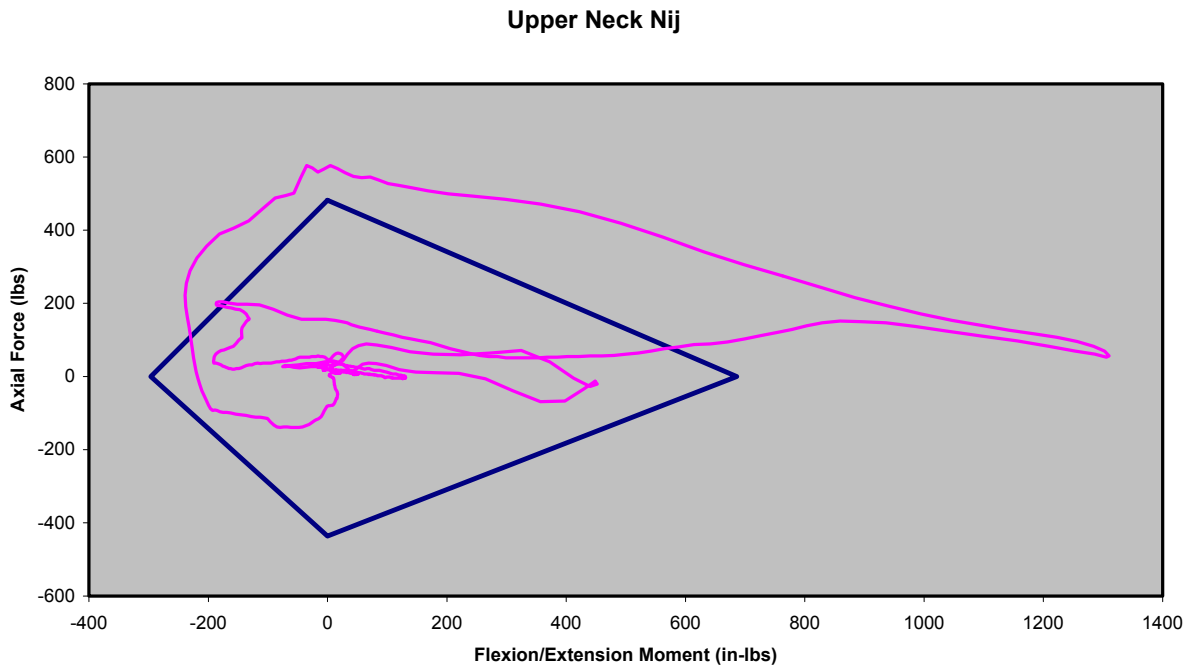

Figure B-149: Test 537 (Severe Pulse, 3.5 lb Added Head Weight)

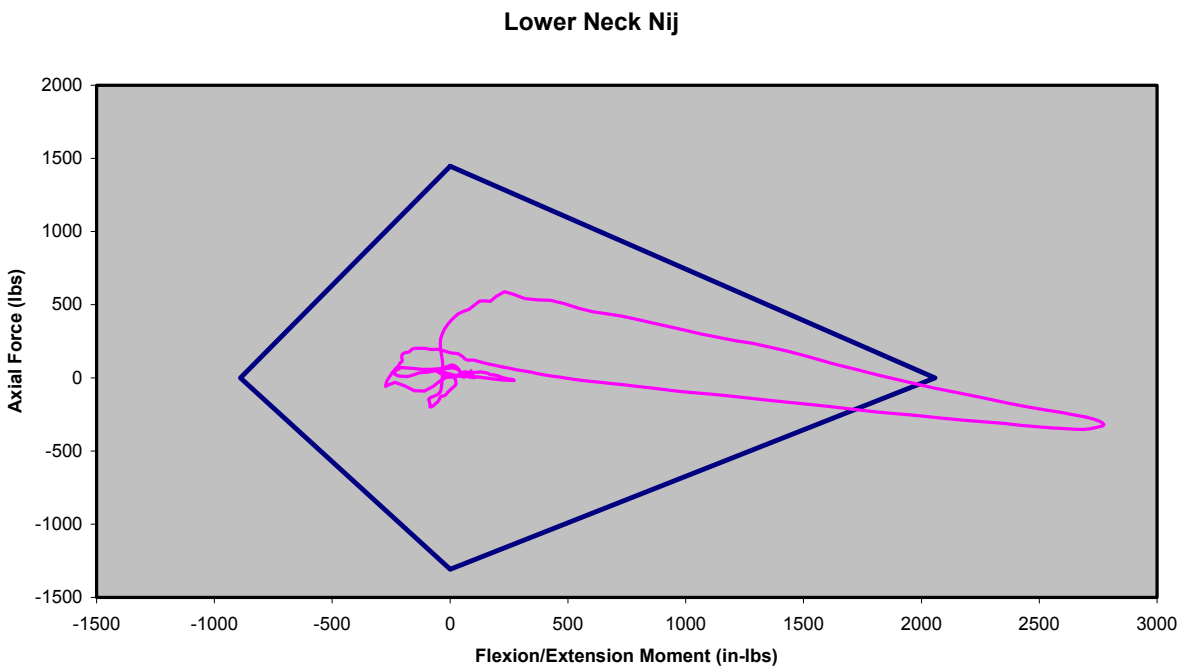

Figure B-150: Test 537 (Severe Pulse, 3.5 lb Added Head Weight)

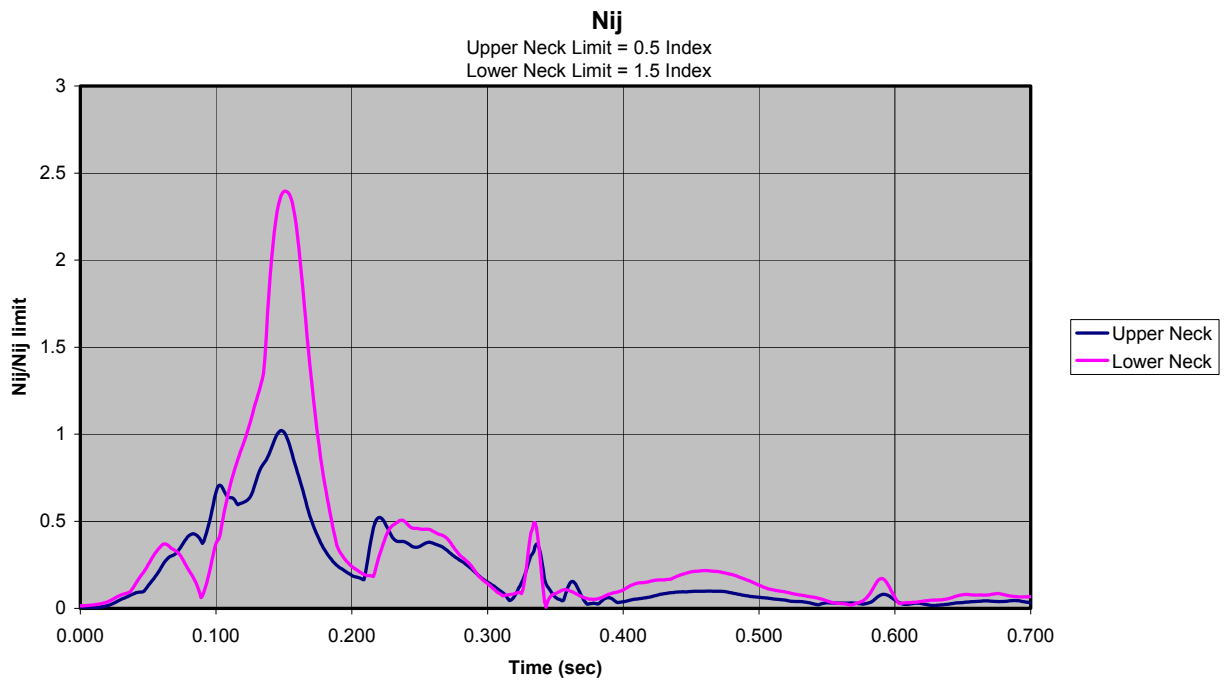

Figure B-151: Test 537 (Severe Pulse, 3.5 lb Added Head Weight)

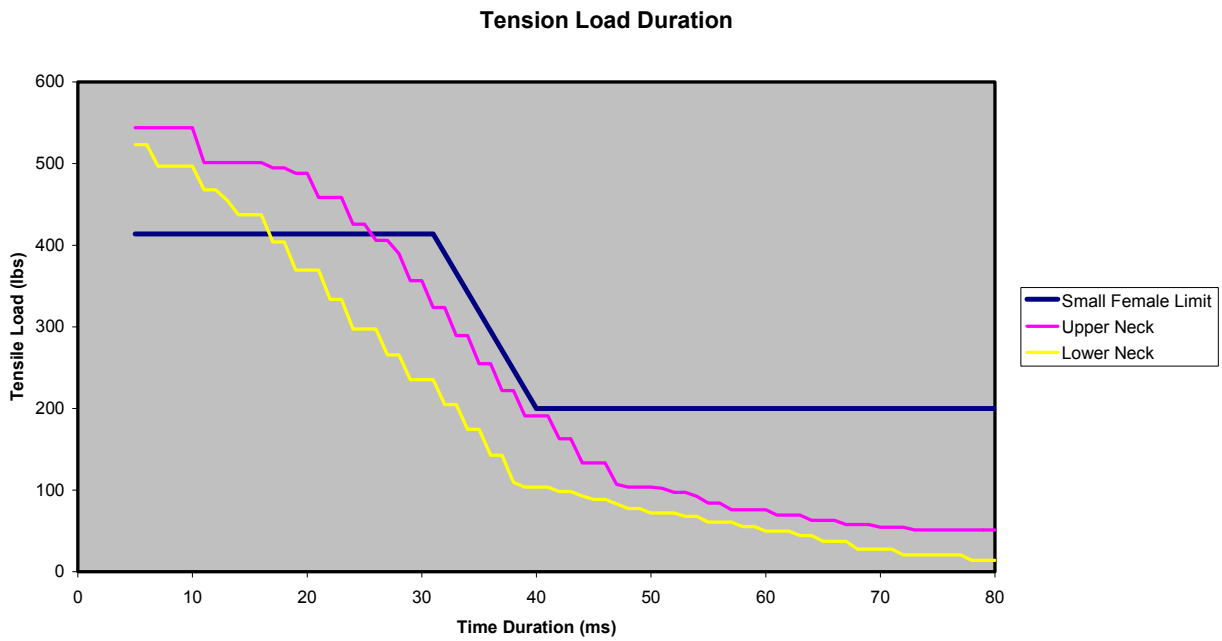

Figure B-152: Test 537 (Severe Pulse, 3.5 lb Added Head Weight)

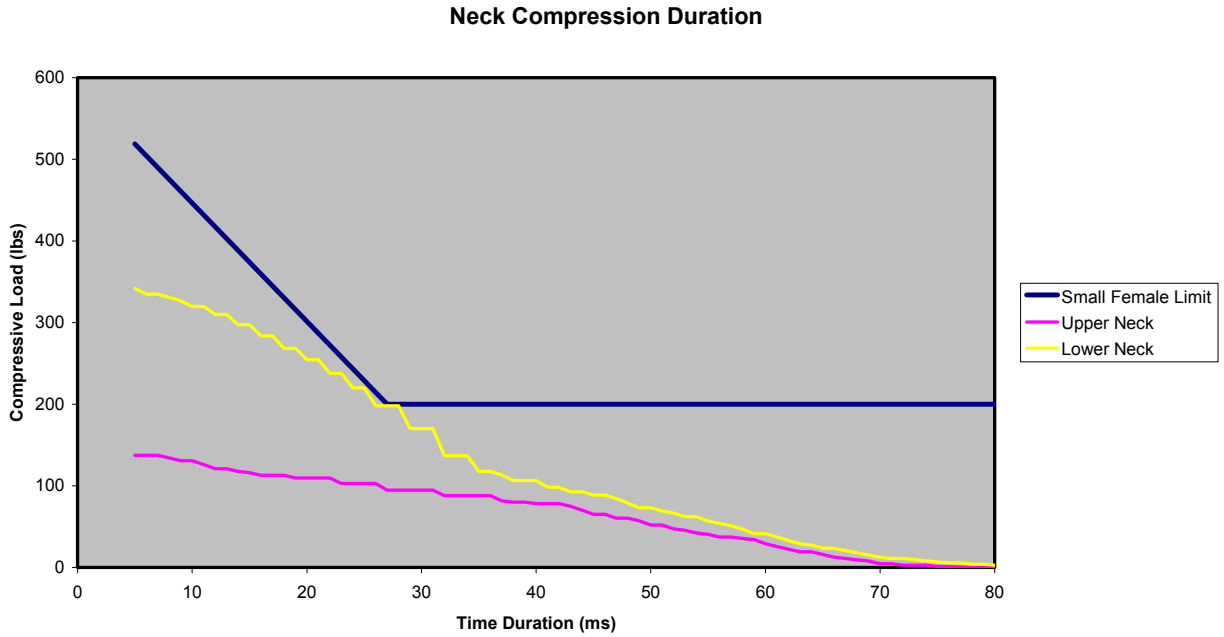

Figure B-153: Test 537 (Severe Pulse, 3.5 lb Added Head Weight)

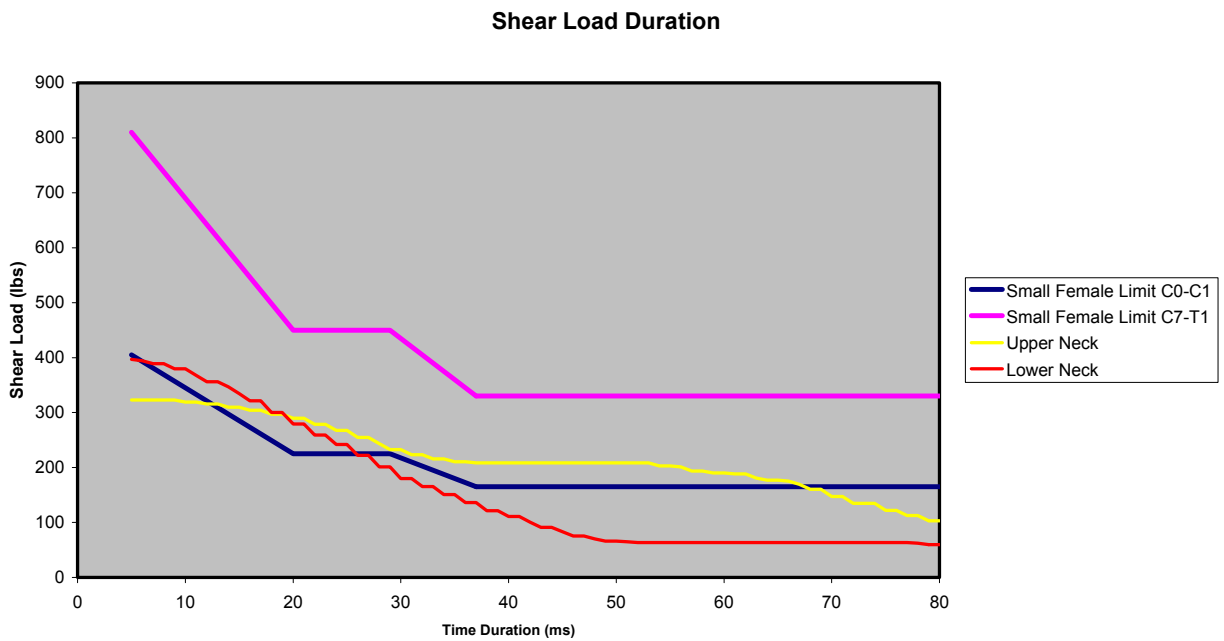

Figure B-154: Test 537 (Severe Pulse, 3.5 lb Added Head Weight)

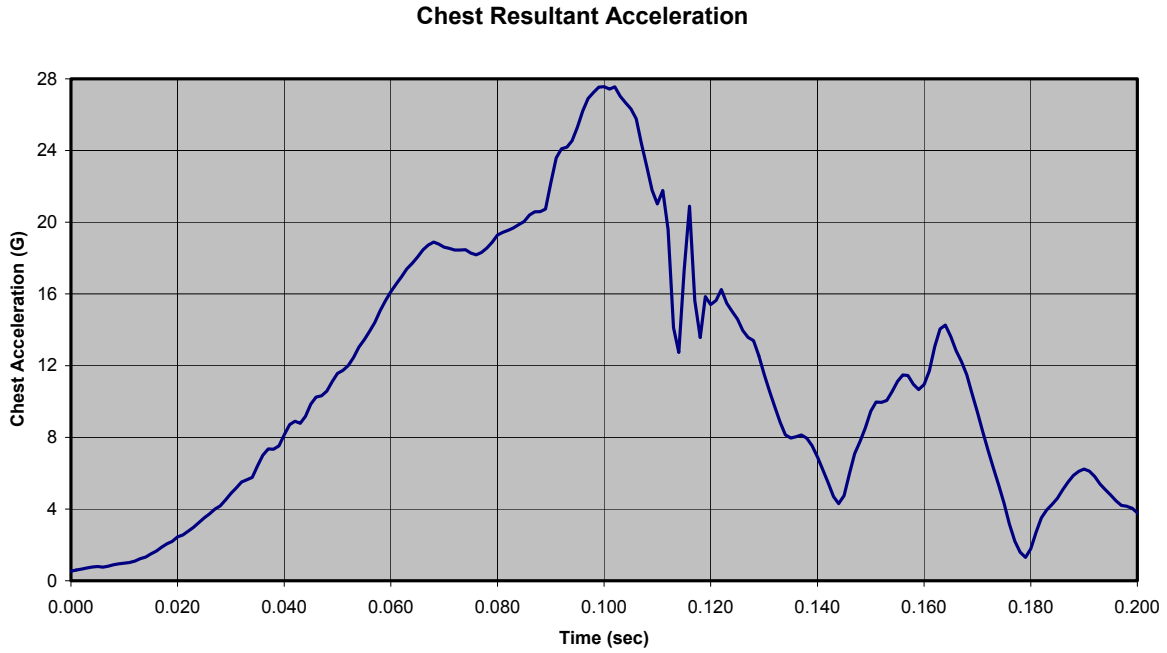

Figure B-155: Test 538 (Severe Pulse, 4.0 lb Added Head Weight)

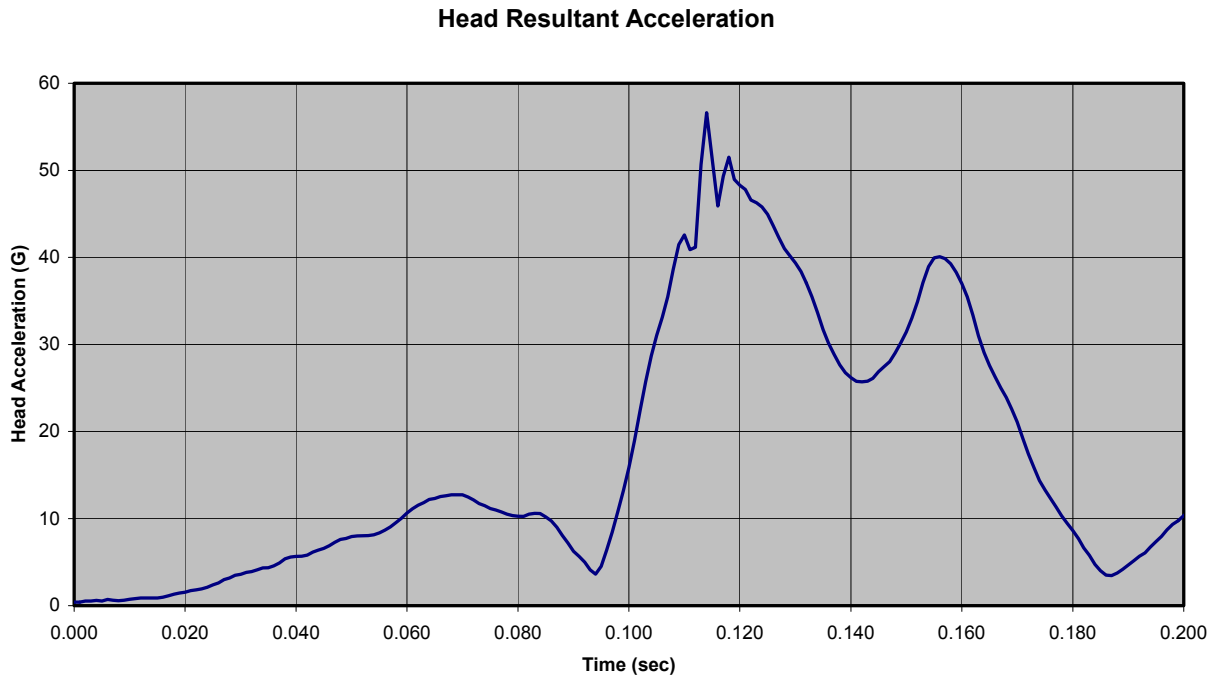

Figure B-156: Test 538 (Severe Pulse, 4.0 lb Added Head Weight)



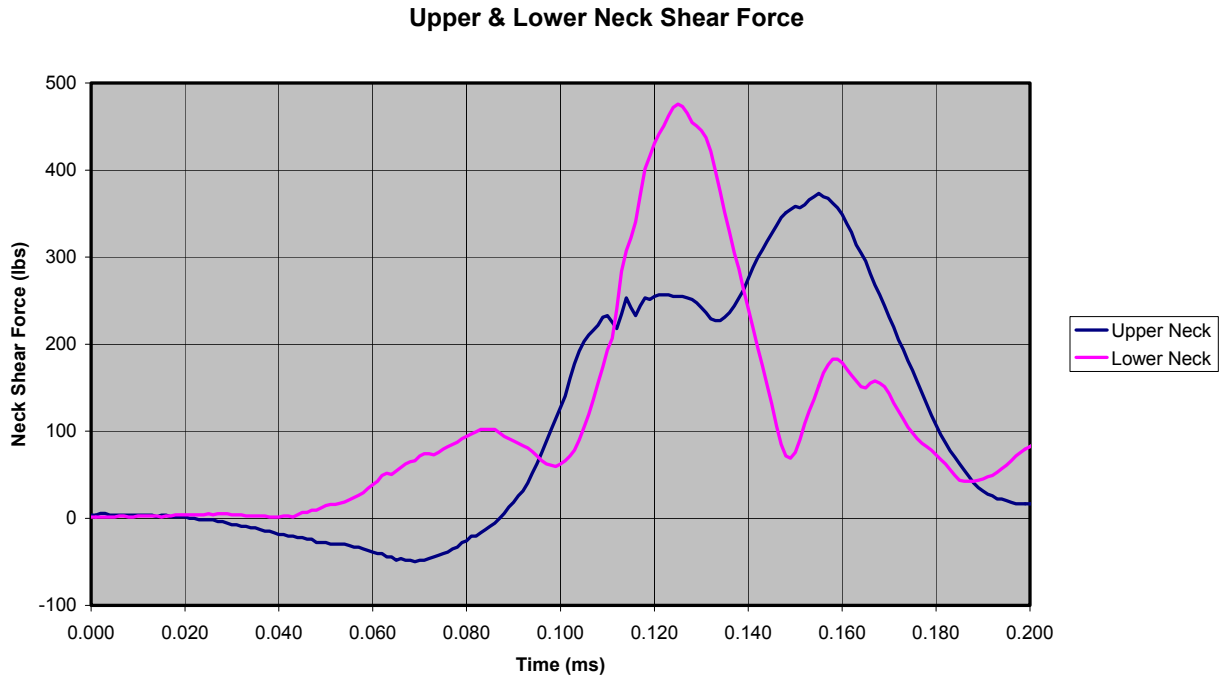

Figure B-157: Test 538 (Severe Pulse, 4.0 lb Added Head Weight)

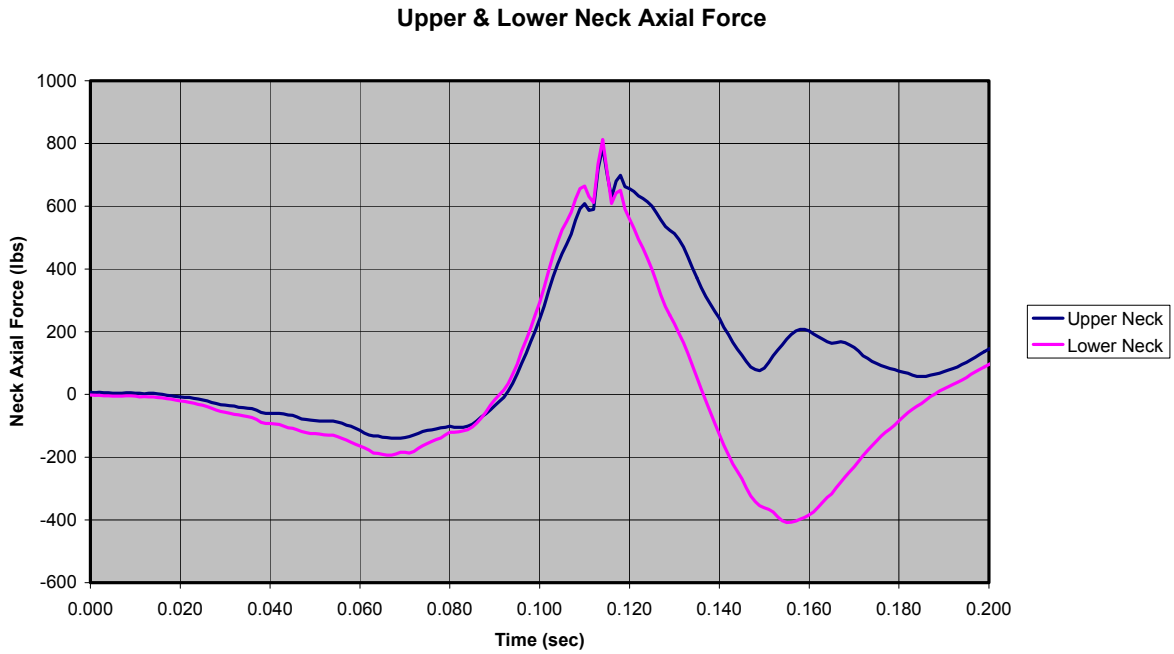

Figure B-158: Test 538 (Severe Pulse, 4.0 lb Added Head Weight)

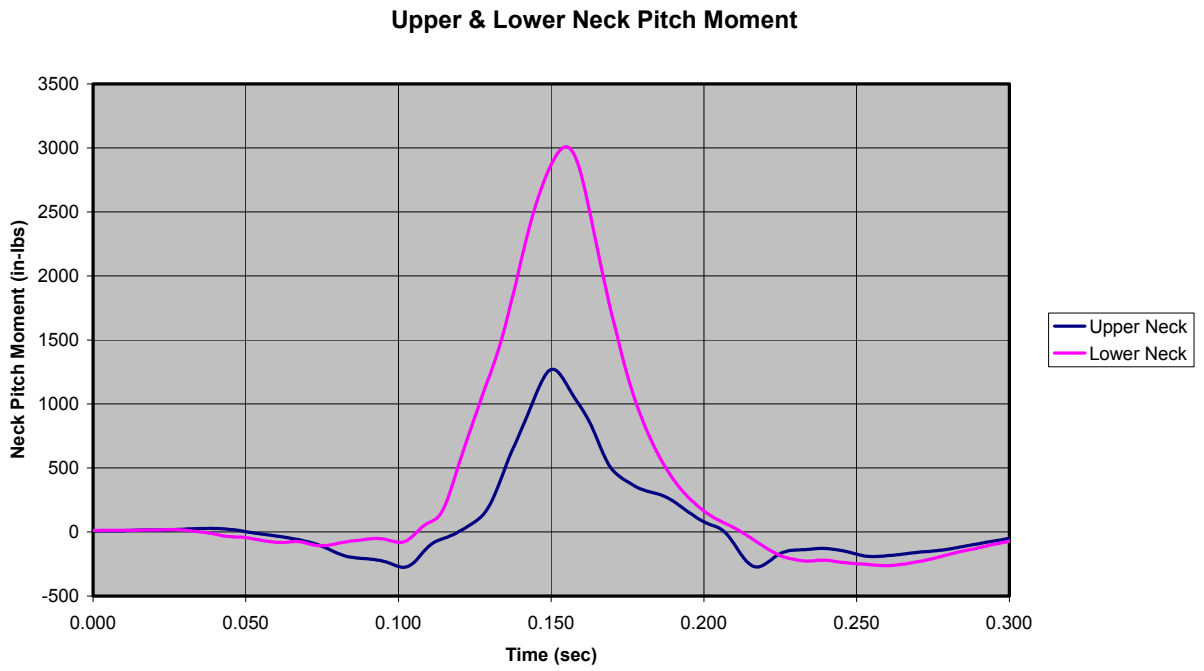

Figure B-159: Test 538 (Severe Pulse, 4.0 lb Added Head Weight)

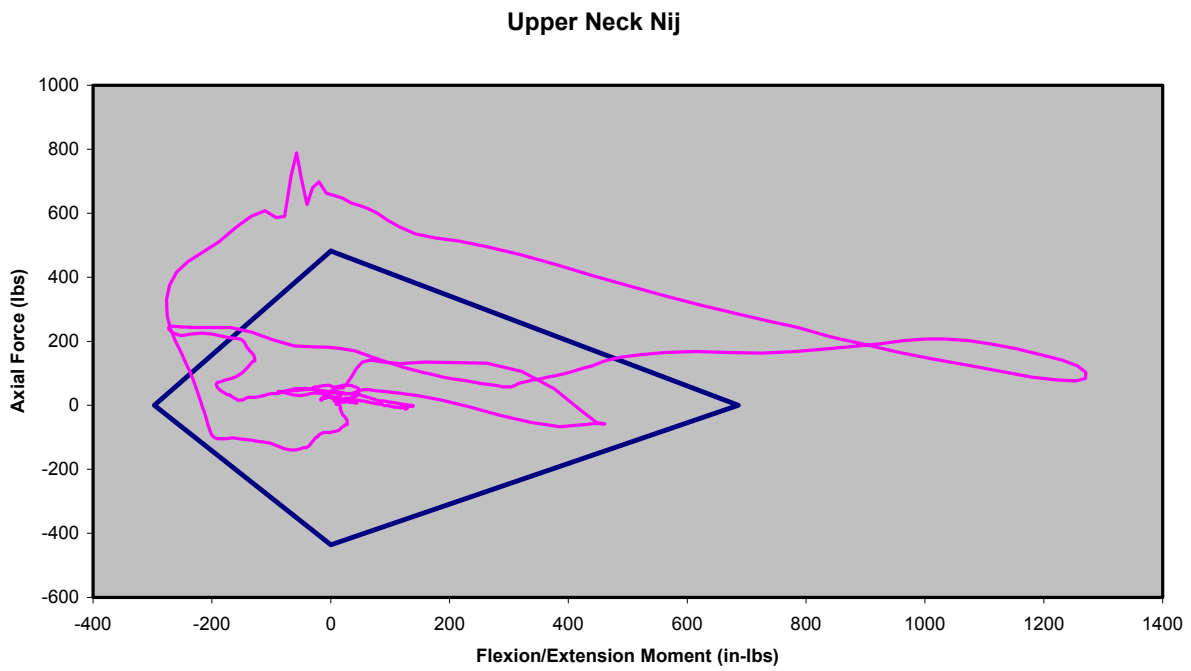

Figure B-160: Test 538 (Severe Pulse, 4.0 lb Added Head Weight)

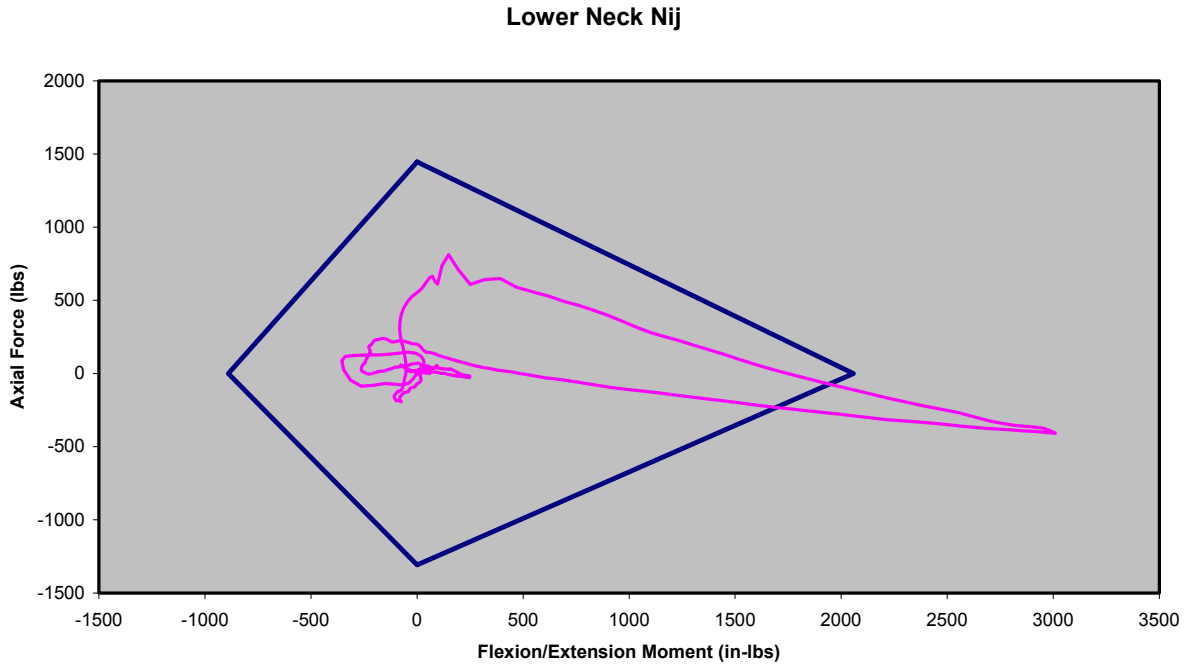

Figure B-161: Test 538 (Severe Pulse, 4.0 lb Added Head Weight)

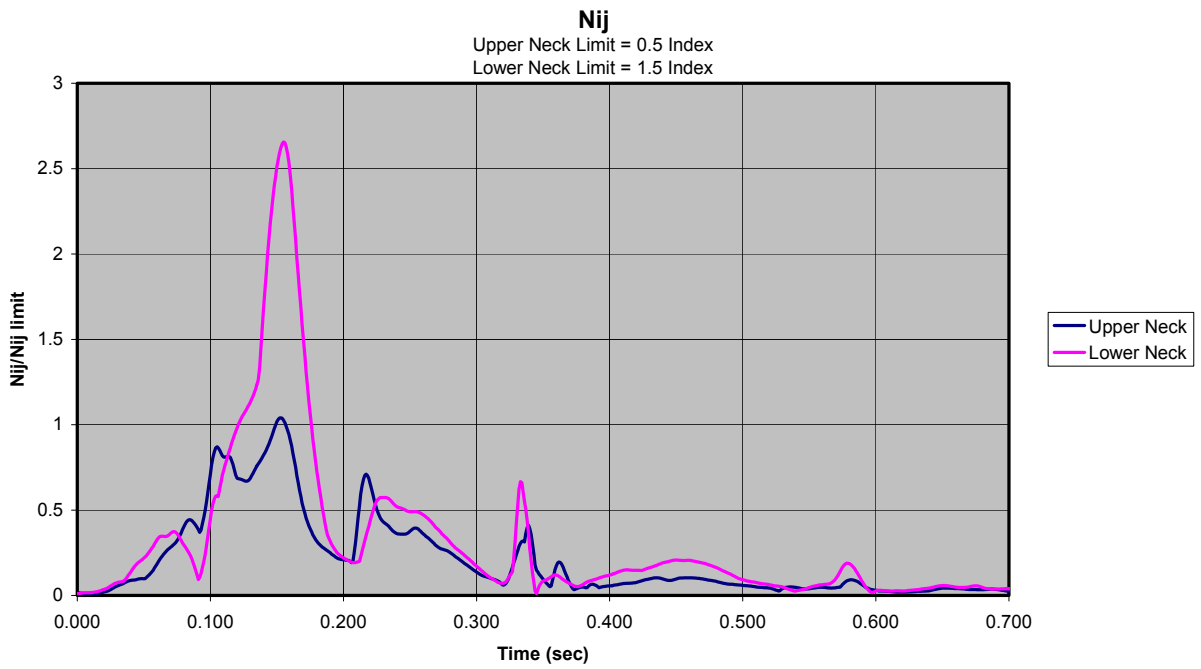

Figure B-162: Test 538 (Severe Pulse, 4.0 lb Added Head Weight)

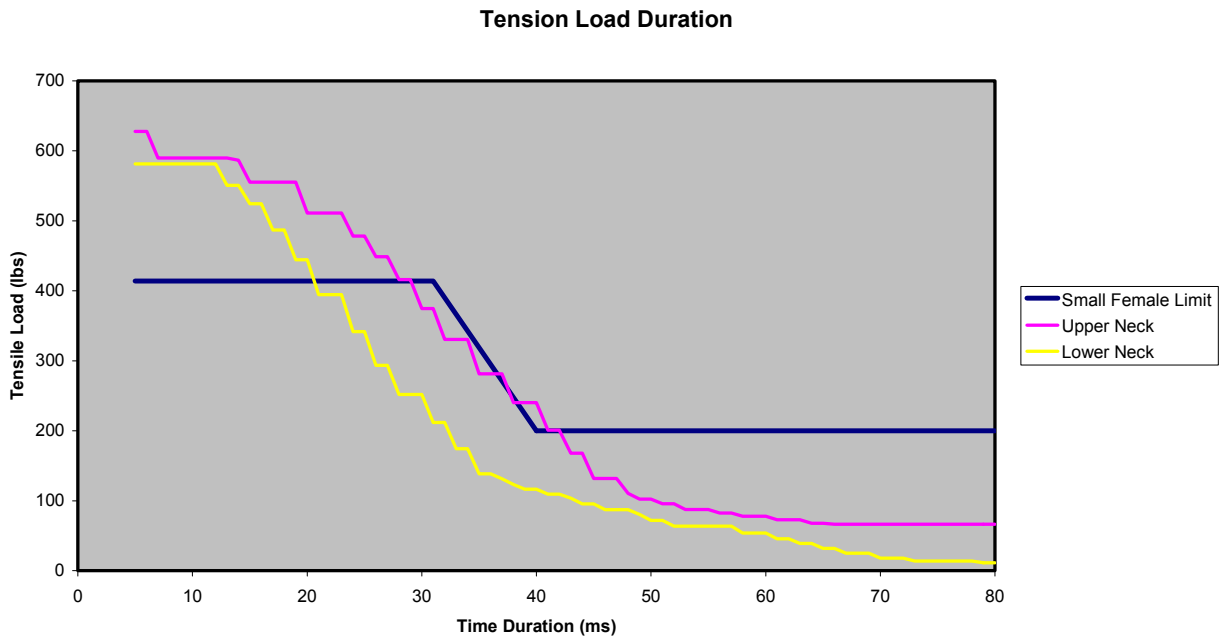

Figure B-163: Test 538 (Severe Pulse, 4.0 lb Added Head Weight)

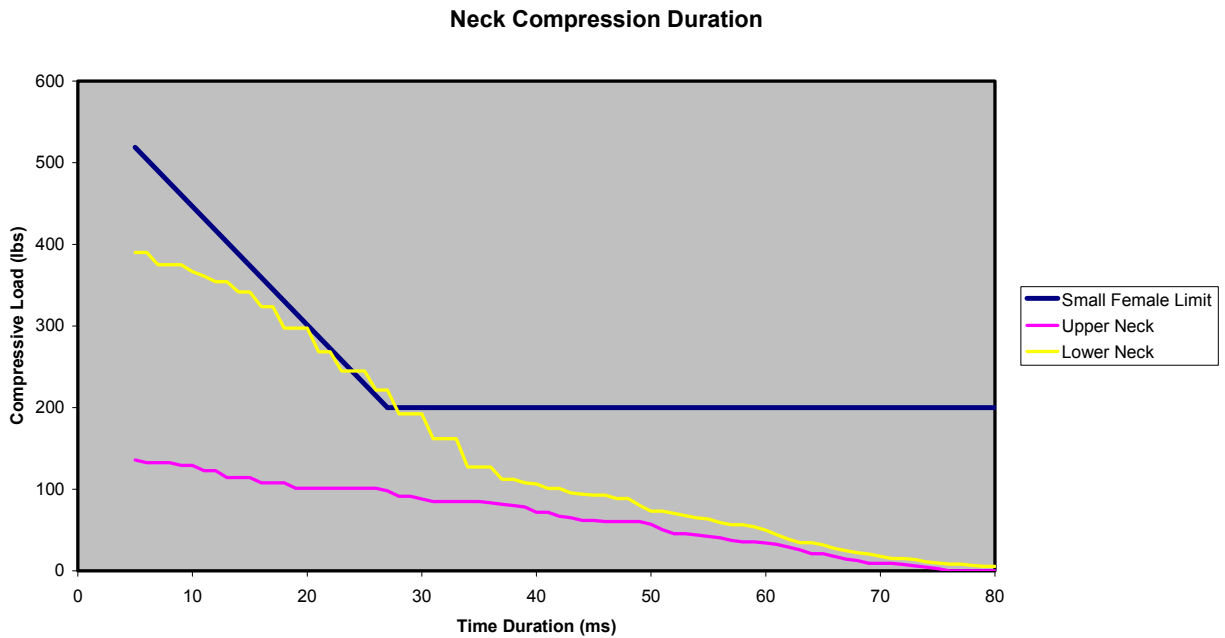

Figure B-164: Test 538 (Severe Pulse, 4.0 lb Added Head Weight)

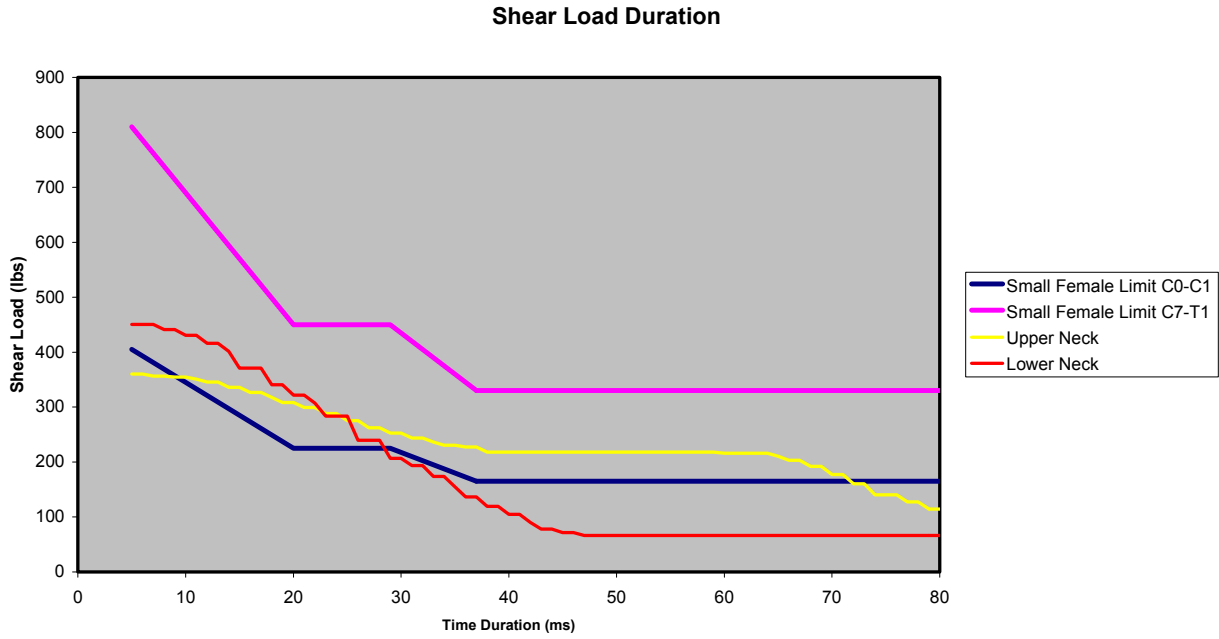

Figure B-165: Test 538 (Severe Pulse, 4.0 lb Added Head Weight)

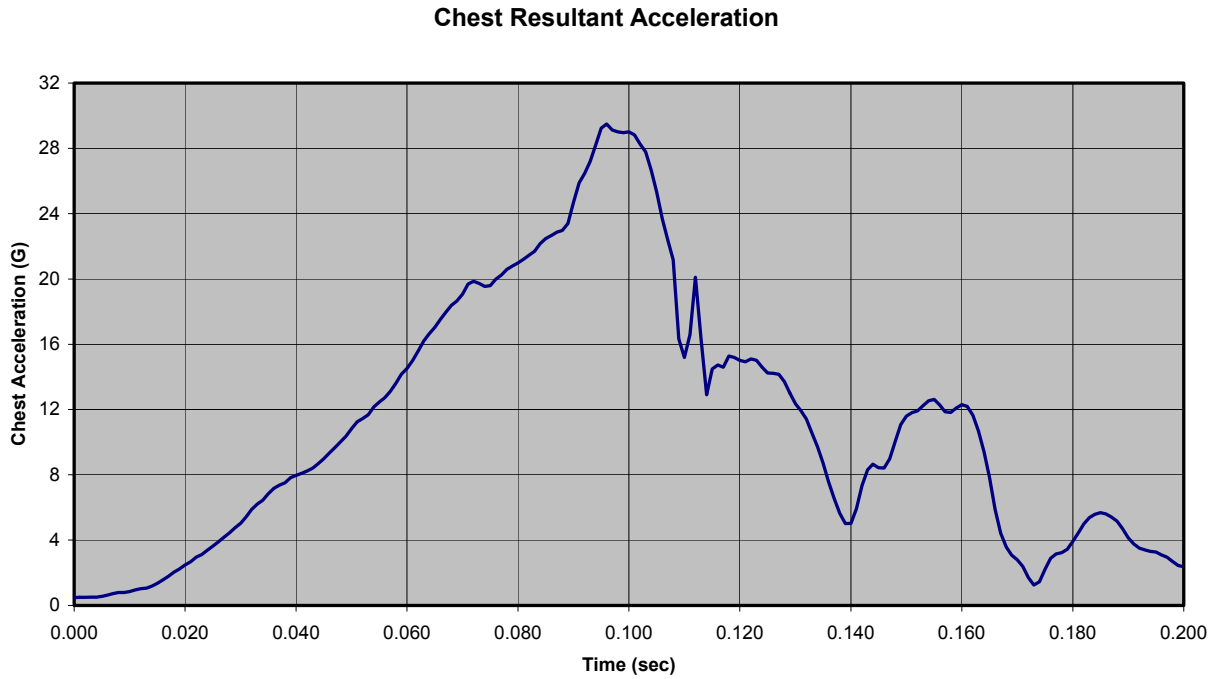

Figure B-166: Test 539 (Severe Pulse, 2.8 lb Added Head Weight)

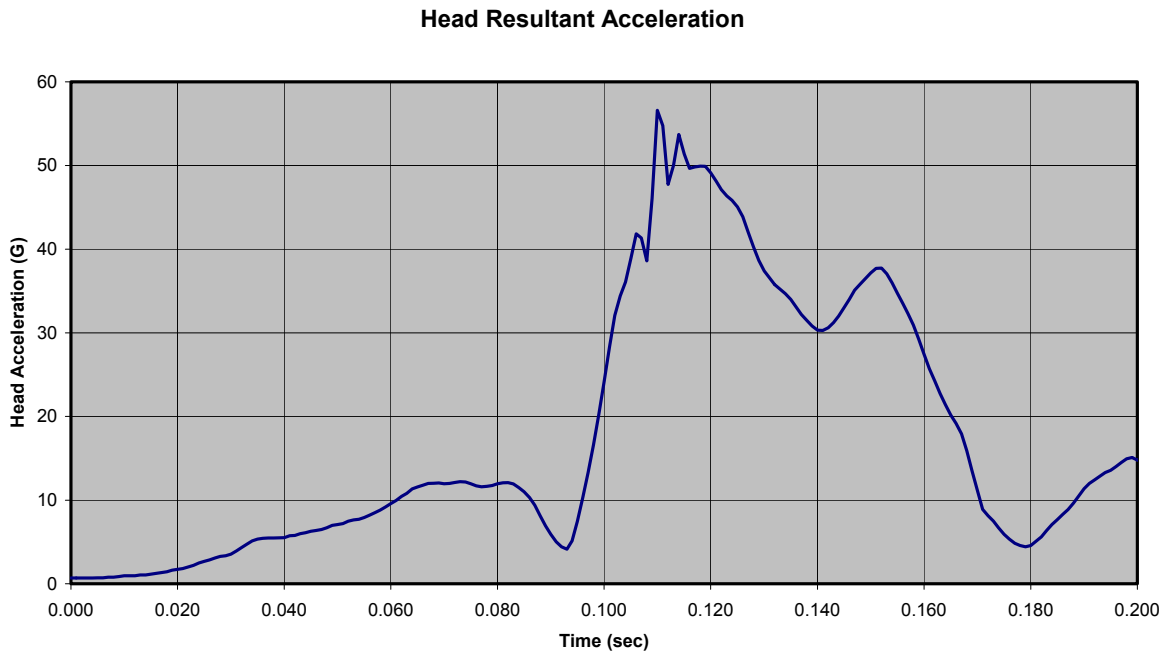

Figure B-167: Test 539 (Severe Pulse, 2.8 lb Added Head Weight)

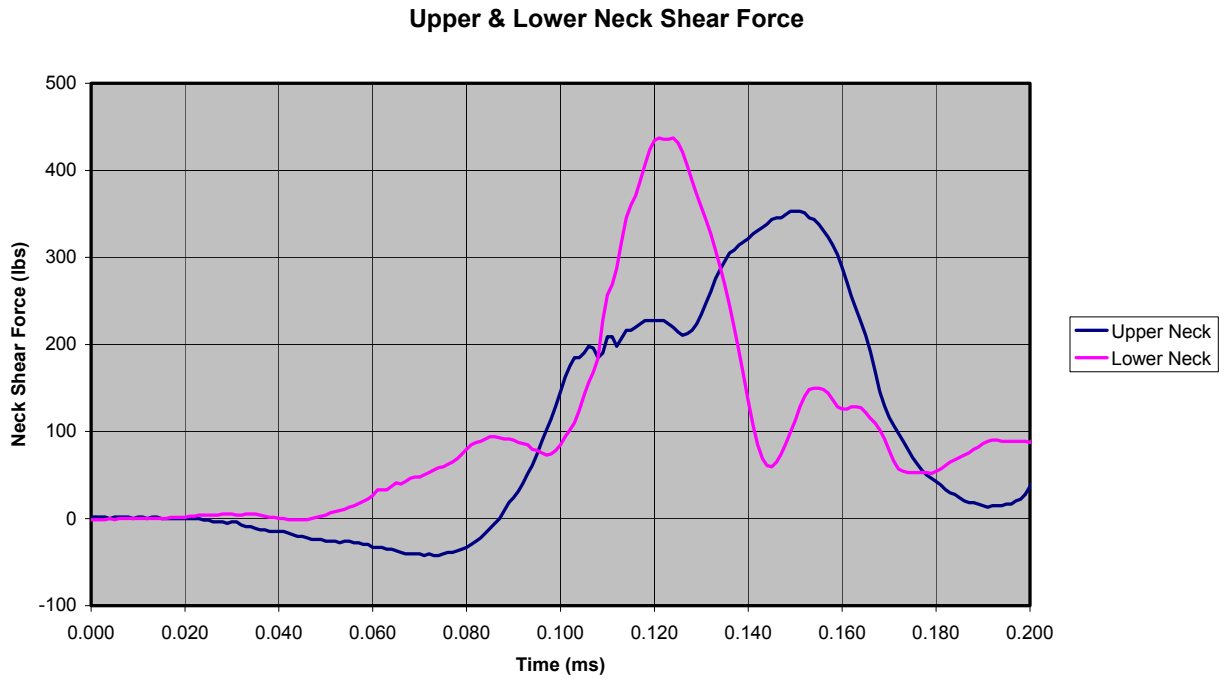

Figure B-168: Test 539 (Severe Pulse, 2.8 lb Added Head Weight)

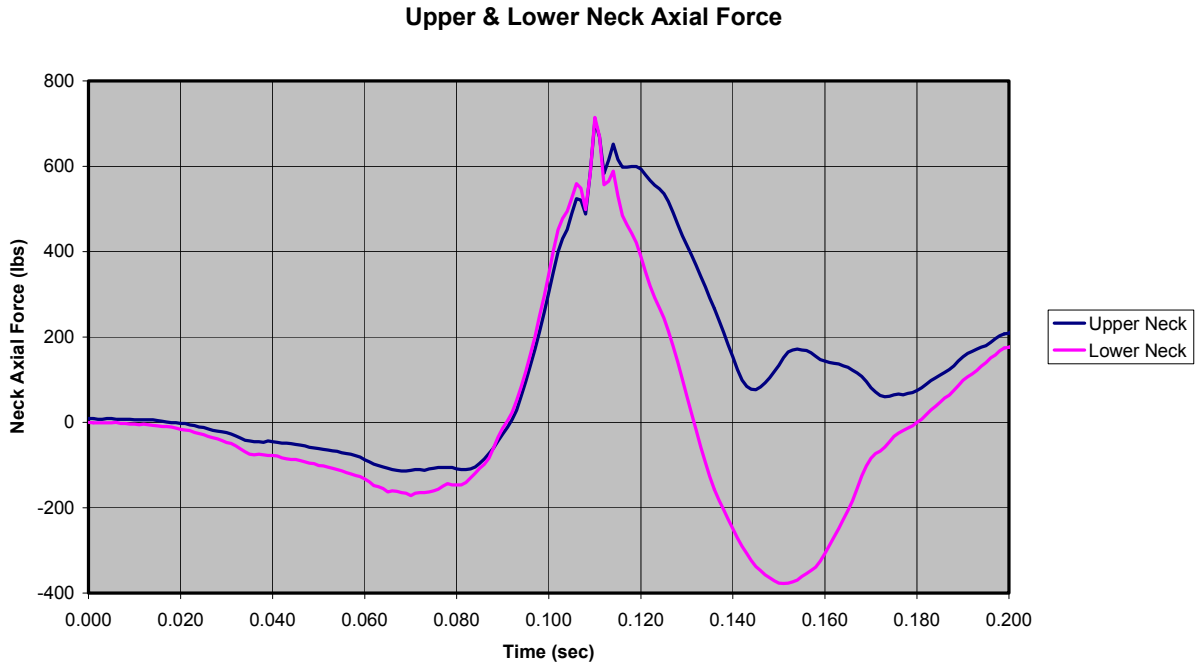

Figure B-169: Test 539 (Severe Pulse, 2.8 lb Added Head Weight)

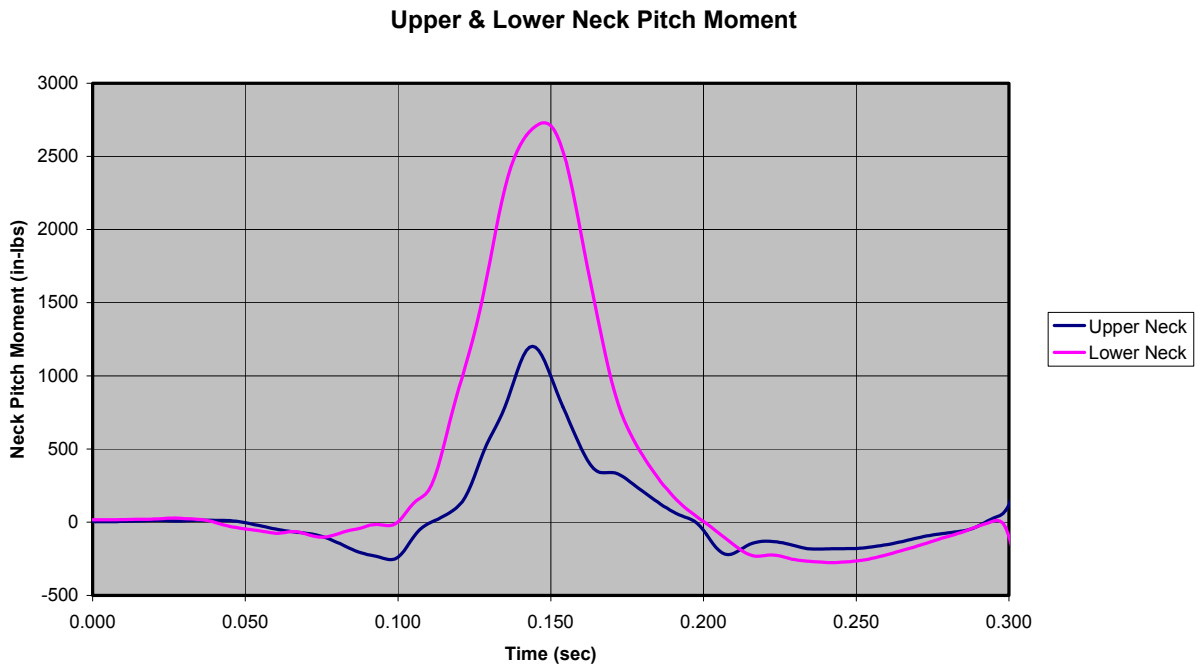

Figure B-170: Test 539 (Severe Pulse, 2.8 lb Added Head Weight)

Upper Neck Nij

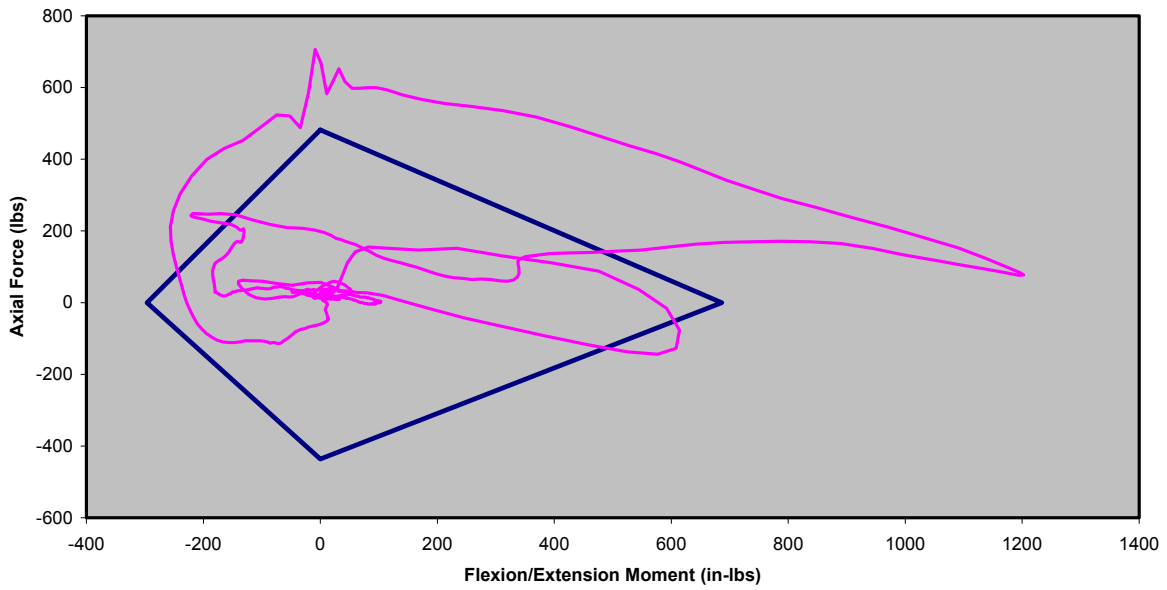

Figure B-171: Test 539 (Severe Pulse, 2.8 lb Added Head Weight)

Lower Neck Nij

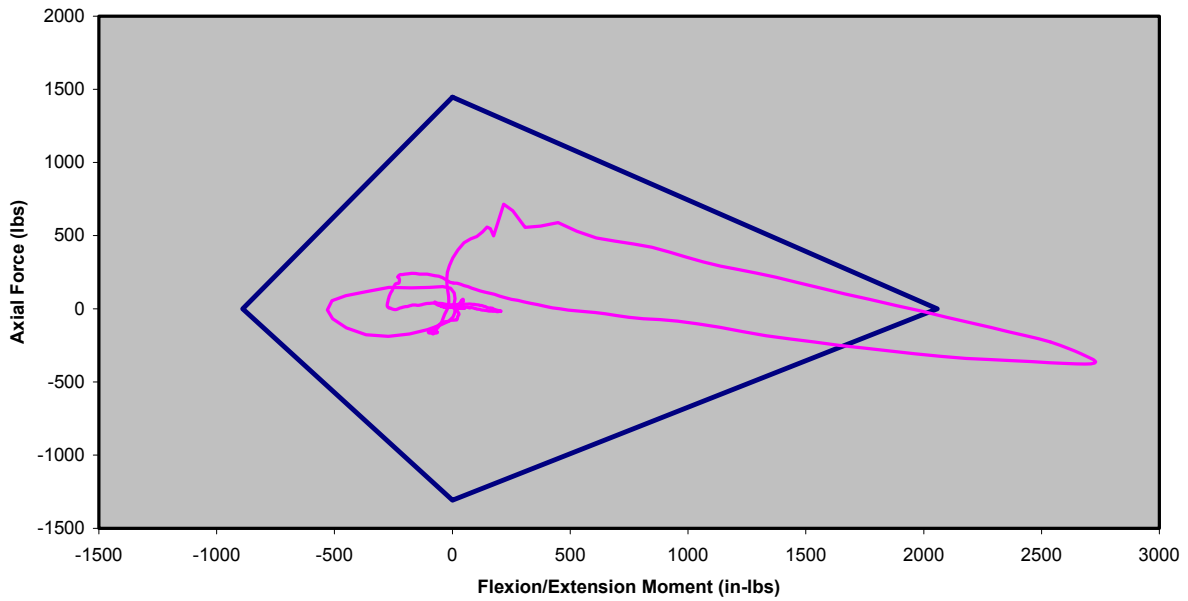

Figure B-172: Test 539 (Severe Pulse, 2.8 lb Added Head Weight)



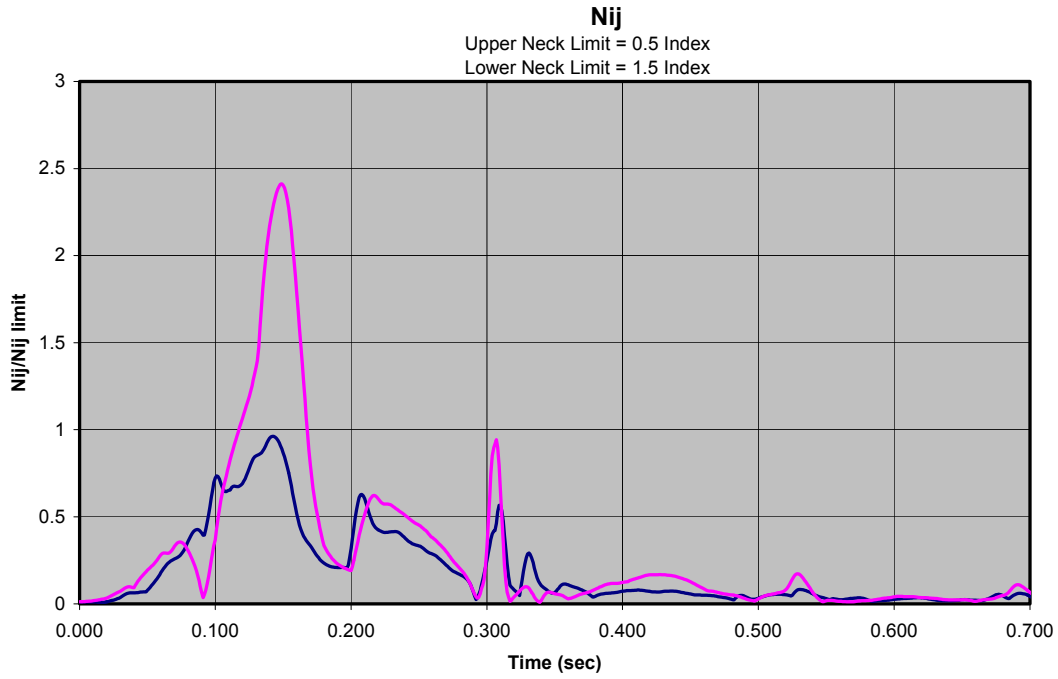

Figure B-173: Test 539 (Severe Pulse, 2.8 lb Added Head Weight)

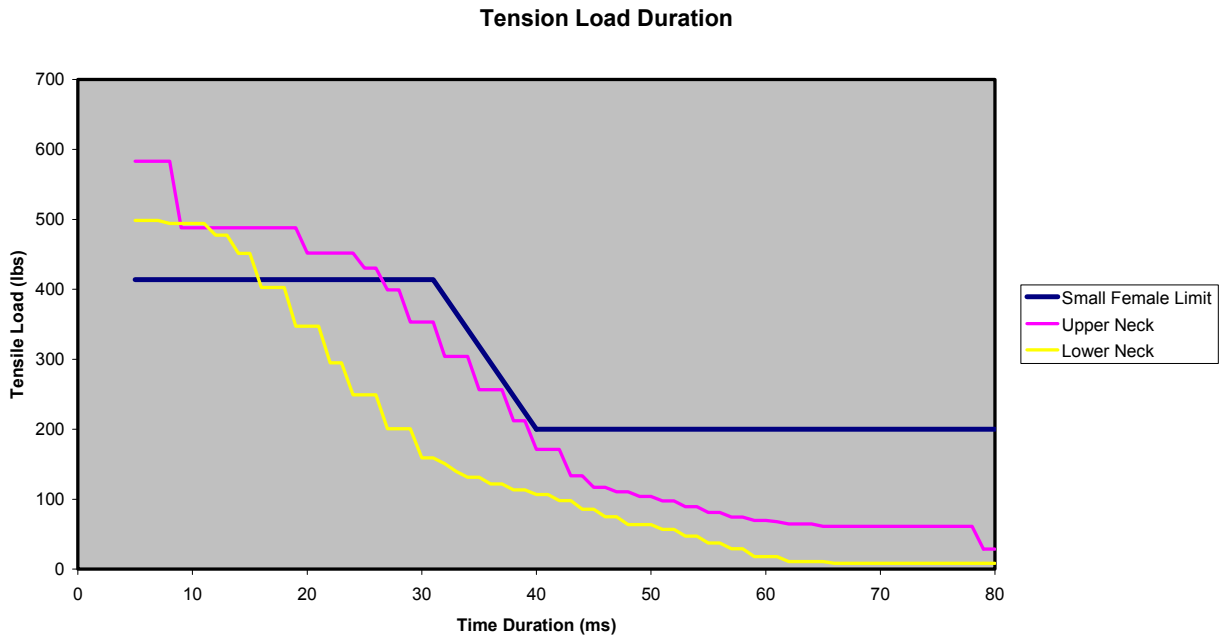

Figure B-174: Test 539 (Severe Pulse, 2.8 lb Added Head Weight)

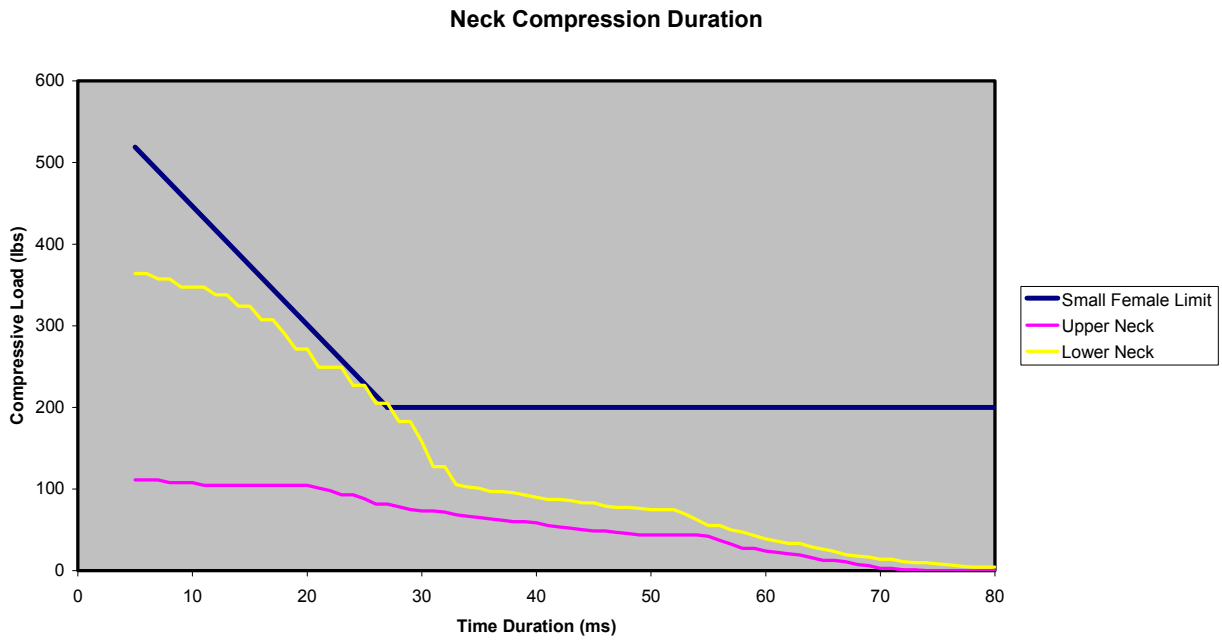

Figure B-175: Test 539 (Severe Pulse, 2.8 lb Added Head Weight)

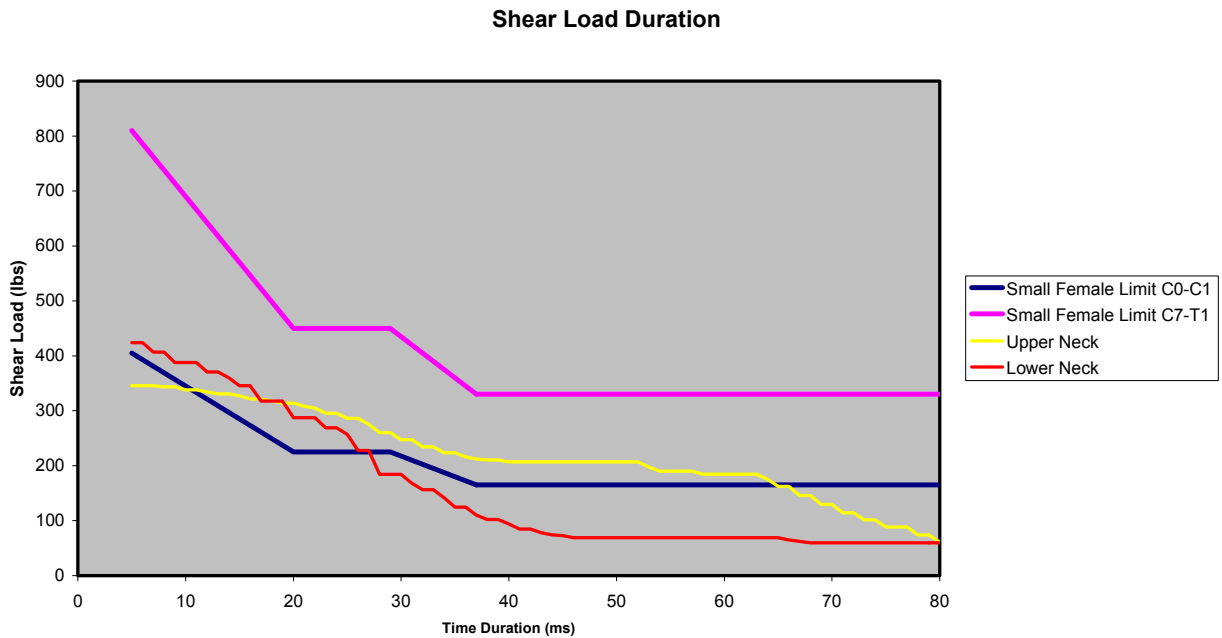

Figure B-176: Test 539 (Severe Pulse, 2.8 lb Added Head Weight)

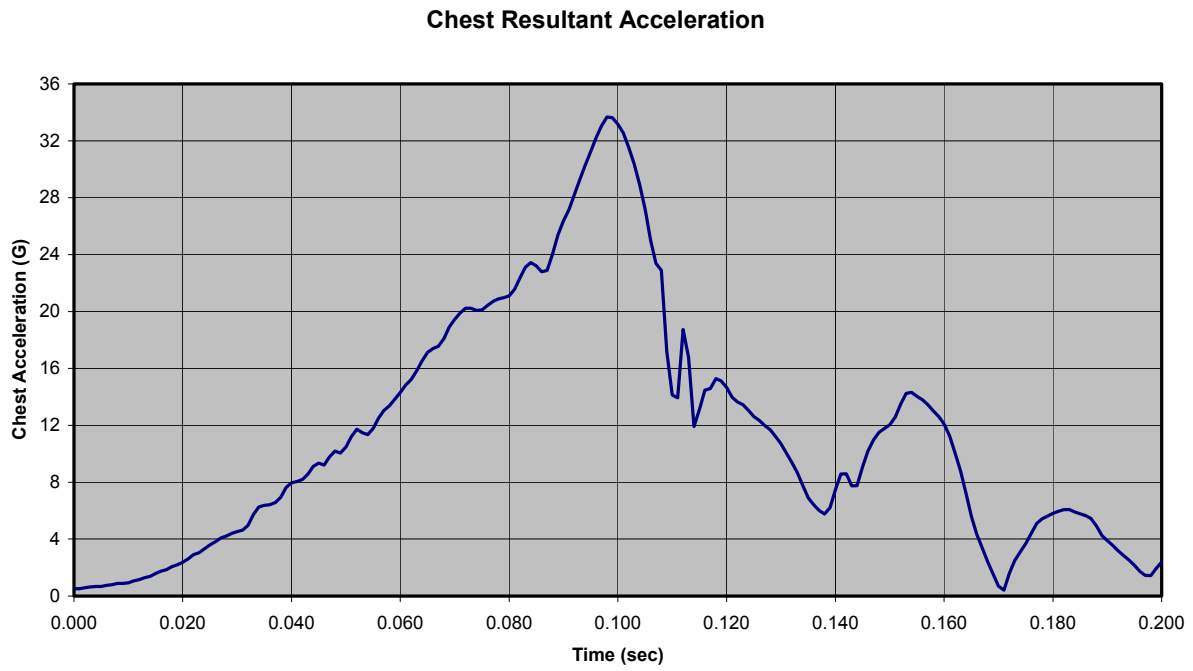

Figure B-177: Test 540 (Severe Pulse, 2.8 lb Added Head Weight)

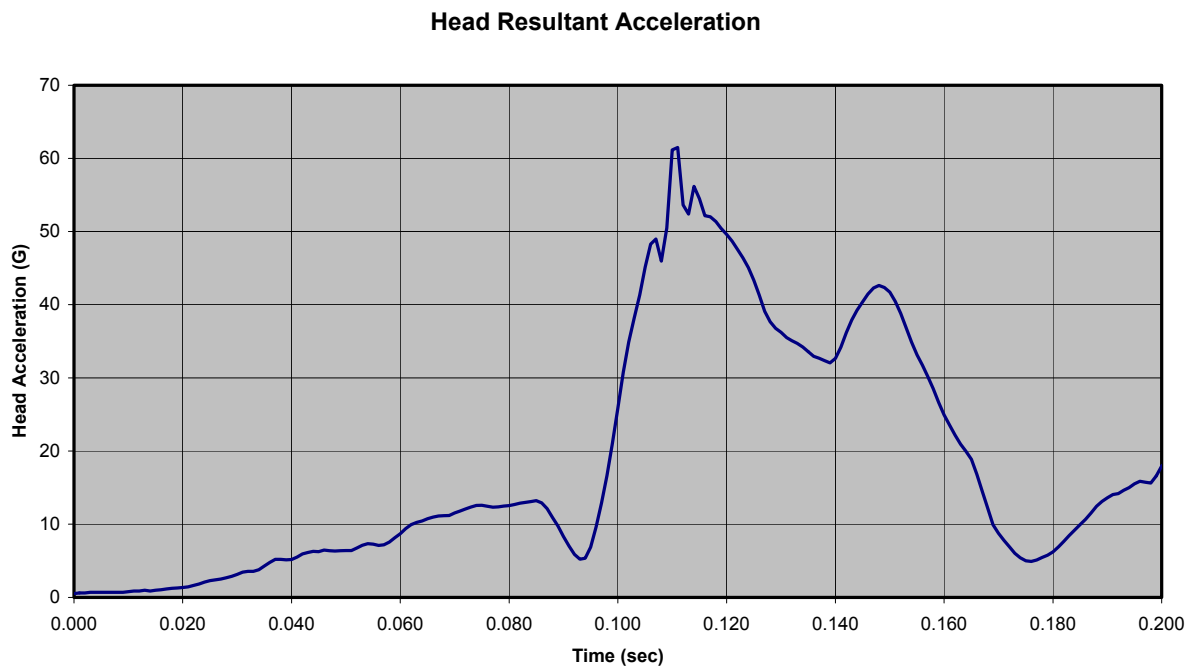

Figure B-178: Test 540 (Severe Pulse, 2.8 lb Added Head Weight)

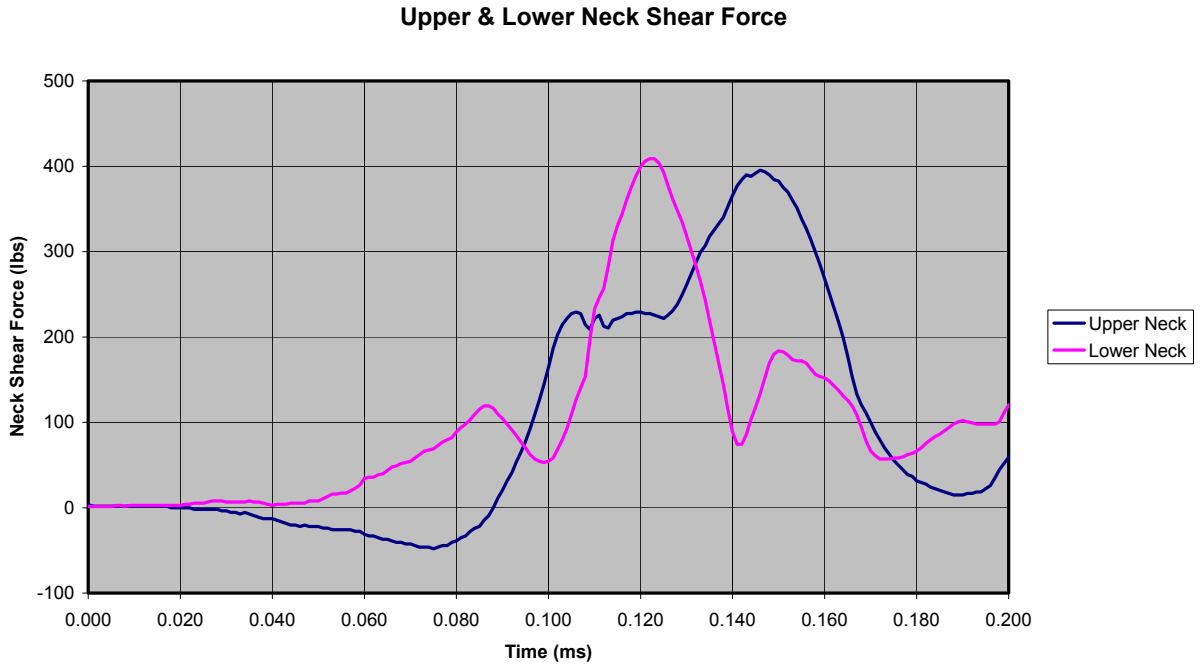

Figure B-179: Test 540 (Severe Pulse, 2.8 lb Added Head Weight)

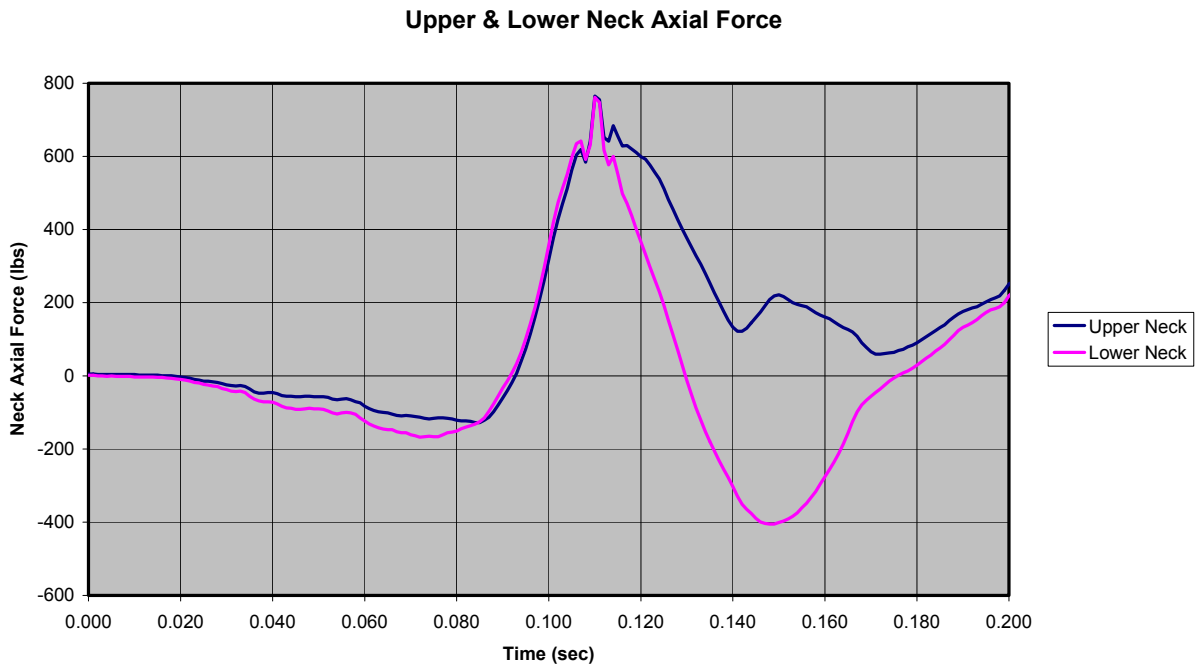

Figure B-180: Test 540 (Severe Pulse, 2.8 lb Added Head Weight)

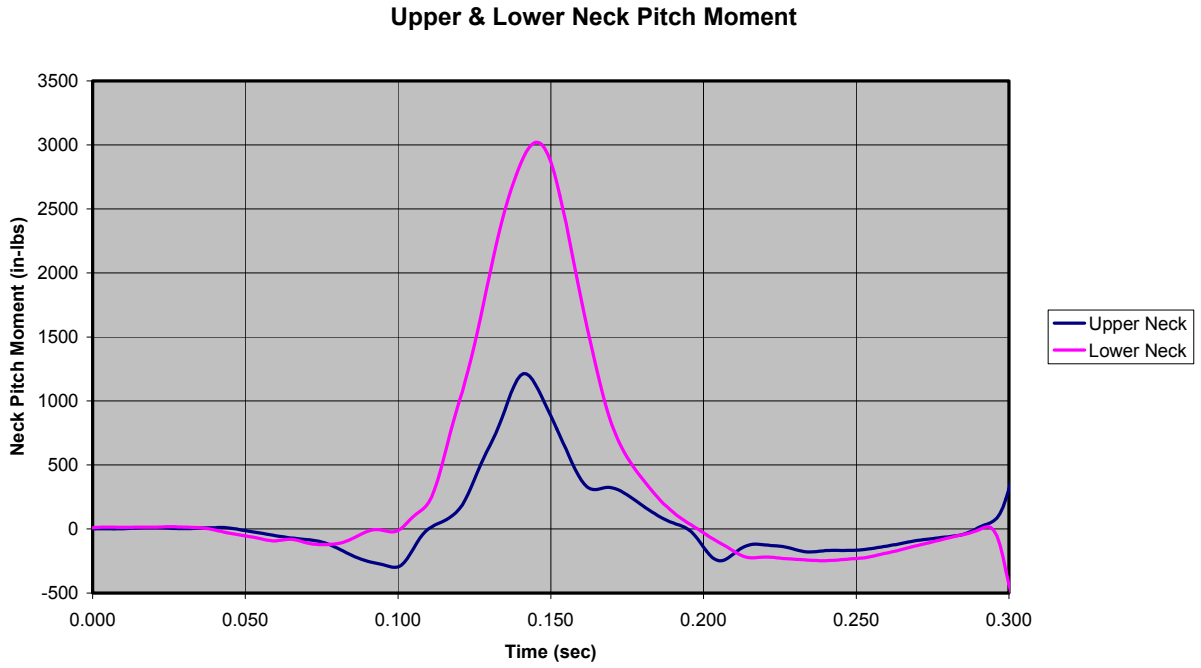

Figure B-181: Test 540 (Severe Pulse, 2.8 lb Added Head Weight)

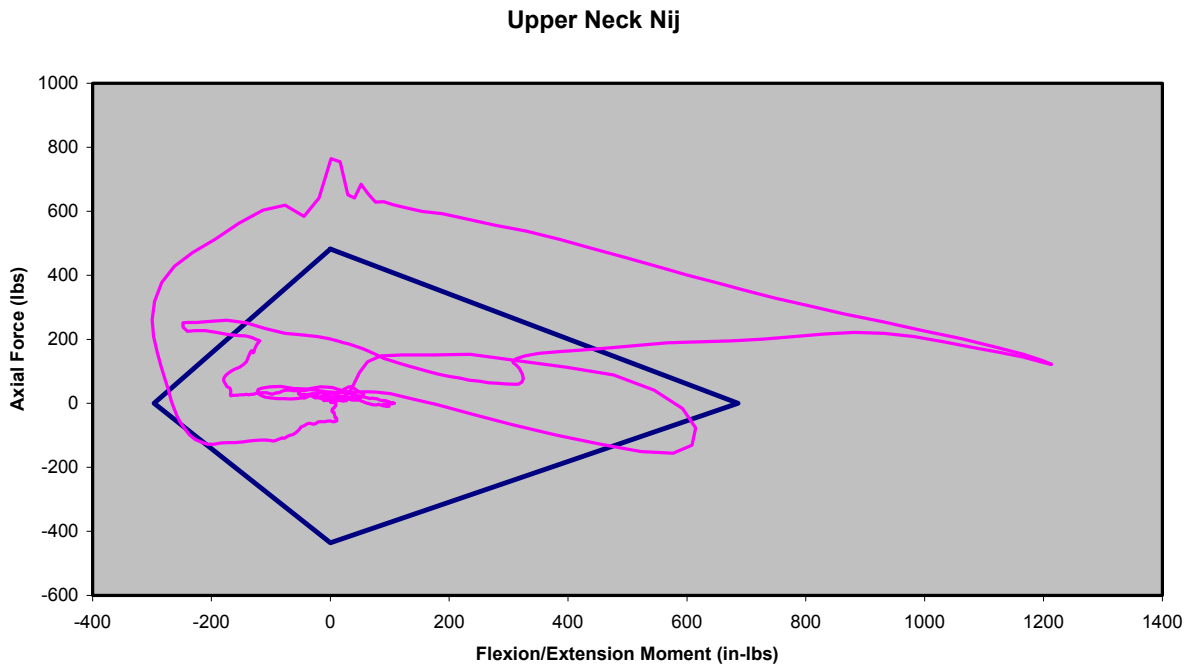

Figure B-182: Test 540 (Severe Pulse, 2.8 lb Added Head Weight)

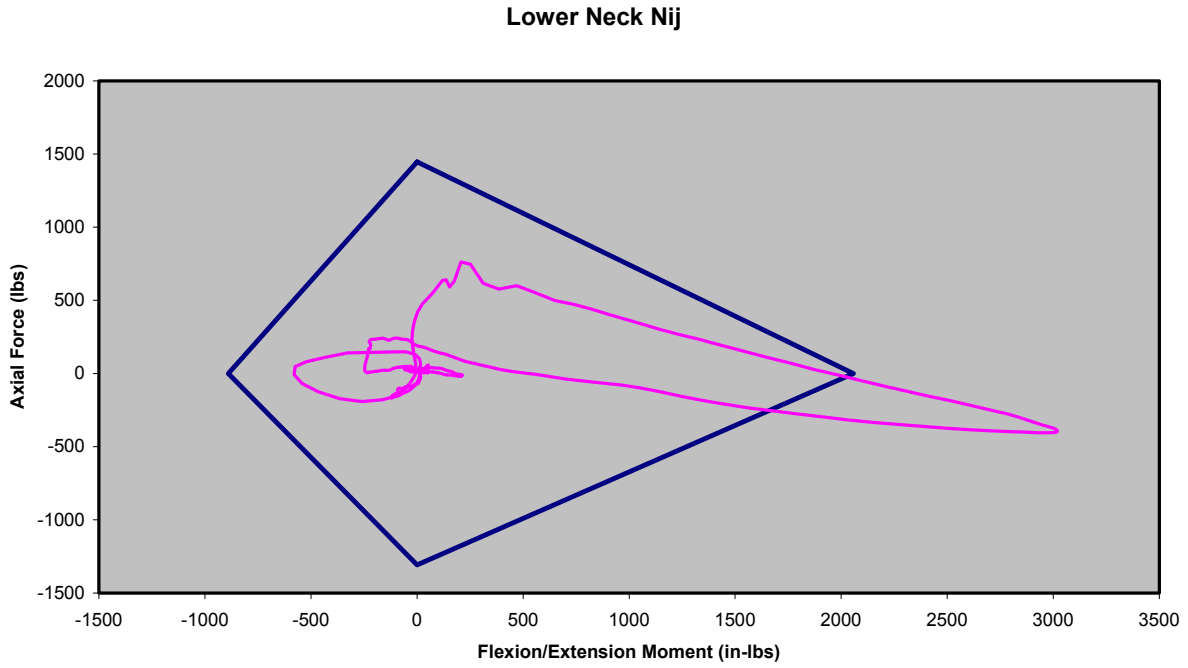

Figure B-183: Test 540 (Severe Pulse, 2.8 lb Added Head Weight)

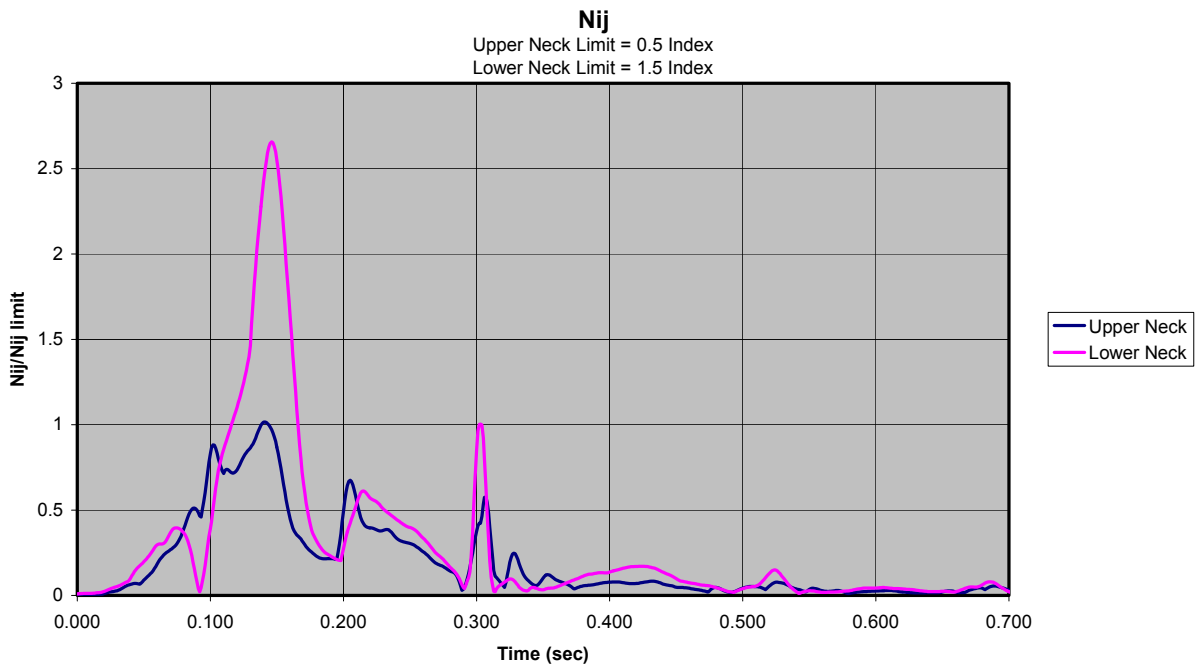

Figure B-184: Test 540 (Severe Pulse, 2.8 lb Added Head Weight)

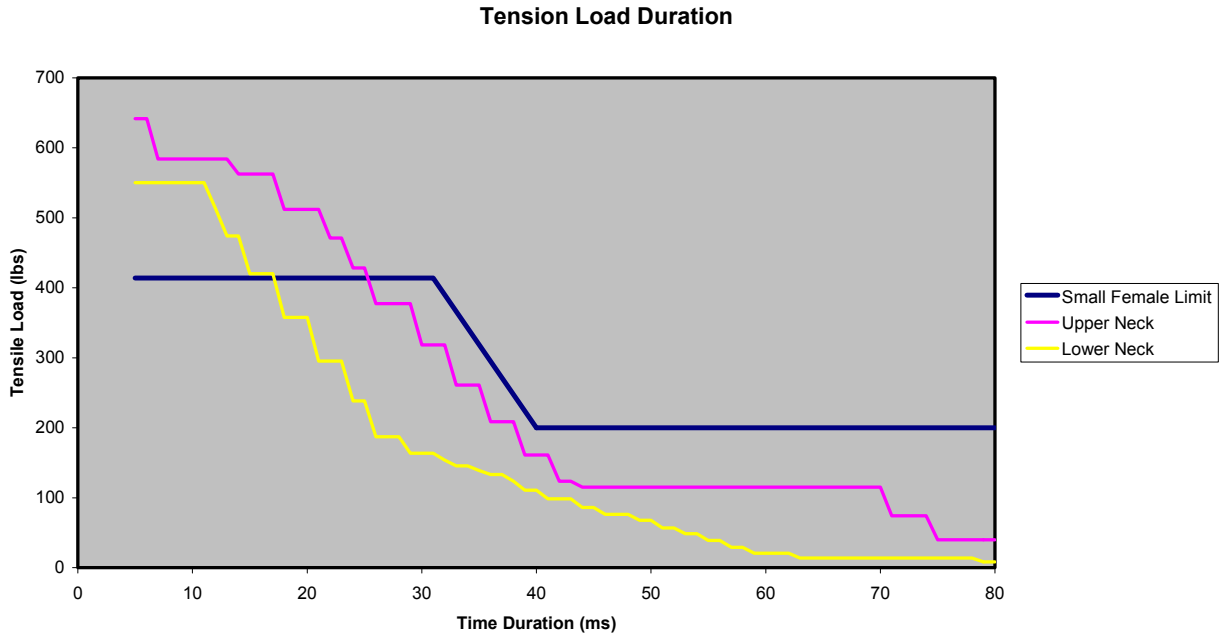

Figure B-185: Test 540 (Severe Pulse, 2.8 lb Added Head Weight)

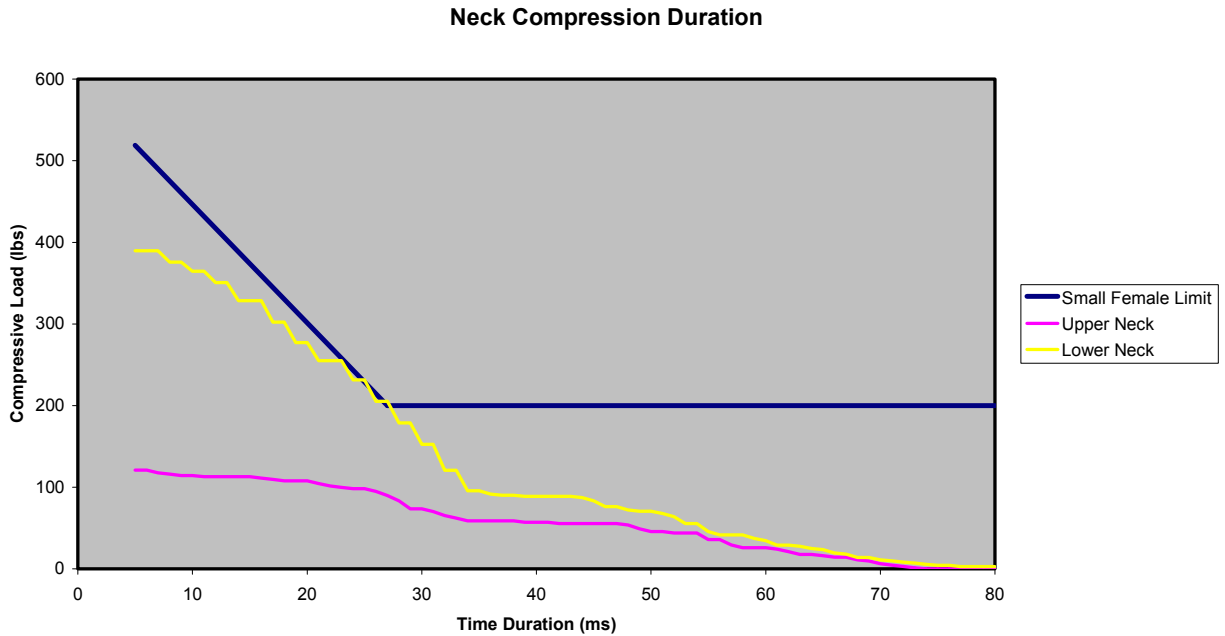

Figure B-186: Test 540 (Severe Pulse, 2.8 lb Added Head Weight)

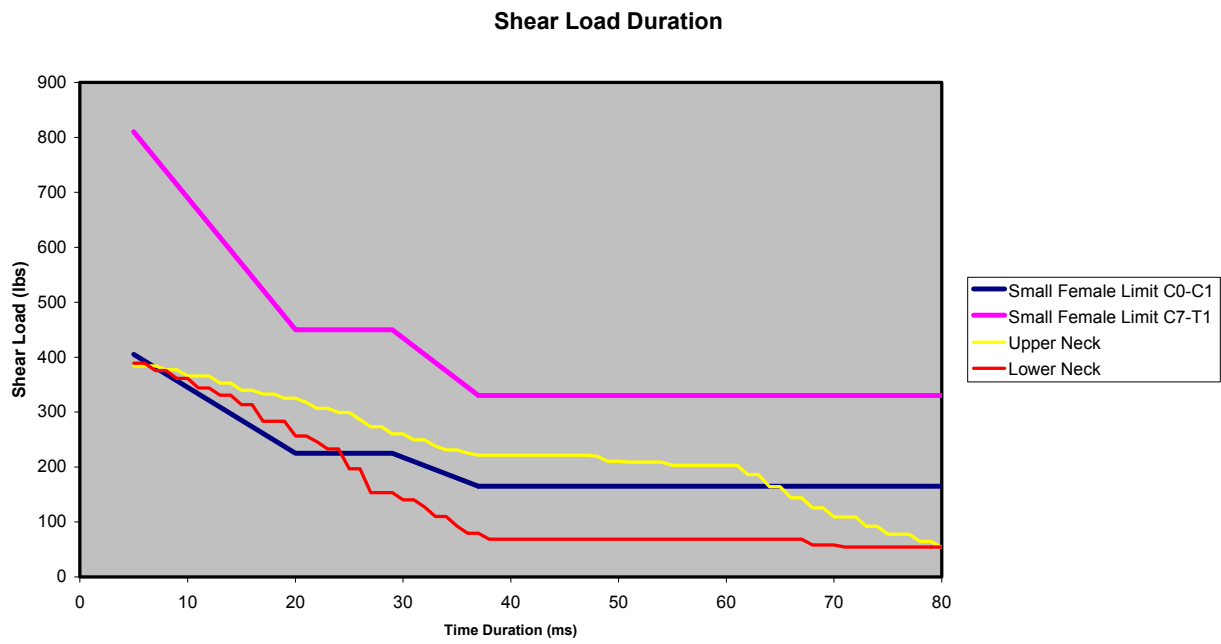

Figure B-187: Test 540 (Severe Pulse, 2.8 lb Added Head Weight)



THIS PAGE INTENTIONALLY LEFT BLANK

APPENDIX C  
FIGURES  
(MID-MALE TESTS)

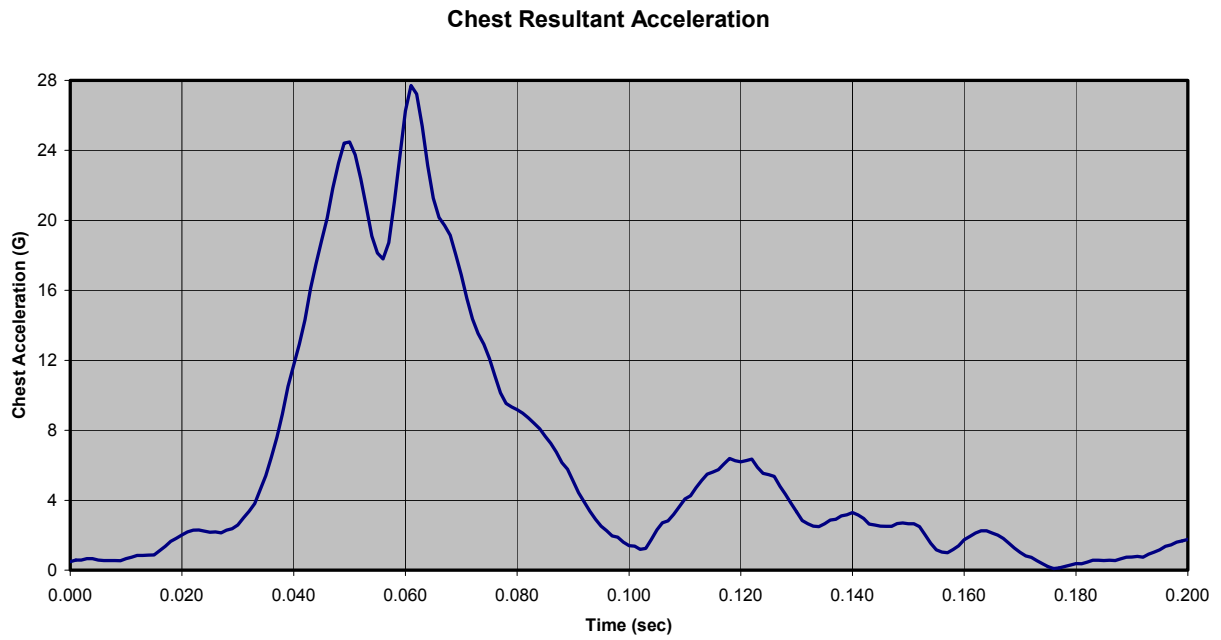

Figure C-1: Test 530 (Low Pulse, 4.0 lb Added Head Weight)

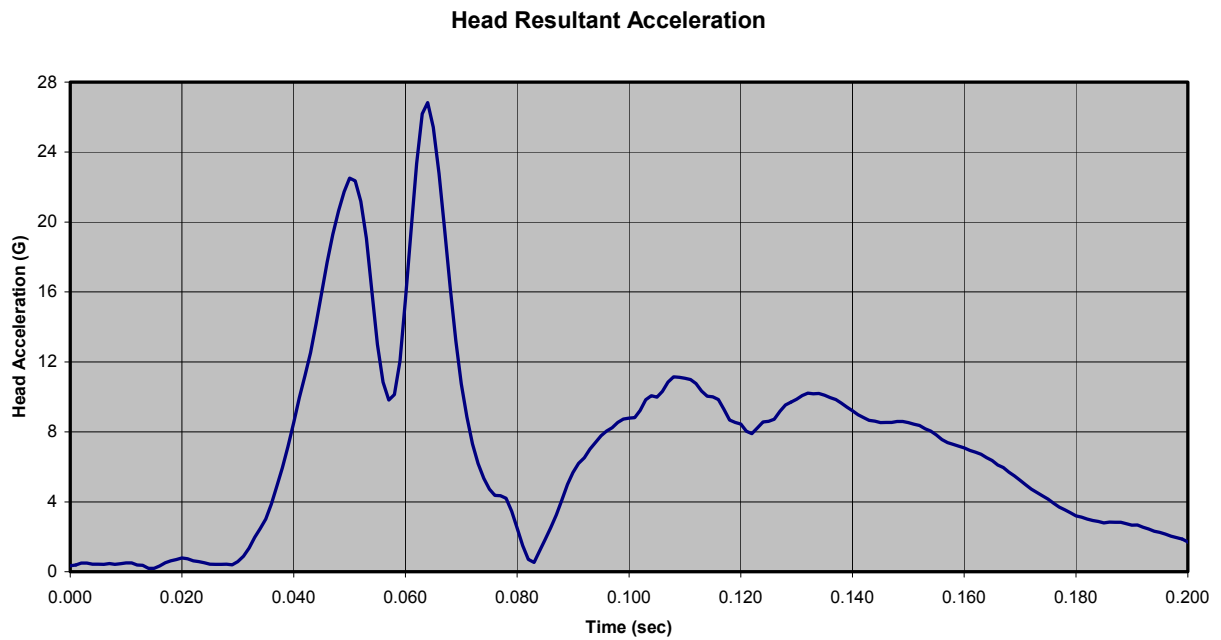

Figure C-2: Test 530 (Low Pulse, 4.0 lb Added Head Weight)

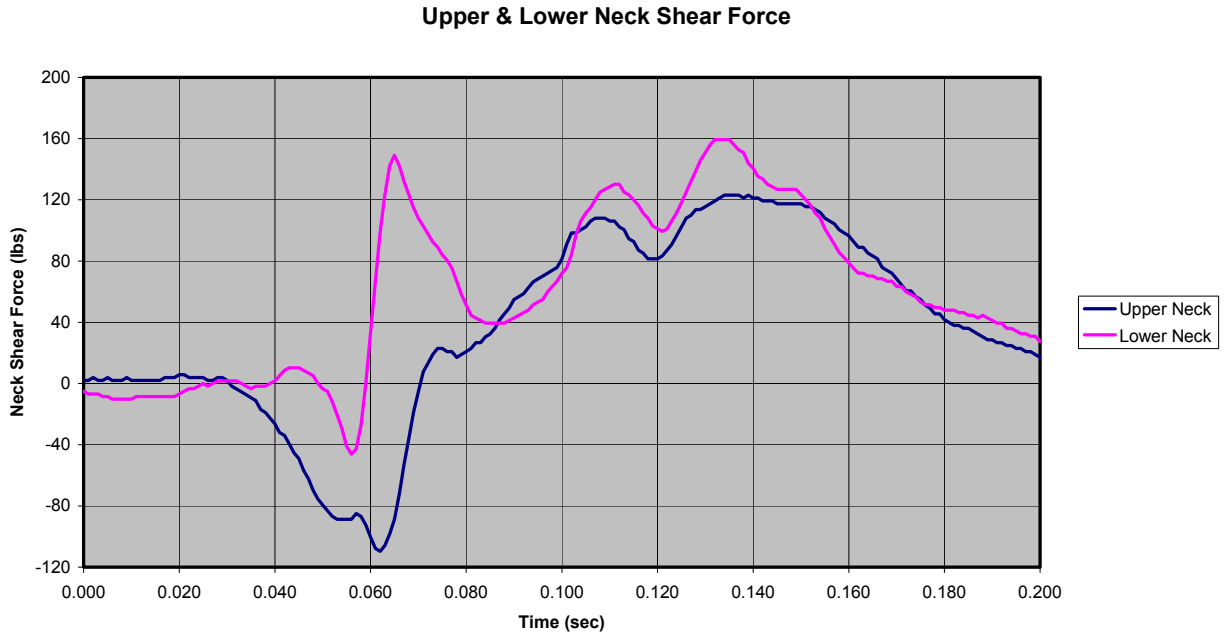

Figure C-3: Test 530 (Low Pulse, 4.0 lb Added Head Weight)

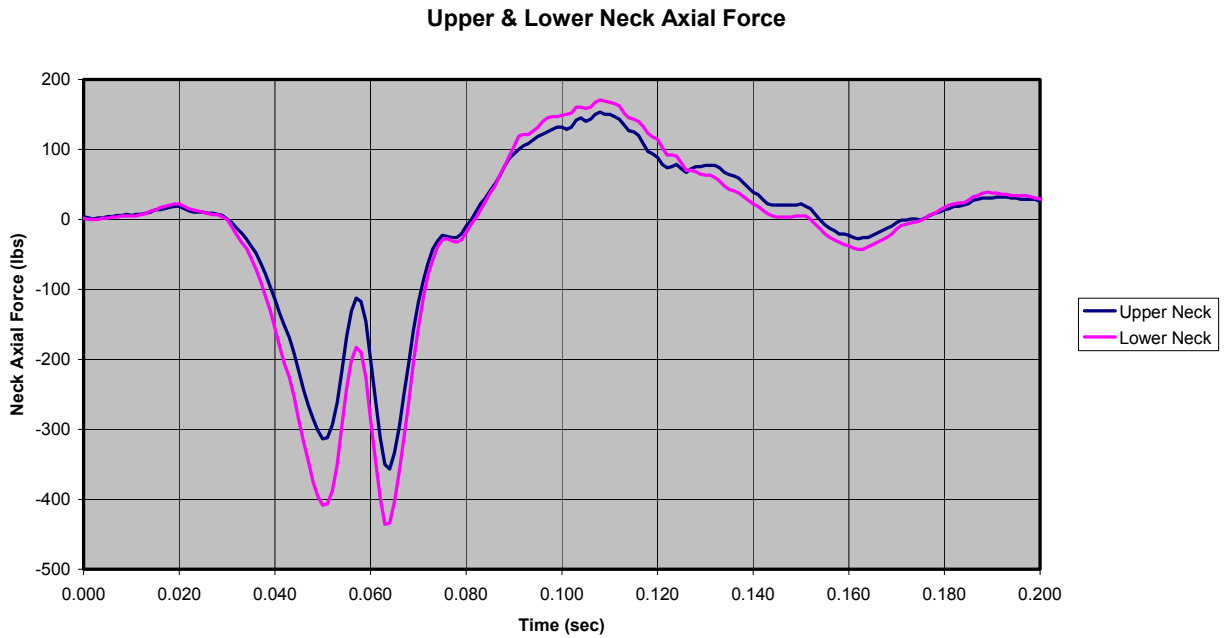

Figure C-4: Test 530 (Low Pulse, 4.0 lb Added Head Weight)

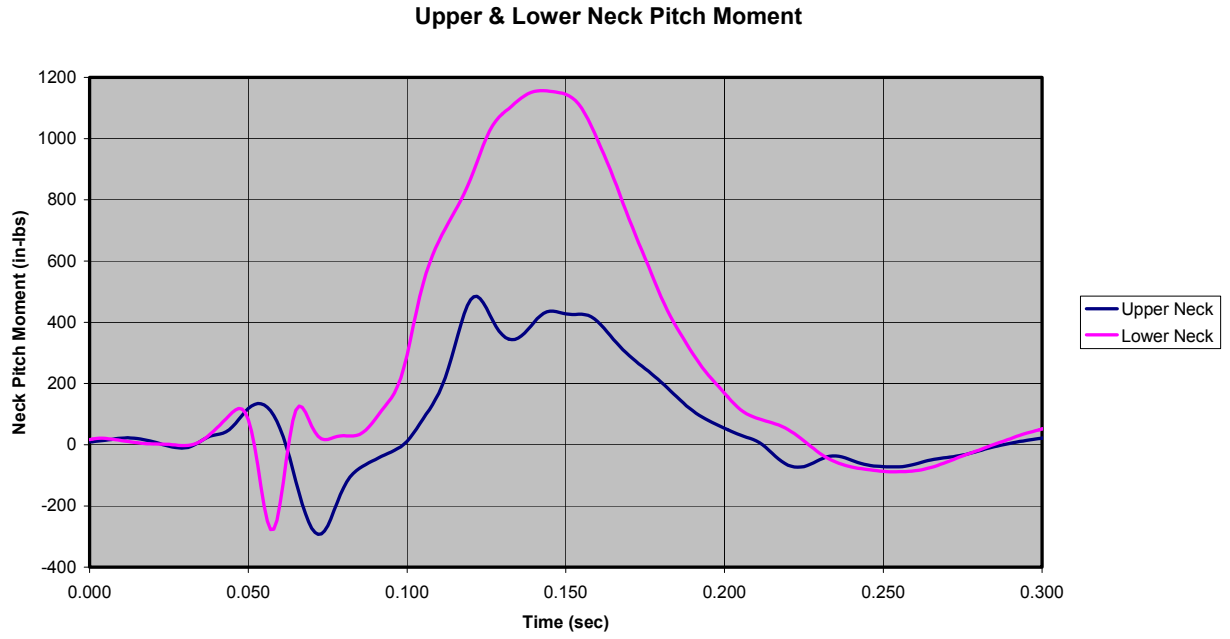

Figure C-5: Test 530 (Low Pulse, 4.0 lb Added Head Weight)

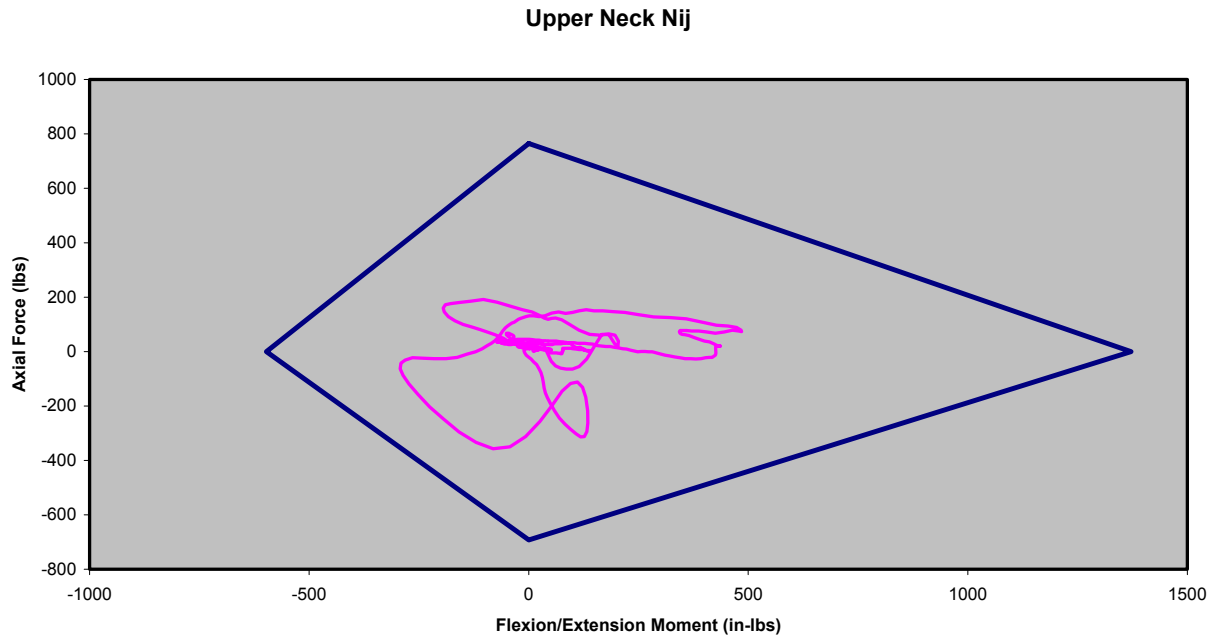

Figure C-6: Test 530 (Low Pulse, 4.0 lb Added Head Weight)

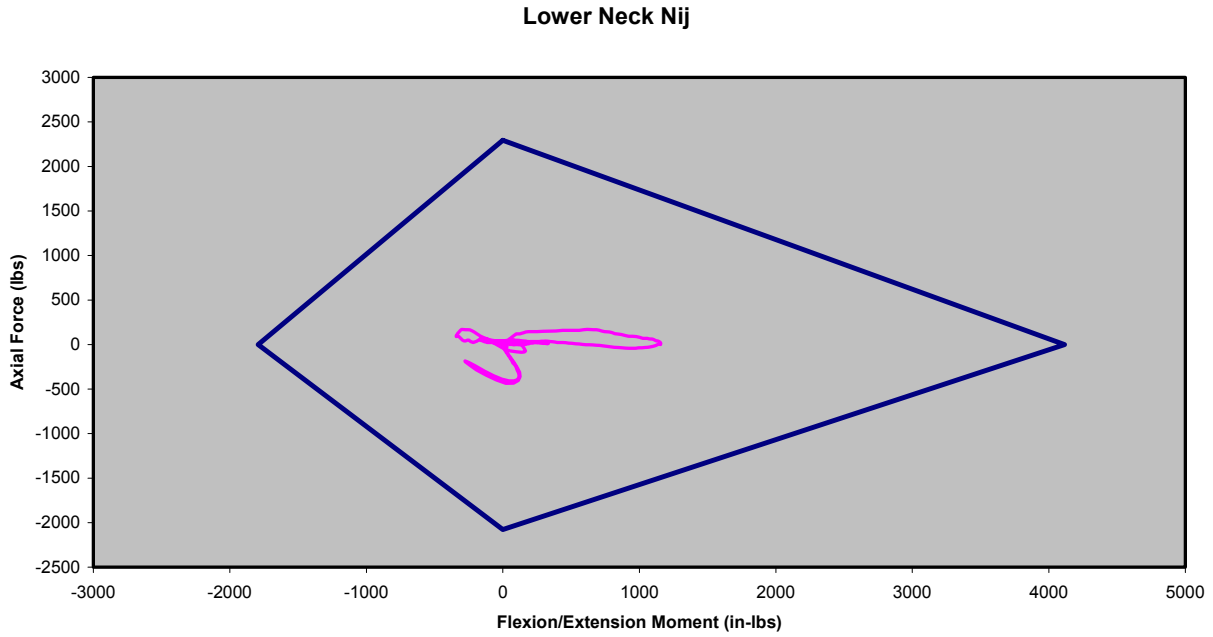

Figure C-7: Test 530 (Low Pulse, 4.0 lb Added Head Weight)

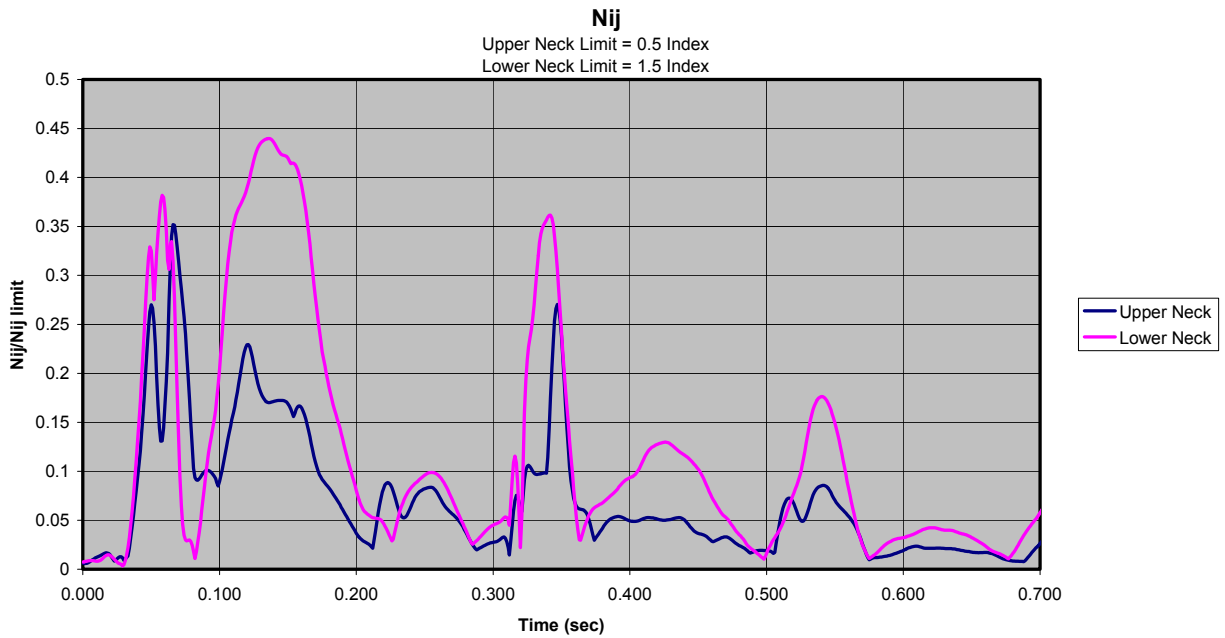

Figure C-8: Test 530 (Low Pulse, 4.0 lb Added Head Weight)

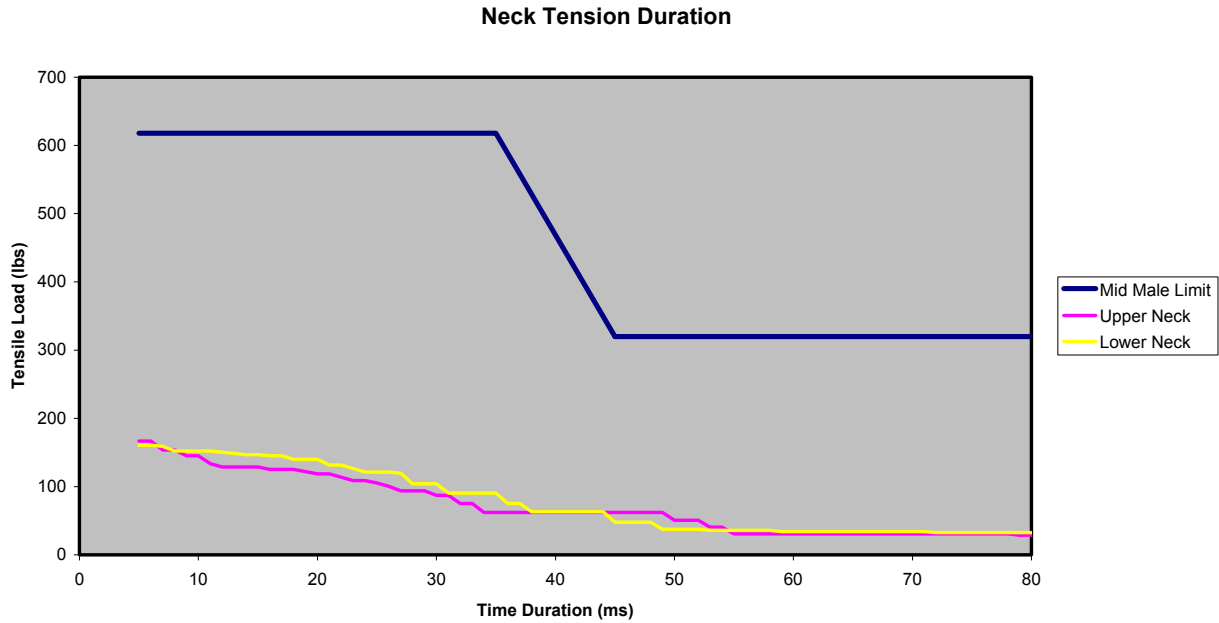

Figure C-9: Test 530 (Low Pulse, 4.0 lb Added Head Weight)

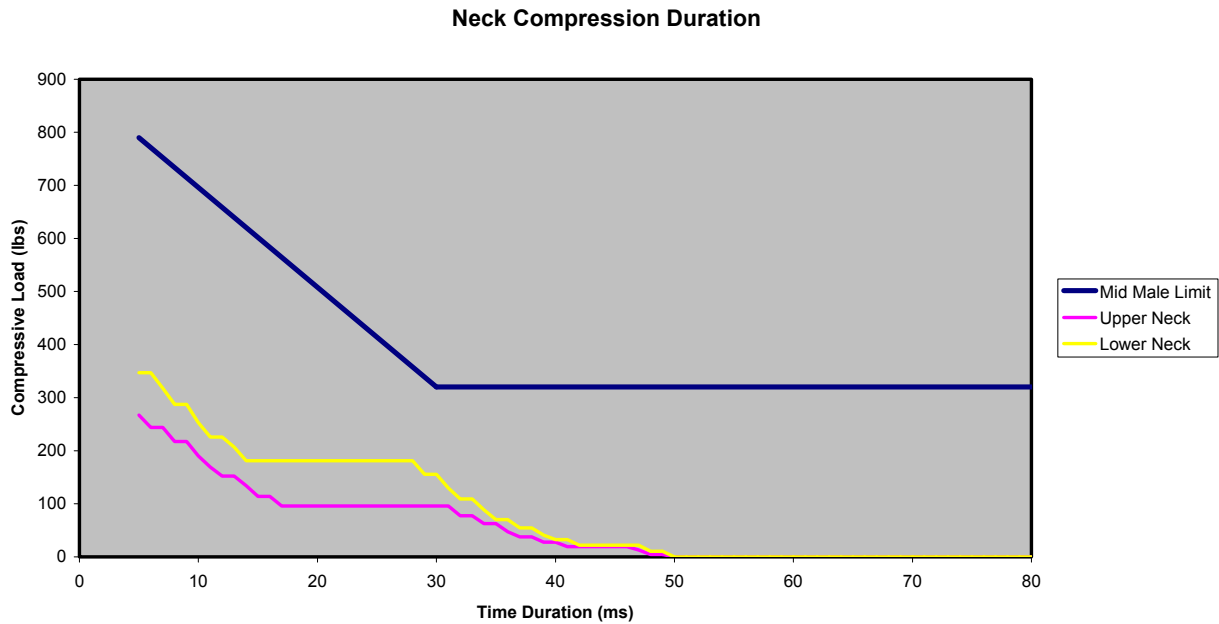

Figure C-10: Test 530 (Low Pulse, 4.0 lb Added Head Weight)

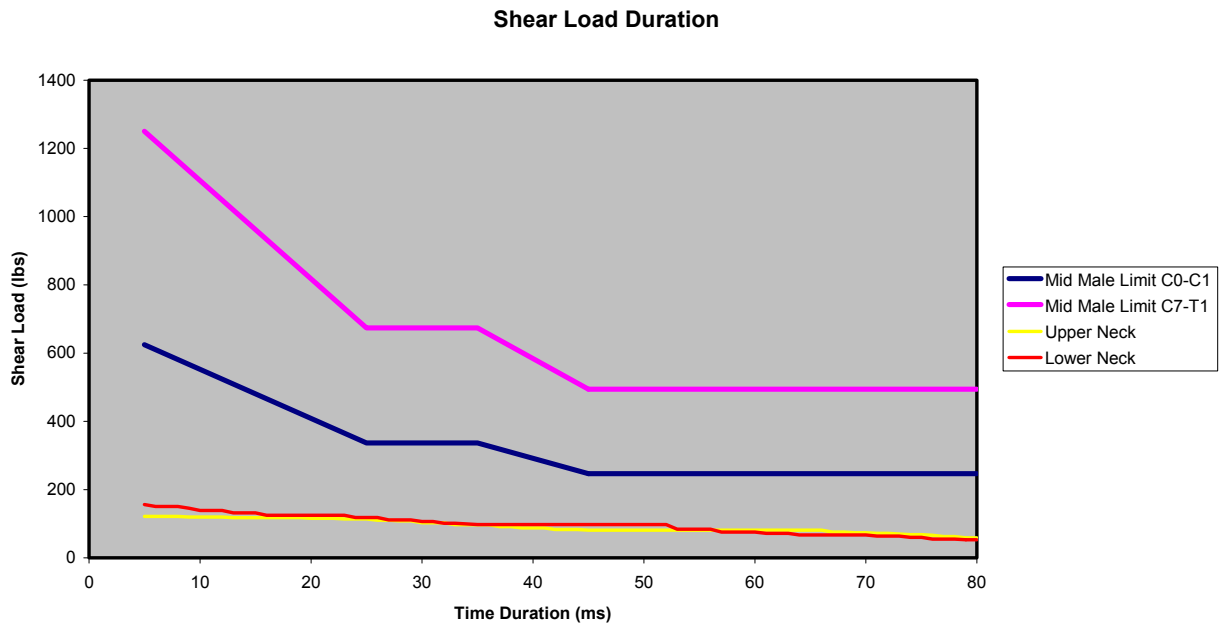

Figure C-11: Test 530 (Low Pulse, 4.0 lb Added Head Weight)

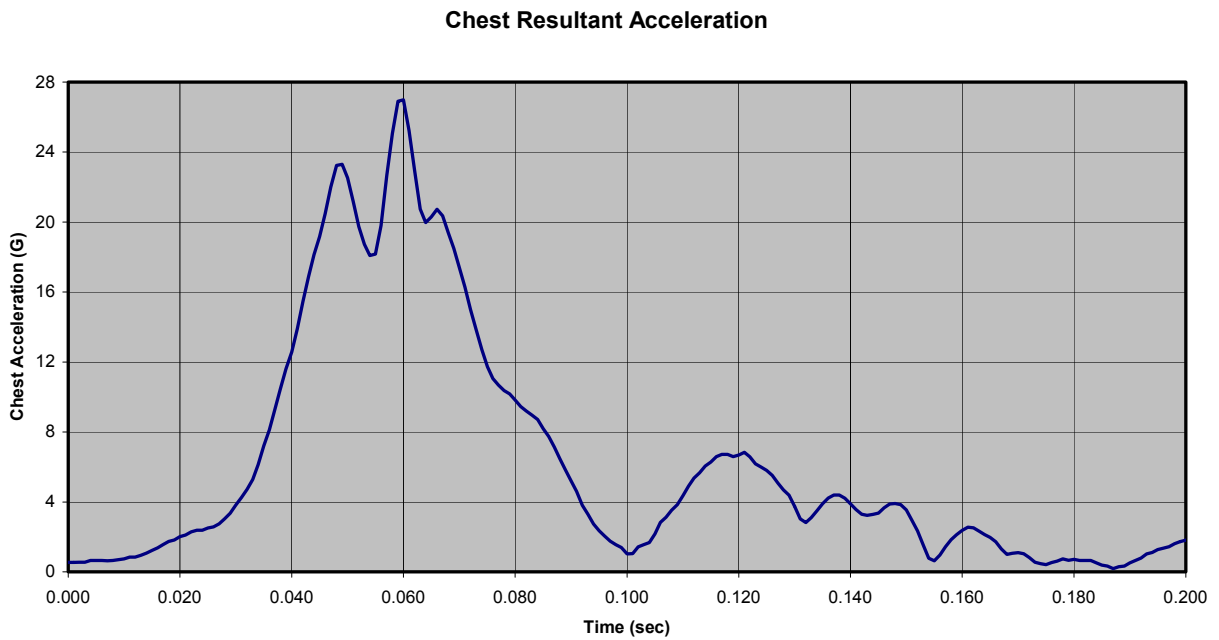

Figure C-12: Test 531 (Low Pulse, 6.0 lb Added Head Weight)



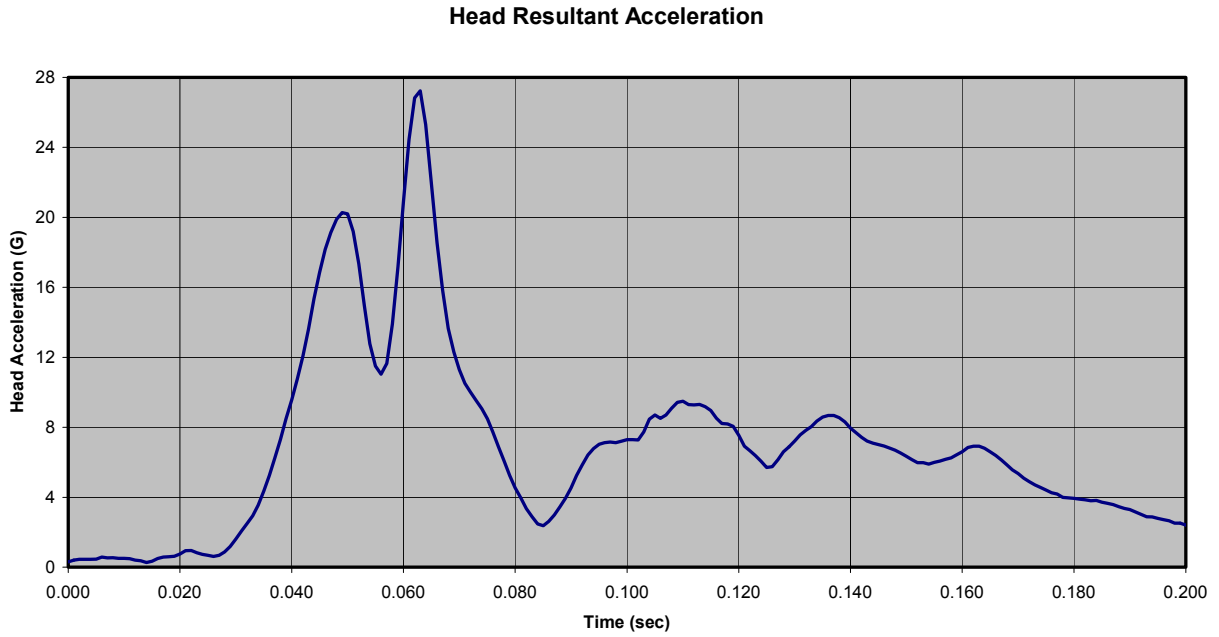

Figure C-13: Test 531 (Low Pulse, 6.0 lb Added Head Weight)

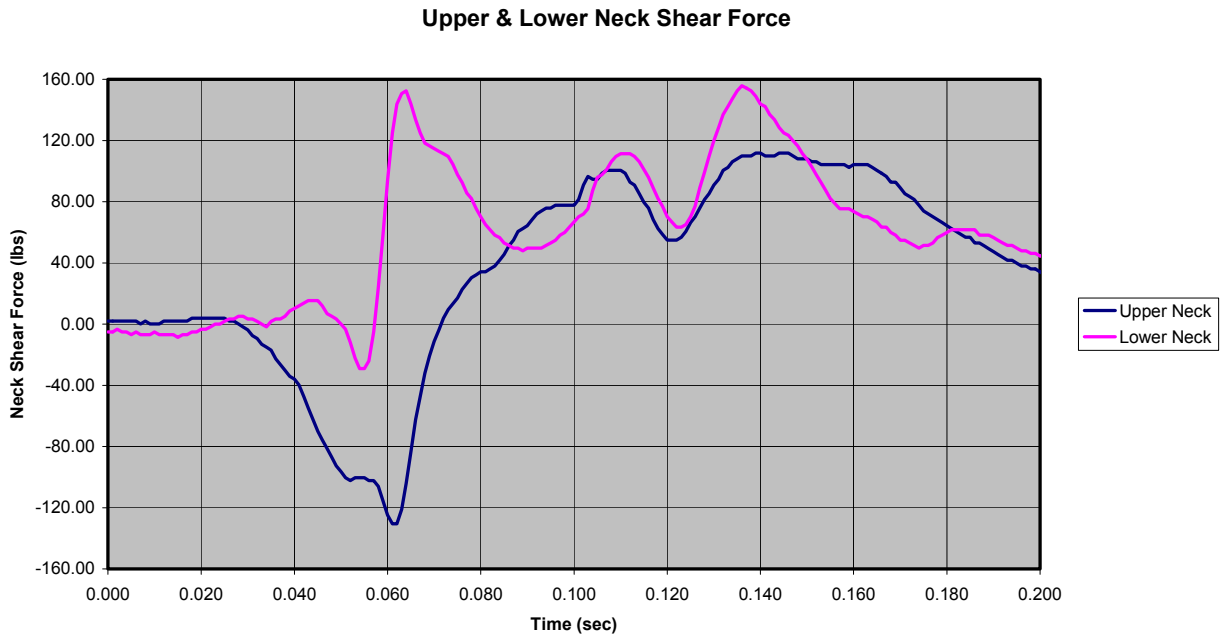

Figure C-14: Test 531 (Low Pulse, 6.0 lb Added Head Weight)

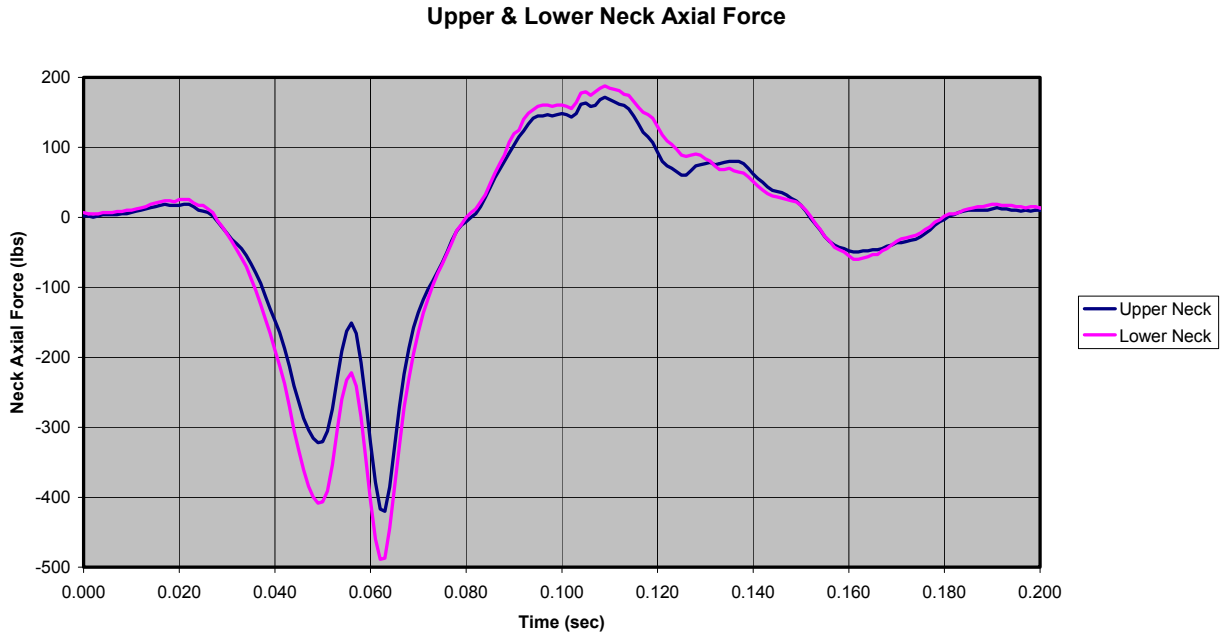

Figure C-15: Test 531 (Low Pulse, 6.0 lb Added Head Weight)

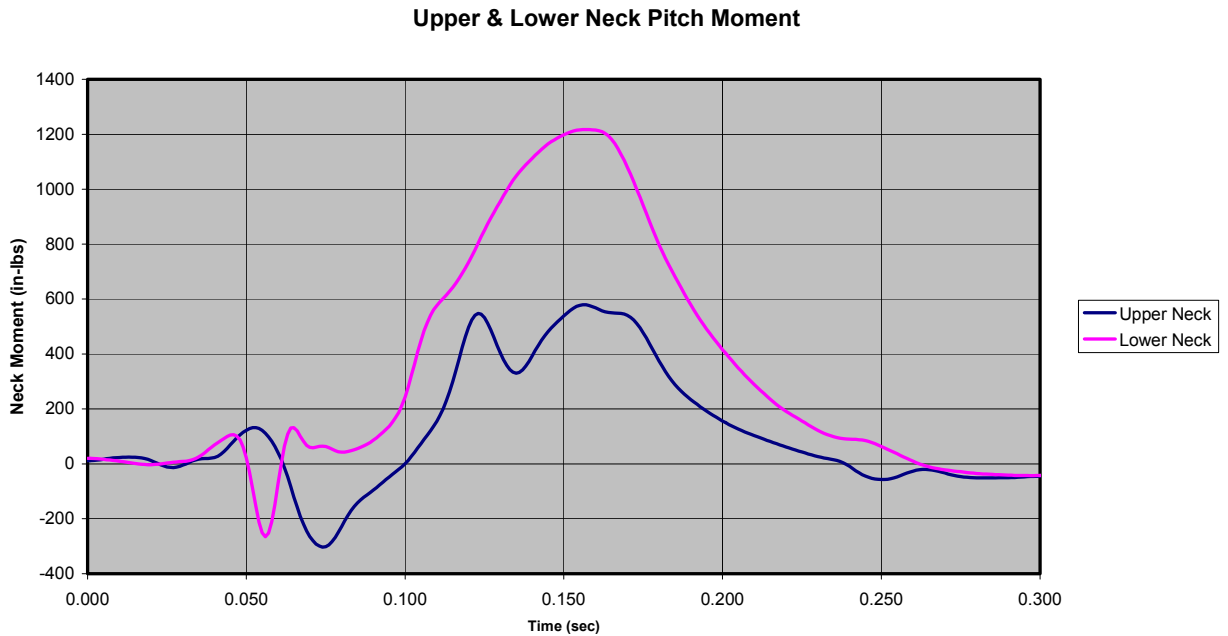

Figure C-16: Test 531 (Low Pulse, 6.0 lb Added Head Weight)

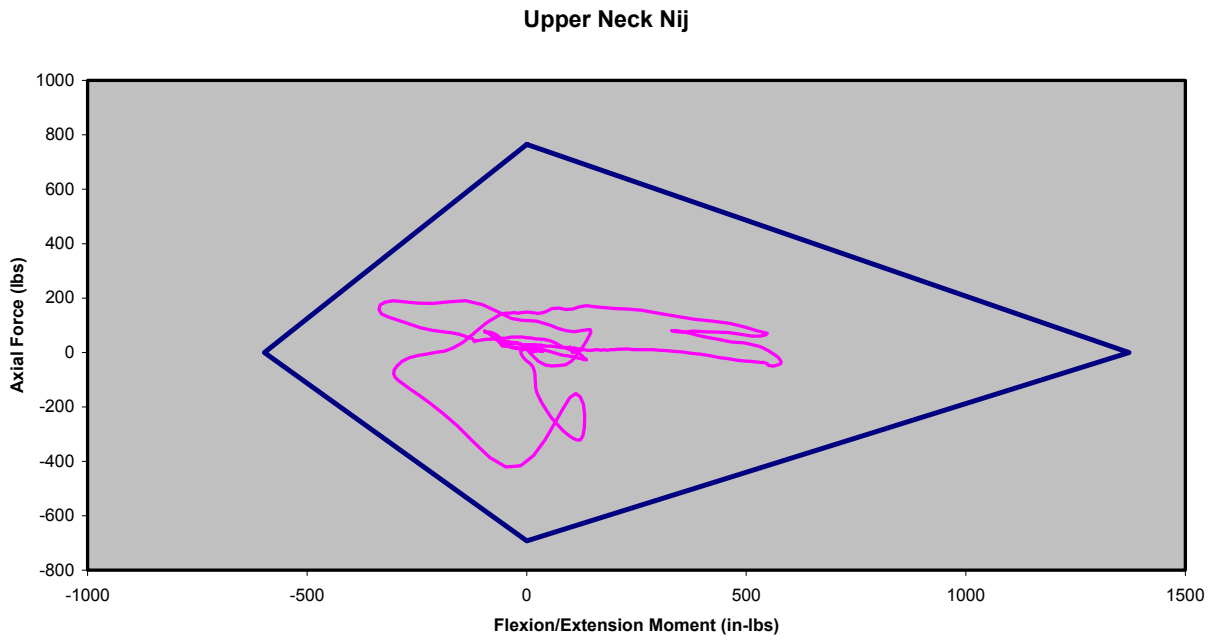

Figure C-17: Test 531 (Low Pulse, 6.0 lb Added Head Weight)

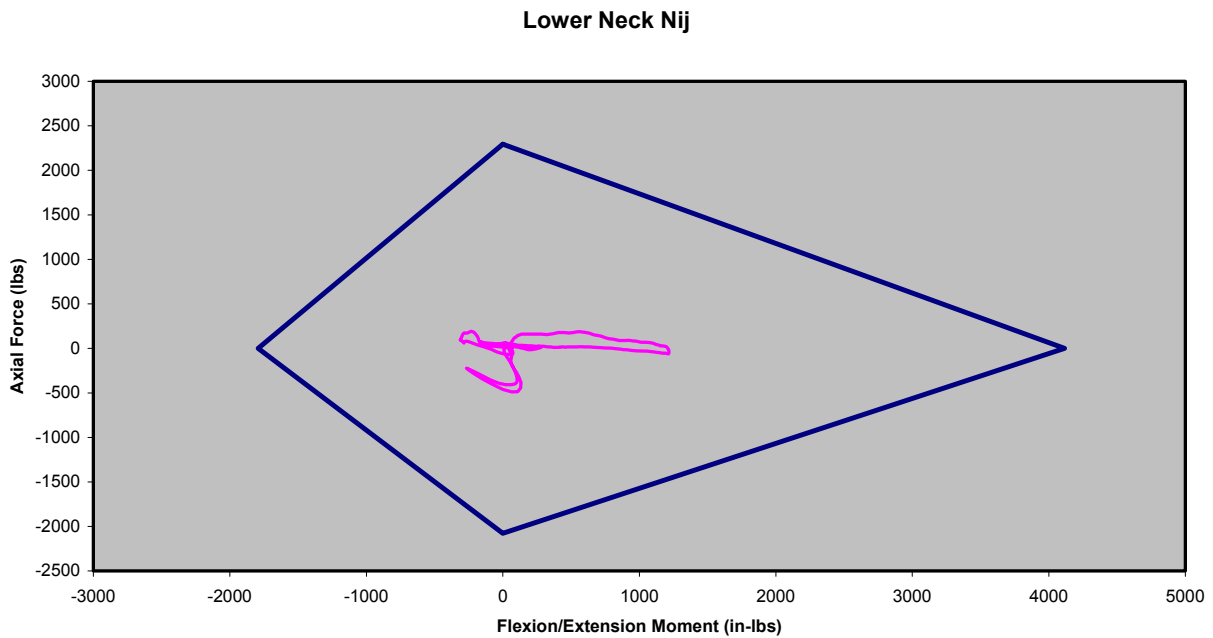

Figure C-18: Test 531 (Low Pulse, 6.0 lb Added Head Weight)

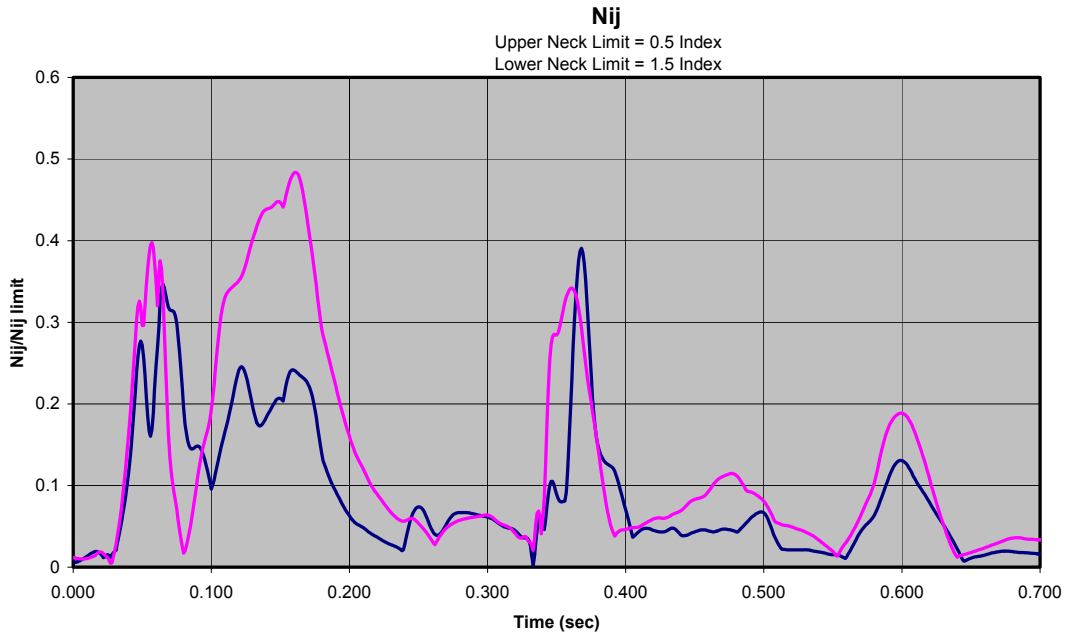

Figure C-19: Test 531 (Low Pulse, 6.0 lb Added Head Weight)

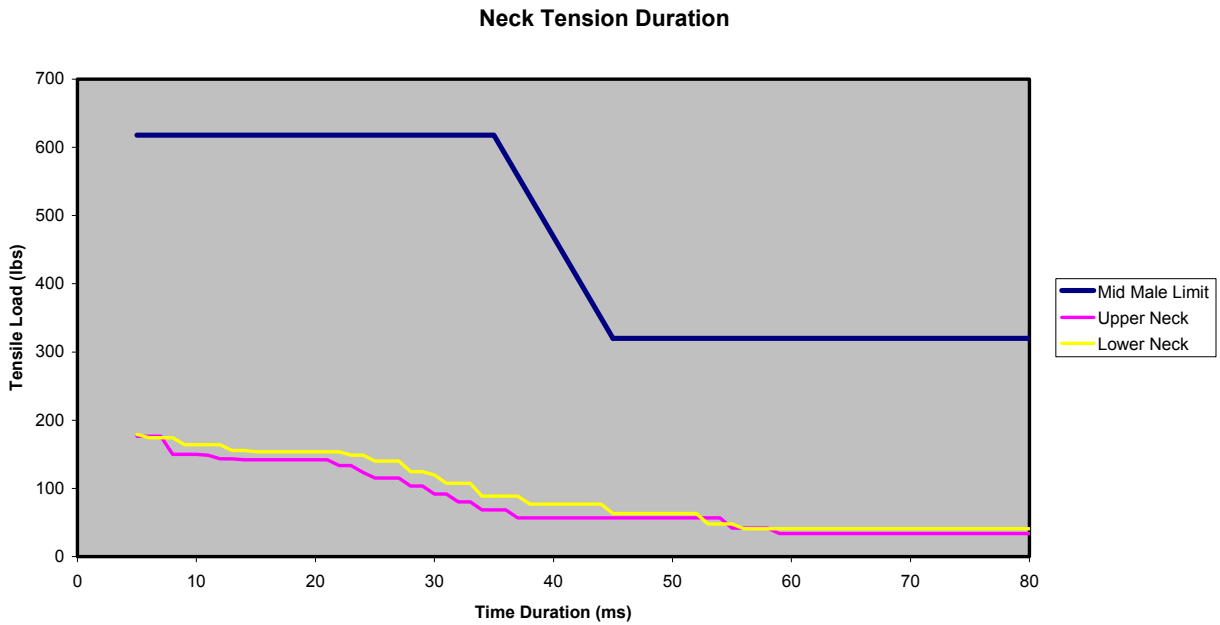

Figure C-20: Test 531 (Low Pulse, 6.0 lb Added Head Weight)

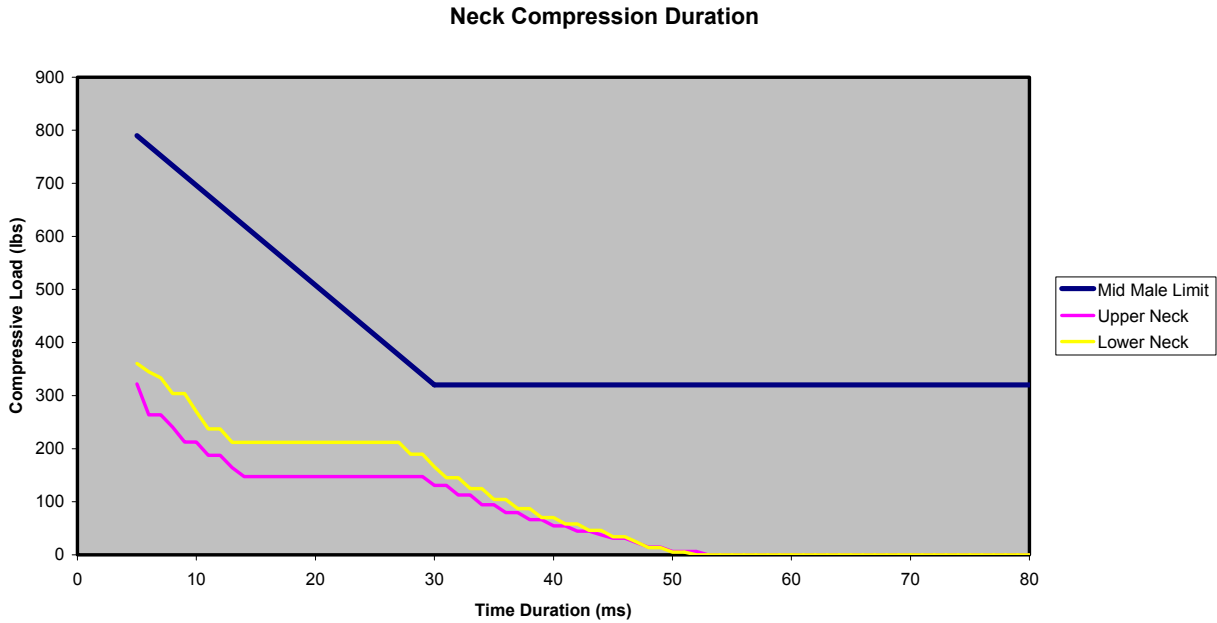

Figure C-21: Test 531 (Low Pulse, 6.0 lb Added Head Weight)

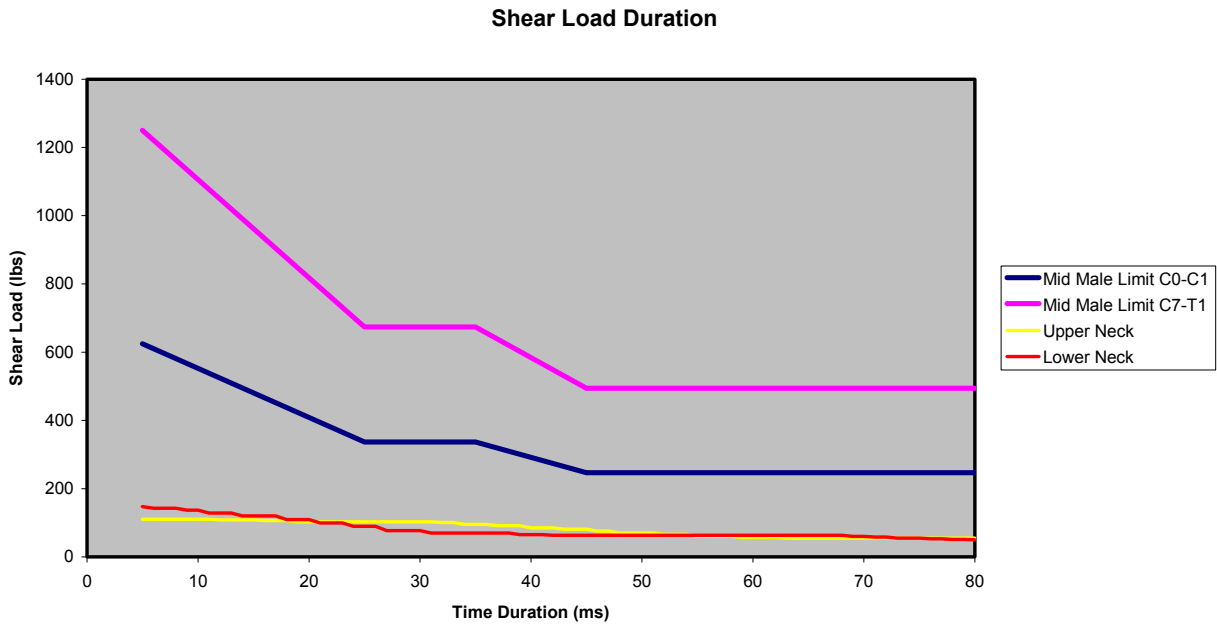

Figure C-22: Test 531 (Low Pulse, 6.0 lb Added Head Weight)

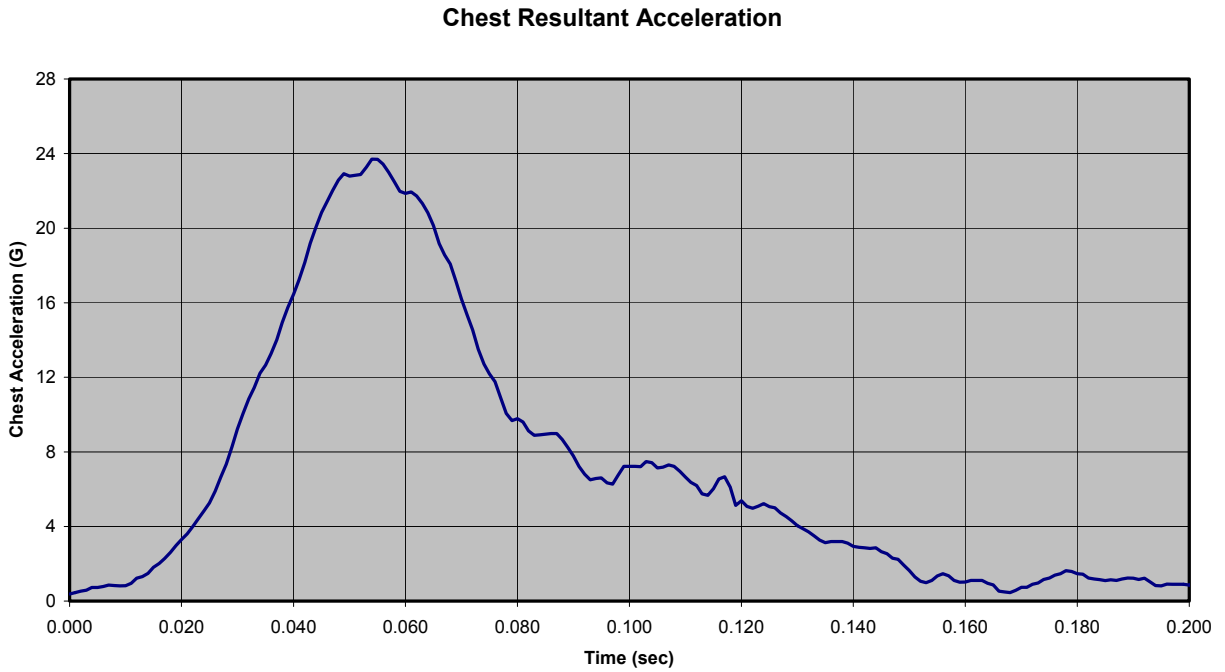

Figure C-23: Test 524 (Medium Pulse, 4.0 lb Added Head Weight)

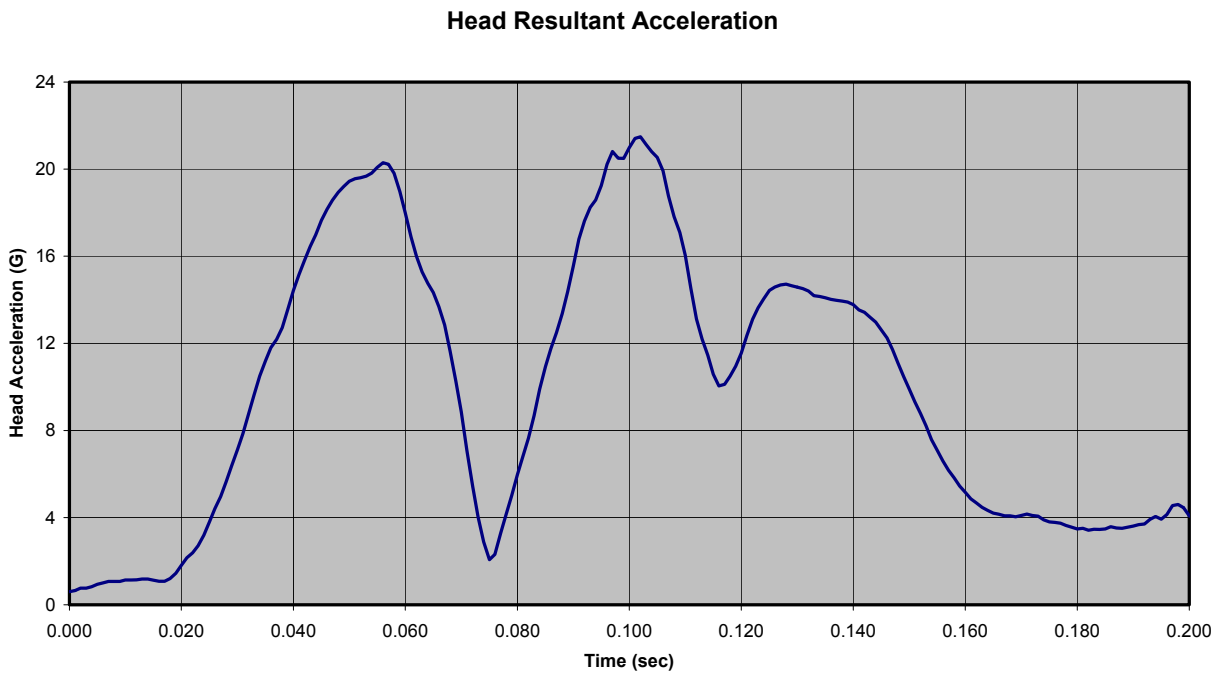

Figure C-24: Test 524 (Medium Pulse, 4.0 lb Added Head Weight)

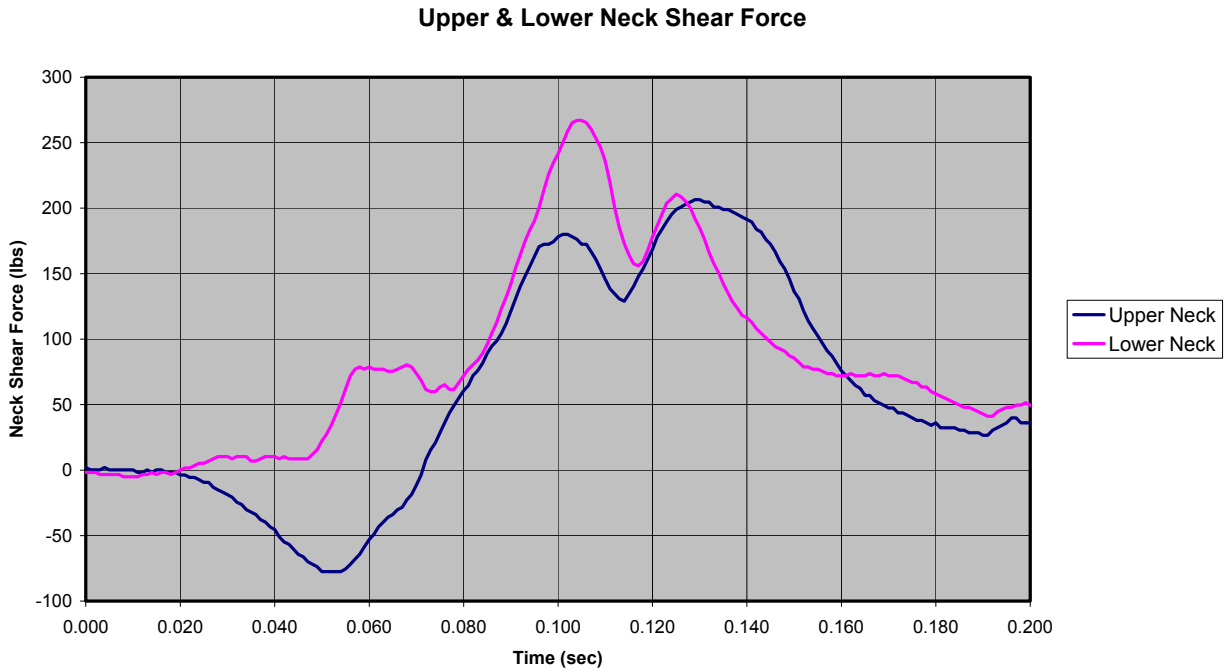

Figure C-25: Test 524 (Medium Pulse, 4.0 lb Added Head Weight)

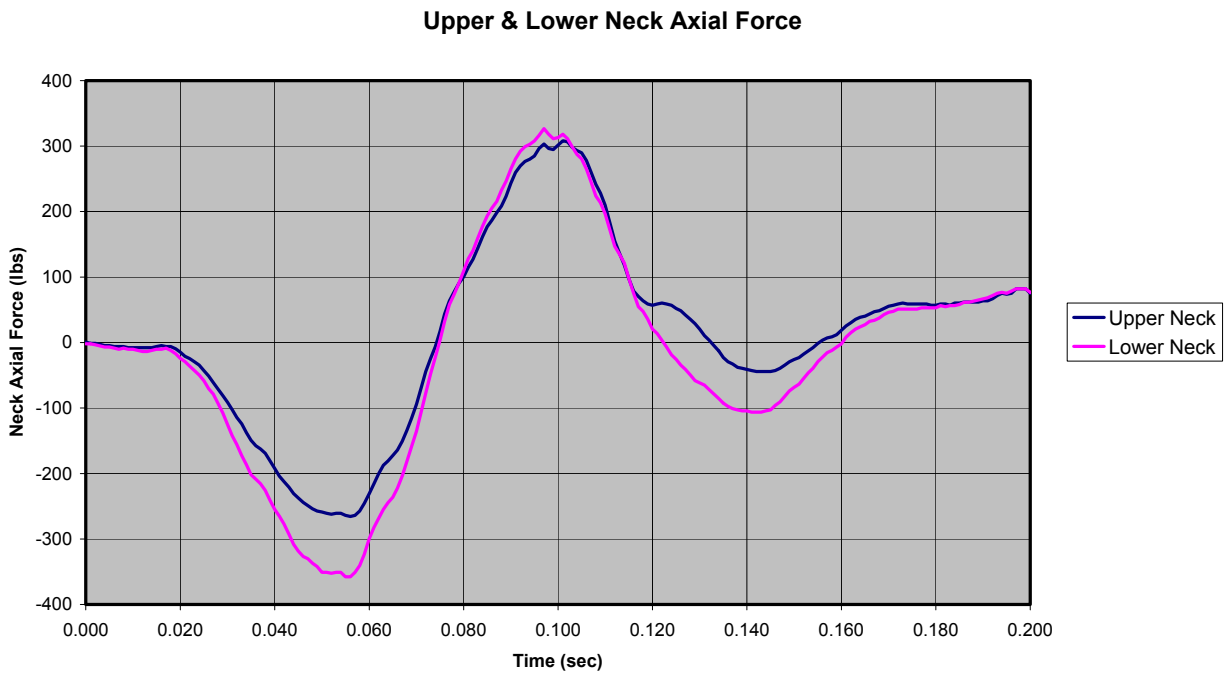

Figure C-26: Test 524 (Medium Pulse, 4.0 lb Added Head Weight)

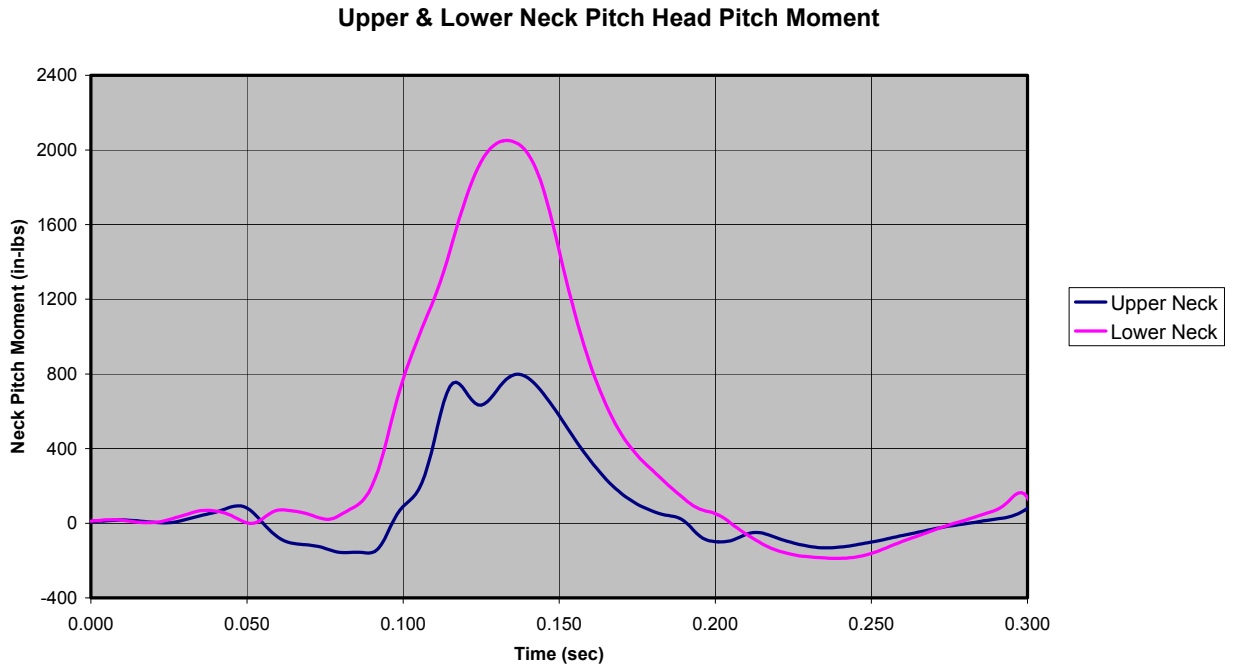

Figure C-27: Test 524 (Medium Pulse, 4.0 lb Added Head Weight)

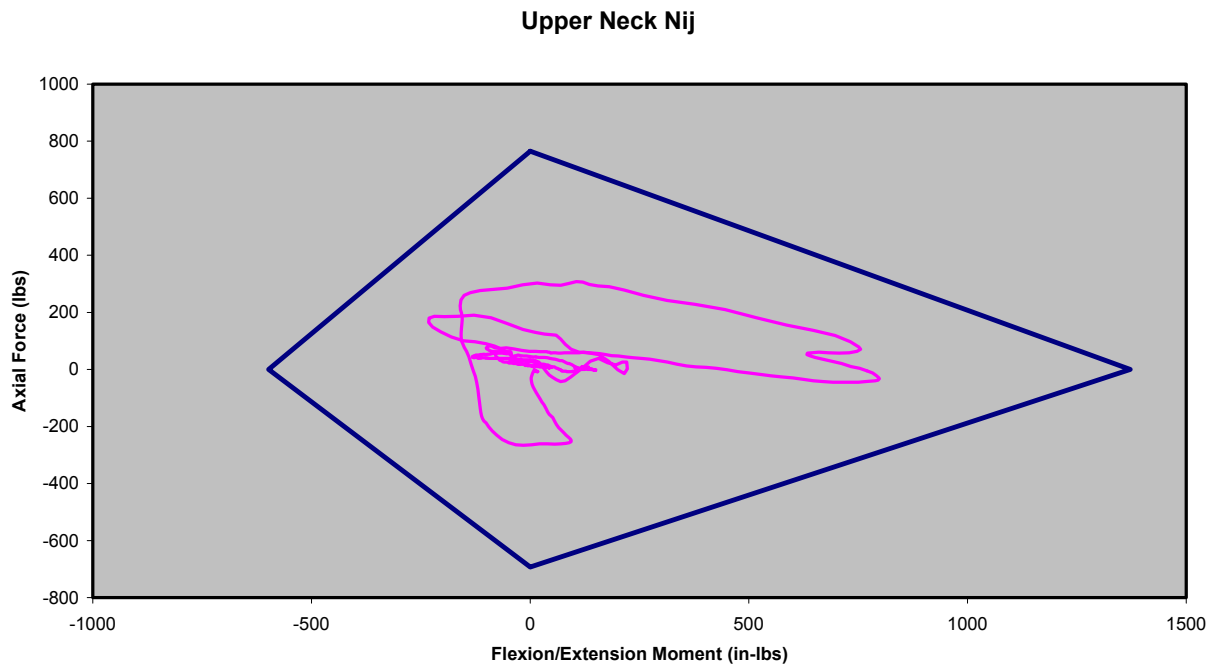

Figure C-28: Test 524 (Medium Pulse, 4.0 lb Added Head Weight)



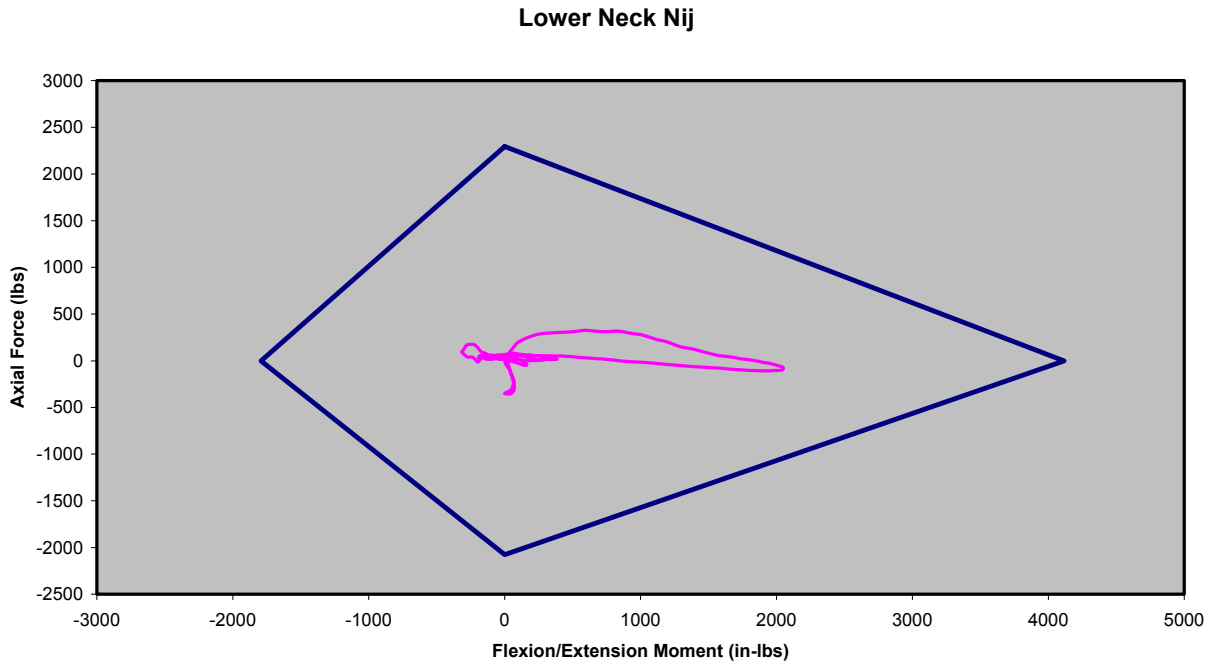

Figure C-29: Test 524 (Medium Pulse, 4.0 lb Added Head Weight)

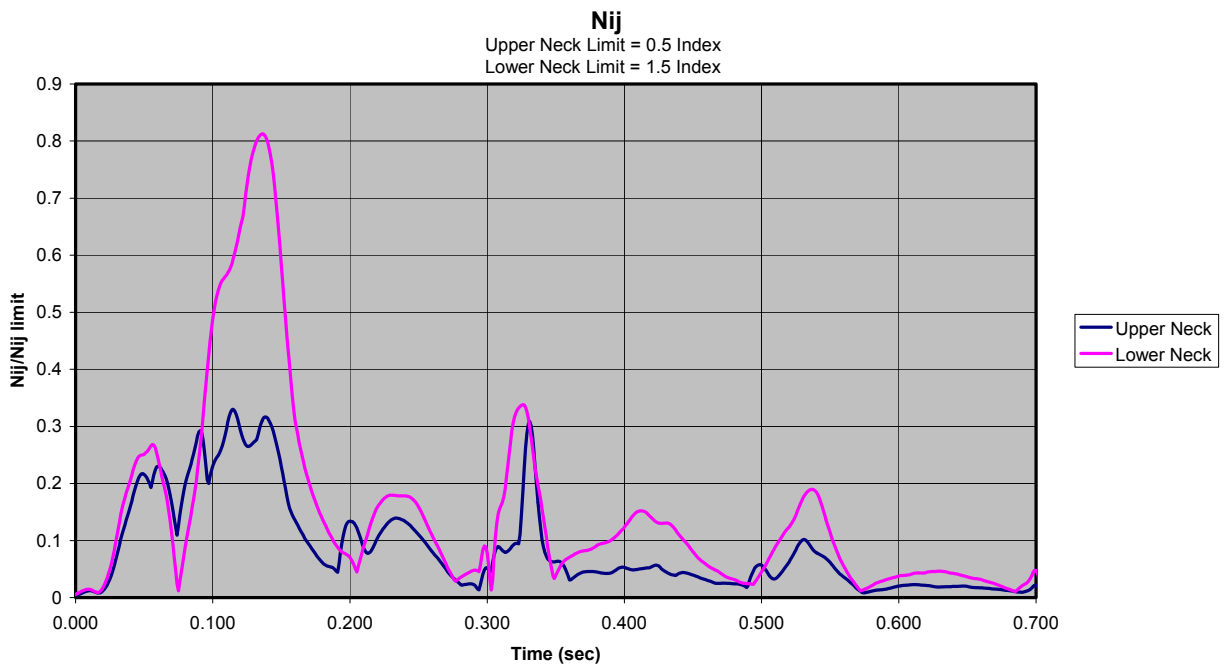

Figure C-30: Test 524 (Medium Pulse, 4.0 lb Added Head Weight)

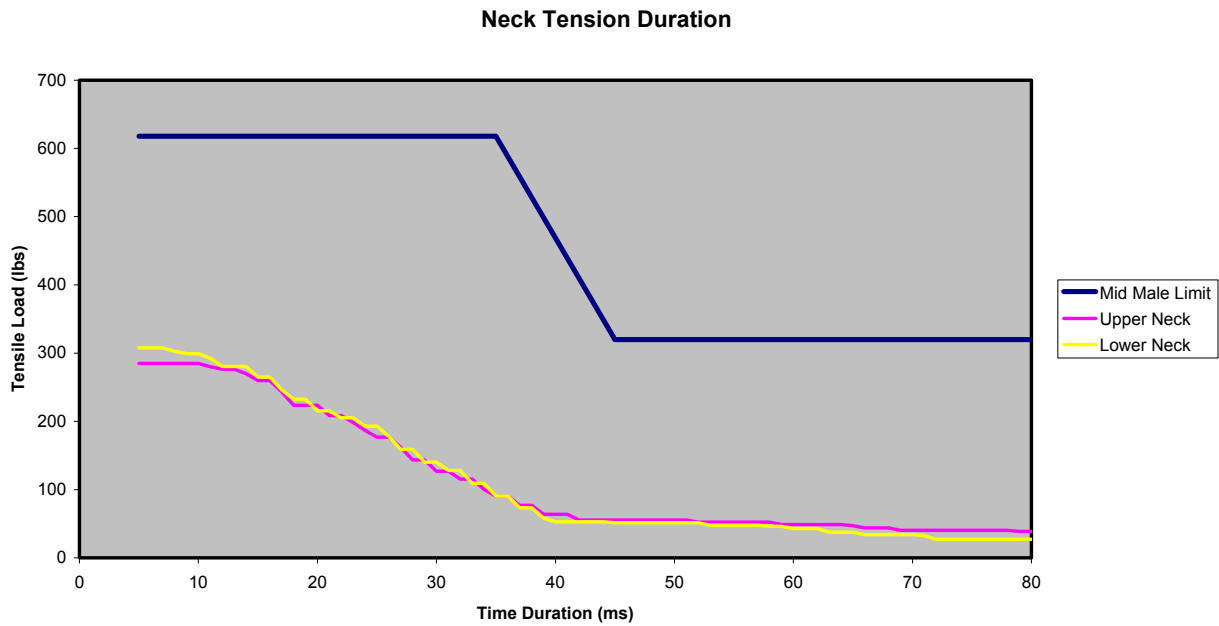

Figure C-31: Test 524 (Medium Pulse, 4.0 lb Added Head Weight)

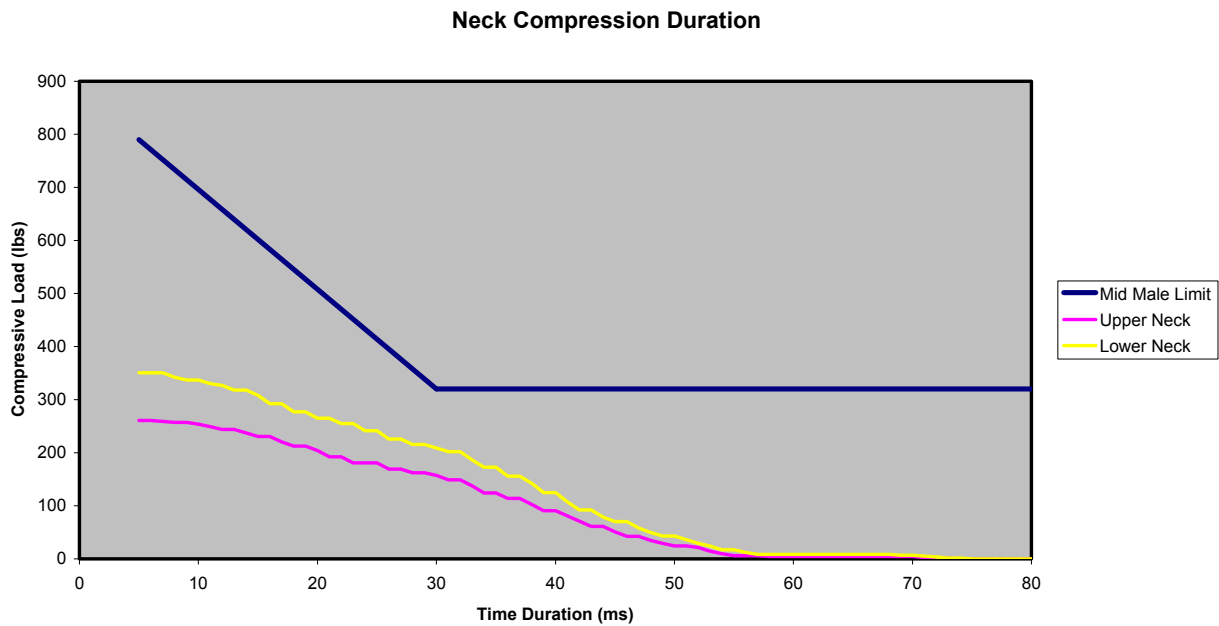

Figure C-32: Test 524 (Medium Pulse, 4.0 lb Added Head Weight)

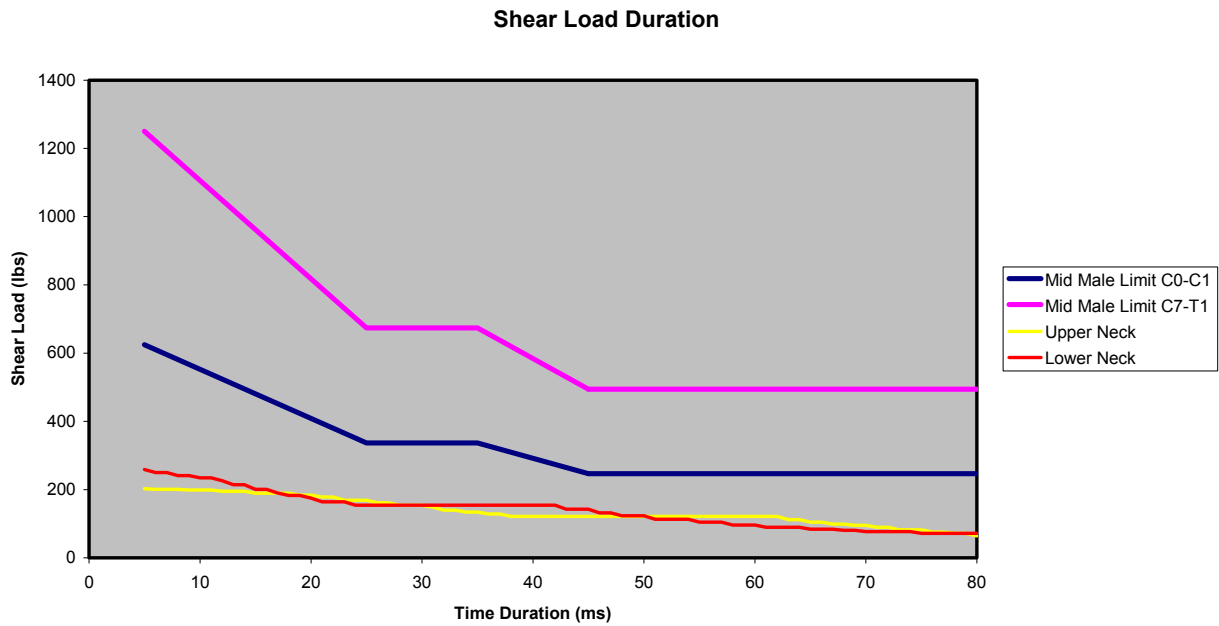

Figure C-33: Test 524 (Medium Pulse, 4.0 lb Added Head Weight)

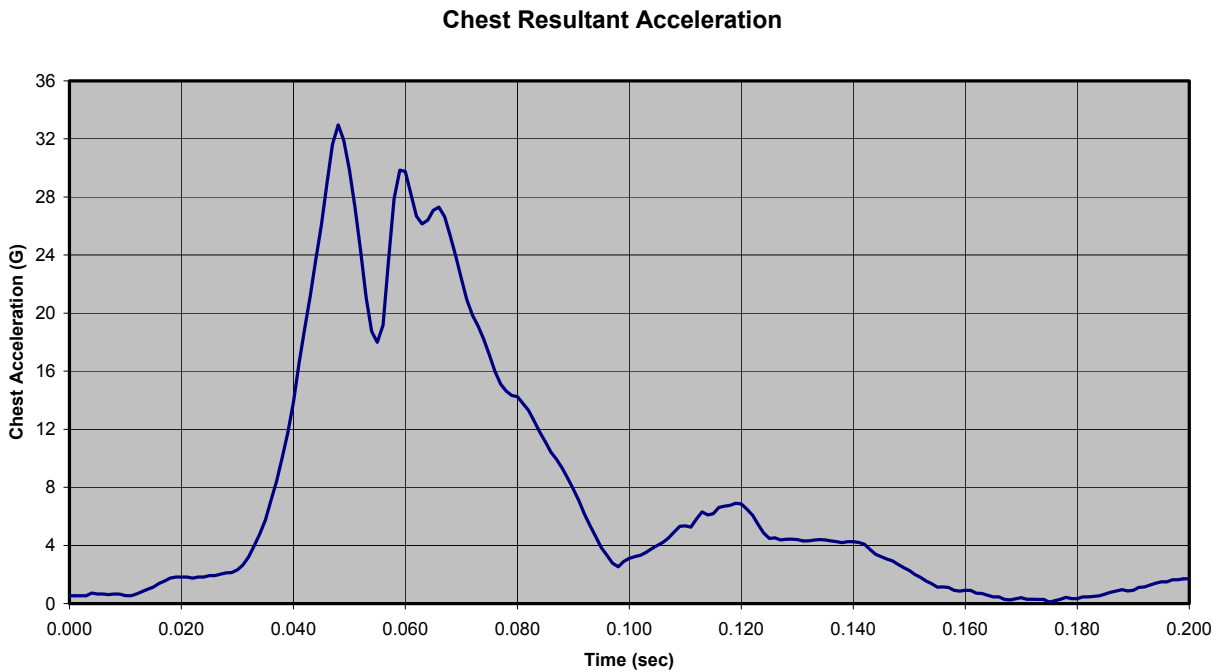

Figure C-34: Test 525 (Medium Pulse, 4.5 lb Added Head Weight)

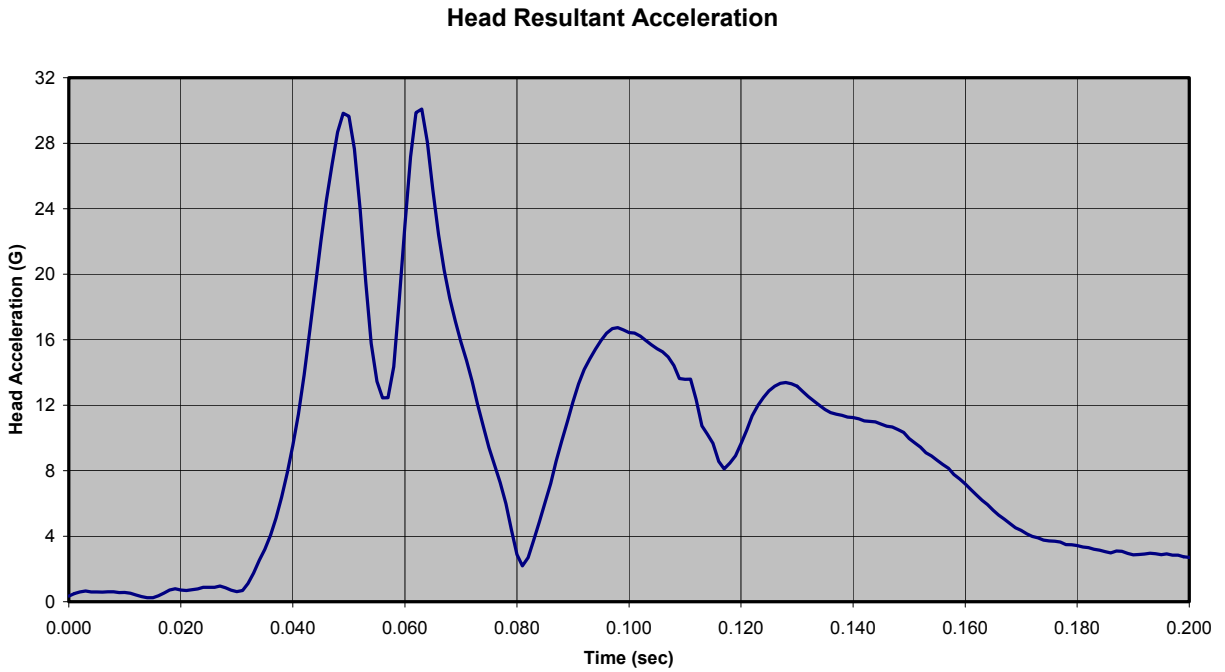

Figure C-35: Test 525 (Medium Pulse, 4.5 lb Added Head Weight)

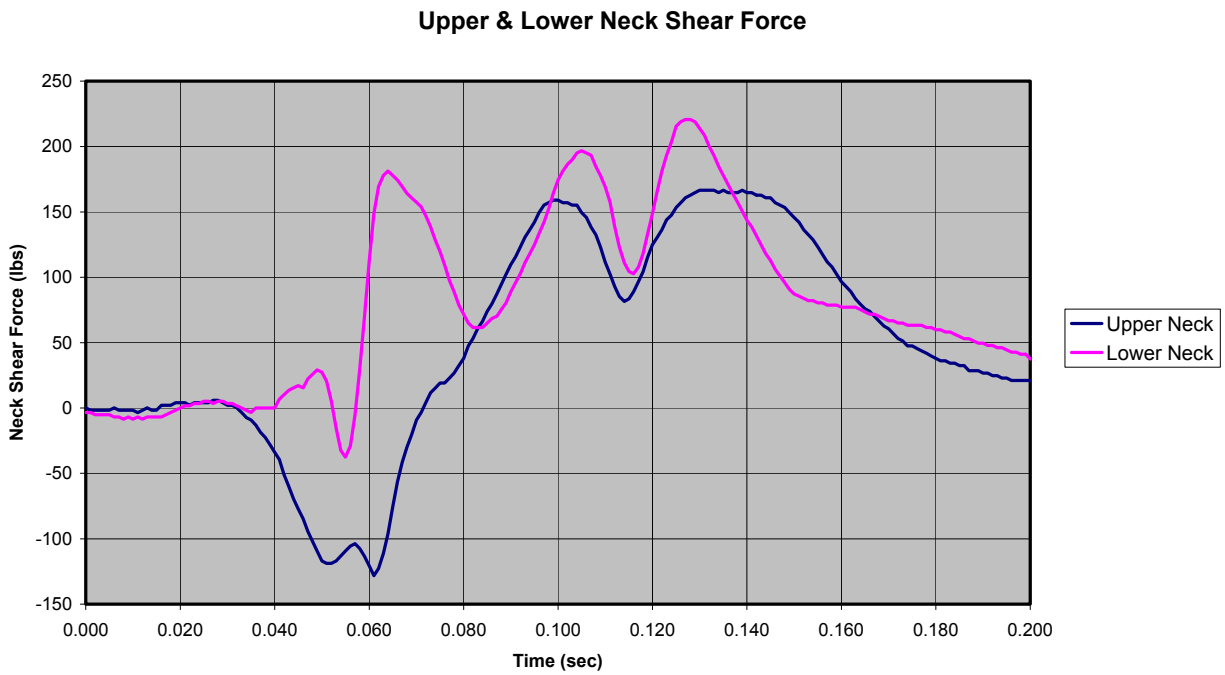

Figure C-36: Test 525 (Medium Pulse, 4.5 lb Added Head Weight)

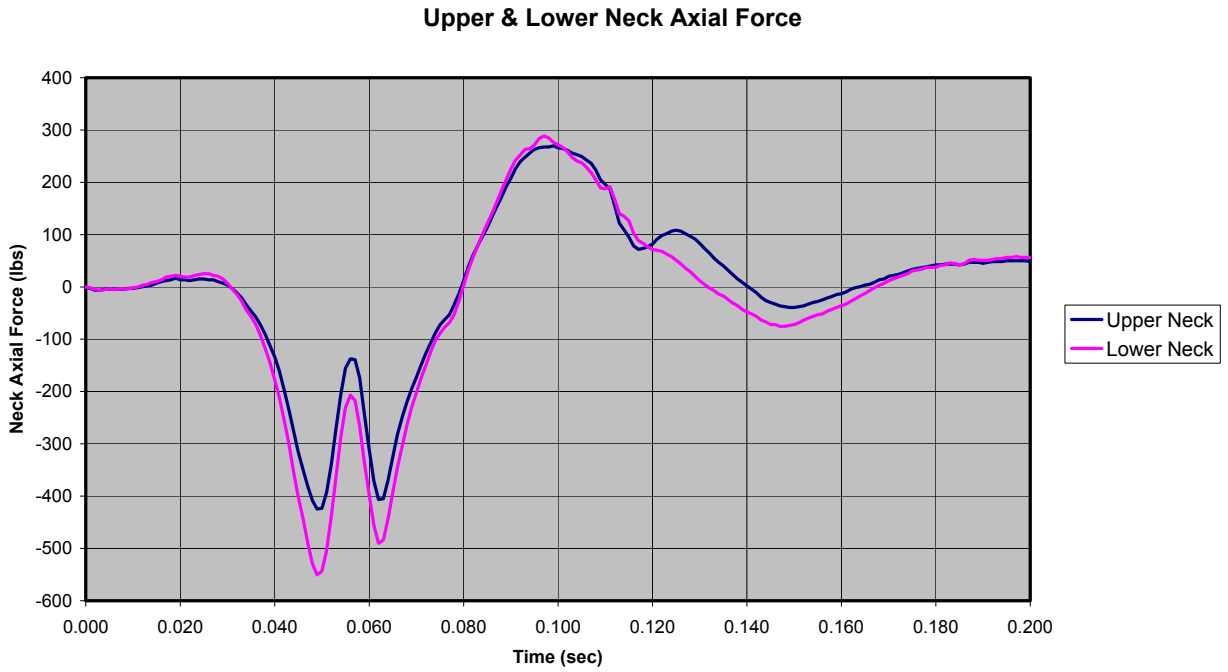

Figure C-37: Test 525 (Medium Pulse, 4.5 lb Added Head Weight)

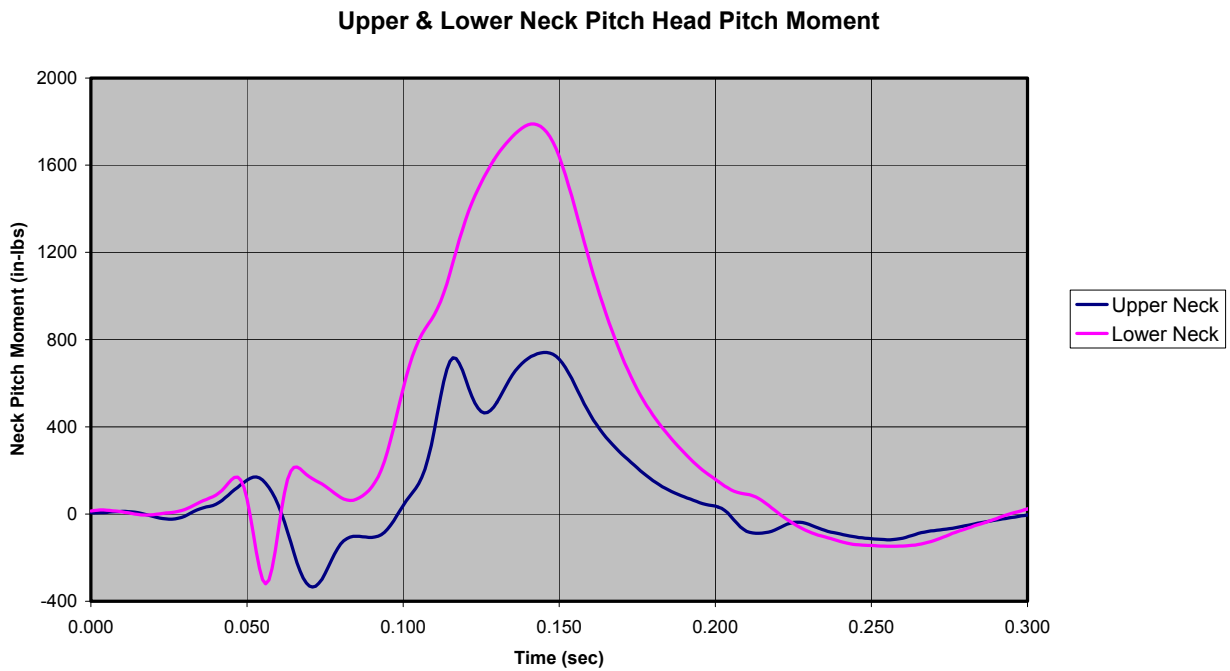

Figure C-38: Test 525 (Medium Pulse, 4.5 lb Added Head Weight)

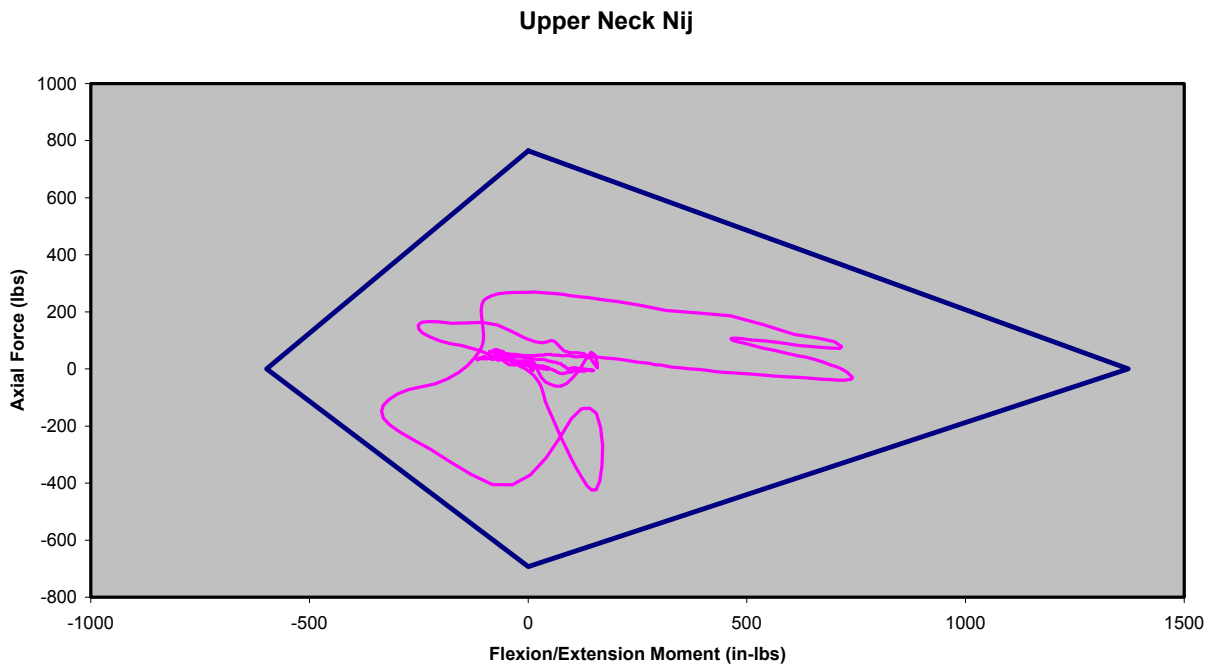

Figure C-39: Test 525 (Medium Pulse, 4.5 lb Added Head Weight)

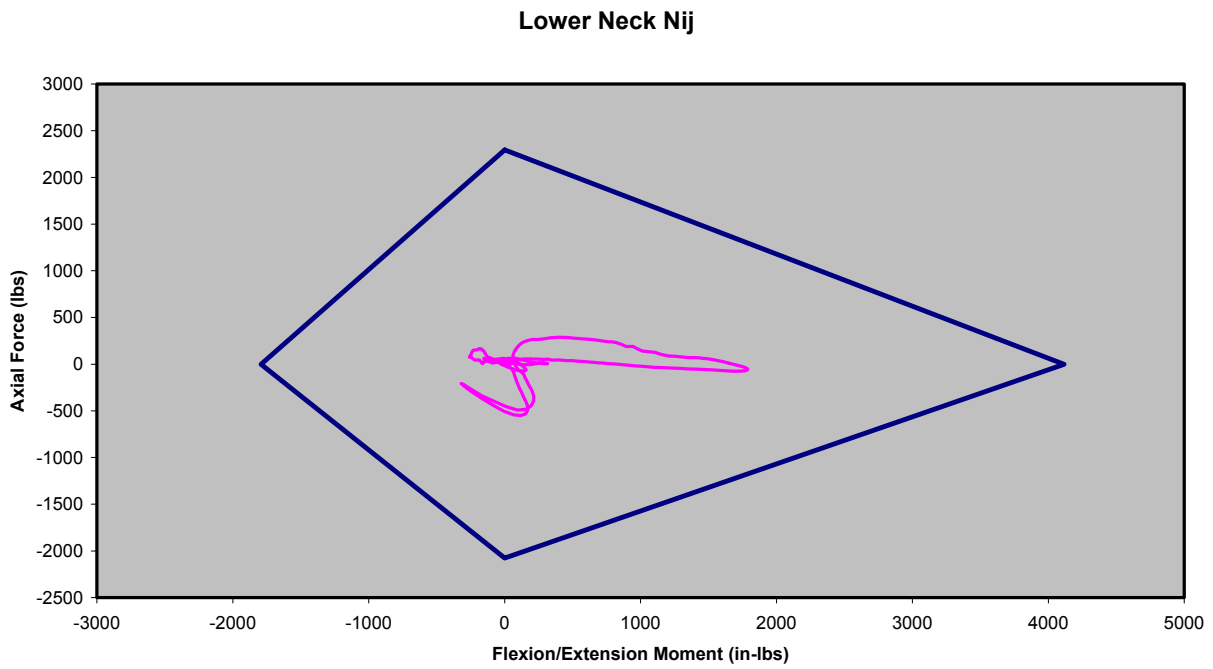

Figure C-40: Test 525 (Medium Pulse, 4.5 lb Added Head Weight)

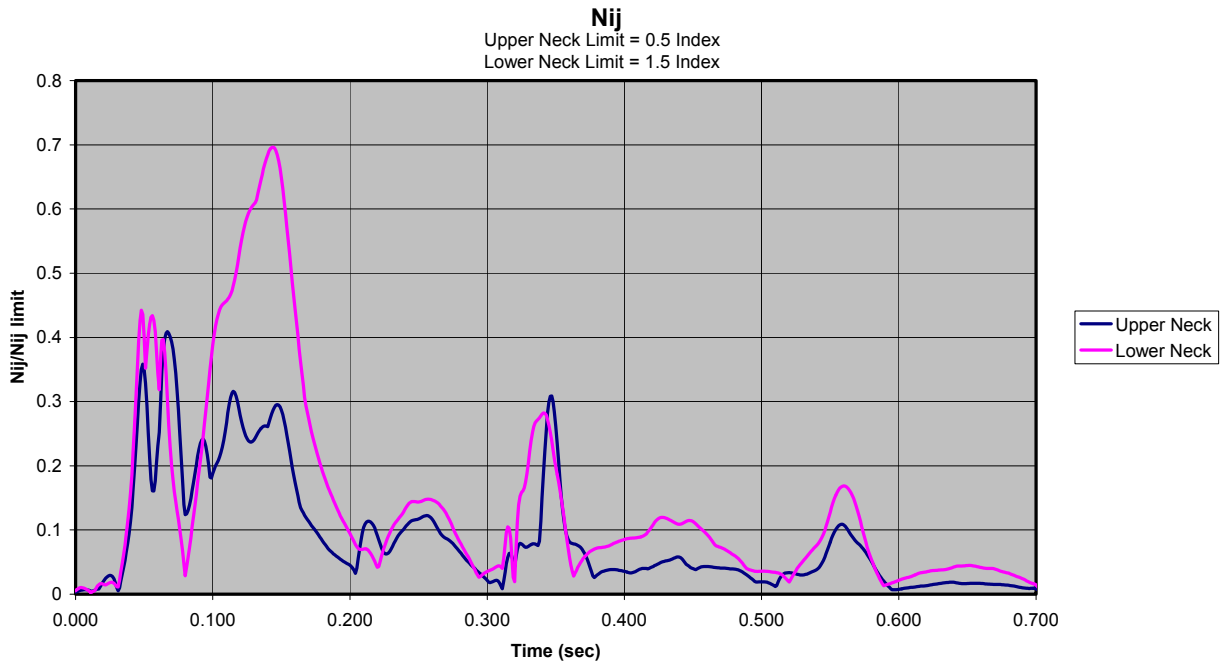

Figure C-41: Test 525 (Medium Pulse, 4.5 lb Added Head Weight)

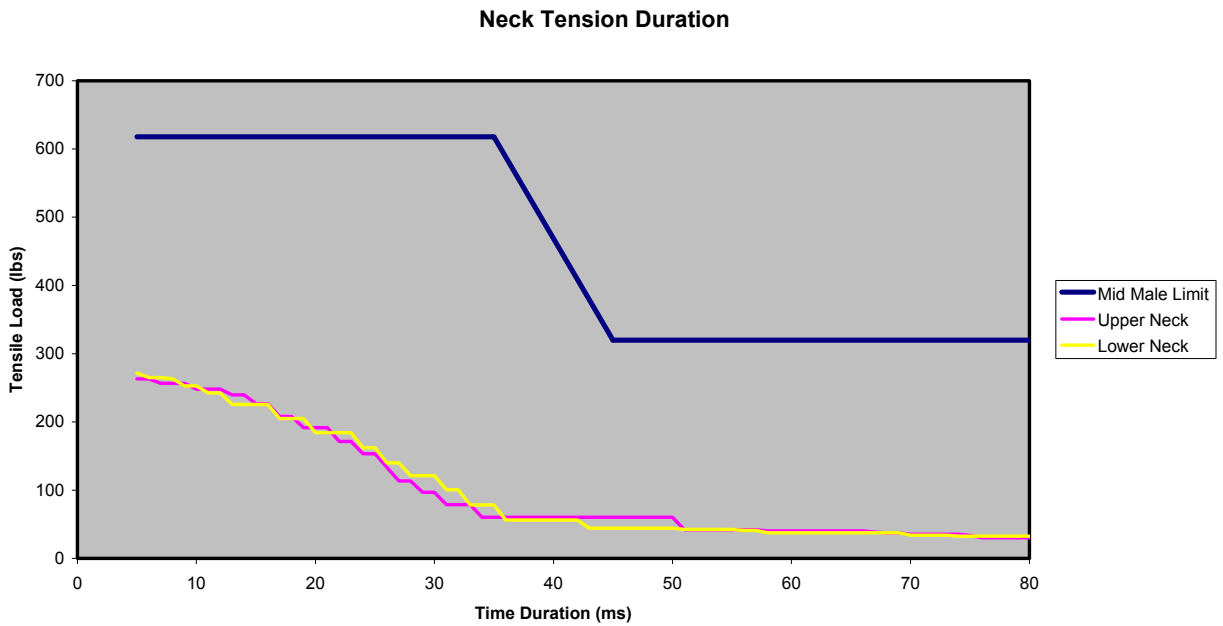

Figure C-42: Test 525 (Medium Pulse, 4.5 lb Added Head Weight)

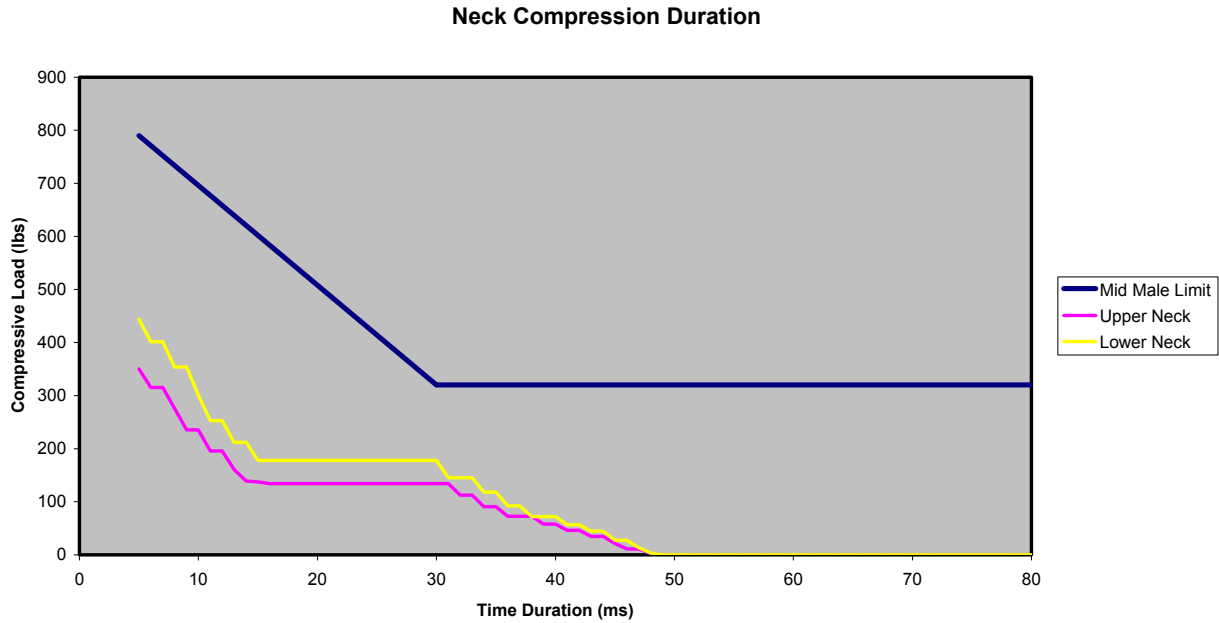

Figure C-43: Test 525 (Medium Pulse, 4.5 lb Added Head Weight)

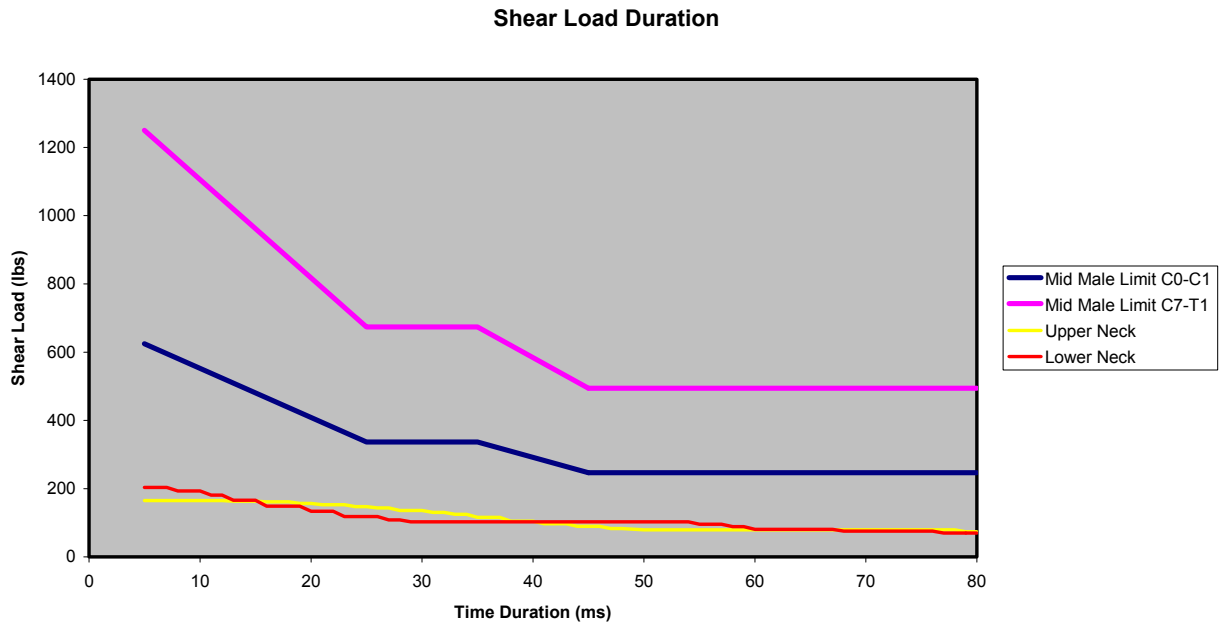

Figure C-44: Test 525 (Medium Pulse, 4.5 lb Added Head Weight)



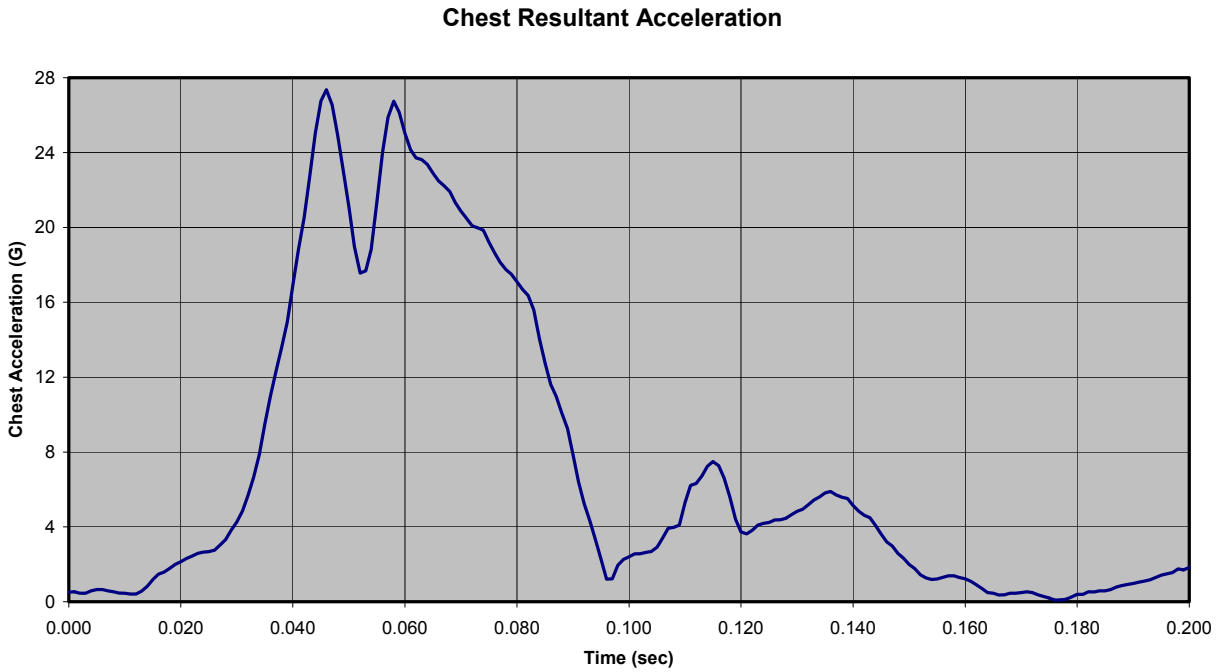

Figure C-45: Test 526 (Medium Pulse, 5.0 lb Added Head Weight)

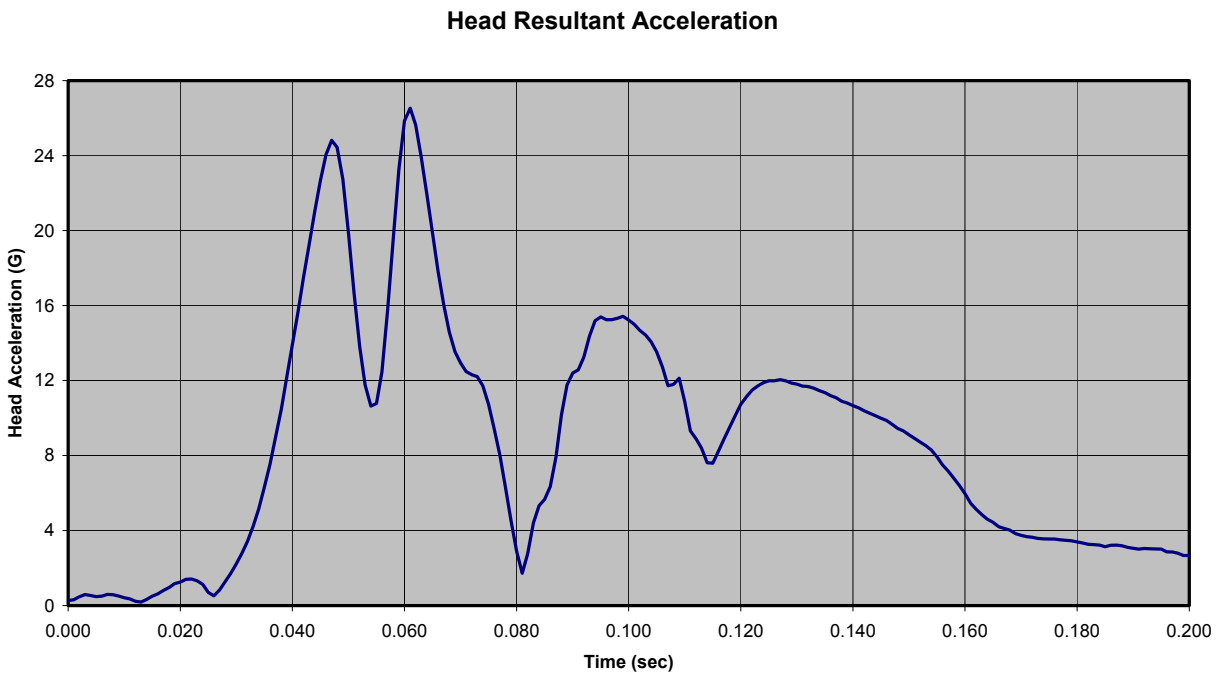

Figure C-46: Test 526 (Medium Pulse, 5.0 lb Added Head Weight)

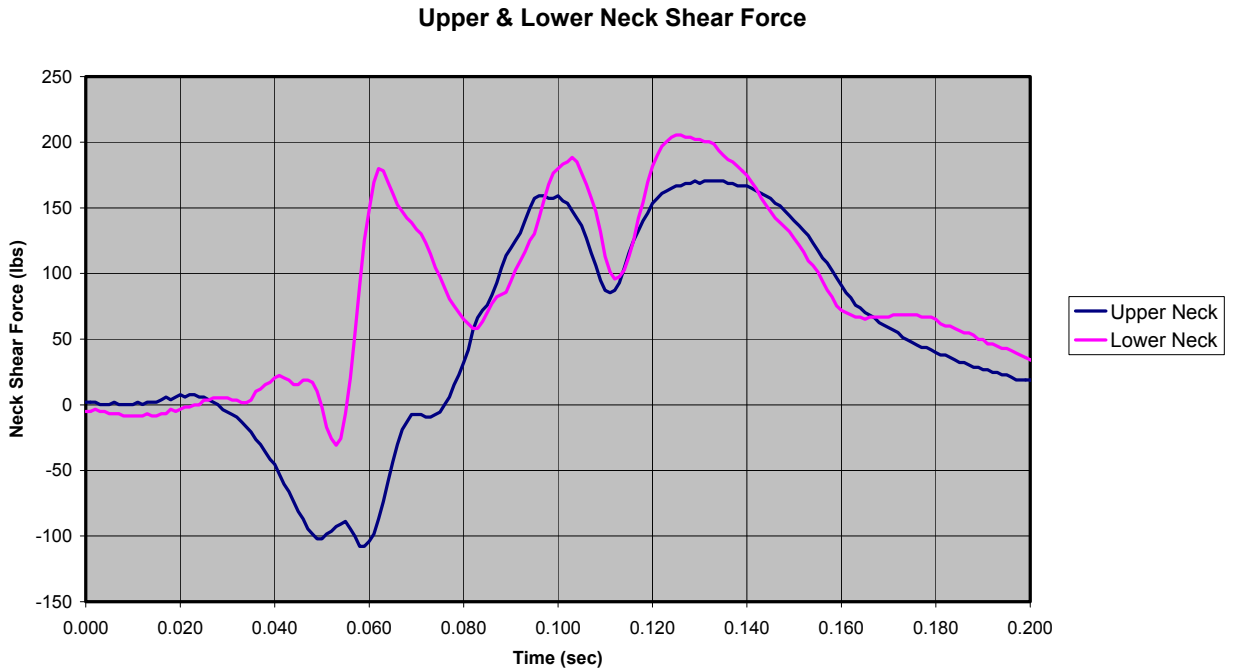

Figure C-47: Test 526 (Medium Pulse, 5.0 lb Added Head Weight)

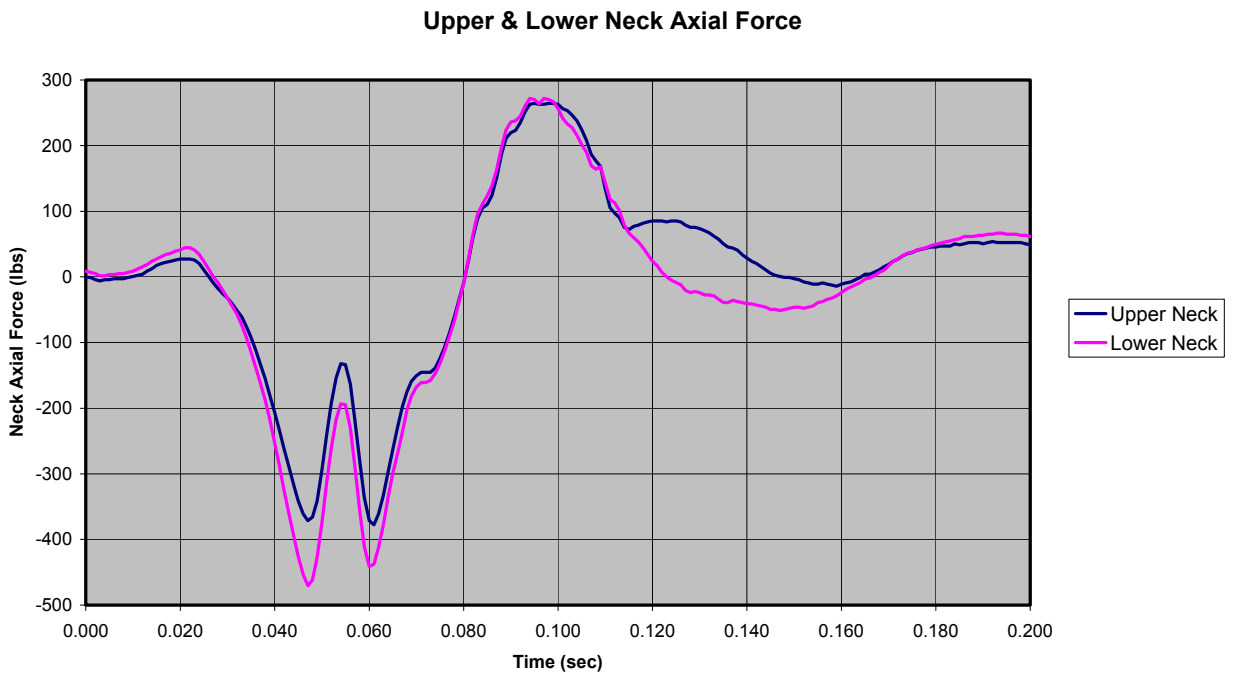

Figure C-48: Test 526 (Medium Pulse, 5.0 lb Added Head Weight)

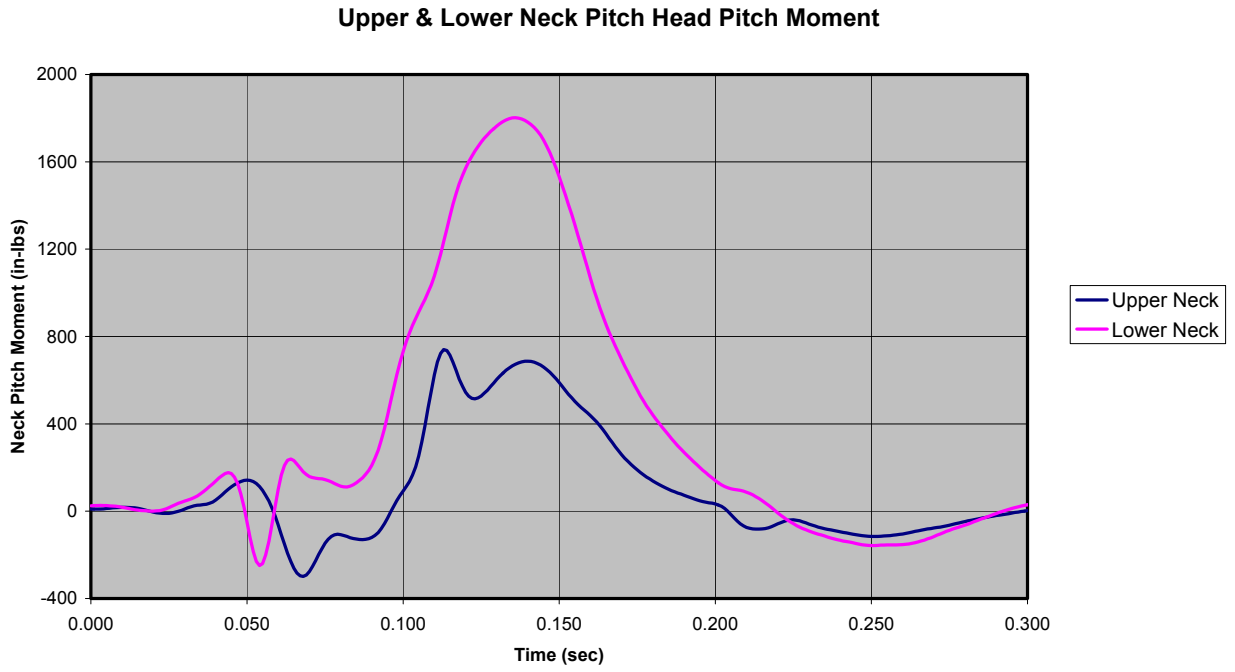

Figure C-49: Test 526 (Medium Pulse, 5.0 lb Added Head Weight)

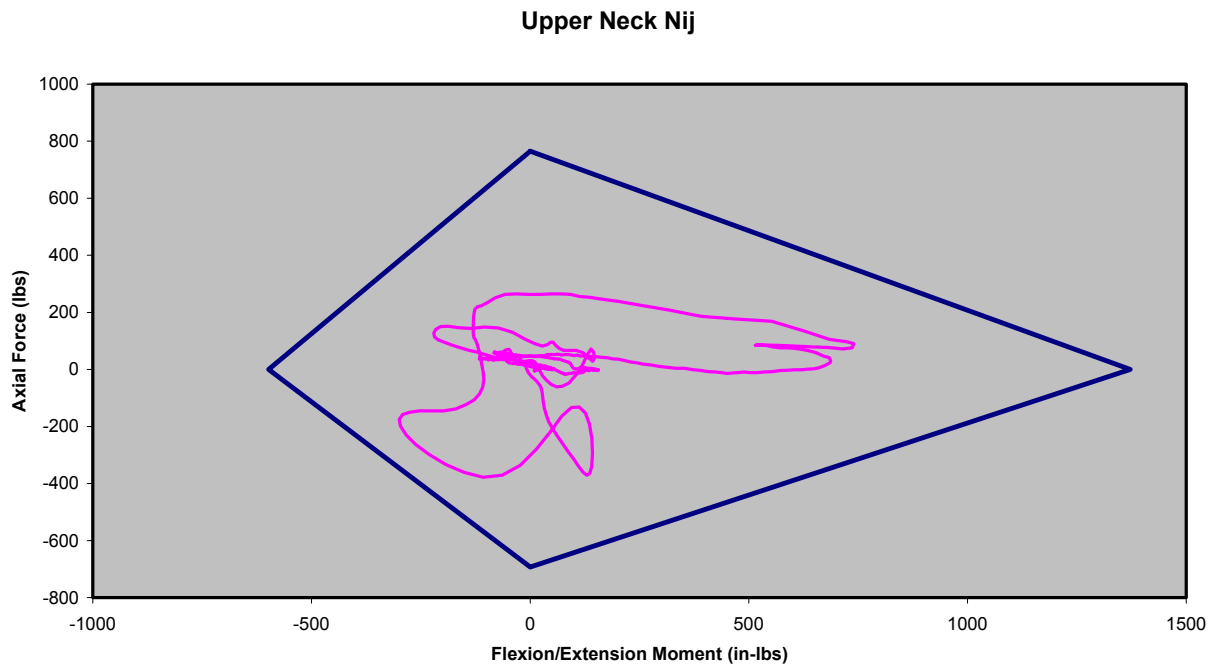

Figure C-50: Test 526 (Medium Pulse, 5.0 lb Added Head Weight)

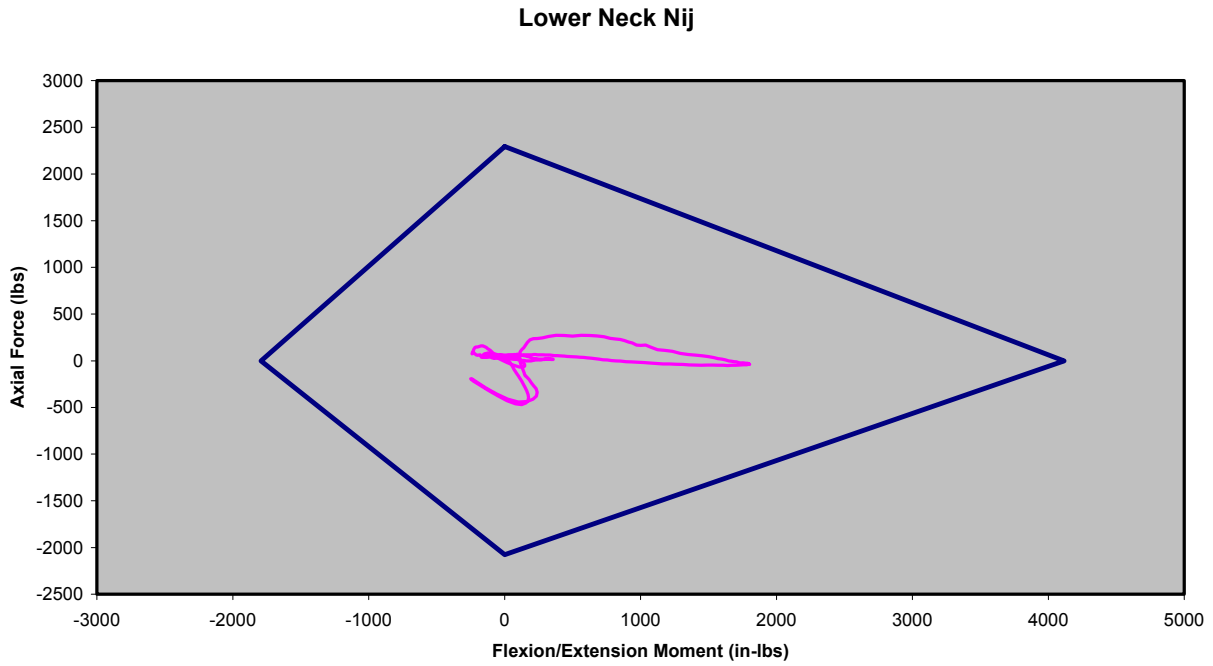

Figure C-51: Test 526 (Medium Pulse, 5.0 lb Added Head Weight)

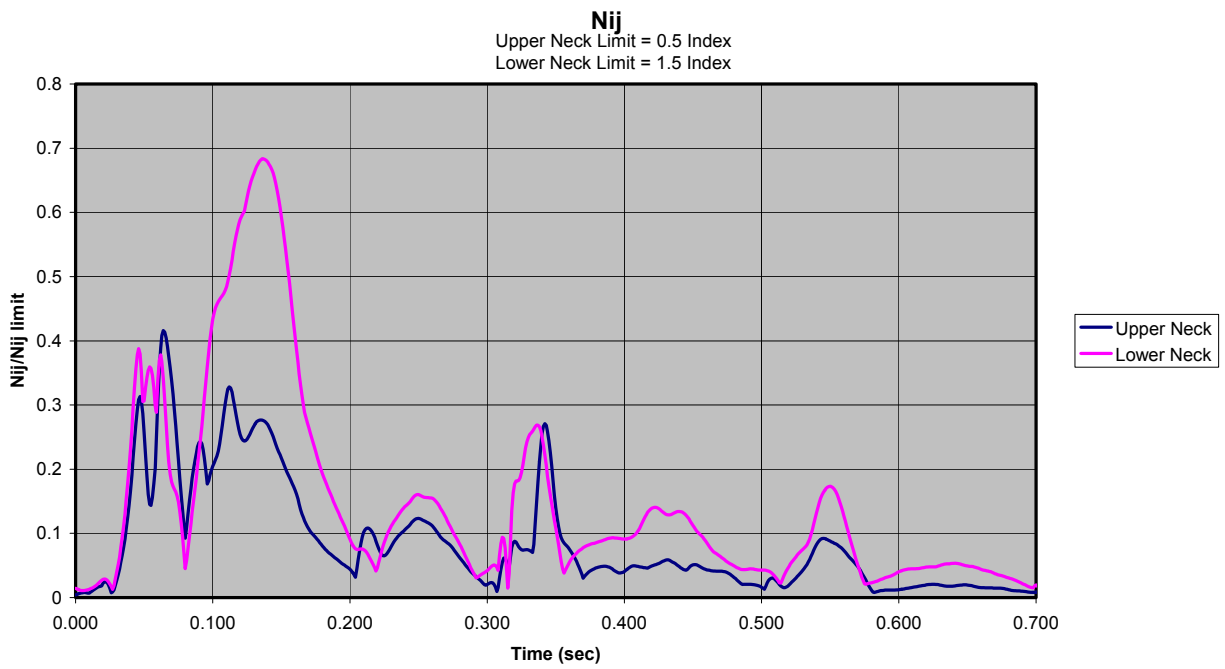

Figure C-52: Test 526 (Medium Pulse, 5.0 lb Added Head Weight)

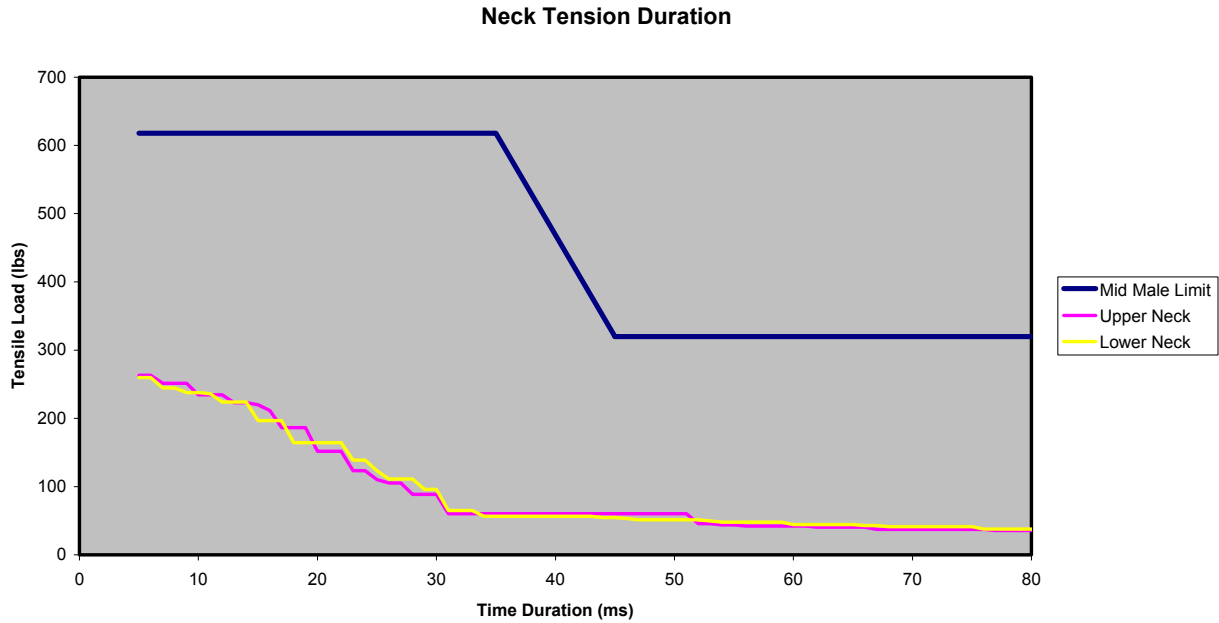

Figure C-53: Test 526 (Medium Pulse, 5.0 lb Added Head Weight)

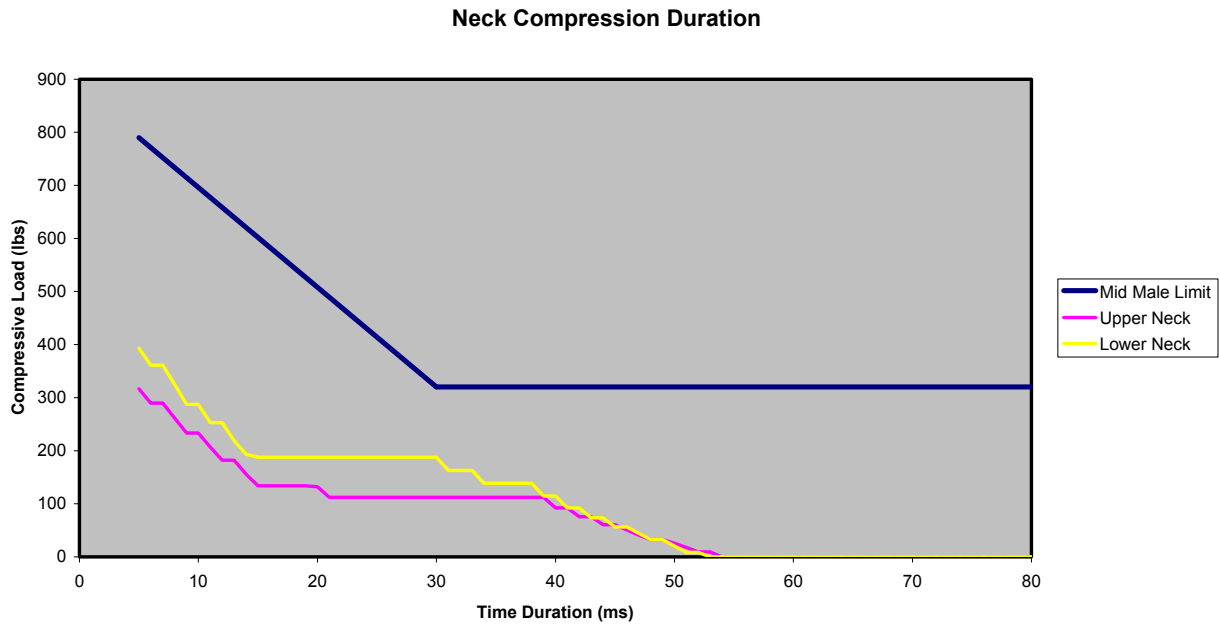

Figure C-54: Test 526 (Medium Pulse, 5.0 lb Added Head Weight)

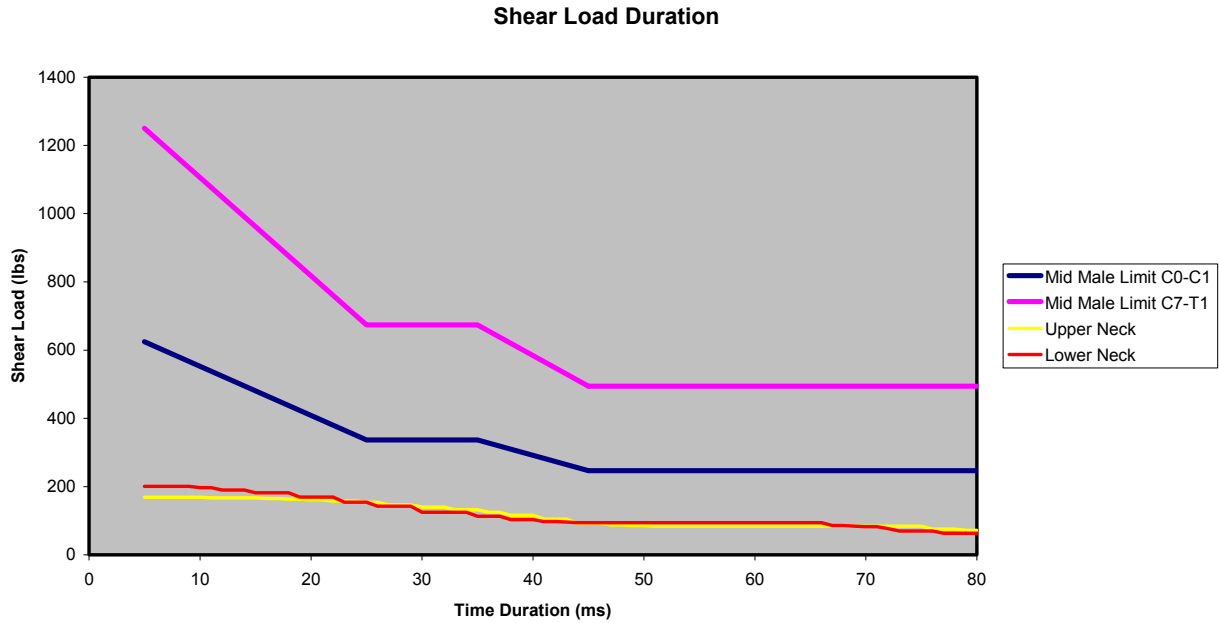

Figure C-55: Test 526 (Medium Pulse, 5.0 lb Added Head Weight)

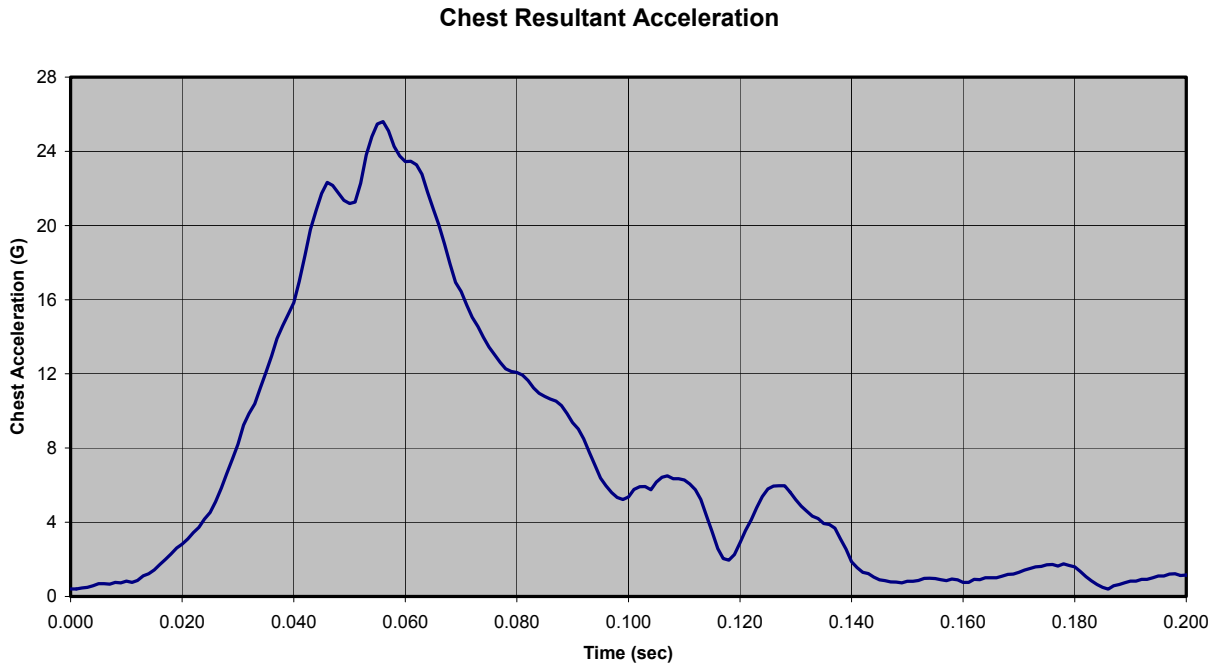

Figure C-56: Test 527 (Medium Pulse, 5.0 lb Added Head Weight)

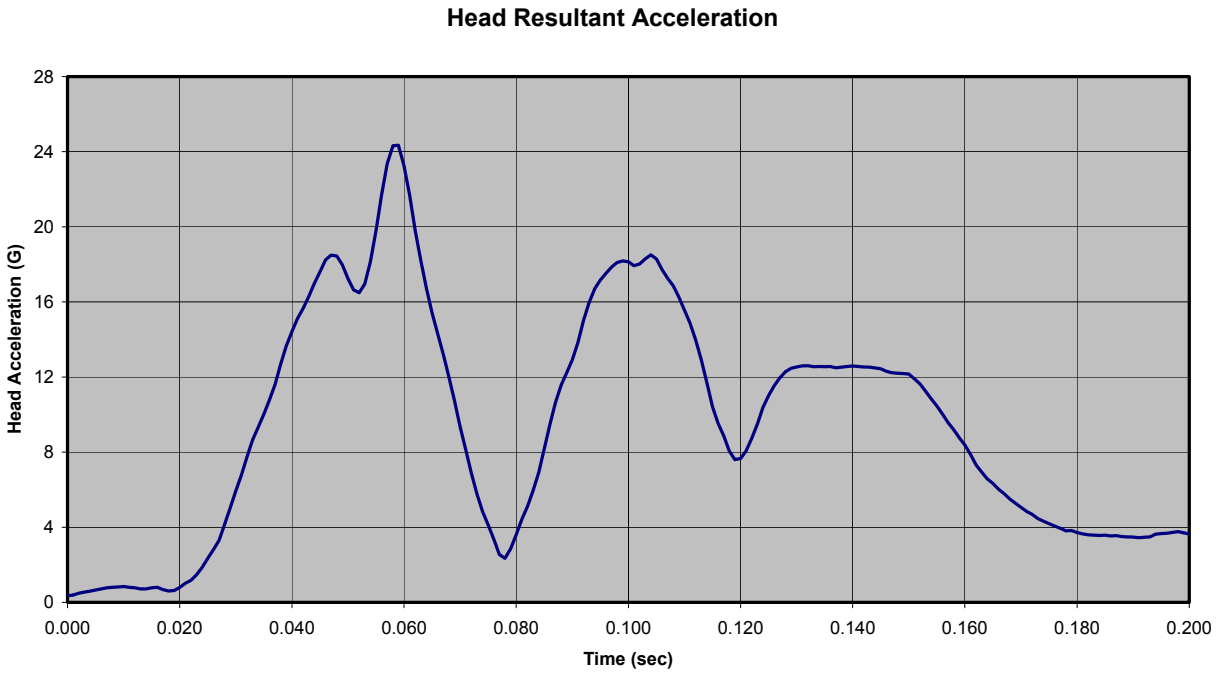

Figure C-57: Test 527 (Medium Pulse, 5.0 lb Added Head Weight)

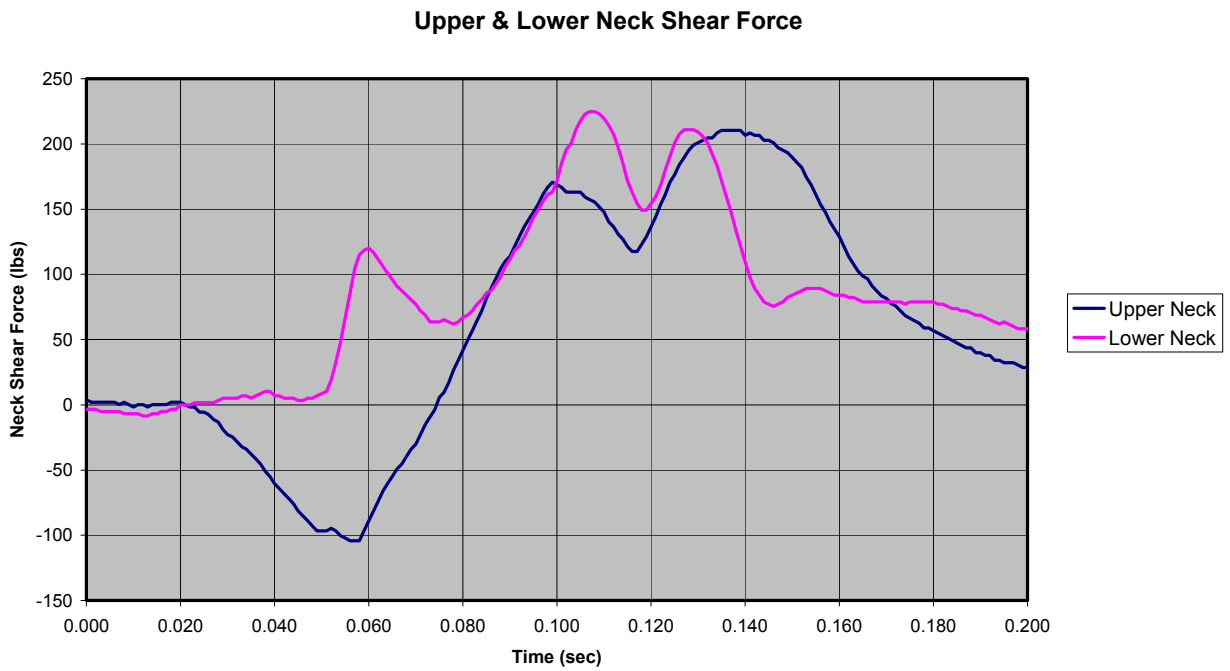

Figure C-58: Test 527 (Medium Pulse, 5.0 lb Added Head Weight)

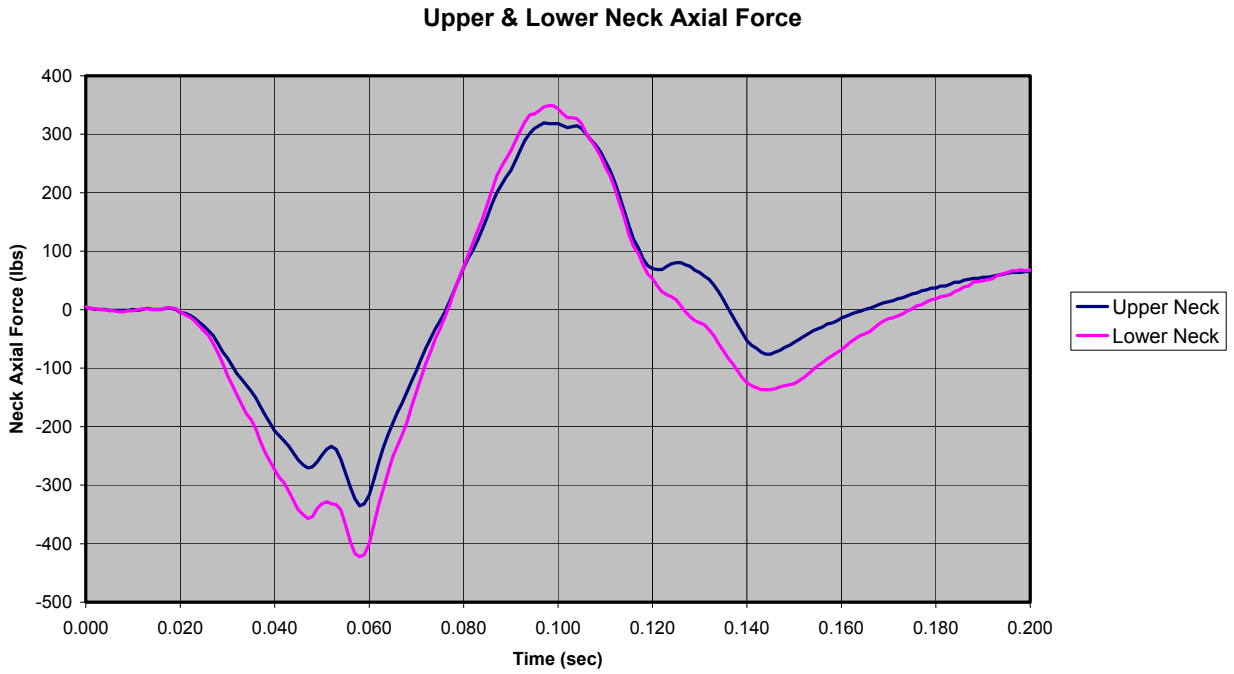

Figure C-59: Test 527 (Medium Pulse, 5.0 lb Added Head Weight)

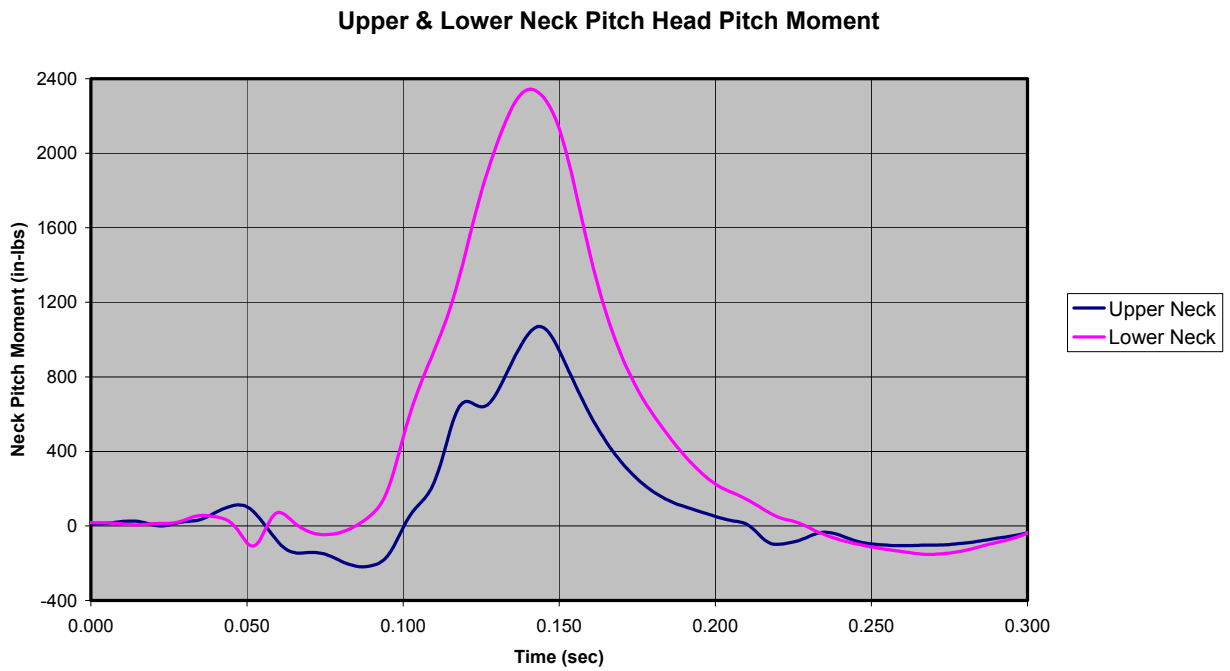

Figure C-60: Test 527 (Medium Pulse, 5.0 lb Added Head Weight)



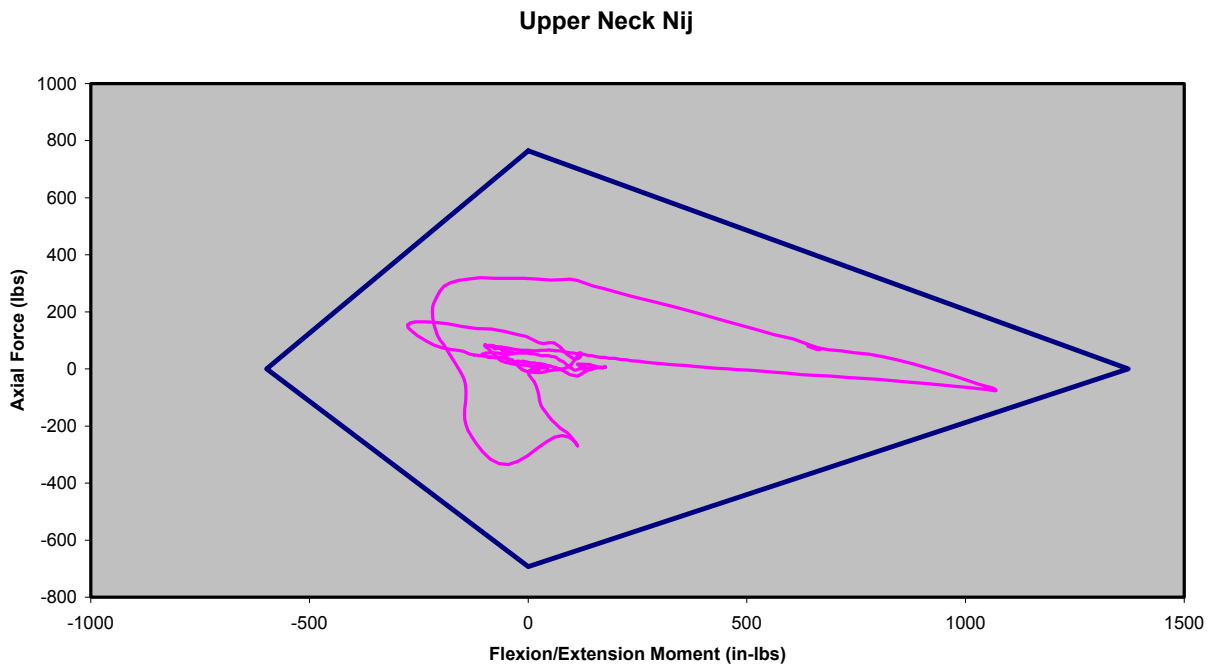

Figure C-61: Test 527 (Medium Pulse, 5.0 lb Added Head Weight)

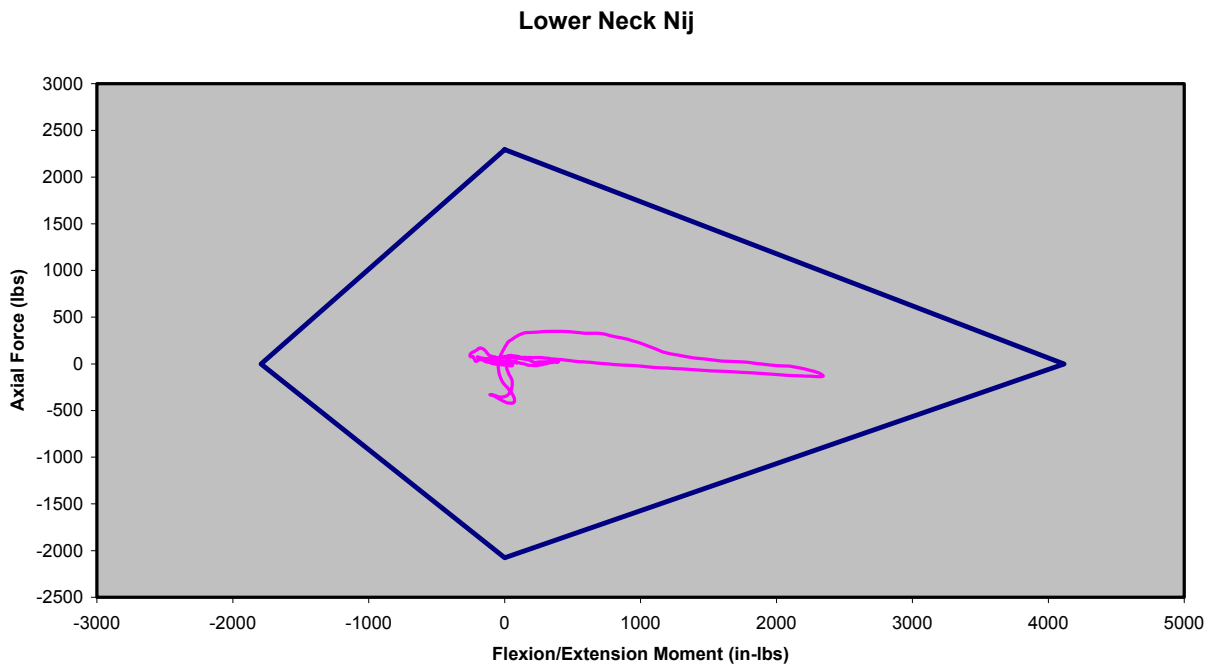

Figure C-62: Test 527 (Medium Pulse, 5.0 lb Added Head Weight)

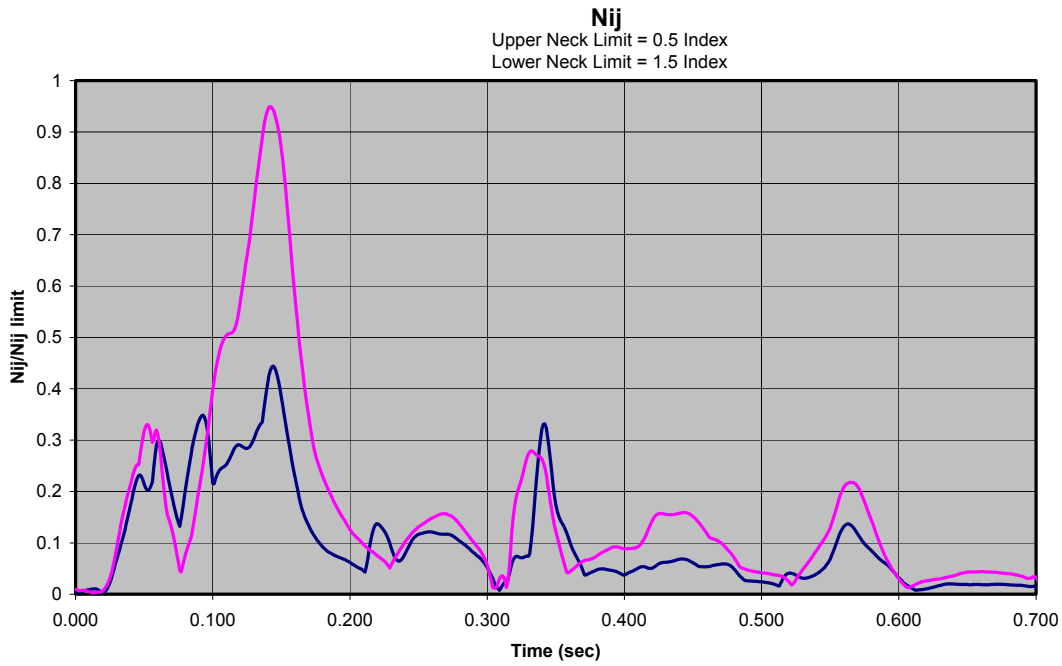

Figure C-63: Test 527 (Medium Pulse, 5.0 lb Added Head Weight)

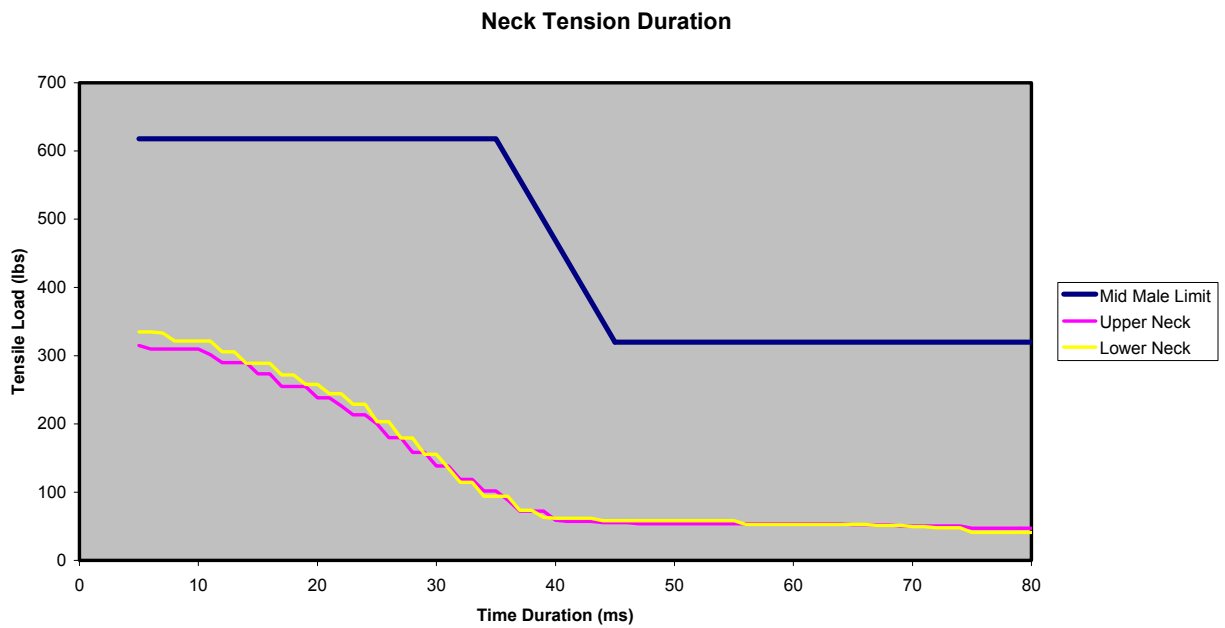

Figure C-64: Test 527 (Medium Pulse, 5.0 lb Added Head Weight)

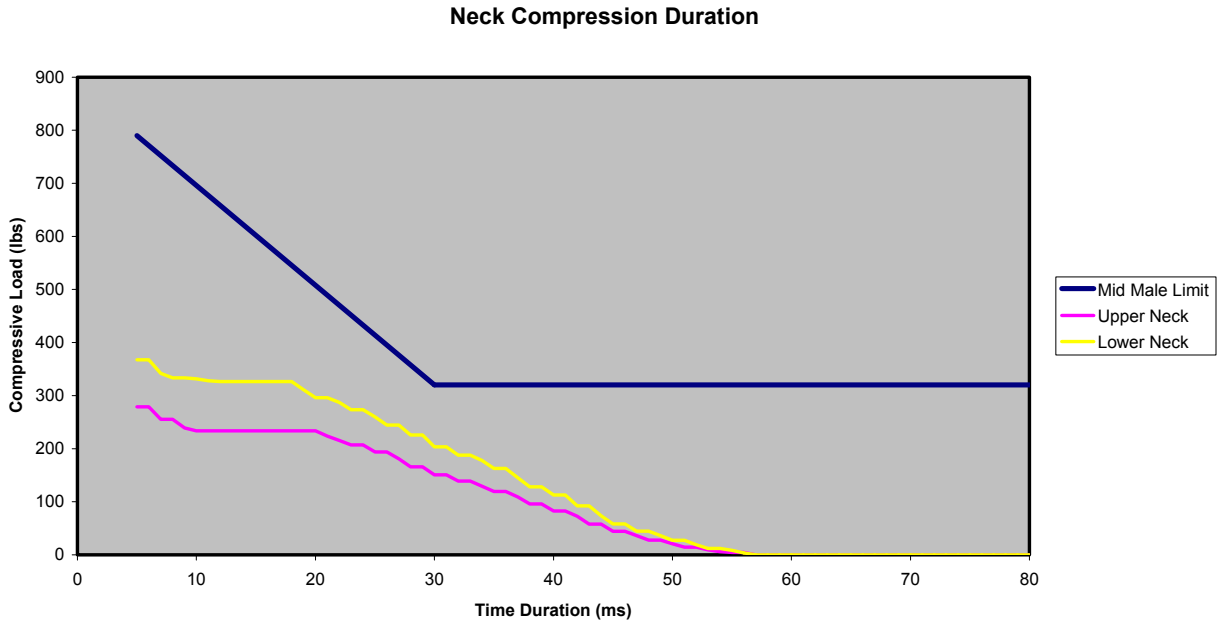

Figure C-65: Test 527 (Medium Pulse, 5.0 lb Added Head Weight)

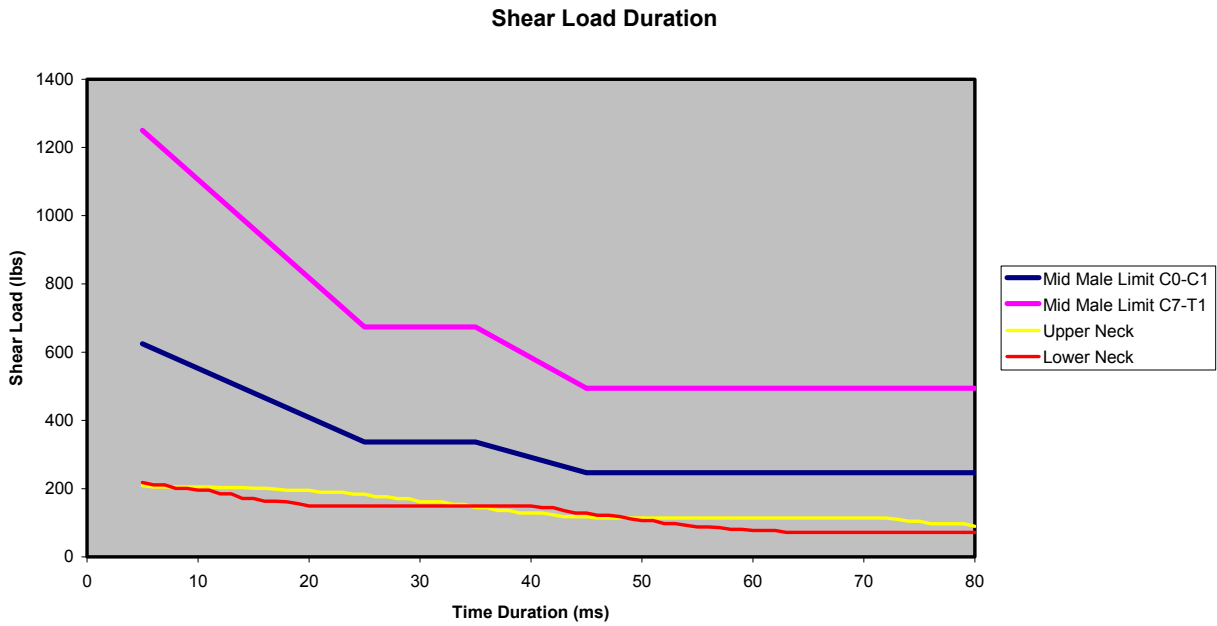

Figure C-66: Test 527 (Medium Pulse, 5.0 lb Added Head Weight)

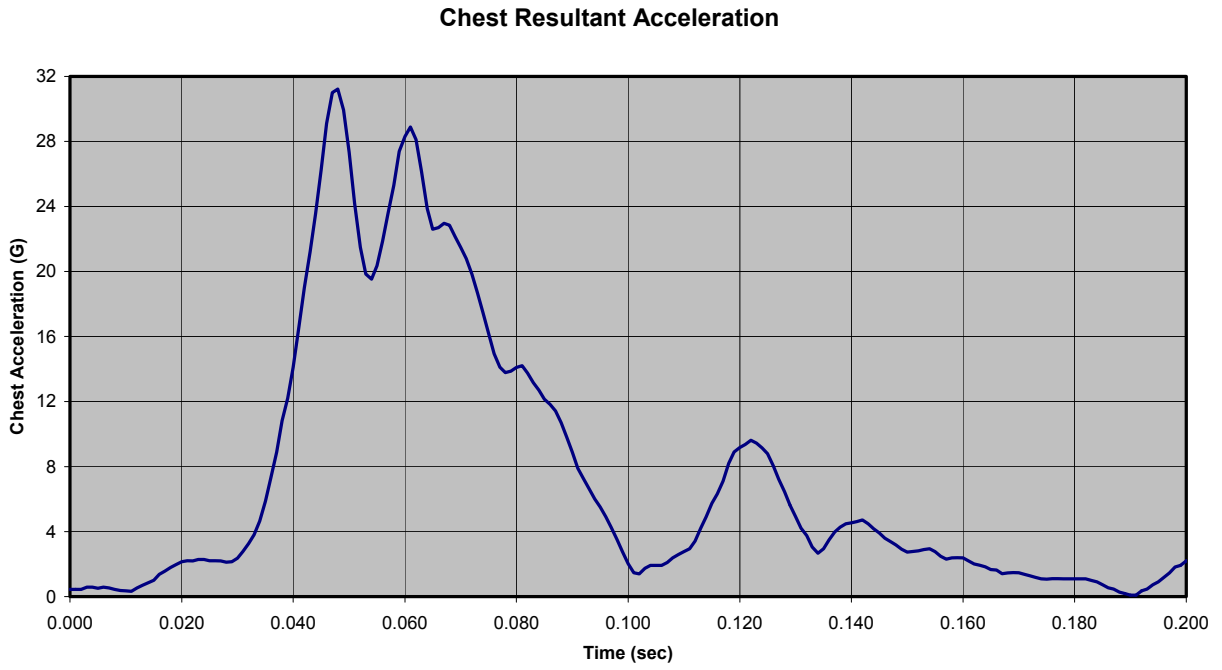

Figure C-67: Test 529 (Medium Pulse, 6.0 lb Added Head Weight)

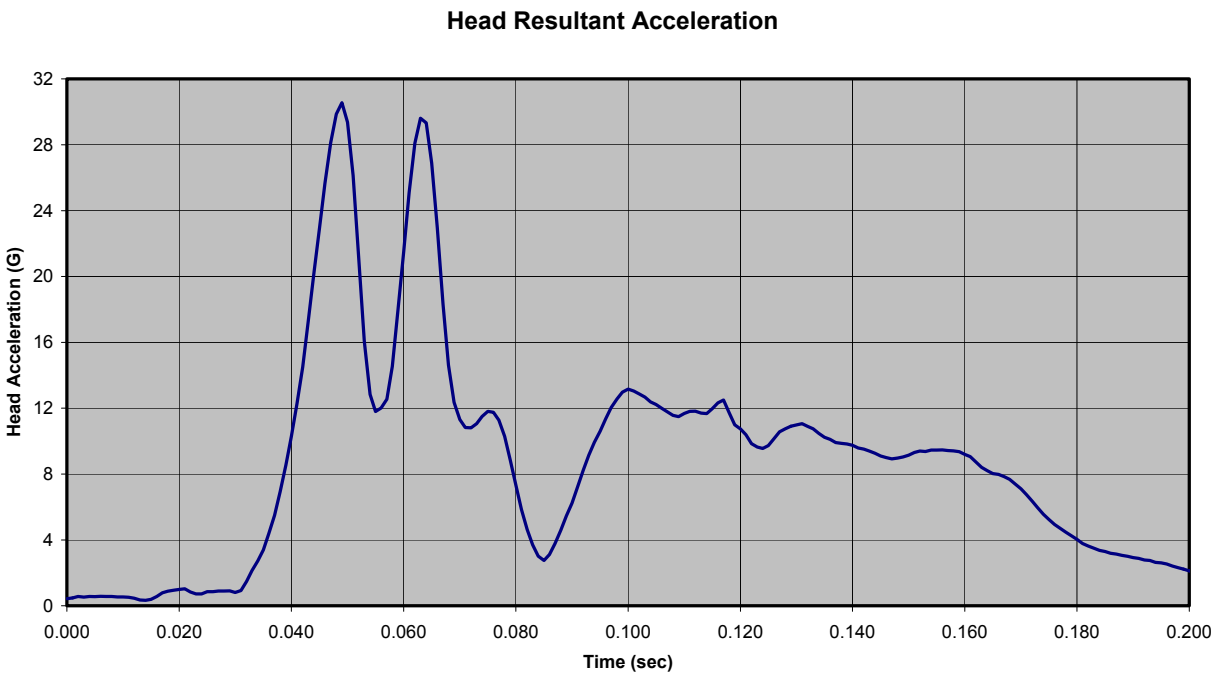

Figure C-68: Test 529 (Medium Pulse, 6.0 lb Added Head Weight)

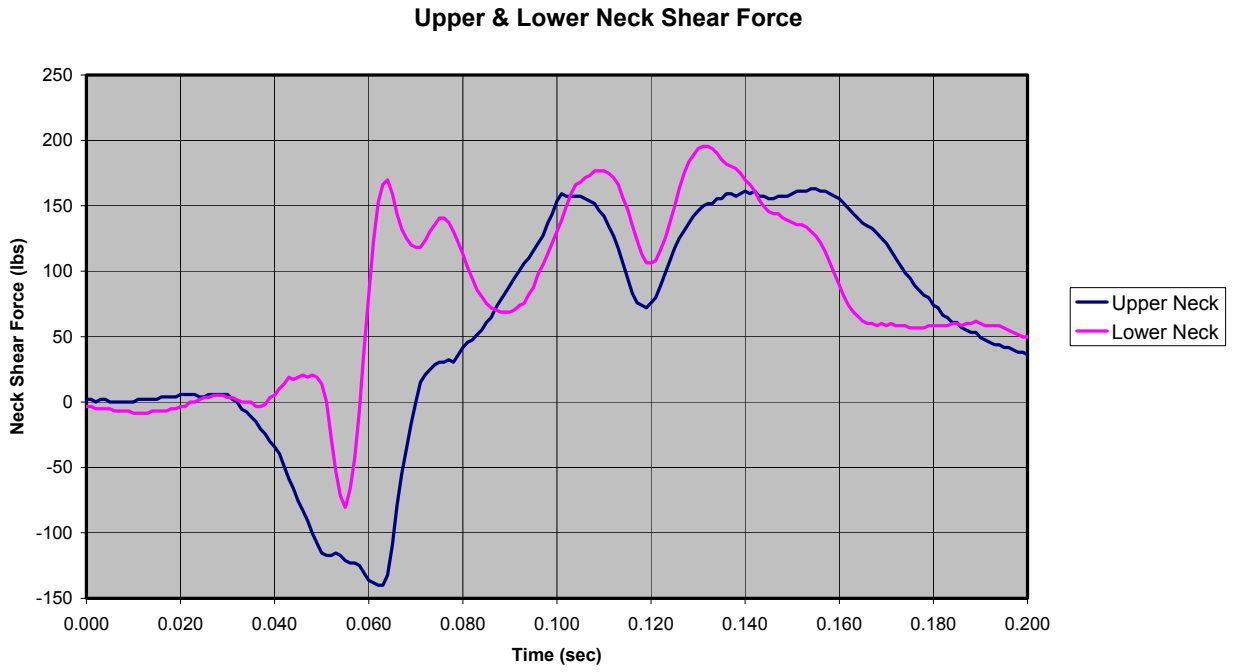

Figure C-69: Test 529 (Medium Pulse, 6.0 lb Added Head Weight)

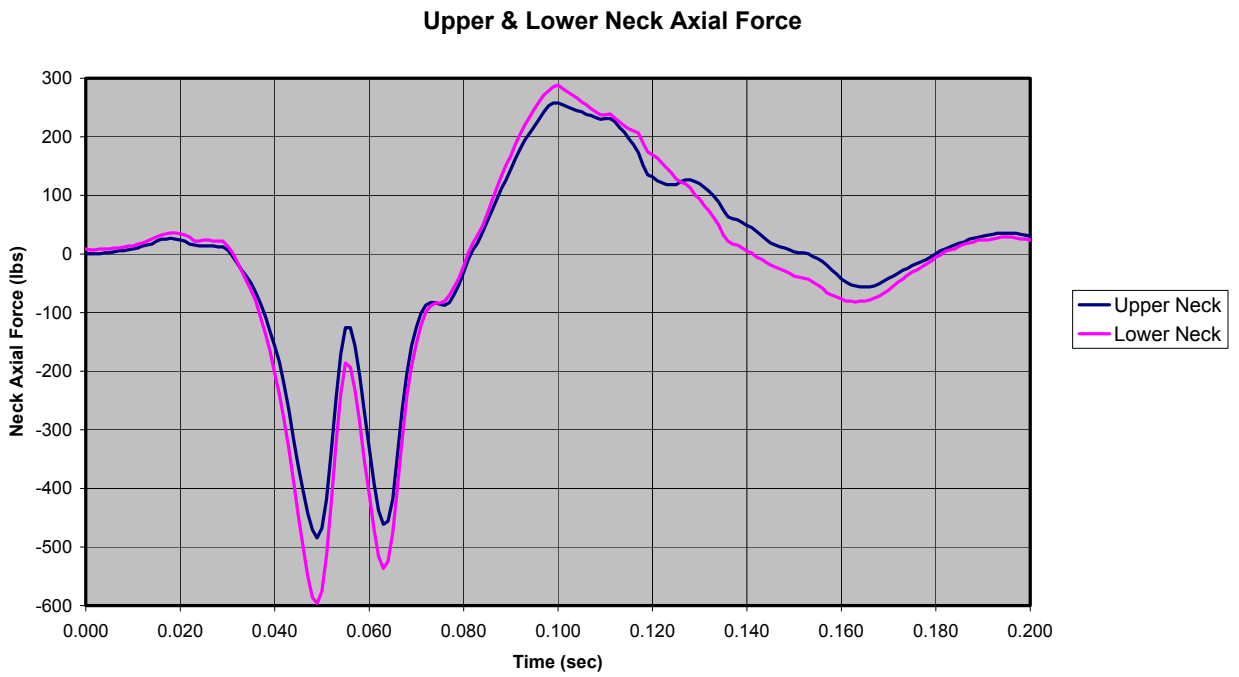

Figure C-70: Test 529 (Medium Pulse, 6.0 lb Added Head Weight)

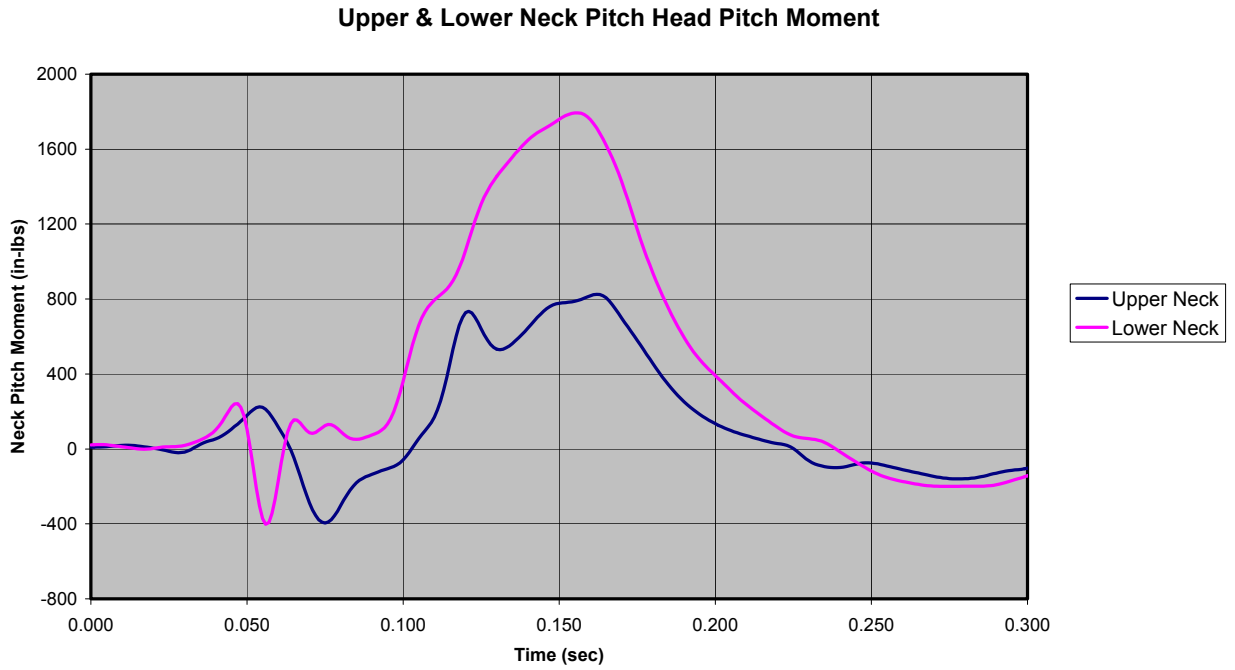

Figure C-71: Test 529 (Medium Pulse, 6.0 lb Added Head Weight)

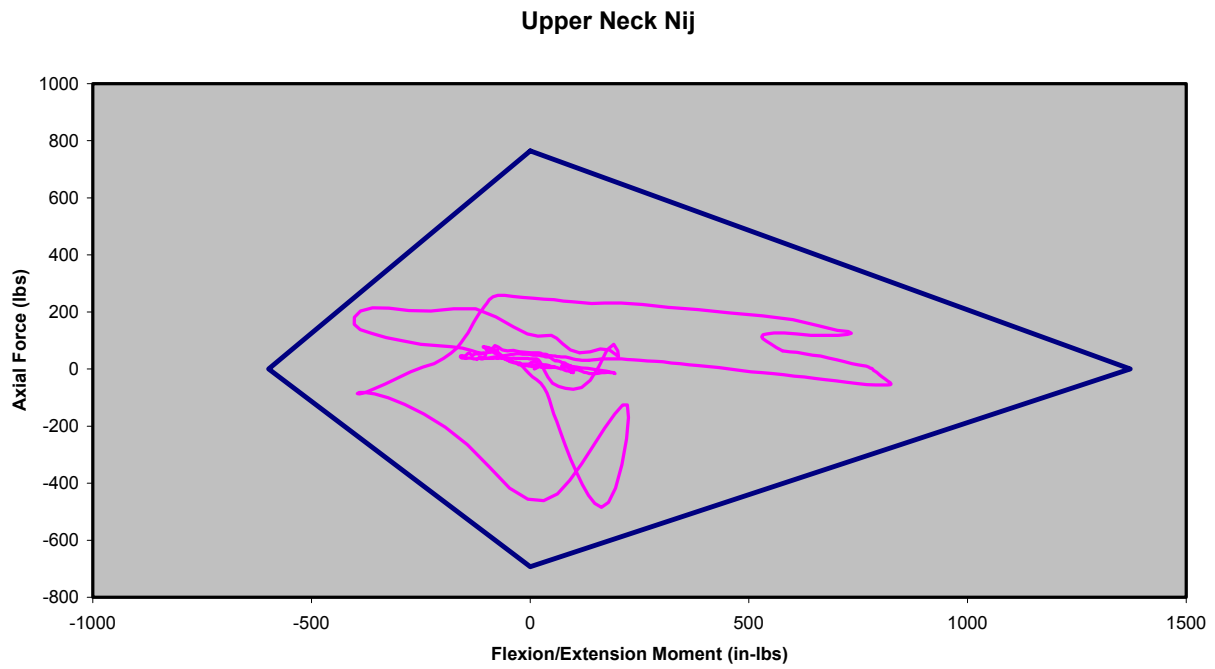

Figure C-72: Test 529 (Medium Pulse, 6.0 lb Added Head Weight)

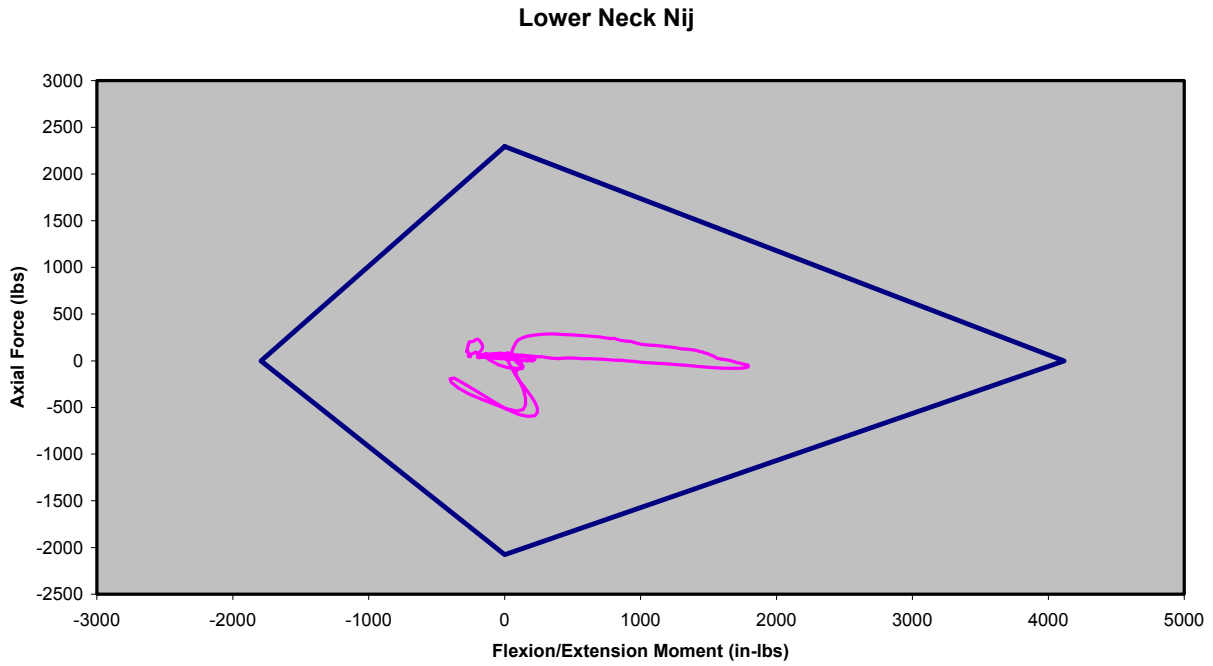

Figure C-73: Test 529 (Medium Pulse, 6.0 lb Added Head Weight)

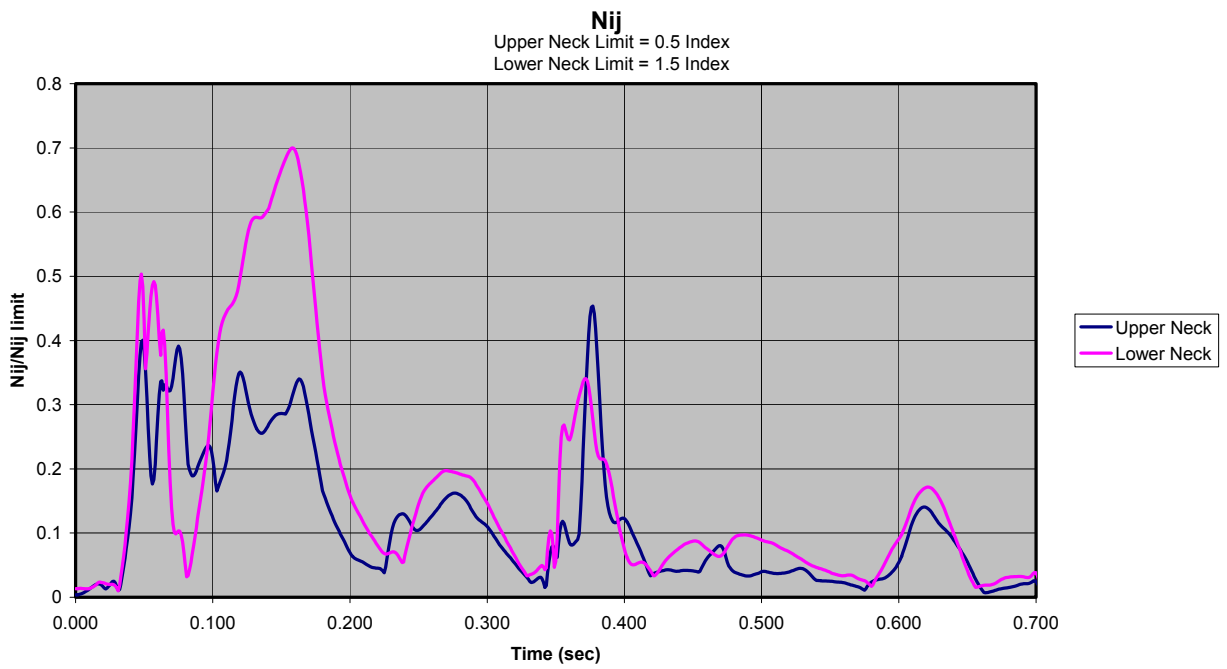

Figure C-74: Test 529 (Medium Pulse, 6.0 lb Added Head Weight)

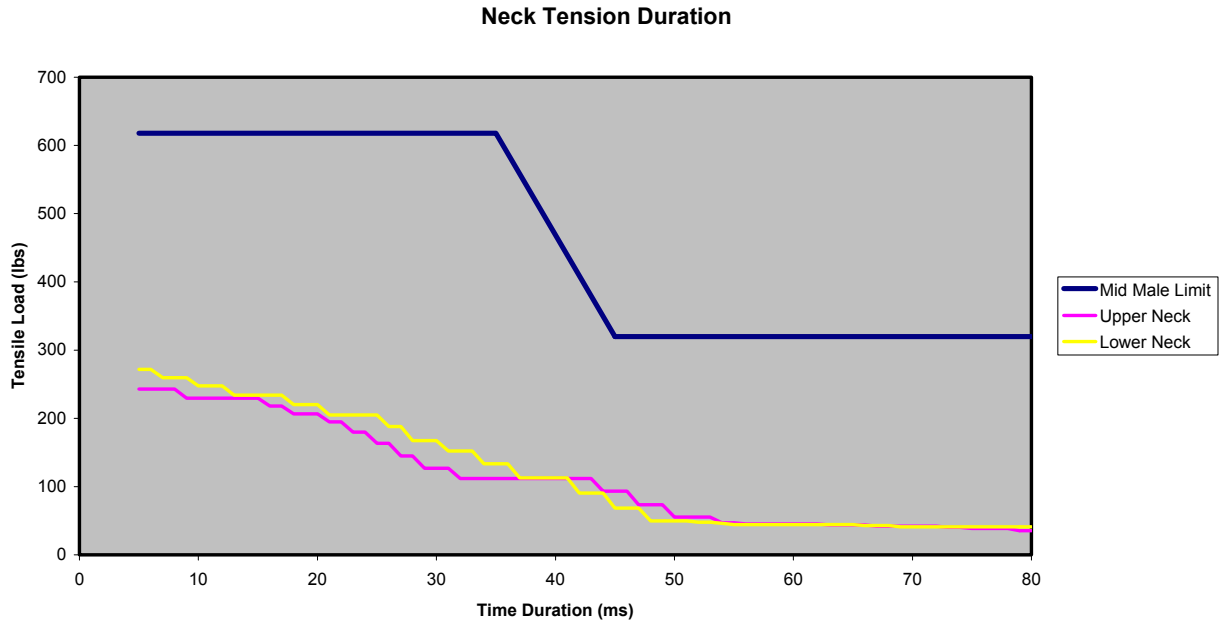

Figure C-75: Test 529 (Medium Pulse, 6.0 lb Added Head Weight)

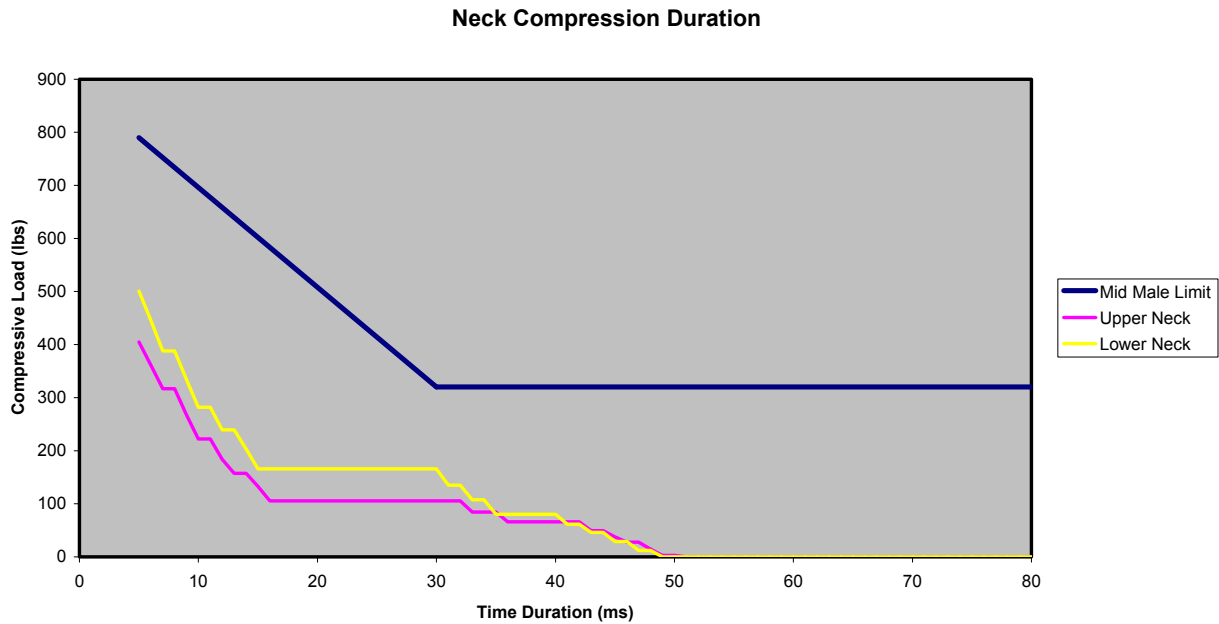

Figure C-76: Test 529 (Medium Pulse, 6.0 lb Added Head Weight)



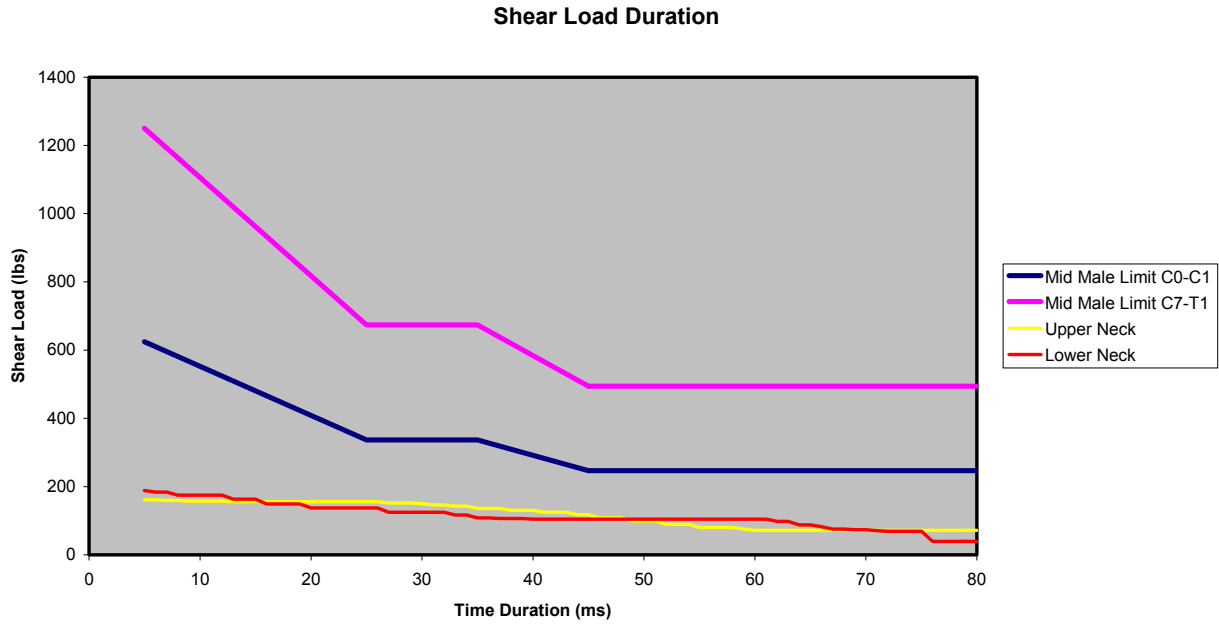

Figure C-77: Test 529 (Medium Pulse, 6.0 lb Added Head Weight)

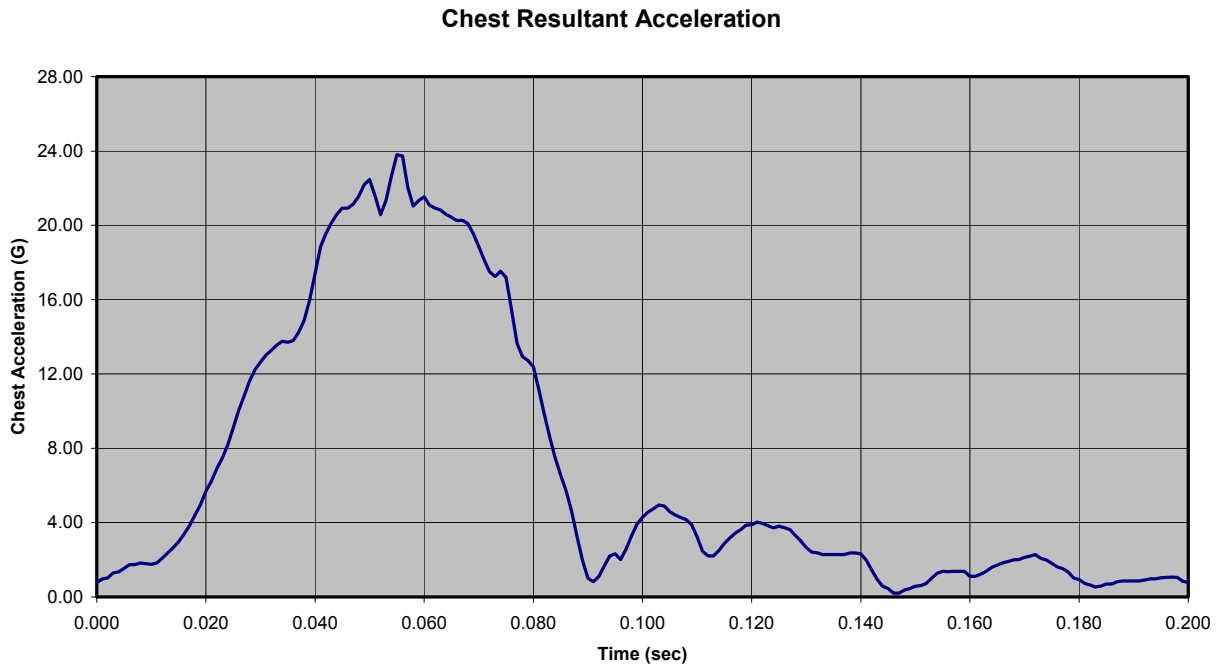

Figure C-78: Test 590 (Medium Pulse, 4.0 lb Added Head Weight)

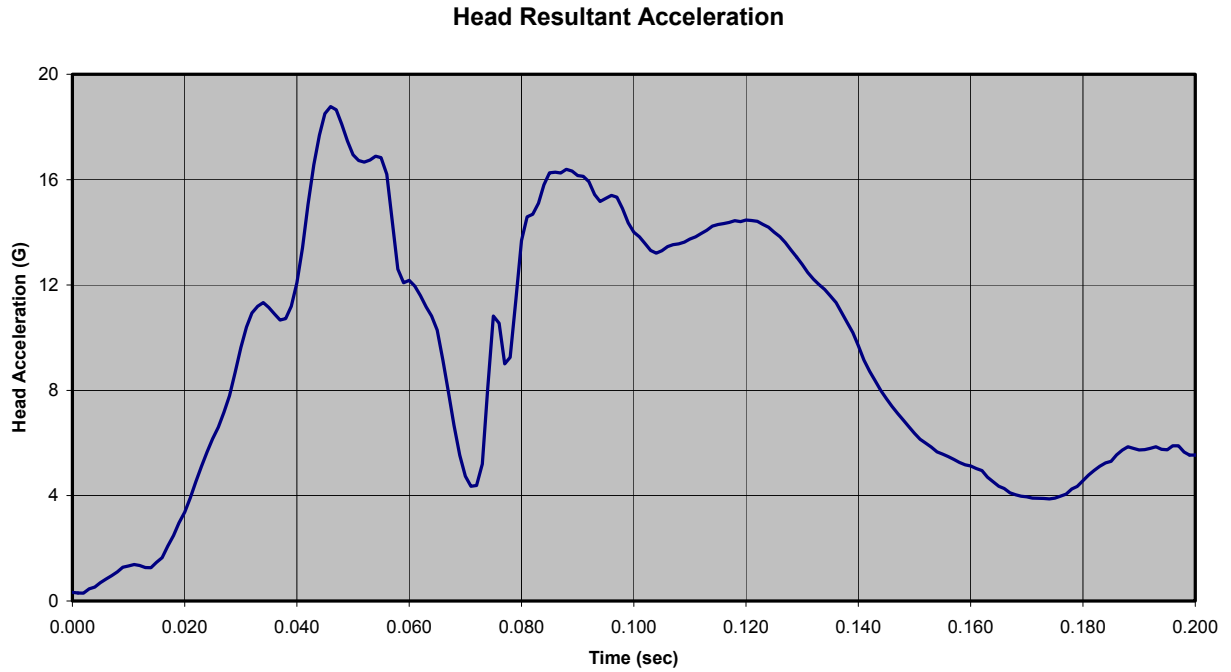

Figure C-79: Test 590 (Medium Pulse, 4.0 lb Added Head Weight)

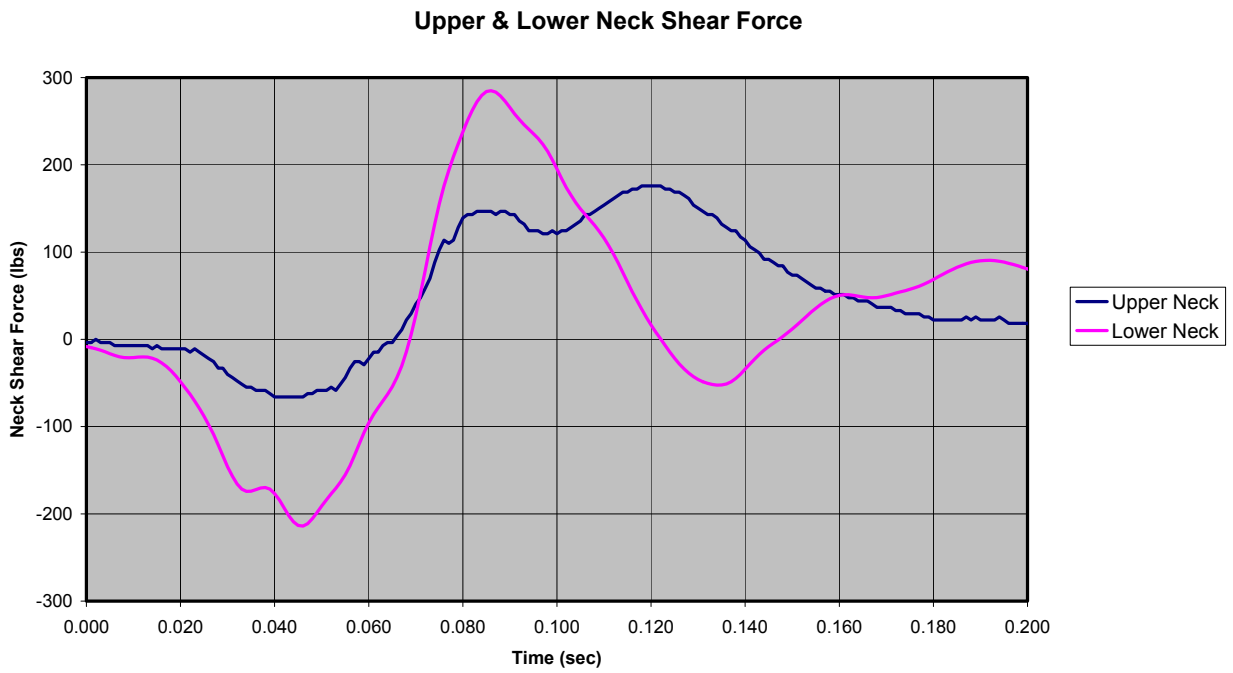

Figure C-80: Test 590 (Medium Pulse, 4.0 lb Added Head Weight)

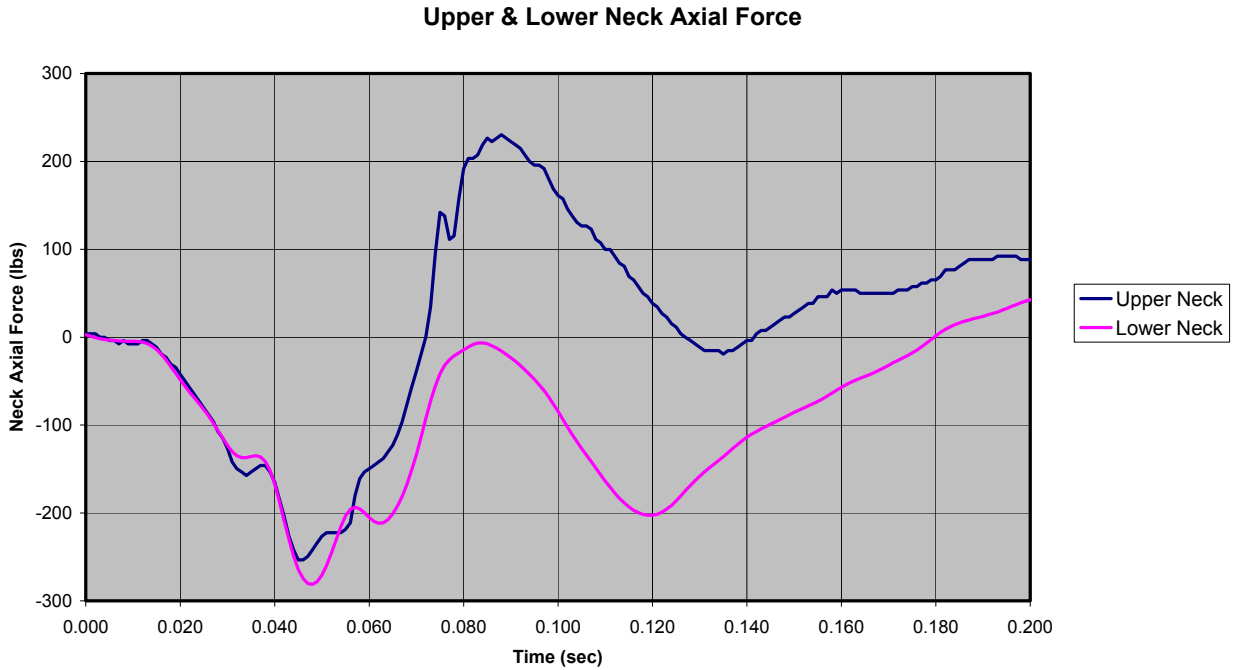

Figure C-81: Test 590 (Medium Pulse, 4.0 lb Added Head Weight)

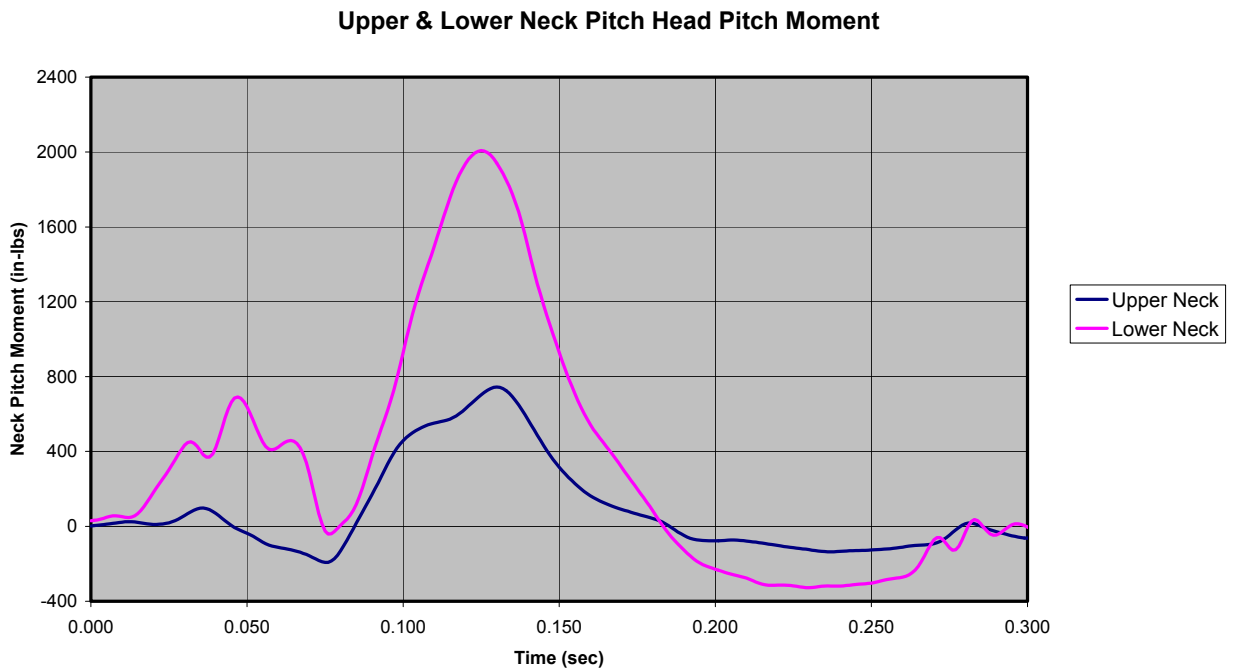

Figure C-82: Test 590 (Medium Pulse, 4.0 lb Added Head Weight)

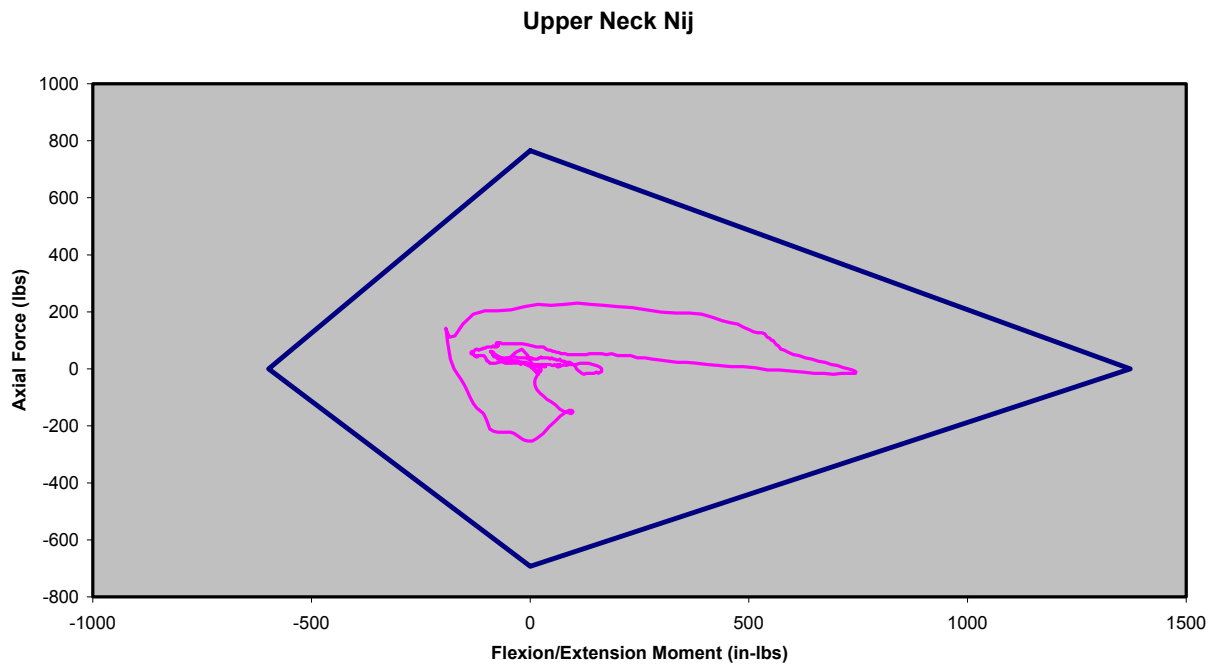

Figure C-83: Test 590 (Medium Pulse, 4.0 lb Added Head Weight)

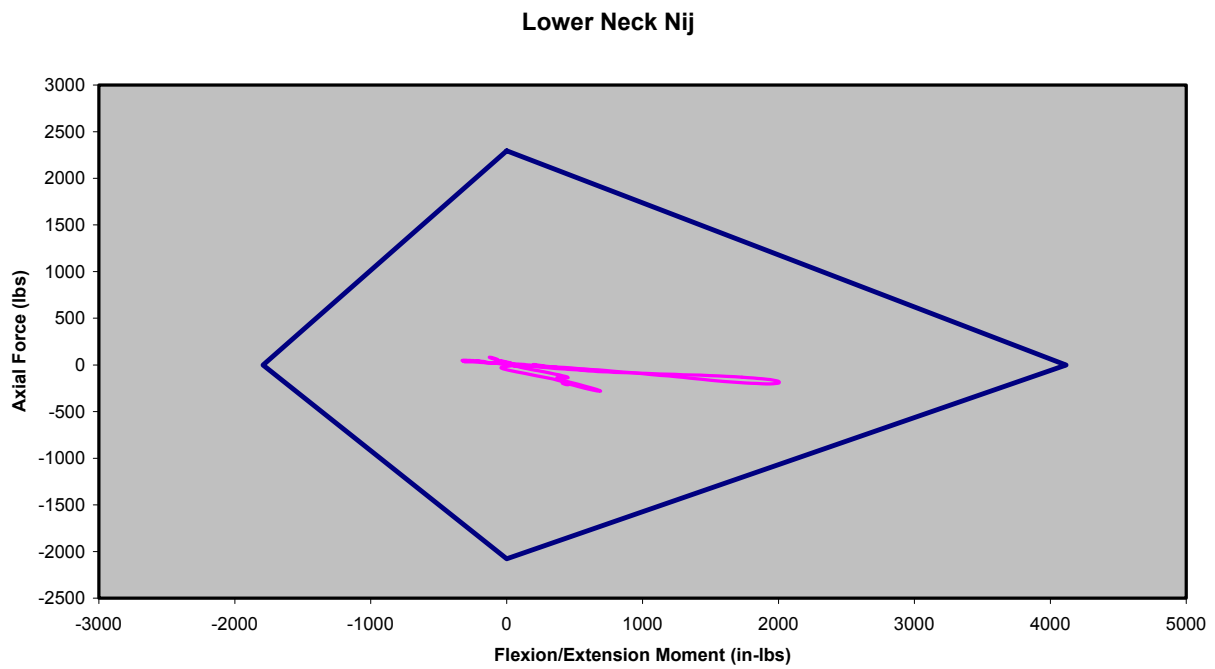

Figure C-84: Test 590 (Medium Pulse, 4.0 lb Added Head Weight)

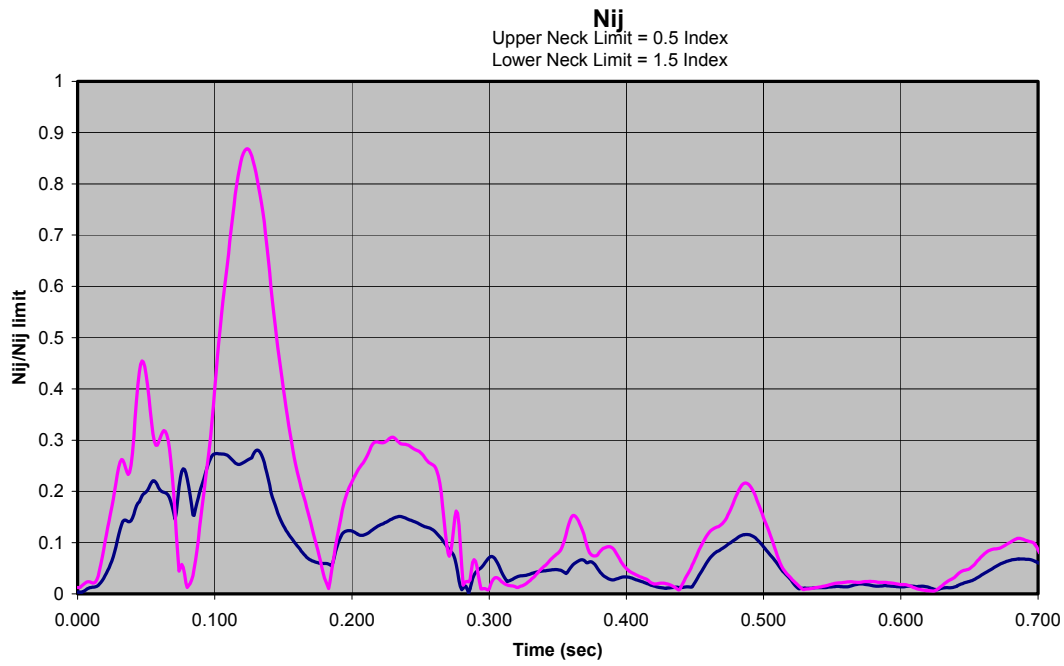

Figure C-85: Test 590 (Medium Pulse, 4.0 lb Added Head Weight)

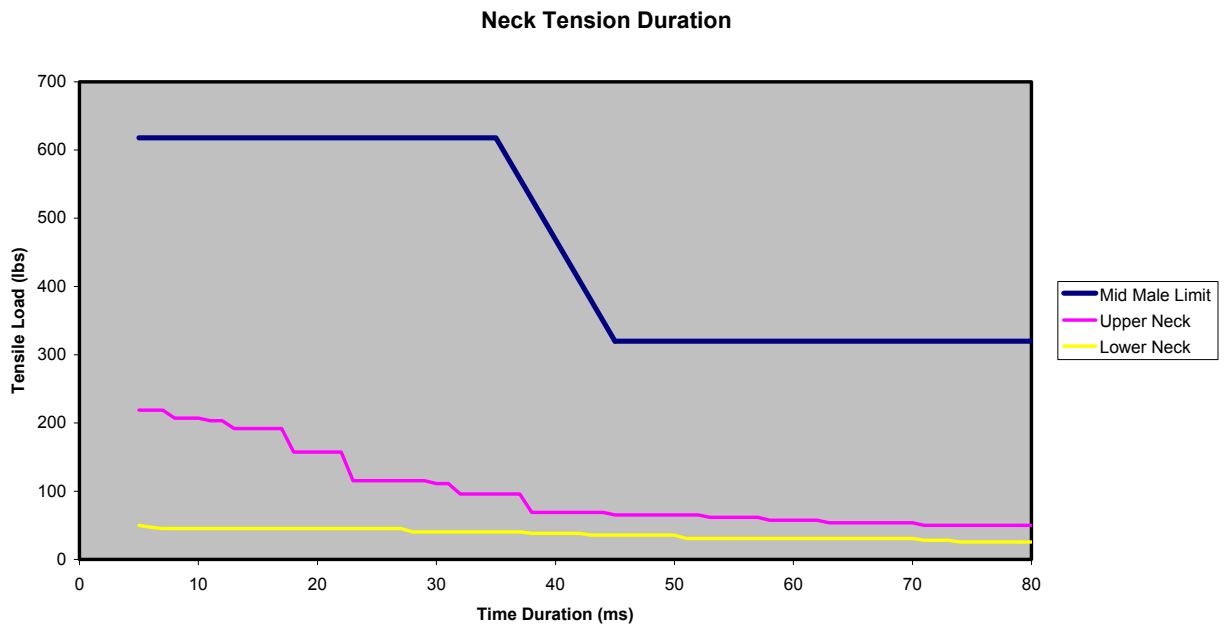

Figure C-86: Test 590 (Medium Pulse, 4.0 lb Added Head Weight)

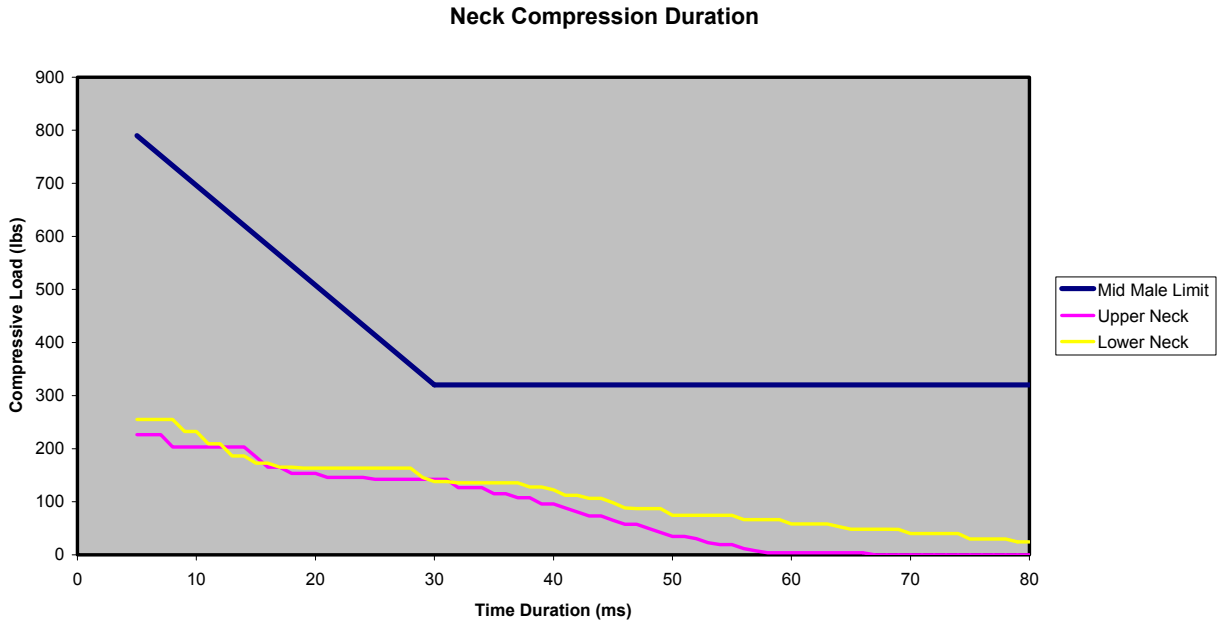

Figure C-87: Test 590 (Medium Pulse, 4.0 lb Added Head Weight)

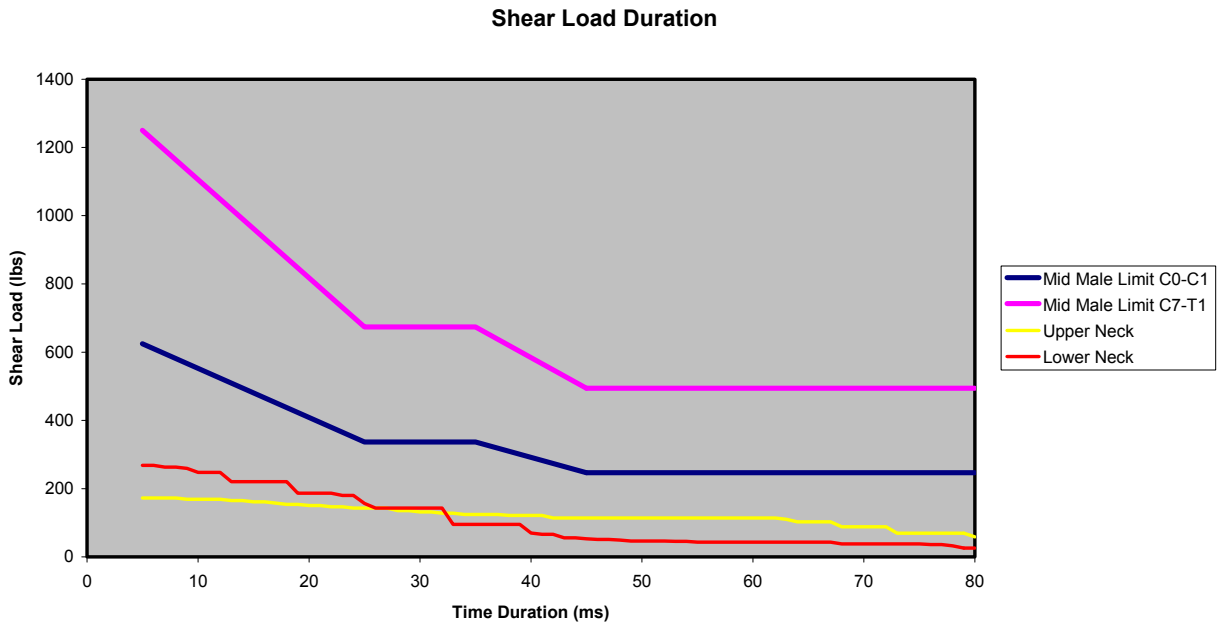

Figure C-88: Test 590 (Medium Pulse, 4.0 lb Added Head Weight)

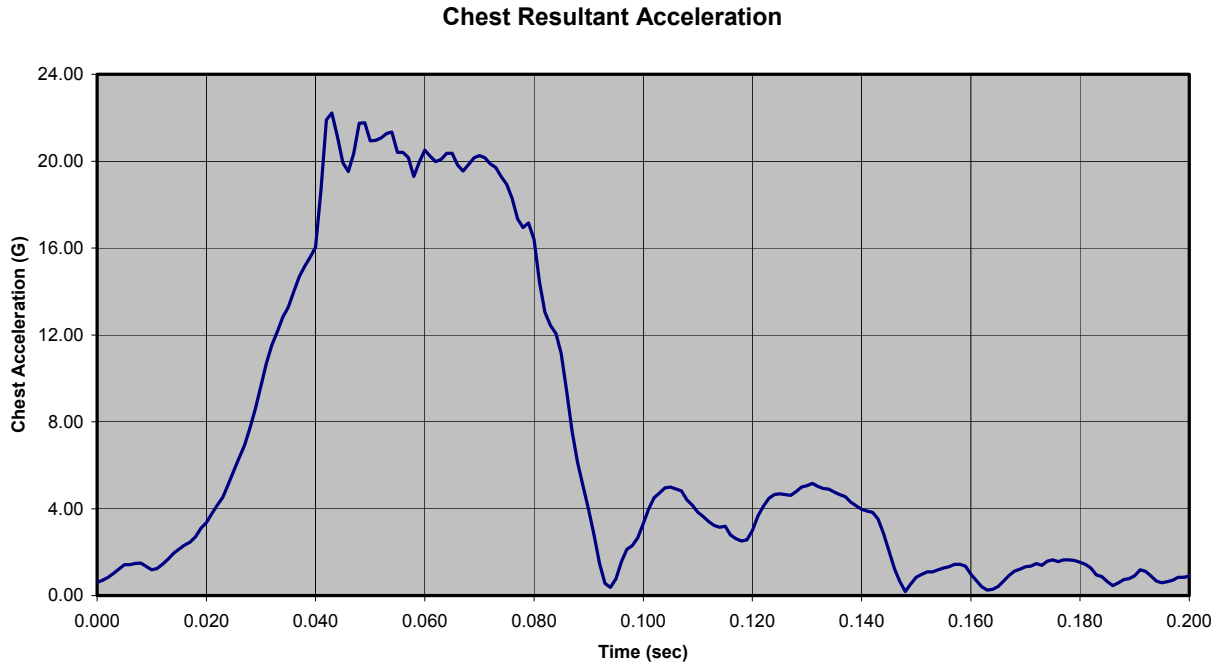

Figure C-89: Test 591 (Medium Pulse, 5.0 lb Added Head Weight)

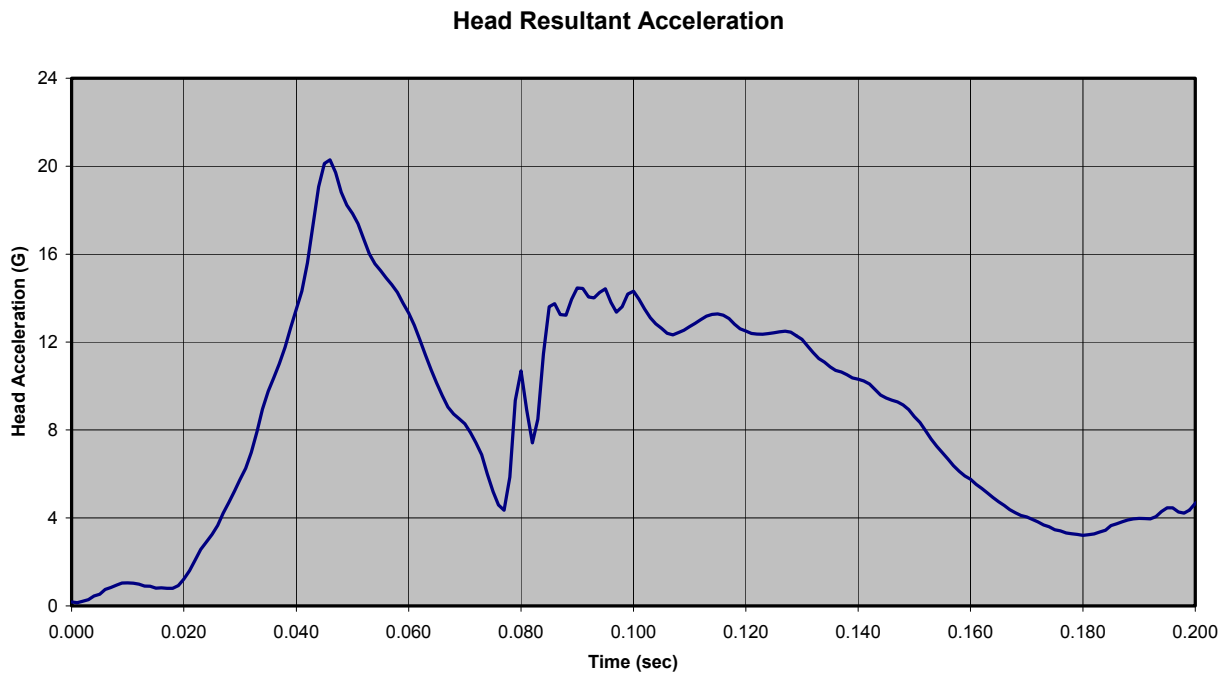

Figure C-90: Test 591 (Medium Pulse, 5.0 lb Added Head Weight)

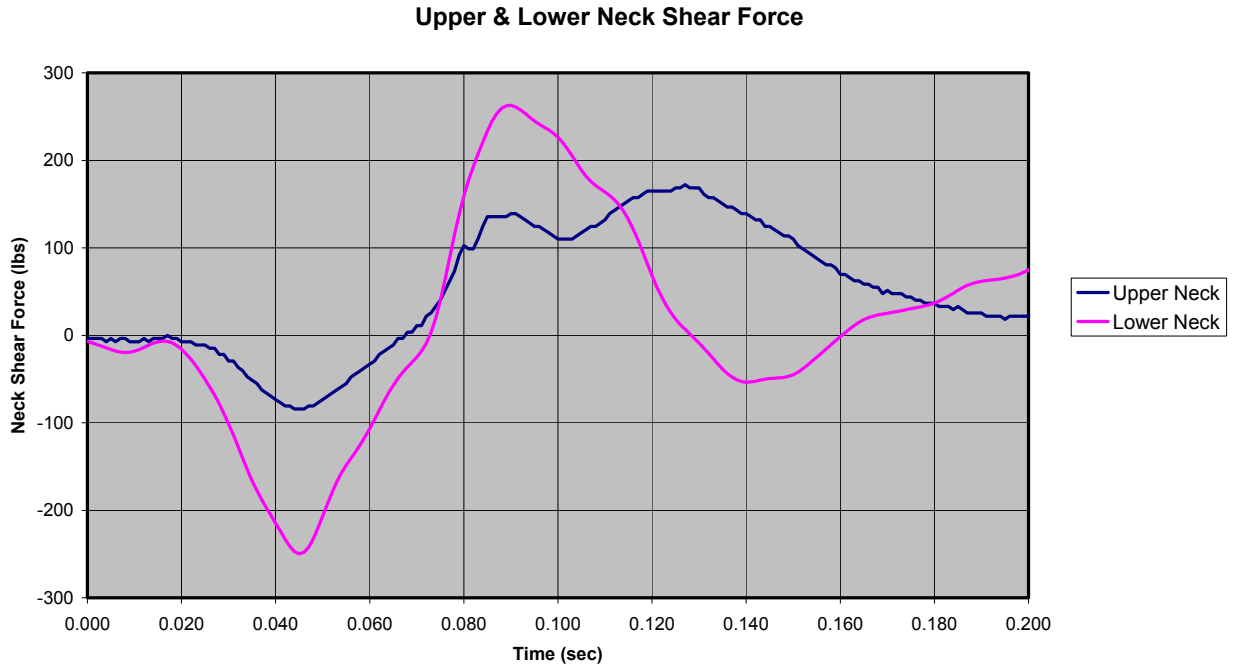

Figure C-91: Test 591 (Medium Pulse, 5.0 lb Added Head Weight)

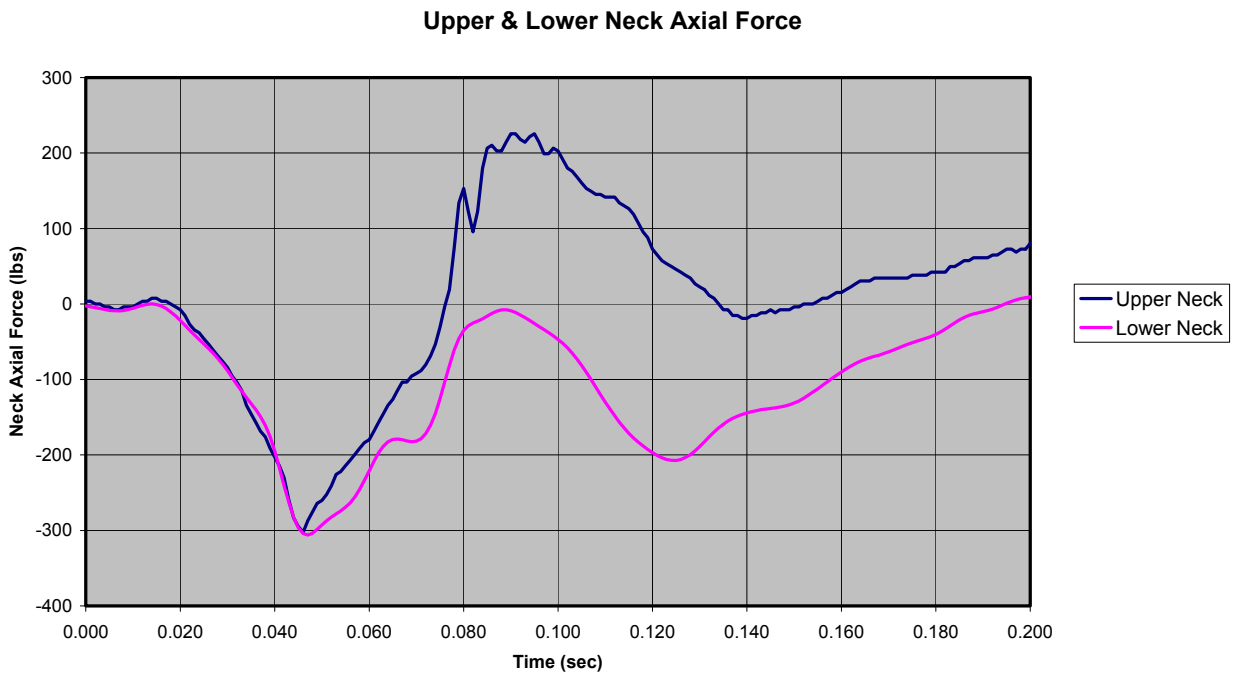

Figure C-92: Test 591 (Medium Pulse, 5.0 lb Added Head Weight)



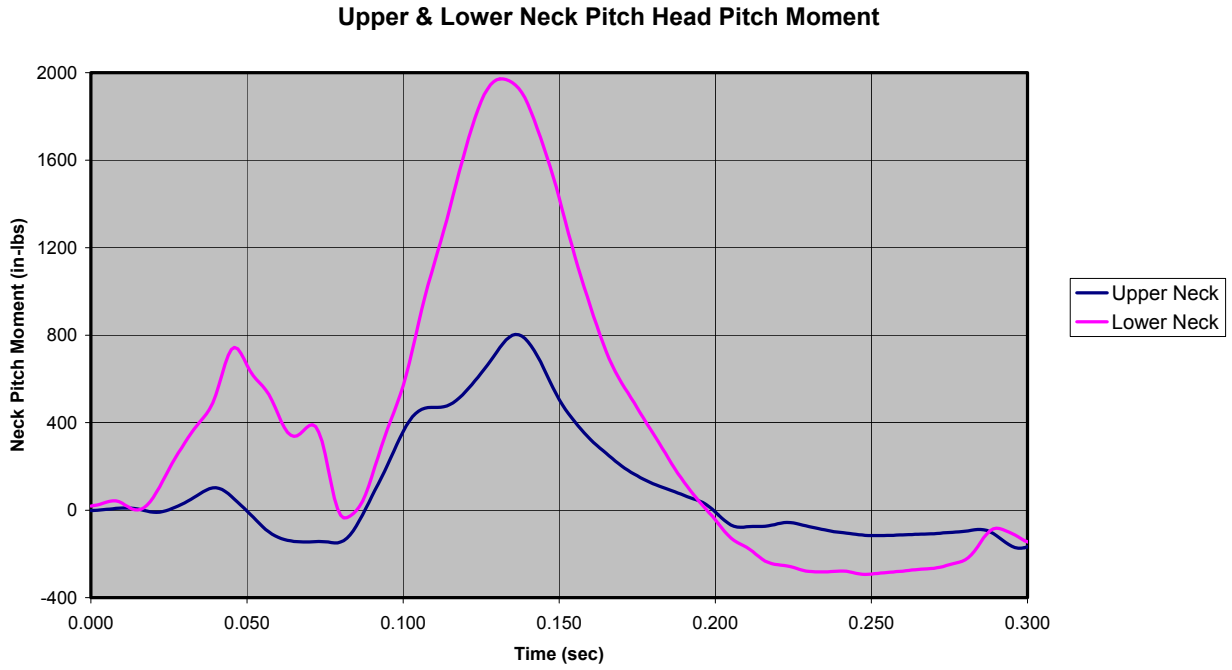

Figure C-93: Test 591 (Medium Pulse, 5.0 lb Added Head Weight)

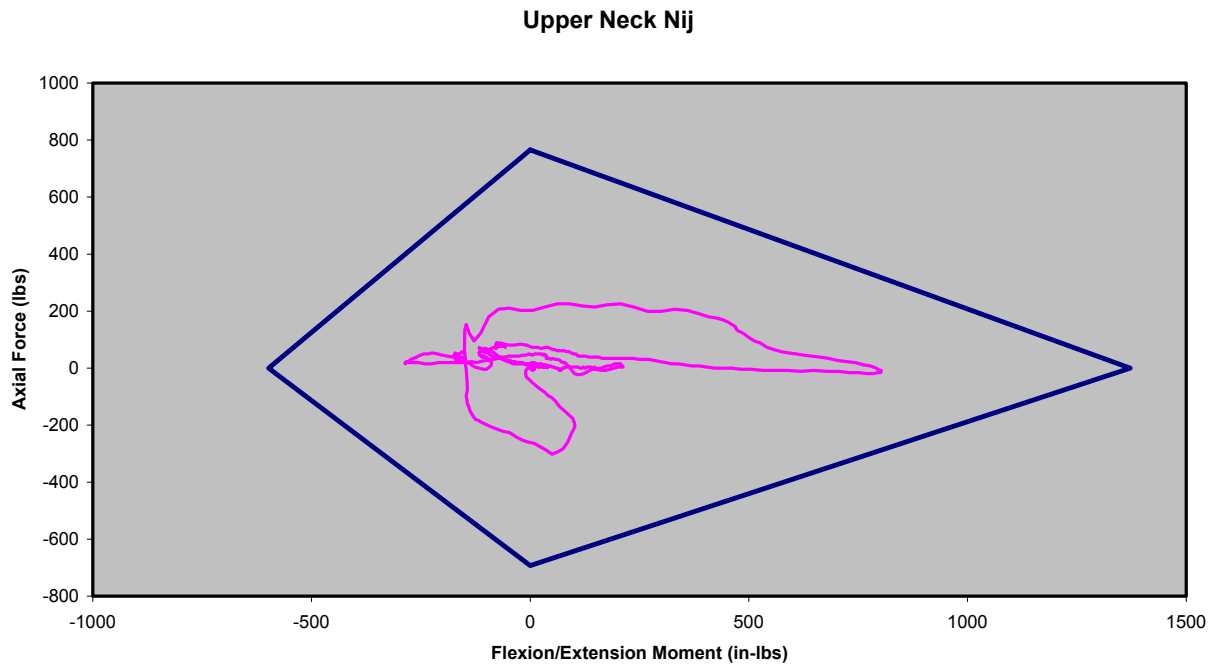

Figure C-94: Test 591 (Medium Pulse, 5.0 lb Added Head Weight)

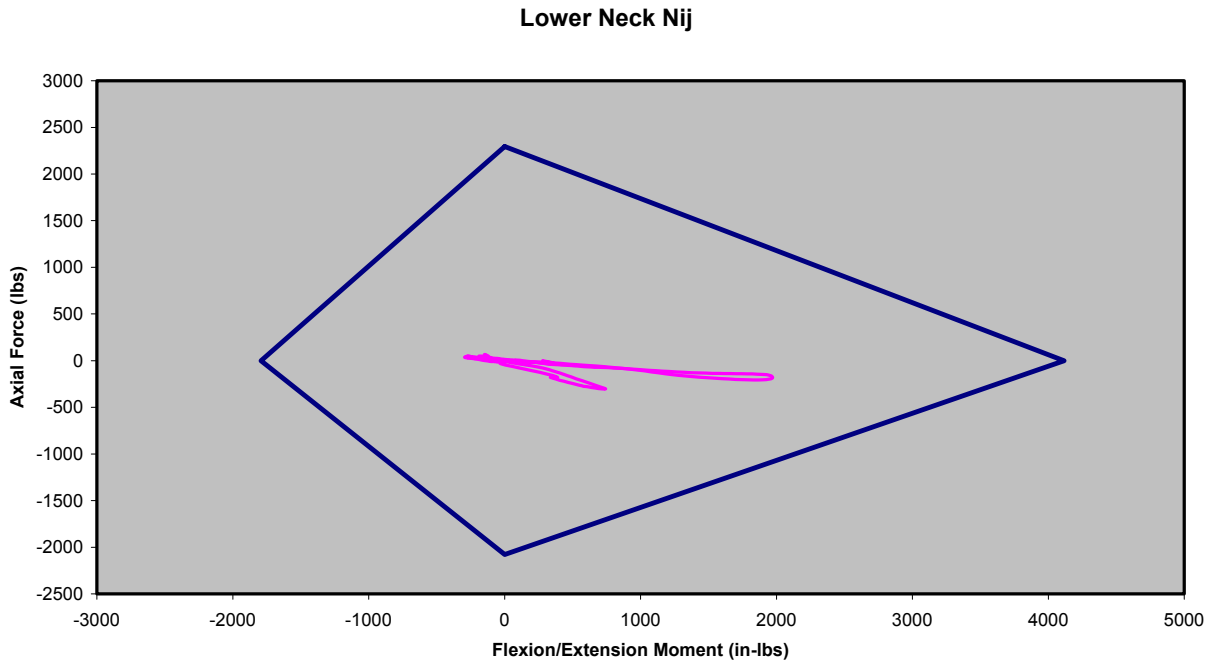

Figure C-95: Test 591 (Medium Pulse, 5.0 lb Added Head Weight)

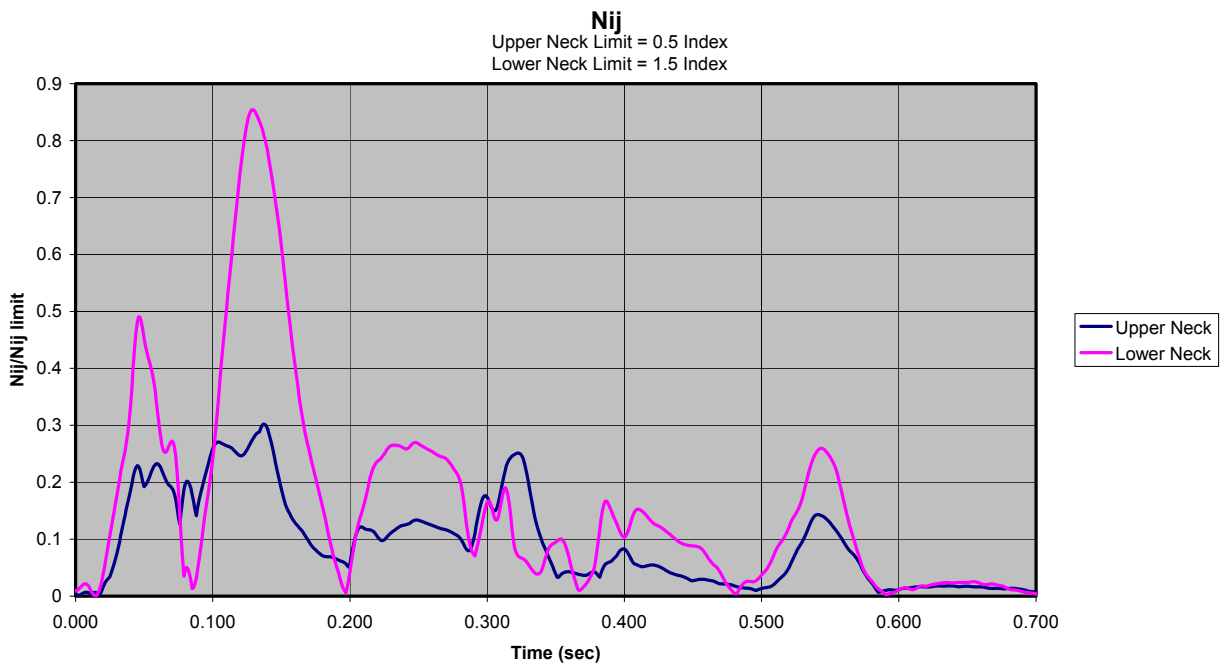

Figure C-96: Test 591 (Medium Pulse, 5.0 lb Added Head Weight)

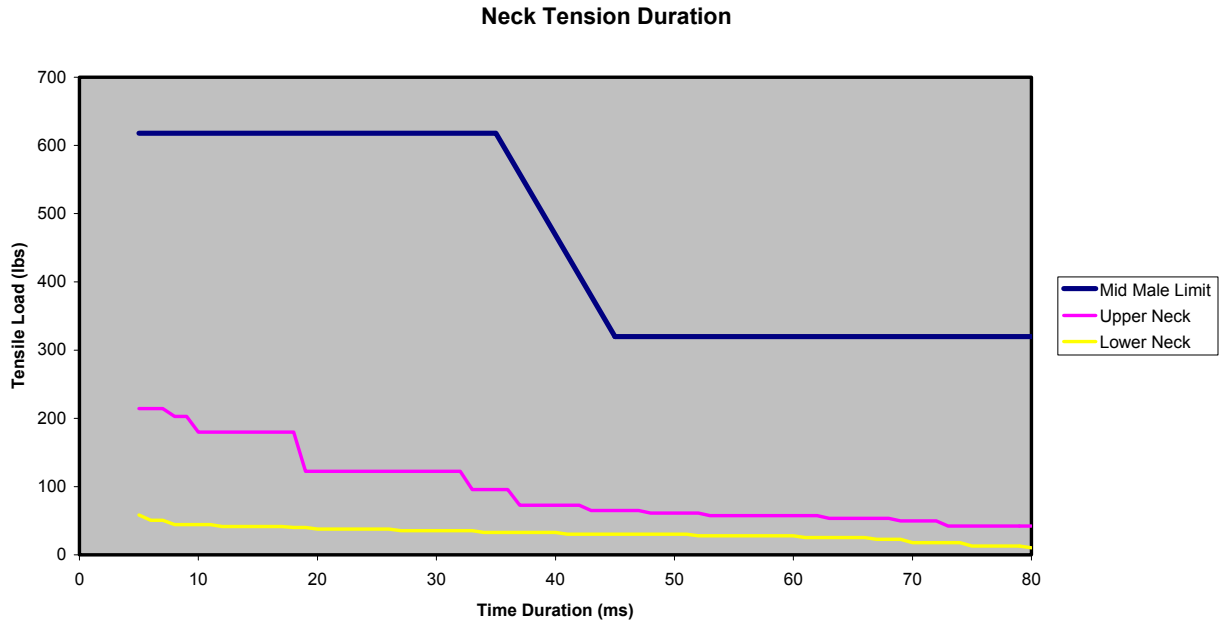

Figure C-97: Test 591 (Medium Pulse, 5.0 lb Added Head Weight)

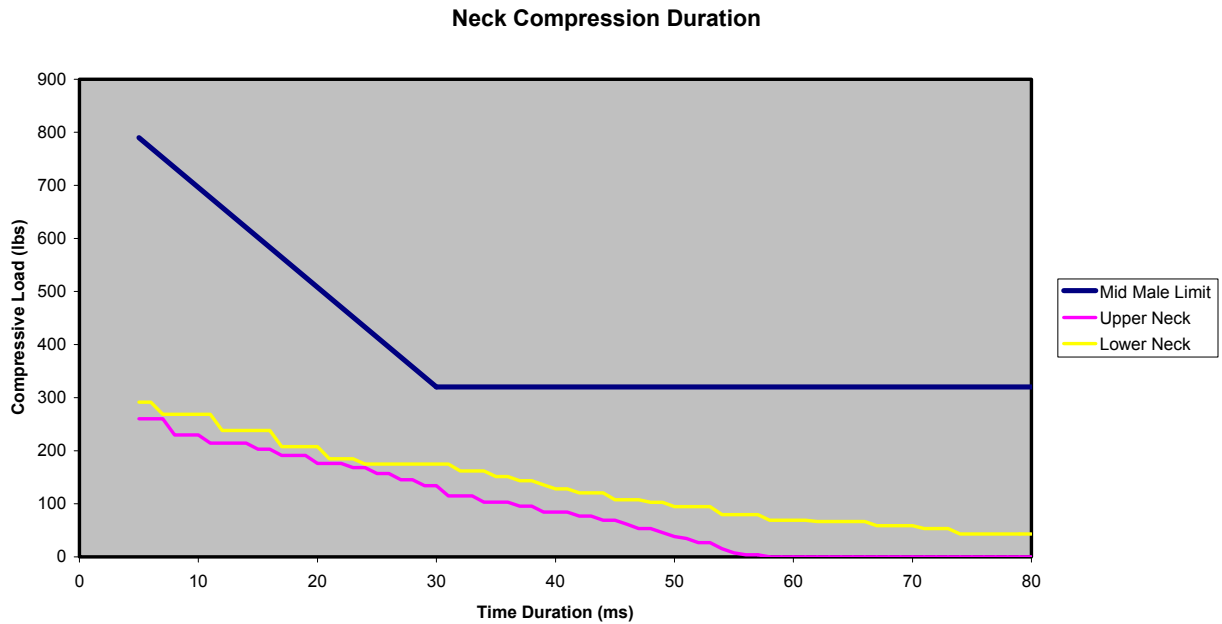

Figure C-98: Test 591 (Medium Pulse, 5.0 lb Added Head Weight)

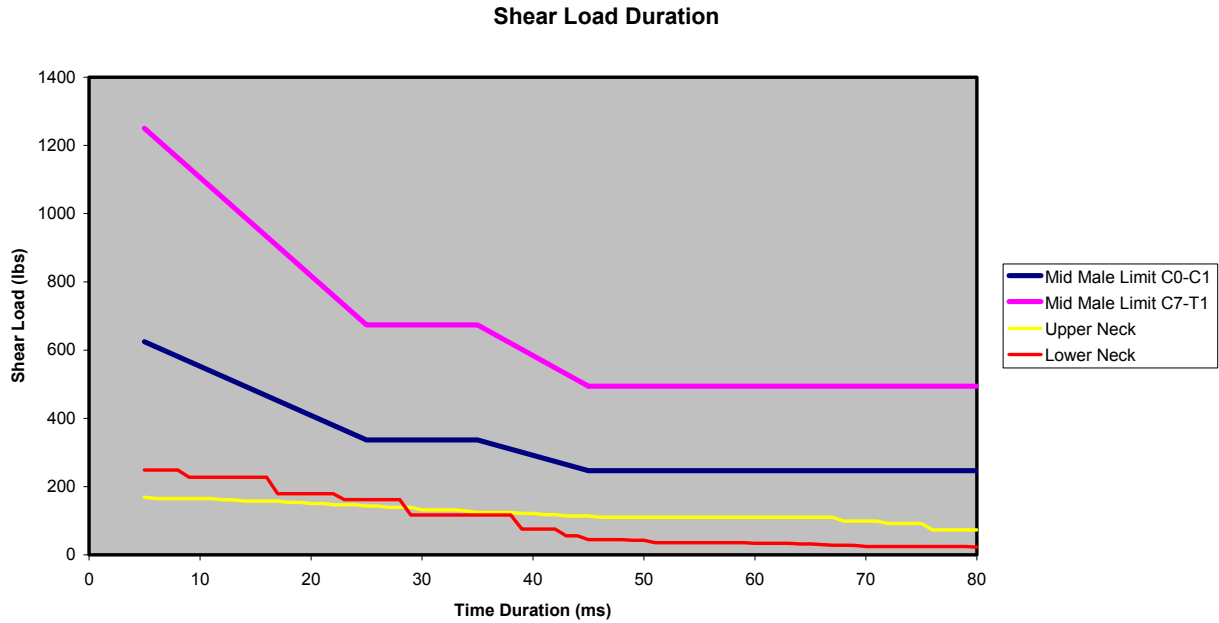

Figure C-99: Test 591 (Medium Pulse, 5.0 lb Added Head Weight)

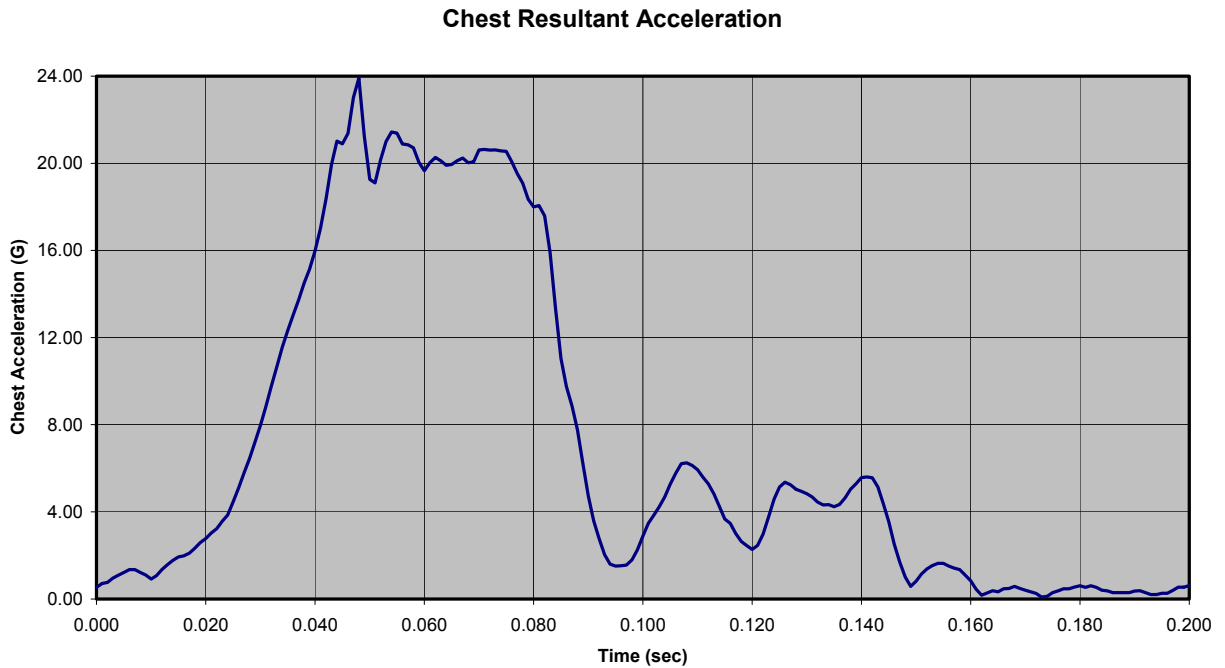

Figure C-100: Test 592 (Medium Pulse, 5.5 lb Added Head Weight)

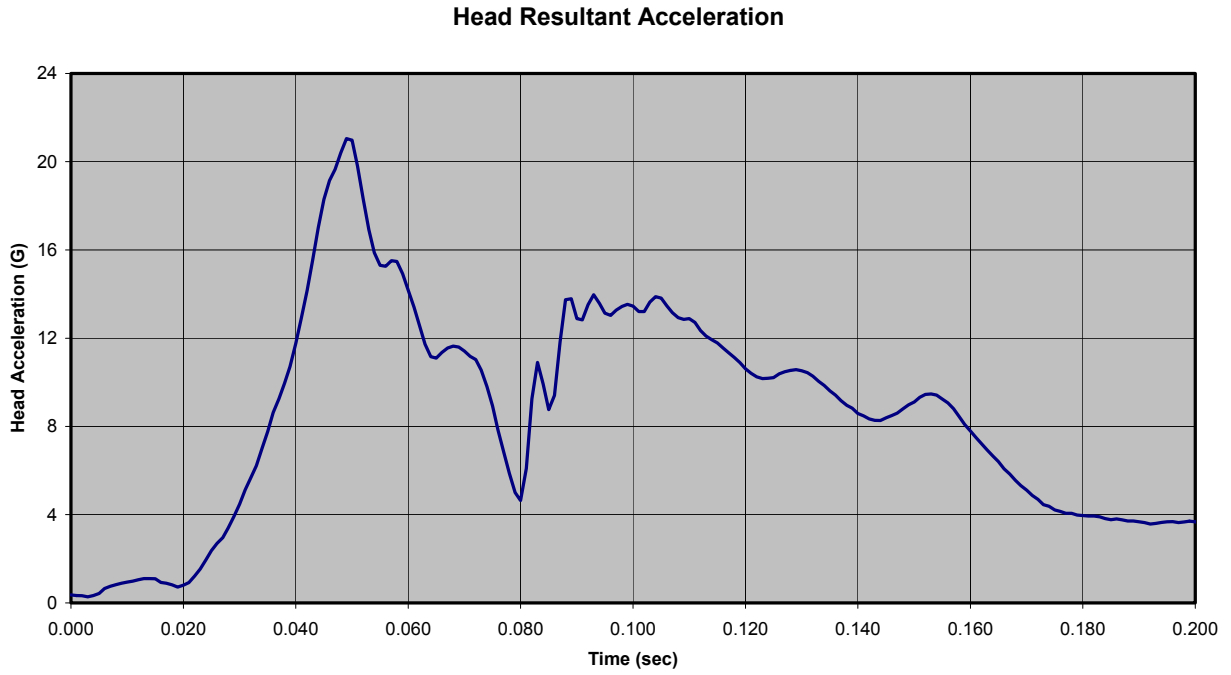

Figure C-101: Test 592 (Medium Pulse, 5.5 lb Added Head Weight)

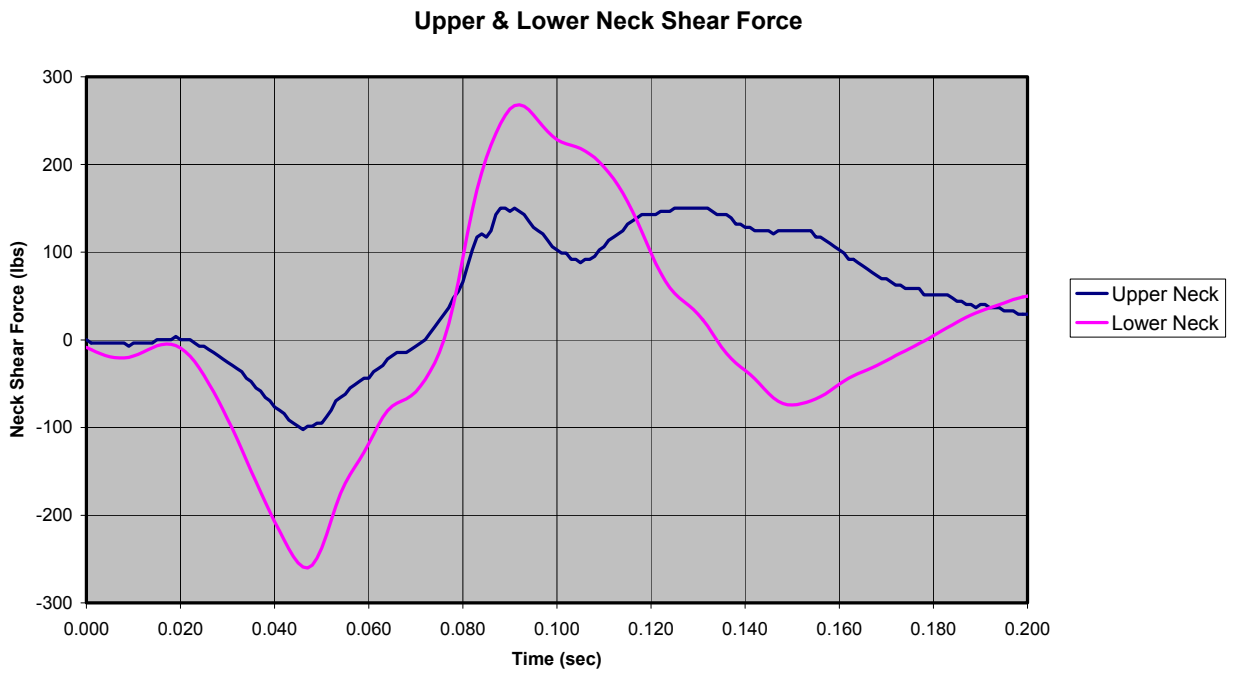

Figure C-102: Test 592 (Medium Pulse, 5.5 lb Added Head Weight)

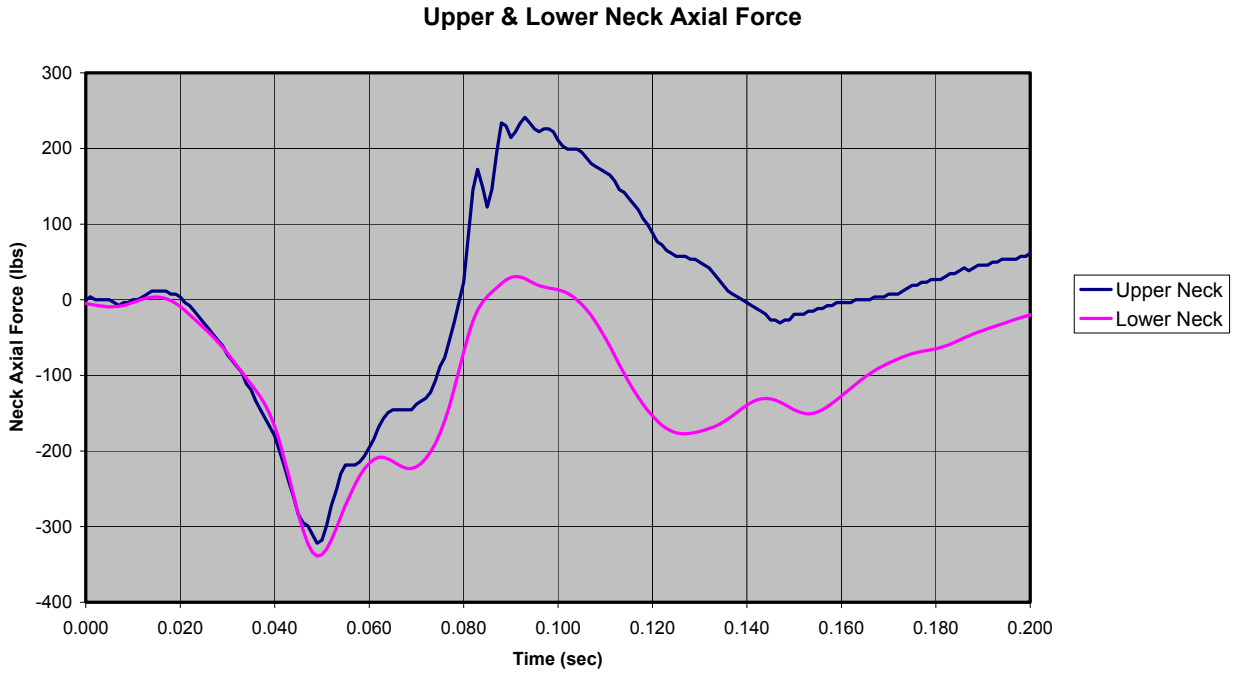

Figure C-103: Test 592 (Medium Pulse, 5.5 lb Added Head Weight)

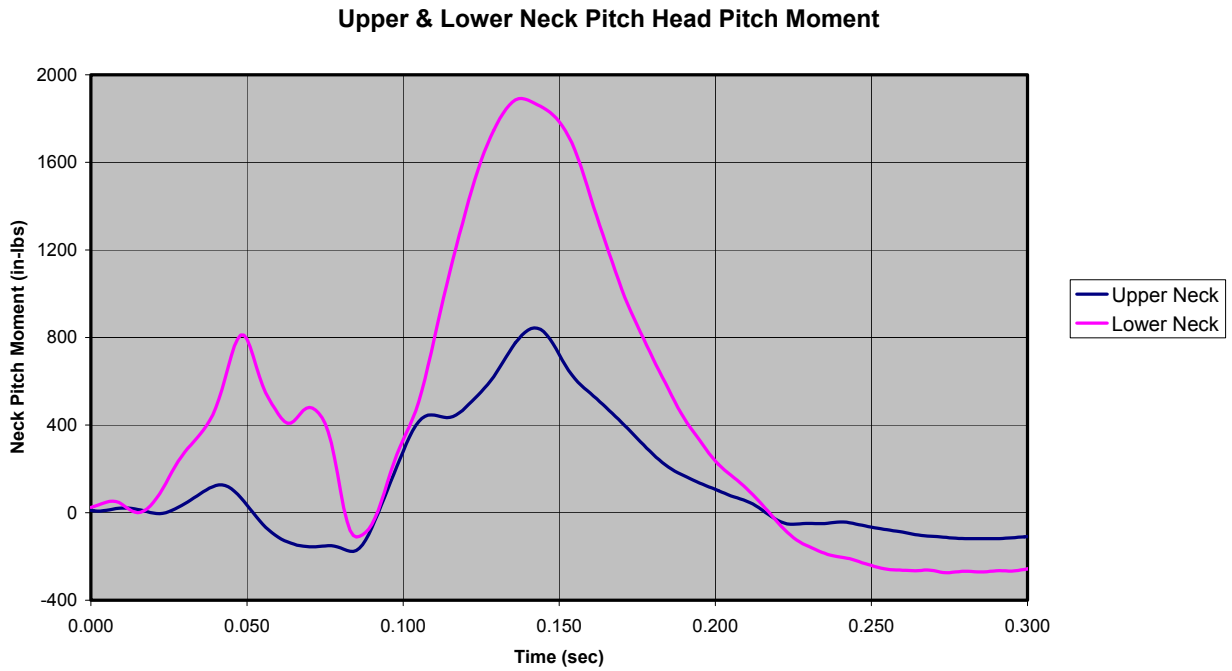

Figure C-104: Test 592 (Medium Pulse, 5.5 lb Added Head Weight)

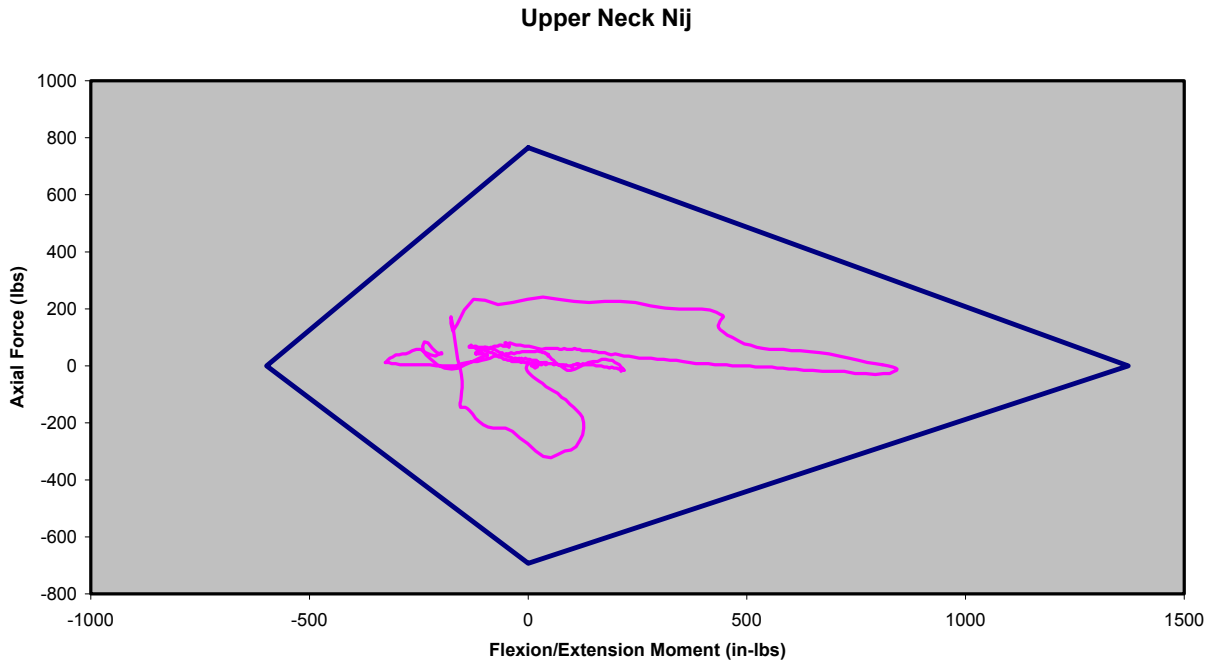

Figure C-105: Test 592 (Medium Pulse, 5.5 lb Added Head Weight)

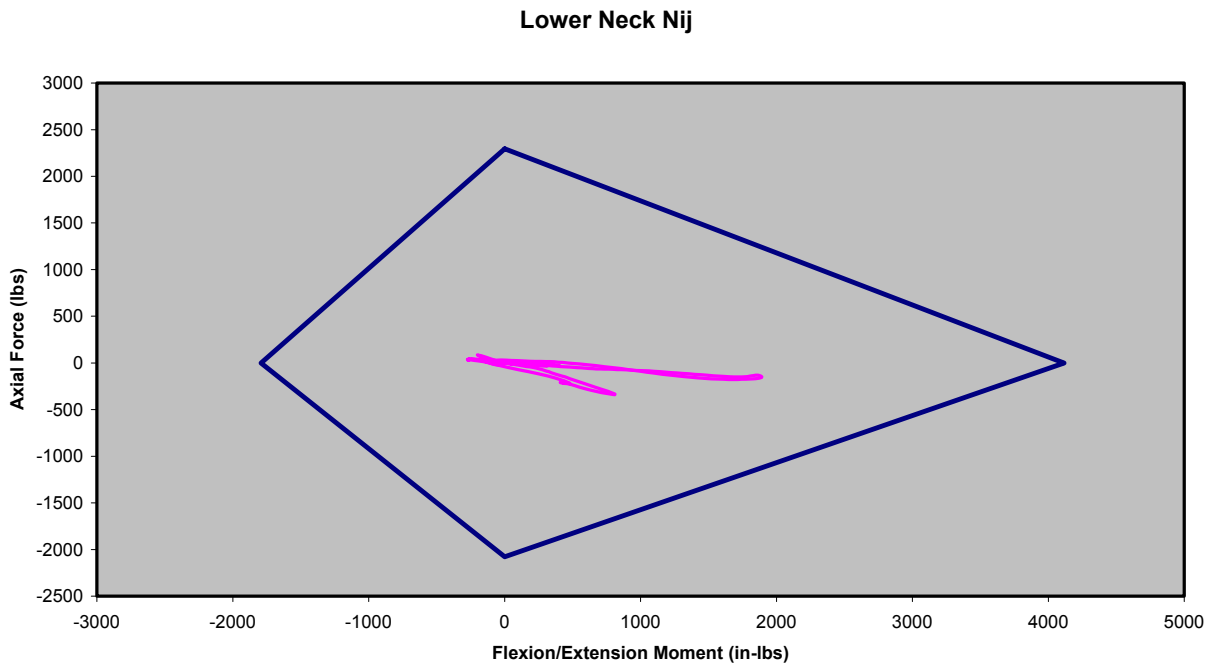

Figure C-106: Test 592 (Medium Pulse, 5.5 lb Added Head Weight)

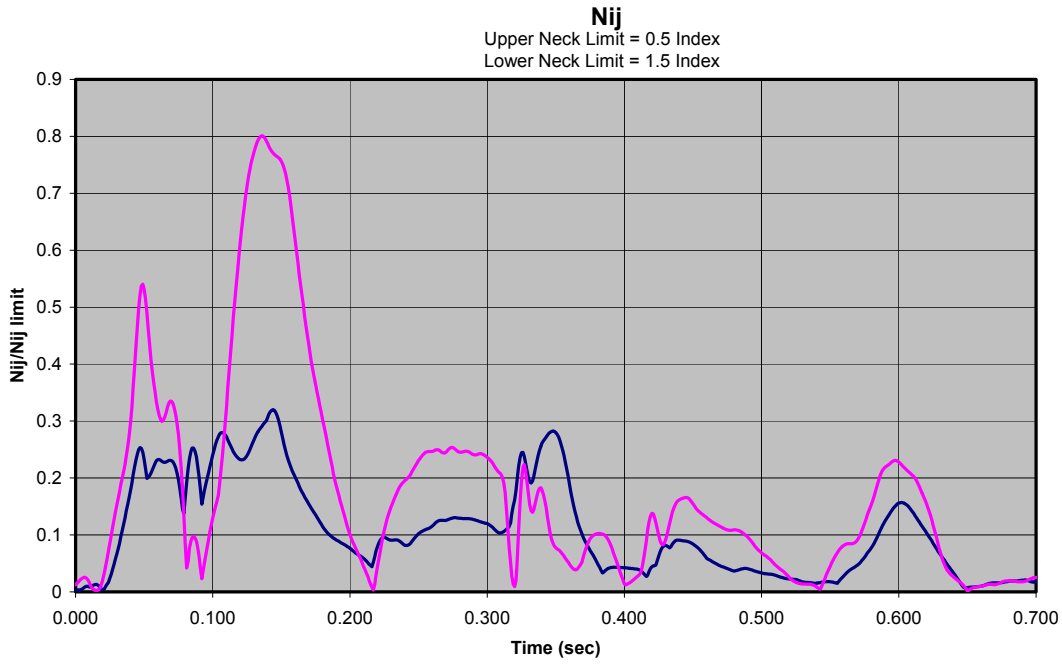

Figure C-107: Test 592 (Medium Pulse, 5.5 lb Added Head Weight)

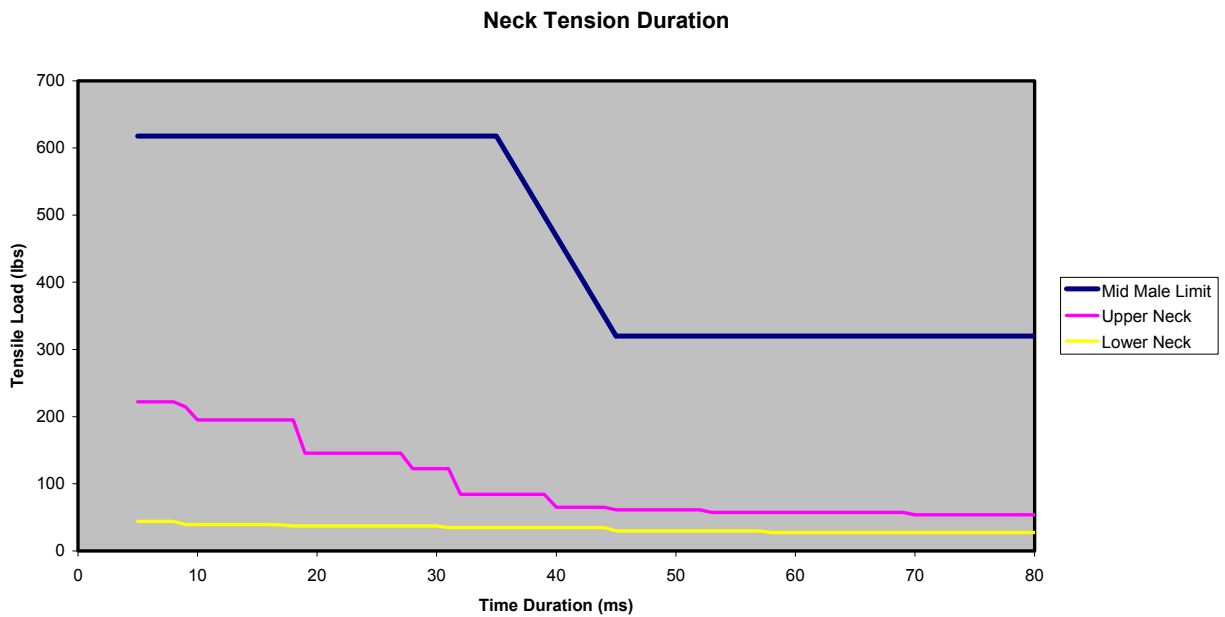

Figure C-108: Test 592 (Medium Pulse, 5.5 lb Added Head Weight)



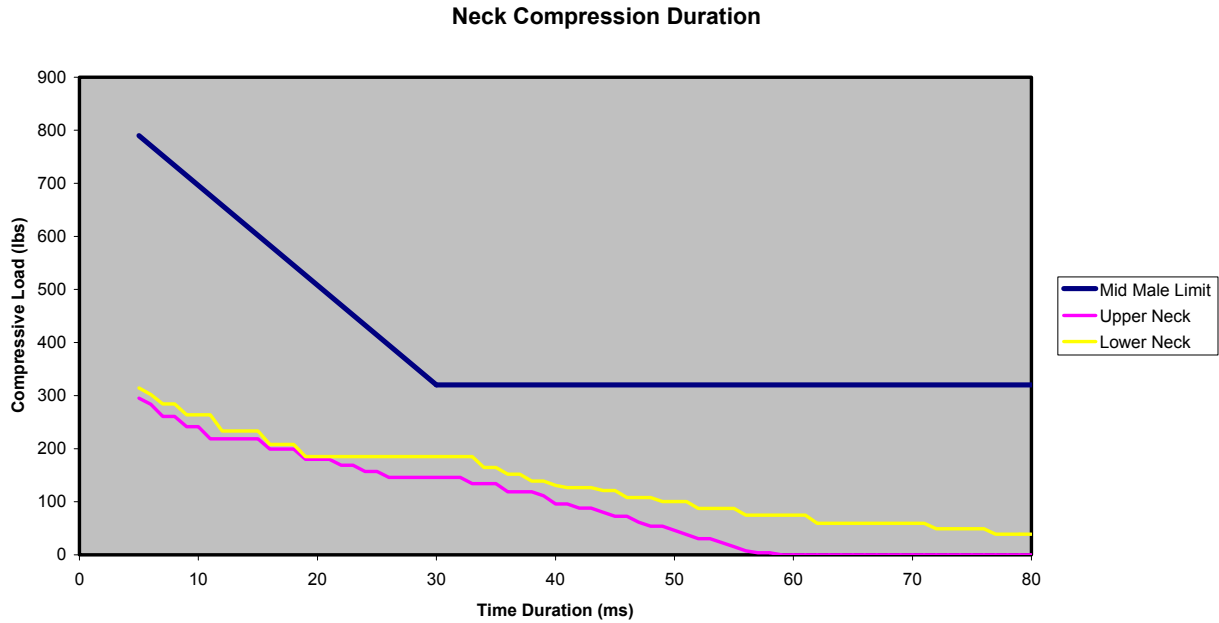

Figure C-109: Test 592 (Medium Pulse, 5.5 lb Added Head Weight)

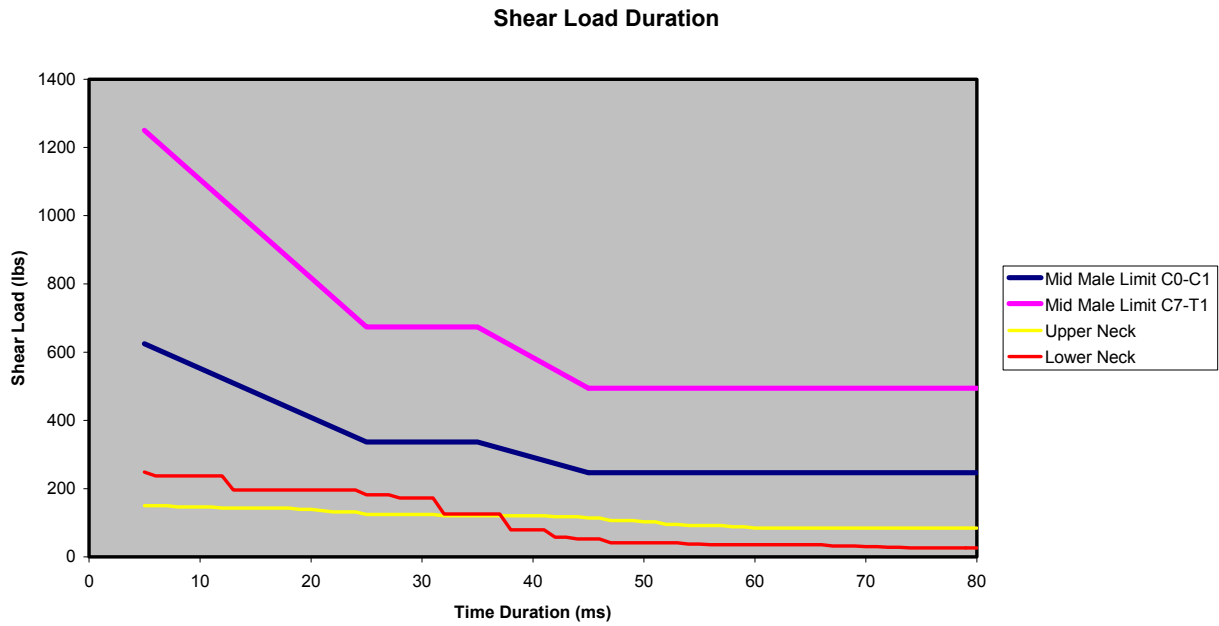

Figure C-110: Test 592 (Medium Pulse, 5.5 lb Added Head Weight)

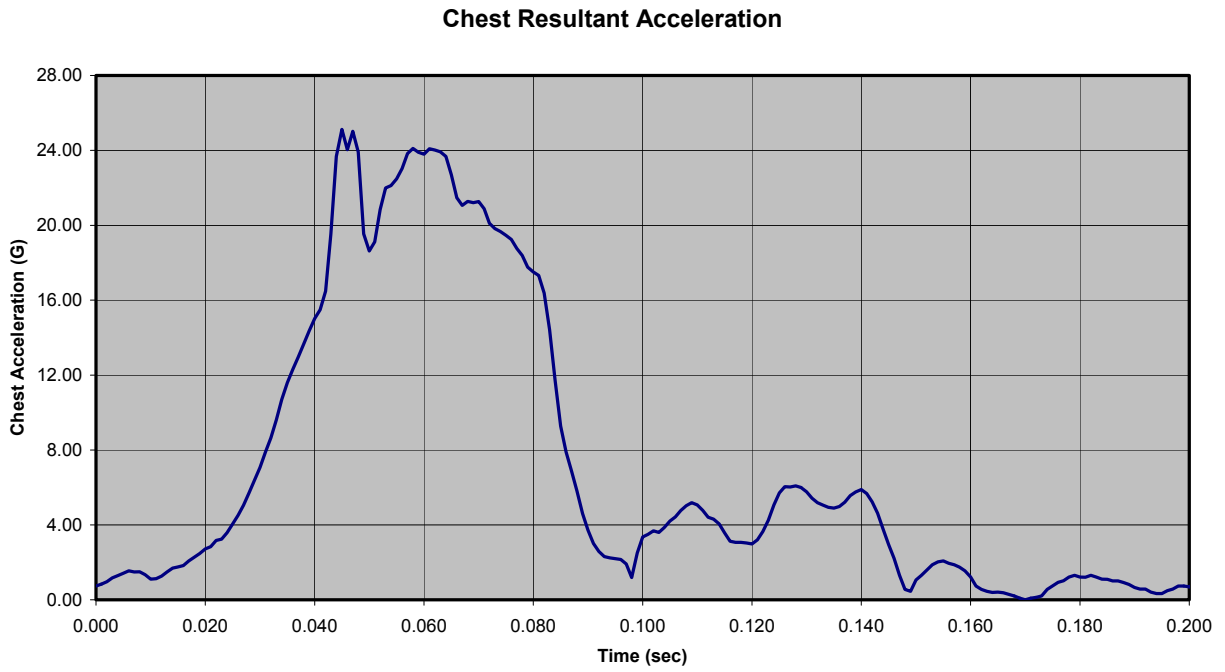

Figure C-111: Test 593 (Medium Pulse, 6.0 lb Added Head Weight)

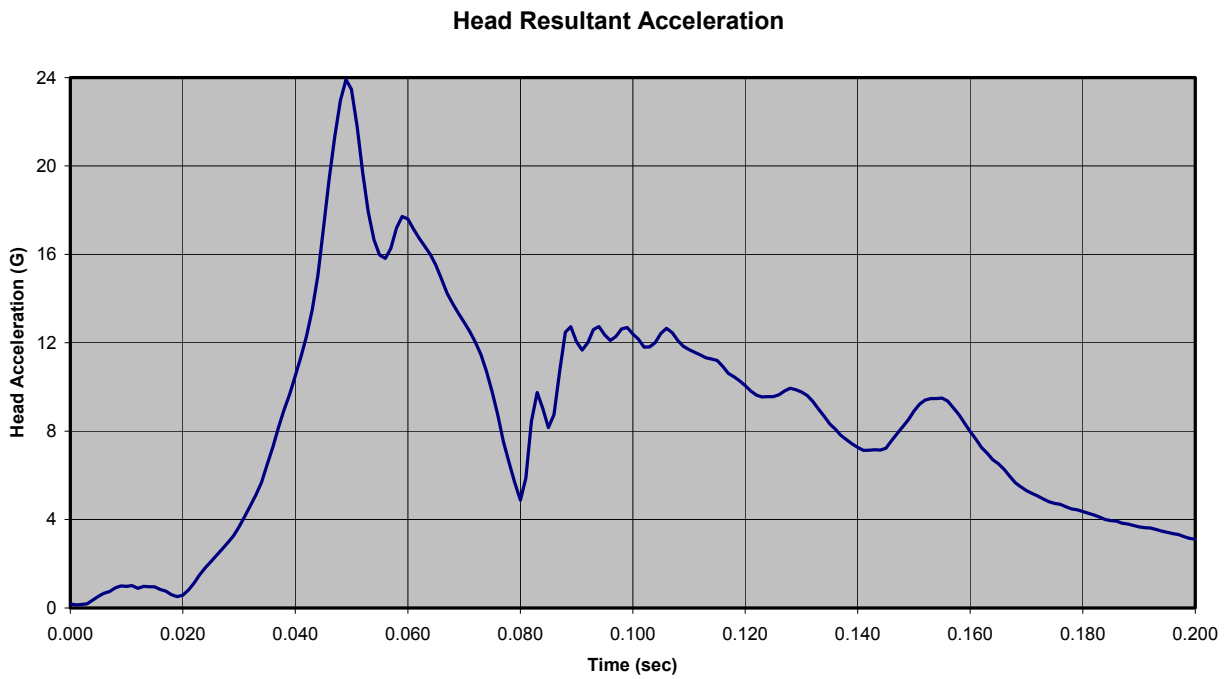

Figure C-112: Test 593 (Medium Pulse, 6.0 lb Added Head Weight)

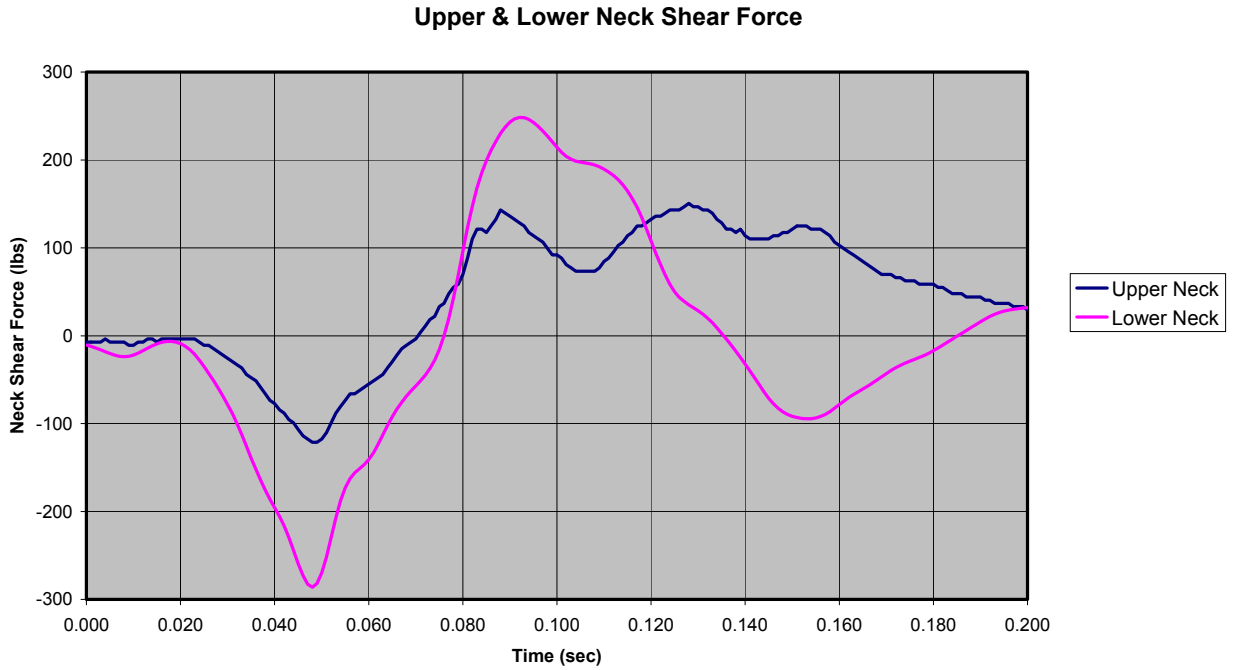

Figure C-113: Test 593 (Medium Pulse, 6.0 lb Added Head Weight)

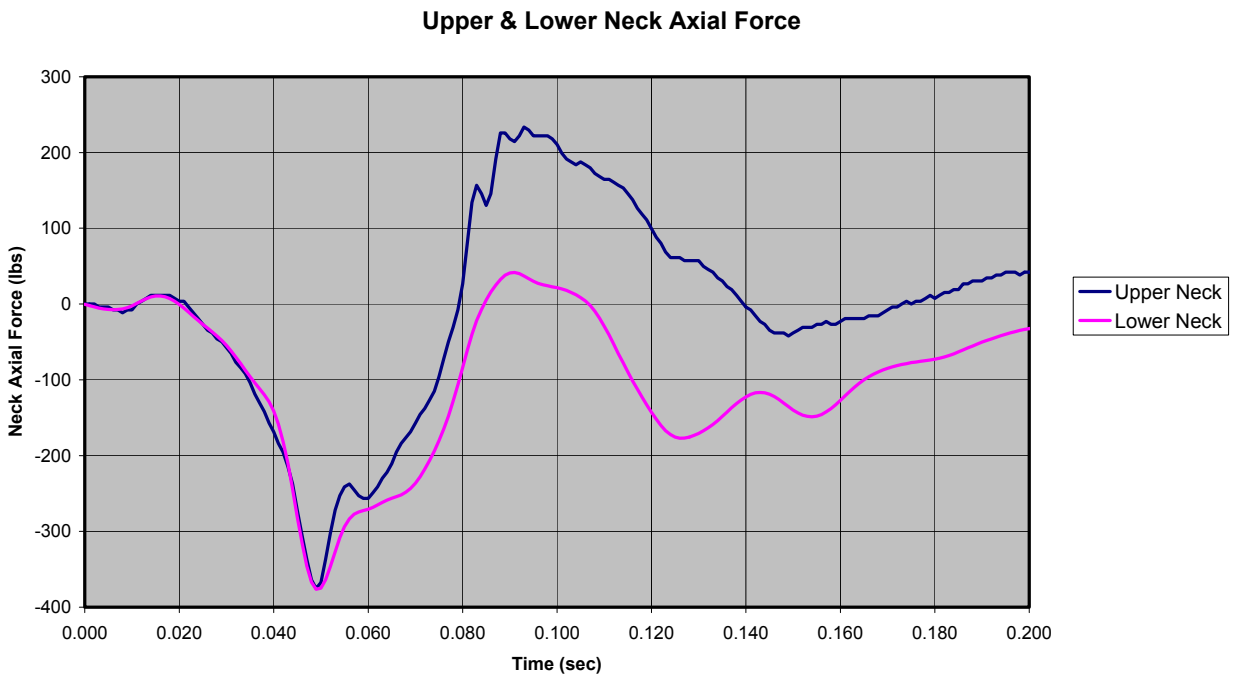

Figure C-114: Test 593 (Medium Pulse, 6.0 lb Added Head Weight)

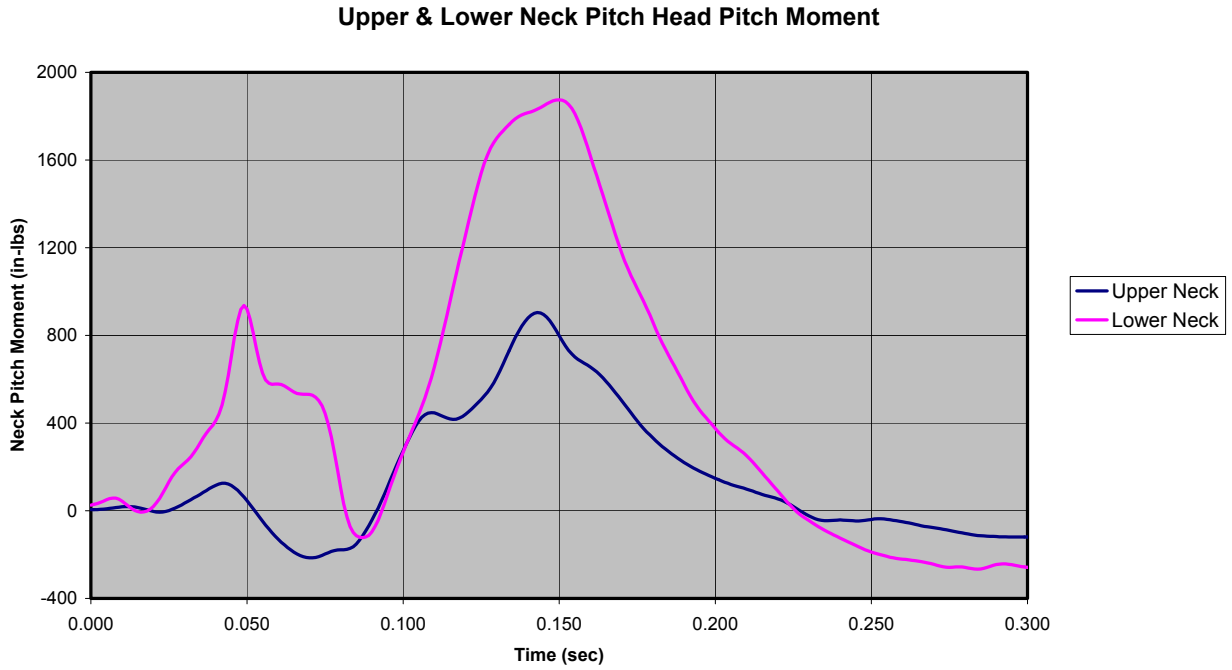

Figure C-115: Test 593 (Medium Pulse, 6.0 lb Added Head Weight)

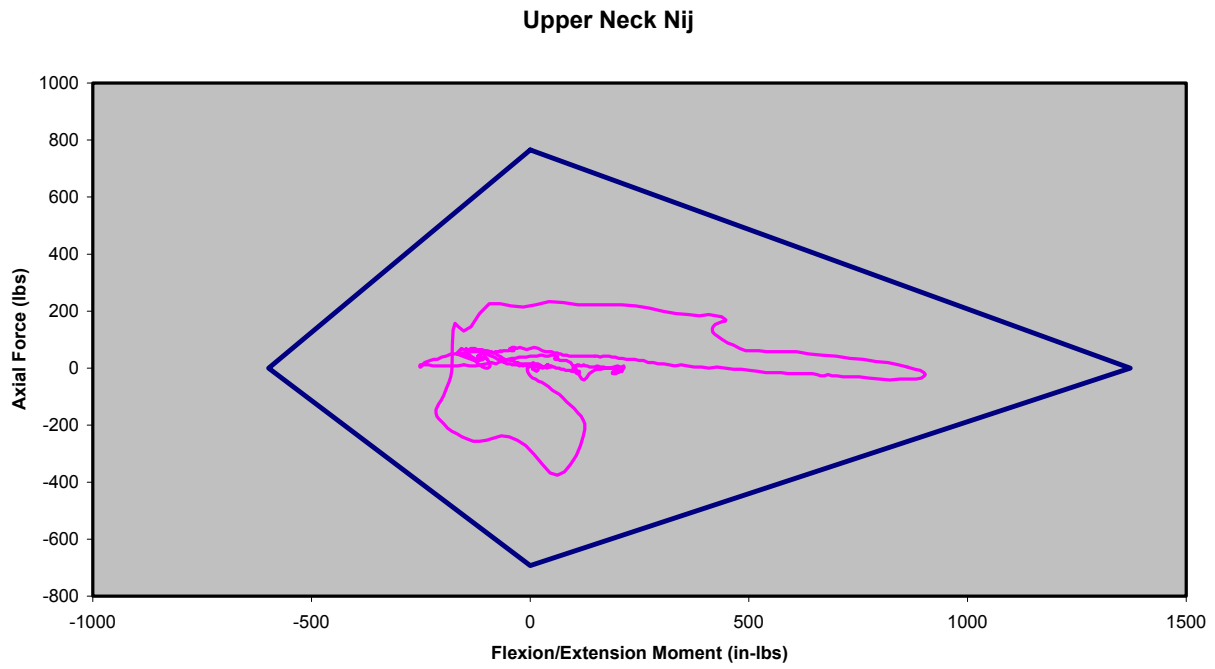

Figure C-116: Test 593 (Medium Pulse, 6.0 lb Added Head Weight)

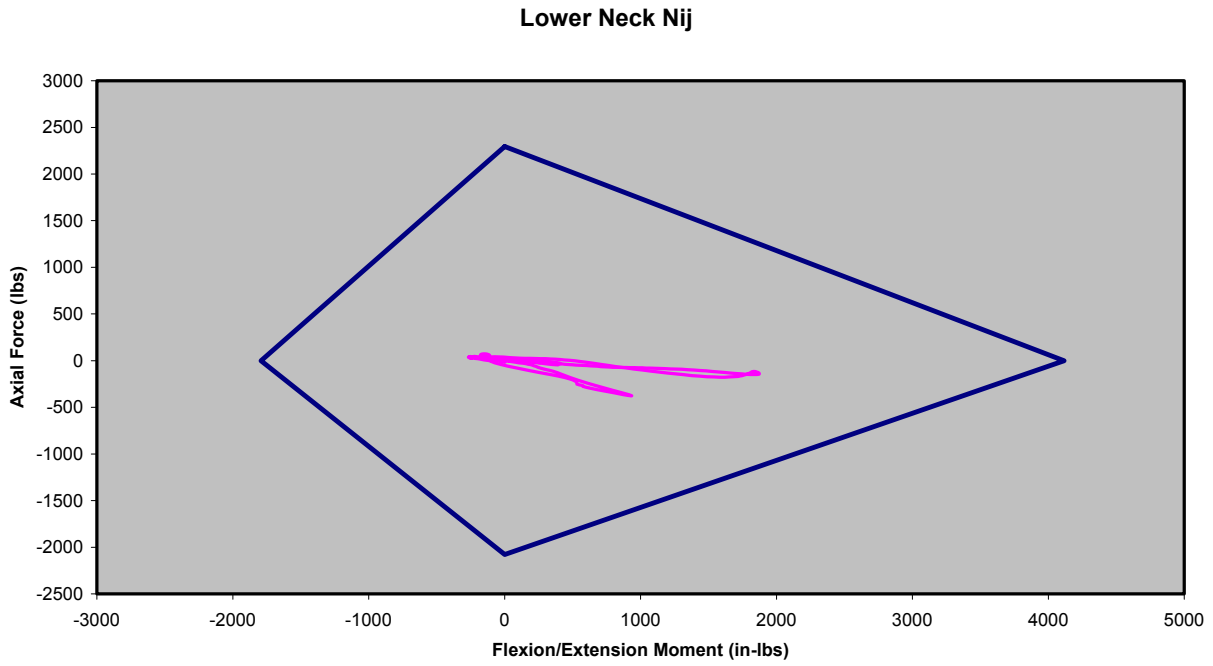

Figure C-117: Test 593 (Medium Pulse, 6.0 lb Added Head Weight)

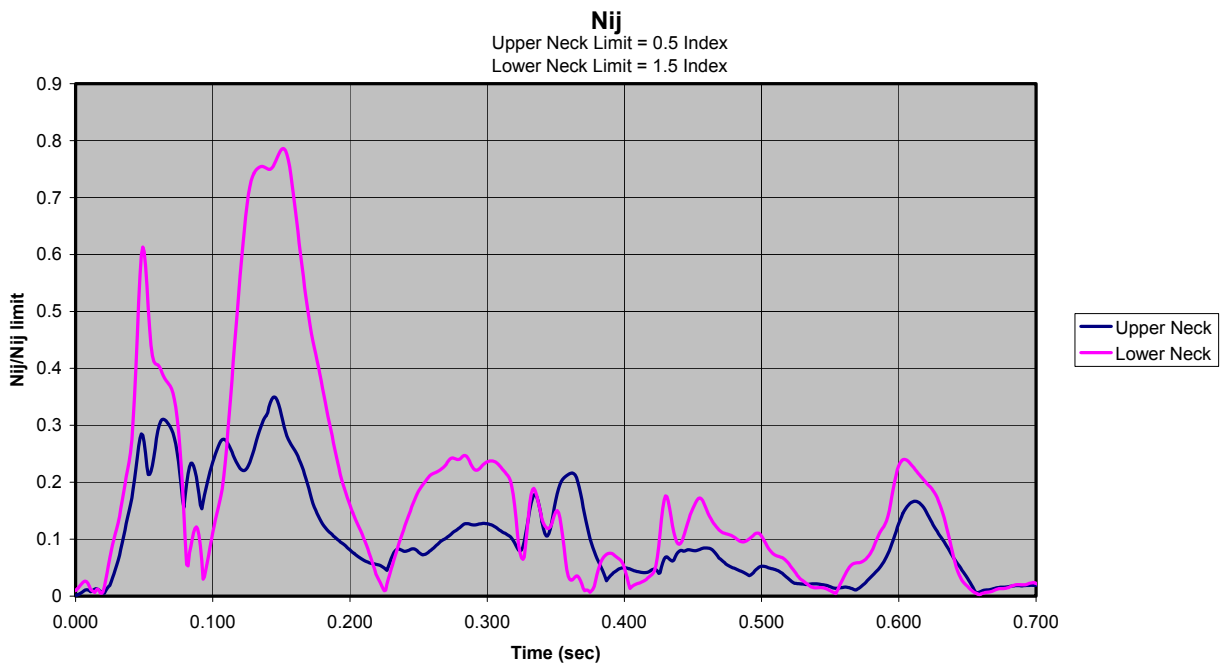

Figure C-118: Test 593 (Medium Pulse, 6.0 lb Added Head Weight)

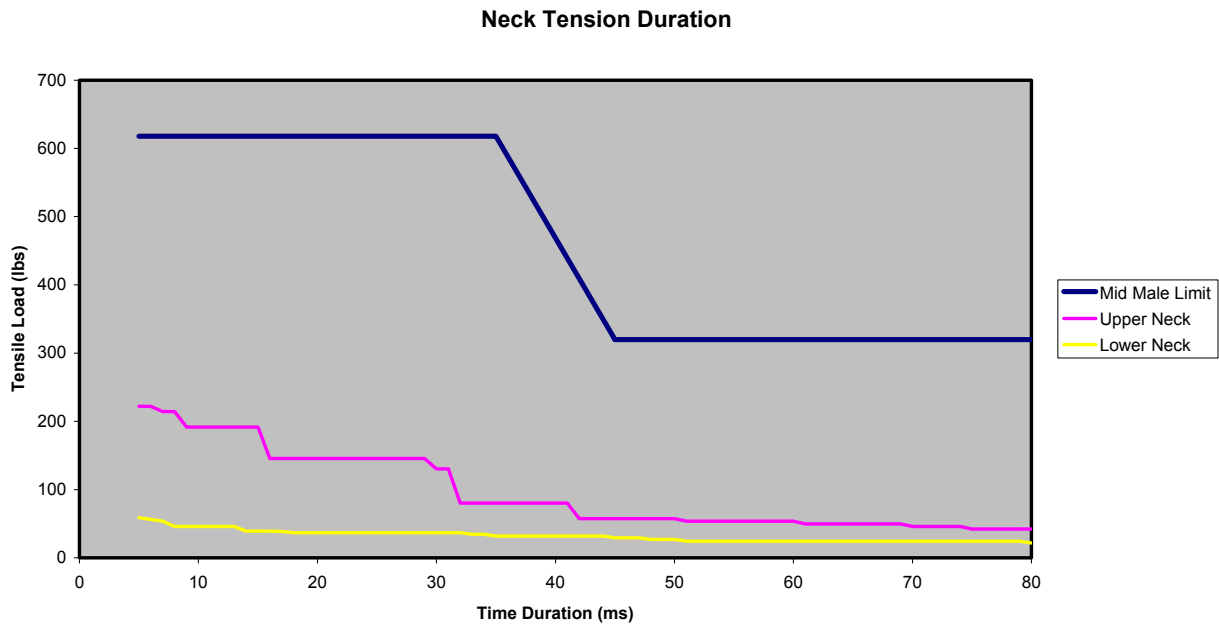

Figure C-119: Test 593 (Medium Pulse, 6.0 lb Added Head Weight)

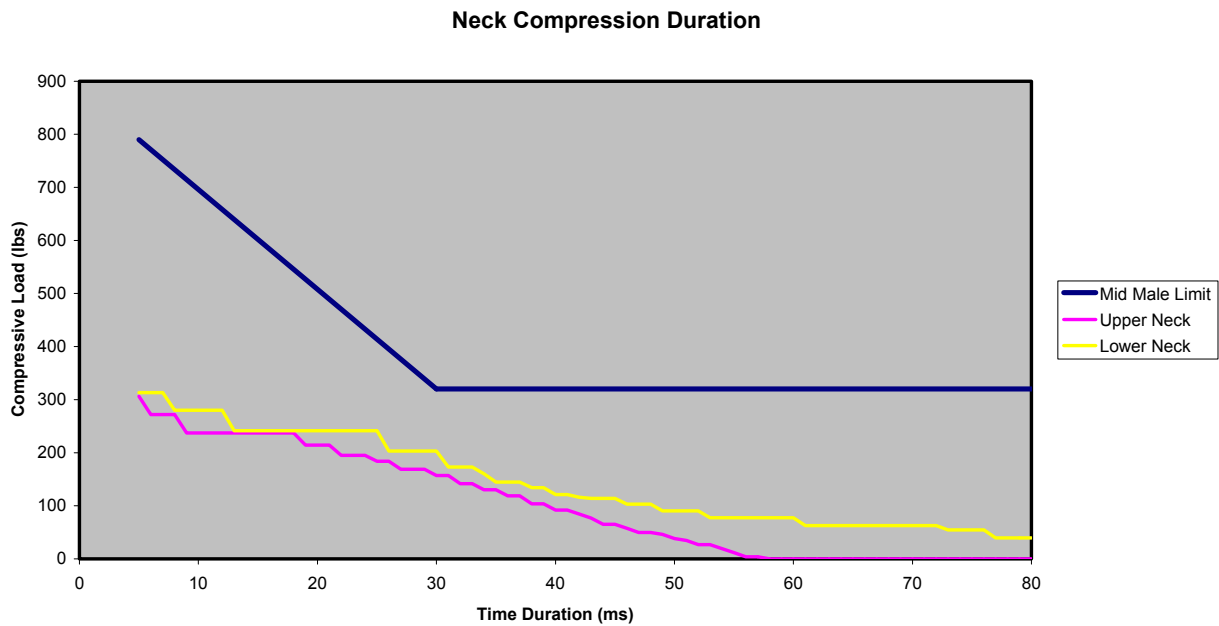

Figure C-120: Test 593 (Medium Pulse, 6.0 lb Added Head Weight)

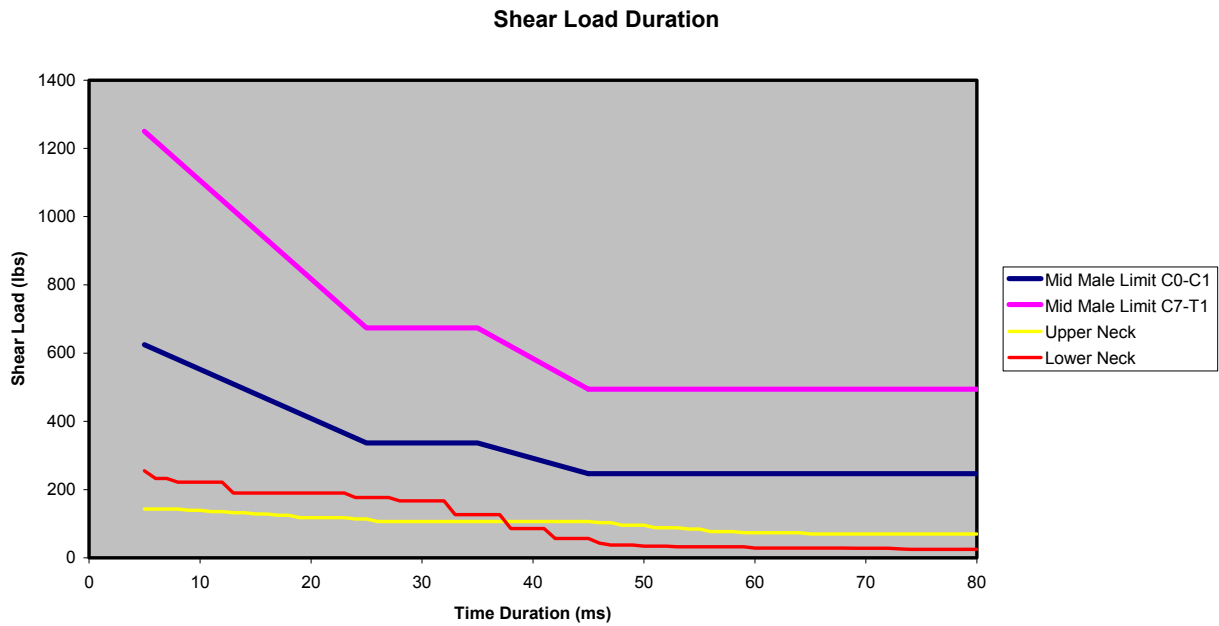

Figure C-121: Test 593 (Medium Pulse, 6.0 lb Added Head Weight)

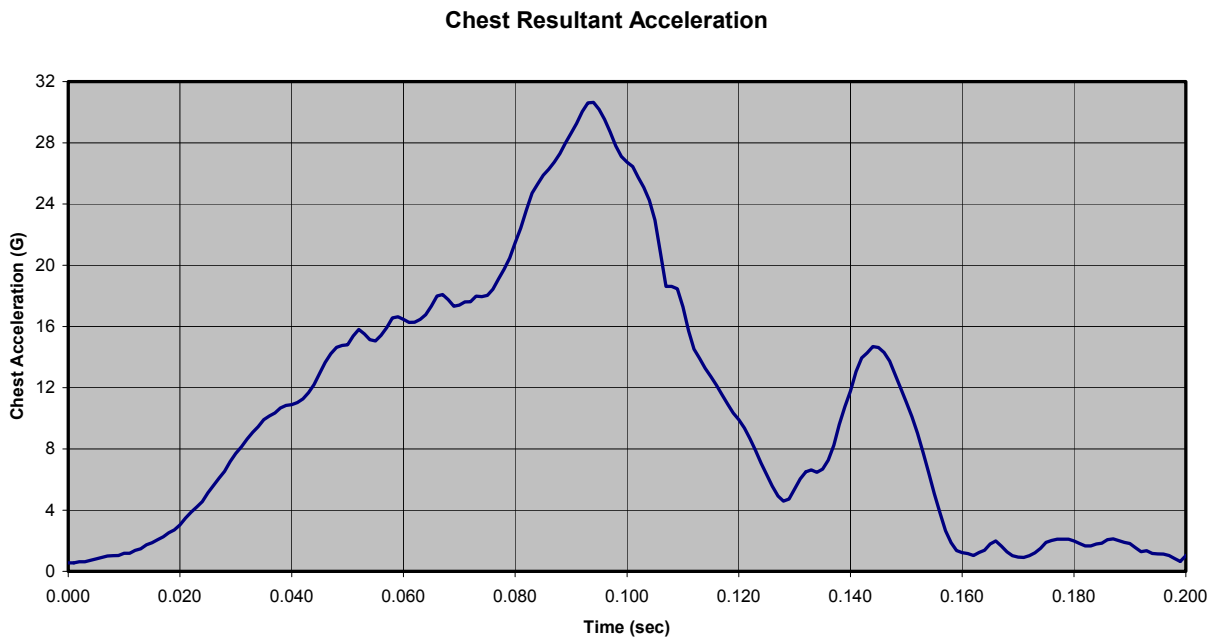

Figure C-122: Test 586 (Severe Pulse, 2.8 lb Added Head Weight)

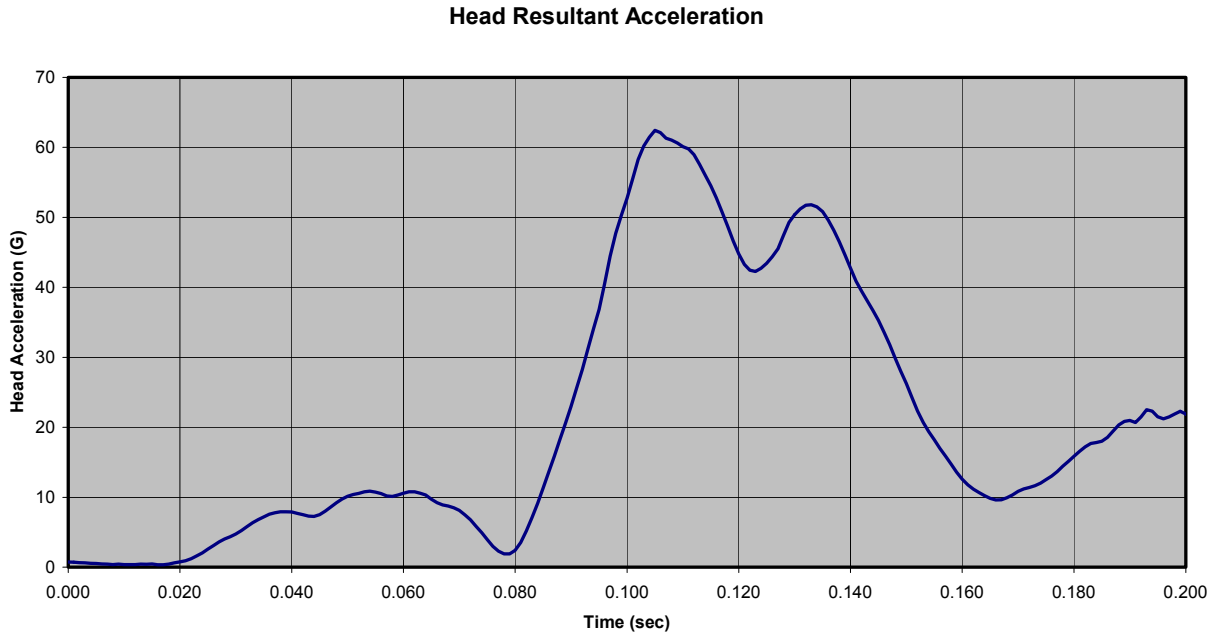

Figure C-123: Test 586 (Severe Pulse, 2.8 lb Added Head Weight)

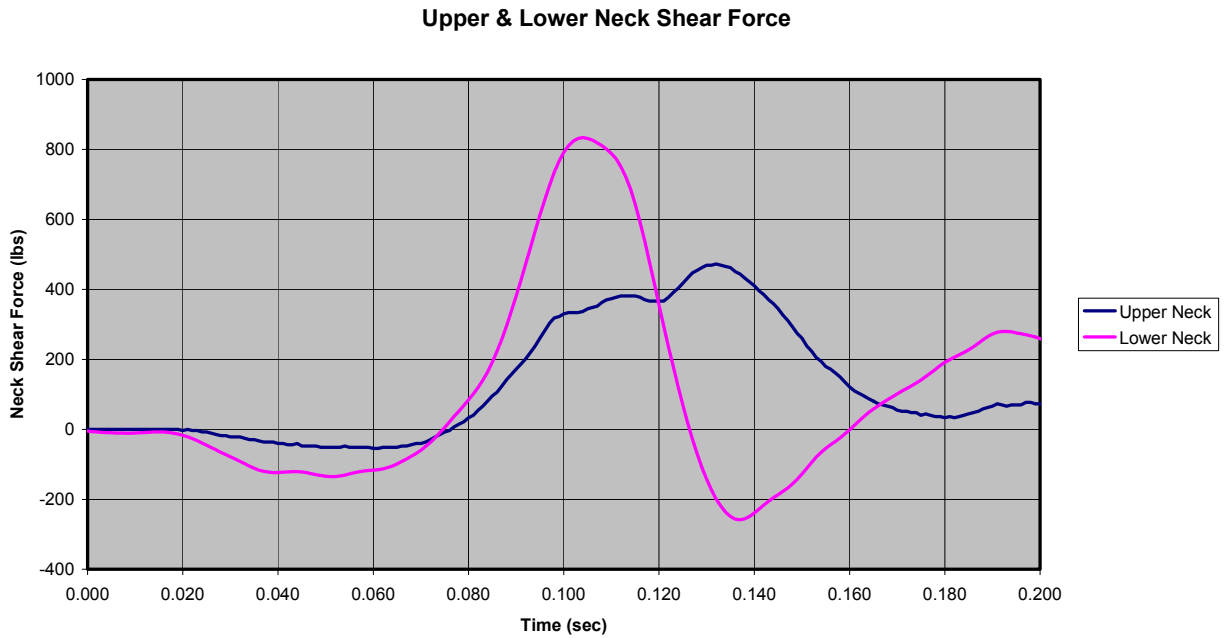

Figure C-124: Test 586 (Severe Pulse, 2.8 lb Added Head Weight)



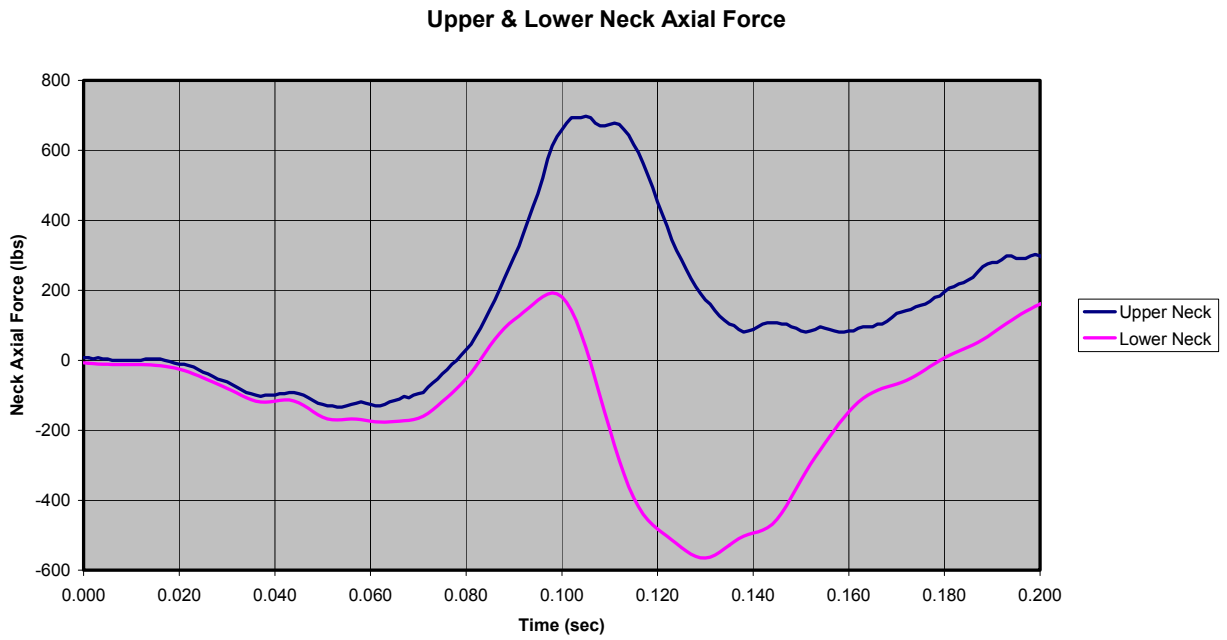

Figure C-125: Test 586 (Severe Pulse, 2.8 lb Added Head Weight)

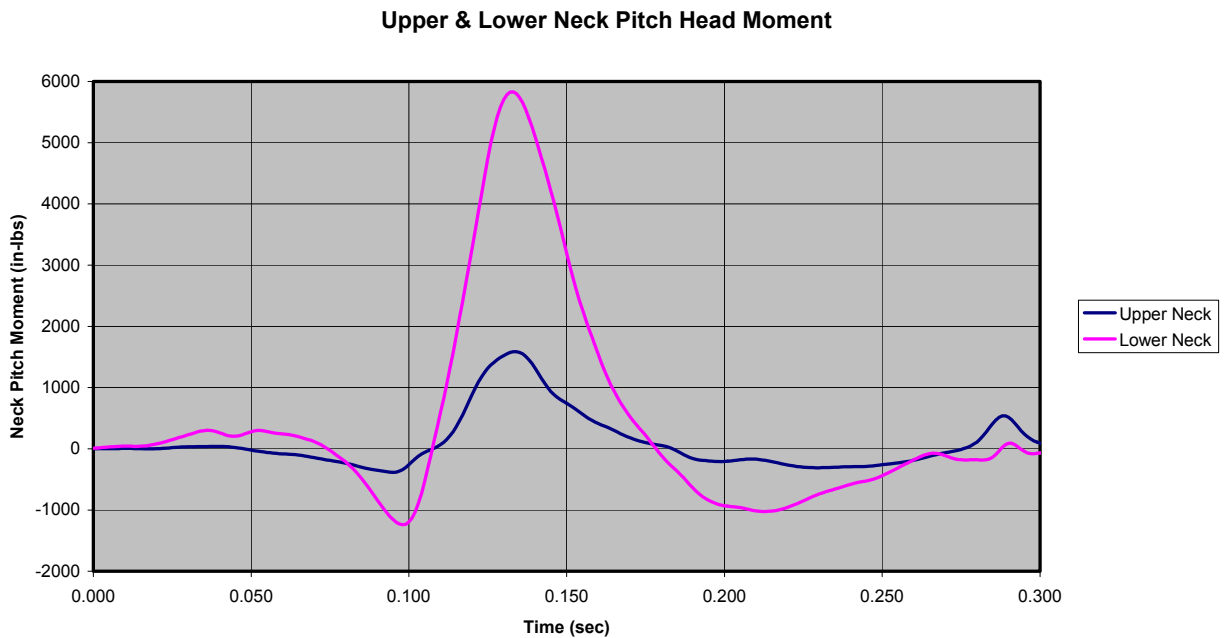

Figure C-126: Test 586 (Severe Pulse, 2.8 lb Added Head Weight)

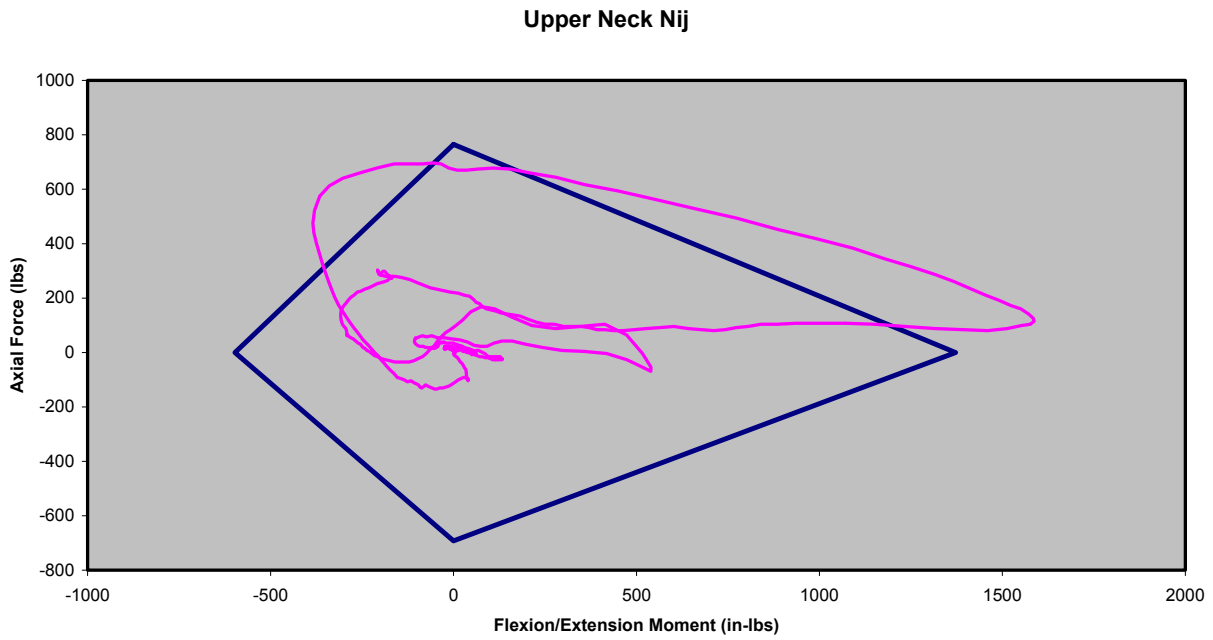

Figure C-127: Test 586 (Severe Pulse, 2.8 lb Added Head Weight)

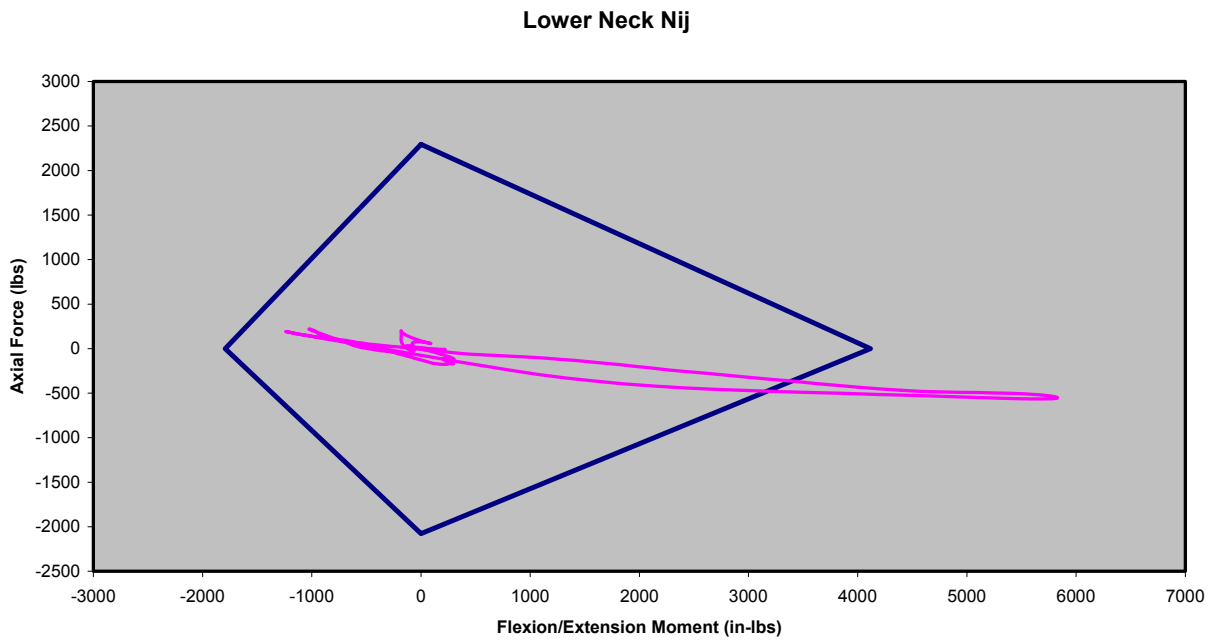

Figure C-128: Test 586 (Severe Pulse, 2.8 lb Added Head Weight)

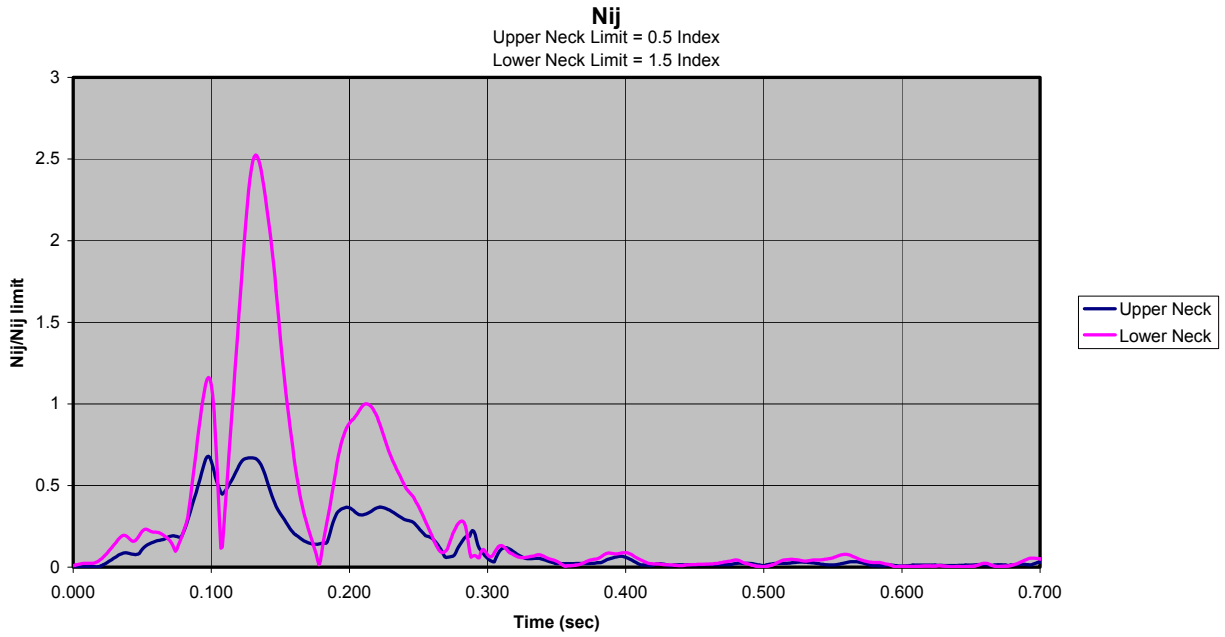

Figure C-129: Test 586 (Severe Pulse, 2.8 lb Added Head Weight)

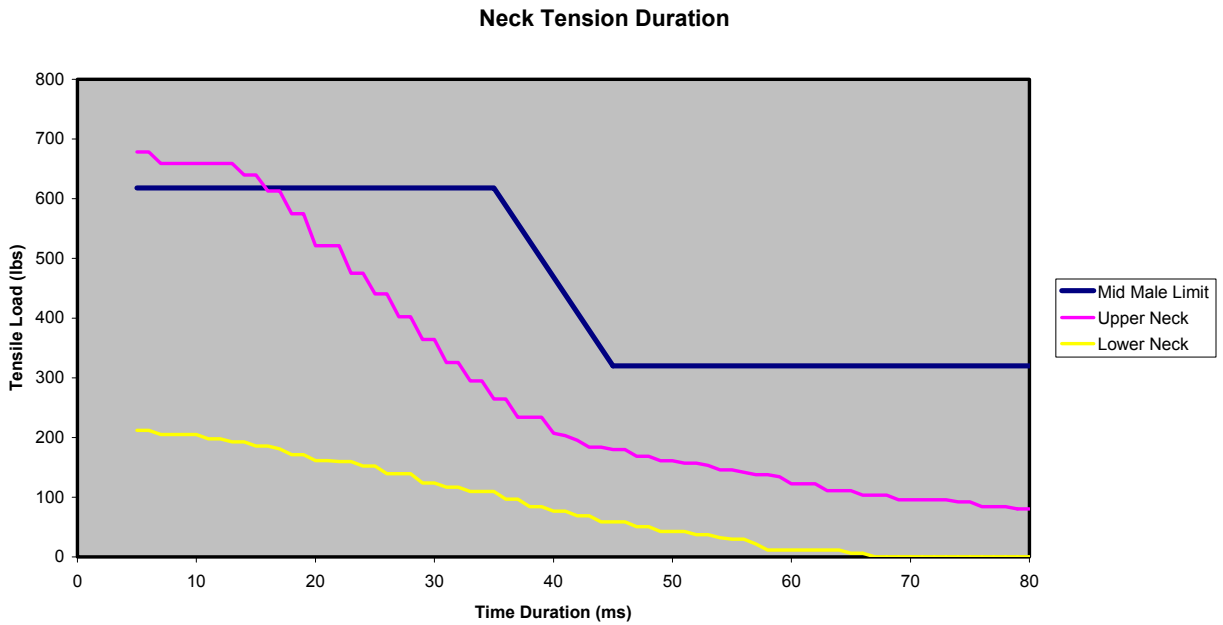

Figure C-130: Test 586 (Severe Pulse, 2.8 lb Added Head Weight)

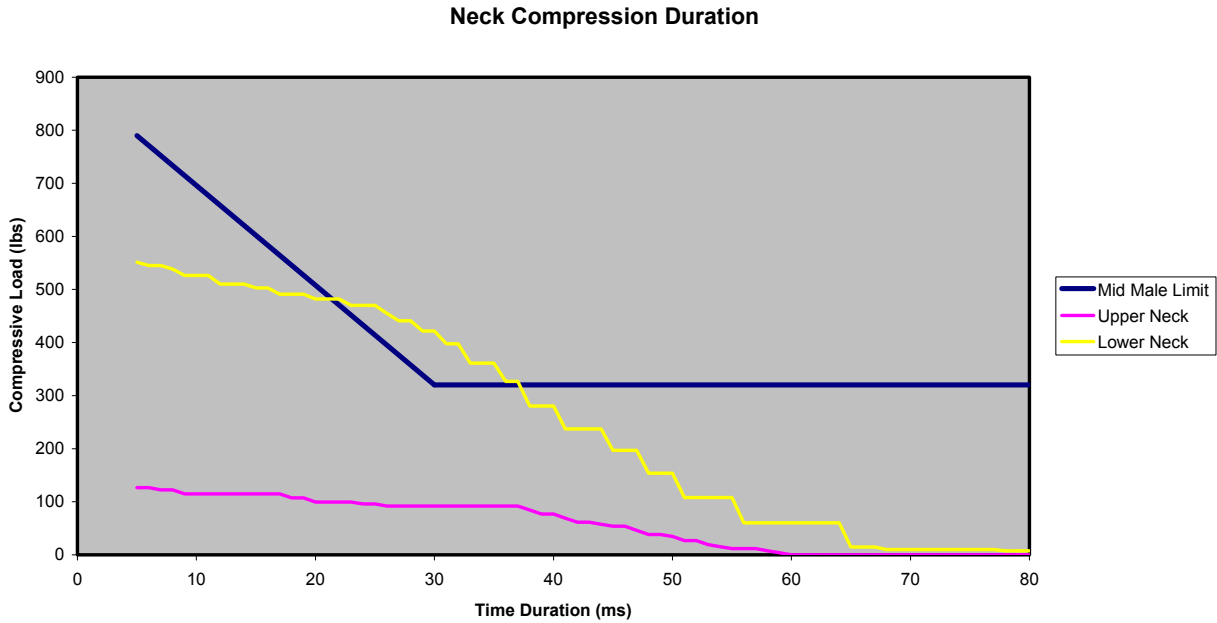

Figure C-131: Test 586 (Severe Pulse, 2.8 lb Added Head Weight)

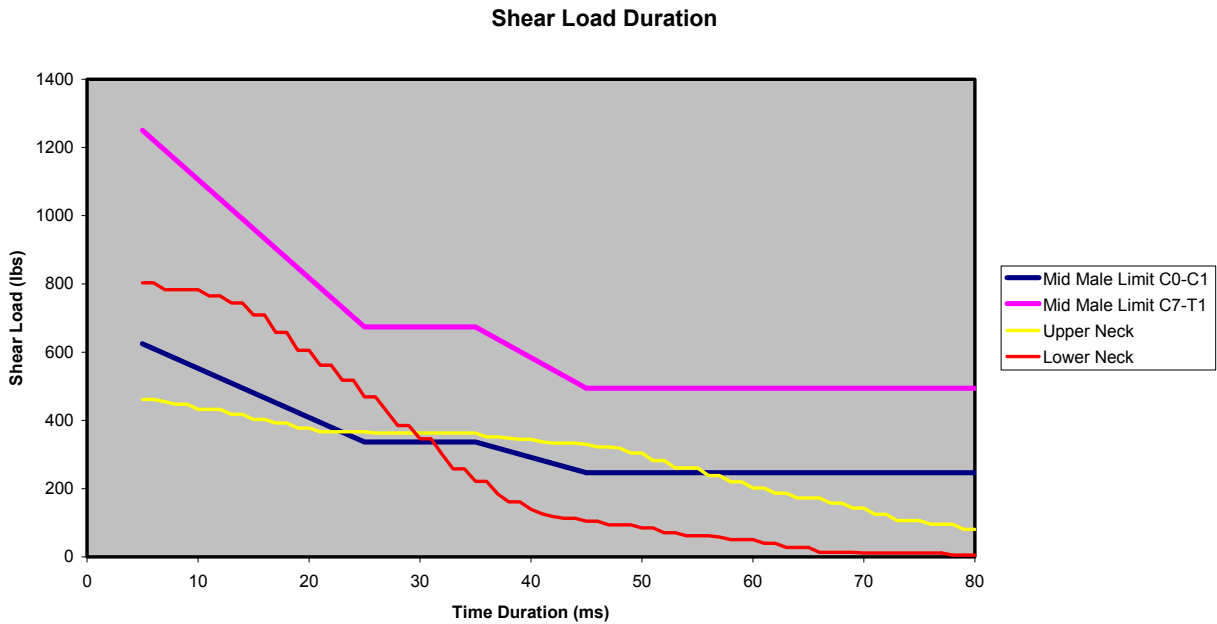

Figure C-132: Test 586 (Severe Pulse, 2.8 lb Added Head Weight)

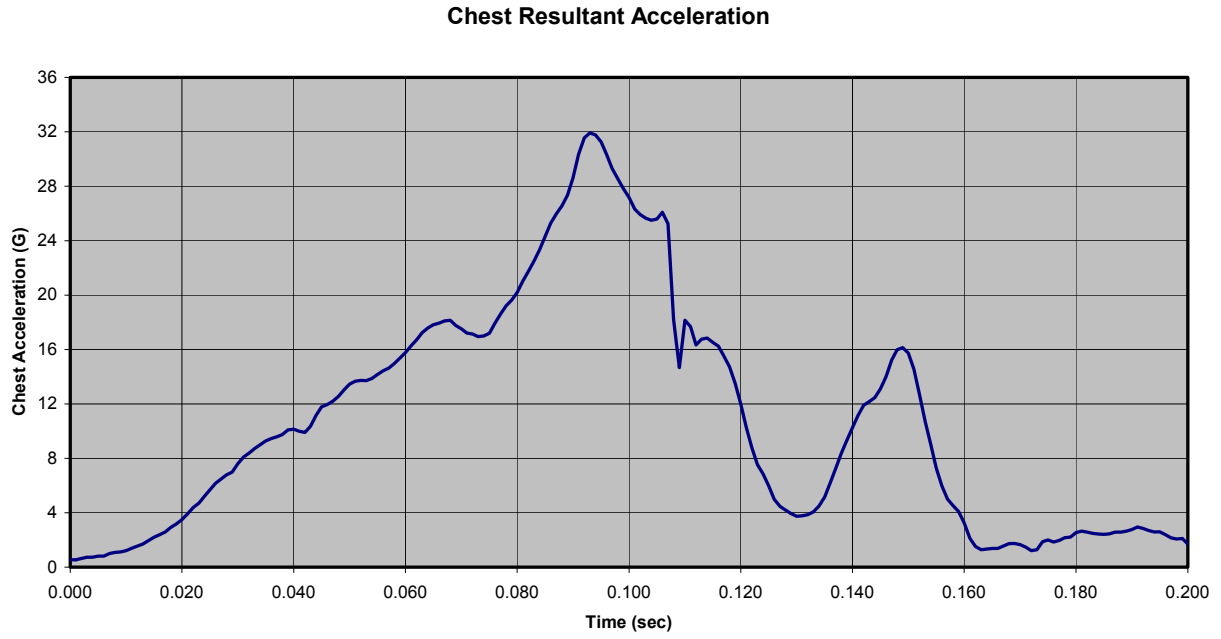

Figure C-133: Test 587 (Severe Pulse, 3.5 lb Added Head Weight)

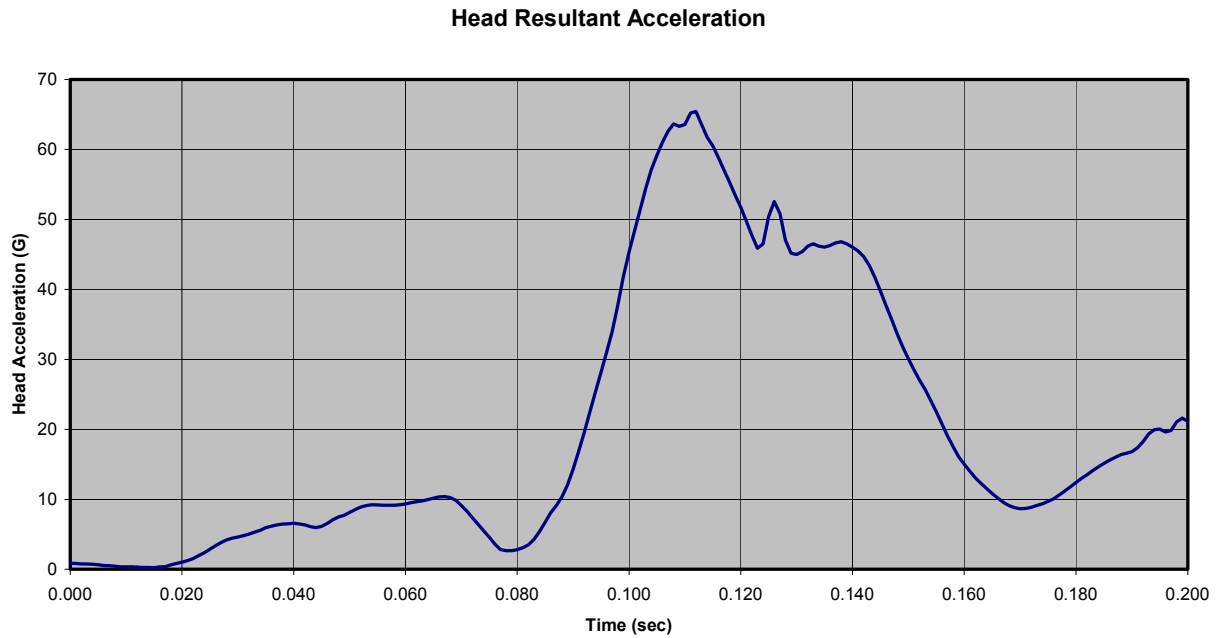

Figure C-134: Test 587 (Severe Pulse, 3.5 lb Added Head Weight)

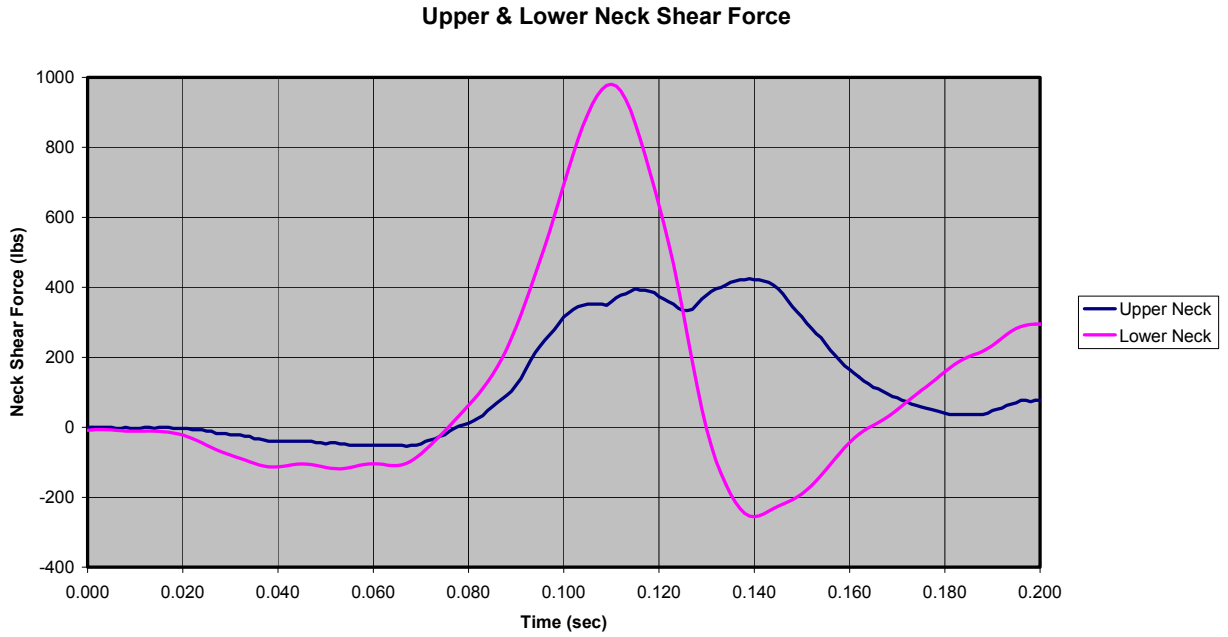

Figure C-135: Test 587 (Severe Pulse, 3.5 lb Added Head Weight)

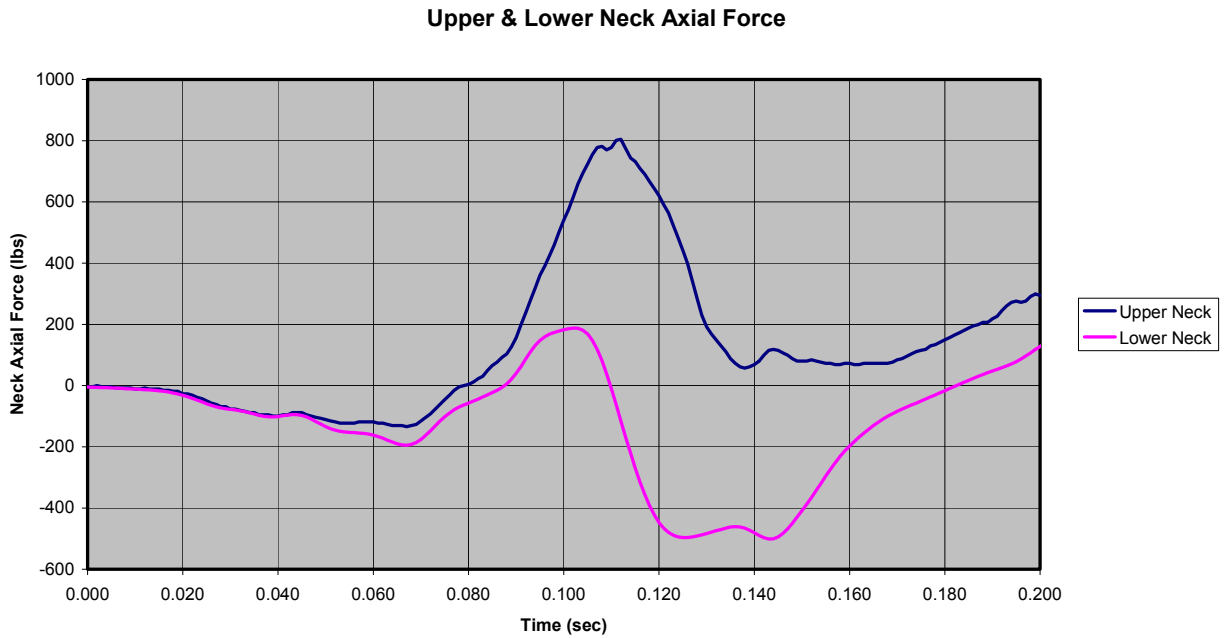

Figure C-136: Test 587 (Severe Pulse, 3.5 lb Added Head Weight)

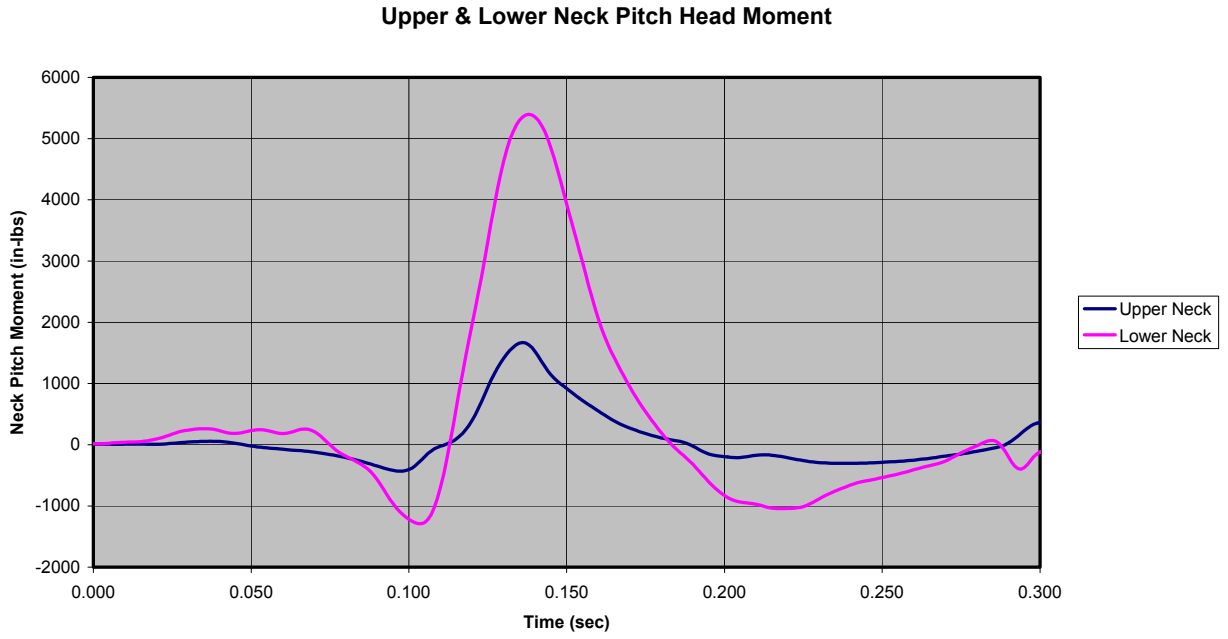

Figure C-137: Test 587 (Severe Pulse, 3.5 lb Added Head Weight)

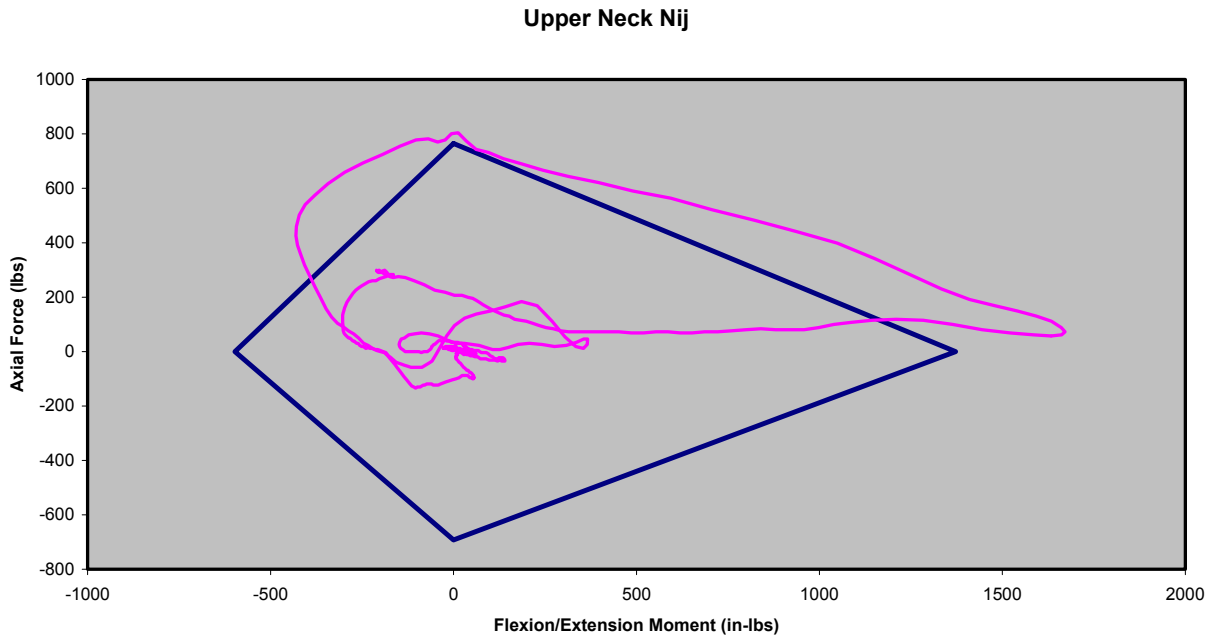

Figure C-138: Test 587 (Severe Pulse, 3.5 lb Added Head Weight)

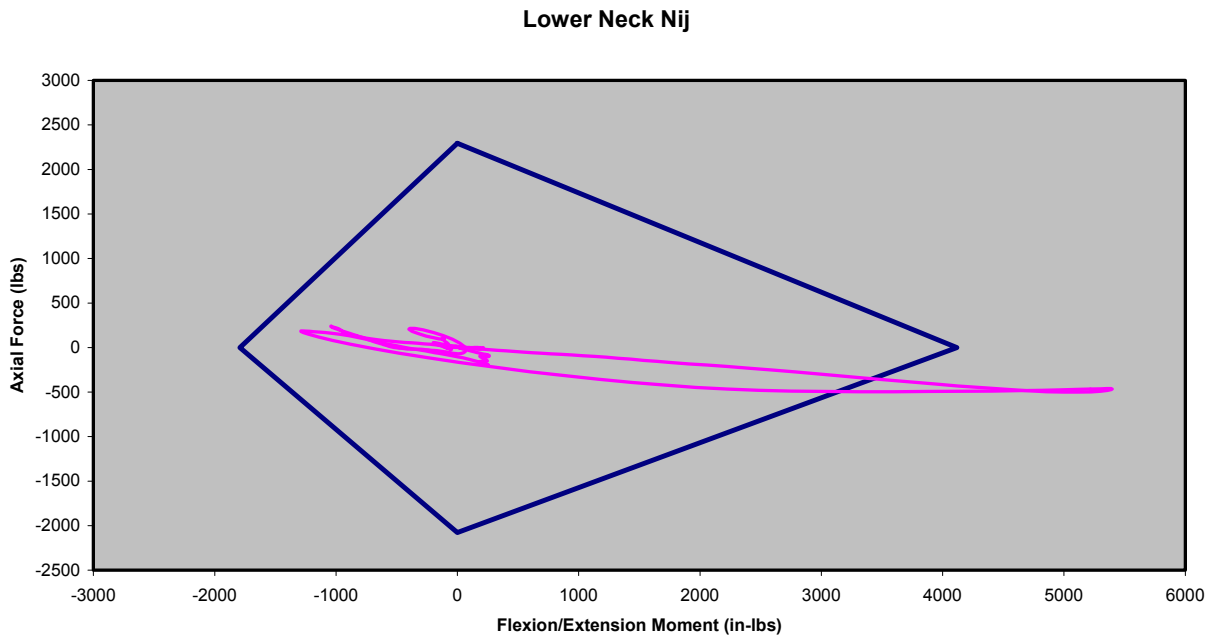

Figure C-139: Test 587 (Severe Pulse, 3.5 lb Added Head Weight)

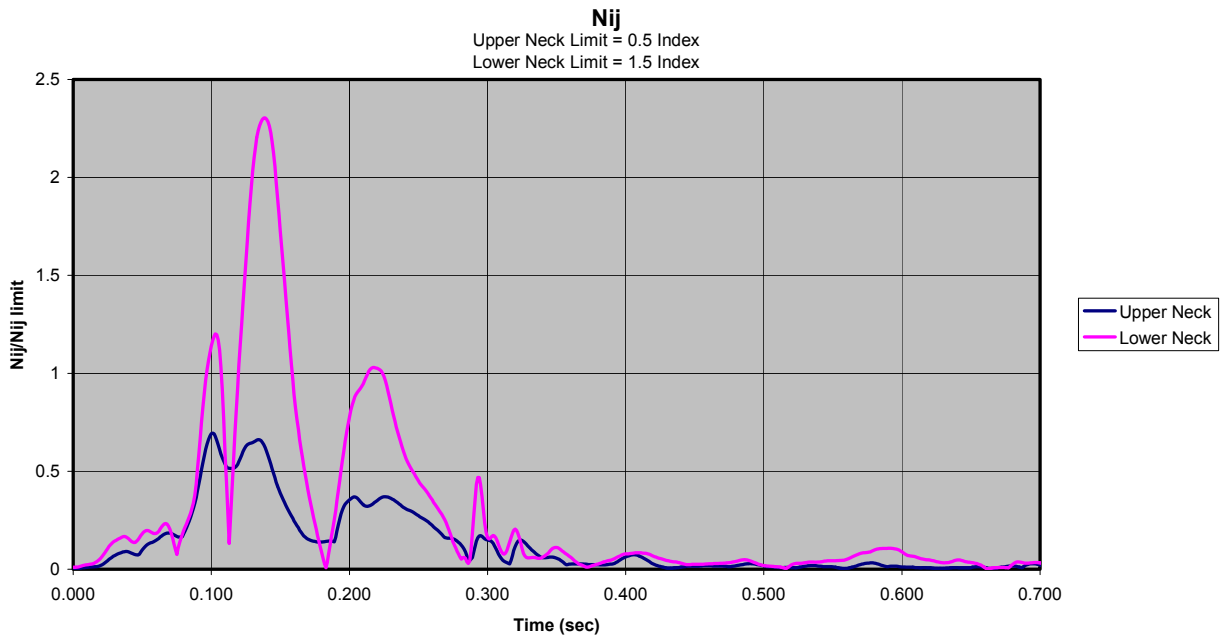

Figure C-140: Test 587 (Severe Pulse, 3.5 lb Added Head Weight)



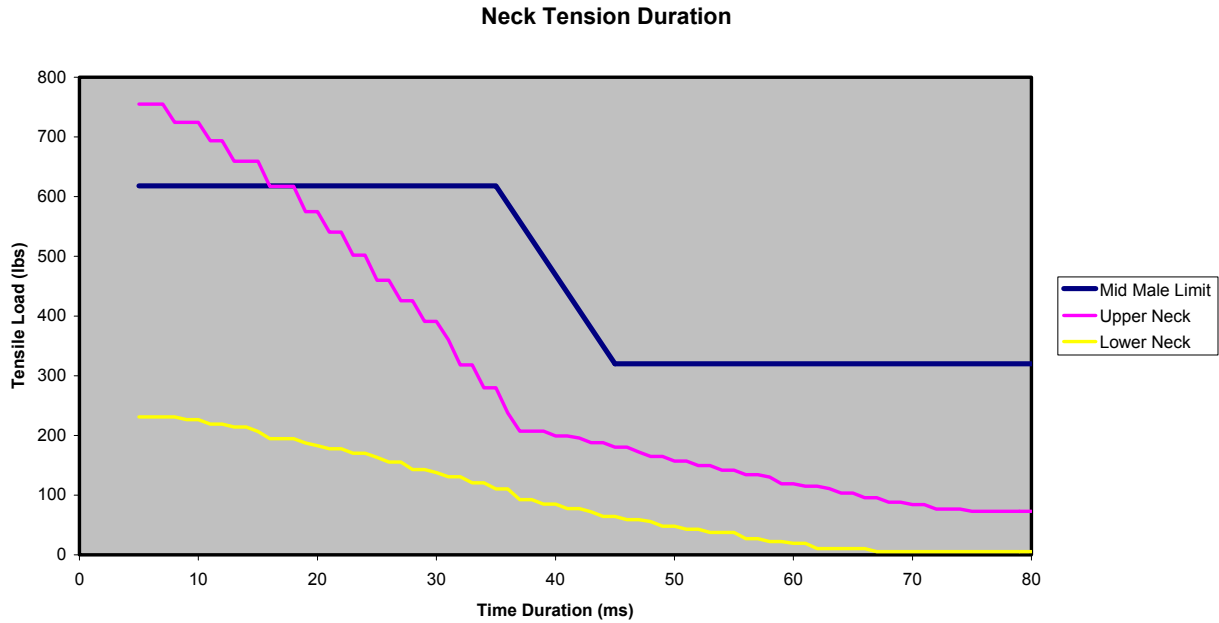

Figure C-141: Test 587 (Severe Pulse, 3.5 lb Added Head Weight)

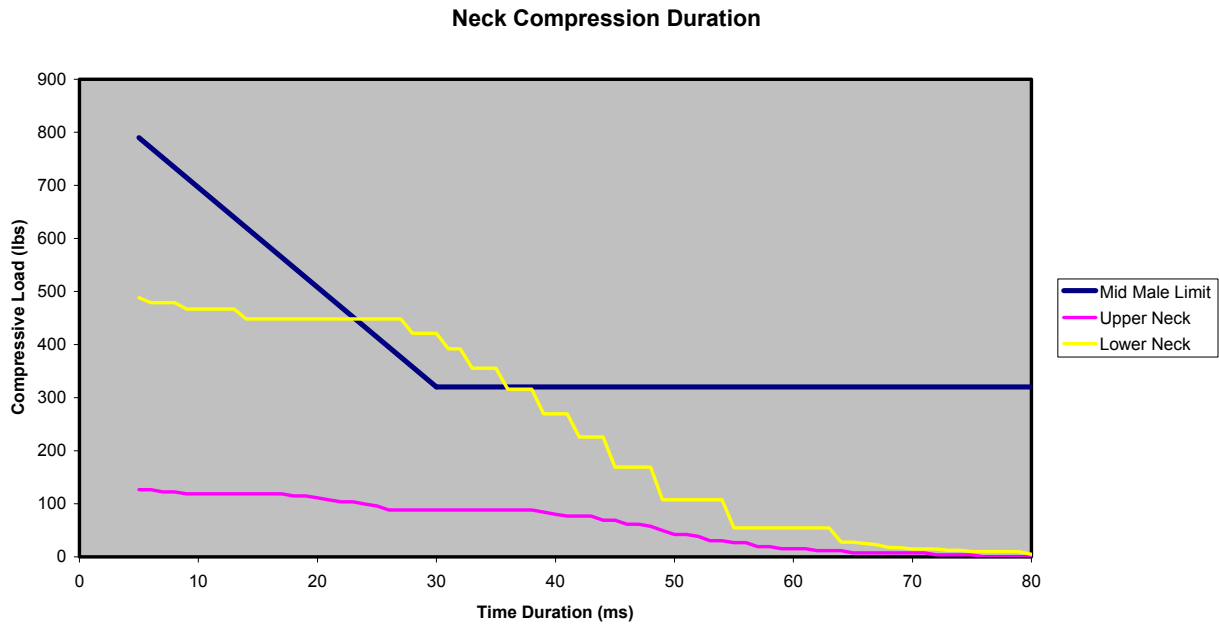

Figure C-142: Test 587 (Severe Pulse, 3.5 lb Added Head Weight)

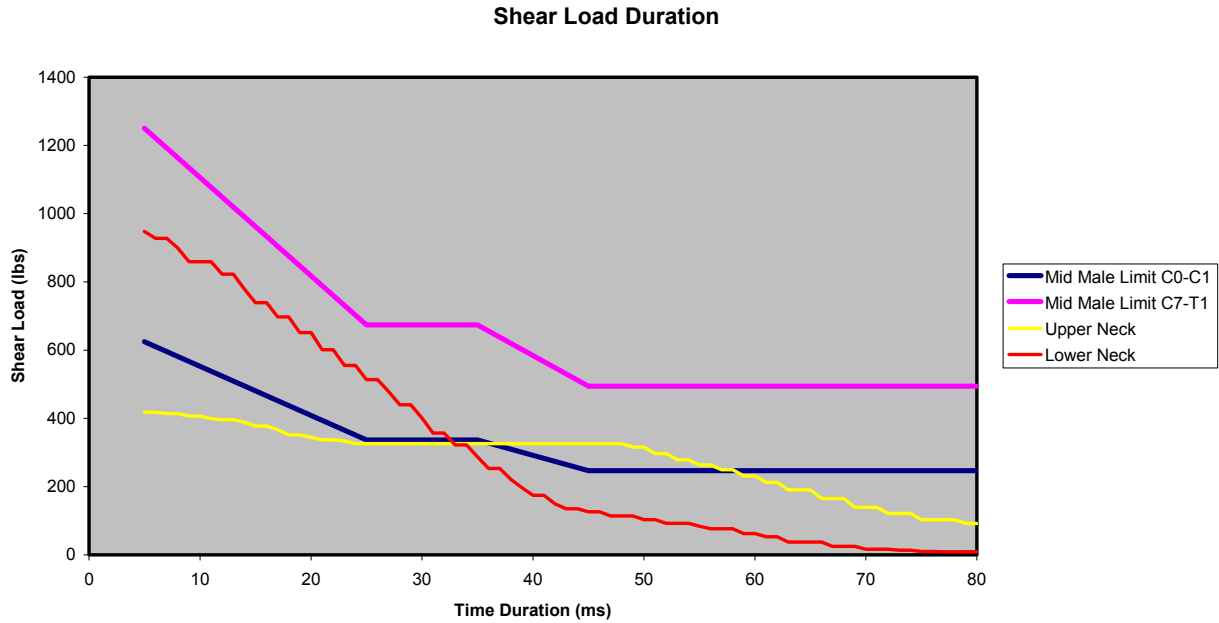

Figure C-143: Test 587 (Severe Pulse, 3.5 lb Added Head Weight)

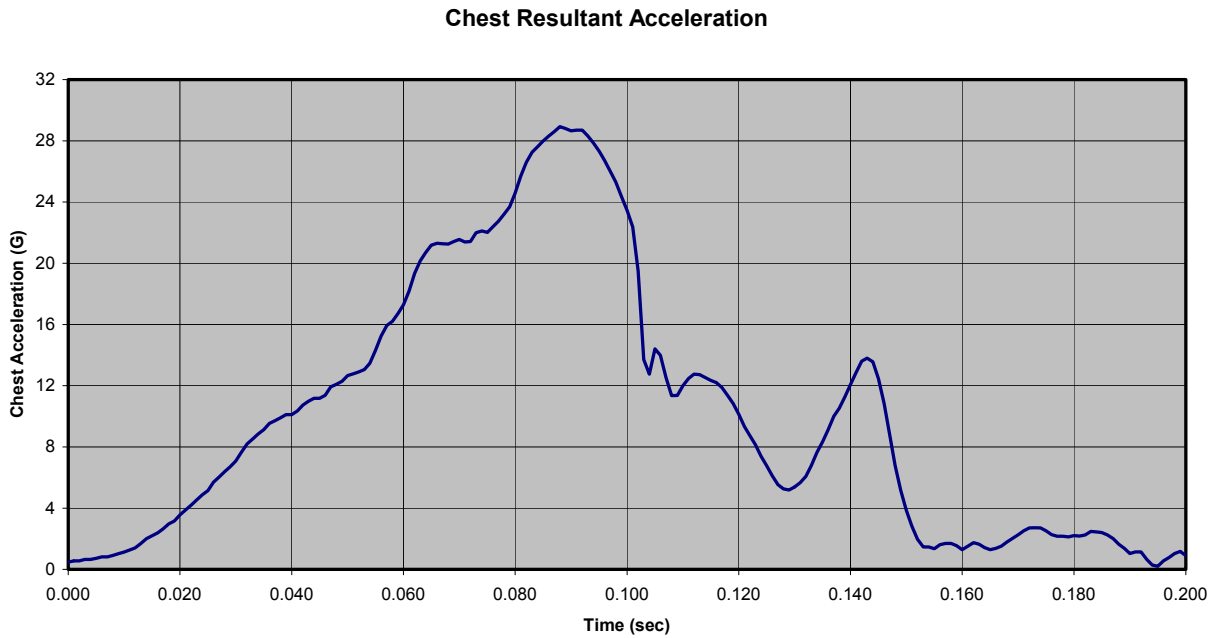

Figure C-144: Test 588 (Severe Pulse, 4.0 lb Added Head Weight)

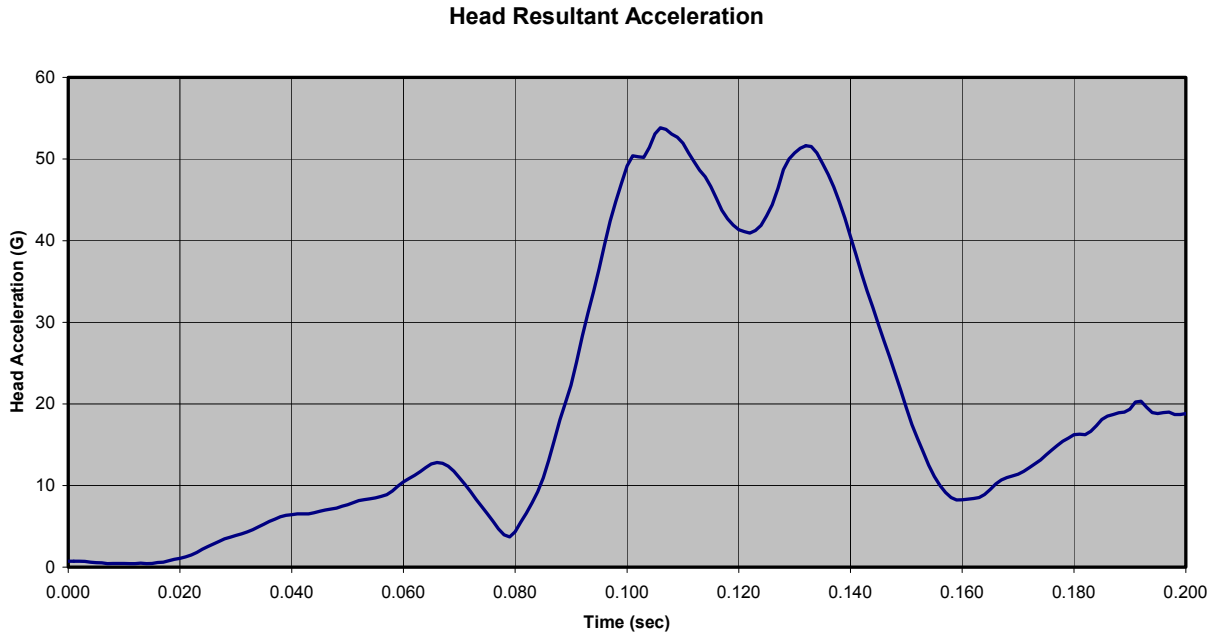

Figure C-145: Test 588 (Severe Pulse, 4.0 lb Added Head Weight)

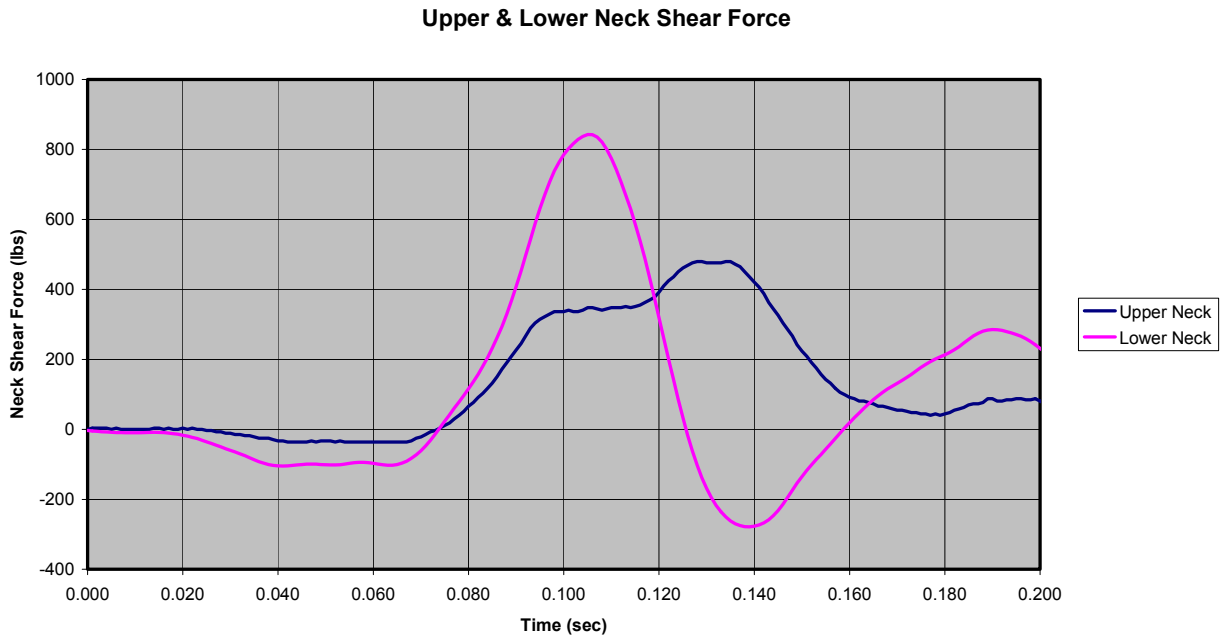

Figure C-146: Test 588 (Severe Pulse, 4.0 lb Added Head Weight)

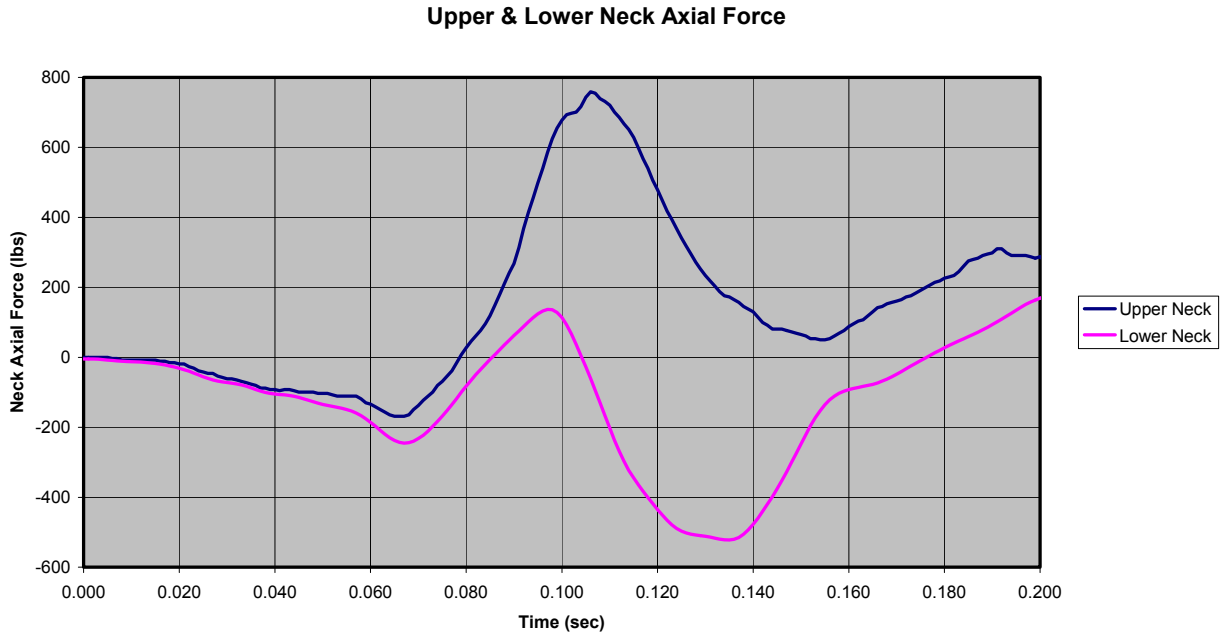

Figure C-147: Test 588 (Severe Pulse, 4.0 lb Added Head Weight)

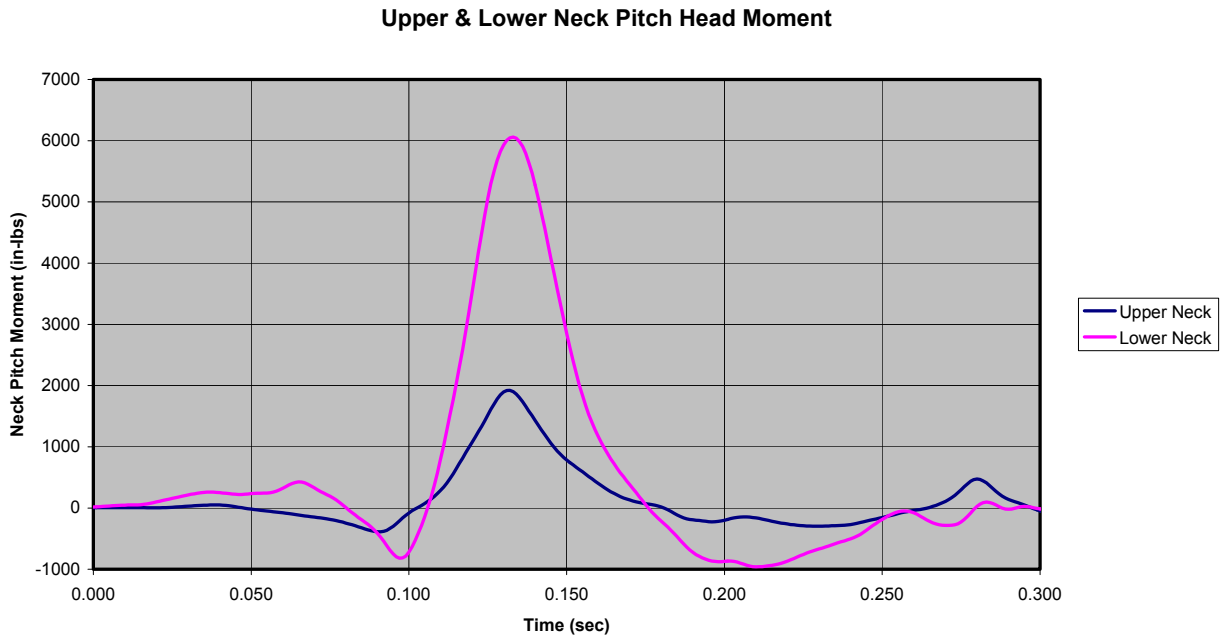

Figure C-148: Test 588 (Severe Pulse, 4.0 lb Added Head Weight)

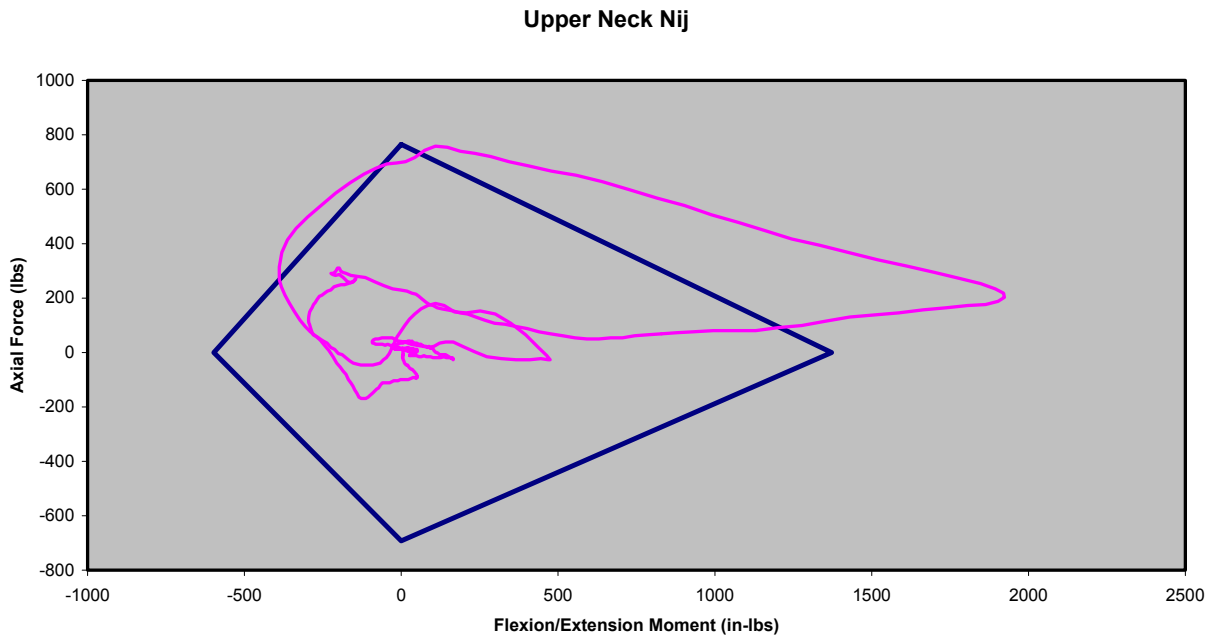

Figure C-149: Test 588 (Severe Pulse, 4.0 lb Added Head Weight)

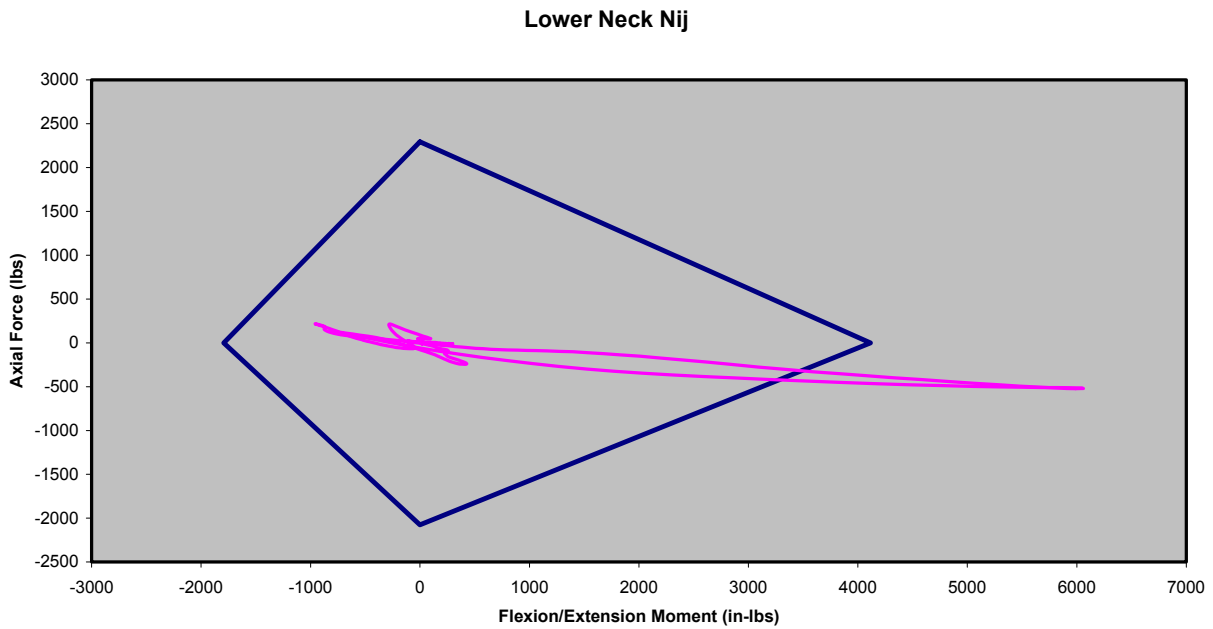

Figure C-150: Test 588 (Severe Pulse, 4.0 lb Added Head Weight)

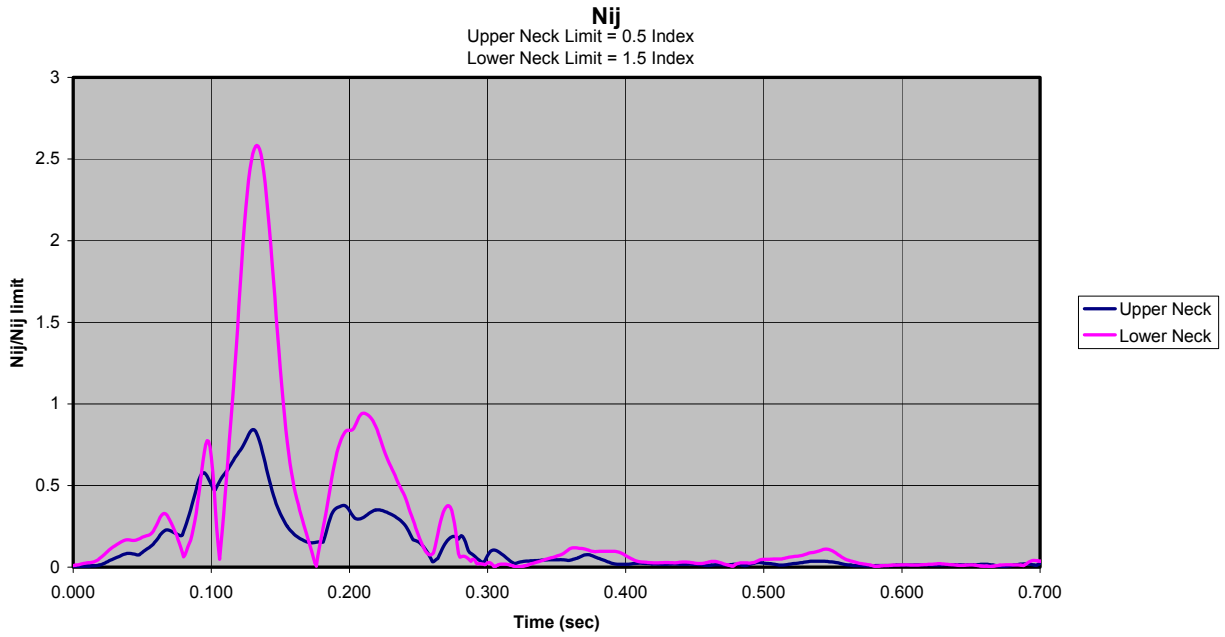

Figure C-151: Test 588 (Severe Pulse, 4.0 lb Added Head Weight)

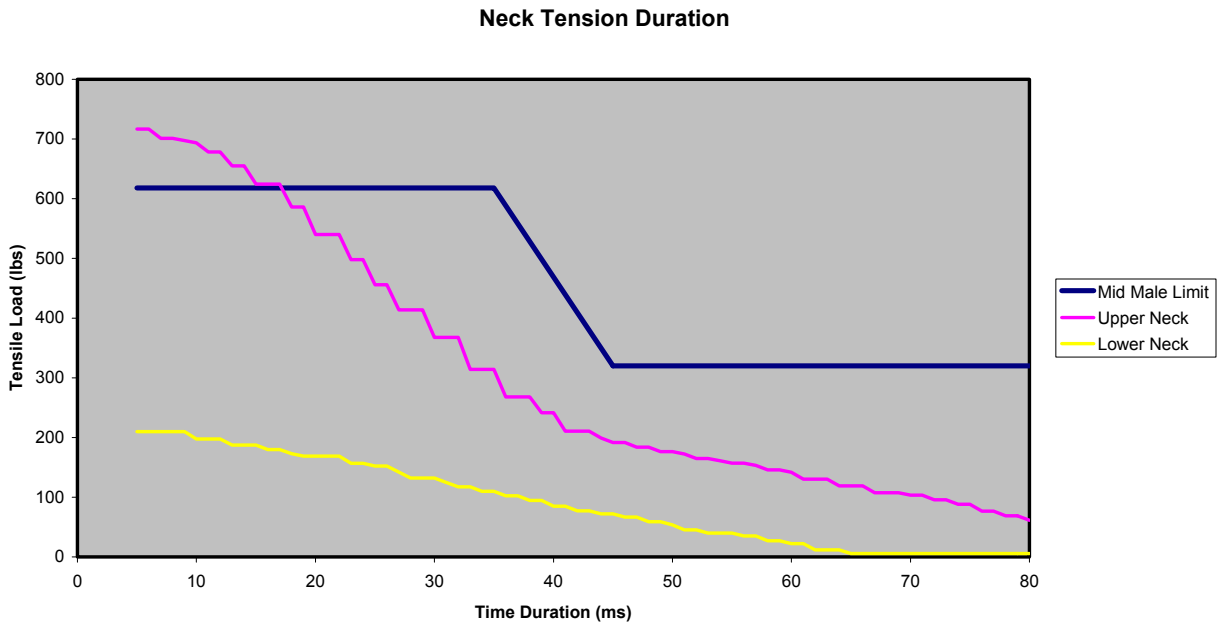

Figure C-152: Test 588 (Severe Pulse, 4.0 lb Added Head Weight)

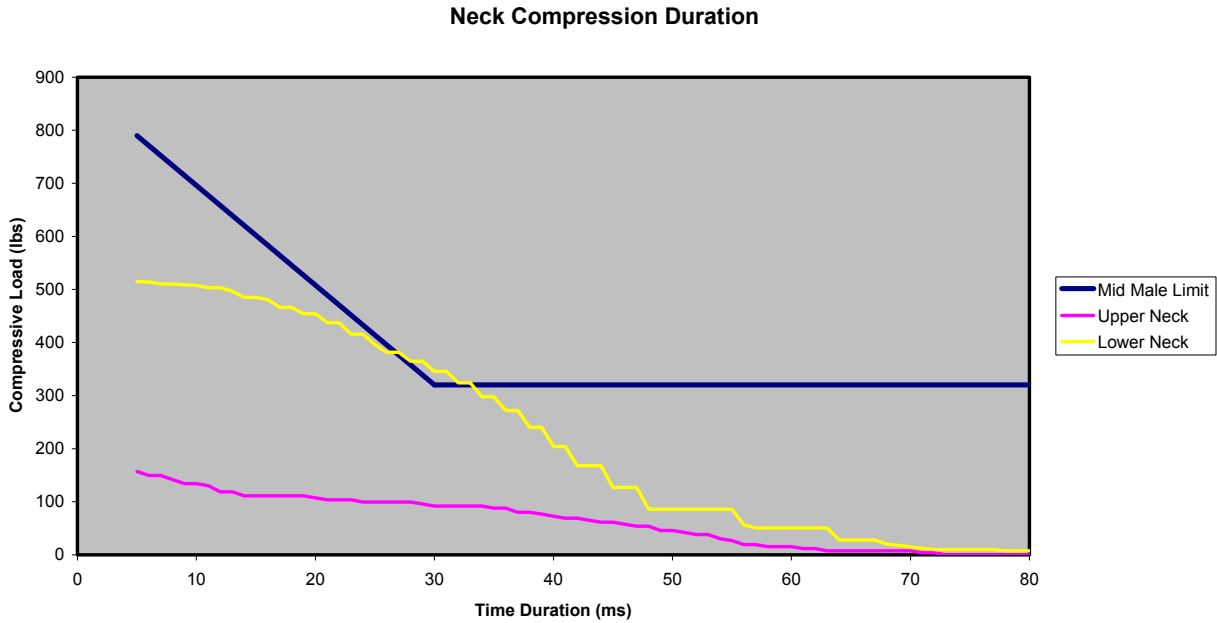

Figure C-153: Test 588 (Severe Pulse, 4.0 lb Added Head Weight)

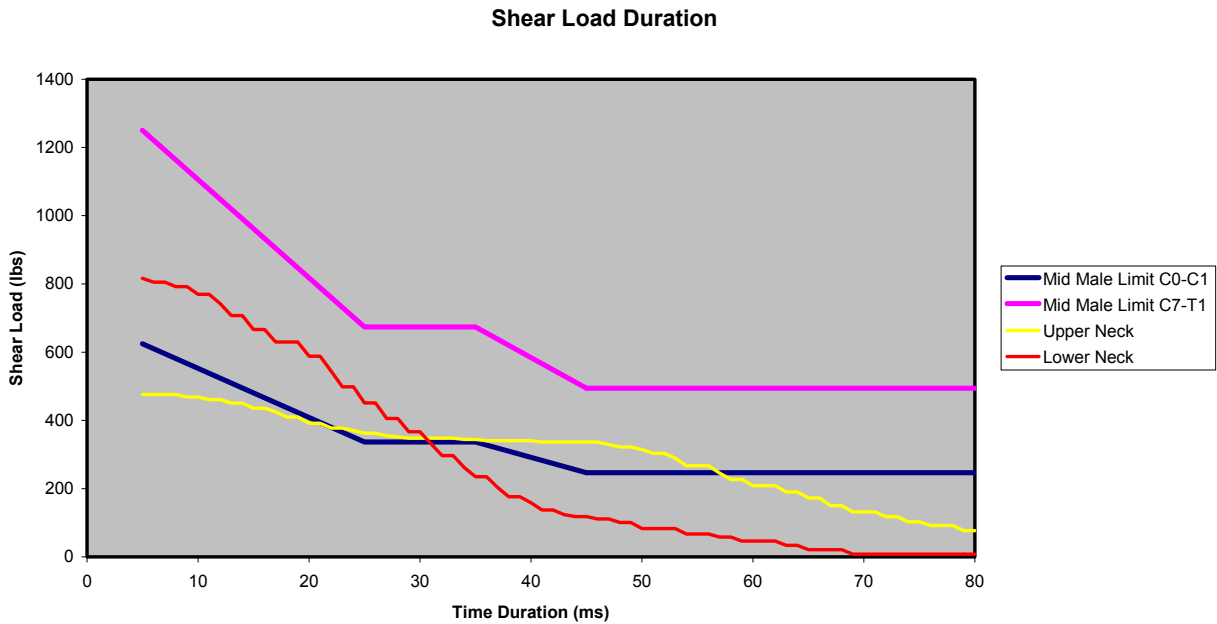

Figure C-154: Test 588 (Severe Pulse, 4.0 lb Added Head Weight)

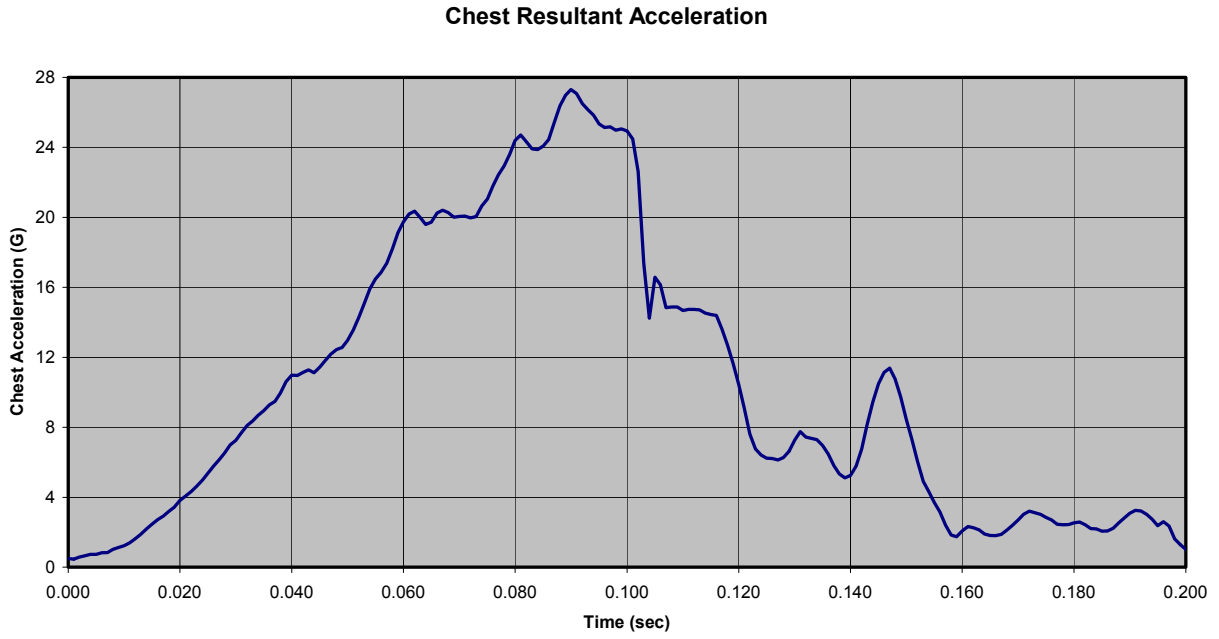

Figure C-155: Test 589 (Severe Pulse, 4.5 lb Added Head Weight)

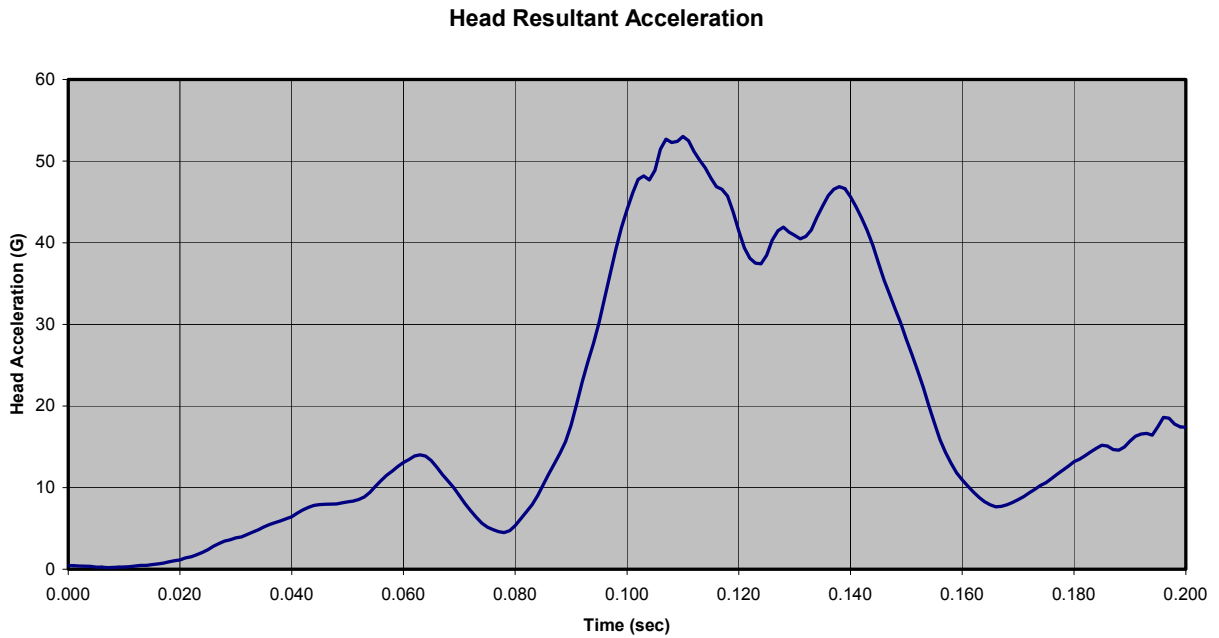

Figure C-156: Test 589 (Severe Pulse, 4.5 lb Added Head Weight)



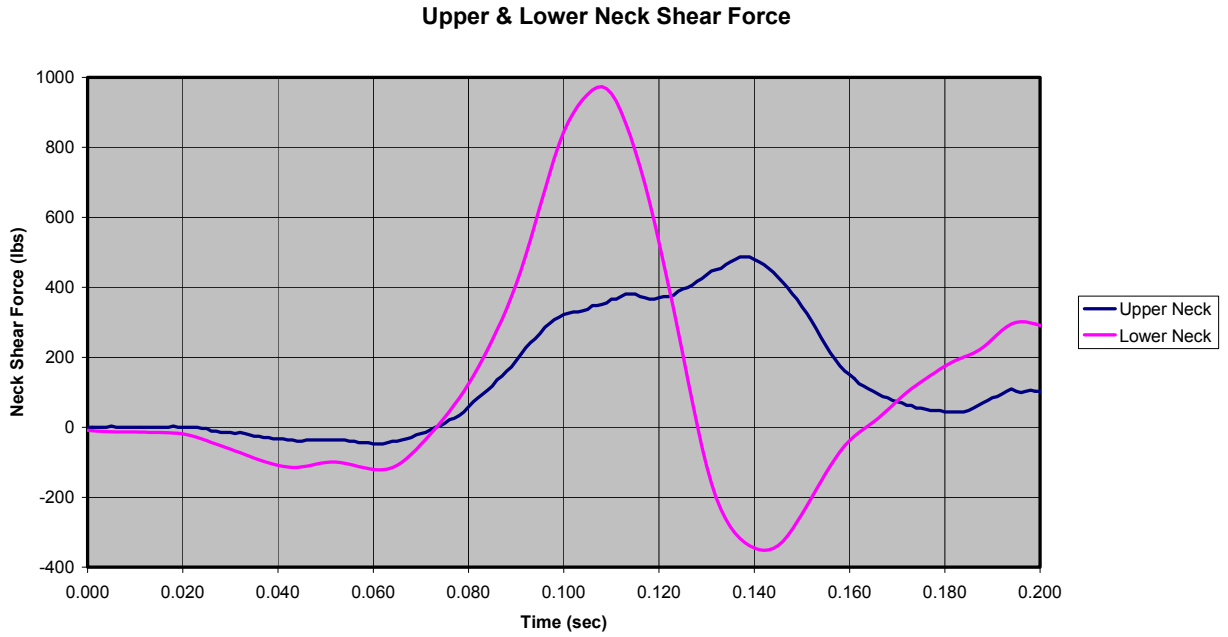

Figure C-157: Test 589 (Severe Pulse, 4.5 lb Added Head Weight)

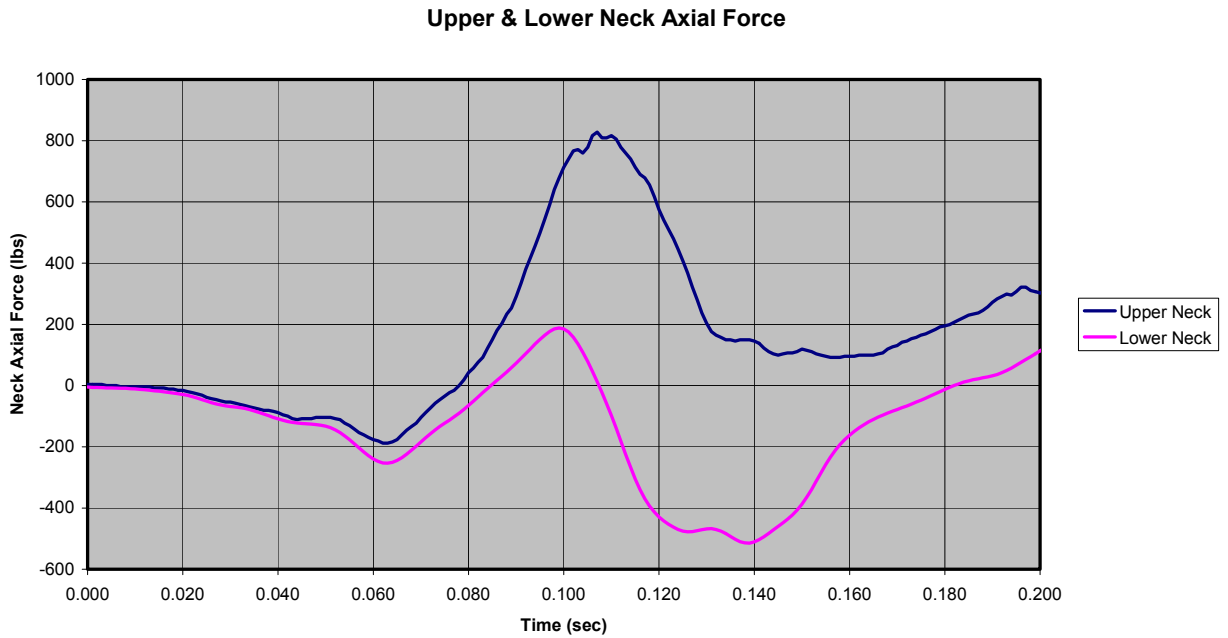

Figure C-158: Test 589 (Severe Pulse, 4.5 lb Added Head Weight)

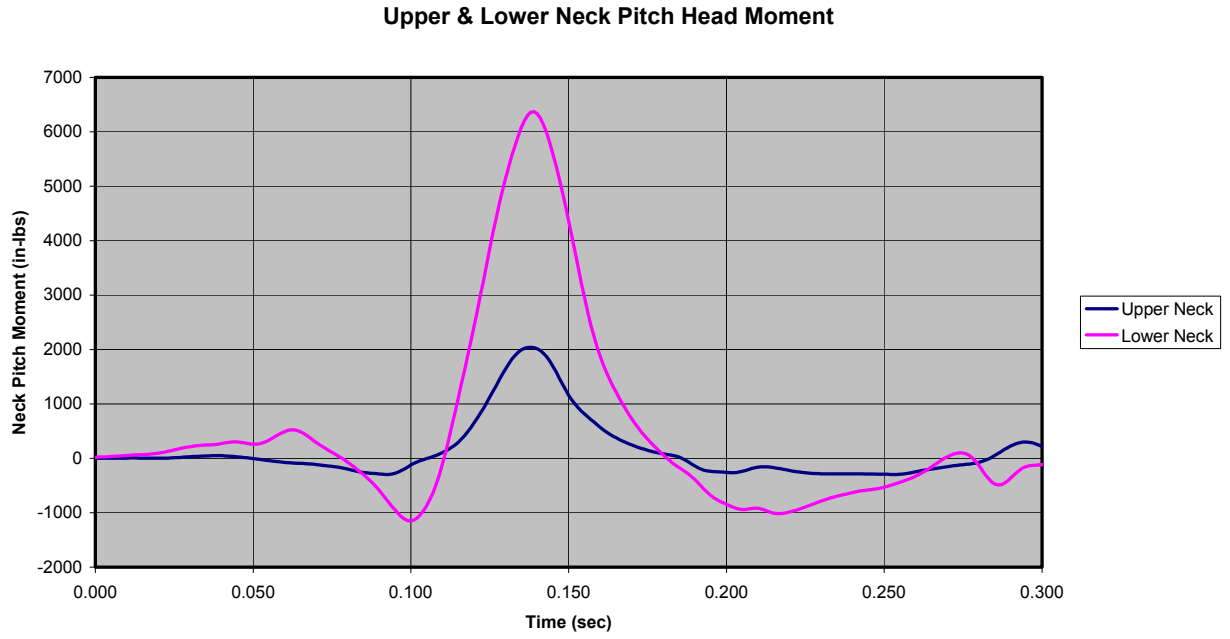

Figure C-159: Test 589 (Severe Pulse, 4.5 lb Added Head Weight)

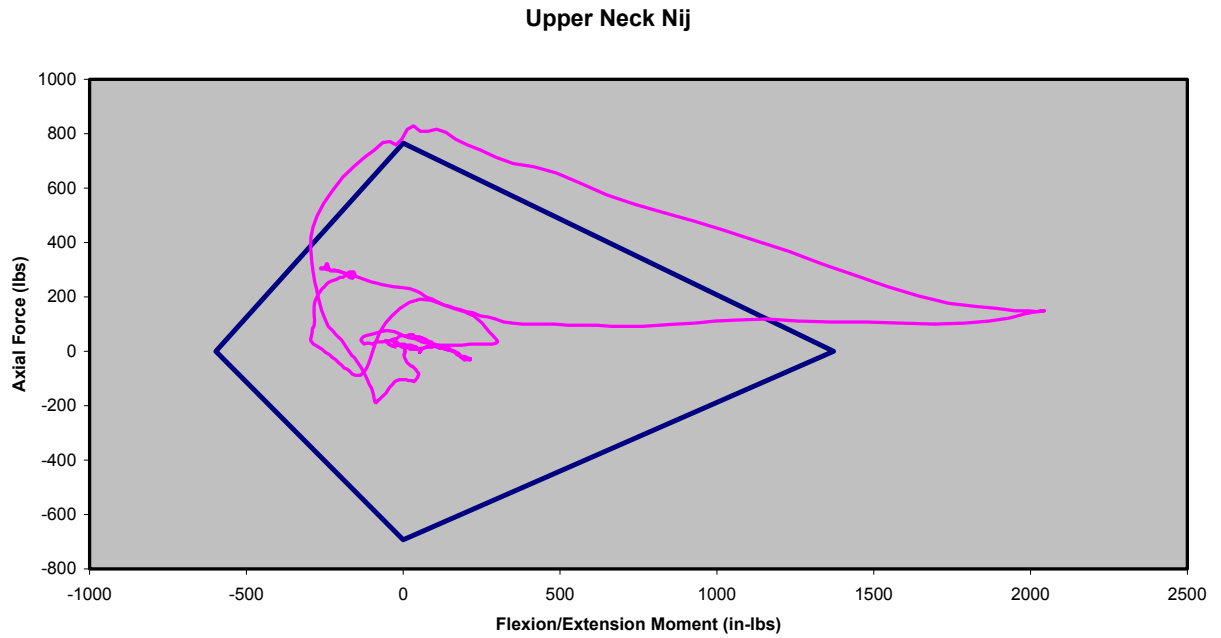

Figure C-160: Test 589 (Severe Pulse, 4.5 lb Added Head Weight)

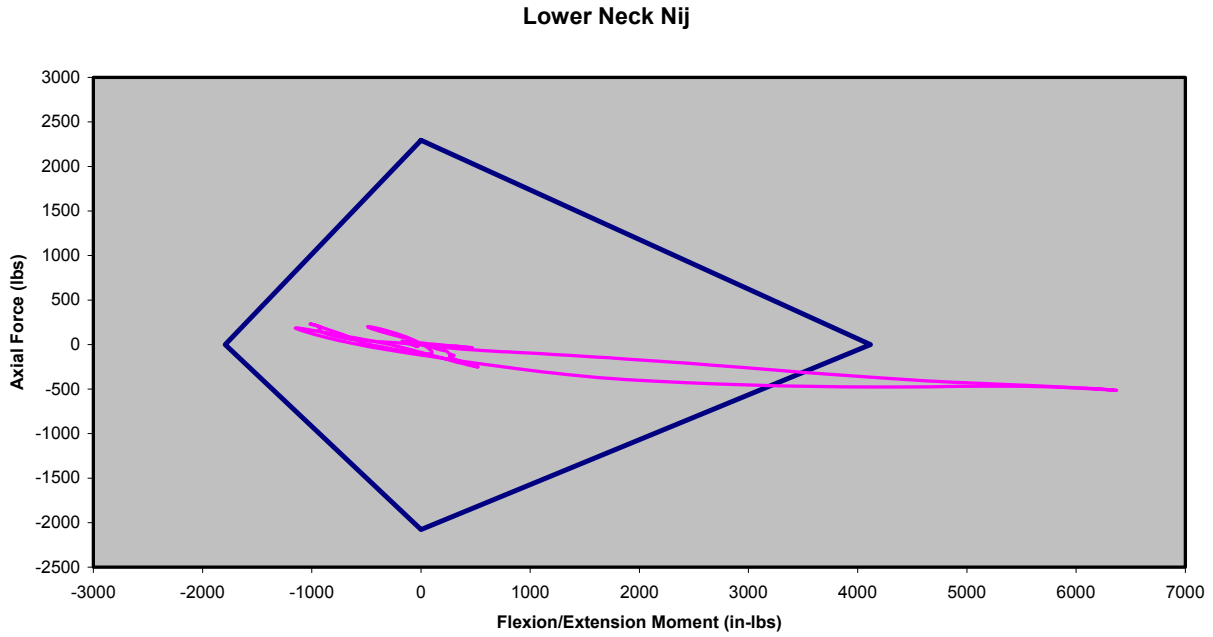

Figure C-161: Test 589 (Severe Pulse, 4.5 lb Added Head Weight)

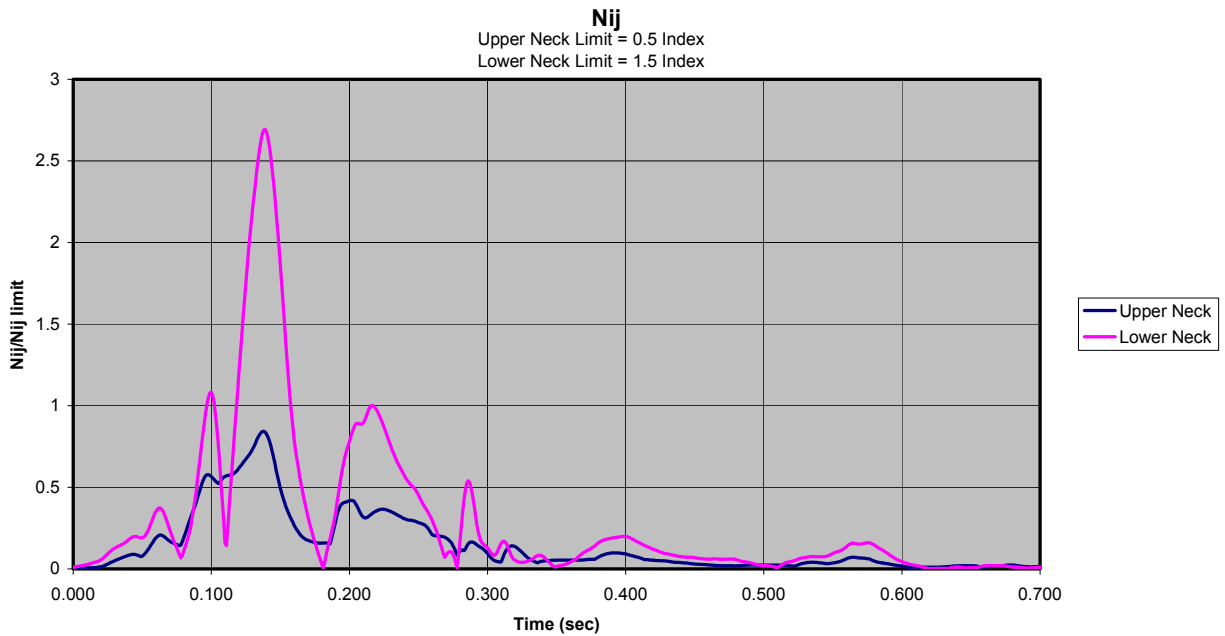

Figure C-162: Test 589 (Severe Pulse, 4.5 lb Added Head Weight)

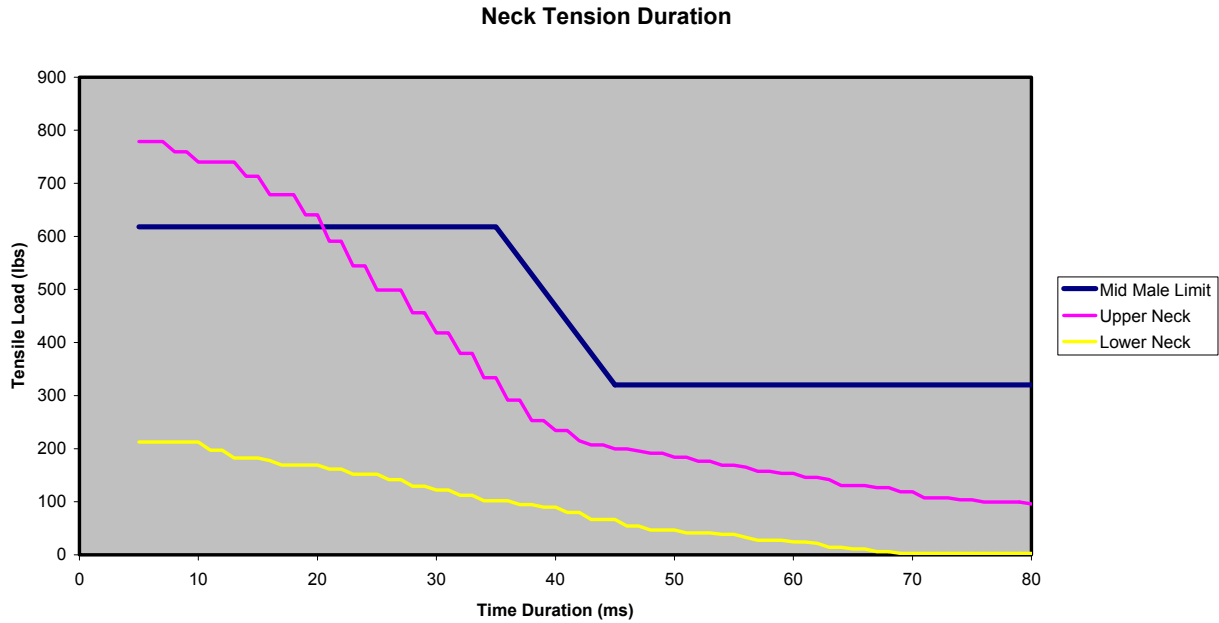

Figure C-163: Test 589 (Severe Pulse, 4.5 lb Added Head Weight)

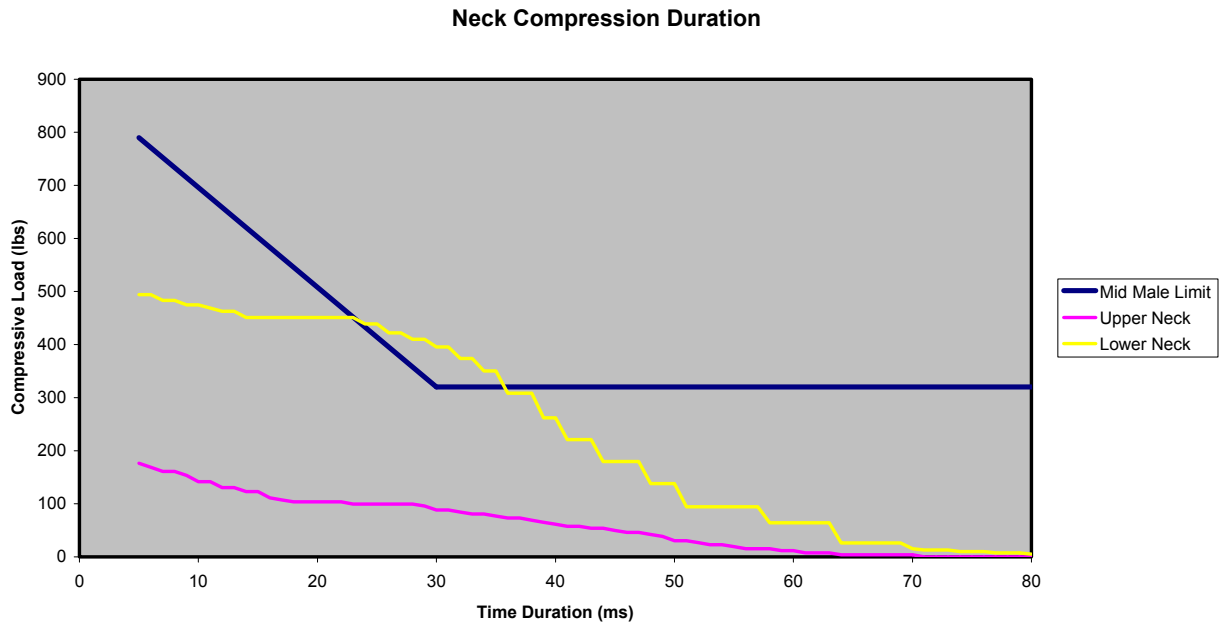

Figure C-164: Test 589 (Severe Pulse, 4.5 lb Added Head Weight)

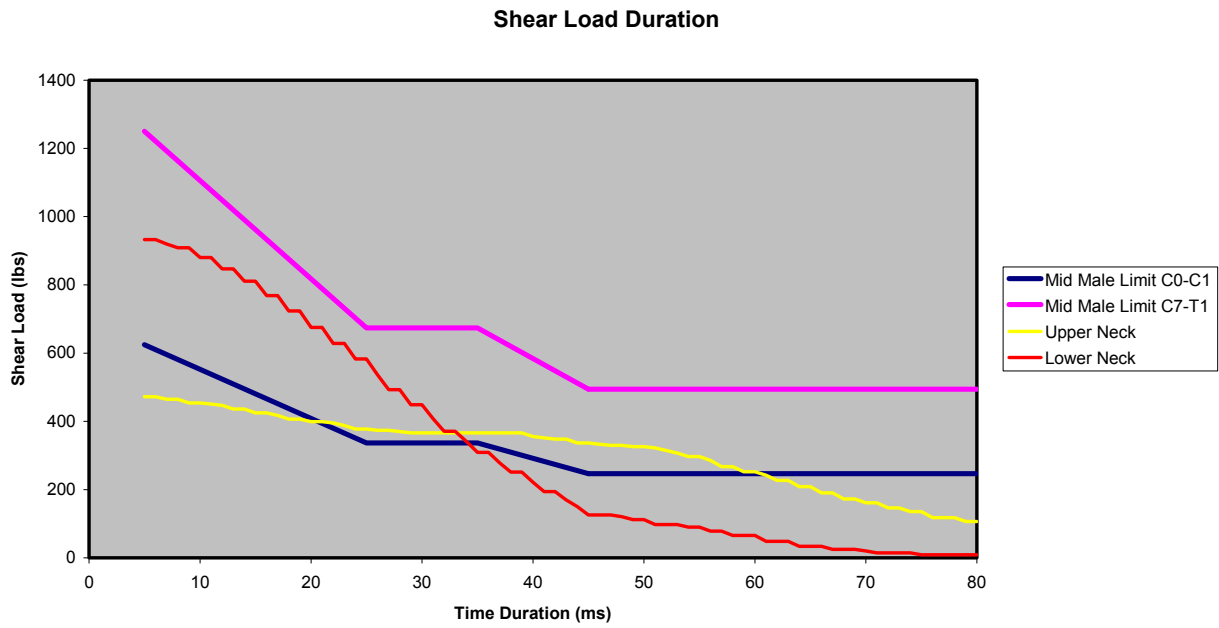

Figure C-165: Test 589 (Severe Pulse, 4.5 lb Added Head Weight)

APPENDIX D  
FIGURES  
(LARGE MALE TESTS)

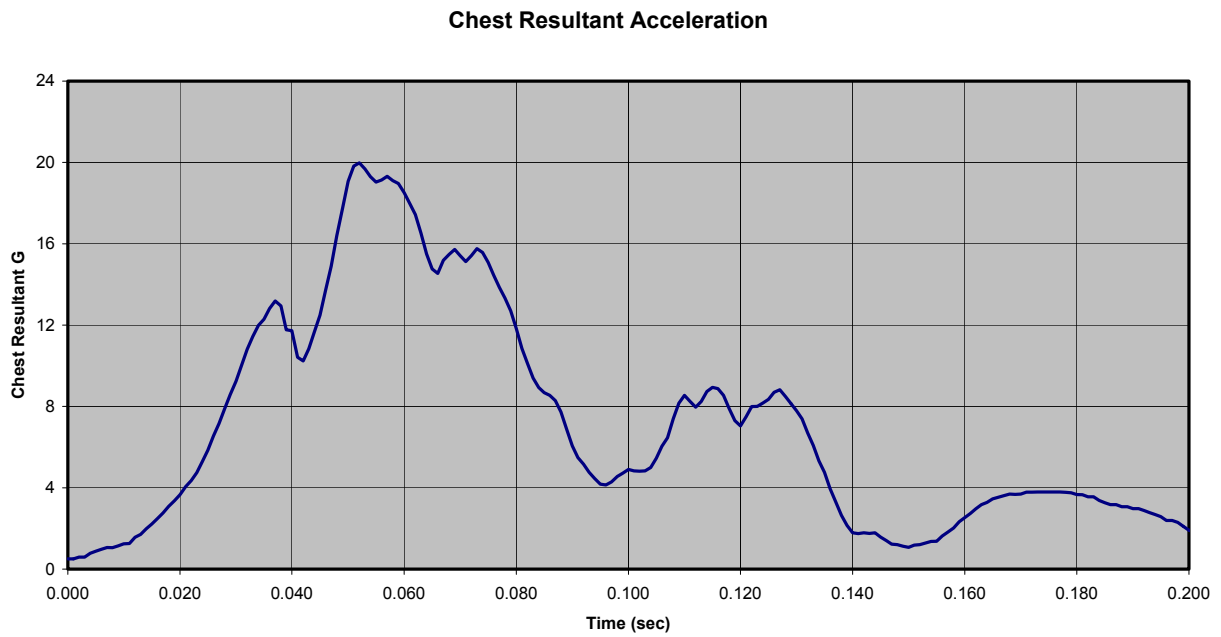

Figure D-1: Test 512 (Low Pulse, 4.0 lb Added Head Weight)

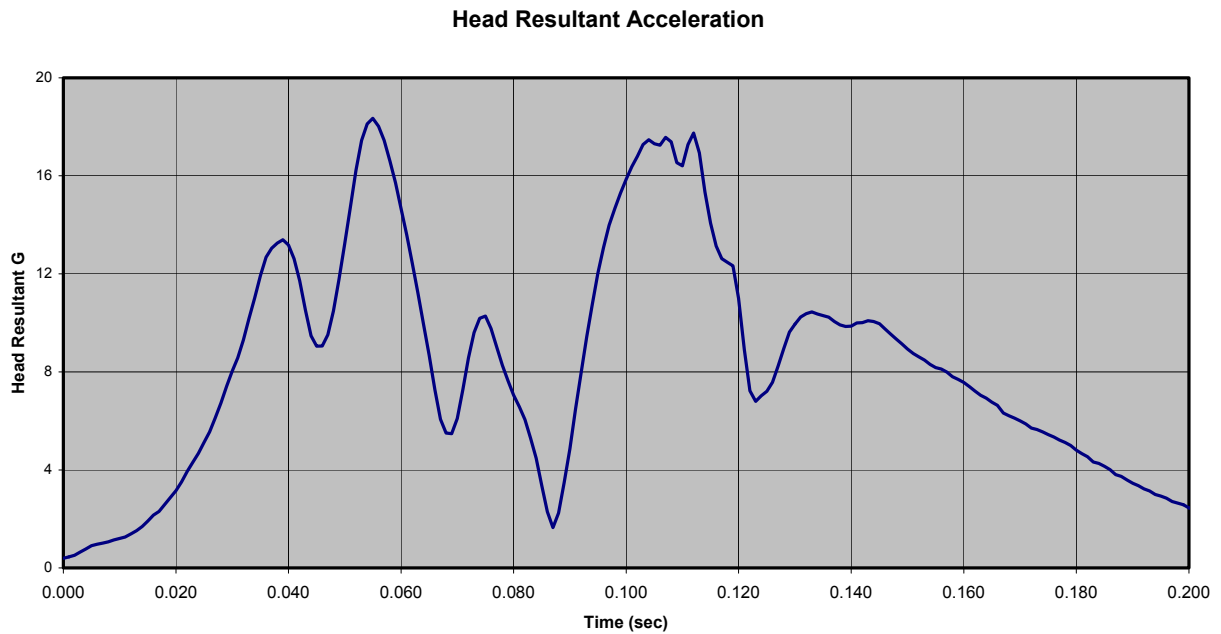

Figure D-2: Test 512 (Low Pulse, 4.0 lb Added Head Weight)

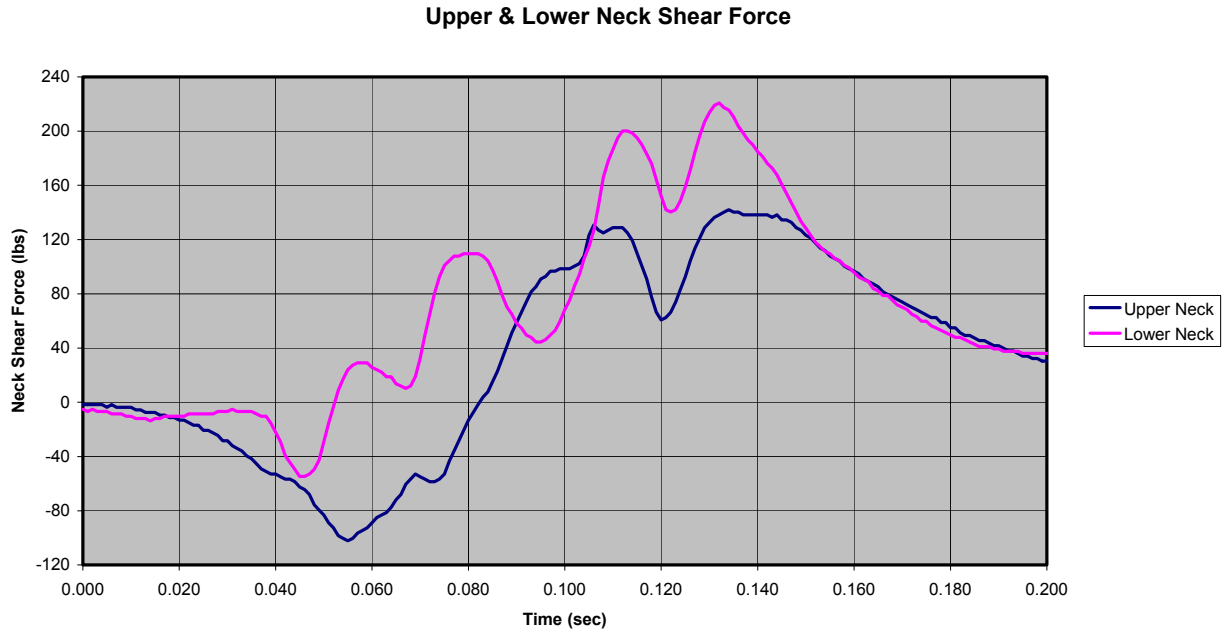

Figure D-3: Test 512 (Low Pulse, 4.0 lb Added Head Weight)

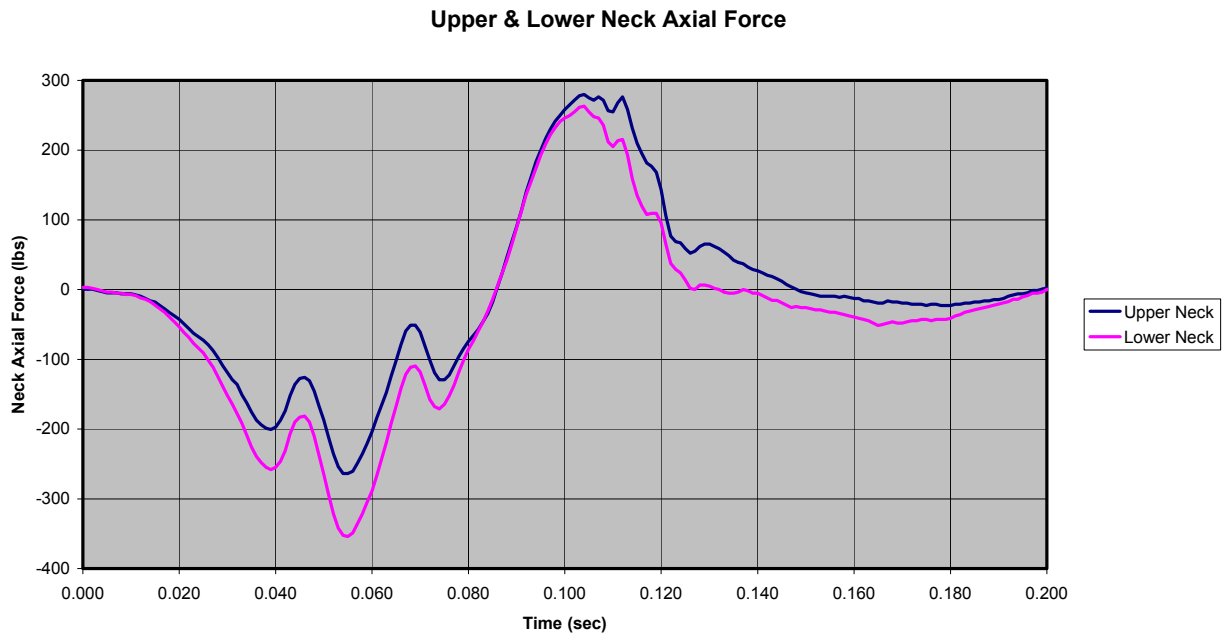

Figure D-4: Test 512 (Low Pulse, 4.0 lb Added Head Weight)



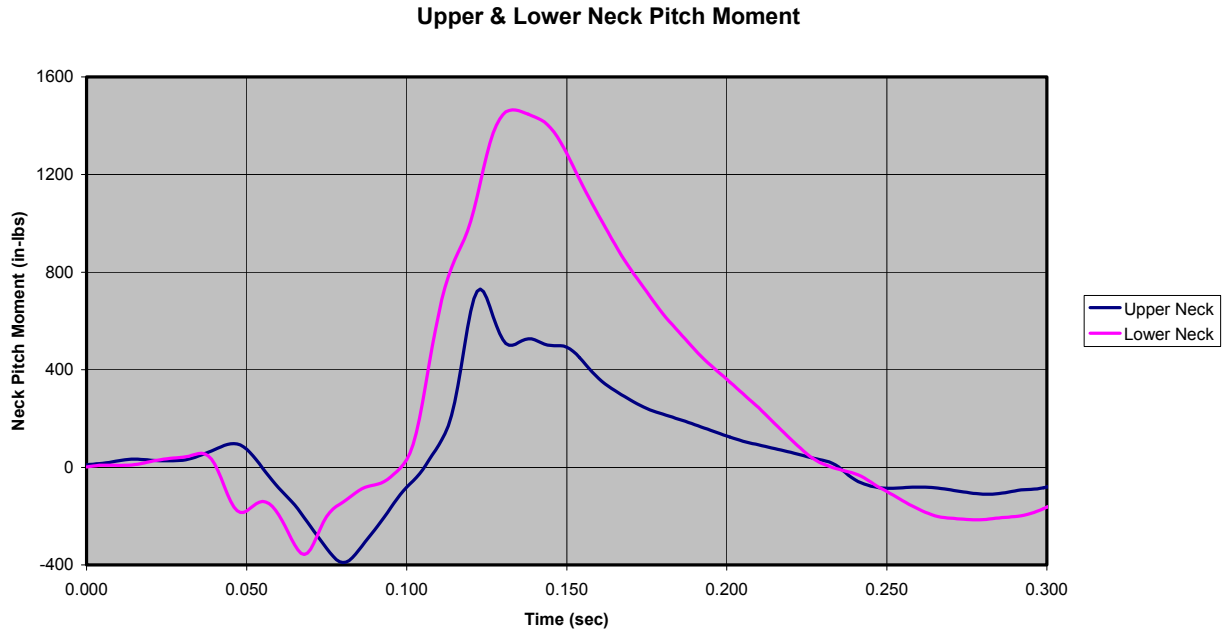

Figure D-5: Test 512 (Low Pulse, 4.0 lb Added Head Weight)

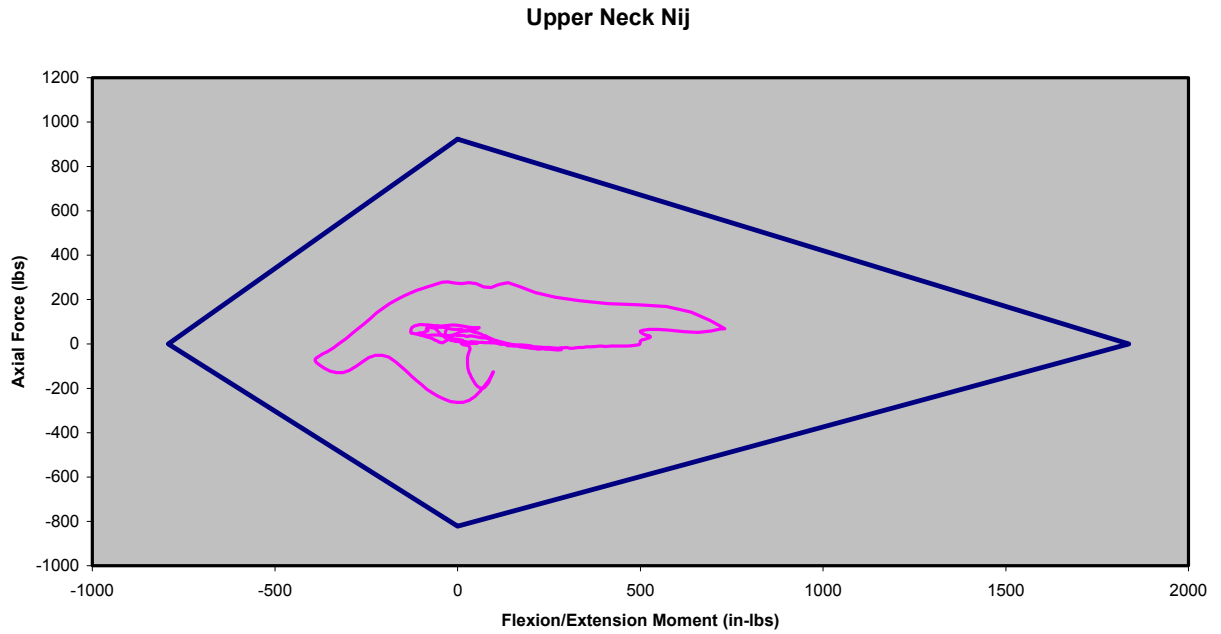

Figure D-6: Test 512 (Low Pulse, 4.0 lb Added Head Weight)

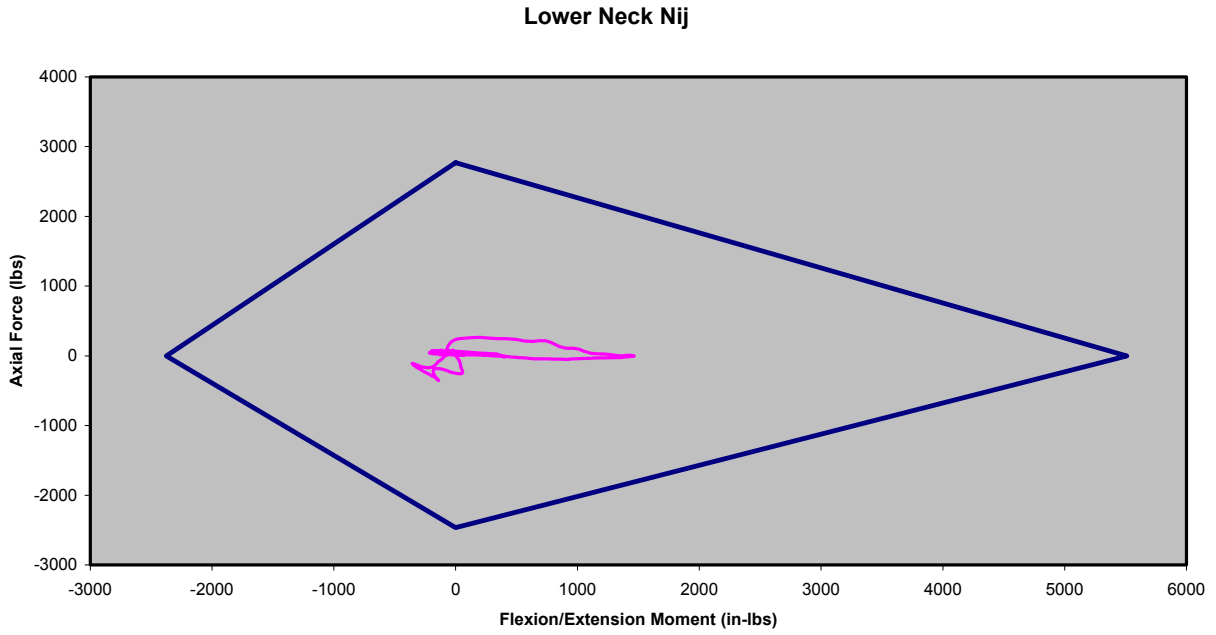

Figure D-7: Test 512 (Low Pulse, 4.0 lb Added Head Weight)

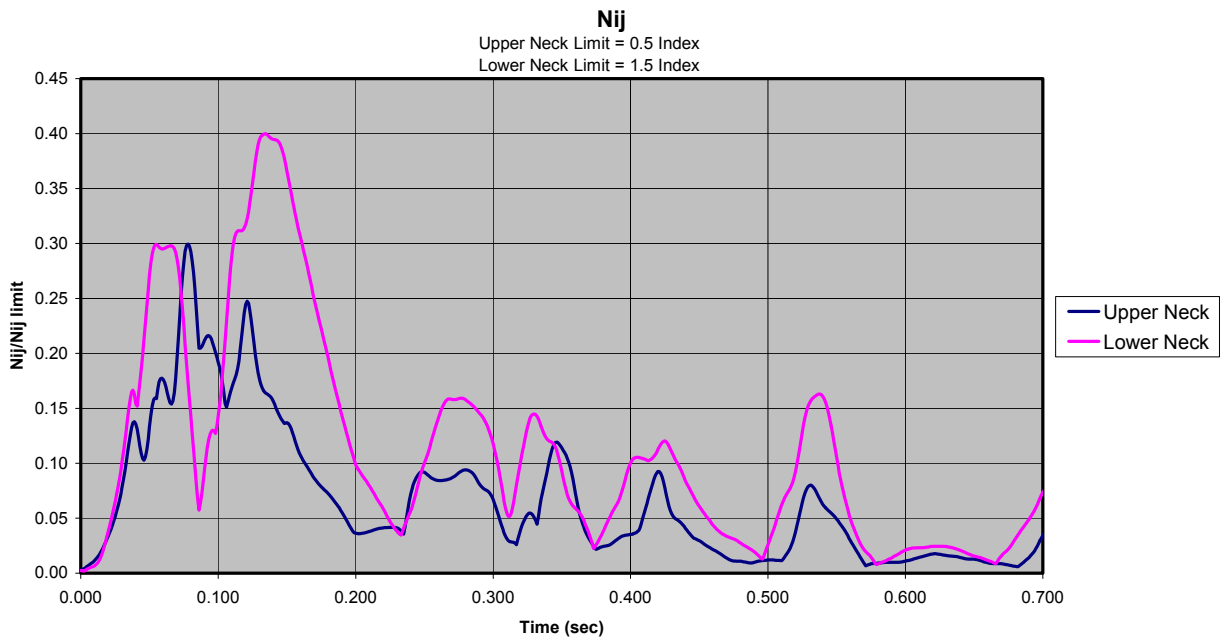

Figure D-8: Test 512 (Low Pulse, 4.0 lb Added Head Weight)

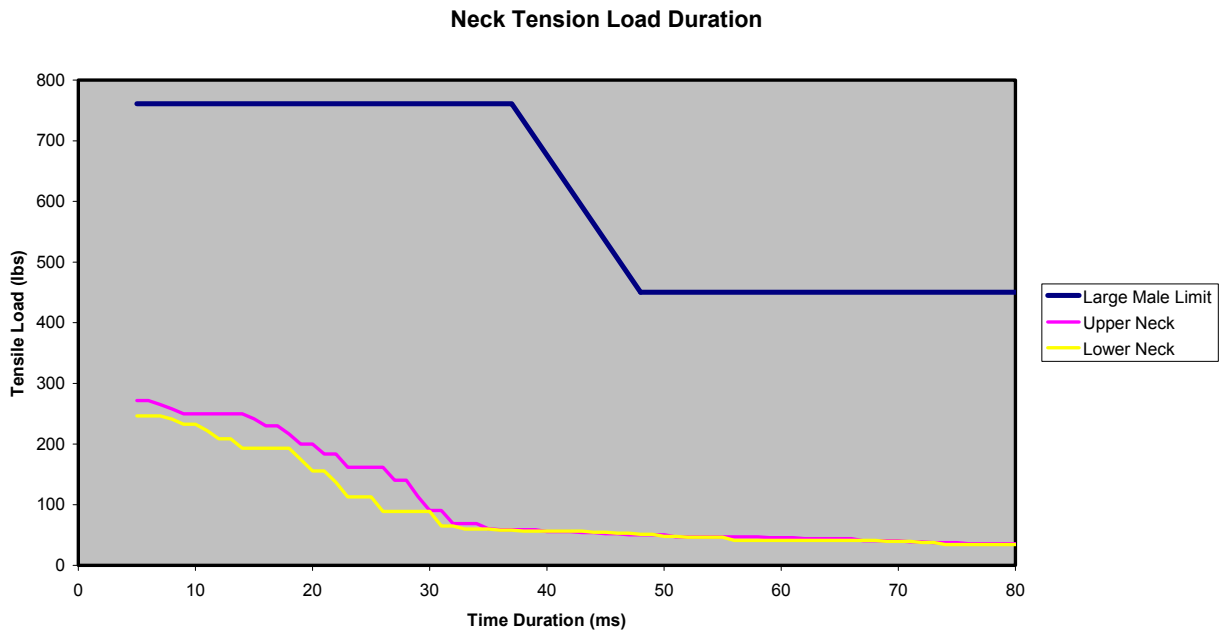

Figure D-9: Test 512 (Low Pulse, 4.0 lb Added Head Weight)

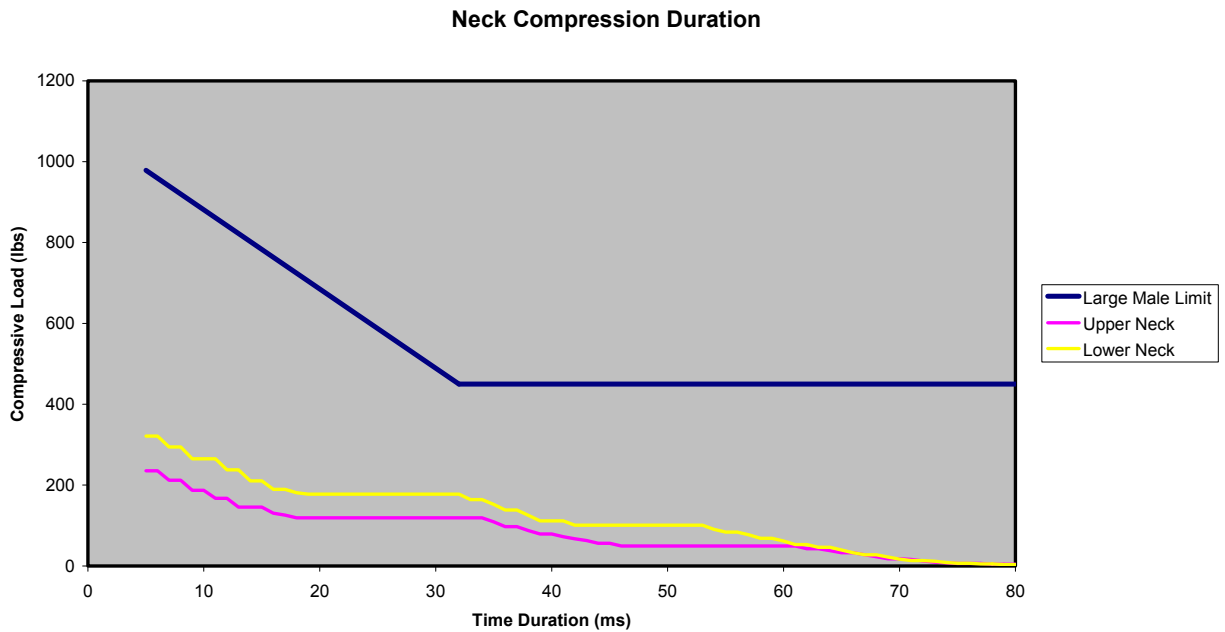

Figure D-10: Test 512 (Low Pulse, 4.0 lb Added Head Weight)

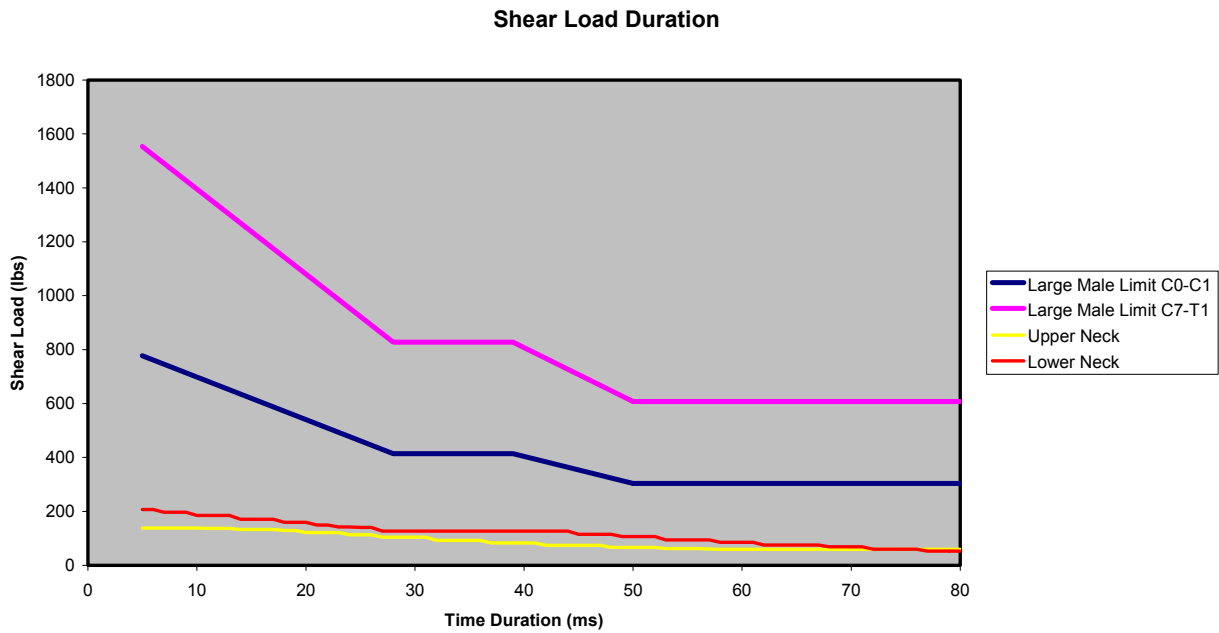

Figure D-11: Test 512 (Low Pulse, 4.0 lb Added Head Weight)

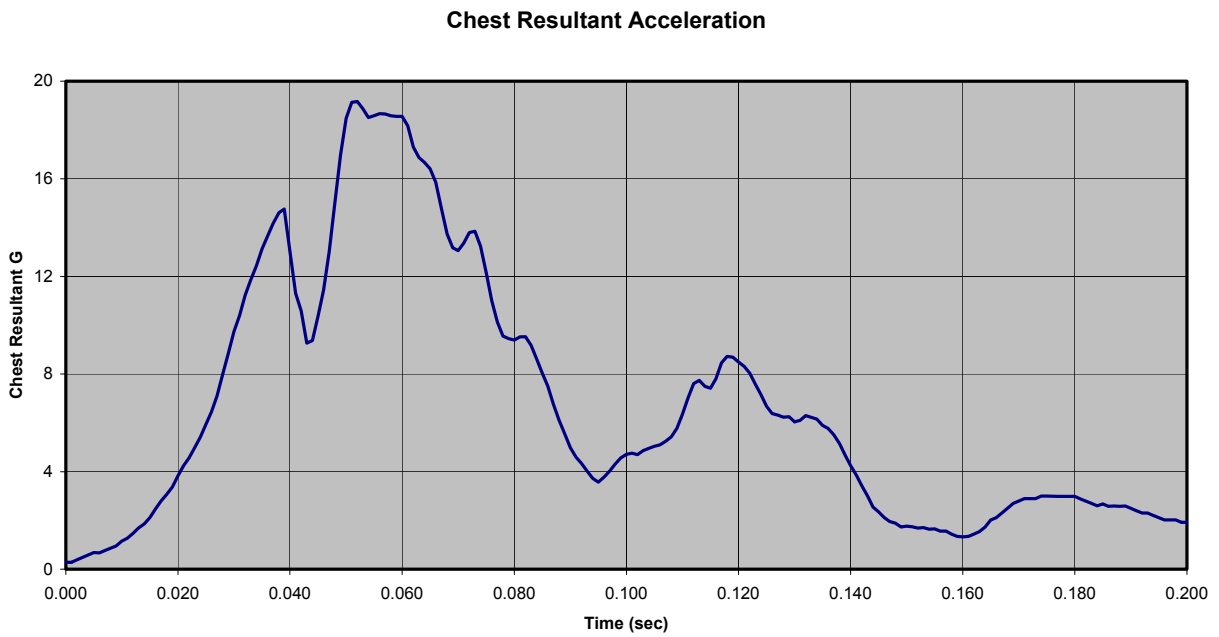

Figure D-12: Test 513 (Low Pulse, 6.0 lb Added Head Weight)

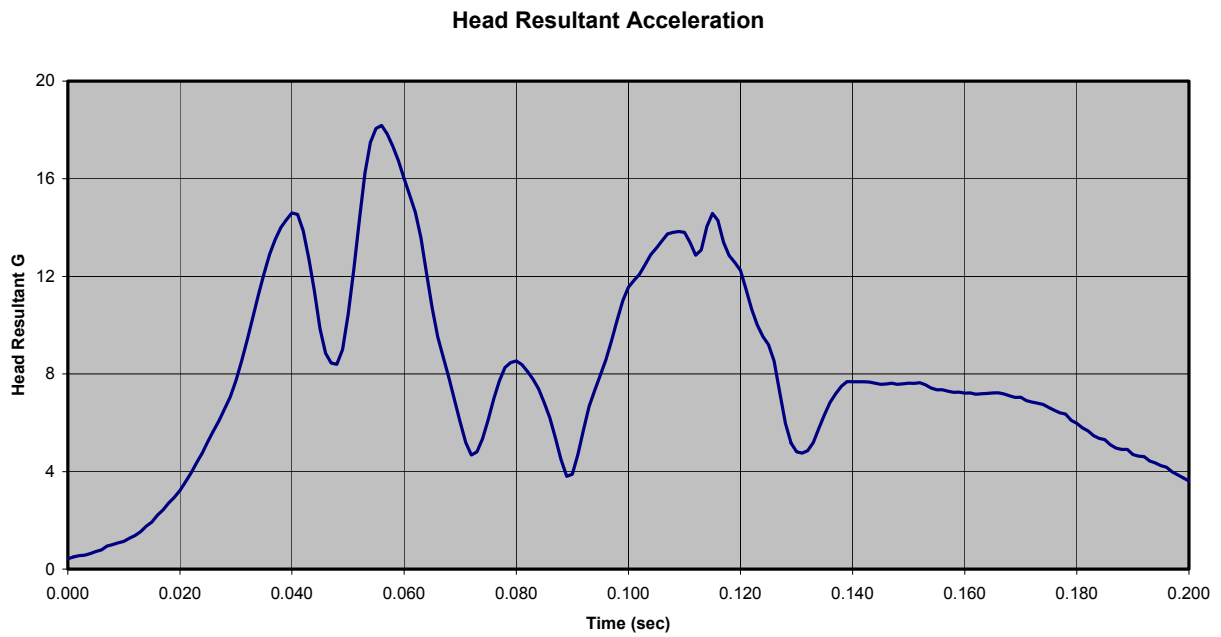

Figure D-13: Test 513 (Low Pulse, 6.0 lb Added Head Weight)

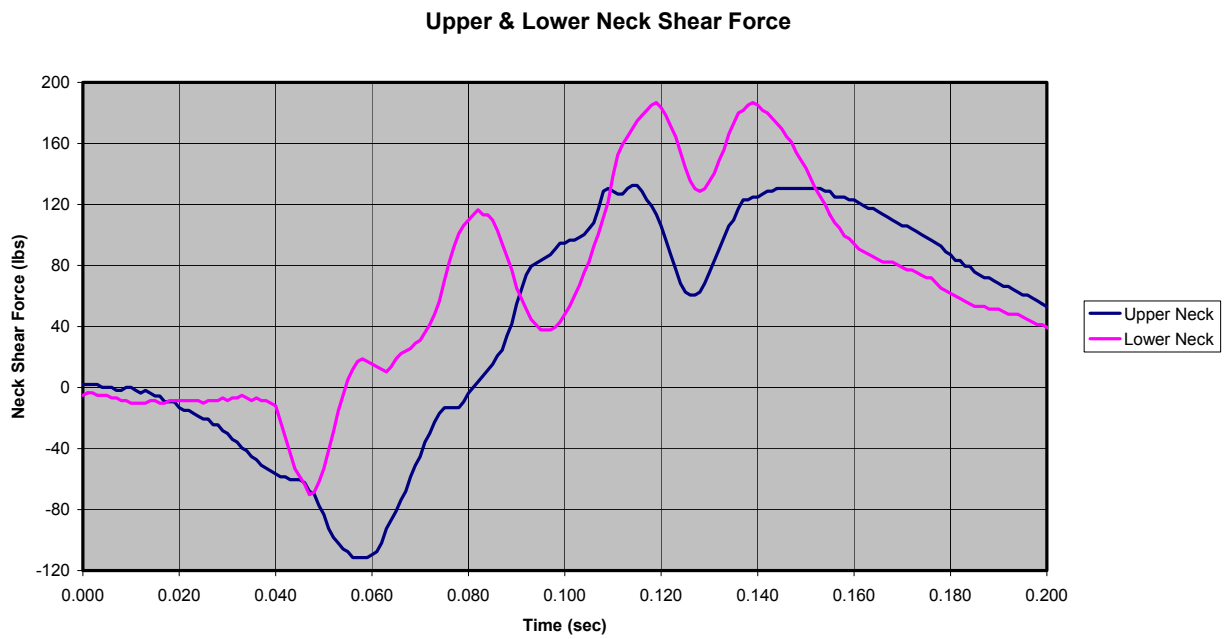

Figure D-14: Test 513 (Low Pulse, 6.0 lb Added Head Weight)

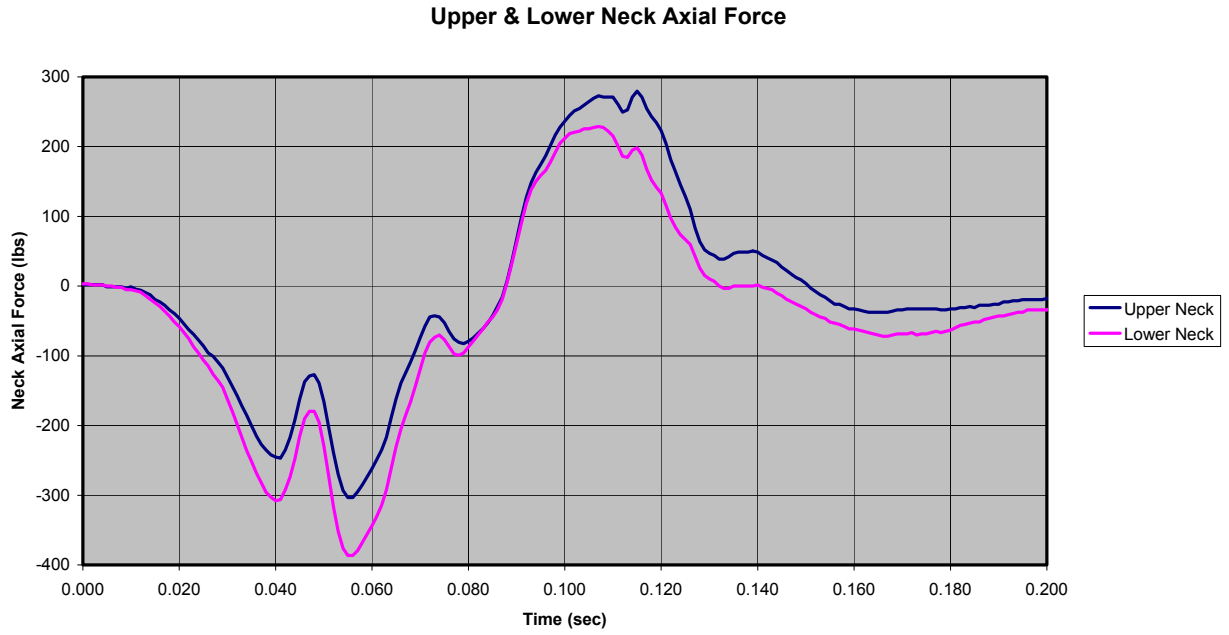

Figure D-15: Test 513 (Low Pulse, 6.0 lb Added Head Weight)

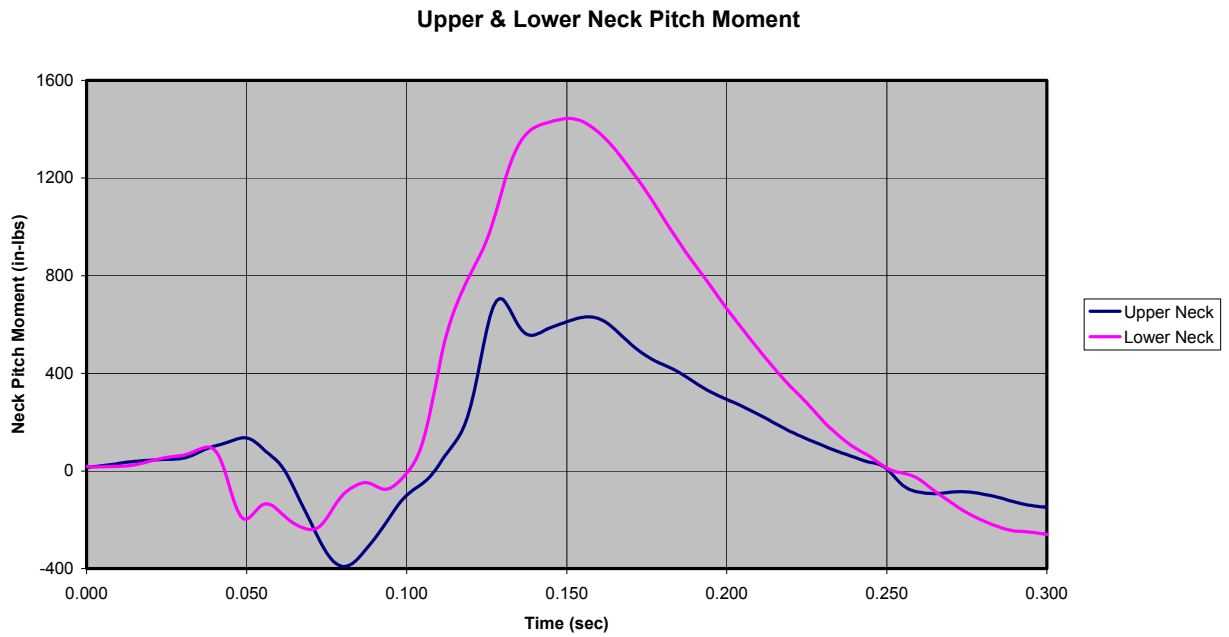

Figure D-16: Test 513 (Low Pulse, 6.0 lb Added Head Weight)

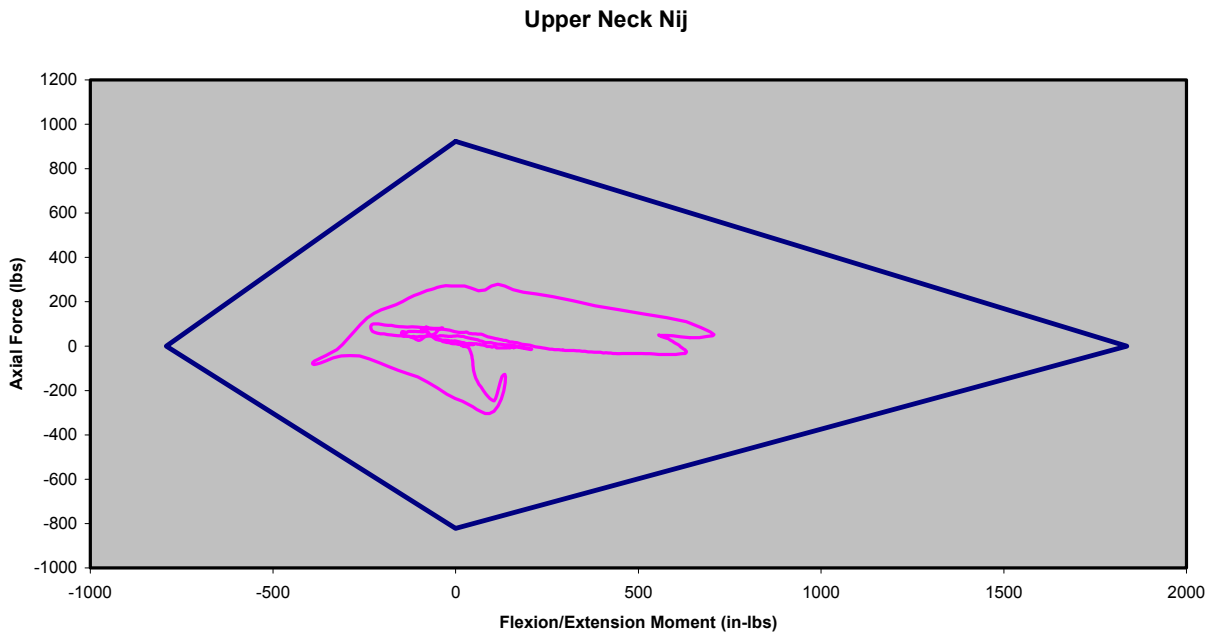

Figure D-17: Test 513 (Low Pulse, 6.0 lb Added Head Weight)

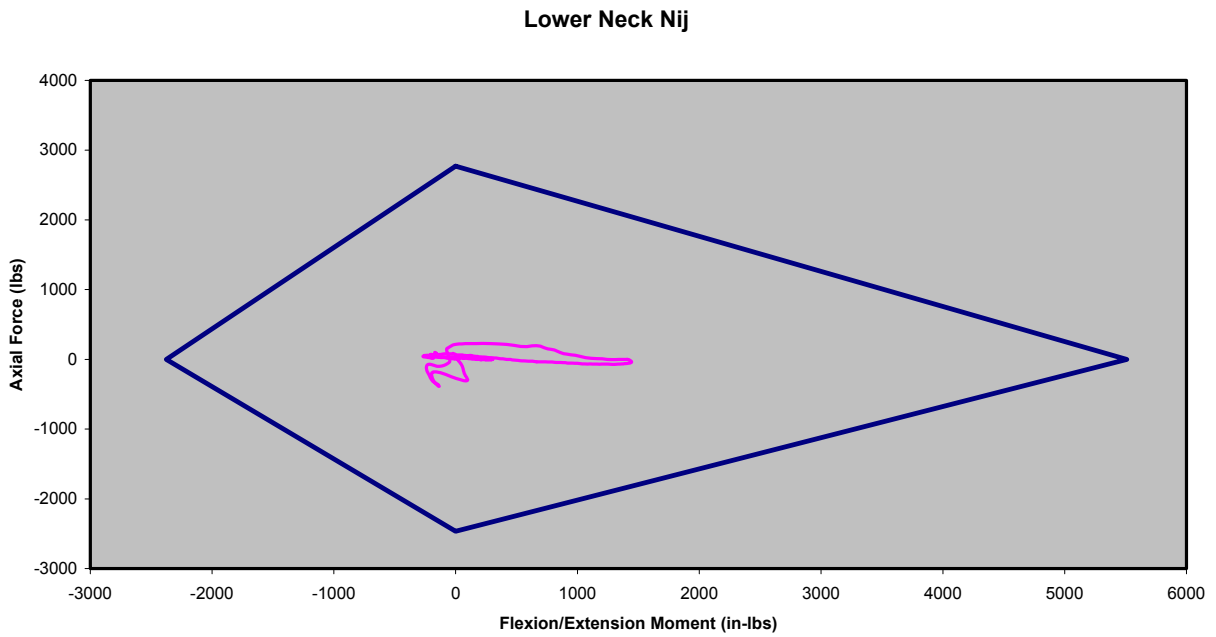

Figure D-18: Test 513 (Low Pulse, 6.0 lb Added Head Weight)

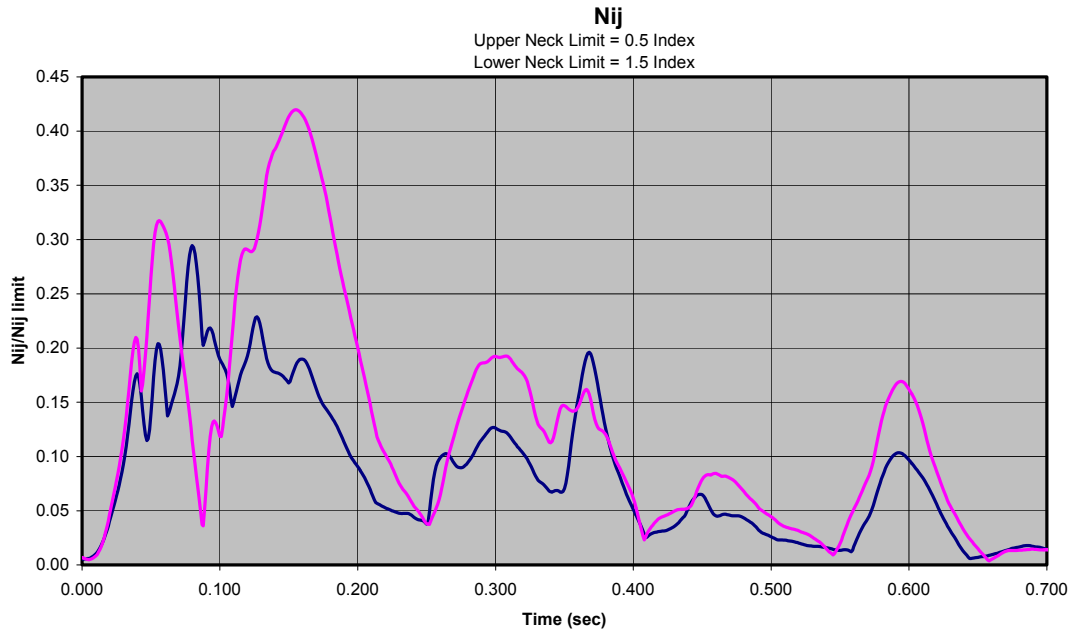

Figure D-19: Test 513 (Low Pulse, 6.0 lb Added Head Weight)

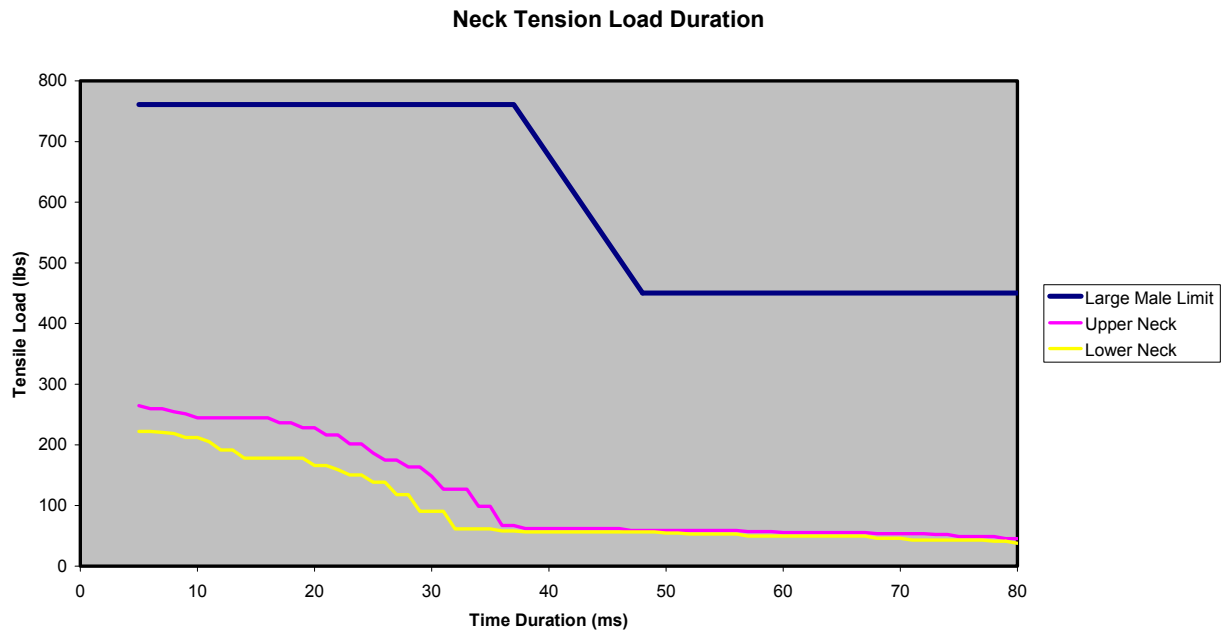

Figure D-20: Test 513 (Low Pulse, 6.0 lb Added Head Weight)



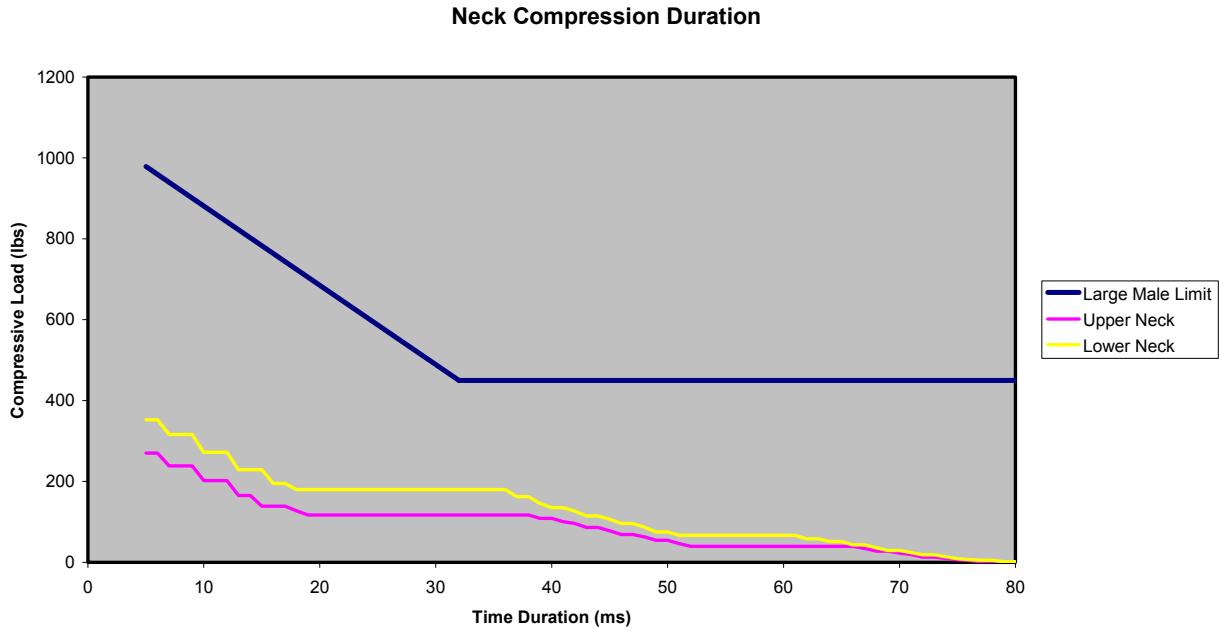

Figure D-21: Test 513 (Low Pulse, 6.0 lb Added Head Weight)

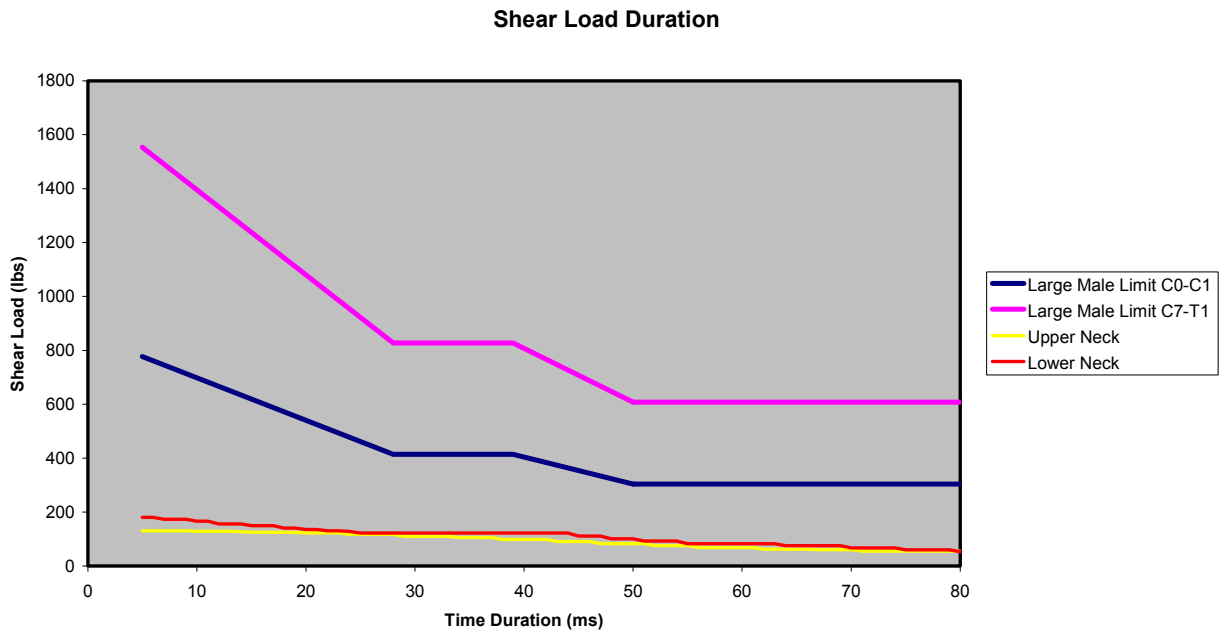

Figure D-22: Test 513 (Low Pulse, 6.0 lb Added Head Weight)

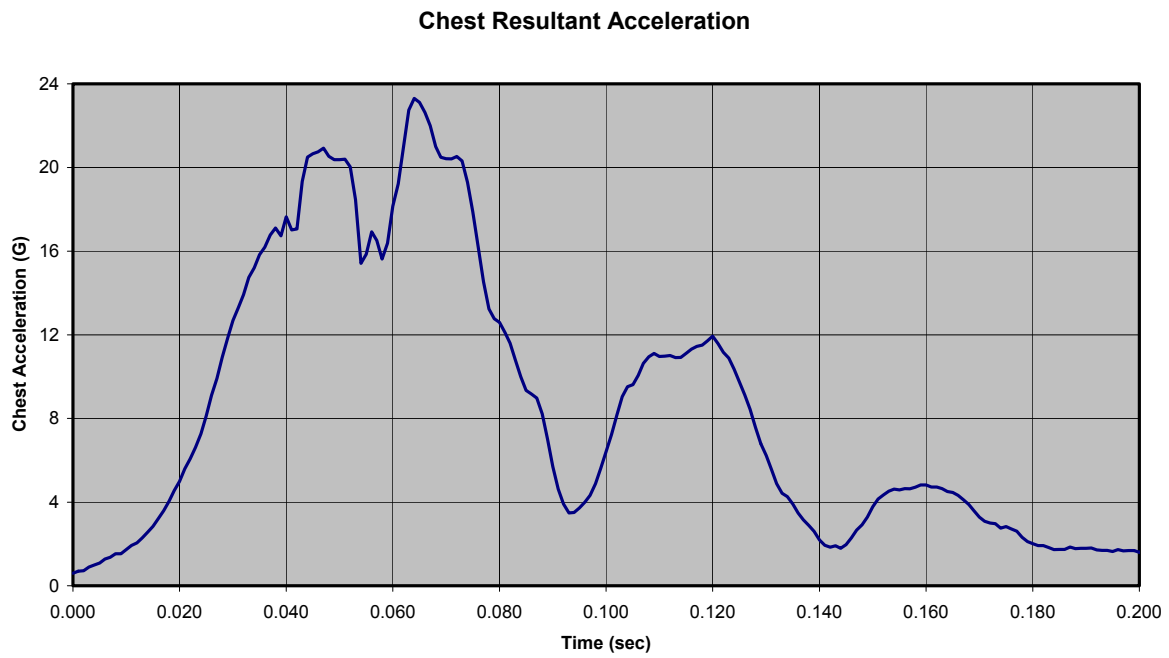

Figure D-23: Test 509 (Medium Pulse, 4.0 lb Added Head Weight)

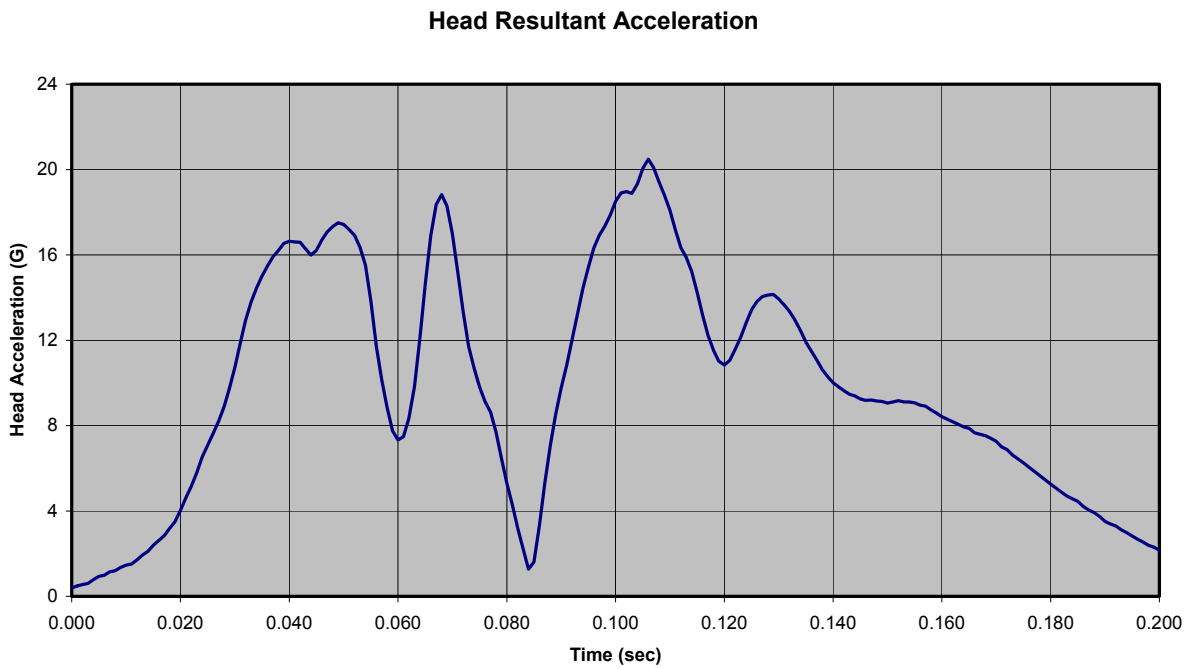

Figure D-24: Test 509 (Medium Pulse, 4.0 lb Added Head Weight)

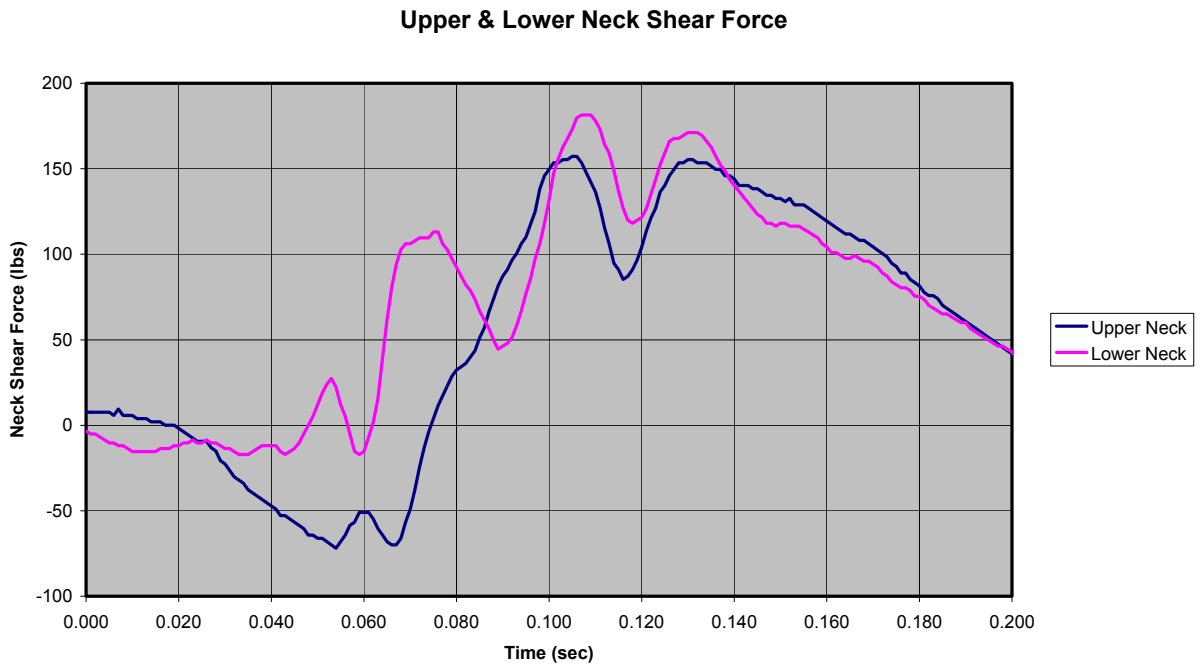

Figure D-25: Test 509 (Medium Pulse, 4.0 lb Added Head Weight)

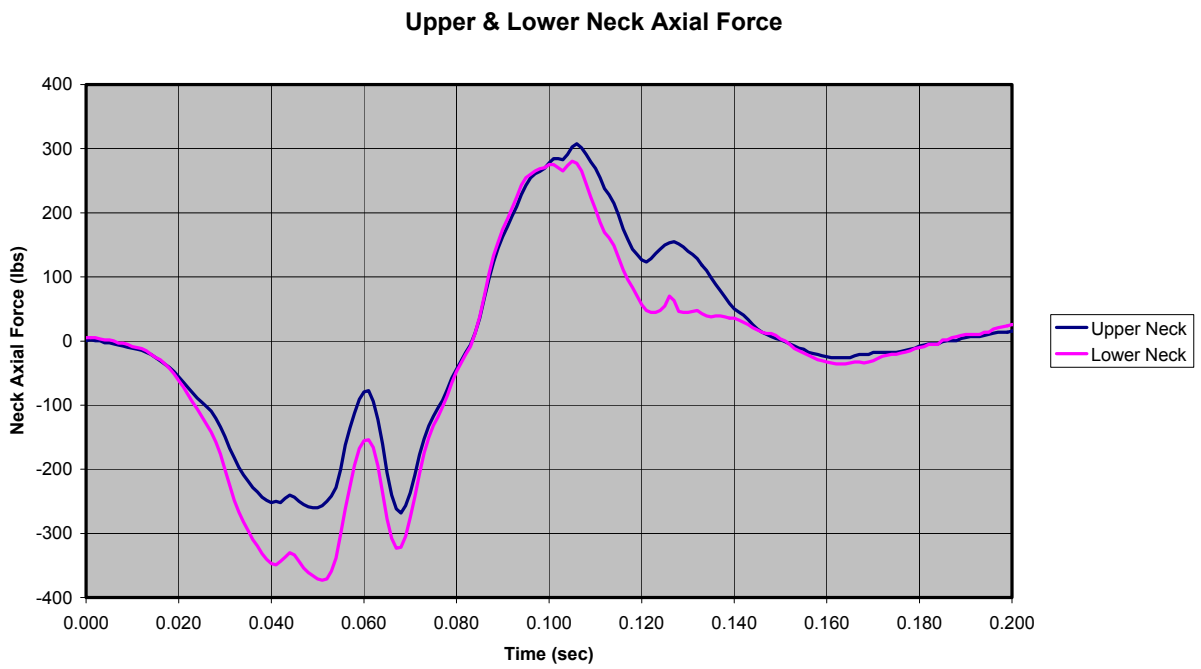

Figure D-26: Test 509 (Medium Pulse, 4.0 lb Added Head Weight)

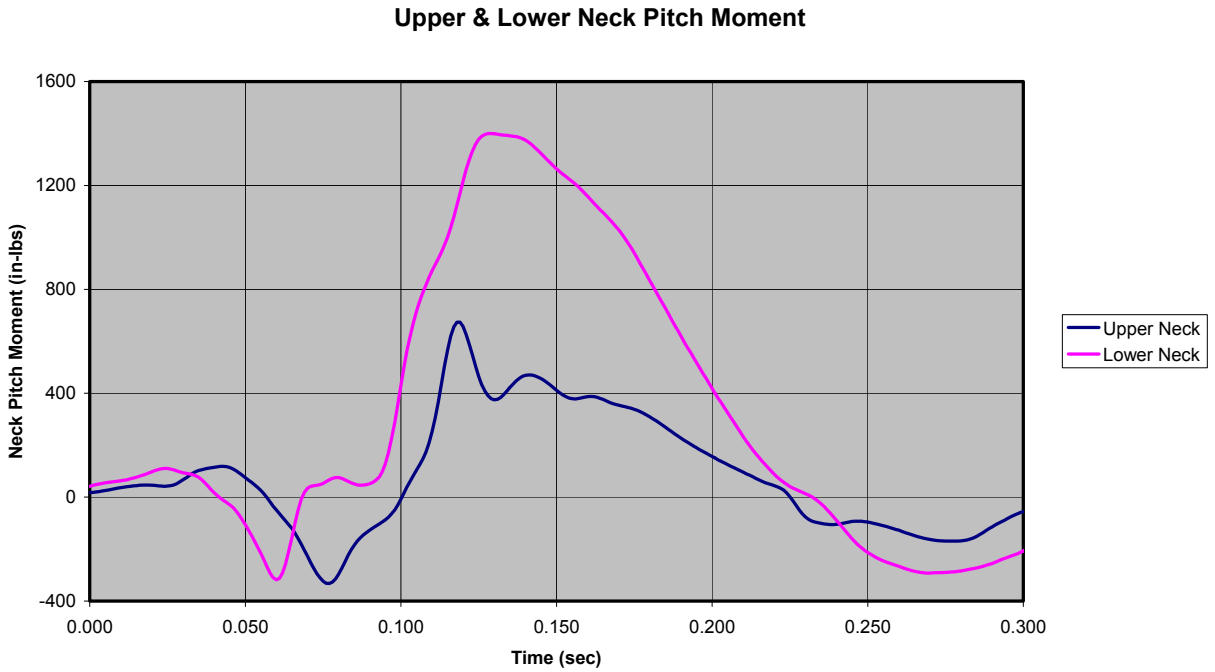

Figure D-27: Test 509 (Medium Pulse, 4.0 lb Added Head Weight)

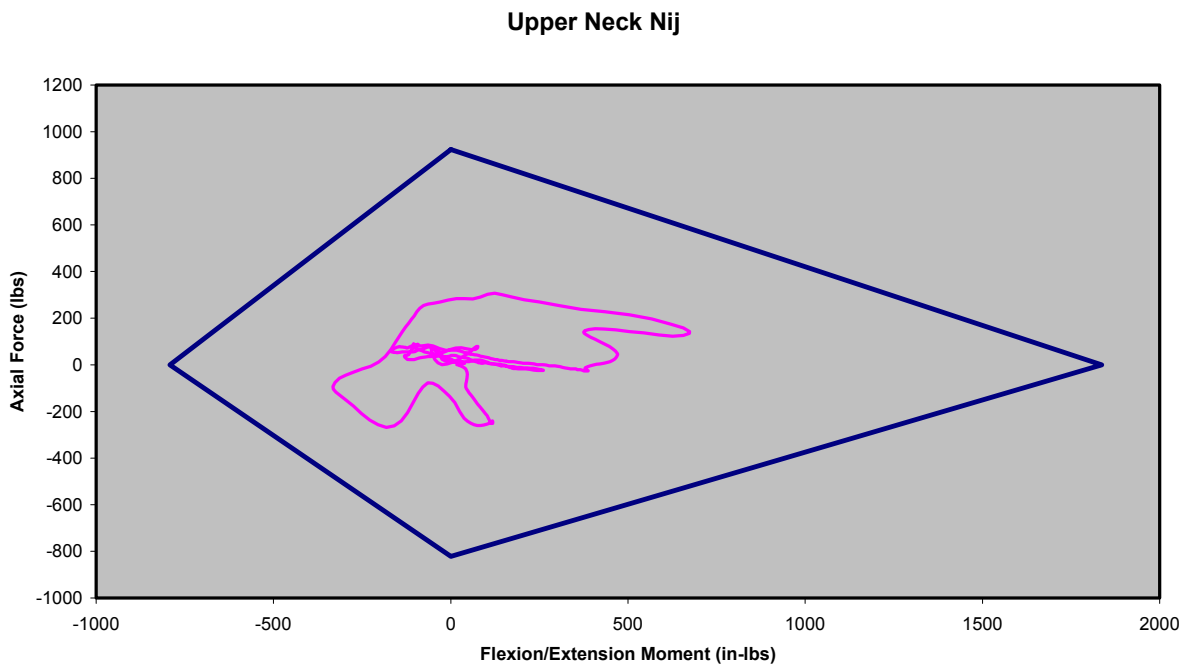

Figure D-28: Test 509 (Medium Pulse, 4.0 lb Added Head Weight)

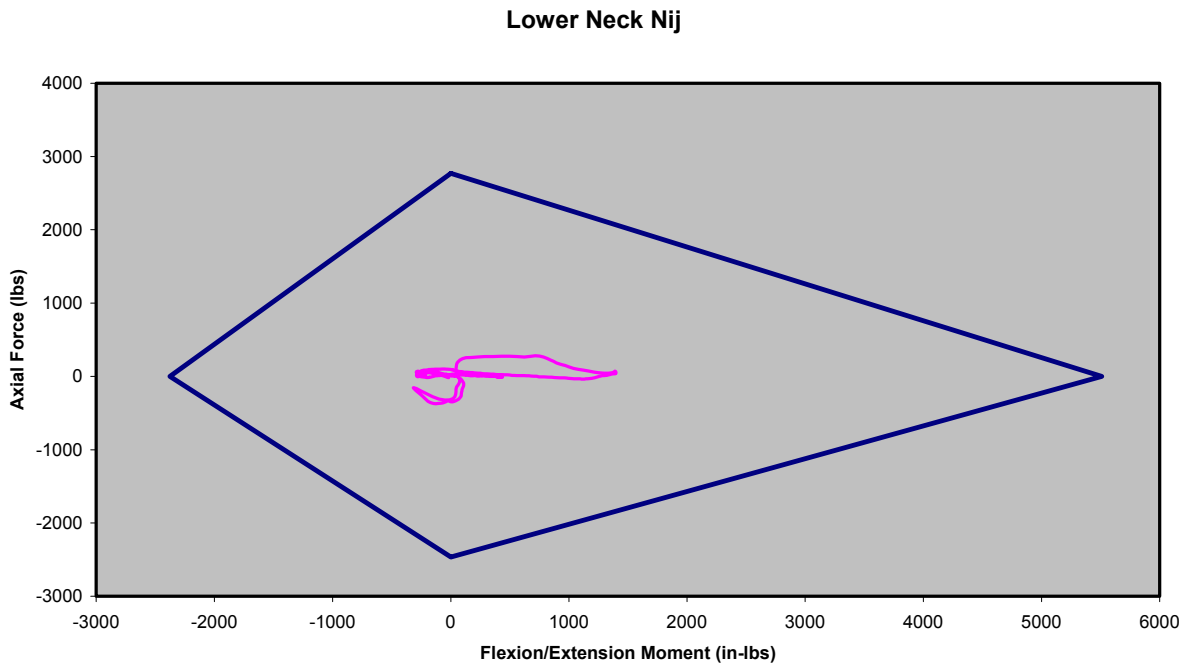

Figure D-29: Test 509 (Medium Pulse, 4.0 lb Added Head Weight)

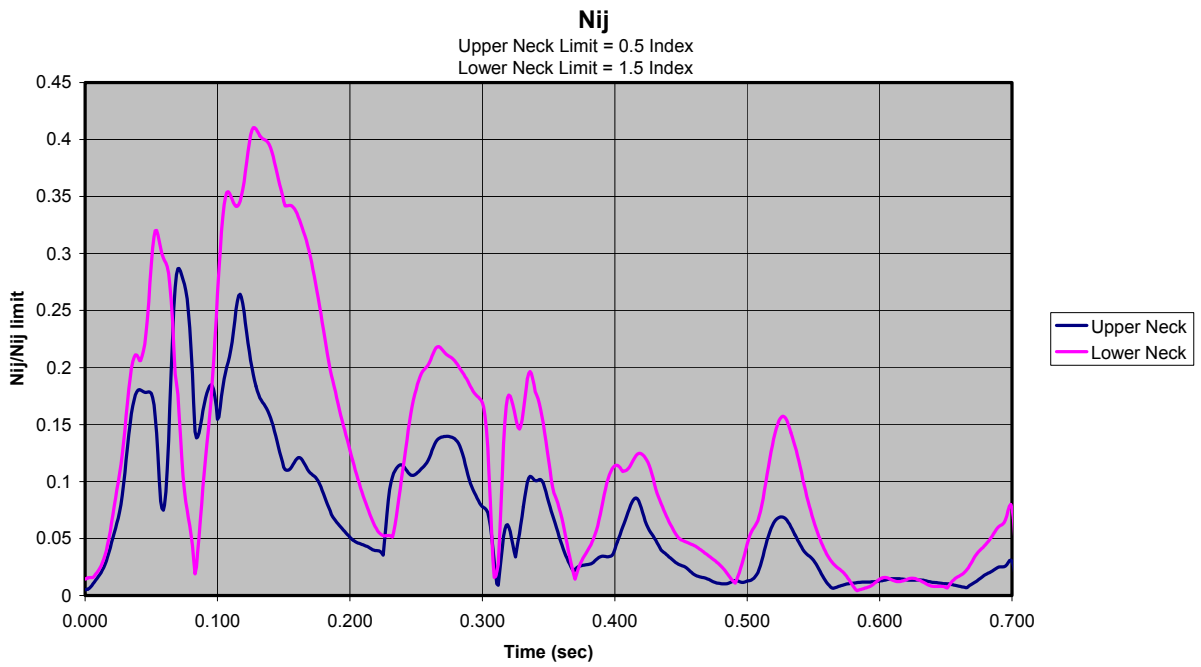

Figure D-30: Test 509 (Medium Pulse, 4.0 lb Added Head Weight)

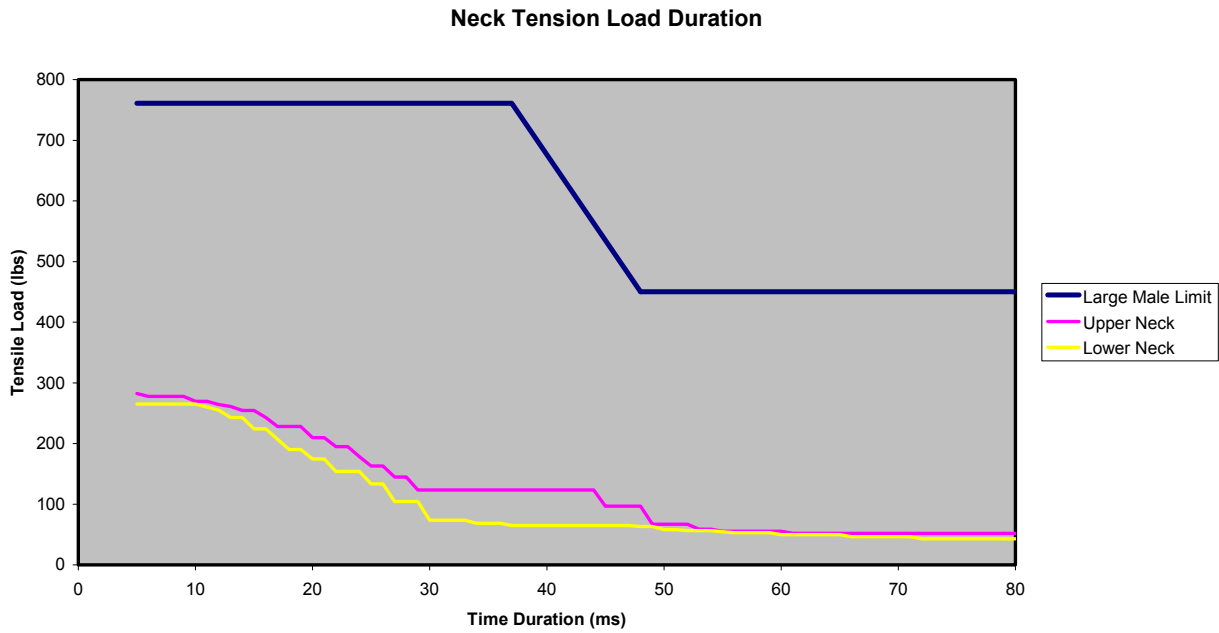

Figure D-31: Test 509 (Medium Pulse, 4.0 lb Added Head Weight)

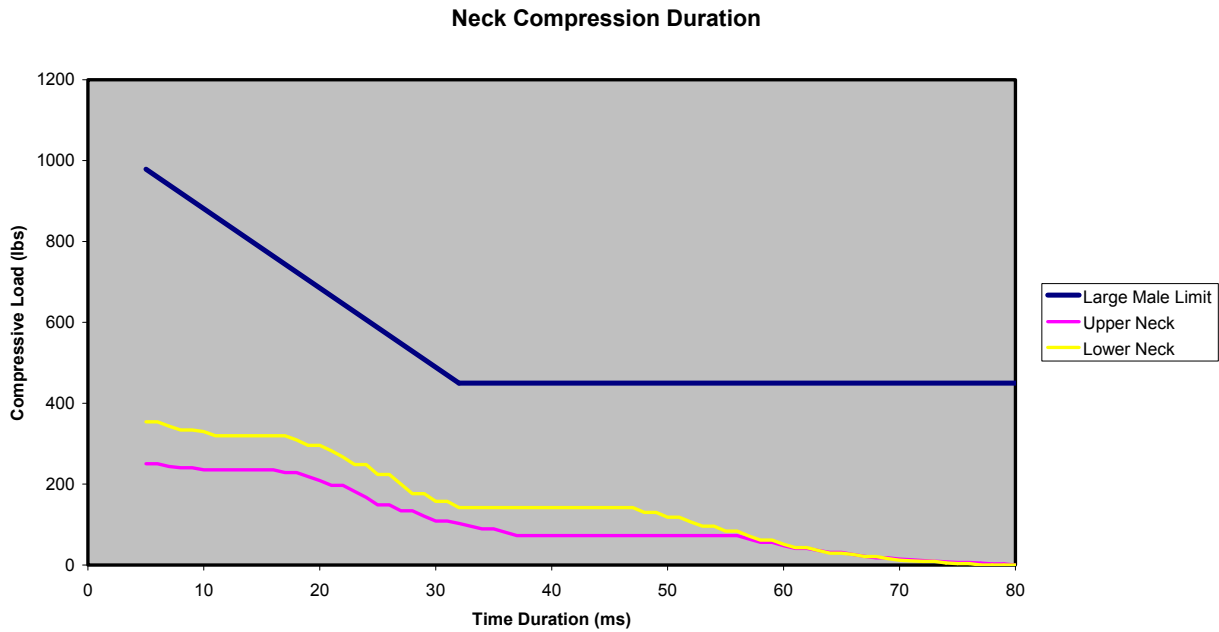

Figure D-32: Test 509 (Medium Pulse, 4.0 lb Added Head Weight)

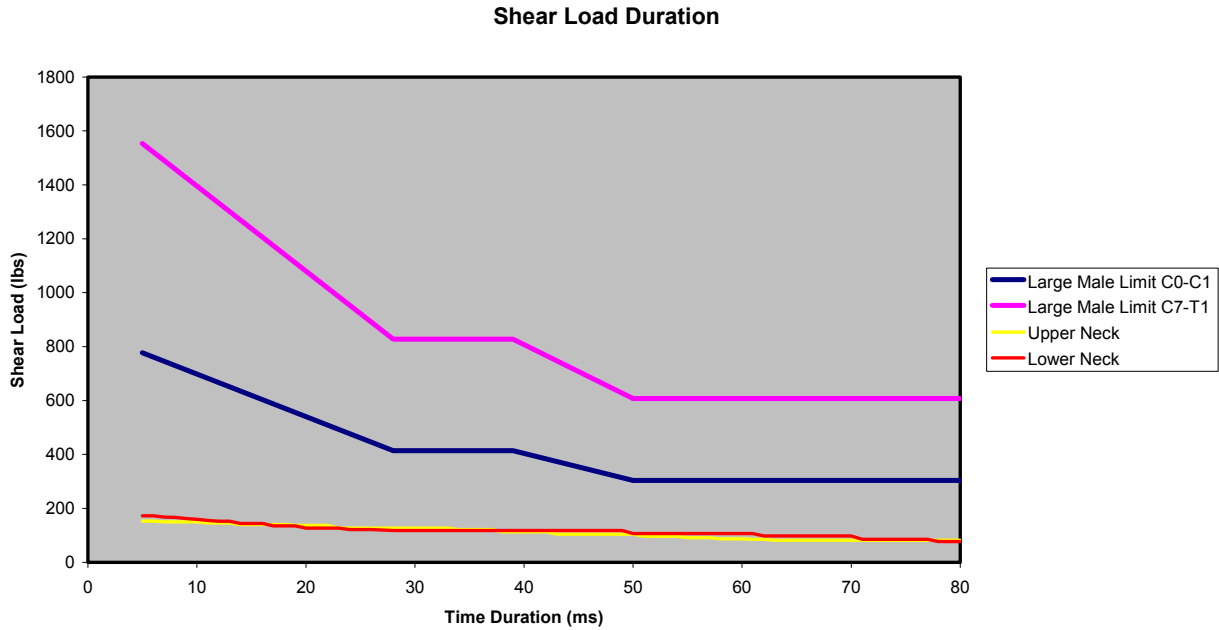

Figure D-33: Test 509 (Medium Pulse, 4.0 lb Added Head Weight)

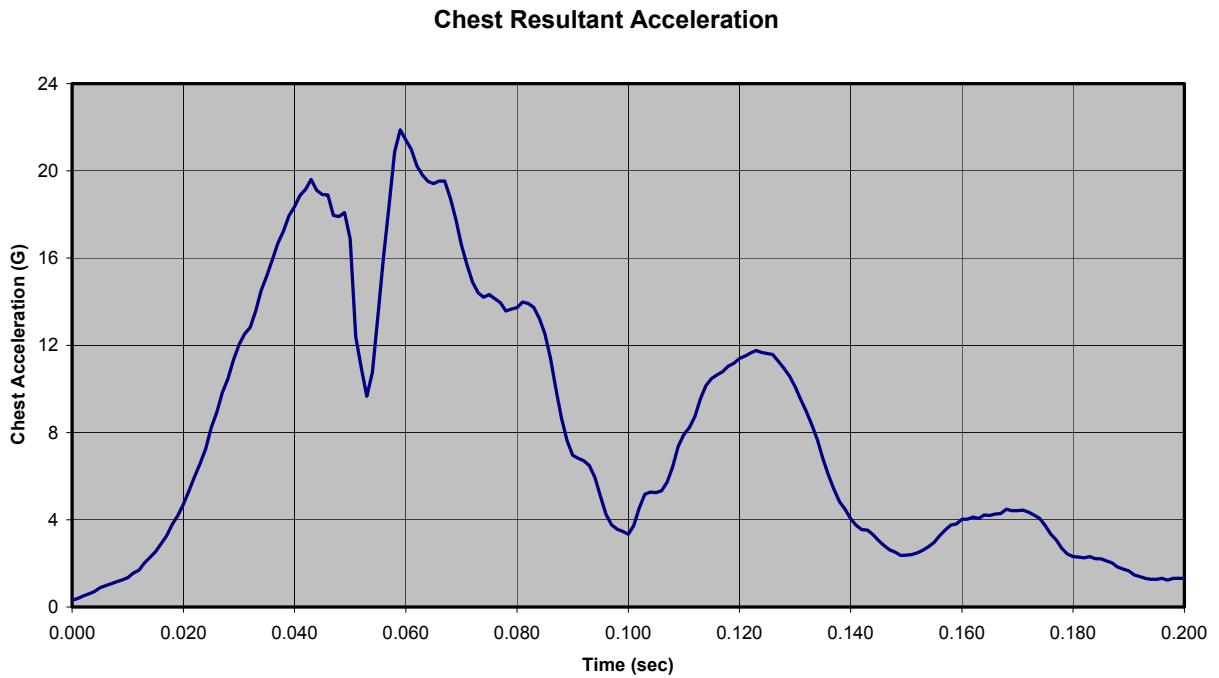

Figure D-34: Test 510 (Medium Pulse, 5.5 lb Added Head Weight)

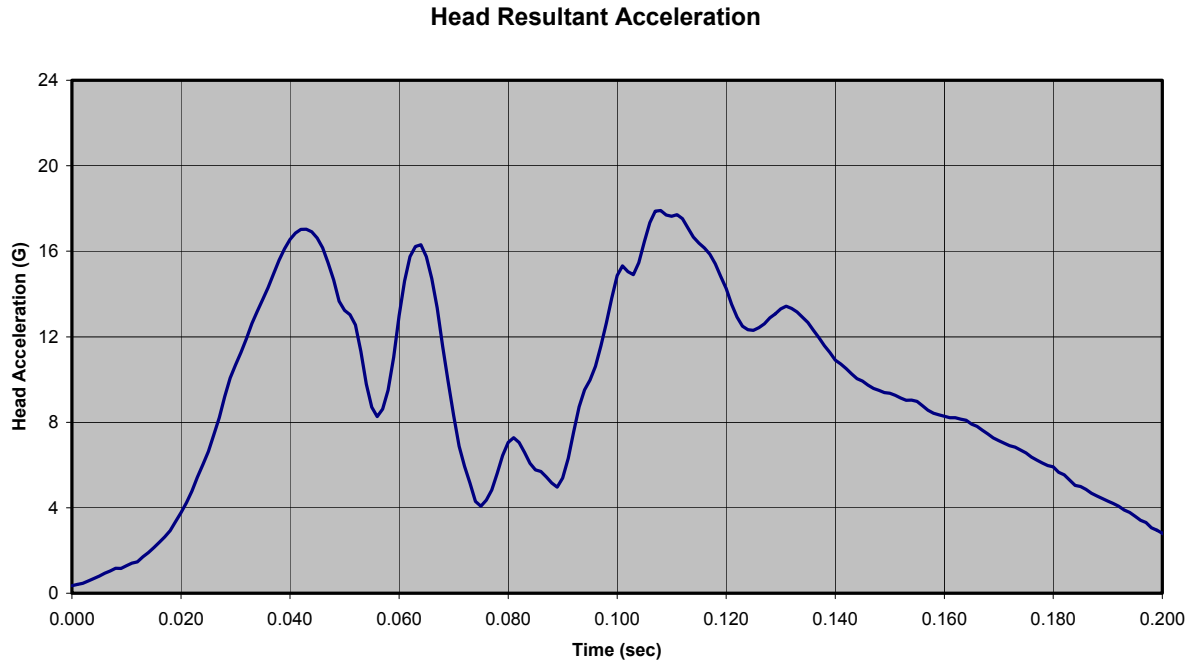

Figure D-35: Test 510 (Medium Pulse, 5.5 lb Added Head Weight)

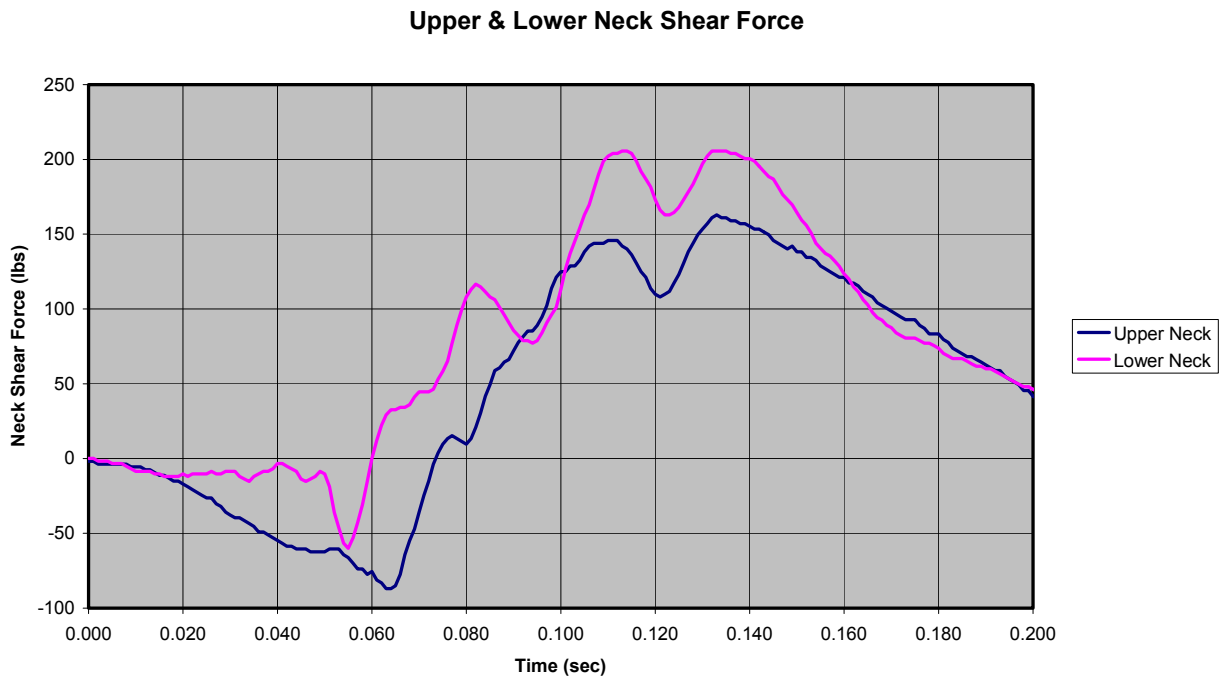

Figure D-36: Test 510 (Medium Pulse, 5.5 lb Added Head Weight)



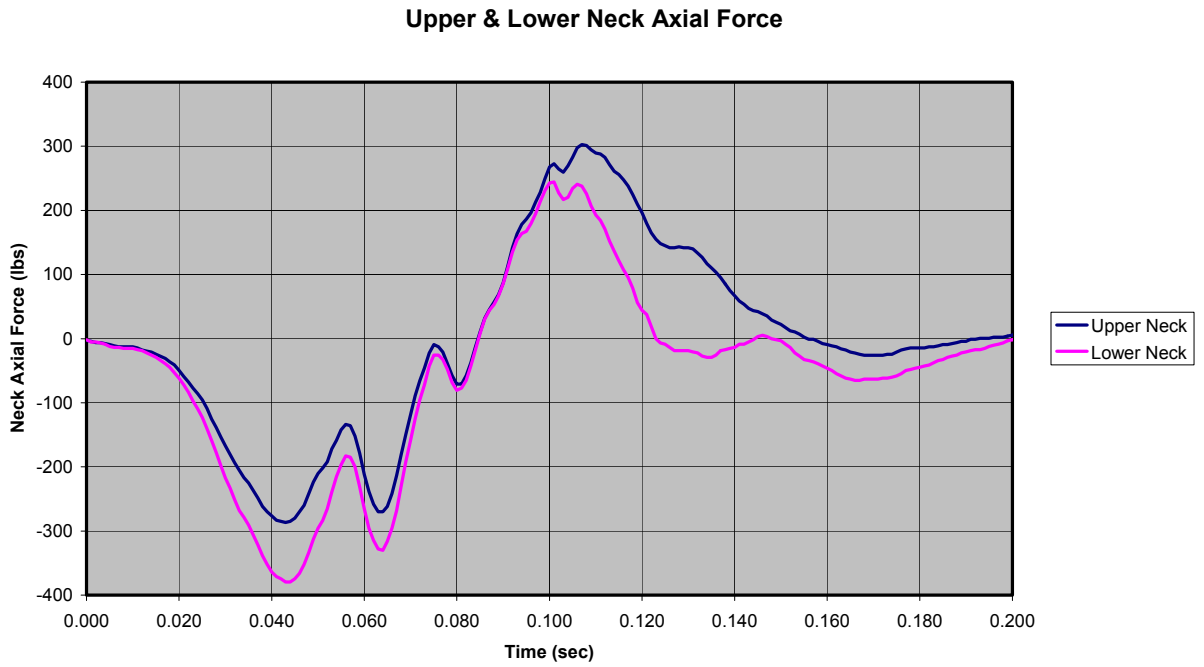

Figure D-37: Test 510 (Medium Pulse, 5.5 lb Added Head Weight)

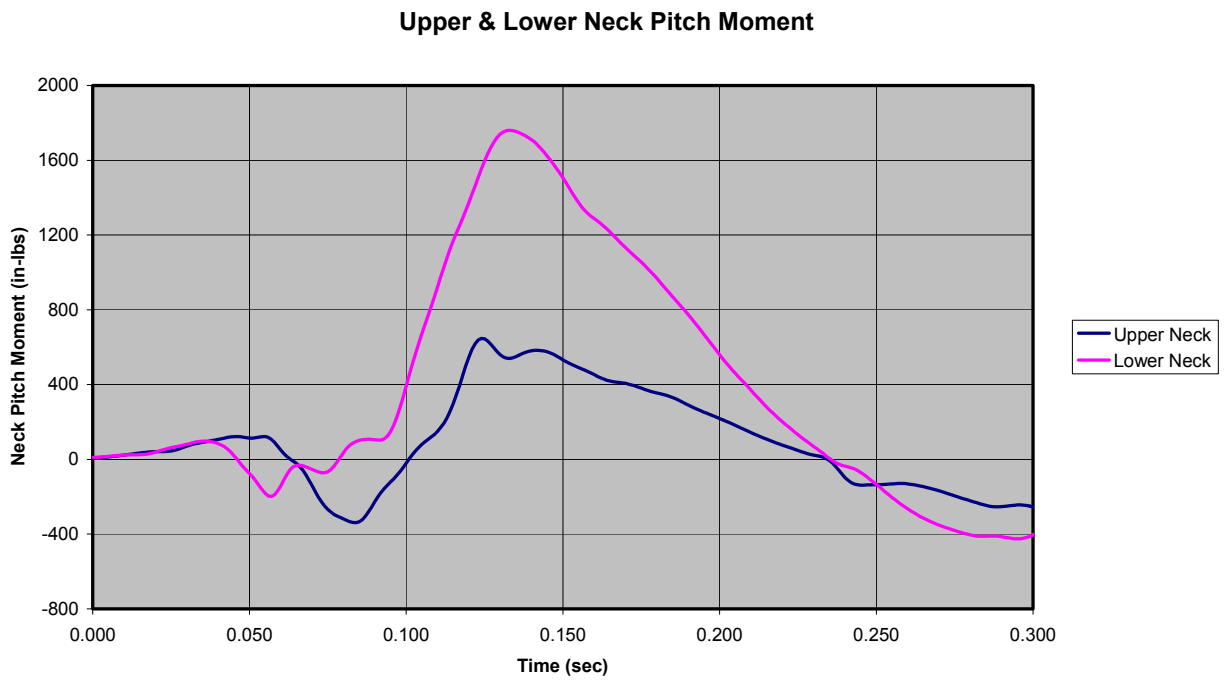

Figure D-38: Test 510 (Medium Pulse, 5.5 lb Added Head Weight)

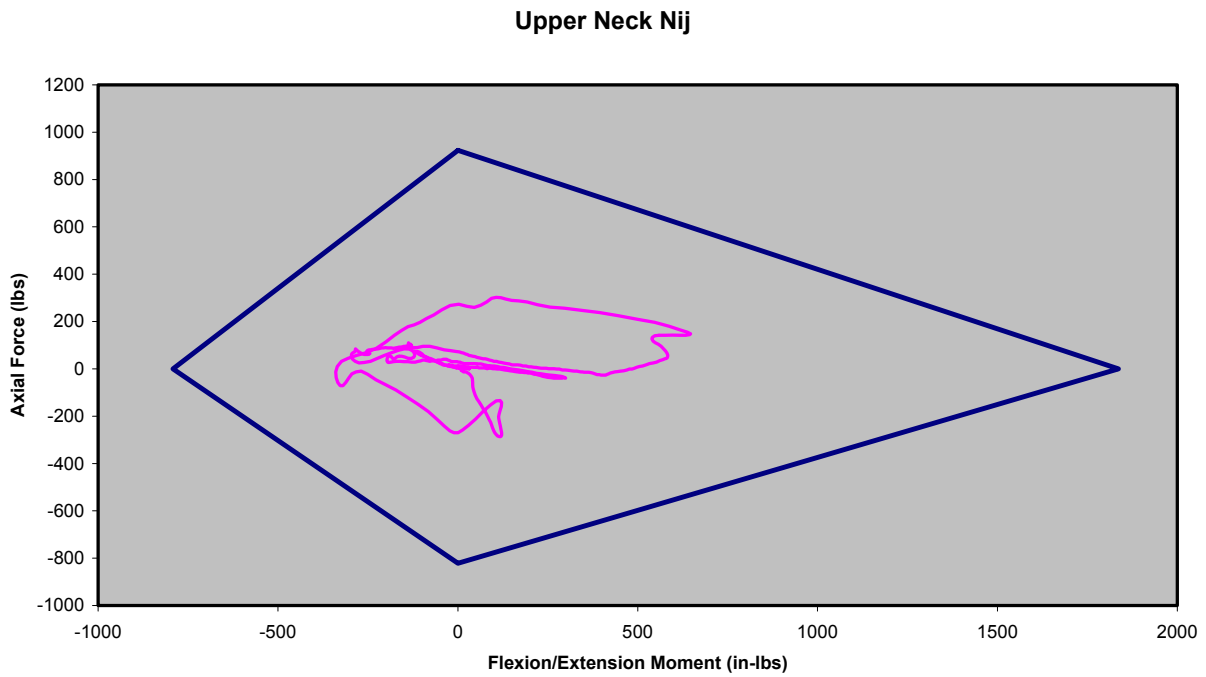

Figure D-39: Test 510 (Medium Pulse, 5.5 lb Added Head Weight)

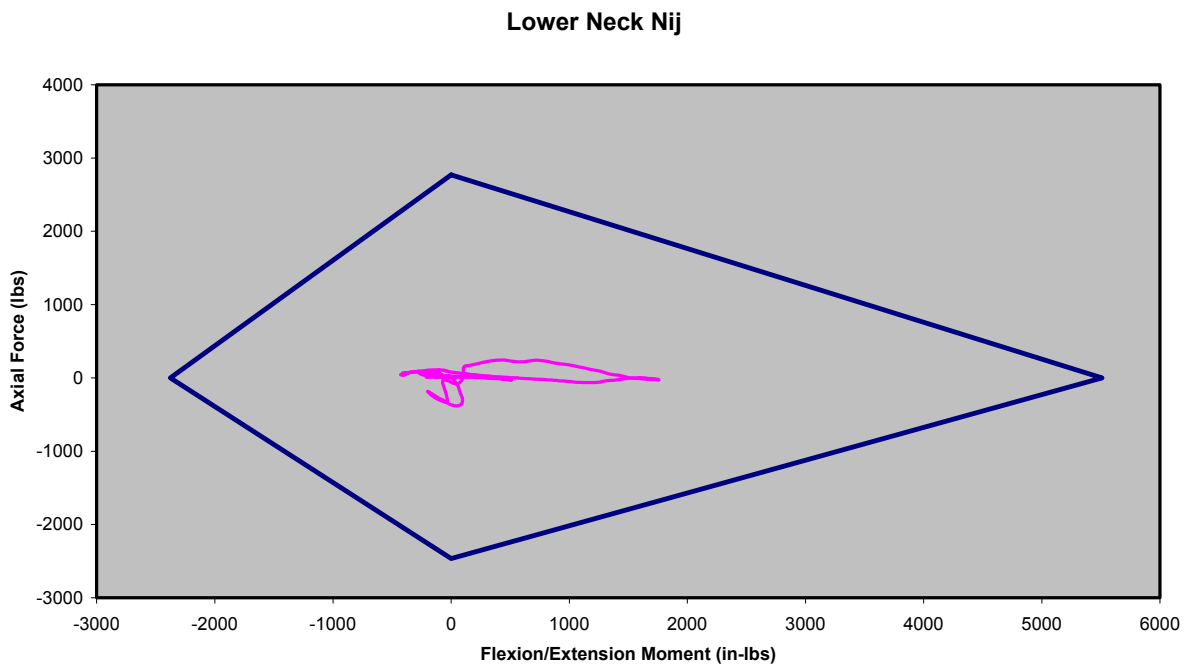

Figure D-40: Test 510 (Medium Pulse, 5.5 lb Added Head Weight)

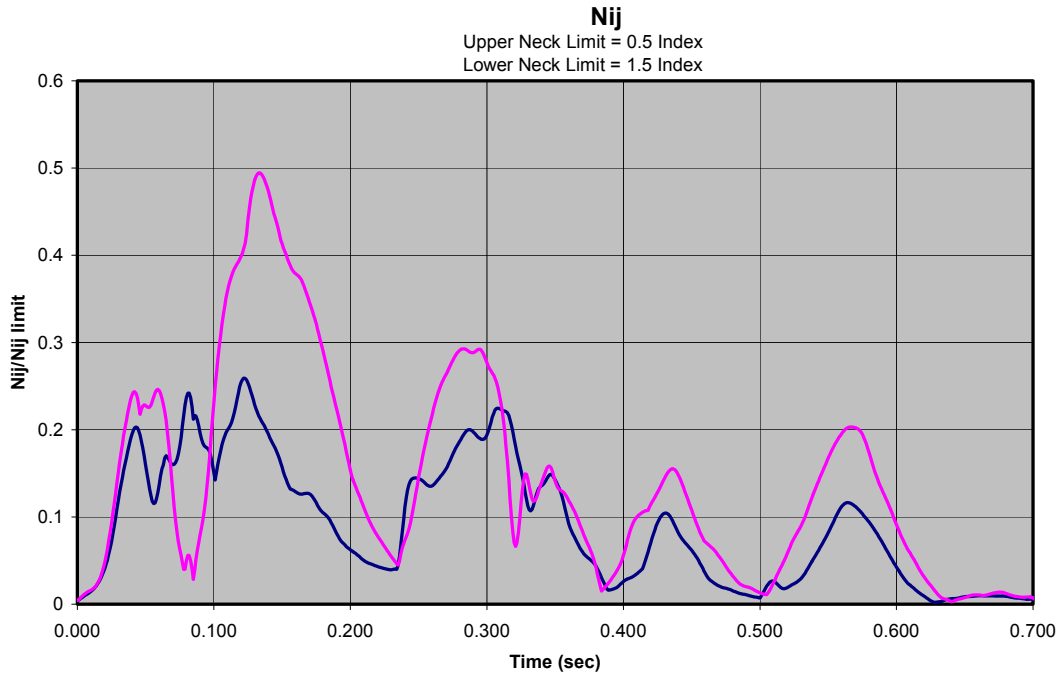

Figure D-41: Test 510 (Medium Pulse, 5.5 lb Added Head Weight)

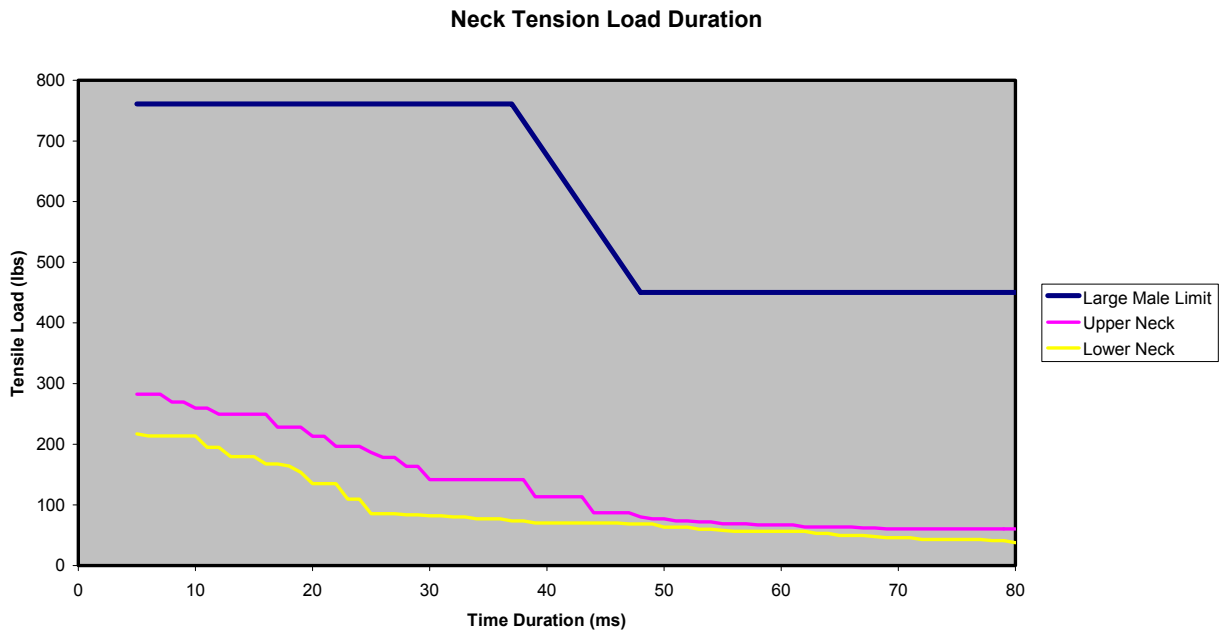

Figure D-42: Test 510 (Medium Pulse, 5.5 lb Added Head Weight)

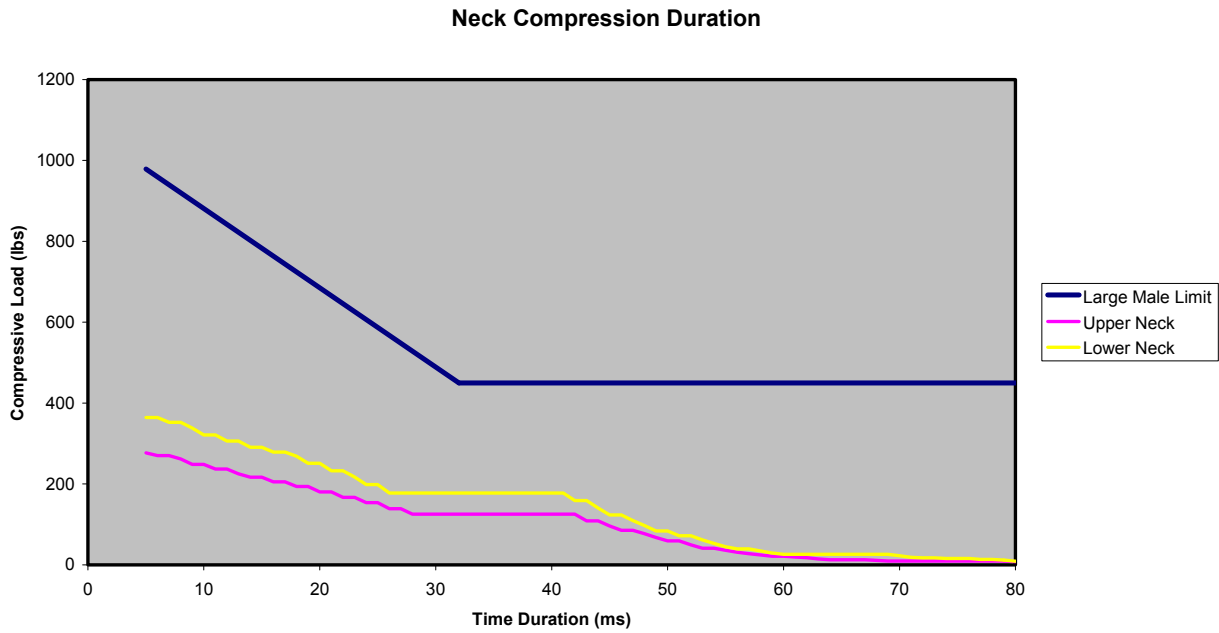

Figure D-43: Test 510 (Medium Pulse, 5.5 lb Added Head Weight)

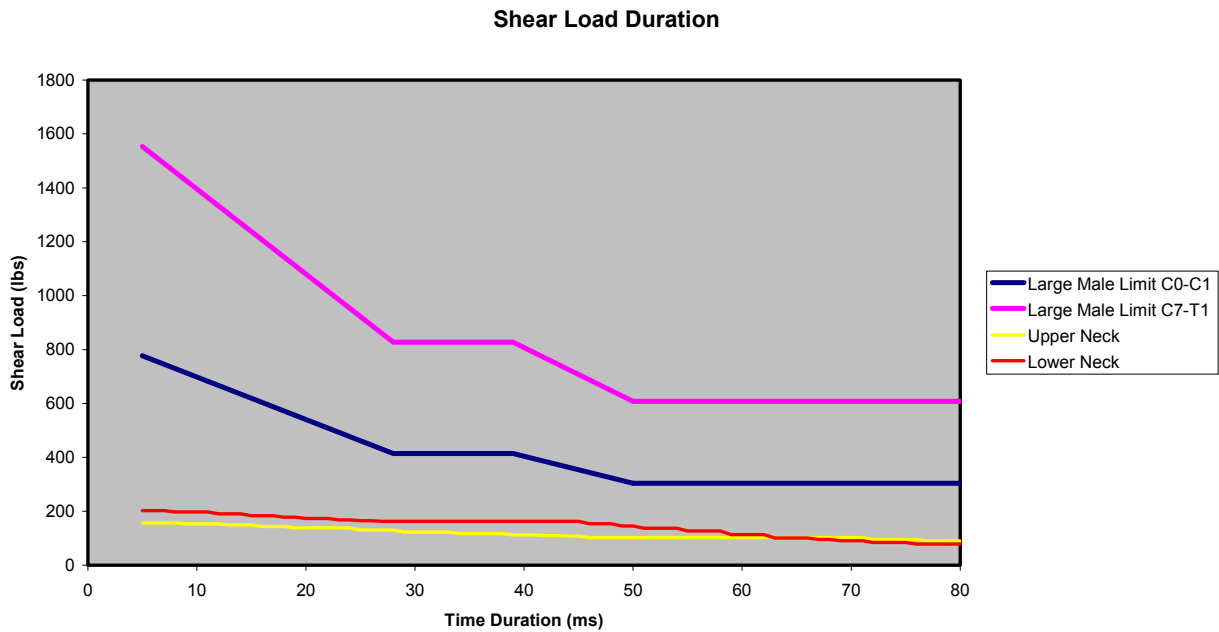

Figure D-44: Test 510 (Medium Pulse, 5.5 lb Added Head Weight)

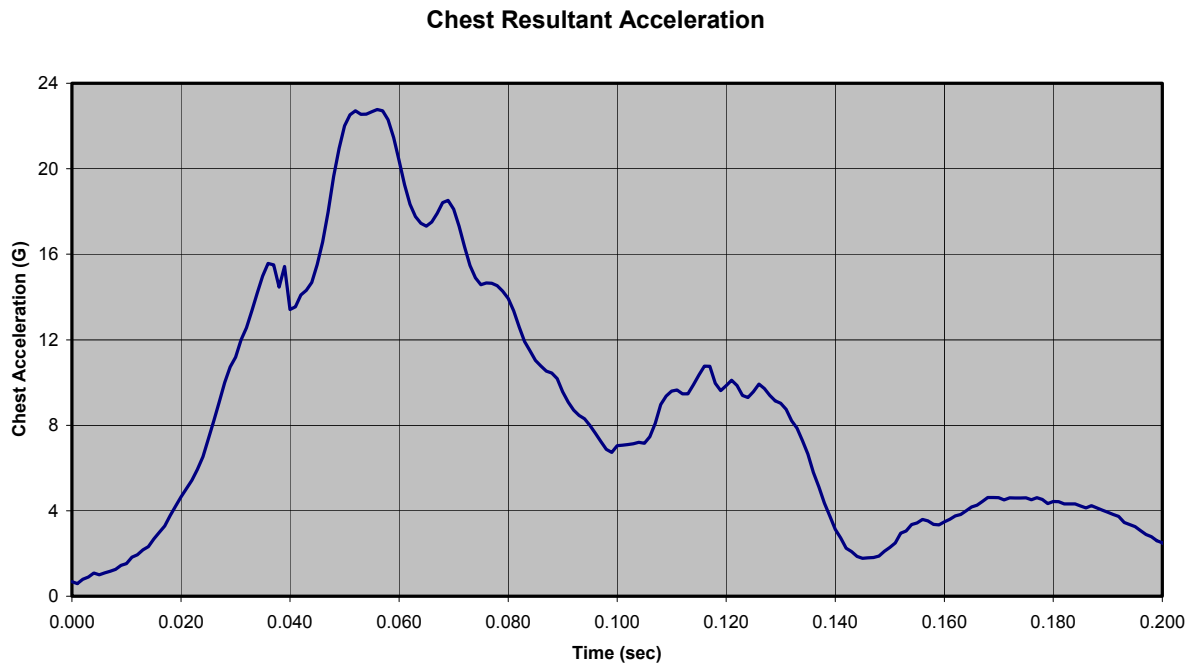

Figure D-45: Test 511 (Medium Pulse, 6.0 lb Added Head Weight)

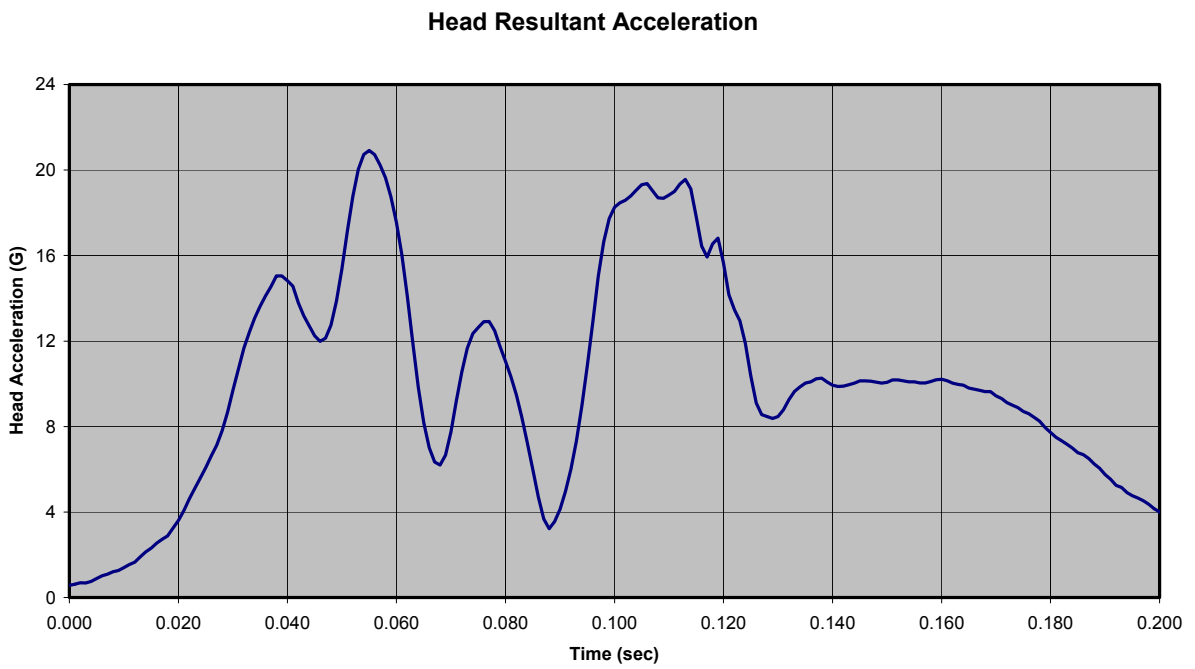

Figure D-46: Test 511 (Medium Pulse, 6.0 lb Added Head Weight)

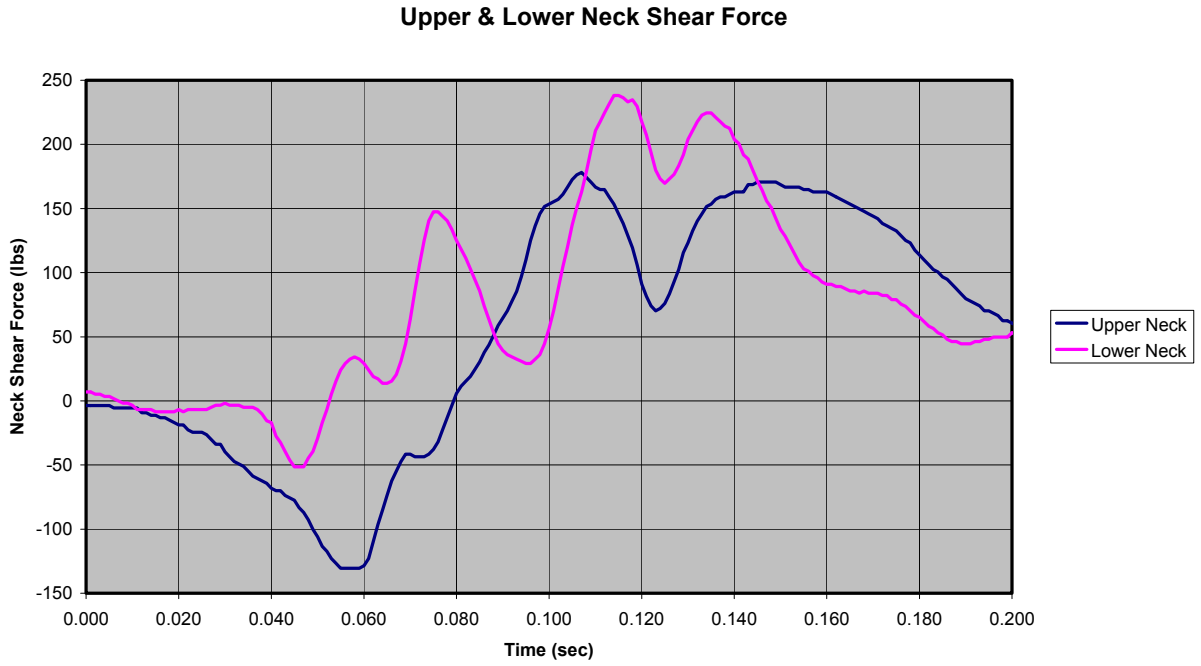

Figure D-47: Test 511 (Medium Pulse, 6.0 lb Added Head Weight)

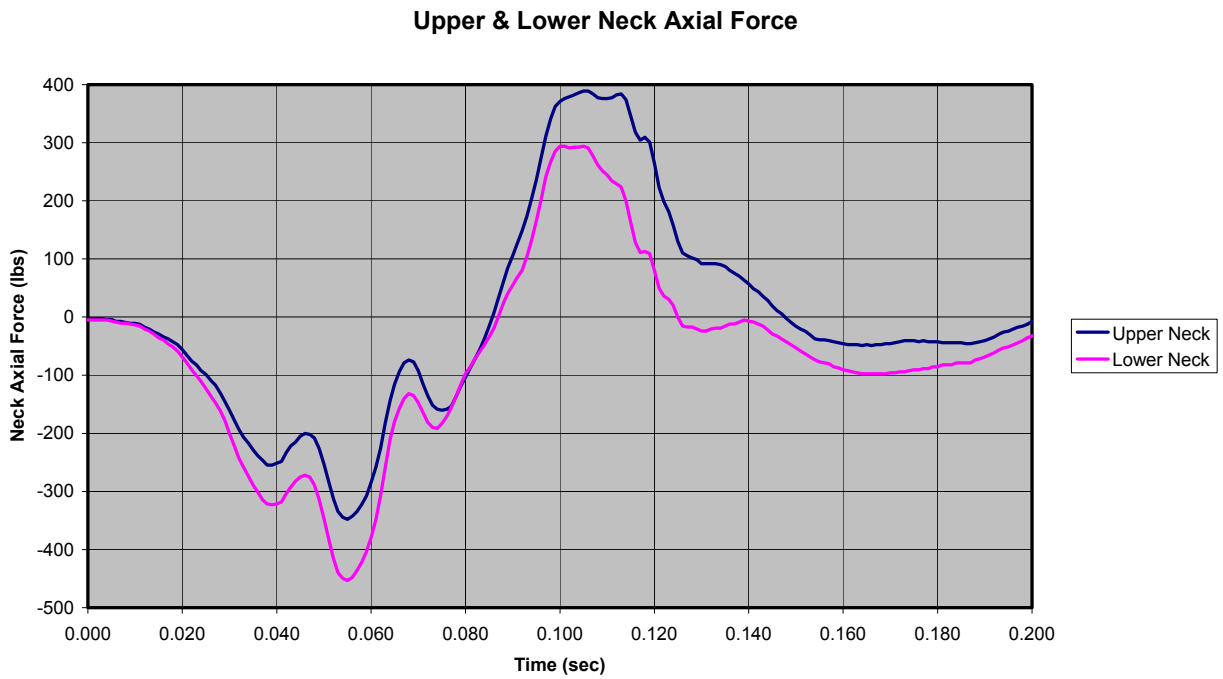

Figure D-48: Test 511 (Medium Pulse, 6.0 lb Added Head Weight)

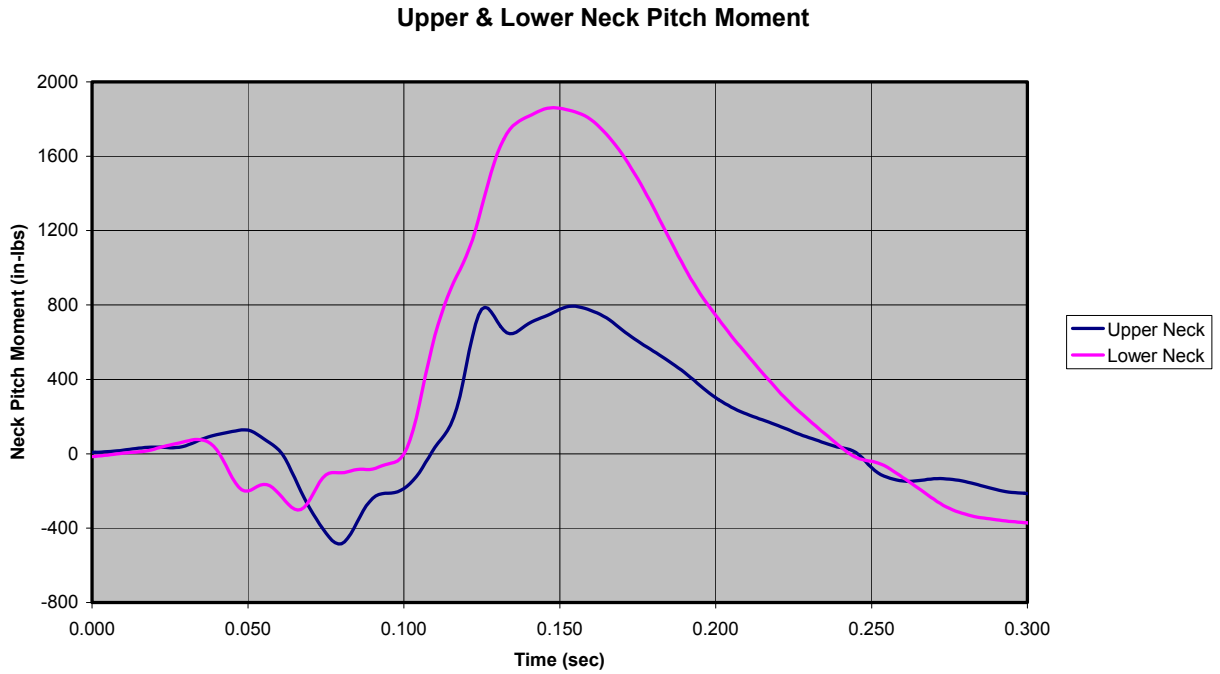

Figure D-49: Test 511 (Medium Pulse, 6.0 lb Added Head Weight)

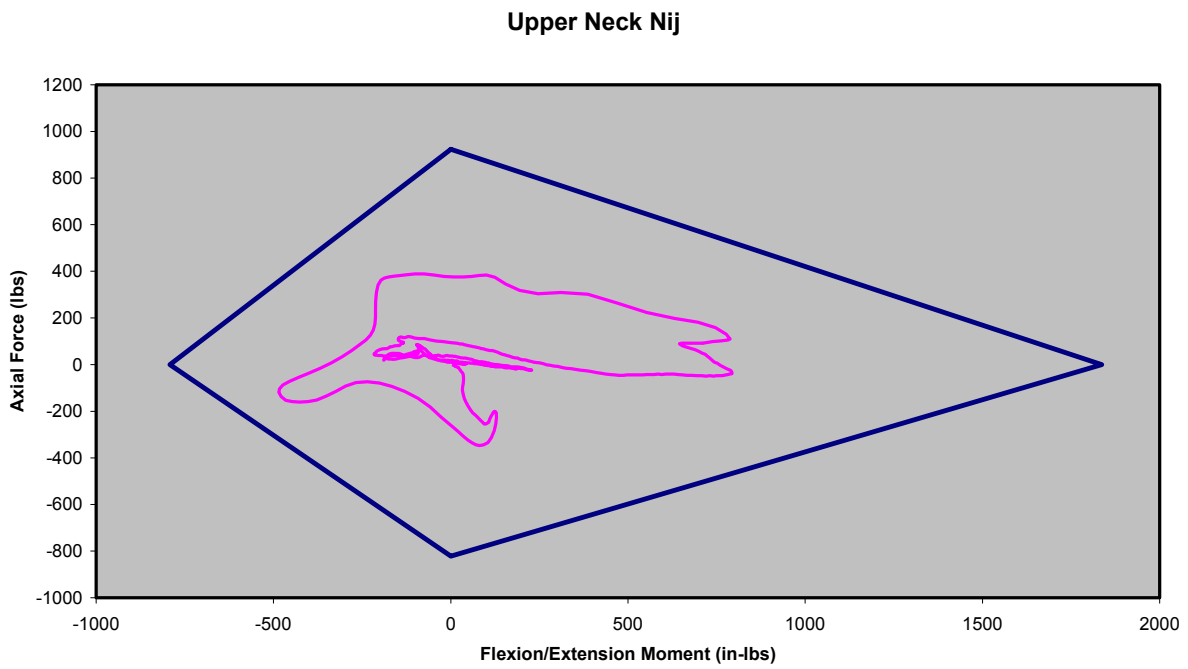

Figure D-50: Test 511 (Medium Pulse, 6.0 lb Added Head Weight)

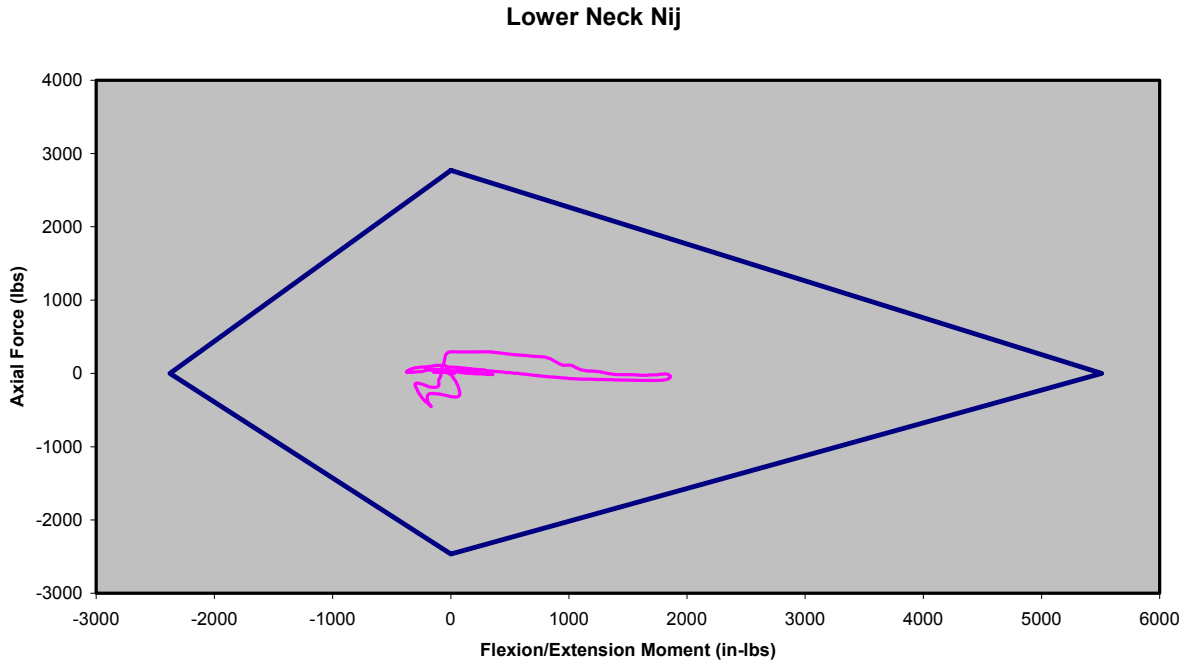

Figure D-51: Test 511 (Medium Pulse, 6.0 lb Added Head Weight)

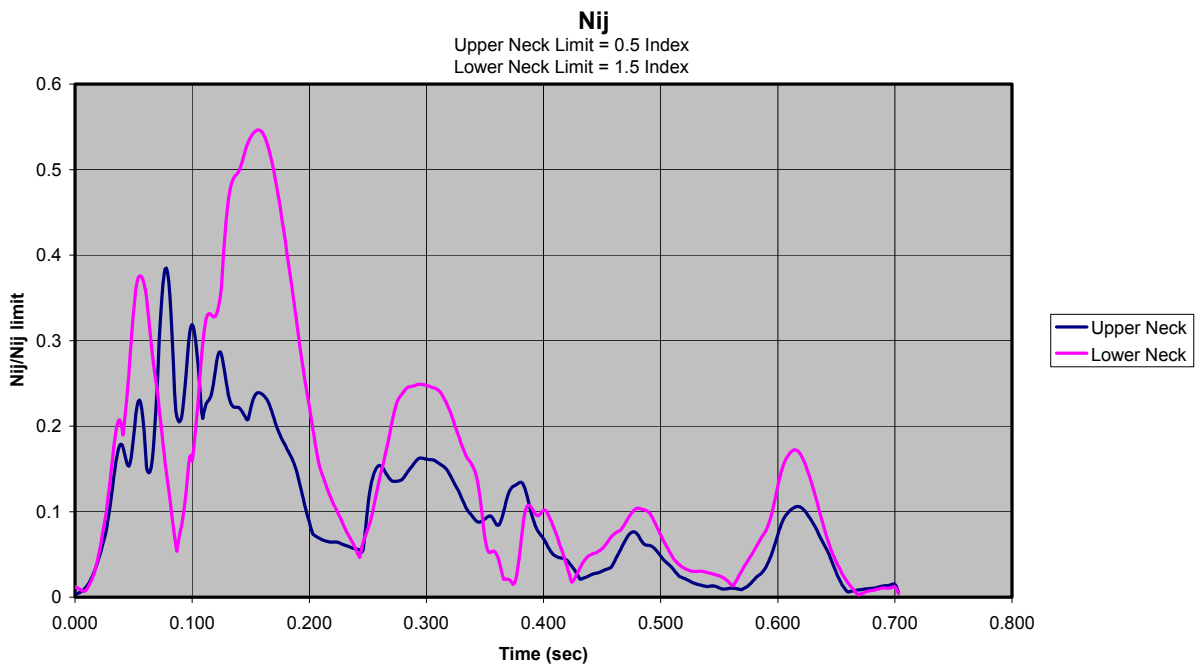

Figure D-52: Test 511 (Medium Pulse, 6.0 lb Added Head Weight)



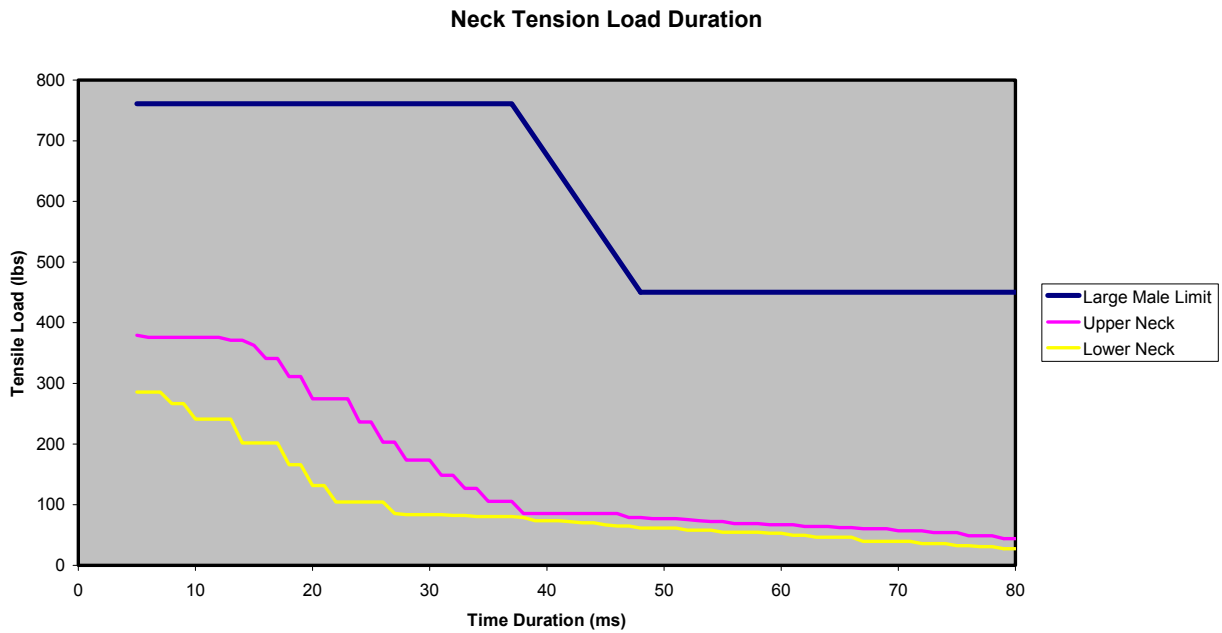

Figure D-53: Test 511 (Medium Pulse, 6.0 lb Added Head Weight)

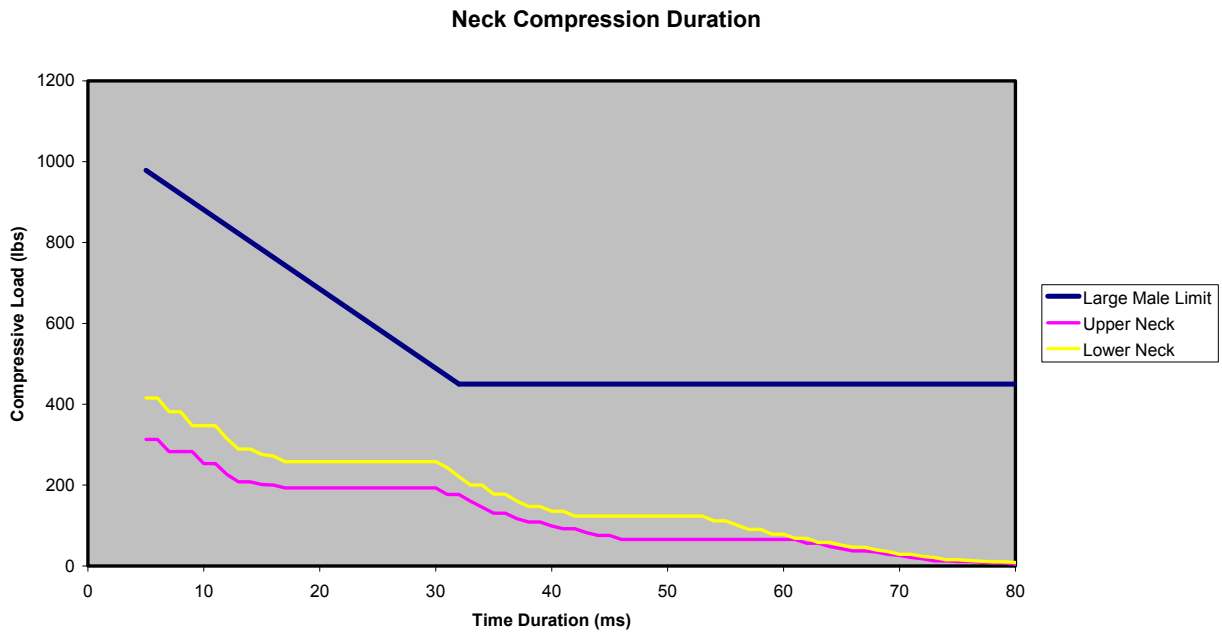

Figure D-54: Test 511 (Medium Pulse, 6.0 lb Added Head Weight)

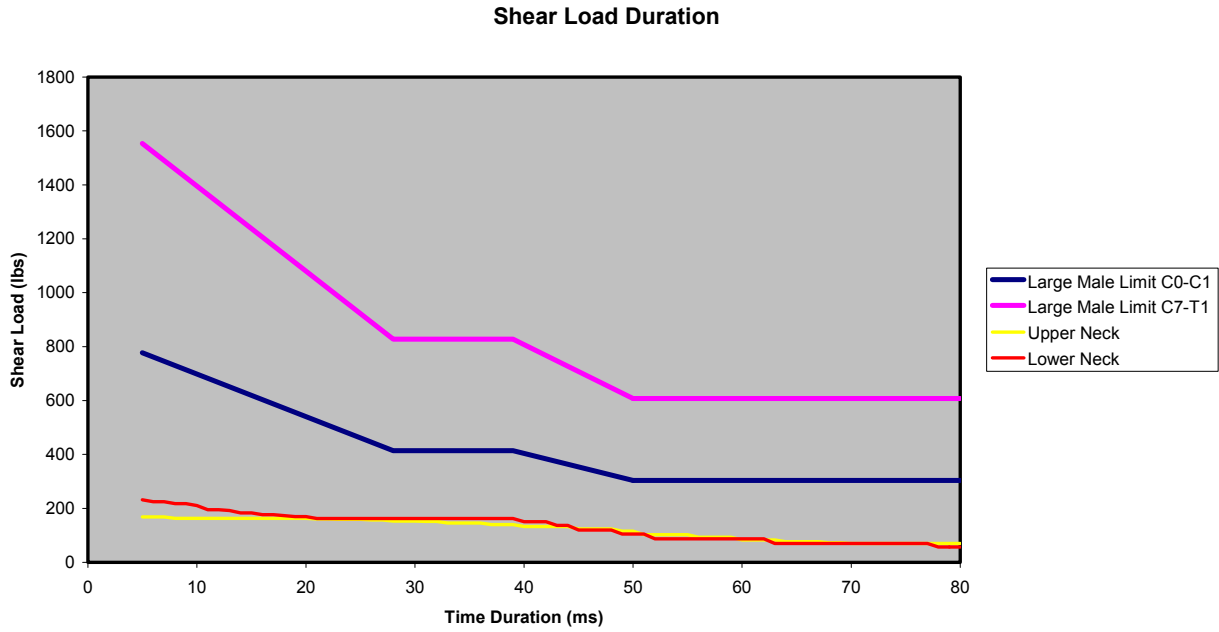

Figure D-55: Test 511 (Medium Pulse, 6.0 lb Added Head Weight)

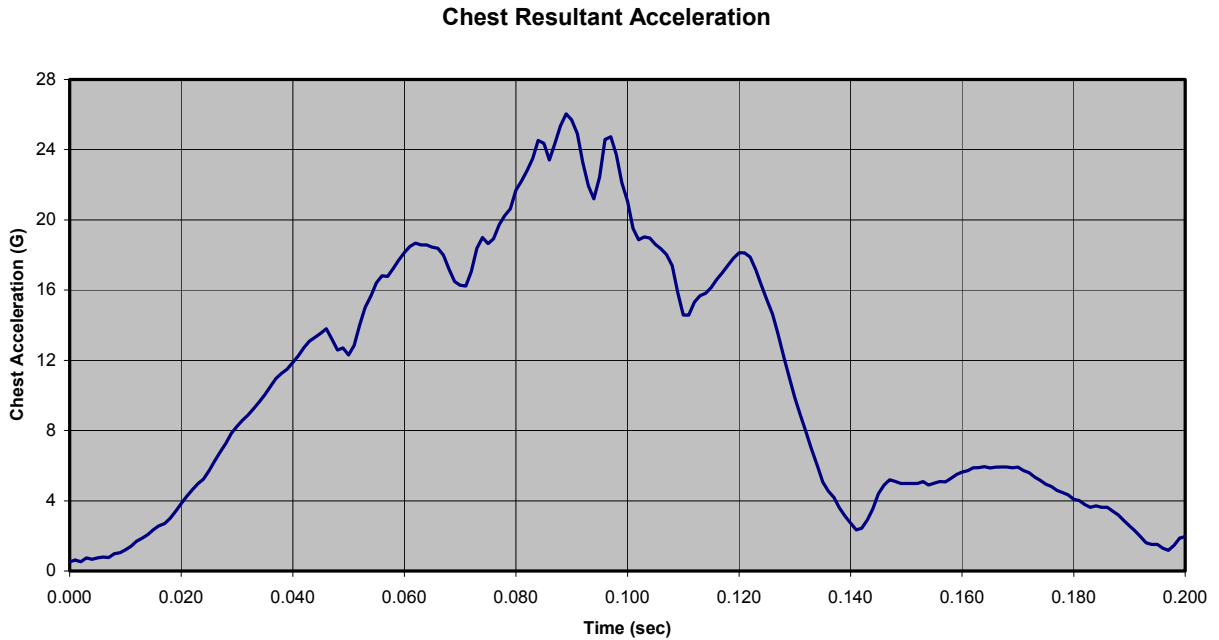

Figure D-56: Test 580 (Severe Pulse, 2.8 lb Added Head Weight)

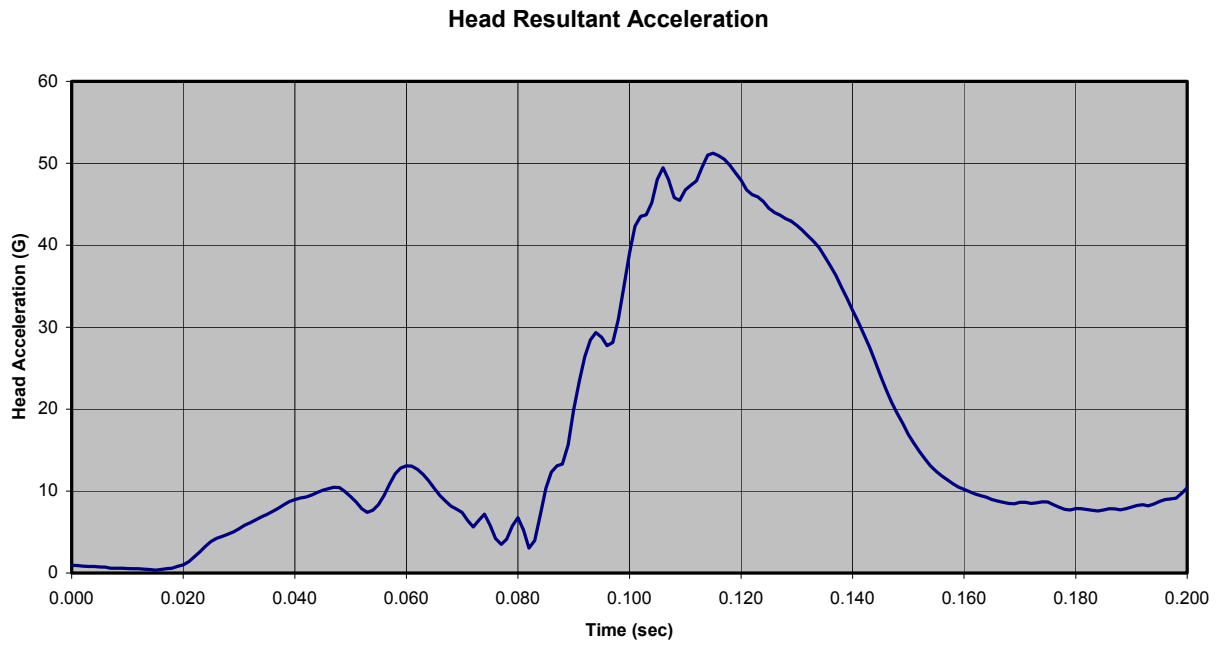

Figure D-57: Test 580 (Severe Pulse, 2.8 lb Added Head Weight)

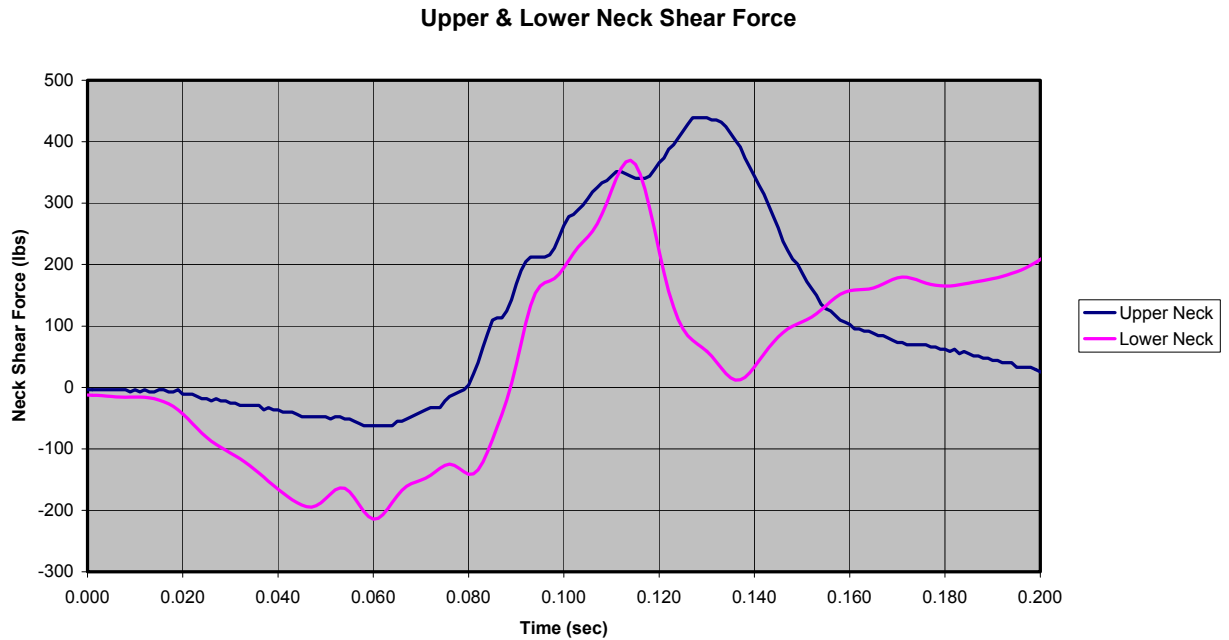

Figure D-58: Test 580 (Severe Pulse, 2.8 lb Added Head Weight)

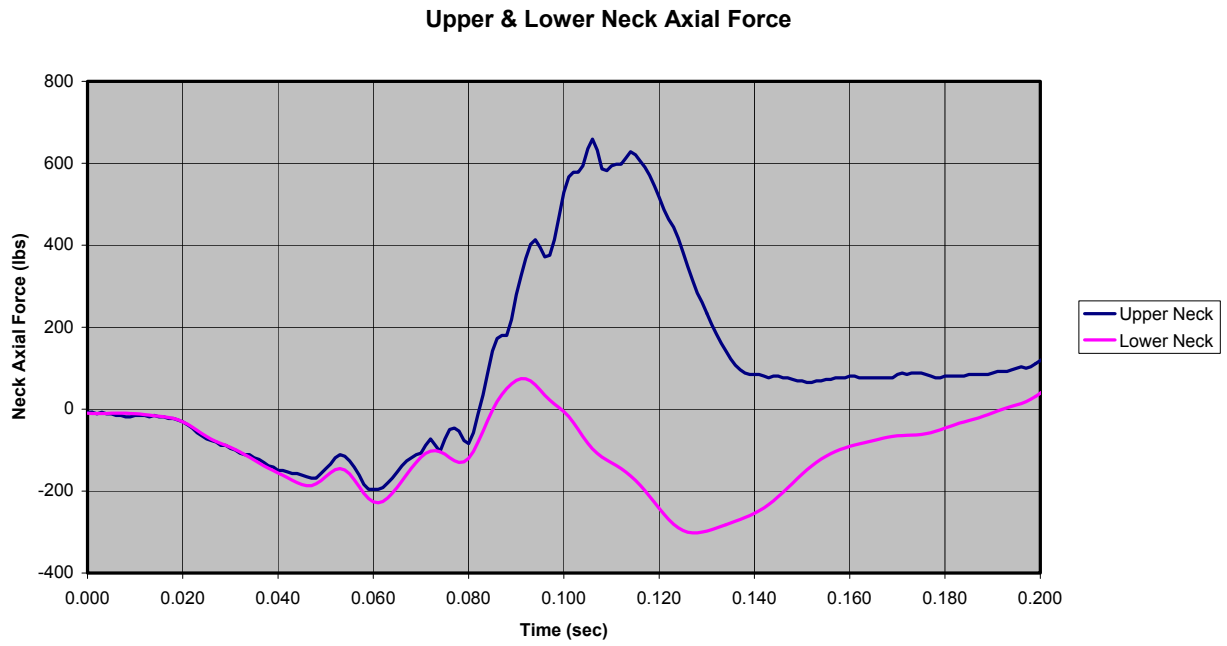

Figure D-59: Test 580 (Severe Pulse, 2.8 lb Added Head Weight)

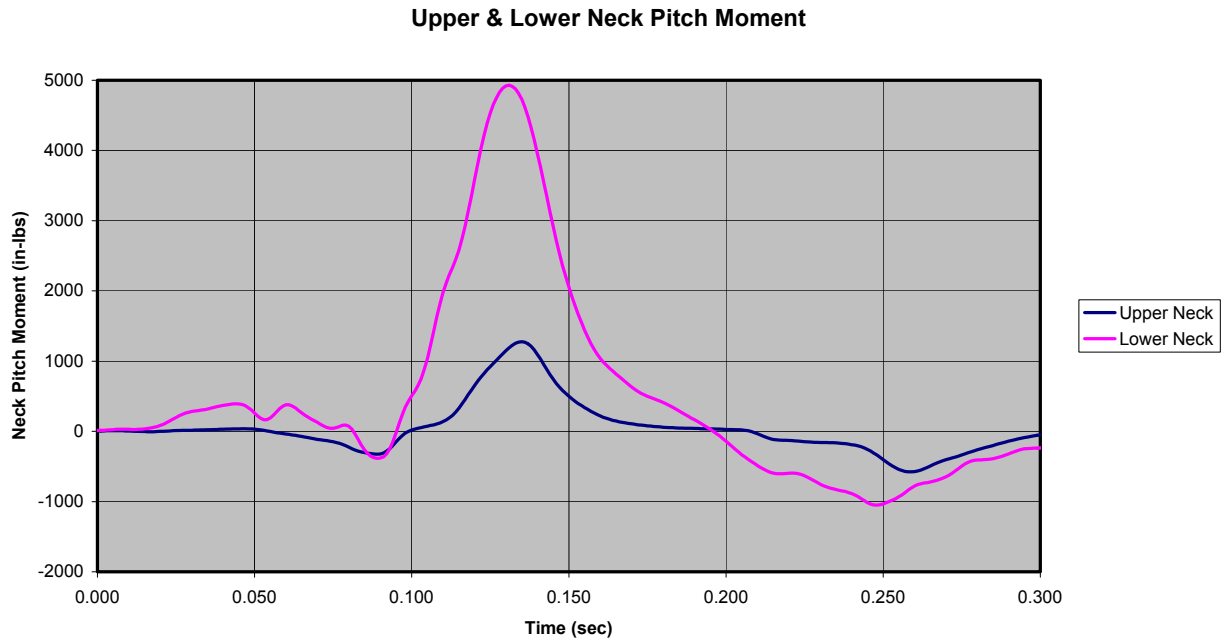

Figure D-60: Test 580 (Severe Pulse, 2.8 lb Added Head Weight)

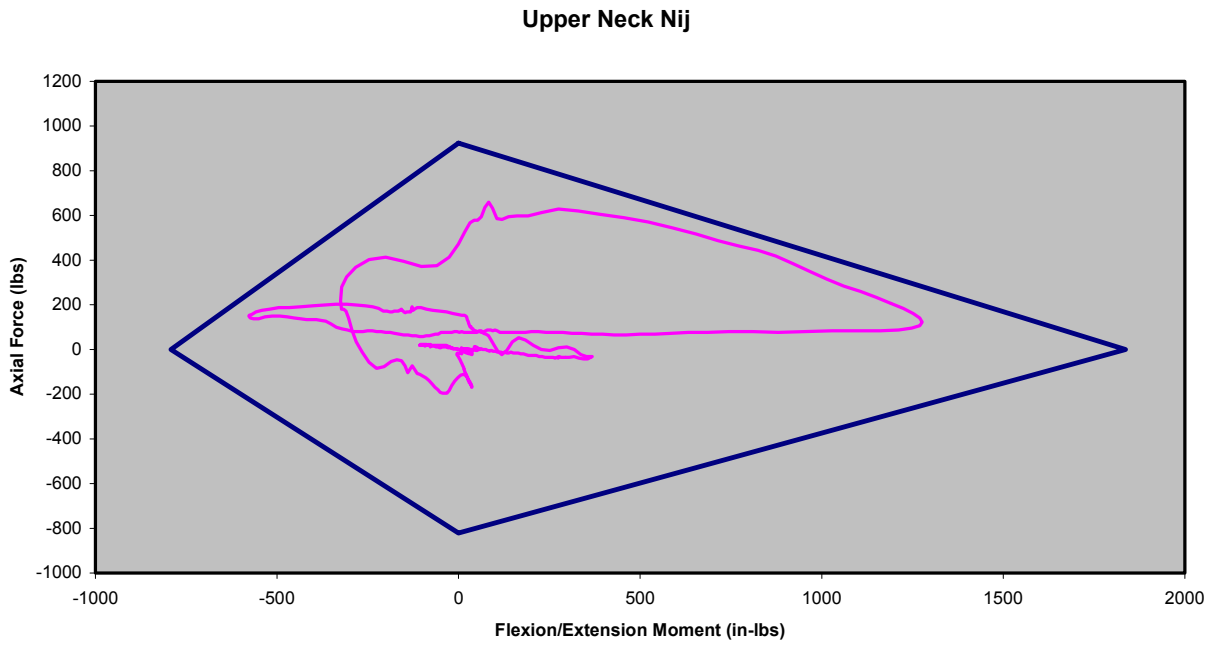

Figure D-61: Test 580 (Severe Pulse, 2.8 lb Added Head Weight)

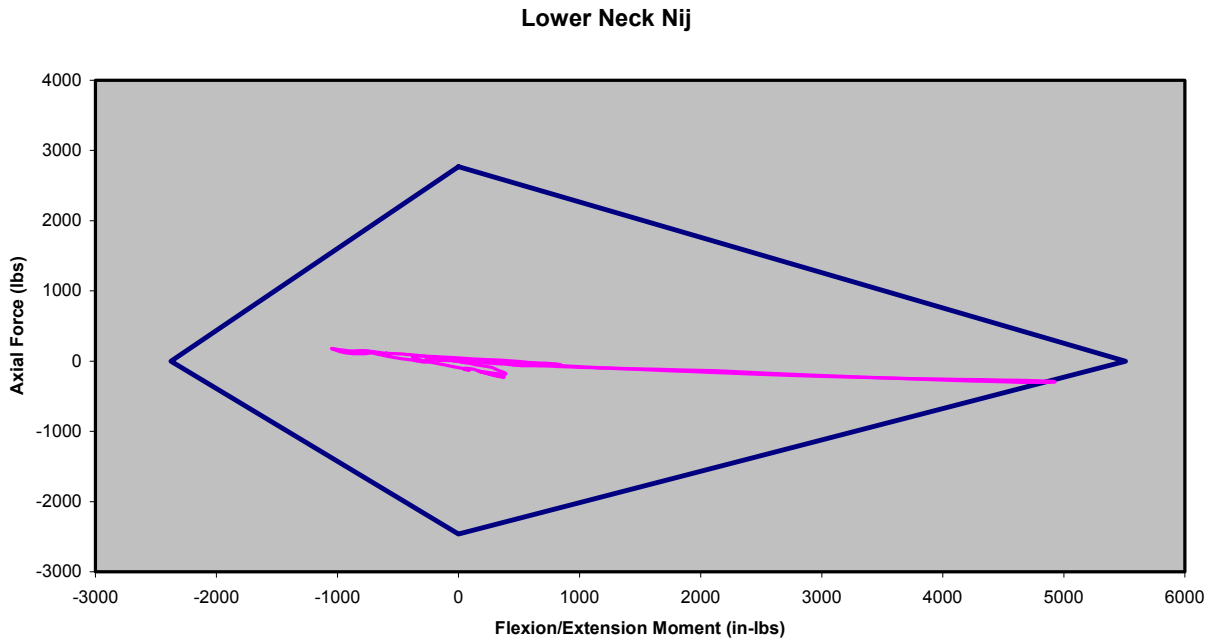

Figure D-62: Test 580 (Severe Pulse, 2.8 lb Added Head Weight)

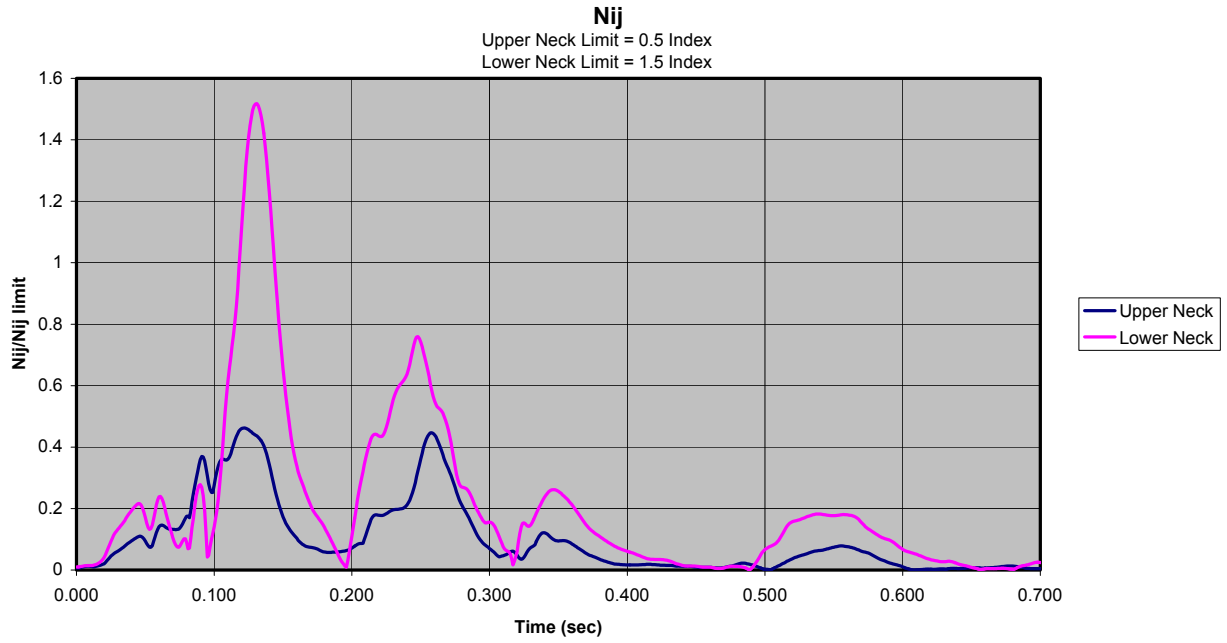

Figure D-63: Test 580 (Severe Pulse, 2.8 lb Added Head Weight)

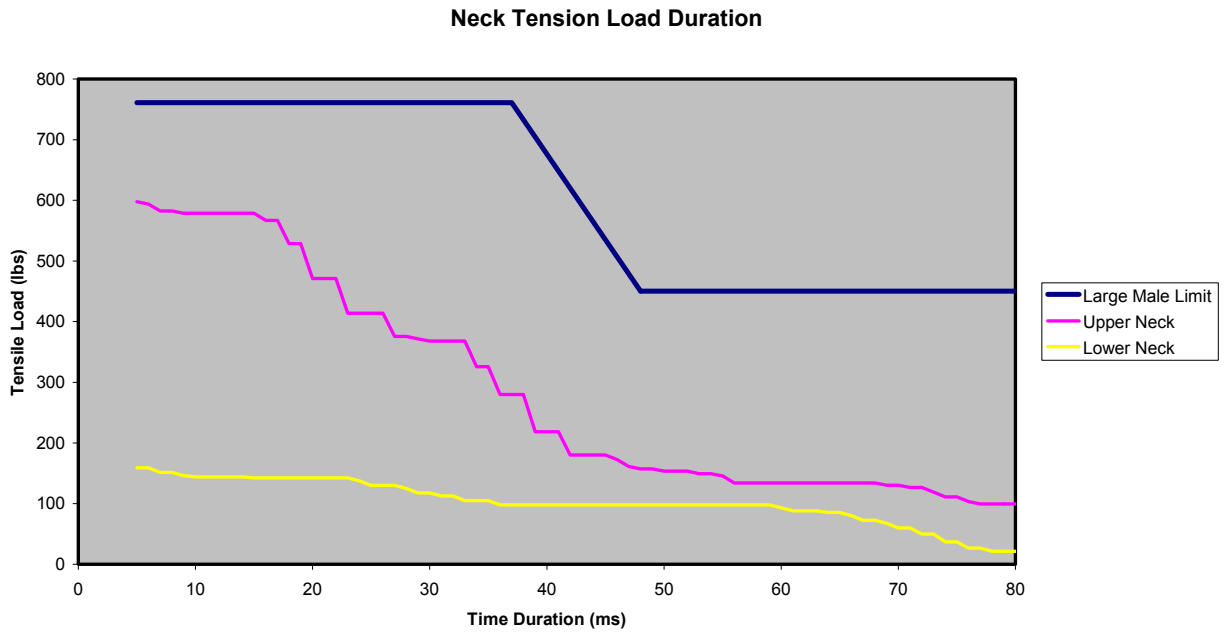

Figure D-64: Test 580 (Severe Pulse, 2.8 lb Added Head Weight)

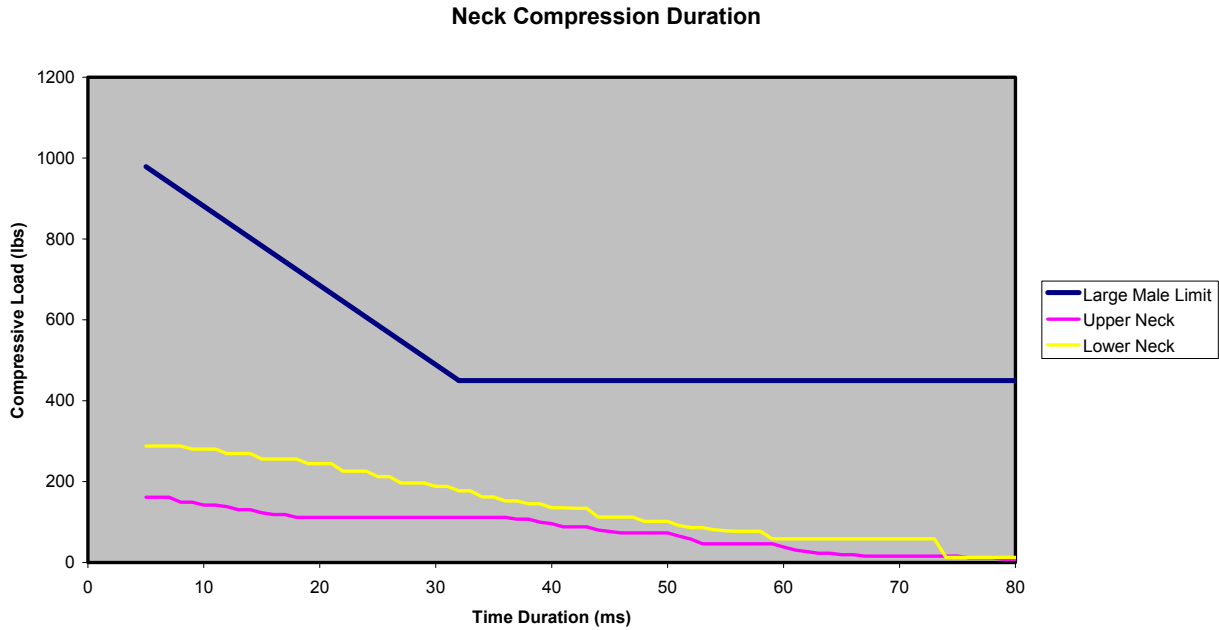

Figure D-65: Test 580 (Severe Pulse, 2.8 lb Added Head Weight)

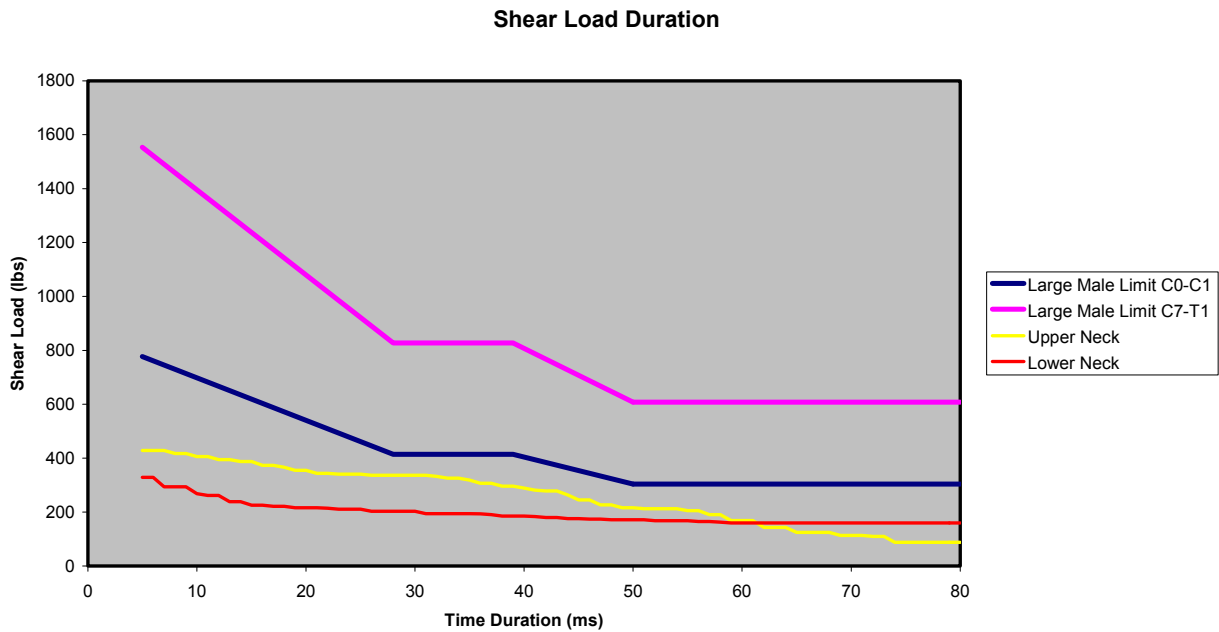

Figure D-66: Test 580 (Severe Pulse, 2.8 lb Added Head Weight)

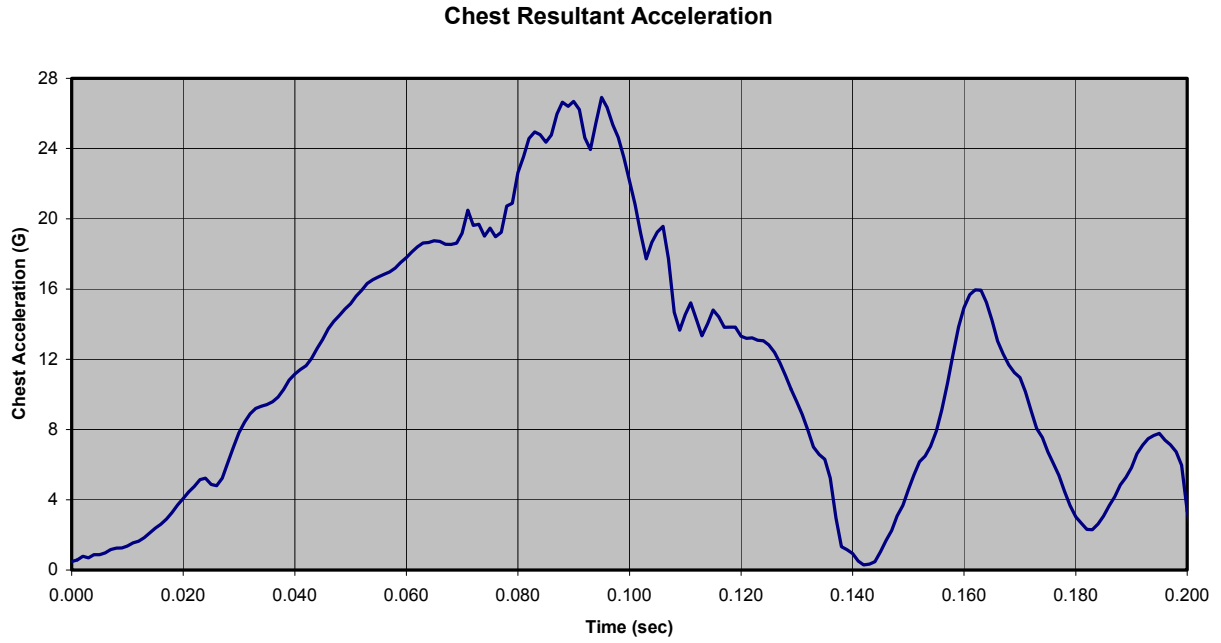

Figure D-67: Test 581 (Severe Pulse, 3.5 lb Added Head Weight)

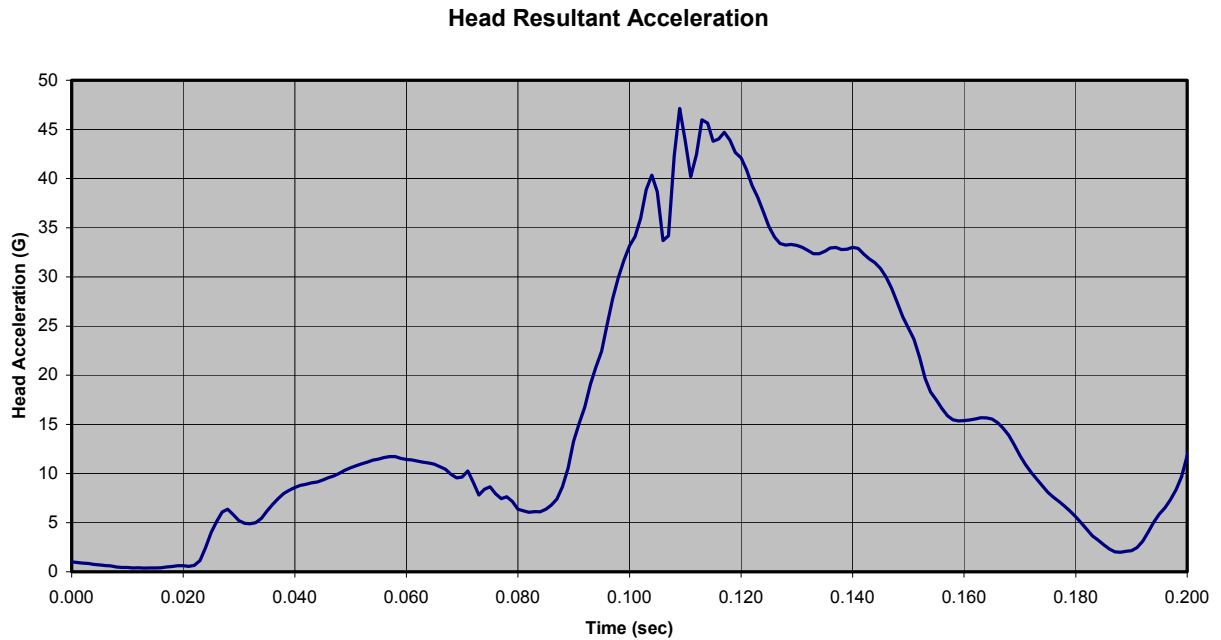

Figure D-68: Test 581 (Severe Pulse, 3.5 lb Added Head Weight)



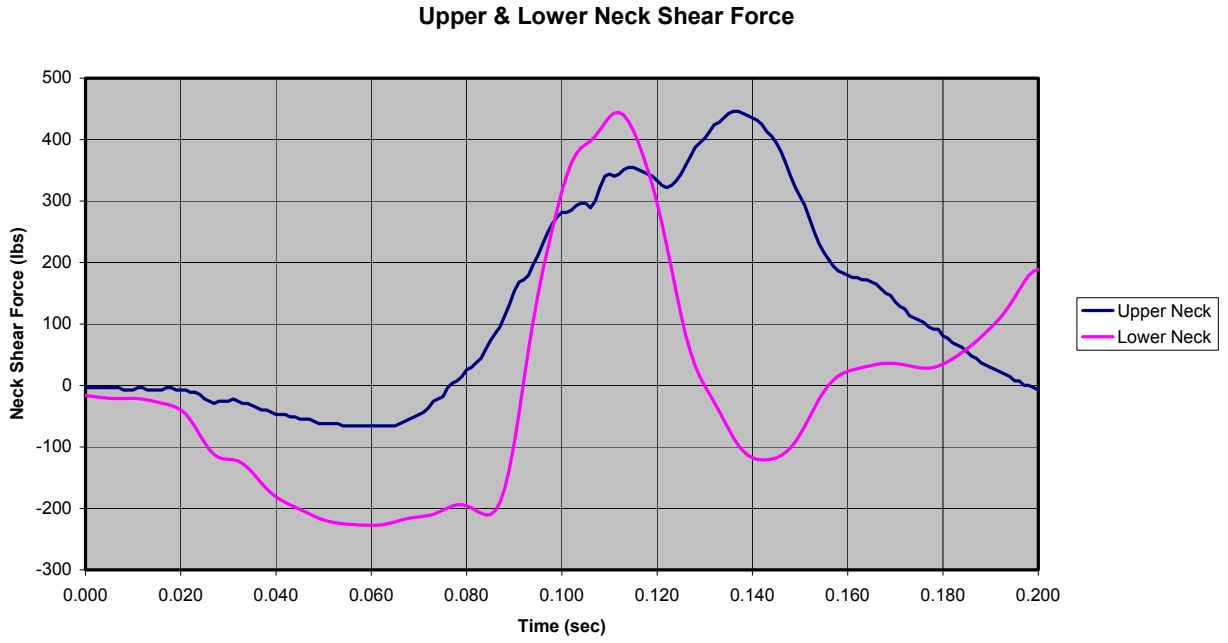

Figure D-69: Test 581 (Severe Pulse, 3.5 lb Added Head Weight)

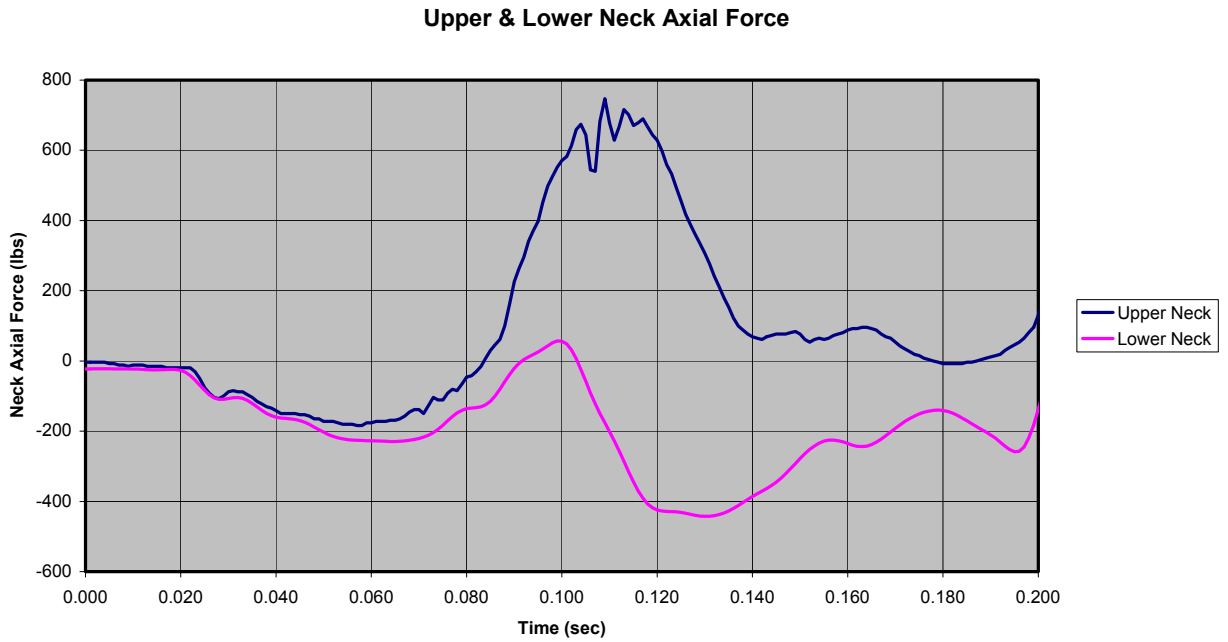

Figure D-70: Test 581 (Severe Pulse, 3.5 lb Added Head Weight)

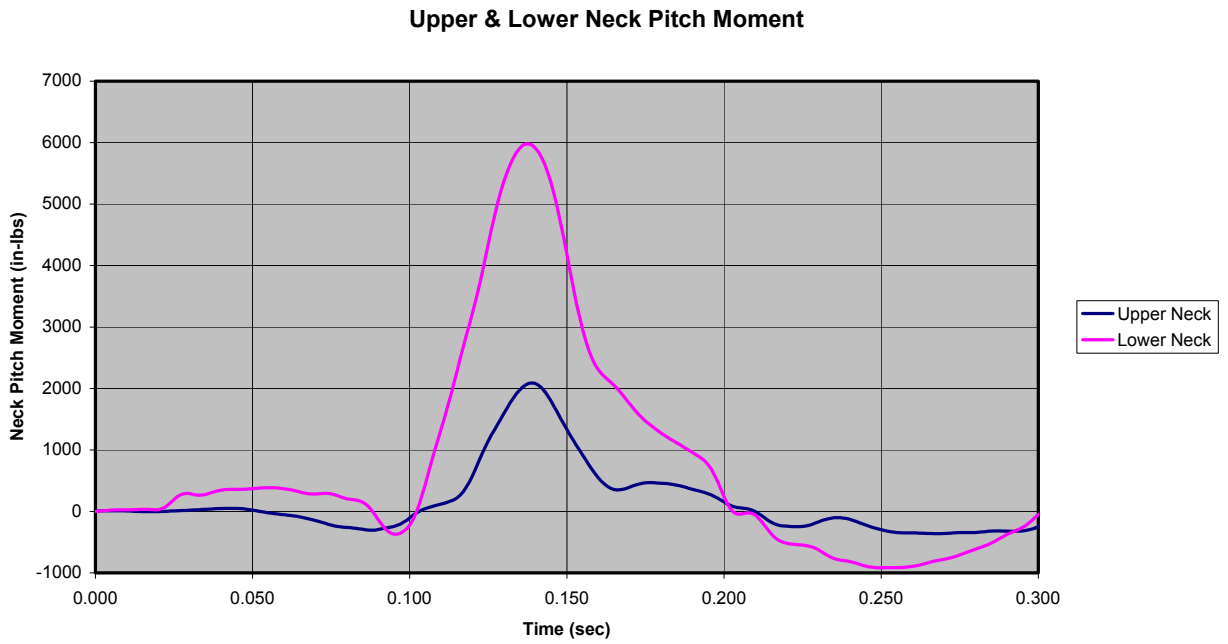

Figure D-71: Test 581 (Severe Pulse, 3.5 lb Added Head Weight)

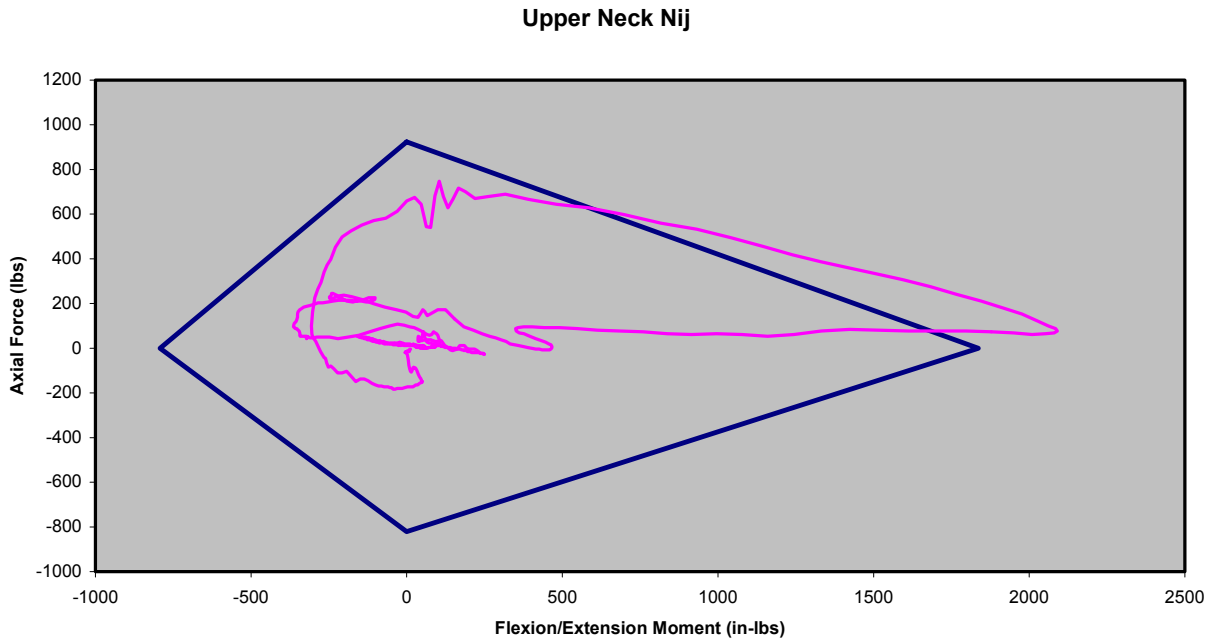

Figure D-72: Test 581 (Severe Pulse, 3.5 lb Added Head Weight)

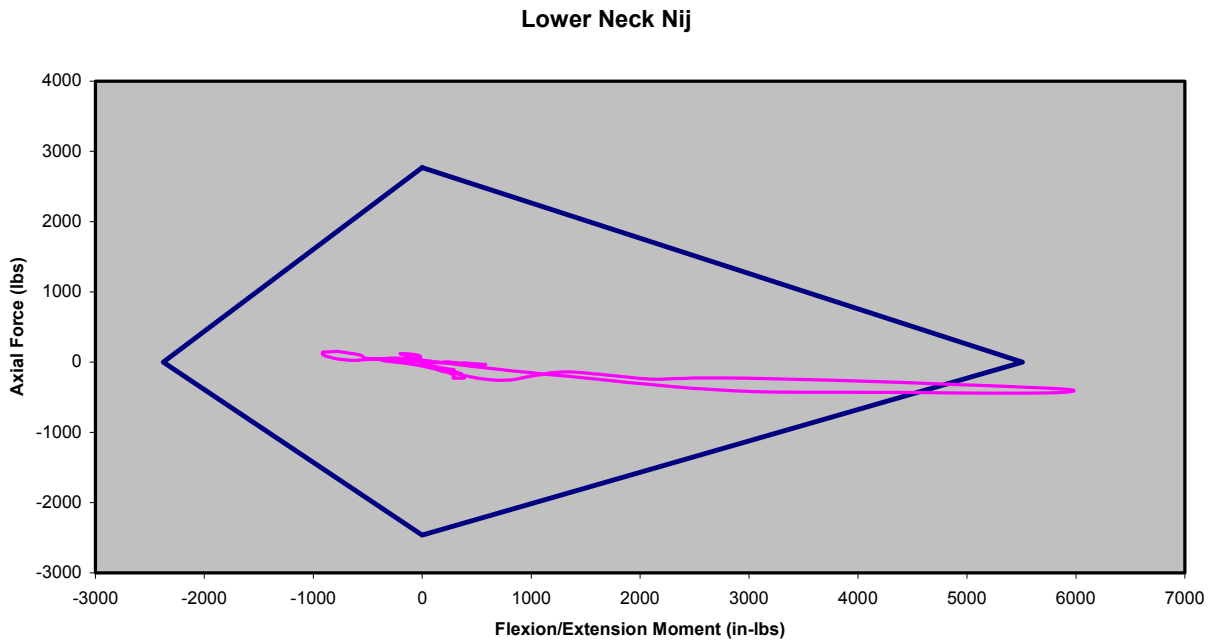

Figure D-73: Test 581 (Severe Pulse, 3.5 lb Added Head Weight)

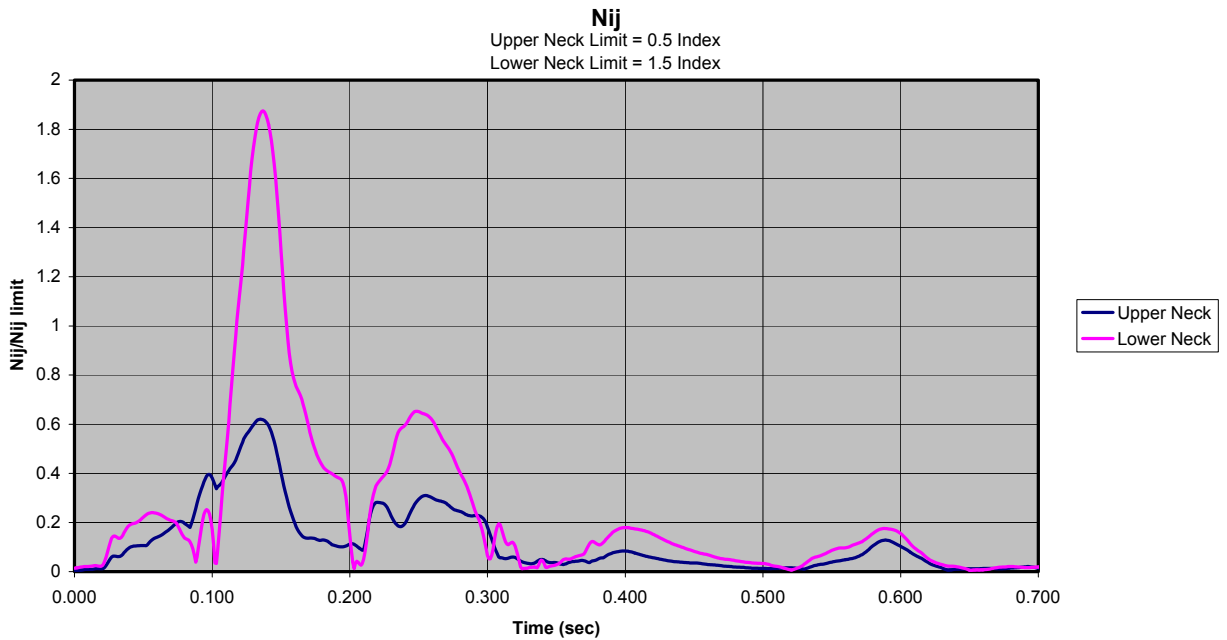

Figure D-74: Test 581 (Severe Pulse, 3.5 lb Added Head Weight)

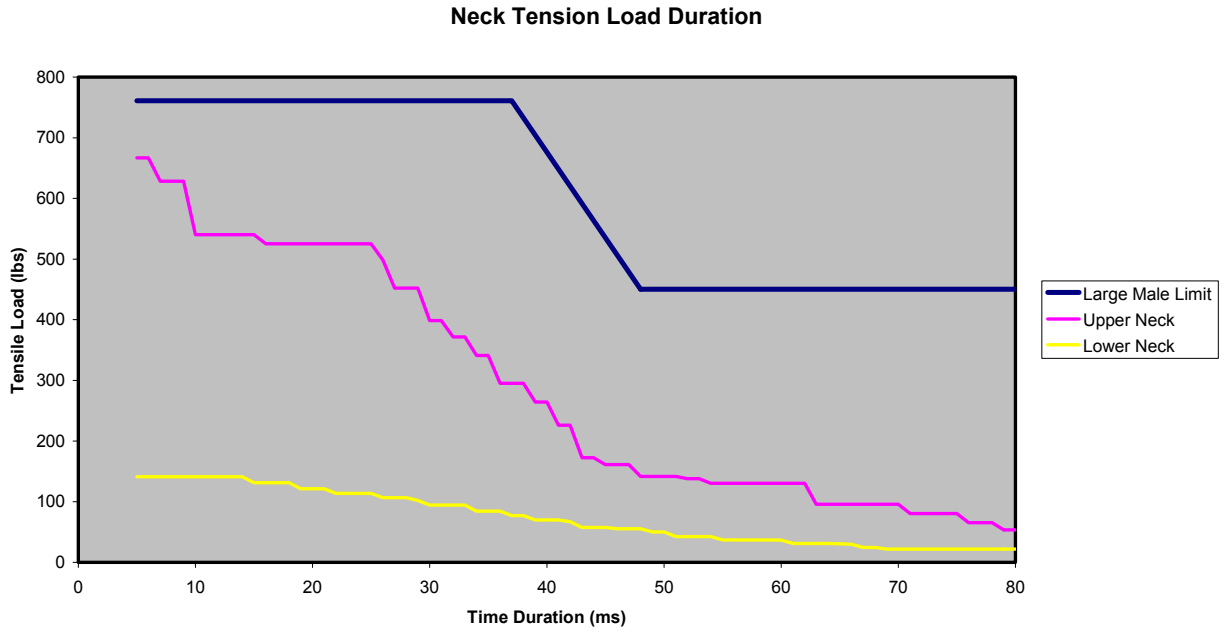

Figure D-75: Test 581 (Severe Pulse, 3.5 lb Added Head Weight)

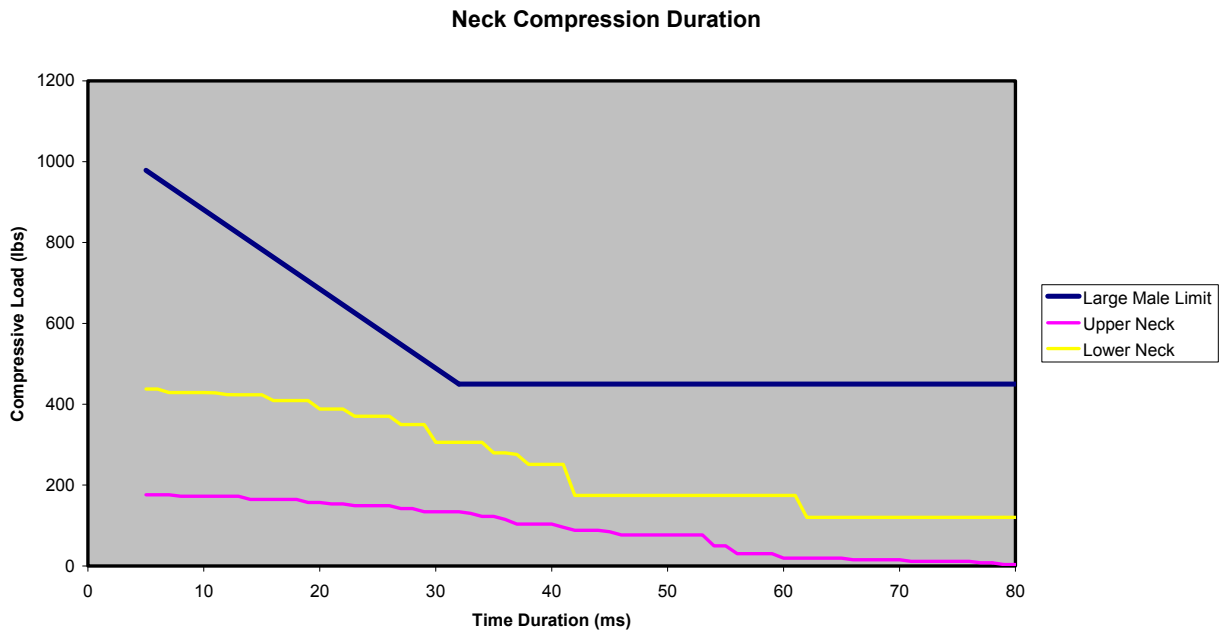

Figure D-76: Test 581 (Severe Pulse, 3.5 lb Added Head Weight)

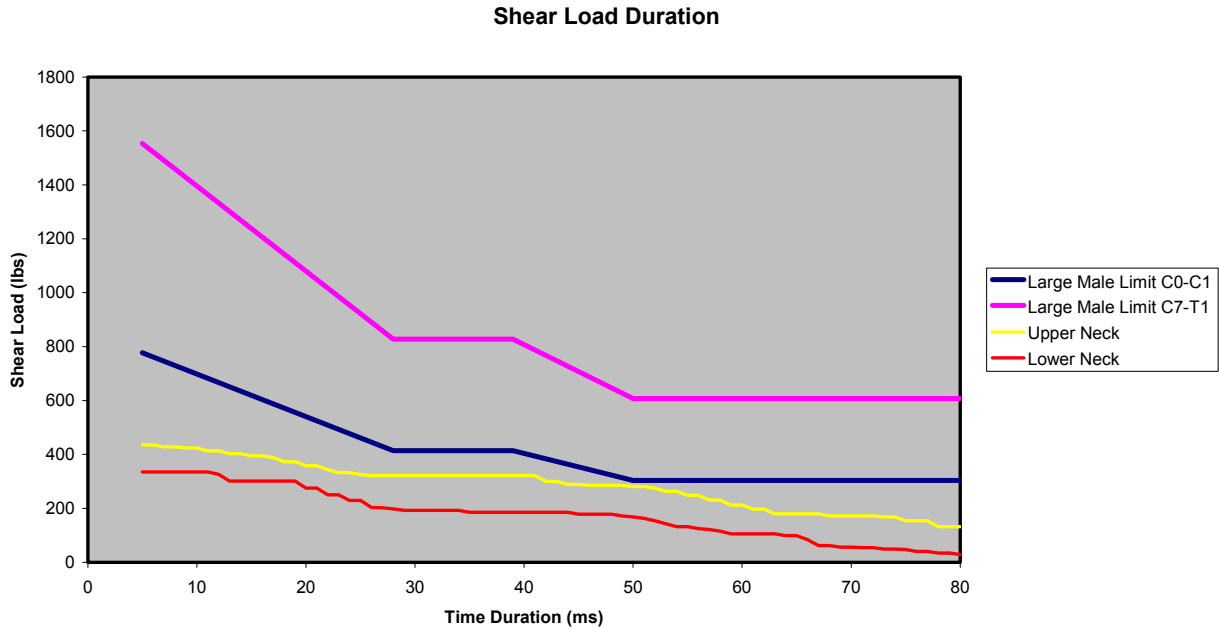

Figure D-77: Test 581 (Severe Pulse, 3.5 lb Added Head Weight)

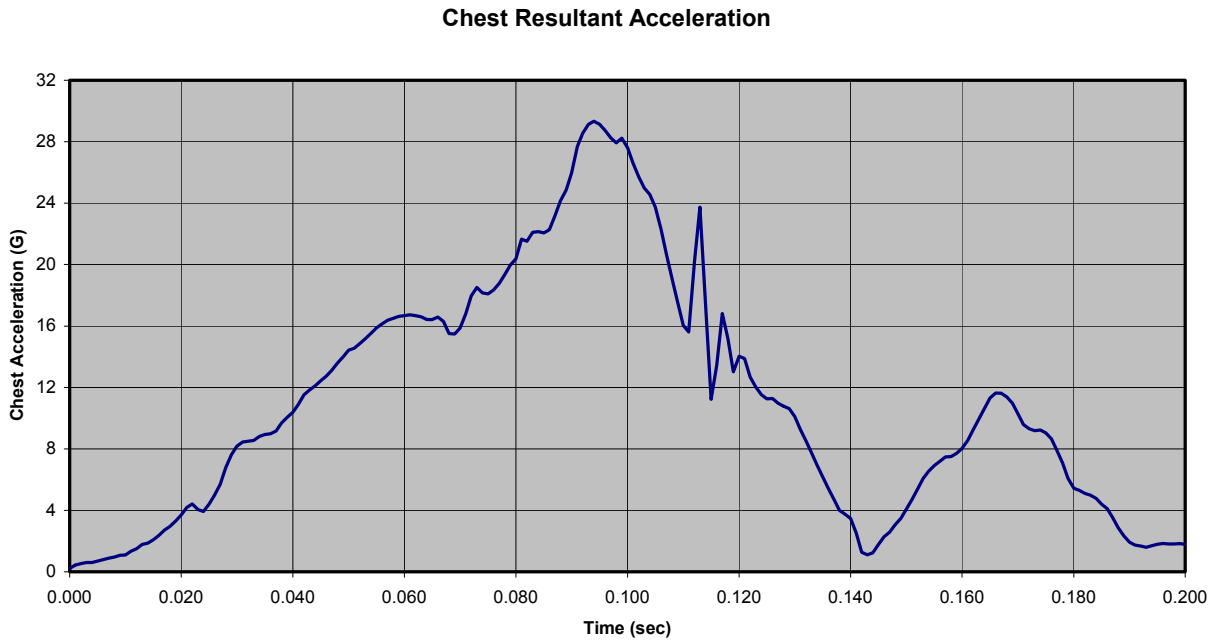

Figure D-78: Test 582 (Severe Pulse, 4.0 lb Added Head Weight)

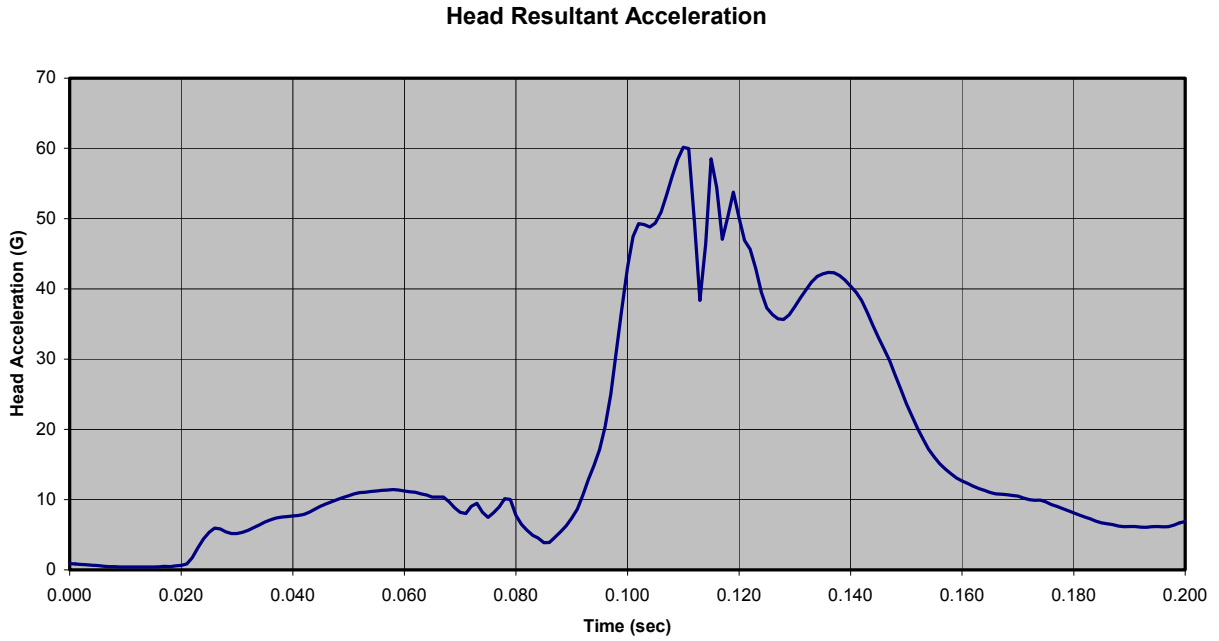

Figure D-79: Test 582 (Severe Pulse, 4.0 lb Added Head Weight)

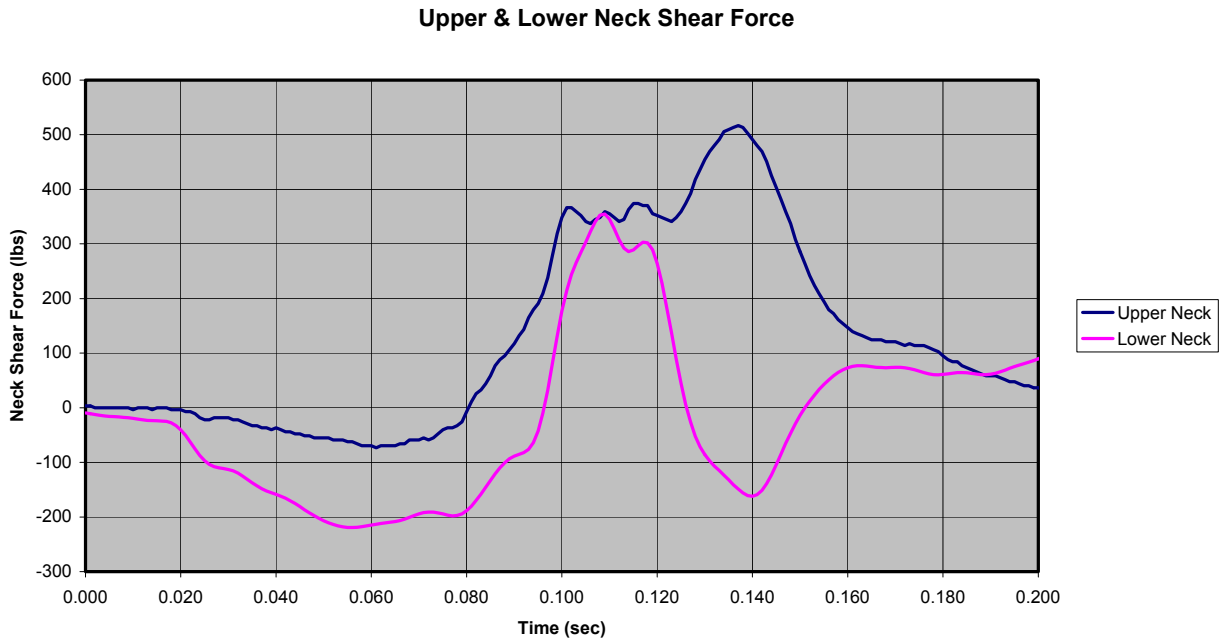

Figure D-80: Test 582 (Severe Pulse, 4.0 lb Added Head Weight)

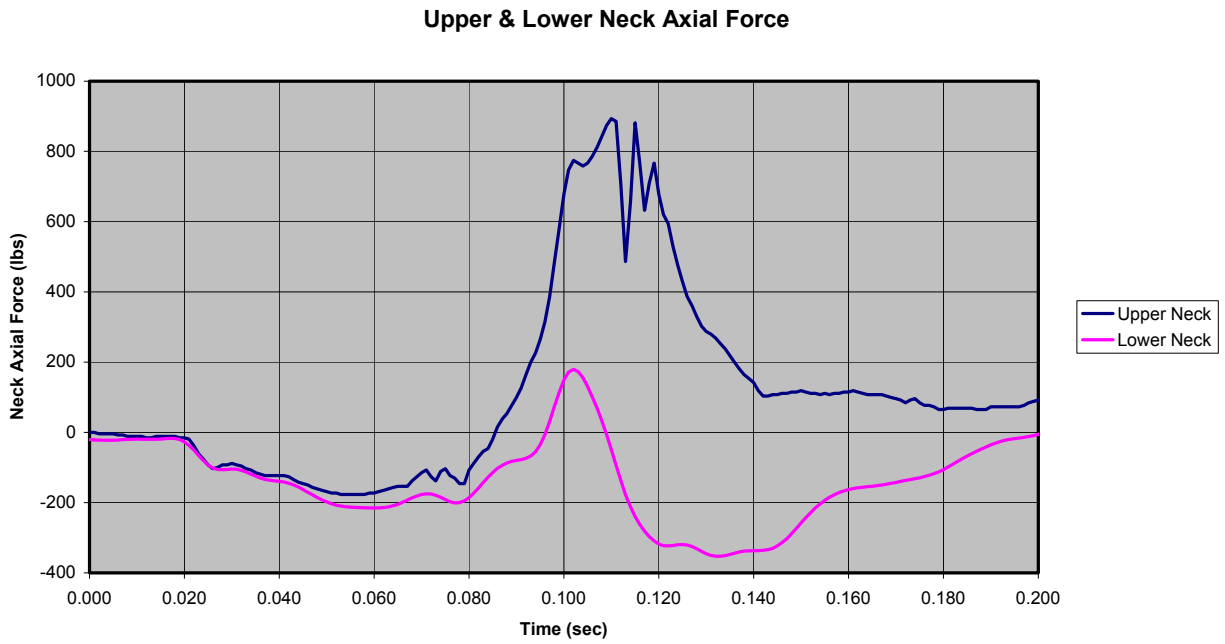

Figure D-81: Test 582 (Severe Pulse, 4.0 lb Added Head Weight)

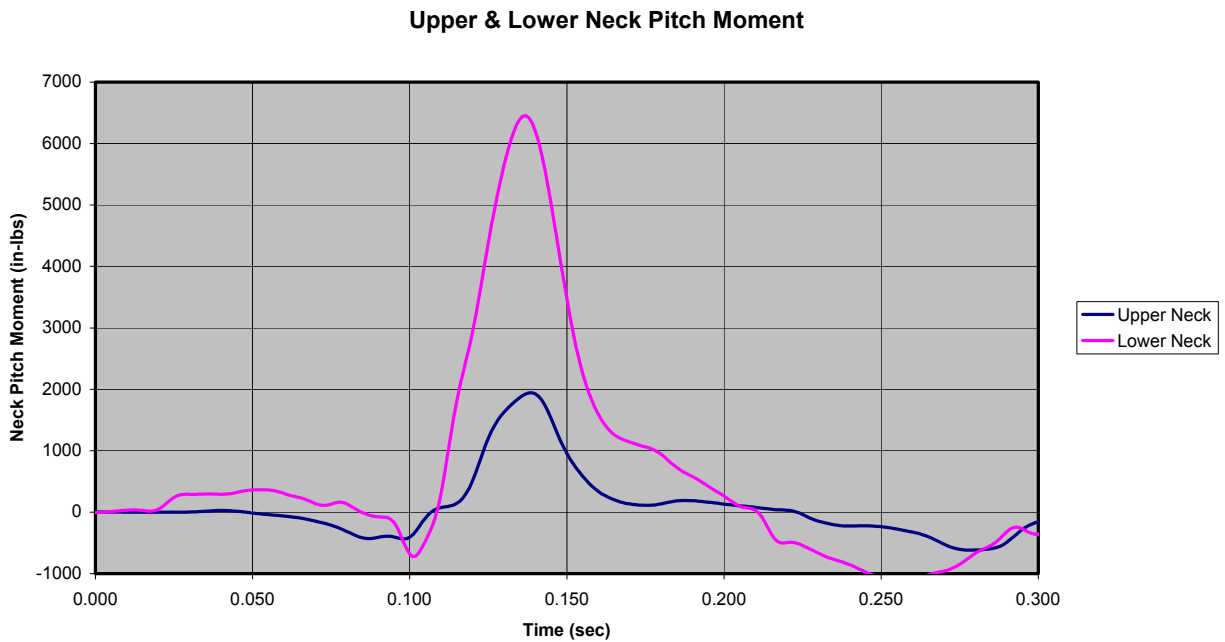

Figure D-82: Test 582 (Severe Pulse, 4.0 lb Added Head Weight)

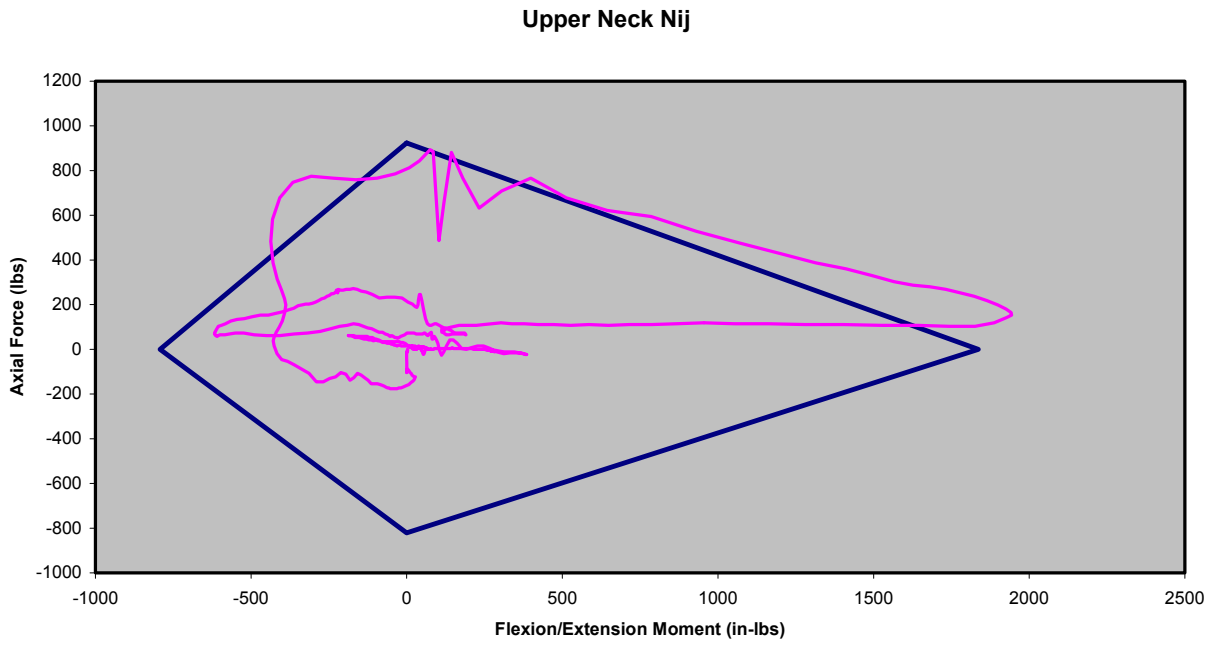

Figure D-83: Test 582 (Severe Pulse, 4.0 lb Added Head Weight)

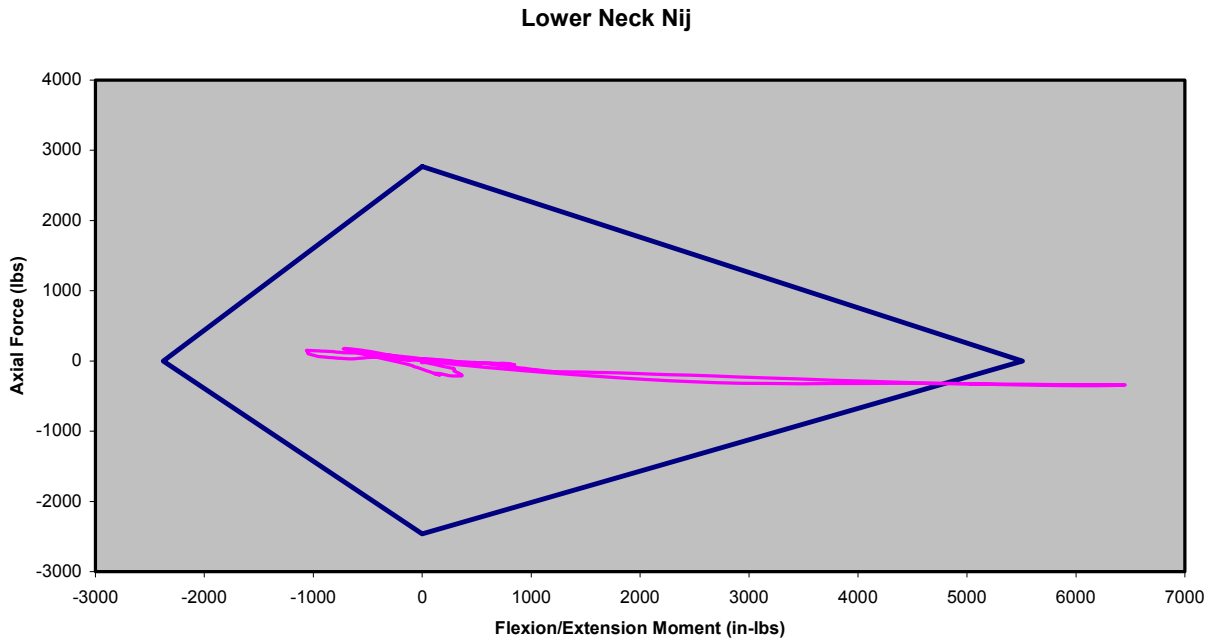

Figure D-84: Test 582 (Severe Pulse, 4.0 lb Added Head Weight)



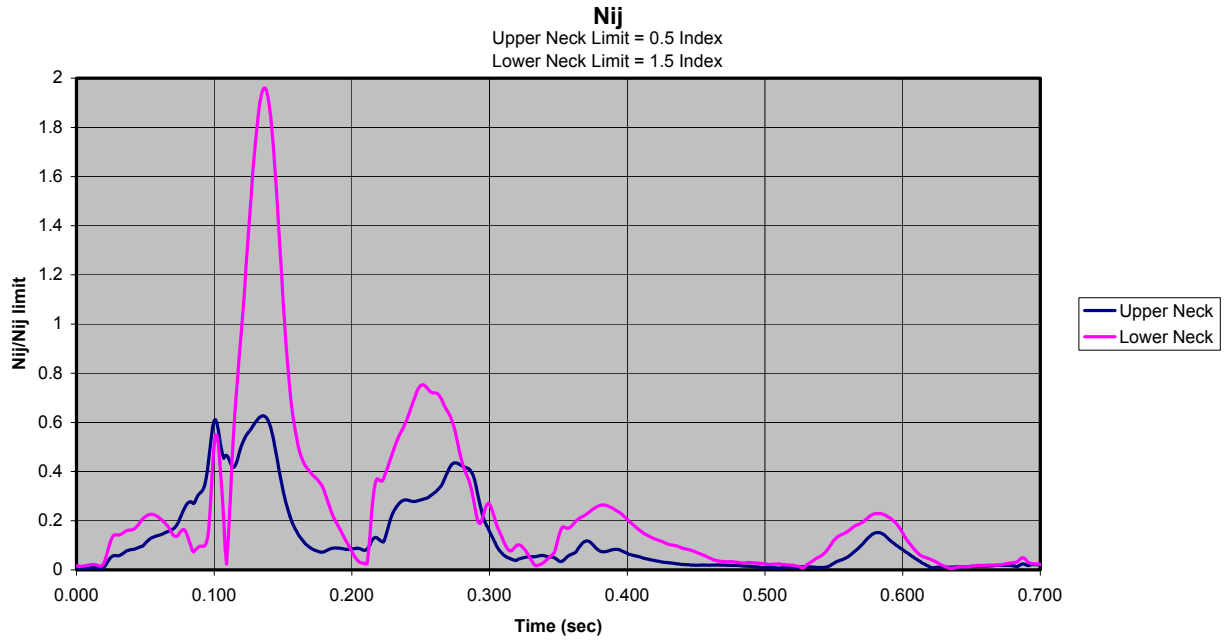

Figure D-85: Test 582 (Severe Pulse, 4.0 lb Added Head Weight)

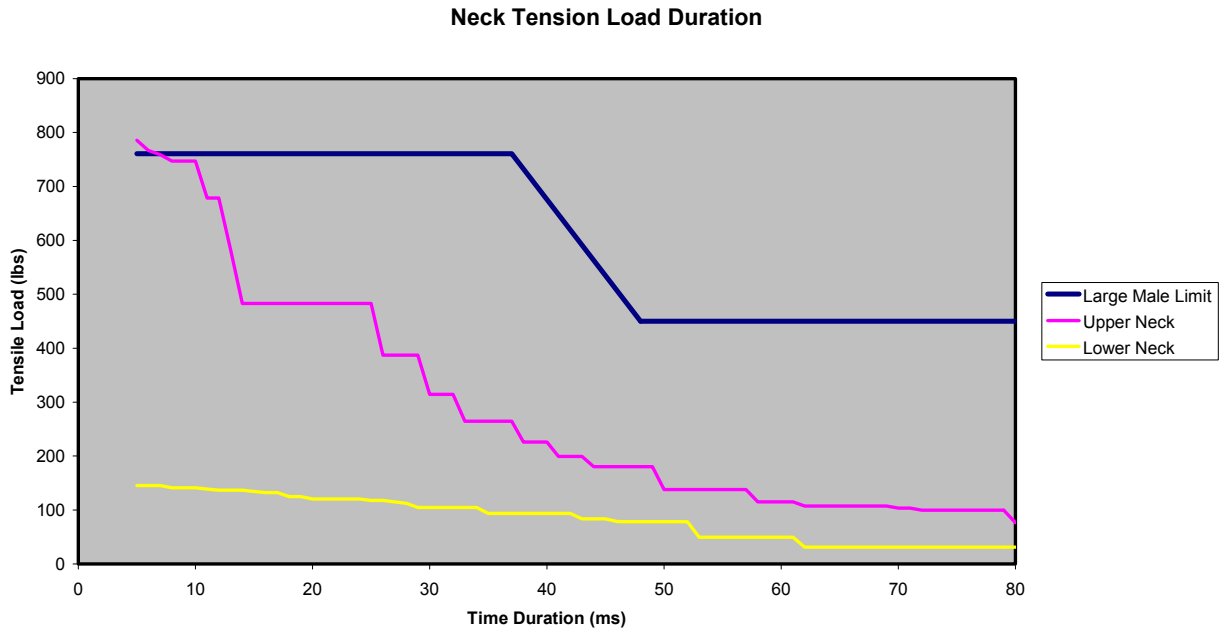

Figure D-86: Test 582 (Severe Pulse, 4.0 lb Added Head Weight)

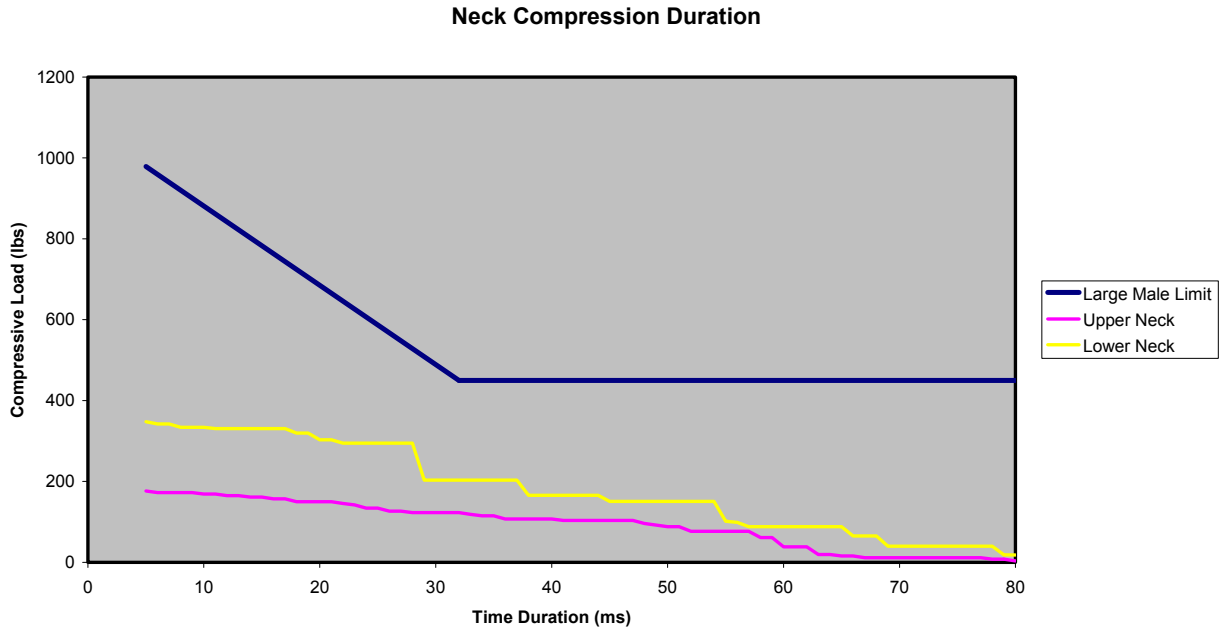

Figure D-87: Test 582 (Severe Pulse, 4.0 lb Added Head Weight)

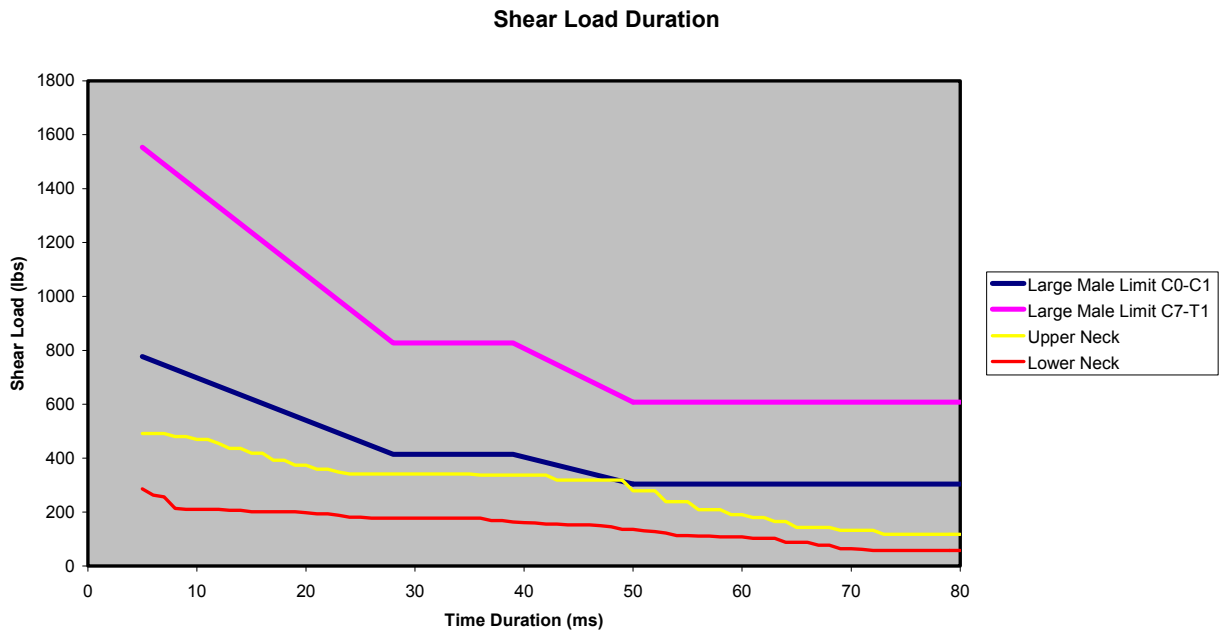

Figure D-88: Test 582 (Severe Pulse, 4.0 lb Added Head Weight)

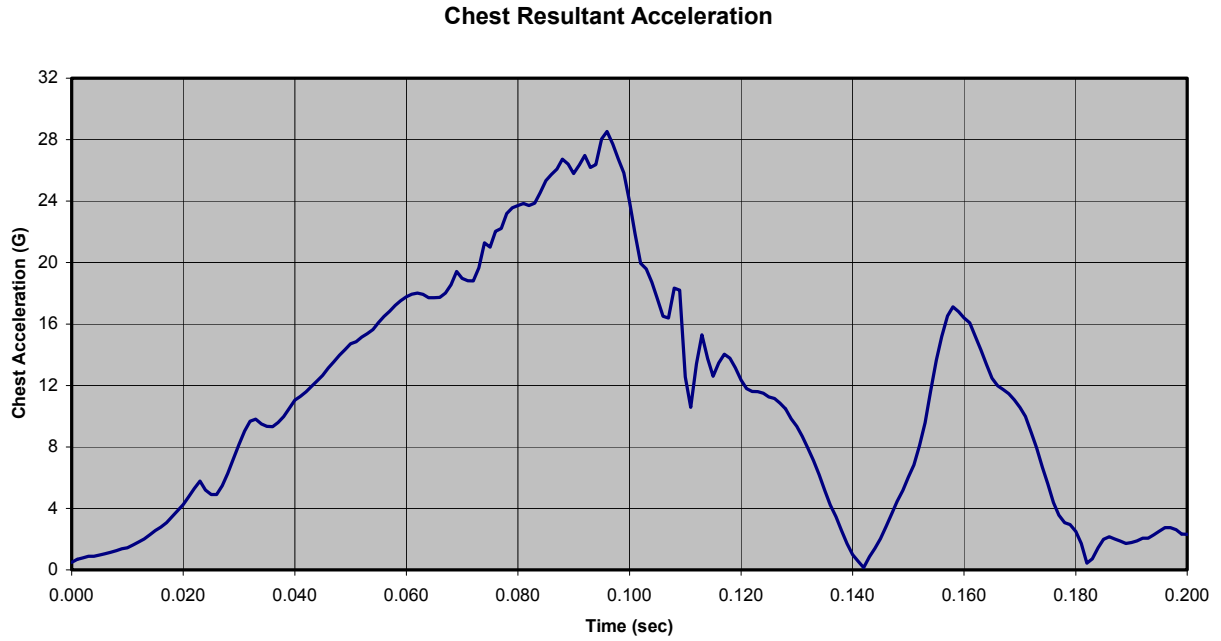

Figure D-89: Test 583 (Severe Pulse, 5.0 lb Added Head Weight)

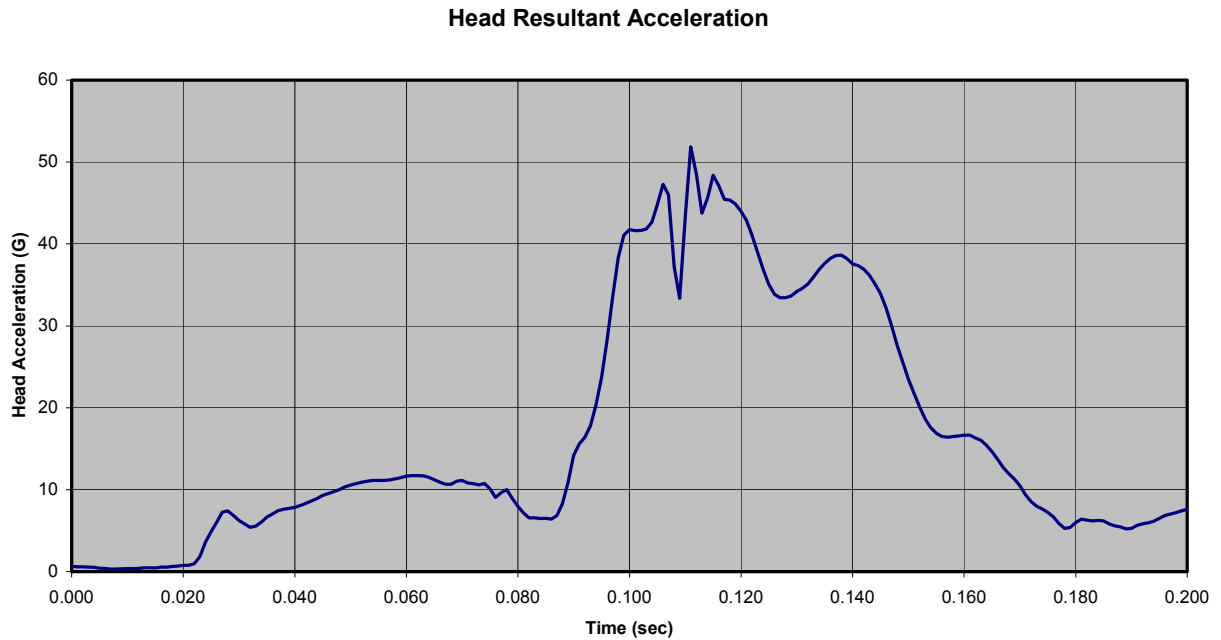

Figure D-90: Test 583 (Severe Pulse, 5.0 lb Added Head Weight)

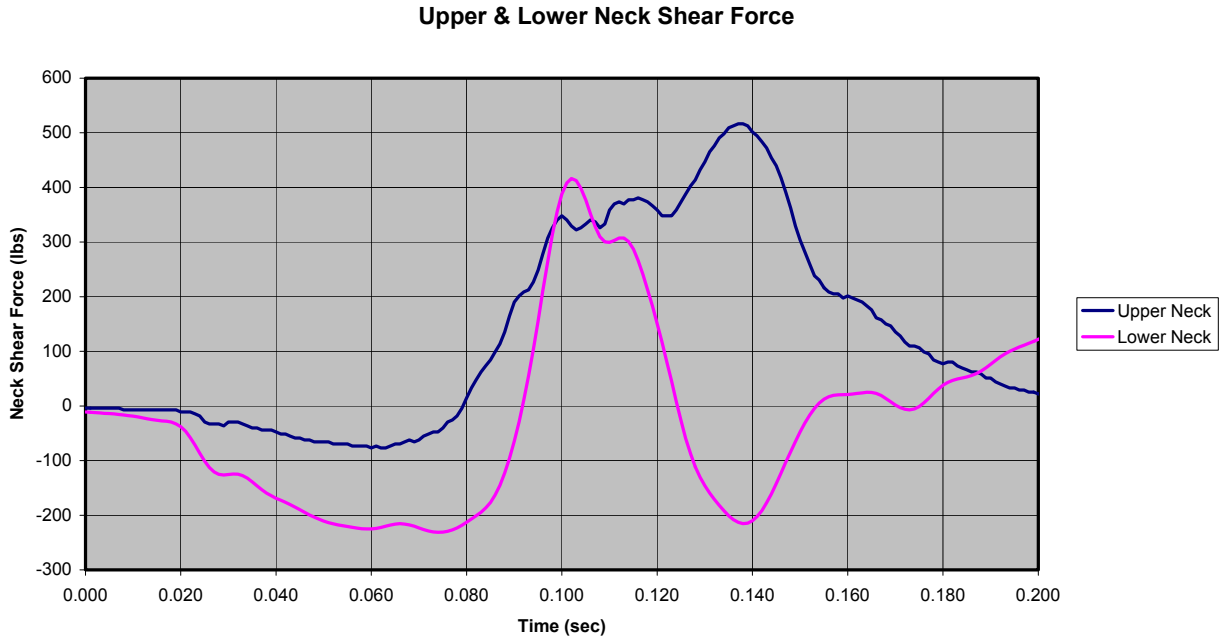

Figure D-91: Test 583 (Severe Pulse, 5.0 lb Added Head Weight)

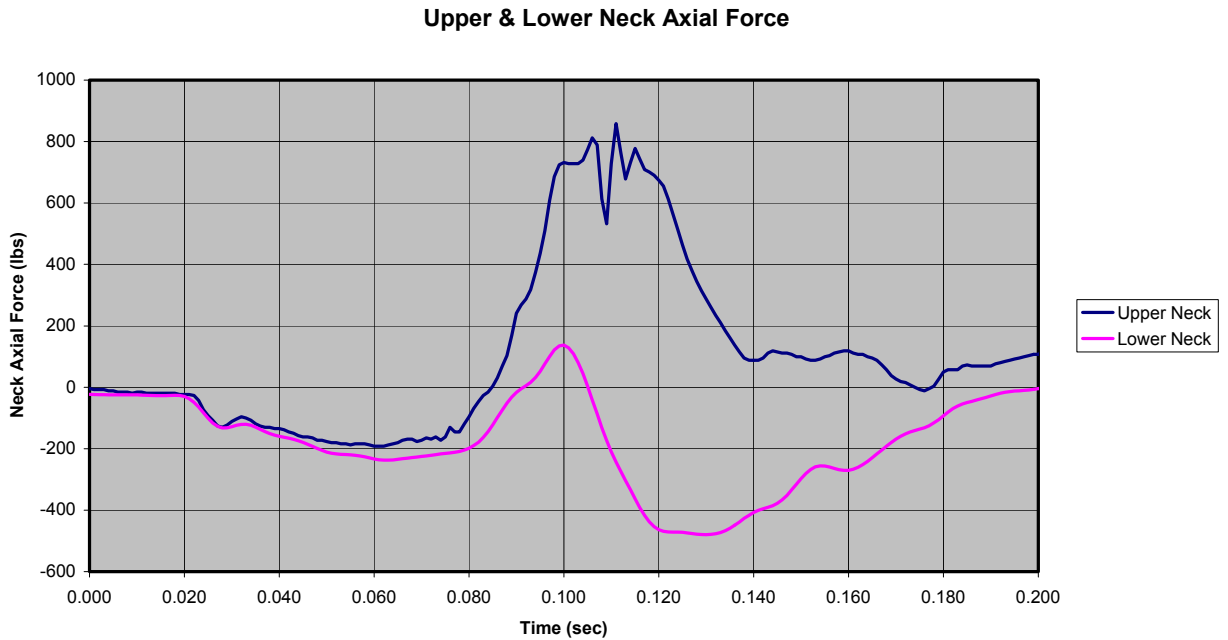

Figure D-92: Test 583 (Severe Pulse, 5.0 lb Added Head Weight)

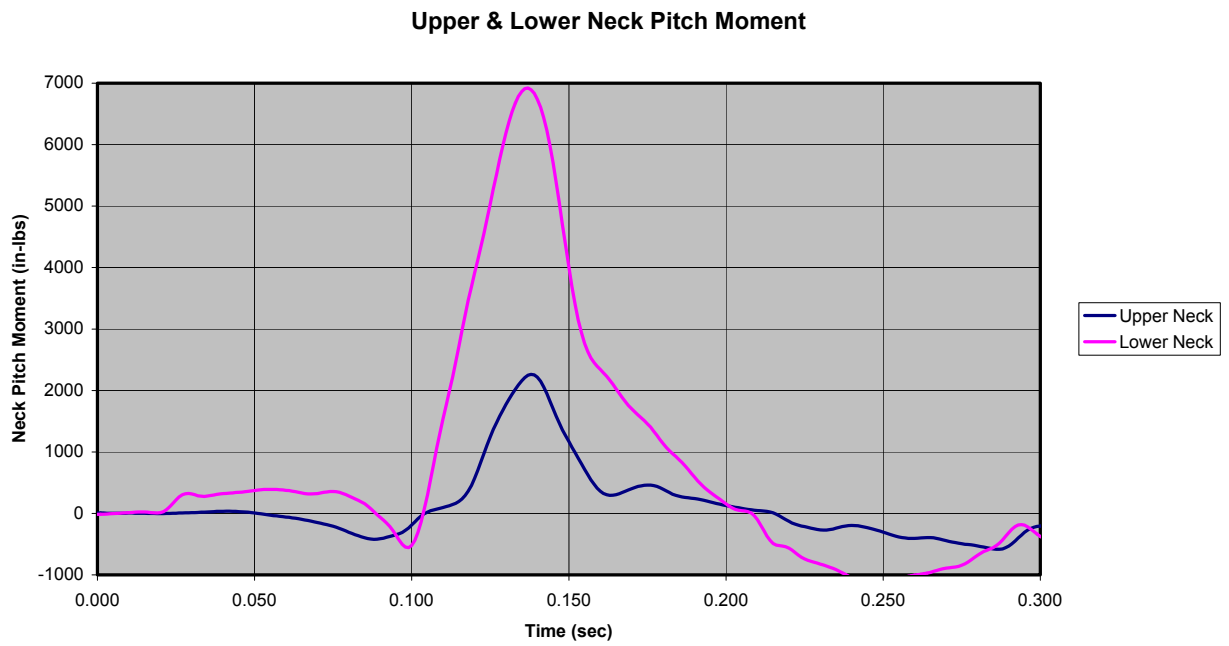

Figure D-93: Test 583 (Severe Pulse, 5.0 lb Added Head Weight)

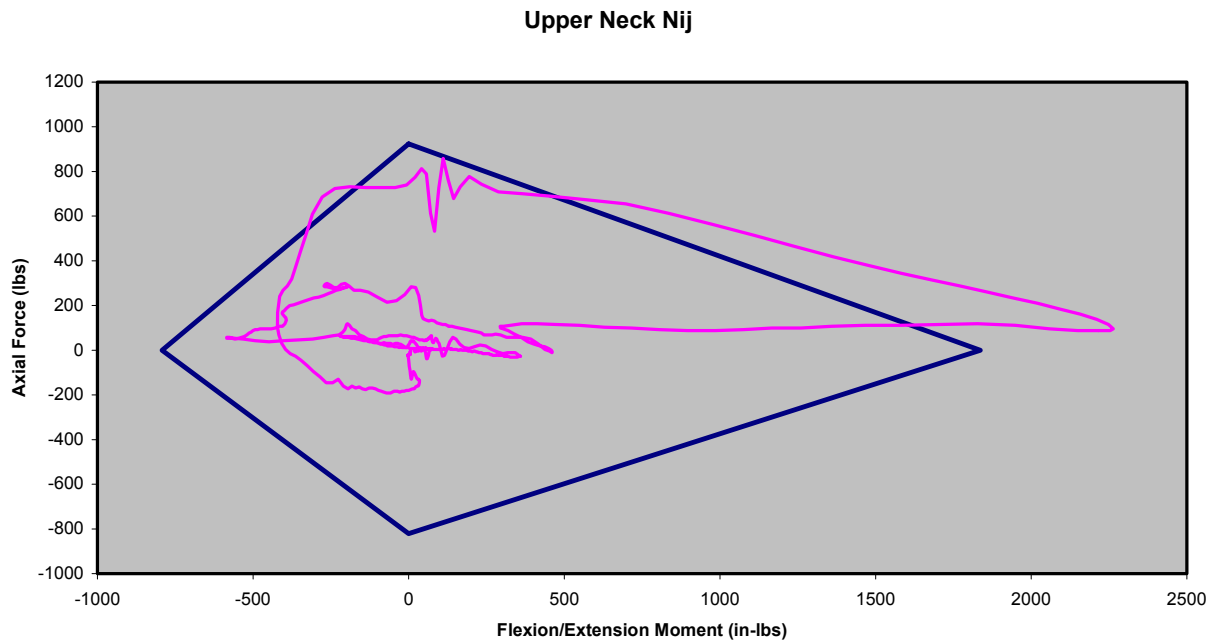

Figure D-94: Test 583 (Severe Pulse, 5.0 lb Added Head Weight)

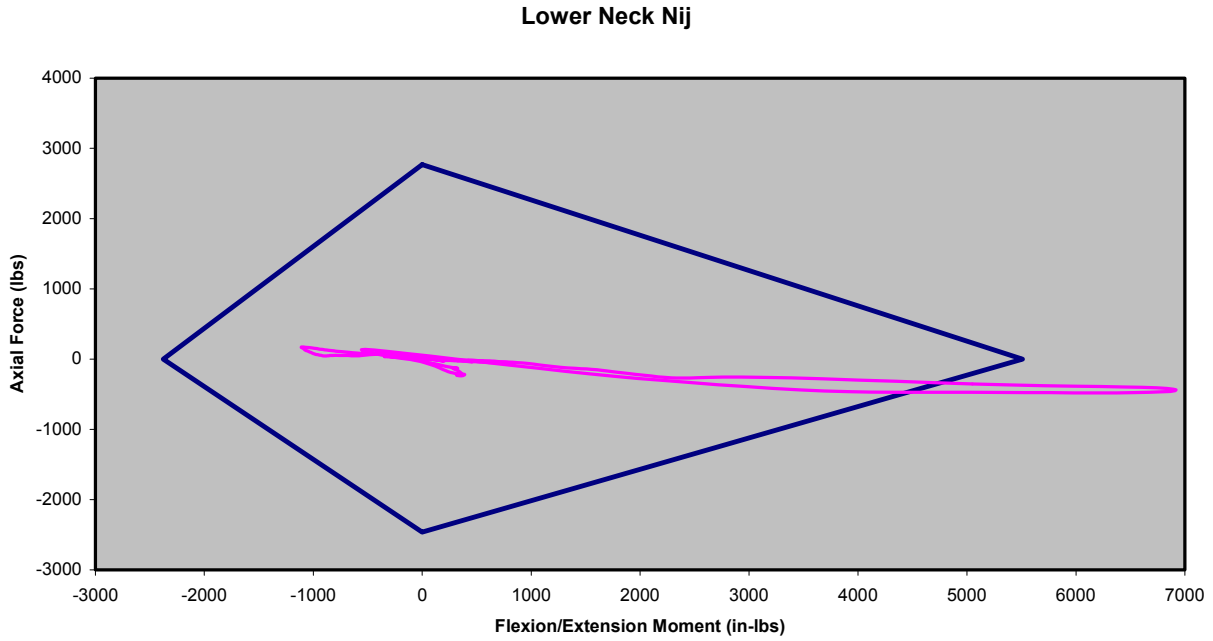

Figure D-95: Test 583 (Severe Pulse, 5.0 lb Added Head Weight)

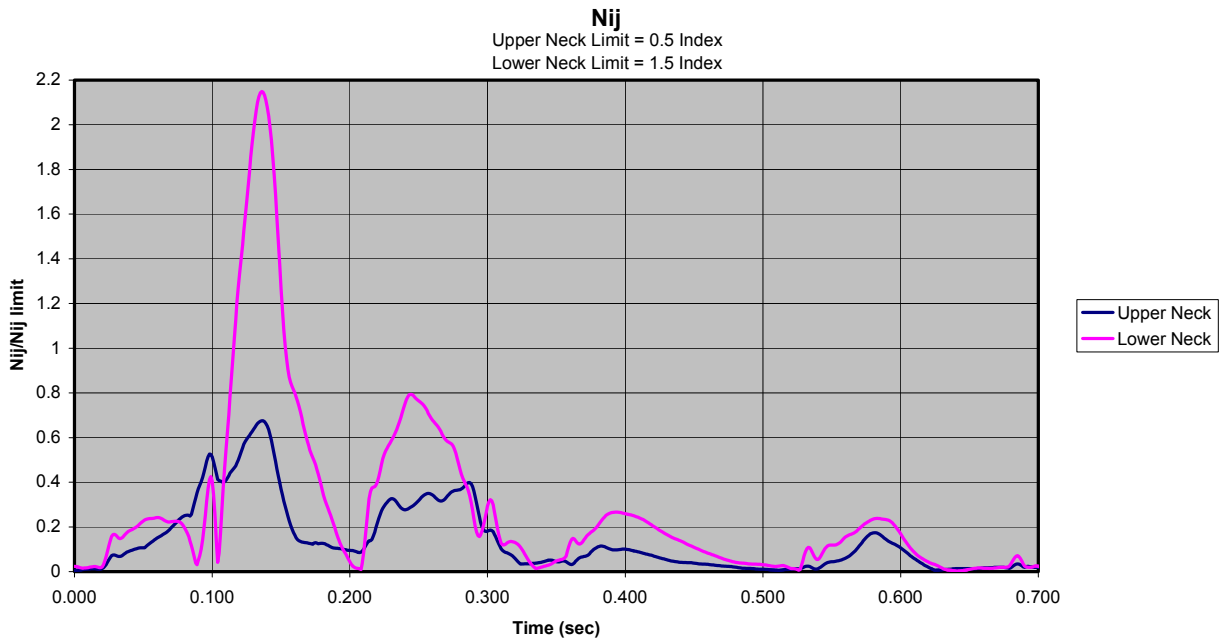

Figure D-96: Test 583 (Severe Pulse, 5.0 lb Added Head Weight)

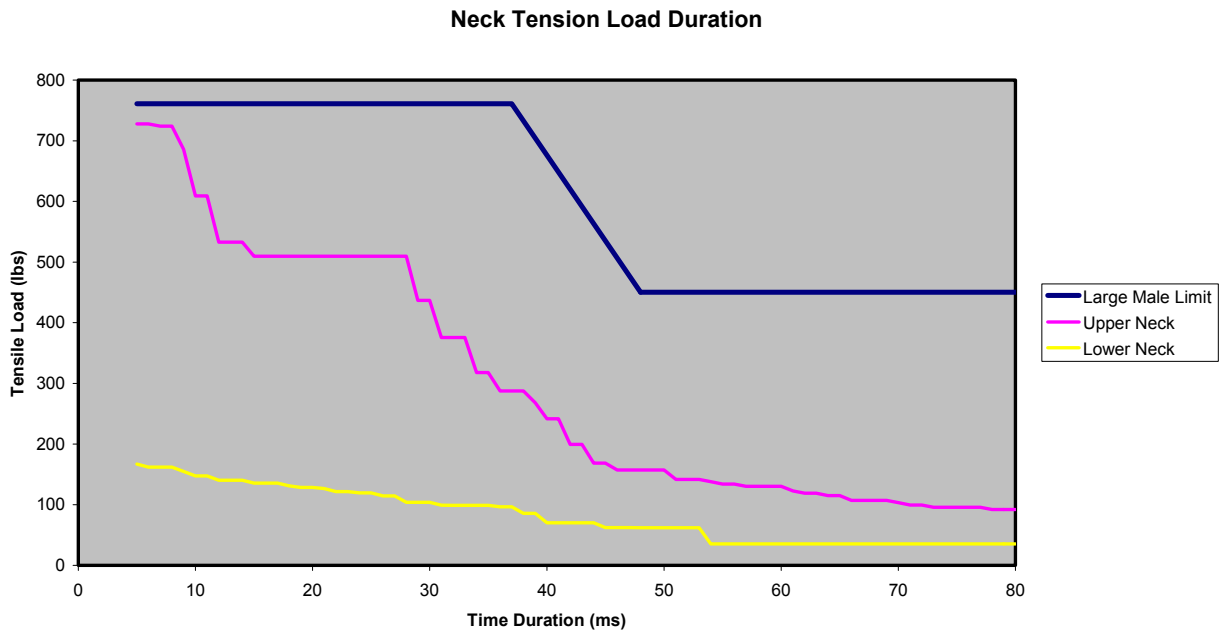

Figure D-97: Test 583 (Severe Pulse, 5.0 lb Added Head Weight)

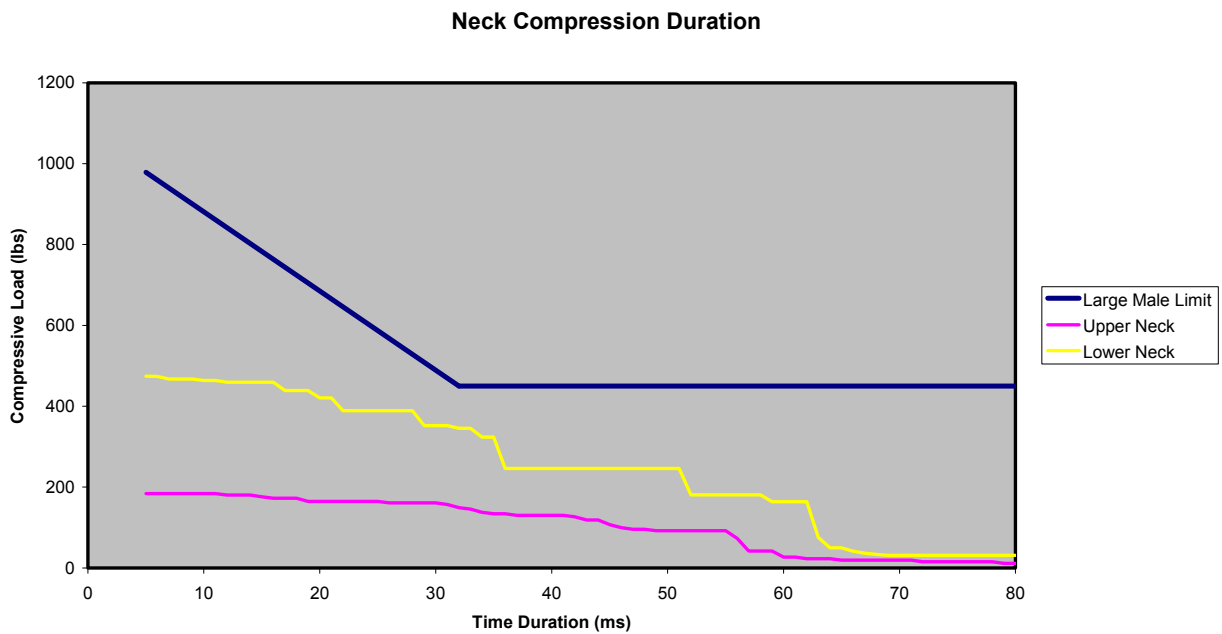

Figure D-98: Test 583 (Severe Pulse, 5.0 lb Added Head Weight)

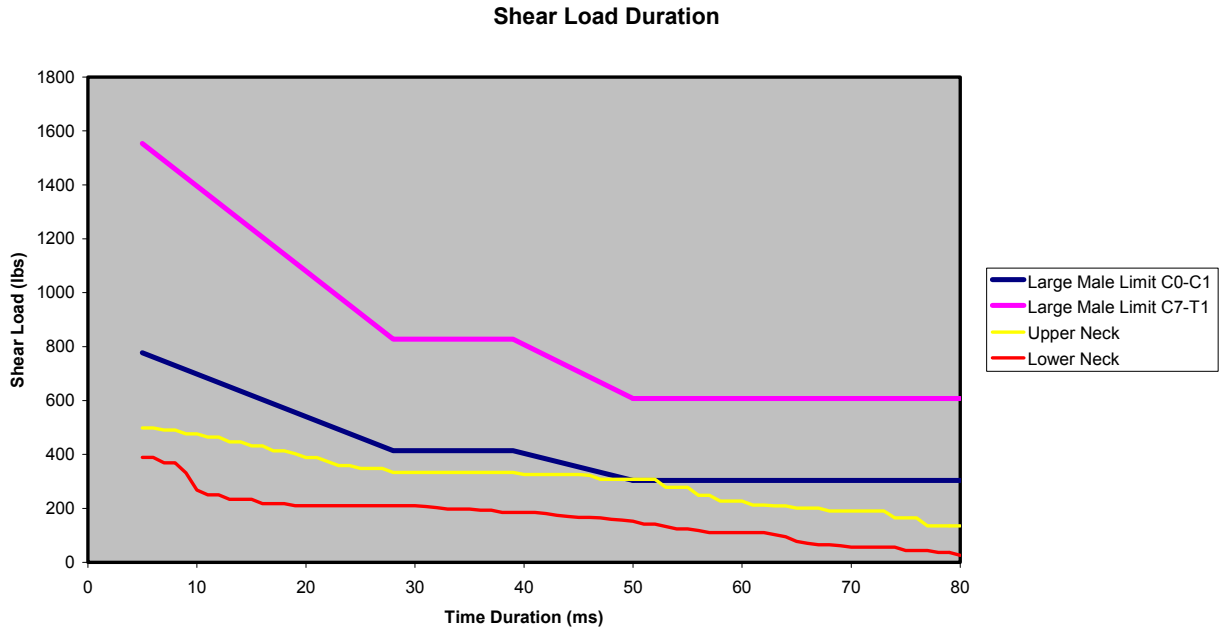

Figure D-99: Test 583 (Severe Pulse, 5.0 lb Added Head Weight)

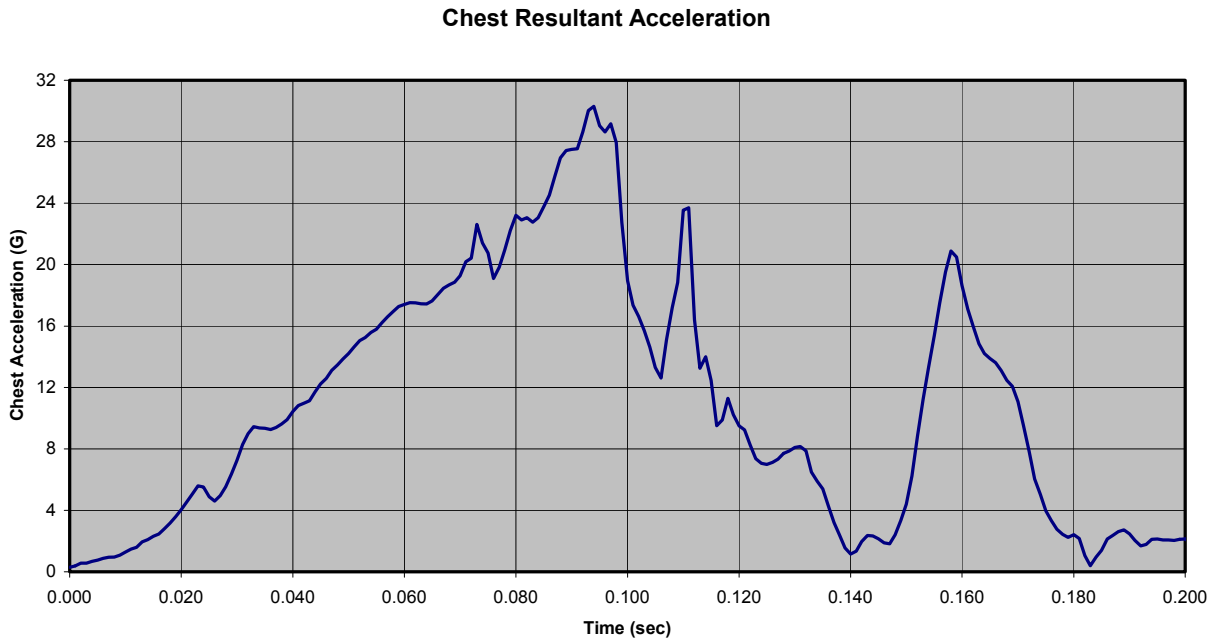

Figure D-100: Test 584 (Severe Pulse, 5.5 lb Added Head Weight)



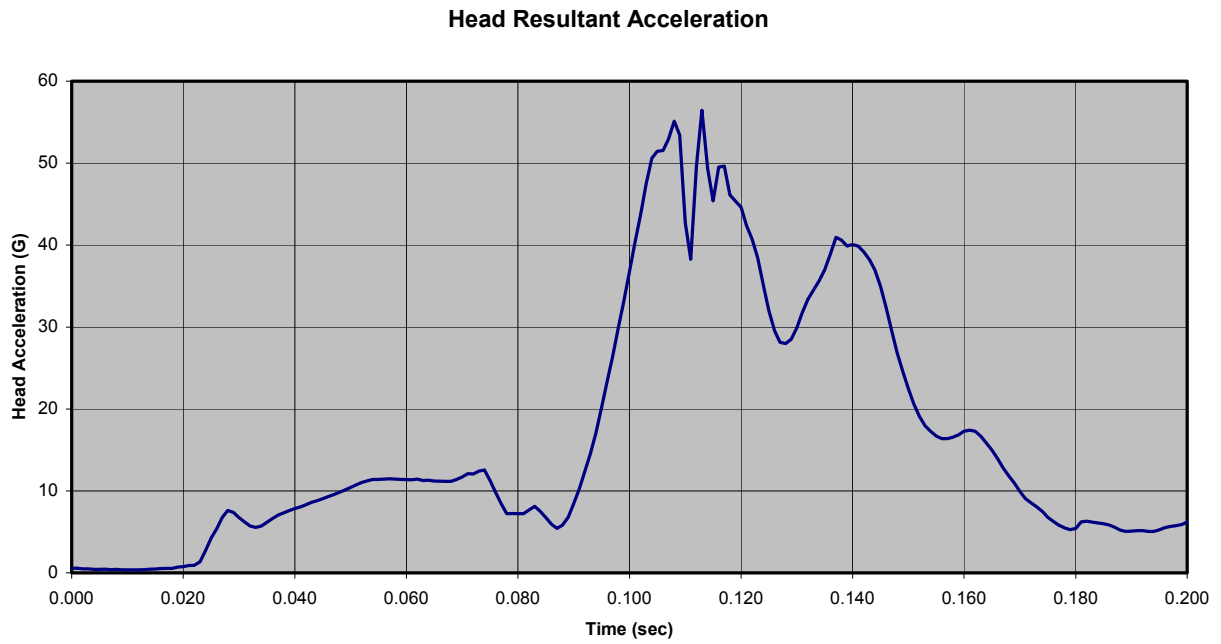

Figure D-101: Test 584 (Severe Pulse, 5.5 lb Added Head Weight)

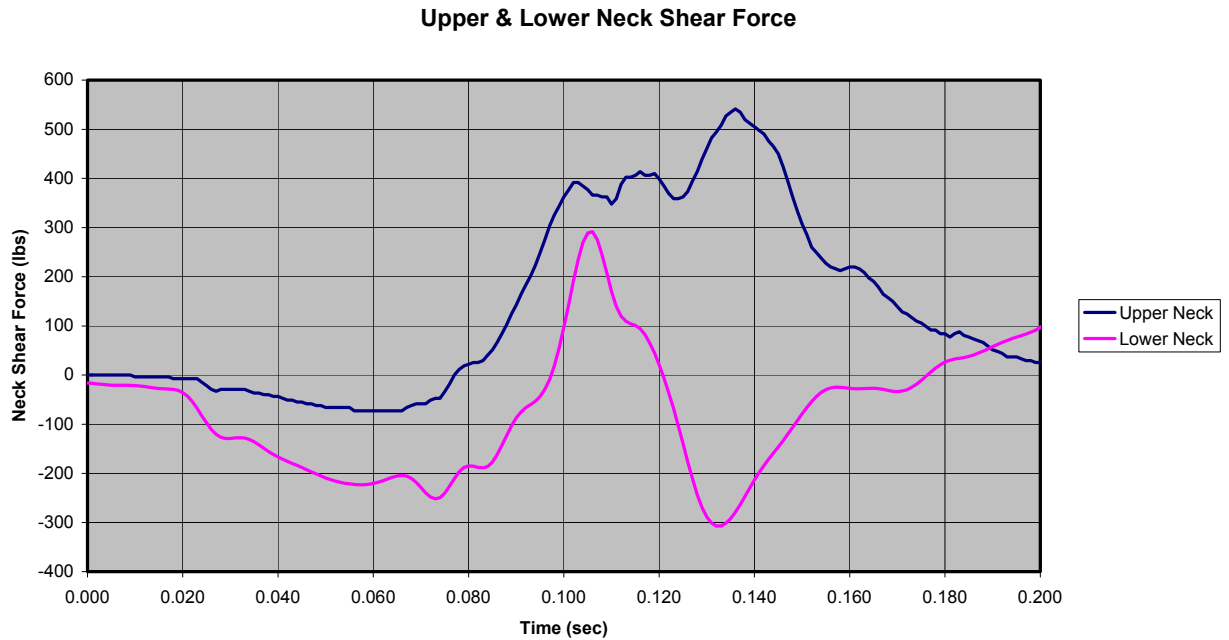

Figure D-102: Test 584 (Severe Pulse, 5.5 lb Added Head Weight)

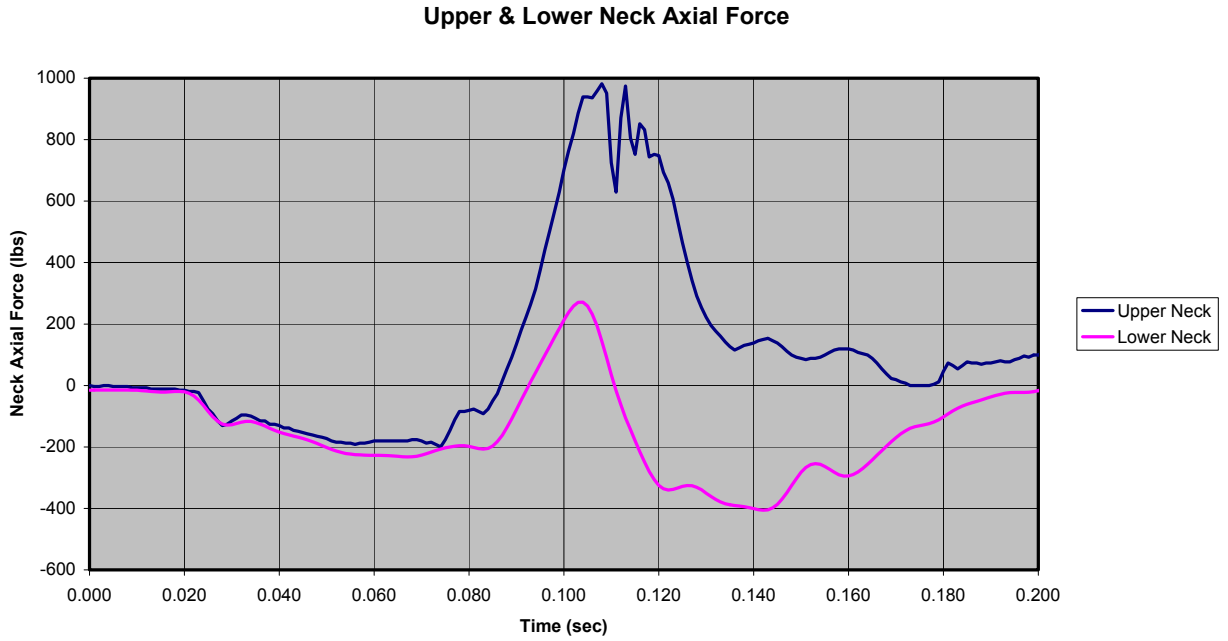

Figure D-103: Test 584 (Severe Pulse, 5.5 lb Added Head Weight)

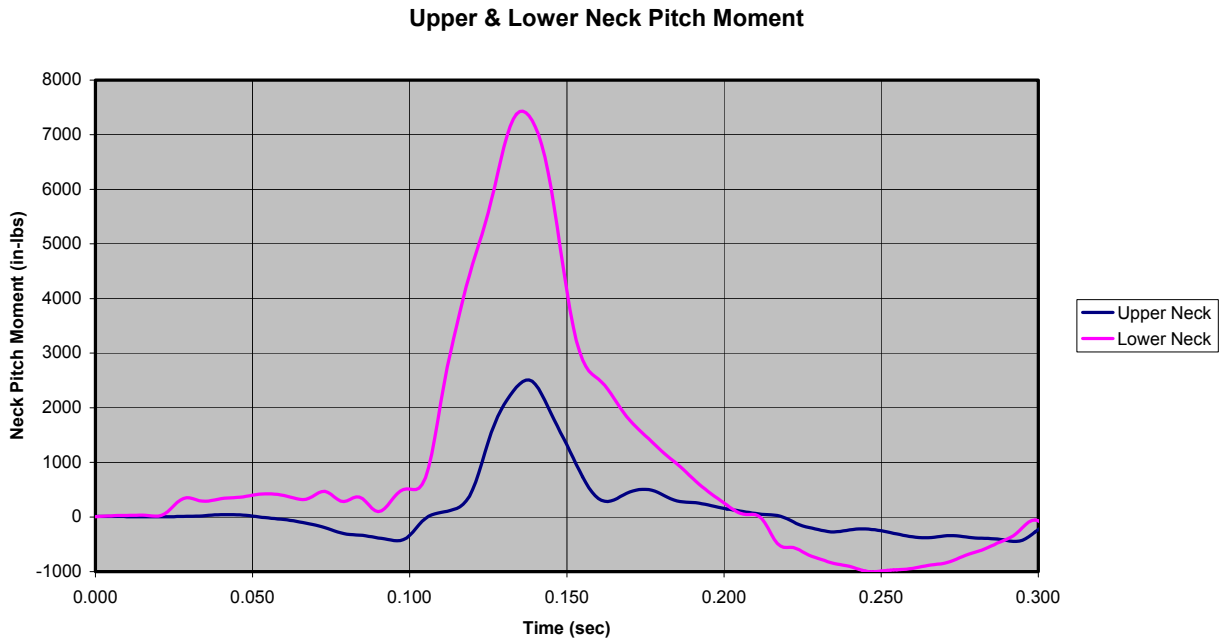

Figure D-104: Test 584 (Severe Pulse, 5.5 lb Added Head Weight)

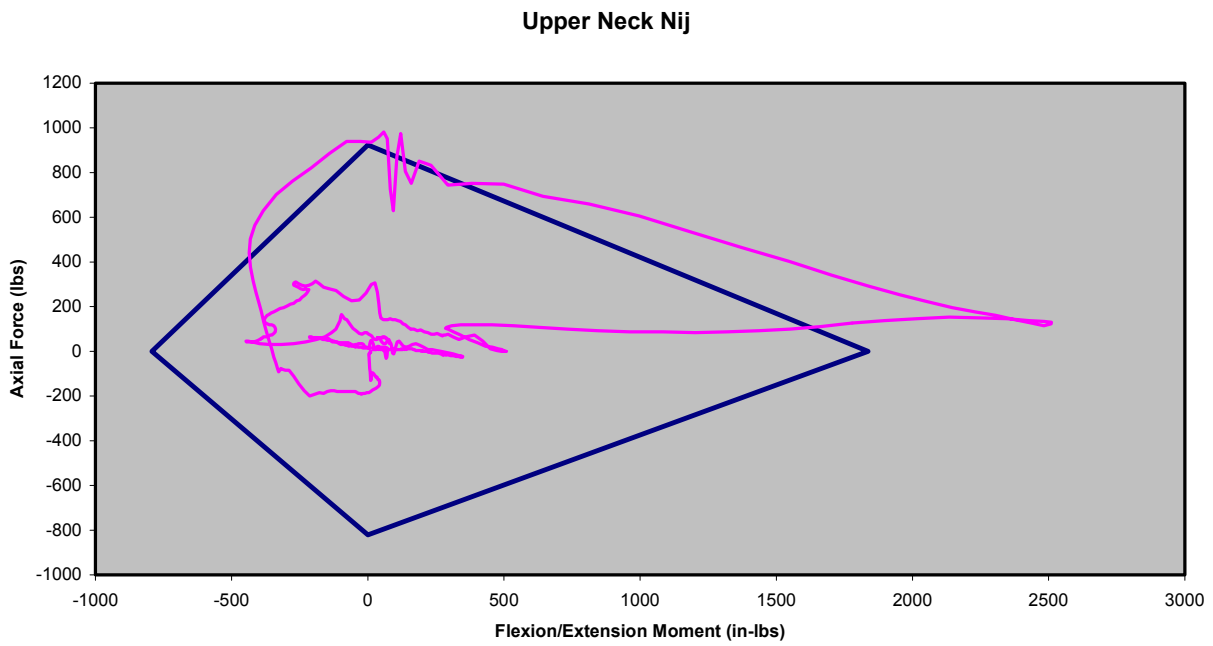

Figure D-105: Test 584 (Severe Pulse, 5.5 lb Added Head Weight)

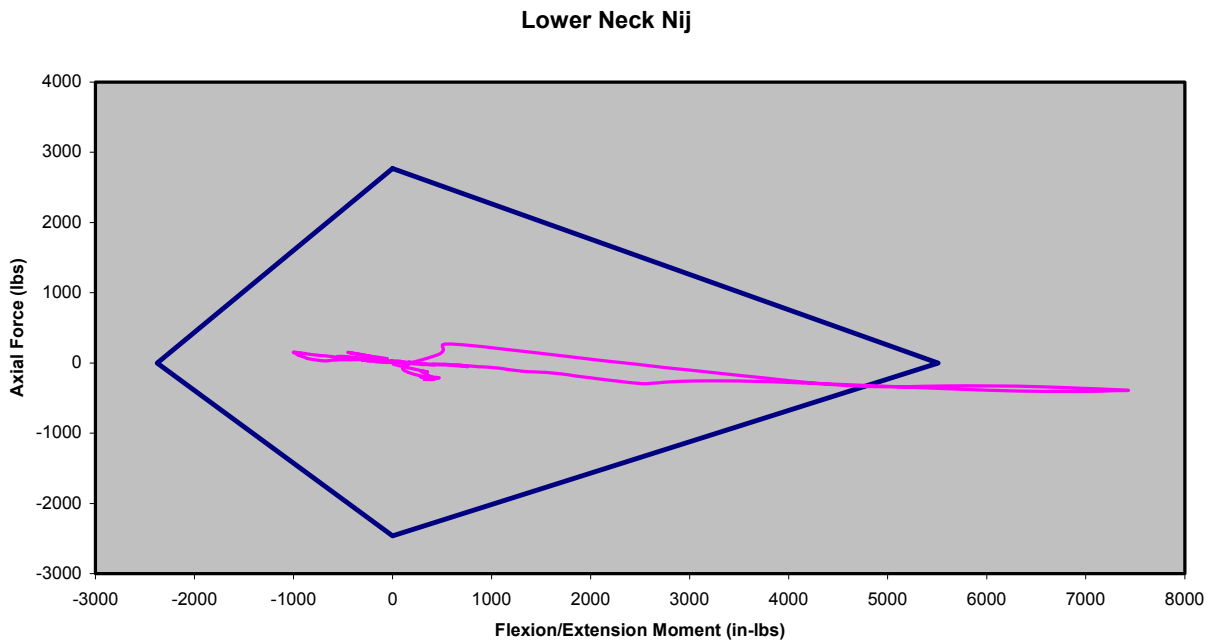

Figure D-106: Test 584 (Severe Pulse, 5.5 lb Added Head Weight)

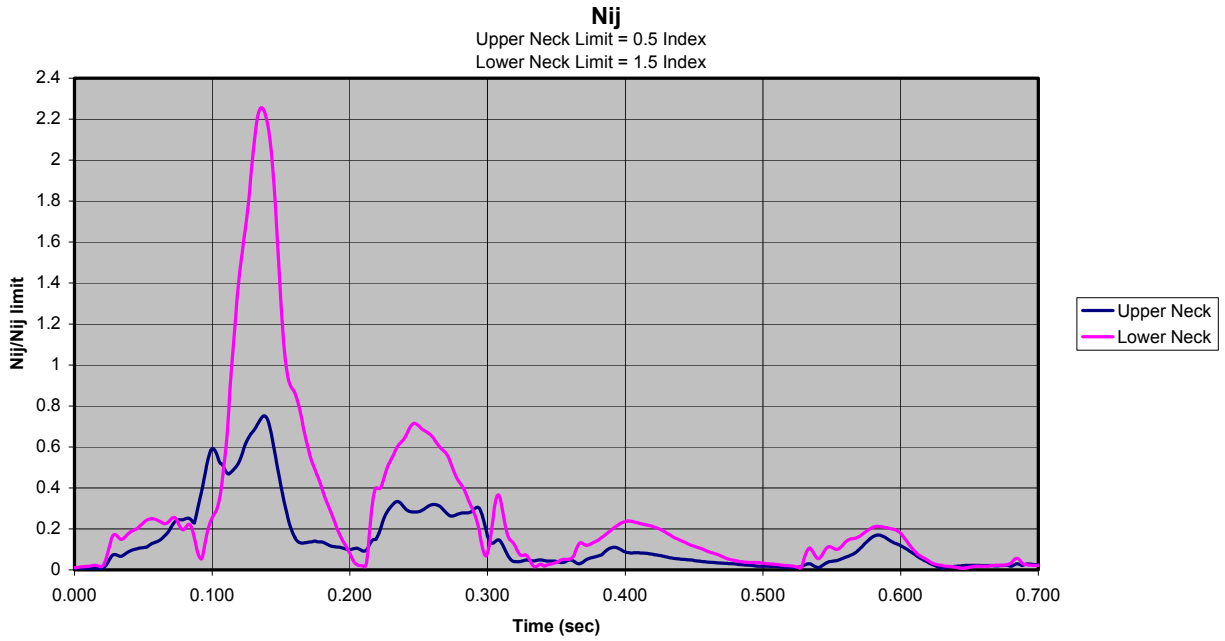

Figure D-107: Test 584 (Severe Pulse, 5.5 lb Added Head Weight)

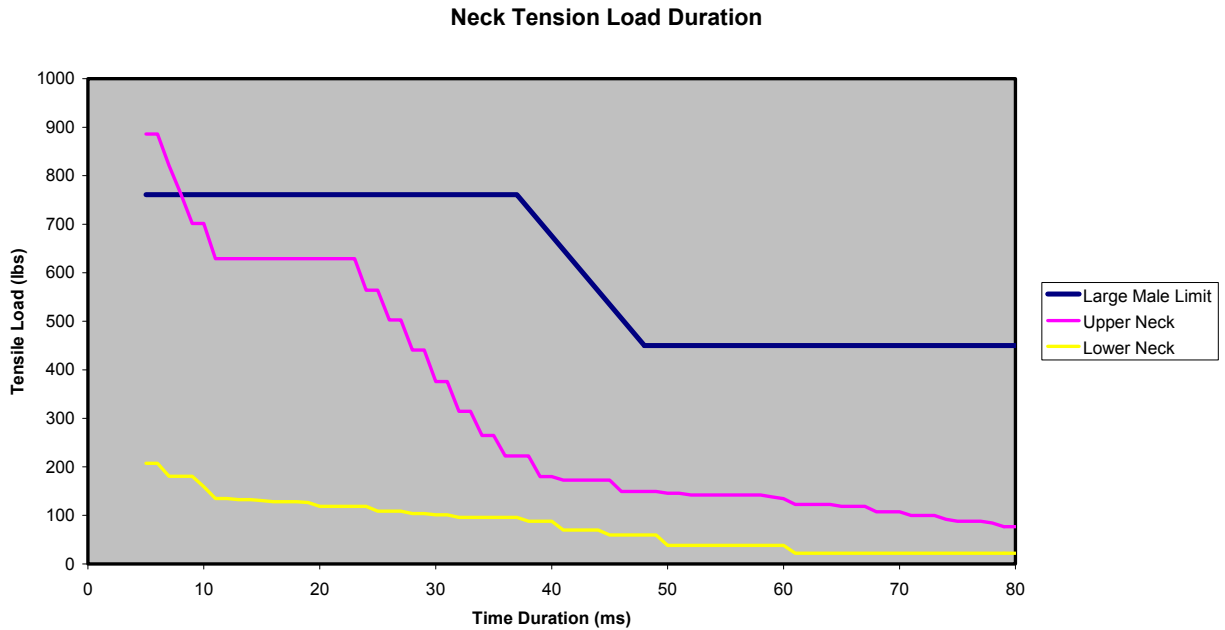

Figure D-108: Test 584 (Severe Pulse, 5.5 lb Added Head Weight)

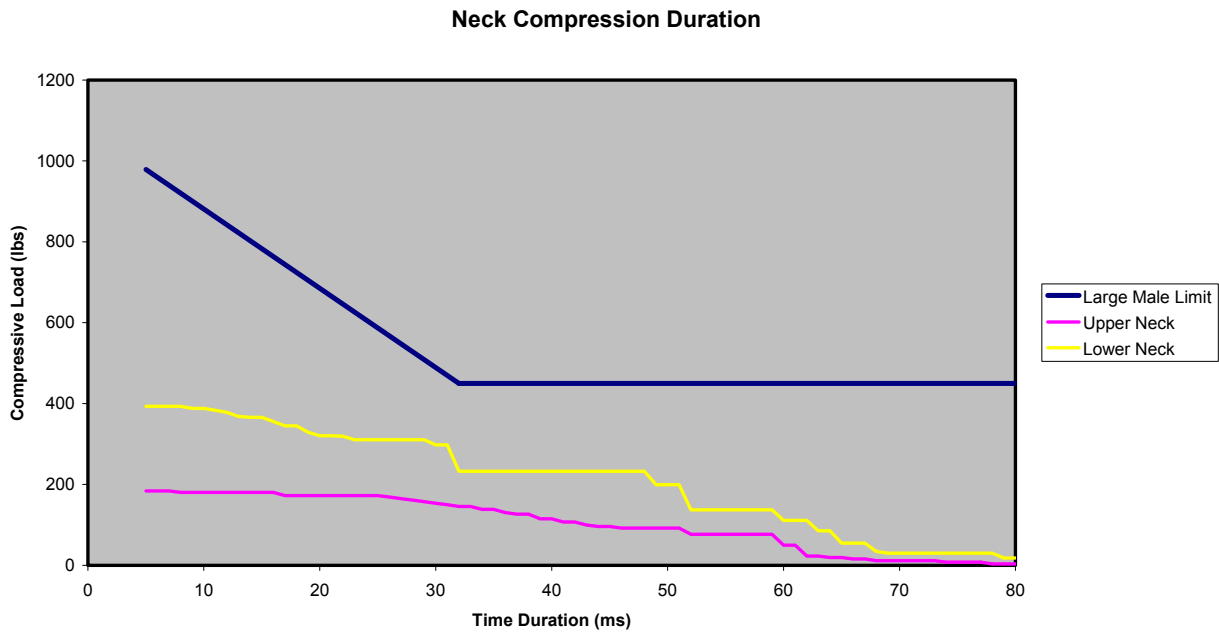

Figure D-109: Test 584 (Severe Pulse, 5.5 lb Added Head Weight)

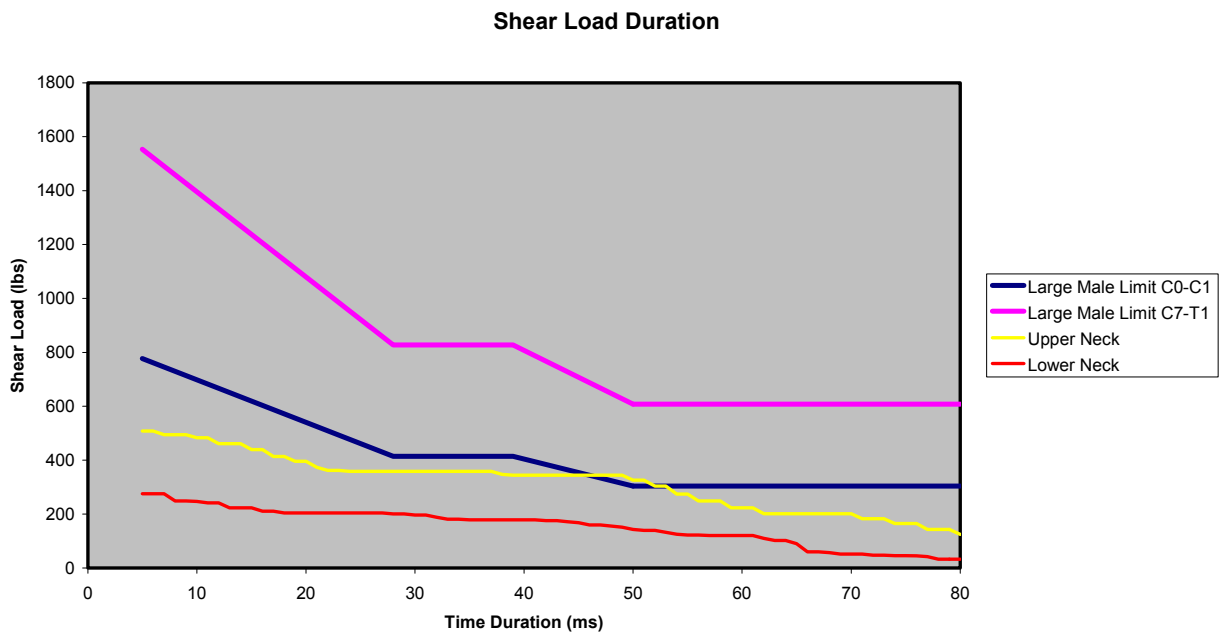

Figure D-110: Test 584 (Severe Pulse, 5.5 lb Added Head Weight)

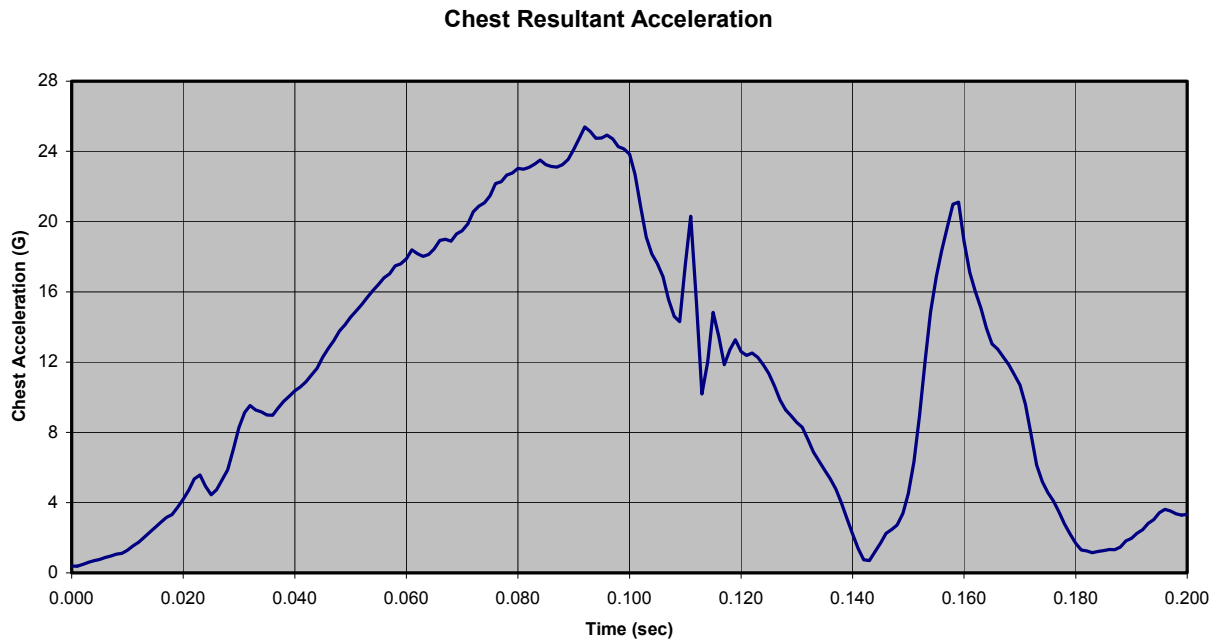

Figure D-111: Test 585 (Severe Pulse, 6.0 lb Added Head Weight)

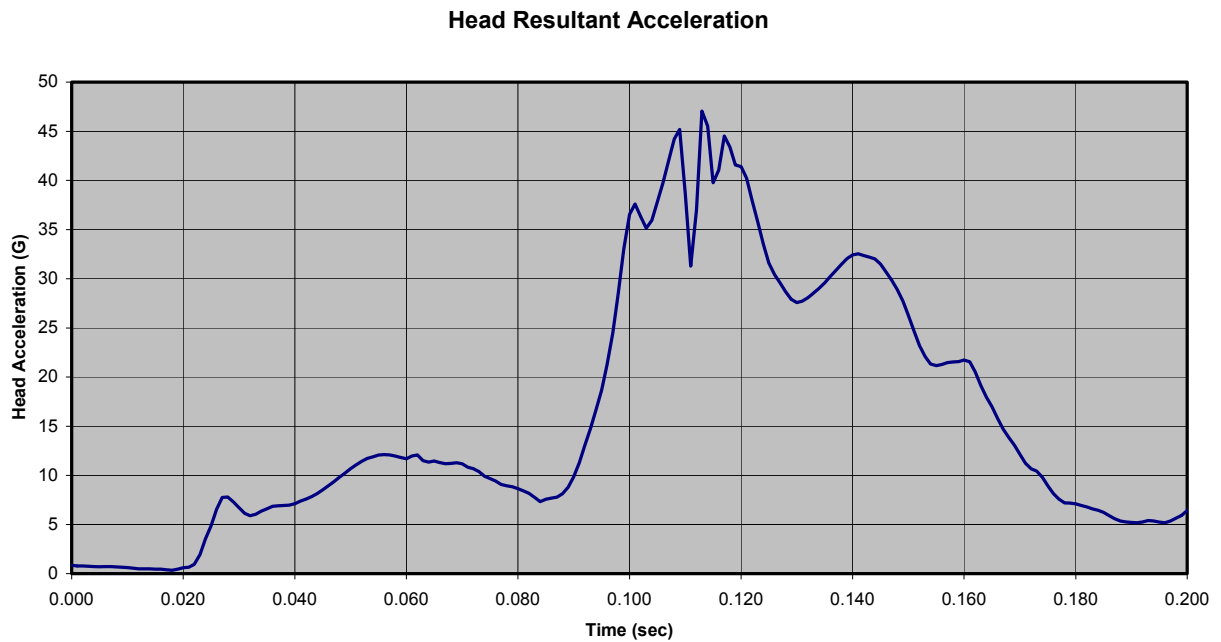

Figure D-112: Test 585 (Severe Pulse, 6.0 lb Added Head Weight)

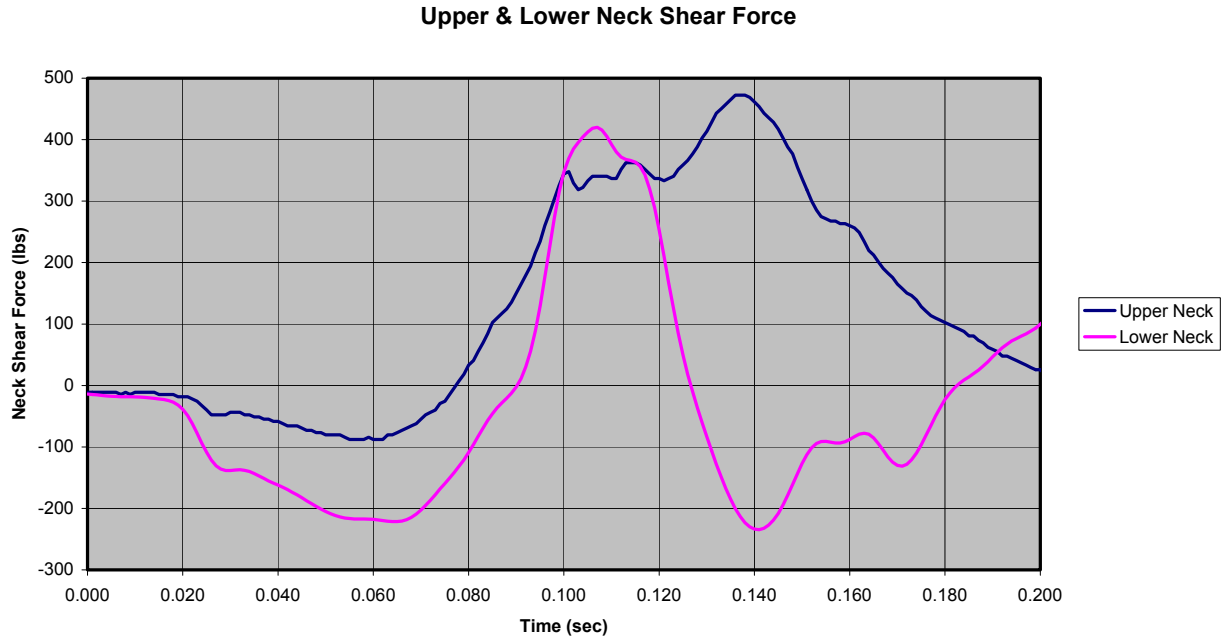

Figure D-113: Test 585 (Severe Pulse, 6.0 lb Added Head Weight)

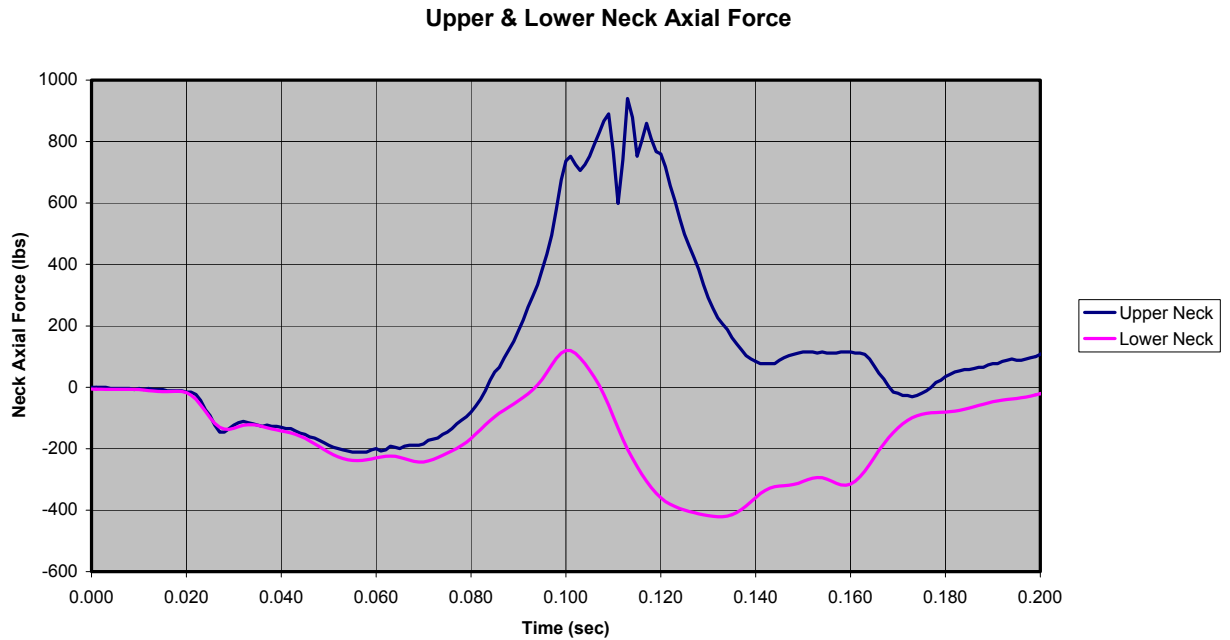

Figure D-114: Test 585 (Severe Pulse, 6.0 lb Added Head Weight)

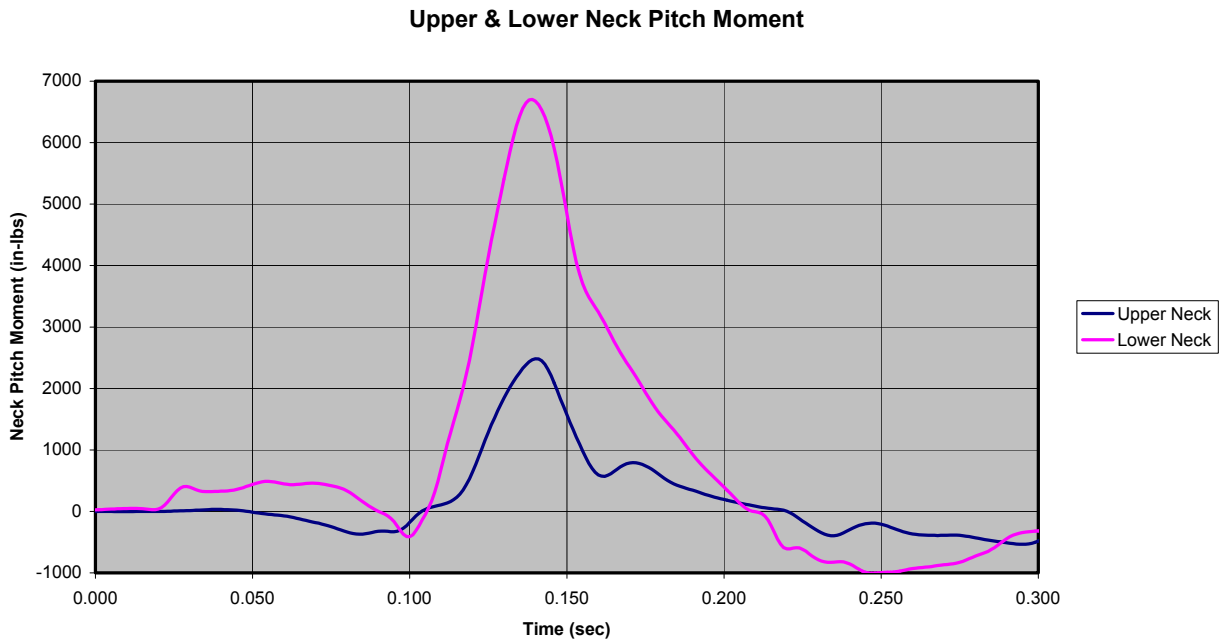

Figure D-115: Test 585 (Severe Pulse, 6.0 lb Added Head Weight)

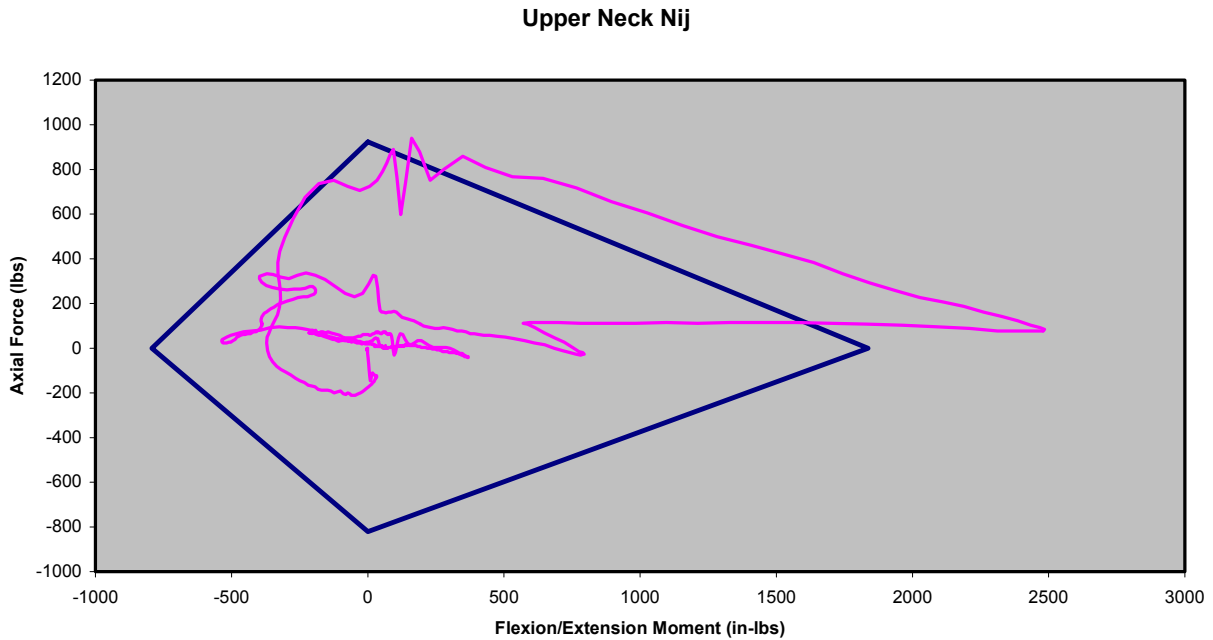

Figure D-116: Test 585 (Severe Pulse, 6.0 lb Added Head Weight)



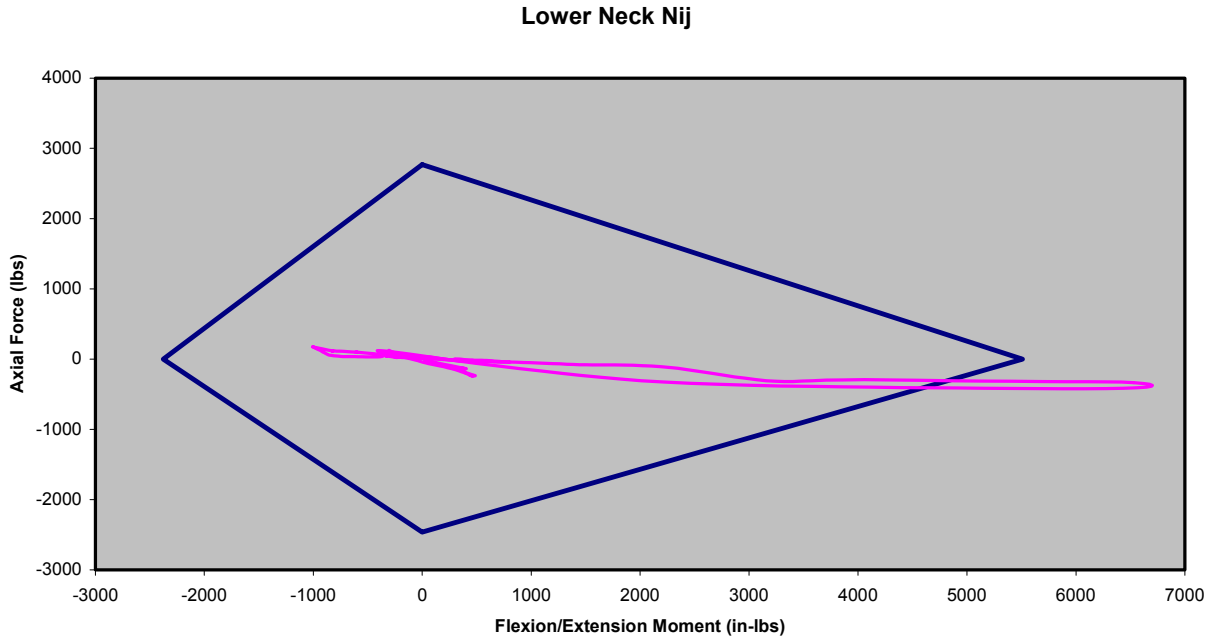

Figure D-117: Test 585 (Severe Pulse, 6.0 lb Added Head Weight)

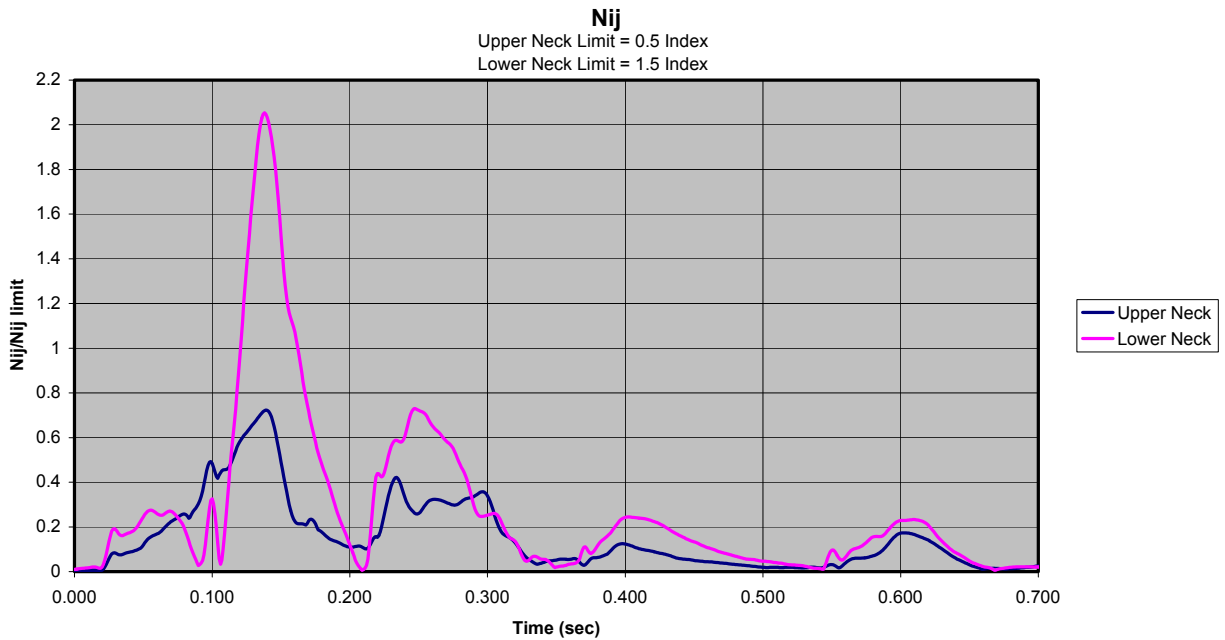

Figure D-118: Test 585 (Severe Pulse, 6.0 lb Added Head Weight)

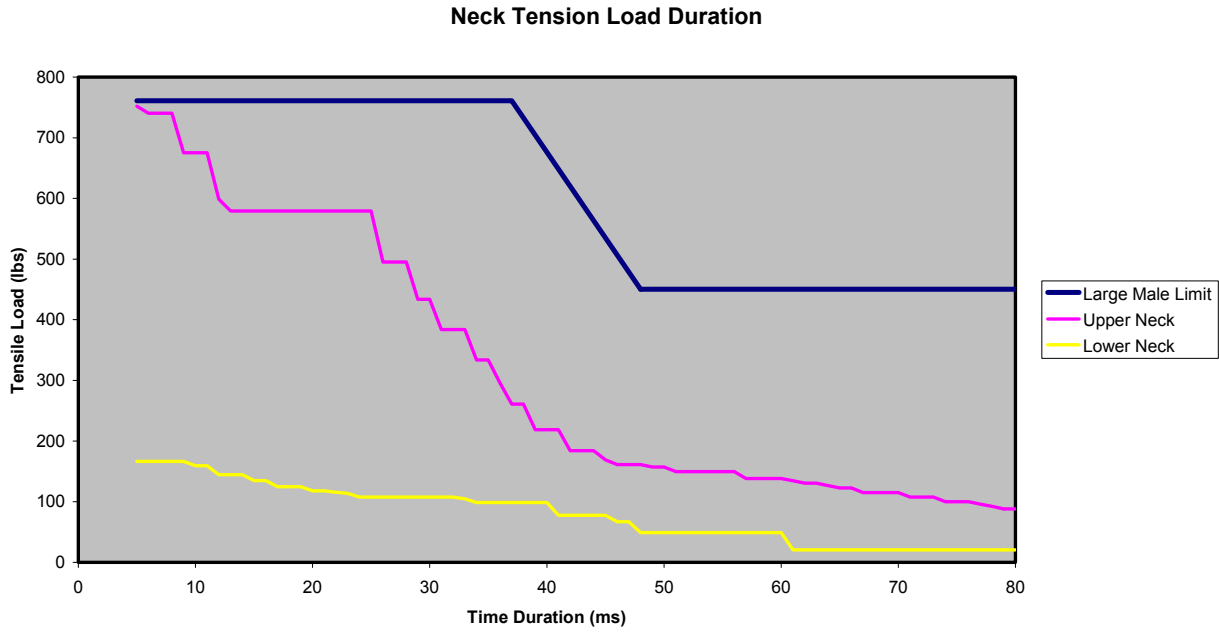

Figure D-119: Test 585 (Severe Pulse, 6.0 lb Added Head Weight)

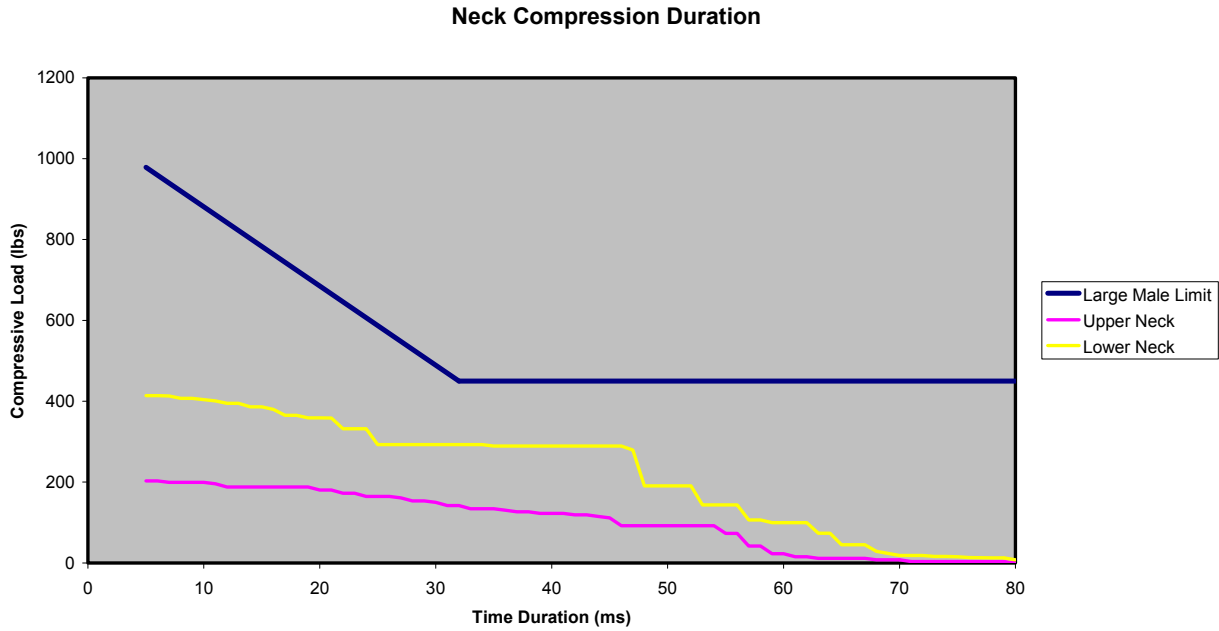

Figure D-120: Test 585 (Severe Pulse, 6.0 lb Added Head Weight)

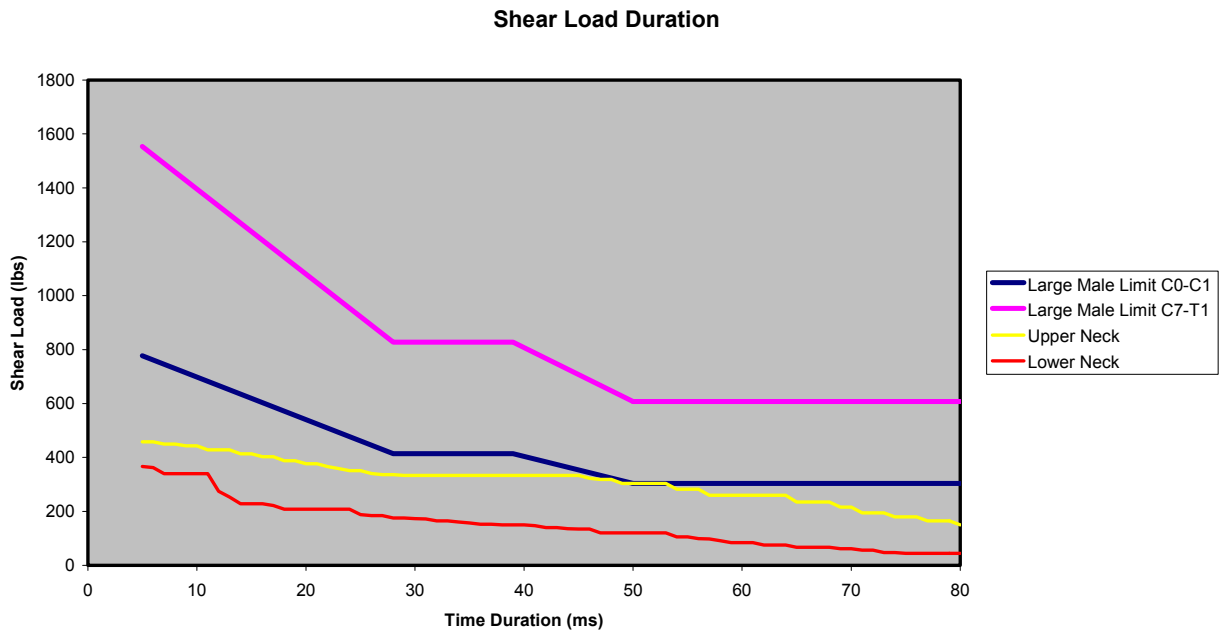

Figure D-121: Test 585 (Severe Pulse, 6.0 lb Added Head Weight)

APPENDIX E  
FIGURES  
(EFFECT OF AVIATOR SIZE, HELMET MASS PROPERTIES, AND PULSE SEVERITY)

Table E-1: Max Values of Recorded Data for all Tests

Test Conditions (Manikin - Pulse)	Test #	Add Head Wt (lbs)	CG Rad (in)	Delta V (ft/s)	Head (G)	Thorax (G)	Head +Fx (lbs)	Head +Fz (lbs)	Head -Fz (lbs)	Head +My (in-lbs)	Head -My (in-lbs)	Neck +Fx (lbs)	Neck +Fz (lbs)	Neck -Fz (lbs)	Neck +My (in-lbs)	Neck -My (in-lbs)	Head Nij	Neck Nij
Small Female - Low Pulse	514	4.0	3.0	25.08	18.7	21.1	90.5	139.7	-209.4	322.4	-106.5	113.9	103.9	-292.4	781.4	-150.1	0.29	0.66
Small Female - Low Pulse	515	5.0	4.0	25.30	23.3	26.0	96.0	167.4	-304.6	493.0	-189.9	108.6	141.2	-402.9	902.8	-161.2	0.39	0.77
Small Female - Low Pulse	516	5.5	4.5	24.94	26.3	28.0	94.1	179.0	-360.4	543.3	-236.2	117.9	165.0	-465.6	930.0	-161.8	0.49	0.80
Small Female - Low Pulse	517	6.0	5.0	24.98	26.7	29.7	99.6	177.6	-362.0	545.4	-217.4	128.5	160.7	-473.7	920.8	-180.8	0.48	0.78
Small Female - Medium Pulse	577	3.5	2.5	32.41	25.3	23.1	118.1	154.5	-232.7	377.3	-162.2	102.5	160.4	-309.7	921.9	-122.6	0.36	0.82
Small Female - Medium Pulse	518	4.0	3.0	31.60	34.5	36.2	153.3	239.6	-422.6	627.6	-242.7	155.0	202.2	-556.6	1307.5	-192.3	0.52	1.16
Small Female - Medium Pulse	578	4.0	3.0	31.99	28.3	29.0	136.7	249.6	-327.8	511.7	-305.2	138.6	288.1	-429.4	1116.7	-111.6	0.63	1.00
Small Female - Medium Pulse	579	4.5	4.0	32.34	30.7	31.2	129.1	269.3	-363.7	578.4	-386.2	165.2	304.3	-473.0	1109.7	-80.7	0.77	0.97
Small Female - Medium Pulse	519	5.0	4.0	31.48	35.3	37.4	129.3	192.1	-483.0	630.7	-267.8	140.4	177.5	-611.5	1100.8	-174.5	0.61	0.95
Small Female - Medium Pulse	520	5.0	5.0	31.70	34.9	36.9	108.8	213.8	-445.8	694.2	-243.5	140.2	182.9	-581.9	1186.1	-171.8	0.53	1.03
Small Female - Medium Pulse	521	5.5	4.0	31.71	35.8	37.9	134.8	234.7	-489.4	754.9	-263.0	168.1	188.4	-630.2	1354.9	-185.4	0.61	1.21
Small Female - Medium Pulse	522	5.5	5.0	31.64	41.7	42.6	134.8	229.9	-548.6	813.5	-264.4	166.8	194.0	-695.3	1380.2	-187.4	0.69	1.22
Small Female - Medium Pulse	523	6.0	5.0	31.62	33.6	37.7	140.3	238.3	-452.6	822.3	-241.6	195.9	179.7	-563.9	1436.9	-202.1	0.65	1.27
Small Female - Severe Pulse	537	3.5	2.5	50.28	43.9	26.2	326.6	576.7	-139.1	1310.4	-238.6	402.1	589.6	-352.9	2774.7	-274.1	1.02	2.40
Small Female - Severe Pulse	538	4.0	3.0	50.05	56.6	27.6	373.1	788.6	-139.1	1270.9	-276.3	475.7	812.3	-408.2	3009.0	-355.3	1.04	2.66
Small Female - Severe Pulse	539	2.8	2.3	50.34	56.6	31.7	352.9	706.2	-143.8	1202.6	-256.2	437.0	714.3	-378.0	2729.8	-530.3	0.96	2.41
Small Female - Severe Pulse	540	2.8	2.3	50.05	61.5	33.7	395.4	764.6	-155.5	1213.8	-299.6	408.8	761.2	-404.9	3020.0	-580.3	1.02	2.66
Mid-Male - Low Pulse	530	4.0	3.0	25.23	26.8	27.7	123.1	191.8	-356.8	484.9	-292.7	159.4	170.8	-435.7	1156.7	-341.1	0.35	0.44
Mid-Male - Low Pulse	531	6.0	5.0	24.74	27.2	27.0	111.8	189.9	-420.3	579.3	-336.4	155.9	191.3	-488.7	1217.2	-312.6	0.39	0.48
Mid-Male - Medium Pulse	524	4.0	3.0	31.52	21.5	23.7	206.5	308.1	-265.5	798.4	-232.1	267.1	326.6	-357.5	2051.2	-316.3	0.33	0.81
Mid-Male - Medium Pulse	525	4.5	4.0	31.08	30.1	33.0	166.6	269.6	-424.9	741.1	-335.3	220.7	288.7	-550.2	1788.6	-320.4	0.41	0.70
Mid-Male - Medium Pulse	526	5.0	4.0	31.32	26.5	27.4	170.5	264.6	-377.7	740.2	-299.1	205.5	272.0	-470.3	1802.1	-249.9	0.42	0.68
Mid-Male - Medium Pulse	527	5.0	5.0	31.37	24.3	25.6	210.3	319.7	-335.2	1070.1	-275.8	224.6	348.6	-422.3	2343.3	-254.4	0.44	0.95
Mid-Male - Medium Pulse	528	5.5	5.0	31.36	26.6	28.2	138.3	239.8	-350.4	693.3	-326.2	176.3	266.5	-425.5	1347.5	-298.1	0.44	0.55
Mid-Male - Medium Pulse	529	6.0	5.0	31.09	30.5	31.2	163.0	257.9	-484.4	825.2	-402.1	195.5	288.7	-596.3	1793.5	-402.3	0.45	0.70
Mid-Male - Medium Pulse	590	4.0	3.0	32.01	19.3	23.8	175.9	230.3	-253.3	744.9	-192.4	285.0	84.8	-281.4	2007.4	-327.7	0.28	0.87
Mid-Male - Medium Pulse	591	5.0	4.0	31.67	20.3	22.2	172.2	225.7	-302.3	803.0	-286.3	262.9	66.6	-306.1	1971.4	-294.0	0.30	0.85
Mid-Male - Medium Pulse	592	5.5	5.0	31.55	21.0	23.9	150.1	241.4	-321.9	843.5	-326.5	268.2	85.2	-339.1	1891.7	-274.2	0.32	0.80
Mid-Male - Medium Pulse	593	6.0	5.0	31.54	23.9	25.1	150.6	233.5	-375.3	903.6	-252.5	286.2	72.8	-376.5	1874.6	-266.8	0.35	0.79
Mid-Male - Severe Pulse	586	2.8	2.3	51.06	62.4	31.5	472.8	697.3	-134.1	1586.7	-384.3	833.8	220.1	-565.3	5830.9	-1240.1	0.68	2.52
Mid-Male - Severe Pulse	587	3.5	2.5	51.16	65.4	31.9	425.1	804.9	-134.2	1671.2	-430.6	980.6	239.6	-501.0	5397.2	-1289.8	0.70	2.30
Mid-Male - Severe Pulse	588	4.0	3.0	51.16	53.9	28.9	479.6	758.6	-168.6	1923.0	-388.8	842.4	217.0	-522.4	6060.3	-958.1	0.84	2.58
Mid-Male - Severe Pulse	589	4.5	4.0	51.38	53.0	27.3	487.0	828.5	-188.0	2043.3	-295.0	973.3	232.3	-514.2	6370.9	-1149.8	0.84	2.69
Large Male - Low Pulse	512	4.0	3.0	25.09	18.3	20.0	142.1	279.8	-263.6	731.1	-390.5	220.7	263.2	-353.9	1465.4	-356.9	0.30	0.40
Large Male - Low Pulse	513	6.0	5.0	24.94	18.2	19.2	132.5	279.5	-303.3	707.0	-391.4	186.8	229.0	-386.4	1444.3	-268.0	0.29	0.42
Large Male - Medium Pulse	509	4.0	3.0	31.05	20.5	23.3	157.2	307.6	-268.4	673.9	-332.2	181.5	280.5	-372.8	1399.9	-318.2	0.29	0.41
Large Male - Medium Pulse	510	5.5	4.0	31.27	17.9	21.9	162.8	302.6	-286.5	646.9	-339.4	205.7	244.4	-379.5	1760.5	-425.3	0.26	0.49
Large Male - Medium Pulse	511	6.0	5.0	30.99	20.9	22.8	178.1	389.1	-347.8	793.7	-484.7	238.2	294.1	-453.3	1861.0	-373.4	0.38	0.55
Large Male - Severe Pulse	580	2.8	2.3	50.03	51.2	26.0	439.0	658.9	-195.5	1276.4	-577.6	369.6	179.4	-302.1	4927.8	-1050.0	0.46	1.52
Large Male - Severe Pulse	581	3.5	2.5	50.42	47.1	26.9	446.3	747.1	-183.9	2090.5	-363.7	444.3	152.4	-442.6	5981.7	-917.0	0.62	1.87
Large Male - Severe Pulse	582	4.0	3.0	50.32	60.1	29.3	516.9	893.1	-176.4	1943.3	-617.5	354.8	179.5	-352.8	6453.4	-1064.3	0.63	1.96
Large Male - Severe Pulse	583	5.0	4.0	50.39	51.9	28.5	516.4	858.1	-191.6	2263.9	-584.5	416.3	173.7	-479.7	6920.2	-1110.9	0.68	2.15
Large Male - Severe Pulse	584	5.5	4.0	50.19	56.4	30.3	541.6	981.8	-199.5	2510.4	-447.1	307.2	270.7	-406.0	7431.7	-1002.0	0.75	2.26
Large Male - Severe Pulse	585	6.0	5.0	50.44	47.0	25.4	472.2	939.9	-211.0	2485.0	-536.1	420.1	175.9	-421.3	6702.9	-1005.4	0.72	2.05

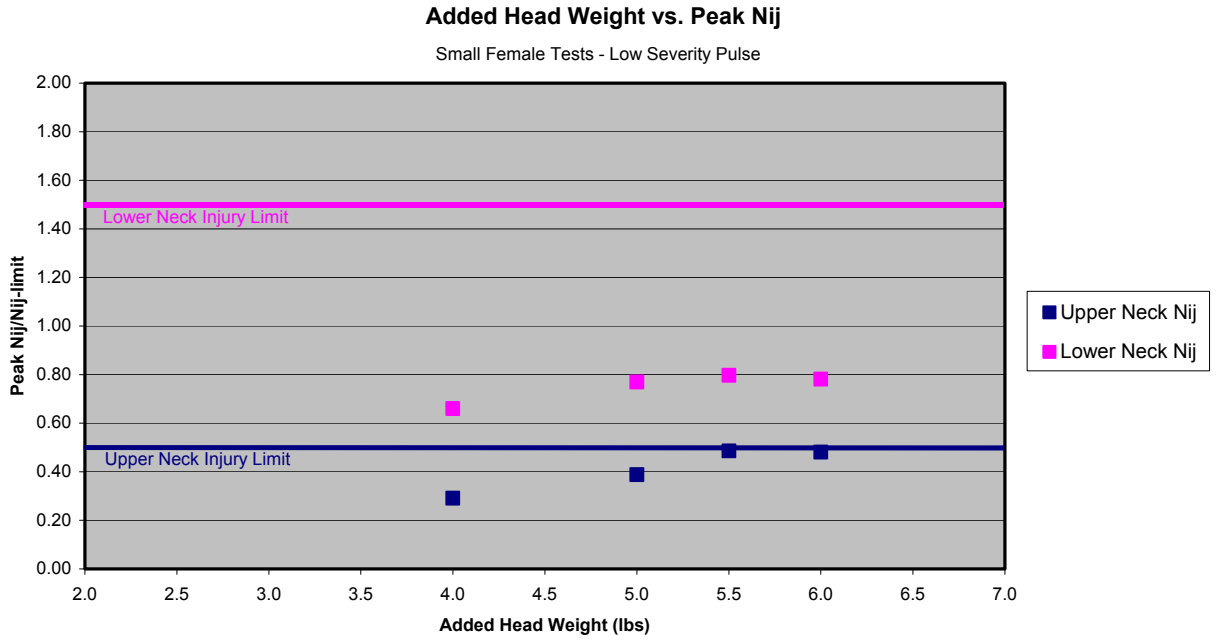

Figure E-1: Peak Nij Values (Small Female, Low Severity Pulse)

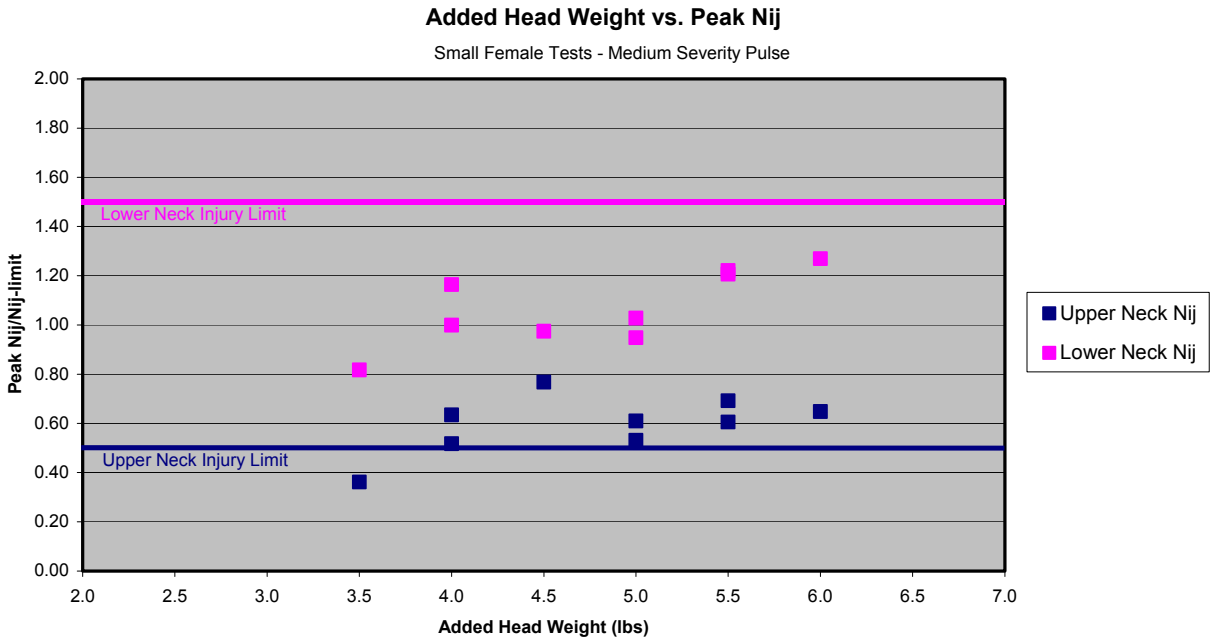

Figure E-2: Peak Nij Values (Small Female, Medium Severity Pulse)

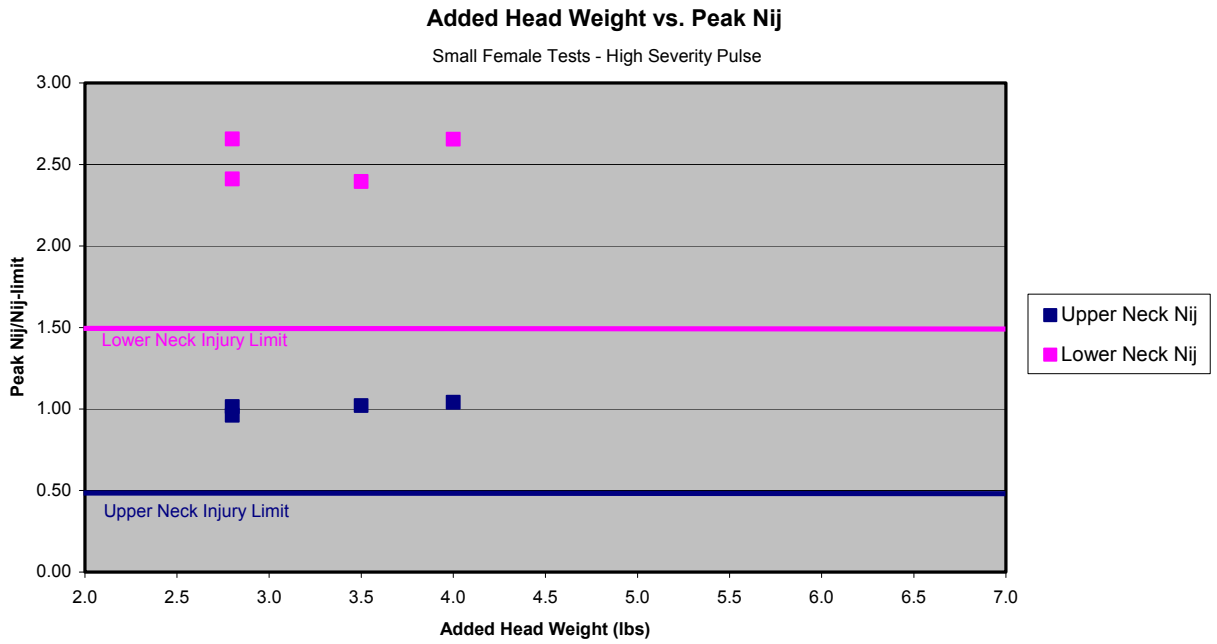

Figure E-3: Peak Nij Values (Small Female, High Severity Pulse)

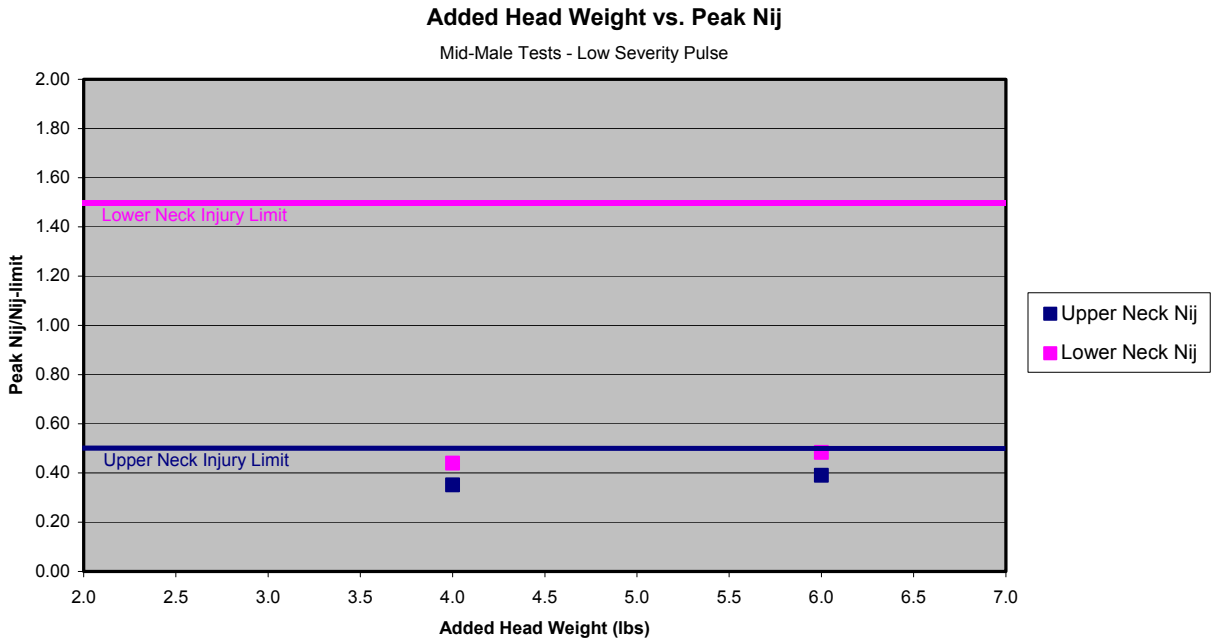

Figure E-4: Peak Nij Values (Mid-Male, Low Severity Pulse)

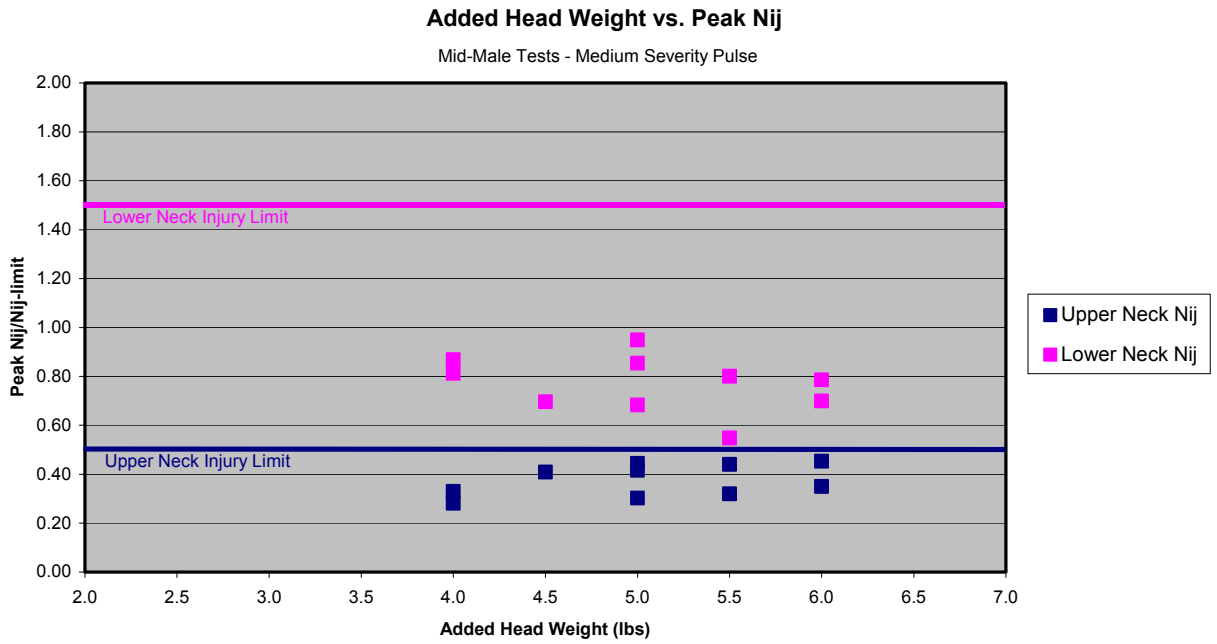

Figure E-5: Peak Nij Values (Mid-Male, Medium Severity Pulse)

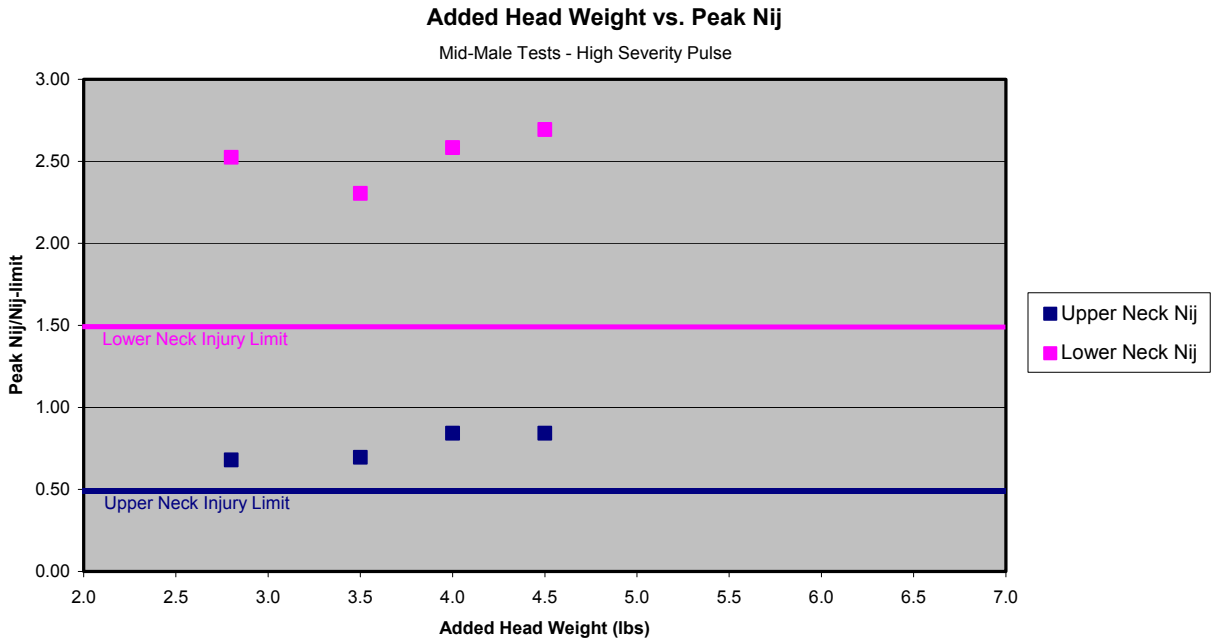

Figure E-6: Peak Nij Values (Mid-Male, High Severity Pulse)



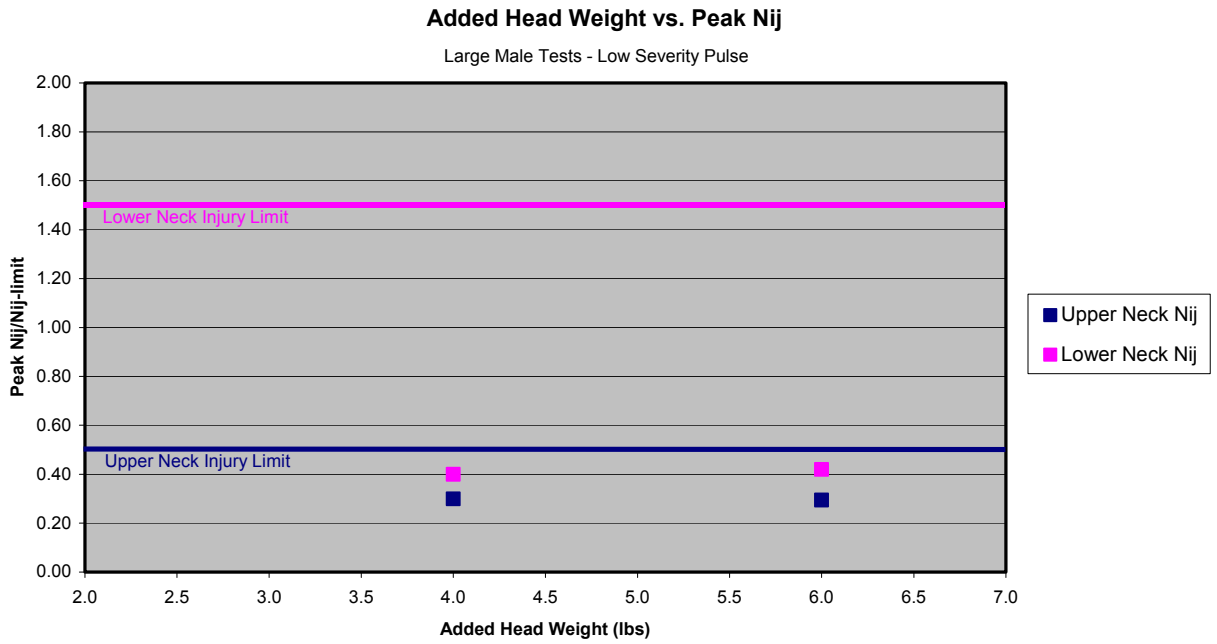

Figure E-7: Peak Nij Values (Large Male, Low Severity Pulse)

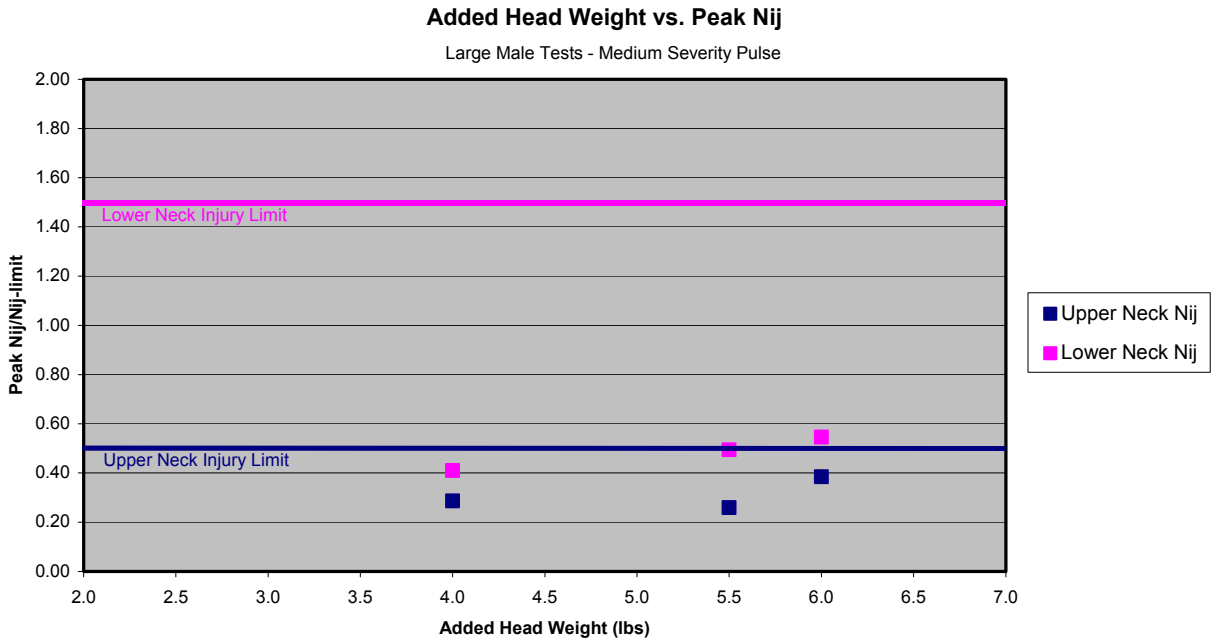

Figure E-8: Peak Nij Values (Large Male, Medium Severity Pulse)

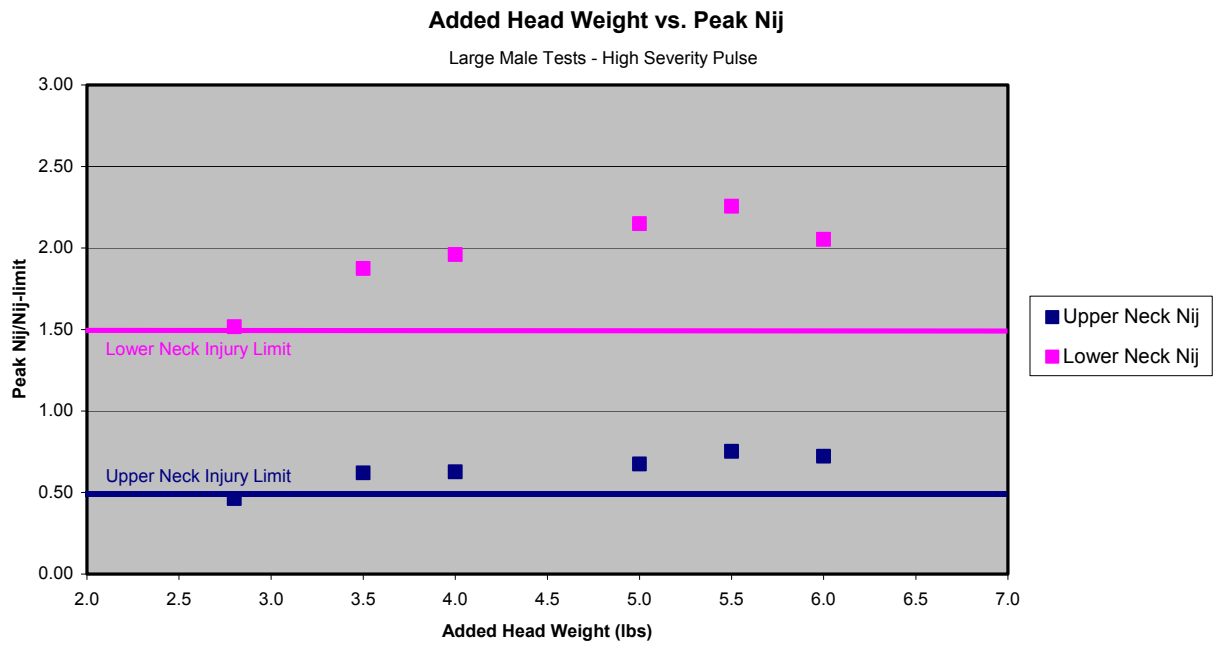

Figure E-9: Peak Nij Values (Large Male, High Severity Pulse)

THIS PAGE INTENTIONALLY LEFT BLANK

APPENDIX F  
STILL PHOTOGRAPHS

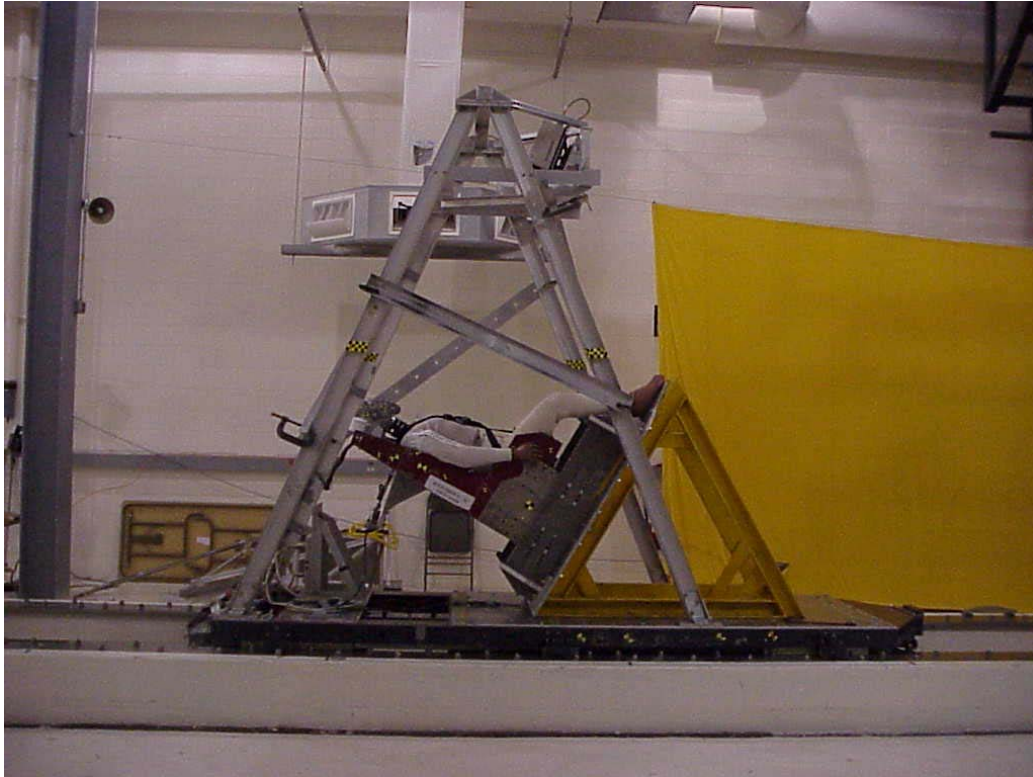

Figure F-1: Overall Test Setup

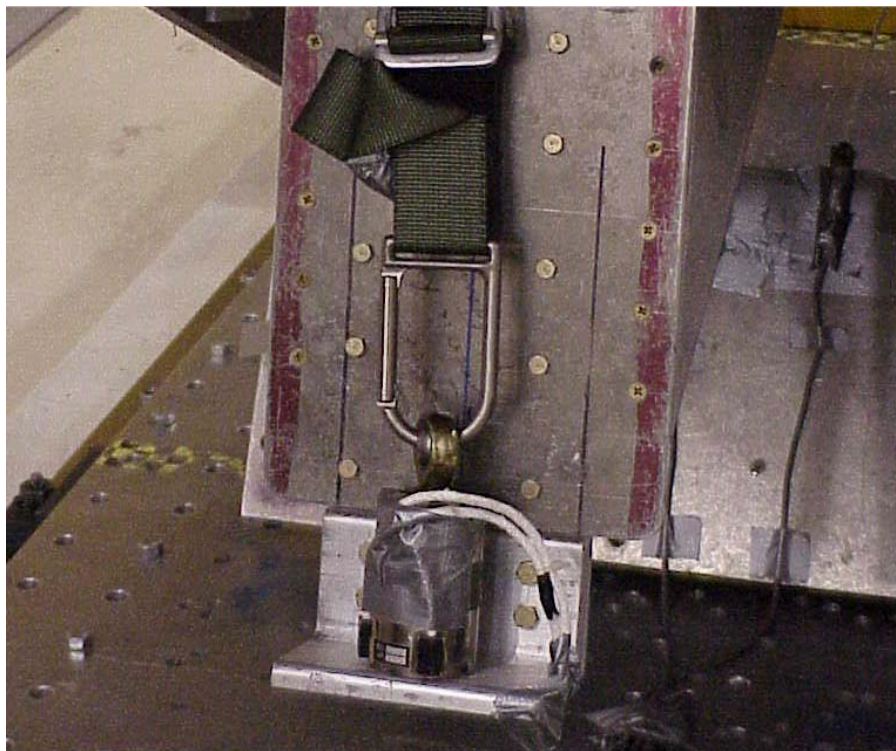

Figure F-2: Load Cell Integrated into 4-Point Restraint Yoke



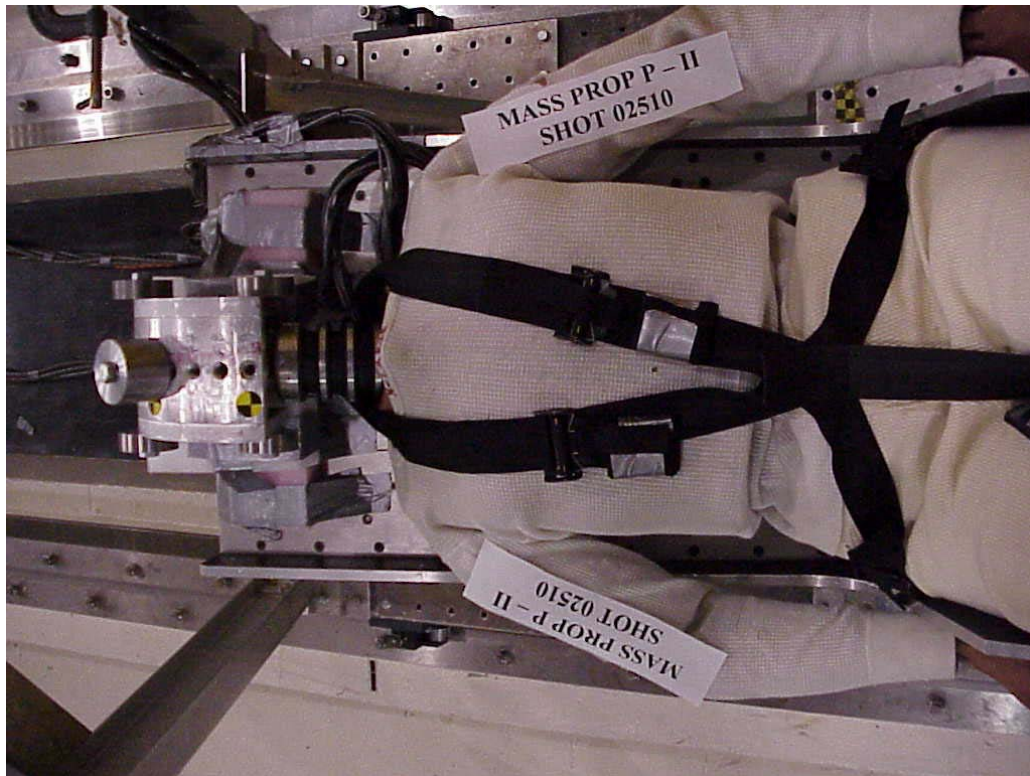

Figure F-3: Front Overhead View of Typical Test Setup

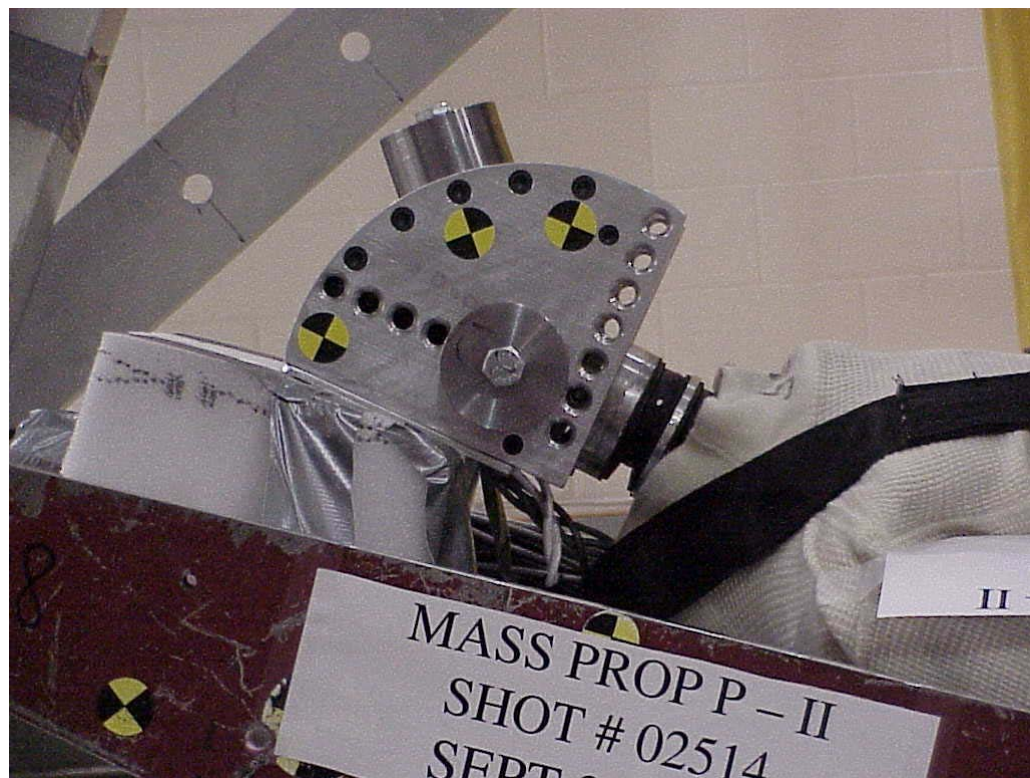

Figure F-4: Small Female with 4 lb Added Head Mass



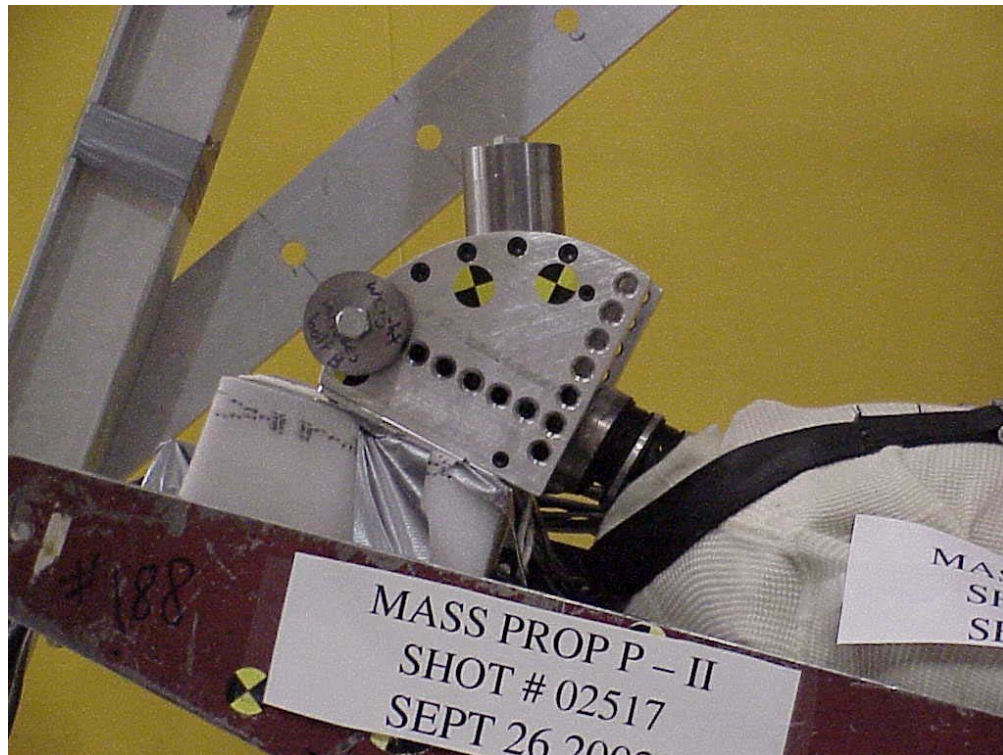

Figure F-5: Small Female with 6 lb Added Head Mass

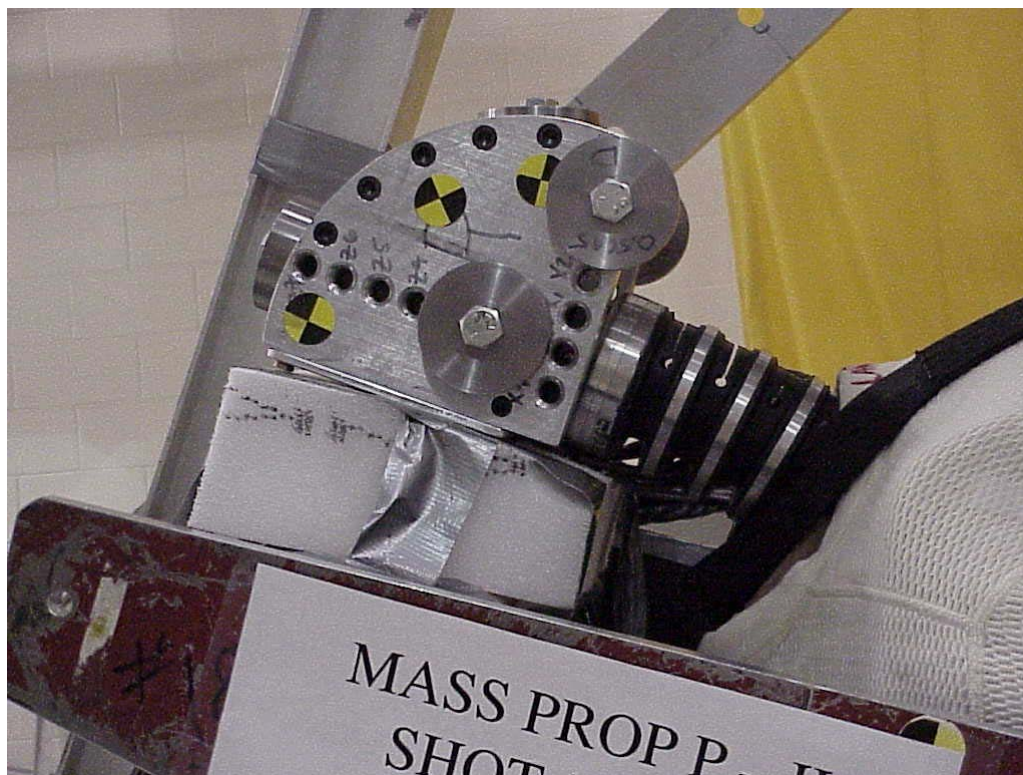

Figure F-6: Mid-size Male with 4 lb Added Head Mass



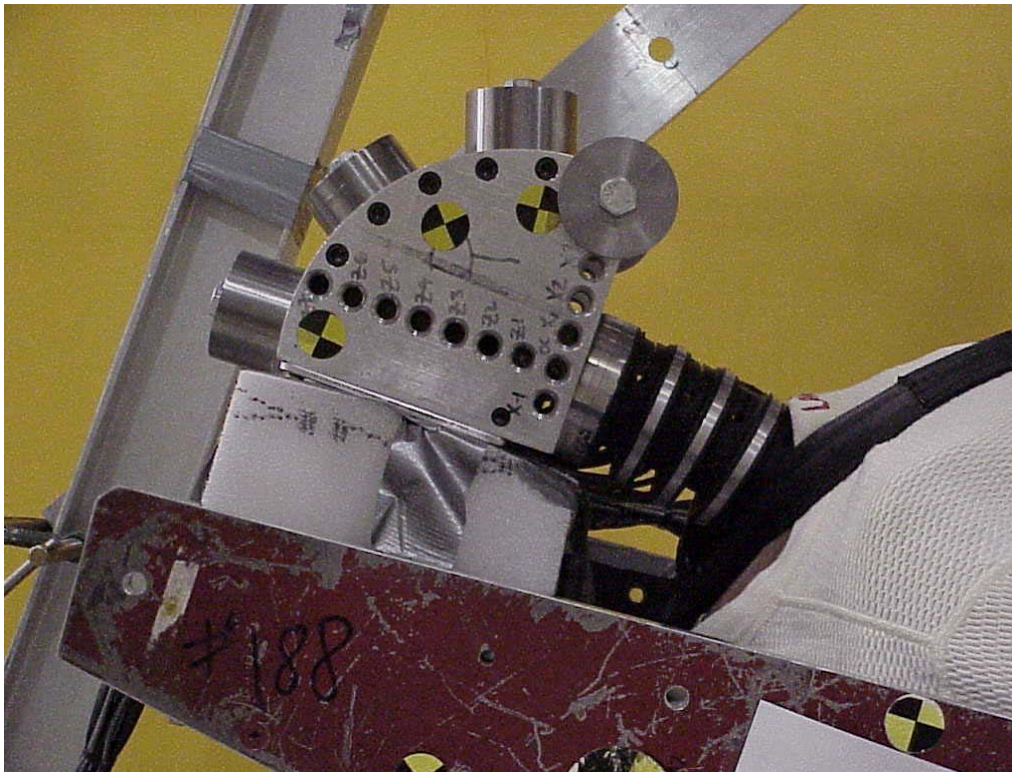

Figure F-7: Mid-size Male with 6 lb Added Head Mass



Figure F-8: Large Male with 4 lb Added Head Mass



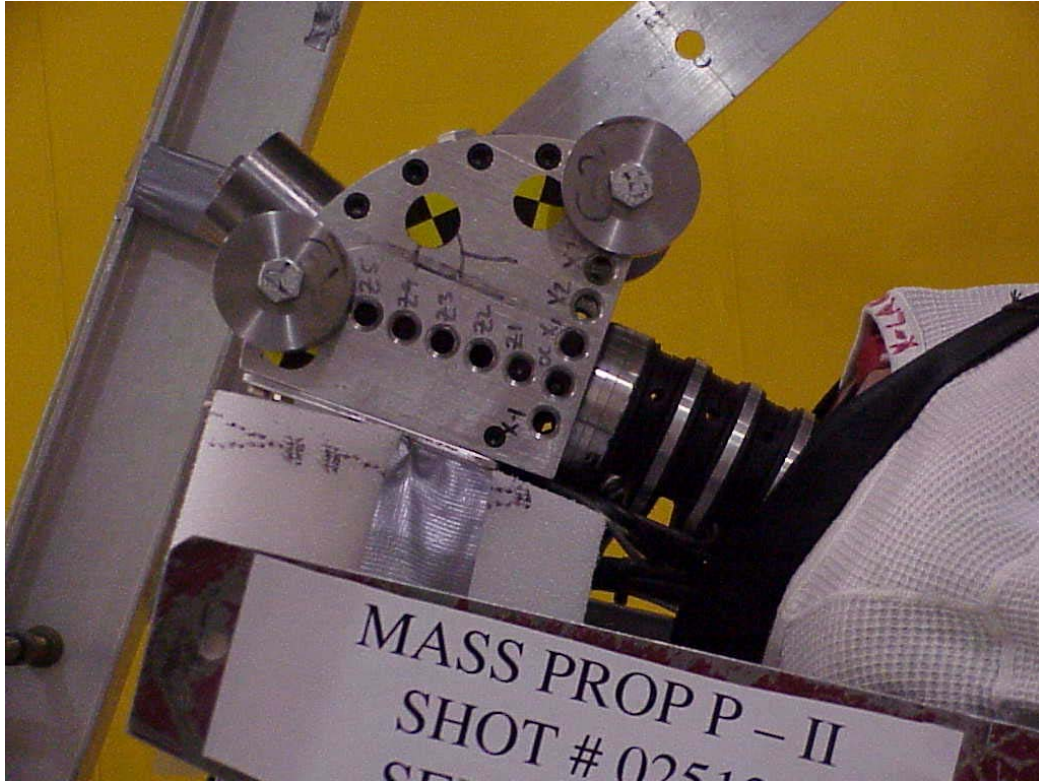

Figure F-9: Large Male with 6 lb Added Head Mass

APPENDIX G  
NECK INJURY CRITERIA

NECK TENSION LIMITS

The maximum acceptable neck tension (lifting force) limits measured at the occipital condyles (C0-C1, upper neck) and cervical vertebrae (C7-T1, lower neck) are defined in table G-1 (use linear interpolation for intermediate values in force and time duration) and graphically displayed in figure G-1. These limits represent the maximum allowable load that can be sustained for a given duration.

Table G-1: Neck Tension Force and Duration Limits for a Given Occupant Size

Small Female Hybrid III Type Manikin (96 to 118 lb)		Mid-Size Male Hybrid III Type Manikin		Large Male Hybrid III Type Manikin (200 to 245 lb)	
Duration (msec)	Tension at C0-C1 & C7-T1 (lb)	Duration (msec)	Tension at C0-C1 & C7-T1 (lb)	Duration (msec)	Tension at C0-C1 & C7-T1 (lb)
5	414	5	618	5	761
31	414	35	618	37	761
40	200	45	320	48	450
80	200	80	320	80	450

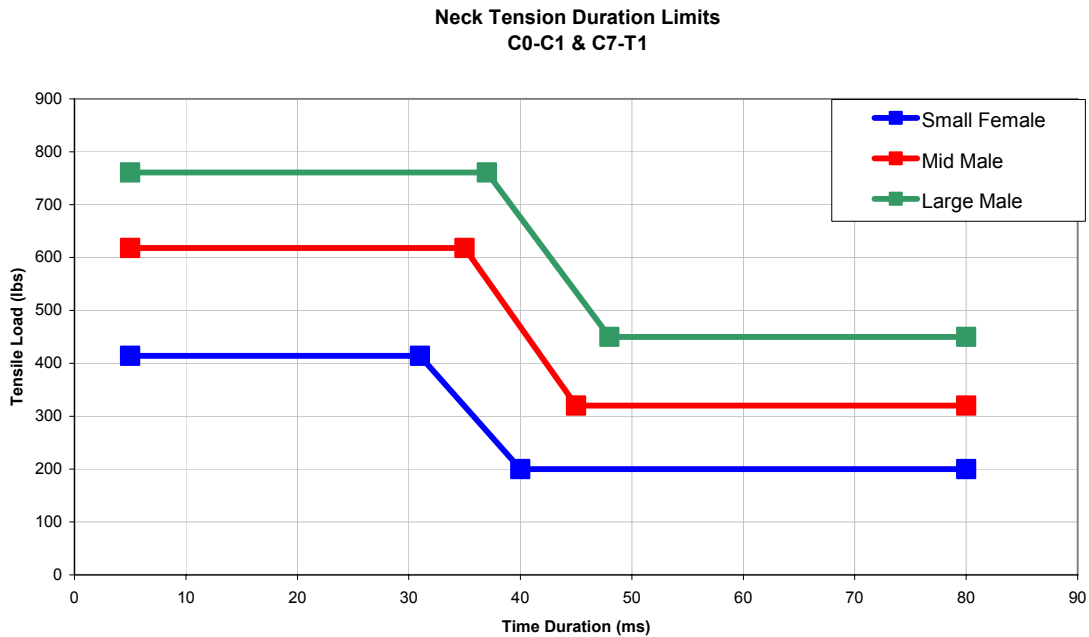

Figure G-1: Neck Tension Duration Limits (C0-C1 and C7-T1)

NECK COMPRESSION LIMITS

The maximum acceptable cervical compression force limits are defined in table G-2 (use linear interpolation for intermediate values in force and time duration) and graphically displayed in figure G-2.

Table G-2: Neck Compression Force Limits for a Given Occupant Size

Small Female Hybrid III Type Manikin (96 to 118 lb)		Mid-Size Male Hybrid III Type Manikin		Large Male Hybrid III Type Manikin (200 to 245 lb)	
Duration (msec)	Compression at C0-C1 & C7-T1 (lb)	Duration (msec)	Compression at C0-C1 & C7-T1 (lb)	Duration (msec)	Compression at C0-C1 & C7-T1 (lb)
5	519	5	790	5	979
27	200	30	320	32	450
80	200	80	320	80	450

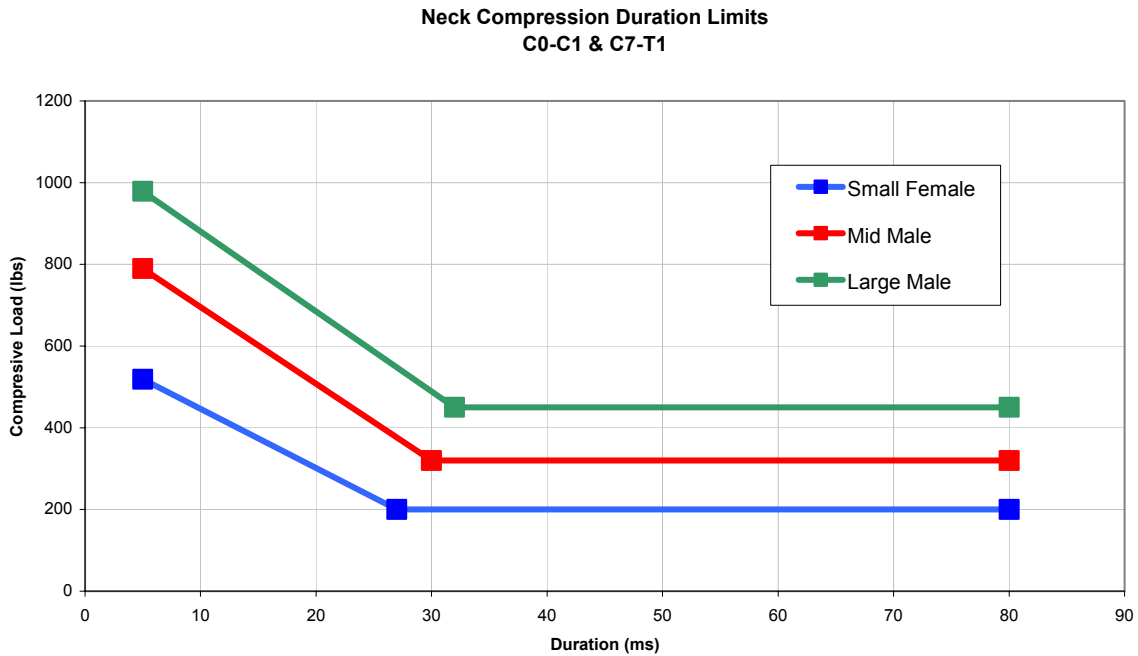

Figure G-2: Neck Compression Duration Limits (Co-C1 and C7-T1)

NECK SHEAR FORCE LIMITS

The maximum acceptable cervical shear force limits are defined in table G-3 (use linear interpolation for intermediate values in force and time duration) and graphically displayed in figures G-3 and G-4.

Table G-3: Neck Shear Force Limits for a Given Occupant Size

Small Female Hybrid III Type Manikin (96 to 118 lb)		Mid-Size Male Hybrid III Type Manikin		Large Male Hybrid III Type Manikin (200 to 245 lb)	
Duration (msec)	Resultant Shear at C0-C1 (lb)	Duration (msec)	Resultant Shear at C0-C1 (lb)	Duration (msec)	Resultant Shear at C0-C1 (lb)
5	405	5	625	5	777
20	225	25	337	28	414
29	225	35	337	39	414
37	165	45	247	50	304
80	165	80	247	80	304

Duration (msec)	Resultant Shear at C7-T1 (lb)	Duration (msec)	Resultant Shear at C7-T1 (lb)	Duration (msec)	Resultant Shear at C7-T1 (lb)
5	810	5	1250	5	1554
20	450	25	674	28	828
29	450	35	674	39	828
37	330	45	494	50	608
80	330	80	494	80	608

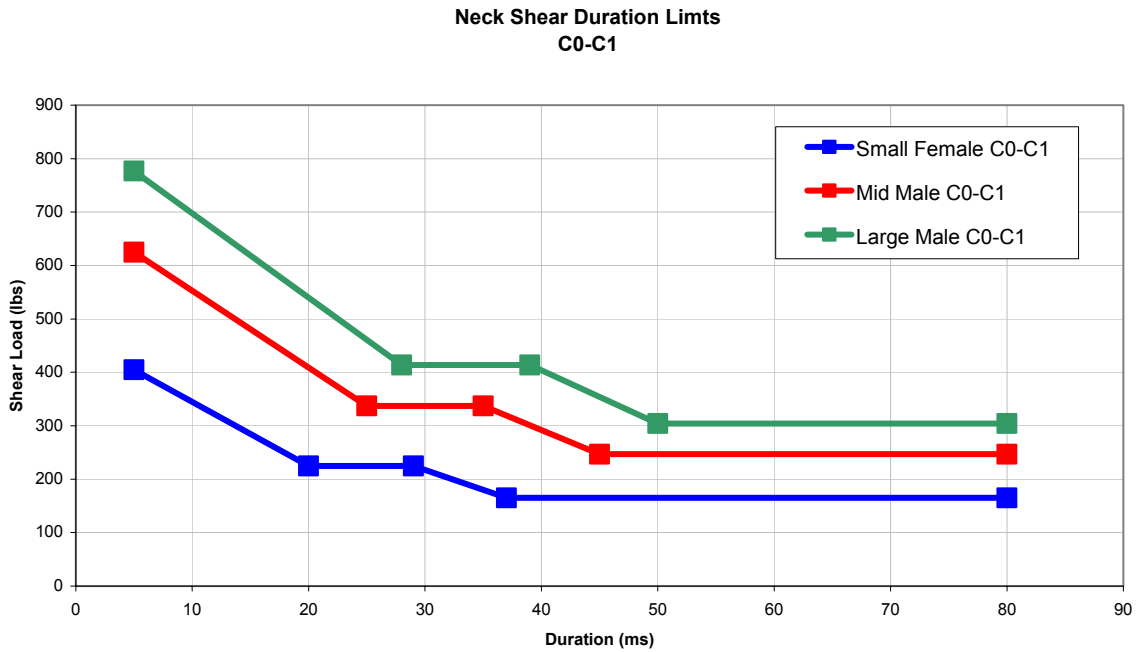

Figure G-3: Neck Shear Duration Limits (C0-C1)

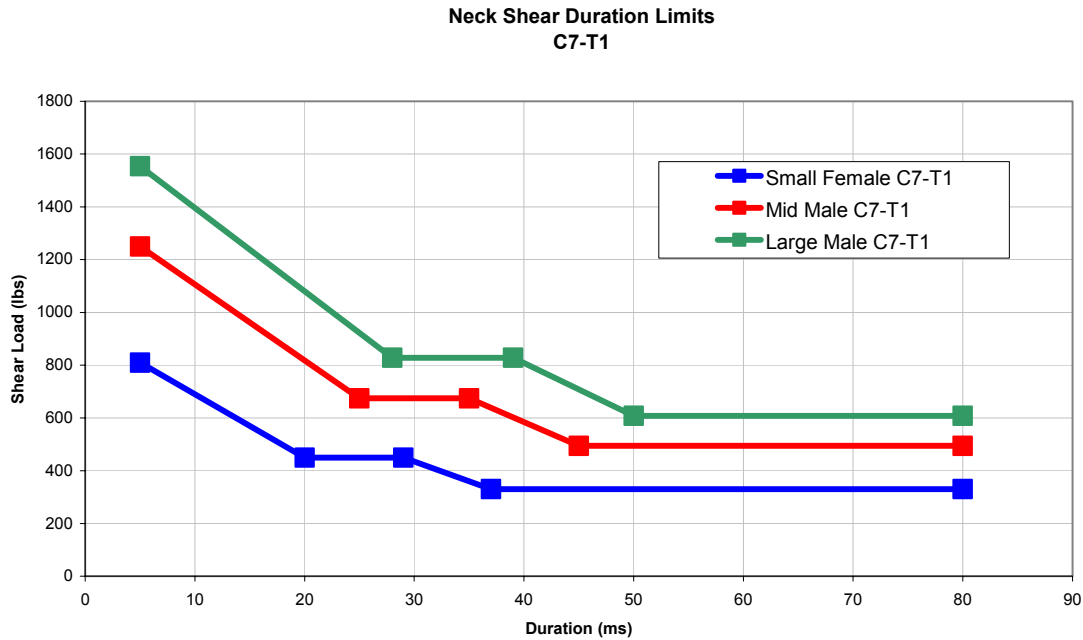

Figure G-4: Neck Shear Duration Limits (C7-T1)

#### COMBINED NECK MOMENT AND LOAD LIMITS

The maximum combined-cervical-force-and-moment limit, expressed as Neck Injury Criteria ( $N_{ij}$ ), is 0.5, as measured at the occipital condyles (C0-C1). The maximum  $N_{ij}$  as measured at the cervical vertebrae (C7-T1) is 1.5.  $N_{ij}$  is not applied for pure tension or compression.  $N_{ij}$  is calculated from the following equation:

$$N_{ij} = \frac{F_z}{F_{int}} + \frac{M_y}{M_{int}}$$

where:

$F_z$  is the axial tension/compression load.

$F_{int}$  is the critical intercept load (defined in table G-4).

$M_y$  is the flexion/extension bending moment.

$M_{int}$  is the critical intercept moment (defined in table G-4 and graphically displayed in figures G-5 and G-6).

Table G-4: Critical Intercept Values for Nij Calculation at C0-C1 for a Given Occupant Size

	Small Female Hybrid III Type Manikin (96 to 118 lb)	Mid-Size Male Hybrid III Type Manikin	Large Male Hybrid III Type Manikin (200 to 245 lb)
Tension (lb) (+F <sub>z</sub> )	964	1,530	1,847
Compression (lb) (-F <sub>z</sub> )	872	1,385	1,673
Flexion (in.-lb) (+My)	1,372	2,744	3,673
Extension (in.-lb) (-My)	593	1,195	1,584

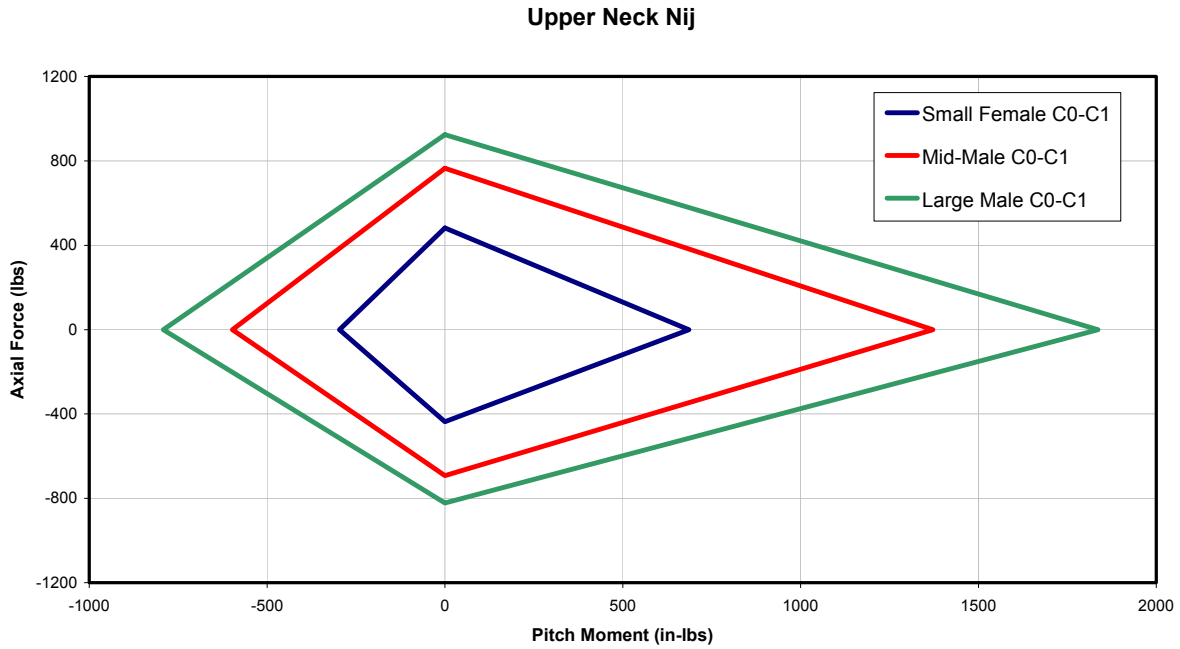

Figure G-5: Upper Neck Nij

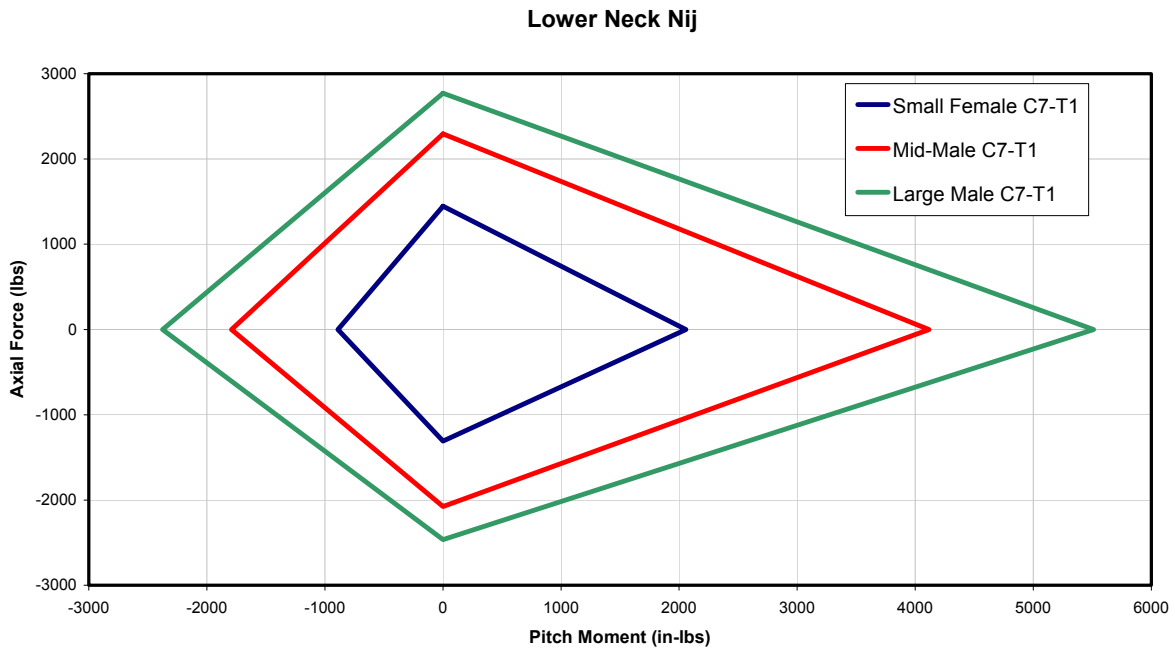

Figure G-6: Lower Neck Nij

DISTRIBUTION:

NAVAIRWARCENACDIV (4.6.2.1), Bldg. 2187, Room 1280-F4 (2)  
48110 Shaw Road, Patuxent River, MD 20670

NAVAIRSYSCOM (AIR-5.0E), Bldg. 304, Room 120 (1)  
22541 Millstone Road, Patuxent River, MD 20670-1606

NAVAIRSYSCOM (AIR-4.11), Bldg. 304, Room 102 (1)  
22541 Millstone Road, Patuxent River, MD 20670-1606

NAVAIRWARCENACDIV (7.2.5.1), Bldg. 405, Room 108 (1)  
22133 Arnold Circle, Patuxent River, MD 20670-1551

NAVTESTWINGLANT (55TW01A), Bldg. 304, Room 200 (1)  
22541 Millstone Road, Patuxent River, MD 20670-1606

DTIC (1)  
8725 John J. Kingman Road, Suite 0944, Ft. Belvoir, VA 22060-6218



**UNCLASSIFIED**

**UNCLASSIFIED**