

UNCLASSIFIED

AD NUMBER

ADB019780

LIMITATION CHANGES

TO:

Approved for public release; distribution is unlimited.

FROM:

Distribution authorized to U.S. Gov't. agencies only; Test and Evaluation; 15 JUL 1977. Other requests shall be referred to Air Force Materials Lab., Wright-Patterson AFB, OH 45433.

AUTHORITY

AFWAL ltr 17 Jan 1989

THIS PAGE IS UNCLASSIFIED

THIS REPORT HAS BEEN DELIMITED
AND CLEARED FOR PUBLIC RELEASE
UNDER DOD DIRECTIVE 5200.20 AND
NO RESTRICTIONS ARE IMPOSED UPON
ITS USE AND DISCLOSURE.

DISTRIBUTION STATEMENT A

APPROVED FOR PUBLIC RELEASE;
DISTRIBUTION UNLIMITED.

(2) (12)

19

AD B O 1 9 7 8 0

ALUMINUM ALLOY 7050 EXTRUSIONS

ALUMINUM COMPANY OF AMERICA
ALCOA LABORATORIES
ALCOA CENTER, PA 15069

D D C
PAPER
JUL 12 1977
REGISTERED

MARCH 1977

FINAL REPORT

Distribution limited to U.S. gov't. agencies only;
Test and Evaluation; 15 JUL 1977. Other requests
for this document must be referred to

AFML/LTMA
W.P. AFB, Ohio 45433

~~Approved for public release; distribution unlimited~~

AU NO. _____
BDC FILE COPY

AIR FORCE MATERIALS LABORATORY
AIR FORCE WRIGHT AERONAUTICAL LABORATORIES
AIR FORCE SYSTEMS COMMAND
WRIGHT-PATTERSON AIR FORCE BASE, OHIO 45433

DISCLAIMER NOTICE

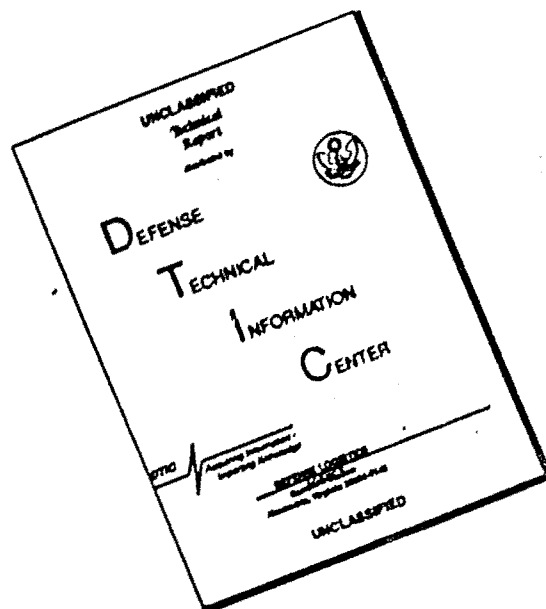

THIS DOCUMENT IS BEST QUALITY AVAILABLE. THE COPY FURNISHED TO DTIC CONTAINED A SIGNIFICANT NUMBER OF PAGES WHICH DO NOT REPRODUCE LEGIBLY.

NOTICES

When Government drawings, specifications, or other data are used for any other purpose other than in connection with a definitely related Government procurement operation, the United States Government thereby incurs no responsibility for any obligation whatsoever; and the fact that the Government may have formulated, furnished, or in any way supplied the said drawings, specifications, or other data, is not to be regarded by implication or otherwise as in any manner licensing the holder or any other person or corporation or conveying any rights or permission to manufacture, use, or sell any patented invention that may in any way be related thereto.

Copies of this report should not be returned unless return is required by security considerations, contractual obligations, or notice on a specific document.

This final report was submitted by Aluminum Company of America, Alcoa Center, PA, under Contract F33615-73-C-5015, Manufacturing Methods Project 244-3, "Alloy 7050 Extrusions." Messrs Theodore S. Felker and Norman Klarquist, AFML/LTM, were the laboratory program managers.

This technical report has been reviewed and is approved for publication.

Norman E. Klarquist
NORMAN E. KLARQUIST
Project Monitor

FOR THE DIRECTOR

H. A. Johnson
H. A. JOHNSON
Chief, Metals Branch
Manufacturing Technology Division

AIR FORCE - 2 JUN 77 - 200

ACQUISITION BY	
NTIS	Work Section <input type="checkbox"/>
DDC	Buff Section <input checked="" type="checkbox"/>
UNANNOUNCED	
JUSTIFICATION	
BY DISTRIBUTION/AVAILABILITY CODES	
Dist.	AVAIL. and/or SPECIAL
B	

Unclassified

SECURITY CLASSIFICATION OF THIS PAGE (When Data Entered)

19 REPORT DOCUMENTATION PAGE		READ INSTRUCTIONS BEFORE COMPLETING FORM	
1. REPORT NUMBER AFML-TR-76-129 ✓	2. GOVT ACCESSION NO.	3. RECIPIENT'S CATALOG NUMBER	
4. TITLE (and Subtitle) Aluminum Alloy 7050 Extrusions .		7. TYPE OF REPORT & PERIOD COVERED Final rept. Mar 73 - Jun 76	
		8. PERFORMING ORG. REPORT NUMBER 56-76-GE60	
7. AUTHOR(s) J. T./Staley, J. E./Jacoby, R. E./Davies, G. E./Nordmark J. D./Walsh, and F. R. Kucolph		6. CONTRACT OR GRANT NUMBER(s) F33615-73-C-5015	
9. PERFORMING ORGANIZATION NAME AND ADDRESS Aluminum Company of America ✓ Alcoa Laboratories Alcoa Center, Pa. 15069		10. PROGRAM ELEMENT, PROJECT, TASK AREA & WORK UNIT NUMBERS Project No. 244-3	
11. CONTROLLING OFFICE NAME AND ADDRESS United States Air Force Air Force Systems Command, HQ 4950th Test Wing, 4950/Pm RB, WPAFB, Ohio 45433		12. REPORT DATE March 1977	
		13. NUMBER OF PAGES 343	
14. MONITORING AGENCY NAME & ADDRESS (if different from Controlling Office) <i>(Handwritten: 344P)</i>		15. SECURITY CLASS. (of this report) Unclassified	
		15a. DECLASSIFICATION/DOWNGRADING SCHEDULE	
16. DISTRIBUTION STATEMENT (of this Report) UNITED STATES GOVERNMENT ONLY			
17. DISTRIBUTION STATEMENT (of the abstract entered in Block 20, if different from Report)			
18. SUPPLEMENTARY NOTES None			
19. KEY WORDS (Continue on reverse side if necessary and identify by block number) 7050 Extruded Shapes Shear Fracture Toughness Aluminum Tensile Bearing Fatigue Alloy Compressive Modulus of Elasticity Crack Propagation Ingot Fabricating Stress-Strain Stress-Corrosion Casting Heat Treatment Exfoliation			
20. ABSTRACT (Continue on reverse side if necessary and identify by block number) Practices for casting 25 and 35-inch diameter alloy 7050 ingot were developed; effects of fabricating variables on mechanical properties and corrosion characteristics were evaluated, and aging conditions were established to produce two tempers, T7651X and T7351X, having two combinations of strength, stress-corrosion characteristics, and toughness. Twenty extruded shapes were subsequently fabricated to provide material for determination of design mechanical properties, modulus of elasticity, stress-strain curves, fracture toughness (K_{Ic}), fatigue strengths, fatigue crack propagation rates, and stress-corrosion and corrosion			

D D C
 REPRODUCED
 JUL 12 1977
 RECEIVED
 A

017460

5B

20. Abstract

→ characteristics. The alloy 7050 extrusions developed combinations of properties desired by the airframe industry that were superior to those of extrusions of commercially established aluminum alloys. ←

SUMMARY

Practices for casting 25-inch and 35-inch diameter 7050 ingots were developed in the laboratory; then the technology was modified so that ingots could be cast under commercial conditions. An important factor in producing sound ingot was attaining an ingot surface equilibrium temperature between 410°F and 440°F during casting. If the equilibrium temperature was much below 410°F, the stresses induced during solidification cracked the ingot violently. If, on the other hand, the equilibrium temperature was much above 440°F, either the ingots cracked because the center was still very weak or the center was unacceptably porous. Proper control was achieved by careful positioning of the device to remove ingot cooling water below the mold (wiper). Preventing cracking before the ingot initially reached the wiper was also very important. Close attention to starting casting rate and to bottom block cooling was required to prevent cracking during the start-up.

Effects of extrusion temperature of heavy sections and of extrusion temperature, extrusion ratio, and width/thickness ratio of lighter sections were evaluated. Extrusion temperature within the range possible in the fabrication of wide, heavy shapes had no effect on structure or properties. For smaller sections, high extrusion temperatures, high extrusion ratios, and low width/thickness ratios favored more attractive combinations of strength, notch toughness, and resistances to stress-corrosion cracking and exfoliation corrosion.

Second-step aging conditions were established to produce 7050 extrusions having either high resistance to exfoliation corrosion with resistance to stress-corrosion cracking substantially better than that of 7075-T651X (7050-T7651X) or a resistance to stress-corrosion cracking comparable to that of 7075-T7351X (7050-T7351X). Treatments of 8 and 12 hours at 350°F, or their equivalent, are recommended for 7050-T7651X and 7050-T7351X, respectively.

To provide material for determination of mechanical and corrosion characteristics, twenty extrusions were fabricated from 25-inch and 35-inch diameter ingots in three phases: (1) five 7050-T7351X extrusions (two aircraft sections and three rectangles) from a 21-inch diameter extrusion cylinder, (2) five 7050-T7351X and five 7050-T7651X aircraft sections from 25-inch and 29-inch diameter extrusion cylinders, (3) five additional 7050-T7351X panels for a possible C5A wing retrofit from a 29-inch diameter cylinder.

The extrusions were subjected to a variety of tests. Tensile, compressive, shear, bearing, stress-strain, and modulus of elasticity tests were performed, and ratios of the various properties to the tensile ultimate and yield strengths were calculated. The results indicated that temper, thickness, and extrusion size had an effect on the value of the ratios. Plane strain fracture toughness tests indicated that the 7050 extrusions developed a combination of strength and toughness that was superior to that of commercially established alloy extrusions. Accelerated corrosion tests predicted

that both 7050-T7651X and 7050-T7351X extrusions will be highly resistant to exfoliation corrosion in natural environments. Accelerated stress-corrosion tests indicated that 7050-T7651X extrusions with strength levels approaching those of 7075-T651X in thin sections and exceeding them in thick sections develop appreciably higher resistance to stress-corrosion cracking. Thick sections of 7050-T7351X develop a resistance to stress-corrosion cracking similar to that of 7075-T7351X and have higher strength. Wide sections with a cross-sectional area greater than about 61 in.² may have a slightly lower resistance to stress-corrosion cracking than when the cross-sectional area is less than about 43 in.². Fatigue test performances of smooth and notched specimens and rates of fatigue crack growth for 7050-T7651X and T7351X extrusions were comparable to the performances of previously tested 7050-T7651X extrusions.

PREFACE

This investigation was conducted for the U.S. Air Force Materials Laboratory, Wright-Patterson Air Force Base, Ohio, under Contract No. F33615-73-C-5015, Project No. 244-3, by Alcoa Laboratories, Alcoa Center Pa., with the cooperation of Alcoa's Lafayette Works, Lafayette, Indiana. Almost all of the work was performed during the period March 1973 through June 1976, and a draft of the report was submitted in July 1976. An extension was subsequently awarded to obtain supplementary fatigue crack propagation data. A draft of the section containing this data was submitted in January 1977.

Mr. J. T. Staley was project coordinator. Dr. W. J. Bergmann, Mr. J. E. Jacoby, Mr. G. G. Owen, and Mr. D. A. Linde developed the ingot casting processes. Mr. Staley developed the aging practices. Mr. A. H. Sorensen supervised the fabricating and heat treating operations. Mr. J. W. Coursen began and Mr. R. E. Davies completed determining the design mechanical properties, fracture toughness, and S-N fatigue in ambient air; Mr. Davies derived the values for MIL-HDBK-5 properties. Mr. G. E. Nordmark determined the S-N fatigue properties in salt fog and the fatigue propagation rates. Mr. J. D. Walsh determined the exfoliation and stress-corrosion characteristics; Mr. D. O. Sprowls, Mr. B. M. Ponchel, and Mr. Staley contributed to the analyses. Mr. F. F. Rudolph correlated ultrasonic inspection response with mechanical properties. Mr. R. R. Senz and Mr. S. F. Collis developed the specifications. Mr. R. R. Sawtell analyzed the data relating notch toughness to fabricating practice and section geometry and wrote Appendix D. Dr. B. K. Park related microstructure to resistance to stress-corrosion cracking and wrote Appendix C.

Messrs T. S. Felker and N. E. Klarquist (AFML/LTM) were Project Monitors for the Air Force.

TABLE OF CONTENTS

<u>Section</u>		<u>Page</u>
I.	INTRODUCTION-----	1
II.	ESTABLISH MANUFACTURING METHODS-----	2
	1. Ingot Casting-----	2
	a. Background and Objective-----	2
	b. 25-Inch Diameter Casting Trials - Laboratory-----	3
	c. 25-Inch Diameter Casting Trials - Plant--	7
	d. 35-Inch Diameter Casting Trials - Laboratory-----	7
	e. 35-Inch Diameter Casting Trials - Plant--	9
	2. Processing-----	10
	a. Fabricating-----	10
	(1) Heavier Sections-----	10
	(2) Lighter Sections-----	14
	(3) Conclusions-----	21
	b. Heat Treating-----	22
III.	PRODUCE EXTRUSIONS-----	27
	1. Ingot Casting-----	27
	2. Extrusion and Heat Treatment-----	30
	a. 21-Inch Diameter Cylinder-----	30
	b. 25 and 29-Inch Diameter Cylinders-----	31
	c. Additional C5A Wing Plank Extrusions-----	33
IV.	EVALUATE-----	34
	1. Composition-----	34
	2. Ultrasonically-Detected Discontinuities-----	34
	3. Design Mechanical Properties-----	35
	a. Tensile, Compressive, Shear and Bearing--	35
	(1) Procedure-----	35
	(2) Results and Discussion-----	37
	b. Stress-Strain, Compressive Tangent- Modulus Curves, and Modulus of Elasticity-----	39
	(1) Procedure-----	39
	(2) Results-----	40
	(3) Conclusion-----	41
	c. Derived MIL-HDBK-5 Properties-----	41
	(1) Conclusion-----	44
	4. Fracture Toughness-----	44
	a. Procedure-----	44
	b. Results and Discussion-----	45
	c. Conclusions-----	47

TABLE OF CONTENTS (CONTINUED)

<u>Section</u>	<u>Page</u>
5. S-N Fatigue-----	48
a. Laboratory Air-----	48
(1) Procedure-----	48
(2) Results and Discussion-----	48
(3) Conclusions-----	51
b. Salt-Fog Environment-----	51
(1) Procedure-----	51
(2) Results and Discussion-----	51
(3) Conclusions-----	52
6. Fatigue Crack Propagation (Normal ΔK)-----	52
a. Procedure-----	52
b. Results and Discussion-----	54
c. Conclusion-----	56
7. Fatigue Crack Propagation (Low ΔK)-----	56
8. Corrosion Characteristics-----	57
a. Procedure-----	57
(1) Resistance to Exfoliation-----	57
(2) Resistance to SCC - Smooth Specimens	57
(3) Resistance to SCC - Precracked	59
Specimens-----	59
b. Results and Discussion-----	60
(1) Resistance to Exfoliation-----	60
(2) Resistance to SCC - Smooth Specimens	61
(3) Resistance to SCC - Precracked	64
Specimens-----	64
(4) Comparison of Test Results for	70
Precracked and Smooth SCC Specimens-	70
c. Conclusions-----	71
 V. ESTABLISH SPECIFICATIONS AND QUALITY CONTROL	
PROCEDURES-----	72
1. Lot Release Criteria-----	72
a. Minimum Electrical Conductivity and	72
Maximum Yield Strength-----	72
b. Minimum Tensile Properties-----	74
c. Fracture Toughness-----	75
2. Summary-----	76
3. Other Pertinent Specifications-----	76
4. Qualification Procedure-----	77
5. Heat Treatment Recommendations-----	77
 VI. CONCLUSIONS-----	78
 APPENDIX A - Low Crack Growth Rate Fatigue Propagation	
Tests-----	251
APPENDIX B - SCC Crack Growth Curves-----	258
APPENDIX C - Resistance to SCC and Microstructure-----	301
APPENDIX D - Effect of Section Geometry and Fabrication	
on Notch Tensile-Yield Strength Ratio-----	315
REFERENCES-----	332
DISTRIBUTION LIST-----	337

LIST OF ILLUSTRATIONS

<u>No.</u>		<u>Page</u>
1	Alcoa Level Pour Mold-----	159
2	Bottom Block-----	160
3	Alcoa 181 Process-----	161
4	7050 - 25-Inch Diameter Ingot, S-388511-C3 - Top End-----	162
5	Alcoa Section 263902 - Alloy 7050 Extrusion-----	163
6	Shows no Significant Effect of Extrusion Tempera- ture on Microstructure-----	164
7a	Microstructures at Surface and Midplane Near Front of Alloy 7050 Extrusion Fabricated at 750°F-----	165
7b	Microstructures at Surface and Midplane Near Rear of Alloy 7050 Extrusion Fabricated at 750°F-----	166
7c	Microstructures at Surface and Midplane Near Front of Alloy 7050 Extrusion Fabricated at 800°F-----	167
7d	Microstructures at Surface and Midplane Near Rear of Alloy 7050 Extrusion Fabricated at 800°F-----	168
8	Notch Tensile Specimen-----	169
9a	Macrostructures of Alloy 7050 Rectangles Extruded from 21-Inch Diameter Billets at High Extrusion Temperature-----	170
9b	Macrostructures of Alloy 7050 Rectangles Extruded from 21-Inch Diameter Billets at Low Extrusion Temperature-----	171
9c	Macrostructures of Alloy 7050 Rectangles Extruded from 11-Inch Diameter Billets at Low Extrusion Temperature-----	172
9d	Macrostructures of Alloy 7050 Rectangles Extruded from 11-Inch Diameter Billets at High Extrusion Temperature-----	173
10	Yield Strength vs Overaging Time, 7050 Extrusions--	174

LIST OF ILLUSTRATIONS (CONTINUED)

<u>No.</u>		<u>Page</u>
11	Notch Tensile-Yield Ratio vs Yield Strength for 7050 Extrusions-----	175
12a	Longitudinal Section at Midplane of 1.5 x 7.5" thick Rectangular Bar 7050 Alloy Extrusion Fabri- cated at Extrusion Ratio 32-----	176
12b	Longitudinal Section at Midplane of 1.5 x 7.5" thick Rectangular Bar 7050 Alloy Extrusion Fabri- cated at Extrusion Ratio 9-----	176
12c	Longitudinal Section at Midplane of 2.75 x 4.0" thick Rectangular Bar 7050 Alloy Extrusion Fabri- cated at Extrusion Ratio 32-----	177
12d	Longitudinal Section at Midplane of 2.75 x 4.0" thick Rectangular Bar 7050 Alloy Extrusion Fabri- cated at Extrusion Ratio 9-----	177
13a	Grain Structure at Stress-Corrosion Test Specimen Location in 2.75-inch x 4.0-inch Section Extruded at Low Temperature-----	178
13b	Grain Structure at Stress-Corrosion Test Specimen Location in 1.5-inch x 7.5-inch Section Extruded at Low Temperature-----	179
14	Grain Structure at Stress-Corrosion Test Specimen Location in 1.5-inch x 7.5-inch Section Extruded at High Temperature-----	180
15	Photograph of 35-Inch Diameter 7050 Ingot-----	181
16	Macroetched Cross-Sections of Alloy 7050-T73510 Rectangular Extrusions-----	182
17	Macroetched Cross-Sections of Alloy 7050-T73510 Panel Extrusions-----	183
18	Macroetched Cross-Sections of Alcoa Section 165822 Alloy 7050 Extrusions-----	184
19	Macroetched Cross-Sections of Alcoa Section 213592 Alloy 7050 Extrusions-----	185
20	Macroetched Cross-Sections of Alcoa Section 263902 Alloy 7050 Extrusions-----	186

LIST OF ILLUSTRATIONS (CONTINUED)

<u>No.</u>		<u>Page</u>
21	Macroetched Cross-Sections of Alcoa Section 291812 Alloy 7050 Extrusions-----	187
22	Macroetched Cross-Sections of Alcoa Section 900102 Alloy 7050 Extrusions-----	188
23	Illustrates Details of Joggled End of Extrusion for C5A-----	189
24	Joggled Extrusions for C5A. Joggled Ends Face Camera-----	190
25	Axial-Stress Fatigue Data for Smooth Specimens of 7050-T7351X Extruded Shapes, Section 291812-----	191
26	Tensile Specimens-----	192
27	Compressive and Shear Specimens-----	193
28	Bearing Specimen-----	194
29	Typical Stress-Strain and Compressive Tangent-Modulus Curves for 7050-T7651X Aluminum Alloy (Extruded Shapes) at Room Temperature - Thickness: <1.99 in.-----	195
30	Typical Stress-Strain and Compressive Tangent-Modulus Curves for 7050-T7651X Aluminum Alloy (Extruded Shapes) at Room Temperature - Thickness: 2.000-5.000 in.-----	196
31	Typical Stress-Strain and Compressive Tangent-Modulus Curves for 7050-T7351X Aluminum Alloy (Extruded Shapes) at Room Temperature - Thickness: <1.999 in.-----	197
32	Typical Stress-Strain and Compressive Tangent-Modulus Curves for 7050-T7351X Aluminum Alloy (Extruded Shapes) at Room Temperature - Thickness: 2.000-5.000 in.-----	198
33	Average Stress-Strain and Compressive Tangent-Modulus Curves for 7050-T7351X Extruded Aluminum Alloy C5A Wing Panels at Room Temperature-----	199
34	Compact Fracture Toughness Specimen-----	200
35	Fracture Specimen Orientations-----	201

LIST OF ILLUSTRATIONS (CONTINUED)

<u>No.</u>		<u>Page</u>
36	Setup for Fatigue Precracking of Compact Tension Fracture Toughness Specimens-----	202
37	Setup for Testing Compact Tension Fracture Toughness Specimens-----	203
38	K_{Ic} vs Thickness of 7050-T7651X and 7050-T7351X Extruded Shapes-----	204
39	K_{Ic} vs Tensile Yield Strength of 7050-T7651X and 7050-T7351X Extruded Shapes-----	205
40	Compares Strength and Toughness of 7050 and 7175 Extrusions, Section 900102, Wing Panel for C5A-----	206
41	Smooth and Notched Axial-Stress Fatigue Specimens---	207
42	Axial-Stress Fatigue Data for Smooth Specimens of 7050-T7651X and T7351X Extruded Shapes, $R=+0.1$ -----	208
43	Axial-Stress Fatigue Data for Smooth Specimens of 7050-T7651X and T7351X Extruded Shapes, $R=-1.0$ -----	209
44	Axial-Stress Fatigue Data for Smooth Specimens of 7050-T7351X Extruded Shapes, $<43 \text{ in.}^2$ -----	210
45	Axial-Stress Fatigue Data for Smooth Specimens of 7050-T7351X Extruded Shapes, 61 to 66 in.^2 , $R=+0.1$ --	211
46	Axial-Stress Fatigue Data for Smooth Specimens of 7050-T7351X Extruded Shapes, 61 to 66 in.^2 , $R=-1.0$ --	212
47	Axial-Stress Fatigue Data for Notched Specimens of 7050-T7651X and T7351X Extruded Shapes, $R=+0.1$ -----	213
48	Axial-Stress Fatigue Data for Notched Specimens of 7050-T7651X and T7351X Extruded Shapes, $R=-1.0$ -----	214
49	Axial-Stress Fatigue Data for Notched Specimens of 7050-T7351X Extruded Shapes, $<43 \text{ in.}^2$ -----	215
50	Axial-Stress Fatigue Data for Notched Specimens of 7050-T7351X Extruded Shapes, 61 to 66 in.^2 , $R=+0.1$ --	216
51	Axial-Stress Fatigue Data for Notched Specimens of 7050-T7351X Extruded Shapes, 61 to 66 in.^2 , $R=-1.0$ --	217

LIST OF ILLUSTRATIONS (CONTINUED)

<u>No.</u>		<u>Page</u>
52	Smooth and Notched Fatigue of 7050-T7651X, Salt Fog, R=0-----	218
53	Smooth and Notched Fatigue of 7050-T7351X, Salt Fog, R=0-----	219
54	Smooth and Notched Fatigue of 7050-T7351X, Salt Fog, R=0-----	220
55	Dimensions for Compact Fatigue Crack Propagation Specimen-----	221
56	Setup for Fatigue Crack Propagation Tests in Humid Environment-----	222
57	Compact Crack Propagation Specimen in Fatigue Machine-----	223
58	Fatigue Crack Growth Data for 0.915 in. 7050- T7651X Extrusion, L-T Orientation-----	224
59	Fatigue Crack Growth Data for 0.915 in. 7050- T7651X Extrusion, T-L Orientation-----	225
60	Fatigue Crack Growth Data for 0.915 in. 7050- T7351X Extrusion, L-T Orientation-----	226
61	Fatigue Crack Growth Data for 0.915 in. 7050- T7351X Extrusion, T-L Orientation-----	227
62	Fatigue Crack Growth Data for 5x6-1/4 in. 7050- T7351X Extrusion, T-L Orientation-----	228
63	Fatigue Crack Growth Data for 5x6-1/4 in. 7050- T7351X Extrusion, S-T Orientation-----	229
64	Fatigue Crack Growth Data for C5A Extruded Panels, 7050-T7351X, L-T Orientation, Dry Air-----	230
65	Fatigue Crack Growth Data for C5A Extruded Panels, 7050-T7351X, L-T Orientation, Moist Air-----	231
66	Fatigue Crack Growth Data for C5A Extruded Panels, 7050-T7351X, T-L Orientation, Dry Air-----	232
67	Fatigue Crack Growth Data for C5A Extruded Panels, 7050-T7351X, T-L Orientation, Moist Air-----	233

LIST OF ILLUSTRATIONS (CONTINUED)

<u>No.</u>	<u>Page</u>
68	Fatigue Crack Growth Data for C5A Extruded Panels, 7050-T7351X, T-L Orientation, Moist Air, R=0.5-----234
69	Four Degrees of Severity of Exfoliation Corrosion per ASTM Standard Method Test G34-72-----235
70	(a) 1/8-in. Diameter Tensile Specimen, Various Parts of Stressing Frame and Final Stressed Assembly for Stress-Corrosion Tests (b) Synchronous Loading Device Used to Stress Specimens-----236
71	Configuration of Double Cantilever Beam (DCB) Specimen Used for SCC Tests-----237
72	Ring-Loaded Precracked Compact Tension Specimen-----238
73	Summary of Accelerated SCC Test Results for 1.2-5.0" Thick Alloy 7050 Extruded Sections (Test Stress - 45 ksi)-----239
74	Summary of Accelerated SCC Test Results for 1.2-5.0" Thick Alloy 7050 Extruded Sections (Test Stress - 25 ksi)-----240
75	Environmental Crack Growth of Short-Transverse 7050 Alloy DCB Specimens Exposed to 3.5% NaCl Solution Dropwise-----241
76	Illustrates Fracture Surface, Crack Profile and Intergranular Nature of SCC Growth in Short-Transverse (S-L) DCB Specimens from a 7050-T7351X Section (Die No. 900102)-----242
77	Illustrates Fracture Surface, Crack Profile and Intergranular SCC Growth in Short Transverse (S-L) DCB Specimens from a 7050-T7651X Section (Die No. 900102)-----243
78	K_I - Rate Data for Tests of 7050 Alloy Extrusions---244
79	Changing Stress Intensity of Short-Transverse 7050-T7351 Alloy DCB Specimens Exposed to 3.5% NaCl Solution Dropwise-----245
80	Summary of Accelerated SCC Test Results for 1.2-5.0" Thick Alloy 7050-T7XXX Extruded Shapes Less Than 43 Square Inches in Cross Section (Test Stress-45 ksi)-----246

LIST OF ILLUSTRATIONS (CONTINUED)

<u>No.</u>		<u>Page</u>
81	Short-Transverse Stress-Corrosion Tests of 7050-T7351X Extruded Shapes (1.2-5.0" Thick, Less than 43 in.)-----	247
82	Summary of Exfoliation Test Results for 0.4-5.0" Thick Alloy 7050-T7XXX Extruded Shapes-----	248
83	Short-Transverse Stress-Corrosion Tests of 7050-T7651X Extruded Shapes (1.2-5.0" Thick)-----	249
84	Factor for Calculation of Equivalent Artificial Aging Conditions-----	250
A-1	Fatigue Crack Growth Data for C5A Extruded Panel, 7050-T7351X, L-T Orientation, R=0.1-----	254
A-2	Fatigue Crack Growth Data for C5A Extruded Panel, 7050-T7351X, L-T Orientation, R=0.5-----	255
A-3	Fatigue Crack Growth Data for C5A Extruded Panel, 7050-T7351X, T-L Orientation, R=0.5-----	256
A-4	Effects of Moisture Content on Fatigue Crack Growth of Aluminum Alloys-----	257
B-1	Environmental Crack Growth, S429204-1, -2-----	259
B-2	Environmental Crack Growth, S429207-1, -2-----	260
B-3	Environmental Crack Growth, S421137-2, -3-----	261
B-4	Environmental Crack Growth, S421333-1, -2-----	262
B-5	Environmental Crack Growth, S421336-1, -2-----	263
B-6	Environmental Crack Growth, S421132-2, -3-----	264
B-7	Environmental Crack Growth, S411287-1, -2-----	265
B-8	Environmental Crack Growth, S411284-1, -2-----	266
B-9	Environmental Crack Growth, S411285-1, -2-----	267
B-10	Environmental Crack Growth, S411286-1, -2-----	268
B-11	Environmental Crack Growth, S421135-2, -3-----	269

LIST OF ILLUSTRATIONS (CONTINUED)

<u>No.</u>		<u>Page</u>
B-12	Environmental Crack Growth, S421143-2, -3-----	270
B-13	Best Estimate of K-Rate Curves for S421136-----	271
B-14	Best Estimate of K-Rate Curves for S429204-----	272
B-15	Best Estimate of K-Rate Curves for S421132-----	273
B-16	Best Estimate of K-Rate Curves for S429207-----	274
B-17	Salt-Dichromate Solution Test for S421132-SL 8-----	275
B-18	Salt-Dichromate Solution Test for S421132-SL 7-----	276
B-19	Salt-Dichromate Solution Test for S421132-SL 9-----	277
B-20	Salt-Dichromate Solution Test for S421333-SL 8-----	278
B-21	Salt-Dichromate Solution Test for S421333-SL 6-----	279
B-22	Salt-Dichromate Solution Test for S421333-SL 9-----	280
B-23	Salt-Dichromate Solution Test for S421336-SL 8-----	281
B-24	Salt Dichromate Solution Test for S421336-SL 7-----	282
B-25	Salt-Dichromate Solution Test for S421336-SL 9-----	283
B-26	Salt-Dichromate Solution Test for S421336-SL 6-----	284
B-27	Salt-Dichromate Solution Test for S421143-SL 8-----	285
B-28	Salt-Dichromate Solution Test for S421143-SL 9-----	286
B-29	Salt-Dichromate Solution Test for S421143-SL 7-----	287
B-30	Computer Print-Out for S421132-SL 8-----	288
B-31	Computer Print-Out for S421132-SL 7-----	289
B-32	Computer Print-Out for S421132-SL 9-----	290
B-33	Computer Print-Out for S421333-SL 8-----	291
B-34	Computer Print-Out for S421333-SL 6-----	292
B-35	Computer Print-Out for S421333-SL 9-----	293

LIST OF ILLUSTRATIONS (CONTINUED)

<u>No.</u>		<u>Page</u>
B-36	Computer Print-Out for S421336-SL 8-----	294
B-37	Computer Print-Out for S421336-SL 7-----	295
B-38	Computer Print-Out for S421336-SL 9-----	296
B-39	Computer Print-Out for S421336-SL 6-----	297
B-40	Computer Print-Out for S421143-SL 8-----	298
B-41	Computer Print-Out for S421143-SL 9-----	299
B-42	Computer Print-Out for S421143-SL 7-----	300
C-1	SCC Test Performance at Applied Stress of 45 ksi----	307
C-2	Optical Micrographs of 7050 Extrusions-----	308
C-3	Optical Micrographs of Rectangle, S437682-3-----	309
C-4	Optical Micrographs of Wing Plank, S421333-----	310
C-5	Optical Micrographs of Spar, S442116-----	311
C-6	Transmission Electron Micrographs of Rectangle, S437682-3-----	312
C-7	Transmission Electron Micrographs of Spar, S442116-----	313
C-8	Scanning Electron Micrograph Showing Fracture Surface of Rectangle, S437682-----	314
D-1	Illustrates Relative Effects of Variants on Longitudinal Notch Toughness-----	326
D-2	Illustrates Relative Effects of Variants on Long-Transverse Notch Toughness-----	327
D-3	Illustrates Relative Effects of Variants on Short-Transverse Notch Toughness-----	328
D-4	Notch Toughness vs Yield Strength - Longitudinal----	329
D-5	Notch Toughness vs Yield Strength - Long-Transverse-	330
D-6	Notch Toughness vs Yield Strength - Short-Transverse	331

LIST OF TABLES

<u>No.</u>		<u>Page</u>
1	Summary of 7050 25-In. Diameter Ingot Casting at Alcoa's Lafayette Works-----	80
2	7050 - 35-Inch Diameter Ingot - Casting Data-----	81
3	7050 - 35-Inch Diameter Ingot Casting at Lafayette-	82
4	Chemical Analyses of Ingots Used to Fabricate 7050 Extrusions-----	83
5	Tensile Properties of Alloy 7050-T76511 Extrusion--	84
6	Exfoliation and SCC Test Results for 1.8" Thick Alloy 7050-T7XXX Extrusions-----	85
7	Results of Supplemental SCC Tests of 1.8" Thick Alloy 7050-T7XXX Extrusions - Section No. 263902---	86
8	Results of Accelerated SCC Tests for 1.8" Thick Alloy 7050-T7XXX Extrusions - Section No. 263902---	87
9	Alloy 7050 Extrusion Conditions-----	88
10	Chemical Analyses of Ingots Used to Fabricate Alloy 7050 Extrusions-----	89
11	Longitudinal Yield Strength and Electrical Conductivity of 1.5-Inch x 7.5-Inch Rectangular Alloy 7050 Extrusions-----	90
12	Longitudinal Yield Strength and Electrical Conductivity of 2.7-Inch x 4-Inch Rectangular Alloy 7050 Extrusions-----	91
13	Longitudinal Tensile Properties of 1.5-Inch x 7.5 Inch Rectangular Alloy 7050 Extrusions-----	92
14	Long-Transverse Tensile Properties of 1.5-Inch x 7.5-Inch Rectangular Alloy 7050 Extrusions-----	94
15	Short-Transverse Tensile Properties of 1.5-Inch x 7.5-Inch Rectangular Alloy 7050 Extrusions-----	96
16	Longitudinal Tensile Properties of 2.7-Inch x 4-Inch Rectangular Alloy 7050 Extrusions-----	98

LIST OF TABLES (CONTINUED)

<u>No.</u>		<u>Page</u>
17	Long-Transverse Tensile Properties of 2.75-Inch x 4-Inch Rectangular Alloy 7050 Extrusions-----	99
18	Short-Transverse Tensile Properties of 2.75-Inch x 4-Inch Rectangular Alloy 7050 Extrusions-----	100
19	Results of Exfoliation Tests Conducted on 1.5" x 7.5" Rectangular 7050 Alloy Extrusions Exposed in an EXCO Test Solution for 48 Hours-----	101
20	Results of Exfoliation Tests Conducted on 2.7" x 4" Rectangular 7050 Alloy Extrusions Exposed in an EXCO Test Solution for 48 Hours-----	104
21	Stress-Corrosion Test Results of 1.5-Inch x 7.5-Inch Rectangular Alloy 7050 Extrusions-----	106
22	Stress-Corrosion Test Results of 2.75-Inch x 4-Inch Rectangular Alloy 7050 Extrusions-----	108
23	Effect of Second-Step Aging Time on 7050 Extrusions-----	109
24	Results of Probit Analysis-----	110
25	Results of Regression Analysis Relating Specimen Failure Time to Longitudinal Yield Strength-----	111
26	35-Inch Diameter 7050 Alloy Ingot - Casting Data---	112
27	Extrusion Press Data (21-Inch Cylinder)-----	113
28	Longitudinal Tensile Properties and Electrical Conductivities of 7050-T7351X Extrusions from 21-In. Dia. Cylinder-----	114
29	Extrusion Press Data (25-Inch and 29-Inch Cylinders)-----	115
30	Longitudinal Tensile Properties and Electrical Conductivities of 7050-T7651X Extrusions from 25 and 29-In. Cylinders-----	116
31	Longitudinal Tensile Properties and Electrical Conductivities of 7050-T7351X Extrusions from 25 and 29-In. Cylinders-----	117

LIST OF TABLES (CONTINUED)

<u>No.</u>		<u>Page</u>
32	Results of Plant Quality Control Tests of 7050-T7351X Extrusions-----	118
33	Chemical Analyses of Extrusions from 21-In. Dia. Cylinder-----	119
34	Chemical Analyses of Extrusions from 25-Inch and 29-Inch Cylinders-----	120
35	Chemical Analyses of 7050 Ingots Fabricated Into Alcoa Section 900102 (C5A Wing Panel)-----	121
36	Ultrasonic Inspection Results for 7050-T7351X Extrusion Section 291812 - Lot 35767-A1-15-1, Specimen 421132-2-----	122
37	Ultrasonic Inspection Results for 7050-T7351X Extrusion Section 291812 - Lot 35767-A1-15, Specimen 421132-1-----	123
38	Results of Ultrasonic Inspection of Mechanical Property Samples of 7050-T7351X Extrusions - Section 291812 - Autiac Instrument-----	124
39	Results of Tensile Tests on 7050-T7351X Specimens from Section 291812-----	125
40	Results of Tensile, Compressive, Shear and Bearing Tests of 7050-T7651X Extruded Shapes-----	126
41	Mechanical Properties of 7050-T7651X Extruded Shapes, Cross-Sectional Area <32 in. ² -----	127
42	Results of Tensile, Compressive, Shear and Bearing Tests of 7050-T7351X Extruded Shapes, Cross-Sectional Area <43 in. ² -----	128
43	Results of Tensile, Compressive, Shear and Bearing Tests of 7050-T7351X Extruded Shapes, Cross-Sectional Area 61 to 66 in. ² -----	129
44	Results of Tensile and Compressive Stress-Strain and Modulus of Elasticity Tests of 7050-T7651X and T7351X Extruded Shapes-----	130

LIST OF TABLES (CONTINUED)

<u>No.</u>		<u>Page</u>
45	Ratios Among Tensile, Compressive and Shear Properties of 7050-T76511 Extruded Shapes-----	131
46	Ratios Among Tensile, Compressive and Shear Properties of 7050-T7351X Extruded Shapes-----	132
47	Ratios Among Tensile and Bearing Properties of 7050-T7651X Extruded Shapes-----	133
48	Ratios Among Tensile and Bearing Properties of 7050-T7351X Extruded Shapes-----	134
49	Summary of Statistical Analyses of Ratios Among Tensile, Compressive, Shear and Bearing Properties of 7050-T7651X Extruded Shapes, Cross-Sectional Area <43 in. ² -----	135
50	Summary of Statistical Analyses of Ratios Among Tensile, Compressive, Shear and Bearing Properties of 7050-T7351X Extruded Shapes, Cross-Sectional Area <43 in. ² -----	136
51	Summary of Statistical Analyses of Ratios Among Tensile, Compressive, Shear and Bearing Properties of 7050-T7651X and 7050-T7351X Extruded Shapes, Cross-Sectional Area 61 to 66 in. ² -----	137
52	Ratios for Computing Design Mechanical Properties of 7050-T7651X Extruded Shapes, Cross-Sectional Area <43 in. ² -----	138
53	Ratios for Computing Design Mechanical Properties of 7050-T7351X Extruded Shapes-----	139
54	Computed Design Mechanical Properties of 7050-T7651X Extruded Shapes-----	140
55	Computed Design Mechanical Properties of 7050-T7351X Extruded Shapes-----	141
56	Results of Compact Fracture Toughness Tests of 7050-T7651X Extruded Shapes-----	142
57	Results of Compact Fracture Toughness Tests of 7050-T7651X Extruded Shapes, Cross-Sectional Area <32 in. ² -----	143

LIST OF TABLES (CONTINUED)

<u>No.</u>		<u>Page</u>
58	Results of Compact Fracture Toughness Tests of 7050-T7351X Extruded Shapes, Cross-Sectional Area ≥ 43 in. ² -----	144
59	Results of Compact Fracture Toughness Tests of 7050-T7351X Extruded Shapes, Cross-Sectional Area 61 to 66 in. ² -----	145
60	Summary of Results of Compact Fracture Toughness Tests of 7050-T7651X and 7050-T7351X Extruded Shapes-----	146
61	Average Axial-Stress Fatigue Strength for Smooth and Notched 7050 Specimens Tested in Salt Fog-----	147
62	Rates of Fatigue Crack Propagation in 7050 Extrusions-----	148
63	Results of Accelerated SCC Tests of 7050-T7351X Extruded Shapes-----	149
64	Results of Accelerated SCC Tests of 7050-T7651X Extruded Shapes-----	151
65	Status of Atmospheric Tests of 7050-T7351X Extruded Shapes-----	152
66	Status of Atmospheric SCC Tests of 7050-T7651X Extruded Shapes-----	153
67	Results of SCC Tests of Precracked Specimens from 7050-T7351X Extruded Shapes-----	154
68	Results of SCC Tests of Precracked Specimens from 7050-T7651X Extruded Shapes-----	155
69	Results of Tests of Ring Loaded Short-Transverse Transverse Compact Specimens of 7050-T7351X and T7651X Extruded Shapes-----	156
70	Comparative SCC Data for DCB's and Smooth Specimens in Accelerated Tests-----	157
71	Lot Release Criteria and Exfoliation Corrosion, Stress-Corrosion, and Fracture Toughness Characteristics of Alloy 7050 Extrusions-----	158

LIST OF TABLES (CONTINUED)

<u>No.</u>		<u>Page</u>
A-1	Test Program to Determine Fatigue Crack Propagation at Low Stress Intensities for 7050-T73511 C5A Extruded Wing Panel-----	253
C-1	Stress-Corrosion Test Performance-----	306
D-1	Results of Multiple Regression Analysis of Longitudinal NTS/YS-----	323
D-2	Results of Multiple Regression Analysis of Long-Transverse NTS/YS-----	324
D-3	Results of Multiple Regression Analysis of Short-Transverse NTS/YS-----	325

I. INTRODUCTION

Alloy 7050 is a recently introduced Al-Zn-Mg-Cu-Zr alloy developed at Alcoa Laboratories under partial sponsorship of the Air Force Materials Laboratory¹ and the Naval Air Systems Command.²⁻⁴ It provides significantly improved combinations of strength, resistance to exfoliation corrosion and stress-corrosion cracking, and fracture toughness compared to commercially established alloys.

Because of the favorable characteristics of 7050, design properties for use in MIL-HDBK-5 and fracture toughness, fatigue, and corrosion characteristics have been determined for plate, sheet, forgings, and 7050-T7651X extrusions made from ingots up to 22 inches in diameter.⁵ Data for 7050-T7651X extrusions made from 25 to 35-inch diameter ingot, such as are required for sections of aircraft such as the C130, C5A, and B1, however, are needed to make the MIL-HDBK-5 compilation complete. Moreover, an extremely high resistance to stress-corrosion cracking such as exhibited by 7075-T7351X is needed in applications where high stress is unavoidable in sections having exposed end grain structure and where the low strength of 7075-T7351X extrusions is unacceptable. A T7351X temper for 7050 extrusions would fill this need.

The objectives of this investigation were to (1) develop casting processes for 25 and 35-inch diameter ingot; (2) evaluate effects of fabricating variables and section geometry on properties of extrusions; (3) develop aging practices to provide (a) strength comparable to that of 7075-T6 with high resistance to exfoliation

corrosion and improved resistance to stress-corrosion cracking and (b) resistance to stress-corrosion cracking comparable to that of 7075-T73 with higher strength; (4) produce extrusions and determine MIL-HDBK-5 design mechanical properties and the fracture, fatigue, and corrosion characteristics; and (5) prepare preliminary material and process specifications, quality control, and acceptance criteria.

All objectives were met. The data established that 7050 extrusions develop combinations of properties desired by the aerospace industry that are more attractive than the properties of extrusions of commercially established alloys.

II. ESTABLISH MANUFACTURING METHODS

1. Ingot Casting

a. Background and Objective

The two major problems in casting large diameter ingot in high-strength alloys like 7050 are cracking and center porosity. The initial part of our work concentrated on developing a casting procedure to produce 25-inch diameter 7050 alloy ingot. The Alcoa level-pour casting method was selected for this work because of its known capability to produce high-quality ingot suitable for aircraft structures. Limited casting of this alloy prior to the contract indicated that elimination of ingot cracking would present the major challenge. Minimizing center porosity requires fine tuning of several production parameters and a clear understanding of the cracking characteristics of 7050 alloy since there is a definite interaction between these two critical ingot characteristics.

The casting conditions that define the depth and shape of the molten metal pool are the major factors one can use to minimize center porosity and eliminate cracking. Included in the casting parameters that can have a pronounced influence are: initial casting rate, bottom block material and cooling, running casting rate, metal temperature, rate of heat removal in the mold, rate of heat extraction below the mold, and duration of water cooling below the mold.

b. 25-Inch Diameter Casting Trials - Laboratory

A special Alcoa level-pour mold (Figure 1) was fabricated to provide maximum control of the water application to the mold and the ingot. Likewise, water-cooled aluminum and steel bottom blocks (Figure 2) were fabricated for use with this tooling. Metal was melted in a 10,000-lb capacity open-hearth furnace. Charge components were primary aluminum and alloying elements. The 7050 alloy melt passed through an Alcoa 181 process* unit (Figure 3) in the transfer system enroute to the mold. This equipment filtered out inclusions and degassed (removed hydrogen from) the molten metal. The metal was then cast in the level-pour mold. The cooling water was completely removed from the ingot several inches below the bottom of the mold with a wiper.

Due to the large number of casting parameters associated with this type of ingot casting, certain items were held constant during the trials while other more critical parameters were varied

*U.S. Patent 3,039,864

deliberately. The casting rate, water cooling rate, length of the ingot-cooling zone, bottom block material, and starting casting were treated as variables in these tests.

Both aluminum and steel water-cooled starting blocks were employed. Due to the improved bottom cooling associated with an aluminum block, there were indications that higher starting casting rates could be used without encountering butt cracks. Ultimately, it was demonstrated that crack-free ingot could be produced with either bottom block provided the starting casting rate was adjusted to match the particular block material used.

The starting casting rate was a crucial variable because it, along with several other variables, determined the rate of heat removal from the ingot butt before the ingot reached the wiper. It became apparent early in this work that butt cracking must be avoided because such cracks generally propagated the full length of the ingot. It was important that the ingot reach the wiper in a crack-free condition and that the hot core then reheat the surface to a desirable equilibrium temperature (410 to 440°F). The combined influence of bottom block material and cooling, starting casting rate and duration, length of the ingot cooling zone, and the running casting rate basically determined whether the ingot hot cracked before reaching the wiper, cold cracked before or after reaching the wiper, or was crack-free. By adjusting these variables and determining the condition of the ingot (crack-free or cracked) as well as the equilibrium reheat temperature, it was possible to zero in on the optimum practice. However, with 7050 alloy this proved

to be an extremely difficult task because it was not easy to tell the difference between hot and cold cracks since both types generated loud audible sounds. As a result, ultrasonic techniques were employed early in each drop to determine the soundness of the butt as soon as it emerged below the wiper. This inspection method became an invaluable tool in the development of the crack-free casting practice.

The cooling rate was determined by the amount of mold cooling, the amount of ingot cooling, and the distance that the water was allowed to run on the ingot. Mold cooling was set at maximum because it is desirable to develop a thick ingot shell while the ingot is in contact with the mold. Once the ingot shrinks away from the mold the effectiveness of the mold cooling is very limited. Ingot cooling was adjusted to provide a good water pattern on the ingot and still permit complete removal of the water by the three-inch deep wiper pan. With these basic water limitations, the location of the wiper below the mold was adjusted to bring the equilibrium reheat temperature into the desired temperature range.

The proper use of wiper technology cannot be overemphasized. Choosing the proper location below the mold for water removal has a tremendous impact on the overall ingot quality. A wiper that is positioned too high creates a porous ingot center, and if it is positioned too low the ingot cracks due to excessive residual stresses during cooling. No leakage of water through the wiper can be tolerated with 7050 alloy.

As mentioned previously, the starting casting rate was set to insure that the ingot reached the wiper crack-free. The running casting rate was adjusted to generate an acceptable surface and minimize freezing in the insulating header of the mold. Acceptable surfaces could be obtained with only a limited range in casting rate, so, therefore, it was possible to have only a minor impact on reheat temperature with casting rate. For our purposes an acceptable surface was defined as a surface smooth enough to permit complete removal of the ingot water with a rubber wiper.

Experiments were conducted in the laboratory to explore the acceptable range for each of the major variables described above. This work produced crack-free ingot and the recommended casting procedure for plant trial was as follows:

MOLD - Special Alcoa level-pour
BOTTOM BLOCK - Water-cooled aluminum
METAL TEMPERATURE - 1280-1320°F
START CASTING RATE - 1.00 ipm
RUNNING CASTING RATE - 0.85 ipm
MOLD COOLING - 60 gpm
INGOT COOLING - 80 gpm
WIPER DISTANCE - 5.75 inches
DURATION OF BOTTOM BLOCK COOLING - 8 minutes

This practice produced ingot with a fine, equiaxed grain size (ASTM macrograin size M 12.5 to M 11.5) (Figure 4). The dendrite arm spacing was relatively fine and uniform (0.0019-in. surface to

0.0021-in. center) for an ingot of this size. The ingot was sound except for a few small pores (1 void/sq in. surface to 21 voids/sq in. micradius) as determined by dye penetrant inspection techniques. All of the voids were less than 30 microns in diameter.

c. 25-Inch Diameter Casting Trials - Plant

The tooling used in the 25-inch diameter casting trials at the laboratory was transferred to Lafayette Works and installed at a ladle casting station. The initial trial with the casting practice developed in the laboratory was unsuccessful due to an excessive amount of butt cracking. This problem was attributed to differences between the laboratory and plant water quench-abilities and water supply systems. To compensate, it was necessary to adjust the cooling conditions associated with the start. The following items were changed from the recommended laboratory practice:

BOTTOM BLOCK MATERIAL - Aluminum to steel

START CASTING RATE - 1.00 to 1.05 ipm

MOLD COOLING - 60 to 44 gpm

A number of ingots were cast using the revised practice. Most of these ingots contained short butt cracks which are of little consequence because the defective portion was confined to the normal end crop. Details of the casting trials that successfully completed the work on 25-inch diameter 7050 alloy ingot are tabulated in Table 1.

d. 35-Inch Diameter Casting Trials - Laboratory

The work with the 25-inch diameter 7050 alloy ingot provided a foundation for our 35-inch diameter work. A special Alcoa

level-pour mold (Figure 1) and a water-cooled steel bottom block (Figure 2) were fabricated and installed for use in a setup identical to the one used for the 25-inch diameter laboratory tests. The same basic philosophy for developing a casting practice used with the 25-inch diameter ingot was employed, namely, the most influential casting variables were varied and the other items were held as constant as possible. The items varied were: metal feed rate, start casting rate, duration of start casting rate, duration of bottom block cooling, wiper distance, and running casting rate.

This larger ingot size initially generated more violent cracks but ultimately crack-free ingot was produced. A tabulation of the successful laboratory casts of 35-inch diameter 7050 alloy ingot is shown in Table 2. The recommended casting procedure for plant trials was as follows:

MOLD - Special Alcoa level pour
BOTTOM BLOCK - Water-cooled steel
METAL TEMPERATURE - 1265-1295°F
START CASTING RATE - 0.90 ipm for 7.8 minutes
RUNNING CASTING RATE - 0.65 ipm
MOLD COOLING - 50 gpm
INGOT COOLING - 120 gpm
WIPER DISTANCE - 7 inches
DURATION OF BOTTOM-BLOCK COOLING - 16.5 minutes
MOLD FILL - 3 minutes

e. 35-Inch Diameter Casting Trials - Plant

The tooling used for the laboratory casting trials was transferred to Alcoa's Lafayette Works and installed on a ladle pour casting unit. After some minor adjustments, five crack-free ingots were cast as shown in Table 3. The need for the adjustments was again attributed to the differences between the laboratory and plant water quenchabilities and water supply systems. Items altered from the successful laboratory practice were:

WIPER DISTANCE - 7 inches to 8 inches
RUN CASTING RATE - 0.65 to 0.61 ipm
DURATION OF BOTTOM-BLOCK COOLING - 16.5 to 15 minutes

At this point the experimental work was considered complete. However, when we were called upon to produce additional 35-inch diameter ingot for fabrication of extrusions, we were unable to cast a crack-free ingot. During this period, 38 consecutive cracked ingot with a weight of approximately 200,000 lb were cast. As a result, a contract extension was negotiated to provide the time and funding to fulfill the contract requirements.

Casting trials performed on 25 and 30-inch diameter 7050 alloy ingot using development funds provided by the Aluminum Company of America resulted in the formulation of a new concept for casting large diameter 7050 alloy ingot. Due to the success with these smaller diameter ingot, a completely new practice was developed for 35-inch diameter ingot. Most of the production parameters were extrapolated from the practices for the smaller size ingots, and successful practices were developed. These practices are discussed in detail in the section "Produce Extrusions," page 27.

2. Processing

a. Fabricating

Effects of fabricating practice were examined in two subprograms. In one, the object was to determine the effects of modifying the extrusion temperature within the limits possible in extruding heavy sections of strong alloys. In the other subprogram, the object was to determine, for lighter sections, the effects of extrusion temperature, extrusion ratio, product aspect ratio (width:thickness), test specimen location (front or rear of the extrusion), and aging conditions.

(1) Heavier Sections

Two laboratory cast 25-inch diameter 7050 ingots (Table 4) were extruded on the 14,000-ton extrusion press at Alcoa's Lafayette Works. The ingots were preheated by a two-step practice consisting of 4 hours at 890°F followed by 36 hours at 900°F. The unscalped ingots were extruded into Alcoa section 263902 (Figure 5) at either 800 or 750°F. Cylinder temperature was 750°F. The extrusions were solution heat treated 1 hour at 900°F in a production furnace, then immersion quenched into a tank below the furnace containing water at 80°F maximum temperature. The solution heat treated extrusions were subsequently stretched between 1 and 2% on a 3,000,000-lb stretcher, then aged four days at room temperature plus 24 hours at 240-255°F followed by an aging step at a furnace setting of 325°F. About 4-2/3 hours after the load couple reached 310°F, the fan belt on one of the air circulating fans in the age oven broke, so the load was pulled while the fan belt was being replaced.

The load was subsequently returned to the oven and soak time was counted when the load couple reached 310°F. The metal was at or above 310°F for 15 hours.

Twenty 4-foot lengths of the extrusions were ultrasonically inspected per MIL-I-8950 Class A, and all pieces except two were acceptable.

Structural examinations of the extrusions revealed no significant effect of extrusion temperature. Macrostructures (Figure 6) and microstructures (Figures 7a-7d) were comparable, and X-ray diffraction revealed only insignificant differences in the degree of recrystallization at the midplane. The fine-grained structure immediately below the coarse-grained, recrystallized structure at the surface of the rear of the extrusions is unusual. Generally, in high-strength aluminum alloys, the structure immediately below the recrystallized skin is similar to the structure near the midplane. The fine-grained structure at the rear of the extrusions extended into the thickness for about .05 inch to .06 inch; below this, for about .06 inch to .08 inch, the structure resembled that at the front of the extrusion immediately below the coarse layer. Additional work, not within the scope of this contract, would be required to determine effects of this fine-grained structure on properties.

Tensile and notch-tensile (Figure 8) tests of specimens from the front and rear of the extrusions (Table 5) indicate that the difference in extrusion temperature had no effect on either tensile properties or notch toughness.

Lengths of these extrusions were aged for additional times at 325°F in the laboratory to determine whether extrusion temperature affected the combinations of strength and corrosion resistance that can be developed in 7050 extrusions fabricated from large ingot. To determine resistance to exfoliation corrosion, panels machined to expose either the midplane (T/2) or a plane 10% below the extruded surface (T/10) were exposed to the EXCO test (ASTM G34-72).

Extrusion temperatures within the limits examined had no effect on the combination of strength and corrosion characteristics developed (Table 6). All panels from extrusions aged to longitudinal yield strengths of 79 ksi or less developed an E-A level of resistance to exfoliation corrosion. Correlations with lengthy outdoor exposures in a seacoast environment predict that 7XXX alloy products receiving a rating of P or E-A and possibly E-B after a time period of 48 hours in the EXCO test will be free from exfoliation in outdoor service while material receiving an E-C or E-D rating will exfoliate.

To determine resistance to stressⁱ-corrosion cracking, 1/8-inch diameter short-transverse tension specimens were stressed between 25 and 45 ksi and exposed to 3.5% NaCl by alternate immersion according to Federal Test Standard 151b, Method 823. The standard exposure time in this predictive test has been 30 days, but a 20-day exposure period is now recommended for 7XXX alloys containing Cu (ASTM G47-76). Longer exposure times can lead to spurious failures that are not caused by intergranular stress-corrosion cracking.

Extrusion temperature had no effect on the combination of strength and resistance to stress-corrosion cracking developed in these extrusions (Table 6). Short-transverse specimens from extrusions aged to longitudinal yield strengths less than 75 ksi passed the recommended 20-day test period at a stress of 25 ksi, but all lots failed the 30-day SCC test (3.5% NaCl alternate immersion) when stressed at 25 ksi and higher stresses.

Supplemental tests were performed to determine the resistance to stress-corrosion cracking of some of these extrusions at 20 ksi. Selected samples were retested at 25 ksi. Statistically significant differences were noted between the initial and supplemental test results for three of the four sections tested (Table 7). However, specimens from all but one section again failed the 30-day SCC test when stressed at 25 ksi, thereby confirming the initial test results. At the 20 ksi stress, one specimen from the highest strength (78.8 ksi) section failed, and all the remaining specimens readily passed the 30-day SCC test.

Tests were also conducted on sections aged to lower longitudinal yield strengths of 65.8, 68.8, and 70.2 ksi (Table 8). One test specimen from the section aged to 70.2 ksi failed in less than 30 days but passed the 20-day exposure period at a stress of 45 ksi. All of the other specimens passed the 30-day exposure, but additional failures occurred with longer exposure (36-84 days). Microscopic examination revealed mixed intergranular-transgranular cracking in specimens which failed in 45 days or less and transgranular cracking in specimens which failed after 50 days exposure.

The results of this work indicate that extrusion temperature of heavy 7050 sections within the limits imposed by available equipment has no detectable effect on structure, mechanical properties, and resistances to stress-corrosion cracking or exfoliation corrosion.

(2) Lighter Sections

Ten rectangular extrusions were extruded from plant cast 25-inch diameter 7050 ingot as detailed in Table 9 to evaluate extrusion ratio, extrusion temperature, section geometry, aging time, and test specimen location. These extrusions were solution heat treated 80 minutes at 890-900°F, quenched by immersion in water at less than 90°F, stretched 2 percent, and aged 24 hours at 240-255°F.

Chemical analyses of the ingots used to fabricate the extrusions (Table 10) showed that the compositions of all of the extrusions except for the one fabricated from cast No. 593-9 (low Mg) were similar. Consequently, differences in properties among the other extrusions can safely be attributed to the processing conditions. Because data from the sole extrusion fabricated from the ingot containing low Mg was not included in the analysis, the difference in composition did not affect the analysis of the results of this experiment. (The process for this extrusion was replicated using other ingots.)

Macrostructure of the extrusions revealed some effects of the processing conditions (Figures 9a-9d). The most pronounced effect was the thick, recrystallized skin at the rear of the sections extruded with a low ratio at a low temperature. The

absence of this thick band in the extrusion extruded with a high ratio at the low temperature is attributed to the longer butt left in the press. Another notable feature was the coarser macrostructure at the front of the sections extruded at the high temperature, and the presence of annuli at the rear of most of the extrusions.

Sections from the front and rear were aged in the laboratory for an additional 6 to 32 hours at 325°F. Electrical conductivity measurements (Tables 11 and 12); tensile and notch-tensile tests in the longitudinal, long-transverse, and short-transverse directions (Tables 13 through 18); exfoliation corrosion tests at the midplane (Tables 19 and 20); and stress-corrosion cracking tests in the short-transverse direction (Tables 21 and 22) were used to evaluate these extrusions. Test procedures were similar to those used to evaluate the heavier extrusion (Alcoa section 263902).

The tensile properties confirmed that strengths of the extrusion fabricated from the ingot containing the low Mg (S. No. 437679) were lower than those of extrusions fabricated similarly (S. Nos. 437680 and 437681). Consequently, tensile test results of this extrusion were not used in comparisons with the other extrusions in the experiment.

Analysis of the data revealed an interaction among strength, electrical conductivity, extrusion shape, extrusion ratio, and extrusion temperature. The 1.5-inch x 7.5-inch extrusions extruded at a ratio of 9 developed significantly lower

strengths than 1.5-inch x 7.5-inch extrusions extruded with a ratio of 32 and 2.75-inch x 4-inch extrusions extruded with either ratio (Figure 10). This phenomenon is tentatively attributed to a combination of differences in degree of recrystallization and aging kinetics; the strength of the section extruded at 600°F was below that of all other sections when compared on an equal electrical conductivity basis, while strength of the section extruded at 820°F was generally comparable to that of the other extrusions when compared at equal electrical conductivities above 39.5% I.A.C.S.

Effects on notch toughness of yield strength, fabricating variables, test specimen location and orientation, and section geometry were determined by regression analysis. Procedure, results, and discussion are presented in Appendix A. The most significant findings are illustrated in Figure 11. As anticipated, test specimen orientation and yield strength had the largest effects. The rate of decrease of notch toughness with increasing yield strength was smallest in the longitudinal direction and largest in the short-transverse direction. Test specimen location also had an effect; the rear of the extrusion generally developed slightly higher toughness than the front. Fabricating variables and section geometry had effects which strongly depended on test direction. In the long-transverse direction, aspect ratio had the strongest effect. Notch toughness of the 1-1/2-inch x 7-1/2-inch extrusions was higher than that of the 2-3/4-inch x 4-inch extrusions, particularly at high-strength levels. Extrusion ratio had a smaller effect; the higher extrusion ratio gave higher toughness, particularly

at low-strength levels. Extrusion temperature had no significant effect. In the short-transverse direction, increasing extrusion ratio had a large positive effect, while increasing extrusion temperature had a smaller positive effect. Effects of aspect ratio were insignificant. In the longitudinal direction, effects of section geometry and extrusion conditions were both insignificant.

Resistance to exfoliation corrosion was rated on the basis of visual examinations of the corroded midplane of the extruded panels after exposure in the EXCO test. Based on this predictive test, all of the 7050 extrusions in this experiment that had been aged 15 or more hours at 325°F (longitudinal yield strengths up to 80 ksi) are anticipated to have good resistance to exfoliation corrosion in natural environments. Resistance of the extrusions having the lower aspect ratio was generally superior, but extrusion temperature and extrusion ratio had no apparent effect. Supplementary metallographic examinations on representative corroded specimens that had been aged 15 hours at 325°F (shortest acceptable time based on visual examination) and had been exposed for 48 hours (longest exposure period) revealed no evidence of exfoliation (Figures 12a-12d).

The stress-corrosion test results were analyzed in three ways: (1) Percent survival to determine effects of aging time, (2) Multivariable probit analyses to determine effects of fabricating conditions and section geometry, (3) Failure time:yield strength regression analysis to determine effects of section geometry.

(1) Percent Survival - To determine effects of aging time, analysis was performed on the basis of both the older 30-day test

specification and the current 20-day ASTM test specification. Results of this analysis, Table 23, revealed two salient points in terms of the objectives of this contract.

First, all of the 7050 extrusions aged 15 hours at 325°F or longer developed a short-transverse resistance to stress-corrosion cracking that was substantially higher than that expected of 7075-T6. Whereas 100 percent and 97 percent of the 7050 test specimens aged 15 hours survived the 20 and 30-day specifications, respectively, at a stress level of 25 ksi, and 100 percent of the 7050 specimens aged 20 hours or longer survived both periods, no 7075-T6 test specimens exposed at this stress level would be expected to survive. Moreover, comparing the 72.6 to 81.0 ksi longitudinal yield strengths of the 7050 extrusions aged in this manner with the 72 ksi guaranteed longitudinal yield strength of 7075-T651X extrusions indicates that the goal of developing strength equal to that of 7075-T6 with improved resistance to stress-corrosion cracking can be realized with 7050 extrusions, for a wide range of fabricating conditions and section geometries.

Second, all of the 7050 extrusions aged 32 hours at 325°F developed a resistance to stress-corrosion cracking in the accelerated test that was comparable to that of 7075-T73 in that no specimens failed the 30-day exposure at a stress level of 45 ksi. The 63.7 to 71.8 ksi longitudinal yield strengths of the 7050 extrusions aged in this manner are sufficiently above the 59 ksi guaranteed yield strength of 7075-T7351X extrusions to indicate that 7050 extrusions can meet the goal of developing higher

strength than 7075-T73 at comparable resistance to stress-corrosion cracking.

(2) Probit Analysis - A 30-day exposure period was selected for multivariable probit analysis of the effects of the fabricating conditions and section geometry on stress-corrosion test performance. This method of analysis is used to evaluate mean stress-corrosion resistance.⁶ The criterion that results from this analysis is called mean critical strength. The higher the mean critical strength, the more favorable the combination of strength and resistance to stress-corrosion cracking. Mean critical longitudinal yield strength was used as the basis for comparison of effects of extrusion temperature, extrusion ratio, and section aspect ratio. Results of the analysis (Table 24) indicate that aspect ratio was the most important factor affecting the combination of yield strength and stress-corrosion resistance that could be developed. The 1.5-inch x 7.5-inch extrusions (aspect ratio 5) had to be aged to a strength 5 ksi lower than that of the 2.75-inch x 4.0-inch extrusions (aspect ratio 1.45) to develop comparable resistance to stress-corrosion cracking. Extrusion ratio had no detectable effect, but extrusion temperature had a noticeable effect. Increasing the extrusion temperature from the low level of 600°F to 800°F increased the mean critical yield strength by as much as 4 ksi.

The effects of aspect ratio and extrusion temperature on the combination of yield strength and resistance to exfoliation corrosion that can be developed in alloy 7050 extrusions are attributed to their effects on grain morphology. Whereas the

grain boundaries of the 2.75-inch x 4.0-inch extrusions (lower aspect ratio) were very irregular, Figure 13a, the grain boundaries of the 1.5-inch x 7.5-inch extrusion (high aspect ratio) were much straighter, Figure 13b. Because exfoliation attack and stress-corrosion cracks could easily proceed along the straight boundaries but would be forced to follow a tortuous path along irregular boundaries, the resistance to corrosion and stress corrosion of the material having the irregular boundaries would be higher. Increasing the extrusion temperature of the 1.5-inch x 7.5-inch extrusions modified the grain boundaries, particularly in the transverse plane perpendicular to the extrusion direction, Figure 14.

(3) Failure Time:Yield Strength Regression - A relationship of the form, $\ln t_f = A + B(YS)$, was used to relate specimen failure time, t_f , to longitudinal yield strength, YS. Inspection of the data prior to regression analysis revealed three separate relationships between fracture time and yield strength. In the high-strength region (short overaging times), fracture times were shorter than about one week and were essentially independent of yield strength. In the low-strength region (long overaging times), fracture times were generally longer than 40 days and increased little with decreasing strength. In the intermediate strength region, fracture times were intermediate and log fracture time increased linearly with decreasing yield strength. The results of tests of specimens in the intermediate strength range were used in the regression analysis to determine the effect of yield strength on fracture time. The best estimate of the yield strengths of the

1.5-inch x 7.5-inch (high aspect ratio) and the 2.75-inch x 4.00-inch (low aspect ratio) extrusions that would have fracture times that equaled 30 days (Table 25) confirms the probit analysis in that the high aspect ratio extrusions had to be overaged to lower strength to develop similar average SCC test performance. Additional statistical analyses, however, could not reject the hypothesis that aspect ratio had no effect on yield strength at which there is a high probability that time to fracture for almost all specimens would pass a 30-day exposure period. Many more tests would have to be performed to determine with high confidence whether extrusions with low aspect ratios could be overaged a lesser amount (higher strengths) and develop in the long-run equivalent SCC test performance to high aspect ratio extrusions. In the interim, it would seem prudent to base aging practices for all extrusions on the most conservative case, i.e., high aspect ratio extrusions.

(3) Conclusions

Conclusions regarding effects of fabricating practice on properties of 7050 extrusions can be summarized as follows.

1. Extrusion temperature within the range possible in the fabrication of wide, heavy extrusions (~750 to 800°F) has no effect on metallurgical structure, mechanical properties, and resistances to stress-corrosion cracking and exfoliation corrosion. Considering the wider range of temperature (~600 to 800°F) possible in extruding smaller sections, however, higher extrusion temperature favored more attractive combinations of strength, notch toughness, and resistance to stress-corrosion cracking. Maximum

extrusion speed usually decreases with increasing temperature, however, so productivity will decrease and costs will increase with increasing extrusion temperature. Consequently, any benefit must be assessed on a cost effectiveness basis.

2. Extrusion ratio also had an effect on the combination of strength, toughness, and resistance to stress-corrosion cracking that can be developed. High extrusion ratios are favorable. For many shapes, however, extrusion ratio cannot be varied. For others, economics usually dictate the choice.

3. Section geometry had a larger effect than fabricating variables. Sections having low aspect ratios develop more attractive combinations of strength, toughness, and resistance to exfoliation corrosion and stress-corrosion cracking.

4. Extrusions aged 15 hours at 325°F developed longitudinal yield strengths comparable to those of 7075-T651X extrusions, a resistance to exfoliation corrosion that is predicted to be excellent in natural environments, and a resistance to stress-corrosion cracking in the critical short-transverse direction that is far superior to that of 7075-T6. Extrusions aged 32 hours at 325°F developed combinations of strength and resistance to stress-corrosion cracking that exceeded those of 7075-T73.

b. Heat Treating

The solution heat treatment conditions for 7050 extrusions were previously established, so heat treatment work was confined to aging. That resistances to stress-corrosion cracking and exfoliation corrosion of Al-Zn-Mg-Cu alloy products increase with aging

time beyond peak strength at temperatures above about 300°F has been established for years, and alloy 7050 is no exception. Quantitative relationships between the degree of overaging and the level of resistance of 7050 extrusions, however, were needed. Consequently, aging conditions which will produce desired levels of strength and corrosion characteristics were determined during this contract.

In the early stages, an attempt was made to use a laboratory solution heat treated and unstretched extrusion to correlate second-step aging time at 325°F with strength and resistances to exfoliation corrosion and stress-corrosion cracking. Subsequent unreported work funded by the contractor indicated, however, that stretching had an effect on aging kinetics as well as on the combination of strength and resistance to stress-corrosion cracking that was developed in 7050 extrusions. Consequently, the work with unstretched extrusions, presented in progress reports, will not be repeated in this final report.

The approach finally used to recommend aging practices was to combine data from this contract with unreported Alcoa data on stretched extrusions and correlate longitudinal yield strength achieved by overaging with resistances to stress-corrosion cracking in the short-transverse direction and to exfoliation corrosion. Then aging practices which would produce the desired results were calculated from knowledge of the overaging kinetics.

Analysis of the data indicated that the combination of strength and corrosion characteristics that would be developed

depended to a large extent on extrusion shape. Wide, thin ($\sqrt{2}$") extrusions had to be overaged to lower strengths to develop the same corrosion characteristics as narrow, thick sections. Interim reports suggested that different strength levels (and, therefore, aging practices) be established for 7050 extrusions on the basis of aspect ratio, but this approach is not recommended at this time. Instead, aging practices were selected that give high confidence that 7050 extrusions of any shape will develop the level of strength and have the resistances to stress-corrosion cracking and exfoliation corrosion that is specified for a particular temper.

Preliminary analyses of the longitudinal yield strength and stress-corrosion test data indicated that the maximum longitudinal yield strength of wide, thin 7050-T7351X extrusions should be no greater than about 73 ksi to provide high confidence that short-transverse specimens would survive 30 days in the alternate immersion test at a stress level of 45 ksi. Preliminary analysis of the longitudinal yield strength and exfoliation test data indicated that the maximum longitudinal yield strength of wide, thin 7050-T7651X extrusions should be no greater than about 78 ksi to provide high confidence that test panels would display an acceptable degree of exfoliation ($E-B$ in the EXCO test).

Knowledge and application of the aging kinetics of 7050 provided the ability to predict aging conditions required to develop the desired strength. The kinetics of the decrease in yield strength on overaging 7050 at temperatures in the 300-360°F

temperature range have been described analytically by the following equation.⁷

$$YS = \alpha \exp - \left(t/F_{YS} \right), \quad (1)$$

where: YS = yield strength, ksi, after aging for any time, t, in hours,

α = factor which depends on composition, fabrication practices, and test direction,

$$F_{YS} = 1.45 \times 10^{-16} \exp \left(\frac{32562}{T+460} \right), \quad (2)$$

where: T = aging temperature, °F.

During commercial precipitation heat treatments, the time required to heat to the soak temperature may be longer than the soak time, so effects of heating time on properties must also be considered. For alloy 7050 in overaged tempers, the net effect of the precipitation during heating is to decrease strength relative to that obtained on material heated at faster rates even though strength is initially increasing during the heatup.

Because the 300 to 360°F overaging reactions are isokinetic, i.e., differ only by a time factor, effects of heating through this temperature range to the maximum artificial aging temperature are additive. The solution of the following equation estimates the decrease in yield strength of overaged 7050 attributable to precipitation during heating:

$$YS \text{ loss} = \alpha \left[1 - \exp - \left(\int_{t_0}^{t_s} \frac{dt}{F_{YS}} \right) \right], \quad (3)$$

where: t_o = time at start of heating,

t_s = time at end of heating.

Yield strength after any type of heating curve followed by an isothermal precipitation heat treatment can be estimated by combining effects of heating to the aging temperature and soak time at the aging temperature:

$$YS = \alpha \exp - \left[t/F_{YS} \right] = \alpha \exp - \left[t_c/F_{YS} + \int_{t_o}^{t_s} \frac{dt}{F_{YS}} \right], \quad (4)$$

where: t_c = hold time at constant temperature.

Equation (4) provides the basis for selecting a nominal aging time, t , to provide the desired yield strength and gives the furnace operator a method of compensating for heating rate and for differences in soak temperature between that desired and attained.

The effects of neglecting to compensate for soaking at temperatures other than at 350°F can be large. For example, the calculated difference in strength between 7050 extrusions soaked 8 hours at either 345°F or 355°F is ~7 ksi, and the calculated difference in strength between 7050 extrusions soaked 8 hours at either 340°F or 360°F is ~14 ksi. Neglecting to compensate for time spent during heating to the soak temperature will increase the variability. Alcca has patented* a process for compensating for precipitation during heating and for soaking at temperatures different from the set point.

*USP 3645804.

The appropriate aging times at 350°F to develop strengths 5 ksi below the estimated maximums of 78 ksi for 7050-T7651X and 73 ksi for 7050-T7351X were estimated using the following relationship:

$$YS = \alpha \exp - (t/41.69), \quad (5)$$

where: YS = yield strength after aging for time, t, in hours,

α = estimated to be a mean of 89.5 ksi for 7050 extrusions from analysis of a variety of tests.

Solving this equation for t gives values of 8.5 and 11.5 hours aging times for YS of 73 and 68 ksi (5 ksi below the estimated maximum for T7651X and T7351X), respectively. Rounding off gives estimates of 8 hours at 350°F for 7050-T7651X and 12 hours at 350°F for 7050-T7351X.

In conclusion, the equivalent of 8 and 12 hours at 350°F, respectively, are indicated to be initial guidelines for second-step aging practices for 7050-T7651X and T7351X extrusions. Failure to compensate for aging during heatup and for soak temperatures that are more than a few degrees from the nominal soak temperature can lead to the development of strengths which are either higher or lower than acceptable.

III. PRODUCE EXTRUSIONS

1. Ingot Casting

Sufficient 25-inch diameter ingots were cast in Phase I so that no additional ingots of this size were required to produce the extrusions needed for Phase II.

The 35-inch diameter ingots were cast using Alcoa's production level-pour mold (Figure 1). The metal was melted in a 60,000-lb melting furnace and transferred to a 60,000-lb holding hearth. There was no metal treatment or grain refinement in the holding furnace. During casting, the metal passed through Alcoa 528 (U.S. Patent 3,373,305) and 181 (U.S. Patent 3,039,864) process units to filter out solid foreign material and remove hydrogen just before the molten metal entered the molds. The metal was grain refined using Kawecki TIBOR rod in the transfer system. The ingots were cast two at a time.

For each drop, the metal was permitted to flow slowly into the water-cooled mold for three minutes before the platen was started down. Water was applied to each mold at 140 gpm. This water was allowed to flow down the surface of the ingot for ten inches and then was completely removed. The metal depth above the water-cooled steel starting block (Figure 2) was approximately four inches when the starting casting rate was initiated. The initial 8.5 inches of ingot was cast at 0.6 ipm and then the bottom block cooling was turned off and the casting rate was increased to 0.7 ipm. At this stage, the ingot butt was approximately half way between the bottom of the mold and the wiper. These conditions of casting speed, water volume, and wiper location set up an ingot surface equilibrium temperature of 430°F.

This equilibrium temperature is determined by the flow of heat from the hot ingot center into the water-cooled ingot shell. As a result of all the cooling water being removed by the

wiper located ten inches below the mold, the equilibrium temperature was achieved eight to ten inches below the wiper. This reheating of the water-cooled ingot shell relieved stresses that developed in the ingot during solidification.

A total of sixteen ingots approximately 180 inches long were cast using the practices shown in Table 26. Eleven of the ingots contained at least 152 inches of crack-free metal. A typical ingot is shown in Figure 15.

As noted in the remarks column of Table 26, all except one of the usable ingots contained short butt cracks of the shear type. Minor modifications in the casting practice will eliminate these nuisance-type cracks. Since a substantial butt crop is required on this type of ingot, very little metal was lost as a result of this type of cracking.

An etched slice taken from a representative ingot revealed an equiaxed grain structure which was somewhat coarser in the center of the ingot. The ASTM macro grain size at various locations was: M 11.9 outside, M 9.3 mid-radius and center. A dye penetrant examination revealed a small amount of fine porosity. We noted zero voids/sq in. at the outside, 12 voids/sq in. at the mid-radius, and 20 voids/sq in. at the center. A metallographic examination showed a relatively fine dendritic structure for a large ingot. The dendrite arm spacings measured at the locations noted were: 0.0020 inch one inch from surface, 0.0030 inch mid-radius, 0.0030 inch center. These quality control tests all indicate the ingot was sound and suitable for further fabrication.

The necessity to alter the casting practice for the 35-inch diameter production ingot after the original success in the laboratory and the plant during Phase I warrants further explanation. As previously explained, a casting practice requires a balance of several interrelated factors. There is never a single unique practice for a given alloy and size. As a result, failure of casting practices to reproduce is not an uncommon occurrence. Establishing an acceptable plant practice requires finding a set of conditions which afford sufficient safety factor to permit commercial recoveries in a production plant environment. Apparently, the first set of casting conditions were adequate in the laboratory and in the plant when "things were just right." The second set of casting parameters were necessary to establish a real world production practice which requires a little less control than the original casting practice.

2. Extrusion and Heat Treatment

The extrusions for MIL-HDBK-5 testing were produced in three stages: (1) 7050-T7351X extrusions from a 21-inch diameter cylinder, (2) 7050-T7651X and 7050-T7351X extrusions from 25 and 29-inch diameter cylinders, (3) additional C5A wing plank 7050-T7351X extrusions.

a. 21-Inch Diameter Cylinder

Five extrusions were produced from 25-inch diameter ingot scalped to 21 inches and preheated 4 hours at 860-880°F plus 36 hours at 880-900°F. Billets were extruded into two aircraft sections

and three rectangles (1.5-in. x 7.5-in., 3.5-in. x 7.5-in., and 5.0-in. x 6.25-in.) (Figures 16 and 17) using the practices in Table 27.

All of the extrusions were solution heat treated in the same furnace load for 80 minutes soak at 890-900°F and quenched by immersion in cold water. All were stretched 1 to 3% permanent set. Subsequent straightening was not performed.

Because these extrusions were aged prior to the development of a guideline for aging 7050-T7351X extrusions, the practice was selected by estimating from available data. A practice of 24 hours at 240-255°F followed by the equivalent of 31 hours at 320°F was selected. Plant quality control tensile tests (Table 28) showed that longitudinal yield strengths were about 1 to 4 ksi below the desired maximum of 73 ksi.

The finished extrusions were inspected per MIL-I-8950, Class A and all were acceptable.

b. 25 and 29-Inch Diameter Cylinders

These extrusions were produced from 25-inch and 35-inch diameter ingots preheated 16 hours at 860-880°F plus 36 hours at 880-900°F. The 35-inch diameter ingots were scalped to 29-inch diameter billet and with the 25-inch diameter ingots were extruded into five aircraft shapes (Figures 18 through 22) using the practices in Table 29. An extra extrusion of section 900102 was produced full length to demonstrate the capability of fabricating the widest and thickest extrusions needed for the proposed C5A wing modification.

All of the extrusions were heat treated for 80 minutes at 890-900°F, quenched into cold water, and stretched 1 to 3%. The extra length of 900102 was joggled (kinked) per Figure 23.

Six of the extrusions were subsequently aged using the equivalent of 8 hours at 350°F following a first-step of 24 hours at 240-255°F. Discounting results from the rear of one of the extrusions (extrusion had begun to recrystallize at test specimen location), plant tensile tests (Table 30) confirmed that 8 hours at 350°F was an appropriate second-step aging practice for 7050-T7651X extrusions. The mean longitudinal yield strength of specimens taken from the front and rear was 73.3 ksi (73 ksi target).

The remaining six extrusions were aged 24 hours at 240-255°F followed by the equivalent of 12 hours at 350°F. Plant test results (Table 30) indicated that the time of the second step may be slightly short for aging 7050-T7351X extrusions. The mean longitudinal yield strength of specimens taken from the front and rear was 69.2 ksi (68 ksi target). Two of the extrusions, however, had yield strengths slightly higher and/or electrical conductivities slightly lower than preliminary analysis suggested were appropriate for 7050-T7351X extrusions. Consequently, they were aged the equivalent of an additional 4 hours at 350°F, and mean strengths dropped to 68.5 ksi.

The extrusions were ultrasonically inspected at the plant per MIL-I-8950, Class A. All of the extrusions met this level except two 10-foot lengths of section 291812 which were suspect.

c. Additional C5A Wing Plank Extrusions

Ten ingots were preheated as described in the preceding section. Full length, 29-inch diameter x 76-inch billets were extruded at 740°F to 790°F with a cylinder temperature of 800°F.

Five of the billets were solution heat treated one hour at 890-900°F and quenched in cold water. Pieces 17 and 19 were heat treated in one load, and pieces 20, 21, and 24 were heat treated in another load. The solution heat treated extrusions were stretched 1-3%, sawed to 21 foot lengths, and joggled on one end within four hours of quenching.

The heat treated extrusions were ultrasonically inspected using standard procedures, and all met the requirements of MIL-I-8950, Class A.

The front and rear 21-foot sections of the solution heat treated panels were artificially aged 4 hours at 240-255°F plus the equivalent of 12 hours at 350°F. The front lengths were aged in one load and the rear lengths in another.

Longitudinal tensile properties and electrical conductivities were determined at the plant (Table 32). Mean longitudinal yield strength was 65.6 ksi. Despite the differences in composition, solution heat treatment batch, age load, and test location, the range in strengths was small (63.6 to 66.8 ksi yield strength and 74.4 to 76.7 ksi ultimate tensile strength). The electrical conductivity values fell within the band of yield strength versus electrical conductivity that had previously been observed for 7050-T7XXX extrusions.

IV. EVALUATE

1. Composition

The compositions of all extrusions were well within the limits of 5.7-6.7% Zn, 1.9-2.6% Mg, 2.0-2.6% Cu, 0.08-0.15% Zr, 0.15% max Fe, and 0.12% max Si (Tables 33, 34, and 35). The means and estimates of the standard deviation for the major alloying elements were 6.19%, 0.17% (Zn); 2.19%, 0.09% (Mg); and 2.23%, 0.11% (Cu). The means agreed favorably with the nominal 6.2% Zn, 2.25% Mg, and 2.3% Cu, and the estimates of the standard deviations suggest that future problems in meeting these limits will be minimal. Impurity contents ranged from 0.08 to 0.13% Fe and 0.04 to 0.10% Si, while Zr content ranged between 0.09 and 0.11%.

2. Ultrasonically-Detected Discontinuities

Tests were made on the two ten-foot lengths of section 291812 which were suspect on the basis of plant ultrasonic tests. The two lengths were reinspected at Alcoa Laboratories, and the indications did not exceed Class A of MIL-I-8950 (Tables 36 and 37). The locations of all indications exceeding 30% of that made by a test block having a 3/64-inch flat bottom hole at comparable metal distance were marked on the surface of the extrusion, and longitudinal and long-transverse tensile and axial-stress fatigue specimens were machined to position the discontinuity in the approximate center of the gauge length. These specimens were re-ultrasonically inspected after rough preparation to confirm that the discontinuity was present in the specimen. The transverse tensile blanks did not contain

discontinuities. Table 38 shows the results of the ultrasonic inspection of the specimen blanks and correlates these data with those obtained on the extrusions. The specimen blanks contained discontinuities classed as 3-, 3, and 3+. Discontinuities of this size whose centers are not closer than one inch are permitted in MIL-I-8950, Class A.

Table 39 presents the results of the tensile properties. The differences between yield and tensile strengths and the elongation and reduction in area values indicate that the presence of a discontinuity had no effect.

The axial-stress fatigue data are plotted in Figure 25 with data obtained on specimens which contained no discontinuities. They show no effect of discontinuities on fatigue life.

3. Design Mechanical Properties

a. Tensile, Compressive, Shear and Bearing

(1) Procedure

Tensile, compressive, shear, and bearing tests were made using the smallest suitable range of an Amsler 20,000-lb (type 105XBDA58), an Olsen Electomatic 30,000-lb, an Olsen Super-L 20,000-lb, or a Southwark-Tate-Emery 50,000-lb capacity Universal Testing Machine. The accuracy of these machines was always within that required by ASTM Method E4.⁸

In general, the test specimens were the same as those used in previous investigations of plate, extrusions, and forgings.⁹⁻¹⁴ Single tests of each type of specimen were made. Longitudinal specimens were taken in the locations specified in ASTM B557¹⁵ and

long-transverse and short-transverse specimens were taken from the center of the width and thickness of the predominate part of the section.

Tensile tests were made in accordance with ASTM E8¹⁶ with 1/2-in. diameter tapered seat specimens, except where it was necessary to use subsize round specimens (Figure 26). The yield strengths were determined from autographically recorded load-strain diagrams.

Compressive tests of cylindrical specimens (Figure 27) were made in accordance with ASTM E9¹⁷ using a subpress (Figure 3 of ASTM E9). The yield strengths were determined from autographically recorded load-strain diagrams.

Shear tests were made of cylindrical specimens (Figure 27) in an Amsler double-shear tool in which a 1-inch length is sheared from the center of a 3-inch long specimen, the end thirds being supported throughout their length.¹⁸ In the tests of longitudinal and long-transverse specimens, the loads were applied in the direction normal (ST) to the major surface of the extruded shape; in the tests of short-transverse specimens, the loads were applied in the longitudinal direction.¹⁸

Bearing tests were made in accordance with ASTM E238¹⁹ using flatwise longitudinal and long-transverse specimens of the type shown in Figure 28. The bearing ultimate and yield strengths were determined at edge distances of 1.5 and 2.0 times the pin diameter. The bearing yield strength was obtained by determining the load at a permanent deformation of 2 percent of the pin diameter

as indicated on an autographic load-deformation diagram. The specimens and test fixtures were cleaned ultrasonically as prescribed in ASTM E238.

(2) Results and Discussion

The results of the tensile, compressive, shear, and bearing tests for the five lots of 7050-T7651X shapes are shown in Table 40 and those for the 7050-T7651X shapes tested on a NASC contract are shown in Table 41. The corresponding results for the 7050-T7351X shapes are shown in Table 42 (section area $\bar{43}$ in.²) and Table 43 (section area 61 to 66 in.²). The longitudinal tensile properties of all shapes met applicable tentative minimum values.²⁰

For a particular temper, level of properties depended on type of test, section thickness, and test direction. The longitudinal tensile ultimate and the longitudinal tensile and compressive yield strengths increased a few percent, and the corresponding long-transverse tensile ultimate and yield strengths decreased as much as 8 percent as the section thickness increased; the long-transverse compressive yield strengths decreased little, if any, with thickness. The small amount of short-transverse data indicated the same general trend with thickness as the corresponding long-transverse data. The longitudinal tensile elongation values decreased slightly with increasing thickness while the long-transverse and short-transverse elongation values decreased to a greater extent. As with extrusions in other alloys, the long-transverse elongation values tended to approach those of the

short-transverse direction as the aspect (width-to-thickness) ratio decreased. There was no significant decrease in shear strengths with increased thickness for the T7651X temper, but a few ksi decrease for the T7351X temper. Bearing properties in general showed little decrease with thickness, at most an average of 7 ksi.

Effect of temper on the level of properties developed depended mainly on the property and on the test direction. The differences in tensile strength levels of the two tempers were in a range from 4 to 6 ksi for ultimate strengths and 5 to 8 ksi for tensile yield strengths; the largest and smallest spread was in the longitudinal and short-transverse properties, respectively. The spread in compressive yield strengths averaged about 8 ksi. The only significant differences in elongation values were in the mid-to-thick range of the long-transverse and short-transverse directions; the elongation values for the T7351X temper were up to twice those of the T7651X temper. Differences in shear strengths averaged about 3 to 6 ksi, and bearing property differences averaged from 8 to 12 ksi.

Sections 900102 (C5A panels) and 291812 (cross-sectional area, 61 to 66 in.²) exhibited a relatively high level of tensile and compressive properties compared to those of the shapes of smaller cross-sectional areas having comparable section thicknesses. Generally, the longitudinal and short-transverse strengths averaged only 3 to 5 ksi lower than, and the long-transverse strengths about equal to, those of the smaller shapes. The corresponding shear and

bearing properties were generally in the same range as those of the smaller shapes.

b. Stress-Strain, Compressive Tangent-Modulus Curves, and Modulus of Elasticity

(1) Procedure

Tensile and compressive stress-strain tests were made of longitudinal, long-transverse, and when possible, short-transverse specimens from representative lots of each temper. The tests were, in general, conducted in accordance with ASTM E111.²¹ The tensile and compressive specimens were of the type shown in Figures 26 and 27, respectively.

Loads were measured with Revere Super Precision-type load cells having an accuracy, traceable to the National Bureau of Standards, of 0.1 percent of rated output. Strains were measured with Micro-Measurements Type CEA-13-062UW-350 and CEA-13-125UW-350 strain gauges. These gauges have a gauge factor accuracy of 0.5 percent and a resistance accuracy of 0.3 percent. Overall accuracy of the load measurement was 0.5 percent of reading or 0.25 percent of full scale, whichever was larger. Strain measurement accuracy was 0.7 percent of reading or 0.5 percent of full scale, whichever was larger; the accuracy of the gauges was well within the requirements established for Class B1 extensometers in ASTM E83.²²

The tests were carried beyond the yield strength of the material. The stress and strain signals were recorded on a Mosley X-Y recorder for monitoring purposes and in computer storage. The modulus of elasticity values were determined from Tuckerman analysis plots of each test as described in ASTM E111. Typical (and average

for the T7351X C5A panels) tensile and compressive stress-strain curves were developed for each temper by methods equivalent to those outlined in MIL-HDBK-5 Guidelines.²³ The compressive tangent-modulus curves were developed from the typical and average compressive stress-strain curves. The data obtained on an NASC contract for the T7651X temper were also included to establish the typical curves.⁵

(2) Results

The results of the tensile and compressive stress-strain and modulus of elasticity tests are summarized in Table 44. The modulus of elasticity values averaged about the same for both tempers. The nominal values were 10.3×10^3 ksi in tension and 10.7×10^3 ksi in compression. In tension, the longitudinal values averaged 0.5 percent lower, long-transverse values averaged 1.6 percent higher and the short-transverse values average 1 percent lower than the nominal value of 10.3; in compression, they averaged: longitudinal - equal to, long-transverse - 3 percent higher than, and short-transverse - 1.2 percent higher (T7651X) and 0.4 percent lower (T7351X) than the nominal value of 10.7

The typical stress-strain and compressive tangent-modulus curves were developed for two thickness ranges of each temper, ≈ 1.999 in. and 2.000 to 5.000 in., areas ≈ 43 in.². These are shown in Figures 29 and 30 for the T7651X and Figures 31 and 32 for the T7351X shapes. The typical longitudinal tensile yield strengths were based on production data, and the yield strengths for the other curves were established from the average ratios of the yield strengths in Tables 40 through 43 and the corresponding typical longitudinal tensile yield strength.

Average stress-strain and compressive tangent-modulus curves are shown in Figure 33 for the 7050-T7351X extruded C5A panels since there is presently insufficient production data to establish typical longitudinal tensile yield strengths of shapes of such large cross-sectional areas. These curves are based on the average of the properties shown in Table 43 for the six lots of C5A panels (section 900102) and stress-strain tests of two of these lots.

(3) Conclusion

The modulus of elasticity values for 7050-T7351X are comparable to those of 7050-T7651X. The average values are 10.3×10^3 ksi in tension and 10.7×10^3 ksi in compression.

c. Derived MIL-HDBK-5 Properties

The ratios among the tensile, compressive, and shear properties are shown in Table 45 for the T7651X temper and Table 46 for the T7351X temper; the corresponding bearing/tensile ratios are shown in Tables 47 and 48, respectively. The ratios computed for the samples with cross-sectional areas 61 to 66 in.² were not included in the statistical analyses of ratios of samples $\bar{\approx}43$ in.². The ratios of the former, when plotted versus thickness, were in most instances higher than those of the latter; an exception was the longitudinal compressive ratios, $CYS(L)/TYS(L)$, which were slightly lower. Consequently, ratios for 13 lots of the T7651X temper, $\bar{\approx}43$ in.², eight lots of the T7351X, $\bar{\approx}43$ in.², and seven lots of the T7351X, 61 to 66 in.² were analyzed statistically. Two lots were not sufficient for analysis of the T7651X, 61 to 66 in.². Ten lots are necessary for acceptance of derived properties in MIL-HDBK-5.

The distribution of the ratios, number of ratios (n), mean ratios (\bar{R}), intercepts and slopes of the regression lines (a and b , respectively), and the standard deviations ($\sigma_{\bar{R}}$) are shown in Table 49 for the T7651X, $\bar{z}43$ in.², Table 50 for the T7351X, $\bar{z}43$ in.², and Table 51 for the T7651X and T7351X, 61 to 66 in.². The statistical analyses of the ratios were made by procedures outlined in Chapter 9 of MIL-HDBK-5, Guidelines for Presentation of Data.²³ A regression analysis of each group of ratios was made to determine whether the ratios showed correlation with thickness; where such correlation was indicated, Min. \bar{R} values were selected which correspond with the lower limit of the confidence band around the regression line at the highest end of each respective thickness range. When no correlation was indicated, a single value of Min. \bar{R} was selected for all thicknesses. Regression was indicated for all groups of ratios with the exception of CYS(L)/TYS(L) ratios of both tempers, $\bar{z}43$ in.² cross-section area. Also, an analysis of the ratios for the seven lots of the T7351X temper, 61 to 66 in.², was made. The minimum ratios for the T7651X and T7351X shapes are shown in Tables 52 and 53, respectively.

Since no grain directions are shown for shear and bearing minimum properties in MIL-HDBK-5 and data were obtained for more than one direction, the lowest of the longitudinal or long-transverse Min. \bar{R} were used to establish the derived properties. The few short-transverse shear tests made of the thicker shapes indicate that the shear strengths for this direction were somewhat lower than those for the other two directions. This is also the case for

other alloys and products. The longitudinal and long-transverse shear data were used to establish the derived shear minimum values so as to be consistent with procedures used for other alloys and products.

The MIL-HDBK-5 mechanical properties are shown in Tables 54 and 55, respectively, for the T7651X and T7351X extruded shapes. These values were based on the ratios for shapes having cross-sectional areas ≥ 43 in.². Those for the T7351X temper were based on tests of eight lots, two less than required by MIL-HDBK-5 Guidelines. No limitations in product size have been indicated in Tables 54 and 55; more production tensile data are needed in order to establish such limits. No minimum longitudinal tensile properties have been established for the shapes with large cross-sectional areas and, therefore, a MIL-HDBK-5 table of design properties could not be developed. Additional data, over a wider thickness range, is also necessary to meet the ten lot requirement.

In the previous discussion, it was pointed out that the longitudinal tensile ultimate and yield strength increased as the section thickness increased. All the other properties, with the exception of the longitudinal compressive yield strengths, showed little or no change or a small decrease in strength with increasing thickness. The longitudinal tensile properties were used as the base properties for calculating the ratios, i.e., they were the denominator values and the others the numerator. The increase in the longitudinal tensile properties, indicated by the test data, were not reflected in the corresponding minimum longi-

tudinal tensile properties to which the reduced ratios were applied to obtain the derived minimum properties. Consequently, the derived minimum properties generally indicate larger decreases in strength than those indicated by the test data. In the case of the longitudinal compressive yield strengths, which increased with thickness, the corresponding derived minimum properties show no change with thickness. If the test data for the longitudinal tensile properties are indicative of the strength levels to be obtained from current and future production, revisions of the minimum properties would seem appropriate when sufficient data are obtained. Consequently, the derived properties would then be brought more in line with the capabilities of the material.

(1) Conclusion

The ratios among the tensile, compressive, shear, and bearing properties for the section with cross-sectional areas of 61.53 (C5A panels) and 65.37 (section 291812) in.² are, with the exception of the longitudinal compressive yield strengths, higher than those of the smaller shapes in the same thickness ranges.

4. Fracture Toughness

a. Procedure

Duplicate fatigue-cracked compact fracture toughness specimens of the type shown in Figure 34 were used to determine the plane-strain stress intensity factor, K_{IC} , of each lot of extruded

shapes. The specimen orientations, shown in Figure 35, dimensions, notches, fatigue cracking, and testing procedures were essentially in accordance with ASTM E399-4.²⁴ The specimens were fatigue cracked by axial loading in Krouse fatigue machines. The test setups for fatigue precracking and fracture toughness testing are shown in Figures 36 and 37, respectively. The tests were made in a 30,000-lb capacity Olsen Electromatic Testing Machine, and plots of load versus crack-opening displacement were recorded using a Mosley X-Y recorder. Candidate values of critical plane-strain stress-intensity factor, K_Q , were calculated using the load at 5 percent secant offset which is equivalent to about 2 percent of crack extension. If all the validity criteria specified in ASTM Method E399-4 were met, the candidate value was designated as K_{IC} .

b. Results and Discussion

The results of the fracture toughness tests for the five lots of 7050-T7651X shapes are shown in Table 56 and those for the 7050-T7651X shapes tested on an NASC contract⁵ are shown in Table 57. The corresponding results for the T7351X shapes are shown in Table 58 (section area ≈ 43 in.²) and Table 59 (section area 61 to 66 in.²). The K_Q values which failed to meet, but were very close to meeting, any one of the validity criteria specified in ASTM Method E399-74 are indicated as meaningful values, i.e., the values are a good indication of the K_{IC} value. All results are summarized in Table 60.

The K_{IC} values versus thickness are plotted in Figure 38; meaningful values are plotted as valid. As anticipated, material in the lower strength T7351X temper generally developed higher

toughness. For the L-T orientation, the T7651X values indicated a decrease in K_{IC} from a level of 38 $\text{ksi}\sqrt{\text{in.}}$ to a level of 26 $\text{ksi}\sqrt{\text{in.}}$ with increasing thickness from 1 in. to 5 in. For the T7351X temper, however, no significant change in toughness was indicated; K_{IC} was constant at a level of about 40 $\text{ksi}\sqrt{\text{in.}}$ For the T-L orientation, the sections in the T7351X and T7651X tempers were 38 and 32 $\text{ksi}\sqrt{\text{in.}}$, respectively, for sections less than 1 in. The K_{IC} values of material in both tempers decreased progressively with increasing thickness to levels of 23 and 17 ksi for the 5-in. thick rectangles. The data for the S-L orientation indicated that material in both tempers developed comparable toughness in sections less than 2-in. thick (20 to 26 $\text{ksi}\sqrt{\text{in.}}$). In thicker sections, K_{IC} values of material in the T7651X temper decreased to a level of 16 to 18 $\text{ksi}\sqrt{\text{in.}}$, but, as with the L-T data, the T7351X indicated no change in toughness with thickness. The toughness levels of the large shapes (61 to 66 in.^2), most of which were the C5A panels, were generally equivalent to those of the small shapes.

The K_{IC} values versus tensile yield strengths are plotted in Figure 39. Data for some other shapes, aged to various levels of yield strength, are also shown and extend the range of values beyond those obtained in this contract. Generally, the 7050 shapes exhibited a high level of toughness while maintaining yield strengths at the higher strength end of the range indicated for commercially-established alloys. (About 90 percent of the data for the

commercially-established alloys fall in the lower half of the band for the L-T orientation). Excluding the lots from Producer B and the 3.5 x 7.5 and 5.0 x 6.25-in. shapes, the T-L and S-L data fall above these ranges. The relatively low values obtained for 3.5 and 5.0-in. thick shapes are related to the low aspect ratio of the shapes. As the width to thickness ratio decreases, the T-L K_{IC} values approach those of S-L values.

The connected open squares in Figure 39 are those for the six lots of T7351X C5A panels. The rather broad range in K_{IC} values obtained for the narrow range of yield strengths, 2 to 4 ksi, are attributed to differences in the iron content from lot to lot, 0.08 to 0.13 percent. As the purity level increased, the toughness increased approximately $10 \text{ ksi}\sqrt{\text{in.}}$ for the L-T and T-L orientations and about $6 \text{ ksi}\sqrt{\text{in.}}$ for the S-L orientation.

The combination of strength and toughness of these C5A panels was significantly higher than that of 7175-T7651X and 7175-T7351X panels which were made and tested under another contract²⁵ (Figure 40).

One of the T7351X C5A panels was checked for variations in toughness of the L-T orientation at the front, center, rear, and quarter points of the 42-foot length. The spread in K_{IC} values was $1.7 \text{ ksi}\sqrt{\text{in.}}$ and, as shown in Table 43, there was also little variation in the corresponding tensile properties.

c. Conclusions

Extruded shapes of 7050-T7651X and T7351X exhibit a higher combination of strength and toughness, K_{IC} , than that of established

commercial alloy extrusions. Considering identical sections, the advantage of 7050 in the L-T, T-L, and S-L directions is about 10, 9, and 5 ksi $\sqrt{\text{in.}}$, respectively.

Large extruded shapes with high aspect ratios develop levels of toughness equivalent to those of smaller shapes of comparable thickness.

5. S-N Fatigue

a. Laboratory Air

(1) Procedure

The axial-stress fatigue properties were determined with smooth and notched, $K_t = 3$, specimens of the type shown in Figure 41. Longitudinal and long-transverse specimens were taken from the same locations in the cross-sections as the tensile specimens. Tests were made at stress ratios* of $R = +0.1$ and -1.0 of representative lots. A sufficient number of tests were made of some lots to obtain the fatigue strengths between 10^3 and 10^7 cycles; at least three tests were made of other lots at various stress levels for $R = +0.1$ only. Tests were made in Krouse fatigue machines operating at 13.3, 25.0, and 28.0 Hz.

(2) Results and Discussion

Smooth Specimens, $K_t = 1$. The results of the fatigue tests of three 7050-T7651X shapes and those for the corresponding shapes in the T7351X temper are shown in Figure 42 ($R = +0.1$) and Figure 43 ($R = -1.0$). The data developed previously for the T7651X temper

* Stress ratio, $R = \frac{\text{minimum stress}}{\text{maximum stress}}$.

are represented by the band ($R = 0.0$) in Figure 42 and a curve for one lot in Figure 43 ($R = -1.0$). The data for $R = +0.1$ of both tempers generally fell within the band for the T7651X shapes, $\bar{c}32$ in. cross-sectional area. There were no discernible differences between the fatigue strengths of the two tempers. The data for $R = -1.0$ (Figure 43) were generally evenly distributed about the curve for the 1.161-in. thick 7050-T7651X shape.

With the exception of the data for long-transverse specimens of the 3.5 and 5.0-in. thick shapes, the data for the five 7050-T7351X shapes having cross-sectional areas less than 43 in.², Figure 44 ($R = +0.1$), fell within a band established from the data in Figure 42 for the T7651X temper. This band for the T7651X temper would probably be broader and encompass the long-transverse T7351X data if it included data for shapes similar to those of the T7351X temper. The observation that only the narrow shapes exhibited large differences between fatigue lives of the longitudinal and long-transverse specimens appears to be related to the differences in the aspect ratios of the shapes. The ratios of width to thickness for the wider shapes were between 6 and 26 while those for the 3.5 and 5.0-in. thick shapes were 2.14 and 1.25, respectively.

The data for the C5A panel, 61.53 in.² cross-section, and also the 2.93-in. thick shape, 65.37 in.², are shown in Figure 45 ($R = +0.1$) along with a band established from data for the 7050-T7351X shapes, $\bar{c}43$ in.² (Figure 44) and Figure 46 ($R = -1.0$) along with a curve established from data for the 7050-T7351X section

263902 (Figure 43). Generally the fatigue strengths for the large panels fell within the band for $R = +0.1$ and those for $R = -1.0$ were generally evenly distributed about the curve for section 263902.

Notched Specimens, $K_t = 3$. The results of the fatigue tests of three 7050-T7651X shapes and those for the corresponding shapes of 7050-T7351X are shown in Figure 47 ($R = +0.1$) and Figure 48 ($R = -1.0$). The data for both tempers ($R = +0.1$) fell in the same general range as those for the 7050-T7651X shapes ($\bar{c}32 \text{ in.}^2$) tested previously at $R = 0.0$. At $R = -1.0$, the data averaged slightly higher than those for the 1.161-in. thick 7050-T7651X shape. As with the data for smooth specimens, there were no noticeable differences between the fatigue properties of the two tempers. This is also indicated in Figure 49 where the data for the five lots of 7050-T7351X shapes having cross-sectional areas less than 43 in.^2 are plotted with a band developed from the T7651X data in Figure 47. Both the longitudinal and long-transverse data fell in a narrow range.

The results of the tests of the C5A panels, 61.53 in.^2 cross-section, and also the 2.93-in. thick shape, 65.37 in.^2 , are shown in Figure 50 ($R = +0.1$) along with a band for data of the 7050-T7351X shapes, $\bar{c}43 \text{ in.}^2$ (Figure 49) and Figure 51 ($R = -1.0$) along with a curve for data of the 7050-T7351X section 263902 (Figure 47). The data for these large shapes tested at $R = +0.1$ fell in the lower part of the rather narrow band and for $R = -1.0$, the data were in general agreement with the average curve except beyond about 10^5 cycles where data for one lot fell about 2 ksi below the average curve for section 263902.

(3) Conclusions

Extruded shapes of 7050-T7651X and 7050-T7351X exhibit about the same level of fatigue strengths.

Extruded shapes of 7050 with cross-sectional areas greater than 43 in.² have fatigue strengths generally equivalent to those of smaller shapes.

Extruded shapes of 7050 with high aspect ratios have about the same fatigue strengths in the longitudinal and long-transverse directions. As with other alloys, shapes of 7050 with aspect ratios less than 3 can be expected to develop fatigue strengths, $K_t = 1$, for the long-transverse direction lower than those for the longitudinal direction; for $K_t = 3$, the effect of aspect ratio of shapes does not appear to be significant.

b. Salt-Fog Environment

(1) Procedure

Smooth and notched specimens similar to those used for the test in laboratory air were subjected to axial stress fatigue tests ($R = 0.0$) in a salt-fog environment. Specimens were taken in the long-transverse direction from most of the lots tested in lab air. The test sections were subjected to a 20-second spray of a 3.5% salt solution at 5 minute intervals during tests in 5,000-lb capacity Krouse fatigue machines operating at 18.3 Hz.

(2) Results and Discussion

As reported for several 7050 products,⁵ the salt-fog environment substantially lowered the long life fatigue strength

of all extrusions (Figures 52 to 54). Failures of smooth specimens lasting more than a day (1,580,000 cycles) initiated in corroded areas; for 10^7 cycles to failure the fatigue strengths of smooth specimens are equal to those of mildly-notched specimens, $K_t = 3$, tested in air.

(3) Conclusions

The corrosion-fatigue strengths of the smooth and mildly-notched, $K_t = 3$, specimens of the 7050-T7651X extrusions (Figure 52) are comparable to the scatter band shown for smooth and sharply notched, $K_t \geq 12$, specimens.⁵ In air the specimens having the sharp notch would have lower fatigue strengths than specimens having a mild notch. However, the corrosive environment apparently negates the difference in notch severity.

The corrosion-fatigue strengths of specimens from the 7050-T7351X extruded wing planks (Figure 54) are equivalent to those of the other 7050-T7351X extrusions (Figure 53).

The corrosion-fatigue strengths of smooth specimens from 7050-T7651X and T7351X extrusions (Table 61) are equivalent to those of specimens from plate and hand forgings. The values for notched plate specimens, $K_t \geq 12$, are 1 or 2 ksi lower than those of hand forgings, $K_t \geq 12$, and the various extrusions, $K_t = 3$ and ≥ 12 .

6. Fatigue Crack Propagation (Normal ΔK)

a. Procedure

Fatigue-crack propagation rates were determined using compact specimens (Figure 55). Data were developed for each temper

in dry air and moist air. Specimens were taken in the T-L and L-T orientations, and where possible, in the S-L orientation.

Tests were made in load control in MTS closed loop, servo-controlled, test systems (Figure 56) at rate of, generally, 15 or 20 Hz; some tests were slowed in the final stages. Humidity was controlled within test chambers. Dry air (relative humidity <10 percent) was obtained using dessicants; moist air (relative humidity >90 percent) was obtained by forcing moist air through the chamber.

Fatigue precracks were generally started at $R = 0.1$ at maximum test loads used in subsequent $R = 1/3$ data acquisition. The final one third of precracking was usually accomplished at test loads. Visual-crack length measurements were made using low power magnification (15X) and a series of reference grid lines (0.02 in.) photographically printed on both sides of the specimen (Figure 57).

As occurred in some of the previous tests of 7050 extrusions,* the crack of the second L-T specimen tested grew at an angle to the transverse direction and finally altered to a longitudinal direction. To eliminate this behavior, the width of the remaining L-T specimens was reduced to change the H/W ratio from 0.485 to 0.60.

The rate of fatigue-crack growth, $\Delta a/\Delta N$, was determined from crack length, a , versus number of cycles, N , data evaluating incrementally the derivative of a versus N . These growth rates were plotted against the range in stress intensity evaluated at the average crack length over which the Δa increment was taken. The expression for stress intensity was:

*See pp 44-45 of Ref. 5 for discussion.

$$\Delta K = \frac{\Delta P \sqrt{a}}{BW} Y,$$

where: P = load, thousand pounds,

$$Y, (H/W=0.485) = 30.96 - 195.8 \left(\frac{a}{W}\right) + 730.6 \left(\frac{a}{W}\right)^2 - 1186.3 \left(\frac{a}{W}\right)^3 + 754.6 \left(\frac{a}{W}\right)^4, \quad (\text{Ref. 26})$$

$$Y, (H/W=0.6) = 29.6 - 185.5 \frac{a}{W} + 655.7 \left(\frac{a}{W}\right)^2 - 1017.0 \left(\frac{a}{W}\right)^3 + 638.9 \left(\frac{a}{W}\right)^4, \quad (\text{Ref. 27})$$

A, B, W, and H (see Figure 55).

b. Results and Discussion

The fatigue crack growth data are plotted in Figures 58 to 68. There is generally good agreement between overlapping portions of $da/dN-\Delta K$ data for duplicate specimens, whose tests were started at different stress intensities. Average growth rates are summarized in Table 62 along with comparable data from previous investigations. The effects of specimen size, orientation, environment, temper, and lot are discussed below.

7050-T7651X Extrusions (Figures 58 and 59)

The results for specimens LT-1 and LT-3, having H/W ratios of 0.6 and 0.485, respectively, are shown in Figure 58 to be equivalent. Accordingly, differing H/W ratios are not considered in subsequent comparisons of L-T and T-L specimens. Growth rates tended to be slightly faster for the T-L specimens in both environments at medium stress intensities; growth rates in moist air were about three times faster than those in dry air. The rates for both orientations and environments were comparable to those reported⁵ for 7050-T7651X extrusions of similar thickness.

7050-T7351X Extrusions (Figures 60 to 63))

For 0.915-in. extrusions, Table 62 shows equivalent fatigue crack growth rates for the T7351X and T7651X tempers. For the thick extrusion, the S-T specimen (Figure 63) exhibited more of an environmental effect than the T-L specimens at medium stress intensities and showed slower growth rates than the T-L specimens at the high stress intensities. In Reference 5, propagation for similar thick 7050-T7651X extrusions was much faster for S-L specimens at the higher stress intensities.

7050-T7351X C5A Wing Panel Extrusions (Figures 64 to 68)

The variations in composition listed in Table 35 had no apparent effect on the rate of crack growth; Figures 64 to 67 show relatively small scatter for specimens from two to five lots. In several cases, little environmental effect is shown at high and low stress intensities although propagation at the intermediate levels is substantially faster in the moist environment. In dry air, crack growth in the C5A panels was comparable to that in most T7351X and T7651X extrusions; in moist air, propagation in the C5A panels was slower at the higher stress intensities than in comparably oriented specimens of the other extrusions.

The results of an $R = 1/2$ test started at low crack-growth rates are plotted in Figure 68. At low stress intensities, the rates for the $R = 1/2$ test are slower than shown in Figure 65 for tests at $R = 1/3$. However, for rates above 2×10^6 in./cycle, the data fall within the range of results for the $R = 1/3$ tests.

c. Conclusion

Fatigue crack-growth rates of the 7050-T7651X and T7351X extrusions in the L-T and T-L directions are comparable to those previously reported for 7050-T7651X extrusions.

7. Fatigue Crack Propagation (Low ΔK)

Additional fatigue crack propagation tests were conducted to obtain low growth rate data needed for design data requirements of the C5A and other aircraft. Tests were limited to the C5A extrusion (S. 421332) for which the most $R=1/3$ data were available. The test matrix given in Appendix Table A-1 included the effects of orientation and environment on propagation at $R=0.1$ and 0.5 .

The tests were performed at rates of 10 to 50 Hz rather than 15 or 20 Hz as used for the tests at higher stress intensities. To facilitate the faster loadings, a smaller 0.25-in. thick specimen was used (Figure 55). The slower rates were used for portions of the tests to allow the machines to be operated overnight and during weekends and to maintain satisfactory load response as displacement increased in the latter stages of the tests. There was no apparent variation with frequency.

The results of these tests, presented in Appendix A, support the following conclusions.

1. Threshold values of stress intensity, below which propagation does not occur, were indicated to be about $1.5 \text{ ksi}\sqrt{\text{in.}}$ and $1.0 \text{ ksi}\sqrt{\text{in.}}$ for T-L and L-T specimens, respectively, at $R=0.5$ and $2.5 \text{ ksi}\sqrt{\text{in.}}$ for L-T specimens at $R=0.1$.
2. For low growth rates, crack growth was equivalent in dry and moist air.

8. Corrosion Characteristics

The corrosion test program included the evaluation of resistance to exfoliation corrosion and resistance to stress-corrosion cracking (SCC). The SCC tests were conducted with both smooth test specimens and linear fracture mechanics-type precracked specimens, although primary emphasis was placed on the smooth specimen tests.

a. Procedure

(1) Resistance to Exfoliation

The resistance to exfoliation was evaluated by means of 2 x 4-in. panels machined to the T/2 or T/10 (T7651X temper only) plane (50 or 10 percent of the section thickness machined from the surface of the predominant portion of the section) and exposed to the EXCO test per ASTM G34.²⁸ The EXCO test involves immersion for a period of 48 hours in a 4 M NaCl + 0.5 M KNO₃ + 0.1 M HNO₃ solution. In addition, similarly machined test panels, 4 x 9-in., were exposed to the seacoast atmosphere at Point Judith, R.I. Specimens exposed to the EXCO test were rated visually using the photographic standards contained in ASTM G34 (Figure 69).

(2) Resistance to SCC - Smooth Specimens

The resistance to SCC of susceptible alloys and tempers is most critical in the short-transverse direction relative to the grain flow pattern; therefore, the majority of tests were made on specimens oriented in that direction. Selected items were also tested in the longitudinal and long-transverse directions.

Tests were conducted principally with 0.125-in. diameter tensile bars meeting the requirements of ASTM E8; 0.750-in. O.D.

C-ring specimens (ASTM G38-73) were employed when the section thickness precluded use of the tensile bar. The specimens were centered in the thickness of the predominant portion of the section, and were confined to the central third relative to the width of the section. No specimens were removed in regions containing reinforcing ribs which could alter the grain flow pattern (ASTM G47-76).

The tensile bars were stressed in triplicate by axially loading in "constant strain" type fixtures, Figure 70a, using a synchronous loading device of the type shown in Figure 70b. C-ring specimens were also stressed in triplicate to a deflection calculated to impart the desired tensile stress on the specimen surface. Longitudinal and long-transverse specimens were stressed at 75 percent of the actual yield strength, while the test stresses for the short-transverse specimens varied with temper and sequence of testing. Specimens from all of the T7351X temper sections were stressed at 52 and 45 ksi, and sections received during the latter stages of the contract were also stressed at 35 ksi. The specimens from T7651X temper sections tested previously under Naval Contract N00019-72-C-0512⁵ were stressed at 45, 35, and 25 ksi (only the 35 and 25 ksi test stresses are included in the tabular data), and specimens from sections produced under this contract were stressed at 25 and 17 ksi. The latter level corresponds to 25 percent of the guaranteed longitudinal yield strength.

Specimens were exposed to three environments: (a) 3.5% NaCl by alternate immersion per ASTM G44-75;²⁹ (b) seacoast atmosphere at Point Judith, Rhode Island; and (c) industrial atmosphere

at Alcoa Center, Pa. Atmospheric tests are scheduled for a minimum of four years; however, at this time only specimens from the aforesaid Naval contract have completed exposure periods of more than 22 months.

(3) Resistance to SCC - Precracked Specimens

Tests were conducted on selected items to determine rates of SCC propagation as a function of the mechanical crack driving force, and to estimate the stress-intensity (K_{ISCC}) below which SCC will not occur in a specific environment. Bolt loaded double cantilever beam (DCB) specimens of the type shown in Figure 71 were employed to determine the SCC propagation rates, and standard compact tension specimens (ASTM E399) were used for tests to estimate K_{ISCC} . All specimens were of S-L orientation, and were removed from the extruded sections at the locations described for smooth specimens in the preceding section.

Duplicate DCB specimens were precracked in tension with a drop of a 3.5 percent NaCl solution being added during the final stages of precracking. The specimens were then held for a period of 30 days in a laboratory environment with air at $80^{\circ}\text{F} \pm 2^{\circ}\text{F}$ and 45 percent ($\pm 6\%$) relative humidity. A few drops of 3.5% NaCl were added to the crack three times each day. Crack growth was monitored with an ultrasonic detection device developed at Alcoa Laboratories, and crack propagation rates were determined by calculating the average growth rates over both 15 and 30-day periods. Stress-intensities were calculated as a function of crack opening displacement (COD) and crack length using the formula

developed by Hyatt.³⁰ These data were used in the manner explained later to determine the initial load levels for "crack-initiation" tests of compact tension specimens.

Fatigue precracked compact tension specimens were loaded with elastic rings and immersed in an inhibited and buffered NaCl solution of the formula: 0.6 M (3.5%) NaCl + 0.02 M Na₂Cr₂O₇ + 0.07 M NaC₂H₃O₂ + HC₂H₃O₂ to pH 4.0. A typical ring-loaded setup is shown in Figure 72. The load rings and clip gauges were instrumented with strain gauges, and both load and crack opening displacement (COD) were automatically monitored every 8 hours with a multichannel digital strain indicator. These readings were printed on a teletype and punched on paper tape for subsequent computer analysis. Complete details of the test procedure are given in a paper presented at the 1974 Tri-Service Conference on Corrosion of Military Equipment.³¹

b. Results and Discussion

(1) Resistance to Exfoliation

All of the extruded sections showed a high resistance to exfoliation in the EXCO immersion test, showing only pitting or minor exfoliation of the degree E-A (Figure 69) when tested at either the T/10 plane (T7651X temper) or midplane (T7651X and T7351X tempers) of the section.

Tests of 7075 and 7178^{32,33} in a seacoast atmosphere have shown the development of minor exfoliation (degree E-A) in this aggressive accelerated test to be of little practical significance for similar products. It is expected that it will be shown to be

equally insignificant for alloy 7050 products with the attainment of more lengthy atmospheric exposure.

At the time this report was prepared, tests of alloy 7050-T7651X and T7351X extruded sections had progressed for periods of 9-42 months in the seacoast atmosphere with no evidence of exfoliation attack.

(2) Resistance to SCC - Smooth Specimens

The results of accelerated tests of the 7050-T7351X and T7651X extruded sections are listed in Tables 63 and 64, respectively; and the status of atmospheric tests of selected sections is shown in Tables 65 and 66. Since the majority of the atmospheric tests are of relatively short duration, the following discussion of test results will pertain exclusively to the accelerated test data.*

T7351X Temper. Longitudinal and long-transverse specimens showed a high degree of resistance to SCC. Only one 84-day test failure occurred among specimens from the seven sections tested, and microscopic examination showed that it was associated with severe pitting and transgranular cracking not typical of SCC.

The short-transverse SCC performance had not been established at the inception of this contract, but it was expected to be comparable to 7075-T7351X sections which are required to pass a 30-day test at 75 percent of the specified yield strength (~45 ksi). Ten of the thirteen sections performed as expected; one section (die No. 263902) failed the 30-day test but survived the 20-day exposure period specified in the recently approved standard recommended

*See Appendix C for relationship of microstructure to SCC test performance.

practice for SCC testing of 7XXX alloy products (ASTM G47-76);³⁴ the remaining two sections (die No. 900102) did not survive the 20-day test period.

The short-transverse SCC performance of the relatively wide shapes appeared to be influenced by the total cross-sectional area; i.e., shapes with areas less than 43 in.², provided the expected resistance to SCC at higher strengths than did shapes with areas of 61 to 66 in.². This was illustrated graphically in Figure 73 by a summary of log time to failure as a function of longitudinal yield strength over a wide range of strengths for alloy 7050 extrusions tested at a sustained stress of 45 ksi. (Sections which had been fabricated under conditions that would be atypical of routine plant procedures were not included.) Prior analyses have shown that such graphical summaries typically exhibit three regions of behavior:

- (1) High strength regions characterized by rapid SCC failure.
- (2) Low strength regions characterized by long time failures that tend to occur by mechanisms other than intergranular SCC.
- (3) Intermediate strength regions over which there is a region of transition from rapid SCC failures to long time failures.

The latter region is of particular interest in determining the level of yield strength at which the time to failure would be expected to exceed a specific time period. A line drawn to show the lower bound of the data in the transition region for shapes of less than 43 in.² in cross-section indicated that these shapes should pass a 30-day test at a stress level of 45 ksi when aged to strengths as high as 68 to 69 ksi. On the other hand, this

line approximated only the median performance of the large 61 to 66 in.² sections. The lower bound of the transition region for larger sections would be shifted toward lower strengths than that shown for sections less than 43 in.², but the actual position cannot be accurately established without additional testing. It is also possible that the lower bound for sections less than 43 in.² would also shift if more tests were made of items with a yield strength of about 68 ksi.

T7651X Temper. Longitudinal and long-transverse specimens showed good resistance to SCC. Long time failures (58-84 days) were encountered with specimens from four of the six sections tested, but the failures again resulted from severe pitting and transgranular cracking not typical of SCC.

Short-transverse specimens from the various sections also displayed the expected level of resistance to SCC (the stated contract goal was a resistance superior to that of 7075-T651X). Seven of the nine sections tested passed the 30-day test at a 25 ksi stress level. Specimens from the remaining two sections failed in less than 20 days at the 25 ksi test stress but passed the 30-day test at a slightly lower stress of 20 ksi. In contrast, specimens from 7075-T651X extrusions stressed at 20 ksi would be expected to fail in less than one week.

A graphical summary of accumulated SCC data over a wide range of strengths was also made for specimens tested at the 25 ksi stress level. This summary (Figure 74) showed that sections should pass a 30-day test at the 25 ksi stress level when aged to strengths as high as 74 ksi. There were no observed differences in performance due to cross-sectional area, although it should be noted that only two shapes with cross-sectional areas in the 61 to 66 in.² range have been tested.

(3) Resistance to SCC - Precracked Specimens

Bolt-Loaded DCB Specimens. The identification of the items selected for testing by this method and a summary of the SCC growth rate data are given in Tables 67 and 68. A summary of the SCC growth curves is shown in Figure 75 by a cross-hatched band for each temper which is bounded by the highest and lowest graph obtained for that temper. (Individual crack growth curves for all test specimens are shown in Appendix B, Figures 1-12). Photographs and micrographs illustrating the intergranular nature of the SCC growth in both the T7351X and T7651X temper sections are shown in Figures 76 and 77.

It is generally agreed that to fully characterize the resistance to SCC by this test method a complete curve of the SCC growth rate as a function of the instantaneous stress intensity factor, K_I , is required. Regression analyses were made of the crack length as a function of exposure time to obtain the best fitting curves from the raw data. Growth rates were then obtained by differentiation of the regression equations. The K-Rate curves obtained by this procedure had typical shapes for a few of the materials but were very erratic for the others and generally not useful for estimating the approximate "plateau" SCC growth rates. (Sample graphs are included in Appendix B, Figures 13-16). This difficulty has been previously experienced in tests of other materials with improved resistance to SCC for which the crack growth curves have various forms and frequently appear to be stepped. Several

methods of smoothing the crack growth curves have been tried with varying degrees of success. For the data obtained in this test program, approximate "plateau" velocities for the K-Rate curves were determined by a procedure that is believed to best represent the initial sustained SCC growth in these materials. This involves simply a calculation of the overall average rate of growth taken over the first 15 days of exposure.³⁵

The SCC growth curves for T7351X temper shapes were fairly straight with no definite arrests, although there were steps in some instances. Such steps could be indicative of tendencies for the cracks to arrest but pushed on by the wedging action of corrosion products formed close to the crack tip. Average 15-day growth rates ranged from 1.6 to 3.5×10^{-4} in./hr for five sections and was 6.1×10^{-4} in./hr for one exceptional section (growth curve shown as upper bound for T7351X in Figure 75). The performance of the DCB specimens of this item seems anomalous and it is planned to perform a retest. The growth curves for T7651X shapes had average 15-day growth rates of 4.5 to 8.5×10^{-4} in./hr, and after about 15 to 25 days, the curves started to bend over as though approaching arrest; however, no definite arrests were achieved. Because definite arrests of SCC were not obtained, and because of a strong suspicion of corrosion product wedging, it was not possible to obtain good estimates of threshold stress intensities. Although SCC growth data are not available for extrusions of other alloys for comparison with these data, it is considered significant that

the crack growth for the 7050-T7651X and T7351X extrusions was intermediate between that developed in 7075-T651 and T7351 plate, as shown in Figure 75.

The K_I -Rate data for the 7050-T7351X and T7651X extrusions are shown in Figure 78 in comparison with data for plate of 7075-T7351, 7075-T651, and 7079-T651. A dashed line indicates the upper bound for the T7351X data if the anomalous test results for the 3.5-in. x 7.5-in. section are not included. Although reliable threshold stress intensity factors for SCC cannot be obtained from this graph, it appears that for these T7 temper extrusions of 7050 alloy both the threshold stress intensity and the SCC growth rates at high stress intensity levels are definitely more favorable than for 7075-T651 and 7079-T651.

Ring-Loaded Compact Tension Specimens. As a result of the difficulties in estimating $K_{I_{SCC}}$ by the "crack-arrest" procedure, a limited number of additional tests were conducted by the "crack initiation" procedure³¹ to estimate threshold stress intensities for both T7351X and T7651X temper shapes. Table 69 identifies the sections tested and summarizes the results of the ring-loaded SCC initiation tests.

The levels of stress-intensity to be applied in the ring-load tests were determined from graphs of the DCB data showing the decrease in stress-intensity with exposure time (Figure 79). Levels which would be expected to be above and below the suspected threshold stress intensity factors were selected in the manner shown

and were expressed as a fraction of the initial stress intensity calculated for the DCB specimen. The compact tension specimens were initially loaded to similar percentages of K_{IC} . These target values were between 70 and 95 percent of the critical stress intensity (K_{IC}) for the T7351X temper materials, and between 40 and 65 percent for the T7651X temper section (data for the second T7651X temper section were generated under a prior contract⁵). As can be seen from Table 69, the calculated initial stress intensity factors (K_{Ii}) were usually slightly higher than the target values due to the different methods used to determine initial crack length. The calculated crack lengths are considered more accurate since they reflect an integrated average crack length based on measurement of load and COD as opposed to an estimated value based on side measurements.

The crack length at fracture was usually clearly defined and, in general, the crack length measured on the fracture surface was close to the calculated value. Differences larger than about 0.04 in. for certain specimens exposed more than 2000 hours can be attributed to long term drift in the clip gauge readings, and in these cases the calculated K_{If} values were considered to be in error. The stress intensity level at fracture was usually about equal to or slightly higher than K_{IC} , as would be expected.

Insight into the behavior of each specimen during test can be obtained from the load and COD versus time plots and computer print-outs shown in Appendix B (Figures 17-42).

Specimens from the T7351X temper sections fractured at relatively short times when loaded to 85 percent of K_{IC} or greater, while specimens loaded to 70 or 75 percent had not fractured after 2800-3000 hours. However, the recorded COD readings for the latter specimens indicated that a small amount of crack growth was occurring and fractographic examination of the specimens, which were removed from test and broken apart, showed this growth to be intergranular and typical of SCC.

Nearly all of the specimens underwent an incubation period during which no crack growth occurred at the beginning of the test; the duration of this period increased with decreasing applied stress intensity, and for the specimens loaded to 70 and 75 percent K_{IC} ranged from about 200-800 hours. Crack growth then progressed very slowly, on the order of 6×10^{-5} inches per hour, over the remaining 2000 or more hours of exposure. Therefore, it was concluded that these levels of K_{Ii} were just slightly above the threshold stress-intensity factor for the sections tested by this procedure.

Specimens from the T7651X temper section loaded to K_{Ii} values of 65, 50, and 40 percent of K_{IC} all showed significant crack growth which metallographic or fractographic examination confirmed to be SCC. Growth began in the specimen loaded to 40 percent K_{IC} after approximately 360 hours and progressed at a rate of 3.5×10^{-5} inches per hours. Fracture had not occurred when the test was terminated at 2300 hours, again suggesting that this specimen was loaded very slightly above the threshold stress intensity.

The levels of K_{Isc} estimated from the results of the ring load "crack-initiation" tests are listed below together with similar values for alloy 7075-T651 and T7351 plate determined previously:³¹

<u>Sample Number</u>	<u>Temper</u>	Estimated K_{Isc}	
		<u>% K_{Ic}</u>	<u>ksi$\sqrt{in.}$</u>
421132-2	T7351X	70-75	~15
421333	T7351X	70-75	~15
421336	T7351X	65-70	~18
421443	T7651X	35-40	~ 7
7075-T651 Plate (2.5 in.)		20	~ 4
7075-T7351 Plate (2.5 in.)		85	~18

In considering the above estimates of K_{Isc} , it should be noted that the corrosive utilized for the ring load tests has been shown to induce corrosion product wedging in tests of other aluminum alloys after exposure of about 600 hours. It is conceivable that similar wedging may have occurred prior to crack-initiation in specimens from samples 421132-2 and 421336 which experienced incubation periods of 500 and 800 hours, respectively. If so, the estimates of K_{Isc} would be slightly low for these samples.

The K_{Isc} values listed above provide a quantitative measure of the relative resistance to SCC that assists in the ranking of alloys and tempers, but these data are not recommended for use in design. The apparent K_{Isc} values for a given alloy and temper can vary between samples of the same size and shape and also between samples from different shapes. They are also dependent upon the specific test conditions, especially the nature of the

corroderent and possible extraneous effects such as wedging by corrosion products. At present there are no data to relate estimates of threshold stress intensities in accelerated tests with those in atmospheric environments for the alloys investigated in this program.

(4) Comparison of Test Results for Precracked and Smooth SCC Specimens

In order to compare the DCB and the smooth tension specimen test results, the 15-day average SCC growth rate data were arranged in a special table, along with the smooth tension specimen SCC test data in order of increasing longitudinal yield strength; the electrical conductivity, section thickness, and cross-sectional areas also were included (Table 70). It is evident that the two types of SCC test data are in agreement in broad differences that characterize the T7351X and T7651X tempers, except for the anomalous DCB test results for one of the T7351X temper items. For the T7651X temper, the SCC growth rates paralleled the failure data from the tensile bars, but neither type of SCC data paralleled the progressive changes in yield strength and electrical conductivity. This incongruity no doubt is a result of the grouping of various lots and extruded shapes together to represent that temper. In the case of the T7351X temper, where there were included three lots of the one shape (1.8-in. x 27.36-in.), there was good parallelism of the two types of SCC data with the changes in yield strength and electrical conductivity for that shape.

In the previous section on SCC test results for smooth specimens, it was reported that wide T7351 temper shapes with a

cross-sectional area of 61-66-in.² were not as resistant to SCC on an equivalent strength basis as those with an area less than 43-in.² (Figure 73). This trend cannot be confirmed with the SCC growth rate data from the precracked specimens, however, because of too few tests of sections with the same strength level.

c. Conclusions

The following conclusions are based on predictive accelerated corrosion tests performed in accordance with ASTM standards:

1. Extruded 7050-T7351X and T7651X sections in all shapes and sizes will provide a high resistance to exfoliation corrosion in anticipated aircraft service environments similar to that of 7075-T7351X and T7651X, respectively.

2. Extruded sections of 7050-T7351X have a high resistance to SCC similar to that of 7075-T7351X.

3. Extruded sections of 7050-T7651X will provide not only a high resistance to exfoliation but also an improved resistance to SCC compared to that of 7075-T651X.

4. Limited tests indicate that wide extruded sections with a cross-sectional area greater than about 61-in.² may have a slightly lower combination of strength and resistance to SCC than when the cross-sectional area is less than 43-in.².

5. Stress-corrosion crack propagation rate data obtained from tests of mechanically precracked DCB specimens showed general trends similar to those obtained from tests of smooth tension specimens, but further evaluation of this method with highly resistant materials is required before it should be recommended as a primary method of testing.

V. ESTABLISH SPECIFICATIONS AND QUALITY CONTROL PROCEDURES

1. Lot Release Criteria

a. Minimum Electrical Conductivity and Maximum Yield Strength

Comprehensive analyses were performed on the accumulated data for alloy 7050-T7XXX extruded shapes to determine appropriate levels of strength and electrical conductivity for sections that demonstrate the resistance to SCC and exfoliation corrosion expected of the T7351X and T7651X-type tempers. It was considered that the T7351X temper should be capable of completing a 30-day, 3.5% NaCl alternate immersion test when stressed in the short-transverse direction to a level of 45 ksi (75% GYS), and that the T7651X temper would show exfoliation corrosion less than the degree E-B (Figure 69) at the T/10 plane when tested in accordance with ASTM G34-72. Consideration was also given to the level of SCC performance that would be expected of T7651X temper sections that developed the stated resistance to exfoliation.

T7351X Temper

To determine the levels of electrical conductivity and longitudinal yield strength that would be commensurate with the stated SCC requirement, the SCC test results from Figure 73 were plotted in a form that would show a relationship to these properties (Figure 80). Data for the wide extrusions with cross-sectional areas of 61 to 66-in.² were not included since their SCC resistance was not consistent with that of the remaining sections. Each point in Figure 80 represents a lot, and is coded to show the SCC test results for three or more test specimens. It was shown in Figure 73

that shapes with cross-sectional areas less than 43-in.² and longitudinal yield strengths of about 68 to 69 ksi completed the 30-day SCC test at the 45 ksi test stress. It can be seen in Figure 80 that at a yield of 69 ksi the average electrical conductivity would be about 41% IACS.

Statistical analyses of the data indicated that if the electrical conductivity were 41% or higher, the probability of a test specimen failing the 30-day SCC test would be less than 5% (90% confidence level), and there would be no need to impose a maximum on the yield strength. Also, the SCC test performance would be at least as good for lots with a conductivity in the 40.0-40.9% IACS range provided the yield strength did not exceed 69 ksi. The dashed line in Figure 80 indicates the lot release criteria recommended by Alcoa²⁰ for 7050-T7351X extruded shapes up to 5 inches thick. Stress-corrosion tests of additional lots with cross-sectional areas greater than 43-in.² are needed before an appropriate SCC test stress level for these larger sections can be established.

The SCC performance of specimens from extruded shapes conforming to these criteria is illustrated in Figure 81 (each point represents a single test specimen).

T7651X Temper

Graphical analysis similar to that described above (Figure 82) showed that all sections (regardless of cross-sectional area) aged to yield strengths of 79 ksi or less showed the desired resistance to exfoliation (less than the degree E-B), and that the average electrical conductivity of sections aged to that strength would be about 39% IACS.

Statistical analyses of the data indicated that if the electrical conductivity were 39% or higher, the extruded shape would have a high probability of compliance with a corrosion capability requiring exfoliation less than the degree E-B when tested at the T/10 plane in the EXCO test, and there would be no need to specify a maximum yield strength. The dashed line in Figure 81 indicates the lot release criteria recommended by Alcoa²⁰ for 7050-T7651X extruded shapes up to 5 inches thick.

The SCC performance of specimens from extruded shapes conforming to these criteria is illustrated in Figure 83. It is apparent that all sections will not complete a 30-day SCC test when stressed at 25 ksi. All extruded sections of 7050-T7651X tested to date completed the SCC test when stressed at 20 ksi, but there have not been sufficient tests to develop the desired confidence at this level. Alcoa is willing to guarantee that short-transverse specimens stressed at 25% of the tentative guaranteed longitudinal yield strength (~17 ksi) are capable of passing the 20-day test per ASTM G47-76.²⁰

b. Minimum Tensile Properties

Experience has indicated that a 9 to 10 ksi spread between maximum and minimum longitudinal yield strengths of 7XXX extrusions can be obtained with close controls. Consequently, tentative minimum longitudinal yield strengths were established at levels 9 or 10 ksi below the maximum strengths which provided the desired corrosion characteristics. Minimum tensile yield strengths of 69 ksi and 60 ksi, respectively, were tentatively established for 7050-T7651X and

7050-T7351X extrusions regardless of thickness. Minimum ultimate tensile strengths were established at levels 10 ksi higher from ratios of tensile ultimate to tensile yield strengths. Minimum elongation values of 7 and 8 percent in 2 inches were established by inspection of available data.

c. Fracture Toughness

The level of fracture toughness developed in the L-T and S-L directions of 7050 extrusions depended on yield strength, impurity level, fabricating practice, section thickness, and producer. The data in Tables 57 through 60 and the plot of K_{IC} versus yield strength in Figure 39 indicate that any properly fabricated Alcoa 7050-T7351X extrusion is capable of developing L-T and S-L K_{IC} values ≥ 32 and $16 \text{ ksi}\sqrt{\text{in.}}$, respectively. The data also indicate that any properly fabricated Alcoa 7050-T7651X extrusion is capable of developing L-T and S-L K_{IC} values ≥ 27 and $13 \text{ ksi}\sqrt{\text{in.}}$, respectively. Some extrusions are capable of developing slightly higher toughness in the S-L direction.

The level of toughness in the T-L direction depended more heavily on product thickness and also on section aspect ratio (width/thickness). The data indicate that any properly fabricated Alcoa 7050-T7351X and T7651X extrusions <2 inches thick are capable of developing T-L K_{IC} values $> 28 \text{ ksi}\sqrt{\text{in.}}$ and $23 \text{ ksi}\sqrt{\text{in.}}$, respectively. For thicker sections, the capabilities decrease with decreasing aspect ratio until they approach those of the S-L direction.

Alcoa is willing to guarantee these values provided that they perform tests per ASTM E399. That other producers will also be

able to guarantee the same levels after they gain experience is anticipated.

2. Summary

The exfoliation corrosion, stress-corrosion, and fracture toughness characteristics of 7050-T7651X and T7351X extrusions are presented in Table 71 along with associated electrical conductivity values and tensile properties that are recommended as lot release criteria. Alcoa proposes that material having a cross-sectional area less than 43 in.² be released for shipment on the basis of meeting the electrical conductivity values, tensile properties, and fracture toughness values shown in this table. Stress-corrosion tests of larger sections (stress level to be negotiated) must be performed until sufficient data are generated. Alcoa also anticipates that enough confidence will soon be gained in secondary indications of fracture toughness (e.g., ratio of notch tensile strength to yield strength) so that in the future the expensive K_{IC} test can be eliminated as a lot release criterion.

3. Other Pertinent Specifications

ASTM B557 is appropriate for specifying sampling and test procedures for determination of tensile properties. Specimens for determining K_{IC} should be removed from locations adjacent to the tension test coupons.

ASTM B342 is appropriate for specifying test procedures for determining electrical conductivity by the eddy current method. Test location is specified in Table 4.3 of the 1976 issue of Aluminum Standards and Data by the Aluminum Association.

MIL-I-8950 is appropriate for specifying ultrasonic inspection procedures.

4. Qualification Procedure

It is recommended that each producer qualify his processing by testing three lots in the EXCO test (ASTM G34-72) and/or the alternate immersion stress-corrosion test (ASTM G47-76). After these tests are successfully completed, it is recommended that the capability to develop the exfoliation and stress-corrosion characteristics be evaluated using tensile tests and electrical conductivity measurements.

5. Heat Treatment Recommendations

No investigation was made of solution heat treatment and first-step elevated temperature precipitation heat treatment practices, so no recommendations can be made from the results of this contract. Second-step precipitation heat treatment practice, however, was investigated. Any practices which provide tensile properties and electrical conductivity values which fulfill the lot acceptance criteria are acceptable. Second-step treatments of 8 hours at 350°F for 7050-T7651X and 12 hours at 350°F for 7050-T7351X extrusions are recommended as nominal practices at this time. After production experience is acquired, the nominal times may have to be modified.

To assist in selecting alternate nominal practices, equivalent second-step aging time for second-step precipitation treatments at temperatures between 300 and 360°F may be determined by use of the following equation:

$$t_T = t_{350} / \exp 40.2 - \frac{32562}{T + 460}, \quad (5)$$

where: t_{350} = nominal aging time at 350°F

T = temperature in °F,

t_T = time at desired aging temperature.

The value of $\exp 40.2 - \frac{32562}{T + 460}$ may be taken from Figure 84 or may be calculated. For example, the equivalent time to age 7050 at 325°F when the nominal aging practice is 8 hours at 350°F is determined as follows:

$$t_{325} = 8 / \exp 40.2 - \frac{32562}{325 + 460} = 29 \text{ hours.}$$

Deviating from the nominal aging temperature by more than about 5°F or neglecting to compensate for aging during heating to the soak temperature can lead to the development of strength and electrical conductivity values outside the lot release criteria limits. Consequently, compensation either manually by the furnace operator or automatically by an Alcoa patented process* is recommended.

VI. CONCLUSIONS

1. Commercial quality 25 and 35-inch diameter 7050 ingot can be cast successfully under production conditions.
2. The ingots can be readily fabricated into both simple sections and aircraft shapes.

*U.S.P. 3645804.

3. Extrusion temperature, extrusion ratio, and section size and shape affect the combination of strength, toughness, and resistance to stress-corrosion cracking that can be developed in the extrusions. Sections up to 43 in.² cross-section, having low ratios of width to thickness (aspect ratio) and fabricated at a high extrusion temperature with a high extrusion ratio develop the most attractive combinations of these properties.
4. All 7050 extrusions, however, can be heat treated to develop the following combinations of properties in the T7651X and T7351X tempers, respectively:
 - (a) Strength approaching that of 7075-T651X in thin sections and exceeding it in thick sections; high resistance to exfoliation corrosion; improved resistance to stress-corrosion cracking; and higher toughness.
 - (b) Strength higher than that of 7075-T7351X; high resistance to exfoliation corrosion; comparable resistance to stress-corrosion cracking; and higher toughness.
5. Wide extrusions with a cross-sectional area greater than about 61 in.² may develop a slightly lower combination of strength and resistance to stress-corrosion cracking than those with a cross-sectional area less than about 43 in.².
6. Temper, thickness, and section size of 7050-T7651X and T7351X extrusions affect the value of ratios of secondary design mechanical properties to tensile strengths.
7. Fatigue characteristics of both 7050-T7651X and T7351X extrusions were comparable to the fatigue characteristics of previously tested 7050-T7651X extrusions.

TABLE 1

SUMMARY OF 705C 25-IN. DIAMETER INGOT CASTING AT ALCOA'S LAFAYETTE WORKS

Cast No. 593 (December 1973)

Drop	Ladle	Fe/Si %	Fe:Si Ratio	Bottom Block Cooling		Mold Fill Time, min	Ingot Cooling Rate, gpm	Casting Rate		Metal Temp, °F	Ingot Reheat 2 in., °F	Cracking		Remarks
				in.	min			ipm	ijm			Hot Length, in.	Cold at in.	
1		.09/.08	1.1	0	.35	.35	60	1.04	.84	9	480	11		Full length ingot
2	4	.10/.08	1.25	7	.45	.45	60	1.03	.85	9.5	470	17		Full length ingot
3	5	.10/.08	1.25	0	.35	.45	60	1.05	.85	9.5	470	17		
4	5	.10/.08	1.25	0	.35	1.25	60	1.05	.85	10	470	15		
5	5	.10/.08	1.25	7	8.5	1.4	60	1.05	.86	10.5	470	--	--	72 in. lg
6	6	.10/.08	1.25	0	.35	.80	80	1.03	.84	10	460	28		Cold bottom block
7	6	.11/.08	1.4	0	.35	.60	80	1.05	.85	10	460	9		
8	6	.11/.09	1.2	7.5	8.3	1.65	80	1.03	.84	11	470	8		
9	7	.11/.09	1.2	8.5	8.6	1.25	80	1.04	.84	10.5	470	28		Cold bottom block
10	7	.10/.09	1.1	0	.35	.35	80	1.03	.85	13	470	17		
11	8	.10/.09	1.1	8	8.6	1.35	80	1.04	.85	9	465	12		Full length ingot
12	9	.10/.09	1.1	8	8.6	1.35	60	1.05	.86	9	465	13		Full length ingot
13	10	.11/.09	1.2	8.5	8.6	1.15	60	1.06	.84	8	440	26		
14	10	.12/.10	1.2	8.5	8.6	1.12	60	1.04	.84	9.5	470	17		Full length ingot
15	11			8	8.6	1.50	60	1.04	.84	10	470	18.5		Single port feed

- Notes:
1. Steel block w. 9 in. diameter Fiberfrax pad.
 2. Ingot cooling 5.75 in. below mold.
 3. Peripheral metal distribution except Drop 15.
 4. Mold cooling rate 44 gpm.
 5. Head in basin 3-3/4 to 4-1/2 in.
 6. H₂ of metal in basin .10 ml/100 g (Drop 1).

TABLE 2

7050 - 35-INCH DIAMETER INGOT - CASTING DATA

Ingot No.	Mold Fill	Pouring Temp, °F	Casting Rate Cycle		Bottom Block Cooling Duration, min.	Ingot Cooling Below Mold		Ingot Length, in.	Cracking	Remarks
			Start ipm	Duration min		Length in.	Avg Surf. Temp, °F			
389135A	Slow	1250-1270	.78	6.4	16.7	7	320	400	Yes	
389135B	Slow	1260-1275	.76	6.6	16.9	7	360	430	Yes	Pad
389136	Slow	1270-1285	.65	123	17.9	7	330	420	Yes	Pad
3891378A	Fast	1270-1280	.65	58	16.4	7	410	410	Yes	Pad
3891378B	Slow	1270-1280	.80+	7.5-	9.8	7	430	430	Yes	
389379A	Slow	1270-1280	.96	6.3	15.4	7	410	410	No	
389379B	Slow	1275-1280	.88	6.8	16.1	7	410	410	No	
389380	Slow	1265-1285	.90	6.7	15.7	7	420	420	No	
389382	Slow	1275-1295	.90	6.7	15.8	7	330	420	No	
389383A	Slow	1255-1295	.90	6.7	15.5	8	320	420	No	
389383B	Slow	1290-1295	.90	6.7	15.0	9	280	420	Yes	

Cast at Alcoa Laboratories, Alcoa Technical Center.

TABLE 3
7050 - 35 IN. DIAMETER INGOT CASTING AT LAFAYETTE

Ingot No.	Mold Fill min	Pouring Temp °F	Casting Rate Cycle		Bottom Block Cooling Duration min	Ingot Reheat °F	Cracking
			Start ipm	Running ipm			
1	2.6	1265-1295	.9	7.8	16.3	420	yes
2	3	1280-1310	.9	7.8	17.5	460	"
3	3.15	1275	.9	6.7	15.7		"
4	3.20	1275	.9	8.1	15.0	450	no
5	3.05	1275	.9	7.8	15.0	440	yes
6	3.10	1270-1275	.9	7.8	14.5	420	"
7	3.25	1275-1290	.9	7.2	15.5	440	"
8	3	1275-1280	.9	7.8	14.8	430	"
9	2.7	1255-1260	.75	9.3	15.7	460	"
10	2.83	1260-1265	.9	6.7	14.6	430	"
11	1.9	1255	.9	14.4	6.7	480	"
13	3	1260-1270	.9	6.7	15.8	400	"
14	3	1260-1280	.9	7.8	15.0	440	no
15	3.1	1270	.9	7.8	15.2	440	"
16	3	1260-1270	.9	7.8	14.9	430	"
18	3	1260-1280	.9	7.8		430	"

Note: Distance for direct ingot cooling--8 in.

TABLE 4

CHEMICAL ANALYSES OF INGOTS USED TO FABRICATE 7050 EXTRUSIONS

<u>S. No.</u>	<u>Zn</u>	<u>Mg</u>	<u>Cu</u>	<u>Zr</u>	<u>Fe</u>	<u>Si</u>	<u>Ti</u>
427231	6.30	2.32	2.43	0.11	0.11	0.07	0.03
427232	6.07	2.26	2.52	0.11	0.13	0.06	0.03

TABLE 5

TENSILE PROPERTIES OF ALLOY 7050-T76511 EXTRUSION

Alcoa Section 263902

	<u>T.S.,</u> ksi	<u>Y.S.,</u> ksi	<u>El.,</u> %	<u>R. of A.,</u> %	<u>N.T.S.,</u> ksi	<u>NTS/YS</u>
Extruded at 800°F - S-427231						
Front L	88.2	82.8	11.7	21	105.4	1.27
LT	86.4	81.0	9.4	18	96.0	1.19
ST	82.8	76.6	3.1	6	54.2	0.71
Rear L	86.4	80.8	12.5	25	104.2	1.29
LT	86.0	80.0	12.5	27	94.8	1.19
ST	82.2	74.2	6.3	7	61.8	0.83
Extruded at 750°F - S-427232						
Front L	86.7	81.6	10.9	24	105.8	1.30
LT	84.3	78.4	10.1	21	92.7	1.18
ST	82.6	74.4	3.1	5	56.4	0.76
Rear L	88.1	83.1	12.5	28	105.8	1.27
LT	86.0	80.6	12.5	28	94.8	1.18
ST	84.6	76.8	7.8	9	66.7	0.87

TABLE 6

EXFOLIATION AND SCC TEST RESULTS FOR 1.8" THICK ALLOY 7050-T7XXX EXTRUSIONS

Section No. 263902

S. No.	Test Direction	Tensile Properties ¹		EXCO	Exf. Test ²	Resistance to Stress-Corrosion Cracking ³						
		T.S., ksi	Y.S., ksi			El. %	Surface Test	Visual Rating	Str. 45 ksi	Str. 35 ksi	Str. 25 ksi	
427231 ⁵	L	87.3	81.8	12.1	T/10	E-B	6/6	2,2,2,3,3,3	6/6	3,3,3,3,3,5	6/6	3,3,4,4,4,52,66
	S-T	82.5	75.8	4.7	T/2	E-C						
442116	L	84.1	77.4	12.5	T/10	E-A	3/3	3,3,16	3/3	16,17,17	3/3	17,18,36
	S-T	79.6	72.2	4.7	T/2	E-A						
442118	L	82.9	76.1	12.0	T/10	E-A	3/3	17,18,18	3/3	16,18,18	3/3	18,18,22
	S-T	79.7	70.9	3.1	T/2	E-A						
442120	L	81.9	74.9	13.0	T/10	E-A	3/3	16,16,22	3/3	15,17,18	3/3	27,29,44
	S-T	77.8	69.8	4.7	T/2	E-A						
427232 ⁵	L	87.4	82.3	11.7	T/10	E-B	6/6	2,2,2,2,2,3	6/6	2,3,3,3,3,3	6/6	2,2,3,3,3,3
	S-T	83.6	75.6	5.4	T/2	E-B						
442117	L	84.8	78.8	12.5	T/10	E-A	3/3	3,3,3	3/3	3,3,5	3/3	3,18,22
	S-T	80.3	72.9	3.6	T/2	E-A						
442119	L	82.1	74.9	12.5	T/10	E-A	3/3	22,22,22	3/3	16,18,22	3/3	27,39,44
	S-T	78.1	69.2	6.3	T/2	E-A						
442121	L	81.8	74.6	12.5	T/10	E-A	3/3	18,18,22	3/3	17,18,22	3/3	22,29,36
	S-T	78.5	70.3	6.3	T/2	E-A						

- NOTES:
1. Results are the average of tests of either 3 or 4 tension specimens, 0.160" dia.
 2. Visual ratings based upon ASTM standards for exfoliation (Designation G34-72).
 3. Tests of 0.125" dia. short-transverse bars exposed to 3.5% NaCl alternate immersion (Method 823). Data shown are for test duration of 84 days.
 4. F/N denotes number of specimens failed over number exposed.
 5. Originally aged temper.

TABLE 7

RESULTS OF SUPPLEMENTAL SCC TESTS OF 1.8" THICK ALLOY 7050-T7XXX EXTRUSIONS - SECTION NO. 263302

S.No.	Test Direction	Tensile Properties (1)		EC(2) & IACS	Resistance to Stress-Corrosion Cracking(3)	
		TS ksi	YS(4) ksi		Initial Tests Str. 25 ksi F/N(5)	Supplemental Tests Str. 20 ksi F/N
					Extrusion Temperature - 800°F	
442116	L	84.1	77.4	39.2	3/3	17,18,36
	ST	79.6	72.2	4.7	5/5	22,49,67,73, 73
442120	L	81.9	74.9	39.9	3/3	27,29,44
	ST	77.8	69.8	----	4/5	22,84,84,84, (1-OK)
						75,75,75(2-OK)
						Extrusion Temperature - 750°F
442117	L	84.8	78.8	38.7	3/3	3,6,18
	ST	80.3	72.9	----	5/5	4,4,4,6,6
442121	L	81.8	74.6	39.7	3/3	22,29,36
	ST	78.5	70.3	----	5/5	40,75,75,75, 84

Notes: (1) Results are the average of tests of either 3 or 4 tension specimens, 0.160" dia.

(2) Electrical conductivity measured on machined T/2 surface.

(3) Tests of 0.125" dia. short-transverse tensile bars exposed to 3.5% NaCl alternate immersion (Federal Test Standard 151b, Method 823). Maximum test duration of 84 days.

(4) Offset equals 0.2 per cent.

(5) F/N denotes number of specimens failed over number exposed.

TABLE 8

RESULTS OF ACCELERATED SCC TESTS FOR 1.8" THICK ALLOY 7050-T7XXX
EXTRUSIONS(1) - SECTION NO. 263902

S.No.	Test Direction	Tensile Properties (2)		EC (3) % IACS	Resistance to Stress-Corrosion Cracking(4)					
		TS ksi	YS(5) ksi		% El.	Str. 45 ksi F/N(6)	Days	Str. 35 ksi F/N	Days	
445996	L	79.5	70.2	12.5	3/3	22,36,84	3/3	51,51,51	3/3	73,84,84
	ST	77.7	66.4	7.3						
445997	L	78.6	68.8	12.5	3/3	45,68,73	3/3	51,56,67	3/3	84,84,84
	ST	77.2	65.0	8.3						
445998	L	76.9	65.8	14.6	3/3	73,74,84	1/3	84(2-OK)	0/3	OK
	ST	75.1	61.9	9.4						

87

Notes: (1) Section extruded at 750°F, partially aged to T7X temper at Lafayette, then aged to listed strengths at Alcoa Laboratories.

(2) Results are the average of tests of three tension specimens, 0.160" Dia.

(3) Electrical conductivity measured on machined T/2 surface.

(4) Tests of 0.125" dia. short-transverse tensile bars exposed to 3.5% NaCl alternate immersion (Federal Test Standard 151b, Method 823). Maximum test duration of 84 days.

(5) Offset equals 0.2 per cent.

(6) F/N denotes number of specimens failed over number exposed.

TABLE 9

ALLOY 7050 EXTRUSION CONDITIONS

<u>S-Number</u>	<u>Section Size</u>	<u>Billet Size</u>	<u>Billet Temperature</u>	<u>Cylinder Temperature</u>	<u>Speed F.P.M.</u>	<u>Break Out Pressure, Psi</u>	<u>Butt Length</u>
437682 ¹	1.5" x 7.5"	21"Ø x 18"	780°F	725°F	2	2500	4"
437679 ³	1.5" x 7.5"	21"Ø x 13"	600°F	725°F	3	2900	4"
437680 ²	1.5" x 7.5"	21"Ø x 18"	610°F	725°F	3	2900	4"
437681 ²	1.5" x 7.5"	21"Ø x 18"	600°F	730°F	3	3100	4"
437686 ¹	2.75" x 4"	21"Ø x 18"	775°F	730°F	2	2100	5"
437685 ²	2.75" x 4"	21"Ø x 18"	610°F	730°F	3	3000	4"
437678 ⁴	1.5" x 7.5"	11"Ø x 20"	820°F	690°F	2-3/4	3800	3"
437677 ⁴	1.5" x 7.5"	11"Ø x 20"	600°F	690°F	5	5000	2-1/4"
437684 ⁴	2.75" x 4"	11"Ø x 20"	810°F	690°F	2-4	3500	3"
437683 ⁴	2.75" x 4"	11"Ø x 20"	610°F	690°F	4	5000	2"

- Notes: 1. Fabricated from Cast No. 593-3 (See Table 10).
 2. Fabricated from Cast No. 593-4 (See Table 10).
 3. Fabricated from Cast No. 593-9 (See Table 10).
 4. Fabricated from Cast No. 619-7 (See Table 10).

TABLE 10

CHEMICAL ANALYSES OF INGOTS USED TO FABRICATE ALLOY 7050 EXTRUSIONS

<u>Cast No.</u>	<u>Zn</u>	<u>Mg</u>	<u>Cu</u>	<u>Zr</u>	<u>Fe</u>	<u>Si</u>	<u>Cr</u>
593-3	6.48	2.39	2.19	0.11	0.09	0.08	0.02
593-4	6.39	2.40	2.21	0.11	0.10	0.08	0.02
593-9	6.48	2.20	2.21	0.11	0.10	0.09	0.02
619-7	6.25	2.47	2.32	0.10	0.10	0.07	0.00

See Table 9 to relate Cast No. to Extrusion Sample No.

TABLE 11

LONGITUDINAL YIELD STRENGTH AND ELECTRICAL CONDUCTIVITY
OF 1.5-INCH X 7.5-INCH RECTANGULAR
ALLOY 7050 EXTRUSIONS

S. No.	Extr. Ratio	Extr. Temp, °F	2nd- Step Age, hr*	Front		Rear	
				E. C., % IACS	Y.S., ksi	E. C., % IACS	Y.S., ksi
437682-6	32	780	6	35.8	87.6	35.8	86.8
-1			8	37.3	83.7	37.3	83.5
-3			15	39.0	78.5	39.2	77.2
-5			20	40.1	73.1	39.9	74.2
-2			24	40.1	73.1	39.9	72.6
-4			32	41.1	68.0	40.8	69.3
437679-6	32	600	6	37.0	85.2	36.7	86.5
-1			8	37.7	82.3	37.2	83.8
-3			15	39.9	76.2	39.6	77.4
-5			20	40.6	69.5	40.3	71.6
-2			24	40.4	70.6	40.6	68.8
-4			32	41.5	64.4	41.5	66.5
437680-6	32	610	6	35.4	86.9	35.4	86.9
-1			8	36.4	84.3	36.1	85.1
-3			15	38.4	78.6	38.4	78.5
-5			20	39.4	73.9	39.1	75.6
-2			24	39.6	73.4	39.6	72.3
-4			32	40.4	69.3	40.4	68.3
437681-6	32	600	6	35.5	86.8	35.5	87.3
-1			8	37.1	83.2	36.9	83.8
-3			15	38.9	78.5	38.9	76.7
-5			20	39.6	73.6	39.4	74.4
-2			24	39.7	72.8	39.4	73.9
-4			32	40.8	67.5	40.3	71.1
437678-6	9	820	6	36.7	81.4	36.4	82.2
-3			15	37.9	72.6	39.7	73.9
-2			24	40.5	67.8	40.1	69.5
-4			32	41.5	63.7	41.4	63.4
437677-6	9	600	6	35.5	80.7	35.1	82.8
-3			15	38.9	75.1	38.5	74.4
-2			24	39.9	68.8	39.3	69.5
-4			32	40.4	66.7	40.1	65.4

*hours at 325°F.

TABLE 12

LONGITUDINAL YIELD STRENGTH AND ELECTRICAL CONDUCTIVITY
OF 2.7-INCH X 4-INCH RECTANGULAR
ALLOY 7050 EXTRUSIONS

S. No.	Extr. Ratio	Extr. Temp, °F	2nd- Step Age, hr*	Front		Rear	
				E. C., % IACS	Y.S., ksi	E. C., % IACS	Y.S., ksi
437686-6	32	775	6	36.1	88.0	35.8	89.1
-1			8	36.9	n.d.	36.3	87.1
-3			15	39.5	77.4	39.3	79.2
-5			20	40.0	74.6	39.7	76.2
-2			24	40.3	72.9	40.4	73.4
-4			32	40.8	69.5	40.8	70.3
437685-6	32	610	6	35.6	88.9	35.4	87.9
-1			8	36.6	85.7	36.0	88.1
-3			15	38.8	78.5	38.4	81.0
-5			20	39.6	74.6	39.6	74.1
-2			24	39.5	74.4	40.0	73.6
-4			32	40.7	68.2	40.3	71.8
437684-6	9	810	6	35.5	86.8	35.6	87.6
-3			15	39.5	77.4	39.1	78.1
-2			24	40.3	71.6	40.1	72.6
-4			32	41.2	66.7	40.5	70.0
437683-6	9	610	6	34.9	88.0	34.9	88.4
-3			15	38.6	79.5	38.4	79.0
-2			24	40.2	73.4	39.2	75.0
-4			32	40.5	70.0	40.5	69.3

*hours at 325°F.

n.d. = not determined due to instrument malfunction.

TABLE 13

LONGITUDINAL TENSILE PROPERTIES OF 1.5-INCH X 7.5 INCH RECTANGULAR ALLOY 7050 EXTRUSIONS

S. No.	Extr. Ratio	Extr. Temp, °F	2nd-Step Age, Hrs	Front				Rear							
				Tensile Properties		Notch Tensile		Tensile Properties		Notch Tensile					
				T.S., ksi	Y.S., ksi	% El. in 2"	R of A, %	N.T.S., ksi	NTS/YS	T.S., ksi	Y.S., ksi	% El. in 2"	R of A, %	N.T.S., ksi	NTS/YS
437682-6	32	780	6	92.3	87.6	12.0	29	113.4	1.29	91.6	86.8	11.0	27	114.9	1.32
-1			8	89.0	83.7	12.0	30	110.8	1.32	88.9	83.5	12.0	30	111.3	1.33
-3			15	85.2	78.5	13.0	36	108.8	1.39	84.2	77.2	13.0	35	107.3	1.39
-5			20	80.8	73.1	13.5	34	106.2	1.45	81.8	74.2	13.0	37	107.8	1.45
-2			24	80.9	73.1	13.5	38	106.2	1.45	80.7	72.6	13.0	36	105.7	1.46
-4			32	77.1	68.0	13.5	38	102.1	1.50	78.1	69.3	14.0	38	104.2	1.50
437679-6	32	600	6	90.9	85.2	10.5	19	111.8	1.31	91.9	86.5	11.0	23	117.5	1.36
-1			8	89.9	82.3	11.0	20	112.4	1.37	89.8	83.8	12.0	27	114.4	1.37
-3			15	84.0	76.2	12.0	24	108.8	1.43	84.9	77.4	13.5	30	110.3	1.43
-5			20	79.0	69.5	13.0	32	103.2	1.48	80.8	71.6	13.0	33	106.2	1.48
-2			24	79.8	70.6	12.0	29	103.2	1.46	78.5	68.8	13.5	34	102.7	1.49
-4			32	75.1	54.4	13.0	33	97.5	1.51	76.9	66.5	13.0	33	101.6	1.53
437680-6	32	610	6	92.6	86.9	10.0	24	114.4	1.32	92.6	86.9	10.5	25	115.4	1.33
-1			8	90.8	84.3	10.0	22	112.9	1.34	91.3	85.1	10.5	25	112.9	1.33
-3			15	86.3	78.6	11.0	24	109.8	1.40	86.1	78.5	12.0	31	111.8	1.42
-5			20	82.7	73.9	12.0	28	106.2	1.44	83.7	75.6	12.0	33	107.8	1.43
-2			24	82.1	73.4	12.0	29	105.2	1.43	81.2	72.3	13.0	34	105.7	1.46
-4			32	79.1	69.3	12.0	32	102.1	1.47	78.5	68.3	13.0	36	102.1	1.49

Single tests of 0.5-inch diameter tension and 0.5-inch diameter notch tension specimens.

TABLE 13 (CONTINUED)

LONGITUDINAL TENSILE PROPERTIES OF 1.5-INCH X 7.5-INCH RECTANGULAR ALLOY 7050 EXTRUSIONS

S. No.	Extr. Ratio	Extr. Temp, °F	2nd-Step Age, Hrs	Front				Rear							
				Tensile Properties		Notch Tensile		Tensile Properties		Notch Tensile					
				T.S., ksi	Y.S., ksi	El. in 2"	R of A, %	T.S., ksi	Y.S., ksi	El. in 2"	R of A, %	T.S., ksi	Y.S., ksi	El. in 2"	R of A, %
437681-6	32	600	6	92.3	86.8	9.5	19	111.8	1.29	92.9	87.3	10.5	24	115.9	1.33
-1			8	89.6	83.2	10.0	18	109.3	1.31	90.0	83.8	11.0	25	113.9	1.36
-3			15	86.0	78.5	11.0	26	108.3	1.38	84.0	76.7	11.0	29	110.8	1.44
-5			20	82.3	73.6	11.5	29	105.7	1.44	82.7	74.4	12.0	32	106.7	1.43
-2			24	81.5	72.8	11.0	25	103.7	1.42	82.2	73.9	12.0	32	104.7	1.42
-4			32	77.6	67.5	12.5	31	99.6	1.48	80.5	71.1	12.0	32	103.7	1.46
437678-6	9	820	6	87.5	81.4	11.5	30	112.4	1.38	88.3	82.2	13.0	28	114.9	1.40
-3			15	81.1	72.6	14.0	34	106.7	1.47	81.7	73.9	12.5	35	108.8	1.47
-2			24	76.6	67.8	14.0	35	101.6	1.50	78.9	69.5	14.0	36	104.7	1.51
-4			32	74.5	63.7	14.0	38	98.6	1.55	74.0	63.4	15.0	42	99.1	1.56
437677-6	9	600	6	87.6	80.7	11.0	24	111.3	1.38	89.9	82.8	11.0	23	112.4	1.36
-3			15	83.7	75.1	11.5	27	107.3	1.43	83.1	74.4	13.0	29	105.7	1.42
-2			24	78.9	68.8	12.0	29	101.1	1.47	79.3	69.5	12.5	31	101.6	1.46
-4			32	77.2	66.7	13.0	30	99.1	1.49	77.1	65.4	13.0	32	98.6	1.51

Single tests of 0.5-inch diameter tension and 0.5-inch diameter notch tension specimens.

TABLE 14

LONG-TRANSVERSE TENSILE PROPERTIES OF 1.5-INCH X 7.5-INCH RECTANGULAR ALLOY 7050 EXTRUSIONS

S. No.	Extr. Ratio	Extr. Temp, °F	2nd-Step Age, Hrs	Front						Rear					
				Tensile Properties			Notch Tensile			Tensile Properties			Notch Tensile		
				T.S., ksi	Y.S., ksi	% El. in 1.4"	R of A, %	N.T.S., ksi	NTS/YS	T.S., ksi	Y.S., ksi	% El. in 1.4"	P of A, %	T.S., ksi	Y.S., ksi
437682-6	32	780	6	87.0	82.9	10.7	24	95.0	1.15	86.5	82.4	12.1	28	82.7	1.00
-1			8	85.3	80.9	11.4	28	85.8	1.06	84.7	79.4	10.7	26	93.0	1.17
-3			15	81.4	75.2	12.1	26	96.0	1.29	81.1	74.4	12.9	29	97.0	1.30
-5			20	78.0	70.4	12.1	30	97.0	1.38	78.8	71.6	12.1	27	96.5	1.35
-2			24	78.7	70.9	13.6	31	97.0	1.37	78.0	70.0	13.6	32	97.0	1.39
-4			32	75.4	66.1	12.1	32	95.0	1.47	76.1	67.2	13.6	36	95.0	1.41
437679-6	32	600	6	86.0	81.9	10.7	24	91.9	1.12	86.2	82.4	10.7	23	99.6	1.21
-1			8	85.1	80.7	10.0	15	87.3	1.08	84.3	79.7	11.4	26	97.5	1.22
-3			15	80.5	74.2	10.7	26	95.5	1.29	80.2	74.2	12.1	25	99.6	1.34
-5			20	76.3	67.8	12.1	23	95.0	1.40	77.3	69.7	12.1	26	97.0	1.39
-2			24	76.9	68.9	11.4	23	95.0	1.38	75.3	66.7	12.9	28	94.5	1.42
-4			32	72.6	62.7	11.4	24	91.9	1.47	73.6	64.8	12.1	28	92.4	1.43
437680-6	32	610	6	86.0	80.9	9.3	16	91.9	1.18	85.8	82.1	8.6	25	99.6	1.21
-1			8	84.0	78.9	10.7	21	89.8	1.14	86.1	81.2	11.4	25	92.4	1.14
-3			15	82.9	76.7	12.1	20	96.0	1.25	82.5	76.2	11.4	26	97.5	1.28
-5			20	79.5	71.9	12.1	24	95.5	1.33	79.9	73.2	12.1	27	92.4	1.26
-2			24	79.6	71.6	10.7	22	97.0	1.36	77.7	69.9	11.4	26	95.0	1.36
-4			32	77.1	67.9	12.1	21	94.0	1.36	75.5	66.4	12.1	27	94.0	1.42

Single tests of 0.357-inch diameter tension specimens and 0.5-inch diameter notch tension specimens.

TABLE 14 (CONTINUED)

LONG-TRANSVERSE TENSILE PROPERTIES OF 1.5-INCH X 7.5-INCH RECTANGULAR ALLOY 7050 EXTRUSIONS

S. No.	Extr. Ratio	Extr. Temp, °F	2nd-Step Age, Hrs	Front				Rear							
				Tensile Properties		Notch Tensile		Tensile Properties		Notch Tensile					
				T.S., ksi	Y.S., ksi	% El. in 1.4"	R of A, %	N.T.S., ksi	NTS/YS	T.S., ksi	Y.S., ksi	% El. in 1.4"	R of A, %	N.T.S., ksi	NTS/YS
437681-6	32	600	6	87.9	83.2	10.0	19	86.8	1.04	90.0	83.4	10.7	21	83.3	1.01
-1			8	85.3	79.9	9.3	17	91.9	1.15	85.5	80.2	10.0	24	93.0	1.16
-3			15	81.6	75.4	10.0	19	91.9	1.22	81.1	74.9	10.7	25	96.5	1.29
-5			20	79.3	71.7	10.7	20	93.5	1.30	79.0	71.7	12.1	26	97.0	1.35
-2			24	78.5	70.2	11.4	20	93.5	1.33	78.9	71.2	11.4	26	96.5	1.36
-4			32	75.1	65.4	11.4	23	91.4	1.40	76.7	68.2	12.1	25	94.5	1.39
437678-6	9	820	6	84.4	78.9	10.7	22	101.1	1.28	84.1	79.4	12.1	20	90.9	1.14
-3			15	79.9	72.2	11.4	24	96.5	1.34	79.9	72.7	12.1	29	95.0	1.31
-2			24	75.9	66.2	13.9	26	94.0	1.42	77.1	68.1	14.3	27	96.5	1.42
-4			32	73.5	62.9	13.6	30	91.4	1.45	72.3	62.2	10.7	34	91.9	1.48
437677-6	9	600	6	85.6	78.7	11.4	20	89.9	1.14	85.0	79.2	10.2	21	93.0	1.17
-3			15	80.1	71.9	12.1	23	91.4	1.27	80.3	72.2	12.1	23	93.5	1.30
-2			24	76.9	66.7	12.1	24	89.9	1.35	76.9	67.2	12.1	25	91.9	1.37
-4			32	75.1	64.4	12.1	25	88.9	1.38	73.6	63.0	12.1	28	91.4	1.45

Single tests of 0.357-inch diameter tension specimens and 0.5-inch diameter notch tension specimens.

TABLE 15

SHOT-TRANSVERSE TENSILE PROPERTIES OF 1.5-INCH X 7.5-INCH RECTANGULAR ALLOY 7050 EXTRUSION

S. No.	Extr. Ratio	Extr. Temp, °F	2nd-Step Age, Hrs	Front				Rear					
				Tensile Properties		Notch Tensile		Tensile Properties		Notch Tensile			
				T.S., ksi	Y.S., ksi	% El. in 0.5"	N.T.S., ksi	NTS/YS	T.S., ksi	Y.S., ksi	% El. in 0.5"	N.T.S., ksi	NTS/YS
437682-6	32	780	6	88.9	78.7	8.0	63.8	0.81	88.3	78.0	8.0	65.4	0.84
-1			8	86.2	75.8	8.0	63.3	0.84	86.8	76.6	8.0	62.3	0.81
-3			15	83.6	72.2	8.0	74.6	1.03	82.7	71.4	8.0	99.6	1.39
-5			20	80.1	68.2	8.0	83.8	1.23	80.7	68.9	10.0	83.2	1.20
-2			24	79.4	67.9	10.0	84.8	1.28	79.4	67.7	8.0	82.7	1.22
-4			32	76.7	63.6	10.0	86.8	1.36	77.9	65.1	10.0	84.3	1.29
437679-6	32	600	6	86.6	76.8	8.0	66.9	0.87	87.0	26.5	8.0	68.4	0.89
-1			8	85.4	75.5	8.0	67.4	0.89	85.8	75.0	8.0	70.5	0.94
-3			15	81.0	69.7	6.0	71.5	1.03	82.5	70.0	10.0	79.7	1.14
-5			20	78.2	65.6	8.0	77.6	1.18	78.0	65.6	10.0	86.8	1.32
-2			24	76.7	64.1	8.0	79.7	1.24	76.4	63.9	10.0	84.3	1.32
-4			32	73.7	60.7	8.0	80.2	1.32	76.0	62.0	10.0	85.8	1.38
437680-6	32	610	6	88.2	77.5	6.0	61.3	0.79	89.5	78.4	8.0	64.9	0.83
-1			8	86.6	75.8	6.0	56.7	0.75	88.3	76.3	8.0	65.4	0.86
-3			15	83.6	71.5	8.0	70.5	0.99	83.6	71.0	8.0	79.2	1.12
-5			20	79.8	67.9	8.0	74.1	1.09	80.9	68.6	10.0	79.2	1.16
-2			24	80.2	67.4	8.0	75.1	1.11	80.2	66.6	8.0	80.7	1.21
-4			32	76.5	64.1	8.0	77.1	1.20	76.8	63.1	8.0	86.8	1.38

Single tests of 0.125-inch diameter tension and 0.5-inch diameter notch tension specimens. Because the length of the notched specimens was not standard, results are useful for internal comparison only.

TABLE 15 (CONTINUED)

SHORT-TRANSVERSE TENSILE PROPERTIES OF 1.5-INCH X 7.5-INCH RECTANGULAR ALLOY 7050 EXTRUSION

S. No.	Extr. Ratio	Extr. Temp, °F	2nd-Step Age, Hrs	Front			Rear						
				T.S., ksi	Y.S., ksi	% El. in 0.5"	T.S., ksi	Y.S., ksi	% El. in 0.5"				
437681-6	32	600	6	87.5	76.6	4.0	57.7	0.75	80.2	76.8	8.0	63.3	0.82
-1			8	85.8	75.2	6.0	64.4	0.86	87.0	74.9	8.0	66.9	0.89
-3			15	82.7	71.4	8.0	68.9	0.96	82.7	69.8	8.0	74.1	1.06
-5			20	80.7	67.7	8.0	70.5	1.04	79.9	67.7	10.0	79.7	1.18
-2			24	78.7	66.3	8.0	70.0	1.06	80.7	67.5	10.0	79.2	1.17
-4			32	76.5	62.7	8.0	76.6	1.22	77.9	64.8	10.0	85.3	1.32
437678-6	9	820	6	83.6	73.2	8.0	69.5	0.95	85.6	75.0	8.0	64.9	0.86
-3			15	79.5	68.2	8.0	71.0	1.04	79.6	69.2	8.0	71.5	1.03
-2			24	75.3	62.9	8.0	75.1	1.19	77.9	64.8	8.0	78.1	1.20
-4			32	73.5	60.2	8.0	77.1	1.28	74.0	60.5	10.0	82.7	1.37
437677-6	9	600	6	85.9	74.4	6.0	57.7	0.78	85.9	73.8	2.0	60.8	0.82
-3			15	81.3	68.5	8.0	63.8	0.93	80.6	68.5	8.0	71.0	1.04
-2			24	77.7	64.3	8.0	65.4	1.02	77.6	63.9	8.0	66.4	1.04
-4			32	75.6	62.2	8.0	68.9	1.11	74.9	61.0	8.0	75.1	1.23

Single tests of 0.125-inch diameter tension and 0.5-inch diameter notch tension specimens. Because the length of the notched specimens was not standard, results are useful for internal comparison only.

TABLE 16

LONGITUDINAL TENSILE PROPERTIES OF 2.7-INCH X 4-INCH RECTANGULAR ALLOY 7050 EXTRUSIONS

S. No.	Extr. Ratio	Extr. Temp, °F	2nd-Step Age, Hrs	Front				Rear							
				Tensile Properties		Notch Tensile		Tensile Properties		Notch Tensile					
				T.S., ksi	Y.S., ksi	% El. in 2"	R of A, %	T.S., ksi	Y.S., ksi	% El. in 2"	R of A, %	T.S., ksi	Y.S., ksi	% El. in 2"	R of A, %
437686-6	32	775	6	92.6	88.0	10.0	24	115.9	1.32	94.5	89.1	10.0	24	118.0	1.32
-1			8	89.8	n.d.	10.5	26	113.9	--	92.5	87.1	10.5	26	116.4	1.33
-3			15	84.0	77.4	12.5	34	108.3	1.40	86.3	79.2	12.0	33	111.8	1.41
-5			20	81.5	74.6	12.0	36	107.3	1.44	83.4	76.2	12.5	35	107.3	1.41
-2			24	80.3	72.9	12.0	34	104.7	1.44	81.2	73.4	12.0	36	105.7	1.44
-4			32	77.7	69.5	13.0	36	102.1	1.47	79.2	70.3	13.0	32	101.6	1.45
437685-6	32	610	6	93.9	88.9	8.0	11	113.9	1.28	93.9	87.9	9.5	22	118.0	1.34
-1			8	91.4	85.7	10.0	22	111.8	1.30	93.7	88.1	10.0	22	118.5	1.35
-3			15	85.2	78.5	10.5	26	107.3	1.37	88.0	81.0	11.0	27	111.8	1.38
-5			20	82.1	74.6	12.0	29	106.7	1.43	82.4	74.1	12.0	32	104.2	1.41
-2			24	81.8	74.4	11.0	29	104.2	1.40	82.0	73.6	11.0	29	105.7	1.44
-4			32	77.1	68.2	12.0	31	100.1	1.47	80.7	71.8	12.0	32	102.7	1.43
437684-6	9	810	6	92.0	86.8	10.5	23	115.9	1.34	93.1	87.6	11.0	26	117.0	1.34
-3			15	84.3	77.4	12.0	31	108.3	1.40	81.9	78.1	12.0	32	110.3	1.41
-2			24	79.8	71.6	12.0	32	103.7	1.45	80.3	72.6	12.0	34	104.7	1.44
-4			32	76.0	66.7	13.0	38	100.1	1.50	78.7	70.0	14.0	38	103.2	1.47
437683-6	9	610	6	93.5	88.0	10.0	22	115.9	1.32	94.2	88.4	11.0	24	118.5	1.34
-3			15	86.3	79.5	11.5	28	109.3	1.37	85.8	79.0	11.0	29	110.3	1.40
-2			24	81.3	73.4	12.0	29	104.2	1.42	82.7	75.0	12.0	32	112.7	1.50
-4			32	78.8	70.0	12.0	32	102.7	1.47	72.1	69.3	12.0	35	103.2	1.49

n.d. = not determined due to instrument malfunction.

Single tests of 0.5-inch diameter tension and 0.5-inch diameter notch tension specimens.

TABLE 17

LONG-TRANSVERSE TENSILE PROPERTIES OF 2.75-INCH X 4-INCH RECTANGULAR ALLOY 7050 EXTRUSIONS

S. NO.	Extr. Ratio	Extr. Temp, °F	2nd-Step Age, Hrs	Front						Rear					
				Tensile Properties			Notch Tensile			Tensile Properties			Notch Tensile		
				T.S., ksi	Y.S., ksi	% El. in 1.4"	R of A, %	N.T.S., ksi	NTS/YS	T.S., ksi	Y.S., ksi	% El. in 1.4"	R of A, %	N.T.S., ksi	NTS/YS
437686-6	32	775	6	84.3	79.4	3.6	4	62.3	0.78	84.3	78.4	7.1	11	66.9	0.85
-1			8	81.6	76.0	4.3	8	74.1	0.98	82.7	77.2	5.0	7	74.6	0.97
-3			15	77.9	70.9	5.7	8	82.2	1.16	77.7	70.7	8.6	8	88.4	1.25
-5			20	76.6	68.7	6.4	6	85.3	1.24	76.5	68.7	8.6	13	86.8	1.26
-2			24	75.0	66.7	5.7	9	82.7	1.24	74.3	65.7	8.6	13	87.8	1.34
-4			32	73.3	64.2	8.6	10	85.3	1.33	72.3	62.7	10.7	16	86.3	1.36
437685-6	32	610	6	84.1	79.2	5.0	7	66.9	0.84	83.8	78.5	9.3	14	71.5	0.91
-1			8	81.8	76.1	5.7	9	64.4	0.85	82.5	76.9	7.1	7	72.5	0.94
-3			15	78.0	71.3	7.1	9	78.7	1.10	78.5	71.7	7.9	9	83.8	1.17
-5			20	76.0	68.3	7.9	10	81.7	1.20	75.3	66.9	10.0	16	86.3	1.29
-2			24	76.1	68.2	7.9	11	80.2	1.18	73.8	65.2	9.3	23	88.4	1.36
-4			32	71.9	62.4	10.0	14	82.7	1.32	73.7	64.4	9.3	16	84.8	1.32
437684-6	9	810	6	84.1	78.2	6.4	7	65.4	0.87	83.7	78.2	5.7	8	71.0	0.91
-3			15	78.7	70.9	7.9	8	74.1	1.04	79.2	72.1	7.9	9	76.6	1.06
-2			24	75.5	66.2	7.1	8	76.6	1.16	75.7	66.9	7.9	10	80.2	1.20
-4			32	72.2	62.1	8.6	11	80.7	1.30	74.1	63.0	8.6	15	82.2	1.30
437683-6	9	610	6	83.9	78.2	5.0	10	65.4	0.84	83.9	78.4	5.7	7	71.5	0.91
-3			15	79.5	72.7	7.9	9	71.5	0.98	78.7	71.7	7.1	10	70.0	0.98
-2			24	75.5	67.2	9.3	16	79.2	1.18	76.5	68.4	7.9	11	78.7	1.15
-4			32	73.7	64.7	8.6	16	82.7	1.28	73.2	63.9	10.0	14	84.3	1.32

Single tests of 0.357-inch diameter tension specimens and 0.5-inch diameter notch tension specimens.

TABLE 18

SHORT-TRANSVERSE TENSILE PROPERTIES OF 2.75-INCH X 4-INCH RECTANGULAR ALLOY 7050 EXTRUSION

S. No.	Extr. Ratio	Extr. Temp, °F	2nd-Step Age, Hrs	Front				Rear					
				Tensile Properties		Notch Tensile		Tensile Properties		Notch Tensile			
				T.S., ksi	Y.S., ksi	% El. in 0.5"	N.T.S., ksi	NTS/YS	T.S., ksi	Y.S., ksi	% El. in 0.5"	N.T.S., ksi	NTS/YS
437686-6	3?	775	6	82.8	76.4	4.0	62.3	0.82	86.3	77.4	6.0	65.4	0.84
-1			8	80.4	72.9	4.0	60.3	0.83	84.2	76.1	6.0	67.9	0.89
-3			15	79.7	70.0	6.0	75.1	1.07	79.4	69.4	8.0	75.6	1.09
-5			20	76.6	66.9	6.0	75.1	1.12	78.7	68.3	8.0	82.2	1.20
-2			24	75.9	66.3	6.0	76.6	1.18	76.4	65.3	8.0	81.7	1.25
-4			32	73.4	63.2	6.0	78.1	1.24	74.5	62.9	8.0	83.2	1.32
437685-6	32	610	6	84.8	77.4	4.0	58.2	0.75	85.0	76.6	8.0	62.3	0.81
-1			8	82.2	74.2	4.0	58.7	0.79	83.7	75.5	4.0	60.8	0.80
-3			15	78.9	69.6	8.0	71.5	1.03	79.8	70.5	8.0	67.9	0.96
-5			20	76.9	66.5	8.0	71.0	1.07	76.9	65.8	8.0	80.7	1.23
-2			24	76.2	65.8	8.0	76.6	1.16	75.3	64.4	8.0	80.7	1.25
-4			32	73.3	61.7	8.0	78.7	1.28	74.6	63.2	8.0	83.8	1.33
437684-6	9	810	6	83.5	76.1	4.0	57.7	0.77	85.6	77.4	4.0	64.9	0.87
-3			15	78.0	68.4	6.0	65.9	0.96	80.2	70.7	6.0	67.4	0.95
-2			24	75.2	64.4	8.0	71.0	1.10	75.8	65.0	8.0	74.1	1.14
-4			32	72.7	61.0	8.0	77.1	1.26	75.0	64.1	6.0	78.1	1.22
437683-6	9	610	6	84.6	76.8	4.0	57.2	0.74	79.3	69.8	6.0	65.4	0.94
-3			15	79.8	70.6	6.0	65.4	0.93	76.3	66.2	6.0	71.5	1.08
-2			24	79.0	70.2	4.0	70.5	1.00	74.8	62.9	8.0	73.0	1.16
-4			32	76.2	65.8	6.0	74.1	1.13	74.1	62.6	6.0	80.2	1.28

Single tests of 0.125-inch diameter tension and 0.5-inch diameter notch tension specimens. Because the length of the notched specimens was not standard, results are useful for internal comparison only.

TABLE 19
RESULTS OF EXFOLIATION TESTS CONDUCTED ON 1.5" X 7.5" RECTANGULAR 7050 ALLOY EXTRUSIONS
EXPOSED IN AN EXCO TEST SOLUTION FOR 48 HOURS

S. No.	Specimen Number	Test Location	Extr. Ratio	Extr. Temp, °F	2nd-Step Age, Hrs/325°F	E.C., % IACS	Exfoliation Ratings			
							4 Hrs	21 Hrs	24 Hrs	48 Hrs
437682	F6	Front	32	780	6	35.8	P	EB	ED	ED
	F1				7.7	37.3	EA	EB	EC	ED
	F3				15	39.0	EA	EA	EA	EA
	F5				20	40.1	P	P	P	P
	F2				24	40.1	P	P	P	P
	F4				32	41.1	P	P	P	P
	R6	Rear	32	780	6	35.8	P	EC	ED	ED
	R1				7.7	37.3	EA	EB	EC	ED
	R3				15	39.2	EA	EA	EA	EA
	R5				20	39.9	P	EA	EA	EA
	R2				24	39.9	P	EA	EA	EA
	R4				32	40.8	P	P	P	P
437679	F6	Front	32	600	6	37.0	P	EB	EC	ED
	F1				7.7	37.7	P	EA	EA	EA
	F3				15	39.9	P	P	EA	EA
	F5				20	40.6	P	P	P	EA
	F2				24	40.4	P	P	P	P
	F4				32	41.5	P	P	P	EA
	R6	Rear	32	600	6	36.7	P	EB	EB	ED
	R1				7.7	37.2	EA	EB	EB	EC
	R3				15	39.6	P	P	EA	EA
	R5				20	40.3	P	P	EA	EA
	R2				24	40.6	P	P	P	P
	R4				32	41.5	P	P	P	EA

TABLE 19 (CONTINUED)

RESULTS OF EXFOLIATION TESTS CONDUCTED ON 1.5" X 7.5" RECTANGULAR 7050 ALLOY EXTRUSIONS
EXPOSED IN AN EXCO TEST SOLUTION FOR 48 HOURS

S. No.	Specimen Number	Test Location	Extr. Ratio	Extr. Temp, °F	2nd-Step Age, Hrs/325°F	E.C., % IACS	Exfoliation Ratings				
							4 Hrs	21 Hrs	24 Hrs	48 Hrs	
437678	F6	Front	9	820	6	36.7	N	EB	EB	EB	EC
	F3				15	39.9	P	EA	EA	EA	EA
	F2				24	40.5	P	EA	EA	EA	EA
	F4				32	41.5	P	EA	EA	EA	EA
437677	R6	Rear	9	820	6	36.4	N	EC	EC	EC	ED
	R3				15	39.7	P	EA	EA	EA	EA
	R2				24	40.1	P	P	P	EA	EA
	R4				32	41.4	P	P	P	P	EA
437677	F6	Front	9	600	6	35.5	N	EB	EB	EB	EB
	F3				15	38.9	P	EA	EA	EA	EA
	F2				24	39.9	P	P	P	P	P
	F4				32	40.4	P	EA	EA	EA	EA
437677	R6	Rear	9	600	6	35.1	N	EB	EB	EB	ED
	R3				15	38.5	P	EA	EA	EA	EA
	R2				24	39.3	P	EA	EA	EA	EA
	R4				32	40.1	P	EA	EA	EA	EA

Ratings were taken using photograph B from ASTM G34, EXCO Tests:

N = no corrosion.

P = pitting, no exfoliation.

A through D = exfoliation in increasing order of severity.

Correlations with lengthy outdoor exposures in seacoast environment indicate that material receiving a rating of P or A and possibly B in the EXCO test will not exfoliate outdoors. Material receiving a C or D rating will exfoliate outdoors.

TABLE 19 (CONTINUED)
 RESULTS OF EXFOLIATION TESTS CONDUCTED ON 1.5" X 7.5" RECTANGULAR 7050 ALLOY EXTRUSIONS
 EXPOSED IN AN EXCO TEST SOLUTION FOR 48 HOURS

S. No.	Specimen Number	Test Location	Extr. Ratio	Extr. Temp, °F	2nd-Step Age, Hrs/325°F	C.C., % IACS	Exfoliation Ratings			
							4 Hrs	21 Hrs	24 Hrs	48 Hrs
437680	F6	Front	32	610	6	35.4	N	EB	EC	ED
	F1						EB	EC	ED	
	F3						EA	EA	EA	
	F5						P	P	EA	
	F2	Rear	32	610	20	39.4	P	P	P	EA
	F4						P	P	P	EA
	R6						P	EC	ED	ED
	R1						EA	EC	EC	ED
437681	R3	Front	32	600	15	38.4	P	EA	EA	EA
	R5						P	EA	EA	EA
	R2						P	P	P	P
	R4						P	P	P	P
	R6	Rear	32	600	24	39.6	P	P	P	P
	R1						P	P	P	P
	R3						P	EB	EB	ED
	R5						P	EB	EB	ED
437681	R2	Front	32	600	20	39.1	P	EA	EA	EA
	R4						P	EA	EA	EA
	F6						P	P	P	P
	F1						P	P	P	P
	R6	Rear	32	600	32	40.4	P	P	P	P
	R1						P	P	P	P
	R3						P	P	P	P
	R5						P	P	P	P
437681	R2	Front	32	600	7.7	35.5	P	EB	EB	ED
	R4						P	EB	EB	ED
	F6						P	EA	EA	EA
	F1						P	EA	EA	EA
	R6	Rear	32	600	15	38.9	P	EA	EA	EA
	R1						P	EA	EA	EA
	R3						P	EA	EA	EA
	R5						P	EA	EA	EA
437681	R2	Front	32	600	20	39.6	P	EA	EA	EA
	R4						P	EA	EA	EA
	F6						P	EA	EA	EA
	F1						P	EA	EA	EA
	R6	Rear	32	600	24	39.7	P	EA	EA	EA
	R1						P	EA	EA	EA
	R3						P	EA	EA	EA
	R5						P	EA	EA	EA
437681	R2	Front	32	600	32	40.8	P	EA	EA	EA
	R4						P	EA	EA	EA
	F6						P	EA	EA	EA
	F1						P	EA	EA	EA
	R6	Rear	32	600	6	35.5	P	EC	EC	ED
	R1						EA	EC	ED	ED
	R3						P	P	EA	EA
	R5						P	P	EA	EA
437681	R2	Front	32	600	7.7	36.1	P	P	P	P
	R4						P	P	P	P
	F6						P	P	P	P
	F1						P	P	P	P
	R6	Rear	32	600	15	38.9	P	P	P	P
	R1						P	P	P	P
	R3						P	P	P	P
	R5						P	P	P	P
437681	R2	Front	32	600	20	39.4	P	P	P	P
	R4						P	P	P	P
	F6						P	P	P	P
	F1						P	P	P	P
	R6	Rear	32	600	24	39.4	P	P	P	P
	R1						P	P	P	P
	R3						P	P	P	P
	R5						P	P	P	P
437681	R2	Front	32	600	32	40.3	P	P	P	P
	R4						P	P	P	P
	F6						P	P	P	P
	F1						P	P	P	P
	R6	Rear	32	600	6	35.5	P	P	P	P
	R1						P	P	P	P
	R3						P	P	P	P
	R5						P	P	P	P

TABLE 20

RESULTS OF EXFOLIATION TESTS CONDUCTED ON 2.7" X 4" RECTANGULAR 7050 ALLOY EXTRUSIONS
EXPOSED IN AN EXCO TEST SOLUTION FOR 48 HOURS

S. No.	Specimen Number	Test Location	Extr. Ratio	Extr. Temp, °F	2nd-Step Age, Hrs/325°F	E.C., % IACS	Exfoliation Ratings						
							4 Hrs	21 Hrs	24 Hrs	48 Hrs			
437686	F6	Front	32	775	6	36.1	N	EA	EA	EA	EA	EA	EA
	F1				7.7	36.9	N	EA	EA	EA	EA	EA	EA
	F3				15	39.5	P	P	P	P	P	P	P
	F5				20	40.0	P	P	P	P	P	P	P
	F2				24	40.2	P	P	P	P	P	P	P
	F4				32	40.8	P	P	P	P	P	P	P
	R6	Rear	32	775	6	35.8	N	EA	EA	EA	EA	EA	EA
	R1				7.7	36.3	N	EA	EA	EA	EA	EA	EA
437685	R3				15	39.3	P	P	P	P	P	P	P
	R5				20	39.7	P	P	P	P	P	P	P
	R2				24	40.4	P	P	P	P	P	P	P
	R4				32	40.8	P	P	P	P	P	P	P
	F6	Front	32	610	6	35.6	N	EA	EA	EA	EA	EA	EA
	F1				7.7	36.6	N	EA	EA	EA	EA	EA	EA
	F3				15	38.8	P	P	P	P	P	P	P
	F5				20	39.6	P	P	P	P	P	P	P
437685	F2				24	39.5	P	P	P	P	P	P	P
	F4				32	40.7	P	P	P	P	P	P	P
	R6	Rear	32	610	6	35.4	N	EA	EA	EA	EA	EA	EA
	R1				7.7	36.0	N	EA	EA	EA	EA	EA	EA
	R3				15	38.4	P	P	P	P	P	P	P
	R5				20	39.6	P	P	P	P	P	P	P
	R2				24	40.0	P	P	P	P	P	P	P
	R4				32	40.3	P	P	P	P	P	P	P

TABLE 20 (CONTINUED)

RESULTS OF EXFOLIATION TESTS CONDUCTED ON 2.7" X 4" RECTANGULAR 7050 ALLOY EXTRUSIONS
EXPOSED IN AN EXCO TEST SOLUTION FOR 48 HOURS

S. No.	Specimen Number	Test Location	Extr. Ratio	Extr. Temp, °F	2nd-Step Age, Hrs/325°F	E.C., % IACS	Exfoliation Ratings				
							4 Hrs	21 Hrs	24 Hrs	48 Hrs	
437684	F6	Front	9	810	6	35.5	N	EA	EA	EA	EB
	F3				15	39.5	P	P	P	P	P
	F2				24	40.3	P	P	P	P	P
	F4				32	41.2	P	P	P	P	P
437683	R6	Rear	9	810	6	35.6	N	EA	EA	EA	EB
	R3				15	39.1	P	P	P	P	EA
	R2				24	40.1	P	P	P	P	EA
	R4				32	40.5	P	P	P	P	EA
437683	F6	Front	9	610	6	34.9	P	EA	EA	EA	EB
	F3				15	38.6	P	EA	EA	EA	EA
	F2				24	40.2	P	EA	EA	EA	EA
	F4				32	40.5	P	P	P	P	EA
437683	R6	Rear	9	610	6	34.9	P	EA	EA	EA	EB
	R3				15	38.4	P	P	P	P	P
	R2				24	39.2	P	P	P	P	P
	R4				32	40.5	P	P	P	P	P

Ratings were taken using photograph B from ASTM G34, EXCO Tests:

N = no corrosion.

P = pitting, no exfoliation.

A through D = exfoliation in increasing order of severity.

Correlations with lengthy outdoor exposures in seacoast environment indicate that material receiving a rating of P or A and possibly B in the EXCO test will not exfoliate outdoors. Material receiving a C or D rating will exfoliate outdoors.

TABLE 21

STRESS-CORROSION TEST RESULTS OF 1.5-INCH X 7.5-INCH RECTANGULAR ALLOY 7050 EXTRUSIONS

S. No.	Extr. Ratio	Ext. Temp, °F	2nd-Step Age, Hrs	Test Location	L.Y.S., ksi	Days to Fail After Exposure at Indicated Stress Levels		
						45 ksi	35 ksi	25 ksi
437682-6	32	780	6	Rear	86.8	2,2,2	2,2,2	2,2,3
-1			8		83.5	2,3,OK	3,2,2	2,5,43
-3			15		77.2	35,36,40	34,49,105	105,OK,OK
-5			20		74.2	18,44,105	105,105,OK	137,OK,OK
-2			24		72.6	55,64,73	OK,OK,OK	88,105,OK
-4			32		69.3	64,119,OK	OK,OK,OK	OK,OK,OK
437679-6	32	600	6	Front	85.2	2,2,2	2,2,2	2,2,10
-1			8		82.3	2,2,2	4,2,5	4,4,40
-3			15		76.2	22,33,38	60,105,OK	64,105,105
-5			20		69.5	58,64,71	87,105,OK	105,OK,OK
-2			24		70.6	68,105,105	OK,OK,OK	OK,OK,OK
-4			32		64.4	OK,OK,OK	OK,OK,OK	105,OK,OK
437680-6	32	610	6	Front	86.9	1,2,2	1,1,2	2,2,2
-1			8		84.3	1,1,2	2,2,2	2,2,2
-3			15		78.6	4,4,4	5,5,5	39,49,105
-5			20		73.9	28,OK,OK	55,55,105	76,105,OK
-2			24		73.4	15,OK,OK	OK,OK,OK	OK,OK,OK
-4			32		69.3	49,49,53	55,88,105	105,134,OK

Triplicate 0.125-inch diameter short-transverse specimens exposed by alternate immersion in 3.5% NaCl solution according to Method 823 of Fed. Test Method Std. No. 151.

OK = survived 138 days.

TABLE 21 (CONTINUED)

STRESS-CORROSION TEST RESULTS OF 1.5-INCH X 7.5-INCH RECTANGULAR ALLOY 7050 EXTRUSIONS

S. No.	Extr. Ratio	Ext. Temp, °F	2nd-Step Age, Hrs	Test Location	L.Y.S., ksi	Days to Fail After Exposure at Indicated Stress Levels		
						45 ksi	35 ksi	25 ksi
437681-6	32	600	6	Front	86.8	2,2,2	2,2,2	2,2,2
-1			8		83.2	1,1,1	2,2,2	3,3,3
-3			15		78.5	5,5,10	6,22,25	27,36,49
-5			20		73.6	27,30,51	34,105,105	73,105,105
-2			24		72.8	40,49,49	27,38,105	105,105,105
-4			32		67.5	55,55,64	54,OK,OK	OK,OK,OK
437678-6	9	820	6	Front	81.4	3,3,2	2,3,4	4,5,113
-3			15		72.6	55,64,73	OK,OK,OK	88,105,OK
-2			24		67.8	66,73,OK	OK,OK,OK	OK,OK,OK
-4			32		63.7	64,76,OK	66,83,88	130,OK,OK
437677-6	9	600	6	Rear	82.8	2,2,2	2,2,2	2,2,2
-3			15		74.4	17,22,26	44,105,105	71,134,OK
-2			24		69.5	58,64,71	87,105,OK	105,OK,OK
-4			32		65.4	64,105,105	100,100,105	OK,OK,OK

Triplicate 0.125-inch diameter short-transverse specimens exposed by alternate immersion in 3.5% NaCl solution according to Method 823 of Fed. Test Method Std. No. 15].

OK = survived 138 days.

TABLE 22

STRESS-CORROSION TEST RESULTS OF 2.75-INCH X 4-INCH RECTANGULAR ALLOY 7050 EXTRUSIONS

S. No.	Extr. Ratio	Extr. Temp, °F	2nd-Step Age, Hrs	Test Location	L.Y.S., ksi	Days to Fail After Exposure at Indicated Stress Levels		
						45 ksi	35 ksi	25 ksi
437686-6	32	775	6	Front	88.0	2,2,2	2,2,2	2,3,3
-1			8		86.0*	2,2,2	2,2,2	2,5,5
-3			15		77.4	22,88,OK	26,43,93	83,124,136
-5			20		74.6	39,49,49	64,105,OK	105,117,OK
-2			24		72.9	47,72,73	58,87,91	OK,OK,OK
-4			32		69.5	OK,OK,OK	80,105,OK	OK,OK,OK
437685-6	32	610	6	Rear	87.9	2,2,2	4,15,18	4,15,74
-1			8		88.1	3,5,5	15,27,34	54,124,OK
-3			15		81.0	38,60,60	41,71,OK	OK,OK,OK
-5			20		74.1	71,83,93	OK,OK,OK	OK,OK,OK
-2			24		73.6	55,74,OK	105,OK,OK	OK,OK,OK
-4			32		71.3	74,105,105	OK,OK,OK	OK,OK,OK
437684-6	9	810	6	Rear	87.6	2,2,2	2,2,2	53,54,68
-3			15		78.1	36,55,100	87,OK,OK	93,OK,OK
-2			24		72.6	60,72,OK	99,OK,OK	OK,OK,OK
-4			32		70.0	71,73,90	OK,OK,OK	OK,OK,OK
437683-6	9	610	6	Front	88.4	2,2,2	2,2,2	2,2,3
-3			15		79.0	5,15,48	28,48,137	55,66,87
-2			24		75.0	105,105,OK	76,83,105	80,125,OK
-4			32		69.3	58,65,76	87,116,116	OK,OK,OK

*Estimated

Triplicate 0.125-inch diameter short-transverse specimens exposed by alternate immersion in 3.5% NaCl solution according to Method 823 of Fed. Test Method Std. No. 151.

OK = survived 138 days.

TABLE 23

EFFECT OF SECOND-STEP AGING TIME ON 7050 EXTRUSIONS

Stress-Corrosion Test Performance

Hrs Aging at 325°F	Percent Surviving 20-day Exposure at Indicated Stress			Percent Surviving 30-day Exposure at Indicated Stress			Range of L. Y.S., ksi
	25 ksi	35 ksi	45 ksi	25 ksi	35 ksi	45 ksi	
6	17	0	0	17	0	0	81.4-88.0
8	33	13	13	33	7	13	82.3-88.1
15	100	87	67	97	77	57	72.6-81.0
20	100	100	94	100	100	78	69.5-74.6
24	100	100	97	100	93	97	67.8-73.6
32	100	100	100	100	100	100	63.7-71.8
7075-T6*	0	0	0	0	0	0	72-?
7075-T73*	100	100	100	100	100	100	59-71

*Typical Performance.

TABLE 24

RESULTS OF PROBIT ANALYSIS

<u>Variant</u>	<u>Level</u>	<u>25 ksi</u>	<u>35 ksi</u>	<u>45 ksi</u>
Aspect Ratio*	5	80.1	78.3	76.4
	1.5	86.7	83.5	80.4
Extrusion Temperature†	600-610°F	79.5	77.0	74.5
	780-820°F	81.1	80.0	78.9
Extrusion Ratio†	9	79.6	76.9	74.3
	32	79.4	77.2	74.9

*All extrusion temperatures and ratios.

†Aspect ratio 5.

TABLE 25

RESULTS OF REGRESSION ANALYSIS RELATING SPECIMEN FAILURE TIME TO
LONGITUDINAL YIELD STRENGTH

Extrusion Dimension, in.	Applied Stress, ksi	Regression Equation ¹		L.Y.S. ² at 30-day Life
		Slope A	Intercept B	
1.5x7.5	25	40.8301	-0.47218	79.3
2.75x4.0	25	18.9522	-0.18446	84.3
1.5x7.5	35	35.9554	-0.42388	76.0
2.75x4.0	35	22.2904	-0.23437	80.6
1.5x7.5	45	31.9345	-0.37866	75.4
2.75x4.0	45	20.0786	-0.21533	77.4

1. \log_e Failure Time = A + B (L.Y.S.).

2. Best estimate of longitudinal yield strength at which it would be expected that one-half of the tested specimens would have failure times that exceed 30 days.

TABLE 20

35-INCH DIAMETER 7050 ALLOY IRGOT - CASTING DATA

Cast and Sample	Casting Rate Cycle		Bottom Block Cooling Duration (Min.)	Wiper Distance (inches)	Reheat Temp. (°F)	Basin Pouring Temperature (°F)	Water Flow Rate Mold + Ingot (gpm)	Remarks
	Start (ipm)	Duration (Min.)						
942-21	0.61	14.0	14.0	10	430	1215	140	#1 Crack free #2 Cracked
942-22	0.61	14.0	14.0	10	430	1205	140	#1 14" Shear Crack #2 Cracked
942-23	0.59	13.6	13.6	10	420	1220	140	#1 20" Shear Crack #2 Cracked
942-24	0.60	14.2	14.2	10	435	1210	140	#1 24" Shear Crack #2 24" Shear Crack
942-25	0.62	13.7	13.7	10	430	1210	140	#1 25" Shear Crack #2 25" Shear Crack
942-26	0.60	14.2	14.2	10	440	1250	140	#1 & #2 Cracked
942-27	0.60	14.2	14.2	10	430	1250	140	#1 24" Shear Crack #2 24" Shear Crack
942-28	0.60	14.2	14.2	10	410	1202	140	#1 20" Shear Crack #2 20" Shear Crack

Notes: 1. Tibor rod feed rate 36 ipm.

2. 5" long aluminum mold.

3. Bottom Block - Steel (stepped and water cooled).

4. Lubricant - Castor Oil.

5. Holding hearth temperature - 1340 - 1360°F.

6. Filter temperature - 1280 - 1340°F.

7. Mold fill time - 3 min.

TABLE 27

EXTRUSION PRESS DATA (21-INCH CYLINDER)

<u>Alcoa Lab S. No.</u>	<u>Size or Sect. No.</u>	<u>Cylinder Temp, °F</u>	<u>Billet Temp, °F</u>	<u>Billet Size, dia x l, in.</u>
429204	231372	730	700	21 x 32
429205	213592	730	700	21 x 18
429206	1.5"x7.5"	725	680	21 x 18
429207	3.5"x7.5"	730	600	21 x 28
429208	5.0"x6.25"	730	610	21 x 40

TABLE 28

LONGITUDINAL TENSILE PROPERTIES AND ELECTRICAL CONDUCTIVITIES
OF 7050-T7351X EXTRUSIONS FROM 21-IN. DIA. CYLINDER

Alcoa Lab S. No.	Size or Section No.	Front			Rear				
		T.S., ksi	Y.S., ksi	% El. in 4D	E. C., & IACS	T.S., ksi	Y.S., ksi	% El. in 4D	E. C., & IACS
429204	231372	78.5	69.3	15.5	41.5	79.3	69.9	14.0	41.8
429205	213592	79.9	70.9	14.5	41.1	79.6	71.1	14.5	40.8
429206	1.5"x7.5"	78.6	69.9	14.0	41.7	79.3	70.9	15.0	41.6
429207	3.5"x7.5"	78.4	69.5	13.0	42.7	79.4	71.1	14.0	42.7
429208	5.0"x6.25"	79.9	72.1	11.5	41.9	78.9	70.8	13.0	42.7

TABLE 29

EXTRUSION PRESS DATA (25-INCH AND 29-INCH CYLINDERS)

<u>Alcoa Lab S. No.</u>	<u>Section No.</u>	<u>Temper</u>	<u>Cast Sample No.</u>	<u>Cylinder Temp, °F</u>	<u>Ingot Extrusion Temp, °F</u>	<u>Billet Size dia x l, in.</u>
421141	313002	T76510	25A	740	750	25 x 36
421139		T73510				
421136	165822	T76510	24	800	750	25 x 24
421140	165822	T73510	28	800	740	25 x 24
421134	263902	T76510	26	800	770	25 x 36
421133	263902	T73510	28	800	740	25 x 32
421143	291812	T76510	19	800	780	29 x 44
421132	291812	T73510	16A	800	770	29 x 44
421135	900102	T76510	21A	820	790	29 x 40
421142	900102*	T76510	18A	820	780	29 x 76
421138		T73510				
421137	900102	T73510	19	820	780	29 x 40

*Joggled.

29-inch diameter billets machined from 35-inch diameter ingot.

TABLE 30

LONGITUDINAL TENSILE PROPERTIES AND ELECTRICAL CONDUCTIVITIES
OF 7050-T7651X EXTRUSIONS FROM 25 AND 29-IN. CYLINDERS

Alcoa Lab S. No.	Ingot Diameter, in.	Section Number	Front			Rear				
			T.S., ksi	Y.S., ksi	% El. in 4D	E. C., % IACS	T.S., ksi	Y.S., ksi	% El. in 4D	E. C., % IACS
421141	25	313002††	81.4	72.4	14.5	39.4	73.9	65.2	17.0	41.7
							*73.7	64.6	10.5	
							**78.8	68.3	15.5	
421136	25	165822	83.4	74.3	14.0	38.1	83.6	74.6	14.0	38.2
421134	25	263902	81.4	73.3	13.0	38.4	84.6	76.1	15.0	38.0
421143	35	291812	83.1	75.8	12.5	39.1	83.9	76.8	13.5	38.8
421135	35	900102	80.6	71.8	13.5	39.0	82.6	73.6	14.0	38.9
421138	35	900102†	77.6	69.0	15.5	41.0	77.6	68.3	14.5	41.4

Aged 8 hours at 350°F second step.

*Retest at adjacent location.

**Retest several inches away.

Metallographic examination revealed that the extrusion was beginning to recrystallize at this location.

†Joggled, but tests not in joggled area.

††"Front" test was from front of rear half.

TABLE 31

LONGITUDINAL TENSILE PROPERTIES AND ELECTRICAL CONDUCTIVITIES
OF 7050-T7351X EXTRUSIONS FROM 25 AND 29-IN. CYLINDERS

Alcoa Lab S. No.	Ingot Diameter, in.	Section Number	Front			Rear				
			T.S., ksi	Y.S., ksi	% El. in 4D & IACS	T.S., ksi	Y.S., ksi	% El. in 4D & IACS		
421139	25	313002†	77.8	67.0	15.5	41.1	77.9	67.4	14.0	41.1
421140	25	165822	82.1	71.7	14.5	39.7	78.9	68.4	14.5	40.8
421133	25	263902	82.1	72.2	13.5	39.9	83.4	73.4	13.0	39.2
421132	35	291812	79.5	69.2	12.0	40.7	82.6	73.9	13.0	40.1
421137	35	900102	77.9	67.7	13.5	40.9	78.9	68.0	13.5	40.9
421142	35	900102*	76.6	66.5	14.0	41.7	75.7	65.5	15.5	41.7

Aged 12 hours at 350°F second step.

*Joggled, but tests not in joggled area.

†"Rear" test was from rear of front half.

TABLE 32

RESULTS OF PLANT QUALITY CONTROL TESTS OF 7050-T735LX EXTRUSIONS
(Section 900102)

Alcoa Lab S. No.	Plant No.	Test Location		Solution Heat Treat Batch	Age Load	Longitudinal Tensile Properties†			E. C., % IACS*
		Front	Rear			T.S., ksi	Y.S., ksi	El., %	
421332	17-1 17	Front		1	A	76.2	66.0	12.5	40.0
		Rear		1	B	74.9	64.5	14.5	41.0
421333	19-1 19	Front		1	A	75.9	66.2	14.5	42.4
		Rear		1	B	76.4	65.8	14.0	41.1
421334	20-1 20	Front		2	A	76.9	66.7	13.5	40.8
		Rear		2	B	76.1	66.2	14.0	40.9
421335	21-1 21	Front		2	A	76.0	66.4	14.5	41.5
		Rear		2	B	74.4	64.0	16.0	41.1
421336	24-1 24	Front		2	A	76.3	66.8	13.5	42.5
		Rear		2	B	73.8	63.6	16.0	41.5

†Single tests of 1/2-inch dia. specimens.

*Measurement taken at location specified for 7075-T73XXX
per QQ-A-200/11D.

TABLE 33

CHEMICAL ANALYSES OF EXTRUSIONS FROM 21-IN. DIA. CYLINDER

Alcoa Lab S. No.	Zn	Mg	Cu	Zr	Mn	Cr	Fe	Si	Ti	Ni
429204	6.35	2.20	2.29	0.12	0.00	0.00	0.13	0.07	0.04	0.00
429205	6.53	2.25	2.13	0.11	0.00	0.02	0.10	0.09	0.02	0.00
429206	6.36	2.18	2.06	0.11	0.00	0.02	0.10	0.09	0.03	0.00
429207	6.20	2.15	2.30	0.11	0.00	0.00	0.08	0.06	0.02	0.00
429208	6.16	2.09	2.24	0.12	0.00	0.00	0.10	0.07	0.03	0.00

TABLE 34

CHEMICAL ANALYSES OF EXTRUSIONS FROM 25-INCH AND 29-INCH CYLINDERS

<u>Alcoa Lab S. No.</u>	<u>Cast Sample No.</u>	<u>Zn</u>	<u>Mg</u>	<u>Cu</u>	<u>Zr</u>	<u>Mn</u>	<u>Cr</u>	<u>Fe</u>	<u>Si</u>	<u>Ti</u>	<u>Ni</u>
421132	16A	6.14	2.27	2.13	0.10	0.00	0.00	0.11	0.04	0.02	0.00
421137, 43	19	6.46	2.30	2.23	0.09	0.00	0.00	0.11	0.05	0.03	0.00
421135	21A	6.10	2.12	2.12	0.10	0.00	0.00	0.10	0.04	0.02	0.00
421139, 41	25A	6.13	2.11	2.20	0.09	0.00	0.00	0.10	0.04	0.03	0.00
421136	24	6.20	2.18	2.08	0.10	0.00	0.00	0.09	0.04	0.03	0.00
421134	26	5.90	2.06	2.19	0.10	0.00	0.00	0.09	0.05	0.03	0.00
421133, 40	28	6.01	2.26	2.13	0.10	0.00	0.00	0.09	0.04	0.03	0.01
421138, 42	18A	6.19	2.06	2.22	0.10	0.00	0.00	0.12	0.04	0.03	0.00

TABLE 35

CHEMICAL ANALYSES OF 7050 INGOTS FABRICATED INTO ALCOA SECTION 900102
(C5A MING PANEL)

<u>Alcoa Lab S. No.</u>	<u>Plant No.</u>	<u>Zn</u>	<u>Mg</u>	<u>Cu</u>	<u>Zr</u>	<u>Mn</u>	<u>Cr</u>	<u>Fe</u>	<u>Si</u>	<u>Ti</u>
421332	16, 17	5.99	2.23	2.32	0.10	0.00	0.01	0.10	0.08	0.02
421333	18, 19	6.33	2.34	2.44	0.11	0.00	0.00	0.13	0.09	0.03
421334	20	6.32	2.31	2.39	0.10	0.00	0.01	0.12	0.10	0.03
421335	21, 22	6.10	2.18	2.24	0.10	0.00	0.00	0.09	0.06	0.02
421336	15, 24	6.01	2.12	2.35	0.10	0.00	0.00	0.08	0.05	0.02

TABLE 36

ULTRASONIC INSPECTION RESULTS FOR 7050-T7351X
 EXTRUSION SECTION 291812 - LOT 35767-A1-15-1
SPECIMEN 421132-2

5 MHz, 3/4 IN. DIA., TYPE 2 SEARCH UNIT - UM721
 TEST STANDARDIZATION - 2.0 IN. ON 3-0250 BLOCK - GAIN 2.2x.1

<u>INDICATION NO.</u>	<u>DEPTH, INCHES</u>	<u>SIZE</u>	<u>SIZE - % OF #3</u>	<u>REMARKS</u>
1	3/4	3-	33%	Isolated Indication
2	3-7/8	3-	60%	Isolated Indication
3	4-1/4	3-	50%	Isolated Indication
4	1-3/4	3	100%	Isolated Indication, Angular
5	3/4	3-	66%	Isolated Indication
6	1-1/2	3-	50%	Isolated Indication
7	1-5/8	3-	60%	Isolated Indication
8	2	3+	110%	Isolated Indication
9	.4	5-	180%	Isolated Indication
10	2	3-	55%	Isolated Indication
11	2-1/2	3+	130%	Isolated Indication
12	3/4	3+	140%	Isolated Indication
13	1	3-	95%	Isolated Indication

All indications marked on surface of specimens.

TABLE 37

ULTRASONIC INSPECTION RESULTS FOR 7050-T7351X
 EXTRUSION SECTION 291812 - LOT 35767-A1-15
 SPECIMEN 421132-1

5 MHz, 3/4 IN. DIA., TYPE Z SEARCH UNIT - UM721
 TEST STANDARDIZATION - 2.0 IN. ON 3-0250 BLOCK - GAIN 2.2x.1

INDICATION NO.	DEPTH, INCHES	SIZE	SIZE - % OF #3	REMARKS
1	1/2	3-	40%	Stringer 57 In. Long
2	2-1/2	3+	105%	Isolated Indication
3	1-7/8	5-	170%	Isolated Indication
4	1-1/4	5-	180%	Isolated Indication
5	3/4	3-	66%	Stringer 34 In. Long

All indications marked on specimen.

TABLE 38

RESULTS OF ULTRASONIC INSPECTION OF MECHANICAL PROPERTY SAMPLES OF
 7050-T7351X EXTRUSIONS - SECTION 291812 - AUTIAC INSTRUMENT
 10 MHZ LITHIUM SULPHATE, 3/4 IN. DIA. SEARCH UNIT - Q6111A
 S. NO. 421132-1 AND 421132-2

IDENTIFICATION	INDICATION PRESENT	INDICATION SIZE	DEPTH, IN.		INDICATION NO. IN EXTRUSION	INDICATION SIZE IN EXTRUSION	DEPTH, IN.		SPECIMEN TESTED
			TEST SURFACE	FROM SURFACE			FROM SURFACE	EXTRUSION SURFACE	
421132 Axial Fatigue Specimens	Yes	3+	3/8	9	5-	.4	Yes	Yes	
	Yes	3+	7/16	2	3+	2-1/2	Yes	Yes	
	Yes	3+	3/8	11	3+	2-1/2	Yes	Yes	
	Yes	3-	3/4	13	3-	1	Yes	Yes	
	Yes	3-	7/16	5	3-	3/4	Yes	Yes	
	Yes	3-	7/16	1	3-	1/2	Yes	Yes	
	None	--	--	1	3-	1/2	No	No	
	Yes	3-	3/8	1	3-	1/2	Yes	Yes	
	None	--	--	--	3-	3-	1/2	No	No
421132 Tensile Specimens	None	--	--	1	3-	1/2	No	No	
	None	--	--	1	3-	1/2	No	No	
	Yes	3+	7/16	4	5-	1-1/4	Yes	Yes	
	None	--	--	1	3-	1/2	Yes	Yes	
	Yes	3+	3/8	8	3+	2	Yes	Yes	
	Yes	3	3/4	10	3-	2	Yes	Yes	

NOTE: L and T are longitudinal and long-transverse specimens.

TABLE 39

RESULTS OF TENSILE TESTS ON 7050-T7351X SPECIMENS FROM
SECTION 291812 - S. NOS. 421132-1 AND 421132-2

<u>SPECIMEN NO.</u>	<u>T.S., ksi</u>	<u>Y.S., ksi</u>	<u>% EL., 2-IN.</u>	<u>R OF A, %</u>	<u>DISCONTINUITY</u>
421132 1-L1A	77.6	69.2	12.0	32	Yes
1-L4A	77.3	68.1	13.0	34	No
2-L2A	74.9	64.9	12.5	30	Yes
2-L3A	74.6	64.7	13.0	31	Yes
L	77.2	68.5	12.0	31	No

NOTE: All tests in longitudinal direction.

TABLE 40
RESULTS OF TENSILE, COMPRESSIVE, SHEAR AND BEARING TESTS OF
7050-77651- EXTRUDED SHAPES
(APML CONTRACT NO. F33615-73-C-5015)

Thickness and Width, in.	Section Number or Shape	Section Number or Shape	Al Sample Number	Specimen Location	Specimen (a)	Tensile Strength, ksi	Tensile Yield Strength, ksi	Elongation, in.-%	Compressive Yield Strength, ksi	Shear Strength, ksi	Bearing Strength, (d) ksi	
											σ ₁ = 2.0	σ ₂ = 2.0
0.765 x 22.38	313002	421141	W/4	W/2	LT	79.7	71.0	14.0	70.6	46.2	117.2	150.4
						79.2	70.3	14.5	73.4	45.5	119.2	154.4
0.91 x 24.21	165822	421136	T/2, W/4	T/2, W/2	LT	82.7	74.6	13.0	74.7	47.8	125.3	161.1
						81.5	72.8	12.0	75.6	47.1	124.3	160.3
1.8 x 17.09	263902	421134	T/4, W/4	T/2, W/2	LT	80.3	73.1	13.0	72.6	47.1	121.9	155.4
						78.8	71.0	12.0	75.3	45.5	120.1	155.7
						Cross-Sectional Area < 43 in. ²						
1.8 x 27.36	900102	421135	T/4, W/4	T/2, W/2	ST	79.9	72.0	12.5	71.9	46.1	123.2	155.8
						80.0	71.0	11.0	75.0	46.7	123.3	158.0
2.93 x 18.1	291812	421143	T/4, W/4	T/2, W/2	ST	74.5	66.2	4.7	75.9	42.3	---	---
						82.9	76.8	11.0	75.7	48.2	123.4	160.3
						Cross-Sectional Area 61 to 66 in. ²						
						79.0	74.8	8.0	79.3	47.1	127.0	169.2
						79.0	70.9	5.0	79.1	38.7	---	---

NOTES: (a) T - Thickness, W - Width of shape.
(b) Offset equals 0.2 per cent.
(c) Load UT specimens - loads applied in short-transverse direction; ST specimens - loads applied in longitudinal direction.
(d) Specimens and test fixtures cleaned ultrasonically; yield strength - offset equals 2 per cent of pin diameter.

TABLE 41
 SUPPLEMENTAL DATA (e)
 MECHANICAL PROPERTIES OF 7050-T7651X EXTRUDED SHAPES, CROSS-SECTIONAL AREA $\geq 32 \text{ in.}^2$
 (NAC CONTRACT NO. N00019-73-C-0512)

Thickness and Width, in.	Cross-sectional Area, in.^2	Section Number or Shape	Al Sample Number	Specimen Location and Direction	Tensile Strength, ksi	Tensile Yield Strength, ksi	Elongation in 4 σ , %	Compressive Yield Strength, ksi	Shear Strength, ksi	Tearing Strength, (d) ksi	Tearing Yield Strength, (d) ksi
0.187 x 22.56	4.78	Rectangle	411286	W/4 L	85.1 85.4	75.9 76.9	10.0 10.0	61.9 76.9	47.4 45.9	122.1 123.2	159.0 160.2
0.402 x 15.56	8.17	Rectangle	411289	W/4 L	83.8 83.4	76.6 73.0	14.0 10.0	76.2 81.3	49.4 49.6	128.8 131.2	164.2 167.6
0.665 x 16.9	18.53	Rectangle	411290	T/2, W/4 L	85.4 84.1	78.2 76.9	14.3 12.9	76.8 80.0	48.9 48.8	126.7 127.7	162.4 163.2
0.841 x 17.18 (e)	19.47	Rectangle	411287	T/2, W/4 L	82.8 81.6	75.2 74.1	11.0 11.0	79.1 76.0	47.1 45.1	121.9 124.7	160.2 159.1
1.161 x 17.35	29.44	Rectangle	411287	T/2, W/4 L	83.6 82.5	76.4 74.4	12.0 11.0	76.9 79.2	49.6 48.7	127.9 126.3	163.7 163.2
1.5 x 7.5	11.25	Rectangle	411284	T/2, W/4 L	85.0 82.0 82.3	78.4 75.3 69.8	13.0 12.0 8.0	80.5 79.9 82.2	48.5 48.3 --	126.9 126.5 ---	162.6 164.3 ---
2.0 x 8.0 (e)	16.0	Rectangle	411279	T/4, W/4 L	81.6 78.9 76.0	75.6 71.0 66.7	13.0 10.0 6.0	76.5 75.3 75.7	45.8 44.4 40.8	120.9 119.2 ---	156.9 154.2 ---
3.5 x 7.5	26.25	Rectangle	411285	T/4, W/4 L	86.6 80.3 79.9	80.5 74.1 70.9	11.0 7.0 2.9	89.1 79.0 76.9	48.2 47.0 43.6	124.9 121.5 ---	158.8 156.9 ---
4.0 x 8.0 (e)	32.0	Rectangle	411280	T/4, W/4 L	84.6 76.1 75.1	79.7 71.8 68.9	11.0 4.0 2.9	81.0 77.3 75.3	46.8 45.7 39.3	123.6 116.3 ---	156.1 153.4 ---
5.0 x 6.25	31.25	Rectangle	411286	T/4, W/4 L	87.6 82.6 76.5	82.3 72.6 70.3	11.0 3.0 3.0	84.8 77.8 76.0	48.3 46.7 42.4	118.3 (f) 106.8 (f) ---	156.3 (f) 143.1 (f) ---
UP thru 2.099 in. 3.000 thru 5.000 in.	(Area $\geq 20 \text{ in.}^2$ (Area $\leq 32 \text{ in.}^2$)				79 79	69 69	7 7	-- --	-- --	-- --	-- --

(a) T - Thickness, W - Width, L - Longitudinal, LT - Long-Transverse, ST - Short-Transverse.
 (b) Offset equals 0.2 per cent.
 (c) L and LT specimens - loads applied in short-transverse direction; ST specimens - load applied in longitudinal direction.
 (d) Specimens taken near edge of width; location not comparable to those of other shapes. Data not included for determining ratios.
 (e) Specimens taken near edge of width; location not comparable to those of other shapes. Data not included for determining ratios.
 (f) Reference 5.

TABLE 42
 RESULTS OF TENSILE, COMPRESSIVE, BEAR AND BEAR-UP TESTS ON 7050-T3611
 EXTRUDED SQUARE, PRODUCTION AREA 1-43 IN.
 (AAMI REPORT NO. 73-15-73-5-15)

Thickness and Width, in.	Cross-sectional Area, in.	Section Number	Al Sample Number	Section Location	Section Orientation	Tensile Strength, Ksi	Tensile Elongation, %	Plasticity, in.	Compressive Yield Strength, Ksi	Bear Strength, Ksi	Bear-Up Strength, Ksi	Yield Strength, Ksi	Ultimate Strength, Ksi
1.46 x 1.43	15.53	31349	421005	3/4	L	74.7	70.9	14.2	71.8	44.6	112.1	145.1	111.7
				4/2	L	77.8	63.8	11.4	72.3	44.6	115.3	146.7	114.7
0.765 x 22.28	22.65	31300	421143	1/2, 3/4	L	76.7	67.8	14.5	66.7	45.1	112.4	147.2	107.8
				1/2, 4/2	L	75.7	66.0	12.5	68.0	43.2	114.7	145.7	114.3
0.915 x 24.21	26.57	145822	421140	1/2, 3/4	L	78.5	68.7	13.5	64.0	46.5	117.7	156.4	113.7
				1/2, 4/2	L	75.2	64.7	11.5	64.0	44.2	117.8	151.4	111.3
1.161 x 17.35	20.44	211372	424204	1/2, 3/4	L	78.4	70.0	12.0	70.0	45.4	114.5	151.5	115.8
				1/2, 4/2	L	76.4	68.8	10.5	72.4	43.1	113.5	147.5	114.7
1.5 x 7.5	11.25	Rectangle	424208	1/2, 3/4	L	78.3	70.4	13.2	72.4	45.1	118.2	151.0	118.6
				1/2, 4/2	L	76.1	68.7	11.5	71.1	44.1	118.1	152.0	118.6
				1/2, 4/2	L	74.4	64.5	8.5	72.3	44.1	118.1	152.0	118.6
1.6 x 17.09	42.09	313402	421133	1/4, 3/4	L	79.7	74.3	13.0	68.5	46.5	115.0	150.8	113.7
				1/2, 3/4	L	72.2	67.7	11.5	71.1	45.1	115.0	150.8	113.7
				1/2, 4/2	L	74.1	67.4	6.2	72.1	44.1	115.0	150.8	113.7
3.5 x 7.5	26.25	Rectangle	424207	1/4, 3/4	L	80.7	75.8	10.0	74.6	44.4	115.3	150.1	115.8
				1/2, 3/4	L	72.4	68.2	7.5	70.1	44.2	115.8	145.2	115.8
				1/2, 4/2	L	74.1	67.2	7.4	70.3	43.8	115.8	145.2	115.8
5.0 x 6.25	31.25	Rectangle	424206	1/4, 3/4	L	74.5	71.8	13.0	73.4	43.9	107.1	139.7	108.8
				1/2, 3/4	L	72.5	64.2	7.0	66.5	42.5	102.4	132.7	108.8
				1/2, 4/2	L	73.1	63.2	7.0	67.6	41.6	102.4	132.7	108.8

NOTE: (A) T - Thickness, W - Width, L - Longitudinal, LT - Long-Transverse, TT - Short-Transverse.
 (B) Offset equals 0.2 per cent.
 (C) L and LT specimens - loads applied in short-transverse direction; TT specimens - loads applied in longitudinal direction.
 (D) Specimens and test fixtures cleaned ultrasonically; yield strength - offset equals 2 per cent of pin diameter.
 (E) Value not obtained; extensometer malfunctioned.
 (F) Specimen taken near edge of width; location not comparable to those of other shapes.
 (G) Data not included for determining ratios.

TABLE 43
 RESULTS OF TENSILE, COMPRESSIVE, SHEAR AND BEARING TESTS OF 7050-T7351X
 EXTRUDED SHAPES, CROSS-SECTIONAL AREA 61 TO 66 IN.²
 (APML CONTRACT NO. F33615-73-C-5015)

Thickness and Width, in.	Cross-Sectional Area, in. ²	Section Number or Shape	AL Sample Number	Specimen Direction (a)	Tensile Strength, ksi	Tensile Yield Strength, ksi	Elongation in 4D, %	Compressive Yield Strength, ksi	Shear Strength, (c) ksi	Bearing Strength, (d) ksi			
										$\frac{e}{W} = 1.5$	$\frac{e}{W} = 2.0$	$\frac{e}{W} = 1.5$	$\frac{e}{W} = 2.0$
1.8 x 27.36	61.53	900102	421137	L	76.6	67.2	13.0	66.8	45.1	114.1	147.5	93.9	111.9
				LT	76.4	66.7	12.5	69.8	44.2	115.1	149.2	94.6	114.0
				ST	73.9	63.2	7.8	70.6	38.3	---	---	---	---
1.8 x 27.36	61.53	900102	421332	L (Front)	76.7	67.8	13.0	---	---	---	---	---	---
				L (Rear)	77.4	69.0	13.0	---	---	---	---	---	---
				L (45°)	77.2	66.3	13.5	67.0	45.2	115.0	152.0	94.6	113.7
				L (3/4)	77.2	66.5	13.0	---	---	---	---	---	---
				L (Bearing)	76.7	66.5	12.0	69.8	43.8	117.0	151.1	95.6	113.7
				LT	72.8	61.2	4.7	71.3	---	---	---	---	---
1.8 x 27.36	61.53	900102	421333	L	77.8	69.0	12.5	68.5	46.0	119.9	154.6	99.0	115.7
				LT	77.5	68.0	11.0	71.8	44.9	118.5	153.3	102.3	121.4
				ST	72.9	63.8	4.7	72.8	---	---	---	---	---
1.8 x 27.36	61.53	900102	421334	L	76.6	67.2	12.5	66.5	45.3	118.9	152.3	98.1	116.0
				LT	76.5	66.5	11.0	70.0	44.3	115.9	149.7	94.5	115.8
				ST	71.9	61.5	4.7	71.1	---	---	---	---	---
1.8 x 27.36	61.53	900102	421335	L	74.8	65.2	13.5	65.0	43.9	115.1	147.6	97.6	110.1
				LT	74.9	65.0	13.5	68.3	42.9	113.2	147.2	93.7	116.5
				ST	72.4	61.2	6.2	69.3	---	---	---	---	---
1.8 x 27.36	61.53	900102	421336	L	74.1	64.4	14.0	63.7	43.4	113.0	144.7	90.9	109.2
				LT	74.3	63.9	12.5	67.7	41.9	112.8	145.3	93.7	115.7
				ST	72.4	60.4	9.4	68.5	---	---	---	---	---
2.93 x 18.1	65.37	291812	421132	L	77.2	68.5	12.0	68.8	45.5	114.6	148.5	95.2	113.4
				LT	76.5	67.2	11.0	70.6	45.1	116.5	153.3	95.6	120.8
				ST	73.8	62.8	5.0	70.1	38.7	---	---	---	---

NOTES: (a) L - Longitudinal (T/4, W/4); LT - Long-Transverse (T/2, W/2); ST - Short-Transverse (T/2, W/2); T - Thickness, W - Width.
 (b) Location in length of specimens from S-421332 indicated in parenthesis.
 (c) Offset equal 0.2 per cent.
 (d) L and LT specimens loaded in short-transverse direction; ST specimens - load applied in longitudinal direction. Specimens and test fixtures cleaned ultrasonically, yield strength - offset equals 2 per cent of pin diameter.

TABLE 44
RESULTS OF TENSILE AND COMPRESSIVE STRESS-STRAIN AND MODULUS OF ELASTICITY TESTS
OF 7050-T7651X AND T7351X EXTRUDED SHAPES
(APML CONTRACT NO. F33615-73-C-5015)

Thickness and width, in.	Cross-section or Area, in.	Section Number or Shape	AL Sample Number	Longitudinal		Long-Transverse		Short-Transverse							
				Tensile Yield Strength, (a) Ksi	Modulus, 10 ³ Ksi	Yield Strength, (a) Ksi	Modulus, 10 ³ Ksi	Yield Strength, (a) Ksi	Modulus, 10 ³ Ksi	Yield Strength, (a) Ksi	Modulus, 10 ³ Ksi				
				<u>7050-T7651X</u>											
0.187 x 22.56 (c)	4.78	86366	411288	78.1	10.37	78.7	10.88	77.4	10.55	80.3	11.03	77.4	10.55	80.3	11.03
0.665 x 16.9 (c)	14.53	213502	411290	76.8	10.10	79.2	10.71	75.3	10.56	80.0	11.06	75.3	10.56	80.0	11.06
0.765 x 22.38 (c)	22.65	313002	421141	70.4	10.20	69.0	10.65	69.1	10.60	73.4	11.12	69.1	10.60	73.4	11.12
1.161 x 17.35 (c)	29.44	231372	411287	76.5	9.98	78.2	10.62	74.5	10.44	73.9	11.05	74.5	10.44	73.9	11.05
2.93 x 18.1 (c)	65.37	291812	421143	75.5	10.28	75.9	10.72	73.2	10.47	78.7	11.08	73.2	10.47	78.7	11.08
3.50 x 7.51 (c)	26.25	Rectangle	411285	80.7	10.39	83.7	10.86	73.8	10.47	79.2	10.95	73.8	10.47	79.2	10.95
5.00 x 6.25 (c)	31.25	Rectangle	411286	82.3	10.32	84.2	10.68	72.3	10.52	78.5	11.02	72.3	10.52	78.5	11.02
Average					10.24		10.73		10.45		11.03		10.45		11.03
				<u>7050-T7351X</u>											
0.665 x 16.9	14.53	213502	429205	71.0	10.29	77.6	10.59	68.2	10.45	72.1	11.03	68.2	10.45	72.1	11.03
0.765 x 22.38	22.65	313002	421139	66.2	10.21	65.5	10.63	64.2	10.58	67.8	11.09	64.2	10.58	67.8	11.09
1.8 x 7.5	11.25	Rectangle	429206	70.4	10.31	72.0	10.69	68.1	10.35	72.0	11.01	68.1	10.35	72.0	11.01
1.8 x 27.25	61.25	900102	421137	69.8	10.27	68.8	10.70	66.7	10.50	72.0	11.12	66.7	10.50	72.0	11.12
2.93 x 18.1	61.25	291812	421138	63.4	10.26	63.8	10.69	62.3	10.45	67.0	11.16	62.3	10.45	67.0	11.16
3.50 x 7.51	31.25	Rectangle	429206	71.6	10.40	73.9	10.70	63.9	10.28	68.6	11.24	63.9	10.28	68.6	11.24
5.00 x 6.25	31.25	Rectangle	429206	71.6	10.40	73.9	10.70	63.9	10.28	68.6	11.24	63.9	10.28	68.6	11.24
Average					10.26		10.66		10.47		11.02		10.47		11.02

NOTES: (a) Offset equals 0.2 per cent.
(b) Compressive modulus values are based on a stress range of 0 to elastic limit.
(c) Reference 5.

TABLE 45
RATIOS AMONG TENSILE, COMPRESSIVE AND SHEAR PROPERTIES
OF 7050-176511 EXTRUDED SHAPES

(AFML CONTRACT NO. F33615-73-C-5015)

Thickness and Width, in.	Cross-Sectional Area, in.	Section Number or Shape	AL Sample Number	$\frac{TUS(L)}{TUS(L)}$	$\frac{TUS(ST)}{TUS(L)}$	$\frac{TYS(LT)}{TYS(L)}$	$\frac{TYS(LT)}{TYS(L)}$	$\frac{TYS(ST)}{TYS(L)}$	$\frac{CYS(L)}{TYS(L)}$	$\frac{CYS(LT)}{TYS(L)}$	$\frac{CYS(ST)}{TYS(L)}$	$\frac{SUS(L)}{TUS(L)}$	$\frac{SUS(LT)}{TUS(L)}$	$\frac{SUS(ST)}{TUS(L)}$
0.187 x 22.56	4.78	86366	411288	1.004	--	1.013	--	--	1.079	1.040	--	0.577	0.539	--
0.402 x 15.56	8.17	19282	411289	0.995	--	0.966	--	--	1.034	0.075	--	0.589	0.592	--
0.665 x 16.9	14.53	213592	411290	0.985	--	0.983	--	--	1.008	1.023	--	0.573	0.548	--
0.765 x 22.38	22.65	313002	421141	0.994	--	0.990	--	--	0.994	1.034	--	0.580	0.571	--
0.841 x 17.18	19.47	53717	411552	0.986	--	0.985	--	--	1.052	1.011	--	0.569	0.545	--
0.915 x 24.21	28.57	165822	421136	0.985	--	0.976	--	--	1.001	1.016	--	0.578	0.570	--
1.161 x 17.35	29.44	231372	411287	0.987	--	0.974	--	--	1.007	1.037	--	0.593	0.583	--
1.5 x 7.5	11.25	Rectangle	411284	0.965	0.968	0.960	0.890	0.918	1.027	1.019	1.048	0.571	0.568	--
1.8 x 17.09	42.09	263902	421134	0.981	0.955	0.971	0.918	0.928	0.993	1.030	1.040	0.587	0.567	--
1.8 x 27.36(a)	61.53	900102	421135	1.001	0.932	0.994	0.928	0.928	0.999	1.042	1.054	0.602	0.584	0.529
2.0 x 8.0	16.0	Rectangle	411279	0.942	0.931	0.939	0.882	0.882	1.012	0.996	1.001	0.561	0.544	0.500
2.93 x 18.1(a)	65.37	291812	421143	0.986	0.953	0.973	0.922	0.922	0.997	1.031	1.029	0.581	0.568	0.467
3.5 x 7.5	26.25	Rectangle	411285	0.927	0.923	0.920	0.881	0.881	1.020	0.981	0.955	0.557	0.543	0.502
4.0 x 8.0	32.0	Rectangle	411280	0.900	0.888	0.901	0.864	0.864	1.016	0.970	0.945	0.553	0.540	0.465
5.0 x 6.25	31.25	Rectangle	411286	0.881	0.873	0.875	0.854	0.854	1.030	0.945	0.923	0.551	0.533	0.484

NOTE: (a) Values not included in statistical analyses of ratios.

TABLE 46

RATIOS AMONG TENSILE AND BEARING PROPERTIES
OF 7050-T7351X EXTRUDED SHAPES

(AFML CONTRACT NO. F33615-73-C-5015)

Thickness and Width, in.	Cross- Sectional Area, in. ²	Section Number or Shape	AL Sample Number	$\frac{TUS(LT)}{TUS(L)}$	$\frac{TUS(ST)}{TUS(L)}$	$\frac{TYS(LT)}{TYS(L)}$	$\frac{TYS(LT)}{TYS(L)}$	$\frac{TYS(ST)}{TYS(L)}$	$\frac{CYS(L)}{TYS(L)}$	$\frac{CYS(LT)}{TYS(L)}$	$\frac{CYS(ST)}{TYS(L)}$	$\frac{SUS(L)}{TUS(L)}$	$\frac{SUS(LT)}{TUS(L)}$	$\frac{SUS(ST)}{TUS(L)}$
0.665 x 16.9	14.53	213592	429205	0.976	--	0.976	--	1.013	1.020	1.020	--	0.559	0.562	--
0.765 x 22.38	22.65	313002	421139	0.987	--	0.985	--	0.996	1.015	1.015	--	0.588	0.563	--
0.915 x 24.21	28.57	165822	421140	0.983	--	0.971	--	1.004	1.013	1.013	--	0.592	0.563	--
1.161 x 17.35	29.44	231372	429204	0.985	--	0.983	--	1.000	1.037	1.037	--	0.579	0.574	--
1.5 x 7.5	11.25	Rectangle	429206	0.971	1.017	0.959	0.942	1.033	1.021	1.021	1.033	0.576	0.563	--
1.8 x 17.09	42.09	263902	421133	0.981	0.942	0.977	0.900	0.988	1.026	1.026	1.040	0.591	0.573	--
1.8 x 27.36 (a)	61.53	900.02	421137	0.997	0.965	0.993	0.940	0.994	1.039	1.039	1.051	0.589	0.577	0.500
1.8 x 27.36 (a)	61.53	900102	421332	0.997	0.949	0.985	0.907	0.993	1.034	1.034	1.056	0.590	0.573	--
1.8 x 27.36 (a)	61.53	900102	421333	0.996	0.937	0.986	0.925	0.993	1.041	1.041	1.055	0.591	0.577	--
1.8 x 27.36 (a)	61.53	900102	421334	1.003	0.940	0.990	0.915	0.990	1.042	1.042	1.058	0.592	0.579	--
1.8 x 27.36 (a)	61.53	900102	421335	1.001	0.968	0.997	0.939	0.997	1.048	1.048	1.063	0.587	0.574	--
1.8 x 27.36 (a)	61.53	900102	421336	1.003	0.977	0.992	0.938	0.989	1.051	1.051	1.064	0.586	0.565	--
2.93 x 18.1 (a)	65.37	291812	421132	0.991	0.956	0.981	0.917	1.004	1.031	1.031	1.023	0.589	0.584	0.501
3.5 x 7.5	26.25	Rectangle	429207	0.934	0.943	0.927	0.885	1.025	0.963	0.963	0.966	0.553	0.548	0.535
5.0 x 6.25	31.25	Rectangle	429208	0.912	0.919	0.894	0.880	1.022	0.954	0.954	0.944	0.527	0.535	0.523

NOTE: (a) Statistical analyses of ratios made separate from other extruded shapes.

TABLE 47
RATIOS AMONG TENSILE AND BEARING PROPERTIES
OF 7050-T7651X EXTRUDED SHAPES

(AFML CONTRACT NO. F33615-73-C-5015)

Thickness and Width, in.	Cross- Sectional Area, in. ²	Section Number or Shape	AL Sample Number	BUS/TUS(L)		BYS/TYS(L)					
				$\frac{e/D = 1.5}{L} \frac{e/D = 2.0}{LT}$	$\frac{e/D = 2.0}{L} \frac{e/D = 2.0}{LT}$	$\frac{e/D = 1.5}{L} \frac{e/D = 2.0}{LT}$	$\frac{e/D = 2.0}{L} \frac{e/D = 2.0}{LT}$				
0.187 x 22.56	4.87	86366	411288	1.435	1.448	1.868	1.882	1.343	1.353	1.601	1.606
0.402 x 15.56	8.17	191282	411289	1.537	1.566	1.959	2.000	1.451	1.492	1.644	1.795
0.665 x 16.9	14.53	213592	411290	1.438	1.495	1.902	1.911	1.390	1.390	1.584	1.671
0.765 x 22.38	22.65	313002	421141	1.472	1.501	1.887	1.950	1.406	1.430	1.673	1.735
0.841 x 17.18	19.47	53717	411552	1.472	1.506	1.935	1.921	1.388	1.398	1.625	1.625
0.915 x 24.21	28.57	165822	421136	1.515	1.510	1.948	1.938	1.429	1.418	1.637	1.680
1.161 x 17.35	29.44	231372	411287	1.530	1.511	1.958	1.952	1.427	1.407	1.627	1.733
1.5 x 7.5	11.25	Rectangle	411284	1.493	1.488	1.925	1.933	1.351	1.344	1.631	1.589
1.8 x 17.09	42.09	263902	421134	1.518	1.496	1.935	1.939	1.453	1.410	1.677	1.685
1.8 x 27.36 ^(a)	61.53	900102	421135	1.542	1.543	1.950	1.977	1.486	1.464	1.725	1.742
2.0 x 8.0	16.0	Rectangle	411279	1.482	1.461	1.923	1.890	1.340	1.348	1.528	1.522
2.93 x 18.1 ^(a)	65.37	291812	421143	1.489	1.532	1.994	1.971	1.359	1.443	1.611	1.675
3.5 x 7.5	26.25	Rectangle	411285	1.442	1.403	1.834	1.812	1.292	1.282	1.480	1.508
4.0 x 8.0	32.0	Rectangle	411280	1.461	1.375	1.845	1.813	1.316	1.295	1.511	1.479
5.0 x 6.25	31.25	Rectangle	411286	1.357	---	1.784	---	1.284	---	1.493	---

NOTE: (a) Values not included in statistical analyses of ratios.

TABLE 48
RATIOS AMONG TENSILE AND BEARING PROPERTIES
OF 7050-T7351X EXTRUDED SHAPES
(AFML CONTRACT NO. F33615-73-C-5015)

Thickness and Width, in.	Cross-Sectional Area, in. ²	Section Number or Shape	AL Sample Number	$\frac{\text{BUS/TUS(L)}}{\frac{L}{LT} = 1.5 \frac{e/D = 2.0}{L}}$	$\frac{\text{BYS/TYS(L)}}{\frac{L}{LT} = 1.5 \frac{e/D = 2.0}{L}}$
0.665 x 16.9	14.53	213592	429205	1.419 1.447 1.858 1.866	1.340 1.364 1.568 1.621
0.765 x 22.38	22.65	313002	421139	1.471 1.494 1.920 1.939	1.391 1.407 1.609 1.706
0.915 x 24.21	28.57	165822	421140	1.499 1.484 1.943 1.934	1.424 1.389 1.655 1.620
1.161 x 17.35	29.44	231372	429204	1.457 1.444 1.927 1.889	1.397 1.369 1.606 1.646
1.5 x 7.5	11.25	Rectangle	429206	1.484 1.508 1.928 1.941	1.370 1.415 --- 1.683
1.8 x 17.09	42.09	263902	421133	1.499 1.474 1.942 1.939	1.408 1.388 1.727 1.722
1.8 x 27.36 ^(a)	61.53	900102	421137	1.490 1.503 1.926 1.948	1.397 1.408 1.665 1.696
1.8 x 27.36 ^(a)	61.53	900102	421332	1.503 1.529 1.987 1.975	1.401 1.416 1.684 1.684
1.8 x 27.36 ^(a)	61.53	900102	421333	1.541 1.523 1.987 1.970	1.435 1.483 1.677 1.759
1.8 x 27.36 ^(a)	61.53	900102	421334	1.554 1.515 1.991 1.957	1.460 1.406 1.726 1.723
1.8 x 27.36 ^(a)	61.53	900102	421335	1.539 1.513 1.973 1.968	1.497 1.437 1.689 1.787
1.8 x 27.36 ^(a)	61.53	900102	421336	1.525 1.522 1.953 1.961	1.411 1.455 1.696 1.797
2.93 x 18.1 ^(a)	65.37	291812	421132	1.484 1.509 1.924 1.986	1.390 1.396 1.655 1.764
3.5 x 7.5	26.25	Rectangle	429207	1.429 1.388 1.860 1.799	1.361 1.290 1.604 1.536
5.0 x 6.25	31.25	Rectangle	429208	1.347 -- 1.752 --	1.329 -- 1.426 --

NOTE: (a) Statistical analyses of ratios made separate from other extruded shapes.

TABLE 19
SUMMARY OF STATISTICAL ANALYSES OF RATIOS AMONG TENSILE, COMPRESSIVE, SHEAR AND BEARING PROPERTIES
OF 7050-T76519 EXTRUDED SHAPES, CROSS-SECTIONAL AREA = .43 IN.²
(APML CONTRACT NO. F33615-73-C-5015)

Ratio Cell	TSS(LI) TSS(1) TSS(1)		TSS(HI) TSS(1)		CYC(LI) CYC(1) CYC(1)		Ratio Cell		CYC(HI) CYC(1) CYC(1)		Ratio Cell		CYC(LI) CYC(1) CYC(1)		Ratio Cell	
	1	1	1	1	1	1	1.57	1.49	1.57	1.49	1.57	1.49	1.57	1.49	2.00	1.80
1.01	2	1	1.08	1	1	1	1.57	1.49	1.57	1.49	1.57	1.49	1.57	1.49	2.00	1.80
1.02	3	1	1.02	1	1	1	1.56	1.48	1.56	1.48	1.56	1.48	1.56	1.48	1.99	1.80
0.98	3	1	1.06	1	1	4	1.56	1.47	1.56	1.47	1.56	1.47	1.56	1.47	1.98	1.80
0.97	3	1	1.04	1	2	2	1.53	1.45	1.53	1.45	1.53	1.45	1.53	1.45	1.97	1.74
0.96	1	1	1.03	2	3	1	1.53	1.45	1.53	1.45	1.53	1.45	1.53	1.45	1.94	1.73
0.95	1	1	1.02	2	2	1	1.51	1.43	1.51	1.43	1.51	1.43	1.51	1.43	1.94	1.73
0.94	1	1	1.01	1	2	1	1.50	1.42	1.50	1.42	1.50	1.42	1.50	1.42	1.93	1.73
0.92	1	1	1.00	1	1	1	1.49	1.41	1.49	1.41	1.49	1.41	1.49	1.41	1.92	1.72
0.91	1	1	0.99	2	1	1	1.48	1.40	1.48	1.40	1.48	1.40	1.48	1.40	1.91	1.67
0.90	1	1	0.98	1	1	1	1.47	1.39	1.47	1.39	1.47	1.39	1.47	1.39	1.90	1.65
0.88	1	1	0.97	1	1	1	1.46	1.38	1.46	1.38	1.46	1.38	1.46	1.38	1.89	1.65
0.87	1	1	0.96	1	1	1	1.45	1.37	1.45	1.37	1.45	1.37	1.45	1.37	1.88	1.63
0.86	1	1	0.95	1	1	1	1.44	1.36	1.44	1.36	1.44	1.36	1.44	1.36	1.87	1.63
0.85	1	1	0.94	1	1	1	1.43	1.35	1.43	1.35	1.43	1.35	1.43	1.35	1.86	1.62
0.84	1	1	0.93	1	1	1	1.42	1.34	1.42	1.34	1.42	1.34	1.42	1.34	1.85	1.62
0.83	1	1	0.92	1	1	1	1.41	1.33	1.41	1.33	1.41	1.33	1.41	1.33	1.84	1.61
0.82	1	1	0.91	1	1	1	1.40	1.32	1.40	1.32	1.40	1.32	1.40	1.32	1.83	1.61
0.81	1	1	0.90	1	1	1	1.39	1.31	1.39	1.31	1.39	1.31	1.39	1.31	1.82	1.61
0.80	1	1	0.89	1	1	1	1.38	1.30	1.38	1.30	1.38	1.30	1.38	1.30	1.81	1.59
0.79	1	1	0.88	1	1	1	1.37	1.29	1.37	1.29	1.37	1.29	1.37	1.29	1.80	1.59
0.78	1	1	0.87	1	1	1	1.36	1.28	1.36	1.28	1.36	1.28	1.36	1.28	1.78	1.53
0.77	1	1	0.86	1	1	1	1.35	1.27	1.35	1.27	1.35	1.27	1.35	1.27	1.78	1.52
0.76	1	1	0.85	1	1	1	1.34	1.26	1.34	1.26	1.34	1.26	1.34	1.26	1.77	1.52
0.75	1	1	0.84	1	1	1	1.33	1.25	1.33	1.25	1.33	1.25	1.33	1.25	1.76	1.51
0.74	1	1	0.83	1	1	1	1.32	1.24	1.32	1.24	1.32	1.24	1.32	1.24	1.75	1.51
0.73	1	1	0.82	1	1	1	1.31	1.23	1.31	1.23	1.31	1.23	1.31	1.23	1.74	1.51
0.72	1	1	0.81	1	1	1	1.30	1.22	1.30	1.22	1.30	1.22	1.30	1.22	1.73	1.50
0.71	1	1	0.80	1	1	1	1.29	1.21	1.29	1.21	1.29	1.21	1.29	1.21	1.72	1.49
0.70	1	1	0.79	1	1	1	1.28	1.20	1.28	1.20	1.28	1.20	1.28	1.20	1.71	1.48

NOTE: (a) Analysis indicated no regression with thickness; analysis made of ratios only.

TABLE 51

SUMMARY OF STATISTICAL ANALYSES OF RATIOS AMONG TENSILE, COMPRESSIVE, SHEAR AND BEARING PROPERTIES OF 7050-T7651X AND 7050-T7351X ENTRINED SHAPES, CROSS-SECTIONAL AREA C1 TO C6 IN. ²

(APML CONTRACT NO. F33615-73-C-5015)

Ratio Cell	TUS(LT) TUS(CT)		Retic Cell	CYS(L) CYS(LT)		SUS(L) SUS(CT)	SUS(LT) SUS(CT)		e _t = 1.5 Ratio Cell		e _t = 2.0 Ratio Cell																																	
	TUS(L) TUS(CT)	TUS(L) TUS(CT)		CYS(L) CYS(LT)	CYS(L) CYS(LT)		SUS(L) SUS(CT)	SUS(LT) SUS(CT)	Ratio Cell	Ratio Cell	Ratio Cell	Ratio Cell																																
1.00 0.99 0.98 0.97	1 1 1 1	1 1 1 1	1.04 1.03 1.02 1.01 1.00	1 1 2	1 1 1 1	0.60 0.59 0.58 0.57	1 1 1 1	1.49 1.48 1.47 1.46 1.45 1.44 1.36	1 1 1 1 1 1	1.99 1.98 1.97 1.96 1.95	1 1 1 1 1	1.74 1.73 1.72 1.71 1.70 1.69 1.68 1.67 1.61	1 1 1 1 1 1																															
														7050-T7651X (a)																														
														1.00 0.99 0.98	6 1	1 2	1.05 1.04 1.03 1.02 1.01 1.00 0.99	2 3 2	7 4 2 1	0.59 0.58 0.57 0.56	1 1 1 1 1	1.50 1.49 1.48 1.47 1.46 1.45 1.44 1.43 1.42 1.41 1.40 1.39	1 1 1 1 1 1 1	1.99 1.98 1.97 1.96 1.95 1.94 1.93 1.92	2 1 2 1 1 1 1	1.60 1.59 1.58 1.57 1.56 1.55	1 1 1 1 1 1 1																	
																												7050-T7351X (b)																
																												1.00 0.99 0.98	7	0.9429 0.005024 0.99760	1.0406 1.00718 1.01914	7 7 7	0.58429 0.002215 0.58766	0.57557 0.005484 0.57125	1 1 1	1.51943 0.027263 1.49939	1.51628 0.008952 1.50971	7 7 7	1.42729 0.03271 1.39645	1.42871 0.031314 1.40572	7 7 7	1.96300 0.026342 1.94175	1.6443 0.012448 1.95729	7 7 7
7050-T7351X (b)																																												

NOTES: (a) One sample each of sections 90010 and 20181; insufficient data for statistical analyses.
 (b) Six samples of section 90010 and one sample of section 20181. Analyses of ratios only.

TABLE 52

RATIOS FOR COMPUTING DESIGN MECHANICAL PROPERTIES OF 7050-T7651X
EXTRUDED SHAPES, CROSS-SECTIONAL AREA $< 43 \text{ IN.}^2$

(AFML CONTRACT NO. F33615-73-C-5015)

Thickness Range, in.	(AFML CONTRACT NO. F33615-73-C-5015)									
	< 0.249	0.250-0.499	0.500-0.749	0.750-0.999	1.000-1.499	1.500-1.999	2.000-2.499	2.500-2.999	3.000-3.999	4.000-5.000
$F_{tu}(LT)/F_{tu}(L)$	0.996	0.990	0.984	0.978	0.966	0.953	0.940	0.926	0.898	0.870
$F_{ty}(LT)/F_{ty}(L)$	0.987	0.982	0.976	0.970	0.958	0.946	0.933	0.919	0.892	0.863
$F_{cy}(L)/F_{ty}(L)$	1.009	1.009	1.009	1.009	1.009	1.009	1.009	1.009	1.009	1.009
$F_{cy}(LT)/F_{ty}(L)$	1.033	1.029	1.025	1.020	1.011	1.001	0.990	0.978	0.954	0.929
$F_{su}(LT)/F_{tu}(L)$	0.555	0.555	0.554	0.553	0.551	0.547	0.543	0.538	0.526	0.515
$F_{bru}(a)/F_{tu}(L)$ (b)	1.472	1.470	1.469	1.464	1.457	1.443	1.422	1.399	1.352	1.303
$e/D = 1.5$	1.915	1.910	1.905	1.900	1.889	1.875	1.849	1.825	1.774	1.722
$e/D = 2.0$										
$F_{bry}(a)/F_{ty}(L)$ (b)	1.387	1.382	1.377	1.372	1.359	1.338	1.314	1.288	1.234	1.179
$e/D = 1.5$	1.615	1.609	1.602	1.595	1.580	1.562	1.524	1.481	1.392	1.300
$e/D = 2.0$										

NOTES: (a) Separate analysis made for L and LT directions. For each thickness range, the lowest reduced ratio obtained is shown.
(b) Specimens and test fixtures cleaned ultrasonically.

TABLE 53

RATIOS FOR COMPUTING DESIGN MECHANICAL PROPERTIES OF
7050-T7351X EXTRUDED SHAPES
(AFML CONTRACT NO. F33615-73-C-5015)

Cross-Sectional Area, in. ² : Thickness Range, in.:	$\bar{L} < 43$										61 to 66	
	< 0.249	0.249-0.499	0.500-0.749	0.750-0.999	1.000-1.499	1.500-1.999	2.000-2.499	2.500-2.999	3.000-3.999	4.000-5.000	1.499-3.000(c)	3.000(c)
$F_{tu}(LT)/F_{tu}(L)$	0.987	0.983	0.979	0.976	0.967	0.959	0.950	0.941	0.921	0.900	0.995	0.995
$F_{ty}(LT)/F_{ty}(L)$	0.982	0.978	0.974	0.970	0.960	0.951	0.940	0.928	0.906	0.882	0.985	0.985
$F_{cy}(L)/F_{ty}(L)$	1.000	1.000	1.000	1.000	1.000	1.000	1.000	1.000	1.000	1.000	0.991	0.991
$F_{cy}(LT)/F_{ty}(L)$	1.021	1.017	1.014	1.011	1.003	0.995	0.985	0.975	0.952	0.928	1.036	1.036
$F_{su}^{(a)}/F_{tu}(L)$	0.564	0.563	0.562	0.561	0.558	0.554	0.551	0.545	0.528	0.511	0.571	0.571
$F_{brtu}^{(a)}/F_{tu}(L)^{(b)}$												
$e/D = 1.5$	1.453	1.450	1.446	1.443	1.434	1.419	1.397	1.372	1.319	1.265	1.499	1.499
$e/D = 2.0$	1.889	1.886	1.883	1.880	1.866	1.843	1.813	1.780	1.710	1.635	1.942	1.942
$F_{bry}^{(a)}/F_{ty}(L)^{(b)}$												
$e/D = 1.5$	1.367	1.367	1.366	1.365	1.351	1.332	1.308	1.281	1.227	1.168	1.398	1.398
$e/D = 2.0$	1.570	1.568	1.566	1.563	1.554	1.539	1.518	1.492	1.427	1.345	1.668	1.668

NOTES: (a) Separate analysis made for L and LT directions. For each thickness range, the lowest reduced ratio obtained is shown.
 (b) Specimens and test fixtures cleaned ultrasonically.
 (c) Based on tests of six samples of Section 900102 (1.8-in. thick) and one sample of Section 291812 (2.93-in. thick).

TABLE 54
 COMPUTED DESIGN MECHANICAL PROPERTIES OF
 7050-T7651X EXTRUDED SHAPES

ALLOY SPECIFICATION										
FORM		Extruded Shapes								
TEMPER		T76510, T76511								
CROSS-SECTIONAL AREA, in ²										
THICKNESS, in.	}	0.500-	0.750-	1.000-	1.500-	2.000-	2.500-	3.000-	4.000-	
		0.499	0.749	0.999	1.499	1.999	2.499	2.999	3.999	5.000
BASIS		Tentative								
MECHANICAL PROPERTIES										
F _{tu} , ksi	L	79	79	79	79	79	79	79	79	79
	LT	78	77	77	76	75	74	73	71	69
	ST									
F _{ty} , ksi	L	69	69	69	69	69	69	69	69	69
	LT	68	67	67	66	65	64	63	61	59
	ST									
F _{cy} , ksi	L	69	69	69	69	69	69	69	69	69
	LT	71	70	70	70	69	68	67	66	64
	ST									
F _{su} , ksi		44	44	43	43	43	43	42	41	40
F _{bru} , ksi	e/D=1.5	116	116	115	115	114	112	110	107	103
	e/D=2.0	151	150	150	149	148	146	144	140	136
F _{bry} , ksi	e/D=1.5	95	95	94	94	92	90	89	85	81
	e/D=2.0	111	110	110	109	108	105	102	96	90
e, per cent	L	7	7	7	7	7	7	7	7	7
	LT	--	--	--	--	--	--	--	--	--
	ST									
E, 10 ³ ksi		10.3								
E _c , 10 ³ ksi		10.7								
G, 10 ³ ksi		3.9								
μ		0.33								

TABLE 55

COMPUTER TESTING MECHANICAL PROPERTIES OF
 Q66-T301X EXTENDED RANGE

ALLOY SPECIFICATION											
FORM		extruded tubes									
TEMPER		7001, 77011									
CROSS-SECTIONAL AREA, in ²											
THICKNESS, in.	}	0.075	0.09	0.105	0.12	0.135	0.15	0.165	0.18	0.195	0.21
		0.075	0.09	0.105	0.12	0.135	0.15	0.165	0.18	0.195	0.21
BASIS		tentative									
MECHANICAL PROPERTIES											
F _{tu} , ksi	L	70	70	70	70	70	70	70	70	70	70
	LT	--	--	--	--	--	--	--	--	--	--
F _{ty} , ksi	L	60	60	60	60	60	60	60	60	60	60
	LT	50	50	50	50	50	50	50	50	50	50
F _{cy} , ksi	L	60	60	60	60	60	60	60	60	60	60
	LT	61	61	61	61	61	61	61	61	61	61
F _{su} , ksi	L	30	30	30	30	30	30	30	30	30	30
	LT	--	--	--	--	--	--	--	--	--	--
F _{brx} , ksi	e/D=1.5	111	111	111	111	110	110	108	106	105	105
	e/D=2.0	130	130	130	131	130	130	128	126	125	125
F _{bry} , ksi	e/D=1.5	80	80	80	80	81	81	78	77	76	76
	e/D=2.0	91	91	91	91	92	92	91	90	89	89
e, per cent	L	8	8	8	8	8	8	8	8	8	8
	LT	--	--	--	--	--	--	--	--	--	--
E, 10 ³ ksi		11.3									
E _c , 10 ³ ksi		10.7									
G, 10 ³ ksi		2.9									
μ		0.43									

TABLE 5/
 REVIEW OF COAST FATIGUE TESTS FOR 7050-T7451, FORBIDDEN ALLOY
 (AFM CONTRACT NO. F33115-73-0-6045)

Thickness and Width, in.	Section Number	AI Sample Number	Longitudinal (L-L)		Transverse (T-T)		Long-Transverse (L-T)		Torsion			
			Stress Intensity, (a) ksi/in.	Specimen Thickness, Length, in.	Stress Intensity, (a) ksi/in.	Specimen Thickness, Length, in.	Stress Intensity, (a) ksi/in.	Specimen Thickness, Length, in.	Stress Intensity, (a) ksi/in.	Specimen Thickness, Length, in.	Stress Intensity, (a) ksi/in.	Specimen Thickness, Length, in.
0.765 x 28.36	313002	4211-1	71.0	0.77 0.77	70.3	0.77 0.77	1.00 1.01	1.00 1.01	---	---	---	---
			Cross-sectional Area 34.15.2									
			---	---	---	---	---	---	---	---	---	---
0.915 x 24.21	165822	4211-36	74.6	0.92 0.92	76.5	0.92 0.92	0.96 0.99	0.96 0.99	---	---	---	---
			Cross-sectional Area 34.15.2									
			---	---	---	---	---	---	---	---	---	---
1.8 x 17.09	263922	4211-34	73.1	1.75 1.75	71.0	1.75 1.75	2.03 2.03	2.03 2.03	67.1	67.5	67.5	67.5
			Cross-sectional Area 61 to 66 in. 2									
			---	---	---	---	---	---	---	---	---	---
1.8 x 27.36	900102	4211-35	72.0	1.75 1.75	71.6	1.75 1.75	2.04 2.04	2.04 2.04	66.6	67.5	67.5	67.5
			Cross-sectional Area 61 to 66 in. 2									
			---	---	---	---	---	---	---	---	---	---
2.93 x 16.1	291812	4211-43	76.9	2.00 2.00	74.8	2.00 2.00	2.11 2.11	2.11 2.11	70.3	67.5	67.5	67.5
			Cross-sectional Area 61 to 66 in. 2									
			---	---	---	---	---	---	---	---	---	---

NOTES: (a) Offset equals 0.2 per cent.
 (b) K_{fc} values are valid K_{fc} except for the following reasons:
 (c) Specimen not thick enough, $2.5 (K_{fc}/\sigma)^2$ is greater than specimen thickness.
 (d) Ratio of maximum load to 5 per cent secant load greater than 1.1.
 (e) Stress-intensity factor greater than 0.6 K_{fc} for last-step fatigue cracking.
 (m) K_{fc} values are considered meaningful.

TABLE 57
SUPPLEMENTAL DATA (b)

RESULTS OF COMPACT FRACTURE TOUGHNESS TESTS OF 7050-T7651X EXTRUDED SHAPES.

CROSS-SECTIONAL AREA 2 3/4 IN. (BASIC CONTRACT NO. N00019-72-C-0512)

Thickness and Width, in.	Cross-Sectional Area, in. ²	Section Number or Shape	AL Sample Number	Longitudinal (L-T) Specimen			Long-Transverse (T-L) Specimen			Short-Transverse (S-L) Specimen					
				Yield Strength, (a) ksi	Thickness, in.	Crack Length, in.	K _{IC} (b) ksi/in.	Yield Strength, (a) ksi	Thickness, in.	Crack Length, in.	K _{IC} (b) ksi/in.	Yield Strength, (a) ksi	Thickness, in.	Crack Length, in.	
0.402 x 15.56	6.17	Rectangle	411289	75.6	0.35	1.49	33.4 (c,d)	73.0	0.35	1.49	31.8 (c,d)	69.8	0.50	0.50	21.4
					0.35	1.49	35.1 (c,d)			1.49	32.2 (c,d)		0.50	0.51	22.1
0.665 x 16.9	14.53	Rectangle	411290	78.2	0.61	1.52	32.2 (d)	76.9	0.61	1.54	30.4 (d,m)	70.9	1.00	1.00	16.4 (f)
					0.61	1.52	32.0 (d)			1.50	28.6 (d,m)		1.25	1.25	17.1 (f)
0.841 x 17.18 (e)	19.47	Rectangle	411522	75.2	0.82	1.52	23.5 (d)	74.1	0.81	1.47	20.6	70.9	1.50	1.50	18.2
					0.82	1.50	23.5 (d)			1.51	20.6		1.75	1.75	18.2
1.161 x 17.35	29.44	Rectangle	411287	76.4	1.13	1.55	30.7 (d)	74.4	1.13	1.54	26.5	70.9	1.50	1.50	18.2
					1.13	1.56	31.7 (d)			1.53	27.0		1.75	1.75	18.2
1.5 x 7.5	11.25	Rectangle	411284	78.4	1.38	1.62	35.9 (d)	75.3	1.38	1.63	29.7	70.9	1.50	1.50	18.2
					1.38	1.62	37.2 (d,m)			1.62	29.7		1.75	1.75	18.2
2.0 x 8.0 (e)	16.0	Rectangle	411279	75.6	1.50	1.58	31.2 (e,m)	71.0	1.50	1.48	21.9	70.9	1.50	1.50	18.2
					1.50	1.49	29.4			1.50	21.3		1.75	1.75	18.2
3.5 x 7.5	26.25	Rectangle	411285	80.5	1.50	1.52	28.0	74.1	1.50	1.57	20.2	70.9	1.50	1.50	18.2
					1.50	1.57	32.6			1.55	19.9		1.75	1.75	18.2
4.0 x 8.0 (e)	32.0	Rectangle	411280	79.7	1.50	1.54	30.3	71.6	1.50	1.53	19.6	70.9	1.50	1.50	18.2
					1.50	1.52	36.2 (d,m)			1.55	19.6		1.75	1.75	18.2
5.0 x 6.25	31.25	Rectangle	411286	82.3	1.50	1.44	25.8 (d)	72.0	1.50	1.54	17.5	70.9	1.50	1.50	18.2
					1.50	1.51	26.8 (d,e)			1.52	17.0		1.75	1.75	18.2

NOTES: (a) Offset equals 0.2 per cent.
 (b) K_{IC} values are valid K_{IC} except for the following reasons:
 (c) Specimen not thick enough, 2.5 (K_{IC}/σ_y)² is greater than crack length.
 (d) Ratio of maximum load to 5 per cent secant load greater than 1.1.
 (e) Fatigue-crack front curvature exceeded allowed amount.
 (f) Stress-intensity factor greater than 0.6 K_{IC} for last-step fatigue cracking.
 (g) Producer B, others Producer A.
 (h) Reference 5.
 (m) K_{IC} values are considered meaningful.

TABLE 58
 RESULTS OF CONTACT FRACTURE TOUGHNESS TESTS OF 7050-T7351X EXTRUDED CHAFER,
 CROSS-SECTIONAL AREA, 2.43 in.^2
 (APWL CONTRACT NO. F33615-73-C-5015)

Thickness and Width, in.	Cross-Sectional Area, in.	Section Number of Shape	AL Sample Number	Longitudinal (L-T)			Long-Transverse (T-L)			Short-Transverse (S-L)					
				Tensile Yield Strength, ksi	Specimen Thickness, in.	Crack Length, in.	K_{Ic} , ksi/in.	Tensile Yield Strength, ksi	Specimen Thickness, in.	Crack Length, in.	K_{Ic} , ksi/in.	Tensile Yield Strength, ksi	Specimen Thickness, in.	Crack Length, in.	K_{Ic} , ksi/in.
0.645 x 16.9	14.53	213590	429205	70.9	0.66(b) 0.66(b)	1.02 1.02	37.4(e,f) 36.2(f)	69.2	0.77(b) 0.66(b)	1.02 1.01	31.8 31.8	--	--	--	--
0.765 x 22.38	22.65	313002	421139	67.0	0.77 0.77	1.01 1.01	43.0(e,f) 42.5(e,f)	66.0	0.77 0.77	1.00 1.00	38.5(e,f) 38.1(e,f)	--	--	--	--
0.915 x 24.21	28.57	165822	421140	68.7	0.92 0.92	1.01 1.01	35.0 32.8	66.7	0.92 0.92	1.07 1.05	34.1 34.5	--	--	--	--
1.5 x 7.5	11.25	Rectangle	429206	70.6	1.46 1.46	1.60 1.56	40.6(e,m) 41.1	67.7	1.46 1.46	1.61 1.61	31.7 31.5	66.5	0.50 0.50	1.51 1.50	24.6 24.2
1.8 x 17.09	42.00	263902	421133	69.3	1.75 1.75	1.86 1.86	35.1(e,m) 33.7	67.7	1.75 1.75	2.04 2.04	32.2 32.7	62.4	0.75 0.75	0.77 0.78	21.6 21.8
3.5 x 7.5(c)	26.25	Rectangle	429207	72.8	1.50 1.50	1.58 1.76	43.3(h,m) 40.3	67.5	1.50 1.50	1.60 1.60	25.8(h,m) 26.1(h,m)	64.4	1.00 1.00	1.05 1.07	23.5 23.2
5 x 6.25(c)	31.25	Rectangle	429208	71.8	2.00 2.00	2.02 2.03	41.3(e,m) 42.6	64.2	1.50 1.50	1.68 1.57	23.2(h,m) 23.2	63.2	1.50 1.50	1.59 1.61	24.1 24.0
							AVG. 42.0								AVG. 23.2

NOTES:
 (a) Offset equals 0.2 per cent.
 (b) Thickness/width ratio equals 0.25. All other T/2.
 (c) L-T specimens from T/4 location.
 (d) L-T specimens are valid K_{Ic} except for the following reasons:
 (e) Specimens not thick enough, $2.5 (K_{Ic}/\sigma_{ys})^2$ is greater than specimen thickness.
 (f) Fatigue crack too short, $2.5 (K_{Ic}/\sigma_{ys})^2$ is greater than crack length.
 (g) Ratio of maximum load to 5 per cent secant load greater than 1.1.
 (h) Crack length to specimen width ratio not between 0.45 and 0.55.
 (m) K_{Ic} values are considered meaningful.

TABLE 59
 RESULTS OF COMPACT FRACTURE TOUGHNESS TESTS OF 7050-T7351X EXTRUDED SHAPES,
 CROSS-SECTIONAL AREA 61 TO 66 IN.²
 (AFML CONTRACT NO. F33615-73-C-5015)

Thickness and Width, in.	Cross-Section Area, in. ²	Section Number	AL Sample Number	Specimen Location in Length (a)	Longitudinal (L-T) Specimen			Long-Transverse (T-L) Specimen			Short-Transverse (T-T) Specimen		
					Tensile Yield Strength, (b) Ksi	Crack Length, in.	K _{IC} (c) ksi/in.	Tensile Yield Strength, (b) Ksi	Crack Length, in.	K _{IC} (c) ksi/in.	Tensile Yield Strength, (b) Ksi	Crack Length, in.	K _{IC} (c) ksi/in.
1.8 x 27.36	61.53	900102	421137	---	67.2	1.75	37.6	66.7	1.75	2.03	63.2	0.75	25.3
						1.75	38.6		1.60	2.03		0.75	24.2
							AVG. 38.1			AVG. 35.2			AVG. 25.1
					67.8	1.74	37.2						
1.8 x 27.36	61.53	900102	423332	Front 1/4 Mid Mid 3/4 Rear	69.0	1.75	35.5	66.5	1.75	2.00	61.2	0.75	22.9(d)
						1.75	36.9		1.75	2.02		0.75	23.3(d)
							AVG. 36.4			AVG. 33.9			AVG. 20.6
					67.2	1.75	34.7	66.5	1.75	2.04	61.5	0.75	23.0(d)
1.8 x 27.36	61.53	900102	421334	Mid Mid	69.0	1.75	34.2	65.0	1.75	2.03	61.2	0.75	22.9
						1.75	33.6		1.75	2.03		0.75	21.3(d)
							AVG. 33.9			AVG. 32.1			AVG. 20.6
					67.2	1.75	34.8	66.5	1.75	2.03	61.5	0.75	22.3(d)
1.8 x 27.36	61.53	900102	421335	Mid Mid	65.2	1.75	40.3	65.0	1.75	2.02	61.2	0.75	25.0
						1.75	40.4		1.75	2.03		0.75	24.7
							AVG. 40.4			AVG. 36.8			AVG. 24.8
					64.4	1.74	45.0	63.9	1.75	2.02	60.4	0.75	26.0
1.8 x 27.36	61.53	900102	421336	Mid Mid	64.4	1.75	45.2	63.9	1.75	2.02	60.4	0.75	26.6
						1.75	45.2		1.75	2.02		0.75	26.6
							AVG. 45.2			AVG. 40.4			AVG. 26.6
					68.5	2.00	35.6	67.2	2.00	2.11	62.6	0.75	19.9
2.93 x 18.1	65.37	291812	421132	---	68.5	2.00	34.9	67.2	2.00	2.11	62.6	0.75	21.0
							AVG. 35.2			AVG. 27.6			AVG. 20.4

NOTES: (a) Front - front of length; 1/4 midway between front and center; Mid - midway in length; 3/4 midway between center and rear; Rear - rear end of length.
 (b) Offset equals 0.2 per cent.
 (c) K_{IC} values are valid K_{IC} except for the following reason:
 (d) Stress-intensity factor greater than 0.6 K_{IC} for last-step fatigue crack; K_{IC} values are considered meaningful.

TABLE 60

SUMMARY OF RESULTS OF COMPACT FRACTURE TOUGHNESS TESTS OF
7050-T7651X AND 7050-T7351X EXTRUDED SHAPES

(AFML CONTRACT NO. F33615-73-C-5015 AND NASC CONTRACT NO. N00019-72-C-5012)

Thickness and Width, in.	Cross-Sectional Area, in. ²	Section Number	AL Sample Number			AL Sample Number		
			7050-T7651X	7050-T7351X	7050-T7351X	7050-T7351X	7050-T7351X	7050-T7351X
			L-T	T-L	S-L	L-T	T-L	S-L
<u>Cross-Sectional Area \geq 43 in.²</u>								
0.402 x 15.56	8.17	191282	411289	34.8(b)	32.0(b)	---	---	---
0.665 x 16.9	14.53	213592	411290	34.1(b)	29.6	---	---	---
0.765 x 22.38(a)	22.65	313002	421134	39.2(b)	37.9	---	---	---
0.841 x 17.8	19.47	53717	411552	23.5(b)	20.6	---	---	---
0.915 x 24.21	28.57	165222	421136	37.0(b)	35.2	---	---	---
1.161 x 17.35	29.44	231392	411287	31.2(b)	26.8	---	---	---
1.5 x 7.5	11.25	Rectangle	411284	37.5	28.7	---	---	---
1.8 x 17.09	42.09	263902	421134	39.7	35.7	22.2	429206	40.8
2.0 x 8.0	16.0	Rectangle	411279	30.3	21.6	18.2	421133	34.4
3.5 x 7.5	26.25	Rectangle	411285	30.3	20.0	16.4	429207	41.8
4.0 x 8.0	32.0	Rectangle	411280	28.5(b)	19.6	18.2	---	---
5.0 x 6.25	31.25	Rectangle	411286	26.3	17.3	18.0	429208	42.0
<u>Cross-Sectional Area 61 to 66 in.²</u>								
1.8 x 27.36	61.53	900102	421135	33.5	30.6	21.6	421137	38.1
1.8 x 27.36	61.53	900102	---	---	---	---	421332	36.4
1.8 x 27.36	61.53	900102	---	---	---	---	421333	33.9
1.8 x 27.36	61.53	900102	---	---	---	---	421334	34.8
1.8 x 27.36	61.53	900102	---	---	---	---	421335	40.4
1.8 x 27.36	61.53	900102	---	---	---	---	421336	45.2
2.93 x 18.1	65.37	291812	421143	30.3	26.3	15.8	421132	35.2
								35.2
								33.9
								30.9
								32.1
								36.8
								40.4
								45.2
								27.6
								25.1
								23.1
								20.6
								22.9
								24.8
								26.6
								20.4

NOTES: (a) Producer B, others Producer A.
(b) K_Q value not valid K_{IC} value.

TABLE 61

AVERAGE AXIAL-STRESS FATIGUE STRENGTH FOR SMOOTH AND NOTCHED 7050 SPECIMENS TESTED IN SALT FOG

R=0 Transverse Specimens
(Contract No. F33615-73-C-5015)

Alloy and Temper	Product	Thickness or size, in.	Fatigue Strength for Failure at Indicated Number of Cycles					
			Smooth Specimens 10 ⁵ 2x10 ⁶	10 ⁷	10 ⁵ 2x10 ⁶	Notched Specimens, K _t =3.0 10		
7050-T73510X	Extrusion	.915x24 to 5x6	42	20	11	17	8	-
7050-T73511X	Extruded C5A Panel	1.8 x 27	48	16	11	17	7	6
7050-T76510X	Extrusion	.915x24 to 5x6	41	20	11	17	8	-
7050-T76511X(a)	Extrusion	1.161 and 3.5x7.5	47	19	13	15(b)	8(b)	7(b)
7050-T73652(a)	Hand Forging	2-1/2x22 and 5-1/2x22	45	18	13	13(b)	7(b)	6(b)
7050-T73651(a)	Plate	1.0 and 4.0	40	19	13	11(b)	6(b)	5(b)

(a) Ref. 5

(b) K_t ≥ 12

TABLE 62

RATES OF FATIGUE CRACK PROPAGATION IN 7050 EXTRUSIONS
Constant Load Tests - Compact Specimens
 $R = 1/3$
 (Contract F33615-73-C-5015)

Alloy and Temper	Size	Sample No.	Orientation	Data Shown in Fig.	da/dN at indicated $\Delta K(a)$											
					Dry Air						Moist Air					
					4	7	12	4	7	12	4	7	12	4	7	12
7050-T7651X	0.915	421136	L-T	58	-	1.1	8	-	-	-	-	-	4.3	26		
			T-L	59	-	1.7	10	-	-	-	-	.21	5.7	27		
7050-T76511	1.161	411287	L-T	(b)	-	1.0	9	-	-	-	-	-	4.5	30		
			T-L	(b)	-	2.0	12	-	-	-	-	-	5.9	30		
7050-T7351X	0.915	421140	L-T	60	.30	1.1	7	.47	5.0	26	.20	5.0	26			
			T-L	61	.12	2.3	12	.20	5.0	26	.20	5.0	26			
7050-T7351X	5x6-1/4	429208	T-L	62	.21	2.0	25	.31	3.7	33	.57	3.3	16			
			S-T	63	.41	1.4	7	.57	3.3	16	.57	3.3	16			
7050-T7351X	C5A Extruded Panel	421332,3,6	L-T	64,65	.22	0.7	6	.32	2.4	15	.32	2.4	15			
			T-L	66,67	.20	1.4	12	.14	3.1	17	.14	3.1	17			
7050-T73651	1.00" Plate 6.00" Plate	421332(f) 421336	T-L	68	-	-	-	-	-	-	.22(d)	3.6(d)	-			
			T-L	(b)	-	1.8	19	-	-	-	-	4.2	24			
7050-T73651	6.00" Plate	411185 411300	T-L	(b)	-	1.2	14	-	-	-	-	2.6	20			
			L-T	(b)	-	1.4	14	-	-	-	-	2.6	28			
7075-T651	3-1/2x7-1/2	-	S-L	(b)	-	1.5	11	-	-	-	-	2.6	28			
			L-T	(c)	-	-	-	-	-	-	-	6.0(e)	27(e)			

(a) ksi $\sqrt{in.}$
 (b) Ref. 5
 (c) Ref. 10
 (d) $R = 1/2$
 (e) Humidity 30+ 10%
 (f) 421332 through 421336

TABLE 63

RESULTS OF ACCELERATED SCC TESTS OF 7050-T7351X EXTRUDED SHAPES
(AFML CONTRACT NO. F33615-C-5015)

Thickness and Width, In.	Cross Sectional Area, In. ²	Die Number	A.I. Sample Number	E.C. * & IACS	Test Direction	Y.S.+ ksi	75% Y.S.			Stress-Corrosion Cracking Data#				
							F/N**	Days	F/N**	Days	F/N**	Days	F/N**	Days
Sections With Cross-Sectional Areas of < 43 In ²														
0.665 x 16.9	14.53	213592	429205	41.2	L	70.9	0/3	OK - 84	---	---	---	---		
					LT	69.2	0/3	OK - 84	---	---	---	---		
0.920 x 24.21	28.57	165822	421140	40.7	L	68.7	0/3	OK - 84						
					LT	66.7	0/3	OK - 84						
					ST	---	---	---	0/3**	OK - 84	0/3**	OK - 84	0/3**	OK-84
1.161 x 17.35	29.44	231372	429204	41.6	L	70.0	---	---	---	---	---	---		
					ST	---	---	---	0/3**	OK - 84	0/3**	OK - 84	---	
1.5 x 7.5	11.25	-----	429206	41.4	L	70.6	0/3	OK - 84	---	---	---	---		
					LT	67.7	0/3	OK - 84	---	---	---	---		
					ST	66.5	---	---	3/3	56,61.67	3/3	55,76.84	---	
1.8 x 17.09	42.09	263902	421133	40.5	L	69.3	---	---	---	---	---	---		
					ST	62.4	---	---	3/3	7,15,23	3/3	23,23,30	3/3	28,32,37
3.5 x 7.5	26.25	-----	429207	42.0	L	72.8	0/3	OK - 84	---	---	---	---		
					LT	67.5	1/3	84, 2 OK 84	---	---	---	---		
					ST	64.4	---	---	3/3	58,58.82	2/3	72, 84, 1 OK 84	---	
5.0 x 6.25	31.25	-----	429208	42.4	L	71.8	---	---	---	---	---	---		
					ST	63.2	---	---	3/3	55,65.84	0/3	OK - 84	---	

Table 63 (Continued)

Thickness and Width, In.	Cross Sectional Area, In. ²	Die Number	A.L. Sample Number	E.C. * & IACS	Test Direction	Y.S. † ksi	75% Y.S.			52 ksi			45 ksi			35 ksi		
							F/N**	Days	F/N**	Days	F/N**	Days	F/N**	Days	F/N**	Days	F/N**	Days
Sections With Cross-Sectional Areas of 61 - 66 In. ²																		
1.8 x 27.36	61.53	900102	421137	41.8	L	67.2	---	---	---	---	---	---	---	---	---	---	---	---
					ST	63.2	---	---	3/3	33,45,48	3/3	43,48,60	3/3	66,70,71				
1.8 x 27.36	61.53	900102	421332R	41.0	L	68.3	---	---	---	---	---	---	---	---	---	---	---	---
					ST	61.2	---	---	---	---	6/6	18,19,31, 3/3	3/3	57,63, 77				
1.8 x 27.36	61.53	900102	421333R	41.1	L	69.0	0/3	OK - 84	---	---	---	---	---	---	---	---	---	---
					LT	68.0	0/3	OK - 84	---	---	---	---	---	---	---	---	---	---
					ST	63.8	---	---	---	---	6/6	19,23,25, 3/3	3/3	42,47, 84				
1.8 x 27.36	61.53	900102	421334R	41.3	L	67.2	---	---	---	---	---	---	---	---	---	---	---	---
					ST	61.5	---	---	---	---	---	3/3	31,34,40	3/3	40,70,70			
1.8 x 27.36	61.53	900102	421335R	42.2	L	65.2	---	---	---	---	---	---	---	---	---	---	---	---
					ST	61.2	---	---	---	---	---	3/3	40,40,52	2/3	63, 84			1-OK-84
1.8 x 27.36	61.53	900102	421336R	42.5	L	64.4	0/3	OK - 84	---	---	---	---	---	---	---	---	---	---
					LT	63.9	0/3	OK - 84	---	---	---	---	---	---	---	---	---	---
					ST	60.4	---	---	---	---	---	3/3	52,53,64	3/3	52,70, 84			
2.93 x 18.1	65.37	291812	421132-2	41.7	L	68.5	0/3	OK - 84	---	---	---	---	---	---	---	---	---	---
					LT	67.2	0/3	OK - 84	---	---	---	---	---	---	---	---	---	---
					ST	62.8	---	---	3/3	27,29,39	3/3	35,38,40	3/3	48,57,58				

* Conductivity measured on machined T/2 surface
 † Offset equals 0.2 per cent
 # Tests of specimens exposed to 3.5% NaCl alternate immersion (ASTM G44-75); specimens were 0.125" diameter tensile bars except where noted.
 ** F/N denotes number of specimens failed over number exposed
 †† Tested as 0.750" diameter C-ring specimens

TABLE 64

RESULTS OF ACCELERATED SCC TESTS OF 7050-T7651X EXTRUDED SHAPES
(AFML CONTRACT NO. F33615-C-5015)

Thickness and Width, In.	Cross Sectional Area, In. ²	Die Number	A.L. Sample Number	E.C.* % IACS	Test Direction	Y.S.+ ksi	75% Y.S.			35 ksi			25 ksi			17 ksi
							F/N**	Days	OK - 84	F/N**	Days	OK - 84	F/N**	Days	OK - 84	
Sections With Cross-Sectional Areas of < 43 In. ²																
0.402 x 16.56	8.17	191282	411289	39.0	L	75.6	1/3	67.2	OK 84	---	---	---	---	---	---	---
					LT	73.0	1/3	74.2	OK 84	---	---	---	---	---	---	---
0.665 x 16.9	14.52	213592	411290	39.2	L	78.2	0/3	OK - 84	---	---	---	---	---	---	---	---
					LT	76.9	1/3	70.2	OK 84	---	---	---	---	---	---	---
0.841 x 17.18**	22.65	53717	411552	38.2	L	75.2	0/3	OK - 84	---	---	---	---	---	---	---	---
					LT	74.1	1/3	80.2	OK 84	---	---	---	---	---	---	---
0.920 x 24.21	28.57	165822	421136	40.2	L	74.6	0/3	OK - 84	---	---	---	---	---	---	---	---
					LT	72.8	0/3	OK - 84	---	---	---	---	---	---	---	---
					ST	---	---	---	---	---	---	---	---	---	---	0/3** OK - 84
1.5 x 7.5	11.25	-----	411284	39.7	L	78.4	---	---	---	3/3	3,3,4	8/8***	10,30,30, 30,45,66, 84,84	---	---	---
					ST	69.8	---	---	---	---	---	---	---	---	---	---
1.8 x 17.09	42.09	263902	421134	41.1	L	73.1	---	---	---	---	---	---	---	---	---	---
					ST	67.1	---	---	---	---	---	2/3	84,84,1	0/3	OK - 84	---
2.0 x 8.0**	16.0	-----	411279	39.5	L	75.6	---	---	---	---	---	---	---	---	---	---
					ST	66.7	---	---	---	3/3	56,62,71	1/3	71, 2	OK 84	---	---
3.5 x 7.5	26.25	-----	411285	39.5	L	80.5	1/3	84, 2	OK 84	---	---	---	---	---	---	---
					LT	74.1	3/3	58,60,63	---	---	---	---	---	---	---	---
					ST	70.9	---	---	---	3/3	29,39,39	1/3	77,	---	---	---
													2	OK 84	---	---
4.0 x 8.0**	32.0	-----	411280	39.4	L	79.7	---	---	---	---	---	---	---	---	---	---
					ST	68.9	---	---	---	1/3	73,20K 84	0/3	OK - 84	---	---	---
5.0 x 6.25	31.25	-----	411286	39.3	L	82.3	---	---	---	---	---	---	---	---	---	---
					ST	70.3	---	---	---	0/3	OK - 84	0/3	OK - 84	---	---	---
Sections With Cross-Sectional Areas of 61 - 66 In. ²																
1.8 x 27.36	61.51	900102	421135	40.7	L	72.0	---	---	---	---	---	---	---	---	---	---
					ST	66.8	---	---	---	---	---	3/3	62,63,84	0/3	OK - 84	---
2.93 x 18.1	65.47	290812	421143	38.8	L	76.9	0/3	OK - 84	---	---	---	---	---	---	---	---
					LT	74.8	0/3	OK - 84	---	---	---	---	---	---	---	---
					ST	70.9	---	---	---	---	---	---	---	---	---	---

* Conductivity measured on machined T/2 surface
 + Offset equals 0.2 per cent
 * Tests of specimens exposed to 3.5% NaCl alternate immersion (ASTM G44-76): Specimens were 0.125" diameter tensile bars except where noted.
 ** F/N denotes number of specimens failed over number exposed.
 *** Tested as 0.750" diameter C-ring specimens
 **** Producer K, all others from Producer A
 ***** Specimens passed 30 day SCC test at stress level of 20 ksi

TABLE 65

STATUS OF ATMOSPHERIC TESTS OF 7050-T7351X EXTRUDED SHAPES
(AFML CONTRACT NO. F33615-C-5015)

Thickness and Width, In.	Cross Sectional Area, In. ²	A. L. Sample Number	52 ksi			45 ksi			35 ksi		
			F/N*	Days	F/N*	Days	F/N*	Days			
<u>Seacoast Atmosphere</u>											
1.5 x 7.5	11.25	429206	2/3	452, 527, 1-OK-681	1/3	276, 2 OK-681	---	---	---	---	---
1.8 x 17.09	42.09	421133	2/3	102, 252, 1-OK-385	0/3	OK - 385	0/3	OK - 385	0/3	OK - 385	OK - 385
3.5 x 7.5	26.25	429207	0/3	OK - 681	0/3	OK - 681	---	---	---	---	---
5.0 x 6.25	31.25	429208	0/3	OK - 681	0/3	OK - 681	---	---	---	---	---
1.8 x 27.36	61.53	421137	2/3	102, 175, 1-OK-385	1/3	252, 2-OK-385	0/3	OK - 385	0/3	OK - 385	OK - 385
1.8 x 27.36	61.53	421332R	---	-----	2/3	71, 198, 1-OK-283	1/3	128, 151, 1-OK-283	1/3	128, 151, 1-OK-283	128, 2-OK-283
1.8 x 27.36	61.53	421333R	---	-----	2/3	-----	1/3	149, 2-OK-283	0/3	149, 2-OK-283	OK - 283
1.8 x 27.36	61.53	421334R	---	-----	0/3	OK - 283	0/3	OK - 283	0/3	OK - 283	OK - 283
1.8 x 27.36	61.53	421335R	---	-----	0/3	OK - 283	0/3	OK - 283	0/3	OK - 283	OK - 283
1.8 x 27.36	61.53	421336R	---	-----	0/3	OK - 283	0/3	OK - 283	0/3	OK - 283	OK - 283
2.93 x 18.1	65.37	421132-2	3/3	231, 252, 285	0/3	OK - 385	0/3	OK - 385	0/3	OK - 385	OK - 385
<u>Industrial Atmosphere</u>											
1.5 x 7.5	11.25	429206	0/3	OK - 694	0/3	OK - 694	---	---	---	---	---
1.8 x 17.09	42.09	421133	2/3	426, 431, 1-OK-432	0/3	OK - 432	0/3	OK - 432	0/3	OK - 432	OK - 432
3.5 x 7.5	26.25	429207	0/3	OK - 694	0/3	OK - 694	---	---	---	---	---
5.0 x 6.25	31.25	429208	0/3	OK - 694	0/3	OK - 694	---	---	---	---	---
1.8 x 27.36	61.53	421137	0/3	OK - 432	0/3	OK - 432	0/3	OK - 432	0/3	OK - 432	OK - 432
1.8 x 27.36	61.53	421332R	---	-----	0/3	OK - 362	0/3	OK - 362	0/3	OK - 362	OK - 362
1.8 x 27.36	61.53	421333R	---	-----	0/3	OK - 362	0/3	OK - 362	0/3	OK - 362	OK - 362
1.8 x 27.36	61.53	421334R	---	-----	0/3	OK - 362	0/3	OK - 362	0/3	OK - 362	OK - 362
1.8 x 27.36	61.53	421335R	---	-----	0/3	OK - 362	0/3	OK - 362	0/3	OK - 362	OK - 362
1.8 x 27.36	61.53	421336R	---	-----	0/3	OK - 362	0/3	OK - 362	0/3	OK - 362	OK - 362
2.93 x 18.1	65.37	421132-2	0/3	OK - 432	0/3	OK - 432	0/3	OK - 432	0/3	OK - 432	OK - 432

* Tested as 0.125" diameter short transverse tensile bars
+ F/N denotes number of specimens failed over number exposed

Table 66

STATUS OF ATMOSPHERIC SCC TESTS OF 7050-T7651X EXTRUDED SHAPES
(AFML CONTRACT NO. F33615-C-5015)

Thickness and Width, In.	Cross Sectional Area, In. ²	A. L. Sample Number	35 ksi		75 ksi		17 ksi	
			F/N*	Days	F/N*	Days	F/N*	Days
1.5 x 7.5	11.25	411284	3/3	75, 75, 75	2/3	75, 445, 1 OK 1304	---	---
1.8 x 17.09	42.09	421134	---	-----	0/3	OK 385	0/3	OK 385
2.0 x 8.0#	16.0	411279	3/3	445, 1024, 1-OK-1304	0/3	OK 1304	---	---
3.5 x 7.5	26.25	411285	3/3	75, 75, 359	1/3	224, 2 OK 1304	---	---
4.0 x 8.0#	32.0	411280	3/3	224, 224, 359	0/3	OK 1304	---	---
5.0 x 6.25	31.25	411286	1/3	401, 2-OK-681	0/2	OK 681	---	---
1.8 x 27.36	61.53	421135	---	-----	0/3	OK 385	0/3	OK 385
2.93 x 18.1	65.37	421143	---	-----	2/3	102, 231, 1-OK-385	0/3	OK 385
<u>Seacoast Atmosphere</u>								
1.5 x 7.5	11.25	411284	2/3	1097, 1097, 1-OK-1335	1/3	1140, 2-OK-1335	---	---
1.8 x 17.09	42.09	421134	---	-----	0/3	OK 432	0/3	OK 432
2.0 x 8.0#	16.0	411279	0/3	OK 1335	0/3	OK 1335	---	---
3.5 x 7.5	26.25	411285	0/3	OK 1335	0/3	OK 1335	---	---
4.0 x 8.0#	32.0	411280	0/3	OK 1335	0/3	OK 1335	---	---
5.0 x 6.25	31.25	411286	0/3	OK 705	0/3	OK 705	---	---
1.3 x 27.36	61.53	421135	---	-----	0/3	OK 432	0/3	OK 432
2.93 x 18.1	65.37	421143	---	-----	0/3	OK 432	0/3	OK 432
<u>Industrial Atmosphere</u>								

* Tested as 0.125 in. diameter short-transverse tensile bars.

† F/N denotes number of specimens failed over number exposed.

Producer B; all others from Producer A.

Table 67

RESULTS OF SCC TESTS OF PRECRACKED SPECIMENS FROM 7050-T7351X EXTRUDED SHAPES
(AFML CONTRACT NO. F33615-C-5015)

Thickness and Width, In.	Cross Sectional Area In. 2	Die Number	A. L. Sample Number	Test Spec.	C.O.D., In.	Initial Crack Length, In.	Initial Stress-Intensity, K_{Ii} $\sqrt{\text{In.}}$	Environmental Crack Growth, In.		Average Crack Growth Rate In./Hr. x 10 ⁻⁴		Plane-Strain Fracture Toughness, K_{Ic} $\sqrt{\text{In.}}$
								15 Days	30 Days	15 Days	30 Days	
1.161 x 17.35	29.44	231372	429204	SL1	0.024	0.892	24.8	0.099	0.197	2.75	2.73	-----
				SL2	0.024	0.912	24.0	0.094	0.205	2.61	2.85	
3.5 x 7.5	26.25	-----	429207	SL1	0.024	0.868	25.2	0.221	0.267	6.10	3.70	23.4
				SL2	0.024	0.875	24.9	0.222	0.308	6.18	4.28	
1.8 x 27.36	61.53	900102	421137	SL1	0.025	0.907	24.7	0.090	0.221	2.50	3.08	25.1
				SL2	0.028	0.933	26.5	0.097	0.207	2.69	2.87	
1.8 x 27.36	61.53	900102	421333	SL1	0.018	0.827	20.2	0.092	0.182	2.55	2.52	20.6
				SL2	0.019	0.837	21.0	0.092	0.180	2.55	2.50	
1.8 x 27.36	61.53	900102	421336	SL1	0.026	0.875	27.5	0.063	0.117	1.76	1.62	26.6
				SL2	0.027	0.903	26.8	0.048	0.092	1.34	1.27	
2.93 x 18.1	65.37	291812	421132-	SL1	0.023	0.955	21.6	0.080	0.152	2.22	2.11	20.4
				2 SL2	0.023	0.918	22.8	0.173	0.258	4.82	3.59	

Sections With Cross-Sectional Areas of $< 43 \text{ In}^2$

Sections With Cross-Sectional Areas of $61-66 \text{ In}^2$

Notes: Test specimen: Short-transverse (S-L) double cantilever beam bolt loaded to pop-in.

Test environment: Air at 80°F, 45% R.H. plus 3.5% NaCl dropwise three times a day for 30 days.

Table 68

RESULTS OF SCC TESTS OF PRECRACKED SPECIMENS FROM 7050-T7651X EXTRUDED SHAPES
(AFML CONTRACT NO. F33615-C-5015)

Thickness and Width, In.	Cross Sectional Area, In. ²	Die Number	A. L. Sample Number	Test Spec.	C.O.D., In.	Initial Crack Length, In.	Initial Stress-Intensity, K _I √In.	Environmental Crack Growth, In.		Average Crack Growth Rate, In./Hr. x 10 ⁻⁴	Plane-Strain Fracture Toughness, K _{Ic} √In.	
								15 Days	30 Days			
1.161 x 17.35	29.44	231372	411287	SL1	0.022	0.888	22.4	0.156	0.343	4.33	4.76	-----
				SL2	0.020	0.823	22.6	0.207	0.331	5.74	4.60	
1.5 x 7.5	11.25	-----	411284	SL1	0.020	0.839	22.0	0.281	0.421	7.79	5.85	22.2
				SL2	0.021	0.820	23.8	0.310	0.435	8.60	6.04	
3.5 x 7.5	26.25	-----	411285	SL1	0.017	0.846	18.5	0.246	0.340	6.83	4.72	16.4
				SL2	0.016	0.818	18.2	0.263	0.332	7.31	4.61	
5.0 x 6.25	31.25	-----	411286	SL1	0.018	0.854	19.3	0.217	0.275	6.01	3.82	18.0
				SL2	0.018	0.840	19.7	0.240	0.268	6.67	3.72	
Sections With Cross-Sectional Areas of <43 In ²												
1.8 x 27.36	61.53	900102	421135	SL2	0.024	0.858	25.5	0.172	0.409	4.77	5.68	21.6
				SL3	0.024	0.912	23.5	0.157	0.263	4.35	3.66	
2.93 x 18.1	65.37	291812	421143	SL2	0.019	0.895	19.1	0.338	0.497	9.40	6.90	18.8*
				SL3	0.019	0.917	18.5	0.280	0.415	7.78	5.76	
Sections With Cross-Sectional Areas of 61-66 In ²												

Notes: Test specimen: Short-transverse (S-L) double cantilever beam bolt loaded to pop-in.

Test environment: Air at 80°F, 45% R.H. plus 3.5% NaCl dropwise three times a day for 30 days.

* Did not meet ASTM criteria for valid K_{Ic} values. Value considered meaningful.

Table 69

RESULTS OF TESTS OF RING LOADED SHORT TRANSVERSE COMPACT SPECIMENS OF 7050-T7351X AND T7651X EXTRUDED SHAPES

Thickness & Width In.	Die Number	A. I. Sample Number	Test Specimen	Initial Values				Values at Fracture				Plane-Strain Fracture Toughness, K_{Ic} , ksi $\sqrt{in.}$	Time to Fracture Hr.		
				Target (a)		Calculated (b)		Measured (c)		Calculated (b)					
				Crack Length, In.	Load, Lb.	K_{Ic} , ksi $\sqrt{in.}$	ΔK_{Ic}	Crack Length, In.	Load, Lb.	K_{Ic} , ksi $\sqrt{in.}$	Crack Length, In.			Load, Lb.	K_{Ic} , ksi $\sqrt{in.}$
7050-T7351X Temper Shapes															
2.93 x 18.1	291812	421132-2	S-L8 S-L7 S-L9	1.020 1.020 1.015	2615 2332 2203	18.4 16.3 15.3	90 80 75	1.035 1.031 1.028	2619 2329 2233	18.8 16.6 15.8	22.9 19.9 19.0	1.172 1.098 1.170	2547 2298 2190	23.2 18.2 19.8	198 2172(d) 3082(d)
1.8 x 27.36	900102	421333	S-L8 S-L6 S-L9	0.750 0.815 0.755	1762 1375 1453	18.5 16.5 15.4	90 80 75	0.767 0.845 0.780	1773 1380 1460	19.3 17.7 16.3	20.9 20.9 18.0	0.809 0.935 0.980	1765 1328 1149	21.0 21.6 21.5	125 424 3023(d)
1.8 x 27.36	9-0102	421336	S-L8 S-L7 S-L9 S-L6	0.755 0.820 0.760 0.765	2387 1863 1994 1728	25.3 22.6 21.3 18.6	95 85 80 70	0.777 0.851 0.761 0.763	2386 1862 1994 1739	26.4 24.3 21.3 18.7	27.3 24.5 26.7 25.0	0.795 0.861 0.878 0.790	2382 1864 1911 1713	27.4 24.9 26.6 19.6	82 124 1431 2820(d)
7050-T7651X Temper Shapes															
2.93 x 18.1	291812	421143	S-L8 S-L9 S-L7	1.030 1.020 1.025	1719 1344 1067	12.2 9.4 7.5	65 50 40	1.045 1.016 1.069	1718 1348 1071	12.5 9.4 8.1	18.1 ---- 8.8	1.285 1.328 1.185	1621 1248 1062	18.6 15.8 9.9	566 609(f) 2304(d)
5.0 x 6.25 (g)	-----	411286	S-L1 S-L2 S-L3 S-L4	1.000 1.005 1.005 1.000	2120 1850 1570 1325	14.4 12.6 10.8 9.0	80 70 60 50	1.038 1.078 1.030 1.034	2130 1850 1570 1330	15.3 14.2 11.2 9.5	16.6 21.0 18.3 17.6	1.115 1.328 1.333 1.405	2110 1730 1450 1145	17.2 21.9 18.7 19.8	120 540 822 2820

(a) Target values based on crack length measurements on sides of specimen.
 (b) Calculated values based on measurements of loads and crack opening displacements.
 (c) Final crack lengths measured on fracture surfaces. Estimate of K_{Ic} based on last measured load.
 (d) Tests terminated, specimens did not fracture.
 (e) Did not meet ASTM criteria for valid K_{Ic} values. Value considered meaningful.
 (f) Test terminated, specimen sectioned and examined microscopically to determine whether SCC had occurred.
 (g) Read under NASC Contract N00019-72-C-0512(5).

TABLE 70
COMPARATIVE SCC DATA FOR DCB'S AND SMOOTH SPECIMENS IN ACCELERATED TESTS

Thickness and Width, In.	Cross-Sectional Area, In. ²	A.L. Sample Number	Long. YS, ksi	E.C. + % IMCS	DCB Data		Smooth Specimen Data#					
					Avg. Growth Rate - 15 Days In/Hr. x 10	Str. 45 ksi F/N**	Days	Str. 35 ksi F/N	Days	Str. 25 ksi F/N	Days	
1.8 x 27.36	61.53	421336	64.6	42.5	1.6	3/3	52, 53, 64	2/3	52, 70, 1 OK 70	-----	-----	-----
1.8 x 27.36	61.53	421137	67.2	41.8	2.1	3/3	43, 48, 60	3/3	66, 70, 71	-----	-----	-----
2.93 x 18.1	65.37	421132-2	68.5	41.7	3.5	3/3	35, 38, 40	3/3	48, 57, 58	-----	-----	-----
1.8 x 27.36	61.53	421333	69.0	41.1	2.6	6/6	19, 23, 25, 31, 33, 42	2/3	42, 47, 1 OK 70	-----	-----	-----
1.161 x 17.35	29.44	429204	70.0	41.6	2.7	0/3**	OK - 84	---	-----	-----	-----	-----
3.5 x 7.5	26.25	429207	72.8	42.0	6.1	2/3	72, 84, 1 OK 84	---	-----	-----	-----	-----
T7351X Temper Sections												
1.8 x 27.36	61.53	421135	72.0	40.7	4.6	---	-----	---	-----	---	3/3	62, 63, 84
1.161 x 17.35	29.44	411287	76.6	40.2	5.0	---	-----	---	-----	---	---	-----
2.93 x 18.1	65.37	421143	76.9	39.8	8.6	---	-----	---	-----	---	3/3	11, 37, 43
1.5 x 7.5	11.25	411284	78.4	39.7	8.2	---	-----	3/3	3, 3, 4	---	8/8	10, 30, 30, 30, 45, 66, 84, 84
3.5 x 7.5	26.25	411285	80.5	39.5	7.1	---	-----	3/3	29, 39, 39	---	1/3	77, 2 OK 84
5.0 x 6.25	31.25	411286	82.3	39.3	6.3	---	-----	0/3	OK - 84	---	0/3	OK - 84
T7651X Temper Sections												

* Offset equals 0.2 per cent.
 † Conductivity measured on machined T/2 surface
 # Tested as 0.125 in. diameter tensile bars except where noted.
 ** F/N denotes number of specimens failed over number exposed.
 †† Tested as 0.750 in. diameter C-ring specimens.

TABLE 71

LOT RELEASE CRITERIA AND EXFOLIATION CORROSION, STRESS-CORROSION, AND FRACTURE TOUGHNESS CHARACTERISTICS OF ALLOY 7050 EXTRUSIONS

Temper	E. C., & IACS	Thickness, in.	Width/ Thickness	Tensile Test Dir.	T.S., ksi		Y.S., ksi		El. in 2"	Exfoliation Corrosion EXCO Plane	SCC Test Stress, ² & GYS	K _{IC} ksi√in. ³		
					min	max	min	max				L-T	T-L	S-L
T7651X	39	Up thru 2.000	Any	L	79	69	-	-	7	<E-B T/10	25	27	23	16
	39	2.001-5.000	>2	L	79	69	-	-	7	<E-B T/10	25	27	16	13
	39	2.001-5.000	<2	L	79	69	-	-	7	<E-B T/10	25	27	13	13
T7351X	41	Up thru 2.000	Any	L	70	60	-	-	8	<E-B Any	75	32	28	18
	41	2.001-5.000	>2	L	70	60	-	-	8	<E-B Any	75	32	21	16
	41	2.001-5.000	<2	L	70	60	-	-	8	<E-B Any	75	32	18	18
	40	Up thru 2.000	Any	L	70	60	69	8	8	<E-B Any	75	32	28	18
	40	2.001-5.000	>2	L	70	60	69	8	8	<E-B Any	75	32	21	16
	40	2.001-5.000	<2	L	70	60	69	8	8	<E-B Any	75	32	18	18

Notes: 1. Material processed to meet the electrical conductivity and tensile properties shown above shall show exfoliation corrosion less than that pictured in photograph B, Figure 2, of ASTM G34-72 at the plane shown above when tested in accordance with ASTM G34.

2. Material having a cross-sectional area less than 43-in.² and processed to meet the electrical conductivity and tensile properties shown above shall be capable of meeting the requirements of ASTM G47-76 when stressed in the short-transverse direction to the level indicated above. Stress level of larger sections must be negotiated at this time. GYS = guaranteed longitudinal yield strength.

3. Material shall meet the K_{IC} values indicated above when tested in accordance with ASTM E399.

4. Material having a cross-sectional area less than 43-in.² shall be released for shipment on the basis of meeting the electrical conductivities, tensile properties, and fracture toughness values shown above. Stress-corrosion tests of sections greater than 43-in.² must be performed at this time.

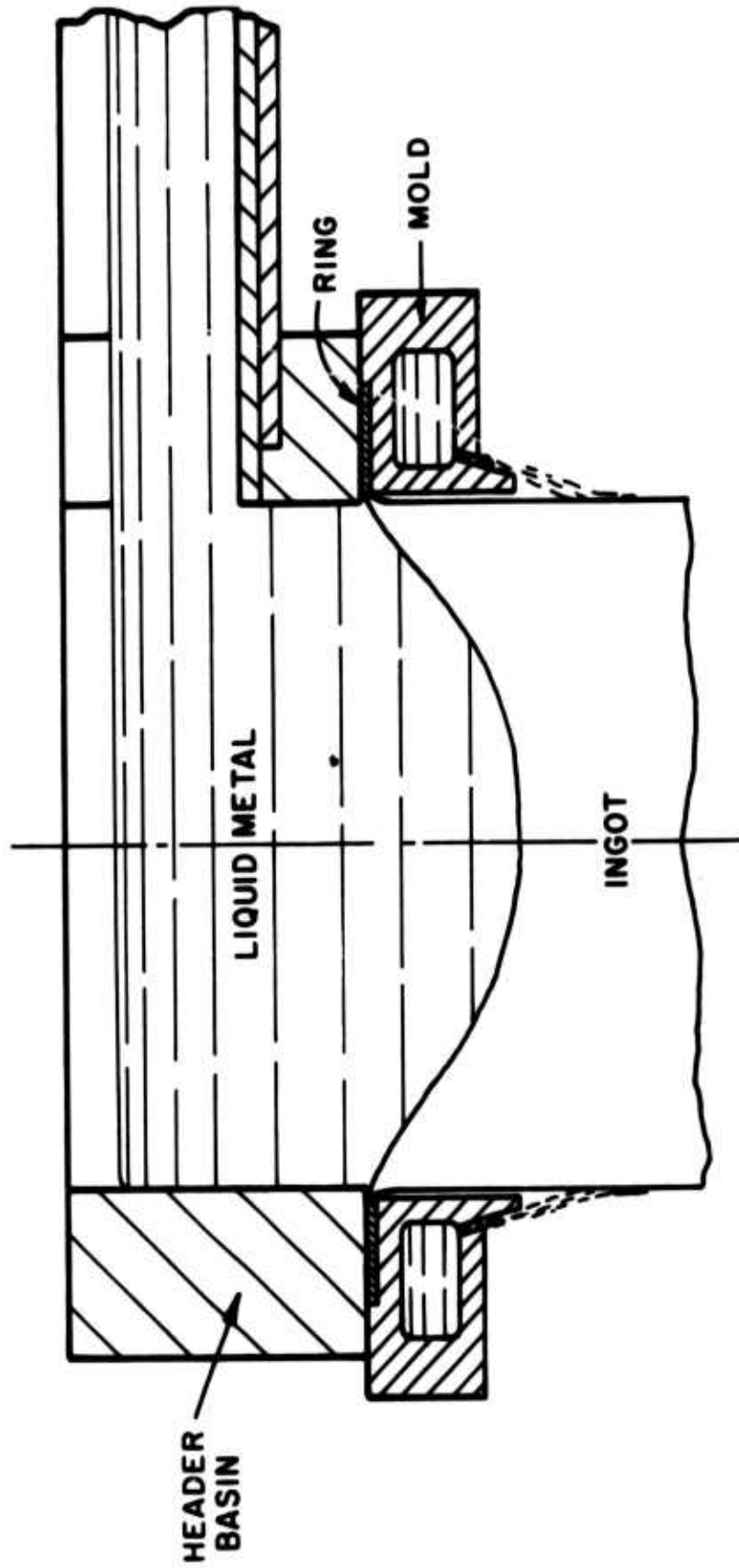

Figure 1 Alcoa Level Pour Mold

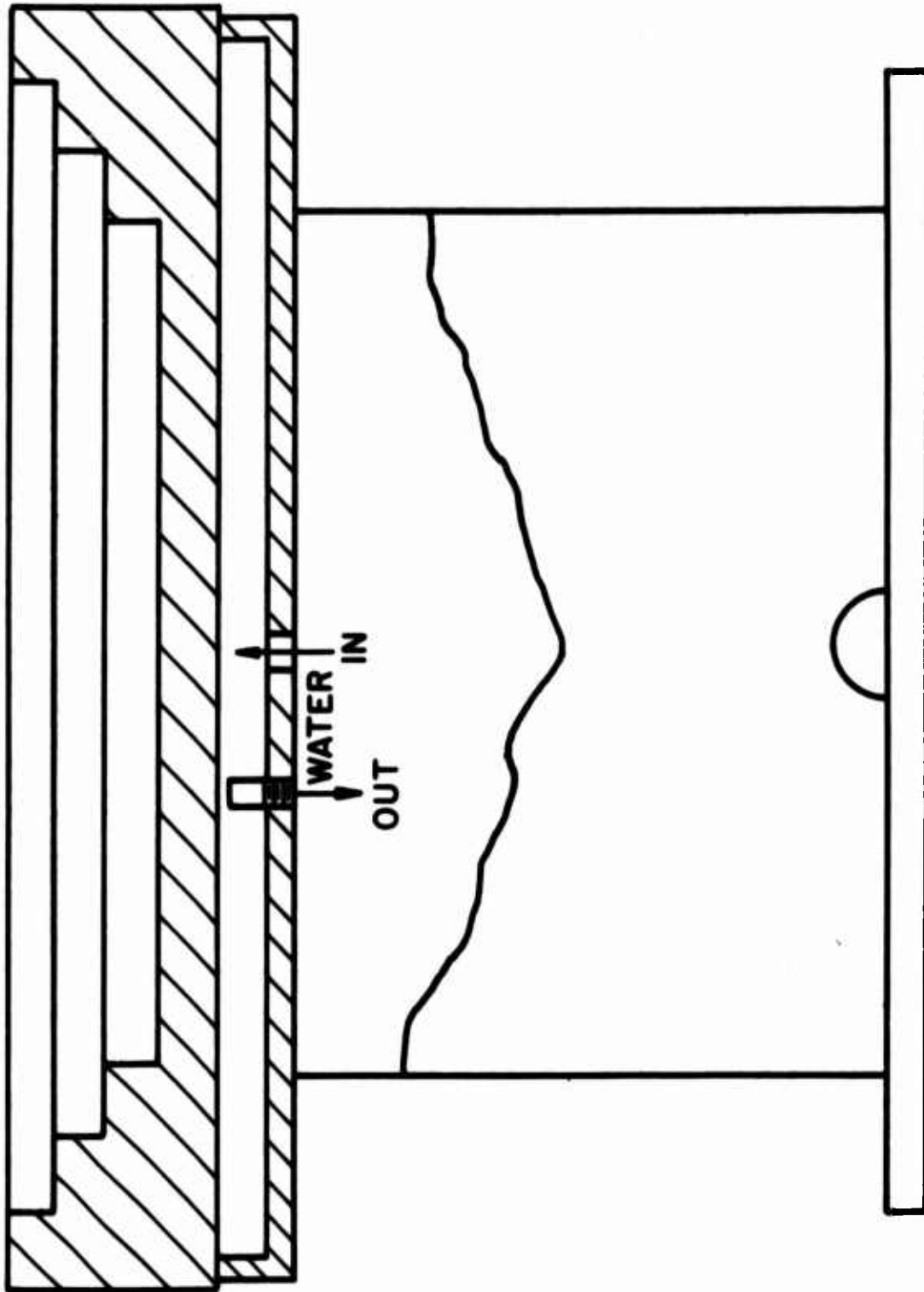

Figure 2 Bottom Block

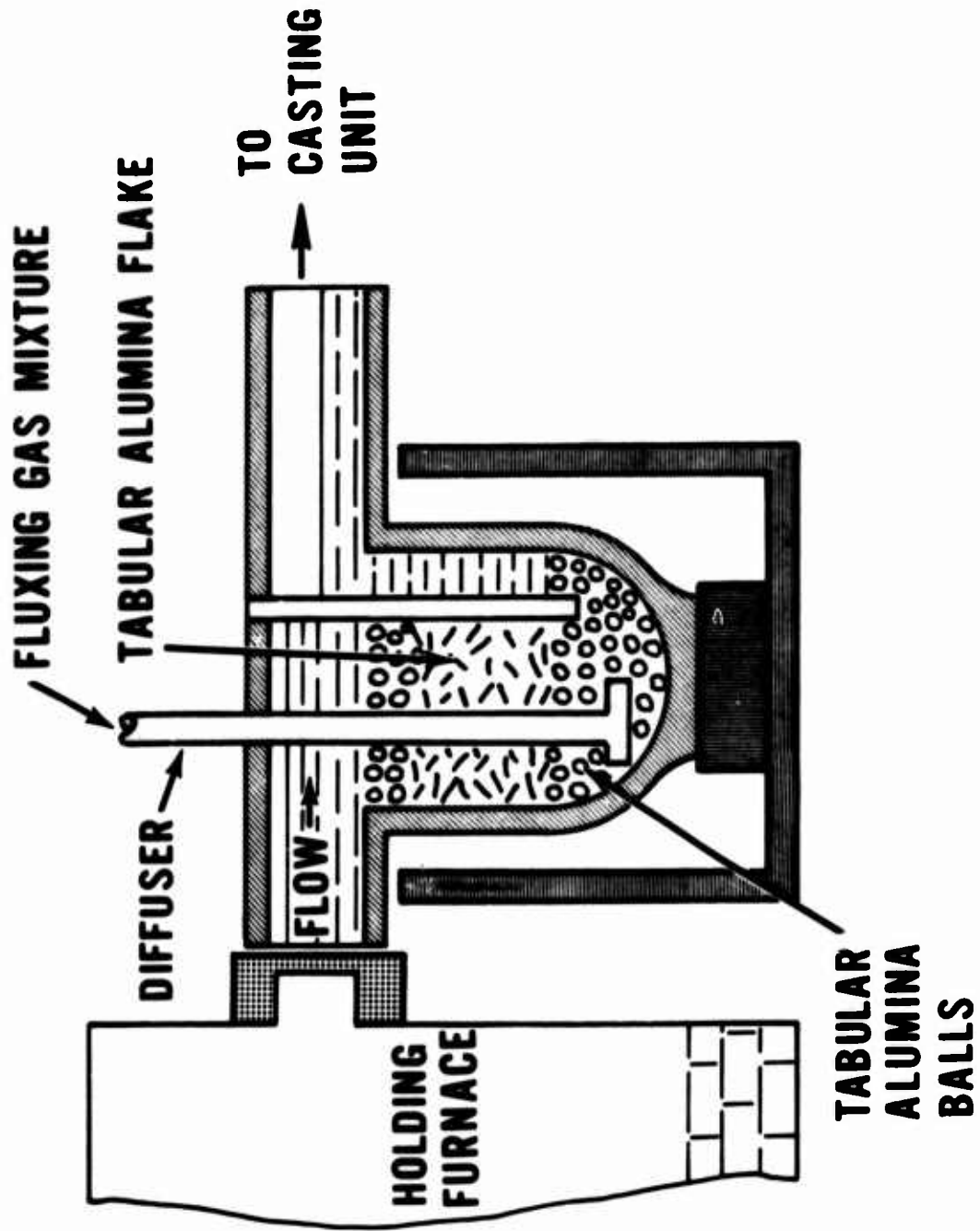

Figure 3 Alcoa 181 Process

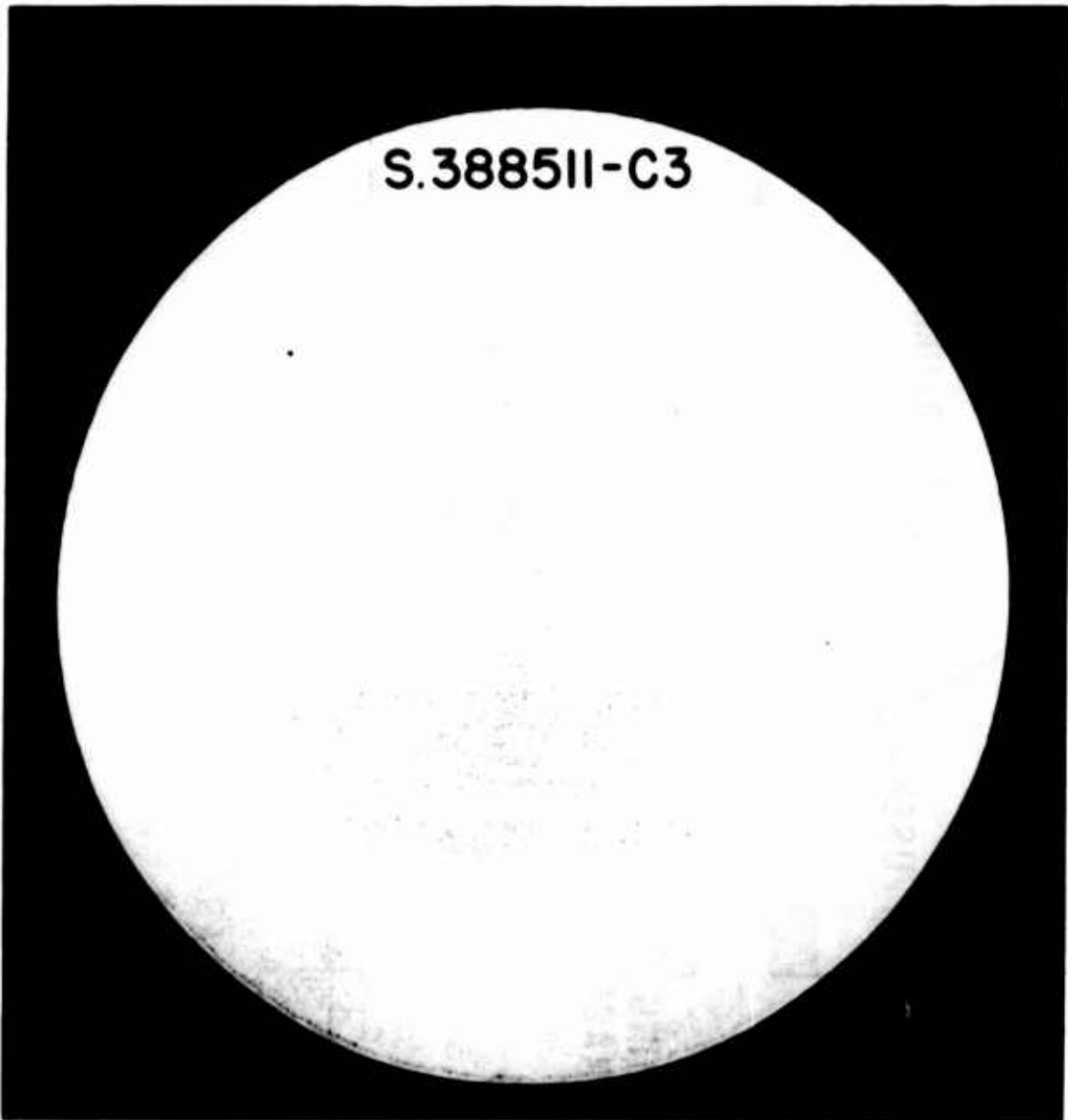

Figure 4 7050 - 25 inch Diameter Ingot, S388511-C3
Top End

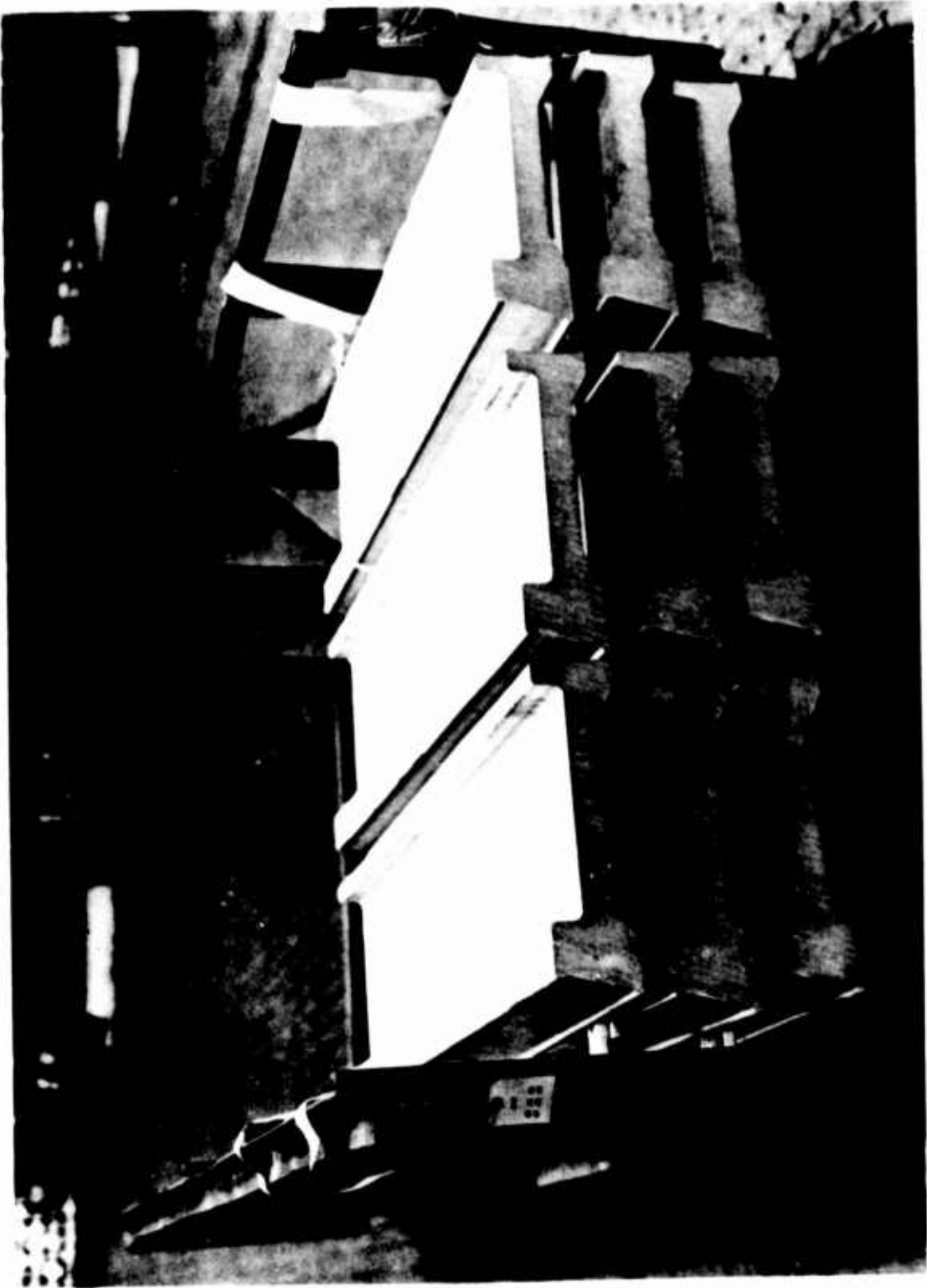

Figure 5 Alcoa Section 263902 Alloy 7050 Extrusions



Figure 6 Shows No Significant Effect of Extrusion Temperature on Macrostructure



SURFACE



MIDPLANE

S-427232 -ALCOA SECTION 263902 - ALLOY 7050
LONGITUDINAL SECTION - POLARIZED LIGHT - 100X

Figure 7a Microstructures at Surface and Midplane Near the Front of an Alloy 7050 Extrusion Fabricated at 750°F

Comparison with Figure 7c Reveals No Significant Effect of a 50°F Difference in Extrusion Temperature on the Depth of the Coarse Layer of Recrystallized Grains That is Characteristically Found on the Surface of High-Strength, Heat Treatable Aluminum Alloy Extrusions, and No Effect on the Sub-Surface Structure



SURFACE

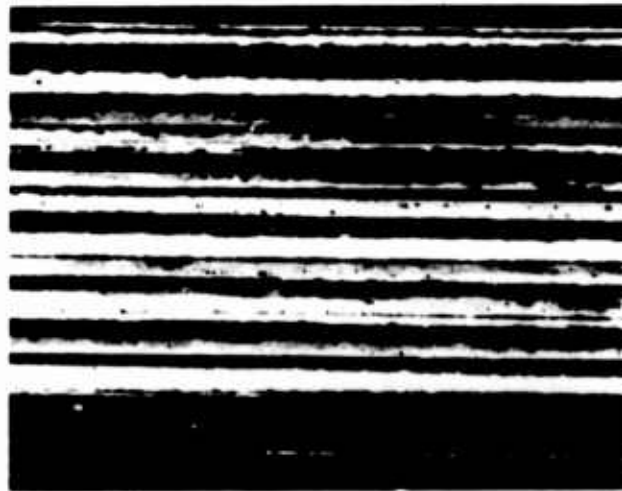

MIDPLANE

S-427232 - ALCOA SECTION 263902 - ALLOY 7050
LONGITUDINAL SECTION - POLARIZED LIGHT - 100X

Figure 7b Microstructures at Surface and Midplane Near the Rear of an Alloy 7050 Extrusion Fabricated at 750 F

Comparison with Figure 7d Reveals No Effect of a 50 F Difference in Extrusion Temperature on the Depth of the Layer of Coarse Recrystallized Grains and on the Sub-Surface Structure. Comparison with Figure c Reveals That the Layer of Coarse Recrystallized Grains is Thicker in the Rear Than the Front. This Difference is Characteristic of High-Strength Aluminum Alloys Extruded by the Direct Process.

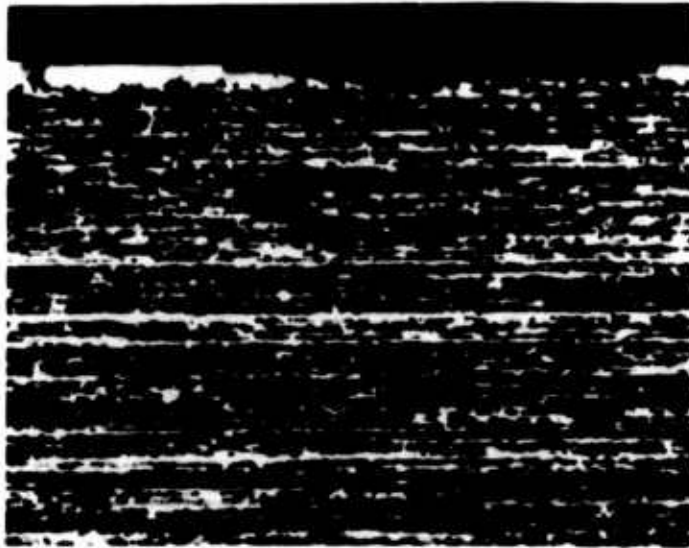

SURFACE



MIDPLANE

S-427231 -ALCOA SECTION 263902 - ALLOY 7050
LONGITUDINAL SECTION - POLARIZED LIGHT - 100X

Figure 7c Microstructures at Surface and Midplane Near the Front of an Alloy 7050 Extrusion Fabricated at 800°F

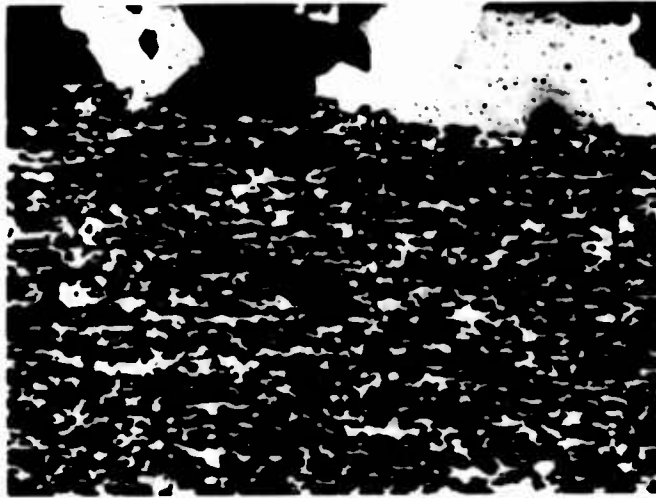

SURFACE

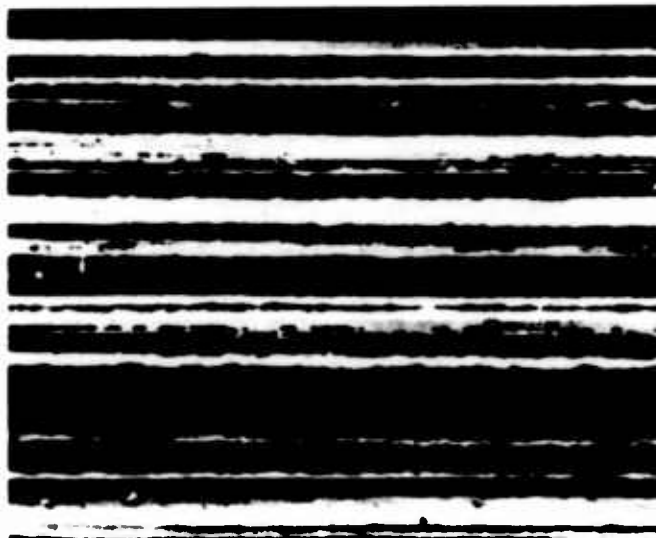

MIDPLANE

**S-427231 -ALCOA SECTION 263902 - ALLOY 7050
LONGITUDINAL SECTION - POLARIZED LIGHT - 100X**

**Figure 7d Microstructures at Surface and Midplane Near the Rear
of an Alloy 7050 Extrusion Fabricated at 800°F**

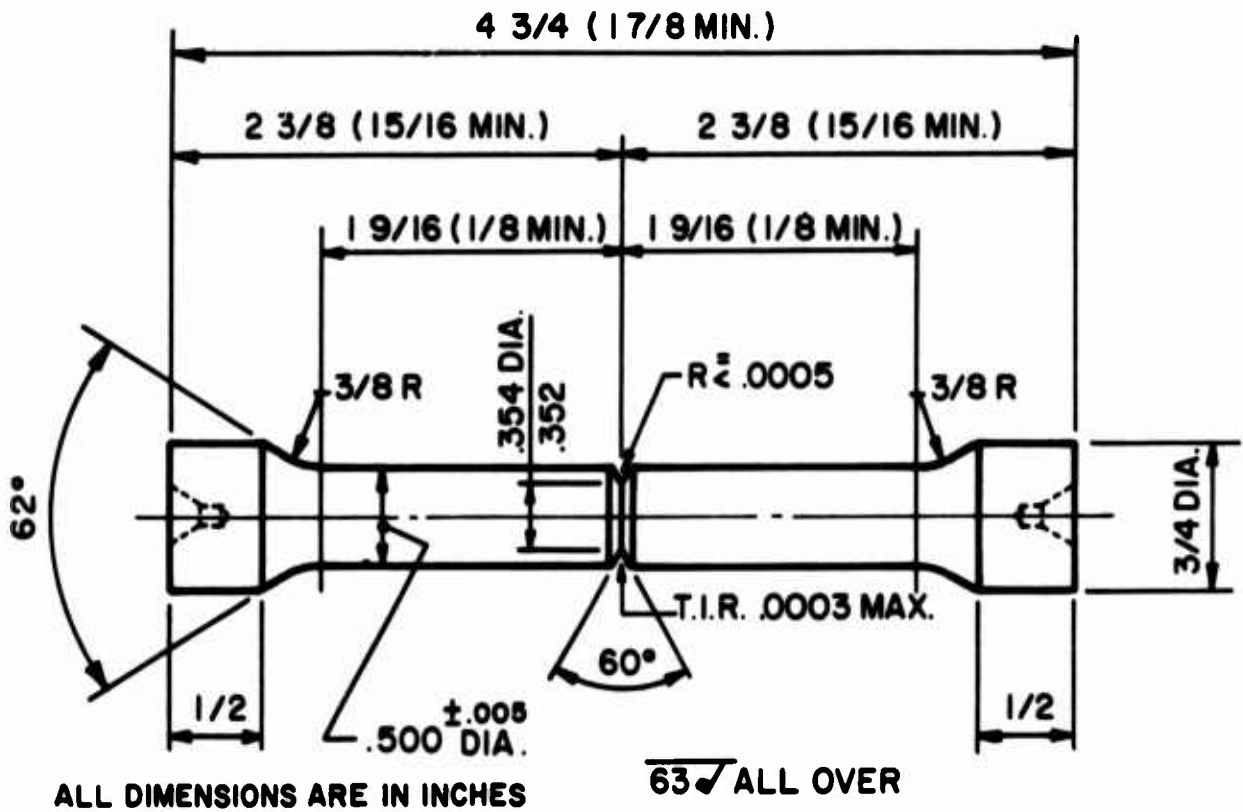

NOTE : TO OBTAIN SHORT-TRANSVERSE SPECIMENS, THE OVERALL LENGTH MAY BE REDUCED BY SHORTENING THE REDUCED SECTION, THE MINIMUM DIMENSIONS ARE SHOWN IN PARENTHESES.

Figure 8 Notch-Tensile Specimen

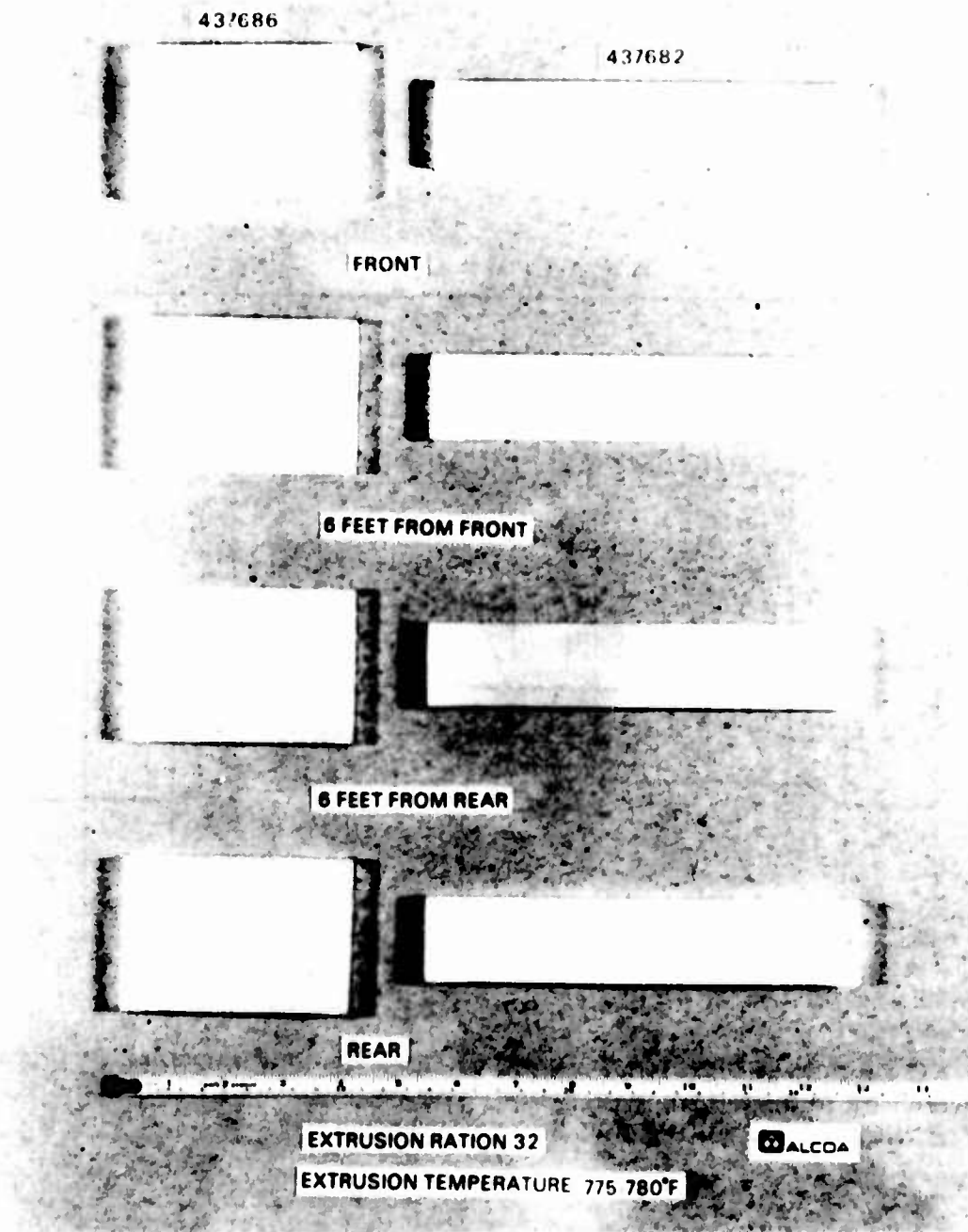

Figure 9a Macrostructures of Alloy 7050 Rectangles Extruded from 21 inch Diameter Billets at High Extrusion Temperature

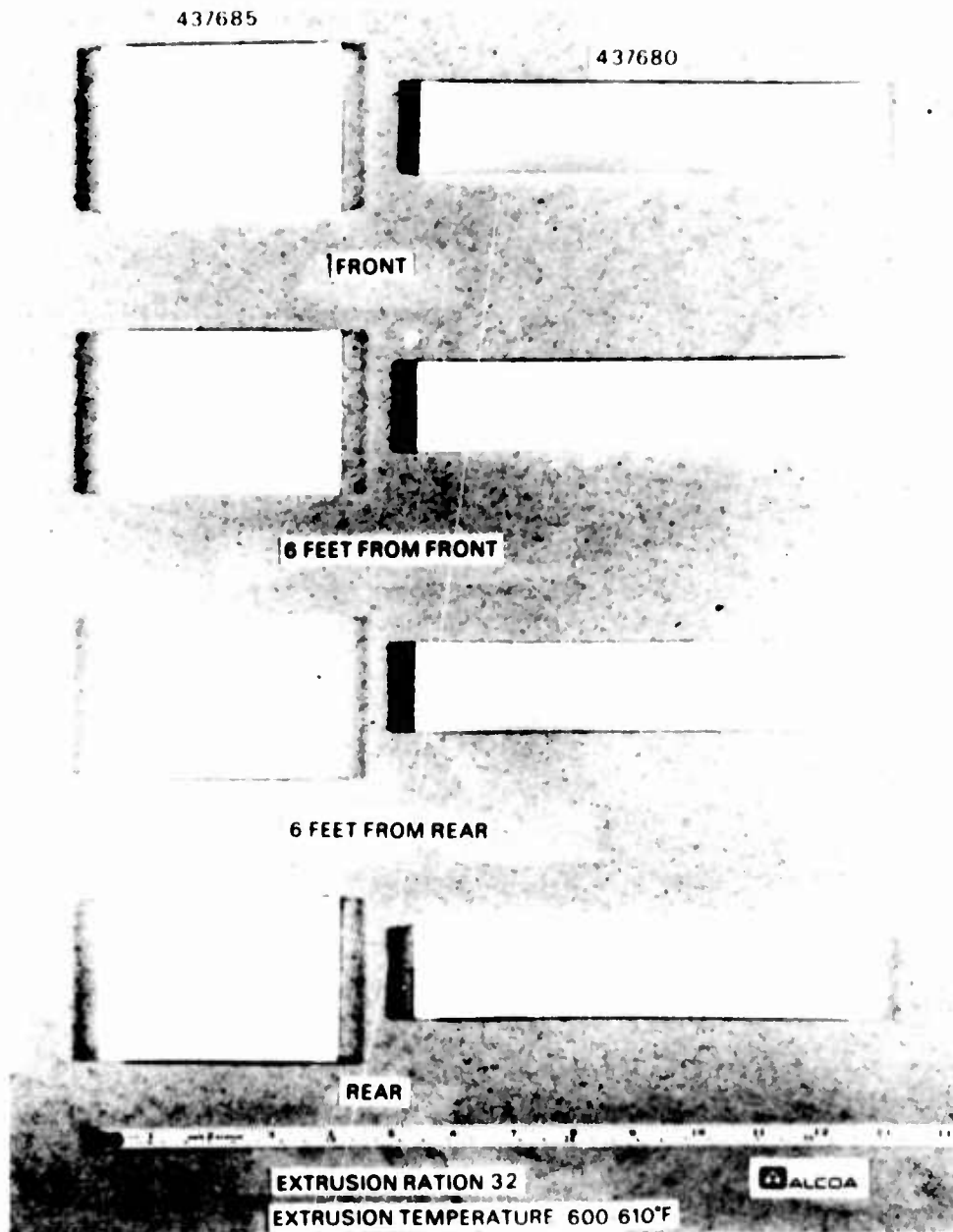

Figure 9b Macrostructure of Alloy 7050 Rectangles Extruded from 21 inch Diameter Billets at Low Extrusion Temperature

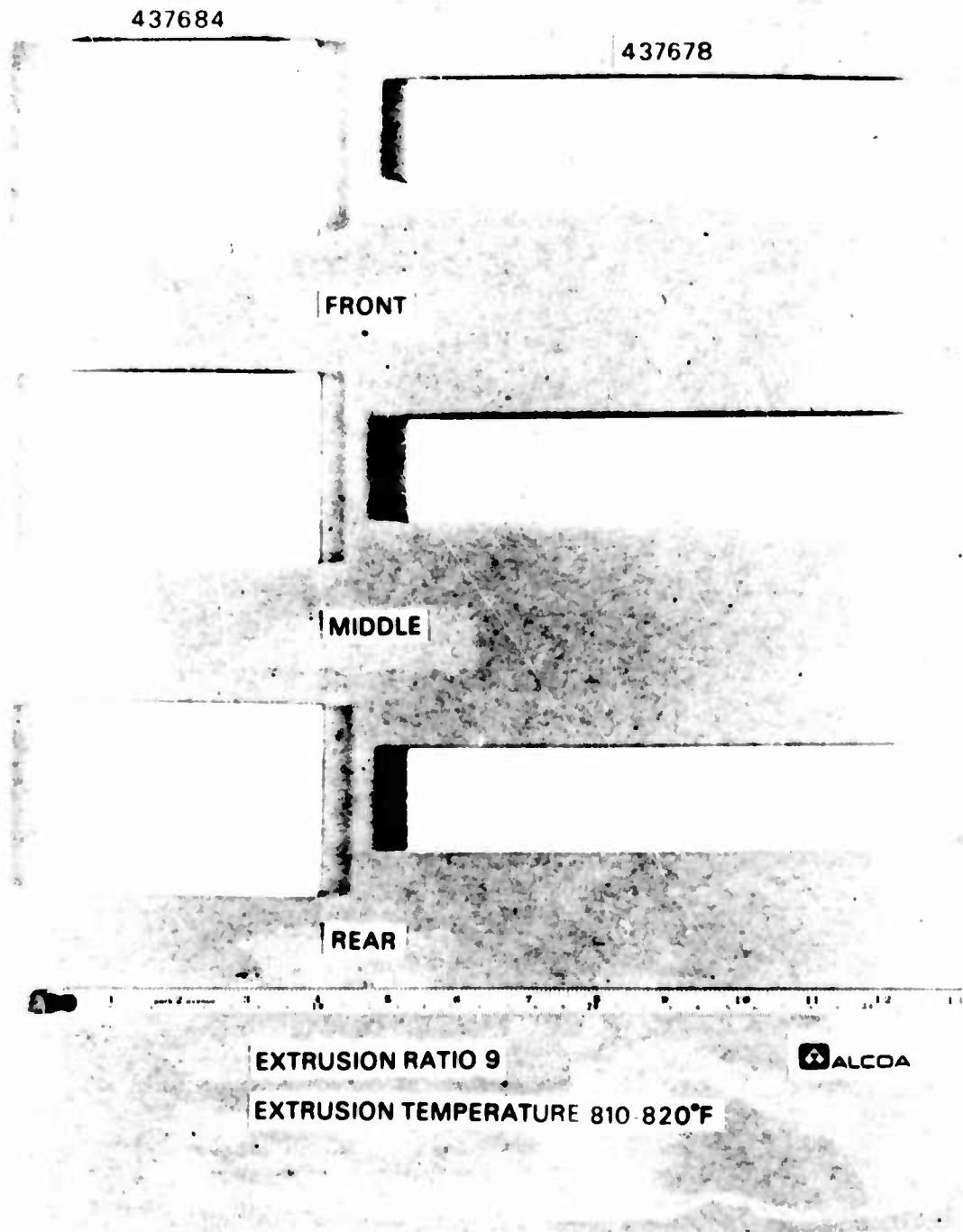

Figure 9c Macrostructures of Alloy 7050 Rectangles Extruded from 11 inch Diameter Billets at High Extrusion Temperature

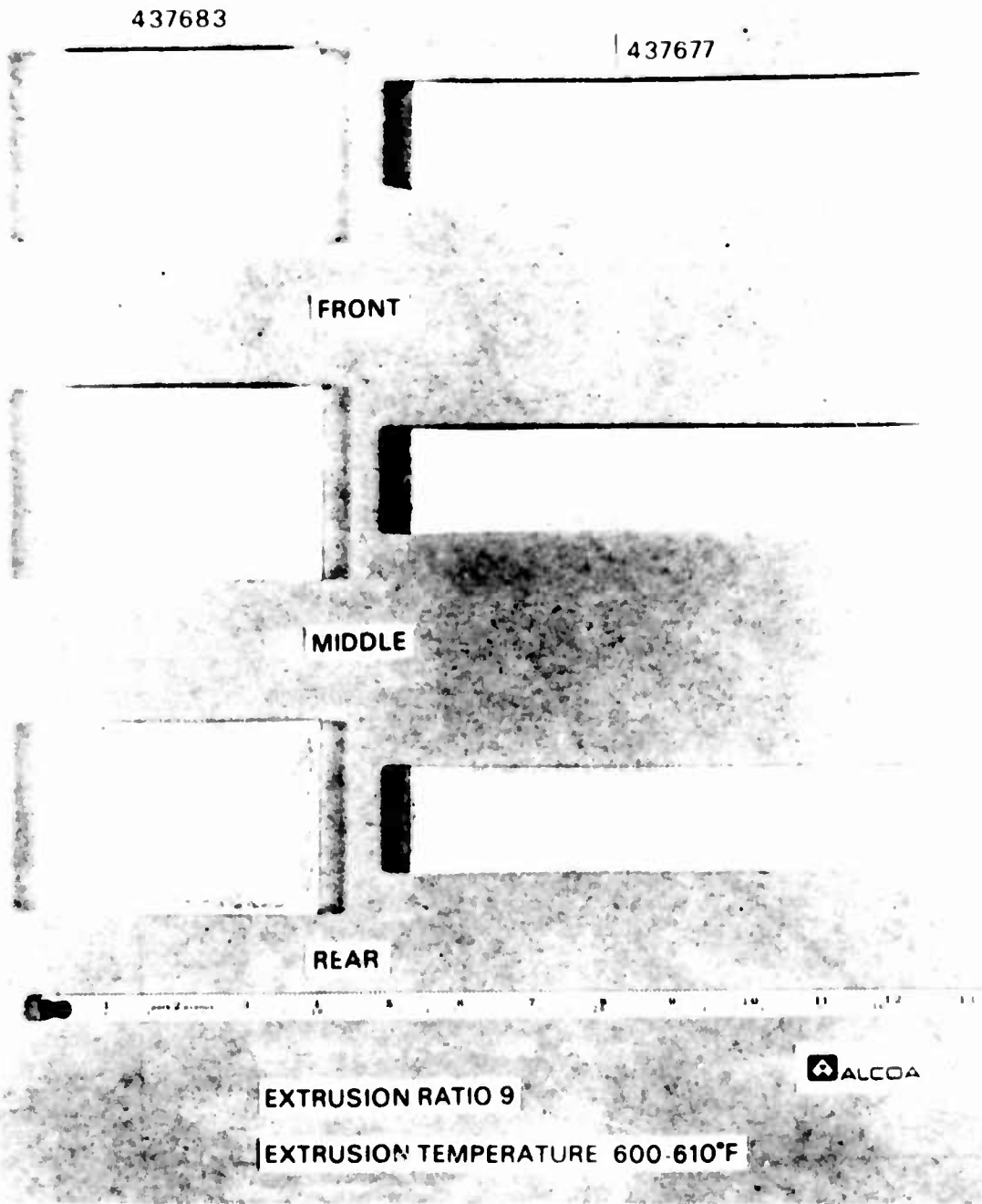

Figure 9d Macrostructures of Alloy 7050 Rectangles Extruded from 11 inch Diameter Billets at Low Extrusion Temperature

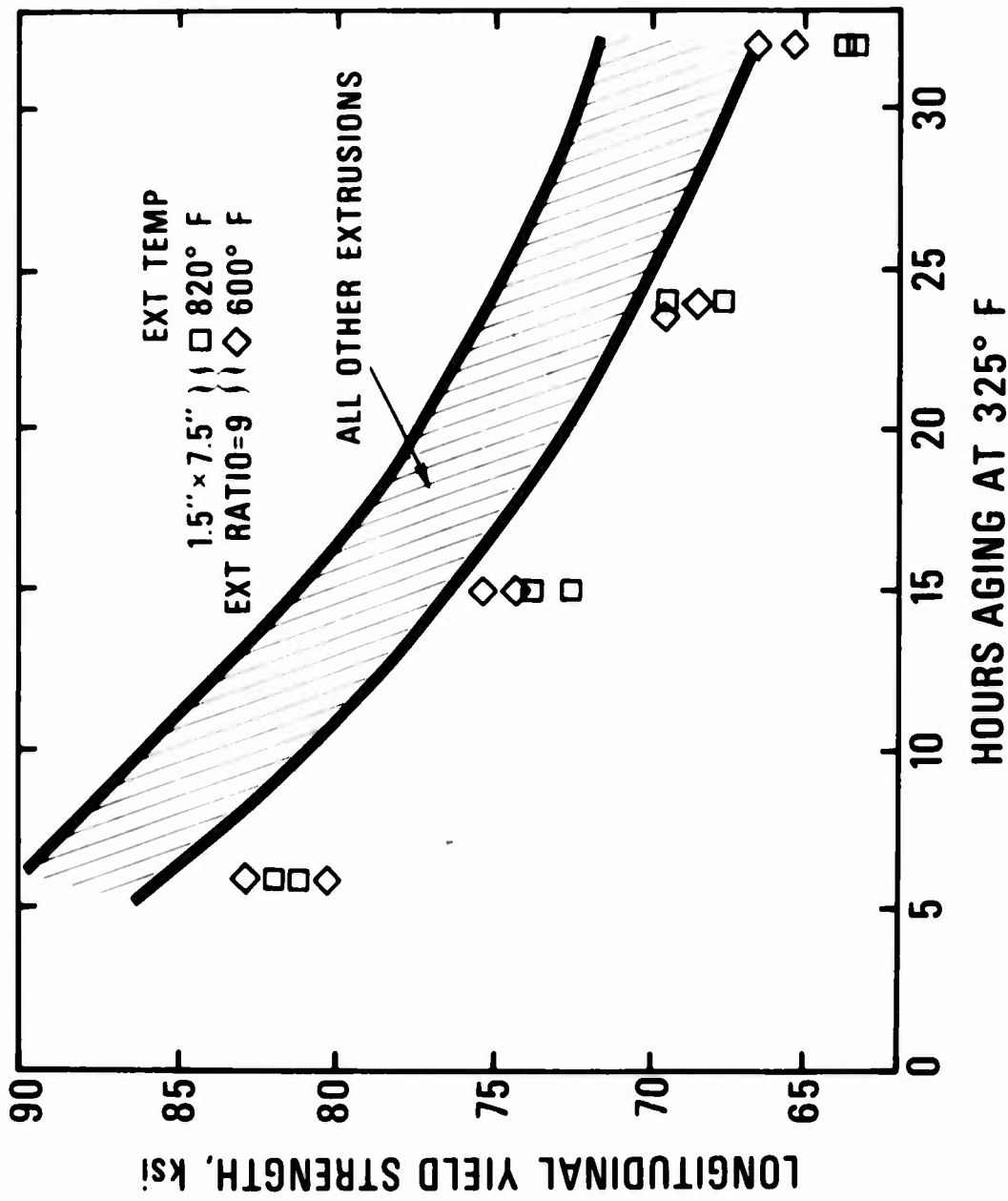

Figure 10 Yield Strength vs Over-Aging Time, 7050 Extrusions

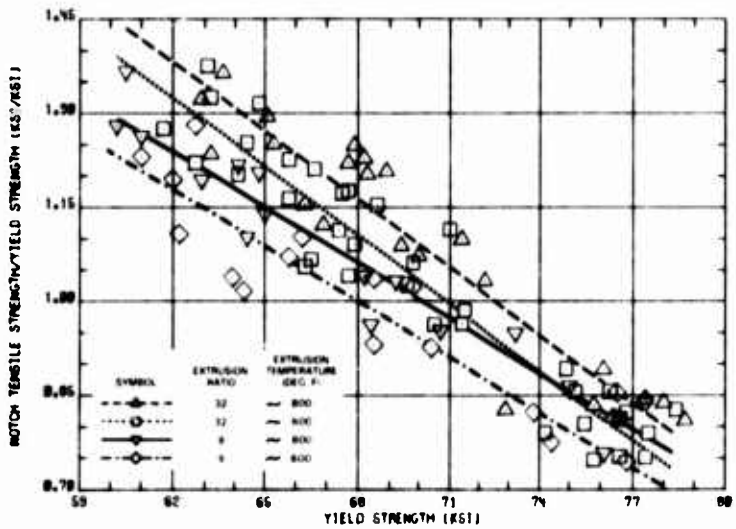
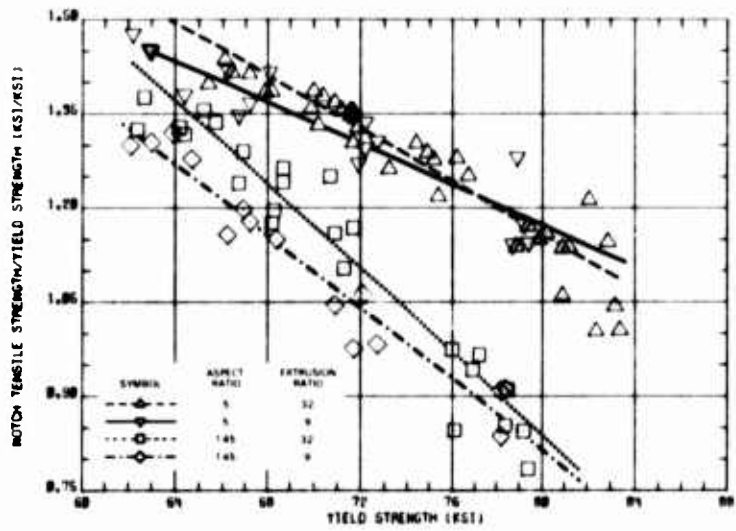
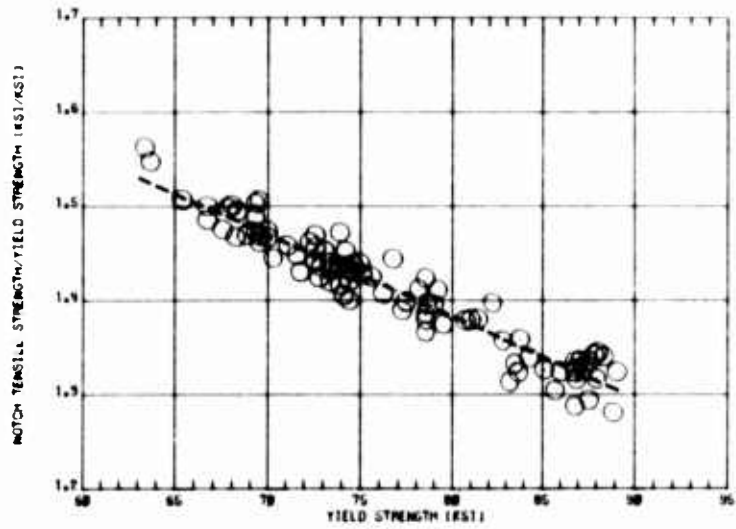
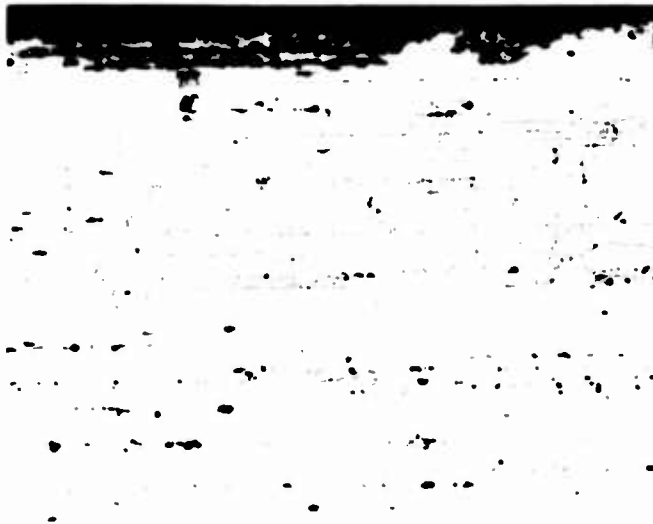

Figure 11 Notch Tensile - Yield Ratio Versus Yield Strength for 7050 Extrusions



S. NO. 437681-F3 100X KELLER'S ETCH

Figure 12a Longitudinal Section at the Midplane of a 1.5 X 7.5" Thick Rectangular Bar 7050 Alloy Extrusion Fabricated at Extrusion Ratio 32, Extrusion Temp 600°F, With Second Step Aging of 15 hrs at 325°F



S. NO. 437677-F3 100X KELLER'S ETCH

Figure 12b Longitudinal Section at the Midplane of a 1.5 X 7.5" Thick Rectangular Bar 7050 Alloy Extrusion Fabricated at Extrusion Ratio 9, Extrusion Temp 600°F, With Second Step Aging of 15 hrs at 325°F

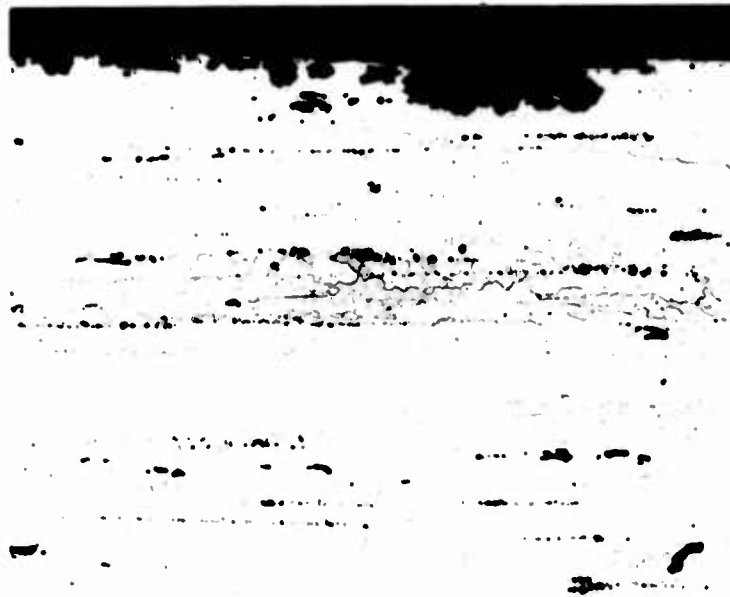

S. NO. 437686F2 100X KELLERS' ETCH

Figure 12c Longitudinal Section at the Midplane of a 2.75 X 4.0" Thick Rectangular Bar 7050 Alloy Extrusion Fabricated at Extrusion Ratio 32, Extrusion Temp, 775°F, With Second Step Aging of 24 hrs at 325°F



S NO. 437683-R4 100X KELLERS' ETCH

Figure 12d Longitudinal Section at the Midplane of a 2.75 X 4.0" Thick Rectangular Bar 7050 Alloy Extrusion Fabricated at Extrusion Ratio 9, Extrusion Temp, 610°F, With a Second Step Aging at 32 hrs at 325°F

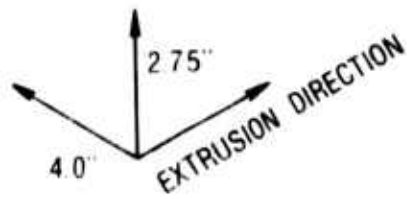
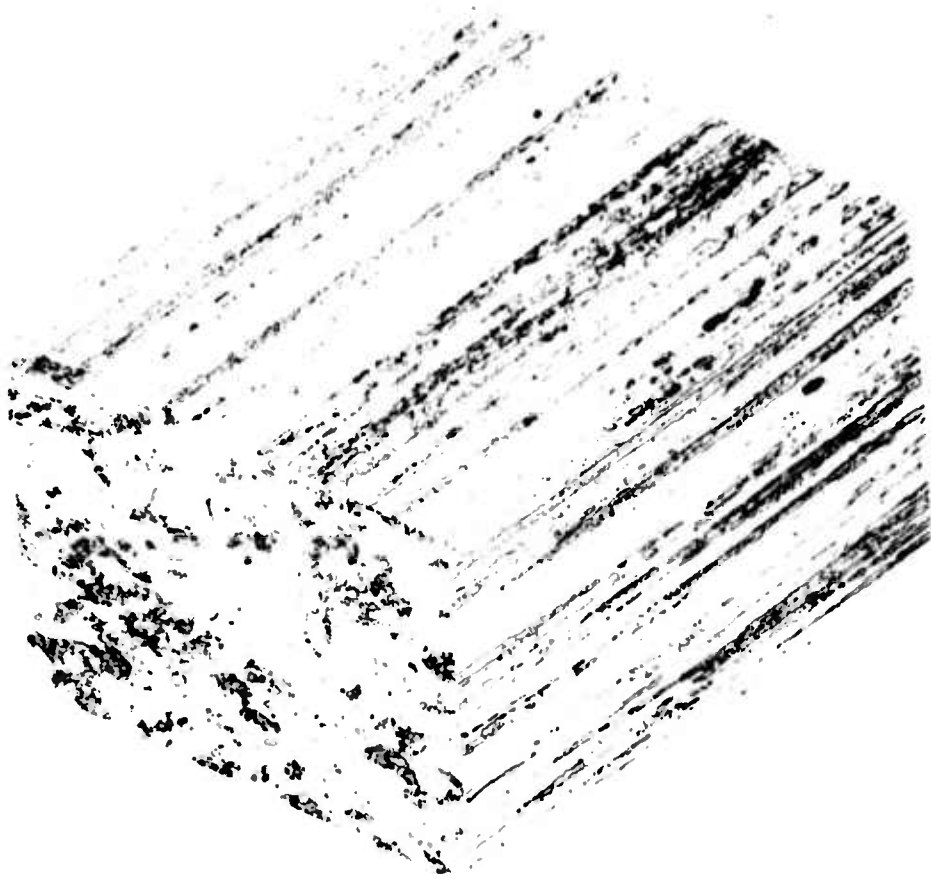

Figure 13a Grain Structure at Stress-Corrosion Test Specimen
Location in 2.75 inch X 4.0 inch Section Extruded
at Low Temperature

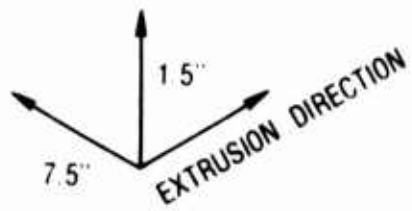
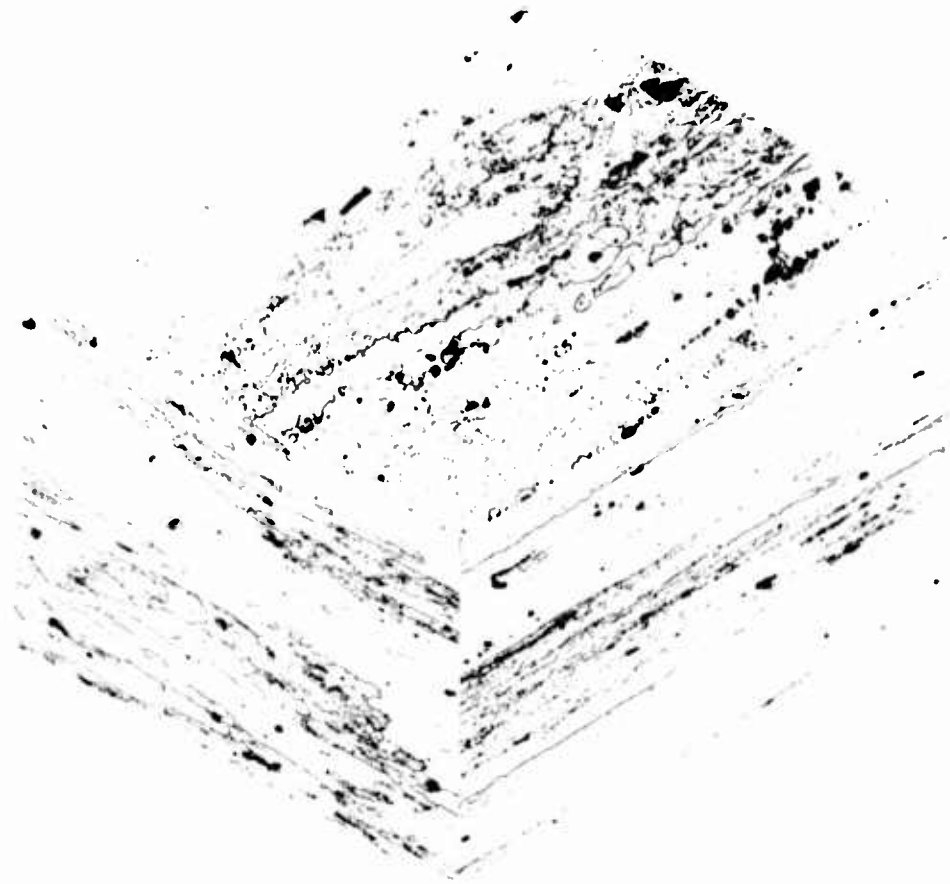

Figure 13b Grain Structure at Stress-Corrosion Test Specimen Location in 1.5 inch X 7.5 inch Section Extruded at Low Temperature

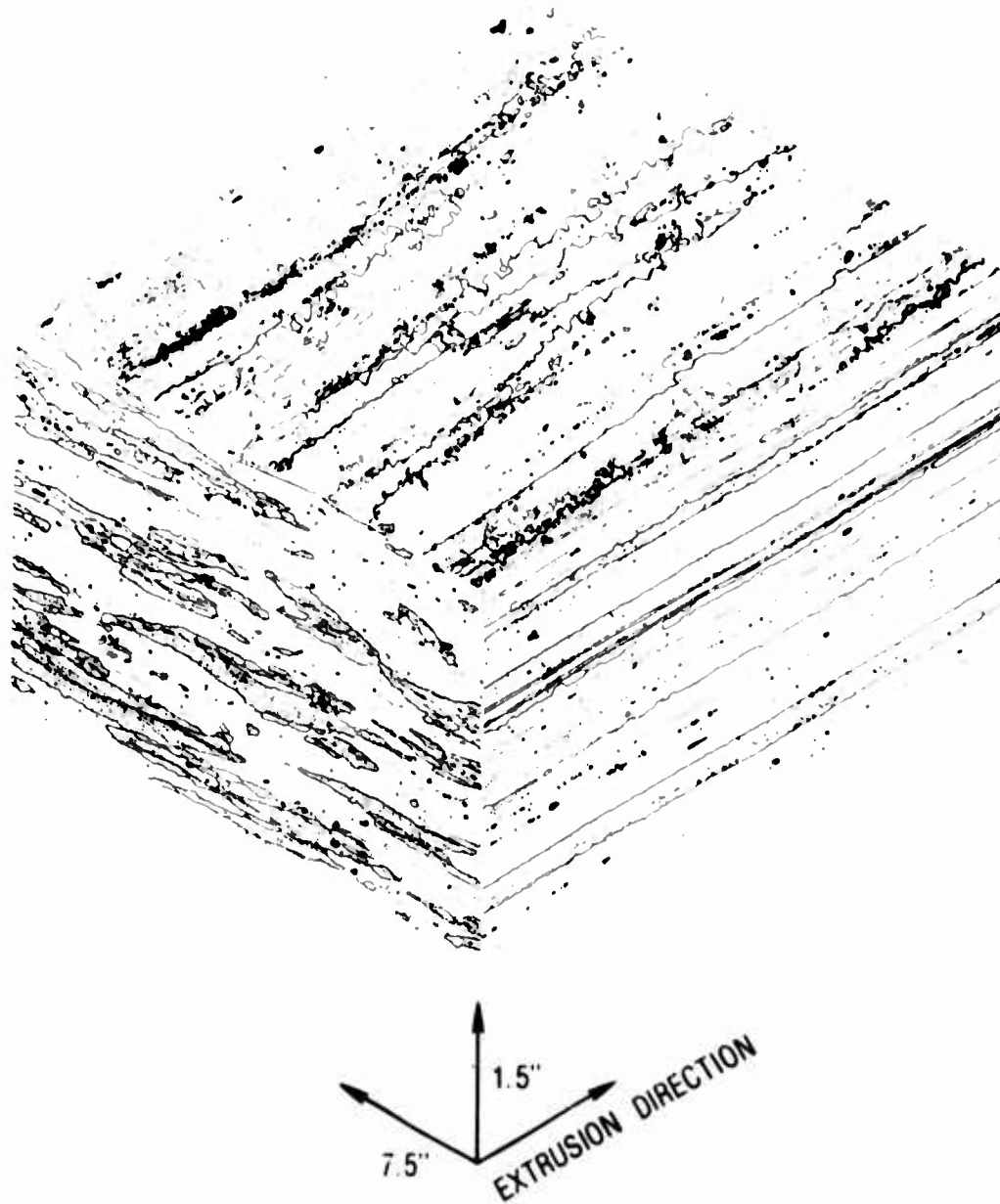

Figure 14 Grain Structure at Stress-Corrosion Test Specimen Location in 1.5 inch X 7.5 inch Section Extruded at High Temperature



Figure 15 Photograph of 35 inch Diameter 7050 Ingot

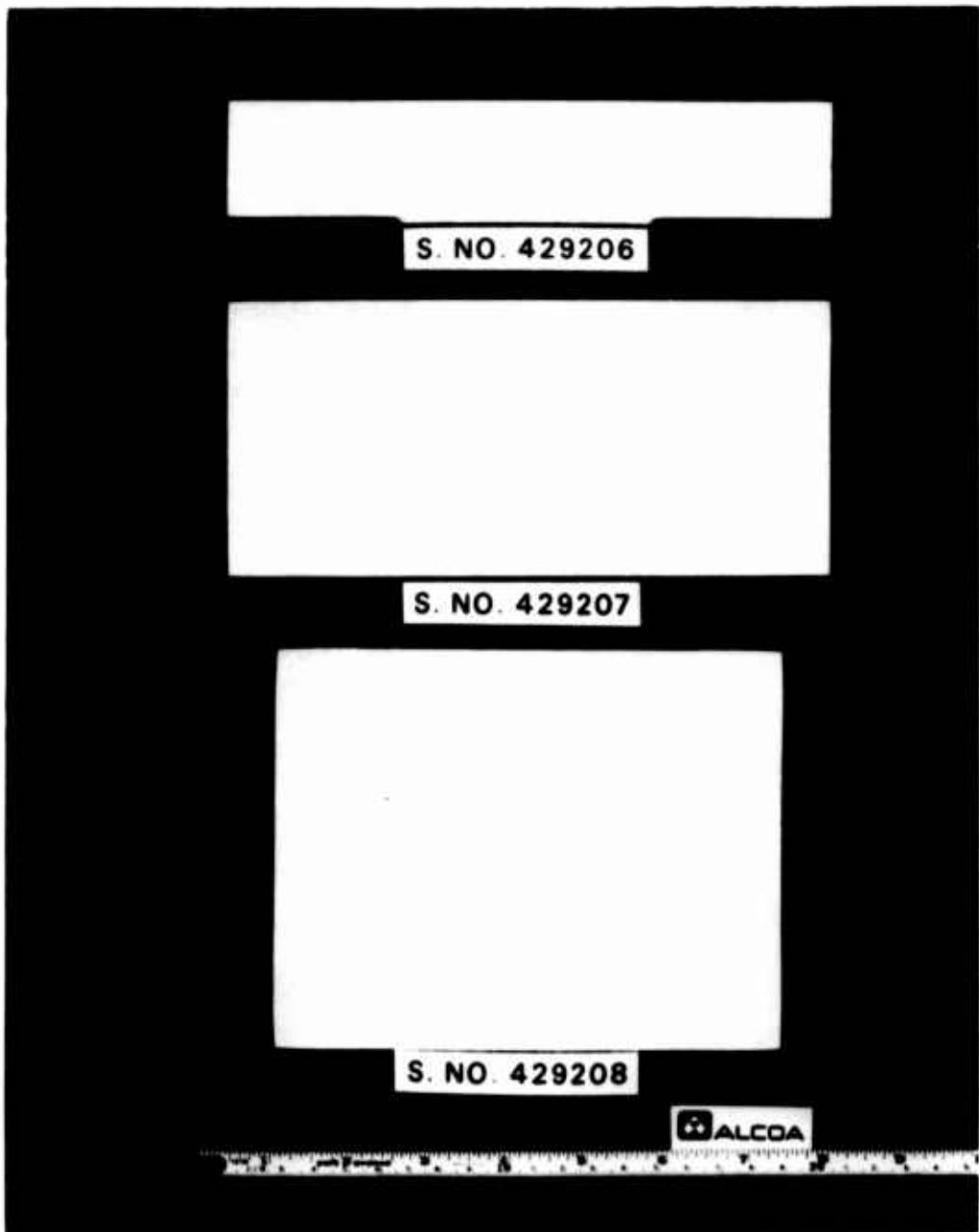

Figure 16 Macroetched Cross Sections of Alloy 7050-T73510 Rectangular Extrusions

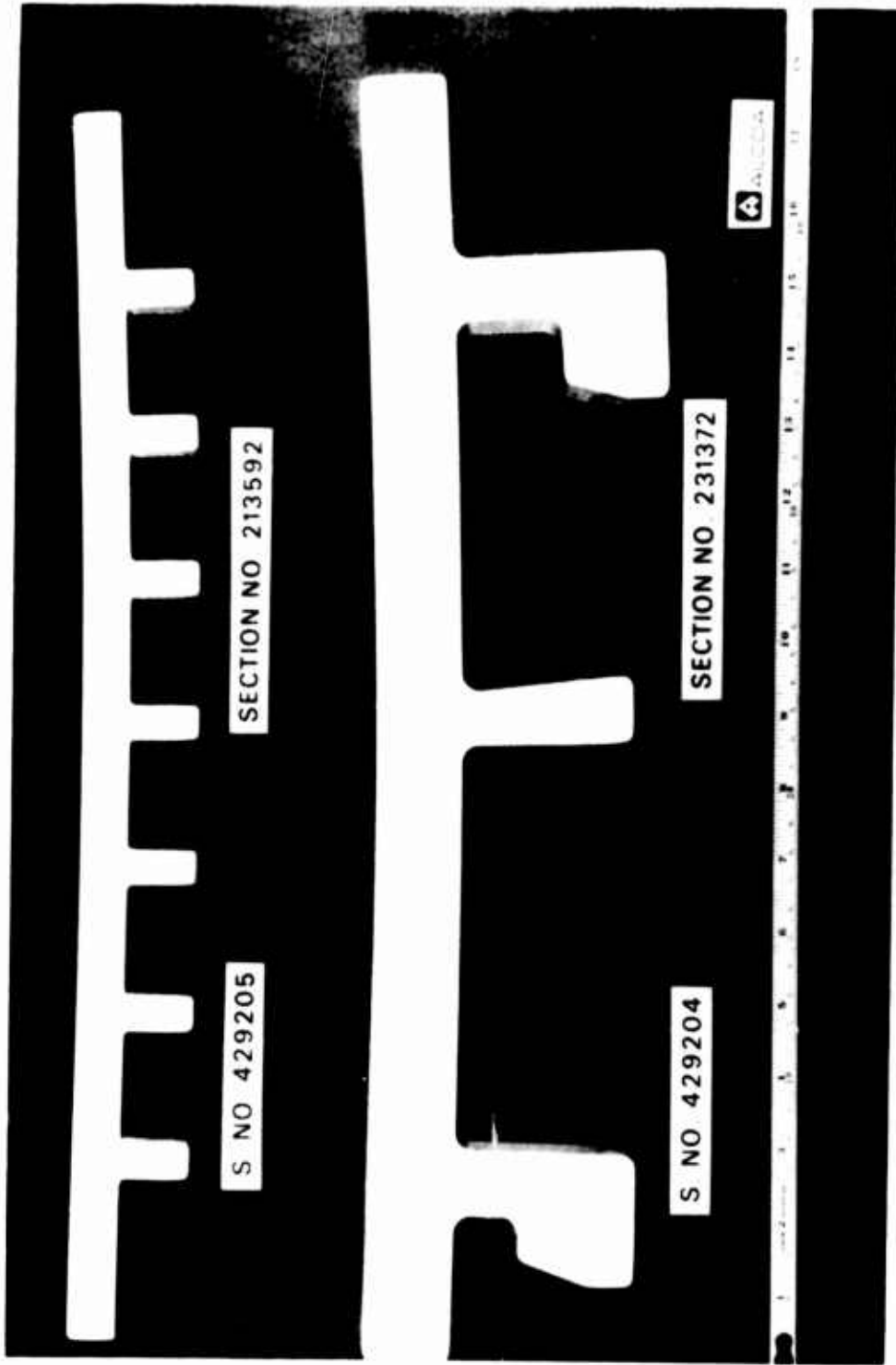

Figure 17 Macroetched Cross Sections of Alloy 7050-T73510 Panel Extrusions

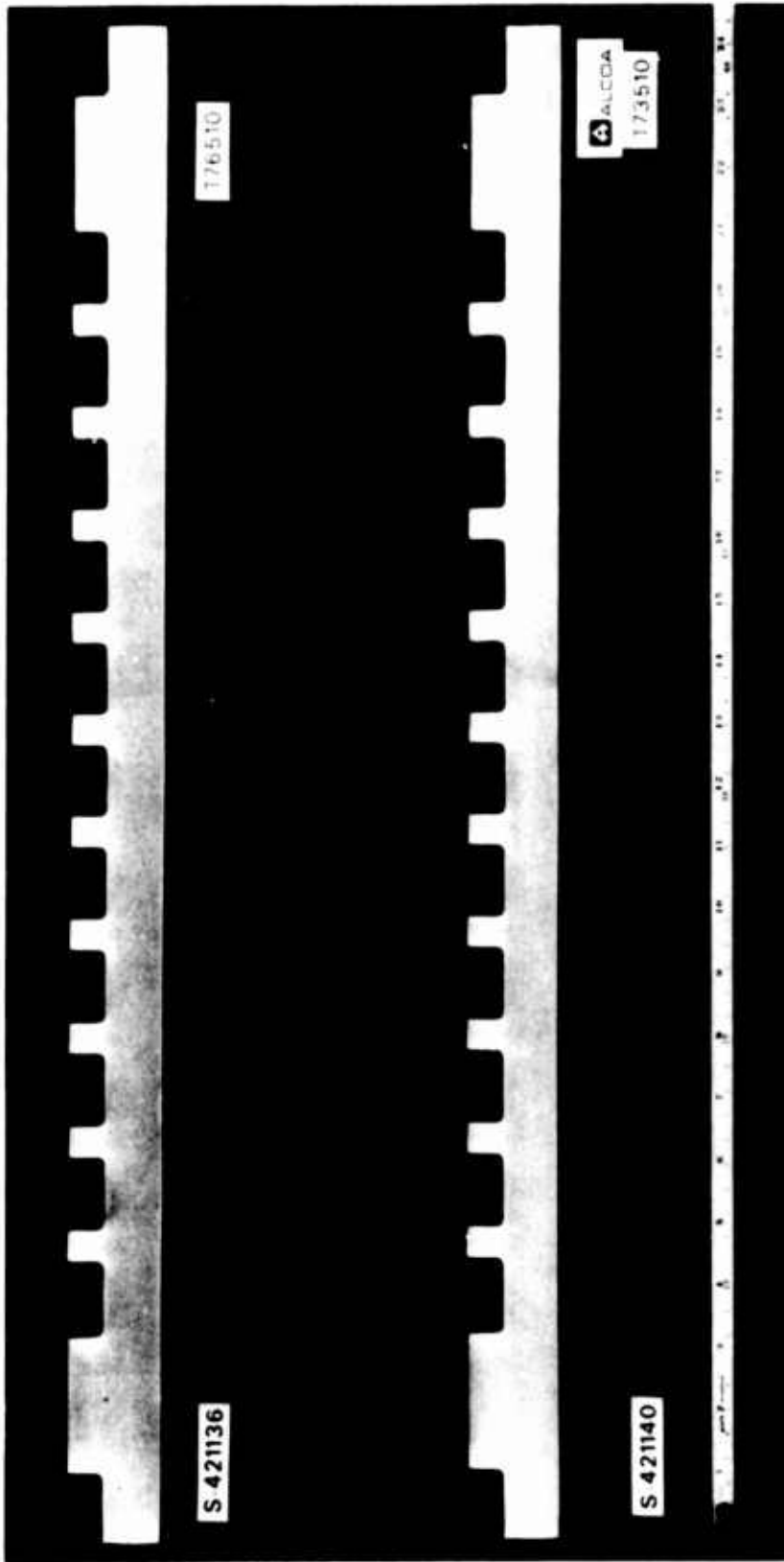

Figure 18 Macroetched Cross Sections of Alcoa Section 165822 Alloy 7050 Extrusions

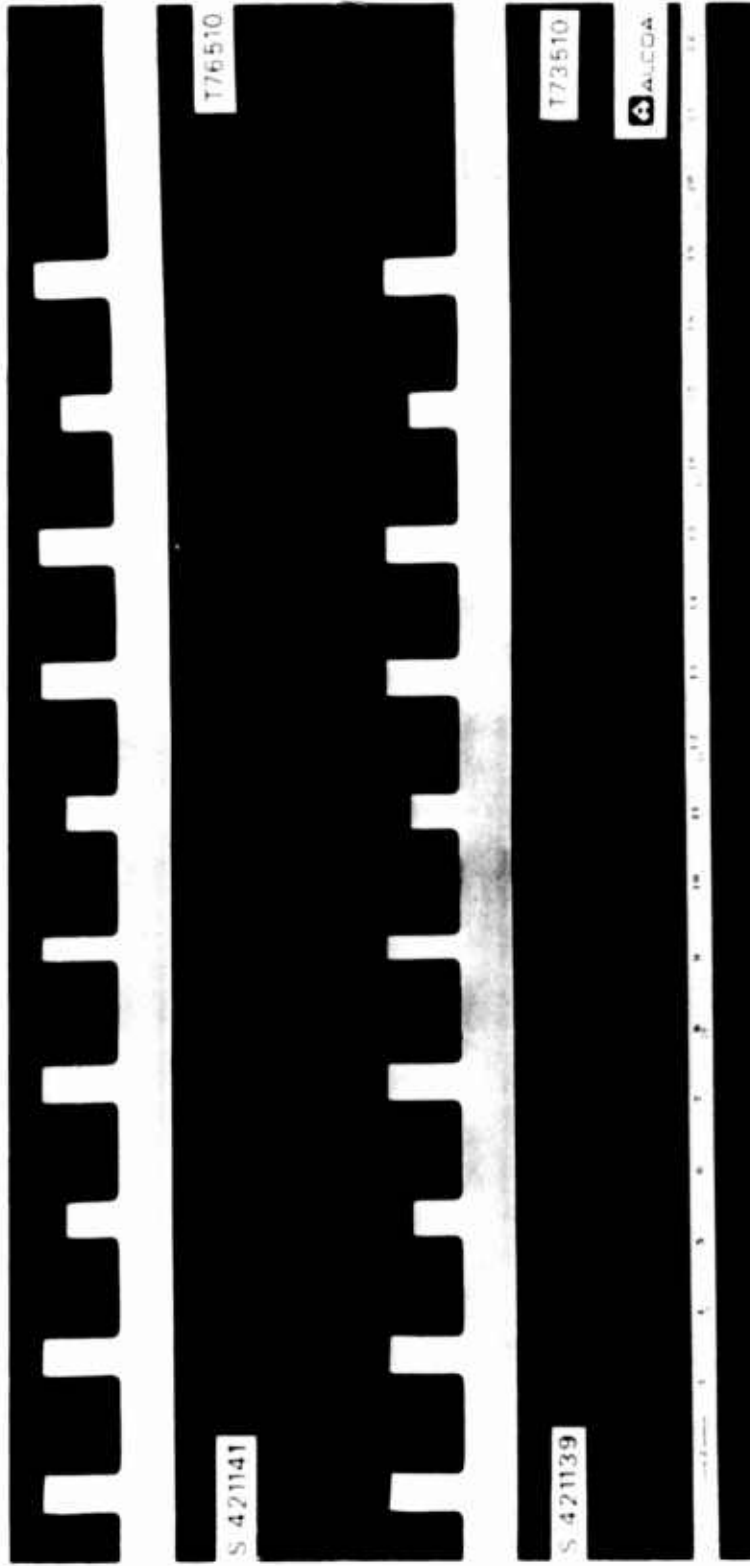

Figure 19 Macroetched Cross Sections of Alcoa Section 213592 Alloy 7050 Extrusions



Figure 20 Macroetched Cross Sections of Alcoa Section 263902 Alloy 7050 Extrusions

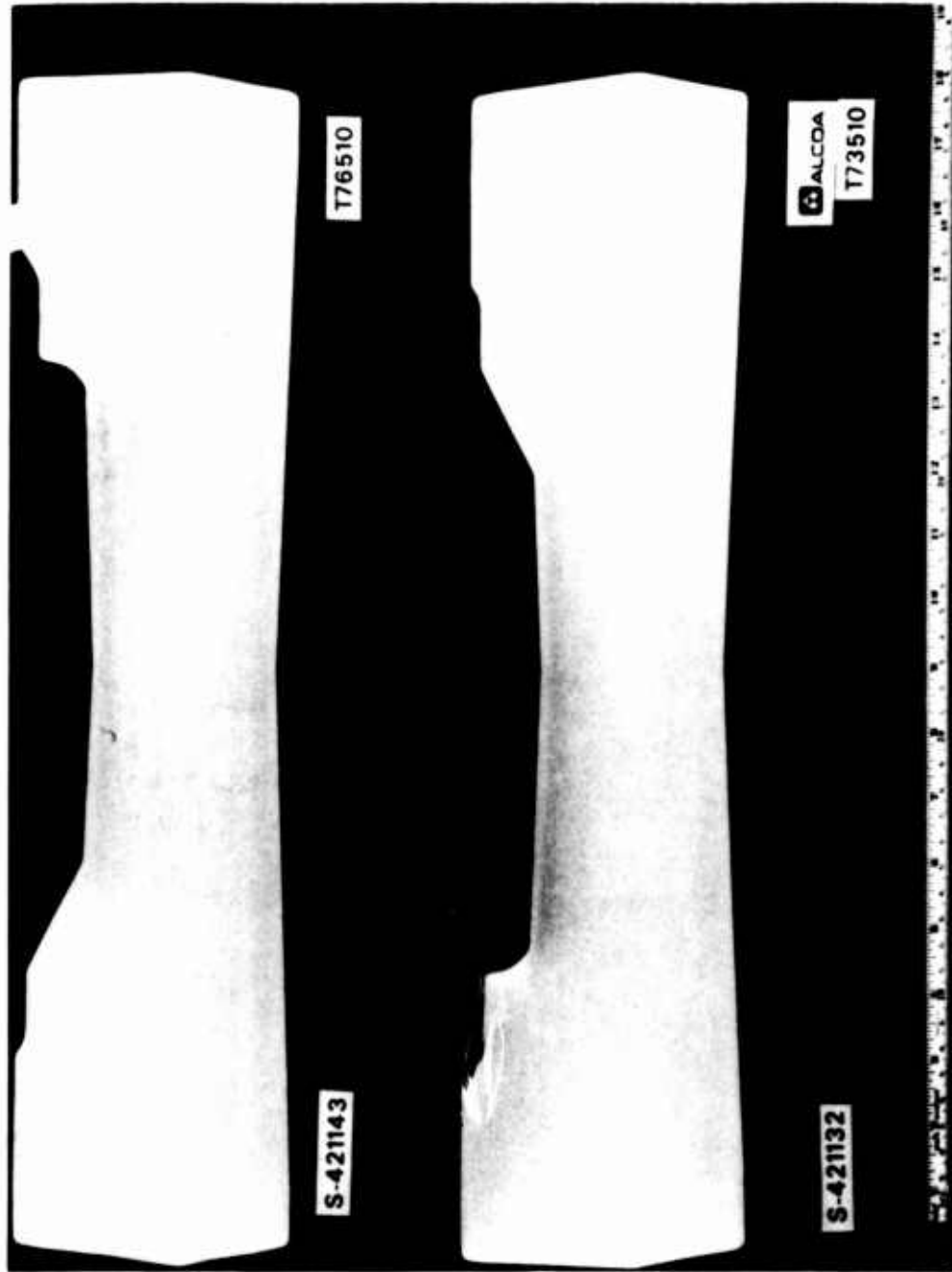

Figure 21 Macroetched Cross Sections of Alcoa Section 291812 Alloy 7050 Extrusions

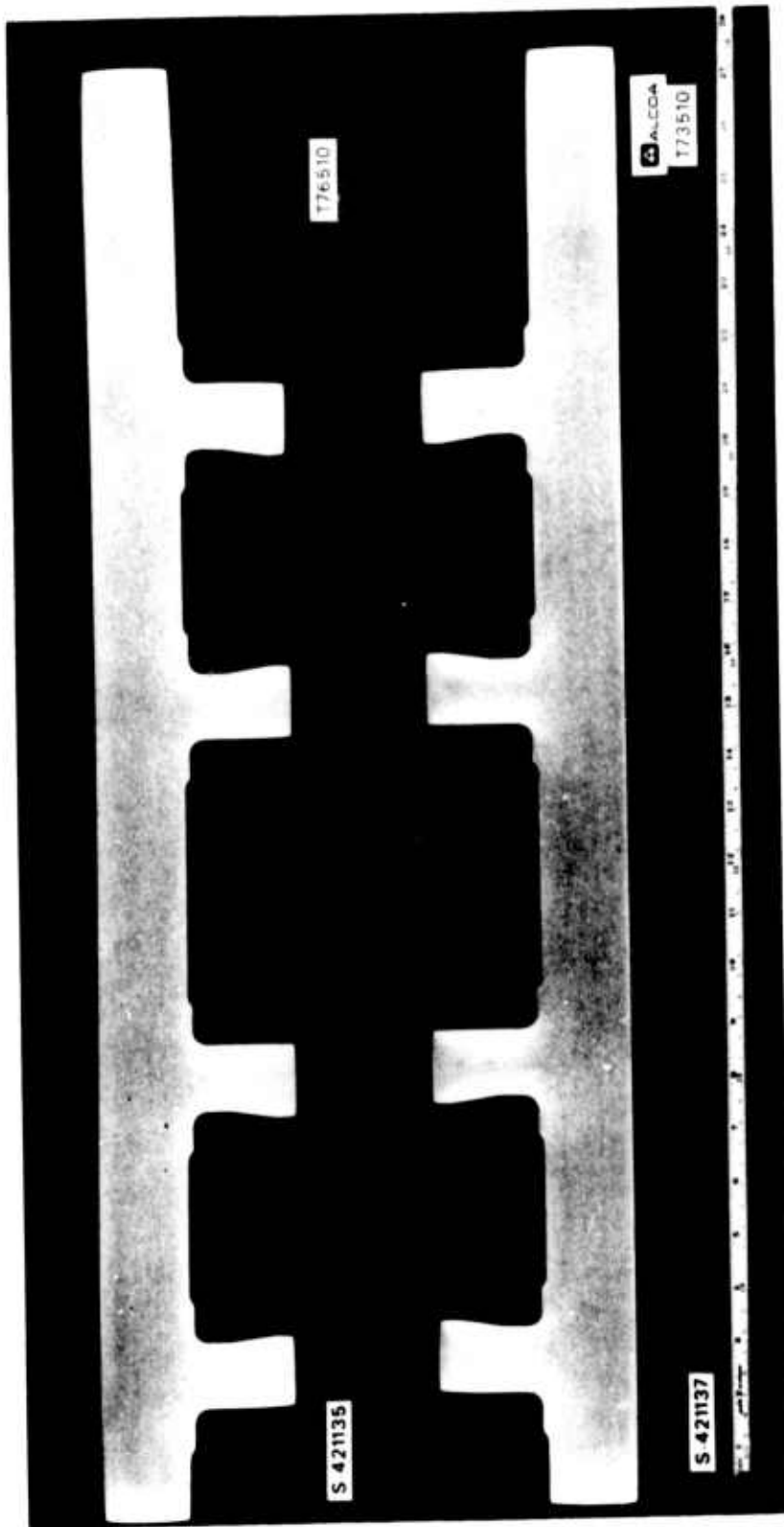

Figure 22 Macroetched Cross Sections of Alcoa Section 900102 Alloy 7050 Extrusions

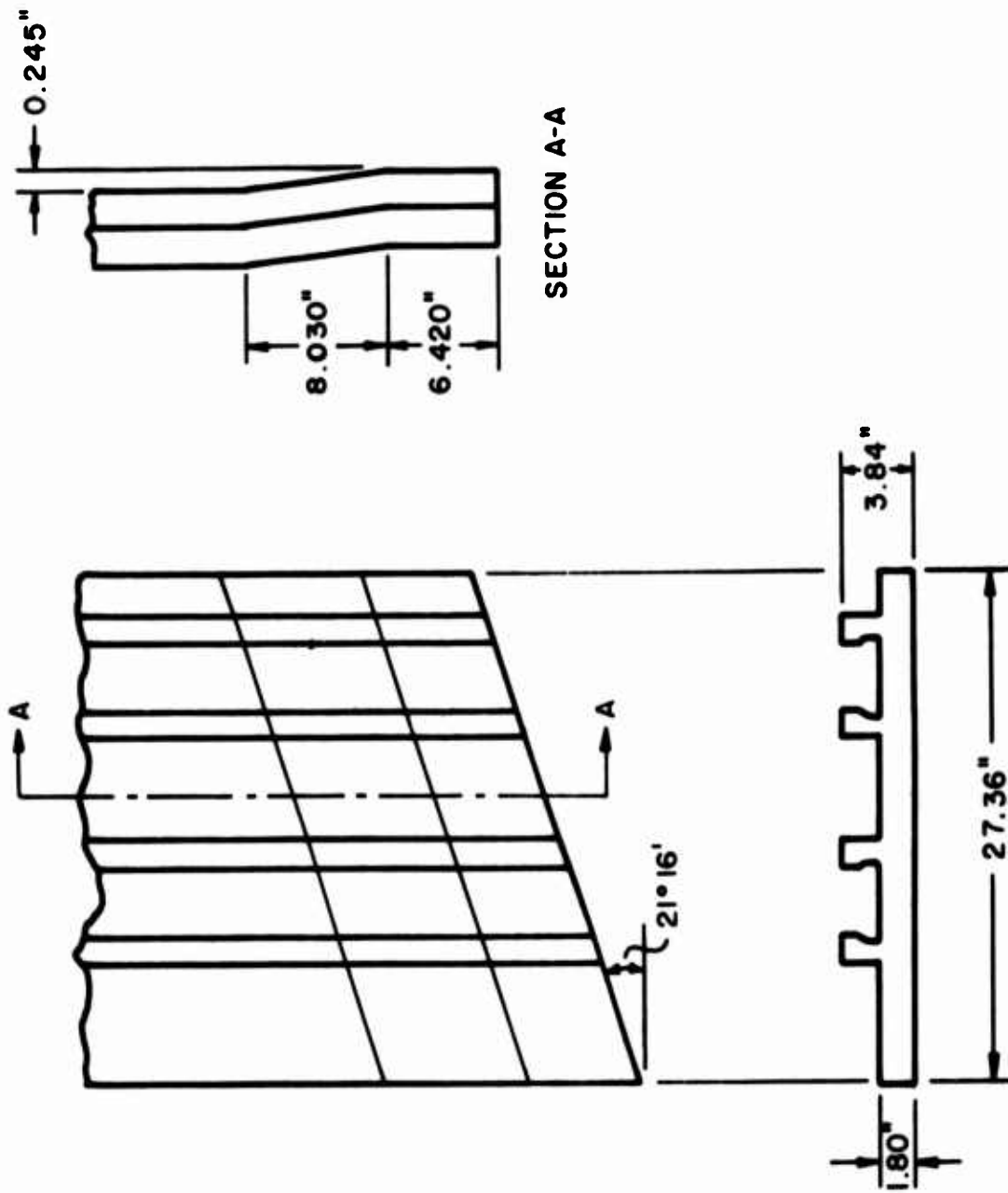

FIG. 23 ILLUSTRATES DETAILS OF JOGGLED END OF EXTRUSION FOR C5A.

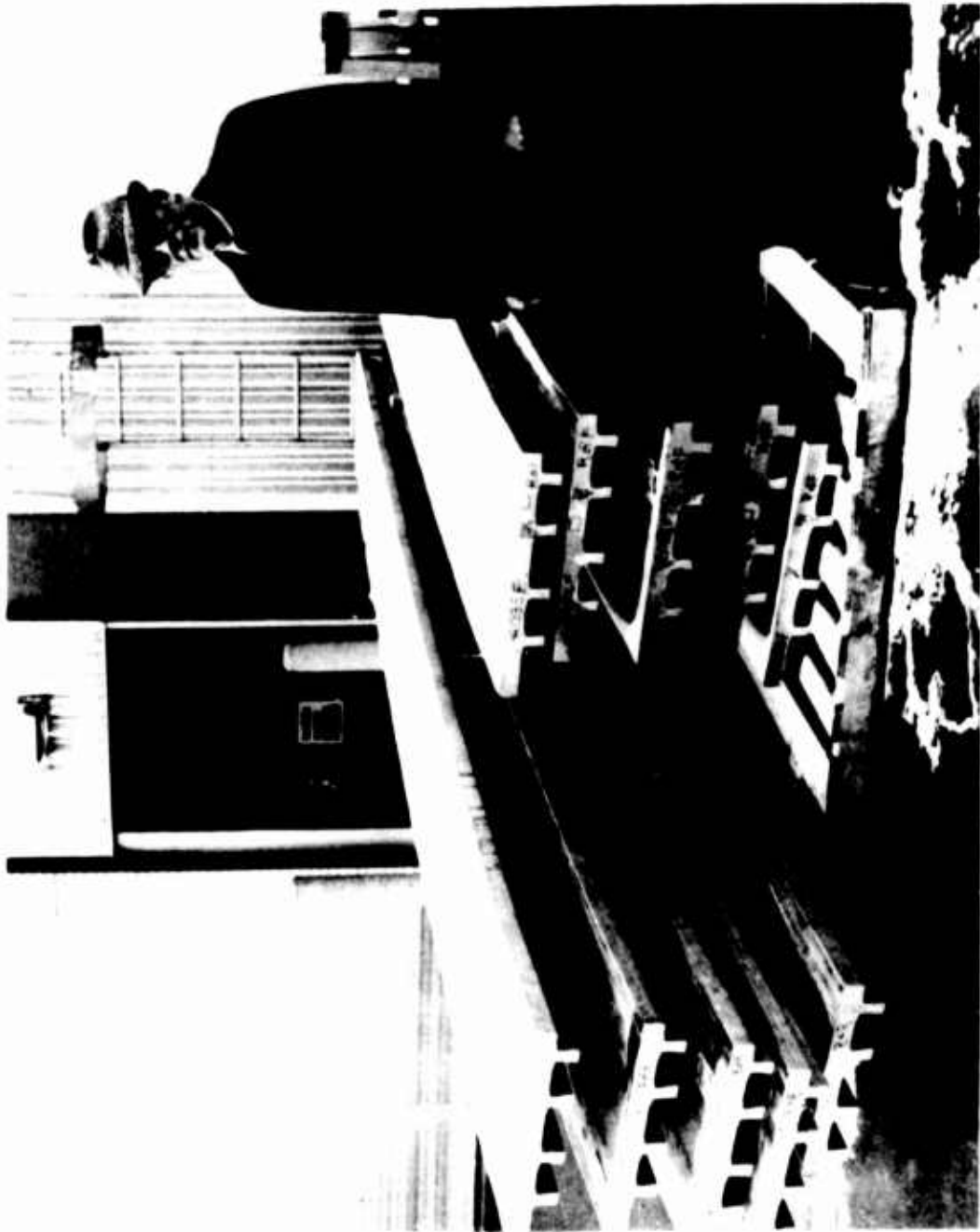

Figure 24 Joggled Extrusions for C5A Joggled Ends Face Camera

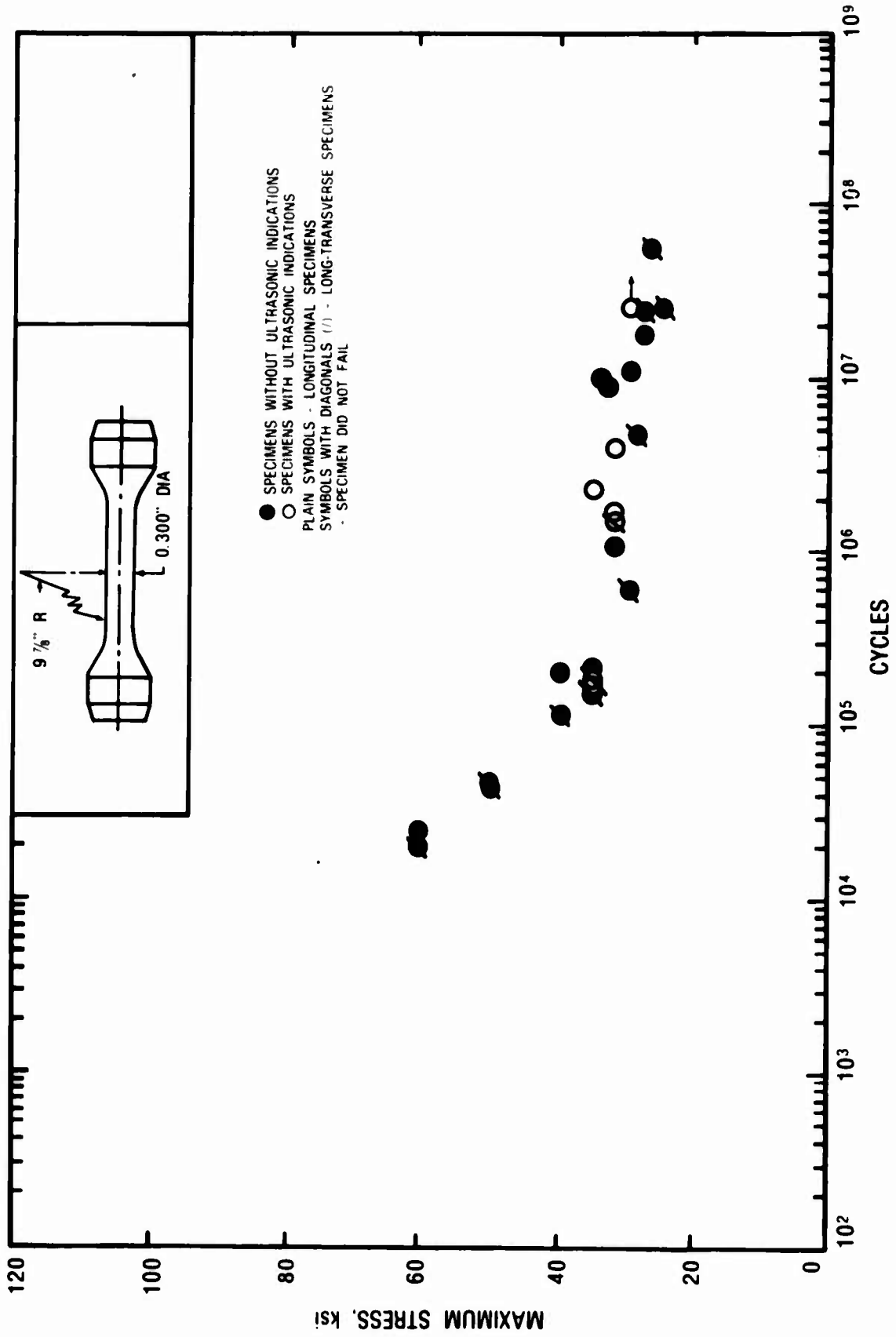
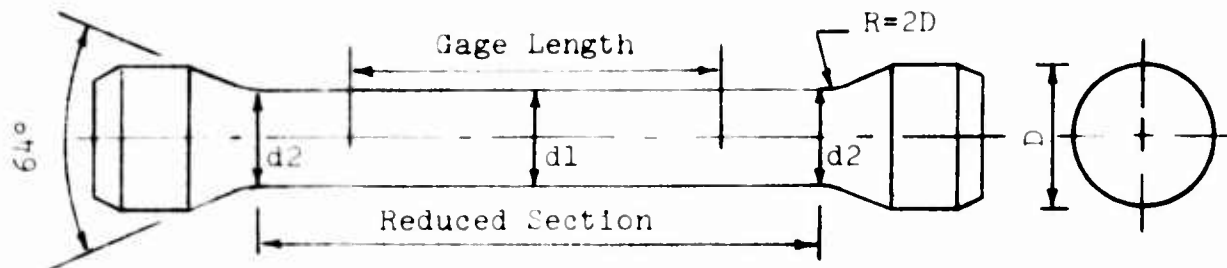
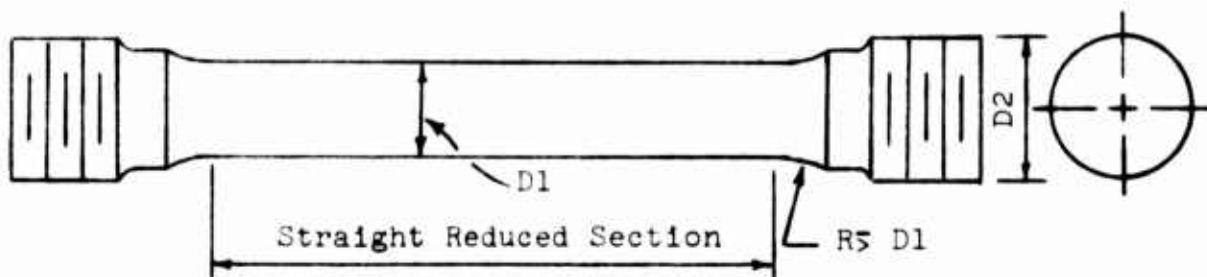

Figure 25 Effect of Ultrasonic Indications on Fatigue Performance



Diameter, in.		Gage Length, in.	Reduced-Section Length, in.	Diameter, (D) in.
d1	d2			
0.500 ± 0.005	d1 + $\frac{0.005}{0.003}$	2.0	3-1/8	3/4
0.357 ± 0.004	d1 + $\frac{0.004}{0.003}$	1.4	2-15/16	17/32
0.250 ± 0.003	d1 + $\frac{0.002}{0.001}$	1.0	1-9/16	3/8
0.160 ± 0.002	d1 + $\frac{0.002}{0.001}$	0.64	1	15/64
0.125 ± 0.001	d1 + $\frac{0.002}{0.001}$	0.50	25/32	3/16

Tapered-Seat Specimens



Diameter, in.		Reduced-Section Length, in.
D1	D2	
0.500 ± 0.003	3/4	3
0.375 ± 0.003	9/16	2-1/2
0.250 ± 0.002	7/16	1-1/2

Stress-Strain and Modulus of Elasticity Specimens

Figure 26 Tensile Specimens

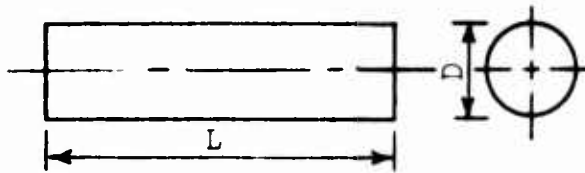

Nominal Diameter, in.	Diameter(D), in.	Length(L), in.
3/4 (a)	$\frac{0.7515}{0.7485}$	3-1/2
1/2 (a)(b)	$\frac{0.4980}{0.4950}$	1-7/8
3/8 (b)	$\frac{0.3765}{0.3735}$	1-1/2

- (a) Specimen for stress-strain tests
 (b) Specimen for autographic tests

Compressive Specimens

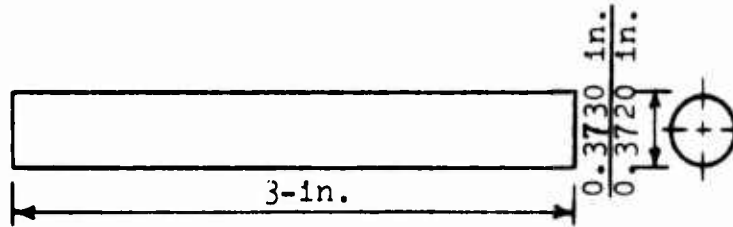

Shear Specimen

Figure 27 Compressive and Shear Specimens

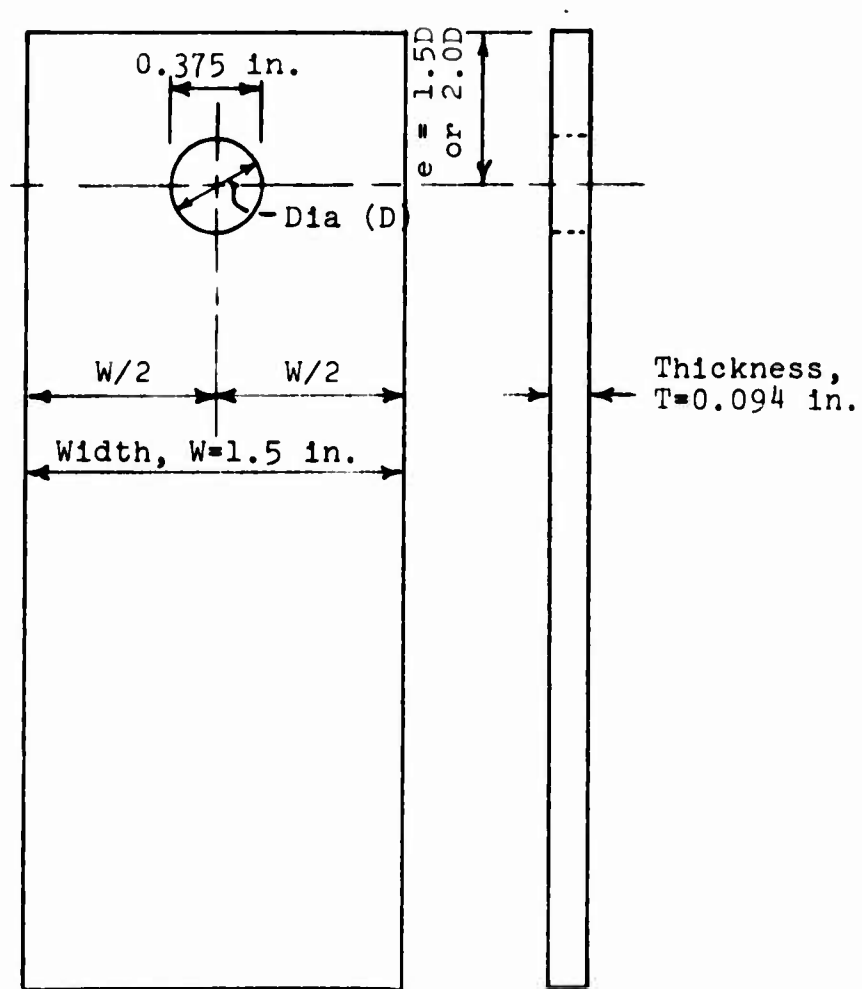

Figure 28 Bearing Specimen

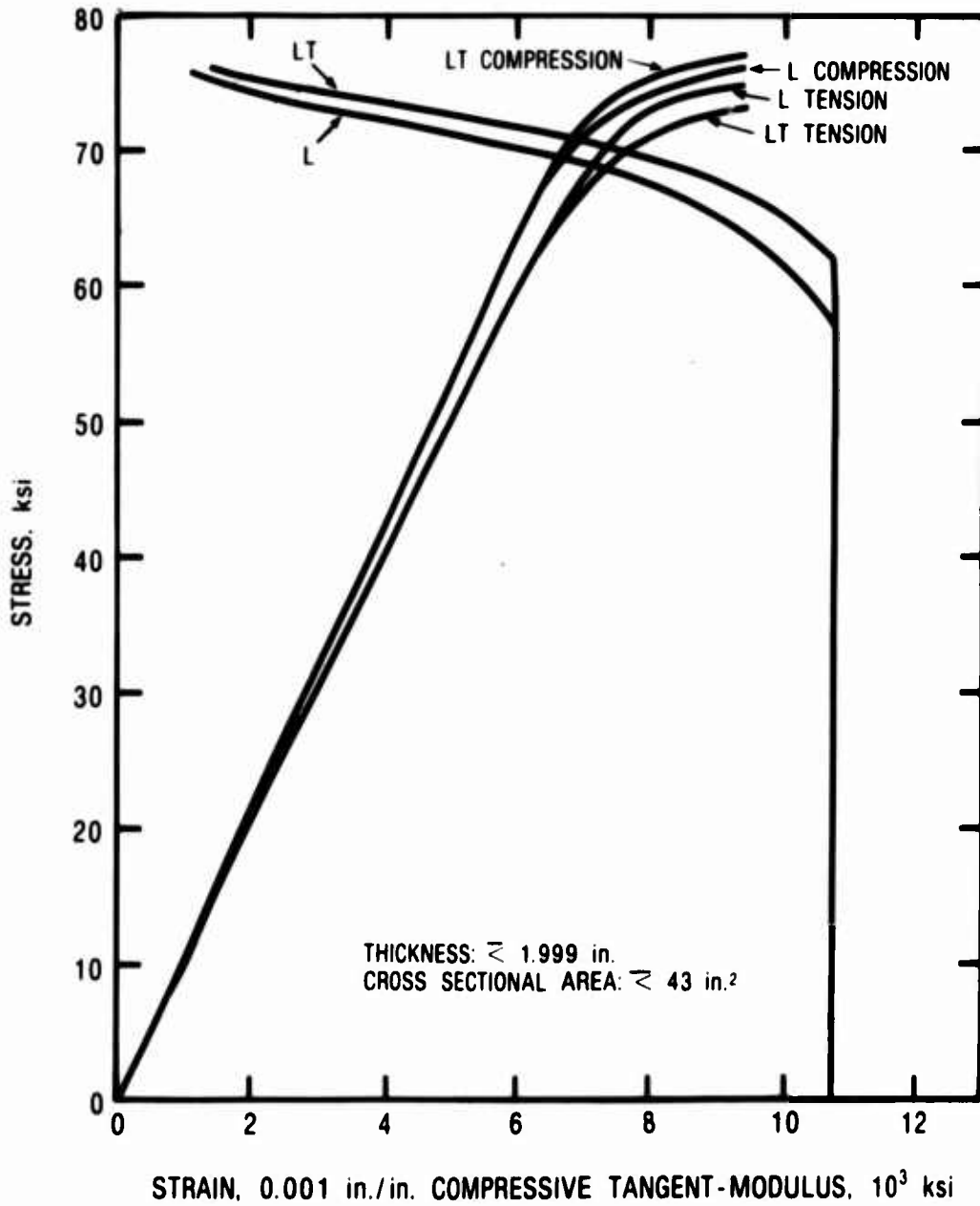

Figure 29 Typical Stress-Strain and Compressive Tangent-Modulus Curves for 7050-T7651X Extruded Shapes

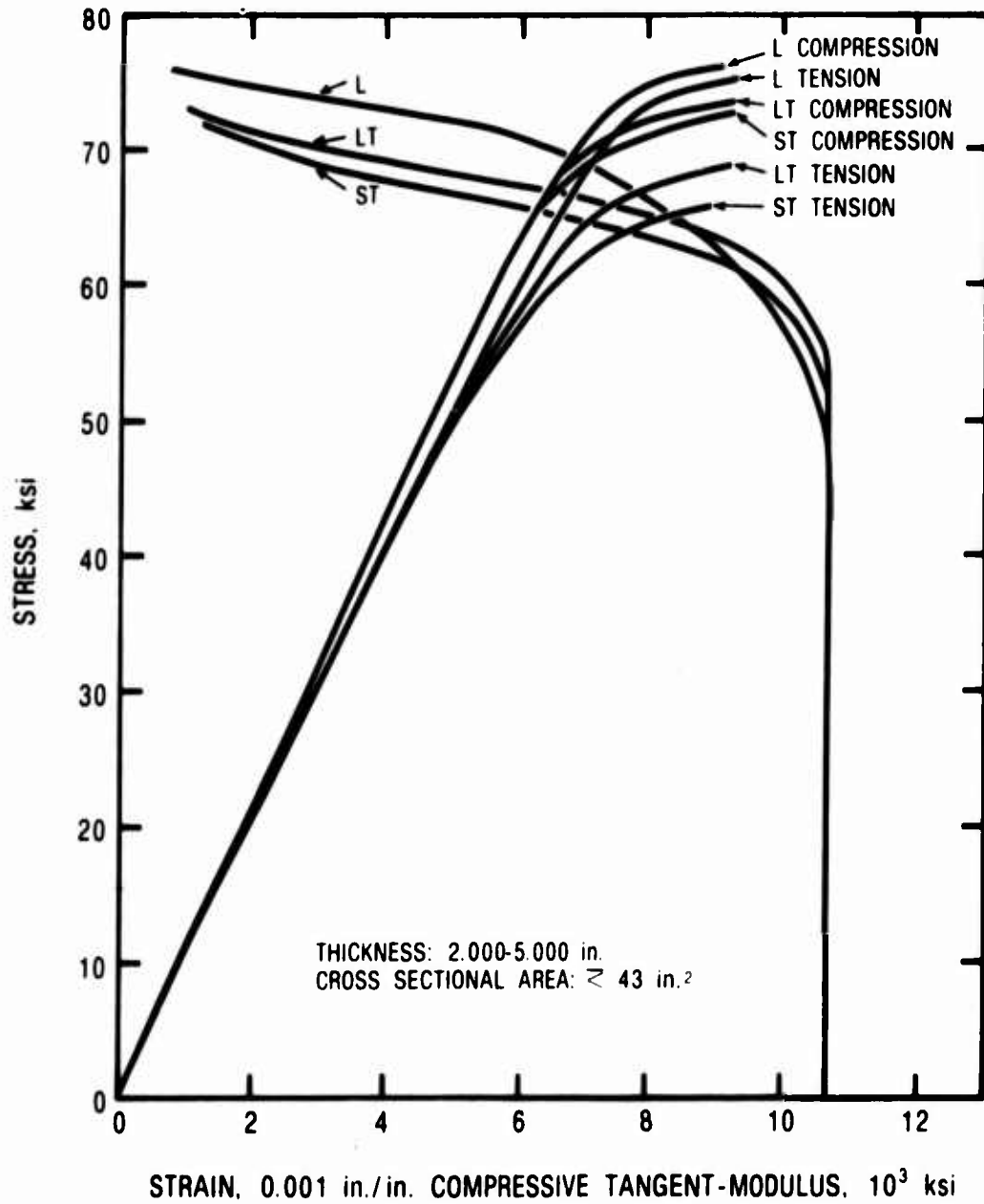

Figure 30 Typical Stress-Strain and Compressive Tangent-Modulus Curves for 7050-T7651X Aluminum Alloy Extruded Shapes

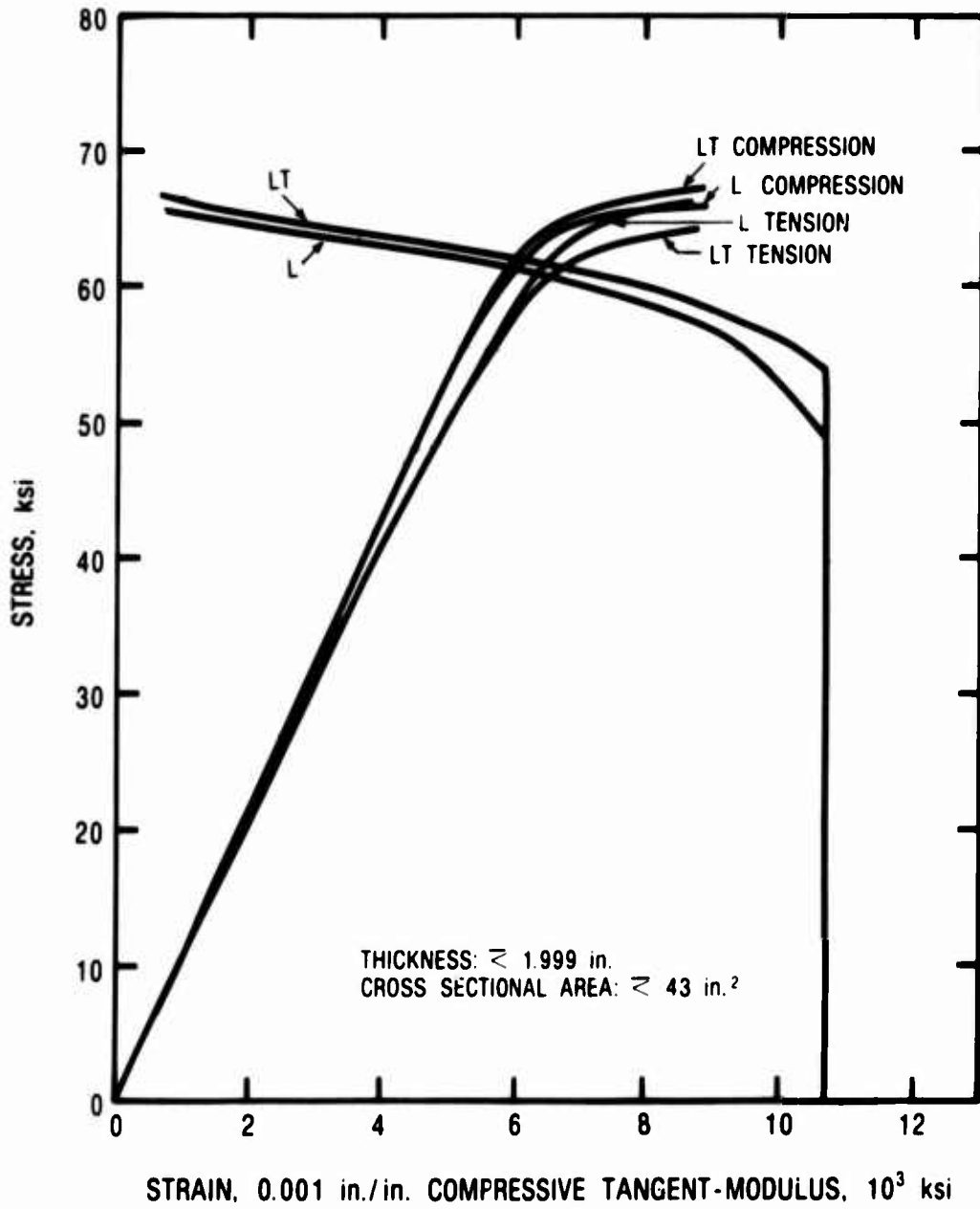

Figure 31 Typical Stress-Strain and Compressive Tangent-Modulus Curves for 7050-T7351X Extruded Shapes

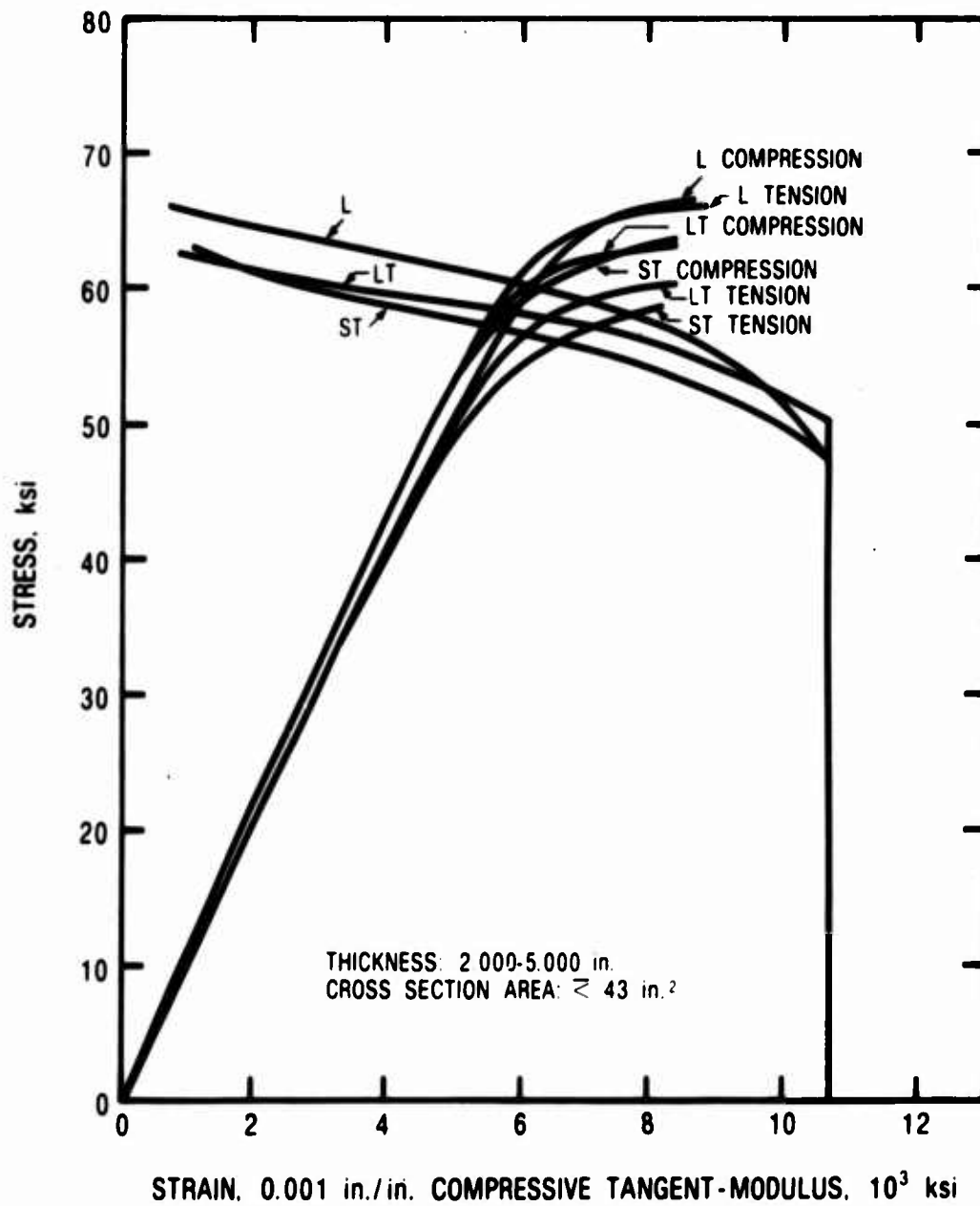

Figure 32 Typical Stress-Strain and Compressive Tangent-Modulus Curves for 7050-T7351X Extruded Shapes

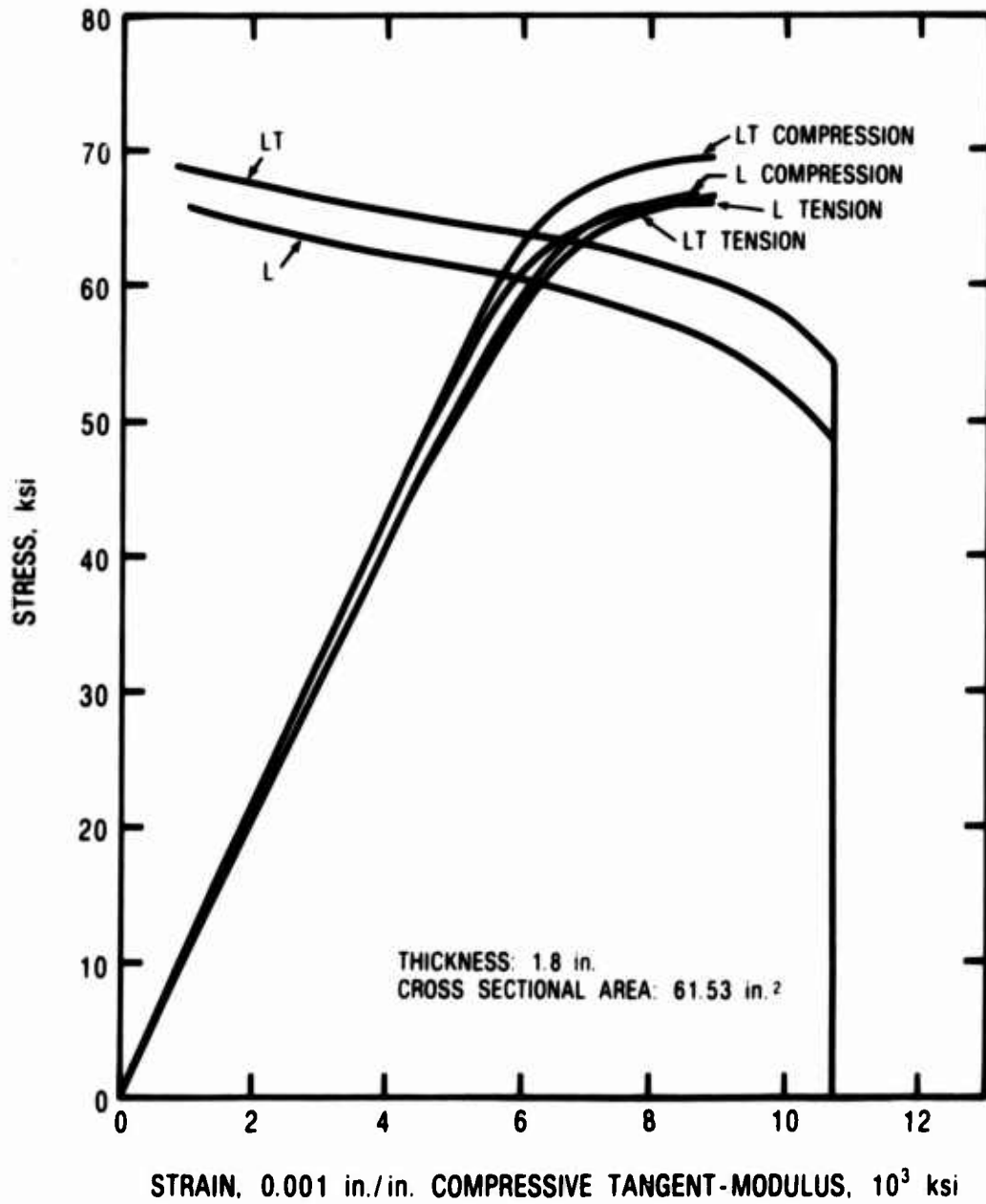
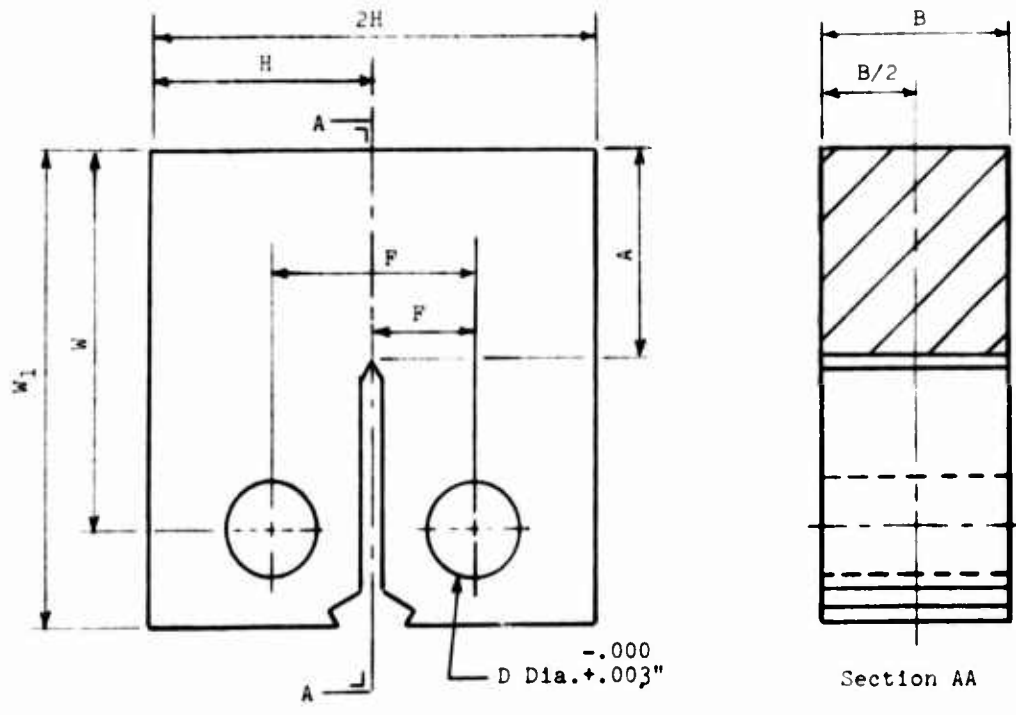
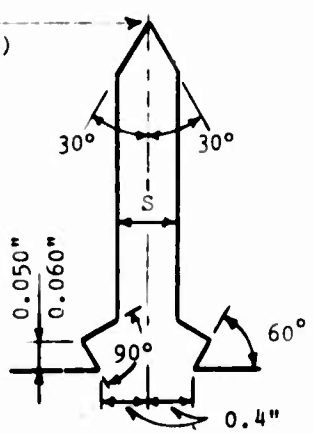

Figure 33 Average Stress-Strain and Compressive Tangent-Modulus Curves for 7050-T7351X Extruded Aluminum Alloy C5A Wing Panels



0.010" R Max
(Notch Root Radius)



- Proportions
- B = Thickness
 - A = 1.1B
 - W = 2B; $W_1 = 2.5B$
 - S = 0.1B
 - F = 2E = 1.10B
 - H = 1.2B
 - D = 0.5B

Figure 34 Compact Fracture Toughness Specimen

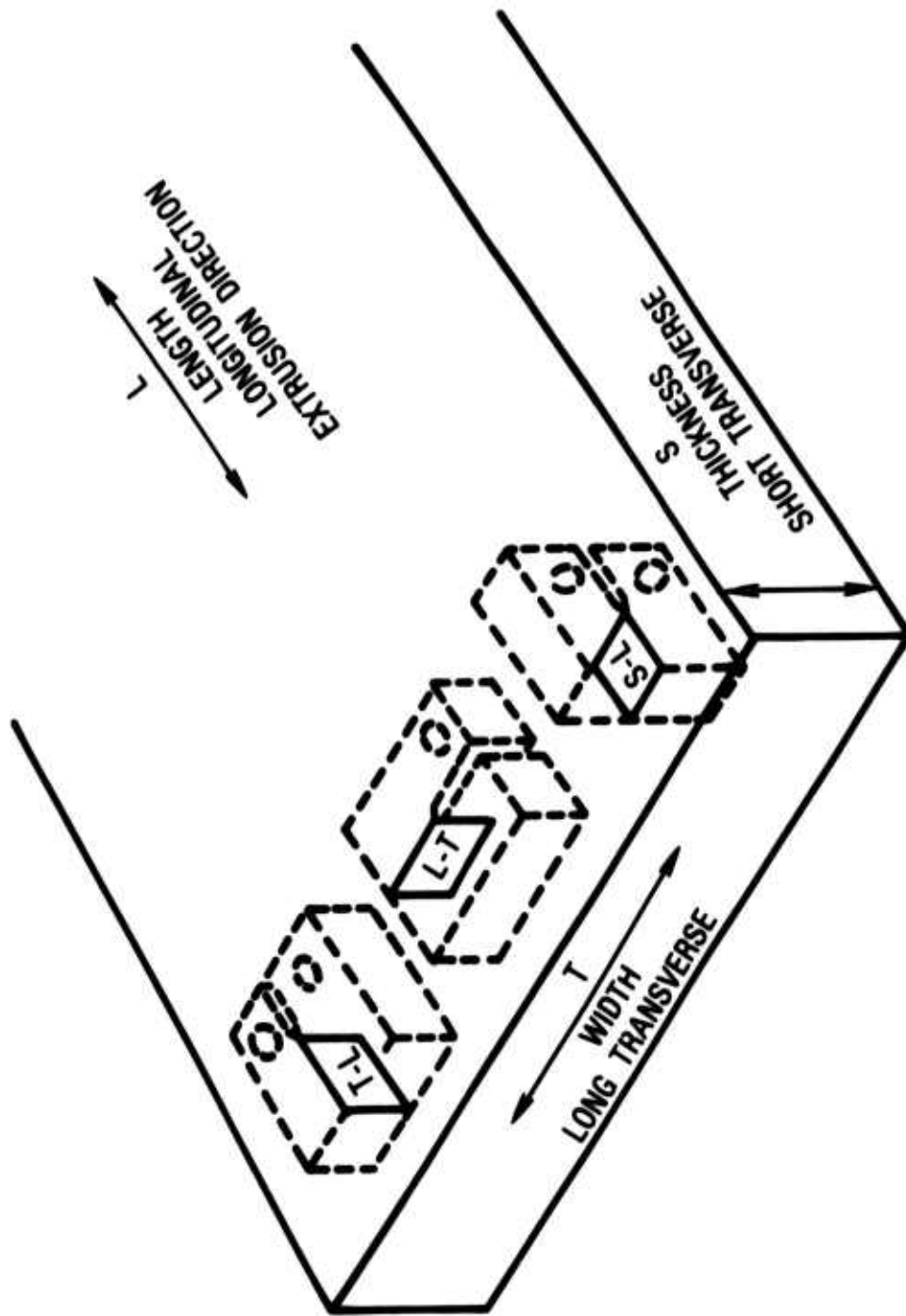

Figure 35 Fracture Specimen Orientations

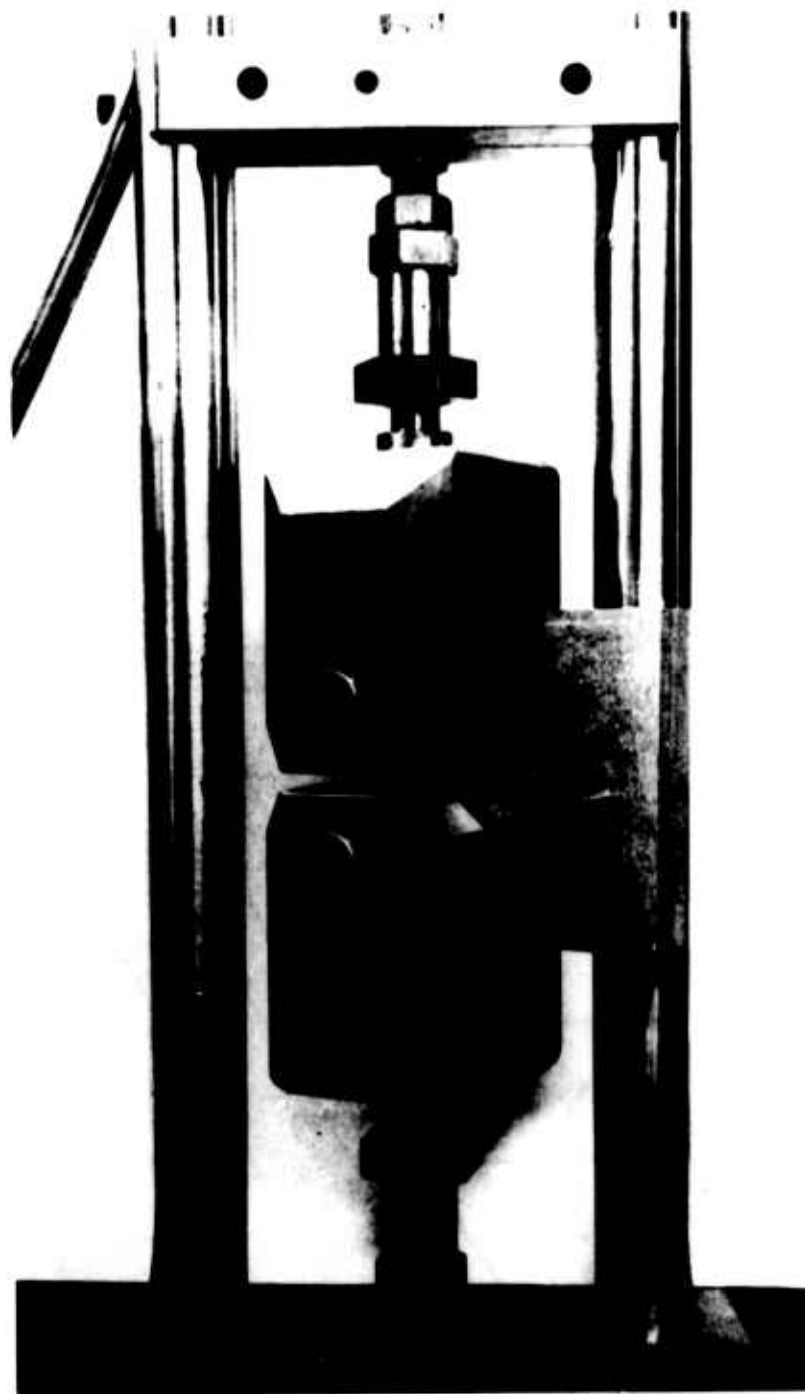

Figure 36 Set-up for Fatigue Precracking of Compact Tension Fracture Toughness Specimens



Figure 37 Set-up for Testing Compact Tension Fracture Toughness Specimens

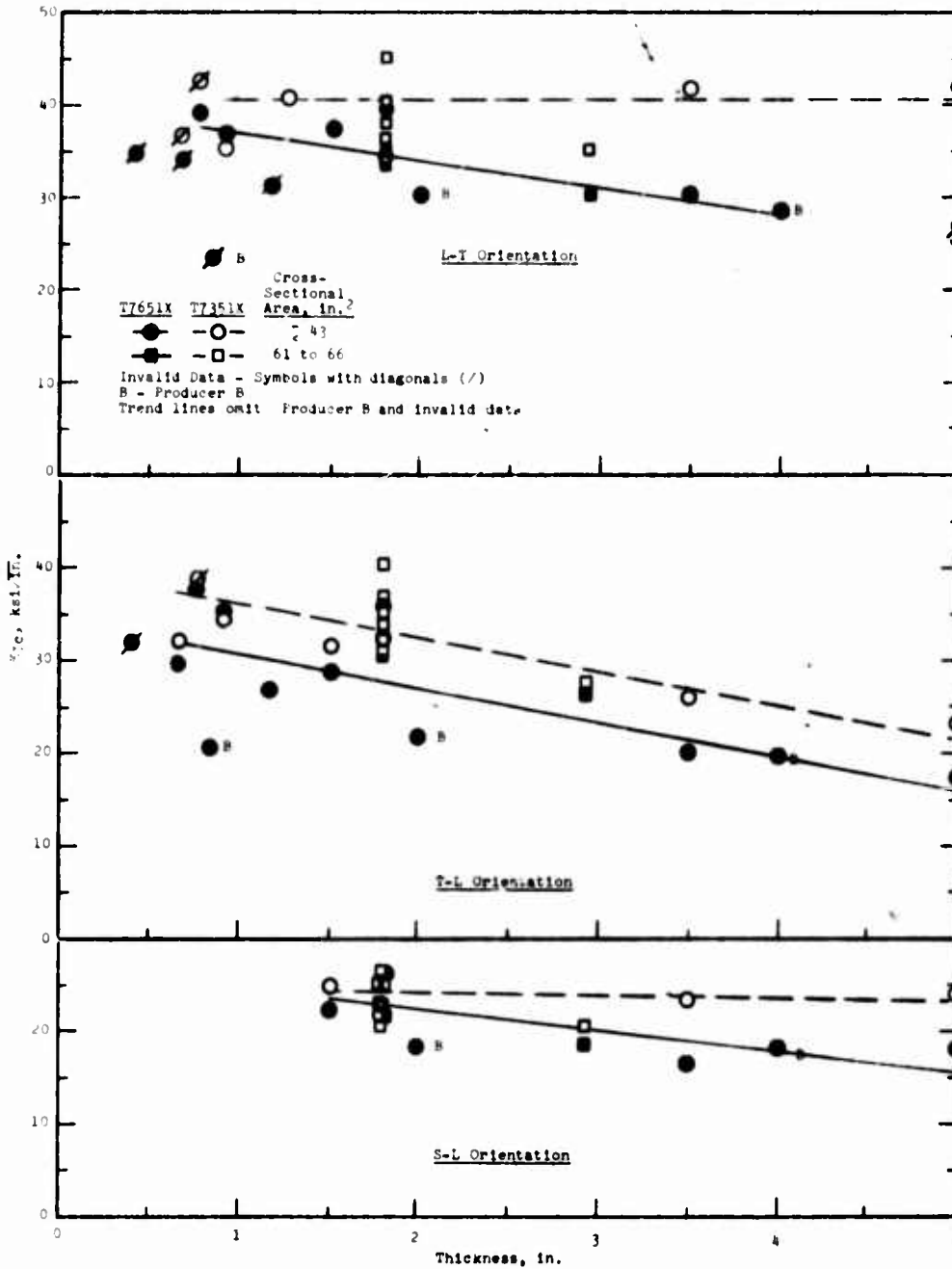

Figure 38 K_{Ic} Versus Thickness of 7050-T7651X and 7050-T7351X Extruded Shapes

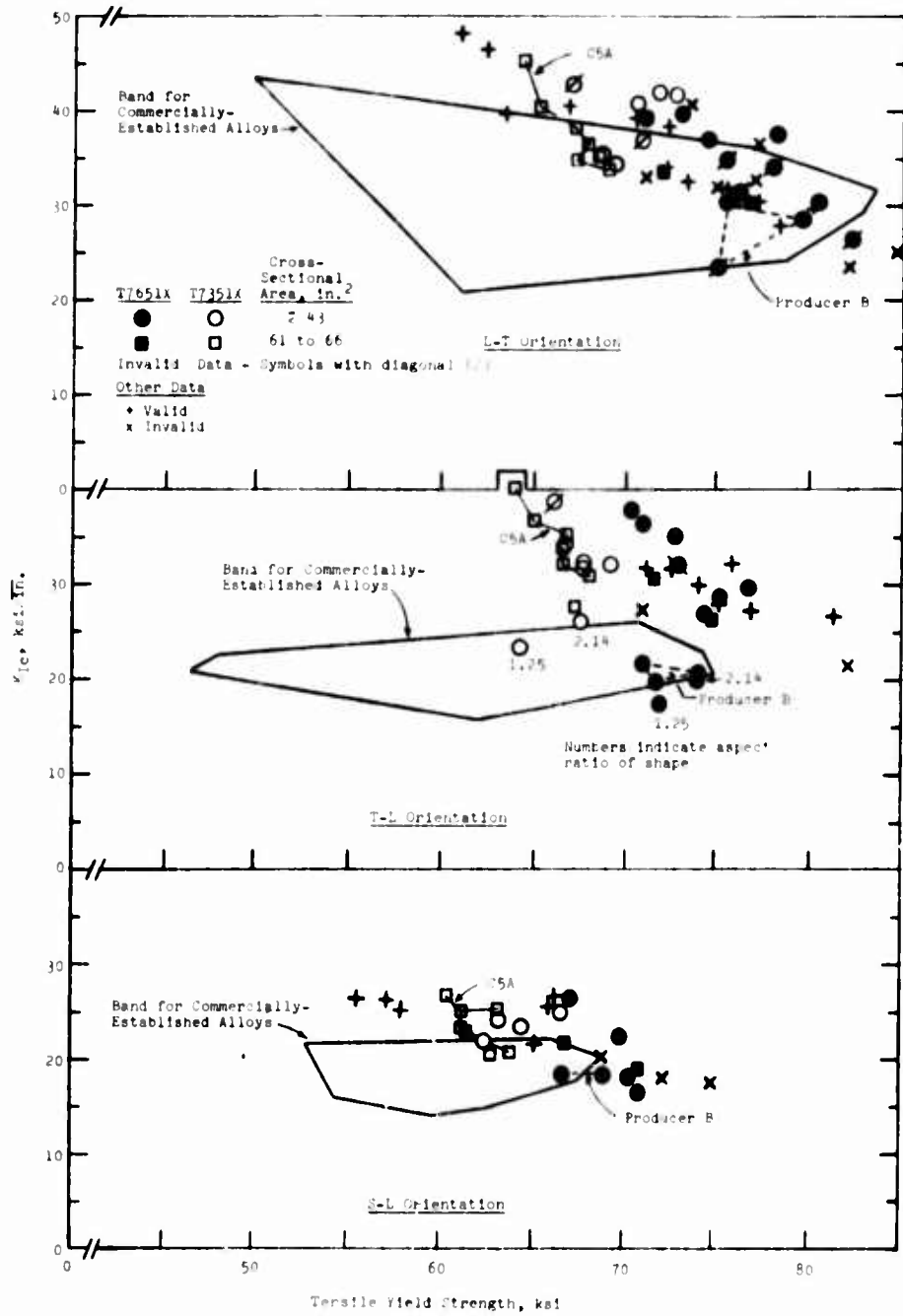

Figure 39 K_{1c} Versus Tensile Yield Strength of 7050-T7651X and 7050-T7351X Extruded Shapes

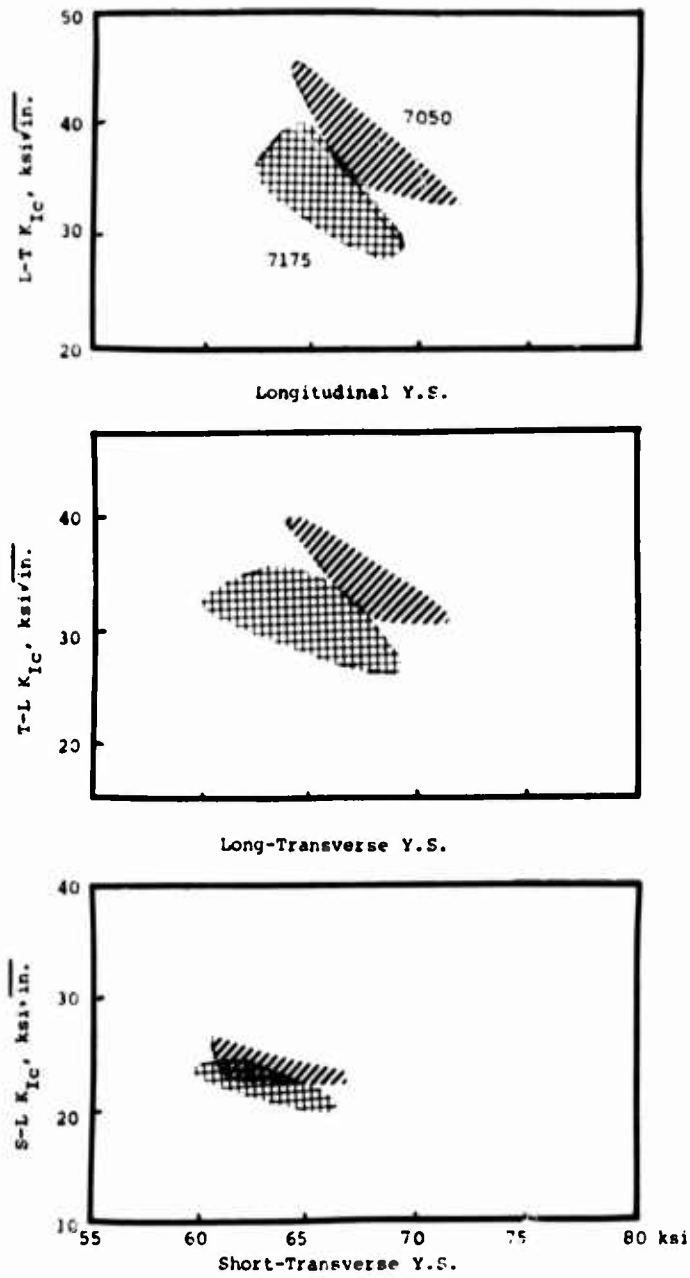
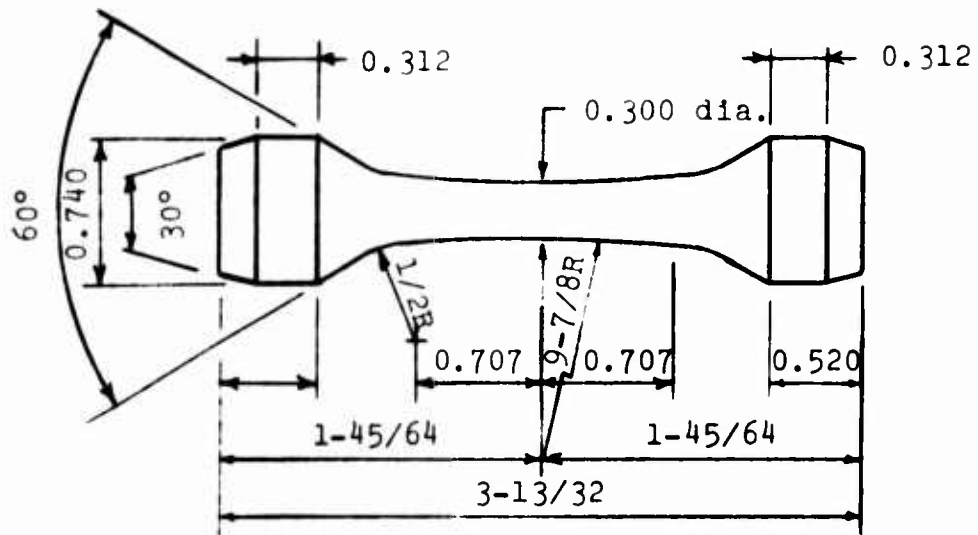
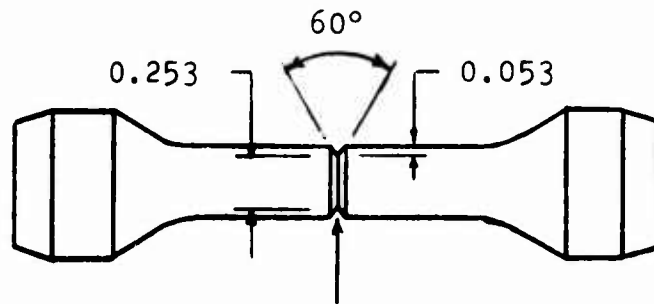

Figure 40. Compares strength and toughness of 7050 and 7175 extrusions, Section 900102, Wing Panel for C5A.



Smooth Specimen



Notch-Tip Radius, $R_t = 0.013$
 $K_t = 3$

Notched Specimen

NOTE: All dimensions
in inches

Figure 41 Smooth and Notched Axial-Stress Fatigue Specimens

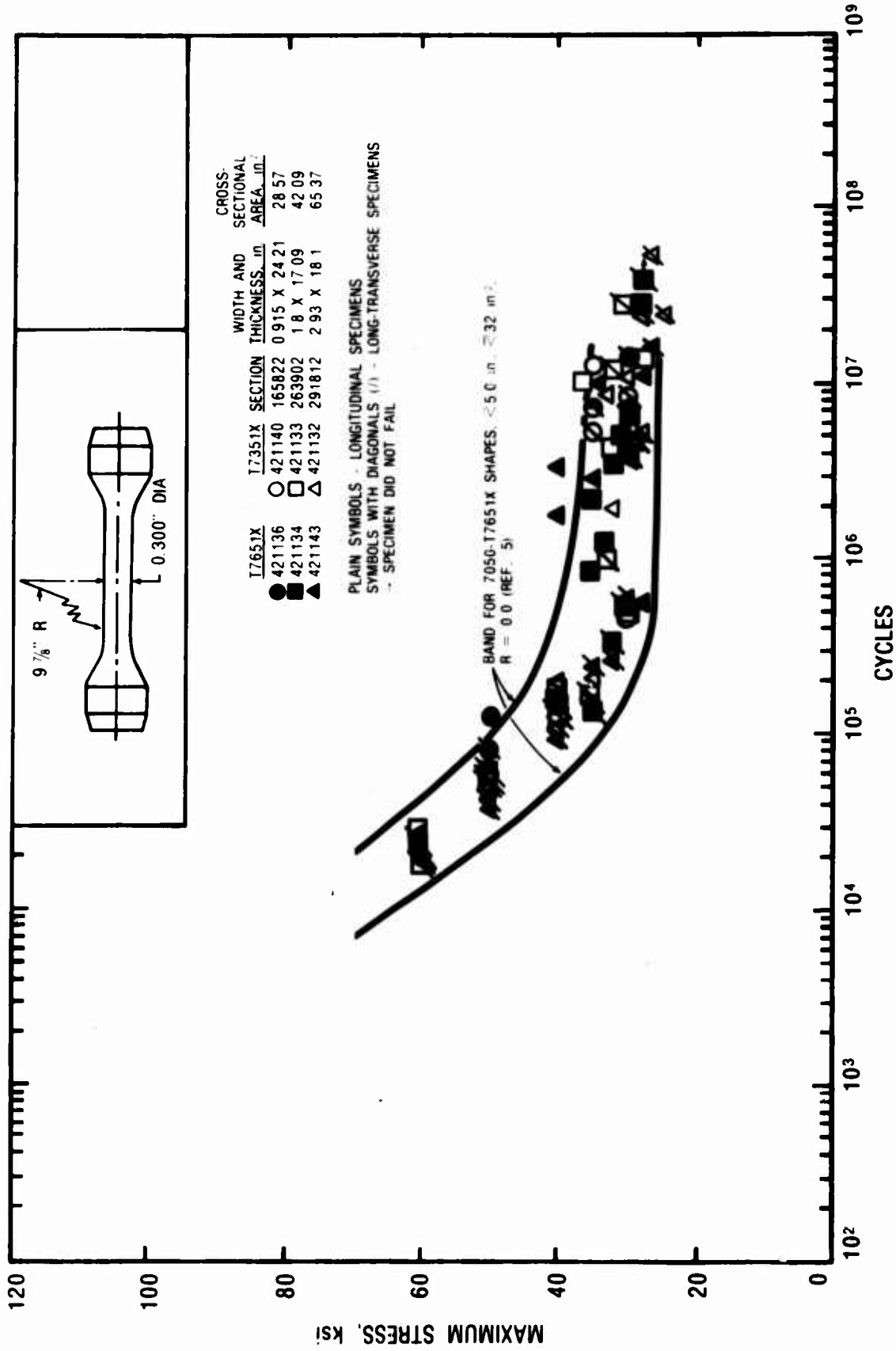

Figure 42 Smooth Fatigue, R = +0.1

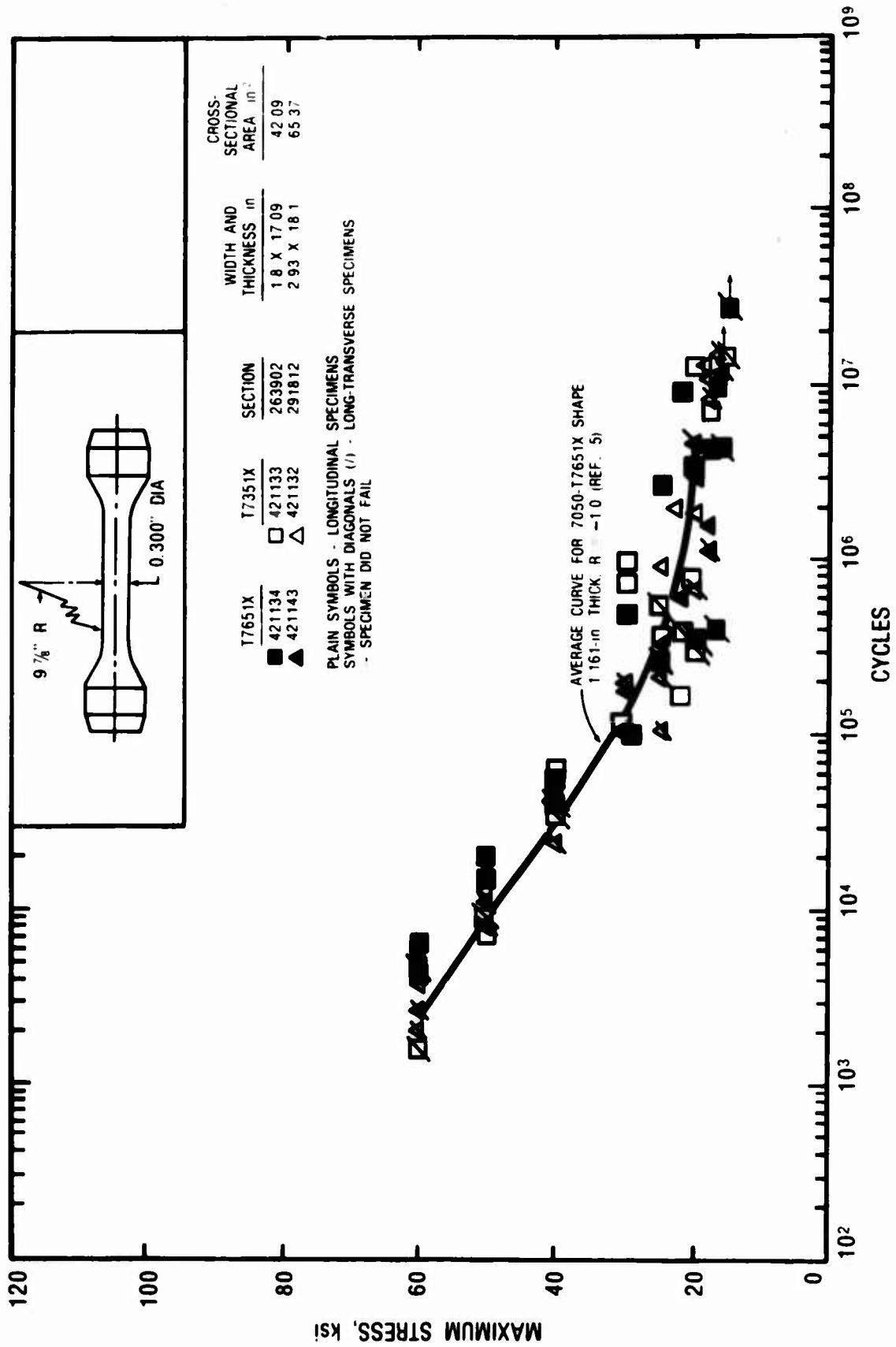

Figure 43 Smooth Fatigue, R=-1.0

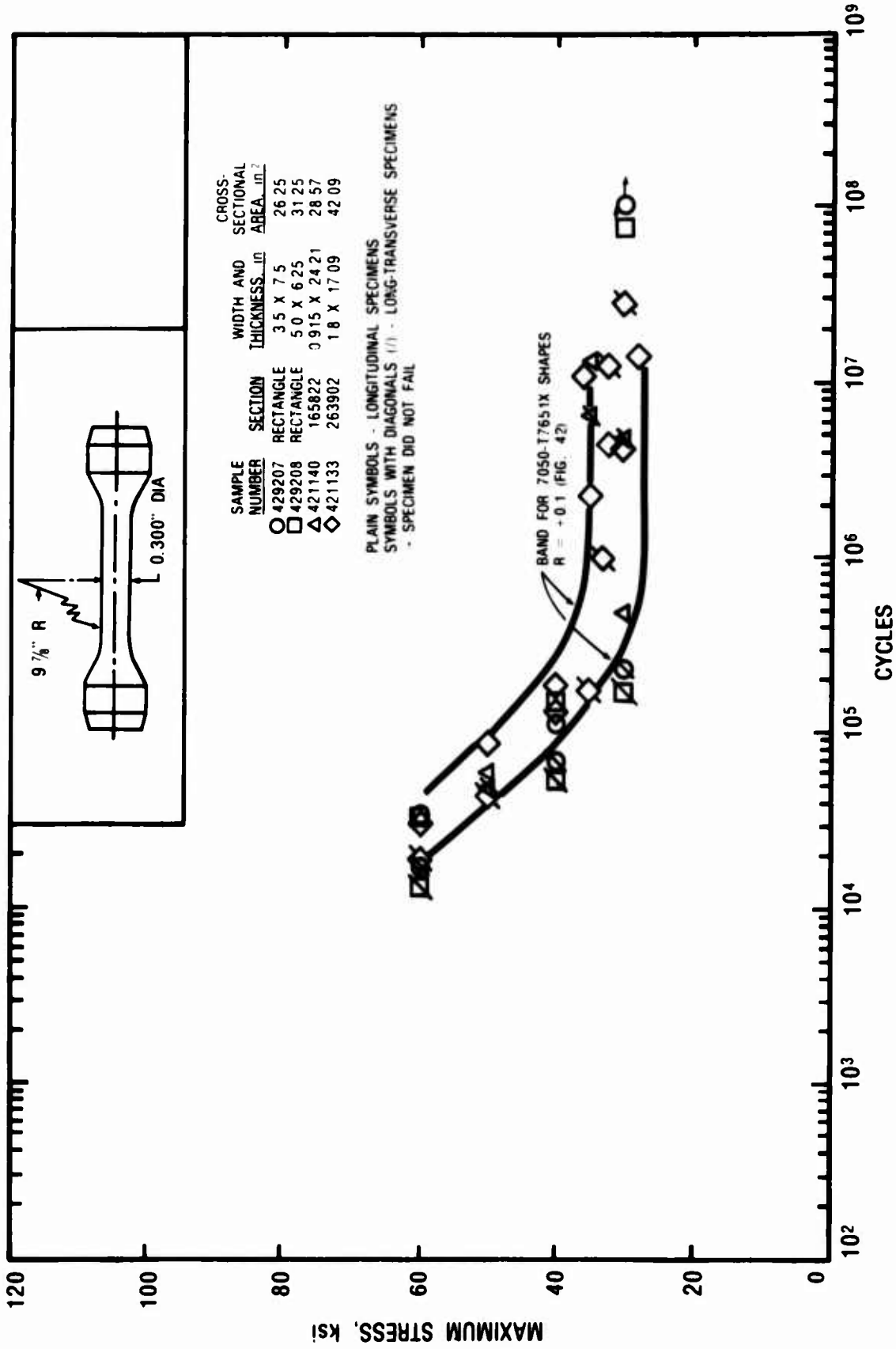

Figure 44 Smooth Fatigue, R=+0.1 (Smaller Shape)

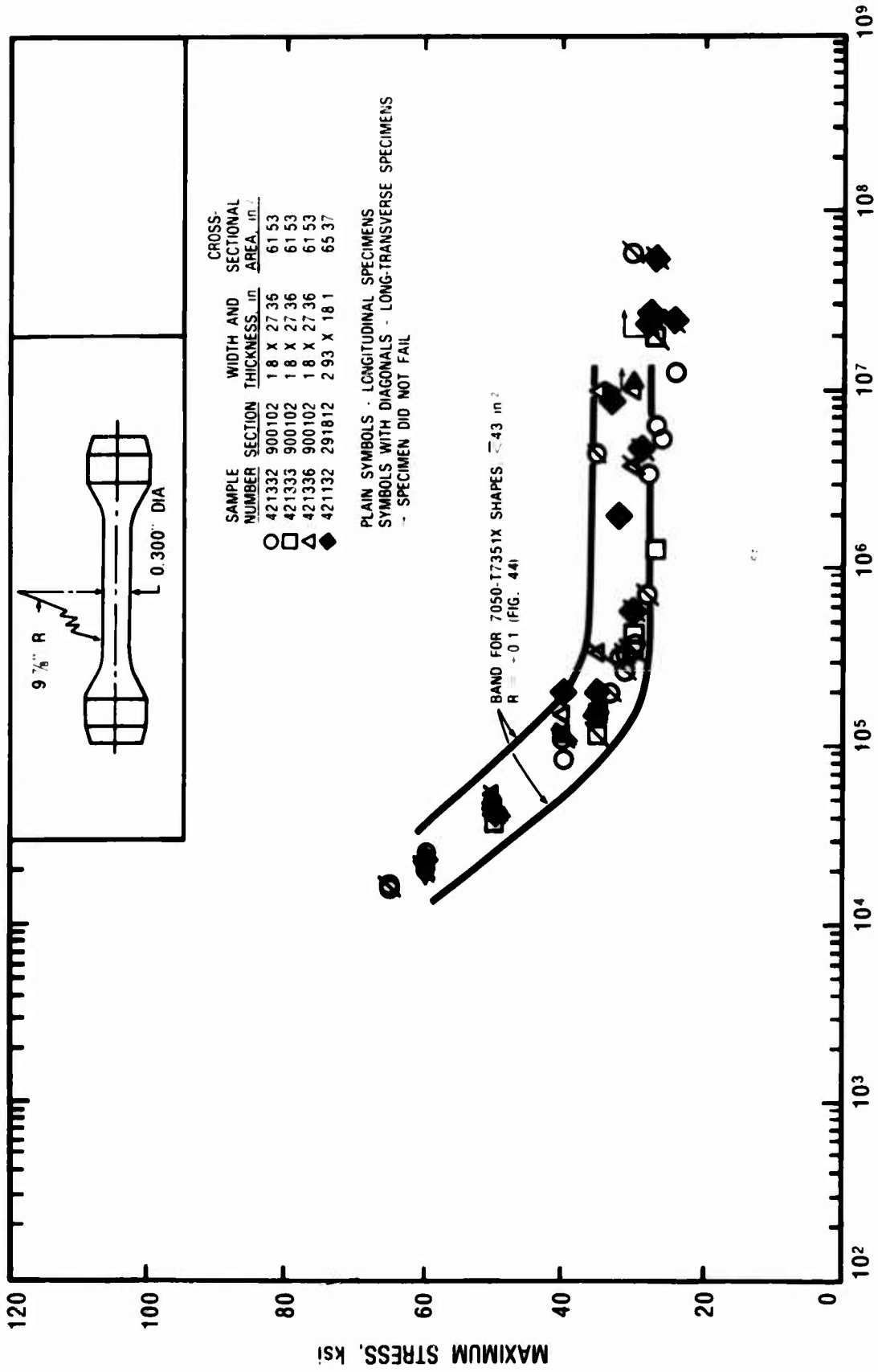

Figure 45 Smooth Fatigue, R=+0.1 (Larger Shape)

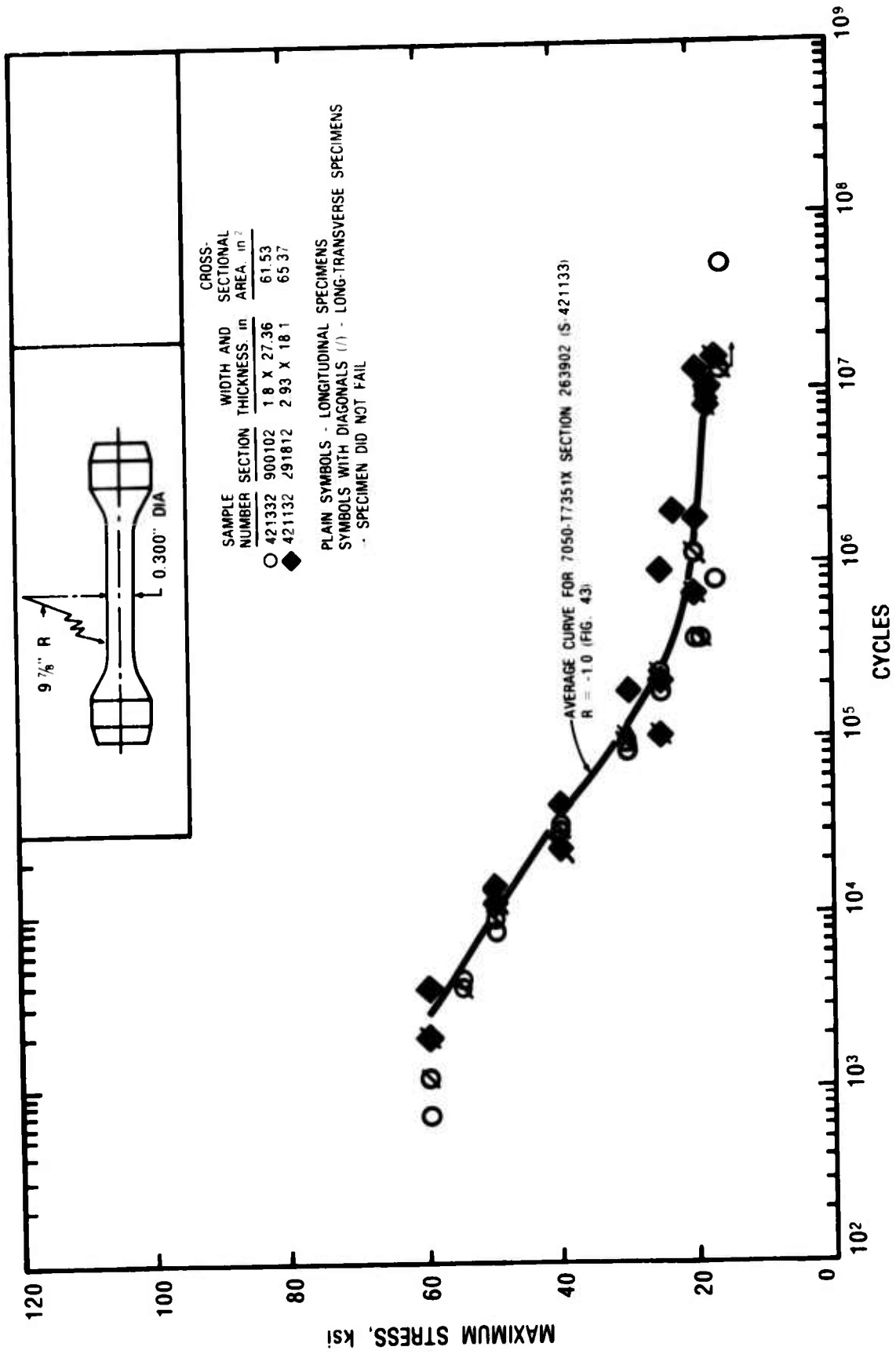

Figure 46 Smooth Fatigue, R = -1.0 (Larger Shape)

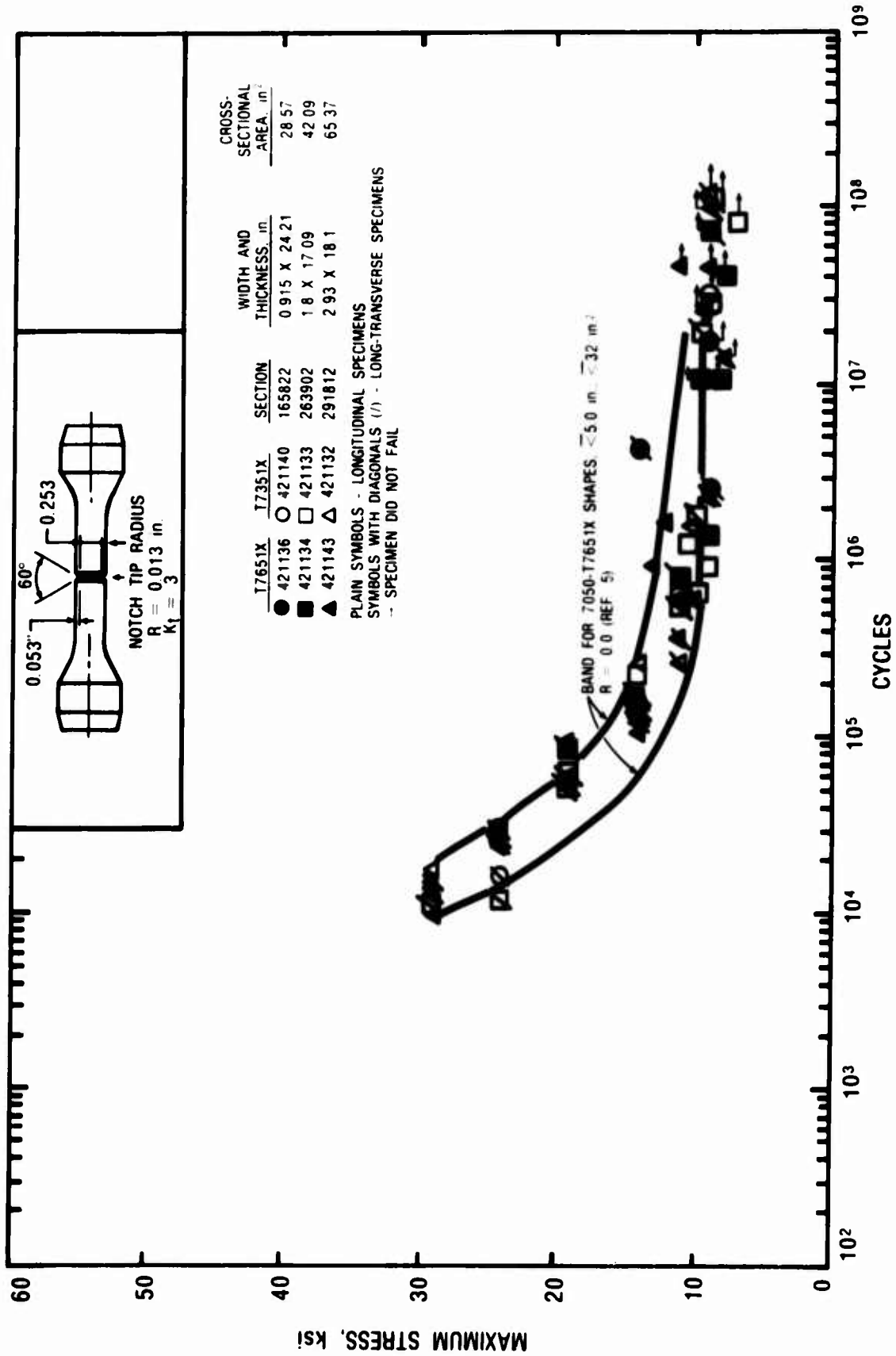

Figure 47 Notch Fatigue, R = +0.1

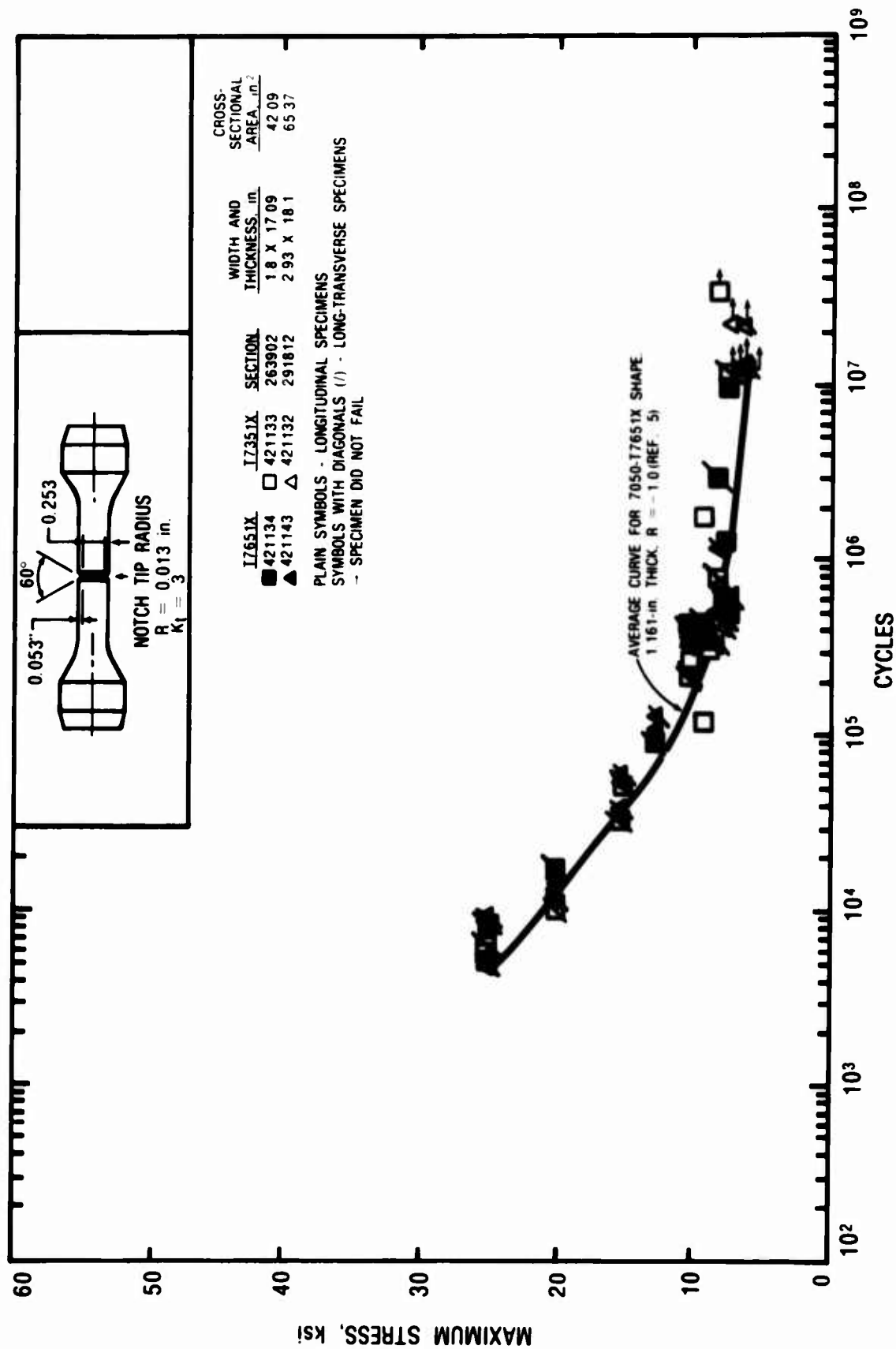

Figure 48 Notch Fatigue, R = -1.0

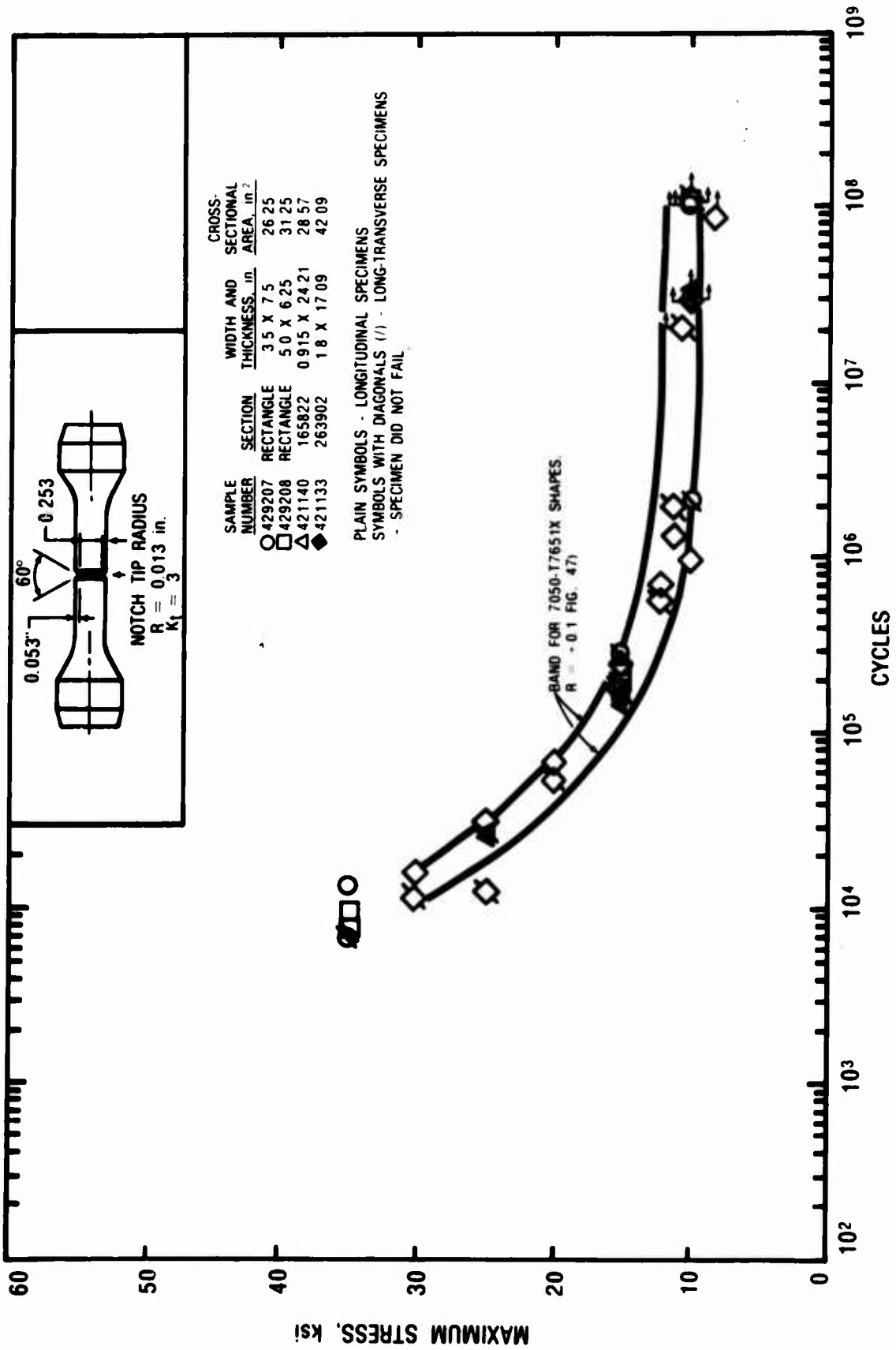

Figure 49 Notch Fatigue, R=+0.1 (Smaller Shape)

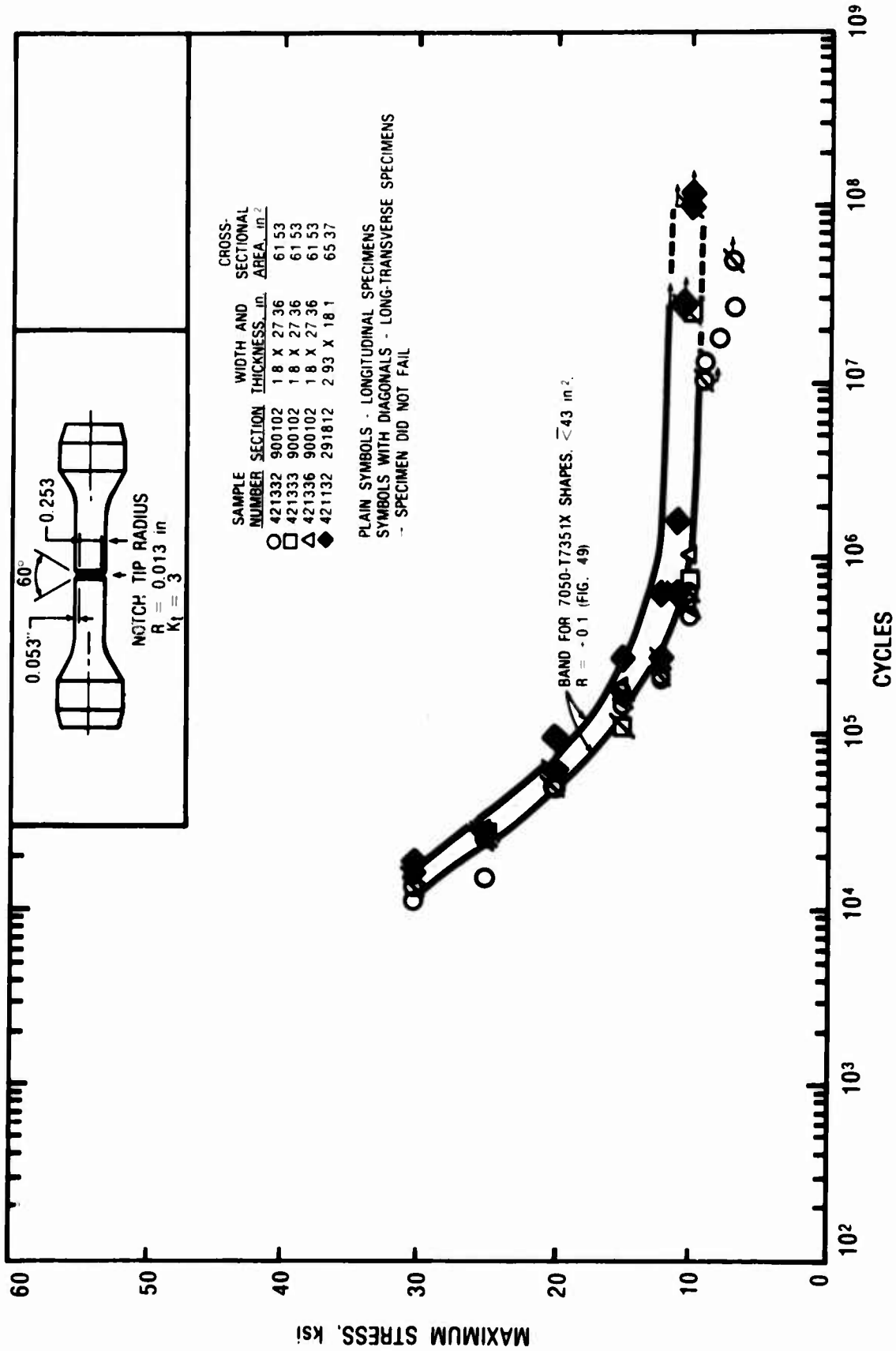

Figure 50 Notch Fatigue, R=+0.1 (Larger Shape)

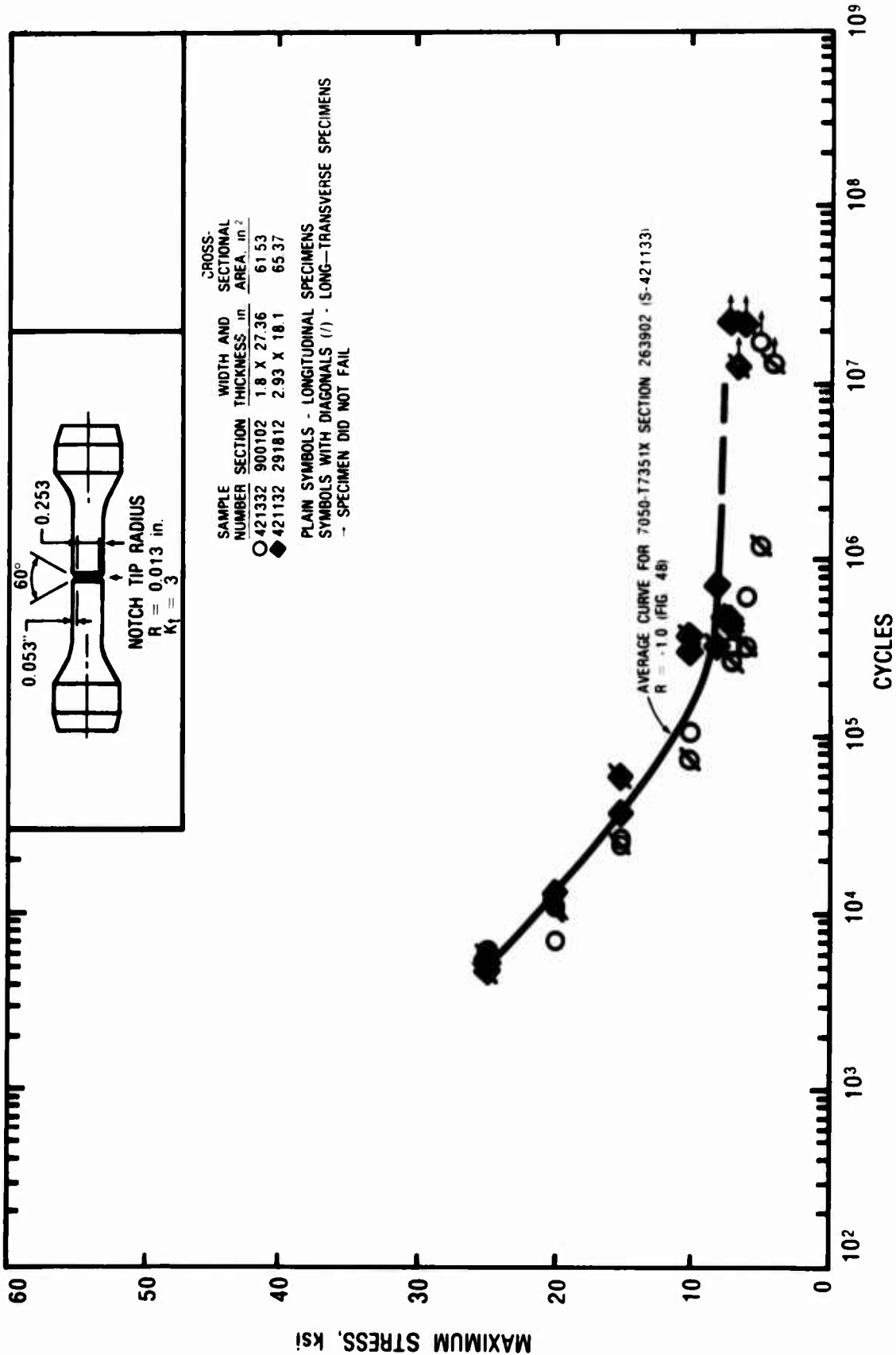

Figure 51 Notch Fatigue, R = -1.0 (Larger Shape)

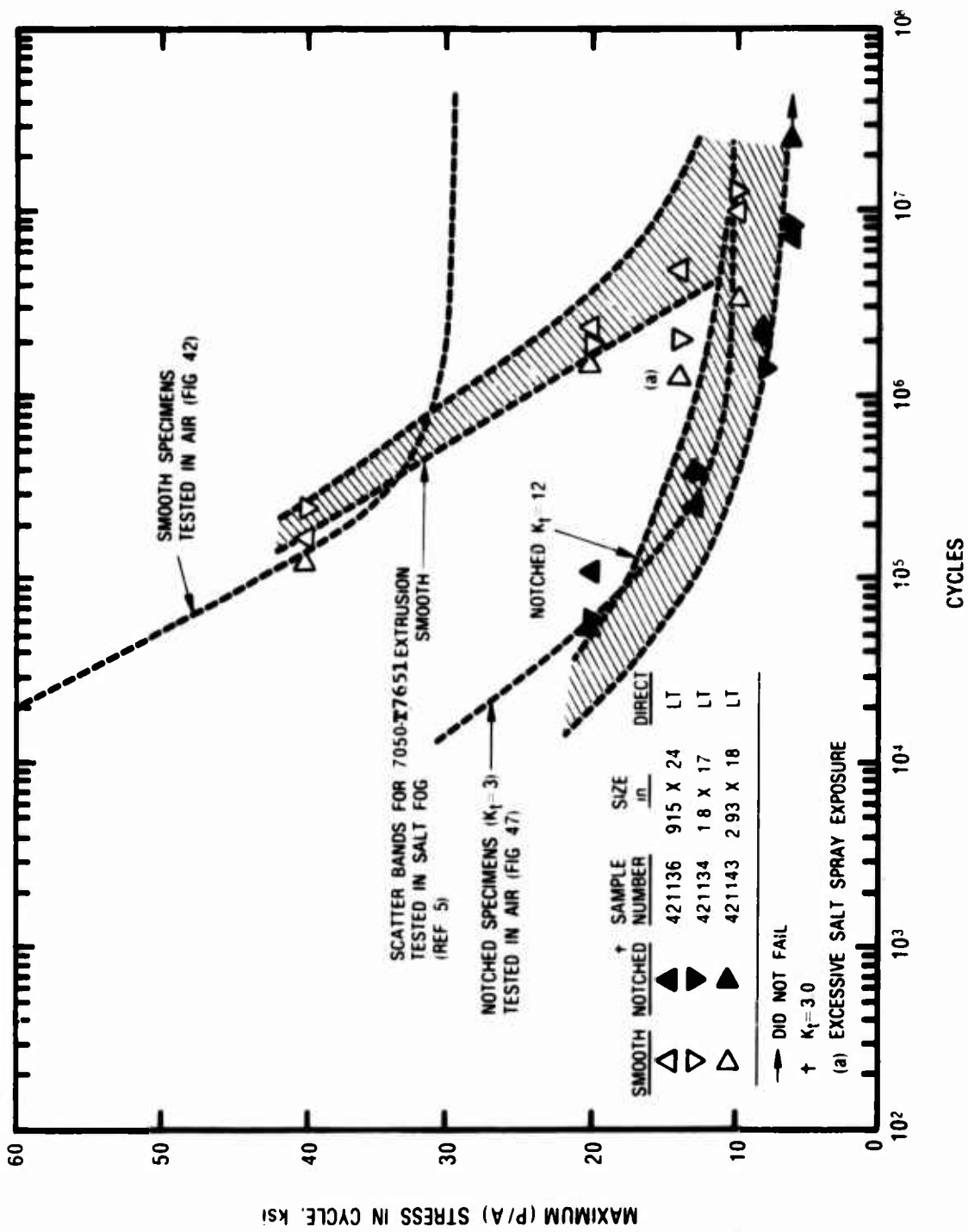

Figure 52 Smooth and Notched Fatigue of 7050-T7651X. Salt Fog. R=0

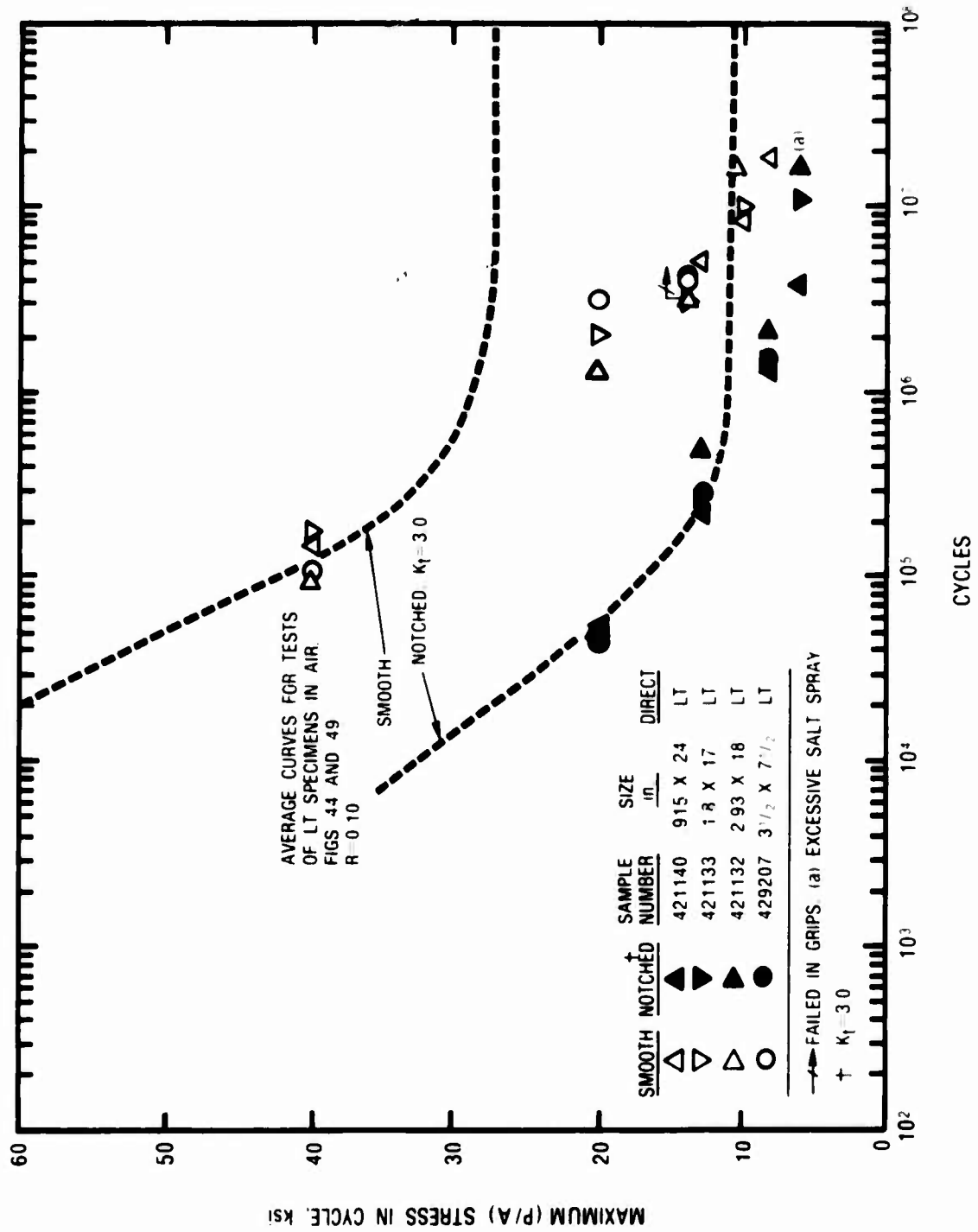

Figure 53 Smooth and Notched Fatigue of 7050-T7351X. Salt Fog. R=0

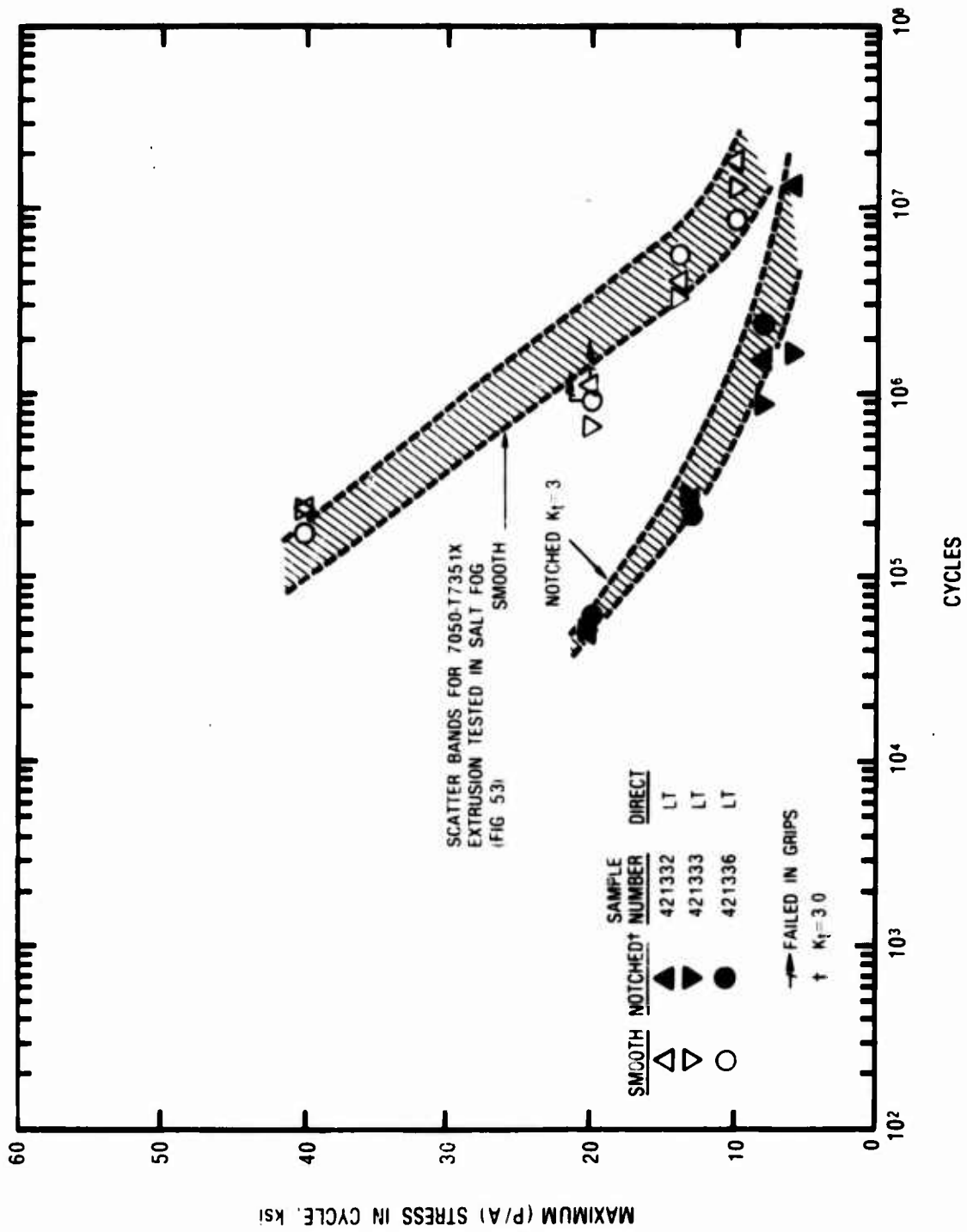
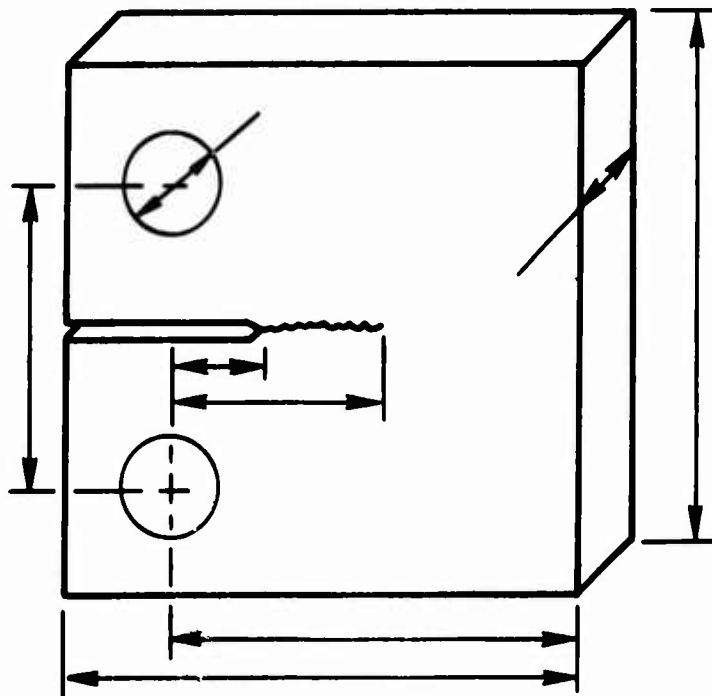

Figure 54 Smooth and Notched Fatigue of 7050-T7351X, Salt Fog, R=0



a = CRACK LENGTH

SPECIAL DIMENSIONS - inches

B	2H	W	A	D	d	W_1	H/W
1.00	3.72	3.805	1.650	0.75	1.151	4.80	0.485
1.00	3.72	3.100	1.650	0.75	1.151	4.10	0.6
0.25	3.00	2.500	1.375	0.375	0.62	3.125	0.6

Figure 55 Dimensions for Compact Fatigue Crack-Propagation Specimen

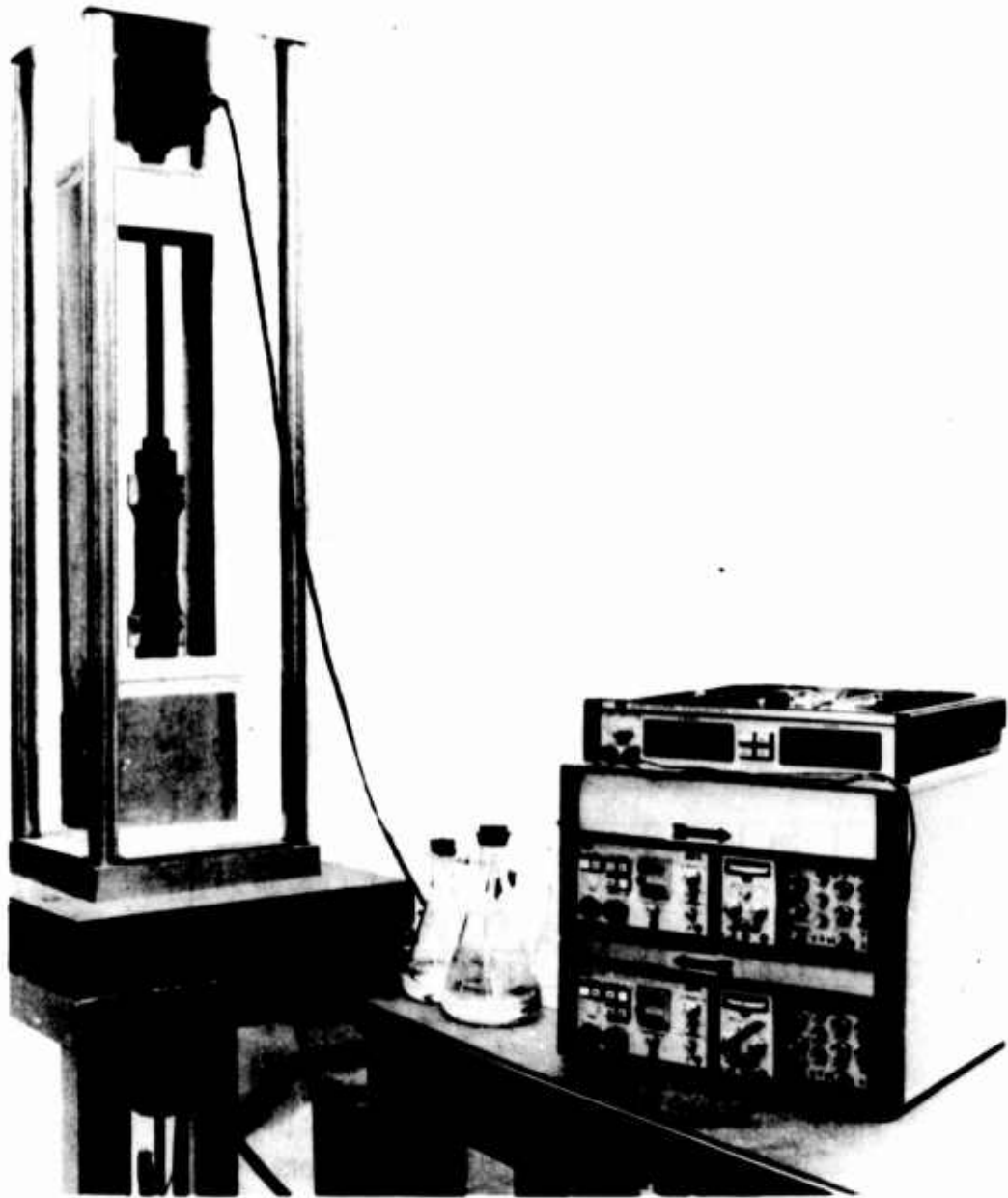

Figure 56 Set-up for Fatigue-Crack Propagation Tests in Humid Environment

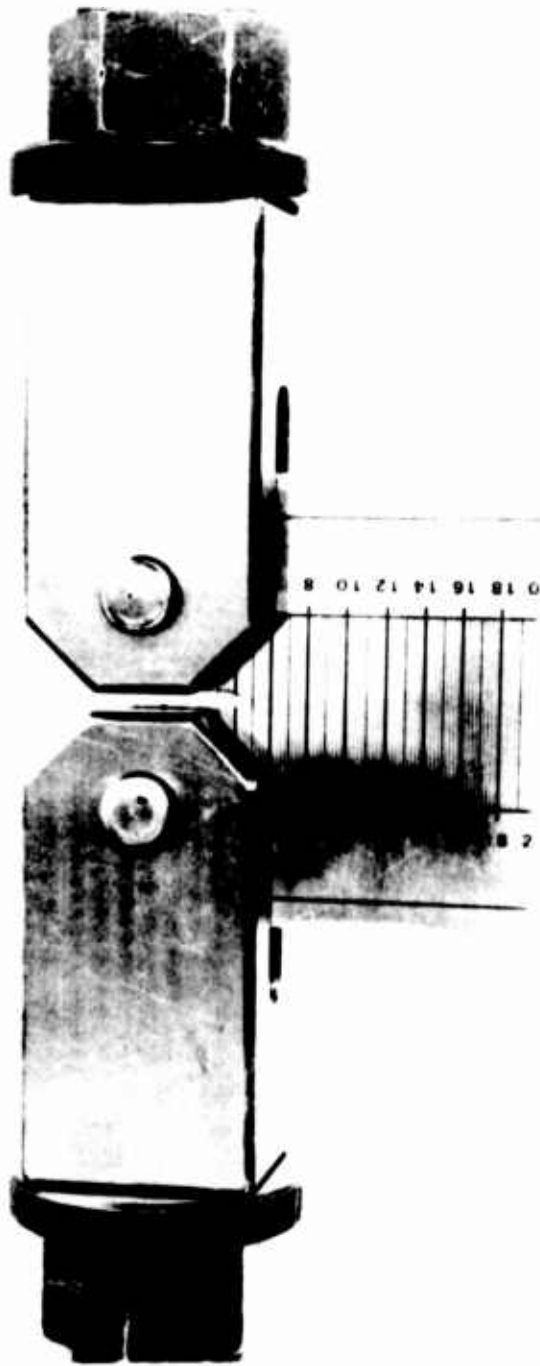

Figure 57 Compact Crack Propagation Specimen in Fatigue Machine

3-MAY-76 09:17 46.7

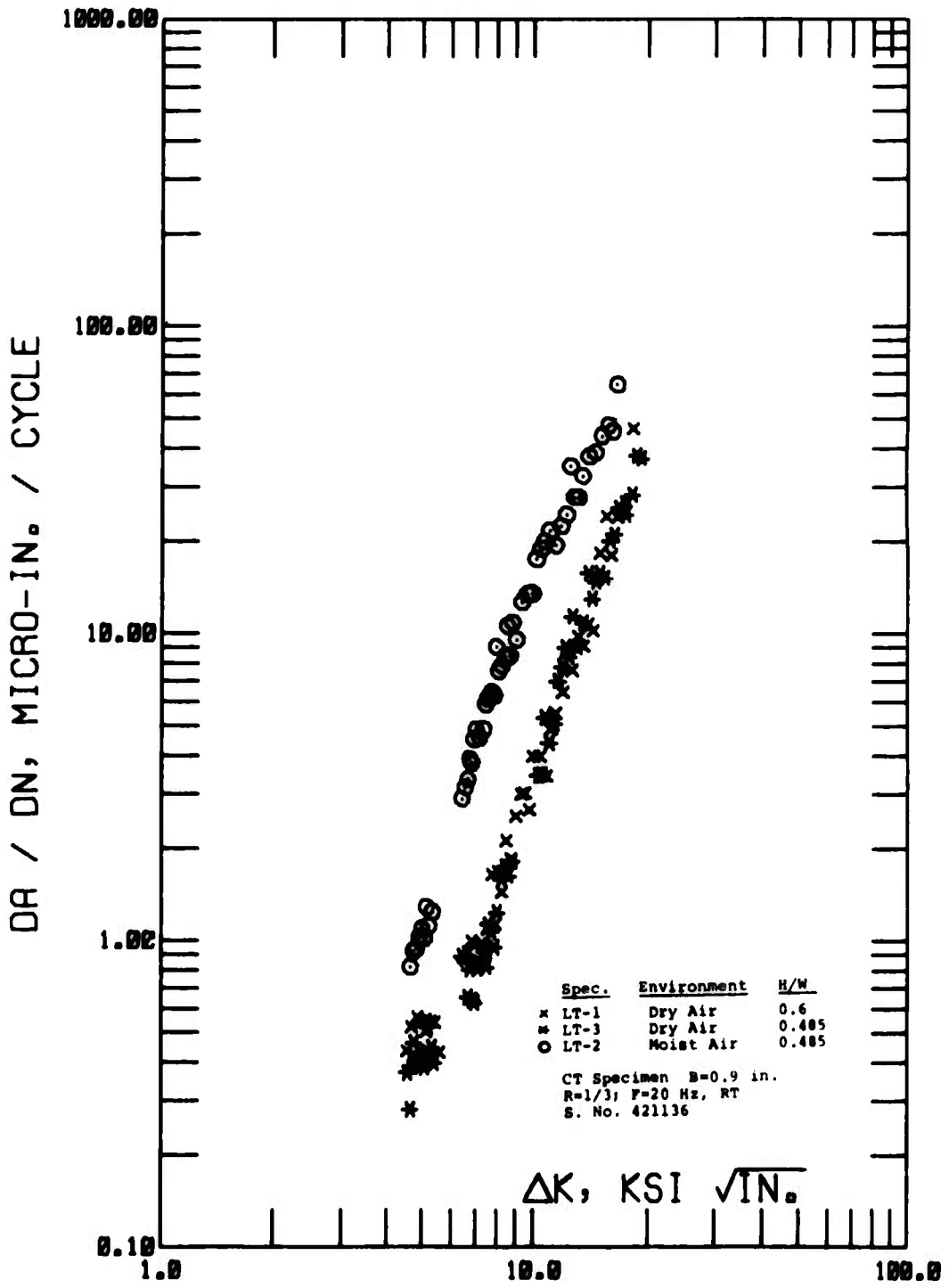

Fig. 58

Fatigue Crack-Growth Data for
0.915-in. 7050-T7651X Extrusion
L-T Orientation

3-MAY-76 09:17 59.0

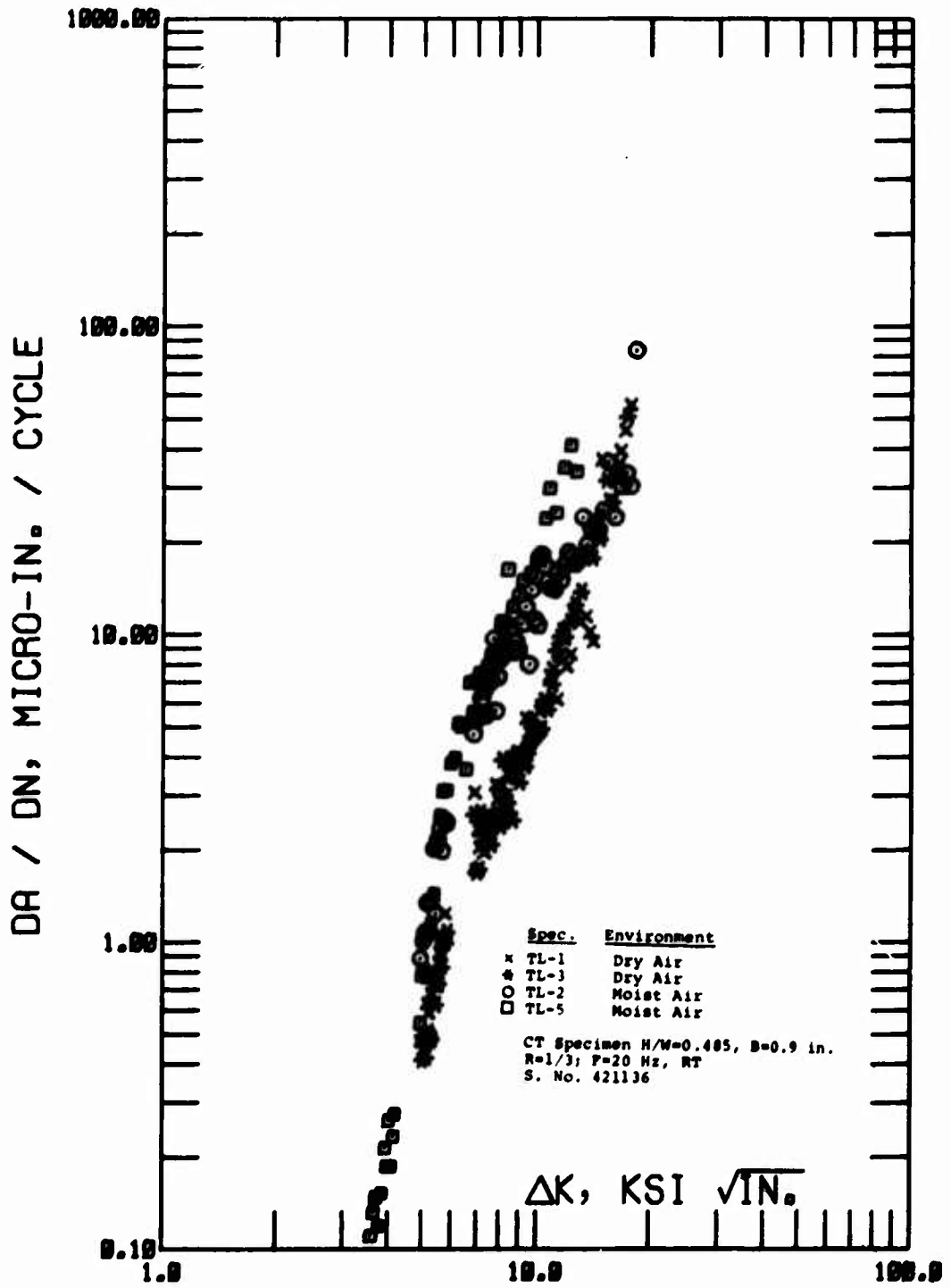

Fig. 59

Fatigue Crack-Growth Data for
0.915-in. 7050-T7651X Extrusion
T-L Orientation

3-MAY-76 09:17 18.4

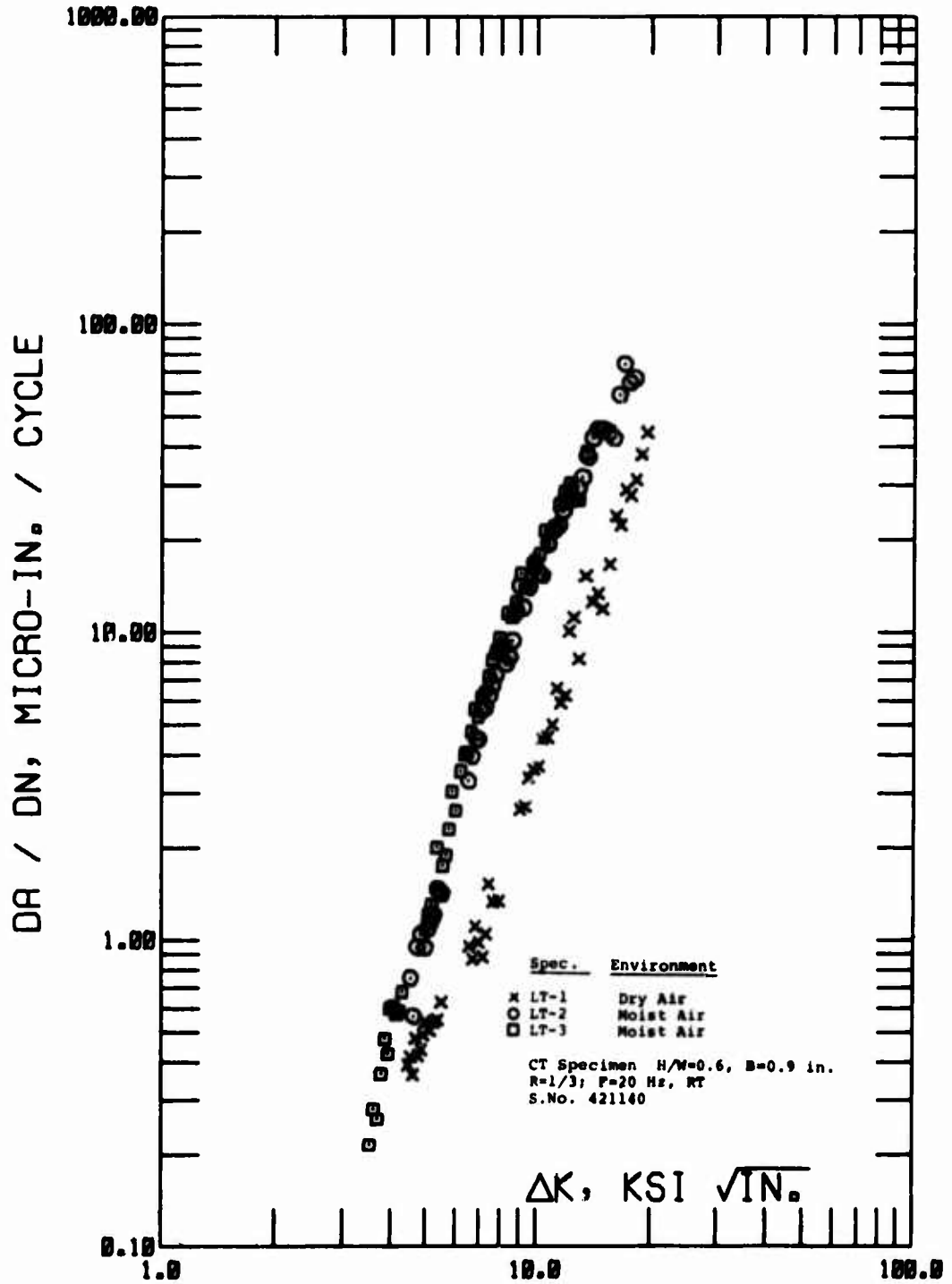

Fig. 60 Fatigue Crack-Growth Data for 0.915-in. 7050-T7351X Extrusion L-T Orientation

3-MAY-76 09:17 30.7

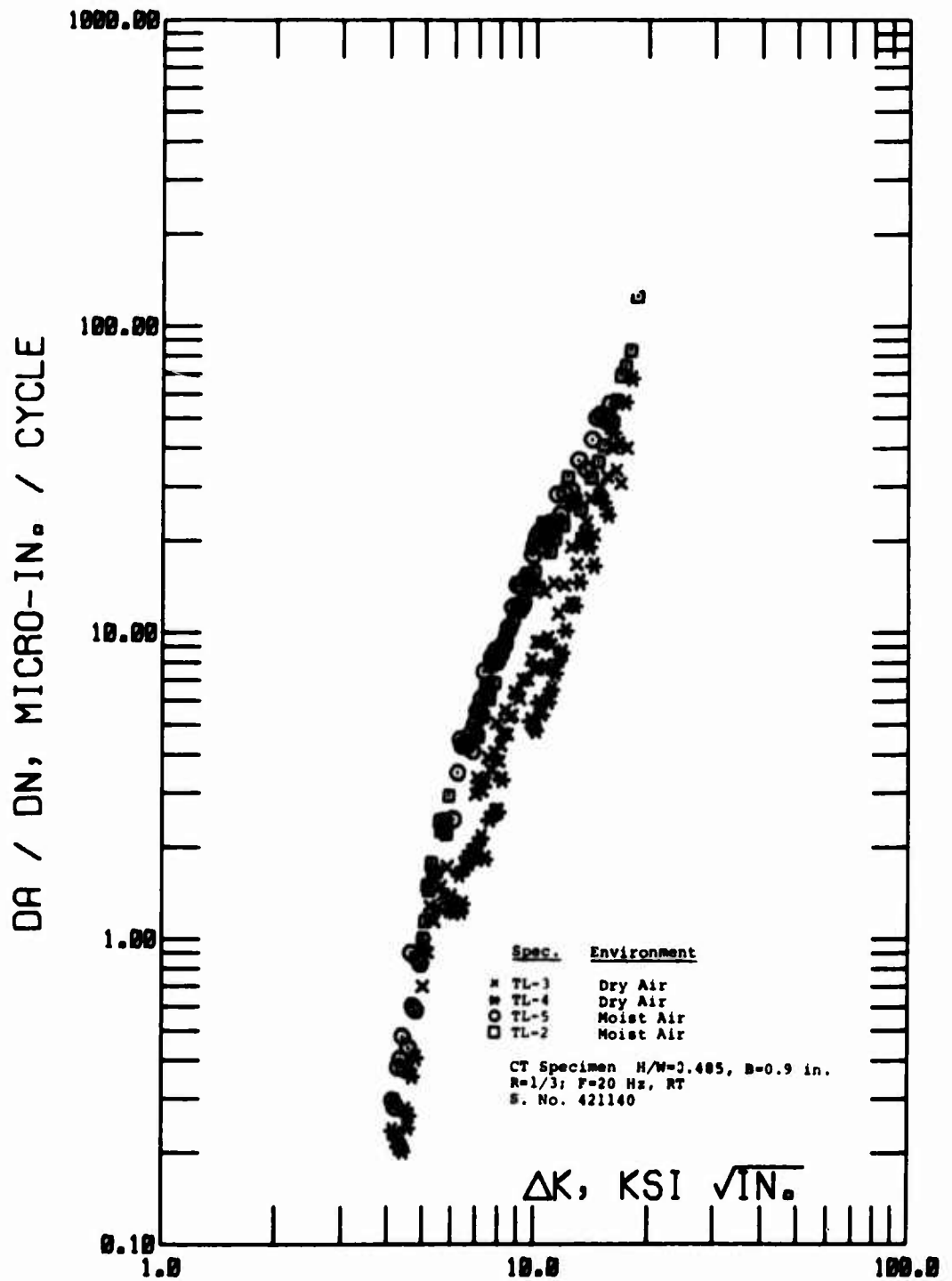

Fig. 61 Fatigue Crack-Growth Data for 0.915-in. 7050-T7351X Extrusion T-L Orientation

3-MAY-76 09:18 14.8

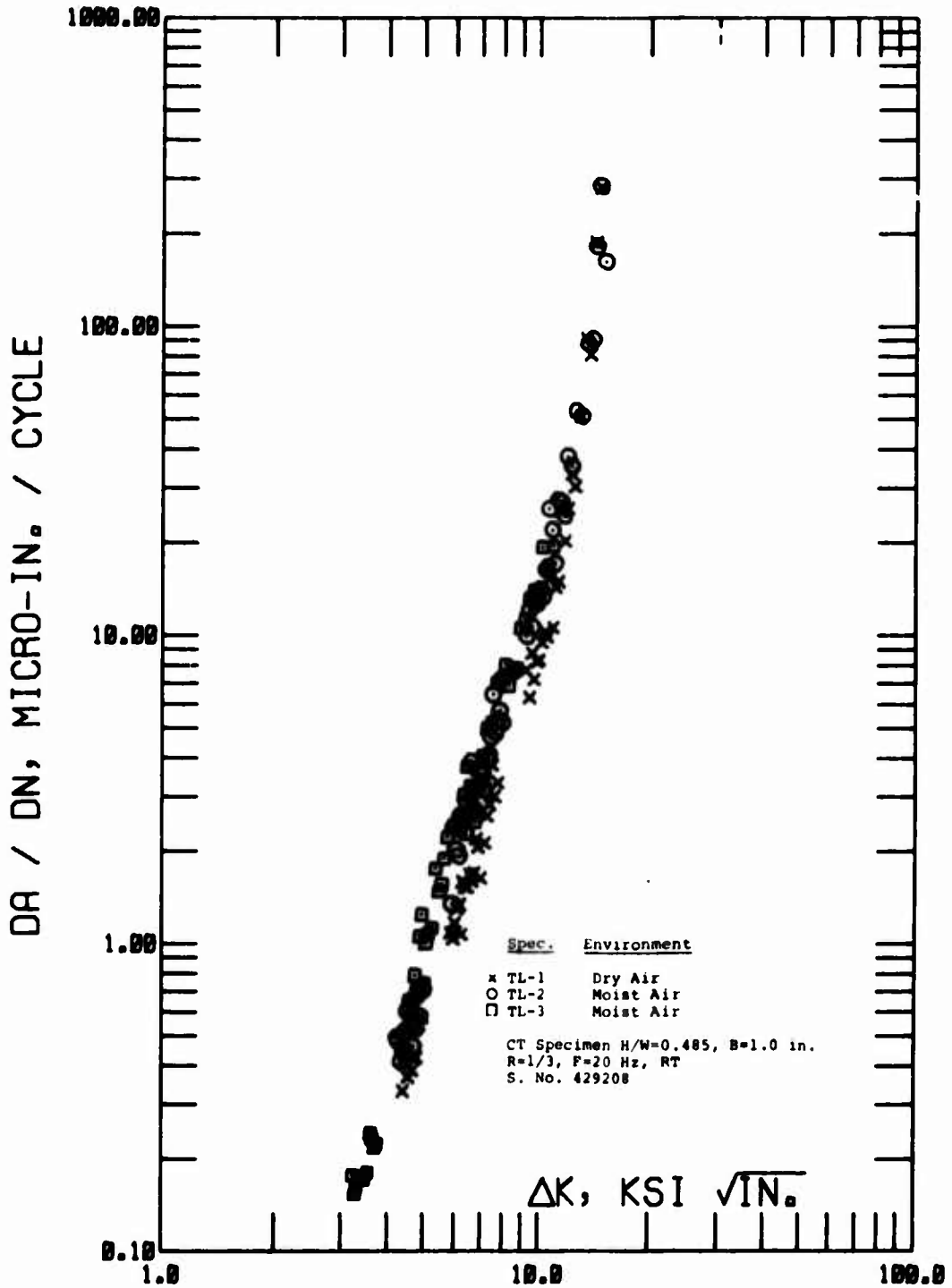

Fig. 62 Fatigue Crack-Growth Data for
5x6-1/4-in. 7075-T7351X Extrusion
T-L Orientation

22-SEP-75 08:33 23.6

DA / DN, MICRO-IN. / CYCLE

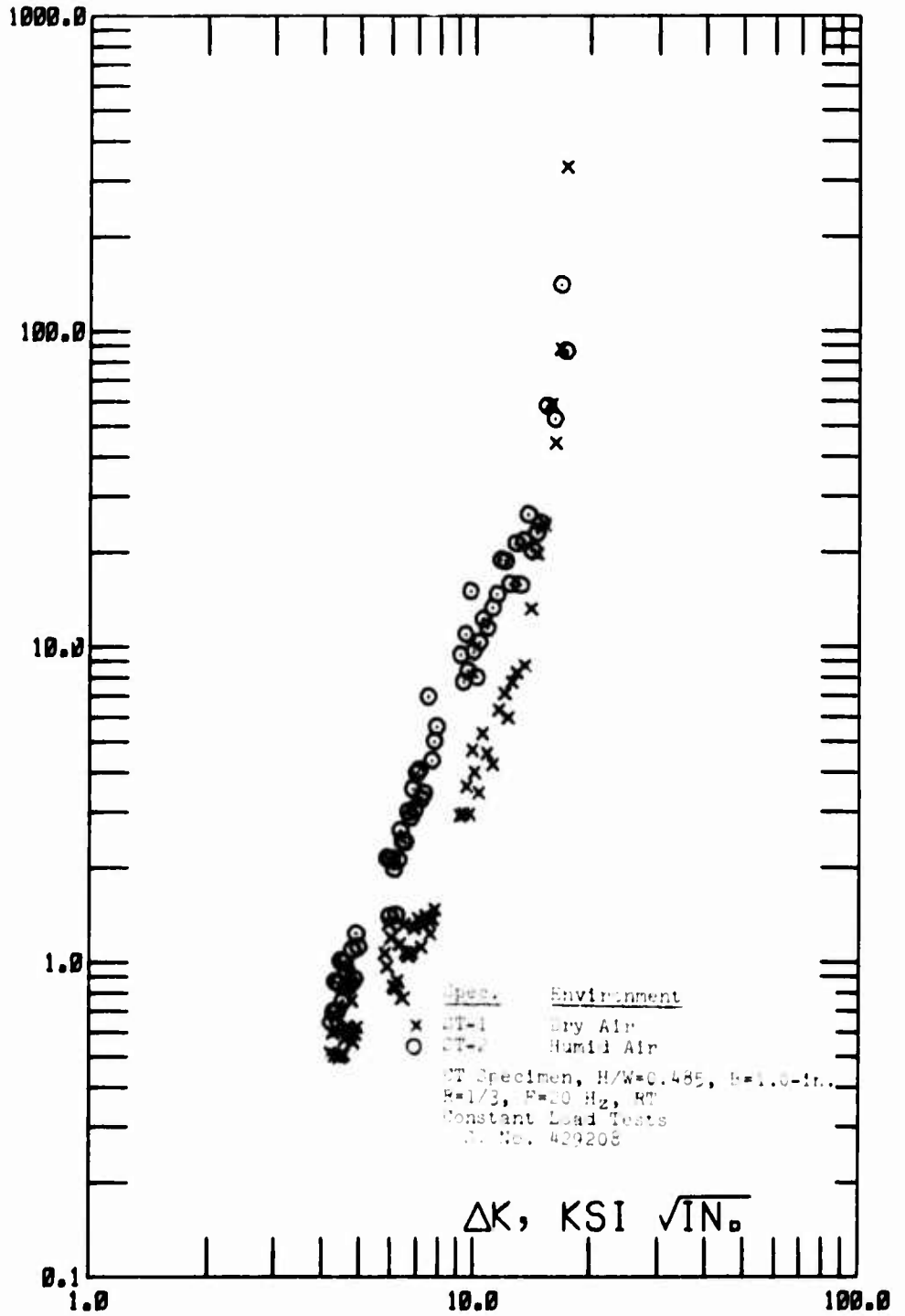

Fig. 63

Fatigue Crack-Growth Data for
 5 x 6-1/4-in. 7050-T7351X Extrusion
 S-T Orientation

12-MAY-76 08:28 17.8

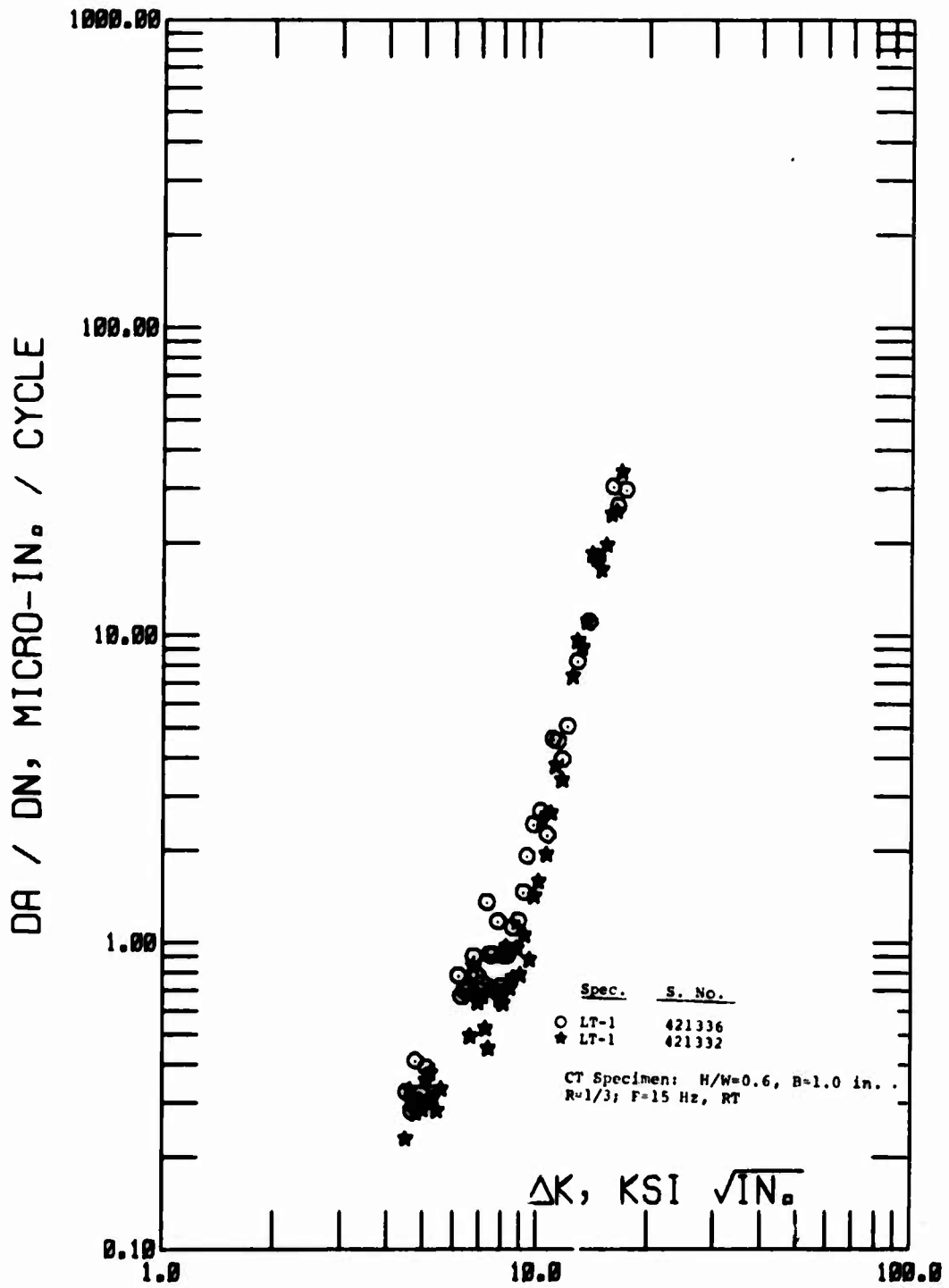

Fig. 64

Fatigue Crack-Growth Data for
C5A Extruded Panels, 7050-T7351X
L-T Orientation - Dry Air

27-MAY-76 08:12 38.5

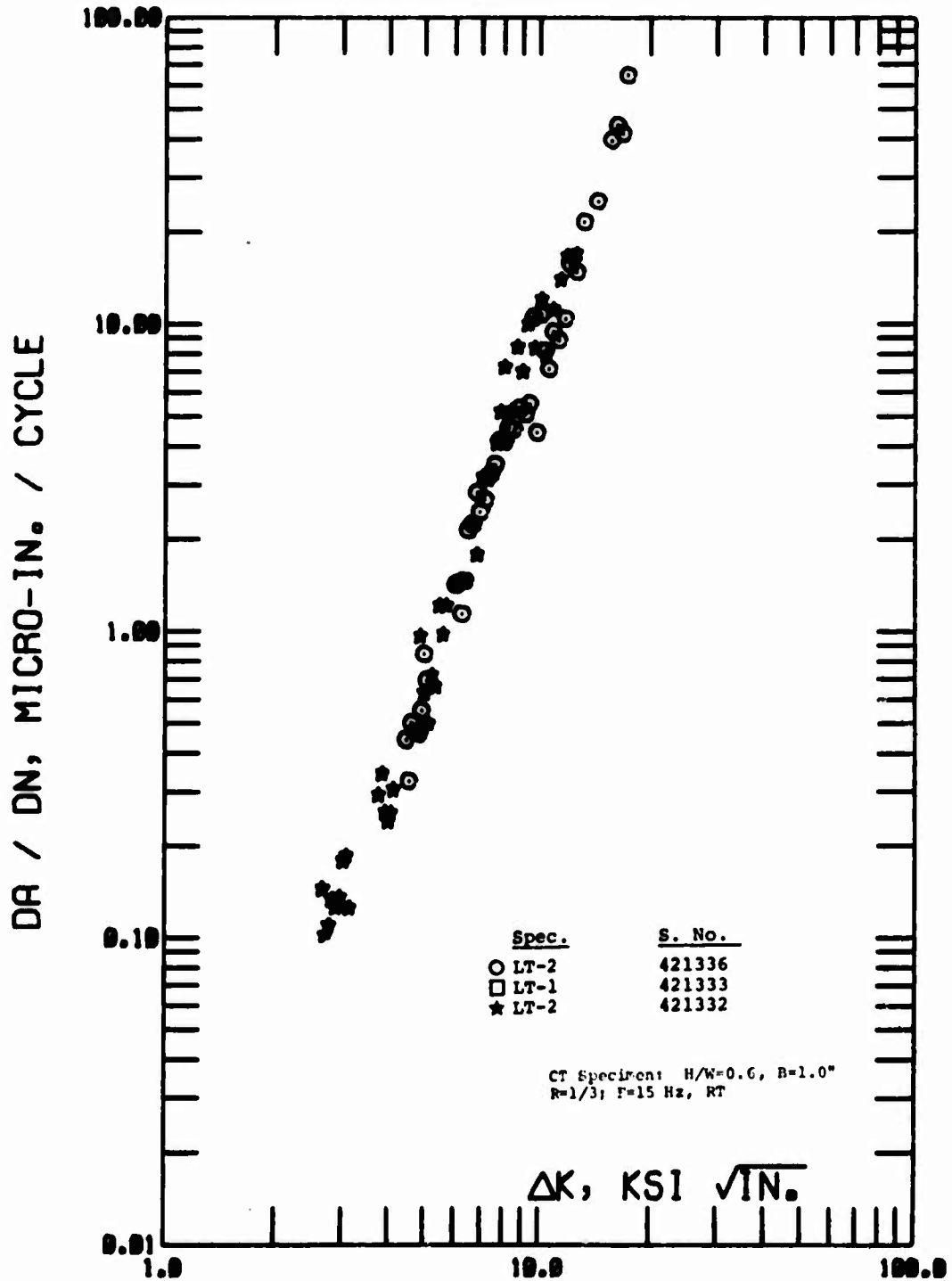

Fig. 65

Fatigue Crack-Growth Data for
C5A Extruded Panels, 7050-T7351X
L-T Orientation - Moist Air

27-MAY-76 08:12 21.4

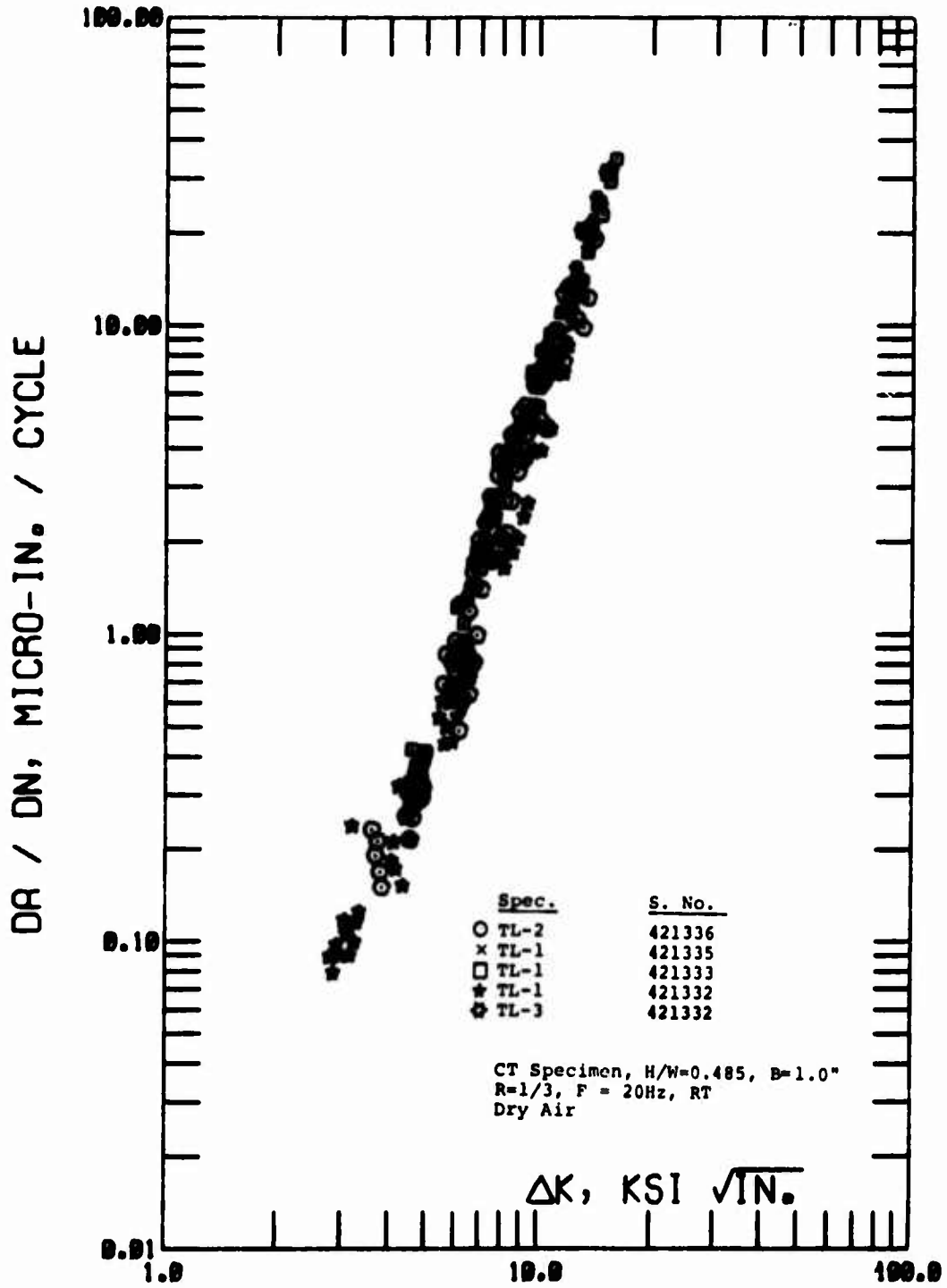

FIG. 66

Fatigue Crack-Growth Data for
C5A Extruded Panels, 7050-T7351X
T-L Orientation - Dry Air

27-MAY-76 08:11 58.0

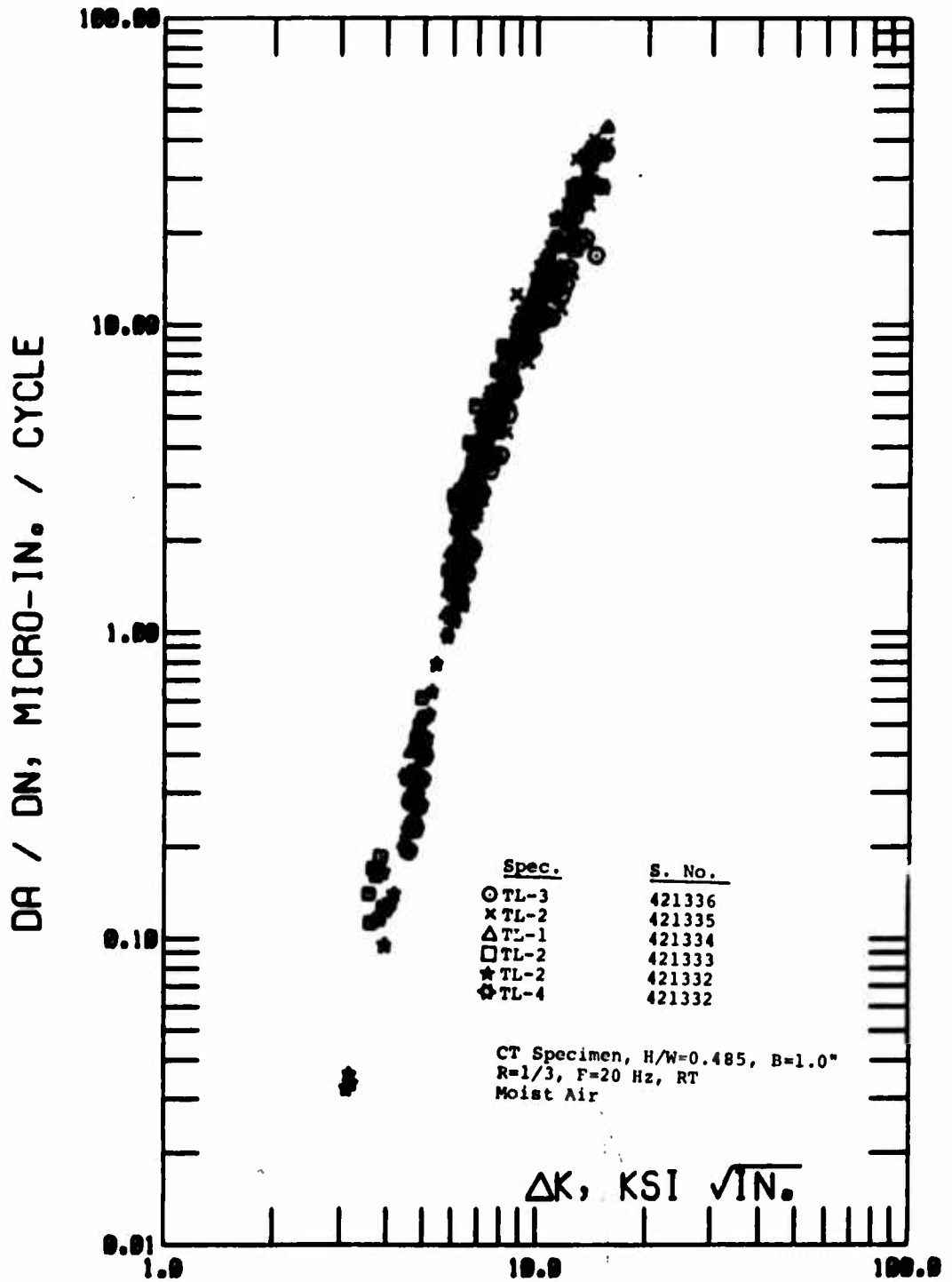

Fig. 67

Fatigue Crack-Growth Data for
C5A Extruded Panels, 7050-T7351X
T-L Orientation - Moist Air

13-MAY-76 11:28 30.5

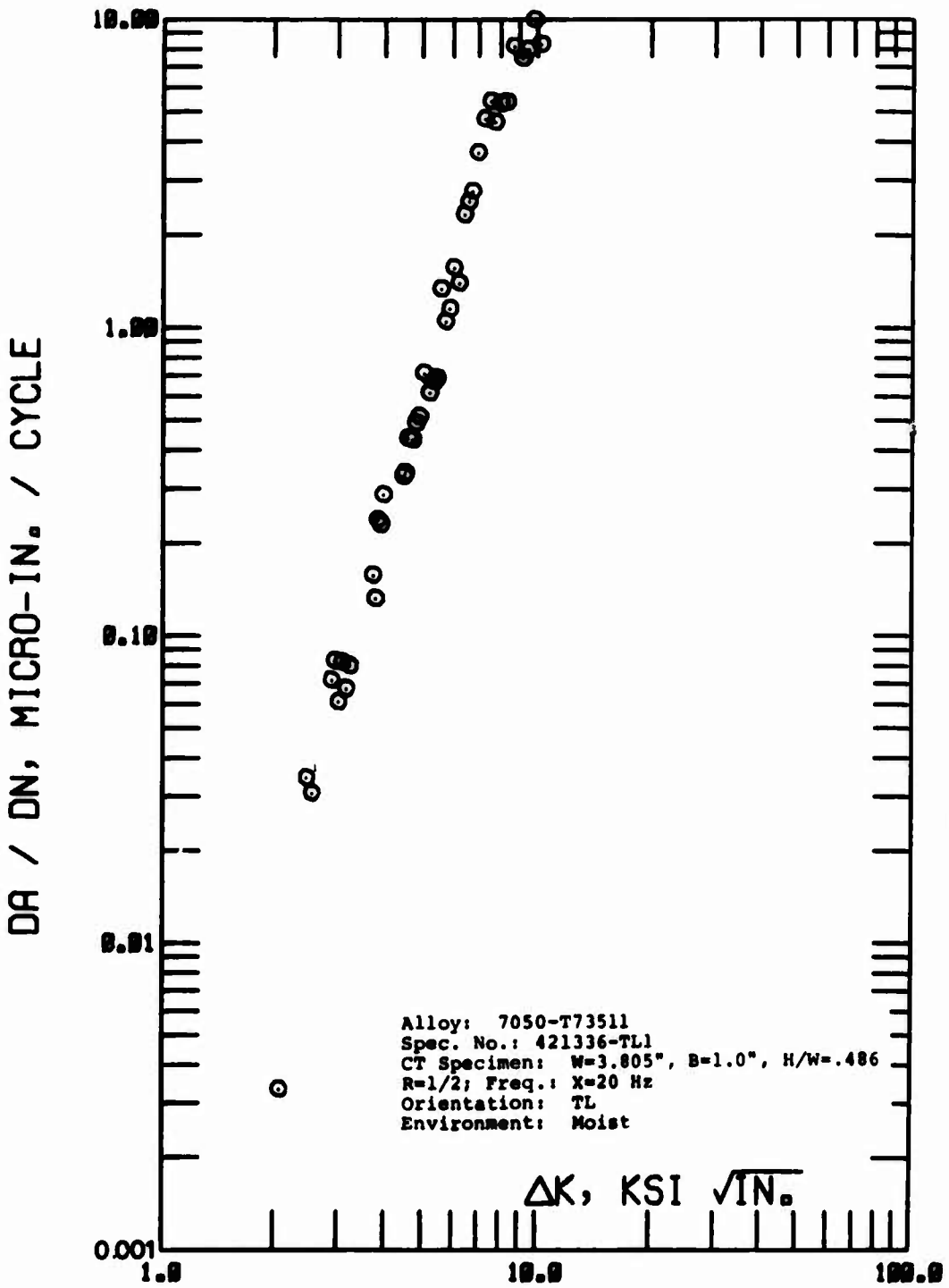
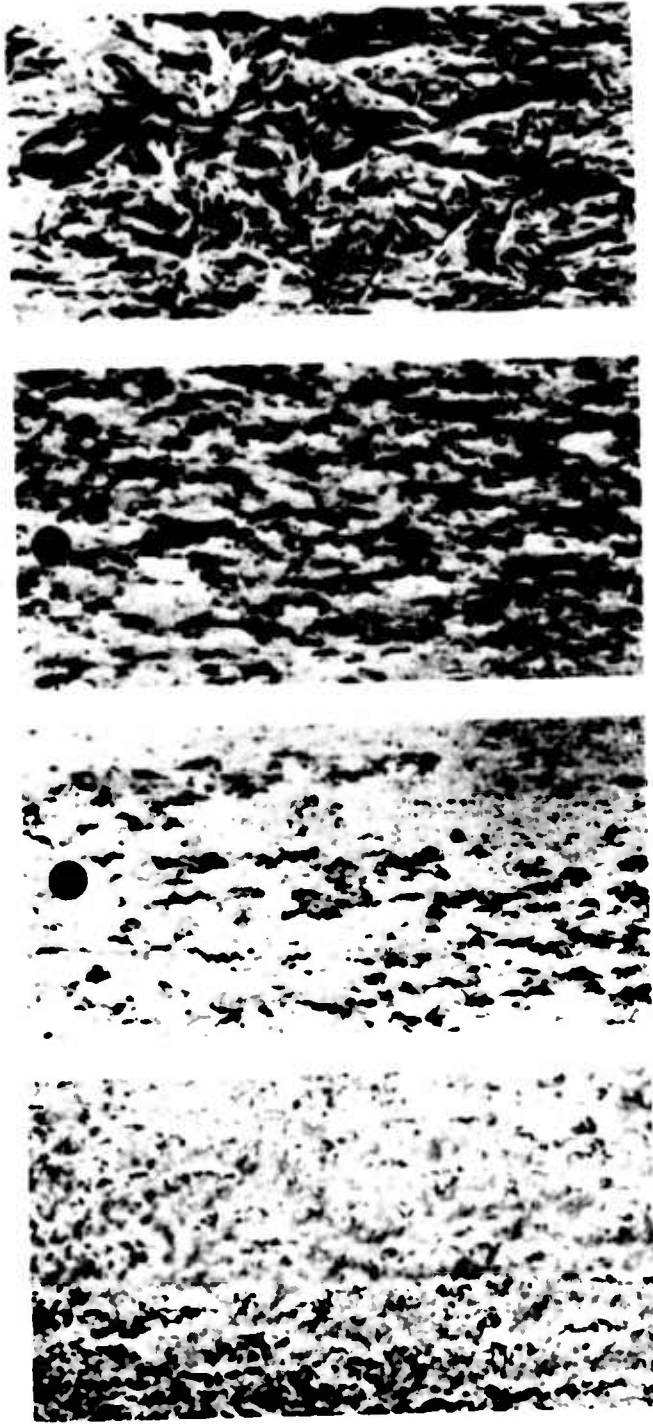

Fig. 68 Fatigue Crack-Growth Data for
C5A Extruded Panels, 7050-T7351X
T-L Orientation - Moist Air - R=0.5



E-D

E-C

E-B

E-A

Figure 69 Four Degrees of Severity of Exfoliation Corrosion per ASTM Standard Method Test G34-72

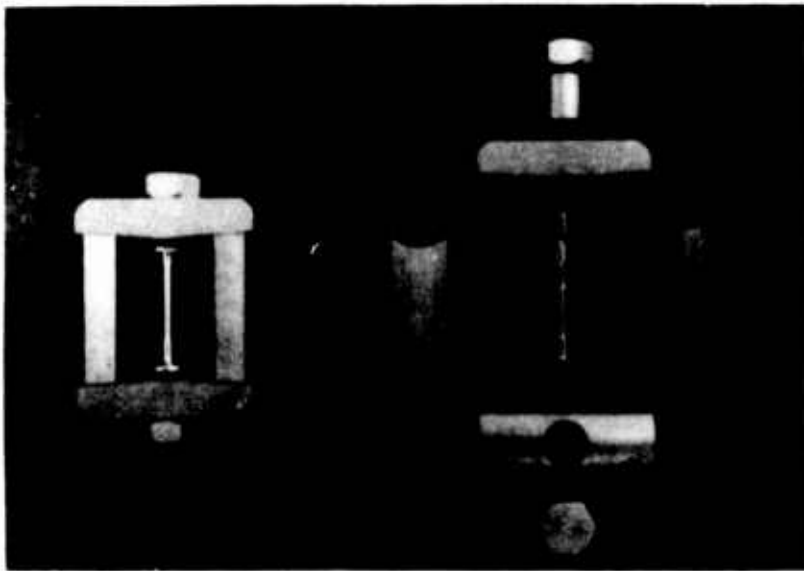

Figure 70a 1/8 in. Diameter Tensile Specimen, Various Parts of the Stressing Frame and Final Stressed Assembly for Stress Corrosion Tests

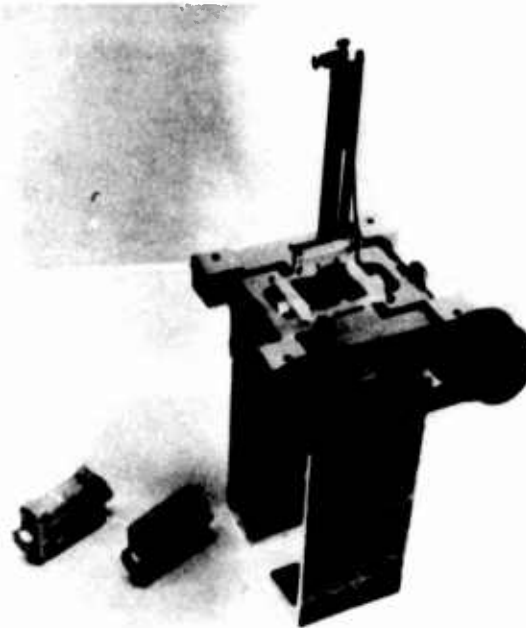

Figure 70b Synchronous Loading Device Used to Stress Specimens Stressed Assembly and One Assembled Finger Tight Ready for Stressing Are Shown to the Left

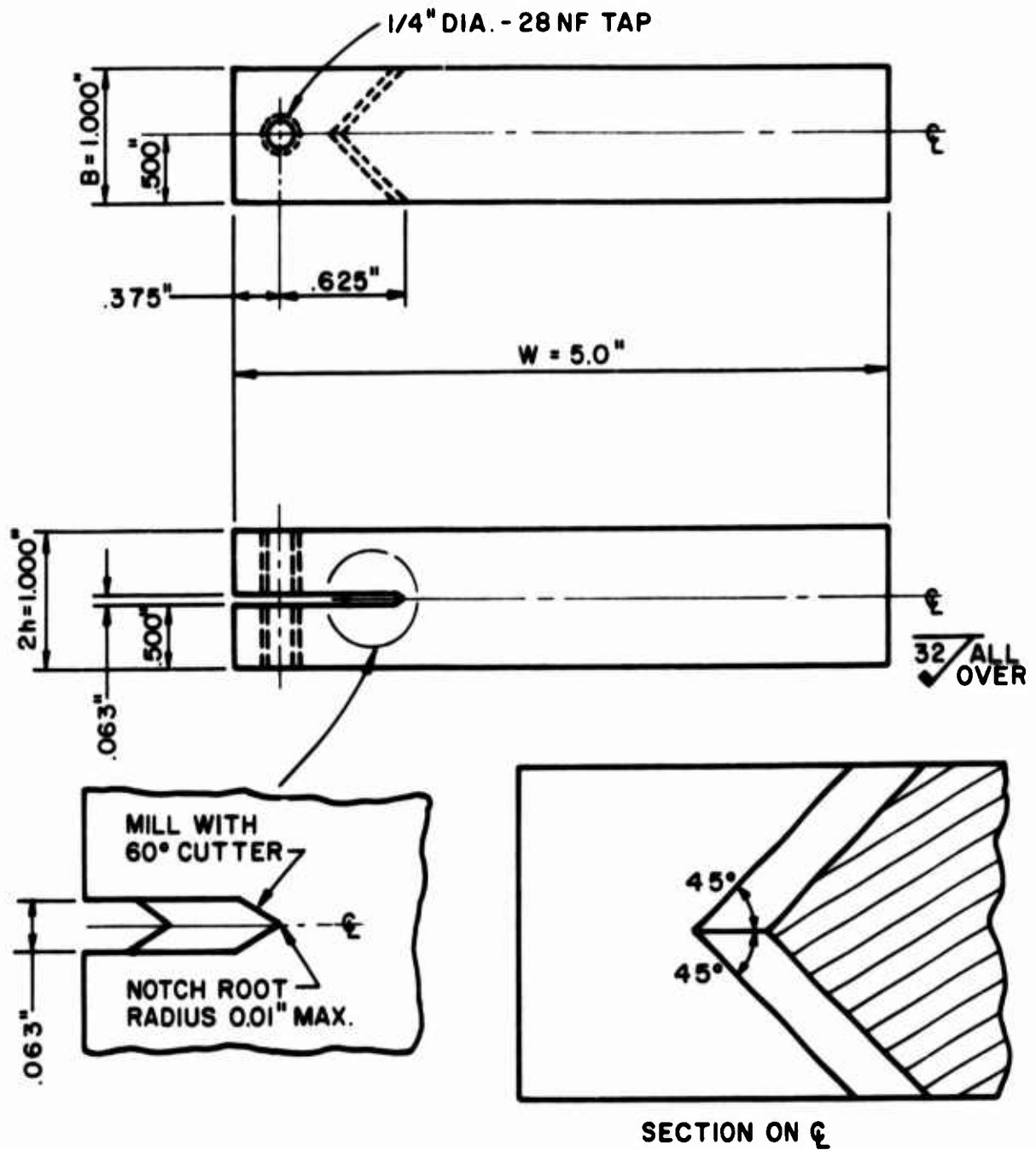

FIG. 71 CONFIGURATION OF DOUBLE CANTILEVER BEAM (DCB) SPECIMEN USED FOR SCC TESTS



Figure 72 Ring-Loaded Precracked Compact Tension Specimen

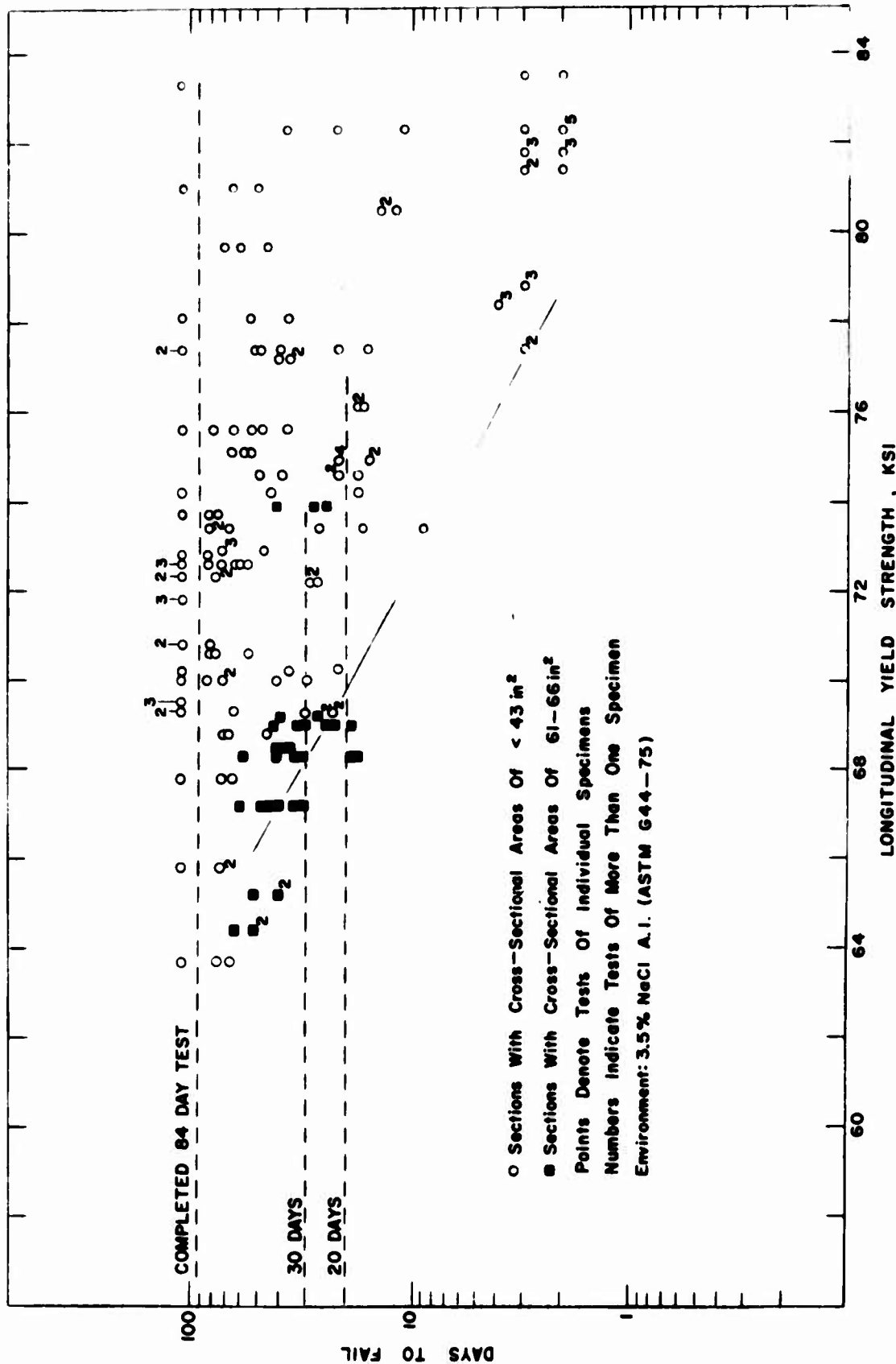

Figure 73 Summary of Accelerated SCC Test Results for 1.2-5.0" Thick Alloy 7050 Extruded Sections
 (Test Stress - 45KSI)

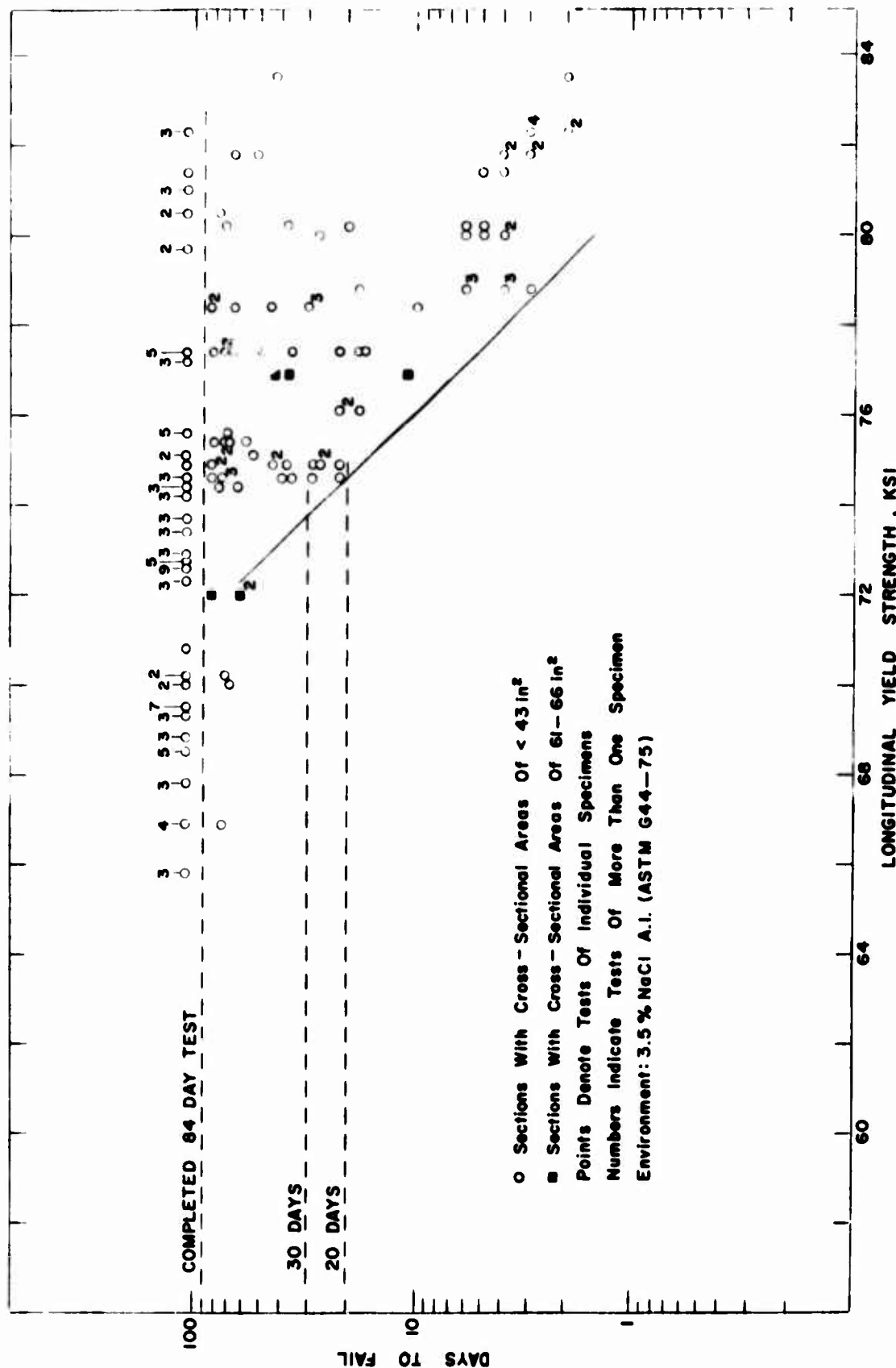

Figure 74 Summary of Accelerated SCC Test Results for 1.2-5.0" Thick Alloy 7050 Extruded Sections
 (Test Stress - 25KSI)

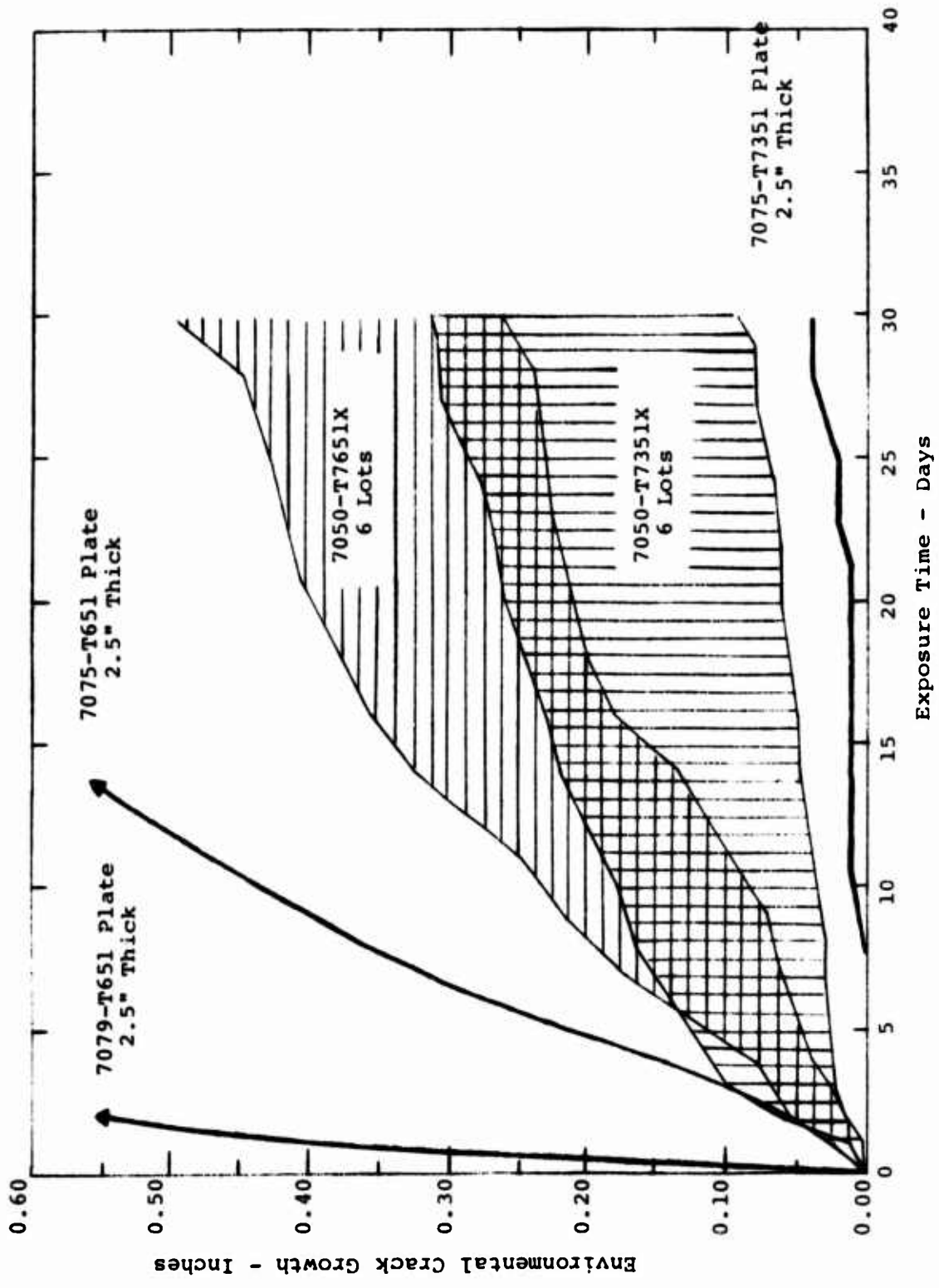

Figure 75 Environmental Crack Growth of Short-Transverse 7050 Alloy DCB Specimens Exposed to 3.5% NaCl Solution Dropwise



SCC

MAG 1.5X



MAG 7.5X



MAG 100X

S NO. 421137

Figure 76 Illustrates Fracture Surface, Crack Profile and Intergranular Nature of SCC Growth in Short Transverse (S-L) DCB Specimens from a 7050-T7351X Section (Die No. 900102)

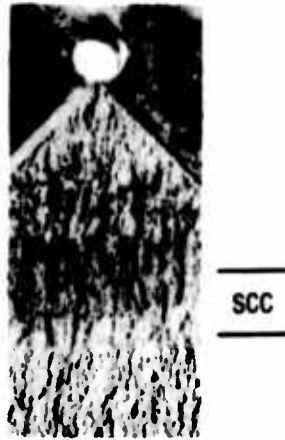

MAG 1.5X



MAG 7.5X

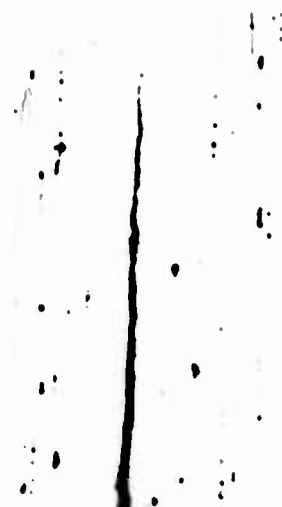

MAG 100X

S NO. 421135

Figure 77 Illustrates Fracture Surface, Crack Profile and Intergranular SCC Growth in Short Transverse (S-L) DCB Specimens from a 7050-T7651X Section (Die No. 900102)

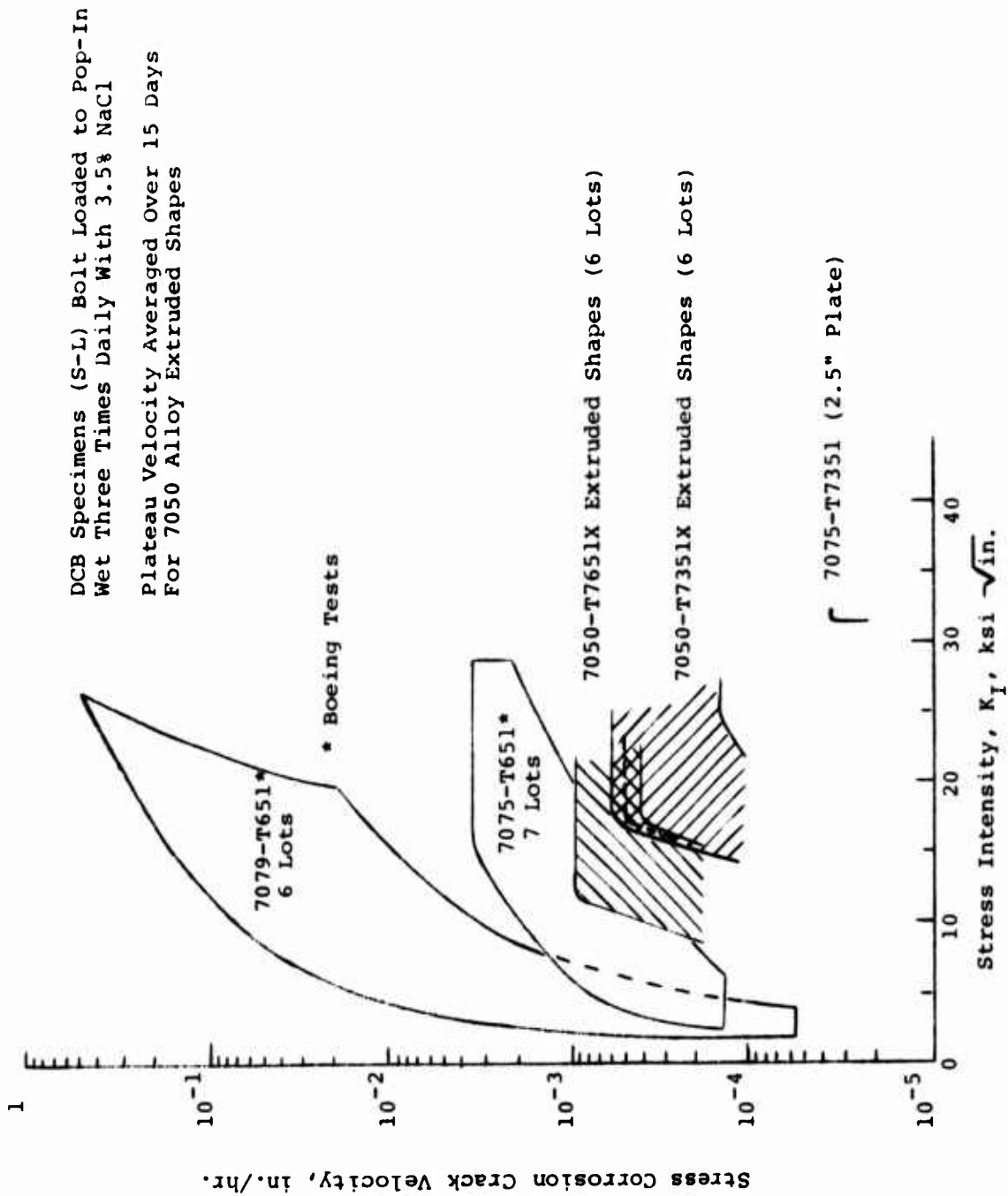

Figure 78 K_I - Rate Data For Tests of 7050 Alloy Extrusions

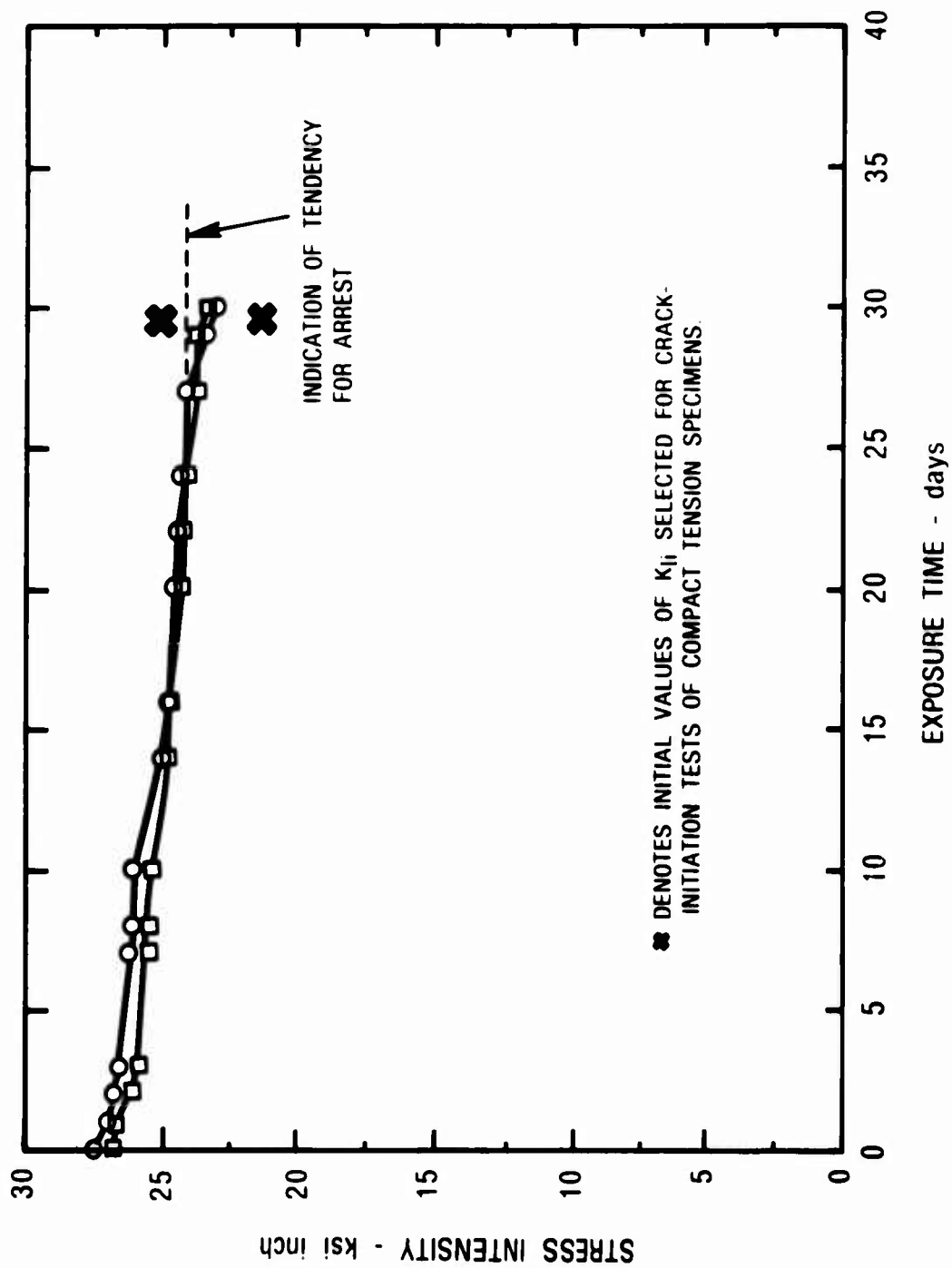

Figure 79 Changing Stress Intensity of Short Transverse 7050-T7351 Alloy DCB Specimens Exposed to 3.5% NaCl Solution Dropwise. S421336-1 (o), -2 (□)

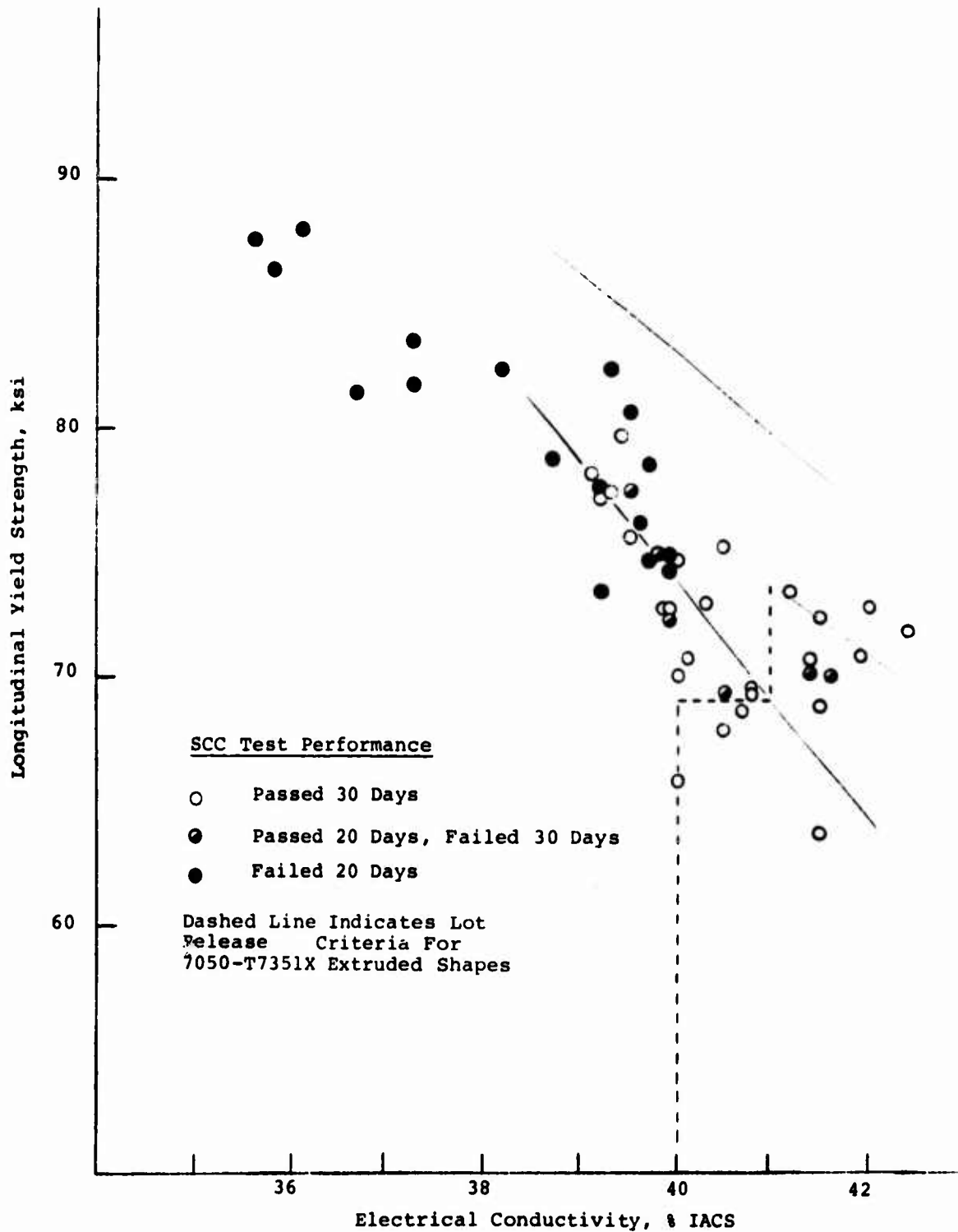

Figure 80 SUMMARY OF ACCELERATED SCC TEST RESULTS FOR 1.2 - 5.0" THICK ALLOY 7050-T7XXX EXTRUDED SHAPES LESS THAN 43 SQUARE INCHES IN CROSS SECTION (TEST STRESS - 45 KSI)

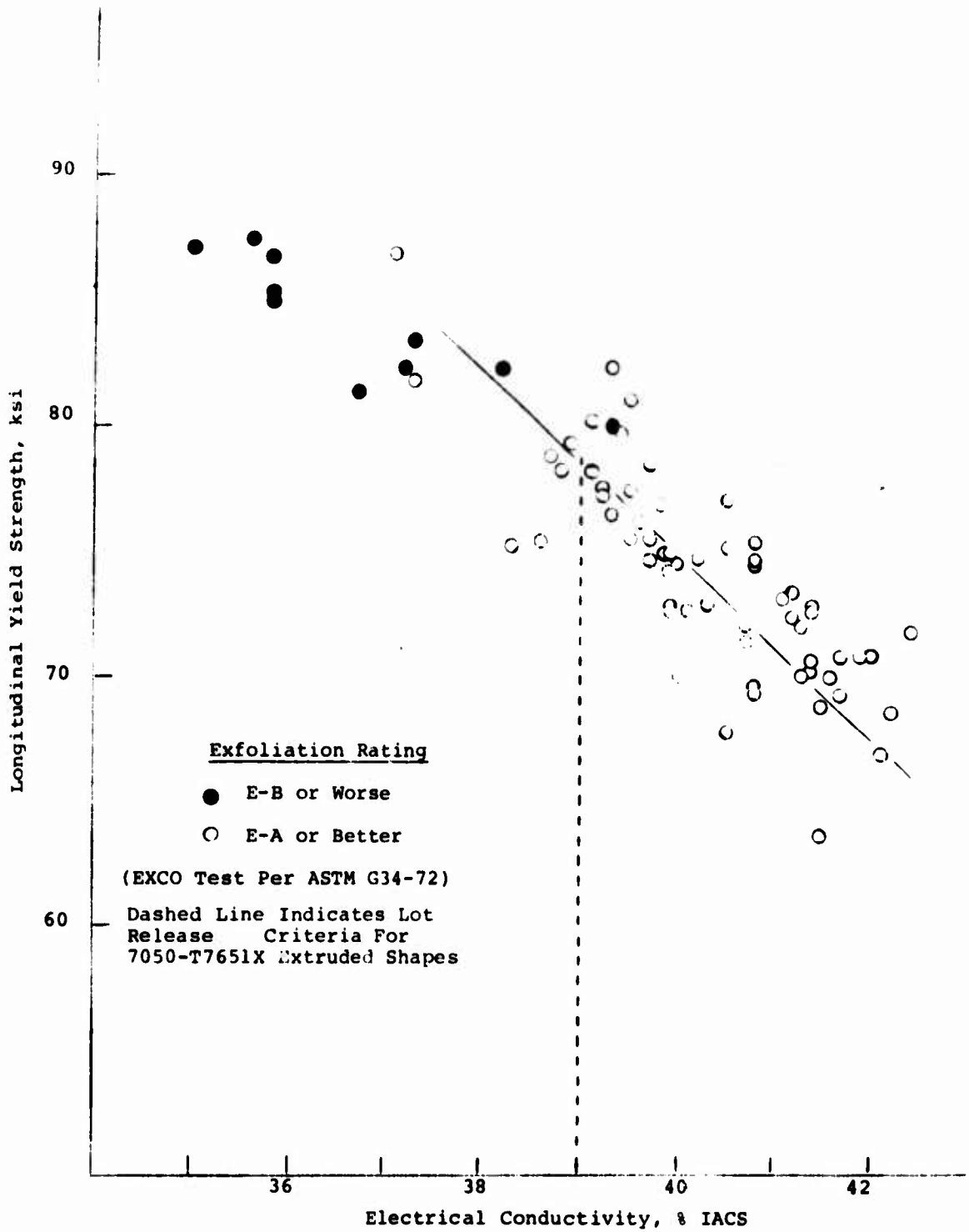

Figure 82 SUMMARY OF EXFOLIATION TEST RESULTS FOR 0.4 - 5.0" THICK ALLOY 7050-T7XXX EXTRUDED SHAPES

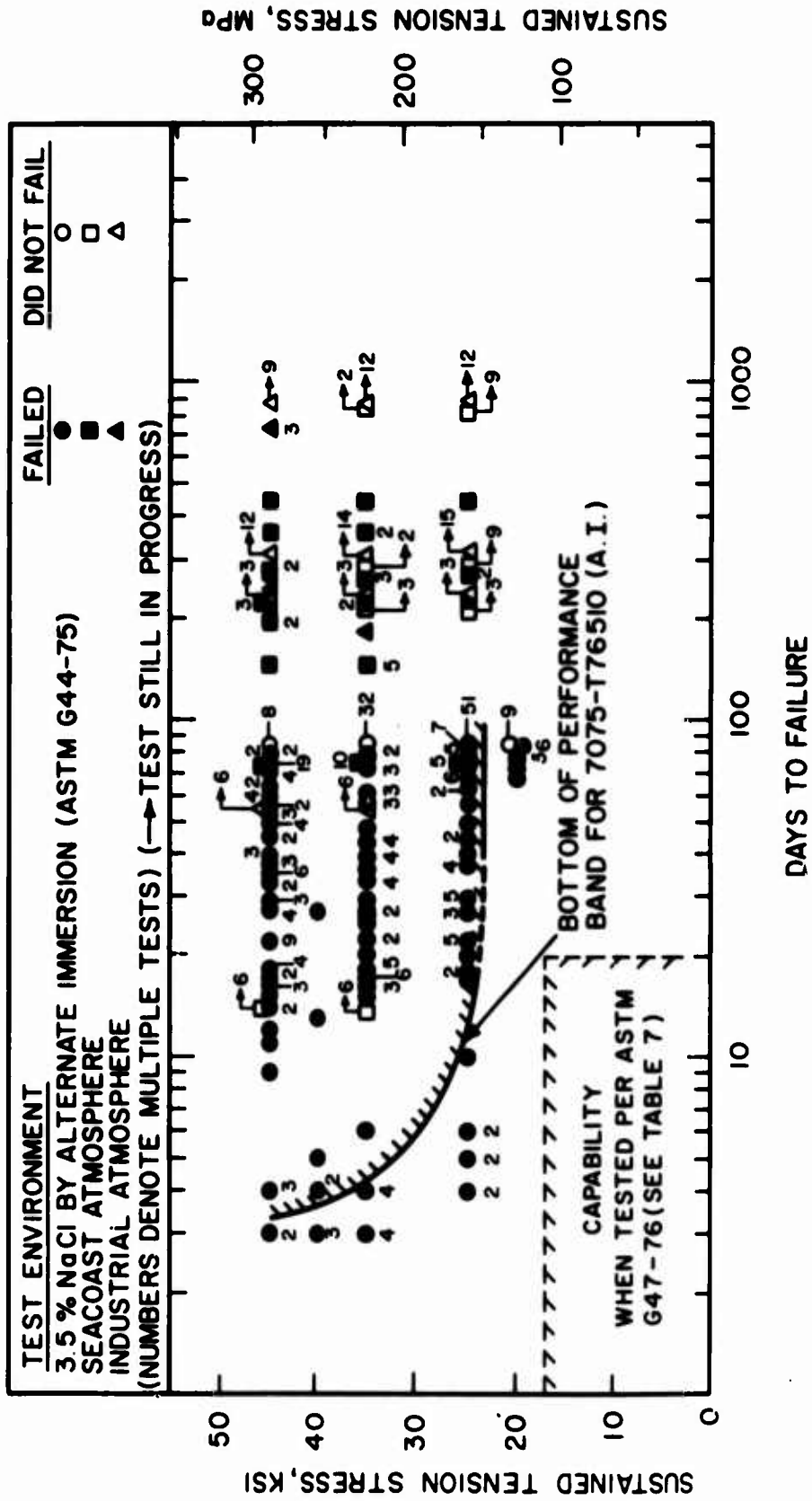

Figure 83 Short-Transverse Stress-Corrosion Tests of 7050-T7651X Extruded Shapes (1.2-5.0" Thick)

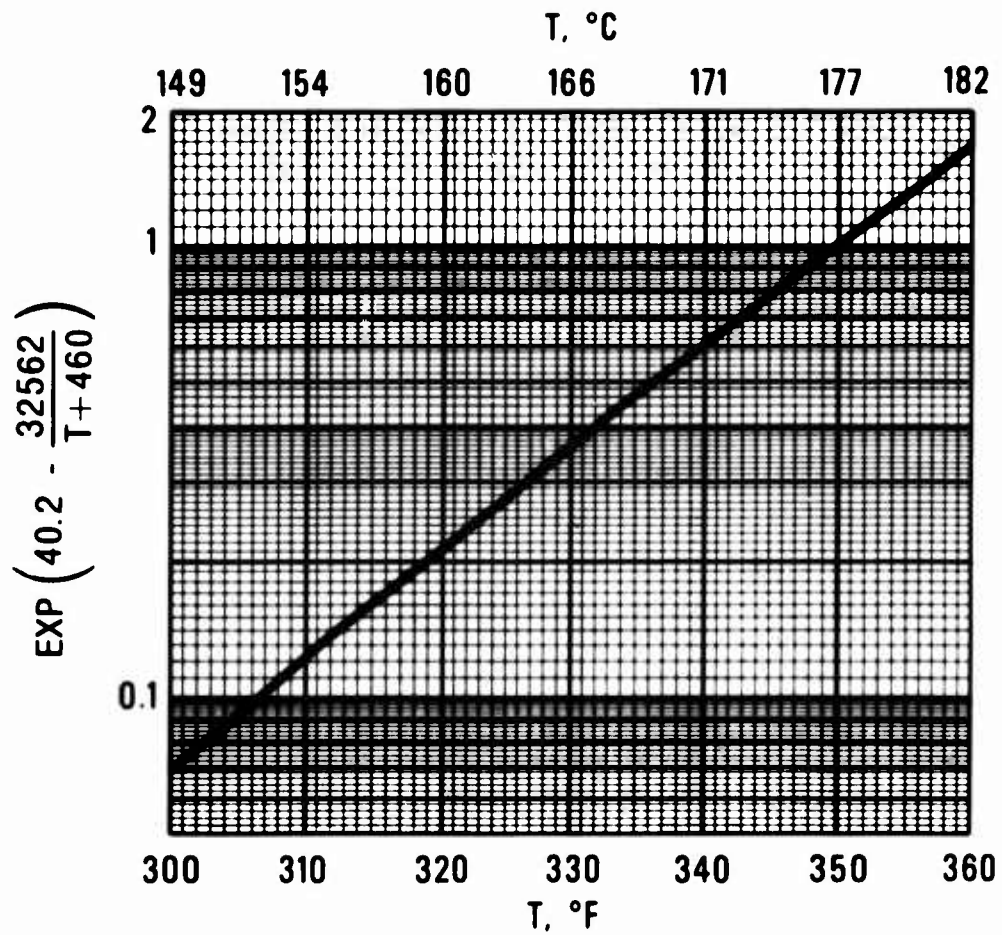

Figure 84 Factor for Calculation of Equivalent Artificial Aging Conditions

APPENDIX A

Low Crack Growth Rate Fatigue Propagation Tests

Crack growth data starting at rates of 10^{-8} to 10^{-7} in /cycle are presented in Figs. A1 - A3. The horizontal scale for these figures has been expanded; accordingly, differences and scatter are emphasized. The following expression was used for stress intensity for these specimens having $H/W=0.6$:

$$K = \frac{P}{B\sqrt{W}} \frac{(2+a/W)}{(1-a/W)^{3/2}} [0.886 + 4.64(a/W) - 13.32(a/W)^2 + 14.72(a/W)^3 - 5.6(a/W)^4]$$

This equation (Ref. 37) is accurate over a greater proportion of the width than the equation given in Ref. 27, so data was taken starting at $H/W=0.30$ instead of 0.35.

Average curves are included in Figs. A-1 and A-2 representing fatigue crack propagation relationships obtained in $R=1/3$ tests of 1-in. thick specimens from the C5A wing panels (Figs. 64 and 65). An increase of propagation rates with increase in stress ratio is shown for the L-T specimens tested in moist air. At low and high stress intensities, growth rates are equivalent in dry and moist environments. The results for both the $R=0.1$ and 0.5 tests of 1/4 in. L-T specimens show substantially less environmental effects at intermediate stress intensities. For the tests in dry air, propagation is, surprisingly, indicated to be faster for $R=0.1$ than for $R=1/3$ at intermediate stress intensities. Fig. A-4 shows data presented by Wei (Ref. 38) concerning the effect of moisture content on fatigue crack growth in an Al-Cu-Mg alloy and in Alclad 7075-T6 sheet. It can be seen that the effect of water

content varies with frequency and stress level but that the transition from no effect of water vapor to maximum increase in rate of propagation at test frequencies of 15 to 50 Hz probably occurs in the range of 5 to 10% relative humidity. Accordingly, it is believed that the anomaly of faster dry air propagation at $R=0.1$ than at $R=1/3$ probably results from variations in humidity within this range. It appears that data obtained in a moist environment presents the only data for this alloy which would be in the practical range for aircraft alloys.

For rates above 10^{-7} in/cycle Fig. A-3 shows good agreement between rates determined for 1/4-in. and 1-in. thick T-L specimens tested in moist air; the more limited, low growth rate data for the 1-in. thick specimen indicates a somewhat higher threshold - the stress intensity below which propagation would not occur. At rates above 10^{-7} in/cycle, propagation was similar for the L-T and T-L specimens in moist air, but the T-L specimen tested in dry air showed a slightly greater environmental advantage. At $R=0.5$, a threshold stress intensity of about $1.5 \text{ ksi}/\sqrt{\text{in.}}$ is indicated for the T-L specimens and about $1.0 \text{ ksi}/\sqrt{\text{in.}}$ for the L-T specimens. Fig. A-1 supports a threshold of about $2.5 \text{ ksi}/\sqrt{\text{in.}}$ for the $R=0.1$ test of L-T specimens.

Table A-1

Test Program to Determine Fatigue Crack Propagation
at Low Stress Intensities for 7050-T73511 C5A Extruded Wing Panel

S. 421332

<u>Orientation</u>	<u>Environment</u>	<u>R</u>	<u>Minimum da/dN, in./Cycle</u>	<u>No. Test</u>
L-T	Humid	.5	10^{-8}	2 (a)
L-T	Humid	.1	10^{-8}	2 (a)
T-L	Humid	.5	10^{-8}	1
L-T	Dry	.5	10^{-8}	1
L-T	Dry	.1	10^{-7}	1
T-L	Dry	.5	10^{-8}	1

(a) First test starts @ $da/dN=10^{-7}$ in/cycle, second @ 10^{-8} in/cycle.

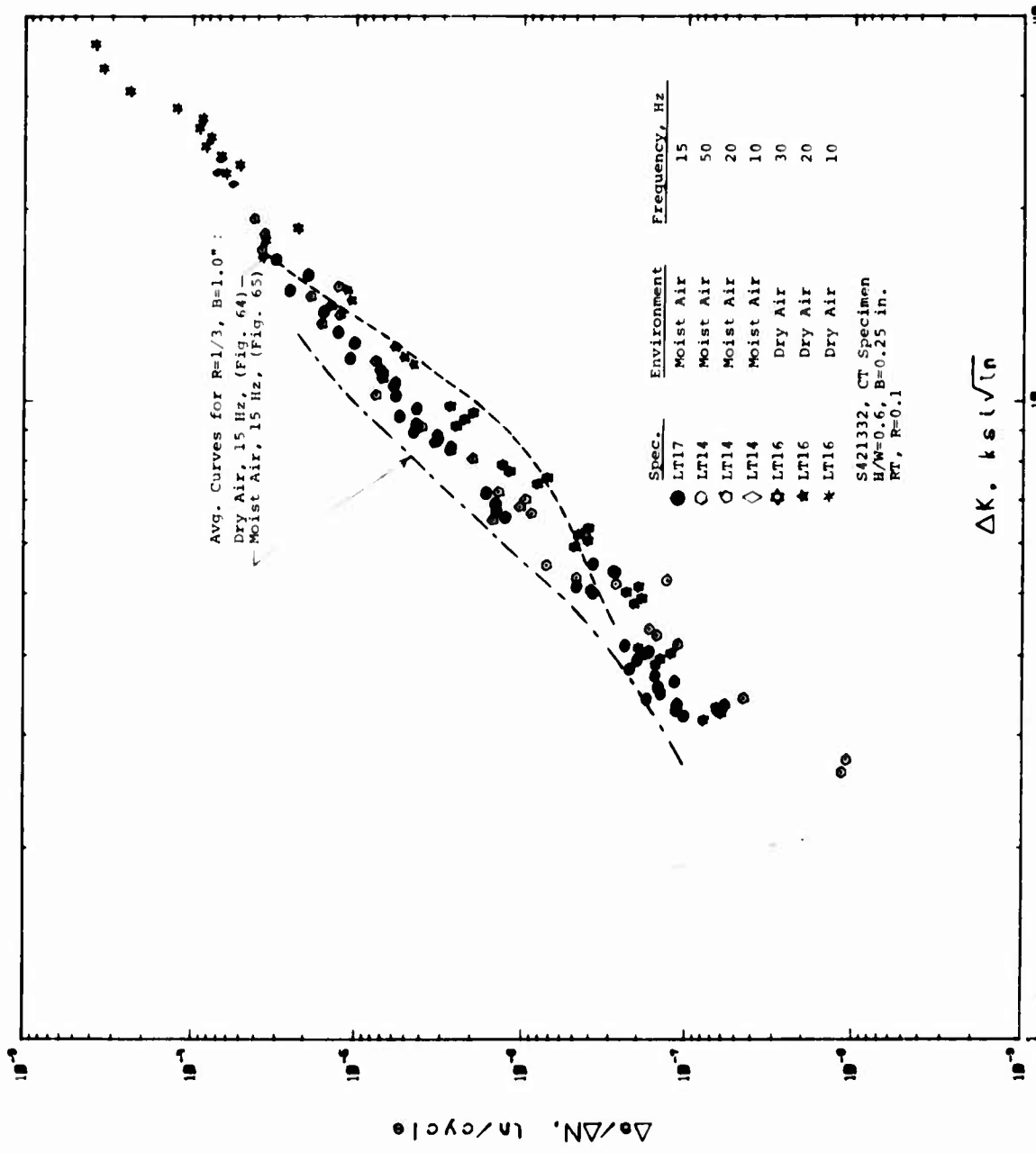

Fig. A-1 Fatigue Crack Growth Data for CSA Extruded Panel, 7050-T7351X, L-T Orientation and $R=0.1$

10-JAN-77 16:34 26.1

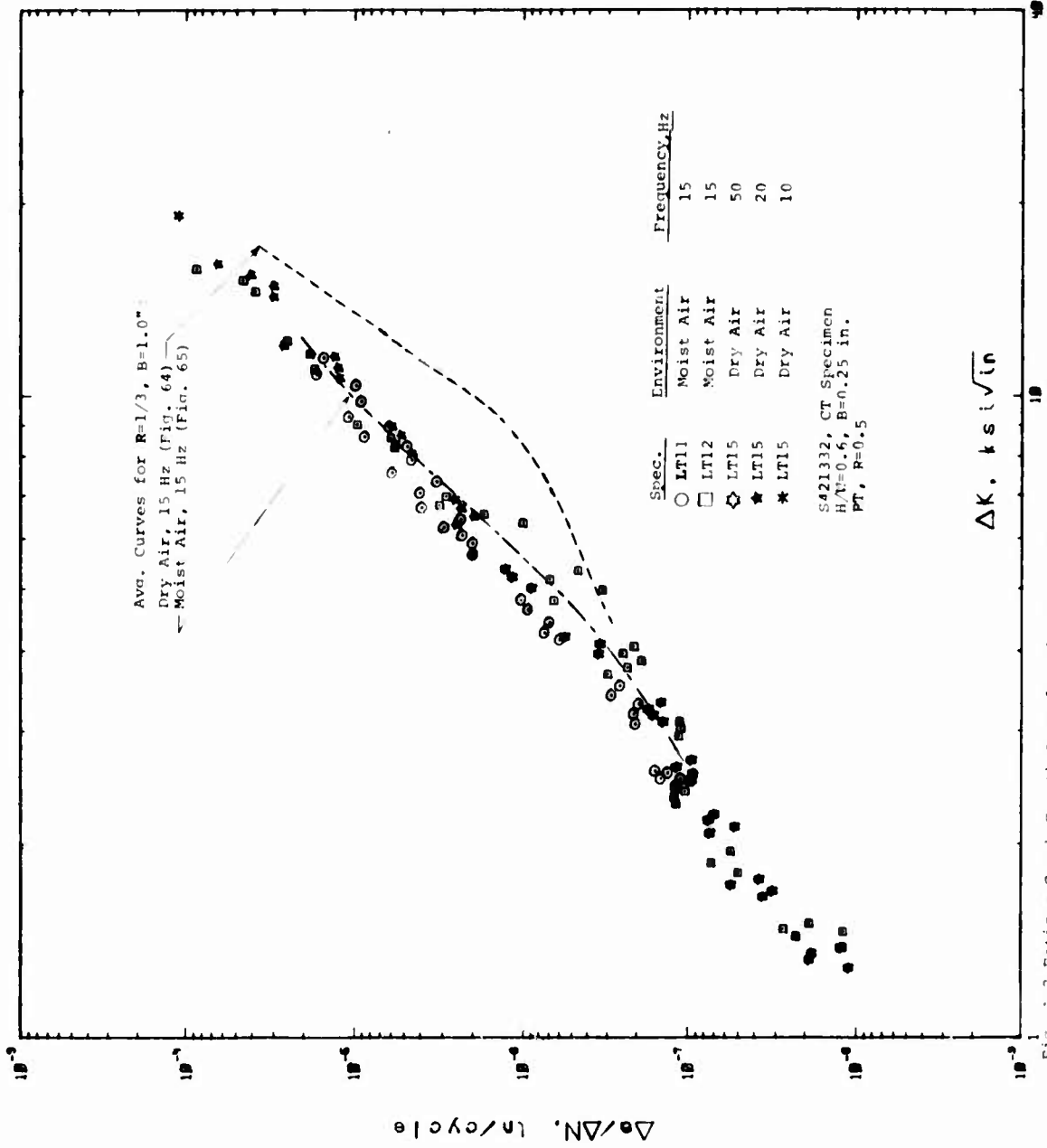

Fig. A-2 Fatigue Crack Growth Data for CSA Extruded Panel, 7050-T7351X, L-T Orientation and $R=0.5$

10-JAN-77 16:34 10.1

25-JAN-77 13:54 40.9

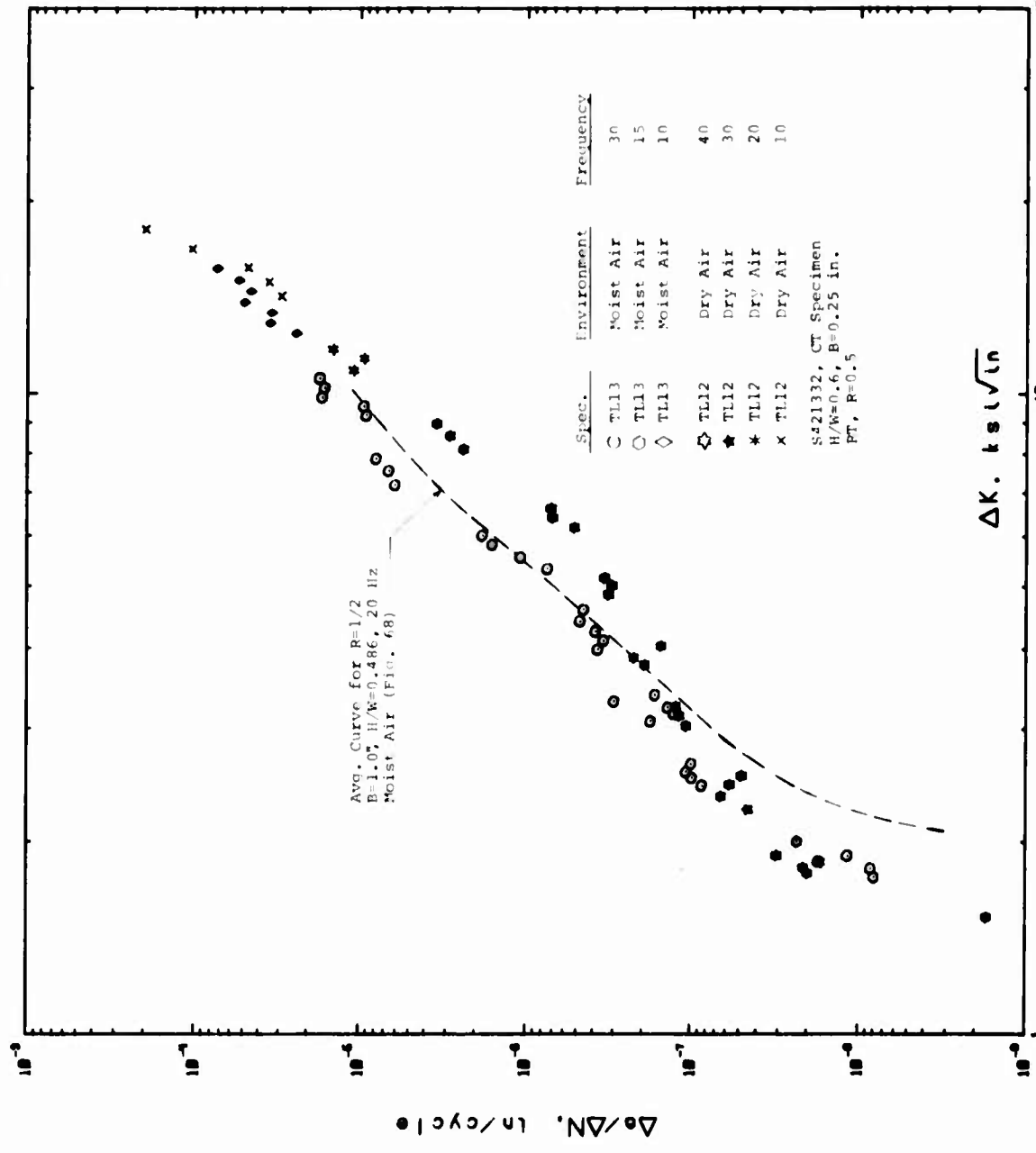
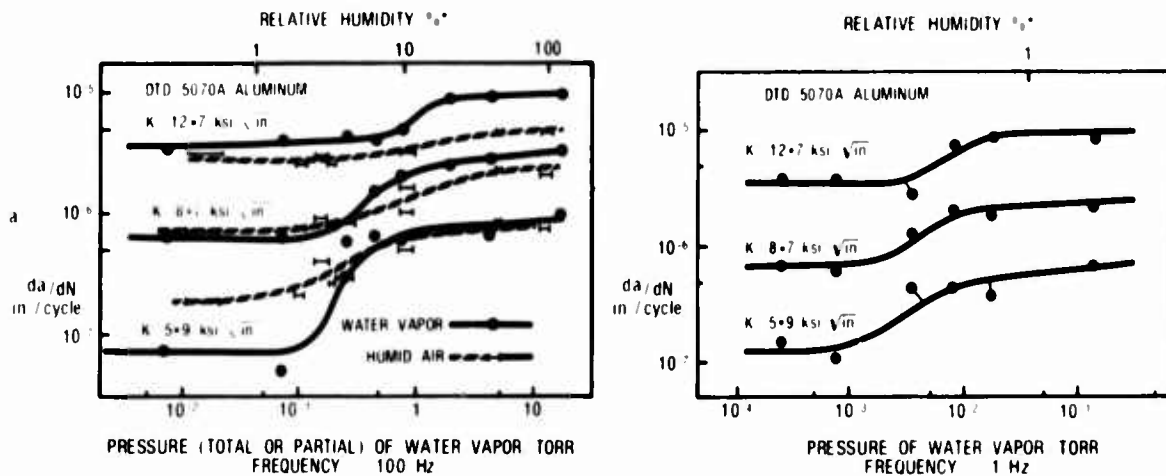
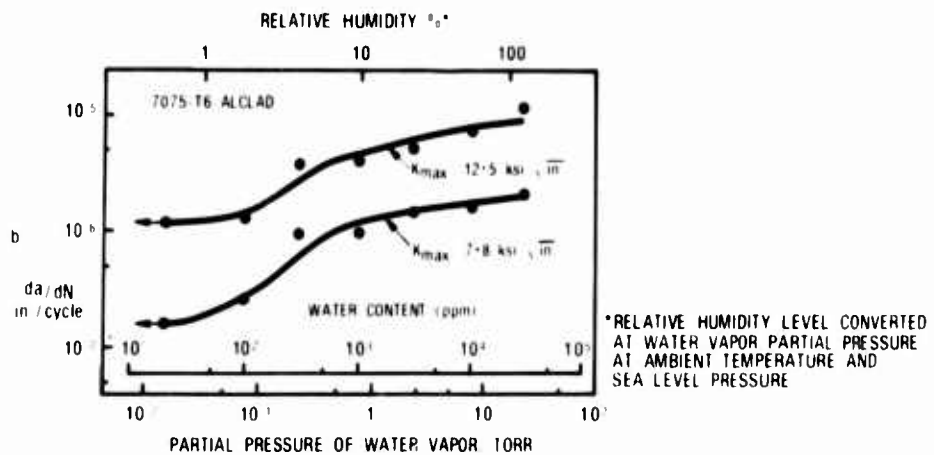

Fig. A-3 Fatigue Crack Growth Data for C5A Extruded Panel, 7050-T7351X, T-L Orientation and P=0.5



THE EFFECT OF MOISTURE CONTENT AND FREQUENCY ON THE RATE OF FATIGUE CRACK GROWTH IN A AlCuMg ALLOY ()



THE EFFECT OF PARTIAL PRESSURE OF WATER VAPOR ON FATIGUE CRACK GROWTH IN A AlZnMg ALLOY AT 57 c/s ()

Figure A-4 Effects of Moisture Content on Fatigue Crack Growth of Aluminum Alloys (REF. 38)

APPENDIX B

SCC CRACK GROWTH CURVES

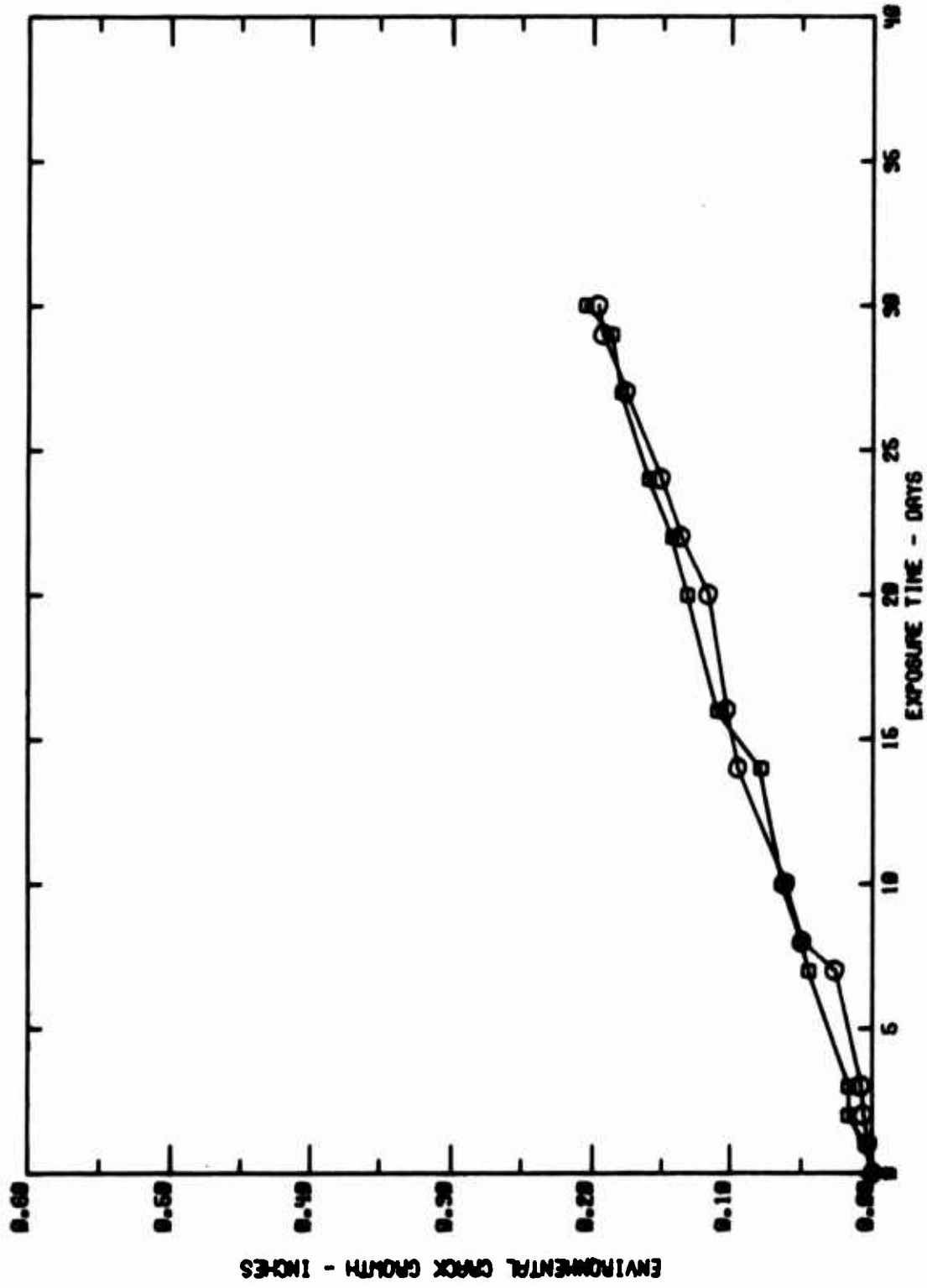

Figure B1 Environmental Crack Growth of Short Transverse 7050-T7351 Alloy DCB Specimens Exposed to 3.5% NaCl Solution Dropwise, S429204-1(○),-2(□)

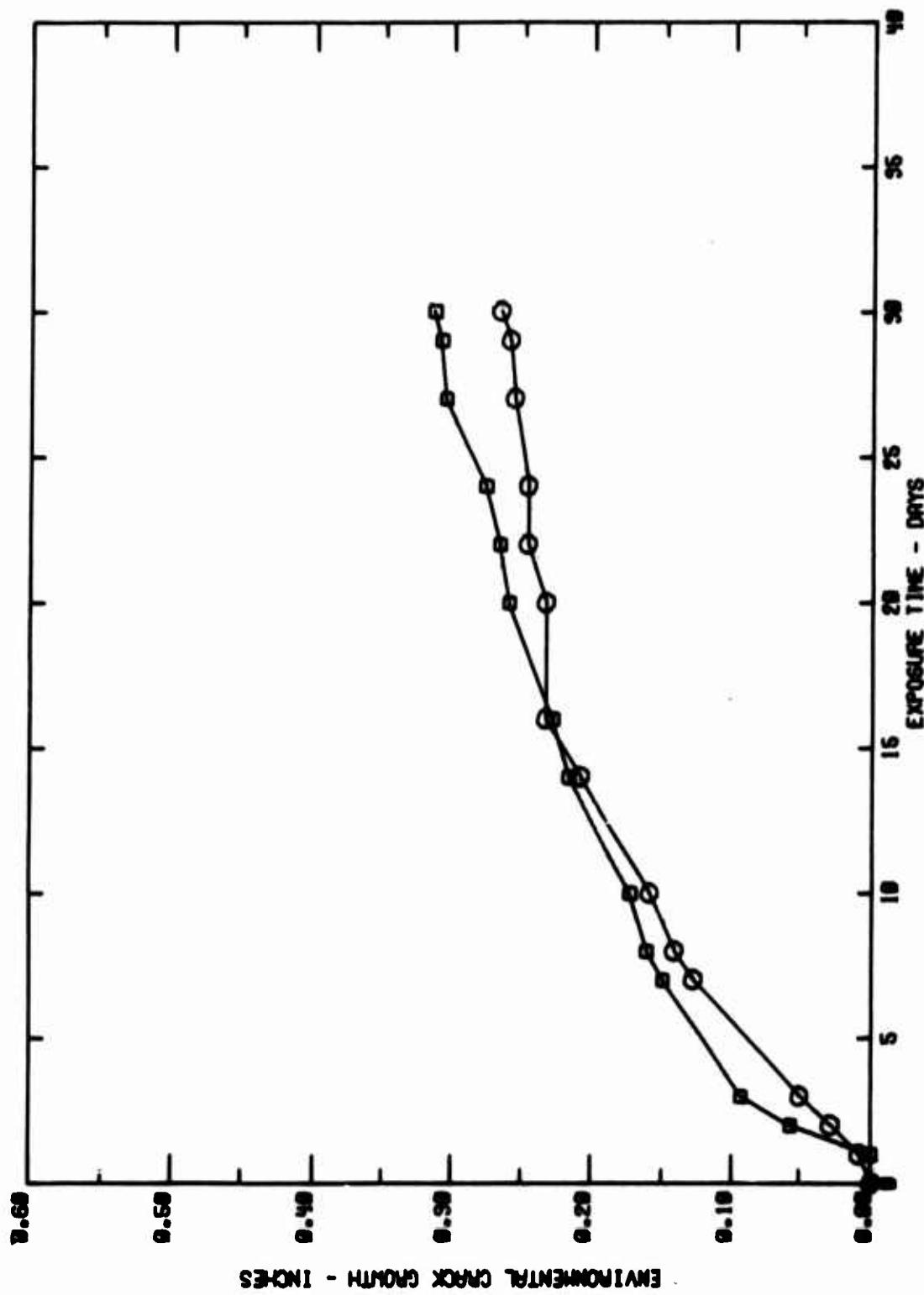

Figure B2 Environmental Crack Growth of Short Transverse 7050-T7351 Alloy DCB Specimens Exposed to 3.5% NaCl Solution Dropwise, S429207-1 (○),-2 (□)

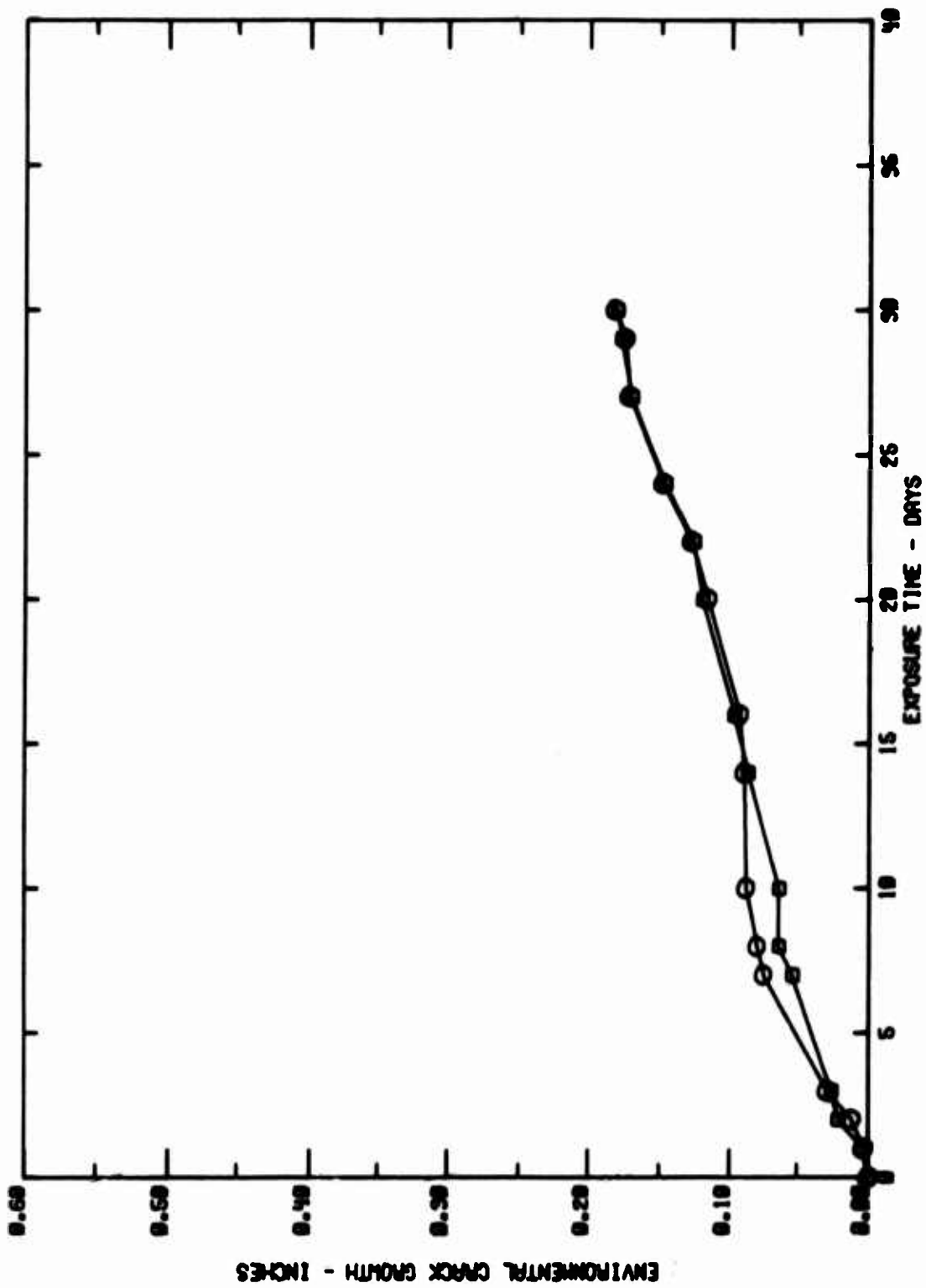

Figure B4 Environmental Crack Growth of Short Transverse 7050-T7351 Alloy DCB Specimens Exposed to 3.5% NaCl Solution Dropwise, S421333-1(O);-2(□)

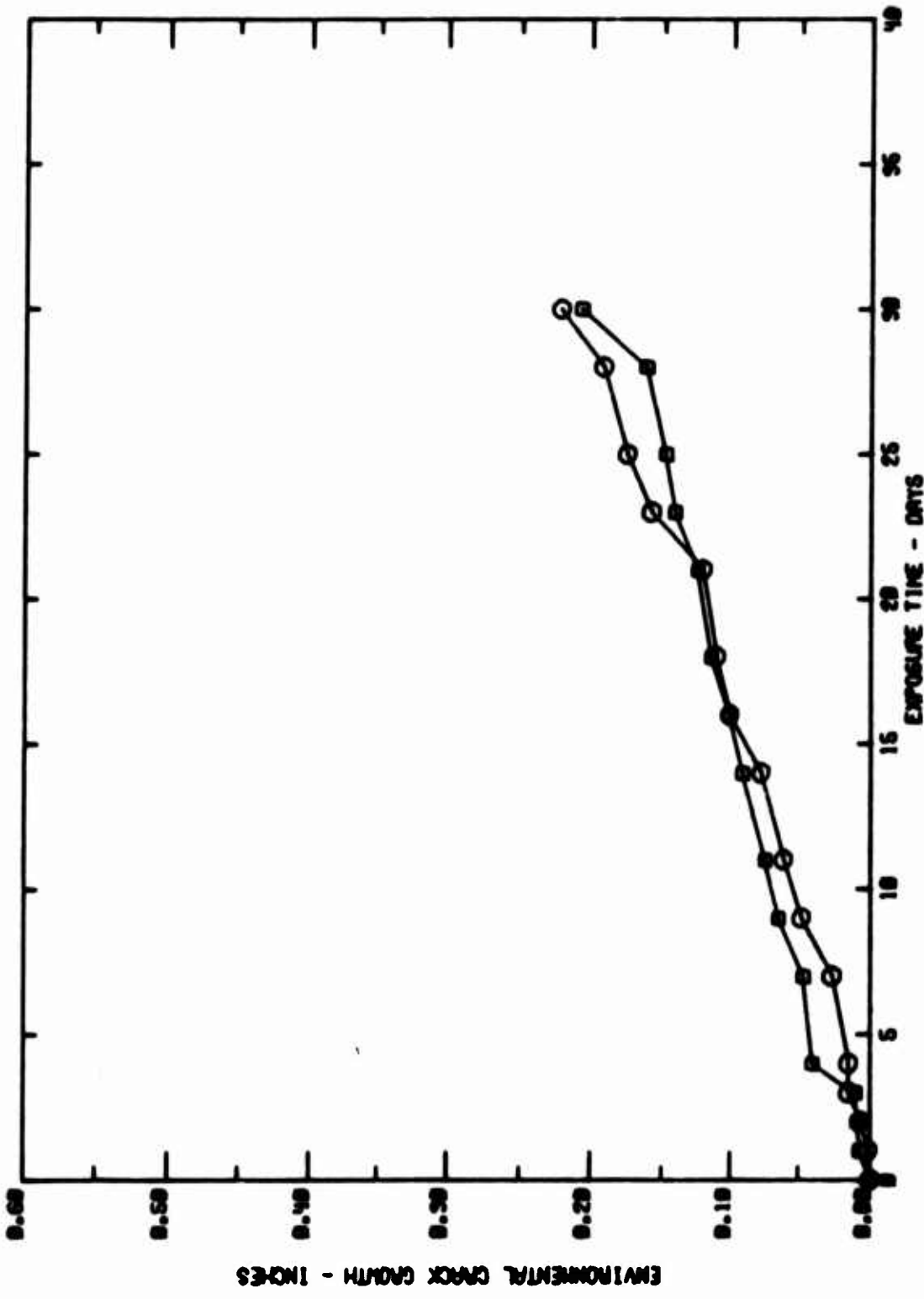

Figure B3 Environmental Crack Growth of Short Transverse 7050-T7351 Alloy DCB Specimens Exposed to 3.5% NaCl Solution Dropwise, S421137-2 (○),-3 (□)

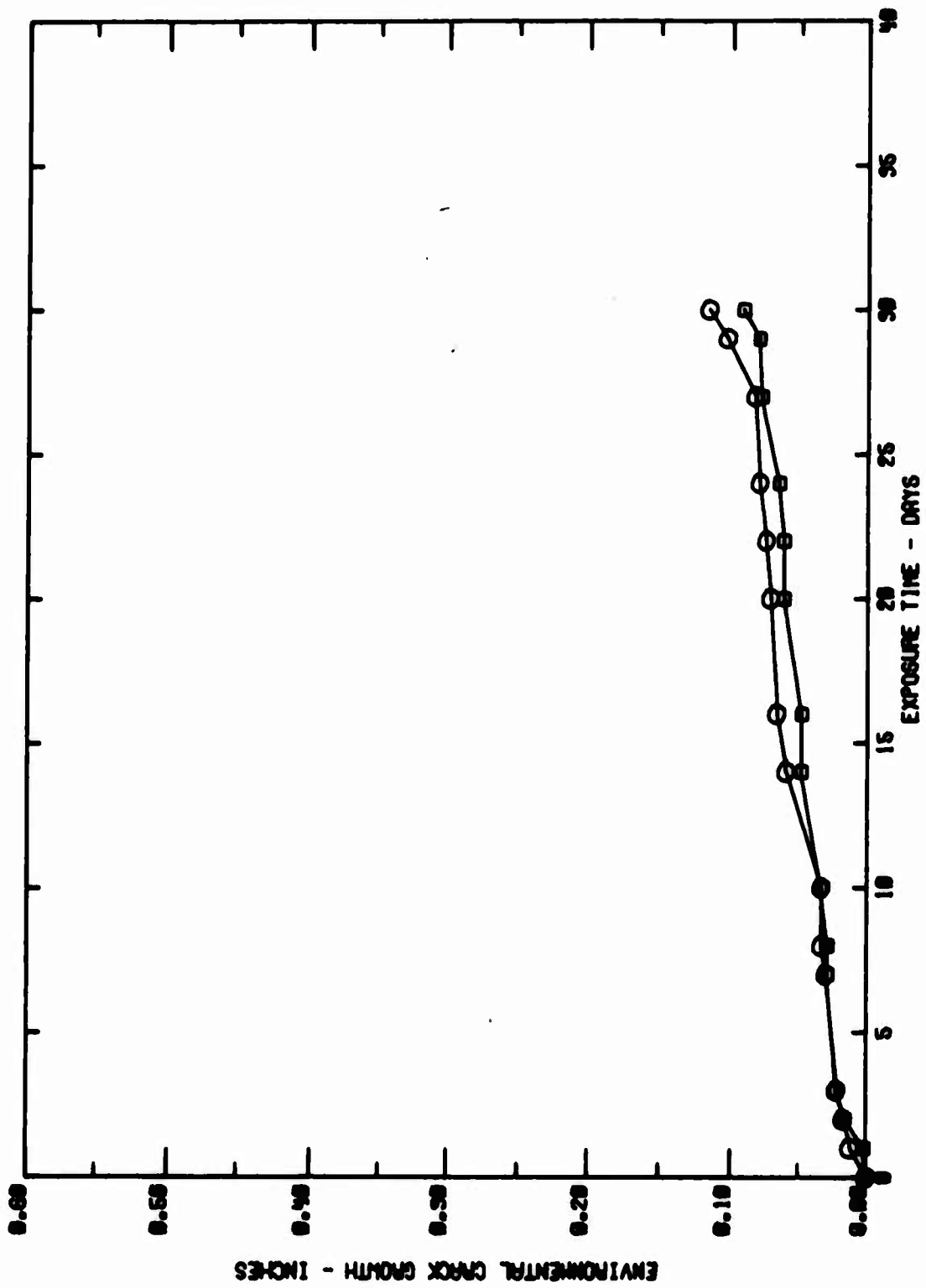

Figure B5 Environmental Crack Growth of Short Transverse 7050-T7351 Alloy DCB Specimens Exposed to 3.5% NaCl Solution Dropwise, S421336-1(O),-2(O)

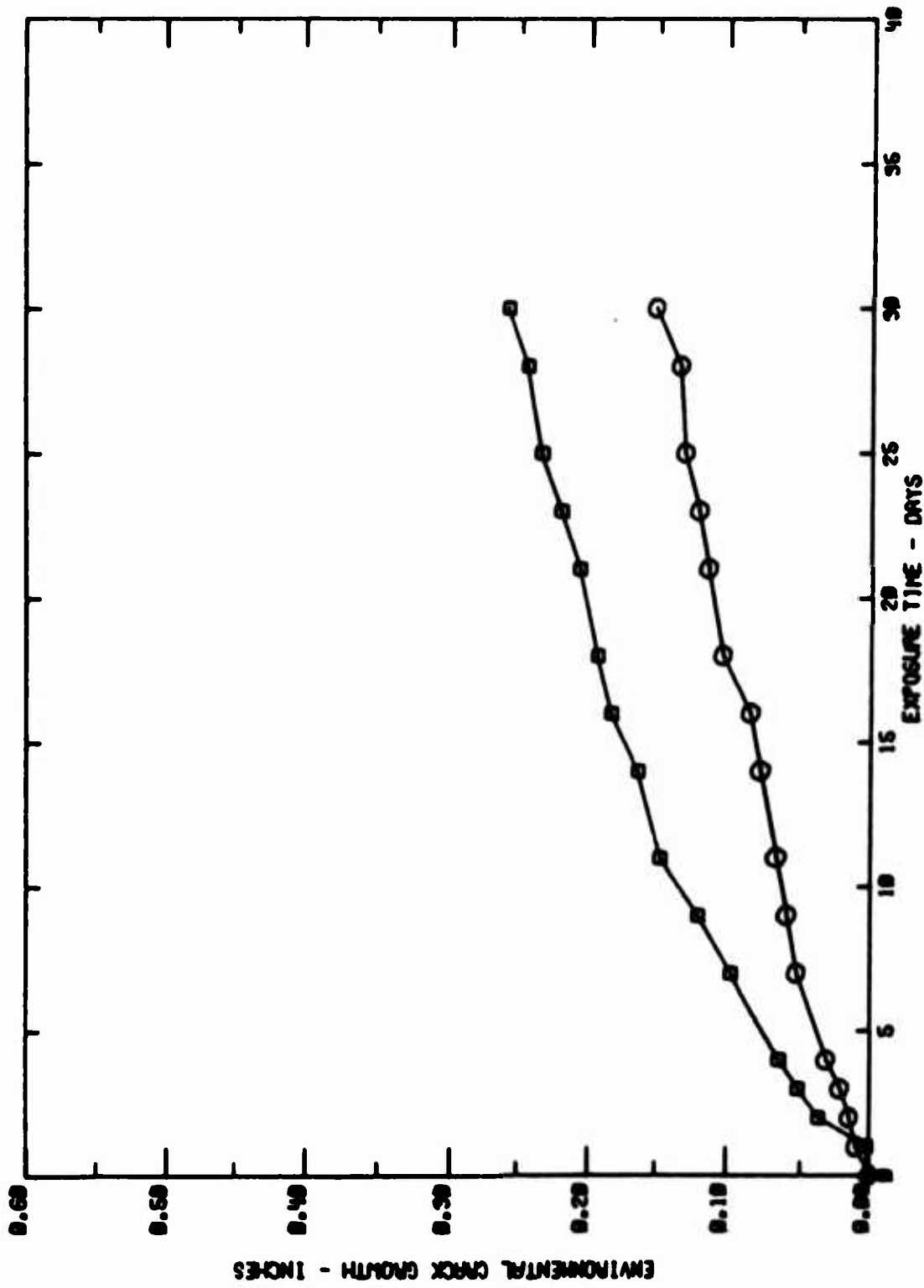

Figure B6 Environmental Crack Growth of Short Transverse 7050-T7351 Alloy DCB Specimens Exposed to 3.5% NaCl Solution Dropwise, S421132-2(O).-3(□)

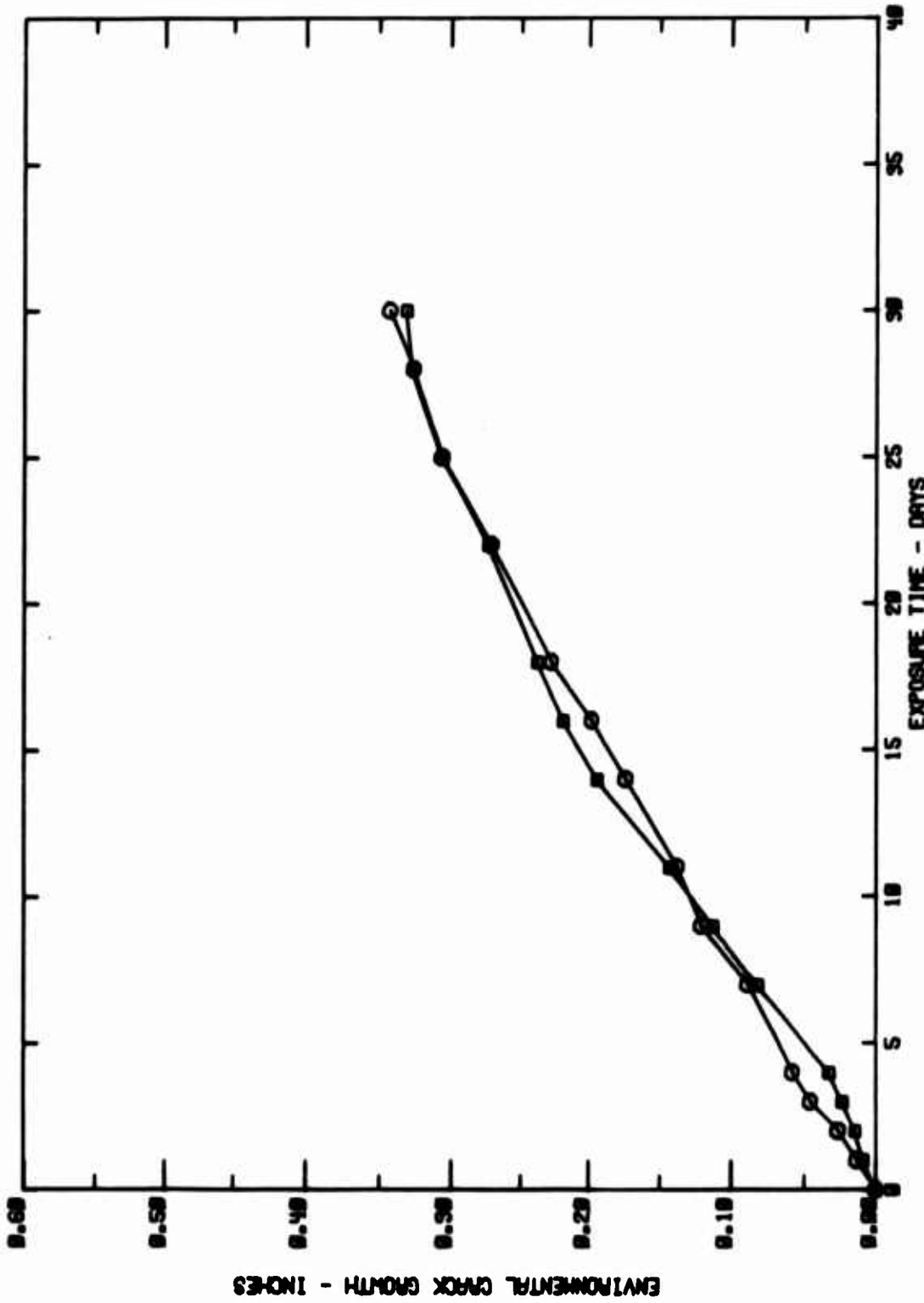

Figure B7 Environmental Crack Growth of Short Transverse 7050-T7651 Alloy DCB Specimens Exposed to 3.5% NaCl Solution Dropwise, S411287-1(O),-2(O)

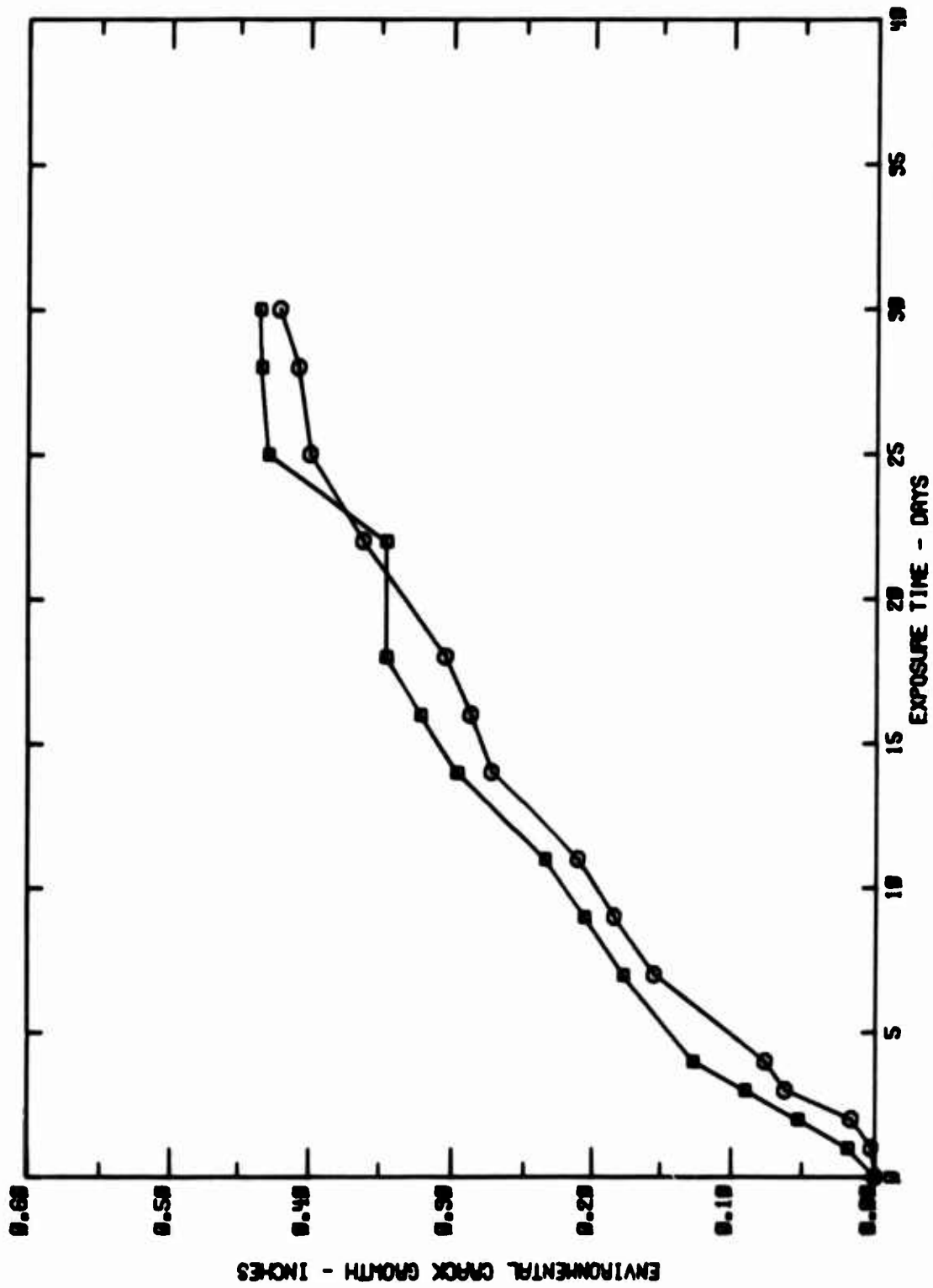

Figure B8 Environmental Crack Growth of Short Transverse 7050-T7651 Alloy DCB Specimens Exposed to 3.5% NaCl Solution Dropwise, S411284-1(O),-2(□)

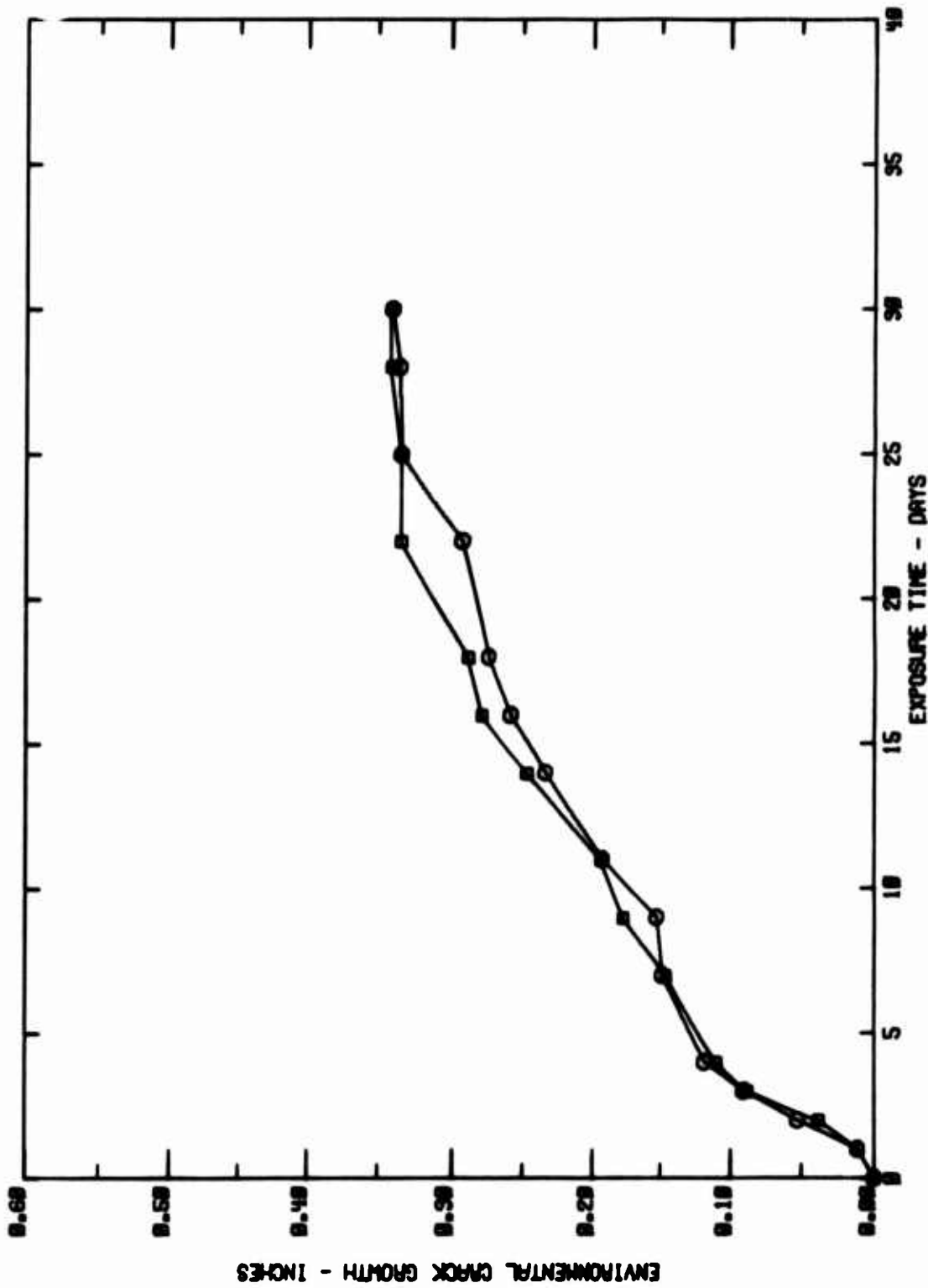

Figure B9 Environmental Crack Growth of Short Transverse 7050-T7651 Alloy DCB Specimens Exposed to 3.5% NaCl Solution Dropwise, S411285-1 (O),-2 (□)

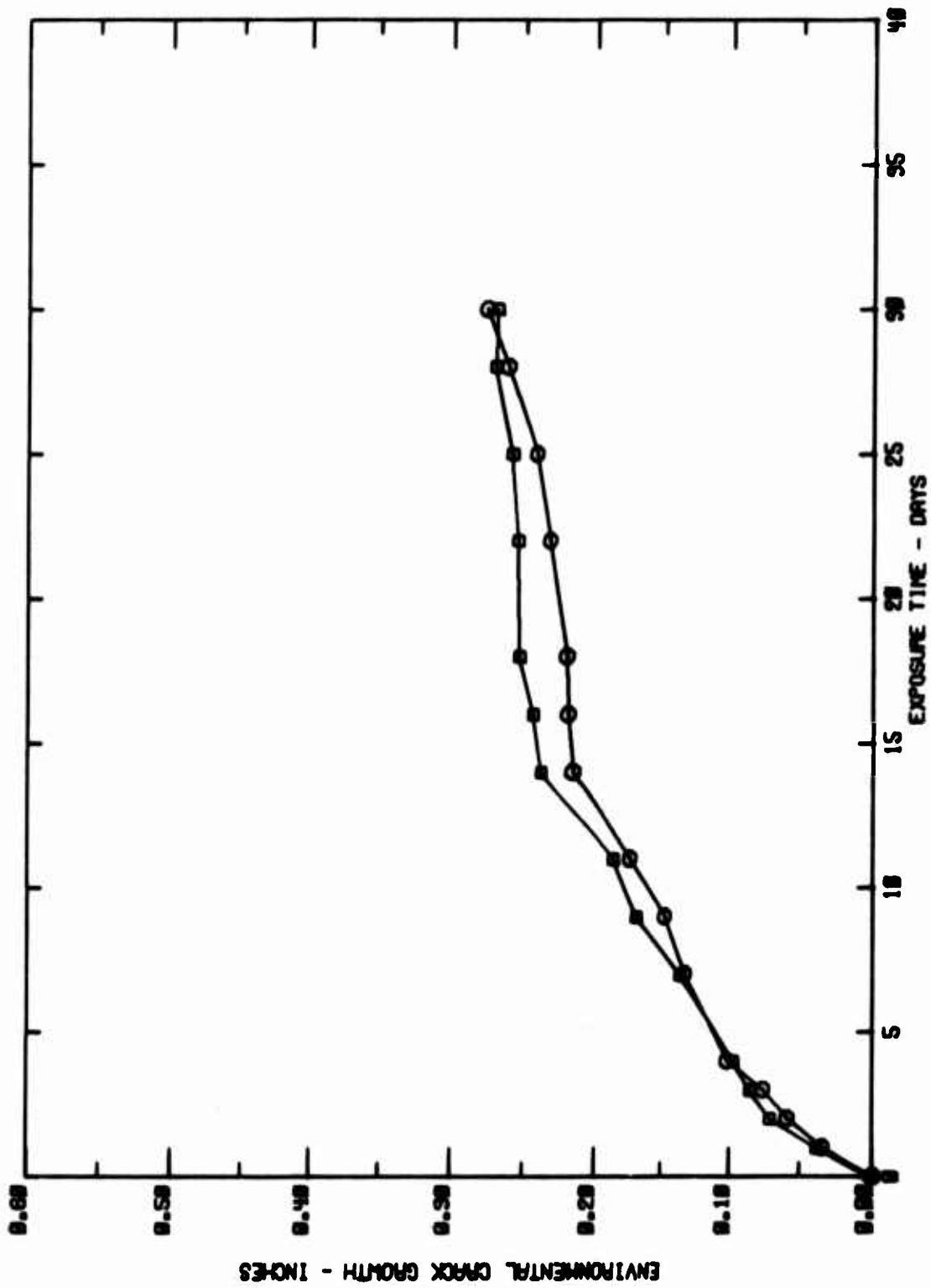

Figure B10 Environmental Crack Growth of Short Transverse 7050-T7651 Alloy DCB Specimens Exposed to 3.5% NaCl Solution Dropwise, S411286-1(○).-2(□)

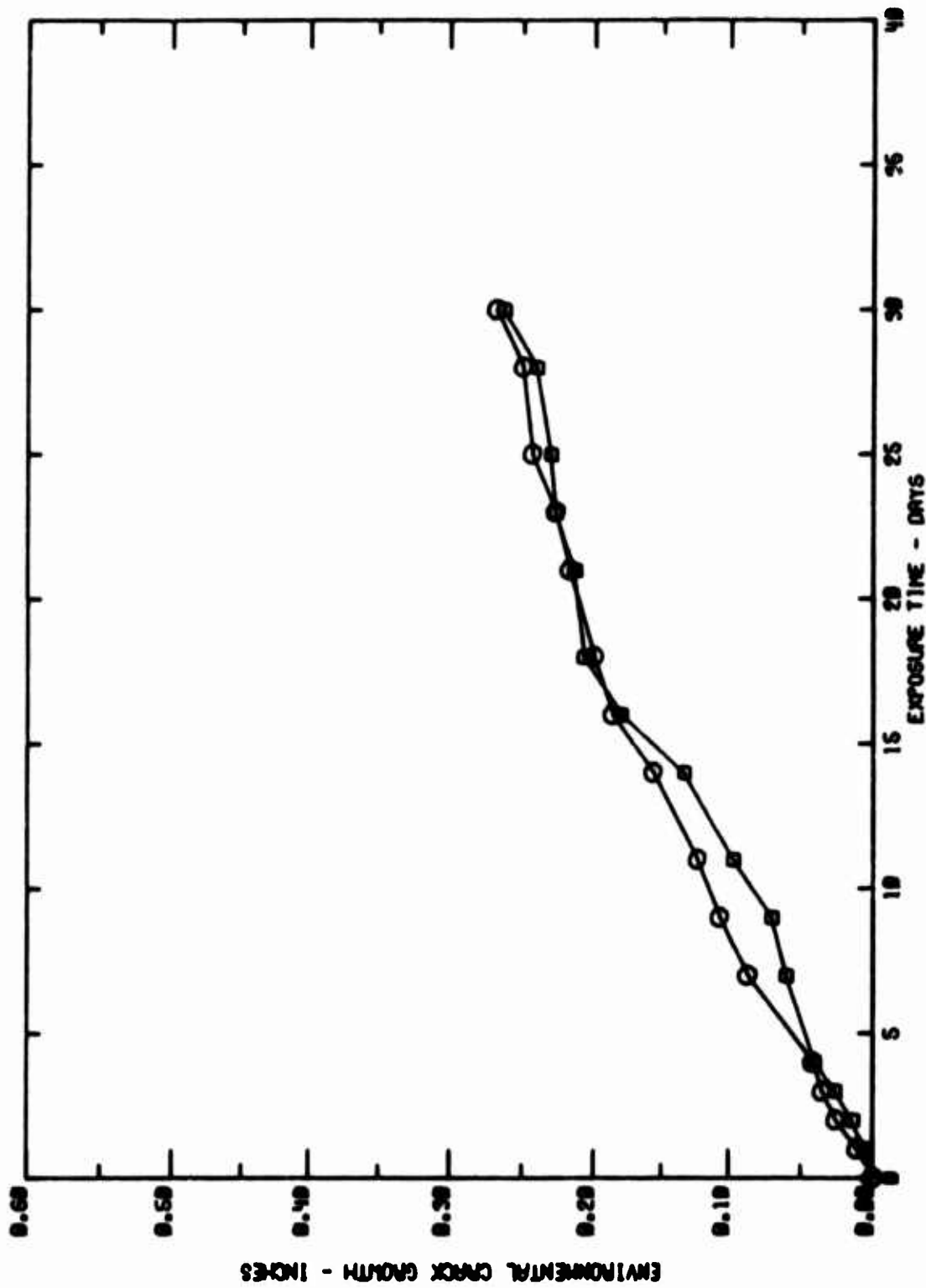

Figure B11 Environmental Crack Growth of Short Transverse 7050-T7651 Alloy DCB Specimens Exposed to 3.5% NaCl Solution Dropwise, S421135-2(O),-3(□)

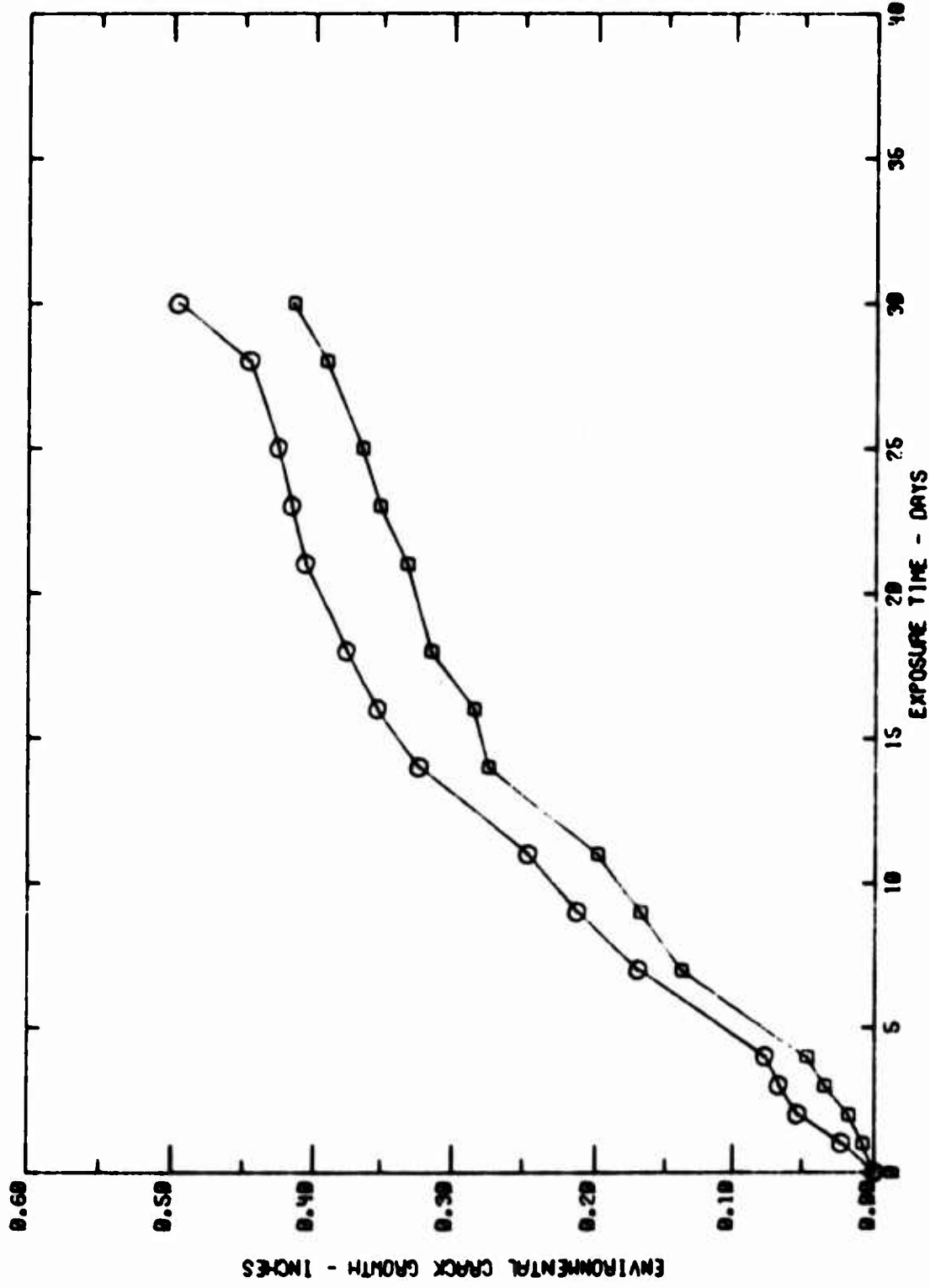

Figure B12 Environmental Crack Growth of Short Transverse 7050-T7651 Alloy DCB Specimens Exposed to 3.5% NaCl Solution Dropwise, S421143-2(○),-3(□)

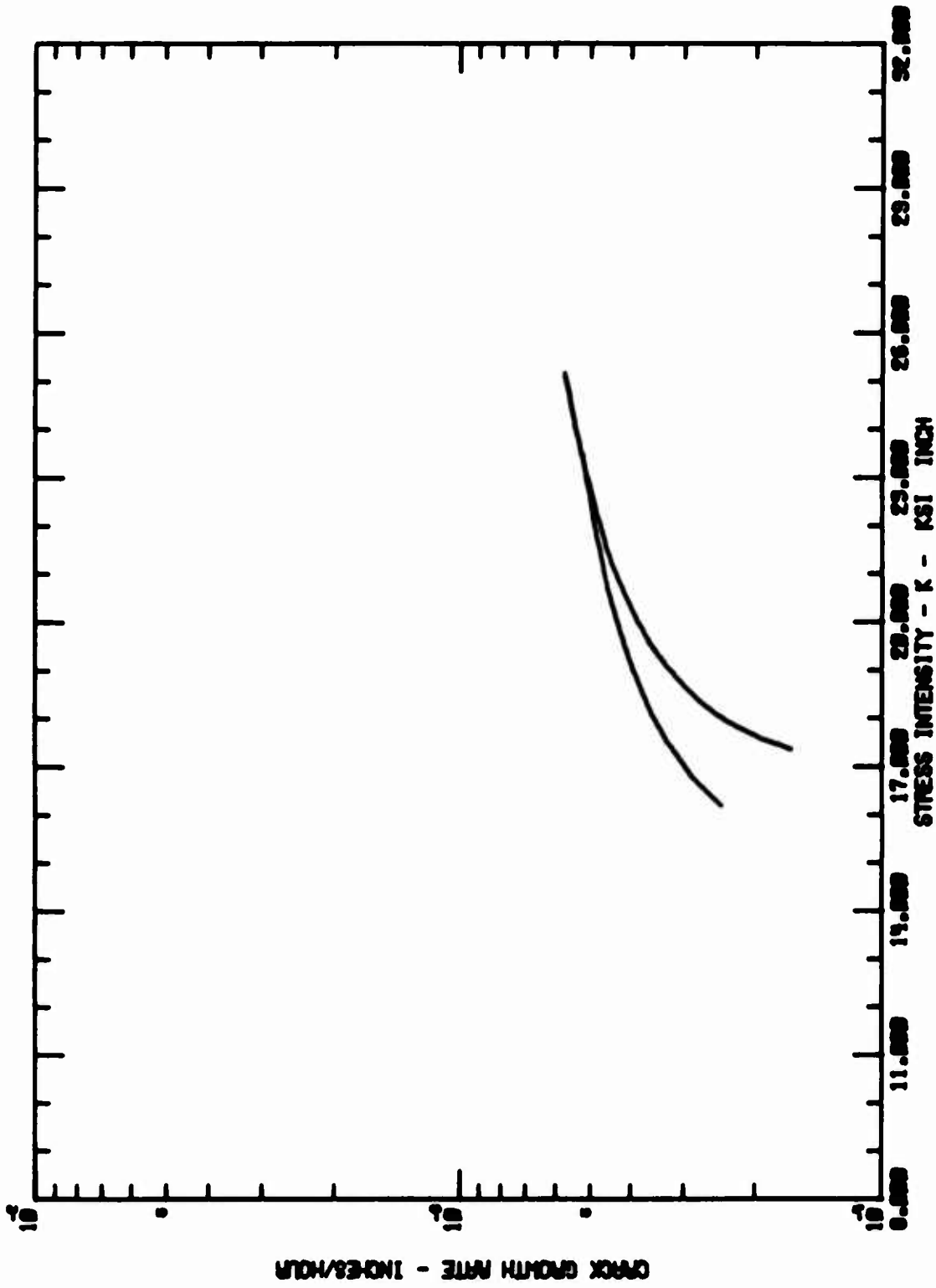

Figure B13 Best Estimate of K-Rate Curves for S-L 7050-T7651 Alloy DCB Specimens Exposed to 3.5% NaCl Solution Dropwise, S421135

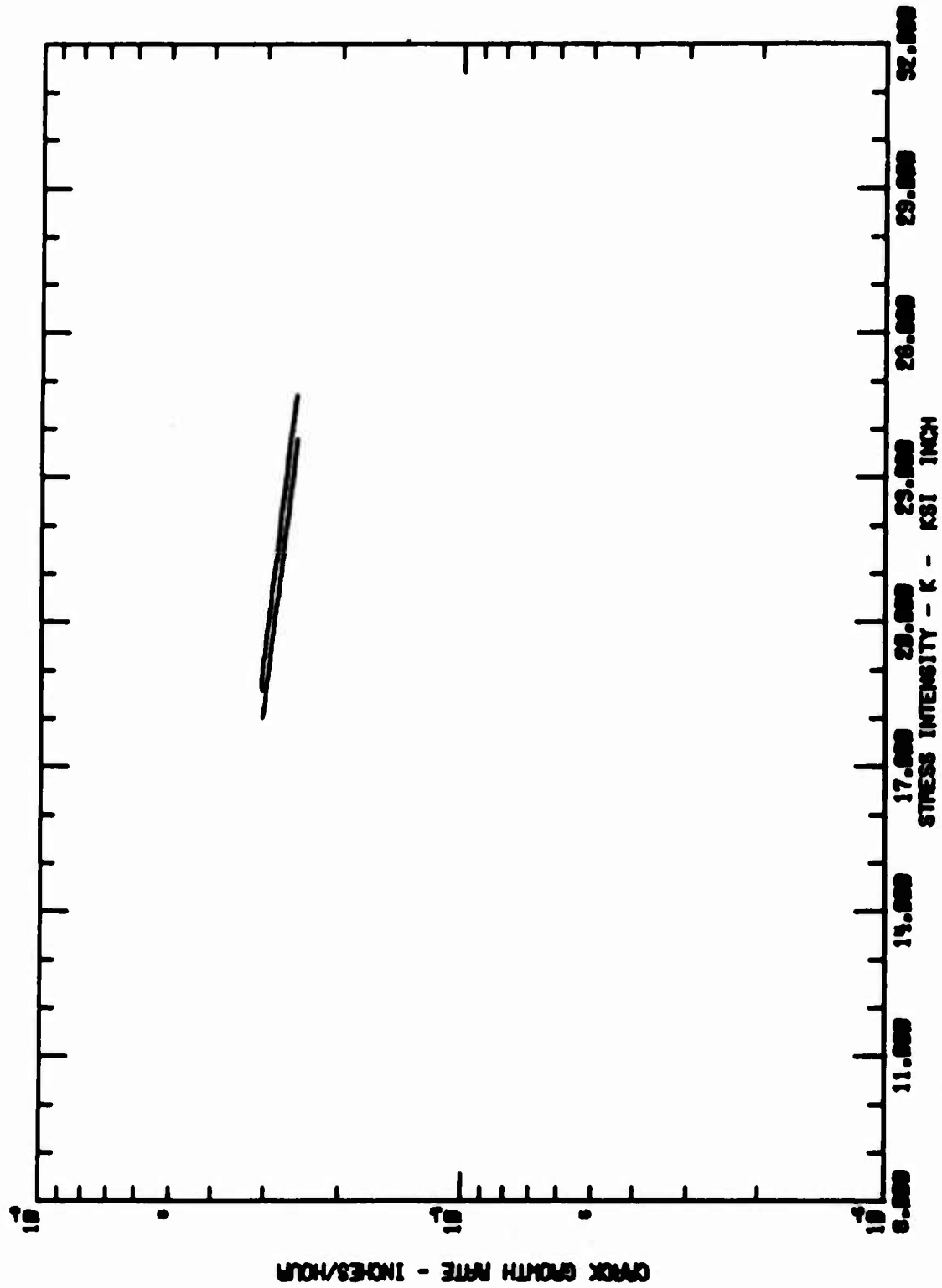

Figure B14 Best Estimate of K-Rate Curves for S-L 7050-T7351 Alloy DCB Specimens Exposed to 3.5% NaCl Solution Dropwise, S429204

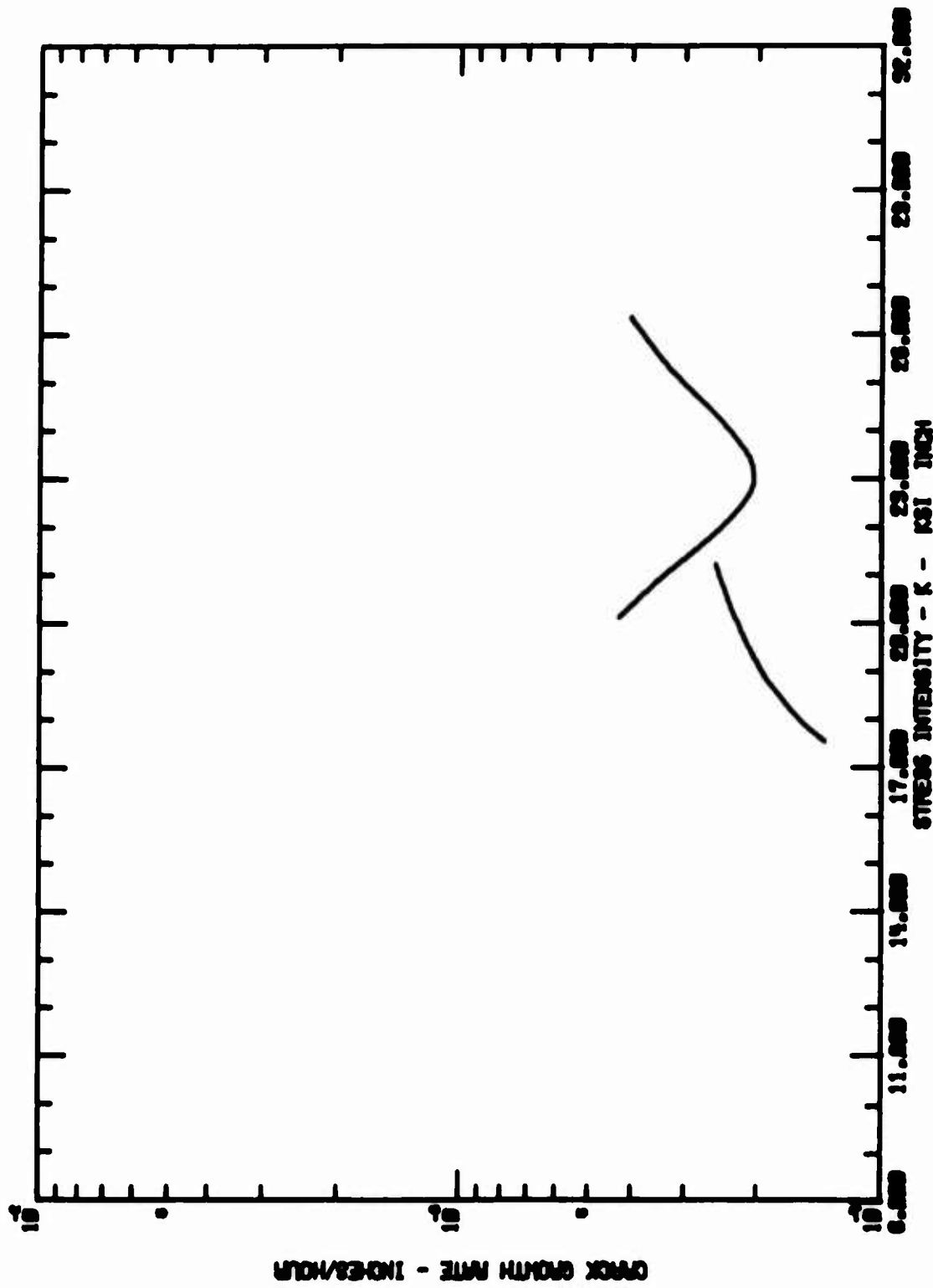

Figure B15 Best Estimate of K-Rate Curves for S-L 7050-T7351 Alloy DCB Specimens Exposed to 3.5% NaCl Solution Dropwise, S421132

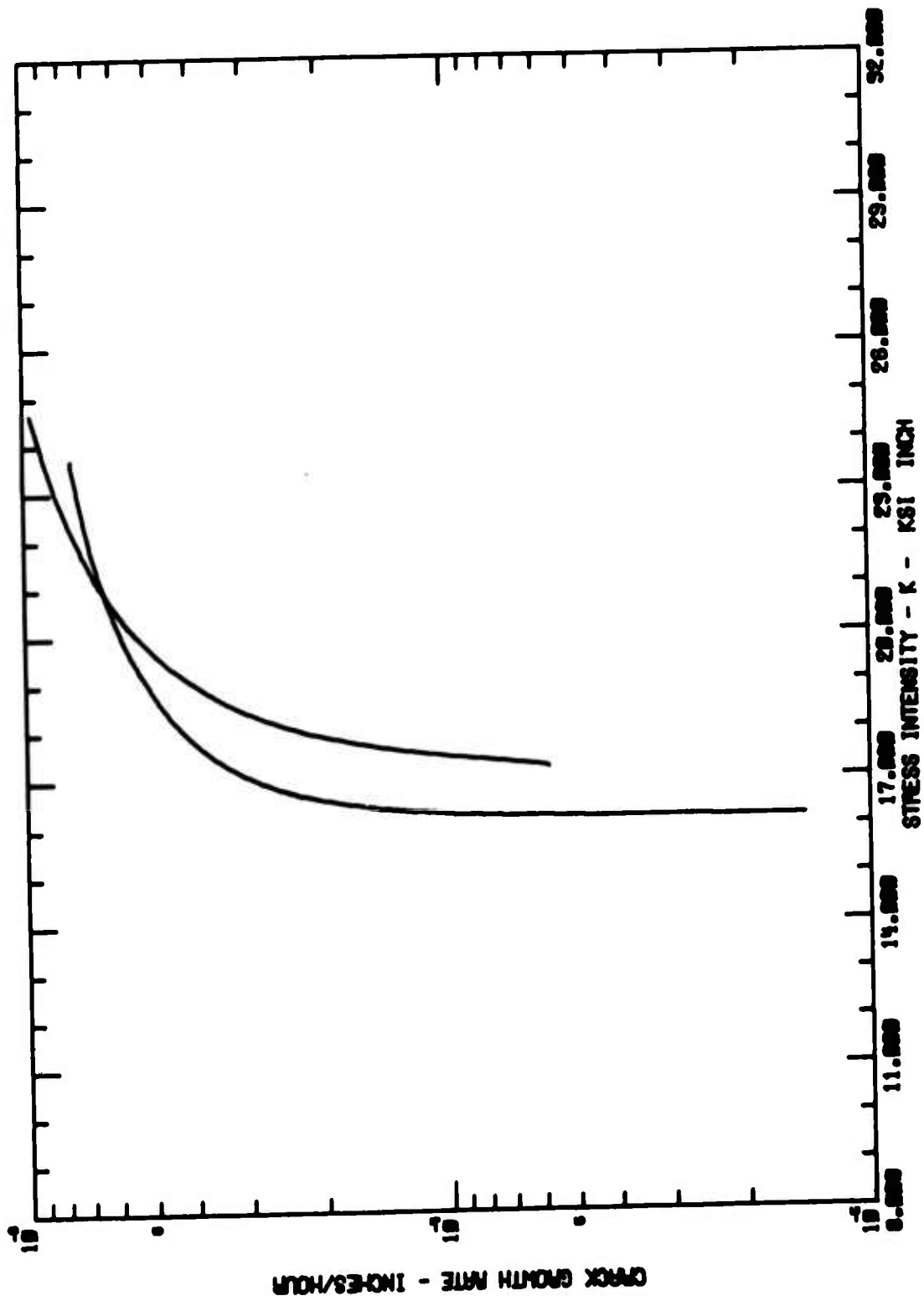

Figure B16 Best Estimate of K-Rate Curves for S-L 7050-T7351 Alloy DCB Specimens Exposed to 3.5% NaCl Solution Dropwise, S429207

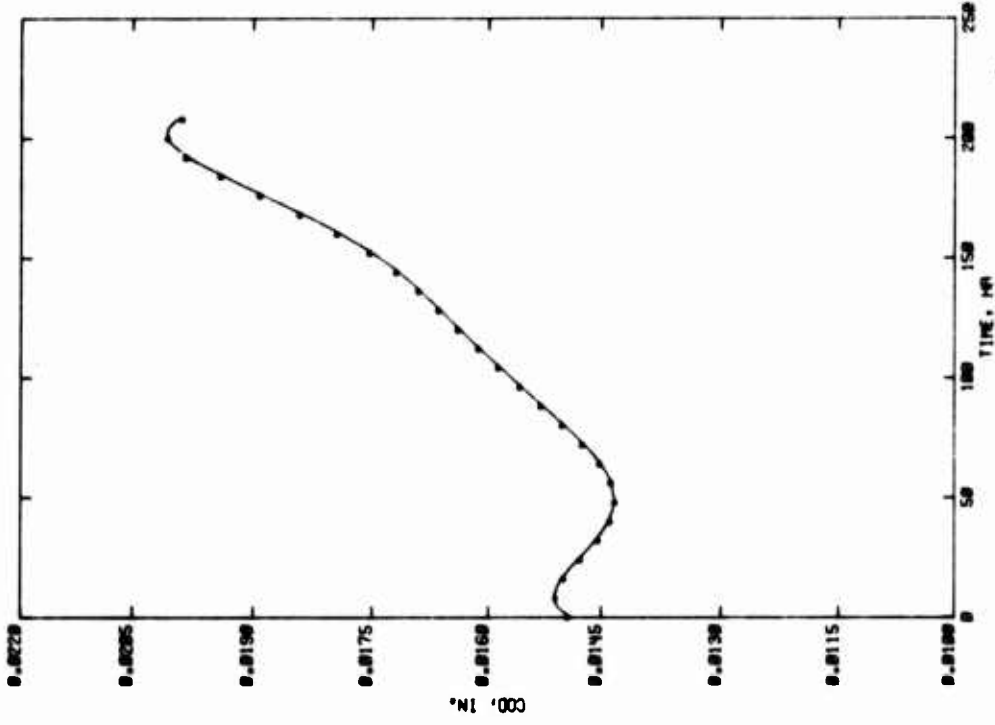
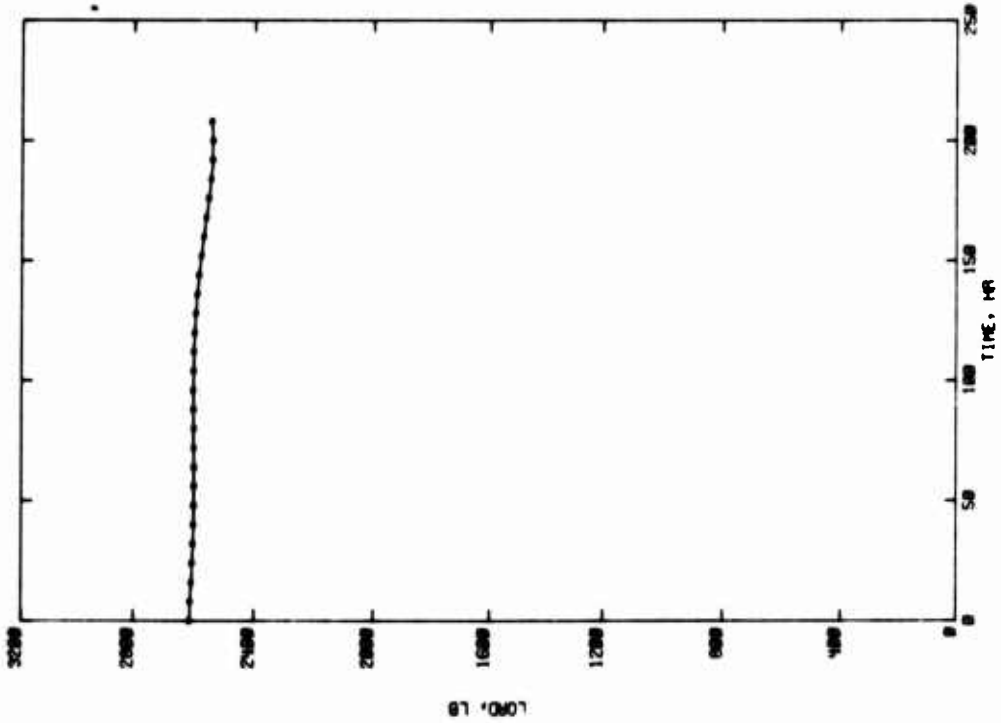

Figure B17 Ring Loaded Compact Tension Specimen of 7050-T7351X Exposed to a Salt-Dichromate Solution.

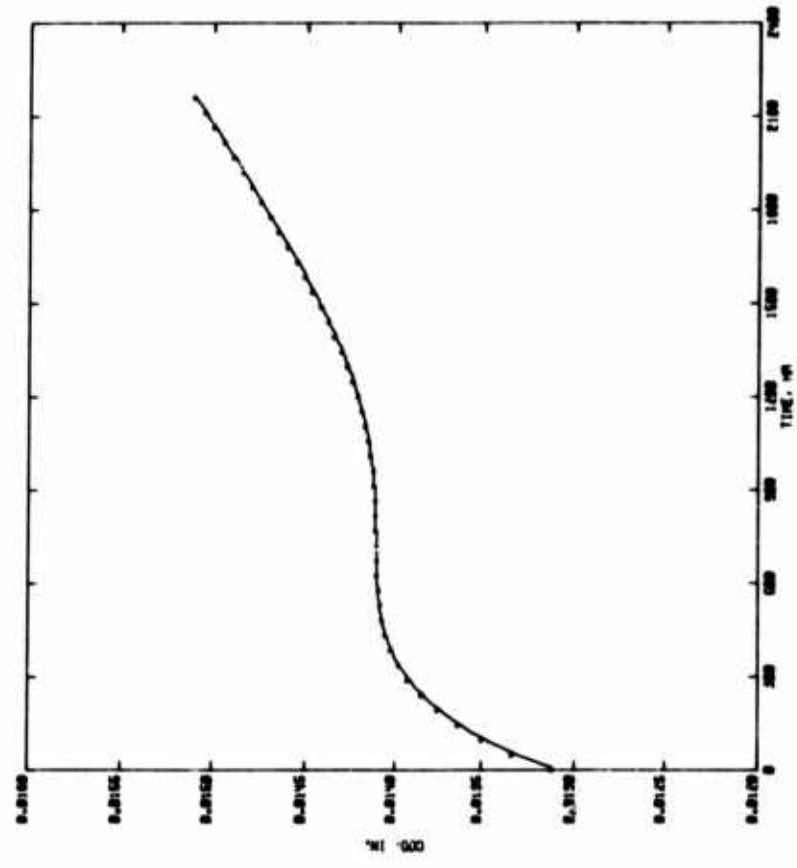
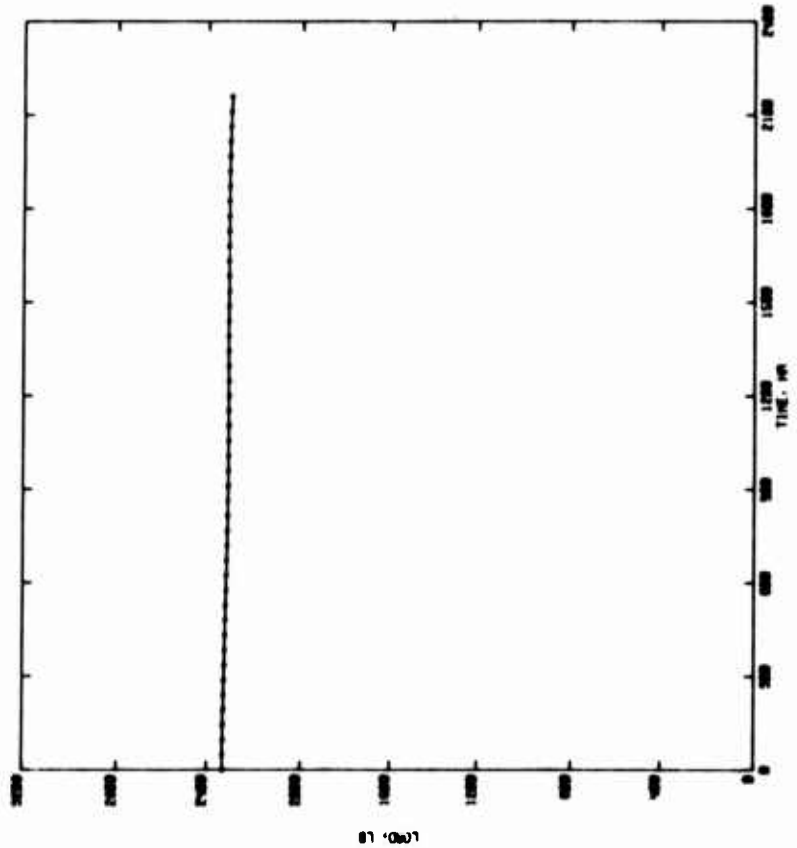

Figure B18 Ring Loaded Compact Tension Specimen of 7050-T7351X Exposed to a Salt-Dichromate Solution

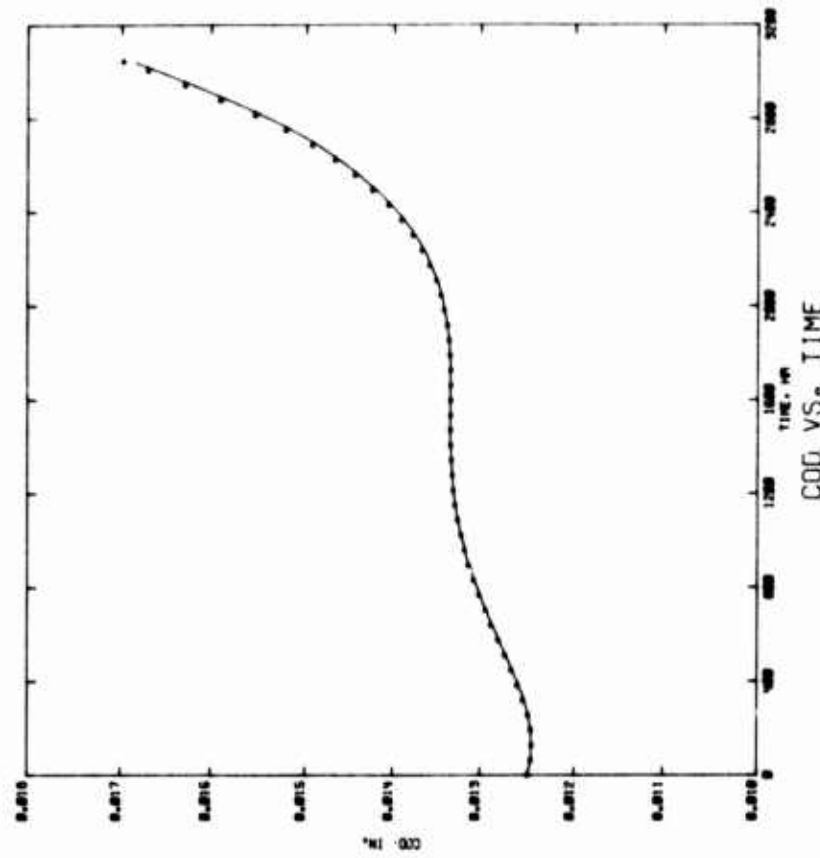
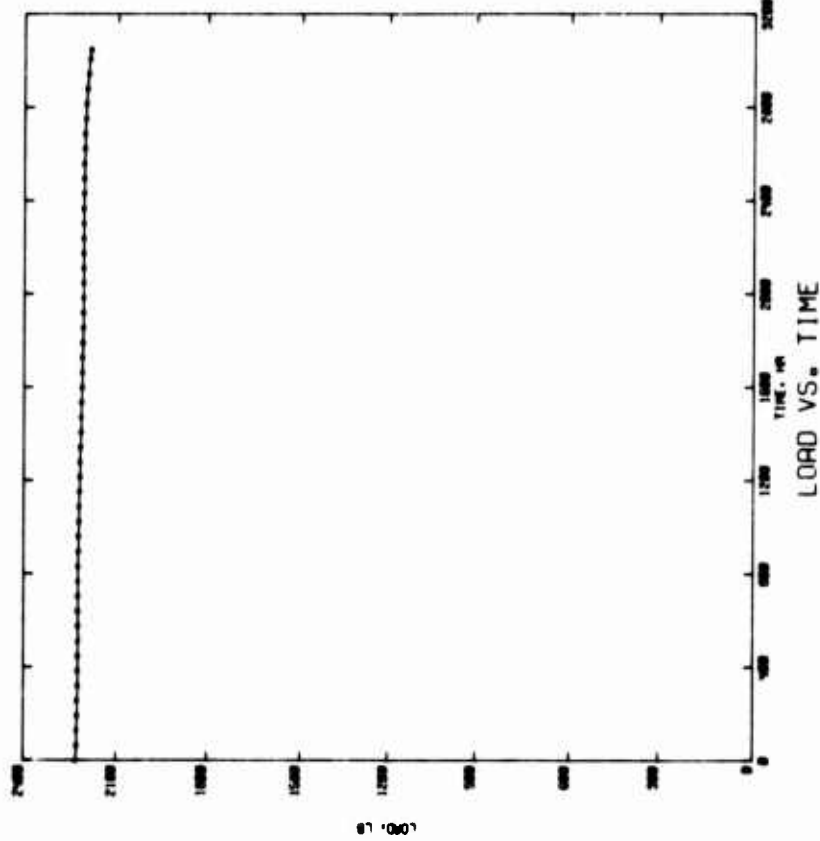

Figure B19 Ring Loaded Compact Tension Specimen of 7050-T7351X Exposed to a Salt-Dichromate Solution.

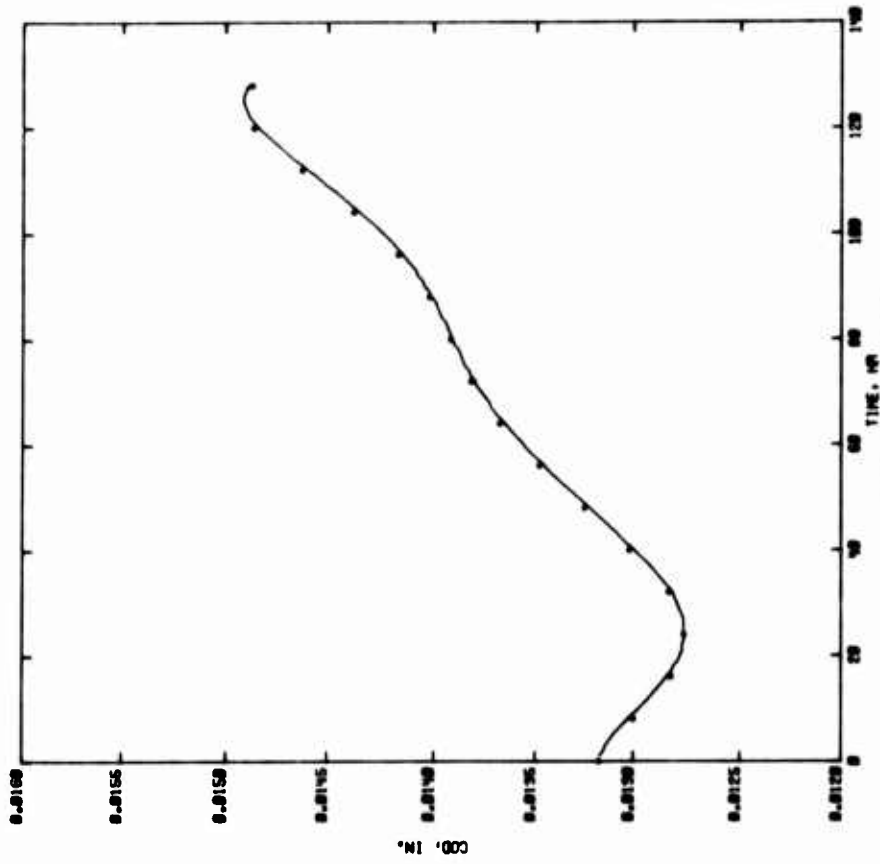
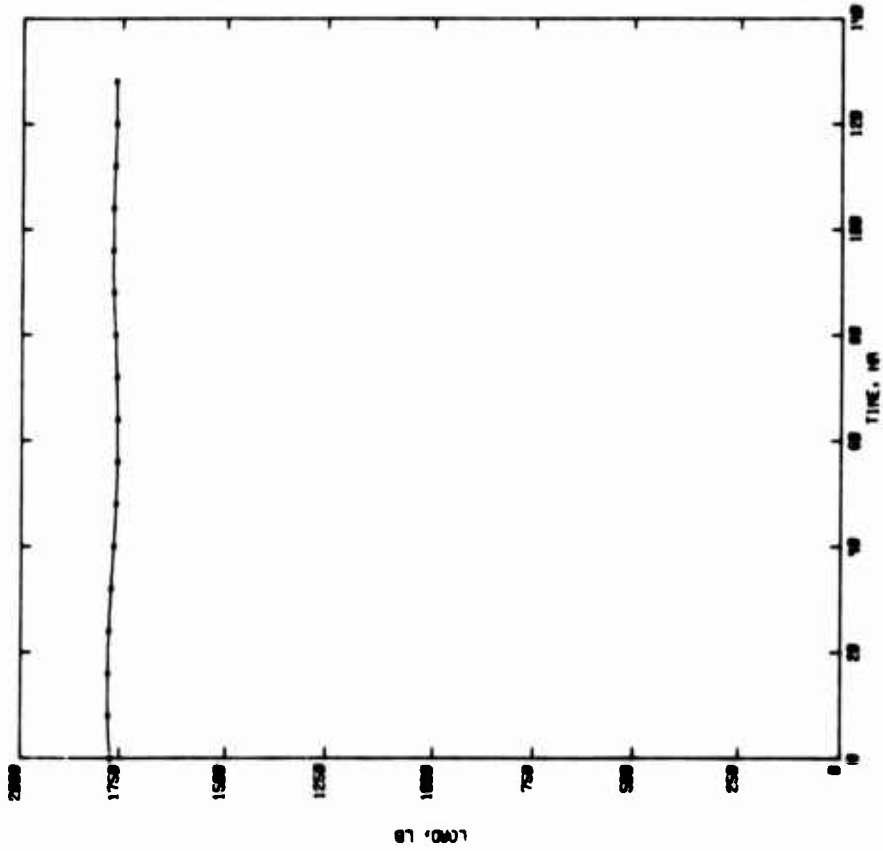

Figure B20 Ring Loaded Compact Tension Specimen of 7050-T7351X Exposed to a Salt-Dichromate Solution.

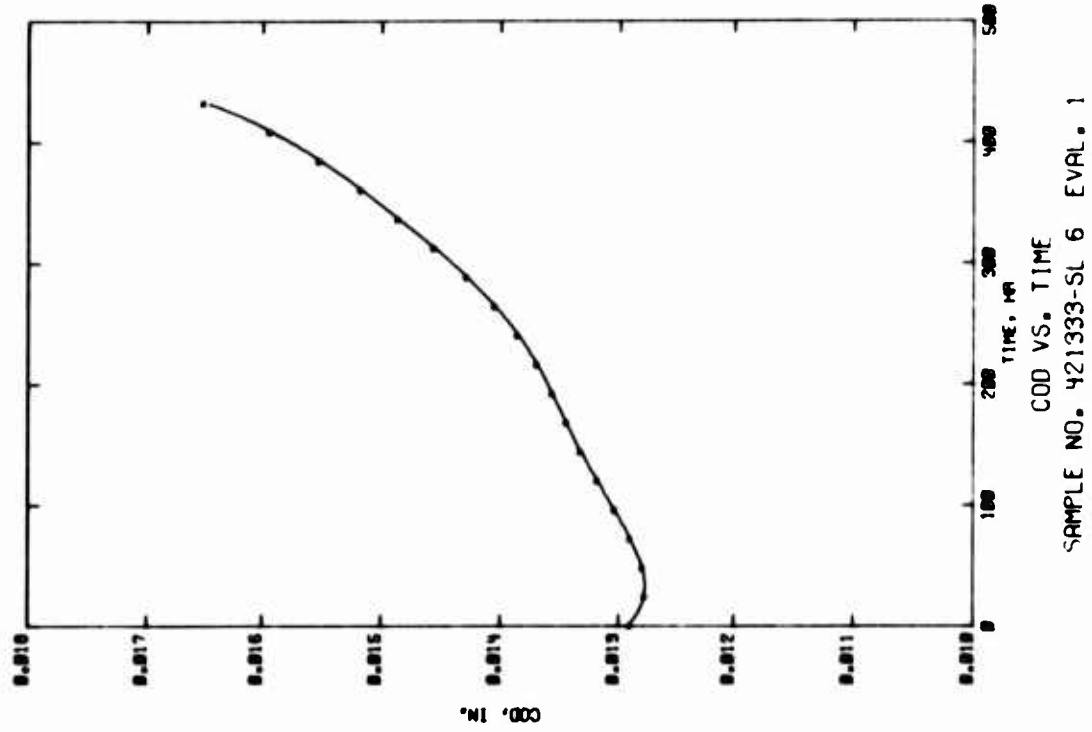
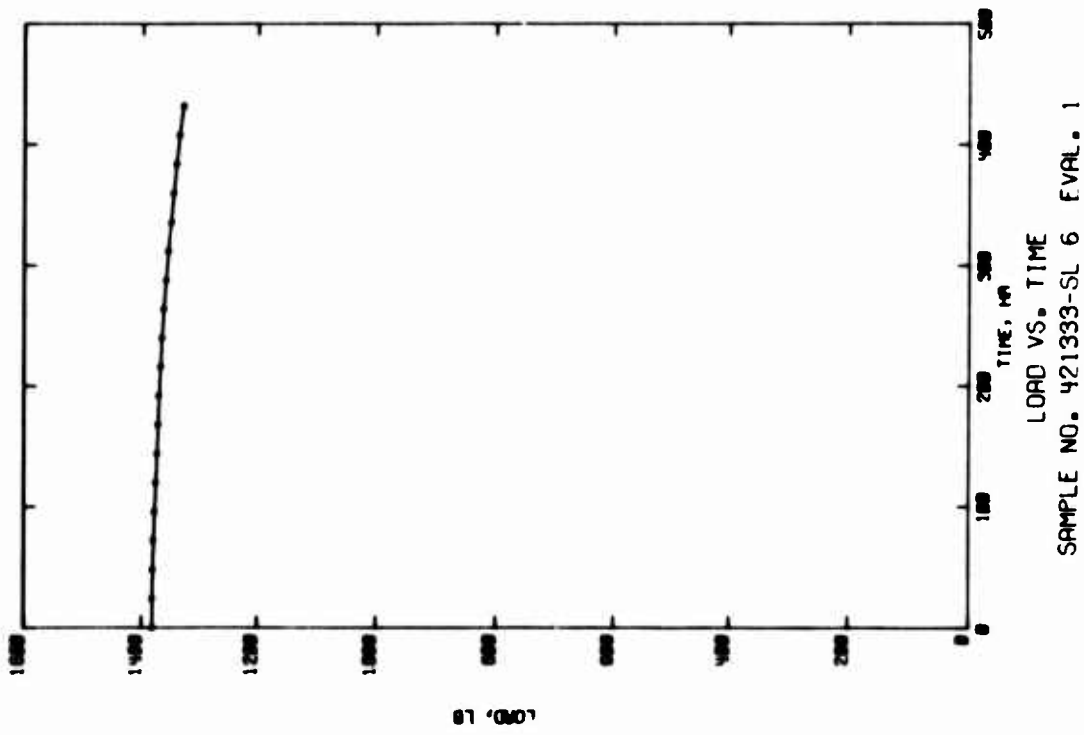

Figure B21 Ring Loaded Compact Tension Specimen of 7050-T7351X Exposed to a Salt-Dichromate Solution.

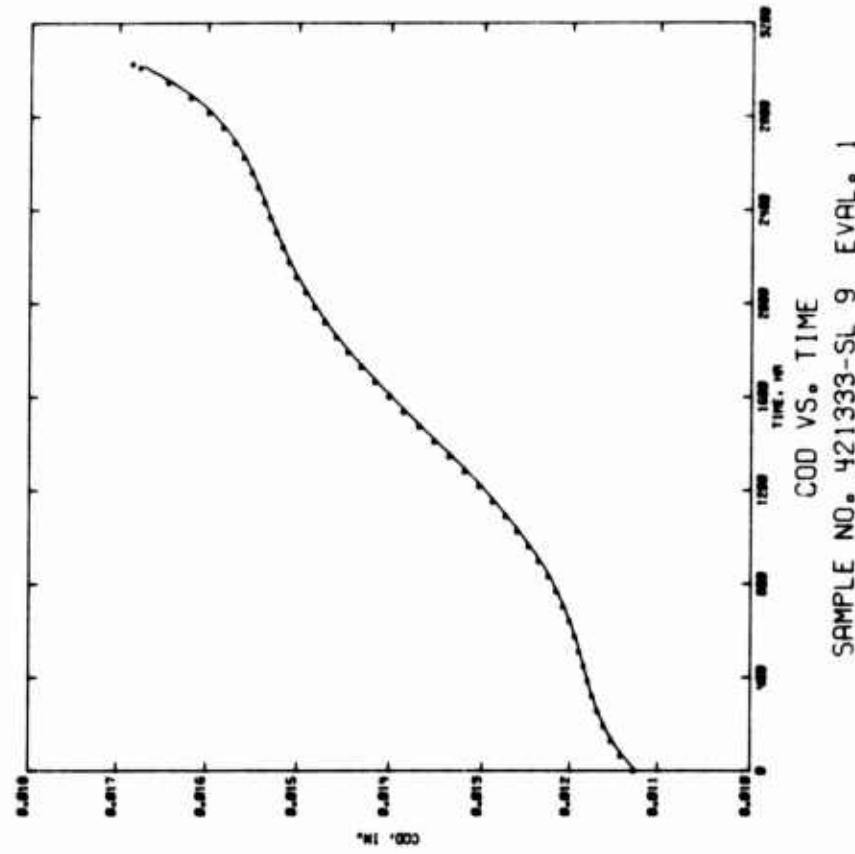
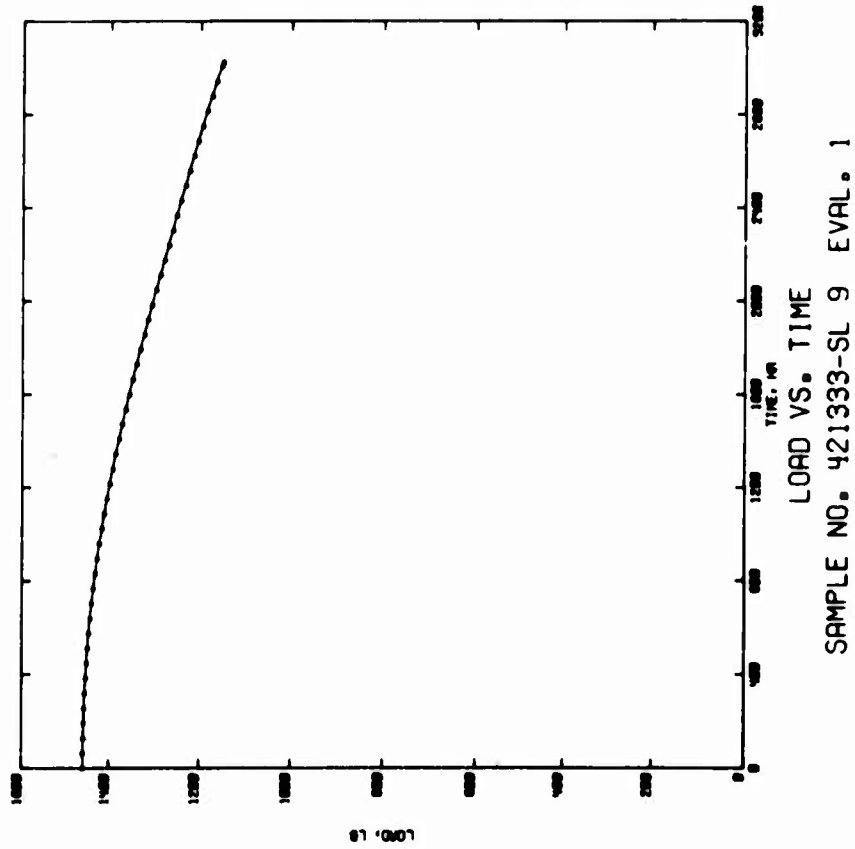

Figure B22 Ring Loaded Compact Tension Specimen of 7050-T7351X Exposed to a Salt-Dichromate Solution.

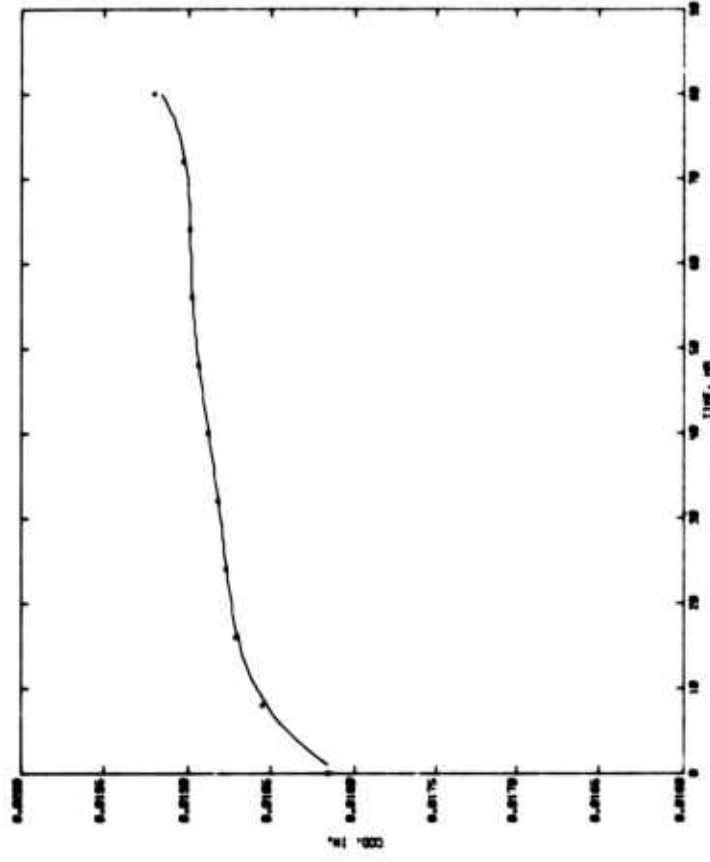
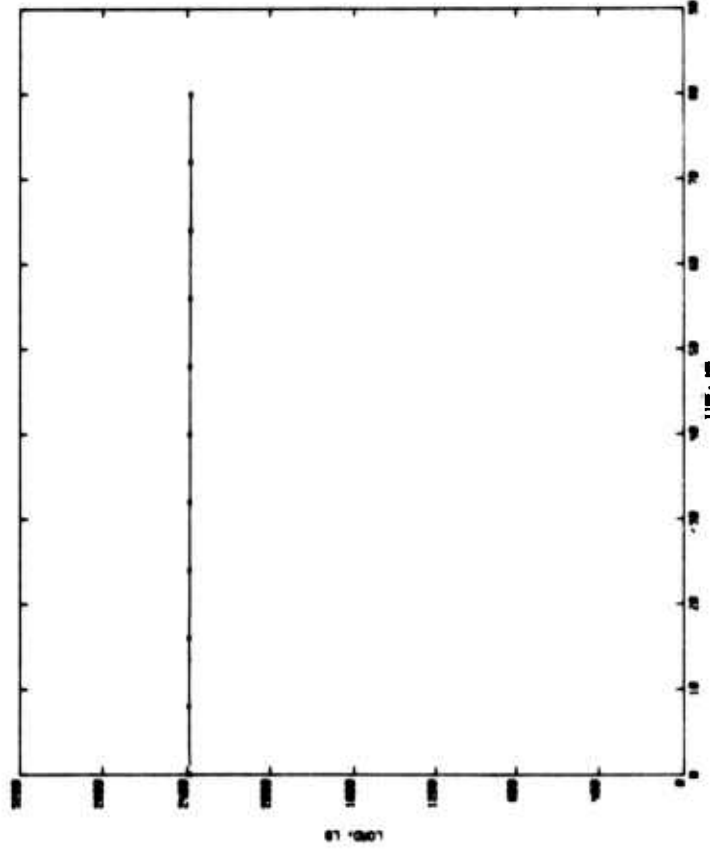

Figure 823 Ring Loaded Compact Tension Specimen of 7050-T7351X Exposed to a Salt-Dichromate Solution

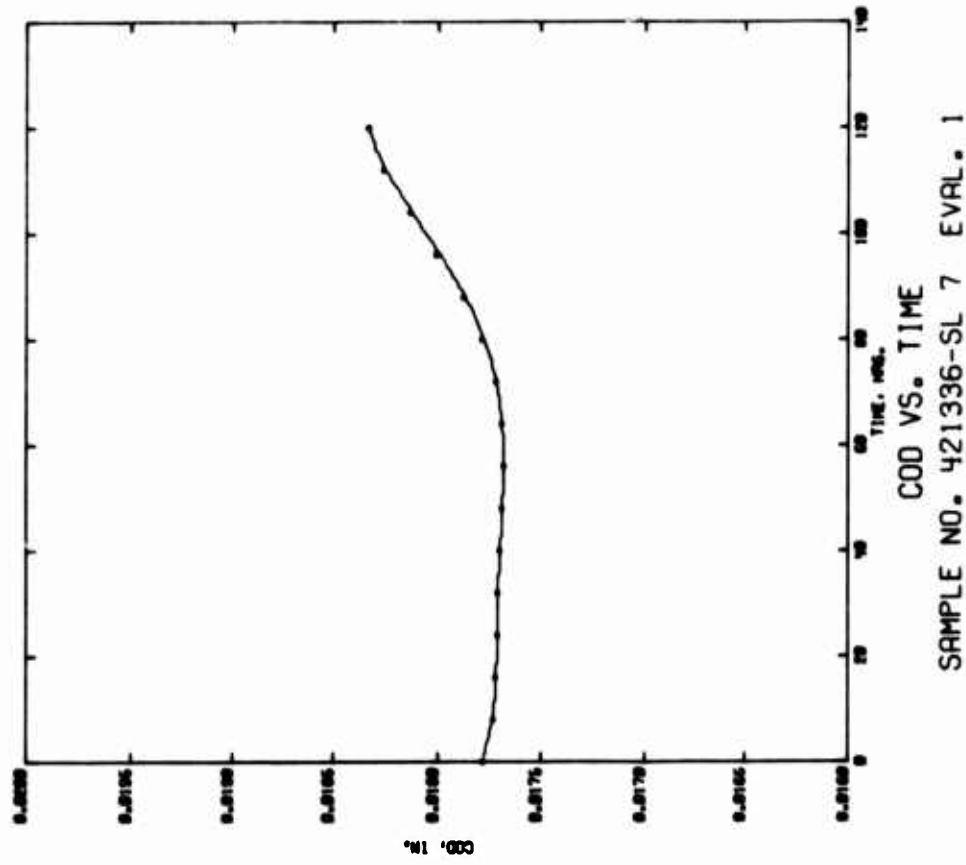
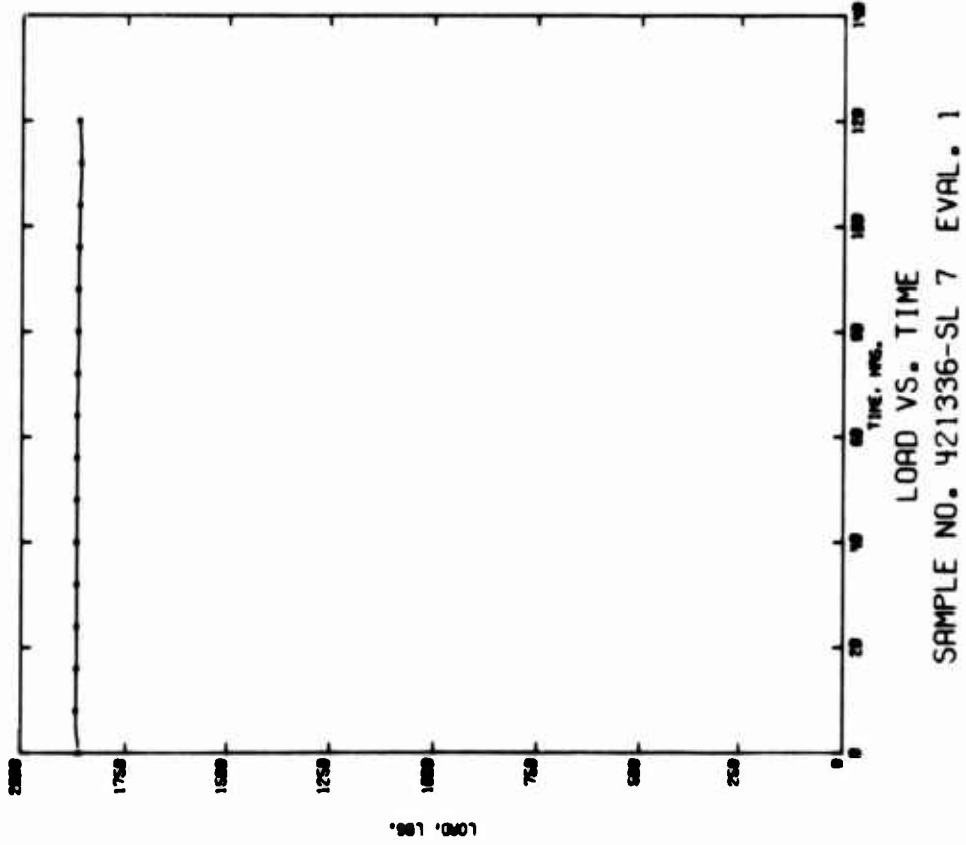

Figure B24 Ring Loaded Compact Tension Specimen of 7050-T7351X Exposed to a Salt-Dichromate Solution.

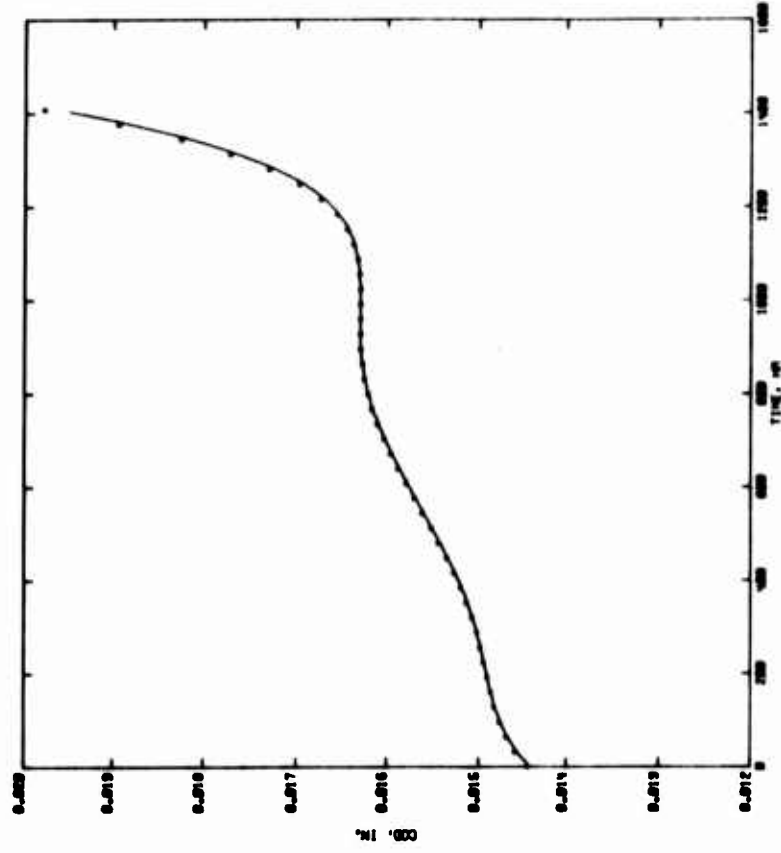
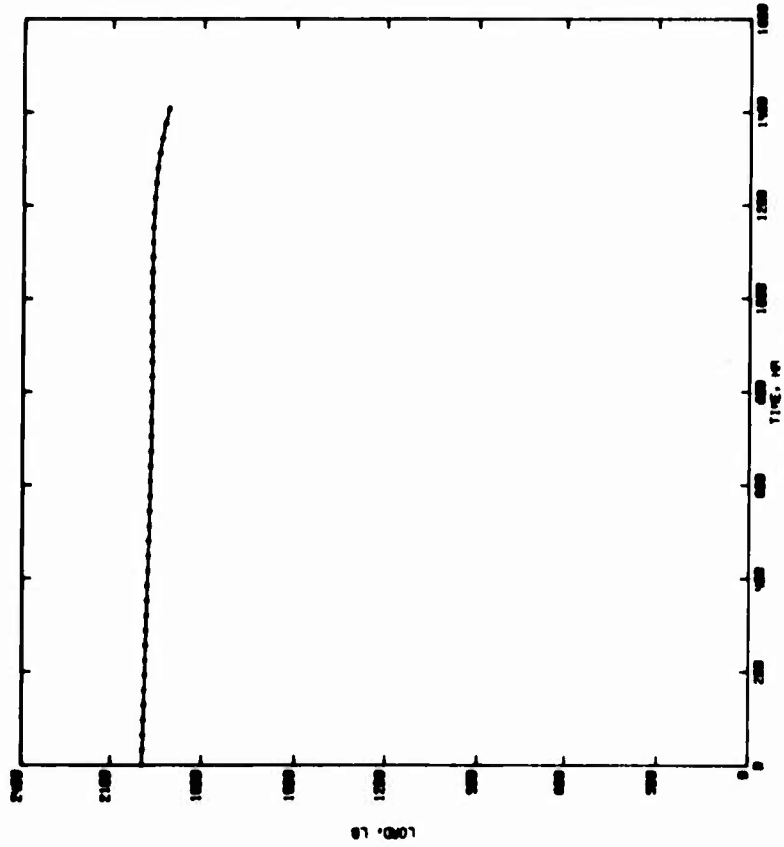

Figure B25 Ring Loaded Compact Tension Specimen of 7050-T7351X Exposed to a Salt-Dichromate Solution

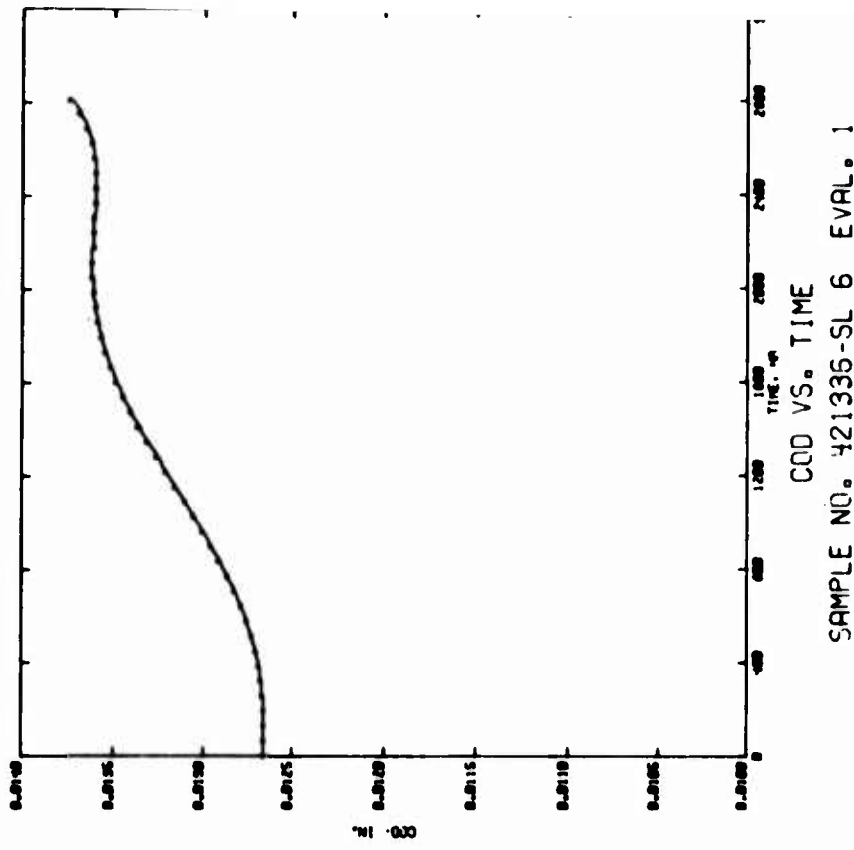
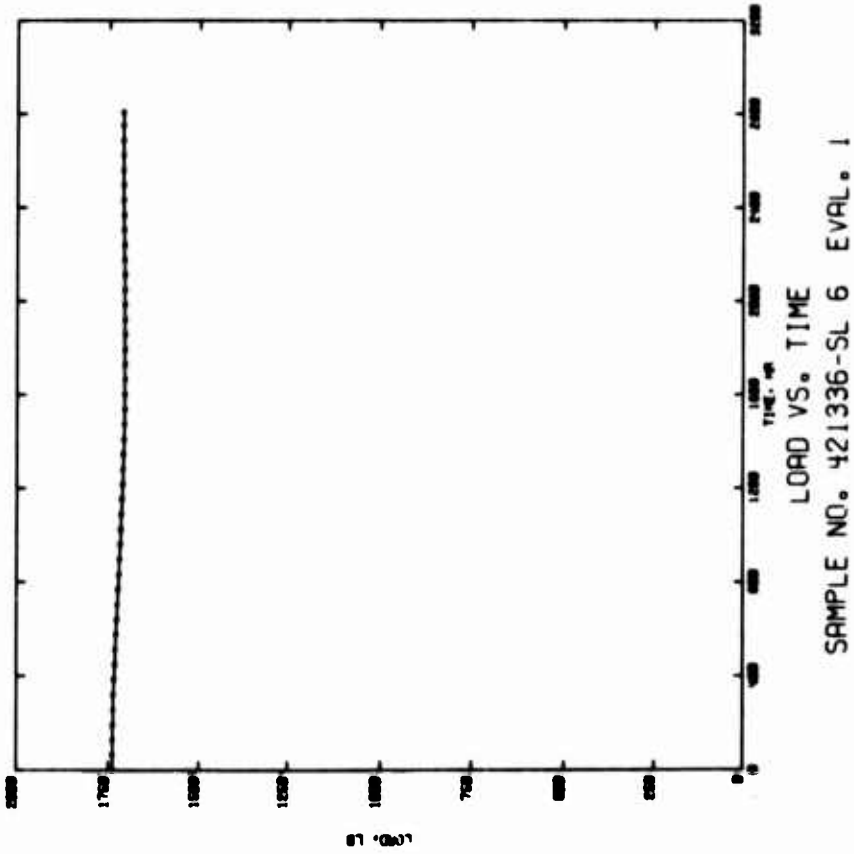

Figure B26 Ring Loaded Compact Tension Specimen of 7050-T7351X Exposed to a Salt-Dichromate Solution.

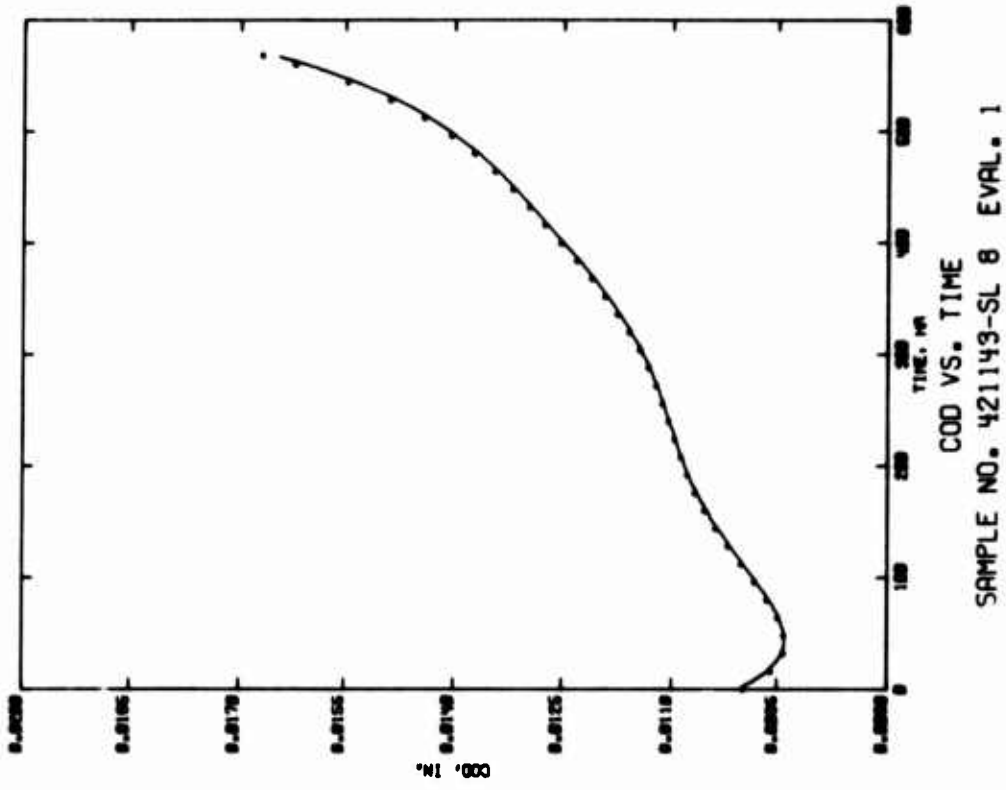
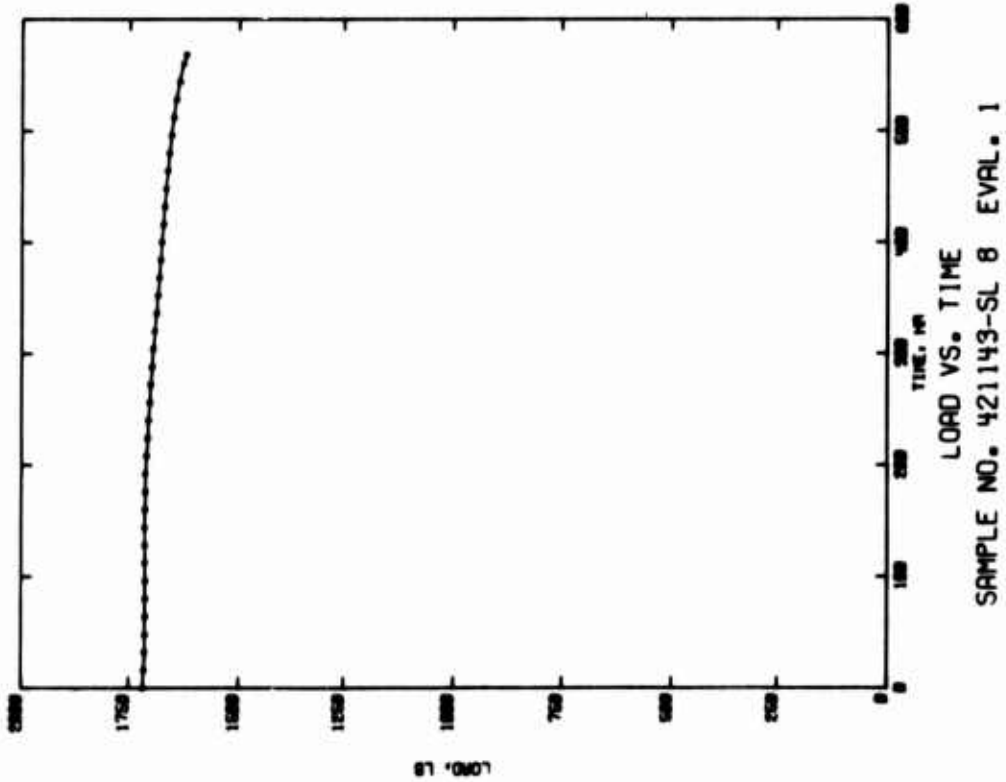

Figure B27 Ring Loaded Compact Tension Specimen of 7050-T7651X Exposed to a Salt-Dichromate Solution.

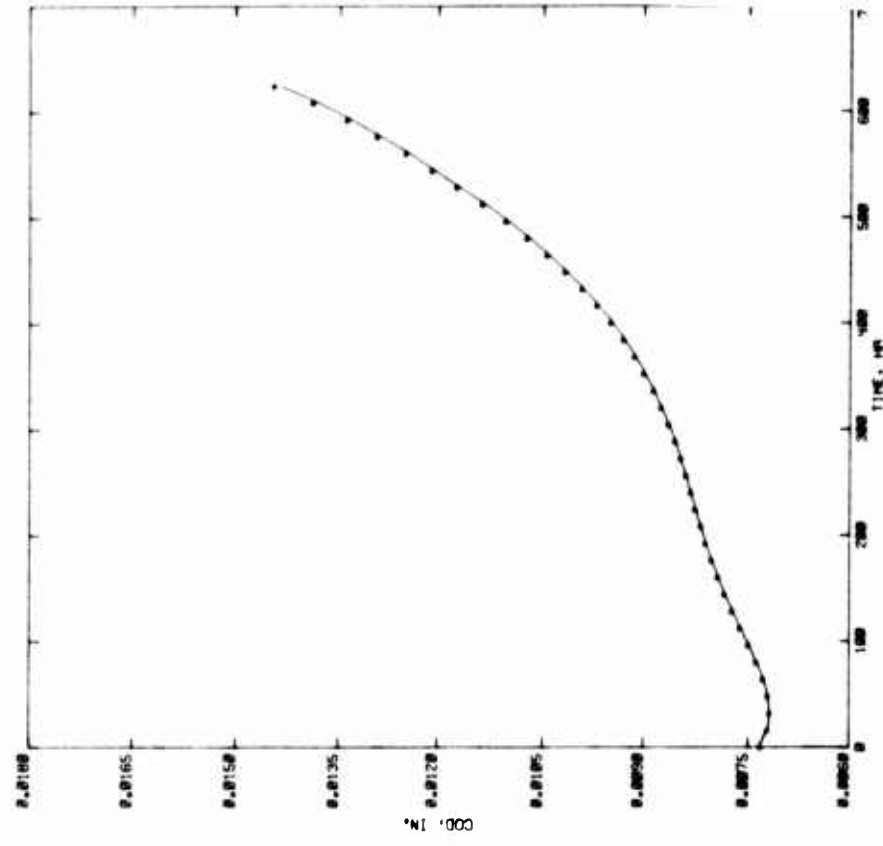
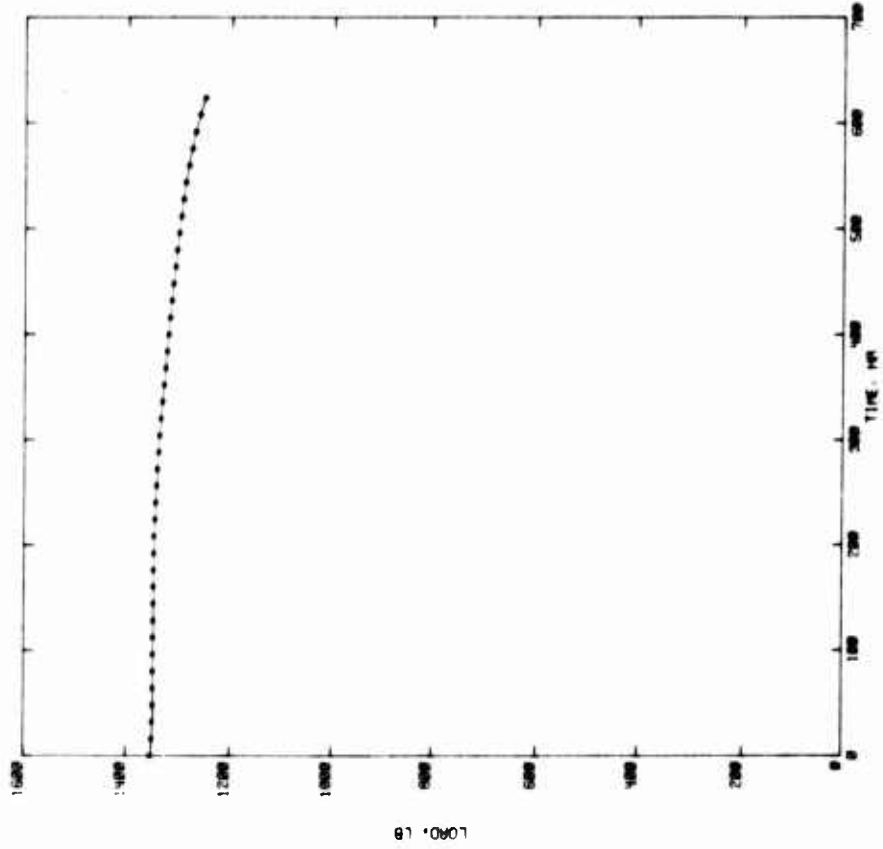
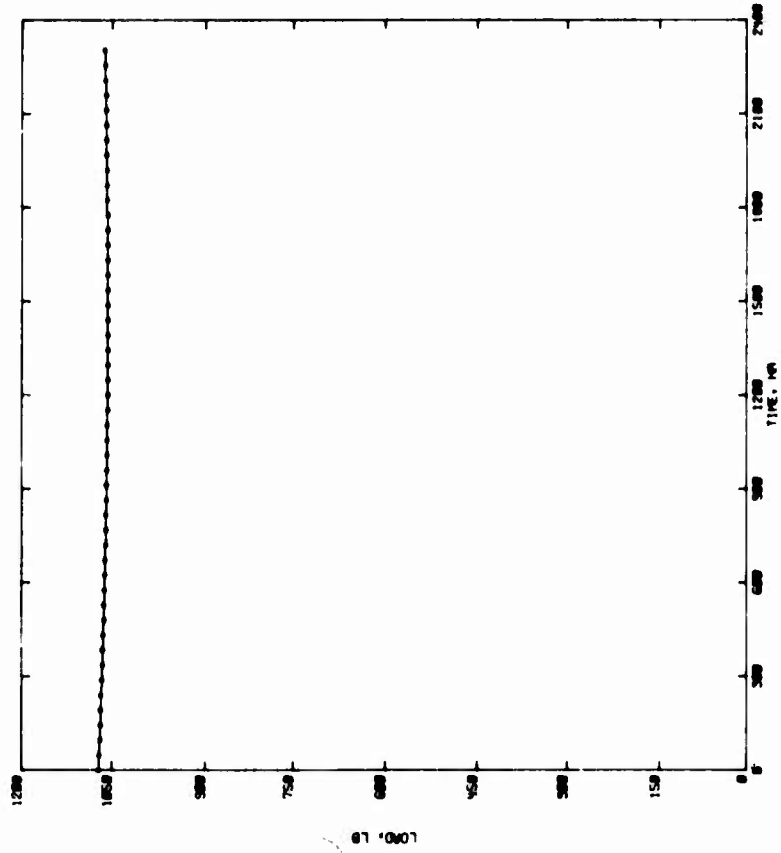
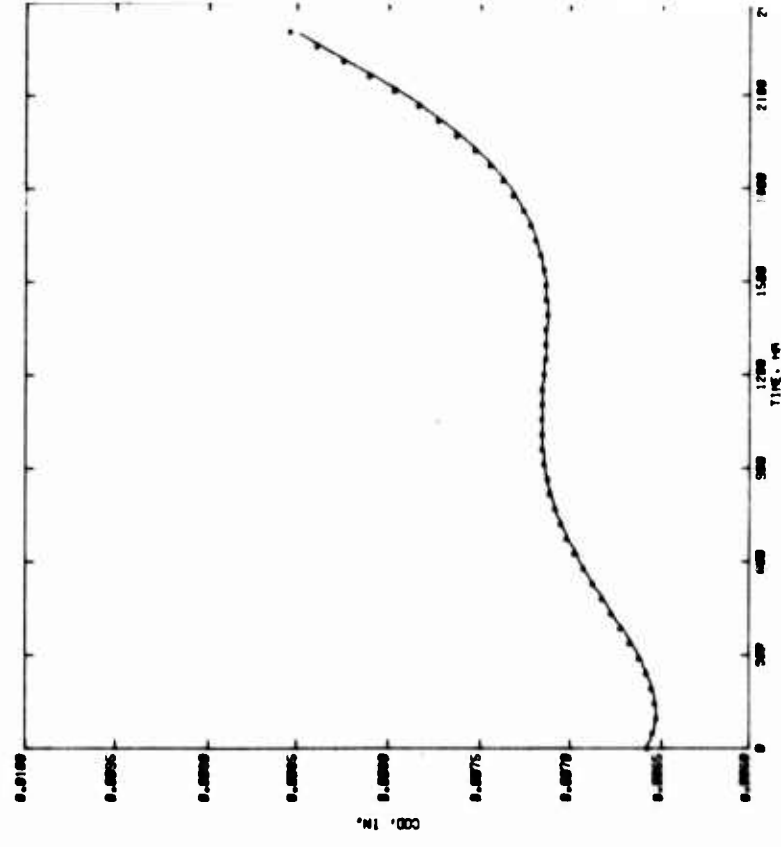

Figure B28 Ring Loaded Compact Tension Specimen of 7050-T7651X Exposed to a Salt-Dichromate Solution.



LOAD VS. TIME
SAMPLE NO. 421143-SL 7 EVAL. 1



COD VS. TIME
SAMPLE NO. 421143-SL 7 EVAL. 1

Figure B29 Ring Loaded Compact Tension Specimen of 7050-T7651X Exposed to a Salt-Dichromate Solution.

Figure B30 Computer Print-Out of Stress Intensities and Crack Growth Rates at Various Intervals During the Test.

EVALUATION NUMBER 1 STRESS CORROSION FRACTURE THICKNESS DATA FOR RING LOADED COMPACT SPECIMENS

ALLOY * TITANIUM TREATMENT PRODUCT EXTENSION SIZE IN 2.03 IN SPEC. LOADED 04-01-70
 SAMPLE NUMBER 42112 SPECIMEN NUMBER SLIP * TECH. TEST NUMBER TYPE TEST II

SPECIMEN THICKNESS 0.007 IN SPECIFIC WEIGHT 2.000 IN INITIAL CRACK LENGTH 1.020 IN TYPE PRE-CHARGE FC 1/2
 RING CONSTANTS 0.500 1.714 GAGE CONSTANTS 50000, 14.714 MODULUS, PSI 10200, INTL KI 18300, PSI-IN

TIME MIN	COL 1	COL 2	COL 3	COL 4	COL 5	COL 6	FILE #
0	0.01492	0.01492	0.01492	0.01492	0.01492	0.01492	ALDATA,000
4	0.01506	0.01506	0.01506	0.01506	0.01506	0.01506	
8	0.01476	0.01476	0.01476	0.01476	0.01476	0.01476	
16	0.01454	0.01454	0.01454	0.01454	0.01454	0.01454	
24	0.01439	0.01439	0.01439	0.01439	0.01439	0.01439	
32	0.01433	0.01433	0.01433	0.01433	0.01433	0.01433	
40	0.01424	0.01424	0.01424	0.01424	0.01424	0.01424	
48	0.01417	0.01417	0.01417	0.01417	0.01417	0.01417	
56	0.01412	0.01412	0.01412	0.01412	0.01412	0.01412	
64	0.01407	0.01407	0.01407	0.01407	0.01407	0.01407	
72	0.01404	0.01404	0.01404	0.01404	0.01404	0.01404	
80	0.01401	0.01401	0.01401	0.01401	0.01401	0.01401	
88	0.01398	0.01398	0.01398	0.01398	0.01398	0.01398	
96	0.01395	0.01395	0.01395	0.01395	0.01395	0.01395	
104	0.01392	0.01392	0.01392	0.01392	0.01392	0.01392	
112	0.01389	0.01389	0.01389	0.01389	0.01389	0.01389	
120	0.01386	0.01386	0.01386	0.01386	0.01386	0.01386	
128	0.01383	0.01383	0.01383	0.01383	0.01383	0.01383	
136	0.01380	0.01380	0.01380	0.01380	0.01380	0.01380	
144	0.01377	0.01377	0.01377	0.01377	0.01377	0.01377	
152	0.01374	0.01374	0.01374	0.01374	0.01374	0.01374	
160	0.01371	0.01371	0.01371	0.01371	0.01371	0.01371	
168	0.01368	0.01368	0.01368	0.01368	0.01368	0.01368	
176	0.01365	0.01365	0.01365	0.01365	0.01365	0.01365	
184	0.01362	0.01362	0.01362	0.01362	0.01362	0.01362	
192	0.01359	0.01359	0.01359	0.01359	0.01359	0.01359	
200	0.01356	0.01356	0.01356	0.01356	0.01356	0.01356	
208	0.01353	0.01353	0.01353	0.01353	0.01353	0.01353	
216	0.01350	0.01350	0.01350	0.01350	0.01350	0.01350	

CRACK LENGTH (IN) COL 4
 CRACK GROWTH RATE (IN/CM) COL 5
 STP. INT. FACTUM (INT. PSI-IN(1/2)) COL 6
 K1 COL 7
 K2 COL 8
 K3 COL 9
 K4 COL 10
 K5 COL 11
 K6 COL 12
 K7 COL 13
 K8 COL 14
 K9 COL 15
 K10 COL 16
 K11 COL 17
 K12 COL 18
 K13 COL 19
 K14 COL 20
 K15 COL 21
 K16 COL 22
 K17 COL 23
 K18 COL 24
 K19 COL 25
 K20 COL 26

STANDARD ERROR = 2.0127265
 LOAD = 0.1100000E+05
 CRACK = 0.7000000E+01
 A = 0.1000000E+01

FILE # ALDATA,000
 FILE # ALDATA,100
 FILE # ALDATA,100

Figure B31 Computer Print-Out of Stress Intensities and Crack Growth Rates at Various Intervals During the Test.

EVALUATION NUMBER 1

STRESS CORROSION FRACTURE TOUGHNESS DATA FOR RING LOADED COMPACT SPECIMENS

ALLOY & TEMPER 7050-T73510 PRODUCT DESIGNATION SIZE, IN 1.075CH SPEC. LOADED 10-00-70
 SAMPLE NUMBER 421132 SPECIMEN NUMBER SL-7 TECH. TEST NUMBER TYPE TEST T1
 SPECIMEN THICKNESS 1.000 IN SPECIMEN WIDTH 2.000 IN INITIAL CRACK LENGTH 1.020 IN TYPE PHE-CRACK FC
 RING CONSTANTS 0.500 IN/IN GAGE CONSTANTS 50000, IN/IN MODULUS, KSI 10200, INTL KI 10320, PSI-IN ^{1/2}

COL 1	COL 2	COL 3	COL 4	COL 5	COL 6	FILE = ALDATA,002
TIME, HRS	LOAD (P), LBS	COEFF., %	CRACK LENGTH (A), IN	CRACK GROWTH RATE (dA/dN), IN/HR	STN. INT. FACTOR (K1), PSI-IN(1/2)	REMARKS CGR DIFF.
0	2120.	0.01312	1.031	0.1540E-03	16570.	0.0000E+00
40	2120.	0.01333	1.030	0.1300E-03	16752.	-0.2400E+04
60	2120.	0.01350	1.043	0.1007E-03	16890.	-0.2124E+04
144	2127.	0.01366	1.046	0.9015E-04	17017.	-0.1863E+04
192	2120.	0.01370	1.052	0.7388E-04	17115.	-0.1622E+04
240	2125.	0.01380	1.055	0.5906E-04	17192.	-0.1400E+04
288	2124.	0.01393	1.050	0.4791E-04	17253.	-0.1197E+04
336	2122.	0.01390	1.060	0.3779E-04	17299.	-0.1012E+04
384	2121.	0.01403	1.061	0.2936E-04	17330.	-0.8432E+03
432	2120.	0.01406	1.064	0.2245E-04	17350.	-0.6909E+03
480	2118.	0.01400	1.064	0.1641E-04	17370.	-0.5539E+03
528	2117.	0.01400	1.064	0.1259E-04	17380.	-0.4317E+03
576	2115.	0.01410	1.065	0.9359E-05	17380.	-0.3234E+03
624	2110.	0.01411	1.065	0.7076E-05	17391.	-0.2242E+03
672	2113.	0.01411	1.066	0.5422E-05	17391.	-0.1454E+03
720	2112.	0.01411	1.066	0.4080E-05	17390.	-0.7419E+02
768	2111.	0.01412	1.066	0.3022E-05	17380.	-0.1313E+02
816	2110.	0.01412	1.066	0.2106E-05	17380.	0.3043E+00
864	2109.	0.01412	1.067	0.1500E-05	17349.	0.7739E+00
912	2108.	0.01413	1.067	0.1079E-05	17302.	0.1008E+05
960	2107.	0.01413	1.067	0.8222E-06	17300.	0.1304E+05
1008	2107.	0.01415	1.068	0.6042E-06	17000.	0.1520E+05
1056	2106.	0.01416	1.068	0.4400E-06	17010.	0.1031E+05
1104	2106.	0.01416	1.069	0.3217E-06	17032.	0.1041E+05
1152	2106.	0.01420	1.069	0.2307E-06	17050.	0.1103E+05
1200	2106.	0.01422	1.070	0.1654E-06	17070.	0.1076E+05
1248	2106.	0.01425	1.071	0.1216E-06	17094.	0.1013E+05
1296	2106.	0.01426	1.072	0.8816E-07	17090.	0.1520E+05
1344	2106.	0.01431	1.073	0.6407E-07	17050.	0.1427E+05
1392	2107.	0.01435	1.074	0.4711E-07	17010.	0.1310E+05
1440	2107.	0.01436	1.075	0.3433E-07	17015.	0.1204E+05
1488	2107.	0.01462	1.076	0.2473E-07	17051.	0.1098E+05
1536	2107.	0.01467	1.077	0.1757E-07	17009.	0.1000E+05
1584	2106.	0.01491	1.079	0.1267E-07	17720.	0.9350E+00
1632	2106.	0.01495	1.080	0.9275E-08	17760.	0.8049E+00
1680	2106.	0.01490	1.081	0.6844E-08	17809.	0.6901E+00
1728	2106.	0.01465	1.083	0.5030E-08	17851.	0.5902E+00
1776	2104.	0.01460	1.084	0.3661E-08	17893.	0.5022E+00
1824	2104.	0.01474	1.086	0.2658E-08	17935.	0.4174E+00
1872	2107.	0.01470	1.087	0.1908E-08	17970.	0.3394E+00
1920	2107.	0.01494	1.084	0.1367E-08	18021.	0.2609E+00

1968	2106.	0.01480	1.090	0.1073E-08	18006.	0.2065E+00
2016	2109.	0.01496	1.092	0.7870E-09	18100.	0.2533E+00
2064	2103.	0.01500	1.094	0.5830E-09	18152.	0.2040E+00
2112	2101.	0.01504	1.096	0.4313E-09	18190.	0.1770E+00
2160	2200.	0.01511	1.098	0.3069E-09	18244.	0.1554E+00

CALCULATED STRESS VALUES
 MEASURED (A) AFTER FRACTURE

1.147

19807.

STANDARD DEVIATION = 1.403650

LOAD = 0.1155E+04 - 0.2041E+02 - 0.3101E+04E+02 0.1042E+07E+03 - 0.7003E-11E+04.

COE = 0.0001E+03 0.2201E+00E+02 - 0.6100E+03E+02 0.3300E+00E+03 - 0.1227E+00E+04 0.1672E-13E+05

A = 0.1030E+01 0.1540E+01E+02 - 0.2000E+04E+02 0.2100E+00E+03 - 0.0265E-13E+04 0.1201E-16E+05

COL. 1 = TIME IMP. COL. 2 = LOAD EVAL. COL. 3 = COE EVAL. COL. 4 = CRACK EVAL. FILE = ALDATA,102

Figure B32 Computer Print-Out of Stress Intensities and Crack Growth Rates at Various Intervals During the Test.

EVALUATION NUMBER 1

STRESS CORROSION FRACTURE TOUGHNESS DATA FOR RING LOADED COMPACT SPECIMENS

ALLOY + TENSILE 7075-T73510 PRODUCT EXTRUSION SIZE, IN 2.037MM SPEC. LOADED 10-00-76
 RAMPID NUMBER 421132 SPECIMEN NUMBER SL-0 WFCM, TEST NUMBER TYPE TEST T1
 SPECIMEN THICKNESS 1.000 IN SPECIMEN WIDTH 2.000 IN INITIAL CRACK LENGTH 1.015 IN TYPE PRE-CRACK PC
 RING DIAMETER 0.500 IN/IN GAGE CONSTANT 50000, IN/IN MODULUS, PSI 10200, INVL RI 15300, PSI=IN 1/2

COL. 1	COL. 2	COL. 3	COL. 4	COL. 5	COL. 6	FILE # ALDATA.001
TIME, HRS	LOAD (P), LBS	CRACK (C), IN	CRACK LENGTH (A), IN	CRACK GROWTH RATE (ΔC/DT), IN/HR	SYM. INT. FACTOR (FI), PSI=IN(1/2)	REMARKS CGR DIFF.
0	2231.	0.01249	1.028	0.2925E-04	15820.	0.0000E+00
54	2231.	0.01246	1.027	0.1227E-04	15704.	0.1098E+04
120	2230.	0.01249	1.027	0.1794E-05	15773.	0.1407E+04
192	2229.	0.01244	1.028	0.1321E-04	15703.	0.1143E+04
258	2229.	0.01240	1.029	0.2223E-04	15809.	0.0013E+05
320	2229.	0.01250	1.030	0.2908E-04	15840.	0.0034E+05
384	2229.	0.01240	1.032	0.3400E-04	15890.	0.0023E+05
468	2229.	0.01244	1.035	0.3722E-04	15952.	0.0210E+05
512	2229.	0.01273	1.037	0.3895E-04	16011.	0.1720E+05
576	2229.	0.01280	1.040	0.3930E-04	16072.	0.0302E+05
640	2229.	0.01288	1.042	0.3873E-04	16132.	0.0070E+05
704	2229.	0.01294	1.046	0.3710E-04	16191.	0.0190E+05
768	2227.	0.01301	1.047	0.3497E-04	16240.	0.0229E+05
832	2227.	0.01307	1.049	0.3201E-04	16297.	0.0280E+05
896	2226.	0.01313	1.051	0.3074E-04	16343.	0.0268E+05
960	2226.	0.01317	1.052	0.2922E-04	16383.	0.0320E+05
1024	2225.	0.01321	1.054	0.2159E-04	16416.	0.0335E+05
1088	2224.	0.01325	1.055	0.1797E-04	16444.	0.0320E+05
1152	2223.	0.01328	1.056	0.1400E-04	16460.	0.0492E+05
1216	2222.	0.01330	1.057	0.1125E-04	16481.	0.0321E+05
1280	2221.	0.01331	1.058	0.8370E-05	16492.	0.0207E+05
1344	2220.	0.01332	1.059	0.5947E-05	16499.	0.0242E+05
1408	2219.	0.01333	1.059	0.4052E-05	16500.	0.0109E+05
1472	2218.	0.01333	1.059	0.2700E-05	16499.	0.0120E+05
1536	2217.	0.01333	1.059	0.2140E-05	16497.	0.0074E+05
1600	2216.	0.01333	1.059	0.2200E-05	16495.	0.0127E+04
1664	2215.	0.01333	1.059	0.3199E-05	16493.	0.0114E+04
1728	2215.	0.01333	1.060	0.4036E-05	16494.	0.0173E+05
1792	2214.	0.01334	1.060	0.7523E-05	16499.	0.0200E+05
1856	2213.	0.01335	1.061	0.1099E-04	16510.	0.0404E+05
1920	2213.	0.01337	1.061	0.1536E-04	16527.	0.0251E+05
1984	2212.	0.01341	1.063	0.2050E-04	16554.	0.0261E+05
2048	2212.	0.01345	1.064	0.2670E-04	16591.	0.0125E+05
2112	2212.	0.01350	1.066	0.3370E-04	16639.	0.0094E+05
2176	2212.	0.01354	1.068	0.4154E-04	16702.	0.0100E+05
2240	2212.	0.01367	1.071	0.5019E-04	16781.	0.0049E+05
2304	2212.	0.01378	1.075	0.5900E-04	16874.	0.0017E+05
2368	2212.	0.01391	1.079	0.6974E-04	16980.	0.0103E+04
2432	2211.	0.01404	1.083	0.8052E-04	17128.	0.0107E+04
2496	2211.	0.01424	1.084	0.9190E-04	17283.	0.0137E+04
2560	2211.	0.01444	1.084	0.1030E-03	17403.	0.0100E+04

CALCULATED AT BASED ON MEASUREMENT (A) AFTER FRACTURE

STANDARD ERROR = 1.73707e3

LOAD = 0.1114E+04 ± 0.1402E+01 ± 0.3608E+04E±2 ± 0.3902E+07E±3 ± 0.1651E+10E±4 ± 0.2401E+14E±5

CRACK = 0.0247E+03 ± 0.0243E+01 ± 0.2077E+03E±2 ± 0.1843E+05E±3 ± 0.6029E+10E±4 ± 0.5919E+14E±5

A = 0.1028E+01 ± 0.2925E+04 ± 0.1447E+06E±2 ± 0.1203E+09E±3 ± 0.4337E+13E±4 ± 0.6540E+17E±5

COL. 1 = TIME HRS. COL. 2 = LOAD EVAL. COL. 3 = CRACK EVAL. COL. 4 = CRACK EVAL. FILE = ALDATA.001

Figure B33 Computer Print-Out of Stress Intensities and Crack Growth Rates at Various Intervals During the Test.

EVALUATION NUMBER 1 STRESS CORRUSSION FRACTURE TOUGHNESS DATA FOR RING LOADED COMPACT SPECIMENS

ALLOY * TEMPER 7050-T73510 PRODUCT FERRUSION SIZE, IN 1.8 INCH SPEC, LOADED 00-01-70
 SAMPLE NUMBER 621333 SPECIMEN NUMBER SL-6 TECH. TEST NUMBER TYPE TEST T1

SPECIMEN DIMENSIONS 0.745 IN SPECIMEN WIDTH 1.500 IN INITIAL CRACK LENGTH 0.750 IN TYPE PRE-CRACK 1/2
 RING CONSTANTS 0.500 IN/LOAD GAGE CONSTANTS 50000, IN/IN MODULUS, KSI 10200, INL AI 10071, PSI-IN 1/2

TIME, HRS	LOAD (P), LBS	COL 2	COL 3	COL 4	COL 5	COL 6	FILE #	REMARKS
0	1773	0.01917	CRACK LENGTH (A), IN	CRACK GROWTH RATE (ADDT), IN/HR	STR. INT. FACTOR (AI), PSI-IN(1/2)	0.000E+00	CGA DIFF.	
4	1779	0.01900	0.767	-0.7110E-03	19325	0.3073E-00		
14	1780	0.01283	0.758	-0.6731E-03	19188	0.3403E-00		
24	1774	0.01277	0.757	-0.1169E-03	19029	0.4457E-03		
32	1773	0.01264	0.759	0.5104E-03	19009	0.3945E-03		
40	1764	0.01302	0.765	0.7563E-03	18158	0.2488E-03		
44	1761	0.01323	0.772	0.8187E-03	19368	0.6230E-04		
54	1754	0.01348	0.778	0.7165E-03	19570	-0.1021E-03		
64	1754	0.01368	0.782	0.5133E-03	19766	-0.2022E-03		
72	1760	0.01382	0.785	0.3004E-03	19916	-0.2129E-03		
80	1765	0.01392	0.787	0.1748E-03	20034	-0.1236E-03		
84	1764	0.01402	0.789	0.2104E-03	20148	0.3964E-04		
96	1771	0.01416	0.791	0.4242E-03	20295	0.2137E-03		
104	1771	0.01437	0.796	0.7352E-03	20501	0.3111E-03		
112	1768	0.01683	0.803	0.9191E-03	20757	0.1839E-03		
120	1764	0.01487	0.809	0.5553E-03	20986	-0.3030E-03		
124	1765	0.01488	0.809	-0.1031E-02	20994	-0.1506E-02		

ALGORITHM: STIFF BAREN NM
 WASHING (A) AFTER FRACTURE

STANDARD FORM = 2.1149742 20002.

LOAD = 0.4466E+03 0.4347E+00T+0 = 0.7184E-02T+0 = 0.6252E-03T+0 0.1743E-04T+0 = 0.1949E-06T+0
 * 0.4545E+09T+0

CRD = 0.4443E+03 -0.4849E+01T+0 = 0.9742E-01T+0 0.5591E-02T+0 = 0.9649E-04T+0 0.7164E-06T+0
 * -0.1032E+04T+0

A = 0.7472E+00 -0.7114E-03T+0 = 0.1202E-04T+0 0.1621E-03T+0 = -0.2308E-07T+0 0.3894E-10T+0
 * 0.9433E-12T+0 -0.4518E-14T+0

COL. 1 = TIME INC. COL. 2 = LOAD EVAL. COL. 3 = CRD EVAL. COL. 4 = CRACK EVAL. COL. 5 = ALGORITHM

Figure B34 Computer Print-Out of Stress Intensities and Crack Growth Rates at Various Intervals During the Test.

EVALUATION NUMBER 1

STRESS CORROSION FRACTURE TOUGHNESS DATA FOR KING LOADED COMPACT SPECIMENS

AGENCY TEST # 7000774510 PRODUCT EXTENSION SIZE IN 1.0 INCH SPEC. LOADED 08-01-78

SAMPLE NUMBER 021433 SPECIMEN NUMBER 5006 MECH. TEST NUMBER TYPE TEST T1

SPECIMEN THICKNESS 0.750 IN SPECIMEN WIDTH 1.500 IN INITIAL CRACK LENGTH 0.015 IN TYPE PRE-CRACK FC 1/2

PIG CONSTANT 0.500 IN/IN GAGE CONSTANT 50000. IN/IN MODULUS, PSI 10200. INFL #1 10045, PSI-IN

TIME, HRS	LOAD (LBS)	CRACK LENGTH (A), IN	CRACK GROWTH RATE (ADMT), IN/HR	STRESS INT. FACTOR (KI), PSI-IN(1/2)	REMARKS
0	1340	0.01290	-0.3559E-03	17700.	0.0000E+00
24	1340	0.01277	-0.4637E-04	17570.	0.3091E+03
48	1340	0.01270	0.0000E+00	17592.	0.1350E+03
72	1374	0.01290	0.1672E-03	17703.	0.3699E+04
96	1377	0.01304	0.1377E-03	17851.	0.4496E+05
120	1375	0.01319	0.1577E-03	18003.	-0.1497E+04
144	1373	0.01333	0.1426E-03	18143.	-0.5720E+05
168	1371	0.01345	0.1399E-03	18270.	0.8909E+05
192	1370	0.01357	0.1459E-03	18396.	0.2274E+06
216	1407	0.01370	0.1666E-03	18531.	0.3210E+04
240	1405	0.01384	0.2000E-03	18697.	0.3560E+04
264	1402	0.01404	0.2364E-03	18903.	0.3320E+04
288	1354	0.01420	0.2496E-03	19153.	0.2710E+04
312	1356	0.01456	0.2968E-03	19462.	0.2115E+04
336	1349	0.01484	0.3170E-03	19763.	0.2080E+06
360	1345	0.01518	0.3380E-03	20107.	0.3380E+06
384	1340	0.01553	0.3727E-03	20483.	0.4937E+04
408	1335	0.01594	0.4421E-03	20932.	0.1389E+03
432	1324	0.01651	0.5660E-03	21537.	

COL 1 - TIME INC. COL 2 - LOAD EVAL. COL 3 - CRACK EVAL. COL 4 - CRACK EVAL. COL 5 - MODULUS, PSI COL 6 - FILE # ALDATA.007

CALCULATED STRESS AFTER FRACTURE MEASURED (A) AFTER FRACTURE

STANDARD ERROR = 0.7517807

LOAD = 0.0000E+00 7.4010E-01E+00 0.0000E-03E+02 0.3021E-05E+03 0.1259E-07E+04 -0.1102E-09E+05

CRACK = 0.0000E+00 -0.4637E-04 0.0015E-02E+02 -0.4670E-04E+03 -0.9030E-08E+04 0.7224E-09E+05

A = 0.0000E+00 -0.3559E-03 0.0015E-02E+02 -0.4670E-04E+03 0.2496E-07E+04 -0.4524E-12E+05

COL 1 - TIME INC. COL 2 - LOAD EVAL. COL 3 - CRACK EVAL. COL 4 - CRACK EVAL. COL 5 - MODULUS, PSI COL 6 - FILE # ALDATA.107

Figure B35 Computer Print-Out of Stress Intensities and Crack Growth Rates at Various Intervals During the Test.

EVALUATION NUMBER 1 STRESS CORROSION FRACTURE TOUGHNESS DATA FOR BING LOADED COMPACT SPECIMENS

ALLOY & TEMPER 7050-T73510 PRODUCT EXTENSION SIZE 1.47INCH SPEC. LOADED 10-00-76
 SAMPLE NUMBER 42131 SPECIMEN NUMBER SI-9 TECH. TEST NUMBER TYPE TEST 11
 SPECIMEN THICKNESS 0.765 IN. SPECIMEN WIDTH 1.500 IN. INITIAL CRACK LENGTH 0.755 IN. TYPE PRE-CRACK FC 1/2
 BING CONSTANT 0.400 IN/IN GAGE CONSTANT 5000. IN/IN MODULUS, KSI 10200. INTL RI 15450, PSI-IN

COL. 1	COL. 2	COL. 3	COL. 4	COL. 5	COL. 6	FILE # ALDATA,004
TIME, HRS	LOAD, LBS	COD, IN	CRACK LENGTH (A), IN	CRACK GROWTH RATE (ADDT), IN/HR	STP. INT. FACTOR (RI), PSI-IN(1/2)	RR, IN/HR
0	1460.	0.01127	0.760	0.0150E-04	1633.	0.0000E+00
06	1460.	0.01132	0.764	0.5011E-04	1667.	0.1119E-04
126	1455.	0.01151	0.787	0.4144E-04	1653.	0.4473E-03
132	1455.	0.01181	0.790	0.3475E-04	1667.	0.5400E-03
256	1457.	0.01188	0.792	0.3212E-04	1673.	0.3027E-03
320	1456.	0.01176	0.794	0.3060E-04	1676.	0.1045E-03
384	1456.	0.01170	0.796	0.3047E-04	1683.	0.1019E-03
448	1452.	0.01184	0.798	0.3188E-04	1687.	0.1615E-03
512	1450.	0.01190	0.800	0.3445E-04	1691.	0.2500E-03
576	1447.	0.01195	0.802	0.3701E-04	1695.	0.3484E-03
640	1444.	0.01201	0.804	0.4210E-04	1701.	0.4172E-03
704	1441.	0.01209	0.807	0.4676E-04	1708.	0.4699E-03
768	1437.	0.01217	0.810	0.5172E-04	1715.	0.4956E-03
832	1437.	0.01226	0.816	0.5580E-04	1722.	0.5033E-03
896	1429.	0.01237	0.817	0.6185E-04	1724.	0.5053E-03
960	1429.	0.01248	0.822	0.6874E-04	1727.	0.4403E-03
1024	1417.	0.01261	0.826	0.7133E-04	1751.	0.4580E-03
1088	1412.	0.01274	0.831	0.7551E-04	1766.	0.4187E-03
1152	1408.	0.01288	0.836	0.7921E-04	1777.	0.4090E-03
1216	1392.	0.01304	0.841	0.8213E-04	1793.	0.4120E-03
1280	1392.	0.01320	0.847	0.8803E-04	1804.	0.2499E-03
1344	1380.	0.01334	0.853	0.9666E-04	1823.	0.1930E-03
1408	1375.	0.01352	0.856	0.8760E-04	1832.	0.1135E-03
1472	1371.	0.01368	0.860	0.8823E-04	1848.	0.4311E-04
1536	1363.	0.01385	0.860	0.8790E-04	1870.	0.2008E-03
1600	1355.	0.01401	0.875	0.8701E-04	1887.	0.4950E-03
1664	1347.	0.01416	0.881	0.8563E-04	1900.	0.1582E-03
1728	1337.	0.01431	0.886	0.8177E-04	1914.	0.2165E-03
1792	1331.	0.01445	0.891	0.8054E-04	1924.	0.2676E-03
1856	1322.	0.01456	0.896	0.7749E-04	1941.	0.3699E-03
1920	1314.	0.01471	0.901	0.7407E-04	1952.	0.3410E-03
1984	1305.	0.01482	0.905	0.7060E-04	1963.	0.3018E-03
2048	1296.	0.01492	0.906	0.6870E-04	1972.	0.3040E-03
2112	1287.	0.01502	0.911	0.6114E-04	1980.	0.3591E-03
2176	1274.	0.01510	0.917	0.5985E-04	1987.	0.3332E-03
2240	1264.	0.01517	0.921	0.5697E-04	1994.	0.3009E-03
2304	1260.	0.01524	0.925	0.5672E-04	1997.	0.3263E-03
2368	1251.	0.01531	0.928	0.5338E-04	2004.	0.1300E-03
2432	1242.	0.01537	0.932	0.5106E-04	2009.	0.2820E-03
2496	1232.	0.01544	0.935	0.5413E-04	2015.	0.1065E-03
2560	1221.	0.01541	0.936	0.5806E-04	2020.	0.2070E-03
2624	1211.	0.01560	0.941	0.6130E-04	2021.	0.4575E-03
2688	1204.	0.01570	0.947	0.6215E-04	2017.	0.6770E-03
2752	1194.	0.01583	0.952	0.7743E-04	2040.	0.4201E-03
2816	1184.	0.01599	0.957	0.8954E-04	2042.	0.1212E-04
2880	1171.	0.01614	0.963	0.1049E-03	2037.	0.1531E-04
2944	1163.	0.01644	0.970	0.1237E-03	2109.	0.1007E-04
3008	1152.	0.01674	0.978	0.1485E-03	2132.	0.2200E-04
3072	1149.	0.01685	0.980	0.1529E-03	2140.	0.6361E-03

CALCULATED SIF BASED ON MEASUREMENT (A) AFTER FRACTURE 0.920 10002.
 STANDARD ERROR = 1.1076104
 LOAD = 0.7301E+03 ± 0.2194E+02 ± 0.4810E+02 ± 0.1593E+02 ± 0.7809E+11 ± 0.043E+14
 COD = 0.5630E+03 ± 0.1270E+02 ± 0.2400E+03 ± 0.2044E+04 ± 0.1247E+04 ± 0.1707E+13
 A = 0.7807E+00 ± 0.4150E+04 ± 0.1013E+04 ± 0.1330E+09 ± 0.5714E+13 ± 0.8070E+17

COL. 1 = TIME IN. COL. 2 = LOAD EVAL. COL. 3 = COD EVAL. COL. 4 = CRACK EVAL. FILE # ALDATA,104

Figure B36 Computer Print-Out of Stress Intensities and Crack Growth Rates at Various Intervals During the Test.

EVALUATION NUMBER 1
 STRESS CORRUSSION FRACTURE TOUGHNESS DATA FOR RING LOADED COMPACT SPECIMENS

ALLOY & TEMPER 7050-T73513 PHENOLIC EXTRUSION SIZE, IN 1.0 THICK SPEC. LOADED 04-01-76
 SAMPLE NUMBER 42133a SPECIMEN NUMBER SL-4 WFCM, TEST NUMBER TYPE TEST T1

SPECIMEN DIMENSIONS 0.768 IN SPECIMEN WIDTH 1.500 IN INITIAL CRACK LENGTH 0.755 IN TYPE PRE-CRACK FC 1/2
 RING CONSTANT 0.500 IN/IN GAGE CONSTANT 5000, IN/IN MODULUS, KSI 10200. INTL K1 25203, PSI-IN

TIME, HRS	COL 1	COL 2	COL 3	COL 4	COL 5	COL 6	REMARKS
0	LOAD(P)	C-CRACK	C-CRACK	CRACK LENGTH (A), IN	CRACK GROWTH RATE (ADDT), IN/HR	STRESS INT. FACTOR (KI), PSI-IN(1/2)	CGM DIFF
0	2186.	0.01814	0.777	0.1110E-02	26398.	0.0000E+00	0.0000E+00
4	2192.	0.01855	0.783	0.4884E-03	26809.	-0.0235E-03	-0.0235E-03
14	2191.	0.01871	0.786	0.2228E-03	26956.	-0.2630E-03	-0.2630E-03
24	2189.	0.01877	0.787	0.1524E-03	27013.	-0.7034E-04	-0.7034E-04
32	2186.	0.01842	0.788	0.1544E-03	27062.	0.1988E-03	0.1988E-03
40	2188.	0.01888	0.789	0.1533E-03	27120.	-0.1087E-03	-0.1087E-03
44	2187.	0.01894	0.790	0.1184E-03	27174.	-0.4391E-04	-0.4391E-04
54	2185.	0.01894	0.791	0.8649E-04	27209.	-0.3095E-04	-0.3095E-04
64	2186.	0.01899	0.791	0.6191E-04	27213.	-0.0500E-03	-0.0500E-03
72	2184.	0.01903	0.792	0.2007E-03	27250.	0.1468E-03	0.1468E-03
80	2182.	0.01920	0.795	0.6554E-03	27416.	0.4687E-03	0.4687E-03

FILE = ALDATA.002

CALCULATED SIF BASED ON MEASURED (A) AFTER FRACTURE 0.793 27200.

STANDARD ERROR = 0.018553

LOAD = 0.1193E+04 0.768E+00 0.7234E-01 0.2014E-02 0.5910E-04 0.5866E-00 0.3222E-00
 = -0.2203E-00

CRACK = 0.9078E+03 0.3748E+01 0.1909E+00 0.5337E-02 0.8779E-04 0.3222E-00
 = 0.0276E-00

A = 0.7760E+00 0.1111E-02 0.5460E-04 0.1400E-03 0.1012E-07 0.0276E-00
 = 0.0276E-00

COL 1 = TIME INC. COL 2 = LOAD EVAL. COL 3 = CRACK EVAL. COL 4 = CRACK EVAL. COL 5 = CRACK EVAL. COL 6 = ALDATA.102

Figure B37 Computer Print-Out of Stress Intensities and Crack Growth Rates at Various Intervals During the Test.

```

EVALUATION NUMBER 1
STRESS CORRELATION FRACTURE TOUGHNESS DATA FOR HING LOADED COMPACT SPECIMENS

ALLOY 0 7050-T73510 DENSITY 7.800E-08 SIZE, IN 1.0 THICK SPEC. LOADED 04-01-76
SAMPLE NUMBER 42133 SECTION NUMBER SL-7 MECH. TEST NUMBER TYPE TEST T1

SPECIMEN THICKNESS 0.750 IN. SPECIMEN WIDTH 1.500 IN INITIAL CRACK LENGTH 0.020 IN TYPE PRE-CRACK IC 1/2
DIAG CONSTANT 0.500 IN/IN GAGE CONSTANTS S0000, IN/IN MODULUS, PSI 10200. INTL KI 22000. PSI-IN

COL 1 COL 2 COL 3 COL 4 COL 5 COL 6 COL 7 COL 8 COL 9 COL 10 COL 11 COL 12
TIME LMS LCM(P). CUM(V). CRACK LENGTH CRACK GROWTH RATE STH, INT. FACTOR REMARKS
MRS IN IN (IN/IN) IN/IN (KI), PSI-IN(1/2) CGR DIFF.
0 1862 0.01778 0.051 0.00000E+00 0.00000E+00 0.00000E+00
4 1864 0.01773 0.049 0.00000E+00 0.00000E+00 0.00000E+00
8 1866 0.01772 0.049 0.00000E+00 0.00000E+00 0.00000E+00
12 1867 0.01771 0.049 0.00000E+00 0.00000E+00 0.00000E+00
16 1867 0.01771 0.049 0.00000E+00 0.00000E+00 0.00000E+00
20 1867 0.01770 0.049 0.00000E+00 0.00000E+00 0.00000E+00
24 1868 0.01769 0.049 0.00000E+00 0.00000E+00 0.00000E+00
28 1867 0.01769 0.049 0.00000E+00 0.00000E+00 0.00000E+00
32 1867 0.01772 0.049 0.00000E+00 0.00000E+00 0.00000E+00
36 1865 0.01774 0.053 0.00000E+00 0.00000E+00 0.00000E+00
40 1864 0.01601 0.055 0.00000E+00 0.00000E+00 0.00000E+00
44 1862 0.01414 0.056 0.00000E+00 0.00000E+00 0.00000E+00
48 1859 0.01227 0.050 0.00000E+00 0.00000E+00 0.00000E+00
52 1864 0.01144 0.051 0.00000E+00 0.00000E+00 0.00000E+00

CALCULATED SIP MASHU IN
MEASURED (A) AFTER FRACTURE

STANDARD ERROR 0.21007-1

LOAD 0 0.9300E+03 0.2043E+01 0.7857E-01 0.2955E-02 0.3267E-04 0.3919E-06
0.2043E-07 0.1049E-10 0.0000E-13 0.0000E-16 0.0000E-19 0.0000E-22

CRACK 0 0.0002E+03 0.0005E+01 0.2840E-01 0.7357E-03 0.0007E-05 0.0000E-07
0.0000E-09 0.0000E-11 0.0000E-13 0.0000E-15 0.0000E-17 0.0000E-19

A 0 0.0011E+00 0.0020E-01 0.0020E-02 0.0020E-03 0.0020E-04 0.0020E-05
0.0020E-06 0.0020E-07 0.0020E-08 0.0020E-09 0.0020E-10 0.0020E-11

COL. 1 - TIME I-C. COL. 2 - LOAD EVAL. COL. 3 - CRACK EVAL. COL. 4 - CRACK EVAL. COL. 5 - CRACK EVAL. COL. 6 - ALDATA.101
  
```

Figure B38 Computer Print-Out of Stress Intensities and Crack Growth Rates at Various Intervals During the Test.

EVALUATION NUMBER 1 STRESS CORRELATION FRACTURE TOUGHNESS DATA FOR PING LOADED COMPACT SPECIMENS

ALLOY + THERM. T000077310 PRODUCT DESCRIPTION SIZE, IN 1.875X SPEC. LOADED 10-06-76
 RANDID NUMBER 421134 APPLIC. NUMBER AL-9 MECH. TEST NUMBER TYPE TEST T1
 SPECIMEN THICKNESS 0.750 IN SPECIMEN WIDTH 1.500 IN INITIAL CRACK LENGTH 0.760 IN TYPE PRE-CRACK FC 1/2
 PING CONSTANT 0.500 IN/IN GAGE CONSTANT 50000. IN/IN MODULUS, PSI 10200. INTL RI 21200, PSI-IN

COL 1	COL 2	COL 3	COL 4	COL 5	COL 6	FILE = ALDATA.001
TIME, MIN	LOAD, LBS	CORRECT. LOAD, LBS	CRACK LENGTH (A), IN	CRACK GROWTH RATE (ADD), IN/MP	STR. INT. FACTOR (RI), PSI-IN(1/2)	REMARKS CGR DIFF.
0	1000.	0.01401	0.761	0.1100E+03	21322.	0.0000E+00
32	1000.	0.01404	0.761	0.0820E+04	21453.	-0.2033E+04
64	1000.	0.01404	0.767	0.0610E+04	21550.	-0.1910E+04
96	1000.	0.01404	0.769	0.0225E+04	21621.	-0.1389E+04
128	1000.	0.01402	0.771	0.0225E+04	21673.	-0.0932E+05
160	1000.	0.01404	0.772	0.0730E+04	21713.	-0.5500E+05
192	1000.	0.01400	0.773	0.0407E+04	21747.	-0.2403E+05
224	1000.	0.01404	0.774	0.0303E+04	21774.	-0.4011E+07
256	1000.	0.01404	0.774	0.0302E+04	21812.	0.1700E+05
288	1000.	0.01404	0.776	0.0302E+04	21849.	0.3100E+05
320	1000.	0.01402	0.776	0.0302E+04	21892.	0.3910E+05
352	1000.	0.01402	0.777	0.0302E+04	21941.	0.4000E+05
384	1000.	0.01402	0.779	0.0302E+04	21961.	0.4290E+05
416	1000.	0.01402	0.780	0.0302E+04	22001.	0.4290E+05
448	1000.	0.01402	0.782	0.0302E+04	22047.	0.4452E+05
480	1000.	0.01402	0.784	0.0302E+04	22140.	0.3340E+05
512	1000.	0.01402	0.784	0.0302E+04	22219.	0.2500E+05
544	1000.	0.01402	0.784	0.0302E+04	22302.	0.1400E+05
576	1000.	0.01402	0.784	0.0302E+04	22388.	0.3070E+05
608	1000.	0.01402	0.784	0.0302E+04	22470.	-0.0750E+05
640	1000.	0.01402	0.784	0.0302E+04	22547.	-0.2110E+05
672	1000.	0.01402	0.784	0.0302E+04	22603.	-0.3320E+05
704	1000.	0.01402	0.784	0.0302E+04	22647.	-0.4452E+05
736	1000.	0.01402	0.784	0.0302E+04	22727.	-0.5440E+05
768	1000.	0.01402	0.784	0.0302E+04	22800.	-0.5440E+05
800	1000.	0.01402	0.784	0.0302E+04	22865.	-0.6250E+05
832	1000.	0.01402	0.784	0.0302E+04	22921.	-0.6250E+05
864	1000.	0.01402	0.784	0.0302E+04	22967.	-0.7100E+05
896	1000.	0.01402	0.784	0.0302E+04	23002.	-0.7047E+05
928	1000.	0.01402	0.784	0.0302E+04	23027.	-0.6990E+05
960	1000.	0.01402	0.784	0.0302E+04	23042.	-0.5710E+05
992	1000.	0.01402	0.784	0.0302E+04	23068.	-0.4300E+05
1024	1000.	0.01402	0.784	0.0302E+04	23080.	-0.2840E+05
1056	1000.	0.01402	0.784	0.0302E+04	23080.	-0.1705E+05
1088	1000.	0.01402	0.784	0.0302E+04	23080.	0.3301E+05
1120	1000.	0.01402	0.784	0.0302E+04	23080.	0.7240E+05
1152	1000.	0.01402	0.784	0.0302E+04	23080.	0.1190E+06
1184	1000.	0.01402	0.784	0.0302E+04	23130.	0.1730E+06
1216	1000.	0.01402	0.784	0.0302E+04	23192.	0.2307E+06
1248	1000.	0.01402	0.784	0.0302E+04	23200.	0.3000E+06
1280	1000.	0.01402	0.784	0.0302E+04	23272.	0.3400E+06
1312	1000.	0.01402	0.784	0.0302E+04	23307.	0.4020E+06
1344	1000.	0.01402	0.784	0.0302E+04	24020.	0.5450E+06
1376	1000.	0.01402	0.784	0.0302E+04	24440.	0.6992E+06
1408	1000.	0.01402	0.784	0.0302E+04	24600.	0.8247E+06
1440	1000.	0.01402	0.784	0.0302E+04	25705.	0.9020E+06
1472	1000.	0.01402	0.784	0.0302E+04	26503.	0.1113E+07

PLATEAUED BY HARD IN MEASUREMENTS AT FRACTURE

STRESS INTENSITY = 1.000001

LOAD = 0.0970E+05 0.3140E+05 0.7827E+04 0.2231E+06 0.2640E+07 0.1031E+12
 CGR = 0.7210E+03 0.2543E+05 0.1182E+07 0.3000E+09 0.3027E+08 0.1042E+11
 A = 0.2012E+04 0.1100E+05 0.4480E+07 0.1140E+08 0.1170E+11 0.4113E+15
 COL 1 = TIME INC. COL 2 = LOAD EVAL. COL 3 = CGR EVAL. COL 4 = CRACK EVAL. FILE = ALDATA.101

Figure B39 Computer Print-Out of Stress Intensities and Crack Growth Rates at Various Intervals During the Test.

EVALUATION NUMBER 1

STRESS CORRUPTION FRACTURE TOUGHNESS DATA FOR RING LOADED COMPACT SPECIMENS

ALLOY & TENSILE 7050-T73510 PRODUCT DESCRIPTION 5120 IN 1,074PK SPEC. LOADED 10-00-76
 SAMPLE NUMBER 42111A SPECIMEN NUMBER SL-6 MFCM. TEST NUMBER TYPE TEST FI
 SPECIMEN THICKNESS 0.750 IN SPECIMEN WIDTH 1.500 IN INITIAL CRACK LENGTH 0.765 IN TYPE PWF=CHACKI FC 1/2
 RING CONSTANT 0.500 IN/IN GAGE CONSTANT 5000. IN/IN MODULUS, PSI 10200. INFL RI 10420, PSI=14

COL. 1	COL. 2	COL. 3	COL. 4	COL. 5	COL. 6	FILE # ALDATA.001
TIME, MRS	LOADS, LBS	CODES, IN	CRACK LENGTH (A), IN	CRACK GROWTH RATE (DDOT), 1/IN/HR	STP. INT. FACTOR (K1), PSI-IN(1/2)	MEMBERS CGM 1-100
0	1710	0.01266	0.763	0.1311E-05	10003	0.0000E+00
44	1710	0.01266	0.764	0.1494E-06	10002	0.1400E+05
124	1710	0.01266	0.763	0.1911E-05	10002	0.1700E+05
192	1710	0.01266	0.763	0.1694E-05	10003	0.1904E+05
254	1710	0.01267	0.764	0.0031E-05	10000	0.2137E+05
320	1710	0.01268	0.764	0.0256E-05	10071	0.2225E+05
381	1710	0.01269	0.765	0.1051E-04	10000	0.2252E+05
444	1710	0.01271	0.765	0.1273E-04	10093	0.2223E+05
512	1710	0.01271	0.766	0.1447E-04	10110	0.2140E+05
574	1710	0.01274	0.767	0.1000E-04	10731	0.2019E+05
640	1710	0.01274	0.768	0.1757E-04	10750	0.1954E+05
704	1710	0.01281	0.770	0.2040E-04	10765	0.1853E+05
764	1710	0.01287	0.771	0.2182E-04	10819	0.1422E+05
832	1710	0.01292	0.773	0.2290E-04	10855	0.1100E+05
894	1710	0.01294	0.774	0.2380E-04	10894	0.0893E+05
960	1710	0.01301	0.776	0.2467E-04	10930	0.0543E+05
1024	1710	0.01306	0.777	0.2477E-04	10970	0.2450E+06
1084	1710	0.01311	0.779	0.2476E-04	10025	0.1253E+07
1152	1710	0.01317	0.780	0.2444E-04	10071	0.1203E+06
1214	1710	0.01322	0.782	0.2381E-04	10117	0.0231E+06
1280	1710	0.01327	0.783	0.2290E-04	10163	0.0410E+06
1344	1710	0.01332	0.785	0.2170E-04	10207	0.1194E+05
1408	1710	0.01337	0.786	0.2028E-04	10250	0.1452E+05
1472	1708	0.01341	0.787	0.1857E-04	10291	0.1006E+05
1534	1704	0.01345	0.789	0.1668E-04	10329	0.1400E+05
1600	1704	0.01349	0.790	0.1442E-04	10363	0.2057E+05
1664	1703	0.01352	0.790	0.1243E-04	10394	0.2145E+05
1728	1703	0.01355	0.791	0.1017E-04	10421	0.2200E+05
1792	1703	0.01357	0.792	0.7065E-05	10447	0.2301E+05
1854	1703	0.01359	0.792	0.5588E-05	10467	0.2279E+05
1920	1703	0.01360	0.792	0.3390E-05	10475	0.2190E+05
1984	1703	0.01361	0.791	0.1341E-05	10485	0.2040E+05
2048	1704	0.01362	0.793	0.4000E-06	10491	0.1831E+05
2112	1704	0.01362	0.793	0.2027E-05	10493	0.1537E+05
2174	1704	0.01361	0.792	0.1917E-05	10491	0.1104E+05
2240	1704	0.01361	0.792	0.1895E-05	10491	0.7047E+06
2304	1710	0.01361	0.792	0.4041E-05	10488	0.1953E+06
2368	1710	0.01360	0.792	0.3561E-05	10485	0.4845E+06
2432	1711	0.01360	0.792	0.2320E-05	10485	0.1215E+05
2494	1711	0.01360	0.791	0.2007E-05	10485	0.2000E+05
2560	1710	0.01361	0.792	0.2003E-05	10497	0.3047E+05
2624	1712	0.01362	0.792	0.0910E+05	10514	0.4124E+05
2684	1713	0.01365	0.792	0.1225E+04	10541	0.5321E+05
2747	1713	0.01369	0.793	0.1890E+04	10591	0.0045E+05
2808	1713	0.01374	0.794	0.2500E+04	10630	0.7002E+05

PRELIMINARY STP BASED ON MEASURED (A) AFTER FRACTURE

0.496

24985

STANDARD DEVIATION = 2.0121332

LOAD = 0.0000E+00 0.1443E+02 0.2630E+04 0.1440E+07 0.2315E+11

CODE = 0.0000E+00 0.4240E+07 0.1032E+05 0.4130E+07 0.2740E+10 0.4935E+14

A = 0.7027E+00 0.1311E+05 0.1003E+07 0.1544E+10 0.1323E+11 0.2500E+17

COL. 1 = TIME INC. COL. 2 = LOAD EVAL. COL. 3 = CODE EVAL. COL. 4 = CRACK EVAL. FILE = ALDATA.001

Figure B40 Computer Print-Out of Stress Intensities and Crack Growth Rates at Various Intervals During the Test.

EVALUATION NUMBER 1

STRESS CORROSION FRACTURE TOUGHNESS DATA FOR RING LOADED COMPACT SPECIMENS

ALLOY & TEMPER 7050-T74510 MILDUCT DETRUSTION SIZE, IN 2.93 THK SPEC. LOADED 04-01-76
 SAMPLE NUMBER 021141 SPECIMEN NUMBER SL-4 TECH. TEST NUMBER TYPE TEST T1
 APPARENT THICKNESS 1.000 IN SPECIMEN WIDTH 4.000 IN INITIAL CRACK LENGTH 1.020 IN TYPE PDL=CRACK FC
 RING CONSTANTS 0.500 IN/IN GAGE CONSTANTS 5000. IN/IN MODULUS, PSI 10200. INFL RE 12196. PSI-IN 1/2

COL 1	COL 2	COL 3	COL 4	COL 5	COL 6	FILE # ALDATA,004
TIME, MINS	LOAD (P), LBS	CMOVE, IN	CRACK LENGTH (A), IN	CRACK GROWTH RATE (ADOT), IN/MIN	STH, INT. FACTOR (KI), PSI-IN(1/2)	REMARKS CGM DIFF.
0	1714	0.00000	1.045	-0.1304E+02	12494	0.0000E+00
14	1714	0.00050	1.020	-0.0921E+03	12145	0.0710E+03
32	1714	0.00041	1.020	-0.2084E+03	11995	0.4037E+03
44	1713	0.00040	1.020	0.1236E+03	11982	0.3320E+03
54	1713	0.00040	1.024	0.3359E+03	12059	0.2122E+03
60	1713	0.00065	1.031	0.4561E+03	12190	0.1203E+03
94	1713	0.00083	1.039	0.5083E+03	12349	0.5214E+04
112	1714	0.01003	1.047	0.5125E+03	12510	0.0210E+05
128	1714	0.01022	1.055	0.6056E+03	12677	-0.2691E+06
144	1714	0.01030	1.063	0.4412E+03	12625	-0.4436E+06
160	1713	0.01054	1.069	0.3902E+03	12955	-0.5099E+06
176	1713	0.01067	1.075	0.3408E+03	13067	-0.4930E+06
192	1712	0.01076	1.079	0.2969E+03	13163	-0.4190E+06
208	1710	0.01087	1.084	0.2684E+03	13246	-0.3807E+06
224	1704	0.01096	1.088	0.2511E+03	13320	-0.1721E+06
240	1700	0.01105	1.092	0.2478E+03	13392	-0.3339E+06
256	1701	0.01114	1.096	0.2576E+03	13465	0.9766E+05
272	1701	0.01123	1.100	0.2707E+03	13546	0.2111E+06
288	1698	0.01134	1.105	0.3006E+03	13637	0.2995E+06
304	1695	0.01146	1.111	0.3466E+03	13742	0.3563E+06
320	1692	0.01150	1.117	0.3930E+03	13861	0.3554E+06
336	1688	0.01174	1.123	0.4211E+03	13997	0.3014E+06
352	1685	0.01193	1.130	0.4501E+03	14149	0.2496E+06
368	1682	0.01211	1.136	0.4657E+03	14315	0.2960E+06
384	1679	0.01231	1.144	0.5086E+03	14494	0.2290E+06
400	1676	0.01252	1.154	0.5246E+03	14684	0.1601E+06
416	1673	0.01274	1.162	0.5349E+03	14883	0.1030E+06
432	1670	0.01296	1.170	0.5424E+03	15092	0.7435E+05
448	1667	0.01320	1.179	0.5517E+03	15311	0.9336E+05
464	1664	0.01345	1.188	0.5609E+03	15546	0.1017E+06
480	1660	0.01373	1.197	0.6003E+03	15804	0.3645E+06
496	1655	0.01404	1.208	0.6732E+03	16100	0.6003E+06
512	1650	0.01441	1.220	0.7455E+03	16452	0.1123E+07
528	1644	0.01487	1.234	0.9616E+03	16889	0.1762E+07
544	1638	0.01546	1.252	0.1224E+02	17445	0.2614E+07
560	1627	0.01622	1.273	0.1507E+02	18162	0.3733E+07
576	1621	0.01669	1.285	0.1436E+02	18997	0.2375E+07

CALCULATED STP BASED ON MEASURED (A) AFTER FRACTURE 1.272 18059.

STANDARD ERROR = 1.702e-237

LOAD = 0.4591E+03 ± 0.1117E+01 0.1544E+02E+2 ± 0.0615E+05Tee3 0.1771E+07Tee4 ± 0.1200E+10Tee5

CMO = 0.4996E+03 ± 0.1704E+01 0.3040E+01Tee2 ± 0.1909E+03Tee3 0.5780E+06Tee4 ± 0.8419E+09Tee5

A = 0.1043E+01 ± 0.1148E+01 0.2415E+04Tee2 ± 0.1490E+06Tee3 0.4631E+09Tee4 ± 0.8339E+12Tee5

COL. 1 = TIME INC. COL. 2 = LOAD EVAL. COL. 3 = CMO EVAL. COL. 4 = CRACK EVAL. FILE # ALDATA,100

Figure B41 Computer Print-Out of Stress Intensities and Crack Growth Rates at Various Intervals During the Test.

EVALUATION NUMBER 1

STRESS CORROSION FRACTURE TOUGHNESS DATA FOR RING LOADED COMPACT SPECIMENS

ALLOY + TEMPR 7050-T76510 PRODUCT EXTRUSION SIZE, IN 2.93 THK SPEC. LOADED 04-01-76
 SAMPLE NUMBER 021143 SPECIMEN NUMBER SL- 9 MECH. TEST NUMBER TYPE TEST T1
 SPECIMEN THICKNESS 1.000 IN SPECIMEN WIDTH 2.000 IN INITIAL CRACK LENGTH 1.020 IN TYPE PRE-CRACK FC
 RING CONSTANT 0.500 IN/LM GAGE CONSTANT 90000. IN/IN MODULUS, KSI 10300. INFL KI 9307, PSI-IN 1/3

COL 1	COL 2	COL 3	COL 4	COL 5	COL 6	FILE # ALDATA.005
TIME, HRS	LOAD (P), LBS	CODIV, IN	CRACK LENGTH (A), IN	CRACK GROWTH RATE (ADOT), IN/HR	STR. INT. FACTOR (FI), PSI-IN(1/2)	REMARKS CGR DIFF.
0	1344.	0.00713	1.010	0.1000E-03	9276.	0.0000E+00
10	1340.	0.00722	1.010	0.2724E-04	9276.	0.1279E-03
12	1345.	0.00719	1.009	0.1279E-03	9248.	0.1007E-03
18	1344.	0.00722	1.011	0.2050E-03	9272.	0.7704E-04
24	1344.	0.00729	1.010	0.2017E-01	9331.	0.0677E-04
30	1344.	0.00739	1.021	0.3014E-03	9412.	0.3906E-04
36	1344.	0.00750	1.027	0.3209E-03	9505.	0.2050E-04
112	1344.	0.00762	1.034	0.3410E-03	9608.	0.1409E-04
120	1344.	0.00774	1.040	0.3662E-03	9707.	0.0240E-05
144	1344.	0.00789	1.046	0.3850E-03	9801.	-0.1263E-05
160	1344.	0.00795	1.052	0.3393E-03	9889.	-0.0017E-05
176	1344.	0.00804	1.057	0.3313E-03	9968.	-0.0023E-05
192	1343.	0.00813	1.062	0.3220E-03	10040.	-0.0020E-05
208	1343.	0.00820	1.066	0.3140E-03	10105.	-0.7707E-05
224	1341.	0.00828	1.070	0.3093E-03	10165.	-0.0040E-05
240	1340.	0.00834	1.074	0.3071E-03	10223.	-0.2190E-05
256	1334.	0.00841	1.079	0.3002E-03	10280.	0.2114E-05
272	1337.	0.00848	1.083	0.3160E-03	10340.	0.7169E-05
288	1334.	0.00856	1.088	0.3291E-03	10405.	0.1275E-04
304	1332.	0.00865	1.093	0.3670E-03	10470.	0.1060E-04
320	1330.	0.00875	1.099	0.3720E-03	10532.	0.2674E-04
336	1327.	0.00886	1.105	0.4033E-03	10600.	0.2073E-04
352	1324.	0.00900	1.112	0.4397E-03	10772.	0.2040E-04
368	1321.	0.00914	1.121	0.4014E-03	10902.	0.0171E-04
384	1319.	0.00931	1.129	0.5277E-03	11050.	0.0030E-04
400	1315.	0.00950	1.139	0.5777E-03	11210.	0.0001E-04
416	1312.	0.00971	1.150	0.6200E-03	11400.	0.0205E-04
432	1309.	0.00993	1.161	0.6040E-03	11610.	0.0401E-04
448	1306.	0.01019	1.172	0.7203E-03	11840.	0.0390E-04
464	1302.	0.01045	1.185	0.7904E-03	12090.	0.0311E-04
480	1299.	0.01074	1.197	0.8309E-03	12360.	0.0044E-04
496	1295.	0.01105	1.210	0.8610E-03	12660.	0.0209E-04
512	1291.	0.01130	1.224	0.9162E-03	12972.	0.0404E-04
528	1287.	0.01173	1.237	0.9404E-03	13305.	0.2014E-04
544	1283.	0.01210	1.251	0.9513E-03	13659.	0.1094E-04
560	1277.	0.01250	1.266	0.9402E-03	14035.	-0.0140E-05
576	1271.	0.01293	1.281	0.9210E-03	14430.	-0.0037E-04
592	1265.	0.01339	1.296	0.9750E-03	14800.	-0.0070E-04
608	1257.	0.01390	1.311	0.9023E-03	15210.	-0.7270E-04
624	1244.	0.01445	1.328	0.6999E-03	15602.	-0.1024E-03

CALCULATED SIF BASED ON MEASURED (A) AFTER FRACTURE

1.305

16974.

STANDARD ERROR = 1.0137100

LOAD = 0.0742E+03 = 0.0775E+01T 0.1077E+02T+02 = 0.5121E+05T+03 0.9157E+08T+04 = 0.5900E+11T+05

COD = 0.3067E+03 = 0.5130E+01T 0.1084E+01T+02 = 0.0209E+04T+03 0.1650E+06T+04 = 0.2035E+09T+05
 0.0658E+13T+06

A = 0.1010E+01 = 0.1006E+03T 0.0454E+05T+02 = 0.2016E+07T+03 0.3020E+10T+04 = 0.2501E+13T+05

COL. 1 = TIME INC. COL. 2 = LOAD EVAL. COL. 3 = COD EVAL. COL. 4 = CRACK EVAL. FILE # ALDATA.100

Figure B42 Computer Print-Out of Stress Intensities and Crack Growth Rates at Various Intervals During the Test.

EVALUATION NUMBER 1
 STRESS CORROSION FRACTURE TOUGHNESS DATA FOR RING LOADED COMPACT SPECIMENS

ALLOY & TEMPER 7050-T73510 PRODUCT DISTRIBUTION SIZE, IN 2.075X3
 SPEC. LOADED 10-06-74
 SAMPLE NUMBER 42114 SPECIMEN NUMBER SL-7 MECH. TEST NUMBER TYPE TEST II

SPECIMEN THICKNESS 1.000 IN SPECIMEN WIDTH 2.000 IN INITIAL CRACK LENGTH 1.025 IN TYPE PRE-CRACK PC 1/2
 RING CONSTANTS 0.500 IN/IN GAGE CONSTANTS 90000, IN/IN MODULUS, PSI 19200, IN/IN INFL AT 7520, PSI-IN

COL 1	COL 2	COL 3	COL 4	COL 5	COL 6	FILE # ALDATA.005
TIME, HRS	LOAD (KIP)	CRACK (IN)	CRACK LENGTH (IN)	CRACK GROWTH RATE (IN/H)	STP. INT. FACTOR (KI), PSI-IN(1/2)	REMARKS CGM DIFF.
0	1071	0.00654	1.000	0.5835E-04	8044	0.0000E+00
40	1070	0.00654	1.007	0.7303E-04	8041	0.3331E-04
80	1069	0.00654	1.004	0.4445E-05	8047	0.2750E-04
104	1068	0.00654	1.007	0.2066E-04	8049	0.2221E-04
128	1068	0.00654	1.009	0.4012E-04	8066	0.1744E-04
152	1068	0.00654	1.011	0.5720E-04	8072	0.1316E-04
176	1067	0.00650	1.014	0.6063E-04	8120	0.9350E-05
200	1068	0.00650	1.017	0.7242E-04	8160	0.5957E-05
224	1068	0.00651	1.017	0.7547E-04	8209	0.3053E-05
248	1068	0.00673	1.021	0.7620E-04	8254	0.5267E-06
272	1068	0.00673	1.025	0.7450E-04	8300	-0.1013E-05
296	1068	0.00683	1.028	0.7450E-04	8344	-0.3380E-05
320	1068	0.00688	1.032	0.7120E-04	8380	-0.4813E-05
344	1067	0.00693	1.035	0.6630E-04	8420	-0.5916E-05
368	1067	0.00698	1.038	0.6047E-04	8450	-0.6715E-05
392	1067	0.00698	1.041	0.5376E-04	8490	-0.7231E-05
416	1067	0.00705	1.043	0.4693E-04	8510	-0.7484E-05
440	1067	0.00705	1.045	0.3944E-04	8537	-0.7494E-05
464	1067	0.00711	1.047	0.3155E-04	8553	-0.7284E-05
488	1067	0.00712	1.048	0.2420E-04	8565	-0.6874E-05
512	1067	0.00714	1.049	0.1719E-04	8572	-0.6283E-05
536	1067	0.00715	1.049	0.1111E-04	8576	-0.5546E-05
560	1067	0.00715	1.049	0.5572E-05	8576	-0.4847E-05
584	1067	0.00715	1.049	0.4253E-05	8574	-0.3861E-05
608	1067	0.00715	1.049	0.2710E-05	8574	-0.2539E-05
632	1067	0.00715	1.049	-0.5250E-05	8569	-0.1362E-05
656	1067	0.00715	1.049	0.0017E-05	8564	-0.1202E-06
680	1067	0.00714	1.049	-0.6745E-05	8558	0.1140E-05
704	1067	0.00713	1.049	-0.5005E-05	8553	0.2022E-05
728	1067	0.00713	1.049	0.3144E-05	8549	0.1677E-05
752	1067	0.00712	1.049	0.5130E-04	8547	0.4944E-05
776	1067	0.00713	1.049	0.5457E-05	8549	0.1468E-05
800	1067	0.00713	1.049	0.1100E-04	8555	0.1468E-05
824	1067	0.00713	1.049	0.1007E-04	8566	0.7274E-05
848	1067	0.00714	1.049	0.1007E-04	8562	0.5316E-05
872	1067	0.00714	1.049	0.2719E-04	8562	0.4245E-05
896	1067	0.00714	1.049	0.3643E-04	8560	0.1004E-04
920	1067	0.00714	1.049	0.4046E-04	8570	0.1009E-04
944	1067	0.00722	1.049	0.3717E-04	8570	0.1117E-04
968	1067	0.00726	1.049	0.8033E-04	8720	0.1148E-04
992	1067	0.00732	1.049	0.7978E-04	8781	0.1148E-04
1016	1067	0.00738	1.049	0.9130E-04	8840	0.1151E-04
1040	1067	0.00745	1.049	0.9130E-04	8875	0.1135E-04
1064	1067	0.00753	1.049	0.1020E-03		
1088	1067	0.00743	1.049	0.1136E-03	9012	0.1002E-04
1112	1067	0.00743	1.044	0.1230E-03	9109	0.1022E-04
1136	1067	0.00744	1.040	0.1330E-03	9216	0.9220E-05
1160	1067	0.00744	1.037	0.1409E-03	9322	0.7912E-05
1184	1067	0.00747	1.033	0.1472E-03	9457	0.6200E-05
1208	1067	0.00747	1.030	0.1514E-03	9591	0.4240E-05
1232	1067	0.00746	1.027	0.1533E-03	9731	0.1496E-05
1256	1067	0.00746	1.024	0.1523E-03	9877	-0.9360E-06

PAI-CALCATED ATP BASED ON
 MEASUREMENT (A) AFTER FRACTURING 1.120 8045.

STANDARD ERROR = 0.0151007

LOAD = 0.5155E+03 = 0.5144E+02 = 0.335E+05T0020

CRACK = 0.3291E+03 = 0.5144E+01T0 = 0.2970E+03T0020 = 0.3420E+06T0030 = 0.1590E+09T0040 = 0.2372E+13T005

A = 0.1008E+03 = 0.4645E+04T0 = 0.3792E+04T0020 = 0.4009E+09T0030 = 0.2122E+12T0040 = 0.2253E+16T005

COL. 1 = TIME INC. COL. 2 = LOAD EVAL. COL. 3 = CRACK EVAL. COL. 4 = CRACK EVAL. FILE # ALDATA.105

APPENDIX C

RESISTANCE TO SCC AND MICROSTRUCTURE

by

B. K. Park

INTRODUCTION

Resistance to stress-corrosion cracking in the short-transverse direction of commercially established 7XXX extrusions depends on section geometry as well as on the level of yield strength obtained by overaging, and alloy 7050 extrusions also exhibit this phenomenon (Figure C-1). This effect has in the past been associated with differences in the shape of the grains as affected by the shape of the extrusion.³⁶ Extrusions which are wide with respect to their thickness have microstructures consisting of thin, wide, long grains. Similarly, extrusions which are narrow with respect to their thickness have microstructures consisting of grains which are relatively equiaxial when viewed in the direction of extruding. The extrusions having the wide, thin grains generally have lower resistance to stress-corrosion cracking in the short-transverse direction.

The purpose of this part of the investigation was to examine the microstructures of three alloy 7050 extrusions having different shapes and resistances to stress-corrosion cracking to determine if factors other than grain shape may contribute to the stress-corrosion characteristics.

MATERIAL

A C5A wing plank extrusion (section No. 200102 and specimen No. 421333), a wing spar (section No. 263902 and specimen No. 442116) and a 1-1/2 in. x 7-1/2 in. rectangle (specimen No. 437682-3) were selected for detailed examination. This selection provided comparison at equal high yield strengths with different responses to stress-corrosion testing (rectangle vs spar) and similar stress-corrosion test performances at different strength levels (rectangle vs plank). Test performances with a stress level of 45 ksi are plotted in Figure C-1, and detailed results are presented in Table C-1.

EXPERIMENTAL

For thin foils for transmission electron microscopy (TEM), several strips were cut out from areas adjacent to the region where stress-corrosion cracking (SCC) samples were taken. Since SCC tests were made on short-transverse specimens and fracture occurred near the midplane, 3 mm diameter discs were cut out at this location of the plate by Servomet (spark erosion machine). The discs were oriented parallel to the fracture plane of the SCC test specimen. Then the discs were planed down to roughly 5 mils thickness, also using Servomet, and then, finally, electropolished using a jet polishing method. The electrolyte consisting of 25 vol.% nitric and 75 vol.% methanol was used at -20°F.

The thin foils were examined by a Phillips 301G equipped with eucentric goniometer stage. The operating voltage of the microscope was 100 Kv. Dark field as well as bright field mode

was utilized for the TEM examination. Also, samples for light microscopy were taken from areas adjacent to the TEM strips and etched by Keller's etch. The degree of recrystallization was checked by light microscopy at the midplane and near the surface. In addition to TEM and light microscopy, pinhole X-ray diffraction was supplemented to determine the degree of recrystallization.

RESULTS AND DISCUSSION

The typical size and distribution of constituent particles are shown in Figures C-2a through C-2c. In the micrographs, one can see that the constituent particles are broken into small pieces during fabrication. By comparing three different cross-sections in the extrusions, it was found that there were no appreciable differences in the size and distribution of constituents.

Shown in Figures C-3, C-4, and C-5 are optical micrographs of the three different extrusion sections after Keller's etch. The rectangle (S.No. 437682-3) was found to have the lowest degree of recrystallization, the spar (S.No. 442116) the highest, and the wing plank (S.No. 421333) in-between. These observations made by optical microscopy are consistent with the findings made by X-ray diffraction and by TEM.

Figures C-6a and C-6b represent typical bright field TEM micrographs of the rectangle. By a proper tilting of the sample, one can see in Figure C-6a a relatively high density of dislocations and occasional subgrain boundaries. In Figure C-6b, the sample was tilted in such a way that particles are in contrast. The size and distribution of η' phase particles in the alloy are better shown by

a dark field micrograph using a reflection of η' (Figure C-6c). It can be seen that there are two size ranges of η' particles apparently caused by a two-step aging practice. This partially recrystallized (recrystallization just started) structure present in the rectangle will be compared with those in other sections.

Figure C-7a shows a bright field TEM micrograph and Figure C-7b a dark field micrograph of the wing spar. The density of dislocation was lower and subgrains were less frequent compared to the rectangle. This confirms the X-ray and optical microscopy results and indicates that compared to the rectangle, the spar, which has a lower SCC resistance, has a higher degree of recrystallization. As can be seen in Figures C-6c and C-7b, the size of η' particles is slightly smaller in the spar section. The degree of recrystallization in the wing plank was between that of the spar and the rectangle.

Scanning electron micrographs of failed SCC test specimens revealed that the environment-affected area was highly corroded and consisted mainly of intergranular fracture. As expected, ductile dimples were observed in the tensile overload region. Depending on the time to failure, the severity of corrosion varied from sample to sample. In general, not much information was obtained from the fracture surface. A typical, low magnification SEM micrograph is shown in Figure C-8.

SUMMARY AND CONCLUSIONS

It may be most logical to compare the rectangle to the wing spar because the two sections had the same yield strength.

Under the applied stress of 45 ksi, therefore, the same ratio of applied stress to Y.S. was obtained. From X-ray, TEM, and light microscopy, the rectangle had the lowest degree of recrystallization and the spar the highest. Also, from the TEM micrographs, the precipitate particles were slightly larger in the rectangle section compared to the spar. Therefore, the higher SCC resistance observed in the rectangle correlates with a combination of lower degree of recrystallization and slightly coarser η' particles in the matrix (and possibly also coarser η' or η particles along subgrains and grain boundaries). Examination of many more samples, not within the scope of this investigation, must be made, however, before a cause and effect relationship can be attributed to this correlation.

TABLE C-1 - STRESS-CORROSION TEST PERFORMANCE

Specimen No.	Section No.	Shape	Long. Y.S., ksi	E. C., % IACS	Days to Fail in 3.5% NaCl by Alternate Immersion		
					45 ksi	35 ksi	25 ksi
439513	-	Rectangle	77.2	39.2	35,36,40	34,49,105	105,OK,OK
421333	900102	Plank	69.0	41.1	19,23,25, 31,33,42	42,47,84	No test
442116	263902	Spar	77.4	39.2	3,3,16	16,17,17	17,18,22,36, 49,67,73,73

OK = survived 138 days.

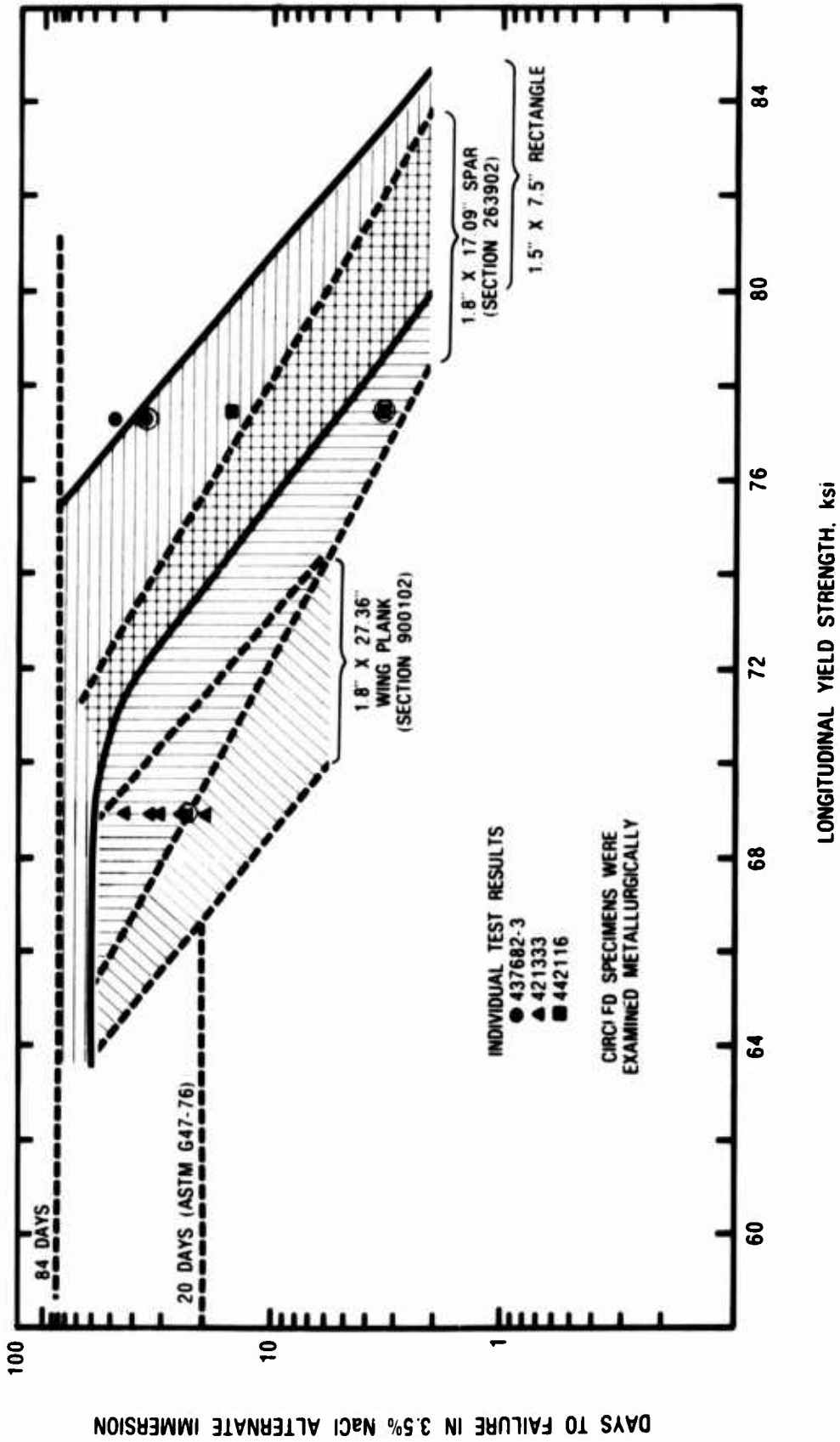

Figure C-1 Shows SCC Test Performance at Applied Stress of 45 ksi



(a) Rectangle - S.No. 437682-3



(b) Plank - S.No. 900102

200X Longitudinal section at midplane As Polished

Figure C-2 - Optical Micrographs of 7050 Extrusions.



(a) Longitudinal Section Near Surface



(b) Longitudinal Section T/2



(c) Transverse Section T/2

100X Keller's Etch
Figure C-3 - Optical Micrographs of Rectangle, S.No. 437682-3.



(a) Longitudinal Section Near Surface

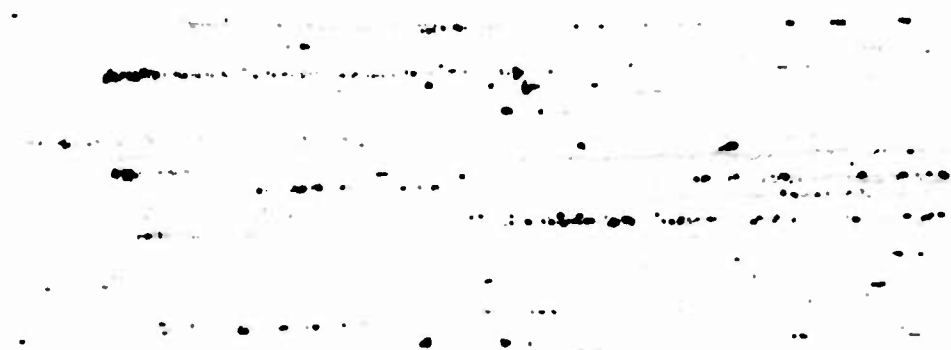

(b) Longitudinal Section T/2



(c) Transverse Section T/2

100X Keller's Etch
Figure C-4 - Optical Micrographs of Wing Plank, S.No. 421333.



(a) Longitudinal Section Near Surface



(b) Longitudinal Section T/2



(c) Transverse Section T/2

100X

Keller's Etch

Figure C-5 - Optical Micrographs of Spar, S.No. 442116.

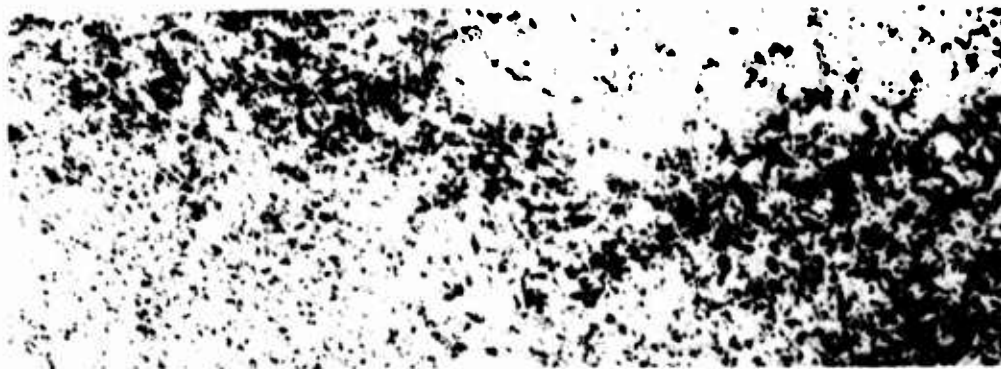

(a) Bright Field



(b) Bright Field

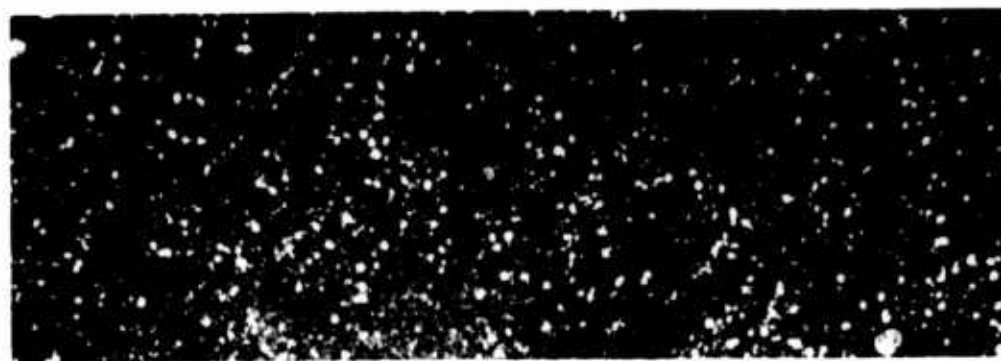

(c) Dark Field

36,000X

Figure C-6 - Transmission Electron Micrographs of Rectangle,
S.No. 437682-3.

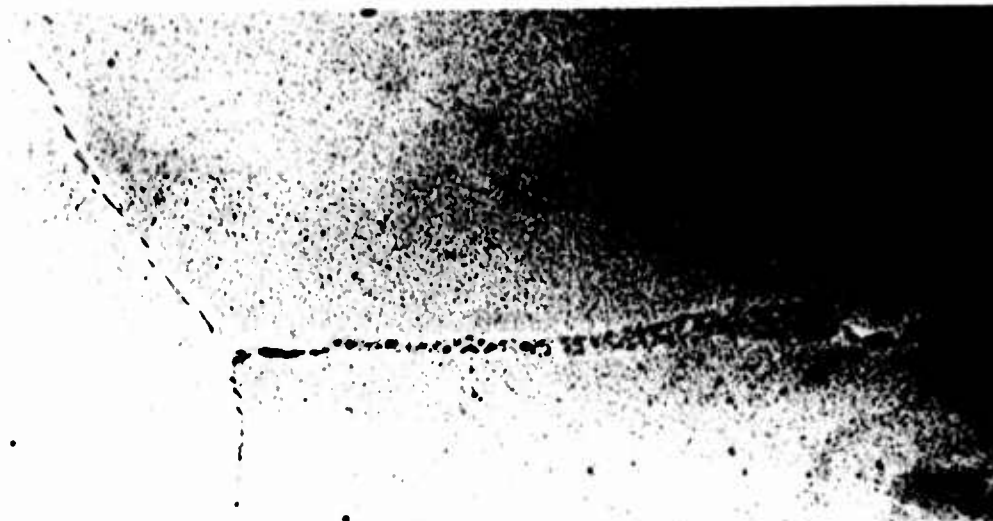

(a) Bright Field

26,000X

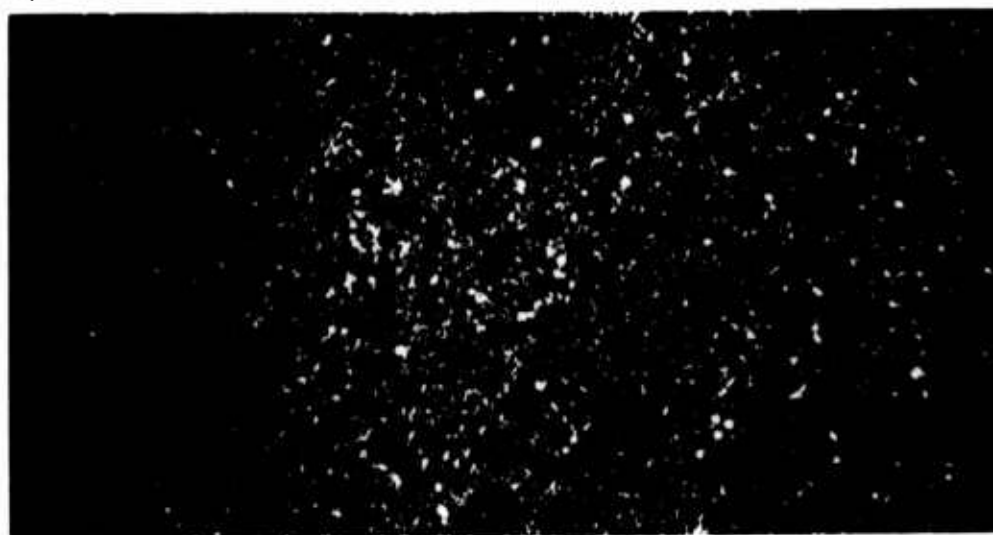

(b) Dark Field

44,000X

Figure C-7 - Transmission Electron Micrographs of Spar,
S.No. 442116.



20X

Figure C-8 - Scanning Electron Micrograph Showing the Fracture Surface of Rectangle, S.No. 437682.

APPENDIX D

EFFECTS OF SECTION GEOMETRY AND FABRICATION ON
NOTCH TENSILE STRENGTH-YIELD STRENGTH RATIO

by

R. R. Sawtell

PROCEDURE

Review of the data indicated that notch toughness of extrusions fabricated in this work depended on extrusion temperature, extrusion ratio, yield strength, test specimen location, and section shape. In an effort to define these effects quantitatively, the notch tensile strength/yield strength ratios (NTS/YS) of these extrusions were analyzed statistically using multivariate regression analysis. The model constructed for this purpose included both first-order main effects and two-factor interactions. All variables listed above were included. Consequently, the model was of the following form:

$$\text{NTS/YS} = B_0 + B_1(X_1) + B_2(X_2) + B_3(X_3) + B_4(X_4) + B_5(X_5) + \sum \sum B_{ij}(X_i, X_j) \quad j=1,5; i=1,5 \quad (1)$$

where: X_1 = specimen location,

X_2 = aspect ratio,

X_3 = extrusion ratio,

X_4 = extrusion temperature,

X_5 = yield strength.

To reduce the artificial correlations, simple and multiple, that are frequently generated in constructing second-order terms,

(interactions, etc.), the five independent variables were scaled to a maximum of +1 and a minimum of -1. Under these conditions, the value of the intercept represents the NTS/YS that would be predicted if all independent variables were held at their mean values. As an added benefit, the coefficients rendered in the regression represent fully normalized estimates of the individual main effects and interactions. Thus, the confusing effects of the absolute magnitudes of the independent variables are eliminated and direct comparison of the numerical values of the coefficients yield their respective relative influences. Further, each of the coefficients represents the magnitude and direction of change that would be expected to be produced in NTS/YS when the variable of interest is changed from its mean value to its maximum.

The interactive effects are more complicated, but can always be resolved by determining the product of the values of the two independent variables in question. The numerical value of the interaction coefficients indicates the effects of raising each of two independent variables to their maximum or minimum simultaneously ($1 \times 1 = 1$ or $-1 \times -1 = 1$).

RESULTS

The results of the regressions are detailed in Tables D-1 through D-3 for the longitudinal, long-transverse, and short-transverse testing orientations, respectively. Very high F-ratios and R^2 values were recorded for each of the three regressions which indicates that a very large percentage of the variation in NTS/YS was accounted for by the model. The regression coefficients,

B(I), for main effects and interactions that were determined to be statistically significant at the 95% confidence interval based on a t-test are listed in Tables D-1 through D-3.

The $R(I)^2$ values, a measure of the degree of multiple correlation between independent variables, are also presented in these tables. High multiple correlations produce unrealistic and unstable regression coefficients because a given level of response can be produced in a variety of ways. Although ideally $R(I)^2$ should be zero, the values listed in Tables D-1 through D-3 are considered to be acceptably small.

The relative influence values, also given in these tables, indicate the percentage of total variation in NTS/YS that each independent variable is capable of producing. These values do not sum to 100% because of the non-zero $R(I)^2$. In the case of non-zero $R(I)^2$, the model can accommodate a given level of variation in NTS/YS through variations in two or more independent variables. Hence, a certain level of influence is counted more than once.

As mentioned previously, the regression coefficients derived in this analysis represent normalized estimates of the relative effects of each factor and thus are useful for comparison. Consequently, the statistically significant coefficients have been plotted in bar-graph form and are shown in Figures D-1 through D-3 for the longitudinal, long-transverse, and short-transverse directions, respectively.

Longitudinal

A total of eight factors were found to have a statistically significant effect on longitudinal NTS/YS: the five main

effects and three interactions. The statistically significant interactions were location-yield, aspect ratio-yield, and extrusion temperature-yield. The effects of yield strength greatly outweighed all, but each of these eight factors produced statistically significant changes in NTS/YS as shown in Figure D-1. Further, even though the other seven factors probably do affect notch toughness, these effects are not practically significant. (Based on correlations between NTS/YS and K_{IC} ,³⁷ a change in the level from the lowest to the highest examined represents at most a $0.5 \text{ ksi}\sqrt{\text{in.}}$ change in K_{IC} .) Because these effects are not important commercially, NTS/YS in the longitudinal direction can be described simply as a function of yield strength. This simplification yields a model of the form:

$$\text{NTS/YS} = 2.071 - 0.008584(\text{YS}), \quad (2)$$

where NTS/YS decreases with increasing yield strength. This effect is illustrated in Figure D-4 where NTS/YS is plotted versus yield strength. Both the actual data points and predictions based on (2) are shown. In support of the contention that other factors did not significantly affect toughness in this direction, the data are compressed about the line illustrating the effects of yield strength.

Long-Transverse

A total of nine factors were found to have a statistically significant effect on long-transverse NTS/YS. These include the five main effects and the specimen location-aspect ratio, aspect ratio-extrusion ratio, aspect ratio-yield strength, and extrusion

ratio-yield strength interactions. Not all of these effects are considered to be practically significant. As shown in Figure D-2, aspect ratio and yield strength produce the largest effects. These main effects and the aspect ratio-yield strength and extrusion ratio-yield strength interaction were considered to be practically significant. Consequently, effects of aspect ratio, yield strength, and extrusion ratio adequately describe the NTS/YS in the long-transverse direction. In this case, a model of the following form results:

$$\begin{aligned}
 \text{NTS/YS} = & 2.5490 + 0.02441(\text{AR}) + 0.01469(\text{ER}) - 0.02212(\text{YS}) \\
 & + 0.0005188(\text{AR})(\text{YS}) + 0.00046819(\text{AR})(\text{ER}) \\
 & - 0.00020148(\text{ER})(\text{YS}), \qquad (3)
 \end{aligned}$$

where NTS/YS decreases with increasing yield strength and increases with increasing aspect ratio or extrusion ratio. Aspect ratio has a moderate effect at low yield strengths, but at high yield strengths, it has the largest effect of any fabricating variable. In contrast, extrusion ratio had the largest effect at low yield strengths. These effects are illustrated in Figure D-5 where NTS is plotted versus yield strength for the long-transverse direction. Both actual data and predictions for high and low aspect ratios and high and low extrusion ratios are shown. The predictions are complex and reflect the interactions between variables. Extrusions fabricated using the high extrusion ratio (32) and the high aspect ratio (5) generally developed the best combinations of notch toughness and strength in the long-transverse direction. However, at very

high strengths (above 77 ksi) which are above the maximum acceptable strengths dictated by corrosion considerations, high aspect ratio extrusions fabricated using low extrusion ratios exhibited the best notch toughness.

Short-Transverse

In the short-transverse direction, nine factors were found to have a statistically significant effect on NTS/YS. These include the five main effects and the location-extrusion temperature, aspect ratio-extrusion ratio, aspect ratio-extrusion temperature, and extrusion ratio-yield strength interactions. The effects of extrusion ratio, extrusion temperature, yield strength, and the extrusion ratio-yield strength interaction were considered to be practically significant. Specimen location was discounted for the model, not because of its magnitude, but because it is not a controllable parameter. These conditions yield a model of the following form:

$$\begin{aligned} \text{NTS/YS} = & 2.6006 + 0.02491(\text{ER}) + 0.000294545(\text{ET}) \\ & - 0.0267175(\text{YS}) - 0.00029988(\text{ER})(\text{YS}), \end{aligned} \quad (4)$$

where NTS/YS is increased by increasing extrusion ratio or extrusion temperature, and decreased by increasing yield strength. Extrusion ratio had a large effect at high yield strength, but a much smaller effect at lower yield strength. These effects are illustrated graphically in Figure D-6 where notch toughness is plotted versus yield strength. Both actual data and predictions for high and low extrusion ratio and high and low extrusion

temperature are shown. Sections extruded using high ratios and high temperatures developed the best combinations of toughness and strength in the short-transverse direction.

SUMMARY

The notch tensile strength and yield strength data for alloy 7050 extrusions fabricated under a variety of conditions have been analyzed using multiple regression techniques. Specifically, this analysis yielded effects of specimen location along the length of the extrusion (front to rear), section aspect ratio (width + thickness), extrusion ratio, extrusion temperature, and yield strength on notch tensile strength/yield strength ratios in the longitudinal, long-transverse, and short-transverse directions.

All of these factors were found to have a statistically significant influence on NTS/YS, although not all were considered to be practically significant in every test direction. Increasing either aspect ratio, extrusion ratio, or extrusion temperature increased NTS/YS, while increasing yield strength decreased it. The rear of the extrusion generally developed higher notch toughness. The highest average notch toughness was developed in the longitudinal direction and the lowest in the short-transverse direction. The effect of yield strength, specimen location, extrusion ratio and extrusion temperature were greatest in the short-transverse direction while aspect ratio had its largest effect in the long-transverse direction. Only yield strength had a commercially significant effect on notch toughness in the longitudinal direction.

Interactions between independent variables were also responsible for practically significant differences in NTS/YS. These interactions generally involved yield strength and, hence, reflect variations in the inverse dependence of NTS/YS on yield strength. The largest interaction occurred in the long-transverse direction between aspect ratio and yield strength and was positive; i.e., effect of aspect ratio was greatest at high yield strengths. Smaller but practically significant negative interactions also occurred between extrusion ratio and yield strength in the long-transverse and short-transverse directions; effect of extrusion ratio was greatest at low yield strengths.

From this analysis, the optimum combination of NTS/YS and yield strength is predicted to be developed at the rear of high aspect ratio sections fabricated using high extrusion ratios and high temperatures.

TABLE D-1 - RESULTS OF MULTIPLE REGRESSION ANALYSIS OF LONGITUDINAL NTS/YS

<u>Variable</u>	<u>Coefficient, B(I)</u>	<u>t Value</u>	<u>R(I)², %</u>	<u>Relative Influence, %</u>
Intercept	1.41646			
Locations (LCT)	-0.0066096	4.4	1.07	5
Aspect Ratio (AR)	0.0031179	2.2	6.55	2
Extrusion Ratio (ER)	-0.0035487	2.4	10.35	3
Extrusion Temp. (ET)	0.0061178	3.7	4.55	4
Yield Strength (YS)	-0.11030	41.4	11.04	78
(LCT) (YS)	-0.0070588	2.8	9.93	5
(AR) (YS)	-0.011128	4.3	4.06	7
(ET) (YS)	-0.0066616	2.3	3.80	4
F-Value	265.7			
Residual RMS	0.0012984			
R ²	96.24%			

TABLE D-2 - RESULTS OF MULTIPLE REGRESSION ANALYSIS OF LONG-TRANSVERSE NTS/Y5

<u>Variable</u>	<u>Coefficient, B(I)</u>	<u>t Value</u>	<u>R(I)², %</u>	<u>Relative Influence, %</u>
Intercept	1.17177	3.4	1.74	4
Location (LCT)	-0.014222	27.7	17.99	37
Aspect Ratio (AR)	0.127041	3.8	15.19	5
Extrusion Ratio (ER)	0.017886	2.1	4.83	3
Extrusion Temp. (ET)	0.010696	32.1	18.56	76
Yield Strength (YS)	-0.26245	2.3	1.74	3
(LCT) (AR)	0.0095319	2.1	15.45	3
(AR) (ER)	-0.0092937	8.0	10.76	18
(AR) (YS)	0.063623	3.0	15.89	7
(ER) (YS)	-0.024681			
F-Value	181.8			
Residual RMS	0.0039536			
R ²	95.23%			

TABLE D-3 - RESULTS OF MULTIPLE REGRESSION ANALYSIS OF SHORT-TRANSVERSE NTS/YS

Variable	Coefficient, B(I)	t-Value	R(I) ² , %	Relative Influence, %
Intercept	1.03876			
Location (LCT)	-0.03115	7.2	5.94	10
Aspect Ratio (AR)	0.010178	2.2	13.62	3
Extrusion Ratio (ER)	0.04710	10.1	10.67	15
Extrusion Temp. (ET)	0.032394	6.3	7.12	10
Yield Strength (YS)	-0.30408	38.3	13.14	96
(LCT) (ET)	0.0099721	2.0	6.06	3
(AR) (ER)	0.020371	4.5	13.58	6
(AR) (ET)	0.01990	3.9	10.39	6
(ER) (YS)	-0.031861	4.0	9.41	9
F-Value	197.7			
Residual RMS	0.0040088			
R ²	95.59%			

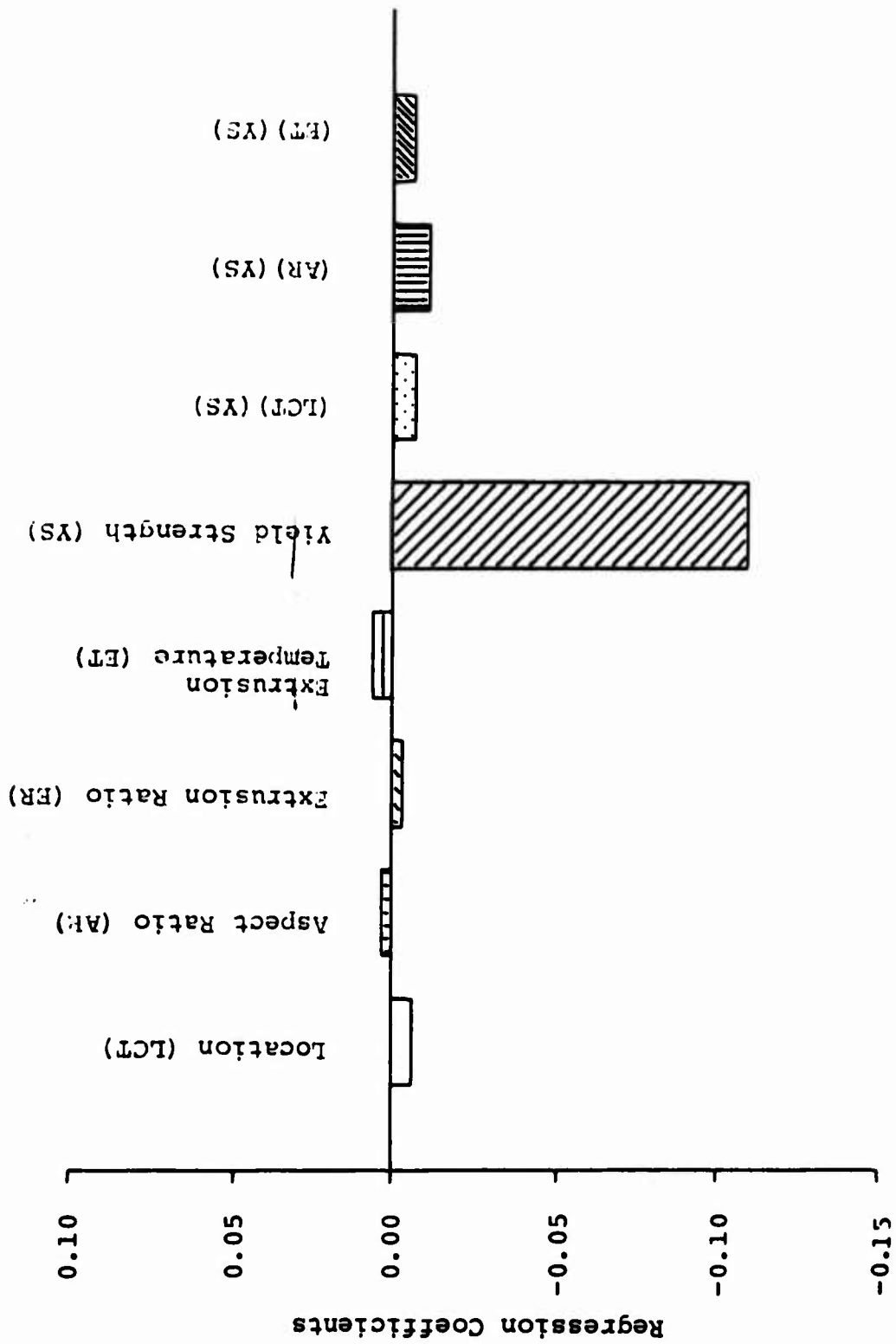

Figure D-1 - Illustrates relative effects of variants on longitudinal notch toughness.

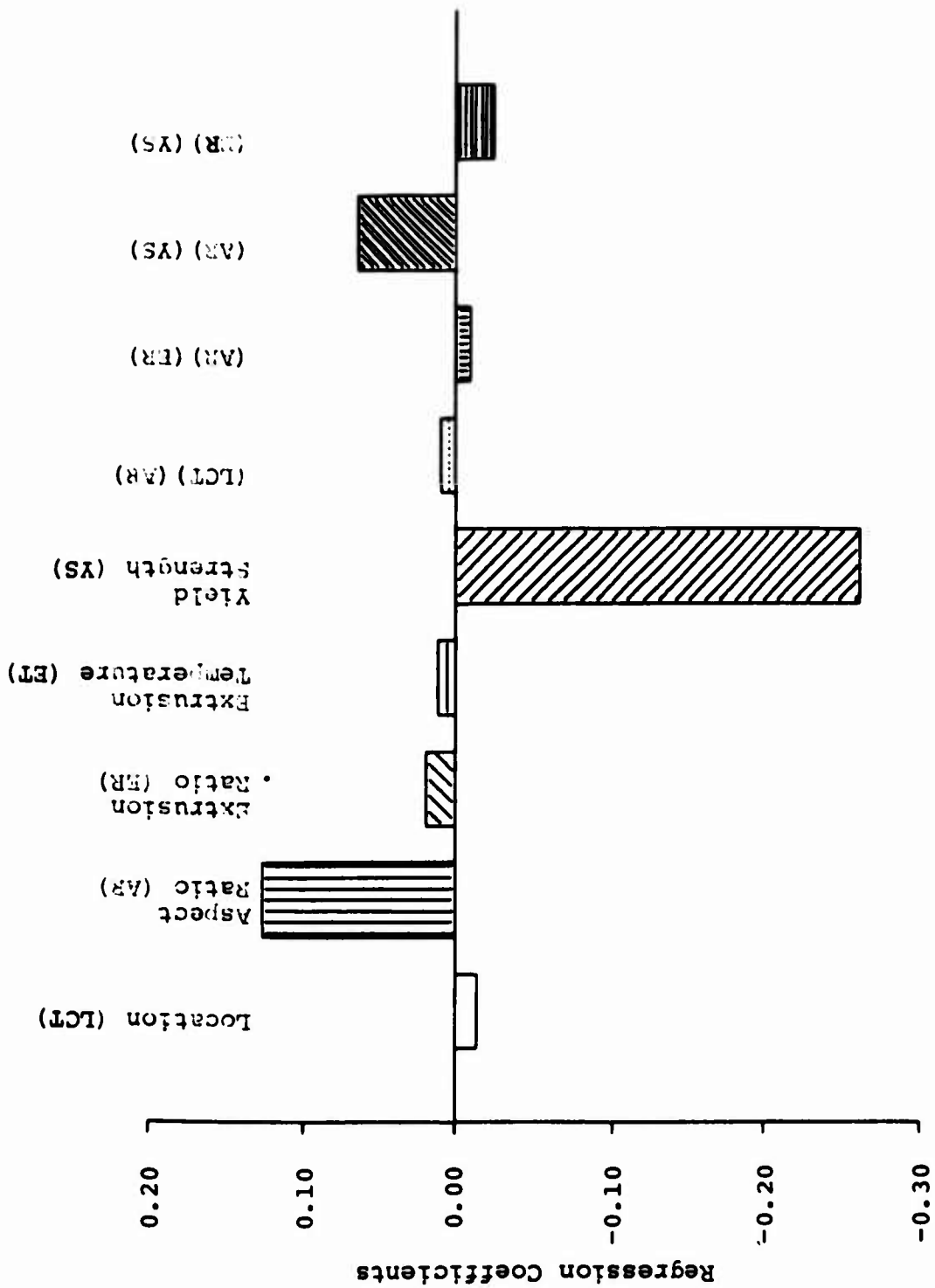

Figure D-2 - Illustrates relative effects of variants on long-transverse notch toughness.

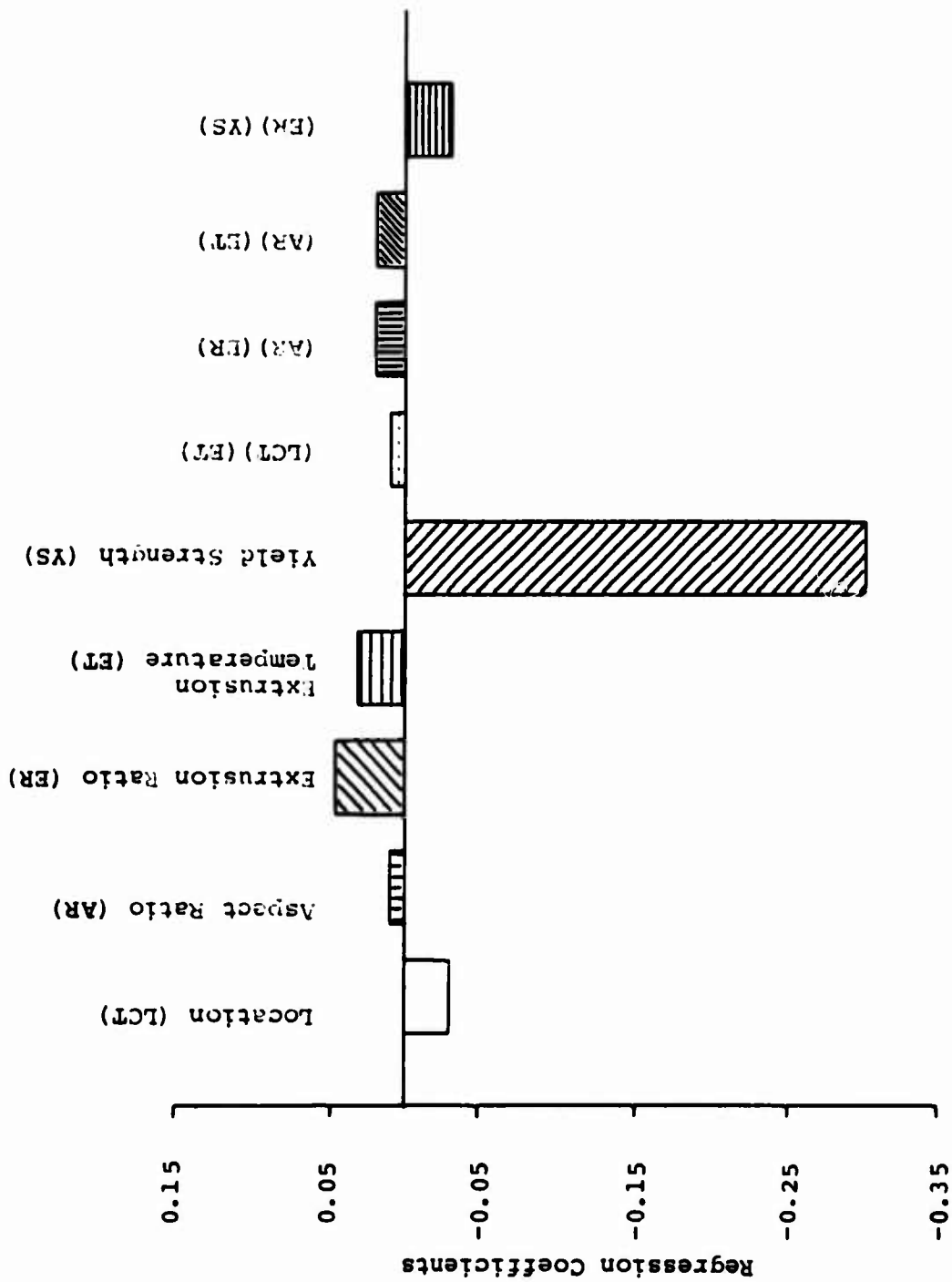

Figure D-3 - Illustrates relative effects of variants on short-transverse notch toughness.

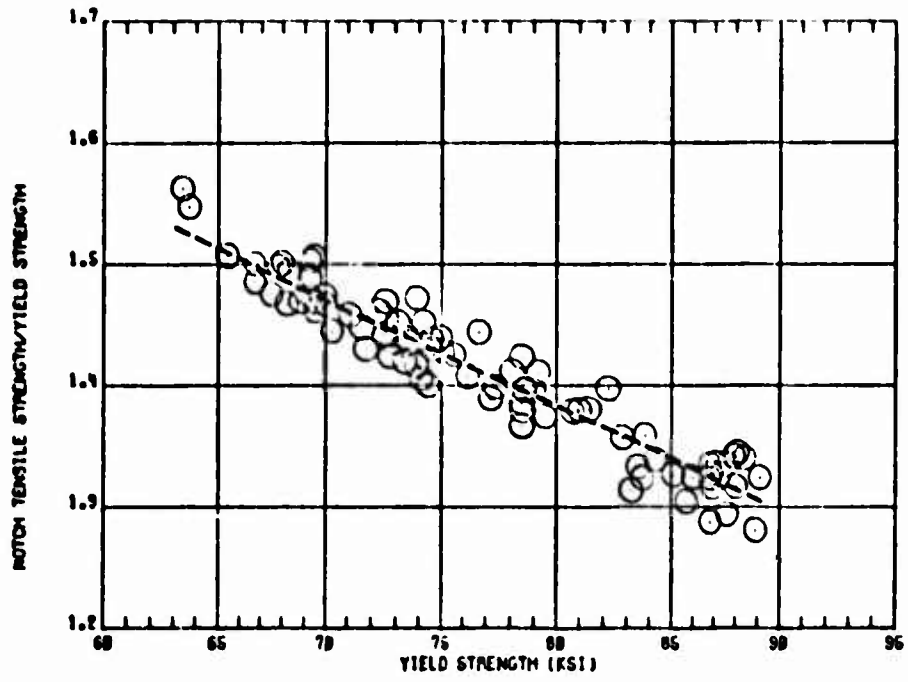

Figure D-4 - Notch Toughness vs Yield Strength - Longitudinal.

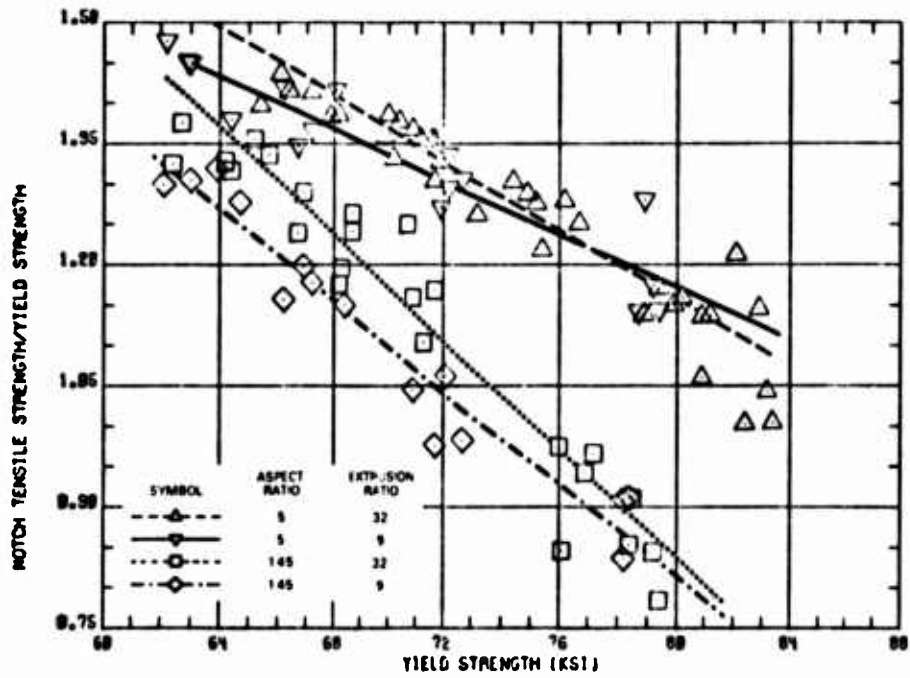

Figure D-5 - Notch Toughness vs Yield Strength - Long-Transverse.

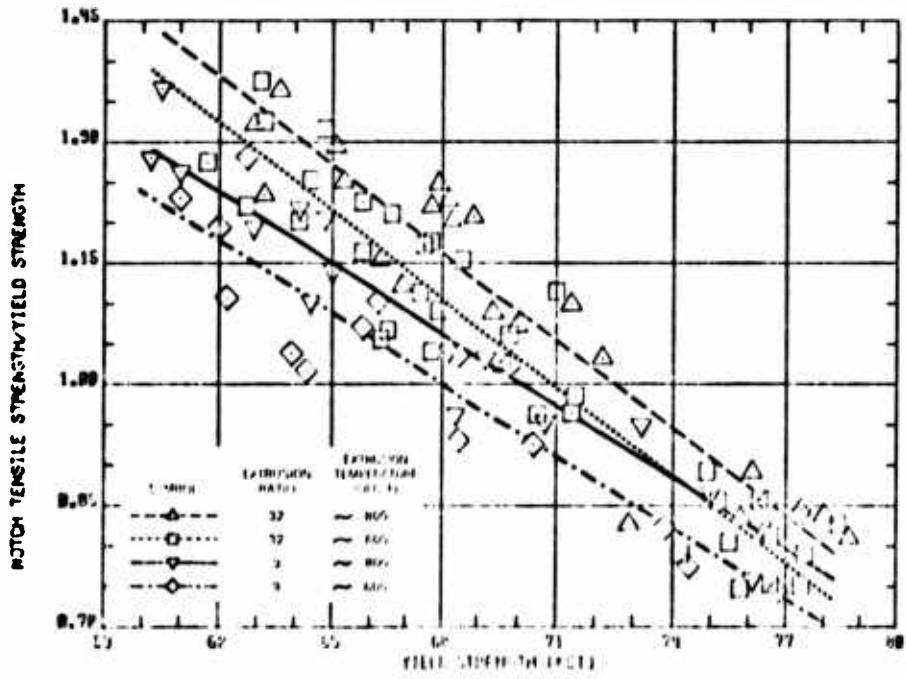

Figure D-6 - Notch Toughness vs Yield Strength - Short-Transverse.

REFERENCES

1. J. T. Staley and H. Y. Hunsicker, "Exploratory Development of High-Strength, Stress-Corrosion Resistant Aluminum Alloy for Use in Thick Section Applications," Technical Report AFML-TR-70-256, October 1970.
2. J. T. Staley, "Investigation to Develop a High-Strength, Stress-Corrosion Resistant Aluminum Aircraft Alloy," Final Report under Naval Air Systems Command Contract N00019-69-C-0292, January 1970.
3. J. T. Staley, "Investigation to Develop a High-Strength, Stress-Corrosion Resistant Naval Aircraft Alloy," Final Report under Naval Air Systems Command Contract N00019-70-C-0118, November 1970.
4. J. T. Staley, "Further Development of Aluminum Alloy X7050," Final Report under Naval Air Systems Command Contract N00019-71-C-0131, May 1972.
5. R. E. Davies, G. E. Nordmark, and J. D. Walsh, "Design Mechanical Properties, Fracture Toughness, Exfoliation and Stress-Corrosion Resistance of 7050 Sheet, Plate, Hand Forgings, Die Forgings and Extrusions," Final Report under Naval Air Systems Command Contract N00019-72-C-0512, July 1975.
6. J. T. Staley, "Evaluating New Aluminum Forging Alloys," Materials Engineering Quarterly, November 1974.
7. J. T. Staley, "Aging Kinetics of Aluminum Alloy 7050," Metallurgical Transactions, Vol 5, April 1974.

8. "Standard Methods of Verification of Testing Machines, E4-72," 1973 Book of ASTM Standards, Part 31.
9. G. W. Stickley and D. J. Brownhill, "Mechanical Properties of Stress-Relieved Stretched Aluminum Alloy Plate," Technical Report AFML-TDR-64-105, May 1964.
10. J. G. Kaufman, G. E. Nordmark, and B. W. Lifka, "Fracture Toughness, Fatigue and Corrosion Characteristics of 7075-T651, 7075-T7351, and 7079-T651 Aluminum Alloys," Technical Report AFML-TR-65-170, May 1965.
11. J. G. Kaufman, G. E. Nordmark, and B. W. Lifka, "Fracture Toughness, Fatigue and Corrosion Characteristics of 2020-T651, 2024-T851, 2219-T851 and 7001-T75 Aluminum Alloys," Technical Report AFML-TR-66-291, September 1966.
12. D. J. Brownhill, R. E. Davies, and D. O. Sprowls, "Mechanical Properties, Including Fracture Toughness and Fatigue, and Resistance to Stress-Corrosion Cracking, of Stress-Relieved Stretched Aluminum Alloy Extrusions," Technical Report AFML-TR-68-34, February 1968.
13. D. J. Brownhill, C. F. Babilon, G. E. Nordmark, and D. O. Sprowls, "Mechanical Properties Including Fracture Toughness and Fatigue, Corrosion Characteristics and Fatigue Crack Propagation Rates of Stress-Relieved Aluminum Alloy Hand Forgings," Technical Report AFML-TR-70-10, February 1970.
14. C. F. Babilon, R. H. Wygonik, G. E. Nordmark, and B. W. Lifka, "Mechanical Properties, Fracture Toughness, Fatigue, Environmental Fatigue Crack Growth Rates and Corrosion Characteristics

- of High Toughness Aluminum Alloy Forgings, Sheet and Plate,"
Technical Report AFML-TR-73-83, April 1973.
15. "Standard Methods of Tension Testing Wrought and Cast Aluminum
Aluminum and Magnesium Alloy Products, B557-73," 1974 Book of
ASTM Standards, Part 7.
 16. "Standard Methods of Tension Testing of Metallic Materials,
E8-69," 1973 Book of ASTM Standards, Part 31.
 17. "Standard Methods of Compression Testing of Metallic Materials,
E9-70," 1973 Book of ASTM Standards, Part 31.
 18. R. E. Davies and J. G. Kaufman, "Effects of Test Method and
Specimen Orientation on Shear Strengths of Aluminum Alloys,"
ASTM Proceedings, Vol 64, 1964, pp 999-1010.
 19. "Standard Method for Pin-Type Bearing Test of Metallic
Materials, E238-68," 1973 Book of ASTM Standards, Part 31.
 20. Alcoa Green Letter, "Alcoa Alloy 7050," 1st Revised Issue,
April 1976.
 21. "Standard Method for Determination of Young's Modulus at
Room Temperature, E111-61," 1973 Book of ASTM Standards,
Part 31.
 22. "Standard Method of Verification and Classification of
Extensometers, E83-67," 1973 Book of ASTM Standards, Part 31.
 23. Military Standardization Handbook, Metallic Materials and
Elements for Aerospace Vehicle Structures, Vol 1,
September 1, 1971.
 24. "Standard Method of Test for Plane-Strain Fracture Toughness of
Metallic Materials," November 1975 Book of ASTM Standards, Part 10.

25. WPAFB Contract F33615-74-L-5171.
26. W. G. Clark, Jr., ASTM E24.4, "Fatigue Crack Growth Rate Testing Round Robin Program," Task Group Progress Report No. 3, May 14, 1971.
27. E. T. Wessel, "State of the Art of the WOL Specimen for K_{Ic} Fracture Toughness Testing," Journal of Engineering, Fracture Mechanics, Vol 1, No. 1, Une 1968, p 77.
28. "Standard Method of Test for Exfoliation Corrosion Susceptibility in 7XXX Series Copper-Containing Aluminum Alloys (EXCO Test)," G34-72, 1975 Book of ASTM Standards, Part 10.
29. "Standard Recommended Practice for Alternate Immersion Stress-Corrosion Testing in 3.5% Sodium Chloride Solution," G44-75.
30. M. V. Hyatt, "Use of Precrack Specimens in Stress-Corrosion Testing of High-Strength Aluminum Alloys," Corrosion, Vol 26, No. 11, November 1970, pp 487-503.
31. J. G. Kaufman, J. W. Coursen, and D. O. Sprowls, "An Automated Method for Evaluating Resistance to Stress-Corrosion Cracking with Ring Loaded Precracked Specimens," Proceedings of The Triservice Corrosion of Military Equipment Conference, 29-31 October 1974, AFML-TR-75-42, Vol II, p 221.
32. D. O. Sprowls and B. W. Lifka, "Relationship of Accelerated Test Methods for Exfoliation Resistance in 7XXX Series with Exposure to a Seacoast Atmosphere," Corrosion in Natural Environments, ASTM STP558, 1974.
33. D. O. Sprowls, T. J. Summerson, and F. E. Loftin, "Exfoliation Corrosion Testing of 7075 and 7178 Aluminum Alloys - Interim

Report on Atmospheric Exposure Tests," Corrosion in Natural Environments, ASTM STP558, 1974.

34. "Standard Recommended Practice for Determining Susceptibility to Stress-Corrosion Cracking of High-Strength 7XXX Aluminum Alloy Products," G47-76.
35. D. O. Sprowls, J. W. Coursen, and J. D. Walsh, "Evaluating Stress-Corrosion Crack Propagation Rates in High-Strength Aluminum Alloys with Bolt-Loaded Precracked Double Cantilever Beam Specimens," Proceedings of the Triservice Corrosion of Military Equipment Conference, 29-31 October 1974, AFML-TR-75-42, Vol II, p 1.
36. R. H. Brown, D. O. Sprowls, and M. B. Shumaker, "The Resistance of Wrought High-Strength Aluminum Alloys to Stress-Corrosion Cracking," Stress-Corrosion Cracking of Metals - A State of the Art, ASTM STP 518, American Society for Testing and Materials, 1972, pp 87-118.
37. John E. Srawley, "Wide Range Stress Intensity Factor Expressions for ASTM E399 Standard Fracture Toughness Specimens," International Journal of Fracture, Vol 12, No. 3, June 1976.
38. R. P. Wei, "Some Aspects of Environment-Enhanced Fatigue-Crack Growth," Engineering Fracture Mechanics, Vol 1, No. 4, April 1970.

DISTRIBUTION LIST

AFML/MX (5 cys)
Wright-Patterson AFB, Ohio 45433

AFML/LLS, Dr. Larry Bidwell (3 cys)
Wright-Patterson AFB, Ohio 45433

AFML/LLN, Dr. V. J. Russo
Wright-Patterson AFB, Ohio 45433

AFML/LLM, Dr. H. A. Lipsitt
Wright-Patterson AFB, Ohio 45433

FTD/PDRR, Maj. L. A. Jacobson
Wright-Patterson AFB, Ohio 45433

Air University Library
Maxwell AFB, Ala 36112

AFML/LLS, Lt. J. S. Santner
Wright-Patterson AFB, Ohio 45433

DDC-TC (2 cys)
Cameron Station
Alexandria, Virginia 22314

AFML/LLN, Mr. Walt Griffith
Wright-Patterson AFB, Ohio 45433

AFML/LLN, Dr. W. H. Reimann
Wright-Patterson AFB, Ohio 45433

AFML/LTM, Mr. N. E. Klarquist (6 cys)
Wright-Patterson AFB, Ohio 45433

AFML/MXA, Mr. G. C. Young
Wright-Patterson AFB, Ohio 45433

AFML/MXE, Mr. C. L. Harmsworth
Wright-Patterson AFB, Ohio 45433

U.S. Army
Frankford Arsenal
Pitman-Dunn Inst for Rsch
Attn: Director Materials Engr Div
Dr. J. Waldman
SMUFA, L 3000, Bldg 64-4
Philadelphia, Pa. 19137

Army Materials & Mechanics Rsch Ctr
Attn: Technical Info Branch
Watertown, Mass 02172

U. S. Army Materials Rsch Agency
Attn: Chief
Materials Engrg Div
Watertown Arsenal
Watertown, Mass. 02172

NASA
Langley Rsch Center
Structures Rsch Div
Langley AFB, Va. 23365

NASA
Lewis Rsch Center
Attn: Mr. W. F. Brown, Jr.
Mail Stop 105-1
21000 Brookpark Rd
Cleveland, Ohio 44135

Commanding Officer
Naval Air Development Center
(Aero Materials Department)
Johnsville
Warminster, Pa. 18974

Director
Naval Research Laboratory
(Code 2020)
Washington, D. C. 20390

Commander
Naval Air Systems Command
Dept. of the Navy
Attn: AIR 520311, Mr. R. Schmidt
Washington, D. C. 20360

Office of Naval Rsch
Attn: Metallurgy Br., ONR-471
Washington, D. C. 20360

Air Force Systems Command
AFSC/DLFF (Capt. M. Wallace)
Andrews AFB, MD 20334

Air Force Systems Command
AFSC/PPD
Andrews AFB, MD 20334

DISTRIBUTION LIST

Aerojet-General Corp
Attn: Mr. Carl Hartbower
P. O. Box 1947
Sacramento, CA 95809

Aerojet-General Corp
Attn: Librarian
9236 East Hall Road
Downey, CA 90240

Aerojet-General Nucleonics
Attn: Mgr., Metallurgy Dept
P.O. Box 77
San Ramone, CA 94583

Aerospace Corp
Attn: Library, Tech. Rpts
P.O. Box 95085
Los Angeles, CA 90045

Aluminum Co of America
Alcoa Labs
Attn: Mr. E. H. Spuhler
New Kensington, Pa 15068

Aluminum Co of America
Attn: Mr. Gregory Barthold
1200 Ring Bldg
Washington, DC 20036

Aluminum Co of America
Alcoa Labs
Attn: Mr. J. P. Lyle
Alcoa Technical Center
Alcoa Center, Pa 15069

Aluminum Co of America
Alcoa Labs
Attn: Mr. H. Y. Hunsicker
Alcoa Technical Center
Alcoa Center, Pa 15069

Aluminum Co of America (50)
Alcoa Labs
Attn: Mr. J. T. Staley
Alcoa Technical Center
Alcoa Center, Pa 15069

Battelle Memorial Inst.
Attn: Dr. B. Wilcox
505 King Avenue
Columbus, Ohio 43201

Battelle Memorial Inst.
Metals & Ceramics Info Ctr
505 King Avenue
Columbus, Ohio 43201

Beech Aircraft Corporation
Attn: Mr. W. G. Pierpont, M.S. E-10
Chief - Technical Engineer, R&D
9709 East Central, P.O. Box 85
Wichita, Kansas 67201

Bell Helicopter Co
Attn: Tech. Library
Attn: Mr. Don Dashfield
P.O. Box 482
Fort Worth, Texas 76100

The Bendix Corp
Bendix Products Aerospace Div
Attn: Mr. John Grodrian
717 North Bendix Drive
South Bend, Ind 46620

The Boeing Co
Commercial Airplane Co
Attn: Mr. M. V. Hyatt
Org. 6-8830
Mail Stop 73-43
P.O. Box 3707
Renton, Washington 98124

The Boeing Co
Aerospace Library
Attn: 8K-38 Librarian
P.O. Box 3999
Seattle, Washington 98124

The Boeing Co
Wichita Div
Attn: Engineering Library &
Mat'ls & Proc Unit
Attn: Mr. Gayle Wadsworth
Wichita, Kansas 67201

DISTRIBUTION LIST

The Boeing Co
Vertol Division
Attn: Mr. Warren Leibermann
Materials and Process Department
Boeing Center
P.O. Box 16858
Philadelphia, Pa. 19142

Bohn Aluminum & Brass Corp
Research Div
Attn: Dr. G. V. Kingsley
Dir of Rsch
8007 Jos Camp
Detroit, Mich. 48211

Cornell Aeronautical Lab., Inc.
Attn: Technical Library
Buffalo, N.Y. 14221

Curtiss-Wright Corp
Wright Aeronautical Div
Attn: Manager of Metallurgy
Wood-Ridge, N.J. 12789

Curtiss-Wright Corp
Propeller Div
Attn: Chief Metallurgist
Caldwell, N.J. 07006

Curtiss-Wright Corp
Metals Processing Div
Attn: Mgr., Materials &
Processes Lab
P.O. Box 13
Buffalo, N.Y. 14215

Detroit Diesel Allison Div., GMC
Attn: Mat'ls Sciences Section
Materials Labs
P.O. Box 894
Indianapolis, Ind. 46206

Fairchild Hiller
Republic Aviation Div
Attn: Technical Library
Attn: Mr. Jules Stock
Farmingdale, L.I., N.Y. 11735

Ford Motor Co
Scientific Lab
Attn: Mr. J. J. Harwood, Mgr.
Metallurgy Dept
P.O. Box 2053
2000 Rotunda Drive
Dearborn, Mich. 48120

General Dynamics/Convair Div
Attn: C. J. Kropp, Metallurgist
Attn: Mr. Robt. Tryon
Mail Zone 572-10
P.O. Box 1128
San Diego, CA 92112

General Dynamics/Pamona
Mail Zone 6-76
P.O. Box 1011
Pamona, CA 91766

General Dynamics/Astronautics
Attn: Chief, Materials Rsch
Mail Zone 592-10
P.O. Box 166
San Diego, CA 92112

General Dynamics/Fort Worth
Attn: Structural Sciences Group
Rsch Library
Attn: Mr. Tom Coyle
P.O. Box 748
Fort Worth, Texas 76101

General Electric Co
Technical Info Ctr
Mail Drop N-32
Cincinnati, OH 45215

General Electric Co
Missile & Space Div
Attn: Technical Library
P.O. Box 8555
Philadelphia, Pa. 19101

Grumman Aircraft Engineering Corp
Attn: Head, Mat'ls Rsch Group
Grumman Rsch Dept
Bethpage, N.Y. 11714

DISTRIBUTION LIST

Grumman Aircraft Engineering Corp
Plant 12
Attn: Mr. Ron Heitzmann
Bethpage, L.I., N.Y. 11714

Hamilton Standard Div
United Aircraft Corp
Attn: Chief, Mat'ls & Processes
Windsor Locks, Conn 06096

International Harvester Co
Solar Div
Attn: Director, Research
2200 Pacific Highway
San Diego, CA 92112

Kaiser Aluminum & Chemical Corp
Attn: Mr. L. J. Barker
Center for Technology
P.O. Box 870
Pleasanton, CA 94566

Kaiser Aluminum & Chemical Corp
Attn: Dr. E. J. Westerman
Center for Technology
Pleasanton, CA 94566

Kaiser Aluminum & Chemical Corp
Attn: Dr. W. J. Helfrich
Center for Technology
Pleasanton, CA 94566

Ladash Co
Metallurgical Rsch & Dev Div
Attn: Technical Library
Cudahy, Wisconsin 53110

Ling-Temco-Vought, Inc
LTV Astronautics Div
Attn: Chief, Materials Engrg
Attn: Mr. Oliver Cook
P.O. Box 6267
Dallas, Texas 75222

Lockheed-California Co
Attn: Technical Info Ctr
Dept 7840, Bldg 63
Attn: Mr. Geo. Wald
P.O. Box 551
Burbank, CA 91503

Lockheed-Georgia Co
Attn: Sci-Tech Info Center
Dept 72-34, Zone 26
Marietta, GA 30061

Lockheed Missiles & Space Co
Technical Info Ctr (50-14)
3251 Hanover St
Palo Alto, CA 94304

Lockheed Missiles & Space Co
Attn: Mr. Donald E. Piper
Metallurgy & Composites Lab
Bldg 204
3251 Hanover St
Palo Alto, CA 94304

McDonnell-Douglas Astronautics Co-West
Attn: Materials, Methods, Rsch & Engr
5301 Bolsa Ave
Huntington Beach, CA 92647

McDonnell-Douglas Corp
Attn: Materials & Process Div
Dept 272
P.O. Box 516
St. Louis, Mo 63166

McDonnell-Douglas Corp
Douglas Aircraft Div
Attn: Assistant Chief,
Mat'ls Rsch & Proc Eng
Long Beach, CA 90801

The Marquardt Corp
Attn: Technical Library
16555 Saticoy St
Van Nuys, CA 91409

Martin Marietta Aluminum, Inc
Attn: Technical Director
19200 South Western Avenue
Torrance, CA 90503

Martin Marietta Corp
Denver Div
Attn: Technical Library
P.O. Box 179
Denver, Colo 80201

DISTRIBUTION LIST

Martin Marietta Corp
Attn: Mr. Richard C. Hall
Mail Point 105
Orlando, Fla 32805

Materials Rsch Laboratories, Inc
Attn: Dr. E. J. Ripling
22333 Governors Highway
Richton Park, Ill 60471

Mechanical Properties Data Ctr
Befour Stulen, Inc
13919 W. Bay Shore Drive
Traverse City, Mich. 49684

Melpar, Inc.
Attn: Mr. R. E. Miller
3000 Arlington Blvd
Falls Church, Va 22040

Midwest Rsch Institute
Attn: Dr. Sheldon L. Levy, Dir
Mathematics & Physics Div
425 Volker Blvd
Kansas City, Mo 64110

New England Materials Lab., Inc.
35 Commercial St
Medford, Mass. 02155

Northrop Corp
Norair Div
Attn: Tech. Info 3924-32
(For Metallurgical Engr.)
Attn: Mr. Don Roda
3901 West Broadway
Hawthorne, CA 90250

Olin Corp
Aluminum Div
Attn: Supervisor, Product Div
P.O. Box 164
Hannibal, OH 43931

Oregon Metallurgical Corp
Attn: Tech Library
P.O. Box 484
Albany, Oregon 12200

Oak Ridge National Lab
Metallurgy Div
P.O. Box X
Oak Ridge, Tenn 37831

Philco Ford Corp
Aeronutronic Div
Tech Info Services-Acquisitions
Ford Road
Newport Beach, CA 92663

Pratt & Whitney Aircraft Div
United Aircraft Corp
Attn: Chief, Mat'l's Engr
400 Main St
East Hartford, Conn. 06108

Pratt & Whitney Aircraft Div
United Aircraft Corp
Attn: Technical Library
P.O. Box 2691
West Palm Beach, Fla 33402

Reactive Metals, Inc
Attn: Mr. O. Berteau
Niles, Ohio 44446

Research Inst. for Advanced Studies
(Martin Co)
Attn: Dr. E. N. Pugh
1450 South Rolling Rd
Baltimore, Maryland 21227

Revere Copper & Brass, Inc
Attn: Dr. L. F. Mondolfo
Mgr., Metallurgical Res. Ctr
Rome, N.Y. 13440

Reynolds Metals Co
Attn: Mr. G. B. Bailey, Mgr.
Government Services
503 World Center Bldg
Washington, D.C. 20006

Reynolds Metals Co.
Attn: Dr. D. S. Thompson
Metallurgical Res Div
4th & Canal Streets
Richmond, VA 23218

DISTRIBUTION LIST

Rockwell International Corp
Atomics International Div
Engineering Mat'ls Group,
Fuel & Mat'ls
8900 Desota St
Canoga Park, CA 91303

Rockwell International Corp
Rocketdyne Div
Attn: Librarian, Dept 586-306
6633 Canoga Avenue
Canoga Park, CA 91304

Rockwell International Corp
Attn: Engrg Tech Library
Attn: Mr. Gary Keller
International Airport
Los Angeles, CA 90045

Rockwell International Corp
Attn: Technical Library
Attn: Mr. Paul Maynard
4300 East Fifth Avenue
Columbus, OH 43216

Rockwell International Corp
Rocketdyne Div
Solid Rocket Div
Attn: Library
McGregor, Texas 76657

Rockwell International Corp
Los Angeles Div
Attn: Dr. A. W. Sommer, Supervisor
Metallurgy Rsch & Engineering
International Airport
Los Angeles, CA 90009

Rockwell International Science Ctr
Attn: Dr. J. C. Williams
Physical Metallurgy Div
Thousand Oaks, CA 91360

Rohr Aircraft Co.
Attn: Chief, Mat'ls & Process Eng
Chula Vista, CA 92012

Ryan Aeronautical Co
Attn: Tech. Library
2701 Harbor Drive
San Diego, CA 92112

Sandia Laboratories, Inc
P.O. Box 580
Attn: Mr. Charles Maak
Albuquerque, N. M. 87115

Sikorsky Aircraft Div
United Aircraft Corp
Attn: Technical Library
Attn: Mr. Mike Solakind
Stratford, Conn. 06497

Southern Rsch Inst
Attn: Head, Metallurgy Div
2000 Ninth Avenue South
Birmingham, Ala 35205

Southwest Rsch Inst
Dept of Materials Engrg
8500 Culebra Rd
San Antonio, Texas 78206

Stanford Rsch Inst
Attn: G-037 External Reports
Menlo Park, CA 94025

Teledyne Materials Rsch
303 Bear Hill Rd
Waltham, Mass 02154

TRW, Inc
TRW Equipment Laboratories
Attn: Mr. J. N. McCarthy
23555 Euclid Ave
Cleveland, OH 44117

TRW Systems
Attn: Tech Library
One Space Park
Redondo Beach, CA 90278

Union Carbide Metals Co
Attn: Techn. Dept Library
4625 Royal Ave
P.O. Box 580
Niagara Falls, N.Y. 14300

Westinghouse Electric Corp
Rsch Lab
Attn: Tech Library
Beulah Rd, Churchill Borough
Pittsburgh, Pa. 15235

DISTRIBUTION LIST

Wyman-Gordon Co
Technical Info Ctr, R&D
North Grafton Plant
North Grafton, Mass. 01601

Sandia Laboratories
Attn: Mr. H. J. Rack
Mechanical Metallurgy
Division 5532
Albuquerque, NM 87115

Carnegie-Mellon University
Attn: Dept of Metallurgy &
Mat'ls Sciences
Schenley Park
Pittsburgh, Pa. 15213

Lockheed-Georgia Co
Attn: Mr. E. J. Batch
Dept. 72-26
Zone 459
Marietta, GA 30060

California Inst of Tech
Jet Propulsion Lab
Attn: Chief, Materials Rsch Sec
4800 Oak Grove Drive
Pasadena, CA 91103

Lockheed-California Company
Attn: Mr. John H. Wooley
Materials & Producibility Div.
Bldg. 63, Plant A-1
Burbank, CA 91503

University of Dayton Rsch Inst
Attn: Tech Library
300 College Park Avenue
Dayton, Ohio 45409

Douglas Aircraft Company
McDonnell Douglas Corp.
Attn: Mr. H. C. Schjelderup
3855 Lakewood Blvd
Long Beach, CA 90846

ITT Research Institute
Attn: Mr. H. Schwartzbart
10 West 35th St.
Chicago, Ill 60616

Cessna Aircraft Company
Attn: Mr. Dail Graham
Wallace Division
P.O. Box 1977
Wichita, Kansas 67201

University of Illinois
Metallurgical Engrg Dept
Urbana. Ill 61801

Lockheed-Georgia Company
Dept. 71-11, Zone 56
Attn: Mr. Jud Carter
Marietta, Georgia 30061

Dept. of Met. & Materials Science
Lehigh University
Whitaker Laboratory #5
Bethlehem, Pennsylvania 18015

The Ohio State University
Dept of Metallurgical Engrg
Attn: Prof. J. W. Spretnak
124 West 17th Avenue
Columbus, OH 43210

The Ohio State University
Dept of Metallurgical Engrg
Attn: Prof Powell
116 West 19th Ave
Columbus, Ohio 43210