

UNCLASSIFIED

AD NUMBER

ADB017373

LIMITATION CHANGES

TO:

Approved for public release; distribution is unlimited.

FROM:

Distribution authorized to U.S. Gov't. agencies only; Proprietary Information; OCT 1976. Other requests shall be referred to Fleet Material Support Office, Mechanicsburg, PA.

AUTHORITY

FMSO ltr 10 Nov 1977

THIS PAGE IS UNCLASSIFIED

THIS REPORT HAS BEEN DELIMITED
AND CLEARED FOR PUBLIC RELEASE
UNDER DOD DIRECTIVE 5200.20 AND
NO RESTRICTIONS ARE IMPOSED UPON
ITS USE AND DISCLOSURE.

DISTRIBUTION STATEMENT A

APPROVED FOR PUBLIC RELEASE
DISTRIBUTION UNLIMITED.

ADBO 17373

A PLAN FOR GATHERING AND REPORTING
NETWORK STATISTICS FOR THE
LOGISTICS DATA COMMUNICATIONS NETWORK

COPY AVAILABLE TO DDC DOES NOT
PERMIT FULLY LEGIBLE PRODUCTION

October 1976

DDC
RECEIVED
MAR 11 1977
C

Distribution limited to U.S. Gov't. agencies only;
Proprietary Info.; 11 MAR 1977. Other requests
for this document must be referred to

Prepared For
Fleet Material Support Office
Naval Supply Systems
Mechanicsburg, PA 17055

Code 9642
FR095.03R

Prepared by
Network Analysis Corporation
410 Pine Street
Vienna, VA 22180

Form with fields for ADDRESS, BY, and other administrative information. Includes a checkmark and a large letter 'B' in a box.

AD No. _____
DDC FILE COPY

2

1

DOCUMENT CONTROL DATA - R & D

(Security classification of title, body of abstract and indexing annotation must be entered when the overall report is classified)

1. ORIGINATING ACTIVITY (Corporate author) Navy Fleet Material Support Office Code 9642 Mechanicsburg, PA 17055	2a. REPORT SECURITY CLASSIFICATION Unclassified
	2b. GROUP

3. REPORT TITLE
A plan for gathering and Reporting Network Statistics for the Logistics Data Communications Network.

4. DESCRIPTIVE NOTES (Type of report and inclusive dates)
None

5. AUTHOR(S) (First name, middle initial, last name)
Network Analysis Corporation
410 Pine Street
Vienna, VA 22180

6. REPORT DATE 11 Oct 1976	7a. TOTAL NO. OF PAGES 127 218 p.	7b. NO. OF REFS None
-------------------------------	--------------------------------------	-------------------------

8a. CONTRACT OR GRANT NO. 15 N00104-76-D-5532 - new	9a. ORIGINATOR'S REPORT NUMBER(S) FR095.03R Internal number
b. PROJECT NO.	

9b. OTHER REPORT NO(S) (Any other numbers that may be assigned this report)
None

10. DISTRIBUTION STATEMENT
Limited distribution - U.S. Agencies only.
Navy Fleet Material Support Office
Code 9642
Mechanicsburg, Pa. 17055

Distribution limited to U.S. Gov't. agencies only; Proprietary info.; for this document must be referred to 11 MAR 1977 Other requests

11. SUPPLEMENTARY NOTES None	12. SPONSORING MILITARY ACTIVITY Naval Supply Systems Command Washington, DC 20376
---------------------------------	--

13. ABSTRACT
This is a study of statistics that should be gathered and a means of collecting these statistics for the Logistics Data Communications Network (LDCN) and the concepts needed for implementation of the package. The approach for gathering statistics centers on a history tape concept.

KEYWORDS
system management
network control
report design
measurement mechanisms
processing methodology
statistical processing



410 097

TABLE OF CONTENTS

<u>Chapter</u>	<u>Page</u>
1. Introduction	
1.1 Goals and Constraints	1.2
1.2 Organization	1.3
2. System Management	
2.1 LDCN Configuration	2.1
2.1.1 System Operation	2.2
2.1.2 Interactive Terminals	2.3
2.1.3 Remote Job Entry	2.5
2.1.4 AUTODIN Entry	2.6
2.1.5 FEP Operation	2.6
2.2 Network Control and Management Functions	2.8
2.3 Manual Measurement Subsystem	2.11
2.3.1 Network Configuration and Cost Summary	2.12
2.3.2 Site Characteristics	2.13
2.3.3 Communication Devices	2.14
2.3.4 Final Remarks	2.14
3. Report Design	
3.1 Rules for Preparing Tables and Graphs	3.2
3.1.1 Tables	3.3
3.1.2 Graphs	3.5
3.2 Overview of Proposed LDCN Data	3.8
3.3 Proposed Reports	3.11
3.3.1 Core Utilization Report	3.12
3.3.2 Management Reports	3.12
3.3.3 Operational Reports	3.14
3.4 Engineering Reports	3.15
3.4.1 User Statistics	3.16
3.4.2 Traffic Statistics	3.17

<u>Chapter</u>	<u>Page</u>
3.4.3 Response Time	3.17
3.4.4 Message Lengths	3.18
3.4.5 CPU Utilization	3.18
3.4.6 Exception Refinements	3.19
3.5 Implementation Schedule	3.19
4. Measurement Mechanisms	
4.1 Approach	4.1
4.2 Statistical Blocks	4.3
4.2.1 Configuration Statistics	4.3
4.2.2 Traffic and Message Statistics	4.4
4.2.3 Response-Time Statistics	4.4
4.2.4 System Utilization Statistics	4.6
4.2.5 Queue Statistics	4.6
4.2.6 Error Statistics	4.7
4.3 Summary	4.8
5. Processing Methodology	
5.1 Simple Processing Methodologies	5.1
5.2 Intermediate Processing Methodologies	5.2
5.3 Need for a Data Base	5.4
5.4 Complex Processing Methodologies	5.4
5.5 Statistical Processing Overview	5.5
5.5.1 Files	5.5
5.5.2 Processing Organization	5.8
6. Summary	
A.1 Introduction	A.1
A.2 DS-714 Telex System	A.2

<u>Chapter</u>	<u>Page</u>
A.3 The Communication Control System	A.17
A.4 The S Network Reports	A.28
A.5 NASDAQ System	A.37
A.5.1 Summary of NASDAQ Error Monitoring Procedures .	A.38
A.5.1.1 Regional Circuits	A.38
A.5.1.2 Trunk Circuits	A.39
A.5.2 Short-Term Error Rate Monitoring	A.42
A.6 The SSADARS Statistics	A.48
A.7 ARPA Network Statistics	A.61
A.7.1 Accumulated Statistics	A.63
A.7.2 Snapshot Statistics	A.65
A.7.3 Trace Data Statistics	A.65
A.7.4 Status Reports	A.66

LIST OF FIGURES

<u>Figure</u>		<u>Page</u>
2.1	Network Configuration	2.17
2.2	Network Configuration and Cost Summary	2.18
2.3	Form for Location Dependent Data	2.19
2.4	Form for Communication Device Data	2.20
2.5	Form for Data on Modems and Line Termination Equipment	2.21
2.6	Form for Host Data	2.22
2.7	Form for Terminal Data	2.23
2.8	Form for Data on Communication Facilities	2.24
3.1	Sample of an Unformatted Table	3.21
3.2	Sample of a Formatted Table	3.22
3.3	Sample Table	3.23
3.4	Sample of a Computer-Generated Graph	3.24
3.5	Sample of a Hand-Drawn Graph from Computer- Supplied Data	3.25
3.6	Sample Graph	3.26
3.7	Importance to Y-Axis Zero Point	3.26
3.8	Summary of the Data Proposed for Collection by the LDCN	3.27
3.9	Core Utilization Report	3.31
3.10	LDCN Status Summary	3.32
3.11	LDCN Traffic Summary Plot-Messages Per Week	3.34
3.12	LDCN Traffic Summary Plot-Average No. of Messages/Hr.	3.35
3.13	System Status Exception Report	3.36
3.14	Real-Time Reports	3.37
3.15	LDCN CPU Utilization Summary	3.38
3.16	System Status Report	3.39
3.17	Buffer Usage Exception Report	3.40

<u>Figure</u>	<u>Page</u>
3.18 Output Queue Exception Report	3.41
3.19 Line Notification Report	3.42
3.20 Password Failure Report	3.43
3.21 Line Utilization Report	3.44
3.22 CPU Utilization Exception Report	3.45
3.23 Disk Utilization Exception Report	3.46
3.24 Congestion Report	3.47
3.25 LDCN User Status Report	3.48
3.26 User Status Report by System	3.49
3.27 User Status Plot	3.50
3.28 System Configuration	3.51
3.29 System Signon-Signoff Report	3.52
3.30 LDCN Traffic Statistics Report	3.53
3.31 LDCN Traffic Statistics Report	3.55
3.32 LDCN Traffic Statistics Report	3.57
3.33 Traffic Statistics Report by System and Traffic Type	3.59
3.34 Traffic Statistics Plot	3.61
3.35 LDCN Response Time Report	3.62
3.36 Response-Time Report by System	3.63
3.37 Response-Time Report by Component	3.64
3.38 LDCN Message Length Statistics Report	3.66
3.39 Message Length Statistics Report by System and Traffic Type	3.68
3.40 Input Message Length Histogram	3.70
3.41 Output Message Length Histogram	3.71
3.42 CPU Utilization Report	3.72
3.43 CPU Utilization Report by Module	3.73
3.44 CPU Module Access Report	3.74
3.45 CPU Utilization Plot	3.75

<u>Figure</u>	<u>Page</u>
3.46 Buffer Usage Report	3.76
3.47 Buffer Usage Plot	3.77
3.48 Output Queue Report	3.78
3.49 Output Queue Plot	3.79
3.50 Line Error Report	3.80
3.51 Line Utilization Report	3.81
3.52 Disk Utilization Report	3.82
3.53 Disk Utilization Plot	3.83
3.54 Batch Queue Report	3.84
4.1 Configuration Statistical Records	4.9
4.2 Traffic and Message Statistical Records	4.10
4.3 Response Time Statistical Records	4.12
4.4 System Utilization Statistical Records	4.13
4.5 Queue Statistical Records	4.14
4.6 Error Statistical Records	4.15
A.3.1 System Configuration Report	A.21
A.3.2 Terminal I/O Report	A.22
A.3.3 Application Program Report	A.23
A.3.4 Frequency of Programs Report	A.24
A.3.5 Terminal I/O Frequency Report	A.25
A.3.6 Line I/O Frequency Report	A.26
A.3.7 Frequency of I/O Format Report	A.27
A.4.1 Network Traffic Report	A.32
A.4.2 TCAM Statistics per Line	A.33
A.4.3 Summary Error Reports per Line	A.34
A.4.4 Line Utilization Report	A.35
A.4.5 System Measurement Summary Report	A.36
A.6.1 SSADARS Operations Report	A.51
A.6.2 Statistics From the SSADARS Log Tapes	A.52
A.6.3 Concentrator Traffic Report	A.53
A.6.4 Star Incoming Volume Report	A.54
A.6.5 Star Outgoing Volume Report	A.55
A.6.6 Response Time Report-RECV	A.56

<u>Figure</u>	<u>Page</u>
A.6.7 Response Time Report-CRTR	A.57
A.6.8 Statistics for Concentrator A	A.58
A.6.9 Time Stamp Identification	A.59
A.6.10 San Francisco Concentrator	A.60
7.1 Typical Accumulated Statistics Printout	A.68

LIST OF TABLES

<u>Table</u>	<u>Page</u>
2.1 Documents Concerning the LDCN	2.16
3.1 What and When to Implement	3.85
5.1 Outputs and Corresponding Inputs: Simple Processing Methodologies	5.11
5.2 Outputs and Corresponding Inputs: Intermediate Processing Methodologies	5.12
5.3 Outputs and Corresponding Inputs: Data Base Needed to Store Other Data	5.13
5.4 Outputs and Other Corresponding Inputs: Complex Processing Methodology	5.14
A.2.1 Parameters That Must be Stored on The History Tape	A.7
A.2.2 Logs Written on the History Tape	A.9
A.2.3 Receive Selection Log Entries for Statistical Analysis	A.10
A.2.4 Input Cancel Codes	A.11
A.2.5 Call Extension Log Entries for Statistical Analysis	A.13
A.2.6 Output Cancel Codes	A.14
A.2.7 Regular Call Record Entries for Statistical Analysis	A.16
A.5.1 2-Sided 95% Confidence Level for Error Probabilities	A.45
A.5.2 Transmission Lengths for Error Estimation	A.47

1. INTRODUCTION

The Navy Fleet Material Support Office (FMSO) is currently evolving an integrated, real-time data communications network to provide a large number of dispersed Navy sites with logistics information necessary for effective and efficient logistics support. The Logistics Data Communications Network (LDCN) will enable remote sites to directly access major logistic data bases at two Inventory Control Points (ICP's) located at the Ship Parts Control Center (SPCC), Harrisburg, Pennsylvania, and the Aviation Supply Office (ASO), Philadelphia, Pennsylvania. Programmable communications concentrators at selected remote sites will be used for cost-effective interfacing of low speed terminals with the computer complexes managing the data bases. These complexes each have two U494 computers; SPCC also has an IBM 360/65, while ASO has a Burroughs 3500. Interdata 7/32 minicomputers will act as Front End Processors (FEP's) at each of these complexes to serve the communication functions for the main computers. In addition, FMSO has designated the FEP's to be the collectors and recorders of statistical data for the LDCN.

Many times in the past, the statistics collected and reported by a network were afterthoughts of the design process. In these networks, certain key statistics were either not collected or required a high processing overhead to collect, while reports were generally unreadable with important information buried among reams of statistics of questionable merit. In these systems, statistics quickly fell into disuse, causing network management to be driven primarily by network events such as failures, rather than network management being the primary driver of events for network efficiency. Recognizing the pitfall of this approach, FMSO has identified the need to formulate a comprehensive statistics package in the early design stages of the FEP. As input to this formulation, FMSO requested Network Analysis Corporation (NAC) to study statistics for the LDCN and generate concepts for the implementation of such a package. This report is a summary of those concepts.

1.1 Goals and Constraints

The purpose of NAC's statistical study is to describe functionally a statistical package for the LDCN, including:

- Identification and functional description of the statistics appropriate in reports for operational management, network operators, and network engineers.
- Identification of the data to be obtained from the LDCN to enable the statistics processing.
- Identification of the mechanisms and their placement for obtaining the necessary data.
- Description of the processing mechanisms to transform the data into desired reports.

This report is the result of that study, and serves as an input to the FMSO statistical design team. Both FMSO and NAC recognize that only FMSO has all the facts on its needs and the resources available to implement a statistical package. As such, only a fraction of the concepts described here might be implemented in the LDCN. Thus, this report is not a description of what the LDCN statistical package might be, but rather a comprehensive input to facilitate determination and implementation of an appropriate package by FMSO.

At the start of this study, FMSO suggested NAC consider three constraints to the problem. Upon evaluation by NAC, these constraints were deemed reasonable and followed. The three constraints were:

- Statistics should be designed for the LDCN. NAC could use its knowledge of the statistics collected on other networks, but the concepts generated by NAC for FMSO consideration had to relate to the LDCN.

- The majority of the statistical data should be collected by the front ends, not the concentrators or host computers. The concentrators could do some statistical collection, but would be limited since all statistical data would be kept in primary storage. The front ends were to eliminate processing overhead in the hosts; thus it does not make sense to place statistics in the hosts when the front ends should have sufficient host statistical data available from their normal communications with the hosts.
- Only essential statistics should be processed on-line. By essential statistics we mean the network status information needed by operational personnel to respond to immediate network problems.

Once again, it should be noted that this report describes a way statistics could be collected in the LDCN, not the way statistics will be collected in the LDCN.

1.2 Organization

This report on statistics is divided into six sections and one appendix. Section 2 gives an overview of the LDCN, statistics, and network management. Section 3 deals with the design of statistical reports for managers, operators, and engineers. The measurement mechanisms needed to obtain statistical data is presented in Section 4, while the algorithms to convert the raw data into meaningful statistics is given in Section 5. Section 6 summarizes the findings of the previous sections. Finally, Appendix A describes some of the statistics collected by current systems. This appendix is for background information only; it does not provide every detail of the statistics collected on current networks, for that is beyond the scope of this study.

2. SYSTEM MANAGEMENT

In order to develop a statistical package for the LDCN, one must first have an overview of the network. To this end, Section 2.1 presents an overview of the LDCN. The information in this section is a summary of discussions with FMSO personnel and the documentation of network concepts found in the references of Table 2.1. For further information on the LDCN, one is referred to these documents.

Besides having an overview of the LDCN, a designer needs an overview of the role statistics play in network control and management functions in order to design an effective statistical package. Section 2.2 deals with this topic. Finally, Section 2.3 discusses the need for a manual measurement subsystem in a network statistical package. This subsystem creates a central file of descriptive information on the network. Because of the manual nature of this subsystem, it is often overlooked by designers of statistical packages.

2.1 LDCN Configuration

FMSO manages major logistics data bases at two ICP's; one at the Ship Parts Control Center (SPCC) at Mechanicsburg, Pennsylvania, and the other at the Aviation Supply Office (ASO) at Philadelphia, Pennsylvania. The SPCC computer complex contains two U494 computers and an IBM 360/65. The ASO computer complex contains two U494 computers and a Burroughs 3500. At each ICP, one U494 supports real-time processing activity for an Inventory Control (IC) data base, and the other U494 supports real-time processing for a Weapons System (WS) data base. At both locations, each U494 can access the other's data base in a read-only mode. The IBM 360/65 maintains a Material Maintenance Management (3M) data base, and the B3500 is used to track progress of high priority stock transactions for air logistics support.

Approximately 775 terminals will access the data bases through nine programmable communications processors used as concentrators. Two of the nine concentrators will be located at SPCC for local terminal access, and, similarly, two will be located at ASO. The remaining five concentrators will be located in Washington, DC, San Diego, California, Oakland, California, Jacksonville, Florida, and Norfolk, Virginia. The tentative network architecture calls for each of the concentrators to be dual-homed to the two ICP's. An estimate of the terminal distribution by location and category is shown in Figure 2.1.

The FEP's will serve to interface the main computers at each ICP with the remote concentrators. The concentrator-FEP connections are tentatively planned to be through dedicated 9600 bps circuits. The FEP-main computer connections are tentatively planned to be through direct channel interfaces. The FEP's will also be used to interface with the AUTODIN CDC-1700 interface terminals, one interface at each ICP. The interface will be through dedicated 1200 bps or 2400 bps circuits.

The overall network configuration is shown in Figure 2.1.

2.1.1 System Operation

The system operation is transaction oriented, with two basic types of transactions: upquiries to update the data base, and inquiries to extract information from the data base. The transactions may also be divided into those requiring real-time processing and those which may be grouped for batch processing. For convenience, we will identify those requiring real-time processing as RTT's (Real-Time Transactions) and those which may be grouped for batch processing as PBT's (Possible-Batched Transactions). PBT's are batched according to application programs, with a processing schedule based on batch size, waiting time, and absolute time.

Both RTT's and PBT's may enter the system through interactive terminals. Remote Job Entry (RJE) terminals and the AUTODIN interface are assumed to enter PBT's 99% of the time. The system operation is described below in terms of these three methods of transaction entry and the handling of batched transactions.

2.1.2 Interactive Terminals

The system operation is best described in terms of the user activities at the terminal. The initiation of an up-quiry or inquiry first requires establishment of communications with the system. The terminal operator does this by initiating a request for service by typing the HERE-IS character. This signals the concentrator that a new activity is to be commenced, and the concentrator signifies its ready status by return of the characters "USER-ID:". The operator then enters his USER-ID and depresses the END-OF-TEXT key. The concentrator responds with the characters "PASSWORD:" followed by three eight-character random series overprinted one on the other. The user keys in his password in the overprinted area and depresses the END-OF-TEXT key. The concentrator then verifies the password; if not correct, the concentrator will request the password two more times before disconnecting the terminal. If the password is correct, the concentrator responds with the prompt "SYSTEM:". The user then keys in the system code for the system he wishes to access. The system codes are:

AICS = ASO - Inventory Control System

AWPS = ASO - Weapons System

ASCC = ASO - Air Station Control Center

AANY = ASO - either U494 (ICS or WPS)

ATST = ASO - test system

SICS = SPCC - Inventory Control System

SWPS = SPCC - Weapons System

SMMM = SPCC - 3M System

SANY = SPCC - either U494 (ICS or WPS)

STST = SPCC - test system

Upon a successful sign-on the concentrator responds with the prompt ":" and forwards the sign-on information to the FEP. This affirmative response then allows the terminal operator to enter the appropriate data. When this activity is complete, the concentrator has within it the transaction (upquiry or inquiry) for transfer to the appropriate FEP. The concentrator then adds an appropriate routing header to the transaction, and queues the transaction with transactions from other terminals for transfer to the appropriate FEP.

After transfer of the transaction to the FEP is complete, the FEP examines the transaction, and if the transaction is identified as an RTT, it is immediately placed on queue for transfer to the appropriate main computer. If the transaction is identified as a PBT, it is placed on the appropriate application queue, and will remain there until the application batch is to be processed.

Processing of transactions by the main computer results in outputs to be returned to the user. These outputs are immediately transferred from the main computers to the FEP where they are then processed to determine appropriate routing, and queued for transfer to the appropriate concentrator.

The current design of the concentrator does not use auxiliary storage for buffering. Consequently, the FEP must queue the output until the concentrator has sufficient buffering available for the first part of the output to be delivered to the terminal. Once transfer of the output from the FEP is initiated, the concentrator continuously delivers the output to the terminal, using double buffering to enable the request of each new part of output from the FEP without an interruption in transmission to the terminal. The life cycle of the transaction is complete when the last character of the output is delivered to the terminal.

There may be considerable time between the completion of the transaction input and return of the output. During this time, the operator may initiate input of another transaction. If this is done, transmission of an output to the terminal must wait for completion of the input process. In addition, at any time after signing-on a user can change systems at the complex to which he has access by keying in the characters "SYSTEM: XXXX" where XXXX is the new system code.

A user completes a session on a terminal by using the "OFF" command or depressing the HERE-IS key to initiate a new sign-on. When this information is forwarded to the FEP, the FEP must hold all outputs received for that terminal and USER-ID until its next sign-on.

2.1.3 Remote Job Entry

Several RJE terminals (card readers plus line printers) will be connected to the concentrators to facilitate entry of batched transactions. In this mode of operation, each transaction will be on one card. The concentrator will simply receive the transactions, determine the FEP to which they are to be forwarded, and place them on the appropriate queue with the appropriate header for transmission to the FEP. Because

the concentrator does not have auxiliary storage buffering, provision must be made for the concentrator to control the RJE input on the basis of buffer availability, or for the RJE transactions to have sufficient priority to ensure that their transmission to the FEP is consistently faster than their input to the concentrator.

Once the RJE transactions reach the FEP, they are processed as ordinary PBT's. This processing is described in Section 2.1.5. It is assumed that transactions entered by RJE will be primarily PBT's, but with an occasional RTT (1%).

2.1.4 AUTODIN Entry

The FEP will receive transactions through the AUTODIN interface. These transactions will basically be handled by the FEP in the same manner as transactions received from RJE terminals through the concentrator. However, some additional processing for editing will be necessary.

2.1.5 FEP Operation

The FEP will receive transactions from the AUTODIN interface and from the concentrators. As the transactions are received, they are identified as RTT's or PBT's. RTT's are immediately placed on queue for transfer to the appropriate main computer. PBT's are placed on the appropriate application queue.

Each application queue will be a batch for processing by the appropriate main computer. Each batch will have a processing schedule that may be based on batch size, waiting time, or periodic processing. Examples of such rules are:

- a. Process every three hours or whenever the batch reaches 50 transactions.
- b. Process whenever the batch reaches 20 transactions or whenever the longest waiting transaction has waited six hours.
- c. Process at 8:00 p.m.

When a transaction entered through a concentrator is processed by a main computer, an output is generated for return to the user. This output is immediately transferred to the FEP. If the transaction was an RTT, the output is immediately queued for transfer to the appropriate concentrator. The transfer will be effected as described earlier.

If the transaction is a PBT, the output will be destined for a line printer. The outputs are queued on the basis of destination until the batch processing is complete. The outputs destined for line printers will then be transferred to the appropriate concentrators with the same double buffering technique described earlier for RTT's.

Not all transactions arriving over the AUTODIN interface will generate outputs. The outputs that are generated will be immediately transferred to the FEP where they will be queued until a full AUTODIN message is formed or until the batch processing is complete. The FEP processes the outputs to place them in proper AUTODIN message format, and then transfers the message to the AUTODIN host processor. This process will continue until all outputs have been transferred.

2.2 Network Control and Management Functions

One of the major aspects in the design of a communications network is the network control and management functions. The LDCN is no exception; many such functions can be identified for the LDCN, including:

- **System Monitoring and Notification:** The LDCN should be able to identify inoperable system elements and notify appropriate parties.
- **Facility Monitoring and Correction:** Circuit error rates and operating conditions should be monitored, and when unacceptable, corrective action such as dial-backup should be executed.
- **Diagnostic Assistance:** When facilities fail, the LDCN should be able to provide assistance to an operator or other remote intelligence to isolate the cause of failure.
- **Flow Control:** The LDCN should provide a mechanism for graceful degradation of performance during overload conditions.
- **Operational Statistics:** The LDCN should gather operational statistics, such as circuit error rates and failure frequency, to enable system reconfiguration as required.
- **Traffic Statistics:** Statistics on message lengths, message types, etc., should be obtained to permit system design changes as required and for future design efforts.

- Performance Statistics: Throughput and delays should be measured to enable calibration of system performance.
- Utilization Statistics: Processor utilization, buffer utilization, etc., should be measured to enable identification and correction of marginal situations before bottlenecks develop.
- System Component Statistics: A list of components (terminals, lines, modems, processors) with cost and functional specifications should be kept for network design purposes.
- System Location Statistics: Each location containing LDCN components should have a record containing site name, address, phone number, and V&H coordinates (or latitude and longitude). These records would be used in network design and maintenance functions.
- Monthly Cost Statistics: Every month a breakdown of system costs - line charges, drop charges, Telpak charges, processor charges, maintenance charges, and possibly personnel charges - should be produced. These statistics would keep management informed of the cost of providing network services to its customers.
- Operating System Characteristics: Documents describing the line disciplines, polling sequences, addressing sequences, message priorities, and other functions of the operating system should be kept in a central file for reference by network management, operators, and engineers.

From the above list, it can be seen that statistics play an important role in network control and management functions. Of the 12 functions given, only diagnostic assistance and flow control fall outside the realm of network statistics. Diagnostic assistance is primarily a tech control function, while flow control is a mechanism to provide network integrity during traffic surges. Although not part of the statistical package, statistics should be collected on these functions.

The need for the above statistics arises within an on-going network management effort because sufficient information must be acquired to support necessary operational or economic decisions. Failure to collect statistics can have a major impact on the network; for example, it can result in an ineffective system; further, it could also lead to the dropping of a system of high potential value.

Network statistical packages are usually designed to contain several layers of reports which can be produced by operator request. These outputs are layered because the amount and type of reported statistics should depend upon the volatility of network growth, with network cutover and traffic surges requiring detailed reports and predictable network performance requiring summary reports. Statistics should never be reported and/or analyzed for their own sake. Continuing surveillance should be maintained over the potential impact of the reported statistics on network management decisions. Any time it appears the statistics will have no effect on the network management decisions, they should be dropped from the reporting process.

The reporting of all statistics requires the collection of all statistical data. However, the layered reporting process recommended above offers network designers a choice. Some designers might require the collection of detailed data on the assumption that detailed reports for a specific day

may be requested on the basis of the summary reports. Other designers set flags in the concentrator and front end operating systems to allow statistical data to be collected only after a request for a certain statistical report is made. Many designers use a combination of the two approaches. In these cases, the decision as into which of the categories certain data falls is made on the basis of the processing overhead of collecting the data versus the cost of not always having the data at hand. Finally, statistical packages should usually have network performance limits incorporated into them so that exception reports can be produced when the limits are exceeded. These reports should then trigger requests by management and operations for more detailed reports.

2.3 Manual Measurement Subsystem

Of the 10 statically-related functions mentioned in Section 2.2, facility monitoring and correction, system monitoring and correction, and operational, traffic, performance, and utilization statistics are functions of the computerized measurement subsystem of the statistical package. These functions are performed by computers, so it is possible to insert counting and recording loops into the programs so the computers will automatically perform the statistics collection function. Beyond this capability it is possible in certain cases to add logic to the recording loops so that a sampling plan is implemented at the same time. Thus, in these cases, the data can be received from the computers in a ready-to-analyze statistical format.

System component and location statistics, monthly cost statistics, and operating system characteristics are functions of the manual measurement subsystem of the statistical package. All these statistics can be kept in a

computerized data base; however, the input for these statistics must be manually entered into the system. Figures 2.2 - 2.8 show sample forms that can be used to collect this information. Figure 2.2 requests the data needed for the monthly cost statistics and operating system characteristics; this form gives an overview of the network, showing where communications equipment and facilities are located, providing the cost associated with each component, and gathering documentation on a network description. The form shown in Figure 2.3 is used to collect system location statistics, while Figures 2.4 - 2.8 are used to obtain information for system component statistics. Finally, it should be noted that Figures 2.4 - 2.8 request information on each type of network component, not on each component itself. Let us now look at some of these forms in slightly more detail.

2.3.1 Network Configuration and Cost Summary

The Network Configuration and Cost Summary form (Figure 2.2) requests five types of information. The first type of information is on the network communication equipment. Each item under this type is assigned an identification number by the network control center (NCC). The site name at which the item is located is given; this name corresponds to the name of a site on a Location Dependent Data form. Each item also has a device code assigned to it which can be used to find the appropriate Device Data form for a description of the device. The monthly charges for the item are given, as is the identification numbers of other equipment directly connected to the item.

The information requested for communication facilities includes the equipment identification numbers for the endpoints of the facility segment. These numbers correspond to those given above, so other location data is not needed. Facility code information relates this segment to tariff

and descriptive data found on a Facility Data form, while the facility identification number will be assigned to the segment by the NCC. For multidrop lines, the same identification number would be used for all segments, although the facility codes could be different for each segment. Finally, monthly charges are given for each facility.

The name, business address, and telephone number of each person involved with the running of the network should be given. In addition to this information, the function of the person in the network should be listed. The total monthly personnel costs should be given in this section, although the salary of each person must not be present (i.e., the Privacy Act would probably prohibit it).

Other network costs, such as buildings, electricity, water, and taxes, should be included on the form. Finally the total monthly network cost should be found on the form. Descriptive documentation on the network, protocols, etc., should then be filed with this form for reference at a later date.

2.3.2 Site Characteristics

The information contained on the Location Dependent Data forms (Figure 2.3) includes the name and mailing address of a network node or site. In addition to this information, the network telephone numbers associated with the site should be given, as well as a description of for what the telephone numbers are used. Finally, V&H coordinates or latitude and longitude should be given for each site. This information is needed for network design purposes. If some forms have V&H data while others have latitude and longitude, a program can be run to convert all data into V&H coordinates. Thus computer generated network designs are possible with these forms.

2.3.3 Communication Devices

The five other forms associated with the manual measurement subsystem are similar in nature. Because of this, we will focus on only one of these, the Device Data form (Figure 2.4). This form contains a device code which allows a piece of equipment on the Network Summary form to be related to it. The manufacturer and his designation of the device is given, as is a functional keyword as to the device type. The number and kind of terminations allowed by the device are given, as is the various costs associated with the device. A descriptive narrative of the device and its function is given; this description could be placed on a data base along with the other device information. Finally, detailed functional specifications and other vendor literature would be filed with the form for future reference.

2.3.4 Final Remarks

Whether or not the above information is placed in a computerized data base, the forms containing the information should be stored in a central file at the NCC for reference by management, operators, and engineers. In addition, these forms should be updated as new sites, devices, personnel, and system characteristics are added. The forms should be signed-out before being removed from the file and signed-in when returned. By following these suggestions the manual measurement subsystem, a necessary portion of the network statistics, will not be overlooked.

The computerized measurement subsystem envisioned by NAC for the LDCN is somewhat more complex than the manual measurement subsystem. In this subsystem, the type of statistical reports for management, operators, and engineers must be based on the data that can be collected in the network and massaged by algorithms run on an Interdata 7/32.

Because of this complexity, the next three sections of the report deal with the computerized measurement subsystem. Section 3 discusses the design of statistical reports proposed for the LDCN, while Section 4 considers possible data measurement mechanisms. Finally, Section 5 focuses on a processing methodology needed to convert the data collected in Section 4 to the reports of Section 3.

NETWORK ANALYSIS CORPORATION

1. Capacity Analysis of Data Communication Concentrators, NAC Report FR.043.01R, Network Analysis Corporation, Glen Cove, New York
2. Feasibility Analysis of PDP-11 Minicomputer Front End Processor, NAC Report FR.060.01, Network Analysis Corporation, Glen Cove, New York
3. Configuration Designs for LDCN Communication Processors, NAC Report FR.095.01R, Network Analysis Corporation, Glen Cove, New York
4. LDC Design Group Meeting Memorandum 10462/3-1, dated 19 March 1976
5. LDCN Sign-on/Sign-off Procedures, draft copy of memorandum

TABLE 2.1: DOCUMENTS CONCERNING THE LDCN

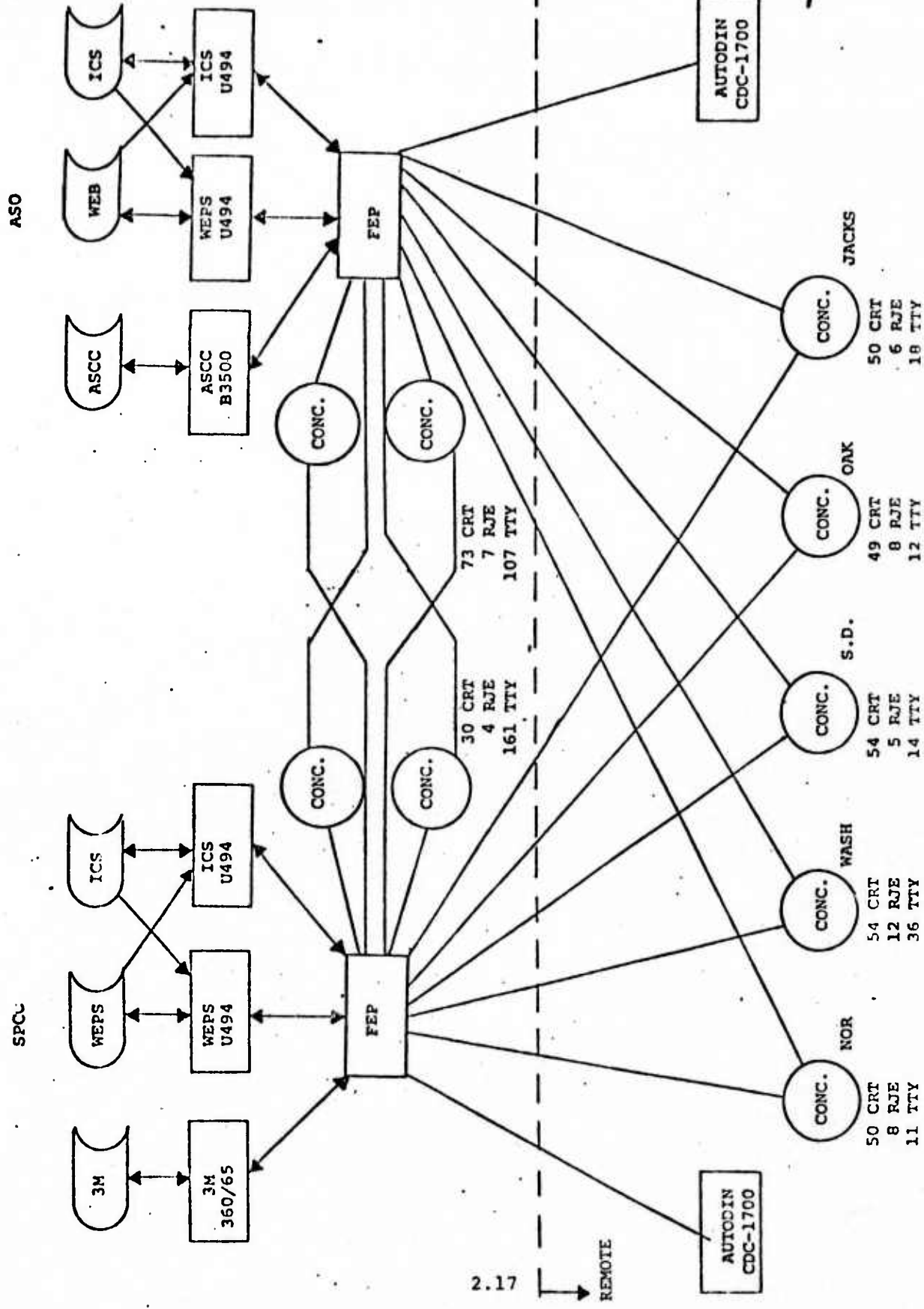

FIGURE 2.1: NETWORK CONFIGURATION

2.17

REMOTE

LDCN NETWORK

1. Communication Equipment

<u>Eq. ID</u>	<u>Site Name</u>	<u>Device, Host, or Terminal Code</u>	<u>Monthly Charges</u>		<u>Connects to Eq. ID(s)</u>
			<u>Lease or Amortization</u>	<u>Maintenance</u>	
1.					
2.					
3.					
⋮					

2. Communication Facilities

<u>Endpoints</u>		<u>Facility Code</u>	<u>Facility ID*</u>	<u>Monthly Charges</u>	
<u>Eq. ID 1</u>	<u>Eq. ID 2</u>			<u>Line</u>	<u>Drop & Termination</u>

3. Communication Personnel

<u>Name</u>	<u>Address</u>	<u>Telephone</u>	<u>Function</u>

Total Personnel Costs:

4. Other Costs

Building	_____
Electricity	_____
⋮	
Total	_____

5. Attach documents describing the network, protocols, etc., to this sheet

* For multidrop lines list all branches using the same ID

Figure 2.2: NETWORK CONFIGURATION AND COST SUMMARY

SITE CHARACTERISTICS

1. NAME _____
2. ADDRESS _____
3. CITY _____
4. STATE _____
5. ZIP _____
6. AREA CODE AND TELEPHONE NUMBER(S) _____
7. LONGITUDE _____
8. LATITUDE _____
9. V COORDINATE _____
10. H COORDINATE _____

Figure 2.3: FORM FOR LOCATION DEPENDENT DATA

COMMUNICATION DEVICES*

- 1. Device Code _____
- 2. Manufacturer's Type or Part No. _____
- 3. Manufacturer _____
- 4. Device Type (Concentrator, Multiplexer, Terminal Controller, Front End) _____

5. Terminations

Number	Allowable Terminals (Terminal Codes)	Allowable Facilities (Facility Codes)	Speed(s)
_____	_____	_____	_____
_____	_____	_____	_____
_____	_____	_____	_____

6. Costs

Purchase: _____ Lease: _____ Installation: _____
Maintenance: _____

7. Device Function (Narrative):

8. Attach functional specifications and other documents for this device to this sheet.

* Excluding terminals and hosts

Figure 2.4: FORM FOR COMMUNICATION DEVICE DATA

MODEMS AND LINE TERMINATION EQUIPMENT

1. Device Code _____
2. Manufacturers Type or Part Number _____
3. Manufacturer _____
4. Modulation Method _____
5. Compatibility with Bell _____
6. Channel Speed(s) _____
7. Leased Line/Dial Up _____
8. Multiport Class _____
9. Costs
Purchase: _____ Lease: _____ Installation: _____
Maintenance: _____
10. Attach functional specifications and other documents for this device to this sheet.

Figure 2.5: FORM FOR DATA ON MODEMS AND LINE TERMINATION EQUIPMENT

HOST CHARACTERISTICS

1. Host Code _____
2. Manufacturers Type or Part Number _____
3. Manufacturer _____
4. Allowable Communications Access Modes _____

Speed	Asynch/Synch
.	.
.	.
.	.
5. Polling Disciplines _____
6. Costs
Purchase: _____ Lease: _____ Installation: _____ Maintenance: _____
7. Host Functions (Narrative)

8. Attach functional specifications and other documents for this device to this sheet.

Figure 2.6: FORM FOR HOST DATA

Terminal Characteristics

1. Terminal Code _____
2. Manufacturer's Type or Part No. _____
3. Manufacturer _____
4. Asynchronous or synchronous _____
5. Buffer size (0 if unbuffered) _____
6. Allowable Transmission Speeds _____
7. Allowable Reception Speeds _____
8. Hard copy/CRT or both _____
9. Polled/Unpolled _____
10. Code Used (Baudot, ASCII, EBCDIC) _____
11. MTBF, MTR _____, _____
12. Half/Full Duplex or both _____
13. Costs
Purchase: _____ Lease: _____ Installation: _____ Maintenance: _____
14. Attach functional specifications and other documents for this device to this sheet.

Figure 2.7: FORM FOR TERMINAL DATA

COMMUNICATION FACILITY CHARACTERISTICS

1. Facility Code _____
2. Tariff or Vendor ID _____
3. Vendor or Source _____
4. Mode (Packet, Digital, Analog) _____
5. Tarrif Cost Structure _____
6. Bit Error Rate _____
7. Modem Code _____
8. Attach functional specifications and other documents for this device to this sheet.

Figure 2.8: FORM FOR DATA ON COMMUNICATION FACILITIES

3. REPORT DESIGN

This section describes the management, operation and engineering reports proposed by NAC for the computerized measurement subsystem of the LDCN's statistical package. The data in each report is based on the functions of the persons receiving the report. Thus management reports would be produced off-line and contain summary data on network performance and traffic characteristics, while operations would obtain more detailed network summary reports in addition to on-line reports of network status. Engineering reports would contain detailed statistics on each aspect of the network's performance; these reports would be used for network troubleshooting and debugging. In addition, management and operations would receive exception reports when system performance limits were exceeded.

The statistical contents of each report reflect the needs of each level of personnel in the network hierarchy. Network managers are generally interested in whether the overall system performance is within limits, the amount of traffic supported by the network, and the growth of the network since cutover. In addition, management must be informed about potential system bottlenecks or inadequate system performance, as they are ultimately responsible for the running of the network. Summary network reports thus serve the basic need of management while exception reports guarantee management of information on potential or real system problems. On the next level, the personnel in operations need real-time network statistics so they can take immediate action on failed components and network bottlenecks. In addition, operations require a more detailed summary of the network performance so they can follow, predict, and correct potential bottlenecks before they occur. Finally, on the lowest level, engineering reports present the most detailed statistics of all reports. These reports are used to reconstruct the

conditions under which a system failure occurred or to shed light on questions raised by the management and operations reports. Due to the level of detail, engineering reports are usually quite large; because of this, the reports may be periodically produced over a greater time interval than management and operations reports (e.g., once a month rather than once a week), or upon request for specific data.

Before describing the statistical reports, two topics are discussed. First, the rules for effective presentation of data in tables and graphs are reviewed in Section 3.1. Many of these are common sense rules followed in the normal course of preparing tables and graphs; however, this section is envisioned as a reference for the FMSO design team when it develops the LDCN statistical package. Second, an overview of the data proposed for gathering for the LDCN statistics is given in Section 3.2 so that the statistics described in the reports that follow can be mapped into the overall picture. After this, the various reports are described.

3.1 Rules for Preparing Tables and Graphs

In the course of developing proposed reports for FMSO consideration, NAC recognized that some fraction of the reports would not fulfill FMSO's needs. This fraction of reports would contain those with too much data, with too little data, with the wrong type of data, and with the wrong report format. NAC also recognized that because of this, FMSO personnel would have to design statistical reports for the LDCN. To aid the design team in developing the actual report formats, the current section on preparing tables and graphs is given.

The material given in this section is not new. The rules presented here were learned by the author when he attended an in-house seminar while working at Bell Laboratories in 1973. Figures 3.3, 3.6, and 3.7 were from a handout given at that seminar.

3.1.1 Tables

In the outputting of statistical tables, care should be taken to format the data so it will be useful to the persons reading the tables. If the table is not easy to read and/or the information being presented is not discernable, the table has failed its purpose. An example of this is shown in Figure 3.1, which presents a typical list from a computerized data base. After looking at Figure 3.1, one might assume the first column represented locations while the other columns were V&H coordinates; however, one has no quick way of verifying this assumption or of knowing what the locations represent. Figure 3.2 shows the same type of data after formatting. In this figure the locations and V&H coordinates are spelled out; further, one knows the data in the table represents potential new terminal sites by 1978. The difference due to formatting is dramatic; Figure 3.2 has been used in presentations and briefings of its network, while Figure 3.1 was not used for this purpose.

In order to format data into tables, one must know the basic parts of a statistical table. These basic parts are illustrated in Figure 3.3:

- a. The "title" should list such important factors as the type of material presented, its classification, the geographic region to which it refers, and the period covered. Titles should not be excessively long; so when a substantial amount of information must be given, sub-titles should be used to elaborate on the title.
- b. The "prefatory note" describes the figures in the table, including the units represented by the figures and any special characteristics or limitations of the data.

- c. The "caption" (column headings) and the "stub" (row identification - usually on the left) should be clear and very concise.
- d. The "unit of measurement" is used in the caption or stub as needed. It is not needed in Figure 3.3; however, if there were several different columns of data, the units of measurement would be inserted for each column. In this case, the prefatory note would be made more general or eliminated.
- e. The "body" of the table contains the rows and columns of actual data. The body should be spaced or divided by rulings so that each data item can be conveniently found.
- f. The "footnote" is used to explain some specific part of the table. It is placed immediately beneath the table and above any source note. Each footnote should be indicated by a symbol. Letters may be used to indicate footnotes only if there is no chance of mistaking them for data; for this reason, numbers should never be used to indicate footnotes.
- g. The "source note" is placed at the bottom of the table. Source notes should give the primary source of data along with the place where the data was actually found, if the two should be different. Source information should include: Author, Title, Volume, Series, Page, Publisher, Place of Publication, and Date. Source notes are usually not found in computer-generated tables.

Careful arrangement of a table facilitates reading, analysis, and comparison of data. Further, items can be

arranged to emphasize selected elements or specific aspects of data. The following are possible ways to arrange data in a table:

- a. Alphabetically according to item name. This is the most frequently used data arrangement in general-purpose tables.
- b. Chronologically according to the time of occurrence. Dates are arranged from the earliest to the latest and positioned so they move down the stub or across the captions from left to right.
- c. Geographically according to a customary classification such as country, state, county; or according to any customary listing such as cities by state region.
- d. Magnitude according to some aspect of size. The largest or the smallest number is placed at the top of the column while the others are arranged in descending or ascending order, as required. Similarly, caption rows are arranged in the same manner, from left to right.
- e. By customary classification, as in the case of non-serial data. For example, men, women, and children are rarely listed in any other order.

3.1.2 Graphs

As effective as a properly designed statistical table can be, a graph can be a more interesting and effective device for recording and illustrating the essential features

of a set of data and for pointing out the conclusions that can be drawn. For this reason, extensive use is made of such devices in presenting information to management or supervisory people who need a quick grasp of a broad situation. Unfortunately, the graphics capability of many printers leave much to be desired. Figure 3.4 shows a sample graphic output from a printer. The minimum and maximum values of X and Y are given, and the lower and upper values of Y are listed in the two columns next to the graph. However, the graph has to be rotated 90 degrees counterclockwise to obtain the proper perspective of the graph. Because of this and other inadequacies, many operation groups have an aide who will plot graphs from the data given them. Figure 3.5 is a sample of such a graph.

Because the purpose of all graphs is to convey certain information quickly and effectively, they must be kept as simple as possible. The natural tendency to include additional material must be resisted or the result will be complex presentations that defeat the basic purpose. Further, since graphs tend to catch the eye of the reader, they are often read out of context, making it extremely important that each one be complete and self-contained so the casual reader will still get the true meaning of the data presented. This is also important because of the tendency to use graphs out of context in speeches, special presentations, and technical papers.

The rules for graphs are similar to those cited for data tables. But since there are slight differences, applicable rules for graphs are best reviewed in full. These include:

- a. Every graph (see sample in Figure 3.6) should have a clear and concise title which includes information about the type of the data, the geographical location, and the period covered. The title

usually appears below printed graphs; otherwise, it is customary to put it at the top.

- b. Coordinate lines should be held to a minimum, while the curves should stand out sharply against the background.
- c. To increase understanding, the curves should be as few in number as possible, and each should stand out clearly. To do this, different symbols should be used for each curve.
- d. Any footnotes should be placed under the lower-left of the graph.
- e. If the data is not obtained from a computer, its source should be under the lower-left corner of the graph, below any footnotes.
- f. Scales of values should be placed along the X- and Y-axis to give a general indication of the sizes represented on the graph. Fine graduations are unnecessary, since it is not intended that actual values will be read from a graph. Such values are obtained from the tables which should also be part of the output.
- g. Time measurements are customarily put on the X-axis.
- h. On the Y-axis, the values should run from zero (or the smallest value) at the bottom of the graph to the highest value at the top. On the X-axis, the values should run from the lowest on the left to the highest on the right.

- i. Each axis should have its own caption to specify the units used unless they are completely obvious. The X-axis caption should be centered directly beneath the X-axis, while the Y-axis caption should be placed at the top of the Y-axis.
- j. The zero point should usually be included on the Y-axis. If it is not, the graph can be misleading in the apparent relationships of the data it presents (Figure 3.7). Note how inclusion of the zero point on the Y-axis in Graph 2 of Figure 3.7 indicates an entirely different ratio between the highs and lows.

If lack of space makes it inconvenient to use a zero point, a scale break can be inserted to signal the reader that a portion of the scale has been omitted.

- k. If spaces on the X-axis are used to indicate a time interval, the value for each period should be plotted at the midpoint of the interval (Figure 3.7). If the periods coincide with the coordinate lines, the points are plotted on the coordinates.

By following these simple rules, the tables and graphs of the network statistical package will convey their information quickly and effectively.

3.2 Overview of Proposed LDCN Data

In reading the following sections of the study, one might wonder what methodology was used by NAC to arrive at the proposed reports and data collection mechanisms. Basically, a listing of the possible statistics for communication networks was first created. The data needed to produce these

statistics was then determined. NAC's understanding of the LDCN was then used to determine which of this data could be straightforwardly collected by the LDCN. From this information, NAC developed a set of "proposed statistics" for the LDCN. Finally, the proposed reports were developed based on the proposed statistics.

When FMSO designs the LDCN statistical package, it should follow a similar methodology. Listings of possible network statistics and the data needed to produce them can be created from the information found in this report, the NAC documents listed in Table 2.1, and NAC document FR.095.02 - Simulation Specification for Modelling the Logistics Data Communication Network. Having mentioned this, let us now briefly look at the data NAC proposes for collection by the LDCN.

The proposed data falls into seven broad categories. The first category is data for System Configuration Statistics. In this group falls such data as the number of users on the system at any given time and their connectivity in the network (i.e., concentrator, front end, and system being accessed). Also in this category is data on host, front end, concentrator, and line status, such as start-up, shut-down, failure, and restoral reports. Such reports can be used by management to see if the contracted network reliability figures are being met.

The second set of data is for Traffic Statistics. This data centers around the ability of the front ends to capture information on message arrival times, source and destination information, and message type information (i.e., terminal-terminal, broadcast, inquiry, upquiry, batch, real-time, and/or AUTODIN traffic). This same data is needed for Message Statistics; in addition, message input and output length data is collected.

The data proposed for Response Time Statistics can be divided into those collected at the concentrators and those collected at the front ends. At the front ends, time and

date information is collected when the last segment of an input is successfully received, when the first segment of a real-time input message is placed on an output queue, and when the output buffer for the last segment of a real-time input message is released. Output timings are taken when the first segment is successfully received, when the first segment is placed on an output queue, and when the output buffer for the first output segment is released. These values allow determination of front end processing times, host processing times, and queuing and transmission times experienced by segments leaving the front ends. In addition to this data, an indication of when an output message is blocked from immediate delivery should be recorded. Finally, concentrators should be able to collect information on their average processing time of a segment, and on the queuing and transmission times of input segments to the front ends. This data will then allow response time - throughput calculations for real-time messages.

Utilization Statistics include CPU, disk, buffer, line, and core utilization. Core utilization data is on the borderline between the manual and computerized measurement subsystem. This data is obtained from a core map; however, the data need only be collected as new programs or buffer requirements are added to the system. Line utilization statistics can be determined from the data collected for System Configuration, Message Length, and Traffic Statistics. CPU, disk, and buffer utilization data depends upon the approach chosen by the system implementors, since both hardware and software monitoring is possible. Because of this, NAC does not recommend an approach for collecting this data; however, we do recommend that the data be collected.

The data for Queue Statistics could be obtained by either keeping track of the time each item is on queue, or by sampling the queue length each N milliseconds. For heavily loaded systems, the latter approach is more efficient. The former approach is more accurate; in addition, for lightly

loaded systems, it may be argued to be more efficient. NAC proposes initially implementing the latter approach. In addition to this data, the LDCN should collect data on whether a batch queue leaves the front end because of time or size criteria, as well as the number of entries in the queue.

Finally, data for Error Statistics should be collected. This data includes line error reports, concentrator and front end congestion reports, queue overflow reports, and other miscellaneous reports. NAC feels the data for these reports is readily available for collection by the front ends.

Figure 3.8 is a summary of the data proposed for collection by the LDCN. After reviewing this report and determining what data will be collected by the LDCN, FMSO personnel should create a similar figure for their own use and for documentation purposes.

3.3 Proposed Reports

This section describes the reports proposed by NAC for the LDCN computerized statistical package. Section 3.3.1 describes the core utilization report, which is included in the computerized subsystem only because data from a computer's core map is required. Section 3.3.2 reviews the three weekly summary reports and one exception report that should be received by management. In addition to these reports, personnel in operations should receive real-time, on-line reports, two additional weekly summary reports, and eight additional exception reports. Section 3.3.3 describes these operational reports. Section 3.3.4 discusses 30 possible engineering reports, telling when and where they may be used. Finally, Section 3.3.5 indicates an implementation schedule and the relative importance of each of the above reports.

3.3.1 Core Utilization Report

Figure 3.9 shows the proposed output for the core utilization report. The date the report is produced is given, as well as the concentrator or front end referred to by the report. Each entry in the report contains a program or storage identifier, the start and end values of the region it uses, and the region size in bytes. Core utilization reports should be produced only after changes are implemented to programs and storages in the communication devices. After being produced, these reports should be filed behind the Configuration Report of the manual measurement subsystem. Because of these facts, core utilization reports are said to be on the borderline between the manual and computerized measurement subsystems.

3.3.2 Management Reports

The theory behind management reports is to supply enough useful information so that a system can be tracked, but not too much information so that those reports will be read. In addition, system status exception reports are needed so management is made aware of major system problems and can bring its weight to bear on the solution. To fill this bill, the weekly summary reports of Figures 3.10-3.12 are proposed, as is the system status exception report of Figure 3.13.

Figure 3.10 presents the summary statistics needed to track the system. User, Traffic, and Response Time Statistics are given for the whole LDCN and for the ASO and SPCC subsystems, while Message Length Statistics are only given for the whole LDCN. The User Section of the report gives the total number of logons during the week, and the average number of users per hour during some prime-time period defined by LDCN management. By using only a prime-time

period in this and other reports, a more accurate picture of average utilization is seen, since lowly-utilized, off-peak hours are excluded from the average. The Traffic Section of the report gives the total number of messages for the week and the average number of messages per hour during the prime-time period. In addition, the traffic data is given for each message type so that an accurate model of the traffic can be obtained. The Response Time Section of the report gives the average time from successful reception of the last buffer of input into the concentrator until the first segment of the output is on queue for output by the concentrator. This response time corresponds to the traffic level shown for real-time messages per hour in the traffic section, so that a simulation model could be calibrated with the real system. Finally, the Message Length Section of the report gives the mean, standard deviation, and maximum character lengths for the inputs and outputs of each message type.

The Traffic Summary Plots of Figures 3.11-3.12 are used to show the traffic growth of the system for up to two years. Figure 3.11 is a plot for total messages per week, while Figure 3.12 is a plot for the average number of messages per hour per week. Both reports would show seasonal trends and as such only one or the other need be produced; however, by comparing the relative slopes of each graph, one could determine if the daily time interval for "average number per hour" should be increased to pick up an increase in "off-hours" traffic. Both reports could be produced on a weekly basis; however, LDCN management could just as easily receive one plot weekly and the other plot on a quarterly basis.

The System Status Exception Report is printed on a weekly basis only if some system component was unavailable for a period of time longer than the performance limit set for it. The report lists the component, the times it was unavailable on a given day, the reasons it was unavailable, and its

performance limit. By having this report, management would be alerted to major system problems, so they could use their position to help correct them.

3.3.3 Operational Reports

Operational personnel are involved with the everyday running of the system. Thus, in addition to receiving the managerial reports, operational personnel need on-line outputs to handle real-time system problems. Four on-line reports are proposed for the LDCN. The first is a System Status Update (Figure 3.14a) printed whenever a system component becomes available or unavailable. Along with the Buffer and Queue Overflow Update (Figure 3.14b) and the Excessive Line Error Update (Figure 3.14c), the System Status Update allows operations to reconfigure the network to temporarily solve system problems. The final on-line report is Invalid Password Update (Figure 3.14d), printed whenever an attempted entry to the system by terminal id XXXX fails because of three invalid password attempts. All four on-line reports will be printed at the LDCN network control center console.

To further aid operational personnel in the performance of their job, two additional weekly summary reports and eight exception reports are proposed. The LDCN CPU Utilization Summary Report (Figure 3.15) gives the average utilization during prime-time for each LDCN concentrator and front end. Along with the LDCN Status Summary Report, this report would allow operations to correlate CPU utilization growth with LDCN traffic growth and determine when processors would become saturated. The System Status Report (Figure 3.16) is a summary of the on-line System Status Update Reports which would allow operations to determine what equipment should be replaced. In addition, the System Status Report indicates whether Manual or Automatic Intervention was used to accomplish a given action.

The Buffer Usage Exception Report (Figure 3.17) and the Output Queue Exception Report (Figure 3.18) give a summary of the on-line Buffer and Queue Overflow Update Reports. These reports also list buffer pools and queues whose lengths exceeded a warning limit but did not overflow. The maximum length observed, the maximum length before overflow, and the warning limit would also be reported.

The Line Notification Report (Figure 3.19) summarizes the on-line Excessive Error Update Reports on a line identification basis, while the Password Failure Report (Figure 3.20) summarizes the on-line Invalid Password Update Reports on a terminal identifier basis. These exception reports would allow operations to determine whether certain line and access problems are transient or chronic; once this determination was made, appropriate action could be taken.

The Line Utilization Exception Report (Figure 3.21), the CPU Utilization Exception Report (Figure 3.22), and the Disk Utilization Exception Report (Figure 3.23) would be printed whenever the hourly utilization of a line, CPU, or disk exceeds its specified utilization performance limit. The component identifier is given, as well as the date and time the limit was exceeded. Also given is the component's observed utilization and performance limit. The Congestion Report (Figure 3.24) lists the number of times a concentrator or front end had to stop receiving traffic because of internal congestion. In addition, the average "congestion interval" observed for each component is given. These four exception reports would allow operations to make adjustments to the network before the reported minor problems became major ones.

3.4 Engineering Reports

The purpose of engineering reports is to provide detailed data to questions raised in the management and operational

reports. To this end, thirty engineering reports in six different areas are proposed for consideration by FMSO personnel. It is expected that only a fraction of these reports would be implemented; however, all are listed to allow FMSO to make the final decision for implementation.

3.4.1 User Statistics

The User Statistics Engineering Reports consist of five documents. The basic report is the LDCN User Status Report (Figure 3.25), which lists on a daily basis the total number of logons, average number of users per hour over prime time, average number of users per peak hour, and the hour during which the peak occurred. These statistics are given for the LDCN network, and for the ASO and SPCC systems. The User Status Report by System (Figure 3.26) would allow the data for the user status report to be filtered by System and Concentrator before being reported. User Status Plots (Figure 3.27) show the average number of users over 15 minute intervals for a given day. The User Status Reports could be used to observe the daily effects of a system cut-over; this is probably the only time when either report would be requested. However, User Status Plots for the entire LDCN should be produced after each system cutover or every six months, as this report would allow operations and management to see the distribution of users over a day as the network grows.

The System Configuration Report (Figure 3.28) is the fourth report on user statistics. This document gives a snapshot of the LDCN at a given minute, and shows the connectivity of users in the network at that minute. Conversely, the System Signon-Signoff Report (Figure 3.29) gives the connectivity of users over an entire day. The System Configuration Report would be shorter than the Signon-Signoff Report;

however, both reports would probably be used only for debugging purposes. As such, these reports should be implemented last, if at all.

3.4.2 Traffic Statistics

The Traffic Statistics Engineering Reports would also consist of five documents. The LDCN Traffic Statistics Report for the entire network (Figure 3.30) and for the SPCC and ASO Systems (Figures 3.31-3.32) map the weekly traffic statistics found on the LDCN Status Summary onto a daily basis. In addition, the peak-hour traffic breakdown is given for each day. The Traffic Statistics Report by System and Traffic Type (Figure 3.33) allows the traffic data to be filtered by System, Concentrator, and Traffic Type before being reported, while Traffic Statistic Plots (Figure 3.34) show the number of messages received over 15-minute intervals for a given day. As in the User Statistic Reports, the Traffic Reports probably would be requested only during system cutover, while Traffic Statistic Plots for the entire LDCN would be produced after each system cutover or every six months.

3.4.3 Response Time

Three reports would deal with response times. The LDCN Response Time Report (Figure 3.35) maps the average response time and traffic load found on the LDCN Status Summary onto a daily basis. The peak-hour response time and traffic load is also given for each day. The Response Time Report by System (Figure 3.36) filters the data by System and Concentrator before reporting, while the Response Time Report by Component (Figure 3.37) shows the processing and queuing times for a specific concentrator or front end. These reports would be requested only when a question on response times

arose. When this occurred, the Report by System could be run to isolate the problem to a set of specific concentrators and/or systems. The Report by Component would then be run for the selected items, which would hopefully answer the question. Given this scenario, all three reports should eventually be implemented.

3.4.4 Message Lengths

Four reports would deal with message length statistics. The Message Length Statistic Report (Figure 3.38) maps the data found on the LDCN Status Summary onto the ASO and SPCC Systems, while the Report by System and Traffic Type (Figure 3.39) filters the message length data before processing the report. Message length histograms for input and output (Figures 3.40-3.41) are also suggested for implementation. While the Statistical Reports would only be used for debugging purposes, the histograms would be run after system implementation and when the mean or standard deviation of a message type varied significantly from normal. Because of this, the histograms should be implemented before the other message length reports.

3.4.5 CPU Utilization

CPU Utilization Engineering Reports would consist of four documents. The CPU Utilization Report (Figure 3.42) lists on a daily basis the data found in the LDCN CPU Utilization Summary; in addition, daily peak-hour utilization is given. The CPU Utilization Report by Module (Figure 3.43) further refines the statistics of Figure 3.42, while the CPU Module Access Report (Figure 3.44) looks at module accesses rather than module utilization. Finally, CPU Utilization Plots (Figure 3.45) shows the average utilization of a CPU over 15-minute intervals for a given day. All four

reports could be used to provide detailed information on questions raised by the CPU Utilization Summary or Exception Reports; however, the CPU Utilization Plots would probably be the most used. Because of this, we recommend the plots be implemented before the other CPU Utilization Reports.

3.4.6 Exception Refinements

Similar to the CPU Engineering Reports, eight reports would provide detailed information on questions raised by the Buffer Usage, Output Queue, Line Notification, Line Utilization, and Disk Utilization Exception Reports. Figures 3.46-3.53 show the format of these reports. Finally, the Batch Queue Report (Figure 3.54) would be used to show the ratio of time criteria batches to size criteria batches. This report would mostly be used for system modeling purposes.

3.5 Implementation Schedule

The above reports are a subset of the universe of possible reports for the LDCN; however, NAC feels they cover all the key statistics in the LDCN's universe. The question of which of these reports should be implemented may now be asked. There is some rationale in implementing all the reports; however, NAC feels that this would require FMSO to dedicate extraordinary resources to the statistical package. Assuming a more realizable, limited commitment by FMSO personnel to the problem, NAC developed Table 3.1. This table ranks the reports in terms of most important to least important. Rather than order the reports in terms of importance, seven levels of importance are given. This latter approach is easier and somewhat more fair than a total ordering of reports, since the importance of a report depends on a number of factors which cannot be defined precisely.

After defining the various report levels, NAC then attempted to correlate these levels to the latest possible times the reports could be implemented without having a major impact on the network by not providing "necessary" data. Thus management reports and operational real-time reports should be implemented by system cutover. These reports would allow the network to be tracked from cutover, and could be used to calibrate network models. Within the next 6-9 months, the other operational exception reports should be implemented. These reports require "exceptional" conditions to occur to be produced; thus to test them, the exceptional performance limit of each item must be set lower than the normal performance seen from the item. After the reports are checked, the limits would be set to their proper values. Two additional exception type reports should be available by the end of the first year. By the end of the second year, NAC would expect the LDCN to have implemented key engineering reports, although we feel the traffic statistic plot and the message length histograms should be implemented before this period if possible. Finally, the other engineering reports basically filter the data found above. Because of this, these reports should be added to the statistical package only if they are requested by LDCN network control center personnel, and/or if they can be implemented easily along with one of the above "necessary" reports.

Whether or not the above schedule is followed, a similar approach to the problem is recommended for the LDCN statistical package design team.

BLUM LAKE	6097	4526
BIRIP	5538	5166
GRAHAM	5628	4580
BRAIDON	5728	4940
BROOKLYN CENTER (TC)	5781	4525
BROOKVILLE	5661	4847
BROOKS VALLEY	5872	5062
BUFFALO	5760	4629
BUFFALO LAKE	5913	4695
BURNSVILLE (TC)	5781	4525
CALDONIA	5927	4150
CAMBELL	5748	5063
CANY	6018	4929
CANYON FALLS	5850	4433
CARLTON	5395	4563
CASPER LAKE	5389	4923
CASSIA	5840	4555
CASSIA LAKE	5678	4509
CASSIA	5840	4968
CASSIA PINES (TC)	5781	4525
CLAIR CITY	5915	4822
CLAIRISSA	5656	4863
CLARKFIELD	5984	4871
CLOQUET	5388	4572
COLUMBIA SPRING	5760	4732
COLUMBIA RAINIE	5335	4757
COLUMBIA HEIGHTS (TC)	5781	4525
COSBY	5526	4755
DAKOTA CTRY	5781	4525
DISSEL COKATO	5819	4664
DIXSON	5961	4918
DOLAN	5801	4604
DODGE CENTER	5940	4382
DULWORTH (MOORHEAD)	5615	5177
EAST CHAIN	6128	4557
EAST GRAND FORKS	5415	5299
EVEN PRAIRIE (TC)	5781	4525
EGERTON	6177	4841
EMINA (TC)	5781	4525
ELBOW LAKE	5745	4995
ELLSWORTH	6241	4794
EY	5118	4602
ESKO (DULUTH)	5352	4530
FAIRFAX	5961	4692
FARMONT	6118	4578
FERTILE	5455	5166
FISHER	5430	5258
FLOODWOOD	5376	4654
FOLEY	5685	4677
FOREST LAKE	5704	4513
FOSSTON	5416	5096
FRAZEE	5583	5018
FREEBORN	6038	4460
FRIEDLEY (TC)	5781	4525
GARY	5485	5150
GAYLORD	5925	4622
GENWOOD	5779	4884
GYNDON	5603	5153
GOLDEN VALLEY (TC)	5781	4525
GONVICK	5369	5078
GOODHUE	5852	4383
GOODRIDGE	5306	5151

Figure 3.1 - SAMPLE OF AN UNFORMATTED TABLE

POTENTIAL NEW TERMINAL SITES BY 1976

LOCATION	V	H	LOCATION	V	H	LOCATION	V	H
AITKIN	5502	4727	ELMORE	6123	4513	NEWFOLDEN	5293	5241
ALDEN	6037	4455	ERMONS	6086	4425	NEW RICHLAND	6009	4461
ALVARADO	5534	5315	ERSKINE	5414	5139	NORTHFIELD	5076	4464
AMROY	6051	4556	EVANSVILLE	5725	4936	OGILVIE	5622	4625
ARGYLE	5324	5304	FINLAYSON	5518	4988	OKABENA	6153	4711
ASHBY	5716	4981	FRANKLIN	5972	4717	OKLEE	5370	5132
ASKOV	5511	4567	FROST	6097	4495	OLIVIA	5928	4751
ATWATER	5844	4752	FULDA	6145	4765	ONAMIA	5591	4679
AUBURN	5570	5068	GARDEN CITY	6020	4570	OSLO	5368	5336
RACKUS	5495	4863	GLENCOE	5876	4633	PEQUOT LAKES	5525	4815
RADGER	5190	5234	GLENVILLE	6065	4402	PETERSON	5921	4213
BEARDSLEY	5874	5062	GRAHADA	6103	4566	PIERZ	5636	4731
BECKER	5736	4650	HALLOCK	5242	5337	PILLAGER	5590	4814
BELLE PLAINE	5082	4565	HALSTAD	5522	5225	PINE RIVER	5507	4838
BELLINGHAM	5934	4967	HARMONY	5973	4216	PLUMMER	5366	5164
RELVICH	5983	4785	HECTOR	5918	4710	PRESTON	5960	4230
BERTINA	5637	4891	HENDRUM	5538	5216	PRINCCYTON	5684	4623
RIG LAKE	5740	4624	HENNING	5649	4947	PRINSBURG	5909	4793
BIRD ISLAND	5924	4737	HERON LAKE	6142	4716	RENVILLE	5938	4745
BREHSTER	6171	4729	HILL CITY	5406	4751	ROUND LAKE	6203	4716
BROWTON	5897	4657	HOUSTON	5906	4773	ROYALTON	5676	4745
BUHL	5254	4687	HUMBOLDT	5220	5389	RUSH CITY	5623	4549
BUTTERFIELD	6078	4653	ISLE	5566	4637	RUSHFORD	5910	4283
CEYLON	6154	4593	JORDAN	5846	4548	ST CHARLES	5900	4262
CHAUDLER	6154	4819	KARLSTAD	5259	5283	ST MICHAEL	5760	4603
CHATFIELD	5932	4270	KENNINGTON	5772	4938	SANDSTONE	5529	4574
CHISHOLM	5262	4700	KERKHOVEN	5856	4833	SEBEKA	5565	4925
CLAREMONT	5947	4403	KIESTER	6093	4460	SHERBURN	6135	4618
CLEARBROOK	5374	5062	LAKE BENTON	6109	4694	SILVER LAKE	5894	4649
CLEVELAND	5945	4547	LANCASTER	5218	5345	SPRING GROVE	5951	4163
CLIMAX	5463	5245	LANESBORO	5943	4226	SPRING VALLEY	5977	4284
CLINTON	5878	5015	LE SUEUR	5924	4570	STARBUCK	5794	4901
COMFREY	6055	4682	LYLE	6048	4347	STORCKEN	6094	4736
COOK	5180	4708	LIND	6059	4849	STRANDQUIST	5272	5268
COSMOS	5078	4723	MADEL	5968	4179	TAYLORS FALLS	5658	4479
COTTONWOOD	6005	4835	MAPELTON	6030	4531	TWIN VALLEY	5507	5141
CROMWELL	5421	4627	MAYNARD	5931	4032	ULEN	5545	5125
CROOKSTON	5424	5229	MAZEPPA	5871	4359	UNDERWOOD	5680	5004
CYRUS	5806	4929	MCINTOSH	5412	5119	UPSALA	5697	4782
DANUDE	5933	4769	MELROSE	5739	4804	VERNDALE	5607	4894
DEER CREEK	5627	4936	MENANGA	5542	4936	VILLARD	5758	4872
DEER RIVER	5349	4810	MILROY	6034	4802	VALDOOF	6014	4494
DELANVAN	6068	4526	MINNESOTA LAKE	6031	4876	WALNUT GROVE	6067	4775
EAGLE BEND	5654	4878	MINNESOTA LAKE	6041	4583	WATERTOWN	5819	4606
ECHO	5905	4798	MORRISTOWN	5940	4483	WINNEBAGO	6077	4546
ELGIN	5800	4306	MOUNTAIN LAKE	6090	4671	WINSTED	5832	4635
ELLENDALE	6000	4431	MURDOCK	5863	4847	WOLF LAKE	5547	4976
			NEVIS	5484	4919			

Figure 3.2 - SAMPLE OF A FORMATTED TABLE

POPULATION OF THE UNITED STATES (Title)
BY GEOGRAPHIC DIVISIONS, 1960

(Population In Thousands) (Prefatory Note)

DIVISION	POPULATION	PERCENT OF TOTAL ^c	(Column Headings)
<u>United States</u>	<u>179,323</u>	<u>100.0</u>	
New England	10,509	5.9	
Middle Atlantic	34,168	19.0	
East North Central	36,226	20.2	
West North Central	15,394	8.6	
South Atlantic	25,972	14.5	
East South Central	12,050	6.7	
West South Central	16,951	9.5	
Mountain	6,855	3.8	
Pacific	21,198	11.8	
<p>*Percentage rounded to one decimal place. (Footnote)</p>			
<p>Source: U.S. Bureau of the Census, Statistical Abstract of the United States, 1966, 87th edition, (Washington, D.C., 1966) p.12.</p>			(Source Note)

Figure 3.3 - SAMPLE TABLE

LOWER BOUNDS

MINIMUM Y =

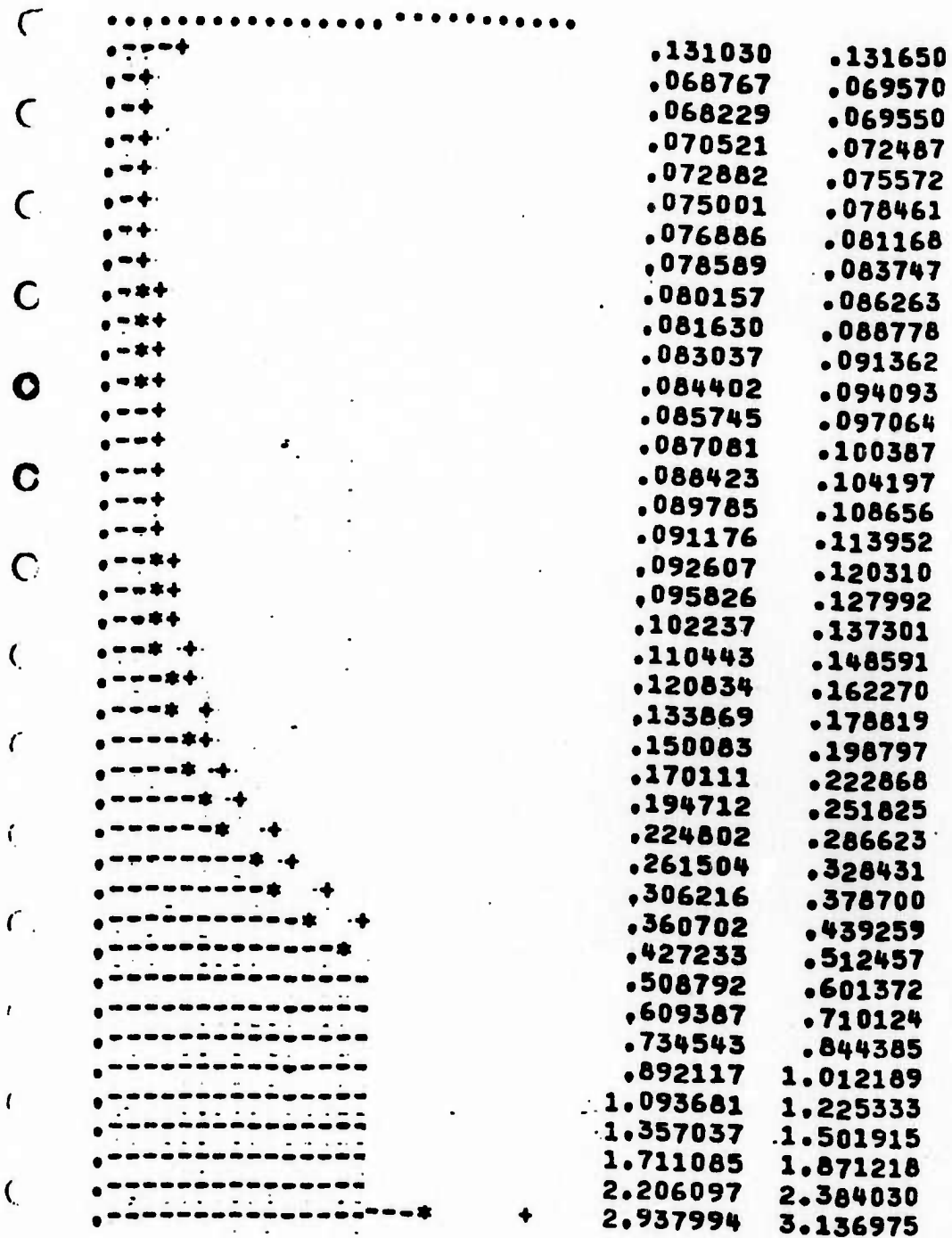
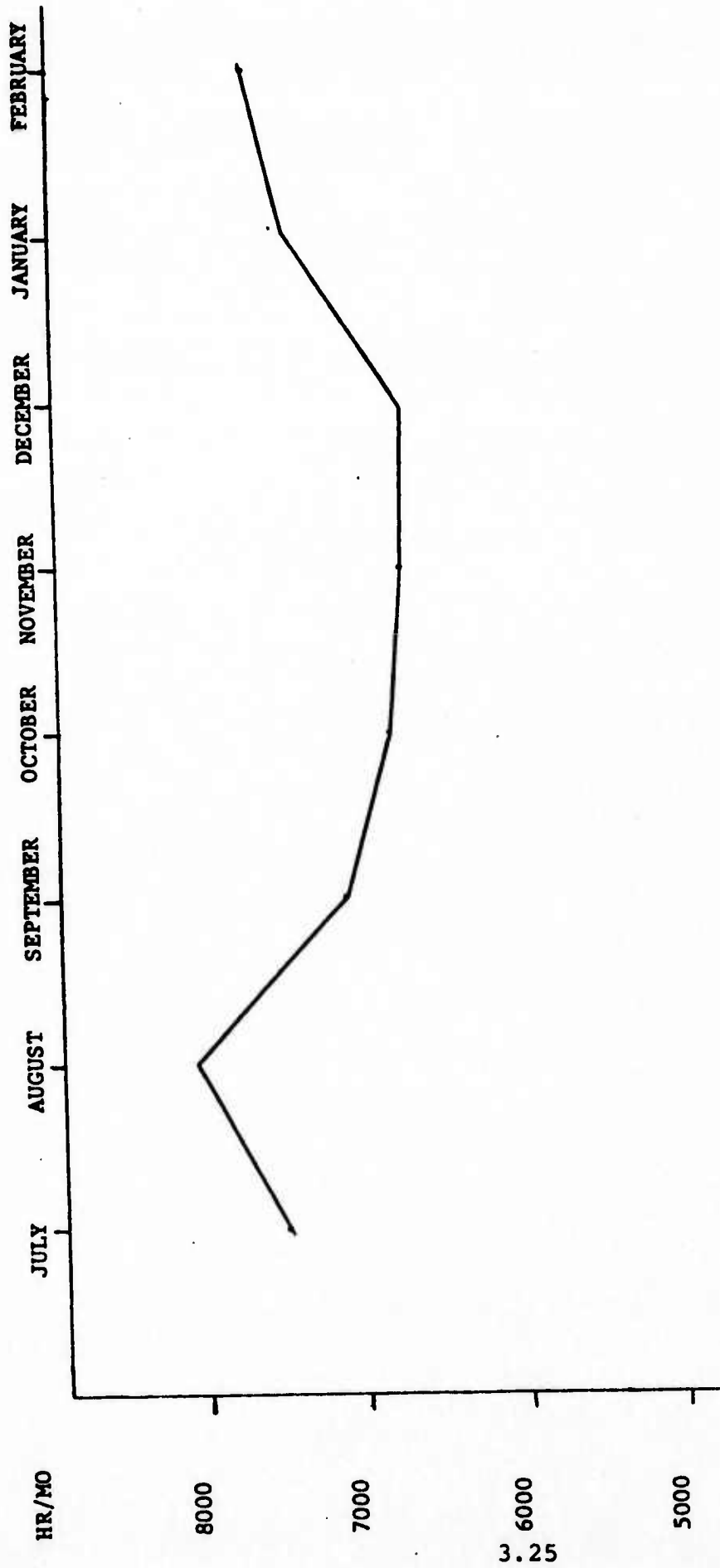

Figure 3.4 - SAMPLE OF A COMPUTER-GENERATED GRAPH



TELECOMMUNICATIONS WORKLOAD
JULY 75 THRU FEB 76

Figure 3.5 - SAMPLE OF A HAND-DRAWN GRAPH FROM COMPUTER-SUPPLIED DATA

PIG IRON PRODUCTION IN THE UNITED STATES, 1923-1930* — (Title)

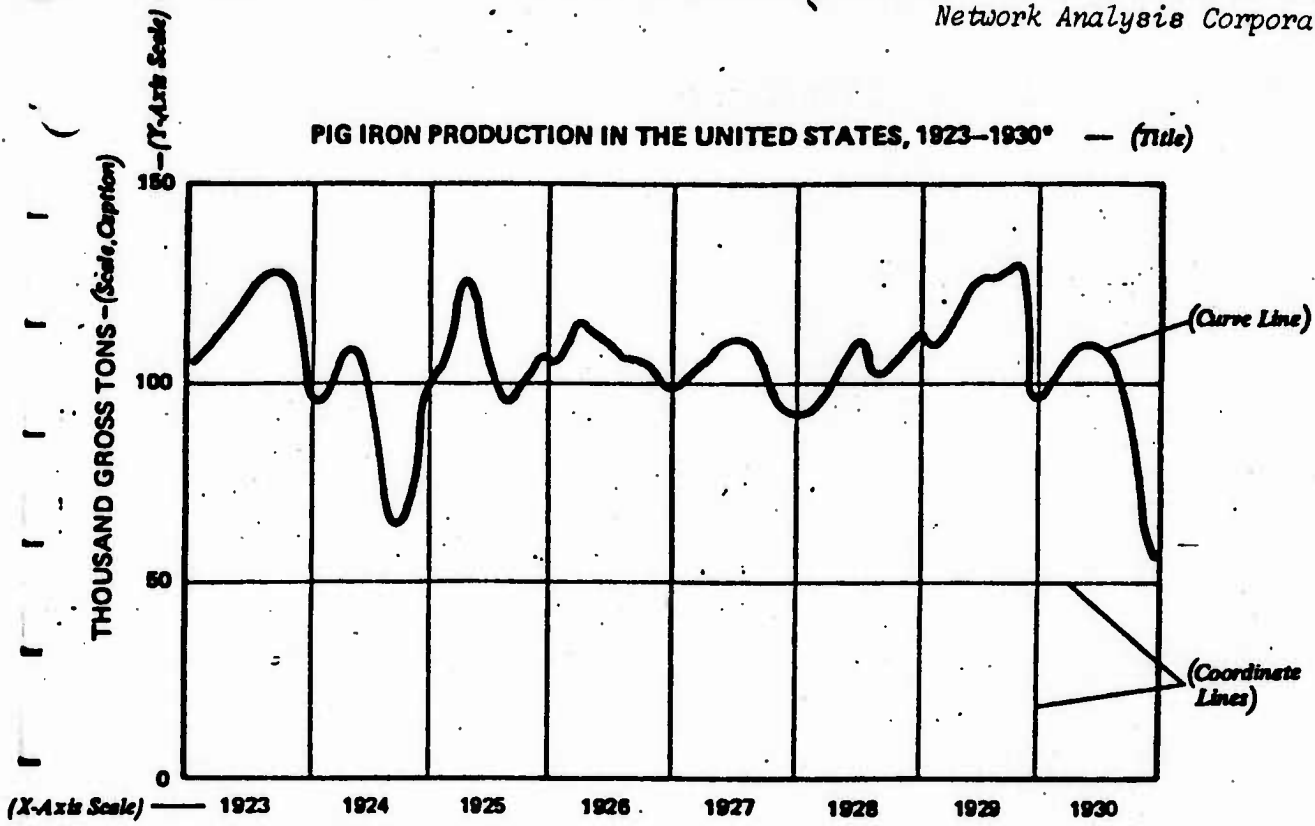

*Average Daily Production (Footnote)

Source: Iron Age (Source)

Figure 3.6 - SAMPLE GRAPH

STEEL INGOT PRODUCTION IN THE UNITED STATES, 1925-1930

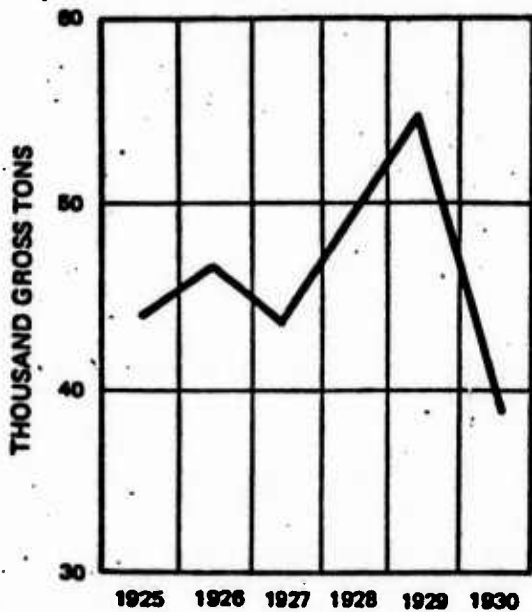

GRAPH 1

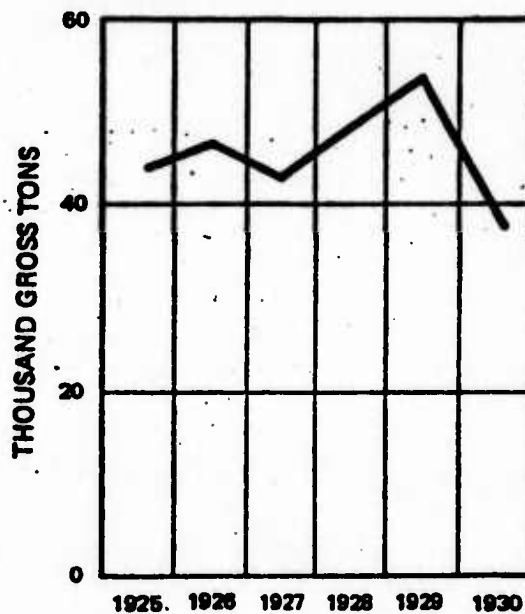

GRAPH 2

Source: American Iron and Steel Institute

Figure 3.7 - IMPORTANCE TO Y-AXIS ZERO POINT

Figure 3.8

SUMMARY OF THE DATA PROPOSED FOR COLLECTION BY THE LDCN

I. Data for System Configuration Statistics

A. Terminal Logon, Logoff, and System Change

1. Terminal Identification
2. Password
3. Terminal Type
 - a) CRT, TTY, or RJE
 - b) Linespeed
 - c) Character Code
 - d) Synchronous or Asynchronous
 - e) Buffered or Non-Buffered
 - f) Dial-In or Leased Line
4. System Accessed
5. Concentrator Accessed
6. Time and Date of Action (Logon, Logoff, or Change)

B. FEP, Concentrator, and Host Start-Up, Shut-Down, Failure, Restoral

1. Equipment Identification
2. Time and Date of Action

C. FEP - Concentrator Line Status (Up, Down)

1. Line Identification
2. Time and Date of Action
3. Operator-Initiated or Automatic

D. FEP - Concentrator Dial-Backup Status (Start Use, End Use)

1. FEP and Concentrator Identification
2. Time and Date of Action
3. Operator-Initiated or Automatic

II. Data for Traffic Statistics

A. Date and Time Message Successfully Enters FEP

B. Traffic Flow

1. Terminal Identification
2. System
3. Count of Number of Entries from that Terminal to that System
During this Session - Message Number

C. Traffic Type - Message Type

1. Terminal-Terminal
2. Broadcast
3. Program Type
 - a) Inquiry or Upquiry
 - b) Batch or Real-Time
 - c) AUTODIN or Non-AUTODIN

III. Data for Message Length Statistics

- A. Date and Time Message Successfully Enters FEP on Input and Output
- B. Message Type
- C. Terminal and System Identifiers
- D. Input and Output Message Length
- E. Message Number

IV. Data for Response Time Statistics

- A. FEP and Concentrator Timings on Input and Output
 1. Buffer Allocated for Segment
 2. Segment Successfully Received
 3. Segment Placed on Output Queue
 4. Buffer for Segment Released
- B. Output Status Flag
 1. Output Blocked by Another Transmission
 2. Output Stored Until Next Session
- C. Traffic Load

V. Data for System Utilization Statistics

- A. CPU Utilizations for FEPs and Concentrators
 1. Overall Utilization by CPU
 2. On a Module-by-Module Basis per CPU
- B. Disk Utilization for FEPs (and Concentrators)
 1. Seek Time
 2. Processing

- C. Buffer Utilization for FEPs and Concentrators
 - 1. Buffer Allocation and Restoration Times
- D. Line Utilization for FEP - Concentrator Lines and FEP-Host Channels
 - 1. Line or Channel Identification
 - 2. Number of Characters Transmitted and Direction of Transmission
 - 3. Number of Retransmissions on Line
 - 4. Linespeed and Character Code
- E. Core Utilization for FEPs and Concentrators
 - 1. Programs
 - a) O/S
 - b) Applications
 - 2. Buffering

VI. Data for Queuing Statistics

- A. FEP Output Queues to Hosts and Concentrators, Concentrator Output Queues to FEPs
 - 1. Equipment Identification and Queue Number
 - 2. Time Segment Placed on Output Queue
 - 3. Current Number of Entries on Queue
 - 4. Total Number of Entries on Queue
 - 5. Time Buffer is Released
- B. FEP Batch Queues
 - 1. FEP Identification and Queue Number
 - 2. Number of Items in Batch
 - 3. Criteria Flag
 - a) Batch Limit Met
 - b) Time Limit Met

VII. Data for Error Statistics

- A. Terminal-Concentrator Line Errors
 - 1. Line Identification
 - 2. Error Type
 - a) Message in Error - Retransmit
 - b) User Requests Message Retransmission

- B. FEP - Concentrator Line Error
 - 1. Line Identification
 - 2. Error Type
 - a) Message in Error - Retransmit
 - b) Time-Out Occurred
 - c) Terminal Requests Message Retransmission
 - d) Concentrator Requests All Messages be Retransmitted
- C. FEP-Host Channel Errors
 - 1. Channel Identification
 - 2. Error Type
 - a) Message in Error - Retransmit
 - b) Time-Out Occurred
- D. Congestion Reports
 - 1. Concentrator: FEP-Concentrator Messages
 - a) Concentrator Congested - Wait
 - b) Continue Transmission
 - 2. FEP: FEP-Host Messages
 - a) FEP Congested - Retransmit After Pause
 - b) FEP Workload Excessive - Wait
 - c) Continue Transmission
 - 3. Queues
 - a) N% Utilized
 - b) Queue Overflow
- E. Other Errors Detected by FEP
 - 1. Transmission from Host Queue N Lost - Please Retransmit
 - 2. Three Incorrect Passwords Detected

CORE UTILIZATION REPORT

mm/dd/yy

{ FEP: xxxxxxxx }
 { CONCENTRATOR: xxxxxxxx }

SIZE IN BYTES

END OF REGION

START OF REGION

PROGRAM/STORAGE

Q/S

::

APPLICATIONS

::

BUFFER POOLS

::

TOTAL CORE OF MACHINE:

TOTAL CORE USED:

TOTAL CORE AVAILABLE:

Figure 3.9

LDCN STATUS SUMMARY

FOR WEEK FROM mm/dd/yy TO mm/dd/yy

	<u>LDCN</u>	<u>ASO</u>	<u>SPCC</u>
1. TOTAL NO. OF LOGONS	xxx	xxx	xxx
AVERAGE NO. OF USERS/HR. FROM hh:mm TO hh:mm	xxx	xxx	xxx

	<u>TOTAL FOR WEEK</u>	<u>AVERAGE NO./HR.</u>	<u>TOTAL FOR WEEK</u>	<u>AVERAGE NO./HR.</u>	<u>TOTAL FOR WEEK</u>	<u>AVERAGE NO./HR.</u>
2. TRAFFIC STATISTICS						
ALL MESSAGES	xxx	xxx	xxx	xxx	xxx	xxx
COMPUTER MESSAGES	xxx	xxx	xxx	xxx	xxx	xxx
INQUIRY	xxx	xxx	xxx	xxx	xxx	xxx
UPQUIRY	xxx	xxx	xxx	xxx	xxx	xxx
BATCH	xxx	xxx	xxx	xxx	xxx	xxx
REAL-TIME	xxx	xxx	xxx	xxx	xxx	xxx
NON-AUTODIN	xxx	xxx	xxx	xxx	xxx	xxx
AUTODIN	xxx	xxx	xxx	xxx	xxx	xxx
OTHER MESSAGES	xxx	xxx	xxx	xxx	xxx	xxx
TERMINAL-TERMINAL	xxx	xxx	xxx	xxx	xxx	xxx
BROADCAST	xxx	xxx	xxx	xxx	xxx	xxx
3. AVERAGE RESPONSE TIME FOR REAL-TIME MESSAGES (SEC)	xxx	xxx	xxx	xxx	xxx	xxx

	<u>INPUT (CHARS)</u>		<u>OUTPUT (CHARS)</u>	
	<u>MEAN</u>	<u>S.D.</u>	<u>MEAN</u>	<u>S.D.</u>
4. MESSAGE LENGTH STATISTICS				
ALL MESSAGES	xxx	xxx	xxx	xxx
COMPUTER MESSAGES	xxx	xxx	xxx	xxx

Figure 3.10

LDCN STATUS SUMMARY (continued)
FOR WEEK FROM mm/dd/yy TO mm/dd/yy

INPUT (CHARS)		OUTPUT (CHARS)	
MEAN	S.D.	MEAN	S.D.

INQUIRY
UPQUIRY

BATCH
REAL-TIME

NON-AUTODIN
AUTODIN

OTHER MESSAGES

TERMINAL-TERMINAL
BROADCAST

LDCN TRAFFIC SUMMARY PLOT-MESSAGES PER WEEK

mm/dd/yy

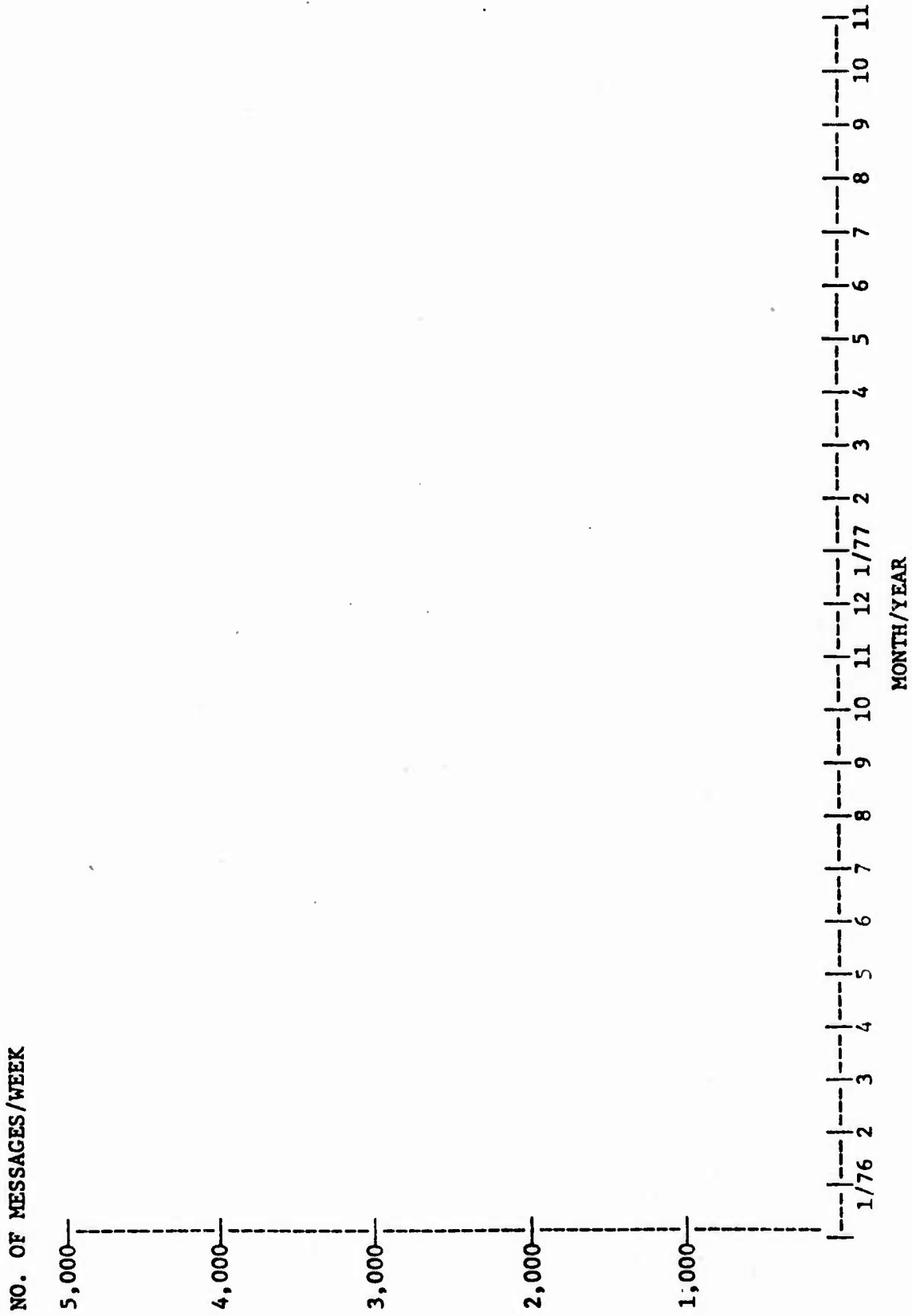
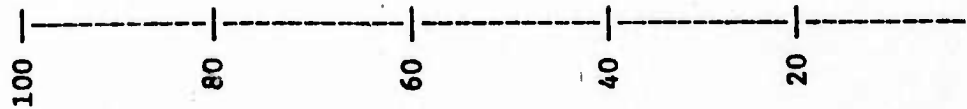

Figure 3.11

LDCN TRAFFIC SUMMARY PLOT - AVERAGE NO. OF MESSAGES/HR.

mm/dd/yy

AVG. NO. OF
MSG. /HR.



3.35

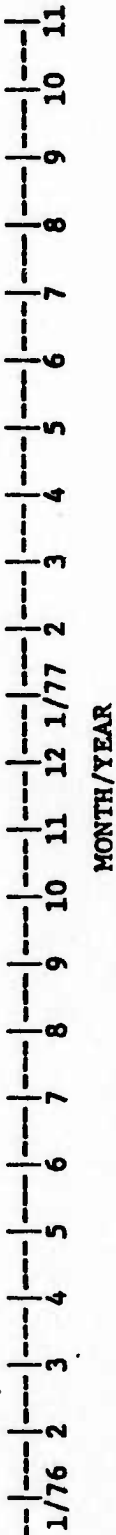

Figure 3.12

SYSTEM STATUS EXCEPTION REPORT
 FOR WEEK FROM mm/dd/yy TO mm/dd/yy

EQUIPMENT OR LINE ID.	DATE	TIME UNAVAILABLE		REASON	PERFORMANCE LIMIT FOR ITEM (UNAVAILABLE HOURS PER DAY)
		FROM	TO		
xxxxxxx	mm/dd	hh:mm	hh:mm	SHUT-DOWN FAILURE	
..					

Figure 3.13

- mm/dd/yy hh:mm {
CONCENTRATOR: xxxx
FEP: xxxx
LINE: xxxx
}
- a) System Status Update Report {
STARTED-UP
SHUT-DOWN
FAILED
RESTORED
}
- mm/dd/yy hh:mm {
CONCENTRATOR: xxxx
FEP: xxxx
}
- b) Buffer and Queue Overflow Update Report {
BUFFER POOL: xxxx
QUEUE: xxxx
}
- OVERFLOW
- mm/dd/yy hh:mm LINE: xxxx EXCESSIVE ERRORS: {
HITS
TIME-OUTS
--
}
- c) Excessive Line Error Update Report
- mm/dd/yy hh:mm USER ID: xxxx INVALID PASSWORD
- d) Invalid Password Update Report

Figure 3.14 - REAL-TIME REPORTS

LDCN CPU UTILIZATION SUMMARY
FOR WEEK FROM mm/dd/yy TO mm/dd/yy

FEP OR CONCENTRATOR ID. AV. UTILIZATION FROM hh:mm TO hh:mm

xxx
xxx

.xxx
.xxx

Figure 3.15

SYSTEM STATUS REPORT
 FOR WEEK FROM mm/dd/yy TO mm/dd/yy

DATE	TIME	EQUIPMENT OR LINE ID.	ACTION			OPERATOR
			START-UP	SHUT-DOWN	FAILURE	
mm/dd	hh:mm	xxxxxxx	X			OPERATOR
	hh:mm				X	
	:					
	hh:mm					
mm/dd	hh:mm		X			AUTOMATIC
	:					

Figure 3.16

BUFFER USAGE EXCEPTION REPORT
 FOR WEEK FROM mm/dd/yy TO mm/dd/yy

<u>CONCENTRATOR OR FEP ID</u>	<u>BUFFER POOL ID.</u>	<u>DATE</u>	<u>TIME</u>	<u>OVERFLOW</u>	<u>BUFFER LIMIT EXCEEDED</u>	<u>MAXIMUM BUFFERS IN USE</u>	<u>NO. OF BUFFERS IN POOL</u>	<u>CURRENT BUFFER LIMIT</u>
XXXXXX	XXXXXX	mm/dd	hh:mm		X			
XXXXXX	XXXXXX	mm/dd	hh:mm	X				

Figure 3.17

OUTPUT QUEUE EXCEPTION REPORT
 FOR WEEK FROM mm/dd/yy TO mm/dd/yy

<u>FROM</u>	<u>TO</u>	<u>DATE</u>	<u>TIME</u>	<u>QUEUE OVERFLOW</u>	<u>QUEUE LIMIT EXCEEDED</u>	<u>MAXIMUM LENGTH OBSERVED</u>	<u>MAXIMUM QUEUE SIZE</u>	<u>CURRENT QUEUE LIMIT</u>
xxxxxx	xxxxxx	mm/dd	hh:mm		X			
xxxxxx	xxxxxx	mm/dd	hh:mm	X				
	:							

Figure 3.18

LINE NOTIFICATION REPORT

FOR WEEK FROM mm/dd/yy TO mm/dd/yy

<u>LINE IDENTIFIER</u>	<u>NUMBER OF OPERATOR NOTIFICATIONS</u>	<u>TIME-OUT</u>
<u>TOTAL</u>	<u>ERROR IN MESSAGE</u>	

XXXXXX
:
:

(list in descending order by TOTAL; cutoff limit on TOTAL can be set)

Figure 3.19

PASSWORD FAILURE REPORT

FOR WEEK FROM mm/dd/yy TO mm/dd/yy

<u>USER ID.</u>	<u>DATE</u>	<u>TIME</u>
xxxxxx	mm/dd	hh:mm hh:mm
	mm/dd	hh:mm
xxxxxx	mm/dd	hh:mm

(list in descending order by number of entries per user id)

Figure 3.20

LINE UTILIZATION EXCEPTION REPORT
 FOR WEEK FROM mm/dd/yy TO mm/dd/yy

CHANNEL OR LINE ID.	DATE	TIME		NO. OF HOURS	UTILIZATION OBSERVED	UTILIZATION PERFORMANCE LIMIT
		FROM	TO			
xxxxxx	mm/dd	hh:mm	hh:mm		(0)	.xxx

Figure 3.21

CPU UTILIZATION EXCEPTION REPORT
FOR WEEK FROM mm/dd/yy TO mm/dd/yy

CONCENTRATOR OR FEP ID.	DATE	TIME		UTILIZATION OBSERVED	UTILIZATION PERFORMANCE LIMIT
		FROM	TO		
XXXXXX	mm/dd	hh:mm	hh:mm		
:					
:					

Figure 3.22

DISK UTILIZATION EXCEPTION REPORT
FOR WEEK FROM mm/dd/yy TO mm/dd/yy

<u>CONCENTRATOR OR FEP ID.</u>	<u>DISK ID.</u>	<u>DATE</u>	<u>FROM</u>	<u>TO</u>	<u>NO. OF HOURS</u>	<u>UTILIZATION OBSERVED</u>	<u>UTILIZATION PERFORMANCE LIMIT</u>
xxxxxx		mm/dd	hh:mm	hh:mm			
..							

Figure 3.23

CONGESTION REPORT

FOR WEEK FROM mm/dd/yy TO mm/dd/yy

<u>CONCENTRATOR OR FEP ID.</u>	<u>NO. OF "CONGESTED-DON'T TRANSMIT" ISSUED</u>	<u>AVERAGE CONGESTION INTERVAL</u>	<u>NO. OF "CONGESTED-RETRANSMIT AFTER PAUSE" ISSUED (FOR FEP ONLY)</u>
------------------------------------	---	--	--

XXXXXX

::

(list in descending order by number of "DON'T TRANSMIT" issued)

Figure 3.24

LDCN USER STATUS REPORT
FOR WEEK FROM mm/dd/yy TO mm/dd/yy

mm/dd mm/dd mm/dd mm/dd mm/dd

TOTAL

TOTAL NO. OF LOGONS
AVERAGE NO. OF USERS/HR.
FROM hh:mm TO hh:mm
PEAK NO. OF USERS/HR.
HOUR AT WHICH PEAK OCCURRED

SPCC

TOTAL NO. OF LOGONS
AVERAGE NO. OF USERS/HR.
FROM hh:mm TO hh:mm
PEAK NO. OF USERS/HR.
HOUR AT WHICH PEAK OCCURRED

ASO

TOTAL NO. OF LOGONS
AVERAGE NO. OF USERS/HR.
FROM hh:mm TO hh:mm
PEAK NO. OF USERS/HR.
HOUR AT WHICH PEAK OCCURRED

Figure 3.25

USER STATUS REPORT BY SYSTEM

FOR WEEK FROM mm/dd/yy TO mm/dd/yy

mm/dd mm/dd mm/dd mm/dd mm/dd mm/dd

SYSTEM: { ALL ASO AXXX SPCC Sxxx }

CONCENTRATOR: { ALL AUTODIN Identifier }

TOTAL NO. OF LOGONS
AVERAGE NO. OF USERS/HR.
FROM hh:mm TO hh:mm
PEAK NO. OF USERS/HR.
HOUR AT WHICH PEAK OCCURRED

SYSTEM: xxxxx CONCENTRATOR: xxxxxx

TOTAL NO. OF LOGONS
AVERAGE NO. OF USERS/HR.
FROM hh:mm TO hh:mm
PEAK NO. OF USERS/HR.
HOUR AT WHICH PEAK OCCURRED

SYSTEM: xxxxx CONCENTRATOR: xxxxxx

::

Figure 3.26

USER STATUS PLOT FOR mm/dd/yy

SYSTEM: xxxx CONCENTRATOR: xxxxxx

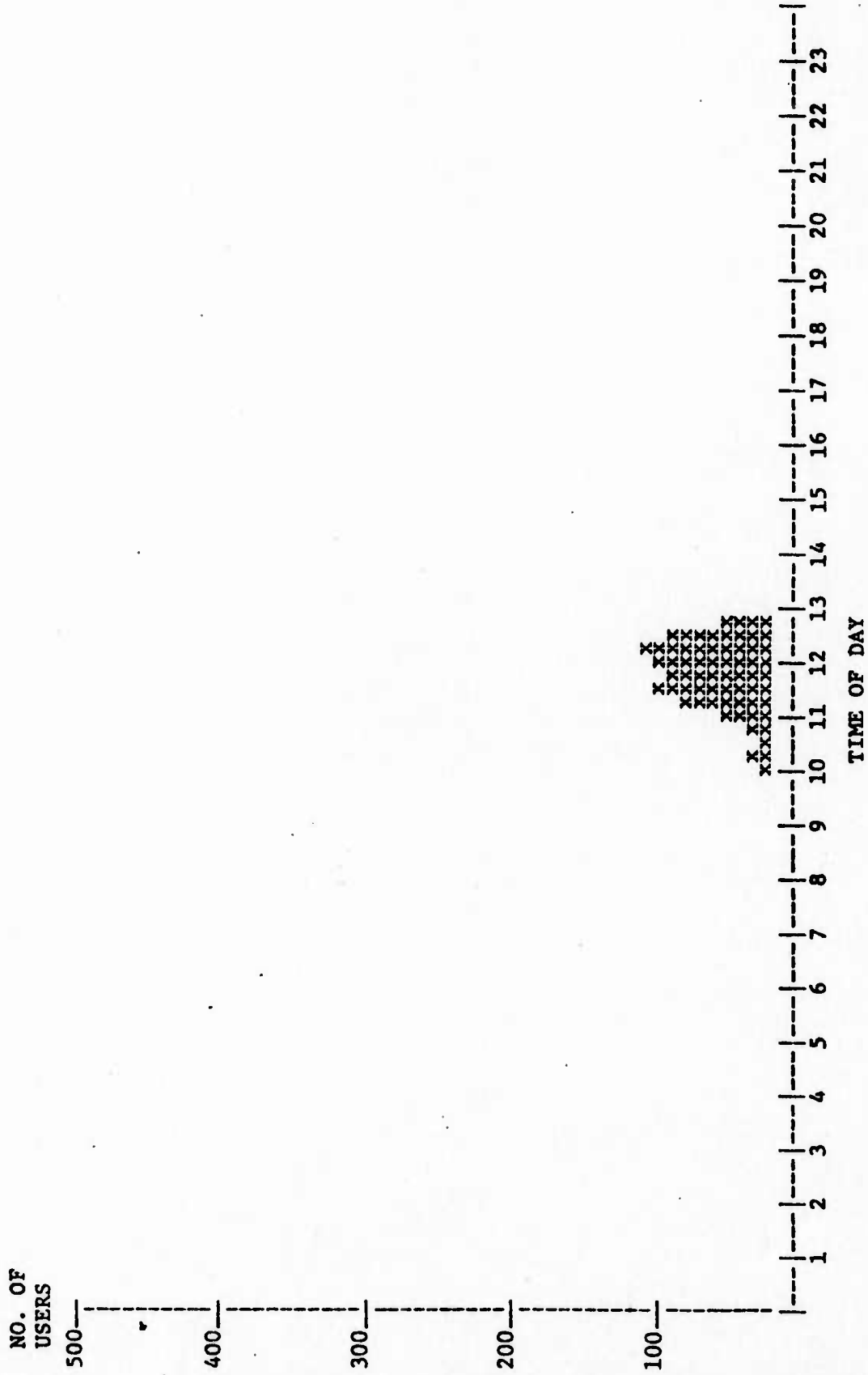

Figure 3.27

SYSTEM CONFIGURATION AT hh:mm mm/dd/yy

TERMINAL ID.	CONCENTRATOR ID.	SYSTEM ID.	TERMINAL TYPE(*)	TERMINAL ID.	CONCENTRATOR ID.	SYSTEM ID.	TERMINAL TYPE(*)
...				...			

*SEE XXXX FOR EXPLANATION OF TERMINAL TYPES

Figure 3.28

SYSTEM SIGNON-SIGNOFF REPORT FOR mm/dd/yy

<u>TERMINAL</u> <u>ID.</u>	<u>CONCENTRATOR</u> <u>TO</u>	<u>SYSTEM</u> <u>TO</u>	<u>TIME OF</u> <u>SIGNON</u>	<u>TIME OF</u> <u>SIGNOFF</u>	<u>HOURS ON</u> <u>SYSTEM</u>	<u>TERMINAL</u> <u>ID.</u>	<u>CONCENTRATOR</u> <u>ID.</u>	<u>SYSTEM</u> <u>ID.</u>	<u>TIME OF</u> <u>SIGNON</u>	<u>TIME OF</u> <u>SIGNOFF</u>	<u>HOURS ON</u> <u>SYSTEM</u>
..						..					

Figure 3.29

LDCN TRAFFIC STATISTICS REPORT
 FOR WEEK FROM mm/dd/yy TO mm/dd/yy

mm/dd mm/dd mm/dd mm/dd mm/dd

TOTAL	XXXXX
TOTAL NO. OF MESSAGES	XXXXX
COMPUTER MESSAGES	XXXXX
INQUIRY	XXXX
UPQUIRY	XXXX
BATCH	XXXX
REAL-TIME	XXXX
NON-AUTODIN	XXXX
AUTODIN	XXXX
OTHER MESSAGES	XXXX
TERMINAL-TERMINAL	XXX
BROADCAST	XXX
AVERAGE NO. OF MESSAGES/HR	XXX
FROM hh:mm TO hh:mm	
COMPUTER MESSAGES	XXXXX
INQUIRY	XXXX
UPQUIRY	XXXX
BATCH	XXXX
REAL-TIME	XXXX
NON-AUTODIN	XXXX
AUTODIN	XXXX
OTHER MESSAGES	XXXX
TERMINAL-TERMINAL	XXX
BROADCAST	XXX
PEAK NO. OF MESSAGES/HR	
COMPUTER MESSAGES	XXXXX
INQUIRY	XXXX
UPQUIRY	XXXX

Figure 3.30

LDCN TRAFFIC STATISTICS REPORT (continued)
FOR WEEK FROM mm/dd/yy TO mm/dd/yy

	<u>mm/dd</u>	<u>mm/dd</u>	<u>mm/dd</u>	<u>mm/dd</u>	<u>mm/dd</u>	<u>mm/dd</u>
BATCH	XXXX					
REAL-TIME	XXXX					
NON-AUTODIN	XXXX					
AUTODIN	XXXX					
OTHER MESSAGES	XXXX					
TERMINAL-TERMINAL	XX					
BROADCAST	XX					

HOUR AT WHICH PEAK OCCURRED

LDCN TRAFFIC STATISTICS REPORT
FOR WEEK FROM mm/dd/yy TO mm/dd/yy

mm/dd mm/dd mm/dd mm/dd mm/dd

SPCC

TOTAL NO. OF MESSAGES

XXXXX

COMPUTER MESSAGES

XXXXX

INQUIRY

XXXX

UPQUIRY

XXXX

BATCH

XXXX

REAL-TIME

XXXX

NON-AUTODIN

XXXX

AUTODIN

XXXX

OTHER MESSAGES

XXXX

TERMINAL-TERMINAL

XXX

BROADCAST

XXX

AVERAGE NO. OF MESSAGES/HR
FROM hh:mm TO hh:mm

XXX

COMPUTER MESSAGES

XXXXX

INQUIRY

XXXX

UPQUIRY

XXXX

BATCH

XXXX

REAL-TIME

XXXX

NON-AUTODIN

XXXX

AUTODIN

XXXX

OTHER MESSAGES

XXXX

TERMINAL-TERMINAL

XXX

BROADCAST

XXX

PEAK NO. OF MESSAGES/HR

COMPUTER MESSAGES

XXXXX

INQUIRY

XXXX

UPQUIRY

XXXX

Figure 3.31

LDCN TRAFFIC STATISTICS REPORT (continued)
FOR WEEK FROM mm/dd/yy TO mm/dd/yy

	<u>mm/dd</u>	<u>mm/dd</u>	<u>mm/dd</u>	<u>mm/dd</u>	<u>mm/dd</u>	<u>mm/dd</u>
BATCH	XXXX					
REAL-TIME	XXXX					
NON-AUTODIN	XXXX					
AUTODIN	XXXX					
OTHER MESSAGES	XXXX					
TERMINAL-TERMINAL BROADCAST	XXX					
	XXX					

HOUR AT WHICH PEAK OCCURRED

LDCN TRAFFIC STATISTICS REPORT
FOR WEEK FROM mm/dd/yy TO mm/dd/yy

mm/dd mm/dd mm/dd mm/dd mm/dd mm/dd

ASO

TOTAL NO. OF MESSAGES

COMPUTER MESSAGES

INQUIRY
UPQUIRY

BATCH
REAL-TIME

NON-AUTODIN
AUTODIN

OTHER MESSAGES

TERMINAL-TERMINAL
BROADCAST

AVERAGE NO. OF MESSAGES/HR
FROM hh:mm TO hh:mm

COMPUTER MESSAGES

INQUIRY
UPQUIRY

BATCH
REAL-TIME

NON-AUTODIN
AUTODIN

OTHER MESSAGES

TERMINAL-TERMINAL
BROADCAST

PEAK NO. OF MESSAGES/HR

COMPUTER MESSAGES

INQUIRY
UPQUIRY

XXXXX

XXXXXX

XXXXX

XXXXX

XXXXX

XXXXX

XXXXX

XXXXX

XXXXX

XXX

XXX

XXX

XXXXX

XXXXX

XXXXX

XXXXX

XXXXX

XXXXX

XXXXX

XXXXX

XXX

XXX

XXXXX

XXXXX

XXXXX

Figure 3.32

LDCN TRAFFIC STATISTICS REPORT (continued)
FOR WEEK FROM mm/dd/yy TO mm/dd/yy

	<u>mm/dd</u>	<u>mm/dd</u>	<u>mm/dd</u>	<u>mm/dd</u>	<u>mm/dd</u>	<u>mm/dd</u>
BATCH	XXXX					
REAL-TIME	XXXX					
NON-AUTODIN	XXXX					
AUTODIN	XXXX					
OTHER MESSAGES	XXXX					
TERMINAL-TERMINAL	XXX					
BROADCAST	XXX					

HOUR AT WHICH PEAK OCCURRED

TRAFFIC STATISTICS REPORT BY SYSTEM AND TRAFFIC TYPE

FOR WEEK FROM mm/dd/yy TO mm/dd/yy

	mm/dd	mm/dd	mm/dd	mm/dd	mm/dd	mm/dd
SYSTEM: { ALL ASO Axxx SPCC Sxxx }						
CONCENTRATOR: { ALL AUTODIN Identifier }						
TRAFFIC TYPE: { ALL COMPUTER OTHER INQUIRY (, xxxxx) UPQUIRY (, xxxxx) : :						
TOTAL NO. OF MESSAGES	xxxxx					
COMPUTER MESSAGES	xxxxx					
INQUIRY	xxxxx					
UPQUIRY	xxxxx					
BATCH	xxxxx					
REAL-TIME	xxxxx					
NON-AUTODIN	xxxxx					
AUTODIN	xxxxx					
OTHER MESSAGES	xxxxx					
TERMINAL-TERMINAL	xxx					
BROADCAST	xxx					
AVERAGE NO. OF MESSAGES/HR	xxx					
FROM hh:mm TO hh:mm						
COMPUTER MESSAGES	xxxxxx					
INQUIRY	xxxxx					
UPQUIRY	xxxxx					
BATCH	xxxxx					
REAL-TIME	xxxxx					
NON-AUTODIN	xxxxx					
AUTODIN	xxxxx					

Figure 3.33

TRAFFIC STATISTICS REPORT BY SYSTEM AND TRAFFIC TYPE (continued)
 FOR WEEK FROM mm/dd/yy TO mm/dd/yy

	<u>mm/dd</u>	<u>mm/dd</u>	<u>mm/dd</u>	<u>mm/dd</u>	<u>mm/dd</u>
OTHER MESSAGES	XXXX				
TERMINAL-TERMINAL	XXX				
BROADCAST	XXX				
PEAK NO. OF MESSAGES/HR					
COMPUTER MESSAGES	XXXXX				
INQUIRY	XXXX				
UPQUIRY	XXXX				
BATCH	XXXX				
REAL-TIME	XXXX				
NON-AUTODIN	XXXX				
AUTODIN	XXXX				
OTHER MESSAGES	XXXX				
TERMINAL-TERMINAL	XXX				
BROADCAST	XXX				
HOUR AT WHICH PEAK OCCURRED					

TRAFFIC STATISTICS PLOT FOR mm/dd/yy

SYSTEM: xxxxx

CONCENTRATOR: xxxxxx

NO. OF MESSAGES

TRAFFIC TYPE: xxxxxx

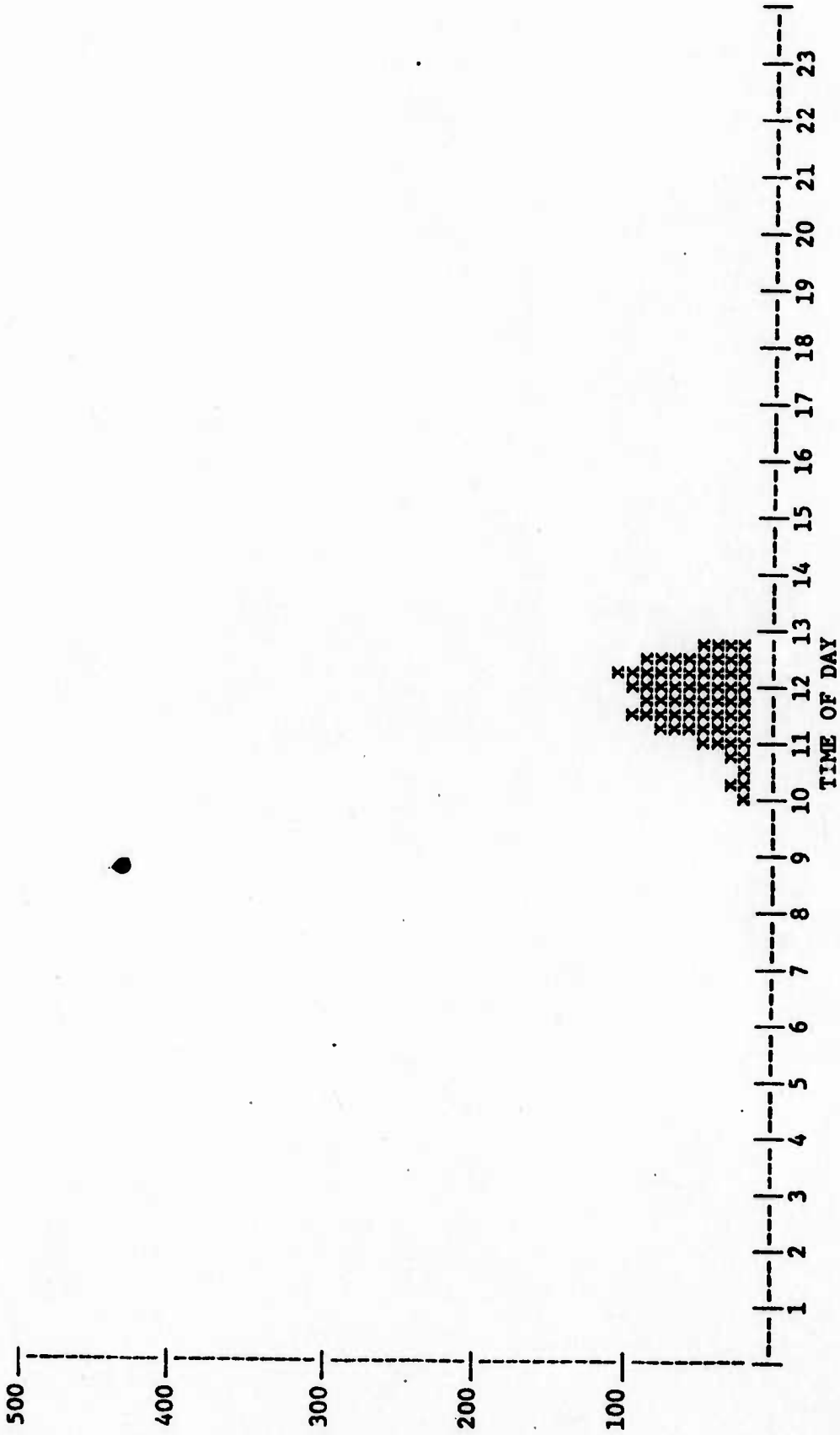

Figure 3.34

LDCN RESPONSE TIME REPORT

FOR WEEK FROM mm/dd/yy TO mm/dd/yy

(REAL-TIME MESSAGES ONLY) mm/dd mm/dd mm/dd mm/dd mm/dd

TOTAL

FROM hh:mm TO hh:mm

AVERAGE NO. OF MESSAGES/HR. xxx
 AVERAGE RESPONSE TIME (SEC.) xxx

PEAK HOUR xx

NO. OF MESSAGES xxx
 AVERAGE RESPONSE TIME (SEC.) xxx

SPCC

FROM hh:mm TO hh:mm

AVERAGE NO. OF MESSAGES/HR. xxx
 AVERAGE RESPONSE TIME (SEC.) xxx

PEAK HOUR xx

NO. OF MESSAGES xxx
 AVERAGE RESPONSE TIME (SEC.) xxx

ASO

FROM hh:mm TO hh:mm

AVERAGE NO. OF MESSAGES/HR. xxx
 AVERAGE RESPONSE TIME (SEC.) xxx

PEAK HOUR xx

NO. OF MESSAGES xxx
 AVERAGE RESPONSE TIME (SEC.) xxx

Figure 3.35

RESPONSE TIME REPORT BY SYSTEM

FOR WEEK FROM mm/dd/yy TO mm/dd/yy

(REAL-TIME MESSAGES ONLY) mm/dd mm/dd mm/dd mm/dd mm/dd

SYSTEM: xxxxxx CONCENTRATOR: xxxxxx

FROM hh:mm TO hh:mm

AVERAGE NO. OF MESSAGES/HR. xxx
 AVERAGE RESPONSE TIME (SEC.) xxx

PEAK HOUR xx

NO. OF MESSAGES xxx
 AVERAGE RESPONSE TIME (SEC.) xxx

SYSTEM: xxxxxx CONCENTRATOR: xxxxxx

FROM hh:mm TO hh:mm

AVERAGE NO. OF MESSAGES/HR. xxx
 AVERAGE RESPONSE TIME (SEC.) xxx

PEAK HOUR xx

NO. OF MESSAGES xxx
 AVERAGE RESPONSE TIME (SEC.) xxx

SYSTEM: xxxxxx CONCENTRATOR: xxxxxx

..

Figure 3.36

RESPONSE-TIME REPORT BY COMPONENT
FOR WEEK FROM mm/dd/yy TO mm/dd/yy

mm/dd

mm/dd

mm/dd

mm/dd

mm/dd

mm/dd

mm/dd

(REAL-TIME MESSAGES ONLY)

CONCENTRATOR: xxxxxx

INPUT

xxx

AVERAGE NO. OF MESSAGES/HR.
FROM hh:mm TO hh:mm

AVG. PROCESSING TIME (SEC)
QUEUE & TRANSMISSION TIME (SEC)
TIME BUFFER IS HELD (SEC)

PEAK NO. OF MESSAGES/HR.

AVG. PROCESSING TIME (SEC)
QUEUE & TRANSMISSION TIME (SEC)
TIME BUFFER IS HELD (SEC)

OUTPUT

xxx

AVERAGE NO. OF MESSAGES/HR.
FROM hh:mm TO hh:mm

AVG. PROCESSING TIME (SEC)
QUEUE & TRANSMISSION TIME (SEC)
TIME BUFFER IS HELD (SEC)

PEAK NO. OF MESSAGES/HR.

AVG. PROCESSING TIME (SEC)
QUEUE & TRANSMISSION TIME (SEC)
TIME BUFFER IS HELD (SEC)

FEP: xxxxxx

INPUT

xxx

AVERAGE NO. OF MESSAGES/HR.
FROM hh:mm TO hh:mm

RESPONSE-TIME REPORT BY COMPONENT (continued)

FOR WEEK FROM mm/dd/yy TO mm/dd/yy

(REAL-TIME MESSAGES ONLY) mm/dd mm/dd mm/dd mm/dd mm/dd

AVG. PROCESSING TIME (SEC)
QUEUE & TRANSMISSION TIME (SEC)

PEAK NO. OF MESSAGES/HR.

AVG. PROCESSING TIME (SEC)
QUEUE & TRANSMISSION TIME (SEC)

OUTPUT

AVERAGE NO. OF MESSAGES/HR. xxx
FROM hh:mm TO hh:mm

AVG. PROCESSING TIME (SEC)
QUEUE & TRANSMISSION TIME (SEC)

PEAK NO. OF MESSAGES/HR.

AVG. PROCESSING TIME (SEC)
QUEUE & TRANSMISSION TIME (SEC)

HOST PROCESSING

AVERAGE NO. OF MESSAGES/HR. xxx
AVG. PROCESSING TIME (SEC) xxx

PEAK NO. OF MESSAGES/HR. xxx
AVG. PROCESSING TIME (SEC) xxx

{ FEP: xxxxxx
 CONCENTRATOR: xxxxxx }

LDCN MESSAGE LENGTH STATISTICS REPORT
 FOR WEEK FROM mm/dd/yy TO mm/dd/yy

<u>INPUT STATISTICS (CHARS)</u>		<u>OUTPUT STATISTICS (CHARS)</u>	
<u>MEAN</u>	<u>S.D.</u>	<u>MEAN</u>	<u>S.D.</u>
	<u>MAXIMUM</u>		<u>MAXIMUM</u>

TOTAL			
ALL MESSAGES			
COMPUTER MESSAGES			
INQUIRY			
UPQUIRY			
BATCH			
REAL TIME			
NON-AUTODIN			
AUTODIN			
OTHER MESSAGES			
TERMINAL-TERMINAL			
BROADCAST			
SPCC			
ALL MESSAGES			
COMPUTER MESSAGES			
INQUIRY			
UPQUIRY			

Figure 3.38

LDCN MESSAGE LENGTH STATISTICS REPORT (continued)

FOR WEEK FROM mm/dd/yy TO mm/dd/yy

<u>INPUT STATISTICS (CHARS)</u>	<u>OUTPUT STATISTICS (CHARS)</u>
<u>MEAN</u> <u>S.D.</u> <u>MAXIMUM</u>	<u>MEAN</u> <u>S.D.</u> <u>MAXIMUM</u>

BATCH
REAL TIME

NON-AUTODIN
AUTODIN

OTHER MESSAGES

TERMINAL-TERMINAL
BROADCAST

ASO

ALL MESSAGES

3.67

COMPUTER MESSAGES

INQUIRY
UPQUIRY

BATCH
REAL TIME

NON-AUTODIN

OTHER MESSAGES

TERMINAL-TERMINAL
BROADCAST

MESSAGE LENGTH STATISTICS REPORT BY SYSTEM AND TRAFFIC TYPE

FOR WEEK FROM mm/dd/yy TO mm/dd/yy

INPUT STATISTICS (CHARS)		OUTPUT STATISTICS (CHARS)	
MEAN	S.D.	MEAN	S.D.

CONCENTRATOR: xxxxxx TRAFFIC TYPE: xxxxxx

SYSTEM: xxxxxx

ALL MESSAGES

COMPUTER MESSAGES

INQUIRY
UPQUIRY

BATCH
REAL TIME

NON-AUTODIN
AUTODIN

OTHER MESSAGES

TERMINAL-TERMINAL
BROADCAST

SYSTEM: xxxxxx

ALL MESSAGES

COMPUTER MESSAGES

INQUIRY
UPQUIRY

Figure 3.39

MESSAGE LENGTH STATISTICS REPORT BY SYSTEM AND TRAFFIC TYPE (continued)

FOR WEEK FROM mm/dd/yy TO mm/dd/yy

INPUT STATISTICS (CHARS)		OUTPUT STATISTICS (CHARS)	
MEAN	S.D.	MEAN	S.D.
MAXIMUM		MAXIMUM	

BATCH
REAL TIME

NON-AUTODIN
AUTODIN

OTHER MESSAGES

TERMINAL-TERMINAL
BROADCAST

SYSTEM:
:
:
3.69

INPUT MESSAGE LENGTH HISTOGRAM FOR mm/dd/yy

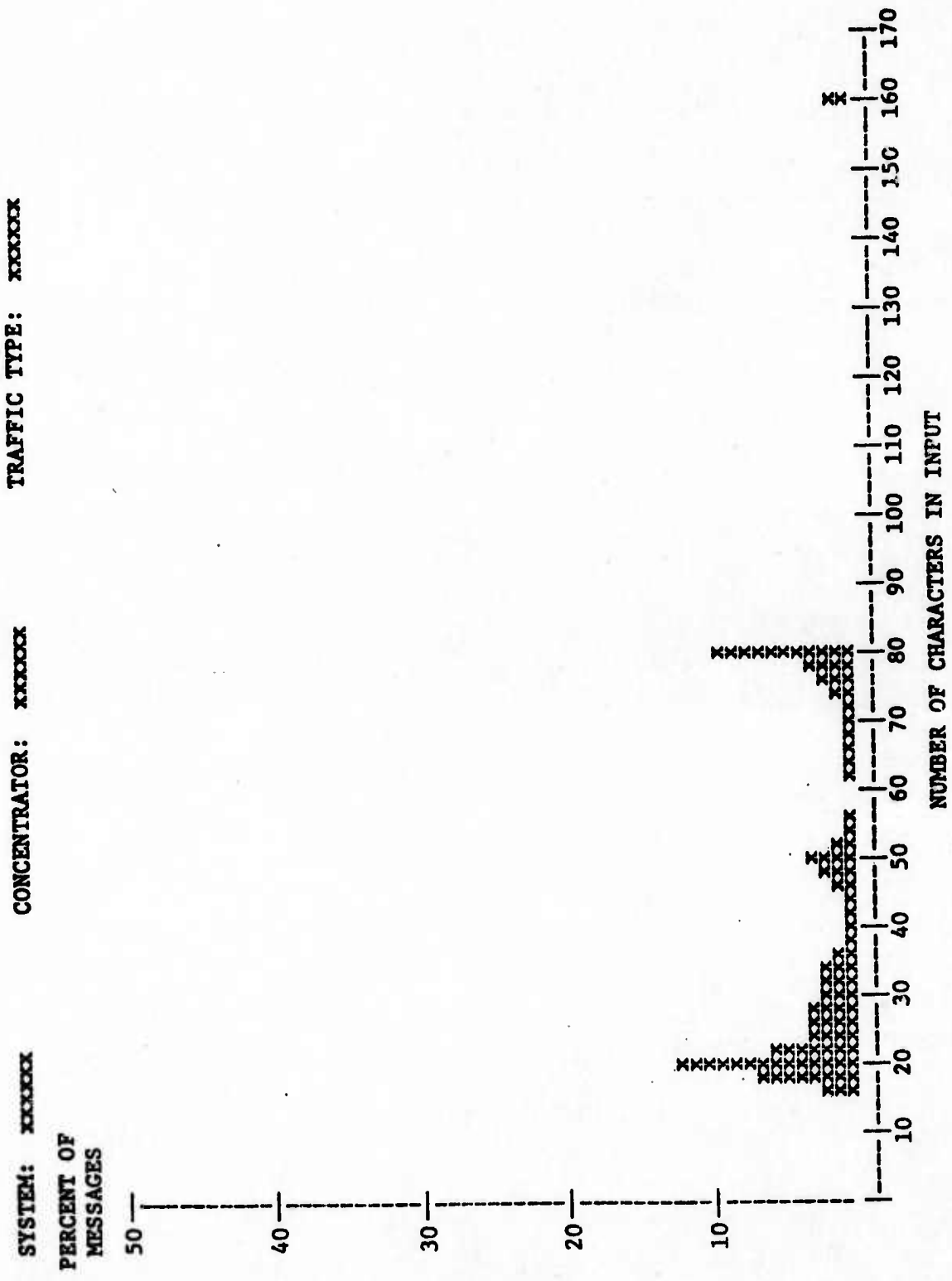

Figure 3.40

OUTPUT MESSAGE LENGTH HISTOGRAM FOR mm/dd/yy

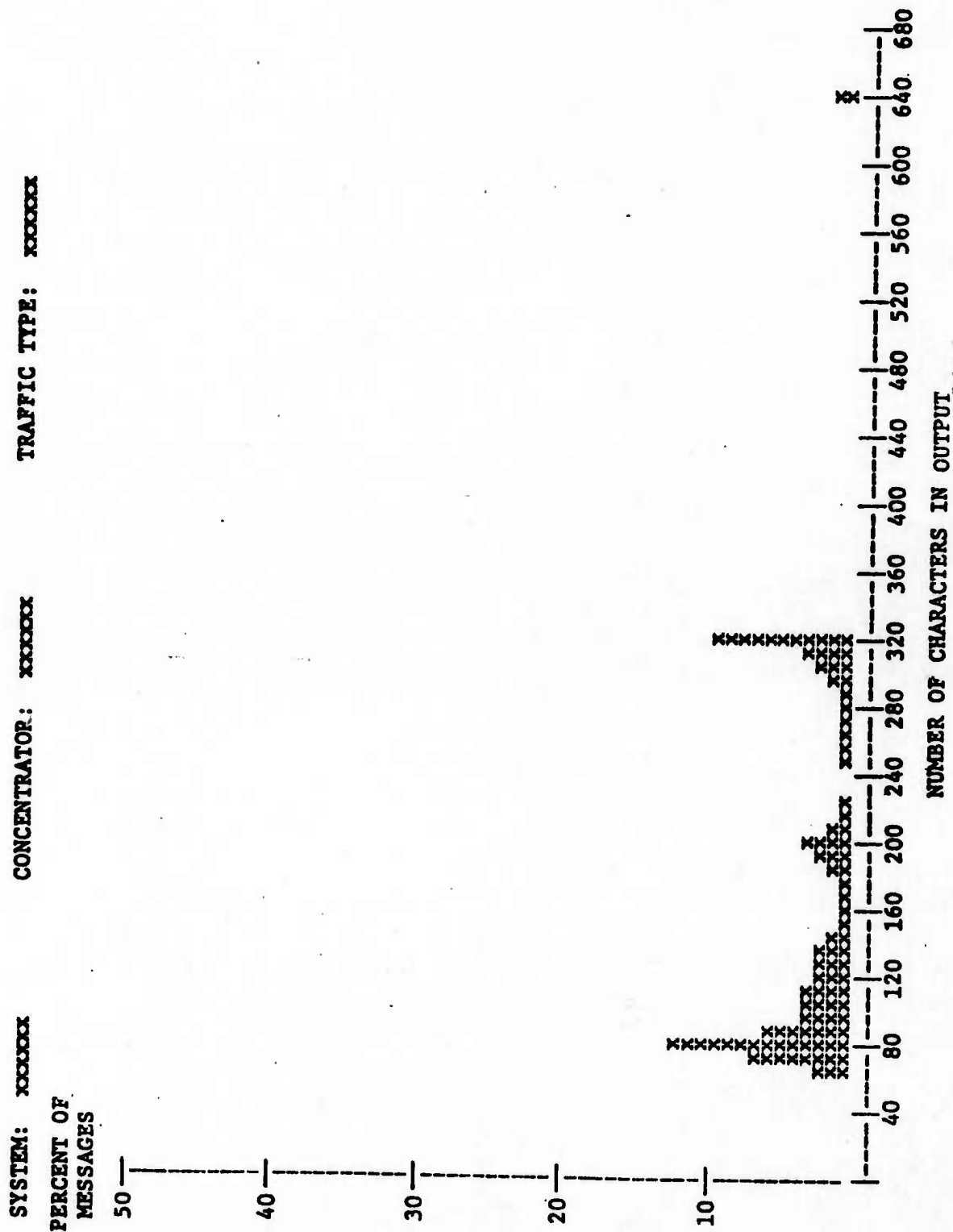

Figure 3.41

CPU UTILIZATION REPORT

FOR WEEK FROM mm/dd/yy TO mm/dd/yy

mm/dd

mm/dd

mm/dd

mm/dd

mm/dd

mm/dd

mm/dd

{ FEP: xxxxxx
 CONCENTRATOR: xxxxxx
 AVERAGE UTILIZATION
 FROM hh:mm TO hh:mm
 UTILIZATION DURING PEAK HOUR
 HOUR AT WHICH PEAK OCCURRED

{ FEP: xxxxxx
 CONCENTRATOR: xxxxxx
 AVERAGE UTILIZATION
 FROM hh:mm TO hh:mm
 UTILIZATION DURING PEAK HOUR
 HOUR AT WHICH PEAK OCCURRED

{ FEP: xxxxxx
 CONCENTRATOR: xxxxxx
 ..

Figure 3.42

CPU UTILIZATION REPORT BY MODULE
 FOR WEEK FROM mm/dd/yy TO mm/dd/yy

mm/dd mm/dd mm/dd mm/dd mm/dd

{ FEP: xxxxxx
 CONCENTRATOR: xxxxxx }

AVERAGE UTILIZATION
 FROM hh:mm TO hh:mm
 program a
 program b
 .
 .

.xxx
 .xxx
 .
 .
 .xxx

TOTAL
 UTILIZATION DURING PEAK HOUR
 program a
 program b
 .
 .
 TOTAL
 HOUR AT WHICH PEAK OCCURRED

.xxx
 .xxx
 .
 .
 .xxx

{ FEP: xxxxxx
 CONCENTRATOR: xxxxxx }

AVERAGE UTILIZATION
 FROM hh:mm TO hh:mm
 program a
 program b
 .
 .

TOTAL
 UTILIZATION DURING PEAK HOUR
 program a
 program b
 .
 .
 TOTAL
 HOUR AT WHICH PEAK OCCURRED

{ FEP: xxxxxx
 CONCENTRATOR: xxxxxx }

Figure 3.43

CPU MODULE ACCESS REPORT

FOR WEEK FROM mm/dd/yy TO mm/dd/yy

mm/dd mm/dd mm/dd mm/dd mm/dd

FEP: xxxxxx
CONCENTRATOR: xxxxxx

AVERAGE NO. OF ACCESSES

FROM hh:mm TO hh:mm

program a

program b

...

TOTAL

NO. OF ACCESSES DURING PEAK HOUR

program a

program b

...

TOTAL

HOUR AT WHICH PEAK OCCURRED

FEP: xxxxxx
CONCENTRATOR: xxxxxx

AVERAGE NO. OF ACCESSES

FROM hh:mm TO hh:mm

program a

program b

...

TOTAL

NO. OF ACCESSES DURING PEAK HOUR

program a

program b

...

TOTAL

HOUR AT WHICH PEAK OCCURRED

FEP: xxxxxx
CONCENTRATOR: xxxxxx

xxxx
xxxx
...
xxxx
xxxx
xxx
...
xxx

Figure 3.44

CPU UTILIZATION PLOT FOR mm/dd/yy

FEP: xxxxxx
CONCENTRATOR: xxxxxx
UTILIZATION

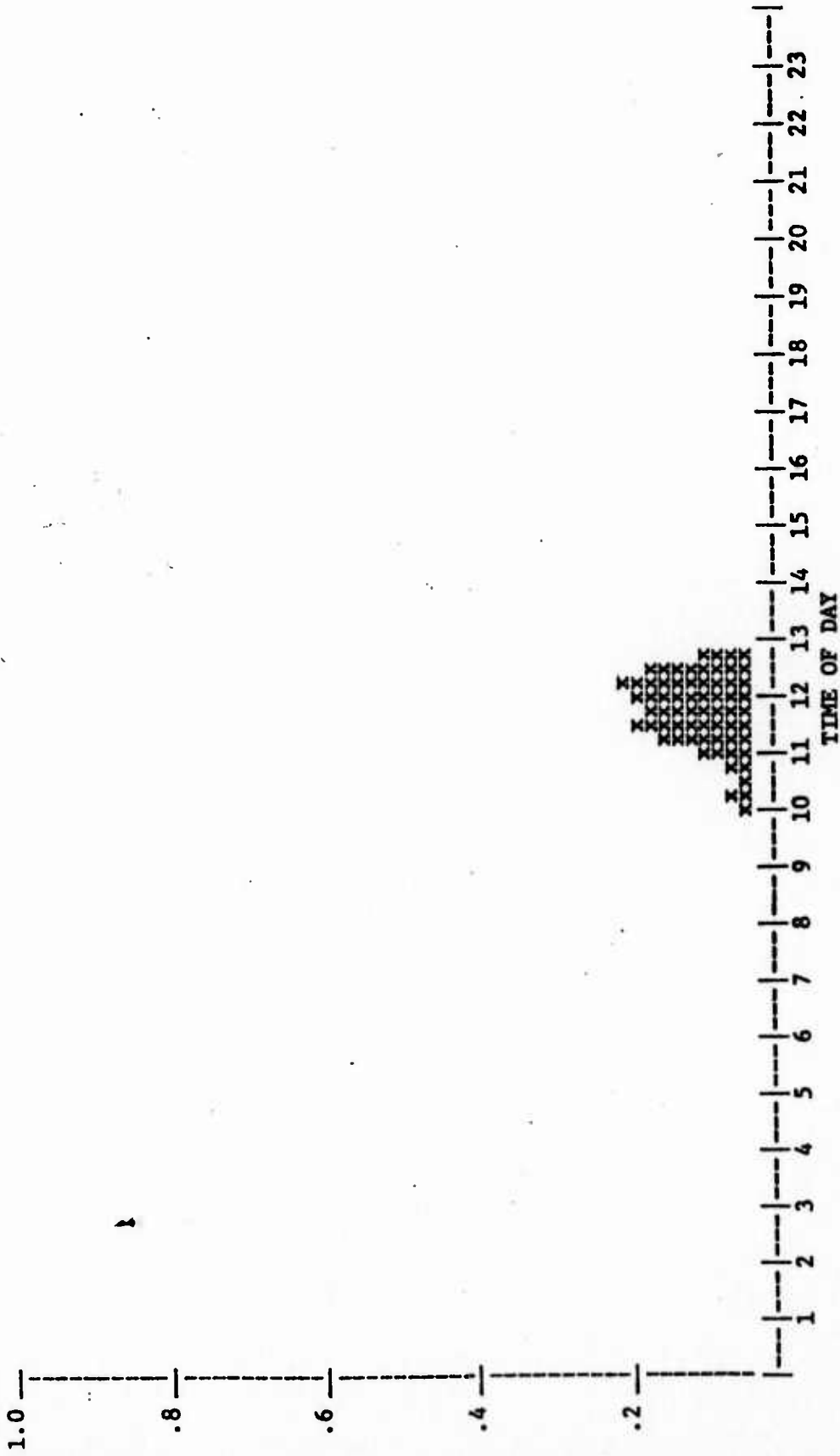

Figure 3.45

BUFFER USAGE REPORT

FOR WEEK FROM mm/dd/yy TO mm/dd/yy

mm/dd mm/dd mm/dd mm/dd mm/dd

FEP: xxxxxx }
CONCENTRATOR: xxxxxx }
BUFFER POOL: xxxxxx NO. OF BUFFERS: xxx

TOTAL NO. OF ALLOCATIONS

AVERAGE BUFFER USAGE/HOUR

FROM hh:mm TO hh:mm

PEAK BUFFER USAGE/HOUR

HOUR AT WHICH PEAK OCCURRED

FEP: xxxxxx }
CONCENTRATOR: xxxxxx }
BUFFER POOL: xxxxxx NO. OF BUFFERS: xxx

TOTAL NO. OF ALLOCATIONS

AVERAGE BUFFER USAGE/HOUR

FROM hh:mm TO hh:mm

PEAK BUFFER USAGE/HOUR

HOUR AT WHICH PEAK OCCURRED

FEP: xxxxxx }
CONCENTRATOR: xxxxxx }
BUFFER POOL: xxxxxx NO. OF BUFFERS: xxx

⋮

Figure 3.46

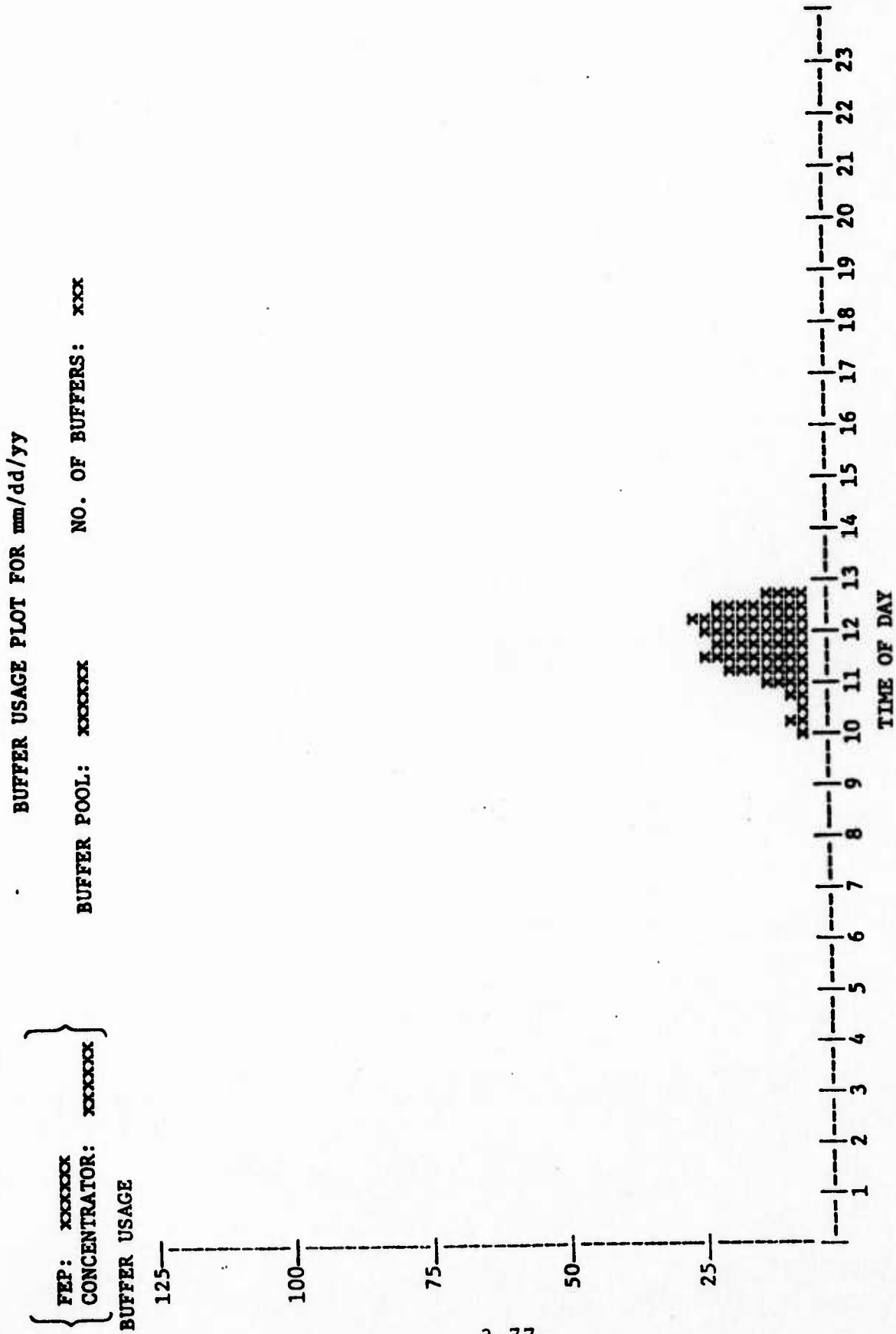

Figure 3.47

OUTPUT QUEUE REPORT

FOR WEEK FROM mm/dd/yy TO mm/dd/yy

mm/dd

mm/dd

mm/dd

mm/dd

mm/dd

mm/dd

mm/dd

ICS
 WEPS
 EITHER 494
 IBM 360
 B 3500
 FEP: xxxxx
 CONC: xxxxx
 AUTODIN

FROM {
 FEP: xxxxx
 CONCENTRATOR:
 xxxxx
 }

TO

TOTAL NO. OF ENTRIES
 AVERAGE QUEUE LENGTH
 FROM hh:mm TO hh:mm
 PEAK QUEUE LENGTH
 HOUR AT WHICH PEAK OCCURRED

3.78

FROM xxxxx TO xxxxx

TOTAL NO. OF ENTRIES
 AVERAGE QUEUE LENGTH
 FROM hh:mm TO hh:mm
 PEAK QUEUE LENGTH
 HOUR AT WHICH PEAK OCCURRED

FROM xxxxx TO xxxxx

::

Figure 3.48

OUTPUT QUEUE PLOT FOR mm/dd/yy

FROM xxxxxx TO xxxxxx

QUEUE
LENGTH

50

40

30

20

10

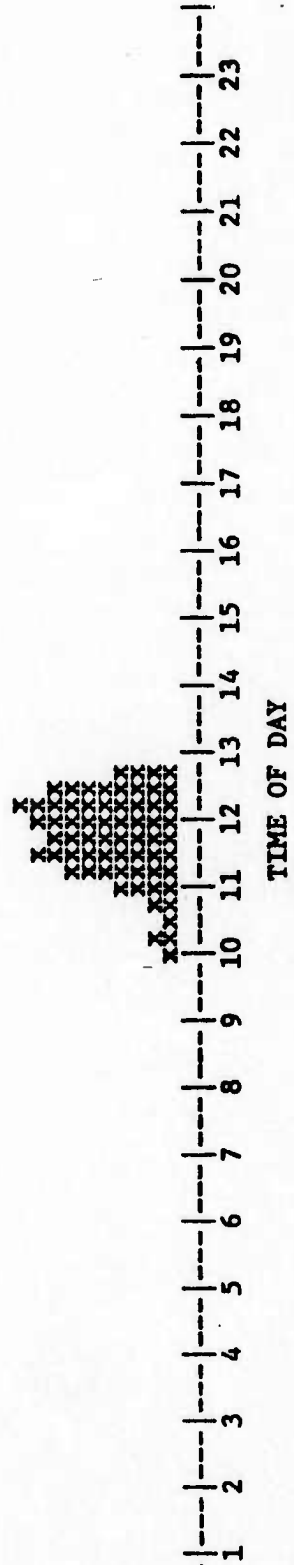

TIME OF DAY

LINE ERROR REPORT

FOR WEEK FROM mm/dd/yy TO mm/dd/yy

mm/dd mm/dd mm/dd mm/dd mm/dd mm/dd

LINE IDENTIFIER: xxxxxx TIME-OUT LIMIT/HOUR: xx MESSAGE ERROR LIMIT/HOUR: xx

ERRORS PER DAY
 MESSAGES IN ERROR
 TIME-OUT
 TOTAL

xx
 xx
 xx

PEAK ERRORS PER HOUR (*)
 MESSAGES IN ERROR
 TIME-OUT
 TOTAL

xx
 xx
 xx

NUMBER OF RETRANSMISSION REQUESTS PER DAY

TERMINAL REQUESTS
 CONCENTRATOR REQUESTS

xx
 xx

NUMBER OF OPERATOR NOTIFICATIONS PER DAY
 MESSAGES IN ERROR
 TIME-OUT
 TOTAL

xx
 xx
 xx

LINE IDENTIFIER: xxxxxx TIME-OUT LIMIT/HOUR: xx MESSAGE ERROR LIMIT/HOUR: xx

::

 *EACH OF THE FOLLOWING VALUES MAY OCCUR AT A DIFFERENT PEAK HOUR. THUS THE TOTAL IS NOT THE SUM OF THE
 OTHER TWO VALUES

Figure 3.50

LINE UTILIZATION REPORT

FOR WEEK FROM mm/dd/yy TO mm/dd/yy

mm/dd mm/dd mm/dd mm/dd mm/dd mm/dd

CAPACITY IN BPS: xxxxx BITS/CHAR INPUT: xxxxx BITS/CHAR OUTPUT: xxxxx

{ LINE: xxxxxx CHANNEL: xxxxxx } LINE DISCIPLINE: { HDX FDX }

AVERAGE UTILIZATION FROM hh:mm TO hh:mm

INPUT OUTPUT TOTAL

UTILIZATION DURING PEAK HOUR

INPUT OUTPUT TOTAL

HOUR AT WHICH PEAK OCCURRED

{ LINE: xxxxxx CHANNEL: xxxxxx } LINE DISCIPLINE: { HDX FDX }

CAPACITY IN BPS: xxxxx BITS/CHAR INPUT: xxxxx BITS/CHAR OUTPUT: xxxxx

Figure 3.51

DISK UTILIZATION REPORT

FOR WEEK FROM mm/dd/yy TO mm/dd/yy

mm/dd mm/dd mm/dd mm/dd mm/dd mm/dd

FEP: xxxxxx
CONCENTRATOR: xxxxxx }
DISK: xxxxxx

TOTAL NO. OF ACCESSES

AVERAGE UTILIZATION
FROM hh:mm TO hh:mm

AVERAGE NO. OF ACCESSES
SEEK TIME UTILIZATION
PROCESSING TIME UTILIZATION
TOTAL UTILIZATION

xxxxx
.xxx
.xxx
.xxx

UTILIZATION DURING PEAK HOUR

NO. OF ACCESSES
SEEK TIME UTILIZATION
PROCESSING TIME UTILIZATION
TOTAL UTILIZATION

xxxxx
.xxx
.xxx
.xxx

HOUR AT WHICH PEAK OCCURRED

FEP: xxxxxx
CONCENTRATOR: xxxxxx }
DISK: xxxxxx

Figure 3.52

DISK UTILIZATION PLOT FOR mm/dd/yy

FEP: xxxxxx
CONCENTRATOR: xxxxxx
UTILIZATION

DISK: xxxxxx

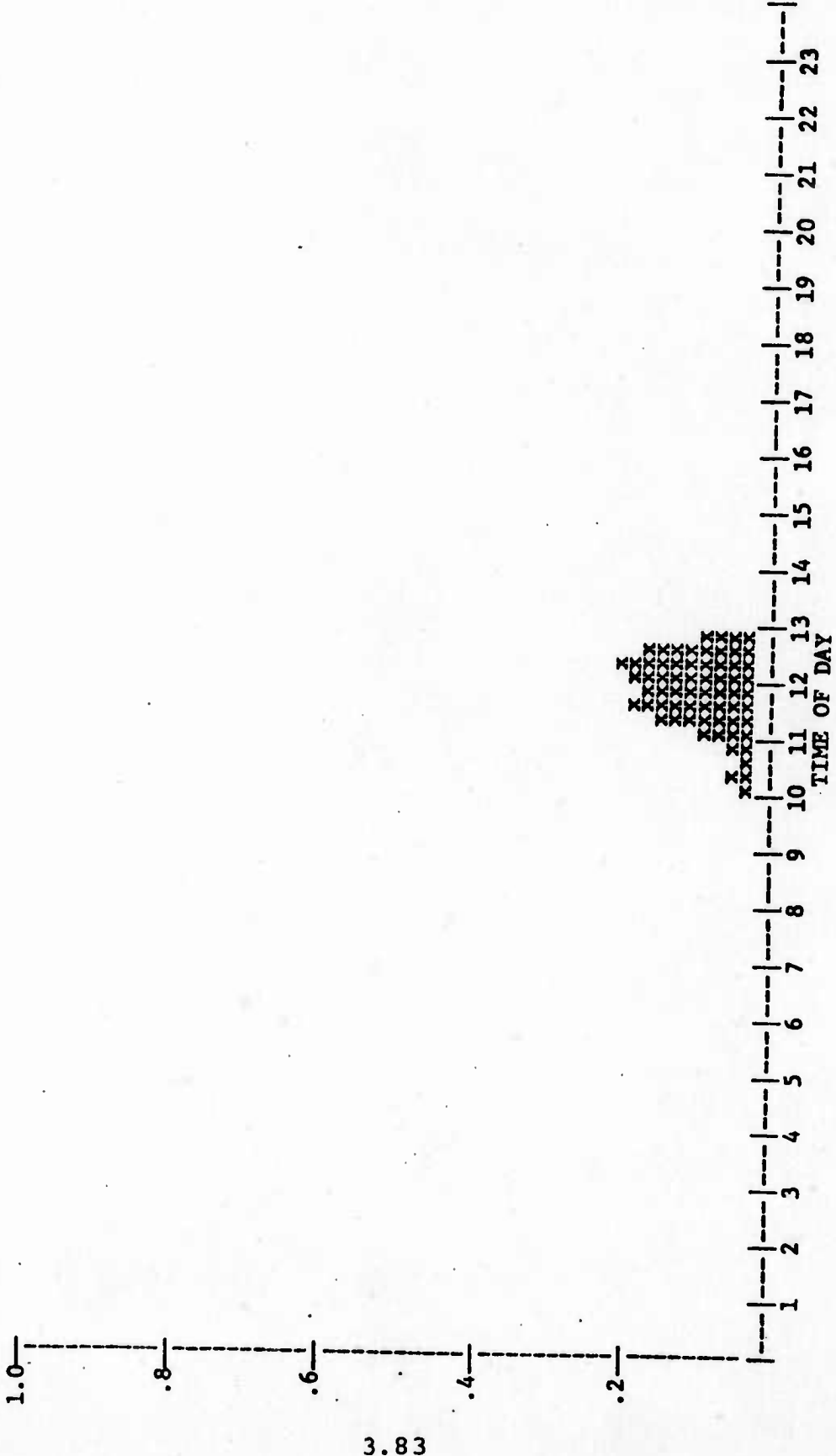

Figure 3.53

BATCH QUEUE REPORT

FOR WEEK FROM mm/dd/yy TO mm/dd/yy

mm/dd mm/dd mm/dd mm/dd mm/dd mm/dd

FEP: xxxxxx BATCH QUEUE: xxxxxx TRANSACTION LIMIT: xx TIME LIMIT: hh:mm

NO. OF BATCHES

TRANSACTION LIMIT xx
TIME LIMIT xx
TOTAL xx

AVERAGE NUMBER OF TRANSACTIONS:
OVER ALL BATCHES
OVER TIME BATCHES

MAXIMUM NUMBER OF TRANSACTIONS/BATCH

FEP: xxxxxx BATCH QUEUE: xxxxxx TRANSACTION LIMIT: xx TIME LIMIT: hh:mm

::

Figure 3.54

REPORT	RANK	REPORT	RANK
Management		Engineering (Cont)	
LDCN Status Summary	1	CPU Utilization Plot	4
LDCN Traffic Summary Plots	1	Buffer Usage Plot	4
System Status Exception Report	1	Disk Utilization Plot	4
Operations		Batch Queue Report	4
Real-Time Reports	1	LDCN User Status Report	5
LDCN CPU Utilization Summary	1	CPU Utilization Report	5
Buffer Usage Exception Report	2	Buffer Usage Report	5
Output Queue Exception Report	2	Output Queue Report	5
Line Utilization Exception Report	2	Output Queue Plot	5
CPU Utilization Exception Report	2	Line Utilization Report	5
Disk Utilization Exception Report	2	Disk Utilization Report	5
Line Notification Report -		Response Time by System	5
Weekly Summary of Line Errors	3	Response Time by Component	5
Congestion Report	3	User Status Report by System	6
System Status Report	5	Traffic by System and Type	6
Password Failure	6	LDCN Message Length Daily	
Engineering		Statistics	6
User Status Plot	4	Daily Message Length Statistics	
LDCN Traffic Statistics Reports	4	by System & Type	6
Traffic Statistics Plots	4	CPU Utilization by Module	6
LDCN Response Time Report	4	CPU Module Access Report	6
Input & Output Message Length		Line Error Breakdown by Day	6
Histograms	4	System Configuration	7
		System Signon-Signoff	7

	RANK	IMPLEMENT BY	
<p>Most Important</p> <p>Least Important</p>	1	System Cutover	<p>Basic Data</p> <p>Filters</p>
	2	Within 6-9 months	
	3	Within 1 year	
	4	Within 2 years	
	5	If wanted by personnel	
	6	And/or if easy to implement	
	7	When implementing above	

Table 3.1 - WHAT AND WHEN TO IMPLEMENT

4. MEASUREMENT MECHANISMS

4.1 Approach

In the previous section, the proposed statistical reports for the LDCN were discussed. In this section, a way of collecting the data for these reports is proposed. This collection process is designed on the assumption that the collection mechanisms will be an integral part of the operating system and will have minimal impact on the processors. Thus it is envisioned that none of the collection processes would be under operator control for start-up or shut-down, except for the system snapshot record, which would require operator initiation of the snapshot.

The proposed collection mechanisms are based on a "history tape" recording system; that is, each front end would journal statistical data on a magnetic tape as the data became available. Each tape's label would identify the front end that produced it. For efficient tape utilization, blocks of 50-100 statistical records would be written to tape. Each block would have a header containing the date and time of the first and last records on the block, and a cell indicating one of six block types. These block types are described in Section 4.2.

The above tape format would permit efficient off-line processing of statistical data, since blocks of records which have the wrong type data or wrong time period could be quickly ignored. To form these blocks, records would be grouped on disk before being written to tape. Thus six different groups would be collected on disk at any given time. If disk space prohibited the use of six groups, fewer groups could be implemented; however, off-line processing could increase due to an increase in scanning individual unwanted records. Similarly, the number of records per block should be chosen to minimize the processing of

unwanted records. For example, a 1000 record block might contain records spanning two hours. If only the second hour's data is needed, then 500 unwanted records could be processed to get to the needed data. However, blocks of 100 records would span 12 minutes; thus only five block headers would be processed before arriving at the needed data. As the network becomes more heavily utilized, longer blocks could be created; however, disk space constraints would prohibit infinite expansion. For these reasons, we suggest an initial blocksize of 50-100 records.

As a minimum, each front end should have enough history tapes to be on a 30-day "reuse" cycle. Sixty to 90 day cycles are more typical for "history tape" systems; thus we recommend consideration of these cycle lengths for the LDCN. During a cycle, a front end would collect data on a history tape. Since it would be easier for the network control center (NCC) to process tapes on a daily basis rather than on a weekly basis, a front end would daily send its completed history tape to the NCC; in addition, the statistical reports to be produced for the week would have to be known in advance of the week. All history tapes would nominally be held by the NCC for at most two weeks: one week for the processing of weekly summary reports, and one week for the processing of engineering reports requested on the basis of the summary reports. At the end of this period, the tape would be returned to the front end for reuse. This scenario describes an instantaneous interaction between front ends and the NCC, and between summary reports and requests for detailed data. In actuality, a day to a week could transpire between these items. For these reasons, we feel a 30-day cycle is a minimum requirement.

Finally, since each concentrator will be dual-homed to two front ends, each would output its statistics to its primary front end unless otherwise notified.

4.2 Statistical Blocks

The data proposed for collection by the LDCN would be formatted into one of 26 records for the history tape. Each record would contain a record identity number, the size of the record in bytes, and the date and time the data was received by the front end. The front end would be responsible for identifying the concentrator, host, or component represented by the data, if this information was not part of the data. Finally, as each record was written to disk, it could also be printed at a console. Thus, a hook for on-line statistics would be available, although we are not recommending its use at this time.

The proposed records for the LDCN can be placed into six statistical block types. These types are Configuration Statistics, Traffic and Message Statistics, Response Time Statistics, System Utilization Statistics, Queuing Statistics, and Error Statistics. Let us now look at these block types in more detail.

4.2.1 Configuration Statistics

The five record types composing the Configuration Statistical Block are shown in Figure 4.1. Logon, system change, and logoff records would be created when the concentrator-supplied data was entered in the FEP's Configuration Table. Status change records would be recorded when an on-line status change report was printed at the FEP's console. These four records would be sufficient for all configuration processing needs; however, the System Configuration Report could be more easily produced if at "snapshot time," each active entry in the FEP's Configuration Table was captured in a System Snapshot record. This record is, therefore, proposed as the fifth configuration data record; in addition, it is the only one of the proposed records that would be collected by operator initiation.

4.2.2 Traffic and Message Statistics

The two record types composing the Traffic and Message Statistical Block are shown in Figure 4.2. These records would be produced by the FEP after it had successfully received an entire input or output message. The message lengths could be calculated as follows. As the first segment of an input message was processed by a FEP, an entry would be made in an I/O Table. Each entry in the table would contain space for Concentrator and Terminal ID, Message Number, Message Type, Program Type, and Message Size. The first input segment would supply the initial data for all six fields. Each additional input message segment would add its segment size to the message size field in the corresponding message entry. After the last input segment had added its segment size to the corresponding Message Size field, the Input Message Record would be created and the entry in the I/O Table would be deleted. A similar procedure would be used to create the Output Message Record.

4.2.3 Response-Time Statistics

The Response-Time Statistics Block is composed of eight record types (Figure 4.3). Concentrator-Input Records and Concentrator-Output Records should be received from concentrators once every 15 minutes to one hour, with NAC recommending the former value. These records could be created as follows. Each concentrator would have four 32-bit words set aside for input, and four set aside for output. Word one would be a processing time cell; the second would be a queuing time cell, while the third would be a buffer utilization cell. The fourth cell would contain a count of the number of entries in the other cells. When a buffer was allocated for an input segment, the concentrator would subtract the rightmost 16 bits of a one millisecond interval timer from the third input cell.

When the input segment was successfully within the concentrator, the rightmost 16 bits of the timer would be subtracted from the first cell. When the segment was placed on the concentrator's output queue, the rightmost 16 bits of the timer would be added to cell one and subtracted from cell two. Finally, when the buffer for the segment was released, the rightmost 16 bits of the timer would be added to cells two and three, and cell four would be tallied by one. (It should be noted that although "halfword" arithmetic is being carried out in the cells, the entire 32 bits would contain timing data, with the high order bits being a result of carries out of the low order bits.) A similar operation would be performed for the output message segments. Finally, once every 15 minutes to one hour (a system-defined parameter), the concentrator would send the four input cells and four output cells to its primary FEP and would then zero out the cells. Upon receiving this information, the FEP would append the proper record header and place the record on disk for future processing by the statistics program.

The FEP Input-In Record would be created by the FEP when the last segment of an input message was successfully received. The Input-Out Record would be created when the first segment of a real-time input message was placed on one of the FEP's output queues. When the output buffer for the last segment of a real-time input message was released, the Input-Done Record would be generated. On the message output side, the Output-In Record would be generated when the first segment of an output was successfully received by the FEP, while the Output-Out Record would be created when that first segment was placed on an output queue for a concentrator. The Output Status Flag of the Output-Out Record would indicate whether the message was blocked by another transmission or by the terminal logging off the system. Finally, the Output-Done Record would be created when the output buffer for the first segment was released.

4.2.4 System Utilization Statistics

The System Utilization Statistical Block contains four types of records. The CPU and Disk Records would be collected for both FEP's and concentrators, while the Buffer Records would only be collected for the FEP's. (Concentrator buffer utilization would be obtained from the Response Time Statistical Records.) Raw utilization data would be obtained in the concentrator and FEP software programs which could periodically sample device utilization and forward this information to the appropriate FEP. In addition, a 32-bit word would be kept by the operating system for each program module and disk. Whenever an access was made to a module or disk, the appropriate word would be tallied. This data would be sent along with the utilization to the FEP; when this was done, the cells would be reinitialized to zero. At the FEP, the raw data would be formatted into the appropriate records. Figure 4.4 shows the four utilization records.

4.2.5 Queue Statistics

There are two types of Queue Statistical Records (Figure 4.5). The Queue Record would use data from software programs that could sample the queue every N milliseconds to determine the average queue length. In addition, each queue could have three cells associated with it. The first cell would contain the total number of entries on the queue; it would be tallied each time an item joined the queue. The second cell would contain the maximum queue length observed while the third cell would have the current queue length. When an item joined the queue, the third cell would be tallied and compared against the second cell; if the third cell was larger, then the second cell would receive the third cell's value. Cell one would then be tallied. When an item left the queue, the third cell would be decremented by one. The first and

second cells would be reported along with the average queue length in the Queue Record; after this data was sent to the appropriate FEP, the first cell would be set to zero and the second would be set to the current queue length.

The Batch Report is the second type of Queue Statistical Record. This record would contain the number of transactions on the batch queue, in addition to whether the queue was outputted because of time or size criteria. This record would be created by the FEP when it placed the batch on an output queue.

4.2.6 Error Statistics

Five types of reports are contained in the Error Statistics Block. Line Error Records (Figure 4.6) would be written by the FEP whenever a retransmission was requested over a line. The FEP could automatically create these records when it received or gave a retransmission request; thus only concentrator-terminal lines would have to be handled by the concentrator. When it received or gave a request to a terminal, the concentrator would forward the information to the appropriate FEP for journalling. In addition, at the FEP, the number of "time-out" and "error in message" errors could be tallied in two cells associated with an "active I/O line" table. If either cell was greater than its permissible limit, or if the addition of the cells was greater than their allowed combined limit, an Excessive Line Error Report would be issued on-line and journalled on the history tape. Whenever a line or buffer overflow occurred, the information would be sent to the FEP for on-line reporting and capture in the Overflow Error Record. Similarly, password failure data would be reported on-line and recorded in a Password Failure Record. Finally, Congestion Error Records would be produced whenever "congestion requests" were issued or received by the FEP.

4.3 Summary

This section presented an overview of the data needed for the proposed statistical reports of Section 3. A possible mechanism to collect this data was also presented. In the next section, some algorithms to convert this raw data into the reports are given.

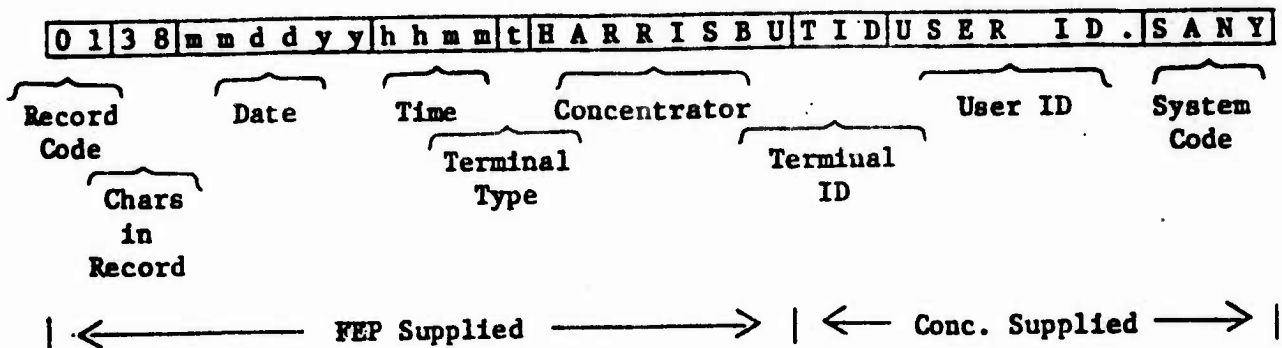

a) Logon Record

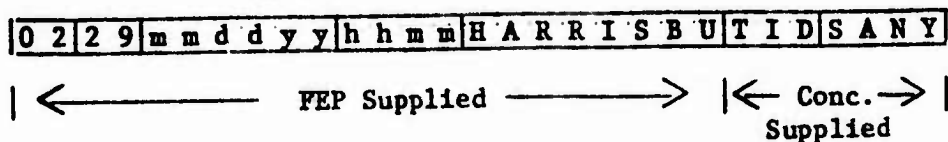

b) System Change Record

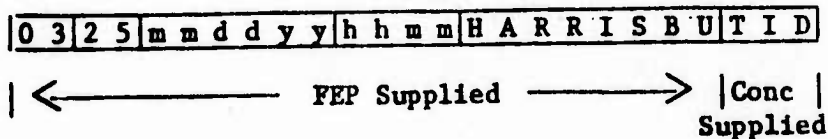

c) Logoff Record

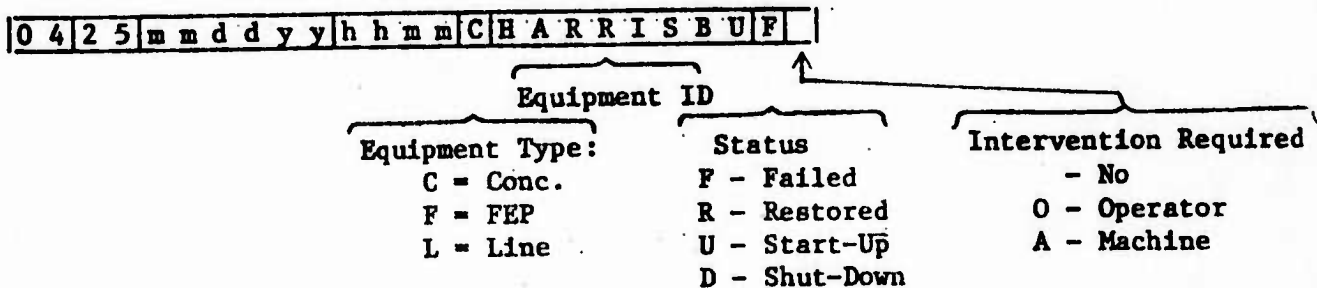

d) Status Record

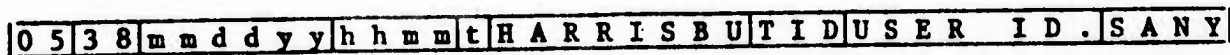

e) System Snapshot

Figure 4.1 - CONFIGURATION STATISTICAL RECORDS

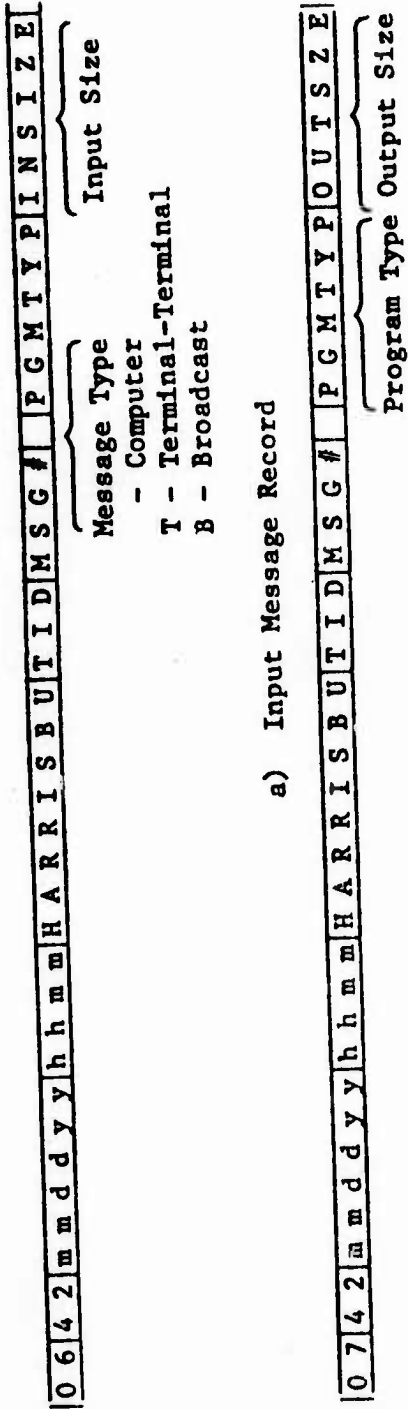

Message Type
 - Computer
 T - Terminal-Terminal
 B - Broadcast

Figure 4.2 - TRAFFIC AND MESSAGE STATISTICAL RECORDS

0 8 | 3 8 | m m d d y y | h h m m | H A R R I S B U | C E L 1 | C E L 2 | C E L 3 | C E L 4

Concentrator ID

Queuing Time

No. of Entries

Processing Time

Buffer Utili.

| Binary Values from Concentrator |

a) Concentrator Input Record

0 9 | 3 8 | m m d d y y | h h m m | H A R R I S B U | C E L 1 | C E L 2 | C E L 3 | C E L 4

b) Concentrator Output Record

1 0 | 3 1 | m m d d y y | h h m m | H A R R I S B U | T I D | M S G # | b b b b

32 Binary Bits
From 1 MSec Interval Timer

c) FEP Input In Record

1 1 | 3 1 | m m d d y y | h h m m | H A R R I S B U | T I D | M S G # | b b b b

d) FEP Input Out Record

1 2 | 3 1 | m m d d y y | h h m m | H A R R I S B U | T I D | M S G # | b b b b

e) FEP Input Done Record

1 3 | 3 1 | m m d d y y | h h m m | H A R R I S B U | T I D | M S G # | b b b b

f) FEP Output in Record

1 4 | 3 2 | m m d d y y | h h m m | H A R R I S B U | T I D | M S G # | b b b b

Output Status Flag
- No Blocking
T - Terminal
S - New Session

g) FEP Output Out Record

1 5 | 3 1 | m m d d y y | h h m m | H A R R I S B U | T I D | M S G # | b b b b

h) FEP Output Done Record

Figure 4.3 - RESPONSE TIME STATISTICAL RECORDS

0 8 | 3 8 | m m d d y y | h h m m | H A R R I S B U | C E L 1 | C E L 2 | C E L 3 | C E L 4 |

Concentrator ID

Queuing Time

No. of Entries

Processing Time

Buffer Util.

Binary Values from Concentrator

a) Concentrator Input Record

0 9 | 3 8 | m m d d y y | h h m m | H A R R I S B U | C E L 1 | C E L 2 | C E L 3 | C E L 4 |

b) Concentrator Output Record

1 0 | 3 1 | m m d d y y | h h m m | H A R R I S B U | T I D | M S G # | b b b b |

32 Binary Bits
From 1 MSec Interval Timer

c) FEP Input In Record

1 1 | 3 1 | m m d d y y | h h m m | H A R R I S B U | T I D | M S G # | b b b b |

d) FEP Input Out Record

1 2 | 3 1 | m m d d y y | h h m m | H A R R I S B U | T I D | M S G # | b b b b |

e) FEP Input Done Record

1 3 | 3 1 | m m d d y y | h h m m | H A R R I S B U | T I D | M S G # | b b b b |

f) FEP Output in Record

1 4 | 3 2 | m m d d y y | h h m m | H A R R I S B U | T I D | M S G # | b b b b |

Output Status Flag
- No Blocking
T - Terminal
S - New Session

g) FEP Output Out Record

1 5 | 3 1 | m m d d y y | h h m m | H A R R I S B U | T I D | M S G # | b b b b |

h) FEP Output Done Record

Figure 4.3 - RESPONSE TIME STATISTICAL RECORDS

1627 m m d d y y h h m m C H A R R I S B U x x x x

Flag ID CPU
F - FEP Utilization
C - Conc.

a) CPU Utilization Record

1733 m m d d y y h h m m C H A R R I S B U P G M I D x x x x x x x x

Program ID No. of Accesses
Utilization

b) CPU Utilization by Module

1839 m m d d y y h h m m C H A R R I S B U D I S K I D . x x x x x x x x

Disk ID Utilization
No. of Accesses

c) Disk Utilization Record

1935 m m d d y y h h m m C H A R R I S B U B U F F E R I D . x x x x

Buffer ID Utilization

d) Buffer Utilization Record

Figure 4.4 - SYSTEM UTILIZATION STATISTICAL RECORDS

2043	mm	dd	yy	hh	mm	CHARRIS	BU	TPUT	I	x	x	x	x	x	x	x	x	x	x	x	x					
Flag C - Conc F - FEP				ID				Queue ID											Total Number of Entries on Queue				Maximum Queue Length			
				Av. Queue Length																						

a) Queue Record

2135	mm	dd	yy	hh	mm	FEP	ID				T	x	x	x	x			
FEP ID				Batch Queue ID				No. on Queue										
Criteria Flag T - Time B - Batch																		

b) Batch Record

Figure 4.5 - QUEUE STATISTICAL RECORDS

2 2 | 2 3 | m m d d y y | h h m m | L I N E I D . x |

Error Type:

- M - Message in Error
- T - Time Out
- U - User Request Retransmission
- C - Conc Request Retransmission
- L - Message Lost - Please Retransmission

a) Line Error Record

2 3 | 2 4 | m m d d y y | h h m m | C H A R R I S B U |

EQ. Type
F - FEP
C - Conc.

ID

↑ Congestion Report =
W - Wait
C - Continue
P - Pause

b) Congestion Error Record

2 4 | 3 2 | m m d d y y | h h m m | C H A R R I S B U B O U T P U T 1 |

EQ. Type
ID

Type ID
B - Buffer
Q - Queue

c) Overflow Error Record

2 5 | 2 3 | m m d d y y | h h m m | L I N E I D . |

↑ Error
- Both
H - Hits
T - Timeouts

d) Excessive Line Error Record

2 6 | 3 0 | m m d d y y | h h m m | H A R R I S B U U S E R I D |

Concentrator ID

e) Password Failure Record

Figure 4.6 - ERROR STATISTICAL RECORDS

5. PROCESSING METHODOLOGY

In Section 3, 44 management, operational, and engineering reports were proposed, while 26 statistical records were proposed in the preceeding section. In order to convert the above input records into output reports, a processing methodology must be defined. The methodology can be as simple as list all type X input records, or as complicated as multiply field A of card B by field C of card D and use result as a pointer into a data base for the value to be printed. The more complicated the methodology, the more costly is the statistics subsystem.

This section discusses a proposed methodology for the LDCN statistical package. Section 5.1 discusses those output reports that would be little more than line-by-line listings of various input records, while Section 5.2 discusses those reports with intermediate processing requirements. The use of a data base in producing reports is discussed in Section 5.3. Finally, Section 5.4 reviews the complex processing requirements proposed for the LDCN reports, while Section 5.5 gives an overview of a set of programs that could be used to process the statistical reports.

5.1 Simple Processing Methodologies

Of the 44 proposed LDCN outputs, 15 are little more than line-by-line transfers from an input record to an output line. Table 5.1 shows these output reports and the corresponding input records. The System Status Report and the System Configuration report are line-by-line transfers as are the CPU Utilization, Buffer Usage, Output Queue, and Disk Utilization Plots. To obtain the message length histograms, the number messages of length N would be counted and divided by the total number of messages to obtain a point on the graph equal to (character size N, percent of messages).

The Traffic Statistics Plot would be obtained by counting the number of messages over each time interval, while the User Status Plot could be obtained by listing the cumulative number of daily logons at each time period of interest on the graph and subtracting the cumulative number of logoffs from this value. The Password Failure Report, Line Notification Report, and Congestion Report would require the input records to be sorted according to component identifier before being tallied. The Average Congestion Interval on the Congestion Report would be obtained by summing the times on all the "continue" records, subtracting from this the time on all the "wait" records, and dividing by the number of "wait" records. The LDCN CPU Utilization Summary would require using only those utilization records collected during the prime time. These records would then be sorted according to CPU; the utilizations for a given CPU are then summed and divided by the number of records for that CPU. Finally, the System Signon-Signoff Report would require the matching of Logon and Logoff Records before an output line was produced.

5.2 Intermediate Processing Methodologies

The 11 reports listed in Table 5.2 would require intermediate processing methodologies to be produced. Of the 11 reports listed, the CPU Utilization, Buffer Usage, Output Queue, and Disk Utilization Reports are all very similar in nature. Thus by mentioning a processing strategy for the CPU Utilization Report, the processing for the other reports should become obvious. The CPU Utilization Report is a more detailed version of the LDCN CPU Utilization Summary discussed above. Whereas the Summary would list a weekly, prime-time, average utilization, the CPU Utilization Report would list prime-time, average utilization on a daily basis. In addition, CPU Utilization would be calculated on an hour-by-hour basis to determine the peak utilization per hour and its peak hour.

The CPU Utilization Report by Module and CPU Module Access Report would require more processing and sorting to be produced. These reports are more detailed copies of the CPU Utilization Report. It should also be noted that the peak hour utilization on these reports would refer to the total, not to each individual component.

The values listed in the three response time reports would be approximate. An example of response time calculations for a given hour would be:

- a. Sum together the processing time fields for all Concentrator Input Records. Also apply this addition to the queuing time fields, the buffer utilization fields, and the number of entries field.
- b. Follow a similar procedure for the Concentrator Output Records.
- c. Divide the number of entries field into the other three fields for both record types.
- d. Sort FEP Records 10-15 into sets based on Concentrator, Terminal ID, and Message Number.
- e. Discard incomplete sets, as well as sets whose Output Status Flag in Record 14 is set to "S".
- f. Calculate the time difference in seconds between Records 10 and 15 and average over all remaining sets.
- g. The average response time for the hour is approximately the processing and queuing times from the Concentrator Input Records plus the value in (f) plus the processing time value from the Concentrator Output Records.

Other response time values and components would be possible from these values, however, the above steps show how such calculations could be carried out.

Finally, the User Status Reports would have to worry about logons occurring before prime-time and lasting into prime time, as this would affect the validity of the reports. There would be no easy way to remedy this problem except by processing logon-logoff records with time values starting about two hours before prime-time.

5.3 Need for a Data Base

Thirteen proposed LDCN reports would require outside data to be produced. These 13 are listed in Table 5.3 along with the data required. In processing the reports, the LDCN statistical package would follow the methodologies mentioned above.

The data listed in Table 5.3 suggests that at least two data bases should be established for statistics. The first data base would contain the data needed for the summary plots, while the second would contain component performance limits and component specifications. With these data bases all 13 reports could be easily produced.

5.4 Complex Processing Methodologies

The five remaining LDCN reports shown in Table 5.4 fall into the Complex Processing Methodology Class. These reports are concerned with obtaining the mean, standard deviation, and maximum message lengths. The following algorithm could be used to determine each of these values from a given set of data:

```

INITIALIZATION:  MAX = 0;
                  XOLD = 0;
                  SOLD = 0;
                  N = 0;

INPUT:  READ LENGTH;
IF LENGTH > MAX THEN MAX = LENGTH;          /*RUNNING MAXIMUM*/
        X = LENGTH;
        XNEW = (XOLD*N+X)/(N+1); /*RUNNING MEAN*/
        SNEW = (N*(SOLD+XOLD*XOLD-2*XNEW*XOLD
                +XNEW*XNEW)+(X-XNEW)**2)/(N+1);
                                                /*RUNNING SD*/

        N = N + 1;
        XOLD = XNEW;
        SOLD = SNEW;
IF (MORE DATA) THEN GO TO INPUT:
ELSE OUTPUT XOLD, SQRT (SOLD), MAX:

```

Where XOLD, SQRT (SOLD), and MAX are the mean, standard deviation, and maximum, respectively.

5.5 Statistical Processing Overview

There are many possible processing scenarios for converting the LDCN statistical input records into output reports. One such scenario incorporates the use of seven files and four distinct program types. This scenario allows for the processing of history tapes on a day-by-day basis, and notifies the program operators of missing data before printing out the reports. This scenario is described below in terms of the different files and program types.

5.5.1 Files

The seven files proposed for use in processing the LDCN statistical data are:

- a. The Total Traffic per Week file would be a sequential file which would contain two-field entries. The first field entry would contain the start date of the week (MMDDYY), while the second entry would contain the total number of LDCN messages for that week. An entry would be placed at the end of the file when the weekly LDCN Status Summary was created; the last 104 entries would then be used to create the Traffic Summary Plot. Once a year an update program would be run to discard file entries more than two years old and to compress the file.
- b. The Average Traffic per Hour file would be a sequential file similar to the one above.
- c. The Performance file would be an indexed file which would use device identification numbers and device types as indices. CPU and disk entries would also have fields for down-time and utilization limits. Buffer and queue entries would contain the warning limit size and the maximum buffer or queue size, while batch queue entries would contain information on time and size criteria. Line and channel entries would contain down-time and utilization limits, error limits for messages, time-outs, and combinations of the two, and line characteristics (line discipline, capacity, and character codes). This file would be updated when changes to the system were made.
- d. The Traffic Algorithm file would be an indexed file which would map terminal identification, system accessed, and program type into batch, real-time, inquiry, upquiry, AUTODIN, and non-AUTODIN traffic types. Indexing would be performed on the first three fields of this nine field card.

- e. The Output Information file would be a sequential file sorted by output report number. Each entry would contain an output report number, the input records needed to produce that report, and the filtering limits permissible for that report (e.g., data needed for entire week or just one day, prime-time hours allowed, and system, concentrator, and traffic filters allowed).

- f. The Output Request file would be a sequential file of the reports requested from the LDCN. Each entry in this file would contain a request number, an output report number, the start date of the week for which the report is requested, the filtering limits to be used in preparing the report (e.g., start and end values for the prime time), and two seven character fields. One field would indicate the day's data needed to be collected from the SPCC system in order to produce the report; the other field would indicate this for the ASO system. A "1" in position i of either field would indicate data needed to be collected for the i^{th} day of the week; a "0" would indicate that data was not needed for that day; while a "2" would indicate data was already collected for that day. This file can thus be used to give the status of each output request.

- g. The Output Data file would be used to store output results for formatting by the report generator. This indexed file would contain information on all reports; each entry would therefore contain request number, output report number, date, information segment number, FEP accessed, and the output information. Indexing would be by request and report number.

5.5.2 Processing Organization

The above seven files would interact as follows. At the beginning of each week, the LDCN Network Control Center (NCC) would run a program which appended requests for the managerial and operational reports onto the Output Request file. In addition, a program would be run which placed the engineering report requests for the week on the file. This second program would use the Output Information file to validate the engineering requests inputted; incorrect requests would not be placed on file but outputted along with an error code. These requests could then be corrected and re-entered by the second program. Both programs would set the appropriate bytes in the ASO and SPCC fields of each new Output Request entry to one. Because of this, these programs could be run anytime during the processing cycle.

As each tape from the ASO or SPCC front end arrived daily at the NCC, it would be processed by a second distinct program type. This program would use the Output Information file and Output Request file to determine what data needed processing and outputting on the Output Data file. The program would use the Traffic Algorithm file to determine traffic and message type information, while the Performance file would be used to determine what information should be outputted for the exception reports. Each tape processed by the program would have a header indicating the FEP it came from, so the filtering of data according to the ASO or SPCC system would not occur on an individual record basis, but on an entire tape basis. If data were to be filtered according to subsystems (e.g., AICS or AWPS), a temporary file indexed by subsystem and terminal would be created to journal the logon-logoff periods of each terminal on each subsystem. Other input records would then be filtered against this file in order to obtain the appropriate output report segment. Similarly, other temporary files or storage will be needed

for calculating and processing the various output report segments. When the program is done processing the tape, it changes the appropriate byte of the ASO or SPCC field of each appropriate Output Request entry from a one to a two; it then formats each output segment and places it on the Output Data file.

The third distinct program type would be run at the end of the week. This program would first check the Output Request file to see if some data was processed on each day required by each output request. This check is performed by looking for a value of one in the ASO and SPCC fields of each entry. If some ones were found, the program would output on the console and on the printer the needed tapes by system type and date. It would then ask the operator "GO OR NOGO?". If the operator responded "NOGO," the program would terminate so the operator could run the second program type to input the needed data. If the operator responded "GO," the output requests with missing data would not produce reports at this time. This would allow the missing data to be inputted during the next week. However, to guarantee that all output requests are eventually satisfied, the program would output all reports whose collection week was more than N weeks before the current processing date. For the LDCN, an N equal to two is appropriate. Thus with this value, all detailed data for engineering reports requested as a result of the summary report data must be present at reporting time or the reports will be produced without the data. For each request to be filled, the program would then collect, sort, process, and format the appropriate output segments into a complete report. Finally, the program would make the appropriate entries on the Total Traffic per Week and Average Traffic per Hour files, and output the reports associated with these files.

The last program type would be run after the above program. This program would purge the filled requests from the Output Request file and compress the file. It would also purge the reported data from the Output Data file and compress it. These functions are performed in a separate

program run after the above report generator so that the report generator can be run more than once (e.g., after an abend or to produce more copies of the reports).

The above processing scheme would make program restarts fairly easy. If the system abended during the first programs, the Output Request file would be purged of all entries beyond the last request number of the last run, and the programs would be rerun. If an abend occurred during a type two program, the program could be rerun after all twos in the Output Request file for the given FEP and given data were changed to one, and after all entries in the Output Data file for the given FEP and date were purged. A type three program would just be rerun after an abend, as would a type four program.

For the above reasons, the processing scenario mentioned above is suggested for implementation by the LDCN.

OUTPUT REPORTS	INPUT RECORDS
LDCN CPU Utilization Summary	16 - CPU Utilization Record
System Status Report	04 - Status Record
Line Notification Report	25 - Excessive Line Error Record
Password Failure Report	26 - Password Failure Record
Congestion Report	23 - Congestion Record
User Status Plot	{ 01 - Logon Record 03 - Logoff Record
System Configuration	05 - System Snapshot
System Signon-Signoff	{ 01 - Logon Record 03 - Logoff Record
Traffic Statistics Plot	06 - Input Message Record
Input Message Length Histogram	06 - Input Message Record
Output Message Length Histogram	07 - Output Message Record
CPU Utilization Plot	16 - CPU Utilization Record
Buffer Usage Plot	{ 08 - Concentrator Input Record 09 - Concentrator Output Record 19 - Buffer Utilization Record
Output Queue Plot	20 - Queue Record
Disk Utilization Plot	18 - Disk Utilization Record

Table 5.1 - OUTPUTS AND CORRESPONDING INPUTS:
SIMPLE PROCESSING METHODOLOGIES

OUTPUT REPORTS	INPUT RECORDS
LDCN Response Time Report Response Time Report by System Response Time Report by Component	08 - 15: Response Time Statistical Records
CPU Utilization Report	16: CPU Utilization Record
CPU Utilization Report by Module CPU Module Access Report	17: CPU Utilization by Module
Buffer Usage Report	{ 08: Concentrator Input Record 09: Concentrator Output Record 19: Buffer Utilization Record
Output Queue Report	20: Queue Record
LDCN User Status Report User Status Report by System	01 - 03: Configuration Statistic Records
Disk Utilization Report	18: Disk Utilization Record

Table 5.2 - OUTPUTS AND CORRESPONDING INPUTS:
INTERMEDIATE PROCESSING METHODOLOGY

OUTPUT REPORTS	INPUT RECORDS	OTHER DATA NEEDED
LDCN Traffic Summary Plots - Messages Per Week - Av. No. of Msgs/Hr	--	Data from Current and Past LDCN Status Summaries
System Status Exception Report	04 - Status Record	Equipment or Line Performance Limit
Output Queue Exception Report	{ 20 - Queue Record 24 - Overflow Error Record	Maximum Queue Length, Current Queue Limit
Buffer Usage Exception Report	{ 08 - Concentrator Input Record 09 - Concentrator Output Record 19 - Buffer Utilization Record 24 - Overflow Error Record	No. of Buffers in Pool, Current Buffer Limit
PU Utilization Exception Report	16 - CPU Utilization Record	Utilization Performance Limit
Disk Utilization Exception Report	18 - Disk Utilization Record	Utilization Performance Limit
LDC Traffic Statistics Reports - Total - ASO - SPCC - By System and Traffic Type	06 - Input Message Record	Algorithm to go from Concentrator, Terminal ID, and Program Type to Classification for Inquiry, Batch, Real-Time, Etc.
Line Error Report	{ 22 - Line Error Record 25 - Excessive Line Error Record	Time-Out and Message Error Limits
Batch Queue Report	21 - Batch Record	Size and Time Criteria

Table 5.3 - OUTPUTS AND CORRESPONDING INPUTS:
DATA BASE NEEDED TO STORE OTHER DATA

OUTPUT REPORTS	INPUT RECORDS	OTHER DATA NEEDED
LDCN Status Summary	{ 01 - Logon Record 03 - Logoff Record 06 - Input Message Record 07 - Output Message Record 08-15 - Response Time Statistical Records	Algorithm to go From Program Type to Traffic Type
LDCN Message Length Statistics Report	{ 06 - Input Message Record 07 - Output Message Record	Algorithm to go From Program Type to Traffic Type
Message Length Statistics Report by System and Traffic Type	{ 06 - Input Message Record 07 - Output Message Record	Algorithm to go From Program Type to Traffic Type
LDCN Utilization Report } Line Utilization Exception Report }	06 - Input Message Record 07 - Output Message Record 22 - Line Error Record	{ Line Discipline, Capacity in BPS, Character Code, Performance Limit

Table 5.4 - OUTPUTS AND CORRESPONDING INPUTS:
COMPLEX PROCESSING METHODOLOGY

6. SUMMARY

This report presented a study on proposed statistics for the LDCN. Section 2 gave an overview of the LDCN, statistics, and network management. In this section, the manual collection subsystem of the LDCN statistical package was described. Sections 3, 4, and 5 then focused on the computerized subsystem. Section 3 dealt with the design of statistical reports for managers, operators, and engineers. In all, 44 reports were considered. The proposed measurement mechanisms to obtain statistical data were presented in Section 4. The approach used centered on a history tape concept, with some 26 statistical records being proposed for collection by the LDCN. Finally, some algorithms to convert the raw data into meaningful statistics were given in Section 5.

A.1 INTRODUCTION

This appendix presents the statistics collected by various current systems in order to manage and control their operation and growth. The knowledge of these statistics served as background information for the derivation of the LDCN statistics proposed in the previous sections of this document. The statistics described are by no means a complete treatise on the subject, nor are they unique to the examples mentioned. These examples, however, highlight key ideas that were used to derive the statistics of other systems with similar functions and characteristics.

The first set of statistics described is from the Philips DS-714 computer used as a Telex Switch. The DS-714 system collects fairly detailed data since the collection of data on billable calls (company revenue) and on unsuccessful calls (lost revenue) is very important to the survival and growth of a Telex company. This first section thus only focuses on the data collected by the System.

The second set of statistics described is for a Communications Control System, a terminal network used for customer ordering, inventory control, and processing of company accounts. This system's statistics are relatively simple and straightforward, while the statistics presented for the S network of a major insurance company are somewhat more complex. The procedures used in monitoring error statistics in the NASDAQ system are then presented, followed by the statistics collected in a Social Security Administration network. Finally, the last set of statistics described are those of the ARPA Network, a multipacket-transmission, computer network system sponsored by the Advanced Research Projects Agency (ARPA).

A.2 DS-714 TELEX SYSTEM

A Philips DS-714 Telex Switch can be used to route telegraph messages in the United States or between the United States and foreign countries. To understand some of the statistics collected by the switch in performing this task, an overview of the Telex operation is helpful. Basically, after a call arrives at a Telex Switch over an input circuit, the switch attempts to locate and seize an available path to the requested party. Several attempts are made by the switch to extend (complete) the call. If none of the extensions are successful, a "busy signal" is returned to the caller; the caller may then hang up (causing the input circuit to be disconnected from the system) or place another call request to the switch. Billing information is collected on successfully completed calls. If the called party terminates the call, the switch disconnects the output circuit and allows the caller to place another call request; when the caller terminates the call, both the input and output circuits are disconnected from the switch.

Three types of reports are produced on a Telex Switch:

- a. Accounting and billing reports,
- b. On-line and off-line system performance reports,
and
- c. Management information reports on traffic patterns
and business growth.

To obtain these reports, all information concerning calls placed through the DS-714 Telex System are logged on a history tape. In the journalling process, the data is first logged on a disk; after a specific number of records have been written, they are grouped into a block. A header giving the

date, time, and block size is then appended to the block, and the block is written to the history tape. By using this scheme, one reduces the processing associated with advancing to a particular starting time by skipping over blocks instead of individual records.

Table A.2.1 lists the minimum information required for journalling of each Telex call. On input, each call is given a reference number so that it may be tracked through the system. The input line of the call is stored, as is the time (month, day, hour, minute) the call enters the system. For accuracy in determining the total time of the call in the system, the connect time as represented by the system's clock is logged. The caller's account number is also recorded; if it is invalid, the reason it is invalid along with the caller's response to this fact is logged. The logging of selection information for the called party is similar to that for caller account numbers. For each output attempt, the output line and the time it was seized is reported, as is the disconnect time and the reason for an unsuccessful attempt. If the output attempt is successful, the start and end of the billing time is logged. Finally, the disconnect time and the originator of the disconnect is recorded.

In addition to the parameters listed in Table A.2.1, system status records are logged on the history tape. Because of this, the DS-714 history tape is composed of nine different "logs". Table A.2.2 lists the nine history tape logs; of these, the first three contain the parameters of Table A.2.1 for messages requiring immediate delivery. These three logs are a major source of statistics for the Telex system; thus they are now looked at in more detail.

Table A.2.3 shows some of the entries in the Receive Selection Log. Of these, the message number, input bundle area code, and circuit number are used to identify a call from a geographic area such as the U. K. or France. The time the call request is received is given, as is a flag

indicating whether the caller originated the request or responded to a "next message" prompt from the system after the called party disconnected. The log's cancel code indicates the disposition of the call during the receive selection, with a zero in this field indicating a good selection. Table A.2.4 lists the other input cancel codes. Understanding the meaning of these cancel codes is not important; however, it should be noted that the DS-714 recognizes a number of very specific error conditions on input. This recognition is important to a Telex company because an unsuccessful call is lost revenue to them. As such, the company needs to know what errors are due to the user and what errors are due to the system so that these problems can be corrected whenever possible, thereby increasing revenue.

The relevant entries of the Call Extension Log are shown in Table A.2.5. The message number and input bundle and circuit relate this log to the corresponding Receive Selection Log. Output bundle and circuit information is given. The duration of the call extension is obtained by subtracting the end time from the seize time, and the disposition of the extension is given by the cancel code. Table A.2.6 lists the output cancel codes for a call extension log; once again, understanding the meaning of the various codes is not as important as recognizing that a company needs to know about specific errors in order to improve service and increase revenue. A final point should be noted about the call extension log. Currently, the count of which attempt a particular call extension is is not recorded by the DS-714. Thus to determine the number of extensions per call, call extension logs must be matched to their corresponding receive selection logs. Since the processing associated with the matching of records must be performed for other statistics, the omission of the count is not important; however, for other systems, processing time can be saved by recording this value.

Table A.2.7 shows the entries of interest in the Regular Call Record. The message number, input bundle, and circuit is again given, as is the output bundle and circuit of the last call extension. Billing, cancel code, and disconnect information is also given. The regular call record is complete for billing runs; however, it could be considered incomplete for statistical purposes. A more complete call record would contain the receive time interval timer and FST flag from the receive selection log, the end interval timer from the last call extension log for the message, and the count of which attempt the last call extension was. This new log would eliminate the matching of receive selection logs to regular call records to obtain total time for a call. In addition, the length of time an originator would wait for a call connect before disconnecting could be easily obtained, as well as the extension at which disconnection occurs. All these statistics are necessary in the monitoring of Telex lines; to obtain them by a matching process is not always cost effective. However, in this case, the format of the regular call record is justified. To create the above "extended" record, either the values from each component log would have to be carried in the message header, or the values would be stored on disk and the DS-714 would have to match these values to the regular call record in a real-time mode. After analysis, it was determined the processing time for an off-line matching of records was more appropriate than the additional core required for either of the above cases; in addition, Philips felt that off-line processing was more cost-effective than the on-line processing required in the second case. Thus, in trading off various factors, Philips went with the above call record.

The many complex outputs produced by the DS-714 Telex System statistical programs will not be discussed here. However, it should be noted that the statistical programs are useless without the raw data from the history tapes. By

having the DS-714 record statistics as they occur, Philips has potential problems associated with the matching of logs to obtain certain statistics. Some of these problems are avoided by having certain logs, like the regular call record, contain all information needed for a billing run; in addition, logs like the regular call record can be used to determine the traffic passing through the system. These types of programs are run on a daily basis; programs that require the matching of logs to monitor network performance (e.g., line utilization or the time spent in servicing a call) are run on a less frequent periodic basis (e.g., weekly, monthly, or quarterly).

Input Parameters (For Each Call)

- a) Line number, (sufficient information to define the hardware used for the call).
- b) Month, day, hour, minute.
- c) Time "Call Request" was received.* (Start of Input line holding time).
- d) Call reference number.

Calling Network Supplied Parameters

- a) Answerback or number of calling subscriber (if information not acceptable, the type of canned message sent and the subscriber's response).
- b) Selection (if information not acceptable, the type of canned message sent and the reselection). If the call is handled by an operator, the selection given by the operator, if any.

Output Parameters (For Each Output Attempt)

- a) Line number (sufficient information to define the hardware and route used for the attempt).
- b) Time line seized.*
- c) Response and time* of disconnect or
- d) Answerback of called party and time of call connect.

*Internal System Time in Seconds

Table A.2.1 - PARAMETERS THAT MUST BE STORED ON THE HISTORY TAPE

Call Duration Parameters (For Successful Calls)

- a) Start time of billing duration.* (If this time cannot be derived from the time of the call connect).
- b) End time of billing duration.*

Call Disconnect Parameters (For Each Call)

- a) Origin and type of disconnect.
- b) Time disconnect signal received.*
- c) Time output line disconnected.*
- d) End time of billable duration.*
- e) Time input line disconnected.*
- f) Month, day, hour, minute.

*Internal System Time in Seconds

Table A.2.1 - (Continued)

<u>Log Type</u>	<u>Log Name</u>	<u>Contains</u>
1	Receive Selection Log	Information on the call request.
2	Call Extension Log	Information on each call extension.
3	Regular Call Log	Information on a successfully completed call.
4	Safe EOM-In Log	Information on a store and forward message inputted into the switch.
5	Safe EOM-Out Log	Information on the delivery attempt of a store and forward message.
6	Disconnect Log	Information on the disconnection of a caller who does not stop transmitting characters.
7	False Seizure Log	Information on the seizure of an input line without any call request being made.
8	Startup-Restart-Switchover Log	Information on the data and time of a system startup, restart, or switchover.
9	Text Billing Log	Information on the first characters of a text billing message.

Table A.2.2 - LOGS WRITTEN ON THE HISTORY TAPE

1. Telex Message Number - for internal call identification.
2.
 - a) Input Bundle Area code,
 - b) Input Circuit Number.
3.
 - a) Receive Time (Month, Day, Hour, Minute).
 - b) Receive Time Interval Timer - the rightmost 18 bits of the one second system interval clock.
 - c) FST =

{	0-Receive Time is the time a solicitation for the next message was sent to the caller.
	1-Receive Time is the time the calling party connected to the system.
4. Cancel Code - the reason the request was "disposed of" before a call extension could occur.

Table A.2.3 - RECEIVE SELECTION LOG ENTRIES FOR STATISTICAL ANALYSIS

- 0-Good Selection
- 1-Registered Numbers Not Allowed With Associated Option Code
- 2-Selection Error (for all other errors)
- 3-Program Illogical Error
- 4-Area Code Barred
- 5-Invalid F.69 Code
- 6-Unknown Area Code
- 7-Compare Failure on Special F.69 Code
- 8-Forbidden Digit Detected
- 9-Abbreviated Code Unassignable
- 10-Abbreviated Code Invalid for Associated Answerback
- 11-Too Many Selection Digits
- 12-No Route to Directly Connected Subscriber
- 13-No Route to Directly Connected Subscriber (no disc in system)
- 14-Two Option Codes in Selection
- 15-Option Code Barred
- 16-Area Code Not Serviced
- 17-Continuous Input From Caller
- 18-Caller Disconnected
- 19-Caller Cancelled with Five L's
- 20-Distortion Analyzer Not Available
- 21-No Valid Selection Characters Input
- 22-Insufficient Resources, Multiple Number Request
- 23-No Match on Registered Number Look-Up
- 24-No Match on Registered Number Look-Up (no disc)
- 25-No Match on Dial Code Related to Registered Number
- 26-No Match on Dial Code Related to Registered Number (no disc)
- 27-Not Enough Blocks, Capture Data Option Code
- 28-(Not Used)
- 29-Retrieval/Supervisor Command Parameter Error
- 30-Caller Responded "NG" to Called Answerback for SAFE Input
- 31-Security Code Violation for Retrieval
- 32-System Critical Level Reached for SAFE Traffic
- 33-Called Circuit: No Answerback Received

Table A.2.4 - INPUT CANCEL CODES

- 34-Called Circuit Answerback Error
- 35-Barred Collect Call
- 36-Caller Circuit Error
- 37-Caller Fails to Respond With OK or NG to SAFE Answerback After Second Request
- 38-Circuit is Busy for "Place Call on Specified Circuit" Option Code
- 39-Illegal Call Attempt
- 40-Illegal Call Attempt
- 41-SAFE Option to a Barred Destination
- 42-Hour, Minute Field Error - Special Delivery, Book
- 43-TELEX Number Field Error - Cancel, Request for Credit
- 44-Circuit Number Error (Place Call on Specified Circuit)
- 45-No Match on Answerback Look-Up
- 46-No Match on Answerback Look-Up (no disc)
- 47-Input Bundle Time-Out, Prior to Cross Connect

Table A.2.4 - (Continued)

1. Telex Message Number
2. a) Input Bundle Area Code
b) Input Circuit Number
3. a) Output Bundle Area Code
b) Output Circuit Number
4. a) Output Circuit Seize Time (Month, Day, Hour, Minute)
b) Output Circuit Seize Time Interval Timer
5. End Interval Timer - the time a call connect was received or the circuit disconnect time for incomplete extensions.
6. Cancel Code - the reason the call extension was not successful.

- 0-Good Extension
- 1-Occupied
- 2-OCC Received (semi-manual extension)
- 3-No Circuits
- 4-NC Received (semi-manual extension)
- 5-ABS Received
- 6-ABS Received (semi-manual extension)
- 7-Improper Answerback
- 8-NA Received
- 9-DER Received (semi-manual extension)
- 10-NA Received (semi-manual extension)
- 11-Subscriber's File Changed
- 12-NCH Received (semi-manual extension)
- 13-NP Received (semi-manual extension)
- 14-Country Name Not in File (with disc)
- 15-Country Name Not in File (without disc)
- 16-Invalid Input (Semi-manual extension)
- 17-Second Attempt Failure (semi-manual extension)
- 18-Caller Circuit Disconnected
- 19-Five L's Received
- 20-Called Circuit Error
- 21-No Available Route
- 22-NC Received
- 23-DER Received
- 24-No Call Confirm
- 25-No PTS
- 26-Call Connect Timeout
- 27-OCC Received
- 28-Called Circuit Disconnected
- 29-NP Received
- 30-NCH Received
- 31-Call Back Look-Up Failure
- 32-System Critical Level Reached
- 33-Head-On Collision

Table A.2.6 - OUTPUT CANCEL. CODES

- 34-Answerback Mismatch
- 35-DER Received After Call Connect
- 36-Caller Circuit Error
- 37-No Data Connect
- 38-No DLO
- 39-Disconnect Alarm
- 40-Abandon Call
- 41-Semi-Manual Error, Requiring a SWBD
- 42-DSUB Unavailable, But Not Busy With Call
- 43-DSUB Called Circuit Error
- 44-DSUB Call Connect Time-Out
- 45-(Not Used)
- 46-(Not Used)
- 47-Input Bundle Time-Out, Prior to Cross Connect

Table A.2.6 - (Continued)

1. Telex Message Number
2. a) Input Bundle Area Code,
b) Input Circuit Number.
3. a) Output Bundle Area Code,
b) Output Circuit Number.
4. Billing Start Time Seconds Counter
5. a) End Billing Time Seconds Counter
b) BT - if BT is not zero, then the end time counter is valid
6. FST - if FST is one, then the receive time is placed in the billing start and end time
7. a) Cancel Code
b) OUTC = $\begin{cases} 0\text{-Cancel Code refers to the call request} \\ 1\text{-Cancel Code refers to the call extension} \end{cases}$
8. Originator Disconnect Time Seconds Counter
9. Called Party Disconnect Time Seconds Counter
10. DIS - gives the type of disconnect for a call
11. Actual Time the log was created (Month, Day, Hour, Minute)

Table A.2.7 - REGULAR CALL RECORD ENTRIES FOR STATISTICAL ANALYSIS

A.3 THE COMMUNICATIONS CONTROL SYSTEM

Many large manufacturing firms have in-house computer networks. One such system is located in an East Chicago, Indiana plant. Called the Communications Control System (CCSYS) primary terminal system, the network has a data base management system which permits on-line accessing and updating of data on customer orders and their processing, inventory control, and company accounts. Like the DS714 Telex System, statistics for the CCSYS primary terminal system are continually collected on a history tape. Some of the statistical records collected on the tape are:

- a. System configuration records list all terminals that are currently under CCSYS control. System configuration records are produced as a result of an operator request for configuration status, and contain the time (hour, minute, second) and date (month, day, year) the record was created, the line number and terminal identifier for an active terminal, and the type of terminal (CRT or teletypewriter).
- b. A line status record is produced each time the CCSYS operator drops a line from the system or reinstates a line to the system. The record contains the time and date of the action, as well as the line number and line status due to the action (up or down).
- c. An application sign-on/off record is produced each time a terminal user enters a valid application. (An application in the CCSYS is a set of COBOL programs that perform a series of related tasks.) The sign-on/off record contains the terminal identifier and application name, the time and date of the activity, and the activity (sign-on or sign-off).

- d. An application program record is produced each time a COBOL program is executed. This record contains the name of the program being executed, its core requirement in bytes, the application it is running under, the terminal which is using it and the start time and date and the end time and date of the program's execution. In addition, the number of unsuccessful loads of the program for this execution due to insufficient core is recorded; from this, one can determine when core becomes a system bottleneck. Finally, the application program record indicates whether the program was loaded by a CCSYS special control feature.

- e. A terminal I/O record is produced each time a read or write operation is completed to a terminal. This record contains the time and date of the operation, the type of operation (read or write), the name of the format that was used, the program that initiated the I/O, the length (in bytes) of the data transmitted, and the segment number of the input or output. This record also contains the terminal identifier and application name.

- f. Each time a terminal abends, an abend record is produced on the history tape. This record contains the name of the abending terminal, its line number, the time and date of the abend, the abend type (system or user), and the abend completion code.

- g. Core allocation records list whether the various CCSYS core regions are allocated or free. These records also contain the date and time the record was created, as well as the region's starting address, ending address, and size.

The CCSYS data reduction program produces reports from the history tape. Control cards for the program specify the time period for which reports are desired and the desired reports. Ten reports may be produced by the program:

- a. System Configuration Report
- b. Line Status Report
- c. Sign-On/Off Report
- d. Application Program Report
- e. Terminal I/O Report
- f. Abend Report
- g. Frequency of Programs Report
- h. Terminal I/O Frequency Report
- i. Line I/O Frequency Report
- j. Frequency of I/O Formats Report

The first six reports are simply a line per record listing of the raw data records. Thus, a request for these reports over a time period exceeding one hour may result in a voluminous report when the CCSYS system is heavily active during the specified period. Figures A.3.1-A.3.3 show three of these six reports. Figure A.3.1 shows the System Configuration Report; the "P" in the type field refers to a hardcopy printer, while a "T" refers to a CRT Tube. Figure A.3.2 shows the Terminal I/O Report. The "W" in this report refers to a write (output) operation, while an "R" refers to a read

(input) operation. Finally, the Application Program Report is presented in Figure A.3.3. It should be noted that the "Seconds Used" field in this report is not part of the application program record, but is calculated by the statistical program from the "Start Time" and "End Time" fields.

Rather than deal with line-by-line data, CCSYS management can obtain four summary reports from the statistical program. The first is the Frequency of Programs Report, which lists each program executed during a given hour only once. For each program listed, the total number of executions for the hour are given, as is the total execution time. The average execution time is also given; this value is obtained by the integer division of the total execution time by the total number of executions. Finally, the program size and total number of unsuccessful program loads are given for each entry. Figure A.3.4 shows a sample report output.

Two summary reports are very similar in nature. The Terminal I/O Frequency Report (Figure A.3.5) lists each terminal's I/O activity on an hourly basis. The total number of reads and writes are given for each terminal, as is the total number of bytes inputted and outputted. The Line I/O Frequency Report (Figure A.3.6) groups the above terminal data by line identifier and then reports this I/O activity for each line. The final summary report is the Frequency of I/O Format Report. This report lists the number of times each format is used on an hourly basis, along with the average message length. Figure A.3.7 shows a sample Frequency of I/O Format Report.

The statistics collected by the CCSYS are fairly simple and straightforward. Other systems collect more complex data; thus we will now look at one of these systems.

DATE	TIME	LINE	TERMINAL	TYPE
12 02 74	13 44 23	030	L0300001	P
12 02 74	13 44 25	03B	L03A0002	P
12 02 74	13 44 25	042	L0420001	T
12 02 74	13 44 25	060	L0604050	T
12 02 74	13 44 25	060	L0604051	T
12 02 74	13 44 25	060	L0604052	T

Figure A.3.1 - SYSTEM CONFIGURATION REPORT

DATE	TIME	TYPE	FORMAT	LENGTH	SEGMENT NO.	TERMINAL	APPLICATION	PROGRAM
12 02 74	13 44 29	W	D8030220	95	2	LOB00001	ENTR	APPLEXEC
12 02 74	13 44 34	W	D0240010	768	3	L0664252	SHIP	APPLEXEC
12 02 74	13 44 35	R	D8030220	21	1	LOB00001	ENTR	APPLEXEC
12 02 74	13 44 35	W	D5730030	234	3	L0614052	SHIP3CS	APPLEXEC
12 02 74	13 44 35	W	D8030230	482	2	LOB00001	ENTR	BOOKSCHD
12 02 74	13 44 35	W	D8030220	102	3	L06C4051	ENTR	APPLEXEC

Figure A.3.2 - TERMINAL I/O REPORT

DATE	TIME	CORE RETRIES	SIZE	PROGRAM	APPLI- CATIONS	TERMINAL	END DATE	END TIME	SEC USED
12 02 74	13 44 35	0	1496	BOOKSCHD	ENTR	LOB00001	12 02 74	13 44 35	0
12 02 74	13 44 43	0	18832	A8030780	ENTR	LOB00001	12 02 74	13 44 43	0
12 02 74	13 44 45	0	1800	SHIPPING	SHIP3CS	L0614052	12 02 74	13 44 45	0
12 02 74	13 44 51	0	1496	BOOKSCHD	ENTR	L06C4051	12 02 74	13 44 51	0
12 02 74	13 44 52	0	1984	FLATSISY	YANKEE	LOB20001	12 02 74	13 44 52	0
12 02 74	13 44 58	0	37432	A0313010	YANKEE	LOB20001	12 02 74	13 44 58	0

Figure A.3.3 - APPLICATION PROGRAM REPORT

PROGRAM	SIZE	NO	TOTAL SEC	AVE SEC	TOT RETRIES	DATE	HOUR
A0240370	65576	20	39	1	0	12 02 74	13
A0240380	28720	14	10	0	0	12 02 74	13
A0240390	27728	14	12	0	0	12 02 74	13
A0240400	25512	11	2	0	0	12 02 74	13

Figure A.3.4 - FREQUENCY OF PROGRAMS REPORT

TERMINAL	NO. READS	NO. WRITES	BYTES IN	BYTES OUT	TOT NO.	TOTAL BYTES	DATE	HOUR
LOB00001	8	8	347	5657	16	6004	12 02 74	13
LOB20001	31	32	2202	40426	63	42628	12 02 74	13
L06A4051	8	9	888	9125	17	10013	12 02 74	13
L06A4052	8	9	398	6154	17	6552	12 02 74	13

Figure A.3.5 - TERMINAL I/O FREQUENCY REPORT

LINE	NO. READS	NO. WRITES	BYTES IN	BYTES OUT	TOT NO.	TOTAL BYTES	DATE	HOUR
LOB0	8	8	347	5657	16	6004	12 02 74	13
LOB2	31	32	2202	40426	63	42628	12 02 74	13
L06A	28	32	1844	24544	60	26388	12 02 74	13
L06C	26	33	2053	28056	59	30109	12 02 74	13

Figure A.3.6 - LINE I/O FREQUENCY REPORT

FORMAT	TYPE	LENGTH	NUMBER	DATE	HOUR
A8040020	W	915	9	12 02 74	13
A8040020	R	23	8	12 02 74	13
A8040040	W	1355	9	12 02 74	13
A8040040	R	35	8	12 02 74	13

Figure A.3.7 - FREQUENCY OF I/O FORMAT REPORT

A.4 THE S NETWORK REPORTS

The S Network connects terminals in an insurance company's branch offices to an IBM 370 computer on the east coast. Data describing newly written auto and homeowners policies and updates to the descriptions of existing policies are input at the terminals, and information about these policies is returned to the branch offices as acknowledgements and forms. In addition, the S Network handles the transmission of administrative messages between branch offices and the central computer site.

The traffic, reliability, response time, and system statistics collected by the S Network are used to manage the system's operation and growth. Together, these statistics form a complete picture of the system for purposes of analysis, maintenance, and future planning. Let us now look at some of these reports in more detail.

Network traffic statistics are used in system response time and capacity analyses, and to make meaningful projections on system growth. The S Network reports system traffic statistics on a per terminal per day basis, giving such information as:

- a. The number of messages that originated from a terminal,
- b. The average message length,
- c. The total number of characters transmitted from each terminal.

Similar traffic characteristics are reported for messages destined for each terminal. Figure A.4.1 shows a sample traffic report. The number of messages into and out of the processor is also given on this report, as is the number of

I/O errors for the day. Finally, traffic reports on a per line basis can be used to produce line utilization statistics. The S Network thus produces a line traffic report (Figure A.4.2) listing the terminals which utilize the same line and their traffic characteristics.

A necessity in the collection of system statistics is the monitoring of system error performance since knowing the frequency of terminal errors, line errors, and operator errors is important for network maintenance. The S Network provides a daily error report on a per line basis. This report lists the number of errors which have occurred during different time segments of message handling such as:

- Origination error
- Destination error
- Data Check Addressing error
- Data Check error
- Data Check Polling error

A typical summary error report is shown in Figure A.4.3. On this report, note that total origination/destination message traffic is given along with the above mentioned errors.

When the traffic volume at each office is known, as well as the mean values for positive polling and addressing time, and the offices on each multidrop line, then line utilization can be computed. The S Network reports current line utilization in time frames of 15 minutes for the active periods of the day. The number of messages, number of data characters and the percent of line utilization is given, as is the average and peak hour utilization. This report is shown in Figure A.4.4.

Finally, response time statistics indicate which areas in the system are under-utilized or over-utilized and thus highlight those areas in need of change. System response time measurements also add to an overall understanding of the system's throughput capability and the nearness of the current loading to the system's capacity. The S system has a comprehensive response time report. The central processor of the network operates on two queues (SAFA, SAFB). SAFB is a low priority queue for office-to-office type messages which can be held for deferred processing. Roughly half of the inputs to the S Network are handled in this way. SAFA is a real-time, high priority queue. Some of the S system's response time components are:

- Bid to poll time
- Queue In to Receive In time
- Receive In to Receive Out time (RIRO)
- Queue In to Receive Out time (QIRO)
- SAFA transactions per min. (SAFA TRX/MIN)
- SAFB transactions per min. (SAFB TRX/MIN)
- SCAN transactions per min. (SCAN TRX/MIN)

Figure A.4.5 shows a typical S system measurement report. In this report, response time components are listed on an hourly basis. The average number of transactions per queue is also recorded, as well as total transactions per CPU. Transactions per channel and per line are also recorded.

Many other systems have similar statistics. The NASDAQ System is such a system; in addition, the error statistic aspect of this system was studied by NAC. Let us now look at the error statistics of the NASDAQ System.

SYSTEM STATISTICS FOR THE DAY 06/14/76

TERMINAL	ORIGINATION MSG STATS			DESTINATION MSG STATS			TOTAL MSG STATS		
	NO MSG	TOT CHAR	AVG MSG LNTH	NO MSG	TOT CHAR	AVG MSG LNTH	NO MSG	TOT CHAR	AVG MSG LNTH
SAFY	0	0	0	0	0	0	0	0	0
MASQ	3,607	1,952,386	541	2,156	82,198	38	5,763	2,034,594	353
TASQ	1,661	127,623	76	1,022	39,900	39	2,683	167,523	62
TAS2	44,006	17,888,230	406	35,131	7,706,725	219	79,137	25,594,955	323
TAS3	1,530	549,048	338	1,509	143,732	95	3,039	692,780	227
TAS4	1,424	386,307	271	270	327,431	1,212	1,694	713,738	42
TAS5	1,024	455,636	444	668	231,184	340	1,692	686,821	405
MCPI	1,581	114,174	72	0	0	0	1	4	4
GENL	0	0	0	1	4	4	1	4	4
.									
.									
.									
PROSS TOTAL	93,182	41,743,859	447	57,119	11,720,496	205	150,301	53,464,155	355
GRAND TOTAL	158,334	55,593,091	351	157,415	55,319,794	391	315,749	110,913,485	351
I/O ERRORS	1,580								
UNSER MSGS	621								
CANC MSGS	306								
ERROR MSGS	1								
GRBAGE CAN	8								

Figure A.4.1 - NETWORK TRAFFIC REPORT

TCAM STATISTICS FOR THE DAY 06/14/76

TERMINAL	ORIGINATION MSG STATS			DESTINATION MSG STATS			TOTAL MSG STATS		
	NO MSG	TOT CHAR	AVG MSG LNTH	NO MSG	TOT CHAR	AVG MSG LNTH	NO MSG	TOT CHAR	AVG MSG LNTH
SADI	111	4,434	29	247	40,644	164	358	45,078	125
DAO3	7	254	37	118	28,194	225	123	25,453	215
POM8	253	10,401	41	414	29,902	71	672	40,363	60
LINE 032 =	371	15,089	40	782	98,740	123	1,153	111,894	97

Figure A.4.2 - TCAM STATISTICS PER LINE

NETWORK ERROR REPORT RUN DATE 05/13/76 NETWORK DATE 05/13/76

03C

SUMMARY REPORT FOR LINE 03C
ERROR COUNT BY HOUR OF THE DAY

	07-08	08-09	09-10	10-11	11-12	12-13	13-14	14-15	15-16	16-17	17-18	18-19	19-20	20-21	21-22	22-23	23-24	DAY TOTAL
ORIG ERR																		0
SEQN ERR																		0
DEST ERR																		0
DATA CHK	1	3	3			5		1	26	3								42
DCHK ADR		3	1						22	2								28
DCHK POL	1		2			5		1	4	1								14
TIME OUT									11	4								15
OTHER																		0
UNSERV	133																	133
TOT ORIG	440	352	210	401	85	275	260	312	26	4	11							2,376
TOT DEST	2753																	2,753

USER SPECIFIED NORMS FOR LINE 03C

ORIG ERR	10	SEQN ERR	10
DEST ERR	10	DATA CHK	6
DCHK ADR	3	DCHK POL	5
TIME OUT	15	OTHER	10
UNSERV	9999	TOT ORIG	9999
TOT DEST	9999		

Figure A.4.3 - SUMMARY ERROR REPORTS PER LINE

LINE 032 UTILIZATION FOR 06/14/76

TIME FRAME	INPUT			OUTPUT			TOTAL		
	NO MSG	DATA CHARS	LINE UTIL	NO MSG	DATA CHARS	LINE UTIL	NO MSG	DATA CHARS	LINE UTIL
0000-0700	NO ACTIVITY								
0700-0715				10	2.240	2.2	10	2.240	2.2
0715-0800	NO ACTIVITY								
0800-0815				02	.498	.4	02	.498	.4
0815-0830	NO ACTIVITY								
0830-0845				06	1.506	1.4	06	1.506	1.4
0845-0900				11	2.712	2.6	11	2.712	2.6
0900-0915				13	2.961	2.9	13	2.961	2.9
0915-0930				31	8.274	8.0	31	8.274	8.0
...									
AVERAGE UTIL. 9AM-5PM 6.0 PEAK UTIL. FROM 1500-1600 OF 10.4									

Figure A.4.4 - LINE UTILIZATION REPORT

FROM TO	SYSTEM MEASUREMENT REPORT											CPU/TRX TP 9-5	
	7:0	8:0	9:0	10:0	11:0	12:0	13:0	14:0	15:0	16:0	17:0		DAILY AVG TP 9-5
SARA TRXMAIN	0.72	16.47	28.13	30.28	30.98	21.99	24.33	37.48	35.30	17.90	17.90	29.30	
SARB TRXMAIN	1.25	50.53	70.27	80.72	84.80	65.17	84.69	104.12	85.38	40.53	40.53	77.37	
SCAN TRXMAIN	146.27	144.25	145.92	145.57	141.30	159.47	159.85	167.30	154.87	151.45	151.45	105.67	
SARA CIRCO	1.84	1.40	1.51	1.57	1.63	1.34	1.49	1.44	1.49	1.77	1.77	1.53	
SARB CIRCO	1.47	1.70	1.88	1.91	1.91	1.69	1.69	1.67	1.63	1.63	1.63	1.78	
SCAN CIRCO	1.89	2.13	2.09	2.10	2.25	1.74	1.89	1.86	2.01	1.95	1.95	1.78	
TOTAL	1.88	1.90	1.87	1.88	1.95	1.75	1.72	1.67	1.76	1.84	1.84	1.71	
SARA RIFD SDEV	1.78	1.30	1.31	1.44	1.34	1.23	1.27	1.29	1.33	1.53	1.53	1.53	
SARB RIFD SDEV	1.02	1.01	1.06	1.02	1.17	1.01	1.06	1.00	1.04	1.11	1.11	1.11	
SCAN RIFD SDEV	4.00	3.00	3.00	3.00	3.00	3.00	3.00	3.00	3.00	3.00	3.00	3.00	
SARA RIFD 90TH	3.00	3.00	3.00	3.00	3.00	3.00	3.00	3.00	3.00	3.00	3.00	3.00	
SARB RIFD 90TH	3.00	3.00	3.00	3.00	3.00	3.00	3.00	3.00	3.00	3.00	3.00	3.00	
SCAN RIFD 90TH	3.00	3.00	3.00	3.00	3.00	3.00	3.00	3.00	3.00	3.00	3.00	3.00	
SARA CIRCO	2.28	1.90	2.25	2.26	2.26	1.80	1.97	1.97	2.16	2.36	2.36	2.13	
SARB CIRCO	2.05	2.44	3.64	4.21	5.03	2.48	2.82	3.48	3.91	2.54	2.54	3.52	
SARA CIRCO SDEV	1.82	1.38	2.58	2.25	1.53	1.34	1.57	1.43	2.29	1.94	1.94	1.94	
SARB CIRCO SDEV	1.30	1.32	3.69	4.18	3.91	1.45	1.71	2.22	4.24	2.27	2.27	2.27	
SCAN CIRCO SDEV	5.00	4.00	4.00	4.00	4.00	4.00	4.00	4.00	4.00	4.00	4.00	4.00	
SARA CIRCO 90TH	4.00	4.00	4.00	4.00	4.00	4.00	4.00	4.00	4.00	4.00	4.00	4.00	
SARB CIRCO 90TH	4.00	4.00	4.00	4.00	4.00	4.00	4.00	4.00	4.00	4.00	4.00	4.00	
SCAN CIRCO 90TH	4.00	4.00	4.00	4.00	4.00	4.00	4.00	4.00	4.00	4.00	4.00	4.00	
CPU SURV	71.24	74.80	74.34	73.61	71.06	72.58	74.85	76.26	75.43	74.80	74.80	74.1	
PERX	20.35	18.30	18.74	18.91	16.39	16.39	19.80	12.49	19.17	19.84	19.84	19.0	
MEM	16.07	35.91	35.12	35.20	37.97	37.97	37.57	38.12	37.23	36.05	36.05	36.4	
OTHER	1.77	1.84	1.85	1.99	1.95	2.12	2.14	2.16	2.04	2.10	2.10	2.0	
TOTAL CPU/TRX	292.23	311.13	307.70	303.41	301.74	272.08	281.45	273.50	292.34	296.34	296.34	292.67	
PERX CPU/TRX	147.96	149.37	145.71	145.09	125.14	142.96	144.26	136.71	144.24	142.82	142.82	143.83	
MEM CPU/TRX	67.42	63.84	63.36	59.17	54.37	61.94	60.37	60.18	59.91	63.37	63.37	60.99	
OTHER CPU/TRX	50.02	51.92	51.04	52.84	48.66	51.66	52.53	52.00	52.87	52.38	52.38	52.09	
CHANNEL 1	24.76	14.89	11.04	16.40	11.63	10.48	16.03	14.74	12.92	14.18	14.18	14.77	
CHANNEL 2	4.01	12.95	15.09	15.11	14.31	10.79	11.36	11.36	12.16	16.66	16.66	12.81	
CHANNEL 3	23.92	20.34	17.94	16.77	14.60	15.75	15.75	15.32	16.66	15.32	15.32	17.12	
CHANNEL 4	8.04	7.67	7.58	7.77	7.44	8.25	8.07	8.30	8.50	10.72	10.72	8.23	
CHANNEL 5	15.60	15.60	11.19	13.35	11.02	12.14	15.04	18.21	14.51	5.44	5.44	15.53	
CHANNEL 6	14.47	14.47	27.52	27.52	23.62	17.42	22.24	34.41	33.30	26.39	26.39	26.20	
AGV101	18.39	16.98	17.67	17.67	17.67	17.67	17.67	17.67	17.67	17.67	17.67	17.67	
AGV102	10.50	16.17	20.71	19.09	19.09	21.58	19.07	19.07	14.75	21.60	21.60	15.69	
AGV103	15.75	15.75	33.38	25.77	22.42	20.87	28.85	28.85	28.85	26.53	26.53	24.88	
AGV104	42.32	37.37	35.00	35.18	27.06	26.73	28.00	28.00	32.00	27.31	27.31	31.47	
AGV105	9.03	10.19	5.00	5.52	4.93	6.13	5.70	5.70	5.45	6.70	6.70	6.26	
AGV106	14.64	10.83	12.02	15.47	10.59	12.12	14.20	14.20	10.72	17.87	17.87	13.76	
AGV107	17.66	17.66	16.66	18.13	8.47	17.61	17.92	17.92	17.61	17.73	17.73	17.73	

Figure A.4.5 - SYSTEM MEASUREMENT SUMMARY REPORT

A.5 NASDAQ SYSTEM

The National Association of Securities Dealers Automated Quotations (NASDAQ) System is an interconnection of computers, communications devices, and terminals designed for the collection and distribution of real-time quotations for the Over-the-Counter Securities Market. Low, medium, and high speed communication lines tie these devices to the NASDAQ Central Processing System in Trumbull, Connecticut which is configured with UNIVAC 1108 processors. The terminals are connected to over-the-counter control units (OCU's) located in subscriber offices. These control units are connected on multidrop regional lines to data concentrators located in Atlanta, Chicago, New York, and San Francisco. These concentrators, configured with Honeywell DDP-516 processors, are connected to the central processing system by trunk lines.

Day-to-day management of the regional circuits include the obvious concern as to actual performance. In this regard, the concentrators and central processors are provided with software for monitoring short and long term error conditions. The short term monitoring conditions are aimed at detecting errors at OCU's and on regional and trunk circuits and provide an alarm as the result of indicated malfunctions. On a long term basis, network management involves monitoring the usage of these circuits as it relates to the growth of terminals on the circuit. The aim of these efforts is the maintenance of an efficient network configuration both from the service standpoint and from the circuit cost standpoint. The tools available for this purpose are programmatic in nature. Other than the measurement of response time, which is done by hardware on a selective basis, actual circuit usage, including an occupancy measurement, is available by extracting data from records maintained as part of the system. With regard to trunk circuits, the concentrator program is used to monitor the real-time

activity in order to provide an alarm under conditions of deteriorated performance.

A.5.1 Summary of NASDAQ Error Monitoring Procedures

The procedures used in the NASDAQ system to report short-term or long-term error rates on both regional and trunk circuits are summarized below.

A.5.1.1 Regional Circuits

a. OCU Polling Function

If three consecutive "no responses" (130 ms time-outs) to polls occur, the concentrator initiates the typeout:

"ERROR LINE XX OCU Y"

b. Transmit Function

If transmission is not completed for any message that has been set up, the concentrator initiates the typeout:

"O/P STALL LINE XX"

c. Short-Term Error Rates

A counter is initialized to the value 240 every five minutes. This counter is incremented and decremented by correct and incorrect messages, respectively. When the count becomes negative, the concentrator initiates the typeout:

"ERRORS LINE XX"

Rules for incrementing and decrementing are:

1. Increment by 1 for each complete Reply message transmitted to an OCU.
2. Increment by 1 for each set of 32 Poll - No Query sequences on a circuit.
3. Decrement by 80 for bad parity in a Query or No Query (EOT) response to a poll; no Start Code (SOH); no End Code (EXT); or when the audit bit in the A2 character of the Query header is set.

d. Long-term Error Rates

An overlay program is available to produce the following daily statistics:

1. Number of valid queries,
2. Number of responses,
3. Number of No Query (EOT) responses, and
4. Number of No Responses (Time-Outs).

A.5.1.2 Trunk Circuits

a. Transmit Function

If transmission is not completed for any message that has been set up, the concentrator initiates the typeout:

"O/P STALL TRUNK XX"

b. Short-Term Error Rates1. At Concentrator

A Counter is initialized to the value 240 every five minutes. This counter is incremented and decremented by correct and incorrect messages, respectively. When the count becomes negative, the concentrator initiates the typeout:

"ERRORS TRUNK X"

Rules for incrementing and decrementing are:

- a. Increment by 1 for each complete message sent to CPC.
- b. Decrement by 80 for each of the following causes:
 - Stalled Trunk condition,
 - Trunk time-out,
 - Bad header in reply from 1108, and
 - Incorrect parity in reply from 1108.

2. At 1108 CPU

- a. Whenever a series of 25 consecutive input messages are received in error over the trunk, the Master Terminal Printer types:

"CLT XX EXCEEDS SERIAL INPUT ERROR LIMIT"

- b. Whenever the total number of input errors for any trunk equals 512, the Master Terminal Printer types:

"CLT XX EXCEEDS CUMULATIVE INPUT ERROR LIMIT"

- c. More than 25 consecutive or 512 total time-outs or more than 25 consecutive or 512 total unexpected interrupts initiates the typeout:

"EXCESSIVE TRANSMISSION ERRORS CLT ERROR CODE YY"

- d. Each concentrator requests the time of day once a minute from the 1108. If the time request is not received by the 1108 for a period of two minutes, the Master Terminal prints:

"CLT XX EXCEEDS TIME INPUT ERROR LIMIT"

c. Long-Term Error Rates

At the concentrator, the overlay program can produce at the end of the day:

1. Number of messages transmitted,
2. Number of messages received, and
3. Number of message errors.

The CPU monitors activity and error counts for each trunk circuit. The counts generated for each trunk are:

1. Total number of messages received from concentrator,
2. Total number of messages received in error,
3. Total number of messages transmitted, and
4. The number of transmit errors.

A.5.2 Short-Term Error Rate Monitoring

In analyzing the above short-term procedures, it was found that a message error rate of one message error per minute would be sustained without detection on regional lines, while 2.4 messages per minute would be sustained without detection on trunk lines. These numbers were then found to translate into character error rates of between 2.2×10^{-4} and 6.6×10^{-4} on regional lines, and between 1.14×10^{-4} and 1.37×10^{-2} on trunk lines, depending upon the number of characters in error per message. Thus, to find the actual error rates of the lines, the message error rate statistics must be matched to character error rate predictions.

In this section, we address the question: How many samples are adequate to accurately estimate the error rate probability of a regional or trunk line? The answer to this question is an essential ingredient in any error rate analysis.

Statistical procedures required to determine error rate probabilities are routine. One transmits a sequence of characters and counts the number of correct characters received. It is then possible to find an interval estimate of the error rate probability at a specified level of confidence.

The error probability is equal to 1 minus the probability of a correct transmission. Define the variable X_i so that $X_i = 1$ if the i^{th} character transmitted is correct and $X_i = 0$ otherwise.

Then, it can be shown that for a reasonably large number of samples

$$\begin{aligned} & [1/(1+K/n)]^{-1} [\bar{x} + K/2n - \{K\bar{x}(1-\bar{x})/n + K^2/4n^2\}^{1/2}] \\ & \leq p \leq \end{aligned}$$

$$[1/(1+K/n)]^{-1} [\bar{x} + K/2n + \{K\bar{x}(1-\bar{x})/n + K^2/4n^2\}^{1/2}].$$

where p is the probability of a correct character transmission.

In these inequalities, n is the number of samples,

$$\bar{x} = (1/n) \sum_{i=1}^n X_i$$

and K is a constant determined through the equation

$$\int (1/\sqrt{2\pi}) \exp(-y^2/2) dy = L/100$$

where L is the confidence level for the interval (expressed as a percentage).

Typical values for the two-sided confidence interval obtained from these equations are given in Table A.5.1. For larger sample sizes, the probability of correct transmission may be assumed to fall, within 95% confidence, in the range

$$\bar{p} - 2\left[\frac{1}{2} \sum_{i=1}^n (x_i - \bar{p})^2\right]^{1/2} \leq \bar{p} \leq \bar{p} + 2\left[\frac{1}{n} \sum_{i=1}^n (x_i - \bar{p})^2\right]^{1/2}$$

Finally, to determine the appropriate number of characters which must be transmitted to adequately estimate the error rate probability p_e , we note that the standard deviation of the sampling distribution is equal to $\sqrt{p_e(1-p_e)/n} \doteq \sqrt{p_e/n}$. Table A.5.2 shows required sample size as a function of error rate and desired accuracy.

On the basis of approximate calculations, it was found that there were 2,000,000 to 4,000,000 transmitted characters per hour over a New York trunk during the busy hour, no more than about 1,000,000 characters per hour over other trunks, and about 500,000 characters per hour on regional lines. Hence, over a one hour period, it is practical to estimate short term error rates with the following accuracies: on regional lines to within about $\pm 50\%$; to within about $\pm 25\%$ on non-New York trunk lines, and to within $\pm 15\%$ on New York trunk lines.

Over a 5 minute interval, the best estimates obtainable could exceed $\pm 100\%$ for regional lines. If all traffic utilized only one trunk from each facility, the error rate estimate for a trunk in New York would be within about $\pm 35\%$ and at other concentration locations about $\pm 75\%$.

As can be seen from the example, care must be taken in converting between message errors and character errors. With these thoughts in mind, we now shift to the statistics collected by another system.

Number of Characters Transmitted	Number of Characters Correctly Transmitted*	Average	Probability of Correct Transmission is	
			At Least	No Greater Than
(n)	$(\sum_{i=1}^n X_i)$	$(\bar{p} = (\sum_{i=1}^n X_i)/n)$		
100	90	.90	.84	.94
	92	.92	.86	.95
	94	.94	.89	.97
	96	.96	.91	.98
	98	.98	.94	.99
	100	1.00	.97	1.00
150	130	.87	.81	.91
	134	.89	.84	.93
	138	.92	.86	.95
	142	.95	.91	.97
	146	.97	.94	.99
	150	1.00	.98	1.00
200	180	.90	.85	.93
	190	.95	.91	.97
	192	.96	.92	.98
	194	.97	.94	.986
	196	.98	.95	.992
	198	.99	.96	.997
	200	1.00	.98	1.000
300	270	.90	.87	.92
	276	.92	.89	.94
	280	.93	.91	.95
	286	.95	.93	.97
	288	.96	.94	.97
	292	.97	.95	.98
	296	.99	.97	.995
	300	1.00	.987	1.000

* $X_i = 1$ if a character is transmitted correctly; $X_i = 0$ otherwise.

Table A.5.1 - 2-SIDED 95% CONFIDENCE LEVEL FOR ERROR PROBABILITIES

Number of Characters Transmitted	Number of Characters Correctly Transmitted*	Average	Probability of Correct Transmission is	
			At Least	No Greater Than
(n)	$(\sum_{i=1}^n X_i)$	$(\bar{p} = (\sum_{i=1}^n X_i)/n)$		
500	440	.88	.85	.90
	452	.90	.88	.92
	460	.92	.90	.94
	468	.94	.92	.95
	476	.95	.93	.97
	484	.97	.95	.98
	492	.98	.97	.992
	496	.99	.98	.997
	500	1.00	.992	1.000
1000	900	.90	.88	.91
	925	.92	.91	.93
	950	.95	.93	.96
	975	.97	.96	.98
	980	.98	.97	.99
	985	.99	.98	.991
	990	.99	.983	.994
	995	.995	.9898	.9976
	1000	1.000	.9973	1.0000
2000	1900	.95	.94	.95
	1950	.975	.969	.980
	1960	.980	.974	.985
	1970	.985	.980	.989
	1980	.990	.986	.993
	1990	.995	.9917	.997
	2000	1.000	.9987	1.000

Table A.5.1 (Continued)

If the Error Probability is no Greater Than	And we Wish an Estimate to Within	Then, we Must Transmit at Least n Characters
		(n)
10^{-3}	$\pm 100\%$	4,000
5×10^{-4}	$\pm 100\%$	8,000
10^{-4}	$\pm 100\%$	40,000
5×10^{-5}	$\pm 100\%$	80,000
10^{-5}	$\pm 100\%$	400,000
10^{-3}	$\pm 50\%$	16,000
5×10^{-3}	$\pm 50\%$	32,000
10^{-4}	$\pm 50\%$	160,000
5×10^{-5}	$\pm 50\%$	320,000
10^{-5}	$\pm 50\%$	1,600,000
10^{-3}	$\pm 25\%$	64,000
5×10^{-4}	$\pm 25\%$	128,000
10^{-4}	$\pm 25\%$	640,000
5×10^{-5}	$\pm 25\%$	1,280,000
10^{-5}	$\pm 25\%$	6,400,000
10^{-3}	$\pm 10\%$	400,000
5×10^{-4}	$\pm 10\%$	800,000
10^{-4}	$\pm 10\%$	4,000,000
5×10^{-5}	$\pm 10\%$	8,000,000
10^{-5}	$\pm 10\%$	40,000,000

Table A.5.2 - TRANSMISSION LENGTHS FOR ERROR ESTIMATION

A.6 THE SSADARS STATISTICS

The Social Security Administration Data Acquisition and Response System (SSADARS) is a nationwide, real-time interactive data communications system serving 1500 SSA field offices. SSADARS was specifically designed to relieve the ever increasing workload on the Advanced Record System (ARS) network and to provide the required on-line data retrieval and file update capability of the Supplemental Security Income (SSI) Program.

The ability to respond to financial crises promptly with minimum inconvenience to the applicant is made possible by the SSADARS query/response system. When a request for an emergency payment is received by a field office, an SSI query (SSIAP) is entered from a terminal key station located in the field office. The query is routed to the Central Computing Facility (CCF) in Baltimore where it is processed against the on-line files in an IBM 370. One file, the SSI data base, contains most SSI records. Processing against this file determines if the applicant has previously applied and been accepted for SSI benefits. A second file, the advance payment file, contains a record of all emergency payments granted since the last update to the SSI data base. The information obtained from the file searches is formatted into a response message and returned to the field office within seconds of query submission.

In addition to the SSI queries, SSADARS handles field office entry data transactions for batch processing at the CCF. After the batch processing is complete, responses to the data messages are sent to terminal printers in the field offices. Inter-office administrative messages are also handled by the SSADARS network. A message originated at any field office or at the CCF may be sent to any other terminal or terminal group in the network.

The network hardware configuration used in SSADARS is designed to meet, among other objectives, expanding telecommunication requirements. The basic system components are the remote data entry terminals located in the field offices, and the concentrators (IS/1000 minicomputers) located in six centers and in Baltimore. Communications between the field offices and the concentrators are over low speed telephone lines. Each concentrator is connected to the CCF by two high speed lines.

The gathering of statistics for reliable management of system operation and growth is of paramount importance in the SSADARS. Thus, SSADARS software was designed to generate a variety of statistical reports, some of which are listed below:

- a. SSADARS Operations Report (Figure A.6.1)
This report lists how many times a hardware or a software module within the SSADARS complex ceased to perform, as well as the down time and the cause.
- b. Statistics From the SSADARS Log Tapes (Figure A.6.2)
This figure shows the volume of queries, messages, and requests processed by the system on a given day. Monthly and yearly totals are also given.
- c. Concentrator Traffic Reports (Figure A.6.3)
These reports list the level of message and query traffic per concentrator for a given operating time period.
- d. Start Incoming and Outgoing Message Volume Reports (Figures A.6.4-A.6.5)
These reports show the message volume per hour versus time for incoming and outgoing CCF messages.

e. Response Time Reports (Figures A.6.6-A.6.7)

The response time report for the concentrator-CCF network component is shown in Figure A.6.6. This report shows the average response time and standard deviation for a sample size of received queries or messages. Table A.6.7 shows the total network response time. Note that both reports cover a reporting period of two consecutive days (39 hours).

f. Concentrator Statistics (Figure A.6.8)

This statistical report is a comprehensive listing of a concentrator's queuing components. The total number of messages transmitted and received are given, as well as the total number of NAK's, device errors, device accesses, and queue entries. The average number of items per minute is also given, as is the standard deviation.

g. Concentrator Timing Statistics (Figure A.6.10)

These statistics provide the average processing times and standard deviations for various message types. The time stamp identification for these statistics is shown in Figure A.6.9.

SSADARS OPERATIONS REPORT

Reporting Period: July 22, 1976

Network Analysis Corporation

Unit/System	# of Halts	Up Time	Unscheduled Down Time	Comments
SSADARS Availability	2	21.7 hrs.	1 hr. 49 mins.	Iitel Controller
IBM System 16	3	20.5 hrs.	3 hrs. 1 min.	2-Iitel Channel Errors 1-Iitel Controller
IBM System 17	4	11.8 hrs.	2 hrs. 56 mins.	3-Iitel Controller 1-Operational
SSADARS Software	0	21.7 hrs.	0	
1-Baltimore #1	1	23.9 hrs.	1 min.	Software
2-New York #1	0	24.0 hrs.	0	
B-New York #2	0	24.0 hrs.	0	
3-San Francisco #1	0	24.0 hrs.	0	
-San Francisco #2	2	23.9 hrs.	2 mins.	1-Operational 1-Software
4-Chicago #1	0	24.0 hrs.	0	
C-Chicago #2	1	23.9 hrs.	2 mins.	Operational
5-Kansas City #1	0	24.0 hrs.	0	
D-Kansas City #2	0	24.0 hrs.	0	
6-Philadelphia #1	0	24.0 hrs.	0	
7-Birmingham #1	0	24.0 hrs.	0	
8-Birmingham #2	0	24.0 hrs.	0	

Figure A.6.1

STATISTICS FROM THE SSADARS LOG TAPES

Date: July 22, 1976

SSADARS SYSTEM AVAILABILITY

21 Hrs. 46 Mins.

<u>Totals</u>	<u>SSI Queries</u>	<u>MBR Queries</u>	<u>Data Messages</u>	<u>MADCAP Messages</u>	<u>ADV. PAY Requests</u>
Daily:	108,912	10,150	148,263	4,900	37
Monthly:					
Jan	2,428,827	113,111	3,127,834	90,280	1,229
Feb	2,099,866	107,916	2,864,655	76,955	949
March	2,754,645	156,556	3,538,278	87,975	868
April	2,551,858	156,066	3,426,298	89,433	822
May	2,119,473	169,897	3,171,574	75,824	715
June	2,492,817	193,836	3,292,753	96,508	908
July	1,766,143	154,526	2,404,243	57,775	626
Aug					
Sep					
Oct					
Nov					
Dec					
Annual:					
1974	18,028,600	0*	4,510,839	0*	141,714
1975	29,356,915	395,156	26,784,759	677,530	23,768
1976	16,214,983	1,051,525	21,961,027	564,740	6,217

*No Figures Available

Figure A.6.2
A.52

STAF
 CONCENTRATION-TRAFFIC REPORT
 REPORT PERIOD: 07/22/70
 REPORT COVERED: 07/21/70 TO 07/22/70 14 HRS 000

	ADV PAY MESSAGES	TYPE MESSAGES	APPT MESSAGE	CARD FROM	CAT CUMPUT MESSAGES	REC'D MESSAGES	ONLINE EDIT MESSAGES	PHILING UNIT COLLECTIONS
BALTIMORE #1	1	2,081	201	1,011	0,071	0,077	4	0
NEW YORK #1	2	1,327	02	1,003	0,407	0,044	107	21
SAN FRANCISCO #1	6	1,132	603	2,025	0,323	10,350	5	0
CHICAGO #1	2	1,241	327	1,213	4,020	6,030	16	21
KANSAS CITY #1	2	1,070	110	1,000	1,207	4,150	5	1
PHILADELPHIA #1	3	2,708	32	700	0,123	2,007	2	1
BIRMINGHAM #1	6	1,101	241	700	0,003	0,099	49	7
BIRMINGHAM #2	6	1,104	202	001	7,020	0,112	36	4
SYSTEM 0	0	0	0	00	1	15	0	0
SAN FRANCISCO #2	7	1,411	703	2,150	0,104	10,224	1	3
NEW YORK #2	3	1,104	07	1,000	0,172	6,027	21	24
CHICAGO #2	1	1,427	100	1,000	4,000	1,000	56	7
KANSAS CITY #2	4	1,000	104	040	3,020	4,000	3	0
TOTALS	37	14,524	3,076	10,036	11,000	84,000	207	81

Figure A.6.3

REPORT COVERED: 07/21/76 TO 07/27/76 IN PERS. SYSTEM: F17M

STAR INCLUSIVE VOLUME REPORT

VOLUME (MSE PER HOUR)	07/21/76	07/22/76	07/23/76	07/24/76	07/25/76	07/26/76	07/27/76
25000							
24000							
23000							
22000							
21000							
20000							
19000							
18000							
17000							
16000							
15000							
14000							
13000							
12000							
11000							
10000							
9000							
8000							
7000							
6000							
5000							
4000							
3000							
2000							
1000							

07/21/76 07/27/76 Figure A.6.4

STAR OUTGOING VOLUME REPORT

REPORT COVERS: 07/21/76 21 HRS. - 07/22/76 10 HRS 10T

VOLUME
(MIC PER HOUR)

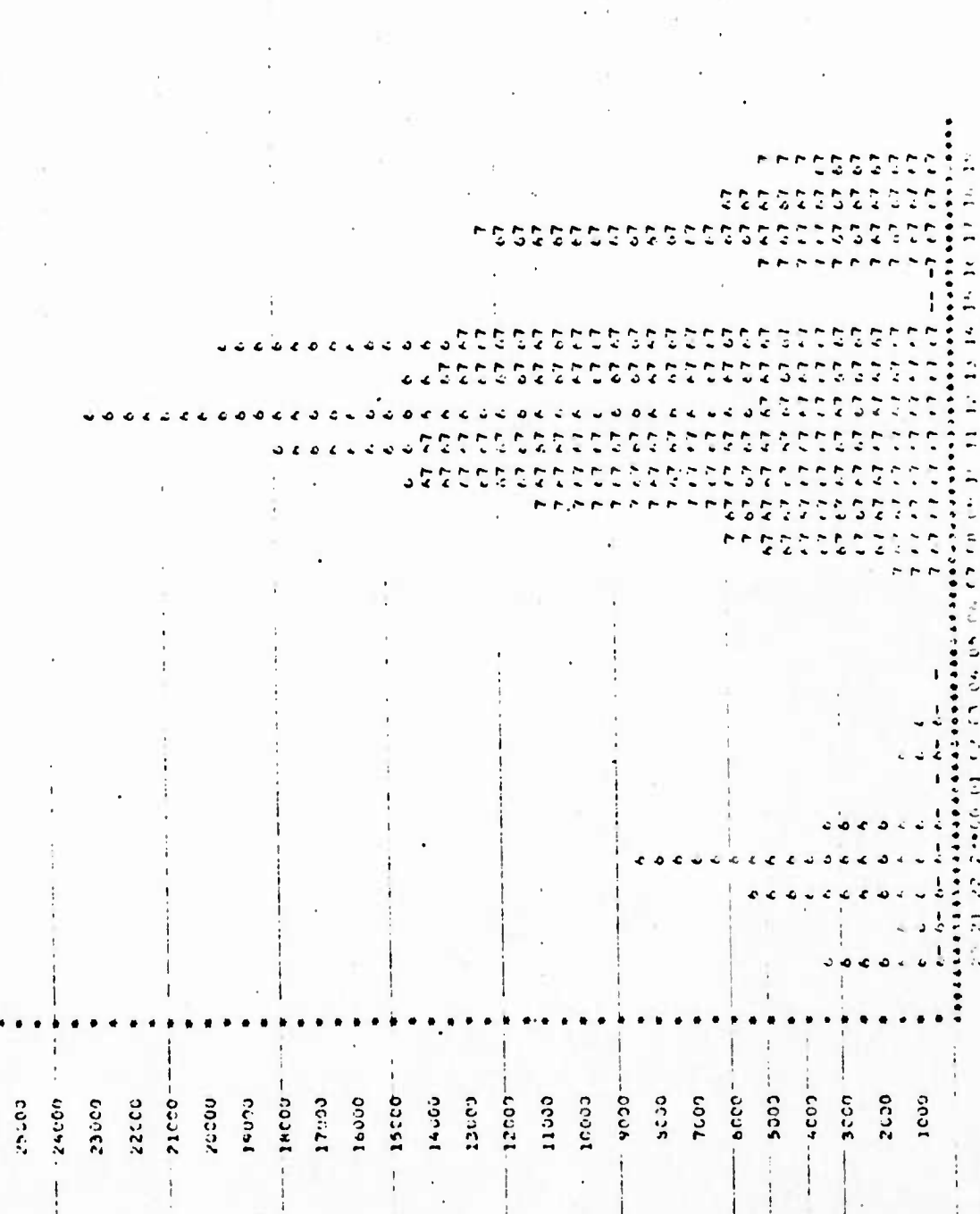

A.55

07/21/76

07/22/76

Figure A.6.5

Figure A.6.6

	REPORT COVERS: 07/21/74 TO 08/01/74	RESPONSE TIME REPORT - PICV	07/21/74 TO 08/01/74	10 MESSAGES	101	SYSTEMS	101
	SSI QUERY	REP QUERY	DATA MESSAGES	FEU MESSAGES	TOPS MESSAGES	ADMS MESSAGES	UNICC MESSAGES
BALTIMORE #1	3.60	2.21	2.77		2.00	9.74	
STANDARD DEVIATION	7.29	1.46	3.87		1.48	42.67	
SAMPLE SIZE	35	14	24		10	50	
NEW YORK #1	3.04	13.24	3.75			6.51	
STANDARD DEVIATION	2.70	6.80	2.74			6.00	
SAMPLE SIZE	67	1	25			12	
SAN FRANCISCO #1	6.15	5.24	3.44	0.07		6.34	
STANDARD DEVIATION	4.22	4.65	4.60	2.12		6.20	
SAMPLE SIZE	101	3	76	3		20	
CHICAGO #1	3.26	1.20	3.11			1.47	
STANDARD DEVIATION	7.08	0.77	7.17			0.27	
SAMPLE SIZE	82	1	61			0	
NAMES CITY #1	4.73	1.00	2.80		2.19	2.32	
STANDARD DEVIATION	7.72	0.50	2.74		2.95	1.16	
SAMPLE SIZE	67	1	63		12	8	
PHILADELPHIA #1	2.42	1.01	2.14			2.09	
STANDARD DEVIATION	2.16	0.09	1.52			1.06	
SAMPLE SIZE	45	2	31			17	
BIRMINGHAM #1	3.77	4.16	3.04			5.63	
STANDARD DEVIATION	3.45	4.09	3.76			4.28	
SAMPLE SIZE	90	13	69			17	
BIRMINGHAM #2	6.25	4.80	3.62		1.30	2.44	
STANDARD DEVIATION	18.40	6.00	4.71		3.00	3.13	
SAMPLE SIZE	126	12	78		24	16	
SYSTEM 0	0.00					2.75	
STANDARD DEVIATION	0.00					1.07	
SAMPLE SIZE	1					2	
SAN FRANCISCO #2	3.63	30.26	1.97		2.03	2.24	
STANDARD DEVIATION	5.19	0.00	7.68		2.74	2.63	
SAMPLE SIZE	193	1	64		11	21	
NEW YORK #2	3.24	1.91	2.51		2.57	2.60	
STANDARD DEVIATION	3.44	0.39	2.12		2.27	2.78	
SAMPLE SIZE	40	2	73		24	10	
CHICAGO #2	2.21	5.01	3.00			3.95	
STANDARD DEVIATION	1.40	2.47	2.76			1.07	
SAMPLE SIZE	40	1	34			14	
NAMES CITY #2	7.28	1.00	2.00		3.07	2.17	
STANDARD DEVIATION	27.22	0.70	2.26		2.74	2.02	
SAMPLE SIZE	60	0	41		21	10	
NATIONAL AVERAGE	5.00	2.76	4.67	0.00	2.02	3.11	0.00

REPORT COVERS: 07/21/76 20 MPH - 07/22/76 10 MPH 10Y SYSTEMS: DUTY

	SSI	MFK	DATA	TOPS	ALMS	SPICC
	COV	COV	MESSAGES	MESSAGE	MESSAGES	WORKS
BALTIMORE #1	5.20	4.55	4.30	1.87		
STANDARD DEVIATION	4.64	5.50	3.93	2.97		
SAMPLE SIZE	117	24	22	27		
NEW YORK #1	5.52	3.44	3.05	4.87		
STANDARD DEVIATION	6.58	3.44	1.63	16.03		
SAMPLE SIZE	415	15	3	25		
SAN FRANCISCO #1	13.72	5.18	7.90			
STANDARD DEVIATION	28.45	7.21	3.22			
SAMPLE SIZE	162	17	1			
CHICAGO #1	5.83	2.56		4.58		
STANDARD DEVIATION	30.74	3.17		6.37		
SAMPLE SIZE	198	30		2		
KANSAS CITY #1	5.14	2.74	4.62	11.12		
STANDARD DEVIATION	11.90	2.13	3.58	0.01		
SAMPLE SIZE	224	11	21	1		
PHILADELPHIA #1	3.74	1.86		5.02		
STANDARD DEVIATION	4.81	6.96		3.22		
SAMPLE SIZE	167	3		31		
BIRMINGHAM #1	7.16	5.90	1.37			
STANDARD DEVIATION	15.26	2.42	0.07			
SAMPLE SIZE	247	98	2			
BIRMINGHAM #2	7.15	6.11		5.67		
STANDARD DEVIATION	14.16	7.30		4.12		
SAMPLE SIZE	283	70		9		
SYSTEM C						
STANDARD DEVIATION						
SAMPLE SIZE						
SAN FRANCISCO #2	10.13	6.68	7.24	41.74		
STANDARD DEVIATION	20.36	5.25	2.21	75.87		
SAMPLE SIZE	410	15	2	4		
NEW YORK #2	4.90	4.85	5.22	6.60		
STANDARD DEVIATION	5.02	3.90	4.31	4.00		
SAMPLE SIZE	391	26	1	7		
CHICAGO #2	3.75	2.73	3.26			
STANDARD DEVIATION	2.74	2.05	0.30			
SAMPLE SIZE	225	24	1			
KANSAS CITY #2	5.97	3.07		4.75		
STANDARD DEVIATION	6.74	2.05		2.77		
SAMPLE SIZE	176	15		4		
NATIONAL AVERAGE	7.06	5.04	4.06	6.10	6.00	6.00

Figure A.6.7

STATISTICS FOR CONCENTRATOR A FROM 0004 TO 0400 G. M. TIME DATE 76020 N=233

	Transmits on High Speed Lines 1&2 and Low Speed Lines				Receives on High Speed Lines 1&2 and Low Speed Lines				NAK's on XMT in Applications				NAK's on RCV in Applications				NAK's on XMT in Drivers				NAK's on RCV in Drivers			
	XMT1	XMT2	XMTU	RCV1	RCV2	RCVU	N1AX	N2AX	NUAX	N1AR	N2AR	NUAR	N1DX	N2DX	NUDX	N1DR	N2DR	NUDR	N1DY	N2DY	NUDY	N1DV	N2DV	NUDV
Total	2401	2257	10882	4642	2667	5965	00	00	00	00	00	28	26	27	24	01	15	94						
AV/MN	10.3	9.6	46.7	19.9	11.4	25.6	0.0	0.0	0.0	0.0	0.1	0.1	0.1	0.1	0.1	0.0	0.0	0.4						
SDV	9.9	8.6	41.5	17.9	17.1	28.2	0.0	0.0	0.0	0.0	0.3	0.3	0.3	0.3	0.0	0.0	0.4	1.3						

	RVI's		Time Outs		Over Run Line 1		Over Run Line 2		Over Run I/O Buffers Available		Dynamic Memory Available		Busy Devices		Idle Devices		Hard Down		Temp Down	
	RVIS	SENQ	TODB	TO3	ORN1	ORN2	ORN1	ORN2	ORNU	FBUF	DYNC	DYNC	BUSY	DVCS	IDLE	IDLE	HDWN	HDWN	TDRN	TDRN
Total	00	00	03	03	01	03	00	00	10806	845419	19805	1669	68036	48329	2150	876				
AV/MN	0.0	0.0	0.0	0.0	0.0	0.0	0.0	0.0	46.3	3628.4	85.0	7.1	292.0	207.4	9.2	3.7				
SDV	0.0	0.0	0.1	0.1	0.0	0.1	0.0	0.0	10.6	211.7	0.0	5.7	0.0	6.9	1.8	2.6				

	INPUT QUEUE			MESSAGE TO SWITCH			OVERLAY QUEUE			QUEUE TO DISK			QUEUE TO HOST		
	IDPQ	HIGH	GT.5	MSLQ	HIGH	GT.5	OVQ2	HIGH	GT.5	DMQ2	HIGH	GT.5	MAC2	HIGH	GT.5
Total	15	02	00	00	00	00	1223	137	358	01	01	00	06	01	00
AV/MN	0.0	0.0	0.0	0.0	0.0	0.0	5.2	0.5	1.5	0.0	0.0	0.0	0.0	0.0	0.0
SDV	0.2	0.0	0.0	0.0	0.0	0.0	2.1	0.5	1.2	0.0	0.0	0.0	0.1	0.0	0.0

Figure A.6.8

C O N C E N T R A T O R T I M E S T A M P I N G

T I M E S T A M P

T0 - THE FIRST TIME THE MESSAGE IS COMPLETELY IN THE CONCENTRATOR AND READY FOR

PROCESSING. T1 HAS ALREADY BEEN EDITED.

T1 - THE FINAL ACK HAS BEEN RECEIVED FROM THE 370.

T2 - THE CONCENTRATOR HAS RECEIVED THE FIRST PAGE OF THE RESPONSE.

T3 - THE MESSAGE HAS ENTERED MSSALL FOR FORMATTING AND ROUTING.

T4 - THE MESSAGE IS LEAVING MSSALL AND QUEUED TO THE ROUTINE THAT WILL PUT IT ON THE TERMINAL QUEUE.

T5 - FINAL RESPONSE FROM TERMINAL CONTROLLER.

L1 = (INPUT MESSAGE LENGTH) / 900 CPS

L2 = (OUTPUT MESSAGE LENGTH) / 900 CPS

L3 = (OUTPUT MESSAGE LENGTH) / 120 CPS

TERMINAL IO LINE = I1 - I0 - L1

PROCEDURE IN 370 = T2 - T1 - L2

PROC IN MSSALL = T4 - T3

MSL TO LSL = T5 - T2 - L3

RCV_RESPONSE = T5 - T0 * THESE RESPONSE TIMES DO NOT INCLUDE EDITING TIME AND

CRTR_RESPONSE = T5 - T0 * 8.3 MILLISECONDS SHOULD BE ADDED FOR DELIVERY

OTHER_RESPONSES = T5 - T0 * OF THE FIRST CHARACTER

Figure A.6.9 - TIME STAMP IDENTIFICATION

Signal message handler

SAN FRANCISCO CONCENTRATOR A DATE 76020 0001 TO 0400 GMT

PPCC AVERAGE TIMES
AND MESSAGE LENGTHS

	SS10	SS11	SS12	DATH	AUMS	CARD	DATA
TERMINAL TO LINE	0.4263	0.0000	0.8974	0.5303	0.3775	0.0000	0.0000
SDV	1.2789	0.0000	1.0606	0.4548	0.0364	0.0000	0.0000
PRECEDULE IN STD	2.1759	0.0000	2.8157	1.0450	0.7573	0.0000	0.0000
SDV	3.7620	0.0000	1.0871	2.0049	1.0487	0.0000	0.0000
PRCC IN MSSALL	0.2845	0.0000	0.0700	0.0756	0.0450	0.0000	0.0000
SDV	0.4553	0.0000	0.0502	0.0370	0.0158	0.0000	0.0000
MSL TO LSL	1.3333	0.0000	1.5983	0.9785	0.8223	0.0000	0.0000
SDV	2.6191	0.0000	1.8780	0.7590	0.4124	0.0000	0.0000
RCV RESPONSE	4.4109	0.0000	6.0580	3.5980	2.8825	0.0000	0.0000
SDV	2.3224	0.0000	1.6701	2.4030	1.0020	0.0000	0.0000
CRTR RESPONSE	9.7550	0.0000	0.0000	0.0000	0.0000	0.0000	0.0000
SDV	4.4626	0.0000	0.0000	0.0000	0.0000	0.0000	0.0000
OTHER RESPONSE	27.7170	0.0000	0.0000	0.0000	0.0000	0.0000	0.0000
SDV	13.1400	0.0000	0.0000	0.0000	0.0000	0.0000	0.0000
INPUT LENGTH	76.4389	0.0000	119.2000	394.6438	300.2500	0.0000	0.0000
SDV	15.6055	0.0000	11.9063	270.8882	123.5857	0.0000	0.0000
OUTPUT LENGTH	432.4309	0.0000	65.0000	62.0000	62.0000	0.0000	0.0000
SDV	0.0000	0.0000	0.0000	0.0000	0.0000	0.0000	0.0000
TOTAL # MESSAGES	647.0000	0.0000	5.0000	73.0000	8.0000	0.0000	0.0000

A.60

Figure A.6.10

A.7 ARPA NETWORK STATISTICS

The last set of statistics described in this appendix is for the ARPA network. The ARPA network was the world's first large-scale experimental packet-switching network. It consists of approximately 40 switching computers (Interface Message Processors, or IMP's) and 50 Host computers at various sites across the country.

All traffic entering the ARPA network is segmented into messages whose maximum length is 8063 bits. These, in turn, are partitioned into smaller pieces called packets which are, at most, 1008 bits long. The maximum length message is, therefore, partitioned into eight packets, the last of which has a maximum length of 1007 bits.

As messages enter the network from Hosts, they carry with them a 32 bit "leader" which contains the addressing information necessary for delivery to the destination. Incoming messages also carry a small number of "padding" bits for word boundary adjustments between an IMP word size of 16 bits and the various Host word sizes. Packets are transmitted through the network with some additional addressing and control information which adds 168 bits to their length. The packets make their way through the network individually and are passed from IMP to IMP according to an adaptive routing procedure. In each IMP-to-IMP transmission an acknowledgment is returned if the packet was accepted; when possible, these acknowledgments are piggybacked on return traffic. Before they are delivered to the destination Host, the packets of a multipacket message are reassembled at the destination IMP. When the message is transmitted to the destination Host, a special control message (known as a Request for Next Message, or RFNM) is returned from the destination IMP to the source Host; this message acts as an end-to-end acknowledgment in the network. The IMP itself

has buffers for at most 45 packets. The ARPA network spans the United States, crossing over to Hawaii by means of a 50 kilobits per second satellite channel; it extends into Europe by means of a trans-Atlantic 7.2 kilobit per second satellite channel.

Several ARPA sites have developed expertise in selected areas and serve as specialization centers within the network to provide particular skills in hardware/software resources. The University of California, Los Angeles (UCLA) node in the network serves as one such site, namely, the network measurement center (NMC).

The concern for analytic and empirical evaluations of network performance has been an integral part of network development and an early responsibility of the NMC was definition of the necessary measurement capabilities to be implemented in the IMP. The IMP's are small computers (modified Honeywell DDP-516's) that handle the store-and-forward communications of the network with the additional capability of collecting message handling statistics.

The IMP-generated statistic routines are utilized in conjunction with programs at the UCLA-NMC that control the data collection, process the resulting measurement data, and generate the desired levels of artificial traffic. The IMP can gather statistics on the network usage and performance by means of several data-gathering routines which can be selectively enabled at appropriate sites. These routines include the following:

- Accumulated statistics (counts and histograms)
- Snapshot statistics (queue lengths and routing tables)
- Trace Data Statistics (event timing for message flow)
- Status reports

Let us now take a closer look at these routines.

A.7.1 Accumulated Statistics

The accumulated statistics routine has been utilized more frequently than any other measurement tool, since it provides a summary report of the activity at each node where such statistics have been enabled. These data reports include histograms of the lengths of Host-to-IMP or IMP-to-Host messages and of packets that were transmitted on the modem output lines, as well as counts of acknowledgments (ACK), RFNM's, input errors, retransmissions, total words sent, and other pertinent data. Each such data message represents the activity over a 12.8 second interval, this period primarily determined by counter overflow thresholds. The data is sent to NMC as a 390 byte message which is then inspected and either discarded, printed, or put in a file for further data inspecting. When printed, the data is annotated, reformatted, and in some cases additional values are computed. A sample printout is shown in Figure 7.1. This report can be used to develop a reasonably good picture of the network activity over the 12.8 second interval. The various parts of the data report are:

a. Message Size Statistics

Message size statistics are given for both Host-to-IMP and IMP-to-Host data transfers. The statistics on single-packet messages are accumulated in a logarithmic-scale histogram, while multipacket traffic is recorded as a uniform interval histogram. The average number of words in the last packet of a message is also given. The listing shows a total of 220 artificially generated messages received from the Host. The second part of the report shows that these 220 messages were split fairly evenly between six destinations.

b. Round-Trip Statistics

Round-trip times are measured from the receipt of the first packet of the message at the originating IMP to the receipt of the RFNM by this IMP. These data values are accumulated as a sum of round-trip times and a count of the number of round trips, with the average being calculated at the NMC.

c. Message Totals

This table lists the activity for each Host, both real and fake, with the latter being referred to as a GHOST. This table helps determine which Host contributed to the composite Host-to-IMP behavior recorded in the above two sections.

d. Channel Activity Statistics

This table records the activity of the individual modem channels. HELLO and IHY (I heard you) messages are sent periodically and proper counts indicate that the lines are active. The PKTS RECVD total includes these IHY messages, any ACK's and RFNM's received, as well as the number of actual message packets received. Other data includes the number of RFNM's sent, the total number of data words sent, the number of times an arrival found the free storage list empty, and in such cases, the number of times that an unacknowledged store-and-forward packet was discarded to free an input buffer.

e. Packet Size Statistics

This final part of the report shows logarithmic-scale histograms of packet lengths (word lengths) on each modem channel. Only message transmissions are recorded in these histograms, as message traffic such as HELLO's, IHY's, ACK's, and RFNM's are not included.

A.7.2 Snapshot Statistics

The snapshot statistics message contains the queue length and the routing table information for a particular IMP at a particular instant of time. These values are recorded and sent at 0.82 second intervals. This time period is a reasonable compromise between the desire to see a time sequence of state changes and the desire of avoiding changes of the actual system variables caused by sending the statistics too frequently. Like all of the other measurement tools, the snapshots can be enabled or disabled at each individual IMP.

A.7.3 Trace Data Statistics

This form of statistics provides the capability to literally follow a message through the network and learn the route it takes and the delays it encounters. The interpretation of these statistics is complicated since the interpretation depends on the function of the IMP handling the message (i.e., source, store and forward, or destination), as well as on the possibility of retransmissions. Thus, a typical store-and-forward function will result in the following records:

- Time of arrival,
- Time at which the message is processed, i.e., put on an output queue,
- Time at which transmission is initiated, and
- Time when the ACK is received.

All times are recorded in terms of a clock with a 100-micro-second resolution. Other data in the trace message includes the output channel (if on a modem channel), the Host number (or the fake Host number), and the entire header of the packet, which contains the following information:

- Source,
- Destination,
- Link number,
- Message number,
- Packet number, and
- Priority/non-priority status.

A.7.4 Status Reports

In addition to the above measurement tools, a monitoring function is built into the IMP's which outputs status reports to the Hosts once a minute. Contained in the status reports are:

- The up/down status of the real Hosts and channels,
- For each channel, a count of the number of HELLO messages which failed to arrive during the last minute,
- For each channel, a count of the number of packets transmitted during the last minute for which acknowledgements were received, and

- A count of the number of packets entering the IMP from each real Host.

These reports are continually received at the NCC and are processed by a minicomputer which advises the operator of failures in the network and creates summary statistics.

This, then, is a summary of some statistics collected on other networks.

ACCUMULATED STATISTICS SOURCE = UCLA TIME = 29146 DATE = 04-17-71

1. MESSAGE SIZE STATISTICS

1.1 SINGLE PACKET MESSAGES

LENGTH (WORDS)	FROM HOSTS	TO HOSTS
0 - 1	0	0
1 - 3	23	0
4 - 7	29	0
8 - 15	53	0
16 - 31	72	0
32 - 63	31	0

1.2 ALL MESSAGES

LENGTH (PKTS)	FROM HOSTS	TO HOSTS
1	208	0
2	12	0
3	0	1
4	0	0
5	0	0
6	0	0
7	0	0
8	0	0

1.3 AVE. # WORDS IN LAST PACKETS : FROM HOSTS = 17.7 TO HOSTS = 0.0

2. ROUND TRIP STATISTICS

DESTINATION	TOTAL R.T. TIME	# R.T.	AVE. R.T. TIME (MSEC)
UCLA	25	1	20.0
SRI	0	0	0.0
UCSB	10.8	34	24.0
UTAH	24.2	54	58.4
ELN	195	2	74.0
MIT	52.1	35	119.2
RAND	0	0	0.0
SOC	0	0	0.0
MARV	0	0	0.0
LL	570.4	33	132.4
STAN	0	0	0.0
ILL	54.8	46	91.4
CASE	65.5	36	145.6
CPU	0	0	0.0

3. MESSAGE TOTALS

	HOST 0	HOST 1	HOST 2	GHOST 0	GHOST 1	GHOST 2	GHOST 3
# INPUT MESSAGES FROM HOST	220	0	0	0	0	0	2
# CONTROL MESSAGES TO HOST	218	0	1	0	0	0	0

4. CHANNEL ACTIVITY

	# HELLO SENT	# IMY RECVD	# ACK SENT	# ACK RECVD	# PKTS RECVD	# MODEM ERRORS
CHANNEL 1 (TO SRI)	24	23	156	156	335	0
CHANNEL 2 (TO UCSB)	23	24	34	36	94	0
CHANNEL 3 (TO RAND)	23	23	65	39	127	0
CHANNEL 4 (TO)	0	0	0	0	0	0
CHANNEL 5 (TO)	0	0	0	0	0	0
TOTALS	70	70	255	231	556	0

	# RE-TRANS.	# WFAM SENT	# WORDS SENT	FREE LIST EMPTY	# BUFFERS REMOVED
CHANNEL 1 (TO SRI)	0	0	3159	0	0
CHANNEL 2 (TO UCSB)	0	0	604	0	0
CHANNEL 3 (TO RAND)	0	0	690	0	0
CHANNEL 4 (TO)	0	0	0	0	0
CHANNEL 5 (TO)	0	0	0	0	0
TOTALS	0	0	4453	0	0

5. PACKET SIZE STATISTICS (LEAVING THE IMP)

LENGTH (WORDS)	CHANNEL 1 (TO SRI)	CHANNEL 2 (TO UCSB)	CHANNEL 3 (TO RAND)
0 - 1	14	4	5 ..
2 - 3	9	6 ..	2
4 - 7	15	4	7 ..
8 - 15	44	8 ..	7 ..
16 - 31	41	9 ..	15 ..
32 - 63	31	5 ..	4
TOTAL # PKTS	157	35	40

Figure 7.1 - TYPICAL ACCUMULATED STATISTICS PRINTOUT

SUPPLEMENTARY

INFORMATION

Errata

AD-B017 373

Page 4-11 is blank.

DTIC-DDAC
10 Sept 84