

PHOTOGRAPH THIS SHEET

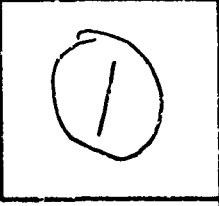

INVENTORY

AD-A995 313

DTIC ACCESSION NUMBER



LEVEL

OPERATION SANDSTONE

NUCLEAR EXPLOSIONS 1948 No.14

DOCUMENT IDENTIFICATION

DISTRIBUTION STATEMENT A

Approved for public release;
Distribution Unlimited

DISTRIBUTION STATEMENT

ACCESSION FOR	
NTIS	GRA&I <input checked="" type="checkbox"/>
DTIC	TAB <input type="checkbox"/>
UNANNOUNCED	<input type="checkbox"/>
JUSTIFICATION	
BY	
DISTRIBUTION /	
AVAILABILITY CODES	
DIST	AVAIL AND/OR SPECIAL
A-1	

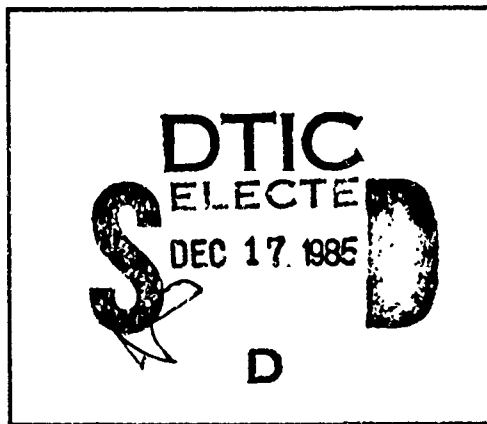

DATE ACCESSIONED

DISTRIBUTION STAMP

UNANNOUNCED

DATE RETURNED

85 12 16 015

DATE RECEIVED IN DTIC

REGISTERED OR CERTIFIED NO.

PHOTOGRAPH THIS SHEET AND RETURN TO DTIC-DDAC

SANDSTONE

#14 C. 33

14

Conf.

~~CONFIDENTIAL~~
~~SECRET~~
UNCLASSIFIED

AD-A995 313

OPERATION SANDSTONE

NUCLEAR EXPLOSIONS

1948

C. 8 B
TECHNICAL LIBRARY
DEC 28 1961
of the
A/2323/61
DEFENSE ATOMIC
SUPPORT AGENCY



Classification cancelled (or changed to) **CONFIDENTIAL**
Authority of TID-9022
by WLB TISOR, date 1-28-60

DTL-01

Approved for public release;
Distribution unlimited

~~CONFIDENTIAL~~
~~SECRET~~

Statement A ✓
Approved for public release;
Distribution unlimited

Classification changed to UNCLASSIFIED
by Authority of Chet ISCM
CN
By DNA [Signature] Date 22 July 85
By DOE [Signature] Date 18 Dec 84

~~CONFIDENTIAL DATA~~
~~SECRET~~
ATOMIC ENERGY 1948
~~CONFIDENTIAL DATA~~

Mud [Signature] 22 July 85
Chet, ISCM

6251608.

UNCLASSIFIED

C 0969

~~SECRET~~

14 + 1801

Sands
RE

~~CONFIDENTIAL~~
~~CONFIDENTIAL~~ ATA

14

SCIENTIFIC DIRECTOR'S REPORT OF ATOMIC WEAPON TESTS
ANNEX 2 PART IX
SLOWLY VARYING LIGHT FROM AN ATOMIC EXPLOSION
AS MEASURED WITH A PHOTOCELL



Statement A
Approved for public release;
Distribution unlimited

M. L. D. [Signature]
Chief FSI 22 July 1958

08

SECRET

SLOWLY VARYING LIGHT FROM AN ATOMIC EXPLOSION
AS MEASURED WITH A PHOTOCCELL

Report Written By

William Ogle

Experimental Work Done By

Robert England

William Ogle

~~CONFIDENTIAL~~
~~RESTRICTED DATA~~
C

July 28, 1948

Statement A

Approved for public release;

-1- Distribution unlimited

Man & Date 22 July 85
Chap. I-SCM

6251608

[REDACTED]

TABLE OF CONTENTS

I INTRODUCTION 3

II APPARATUS 3

III RESULTS 8

APPENDIX A 15

 Table 1 16

 Table 2 17

 Table 3 19

 Table 4 19

SLOWLY VARYING LIGHT FROM AN ATOMIC EXPLOSION
AS MEASURED WITH A PHOTOCELL

I. INTRODUCTION

During the atomic bomb tests of 1948 it became of interest to measure the light intensity from a bomb in the time interval of 0 to 1 second. Such measurements were already being made by Richardson and Butler of NRL; however, these measurements involved the use of a bolometer and Brush recorder, so that the time constant of their apparatus was of the order of a hundredth of a second. Thus, it was thought possible that there might be some fine structure of the light curve that would not be observed with this apparatus. Because of this, shortly after Yoke, England and Ogle decided to try to measure the light from the Zebra shot using a photocell and oscilloscope to record the intensity.

II. APPARATUS

The measurement was made from the AV-5 which was at a distance of 8.9 miles from the bomb. Since no external signal to trigger the oscilloscope sweep was available, it was necessary to use the light itself for this purpose. Two scopes were used: one with a linear sweep length of about 400 microseconds, and the second with an exponential sweep which was about a second long. Because of the long time scale concerned it was not necessary to use a delay line to observe the signal. Tests using flash lamps indicated that the sweeps started within a microsecond of the production of light.

Three 935 photocells were used. One of these, with no absorber around it, was used to trigger the oscilloscope sweeps. The second photocell, which had five layers of white writing paper around it as an absorber, was to observe the

light from 0 to 400 microseconds. This photocell fed a cathode follower which which then put the signal on the vertical plates of a fast sweep scope. The time constant of this circuit was about a microsecond. Sufficient capacity was used to supply current to the photocell and cathode follower so that there would be no appreciable drop in supply voltage over the 400 microsecond interval to be observed. The absorber used would allow full-scale deflection for a light intensity of about 300 suns.

A third photocell was used to observe the light from 0 to 1 second. The two layers of writing paper used as an absorber allowed full-scale deflection at about 9 suns. The time constant of this circuit was about 100 microseconds. A Dumont-type 208 oscilloscope was used to observe this signal; however, a homemade sweep circuit involving the simple charging of a condenser through a resistor was used instead of the built-in sweep circuit. The sweep circuit, power supply, and photocell circuits are shown in Figure 1.

The slow sweep time calibration was obtained by putting a 60-cycle alternating voltage on the plates and triggering the sweep. This calibration was made about ten minutes before the shot and after the circuits had warmed up for some time. The calibration sweep is shown in Figure 2. The intensity calibration was made by taking out the one megohm resistor in series with the 935 and observing the vertical deflection with the photocell pointed at the noon-day sun. This value is defined as "1 sun" for the purposes of this experiment. The calibration is shown in Figure 3, where the bottom line is the sweep with no voltage on the plates, and the top line the sweep with the voltage due to 1 sun on the scope plates.

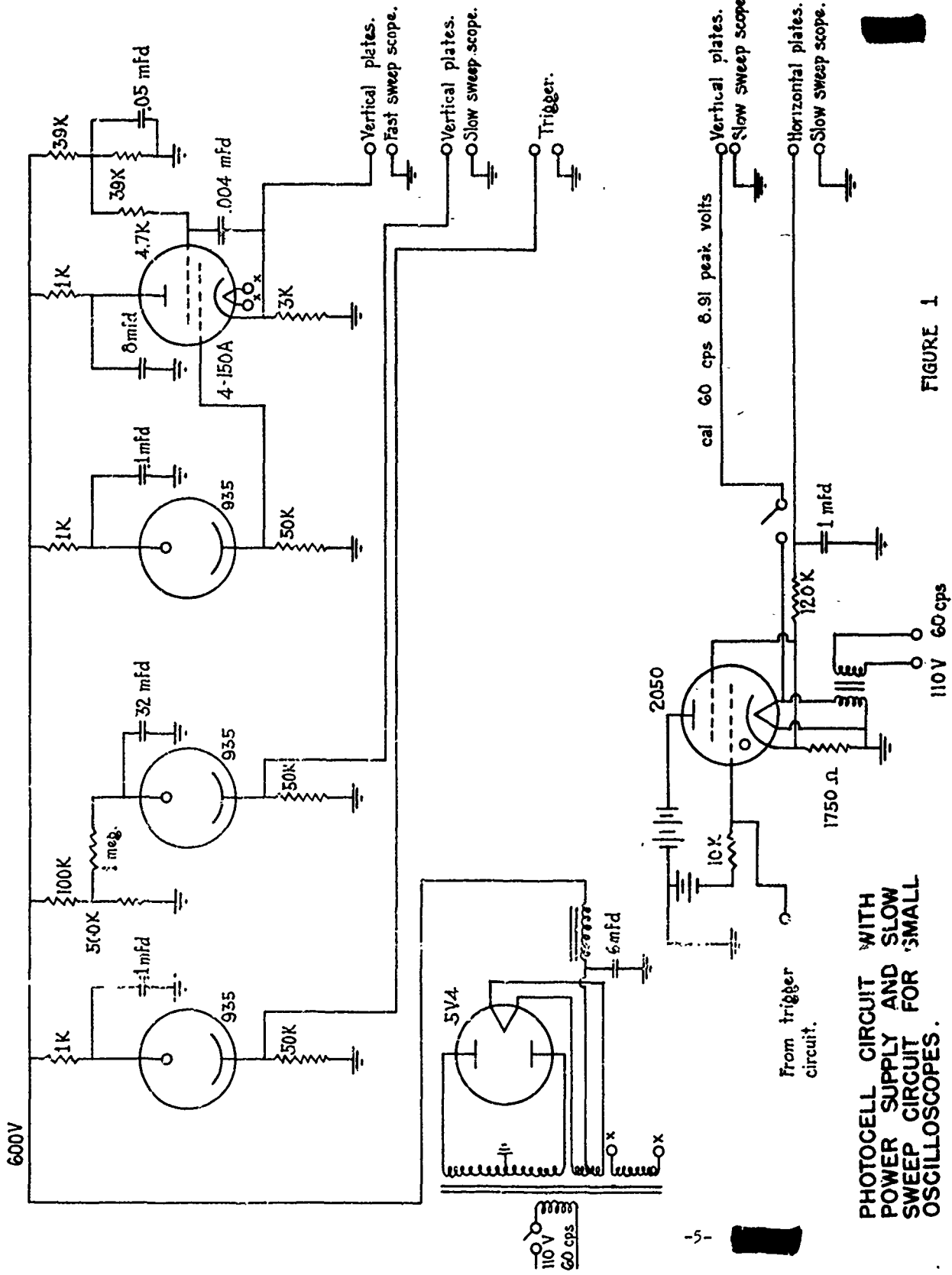

PHOTOCELL CIRCUIT WITH POWER SUPPLY AND SLOW SWEEP CIRCUIT FOR SMALL OSCILLOSCOPES.

FIGURE 1

[REDACTED]

Figure 2
60 cps calibration sweep

[REDACTED]

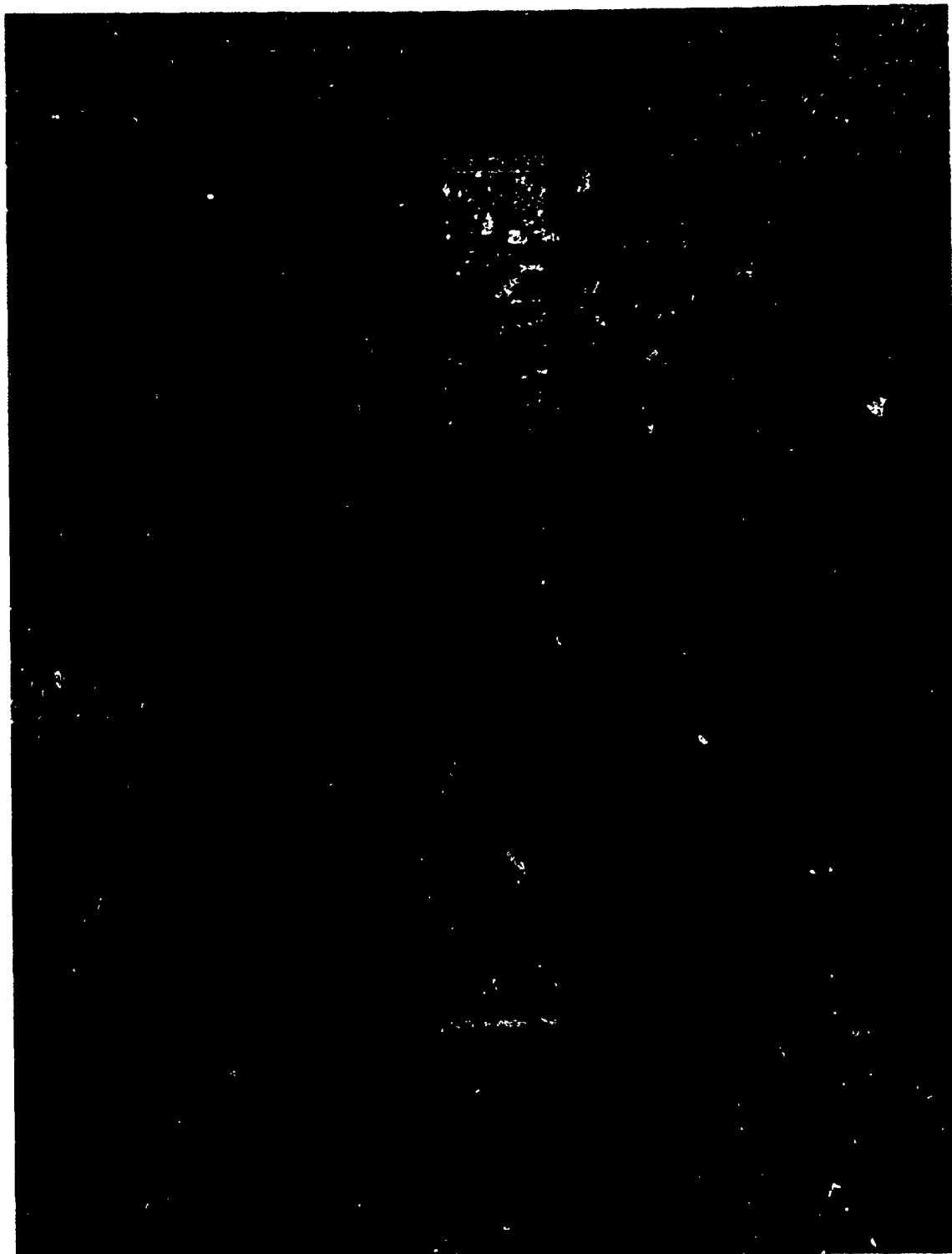
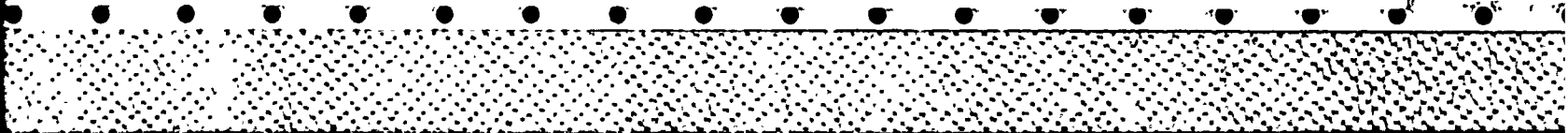
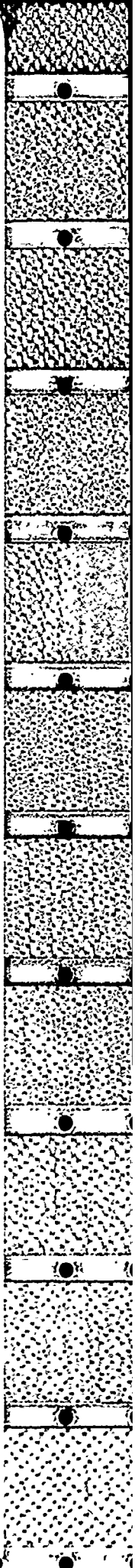
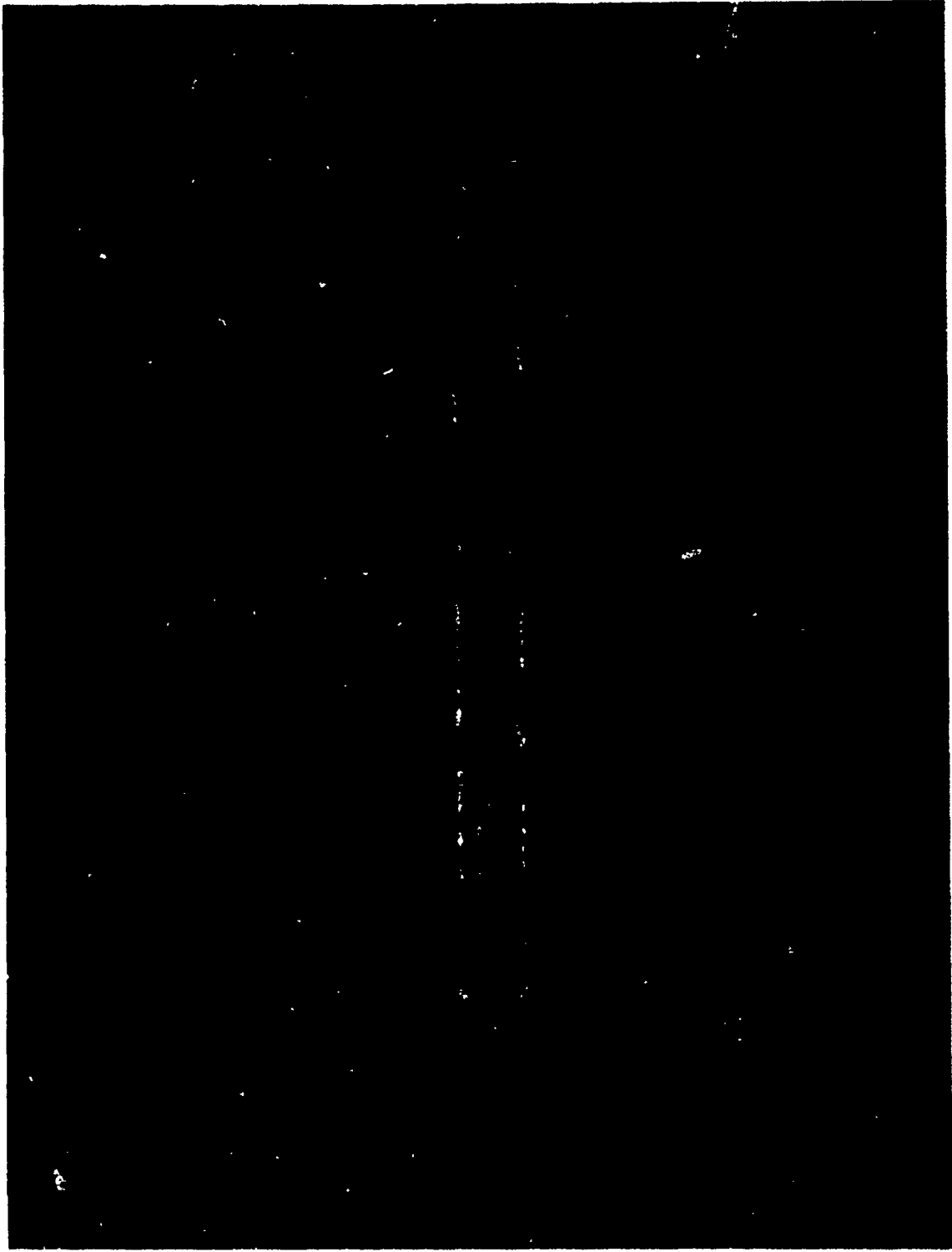



Figure 3
Intensity calibration sweep. The separation
of the lines represents one "sun".





III. RESULTS

No satisfactory trace was obtained on the fast sweep oscilloscope. A trace was obtained with a slight signal observable on it; however, the light intensity was apparently so small compared to what was expected that the signal was not large enough to be usable.

The trace shown in Figure 4 was obtained from the slow sweep oscilloscope. The gap in the top is due to the beam going off the scope face. Figure 5 shows the same trace with the two calibration sweeps superimposed. Since there was no intensity gate on the scope, the spot on the left indicates the zero time position of the beam while the spot on the right indicates the final rest position of the beam. The camera shutter was opened about 5 seconds before the explosion and closed 1 or 2 seconds afterwards.

In order to obtain numbers from the traces all pictures were enlarged to approximately the size of Figures 2, 3, 4, and 5, and the appropriate distances were measured. On the sweep time calibration, lines were drawn through the top, bottom, and middle of the sine wave, and distances measured from the center of the zero spot, thus giving a calibration point every $1/240$ th of a second. The calibration data are given in Table 1 and a plot of that data in Figure 6. The calibration of Figure 3 gives a value of 10.5 millimeter deflection equal to 1 sun.

Points taken from Figure 4 give the data of Table 2. Measurements were made out to the point where the trace starts to come straight down. The time calibration is obviously of no value beyond that point. The times of the last five points could not be determined from the direct calibration curve but were calculated on the basis of the sweep voltage being that due to the charging of a condenser through a resistor. That calculation is given in Appendix A. A



Figure 4
Zebra bomb light oscilloscope trace



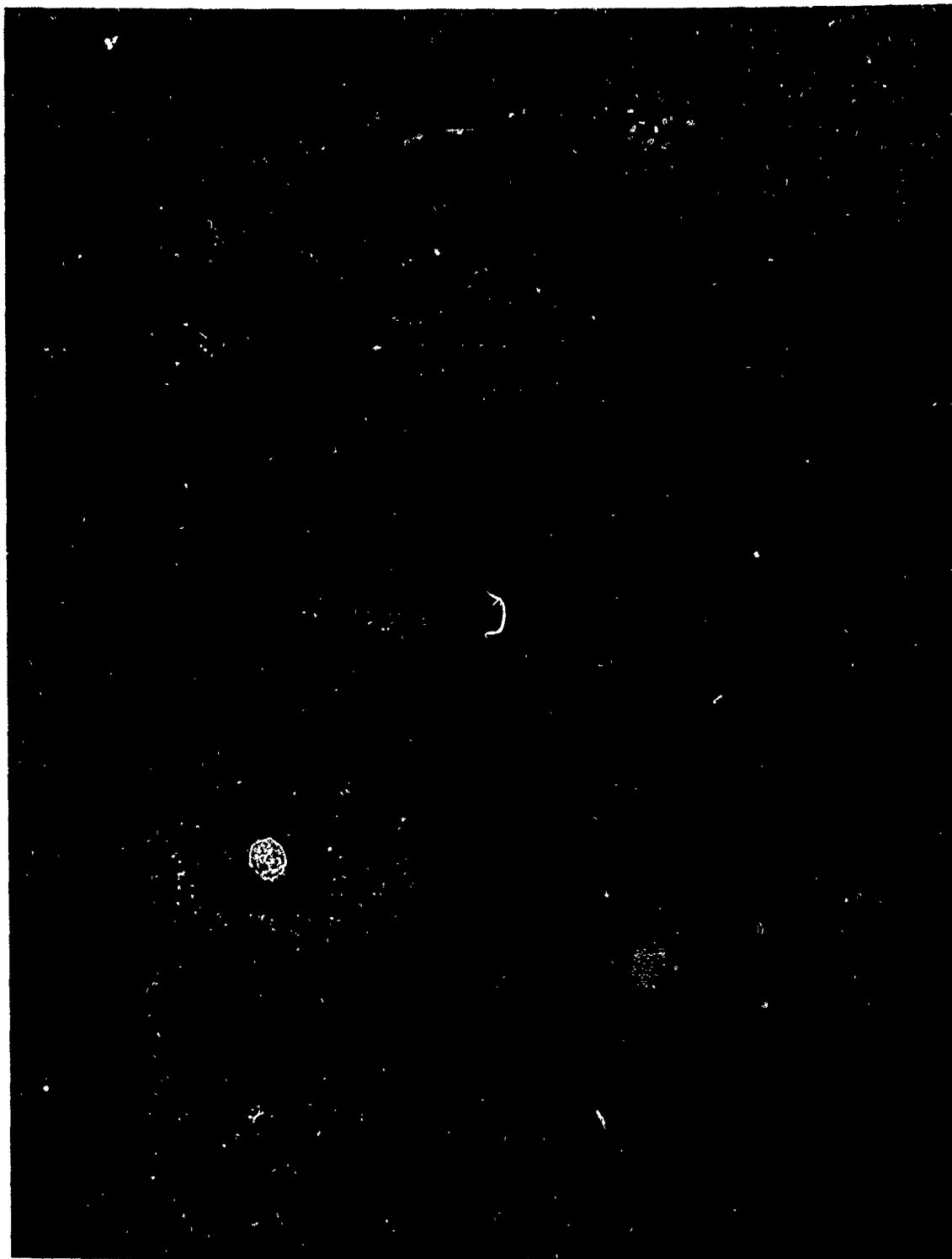
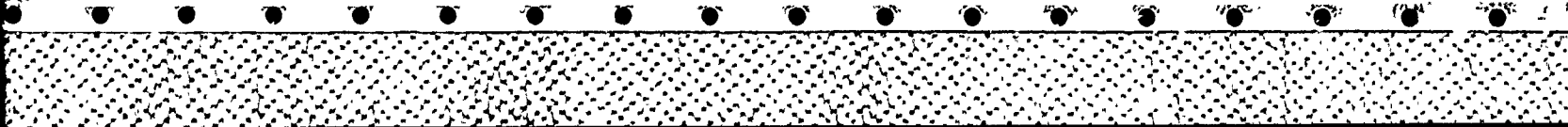
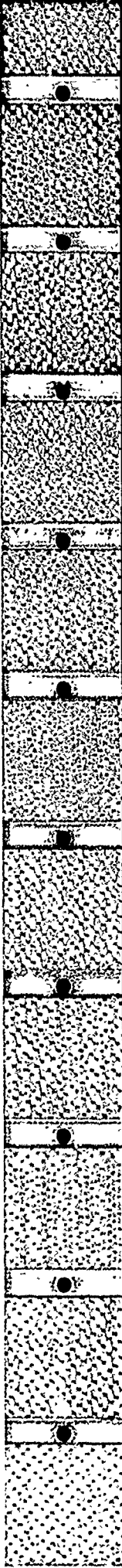
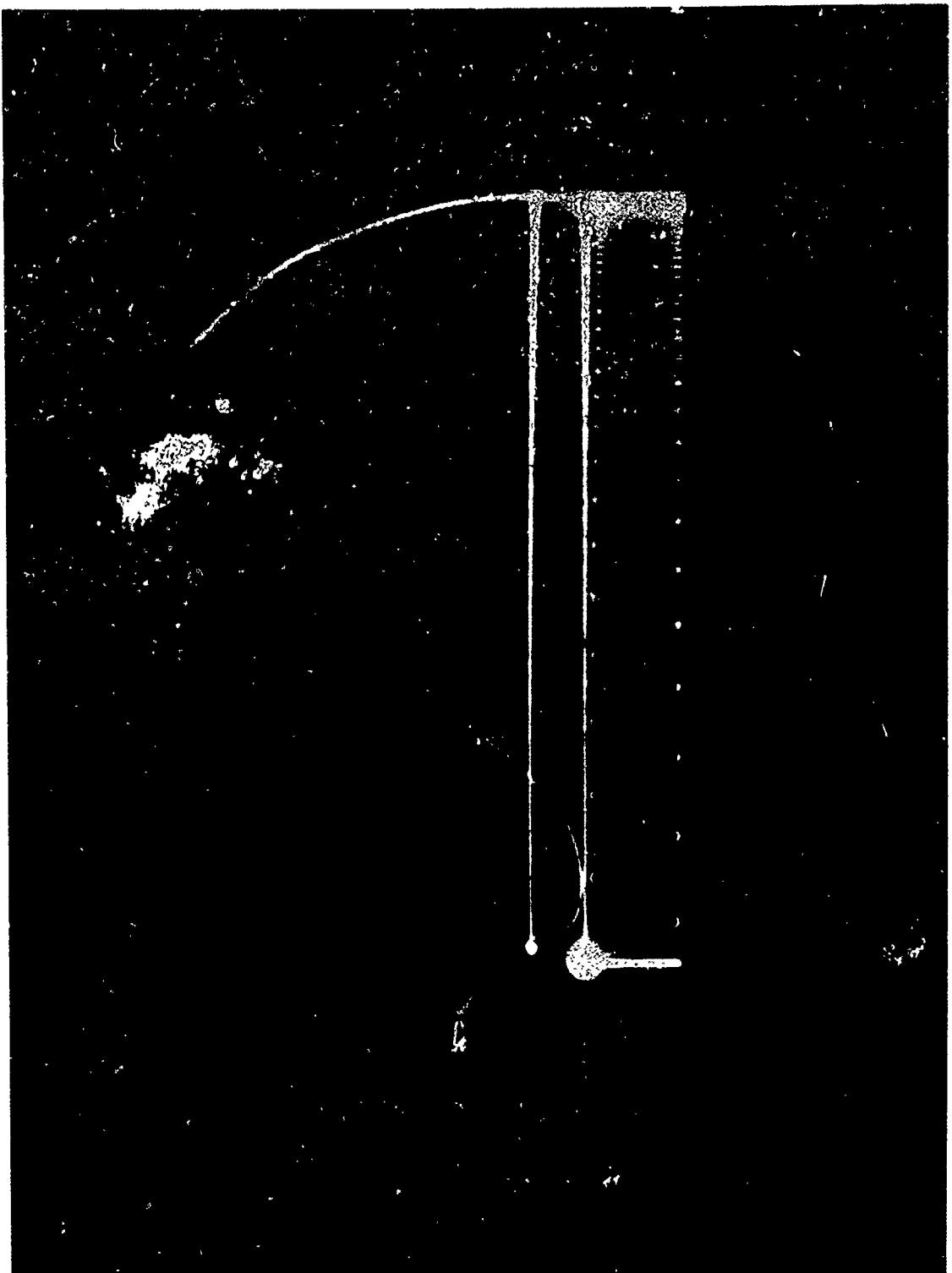



Figure 5

Bomb light oscilloscope trace with
calibration sweeps superimposed.





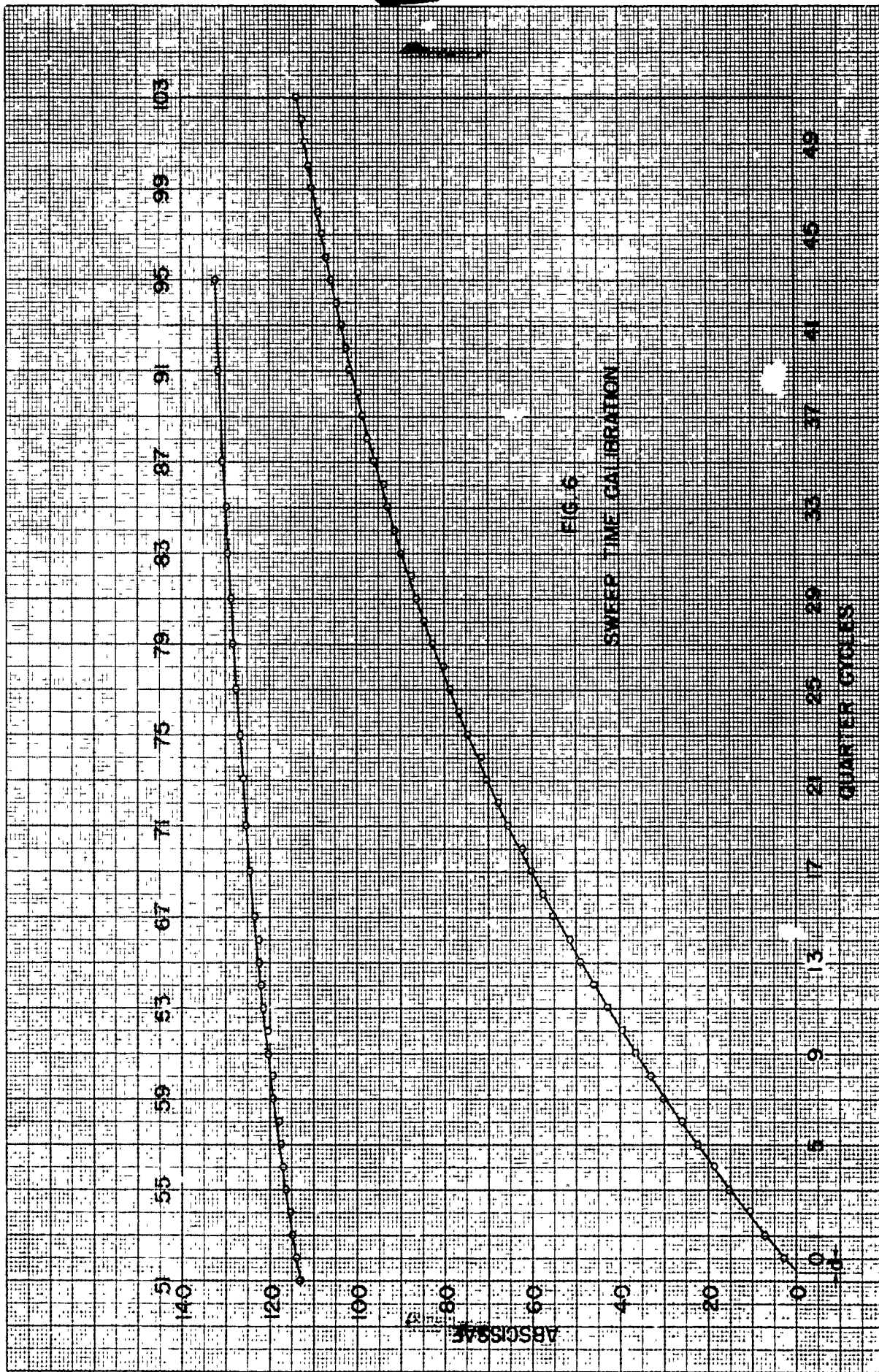

FIG. 5
SWEEP TIME CALIBRATION

graph of the observed data is given in Figure 7. From that graph it can be seen that the light intensity at 8.9 miles from the bomb drops from a peak of some undetermined height somewhere between 0 and 2.5 milliseconds to a minimum of 0.066 suns at 15 milliseconds. It then rises to a second maximum of about 8.8 suns at 125 milliseconds, from which peak it drops slowly down to a negligible value at several seconds.

An attempt was made to fit this second rise to an equation of some sort. A plot on log-log paper is shown in Figure 8, from which it appears that from 20 to 40 milliseconds the light follows the equation

$$S = 3.9 \times 10^{-6} T^{3.41}$$

where S is the intensity in suns and T the time after zero in milliseconds. However, this fit is probably of little significance, since it is well known that practically any curve can be made to fit an exponential of some sort over a small portion of its length.

We would like to express our appreciation to Prof. H. Edgerton of Edgerton, Germeshausen & Grier, Inc. for his most valuable advice in setting up this experiment.

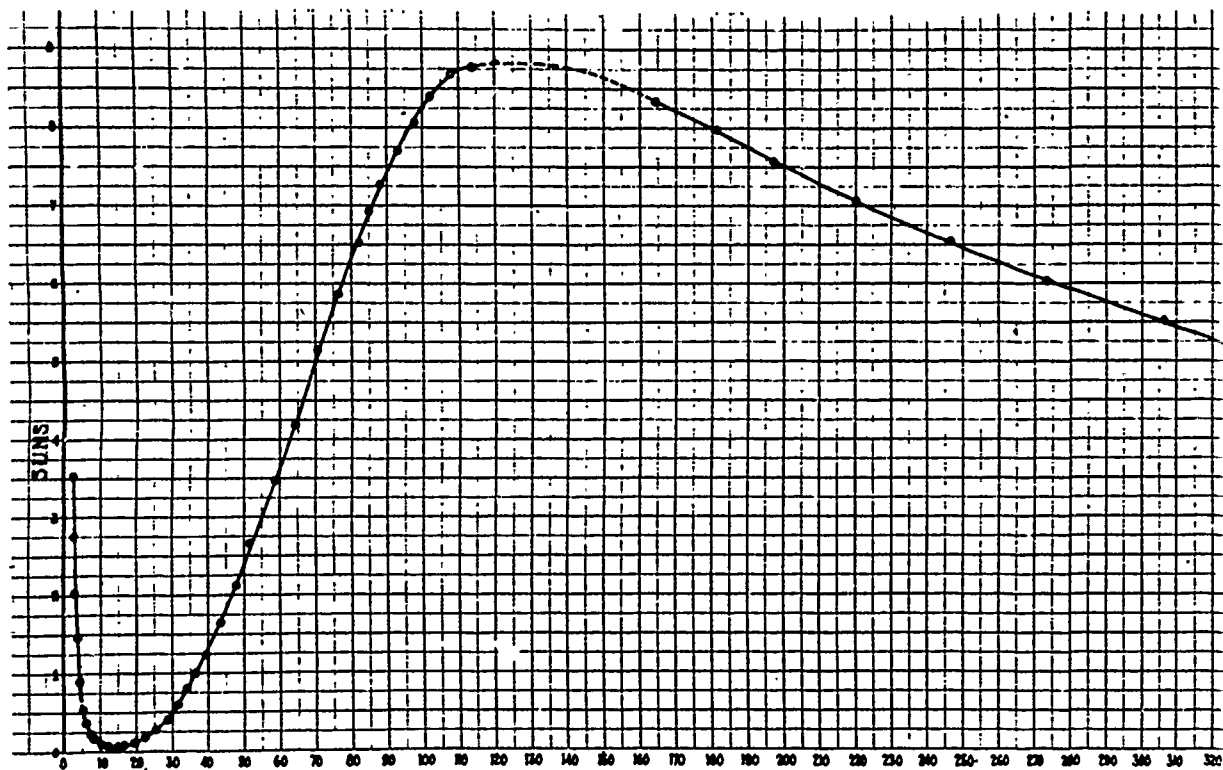

1 of 3

FIGURE 7

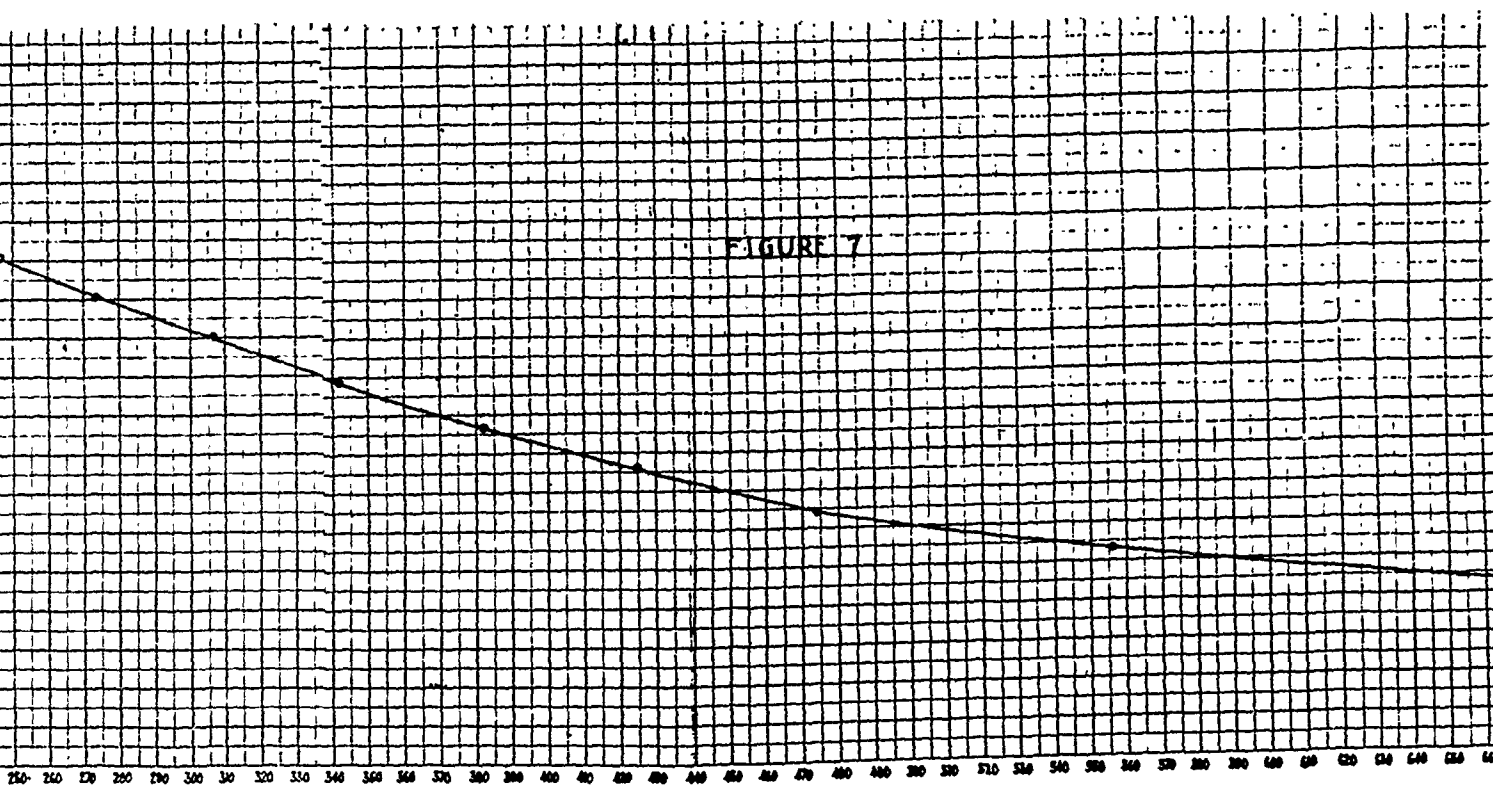

Milliseconds

2 of 2

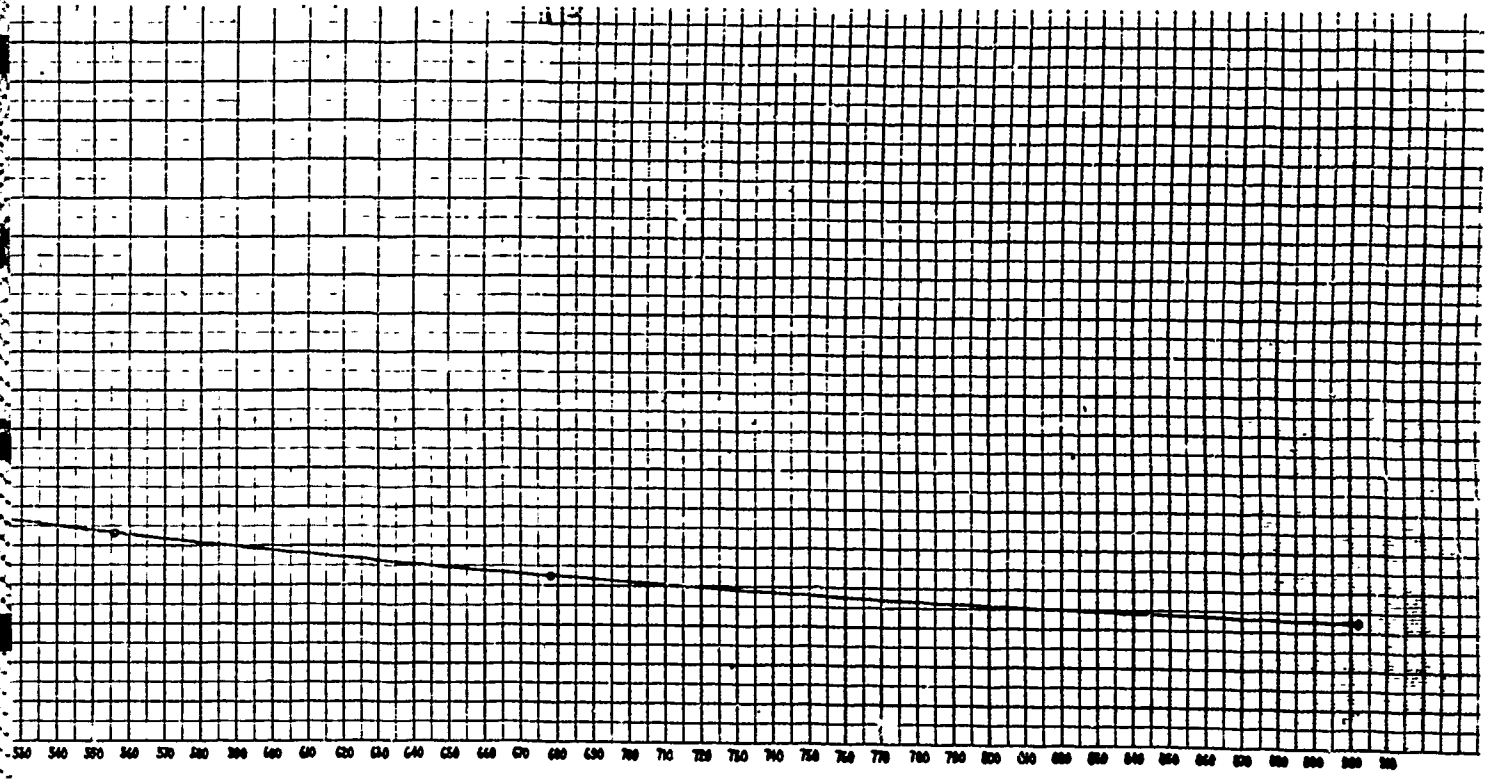

S of 3

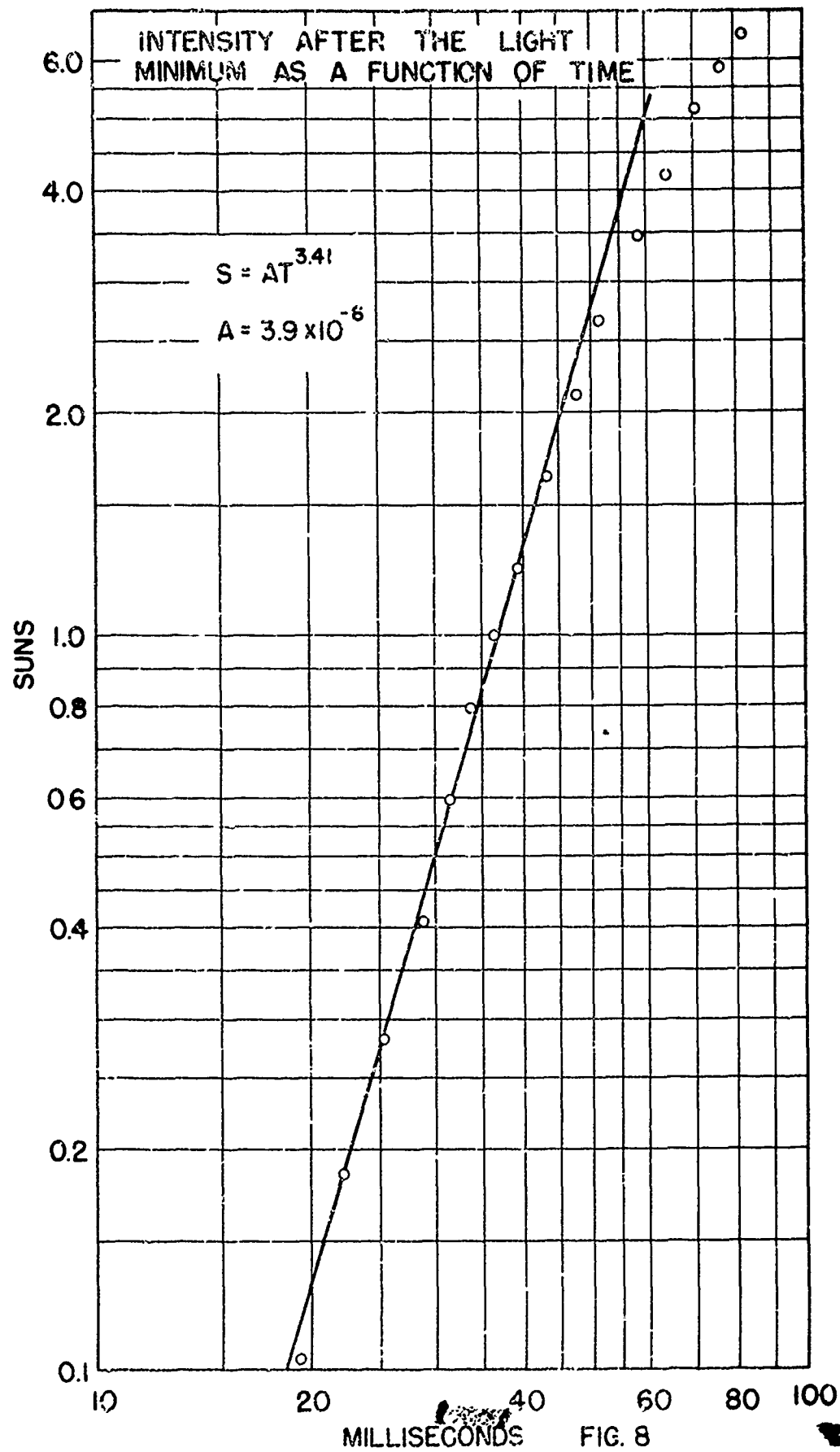

[REDACTED]

APPENDIX A

The object of this calculation is to determine the time after zero at which the oscilloscope beam reached five points, D_n , close to the end of the sweep. The deflection of the beam corresponds to the voltage across the sweep plates, which is determined by the voltage across a condenser being charged through a resistance. The equation for the voltage across such a capacity as a function of time is

$$V = V_0(1 - e^{-\alpha t})$$

where V_0 is the supply potential, assumed to be constant, t is the time after the voltage is applied, and α is the time constant of the circuit.

Thus the deflection of the oscilloscope beam as a function of time is given by

$$D = D_0(1 - e^{-\alpha t})$$

where D is the deflection from zero as a function of time and D_0 is the deflection for $t = \infty$.

Unfortunately the sweep used had a slight overswing, so that the distance between the beginning and final spots cannot be taken as D_0 . Therefore, it is necessary to determine the effective D_0 from the data of Table 1. We can re-write the equation of deflection as a function of time as

$$D_0 e^{-\alpha t} = D_0 - D$$

Thus if we plot $D_0 - D$ as a function of time on semi-log paper we should get a straight line. Conversely, we can determine D_0 by assuming various values for it and plotting the known data. The value of D_0 giving a straight line will then be the correct value. Doing this with the last ten points of Table 1 we obtain the data given in Table 3 in which time is measured in quarter cycles.

Table 1

SWEEP CALIBRATION

Crossing Number	Center Line		Top Line		Bottom Line	
	Time	Abscissae	Time	Abscissae	Time	Abscissae
1	0 + d	3.0 mm	3 + d	15.2 mm	1 + d	7.1 mm
2	2 + d	10.8	7 + d	30.0	5 + d	22.6
3	4 + d	18.8	11 + d	43.0	9 + d	36.6
4	6 + d	25.9	15 + d	55.0	13 + d	49.0
5	8 + d	33.0	19 + d	65.4	17 + d	60.2
6	10 + d	39.4	23 + d	74.7	21 + d	70.1
7	12 + d	46.0	27 + d	82.8	25 + d	78.9
8	14 + d	51.3	31 + d	89.8	29 + d	86.2
9	16 + d	57.5	35 + d	95.9	33 + d	92.9
10	17 + d	62.2	39 + d	101.1	37 + d	98.5
11	18 + d	67.8	43 + d	105.9	41 + d	103.4
12	20 + d	71.8	47 + d	109.9	45 + d	107.9
13	22 + d	76.7	51 + d	113.3	49 + d	111.7
14	24 + d	80.2	55 + d	116.5	53 + d	115.0
15	26 + d	84.7	59 + d	119.1	57 + d	117.8
16	28 + d	87.5	63 + d	121.5	61 + d	120.2
17	30 + d	91.2	67 + d	123.5	65 + d	122.4
18	32 + d	93.9	71 + d	125.2	69 + d	124.3
19	34 + d	97.1	75 + d	126.9	73 + d	126.0
20	36 + d	99.4	79 + d	128.1	77 + d	127.3
21	38 + d	102.2	83 + d	129.3	81 + d	128.5
22	40 + d	104.1	87 + d	130.3	85 + d	129.5
23	42 + d	106.9	91 + d	131.2		
24	44 + d	108.4	95 + d	132.0		
25	46 + d	110.8				
26	48 + d	112.1				
27	50 + d	114.1				
28	52 + d	115.2				
29	54 + d	117.0				
30	56 + d	118.0				
31	58 + d	119.6				
32	60 + d	120.5				
33	62 + d	122.0				
34	64 + d	122.6				

Note: Time is measured in quarter cycles of a 60-cycle per second wave.
d is the time from zero to the first crossing on the center line
and is equal to 0.7 quarter cycles.

Table 2

Signal Amplitude	Suns	Abcissae	Time (mil sec)	Signal Amplitude	Suns	Abcissae	Time (mil sec)
37.0 mm	3.53	2.6 mm	2.58	72.9	6.94	66.8	85.0
29.1	2.76	2.8	2.745	76.4	7.26	68.8	88.1
22.0	2.085	3.0	2.91	80.8	7.7	71.1	93.0
15.5	1.47	3.7	3.75	84.8	8.08	73.9	98.0
9.5	0.9	4.3	4.335	88.2	8.4	76.2	102.0
5.7	0.54	5.1	5.16	91.1	8.69	79.1	107.9
3.7	0.353	5.95	6.045	92.1	8.77	82.0	114.0
2.2	0.2085	7.0	7.08	87.5	8.34	100.8	164.4
1.7	0.161	8.0	8.04	83.7	7.98	105.2	181.1
1.0	0.0948	9.9	10.16	79.5	7.57	109.2	197.0
0.8	0.0759	11.9	12.09	74.1	7.06	114.1	219.5
0.7	0.0664	14.1	14.58	68.9	6.55	118.7	246.5
0.85	0.0805	16.2	16.66	63.4	6.04	122.3	273.5
1.1	0.1042	19.8	19.36	58.0	5.52	126.0	306.5
1.95	0.185	21.1	22.15	51.8	4.93	128.9	342.0
2.95	0.28	24.0	25.4	45.5	4.34	131.1	382.0
4.3	0.408	27.0	28.85	40.0	3.81	132.9	425.0
6.3	0.597	29.4	31.6	33.7	3.21	134.4	474.0
8.4	0.796	31.2	33.9	28.0	2.665	135.9	556.0
10.5	0.995	33.2	36.3	22.2	2.115	136.9	678.0
13.1	1.24	35.6	39.3	17.2	1.64	137.4	902.0
17.3	1.64	38.9	43.35				
22.2	2.115	42.1	47.9				
28.0	2.655	45.1	51.6				
36.6	3.47	50.0	58.75				
44.1	4.19	53.9	64.2				
54.3	5.15	58.2	70.5				
61.8	5.86	62.0	76.6				
68.8	6.52	65.2	82.1				

Note: 10.5 mm signal amplitude = 1 sun.

The values given in Table 3 are plotted in Figure 9, from which it can be seen that 137.5 millimeters is the correct value for D_0 . The value of alpha from the curve is $1/29.833$. Thus we have the equation

$$T = 29.833 \ln_e \left(\frac{137.5}{137.5 - D} \right)$$

Therefore, for the last five points of our curve we find the values given in Table 4 where T is the time measured in quarter cycles, d the additional time because zero cycles is 0.7 cycles from actual zero time, and 4.16 is the factor necessary to give milliseconds.

Table 3

Time	Abscissae	140 - D	137 - D	138 - D	137.5 - D
59	119.1 mm	20.9	17.9	18.9	18.4
63	121.5	18.5	15.5	16.5	16.0
67	123.5	16.5	13.5	14.5	14.0
71	125.2	14.8	11.8	12.8	12.3
75	126.9	13.1	10.1	11.1	10.6
79	128.1	11.9	8.9	9.9	9.4
83	129.3	10.7	7.7	8.7	8.2
87	130.3	9.7	6.7	7.7	7.2
91	131.2	8.8	5.8	6.8	6.3
95	132.0	8.0	5.0	6.0	5.5

Table 4

D	T	T + d	T + d in Milliseconds
132.9	101.3	102.0	425
134.4	113.1	113.8	474
135.9	133.0	133.7	556
136.9	162.1	162.8	678
137.4	215.5	216.2	902

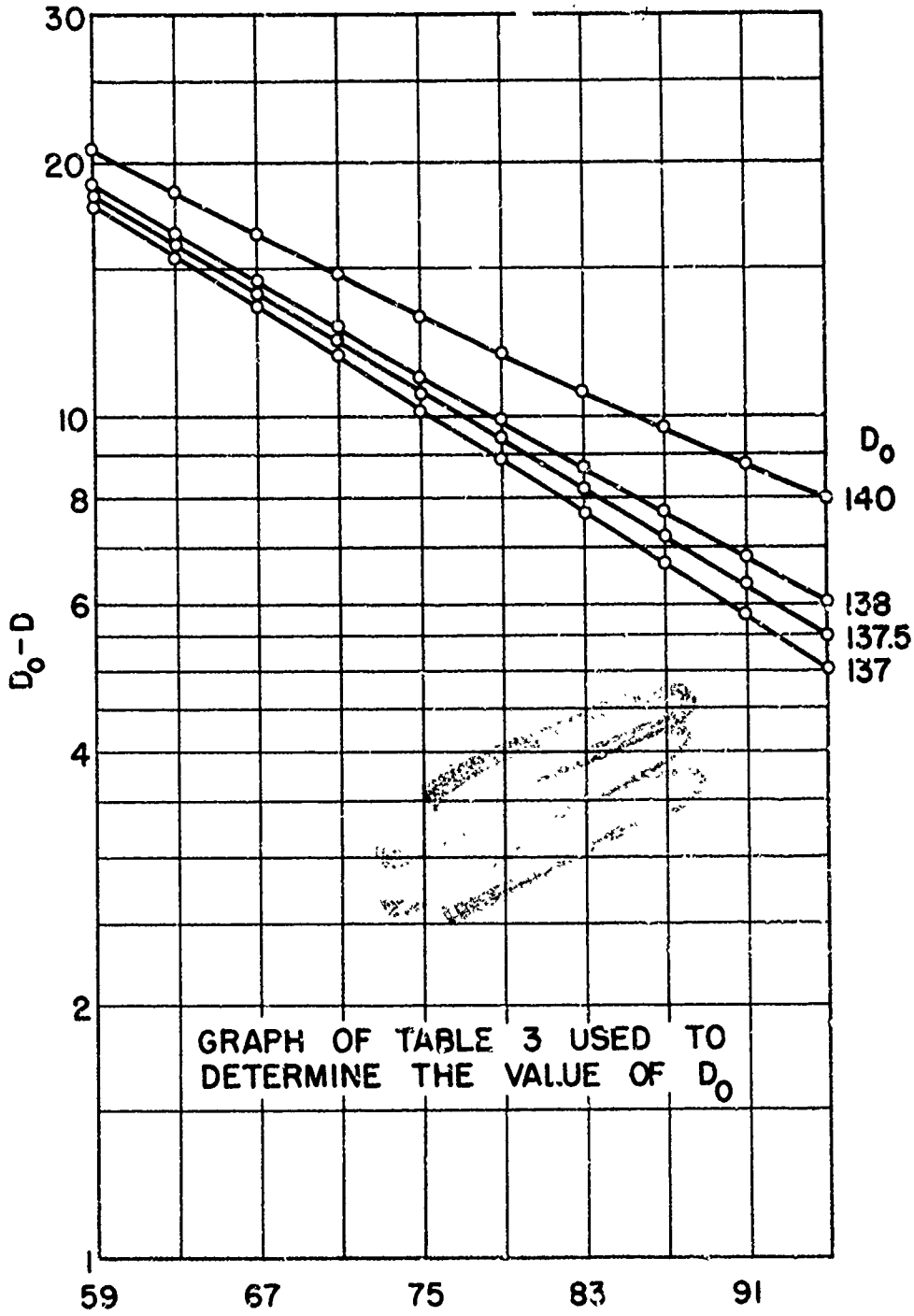

GRAPH OF TABLE 3 USED TO
DETERMINE THE VALUE OF D_0

TIME
FIG. 9

6251