

**U. S. ARMY**

**REFERENCE COPY  
DOES NOT CIRCULATE**

**Technical Note 8-62**

**A Human Engineering Evaluation  
of a  
KFZ-Werk ECRUBE-WERDAN East German Truck, 4x2, H6**

**Robert E. Hedcock**

**August 1962**

**HUMAN ENGINEERING LABORATORIES**

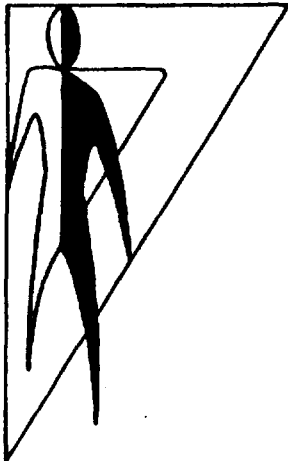

**ABERDEEN PROVING GROUND,  
MARYLAND**

Technical Note 8-62

A Human Engineering Evaluation

of a

KFZ-Werk ECRUBE-WERDAN East German Truck, 4x2, H6

Robert E. Hedgcock

August 1962

APPROVED



JOHN D. WEISZ

Director

Human Engineering Laboratories

U. S. ARMY HUMAN ENGINEERING LABORATORIES  
Aberdeen Proving Ground, Maryland

## ABSTRACT

A human factors evaluation of an East German H6 Truck to determine the desirable human factors features of this model for possible application to future vehicle design.

## CONTENTS

ABSTRACT . . . . .	iii
INTRODUCTION . . . . .	1
OPERATIONAL CHARACTERISTICS . . . . .	5
MAINTENANCE . . . . .	15
COMPONENTS . . . . .	21
SUMMARY . . . . .	29

A Human Engineering Evaluation  
of a  
KFZ-Werk ECRUBE-WERDAN East German Truck, 4x2, H6

INTRODUCTION

A Human Factors Evaluation of a KFZ-Werk ECRUBE-WERDAN East German Truck 4x2, H6, was conducted by the Systems Research Laboratory, U. S. Army Human Engineering Laboratories, to determine the desirable human factors features of this model truck for possible application to future vehicle designs.

Method of Evaluation

A static workspace layout method of evaluation was used to study this truck. This study was conducted in a minimum of time due to availability of the truck.

Russian Standard #9734-61

This vehicle was also evaluated by using Russian Standard #9734-61 (see Reference). This evaluation disclosed that the truck violated some of these requirements. The violations of this standard are illustrated by Table 1. Several of the requirements in Standard #9734-61 are not acceptable by U. S. standards.

Desirable and Undesirable  
Human Engineering Features

The following human engineering features possessed by this truck are considered desirable for consideration in future vehicle design by U. S. standards:

- a. Cab seats
- b. Ingress and egress from cab

TABLE 1

Comparison of KFZ-Werk ECRUBE WERDAN  
East German Truck to Russian Standard #9734-61

<u>Item</u>	<u>Russian Standard Data (Minimum)</u>	<u>East German Truck</u>
Driver's Seat Width	18.9 inches	20.5 inches
Seat Height	13.78 "	14 "
Seat Depth	15.75 "	17 "
Cab Height (from surface of seat cushions)	34.37 "	36 "
Distance from Rim of Steering Wheel to Seat Back	14.57 - 15.35 inches (Range)	13.25 "**
Distance from Clutch to Brake (center to center)	5.92 "	5.75 "**
Distance from Brake to Accelerator (center to center)	4.33 "	4.625 "
Distance from Center of Clutch to Wall	1.95 - 5.92 inches (Range)	6.875 "**

\* Violation of Standard

- c. Maintenance features
  - (1) Hand removable engine-valve covers
  - (2) Easily-drained air system
  - (3) Readily-accessible fuses
  - (4) Captive air connectors
  - (5) Bossed rear differential
- d. Cargo-towing pintle concept
- e. Side-loading feature
- f. Cargo-bed hardware
- g. Engine-compartment drop panels
- h. Spare-tire stowage and handling

The following human engineering features possessed are considered to be undesirable by U. S. standards:

- a. Interior lighting (dash and dome)
- b. Driver vision
- c. Control coding
- d. Battery access
- e. Refueling
- f. Accelerator pedal
- g. Knee and head clearance for driver

TABLE 2

Measurements of Steps and Hand Grasps

<u>Ingress &amp; Egress Features</u>	<u>Distance</u>	<u>Comments</u>
Steps on Side of Cab: 1st Step	21-1/2" from ground	Self-cleaning
2nd Step	13" from 1st step	
Bar Strip on Front Sides of Vehicle	24" from ground	Sill 24" x 9" Dia. 3/8"
Grasp for Cab		Inside Dia. 9-1/2" x 2"



## OPERATIONAL CHARACTERISTICS

### Ingress and Egress

This vehicle provides excellent driver and passenger ingress and egress features. These include excellent steps, catwalks, and hand-grasp handles. These steps and handles are placed at ideal heights and locations to accommodate the 5 - 95th percentile man (Table 2 and Fig. 1 - 4).

### Steering System

The large diameter of this wheel apparently is designed to mechanically offset the high resistance of the steering system. The steering wheel is extremely hard to turn during movement and almost impossible to turn when standing still.

This steering system tends not to return to center and, as a result, requires the operator to manually return the wheel to center. Due to this and the high resistance of the steering wheel, both hands of the operator are occupied during all turning operations of the vehicle.

The optimum steering system would use a wheel with a 20-inch diameter, 3/4-inch grip, and no more than five pounds resistance.

### Foot Pedals

The accelerator pedal is at a 90° angle and, as a result, does not provide the optimum of 15° for comfort. The clutch and brake pedals are of acceptable size and resistance (Fig. 5).

### Driver's Vision

Vision is extremely poor. The large steering wheel obstructs the operator's view to the front (Fig. 6). The ground in front of the truck is visible to the operator of the vehicle approximately eight meters out from the front bumper.



Fig. 1. CAB INTERIOR



Fig. 2. CAB INTERIOR



8

Fig. 3. SIDE STEPS



Fig. 4. FRONT CATWALK

3" BELOW BRAKE PEDAL

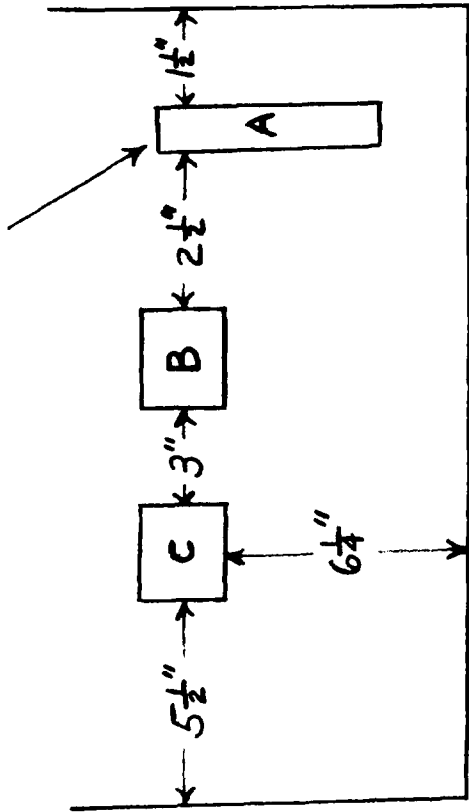

<u>Control</u>	<u>Resistance</u>	<u>Size</u>
Steering Wheel	40 lbs. - Vehicle moving 85 - 100 lbs. - Vehicle stopped	Outside Dia. 21-1/2" Rim Dia. 1-1/4"
Clutch Pedal (C)	25 lbs.	2-3/4" x 3-1/2"
Brake (B)	25 - 30 lbs.	2-3/4" x 3-1/2"
Accelerator (A)	10 lbs.	8-1/4" x 1-1/2"

Fig. 5. PEDAL MEASUREMENTS AND RESISTANCES

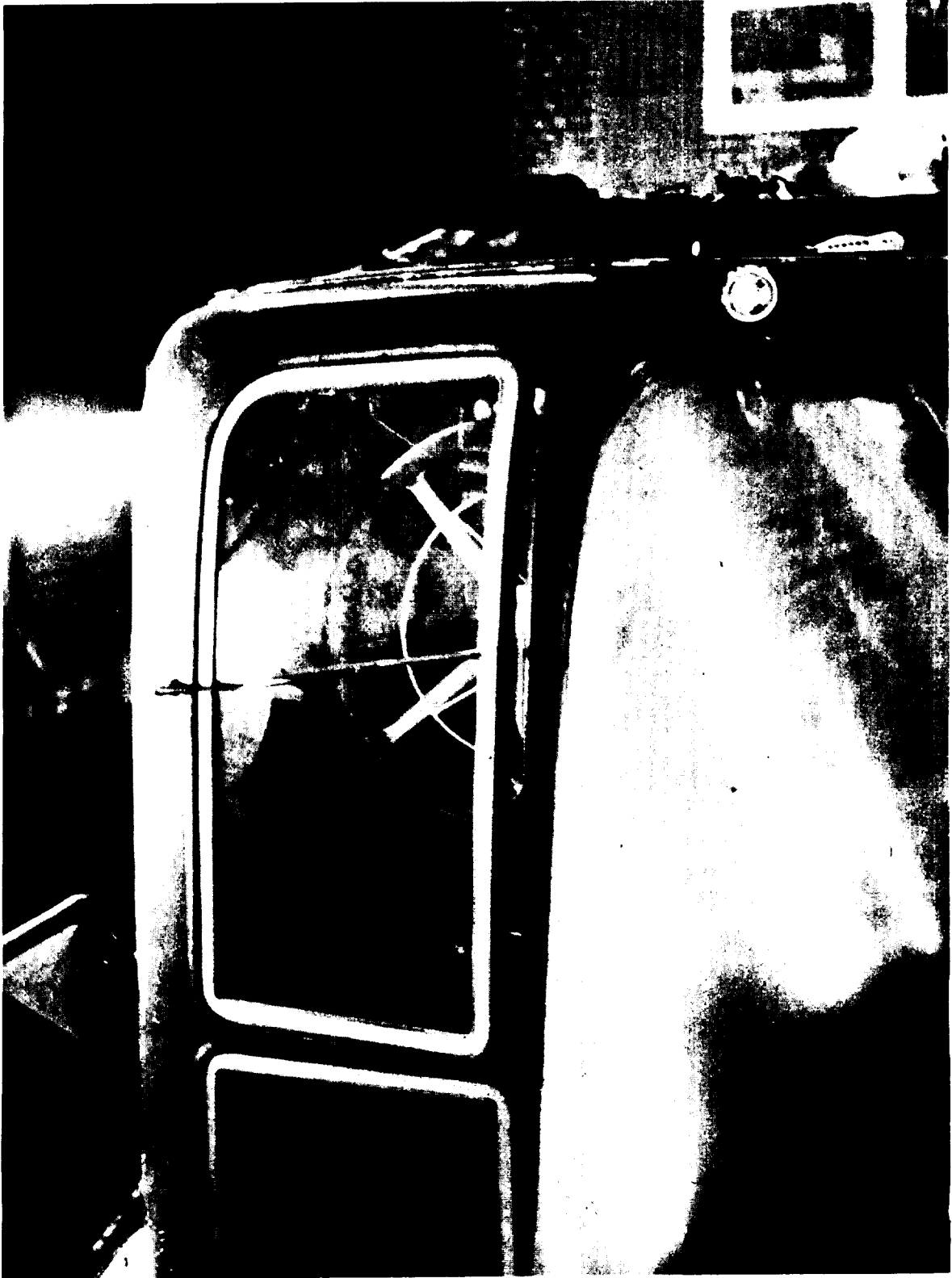
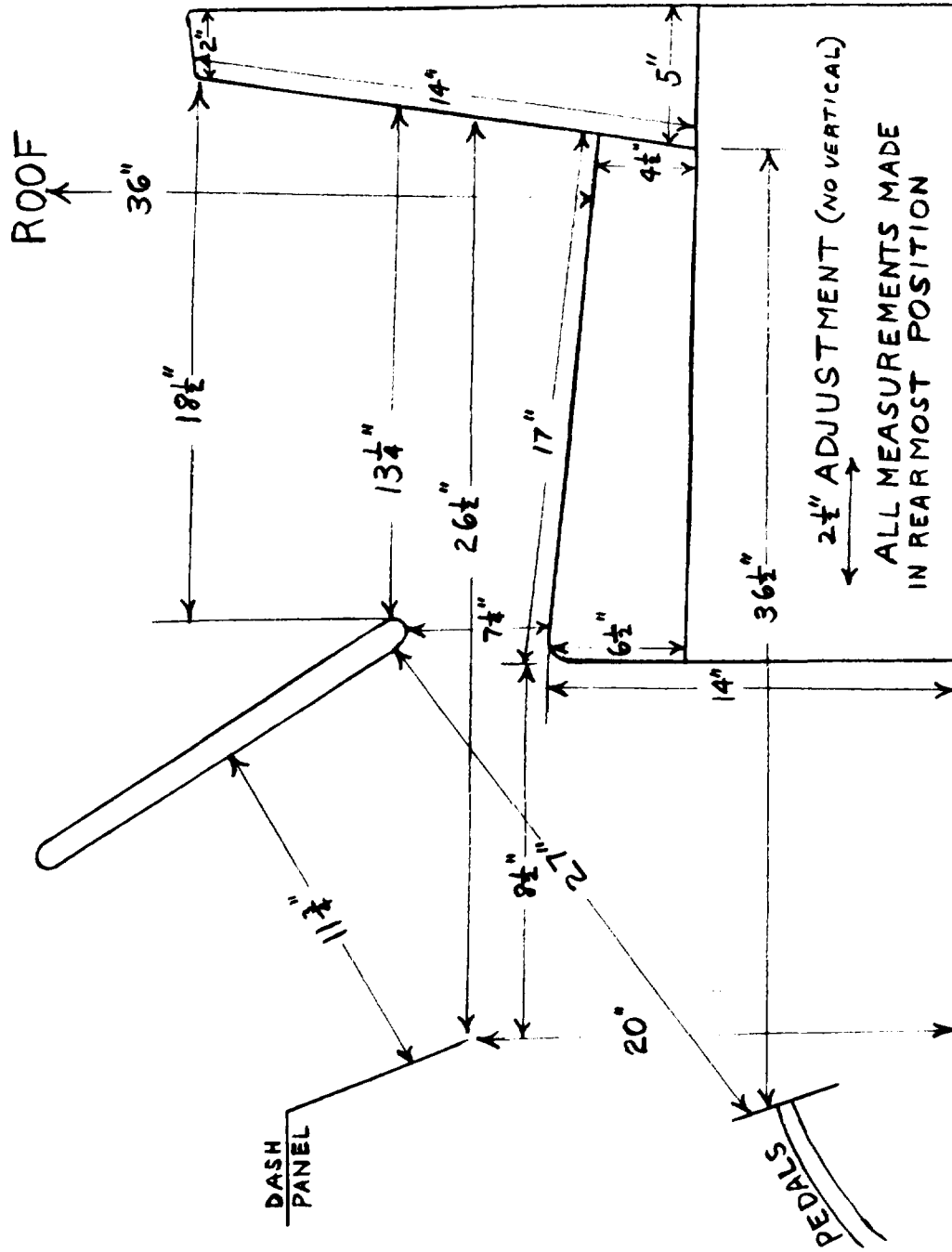

Fig. 6. FRONT VISION



DRIVER'S SEAT WIDTH-20 1/2"

KFZ-WERK ECRUBE WERDAN  
EAST GERMAN TRUCK

Fig. 7. CAB MEASUREMENTS



## Cab Seating

The seats have an excellent contour and cushion thickness (Fig. 1 and 2). The driver's seat has a forward and rear adjustment of 2-1/2 inches. The distance from the back of the seat (with the seat in the rear position) to the dash panel is 26-1/2 inches (Fig. 7). The recommended distance to provide knee clearance for the 95th percentile man is at least 28 inches in the rear position. The steering wheel overhangs the driver's seat, leaving only 7-1/2 inches from the rim of the steering wheel to the seat cushion. A man wearing arctic clothing would be crowded by the steering wheel while driving.

## Interior Lighting

The dash lighting is white and cannot be dimmed, hence providing no night adaptation qualities.

The interior dome light shines directly in the operator's eyes.

## Dashboard

Controls are coded by plastic disks which fit under the knob retainers that they identify. In most cases the outer face of the knob obscures the coding.



Fig. 8. AIR SYSTEM DRAIN

## MAINTENANCE

### Air-Brake System

Most U. S. equipment using air-brake systems requires a man to crawl under the truck and open a petcock to purge the water from the system. This is a daily service.

The air system can be completely drained of water by reaching under the front bumper of the truck and pulling an easily-accessible ring as shown in Figure 8.

### Engine-Valve Cover

The concept of being able to gain access to components requiring servicing by use of the hand only is a highly desirable human factors design feature.

The engine-valve covers can be simply removed by hand. This involves turning a captive handwheel and lifting the valve cover off, giving complete access to the valves for adjustment (Fig. 9 and 10).

### Fuses

Fuses are easily accessible for checking and replacement by opening a small door in the dashboard (Fig. 11).

### Special Fillers

Special fillers are provided in the vehicle on-vehicle equipment to facilitate filling liquid fillers (Fig. 12).

### Refueling

Refueling with a five-gallon can is difficult on this vehicle due to the overhang of the cargo bed and the recessed fuel tank under the cargo bed (Fig. 13). The special fillers provided in the on-vehicle equipment can be used to facilitate refueling.



Fig. 9. ENGINE VALVE COVER

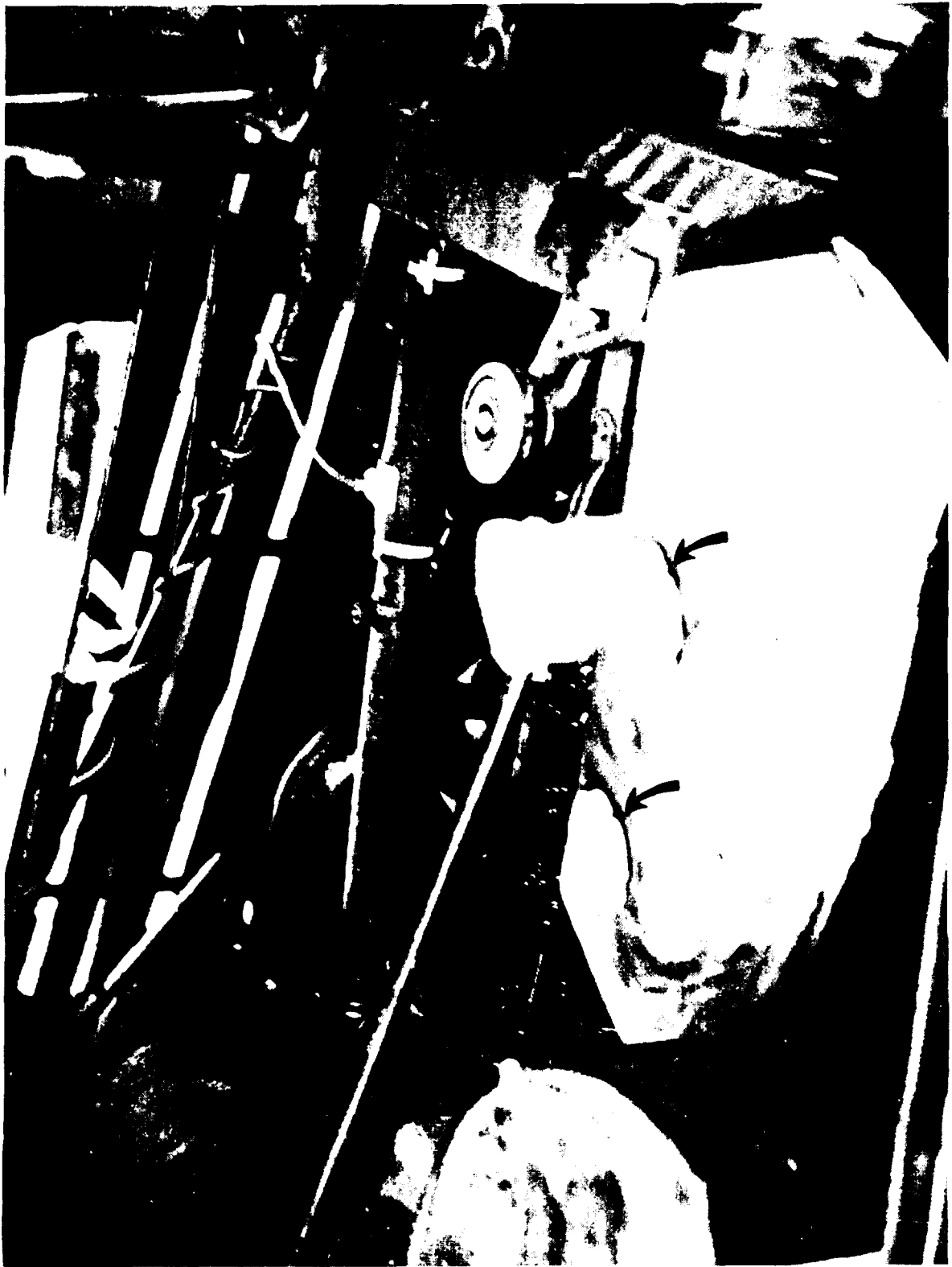

Fig. 10. ENGINE VALVE COVER REMOVED

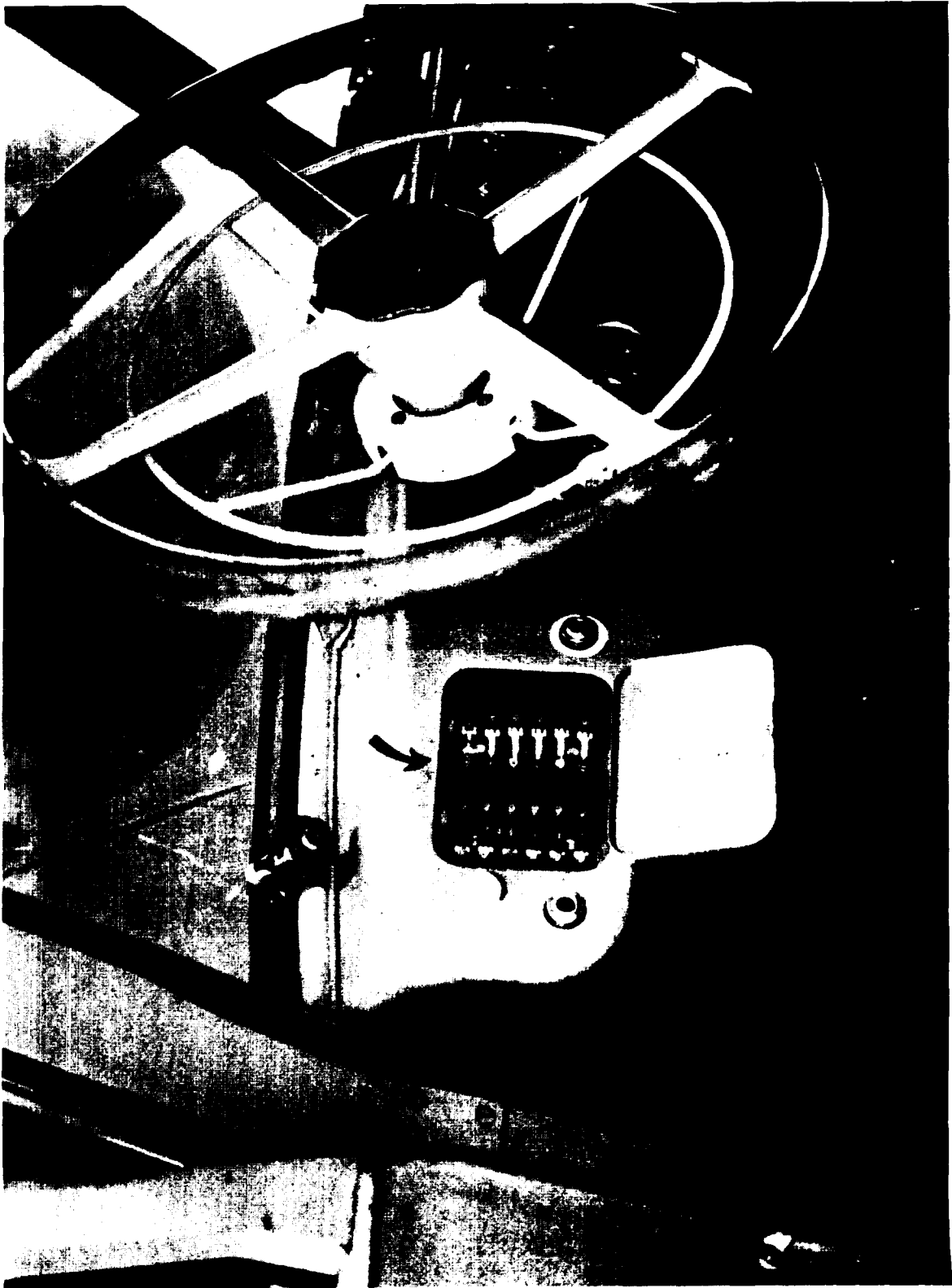

Fig. 11. FUSE LOCATION

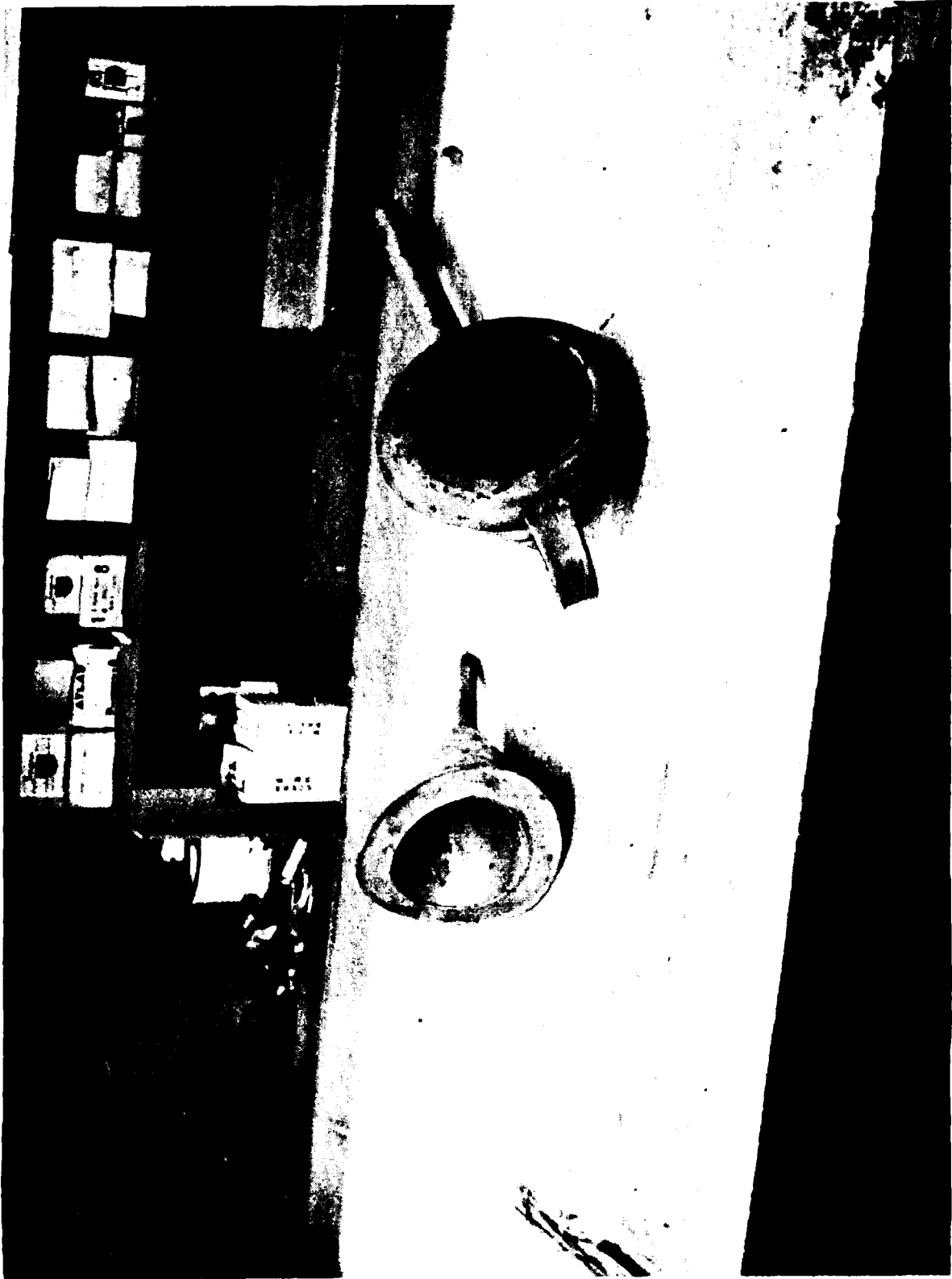

Fig. 12. SPECIAL FILLER



Fig. 13. FUEL TANK



## Battery Access

Batteries in this vehicle are difficult to service and remove. The addition of water to the bottom and removal of the end battery requires the removal of the driver's seat. After the driver's seat has been removed, the extrusion between the seats complicates the above tasks. The batteries are large heavy units for one man to lift (Fig. 14).

## Spare Tire

The spare tire is stored in an easily-accessible position (Fig. 15). A roll-out rack offering mechanical advantage is provided for ease of removal and replacement. Adequate handholds are provided to enable the operator to get a firm grip on the roll-out rack.

# COMPONENTS

## Air-Hose Coupling

The air-hose coupling, as shown in Figure 16, has a captive cover and swings into the locked position. This prevents the loss of the cover by personnel.

## Towing Pintle

The vehicle-towing pintle does not require exact positioning due to its flared flange (Fig. 15). The operator has only to position the trailer hitch within the flange range, and the backing force of the truck will cam the trailer hitch into the locked position.

## Cargo Bed

A good feature of this truck is the side-loading capability. The truck bed can be dropped from all sides at once or in any combination. The retaining hardware is of simple design and easily operable by hand. The retaining device used to hold the entire cargo bed is a simple cam-retaining lever. Cargo-bed sideboard locking hardware used in this vehicle is durable and easy to operate. Handholds and levers are provided for ease of opening and closing this locking hardware (Fig. 17 - 20).



Fig. 14. BATTERIES



Fig. 15. TOWING PINTLE AND SPARE TIRE



Fig. 16. TRAILER AIR BRAKE HITCH

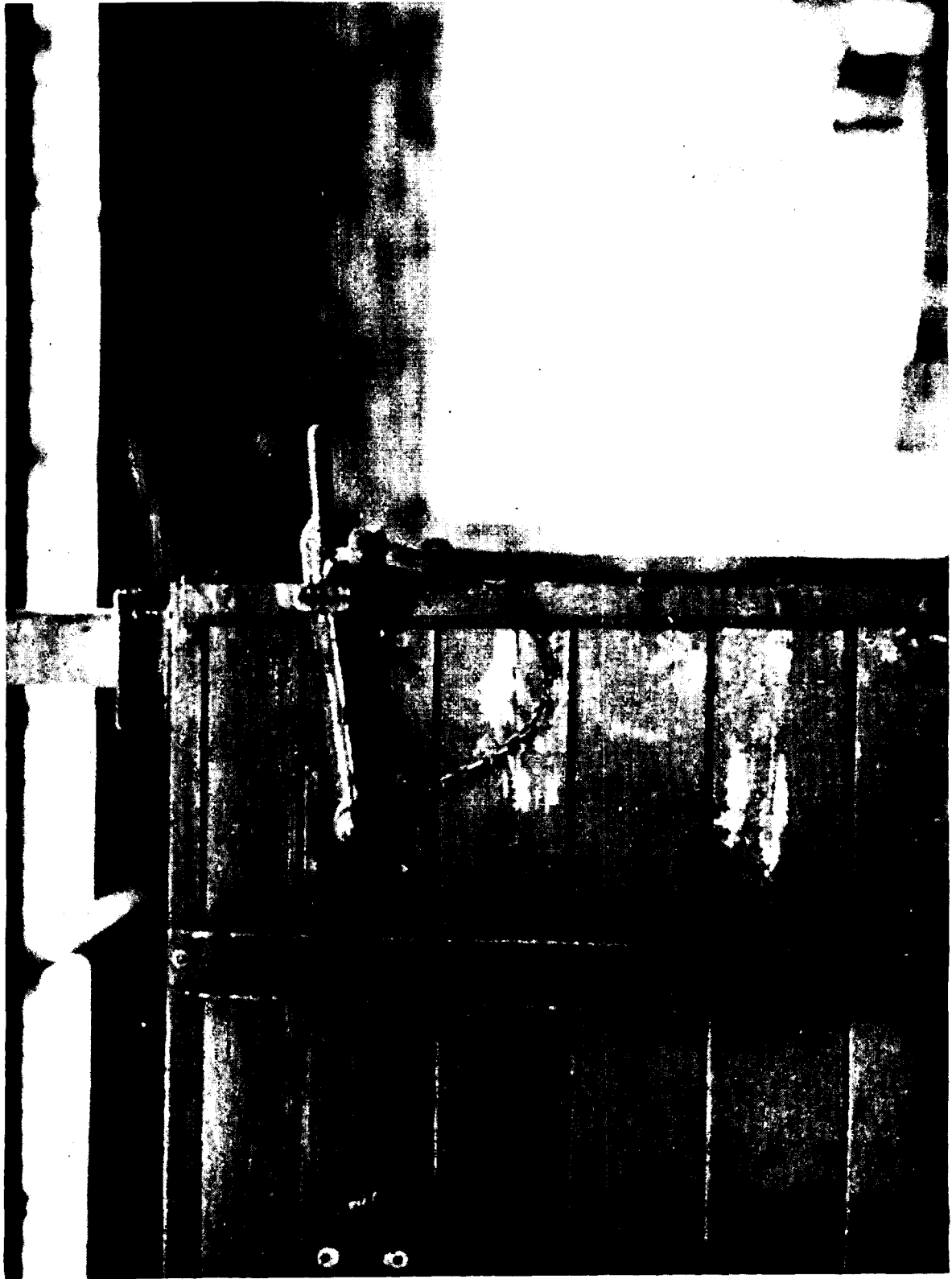

Fig. 17. CARGO BED HARDWARE



Fig. 18. CARGO BED HARDWARE

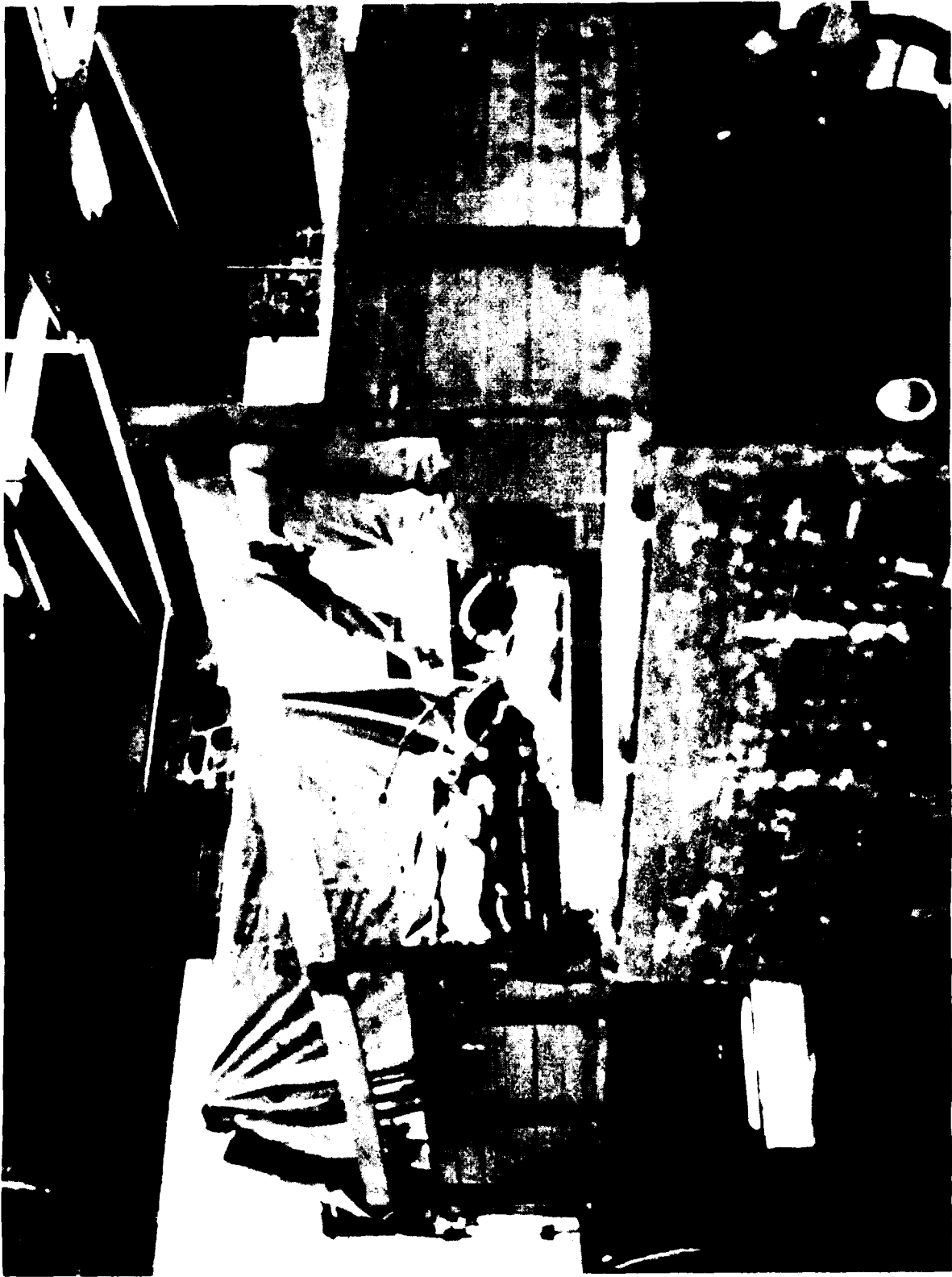

Fig. 19. SIDE LOADING FEATURE



Fig. 20. SIDE LOADING FEATURE



### Wheel Block

An easily-accessible wheel block is provided to block the wheels so the truck will not roll when parked on a grade (Fig. 21).

### Stowage

Stowage space is adequate. Figure 22 illustrates the stowage box provided. Figure 23 illustrates the stowage space provided for fuel cans.

### Rear Differential

The rear differential has a bossed filler. This filler enables an operator to add gear oil easily (Fig. 24).

## SUMMARY

The design of this vehicle has several noteworthy human factor considerations worthy of consideration for inclusion in future U. S. vehicle designs.

This Laboratory would greatly appreciate the opportunity to evaluate any other foreign equipment. Evaluations of this nature should yield a wealth of human factors ideas for possible incorporation into future vehicle designs.



Fig. 21. WHEEL BLOCK.



Fig. 22. STOWAGE BOX



Fig. 23. FUEL CAN STOWAGE

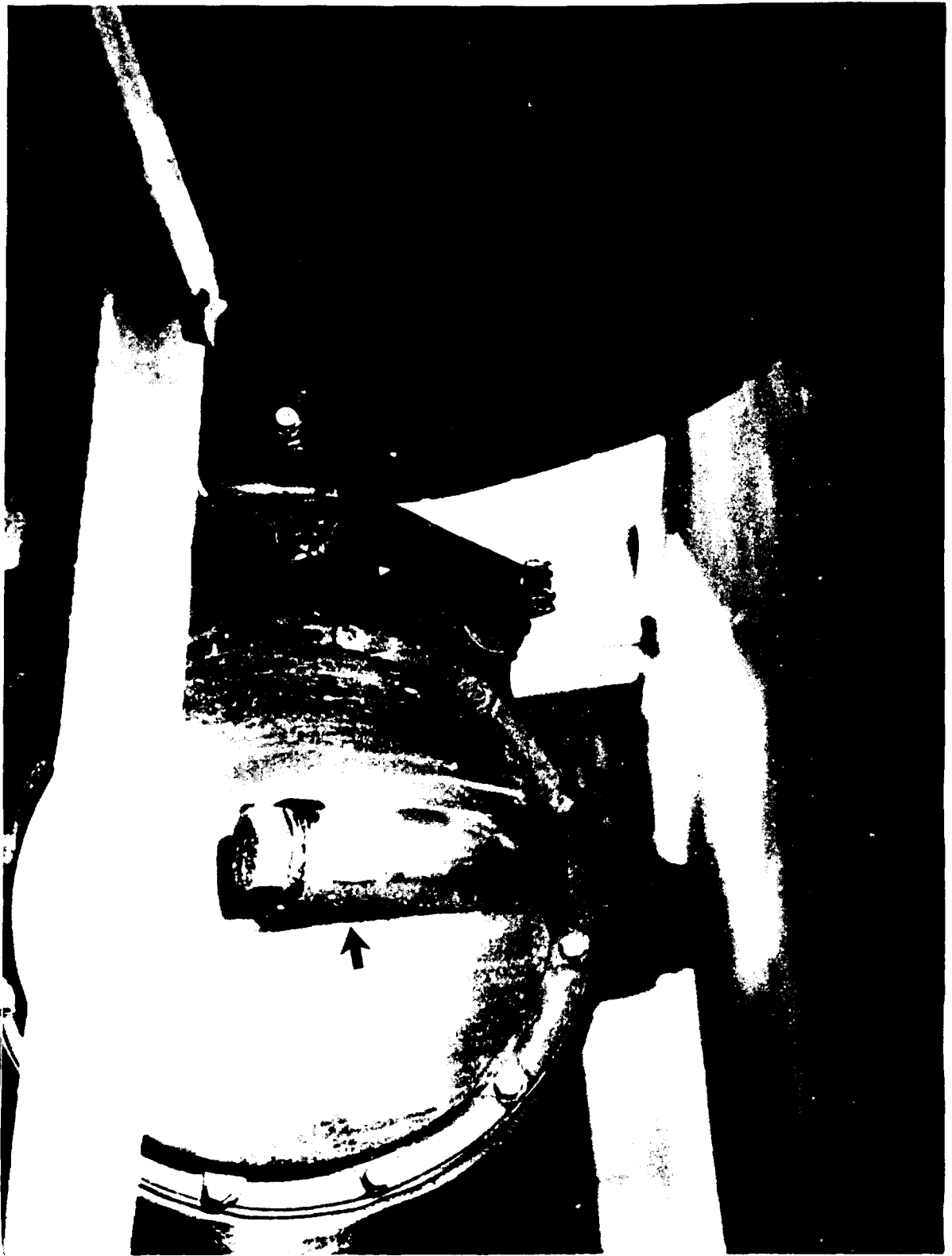

Fig. 24. REAR DIFFERENTIAL FILLER

---

## REFERENCE

Translation from the Russian publication *Automotive Transport*,  
No. 10-1961, New Standards for Truck Cabs.