

# 1

WATERTOWN ARSENAL  
WATERTOWN, MASS.

VAL TR 323.4/1

AD



1  
39

AD - 268776

# WATERTOWN ARSENAL LABORATORIES

AD A951011

6  
LOW TEMPERATURE MECHANICAL PROPERTIES  
OF 300 SERIES STAINLESS STEELS AND TITANIUM.

9  
TECHNICAL REPORT, NO. WAL-TR-323.4/1

14

10  
BY  
THOMAS S. DeSISTO  
FRANK L. CARR

DTIC  
ELECTE  
SEP 1 1 1981  
S D  
A

DATE OF ISSUE - DECEMBER 1961

12 39

11

DTIC FILE COPY

OMS CODE 5010.11.8420051  
RESEARCH OF METALS AND NONMETALLIC MATERIALS FOR ORDNANCE CONSTRUCTION  
D/A PROJECT 5893-32-002

This document has been approved  
for public release and sale; its  
distribution is unlimited.

WATERTOWN ARSENAL  
WATERTOWN 72, MASS.

370850

LB

OFFICIAL FILE 1019

10 190

X 35

ASTIA AVAILABILITY NOTICE

Qualified requesters may obtain copies of this report from ASTIA.  
Copies available at Office of Technical Services \$0.75.

DISPOSITION INSTRUCTIONS

Destroy; do not return

AD

Steels, stainless -  
mechanical properties

Titanium

LOW TEMPERATURE MECHANICAL PROPERTIES  
OF 300 SERIES STAINLESS STEELS AND TITANIUM

Technical Report No. WAL TR 323.4/1

By

Thomas S. DeSisto

and

Frank L. Carr

Date of Issue - December 1961

OMS Code 5010.11.8420051

Research of Metals and Nonmetallic Materials for Ordnance Construction

D/A Project 5B93-32-002

WATERTOWN ARSENAL  
WATERTOWN 72, MASS.

Accession For	
DTIC DATA	<input checked="" type="checkbox"/>
DTIC TAB	<input type="checkbox"/>
Unannounced	<input type="checkbox"/>
Justification	
By	
Distribution/	
Availability Codes	
Dist	Special

*A*

*Transmittal Date 12/28/61*

WATERTOWN ARSENAL LABORATORIES

TITLE

LOW TEMPERATURE MECHANICAL PROPERTIES  
OF 300 SERIES STAINLESS STEELS AND TITANIUM

ABSTRACT

A tensile test cryostat is described for the temperature range -240 F to -452 F, which consists of a temperature recording and control system, and a diameter measurement system which includes a scanning control system. True stress-strain properties of the 300 series stainless steels and iodide and commercially pure titanium were obtained from room temperature to -452 F. Serrated load-elongation curves obtained at -452 F and the sequence of deformation in multi-necked specimens at this temperature are discussed.

*Thomas S. DeSisto*

THOMAS S. DeSISTO  
General Engineer

*Frank L. Carr*

FRANK L. CARR  
Materials Engineer

APPROVED:

*J. F. Sullivan*  
J. F. SULLIVAN  
Director  
Watertown Arsenal Laboratories

REPORT APPROVED

Date: 28 Dec 61

WAL Board of Review

Chairman: *J. Sullivan*

CONTENTS

	Page
ABSTRACT	
INTRODUCTION . . . . .	3
MATERIALS AND PROCEDURE . . . . .	3
Materials, Chemical Analysis and Heat Treatment . . . . .	3
Testing Procedure . . . . .	3
Tensile Test Cryostat . . . . .	5
TEST RESULTS . . . . .	7
300 Series Stainless Steels . . . . .	8
Titanium . . . . .	9
Serrated Load-Elongation Curves . . . . .	9
SUMMARY . . . . .	11
ILLUSTRATIONS . . . . .	13
REFERENCES . . . . .	32

## INTRODUCTION

The use of liquefied gases in electronic devices and missile propellant systems, and the extremely low temperatures which are encountered in outer space, have created a demand by design engineers for mechanical property data of engineering materials at cryogenic temperatures.

While recently, considerable effort has been devoted to obtaining tensile and other mechanical properties of engineering materials at cryogenic temperatures, instantaneous diameter measurements during tensile testing have not been attempted.

Recognizing the importance of the true stress-strain test and the need for specimen diameter measurements in tests where the material deforms by a series of discontinuous yields, Watertown Arsenal Laboratories contracted with A. D. Little, Inc.<sup>1</sup> to construct a tensile test cryostat capable of measuring and recording instantaneous diameter data.

The purpose of this report is threefold:

- a. To describe briefly the tensile test cryostat.
- b. To present engineering and true stress-strain data obtained with this equipment on the 300 series stainless steels and commercially pure and iodide titanium.
- c. To comment on observations noted on the formation and development of necks at -452 F.

## MATERIALS AND PROCEDURE

### Materials, Chemical Analysis and Heat Treatment

The materials used in this investigation together with the specimen nomenclature and chemical analysis are shown in Table I. The stainless steel and commercially pure titanium were utilized in the as-received mill-annealed condition. The iodide titanium was annealed five hours at 1600 F in a vacuum.

### Testing Procedure

Round 0.252-inch diameter tensile specimens, as shown in Figure 1, were used in this testing program. Tests were conducted in a Baldwin 60,000-pound hydraulic testing machine at a controlled platen speed of 0.01 inch per minute. Low temperature tests at -105 F, -240 F and -320 F were conducted in a double-walled metal container. The coolants used were alcohol, with dry ice added, for -105 F; isopentane in the inner container with liquid nitrogen added to the outer container, when needed, for -240 F; and liquid nitrogen at its boiling point, -320 F. Over this

TABLE I

MATERIALS AND CHEMICAL COMPOSITIONS

Material	Stock Diameter (in.)	Chemical Analysis (Weight Percent)										Average Grain Diam. (mm)
		C	Mn	Si	S	P	Ni	Cr	Mo	Cb		
AISI 302	3/4	0.054	1.62	0.49	0.016	0.027	9.4	18.9	-	-	0.063	
303	1/2	0.06	0.75	0.55	0.300	0.025	9.1	17.82	-	-	0.013	
304	1/2	0.05	1.52	0.43	0.019	0.025	9.6	17.96	-	-	0.116	
316	1/2	0.045	1.87	0.06	0.019	0.023	13.43	17.19	2.13	-	0.085	
347	1/2	0.045	1.75	0.53	0.026	0.013	11.07	18.53	-	0.72	0.011	

				Average Grain Diam. (mm)		
C	Fe	O	H	N		
0.016	0.29	0.126	0.0064	0.0035	0.034	
0.009	0.01	0.0294	0.0017	0.006	0.064	

temperature range, an instantaneous diameter gage<sup>2</sup> was used to obtain diameter data for true stress-strain calculations. For tests at -452 F, liquid helium was used in the tensile cryostat.

### Tensile Test Cryostat

The tensile test cryostat consists of a low-temperature tensile test chamber, a temperature recording and control system, and a tensile diameter measurement system which includes a scanning control system. The unit was designed to be compatible with an existing true stress-strain computer.<sup>3</sup> A schematic diagram of the test apparatus is shown in Figure 2. The low-temperature test chamber, designed for the temperature range of -240 F to -452 F, consists of an inner vessel which contains the cooling medium and which comprises the actual test volume to be maintained at the desired test temperature. The inner chamber is surrounded in turn by a vacuum jacket, a liquid nitrogen bath and outside vacuum jacket.

The test chamber is supported by the lower head of the testing machine; the upper head moves relative to the lower head.

Both top and bottom specimen holders are sealed in the cryostat against leakage by removable "O" rings at the ambient ends. The top holder, together with the four diameter-measuring caliper fingers, pass through the cover plate into the test volume through the top of the test chamber, and are part of the measuring-head assembly. The specimen holders were designed to withstand 20,000 pound loads.

The approximate coolant consumption rates for a test at -452 F are as follows:

#### Nitrogen consumption:

precooling loss	3.0 liters
heat-leak loss	0.5 liters per hour

#### Helium consumption:

precooling loss	4.6 liters
heat-leak loss	2.0 liters per hour

The temperature in the test chamber is measured by four copper-constantan thermocouples, one at each end of the four caliper fingers. The thermocouples are connected in series to increase the output signal. The temperature-controller consists of a Leeds and Northrup potentiometer and duration-adjusting type (D.A.T.) controller. The cooling liquid is transferred from a storage Dewar flask to the test volume through a vacuum jacketed helium transfer tube when the solenoid valve connected to the helium exhaust tube of the test chamber is opened on a signal from a relay controlled by the D.A.T. unit.



The diameter-measurement system consists of four caliper fingers spaced at 90 degrees around the 0.252-inch diameter specimen in a plane perpendicular to the specimen axis. The fingers are coupled each to a linear variable differential transformer through a pivoted right angle arm, and are each held against the test specimen by the unbalanced mass of the right angle arm.

The output signal, which is proportional to the average diameter of the specimen, is fed into the true stress-strain computer and can be read visually on a graduated dial or, when used in conjunction with load data from the testing machine, can provide an autographic curve of true stress-strain on a Baldwin MD-2 recorder. If desired, diameter profile data can be obtained on an auxiliary recording system.

A scanning motor mounted on the cover of the test chamber drives the carriage carrying the four caliper fingers over the gage length of the specimen seeking a minimum diameter. An arm, which is friction coupled to the graduated diameter dial of the computer, serves as a memory device. Once minimum diameter is obtained, the fingers scan until a diameter 0.001 inch greater than minimum diameter is obtained, then the direction of scan is reversed on a signal from a microswitch, and the motor drives the fingers back through minimum diameter to a diameter 0.001 inch greater, and then the scan is again reversed. Provision is made for a full gage length scan to study the development of multiple necks. Limit switches are provided to prevent travel of the fingers beyond the shoulders of the specimen.

Records of loads and platen displacement were made on a Baldwin MD-2 recorder, with loads obtained from the testing machine Bourdon tube micro-former and displacement measured by a deflectometer. The deflectometer, placed under the moving platen, was capable of strain read-outs of 0.036 inch per inch of chart displacement. The full range of the unit was 0.5 inch.

After the specimen was mounted into the test chamber and cooled to the desired test temperature, the diameter-indicating dial was adjusted to read the calculated diameter at the test temperature. This was necessary as contraction of the four caliper fingers could indicate a false diameter reduction. For tensile tests, where load displacement records were obtained, the specimen gage length was scanned before and after each serration and the minimum diameters of the several necks were noted and recorded on the curve.

True stress data were obtained by dividing the area of the specimen at the time of the serration into the peak load. These data therefore reflect the upper envelope of the flow stress curve.

## TEST RESULTS

The data obtained in this investigation are plotted in Figures 3 through 19 and tabulated in Table II.

TABLE II  
TENSILE PROPERTIES

Testing Temp (deg F)	Ultimate Tensile Strength (psi)	Elongation (%)	Reduction of Area (%)	True Stress at Max. Load (psi)	Fracture Stress (psi)	True Strain at Max. Load	Fracture Strain
<u>AISI 302 Stainless Steel</u>							
R.T.	94,400	75.0	80.7	149,600	319,550	0.460	1.647
-105	152,400	52.5	73.7	218,700	368,850	0.362	1.338
-240	191,300	48.0	71.7	262,900	422,300	0.318	1.264
-320	219,300	46.0	69.5	292,150	481,150	0.286	1.183
-452	249,500	41.0	54.8	548,500	550,900	0.787	0.794
<u>AISI 303 Stainless Steel</u>							
R.T.	100,200	59.0	67.4	157,800	255,000	0.452	1.119
-105	161,500	43.0	56.8	219,900	299,000	0.299	0.847
-240	206,300	37.0	53.6	266,000	355,200	0.254	0.762
-320	234,100	35.0	51.5	293,500	398,500	0.227	0.718
-452	266,500	29.6	37.0	423,600	423,600	0.462	0.462
<u>AISI 304 Stainless Steel</u>							
R.T.	95,100	65.0	83.4	154,100	330,100	0.482	2.789
-105	151,100	55.0	77.0	211,800	387,900	0.336	1.467
-240	193,800	46.0	73.9	264,200	447,000	0.308	1.339
-320	221,400	46.5	71.8	301,800	488,000	0.308	1.263
-452	242,500	39.0	49.8	363,400	478,100	0.402	0.687
<u>AISI 316 Stainless Steel</u>							
R.T.	93,900	47.0	77.5	133,900	269,700	0.355	1.484
-105	131,500	59.0	78.0	198,800	369,000	0.442	1.517
-240	161,100	60.0	77.7	256,000	435,000	0.462	1.500
-320	184,300	59.0	76.2	270,500	497,400	0.384	1.434
-452	216,400	52.0	59.7	360,200	530,250	0.508	0.907
<u>AISI 317 Stainless Steel</u>							
R.T.	99,300	50.0	73.0	143,200	266,000	0.365	1.300
-105	136,600	53.0	72.2	194,700	326,000	0.355	1.378
-240	172,100	48.0	67.4	238,600	374,400	0.327	1.119
-320	201,400	46.0	65.5	274,500	423,800	0.308	1.065
-452	236,400	38.0	54.7	438,000	500,300	0.593	0.789
<u>A-55 Titanium</u>							
R.T.	68,700	30.0	50.1	77,200	111,300	0.120	0.692
-105	87,500	39.5	60.8	109,100	181,200	0.217	0.934
-240	107,200	58.5	70.7	157,700	254,600	0.384	1.225
-320	139,000	53.5	69.5	200,900	313,400	0.365	1.184
-452	176,500	37.0	55.8	298,700	353,500	0.520	0.771
<u>Iodide Titanium</u>							
R.T.	46,000	61.0	81.5	67,000	144,100	0.374	1.691
-105	72,000	57.0	84.3	102,100	198,700	0.346	1.856
-240	92,400	67.0	88.0	138,700	289,000	0.403	2.120
-320	112,000	72.0	78.2	185,500	290,000	0.503	1.521
-452	143,200	57.5	61.6	247,100	320,400	0.545	0.957

### 300 Series Stainless Steels

The tensile strengths of the 300 series stainless steels, plotted in Figure 3, generally increase with decreasing temperature. This increase is fairly linear to -320 F, but at -452 F the strengths of types 302, 303 and 304 are lower than would be expected by extrapolating from the higher temperatures. This might be taken to indicate a slight degree of embrittlement at -452 F.

The ductility of the stainless steels tested generally decrease with decreasing temperature. An exception is Type 316 which increases from room temperature to -105 F, remains constant to -320 F and drops at -452 F. The least ductile of these materials is Type 303, which has the highest tensile strength.

Linear plots of true stress-strain for the temperature range investigated are plotted in Figures 4 through 8. At the higher strains, the flow stress increases with decreasing temperature. At the lower strains, the nature of the curves are different. In the vicinity of 0.15 to 0.17 strain, the flow stress of Types 302, 303, and 304 is lower at -452 F than at -320 F. Over the same range of strain, the stress of Type 347 at -452 F is coincident to the flow stress curve at -320 F. It is also noted that, at -105 F and below, there is a concave upward trend in the curve in this strain range.

This increased rate of strain hardening has been explained by Powell, et al,<sup>4</sup> to be caused by the strain-induced transformation of retained austenite to martensite. It is observed also that the concave upward trend is not evident in Type 316. This is surprising, as X-ray analysis of the fractured specimens indicated considerable transformation of retained austenite in the threaded and deformed portions of the specimens tested at -452 F. The results are as follows:

<u>Specimen</u>	<u>Retained Austenite %</u>	
	<u>Threads</u>	<u>Shank at Fracture</u>
302	100	0
304	100	1.9
316	100	11.4
347	100	8.0

True stress at maximum load for the 300 series stainless steels plotted in Figure 9 increases with decreasing temperature to -320 F and then increases more markedly. This marked increase at -452 F is attributed to the deformation process, which results in a higher strain at maximum load. The fracture stress, shown in Figure 9, also increases with decreasing temperature. An exception is Type 304 which shows a slight decrease below -320 F.

Strain at maximum load, plotted in Figure 10, generally decreases with decreasing temperature to -320 F and then increases sharply. An

exception is Type 316 which increases from room temperature to -240 F, decreases at -320 F and increases sharply at -452 F. This increase in strain at maximum load below -320 F can be explained by the fact that at -452 F the deformation process is not continuous at any one location and the metal can tolerate a much higher strain before maximum load is reached.

### Titanium

The tensile strengths of the commercially pure (A-55) and iodide titanium, plotted in Figure 11, increase approximately 155% and 210% respectively, from room temperature to -452 F. Over the same temperature range, ductility, as measured by either percent elongation or percent reduction of area, increases from room temperature to either -240 F or -320 F and then decreases at -452 F. It is noted that the ductility of the A-55 material is greater at -452 F than at room temperature. This behavior is common with metals of high purity. In the case of titanium, Guard<sup>5</sup> has shown that the operative deformation mechanisms are dependent upon purity level as well as temperature.

Linear plots of true stress-strain for the temperature range investigated are shown in Figures 12 and 13. Strain at maximum load "M" and fracture strain "F" are noted on each curve. The flow stress of both the A-55 and iodide titanium increases with decreasing temperature.

True stress at maximum load and fracture stress, plotted in Figure 14, increase with decreasing temperature. Of interest is the comparison of these curves over the full temperature range. While the stress at maximum load is greater for the A-55 material over the full temperature range, the fracture stress of the iodide titanium is greater from room temperature to -240 F, but is less at the lower temperature.

True strain at maximum load for the A-55 and iodide titanium, plotted in Figure 15, generally increases with decreasing temperature. This increase coincided with the gradual change in deformation mechanism from predominantly slip to a mixture of slip and twinning at the lower temperatures.

### Serrated Load-Elongation Curves

Tensile stress-strain curves at elevated temperatures often show load serrations, due to strain aging. Similar serrations are evident in tests below -320 F where a different mechanism must be operative. The reasons advanced for these serrations are many and varied.<sup>4,6,7,8</sup> There has not, however, been any attempt to measure instantaneous diameter changes while the specimen is deforming by a series of discontinuous yields.

A typical load-elongation curve for a specimen of 302 tested at -452 F is shown in Figure 16. In this plot, the numbers above the load serrations represent the average diameter of one or several necks at the indicated load. The lowest set of figures represent the diameter of the first neck to form and the subsequent figures represent the additional

necks as they formed. For this specimen the first neck formed in the lower third of the gage length, the second neck formed in the middle and the last neck formed in the upper third of the gage length. As indicated on the plot, the specimen fractured at the first neck formed.

This pattern of events was not the general rule, however, as often the first neck formed in the middle or upper third of the gage length and the specimen fractured at one of the later forming necks. While not noted on the plot, the diameters between the necks were from 0.008 to 0.020 inch greater than the noted diameters. It was also observed that in the portion of the curve where there are two or more necks, load serrations can be accompanied by deformation in a single neck, two necks simultaneously or neither of the necks. In the last case deformation takes place elsewhere along the gage length.

The serrated load-elongation curve for a specimen for Type 316 is shown in Figure 17. It is evident that small serrations begin after considerable plastic flow and then grow in magnitude with increasing stress until fracture occurs. It is also evident that the last full serration is much larger than the preceding serrations and was accompanied by large local deformation.

The serrated load-elongation curve for a specimen of commercially pure titanium is shown in Figure 18. In this plot the first load serration appears to originate from the elastic portion of the curve. The serrations increase in magnitude with increasing stress until fracture occurs. Again, as with Type 316 the last full serration is much larger than the preceding serrations and was accompanied by large local deformation. It is noted that the first 30 serrations resulted in a diameter reduction from 0.252 to 0.222 inch, with each serration accompanied by approximately 0.001 inch diameter change.

The serrated load-elongation curve for a specimen of iodide titanium is plotted in Figure 19. The first serration appears to originate from the elastic portion of the curve and is followed by two others of equal magnitude. Following these initial serrations is an extended portion of strain without serrations which is in turn followed by additional serrations. These additional serrations are preceded by decreasing portions of plastic strain as the serrations increase in magnitude to fracture. This is in contrast to the results for the commercially pure titanium and the stainless steel, where no visible plastic strain occurred except during the load drops. Again, as in previous cases, there is a large characteristic serration immediately preceding fracture. It is assumed that during this serration, an internal crack has formed at some inclusion or otherwise, as the specimen fractures on the elastic portion of the next load cycle with no apparent diameter change.

## SUMMARY

The mechanical properties of the 300 series stainless steels and commercially pure and iodide titanium have been determined from room temperature to -452 F. A tensile cryostat used to obtain the mechanical property data at -452 F was described. True strain at maximum load for the A-55 and iodide titanium increase with decreasing temperature. This increase coincides with the change in deformation mechanism from predominantly slip to a mixture of slip and twinning at the lower temperatures. By contrast, strain at maximum load for the 300 series stainless steel generally decreased with decreasing temperature to -320 F, but increased markedly at -452 F. This marked increase can be explained by the fact that at -452 F the deformation process is not continuous at any one location and the metal can tolerate a much higher strain before maximum load is reached.

All materials tested in this investigation deformed by a series of discontinuous yields at -452 F. Load serrations were accompanied by deformation in a single neck, two necks simultaneously or elsewhere along the gage length. The shape of the serrated load-elongation curve varied with the material. For the 300 series stainless steels, serrations began after considerable plastic strain while for both the A-55 and the iodide titanium the first serration appears to originate from the elastic portion of the curve. However, all specimens tested which fractured beyond maximum load had a large characteristic serration immediately preceding fracture. This serration was accompanied by large local deformation. As the specimens fractured on the next load cycle with no apparent diameter change, it is assumed an internal crack has initiated at some inclusion or otherwise during this serration.

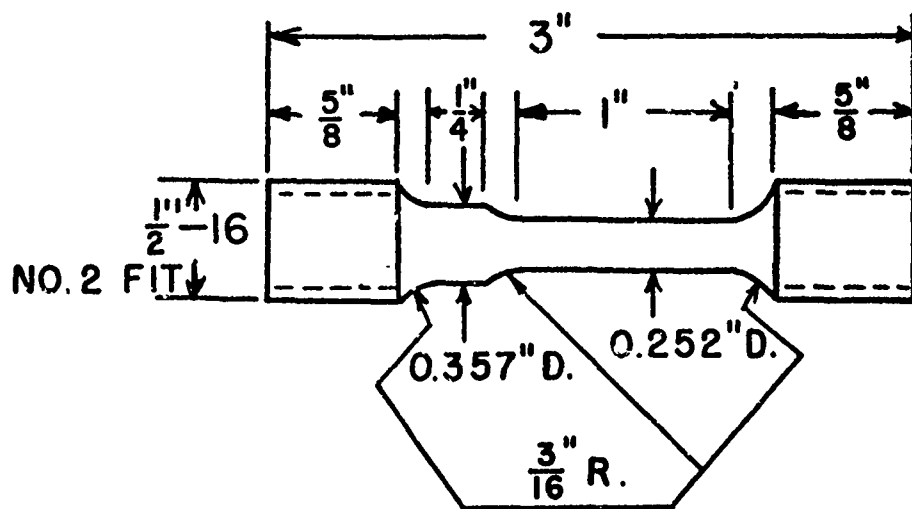

LOW-TEMPERATURE TENSILE SPECIMEN

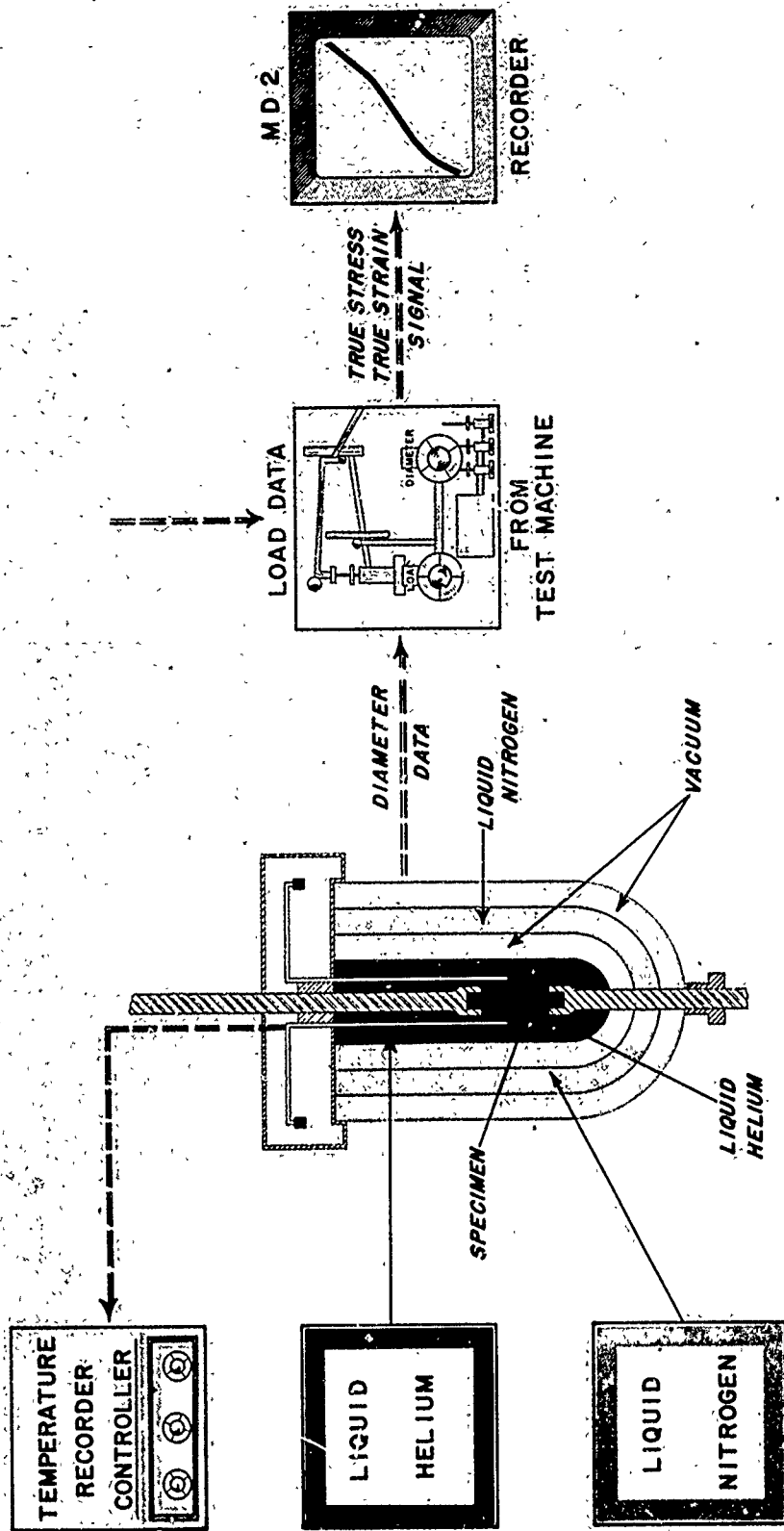

TENSILE TEST CRYOSTAT



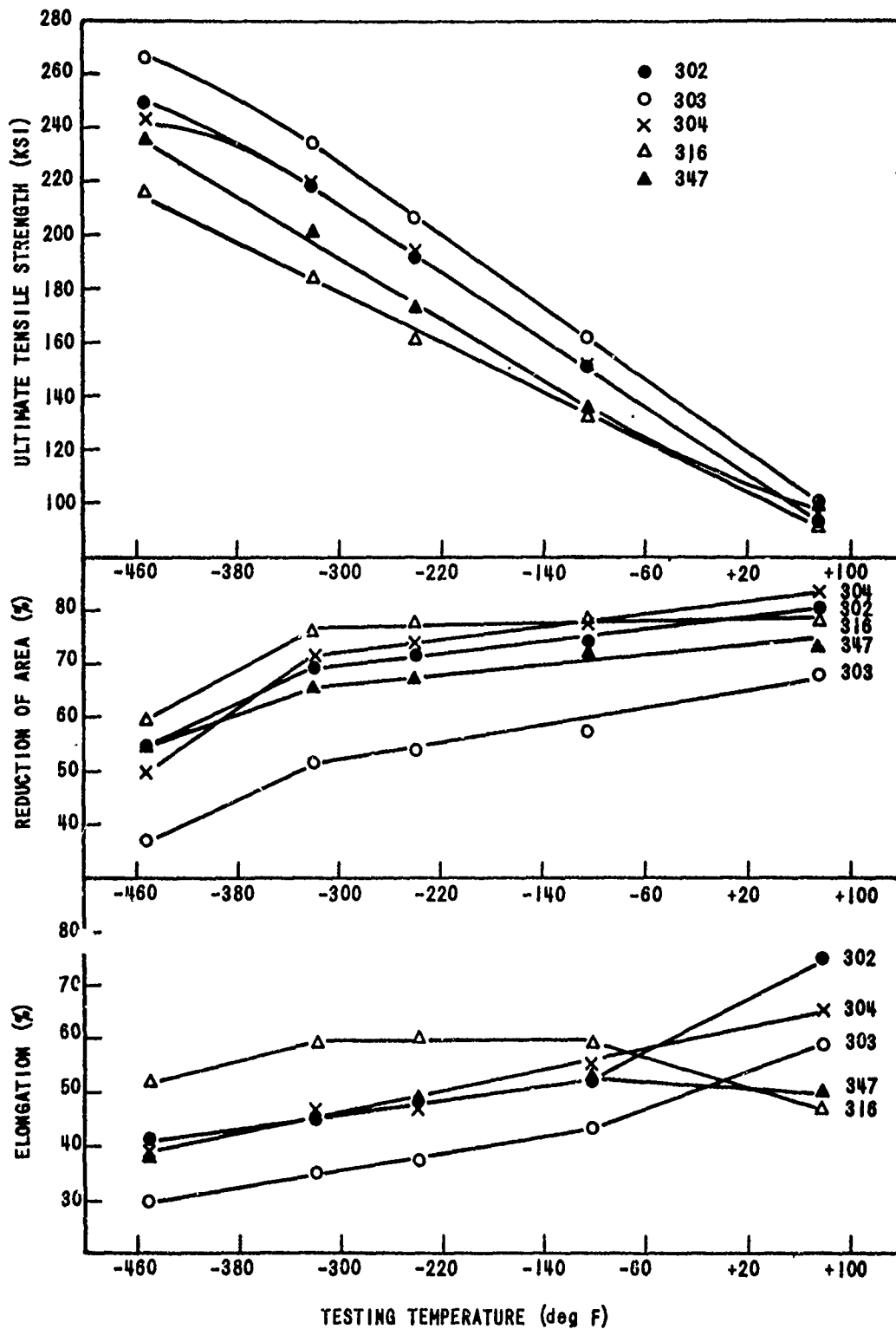

TESTING TEMPERATURE (deg F)  
 ENGINEERING TENSILE PROPERTIES OF 300 SERIES  
 STAINLESS STEELS AT VARIOUS TEMPERATURES

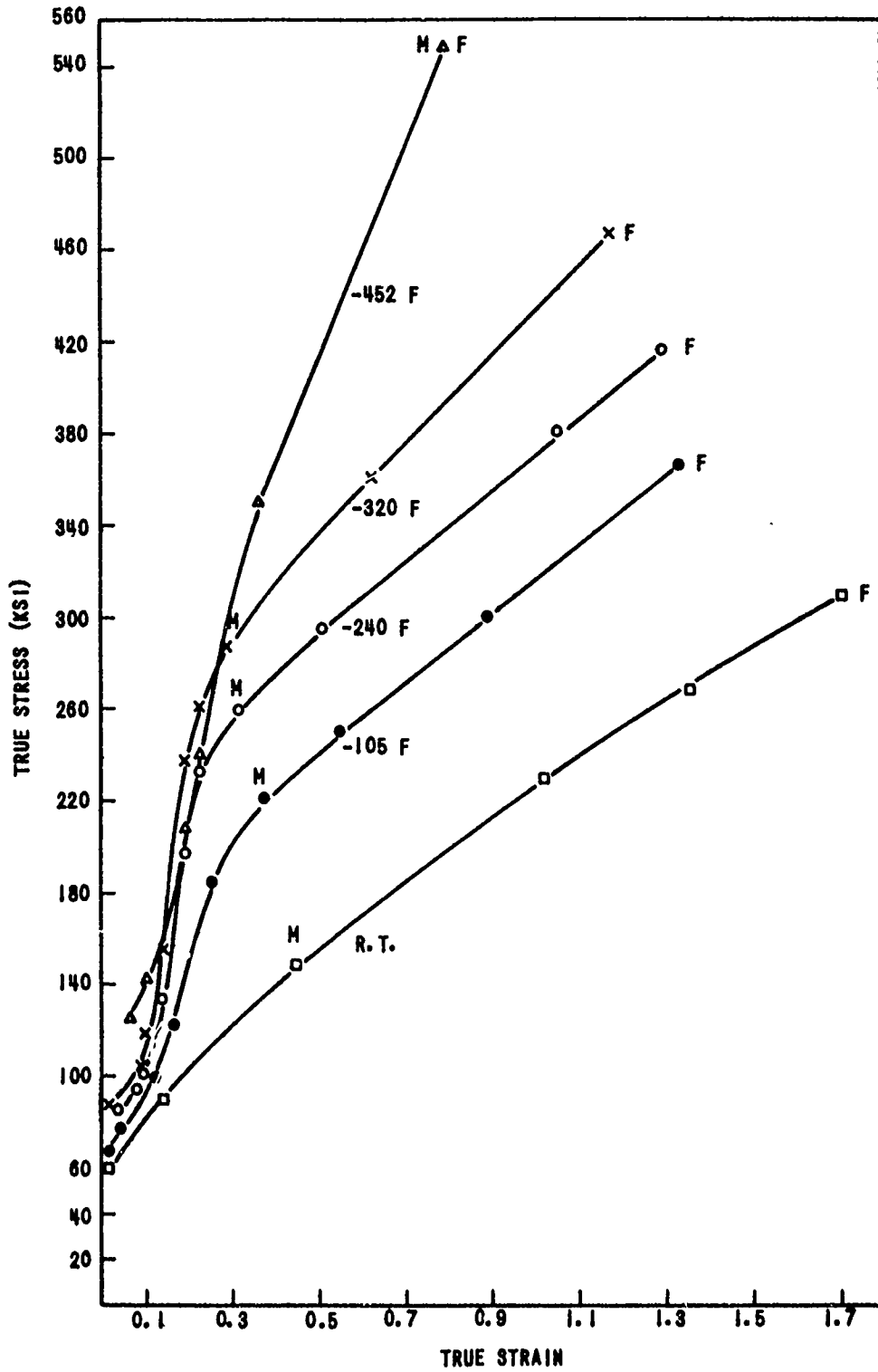

TRUE STRESS-STRAIN CURVES OF AISI 302 STAINLESS STEEL AT VARIOUS TEMPERATURES

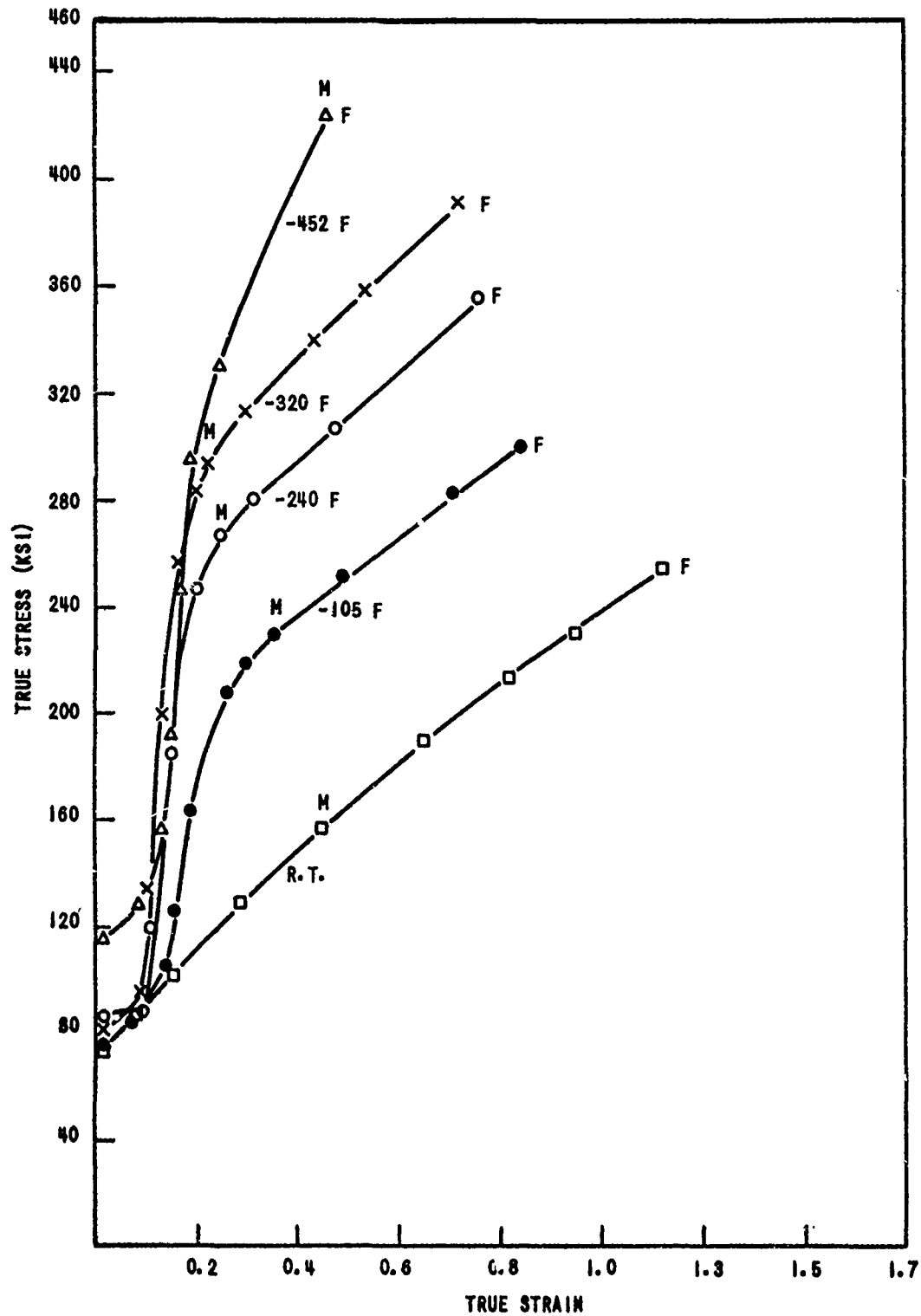

TRUE STRESS-STRAIN CURVES OF AISI 303 STAINLESS STEEL AT VARIOUS TEMPERATURES

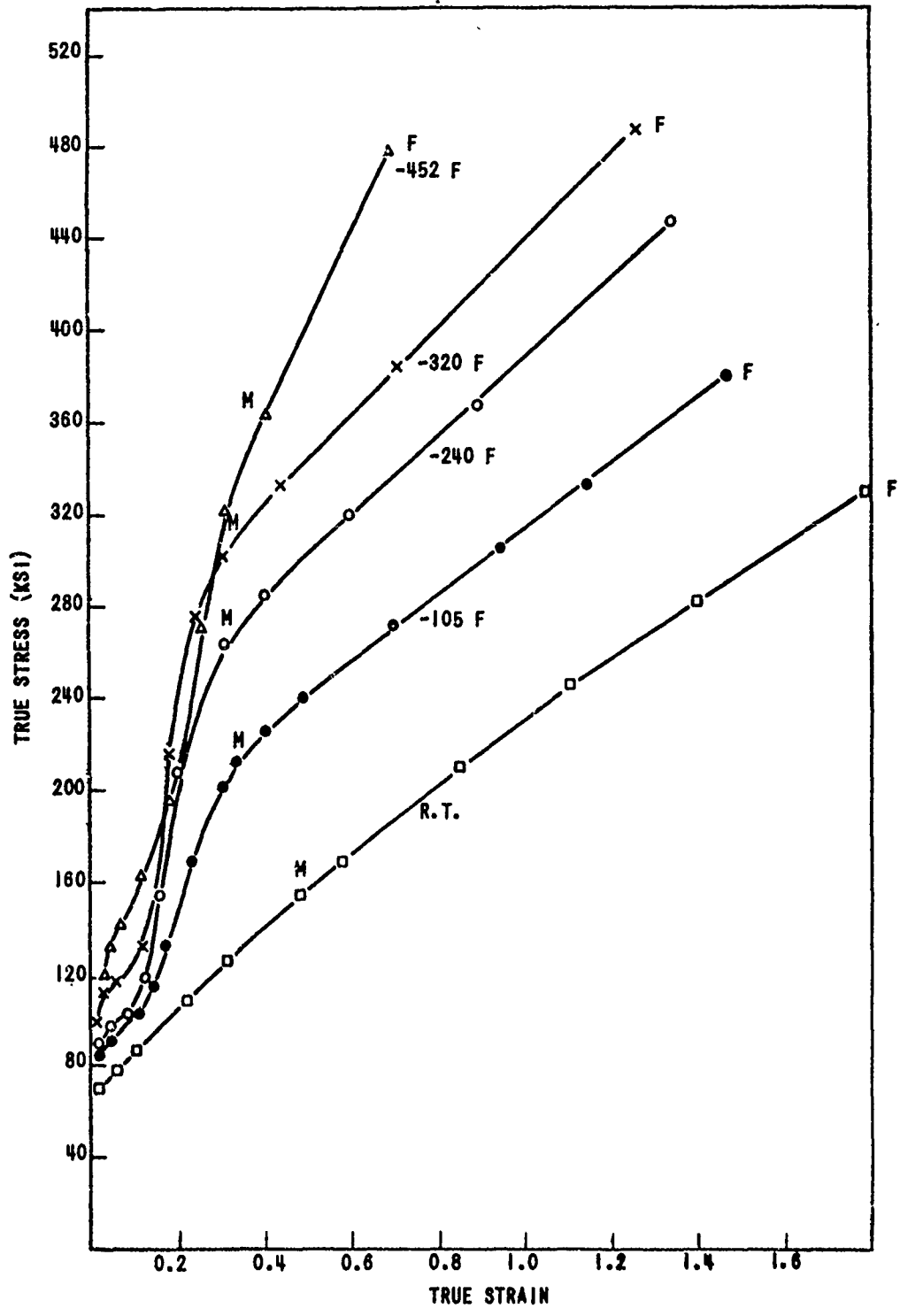

TRUE STRESS-STRAIN CURVES OF AISI 304 STAINLESS STEEL AT VARIOUS TEMPERATURES

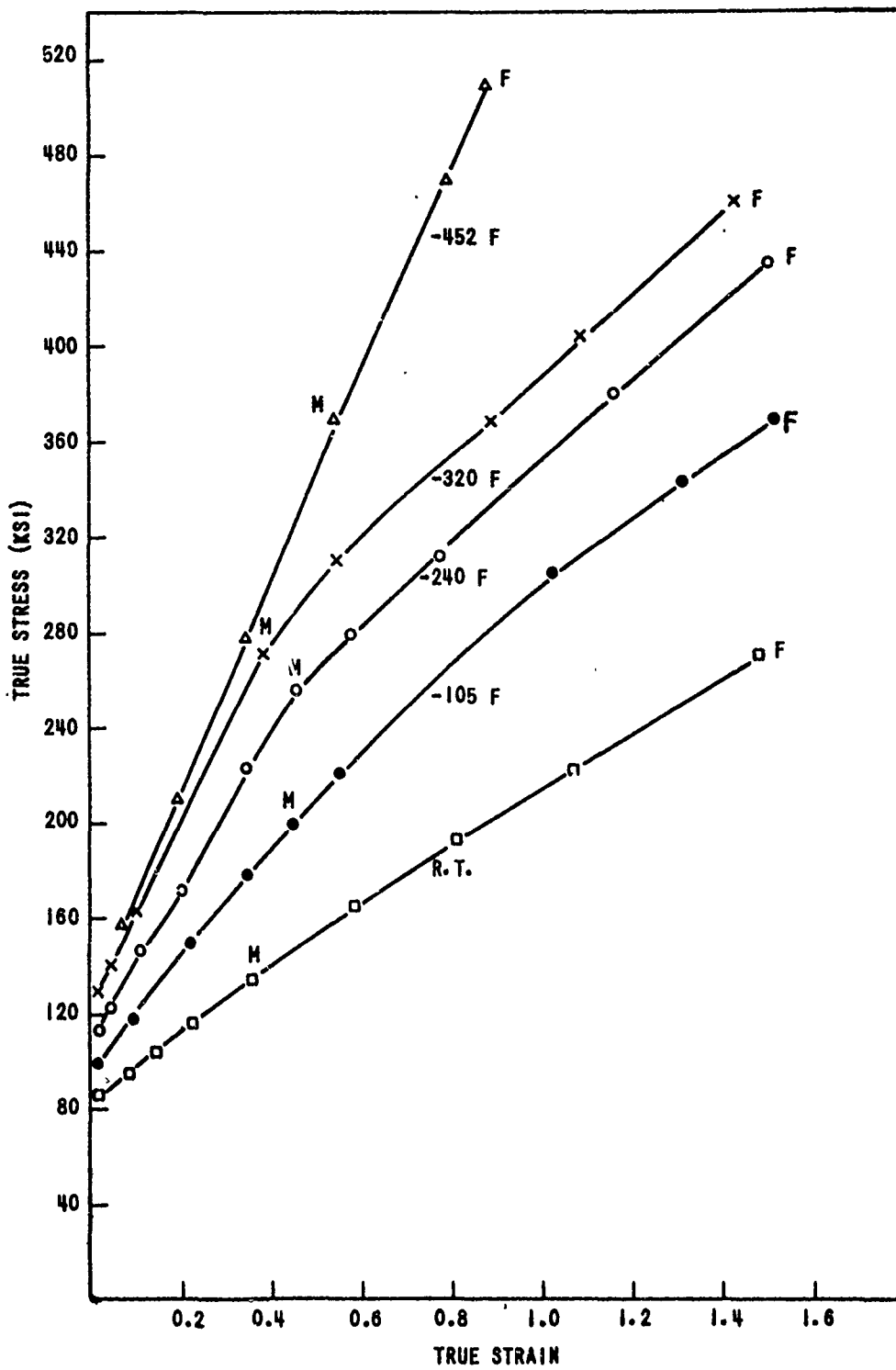

TRUE STRESS-STRAIN CURVES OF AISI 316  
STAINLESS STEEL AT VARIOUS TEMPERATURES

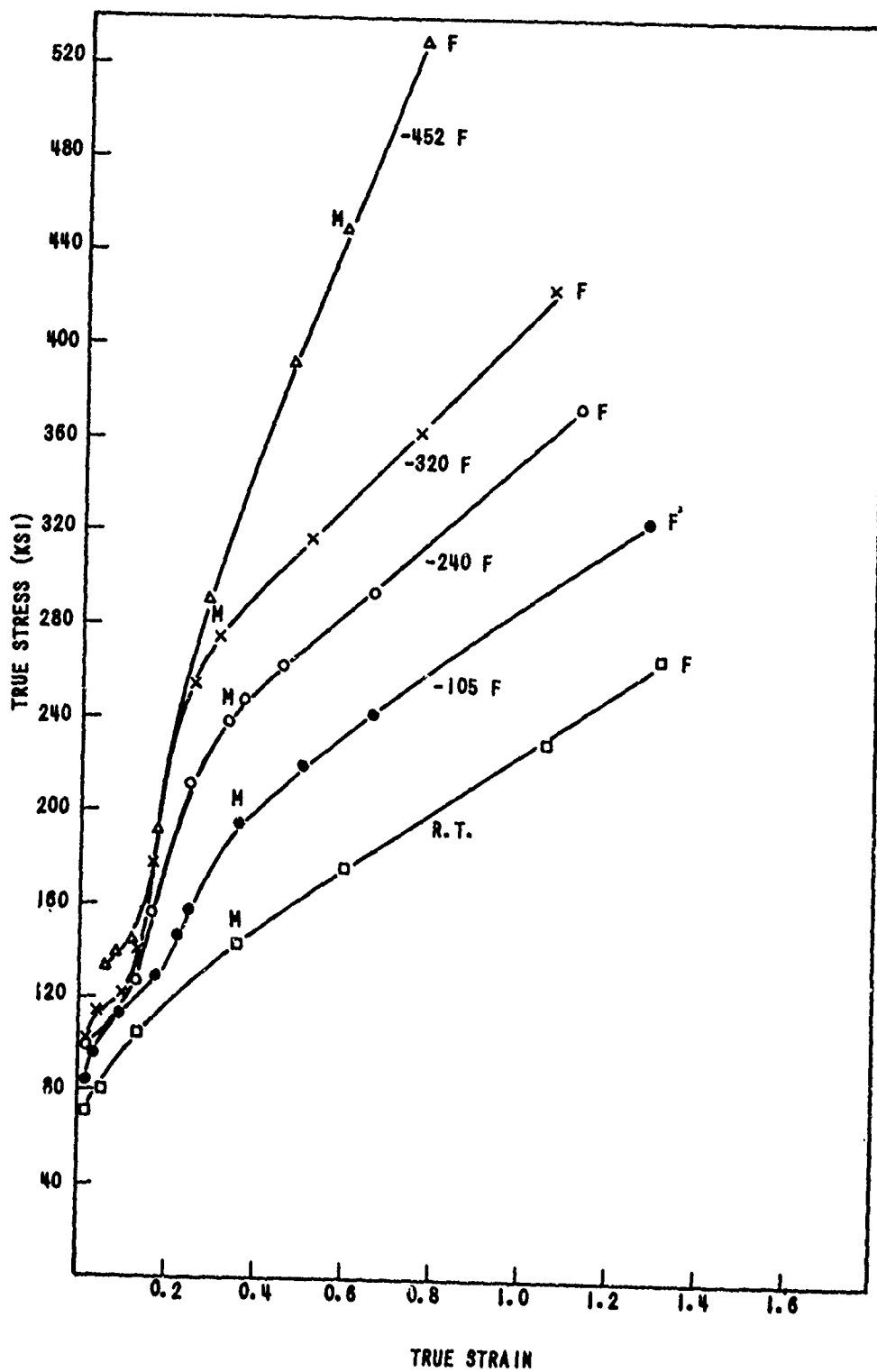

TRUE STRESS-STRAIN CURVES OF AISI 347 STAINLESS STEEL AT VARIOUS TEMPERATURES

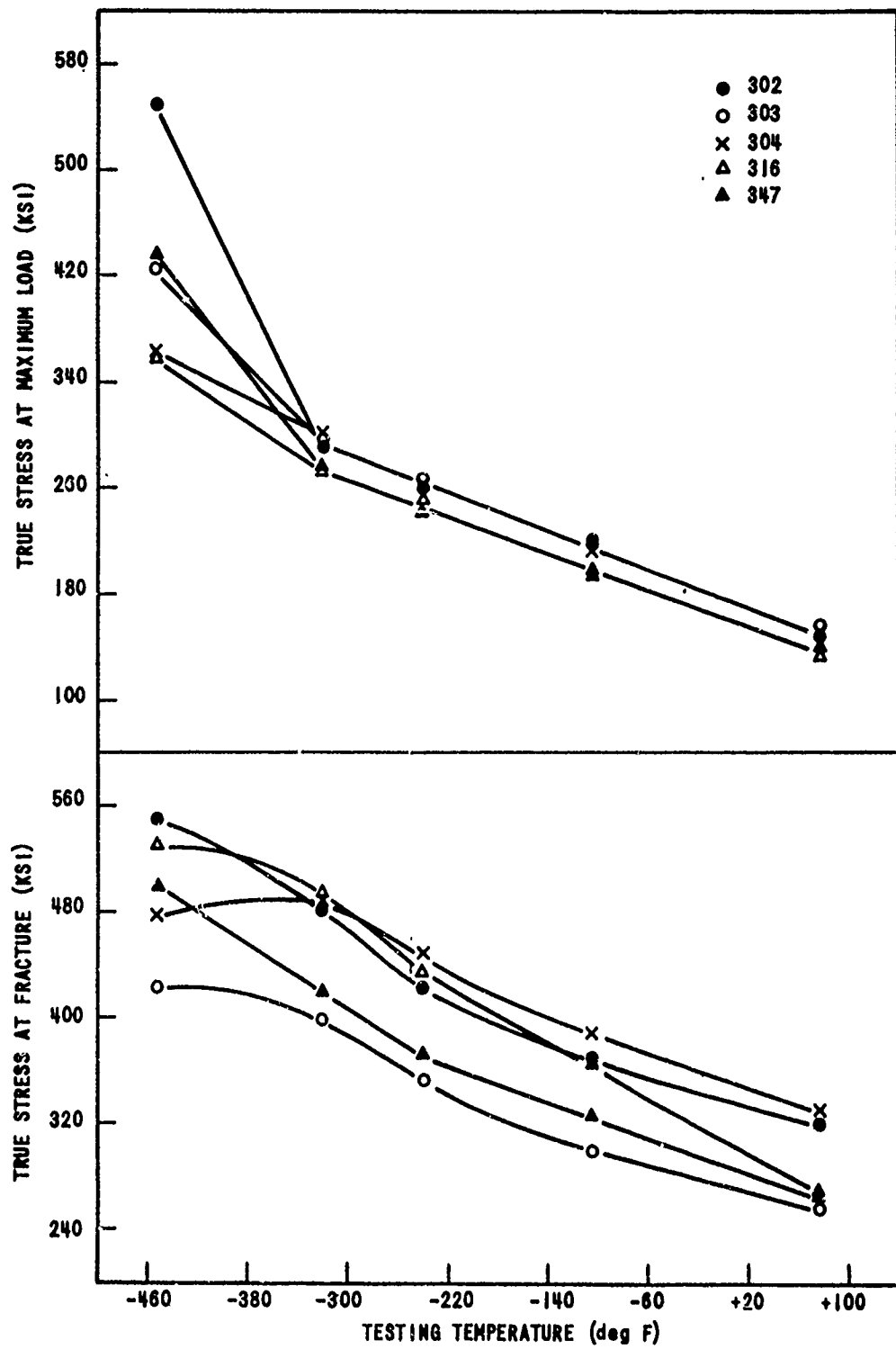

EFFECT OF TEMPERATURE ON TRUE STRESS AT FRACTURE AND MAXIMUM LOAD

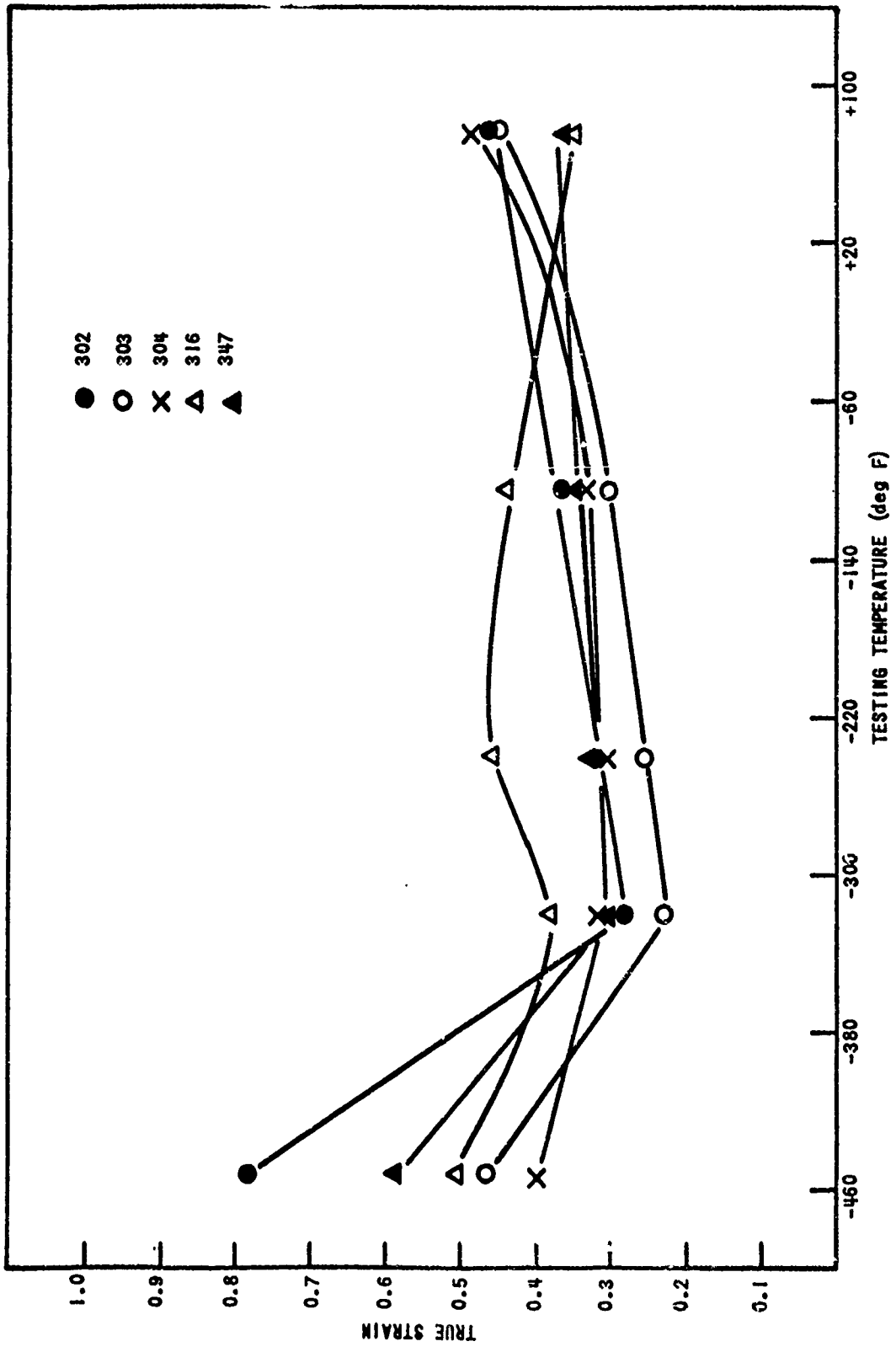

EFFECT OF TEMPERATURE ON TRUE STRAIN AT MAXIMUM LOAD

FIGURE 10



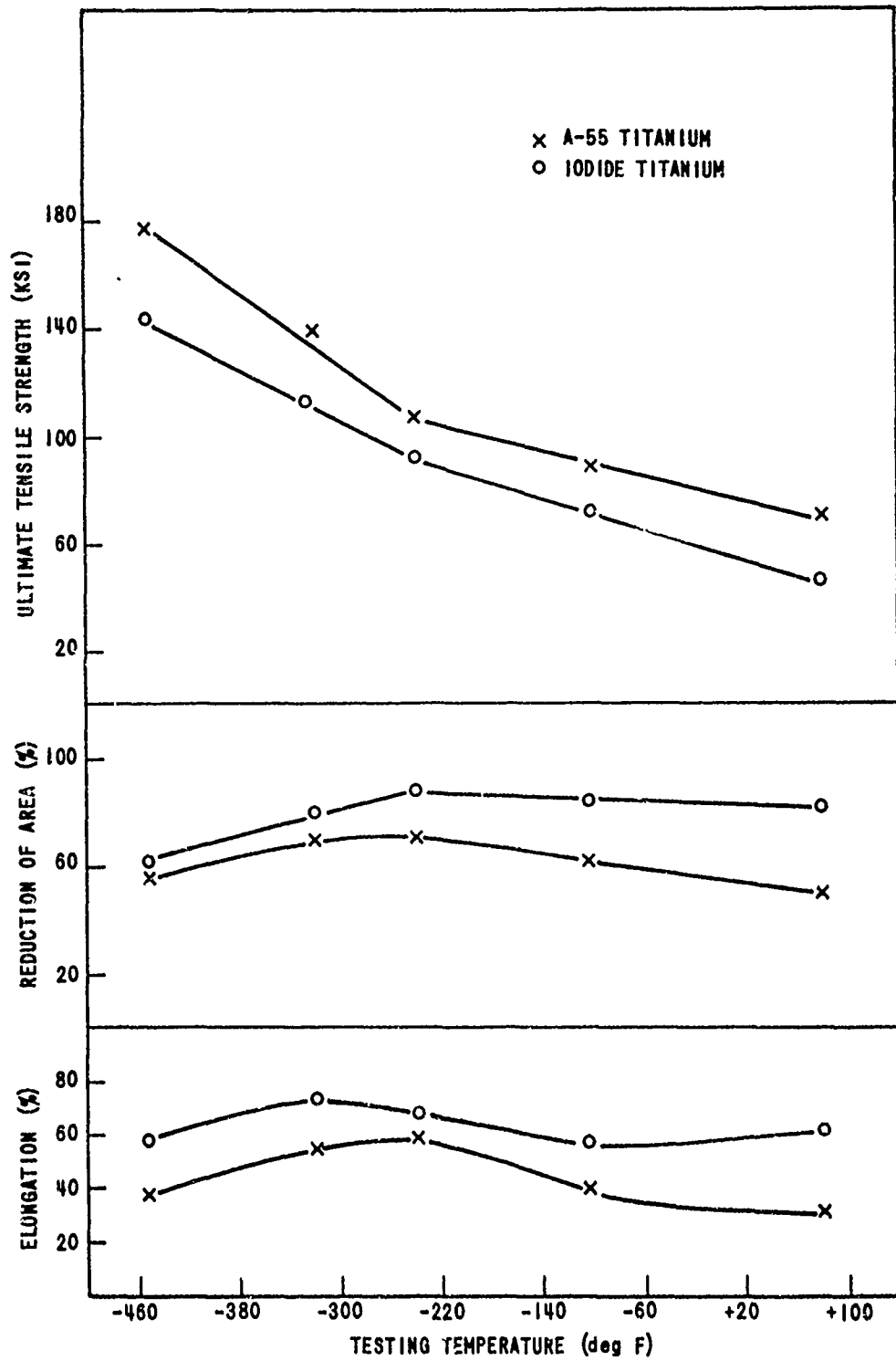

ENGINEERING TENSILE PROPERTIES OF COMMERCIALY PURE AND IODIDE TITANIUM AT VARIOUS TEMPERATURES

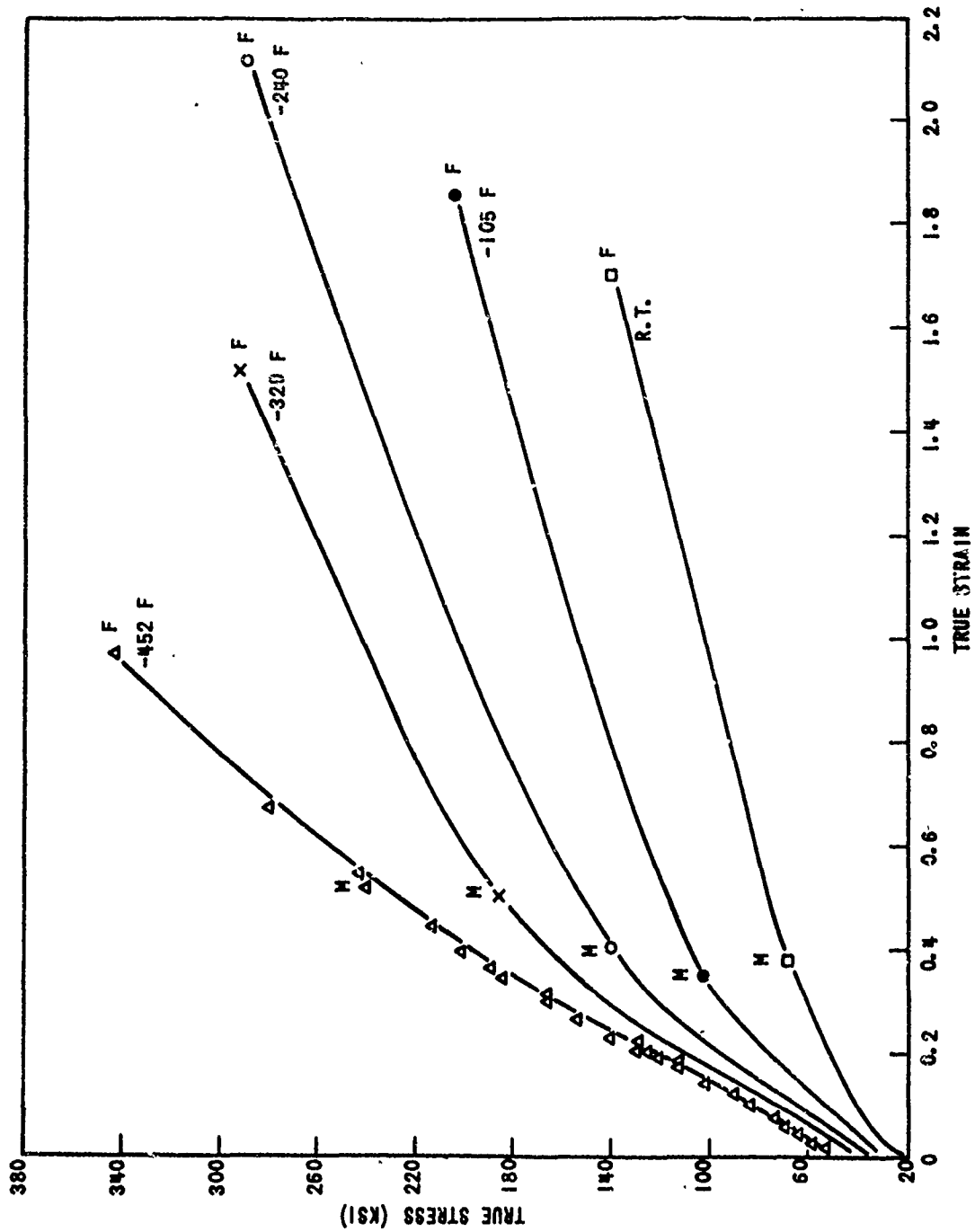

TRUE STRESS-STRAIN CURVES AT VARIOUS TEMPERATURES FOR IODIDE TITANIUM

FIGURE 12

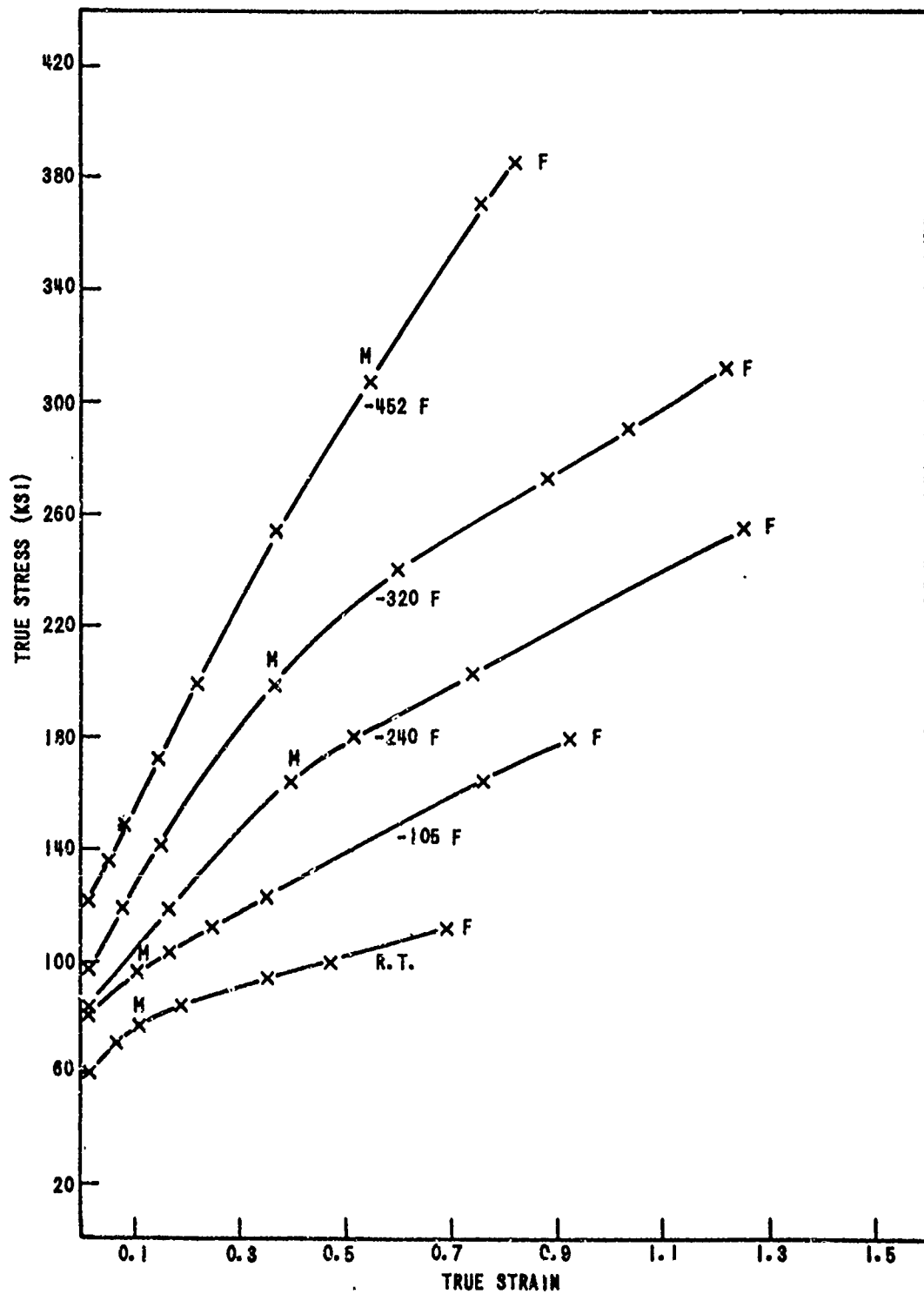

TRUE STRESS-STRAIN CURVES OF A-55 TITANIUM AT VARIOUS TEMPERATURES

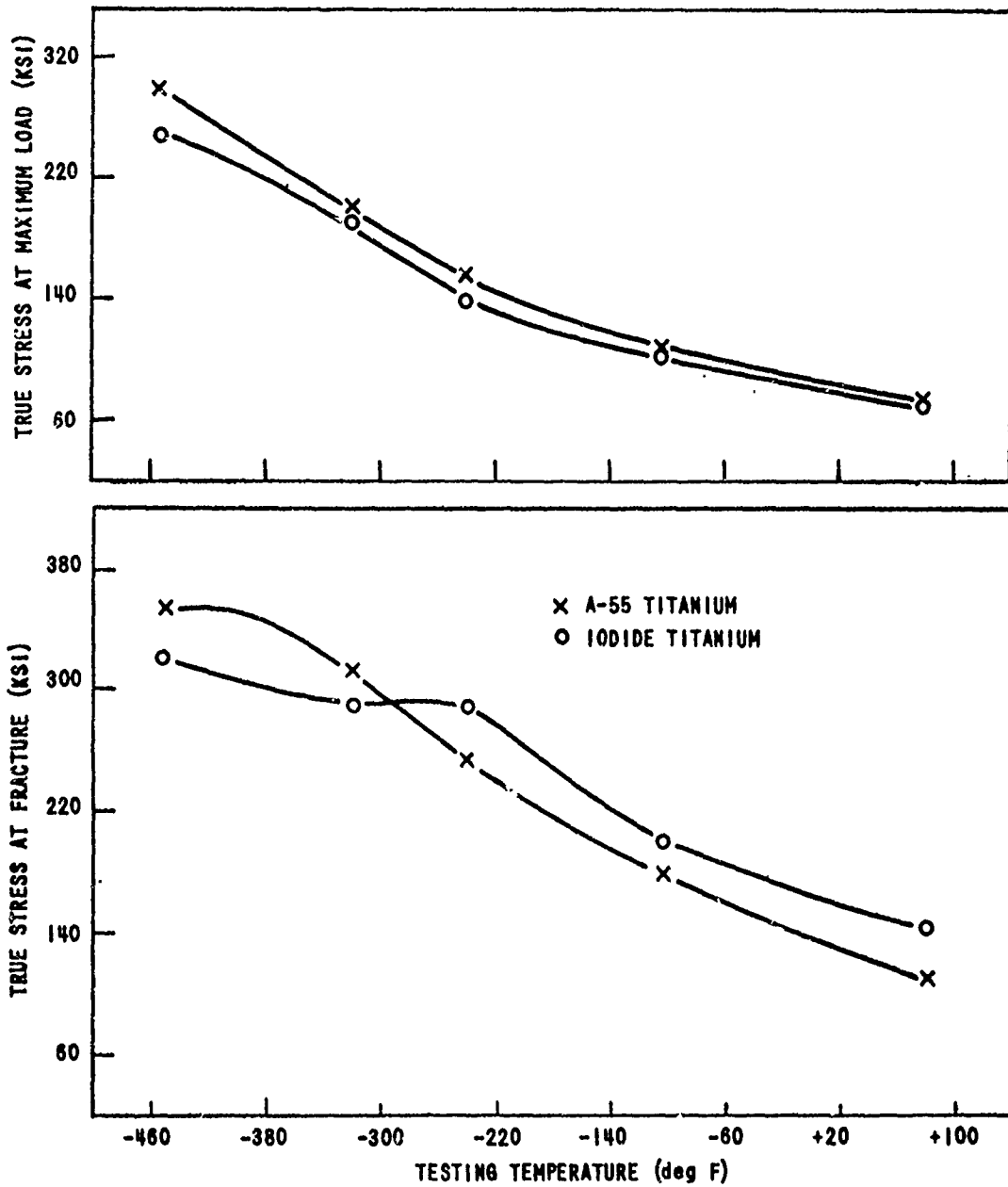

EFFECT OF TEMPERATURE ON TRUE STRESS AT FRACTURE AND MAXIMUM LOAD

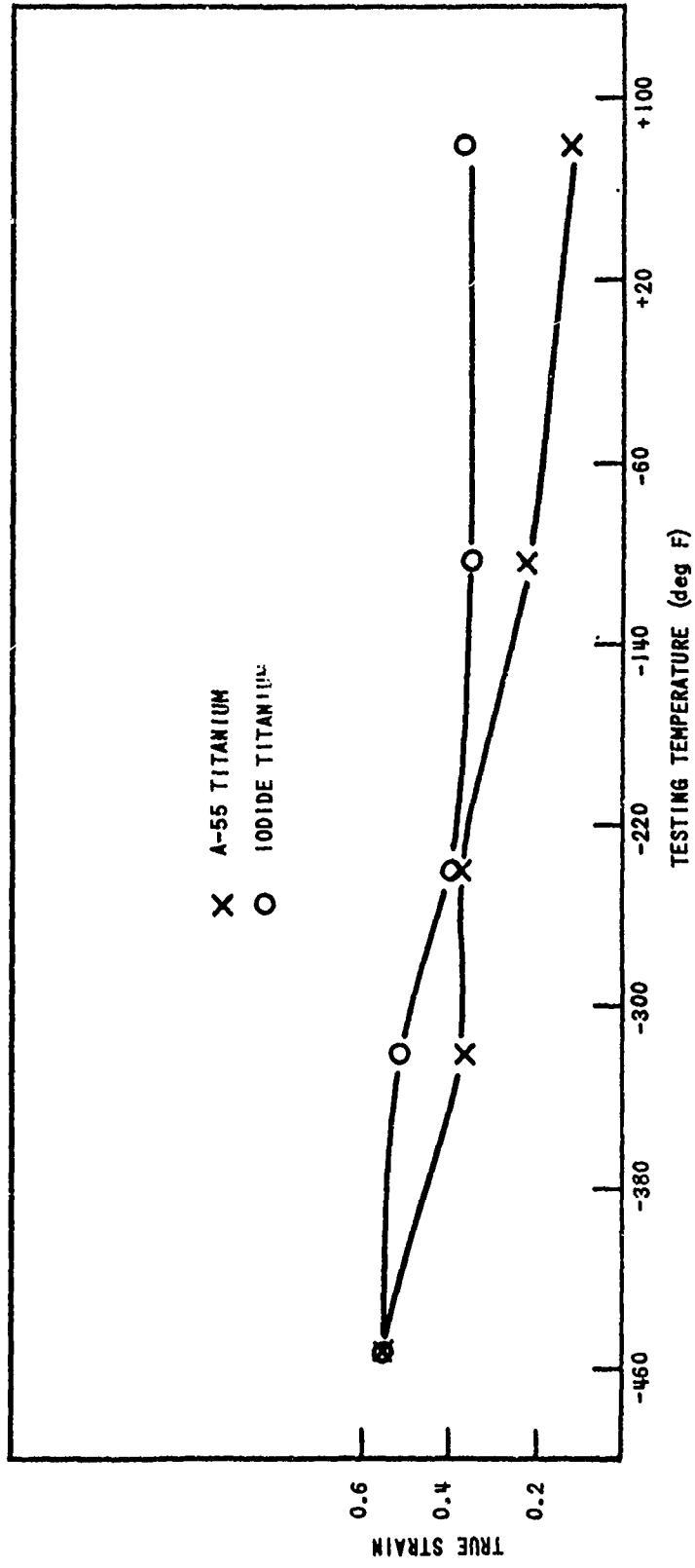

EFFECT OF TEMPERATURE ON TRUE STRAIN AT MAXIMUM LOAD

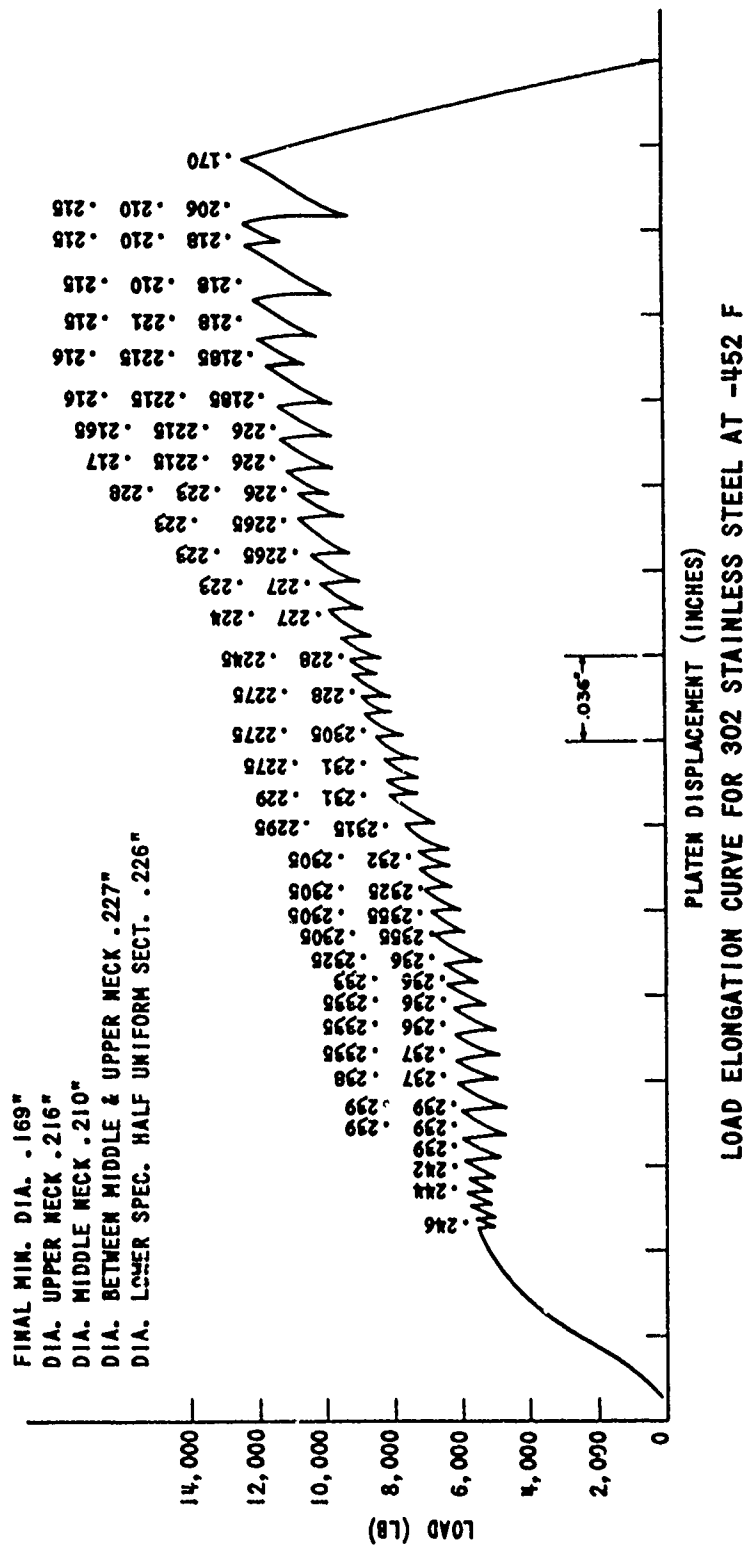

FIGURE 16

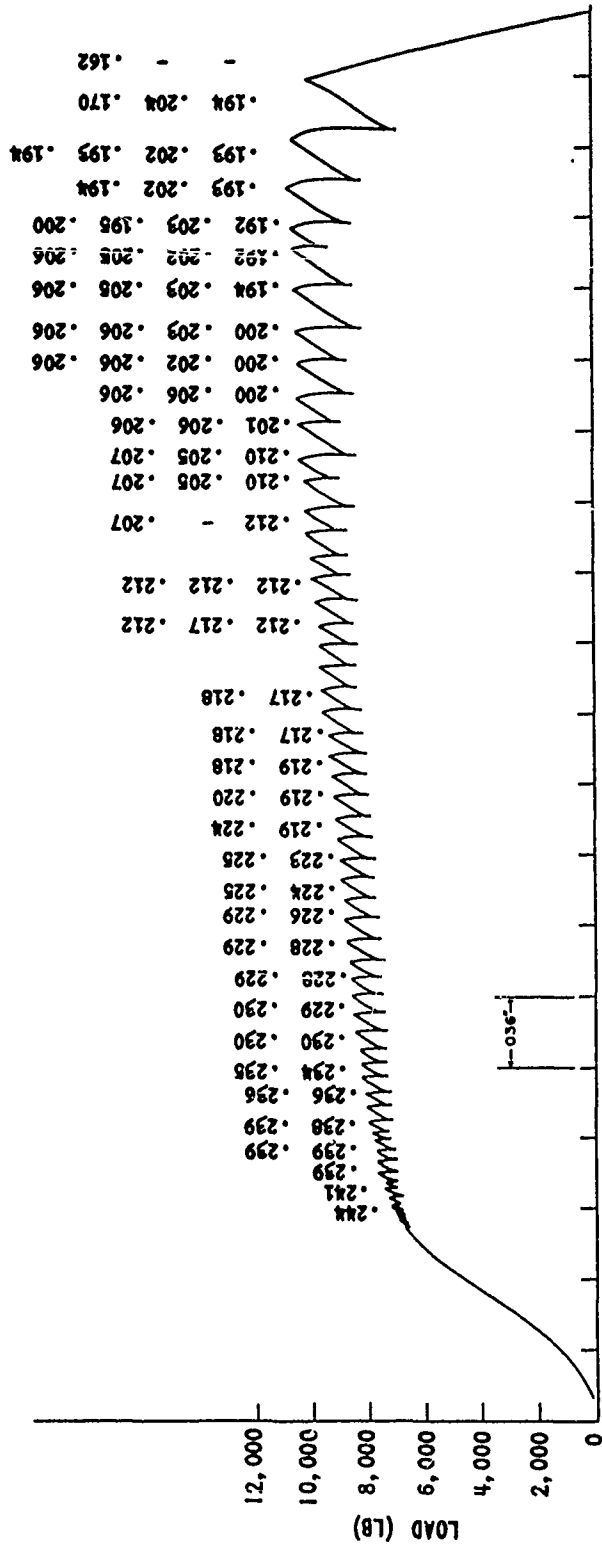
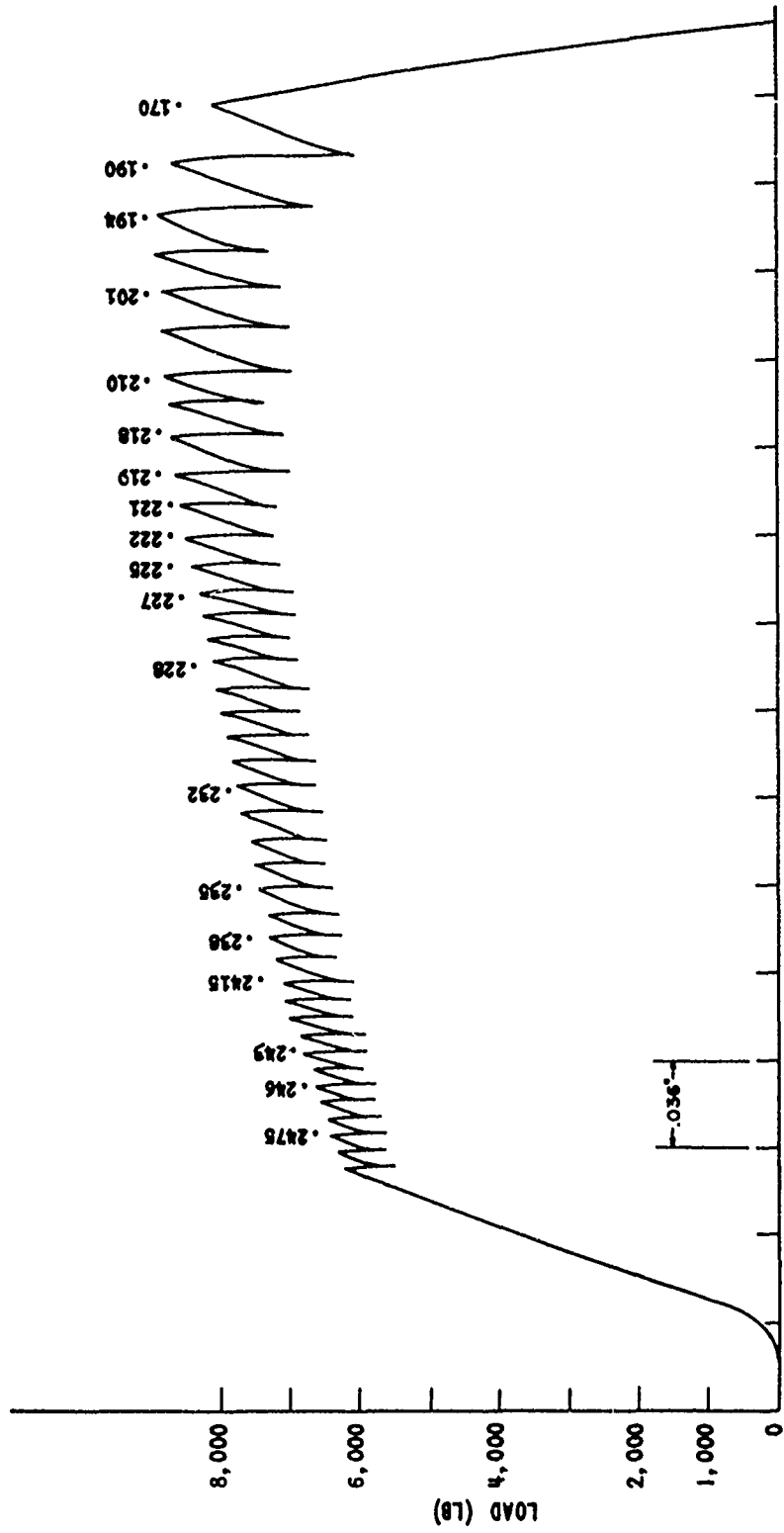
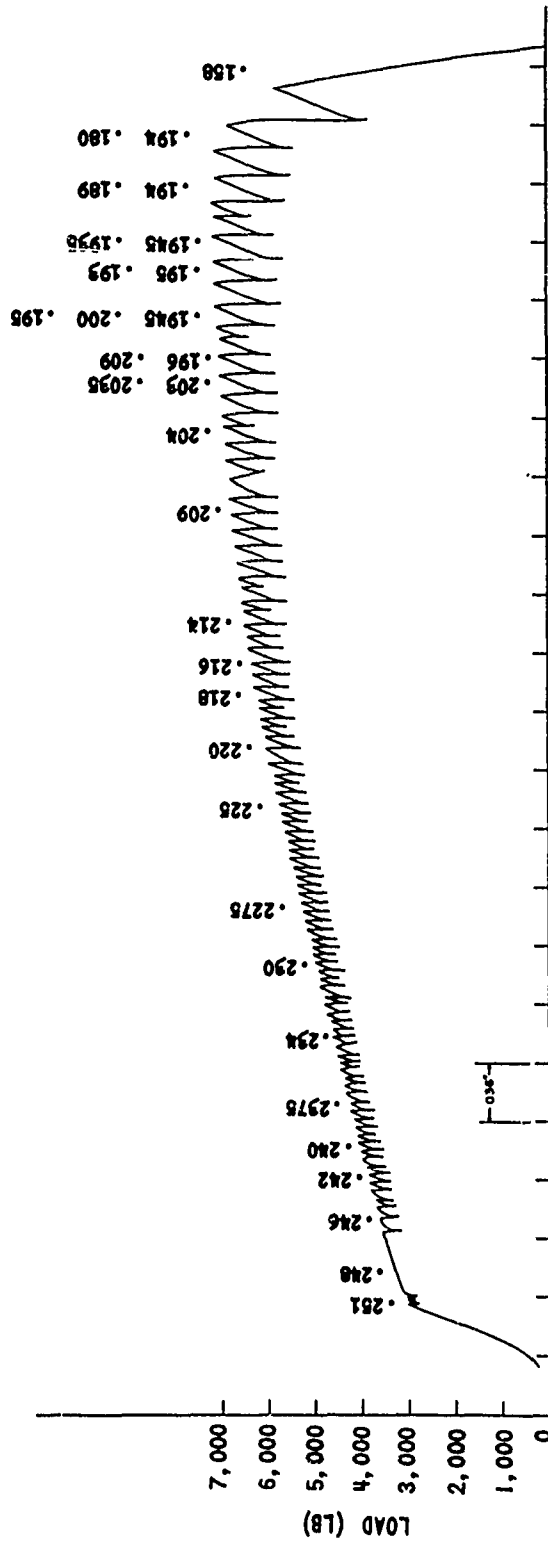

FIGURE 17



LOAD ELONGATION CURVE FOR A-55 TITANIUM AT -452 F





LOAD ELONGATION CURVE FOR IODIDE TITANIUM AT -452 F

#### REFERENCES

1. A. D. LITTLE, INC., Design, Development and Fabrication of One Low Temperature Test Chamber with Instantaneous Diameter Measurement Device, Final Technical Report, Contract DA-19-020-505-ORD-4642, 30 January 1960.
2. NUNES, J., and LARSON, F. R., A Method for Determining the Plastic Flow Properties of Sheet and Round Tensile Specimens, Watertown Arsenal Laboratories, WAL TR 111.1/1, March 1961.
3. DeSISTO, T. S., and DRISCOLL, D. E., True-Stress True-Strain Computer, Watertown Arsenal Laboratories, WAL TR 111/23-1, March 1957.
4. POWELL, G. W., MARSHALL, E. R., and BACKOFEN, W. A., Strain Hardening of Austenitic Stainless Steels, Transactions, ASM, v. 50, 1958, p. 478.
5. GUARD, R. W., Low Temperature Tensile Properties of Titanium; Effect of Annealing Temperature, General Electric Company, Report No. 55-RL-1339, Contract AF-33(616)-2120, July 1955.
6. SMITH, R. L., and RUTHERFORD, J. L., Tensile Properties of Zone Refined Iron in the Temperature Range from 298 K to 4.2 K, Transactions, AIME, v. 209, July 1957, p. 857.
7. WESSEL, E. T., Metals at Low Temperatures, Transactions, ASM, v. 49, 1957, p. 149.
8. ELDEN, A. S., and COLLINS, S. C., Fracture and Yield of 1020 Steel at Low Temperatures, Journal of Applied Physics, American Institute of Physics, v. 22, no. 12, October 1951, p. 1296.

WATERTOWN ARSENAL  
WATERTOWN 72, MASSACHUSETTS

TECHNICAL REPORT DISTRIBUTION

Report No.: WAL TR 323.4/1      Title: Low Temperature Mechanical Properties of 300 Series Stainless Steels and Titanium  
December 1961

Distribution List approved by Ordnance Materials Research Office,  
1 December 1960.

No. of Copies	TO
1	Director, Army Research Office, Department of the Army, Washington 25, D. C.
	Commanding Officer, U. S. Army Research Office (Durham), Box CM, Duke Station, Durham, North Carolina
1	ATTN: ORDOR-ED
	Chief of Ordnance, Department of the Army, Washington 25, D. C.
1	ATTN: ORDTB - Materials
	Commanding General, Aberdeen Proving Ground, Maryland
1	ATTN: Ballistic Research Laboratory
3	ORDBG-IM, Technical Library, Bldg. 313
	Commanding General, Army Ballistic Missile Agency, Redstone Arsenal, Alabama
1	ATTN: Dr. G. H. Reisig
	Commanding General, Ordnance Tank-Automotive Command, Detroit Arsenal, Center Line, Michigan
1	ATTN: ORDMC-RM. 1, Mr. Charles Salter
	Commanding General, Ordnance Weapons Command, Rock Island, Illinois
1	ATTN: ORDOW-IX
2	ORDOW-TX
1	Commanding General, U. S. Army Ordnance Special Weapons Ammunition Command, Dover, New Jersey
	Commanding General, U. S. Army Rocket and Guided Missile Agency, Redstone Arsenal, Alabama
1	ATTN: ORDAB-DV
5	ORDXR-RGA, Mr. R. L. Wetherington
1	ORDXR-RMO, Lt. E. J. Wilson

No. of  
Copies

TO

1 Commanding Officer, Detroit Arsenal, Center Line, Michigan  
ATTN: ORDMX-BMW  
1 ORDMX-AL

1 Commanding Officer, Diamond Ordnance Fuze Laboratories,  
Washington 25, D. C.  
ATTN: ORDTL .012, Technical Reference Branch

2 Commanding Officer, Frankford Arsenal, Philadelphia 37, Pennsylvania  
ATTN: Pitman-Dunn Laboratories

1 Commanding Officer, Ordnance Materials Research Office, Watertown  
Arsenal, Watertown 72, Massachusetts  
ATTN: RPD

1 Commanding Officer, Picatinny Arsenal, Dover, New Jersey  
ATTN: Feltman Research Laboratories

1 Commanding Officer, Rock Island Arsenal, Rock Island, Illinois  
ATTN: Laboratory

1 Commanding Officer, Springfield Armory, Springfield 1, Massachusetts  
ATTN: ORDBD-TX

1 Commanding Officer, Watervliet Arsenal, Watervliet, New York  
ATTN: ORDEF-RT

1 Commanding General, Corps of Engineers, Fort Belvoir, Virginia  
ATTN: Eng. R&D Laboratories

1 Chief, Bureau of Ships, Department of the Navy, Washington 25, D. C.  
ATTN: Code 341

1 Chief, Bureau of Naval Weapons, Department of the Navy, Room 2225,  
Munitions Building, Washington 25, D. C.  
ATTN: RMP

1 Chief, Office of Naval Research, Department of the Navy,  
Washington 25, D. C.  
ATTN: Code 423

1 Chief, Naval Engineering Experimental Station, Department of the  
Navy, Annapolis, Maryland

---

No. of  
Copies

TO

---

1 Commander, Naval Ordnance Test Station, China Lake, California  
ATTN: Code 5557

1 Director, Naval Research Laboratory, Anacostia Station,  
Washington, D. C.  
ATTN: Technical Information Officer

1 Commander, Naval Weapons Laboratory, Dahlgren, Virginia  
ATTN: A & P Laboratory

5 Commander, Wright Air Development Division, Wright-Patterson Air  
Force Base, Ohio  
ATTN: WWRCEE

10 Commander, Armed Services Technical Information Agency,  
Arlington Hall Station, Arlington 12, Virginia  
ATTN: TIPDR

15 U. S. Atomic Energy Commission, Office of Technical Information  
Extension, P. O. Box 62, Oak Ridge, Tennessee

1 Army Reactor Branch, Division of Research Development, Atomic  
Energy Commission, Washington 25, D. C.

1 National Aeronautics and Space Administration, 1520 H Street, N. W.,  
Washington 25, D. C.

1 Director, Jet Propulsion Laboratory, California Institute of  
Technology, Pasadena 3, California  
ATTN: Dr. L. Jaffe

5 Dr. W. R. Lucas, George C. Marshall Space Flight Center,  
Huntsville, Alabama  
ATTN: M-S&M-M

1 Mr. W. A. Wilson, George C. Marshall Space Flight Center,  
Huntsville, Alabama  
ATTN: M-F&AE-M, Bldg. 4720

1 Chief, Bureau of Mines, Eastern Experiment Station, College Park,  
Maryland

1 Defense Metals Information Center, Battelle Memorial Institute,  
Columbus, Ohio

No. of  
Copies

TO

4 British Joint Services Mission, 1800 K Street, N. W.,  
Washington, D. C.  
ATTN: Technical Services Department

3 Canadian Army Staff, 2450 Massachusetts Avenue, Washington 8, D. C.  
ATTN: GSO-I, A&A Section

5 Commanding Officer, Watertown Arsenal, Watertown 72, Massachusetts  
ATTN: ORDBE-LXM, Technical Information Section  
2 Authors

93 -- TOTAL COPIES DISTRIBUTED

213 -- Total Copies Printed

19 -- Extra copies to Authors

1 -- P E

100 -- OTS

100 -- R G H Sw, Amc. 9/62

OTS Price \$0.75

AD Accession No.  
Watertown Arsenal Laboratories, Watertown 72, Mass.  
LOW TEMPERATURE MECHANICAL PROPERTIES OF 300 SERIES  
STAINLESS STEELS AND TITANIUM - Thomas S. DeSisto  
and Frank L. Carr  
Report No. WAL TR 323.4/1, Dec 1961, 32 pp - tables -  
illus, OMS Code 5010.11.8420051, D/A Proj 5B93-32-002,  
Unclassified Report

A tensile test cryostat is described for the tempera-  
ture range -240 F to -452 F, which consists of a  
temperature recording and control system, and a  
diameter measurement system which includes a scanning  
control system. True stress-strain properties of the  
300 series stainless steels and iodide and commercially  
pure titanium were obtained from room temperature to  
-452 F. Serrated load-elongation curves obtained at  
-452 F and the sequence of deformation in multi-necked  
specimens at this temperature are discussed.

NO DISTRIBUTION LIMITATIONS

OTS Price \$0.75

AD Accession No.  
Watertown Arsenal Laboratories, Watertown 72, Mass.  
LOW TEMPERATURE MECHANICAL PROPERTIES OF 300 SERIES  
STAINLESS STEELS AND TITANIUM - Thomas S. DeSisto  
and Frank L. Carr  
Report No. WAL TR 323.4/1, Dec 1961, 32 pp - tables -  
illus, OMS Code 5010.11.8420051, D/A Proj 5B93-32-002,  
Unclassified Report

A tensile test cryostat is described for the tempera-  
ture range -240 F to -452 F, which consists of a  
temperature recording and control system, and a  
diameter measurement system which includes a scanning  
control system. True stress-strain properties of the  
300 series stainless steels and iodide and commercially  
pure titanium were obtained from room temperature to  
-452 F. Serrated load-elongation curves obtained at  
-452 F and the sequence of deformation in multi-necked  
specimens at this temperature are discussed.

NO DISTRIBUTION LIMITATIONS

UNCLASSIFIED

1. Steels, stainless - mechanical properties
2. Titanium

- I. DeSisto, Thomas S.
- II. Carr, Frank L.
- III. OMS Code 5010.11.8420051
- IV. D/A Proj 5B93-32-002

OTS Price \$0.75

AD Accession No.  
Watertown Arsenal Laboratories, Watertown 72, Mass.  
LOW TEMPERATURE MECHANICAL PROPERTIES OF 300 SERIES  
STAINLESS STEELS AND TITANIUM - Thomas S. DeSisto  
and Frank L. Carr  
Report No. WAL TR 323.4/1, Dec 1961, 32 pp - tables -  
illus, OMS Code 5010.11.8420051, D/A Proj 5B93-32-002,  
Unclassified Report

A tensile test cryostat is described for the tempera-  
ture range -240 F to -452 F, which consists of a  
temperature recording and control system, and a  
diameter measurement system which includes a scanning  
control system. True stress-strain properties of the  
300 series stainless steels and iodide and commercially  
pure titanium were obtained from room temperature to  
-452 F. Serrated load-elongation curves obtained at  
-452 F and the sequence of deformation in multi-necked  
specimens at this temperature are discussed.

NO DISTRIBUTION LIMITATIONS

OTS Price \$0.75

AD Accession No.  
Watertown Arsenal Laboratories, Watertown 72, Mass.  
LOW TEMPERATURE MECHANICAL PROPERTIES OF 300 SERIES  
STAINLESS STEELS AND TITANIUM - Thomas S. DeSisto  
and Frank L. Carr  
Report No. WAL TR 323.4/1, Dec 1961, 32 pp - tables -  
illus, OMS Code 5010.11.8420051, D/A Proj 5B93-32-002,  
Unclassified Report

A tensile test cryostat is described for the tempera-  
ture range -240 F to -452 F, which consists of a  
temperature recording and control system, and a  
diameter measurement system which includes a scanning  
control system. True stress-strain properties of the  
300 series stainless steels and iodide and commercially  
pure titanium were obtained from room temperature to  
-452 F. Serrated load-elongation curves obtained at  
-452 F and the sequence of deformation in multi-necked  
specimens at this temperature are discussed.

NO DISTRIBUTION LIMITATIONS

UNCLASSIFIED

1. Steels, stainless - mechanical properties
2. Titanium

- I. DeSisto, Thomas S.
- II. Carr, Frank L.
- III. OMS Code 5010.11.8420051
- IV. D/A Proj 5B93-32-002

UNCLASSIFIED

1. Steels, stainless - mechanical properties
2. Titanium

- I. DeSisto, Thomas S.
- II. Carr, Frank L.
- III. OMS Code 5010.11.8420051
- IV. D/A Proj 5B93-32-002