



AFRL-RI-RS-TR-2014-301

**AN EIGHT ELEMENT S-BAND ANTENNA ARRAY FOR  
EVALUATING DIRECTIONAL MESH NETWORKING USING  
SOFTWARE DEFINED RADIOS**

---

*DECEMBER 2014*

TECHNICAL REPORT

*APPROVED FOR PUBLIC RELEASE; DISTRIBUTION UNLIMITED*

STINFO COPY

**AIR FORCE RESEARCH LABORATORY  
INFORMATION DIRECTORATE**

## NOTICE AND SIGNATURE PAGE

Using Government drawings, specifications, or other data included in this document for any purpose other than Government procurement does not in any way obligate the U.S. Government. The fact that the Government formulated or supplied the drawings, specifications, or other data does not license the holder or any other person or corporation; or convey any rights or permission to manufacture, use, or sell any patented invention that may relate to them.

This report was cleared for public release by the 88<sup>th</sup> ABW, Wright-Patterson AFB Public Affairs Office and is available to the general public, including foreign nationals. Copies may be obtained from the Defense Technical Information Center (DTIC) (<http://www.dtic.mil>).

AFRL-RI-RS-TR-2014-301 HAS BEEN REVIEWED AND IS APPROVED FOR PUBLICATION IN ACCORDANCE WITH ASSIGNED DISTRIBUTION STATEMENT.

FOR THE DIRECTOR:

*/ S /*

RICHARD MICHALAK, Chief  
Information Transmission Branch

*/ S /*

MARK H. LINDERMAN  
Technical Advisor, Computing  
& Communications Division  
Information Directorate

This report is published in the interest of scientific and technical information exchange, and its publication does not constitute the Government's approval or disapproval of its ideas or findings.

# REPORT DOCUMENTATION PAGE

*Form Approved*  
OMB No. 0704-0188

The public reporting burden for this collection of information is estimated to average 1 hour per response, including the time for reviewing instructions, searching existing data sources, gathering and maintaining the data needed, and completing and reviewing the collection of information. Send comments regarding this burden estimate or any other aspect of this collection of information, including suggestions for reducing this burden, to Department of Defense, Washington Headquarters Services, Directorate for Information Operations and Reports (0704-0188), 1215 Jefferson Davis Highway, Suite 1204, Arlington, VA 22202-4302. Respondents should be aware that notwithstanding any other provision of law, no person shall be subject to any penalty for failing to comply with a collection of information if it does not display a currently valid OMB control number.

PLEASE DO NOT RETURN YOUR FORM TO THE ABOVE ADDRESS.

1. REPORT DATE (DD-MM-YYYY) DECEMBER 2014		2. REPORT TYPE TECHNICAL REPORT		3. DATES COVERED (From - To) AUG 2013 – MAR 2014	
4. TITLE AND SUBTITLE  AN EIGHT ELEMENT S-BAND ANTENNA ARRAY FOR EVALUATING DIRECTIONAL MESH NETWORKING USING SOFTWARE DEFINED RADIOS				5a. CONTRACT NUMBER IN-HOUSE	
				5b. GRANT NUMBER N/A	
				5c. PROGRAM ELEMENT NUMBER N/A	
6. AUTHOR(S)  Thomas Scatko				5d. PROJECT NUMBER N/A	
				5e. TASK NUMBER N/A	
				5f. WORK UNIT NUMBER N/A	
7. PERFORMING ORGANIZATION NAME(S) AND ADDRESS(ES) Air Force Research Laboratory/RITE 525 Brooks Road Rome NY 13441-4505				8. PERFORMING ORGANIZATION REPORT NUMBER	
9. SPONSORING/MONITORING AGENCY NAME(S) AND ADDRESS(ES)  Air Force Research Laboratory/RITE 525 Brooks Road Rome NY 13441-4505				10. SPONSOR/MONITOR'S ACRONYM(S) AFRL/RI	
				11. SPONSOR/MONITOR'S REPORT NUMBER AFRL-RI-RS-TR-2014-301	
12. DISTRIBUTION AVAILABILITY STATEMENT  Approved for Public Release; Distribution Unlimited. PA# 88ABW-2014-5866 Date Cleared: 11 Dec 2014					
13. SUPPLEMENTARY NOTES This report presents in house work performed by AFRL scientists and engineers in their official work capacity. No official in house project was established for this work.					
14. ABSTRACT  The design of a S-band linear array antenna intended for use in investigation directional mesh networks is presented. Results of the development activities are presented including descriptions of the antenna test fixture, measured patterns, and recommendations for future use.					
15. SUBJECT TERMS Antenna Array, Beamforming, Directional Mesh Networks					
16. SECURITY CLASSIFICATION OF:			17. LIMITATION OF ABSTRACT  UU	18. NUMBER OF PAGES  49	19a. NAME OF RESPONSIBLE PERSON THOMAS SCATKO
a. REPORT U	b. ABSTRACT U	c. THIS PAGE U			19b. TELEPHONE NUMBER (Include area code) N/A

## TABLE OF CONTENTS

LIST OF FIGURES.....	ii
LIST OF TABLES.....	iii
1.0 SUMMARY.....	1
2.0 INTRODUCTION.....	2
2.1 Mesh Networking using Directional Antennas .....	2
2.2 Design Concept .....	2
3.0 METHODS, ASSUMPTIONS, AND PROCEDURES.....	5
3.1 Key Components.....	5
3.2 Antenna Array.....	6
3.2 Antenna Test Fixture.....	7
3.3 Calculated Antenna Pattern Scan Angles.....	10
4.0 Results and Discussion.....	11
4.1 Antenna Pattern Measurements .....	11
4.2 Antenna Patterns Measured at 3400 MHz .....	12
4.3 Antenna Patterns Measured at 3500 MHz .....	21
4.4 Antenna Patterns Measured at 3600 MHz .....	30
5.0 CONCLUSIONS.....	39
6.0 RECOMMENDATIONS.....	40
6.1 Instrument Case Installation.....	40
6.2 Configuration for Radio, Radar and ELINT Operation.....	41
7.0 REFERENCES.....	42
8.0 LIST OF SYMBOLS, ABBREVIATIONS, AND ACRONYMS.....	43



## LIST OF FIGURES

FIGURE 1: CONCEPT SLIDE 1. ....	2
FIGURE 2: CONCEPT SLIDE 2. ....	3
FIGURE 3: CONCEPT SLIDE 3. ....	4
FIGURE 4: S-BAND PATCH RADIATOR. ....	5
FIGURE 5: 8 X 8 BUTLER MATRIX. ....	5
FIGURE 6: ONE-TO-EIGHT PIN DIODE SWITCH.....	6
FIGURE 7: ARRAY ANTENNA LAYOUT. ....	6
FIGURE 8: ANTENNA TEST FIXTURE / FRONT VIEW. ....	7
FIGURE 9: ANTENNA TEST FIXTURE / TOP VIEW.....	7
FIGURE 10: ANTENNA TEST FIXTURE / INTERIOR VIEW.....	8
FIGURE 11: ANTENNA TEST FIXTURE / REAR VIEW.....	8
FIGURE 12: ASSEMBLED EIGHT ELEMENT S-BAND ANTENNA. ....	9
FIGURE 13: ANTENNA CONTROLLER SET-UP. ....	9
FIGURE 14: CALCULATED ANTENNA PATTERNS / 3500 MHZ / NORMALIZED. ....	10
FIGURE 15: ANTENNA TESTING IN AFRL'S ANECHOIC CHAMBER.....	11
FIGURE 16: BEAM PORT 1 / 3400 MHZ / CARTESIAN PLOT. ....	12
FIGURE 17: BEAM PORT 1 / 3400 MHZ / POLAR PLOT. ....	12
FIGURE 18: BEAM PORT.2 / 3400 MHZ / CARTESIAN PLOT. ....	13
FIGURE 19: BEAM PORT 2 / 3400 MHZ / POLAR PLOT. ....	13
FIGURE 20: BEAM PORT 3 / 3400 MHZ / CARTESIAN PLOT. ....	14
FIGURE 21: BEAM PORT 3 / 3400 MHZ / POLAR PLOT. ....	14
FIGURE 22: BEAM PORT 4 / 3400 MHZ / CARTESIAN PLOT. ....	15
FIGURE 23: BEAM PORT 4 / 3400 MHZ / POLAR PLOT. ....	15
FIGURE 24: BEAM PORT 5 / 3400 MHZ / CARTESIAN PLOT. ....	16
FIGURE 25: BEAM PORT 5 / 3400 MHZ / POLAR PLOT. ....	16
FIGURE 26: BEAM PORT 6 / 3400 MHZ / CARTESIAN PLOT. ....	17
FIGURE 27: BEAM PORT 6 / 3400 MHZ / POLAR PLOT. ....	17
FIGURE 28: BEAM PORT 7 / 3400 MHZ / CARTESIAN PLOT. ....	18
FIGURE 29: BEAM PORT 7 / 3400 MHZ / POLAR PLOT. ....	18
FIGURE 30: BEAM PORT 8 / 3400 MHZ / CARTESIAN PLOT. ....	19
FIGURE 31: BEAM PORT.8 / 3400 MHZ / POLAR PLOT. ....	19
FIGURE 32: EIGHT BEAM OVERLAY / 3400 MHZ / CARTESIAN PLOT. ....	20
FIGURE 33: EIGHT BEAM OVERLAY / 3400 MHZ / POLAR PLOT. ....	20
FIGURE 34: BEAM PORT 1 / 3500 MHZ / CARTESIAN PLOT. ....	21
FIGURE 35: BEAM PORT 1 / 3500 MHZ / POLAR PLOT. ....	21
FIGURE 36: BEAM PORT 2 / 3500 MHZ / CARTESIAN PLOT. ....	22
FIGURE 37: BEAM PORT 2 / 3500 MHZ / POLAR PLOT. ....	22
FIGURE 38: BEAM PORT 3 / 3500 MHZ / CARTESIAN PLOT. ....	23
FIGURE 39: BEAM PORT 3 / 3500 MHZ / POLAR PLOT. ....	23
FIGURE 40: BEAM PORT 4 / 3500 MHZ / CARTESIAN PLOT. ....	24
FIGURE 41: BEAM PORT 4 / 3500 MHZ / POLAR PLOT. ....	24

FIGURE 42: BEAM PORT 5 / 3500 MHZ / CARTESIAN PLOT. ....	25
FIGURE 43: BEAM PORT 5 / 3500 MHZ / POLAR PLOT. ....	25
FIGURE 44: BEAM PORT 6 / 3500 MHZ / CARTESIAN PLOT. ....	26
FIGURE 45: BEAM PORT 6 / 3500 MHZ / POLAR PLOT. ....	26
FIGURE 46: BEAM PORT 7 / 3500 MHZ / CARTESIAN PLOT. ....	27
FIGURE 47: BEAM PORT 7 / 3500 MHZ / POLAR PLOT. ....	27
FIGURE 48: BEAM PORT 8 / 3500 MHZ / CARTESIAN PLOT. ....	28
FIGURE 49: BEAM PORT 8 / 3500 MHZ / POLAR PLOT. ....	28
FIGURE 50: EIGHT BEAM OVERLAY / 3500 MHZ / CARTESIAN PLOT. ....	29
FIGURE 51: EIGHT BEAM OVERLAY / 3500 MHZ / POLAR PLOT. ....	29
FIGURE 52: BEAM PORT 1 / 3600 MHZ / CARTESIAN PLOT. ....	30
FIGURE 53: BEAM PORT 1 / 3600 MHZ / POLAR PLOT. ....	30
FIGURE 54: BEAM PORT 2 / 3600 MHZ / CARTESIAN PLOT. ....	31
FIGURE 55: BEAM PORT 2 / 3600 MHZ / POLAR PLOT. ....	31
FIGURE 56: BEAM PORT 3 / 3600 MHZ / CARTESIAN PLOT. ....	32
FIGURE 57: BEAM PORT 3 / 3600 MHZ / CARTESIAN PLOT. ....	32
FIGURE 58: BEAM PORT 4 / 3600 MHZ / CARTESIAN PLOT. ....	33
FIGURE 59: BEAM PORT 4 / 3600 MHZ / POLAR PLOT. ....	33
FIGURE 60: BEAM PORT 5 / 3600 MHZ / CARTESIAN PLOT. ....	34
FIGURE 61: BEAM PORT 5 / 3600 MHZ / POLAR PLOT. ....	34
FIGURE 62: BEAM PORT 6 / 3600 MHZ / CARTESIAN PLOT. ....	35
FIGURE 63: BEAM PORT 6 / 3600 MHZ / POLAR PLOT. ....	35
FIGURE 64: BEAM PORT 7 / 3600 MHZ / CARTESIAN PLOT. ....	36
FIGURE 65: BEAM PORT 7 / 3600 MHZ / POLAR PLOT. ....	36
FIGURE 66: BEAM PORT 8 / 3600 MHZ / CARTESIAN PLOT. ....	37
FIGURE 67: BEAM PORT 8 / 3600 MHZ / CARTESIAN PLOT. ....	37
FIGURE 68: EIGHT BEAM OVERLAY / 3600 MHZ / CARTESIAN PLOT. ....	38
FIGURE 69: EIGHT BEAM OVERLAY / 3600 MHZ / POLAR PLOT. ....	38
FIGURE 70: INSTRUMENT CASE ANTENNA CONFIGURATION.....	40
FIGURE 71: INSTRUMENT CASE INSTALLATION.....	40
FIGURE 72: TRI-POD MOUNTED FIELD INSTALLATION. ....	41

## LIST OF TABLES

TABLE 1: BEAM SCAN ANGLES.....	10
--------------------------------	----

## 1.0 SUMMARY

This Technical Note presents the design of, as well as preliminary test data for, an S-band linear antenna array intended for use in investigating directional mesh networking. In 2013, AFRL technical personnel proposed, in a briefing to DARPA's WNAN program manager (Dr. Bruce Fette), to explore the application of directional antennas in airborne mesh network using WNAN radios. Unfortunately, neither DARPA, nor AFRL, provided the necessary follow-on support or funding to complete the work. However, an antenna test fixture was assembled in-house, using on-hand RF components, to demonstrate directional beam formation using a linear array and a Butler Matrix beamformer. Results of the development activities are presented including descriptions of the antenna test fixture, measured antenna patterns and recommendations for future use.

## 2.0 INTRODUCTION

### 2.1 Mesh Networking using Directional Antennas

Directional antennas have the potential to significantly improve mesh networking performance. The benefits of using directional antennas include: increased network capacity, improved signal quality, enhanced routing performance, better network connectivity, reduced power consumption, and better anti-jamming capability [1].

### 2.2 Design Concept

A baseline system design concept was developed assuming the availability of IP-based communication nodes residing on manned and unmanned airborne platforms as illustrated in shown in Figure 1. Furthermore, each node consists of a single radio capable of establishing multiple links. Rather than employing omni-directional antennas, to provide the required wide-area spatial coverage, antenna arrays are used to establish highly directive links.

### Airborne Directional Mesh Networking



The diagram shows a grey aircraft on the left with a red antenna array extending from its tail. To the right, a network of four nodes (represented by small aircraft icons) is connected by dashed lines, forming a mesh structure.

**Program Objectives:**

- DTN Behavior With Directional Links
- Directional Beam Switching For Non-interrupted Service
- Omni Antenna for Monitoring Signal Environment
- Coordinated Use of Omni and Directional Antennas for Acquiring and Maintaining Signal Continuity

**Proposed In-House Activities:**

- Use WNAN Radios to Explore Directional Mesh Networking
- Develop Two Eight-Beam Directional Antennas Using: Patch Radiator Antenna Elements, 8 x 8 Butler Matrices and 8 Channel Pin Diode Switches
- Perform Chamber Testing To Verify Antenna Patterns
- Perform Field Tests to Characterize Radio/Directional Antenna Performance

Figure 1: Concept Slide 1.

DARPA's Wireless Network after Next (WNaN) radio was selected for use in the design given its ability to support dynamic network topologies using disruption tolerant networking (DTN) technology [2] as well as operate in the frequency band of the selected beamforming antenna. Figure 2 illustrates one such node configuration where one of the WNaN radio's four channels is connected to an omni-directional antenna while a second channel is connected, to a beamforming antenna. In our design, an 8 x 8 (Butler Matrix) analog beamforming network is employed to generate the required directional beam patterns.

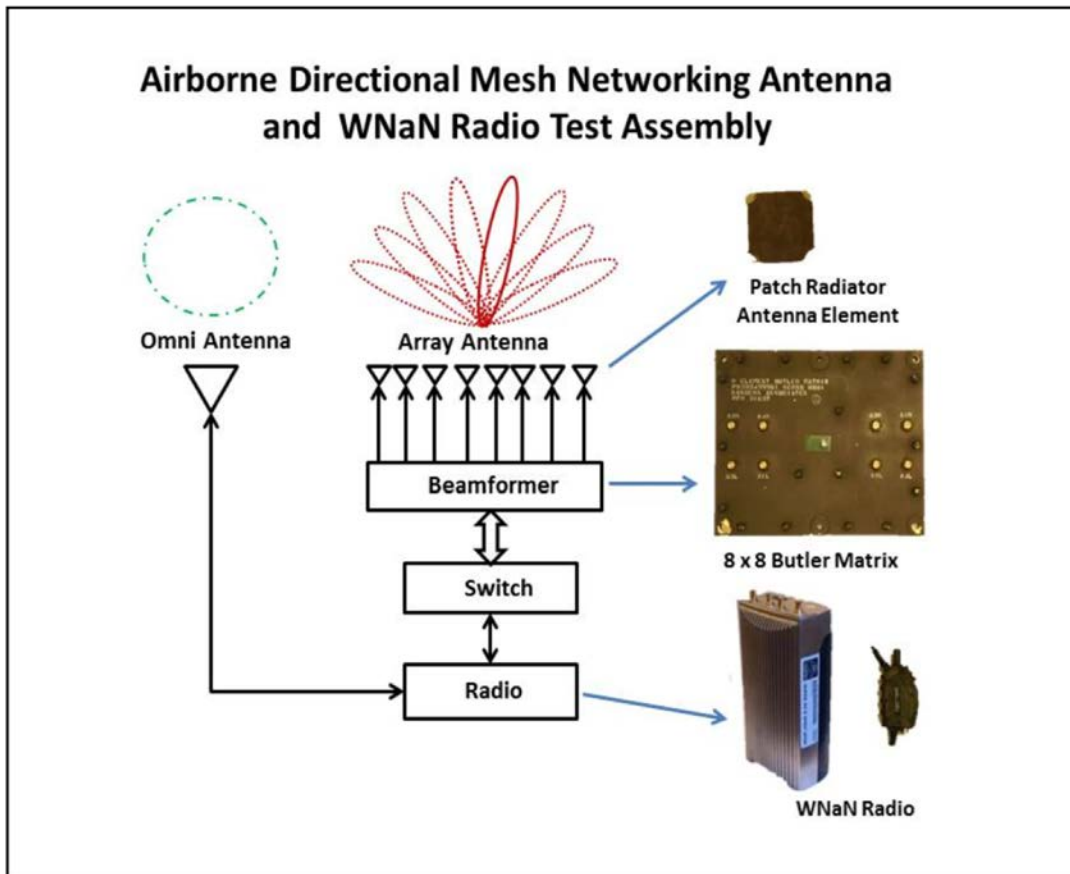
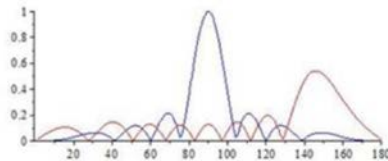

Figure 2: Concept Slide 2.

Some system design and operational considerations associated with use of a directional antenna are presented on the slide provided in Figure 3. One design issue that will impact communication link performance is beam shape loss. Consideration also needs to be given to how beamforming will be utilized by radio operations.

## System Design Considerations

- Account for beam shape losses (gain, beamwidth, sidelobes, etc. ) versus array scan angle and the impacts on radio operations.



- Investigate use of adjacent beams for monitoring signal angle-of-arrival as an aid for beam selection and maintaining link continuity.

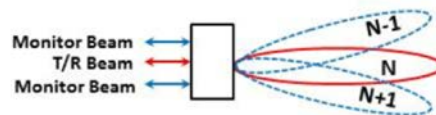

- Explore use of orthogonal waveforms for simultaneous operations using multiple beam positions.

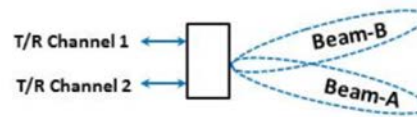

Figure 3: Concept Slide 3.

### 3.0 METHODS, ASSUMPTIONS, AND PROCEDURES

#### 3.1 Key Components

An antenna array was constructed using on-hand, S-band frequency, components. The primary components are: eight patch radiators, an 8 x 8 Butler Matrix, and a one-to-eight channel pin diode RF switch. These components are shown in Figures 4 through 6 respectively.

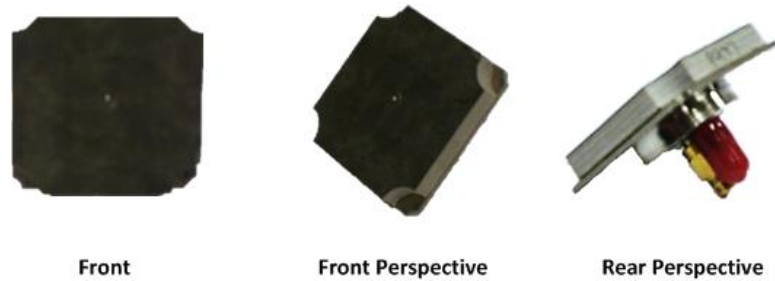

Figure 4: S-Band Patch Radiator.

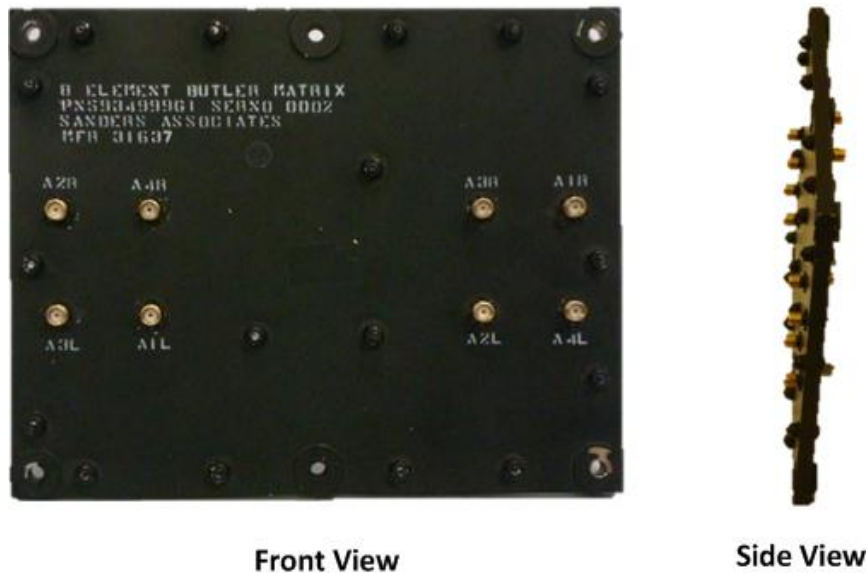

Figure 5: 8 x 8 Butler Matrix.

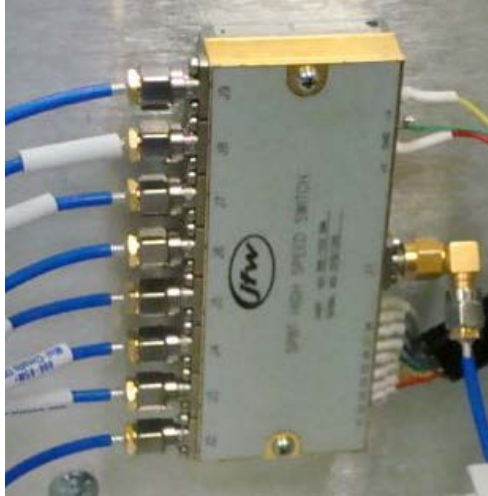

Figure 6: One-to-Eight Pin Diode Switch.

### 3.2 Antenna Array

The assembled eight-element array is shown in Figure 7. The dimensions of the aperture's ground plane were sized to that of a standard 4U high rack panel to facilitate mounting in a transportable instrument case.

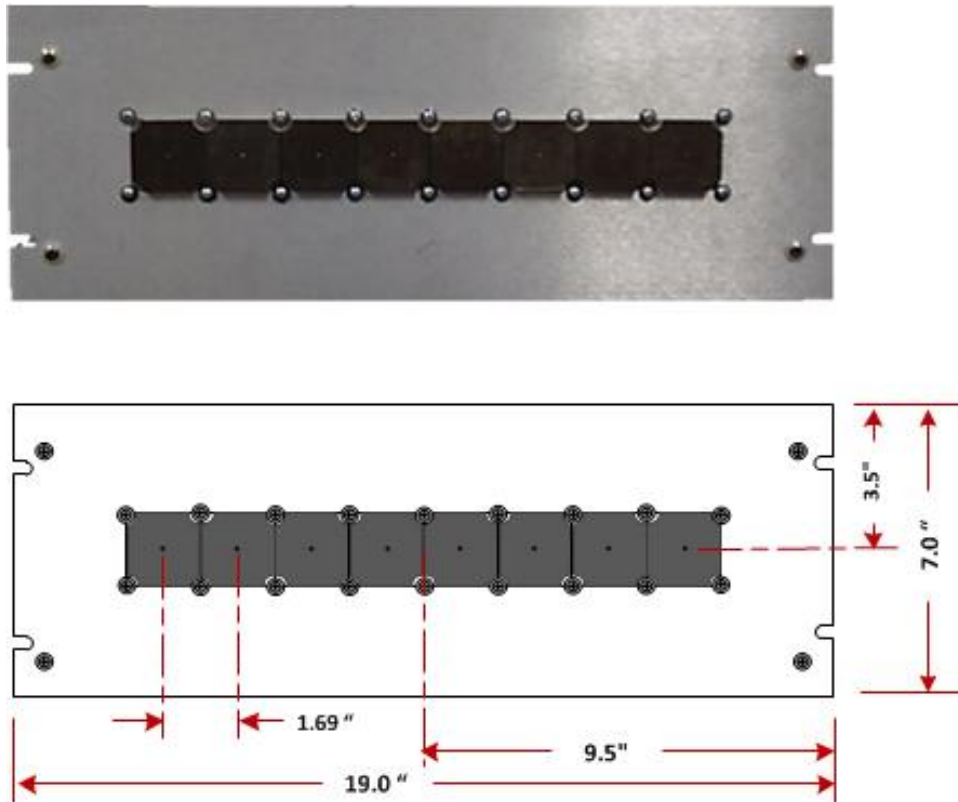

Figure 7: Array Antenna Layout.



### 3.2 Antenna Test Fixture

Various images of the assembled antenna test fixture are provided in Figure 7 through 10 with key components identified.

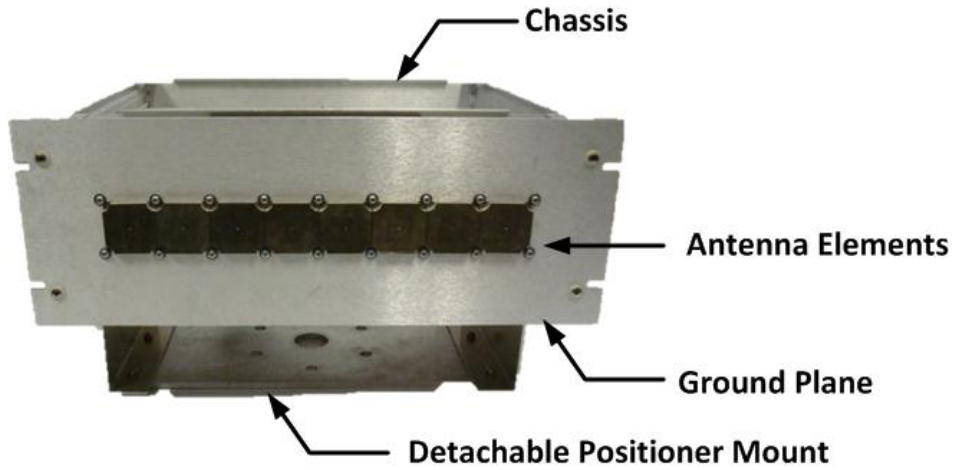

Figure 8: Antenna Test Fixture / Front View.

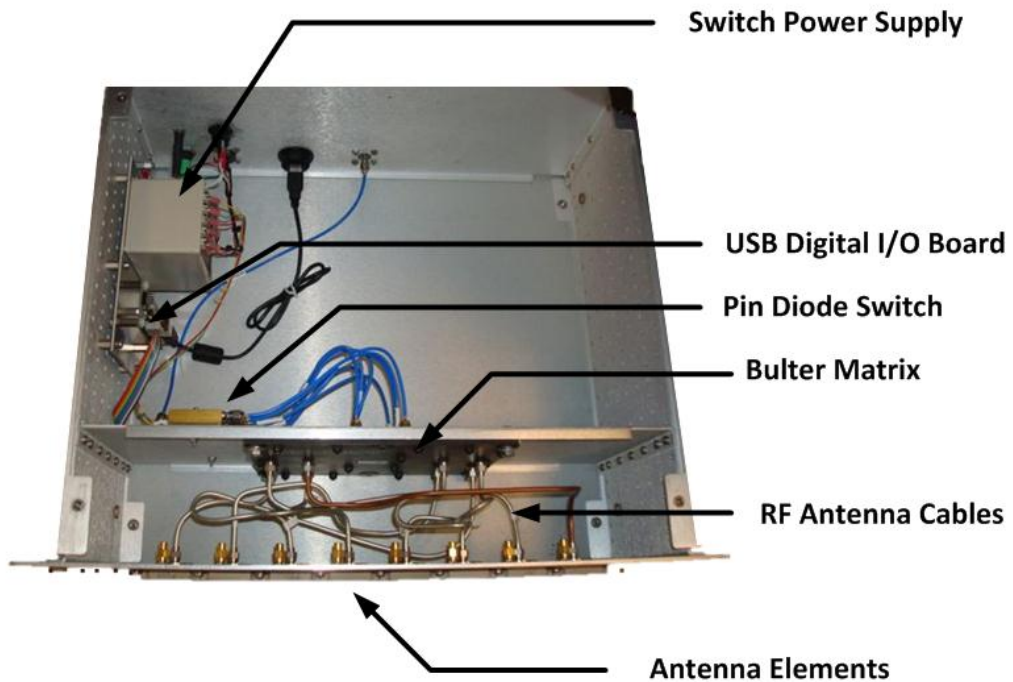
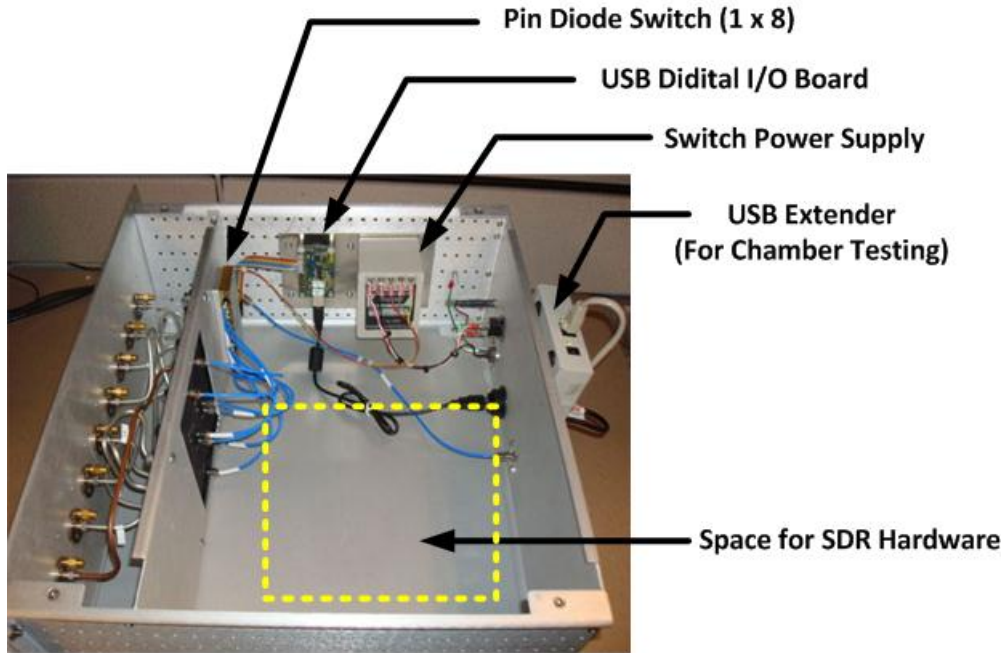

Figure 9: Antenna Test Fixture / Top View.



Antenna Fixture Interior

Figure 10: Antenna Test Fixture / Interior View.

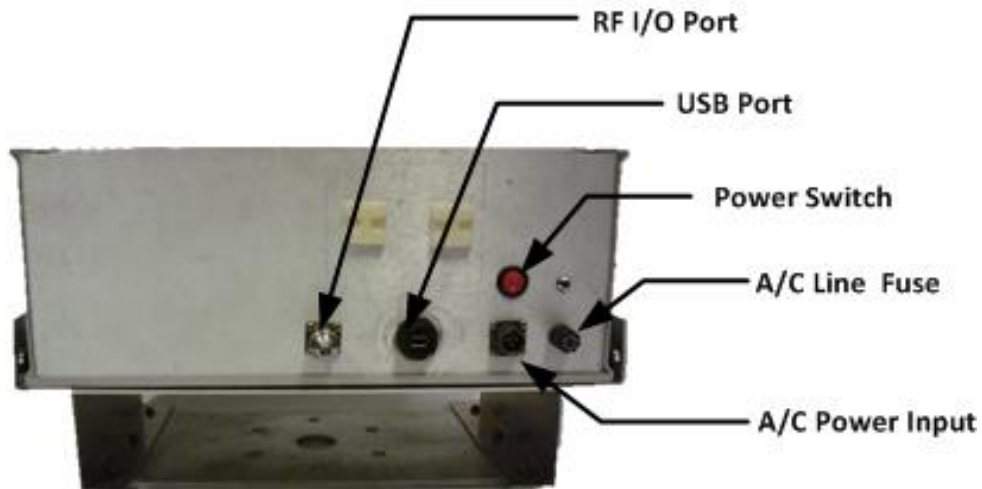

Figure 11: Antenna Test Fixture / Rear View.

The assembled antenna with laptop controller is shown in Figure 12. While a USB extender is required for taking pattern measurements in the anechoic chamber, given that the antenna would be mounted at the top of a model tower and therefore inaccessible, it would not normally be used for typical operations.

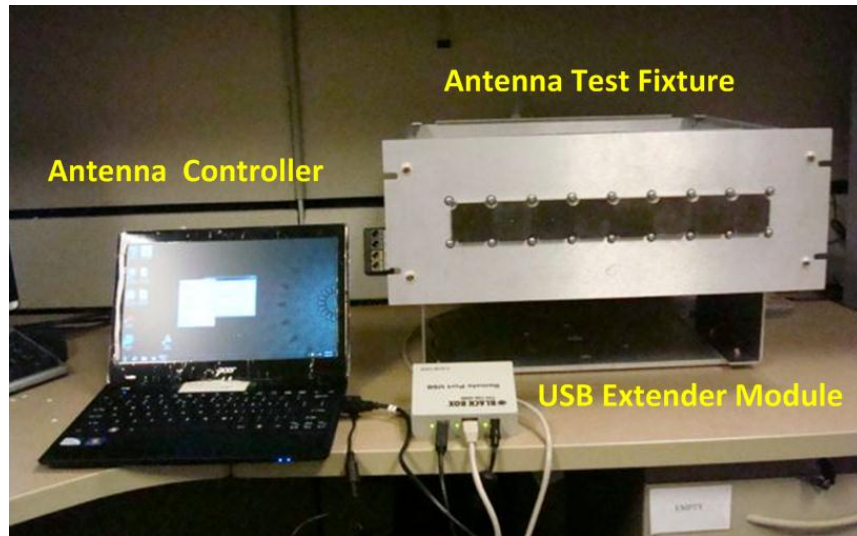

Figure 12: Assembled Eight Element S-Band Antenna.

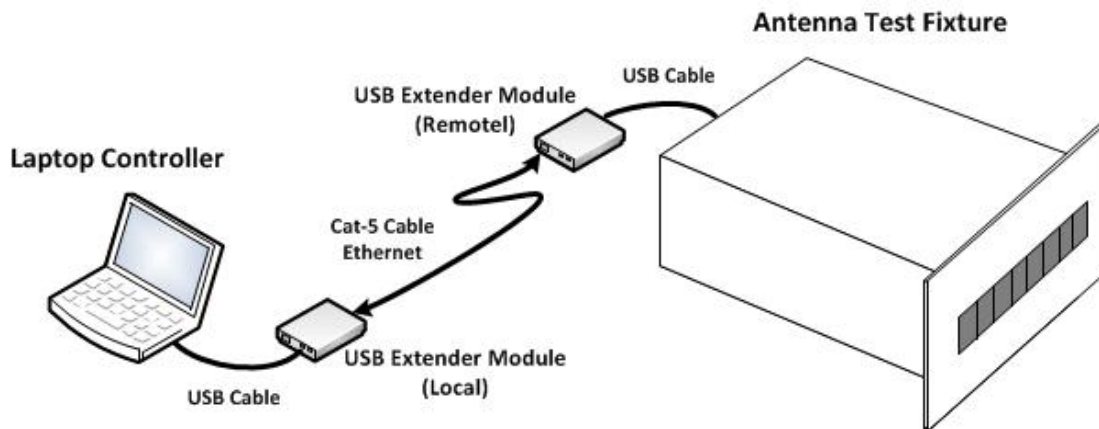

Figure 13: Antenna Controller Set-up.

### 3.3 Calculated Antenna Pattern Scan Angles

An analog beamformer circuit i.e., a Butler Matrix, is used scan the antenna pattern to eight different angle positions. The device used in this design operates at S-band frequencies ranging between 3200 MHz to 3600 MHz. Table 1 lists the various phase gradients produced by each of the Butler Matrix's input ports along with respective scan angles. Calculated antenna patterns (at 3500 MHz) are provided in Figure 14.

Table 1: Calculated Scan Angles.

Beam Number	Butler Matrix Phase Gradient (degrees)	Expected Scan Angle $d = \lambda/2$ (degrees)	Calculated Scan Angle $d = 0.04366 \text{ m}$ (degrees)
1	-157.5	-61	-56
2	-112.5	-38	-37
3	-67.5	-22	-22
4	-22.5	-7	-7
5	22.5	7	7
6	67.5	22	22
7	112.5	38	37
8	157.5	61	56

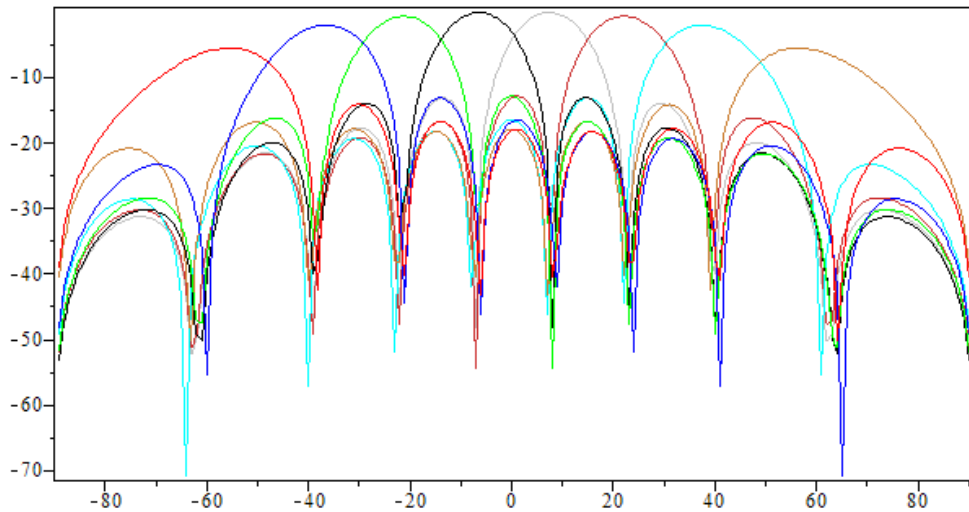

Figure 14: Calculated Antenna Patterns / 3500 MHz / Normalized.

## 4.0 Results and Discussion

Measurements were made to characterize antenna array and beamformer performance. Testing was conducted in AFRL Rome Research Site's anechoic chamber. Data was collected at five frequencies: 3200, 3300, 3400, 3500 and 3600 MHz. Pattern data taken at 3200 MHz and 3300 MHz indicated poor performance and therefore are not included in this report.

### 4.1 Antenna Pattern Measurements

Antenna patterns were measured inside AFRL's anechoic test chamber. The test set-up is shown in Figure 15 with the antenna test fixture mounted to the top of the chamber's model tower. Mounted opposite the antenna test fixture is a standard gain horn used calibration of the chamber's measurement system.

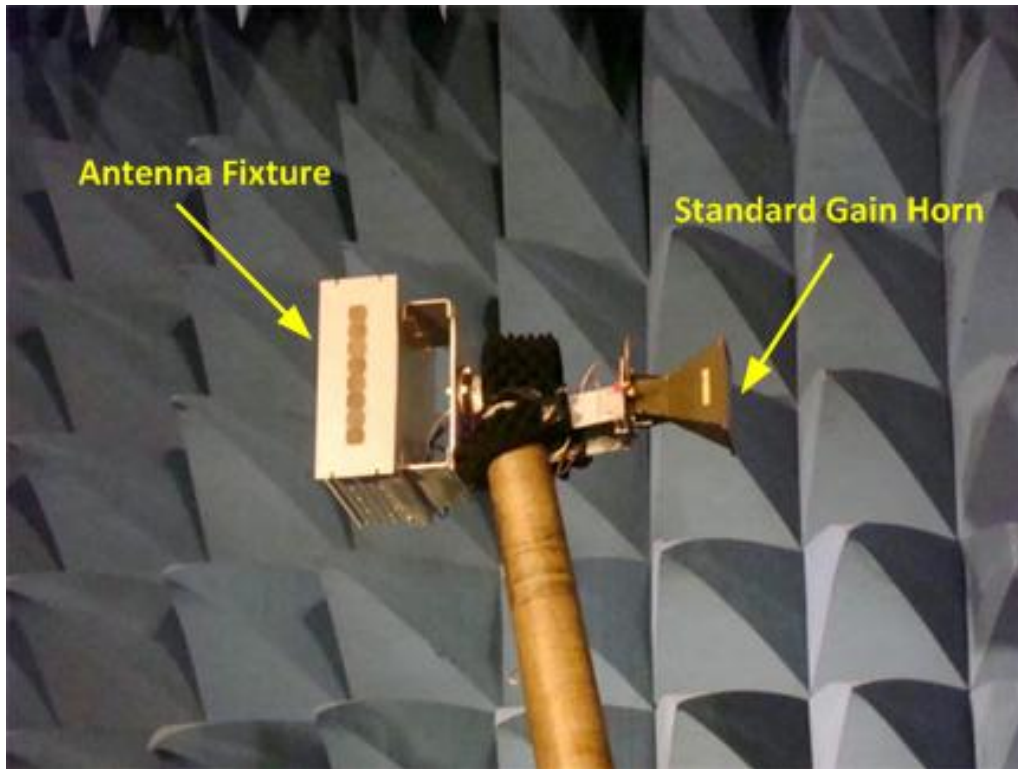

Figure 15: Antenna Testing in AFRL's Anechoic Chamber.

## 4.2 Antenna Patterns Measured at 3400 MHz

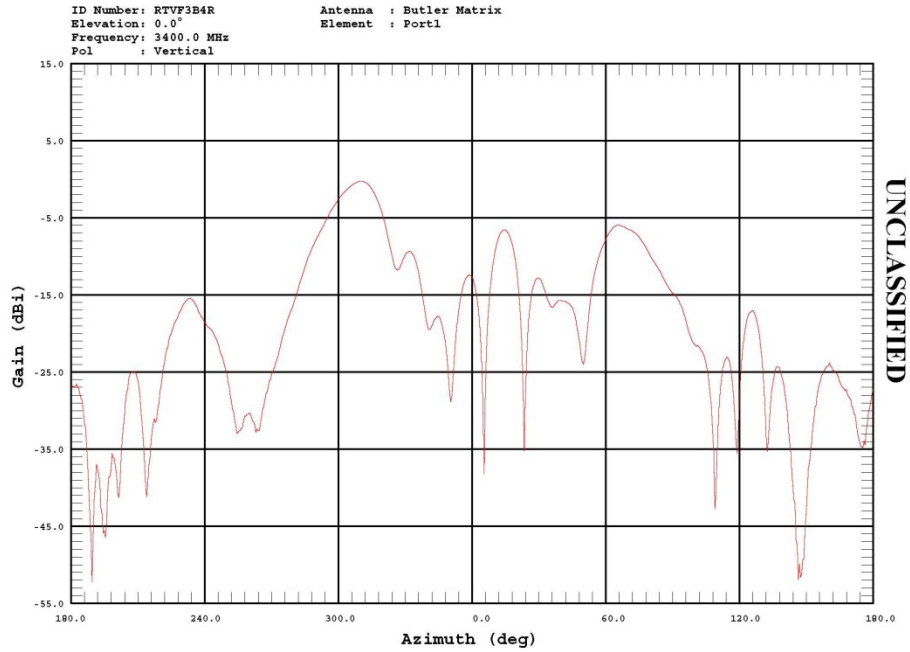

Figure 16: Beam Port 1 / 3400 MHz / Cartesian Plot.

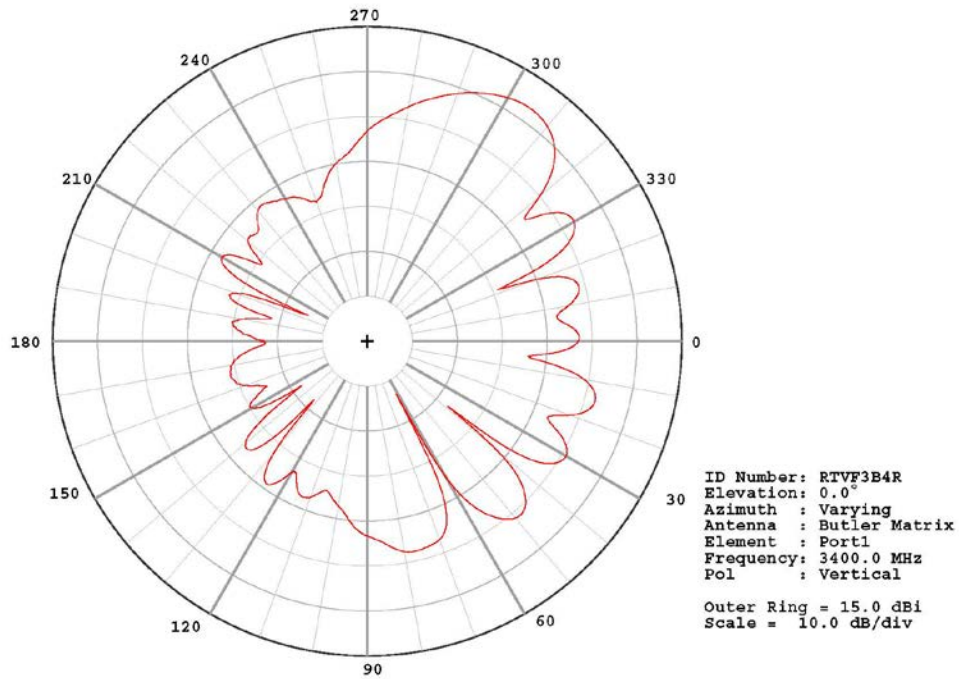

Figure 17: Beam Port 1 / 3400 MHz / Polar Plot.



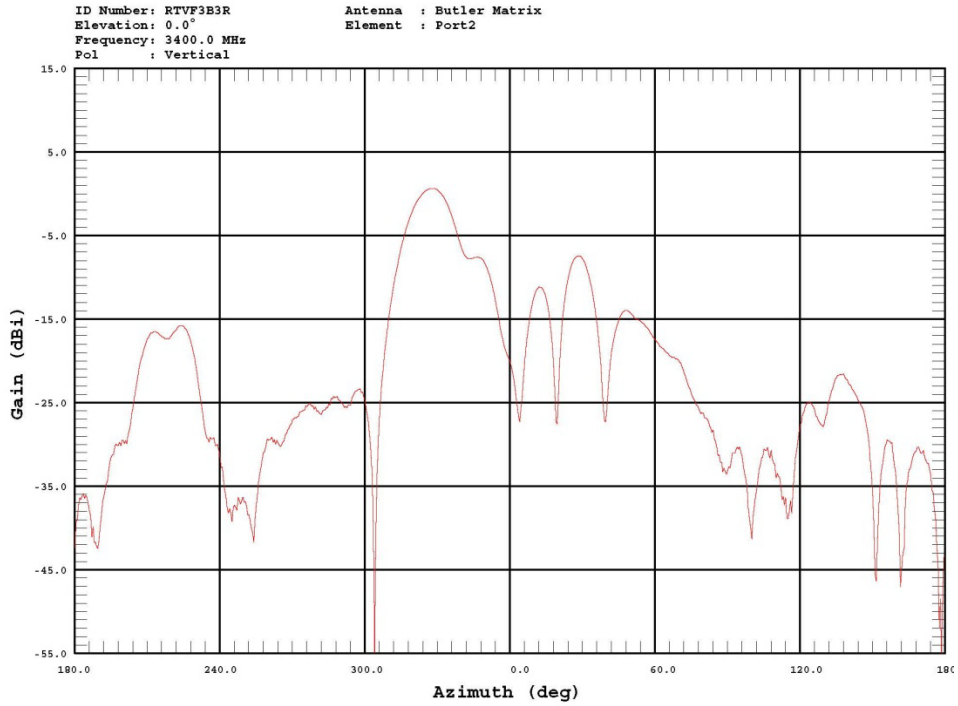

Figure 18: Beam Port.2 / 3400 MHz / Cartesian Plot.

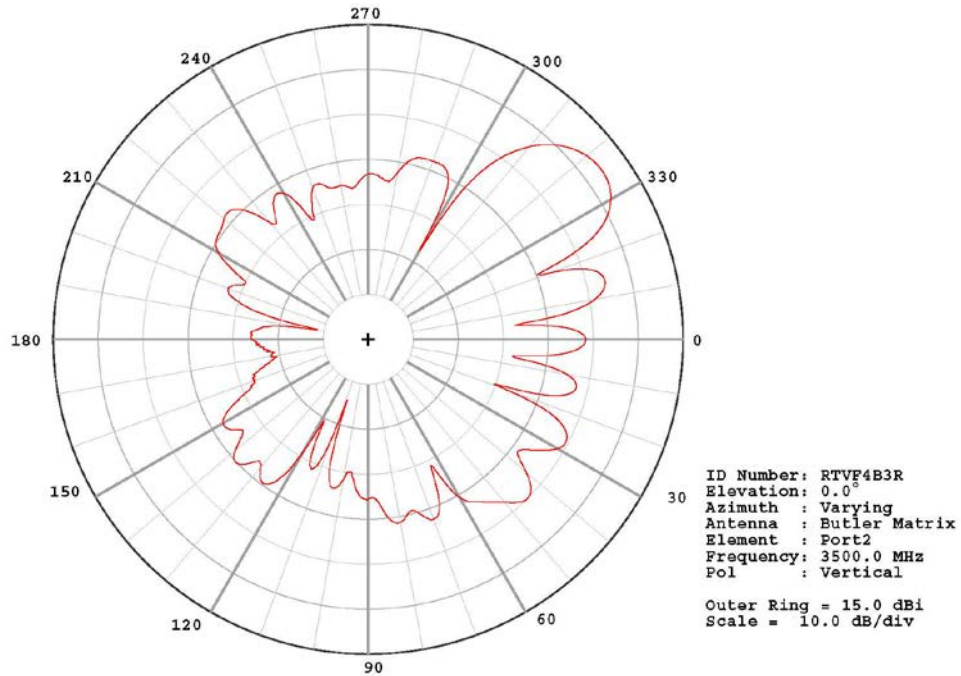

Figure 19: Beam Port 2 / 3400 MHz / Polar Plot.

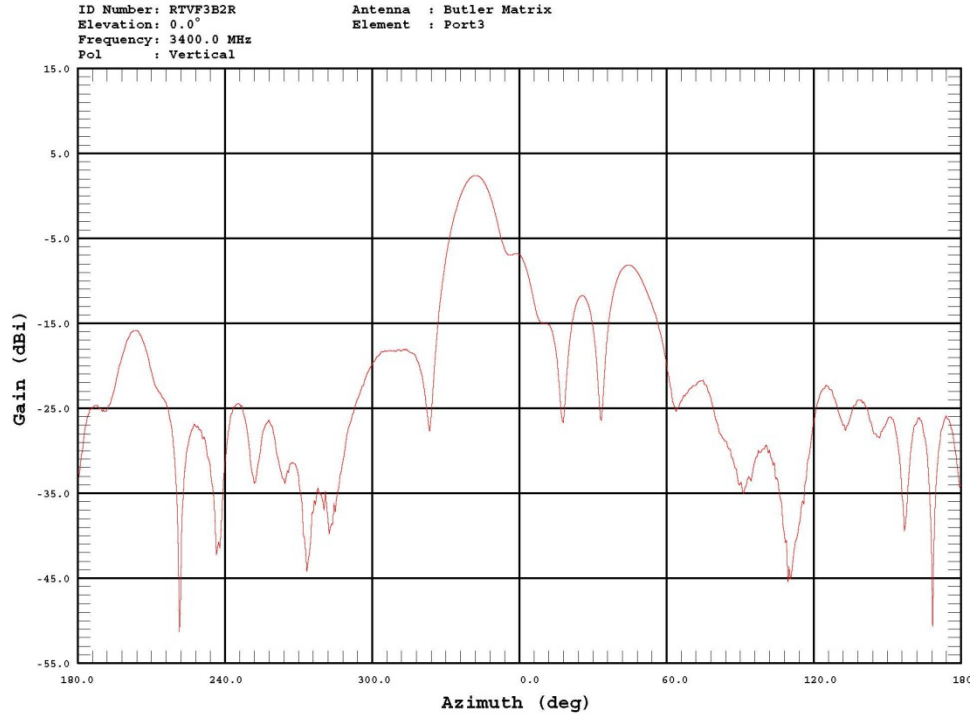

Figure 20: Beam Port 3 / 3400 MHz / Cartesian Plot.

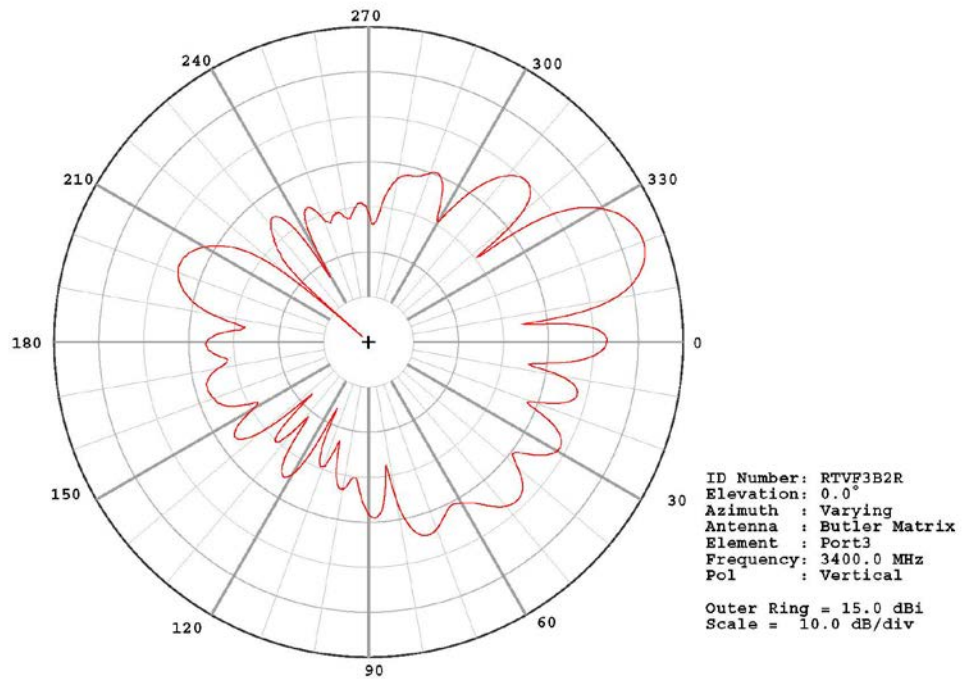

Figure 21: Beam Port 3 / 3400 MHz / Polar Plot.



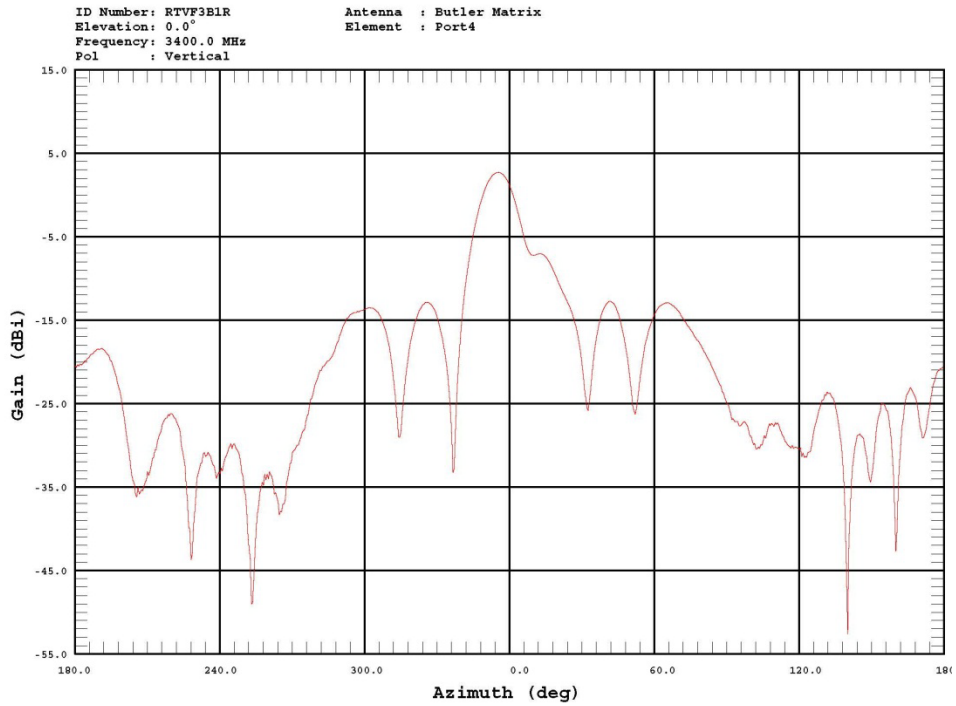

Figure 22: Beam Port 4 / 3400 MHz / Cartesian Plot.

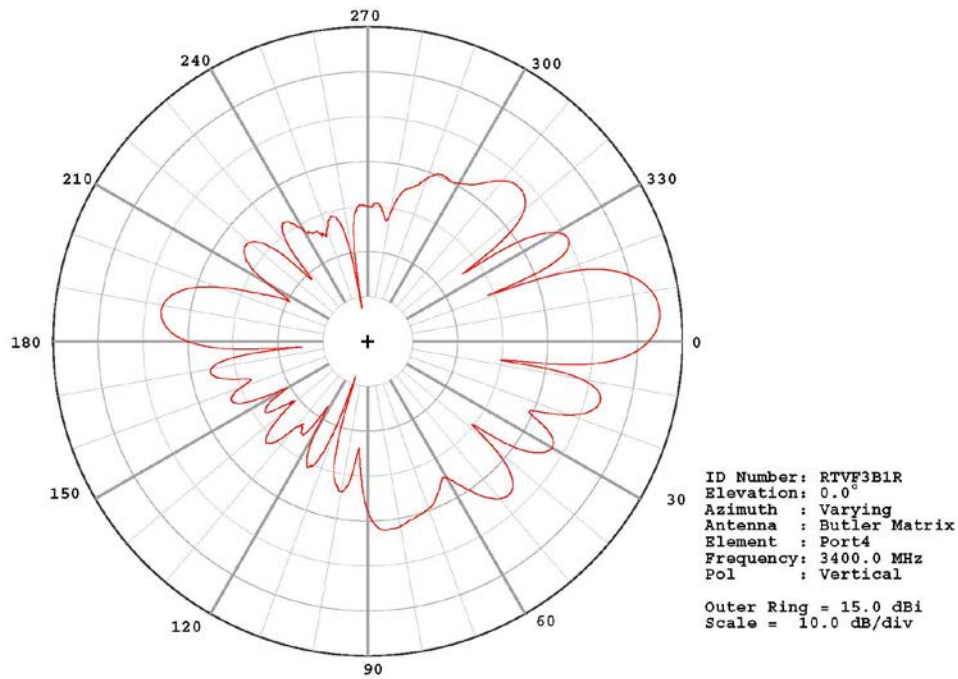

Figure 23: Beam Port 4 / 3400 MHz / Polar Plot.

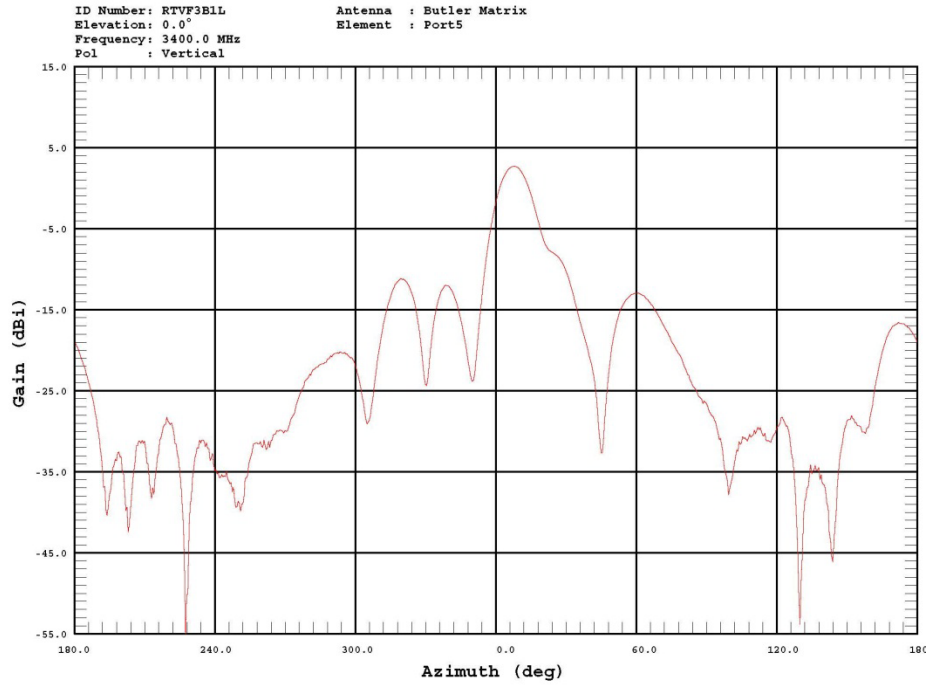

Figure 24: Beam Port 5 / 3400 MHz / Cartesian Plot.

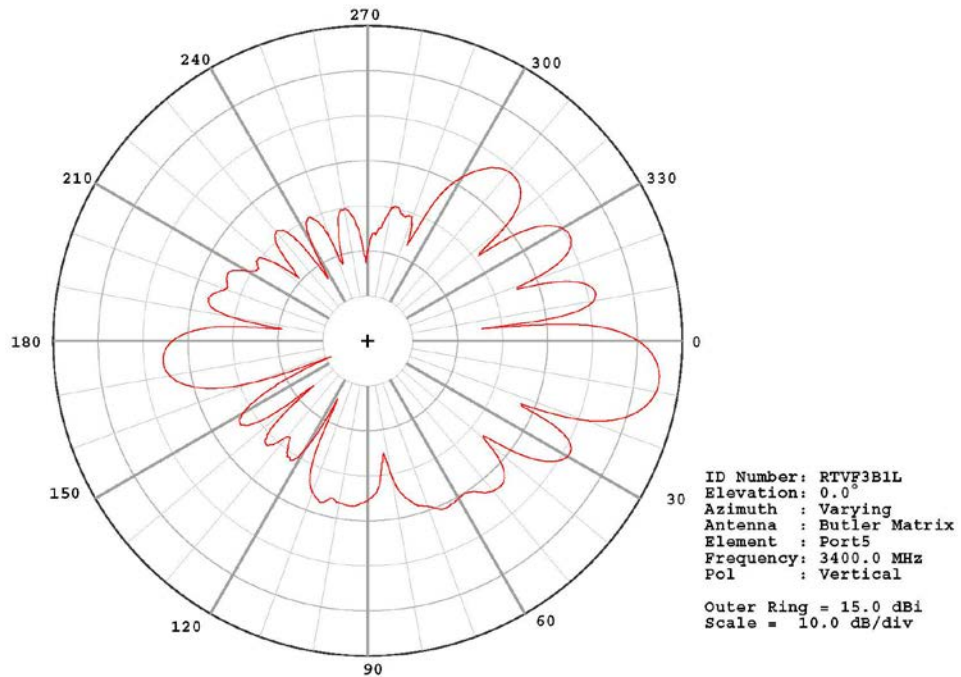

Figure 25: Beam Port 5 / 3400 MHz / Polar Plot.

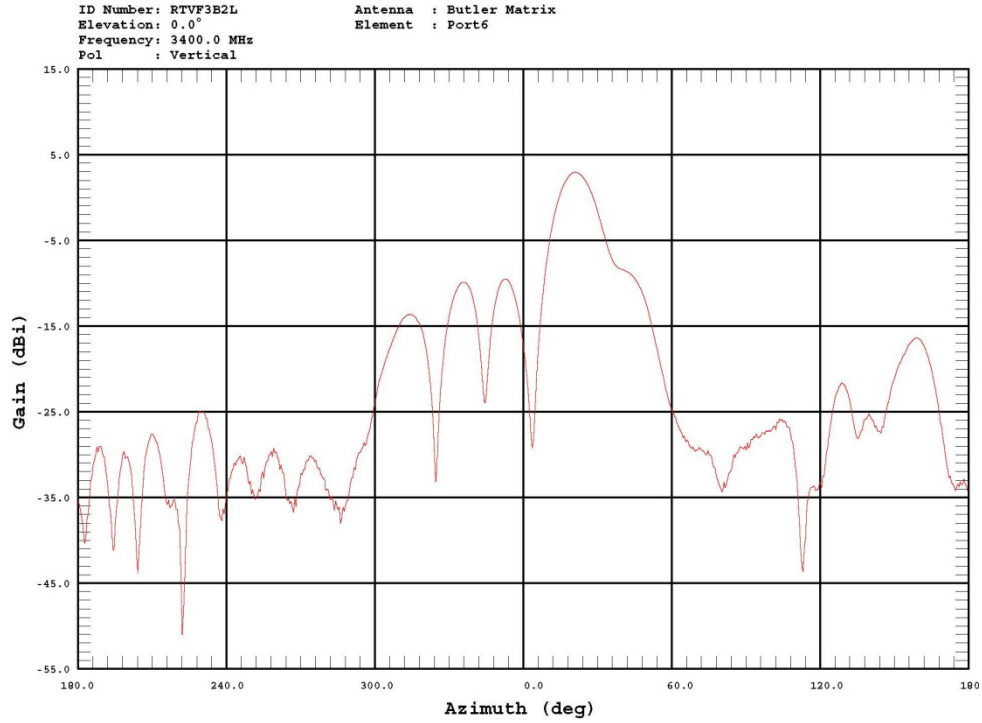

Figure 26: Beam Port 6 / 3400 MHz / Cartesian Plot.

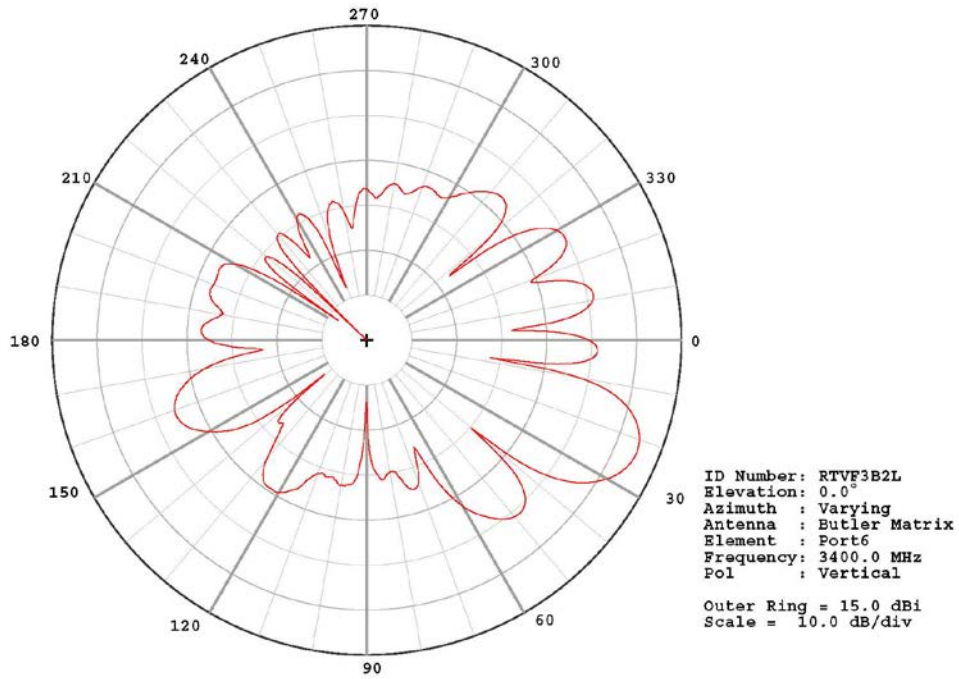

Figure 27: Beam Port 6 / 3400 MHz / Polar Plot.

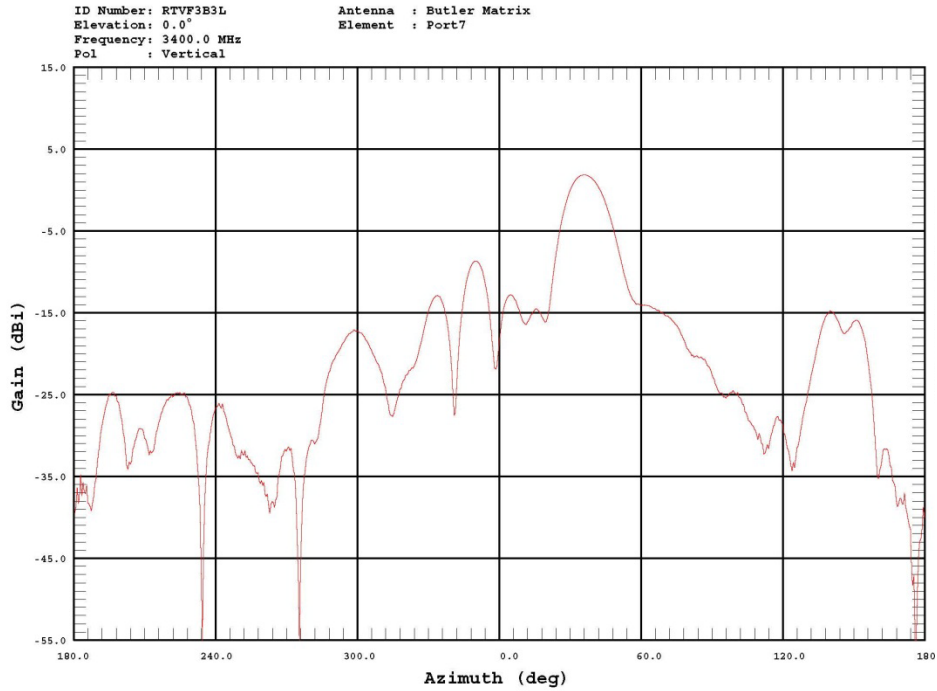

Figure 28: Beam Port 7 / 3400 MHz / Cartesian Plot.

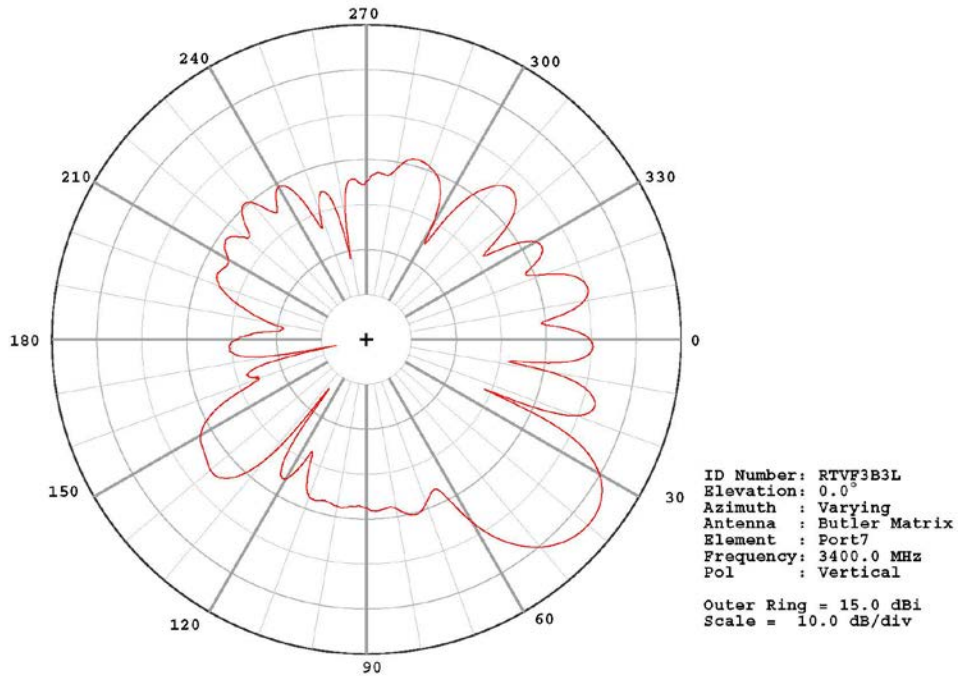

Figure 29: Beam Port 7 / 3400 MHz / Polar Plot.

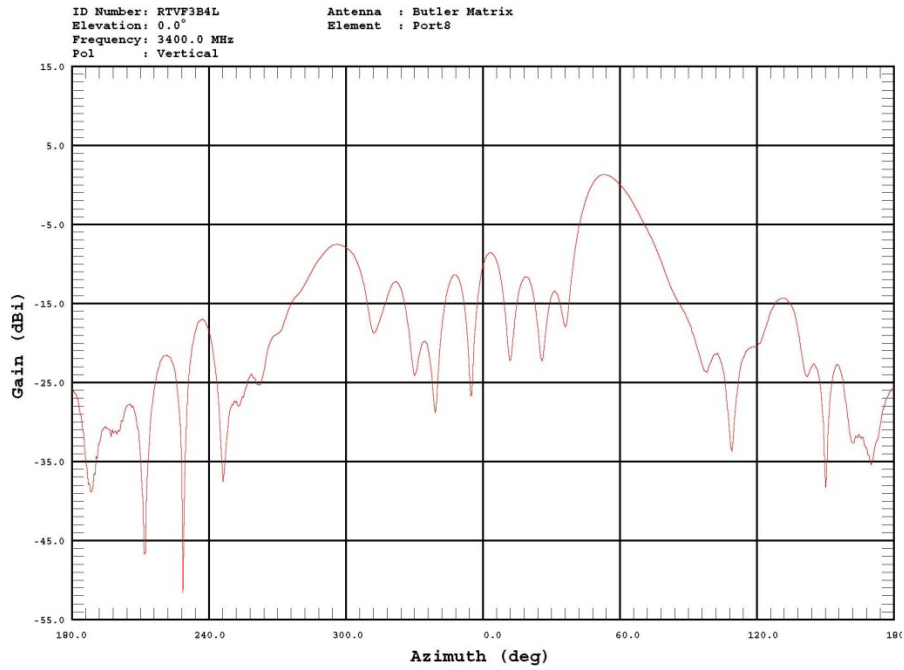

Figure 30: Beam Port 8 / 3400 MHz / Cartesian Plot.

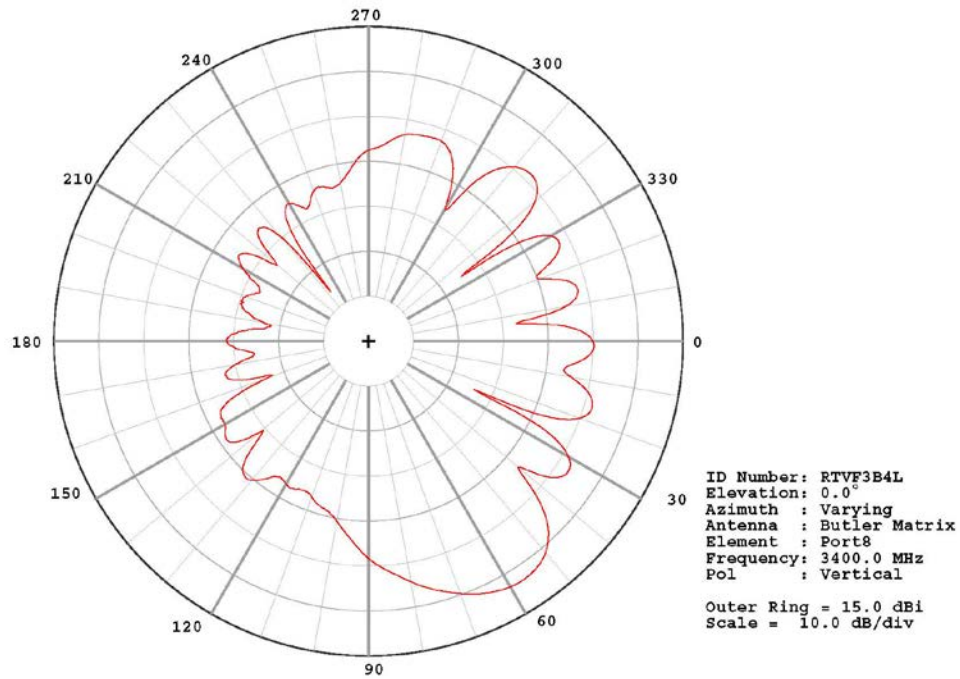

Figure 31: Beam Port.8 / 3400 MHz / Polar Plot.



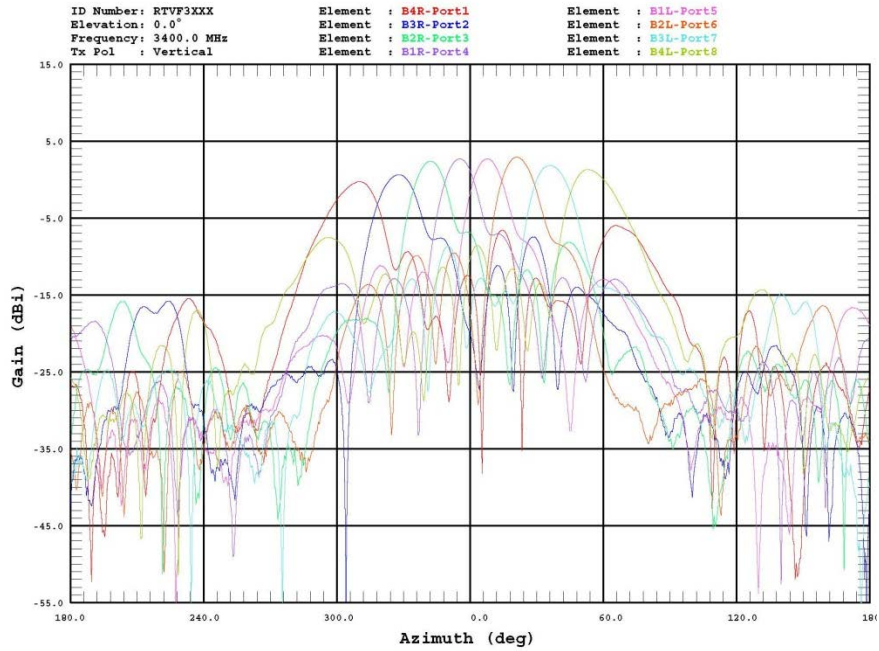

Figure 32: Eight Beam Overlay / 3400 MHz / Cartesian Plot.

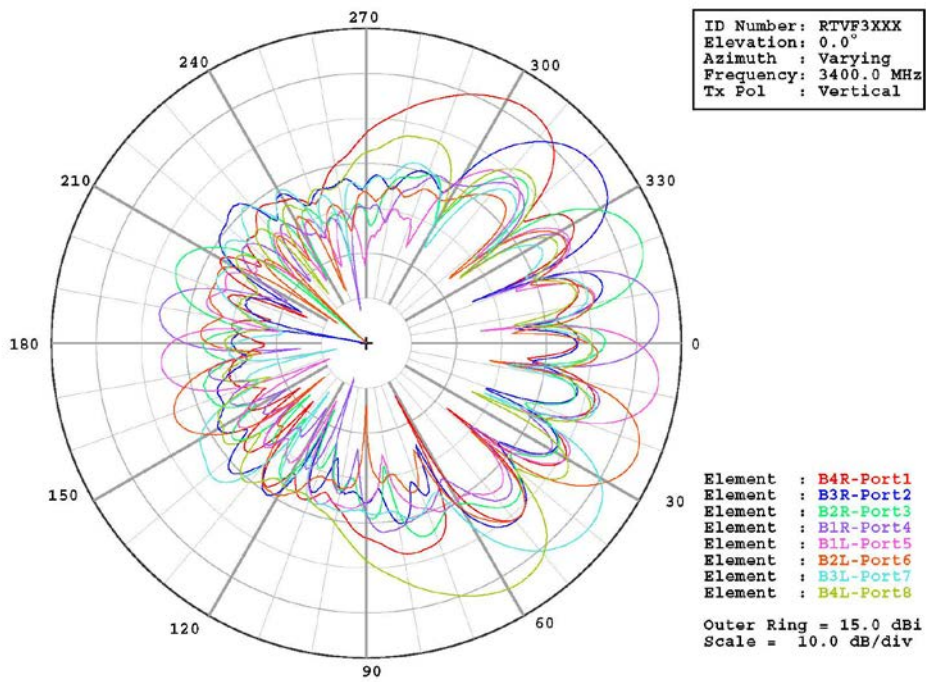

Figure 33: Eight Beam Overlay / 3400 MHz / Polar Plot.

### 4.3 Antenna Patterns Measured at 3500 MHz

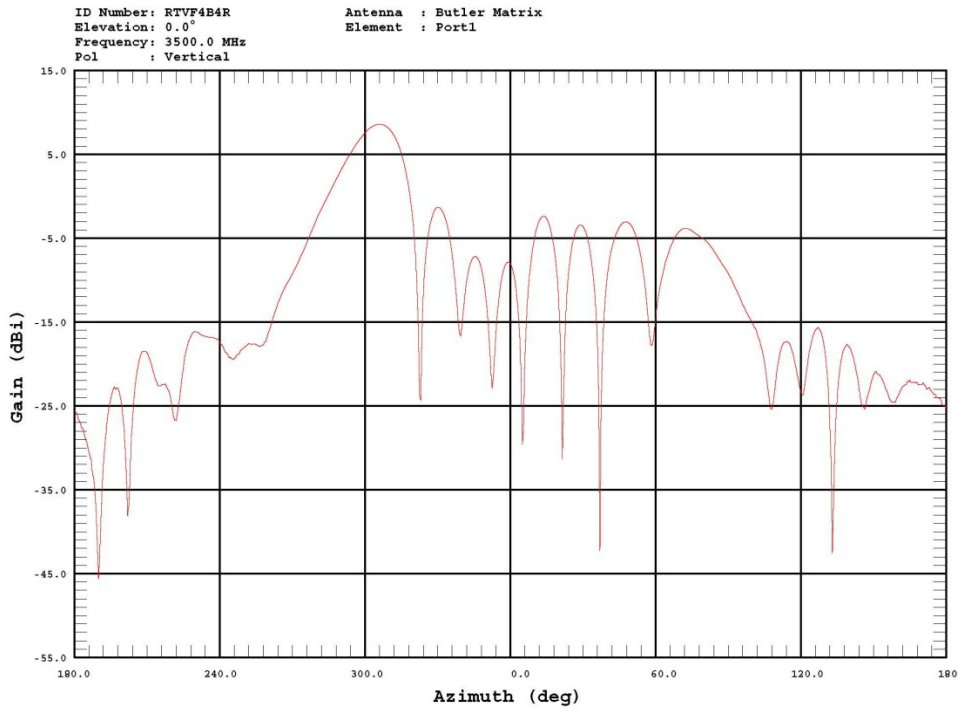

Figure 34: Beam Port 1 / 3500 MHz / Cartesian Plot.

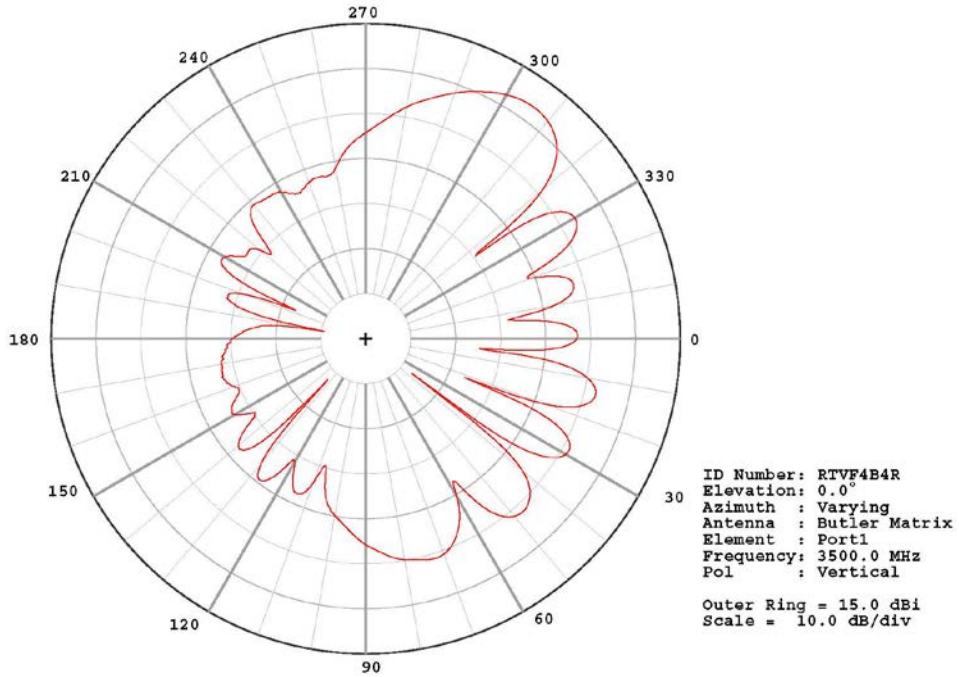

Figure 35: Beam Port 1 / 3500 MHz / Polar Plot.

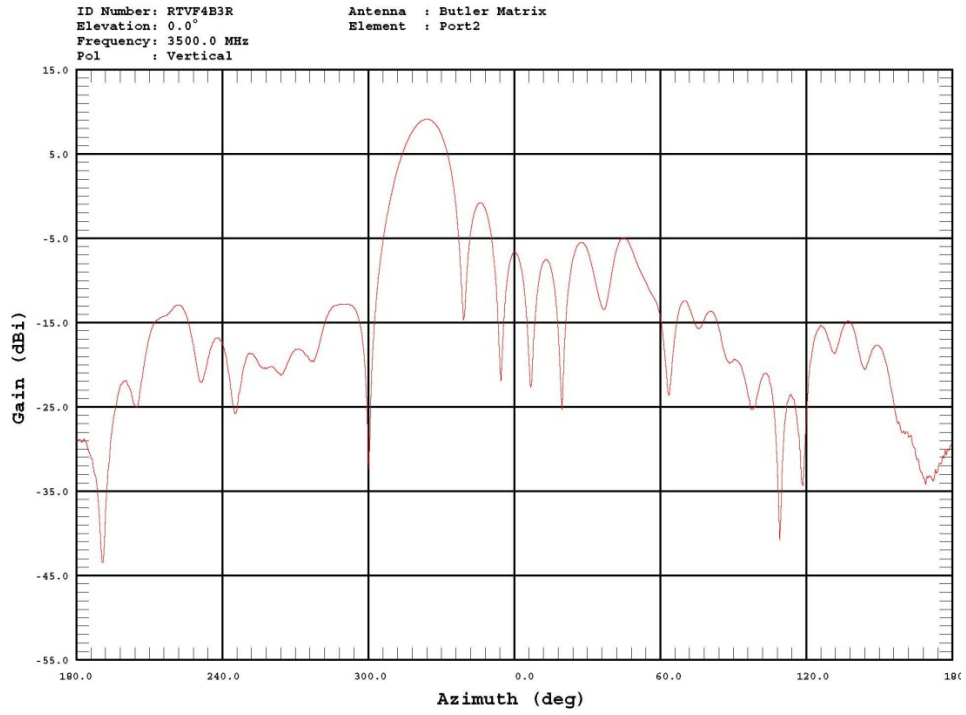

Figure 36: Beam Port 2 / 3500 MHz / Cartesian Plot.

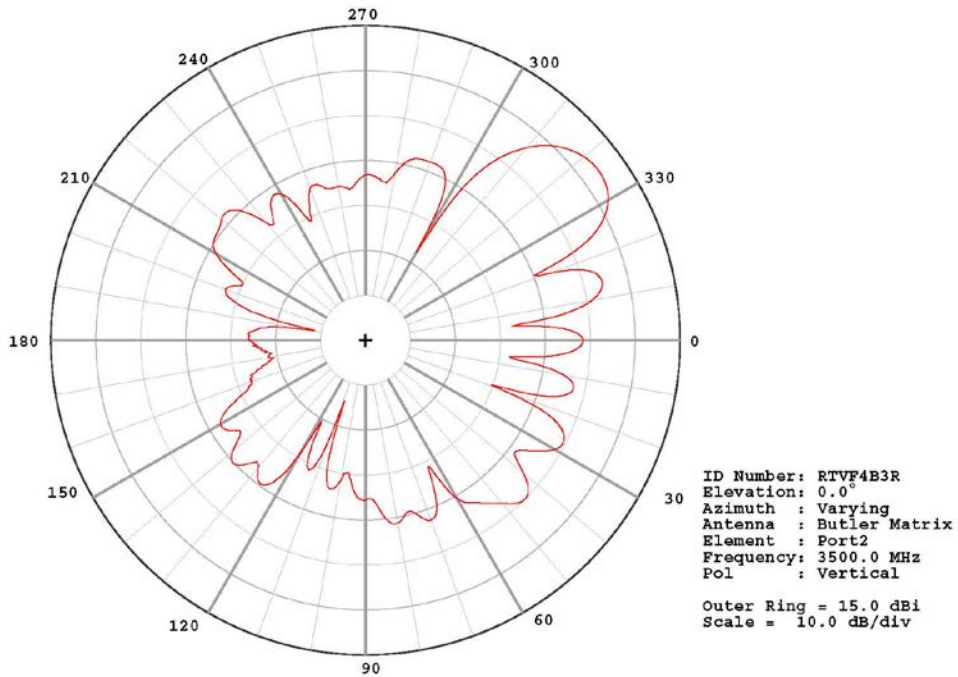

Figure 37: Beam Port 2 / 3500 MHz / Polar Plot.



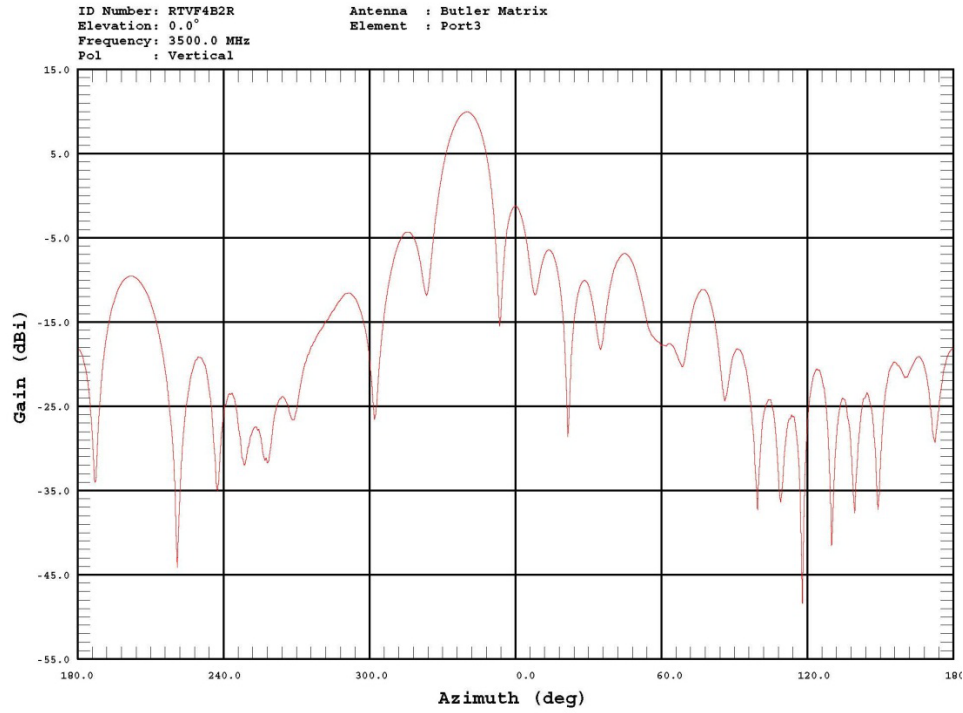

Figure 38: Beam Port 3 / 3500 MHz / Cartesian Plot.

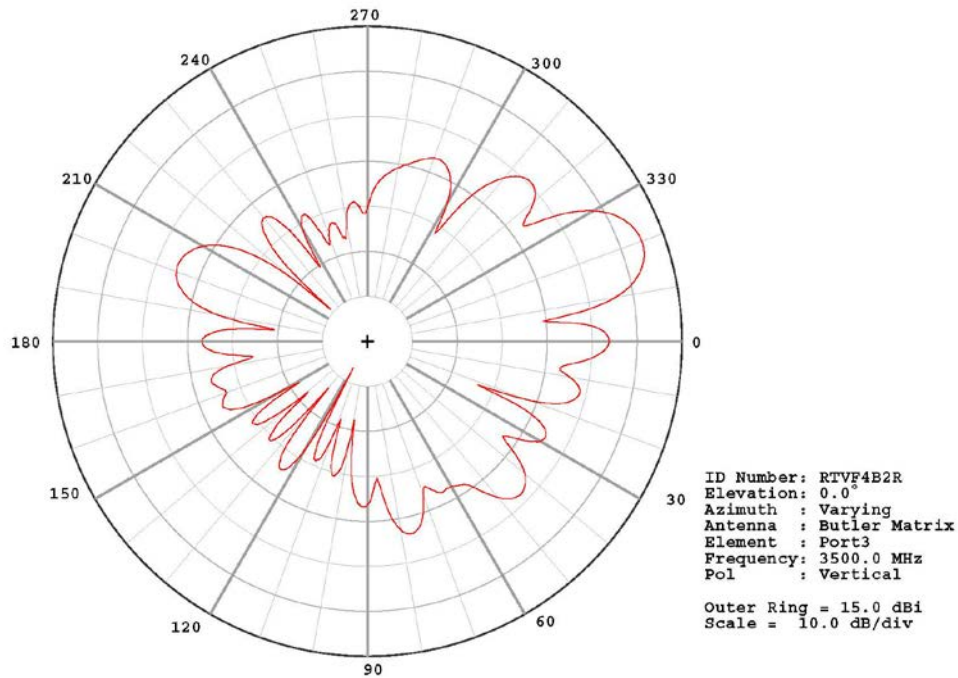

Figure 39: Beam Port 3 / 3500 MHz / Polar Plot.

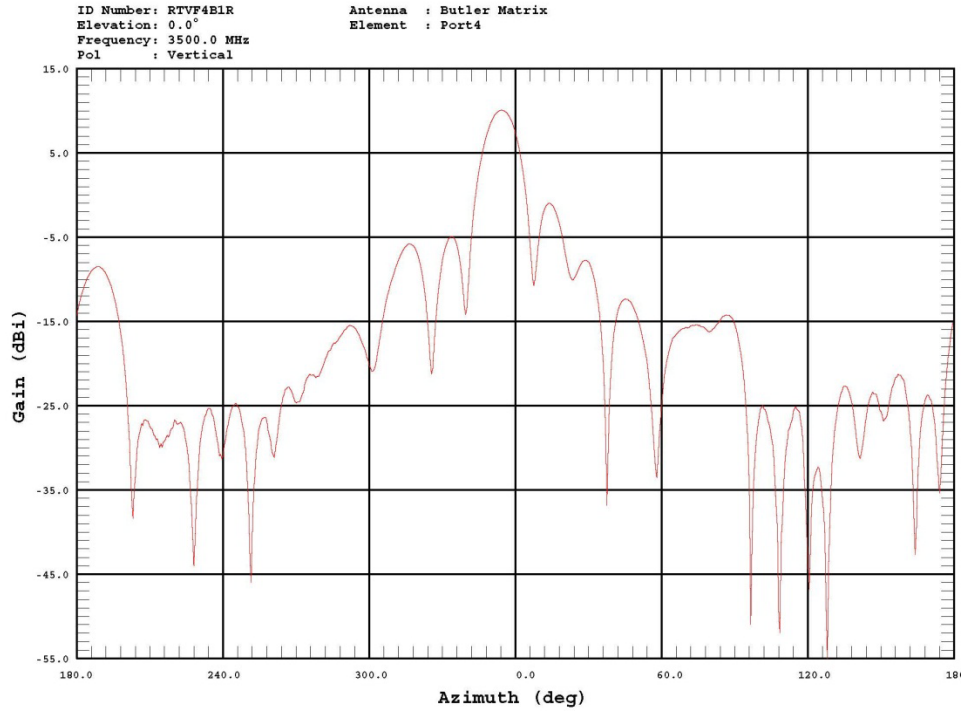

Figure 40: Beam Port 4 / 3500 MHz / Cartesian Plot.

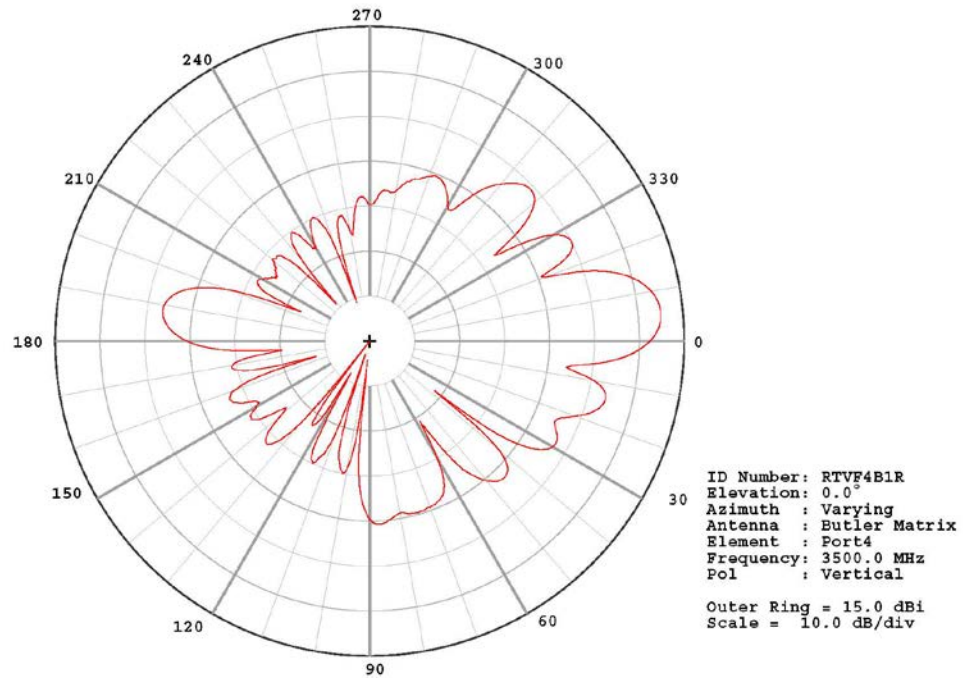

Figure 41: Beam Port 4 / 3500 MHz / Polar Plot.

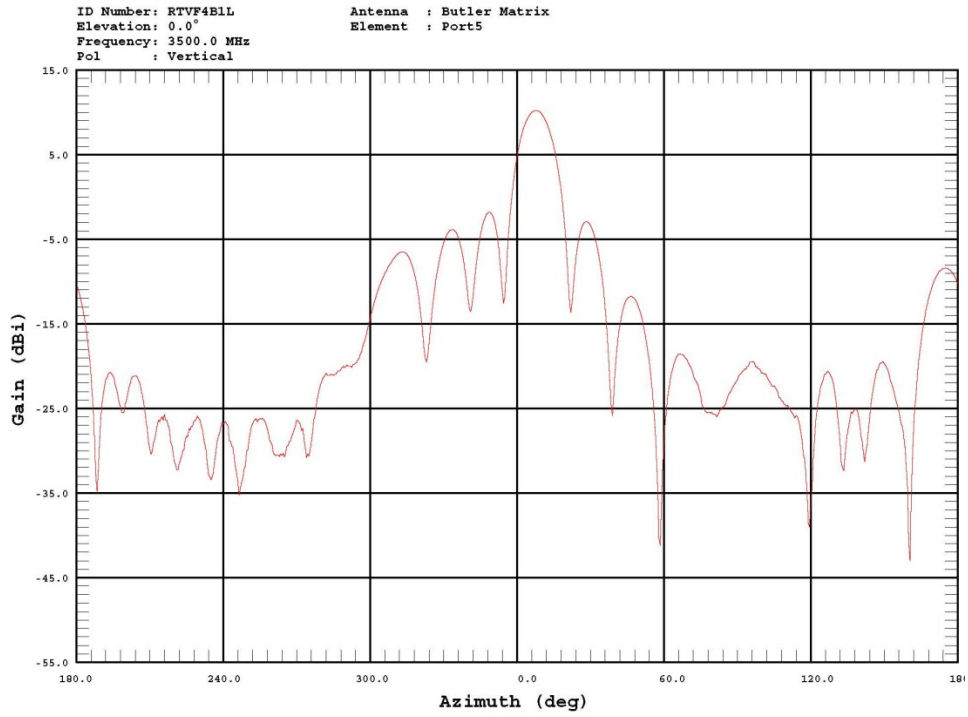

Figure 42: Beam Port 5 / 3500 MHz / Cartesian Plot.

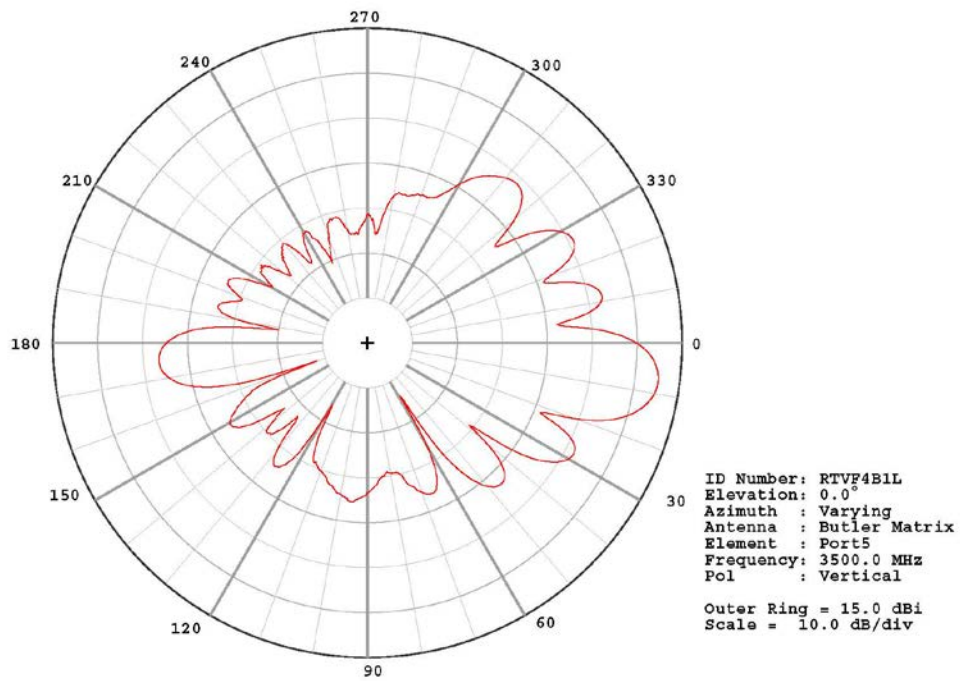

Figure 43: Beam Port 5 / 3500 MHz / Polar Plot.

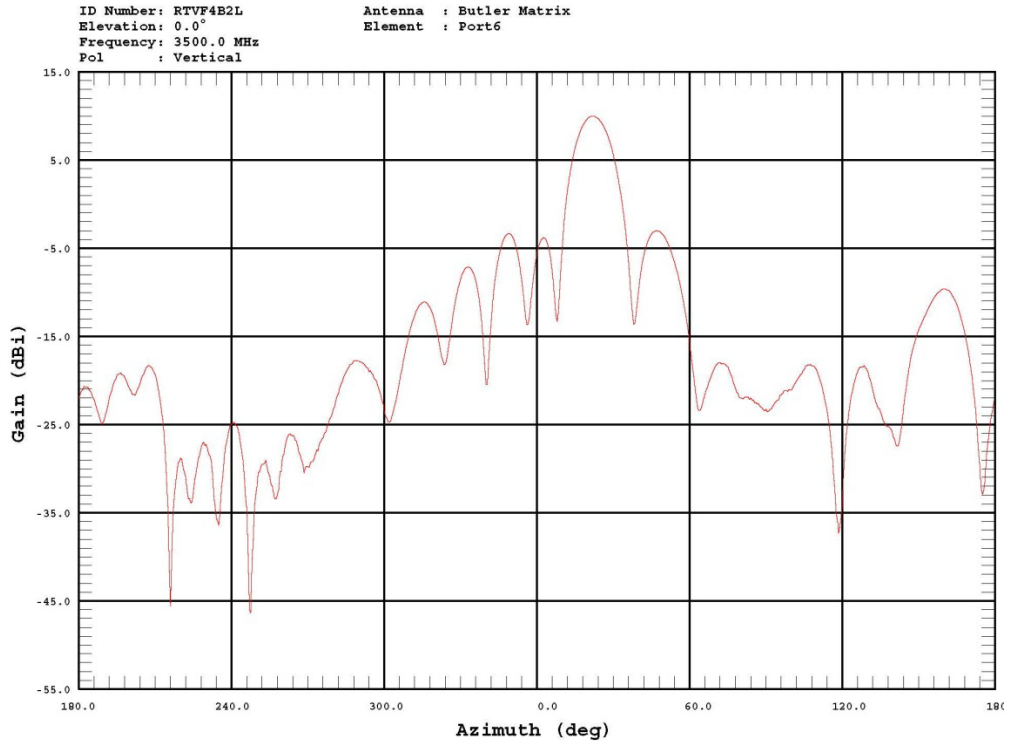

Figure 44: Beam Port 6 / 3500 MHz / Cartesian Plot.

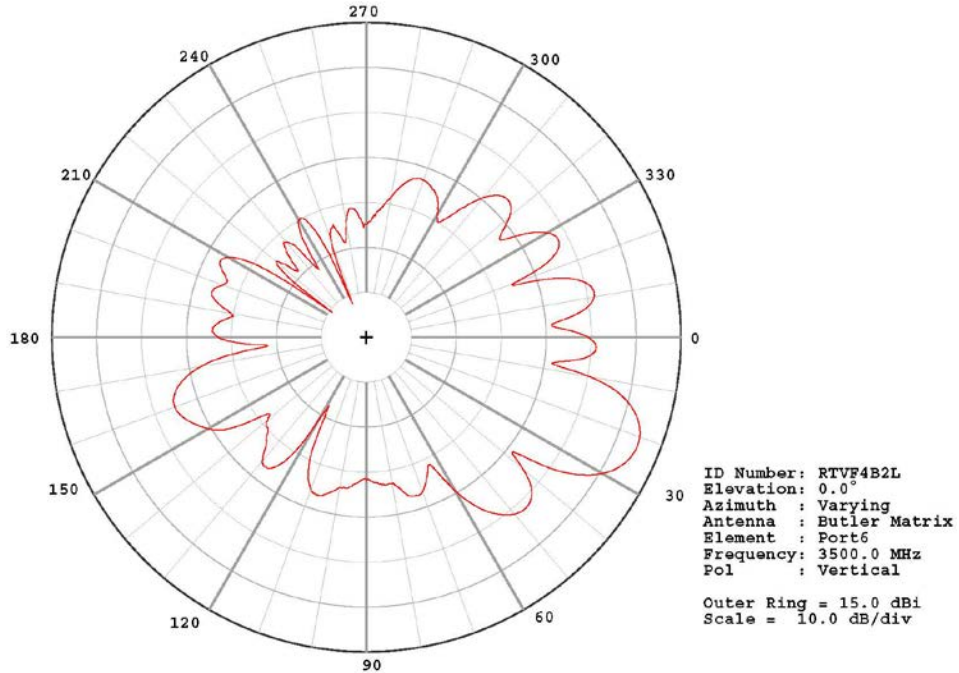

Figure 45: Beam Port 6 / 3500 MHz / Polar Plot.

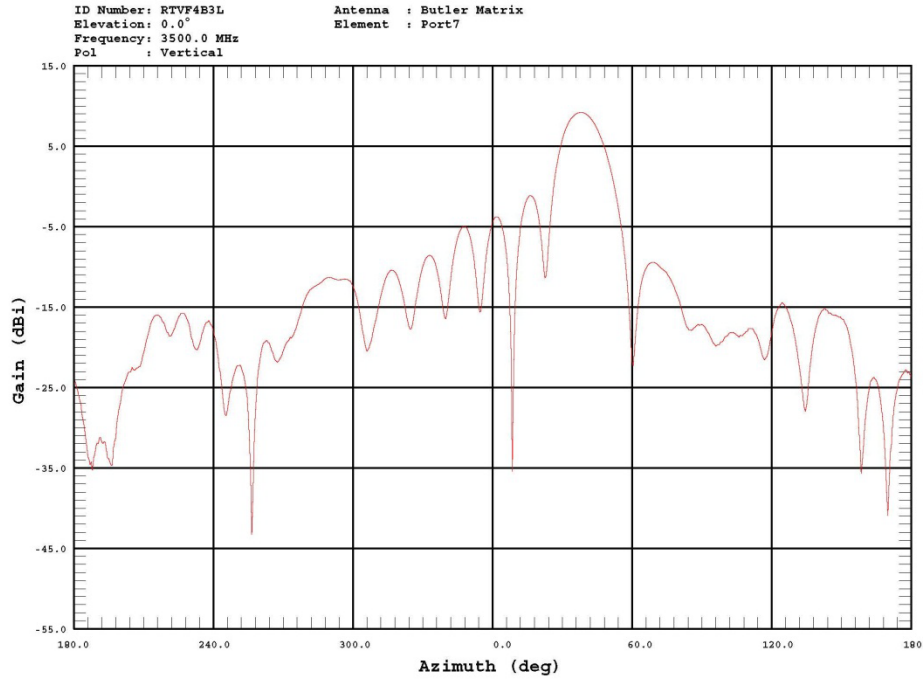

Figure 46: Beam Port 7 / 3500 MHz / Cartesian Plot.

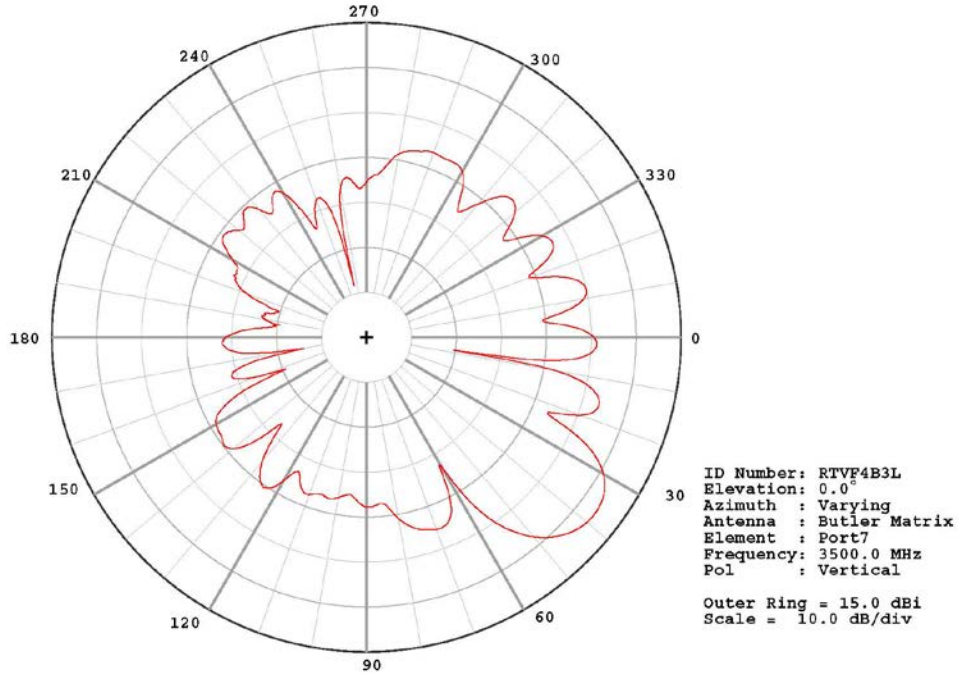

Figure 47: Beam Port 7 / 3500 MHz / Polar Plot.

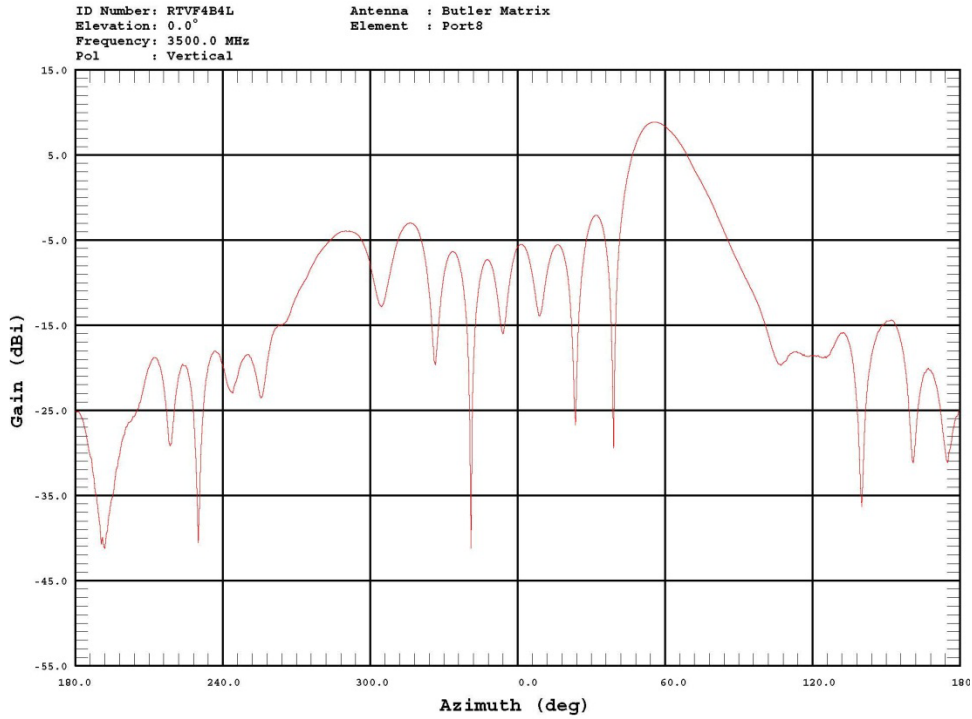

Figure 48: Beam Port 8 / 3500 MHz / Cartesian Plot.

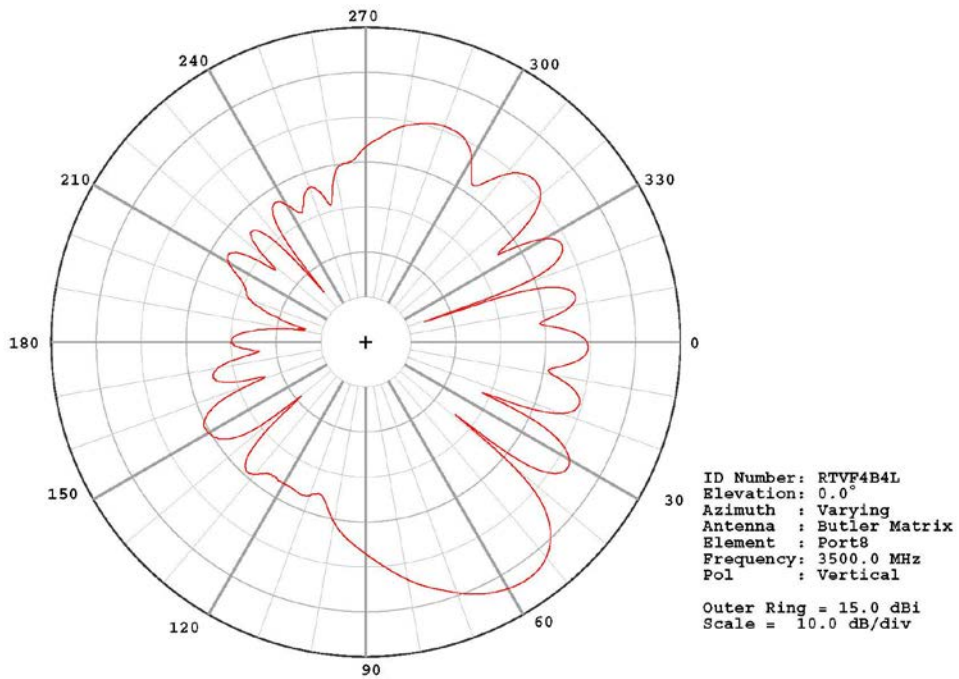

Figure 49: Beam Port 8 / 3500 MHz / Polar Plot.



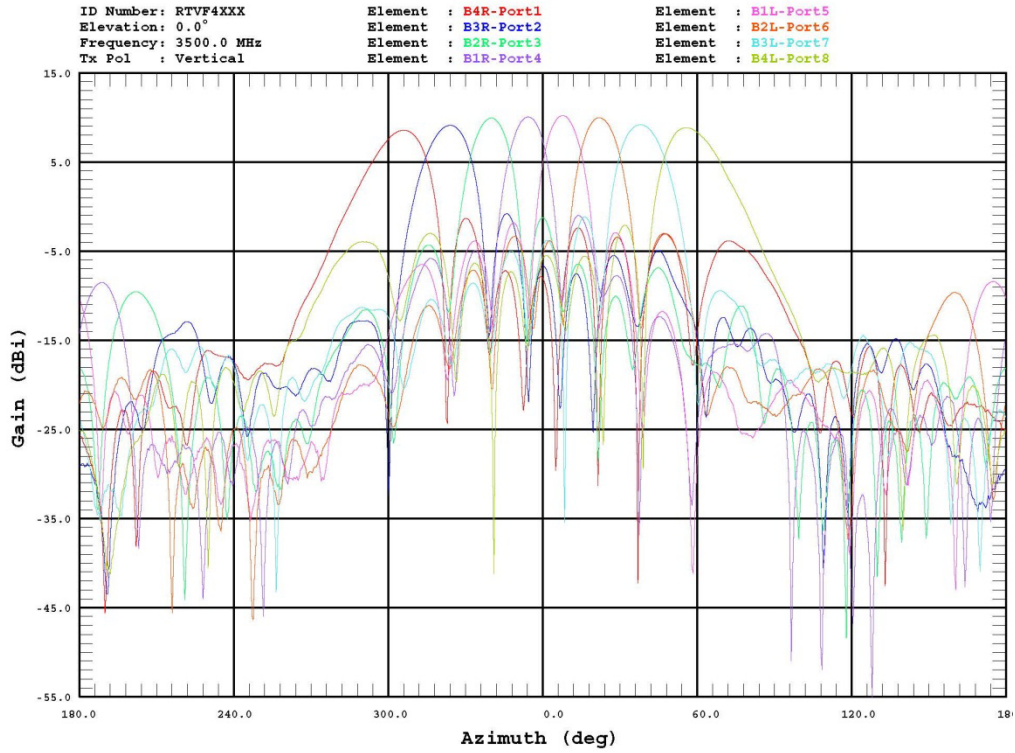

Figure 50: Eight Beam Overlay / 3500 MHz / Cartesian Plot.

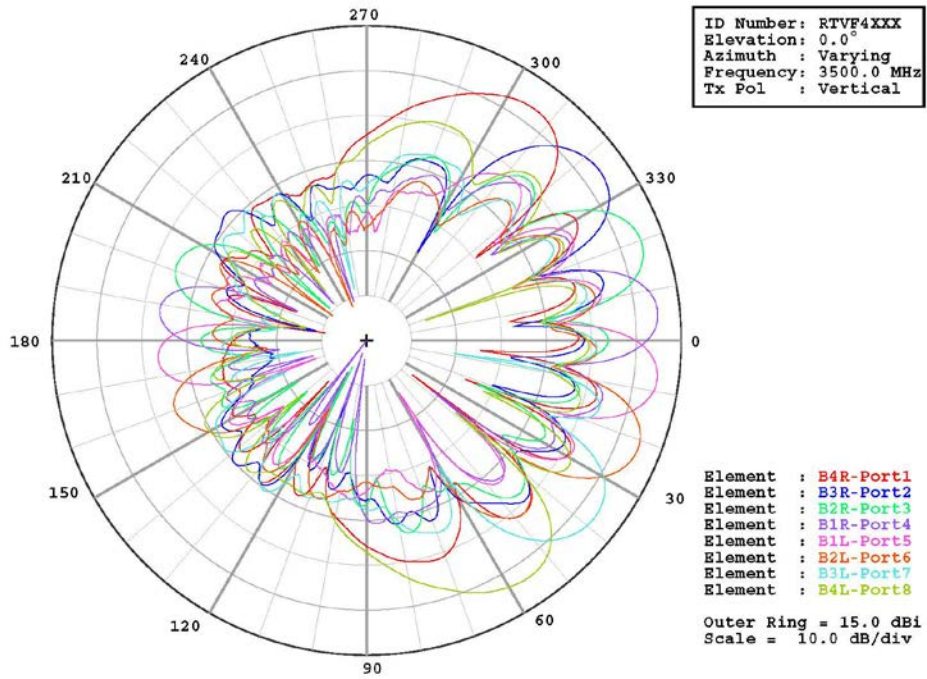

Figure 51: Eight Beam Overlay / 3500 MHz / Polar Plot.

## 4.4 Antenna Patterns Measured at 3600 MHz

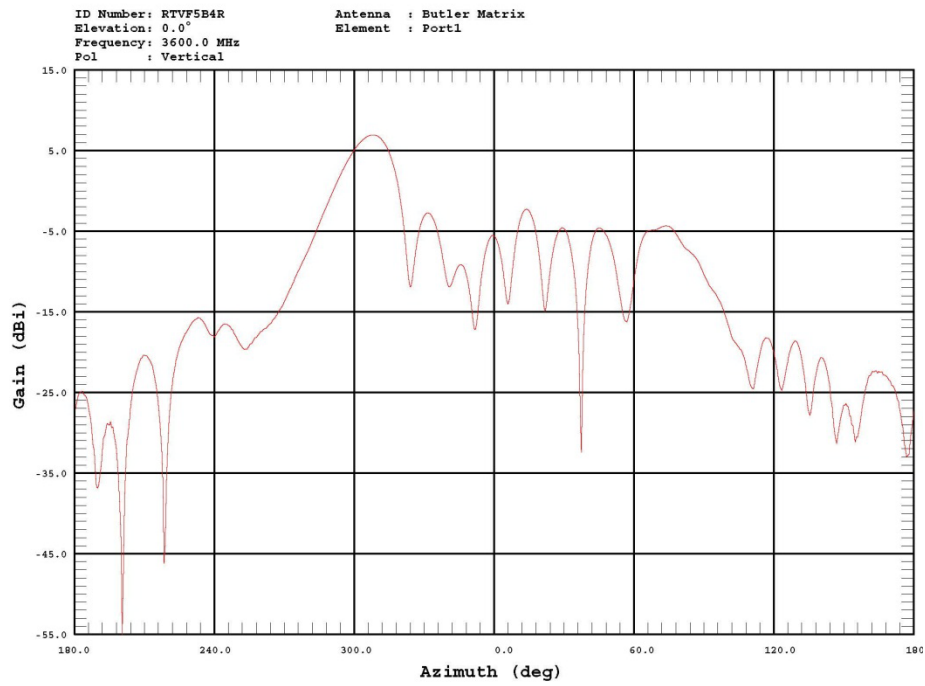

Figure 52: Beam Port 1 / 3600 MHz / Cartesian Plot.

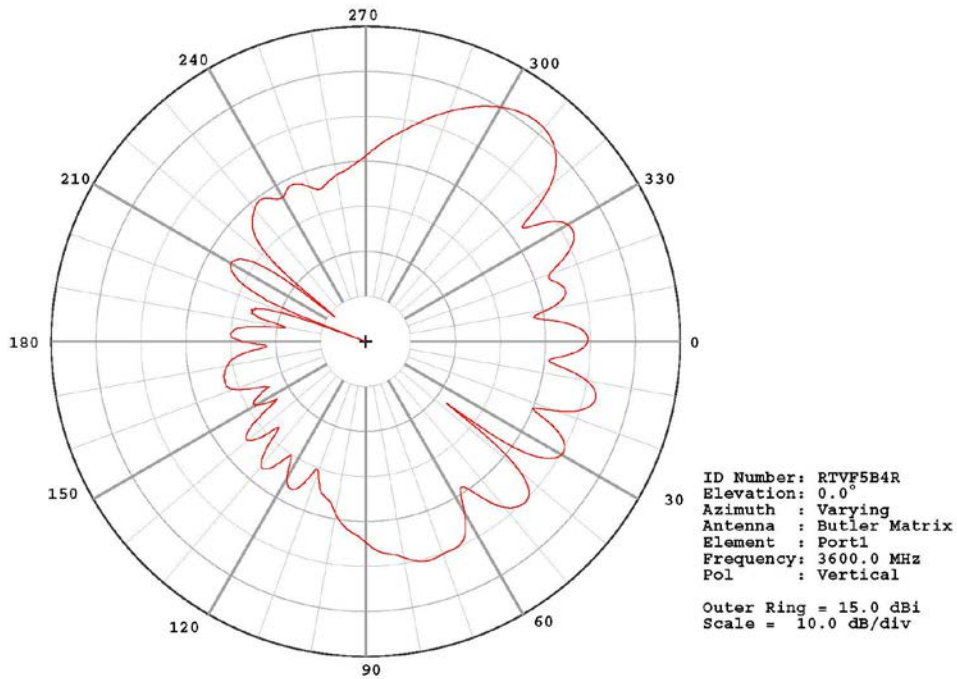

Figure 53: Beam Port 1 / 3600 MHz / Polar Plot.



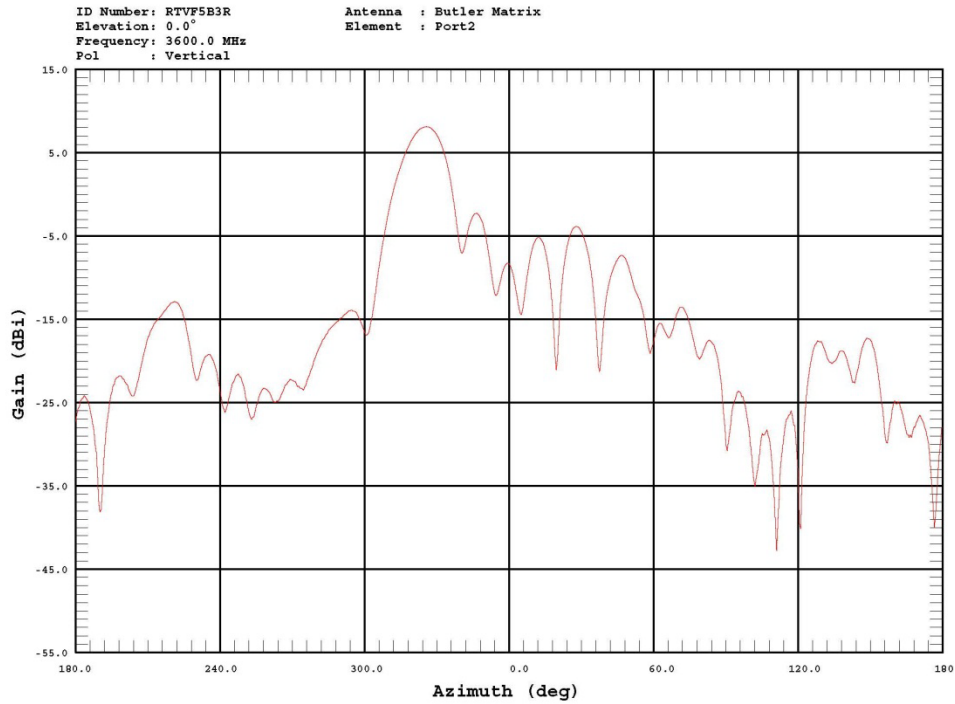

Figure 54: Beam Port 2 / 3600 MHz / Cartesian Plot.

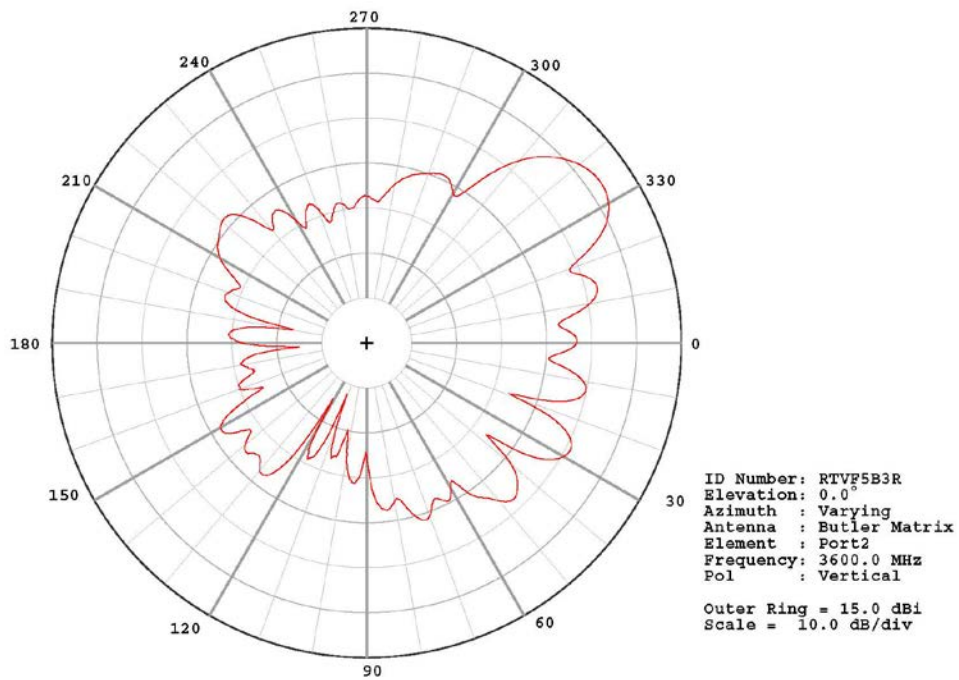

Figure 55: Beam Port 2 / 3600 MHz / Polar Plot.

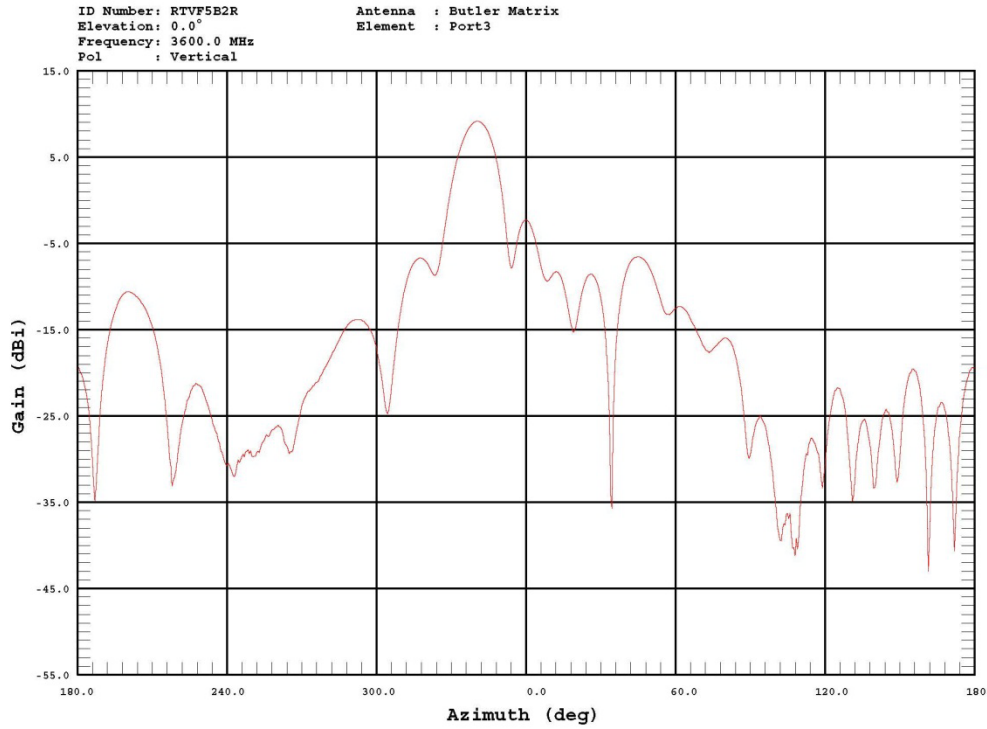

Figure 56: Beam Port 3 / 3600 MHz / Cartesian Plot.

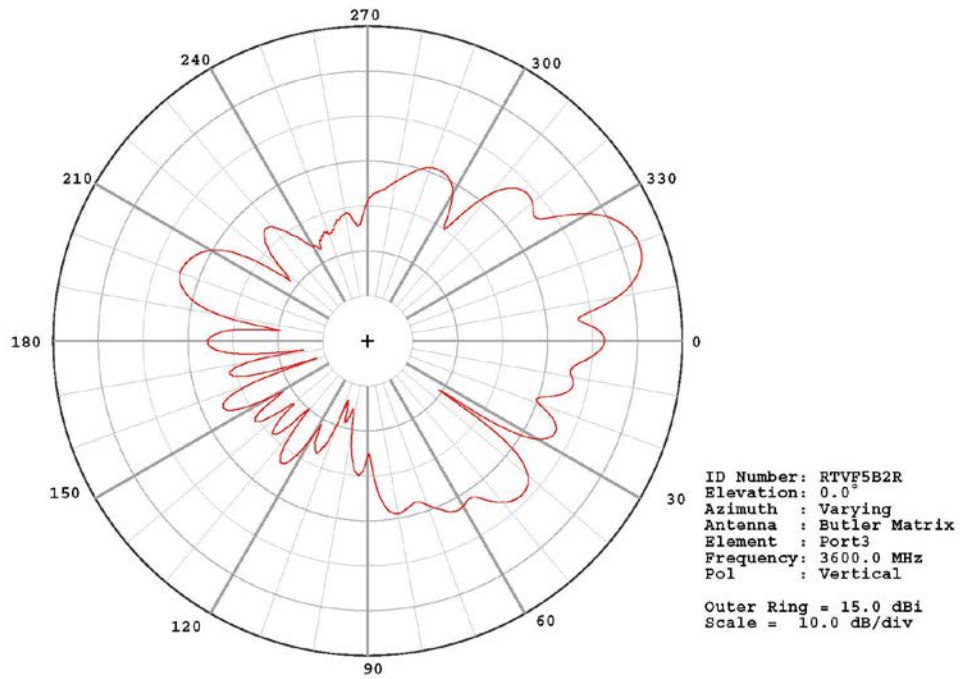

Figure 57: Beam Port 3 / 3600 MHz / Cartesian Plot.

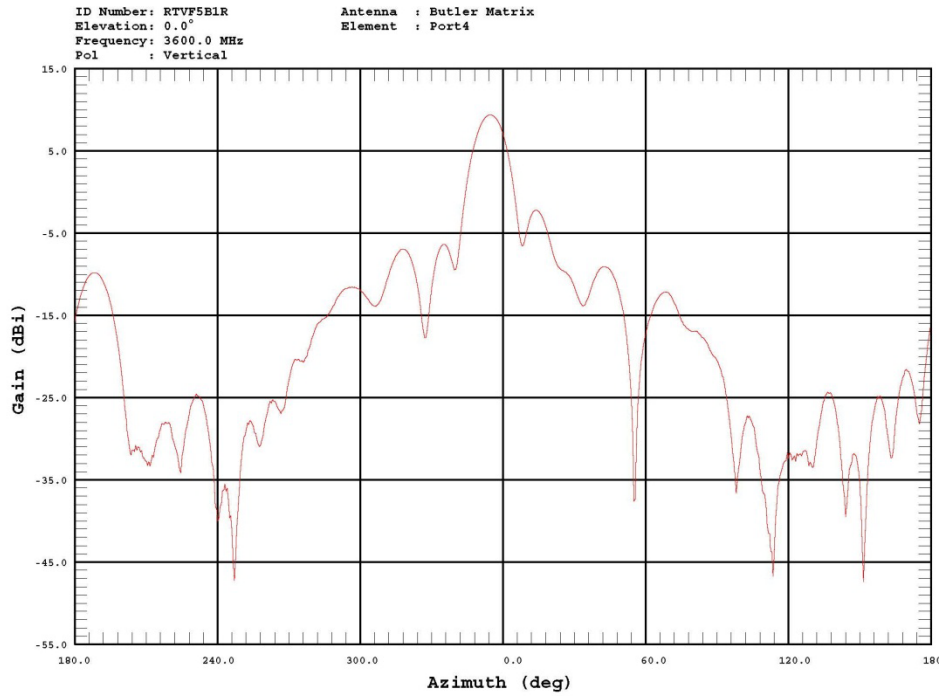

Figure 58: Beam Port 4 / 3600 MHz / Cartesian Plot.

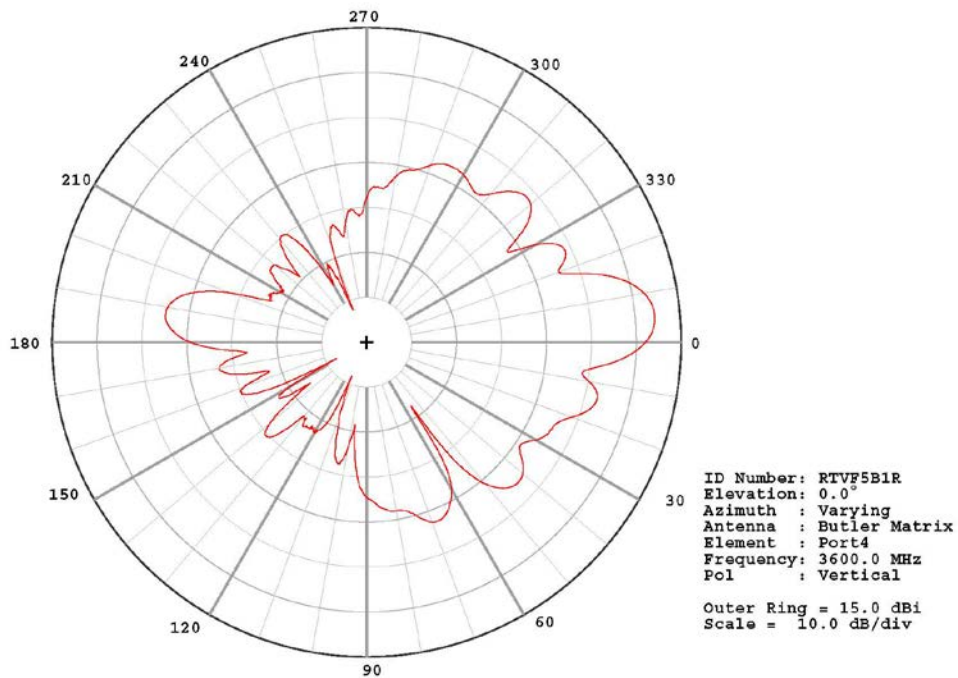

Figure 59: Beam Port 4 / 3600 MHz / Polar Plot.

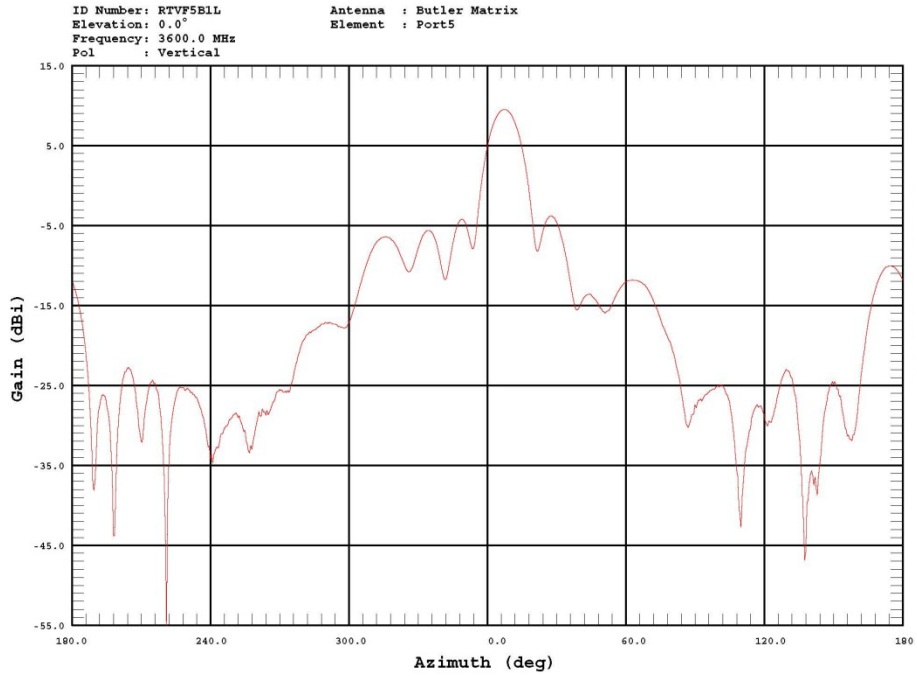

Figure 60: Beam Port 5 / 3600 MHz / Cartesian Plot.

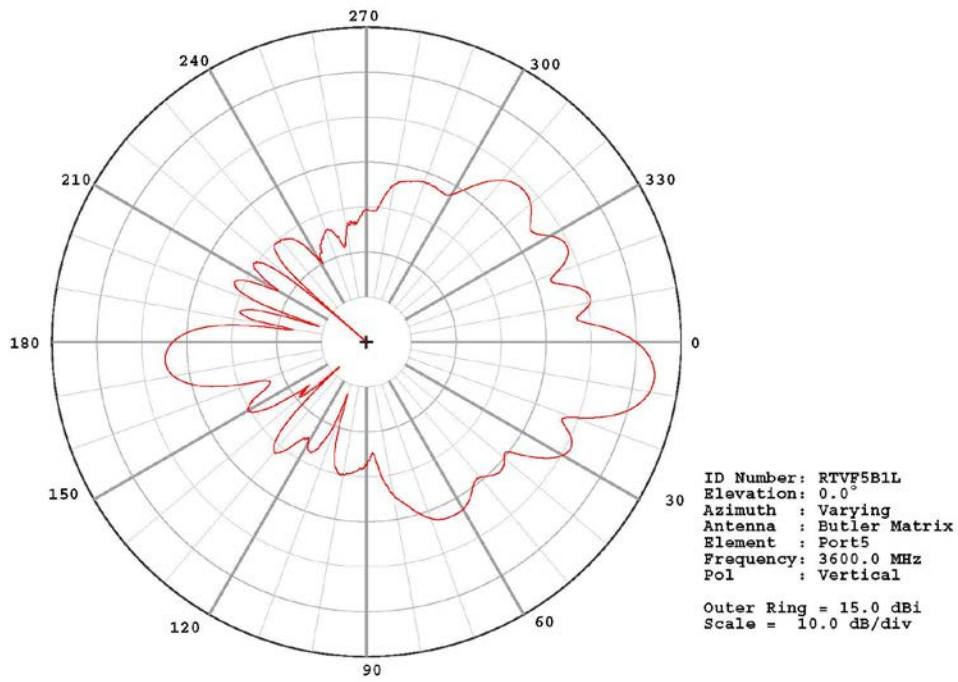

Figure 61: Beam Port 5 / 3600 MHz / Polar Plot.

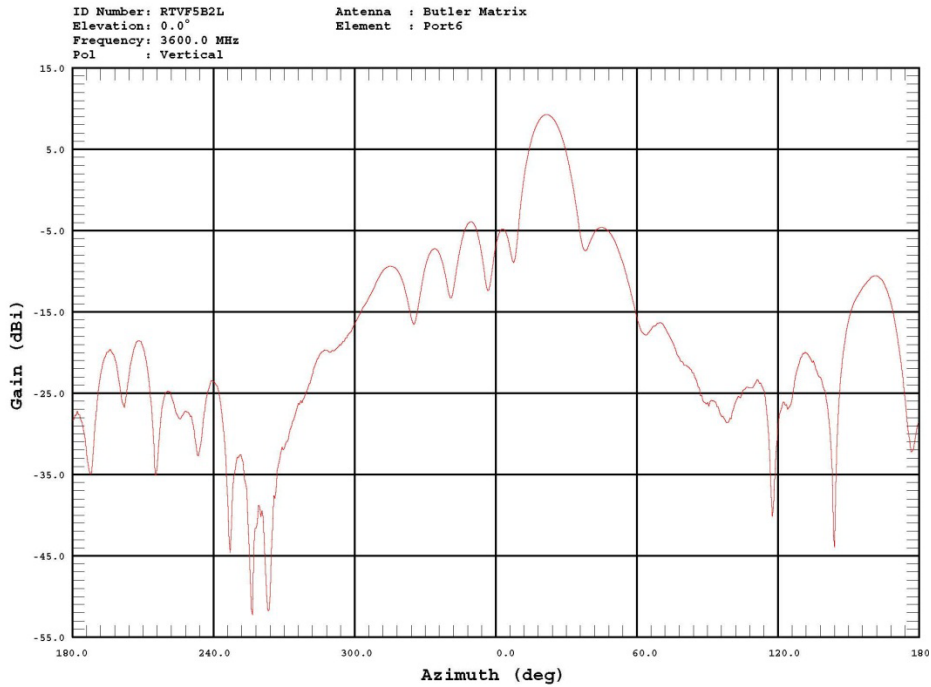

Figure 62: Beam Port 6 / 3600 MHz / Cartesian Plot.

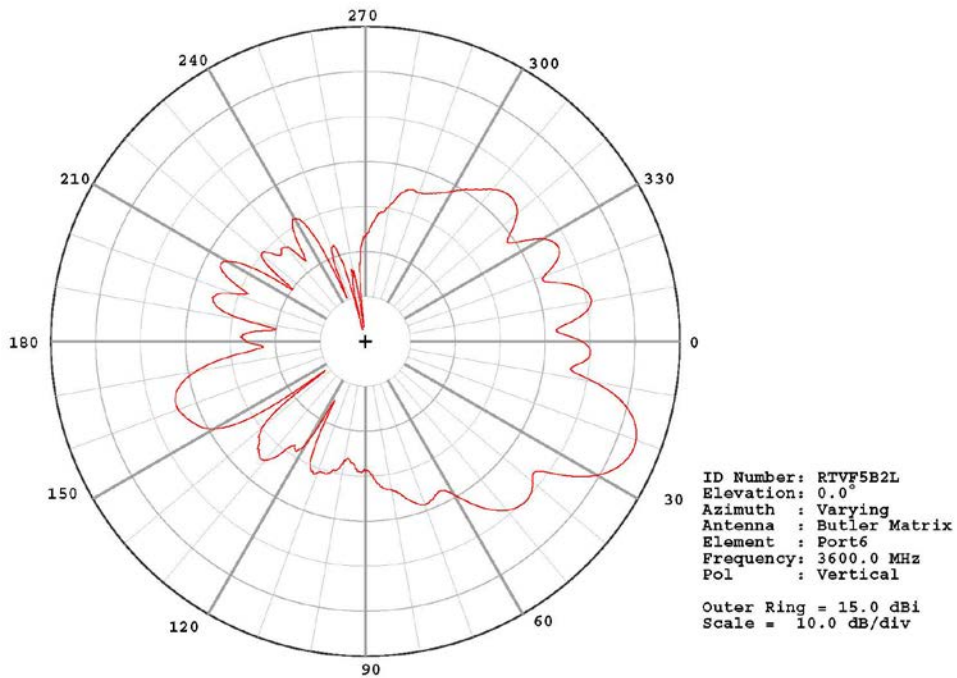

Figure 63: Beam Port 6 / 3600 MHz / Polar Plot.

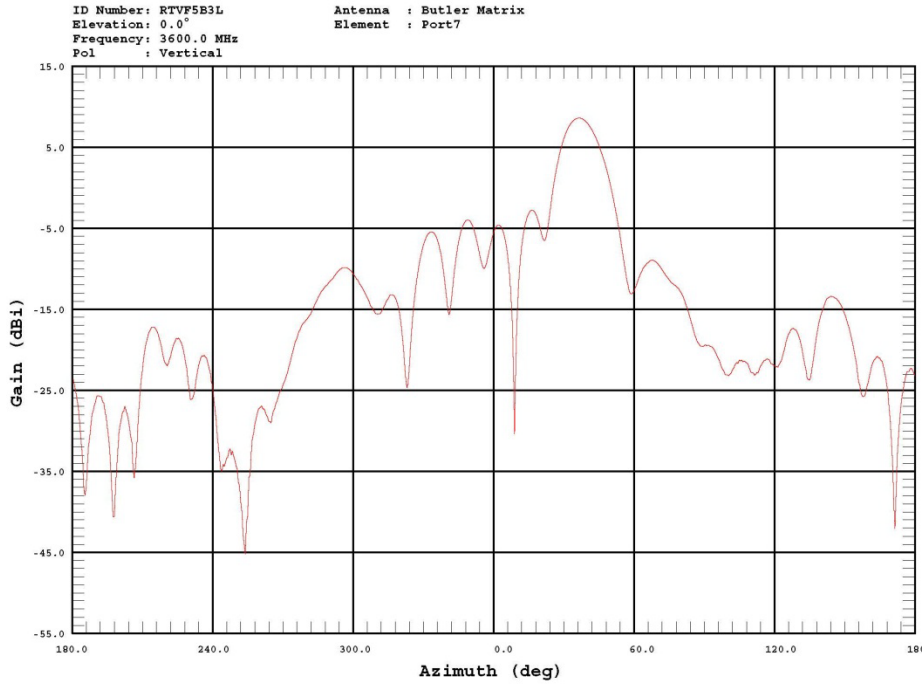

Figure 64: Beam Port 7 / 3600 MHz / Cartesian Plot.

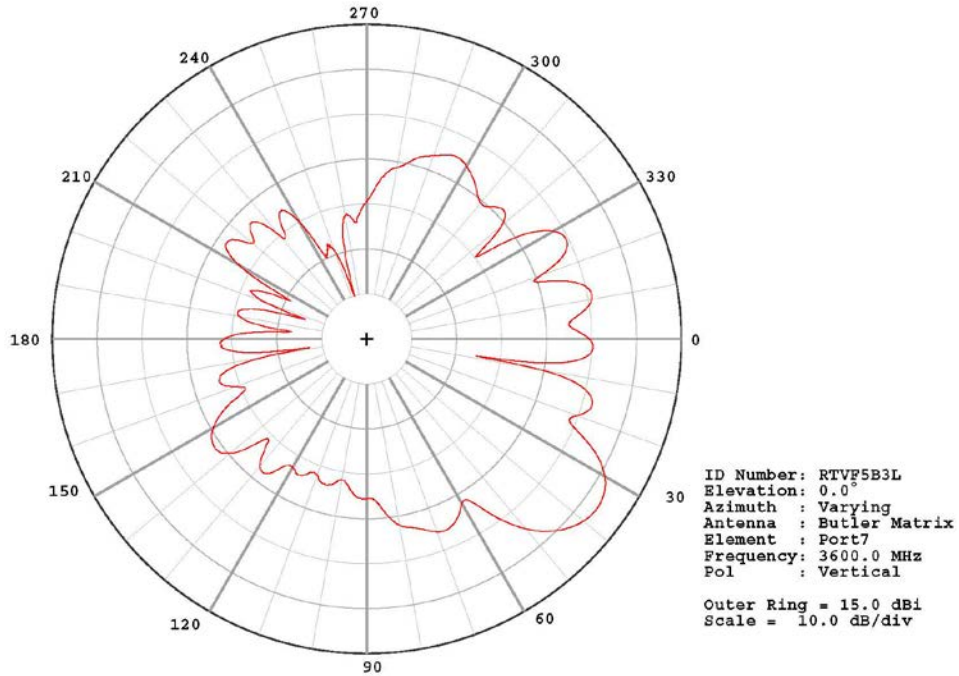

Figure 65: Beam Port 7 / 3600 MHz / Polar Plot.



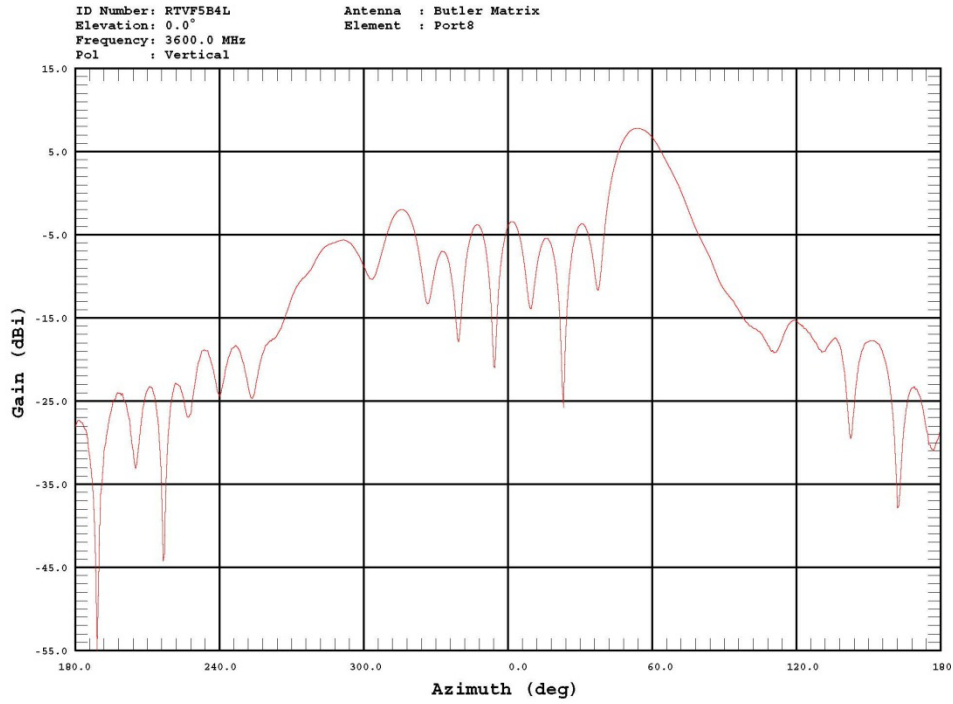

Figure 66: Beam Port 8 / 3600 MHz / Cartesian Plot.

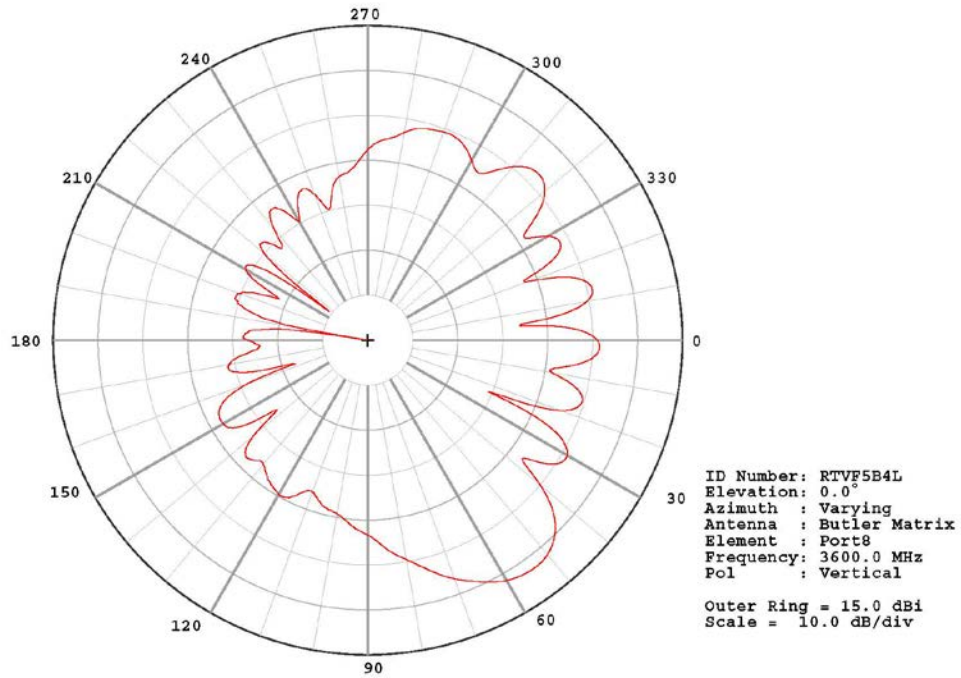

Figure 67: Beam Port 8 / 3600 MHz / Cartesian Plot.

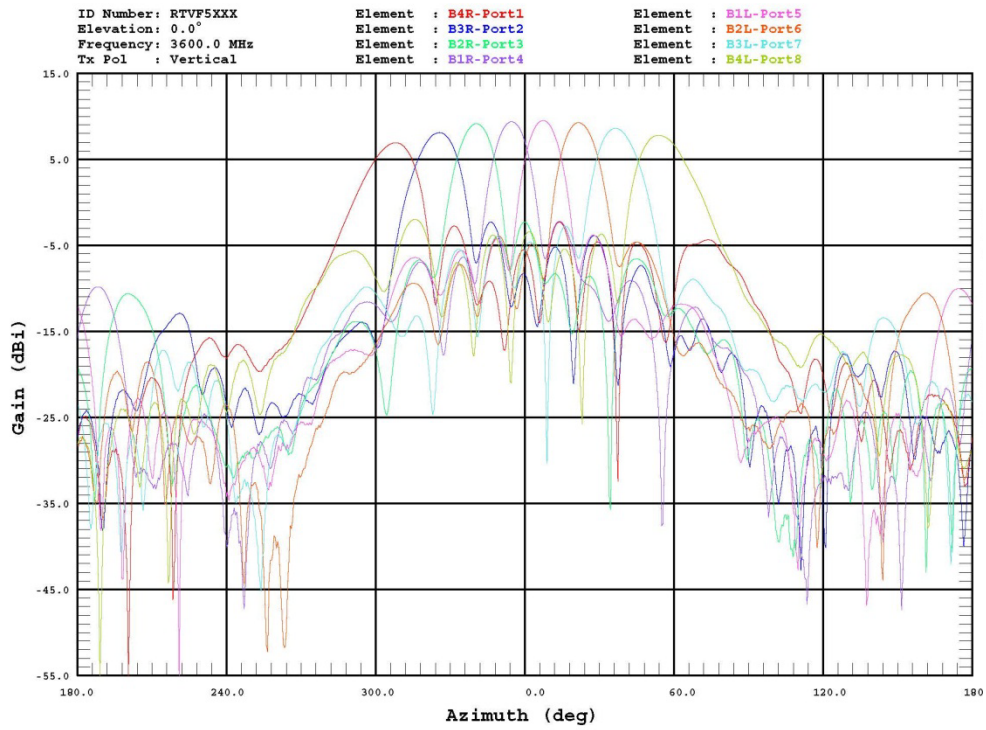

Figure 68: Eight Beam Overlay / 3600 MHz / Cartesian Plot.

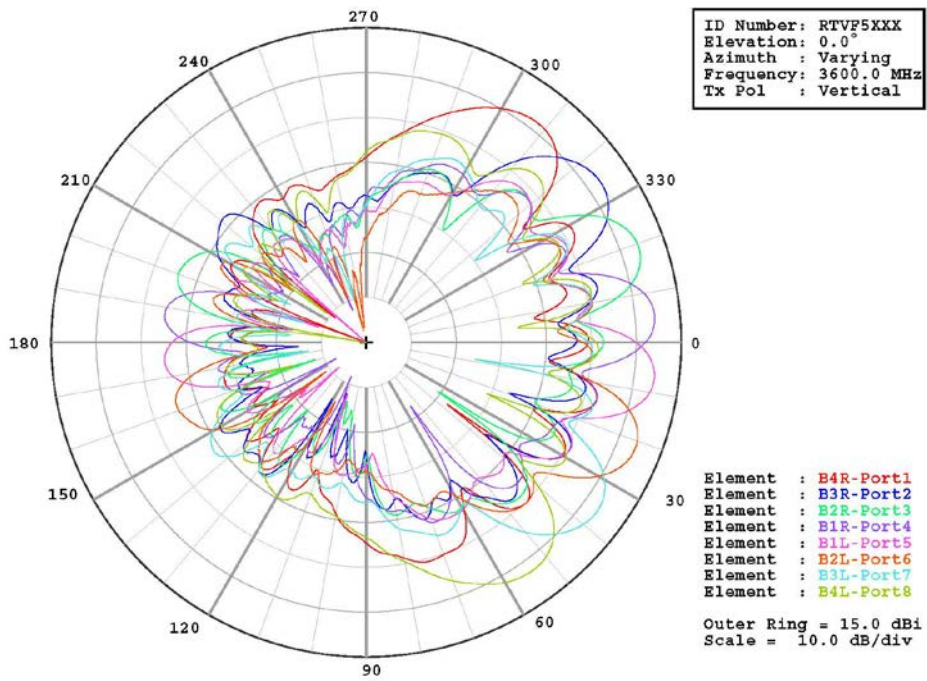

Figure 69: Eight Beam Overlay / 3600 MHz / Polar Plot.



## 5.0 CONCLUSIONS

A small directional antenna array was assembled and characterized for operation between 3400 GHz and 3600 GHZ. The ability to selectively steer the antenna's main lobe to one of eight predetermined angles (-56°, -37°, -22°, -7°, 7°, 22°, -37° and 56° , relative to broadside, or 0°) was demonstrated. Main beam amplitudes were comparable to calculated values. Higher than expected backlobe gain values were measured, however these are quite possibly due the limited size of the aperture ground plane. The ability to switch between beam positions, using the USB-controlled DIO circuit card was verified. Testing with a WNaN radio was not carried out.

## 6.0 RECOMMENDATIONS

### 6.1 Instrument Case Installation

Installing the beaming antenna assembly in a rackmount instrument case would facilitate its use in outdoor experimentation. A typical rackmount configuration is illustrated in Figures 70 and Figure 71. In this instance the antenna and Butler Matrix assembly would be installed in the front section of a standard 4U-high rackmount case, while a circuit-card chassis is installed in the rear section. Figure 72 shows how the unit could be mounted to a tri-pod base.



Figure 70: Instrument Case Antenna Configuration.

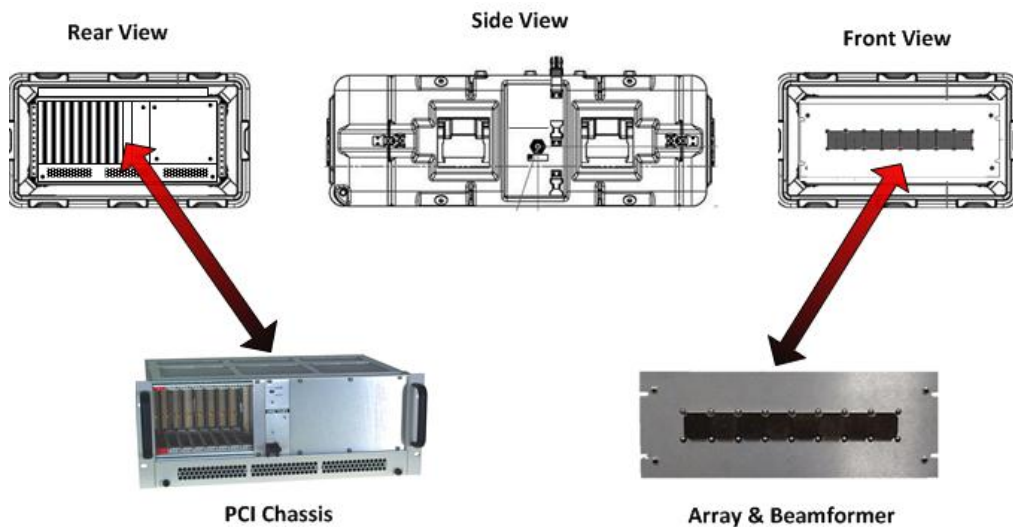

Figure 71: Instrument Case Installation.

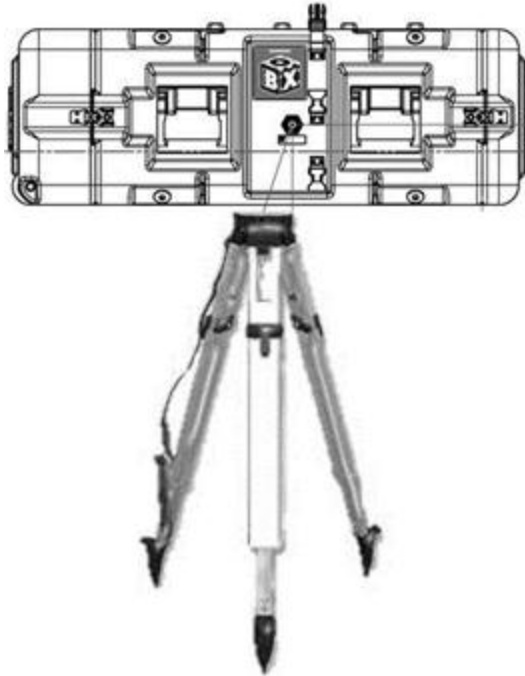

Figure 72: Tri-pod Mounted Field Installation.

## 6.2 Configuration for Radio, Radar and ELINT Operation

While the hardware discussed in this report was originally designed to support (WNaN) radio experiments, with a small amount of effort, the beamforming antenna hardware could be modified to serve as a platform for investigating support joint radio and radar operations. By modifying the transmit waveforms and receive signal-processing tasks, a Software Defined Radio (SDR+) can be made to function as a low-power Software Defined Radar or a narrowband ELINT receiver.

## 7.0 REFERENCES

- [1] G. Li, L. Yang, W. Conner, B. Sadeghi,, “Opportunities and Challenges for Mesh Networks Using Directional Antennas”, in WiMesh Workshop, September 2005.
- [2] J. Redi, and R. Ramanathan, “The DARPA WNaN Network Architecture”, MILCOM 2011.

## 8.0 LIST OF SYMBOLS, ABBREVIATIONS, AND ACRONYMS

DARPA	Defense Advanced Research Projects Agency
DIO	Digital Input/Output
DTN	Disruption Tolerant Networking
ELINT	Electronic Intelligence
IP	Internet Protocol
MHz	Mega-Hertz
RF	Radio Frequency
SDR	Software Defined Radio
SDR+	Software Defined Radio and Radar
USB	Universal Serial Bus
WNAN	Wireless Network after Next