

# Technical Measurement

**A Collaborative Project of PSM, INCOSE, and Industry**

*Technical Report Prepared by*

***Garry J. Roedler, Lockheed Martin***

***Cheryl Jones, US Army***

**27 December 2005**

**Version 1.0**

**INCOSE-TP-2003-020-01**



## Report Documentation Page

*Form Approved*  
*OMB No. 0704-0188*

Public reporting burden for the collection of information is estimated to average 1 hour per response, including the time for reviewing instructions, searching existing data sources, gathering and maintaining the data needed, and completing and reviewing the collection of information. Send comments regarding this burden estimate or any other aspect of this collection of information, including suggestions for reducing this burden, to Washington Headquarters Services, Directorate for Information Operations and Reports, 1215 Jefferson Davis Highway, Suite 1204, Arlington VA 22202-4302. Respondents should be aware that notwithstanding any other provision of law, no person shall be subject to a penalty for failing to comply with a collection of information if it does not display a currently valid OMB control number.

1. REPORT DATE <b>27 DEC 2005</b>	2. REPORT TYPE	3. DATES COVERED <b>00-00-2005 to 00-00-2005</b>			
4. TITLE AND SUBTITLE <b>Technical Measurement</b>		5a. CONTRACT NUMBER			
		5b. GRANT NUMBER			
		5c. PROGRAM ELEMENT NUMBER			
6. AUTHOR(S)		5d. PROJECT NUMBER			
		5e. TASK NUMBER			
		5f. WORK UNIT NUMBER			
7. PERFORMING ORGANIZATION NAME(S) AND ADDRESS(ES) <b>US Army ARDEC, AMSRD-AAR-QEW-D, Building 62, Picatinny Arsenal, NJ, 07806-5000</b>		8. PERFORMING ORGANIZATION REPORT NUMBER			
9. SPONSORING/MONITORING AGENCY NAME(S) AND ADDRESS(ES)		10. SPONSOR/MONITOR'S ACRONYM(S)			
		11. SPONSOR/MONITOR'S REPORT NUMBER(S)			
12. DISTRIBUTION/AVAILABILITY STATEMENT <b>Approved for public release; distribution unlimited</b>					
13. SUPPLEMENTARY NOTES					
14. ABSTRACT					
15. SUBJECT TERMS					
16. SECURITY CLASSIFICATION OF:			17. LIMITATION OF ABSTRACT  <b>Same as Report (SAR)</b>	18. NUMBER OF PAGES  <b>65</b>	19a. NAME OF RESPONSIBLE PERSON
a. REPORT <b>unclassified</b>	b. ABSTRACT <b>unclassified</b>	c. THIS PAGE <b>unclassified</b>			

**This paper is subject to the following copyright restrictions:**

- The PSM Support Center is the sole manager of all PSM products and services and is the only one authorized to modify them. The INCOSE Central Office manages INCOSE products and services and is the only one authorized to modify them. Since this is a collaborative product, modifications are managed through participation of both parties.
- General Use: Permission to reproduce, use this document or parts thereof, and to prepare derivative works from this document is granted, with attribution to PSM , INCOSE and the original author(s), provided this copyright notice is included with all reproductions.
- Supplemental Materials: Additional materials may be added for tailoring or supplemental purposes, if the material developed separately is clearly indicated. A courtesy copy of additional materials shall be forwarded the PSM Support Center, [psm@pica.army.mil](mailto:psm@pica.army.mil). The supplemental materials will remain the property of the author(s) and will not be distributed , but will be coordinated with INCOSE.
- Author Use: Authors have full rights to use their contributions in an unfettered way with credit to the technical source.

## Acknowledgements

In addition to the authors, the following organizations and people were instrumental to the generation of this guidance:

### Organizations:

1. Practical Software and Systems Measurement (PSM)
2. International Council On Systems Engineering (INCOSE)
3. Lockheed Martin Corporation

### Individuals, in addition to the primary authors:

1. John Gaffney, Lockheed Martin
2. John Rieff, Raytheon
3. Ken Stranc, MITRE Corporation

### The following people contributed through providing data or reviews:

- |   |  |
|---|--|
| 1. James Armstrong, Systems and Software Consortium | 23. Mark Kassner, Northrop Grumman                 |
| 2. Erik Aslaksen, Australia                         | 24. William Katzenmeyer, Lockheed Martin           |
| 3. Robert Bardo, Lockheed Martin                    | 25. Ronald Kohl, R. J. Kohl & Associates           |
| 4. Lisa Barhite, Lockheed Martin                    | 26. David R. Lindstrom, Lockheed Martin            |
| 5. Gerald Bauknight, G. C. Bauknight & Associates   | 27. Ralph A. Lurvey, Raytheon                      |
| 6. Robert Beckley, Lockheed Martin                  | 28. Peter Malpass, Federal Aviation Administration |
| 7. Dennis Bielak, Lockheed Martin                   | 29. Robert A. Martin, MITRE Corporation            |
| 8. Nicole Champagne, Lockheed Martin Canada         | 30. Timmie McArthur, Aerospace Corporation         |
| 9. Robert Charette, ITABHI Corporation              | 31. Peter McLoone, Lockheed Martin                 |
| 10. Brenda Coblentz, Department of Energy           | 32. Chris Miller, Systems and Software Consortium  |
| 11. Rita Creel, Aerospace Corporation               | 33. Carl Newman, Lockheed Martin                   |
| 12. Rick Eidson, Lockheed Martin                    | 34. John Noblin, Lockheed Martin                   |
| 13. Douglas Fischer, Lockheed Martin                | 35. Michael Persson, NAVAIR                        |
| 14. Don Gantzer, MITRE Corporation                  | 36. Bruce Powell, Lockheed Martin                  |
| 15. William Golaz, Lockheed Martin                  | 37. Jack Ring, Innovation Management               |
| 16. Francis Haas, Lockheed Martin                   | 38. Jack Samarias, ABN AMRO                        |
| 17. John Hagar, Lockheed Martin                     | 39. Gary Sanders, Sandia National Laboratories     |
| 18. Charles Halligan, Lockheed Martin               | 40. Gary Swanson, Lockheed Martin                  |
| 19. Roger Hildesheim, Lockheed Martin Canada        | 41. Jack Thompson, Lockheed Martin                 |
| 20. Richard Hudson, Lockheed Martin                 | 42. Loren (Mark) Walker, Lockheed Martin           |
| 21. Ray Irvine, Australian DMO                      | 43. K. Williamson, Lockheed Martin                 |
| 22. Scott Jackson, Boeing                           | 44. Richard Wray, Lockheed Martin                  |
|   | 45. JoAnne Zeigler, Lockheed Martin                |

Table of Contents

1 Executive Summary ..... 6

2 Introduction..... 8

    2.1 Background..... 8

    2.2 Objectives ..... 8

    2.3 Organization Of The Guide ..... 8

3 Description Of Technical Measurement And Types Of Technical Measures ..... 9

    3.1 What is Technical Measurement?..... 9

    3.2 What are the Types of Technical Measures? ..... 9

        3.2.1 Measures of Effectiveness (MOEs) ..... 9

        3.2.2 Measures of Performance (MOPs)..... 10

        3.2.3 Technical Performance Measures (TPMs)..... 10

        3.2.4 Key Performance Parameters (KPPs) ..... 11

        3.2.5 Attributes of Technical Measures ..... 12

        3.2.6 Relationship Of MOEs, MOPs, TPMs, and KPPs ..... 14

        3.2.7 Technical Measures and the “V” Model ..... 17

    3.3 Other Terms Relevant to Use of This Guide ..... 18

    3.4 Use and Application Of Technical Measures ..... 19

        3.4.1 Indicators Of Operational Objectives ..... 19

        3.4.2 Indicators Of Technical Solution Progress ..... 19

        3.4.3 Indicators Of Compliance To Performance Requirements..... 19

        3.4.4 Indicators Of Technical Risk ..... 19

4 Measurement Process..... 22

    4.1 The Measurement Process ..... 22

    4.2 Connecting Information Needs to Actual Measures ..... 24

    4.3 Understanding and Using the Measurement Results ..... 25

5 Establishing Commitment For Technical Measurement..... 26

    5.1 General Practice ..... 26

    5.2 Who Are The Stakeholders?..... 26

    5.3 Establishing Joint Objectives Between Acquirer And Supplier ..... 26

6 Planning Technical Measurement..... 28

    6.1 Determining And Prioritizing Information Needs ..... 28

    6.2 Identifying Potential Technical Measures ..... 29

    6.3 Selecting And Specifying Technical Measures ..... 30

        6.3.1 Selecting And Specifying MOEs ..... 30

        6.3.2 Selecting And Specifying MOPs ..... 30

        6.3.3 Selecting TPMs..... 31

        6.3.4 Specifying The TPMs ..... 32

        6.3.5 Technical Measurement Relationship To The WBS ..... 34

        6.3.6 Summary of Selection Guidance ..... 35

    6.4 Integrate Into The Project Processes..... 37

7 Performing Technical Measurement..... 39

    7.1 Collect And Process Data ..... 39

    7.2 Analyze Data..... 39

        7.2.1 General Technical Measurement Analysis ..... 39

        7.2.2 Rigor Of Analysis Techniques..... 41

        7.2.3 Estimation Analysis ..... 42

        7.2.4 Feasibility Analysis..... 42

- 7.2.5 Performance Analysis ..... 43
- 7.2.6 Summary Of Analysis Guidance For Technical Measurement ..... 44
- 7.2.7 Tracking And Providing Status Of Technical Measures ..... 44
- 7.3 Make Recommendations..... 45
  - 7.3.1 General Guidance..... 45
  - 7.3.2 Reporting Analysis Of Alternative Solutions ..... 46
  - 7.3.3 Ongoing Reporting Though The Life Cycle..... 46
- 8 Technical Measurement Checklist..... 48
- 9 Application Of Technical Measurement In Integrated Product Teams (IPTs)..... 50
- 10 Candidate Technical Measures Matrix - Preliminary Draft..... 50
- 11 Technology Readiness Levels..... 54
- 12 Demographics of Questionnaire Respondents ..... 56
  - 12.1 Respondent Demographics ..... 56
  - 12.2 Usage Of MOEs, MOPs, And TPMs ..... 57
- 13 Example of Compatible Set of MOEs, MOPs, and TPMs..... 59
  - 13.1 Overview/Relationships Among MOEs, MOPs, and TPMs..... 59
  - 13.2 Comprehensive Example ..... 60
  - 13.3 Trade-offs and Programmatic Objectives ..... 63
- 14 References..... 64
- 15 Acronyms..... 65

# 1 Executive Summary

This guide provides information on implementing technical measurement on a project. Technical measurement includes Measures of Effectiveness (MOEs), Key Performance Parameters (KPPs), Measures of Performance (MOPs), and/or Technical Performance Measures (TPMs). The following are short definitions of these terms. They are further defined in the Section 3 of this guide.

- MOEs are “operational” measures of success that are closely related to the achievement of mission or operational objectives; i.e., they provide insight into the accomplishment of the mission needs independent of the chosen solution
- MOPs characterize the physical or functional attributes relating to the system operation; i.e., they provide insight into the performance of the specific system
- TPMs measure attributes of a system element within the system to determine how well the system or system element is satisfying specified requirements
- KPPs are a critical subset of the performance parameters representing the most critical capabilities and characteristics

Technical measurement is the set of measurement activities used to provide the supplier and/or acquirer insight into progress in the definition and development of the technical solution, ongoing assessment of the associated risks and issues, and the likelihood of meeting the critical objectives of the acquirer. This insight helps project management make better decisions throughout the life cycle to increase the probability of delivering a technical solution that meets both the specified requirements and the mission needs. The insight is also used in trade-off decisions when performance exceeds the threshold. Technical measurement is planned early in the life cycle and then performed with increasing levels of fidelity as the technical solution is developed.

These technical measures are periodically tracked and reviewed by decision makers throughout the lifecycle to provide insight that enables evaluation and management of technical progress and risks. More specifically, they are used as indicators of the following:

- Insight into likelihood of achieving the operational objectives or capabilities that the acquirer is expecting
- Assessment of technical solution progress towards providing the specified technical solution
- Assessment of how well the technical solution complies with the performance requirements per established plans
- Evaluation of the technical risk as the solution evolves

This guide describes how technical measurement can be applied, using the measurement process described in Practical Software and Systems Measurement. Lessons learned in the areas of establishing commitment, planning, and performing measurement are identified. In addition, candidate technical measures that are commonly used in industry are identified. Figure 1-1 illustrates the relationship between the various types of technical measures.

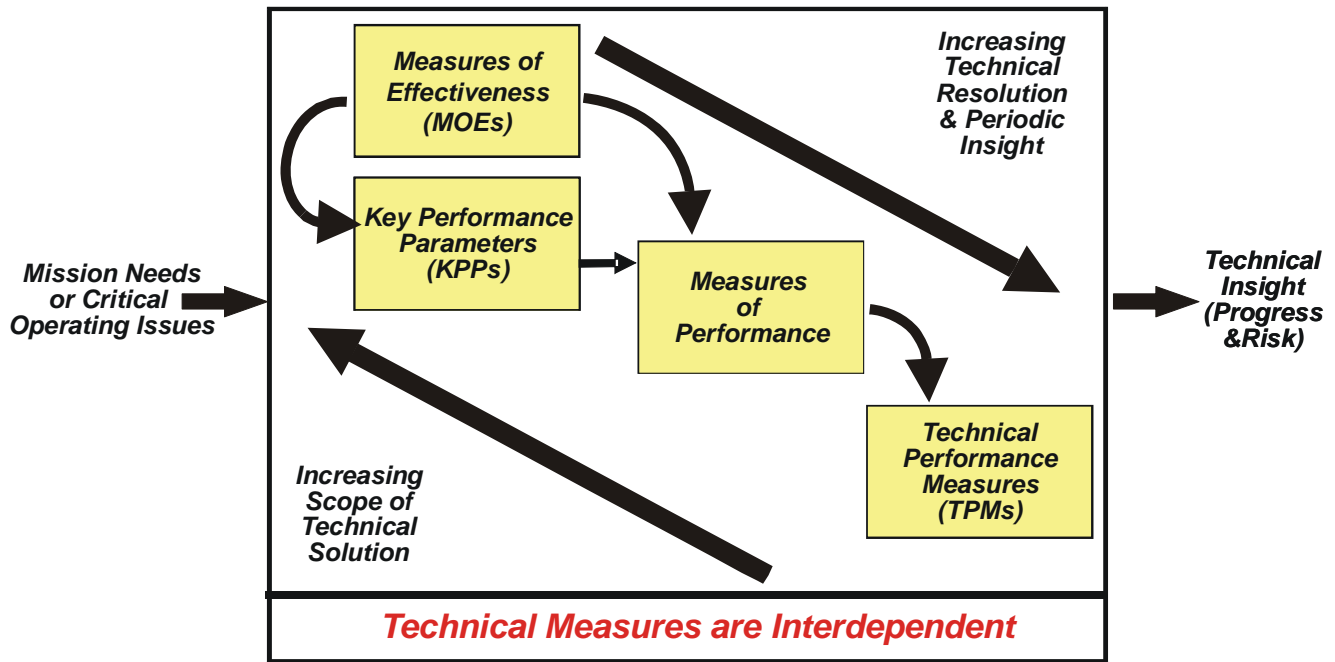

Figure 1-1 Relationship of the Technical Measures

The intended audience for this guide is the acquirer and supplier program and technical management, as well as the technical measurement professionals who must implement technical measurement on their programs. This guidance is intended to provide guidance and lessons learned on implementing technical measurement, as well as sample measures that are commonly used in industry today.

This guidance is the result of a joint project that was conducted between the Practical Software and Systems Measurement (PSM) project, the International Council On Systems Engineering (INCOSE), and various companies including Lockheed Martin. All information is intended to reflect actual proven practice. Thus, a major source of information for this guide was the set of responses to a questionnaire distributed to a broad portion of the systems engineering community.



## 2 Introduction

### 2.1 Background

This guidance is the result of a joint project that was conducted between the Practical Software and Systems Measurement (PSM) project office, the International Council On Systems Engineering (INCOSE), and various companies. It captures an industry proven method to accomplish technical measurement. The project was an outgrowth of joint workshops between PSM and INCOSE during the past few years and some internal work by Lockheed Martin. The approach for the project was to leverage existing measurement guidance and implementation materials to avoid repeating basic measurement guidance or re-inventing the wheel. In addition to leveraging the literature currently available on this subject, this project had an objective to identify what methods are being used across industry. This was done through the administration of questionnaires to a broad range of engineers. More information on the demographics of questionnaire respondents is provided in section 12. This questionnaire provides confirmation of the usage of technical measurement that is described in this guide.

### 2.2 Objectives

The objectives of the Technical Measurement Guide are to create guidance on technical measurement that:

- Establishes guidance that reflects state-of-the-practice in industry
- Establishes lessons learned across industry - i.e., what are the proven methods
- Provides a consistent approach to technical measurement for projects
- Establishes a list of commonly used measures

### 2.3 Organization Of The Guide

Section 3 presents the definitions of the technical measurement terms that are commonly used in government or industry and a general description of their application. A major source of information for this guide was the responses to a questionnaire distributed to a broad portion of the systems engineering community. The basic measurement process defined in PSM is the basis of the measurement process for this guide. Information on the PSM measurement process can be found at <http://www.psmc.com>. This guide will provide tailoring guidance for application to technical measurement in sections 5, 6, and 7. Section 5 discusses the establishment of the commitment needed for technical measurement, Section 6 discusses planning the technical measurement, and Section 7 discusses performing the technical measurement. The remaining sections of the guide include additional information to assist the planning and implementation of the technical measurement. Section 8 contains a TPM checklist, Section 9 discusses implementation for Integrated Product Teams (IPTs), Section 10 contains a matrix of some candidate technical measures, and Section 11 discusses the use of technology readiness levels. The demographics of the survey respondents are provided in section 12. Section 13 provides a comprehensive example that explains the relationships among MOEs, MOPs, and TPMs. Section 14 contains a list of references that are relevant to this guide and Section 15 includes a list of Acronyms.

## 3 Description Of Technical Measurement And Types Of Technical Measures

### 3.1 What is Technical Measurement?

Technical measurement is the set of measurement activities used to provide the supplier and/or acquirer insight into progress in the definition and development of the technical solution and the associated risks and issues. This insight helps project management make better decisions throughout the life cycle to increase the probability of delivering a technical solution that meets both the specified requirements and the mission needs. The insight is also used in trade-off decisions when performance exceeds the threshold. Technical measurement is planned early in the life cycle and then performed with increasing levels of fidelity as the technical solution is developed.

### 3.2 What are the Types of Technical Measures?

This section defines and describes the types of technical measures that are commonly used in government and industry for insight into the performance of the technical solution. Although they may not be used universally, they were found to be used widely by questionnaire respondents. Measurement definitions are derived from leading sources to provide a clear and comprehensive set of definitions.

#### 3.2.1 Measures of Effectiveness (MOEs)

*Definition:* The “operational” measures of success that are closely related to the achievement of the mission or operational objective being evaluated, in the intended operational environment under a specified set of conditions; i.e., how well the solution achieves the intended purpose. (Adapted from DoD 5000.2, DAU, and INCOSE)

MOEs, which are stated from the acquirer (customer/user) viewpoint, are the acquirer’s key indicators of achieving the mission needs for performance, suitability, and affordability across the life cycle. Although they are independent of any particular solution, MOEs are the overall operational success criteria (e.g., mission performance, safety, operability, operational availability, etc.) to be used by the acquirer for the delivered system, services, and/or processes.

MOEs focus on the system’s capability to achieve mission success within the total operational environment. MOEs represent the acquirer’s most important evaluation and acceptance criteria against which the quality of a solution is assessed. They are specific properties that any alternative technical solution must exhibit to be acceptable to the acquirer (i.e., the Standard of Acceptance). In addition to using MOEs to compare and evaluate alternatives, they can also be used for sensitivity analysis of performance from variations of key assumptions and parameters of the potential alternatives. They are also important for test and evaluation because they determine how test results will be judged. Since test planning is directed toward obtaining these measures, it is important that they be defined early.

MOEs are used to:

- Compare operational alternatives
- Investigate performance sensitivities to changes in assumptions from the user’s view

- Define operational requirement values
- Evaluate achievement of key operational performance
- Serve as the Standard of Acceptance for the technical solution

### 3.2.2 Measures of Performance (MOPs)

**Definition:** The measures that characterize physical or functional attributes relating to the system operation, measured or estimated under specified testing and/or operational environment conditions. (Adapted from DoD 5000.2, DAU, INCOSE, and EPI 280-04, LM Integrated Measurement Guidebook)

MOPs measure attributes considered as important to ensure that the system has the capability to achieve operational objectives. MOPs are used to assess whether the system meets design or performance requirements that are necessary to satisfy the Measures of Effectiveness (MOEs). MOPs should be derived from or provide insight for MOEs or other user needs. The relationship between MOEs and MOPs is illustrated in section 3.2.6. MOPs are derived from the supplier's viewpoint and look at how well the delivered system performs or is expected to perform against system level requirements. They address an aspect of the system performance or capability. MOPs often map to Key Performance Parameters (KPPs) or requirements in the system specification. They are expressed in terms of distinctly quantifiable performance features, such as speed, payload, range, or frequency. They are progressively monitored and used during project execution as input to management, including as indicators to aid managing technical risks.

MOPs are used to:

- Compare alternatives to quantify technical or performance requirements as derived from MOEs
  - Support assessment of system design alternatives
  - Support assessment of technical impact of proposed system change alternatives
- Investigate performance sensitivities to changes in assumptions from the technical view
- Refine KPP definitions
- Assess achievement KPPs

This guide treats Measures of Suitability (MOS), as a type of MOP and thus has not included separate guidance. The MOS specifically measures the extent to which the technical solution will integrate into the operational environment. As such, they are often focused on the usability and interoperability aspects of the system, but may also include other quality factors. In some cases, it may be necessary to define and track MOSs separately from the MOPs.

### 3.2.3 Technical Performance Measures (TPMs)

**Definition:** TPMs measure attributes of a system element to determine how well a system or system element is satisfying or expected to satisfy a technical requirement or goal.

These measures are used to assess design progress, compliance to performance requirements, or technical risks. TPMs are derived from or provide insight for the MOPs focusing on the critical technical parameters of specific architectural elements of the system as it is designed and implemented. The relationship between TPMs and MOPs is illustrated in section 3.2.6.

Selection of TPMs should be limited to critical technical thresholds or parameters that, if not met, put the project at cost, schedule, or performance risk. The TPMs are not a full listing of the requirements of the system or system element.

TPMs include the projected performance, such as a performance profile with tolerance bands of acceptable variance. Performance of the system or system element is tracked through the life cycle and compared to the projected and required values. Early in the life cycle the performance values may be estimated, based on simulation and modeling. As the life cycle proceeds, actual data replaces estimates and adds to the fidelity of the information. This measurement of the design solution as it evolves allows action to be taken early in the process, rather than wait until system testing to address performance problems. TPMs enable an assessment of the product design by estimating the values of key performance parameters of the design through engineering analyses and tests. Analysis of these measures provides risk indicators for key performance parameters.

TPMs can include, but are not limited to, range, accuracy, weight, size, power output, timing (throughput, response time, processing time, etc.), security requirements, and the product quality characteristics related to critical operational requirements (reliability figure of merit, failure rate, mean time to failure/repair/restore, availability, fault tolerance, etc.). A matrix of some candidate measures is provided in Table 10-1.

TPMs are used to:

- Forecast the values to be achieved for key performance parameters
- Identify differences between actual versus planned performance
- Assess and predict progress towards achieving the key performance parameters
- Determine the impact of differences between actual and planned performance on system effectiveness
- Provide early identification of risks and detection or prediction of problems requiring management attention (e.g., where negative margins exist)
- Determine where opportunities exist to make design trades to reduce overall risk (e.g., where positive margins exist)
- Early determination of where critical requirement flowdown to the next level of design is inadequate
- Support assessment of system element design alternatives or impacts of proposed change alternatives
- Monitors incorporation and results of new critical technologies

### 3.2.4 Key Performance Parameters (KPPs)

**Definition:** A critical subset of the performance parameters representing those capabilities and characteristics so significant that failure to meet the threshold value of performance can be cause for the concept or system selected to be reevaluated or the project to be reassessed or terminated. (Adapted from Glossary of Defense Acquisition Acronyms and Terms, Defense Acquisition University Press, January 2001)

Each KPP has a threshold and objective value. KPPs are the minimum number of performance parameters needed to characterize the major drivers of operational performance, supportability, and interoperability. The KPPs represent the critical performance requirements (that are a part of

the Critical To Customer (CTC) requirements) and collectively characterize the overall performance in summary form. They allow the stakeholders to evaluate architectural and top-level design decisions against what is considered to be most important.

The acquirer (or designee) defines the KPPs at the time the operational concepts and requirements are defined. Some of the MOPs are usually selected to provide insight into the achievement of KPPs.

The following questions may be useful in determining whether a parameter should be a KPP:

- Is it essential for defining the required capabilities?
- Does it contribute to significant improvement in the operational capabilities of the enterprise?
- Is it achievable and affordable?
- Is it measurable and testable/verifiable?
- Is the attribute reflected by the KPP able to be analyzed throughout the life cycle?
- If not met, will the sponsor of the project be willing to cancel or significantly restructure the project?

Often the acquiring organization has defined mandatory KPPs to be used in specific situations. Some of those are provided here:

- Interoperability and supportability are often required or recommended as a KPPs for information technology systems, which includes any equipment or interconnected system or subsystem of equipment, that is used in the automatic acquisition, storage, manipulation, management, movement, control, display, switching, interchange, transmission, or reception of data or information.
- DoD requires a Net-Ready KPP for all information technology and national security systems that are used to enter, process, store, display, or transmit DoD information and interface with external systems. The Net-Ready KPP must be specified to allow evaluation of interoperability and supportability throughout the system's life.
- Reliability is required to be assessed as a potential KPP in some branches of DoD, since it has been shown to have a significant impact on mission effectiveness, logistics effectiveness, and life cycle costs.
- Force protection and survivability are required KPPs when a manned system or system designed to enhance personnel survivability may be employed in an asymmetric threat environment.
- Cost may also be considered a KPP.

### 3.2.5 Attributes of Technical Measures<sup>1</sup>

Technical Measurement is the continuing verification of the degree of anticipated and actual achievement of technical parameters. Measured values that fall outside established decision criteria (tolerance bands) alert management to take action or perform further investigation. Relevant terms and relationships are defined below and illustrated in Figure 3-1. In many cases, the terms are specific applications of concepts or terms in PSM. In those instances, the relationship to the PSM term or concept is identified in parentheses to aid using the PSM measurement specification template to define the technical measures.

---

<sup>1</sup> This section is derived from the INCOSE Systems Engineering Handbook, Version 2, section 4.2.6, the DSMC Teaching Note, "Technical Performance Measurement", Robert Lightsey, October 1997, and the PSM Measurement Specification Template.

- a. **Achieved-to-Date.** Measured technical progress or estimate of progress plotted and compared with the planned progress at designated milestone dates. Early on, achieved-to-date progress may be estimated through modeling & simulation or analysis. *This measure, also known as the current actual, is usually a base measure, describing a single attribute that is obtained directly by a specified measurement method.*
- b. **Current Estimate.** The value of a technical parameter that is predicted to be achieved with existing resources by the End of Contract (EOC). *The 'Current Estimate' will generally be a derived measure that is calculated based on multiple values of the 'Achieved-to-Date' measure through some specified function.*
- c. **Milestone.** Point in time when an evaluation of a measure is accomplished. Typically, evaluations are made to support management and technical reviews, during significant test events, and may also occur at cost reporting intervals.
- d. **Planned Value (Target).** Predicted value of the technical parameter for the time of measurement based on the planned profile.
- e. **Planned Performance Profile (Analysis Model).** Profile representing the projected time-phased demonstration of a technical parameter requirement. It describes the underlying model of expected behavior of the measures over time.
- f. **Tolerance Band (Decision Criteria).** Management alert limits placed on each side of the planned profile to indicate the envelope or degree of variation allowed. The criteria are used to trigger action or further investigation. Tolerance bands are an acknowledgement of estimating error and reflect acceptable risk limits associated with achieving the performance measured by the TPM.
- g. **Threshold.** The limiting acceptable value of a technical parameter; usually a contractual performance requirement.
- h. **Variance(s).** Two variances are essential. These are derived measures as follows:
  1. Demonstrated Technical Variance – the difference between the 'Planned Value' and the 'Achieved-to-Date' (or demonstrated/measured) value at a specific point in time.
  2. Predicted Technical Variance – the difference between the 'Planned Value' at EOC and the 'Current Estimate' of the parameter.

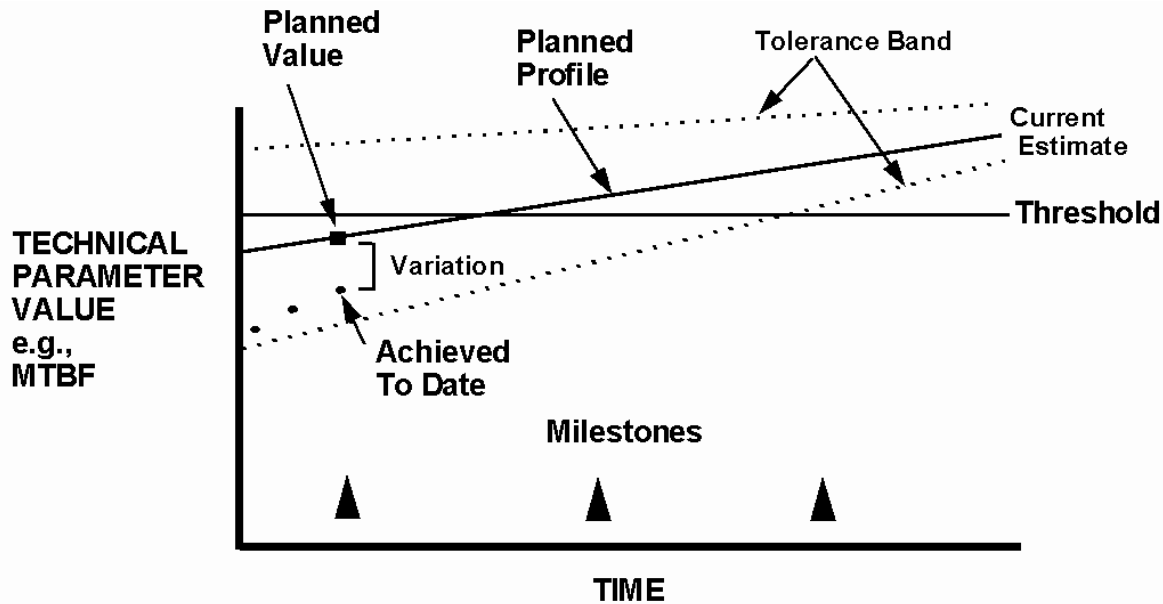

Figure 3-1 Technical Measurement Profile Illustration

### 3.2.6 Relationship Of MOEs, MOPs, TPMs, and KPPs

“The distinction between ‘effectiveness’ and ‘performance’ shows that MOEs and MOPs are formulated from different viewpoints. An MOE refers to the effectiveness of a solution and is independent of any particular solution; an MOP refers to the actual performance of an entity [selected solution]. The MOE refers to the stakeholders’ intention, whereas the MOP is concerned with actual performance [of the supplier’s solution], which may be quite divorced from the stakeholders’ intentions. An MOE will indicate a property which a potential solution must possess in order to meet a need: an MOP will tell what something is capable of doing even if this is not necessarily what the stakeholders want it to do.”<sup>2</sup> Thus, an MOE can be used to validate that the system meets the users' intended needs, and an MOP can be used to verify the system meets the users' stated requirements. This in turn enables the requirements to be validated to meet the users' intended needs. See section 3.2.7 for further details.

“The difference between ‘effectiveness’ and ‘performance’ as applied to a solution [for a given] need is that ‘effectiveness’ is a quality of fitness for service or of producing the results for which it was intended. ‘Performance’ is the quality of ‘doing something’, and ‘doing something’ does not necessarily indicate fitness for service.”<sup>2</sup>

After the solution alternative has been selected, the TPMs then provide a lower level view of specific aspects of the performance of the solution. The lower level measures (MOPs and TPMs) should be defined with the higher level measures (MOEs and MOPs) in mind in order to ensure the measures can be aggregated to provide the necessary insight for system and operational decisions.

Figure 3-2 illustrates the relationship between these technical measures and KPPs. It shows the concept of TPMs being derived from MOPs, and MOPs from MOEs. It also shows that KPPs are generally derived from (but not limited to) MOEs and are a primary influence on the selection of

<sup>2</sup> Sproles, Noel, “Coming to Grips with Measures of Effectiveness”, University of South Australia, July 1998.

the MOPs. As you move from MOEs to MOPs and then to TPMs, the fidelity of the technical insight and ability to get more frequent insight increases. However, the scope of the insight continues to become narrower.

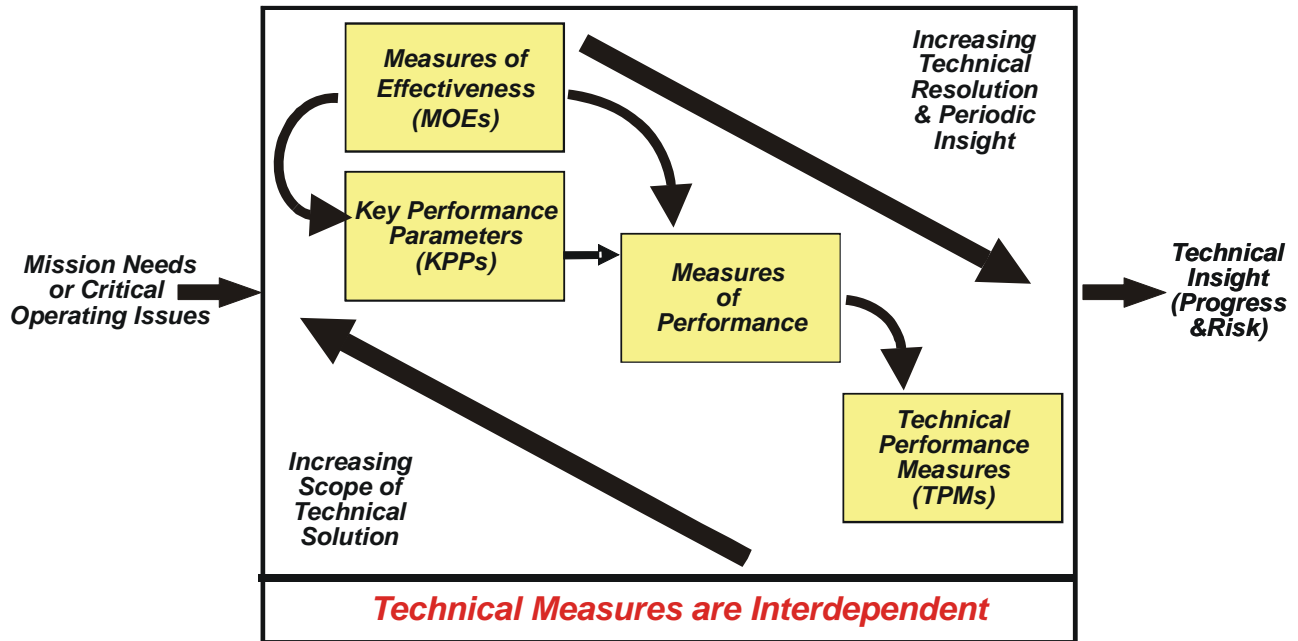

Figure 3-2 Relationship of the Technical Measures

As a simple example of how MOEs, MOPs, and TPMs work together:

- An MOE may be that a data system is needed that does not fail when processing specific mission critical functions
- The MOP could be the derived requirement that the system be able to provide uninterrupted computing for at least 100 hours (although usually there will be multiple MOPs)
- The TPMs that are tracked may include fault tolerance, redundancy, and failure rate

As a more detailed example, consider the following notional scenario for satellite development, as illustrated in Figure 3-3. In this example, Service life is a MOE for the satellite. It is also identified in this example as a KPP, since it is essential to provide orbital corrections required for the mission. Service Life is related to the amount of propulsion capacity for making routine orbital corrections, the battery life, and the life of solar cells. In this example there is a requirement for a service life of 8 years. Propulsion capacity is one of the potential MOPs that provide insight into the service life. Enough capacity is needed to perform four (4) corrections per year, plus a de-orbit operation that is equivalent to three (3) corrections. Propulsion capacity is related to the volume of propellant on-board, the satellite mass, the thruster efficiency, the propellant energy per unit volume, and other factors. The team wants to use known thrusters and propellant so their values are fixed. It is acceptable for the satellite mass to vary, but there is a limit. The project team needs to track the satellite volume that can be allocated for propellant. At first it will be small, but will increase as the design matures, battery size decreases, more efficient physical configurations are found, etc. The potential design changes represent opportunities that can reduce the overall technical risk and increase the probability of mission success. The available volume for propellant needs to be 17.5 liters.



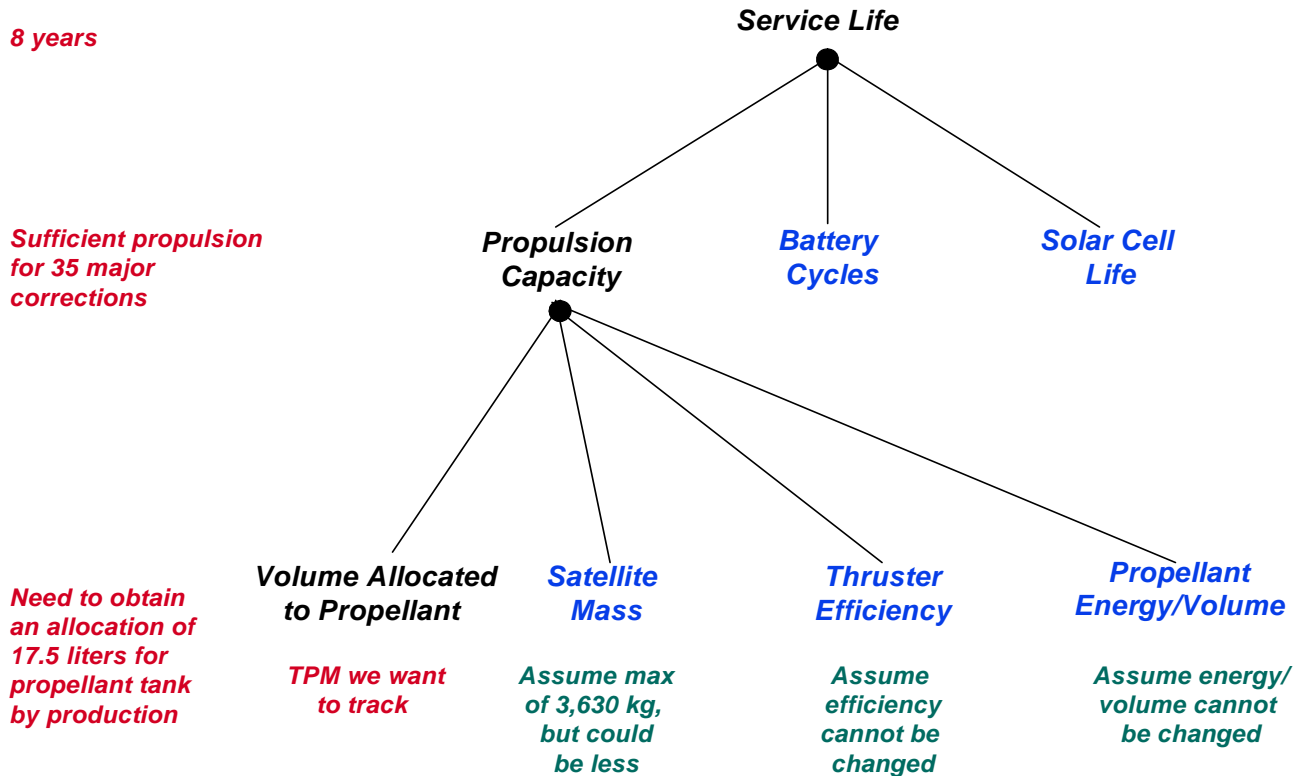

Type	Item	Threshold	Indicator
MOE/KPP	Service Life	At least 8 years	Service Life Expected - trend over time
MOP	Propulsion Capacity	At least 35 major corrections	Orbital Corrections Supported - trend over time
TPM	Volume Allocated to Propellant	At least 17.5 liters	Propellant Tank Capacity - trend over time

**Figure 3-3 Notional Example of Selection of MOEs/KPPs, MOPs, and TPMs**

As illustrated in the technical indicators in Figure 3-4, the propellant tank capacity has increased over time positively impacting number of orbital corrections possible (MOP) and extending service life of satellite (MOE). A battery size and weight reduction in 3Q99 (due to new technology and materials) increased number of orbital corrections immediately due to satellite mass reduction, but reallocation of battery volume for propellant into the design was not realized until 4Q99, after valuable opportunity analysis was performed. However, testing of thrusters and batteries indicated slightly worse efficiency than planned and had negative impacts on the orbital corrections MOP, and hence, the service life MOE in 2Q00 and 4Q00, respectively. A more detailed example of the identification and usage of the technical measures is provided in Section 13.

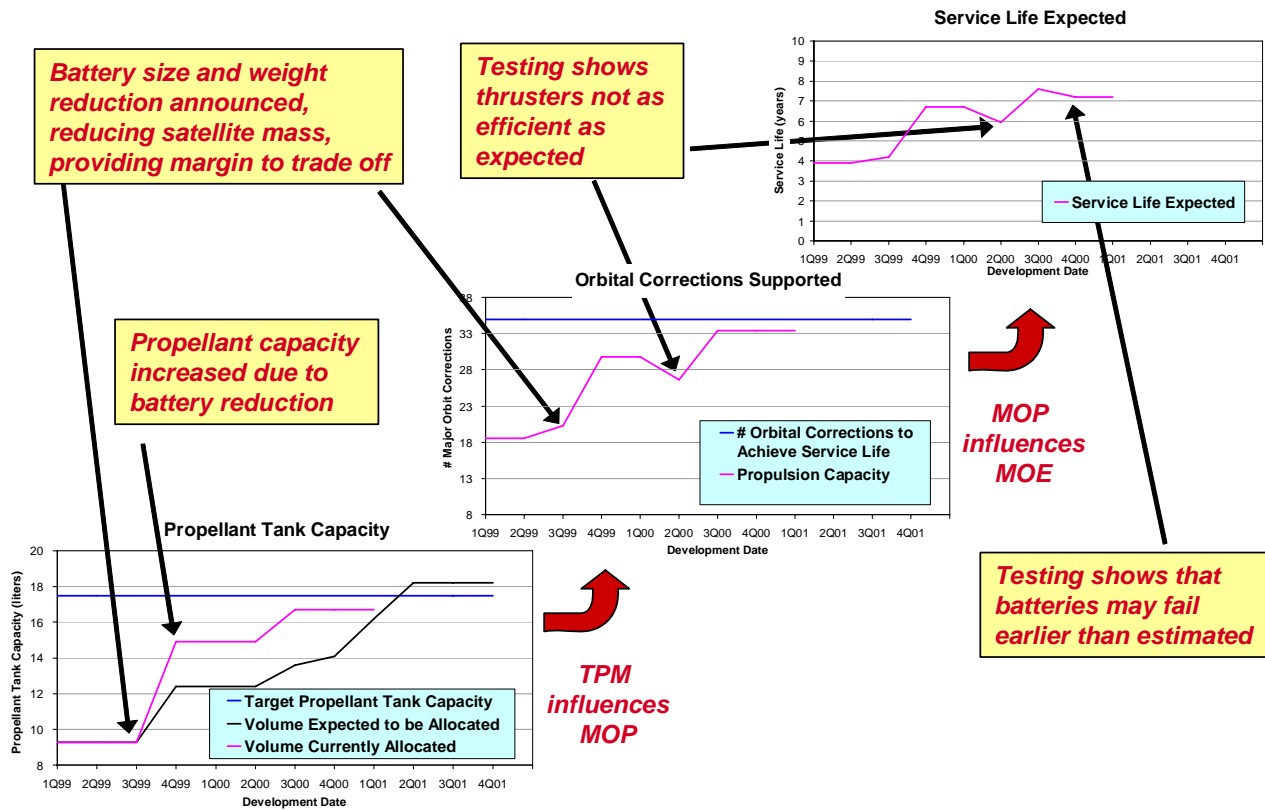

Figure 3-4 Notional Example of Monitoring Technical Measures for Project Decisions

### 3.2.7 Technical Measures and the “V” Model

During the course of the system development, the focus on which type of technical measure (MOE, KPP, MOP, and TPM) applies to provide the necessary insight shifts based on the stakeholders and level of detail being addressed by the development activities at that time. Figure 3-5 uses the “V” model to illustrate the relationship of the measures to the processes. The MOEs apply at the top level, focusing on acquirer needs and validation. MOEs provide a quantification of value to aid in procurement justification, and at the end of the development to quantify the system validation.

KPPs are used by the developer to establish the key requirements necessary to achieve the MOEs. KPPs are used to establish the MOPs, which are measured as soon as possible and repetitively throughout development, testing and evaluation. MOPs can be used to verify the system meets the system technical requirements. This in turn enables these requirements to be validated to meet the mission requirements and acquirer needs.

TPMs are a further break-down of the MOPs (or driven by risks) intended to provide measurable and ongoing insight into the technical progress. They are measured through analysis, modeling and simulation, and then test or the appropriate verification method. During the progress

through the development, periodic estimations of the MOEs are derived using the MOP and TPM values to ensure the MOEs are likely to be met. If not, appropriate actions are taken.

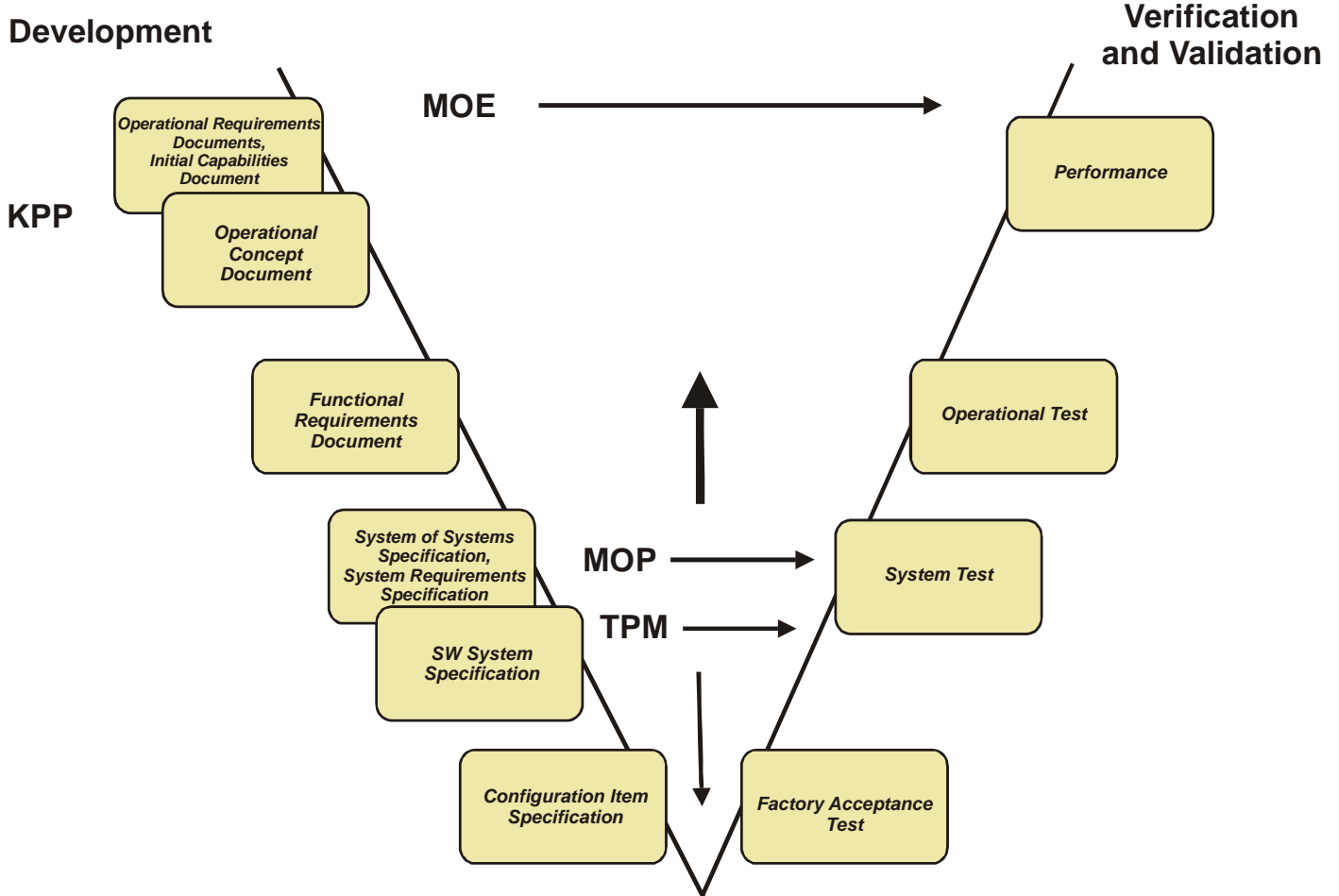

Figure 3-5 MOEs, MOPs, TPMs and the “V” Model of System Development

### 3.3 Other Terms Relevant to Use of This Guide

**Acquirer** - the stakeholder that acquires or procures a product or service from a supplier. (ISO/IEC 15288:2002)

NOTE: Other terms commonly used for an acquirer are buyer, customer, purchaser. The acquirer may at the same time be the owner, user or operating organization. For this guidance acquirer is used in the broadest sense to include all of these parties.

**Customer** – the organization or person that receives a product (ISO 9000:2000)

**Project** - an endeavor with defined start and finish dates undertaken to create a product or service in accordance with specified resources and requirements. (ISO/IEC 15288:2002)

NOTE 1: A project may be viewed as a unique process comprising coordinated and controlled activities and may be composed of activities from the Project Processes and Technical Processes defined in this International Standard.

NOTE 2: For use in this guide, the term Project is used in the broadest sense and includes both Projects and Programs.

**Stakeholder** - a party having a right, share or claim in a system or in its possession of characteristics that meet that party’s needs and expectations (ISO/IEC 15288:2002)

**Supplier** - an organization or an individual that enters into an agreement with the acquirer for the supply of a product or service. (ISO/IEC 15288:2002)

**User** - individual who or group that benefits from a system during its utilization. (ISO/IEC 15288:2002)

NOTE: The role of user and the role of operator may be vested, simultaneously or sequentially, in the same individual or organization.

### **3.4 Use and Application Of Technical Measures**

When tracked and reviewed at key milestones during the lifecycle, technical measures are good indicators of the following:

- Operational Objectives
- Technical Solution Progress
- Compliance to Performance Requirements
- Technical Risk

The following subsections examine these uses and discuss the type of technical measures that are applicable.

#### **3.4.1 Indicators Of Operational Objectives**

These technical measures are used to determine the ability of the technical solution to meet mission needs for performance, suitability, and affordability across the life cycle within the intended operational environment. MOEs look at this from the acquirer perspective, whereas MOPs, which are derived from MOEs, look at this from the supplier perspective. The MOEs characterize customer satisfaction with the performance of the technical solution. The MOPs characterize technical attributes relating to the specified mission (operational) requirements of the technical solution. These attributes are those considered to be key towards ensuring that the system has the capability to achieve mission success.

#### **3.4.2 Indicators Of Technical Solution Progress**

These measures focus on key attributes of the performance, design, manufacturing, and maintenance. One purpose of measuring and tracking these attributes is to ensure progress toward the end goal of providing a system that meets the user's requirements. They can be tracked as the development and deployment of the technical solution evolve to provide early indications of when the progress is not being achieved as needed to meet key milestones. TPMs are the primary measures used to provide this insight as the technical solution evolves.

#### **3.4.3 Indicators Of Compliance To Performance Requirements**

Since MOPs and TPMs measure the technical attributes related to the specified mission and technical requirements, when tracked over time, they can serve as indicators of compliance to the performance requirements of the system and system elements. TPMs are the primary measures used to provide this insight as the technical solution evolves. The results of the TPMs can be used to predict the associated MOP values to provide insight into the likelihood of meeting performance requirements with the delivered system.

#### **3.4.4 Indicators Of Technical Risk**

Another purpose of these measures is to provide insight into technical risks, using that insight to help assess the risks, aid in the determination of the risk treatments, monitor the risk progress,

and identify other technical risks. A technical risk is an event in the project that has a non-zero probability of occurrence and an unfavorable consequence on technical performance or quality (i.e., the event has an unacceptable risk exposure). Technical risks can occur at any time in the life cycle and can lead to a technical solution that does not meet specified requirements, mission needs, or cost and schedule objectives. Measures should be derived from the identified risks or problems (among other drivers). For each measure, there should be at least one risk or problem associated with it. Technical risks are tracked by these measures to provide insight into progress towards meeting critical performance requirements as the technical solution evolves. They provide an early warning about deviations in key technical parameters, which, if not controlled, can impact system success in meeting user needs.

As the technical solution matures, the actual values to date of these measures are compared with the plan. If the actual value meets the plan, it is an indication that the risk-treatment plan (also known as risk-handling strategy) has been effective; if the actual value does not meet the planned value (and is outside the expected variation), it indicates that the plan may need adjustment or that corrective action may be warranted.

The results of the TPMs can be used to derive or predict the associated MOP values to provide insight into technical risk of the delivered system. Generally, the results of one or more MOPs provide input for the MOEs that reflect satisfaction of mission needs. From this perspective, these measures are used to:

- 1) Provide visibility of actual versus planned performance to monitor performance risks or identify other related technical risks,
- 2) Provide early detection or prediction of problems which require management attention, and
- 3) Support assessment of the impact of proposed change alternatives

Use of these measures alerts management to potential performance deficiencies before irrevocable cost or schedule impact occurs. Where a project also has an overall risk assessment program, technical measurement provides data for technical risk planning and assessment. Input from the risk management process will also assist in determining parameter criticality in the TPM selection process.

TPMs provide insight into the progress of the definition and development of the technical solution and specific associated risks (uncertain events) or problems (whether certain to occur or already have occurred). The risks and problems are “management issues” that should have appropriate handling/corrective action plans generated, implemented, and monitored in accordance with the local risk management and project management processes.

Project scheduling should incorporate key dates for retiring risks associated with TPMs. If these risks associated with the TPMs cannot be retired early, there must be sufficient budget and schedule late in the project to deal with the ongoing risk-treatment plans and problems, if they arise.

Because of their inherent risk insight, TPMs have high visibility on projects, especially in technical reviews. The SE lead or SE IPT lead (if IPTs are used) is usually responsible for tracking and briefing status of TPMs at project status meetings, design reviews, and risk/opportunity management board meetings.



## 4 Measurement Process

This section presents an overview of the measurement process from Practical Software and Systems Measurement (PSM) that is used as the underlying measurement process for this guide. For more detailed information about the PSM measurement process, go to: <http://www.psmc.com>.

There are three key measurement concepts that form the basic building blocks for successful measurement application. They are:

1. **Measurement is a consistent but flexible process** that must be tailored to the unique information needs and characteristics of a particular project or organization. These information needs usually change during the life cycle as the environment changes, milestones are accomplished, performance parameters are achieved, risks are treated, etc. Changing information needs drive changes to the measures.
2. **Decision makers must understand what is being measured.** Key decision makers, including both technical and business managers, must be able to connect “What is Being Measured” to “What they need to know”. Measurement must deliver value-added objective results that can be trusted on the day-to-day issues that these managers face.
3. **Measurement must be used to be effective.** The measurement program must play a role in helping decision makers understand project and organization issues and to evaluate and make key trade-offs to optimize overall performance.

These three basic measurement concepts appear to be common sense, but are often ignored. They need to be ingrained in the project and organization to effectively apply measurement. The remainder of this section presents the measurement process and discusses each of these concepts in more depth.

### 4.1 The Measurement Process

An underlying concept of measurement is that it should be flexible and tailorable based on the unique information needs and characteristics of each project or organization. The measurement process must be applied iteratively to effectively adapt to changing information needs and improvements in the measurement process itself.

The PSM measurement process has been the basis for establishing a common process across the software and systems engineering communities. The overall measurement approach has been adopted by the Capability Maturity Model® Integration (CMMI<sup>SM</sup>) as a basis for the measurement and analysis process area and by the international software and systems engineering community, as embodied in the international systems and software engineering standard, ISO/IEC 15939 - Measurement Process. The measurement approach has also been adopted by the International Council on Systems Engineering (INCOSE) in the work of their Measurement Working Group, including the INCOSE SE Measurement Primer. An important aspect of all these initiatives is the consistent treatment of measurement.

The PSM process, shown in Figure 4-1, describes four activities that are part of a successful measurement program:

1. **Establish and Sustain Commitment**: This activity involves establishing the resources, training, and tools to implement a measurement program effectively, and most importantly, ensuring that there is management commitment to use the information that is produced.
2. **Plan Measurement**: In this activity, measures are defined to provide insight into project or organization information needs. This includes identifying what the decision makers need to know, relating these information needs to those entities that can be measured, and then identifying, prioritizing, selecting and specifying prospective measures based on project and organization processes. The specification of the measures provides documentation of the information needs and selected measures to establish a common understanding of what is being measured.
3. **Perform Measurement**: This activity involves collecting and preparing measurement data, performing measurement analysis, and presenting the results so that the information can be used to make decisions. The preparation of the measurement data includes verification, normalization, and aggregation of the data, as applicable. Analysis includes estimation, feasibility analysis of plans, and performance analysis of actual data against plans. The presentation of the results should be in the preferred format of the decision maker, in order to allow accurate and expeditious interpretation of the results.
4. **Evaluate Measurement**: In this activity, both the measurement process and the specific measures should be periodically evaluated and improved as necessary. This activity addresses the following questions:
  - 1) Is the measurement process effective (i.e., is the information being provided reliably, in a cost-effective and timely manner, and used by decision makers)?
  - 2) Are the measures effective (i.e., do they provide the insight needed by the decision makers)?
  - 3) Are there opportunities to improve the process or the measures?



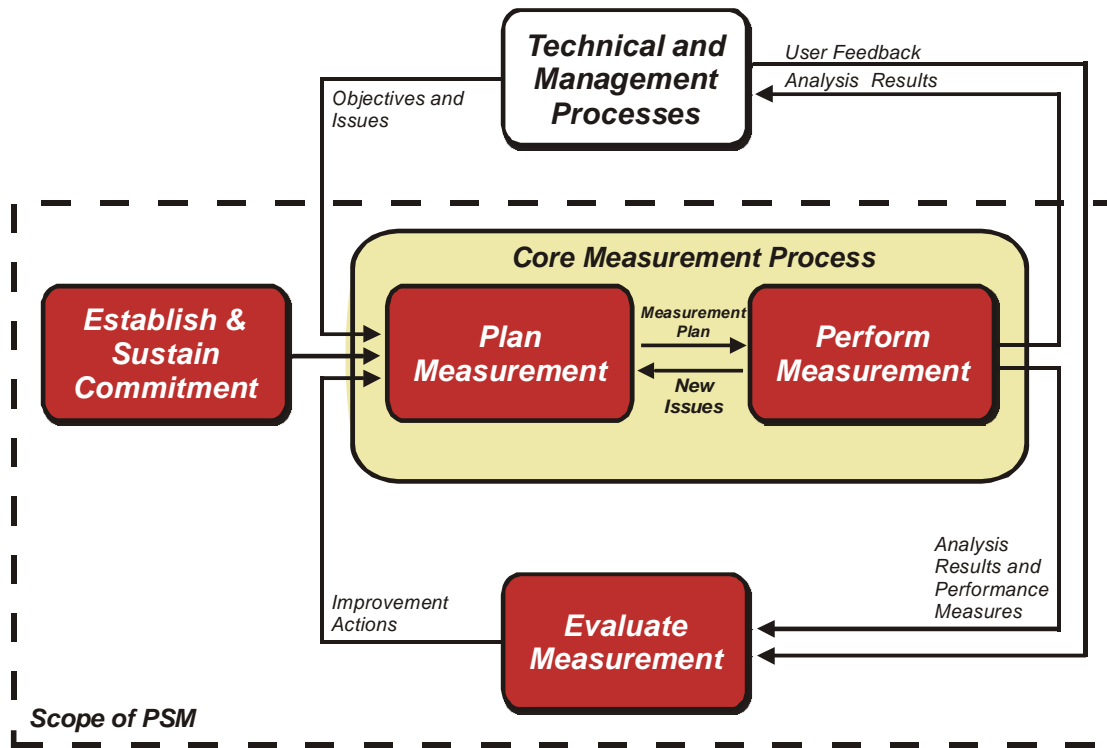

**Figure 4-1 Four Key Activities of the PSM Measurement Process**

A measurement process that is flexible and tailored to project and organizational processes ensures that measurement is cost effective. Data should not be collected or reports distributed that are not needed or are not used. In addition, data collection and reporting should be automated whenever possible to provide an automatic by-product of normal project activity.

The process shown in Figure 4-1 provides a foundation for measurement for many disciplines including software engineering, systems engineering, project management, and process improvement. An important thing to remember is that the same basic measurement process can support a wide variety of distinct and changing information needs in each of these areas.

**4.2 Connecting Information Needs to Actual Measures**

The second basic concept of successful measurement is the communication of meaningful information to the decision makers. It is important that the people who use the measurement information understand what is being measured and how it is to be interpreted.

PSM does this by incorporating a measurement information model that links the entities that are measured to the associated measures and ultimately to the identified information need. The measurement information model provides a structure for specifying how a particular information need will be addressed within the measurement process. This allows the measures to be clearly and consistently defined.

### ***4.3 Understanding and Using the Measurement Results***

The third concept of successful measurement is that the measurement process is an integral part of the way business (or project execution) is conducted. In a successful measurement implementation, the measurement results are regularly used to make decisions. If the members of a project or organization are not able or willing to use measurement data to make decisions, the measurement program is of little use.

To support the use of measurement, information must be obtained early enough to allow managers to take the actions necessary to reduce risks or correct problems. Management decisions cannot wait for a complete set of perfect data to support management decisions, but should be derived from analysis of the best available data, complemented by real-time events, and qualitative insight (including experience).

The risk management and measurement processes should always be closely aligned. Risk management identifies the information needs that can impact project and organizational performance - information needs that should be objectively explained with the measurement results. The measurement data helps to quantify risks, and subsequently provides information about whether risks have been successfully mitigated.

## 5 Establishing Commitment For Technical Measurement

### 5.1 General Practice

As is the case with any part of the measurement program, it is essential to establish the importance of measurement and build commitment to support the measurement tasks throughout the life cycle. The INCOSE SE Measurement Primer provides a good overview of this topic, while the PSM Guidebook provides in-depth discussion. In order to establish commitment, it is necessary to identify the stakeholders and understand their interests. Section 5.2 provides a discussion of the stakeholders for technical measurement. Whenever possible, benefit is obtained from establishing joint commitment and objectives between the stakeholders. Section 5.3 provides a discussion of how to work toward a consistent technical measurement program among the stakeholders.

### 5.2 Who Are The Stakeholders?

The primary stakeholders of technical measurement vary depending on the type of technical measure. Table 5-1 shows the primary stakeholders by types of technical measures, derived from the questionnaire administered for this guide (see section 12 for more information on questionnaire respondents). Since the acquirer is the ultimate stakeholder of the technical solution, the acquirer is obviously a stakeholder of the top-level measures (MOEs and MOPs). As indicated previously, the acquirer usually establishes the MOEs and uses them as part of acceptance criteria. The engineering staff of the supplier is concerned with providing a technical solution that achieves the MOEs, but needs to translate them into measures that focus on the technical aspects of the solution that relate to performance. Thus, they are primary stakeholders for the MOPs and TPMs. Since the IPT structure has members from both the acquirer and supplier, the IPTs will be stakeholders of each of these types of measures. The questionnaires indicated that quality management was mostly focused on the MOEs, since they are responsible for assuring a solution that will satisfy the acquirer.

Primary Stakeholders	MOE	MOP	TPM
Acquirer / Customer	X	X	
Engineering Staff of Supplier		X	X
Integrated Product Team (IPT)	X	X	X
Quality Management	X		

*Note: Each listed item was required to have >40% of respondents to identify it as a primary stakeholder.*

**Table 5-1 Primary Technical Measurement Stakeholders**

### 5.3 Establishing Joint Objectives Between Acquirer And Supplier

It is a good practice to establish joint measurement objectives and information needs between the acquirer and supplier organizations. By working towards joint objectives, one can select and define common measures. This can significantly reduce the overall resources needed to support measurement, while improving team perspectives. The following are recommended actions to help establish joint objectives and identify common information needs:

- Establish agreement on the appropriate level of effort for the technical measurement, including responsibilities.
- Coordinate and prioritize tasks for measurement. Determine which tasks can be jointly supported by the acquirer and supplier and plan accordingly.
- Determine what information is needed by all stakeholders throughout the life cycle. Identify information that can be addressed using the same data, measures, or indicators. Consider developing a joint measurement plan for the measures that address common needs.
- Maximize communication with the acquirer and IPTs, if applicable. Ensure time for reviews with key stakeholders. This includes periodically scheduled reviews and ad hoc reviews, as needed. The reviews should concentrate on outliers and trends observed.
- Establish a common reporting format to improve consistency of interpretation by all stakeholders. When a common format can be selected, it may be more useful and cost-effective. The reports need to include information that both the acquirer and supplier need for monitoring the project and products.

Parameters to be tracked are typically based on the combined needs of the acquirer and the supplier. The measures of interest to the acquirer are those that are focused on operational needs. The supplier will generally track more measures than are reported to the acquirer, as the supplier needs more detailed information.

## 6 Planning Technical Measurement

### 6.1 Determining And Prioritizing Information Needs

Practical Software and Systems Measurement (PSM) has a set of seven information categories that address most of the information needs of a project. They are used to help focus the selection of measures on the set of information needs for which insight is essential for decision support. The technical measures are primarily found in two of these, *Product Size and Stability* and *Product Quality*. These categories focus on the physical and quality attributes of the technical solution that impact performance. Each category contains “measurable concepts” that are used to help add specificity about the information need. The measurable concept generally reflects a specific attribute of the information need that can help prioritize the need and identify potential measures. Table 6-1 shows example PSM Categories and Concepts that can apply to MOEs, MOPs and TPMs. In PSM, the *Product Size and Stability* information category contains two measurable concepts, *Physical Size and Stability* and *Functional Size and Stability*. Only the *Physical Size and Stability* concept is shown here, since the associated potential measures for *Functional Size and Stability* are usually not considered as MOEs, MOPs, or TPMs. The list of associated potential measures does not start to address all possible measures related to performance, since a large majority of requirements could translate into possible technical measures. Identification and selection of measures will be discussed further in section 6.2, and a complete list of proposed candidate measures is included in section 10.

#### PSM-Product-Related-Measurement Information

Information Category	Measurable Concept
Product Size and Stability	Physical Size and Stability
Product Quality	Functional Correctness
	Supportability-Maintainability Efficiency
	Portability-Usability Dependability-Reliability

**Table 6-1 Example PSM Information Categories and Measurable Concepts Applicable to Technical Measurement**

Table 5-1 defines the primary stakeholders who determine the specific issues or information needs that are used to identify potential measures. A discussion of the stakeholders and the types of technical measures are provided in section 5.1. Table 6-2 provides the primary drivers that influence the selection of information needs and associated measures. These stakeholders and drivers were identified through analysis of the technical measurement questionnaire associated with this project.

Primary Drivers	MOE	MOP	TPM
Historical Operational Information	X		
Operational Risks	X		
User Priorities	X		
Measures of Effectiveness		X	
Key Performance Parameters		X	
Customer Priorities		X	X
Technical Requirements		X	X
Technical Alternatives Considered		X	X
Measures of Performance			X

*Note: Each listed item was required to have >40% of respondents to identify it as a primary driver, to be included.*

**Table 6-2 Primary Drivers for Information Need and Measure Identification**

From Table 6-2, it can be deduced that the operational needs (including historical operational information, operational risks, and user priorities) and technical requirements/ parameters (including MOEs, KPPs, MOPs, and technical requirements) are the primary drivers for identifying the information needs and measures of the project. The technically critical insight can often be determined through review of Systems Engineering documentation (such as concept of operation documents, operational requirements documents, or mission needs statements), mission or technical specification requirements, and planned contractual performance incentives and their relationship to the technical measures.

In summary, there are several factors that should be considered in the prioritization of the information needs. These include:

- Magnitude of the contribution of the item to the overall performance
- Maturity of necessary technologies that could be a risk to achieving performance objectives
- Ability to discriminate among design alternatives or other technical decision alternatives
- Ability to handle technical, cost or schedule risk within management resources and reserves
- Impact of risk on design alternatives and solution effectiveness for the user
- Ability to serve as a Standard of Acceptance for the technical solution

**6.2 Identifying Potential Technical Measures**

Applicable potential technical measures need to be identified for the prioritized set of specific information needs (or issues). They are usually related to the technical requirements or parameters for which they are providing insight into progress or risk. It is important to understand what aspect of the technical requirement or measure is important to monitor: the range of performance for a parameter, the stability of the parameter, the progress of a critical technology, etc. The same factors that apply to identification of valid potential measures in PSM also apply here.

Table 6-1 identifies the typical measurable concepts that may be used to help focus technical information needs and identify applicable measures. There are numerous potential MOEs, MOPs and TPMs, since they are related to the performance requirements of the technical solution and can reflect nearly any quantified product (or process) characteristic. Table 10-1

provides a useful example set of measures and provides insight into the scope of application of the measures across engineering applications or domains. Other potential measures can be found in some of the references in section 12.

### **6.3 Selecting And Specifying Technical Measures**

#### **6.3.1 Selecting And Specifying MOEs**

MOEs are usually determined by the acquirer (customer/user) during the development of the mission needs/requirements and operational concepts, and should be included in the Request For Proposal and/or contract. Each MOE should provide insight into at least one operational objective or mission requirement of the delivered technical solution. Of the MOEs, the subset that are so critical that they must be met to continue with the program are designated as Key Performance Parameters (KPPs). Some government organizations require specific KPPs for various aspects of the technical solution depending on the type of system or mission characteristics. See Section 3.2.4 for some examples.

MOEs should not be strongly correlated to each other, in order to provide insight into different operational aspects of the technical solution or solution alternatives. The MOEs should be defined in terms of the acquirer's operational objectives. The MOEs need to provide an independent means to collectively evaluate the alternatives for their fitness to meet the intended purpose, as well as aid system validation through quantification of the operational performance. Thus, the MOEs are usually identified and defined at the beginning of top-level analysis of alternatives. Since the MOEs are defined early in the life cycle, they are usually based on some assumptions. These assumptions must be validated with the users. Otherwise, the assumptions may be incorrect and lead to incorrect or infeasible test criteria.

Although they may be qualitative or subjective (relying on expert judgment), the MOEs are more effective if they are defined quantitatively, including the evaluation criteria and data requirements for each measure. They are generally stated as raw quantities like numbers of something or frequencies of occurrence. Since MOPs and TPMs are successively derived from the MOEs, care should be used to limit the number of MOEs selected (the questionnaires showed a range of 2 to 12 MOEs with an average of 6). It is not unusual to have an order of magnitude more TPMs than MOEs.

#### **6.3.2 Selecting And Specifying MOPs**

MOPs are derived from the MOEs to provide measures based on the technical requirements that address the KPPs that trace to the mission needs. There are generally several MOPs for each MOE (the questionnaires showed a range of 1 to 10 MOPs per MOE with an average of 5). The MOPs that trace to the same MOE will be related in the insight they provide, focusing on a specific system characteristic or alternative. Traceability should be maintained from the MOPs to the system level performance requirements, goals, risks, or issues. The MOPs should also be traceable to the higher level MOEs with the relationship defined, so they can be readily used to provide insight into operational performance risks. It is preferable to have a quantitative relationship.

Collectively, the MOPs should be able to provide insight into system affordability, technical performance, supportability, suitability, and system level technical risk. Thus, the MOPs should be linked to the system level testing of alternatives and KPPs to understand predicted or actual

achievement of the performance requirements and ultimately the mission objectives. As such, the MOPs are usually identified and defined during the planning for test and evaluation. The MOPs should be defined quantitatively, including the evaluation criteria and data requirements for each measure.

### 6.3.3 Selecting TPMs

TPMs are established early in a project (often during the proposal stage), usually by the supplier, and may be part of the acquirer's mission requirements. They are usually derived from MOPs, however, a significant number of respondents to the questionnaire indicated direct derivation from the MOEs (or KPPs). Generally, there is at least one TPM per MOP, but often there are several TPMs per MOP (the questionnaires showed a range of 2-400 TPMs per project, with an average of 54, and 1-7 TPMs per MOP with an average of 4). The TPMs should be selected and defined such that they can provide support trades among possible solutions for achieving KPPs. These measures are used to help evaluate the feasibility of the requirements set with respect to meeting the performance needs of the user for a given candidate technical solution definition, while meeting other objectives. They are strongly influenced by the quality requirements. This ongoing measurement process allows for in-process evaluation and timely corrective actions, if needed. Thus, the selection of TPMs needs to consider these factors and uses.

“Another important consideration is the relationship between the TPM program and risk management. Generally, the parameters selected for tracking should be related to the risk areas on the project. If a particular element of the design has been identified as a risk area, then parameters should be selected which will enable the manager to track progress in that area. For example, if achieving a required aircraft range is considered to be critical and a risk area, then tracking parameters that provide insight into range would be selected, such as aircraft weight, specific fuel consumption, drag, etc. Furthermore, there should be consistency between TPMs and the critical parameters associated with formal testing, although the TPM program will not normally be limited just to those parameters identified as critical for test purposes.”<sup>3</sup>

Insight regarding confidence of achieving MOE or KPP objectives is provided by MOPs at the top-level of the technical solution. The MOPs are traceable to the system-level requirements, which in turn are traceable to the mission requirements and user needs. The lower-level parameters are identified through the requirements allocation process. These parameters represent allocation of system-level requirements to lower levels within the system hierarchy and should be available in the documentation of the functional analysis process. The lower-level parameters are measured by TPMs and are traceable to the MOPs. The KPPs and their measures should be selected using the full scope of the Systems Engineering process. A comprehensive set of key parameters should be selected for the system, for each segment, and for each critical configuration item (CI), on the basis of overall technical importance, technical risk assessment, parametric sensitivity in the engineering models, and interface relationships.

Satisfying a TPM often involves multiple system elements. For example, the aggregate weight of all the hardware components must be less than the system weight TPM, or the interfaces, processors, software, and networks must together satisfy a system throughput TPM. Therefore, TPMs must often be budgeted and allocated to multiple system elements, and tracking/reporting may be required at this lower level of granularity. Allocated TPM budgets should be flowed

---

<sup>3</sup> DSMC Teaching Note, “Technical Performance Measurement”, Robert Lightsey, October 1997



down, not only to development organizations, but also procurement and subcontract management organizations, so purchased items will satisfy their portion of TPMs.

When TPMs are used in a hierarchical manner or TPM budget allocations are in place, a clear roll-up or aggregation methodology should be defined. Because tracking a TPM may be complex, and involve multiple system elements, it may be prudent to use prototyping, simulation or modeling early in a development to demonstrate that the TPM can be satisfied, and to better quantify any risks.

The measures should be selected based on the following criteria:

1. They are the most significant qualifiers or determinants of the total system product, providing insight into key performance parameters and mission success based on one or more of the following:
  - Represent an important performance requirement driving the design of a prime item or a key critical item
  - Defines critical interface performance between system elements or between a system element and the system interfaces
  - Represents key functional capabilities or quality characteristics, identified as having moderate to high technical risks, that warrant continuous monitoring
  - Reflects known concerns about particular system issues
  - Characterizes and assesses performance risk of new technology implementation for system elements
2. Are traceable to specification requirements or goals
3. Time-phased values and tolerance bands can be predicted for each parameter and substantiated during design, development, and test
4. Can be measured on an ongoing basis, directly measured from tests or derived from analyses/models, allowing prediction of or insight into delivered performance
5. Indicate key subcontractor technical requirements and/or inputs, when extended to subcontractors

#### 6.3.4 Specifying The TPMs

TPMs should be defined so they:

- Are traceable to the specified requirements, goals, risks, or issues of the system element
- Are traceable to the higher level MOPs with relationship defined
- Are traceable to applicable WBS elements (preferred, but not always practical)
- Have the ability to track adherence to technical constraints as the technical processes are performed, as well as relationships to cost, schedule, and quality objectives
- Provide insight into IPT/project success on an ongoing basis
- Provide insight into system effectiveness/utility

Tracking TPMs during the development cycle should be an integral part of a quantitative approach to the successful management of project goals and objectives. TPMs should be part of the project's measurement program with the TPMs documented in the measurement plan or the systems engineering plan. A cost-effective approach for accurate and timely measurement and regular reporting of progress toward achieving TPMs is necessary. It is necessary to identify the methods to be used in measuring and assessing each parameter. Analysis and reporting should

be defined in a way to provide an indication of technical progress, potential future impact (predictive indicators), and project status in a composite, easy-to-understand assessment. Appropriate milestones for the TPM data collection, analysis and reporting should be defined. The following discussion refers to the elements of TPMs illustrated in Figure 3-1.

The definitions of the TPMs should include appropriate planned performance profiles, thresholds and tolerance bands (or risk bands). The use of these mechanisms provides a management by exception tool that allows a quick understanding of the performance and trends.

For each selected performance parameter, a planned performance profile must be established. This profile establishes the performance expected over the life of the project. Planned profiles may reflect constant values. This would probably be associated with technically mature, low-risk contract items. In this case, the profile would appear as a horizontal line against time. The requirement is the same at each major milestone. However, most development items are not expected to reflect mature values during initial analysis and testing, since the TPMs are generally chosen to provide insight into areas of higher performance risk. The profiles for these items will be a diagonal or curved line that represents the expected performance growth over time. The growth is expected due to improvements planned in hardware, software, and operational procedures that are reflected by the TPM. The value of the point at the end of development is based on the specified requirement of the TPM parameter. It is advisable to include any major milestones or design/performance events on the profile.

The profile and the actual measured TPM values are plotted and analyzed together. Over time, the measured values, predicted values and parameter requirement should converge. Planned profiles should not be viewed as static, particularly where Systems Engineering/engineering development is still in process. Where trade studies indicate that cost, or time, to achieve a planned requirement is excessive, the requirement values should be re-evaluated.

The thresholds bound the range of acceptable performance for the attribute of the system element being measured in its delivered state. The thresholds are established based on factors such as technical requirements, tolerances, and cost-performance trades. Tolerance bands are defined to reflect acceptable risk limits associated with achieving the performance measured by the TPM based on the planned performance profile. They are placed on each side of the planned performance profile, representing estimating error, and define the region in which it is reasonable to expect that the thresholds will be attained within project constraints. Two-sided tolerance bands are not always possible or necessary, depending on the situation.

The tolerance bands can be subdivided into risk bands, which are regions of low, moderate, and high risks. For example, risk bands may be defined such that a 0 to -5% deviation from the required value is considered Green (low risk), -5 to -10% is considered Yellow (moderate risk), and less than -10% is considered Red (high risk). Different bands may be appropriate for each TPM and the values of the bands change with the planned performance profile. Establishment of tolerance and risk bands depends on several factors such as life cycle stage, defined thresholds, priority of the performance attribute, type of requirement, technology applied, and technical precedence. Risk bands can include TPM values that exceed the defined performance requirement, if it affects the cost-effectiveness of the solution. Associations between technical risk assessed by the TPMs and the project risk assessed by cost and schedule measures should be understood and defined.

TPM parameters are expected to be added, dropped, or modified as the life cycle progresses. Since TPMs (and MOPs) provide insight into technical risks, it is expected that the values will change as the risks of the project or their relative priorities change. TPMs will be added when new risks are identified or existing risks are raised in priority. This may be the result of changes in requirements/needs, risks being mitigated, or risks that were initially overlooked. TPMs may not need to be monitored when their value improves beyond the requirement, reducing the risk to acceptable levels, or if there is no further basis for expectations of future changes in their value. Modifications to TPMs occur when the parameter values of the associated requirements change or changes in the measurement/ analysis techniques are deemed necessary to provide adequate insight. For example, the tolerance bands may also change when trades are made between the technical performance parameters. If some of the margin for a performance parameter is traded to reduce risk in another parameter, then the tolerance bands for the TPMs associated with these parameters will change accordingly. Modifications should be recorded with rationale and approvals and maintained per organizational policy.

Thus, when defining the technical measures, in addition to the information suggested in the definition of measures by PSM or INCOSE, it is good to include the following items of information:

- Requirement, goal, or KPP the measure is traceable to
- Specific performance risk or issue addressed
- Thresholds, tolerance limits, and risk bands that apply
- Definition of the performance profile expected
- Related WBS element
- Applicable part(s) of the life cycle

### 6.3.5 Technical Measurement Relationship To The WBS

To serve as a more comprehensive management tool, the TPM specification may identify the Work Breakdown Structure (WBS) element associated with it. This association provides a connection to the Earned Value Management System (EVMS) and to the schedule. This facilitates management understanding of the cost, schedule and technical relationships. It also provides a complete picture of product status, detection and understanding of development problems, and identification of emerging project and technical risks. When technical risks or problems are identified, the cost and schedule impacts can be determined in a more expeditious manner. However, this is not always practical or cost-effective, if the technical measures are not well correlated to the WBS and system architecture elements. Also, a specific technical measure may not be associated with all of the lower level WBS elements.

A parameter tree, which defines the hierarchy and interrelationships of the technical measures, can be developed from the product elements of the WBS. Developing the TPM parameter tree from the WBS ensures traceability of progress on technical performance to cost and schedule aspects of the work effort (through the cost/schedule control system). Project management can then associate technical performance variances (such as a weight parameter exceeding the tolerance limit by 10 percent) with schedule and budgetary status (e.g., 80 percent of budget expended, less than one month for final value to be achieved). Note that the TPM parameter tree may not perfectly correspond to the WBS in content or degree of detail. For example, in solving a complex software problem, it may be necessary to expand certain parts of the WBS to facilitate parameter tracking in that area. Figure 6-3 below shows an example of a parameter tree that illustrates the TPM to WBS relationship.

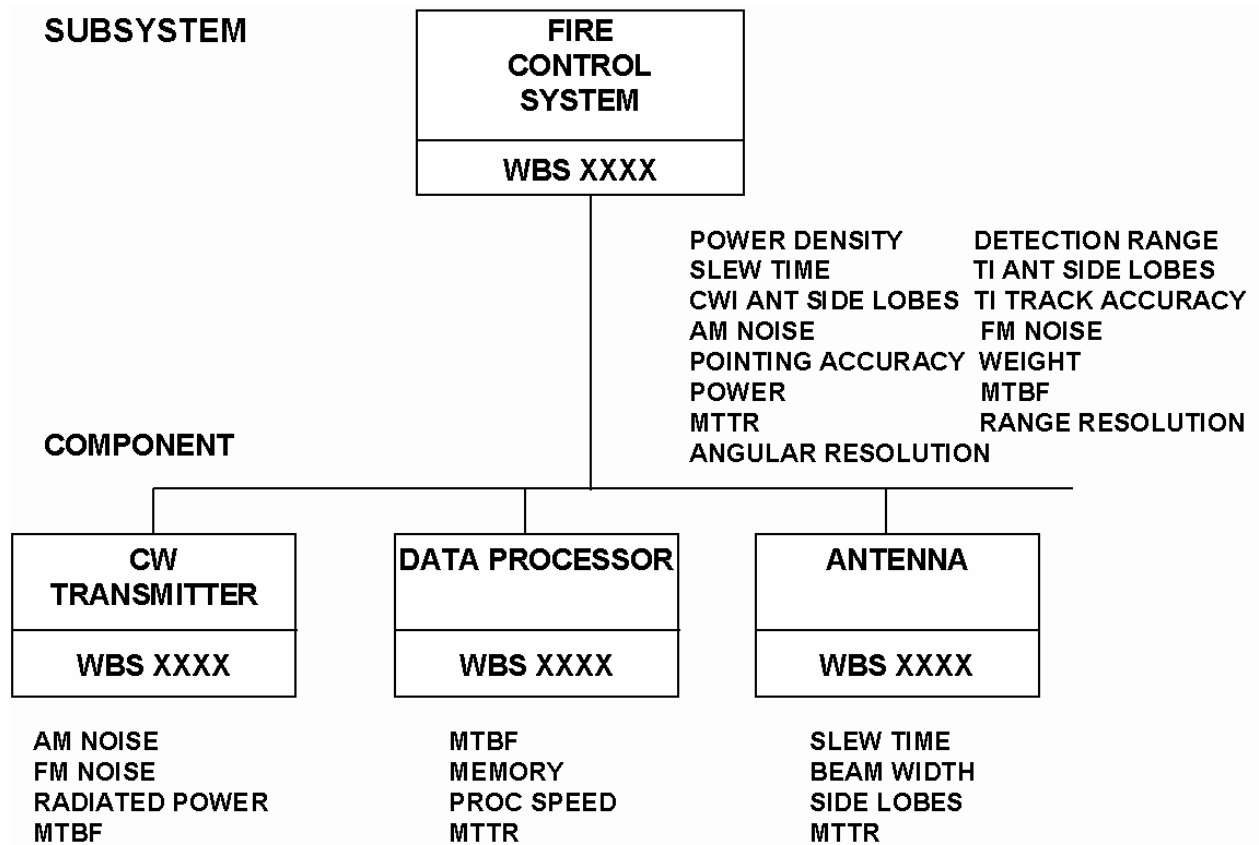

Figure 6-3 Example of Tracking TPMs to WBS Elements<sup>4</sup>

### 6.3.6 Summary of Selection Guidance

Table 6-4 contains guidance that has been derived to assist in the MOE, MOP, and TPM selection.

<sup>4</sup> DSMC Teaching Note, "Technical Performance Measurement", Robert Lightsey, October 1997

MOE	MOP	TPM
Provides insight into at least one operational objective or mission requirement	Should enable calculation of or insight into at least one MOE	Technical risks (including feasibility of requirements)
MOEs should not be strongly correlated: provide insight into different aspects of the operational alternative	A subset should be based on KPPs	Should have ability to support trades among possible solutions for achieving Key Performance Parameters (KPP)
Select and define in the context of the operational objective : no predefined MOEs/values	May be related for insight into a specific system characteristic or alternative	Strongly influenced by quality requirements
Select and define independent of the alternatives at hand : represent an independent means to collectively evaluate the alternatives	Focus on technical risks and support trades of alternative solutions at the system level	Should have ability to track adherence to technical constraints (including physical, technology, and performance)
Select only a few MOE/MOPs : may be an order of magnitude more TPMs	Should collectively provide insight into system affordability	Should have ability to show relationship to risks, cost, schedule & quality objectives
Each KPP should have an associated MOE or MOP	Should be able to be linked to future testing of alternatives and chosen KPPs	May be traceable to applicable WBS elements

**Table 6-4 MOE/MOP/TPM Selection Guidance**

TPMs are expected to be traceable to the needs of the user, while providing concrete technical measurement that can be projected and tracked as the project progresses. For example, a user may have an operational requirement for the technical solution to be survivable under combat conditions for a specified number of missions. The survivability as specified may represent an MOE, and if considered critical enough, a KPP. Direct determination of the achievement of the survivability requirement is dependent on system level test and demonstration under the intended operating conditions. This cannot be determined by itself until the technical solution is fully developed. However, there are measurable parameters of the technical solution that are relevant factors for survivability, such as the probability of escaping a hit. This could be considered the MOP, a measure of an attribute of the technical solution at the system level. This MOP can then be assessed by looking at lower level factors that can be measured periodically as the technical solution is developed, such as radar accuracy, velocity, target accuracy, kill efficiency, and firing rate. These are some of the potential TPMs. Even though these TPMs may be directly measurable, they may have lower level technical parameters on which they are dependent that are easily measurable at more frequent periods or earlier in the development, such as velocity is dependent on weight, dimensions, etc. These lower level TPMs can provide early feedback for high-risk areas of the design.

Therefore, the technical manager can select and track the factors that are most applicable to the technical solution and level of risk. The decision on selection of parameters for TPM tracking must also take into consideration the extent to which the parameter behavior can be projected (profiled over a time period), whether data will be available, and whether or not it can actually be measured. If the parameter cannot be profiled, measured, or is not critical to project success, then it should not be selected as a TPM.

### 6.4 Integrate Into The Project Processes

It is important to understand and plan for the interaction of the measurement activities with both the technical and management processes of the project. Figure 6-5 illustrates the key interactions of these processes with the measurement activities. The technical processes will aid planning and provide essential insight into risk/opportunity and quality management of the technical solution through the life cycle. The management processes require information to enable good and timely decisions. The information needs of these management processes are considered together with the technical requirements and KPPs of the technical processes to form the inputs to the selection and definition of measures. The definitions of the measures determine the data collection requirements (also known as base measures). As the data is collected, it needs to be processed, analyzed and made accessible to management for review and to determine whether actions are warranted. This integration needs to be defined in the plan, including timing, milestones, responsibilities, etc. The project team needs to ensure that the data to be collected is cost-effective to collect versus the insight provided and can be collected as the process is executed. The determination of the fit of data collection to the processes should consider the measurement specifications, the acquirer and supplier processes, and decision points. Responsibility for tracking the technical measures throughout the project must be assigned. Typically, this is assigned to an organization, IPT, or individual with overall system oversight.

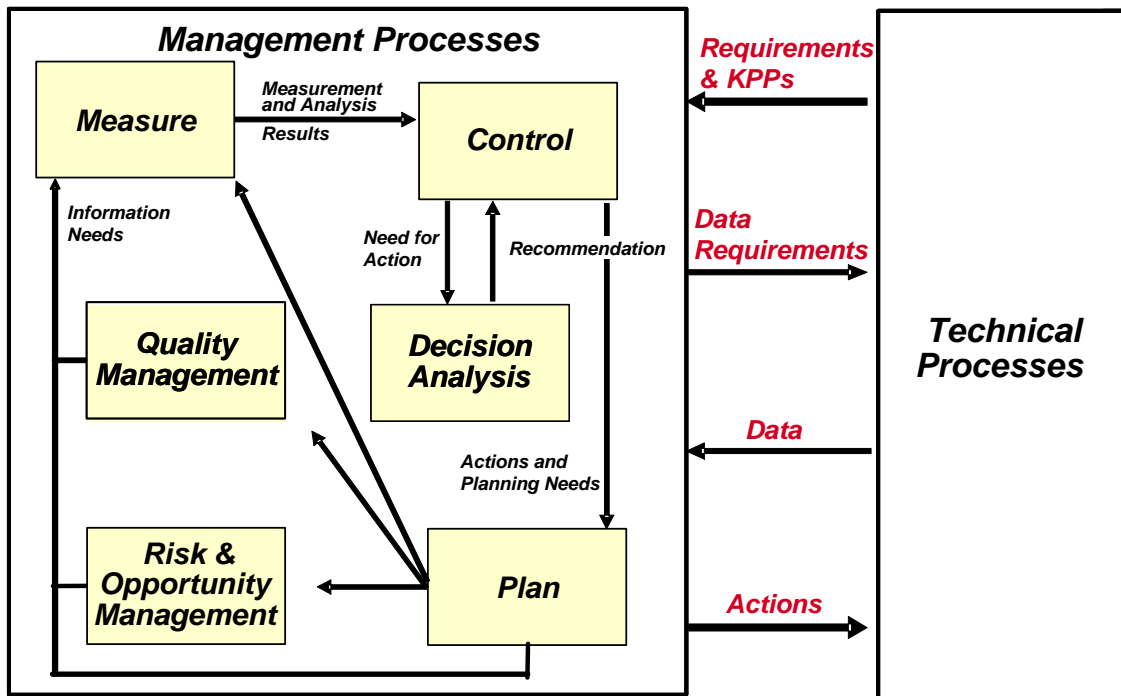

**Note:** Not all relationships shown – only those relevant to this discussion.

**Figure 6-5 Integration of Technical Measurement with Project Processes**

Failure to achieve the technical measures (especially TPMs) often results in significant cost/schedule impacts to projects, and may result in penalties or project cancellation. Where the

measure indicates margin exists for the technical requirement being tracked, there may be an opportunity to use the margin in a technical trade to reduce the overall system risk. Therefore, these measures are always candidates for incorporation into the project's Risk and Opportunity Management program. Interaction with the risk and opportunity management process includes providing the list of TPM parameters for risk assessment; providing the TPM status/profile charts for risk analysis; and receiving the risk "watch list" from the risk and opportunity management process, for potential additional TPM parameters.

## 7 Performing Technical Measurement

The overall process activities for performing the technical measurement are the same as those defined in the PSM and INCOSE documents. This includes the following activities, which will be discussed in this section to the extent that supplemental information or activity variations apply.

- Collect and process data
- Analyze data (from technical measures)
- Make recommendations

### 7.1 Collect And Process Data

The data collected will vary with the point in the life cycle and the test environment. Early in the life cycle the data is likely to be based on modeling, simulation and analysis. As the life cycle continues and implementation begins, the data will be obtained from the test environments, first at the lower levels of the product realization, then from the various levels of integration testing. During early stages of testing, the test environment may not be representative of the intended operational environment. In this situation, the direct measurement of the tests should be supplemented with data from similar systems and estimates to produce the most meaningful results. During qualification testing, the test environment is usually very representative of the intended operating environment. Therefore, the test data may be used directly to calculate the measures. At all points in the life cycle, data should be collected at a level appropriate to provide insight into KPP progress and to localize issues.

Regarding the aggregation and normalization of data, this data processing should account for the relationships of the TPMs to the MOPs and the MOPs to the MOEs. As discussed previously, the TPMs, MOPs, and MOEs often have a hierarchical relationship. The TPMs will be aggregated or processed using defined functions to provide MOPs or insight into the MOPs. Likewise, the MOPs are aggregated or are used as input to functions to provide MOEs or insight into the MOEs. The aggregation functions or methods should be defined in the measurement specification. Sample methods for the aggregation include:

1. Known algebraic relationships
2. Decision analysis methods, such as pair-wise comparisons, trend analysis, objective matrix analysis, and operations research analysis
3. Expert judgment with or without use of statistical techniques, such as Delphi, surveys or questionnaires, and nonparametric methods

It is good practice to establish a repository for technical data, documentation, analysis, and reports to facilitate access by the various stakeholders. Access should be provided according to the measurement plan based on the role and information needs of the stakeholders.

### 7.2 Analyze Data

#### 7.2.1 General Technical Measurement Analysis

Per the PSM guidebook, the analysis task is performed in order to convert data into information that can be used by managers to support decision-making. Typical methods include engineering analysis, modeling and simulation (including scale models, and mathematical models),



comparison, and various levels of system element test. The methods or tools chosen for the analysis is related to such factors as:

- Type of parameters selected
- Maturity of project
- Data availability
- Information needs of the project
- Resource availability (including test, analysis, modeling, or simulation assets)
- Cost of the method versus insight desired
- Life cycle stage
- Type of performance being assessed
- Required fidelity
- Associated risk levels reflected by the measure.

Each method has associated costs, response times and fidelity, thus providing different levels of confidence. The confidence level needed should be weighed against the resources required. Choose the lowest cost method that will provide the confidence level needed at that point in the project and is commensurate with the risk.

At the completion of each evaluation, analysis, or test, results should be recorded for comparison with planned values; any variances must be analyzed. The analysis includes evaluation of the effect of variances on the technical project risk, schedule, and cost. Summary performance status reports should be prepared from the basic parameter status data provided by the technical measurement.

“The performing activity determines the achievement-to-date for each technical parameter. Technical progress is assessed in terms of both allowed variation and the trend in achievement-to-date compared with the planned value profile. When progress in the technical effort supports revision of the current estimate, a new profile and current estimate is developed. Risk assessments and analyses are updated to reflect changes in planned value profiles and current estimates, and impacts on related parameters.

For identified deficiencies, analyses are performed to determine the cause(s) and to assess the impacts on higher-level parameters, interfaces, and system cost effectiveness. Alternative recovery plans are developed with cost, schedule, performance, and risk impacts fully explored. For performance in excess of requirements, the marginal cost benefits and opportunities for reallocation of requirements and resources are assessed and an appropriate course of action defined.”<sup>5</sup>

Since complex system evaluation may involve the assessment of several major system elements through somewhat independent MOEs, the total system evaluation needs to integrate each of the system element assessments. The method for integrating the assessments should be defined when the MOEs are selected and requires knowledge of how the elements interact.

In addition to providing technical risk insight, the predictive trend analysis of the TPMs also serves as a leading indicator for risk insight from the project perspective. This is because

---

<sup>5</sup> Systems Engineering Guide, Version 1.1, Section 2.3.4.8, Air Force, April 1996

problems with the technical progress often show up before the project impact is seen as a traditional earned value control account variance.

During system design and development, “Achieved-to-Date” values should be tracked at each assessment milestone, for each selected parameter, and at each specified level of the WBS. These point estimates, based on either analysis or testing, are then used to forecast the expected value that will be achieved.

Due to the interrelationships of cost, schedule, and technical attributes of providing a technical solution, it is important to assess the technical measures together with cost and schedule measures. (See MIL STD 499B, section 6.4.8 or EIA 632/IS, section 5.2.9)

### 7.2.2 Rigor Of Analysis Techniques

Analytical techniques can be classified as quantitative or qualitative. Quantitative analytical techniques are objective and based on the ability to describe issues in terms of mathematical relationships that allow the use of computational methods, modeling, and simulation. Qualitative techniques can combine objective and subjective input and relies on judgments based on experience (usually of ‘experts’ such as using Delphi Analysis) and analogies/comparisons. The list below describes some advantages and disadvantages of both quantitative and qualitative analysis.

- **Quantitative Analysis**
  - *Advantages*
    - Repeatable
    - Supports parametric analysis
    - Reduces bias; Makes existing biases more visible
    - Usually higher fidelity or accuracy, if valid data used
  - *Disadvantages*
    - Requires significant input data
    - Requires significant time and skill to produce and interpret answers
    - Requires understanding mathematical relationships
    - Results may be difficult to understand by those not performing the analysis if the analysis is fairly complex
- **Qualitative Analysis**
  - *Advantages*
    - Provides quick answers
    - Requires little quantitative input data
    - Doesn’t require understanding mathematical relationships
    - Applicable to complex subjective issues
    - Requires roughly the same effort regardless of issue complexity
  - *Disadvantages*
    - Influenced by selection of experts (no guarantee of repeatability)
    - Not well-suited to parametric analysis
    - Variable expertise
    - Experts with narrow or widely-divergent interests
    - May not use best qualified experts (not identified, not available, can’t afford)
    - Results difficult to interpret relative to quantitative goals

The advantages of one technique are often the disadvantages of the other. In general, quantitative techniques, when practical, are significantly preferable to qualitative techniques. Qualitative techniques include Delphi Analysis, Analytical Hierarchy Process (AHP), and Value Focused

Thinking. The qualitative techniques, are quicker and cost less, but provide lower confidence levels.

### 7.2.3 Estimation Analysis

As presented in the PSM guidebook (Part 4), the analysis task includes estimation analysis, feasibility analysis, and performance analysis. Estimation is essential to project/product planning, first for initial planning, then for subsequent re-planning as some data becomes available and trends can be determined. Due to this, estimation is often the first type of analysis encountered on a project. With respect to the technical measurement, estimation is conducted to provide projections of product attributes, quality, and performance, including the establishment of initial performance profiles with tolerance bands and thresholds. Estimation is conducted to establish target values or numerical expectations for subsequent activities and parameters, based on currently available data. “Estimation uses one measure to predict the value of another.” For example, many technical parameters have direct relationships, such as weight and velocity or acceleration. The first column of Table 7-1 contains some summary guidance based on lessons learned for performing estimation analysis.

It is necessary to re-evaluate the estimates at key milestones in the life cycle, especially as more actual data becomes available. The new estimates will have higher fidelity, since they are based, to some extent, on actual results. As estimates are found to be inadequate or incorrect, it is important to understand other factors that may be affected by the estimate and account for those relationships in any re-planning. This includes understanding that changes in technical parameter estimates may have impacts on cost, schedule, other resources, processes, etc. The PSM guidebook has an analysis model that describes these relationships in a generic sense. The need to change point estimates will generally result in changes to other parts of the performance profile. Table-7-1 also includes specific guidance for updating estimates. Additional general guidance for estimation can be found in the PSM guidebook (Part 4).

### 7.2.4 Feasibility Analysis

Feasibility analysis assesses the likelihood of achieving the estimated values per the progress plan or performance profile. This analysis is conducted during the initial planning and at all subsequent re-plans (due to changes in functionality, availability of actual project data, changes in assumptions, or failure to meet current plans). The feasibility analysis either confirms the planning that resulted from the estimation analysis or provides alternatives that have a higher probability of achievement. Since only parts of the plan cause the plan to be infeasible, it is important to quickly understand and correct those parts. To reach acceptable alternatives, it may be necessary to consider trades among the product, project, and process attributes.

The feasibility analysis is intended to look at the following:

- Basis of the estimate
- Realism of adjustments
- Confidence in the estimation and estimation techniques
- Validity of or changes in assumptions
- Changes in project/product attributes that may affect the estimate
- Comparisons of related KPPs or other relevant parameters

The following are a few key characteristics of a feasible plan for technical achievement:

- The target values support achievement of overall project and product objectives
- The rate of planned progress is reasonable (achievable based on historical performance and current technology)
- Planned performance is consistent with past performance capability as adjusted for new processes and technology (rationale should be understood and agreed to for process and technology adjustments)
- Targets values, such as operational availability, should be reasonable within the context of use
- Risks, especially for unprecedented target values, have been identified and accounted for

Table 7-1 contains some guidance based on lessons learned for performing feasibility analysis. Additional general guidance for feasibility analysis can be found in the PSM guidebook (Part 4).

### 7.2.5 Performance Analysis

Performance analysis is conducted to determine whether the development of the technical solution is meeting the plans, assumptions and targets. If a performance profile has been established, the performance analysis examines whether the TPM is within the established tolerance bands and is likely to achieve the required thresholds. Performance analysis should be conducted periodically after the project has committed to a technical plan.

Performance deviations that exceed the tolerance bands of the planned parameter values of the performance profile reflect problems that must be addressed. Evidence of trends that are likely to exceed the tolerance bands in the future, if not addressed, reflect risks that may require mitigations. Identification and analysis of trends is essential to provide predictive insight and allow management to take action before the associated risks turn into problems. When these risks or problems are identified, it is necessary to determine their cause and assess the potential impact on higher-level parameters (higher-level TPMs, MOPs, and MOEs), interface requirements, and the overall value and cost-effectiveness of the technical solution. Where trends exist and tolerance bands have not yet been exceeded, performance outcomes should be predicted by extrapolating current trends and considering future events and influences. For these problems and higher-rated risks (i.e., likely to exceed tolerance bands), alternatives courses of actions should be developed showing the expected cost, schedule and technical impact of each alternative and the evaluation of the alternatives against established criteria. Where performance exceeds the tolerance bands, such that there is an overachievement of the requirement, opportunities for reallocation of requirements and resources should be examined and tracked.

When the performance has been successful, it is good practice to understand the success in terms of the planning, estimation, feasibility analysis, and corrective or preventive actions put in place. This is the basis of valuable lessons learned for incorporation into the standard processes and for future project work.

It may be necessary to generate additional indicators to provide the insight to complete this task. Two types of indicators that are highly applicable for technical measurement are trend-based indicators and threshold/target-based indicators. Table-7-1 contains some guidance based on lessons learned for executing performance analysis. Additional general guidance for performance analysis can be found in the PSM guidebook (Part 4) and the PSM book, chapters 4 and 5.

### 7.2.6 Summary Of Analysis Guidance For Technical Measurement

Table 7-1 provides a tabular summary of the analysis guidance for MOEs, MOPs and TPMs with respect to estimation, feasibility, and performance analysis tasks. The sequence of these tasks is dependent of project-specific factors.

Estimation Analysis	Feasibility Analysis	Performance Analysis
Identify predictions needed, key drivers of variation, relationships between measurable attributes of the drivers	Determine risk, cost, schedule, and quality impacts reflected by the KPP estimated values	Track actual performance against progress profiles/plans
Collect data for the attributes of the drivers	Investigate whether: <ul style="list-style-type: none"> <li>• Performance parameters have been achieved before</li> <li>• Current technology supports the desired performance within known constraints</li> <li>• Relationships of identified risks</li> <li>• Degree of control over the risks to progress</li> </ul>	Show acceptable ranges of variation that correspond with risks and constraints
Determine quantitative relationships/models <ul style="list-style-type: none"> <li>• May include data from other indicators</li> </ul>		Identify variances of achieved values from plan <ul style="list-style-type: none"> <li>• Variances indicate the current level of risk, which may result from process, technology, or product attributes</li> </ul>
Generate estimate using model		Assess impacts of the variances
Adjust estimate as necessary to account for: <ul style="list-style-type: none"> <li>• Engineering trades</li> <li>• Technology capability and constraints</li> </ul>		
Establish expected growth profiles or other progress plans for the indicators based on estimates	If risk/impact is unacceptable, then: <ul style="list-style-type: none"> <li>• Identify alternative design solutions and estimates, or</li> <li>• Identify and implement risk handling strategies</li> </ul>	Periodically assess achieved values <ul style="list-style-type: none"> <li>• Understand success of corrective/preventive actions</li> <li>• Identify new risks</li> </ul>
Track the indicator against the progress plan/profile and update estimates with partial actual data as it becomes available. Apply rolling wave planning techniques, where applicable.		
Establish confidence intervals based on amount of actual data	Perform decision analysis and take action	

Table 7-1: MOE/MOP/TPM Analysis Guidance

### 7.2.7 Tracking And Providing Status Of Technical Measures

Table 7-2 provides an example of a tracking and status form for technical measurement. It includes the parameter of interest, the required value, its relationship in the design architecture, the predicted performance based on estimation or current trends, and difference between the predicted value and the requirement, and the means by which the prediction was achieved. Each project should define a way to capture and track this information.

Parameter Title	Goal or Requirement	Next Level of Design Concurrence	Predicted Performance/ Current Value	Difference	Justification For Prediction (i.e., Analysis, Test Results, Similarity, etc.)	TPM Status
Critical Availability	Requirement = 99.8% Goal = 99.88%	Attitude Control Subsystem	99.96%	+0.16%	Analysis using limited/early test data	Green
Phase Noise-100 Msps	Requirement = 1.2 RMS Goal = 0.90 RMS	Signal Data Distributor	0.75 RMS	0.45 RMS better than required value	Test Results	Green
Signal Latency	Requirement = +/- 30 ns Goal = +/- 27ns	Signal Data Distributor	+/- 32.8 ns	2.8 ns beyond required value	Test Results	Red

**Table 7-2 Example Technical Measurement Tracking and Status Form**

In addition to the composite tabular tracking, it is often desirable to have individual reports with graphics and narratives for the measures. The graphic will usually allow the analyst and management to more easily identify trends that could be addressed before they turn into problems. “The graphic [see example in Figure 3-1] shows the projected behavior of the selected parameter as a function of time, and further shows actual observations, so that trends and deviations from plan can be identified and assessed. The narrative portion of the report should explain the graphic, addressing the reasons for trends or deviations from plan, assessing the potential impact of the trend or seriousness of those deviations, explaining actions underway to correct the situation if required, and projecting future performance, given the current situation.”<sup>6</sup>

### 7.3 Make Recommendations

#### 7.3.1 General Guidance

It is important to report analysis results and recommendations to management in a timely, efficient and effective manner. The communication of results should include:

- Overall evaluation of the technical status, including known issues and projections of performance through completion
- Identification and assessment of any specific risks, problems, and lack of information. This should include identification of specific outliers or trends, a discussion of their location, causes, and impacts
- Recommendations based on evaluation of alternative actions. Include a brief discussion of the alternatives and their evaluation against established criteria. Highlight the advantages and disadvantages of each
- Potential new risks to be aware of, including those that may result from implementation of proposed actions

<sup>6</sup> Adapted from DSMC Teaching Note, “Technical Performance Measurement”, Robert Lightsey, October 1997

- An indication on all graphs of which direction is considered “good”, making interpretation easier

Both routine reporting and ad hoc reporting needs to be provided. Routine reporting includes monthly, quarterly and annual reports essential to support ongoing management knowledge and decisions. It emphasizes exceptions, highlights significant new information, and provides periodic status. The frequency of the reporting depends in part on the life cycle stage. Ad hoc reporting addresses any reporting requirements that arise from various stakeholders on a request basis. These one-time reports provide timely information to stakeholders for unique information needs and for scheduled reviews or milestones.

Additional general guidance for making decisions from measurement results can be found in the PSM guidebook (Part 4).

### 7.3.2 Reporting Analysis Of Alternative Solutions

During the analysis of alternative solutions, effectiveness results of the MOEs need to be clearly and succinctly packaged, and the manner in which they are presented should minimize opportunities to mislead. “The basic effectiveness results are the MOE evaluations for each alternative. Once the MOE evaluations have been presented, it may also make sense to ‘roll up’ these results. Rolling up results describes any process that aggregates results for individual alternatives. A roll up allows comparing the alternatives using a smaller number of measures. The advantage of having a smaller number of measures carries the obvious disadvantage: information, and along with it potential insight, is lost in the roll up process. Aggregation is acceptable only when the rationale for doing it is sound. This means:

- The aggregation arises naturally from relationships among the MOEs
- The significance of the aggregates is clear
- The aggregates tell a clearer story than the individual MOEs

These are difficult criteria to meet, but nothing less makes good sense. The message is: don't aggregate just to aggregate.”<sup>7</sup> Finally, weighting of MOEs (different values (weights) to different MOEs), should only be done with input from the decision maker. Although it is rare that the MOEs all have the same importance, the relative weighting needs to reflect the view of the decision maker.

### 7.3.3 Ongoing Reporting Though The Life Cycle

If progress toward achieving performance for a given TPM deviates from plan beyond the tolerance bands or trends exist that could exceed the tolerance bands, stakeholders (including engineering management, project management, and other internal & external customers) should be informed so impacts can be minimized, and mitigation/contingency plans initiated. The analysis and evaluation of alternative actions that was done as part of the performance analysis should be summarized and presented to aid the decision-making. Results must be clearly understood by the decision makers. Technical performance (technical risk) should be addressed considering its effect on project performance (cost and schedule risk). The specific corrective actions or mitigations are selected based on the risk levels assessed and their impacts on other factors. Before acting on the outcome of any technical risk assessment, the project management

---

<sup>7</sup> Analysis of Alternatives Handbook, , Section 6, Office of Aerospace Studies, Air Force Materiel Command, February 2002.

team must review the strengths and weaknesses of the approach and understand the impacts to technical, cost, and schedule aspects of the project. The desired actions from a specific technical perspective may not be possible when other technical and project factors are considered. There may be a need to perform trades within the project and technical constraints. The resulting actions may include replanning, process adjustments, new estimates, changes to the design solution, incorporation of new technologies, reallocation of margins (opportunities) to offset risk areas, etc. In some cases, the deviation or trend may not be subject to immediate action due to upcoming events, design modifications, tests, analysis, or related actions.

The performance attributes of system elements that reflect technical risk in a project should be included in each project review. Risk handling strategies and contingency plans with trigger values for execution should be established. The values of the measures should be reviewed against these “triggers” to determine what action, if any, is needed. This treatment of technical risk is an essential part of the project reviews.

Table 7-3, below, is a simple reporting example for tracking TPMs.

System Element				TPM Date of Profile: _____			End Product Baseline		
ID #	Name	Units	Parameter	Achieved-To-Date	Planned Value	Demonstrated Technical Variance	Current Estimate	Threshold (System Requirement)	Predicted Technical Variance

**Table 7-3 Example Reporting Table for Tracking TPMs**



## 8 Technical Measurement Checklist

The following checklists are intended to assist the project team in ensuring the necessary considerations for technical measurement have been accomplished. They are applied throughout the life cycle by the project personnel assigned to perform the technical measurement tasks.

### - General -

1. Have the Technical Measures been developed with a common understanding of the information needs from the relevant stakeholders?
2. Are the Technical Measures for this project identified? Have they followed the selection and specification guidance and criteria?
3. Have the Technical Measures been submitted (and incorporated as necessary) into the project risk and opportunity management program?

### - MOEs -

1. Are the MOEs traceable to the applicable acquirer needs, goals, objectives, and risks?
2. Are the MOEs clearly defined with associated KPPs identified?
3. Does each MOE provide insight into at least one operational objective or mission requirement?
4. Are the MOEs independent of each other; each MOE provides insight into different aspects of the operational alternative?
5. Are the MOEs independent of the technical solution alternatives?
6. Does the set of MOEs address any required KPPs?

### - MOPs -

1. Are the MOPs traceable to the applicable MOEs, KPPs, system-level performance requirements, and risks?
2. Do the MOPs focus on technical risks and support trades of alternative solutions at the system level?
3. Do the MOPs collectively provide insight into the system affordability?
4. Have MOPs been decomposed, budgeted, and allocated to the system elements that satisfy them?
5. Are there MOP reporting mechanisms for each MOP that show progress toward meeting MOPs through aggregation of applicable TPMs and projections analyzed against thresholds at which corrective actions are to be taken?
6. Have prototypes, simulations or models been developed to support analysis of MOPs, where warranted to provide necessary insight? Have these activities been incorporated into the project planning and execution?
7. Has each MOP been assigned to an "owner" or responsible individual/IPT for tracking, making recommendations, and taking action?
8. As a result of MOP analysis, is a revision to the measure warranted? If warranted, has the revision been analyzed and reviewed by the appropriate approval authority or control board?

### - TPMs -

1. Are the TPMs traceable to the applicable MOPs, system element level performance requirements/allocations, quality objectives, risks, and WBS elements?

2. Are there TPM reporting mechanisms for each TPM that show progress toward meeting TPMs, and thresholds at which corrective actions are to be taken?
3. Have TPMs been further decomposed, budgeted, and allocated to lower level system elements that satisfy them, where more granularity is needed based on risk?
4. Have TPM budgets been flowed down to development organizations, procuring organizations and subcontractors?
5. Have prototypes, simulations or models been developed to support analysis of TPMs, where warranted to provide necessary insight? Have these activities been incorporated into the project planning and execution?
6. Has each TPM been assigned to an “owner” or responsible individual/IPT for tracking, making recommendations, and taking action?
7. Have the sources of the TPM measures been identified and the processes generating those measures instrumented in such a manner as to collect the required data.
8. Are TPMs integrated into the project scheduling process? Can any TPM risks be retired early? Is there sufficient schedule/budget to deal with TPM issues late in the project?
9. As a result of TPM analysis, is a revision to the measure warranted? If warranted, has the revision been analyzed and reviewed by the appropriate approval authority or control board?

## 9 Application Of Technical Measurement In Integrated Product Teams (IPTs)

An initial set of KPPs, MOEs, MOPs, and TPMs is generally selected and defined by both the major and support IPTs (Integrated Product Teams), with both acquirer and supplier concurrence, early in the life cycle. Each IPT is responsible for selecting and defining the measures that fall within their area of responsibility. This set is then monitored routinely by the same IPTs during the life cycle execution. A subset of these measures are critical to managing the system integration risks. These are selected with concurrence of the System Integration IPT and are monitored routinely by them. TPMs selected should be those required to track IPT success, and therefore should be a part of the IPT's normal, scheduled work. The IPT is responsible for defining and documenting the TPMs that are applicable to its scope of work. The documentation includes the specifications of the measures, as well as TPM profile and status charts.

The responsible IPT develops the TPM Profile/Status charts (i.e., "tracking" charts), monitors and assesses the status on a continuous basis, focuses efforts on problem areas, reports on the status (during regularly scheduled IPT meetings, project management meetings, and reviews), maintains the records for these parameters, and provides updated TPM values to the IPT responsible for overall system performance, as well as other relevant IPTs. TPM values that are outliers from plan or exhibit negative trends will receive attention by at least the originating IPT, and if deemed necessary, by its parent IPT, and possibly the project management team. It is the responsibility of the associated IPT to work upward through the IPT structure to obtain the proper management visibility, resources, and actions until the situation is resolved. IPTs provide TPM status and explanations when needed. Each subcontractor's TPM values should be reported through its managing IPT, at the same reporting frequency as those of the managing IPT.

The IPT responsible for the overall system performance usually administers the TPM program, coordinating the TPM work of all IPTs, and integrating this work with the technical risk management effort. This includes maintaining a master repository and aggregating TPMs to higher-level TPMs, MOPs, and MOEs for top-level analysis and reporting.

## 10 Candidate Technical Measures Matrix - Preliminary Draft

Table 10-1 is a preliminary draft of a matrix of candidate technical measures. It reflects a compilation of typical measures for many application domains. It is by no means a comprehensive list of all possible technical measures, since any technical requirement could have an associated measure.

Information Category	Measurable Concept	Typical TPM Examples	Domain Applicability	Notes		
<b>Product Size and Stability</b>	<b>Physical Size and Stability</b>					
		Useful Life	Broad	* Also relates to functional correctness concept * Could be system, element, or component (e.g. battery, propulsion)		
		Weight	Moderate	* Weight under various conditions including weight budget * Of the system and/or it's payload		
		Volumetric Capacity	Moderate	* E.g. gas, oil, propellant, coolant, air, liquid, air exchange * Of the system and/or it's payload		
		Power	Moderate	* Includes capacity, budget, and margin * For fuel, battery, etc.		
		Structural Load	Moderate	E.g., weight, bearing, and capacity		
		Links / Connections	Moderate	E.g. virtual or physical, quantity of or concurrent connections		
		Dimensions	Moderate	E.g. height, length, width, depth, perimeter, circumference		
		Launch Area	Limited	Primarily for aircraft, spacecraft, missile domains		
		Coverage Area	Limited	E.g. Antenna, sensor		
		Beam Width	Limited	E.g. of signal transmission		
		<b>Product Quality</b>	<b>Functional Correctness</b>			
				Accuracy	Broad	E.g. target, point position, point estimation, tracking, data transmission, clock, time tag
Operational Environment Characteristics	Broad			E.g. operating and storage temperature, thermal limits, vibration, shock, humidity, nuclear		
Power Performance	Moderate			E.g. conditioning, distribution, range, peak		
Frequency	Moderate			Includes frequency, minimum and maximums, operational bandwidth		
Velocity and Acceleration	Moderate			Maximum, sustained, penetration, for given conditions, etc.		
Emissions	Moderate			Includes infrared, electromagnetic, radio-frequency, nuclear (radiation), etc.		
Interference	Moderate			Includes electromagnetic interference (EMI), Radio-frequency interference (RFI), and others		
		Gain / Noise Performance	Limited	Includes phase noise, receive, transmit, spurious, extraneous, AM/FM/PM		

Information Category	Measurable Concept	Typical TPM Examples	Domain Applicability	Notes
		Kill / Escape Efficiency	Limited	Includes probability of escaping hit
		Take-off and Landing Distance	Limited	* Under various conditions * Primarily for aircraft and spacecraft (only shuttle for landing) domains
		Altitude	Limited	Maximum, minimum, etc.
		Roll and Pitch	Limited	
		Range to Target	Limited	
		Drag	Limited	
		Thrust	Limited	Under various conditions
		Nuclear Hardness	Limited	Includes the ability to operate under specified levels of radiation
	<b>Supportability - Maintainability</b>			
		Maintainability Characteristics	Moderate	May include component isolation, test point visibility
		Maintenance Cost	Moderate	Could also be under Resources and Cost information category, however, for the TPM it is used as a factor in maintenance strategy trades and total ownership cost decisions
		Turnaround Time	Limited	Time necessary to complete an action, return the system to operational status
		Reconfiguration Time	Moderate	Time to reconfigure systems (e.g., multi-purpose) from one state/capability/site configuration to another
	<b>Efficiency</b>			
		Utilization	Broad	* Includes CPU, memory, disk I/O, bus * Includes both standard, peak, degraded modes
		Response Time	Broad	Includes time and rate for response, reaction, refresh, display refresh, database performance
		System Cycle Time and Rates	Broad	* Can include component parts including set-up, initialization, execution, incremental or end-to-end processing time (run-time efficiency), database transaction processing, launch rates, firing rates, etc. * E.g. time to process one new target, a set of database actions, restart time, cold restart time
		Throughput	Moderate	* Includes CPU, memory, disk I/O, bus * Includes both standard, peak, degraded modes
		Power / Fuel Consumption	Moderate	
		Link / Connection Timing	Moderate	Includes budgets

Information Category	Measurable Concept	Typical TPM Examples	Domain Applicability	Notes
		Cooling Efficiency	Moderate	Includes flow, capacity, heating, dissipation
		Signal Efficiency	Limited	Includes signal switching time, receiver signal sensitivity, signal latency, etc.
		Output Power	Limited	Includes power, current, voltage
	<b>Portability</b>			
		Database Scalability	Limited	
	<b>Usability</b>			
		Operational Productivity	Broad	
		Operator Response Time	Broad	
		Operator Errors	Broad	
		Ride Quality	Limited	
	<b>Dependability - Reliability</b>			
		Mean Time To Failure	Broad	<ul style="list-style-type: none"> <li>* Can be "critical" failures</li> <li>* Can be time "to" or time "between"</li> <li>* Can include time to malfunction (including power loss)</li> </ul>
		Failure / Fault Characteristics	Broad	Includes rates, detection efficiency, tolerance, false alarms, bit error rates, error budgets
		Availability / Downtime	Broad	<ul style="list-style-type: none"> <li>* Includes operational availability, link/connection availability among many others</li> <li>* Downtime includes total, scheduled (preventive maintenance), from failures, etc.</li> </ul>
		Mean Time to Restore System	Moderate	<ul style="list-style-type: none"> <li>* Average time to return system to full operational capacity following a failure</li> <li>* Includes saturation recovery time (telecommunication domain)</li> <li>* Restart times may be elements of this measure</li> </ul>
		Mean Time to Repair	Moderate	average time to fix a failure
		Reliability Figure of Merit	Moderate	
<b>Technology Effectiveness</b>	<b>Technology Suitability</b>	Technology Readiness Levels	Broad	Technology Readiness Levels (TRL) are a systematic metric/measurement system that supports assessments of the maturity of a particular technology and the consistent comparison of maturity between different types of technology. See Section 10 for more detail.

Table 10-1 Candidate Technical Measures

## 11 Technology Readiness Levels

A concept related to TPMs is the Technology Readiness Levels (TRLs), originally defined by NASA. The NASA website defines TRLs as: “Technology Readiness Levels (TRL) are a systematic metric/measurement system that supports assessments of the maturity of a particular technology and the consistent comparison of maturity between different types of technology.”

One of the major factors affecting the defined tolerance and risk bands of the TPM is the maturity of the technology incorporated into the design of the technical solution. “TRLs describe the maturity of the technology being used to meet requirements for which the TPMs are indicators. Just as progress on TPMs is a precursor to project/management success (as indicated by earned value), TRLs are a precursor or indicator of potential difficulty in meeting technical performance. A project plan is based on knowledge. The less certain the knowledge (low technology maturity) and more risky the performance (difficult to meet requirements reflected through the TPMs) the more likely the project plan will show stress (re-plan, re-budget, re-schedule). The earlier this is known, the less likely the need for re-baseline.”<sup>8</sup>

Table 11-1 is included as reference information. It is derived from charts prepared by Mike Ferraro of the Defense Contract Management Agency, provided in a briefing entitled “DoD/NDIA Systems Engineering Committee Meeting: Technical Performance Measurement” and dated 12 February 2002.

A GAO Report showed technologies introduced at TRLs of 5 or lower encountered maturation difficulties and contributed to problems in product development. Those products whose technologies reached high TRLs when they were introduced were better able to meet cost, schedule, and performance requirements. As each succeeding level of readiness is demonstrated, unknowns are replaced by knowledge and gap is reduced.

Additional information about TRLs can be found at the following NASA website:  
<http://www.asc.nasa.gov/aboutus/trl-introduction.html>

---

<sup>8</sup> Ferraro presentation

Technology Readiness Levels	Descriptions
1. Basic principles observed and reported.	Lowest level of technology readiness. Scientific research begins to be translated into applied research and development. Examples might include paper studies of a technology's basic properties.
2. Technology concept and/or application formulated.	Invention begins. Once basic principles are observed, practical applications can be invented. The application is speculative and there is no proof or detailed analysis to support the assumption. Examples are still limited to paper studies.
3. Analytical and experimental critical function and/or characteristic proof of concept.	Active research and development is initiated. This includes analytical and laboratory studies to physically validate analytical predictions of separate elements of the technology. Examples include components that are not yet integrated or representative.
4. Component and/or breadboard validation in laboratory environment.	Basic technological components are integrated to establish that the pieces will work together. This is relatively "low fidelity" compared to the eventual system. Examples include integration of "ad hoc" hardware in a laboratory.
5. Component and/or breadboard validation in relevant environment.	Fidelity of breadboard technology increases significantly. The basic technological components are integrated with reasonably realistic supporting elements so that the technology can be tested in a simulated environment. Examples include "high fidelity" laboratory integration of components.
6. System/subsystem model or prototype demonstration in a relevant environment.	Representative model or prototype system, which is well beyond the breadboard tested for TRL 5, is tested in a relevant environment. Represents a major step up in a technology's demonstrated readiness. Examples include testing a prototype in a high fidelity laboratory environment or in simulated operational environment.
7. System prototype demonstration in an operational environment.	Prototype near or at planned operational system. Represents a major step up from TRL 6, requiring the demonstration of an actual system prototype in an operational environment, such as an aircraft, vehicle or space. Examples include testing the prototype in a test bed aircraft.
8. Actual system completed and "flight qualified" through test and demonstration.	Technology has been proven to work in its final form and under expected conditions. In almost all cases, this TRL represents the end of true system development. Examples include development test and evaluation of the system in its intended weapon system to determine if it meets design specifications.
9. Actual system "flight proven" through successful mission operations.	Actual application of the technology in its final form and under mission conditions, such as those encountered in operational test and evaluation. In almost all cases, this is the end of the last "bug fixing" aspects of true system development. Examples include using the system under operational mission conditions.

**Table 11-1 Technology Readiness Level Descriptions**



## 12 Demographics of Questionnaire Respondents

The Technical Measurement Questionnaire (TMQ) was distributed in 2002 to members of the PSM Technical Working Group (TWG), INCOSE Technical Committees (TCs), and to various other interested members of industry and government. There were 31 valid questionnaire respondents. The information in this section provides analysis of respondents' demographics and existing usage of technical measures.

### 12.1 Respondent Demographics

The respondent group was very experienced in the area of technical measurement with nearly 80% of the respondents having more than 5 years experience. Figure 12-1 shows that only 10% of the respondents had 2 or less years of experience with technical measurement.

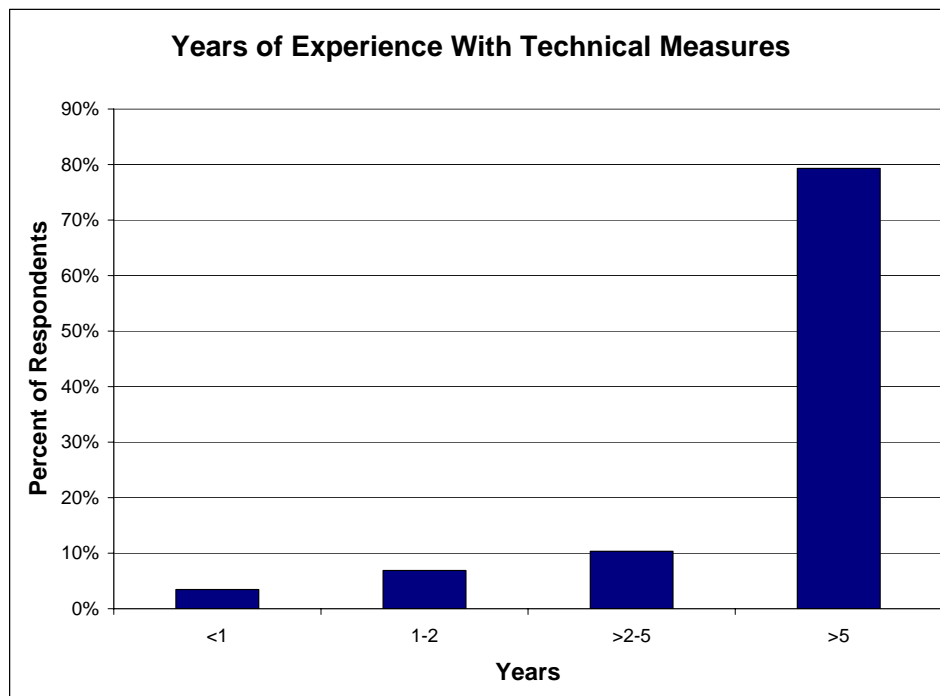

**Figure 12-1 Years of Experience With Technical Measures**

Figure 12-2 shows the distribution of the disciplines of the respondents. This shows that the majority of the respondents were from the areas of systems and software engineering with some representation of quality management/assurance and configuration management. None of the respondents represented hardware engineering or product support disciplines.

With respect to their business areas, the respondents were spread across aerospace, civil aircraft, defense, energy and environment, information and data systems, and information technology. There was a larger number of respondents from aerospace and defense.

Upon examining the roles of the respondents, it was noted that there was a wide range of technical management roles represented. The roles included company president and vice

president, technical/engineering fellows, engineering directors/managers, principal/lead engineers, engineering process project directors/chairs, quality assurance staff, and measurement coordinators/staff. The group of respondents has significant experience in technical measurement and are primarily in technical leadership and management roles in their organizations.

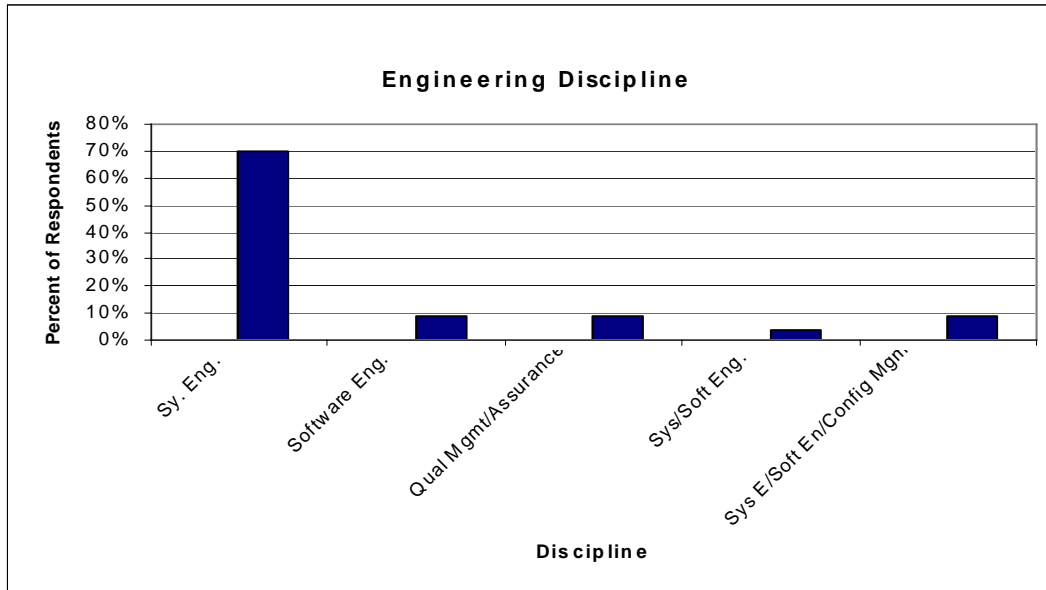
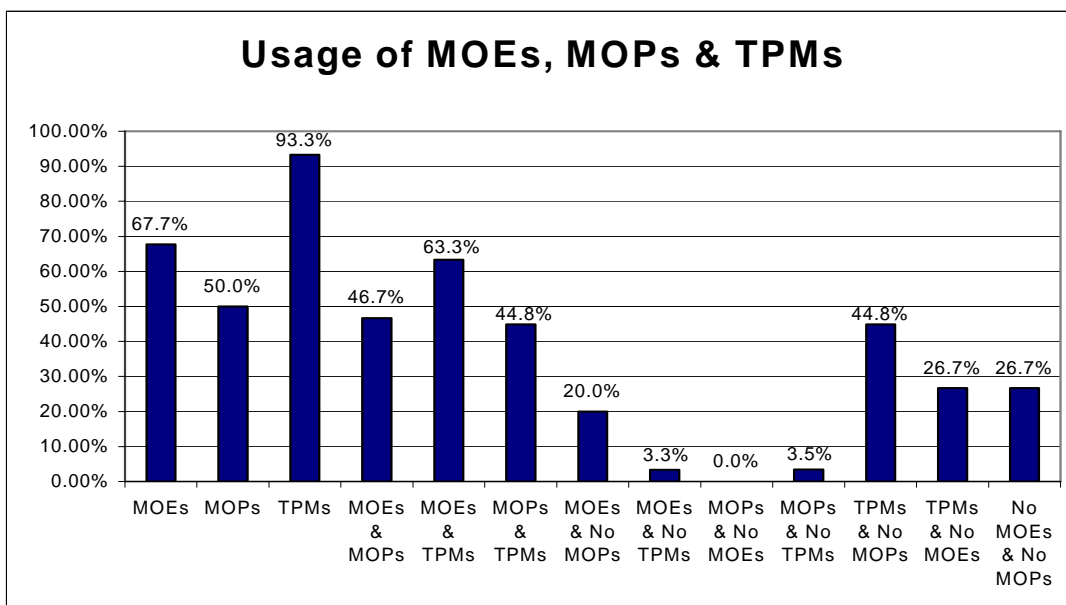

Figure 12-2 Engineering Disciplines of the TMQ Respondents

### 12.2 Usage Of MOEs, MOPs, And TPMs

MOEs, MOPs and TPMs were all used by the respondents, but in varying degrees. Figure 12-3 shows the results of questions regarding usage of these measures. Over two-thirds of the respondents indicated use of MOEs, half of the respondents use MOPs, and nearly all use TPMs.



**Figure 12-3 Usage of MOEs, MOPs, and TPMs**

From reading the text responses, it is apparent that some organizations or projects use a hierarchy of TPMs that include what would otherwise be considered MOPs and possibly MOEs. This may account for the significantly larger percent of respondents indicating use of TPMs than the other types of measures. In addition, MOEs are not often passed down to subcontractors. The results indicated that when MOPs are used, MOEs are also used. However, the opposite is not true.

## 13 Example of Compatible Set of MOEs, MOPs, and TPMs

### 13.1 Overview/Relationships Among MOEs, MOPs, and TPMs

This section provides an example to illustrate the concept. The example pertains to the development of a military aircraft. It is useful to think of MOEs, MOPs, and TPMs as an hierarchy as follows. “Mission” related measures of success (MOEs) are developed by the customer, user, or acquirer, in terms of what needs to be achieved within the operating environment (i.e., the primary mission objectives). MOEs are defined in terms of the effects on the mission. The MOEs are then translated into or elaborated in the MOPs. The MOPs describe the system that is to be built to meet the mission objectives. This description is given in terms of its physical attributes (how big, etc.) and functional attributes (what the system will do when built and operational). The MOPs for the system are elaborated into very specific measures, the TPMs, that can be used during the course of the project to determine if the system appears likely to realize its requirements or not. There can be a current estimate for the final value of a TPM, such as the Manufacturer’s Empty Weight (MEW) for an aircraft (see later in the section for more details of the MEW). Thus, there would be a progression of estimates for the final value of the MEW during the course of the development. If it appears unlikely that the MEW objective will be achieved, then action should be taken to reduce the probability that this will be the case when the development of the aircraft has been completed.

MOEs characterize a system in terms of what it is supposed to do, its “mission,” not how the mission is to be accomplished. However, they may include various limitations on the system. MOEs constitute the highest level of requirements for the system of interest. MOPs deal with the hows at the system level, various aspects of implementation of the mission. TPMs include specific measurable aspects of the implementation of the system elements that can be measured (not estimated or projected) on an ongoing basis during the development cycle. By “measurable” we mean both directly measurable quantities, such as the weight of an element of an aircraft, the number of code statements in a software system as well as indirectly measurable quantities, ones that are based on measurable quantities, such as the mean-time-between-failure of a jet engine turbine blade, or of a unit of software code.

TPMs are measures at a sufficiently detailed level that they can be used during a system development project to assess progress in developing the system and to enhance the degree of confidence that the system, when completed, will achieve objectives of the system reflected by the MOPs, will meet the criteria of mission success given by the MOEs. TPMs are selected so that they parse or decompose the high level requirements imposed upon the system by the MOEs and MOPs to relate to system element requirements. TPMs can be used as part of a closed loop quantitative management process at the level of the organization(s) responsible for meeting the goal values for the TPM(s).

**13.2 Comprehensive Example**

This sub-section provides a somewhat simplified example of a sub-set of MOEs, MOPs, and TPMs that might be used in connection with the development of a new fighter/attack aircraft.

Two principal top level mission requirements for this aircraft are given. These requirements are the basis of MOEs.

Mission Requirement 1: The aircraft has to be able to deliver 4000 pounds of ordnance to targets at a distance of up to 300 nautical miles from the point of takeoff and then return to the point of takeoff without being refueled.

Mission Requirement 2: The aircraft has to be able to remain on station in the vicinity of the target for up to ½ hour and conduct evasive maneuvers from possible enemy aircraft and missiles continuously during that time.

Operational objectives that characterize the mission: 1) Ability to operate on short runways (a particular minimum number of feet would be specified in an actual project); 2) Ability to be operated with a crew of one.

Figure 13-1 presents an example hierarchy of MOEs, MOPs, and TPMs. The MOE is the requirement for the aircraft to be able to carry 4000# of ordnance to its target. The MOP is the Overall Aircraft Weight (or operational weight) that consists of 1 fixed portion and 3 variable portions. The TPM is the MEW (Manufacturer’s Empty Weight), which is the fixed portion of the weight. Additionally, the MEW would likely be further allocated to lower level TPMs for the System Element Weights (per the allocation given in the weight budget). The allocated weights and associated TPMs may each be the responsibility of a separate IPT.

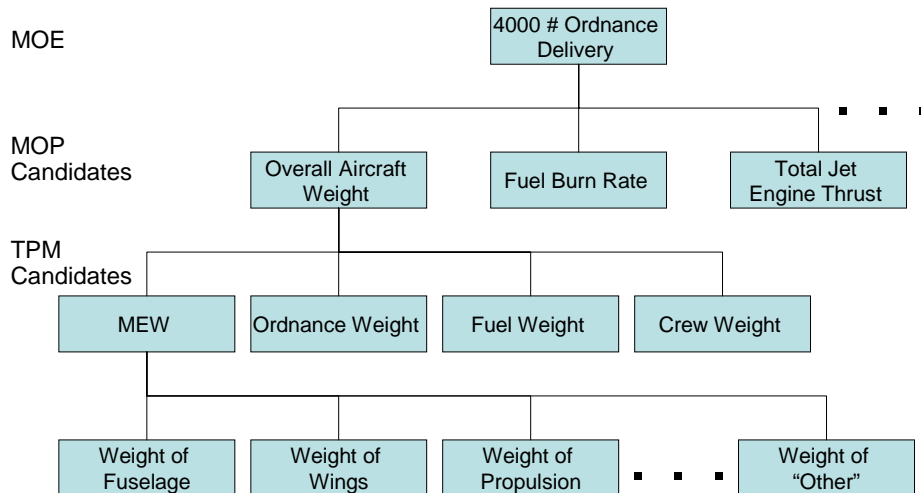

**Figure 13-1 MOE, MOP, and TPM Hierarchy**

Note that each of these requirements, e.g., ability to deliver 4000 pounds of ordnance, probably has a degree of “fuzziness” or flexibility (i.e., range of acceptability that can be used in trades). This degree of flexibility can be stated formally for each MOE by plotting a range of its values versus the utilities associated with them. The utility is a measure of the value to the acquirer associated with a particular value of the MOE. For example, 4000# might have a utility of 1.00; i.e., it meets requirements. But, a carrying capacity of 4500# might have a utility of 1.20; it substantially exceeds requirements, and might provide “extra credit” to the supplier if it could be achieved without sacrificing the attainment of any of the other MOEs or adding cost/schedule. However, a capacity of 3500# might have a utility of 0.80; it substantially underruns the ordnance capacity requirement, but may be suitable, when the degrees of satisfaction of other MOEs and resources are taken into account. However, a carrying capacity of 3000# might have a utility of 0.00; i.e., it is a completely unsatisfactory value. The carrying capacity case, hypothetically, would look like this as a degradation of 500# from the intended 4000# figure would mean that one less 500# bomb could be carried than desired, but it would be minimally satisfactory under certain conditions of a tradeoff, say between aircraft weight and therefore fuel capacity and ordnance carrying and delivery capacity. Figure 13-2 portrays the range of possible ordnance capacity values and their respective utilities.

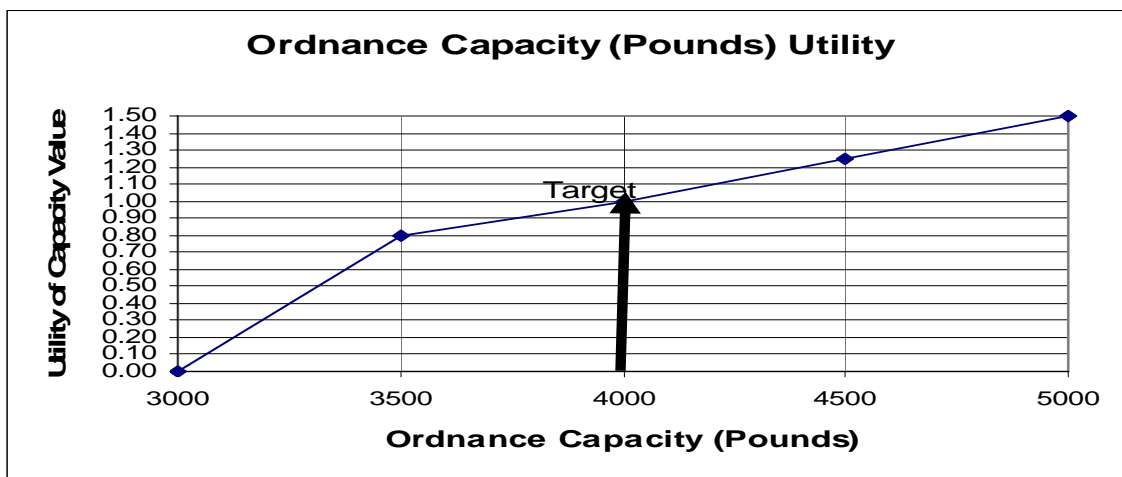

Figure 13-2 Ordnance Capacity Utility

The overall aircraft weight is a key MOP that is now considered. The development of a new aircraft would typically have many lower-level TPMs associated with a budget for the overall aircraft weight. An aircraft’s overall (or operational) weight is the sum of a fixed part and a variable part. The fixed part is the Manufacturer’s Empty Weight, MEW. The variable part is the sum of the weights of the crew, fuel, ordnance, etc., which can be traded to some extent to provide flexibility in the mission. The values for these TPMs could be used during the course of the development of the aircraft to provide detailed ongoing insight into progress and thus the likelihood of meeting the MOP (overall aircraft weight). The target value for overall aircraft weight is selected in part based on its relationship with various measures, such as jet engine thrust and fuel burn rate. The TPM (MEW) planned value is the result of allocation from the MOP (overall aircraft weight). Since the MEW is the fixed weight, the planned value can be tracked throughout the development process. If the projected MEW value at the completion of the development process is anticipated to exceed the goal established for it, action can be taken to try to reduce its actual value (i.e., the MEW upon completion of the aircraft’s development).

An expectation for the range of possible variation from the planned value at various points in the development process might be obtained based on past experience in the development of other aircraft. That experience can be used as part of the quantitative management process to help anticipate problems in attaining the MEW planned value, i.e., possible “weight growth.” On the basis of this past experience, the developers might take some action to avert growth or increase in the estimated actual MEW as the air vehicle is put together. The objectives of reducing likely MEW growth relative to the desired value could be viewed as a process improvement opportunity. Further, this information could be used in connection with trade-off studies in which the air vehicle’s weight is traded off against its capacity to carry ordnance, its prospective operational range, on target loitering time, and take off weight limits. Based on experience with other aircraft developments that the development team might have, they could construct a range of values for MEW that might be anticipated to be estimated or projected during the development process, relative to the planned value. An example is shown in Figure 13-3.

In this example, the planned MEW is 25000# and the aircraft development time is 60 months. The data depicted in the figure would be constructed, based on actual experiential weight and development schedule data from prior aircraft developments that is normalized (i.e., MEW values as percent of planned value and schedule as percent of development effort completed). The data in the figure suggests that problems might be expected in achieving the desired MEW value, as has been the case for past projects. These curves mirror experience in achieving cost objectives as well. Figure 13-4 provides the utilities or values to the project of achieving a range of possible outcomes for MEW. This information can be used, all other things being equal, to anticipate likely difficulties in achieving the MEW objective and taking some action to either relax the goal (i.e., increase the acceptable MEW value) or to take action to ensure that it is achieved. Of course, trade-off studies might show that the desired value of MEW cannot be achieved if the air vehicle structure is to be able to accommodate the amount of ordnance that it must carry and the amount of fuel that it must carry in order to enable the aircraft to reach its target, loiter there a bit, and return to base without in flight refueling being necessary. Conducting such trade studies is not a simple matter. However, being to able quantify and normalize past experience can be extremely useful in the conduct of a new aircraft development project. Indeed, past experience is a good indicator of what might well happen in the new instance, absent any improvements in the aircraft development process.

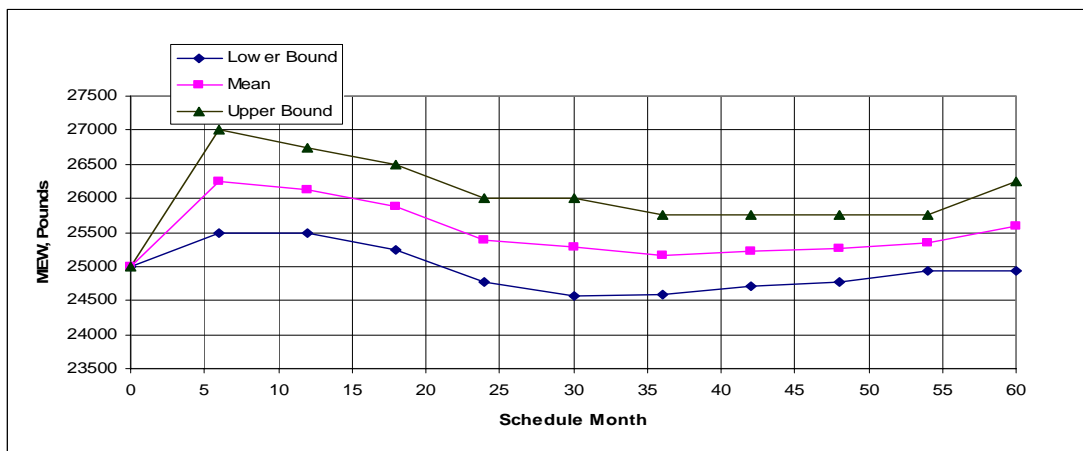

Figure 13-3 Possible MEW Growth vs. Time During Aircraft Development

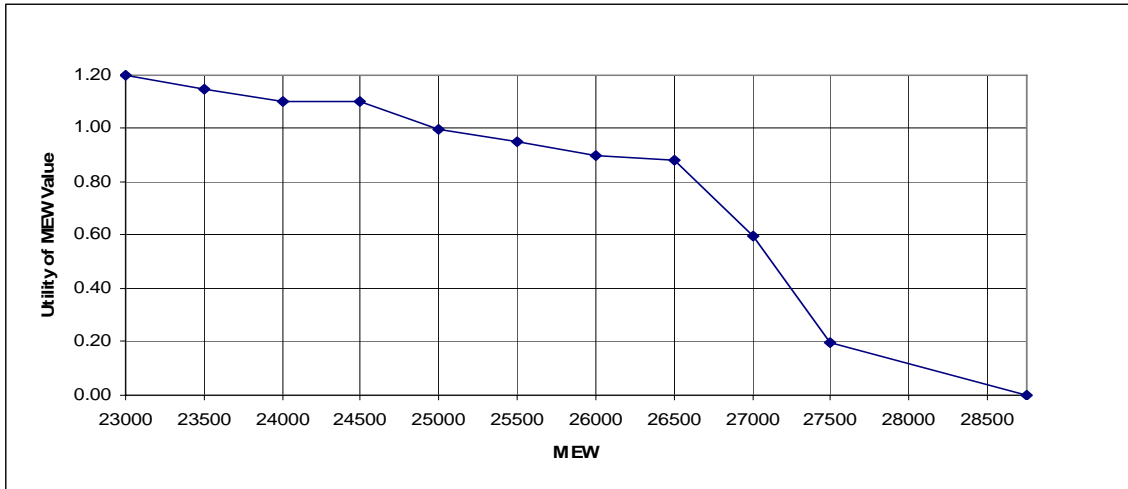

Figure 13-4 Utilities For A Range of Possible MEW Values

### 13.3 Trade-offs and Programmatic Objectives

Based on insight gained from the measures (e.g., MOPs and TPMs), trade-offs might need to be made amongst two or more requirements. For example, the mission requirements to deliver 4000# of ordnance up to 300 nautical miles might be have traded off based on actual measures obtained during the development of the aircraft. For example, it might have been determined that the allocation of capacity for carrying fuel would be insufficient for the aircraft to carry 4000# a distance of 300 nautical miles and then return to its place of mission departure. Other trade-offs might have to be made that deal with measures outside the set {MOEs, MOPs, TPMs}. There might be trade-offs made between programmatic objectives, such as schedule and development cost and some requirement, such as one relating to a defensive weapons targeting capability. During the development of the aircraft, it might be determined that the likely value of MEW exceeds the planned value such that the maximum mission range would have to be reduced from the planned value in the mission requirement (i.e., number one) that states it. In this case, a choice/trade-off might be considered. One alternative would be to spend enough time in the development process to determine how to reduce the (prospective) MEW so that its planned value can be attained and extending the schedule an amount of time sufficient to do so. Another alternative would be to meet schedule and not meet the MEW planned value in the initial delivery of aircraft.



## 14 References

1. McGarry, John, et al, Practical Software Measurement: Objective Information for Decision Makers, Version 5.0, Boston, MA: Addison Wesley, 2002
2. Practical Software Measurement: A Foundation for Objective Project Management, Version 4.0 <[http://www.psmc.com/Prod\\_Current.asp](http://www.psmc.com/Prod_Current.asp)>
3. Technical Measurement Questionnaires, Administered during 2002
4. International Council on Systems Engineering (INCOSE), Systems Engineering Handbook: A "How To" Guide for all Engineers, Version 2.0, July 2000
5. Systems Engineering, MIL-STD-499B Draft, US Department of Defense, May 1994
6. Roedler, G. and Stranc, K., "Measuring Systems Engineering Products," July 2001 <<http://www.psmc.com/UsersGroup2001.asp>>
7. Roedler, G. and Stranc, K., "System Product Measurement," 5 March 2003
8. Systems Engineering Fundamentals, Defense Systems Management College Press, Ft. Belvoir, Virginia, October 1999
9. SE Measurement Primer, International Council On Systems Engineering, Version 1, March 1998
10. ISO/IEC 15288, Systems Engineering-Systems Life Cycle Processes, November 2002
11. ISO/IEC TR 19760, Systems Engineering -A Guide for the Application of ISO/IEC 15288 (System Life Cycle Processes), November 2003
12. Electronics Industries Alliance (EIA) Standard: Processes for Engineering a System: EIA 632, January 1999
13. IEEE Std. 1220-1998: IEEE Standard for Application and Management of the Systems Engineering Process, 1998
14. CJCSM 3170.01B, Operation of the Joint Capabilities Integration and Development System, Enclosure B, Performance Attributes and Key Performance Parameters, 11 May 2005
15. "DoD/NDIA Systems Engineering Committee Meeting: Technical Performance Management", Mike Ferraro, Defense Contract Management Agency, 12 February 2002.
16. DSMC Teaching Note, "Technical Performance Measurement", Robert Lightsey, October 1997 <[http://www.dau.mil/educdept/se\\_pap.asp](http://www.dau.mil/educdept/se_pap.asp)>
17. Test and Evaluation Management Guide, Defense Acquisition University, 2001
18. Defense Acquisition Guidebook, Version 1.0, Office of the Secretary of Defense, October 2004
19. Risk Management Guide for DoD Acquisition 2003, Fifth Edition, Version 2.0
20. Defense Acquisition Deskbook
21. Analysis of Alternatives (AoA) Handbook, Office of Aerospace Studies, Air Force Materiel Command, February 2002 <<http://www.oas.kirtland.af.mil/AoAHandbook/>>
22. Systems Engineering Guide, Version 1.1, Section 2.3.4.8, Air Force, April 1996
23. Sproles, Noel, "Coming to Grips with Measures of Effectiveness", Systems Engineering and Evaluation Centre, University of South Australia, The Levels Campus, Mawson Lakes, South Australia, July 1998.<<http://www.unisa.edu.au/seec/pubs/00papers/sprolesterms.pdf>>
24. DI-S-3619, Technical Performance Measurement Report
25. System Engineering, Army Field Manual (FM) 770-78, Department of the Army, Washington, DC, April 1979
26. IEEE STD 982, Standard Dictionary of Measures of the Software Aspects of Dependability
27. Software Productivity Consortium's Integrated Measurement Guidebook Series
28. INCOSE SE Metrics Guide for Integrated Product Development

## 15 Acronyms

<b>AHP</b>	Analytical Hierarchy Process
<b>CI</b>	Configuration Item
<b>CPU</b>	Computer Processing Unit
<b>CTC</b>	Critical to Customer
<b>EMI</b>	Electromagnetic Interference
<b>EOC</b>	End of Contract
<b>EVMS</b>	Earned Value Management System
<b>IPTs</b>	Integrated Product Teams
<b>KPPs</b>	Key Performance Parameters
<b>MOEs</b>	Measures of Effectiveness
<b>MOPs</b>	Measures of Performance
<b>MOS</b>	Measures of Suitability
<b>RFI</b>	Radio-frequency Interference
<b>TCs</b>	Technical Committees
<b>TMQ</b>	Technical Measurement Questionnaire
<b>TPMs</b>	Technical Performance Measures
<b>TRL</b>	Technical Readiness Level
<b>WBS</b>	Work Breakdown Structure